



(19) 대한민국특허청(KR)
(12) 공개특허공보(A)

(11) 공개번호 10-2019-0129857
(43) 공개일자 2019년11월20일

- (51) 국제특허분류(Int. Cl.)
C12N 15/86 (2006.01) C07K 14/005 (2006.01)
C12N 15/90 (2006.01)
- (52) CPC특허분류
C12N 15/86 (2013.01)
C07K 14/005 (2013.01)
- (21) 출원번호 10-2019-7026425
- (22) 출원일자(국제) 2018년02월17일
심사청구일자 없음
- (85) 번역문제출일자 2019년09월09일
- (86) 국제출원번호 PCT/IB2018/000239
- (87) 국제공개번호 WO 2018/150271
국제공개일자 2018년08월23일
- (30) 우선권주장
62/460,457 2017년02월17일 미국(US)

- (71) 출원인
론자 리미티드
스위스 3930 비스프 론자슈트라체
- (72) 발명자
페어리, 마크
영국, CB8 OPX 서퍽, 뉴마켓, 에이더스트럴 클로즈 30
영, 로버트, 제이.
영국, NW2 1SR 런던, 오프 더 베일, 햄릿 스퀘어 67
세스, 아난디타
미국, 77479 텍사스, 슈거 랜드, 맥쿼리 포인트 엘엔 5315
- (74) 대리인
황이남

전체 청구항 수 : 총 74 항

(54) 발명의 명칭 아데노-관련 바이러스 생산을 위한 포유동물 세포

(57) 요약

본 발명은 4개 이상의 별개의 재조합 표적 부위 (RTS), E1A, E1B 또는 이들의 조합을 포함하는 아데노바이러스 (Ad) 유전자, 및 Ad 유전자에 작동 가능하게 연결된 프로모터를 포함하는 포유동물 세포에 관한 것으로, 여기서 RTS, Ad 유전자, 및 프로모터는 염색체로 통합되고, 재조합 아데노-관련 바이러스 (rAAV) 생산자 숙주 세포를 생성하기 위해 세포를 사용하는 방법; 및 rAAV 생산, 패키지 및 정제하기 위해 AAV 생산자 숙주 세포를 사용하는 방법을 제공할 수 있다.

대표도 - 도1

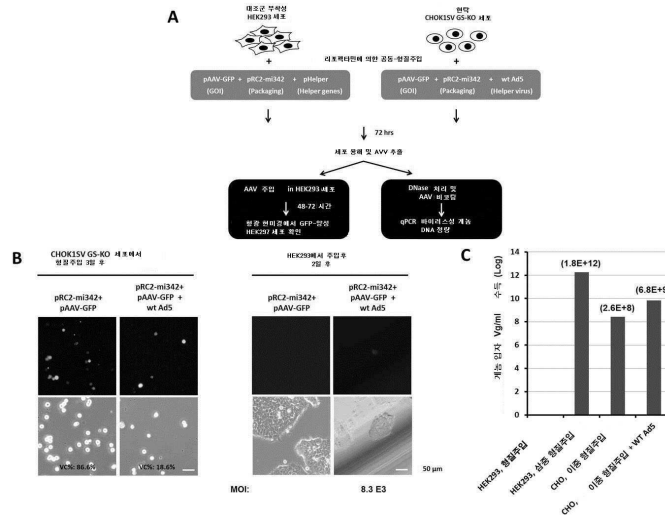

(52) CPC특허분류

C12N 15/90 (2013.01)

C12N 2710/10322 (2013.01)

C12N 2750/14152 (2013.01)

C12N 2800/30 (2013.01)

C12N 2999/007 (2013.01)

명세서

청구범위

청구항 1

(i) 적어도 4개의 별개의 재조합 표적 부위 (RTS), (ii) *E1A*, *E1B* 또는 이들의 조합을 포함하는 아데노바이러스 (Ad) 유전자, 및 (iii) Ad 유전자에 작동 가능하게 연결된 프로모터를 포함하고, 상기 RTS, 상기 Ad 유전자, 및 상기 프로모터는 염색체로 통합되는 것인 포유동물 세포.

청구항 2

제1항에 있어서 상기 세포는, 마우스 세포, 인간 세포, 중국 햄스터 난소 (CHO) 세포, CHO-K1 세포, CHO-DXB11 세포, CHO-DG44 세포, 모든 변이체를 포함하는 CHOK1SV™ 세포. 모든 변이체를 포함하는 CHOK1SV GS-KO™ (글루타민 합성 효소 녹아웃) 세포, 부착성 및 현탁액-적응형(adapted) 변이체를 포함하는 HEK293 세포, HeLa 세포, 또는 HT1080 세포인 포유동물 세포.

청구항 3

제1항 내지 제2항 중 어느 한 항에 있어서, 상기 세포는 4개의 RTS를 포함하는 포유동물 세포.

청구항 4

제1항 내지 제2항 중 어느 한 항에 있어서, 상기 세포는 6개의 RTS를 포함하는 포유동물 세포.

청구항 5

제1항 내지 제4항 중 어느 한 항에 있어서, 상기 세포는 하나 이상의 RTS가 서열 번호 1 내지 30으로 이루어진 군으로부터 선택되는 것인 포유동물 세포.

청구항 6

제1항 내지 제5항 중 어느 한 항에 있어서, 하나 이상의 RTS, Ad 유전자, 및 프로모터가 단일 염색체 좌위에 통합된 것인 포유동물 세포.

청구항 7

제6항에 있어서 상기 염색체 좌위는 *Fer1L4*, *ROSA26*, *HGPRT*, *DHFR*, *COSMC*, *LDHa*, *MGAT1*, *GRIK1*, *NL1*, *NL2*, X 염색체에서 *MIDI*의 첫 번째 인트론, 또는 강화된 발현 및 안정성 영역인 포유동물 세포.

청구항 8

제1항 내지 제7항 중 어느 한 항에 있어서, 부위-특이적 재조합 효소 유전자를 추가로 포함하는 포유동물 세포.

청구항 9

제8항에 있어서, 상기 부위-특이적 재조합 효소 유전자가 염색체로 통합된 것인 포유동물 세포.

청구항 10

제1항 내지 제9항 중 어느 한 항에 있어서, 제2 Ad 유전자를 추가로 포함하고, 상기 제2 Ad 유전자는 염색체로 통합된 것인 포유동물 세포.

청구항 11

제10항에 있어서, 상기 제2 Ad 유전자는 *E1A*, *E1B*, *E2A*, *E4*, *VA*, *MIR342*, 또는 이들의 조합을 포함하는 것인 포유동물 세포.

청구항 12

제11항에 있어서, 상기 제2 Ad 유전자가 아데노바이러스 유형 5 유래인 포유동물 세포.

청구항 13

제10항 내지 제12항 중 어느 한 항에 있어서, 상기 제2 Ad 유전자가 2개의 RTS 사이에 위치하는 것인 포유동물 세포.

청구항 14

제1항 내지 제13항 중 어느 한 항에 있어서, 아데노-관련 바이러스 (AAV) 유전자를 추가로 포함하고, 상기 AAV 유전자는 염색체로 통합된 것인 포유동물 세포.

청구항 15

제14항에 있어서, 상기 AAV 유전자는 *Rep*, *Cap*, 또는 이들의 조합을 포함하는 것인 포유동물 세포.

청구항 16

제16항에 있어서, 상기 AAV 유전자는 아데노-관련 바이러스 유형 2 유래인 포유동물 세포.

청구항 17

제14항 내지 제16항 중 어느 한 항에 있어서, 상기 AAV 유전자는 2개의 RTS 사이에 위치하는 것인 포유동물 세포.

청구항 18

제1항 내지 제17항 중 어느 한 항에 있어서, AAV 벡터 카세트를 추가로 포함하고, 상기 AAV 벡터 카세트는 염색체로 통합된 것인 포유동물 세포.

청구항 19

제18항에 있어서, 상기 AAV 벡터 카세트는 리포터 유전자, 선택 유전자, 치료적 관심 유전자, 또는 이들의 조합을 포함하는 것인 포유동물 세포.

청구항 20

제18항 내지 제19항 중 어느 한 항에 있어서, 상기 AAV 벡터 카세트는 2개의 RTS 사이에 위치하는 것인 포유동물 세포.

청구항 21

제1항 내지 제20항 중 어느 한 항에 있어서, 상기 세포는 헬퍼 바이러스가 실질적으로 없는 것인 포유동물 세포.

청구항 22

(i) 적어도 4개의 별개의 재조합 표적 부위 (RTS), (ii) 아데노바이러스 (Ad) 유전자 *E2A*, *E4*, *VA*, *MIR342* 또는 이들의 조합, 및 (iii) Ad 유전자에 작동 가능하게 연결된 프로모터를 포함하고, 상기 RTS, Ad 유전자 및 프로모터는 염색체로 통합되는 것인 포유동물 세포.

청구항 23

제22항에 있어서, 상기 세포는 마우스 세포, 인간 세포, 중국 햄스터 난소 (CHO) 세포, CHO-K1 세포, CHO-DXB11 세포, CHO-DG44 세포, 모든 변이체를 포함하는 CHOK1SV™ 세포, 모든 변이체를 포함하는 CHOK1SV GS-KO™ (글루타민 합성 효소 녹아웃) 세포, 부착성 및 현탁액-적응형 변이체를 포함하는 HEK293 세포, HeLa 세포, 또는 HT1080 세포인 포유동물 세포.

청구항 24

제22항 내지 제23항 중 어느 한 항에 있어서, 상기 세포는 4개의 RTS를 포함하는 포유동물 세포.

청구항 25

제22항 내지 제23항 중 어느 한 항에 있어서, 상기 세포는 6개의 RTS를 포함하는 포유동물 세포.

청구항 26

제22항 내지 제25항 중 어느 한 항에 있어서, 하나 이상의 RTS가 서열 번호: 1 내지 30으로부터 선택되는 것인 포유동물 세포.

청구항 27

제22항 내지 제26항 중 어느 한 항에 있어서, 상기 RTS, 상기 Ad 유전자, 및 상기 프로모터가 단일 염색체 좌위에 통합된 것인 포유동물 세포.

청구항 28

제27항에 있어서, 상기 염색체 좌위는 *Fer1L4*, *ROSA26*, *HGPRT*, *DHFR*, *COSMC*, *LDHa*, *MGAT1*, *GRIK1*, *NL1*, *NL2*, *X* 염색체상의 *MIDI*의 첫 번째 인트론, 또는 강화된 발현 및 안정성 영역인 포유동물 세포.

청구항 29

제22항 내지 제27항 중 어느 한 항에 있어서, 부위-특이적 재조합 효소 유전자를 추가로 포함하는 것인 포유동물 세포.

청구항 30

제29항에 있어서, 상기 부위-특이적 재조합 효소 유전자가 염색체로 통합된 것인 포유동물 세포.

청구항 31

제22항 내지 제30항 중 어느 한 항에 있어서, 제2 Ad 유전자를 추가로 포함하고, 상기 제2 Ad 유전자는 염색체로 통합된 것인 포유동물 세포.

청구항 32

제31항에 있어서, 상기 제2 Ad 유전자가 *E1A*, *E1B*, *E2A*, *E4*, *VA*, *MIR342*, 또는 이들의 조합을 포함하는 것인 포유동물 세포.

청구항 33

제32항에 있어서, 상기 제2 Ad 유전자가 아테노바이러스 유형 5 유래인 포유동물 세포.

청구항 34

제31항 내지 제33항 중 어느 한 항에 있어서, 상기 제2 Ad 유전자는 2개의 RTS 사이에 위치하는 것인 포유동물 세포.

청구항 35

제22항 내지 제34항 중 어느 한 항에 있어서 상기 세포는, 아테노-관련 바이러스 (AAV) 유전자를 추가로 포함하고, 상기 AAV 유전자는 염색체로 통합된 것인 포유동물 세포.

청구항 36

제35항에 있어서, 상기 AAV 유전자는 *Rep*, *Cap*, 또는 이들의 조합을 포함하는 것인 포유동물 세포.

청구항 37

제36항에 있어서, 상기 AAV 유전자가 아테노-관련 바이러스 유형 2로부터 유래된 것인 포유동물 세포.

청구항 38

제35항 내지 제37항 중 어느 한 항에 있어서, 상기 AAV 유전자가 2개의 RTS 사이에 위치하는 것인 포유동물 세포.

청구항 39

제22항 내지 제38항 중 어느 한 항에 있어서, AAV 벡터 카세트를 추가로 포함하고, 상기 AAV 벡터 카세트는 염색체로 통합된 것인 포유동물 세포.

청구항 40

제39항에 있어서, 상기 AAV 벡터 카세트가 리포터 유전자, 선택 유전자, 치료적 관심 유전자 또는 이들의 조합을 포함하는 것인 포유동물 세포.

청구항 41

제39항 내지 제40항 중 어느 한 항에 있어서, 상기 AAV 벡터 카세트는 2개의 RTS 사이에 위치하는 것인 포유동물 세포.

청구항 42

제20항 내지 제41항 중 어느 한 항에 있어서, 상기 세포는 헬퍼 바이러스가 실질적으로 없는 것인 포유동물 세포.

청구항 43

(i) 적어도 4개의 별개의 제조합 표적 부위 (RTS); (ii) 및 *Rep*, *Cap*, 또는 이들의 조합을 포함하는 아데노-관련 바이러스 (AAV) 유전자를 포함하고, 상기 RTS 및 AAV 유전자는 염색체로 통합되는 것인 포유동물 세포.

청구항 44

제43항에 있어서, 상기 AAV 유전자가 아데노-관련 바이러스 유형 2로부터 유래된 것인 포유동물 세포.

청구항 45

제43항 내지 제44항 중 어느 한 항에 있어서, 상기 세포는 마우스 세포, 인간 세포, 중국 햄스터 난소 (CHO) 세포, CHO-K1 세포, CHO-DXB11 세포, CHO-DG44 세포, 모든 변이체를 포함하는 CHOK1SV™ 세포, 모든 변이체를 포함하는 CHOK1SV GS-KO™ (글루타민 합성 효소 녹아웃) 세포, 부착성 및 현탁액-적응형 변이체를 포함하는 HEK293 세포, HeLa 세포 또는 HT1080 세포인 포유동물 세포.

청구항 46

제43항 내지 제45항 중 어느 한 항에 있어서, 상기 세포는 4개의 RTS를 포함하는 포유동물 세포.

청구항 47

제43항 내지 제45항 중 어느 한 항에 있어서, 상기 세포는 6개의 RTS를 포함하는 포유동물 세포.

청구항 48

제43항 내지 제47항 중 어느 한 항에 있어서, 하나 이상의 RTS가 서열 번호: 1 내지 30으로부터 선택되는 것인 포유동물 세포.

청구항 49

제43항 내지 제48항 중 어느 한 항에 있어서, 상기 RTS 및 상기 AAV 유전자가 단일 염색체 좌위에 통합된 것인 포유동물 세포.

청구항 50

제49항에 있어서, 상기 염색체 좌위는 *Fer1L4*, *ROSA26*, *HGPRT*, *DHFR*, *COSMC*, *LDHa*, *MGAT1*, *GRIK1*, *NL1*, *NL2*, X 염색체상의 *MIDI*의 첫 번째 인트론, 또는 강화된 발현 및 안정성 영역인 포유동물 세포.

청구항 51

제43항 내지 제50항 중 어느 한 항에 있어서, 부위-특이적 재조합 효소 유전자를 추가로 포함하는 것인 포유동물 세포.

청구항 52

제51항에 있어서, 상기 부위-특이적 재조합 효소 유전자가 염색체로 통합된 것인 포유동물 세포.

청구항 53

제43항 내지 제52항 중 어느 한 항에 있어서, Ad 유전자 및 Ad 유전자에 작동 가능하게 연결된 프로모터를 추가로 포함하고, 이에 의해 상기 Ad 유전자 및 상기 프로모터는 염색체로 통합되는 것인 포유동물 세포.

청구항 54

제53항에 있어서, 상기 Ad 유전자는 *E1A*, *E1B*, *E2A*, *E4*, *VA*, *MIR342*, 또는 이들의 조합을 포함하는 것인 포유동물 세포.

청구항 55

제54항에 있어서, 상기 Ad 유전자는 아데노바이러스 유형 5 유래인 포유동물 세포.

청구항 56

제43항 내지 제55항 중 어느 한 항에 있어서, 상기 AAV 유전자는 2개의 RTS 사이에 위치하는 것인 포유동물 세포.

청구항 57

제43항 내지 제56항 중 어느 한 항에 있어서, AAV 벡터 카세트를 추가로 포함하는 포유동물 세포

청구항 58

제57항에 있어서, 상기 AAV 벡터 카세트는 리포터 유전자, 선택 유전자, 치료적 관심 유전자 또는 이들의 조합을 포함하는 것인 포유동물 세포.

청구항 59

제57항 내지 제58항 중 어느 한 항에 있어서, 상기 관심 유전자는 2개의 RTS 사이에 위치하는 것인 포유동물 세포.

청구항 60

제43항 내지 제59항 중 어느 한 항에 있어서, 상기 세포는 헬퍼 바이러스가 실질적으로 없는 것인 포유동물 세포.

청구항 61

- a. 6개의 별개의 재조합 표적 부위 (RTS);
- b. *E1A* 및 *E1B*를 포함하는 아데노바이러스 (Ad) 유전자;
- c. Ad 유전자에 작동 가능하게 연결된 프로모터, 상기 RTS, 상기 Ad 유전자 및 상기 프로모터는 염색체로 통합되고;
- d. *E2A*, *E4*, *VA* 및 *MIR342*를 포함하는 제2 Ad 유전자, 상기 제2 Ad 유전자는 2개의 RTS 사이에 위치하고;
- e. *Rep* 및 *Cap*을 포함하는 아데노-관련 바이러스 (AAV) 유전자, 상기 AAV 유전자는 2개의 RTS 사이에 위치하고; 및
- f. 리포터 유전자, 선택 유전자 또는 치료적 관심 유전자를 포함하는 AAV 벡터 카세트로서, 상기 AAV 벡터 카세

트는 2개의 RTS 사이에 위치하는 AAV 벡터 카세트;를 포함하는 중국 햄스터 난소 (CHO) 세포.

청구항 62

E1A 및 *E1B*를 포함하는 아데노바이러스 (Ad) 유전자 및 Ad 유전자에 작동 가능하게 연결된 프로모터를 포함하는 중국 햄스터 난소 (CHO) 세포; *E2A*, *E4*, *VA* 및 *MIR342*를 포함하는 제2 Ad 유전자; *Rep* 및 *Cap*을 포함하는 아데노-관련 바이러스 (AAV) 유전자; 및 리포터 유전자, 선택 유전자, 치료적 관심 유전자 또는 이들의 조합을 포함하는 AAV 벡터 카세트.

청구항 63

- a. 적어도 4개의 별개의 재조합 표적 부위 (RTS), *E1A*, *E1B* 또는 이들의 조합을 포함하는 아데노바이러스 (Ad) 유전자, 및 상기 Ad 유전자에 작동 가능하게 연결된 프로모터를 포함하는 세포를 제공하는 단계로, 상기 RTS, 상기 Ad 유전자 및 상기 프로모터는 염색체로 통합되고;
 - b. (a)에서 제공된 세포를 아데노-관련 바이러스 (AAV) 유전자, 제2 Ad 유전자, AAV 벡터 카세트, 또는 이들의 조합을 인코딩하는 교환 가능한 카세트를 포함하는 벡터로 형질주입시키는 단계;
 - c. 교환 가능한 카세트를 염색체에 통합시키는 단계; 및
 - d. 염색체에 통합된 교환 가능한 카세트를 갖는 rAAV 생산자 세포를 선별하는 단계;
- 를 포함하는 재조합 아데노-관련 바이러스 (rAAV) 생산자 세포의 제조 방법.

청구항 64

제63항에 있어서, 형질주입 (b)는 2개의 벡터를 갖고, 제1벡터는 제2 Ad 유전자 및 AAV 유전자를 포함하는 교환 가능한 카세트를 포함하고, 제2 벡터는 AAV 벡터 카세트를 포함하는 교환 가능한 카세트를 포함하는 것인 방법.

청구항 65

제63항에 있어서, 형질주입 (b)는 2개의 벡터를 갖고, 제1벡터는 제2 Ad 유전자를 포함하는 교환 가능한 카세트를 포함하고, 제2 벡터는 AAV 유전자를 포함하는 교환 가능한 카세트를 포함하는 것인 방법.

청구항 66

제63항에 있어서, 상기 형질주입 (b)는 3개의 벡터를 갖고, 제1벡터는 제2 Ad 유전자를 포함하는 교환 가능한 카세트를 포함하고, 제2벡터는 AAV 유전자를 포함하는 교환 가능한 카세트를 포함하고, 제3벡터는 AAV 벡터 카세트를 포함하는 교환 가능한 카세트를 포함하는 방법.

청구항 67

제63항 내지 제66항 중 어느 한 항에 있어서, 각각의 교환 가능한 카세트는 세포의 RTS 중 2개와 일치하는 2개의 RTS를 추가로 포함하는 것인 방법.

청구항 68

제63항 내지 제67항 중 어느 한 항에 있어서, 상기 제2 Ad 유전자는 *E1A*, *E1B*, *E2A*, *E4*, *VA*, *MIR342*, 또는 이들의 조합을 포함하는 것인 방법.

청구항 69

제63항 내지 제69항 중 어느 한 항에 있어서, 상기 AAV 유전자는 *Rep*, *Cap*, 또는 이들의 조합을 포함하는 것인 방법.

청구항 70

제63항 내지 제69항 중 어느 한 항에 있어서, 상기 AAV 벡터 카세트는 리포터 유전자, 선택 유전자, 치료적 관심 유전자 또는 이들의 조합을 포함하는 것인 방법.

청구항 71

(i) rAAV로 숙주 세포를 감염시키는 단계, (ii) AAV 벡터 카세트로 패키징된 rAAV 생산 단계, 및 (iii) 상기 패키징된 rAAV를 정제하는 단계로서, 상기 숙주 세포는:

- a. 적어도 4개의 별개의 재조합 표적 부위 (RTS);
- b. *E1A*, *E1B* 또는 이들의 조합을 포함하는 아데노바이러스 (Ad) 유전자;
- c. Ad 유전자에 작동 가능하게 연결된 프로모터로, 상기 RTS, 상기 Ad 유전자 및 상기 프로모터는 염색체로 통합되고;
- d. *E1A*, *E1B*, *E2A*, *E4*, *VA*, *MIR342*, 또는 이들의 조합을 포함하는 제2 Ad 유전자;
- e. *Rep*, *Cap*, 또는 이들의 조합을 포함하는 아데노-관련 바이러스 (AAV) 유전자; 및
- f. 리포터 유전자, 선택 유전자, 치료적 관심 유전자 또는 이들의 조합을 포함하는 AAV 벡터 카세트를 포함하는;

재조합 아데노-관련 바이러스 (rAAV)의 제조 방법.

청구항 72

제71항에 있어서, rAAV 생산 및 패키징에 살아있는 야생형 헬퍼 바이러스가 요구되지 않는 것인 방법.

청구항 73

제71항 내지 제72항 중 어느 한 항에 있어서, rAAV 생산에 *E1A*의 발현이 요구되지 않는 것인 방법.

청구항 74

제71항 내지 제73항 중 어느 한 항에 있어서, 정제 후에 최소 1.0×10^9 vg/mL 활성 rAAV를 얻는 방법.

발명의 설명

기술 분야

[0001] 본 개시 내용은 4개 이상의 별개의 재조합 표적 부위 (RTS), *E1A*, *E1B* 또는 이들의 조합을 포함하는 아데노바이러스 (Ad) 유전자, 및 Ad 유전자에 작동 가능하게 연결된 프로모터를 포함하는 포유동물 세포에 관한 것이며, 여기서 RTS, Ad 유전자 및 프로모터는 염색체-통합된다. 본 발명은 또한 재조합 아데노-관련 바이러스 (rAAV) 생산자 세포를 생산하기 위해 세포를 사용하는 방법 및 살아있는 헬퍼 바이러스 없이 rAAV를 생산, 포장 및 정제하기 위해 rAAV 생산자 세포를 사용하는 방법에 관한 것이다.

배경 기술

[0002] 유전자 치료 제품의 오래 지속되고 효율적인 전달을 얻기 위해 재조합 아데노-관련 바이러스 (rAAV)의 사용이 임상 개발에서 적극적으로 추구하고 있다. rAAV 생산을 위한 바콜로바이러스 기반 플랫폼은 종종 가변적이고 시간이 많이 걸리는 원료를 필요로 한다. HEK293에서의 삼중 형질주입 및 일시적 발현은 확장성이 좋지 않아 제한될 수 있다. 기존의 확장 가능한 HeLa 세포 기반 생산자 세포주 공정은 헬퍼 바이러스로서 야생형 (wt) 아데노바이러스 5 (Ad5)를 필요로 하며, 최종 제품에서 헬퍼 바이러스의 제거는 안전 문제로 인해 중요하다. rAAV를 생산하기 위해 세포주를 구성할 때, 관심 유전자 및 보조 헬퍼 유전자는 일시적으로 발현되거나 숙주 염색체에 통합될 수 있다. 세포 계능의 변형에 사용되는 통상적인 DNA 형질도입 경로는 예측할 수 없는 변형을 겪을 수 있고 바이러스 혈청형의 상이한 요구 사항을 조정하기 위해 쉽게 상호 변경될 수 없다.

[0003] 치료적 재조합 아데노-관련 바이러스 (AAV) 구성물은 복제 결함이며 복제 및 후속 감염 단계를 위해 wt 아데노바이러스 (Ad)의 공동 감염을 필요로 한다. 치료적 재조합 아데노-관련 바이러스 (rAAV) 벡터의 생산은 일반적으로 3가지 상이한 성분이 숙주에 공급될 것을 요구한다: (i) 복제 및 패키징 요소를 제공하는 아데노-관련 바이러스 유전자 *Rep/Cap*, (ii) 바이러스 패키징을 위한 Ad 계능의 헬퍼 바이러스 기능, 및 (iii) 3' 및 5' AAV 역 말단 반복 서열 (ITR) 사이에 위치한 대상 유전자(gene of interest; GOI). 효율적인 유전자 발현, DNA 복제 및 패키징에 필요한 Ad 유전자는 *E1A*, *E1B*, *E2A*, *E4* 및 *VA RNA*를 포함하는 것으로 생각된다. *E1A*는 Ad 감염 동안 만들어진 최초의 유전자 산물 인 것으로 제안된다(Shenk, T. et al., Fields Virology, 3rd ed., 2211-

2148(1996)). *E1A*는 AAV Rep 유전자 프로모터 p5 및 p19로부터 전사를 상향 조절함으로써 및 *E1B*, *E2A* 및 *E4*에 대한 초기 아데노바이러스 프로모터를 활성화시킴으로써 바이러스 복제를 시작하는 신호로서 작용하는 것으로 여겨진다. *E1A*는 또한 AAV 인코딩 단백질 (Rep 및 Cap)이 이 기능을 수행 할 수 없기 때문에 바이러스 DNA 복제를 위해 세포주기의 S- 단계로 숙주 세포를 유도하는데 사용되는 것으로 여겨진다. *E1A*의 역효과는 p53을 안정화시켜 세포예정사(apoptosis)를 유발한다는 것이다(Low et al., *Genes & Dev.* 7:535-545 (1993)). *E1A*의 누출된 발현은 AAV Rep 유전자뿐만 아니라 Ad 유전자를 작동시킬 수 있다. 후자는 세포 증식 억제 및 세포 독성인 것으로 보고되어, *E1A*를 본질적으로 발현하는 세포로부터 안전한 세포주를 얻는 것이 어렵다. 조절된 *E1A* 유전자 발현은 헬퍼 바이러스 비함유 AAV 패키징 세포주의 성공에 결정적인 것으로 보인다.

[0004] rAAV를 생산하기 위해 이들 요소를 함께 가져 오는 다른 세포주 및 다른 접근법이 시도되어왔다. 이들 상이한 세포주는 HEK293 및 HeLa 세포주를 포함한다. 다른 접근법은 또한 바칼로바이러스 시스템의 사용을 포함하였다. 그러나 각 세포주와 접근 방식에는 문제점이 있으며 확장 가능하고 강력한 rAAV 생산 공정을 위한 이상적인 플랫폼은 없다.

[0005] 첫번째 rAAV 생산 단계는 물리적으로 전단된 Ad5 DNA를 사용하여 일차 배아 신장 세포의 형질주입에 의해 생산된 HEK293 세포를 포함한다((Graham F.L. et al., *J. Gen. Virol.* 36:59-74 (1977)). 계능 분석에 따르면, HEK293 세포는 E1 영역 및 추가 측면 서열을 함유하는 아데노바이러스 계능의 좌측 말단 (염기 1-4344)의 통합된 단편을 보유하는 것으로 입증되었다(Louis N. et al, *Virology* 233:423-9 (1997)). 일부 삼중-형질주입 공정은 나머지 필수 요소를 함유하는 플라스미드로 형질 감염하기 위해 접착 성 HEK293 세포를 사용하였다. rAAV 생산에서 HEK293을 사용할 수 있지만, 다양한 적응증 및 의존에 대한 증가하는 벡터 요구를 충족시키기 위해 확장 불가능한 부착성 세포 기반 공정은 안전한 생산자 세포주 대신 일시적 형질주입에 의존한다.

[0006] 두 번째 rAAV 생산 단계는 AAV 유전자 *Rep/Cap* 및 GOI를 모두 함유하는 안정적으로 형질주입된 HeLa 세포 클론의 생산 및 선택을 특징으로 한다. 이어서, 이들 세포주는 wt Ad5에 의해 감염되어 rAAV 입자의 패키징을 개시할 수 있다. 이 방법은 확장 가능하지만, 이 클론의 생산은 길고 노동 집약적인 단계일 수 있으며 이 단계의 최종 산물에서 wt Ad5 바이러스를 제거하면 단계에 여러 단계가 추가된다.

[0007] 세 번째 rAAV 생산 단계는 AAV 유전자 도입을 위한 재조합 바칼로바이러스 (*Rep/Cap*)에 의존하며 SF9 곤충 세포에서 rAAV 생산에 필요한 헬퍼 바이러스 기능을 직접 수행한다. 이 방법은 현탁액 배양에서 확장 가능하지만, 플라크 정제 된 재조합 바칼로바이러스 구조물의 생산을 필요로 하고, 생산물 개발에 더 오랜 시간이 걸린다.

[0008] rAAV 생산을 위한 새롭고 효율적인 플랫폼으로서, 이는 임의의 원하는 AAV 혈청형에 대해 안정적인 생산자 세포주를 생산하는 빠른 공정을 제공하여 이러한 결함을 해결하고 전임상 및 임상 연구에 사용하기 위한 고품질 벡터를 제공하기 위해서는 살아있는 헬퍼 바이러스를 첨가하지 않고도 추가로 높은 확장 가능한 생산 수율을 제공할 수 있다.

[0009] I 형 인터페론 (IFN)은 발견된 최초의 사이토카인이었으며 바이러스 복제를 방해할 수 있는 강력한 능력으로 명명되었다. 많은 바이러스 산물은 단백질 키나아제 (PKR)를 억제하는 인플루엔자 NS1 단백질 및 백시니아 바이러스 E3L 단백질 및 백시니아 바이러스-코딩된 가용성 IFN- 알파/베타 수용체 디코이드(decoys)과 같은 IFN 관련 신호를 차단할 수 있다.

[0010] 중국 햄스터 난소(CHO) 세포 (Puck, *J. Exp. Med.*, 108: 259-268 (1958))는 높은 생산성, 견고한 특성, 안전 기록 및 업계 기록(Birch and Racher, *Adv. Drug Delivery Rev.*, 58:671-685 (2006))으로 인해 포유동물 세포로부터 재조합 단백질의 상업적 생산에 종종 사용되는 잘 특성화 된 세포주이다. 이들의 그러나, CHO 세포는 rAAV의 생산에 이전에 사용되지 않았다.

[0011] 다양한 공보가 본원에 인용되어 있으며, 그 개시 내용은 그 전문이 본원에 참조로 포함된다.

발명의 내용

해결하려는 과제

[0012] 본 발명은 4개 이상의 별개의 재조합 표적 부위 (RTS), *E1A*, *E1B* 또는 이들의 조합을 포함하는 아데노바이러스 (Ad) 유전자, 및 Ad 유전자에 작동 가능하게 연결된 프로모터를 포함하는 포유동물 세포에 관한 것으로, 여기서 RTS, Ad 유전자, 및 프로모터는 염색체로 통합되는 포유동물 세포를 제공하고자 한다. 또한, 재조합 아데노-관련 바이러스 (rAAV) 생산자 숙주 세포를 생성하기 위해 세포를 사용 하는 방법; 및 rAAV 생산, 패키지 및 정제

하기 위해 AAV 생산자 숙주 세포를 사용 하는 방법을 제공하고자 한다.

과제의 해결 수단

[0013]

일부 실시예에서, 본 개시 내용은 (i) 4개 이상의 별개의 재조합 표적 부위 (RTS), (ii) *E1A*, *E1B* 또는 이들의 조합을 포함하는 아데노바이러스 (Ad) 유전자, 및 (iii) Ad 유전자에 작동 가능하게 연결된 프로모터를 포함하는 포유동물 세포를 제공하고, 상기 RTS, Ad 유전자 및 프로모터는 염색체로 통합된다. 일부 실시예에서, 상기 세포는 마우스 세포, 인간 세포, 중국 햄스터 난소 (CHO) 세포, CHO-K1 세포, CHO-DXB11 세포, CHO-DG44 세포, 모든 변이체를 포함하는 CHOK1SV™ 세포 (Lonza, Slough, UK), 모든 변이체를 포함하는 CHOK1SV GS-KO™ (글루타민 합성 효소 녹아웃) 세포 (Lonza, Slough, UK), 부착성 및 현탁액-적응형 변이체를 포함하는 HEK293 세포, HeLa 세포, 또는 HT1080 세포이다. 일부 실시 양태에서, 상기 세포는 4개의 RTS를 포함한다. 일부 실시 양태에서, 상기 세포는 6개의 RTS를 포함한다. 일부 실시 양태에서, 하나 이상의 RTS는 서열 번호 1 내지 30으로 이루어진 군으로부터 선택된다. 일부 실시 양태에서, 하나 이상의 RTS, Ad 유전자 및 프로모터는 단일 염색체 유전자 좌위에 통합된다. 일부 실시 양태에서, 염색체 유전자 좌위는 *Fer1L4*, *ROSA26*, *HGPRT*, *DHFR*, *COSMC*, *LDHa*, *MGAT1*, *GRIK1*, *NL1*, *NL2*, X 염색체상의 *MIDI*의 첫 번째 인트론, 또는 강화된 발현 및 안정성 영역이다(EESYRs, 예를 들어, 미국 특허 7,771,997를 참고한다). 일부 실시 양태에서, 상기 세포는 부위-특이적 재조합 효소 유전자를 포함한다. 일부 실시 양태에서, 상기 부위-특이적 재조합 효소 유전자는 염색체로 통합된다. 일부 실시 양태에서, 상기 세포는 제2 Ad 유전자를 포함하고, 상기 제2 Ad 유전자는 염색체로 통합된다. 일부 실시 양태에서, 제2 Ad 유전자는 *E1A*, *E1B*, *E2A*, *E4*, *VA*, *MIR342*, 또는 이들의 조합을 포함한다. 일부 실시 양태에서, 제2 Ad 유전자는 Ad5 유래의 것이다. 일부 실시 양태에서, 제2 Ad 유전자는 2개의 RTS 사이에 위치된다. 일부 실시 양태에서, 세포는 아데노-관련 바이러스 (AAV) 유전자를 추가로 포함하며, AAV 유전자는 염색체-통합된다. 일부 실시 양태에서, AAV 유전자는 *Rep*, *Cap*, 또는 이들의 조합을 포함한다. 일부 실시 양태에서, AAV 유전자는 아데노-관련 바이러스 유형 2로부터 유래된다. 일부 실시 양태에서, AAV 유전자는 2개의 RTS 사이에 위치된다. 일부 실시 양태에서, 세포는 AAV 벡터 카세트를 추가로 포함하고, 여기서 AAV 벡터 카세트는 염색체 통합된다. 일부 실시 양태에서, AAV 벡터 카세트는 리포터 유전자, 선택 유전자, 치료적 관심 유전자, 또는 이들의 조합을 포함한다. 일부 실시 양태에서, AAV 벡터 카세트는 2개의 RTS 사이에 위치된다. 일부 실시 양태에서, 세포는 헬퍼 바이러스가 실질적으로 없다.

[0014]

일부 실시 양태에서, 본 개시 내용은 (i) 4개 이상의 별개의 재조합 표적 부위 (RTS), (ii) Ad 유전자 *E2A*, *E4*, *VA*, *MIR342* 또는 이들의 조합, 및 (iii) Ad 유전자에 작동 가능하게 연결된 프로모터를 포함하는 포유동물 세포를 제공하고, 상기 RTS, Ad 유전자 및 프로모터는 염색체로 통합된다. 일부 실시 양태에서, 세포는 마우스 세포, 인간 세포, 중국 햄스터 난소 (CHO) 세포, CHO-K1 세포, CHO-DXB11 세포, CHO-DG44 세포, 모든 변이체를 포함하는 CHOK1SV™ 세포, 모든 변이체를 포함하는 CHOK1SV GS-KO™ (글루타민 합성 효소 녹아웃) 세포, 부착성 및 현탁액-적응형 변이체를 포함하는 HEK293 세포, HeLa 세포, 또는 HT1080 세포이다. 일부 실시 양태에서, 세포는 4개의 RTS를 포함한다. 일부 실시 양태에서, 세포는 6개의 RTS를 포함한다. 일부 실시 양태에서, 하나 이상의 RTS는 서열 번호 1 내지 30으로 이루어진 군으로부터 선택된다. 일부 실시 양태에서, RTS, Ad 유전자 및 프로모터는 단일 염색체 유전자 좌위에 통합된다. 일부 실시 양태에서, 염색체 유전자 좌위는 *Fer1L4*, *ROSA26*, *HGPRT*, *DHFR*, *COSMC*, *LDHa*, *MGAT1*, *GRIK1*, *NL1*, *NL2*, X 염색체 상의 *MIDI*의 첫 번째 인트론, 또는 강화된 발현 및 안정성 영역 (EESYRs)이다. 일부 구체 예에서, 세포는 부위-특이적 재조합 효소 유전자를 포함한다. 일부 실시 양태에서, 부위-특이적 재조합 효소 유전자는 염색체로 통합된다. 일부 실시 양태에서, 세포는 제2 Ad 유전자를 추가로 포함하며, 상기 제2 Ad 유전자는 염색체로 통합된다. 일부 실시 양태에서, 제2 Ad 유전자는 *E1A*, *E1B*, *E2A*, *E4*, *VA*, *MIR342*, 또는 이들의 조합을 포함한다. 일부 실시 양태에서, 제2 Ad 유전자는 Ad5 유래된다. 일부 실시 양태에서, 제2 Ad 유전자는 2개의 RTS 사이에 위치된다. 일부 실시 양태에서, 세포는 아데노-관련 바이러스 (AAV) 유전자를 추가로 포함하며, 상기 AAV 유전자는 염색체로 통합된다. 일부 실시 양태에서, AAV 유전자는 *Rep*, *Cap*, 또는 이들의 조합을 포함한다. 일부 실시 양태에서, AAV 유전자는 아데노-관련 바이러스 유형 2로부터 유래된다. 일부 실시 양태에서, AAV 유전자는 2개의 RTS 사이에 위치된다. 일부 실시 양태에서, 세포는 AAV 벡터 카세트를 추가로 포함하고, 상기 AAV 벡터 카세트는 염색체로 통합된다. 일부 실시 양태에서, AAV 벡터 카세트는 리포터 유전자, 선택 유전자, 치료적 관심 유전자 또는 이들의 조합을 포함한다. 일부 실시 양태에서, AAV 벡터 카세트는 2개의 RTS 사이에 위치된다. 일부 실시 양태에서, 세포는 헬퍼 바이러스가 실질적으로 없다.

[0015]

일부 실시 양태에서, 본 개시 내용은 (i) 4개 이상의 별개의 재조합 표적 부위 (RTS), (ii) 및 *Rep*, *Cap*, 또는 이들의 조합을 포함하는 아데노-관련 바이러스 (AAV) 유전자를 포함하는 포유동물 세포를 제공하고, 상기 RTS

및 AAV 유전자는 염색체-로 통합된다. 일부 실시 양태에서, AAV 유전자는 아데노 관련 바이러스 유형 2로부터 유래된다. 일부 실시 양태에서, 세포는 마우스 세포, 인간 세포, 중국 햄스터 난소 (CHO) 세포, CHO-K1 세포, CHO-DXB11 세포, CHO-DG44 세포, 모든 변이체를 포함하는 CHOK1SV™ 세포, 모든 변이체를 포함하는 CHOK1SV GS-KO™ 세포, 부착성 및 현탁액-적응형 변이체를 포함하는 HEK293 세포, HeLa 세포, 또는 HT1080 세포이다. 일부 실시 양태에서, 세포는 4개의 RTS를 포함한다. 일부 실시 양태에서, 세포는 6개의 RTS를 포함한다. 일부 실시 양태에서, 하나 이상의 RTS는 서열 번호 1 내지 30으로 이루어진 군으로부터 선택된다. 일부 실시 양태에서, RTS 및 AAV 유전자는 단일 염색체 유전자 좌위에 통합된다. 일부 실시 양태에서, 염색체 유전자좌는 *Fer1L4*, *ROSA26*, *HGPRT*, *DHFR*, *COSMC*, *LDHa*, *MGAT1*, *GRIK1*, *NL1*, *NL2*, X 염색체 상의 *MIDI*의 첫 번째 인트론, 또는 강화된 발현 및 안정성 영역 (EESYRs)이다. 일부 실시 양태에서, 세포는 부위-특이적 재조합 효소 유전자를 포함한다. 일부 실시 양태에서, 부위-특이적 재조합 효소 유전자는 염색체로 통합된다. 일부 실시 양태에서, 세포는 Ad 유전자 및 Ad 유전자에 작동 가능하게 연결된 프로모터를 추가로 포함하며, 이에 의해 Ad 유전자 및 프로모터는 염색체로 통합된다. 일부 실시 양태에서, Ad 유전자는 *E1A*, *E1B*, *E2A*, *E4*, *VA*, *MIR342* 또는 이들의 조합을 포함한다. 일부 실시 양태에서, Ad 유전자는 Ad5로부터 유래된다. 일부 실시 양태에서, AAV 유전자는 2개의 RTS 사이에 위치된다. 일부 실시 양태에서, 세포는 AAV 벡터 카세트를 추가로 포함하고, 상기 AAV 벡터 카세트는 염색체로 통합된다. 일부 실시 양태에서, AAV 벡터 카세트는 리포터 유전자, 선택 유전자, 치료적 관심 유전자 또는 이들의 조합을 포함한다. 일부 실시 양태에서, AAV 벡터 카세트는 2개의 RTS 사이에 위치된다. 일부 실시 양태에서, 세포는 헬퍼 바이러스가 실질적으로 없다.

[0016] 일부 실시 양태에서, 본 개시 내용은 6개의 별개의 재조합 표적 부위 (RTS), 여기서 하나 이상의 RTS는 서열 번호 1-30으로 이루어진 군으로부터 선택되고, *E1A* 및 *E1B*를 포함하는 아데노바이러스 (Ad) 유전자, Ad 유전자에 작동 가능하게 연결된 프로모터로, 상기 RTS, Ad 유전자 및 프로모터는 염색체로 통합되고, *E2A*, *E4*, *VA*, 및 *MIR342*를 포함하는 제2 Ad 유전자로, 상기 제2 Ad 유전자는 염색체로 통합되고 2개의 RTS 사이에 위치하며, *Rep* 및 *Cap*을 포함하는 아데노-관련 바이러스 (AAV) 유전자로, 상기 AAV 유전자는 염색체로 통합되고 2개의 RTS 사이에 위치하고, 리포터 유전자, 선택 유전자 또는 치료적 관심 유전자를 포함하는 AAV 벡터 카세트를 포함하고, 상기 AAV 벡터 카세트는 염색체로 통합되고 2개의 RTS 사이에 위치되는 중국 햄스터 난소 (CHO) 세포를 제공한다.

[0017] 일부 실시 양태에서, 본 개시 내용은 *E1A* 및 *E1B*를 포함하는 아데노바이러스 (Ad) 유전자 및 Ad 유전자에 작동 가능하게 연결된 프로모터, *E2A*, *E4*, *VA*, 및 *MIR342*를 포함하는 제2 Ad 유전자, *Rep* 및 *Cap*을 포함하는 아데노-관련 바이러스 (AAV) 유전자, 및 리포터 유전자, 선택 유전자, 치료적 관심 유전자 또는 이들의 조합을 포함하는 AAV 벡터 카세트를 포함하는 중국 햄스터 난소 (CHO) 세포를 제공한다.

[0018] 일부 실시 양태에서, 본 개시 내용은 하기를 포함하는 재조합 아데노-관련 바이러스 (rAAV) 생산자 세포의 제조 방법을 제공한다: 4개 이상의 별개의 재조합 표적 부위 (RTS), *E1A*, *E1B*, 또는 이들의 조합을 포함하는 아데노 바이러스 (Ad) 유전자, 및 Ad 유전자에 작동 가능하게 연결된 프로모터를 포함하는 세포를 제공하는 단계로, 상기 RTS, Ad 유전자 및 프로모터는 염색체로 통합되고, 아데노-관련 바이러스 (AAV) 유전자, 제2 Ad 유전자, AAV 벡터 카세트, 또는 이들의 조합을 인코딩하는 교환 가능한 카세트를 포함하는 벡터가 제공된 세포를 형질 감염시키는 단계, 교환 가능한 카세트를 염색체에 통합시키는 단계, 및 교환 가능한 카세트를 염색체에 통합하여 rAAV 생산자 세포를 선택하는 단계를 포함한다. 일부 실시 양태에서, 형질주입은 2개의 벡터에 의한 것이고, 제1 벡터는 제2 Ad 유전자 및 AAV 유전자를 포함하는 교환 가능한 카세트를 포함하고, 제2 벡터는 AAV 벡터 카세트를 포함하는 교환 가능한 카세트를 포함한다. 일부 실시 양태에서, 형질주입은 2개의 벡터에 의하고, 제1 벡터는 제2 Ad 유전자를 포함하는 교환 가능한 카세트를 포함하고, 제2 벡터는 AAV 유전자를 포함하는 교환 가능한 카세트를 포함한다. 일부 실시 양태에서, 형질주입은 3개의 벡터를 사용하며, 제1 벡터는 제2 Ad 유전자를 포함하는 교환 가능한 카세트를 포함하고, 제2 벡터는 AAV 유전자를 포함하는 교환 가능한 카세트를 포함하고, 제3 벡터는 AAV 벡터 카세트를 포함하는 교환 가능한 카세트를 포함한다. 일부 실시 양태에서, 각각의 교환 가능한 카세트는 세포의 RTS 중 2개와 일치하는 2개의 RTS를 추가로 포함한다. 일부 실시 양태에서, 제2 Ad 유전자는 *E1A*, *E1B*, *E2A*, *E4*, *VA*, *MIR342*, 또는 이들의 조합을 포함한다. 일부 실시 양태에서, AAV 유전자는 *Rep*, *Cap*, 또는 이들의 조합을 포함한다. 일부 실시 양태에서, AAV 벡터 카세트는 리포터 유전자, 선택 유전자, 치료적 관심 유전자 또는 이들의 조합을 포함한다.

[0019] 일부 실시 양태에서, 본 개시 내용은 (i) rAAV로 숙주 세포를 감염시키는 단계, (ii) AAV 벡터 카세트로부터 패키징된 rAAV를 생산하는 단계 및 (iii) 패키징된 rAAV로서, 상기 숙주 세포는: 적어도 4개의 별개의 재조합 표적 부위 (RTS), *E1A*, *E1B* 또는 이들의 조합을 포함하는 아데노바이러스 (Ad) 유전자, Ad 유전자에 작동 가능하게 연

결된 프로모터로, 상기 RTS, Ad 유전자 및 프로모터는 염색체로 통합되고 *E1A*, *E1B*, *E2A*, *E4*, *VA*, *MIR342*, 또는 이들의 조합을 포함하는 제2 Ad 유전자, *Rep*, *Cap*, 또는 이들의 조합을 포함하는 아데노-관련 바이러스 (AAV) 유전자, 및 리포터 유전자, 선택 유전자, 치료적 관심 유전자 또는 이들의 조합을 포함하는 AAV 벡터 카세트를 포함하는 재조합 아데노-관련 바이러스 (rAAV)의 제조 방법을 제공한다. 일부 실시예에서 rAAV 생산 및 포장에는 살아있는 야생형 헬퍼 바이러스가 필요하지 않다. 일부 실시예에서, E1A의 발현은 rAAV 생산에 필요하지 않다. 일부 실시예에서, 정제 후 최소 1.0×10^9 vg/mL 활성 AAV가 수득된다.

발명의 효과

[0020]

본 발명은 4개 이상의 별개의 재조합 표적 부위 (RTS), *E1A*, *E1B* 또는 이들의 조합을 포함하는 아데노바이러스 (Ad) 유전자, 및 Ad 유전자에 작동 가능하게 연결된 프로모터를 포함하는 포유동물 세포에 관한 것으로, 여기서 RTS, Ad 유전자, 및 프로모터는 염색체로 통합되고, 재조합 아데노-관련 바이러스 (rAAV) 생산자 숙주 세포를 생성하기 위해 세포를 사용하는 방법; 및 rAAV 생산, 패키지 및 정제하기 위해 AAV 생산자 숙주 세포를 사용하는 방법을 제공할 수 있다.

도면의 간단한 설명

[0021]

도 1은 HEK293 및 CHOK1SV GS-KO™ 세포에서 재조합 아데노-관련 바이러스 (rAAV)의 생산을 보여준다. HEK293 세포에서 플라스미드 삼중 형질주입이 완료되었다 (pAAV-GFP (AAV-400, Cell Biolabs), pRC2-mi342 (6234, Clontech) 및 pHelper (6234, Clontech)). CHOK1SV GS-KO™에서, 보조 바이러스 공동-감염(wt Ad5)으로 이중 형질주입 (pAAV-GFP (AAV-400, Cell Biolabs) 및 pRC2-mi342 (6234, Clontech))을 완료하였다. 도 1a는 실험 설계의 개략도를 도시한다. 도 1B는 형질주입된 CHOK1SV GS-KO™ 세포 (왼쪽) 및 형질주입된 CHOK1SV GS-KO™ 세포로부터의 용해물로 감염된 HEK293 세포에서 녹색 형광 단백질 (GFP) 신호의 검출을 보여준다 (오른쪽). 도 1C는 바이러스 게놈 DNA의 qPCR 분석에 의한 rAAV 역가 CHOK1SV GS-KO™ 및 HEK293 (대조군) 세포의 정량을 보여준다.

도 2는 pMF30 벡터 다이어그램을 보여준다. GS 선택 마커를 갖는 TET 유도성 벡터에서의 E1A.

도 3은 pMF23 벡터 다이어그램을 보여준다. PAC 선택 마커를 갖는 구성적 벡터에서의 E1B.

도 4는 pXC17.4_17Ad5PerProKZ 벡터 다이어그램을 보여준다. E1A 및 E1B는 Qiao et al., *J. Virol.* 76:1904-13 (2002)에 기술된 것과 같이 단일 프로모터 (E1A와 E1B 코딩 서열 사이에 위치한 2 개의 유전자와 바이러스 프로모터 영역 사이의 바이러스 조절 영역 (뉴클레오티드 498-3635)이 유지됨)에서 유지됨)로부터 발현되었다. 주석은 Qiao et al., *J. Virol.* 76:1904-13 (2002)에 설명된 좌표와 일치한다.

도 5는 헬퍼 바이러스없이 이들 세포에서 rAAV 생성을 가능하게 하기 위해 wt Ad5 E1A 및 E1B를 발현하는 CHOK1SV GS-KO™ 폴의 구조를 보여준다. 도 5A는 실험 설계의 개략도이다. 도 5B는 HEK293F, HEK293L, CHOK1SV GS-KO™ 및 CHOK1SV GS-KO™ MOCK 및 CHOK1SV GS-KO™ (E1A_E1B) 폴에서 E1A에 대한 게놈 PCR 생성물의 아가로스 겔 분석을 보여준다. 도 5C는 HEK293F, HEK293L, CHOK1SV GS-KO™ 숙주 및 CHOK1SV GS-KO™ MOCK 및 CHOK1SV GS-KO™ E1A_E1B 폴에서 E1B에 대한 게놈 PCR 생성물의 아가로스 겔 분석을 보여준다. 도 5D는 독시사이클린으로 처리된 HEK293F, HEK293L, CHOK1SV GS-KO™ 숙주 및 CHOK1SV GS-KO™ MOCK 및 CHOK1SV GS-KO™ E1A_E1B 폴에서 E1A에 대한 RT-PCR 산물의 아가로스 겔 분석을 보여준다. 도 5E는 독시사이클린으로 처리된 HEK293F, HEK293L, CHOK1SV GS-KO™ 및 CHOK1SV GS-KO™ MOCK 및 CHOK1SV GS-KO™ E1A_E1B 폴에서 E1B에 대한 RT-PCR 산물의 아가로스 겔 분석을 보여준다. 패널 F는 CHOK1SV GS-KO™ MOCK 및 CHOK1SV GS-KO™ E1A_E1B 폴에서 E1A 및 β-액틴에 대한 단백질 용해물의 웨스턴 블롯 분석을 보여준다.

도 6은 pRC2-miRNA342 (6234, Clontech) (도 6A), pHelper (6234, Clontech) (도 6B) 및 pAAV-GFP (AAV-400, Cell Biolabs) (도 6C)의 벡터 다이어그램을 보여준다.

도 7은 CHOK1SV GS-KO™ 및 HEK293 부위-특이적 통합 세포주에서 3개의 독립적으로 다룰 수 있는 부위-특이적 통합 부위 (SSIS)에 대한 개략도를 보여준다. 도 7a는 단일 또는 이중 기능보고/마커 유전자를 함유하는 랜딩 패드(landing pad) 1의 배열을 도시한다. 리포터 유전자는 SV40E 프로모터의 제어하에 있으며 SV40 PolyA 서열을 갖는다. 호환되지 않는 Frt 부위는 재조합 매개 카세트 교환 (RMCE)을 위해 SV40 프로모터와 hpt-eGFP 유전자 (Frt-A)와 SV40 폴리 A 서열 (Frt-B)의 5' 사이에 위치한다. 도 7b 및 도 7C는 후속 랜딩 패드의 배열이 호환되지 않는 Frt 부위 (C, D, E 및 F) 및 페이로드(payload) 서열의 독립적인 타겟팅을 허용하는 다른 리포터를

포함하는 것을 도시한다. 이 경우 Frt 부위 A-F는 표 2에 설명된 부위 중 하나일 수 있다.

도 8은 CHOK1SV GS-KO™-AAV 생산자 세포를 제조하는 방법에 대한 시스템 개략도를 도시한다. SSIS는 아데노 바이러스 (Ad) 유전자 (헬퍼 유전자), AAV 유전자 (*Rep/Cap*) 및 AAV 벡터 카세트 (예: ITR-GOI-ITR)를 도입하는 데 사용되고, CHOK1SV GS-KO™에서의 추가 Ad 유전자(*E1A/E1B*)는 유도성 프로모터와 함께 다른 곳에 도입된다. 이 경우 Frt 부위 A-F는 표 2에 설명된 부위 중 하나일 수 있다. 도 8a는 CHOK1SV GS-KO™ 및 HEK293 숙주의 단일 부위의 배열을 도시한다. Ad 헬퍼 유전자는 SSIS에 통합되고 *GOI/Rep/Cap* 유전자는 플라스미드에서 일시적으로 발현된다. 도 8b는 CHOK1SV GS-KO™ 및 HEK293 숙주의 이중 부위 배열을 보여준다. Ad 헬퍼 및 *Rep/Cap* 유전자는 두 개의 분리된 SSIS에 통합되며 *GOI*는 플라스미드에서 일시적으로 발현된다. 도 8c는 CHOK1SV GS-KO™ 및 HEK293 숙주의 삼중 부위 배열을 보여준다. 헬퍼, *Rep/Cap* 및 *GOI* 유전자는 세 개의 분리된 SSIS에 통합된다. 일부 경우에, *E1A* 및 *E1B* 유전자는 또한 발현을 향상시키기 위해 SSIS에 통합된다.

도 9는 상이한 부위에서 *GOI* 및 *Rep/Cap* 유전자의 부위 특이적 통합을 이용하는 CHOK1SV GS-KO™ 부위 특이적 통합 (SSI) 숙주에서의 rAAV 생산의 개략도를 보여준다. rAAV를 생성하기 위해, CHOK1SV GS-KO™ SSI 숙주를 wt Ad5로 감염시켜 rAAV 복제에 필요한 헬퍼 유전자 기능을 제공하였다.

도 10은 CHOK1SV GS-KO™ 숙주에서 부위-특이적 통합을 위한 *GOI* 벡터 및 4개의 *Rep/Cap* 유전자 디자인의 개략도를 보여준다. 모든 벡터는 2개의 Frt 부위에 측면이 붙어서 SSI가 CHOK1SV GS-KO™ SSI 숙주 세포로 유입되도록 하였다. 도 10A는 벡터 pLMC31의 구조를 개략적으로 보여준다(AAV 카세트의 어느 한 말단에서 ITR에 의해 측면을 eGFP 리포터 유전자로 rAAV 벡터를 인코딩함). 이 벡터에서 선별 마커는 네오마이신 인산전이효소 (phosphotransferase) I 유전자이고 Frt 부위는 NL1을 표적으로 하기 위해 배열된다. 도 10B는 벡터 pLMC32 (AAV2 *Rep/Cap* 유전자를 암호화하는)의 구조를 개략적으로 도시한다. 이 벡터는 *Rep*의 최소 p5 프로모터(흰색 사각형) 5', *Rep* 발현 및 rAAV 생성의 역제를 감소시키기 위해 2개의 인핸서(enhancer) 요소를 함유하고, *Cap* 발현을 향상시키기 위한 *Cap*의 완전한 p5 프로모터 (흑색 사각형) 3'를 포함한다. 도 10C는 벡터 pLMC33 (AAV2 *Rep/Cap*. 유전자를 인코딩하는)의 구조를 개략적으로 도시한다. 이 벡터는 *Rep*의 최소 p5 프로모터 (흰색 사각형) 5' 및 TATA 박스가 GGGGGG로 돌연변이된 p5mut 프로모터 (검정색 및 회색 사각형)를 포함하여 *Cap*의 프로모터 활성 3'을 감소시킨다. 도 10D는 AAV2 *Rep/Cap* 유전자를 인코딩하는 벡터 pLMC34의 구조를 개략적으로 도시한다. 벡터는 *Rep*의 야생형 p5 프로모터 (흑색 사각형) 5' 및 *Cap*의 돌연변이된 p5 프로모터 (흑색 사각형) 3'를 포함한다. 도 10E는 pLMC35의 벡터의 구조 (AAV2 *Rep/Cap* 유전자를 인코딩하는)를 개략적으로 도시한다. 이 벡터는 *Rep*의 돌연변이된 p5 프로모터 (검정 및 회색 사각형) 5' 및 *Cap*의 3'를 포함한다. pLMC32 내지 pLMC35에서의 선별 마커는 GS cDNA이고 Frt 부위는 *Fer1L4*를 표적으로 하기 위해 배열된다.

도 11은 웨스턴 블롯 분석에 의한 HEK293 및 CHOK1SV GS-KO™ 세포에서 *E1A*, *Rep* 및 *Cap*의 단백질 발현을 보여준다. HEK293 세포는 pHelper (6234, Clontech), *GOI* (pLMC31) 및 하나의 *Rep-Cap* 벡터 (pLMC32-35)로 형질주입되거나 pHelper (6234, Clontech), pRC2-mi342 (6234, Clontech) 및 pAAV-GFP (AAV-400, Cell Biolabs)로 3중 형질주입되었다. 형질주입 3일 후, 단백질 용해물을 웨스턴 블롯팅으로 분석하였다. 도 11. A는 3개의 *E1A* 동형(isoforms) : *E1A* 289R, *E1A* 243R 및 *E1A* 171R의 수준을 보여준다 (Radko et al. (2015) PLoS One. 10 : e0140124). 1 : 1000으로 희석된 마우스 항-*E1A* 항체를 사용하여 *E1A* 단백질 수준을 검출하였다 (Abcam, ab33183). *E1A*, *Rep* 및 *Cap* 단백질 동형의 분자량은 괄호 안에 표시되어 있다. 상이한 벡터로 형질주입된 HEK293 또는 CHOK1SV GS-KO™ 세포에서 *E1A* 단백질 수준의 변화는 없었지만, 각각의 *E1A* 동형의 단백질 수준은 HEK293과 CHOK1SV GS-KO™ 세포에서 상이하였다. 도 11B는 *Rep78* 및 *Rep52* 단백질의 수준을 보여준다. 1:1000으로 희석된 마우스 항 *Rep* 항체(ARP, 03-61069)를 사용하여 *Rep* 단백질 수준을 검출하였다. 괄호 안에 표시된 것은 분자량이다. 상이한 벡터로 형질주입된 HEK293 또는 CHOK1SV GS-KO™ 세포에서 *Rep52* 단백질 수준에는 변화가 없었지만, pLMC34 및 pLMC35로 형질주입된 세포에서는 *Rep78* 단백질 수준이 더 높았다. 도 11. C는 1:1000으로 희석된 마우스 항 *Cap* 항체(ARP, 03-61058)를 사용한 3가지 *Cap* 동형: *VP1*, *VP2* 및 *VP3*의 수준을 보여준다. 괄호 안에 표시된 것은 분자량이다. 상이한 벡터로 형질주입된 HEK293 세포에서 *VP3* 단백질 수준의 변화는 없었으며, *VP1* 및 *VP2*는 HEK293 세포에서 검출되지 않았다. *VP1*, *VP2* 및 *VP3*은 CHOK1SV GS-KO™ 세포에서 검출되지 않았다. 도 11. D는 1 : 1000으로 희석된 마우스 항 베타-액틴 항체(TFS, MA5-1573)를 사용한 베타-액틴 로딩 제어를 나타낸다.

도 12는 HEK293 및 CHOK1SV GS-KO™ 세포에 의해 생성된 rAAV의 감염성을 나타낸다. HEK293 세포를 *Rep/Cap*, *GOI* 및 pHelper(6234, Clontech)로 3중 형질주입시켰다. CHOK1SV GS-KO™ 세포를 *Rep/Cap* 및 *GOI*로 형질주입시키고, wt Ad5로 감염시켰다. 형질주입 후 3일에, 동일한 부위의 미정제 rAAV 수확물을 사용하여 HEK293 세포를 감염시켰다. 형질주입 2일 후, 녹색 형광 및 명 시야 이미지를 얻었다. 녹색 형광은 *GOI*-패키지된 rAAV에 의

해 생성된다. 제시된 눈금 막대는 50 μm 을 나타낸다. 3중 형질주입된 HEK293 세포 (pHelper (6234, Clontech), pRC2-mi342 (6234, Clontech), pAAV-GFP (AAV-400, Cell Biolabs)) (상단 패널)에 의해 생성된 rAAV의 감염성은 CHOK1SV GS-KO™ 세포 (제3 패널)에 의해 형질주입되어 생성된 rAAV보다 높았다. 주목할 만한 것은, pLMC32-35로 형질 감염된 HEK293 세포에 의해 생성된 rAAV의 감염성은 pRC2-mi342 (6234, Clontech) (상부 패널)로 형질주입된 HEK293 세포보다 높았다.

도 13은 SSI가 GOI이고 4개의 Rep-Cap 구성 중 하나를 갖는 CHOK1SV GS-KO™ SSI 호스트 파생 풀의 구성을 보여준다. 풀은 두 단계로 생성되었다.

1단계 1부에서 CHOK1SV GS-KO™ SSI 숙주를 FLP 재조합 효소 벡터 (pMF4)와 하나의 Rep-Cap 벡터 (pLMC32-35)로 형질주입시킨 후 글루타민이 없는 배지에서 선택했다. 1단계 2부에서 CHOK1SV GS-KO™ SSI 숙주는 FLP 재조합 효소 벡터 (pMF4), 하나의 Rep-Cap 벡터 (pLMC32-35) 및 GOI 벡터 (pLMC31)로 형질주입되었고, 그런 다음 제네티신(Geneticin) (500 $\mu\text{g}/\text{mL}$ 또는 750 $\mu\text{g}/\text{mL}$)을 함유하는 글루타민이 없는 배지에서 선택하였다. 이들이 'A' 풀(pool)이 되었다. 2단계에서, 'A' 풀 4-7을 FLP 재조합 효소 (pMF4) 및 GOI 벡터 (pLMC31)로 형질주입시킨 후, 제네티신 (400 $\mu\text{g}/\text{mL}$)을 함유하는 배지에서 선택 하였다. 이들은 'B' 풀이 되었다.

도 14는 표적(on-target) SSI 및 잔류(비-교환) 랜딩 패드를 검출하기 위한 프라이머 위치의 개략도를 도시한다. 프라이머 세트 P5는 Fer1L4 유전자에 위치한 랜딩 패드로의 특정 Rep/Cap 통합을 검출하도록 설계되었다. 예상되는 산물 크기는 1524bp이다. 프라이머 세트 P6은 잔류 랜딩 패드를 감지하도록 설계되었다. 예상되는 산물 크기는 487bp이다. 프라이머 세트 P7은 NL1 유전자 좌위에 위치한 랜딩 패드로의 특정 GOI 통합을 감지하도록 설계되었다. 예상되는 산물 크기는 1446bp이다. 프라이머 세트 P8은 잔류 NL1 랜딩 패드를 감지하도록 설계되었다. 예상되는 산물 크기는 809bp이다.

도 15는 Fer1L4 랜딩 패드로의 Rep/Cap 통합을 위한 게놈 DNA PCR 생성물의 아가로스 겔 분석을 보여준다. 게놈 DNA를 'A' 풀, 'B' 풀, CHOK1SV GS-KO™ 및 CHOK1SV GS-KO™ SSI 숙주에서 수확한 후 PCR에 의해 프라이머 세트 5 또는 6을 사용하여 증폭시켰다. PCR 생성물은 아가로스 겔 전기영동에 의해 해결되었다. 도 15A는 프라이머 세트 P5를 사용하여 Fer1L4 유전자에 위치한 랜딩 패드로의 특정 Rep/Cap 통합을 위한 게놈 DNA PCR 생성물의 아가로스 겔 분석을 보여준다. 예상되는 산물 크기는 1524bp이다. 결과는 'A' 풀 4, 5, 6, 7, 9, 11, 17, 18, 19, 21의 Fer1L4 유전자와 분석된 모든 'B' 풀에 있는 랜딩 패드에 특정 Rep/Cap 통합을 보여준다. 예상대로 CHOK1SV GS-KO™ 및 CHOK1SV GS-KO™ SSI 숙주에서 특이적 Rep/Cap 통합이 감지되지 않았다. 도 15B는 프라이머 세트 P6을 사용하여 Fer1L4 유전자에서 잔류 랜딩 패드에 대한 게놈 DNA PCR 생성물의 아가로스 겔 분석을 보여준다. 예상되는 산물 크기는 487bp이다. 결과는 일부 잔류 랜딩 패드와 18을 제외한 모든 'A' 풀 및 모든 'B' 풀의 Fer1L4 유전자에 있는 랜딩 패드에 불완전한 Rep/Cap 통합을 보여준다. 'A' 풀 19에는 더 작은 PCR 산물이 있었으며, 이는 일부 서열의 손실을 나타낸다. 예상한 바와 같이, Fer1L4 랜딩 패드는 CHOK1SV GS-KO™ 세포에서는 증폭되었지만 CHOK1SV GS-KO™ SSI 숙주에서는 검출되지 않았다.

도 16은 NL1 랜딩 패드로의 GOI 통합을 위한 게놈 DNA PCR 산물의 아가로스 겔 분석을 보여준다. 게놈 DNA를 'A' 풀, 'B' 풀, CHOK1SV GS-KO™ 및 CHOK1SV GS-KO™ SSI 숙주에서 수확한 후 PCR에 의해 프라이머 세트 7 또는 8을 사용하여 증폭하였다. PCR 산물은 아가로스 겔 전기영동에 의해 해결되었다. 도 16A는 프라이머 세트 P7을 사용하여 NL1 랜딩 패드에 특이적 GOI 통합을 위한 게놈 DNA PCR 산물의 아가로스 겔 분석을 보여준다. 예상되는 산물 크기는 1446bp이다. 결과는 모든 'B' 풀의 NL1 위치에 있지만 'A' 풀에는 없는 랜딩 패드에 특정 GOI 통합을 보여준다. 예상대로 CHOK1SV GS-KO™ 및 CHOK1SV GS-KO™ SSI 숙주에서 특이적 GOI 통합이 감지되지 않았다. 도 16B는 프라이머 세트 P8을 사용한 잔류 NL1 랜딩 패드에 대한 게놈 DNA 생성물의 아가로스 겔 분석을 보여준다. 예상되는 산물 크기는 809bp이다. 결과는 잔류 랜딩 패드와 11을 제외한 모든 'A' 풀 및 모든 'B' 풀의 NL1 유전자에 있는 랜딩 패드에 불완전한 GOI 통합을 보여준다. 결과에 따르면 NL1 랜딩 패드는 'A' 풀 11에서는 손상되지 않았지만 GOI는 랜딩 패드에 통합되지 않았다. 예상한 바와 같이, NL1 랜딩 패드는 CHOK1SV GS-KO™ 세포에서 증폭되었지만 CHOK1SV GS-KO™ SSI 숙주에서는 검출되지 않았다.

도 17은 웨스턴 블롯 분석에 의한 wt Ad5 감염된 CHOK1SV GS-KO™ 세포에서 E1A, Rep 및 Cap의 단백질 발현을 보여준다. 'A' 풀과 'B' 풀을 3일 동안 wt Ad5로 감염시킨 후 E1A, Rep, Cap 및 베타-액틴 단백질 발현 분석을 위해 수확하였다. 도 17a는 3개의 E1A 동형: E1A 289R, E1A 243R 및 E1A 171R의 수준을 나타낸다. 1:1000으로 희석된 마우스 항-E1A 항체(Abcam, ab33183)를 사용하여 E1A 단백질 수준을 검출하였다. E1A, Rep 및 Cap 단백질 동형의 분자량은 괄호 안에 표시되어 있다. 3개의 모든 E1A 동형의 수준은 모든 풀에서 동일하였고, CHOK1SV GS-KO™ 세포에서보다 약간 더 높았다. 도 17. B는 Rep78 및 Rep52 단백질의 수준을 보여준다. 1:1000

으로 희석된 마우스 항 Rep 항체(ARP, 03-61069)를 사용하여 Rep 단백질 수준을 검출하였다. 괄호 안에 표시된 것은 분자량이다. Rep78은 검출되지 않았다. Rep52는 'A' 풀 13 및 'B' 풀 6, 7, 8 및 10에서 *로 표시되었다. 도 11. C는 1:1000으로 희석된 마우스 항 Cap 항체를 사용한 3가지 Cap 동형: VP1, VP2 및 VP3의 수준을 보여 준다(ARP, 03-61058). 괄호 안에 표시된 것은 분자량이다. VP1, Vp2 및 VP3이 검출되지 않았다. 도 17. D는 1:1000으로 희석된 마우스 항 베타-액틴 항체(TFS, MA5-1573)를 사용한 베타-액틴 로딩 제어를 나타낸다.

도 18은 AAV2 Rep 및 Cap mRNA의 검출을 위한 프라이머 위치의 개략도를 보여준다. Rep78 및 Rep68에 대한 프라이머 세트 P1. Rep78, Rep68, Rep52 및 Rep40에 대한 프라이머 세트 P2. Rep78 및 Rep52에 대한 프라이머 세트 P3. 총 Rep 및 Cap에 대한 프라이머 세트 P4. *는 VP3 생산에 사용된 대체 ACG 코돈을 나타낸다. AAV2 계놈 구조는 Samulski and Muzyczka., *Annu. Rev. Virol.* 1:427-451 (2014)로부터 변형되었다.

도 19는 형질주입된 HEK293 및 CHOK1SV GS-KOTM 세포로부터의 Rep-Cap 유전자 및 Ad5 헬퍼 유전자에 대한 mRNA 발현 분석을 보여준다. HEK293 세포를 pRC2-mi342 (6234, Clontech), pAAV-GFP (AAV-400, Cell Biolabs) 벡터 (검은색 막대)로 3중 형질주입시켰다. CHOK1SV GS-KOTM 세포를 pRC2-mi342 및 pAAV-GFP로 형질주입시키고, wt Ad5 (흰색 막대)로 감염시켰다. 대조군에는 pRC2-mi342 (왼쪽 막대)로 형질주입된 HEK293 또는 CHOK1SV GS-KOTM 세포가 포함된다. cDNA는 Rep/Cap 및 Ad 헬퍼 유전자에 대한 RT-qPCR 분석을 위해 준비되었다. 발현 데이터를 베타-액틴으로 내부적으로 표준화한 후 HEK293 대조군 샘플과 비교하였다. 프라이머 서열은 도 21에 포함되어 있다. 도 19A는 Rep78 및 Rep68 mRNA 수준을 보여준다. 3중 형질주입 후 HEK293 및 CHOK1SV GS-KOTM 세포에서 ~6- 및 ~5-배 유도가 관찰되었다. 도 19b는 Rep78, Rep68, Rep52 및 Rep40 mRNA 수준을 보여준다. ~11-배 및 ~5-배 유도가 3중 형질주입 후 HEK293 및 CHOK1SV GS-KOTM 세포에서 각각 관찰되었다. 도 19.C는 Rep78 및 Rep52 mRNA 수준을 보여준다. 3중 형질주입 후 HEK293 및 CHOK1SV GS-KOTM 세포에서 ~17- 및 ~4-배 유도가 관찰되었다. 도 19D는 총 Rep 및 Cap mRNA 수준을 나타낸다. ~20-배 및 ~7-배 유도가 (각각) 삼중 형질주입 후 HEK293 및 CHOK1SV GS-KOTM 세포에서 관찰되었다. 도 19E는 E1A mRNA 수준을 보여준다. 삼중 형질주입 후 HEK293에서 ~1-배 유도가 관찰되었다. E1A mRNA는 대조군 CHOK1SV GS-KOTM 세포에서 검출되지 않았으나, 형질주입 및 wt Ad5로의 감염 후에 검출되었다. 도 19.F는 E1B-19K mRNA 수준을 보여준다. 삼중 형질주입 후 HEK293에서 ~1-배 유도가 관찰되었다. E1B-19K mRNA는 대조군 CHOK1SV GS-KOTM 세포에서 검출되지 않았으나, 형질주입 및 wt Ad5로의 감염 후에 검출되었다. 도 19.G는 E1B-55K mRNA 수준을 보여준다. 삼중 형질주입 후 HEK293에서 ~1-배 유도가 관찰되었다. E1B-55K mRNA는 대조군 CHOK1SV GS-KOTM 세포에서 검출되지 않았으나, 형질주입 및 wt Ad5로의 감염 후에 검출되었다. 도 19H는 E2A mRNA 수준을 보여준다. E2A mRNA는 대조군 샘플에서 검출될 수 없었으며, 삼중 형질주입 후에 존재하였다. 도 19.I는 E4 mRNA 수준을 나타낸다. E4 mRNA는 대조군 샘플에서 검출될 수 없었으며, 삼중 형질주입 후에 존재하였다. 도 19.J는 VAI mRNA 수준을 보여준다. VAI mRNA는 대조군 샘플에서 검출될 수 없었으며, 삼중 형질주입 후에 존재하였다. 도 19.K는 VAII mRNA 수준을 나타낸다. VAII mRNA는 대조군 샘플에서 검출될 수 없었으며, 삼중 형질주입 후에 존재하였다. E4를 제외한 모든 관찰된 mRNA 수준은 HEK293 세포와 비교하여 CHOK1SV GS-KOTM에서 더 낮았다(도 19.A-K). 이들 데이터는 Rep-Cap mRNA 유도 및 발현이 HEK293 세포와 비교하여 CHOK1SV GS-KOTM 세포에서 더 낮다는 것을 보여준다.

도 20은 삼중 형질주입된 HEK293 및 CHOK1SV GS-KOTM 세포로부터의 rAAV의 역가를 보여준다. HEK293 세포를 pHelper (6234, Clontech) 및 하나의 pLMC32-35 또는 pRC-mi342 (6234, Clontech) 및 pLMC31 또는 pAAV-GFP (AAV-400, Cell Biolabs) 벡터로 형질주입시켰다. CHOK1SV GS-KOTM 세포를 wt Ad5 및 하나의 pLMC32-35 또는 pRC-mi342 (6234, Clontech) 및 pLMC31 또는 pAAV-GFP (AAV-400, Cell Biolabs) 벡터로 감염시켰다. 형질주입 3일 후, AAV 발현에 대한 TaqMan-qPCR 분석을 위해 DNA를 추출하였다. CHOK1SV GS-KOTM 세포에 의해 생성된 AAV 역가는 HEK293 세포에서보다 낮았고, pHelper (6234, Clontech), pLMC31 및 pLMC32-35를 사용하여 삼중 형질주입된 HEK293 세포에 의해 생성된 역가는 Clontech 벡터 (pHelper (6234, Clontech), pRC2-mi342 (6234, Clontech) 및 pAAV-GFP (AAV-400, Cell Biolabs))를 사용하여 삼중 형질주입된 HEK293 세포에서보다 유의하게 높았다.

도 21은 TaqMan-qPCR 및 계놈 DNA PCR 분석에 사용된 프라이머 서열을 보여준다.

발명을 실시하기 위한 구체적인 내용

[0022] 청구 범위 및/또는 명세서에서 "포함하는" 이라는 용어와 함께 사용될 때 "하나" 라는 단어의 사용은 "하나"를 의미 할 수 있으나, "하나 또는 그 이상", "적어도 하나" 및 "하나 이상"의 의미와 일치한다.

[0023] 본 출원 전체에서, "약" 이라는 용어는 값을 결정하기 위해 사용되는 방법/장치에 대한 고유의 오차 변동 또는 연구 대상자 사이에 존재하는 변동을 포함하는 값을 나타내는데 사용된다. 일반적으로 이 용어는 대략적으로 상

황에 따른 1%, 2%, 3%, 4%, 5%, 6%, 7%, 8%, 9%, 10%, 11%, 12%, 13%, 14%, 15%, 16%, 17%, 18%, 19% 또는 20% 이하의 변동성을 의미하는 것을 포함하는 것으로 의도된다.

- [0024] 청구 범위에서 용어 "또는"은 특별히 선택적인 대안을 단독으로 인용하거나 이러한 선택적 대안이 서로에 대해 독립적인 경우를 제외하고 "및/또는"을 지칭하는데 사용하며, 다만 본 명세서에는 선택적 대안을 단독으로 인용하는 정의 및 " 및/또는" 을 모두 뒷받침한다.
- [0025] 본 명세서 및 청구 범위에 사용된 바와 같이, "포함하는" (및 "포함하는(comprise)" 및 "포함하는(comprises)"과 같은 임의의 형태), "갖는"(및 "갖는다(have)" 및 "갖는다(has)"와 같은 임의의 형태), "포함하는" (및 "포함하다(includes)"및 "포함하다(include)"와 같은 임의의 형태) 또는 "함유하다" (및 "함유하다(contains)" 및 "포함하다(contain)"과 같은 함유의 임의의 형태)의 단어들은 포함하는 또는 개방형이며 추가, 언급되지 않은, 요소 또는 방법 단계를 배제하지 않는다. 본 명세서에서 논의된 임의의 실시예에는 본 발명의 임의의 방법, 시스템, 숙주 세포, 발현 벡터 및/또는 조성물과 관련하여 구현될 수 있는 것으로 고려된다. 또한, 본 발명의 조성물, 시스템, 세포, 및/또는 벡터는 본원에 기재된 임의의 방법을 달성하기 위해 사용될 수 있다.
- [0026] "예를 들어" 라는 용어와 그에 해당하는 약어 "예" (이탤릭체로 표시되든 그렇지 않든)은 언급된 특정 용어가 달리 명시적으로 언급되지 않는 한 참조되거나 인용된 특정예에 제한되지 않는 본 개시의 대표적인 예 및 실시예임을 의미한다.
- [0027] 본 개시 내용은 (i) 적어도 4개의 별개의 재조합 표적 부위 (RTS), (ii) *E1A*, *E1B* 또는 이들의 조합을 포함하는 아데노바이러스 (Ad) 유전자, 및 (iii) Ad 유전자에 작동 가능하게 연결된 프로모터를 포함하는 포유동물 세포를 제공하고, 여기서 RTS, Ad 유전자 및 프로모터는 염색체로 통합된다.
- [0028] "핵산", "핵산 분자", 또는 "올리고뉴클레오티드" 는 공유 연결된 뉴클레오티드를 포함하는 중합체 화합물을 의미한다. 용어 "핵산"은 폴리 리보핵산(RNA) 및 폴리 데옥시리보핵산(DNA)을 포함하고, 이들 둘은 단일 가닥 또는 이중 가닥일 수 있다. DNA는 상보적 DNA(cDNA), 게놈 DNA, 플라스미드 또는 벡터 DNA, 및 합성 DNA를 포함하지만 이에 제한되지는 않는다. RNA는 mRNA, tRNA, rRNA, snRNA, 마이크로 RNA, miRNA 또는 MIRNA를 포함하지만 이에 제한되지는 않는다.
- [0029] 용어 "재조합"은 핵산 분자, 펩타이드, 폴리펩타이드 또는 단백질과 관련하여 사용될 때 자연에 존재하지 않는 것으로 알려진 새로운 유전 물질의 조합을 의미하거나 그로부터 생성된다. 재조합 분자는 재조합 기술 분야에서 이용 가능한 임의의 공지된 기술에 의해 생성될 수 있으며, 중합 효소 연쇄 반응 (PCR), 유전자 절단 (예를 들어, 제한 효소(restriction endonucleases) 사용), 및 핵산 분자, 펩티드 또는 단백질의 고상(solid state) 합성을 포함하나, 이에 제한되지는 않는다. 일부 실시예에서, "재조합"은 자연에 존재하지 않는 것으로 알려진 바이러스 벡터 또는 바이러스를 지칭하며, 예를 들어 바이러스 벡터 또는 바이러스에 하나 이상의 돌연변이, 핵산 삽입, 또는 상동 유전자(heterologous gene)를 갖는 바이러스 벡터 또는 바이러스이다. 일부 실시예에서, "재조합"은 예를 들어 자연에 존재하지 않는
- [0030] 것으로 공지된 세포 또는 숙주 세포를 지칭하며, 예를 들어 세포 또는 숙주 세포에서 하나 이상의 돌연변이, 핵산 삽입, 또는 상동 유전자를 갖는 세포 또는 숙주 세포이다.
- [0031] "단리된" 폴리펩티드, 단백질, 펩티드, 또는 핵산은 이의 본래의(natural) 환경에서 제거된 분자이다. "단리된" 폴리펩티드, 단백질, 펩티드, 또는 핵산은 부형 제, 예컨대 희석제 또는 보조제와 함께 제제화될 수 있으며 여전히 단리된 것으로 간주된다는 것을 이해해야 한다.
- [0032] 핵산 서열 또는 아미노산 서열과 관련하여 용어 "서열 동일성" 또는 "% 동 일성"은 서열이 특정된 비교 창(window)에 걸쳐 정렬될 때 동일한 비교된 서열의 잔기의 백분율을 지칭한다. 비교 창은 서열이 정렬되고 비교될 수 있는 10개 내지 1000개 이상의 잔기의 단편(segment) 일 수 있다. 서열 동일성을 결정하기 위한 정렬 방법은 당 업계에 공지되어 있으며 BLAST (blast.ncbi.nlm.nih.gov/Blast.cgi) 와 같은 공개적으로 이용 가능한 데이터베이스를 사용하여 수행될 수 있다.
- [0033] 일부 실시예에서, 폴리펩티드 또는 핵산 분자는 기준 폴리펩티드 또는 핵산 분자(또는 기준 폴리펩티드 또는 핵산 분자의 단편)와 각각, 약 70% 이상, 약 75% 이상, 약 80% 이상, 약 85% 이상, 약 90% 이상, 약 95% 이상, 약 97% 이상, 약 98% 이상, 약 99% 이상 또는 약 100% 서열 동일성을 갖는다. 본 개시의 특정 실시예에서, 폴리펩티드 또는 핵산 분자는 기준 폴리펩티드 또는 핵산 분자(또는 기준 폴리펩티드 또는 핵산 분자의 단편)와 각각, 약 70% 이상, 약 75% 이상, 약 80% 이상, 약 85% 이상, 약 90% 이상, 약 95% 이상, 약 97% 이상, 약 98% 이상, 또는 약 99% 이상 또는 100%의 서열 동일성을 갖는다. 일부 실시예에서, 폴리펩티드 또는 핵산 분자는 기

준 폴리펩티드 또는 핵산 분자와 각각, 약 90%, 91%, 92%, 93%, 94%, 95%, 96%, 97%, 98%, 99%, 99.5% 서열 동일성을 갖는다.

- [0034] 본원에 사용된 "프로모터", "프로모터 서열" 또는 "프로모터 영역"은 RNA 폴리머라제에 결합할 수 있고 다운 스트림 코딩 또는 비-코딩 서열의 전사를 개시하는데 관여하는 DNA 조절 영역/서열을 지칭한다. 본 개시 내용의 일부 실시예에서, 프로모터 서열은 전사 개시 부위를 포함하고, 배경 위에서 검출 가능한 수준에서 전사를 개시하는데 필요한 최소 수의 염기 또는 요소를 포함하도록 업스트림으로 연장된다. 일부 실시예에서, 프로모터 서열은 전사 개시 부위뿐만 아니라 RNA 폴리머라제의 결합을 담당하는 단백질 결합 도메인을 포함한다. 진핵 생물 프로모터는 종종, 항상 그런 것은 아니지만, "TATA"박스 및 "CAT"박스를 포함한다. 유도성 프로모터를 포함하는 다양한 프로모터가 예를 들어, 본 발명의 숙주 세포 또는 박터에서 유전자 발현을 유도하는데 사용될 수 있다. 일부 실시예에서, 프로모터는 누출(leaky) 프로모터가 아니며, 즉, 프로모터는 본원에 기재된 바와 같은 유전자 생성물 중 어느 하나를 구성적으로 발현하지 않는다.
- [0035] 본원에 언급된 바와 같이, 용어 "포유동물 세포"는 포유 동물의 임의의 구성원으로부터의 세포, 예를 들어, 인간 세포, 마우스 세포, 랫트(rat) 세포, 원숭이 세포, 햄스터 세포 등을 포함한다. 일부 실시예에서, 세포는 마우스 세포, 인간 세포, 중국 햄스터 난소(CHO) 세포, CHO-K1 세포, CHO-DXB11 세포, CHO-DG44 세포, 모든 변이체를 포함하는 CHOK1SV™ 세포(예를 들어, CHOK1SV POTELLIGENT®, Lonza, Slough, UK), 모든 변이체를 포함하는 CHOK1SV GS-KO™(XCeed®, Lonza, Slough, UK) 세포, 부착성 및 현탁액-적응형-변이체를 포함하는 HEK293 세포, HeLa 세포, 또는 HT1080 세포이다.
- [0036] 본원에 언급된 바와 같이, 용어 "염색체로-통합된" 또는 "염색체 통합"은 핵산 서열이 숙주 세포, 예를 들어 포유동물 세포의 염색체에 안정적으로 혼입되는 것을 의미한다. 즉, 숙주 세포, 예를 들어 포유동물 세포의 게놈 DNA (gDNA)에 염색체로 통합된 핵산 서열이다. 일부 실시예에서, 염색체로 통합된 핵산 서열은 안정적이다. 일부 실시예에서, 염색체로 통합된 핵산 서열은 플라스미드 또는 박터 상에 위치하지 않는다. 일부 실시예에서, 염색체로 통합된 핵산 서열은 절단(excise d) 되지 않는다. 일부 실시예에서, 염색체 통합은 크리스퍼 (CRISPR; clustered regularly interspaced short palindromic repeats) 및 CRISPR 관련 단백질 (Cas) 유전자 편집 시스템(CRISPR/CAS)에 의해 매개된다.
- [0037] 본원에 사용된 용어 "재조합 표적 부위-특이적 통합" 또는 "부위-특이적 통합"은 상호 교환 가능하고 하나 이상의 유전자를 숙주 세포 염색체로 도입하는데 사용될 수 있다. 예를 들어, Bode et al., *Biol. Chem.* 381:801-813 (2000), Kolb, *Cloning and Stem Cells* 4:381-392 (2002) 및 Coates et al., *Trends in Biotech.* 23:407-419 (2005), 이들 각각은 참고로 포함된다. 일부 실시예에서, "재조합 표적 부위-특이적 통합" 또는 "부위-특이적 통합"은 특정 부위에서 염색체 내로 핵산 서열의 통합을 지칭한다. 일부 실시예에서, 부위-특이적 통합은 부위-특이적 재조합을 통해 이루어진다. 일부 실시예에서, "부위-특이적 재조합"은 그의 동족 쌍의 서열 또는 표적 부위에서 재조합을 수행하는 특이적 효소에 의한 2개의 DNA 파트너 분자의 재배열을 지칭한다. 상동 재조합과 대조적으로, 부위-특이적 재조합 및 부위-특이적 통합은 파트너 DNA 분자 사이의 DNA 상동성이 거의 필요하지 않으며, RecA-의존적이며, 어떠한 단계에서도 DNA 복제를 포함하지 않는다. 일부 실시예에서, 부위 특이적 재조합은 숙주 세포, 예를 들어, 포유동물 세포에서 핵산의 부위 특이적 통합을 달성하기 위해 부위 특이적 재조합 효소 시스템을 사용한다. 재조합 효소 시스템은 전형적으로 3개의 요소, 즉 2개의 특정 DNA 서열 (재조합 표적 부위) 및 특정 효소 (재조합 효소)로 구성된다. 재조합 효소는 특정 재조합 표적 부위 사이의 재조합 반응을 촉매한다.
- [0038] 당업자에게 공지된 다른 수단을 사용하여 하나 이상의 원하는 핵산 서열 (예를 들어, 유전자)을 삽입할 수 있다. 일부 실시예에서, 하나 이상의 핵산 서열 (예를 들어, 유전자)은 상동 재조합을 사용하여 염색체에 삽입된다. 상동 재조합은 뉴클레오티드 서열이 2개의 유사하거나 동일한 DNA 분자 사이에서 교환되는 유전자 재조합을 지칭한다. 일부 실시예에서, 결실/삽입을 표적으로 하는 영역(예를 들어, 유전자)은 상동 재조합에 의해 결실/삽입된다.
- [0039] 숙주 염색체에서 결실이 절단, 또는 (ii) 염색체에 삽입이 첨가되는 것을 위한 표적화된 영역을 정렬할 수 있다. 일부 실시예에서, 상동 재조합은 재조합 표적 부위, 아데노바이러스 (Ad), 예를 들어, *E1A*, *E1B*, *E2A*, *E4*, *VA*, *MIR342*, 또는 이들의 조합, 및/또는 Ad 유전자에 작동 가능하게 연결된 프로모터를 삽입하기 위해 사용되지 않는다.
- [0040] 재조합 효소(recombinase enzyme) 또는 재조합 효소(recombinase)는 부위-특이적 재조합에서의 재조합을 촉매하는 특정 효소이다. 본 개시 내용의 일부 실시예에서, 부위-특이적 재조합에 사용되는 재조합 효소는 비-포유

류 시스템으로 부터 유래된다. 일부 실시예에서, 재조합 효소는 박테리아, 박테리오파지 또는 효모로부터 유래된다.

[0041] 일부 실시예에서, 재조합 효소를 암호화하는 핵산 서열은 예를 들어 숙주 세포, 예를 들어 포유동물 세포 내로 통합된다. 일부 실시예에서, 재조합 효소를 코딩하는 핵산 서열은 분자 생물학에 공지된 다른 방법에 의해 숙주 세포로 전달된다. 일부 실시예에서, 재조합 효소 폴리펩티드 서열은 세포로 직접 전달 될 수 있다. 일부 실시예에서, 재조합 효소는 Cre 재조합 효소, Dre 재조합 효소, KD 재조합 효소, B2B3 재조합 효소, Hin 재조합 효소, Tre 재조합 효소, λ 인테그라제 (integrase), HK022 인테그라제, HP1 인테그라제, γ δ 레졸베이즈/인버테이스, (resolvase/invertase), a ParA 레졸베이즈/인버테이스, Tn3 레졸베이즈/인버테이스, Gin 레졸베이즈/인버테이스, Φ C31 인테그라제, BxB1 인테그라제, R4 인테그라제 또는 다른 기능적 재조합 효소이다. 예를 들어, Thorpe & Smith, *Proc. Nat'l. Acad. Sci. USA* 95: 5505-5510 (1998); Kuhstoss & Rao, *J. Mol. Biol.* 222: 897-890 (1991); U.S. Pat. No. 5,190,871; Ow & Ausubel, *J. Bacteriol.* 155: 704-713 (1983); Matsuura et al., *J. Bacteriol.* 178: 3374-3376 (1996); Sato et al., *J. Bacteriol.* 172: 1092-1098 (1990); Stragier et al., *Science* 243: 507-512 (1989); Carrasco et al., *Genes Dev.* 8: 74-83 (1994); Bannam et al., *Mol. Microbiol.* 16: 535-551 (1995); Crelin & Rood, *J. Bacteriol.* 179: 5148-5156 (1997).를 참고한다.

[0042] 일부 실시예에서, 본원에 기술된 재조합 효소는 FLP 재조합 효소이다. FLP 재조합 효소는 DNA 복제 동안 사카로마이세스 세레비지에(*Saccharomyces cerevisiae*)의 2 μ m 플라스미드의 카피(copy) 수를 증폭 시키는데 관련된 부위-특이적 재조합 반응을 촉매하는 단백질이다. 일부 실시예에서, 본 개시 내용의 FLP 재조합 효소는 사카로마이세스(*Saccharomyces*) 속의 종으로부터 유래된다. 일부 실시예에서, FLP 재조합 효소는 사카로마이세스 세레비지 애로부터 유래된다. 일부 실시예에서, FLP 재조합 효소는 사카로마이세스 세레비지에 균주로부터 유래된다. 일부 실시예에서, FLP 재조합 효소는 열 안정성 돌연변이체 FLP 재조합 효소이다. 일부 실시예에서, FLP 재조합 효소는 FLP1 또는 FLPe이다. 일부 실시예에서, FLP 재조합 효소를 코딩하는 핵산 서열은 인간 최적화된 코돈을 포함한다.

[0043] 일부 실시예에서, 재조합 효소는 Cre 재조합 효소이다. Cre (재조합을 야기함)는 Int 계열 재조합 효소(Argos et al. (1986) EMBO J 5:433)의 구성원이며 lox 좌위 (X-ing의 위치)의 효율적인 재조합을 수행하는 것으로 나타났다 박테리아뿐만 아니라 진핵 세포에서도 마찬가지로이다(Sauer (1987) Mol. Cell. Biol. 7:2087; Sauer and Henderson (1988) Proc. Natl Acad. Sci. 85:5166). 일부 실시예에서, 본원에 기술되고 사용된 Cre 재조합 효소는 박테리오파지로부터 유래된다. 일부 실시예에서, Cre 재조합 효소는 P1 박테리오파지로부터 유래된다.

[0044] 본원에 언급된 바와 같이, 용어 "재조합 표적 부위", "RTS" 및 "부위-특이적 재조합 효소 표적 부위"는 짧은 부위, 예를 들어, 부위-특이적 재조합 효소에 의해 인식되는 60개 이하의 염기쌍, 핵산 부위 또는 서열을 지칭하고, 이는 부위-특이적 재조합 상황 동안 교차 영역이 된다. 약어 "RTS"는 단일 재조합 표적 부위, 또는 복수의 재조합 표적 부위를 지칭할 수 있다. 일부 실시예에서, RTS는 약 60개 이하 염기쌍, 약 55개 이하 염기쌍, 약 50개 이하 염기쌍, 약 45개 이하 염기쌍, 약 40개 이하 염기쌍, 약 35개 이하 염기쌍, 또는 약 30개 이하의 염기쌍이다. 일부 실시예에서, RTS는 약 30 내지 약 60개의 염기쌍, 약 30 내지 약 55개의 염기쌍, 약 32 내지 약 52개의 염기쌍, 약 34 내지 약 44개의 염기쌍, 약 32개의 염기쌍, 약 34개의 염기쌍, 또는 약 52개의 염기쌍이다. RTS의 예는, 이에 제한되지 않지만, lox 부위, rox 부위, Frt 부위, att 부위 및 dif 부위를 포함한다. 일부 실시예에서, RTS는 표 1, 2, 3 또는 4의 임의의 서열에 제시된 것과 실질적으로 동일한 서열을 갖는 핵산이다.

[0045] 일부 실시예에서, RTS는 표 1로부터 선택된 lox 부위이다. 본원에 언급된 바와 같이, 용어 "lox 부위"는 Cre 재조합 효소가 부위-특이적 재조합을 촉매할 수 있는 뉴클레오티드 서열을 지칭한다. 다양한 비-동일 lox 부위가 당 업계에 공지되어 있다. 다양한 lox 부위의 서열은 이들이 재조합이 일어나는 8-염기쌍 비대칭 코어 영역의 측면에 위치한 동일한 13-염기쌍 반전된 반복물을 모두 포함한다는 점에서 유사하다. 비대칭 코어 영역은 부위의 방향성과 상이한 lox 부위 사이의 변이를 담당한다. 이들의 예시적인(비-제한적인) 예는 자연적으로 발생한 loxP(P1 계통에서 발견된 서열), loxB, loxL 및 loxR (이들은 대장균 염색체에서 발견됨)뿐만 아니라 loxP511, lox Δ 86, lox Δ 117, loxC2, loxP2, loxP3, loxP23, loxC2, loxP2, 및 loxP3와 같은 여러 돌연변이체 또는 변이된 lox 부위를 포함한다. 일부 실시예에서, RTS는 lox Δ 86, lox Δ 117, loxC2, loxP2, loxP3 및 loxP23로부터 선택된 lox 부위이다. 일부 실시예에서, lox RTS는 표 1에서 발견된 서열과 90%, 91%, 92%, 93%, 94%, 95%, 96%, 97%, 98%, 99% 이상, 또는 100% 서열 동일성을 갖는 핵산이다.

표 1

이름	식별자	서열
loxP	SEQ ID NO.: 1	ataacttcgtataatgtatgctatacgaagttat
loxP511	SEQ ID NO.: 2	ataacttcgtataatgtataactatacgaagttat
loxP2272	SEQ ID NO.: 3	ataacttcgtataaagatcctatacgaagttat
loxP5171	SEQ ID NO.: 4	ataacttcgtataatgtactatacgaagttat
loxP2272(V)	SEQ ID NO.: 5	ATAACTTCGTATAGGATACTTTATACGAAGTTAT
pLox2+	SEQ ID NO.: 6	ATAACTTCGTATAATGTATGCTATACGAAGTTAT
loxC2	SEQ ID NO.: 28	ACAACTTCGTATAATGTATGCTATACGAAGTTAT
loxP2	SEQ ID NO.: 29	TACCGTTTCGTATAGTATAGTATATACGAAGTTAT
loxP3	SEQ ID NO.: 30	TACCGTTTCGTATAGTATAGTATATACGAACGGTA

[0047]

일부 실시예에서, RTS는 표 2로부터 선택된 Frt 부위이다. 본원에 언급된 바와 같이, 용어 "Frt 부위"는 효모 2 μm 플라스미드의 FLP 유전자의 생성물인 FLP 재조합 효소는 부위-특이적 재조합을 촉진한다. 다양한 비-동일 Frt 부위는 당 업계에 공지되어 있다. 다양한 Frt 부위의 서열은 이들이 재조합이 일어나는 8-염기쌍 비대칭 코어 영역의 측면에 위치한 동일한 13-염기쌍 반전된 반복물을 모두 포함한다는 점에서 유사하다. 부위의 방향성과 다른 Frt 부위 간의 변화를 담당하는 것은 비대칭 핵심영역이다. 이들의 예시적인 (비-제한적인) 예는 자연적으로 발생하는 Frt, 및 Frt1, Frt2와 같은 몇몇 돌연변이체 또는 변이체 Frt 부위를 포함한다. 일부 실시예에서, RTS는 Frt (F), Frt F1 (F1), Frt F2 (F2), Frt F3 (F3), Frt F4 (F4) 또는 Frt F5 (F5)로부터 선택된 Frt 부위이다. 일부 실시예에서, RTS는 Frt F6 (F6), Frt F7 (F7), Frt F14 (F14), Frt F15 (F15) 또는 Ff61 로부터 선택된 Frt 부위이다. 일부 실시예에서, RTS는 F2 151, Fw2, F2161 및 F2262로부터 선택된 Frt 부위이다. 일부 실시예에서, Frt 재조합 표적 부위는 표 2에 있는 서열과 90%, 91%, 92%, 93%, 94%, 95%, 96%, 97%, 98%, 99% 이상, 또는 100% 서열 동일성을 갖는 핵산이다.

표 2

이름	식별자	서열
F	SEQ ID NO.: 7	gaagttactattccgaagttcctattctctagaagtaggaacttc
F1	SEQ ID NO.: 8	GAAGTTACTATTCCGAAGTTCCTATTCTctagaTagtataggaacttc
F2	SEQ ID NO.: 9	GAAGTTACTATTCCGAAGTTCCTATTCTctacttagtataggaacttc
F3	SEQ ID NO.: 10	GAAGTTACTATTCCGAAGTTCCTATTCTtcaaagtagtataggaacttc
F4	SEQ ID NO.: 11	GAAGTTACTATTCCGAAGTTCCTATTCTctagaagtagtataggaacttc
F5	SEQ ID NO.: 12	gaagttcctattccgaagttcctattcttcaaaagtagtataggaacttc
F6	SEQ ID NO.: 13	gaagttcctattccgaagttcctattctTCaAaaagtagtataggaacttc
F7	SEQ ID NO.: 14	gaagttcctattccgaagttcctattctTCaATaagtagtataggaacttc
F14	SEQ ID NO.: 15	gaagttcctattccgaagttcctattctAtCAGaagtagtataggaacttc
F15	SEQ ID NO.: 16	gaagttcctattccgaagttcctattcttATAgGagtagtataggaacttc
Ff61	SEQ ID NO.: 17	GAAGTTACTATTCCGAAGTTCCTATACTTTCTGGAGAATAGGAAC TTC
F2151	SEQ ID NO.: 18	GAAGTTACTATTCCGAAGTTCCTATACTCTCCAGAGAATAGGAAC TTC
Fw2	SEQ ID NO.: 19	GAAGTTACTATTCCGAAGTTCCTATACTATCTACAGAATAGGAAC TTC
F2161	SEQ ID NO.: 20	GAAGTTACTATTCCGAAGTTCCTATACTCTCTGGAGAATAGGAAC TTC
F2262	SEQ ID NO.: 21	GAAGTTACTATTCCGAAGTTCCTATACTATCTTGAGAATAGGAAC TTC

[0049]

일부 실시예에서, RTS는 표 3으로부터 선택된 rox 부위이다. 본원에 언급된 바와 같이, 용어 "rox 부위"는 Dre 재조합 효소가 부위-특이적 재조합을 촉매할 수 있는 뉴클레오티드 서열을 지칭한다, 다양한 비-동일 rox 부위가 당 업계에 공지되어 있다. 이들의 예시적인 (비-제한적인) 예는 roxR 및 roxF를 포함한다. 일부 실시예에서, 완전 재조합 표적 부위는 표 3에 있는 서열과 90%, 91%, 92%, 93%, 94%, 95%, 96%, 97%, 98%, 99% 이상, 또는 100% 서열 동일성을 갖는 핵산이다.

표 3

이름	식별자	서열
roxF	SEQ ID NO.: 22	TAAC TTAAATAATGCCAATTATTTAAAGTTA
roxR	SEQ ID NO.: 23	TAAC TTAAATAATTGGCATTATTTAAAGTTA

[0050]

[0051] 일부 실시예에서, RTS는 표 4로부터 선택된 att 부위이다. 본원에 언급된 바와 같이, 용어 "att 부위"는 λ 인테그라제 또는 ϕ C31 인테그라제가 부위-특이적 재조합을 촉매할 수 있는 뉴클레오티드 서열을 지칭한다. 동일하지 않은 다양한 att 부위가 당 업계에 알려져 있다. 이들의 예시적인(비-제한적인) 예는 attP, attB, proB, trpC, galT, thrA, 및 rmB를 포함한다. 일부 실시예에서, att 재조합 표적 부위는 표 4에 있는 서열과 90%, 91%, 92%, 93%, 94%, 95%, 96%, 97%, 98%, 99% 이상, 또는 100% 서열 동일성을 갖는 핵산이다.

표 4

[0052]

이름	식별자	서열
att B	SEQ ID NO.: 24	CATCAGGGCGGTCAGGCCGTAGATGTGGAAGAACGGCAGCACGGCGAGGACG
att P	SEQ ID NO.: 25	ATGTGGTCCTTTAGATCCACTGACGTGGGTCAGTGTCTCTAAAGGACTCGCG
att L	SEQ ID NO.: 26	CATCAGGGCGGTCAGGCCGTAGATGTGGGTCAGTGTCTCTAAAGGACTCGCG
att R	SEQ ID NO.: 27	ATGTGGTCCTTTAGATCCACTGACGTGGAAGAACGGCAGCACGGCGAGGACG

[0053] 본 명세서에 언급된 바와 같이, 용어 "별개의 재조합 표적 부위"는 동일하지 않거나 이중- 특이적인 재조합 표적 부위를 지칭한다. 예를 들어 여러 변이된 Frt 부위가 존재하지만 재조합은 일반적으로 두 개의 동일한 Frt 부위 사이에서만 발생할 수 있다. 일부 실시예에서, 별개의 재조합 표적 부위는 동일한 재조합 시스템 (예를 들어, LoxP 및 LoxR)으로부터의 동일하지 않은 재조합 표적 부위를 지칭한다. 일부 실시예에서, 별개의 재조합 표적 부위는 상이한 재조합 시스템 (예를 들어, LoxP 및 Frt)으로부터의 동일하지 않은 재조합 표적 부위를 지칭한다. 일부 실시예에서, 별개의 재조합 표적 부위는 동일한 재조합 시스템으로부터의 재조합 표적 부위 및 동일하지 않은 재조합 시스템 (예를 들어, LoxP, LoxR, Frt 및 Frt1)으로부터의 재조합 표적 부위의 조합을 지칭한다.

[0054] 다양한 RTS 조합을 사용할 수 있다. 일부 실시예에서, 상기 세포는 4개의 RTS를 포함한다. 일부 실시예에서, 상기 세포는 6개의 RTS를 포함한다. 일부 실시예에서, 하나 이상의 RTS는 서열 번호: 1-30으로부터 선택된다. 일부 실시예에서, 하나 이상의 RTS는 서열번호: 1-6으로부터 선택된다. 일부 실시예에서, 하나 이상의 RTS는 서열번호: 28-30으로부터 선택된다. 일부 실시예에서, 하나 이상의 RTS는 서열 번호: 7-21로부터 선택된다. 일부 실시예에서, 적어도 하나의 RTS는 서열 번호: 22-23에서 선택된다. 일부 실시예에서, 하나 이상의 RTS는 서열 번호: 24- 27로부터 선택된다. 일부 실시예에서, 하나 이상의 RTS는 서열 번호: 28-30으로부터 선택된다. 일부 실시예에서, 적어도 4개의 별개의 RTS를 포함하는 세포는 다음 RTS: LoxP_511, Frt_F5, Frt 및 LoxP를 포함한다. 일부 실시예에서, 적어도 4개의 별개의 RTS를 포함하는 세포는 다음 RTS Frt_F14 및 Frt_F15를 포함한다. 일부 실시예에서, 적어도 4개의 별개의 RTS를 포함하는 세포는 다음 RTS: LoxP_511, Frt_F5, Frt, LoxP, Frt_F14 및 Frt_F15를 포함한다. 일부 실시예에서, 적어도 4개의 별개의 RTS를 포함하는 상기 세포는 다음 RTS: Frt_1, Frt_2, Frt_3, Frt_4를 포함한다. 일부 실시예에서, 적어도 4개의 별개의 RTS를 포함하는 세포는 다음의 RTS: Frt_m5, Frt_wt, Frt_m14, Frt_m15, Frt_m7 및 Frt_m6을 포함한다.

[0055] 본원에 언급된 바와 같이, 용어 "랜딩 패드 (landing pad)"는 숙주세포 내로 염색체 로-통합된 제1 재조합 표적 부위를 포함하는 핵산 서열을 지칭한다. 일부 실시예에서, 랜딩 부위는 숙주세포 내로 염색체로 통합된 2개 이상의 재조합 표적 부위를 포함한다. 일부 실시예에서, 세포는 1, 2, 3, 4, 5, 6, 7, 또는 8개의 랜딩 패드를 포함한다. 일부 실시예에서, 랜딩 패드는 최대 1, 2, 3, 4, 5, 6, 7, 8개의 별개의 염색체 좌위에 통합된다.

[0056] 본원에서 언급된 바와 같이, 용어 "아데노바이러스"는 아데노바이러스과 계열의 이중 가닥 DNA를 함유하는 이십면체(icosahedral) 뉴클레오캡시드를 갖는 비-봉입 바이러스를 지칭한다. 50종 이상의 아데노바이러스 아형이 인간으로부터 단리되었고, 많은 추가 아형이 다른 포유동물 및 조류로부터 단리되었다. 조류, 예를 들어, Ishibashi et al., "Adenoviruses of animals," In *The Adenoviruses*, Ginsberg, ed., Plenum Press, New York, N.Y., pp. 497-562 (1984); Strauss, "Adenovirus infections in humans, In *The Adenoviruses*, Ginsberg, ed., Plenum Press, New York, N.Y., pp. 451-596 (1984)를 참고한다. 이들 아형은 현재 아데노바이러스 과에 속하며, 현재 두 가지 속, 즉 포유류아데노바이러스(Mastadenovirus)와 아비아데노바이러스

(Aviadenovirus)로 나뉜다. 모든 아데노바이러스는 형태학적 및 구조적으로 유사하다. 그러나, 인간에서, 아데노바이러스는 다양한 면역학적 특성을 나타내므로 혈청형으로 나뉜다. 두가지 인간 혈청형인 아데노바이러스, 즉 Ad2 및 Ad5는 집중적으로 연구되었으며 아데노바이러스에 대한 대부분의 일반 정보를 제공했다.

[0057] "유전자"는 폴리펩티드를 코딩하는 뉴클레오티드의 어셈블리(assembly)를 말하며, cDNA 및 게놈 DNA 핵산 분자를 포함한다. "유전자"는 또한 코딩 서열의 선행 (5' 비-코딩서열) 및 후속 (3' 비-코딩서열)의 조절 서열로서 작용할 수 있는 핵산 단편을 지칭한다. 일부 실시예에서, 유전자는 다중 카피(copies)와 통합된다. 일부 실시예에서, 유전자는 미리 정의된 카피 수로 통합된다.

[0058] 본원에 언급된 바와 같이, 용어 "아데노바이러스 유전자" 또는 "AV 유전자"는 하나 이상의 아데노바이러스 아형 또는 혈청형으로부터 유래된 하나 이상의 핵산 서열로 구성된 유전자를 지칭한다. 일부 실시예에서, Ad 유전자는 아데노-관련 바이러스 복제 및 패키징에 기여하는 유전자이다. 일부 실시예에서, Ad 유전자는 E1A, E1B, E2A, E4, VA, MIR342, 또는 이들의 조합 또는 임의의 다른 Ad 유전자이다. 일부 실시예에서, 본 개시 내용은 하나 이상의 Ad 유전자가 세포내로 염색체로-통합된 세포를 제공한다. 일부 실시예에서, 본 개시 내용은 E1A, E1B, E2A, E4, VA, MIR342 중 하나 이상이 세포 내로 염색체로-통합된 세포를 제공한다. 일부 실시예에서, Ad 유전자는 E1A를 포함한다. 일부 실시예에서, Ad 유전자는 E1A 및 E1B를 포함한다. 일부 실시예에서, Ad 유전자는 E1A, E1B 및 E2A를 포함한다. 일부 실시예에서, Ad 유전자는 E1A, E1B, E2A 및 E4를 포함한다. 일부 실시예에서, Ad 유전자는 E1A, E1B, E2A, E4 및 VA를 포함한다. 일부 실시예에서, Ad 유전자는 E1A, E1B, E2A, E4, VA 및 MIR342를 포함한다. 일부 실시예에서, Ad 유전자는 E1A 및 E2A를 포함한다. 일부 실시예에서, Ad 유전자는 E1A, E2A 및 E4를 포함한다. 일부 실시예에서, Ad 유전자는 E1A, E2A, E4 및 VA를 포함한다. 일부 실시예에서, Ad 유전자는 E1A, E2A, E4, VA 및 MIR 342를 포함한다. 일부 실시예에서, Ad 유전자는 E1A 및 E4를 포함한다. 일부 실시예에서, Ad 유전자는 E1A, E4 및 VA를 포함한다. 일부 실시예에서, Ad 유전자는 E1A, E4, VA 및 MIR342를 포함한다. 일부 실시예에서, Ad 유전자는 E1A 및 VA를 포함한다. 일부 실시예에서, Ad 유전자는 E1A, VA 및 MIR342를 포함한다. 일부 실시예에서, Ad 유전자는 E1A 및 MIR342를 포함한다. 일부 실시예에서, Ad 유전자는 E1B를 포함한다. 일부 실시예에서, Ad 유전자는 E1B 및 E2A를 포함한다. 일부 실시예에서, Ad 유전자는 E1B, E2A 및 E4를 포함한다. 일부 실시예에서, Ad 유전자는 E1B, E2A, E4 및 VA를 포함한다. 일부 실시예에서, Ad 유전자는 E1B, E2A, E4, VA 및 MIR342를 포함한다. 일부 실시예에서, Ad 유전자는 E1B 및 E4를 포함한다. 일부 실시예에서, Ad 유전자는 E1B, E4 및 VA를 포함한다. 일부 실시예에서, Ad 유전자는 E1B, E4, VA 및 MIR342를 포함한다. 일부 실시예에서, Ad 유전자는 E1B 및 VA를 포함한다. 일부 실시예에서, Ad 유전자는 E1B, VA 및 MIR342를 포함한다. 일부 실시예에서, Ad 유전자는 E2A를 포함한다. 일부 실시예에서, Ad 유전자는 E2A 및 E4를 포함한다. 일부 실시예에서, Ad 유전자는 E2A, E4 및 VA를 포함한다. 일부 실시예에서, Ad 유전자는 E2A, E4, VA 및 MIR342를 포함한다. 일부 실시예에서, Ad 유전자는 E2A 및 VA를 포함한다. 일부 실시예에서, Ad 유전자는 E2A, VA 및 MIR342를 포함한다. 일부 실시예에서, Ad 유전자는 E2A 및 MIR342를 포함한다. 일부 실시예에서, Ad 유전자는 E4를 포함한다. 일부 실시예에서, Ad 유전자는 E4 및 VA를 포함한다. 일부 실시예에서, Ad 유전자는 E4, VA 및 MIR342를 포함한다. 일부 실시예에서, Ad 유전자는 E4 및 MIR342를 포함한다. 일부 실시예에서, Ad 유전자는 VA를 포함한다. 일부 실시예에서, Ad 유전자는 VA 및 MIR342를 포함한다. 일부 실시예에서, Ad 유전자는 MIR342를 포함한다. 일부 실시예에서, 본 발명자들은 Ad 유전자가 E1A, E1B, E2A, E4, VA 및 MIR342를 포함할 때 상기 Ad 유전자가 염색체로 통합되어 보다 일관된 Ad 유전자 발현이 관찰된다는 것을 발견하였다. 일부 실시예에서, Ad 유전자는 E1A, E1B, E2A, E4, VA 및 MIR342로부터 선택된 하나 이상을 포함한다.

[0059] 본원에 언급된 바와 같이, 용어 "조절 요소"는 핵산 서열의 발현의 일부 측면을 제어하는 유전자 요소를 지칭한다. 본원에 사용된 "프로모터"는 작동 가능하게 연결된 코딩 영역의 전사 개시를 용이하게 하는 조절 요소이다. 일부 실시예에서, 프로모터는 Ad 프로모터이다. 본원에 사용된 용어 "AV 프로모터"는 아데노바이러스 시스템으로부터 유래된 조절 요소를 지칭한다. 일부 실시예에서, 프로모터는 AAV 프로모터이다. 본원에 사용된 용어 "AAV 프로모터"는 아데노-관련 바이러스 시스템으로부터 유래된 조절 요소를 지칭한다. 일부 실시예에서, 본 개시 내용은 하나 이상의 AAV 프로모터가 세포 내로 염색체로 통합된 세포를 제공한다. 본원에 사용된 용어 "비-AV 프로모터"는 비-아데노바이러스 시스템으로부터 유래된 조절 요소를 지칭한다. 일부 실시예에서, 비-AV 프로모터는 원핵생물 시스템으로부터 유래된다. 일부 실시예에서, 비-AV 프로모터는 진핵생물 시스템으로부터 유래된다. 일부 실시예에서, 본 개시 내용은 하나 이상의 프로모터가 세포 내로 염색체로 통합되는 세포를 제공한다. 일부 실시예에서, 본 개시 내용은 하나 이상의 비-AV 프로모터가 세포 내로 염색체로 통합된 세포를 제공한다. 일부 실시예에서, 본 개시 내용은 하나 이상의 Ad 프로모터가 세포 내로 염색체로 통합된 세포를 제공한다. 일부 실시예에서, 프로모터는 비-AVR 프로모터이다. 본원에 사용된 용어 "비-AAV 프로모터"는 비 아데노-관련

바이러스 시스템으로부터 유래된 조절 요소를 지칭한다. 일부 실시예에서, 비-AAV 프로모터는 원핵 생물 시스템으로부터 유래된다. 일부 실시예에서, 비-AAV 프로모터는 진핵 생물 시스템으로부터 유래된다. 일부 실시예에서, 본 개시 내용은 하나 이상의 비-AAV 프로모터가 세포 내로 염색체로 통합된 세포를 제공한다.

[0060] 본원에서 언급된 바와 같이, 용어 “조작 가능한 조합으로”, “조작 가능한 순서로” 및 “조작 가능하게 연결된”은 주어진 유전자의 전사 및/또는 원하는 단백질 분자의 합성을 지시할 수 있는 핵산 분자가 생성되는 방식으로 핵산 서열의 연결을 지칭한다. 상기 용어는 또한 기능성 단백질이 생성되는 방식으로 아미노산 서열의 연결을 지칭한다. 일부 실시예에서, Ad 유전자는 프로모터에 작동 가능하게 연결되며, 상기 Ad 유전자는 숙주 세포 계놈 내로 염색체로 통합된다. 일부 실시예에서, Ad 유전자는 비-Ad 프로모터에 작동 가능하게 연결되며, 상기 Ad 유전자는 숙주 세포 계놈으로 염색체로 통합된다. 일부 실시예에서, Ad 유전자는 Ad 프로모터에 작동 가능하게 연결되며, 상기 Ad 유전자는 숙주 세포 계놈 내로 염색체로 통합된다. 일부 실시예에서, AAV 유전자는 프로모터에 작동 가능하게 연결되며, 상기 AAV 유전자는 숙주 세포 계놈 내로 염색체로 통합된다. 일부 실시예에서, AAV 유전자는 비-AAV 프로모터에 작동 가능하게 연결되며, 상기 AAV 유전자는 숙주 세포 계놈 내로 염색체로 통합된다. 일부 실시예에서, AAV 유전자는 AAV 프로모터에 작동 가능하게 연결되며, 상기 AAV 유전자는 숙주 세포 계놈으로 염색체로 통합된다. 일부 실시예에서, GOI는 숙주 세포 계놈 내로 염색체로 통합된다. 일부 실시예에서, GOI 유전자는 비-GOI 프로모터에 작동 가능하게 연결되며, 상기 GOI는 숙주 세포 계놈 내로 염색체로 통합된다. 일부 실시예에서, 재조합 효소 유전자는 프로모터에 작동 가능하게 연결되며, 상기 재조합 효소 유전자는 숙주 세포 계놈으로 염색체로 통합된다. 일부 실시예에서, 재조합 효소 유전자는 프로모터에 작동 가능하게 연결되며, 상기 재조합 효소 유전자는 숙주 세포 계놈에 통합되지 않는다. 일부 실시예에서, 재조합 효소 유전자는 프로모터에 작동 가능하게 연결되며, 상기 재조합 효소 유전자는 숙주 세포 계놈으로 염색체로 통합되지 않는다. 일부 실시예에서, 재조합 효소 유전자는 프로모터에 작동 가능하게 연결되며, 상기 재조합 효소 유전자는 숙주 세포 계놈으로 염색체로 통합되지 않는다.

[0061] 일부 실시예에서, 조절 요소는 유전자 발현을 외인성의(exogenously) 공급된 리간드의 존재에 작동 가능하게 연결시킨다. 일부 실시예에서, Ad 유전자는 프로모터에 작동 가능하게 연결되며, 상기 프로모터는 유전자 발현을 외인성의 공급된 리간드의 존재에 작동 가능하게 연결시키고, Ad 유전자는 숙주 세포 계놈에 염색체로 통합된다. 일부 실시예에서, AAV 유전자는 프로모터에 작동 가능하게 연결되며, 상기 프로모터는 유전자 발현을 외인성의 공급된 리간드의 존재에 작동 가능하게 연결시키고 AAV 유전자는 숙주 세포 계놈에 염색체로 통합된다. 일부 실시예에서, GOI는 프로모터에 작동 가능하게 연결되며, 상기 프로모터는 유전자 발현을 외인성의 공급된 리간드의 존재에 작동 가능하게 연결하고, GOI는 숙주 세포 계놈에 염색체로 통합된다. 일부 실시예에서, 재조합 효소 유전자는 프로모터에 작동 가능하게 연결되며, 상기 프로모터는 유전자 발현을 외인성의 공급된 리간드의 존재에 작동 가능하게 연결시키고, 재조합 효소 유전자는 숙주 세포 계놈에 염색체로 통합된다. 일부 실시예에서, 재조합 효소 유전자는 프로모터에 작동 가능하게 연결되며, 상기 프로모터는 유전자 발현을 외인성의 공급된 리간드의 존재에 작동 가능하게 연결시키고, 재조합 효소 유전자는 숙주 세포 계놈에 염색체로 통합되지 않는다. 일부 실시예에서, E1A 발현은 프로모터에 작동 가능하게 연결되며, 프로모터는 유전자 발현을 rAAV의 생산에 작동 가능하게 연결시킨다. 일부 실시예에서, E1A 발현은 프로모터에 작동 가능하게 연결되며, 여기서 프로모터는 유전자 발현을 외인성의 공급된 리간드의 존재와 작동 가능하게 연결시키고, 유전자 발현은 외인성의 공급된 리간드의 존재를 rAAV의 생산에 작동 가능하게 연결시킨다.

[0062] 일부 실시예에서, 하나 이상의 RTS, Ad 유전자 및 프로모터는 단일 염색체 유전자 좌위에 통합된다. 일부 실시예에서, 제1 Ad 유전자 *E1A* 및 *E1B*, 및 *E2A*, *E4*, *VA* 및 *MIR 342*를 포함하는 제2 Ad 유전자는 2개의 상이한 유전자 좌위상에 존재한다. 일부 실시예에서, 제1 Ad 유전자 *E1A* 및 *E1B*, 및 *E2A*, *E4*, *VA* 및 *MIR 342*를 포함하는 제2 Ad 유전자는 동일한 유전자 좌위상에 존재한다. 일부 실시예에서, 제1 Ad 유전자 *E1A* 및 *E1B*, 및 *E2A*, *E4*, *VA* 및 *MIR 342*를 포함하는 제2 Ad 유전자는 동일한 유전자 좌위이고, 아데노-관련 바이러스 (AAV) 유전자는 다른 유전자 좌위에 있다. 일부 실시예에서, 제1 Ad 유전자 *E1A* 및 *E1B*, 및 *E2A*, *E4*, *VA* 및 *MIR 342*를 포함하는 제2 Ad 유전자는 동일한 유전자 좌위이고, 아데노-관련 바이러스 (AAV) 유전자 및 AAV 벡터 카세트는 상이한 유전자 좌위 상에 있다.

[0063] 본원에 언급된 바와 같이, 용어 “염색체 유전자 좌위”는 하나 이상의 유전자를 포함할 수 있는 세포의 염색체상의 핵산의 정의된 위치를 지칭한다. 일부 실시예에서, 염색체 유전자 좌위는 약 500 염기쌍 내지 약 100,000 염기쌍, 약 5,000 염기쌍 내지 약 75,000 염기쌍, 약 5,000 염기쌍 내지 약 60,000 염기쌍, 약 20,000 염기쌍 내지 약 50,000 염기쌍, 약 30,000 염기쌍 내지 약 50,000 염기쌍, 또는 약 45,000 염기쌍 내지 약 49,000 염기쌍이다. 일부 실시예에서, 염색체 유전자 좌위는 정의된 핵산 서열의 5' 또는 3' 말단까지 약 100 염기쌍,

약 250 염기쌍, 약 500 염기쌍, 약 750 염기쌍 또는 약 1000 염기쌍까지 연장된다. 일부 실시예에서, 염색체 유전자 좌위는 내인성(endogenous) 핵산 서열을 포함한다. 일부 실시예에서, 염색체 유전자 좌위는 분자생물학 분야의 당업자에게 공지된 방법을 사용하여 염색체에 통합된 외인성 뉴클레오티드 서열을 포함한다. 일부 실시예에서, 염색체 유전자 좌위는 염색체 유전자 좌위 내에 통합된 유전자에 의해 암호화된 단백질의 강력하고 안정적인 생산을 제공하는 숙주 세포의 게놈에서 뉴클레오티드 서열을 포함한다. 일부 실시예에서, 염색체 유전자 좌위는 강력하고 안정적인 바이러스 유전자 발현을 제공하는 숙주 세포의 게놈에서 뉴클레오티드 서열을 포함한다. 일부 실시예에서, 염색체 유전자 좌위는 효율적인 부위 특이적 재조합을 제공하는 숙주 세포의 게놈에서 뉴클레오티드 서열을 포함한다. 일부 실시예에서, 염색체 좌위는 Fer1L4(예를 들어, 미국 특허 출원번호 14/409,283 참조), *ROSA26*, *HGPRT*, *DHFR*, *COSMC*, *LDHA* 또는 *MGAT1* 을 포함한다. 일부 실시예에서, 염색체 유전자 좌위는 *NL1* 또는 *NL2*를 포함한다. 일부 실시예에서, 염색체 유전자 좌위는 X 염색체에서 *MIDI*의 첫 번째 인트론이다. 일부 실시예에서, 염색체 유전자 좌위는 향상된 발현 및 안정성 영역(Regeneron, Tarrytown, NY EESYR, 예를 들어, 미국 특허 7,771,997 참조)이다. 일부 실시예에서, 염색체 유전자 좌위 내의 핵산의 적어도 일부가 결실된다.

[0064]

일부 실시예에서, 염색체 유전자 좌위는 표 5에 기재된 바와 같이 NL1 유전자 좌위, NL2 유전자 좌위, NL3 유전자 좌위, NL4 유전자 좌위, NL5 유전자 좌위 또는 NL6 유전자 좌위를 포함한다. 일부 실시예에서, 본 개시 내용은 하나 이상의 RTS, Ad 유전자 및 프로모터가 NL1 유전자 좌위, NL2 유전자 좌위, NL3 유전자 좌위, NL4 유전자 좌위, NL5 유전자 좌위 또는 NL6 유전자 좌위 내에 통합된 2개 이상의 별개의 재조합 표적 부위 (RTS)를 포함하는 포유동물 세포에 관한 것이다. 일부 실시예에서, 제1 Ad 유전자 *E1A* 및 *E1B*, 및 *E2A*, *E4*, 및 *MIR 342*를 포함하는 제2 Ad 유전자는 2개의 상이한 유전자 좌위 상에 있으며, 그 중 하나는 NL1 유전자 좌위, NL2 유전자 좌위, NL3 유전자 좌위, NL4 유전자 좌위, NL5 유전자 좌위 또는 NL6 유전자 좌위 내에 있다. 일부 실시예에서, 제1 Ad 유전자 *E1A* 및 *E1B*, 및 *E2A*, *E4*, *VA* 및 *MIR 342*를 포함하는 제2 Ad 유전자는 NL1 유전자 좌위, NL2 유전자 좌위, NL3 유전자 좌위, NL4 유전자 좌위, NL5 유전자 좌위 또는 NL6 유전자 좌위 내에 있다. 일부 실시예에서, 제1 Ad 유전자 *E1A* 및 *E1B*, 및 *E2A*, *E4*, *VA* 및 *MIR 342*를 포함하는 제2 Ad 유전자는 NL1 유전자 좌위, NL2 유전자 좌위, NL3 유전자 좌위, NL4 유전자 좌위, NL5 유전자 좌위 또는 NL6 유전자 좌위 내에 있다. 일부 실시예에서, 제1 Ad 유전자 *E1A* 및 *E1B*, 및 *E2A*, *E4*, *VA* 및 *MIR342*를 포함하는 제2 Ad 유전자는 NL1 유전자 좌위, NL2 유전자 좌위, NL3 유전자 좌위, NL4 유전자 좌위, NL5 유전자 좌위 또는 NL6 유전자 좌위 내에 있다. 일부 실시예에서, 본 개시 내용은 3개 이상의 별개의 재조합 표적 부위 (RTS)를 포함하는 포유동물 세포에 관한 것으로 여기서 적어도 하나의 RTS, Ad 유전자 및 프로모터는 NL1 유전자 좌위, NL2 유전자 좌위, NL3 유전자 좌위, NL4 유전자 좌위, NL5 유전자 좌위 또는 NL6 유전자 좌위 내에 통합된다. 일부 실시예에서, 본 개시 내용은 4개 이상의 별개의 재조합 표적 부위 (RTS)를 포함하는 포유동물 세포에 관한 것으로 여기서 적어도 하나의 RTS, Ad 유전자 및 프로모터는 NL1 유전자 좌위, NL2 유전자 좌위, NL3 유전자 좌위, NL4 유전자 좌위, NL5 유전자 좌위 또는 NL6 유전자 좌위 내에 통합된다. 일부 실시예에서, 본 개시 내용은 5개 이상의 별개의 재조합 표적부위(RTS)를 포함하는 포유동물 세포에 관한 것으로, 여기서 적어도 하나의 RTS, Ad 유전자 및 프로모터는 NL1 유전자 좌위, NL2 유전자 좌위, NL3 유전자 좌위, NL4 유전자 좌위, NL5 유전자 좌위 또는 NL6 유전자 좌위 내에 통합된다. 일부 실시예에서, 본 개시 내용은 6개 이상의 별개의 재조합 표적 부위 (RTS)를 포함하는 포유동물 세포에 관한 것으로 여기서 적어도 하나의 RTS, Ad 유전자 및 프로모터는 NL1 유전자 좌위, NL2 유전자 좌위, NL3 유전자 좌위, NL4 유전자 좌위, NL5 유전자 좌위 또는 NL6 유전자 좌위 내에 통합된다.

표 5

새로운 유전자 좌위	유전자 좌위 주석			<i>Cricetulus griseus</i> 에서의 유전자 좌위 위치			<i>Homo sapien</i> 에서의 유전자 좌위 위치		
	5' 유전자	유전자 내	3' 유전자	NCBI 참조 서열 (<i>Cricetulus griseus</i>)	백터 위치	랜딩 패드 위치	염색체	백터 위치	랜딩 패드 위치
Fer1	Ergic3	Fer1L4	Spag4	gi 351517716 ref NW_003613833 Scaffold 1492	N/A	24894-26755	Chr 20	33613757-33614117	33630003-33629572
NL1	Col5a2 (pseudo)	주석 달린 유전자 없음	Col5a2	SEQ ID NO: 31 gi 351515650 ref NW_003615899.1 Scaffold 2552	143287	133598	Chr 2	189725696-189726735	189725180-189727852
NL2	LOC103162114	Naa15 (엑손 5&6 사이의 인트론)	Rab33b	SEQ ID NO: 32 gi 351517715 ref NW_003613834.1 Scaffold2422	1303708 to 1308873	1315999	Chr 4	140474660-140474867	140483934-140483457
NL3	CJO004127.1	주석 달린 유전자 없음	Mthfd2	SEQ ID NO: 33 gi 351516540 ref NW_003615009.1 Scaffold3922	279558	N/A	Chr 2	74277198-74297932	N/A
NL4	MORF4L1	주석 달린 유전자 없음	No annotated gene	SEQ ID NO: 34 gi 351516248 ref NW_003615301.1 Scaffold502	173850	N/A	Chr 15	76952458	N/A
NL5	ZNHIT1	주석 달린 유전자 없음	Tatc1	SEQ ID NO: 35 gi 351517397 ref NW_003614152.1 Scaffold3667	779010	N/A	Chr 7	100648176-100653983	N/A
NL6	Ahgef28	Utp15	Ankra	SEQ ID NO: 36 gi 351516857 ref NW_003614592.1 Scaffold7019	225021	N/A	Chr 5	73084488-73084783	N/A
				SEQ ID NO: 37					

[0065]

[0066]

당업자는 "NL1 유전자 좌위 내에 통합된" 또는 "NL2 유전자 좌위 내에 통합된" 이 라는 용어는 유전자 좌위의 임의의 부분으로의 통합을 포함할 것이며, 이는 단지 표시된 게놈 좌표로 제한되지 않는다는 것을 인식할 것이다. 당업자는 "NL1 유전자 좌위 내에 통합된" 또는 "NL2 유전자 좌위 내에 통합된"이라는 용어는 또한 상응하는 유기체에 상응하는 유전자 좌위를 포함할 것이라는 것을 인식할 것이다. 따라서, 일부 실시예에서, 용어 "NL1 유전자 좌위 내에 통합된" 또는 "NL2 유전자 좌위 내에 통합된" 은 표시된 게놈 좌표의 약 50,000 bp 내, 약 40,000 bp 내, 약 30,000 bp 내, 20,000 bp 내 또는 10,000 bp 내 통합을 포함할 것이다.

[0067]

일부 실시예에서, 세포는 부위-특이적 재조합 효소 유전자를 포함한다. 일부 실시예에서, 부위-특이적 재조합 효소 유전자는 염색체로 통합된다.

[0068]

본 명세서에서 언급된 바와 같이, 용어 "2개의 RTS 사이에 위치한"은 2개의 RTS 사이에 위치한 유전자, 즉 RTS 중 하나가 유전자의 5 '에 위치하고 다른 RTS가 3' 에 있는 것을 의미한다. 일부 실시예에서, RTS는 그들 사이에 위치한 유전자에 직접 인접하여 위치한다. 일부 실시예에서, RTS는 그들 사이에 위치한 유전자로부터 정의된 거리에 위치한다. 일부 실시예에서, RTS는 방향성 서열이다. 일부 실시예에서, 이들 사이에 위치한 유전자의 RTS 5 ' 및 3' 은 직접 배향(oriented)된다(즉, 동일한 방향으로 배향된다). 일부 실시예에서, 그들 사이에 위치한 유전자의 RTS 5 ' 및 3' 은 역으로 배향된다(즉, 반대 방향으로 배향된다).

[0069]

일부 실시예에서, 세포는 아데노-관련 바이러스 (AAV) 유전자를 추가로 포함하며, 상기 AAV 유전자는 염색체로 통합된다. AAV 유전자는 임의의 AAV 혈청형으로부터의 임의의 유전자를 포함한다. 일부 실시예에서, AAV 유전자는 *Rep*, *Rep78*, *Rep68*, *Rep52*, *Rep40*, *Cap*, *VP1*, *VP2*, *VP3*, 또는 이들의 조합이다. 일부 실시예에서, AAV 유전자는 아데노 관련 바이러스 유형 2로부터 유래된다. 일부 실시예에서, AAV 유전자는 아데노 관련 바이러스 Anc80 으로부터 유래된다. 일부 실시예에서, AAV 유전자는 ANC80 *Rep* 및 *Cap* 유전자를 포함한다. 일부 실시예에서, AAV 유전자는 2개의 RTS 사이에 위치된다.

[0070]

본원에 언급된 바와 같이, 용어 "아데노-관련 바이러스(AAV)"는 파르보바이러스(*Parvoviridae*) 과 계열 및 의존도파르보바이러스(*Dependoparvovirus*) 속의 단일 가닥 DNA를 포함하는 작은 크기의 복제-결합 비외피 바이러스를 지칭한다. 지금까지 10가지가 넘는 아데노-관련 바이러스 혈청형이 확인되었으며, 혈청형 AAV2가 가장 특징적이다. 다른(비-제한적) AAV 혈청형의 예는 ANC80, AAV1, AAV3, AAV4, AAV5, AAV6, AAV7, AAV8, AAV9, AAV10 및 AAV11 이다. 이들 혈청형에 더하여, AAV 위형(pseudotype)이 개발되었다. AAV 위형은 제1 혈청형의 캡시드 및 제2 혈청형의 게놈을 함유한다(예를 들어, 위형 AAV2/5는 혈청형 AAV2의 게놈 및 AAV5의 캡시드를 갖는 AAV에 상응할 것이다).

- [0071] 본원에 사용된 용어 "재조합 AAV" 또는, "rAAV" 는 상동 유전자를 단백질막으로 싸는(encapsidating) (즉, 단백질 코트로 둘러싸는) AAV 단백질 껍질로 구성된 감염성, 복제-결함 바이러스로, 이는 AAV ITR에 의해 5' 와 3' 이 측면에 있다.
- [0072] 본원에 사용된 용어 복제 가능 아데노바이러스 (RCA)는 재조합 아데노바이러스 벡터와 생산자 세포 계놈에 존재하는 아데노바이러스 유전자 사이의 상동 재조합에 의해 rAAV 생산 동안 때때로 생성되는 활성 아데노바이러스 입자의 바람직하지 않은 오염물을 지칭한다.
- [0073] 본원에 언급된 바와 같이, 용어 "아데노-관련 바이러스 유전자" 는 하나 이상의 아데노-관련 바이러스 혈청형으로부터 유래된 하나 이상의 핵산 서열로 구성된 유전자를 지칭한다. 일부 실시예에서, AAV 유전자는 AAV 복제 및 패키징에 기여하는 유전자를 포함한다.
- [0074] 본원에 언급된 바와 같이, 용어 "Rep" 유전자는 바이러스 계놈의 복제에 총체적으로 필요한 바이러스의 복제 단백질을 암호화하는 AAV 계놈의 당 업계에 인식된 영역을 의미하거나, 또는 AAV-2 DNA 복제를 매개하는 것으로 알려진 인간 헤르페스바이러스 6 (HHV-6) rep 유전자와 같은 이의 기능적 상동체를 의미한다. 따라서, rep 코딩 영역은 적어도 AAV Rep78 및 Rep68("Rep의 긴 형태"), 및 Rep52 및 Rep40("Rep의 짧은 형태"), 또는 이들의 기능적 상동체를 암호화하는 유전자를 포함한다. AAV rep 코딩 영역에 대한 추가 설명. 본원에 사용된 rep 코딩 영역은 임의의 바이러스 혈청형, 예컨대 상기 기재된 AAV 혈청형으로부터 유래될 수 있다. 상기 영역은 모든 야생형 유전자를 포함할 필요는 없지만, rep 유전자가 적합한 표적 세포에서 발현될 때 충분한 통합 기능을 제공하는 한(예를 들어, 뉴클레오티드의 삽입, 결실 또는 치환에 의해) 변경될 수 있다. 예를 들어, Muzyczka, N., *Current Topics in Microbiol, and Immunol.* 158:97-129 (1992); 및 Kotin, R. M., *Human Gene Therapy* 5: 793-801 (1994)를 참고한다.
- [0075] 본원에 언급된 바와 같이, 용어 "Cap'" 유전자는 바이러스의 캡시드 단백질을 코딩하는 AAV 계놈의 당업계에 인식된 영역을 지칭한다. 이들 캡시드 단백질의 예시적인 (비-제한적인) 예는 AAV 캡시드 단백질 VP1, VP2 및 VP3이다. 본 개시에 사용된 Cap 유전자는 임의의 AAV 혈청형 또는 AAV 혈청형의 조합으로부터 유래될 수 있다.
- [0076] 일부 실시예에서, 세포는 제2 Ad 유전자를 포함하고, 상기 제2 Ad 유전자는 염색체 통합된다. 일부 실시예에서, 제2 Ad 유전자는 *E1A, E1B, E2A, E4, VA, MIR342*, 또는 이들의 조합이다. 일부 실시예에서, 제2 Ad 유전자는 Ad5로부터의
- [0077] 것이다. 일부 실시예에서, 제2 Ad 유전자는 2개의 RTS 사이에 위치된다.
- [0078] 일부 실시예에서, 세포는 AAV 벡터 카세트를 추가로 포함하고, 상기 AAV 벡터 카세트는 염색체로 통합된다. 일부 실시예에서, AAV 벡터 카세트는 2개의 RTS 사이에 위치된다.
- [0079] "벡터" 또는 "발현벡터"는 플라스미드, 파지, 바이러스 또는 코스미드(cosmid)와 같은 레플리콘(replicon)으로, 다른 DNA 단편이 부착되어 세포에서 부착된 DNA 단편의 복제 및/또는 발현을 야기할 수 있다. "벡터" 는 에피솜(episomal) (예를 들어, 플라스미드) 및 비 에피솜 벡터를 포함한다. 본 개시 내용의 일부 실시예에서, 벡터는 에피솜 벡터이며, 이는 다수의 세포 생성 후 세포 집단으로부터 제거/손실되며, 예를 들어, 비대칭 분할에 의한다. 용어 "벡터" 는 시험관 내, 생체 내 또는 생체 외에서 핵산 분자를 세포 내로 도입하기 위한 바이러스 및 비-바이러스 수단을 모두 포함한다. 용어 벡터는 합성 벡터를 포함할 수 있다. 벡터는 형질주입, 형질도입, 세포 융합, 및 리포펙션(lipofection)을 포함하지만 이에 제한되지 않는 공지된 방법에 의해 원하는 숙주 세포 내로 도입될 수 있다. 벡터는 프로모터를 포함하는 다양한 조절 요소를 포함할 수 있다.
- [0080] 본원에 사용된 "형질주입"은 벡터를 포함하는 외인성 핵산 분자의 세포로의 도입을 의미한다. "형질 감염된" 세포는 세포 내부의 외인성 핵산 분자를 포함하고 "형질 전환된" 세포는 세포 내의 외인성 핵산 분자가 세포에서 표현형 변화를 유도하는 세포이다. 형질주입된 핵산 분자는 숙주 세포의 계놈 DNA에 통합될 수 있고/또는 세포에 의해, 일시적으로 또는 장기간, 염색체 외적으로 유지될 수 있다. 외인성 핵산 분자 또는 단편을 발현하는 숙주 세포 또는 유기체는 "재조합체", "형질 전환된" 또는 "형질전환의" 유기체로 지칭된다. 다수의 형질주입 기술이 당 업계에 일반적으로 공지되어 있다. 예를 들어, Graham et al., *Virology*, 52:456 (1973); Sambrook et al., *Molecular Cloning, a laboratory manual*, Cold Spring Harbor Laboratories, New York (1989); Davis et al., *Basic Methods in Molecular Biology*, Elsevier (1986); 및 Chu et al., *Gene* 13:197 (1981)를 참조한다. 이러
- [0081] 한 기술은 AAV 벡터 카세트, AAV 헬퍼 구조물 및 기타 핵산 분자와 같은 하나 이

- [0083] 상의 외인성 DNA 일부를 적합한 숙주 세포 내로 도입하는데 사용될 수 있다.
- [0084] 본원에 사용된 용어 “교환 가능한 카세트” 또는 “카세트”는 유전자 및 재조합 부위를 함유하는 한 유형의 이동성 유전 요소이다. 일부 실시예에서, 교환 가능한 카세트는 2개 이상의 RTS를 포함한다. 일부 실시예에서, 교환 가능한 카세트는 리포터 유전자 또는 선택 유전자를 포함한다. 일부 실시예에서, 카세트는 재조합효소-매개 카세트-교환(RMCE)을 통해 교환된다.
- [0085] 본원에 언급된 바와 같이, 용어 “AAV 벡터 카세트”는 아데노-관련 바이러스 혈청형 벡터로부터 유래된 카세트를 지칭한다. AAV 벡터 카세트는 예를 들어, 전체 또는 부분적으로 결실된 하나 이상의 AAV 야생형 유전자를 가질 수 있고, 예를 들어, *Rep* 및/또는 *Cap* 유전자이며, 그러나 기능적 측면 반전 말단 반복부(ITR; inverted terminal repeat) 서열은 유지한다.
- [0086] 본 명세서에서 언급된 바와 같이, 용어 “기능적 측면 반전 말단 반복” 또는 “기능적 측면 ITR” 서열은 145 염기쌍 ITR을 지칭하고, 처음 125 염기쌍은 AAV 벡터 카세트에서 관심 유전자 (GOI)의 5' 및 3' 끝에 위치한 Y 또는 T 형 이중 구조를 형성할 수 있다. ITR 서열은 AAV 게놈의 복제, 구출(rescue), 패키징 및 통합에 필요한 최소 서열을 나타낸다.
- [0087] 본원에 언급된 바와 같이, 용어 “보조 유전자”, “헬퍼 유전자” 및 “보조 헬퍼 유전자”는 rAAV의 복제 또는 패키징을 돕는 제1 유전자를 지칭하도록 상호 교환 가능하게 사용된다. 일부 실시예에서, 헬퍼 유전자는 바이러스 유전자를 포함한다. 일부 실시예에서, 헬퍼 유전자는 Ad 유전자를 포함한다. 일부 실시예에서, 헬퍼 유전자는 AAV 유전자를 포함한다. 일부 실시예에서, 헬퍼 유전자는 AAV 유전자 *rep*, *cap* 또는 이들의 조합을 포함한다. 일부 실시예에서, 헬퍼 유전자는 원핵 생물 유전자를 포함한다. 일부 실시예에서, 헬퍼 유전자는 진핵 생물 유전자를 포함한다. 일부 실시예에서, 헬퍼 유전자는 RNA를 코딩하는 유전자를 포함한다. 일부 실시예에서, 헬퍼 유전자는 인터페론 (IFN) 길항제(antagonist)를 포함한다. 일부 실시예에서, 헬퍼 유전자는 단백질 키나제 R (PKR) 억제제인 단백질을 암호화한다. 일부 실시예에서, 헬퍼 유전자는 인플루엔자 NS1 단백질을 암호화하는 유전자를 포함한다. 일부 실시예에서, 헬퍼 유전자는 백신시아 바이러스(Vaccinia virus) E3L 단백질을 암호화하는 유전자를 포함하고, 예를 들어, de Vries et al, *Gene Ther.* 15:545-52, (2008)를 참조한다. 일부 실시예에서, 헬퍼 유전자는 감염된 세포에서 IFN 반응에 대응하는 바이러스-암호화된 가용성 IFN-알파/베타 수용체 디코이를 암호화한다. 일부 실시예에서, 헬퍼 유전자는 NS1, E3L, 또는 유사한 단백질을 인코딩한다. 일부 실시예에서, 헬퍼 유전자는 NS1, E3L 또는 상동성 서열 또는 모티프를 갖는 단백질을 암호화한다. 본원에서 언급된 바와 같이, 용어 “1 관심 유전자(gene of interest)” 또는 “GOI”는 이중 유전자를 기술하기 위해 사용된다. 본원에서 언급된 바와 같이, 용어 “이중 유전자(heterologous gene)” 또는 “HG”는 코딩 서열 또는 제어 서열과 같은 핵산 서열에 관한 것으로서 핵산 서열을 나타내고, 예를 들어 유전자1, 이는 정상적으로 함께 연결되지 않고, 및/또는 일반적으로 특정 세포와 관련되지 않는다. 일부 실시예에서, 이중 유전자는 코딩 서열 자체가 자연에서 발견되지 않는 구조물 (예를 들어, 본래의 유전자와 상이한 코돈을 갖는 합성 서열)이다. 대립 유전자 변이 또는 자연 발생 돌연변이 사건은 본원에 사용된 이중 DNA를 발생시키지 않는다. 일부 실시예에서, 관심 유전자는 리포터 유전자, 선택 유전자, 치료적 관심 유전자, 또는 이들의 조합을 포함한다.
- [0088] 본원에 언급된 바와 같이, “리포터 유전자”는 발현이 세포 상에 표현형을 부여하여 쉽게 식별 및 측정될 수 있는 유전자이다. 일부 실시예에서, 리포터 유전자는 형광 단백질 유전자를 포함한다. 일부 실시예에서, 리포터 유전자는 선택 유전자를 포함한다.
- [0089] 본원에 언급된 바와 같이, 용어 “선택 유전자”는 필수 영양소가 아닌 배지에서 성장하는 능력을 부여하는 효소 활성을 암호화하는 유전자의 사용을 지칭하고; 또한, 선택 유전자는 선택 유전자가 발현되는 세포에 항생제 또는 약물에 대한 내성을 부여할 수 있다. 선택 유전자는 숙주 세포 상에 특정 표현형을 부여하기 위해 사용될 수 있다. 숙주 세포가 선택 배지에서 성장하기 위해 선택 유전자를 발현해야 할 때, 유전자는 양성 선택 유전자라고 한다. 선택 유전자는 또한 특정 유전자를 함유하는 숙주세포를 선별하는데 사용될 수 있으며; 이러한 방식으로 사용된 선택 유전자는 음성 선택 유전자로 지칭된다.
- [0090] 본원에 언급된 바와 같이, 용어 “치료적 관심 유전자”는 기능적으로 관련된 임의의 뉴클레오티드 서열을 지칭한다. 따라서, 본 개시 내용의 치료적 관심 유전자는 표적 세포 게놈에서 결함 또는 결실된 단백질을 암호화하거나 또는 원하는 생물학적 또는 치료 효과를 갖는 비-천연 단백질을 암호화하는 임의의 원하는 유전자를 포함할 수 있고(예를 들어, 항 바이러스 기능), 또는 서열은 안티센스 또는 리보자임 기능을 갖는 분자에 해당할 수 있다. 적합한 치료적 관심 유전자의 대표적인(비-제한적인) 예는 염증성 질환, 자가 면역, 만성 및 감염성 질환, AIDS, 암, 신경계 질환, 심혈관 질환, 고콜레스테롤혈증을 포함하고; 다양한 빈혈, 지중해 빈혈 및 혈우병을 비

롯한 다양한 혈액 장애; 낭포성 섬유증, 고세병, 아데노신 탈아미노효소 결핍증(ADA), 폐기종 등과 같은 유전적 결함의 치료에 사용되는 것들을 포함한다. 암 및 바이러스 성 질환에 대한 안티센스 요법에 유용한 몇몇 안티센스 올리고뉴클

- [0091] 레오티드 (예를 들어, mRNA의 번역 개시 부위 (AUG 코돈) 주위의 서열에 상보적
- [0092] 인 짧은 올리고 뉴클레오티드)가 공지되어 있고 또한 치료적 관심 유전자의 적합한
- [0093] 예이다.
- [0094] 일부 실시예에서, 세포는 헬퍼 바이러스가 실질적으로 없다. 본 명세서에서 언급된 바와 같이, "헬퍼 바이러스"는 아데노-관련 바이러스의 복제 및 패키징을 가능하게 하기 위해 추가되는 AAV 이외의 바이러스이다. 헬퍼 바이러스의 대표적인(비-제한적인) 예는 아데노바이러스 및 헤르페스 바이러스이다. 일부 실시예에서, 헬퍼 바이러스가 실질적으로 없는 이라는 용어는 세포 당 100 미만, 10 미만, 또는 1 미만의 헬퍼 바이러스를 갖는 세포를 지칭한다. 일부 실시예에서, 헬퍼 바이러스가 실질적으로 없는 이라는 용어는 헬퍼 바이러스가 존재하지 않는 세포 또는 헬퍼 바이러스가 존재하지 않는 세포 집단을 지칭하며, 당업자에게 공지된 검출 방법을 사용한다. 일부 실시예에서, 세포에는 야생형-헬퍼 바이러스가 없다. 일부 실시예에서, 용어 야생형-바이러스는 임의의 다른 바이러스와 독립적으로 세포에서 복제될 수 있는 완전한-비-AAV 바이러스를 지칭한다.
- [0095] 일부 실시예에서, 본 개시 내용은 (i) 4개 이상의 별개의 재조합 표적 부위(RTS), (ii) 아데노바이러스 (Ad) 유전자 *E2A*, *E4*, *VA*, *MIR342* 또는 이들의 조합; 및 (iii) Ad 유전자에 작동 가능하게 연결된 프로모터를 포함하는 포유동물 세포를 제공하고, 상기 RTS, Ad 유전자 및 프로모터는 염색체로 통합된다. 일부 실시예에서, 세포는 마우스 세포, 인간 세포, CHO 세포, CHO-K1 세포, CHO-DXB11 세
- [0096] 포, CHO-DG44 세포, 모든 변이체(예를 들어, CHOK1SV™ POTELLIGENT®)를 포함하는 CHOK1SV™ 세포, 모든 변이체 (예를 들어, XCEED™)를 포함하는 CHOK1SV GS-KO™ 세포, 부착성 및 현탁액-적응형 변이체를 포함하는 HEK293
- [0097] 세포, HeLa 세포 또는 HT1080 세포이다.
- [0098] 일부 실시예에서, 세포는 4개의 RTS를 포함한다. 일부 실시예에서, 세포는 6개의 RTS를 포함한다. 일부 실시예에서, 적어도 하나의 RTS는 서열 번호 1-30으로부터 선택된다. 일부 실시예에서, RTS, Ad 유전자 및 프로모터는 단일 염색체 유전자 좌위에 통합된다. 일부 실시예에서, 염색체 유전자 좌위는 *Fer1L4*, *ROSA26*, *HGPRT*, *DHFR*, *COSMC*, *LDHa*, *MGAT1*, *GRIK1*, *NL1*, *NL2*, *NL3*, *NL4*, *NL5*, *NL6*, X 염색체에서 *MIDI*의 첫 번째 인트론, 또는 강화된 발현 및 안정성 영역(EESYR)이다. 일부 실시예에서, 세포는 부위-특이적 재조합 효소 유전자를 포함한다. 일부 실시예에서, 부위-특이적 재조합 효소 유전자는 염색체로 통합된다. 일부 실시예에서, 세포는 제2 Ad 유전자를 추가로 포함하며, 여기서 제2 Ad 유전자는 염색체로 통합된다. 일부 실시예에서, 제2 Ad 유전자는 *E1A*, *E1B*, *E2A*, *E4*, *VA*, *MIR342*, 또는 이들의 조합을 포함한다. 일부 실시예에서, 제2 Ad 유전자는 Ad5로부터 유래된다. 일부 실시예에서, 제2 Ad 유전자는 2개의 RTS 사이에 위치된다. 일부 실시예에서, 세포는 아데노-관련 바이러스 (AAV) 유전자를 추가로 포함하며, 여기서 AAV 유전자는 염색체로 통합된다. 일부 실시예에서, AAV 유전자는 *Rep*, *Cap*, 또는 이들의 조합을 포함한다. 일부 실시예에서, AAV 유전자는 아데노-관련 바이러스 유형 2로부터 유래된다. 일부 실시예에서, AAV 유전자는 2 개의 RTS 사이에 위치된다. 일부 실시예에서, 세포는 AAV 벡터 카세트를 추가로 포함하고, 상기 AAV 벡터 카세트는 염색체로 통합된다. 일부 실시예에서, AAV 벡터 카세트는 리포터 유전자, 선택 유전자, 치료적 관심 유전자 또는 이들의 조합이다. 일부 실시예에서, AAV 벡터 카세트는 2 개의 RTS 사이에 위치된다. 일부 실시예에서, 세포는 헬퍼 바이러스가 실질적으로 없다.
- [0099] 일부 실시예에서, 본 개시 내용은 (i) 적어도 4개의 별개의 재조합 표적 부위 (RTS); 및 (ii) Rep, Cap, 또는 이들의 조합을 포함하는 아데노-관련 바이러스(AAV) 유전자를 포함하는 포유동물 세포를 제공하고, 상기 RTS 및 AAV 유전자는 염색체로 통합된다. 일부 실시예에서, 세포는 마우스 세포, 인간 세포, CHO 세포, CHO-K1 세포, CHO-DXB11 세포, CHO-DG44 세포, 모든 변이체(예를 들어, CHOK1SV™ POTELLIGENT®)를 포함하는 CHOK1SV™ 세포, 모든 변이체를 포함하는 CHOK1SV GS-KO™ 세포, 부착성 및 현탁액-적응형 변이체를 포함하는 HEK293 세포, HeLa 세포, 또는 HT1080 세포이다. 일부 실시예에서, 세포는 4개의 RTS를 포함한다. 일부 실시예에서, 세포는 6 개의 RTS를 포함한다. 일부 실시예에서, 적어도 하나의 RTS는 서열 번호 1-30으로부터 선택된다. 일부 실시예에서, RTS 및 AAV 유전자는 단일 염색체 유전자 좌위에 통합된다. 일부 실시예에서, 염색체 유전자 좌위는 *Fer1L4*, *ROSA26*, *HGPRT*, *DHFR*, *COSMC*, *LDHa*, *MGAT1*, *GRIK1*, *NL1*, *NL2*, X 염색체에서 *MIDI* 첫 번째 인트론, 또

는 강화된 발현 및 안정성 영역(EESYR)이다. 일부 실시예에서, 세포는 부위-특이적 재조합 효소 유전자를 포함한다. 일부 실시예에서, 부위-특이적 재조합 효소 유전자는 염색체로 통합된다. 일부 실시예에서, 세포는 Ad 유전자 및 Ad 유전자에 작동 가능하게 연결된 프로모터를 추가로 포함하며, 이에 의해 Ad 유전자 및 프로모터는 염색체로 통합된다. 일부 실시예에서, Ad 유전자는 *E1A*, *E1B*, *E2A*, *E4*, *VA*, *MIR342* 또는 이들의 조합을 포함한다. 일부 실시예에서, Ad 유전자는 Ad5로부터 유래된다. 일부 실시예에서, AAV 유전자는 2개의 RTS 사이에 위치된다. 일부 실시예에서, 세포는 AAV 벡터 카세트를 추가로 포함한다. 일부 실시예에서, AAV 벡터 카세트는 리포터 유전자, 선택 유전자, 치료적 관심 유전자 또는 이들의 조합을 포함한다. 일부 실시예에서, 관심 유전자는 2개의 RTS 사이에 위치된다. 일부 실시예에서, 세포는 헬퍼 바이러스가 실질적으로 없다. 일부 실시예에서, 세포는 헬퍼 바이러스가 완전히 없다.

[0100] 일부 실시예에서, 본 개시 내용은 하나 이상의 RTS가 서열 번호 1-30으로 부터 선택되는 6개의 별개의 재조합 표적 부위 (RTS); *E1A* 및 *E1B*를 포함하는 아데노바이러스 (Ad) 유전자; RTS, Ad 유전자 및 프로모터가 염색체로 통합된 Ad 유전자에 작동 가능하게 연결된 프로모터; *E2A*, *E4*, *VA* 및 *MIR 342*를 포함하는 제2 Ad 유전자 (여기서, 제2 Ad 유전자는 2개의 RTS 사이에 위치함); Rep 및 Cap을 포함하는 아데노-관련 바이러스 (AAV) 유전자로, 상기 AAV 유전자는 2개의 RTS 사이에 위치하며; 및 리포터 유전자, 선택 유전자 또는 치료적 관심 유전자를 포함하는 AAV 벡터 카세트를 포함하고, AAV 벡터 카세트는 2개의 RTS 사이에 위치하는 것을 포함하는 중국 햄스터 난소 (CHO) 세포를 제공한다.

[0101] 일부 실시예에서, 본 개시 내용은 *E1A* 및 *E1B*를 포함하는 아데노바이러스(Ad) 유전자 및 Ad 유전자에 작동 가능하게 연결된 프로모터, Rep 및 Cap을 포함하는 아데노-관련 바이러스 (AAV) 유전자인 *E2A*, *E4*, *VA* 및 *MIR 342*를 포함하는 제2 Ad 유전자; 및 리포터 유전자, 선택 유전자, 치료적 관심 유전자 또는 이들의 조합을 포함하는 AAV 벡터 카세트를 포함하는 중국 햄스터 난소 (CHO) 세포를 제공한다.

[0102] 일부 실시예에서, 본 개시 내용은 4개 이상의 별개의 재조합 표적 부위(RTS), *E1A*, *E1B*, 또는 이들의 조합을 포함하는 아데노바이러스 (Ad) 유전자, 및 Ad 유전자에 작동 가능하게 연결된 프로모터로, 상기 RTS, Ad 유전자 및 프로모터는 염색체로 통합되는 세포를 제공하는 단계, 아데노-관련 바이러스 (AAV) 유전자, 제2 Ad 유전자, AAV 벡터 카세트, 또는 이들의 조합을 암호화하는 교환 가능한 카세트를 포함하는 벡터가 제공된 세포의 형질주입 단계, 교환 가능한 카세트를 염색체에 통합시키는 단계, 및 교환 가능한 카세트를 염색체에 통합하여 rAAV 생산자 세포를 선택하는 단계를 포함하는 재조합 아데노-관련 바이러스 (rAAV) 생산자 세포의 제조 방법을 제공한다. 일부 실시예에서, 형질주입은 2개의 벡터에 의하고, 제1 벡터는 제2 Ad 유전자 및 AAV 유전자를 포함하는 교환 가능한 카세트를 포함하고, 제2 벡터는 AAV 벡터 카세트를 포함하는 교환 가능한 카세트를 포함한다. 일부 실시예에서, 형질 감염은 2개의 벡터로 이루어지며, 제1 벡터는 제2 Ad 유전자를 포함하는 교환 가능한 카세트를 포함하고, 제2 벡터는 AAV 유전자를 포함하는 교환 가능한 카세트를 포함한다. 일부 실시예에서, 형질 감염은 3개의 벡터를 사용하며, 제1 벡터는 제2 Ad 유전자를 포함하는 교환 가능한 카세트를 포함하고, 제2 벡터는 AAV 유전자를 포함하는 교환 가능한 카세트를 포함하고, 제3 벡터는 AAV 벡터 카세트를 포함하는 교환 가능한 카세트를 포함한다. 일부 실시예에서, 각각의 교환 가능한 카세트는 세포의 RTS 중 2개와 일치하는 2개의 RTS를 추가로 포함한다. 일부 실시예에서, 본 발명자들은 SSI의 사용은 세포가 유전자 조성이 상동(homogenous)하기 때문에 형질주입된 세포로부터 세포를 클로닝할 필요가 없다는 것을 발견하였다.

[0103] 용어 "일치(matching)"는 2개의 RTS 서열과 관련하여 재조합 효소에 의해 결합될 수 있고 2개의 서열 사이의 부위-특이적 재조합에 영향을 줄 수 있는 능력을 갖는 2개의 서열을 지칭한다. 일부 실시예에서, 세포의 RTS와 일치하는 교환 가능한 카세트의 RTS는 세포의 RTS와 실질적으로 동일한 서열을 갖는 카세트의 RTS를 지칭한다. 일부 실시예에서, 교환 가능한 카세트는 세포에 염색체로 통합된 RTS 중 하나 또는 둘과 실질적으로 동일한 서열을 함유한다.

[0104] 일부 실시예에서, 통합(integrating) 이라는 용어는 통합(integration)을 지칭하고, 예를 들어, 염색체 내로 교환 가능한 카세트의 삽입이다. 일부 실시예에서, 통합은 부위-특이적 재조합에 의해 매개된다.

[0105] 일부 실시예에서, 용어 "선택(selecting)"은 염색체로 통합된 마커를 함유하는 세포를 식별하는 것을 지칭한다. 일부 실시예에서, 선택은 당업자에게 공지된 방법을 사용하여 마커의 존재의 검출을 통해 이루어진다. 일부 실시예에서, 선택은 당업자에게 공지된 방법을 사용하여 마커의 부재의 검출을 통해 이루어진다.

[0106] 일부 실시예에서, 제2 Ad 유전자는 *E1A*, *E1B*, *E2A*, *E4*, *VA*, *MIR342*, 또는 이들의 조합을 포함한다. 일부 실시예에서, AAV 유전자는 Rep, Cap, 또는 이들의 조합이다. 일부 실시예에서, AAV 벡터 카세트는 리포터 유전자, 선택 유전자, 치료적 관심 유전자 또는 이들의 조합을 포함한다.

- [0107] 일부 실시예에서, 본 개시 내용은 (i) 숙주 세포를 AAV로 감염시키는 단계, (ii) AAV 벡터 카세트에 패키징된 rAAV를 생성하는 단계, 및 (iii) 패키징된 rAAV를 정제하는 단계를 포함하고, 상기 숙주 세포는 적어도 4개의 별개의 제조함 표적 부위 (RTS), *E1A*, *E1B* 또는 이들의 조합을 포함하는 아데노바이러스 (Ad) 유전자, Ad 유전자에 작동 가능하게 연결된 프로모터를 포함하고, 상기 RTS, Ad 유전자 및 프로모터는 염색체로 통합되고, *E1A*, *E1B*, *E2A*, *E4*, *VA*, *MIR342*, 또는 이들의 조합을 포함하는 제2 Ad 유전자, *Rep*, *Cap*, 또는 이들의 조합을 포함하는 아데노-관련 바이러스 (AAV) 유전자, 및 리포터 유전자, 선택 유전자, 치료적 관심 유전자 또는 이들의 조합을 포함하는 AAV 벡터 카세트를 포함하는 제조함 아데노-관련 바이러스 (rAAV)의 제조 방법을 제공한다. 일부 실시예에서, rAAV 생산 및 패키징에는 살아있는 야생형 헬퍼 바이러스가 필요하지 않다. 일부 실시예에서, E1A의 발현은 rAAV 생산에 필요하지 않다. 일부 실시예에서, 정제 후 최소 1.0×10^9 vg/mL 활성 rAAV가 수득된다. 본 개시 내용의 일부 실시예에서, rAAV는 복제 경쟁 아데노바이러스 (RCA replication competent adenovirus)가 실질적으로 없는 상태로 얻어진다. 예를 들어, 본 개시 내용의 일부 실시예에서, RCA는 정제 전 검출 한계 미만이다. 바이러스 입자의 정량 방법은 당업자에게 공지되어 있으며, 정량적 중합 효소 연쇄 반응 (qPCR) 분석, 감염 적정 분석, 종말점 회색 분석 및 바이러스성 플라크 분석을 포함할 수 있다. 일부 실시예에서, 본 발명자들은 rAAV 생산자 세포를 제조하기 위한 SSI의 사용이 생산자 세포의 풀이 그의 유전자 구성에서 균질하다는 것을 보장한다는 것을 발견하였다. 일부 실시예에서, 본 발명자들은 rAAV 생산자 세포를 제조하기 위해 SSI의 사용이 생산자 세포의 풀이 그의 효율이 균질하다는 것을 보장한다는 것을 발견하였다. 일부 실시예에서, 본 발명자들은 rAAV 생산자 세포를 제조하기 위한 SSI의 사용이 생산자 세포의 풀이 제1 헬퍼 유전자 대 제2 헬퍼 유전자의 배급(ration)에서 균질하다는 것을 보장한다는 것을 발견하였다. 일부 실시예에서, 본 발명자들은 rAAV 생산자 세포를 제조하기 위한 SSI의 사용이 생산자 세포의 풀이 헬퍼 유전자 대 치료적 관심 유전자의 비에서 균질하다는 것을 발견하였다. 일부 실시예에서, 본 발명자들은 rAAV 생산자 세포를 제조하기 위해 SSI의 사용이보다 일관된 rAAV 생산물 품질을 보장한다는 것을 발견하였다.
- [0108] 본원에 사용된 "아미노산"은 카르복실(-COOH) 및 아미노(-NH₂)기를 모두 함유하는 화합물을 지칭한다. "아미노산"은 천연 및 비천연, 즉 합성 아미노산을 모두 지칭한다. 3 글자 및 단일 문자 약어를 갖는 천연 아미노산은 알라닌 (Ala; A); 아르기닌 (Arg, R); 아스파라긴 (Asn; N); 아스파르트산 (Asp; D); 시스테인 (Cys; C); 글루타민 (Gln; Q); 글루탐산 (Glu; E); 글리신 (Gly; G); 히스티딘 (His; H); 이소류신 (Ile; I); 류신 (Leu; L); 라이신 (Lys; K); 메티오닌 (Met; M); 페닐알라닌(Phe; F); 프롤린 (Pro; P); 세린 (Ser; S); 트레오닌 (Thr; T); 트립토판 (Trp; W); 티로신 (Tyr; Y); 및 발린 (Val; V)을 포함한다.
- [0109] 용어 "펩티드", "폴리펩티드" 및 "단백질"은 본원에서 상호 교환적으로 사용되며, 화학적 또는 생화학적으로 변형되거나 유도체화된 아미노산을 코딩하고 코딩되지 않은 아미노산을 포함할 수 있는 임의의 길이의 아미노산의 중합체 형태, 및 변형된 펩티드 골격을 갖는 폴리펩티드를 지칭한다.
- [0110] 원핵 생물 및/또는 진핵 생물 세포주를 포함하는 원하는 세포주는 본원에 기술된 임의의 적합한 장치, 시설 및 방법을 사용하여 배양될 수 있다. 또한, 실시예에서, 장치, 시설 및 방법은 현탁 세포 또는 고정-의존성 (점착성) 세포를 배양하기에 적합하고, 제약 및 생물약제 제품, 예컨대 폴리펩티드 제품, 핵산 제품 (예를 들어 DNA 또는 RNA), 또는 포유동물 또는 미생물 세포 및/또는 바이러스, 예를 들어 세포 및/또는 바이러스 및 미생물 요법에 사용되는 바이러스를 생산하기에 적합하다.
- [0111] 일부 실시예에서, 세포는 제조함 치료 또는 진단 제품과 같은 제품을 발현하거나 생산한다. 아래에 보다 상세히 기술된 바와 같이, 세포에 의해 생산된 제품의 예는 다음을 포함하고, 이에 제한되지는 않지만, 항체 분자 (예를 들어, 단일 클론 항체, 이중 특이적 항체), 항체 모방체 (항원에 특이적으로 결합하지만 항체와 구조적으로 관련되지 않은 폴리펩타이드 분자, 예를 들어 DARPin, 애피바디(affibodies), 아드넥틴, 또는 IgNAR), 융합 단백질 (예를 들어, Fc 융합 단백질, 키메라 사이토카인), 다른 제조함 단백질 (예를 들어, 글리코실화된 단백질, 효소, 호르몬), 바이러스 치료제 (예를 들어, 항암 종양방괴성(oncolytic) 바이러스, 유전자 치료를 위한 바이러스 벡터 및 바이러스 면역 치료), 세포 치료제 (예를 들어, 다능성 줄기 세포, 중간엽 줄기 세포 및 성체 줄기 세포), 백신 또는 지질 캡슐화된 입자 (예를 들어, 엑소좀, 바이러스 유사 입자), RNA (예를 들어, siRNA) 또는 DNA (예를 들어, 플라스미드 DNA), 항생제 또는 아미노산을 포함한다. 실시예에서, 장치, 시설 및 방법은 바이오시밀러를 생산하는데 사용될 수 있다.
- [0112] 언급한 바와 같이, 실시예에서, 장치, 시설 및 방법은 진핵 세포, 예를 들어 포유 동물 세포 또는 하부 진핵 세포, 예를 들어 효모세포 또는 사상 진균 세포, 또는 원핵 세포, 예컨대 그람 양성 또는 그람 음성 세포 및/또는 진핵 세포 또는 원핵 세포의 생성물, 예를 들어, 진핵 세포에 의해 합성된 단백질, 펩티드, 항생제, 아미노

산, 핵산 (예를 들어, DNA 또는 RNA) 대규모로 생산하는 것을 허용한다. 일부 실시예에서, 미생물 치료요법에 사용되는 미생물 유기체 및 이의 포자의 사용이

- [0113] 또한 개시되어있다. 본 명세서에서 달리 언급되지 않는 한, 장치, 설비 및 방법은
- [0114] 벤치-규모, 파일럿-규모 및 전체 생산 규모 용량을 포함하지만 이에 제한되지 않는 임의의 원하는 부피 또는 생산 능력을 포함할 수 있다.
- [0115] 또한, 본 명세서에서 달리 언급되지 않는 한, 장치, 설비 및 방법은 제한되는 것은 아니지만, 임의의 적합한 반응기(들)를 포함하고 교반 탱크, 에어리프트, 섬유, 마이크로 섬유, 중공섬유, 세라믹 매트릭스, 무동층, 고정층 및/또는 스파우트층 생물 반응기를 포함한다. 본원에 사용된 "반응기"는 발효기 또는 발효 유닛, 또는 임의의 다른 반응 용기를 포함할 수 있으며, "반응기"라는 용어는 "발효기"와 상호 교환적으로 사용된다. 발효기 또는 발효라는 용어는 미생물 및 포유동물 배양 둘 다를 지칭한다. 예를 들어, 일부 측면에서, 예시적인 생물 반응기 유닛은 다음 중 하나 이상 또는 전부를 수행할 수 있다: 영양소 및/또는 탄소 공급원 공급, 적합한 기체 (예: 산소) 주입, 발효 또는 세포 배양 배지의 유입 및 배출 흐름, 가스 및 액체상의 분리, 온도 유지, 산소 및 CO2 수준 유지, pH 수준, 교반(agitation) (예: 교반(stirring)) 및/또는 세척/살균을 수행할 수 있다. 발효 유닛과 같은 예시적인 반응기 유닛은 유닛내에 다수의 반응기를 함유할 수 있고, 예를 들어, 장치는 각각 1, 2, 3, 4, 5, 10, 15, 20, 25, 30, 35, 40, 45, 50, 60, 70, 80, 90 또는 100개 이상의 생물 반응기를 가질 수 있고 및/또는 설비는 설비 내에 단일 또는 다수의 반응기를 갖는 다수의 유닛을 포함할 수 있다. 다양한 실시예에서, 생물 반응기는 बै치(batch), 반유가식(semi fed-batch), 유가식, 관류, 및/또는 연속 발효 공정에 적합할 수 있다.
- [0116] 임의의 적합한 반응기 직경이 사용될 수 있다. 실시예에서, 생물 반응기는 약 100mL 내지 약 50,000L의 부피를 가질 수 있다. 비-제한적인 예는 100mL, 250mL, 500 mL, 750 mL, 1 리터, 2 리터, 3 리터, 4 리터의 부피, 5 리터, 6 리터, 7 리터, 8 리터, 9 리터, 10 리터, 15 리터, 20 리터, 25 리터, 30 리터, 40 리터, 50 리터, 60 리터, 70 리터, 80 리터, 90 리터, 100 리터, 150 리터, 200 리터, 250 리터, 300 리터, 350 리터, 400 리터, 450 리터, 500 리터, 550 리터, 600 리터, 650 리터, 700 리터, 750 리터, 800 리터, 850 리터, 900 리터, 950 리터, 1000 리터, 1500 리터, 2000 리터, 2500 리터, 3000 리터, 3500 리터, 4000 리터, 4 500 리터, 5000 리터, 6000 리터, 7000 리터, 8000 리터, 9000 리터, 10,000 리터, 15,000 리터, 20,000 리터, 및/또는 50,000 리터를 포함한다. 또한, 적합한 반응기는 다용도, 일회용, 일회용 또는 비-일회용일 수 있으며 다음을 포함하는 임의의 적합한 재료로 형성될 수 있고, 스테인레스 스틸 (예: 316L 또는 기타 적합한 스테인레스 스틸) 및 인코넬, 플라스틱 및/또는 유리와 같은 금속 합금을 포함한다.
- [0117] 본 명세서에서 달리 언급되지 않는 한, 실시예에서, 본 명세서에 기술된 장치, 설비 및 방법은 달리 언급되지 않은 생성물의 분리, 정제, 및 격리를 위한 작동 및/또는 장비와 같은 임의의 적절한 유닛 작동 및/또는 장비를 포함할 수 있다. 전통적인 스틱-빌트 시설, 모듈식, 이동 및 임시 시설, 또는 다른 적합한 구조물, 시설 및/또는 레이아웃과 같은 임의의 적합한 시설 및 환경이 사용될 수 있다. 예를 들어, 일부 실시예에서 모듈식 청소된-방이 사용될 수 있다. 추가로 그리고 달리 언급되지 않는 한, 본원에 기술된 장치, 시스템 및 방법은 단일 위치 또는 시설에서 수용 및/또는 수행될 수 있거나, 또는 별개의 또는 다수의 위치 및/또는 시설에서 수용 및/또는 수행될 수 있다.
- [0118] 비-제한적인 예 및 제한없는 예로써, 미국 출원 공개번호 2013/0280797; 2012/0077429; 2011/0280797; 2009/0305626; 및 미국 특허 번호 8,298,054; 7,629,167; 및 5,656,491, 여기에 그 전체 내용이 참조로 포함되며, 적합한 시설, 장비 및/또는 시스템의 예를 설명한다.
- [0119] 실시예에서, 세포는 진핵 세포, 예를 들어 포유동물 세포이다. 포유동물 세포는 예를 들어 인간 또는 설치류 또는 소 세포주 또는 세포 균주일 수 있다. 이러한 세포, 세포주 또는 세포 균주의 예는 예를 들어, 마우스 골수종(NSO)-세포주, 중국 햄스터 난소 (CHO)-세포주, HT1080, H9, HepG2, MCF7, MDBK Jurkat, NIH3T3, PC12, BHK (새끼 햄스터 신장 세포), VERO, SP2/0, YB2/0, YO, C127, L 세포, COS, 예를 들어, COS1 및 COS7, QC1-3, HEK293, VERO, PER.C6, HeLa, EB1, EB2, EB3, 중앙봉괴성 또는 하이브리도마-세포주이다. 바람직하게는 포유동물 세포는 CHO 세포주이다. 일 실시예에서, 세포는 CHO 세포이다. 일 실시예에서, 세포는 CHO-K1 세포, CHOK1SV™ 세포, DG44 CHO 세포, DUXB11 CHO 세포, CHOS, CHO GS 녹-아웃 세포, CHO FUT8 GS 녹-아웃 세포, CHOZN 또는 CHO 유래 세포이다. CHO GS 녹-아웃 세포 (예를 들어, GSKO 세포)는 예를 들어 CHOK1SV GS-KO (Lonza's Xceed®, Expression System, Lonza, Slough, UK의 일부)이다. CHO FUT8 녹아웃 세포는 예를 들어 CHOK1SV™ Potelligent® (Lonza, Slough, UK)이다. 진핵 세포는 또한 조류(avian) 세포, 세포주 또는 세포 균주, 예를

들어 EBx® 세포, EB14, EB24, EB26, EB66 또는 EBv13일 수 있다.

- [0120] 일부 실시예에서, 진핵 세포는 줄기 세포이다. 줄기 세포는 예를 들어, 배아 줄기 세포 (ESC), 성체 줄기 세포, 유도된 다능성 줄기 세포 (iPSC), 조직 특이적 줄기 세포 (예를 들어, 조혈 줄기 세포) 및 중간엽 줄기 세포 (MSC)를 포함하는 다능성 줄기 세포일 수 있다.
- [0121] 일 실시예에서, 세포는 본원에 기술된 임의의 세포의 분화된 형태이다. 일 실시예에서, 세포는 배양에서 임의의 1차 세포로부터 유래된 세포이다. 일부 실시예에서, 세포는 줄기 세포로부터 유래되지 않는다. 예를 들어, 일부 실시예에서, 세포는 개별 환자로부터 또는 확립된 세포 은행으로부터 추출되고 단리된 면역 요법(예를 들어, 림프구)에 사용된다. 일부 실시예에서, 세포는 유전적으로 조작된 세포(즉, CAR-T 등)를 포함할 수 있다.
- [0122] 실시예에서, 세포는 간세포, 예컨대 인간 간세포, 동물 간세포 또는 비-조직질실(parenchymal) 세포이다. 예를 들어, 세포는 판형의(plateable) 대사 가능한 인간 간세포, 판형 유도 적격의 (qualified) 인간 간세포, plateable Qualyst Transporter Certified™ 인간 간세포, 현탁액 적격의 인간 간세포 (10-기증자 및 20-기증자 풀 간세포 포함), 인간 간 쿠퍼 세포, 인간 간 정상 세포, 개 간세포 (단일 및 합동된(pooled) 비글 간세포 포함), 마우스 간세포 (CD-1 및 C57BI/6 간세포 포함), 쥐 간세포 (Sprague-Dawley, Wistar Han 및 Wistar 간세포 포함), 원숭이 간세포 (사이노몰구스 또는 붉은 털 원숭이 간세포 포함), 고양이 간세포 (국내쇼트헤어 간세포 포함), 및 토끼 간세포 (뉴질랜드 화이트 간세포 포함)일 수 있다. 예시적인 간세포는 미국 노스 캐롤라이나 주 27709의 6 Davis Drive Research Triangle Park의 Triangle Research Labs, LLC로부터 시판되고 있다.
- [0123] 일 실시예에서 진핵 세포는 예를 들어, 효모 세포(예: 피키아(*Pichia*) 속(예: 피키아 파스토리스(*Pichia pastoris*), 피키아 메타놀리카(*Pichia methanolica*), 피키아 클루이베리(*Pichia kluyveri*), 및 피키아 안구스타(*Pichia angusta*)), 코마가타엘라(*Komagataella*) 속(예: 코마가타엘라 파스토리스(*Komagataella pastoris*), 코마가타엘라 슈도파스토리스(*Komagataella pseudopastoris*) 또는 코마가타엘라 파피(*Komagataella phaffii*)), 사카로마이세스(*Saccharomyces*) 속(예: 사카로마이세스 세레비지에 (*Saccharomyces cerevisiae*), 사카로 마이세스 클루이베리(*Saccharomyces kluyveri*), 사카로마이세스 우바룸 (*Saccharomyces uvarum*)), 클루이베로마이세스(*Kluyveromyces*) 속(예: 클루이베로마이세스 락티스 (*Kluyveromyces lactis*), 클루이베로마이세스 막시아누스 (*Kluyveromyces marxianus*)), 칸디다(*Candida*) 속(예: 칸디다 우틸리스(*Candida utilis*), 칸디다 카카오이 (*Candida cacaoi*), 칸디다 보이디니 (*Candida boidinii*)), 게오트리쿰 (*Geotrichum*) 속(예: 게오트리쿰 퍼멘탄스 (*Geotrichum fermentans*)), 한세놀라 폴리모르파(*Hansenula polymorpha*), 야로위아 리폴리티카 (*Yarrowia lipolytica*), 또는 쉬조사카로마이세스 폼브 (*Schizosaccharomyces pombe*)와 같은 하류 진핵 세포이다. 바람직하게는 피키아 파스토리스이다. 피키아 파스토리스 균주의 예는 X33, GS115, KM71, KM71H; 및 CBS7435이다.
- [0124] 일 실시예에서, 진핵 세포는 진균 (fungal) 세포(예: 아스퍼질러스 (*Aspergillus*) (아스퍼질러스 니게르 (*A. niger*), 아스퍼질러스 푸미가투스(*A. fumigatus*), 아스퍼질러스 오리재 (*A. oryzae*), 아스퍼질러스 니둘라(*A. nidula*)와 같은), 아크레모늄(*Acremonium*)(예: 아크레모늄 써모필리움(*A. thermophilum*)과 같은), 카에토미움 (*Chaetomium*)(예: 카에토미움 써모필리움(*C. thermophilum*)과 같은), 크리소스포리움(*Chrysosporium*)(예: 크리소스포리움 써모필(*C. thermophile*)과 같은), 동충하초(*Cordyceps*)(예: 번데기동충하초(*C. militaris*)와 같은), 코리나스쿠스 (*Corynascus*), 씨테노마이세스 (*Ctenomyces*), 푸사리움 (*Fusarium*) (예: 푸사리 움 옥시스포룸(*F. oxysporum*)과 같은), 글로메렐라(*Glomerella*)(글로메렐라 그라미니콜라(*G. graminicola*)와 같은), 하이포크레아(*Hypocrea*(하이포크레아 제코리나(*H. jecorina*)와 같은), 마그나포르테(*Magnaporthe*)(마그나포르테 오리재 (*M. oryzae*)와 같은), 마이셀리오프쏘라 (*Myceliophthora*)(마이셀리오프쏘라 써모필(*M. thermophile*)와 같은), 넥트리아(*Nectria*) (넥트리아 헤마토코코아(*N. heamatococca*)와 같은), 뉴로스포라(*Neurospora*)(뉴로스포라 크라싸(*N. crassa*)와 같은), 페니실리움(*Penicillium*), 스포로트리쿰(*Sporotrichum*)(스포로트리쿰 써모필(*S. thermophile*)과 같은), 티엘라비아(*Thielavia*)(티엘라비아 테르스트리스(*T. terrestris*)와 같은), 티엘라비아 헤테로할리카(*heteroyhallica*)와 같은), 트리코더마(*Trichoderma*)(트리코더마 레세이 (*T. reesei*)와 같은), 또는 버티실룸(*Verticillium*) (버티실룸 달리아(*V. dahlia*)와 같은))이다.
- [0125] 일 실시예에서, 진핵 세포는 곤충 세포(예: Sf9, Mimic™ Sf9, Sf21, High Five™(BT1-TN-5B1-4), 또는 BT1-Ea88 세포), 조류 (algae) 세포(예: 암포라(Amphora), 규조류(*Bacillariophyceae*), 두날리엘라(*Dunaliella*, *Chlorella*), 클라미도모나스(*Chlamydomonas*), 시아노피타 (Cyanophyta, 시아노박테리아), 난노클로롭시스 (Nannochloropsis), 스피루리나(Spirulina), 또는 오크로모나스(*Ochromonas*)속의), 또는 식물 세포(예: 단자엽 식물 유래의(예: 옥수수, 쌀, 밀, 또는 강아지풀(*Setaria*)), 또는 쌍떡잎 식물 유래의(예: 카사바(cassava), 감

자, 대두, 토마토, 담배, 자주개자리(alfalfa), 이끼(*Physcomitrella patens*) 또는 애기장대(*Arabidopsis*)이다.

[0126] 일 실시예에서, 세포는 박테리아 또는 원핵 세포이다. 일부 실시예에서, 원핵 세포는 바실러스(*Bacillus*), 스트렙토마이세스 스트렙토코커스(*Streptomyces Streptococcus*), 스태필로코커스(*Staphylococcus*) 또는 락토바실러스(*Lactobacillus*)와 같은 그람-양성 세포이다. 사용될 수 있는 바실러스는 예를 들어 바실러스 서브틸리스(*B. subtilis*), 바실러스 아밀로리퀴파시엔스(*B. amyloliquefaciens*), 바실러스 리체니포르미스(*B. licheniformis*), 바실러스 나토(*B. natto*) 또는 바실러스 메가테리움(*B. megaterium*)이다. 실시예에서, 세포는 바실러스 서브틸리스, 예컨대 바실러스 서브틸리스 3NA 및 바실러스 서브틸리스 168이다. 바실러스는 예를 들어, *Bacillus* Genetic Stock Center, Biological Sciences 556, 484 West 12th Avenue, Columbus OH 43210-1214에서 얻을 수 있다.

[0127] 일 실시예에서, 원핵 세포는 살모넬라 종(*Salmonella spp.*) 또는 대장균(*Escherichia coli*)와 같은 그람 음성 세포이고, 예를 들어, TG1, TG2, W3110, DH1, DHB4, DH5a, HMS 174, HMS174 (DE3), NM533, C600, HB101, JM109, MC4100, XL1-Blue 및 Origami와 같고, 예를 들어, BL-21 또는 BL21 (DE3)과 같은 대장균 B-군주 유래뿐만 아니라, 이들은 모두 시판되고 있다. 적합한 숙주 세포는 예를 들어, DSMZ (Deutsche Sammlung von Mikroorganismen and Zellkulturen GmbH, Braunschweig, Germany) 또는 American Type Culture Collection (ATCC)과 같은 배양물 수집처로부터 상업적으로 입수할 수 있다. 일부 실시예에서, 세포는 치료제로서 사용되는 다른 미생물 총(microbiota)을 포함한다. 여기에는 필라 후벽균(Firmicutes), 의간균류(*Bacteroidetes*), 프로테오박테리아, 베루미크로미아(*Verrumicrobia*), 방선균류(*Actinobacteria*), 푸소박테리움균류(*Fusobacteria*) 및 시아노박테리아에 속하는 인간 마이크로바이옴(microbiome)에 존재하는 미생물 총이 포함된다. 미생물총은 호기성, 엄격한 혐기성 또는 기능성 혐기성 둘 다를 포함할 수 있고 세포 또는 포자를 포함할 수 있다. 치료적 미생물 총은 또한 유전자 조작 유기체 및 그의 변형에 이용된 벡터를 포함할 수 있다. 다른 마이크로바이옴-관련 치료적 유기체는 고세균, 진균 및 바이러스를 포함할 수 있다. 예를 들어, The Human Microbiome Project Consortium. *Nature* 486, 207-214 (14 June 2012); Weinstock, *Nature*, 489 (7415): 250-256 (2012); Lloyd-Price, *Genome Medicine* 8:51 (2016)를 참고한다.

[0128] 일부 실시예에서, 배양된 세포는 치료 용도를 위해 단백질, 예를 들어 항체, 예를 들어 모노클로날 항체 및/또는 재조합 단백질을 생성하는데 사용된다. 실시예에서, 배양된 세포는 펩티드, 아미노산, 지방산 또는 다른 유용한 생화학 중간체 또는 대사산물을 생성한다. 예를 들어, 실시예에서, 약 4000 달톤 내지 약 140,000 달톤 초과 분자량을 갖는 분자가 생성될 수 있다. 실시예에서, 이들 분자는 다양한 복잡성을 가질 수 있고 글리코실화를 포함하는 번역-후 변형을 포함할 수 있다.

[0129] 실시예에서, 단백질은, 예를 들어, 보톡스, 마이오블록(Myobloc), 뉴로블록(Neurobloc), 디스포트(Dysport) (또는 보툴리눔 뉴로톡신의 다른 혈청형), 알글루코시다제 알파(alglucosidase alpha), 닙토마이신(daptomycin), YH-16, 코리오고나 도트로핀 알파(choriogonadotropin alpha), 필그라스티움(filgrastim), 세트로렐릭스(cetrorelix), 인터류킨-2, 알데스류킨(aldesleukin), 테셀류틴(teceleulin), 데니류킨 디프티톡스(denileukin diftotox), 인터페론 알파-n3(주입), 인터페론 알파-n1, DL-8234, 인터페론, 설토리(감마-1a), 인터페론 감마, 티모신 알파 1, 타소너민(tasonermin), DigiFab, 비페라랩 (ViperaTAB), 에치랩(EchiTAB), 크로랩(CroFab), 네시리타이드 (nesiritide), 아바타셉트 (abatacept), 알레파셉트 (alefacept), 레비프 (Rebif), 엡토터미날파(eptoterminalfa), 테리파라타이드(teriparatide) (골다공증), 칼시토닌 주사용(뼈질환), 칼시토닌(비강, 골다공증), 에타너셉트(etanercept), 헤모글로빈 글루타머(glutamer) 250 (소), 드로트레코진 알파, 콜라게나제, 카르페리티드, 재조합 인간 표피 성장 인자(국소 겔, 상처 치유), DWP401, 달베포이틴 알파, 에포에틴 오메가, 에포에틴 베타, 에포에틴 알파, 데시루딘, 레피루딘, 비발리 루딘, 노나코그 알파, 모노닌, 엡타코그(eptacog) 알파 (활성화된), 재조합 인자(recombinant Factor) VIII+VWF, 리콤비네이트(Recombinate) VIII, 인자 VIII (재조합체), 알픈메이트(Alphnmate), 옥토코그 알파, 인자 VIII, 팔리퍼민(palifermin), 인디키나제(Indikinase), 테넥테플라제(tenecteplase), 알테플라제(alteplase), 파미테플라제(pamiteplase), 레테플라제 (reteplase), 나테플라제 (nateplase), 몬테플라제(montepilase), 폴리트로핀(follitropin) 알파, rFSH, hpFSH, 미카펙긴(micafungin), 페그필그라스티움 (pegfilgrastim), 레노그라스티움(lenograstim), 나르토그라스티움 (nartograstim), 세르모레린(sermorelin), 글루카곤, 엑세나타이드, 프람린타이드, 이니글루세라제 (iniglucerase), 갈설투라제 (galsulfase), 류코트로핀 (Leucotropin), 몰그라모스티르(molgramostirn), 트립토렐린 아세테이트 (triptorelin acetate), 히스트렐린 (histrelin) (피하 이식, Hydron), 데슬로렐린(deslorelin), 히스트렐린(histrelin), 나파렐린 (nafarelin), 류프롤리드 서방형 저장소

(leuprolide sustained release depot)(ATRIGEL), 뉴프롤리드 이식 (DUROS), 고세렐린(goserelin), 유트로핀 (Eutropin), KP-102 프로그램, 소마트로핀(somatropin), 메카세르민(mecasermin) (성장 실패), 엔파비르타이드 (enfavirtide), Org-33408, 인슐린 글라진(glargine), 인슐린 글루리신(glulisine), 인슐린(흡입), 인슐린 리스프로(lispro), 인슐린 디터니르(deternir), 인슐린 (구강, 래피드미스트 흡입기(RapidMist)), 메카세르민 린파베이트(mecasermin rinfabate), 아나킨라(anakinra), 셀모류킨(celmoleukin), 99 mTc-알시타이드(alpcitide) 주사, 미엘로피드 (myelopid), 베타세론 (Betaseron), 글라티라머 아세테이트 (glatiramer acetate), 제폰 (Gepon), 사그라모스팀(sargramostim), 오펠베킨(oprelvekin), 인간 백혈구-유래 알파 인터페론, 빌리브 (Bilive), 인슐린 (재조합체), 재조합 인간 인슐린, 인슐린 아스파르트(aspart), 메카세닌(mecasenin), 로페론 (Roferon)-A, 인터페론-알파 2, 알파페론(Alfaferone), 인터페론 알파콘(alfacon)-1, 인터페론 알파, 아보넥스 (Avonex)의 재조합 인간 루테인화 호르몬, 도르나제(dornase) 알파, 트라페민(trafermin), 지코노타이드 (ziconotide), 탈티렐린 (taltirelin), 디보터미날파(diboterminalfa), 아토시반 (atosiban), 베카플러민 (becaplermin), 엡티파타이드(eptifibatide), 제마이라(Zemaira), CTC-111, 샨박(Shanvac)-B, HPV 백신 (4가), 옥트레오타이드(octreotide), 란레오타이드(lanreotide), 안세스틴 (ancestirn), 아갈시다제 (agalsidase) 베타, 아갈시다제 알파, 라로니다제(laronidase), 프레자타이드 카퍼(prezatide copper) 아세테이트 (국소 겔), 라스부리카제(rasburicase), 라니비주맙(ranibizumab), 악티문(Actimmune), PEG-인트론, 트리코민(Tricomin), 재조합 집먼지 진드기 알러지 탈감작 주사, 재조합 인간 부갑상선 호르몬 (PTH) 1-84(sc, 골다공증), 에포에틴 델타, 형질전환 항트롬빈 III, 그란디트로핀(Granditropin), 비트라제(Vitrase), 재조합 인슐린, 인터페론-알파 (구강 로젠지), GEM-21S, 바프레오타이드(vapreotide), 이두르술포제(idursulfase), 옴나파트릴랏(omnapatrilat), 재조합 혈청 알부민, 세르토리주맙 페골 (certolizumab pegol), 글루카르피다제 (glucarpidase), 인간 재조합 C1 에스테라제 억제제 (혈관부종), 라노테플라제(lanoteplase), 재조합 인간 성장 호르몬, 엔푸비르타이드(enfuvirtide)(주사침 없는 주사제, Biojector 2000), VGV-1, 인터페론 (알파), 루시안크탄트(lucinactant), 아비브타딜(aviptadil) (흡입제, 폐질환), 이카티반트(icatibant), 에칼란타이드 (ecallantide), 오미가난(omiganan), 아우로그랩(Aurograb), 펙시가난아세테이트(pexigananacetate), ADI-PEG-20, LDI-200, 데가렐릭스(degarelix), 신트레델린베수도톡스(cintredelinbesudotox), 파블드(Favld), MDX-1379, ISAtx-247, 리라글루타이드(liraglutide), 테리파라타이드(teriparatide) (골다공증), 티파코긴 (tifacogin), AA4500, T4N5 리포솜 로션, 카투막소맙(catumaxomab), DWP413, ART-123, 크라이살린 (Chrysalin), 데스모테플라제(desmoteplase), 아메디플라제(amediplase), 코리폴리트로핀 알파 (corifollitropin alpha), TH-9507, 테두글루타이드(teduglutide), 다이아미드(Diamyd), DWP-412, 성장 호르몬 (서방형 주사제), 재조합체 G-CSF, 인슐린 (흡입형, AIR), 인슐린 (흡입형, 테크노스피어), 인슐린 (흡입성, AERx), RGN-303, DiaPep277, 인터페론 베타(C형 간염 바이러스 감염 (HCV)), 인터페론 알파-n3 (경구용), 벨라타셉트(belatacept), 경피형 인슐린 패치, AMG-531, MBP-8298, 제레셉트(Xerecept), 오오베바칸(opebacan), AIDSVAX, GV-1001, 림포스칸(LymphoScan), 란피르나제(ranpirnase), 리폭시산(Lipoxysan), 루수풀타이드 (lusupultide), MP52(베타-트리칼슘 포스페이트 담체, 골 재생용), 흑색종 백신, 시풀레우셀(sipuleucel)-T, CTP-37, 인세지아(Insegia), 비테스텐(vitespen), 인간 트롬빈 (동결, 수술시 출혈), 트롬빈, 트랜스MID, 알피메프라제(alfimeprase), 퓨리카제(Puricase), 테리리프레신(terlipressin) (정맥주사, 간장 신장형 증후군), EUR-1008M, 재조합 FGF-I (주사제, 혈관 질환), BDM-E, 로티갑타이드(rotigaptide), ETC-216, P-113, MBI-594AN, 듀라마이신(duramycin) (흡입형, 낭포성 섬유증), SCV-07, OPI-45, 엔도스타틴(Endostatin), 안지오스타틴(Angiostatin), ABT-510, 보우만 비르크(Bowman Birk) 저해제 농축물, XMP-629, 99 mTc-하이닉-아넥신 V, 카할라라이드(kahalalide) F, CTCE-9908, 테베렐릭스(teverelix) (연장 방출), 오자렐릭스(ozarelix), 로르니덱신(rornidepsin), BAY-504798, 인터류킨 4, PRX-321, 펩스칸(Pepscan), 이보크타데킨(iboctadekin), 락토페린(rhlactoferrin), TRU-015, IL-21, ATN-161, 실렌지타이드(cilengitide), 알부페론(Albuferon), 비파식스 (Biphaxis), IRX-2, 오메가 인터페론, PCK-3145, CAP-232, 파시레오타이드(pasireotide), huN901-DMI, 난소암 면역치료용 백신, SB-249553, 온코박스(Oncovax)-CL, 온코박스-P, BLP-25, 세르박스-16, 다중-에피토프 펩티드 흑색종 백신 (MART-1, gp100, 티로시나제), 님피타이드(nemifitide), rAAT (흡입용), rAAT (피부용), CGRP (흡입용, 천식), 페그수네르셉트(pegsunercept), 티모신베타4, 플리타덱신(plitidepsin), GTP-200, 라모플라닌 (ramoplanin), GRASPA, OBI-1, AC-100, 연어 칼시토닌 (경구용, 엘리젠), 칼시토닌(경구용, 골다공증), 엑사모렐린(examorelin), 카프로모렐린(capromorelin), 카르데바(Cardeva), 벨라페르민(velafermin), 131I-TM-601, KK-220, T-10, 울라리타이드(ularitide), 데펠레스타트(depelestat), 헤마타이드(hematide), 크리살린 (Chrysalin) (국소용), rNAPc2, 재조합 인자 V111 (PEG화 리포솜성), bFGF, PEG화 재조합 스태필로키나제 (staphylokinase) 변이체, V-10153, 소노라이시스 프롤라이제(SonoLysis Prolyse), 뉴로박스(NeuroVax), CZEN-002, 취도 세포(islet cell) 신생 요법, rGLP-1, BIM-51077, LY-548806, 텍세나타이드(exenatide) (조절방출,

메디소브), AVE-0010, GA-GCB, 아보렐린(avorelin), ACM-9604, 리나클로티드 o에아세테이트(naclotid eacetate), CETi-1, 헤모스판(Hemospan), VAL (주사제), 신속-작용 인슐린 (주사용, Viadel), 비강내 인슐린, 인슐린 (흡입용), 인슐린 경구용, 엘리젠), 제조합 메티오닐 인간 렙틴, 프피트라킨라(trakinra) (피하주사, 슝진), 피트라킨라 (흡입형 건조 분말, 천식), 멀티킨(Multikine), RG-1068, MM-093, NBI-6024, AT-001, PI-0824, Org-39141, Cpn10 (자가면역 질환/염증), 탈락토페린(talactoferrin) (국소용), rEV-131 (안과용), rEV-131 (호흡기 질환), 경구용 제조합 인간 인슐린 (당뇨병), RPI-78M, 오프렐베킨(oprelvekin) (경구용), CYT-99007 CTLA4-Ig, DTY-001, 발라테그라스트(valategrast), 인터페론 알파-n3 (국소용), IRX-3, RDP-58, 타우페론(Tauferon), 담즙 염 자극 리파아제, 메리스파제(Merispase), 알라닌 포스파타제, EP-2104R, 멜라노탄-II, 브레멜라노타이드(bremelanotide), ATL-104, 제조합 인간 마이크로플라스민(microplasmin), AX-200, SEMAX, ACV-1, Xen-2174, CJC-1008, 다이노르핀(dynorphin) A, SI-6603, LAB GHRH, AER-002, BGC-728, 말라리아 백신 (바이로솜, PeviPRO), ALTU-135, 파르보바이러스 B19 백신, 인플루엔자 백신 (제조합 뉴라미니다제), 말라리아 /HBV 백신, 안트락스 백신, Vacc-5q, Vacc-4x, HIV 백신 (경구용), HPV 백신, 타트 독소이드(Tat Toxoid), YPSL, CHS-13340, PTH(1-34) 리포솜 크립 (노바솜), 오스탈린-(Ostabolin)-C, PTH 유사체 (국소용, 건선), MBRI-93.02, MTB72F 백신 (폐결핵), MVA-Ag85A 백신 (폐결핵), FARA04, BA-210, 제조합 플라그 FIV 백신, AG-702, OxSODrol, rBetV1, Der-p1/Der-p2/Der-p7 알레르겐-표적화 백신 (집먼지 진드기 알레르기), PR1 펩티드 항원 (백혈병), 돌연변이 ras 백신, HPV-16 E7 리포솜티드 백신, 라비린틴(labyrinthin) 백신 (선암; adenocarcinoma), CML 백신, WT1-펩티드 백신 (암), IDD-5, CDX-110, 펜트리스(Pentrys), 노렐린(Norelin), CytoFab, P-9808, VT-111, 이크로캡티드(icrocaptide), 텔베르민(telbermin)(피부과, 당뇨발 궤양), 루핀트리 비르(rupintrivir), 레티쿨로스(reticulose), rGRF, HA, 알파-갈락토시다제 A, ACE-011, ALTU-140, CGX-1160, 안지오텐신 치료 백신, D-4F, ETC-642, APP-018, rhMBL, SCV-07 (경구용, 폐결핵), DRF-7295, ABT-828, ErbB2-특이적 이뮤노톡신 (항암제), DT3SSIL-3, TST-10088, PRO-1762, 콤보톡스(Combotox), 콜레사이스토키닌-B/가스 트린-수용체 결합 펩티드, 111In-hEGF, AE-37, 트라스니주맙(trasnizumab)-DM1, 길항제 G, IL-12 (제조합체), PM-02734, IMP-321, rhIGF-BP3, BLX-883, CUV-1647 (국소용), L-19 계 방사면역치료제 (암), Re-188-P-2045, AMG-386, DC/1540/KLH 백신 (암), VX-001, AVE-9633, AC-9301, NY-ESO-1 백신 (펩티드), NA17.A2 펩티드, 흑색 종 백신 (펄스 항원 치료제), 전립선암 백신, CBP-501, 제조합 인간 락토페린 (안구건조증), FX-06, AP-214, WAP-8294A (주사제), ACP-HIP, SUN-11031, 펩티드 YY [3-36] (비만, 비강내 투여), FGLL, 아타시셉트 (atacicept), BR3-Fc, BN-003, BA-058, 인간 부갑상선 호르몬 1-34 (비강, 골다공증), F-18-CCR1, AT-1100 (복강 질환/당뇨병), JPD-003, PTH(7-34) 리포솜 크립 (노바솜), 듀라마이신 (안과용, 안구건조증), CAB-2, CTCE-0214, 글리코PEG화 에리트르톨트로포이틴, EPO-Fc, CNTO-528, AMG-114, JR-013, 인자 XIII, 아미노칸딘 (aminocandin), PN-951, 716155, SUN-E7001, TH-0318, BAY-73-7977, 테베렐릭스 (즉시 방출), EP-51216, hGH (조절 방출, Biosphere), OGP-I, 시푸비르타이드(sifuvirtide), TV4710, ALG-889, Org-41259, rhCC10, F-991, 티모펜틴(thymopentin) (폐질환), r(m)CRP, 간 선택적 인슐린, 수발린(subalin), L19-IL-2 융합 단백질, 엘라 핀(elafin), NMK-150, ALTU-139, EN-122004, rhTPO, 트롬보포이에틴 수용체 작용제 (혈소판 감소성 장애), AL-108, AL-208, 신경 성장인자 길항제 (통증), SLV-317, CGX-1007, INNO-105, 경구형 테리파라타이드 (엘리젠), GEM-OS1, AC-162352, PRX-302, LFn-p24 융합 백신 (테라포어), EP-1043, S 페럼 소아 백신, 말라리아 백신, 나 이세리아 수막염 B군 백신, 신생아 B군 스트렙토코쿠스 백신, 탄저병 백신, HCV 백신 (gpE1+gpE2+MF-59), 중이 염 치료, HCV 백신 (코어 항원+ISCOMATRIX), hPTH(1-34) (경피성, ViaDerm), 768974, SYN-101, PGN-0052, 아비 스쿰닌(aviscumnine), BIM-23190, 폐결핵 백신, 다중-에피토프 티로시나제 펩티드, 암 백신, 엔카스팀, APC-8024, GI-5005, ACC-001, TTS-CD3, 혈관-표적 TNF (고형 종양), 테스모프레신(desmopressin) (경구 조절-방 출), 오너셉트(onercept), 및 TP-9201 등이 있다.

[0130] 일부 실시예에서, 폴리펩티드는 아달리무맙 (HUMIRA), 인플릭시맙 (REMICADE™), 리툽시맙 (RITUXAN™ /MABTHERA™) 에타너셉트(ENBREL™), 베바시주맙(AVASTIN™), 트라스투주맙(HERCEPTIN™), 페그릴라스트림 (NEULASTA™), 또는 바이오시밀러 및 바이오베터(biobetter)를 포함하는 임의의 다른 적합한 폴리펩티드이다.

[0131] 다른 적합한 폴리펩티드는 하기 표 6 및 US2016/0097074의 표 1에 열거된 것들 이다. 당업자는 본 발명의 개시 내용이 본원에 기재된 바와 같은 생산물 및/또는 접합체의 조합을 포함할 수 있음을 이해할 수 있다((즉, 다-단 백질, 변형 단백질 (PEG, 독소, 기타 활성 성분과 결합)).

표 6

[0132]	단백질 산물 인터페론 감마-1b	참조약물 목록 악티뮴(Actimmune) [®]
--------	-----------------------------	---

알테플라제, 조직 플라스미노겐 활성화제	악티바제(Activase) [®] /카트플로(Cathflo) [®]
재조합 항혈우병 인자	아드베이트(Advate)
인간 알부민	알부테인(Albutein) [®]
라로니다제	알두라자임(Aldurazyme) [®]
인터페론 알파-N3, 인간 백혈구 유래	알페론(Alferon) N [®]
인간 항혈우병 인자	알파네이트(Alphanate) [®]
바이러스-여과된 인간 응집 인자 IX	알파나인(AlphaNine) [®] SD
알레파셉트; 재조합 이량체 융합 단백질 LFA3-Ig	아메비브(Amevive) [®]
비발리루딘	안지오맥스(Angiomax) [®]
다르베포에틴 알파	아라네스프(Aranesp) [™]
베바씨주맵	아바스틴(Avastin) [™]
인터페론 베타-1a; 재조합체	아보넥스(Avonex) [®]
응집 인자 IX	베네피크스(BeneFix) [™]
인터페론 베타-1b	베타세론(Betaseron) [®]
토시투모맵	벡사르(BEXXAR) [®]
항혈우병 인자	바이오클레이트(Bioclate) [™]
인간 성장 호르몬	바이오토포핀(BioTropin) [™]
보툴리눔 독소 A형	보톡스(BOTOX) [®]
알렘투주맵	캄파스(Campath) [®]
아크리투모맵; 테크네튬-99 표지됨	CEA-스칸(Scan) [®]
알글루세라제; 변성 형태의 베타-글루코세레브로시다제	세레다제(Ceredase) [®]
이미글루세라제; 재조합 형태의 베타-글루코세레브로시다제	세레자임(Cerezyme) [®]
크로탈리다제 다가 면역 과브 [양]	크로팜(CroFab) [™]
디곡신 면역 과브 [양]	디지팜(DigiFab) [™]
라스부리카제	엘리텍(Elitek) [®]
에타네르셉트	엔브렐(ENBREL) [®]
에포이에틴 알파	에포젠(Epogen) [®]
세톡시맵	에르비톡스(Erbix) [™]
알가시다제 베타	파브라자임(Fabrazyme) [®]
우르폴리트로핀	페리닉스(Ferinx) [™]
폴리트로핀 베타	폴리스티움(Follistim) [™]
테리파라타이드	포르테오(FORTEO) [®]
인간 소마트로핀	게노트로핀(GenoTropin) [®]
글루카곤	글루카젠(GlucaGen) [®]
폴리트로핀 알파	고날(Gonal)-F [®]
항혈우병 인자	헬릭사이트(Helixate) [®]

항혈우병 인자; 인자(XIII)	헤모필(HEMOFIL)
아데포비르 디피복실	헵세라(Hepsera) TM
트라스투주맙	헤르셉틴(Herceptin) [®]
인슐린	휴말로그(Humalog) [®]
항혈우병 인자/본 빌레브랜트 인자 복합체-인간	휴메이트(Humate)-P [®]
소마트로핀	휴마트로페(Humatrope) [®]
아달리무맙	휴미라(HUMIRA) TM
인간 인슐린	휴물린(Humulin) [®]
재조합 인간 히알루로니다제	하일레넥스(Hylenex) TM
인터페론 알파콘-1	인페르젠(Infergen) [®]
에피티피바타이드	인테그릴린(Integrilin) TM
알파-인터페론	인트론(Intron) A [®]
팔리페민	케피반스(Kepivance)
아나킨라	키네렛(Kineret) TM
항혈우병 인자	코게네이트(Kogenate) [®] FS
인슐린 글라진	란투스(Lantus) [®]
과립구 마크로파지 콜로니-모사 인자	류킨(Leukine) [®] / 류킨(Leukine) [®] 액상제
루트로핀 알파 주사제	루베리스(Luveris)
OspA 리포단백질	라이메릭스(LYMERix) TM
라니비주맙	루센티스(LUCENTIS) [®]
갬투주맙 오조가미신	마일로타르그(Mylotarg) TM
갈수과제	나글라자임(Naglazyme) TM
네시리타이드	나트레코르(Natrecor) [®]
페그필그라스티م	네우라스타(Neulasta) TM
오프렐베킨	네우메가(Neumega) [®]
필그라스티م	네우포젠(Neupogen) [®]
파놀레소맙	뉴트로스펙(NeutroSpec) TM (옛이름, 레우테크(LeuTech) [®])
소마트로핀 [rDNA]	노르디트로핀(Norditropin) [®] / 노르디트로핀 노르디플렉스 (Norditropin Nordiflex) [®]
미톡산트론	노반트론(Novantrone) [®]
인슐린; 아연 현탁액	노볼린(Novolin) L [®]
인슐린; 이소판 현탁액	노볼린(Novolin) N [®]
인슐린, 일반형	노볼린(Novolin) R [®]
인슐린	노볼린(Novolin) [®]
응집 인자 VIIa	노보세븐(NovoSeven) [®]
소마트로핀	누트로핀(Nutropin) [®]

면역글로불린 정맥주사제	옥타감(Octagam) [®]
PEG-L-아스파라기나제	온카스파르(Oncaspar) [®]
아바타셉트, 완전 용해형 인간 융합 단백질	오렌시아(Orencia) [™]
무로모맵-CD3	오르토클론(Orthoclone) OKT3 [®]
고분자량 히알루론산	오르토비스크(Orthovisc) [®]
인간 융모막 고나드로핀	오비드렐(Ovidrel) [®]
체내 감퇴 바실러스 칼메트-구에린	파시스(Pacis) [®]
페그 인터페론 알파-2a	페가시스(Pegasys) [®]
인터페론 알파-2b의 페길레이트화 버전	PEG-인트론(Intron) [™]
아바렐릭스(주사용 현탁액); 고나도트로핀-방출 호르몬 길항제	플레낙시스(Plenaxis) [™]
에포이에틴 알파	프로크리트(Procrit) [®]
알데스류킨	프롤류킨(Proleukin), IL-2 [®]
소마트렘	프로트로핀(Protropin) [®]
도르나제 알파	플모자임(Pulmozyme) [®]
에팔리주맵; 선택형 가역성 T-세포 차단제	랍티바(RAPTIVA) [™]
리바비린과 알파 인터페론의 조합물	레벤투론(Rebetron) [™]
인터페론 베타 1a	레비프(Rebif) [®]
항혈우병 인자	리콤비네이트(Recombinate) [®] rAHF
항혈우병 인자	레팩토(ReFacto) [®]
레피루딘	레플루단(Refludan) [®]
인플릭시맵	레미케이드(Remicade) [®]
아비식시맵	레오프로(ReoPro) [™]
레테플라제	레타바세(Retavase) [™]
리투시마	리투산(Rituxan) [™]
인터페론 알파-2 ^a	로페론(Roferon)-A [®]
소마트로핀	세이젠(Saizen) [®]
합성 돼지 세크레틴	세크로플로(SecreFlo) [™]
바실릭시맵	시물렉트(Simlect) [®]
에쿨리주맵	솔리리스(SOLIRIS) [®]
페그비소만트	소마베르트(SOMAVERT) [®]
팔리비주맵; 재조합 생성, 인간화 mAb	사이나기스(Synagis) [™]
타이로트로핀 알파	타이로젠(Thyrogen) [®]
테네크테플라제	TNK카제(TNKase) [™]
나탈리주맵	타이사브리(TYSABRI) [®]
인간 면역글로불린 정맥주사용 5% 및 10% 용액	베노글로불린(Venoglobulin)-S [®]
인터페론 알파-n1, 림프아구	웰페론(Wellferon) [®]

드로트레코긴 알파	자이그리스(Xigris) TM
오말루주맵; 재조합 DNA-유래의 인간화 단클론 항체 표적화 면역글로불린-E	졸라이르(Xolair) [®]
다칼리주맵	제나팍스(Zenapax) [®]
이브리투모맵 티옥세탄	제발린(Zevalin) TM
소마토트로핀	조르브티브(Zorbtive) TM (세로스팀 (Serostim) [®])

[0133] 실시예에서, 폴리펩티드는 표 7에 나타난 바와 같은 호르몬, 혈액 응고/응고 인자, 사이토카인/성장 인자; 항체 분자, 융합 단백질, 단백질 백신, 또는 펩티드이다.

표 7

예시적인 제품

[0134]

치료제 종류	제품	상표명
호르몬	에리트르포이에틴, 에포에인-α 다르베포이에틴-α 성장 호르몬(Growth hormone, GH), 소마토트로핀 인간 각질-자극 호르몬(follicle-stimulating hormone, FSH) 인간 융모막 고나도트로핀 루트로핀-α 글루카곤 성장 호르몬 방출 호르몬 (Growth hormone releasing hormone, GHRH) 세크레틴 갑상선 자극 호르몬 (Thyroid stimulating hormone, TSH), 타이로트로핀	에포젠, 프로크리트 아라네스프 게노트로핀, 휴마트로프, 노르디트로핀, 노브IV비트로핀, 뉴트로핀, 움니트로프, 프로트로핀, 시아젠, 세로스팀, 발트로핀, 고날-F, 폴리스팀 오비드렐, 루베리스 GlcaGen 제레프 치로스팀 (인간 펩티드), 세크레플로 (돼지 펩티드) 타이로젠
혈전/응집 인자	인자 VIIa 인자 VIII 인자 IX 항트롬빈 III (AT-III) 단백질 C 농축물	노보세븐 바이오클레이트, 헬릭세이트, 코제네이트, 리콤비네이트, 레팍토 베네픽스 트롬베이트 III 세프로틴
사이토카인/성장 인자	제 1형 알파-인터페론 인터페론-αn3 (IFN αn3) 인터페론-β1a (rIFN-β) 인터페론-β1b (rIFN-β) 인터페론-γ1b (IFN γ) 알데스류킨 (인터류킨 2(IL2), 표피 흉선세포 활성화 인자; ETAF) 팔리페르민 (각질세포 성장 인자; KGF) 베카플레민 (혈소판-유래 성장 인자; PDGF) 아나킨라 (재조합체 IL1 길항제)	인페르젠 알페론 N 아보넥스, 레비프 베타세론 악티뮴 프로류킨 케피반스 레그라넥스 안틸, 키네렛

<p>항체 분자</p>	<p>베바시주맵 (VEGFA mAb) 세특시맵 (EGFR mAb) 파니투무맵 (EGFR mAb) 알렘투주맵 (CD52 mAb) 리톡시맵 (CD20 키메릭 Ab) 트라스투주맵 (HER2/Neu mAb) 아바타셉트 (CTLA Ab/Fc 융합물) 아달리무맵 (TNF α mAb) 에타네르셉트 (TNF 수용체/Fc 융합물) 인플릭시맵 (TNF α 키메릭 mAb) 알레과셉트 (CD2 융합 단백질) 에팔리주맵 (CD11a mAb) 나탈리주맵 (인테그린 α4 서브유닛 mAb) 에쿨리주맵 (C5mAb) 무로모넵-CD3</p>	<p>아바스틴, 에르비투스 벡티빅스 캄파스 리톡산 헤르셉틴, 오렌시아 휴미라, 엔브렐 레미케이드 아메비브 랍티바, 타이사브리 솔리리스, 오르토클론, OKT3</p>
<p>기타: 융합 단백질/단백질 백신/펩티드</p>	<p>인슐린 헤파티티스 B 표면 항원 (HBsAg) HPV 백신 OspA 항-붉은털 원숭이(Rh) 면역글로불린 G 엔푸비르타이드 스파이더 실크, 가령, 피브리온</p>	<p>휴몰린, 노볼린 엔제릭스, 레콤비박스 HB 가르다실 라임에릭스 로파일락 푸제온 QMONOS</p>

[0135] 실시예에서, 단백질은 다중특이적 단백질, 예를 들어, 표 8에 나타난 바와 같은 이중특이적 항체이다.

[0139] 이러한 접근법에서 mAb 유전자는 랜딩 패드 A 및 B 둘 다를 표적으로 할 수 있다. 폴의 균질성은 단백질 A HPLC에 의한 상청액의 FACS 분류 및 분석에 의해 결정될 수 있다.

[0140] 2 단계: 대다수의 차세대 항체 (예: 4가 이중특이적 항체)의 경우 여러 중쇄 또는 경쇄의 조립은 반복되는 문제이다. 원치 않는 불순물이 거의 없는 최적의 생산물 품질을 얻으려면 안정하고 재현 가능한 4개의 항체 사슬을 발현하는 적절한 CHO클론의 선택이 유리하다. 결과적으로 클론 선택시 ELISA, RP-HPLC 또는 CD-SDS를 활용하는 대량의 제품 분석이 종종 필요하다. 그러나, 다수의 RTS를 포함하는 세포주에서, 다중 사슬 단백질을 암호화하는 유전자는 개별 프로모터로 공간적으로 2개의 부위에 걸쳐 분리된다. 이것은 개개의 사슬의 카피 수 및 상대적인 발현이 형질주입체 풀만큼 일찍 일관되고 엔코딩 전사 단위의 프로모터 강도 또는 카피 수 조작을 통해 개별 폴리펩타이드 쇄의 이용 가능성을 실험적으로 미세 조정할 수 있게 한다. 이것의 장점은 생산물 품질이 보다 일관되어 SSI 생성 풀과 세포주에서 생산된 잘못 접힌 다중 사슬 재조합 단백질의 비율을 줄임으로써 초기 평가의 필요성을 극적으로 회복한다는 것이다. 테스트 분자: 세르구투맙 아무나류킨(cergutumab amunaleukin).

[0141] 3 단계: CHOK1SV GS-KO™ 세포주의 분비 능력을 확장시키는 내인성 단백질의 발현은 제품 역가를 증가시키는 입증된 접근법이다. 후보물질은 PCT 출원 WO2015018703 A1로부터 확인될 수 있고, 표 9 및 10의 후보는 다수의 별개의 재조합 표적 부위 (RTS)를 포함하는 세포주에서 평가될 수 있다. 생성물 역가는 단백질 A HPLC에 의해 측정될 수 있고 항체 어셈블리는 SDS-PAGE 및 IEF에 의해 평가될 수 있다. 테스트 분자: 리톡시맙, cB72.3, 인플릭시맙 및 에타너셉트.

표 9

단계	근거	치료 단백질	보조 유전자
1	qP를 증가시키기 위한 다중 SSI의 mAb 유전자	리톡시맙, cB72.3 및 .H3IK5 등	N/A
2	SSIS로부터 발현된 이중 특이적 mAb 및 > 2 사슬 DtE 유전자	세르구투주맙 아무나류킨 등.	N/A
3	DtE의 제품 품질을 높이기 위한 보조 유전자 발현	인플릭시맙 등.	본원에 참고로 포함된 미국 특허 제 62 / 322,621 호에서 확인된 후보자로부터의 지질 유전자, 도 20에서 발견되는 miRNA 스폰지 벡터, 및 임의의 혈액 인자 프로테아제.

표 10

miR	표적 유전자 (3'UTR에서의 miR 결합 부위)	스폰지 서열 (유전자 3'UTR에서의 miR 표적 서열)	3'UTR 표적 부위의 복제
miR-15b and miR-16-1	CPEB2A	5'-aggggcaacacagctctgctgcta-3'	1, 3, 6, 9 및 12
miR-15b and miR-16-1	CPEB2B	5'-aagctgtattagctttgctgcta-3'	
miR-34c	SRPR α	5'-taatcatgttacaatcactgcc-3'	
miR-708	CNTFR	5'-caccatcagattataagctcctg-3'	
miR-186	EIF3A	5'-cagtcctaaattgaattcttta-3'	

[0144] 실시예

[0145] 실시예1: CHK1SV GS-KO™에서 아데노바이러스 5 바이러스 공동-감염을 통한 일시적 AAV 생산

[0146] CHOK1SV GS-KO™ (Lonza, Slough, UK) 세포가 생물학적으로 rAAV 벡터 단백질을 생산하고 조립할 수 있는지를 결정하기 위해, CHOK1SV GS-KO™ 세포를 2개의 플라스미드-pRC2-mi342 (6234, Clontech) 및 pAAV-GFP (AAV-400, Cell Biolabs), 대조군 벡터(카탈로그 번호: AAV-400 Cell Biolabs, 미국 샌디에고) (도 6), wt Ad5 바이러스(미국 카탈로그 번호: ATCC® VR-1516™, American Type Culture Collection, Manassas, 미국) 존재 하에 (AAV-400, Cell Biolabs) 형질주입시켰다. 자연 조건 하에서, CHOK1SV GS-KO™ 세포는 양이온성 형질주입 시약 (리포펙타민 또는 PEI)의 존재 하에 바이러스 수용체가 없기 때문에 아데노바이러스를 수용하지 못한다; 음으로 하전된 아데노바이러스 5는 CHOK1SV GS-KO™ 세포로 들어갈 수 있어 모든 헬퍼 요소를 제공한다. 이 개념은

CHOK1SV GS-KO™ 세포에 모든 요소 (형질주입에 의한 Rep-Cap 및 GOI 및 감염에 의한 Ad5 요소)가 제공되는 이 평가 실험을 설계하는데 사용되었다. 형질주입/감염 72시간 후에 세포를 수거하고 4회 동결/해동주기를 거친 후 용해시키고, 이어서 임의의 플라스미드 DNA를 용해시키는(digest) 벤조나아제 처리를 수행하였다. 용해물을 AAV 역가에 대해 qPCR에 의해 시험하고, 전이유전자 (녹색 형광 단백질-GFP) 발현에 대한 HEK293의 형질도입 효율에 대해 시험하였다. 이 실험을 위한 대조군으로서, 부착성 HEK293 세포가 사용되었고 HEK293 삼중 형질주입 (pHelper (6234, Clontech), pRC2-mi342 (6234, Clontech), pAAV-GFP (AAV-400, Cell Biolabs)로부터의 세포 용해물 (도 6)은 pRC2-mi342 (6234, Clontech), pAAV-GFP로 형질주입되고 wt Ad5로 감염된 CHOK1SV GS-KO™ 세포와 동일하게 분석되었다. 이 실험의 실험 개요와 결과는 도 1에 도시되었다. 형질주입 후 CHOK1SV GS-KO™ 세포에서 녹색 형광이 검출되어 성공적인 형질주입을 나타냈다(도 1B, 왼쪽 패널). 형질주입 후 CHOK1SV GS-KO™ 세포 용해물을 사용하여 HEK293 세포를 형질도입하였고, 녹색 형광은 비록 낮지만 (도 1B, 오른쪽 패널) HEK293 세포에서 검출되었으며, AAV의 낮은 수준의 생성을 시사한다. qPCR 데이터는 6.8E+09 vg/mL의 AAV 역가를 보여 준다(도 1C). 삼중 형질주입 갖는 양성 대조군 HEK293은 예상대로 1.8e+12의 더 높은 AAV 역가를 생성하였고 음성 대조군인 HEK293 GFP 형질주입에서 AAV가 생성되지 않았다. 요약하면, 이것은 CHOK1SV GS-KO™ 세포가 AAV 패키징에 필요한 모든 알려진 계놈 요소가 제공될 때 AAV를 생산할 수 있음을 보여주는 최초의 알려진 실험이다.

[0147] 실시예2: 바이러스 공동-감염없이 CHOK1SV GS-KO™에서 일시적인 rAAV 생성 CHOK1SV GS-KO™ 세포가 wt Ad5 바이러스가 없는 상태에서 rAAV를 생산할 수 있는지를 결정하기 위해 세포는 Howe *et al.*, 2005와 유사한 접근법으로 Ad5 E1A 및 E1B를 발현하도록 조작되었다. TET-on 프로모터 (pMF30, 도 2)의 제어 하에 E1A, 구성적인 인간 CMV 프로모터 (pMF23, 도 3) 및 Ad5 E1A-E1B 오픈 리딩 프레임(pXC17.4_17AV5PerProKZ, 도 4)의 제어하에 E1B를 발현하는 플라스미드 구조물이 생성되었다. CHOK1SV GS-KO™ 유래 풀은 pMF30으로 형질주입시키고 50 μM L-MSX가 보충된 글루타민이 없는 배지에서 생존할 수 있는 세포를 선택하여 생성되었다 (도 5A). 이 CHOK1SV GS-KO™ E1A를 pMF23으로 형질주입시키고 50 μM L-MSX 및 10 μg/mL 프로마이신(Puromycin)이 보충된 글루타민이 없는 배지에서 생존할 수 있는 세포를 선택했다(도 5A). 물 제어는 모든 계놈 DNA PCR에서 오염되었으나, E1A PCR 생성물은 HEK293F 및 HEK293L 세포 및 pXC17.4_17AV5PerProKZ에서 증폭된 것이 분명하다(도 1B). CHOK1SV GS-KO™ MOCK (MOCK) 및 CHOK1SV GS-KO™ E1A E1B (E1A E1B) 풀을 독시사이클린 (2 μg/ml)을 0 (처리되지 않음), 2, 3, 4 및 7 일 처리하여 TET 프로모터 및 E1A 전사를 활성화했고, 그리고 나서 E1A (도 1D) 및 E1B (도 1E) 용 프라이머를 사용하여 역전사 PCR을 위해 mRNA를 분리하였다. 결과는 독시사이클린으로 처리된 CHOK1SV GS-KO™ E1A E1B 풀 및 HEK293L 세포에서 더 높은 수준의 E1A 243R 및 E1A 171R을 보여준다. 독시사이클린 처리 후 E1B mRNA 생성물의 양은 변하지 않았지만, HEK293L 세포에서는 현저하게 더 높았다. 독시사이클린으로 7일 동안 처리된 CHOK1SV GS-KO™ E1A E1B 풀 (E1A 리리에서 E1A 단백질이 검출되었으며, CHOK1SV GS-KO™ MOCK (MOCK) 단백질 용해물에서는 검출되지 않았다(도 5F). 이 풀 CHOK1SV GS-KO™ E1A_E1B는 독시사이클린 (2 μg/ml)의 유무에 관계없이 rAAV를 생성하는 능력에 대해 시험되었다. E1A 및 E1B 단백질의 높은 발현을 보장하기 위해, CHOK1SV GS-KO™ 세포에서 E1A-E1B 플라스미드 (pXC17.4_17AV5PerProKZ, 도 4)의 일시적 형질주입도 수행하였다. 이들 데이터는 E1A 단백질 발현이 wt Ad 감염에 대한 요구없이 CHO에서 달성될 수 있음을 보여준다. E1B 통합 및 발현 확인은 더 어려웠다.

[0148] 실시예3: 바이러스 공동-감염없이 CHOK1SV GS-KO™ 및 HEK293에서 영구 rAAV 생산.

[0149] 제조합 CHOK1SV™ 세포주(Fer1L4, NL1, 2, 3, 4, 5 및 6(예를 들어, WO2013190032A1 및 EP2711428A1 참조))로부터 확인된 유전자 좌위로서 RMCE 뒤에 적합한 랜딩 패드를 CHOK1SV GS-KO™ 및 HEK293 계놈에 통합시켰다. 이 랜딩 패드 내의 요소 배열의 개략도는 그림 7A, B 및 C에 표시되어 있다. SV40E 프로모터와 선택 마커 사이에 Frt 부위를 배치하면 후속 라운드의 RMCE에서 사용할 수 있다. 호환되지 않는 Frt 부위 (A, B, C, D, E 및 F)와 다른 리포트/선택 마커를 사용하면 부위 주소를 독립적으로 지정할 수 있다. 도 8은 1 (도 8A), 2 (도 8B) 및 3 (도 8C) 부위 CHO- 및 HEK293- 유래 SSI 세포주에서 RMCE 후 AAV, Ad5 및 GOI 유전자의 다양한 배열을 보여준다. HEK293 SSI 숙주를 생성하기 위해, CHOK1SV 유래 벡터 통합 부위 및 랜딩 패드 위치는 캘리포니아 산타크루즈 대학교(UCSC) 인간 계놈 데이터베이스의 독립형 사본을 사용하여 인간 계놈 (버전: Mar. 2006 (NCBI36/hg18))에 대해 BLAT 검색하였다. 이는 CHOK1SV 서열의 25개 이상의 염기쌍에서 95% (및 그 이상) 유사성의 서열을 식별한다. 유사 지역은 IGV 뷰어 (Broad Institute 버전 2.4)에서 시각화되었다. Crispr-Cas9 gRNA는 자사의 Crispr-Cas9 디자인 도구를 사용하여 디자인되었다. CHOK1SV 및 HEK293 유전자 좌위가 표 5에 요약되어 있다.

[0150] 실시예4: CHOK1SV GS-KO™에서 rAAV 생산을 향상시키기 위한 보조 유전자 발현

- [0151] 포유동물 선천 면역 시스템은 바이러스 특징을 인식함으로써 바이러스 감염을 감지하고 강력한 항 바이러스 반응 (예: RIG-1 IFN α 반응)을 활성화 시킨다. RNA 침묵 또는 RNA 간섭 (RNAi)이 포유동물 세포에서 항 바이러스 메커니즘으로 작용한다는 증거가 축적되고 있다. 포유동물 바이러스는 인플루엔자 NS1 단백질 및 백시니아 바이러스 E3L 단백질과 같은 IFN 길항제를 암호화한다(예를 들어, de Vries et al, *Gene Ther.*, 15:545-52 (2008), 이는 PKR을 억제하고, 백시니아 바이러스-인코딩된 가용성 IFN-알파/베타 수용체 디코이는 감염된 세포에서 IFN 반응을 방해한다. IFN 길항제의 공동-발현은 실시예 2 및 3에서 관찰된 불량한 Ad5 및 AAV 유전자 발현을 극복하기 위한 가능한 접근법으로서 조사될 수 있다.
- [0152] 실시예5: 부위 별 통합을 사용하여 CHOK1SV GS-KOTM에서 rAAV 생산
- [0153] 1절: 이중 랜딩패드 CHOK1SV GS-KOTM SSI 숙주의 구성
- [0154] CHOK1SV GS-KOTM SSI 숙주는 CHOK1SV GS-KOTM 숙주의 게놈에 2개의 랜딩 패드를 삽입하여 생성되었다(도 9). 랜딩 패드 A는 Fer1 L4 유전자에 위치하고 (표 11 참조) SV40 초기 프로모터 (SV40E), 하이그로마이신 포스포트랜스퍼라제-eGFP 융합 유전자 (Hpt-eGFP) 및 SV40 폴리아데닐화 서열 (pA)로 구성된다. Hpt-eGFP 유전자 및 SV40 pA는 호환되지 않는 Frt 부위 (각각 Frt₅ 및 Frt_{wt}) 에 의해 측면에 위치하여 재조합 유전자의 RMCE를 CHOK1SV GS-KOTM 게놈으로 촉진시킨다. 랜딩 패드 B는 NL1 유전자 좌위에 위치하고 (표 5 참조) SV40 초기 프로모터 (SV40E), 퓨로마이신(puromycin) N-아세틸트랜스퍼라제-DsRed 융합 유전자 (PAC-DsRed) 및 SV40 폴리아데닐화 서열 (pA)로 구성된다. PAC-DsRed 유전자 및 SV40 pA는 호환되지 않는 Frt 부위 (각각 Frt₁₄ 및 Frt₁₅)에 의해 측면에 위치된다. 두 랜딩 패드에서 SV40E 프로모터와 선택 마커 사이에 Frt 부위를 배치하면 후속 라운드의 RMCE에서 사용할 수 있다. CHOK1SV GS-KOTM SSI 숙주에서 RMCE를 위해 설계된 표적화 벡터에는 대상 랜딩 패드와 호환되는 Frt 사이트의 3'에 즉시 배치된 양성 선택 마커 (예: GS)가 포함되어 있다 (도 9). 벡터의 나머지 부분은 GOI에 대한 전사 단위를 포함하고, 랜딩 패드의 제2 Frt 부위와 호환되는 Frt 부위를 포함한다. 표적화 벡터 DNA (도 10)는 Flp 재조합 효소를 발현하는 벡터와 함께 형질주입된다. 형질주입된 세포를 24 시간 동안 배양한 후, 선택 압력을 가한다(예를 들어, 배양 배지로부터 글루타민의 제거). 성공적인 RMCE는 Hpt-eGFP 또는 PAC-DsRed 유전자의 손실 및 양성 선택 마커 유전자로의 대체에 의해 나타난다. 형광 현미경 또는 유세포 분석기로 세포가 어떻게 나타난다. FACS는 양성 선택에서 회복되는 비-교환 세포를 쉽게 제거한다.
- [0155] 2절: CHOK1SV GS-KOTM SSI 숙주와 호환되는 Rep-Cap 및 GOI 발현 벡터 제작
- [0156] Rep-Cap 및 GOI 유전자를 모두 발현하는 CHOK1SV GS-KOTM SSI 숙주 유래 풀을 생성하기 위해(도 9), 5개의 벡터가 설계되었다(pLMC31-35, 도 10A 내지 E). pLMC31 (도 10A)은 CHOK1SV GS-KOTM SSI 숙주에서 GOI (eGFP) 생산 세포주를 생성하기 위한 표적 벡터이다. eGFP의 전사는 hCMV 주요 중간 초기 유전자 1(hCMV)의 프로모터에 의해 구동되고 β -글로빈 폴리아데닐화 (pA) 서열을 사용한다. 전체 전사 카세트는 바이러스 복제 및 캡슐화에 필요한 유일한시스-작용 요소인 역 말단 반복 (ITR)에 의해 측면에 위치한다. 네오마이신 포스포트랜스퍼라제 I(npt1) 유전자는 Frt₁₄의 3'에 즉시 배열되고 NL1 유전자 좌위의 랜딩 패드에 위치한 SV40E 프로모터에 의해 성공적으로 RMCE 전사된다. pLMC32 내지 35(도 10B 내지 E)는 CHOK1SV GS-KOTM SSI 숙주에서 AAV Rep-Cap 생산 세포주를 생산하기 위한 AAV p5 프로모터의 상이한 형태를 갖는 Rep-Cap 발현 카세트를 함유하는 벡터를 표적화하고 있다(도 10B 내지 E). 야생형 p5 프로모터에 의해 유도된 정상 Rep78 발현은 AAV 생성을 억제하는 것으로 나타났다. 다른 형태의 목표는 AAV 생산을 최대화하기 위해 Cap 발현을 유지하면서 Rep78 발현을 감소시키는 것이다. 글루타민 합성 효소 (GS) cDNA는 Frt₅의 3'에 즉시 배열되고 성공적인 RMCE 전사는 Fer1L4 유전자 좌위의 랜딩 패드에 위치한 SV40E 프로모터에 의해 구동된다. pLMC32(도 10B)에는 두 개의 인헨서 요소가 제거된 최소 p5 (흰색 사각형)가 포함되어 있다. 전체 p5 (흑색 사각형)는 3'의 Cap 유전자에 위치하여 Cap 발현을 향상시킨다. pLMC33(도 10C)에는 최소 p5 프로모터 (흰색 사각형) (PLMC32와 유사)가 있지만 Cap 유전자 3'의 p5^{mut} 프로모터 (흑색 및 회색 사각형)에는 돌연변이 (GGGGGG) TATA 상자가 포함되어 있다. pLMC34 (도 10D)에는 p5 프로모터 (흑색 사각형)가 5'에서 Rep로, TATA 상자가 GGGGGG로 돌연변이된 p5^{mut} 프로모터 (흑색 및 회색 사각형)가 Cap의 3' 끝에 있다. pLMC35(도 10E)는 p5 프로모터 (흑색 및 회색 사각형) 모두에서 TATA 돌연변이를 갖는다. pLMC32-35는 GS cDNA 선택 마커를 사용한다.
- [0157] 3절: 4개의 Rep-Cap 구성으로 삼중 형질주입하여 CHOK1SV GS-KOTM 및 HEK293 세포에서 rAAV 생산
- [0158] wt Ad5 바이러스로 공동-감염된 pOK1SV GS-KOTM 또는 pHelper (6234, Clontech) 벡터로 공동-형질주입된 HEK293에서 rAAV 생산을 지원하기 위한 GOI (pLMC31) 및 Rep-Cap (pLMC32-35) 발현 벡터의 능력. 웨스턴 블롯 분석은 E1A 단백질 발현에 의해 CHOK1SV GS-KOTM 세포에서 wt Ad5의 형질도입을 확인하였고(도 11A), HEK293

세포에서 pLMC31-35 벡터를 사용한 높은 수준의 Rep 및 Cap 단백질 발현을 나타낸 반면, 낮은 수준의 Rep 단백질 발현 및 Cap 단백질은 CHOK1SV GS-KO™ 세포에서 검출되지 않았다(도 11B 및 11C). TaqMan-qPCR 분석 결과 HEK293 세포에서 Clontech (5#, pRC2-mi342 (6234, Clontech) 및 pAAV-GFP)의 원래 플라스미드와 비교하여 이러한 pLMC32-35 벡터로 AAV 역가가 3-5배 증가한 것으로 나타난 반면, CHOK1SV GS-KO™ 세포의 생산량은 더 낮았다(도 20). 감염성 분석은 qPCR 역가를 확인하여 HEK293 샘플에 대한 높은 수준의 바이러스 형질 도입과 CHOK1SV GS-KO™ 샘플에 대한 낮은 수준의 감염을 보여준다(도 12). 요약하면, 이들 데이터는 HEK293 및 CHO 세포에서 AAV 생산을 위한 pLMC32-35 벡터의 기능성을 검증하였으며, 이들은 일단 안정하게 발현된 CHO 세포에서 rAAV 생산이 가능하다는 것을 시사한다.

[0159] 4절: 부위 특이적 통합(SSI; Site Specific Integration)에 의해 Rep-Cap 및 GOI가 안정적으로 발현되는 CHO 세포의 생성.

[0160] GOI와 Rep/Cap을 안정적으로 통합한 CHOK1SV GS-KO™ SSI 숙주가 rAAV 생산을 지원할 수 있는지 확인하기 위해 GOI (pLMC31) 및 각각의 Rep-Cap 벡터 (PLMC32-35)를 FLP 재조합 효소-발현 벡터 (pMF4)로 CHOK1SV GS-KO™ SSI 숙주 내로 형질주입시켰다. Rep-Cap과 GOI를 동시에 또는 순차적으로 통합하여 두 세트의 풀을 생성했다(도 13). Rep-Cap, Fer1L 랜딩 패드, GOI 또는 NL1 랜딩 패드에 어닐링(anneal)하도록 설계된 프라이머를 사용한 PCR 분석(도 14)은 대부분의 풀에서 Fer1L4 유전자에 위치한 랜딩 패드에 Rep/Cap이 성공적으로 통합되었음을 보여준다(도 15A). 2개의 풀 ('A' 풀 18 및 19)을 제외한 나머지 Fer1L4 랜딩 패드의 PCR 산물이 모두 감지되었다. 이 풀에서 완전한 SSI를 나타낸다(도15B). 그러나 GOI는 순차적으로 표적화하여 생성된 풀 (NL) 풀의 NL1 위치에 있는 랜딩 패드에만 통합되었으며('B' 풀) (도 16A) 모든 풀에서 잔류 랜딩 패드가 감지되었다(도 16B). 웨스턴 블롯 분석은 Rep가 안정적으로 발현되는 5개의 풀을 확인하였으나, 반면, Cap 단백질 발현은 감지할 수 없었다(도 17). CHOK1SV GS-KO™ 세포에서 Rep-Cap 발현을 입증하기 위해, 이들 유전자의 mRNA 발현을 TaqMan-qPCR 분석에 의해 분석하였고, Rep 및 Cap의 다른 동형을 검출하기 위해 프라이머를 사용하였다(도 18 및 도 21). Rep-Cap2, GOI 및 pHelper (6234, Clontech) 벡터를 사용한 CHOK1SV GS-KO™ 세포의 형질주입은 GOI (pLMC31) 및 Rep-Cap (pLMC32-35) 벡터와 비교하여(도 19A-C) ~5배 더 높은 Rep mRNA수준 (도 19A-C) 및 Rep 및 Cap mRNA 수준을 ~7배 유도하였다(도 19D). CHOK1SV GS-KO™ 세포가 Rep-Cap2, GOI 및 pHelper (6234, Clontech)로 형질주입된 경우에만 E1A, E1B, E2A, E4 및 VA I mRNA 수준을 검출할 수 있었고, GOI (pLMC31) 및 Rep-Cap (pUV!C32-35)으로 형질주입된 경우는 그렇지 않았다(도 19E-J). VA II mRNA 수준은 CHOK1SV GS-KO™ 세포에서 검출되지 않았다(도 19K). E4를 제외한 모든 관찰된 mRNA 수준은 HEK293 세포와 비교하여CHOK1SV GS-KO™에서 더 낮았다(도 19A-K). 이들 데이터는 Rep-Cap mRNA 유도 및 발현이 HEK293 세포와 비교하여 CHOK1SV GS-KO™ 세포에서 더 낮다는 것을 보여준다. 요약하면, CHOK1SV GS-KO™ 세포는 Ad5 헬퍼 유전자 및 Rep-Cap을 발현할 수 있지만, 이들 유전자의 발현 수준은 추가로 최적화될 필요가 있다.

도면3

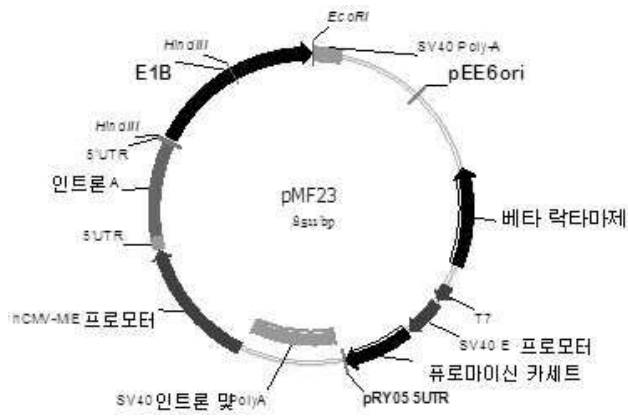

도면4

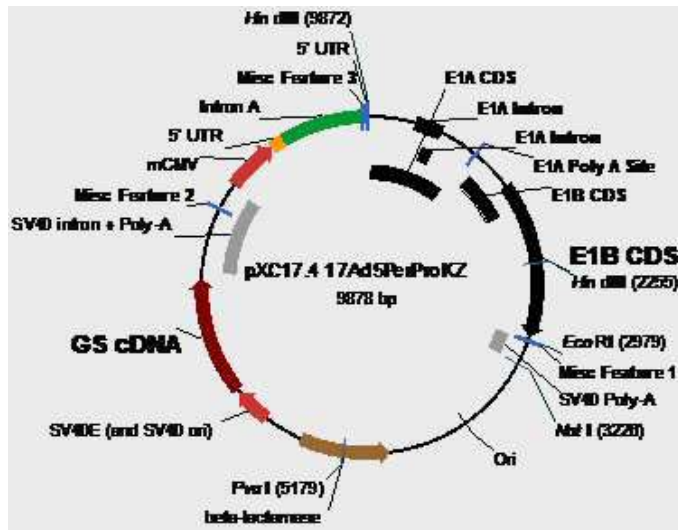

도면5

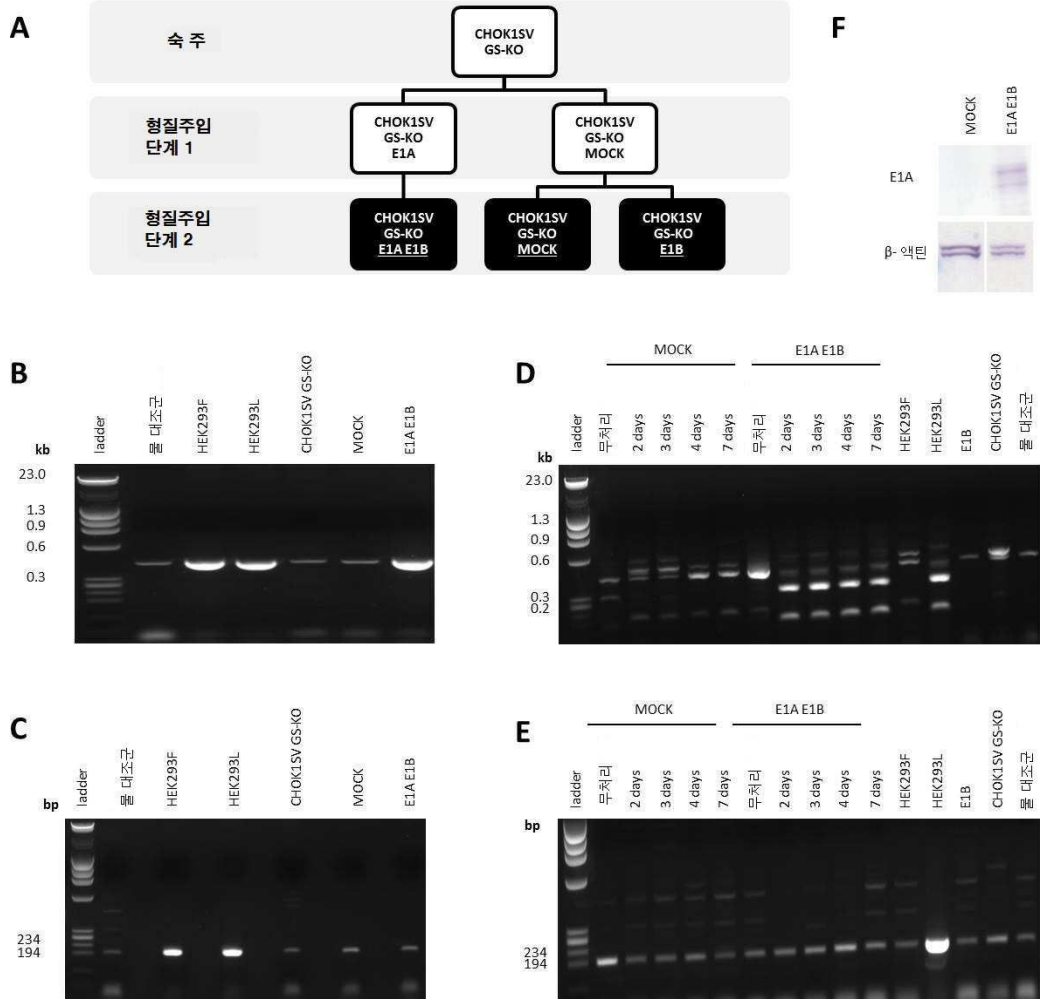

도면6

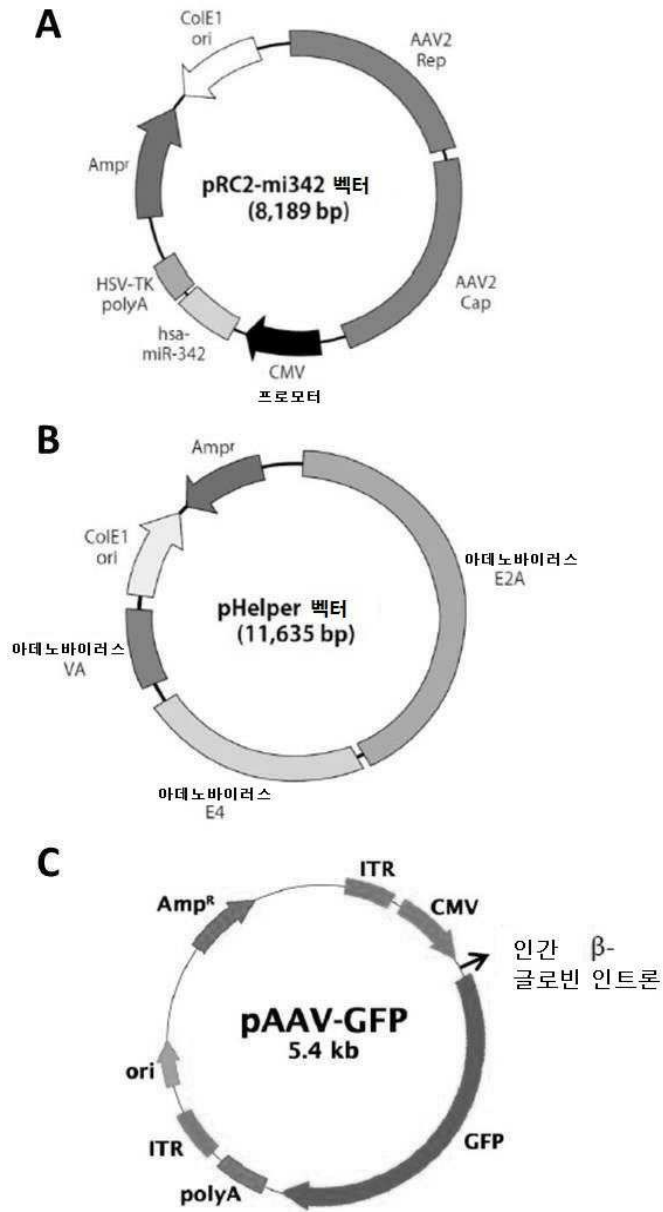

도면7

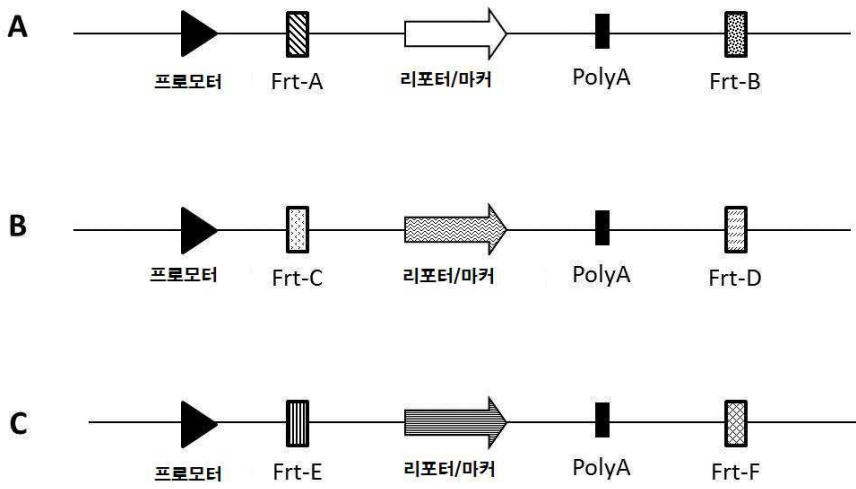

도면8

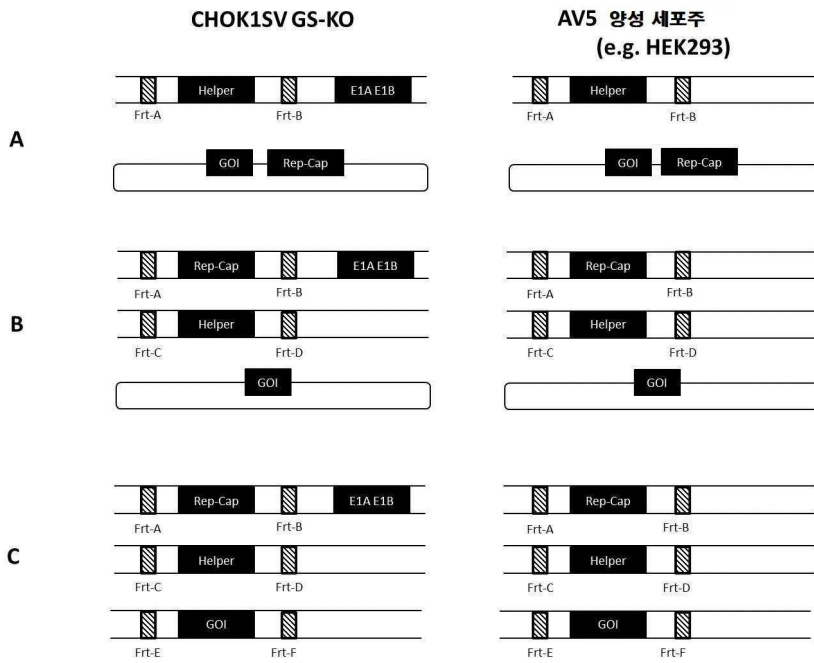

도면9

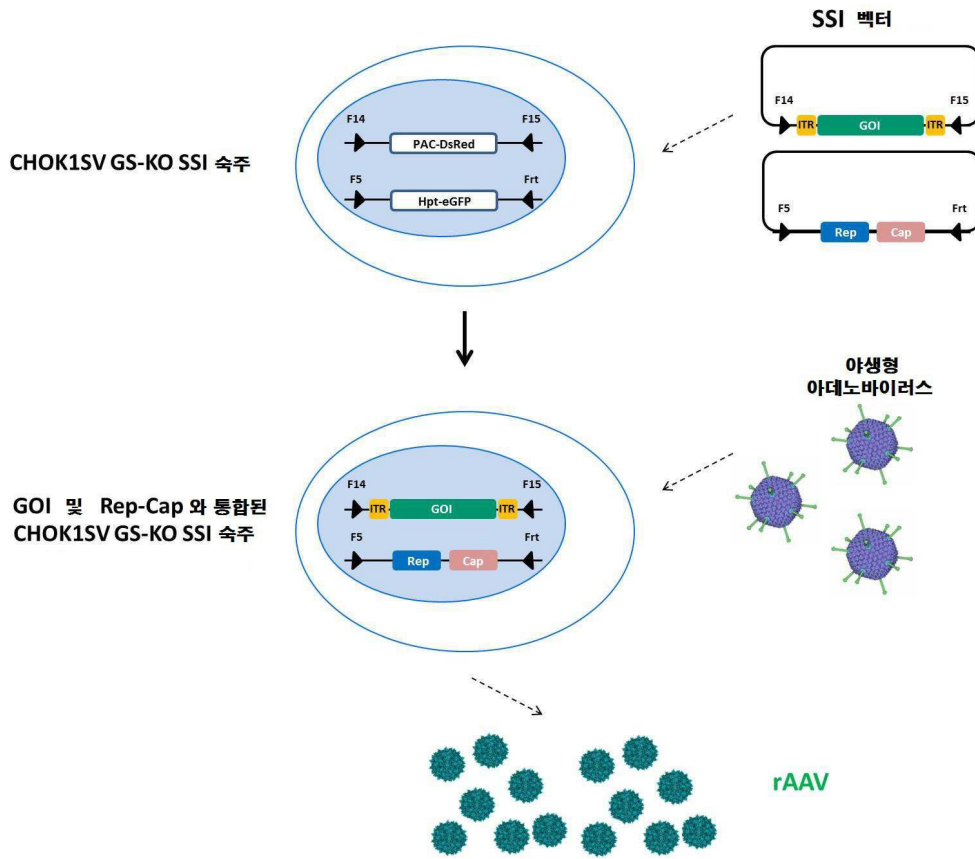

도면10

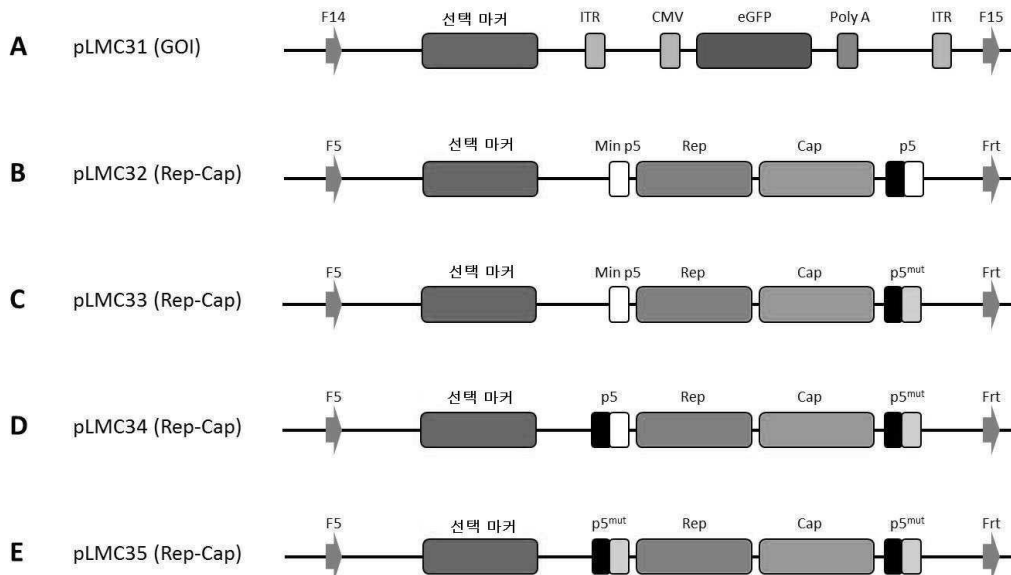

도면11

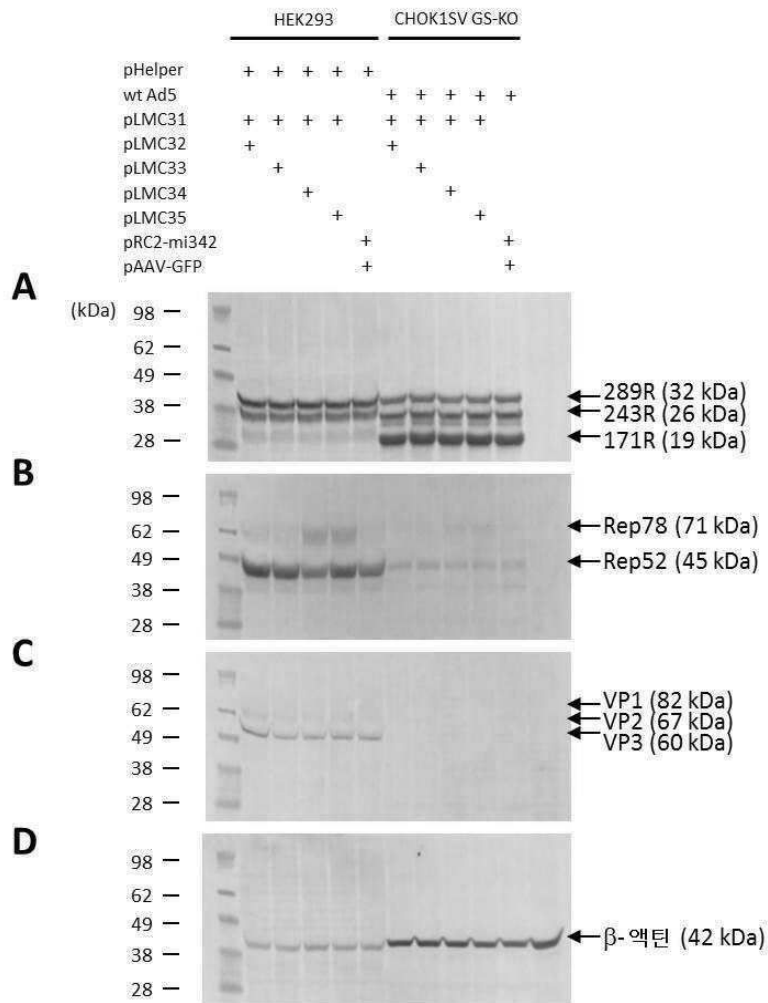

도면12

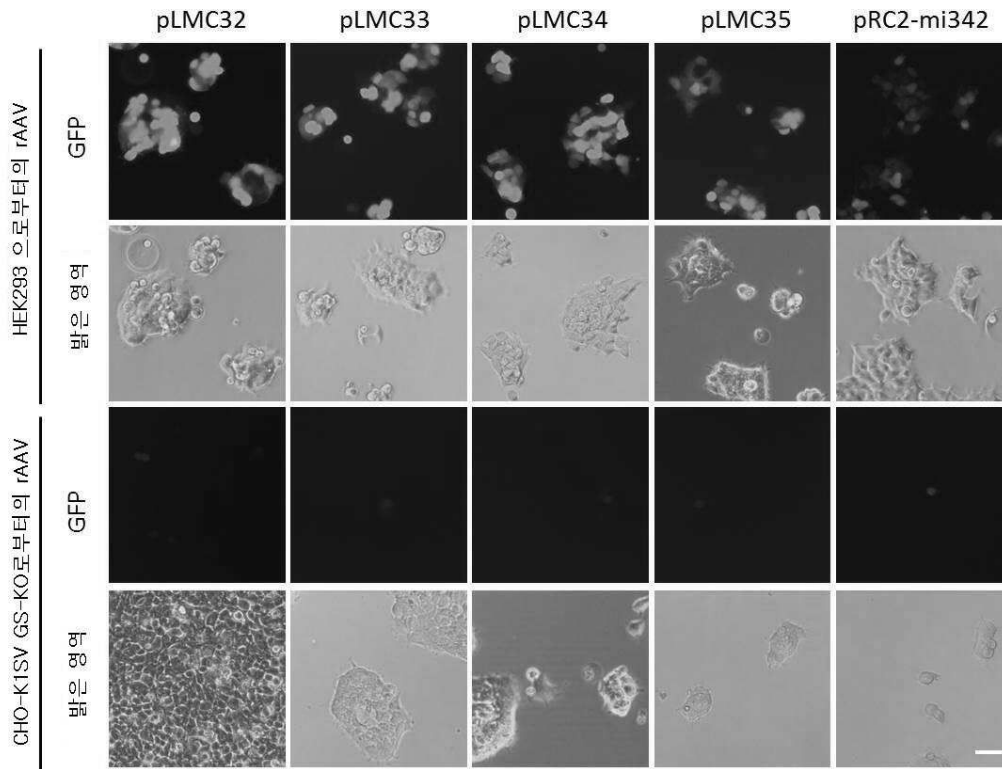

도면13

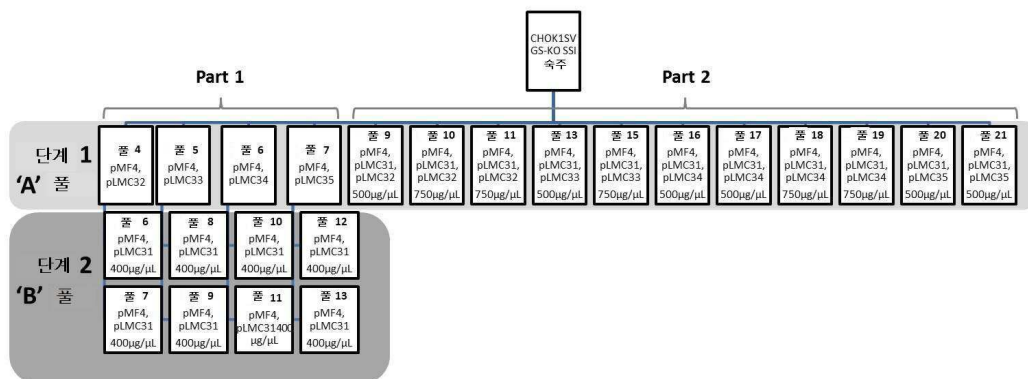

도면14

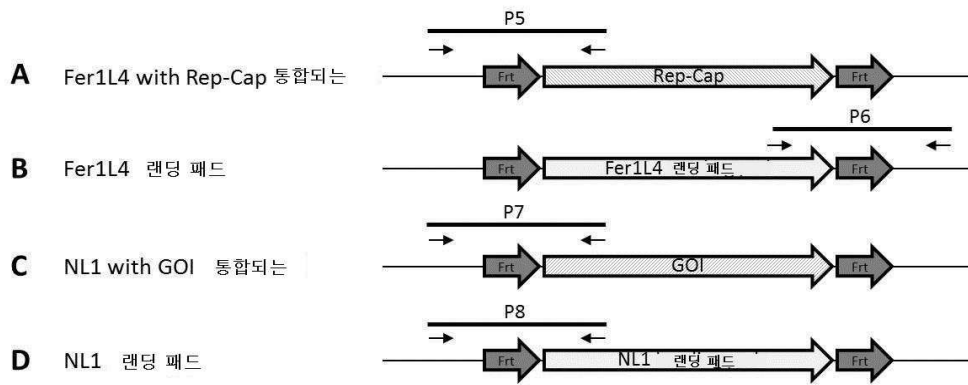

도면15

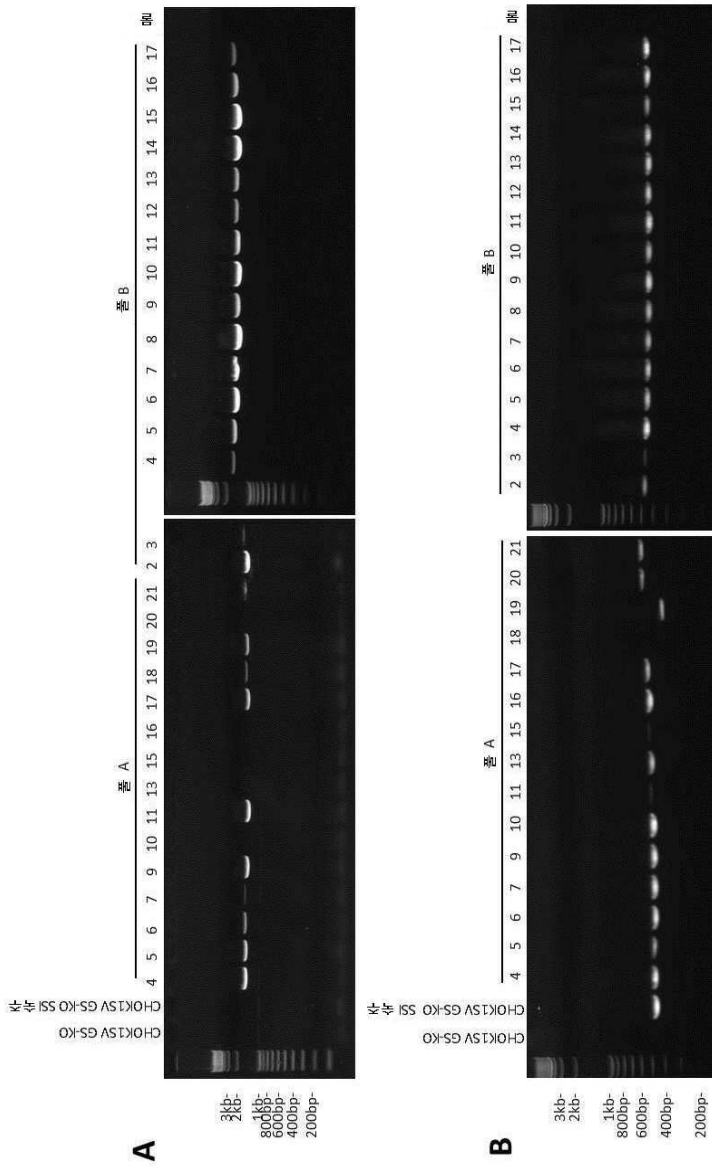

도면16

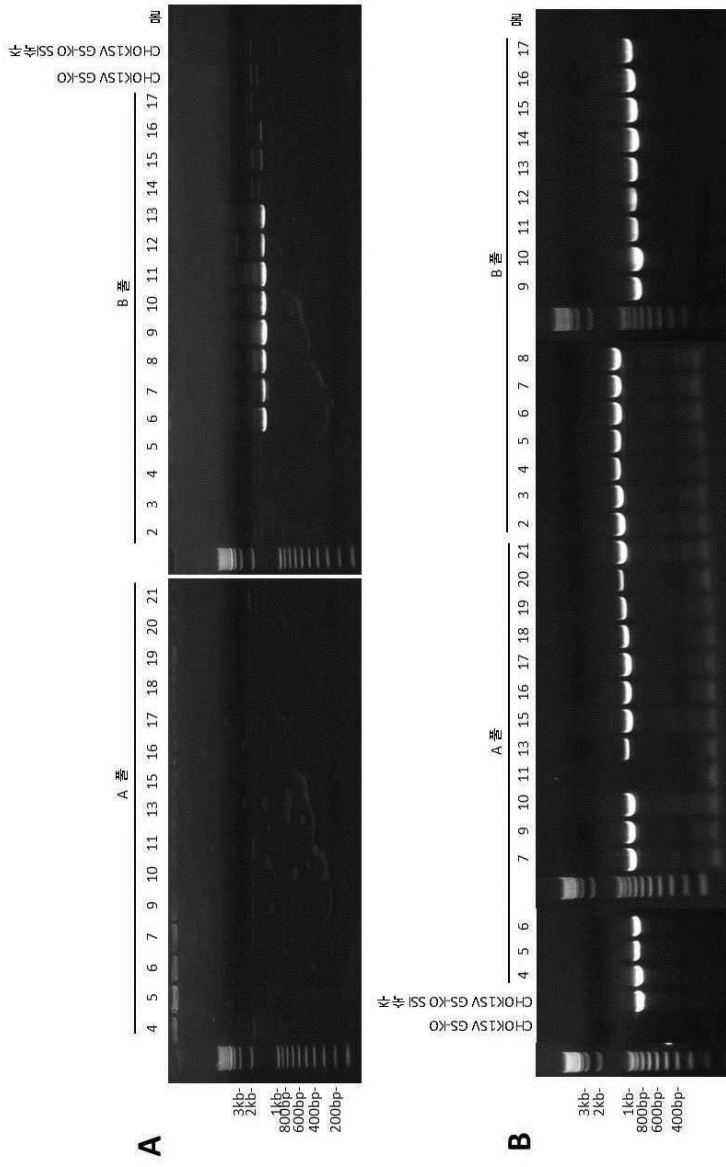

도면17

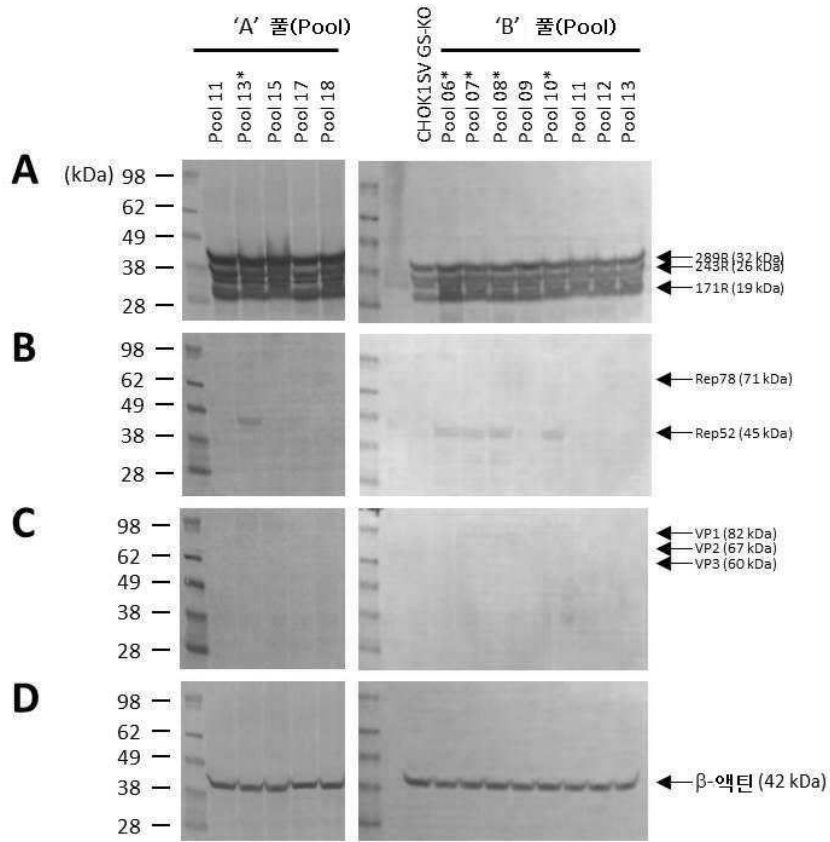

도면18

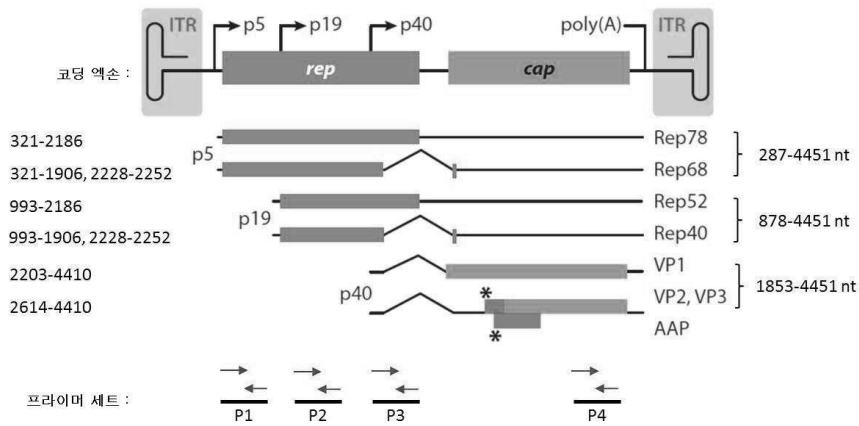

도면19

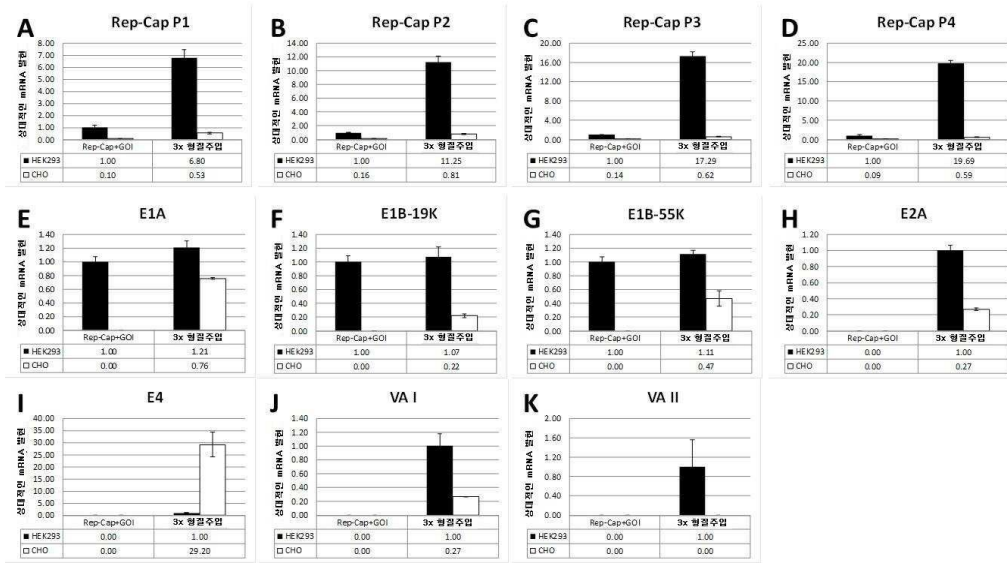

도면20

	1#	2#	3#	4#	5#
HEK293	p헬퍼				
CHOK1SV GS-KO	wt Ad5 (500 MOI)				
Rep-Cap 벡터	pLMC32	pLMC33	pLMC34	pLMC35	pRC2-mi342
GOI 벡터	pLMC31				pAAV-GFP
역가/ HEK293(vg/ml)	4.9E+09	2.9E+09	2.9E+09	2.2E+09	8.4E+08
역가/ CHO (vg/ml)	1.4E+07	1.3E+07	1.8E+07	2.3E+07	3.7E+07

도면21

올리고(Oligo) 이름	서열 (5' to 3')
Rep-Cap-P1-F	TTTGGGACGTTTCCTGAGTC
Rep-Cap-P1-R	CTCATCCACCACCTTGTTCC
Rep-Cap-P2-F	GCAAGACCGGATGTTCAAAT
Rep-Cap-P2-R	CCTCAACCACGTGATCCTTT
Rep-Cap-P3-F	CTGCAGACAATGCGAGAGAA
Rep-Cap-P3-R	CGACAGAAAACGGGTTGAGAT
Rep-Cap-P4-F	GAGTGACATTCGGGACCAGT
Rep-Cap-P4-R	GTCTCTGCCATTGAGGTGGT
E1A-F	GAGGACCTGTGGCATGTTTG
E1A-R	CATTTTAGGACGGCGGGTAG
E1B-19K-F	GAAGTCCTGTGGTGAGCTGT
E1B-19K-R	TGGCCAGAAAATCCAGCAGG
E1B-55K-F	CTGGAAGGTGCTGAGGTACG
E1B-55K-R	CTCAGCTCCTCGGTCACATC
E2A-F	CTTTGGTAGCTGCCTTCCCA
E2A-R	GTATCCTAACGCCAGACCG
E4-F	TAATAAACTCCCCGGGCAGC
E4-R	ACAACGCGTGGACTTCTC
VAI-F	CACTCTCCGTGGTCTGGTG
VAI-R	GTTGTCTGACGTGCGACAC
VAlI-F	TTTCCAAGGGTTGAGTCGCA
VAlI-R	GAATTTGCAAGCGGGGTCTT
Actin-F	CGACATCCGCAAAGACCTCT
Actin-R	AGGATGCTTAGCTCACCTTGA
Fer1L4 with Rep-Cap integrated-P5-F	GGAGTTCAAAGCCAGCTTATACCAACATG
Fer1L4 with Rep-Cap integrated-P5-R	GCTAAAGTTGGTATGGCAGCCTGCACC
Fer1L4 landing pad-P6-F	GGATCACTCTCGGCATGGACGAG
Fer1L4 landing pad-P6-R	CCTCTTCTTCAGCCACAGTCACTTC
NL1 with GOI integrated-P7-F	GCAGCACGAACAAGAGTCAC
NL1 with GOI integrated-P7-R	GAACCTGCGTGAATCCATC
NL1 landing pad-P8-F	GGACATATCTGGGTGAAGGGAGCTG
NL1 landing pad-P8-R	CAGCCGCACGGTAGGCTGTACTCGGTCAT

서열 목록

SEQUENCE LISTING

<110> LONZA LTD.

<120> MAMMALIAN CELLS FOR PRODUCING ADENO-ASSOCIATED VIRUSES

<130> PI-19K1058US

<140> PCT/IB2018/000239

<141> 2018-02-17

<150> US 62/460,457

<151> 2017-02-17

<160> 74

<170> PatentIn version 3.5

<210> 1

<211> 34

<212> DNA

<213> Artificial Sequence

<220><221> source

<223> Synthetic oligonucleotide

<400> 1

ataacttcgt ataatgtatg ctatacgaag ttat 34

<210> 2

<211> 34

<212

> DNA

<213> Artificial Sequence

<220><221> source

<223> Synthetic oligonucleotide

<400> 2

ataacttcgt ataatgtata ctatacgaag ttat 34

<210> 3

<211> 34

<212> DNA

<213> Artificial Sequence

<220><221> source

<223> Synthetic oligonucleotide

<400> 3

ataacttcgt ataaagtatc ctatacgaag ttat 34

<210> 4

<211> 34

<212> DNA

<213> Artificial Sequence

<220><221> source

<223> Synthetic oligonucleotide

<400> 4

ataacttcgt ataatgtgta ctatacgaag ttat 34

<210> 5
 <211> 34
 <212> DNA
 <213> Artificial Sequence
 <220><221> source
 <223> Synthetic oligonucleotide
 <400> 5
 ataacttcgt ataggatact ttatacgaag ttat 34
 <210> 6
 <211> 34
 <212> DNA
 <213> Artificial Sequence
 <220><221> source
 <223> Synthetic oligonucleotide
 <400> 6
 ataacttcgt ataatgtatg ctatacgaag ttat 34
 <210> 7
 <211> 48
 <212> DNA
 <213> Artificial Sequence
 <220><221> source
 <223> Synthetic oligonucleotide
 <400> 7
 gaagttacta ttccgaagtt cctattctct agaaagtata ggaacttc 48
 <210> 8
 <211> 48
 <212> DNA
 <213> Artificial Sequence
 <220><221> source
 <223> Synthetic oligonucleotide
 <400> 8
 gaagttacta ttccgaagtt cctattctct agatagtata ggaacttc 48
 <210> 9
 <211> 48

<212> DNA
 <213> Artificial Sequence
 <220><221> source
 <223> Synthetic oligonucleotide
 <400> 9
 gaagttacta ttccgaagtt cctattctct acttagtata ggaacttc 48
 <210> 10
 <211> 48

<212> DNA
 <213> Artificial Sequence
 <220><221> source
 <223> Synthetic oligonucleotide
 <400> 10
 gaagttacta ttccgaagtt cctattcttc aaatagtata ggaacttc 48
 <210> 11
 <211> 48

<212> DNA
 <213> Artificial Sequence
 <220><221> source
 <223> Synthetic oligonucleotide
 <400> 11
 gaagttacta ttccgaagtt cctattctct agaaggtata ggaacttc 48
 <210> 12
 <211> 48

<212> DNA
 <213> Artificial Sequence
 <220><221> source
 <223> Synthetic oligonucleotide
 <400> 12
 gaagttccta ttccgaagtt cctattcttc aaaaggtata ggaacttc 48
 <210> 13
 <211> 48

<212> DNA

<213> Artificial Sequence
 <220><221> source
 <223> Synthetic oligonucleotide
 <400> 13
 gaagttccta ttccgaagtt cctattcttc aaaaagtata ggaacttc 48
 <210> 14
 <211> 48
 <212> DNA
 <213> Artificial Sequence
 <220><221> source
 <223> Synthetic oligonucleotide
 <400> 14
 gaagttccta ttccgaagtt cctattcttc aataagtata ggaacttc 48
 <210> 15
 <211> 48
 <212> DNA

 <213> Artificial Sequence
 <220><221> source
 <223> Synthetic oligonucleotide
 <400> 15
 gaagttccta ttccgaagtt cctattctat cagaagtata ggaacttc 48
 <210> 16
 <211> 48
 <212> DNA
 <213> Artificial Sequence
 <220><221> source
 <223> Synthetic oligonucleotide
 <400> 16
 gaagttccta ttccgaagtt cctattctta taggagtata ggaacttc 48
 <210> 17
 <211> 48
 <212> DNA
 <213> Artificial Sequence
 <220><221> source

<223> Synthetic oligonucleotide
 <400> 17
 gaagttacta ttccgaagtt cctatacttt ctggagaata ggaacttc 48

<210> 18
 <211> 48
 <212> DNA
 <213> Artificial Sequence
 <220><221> source
 <223> Synthetic oligonucleotide
 <400> 18
 gaagttacta ttccgaagtt cctatactct ccagagaata ggaacttc 48

<210> 19
 <211> 48
 <212> DNA
 <213> Artificial Sequence
 <220><221> source
 <223> Synthetic oligonucleotide
 <400> 19
 gaagttacta ttccgaagtt cctatactat ctacagaata ggaacttc 48

<210> 20
 <211> 48
 <212> DNA
 <213> Artificial Sequence
 <220><221> source
 <223> Synthetic oligonucleotide
 <400> 20
 gaagttacta ttccgaagtt cctatactct ctggagaata ggaacttc 48

<210> 21
 <211> 48
 <212> DNA
 <213> Artificial Sequence
 <220><221> source
 <223> Synthetic oligonucleotide

<400> 21
gaagtacta ttccgaagtt cctatactat cttgagaata ggaacttc 48

<210> 22
<211> 32
<212> DNA
<213> Artificial Sequence
<220><221> source
<223> Synthetic oligonucleotide

<400> 22
taactttaa taatgccaat tatttaaagt ta 32

<210> 23
<211> 32
<212> DNA
<213> Artificial Sequence
<220><221> source
<223> Synthetic oligonucleotide

<400> 23
taactttaa taattggcat tatttaaagt ta 32

<210> 24
<211> 52
<212> DNA
<213> Artificial Sequence
<220><221> source
<223> Synthetic oligonucleotide

<400> 24
catcagggcg gtcaggccgt agatgtggaa gaacggcagc acggcgagga cg 52

<210> 25
<211> 52
<212> DNA
<213> Artificial Sequence
<220><221> source
<223> Synthetic oligonucleotide

<400> 25

atgtggctct ttagatccac tgacgtgggt cagtgtctct aaaggactcg cg 52
 <210> 26
 <211> 52
 <212> DNA
 <213> Artificial Sequence
 <220><221> source
 <223> Synthetic oligonucleotide
 <400> 26
 catcagggcg gtcaggccgt agatgtgggt cagtgtctct aaaggactcg cg 52
 <210> 27
 <211> 52
 <212> DNA
 <213> Artificial Sequence
 <220><221> source
 <223> Synthetic oligonucleotide
 <400> 27
 atgtggctct ttagatccac tgacgtggaa gaacggcagc acggcgagga cg 52
 <210> 28
 <211> 34
 <212> DNA
 <213> Artificial Sequence
 <220><221> source
 <223> Synthetic oligonucleotide
 <400> 28
 acaacttcgt ataagtatg ctatacgaag ttat 34
 <210> 29
 <211> 34
 <212> DNA
 <213> Artificial Sequence
 <220><221> source
 <223> Synthetic oligonucleotide
 <400> 29
 taccgttcgt atagtatagt atatacgaag ttat 34
 <210> 30

<211> 34
 <212> DNA
 <213> Artificial Sequence
 <220><221> source
 <223> Synthetic oligonucleotide
 <400> 30
 taccgttcgt atagtatagt atatacgaac ggta

34

<210> 31
 <211> 1951187
 <212> DNA
 <213> Cricetulus griseus
 <220><221> modified_base
 <222> (52172)..(52214)
 <223> a, c, t, g, unknown or other
 <220><221> modified_base
 <222> (79001)..(79313)
 <223> a, c, t, g, unknown or other
 <220><221> modified_base
 <222> (108056)..(108564)
 <223> a, c, t, g, unknown or other
 <220><221> modified_base
 <222> (114171)..(114194)
 <223> a, c, t, g, unknown or other
 <220><221> modified_base
 <222> (124957)..(125001)
 <223> a, c, t, g, unknown or other

 <220><221> modified_base
 <222> (133924)..(133933)
 <223> a, c, t, g, unknown or other
 <220><221> modified_base
 <222> (220464)..(220571)
 <223> a, c, t, g, unknown or other
 <220><221> modified_base

<222> (239660)..(240268)
<223> a, c, t, g, unknown or other
<220><221> modified_base
<222> (291831)..(292319)
<223> a, c, t, g, unknown or other
<220><221> modified_base
<222> (321827)..(321996)
<223> a, c, t, g, unknown or other
<220><221> modified_base
<222> (322776)..(322794)
<223>
> a, c, t, g, unknown or other
<220><221> modified_base
<222> (327260)..(327294)
<223> a, c, t, g, unknown or other
<220><221> modified_base
<222> (352837)..(353013)
<223> a, c, t, g, unknown or other
<220><221> modified_base
<222> (369896)..(371164)
<223> a, c, t, g, unknown or other
<220><221> modified_base
<222> (399674)..(399863)
<223> a, c, t, g, unknown or other
<220><221> modified_base
<222> (406226)..(406576)
<223> a, c, t, g, unknown or other
<220><221> modified_base

<222> (453719)..(453892)
<223> a, c, t, g, unknown or other
<220><221> modified_base
<222> (454054)..(454253)
<223> a, c, t, g, unknown or other
<220><221> modified_base

<222> (495499)..(496477)
<223> a, c, t, g, unknown or other
<220><221> modified_base
<222> (519979)..(521245)
<223> a, c, t, g, unknown or other
<220><221> modified_base
<222> (582983)..(583123)
<223> a, c, t, g, unknown or other
<220><221> modified_base
<222> (616775)..(616812)
<223> a, c, t, g, unknown or other

<220><221> modified_base
<222> (624906)..(624971)
<223> a, c, t, g, unknown or other
<220><221> modified_base
<222> (639489)..(642305)
<223> a, c, t, g, unknown or other
<220><221> modified_base
<222> (719672)..(719704)
<223> a, c, t, g, unknown or other
<220><221> modified_base
<222> (720531)..(720727)
<223> a, c, t, g, unknown or other
<220><221> modified_base
<222> (726029)..(726071)
<223> a, c, t, g, unknown or other
<220><221> modified_base
<222> (727693)..(727822)
<223>
> a, c, t, g, unknown or other
<220><221> modified_base
<222> (782249)..(782395)
<223> a, c, t, g, unknown or other
<220><221> modified_base

<222> (851142)..(851163)
<223> a, c, t, g, unknown or other
<220><221> modified_base
<222> (891452)..(891678)
<223> a, c, t, g, unknown or other
<220><221> modified_base
<222> (915448)..(915498)
<223> a, c, t, g, unknown or other
<220><221> modified_base
<222> (941764)..(942265)
<223> a, c, t, g, unknown or other
<220><221> modified_base

<222> (1031556)..(1032172)
<223> a, c, t, g, unknown or other
<220><221> modified_base
<222> (1048641)..(1048698)
<223> a, c, t, g, unknown or other
<220><221> modified_base
<222> (1050767)..(1051047)
<223> a, c, t, g, unknown or other
<220><221> modified_base
<222> (1056545)..(1056666)
<223> a, c, t, g, unknown or other
<220><221> modified_base
<222> (1143444)..(1144121)
<223> a, c, t, g, unknown or other
<220><221> modified_base
<222> (1156625)..(1156734)
<223> a, c, t, g, unknown or other

<220><221> modified_base
<222> (1175145)..(1175329)
<223> a, c, t, g, unknown or other
<220><221> modified_base

<222> (1265159)..(1265181)

<223> a, c, t, g, unknown or other

<220><221> modified_base

<222> (1299864)..(1299992)

<223> a, c, t, g, unknown or other

<220><221> modified_base

<222> (1301977)..(1302157)

<223> a, c, t, g, unknown or other

<220><221> modified_base

<222> (1334798)..(1336039)

<223> a, c, t, g, unknown or other

<220><221> modified_base

<222> (1336397)..(1337755)

<223> a, c, t, g, unknown or other

<220><221> modified_base

<222> (1337935)..(1338890)

<223> a, c, t, g, unknown or other

<220><221> modified_base

<222> (1386211)..(1388539)

<223> a, c, t, g, unknown or other

<220><221> modified_base

<222> (1441387)..(1441514)

<223> a, c, t, g, unknown or other

<220><221> modified_base

<222> (1452638)..(1453257)

<223> a, c, t, g, unknown or other

<220><221> modified_base

<222> (1460781)..(1460828)

<223> a, c, t, g, unknown or other

<220><221> modified_base

<222> (1471004)..(1471013)

<223> a, c, t, g, unknown or other

<220><221> modified_base

<222> (1473989)..(1475484)
<223> a, c, t, g, unknown or other
<220><221> modified_base
<222> (1476799)..(1477339)
<223> a, c, t, g, unknown or other
<220><221> modified_base
<222> (1482117)..(1482212)
<223> a, c, t, g, unknown or other
<220><221> modified_base
<222> (1542738)..(1542780)
<223> a, c, t, g, unknown or other
<220><221> modified_base
<222> (1575935)..(1576259)
<223> a, c, t, g, unknown or other

<220><221> modified_base
<222> (1625182)..(1625435)
<223> a, c, t, g, unknown or other
<220><221> modified_base
<222> (1658452)..(1660406)
<223> a, c, t, g, unknown or other
<220><221> modified_base
<222> (1660985)..(1661024)
<223> a, c, t, g, unknown or other
<220><221> modified_base
<222> (1774223)..(1774271)
<223> a, c, t, g, unknown or other
<220><221> modified_base
<222> (1793329)..(1793818)
<223> a, c, t, g, unknown or other
<220><221> modified_base
<222> (1858210)..(1858223)

<223> a, c, t, g, unknown or other
<220><221> modified_base

<222> (1861362)..(1861398)

<223> a, c, t, g, unknown or other

<220><221> modified_base

<222> (1909232)..(1910030)

<223> a, c, t, g, unknown or other

<220><221> modified_base

<222> (1920861)..(1920951)

<223> a, c, t, g, unknown or other

<220><221> modified_base

<222> (1933768)..(1933896)

<223> a, c, t, g, unknown or other

<400> 31

tcatTTTcat gaagatgttt ttaaggtcat tctcttctgc atcatctgcg ttgtgggttt 60

caggtcttgc tgggtgtaggg tctctagact cgagtgggtg catattgggt tttctgttgt 120

tgaatgtgtt ttiatattgt cttcttcaca tcctttcttc cagtgggtat agaaggattc 180

tcttctctc ctagtctggg ggatggaggc aggactggca ccggagaccc ggaagtcctt 240

ggatgtgctg gatcctgtgg aactgagatc tgetgtgtgc agccctctgg catcaggtta 300

ccccaggcag ggcagaagaa gaaaccacc ttcctttttt tgtaagattt tatttattta 360

tttatttatt tatttattta tttatttggg aattgattga ttgattgact gactgactga 420

ttggttgatt gattaattga tacaacattc tgtctccaca tatgcttgca cgccagaaga 480

gggcaccaga ttcattaca gatggttgtg agccaccatg tgattgctgg gaattgaact 540

caggacctct ggacgagcca gtgctcttaa cctctgagcc atctctccag cccccgaaac 600

ccgccttctt ttacttgaag attctccttg atgtcttctg agttcttcta ctgctttct 660

ttttgtaaca tatttactct atcattctgt gtcttactta aggttataac attgttgtga 720

cgatacacca tgaccaaaag caacttggga atctacaaga gtgaccctat tgaaaactcc 780

tagtaatggg aaatatggag cttggaccag ccaccttccg taaccaggca aggcttcctt 840

ccagtggagg gactgggaca ccaacctagc cacaaaaact tcaatctaca atctgtcctg 900

tctgcaagat gtgctgtagt aaagetggca cagaacatgt gggagtggcc aaccaatgac 960

tggccaact taagaccctt gccacagagg gagcccaagc ctgaacctgt ctggagggtt 1020

aggaccacga ggctggatag cccagaaacg taagatagaa ccaaactga acaccccgcc 1080

ccccaaaaag tcaatgagcc ggatactggc tagttgctc atccagcctt aatatgagag 1140

ggtgtgcata gtctcattgc aacatttaca acaagatag ccacgttttc ttgatatctc 1200

tgaaggcctg gccttttctg aagggaatg gaggaggagt cgatctggga gaaaggaag 1260
 gtggggaag ggactggagg agaggaggga ggggaaactg cagtcaggat gtaatatatg 1320
 agagaataaa aatttaataa aagtagaaaa ataaaaagaa aatgattcct gccataaac 1380

tgttatttga gtgactgcaa aaaagaaaa gaaaaagaat aaaagaactt ctaaccatta 1440
 taggatatag tagaaagaaa gaaagaaaga aagaaagaaa gaaagaaaga aagaaagaaa 1500
 gaaagaaaga atgtttaagc attactgatg gcaatataaa aaaaaaaca cttccatcac 1560
 ttttggatag cagaatggct attcctcaaa agctaaatga agacgtagca tactgcccac 1620
 caattccact cctgcttaaa cttaaagact gaaaagaaaa tactcaaata aactctgaac 1680
 atatcattca cagcagctat atgaacaata tcaaaagacg taaaatactc aatgttcat 1740
 ttctggatgg ataagcaaag gtgttatcta catgcaatgg gatattattt agccatgaaa 1800

tgtaactgat aaatgctgca atgtggatga acctaaataa aactacac taagtgaaca 1860
 aagaaaaacc ttaaaggctc acttatttct cattctttga ggcaggggtt caaaactggt 1920
 ctcaaacttg ctagtagtag tccaggccgc tctttacagc ctgcttctg tgtactagaa 1980
 atacaagtgt gtgccacat gcccaatttg atgccacatt aataatttcc atttatctga 2040
 aatgttcaga taagcaatct atacaacaca aatgcataa agctgttaac caggggtttg 2100
 ggtgactac taacaaggac aaggtttctc tctagagtct agaaaatgtt ctcaatgaac 2160
 aacagtgatg gctgaagttt ataattatgc tacaacact aaactgcata tatcaaaata 2220

ataaccact ccacaaagt gtccctcagac cccaggtgg cttctataac agacaaacat 2280
 aaatgtgtga gcaacacaca gacatgtaca tatgtacaca cagaatcctt ttccagagag 2340
 gaaagaagaa aggagctaa ggtatatctt tttatctttt ttttcaaga catggtttct 2400
 ctgtgtagca ctggctatcc tggaaactcat tctgtagacc aggatggcct ctaattcaca 2460
 gagatccacc tgactctgcc ttctgggtta aaggtgtgtg ccttgctaag ggtatatttt 2520
 ttgttttgtt ttttgagacg gtttctctgt ggctttggag gctgccctgg aactagctct 2580
 tgtagaccag gctggcctcg aactcacaga gatcctctgc atctgctct gcctcccag 2640

tgctgggatt aaaggcgtgt gccaccaatg ctggcccta acagtatac ttgatgactc 2700
 tgtagtaagc acacaagagg ccctgagttc aatctccagc accaaaaaa aaaaaaaaa 2760
 aaaaaaaaa aaaaaaaagg agaaaaaaag gggaaggggg gaagcaagag agaagaggat 2820
 atctggctat acatataaca tctatttcat agatttcaaa acaacaata ttattcagga 2880
 caaagaaagt aatctagat gggcagtggt agagcacgcc tttaatcca gcgctcggga 2940
 ggcagaggca ggtggatctc tgtgagttcg aggccagcct gttctacaag agcagtgcc 3000

aggatagtct ccaaagctac acagagaaac cctgtctcga aaaacccaaa aaaaaaaaaa 3060

aaaagtaatt ctaaatgat aacgataata gtcaatgaac aagggaacat atgaatcctg 3120

tttattcaca taggcacaaaa gcttcaaagt acttgagaca aaacatggta gcaagtgcac 3180

caaaattgca gcaaacacac attgaattca atgactctca gtcaacagaa gaacttgggg 3240

gataaaaagg acattagagc tttgaacaat atcctgaatt agctgacatt tgtgaaattc 3300

ttgtcttagt tacagatccg gtacctgtga agaagtgctt ggataaaagc aattaaaggg 3360

agaaggggtc taccttagct cactgatcat gaggtagaag tcacagaagt ggggggtgtg 3420

gaaaacagct caagagagac tgatacacca tgaagacaga gctcacatgg agagttttt 3480

tttattgggg ggaagggaga aagggaaga gaaagagagt gtagagcagc ctcatgggaa 3540

aagagaaaga ggtacaaaga tgcagagaca gagaggcaga gaggcagaca cagagaggta 3600

gagaggcaga gagagagaga gagagagaga gagagagaga tgaatactgg gagacagaga 3660

gagaggcaga gaggcagaga ggcagagaaa gaggacatgg gcaggccatg acttttaag 3720

gggacgtagc tatagtgaag tagctgatga cgttgtcagg accttgagca ggtcagagta 3780

ctgactgagt actggccagc acatctgcc aggtgacagg gagcaggcca gcataatgcc 3840

tgaatggaaa actaatgcta gcactcaact agctttctac ttaatacag cccagagtgc 3900

tatcactgtg tgtgtgtgtg tgtgtgtgtg tgtgtgtgtg tgtgtgtgtg tgtgtgtgtg 3960

tgtgtgtgtg tgttgggtgt ttgcctgcat gtatatctct atgggggtgt cagattcctt 4020

ggaactggag ttacagacag ttgtgatctg ccttgtgggt gctgggaatt gaaccaggc 4080

cctctggaag aacagccagt gcttttagat gctgagccat ctctccagcc tgggtgctaac 4140

cacttttagg gcgagttttt tccacctcaa ataacctaat ccaagtgtgt ccagaagctc 4200

aaccagggt gactctacat attgtcaagt tgctaatcaa tattaacaat cacaagtctt 4260

taccagtaa ccgaatacat attcttgtca agtgtgcaac aaaaatgcac caagacacat 4320

tttattcaga gtcactaac aaacctcagc aaaggcaata tgtatattct ctgattacaa 4380

tggaattcaa ttggaaatca ggaacacaac tcagaaaaaa aatcctcaa tatatcaaaa 4440

ttagaaacct agiattgagc tgggcagtgg tggatgcatgc cttaatccc agcactcagg 4500

aagcagaggc agatagatct ctgagttcaa aactagcctg gtctacagag aaagtccag 4560

aatactcaga ggtacacaga caaacctaa gggggagggg gagaaacctg gtgttaacta 4620

gcccctgagg caaagaagaa ataaaagga aagttaaaag gaactttaac tgaacttgat 4680

gacaaacatg atgaattgt acagattctt cctcggttc ccaaatgaca gcattatagg 4740

tgtgggtcac catgccctgc ttctctgac atttttggga gcacagagag ttgggttca 4800
 gattttgtcc aataatttcc taaaagctgg cttaacactt gtgcctcatc cttgggcatc 4860
 tcctccccat tactgggaag aaggggtgtt tgtcaccagc taggtaagct tcatttctg 4920
 gcttctgtg gtctgtctgg cttcccagaa aggagacagt ttctctggct gacacatggt 4980
 ggtatcgttc tctgttaat gcatattagt tttattttat atttctgtgc ttatgaatat 5040
 ttagcgtgta cctatgccat tacaaaaaaaa gttaccgaag tgagatacat atagctttga 5100
 aataagacag aaatcacaag attgaagatt tggttcagag attagcataa agccctaggt 5160

 ttgatcccta gtctcaaac aacacaacag aaaacaggaa caaataggg aaattcagcc 5220
 aggagtgggt ggtgcatgcc tttaatccca gcactttgga ggcaaaggca ggaggagctc 5280
 tgtgagtttg aggccagcct ggtctacaga gctagctcca ggacaccag ggctacacaa 5340
 aggaaccctg tcacaaaaaa aaaaaagaag attctatagg acacggtttg ttcctgatg 5400
 gaatacctgt tgcaactgtt actagtatct gtaagtgggc catggccatt ggttgaaaa 5460
 gaatgcata ccacttgttc tggctctagt gtttcaggaa tatttgaaa tattacaaac 5520
 tataaaaatg ttgtttaata gctggacggt gggaacccat gcctttagca ctcaggcaaa 5580

 tcctgtgag ttgagacca gcctggtcta ctgagtgagt tccaagacaa ccagggttac 5640
 acagagaaac cgcctcaaca atattgttta ataaatgatt tgggggagtg gaataaaagg 5700
 gttgtaacat gaaaatccat gagagagact gcaaaggaac acaagaaata cttcagactg 5760
 atgaacacag ccagtgtttg atttaagaag tgtcacagat atacacatgt caaaacttac 5820
 caagtcaagg ggctggttaa gactactttc cctcttgacag aggacctgag ttcaatcaac 5880
 attgcaagca tagtgactca caaccagctg taacttcagt ttcattggaat ctgttacagc 5940
 taatcttgggt tgtcagagtg actggatcac ctaaaacata agctactgag tattctgtga 6000

 ggccctttct tagtcaggtt atttgaagca ggaagatcca ccctaaaagt gggtaacacc 6060
 ttctggtggc aacctagata agaagacctg ggagaaggaa acattggttt ttgcctgctt 6120
 gcctcactc tcaactggca gtttattttat cctggttctg tgccattcct tcttcaatat 6180
 tagaaactac tctgagcttc caaatagac tgaagcaggg catgggtggc ccacaccttt 6240
 aatcccagca ctccggaggc agaggcagga ggatctctgt gagtggagg ccagcctggt 6300
 ctacagagcg agtgccacga taggctccaa agctacatag agaaacctg tctcaaaaga 6360
 gagagaaaga gagagagaga gaaaaaacca atatagattg aagatcagca gctattcagg 6420

 aacctccag acctccaatg tcagattagg actactgtga cacctagctt caagtactga 6480
 gccactacag gataggactc tccagtttat tatggactca ttctctggga tggtaagcca 6540
 aaataaactc ttccataagc tgttttggtc atggtgtttt atcatatcaa caaaaagtaa 6600

cttaaacaga agttggcaac agaaagtgat ttactgccat gaagaacatg accatgattt 6660
 ttgtaaaagg ctttttcttt tgggccacca accagctccc aaatcaagac acagagactt 6720
 gctgaagatg ctttcttttt tccattgtac aattttggct tctttgtcaa gtatcaggtg 6780
 ttcataggtg tgggattaa tatctgtgtc ttcaattcca ttgatccaca tatctgtttt 6840

 tatgccaata ccaagctgtt tttattatta tagctttata gtagagcttg aagtcaatga 6900
 tggatgatgcc tctagaagtt cttttattgc acagggttgt tttggctatc ctgggttttg 6960
 tgtttttcca cacaaacttg agtattattc tttccaggtc tgtgaagaat tgtgctggga 7020
 ttttgatgga gattgcattg aatctgtaga ttgcttttgt taagattacc atttttacta 7080
 tgttgatcct acctatccaa gagcatggga gatttttcca ttttctgata tcttcttcaa 7140
 tttctttctt caaagactta aaagtcttc tcatgcaggt ctttcacttg tttagtgaga 7200
 gtgagggaaa tgtttctctg atttctttct catccaattt atcatttcta tatagggggc 7260

 tactgatttt ttttagttta tcttgtacct tgctgtaggg agaaaccctg attagatgta 7320
 ccgctgacca cgcctacttg ggcgtggcca cagttacata acaggggttt aagaagcagg 7380
 gaggcaagaa tgaggctctc tctggcttga ctgaactgac tgggaagcat ttctgggtct 7440
 gtctgctca ggtgcaact tggctactgg ttcttttctg tattttcccc aataaactac 7500
 tggttatcaa catatctctg actccacttt gtaatcatca atacctgat gttgggacce 7560
 agccccaca gggcttttaa gagttgtttt ccagcataac cacaggtacc tectattttc 7620
 ctgacctcat cccactagga tcaatcct gttgtgaacc ctttgacctg gggtttttgt 7680

 aagtttgtat atagggctgc tccacaataa aggtgagaga tattctctca gaaaataacc 7740
 agttgtcttg tggttcatcc aaatctccag gctttcacct aatacttggga cttagtgggtg 7800
 gccaaaggca gccacacct gccagattac tgaaggtgtt tatcagctgt aggagtccc 7860
 tggtagaatt tttgggatca cttatgaata ctataatc atctgcaaat agtaaaagt 7920
 tgacttcttc tttccaatt tgtattcct tgatctcct tttgtgtctt attgctctag 7980
 ctagaacttt gagaaccata ttaaatagat atggagagag tgaacagcct tgtcctgttc 8040
 ctgattttat tggatttct ttaggttttt cttcatttaa gttgatgttg tcagcctatt 8100

 ttctttcaga acccaggacc ctacccatc aatcactaat taagaaaatg cctgcatat 8160
 ttgcctacag atggatctta tggagacctg tagcatgaat aataaaaacc cagagacaga 8220
 tattgggttt caagtgaag atcagaaaag caaagcagcc aaaccagcag agagctctta 8280
 cctctaccaa ggcctggggca atcctgacct caaagtgcc aagactgaat actgaatgcc 8340
 ctgctctat cttacatacc tctctagtgc tggattataa ggcatgaact ctgtttctat 8400
 tttagactga ttcactctca tgtagtcca ggtgcccttc aactcacaga gattcatctg 8460

cctctgtctc ccgagttctg agattaaagg tatgtgccat cactgcccac atctatggct 8520

giggctagct ttgcattcag atcttcagtg gctttaacag atcataagca atatatcacc 8580

acagagacct tttcttaatt gaggatccct cctctcaaat aactagcttg caacaagttg 8640

acataaaact atccagcaca cttaccaact aggaggcaac aagatggctc aacaaataaa 8700

gtcacttgtc accaagcttg acaaacctac atgtatgacc tatactgtgg aaggagaaaa 8760

ccaactcctg taagttgttc tctgacctcc tctctecct ctcctctcc ctctecctct 8820

ccctctccct ctctctcttc tctctcttc tctctcttc tctctcttc tctctgatac 8880

acacacacac acatacacac acacacacat acacaagata aataaacaca caaaaaaatt 8940

taaggattag agagaacaag taatggtaaa gagtatgtgg cagccgggca gtggtggcac 9000

acgcctttaa tcccagcgt caggaggcag aggcaggcag gtctatgagt ttgaggccaa 9060

tctcactagg gttttgaggt tccatgttaa actcagagtc tgtgtgtgtg tgtgtgtgtg 9120

tgtgtgatg tgtctgtctg tctgtctgtc tgtctgtctc tctgtctctg tctctccctc 9180

tctgcctatg gatcagaatg tagttctcag ccaccactcc agtatctgcc cgaatgctgt 9240

catactccct gccatgacaa tggactaact gtgacaactgt aagcaagccc cccaattaaa 9300

tgctttctct tattacagtt gccttgttca tgctgtcttt gcagagaacc taagttcagt 9360

gccaagcacc cagtcagga agctcacaac cacctgtaac ttcatttttg ggatccaaca 9420

ccactcttc agactccaca ggaacctgaa cacaccata tatactcaa cacagacaca 9480

catatgcaca taaaagtaaa aagaaatctt ttttaaaaa tattaagcaa caagccatct 9540

gaaattctga ataggacct agtctgtgtt actgtgtctg ctgtccaagt ttcacatttg 9600

tgctgtgtgt ttgttaagca tgtctttctg tcctactgc ccacgcaact ggtatgcatg 9660

ggtcaggggt cttttcttgc tgccctgagc acgtggcatg gttcaggagt tcctctgccc 9720

atgtgccatg ggttagaatg tgctgcagcg gagtccctg aggetgctac tetgaactec 9780

aaccattgct ggggccctca cagctgagcc tggccaatat aggtgagtct tgtttttcta 9840

tcctcacctg ctggtctgtg aggcattgga agtggggctg tctctgcccc aatgccatc 9900

ctgctgtggg tcttgcttg tggcgggagt ttcctgccc taagcatatg gttgcaaggc 9960

caccatctgc ctggctgccc ggccttctct atgctccaca cacatggcat gcagggagac 10020

cacaagggtc tttttccac ccctgtattg gcaaagggtc tgggattacc agcacacaca 10080

tccccaggtc tctgccctga gcacatggag ctggggcaga tgaactatct ggcctgatcg 10140

ggaccttcta aagaaatggc cttaaagata ttaaaaacta taaaaggac tttgataaga 10200

gtttttatgt tgactgagaa atagagagaa ttaggagac taaagtaata aagagggaaa 10260
 gggaaagaga aatttgctca agaattgctca aaagatcaga ggaataaacc aaaggtatat 10320
 agaaaagtat agagggttaa agcaagccat agaaggtcag aggaaaattg tcgaaggtca 10380
 gagaaaaggt tgttaaaagt cagagaacaa tgtaactgt ttgctatggt ttctcatgtc 10440
 tacaaatfff aaaaattggt aaaataagtt aaaatfttaa ccatactaag ttaattctga 10500
 tftaaaagtt ctgtttatft ctcaagtaaa ttatgtatgc ttgtfttaaa atgttctgtt 10560
 tcctggcata acctaagttc tgttacaagc atacagctaa aacaaatggt gcaagtcacc 10620

 tccatfttat agccagtcac acggcaaact ggtcacatgg ctgactggta gccatfttgc 10680
 taaggttgaa aaaaaagata cttaaaccca catcttgact aaagatgact gcatggaaat 10740
 tagaggtacc atcttagaaa caagftttca attaagattt aaaatgttaa tgcttctata 10800
 tattacagaa agacattaag ggatftttaa tftctfttta aaaccagftt tctaaatgft 10860
 tatgctfttt taaaatgftt ttattaatgt tfttacttaa agagcttcaa tftagaatca 10920
 tftftaagca aagcctgaca atgaaggttc ttgtfttata aaagctgcta atctattata 10980
 agatgttaca gfttatgftt tcagaagtta agfttagggc gfttggcg catacftta 11040

 atcccagcac ttgggagcca gaggcgggtg gatctftgag ttcaaggcca gcctggtcga 11100
 cagagcaagt tccaggacag cctccaaagc cacagaaaaa cctfttctca gaaagaagtt 11160
 aagfttaagc acgcagctaa aatgtgtaca ttagctact gfttaaggaa tataaggtaa 11220
 ctctatgcag tctfaaattt agctgtgcta agfttcaaat atfttctaa gftaaaacca 11280
 gttacagtea ggctgaaaat taattacaga aataagacct taccagcca cctgtatgct 11340
 tcttgtatgc ttaaggcaag taaccaaaaca gaccttaat gcttcagaga tctgcagaat 11400
 atgggattta aatgtttatc tftaaagtct ccaaagaaga ttataggcca cctcagttcc 11460

 tgcacctgga ccagtgagcc tgccagccgc ctgccagaac ctggtctgtg gacaaagctg 11520
 ctggacactg gaaaattgat tgcacccct ttgcctaggc aaaacaaggt cagtctfttc 11580
 catgtccctc tftacagtg agaaaaaaaa atcctctcac cfttataggcc tggngaagat 11640
 tgctgttctt tgagacatct gcctccagct gtaatggaga aacttgggta tagctaactg 11700
 tatatgaact ggcttctgtc actftfttft agattcagat aaaatatacc cftctaagat 11760
 ctctgaata ttaatggttg tcagcttgac agcatcagac agtcaggttc actataggct 11820
 atagtcagta tgttagctga taaagtagtg actacctatt tgttcaggca caagctcaag 11880

 gftfttaggt tftctftggt tgttatctaa gcataaactt aaaggcftt tcatcaggcc 11940
 aaaggcacct ctgttcttaa acaggtftct gcttctggca gacacatctg agtatatcag 12000
 ttgctgacaa caggctgttc ctaaatagac tgcaaccct agacttgctg tggatgtgaa 12060

ccagtccagc tgatgtggac accccctgtc tctgcaacag agtctgccaa cagcttctga 12120
 tggattcccc attgcctaaa ttcctcttt tgcttttgac tagcatttca gccttcttag 12180
 gtccctaact tcatcccaaa gtcagcagga aatagcatgg gaaagaatac gtcgcccatt 12240
 ttcctgggtt gaaatgctaa gtcagaagaa actcccttgc atggggatgc caatatctct 12300

 cactccctga tggggactcg agagagacag caattccatg attggaattt caaaaaaaaa 12360
 aaaaaaaaaa aaggggggaa aggagggccc cccccccct ttcgccagc cataacagcc 12420
 gaacacgtgc ttgtctgact ttgtcttagt cactaggagg ttagatgcct gcctcgtggc 12480
 aaggagacaa tcagaagtta gctggtggtg ctatgcttta tcattctggg tgtgctttac 12540
 cgacaagtgc acagcaatga ctcgaagagc atagcaacca ccctgggagg gcctatgggc 12600
 cataacaacc agttgaccaa tcaacacagg gcaaacctc caagcctgga ggcacaccaa 12660
 tcttgagcct gtgcataccc ctagacactc cttttatgct gccctatcag atctctatgc 12720

 agacacttcg agctgtcttt ctagccatct gccatggtgg gtggatgaaa gaaccgagct 12780
 aacatgggggt tagctcgtta aacaactata ataaagcctc gtgctgtttg catcaaaaaa 12840
 aaatattaag caacagattc actaaatgaa ttttaactat gaaatgaaat acagaattaa 12900
 aaatttcctt agatataaac atacataaag tcaaagcctt aagtaaaaaa agagtaagca 12960
 agcaagtctc ccaacaact attcactgat tctgaaatt gagctgtgga agcaaaatgc 13020
 attccactta cacagtagtt aattccaag gggcagggaa tcatcttcta aattgcaggg 13080
 gcttaaaagg tagaaaagaa tgccattata tccacactta ggcaattgta gagtatttaa 13140

 atgatggatg aaaaacaatt gtgggatact gactagtcaa aaaaacgaag caactaacac 13200
 tcctacataa aagctgtcaa tagtttcttg agctagagat atcattgggc catctttgag 13260
 ttattcagag ttgtctgtag aagaatcatt taaaggttca ctttgtgtt ataaatttag 13320
 ggtgaagact tctgtttgtg tttccttata aaactgtacc ctttatcttt ttggcacaaa 13380
 agatacaaaag tctcttttgt atctgggata taaatcaggg gcaagagtga tggaaaggcag 13440
 agagagccgg tccagcaaca catgcaacca agagtagaca ccactttgga tctggcatcc 13500
 ctgggggagt atgattgcta tggacaatc ttttctacac catgaatatg tattactttc 13560

 attggttaat aaaaagcaga aggctggtag ctgggtagga agttaggcaa gaaagtcaaa 13620
 ttgagaatgc tgggaaggag aagggcagag tcaggaatcc ccaatcagat gcagagggag 13680
 caggagatga acicacatg ctaaataagg taccaccacg tggcagagca taaataaaga 13740
 atatgggtta acttaaaatg taagagctag ttagtaataa gcctgaacta tcagccaaac 13800
 atttagaagt aacattatgt ctccaagtca attatttggg aagcagctgc caggtatttg 13860
 ggaataggca gtccaagaga aatgtccaat tacatacgat tttcatctgg gtcttcttgt 13920

cattttcctt ctggtaactt ttgttatgct tggaaaatth acttttaaag aattgggaaa 13980

 agatccataa cagatgttct cttcaggata agatggacac taacgaggct ggagagatgg 14040
 ctcagtgggt aagagcactg actgttcttc cagaggacct ggcttcaatt cccagcactt 14100
 acatggcagc taagccaaga tctgacacc tcatacagac atatatgcag gcaaacacc 14160
 aatgcacata aaaaatgta aataaataa taataaaaag ttggacactg aaaatagaat 14220
 caactgttca ggactgaacc atactgaaga aggctccct ggctggcat getagttagc 14280
 agagtgtctg aagcagatca cggccagaca caattaacag ttcagcatgt ccaaatacac 14340
 agtctgtttc agaagcaagt atttcaagga ctatttctat tggtaagagc ttacagtgga 14400

 cctgttgata tagctcagtt agtgggaagt actgttcag catgcatgaa gctctagatt 14460
 tgatccccag atagcatac ctggtgtgtt ggttcatgac ttaattcta gcattcagga 14520
 agagggggca gcaaatcaaa ggcctgcccc aattacaaaa gaacctacct caggggaaga 14580
 ggtgagtggg agcattacaa gaattattt tcttttccc catgtggtgc tagggatcta 14640
 atctagggcc ttgcttactc ttaacaagca ttataccact gaggatatac cacaatctc 14700
 atataattgc taaaggagta aagattttaa ctgaaatcta gttctaatta ttccatgcta 14760
 tcatcatgga ttttgatttt tgtgctttt gtttttactt catgaaaata agtgcaatgg 14820

 gaccattcat tgctcagagc ctattaatag ggaaaagctg aaaaagatg gccatgatga 14880
 aaatactcag gccaaaataa ataagtaaat gaacaagtag atgtggttag catttaataa 14940
 caaacactgt gctgagaagc acttaacata gagacagaaa agaaacccat aaataagcca 15000
 agataaaaat gaaacgtaga gacaaaggag ccattaattt atgaaattta ttgttgtaaa 15060
 aagctgttca agtgacaaca aagaaatgtg ctcttcatt tggtaaaaag gtgcttcatg 15120
 atcactgcct tgtctcaaaa gcataaggaa aaactggcca agtccactgt taagccatcc 15180
 actcaggtea agcaatgcat tgatgagtct ttcaaagtgg tctgcagag aatgtgtcct 15240

 ttgagagttt gagaactggc agaggtgatc taaaagaaaa cccagcaaaa gacaatgtaa 15300
 cctgacagta ccatggatgc aggacatgga tagagatgac aggaagttca tggacttat 15360
 gttacctcaa acctgaaagg aagacacatc agacagaacg gcaatgtata tgaggaaga 15420
 agccacacac tccatcaggt gtgtgaggtc tftgaggac tatgaacatt acaaccacag 15480
 taattaatcg gtgaatgggg cacacgctga atacctgatt ggaatacaga ctctcttacc 15540
 cacaacagag ttcagagga agacaggtaa taaaatgat ttcaggcact aaaaattact 15600
 ctaaagattg tgggggacaa gtggttaata ggcattggaa ttaggcagga aaagtgtctt 15660

ctaaacaatg atgttcagag gtgagcacgg agaggtagcc tcaaaattaa aagaaagaaa 15720
 ccaggaaaag agcaagaatc tccaagcca aaacagcatg tataagttcc tgagaacaga 15780
 atataagcaa caaaaaggtc aacagagaat gagtgaagac catcaagttg gaaagtaacc 15840
 ggtacagatc acataggcct gaatcactct ctggctccag tgaaaagcca atggagggcc 15900
 caagcttcag ggtaaatgat ttgaatcaga aagatcacac cagctgtcat ggggcagacc 15960
 ctagaggaga acaagaacag aagcagagaa ggtgaaatct ctagaattct ctagecctgc 16020
 taagaggggt ataaaagcac ctgggctatt cccatgagca gagccacact atgaccagca 16080

 ataccagtc acatacccaa cagagatgtg ccttacggca cacgcacatg gaaacacata 16140
 gcactatcac atgtacgagc tcctacctgg aaacaaccaa tatggcccat cagcaataaa 16200
 cacacaaca acigtgttga taggaaaaca cactcacaga acaaccacgg ggtataagtt 16260
 gagggaaaag aggcagaaat tcaagctaca tactatagaa ttcagtttac aagaaatcaa 16320
 aaccagacaa aaccaaaacta tagtacaaaa gtgggacagg gtatggcaca agcctacagt 16380
 tccagcactc agatggctgg ggagtaacta ggaagcacaat gaagagcatt tctgggtccc 16440
 aaaagccatt ctttttgatc tcagaaatag ttacctgagt gaggtcactg taagaattca 16500

 ctgggcaggg ctgtgggtgt gcacaccttt aatcttagca ctcaggaagc agagggtggc 16560
 tgatctctgt gaatttgagg ccagcctggt ctacacagag agttccaggg cagccagggc 16620
 tacacagaga aatcctgtct ccaaaagaga gacagacaca gagacagaga cagagacaga 16680
 gagacagaca gagacagaga cagagacagg gacagtgttt cattctgtga aatagcccag 16740
 gctggcctgg aactcactat gtccagacta gccttgaatt tgtggctatt tgtagcaggc 16800
 tttcttgaac tgccagtccc caaatcatga cacggagacg tattaatcat gaatgctcag 16860
 ccttagctta ggcttgtttc tctatgtttt gttgttgttt tttttttttt aacttaatt 16920

 aaccatttc ttttcatcta tgtgetgecc caaggttcgt ttacctcacc tacacactgt 16980
 ccatcctgct ttctgtcttt cctgcttctt gtgcacatgg ctggccccct gctggctggt 17040
 tgggtcccc tttctctcgg cccccagcc ccaacgatcc cgttctgccc tagatattgg 17100
 ctgttctctt tttatttgac caatcagggtg ccttcggcag gcaaggttaa atagcaacac 17160
 atctttacat aactaaacaa atgcagcata acaaatgta acatatcttt tttgttgtt 17220
 tctttgtttt gctggttgtt ttttttttct ttttcttgg ttggttgttt ggtttttctt 17280
 tttttctac attgttttat tattattact tacattccaa tcccacttcc tectceccatc 17340

 tgctcctcgg agagggtgag gcctccccta ggaagtctac taagtctgtc ccatcatttc 17400
 cttagaggcag gaacaaggtc ctctcccct cccccagct cctcacteta ccccatcccc 17460
 atgcctagat ccacaaagt cagtttgtgc attagagtta gatcttgac ccaactgccgg 17520

tggcctcata tattattgcc ccagccacac cactgtcacc tgtattcagg gagtgcagtt 17580
 cagtcttatg caggctctcg ggttgtcaga cctgagtcag taatctctca ctagcccggg 17640
 tcagctgatt ctgtgggttt ccccacatg gtcttgactc ctttgttcag attatcactc 17700
 ctccctcacc ttgattgtac tccaggagct tagcccaaaa gttagtgtg gatttctgca 17760

 tctgcttcca tctgtttctg gaagagggtt ctagcttctc tggggttgtg gattgtaggc 17820
 tgggtatctt ttgctttatg tctggtattg acttatgagt gagttaatac tatattgtc 17880
 tttctgggtc tggattacct cactcaggat ggcttttttc tagttccgtc catttgctg 17940
 caaattttag gatgtcattg tttcttactg ctgagtagta cttcattgtg taaatgtac 18000
 acattttttt taccattct tctgttgagg ggcatcaagg ttgttccaa gttctagcta 18060
 tcatgaataa tgttgctatg aacatagttg agcaaatgtc cttgtggtg gaatgtgtct 18120
 cctttgggta catgccc aaa agcggattg cagggtcttg aggtagatca attgctaatt 18180

 ttcttagaaa tcaccatact gatttccaca gaggctgtac aagtccaac tcccagcagc 18240
 aatagaggag tgttcccctt actccacatc ctctccagca taagctgtca tcagtgtttt 18300
 tgatcttaac tattatgac agtataagat atcttagagt gttttgattt gcatttccat 18360
 atgactaagg atgttgagca tttccttaag tgcctttcca ccatttgaga ttgttctgtt 18420
 gagaattctc tgtttagatt tgtaccccat ttttaattgg attatgtggt agtttgatgt 18480
 ccagtttctt gaattctttg tatattttgg agatcaacce tctgtcagat gtgaagtgg 18540
 tgaagacctt ttctattct gtagagagtc attttgcctt ttgctttaga gaagcttctc 18600

 agtttcatta gttctcaatt attaattgtt gataccagtg tctgtgctat tgggtttagt 18660
 tacatttagg aagtggctc ctgtgcctat gcattcaagg gtatttccca ctttctctc 18720
 tatgaggttc agtgtgatg gatttataat gaggtttttg atccaattgg gcttaagttt 18780
 tgtgcatgge gatagttatg gatctatatt cagtcttcta catgtcaact tccagttata 18840
 ctacaacct ctgtcaaaaa tgtgttctt tttccatttt atatttttag cttcttataa 18900
 ggtgttcata ggagtgtggg ttgatatcag ggtattcgat tccattggtc cacctgtcta 18960
 tttttgtgcc aataccaagc tgttttcatt tctgtatctc tatattagag cttgaagtea 19020

 gggatggtga tgccccagg tgatccttta ttatacaggg ttgttttggc taccctgggg 19080
 tttttgttt gttgttttt ccatatcaag ttgagtatta ttctttccag ttctgtgaag 19140
 aattgtgctg ggattttgag ggagattgca ttgaaactgt agattacttt tggtaggatt 19200
 accattttta ctatgttgat cctacctatc catgagcatg gaagatcttt ccattttttt 19260
 gatatcttct ttagagactt aaagtcttc tcatacaggc ctttcacttg tttggctaga 19320
 gttaccccaa galacgttat gttattttg gctattgtaa agatggatat ttctctgatt 19380

tctttctcac cctgtttatc atttatata aggagggcta ctgatttttt ttttttagtt 19440

aatcttgtat cctgctacat tactgtaggt gtttatcagt tgtaggagtc ccctggtaga 19500

atfttggggg tctcttatgt aaactacat atcatcagca aatagtgaag gtttgacttc 19560

ttttccaatt tglatccctt tgatctcctt ttgtggctct attgctctgg ctagaacttc 19620

tagtaccata ttaaatagat ttagacagag tggacagcct tgtcttgta ctgatttcag 19680

tgggatcatt ttgagtttct cttcattaag ttgatgttg gctgttgggt tactgtatat 19740

tgccfttatc atgaagggtg ttgaattttg tcaaaggctt tttcagcatc taatgagacg 19800

accatgtcgt gtttttcttt cagtttgttt atatggtgga ttacattgac agattttcat 19860

atgttgaatc acitgggatga atcctacttg gtaatagtga atgatttttc tgatgtgttc 19920

ttggattcag ttgcccagta ttttattgag tatttttgca tcaatgttca tgagggtaat 19980

tggctgttaa tctcttagt tgtgtctttg tgtgatttag gtatcagggt aactgtagec 20040

ttgtaaaaag ttggcaatg ttccttttgi ttttattgtg tggaataatt tcaggagtaa 20100

tggattatgc tcttctttga atttctggta gaattctgca ctgaaactat ctagecctgg 20160

gctftttttg gttgggagac tattgataac tgtttgtact tcttagggg ttacagtctt 20220

ttatctgttc ttgatttcat ttgggtatgt ggtacttatc tagaaaattg tccatctcct 20280

taaagtcttc caattttgtg gagtacaggt ttttaacta tgtcctgatg atctctgta 20340

tttcttagt gtatgttgtt atgtccgcct tttgtttct gattttgtta atttggatat 20400

tctctgtgtc ttgattaatt tggataaagg ttgtctatt ttgctgaatt tctcaaagaa 20460

ccaattcttt gtctcattga ttctttgtat tgttttcttt gtttctatft tattgatctc 20520

agccttcaat ttgactatft cttgctgtct actcctctg ggtgactctg cttttcttct 20580

agcactttca ggtgttctgt taattcacta gtgtgggatt tttccagctt ctttatgtag 20640

gcatttagtg ctatgaactt ttctcttagc actactttca ttgtgtccca taaatcgggc 20700

aatgttatgg ggtcattttc attaaatttt aagaagtctt taatttcttt cttattttct 20760

tccttgacc agtgggtgaat cagctgatca ctgttaaatt tctatgtgtt tttaggcttt 20820

atgcaatttg ttgttgaatt ctaactttaa gccatgatga tccgattaga tacctggagt 20880

tattccaatt tttttctatc tgttgagggt tgttttgta ctgagtatgt tgtctactgt 20940

tatagtatgt ttgagaagg ttccatgcag tgttaagaag aaagtatatt cttttgtctt 21000

tgggtggaat gtctataga tgtctgttaa gtccatttga gtcataacat attagtccc 21060

ttatttctct gttaaacttc tgtctggcag acctgtccag tgggtgacagt gggatgctga 21120

agtctccac tattagtgtg gggggccttaa ttcattgattt aagctttagt aatgtttctt 21180
 ttacaaatgc ggagaccttg tgtttggggc atagatatta agaattgaga cttccttttg 21240
 atgggttttt ccaatgatga atatgatgcc cttcttcac ttttttgatt gatttttagtt 21300
 agaagictat ttigttagat attaggacag cttgtttctt aggtccctct gattggaaaa 21360
 tttttctcaa tcctaactga ggtaatgttt gtctaaggtt gaggigtgtt tcttgtatgc 21420
 agcaggagga tggattctgt ttttztatcc aatttattag cttgtgtctt tttataggtg 21480
 atttgagacc attcataatta atggatattia atgaccagtg attgctagt tctgttattt 21540

 ttgtttttgt tgggtgtgat ggcattgtgt gttcaattcc cttctttcag atttgcctct 21600
 acaagctcat ctattgcctg tgttcttctg aatgtagctg acttcccttg cattttcctt 21660
 ctagtacttt ctatagggtc gagtttctgg acaggtattg tttaaatctg gctttatcat 21720
 gaaatatttt gttttctcca tttatgatta ttgaaagctt tgctgggtat agtagtctgg 21780
 gctggcatcc gtgtccctt agtgtctgca taatgtgtgt ccaggacctt ctggctttca 21840
 ttgtttctat tgagaagtca ggtgtaagtc tgctttata tgttacctgg accttttatt 21900
 ttgcagttct taatattctt tctttattct gtatgcttat tgttttgatt attatgtggt 21960

 gagggaaactt ttttattggt ccagtctact tgggttctg taagattctt gtactttcat 22020
 aggcattgct tctcttagt tgggaaagt tcttctatg actttgttga atatatttc 22080
 tatgtctttg agttggactt tttctctat cctattatt cttaggttca gcttttctt 22140
 agtgtcccag atttccctga tgttttctg taaggattg ttggatttaa cattttctt 22200
 gaccaattag tctatttcca atattgtatc ttcaatgctt gaaattctct cttccatctc 22260
 ttgtattcta ttgtttatat ttgcatttct ggttctgat tgtttacca gattttccat 22320
 ttccagattt cccttggttt gtgtttctt cattgactct attcagatt tcaaatcttg 22380

 aatcgtttcc ttcacatgtt tgaatgcttt tctttggttt tctttaaggg atttttcgtt 22440
 atctcccaat tgtttgtctt ttcctccatt tctttaaggg actttttctt ttcctcttta 22500
 agggcctcaa tcatctcaa aaagtatgt ttaaggtcgt tgtcttctgc ttcactcca 22560
 ttgggatgtt caggccttgc tgtttagca ccactagttt ctagtgggtc catattgctc 22620
 tttatgttgt tgagtgtgtt cttacctgtt ttctatgctt cttctctcc aatcggata 22680
 ggaggagctt gtgcttcagg ggtctctct tctccaaat ggtatagttg ggagctgtgg 22740
 ttccgttgac cactccttca tgtacaatca gaacagagcc tccagtgatc actcttctg 22800

 gtggaagtgg gcccaaggct caggcagtcg ctctcaagg tgcaggtggg cctacagcta 22860
 cagtaggaag aaggaccacc gctccagtga ttgctctct atgtgaggtg gtgctgaggt 22920
 tccagtggtc actataacag tggggtatct tgaaccaaga aatggcaatg gatgctggct 22980

gggacacagg tgcactttcc cacaggaact tcttgtgata gcttctggaa gccactgttg 23040
 gaagttgctg ctgtcatttc ctccagcagt cactccctgc tcctgggcca gtggctcagg 23100
 cctccctcta aggctgctcc tgggcctgac gctcaggctt ccctcaaaca tatctttaca 23160
 tagttaaata ttctattcca caattgctat cctcccgcct tactaatctg gctacctttt 23220

 agcttttagt taagccattc tcaattgtgt gcagtttagc tctgtgtttt ttgaggtatt 23280
 catttcaacc ttgtttctac taagaataat attttttttc ttttggggg gaaggaagga 23340
 agacacagtc cctctatgaa tctttagctg gcttgcctaa aacaggagct tgtggactgc 23400
 ctggaatagg tgctggaag ggaacttggga tcctctagaa gaggaagaag tgctcttaat 23460
 tgataatcca tcctccagg tgctctatat gtttttatat taaactaaga gagagtgttg 23520
 ccataagtaa cccaaaattc ctttcaattt atagaattta aatctttaac aaaccagtta 23580
 attcaaatct gtaggtaaac cagacttggg gatgcacacc ttttatccca atgctcagaa 23640

 agaaatgctc tcttgagttc caggtaggcc tagtctccat agtgagtttc aggccagtca 23700
 cagatacata gaccctgcct caaaagagaa ttatattatc atagcatggg aaccttgata 23760
 agatatgaac ttttattttt ggtttgagga caaatttttt acttttattt atctattcat 23820
 tgtgaacaac tgcacaagta atatggatat atgcactttg tgcatgaata tgtggaggcc 23880
 agagatcaac ctgggtgtca ttgcacaaga gctactcacc tggtttttga gacagtgtca 23940
 cactgggact tgggcttacc aactaggggt gccagctgg acagtaaac atagagatec 24000
 tatctctcc ccagtgttgt gattaaagtc ttgtaccaga agctaggtga agtgacacag 24060

 cctttaatcc cagcactcag aaatctgaga tatccatata tctctctgta aattcaaggt 24120
 cagcttggtc tacatagtga attccaggcc agggcaacaa agtgaact ctgtctcaga 24180
 aaacaaaaat aacaacaag ttgtctgcca ggccagaact tgcccttaac ctcagctctt 24240
 ggaatggggg gaatgggggt cacagagaca ggcagatttc tgtgaattaa aggacagcct 24300
 tatctacata gtgagttcca ggacagttag agctacatag agaaaactg tatcaaaaga 24360
 taataaata gctgagcagt gacagtgcac gcctttaata tcaacactcc agaggtagag 24420
 ggagagacag gcagatctct gtgttctagg ccggccgggt ctacagagct agttccagta 24480

 catccagggc tacacagaaa aacctgtct tcaggagaaa aaaattaca cctgatcacc 24540
 aacctaatg cttttatca agtgatccat agttaattac aatgaaaaa agataagagg 24600
 caaaattaa aggcaactgt tagagctcag gcaatccaaa tatccagaaa tgagctcaaa 24660
 ctgaattata agaggatttc cagcagttag ataaaagcat gtttctctg acaactgtg 24720
 aaactagttc ccatctgtca aaaggagtaa tttcccttac ctctggcaga gggacaaatg 24780
 gctacctgtg gtttcatatc aaagccatg ctgcctccag gctactcaa tcctactca 24840

caagtattag taatatgttt caaagtccac actggccttt ctcatctcag atccctgctc 24900

tctttgtgtc cctgcccct gtctacgctt gctatcctca ctatcccctt tctggctagt 24960

ctcttttctc tcacaggtaa ccctggctat gtccagtcag tttgtttaac treactgctct 25020

ggactcttcc agatgcctct ttctctctct tattcacaat aaaatccttc cctaataacg 25080

gagcggctcat gtcagtaatt tctttactgc accaccttgc atatagcaac taaatccaaa 25140

gttacactgc tatcttaaaa aataatcttg ggcaactctg gaaaataaga gcacatactg 25200

tgggggttgg agagatggct cagcagacaa gagcaatggc tgctcttcca gaggaccagg 25260

tttcaattcc caggaccac atggcagctc acattgtctg taactccagt cccaggaggg 25320

atccaaagcc ctcttctgtc ctccacaggc tccaggcaca cacatggtga ctagctacac 25380

atgcaagcaa aacatctata cacataaagt aaatgaatga atttagaaga aagaaggggg 25440

tgcataattgc tcttctctgag gatttgaatt agttcctagc acccacatta ggtggtctac 25500

aatcacttct aactcgagct ccaggagat ctgaaacttc tgacctctgc aagtacctgc 25560

attcccgtgc acagacatac acatacacac gactaaaaat agtaaacag acatacacat 25620

acacacgact aaaaatagga aaatagggtc tcagaggtgg cttagtgggtg aagagaaagt 25680

gctgatcttc cagagggcct aagtttagtt cccagcacc acactgggaa ttccaactt 25740

taagaagagc atttcttggc ccaatgtcag gaaaggaag gggcctccag ctagtaaact 25800

ggttgtgttc tgaggttttg tcagatagta aactggttgt gttctgaggt tttgtcagac 25860

agacagaaca aggaaactca aaaccctta cttcaccag cacatagtcc ccaggctgag 25920

ctctgacctt gagcccagag ttagtgacat cctccacctc tgcatcaggg aagatcacct 25980

taaggtttgc atcattccgg ccacacaggt ctgtggaaga acgtttgctg aactgcagaa 26040

aacagagaga atatatgcat ctgtcaggag ttctagaagt tttaggagc agacactgct 26100

cctgttgtct gaggctctcc tgggtctatc acaagcatt tcttttctt ctttttctt 26160

tttaattaat ttatttacgt atccctaca ggccagaaga gggtagcagg tctctttaca 26220

gatggtttga gccaccatgt ggttctctgg aatggaactc aggaccttg gaagagcagg 26280

cagtgtcttt aacggctgag ccacctatcc agccccacag aacatttctt tcttttttt 26340

ttttttttt ttttttttt ttttttttt ctttttttt ttaattaca acaagattga 26400

attacctgac aatcccagt ccttctctcc tccctctc cctaccatc ccccaacta 26460

aaacctccc taccacttcc cttttcttct aatctacaac tgactcaacc tttctgctcc 26520

ctcatgacct ctgcattctt tctttcttc ctttctcatt ctctagctc cctccccct 26580

ctcccatgt tcicaatttg aacagagcat ttcttaatga ggaaatctga agtctcactt 26640
 tgtgtggctg attcaacaat aggacaacat gtggtgcaca acagaaacaa agttctgttg 26700
 actatittta tgaatcaatg aatctttaca gggatactta gagaaacact ctcttgaaaa 26760
 aaaaaagaa agaaagaaag aaaattcaaa acaccaacaa gaaaataaac cagcaaggtc 26820
 ataaaatgaa aaaagtaaga cattttgggc ttgagattga ttgtacagtg tttgtctagc 26880
 acgcaggagg ccttgggttt gatacaaacac cacataaccg gggcatgagg gtgcactcct 26940
 gtaatcccag tgcttaggaa gatatatgca ggaggatcag aaattcaagg tcacccttag 27000

 ctacatagca attttaagat caacctaggt aaactacatg agaccaggtc tcaaaaaagt 27060
 aagaccgaca taaaagagac acatagtgtt attctaaaag gcaaaaacca tgcgtgtgaa 27120
 cttaccctt caaccaatac tagctgggta caaccactg aggtctggtt ggctcttgac 27180
 gcctcttctc tgaagatagt aataagttcc tccaaacgcc ttaatttgac ttcttctgga 27240
 acatcgtcct tcagcctatg atatgcccgt gtcttctatt aaaaaataaa acagaacca 27300
 ggtcactaag gagttagaga atcctcaggg caciaaggag ggaatatatt cattctactc 27360
 acaagttaca gacatgtaat ttggtcctaaa acccaaacct gaaccacatt tatttctcta 27420

 gttctgggaa cattccatga gaaaagggca actaaaatag atctttgtag attcattcta 27480
 aatttagcaa atgaaaatca cactcatggc tggcaggatg ggtcagtggg caaaggtgcc 27540
 tgacaccaag actgatgacc tgaatccaat cctagcccca tacagtggaa tgaaagaacc 27600
 aactccagca agtggccctc tgacctacac aactacaac acatgcacac ccctacaaac 27660
 aggcatacac aaaatcaata agtatacaaa taatacatt taaaaaatca cagactcagg 27720
 ccagggtctg gtggcactcg cctttaatcc cagagtcagg cagatctctg tcaattcaat 27780
 gccagtctgg tctacagaat gagttccagg acaggctcca caacaataca aagaaacct 27840

 gtctcaaaaa accattaaaa aaaagaaaag aaaagaaaat cacagactca aagttagtct 27900
 tcatactagt cctaagttta tatttggaca cagactaaat aatgcataca ctaagctact 27960
 caccagcgt gtttatagag acacagatat aaagcagcct gaactactac taactagtac 28020
 ctaataaatt atggtctatc aacacaatgg agtggttaagc aactgttaat aagataacac 28080
 cacaatact aatgtaattg ttccaaaata ctccaaaatc tgaaatagt aaaatctaat 28140
 caacatgcat gtcgttggtg tagaaagcat tcatgtttat gaacacataa catgtatctg 28200
 gaaactgata aaagaaagaa atcactaaga gtggggctgg cgagatggct cagaggttaa 28260

 gagcactggc tgctcttcca gaggtcctga gttcaattcc cagcaaccac atggtggctc 28320
 acaacctct gtaataggat ctgggtccct ctctctgtgt gcagatatac atggaaacac 28380
 agtgttgtat atatactaaa taaataaaat ctttaaaaaa aaaaaagag aatcactaa 28440

gagtaattgc cticcaaaaag agaactaagc ctgggagcaa caaaaggaag aagtgtttta 28500
accttcacac ttattccat aagcacctat tacctagtca gaaacaataa ttatccttga 28560
aaagtgttta aaaactatcc tgggtataca cttatatatg tctttattct catgctcaaa 28620
tcaagtggag aacaccactg agctaggaaa aagtcaagga ataaaaggaa aagctaaaca 28680

ccactgtctg gagattcaaa ccaatctacc ctgaaagaac taccatatcc acagaggaaa 28740
acagaatggg gactgggtat aagatcctac tcgatgtcag catgttgtaa gtaatgataa 28800
ccatccgatg gcaactgtagg aagcaccact ctaagtgggt tacatgcact atcttattca 28860
agcctcaaaa cacgcctaag ctgggtactgc tattcccact tcaggaagca actaaggact 28920
ttagacaagg tcaactgttac tacatgacaa aggcacattt tgagtgccat acttccattg 28980
tgtgttgaca ggccacttcc cgagtagacc agtcttataa ataatttctc ttgtgcatct 29040
gtgatgtcca ggctctgggg aagtctcact tctgaaatac tgtaaaagat actggccacc 29100

ttacactgac tacagaacac tgagcactgg acttcaattt tgtcttgatt tacttattta 29160
tttgtttgtt ttgtttttaa gacagtctca atctatagtc cagacctgtt tcaaacttaa 29220
gattcccctg cctcaacctc ctaagtctca ggattacagc catatatcac caaaccagc 29280
tacctgcaaa atagttcata aataggaaca ctgacttggg aattttttta agttttattt 29340
atattattat tatacagtat tctgtctaca tgtatgctg caggccagaa gagggcacca 29400
gatctcatta tagatggttg tgagccatca tgtggttggg gggcattgaa ctcggcacct 29460
ctgaaagacc agccagtatt ctaaccact gagcaatctc tccagcccca atctttttgg 29520

gttttatgtg tttttgttt tttcgagaca gggtttctct gtgtatccct tggctgtcct 29580
ggaactcact ccatagacca ggctggcctc gaactcacat agattggcct gtctctgcct 29640
cttgagcact gggatcaaa gaatgcacca ccaccacagc ccagcccagc atggtaattt 29700
tttcatatca atttgctgag gtttgttggc tgtagtgtct aacaccata atgctaatga 29760
tcaggcagcc aagtgaagca gaaggaaaac aggcttgagt ccagccagag caaaaattaa 29820
ctagagaatt aattagagaa attaaaatta aattagagaa attaaaatta attagagaaa 29880
atgacggtaa gatgctgtga tatagctggg tgtggtggca cacacctta attccagcaa 29940

acaagagcag aaccaggtag atctctgagt tcaaggccag cctggttctg agactctgtc 30000
tcaaaacaaa caaaaaatcc tgggatttta caaagtcaaa ctctttccac ccaaccacct 30060
ccaatgagtc ccaagctggt aagaaaacga tgctaattgt ctcccattca ggacttacct 30120
gcctcatgct gtatgcaaag agaaaaccgg cattatactg aacttctcga agtaaagaca 30180
ctgtctgcag gtgateatcc tctgtctctc cacagaagcc agtgatgaag tcgctgctga 30240
ggctcacacc tgtcaatatt caacaaagga ccagtgctta gagactgcta ctgccgacct 30300

cagaaggaat gtgggcattt acgtattaca gaaggaagga aagctgctca gaagtcatta 30360

 cagagcaagg gaaagaggc ttgttttctt acaacatgac agaactggct cctccctcta 30420
 catttcctta agccctagaa aataaatctt ggtttcaaat gctagattca gagacactat 30480
 agacgagcag ttccaacag ccctgcttct gcatggggag ggtgaggac agtgctaaag 30540
 actaaacca gagccttgta tatatgctag acaagcactg ttgtgctaac actaacactc 30600
 cagctcccaa gtccacttt tactagtcaa tctttcgggtg cttcacataa acatatacat 30660
 ctatgtatct tgttttgttg ctattgtttt gataggggat tttttttcc tactgtgcta 30720
 gggacagaac ccattcaacc tctaaactag accgtatcta tgtattttaa ttataataa 30780

 ctgtgtatat gtatatatga tcaaacactg aatttaaatt agcattatgt tcatttacia 30840
 tgcaatgca aaactatcag atactgaata ctggaaatt gctatatggc cgggcagtgg 30900
 tggcacatgc cttaaatccc attacttggg aggcaaagac agatggagct ctgtgagttt 30960
 gaggccagtc tggctctacag agcaagtcc aggacagcta ggactgttaa acagagaaac 31020
 cctgtctcaa aatatcaaaa aaaaaaaaaa aagtgtaca tgtcattagc tattcaatta 31080
 ctccccaaaa ttaatgaca tgactactat ttactccatt ttataaatta caaatcttct 31140
 ttgttgtcat atatccaata atacgtact caatacaaag ccagtatacc cagctgcat 31200

 agcatcctgc cccatcagaa caaaagtatg tftacagctg ggtggtggtg gcatatgcct 31260
 ttagtcccag cactggggag gcagaggcag gtggatctct gtgagttcga gaccagcctg 31320
 gtctacaaga ggtagtcca ggacagcctc caaagccaca gagaaccct gtctcgaaaa 31380
 accaaaaaaaa caaacaaca aacaaaaaca acccacaana gtatgtgtac ataatacaag 31440
 aagcacggtg gcacatatct ttagtctcag cactcaggag acagaggcaa gtgggtcttt 31500
 gtgagttcaa ggccaacctg gtctagtaag ctctgggctc aaaaaggaaa aaataaataa 31560
 ataaaagtgg agggaaattt ctgacattct caatcaata taagcaaat gaagcaaaaa 31620

 cagtaatctt attaggagaa agggggaaaa ggtataatgg gatgtctaaa atctgcctaa 31680
 tttaaagtaga atacgtgata gtgcgtgttt ataatcccag caataacaat gaaagtagaa 31740
 gaccaagttc aaggccacc tgagcaacat aacaagacac tgtgtcaaaa ttcaagcgt 31800
 agagctactc ttcagtggca gagcatatgt ccacaagaca tgaggcttgg atttaatctc 31860
 ttgcaatatg cacacagtca gaaagatgga aaggaaaagt ggaacagaga gaggaaaaca 31920
 gagaagcagc aatgaacat aaaaatacca aaaactatga aatgacacca taaggaattt 31980
 gccaaagagg ctggaaattg agcaagatga atttggactg cggtaatgtg ctcagcattt 32040

cttaatgtac ctgggataca ttctctgata tgatgaacca atgccacata agcttccctt 32100
 gaataatctgc agtaaagaac aaaaagaaaa gacctagttag agaggagaag caaggttacg 32160
 ataagtcttc atgaagctga agttagcctt aaacttctgt tccacctagc tctatctccc 32220
 aagtgtctggg ctcttagggc tacaccacca cacctgactc aatcttattt aaatgagtac 32280
 tatagaaga taatactatg aattcccacg tafattcatt tttcgatttg tgatttcaca 32340
 accacaaatc acagtagaag agtacctgaa agcaccctt tgagccagtg agatgtttca 32400
 gcaagtagat actttctacc aaacctgatg acttcagttc aatccctgga acctacatgg 32460

 tagaagaaga aaaccaactc ctgacaattg tcctctgatt tacatgcaca catgttccag 32520
 ctctaagga cctttcattt aataaatcaa gaaaaaaagt aaacacttaa gaggacctct 32580
 aggggctgga gagatagctc gatggttaag agaactagct gccgctgcag agggcccagg 32640
 ttcagttcct agcgtccaca tggcagctca caatcatctg ccaactccat tgcaggggat 32700
 ctgatgccct ctctggcct ccgtagaag tgcatgcaca tggcagcagg atacacgcag 32760
 gcaaaacaca catacacgta aaaaagagg atccctagat ctttgcctct gtggaaaata 32820
 aggccaagtt ctagtctgt gagctttgcc ttaggtcata ttacccccct ccagtttcc 32880

 ctctgcaaac ttatttcaa agtgagtcaa gtgatctaca ttcatttct aagacctaaa 32940
 aaactttatt atcttgcaa ggtaaaaggc taaaattca aatatggcac ccagcaagca 33000
 ctaatttta aaaaatgtt aagcaaatga gaggtcaat gcttactctg cttaggggat 33060
 acacagaaga aagttcagct gtccatagat acattcaaac aacaaccact tattaatttg 33120
 ctactgtgtg tcatatacta tactaggtcc ttagcaaca atgcagtgtt tagtgattca 33180
 gaaaaactgg aatggttaag gatgtcctct cccaagatg gtctgacct ctctcatgg 33240
 catccagtac acggttgctt ccactctggg ctggcagatg gatctgcttg cagatgttgt 33300

 gtctctcatg aatcagetgt agaactgat taaacaaaac acaatatggg ttacctaagt 33360
 ctaccaaag aatcatgtaa aaaagaatat tctatacatt ctgaaagggt gcagatggaa 33420
 gtttctgtcc tgcaggctc tgcagccctt tagtccaaa taaactca gaggttata 33480
 ttaattataa acggtttggc ctattgceca ggcttcttac taacaaactc ttacaactta 33540
 aattaacca caatccttat ctatgtttag ctgcatggct tggcctca tctattctc 33600
 atcttgctc tctgctct ggttctcgac tactctgcc tctttttcc cagaattctc 33660
 atageccgc ttatgtctcc tgcctggctc ctggccaatc agtattttat taaaccgata 33720

 gaggtgacaa atatttacag tgaacaagaa cattatcca taccaggagg gggttgctgt 33780
 tgtttgttt tgtttacagg cattctgct gacctgct cctgagctct ggaattaaag 33840
 gtgtgaaca tagtactgg tagtatact ctctcattgt ttctctcag aggctaattt 33900

tcaagtaatg aaaaggttga ttgggaactg aggataaagc tcagttagt tagtgactgc 33960
 ttggcattca tgaggctctg gtttcaatcc tcagcagtgc ataaaactag gcatgatagt 34020
 gcacatctgt aatctcagca cttggaggag aggggaagaa tcaggagttc aaggccagcc 34080
 tcaactacac agaccaacat ggactgagac ctgtctcaaa aaataggaag aaagagccag 34140

gcagtggtgg cacacacctt taaccccagc acttgggagg cagaggtaga tggatctctg 34200
 aattcaagge cagcctggtc taaaaagtga attccaggac atccagaaca gtcaggactg 34260
 ttacacagag aaaccatctc aaaaaacaaa agaaaaaag agacagtctt gctaagttgc 34320
 ccttactgge ctgacactca taatccacct atgtcaagct cccaaagcta ggactataag 34380
 catgtatcac tcaactgacca agagctggga tttgaacca cgtgtgcctc aggcttccca 34440
 ctacatcaca ttgcctcctt tgctgttctc actgtatctc caccatgcag ctgcccacct 34500
 tgataaactt ctactacac aagtggcccc aagtccccac tgaaaacat cctatcgctt 34560

caactgatctt aggggaattt aagttttgcc aaaaggccag taattctgca aggagacatt 34620
 gcagtgtaac acagaatccc caaagcagga ttcaaggtct ctgccgtata ctctctgggtc 34680
 caggtataaa tatgcttcag gatgetgcta aaagtttgc acaacactaa atatcagcaa 34740
 cactcacctc atcaggaaaa tccttggggg ggggagaggt gaaacggatc ctcatctcag 34800
 ggtctattct tgaaacctga tccagaagat gggaaaagcg aagccccct tgtttggttt 34860
 tatagttggt agtgaagcca cgactgaggt tggtaggcac tgcattattg aactggatct 34920
 ctgaattgct ccgaaaacta ttaacattct gaccaagaag tgtcattctt ttagccctt 34980

aaaaacagga aaaacatgtt gaaaacaagt ttaaccttct tgaacagctt catctcaaac 35040
 cactaattaa aaattagctc aatctacaa gagccataaa gaaacctgct ttaaatctga 35100
 taatctcaca ctggagtacc ttatctaaag actgaacaac agagtaagac cttaaagagt 35160
 tactgcctg taatcccaac tctcaggaag taaaggcagg tttctgttac catctcaatc 35220
 cctaaaacag aatatactc tctaaagga gttttgtact gtaggagaac ttaaaatggg 35280
 gaggagggga taactttagt atttaagcaa gtaaaaactg agattttaca agctatcagt 35340
 gatggaacta tctgtggatc agacagaggt ggaggagaca ccacaggcta caaagctaga 35400

aaggctatcc tcagcctgct cagaacatgc tcgtatgaag aaagcttggg taacctcacc 35460
 tgctcagaga gcttctctac ttcatctaga atggaggcaa cgggccgact cctctcccgg 35520
 ccacgagtga aaggaacaat gcagtaactg cacatgttgt cacagccccg catgatcgac 35580
 ctagggaaga aagtacaaga acacagttaa caggggagca atgctgtctt agcatgtccc 35640
 atctctgcag ctctcttggg atttttcttt ggtcttggat cctctctgtt ctaagctcac 35700
 actgaactaa tgtgaaatcc gtaagtgtat aatcacagaa tatgaaccag actgtaattg 35760

gtagacatgt tggtagaggaa gcatagtgtt gaggggaaac ggtctgactc agcactgtgg 35820

 agtttctacc gttttgatag gtatattaga tggaaatTTTT tatgcagaga ttgaaaacaa 35880
 actctatgtc tacctatgtt ataaaagaca ctctgaggcc aggcgggtgtt ggtgcatgcc 35940
 tttaatccca gcacttggga ggcagaggca gatgggtctc agtgagtcca agaccagcct 36000
 ggtctacaaa gtgagtcca ggcagaccag gactgttaca cagagaaacc ctgtctcaaa 36060
 aagcaaaaac aaagcaaaaac aaaaagatcc tgaatttaaa ataatagcttg cttttctcat 36120
 acaatctttt tctttgagac agggcttctt gtgggtcaga ctagacttaa actggtatat 36180
 agcaaaaac atggatgagg atcttgaact cctgatgctc ctgcctccat ttccaagtgt 36240

 tgtgtttaca gatatgcatc atcatatctg actctagctt tggttttctg acacaaggtc 36300
 tctcaatgga gctctaaatt gcctagtaca tgctgtggag cccagactgc ccttgaacgc 36360
 acagcaagca atattcctgc ctctgctcc caactgttag gattataagt atgagcctct 36420
 ttcttcccag ctgttgtttt ctatttctga aacaaggctt ttccaaataa cacagattag 36480
 cctggagcaa caatcaacc cagagtgacc ataaactcac aacaatctc ctgctttggc 36540
 ctgagattgt gagcacacac tacagcagtt taaaaaaaaa aaaaaaagt ttctatcaag 36600
 aaagcccaag gcattccctt aagtgaaaat aaacttagaa caataatatt tatgttttaa 36660

 aaggagggtta agaaaagtat ccatatgagt atatgactac atatacaagg aatacttcta 36720
 gaaagattaa ataagaatga ctgacatgga aatctttgag aaatggcctg agaaagcagg 36780
 gatgatgggt gtgaggatc ttacggtatc acatgttgtt ttctgcatgt tgtccataa 36840
 ctgttcaaat gcattccttt cccttatgct caacatagta aactgaaaca tgctcatcct 36900
 ccaggctca catgatgact cacacaaagg cagaagtggc actggggctt gtttgactg 36960
 gcatgatatc tgcataggtc tcatccagag agagaagcac gtttctgccc tgctgacctg 37020
 actccacaac agccagcagc cggggaaggt ctcgataggc atccggtcca gccaaagat 37080

 cgactgtttt ctccctgttg aggatctctc ccttcagtct ctgagccatg cagcctggga 37140
 agcaaaaaga actagtacct cttctgcagt tcacctgttt tctggcttt tgttcagtgc 37200
 acataattta taacttgccc tggagaccag ggtacagaaa acttctctga gtttagtatt 37260
 accctgcaaa actggacca cacaactgaa cccacatctt caaatacaag aaaacatag 37320
 aatatctcag agcaaatcaa ttaaatgtct ggaatgtgca gggaggcatc caaaagcctt 37380
 tccccattt ttccatcac tgctggaggt gcaagtcaga gcctcccaca tactaaccaa 37440
 gcacaccatg agtgagctgc attccctgcc ccccaaagcc tctcaaacat gaaccacctc 37500

ttctcacagt taaagattac ttaccactaa gataaaaagat atccttacat cagaagtctg 37560
 tctataagtt tacaactaca cttaatgctt ttttctcttt cagcccacaa tacttgctaa 37620
 acccatgaga aattatataa ataattatgc agataaaaatt tgtaccccca aaccatcatt 37680
 ttattaagac tataaaacct aaaagcatac cttttacaaa gtctttggaa tggtagttg 37740
 tttggggttt tcttaagat tgttttatta tttttgttta tgtgaatgtg tgcttggtga 37800
 tgtgcatg actgcaggtg cctgcagttc agtaagagt gttggatccc ctgggtctgc 37860
 aattacaggc agttgtgaat tgccaacac aaatgctggg aaccaaacga ggatcctctg 37920

 aaagaacaat atatgctctt aactgctaatac acatctctcc ggccccatag tttggttggtg 37980
 atggctcaga ggtaagagc actgactgct cttccagagt tgctgagttc aattcctagc 38040
 agccacataa tggctcacia ccatgagatc tggcgcctc ttctggcctg caggcataca 38100
 cactgacaga aactgtata cataataaat aaatcttaa aataaagaga aaagaaggga 38160
 gggaggagg caggaggga gggaggcagg gaggaaggaa ggaaggagg aaggaggaa 38220
 ggaaggagg aaggaggca ccaagtcca aatcagttc ttacattaa aaagatttta 38280
 aaaacaatta ggggctggag agatggctca gcagttaaga aactggctg ctctccaga 38340

 ggacctggt tcattcccag cactcacatg gcagtcata actatctta actccagttc 38400
 aggggatctg acacctttat accaatgcac ataaaataaa gtaataaat tttttcaat 38460
 ttttttaatt attgggtggg gtgccgggcg ttggtggcgc acaccttaa tcccagcact 38520
 caggaggcag aggcaggcag atctctgagt ttgaggccag tctggtcttc aggaaagcca 38580
 gagctgttac acagagaac cctgtatcaa aaaaccgaga gagggagaga gagagagaga 38640
 gagagagaga gagagagaga gaaaagaaat gatgcacata ttctctctca gccttgattg 38700
 tggacgtcat gtgactgct gcttgacttc ctgccttct gtcttgactt ccctcagtg 38760

 ataaactgta acctggaatt gcaaagtcaa ataaaactt ttcttccctt ttggtcaggg 38820
 tgcttcatca cagcaacaaa aaaaactaaa atactcctc ttgcatctcc ttcaataaat 38880
 ctcttggtg aggtttgctg tacagtgtga ctttgggta tttcttagct ccctcagag 38940
 ctggaacact tacagtagta atggtgcat aagcacgtga atatactta tactacagaa 39000
 tataataaaa atgattaaaa tggtaggttg atgtatacaa ccattatctt acattttcc 39060
 atgggggttt ctaaaattcc aaaagatttt ataccaagg gcaactataa tgaagtgaaa 39120
 aggaagaaaa ctctctagc atctatctat attaatacagt atgactggat aactgtgtg 39180

 ttgactatca agagtgatta agttaactat actaaaatgg acacgtcca ctaagcataa 39240
 agttaaatat attaaccaa tgggggtcag aaaggatgca tagatcttc ttttgattgg 39300
 ggtatttttt gcatttattt atttatttag cgtgtgtgtg ggtgtgcaca tgctacagta 39360

cccatgtgga ggiccaagtg gggtagttgg ttctctctc ctacatgta catccccaaa 39420
 atcaaaggca gttcaataga ctgatggca agtgctttcc ctgctgagcc acctggccaa 39480
 cccccaaagc acttattttt gaagfatgft tcctgaccac ctgaccaga actgtccaac 39540
 agagctttca aacaaggaga agggacgtgc tggatggaaa tgactggagg tgctgtgtaa 39600

 attggtggac cctcatcaga tgtggctgct gagaagctga gatgtgtctg atgcaaagga 39660
 agaagtgcac ttttgaattt gtttttcaa tgtgactact gactaccata ttggtcaaga 39720
 caggcctgga ttttcaactg ggcttgcttc cgtagttcac atgacaggta actacactgg 39780
 aaactcgtgt tgcctccag actccaaatg ctgaaactgt ctctccctct ctgtactaca 39840
 tgaactgcac caggctctag ggaaaacaca tcaactatctg agcatctact atttctttat 39900
 ttgtttgttt gtttgggttt ttgtttgtt ttgttttttg aaacagggtt tctctctctg 39960
 tgtaccaact ctggttgtcc tagaactcac tctgtagacc aggctggcct ctaactcaca 40020

 gagatctgcc tgcctcttc tgcctcctga gtgctgggat taaaggcgtg caccactacc 40080
 acctgctaa atgcaagctg ttaaatccct catagcagga ataccattat cctactcttt 40140
 tgaaggtttt tgtttgttg ttggttgagt tttttggtt ttggttttta ttttggtttt 40200
 ggttttggct tttttgaga cagggtttct gtgtaacagt cctggctgtt cggctactcc 40260
 gtagaccaag ctgacctga actcacagaa atccacctgc ttctgccttc caagtctgg 40320
 gattaaagc atgcaccact gcctgggaca tctattatct ctaagtgcta caaaaagatc 40380
 ttttagaagc tcatctcat ttaatcttgc aatctctaac atcaagtaa agagattcat 40440

 ggggtagata tggctaattt acacctgtt atccaggcct ctaaagcagc aattctcaat 40500
 ctgtggtcac atatcagata tctgcatat caataccgac atttcgattc ataacagtag 40560
 caaaattaca gttatgaaag tagcaatgaa aataatttta tgggtggggg ggccacaact 40620
 gaagggttgc agaatgagga aggctgagaa ccaactgctc aaaggaaaaa ctctaggaac 40680
 ccaagtctca aaatgaaaa attcattctg aaaatgaatg gatactaga atcccaatcc 40740
 tcagaggtag ccgggaactg gatcgttttg tcttcagggc cttcagctga tgtaaacggt 40800
 tccagatggt ctgctcagcc ttctctctgc aaaatccaaa gaggccaaaa tgagcaggat 40860

 aggagagcag gacagcgagg agaaaatgaa agccatctga gtccttgcaa aggcattctac 40920
 gttgaattca ggaaggcac acagaggcaa actgggaaag caccattgc aatcatctc 40980
 ttccctctaa caatctctc cctacacatc tcaaatcca gactagcttt caagcaaac 41040
 ccaaaagctc cattcttcac aagccttcc ccagctctc tgtgactctc ctcccttcaa 41100
 gtacctcta ccttaactct acttctctg aacatggaat tttgtttttg ttgtttcaca 41160
 catcctgtag cccaggctac cctaaaacac attatgtagc ctgagctgtc ctcaactca 41220

cccatatttc ttgactaccc aagtactgag attacaggca taaaccacca ccccagtta 41280

 tatatgatat ttacttaata ttttccatca gatgttagta gactacttac acacctgtct 41340
 tagtcccctat gtgagaccaa gttctttgga gcctggettt atgatagaag gttcatttec 41400
 aaatctccca taacaaccaa ctgagtatca ttccacaggt cccataaaaa atgtgtcaga 41460
 ttaacaaact aacgtgaaag gcagctgtgg aaatagtaac actaacatgc cttcaacagc 41520
 aataaacaac aaaaaaagag gatgtgttca ctttttetta attcattttt aaaatttgtt 41580
 atgtgtatgg gtattttgcc tacatgtatg tgctcccacc acccctgtgt ctgggatctg 41640
 atcccctaga attggaacta cagacggttg taagctgcca tgtgggagct agggattgag 41700

 cctgagtcct ctagaagagc agtcagtgcct cttactgct gagccatctc tcaagictat 41760
 cacttttgat gaatttctgt tgatcaggta cttcttggca agctctgaag ataccactca 41820
 tatcttttca gaattctgtt tccaaccac tggctacacc tcaaatcagg tatatatatt 41880
 aaagaatatg acattagagc cagggtggtg tggtgcatgc ctttaatccc agcactcagg 41940
 aggcagaggc aggtgaatct atgagtttga ggccagcccg gtctacagag ctagtccag 42000
 gacagccagg gatacacaga gaaacccat ctcaagaaac aaaaaataaa ataaaaaata 42060
 aaataaaaac aaaaaagaat atgccatcag tgaccaaaaa actttaggaa atttgggacc 42120

 tcagcacttt gggtttaaaa attctatata atgtacagag cttggtttgg gcatttttgt 42180
 gattactgtt tgctttgtag acagtttcat tgtgtagtcc aggctggtct ataactcaca 42240
 atcctcccaa ctctgcagt gcagagatta caggtgtgta ttacctgtaa tctgtactca 42300
 gataaaatgg gtctggtgag aggaaaaaaaa aaaaaaaaaa aactcacaga attgctactg 42360
 tgagaattaa actagtacat ccatgtatgc tgtacacatg gaaccgaacc cacaagacat 42420
 gctcatcaca catcagccac ttatatcaag agtatctcta ttacagaaaa accattaact 42480
 ctcggtggcc tggaggcatt ggctcatctc cataagcaag cctccttgac acgattacac 42540

 acaatctatt cactccctat ggaaagaaca aatttgtacc tgatagagca cgtgacaaga 42600
 aggatcacat cagcctaag aagaacaaaa aaaagaaact tataaacttt gacattgacc 42660
 ttgcaaaatc actactatgc agtccacctt ctttttctct attattatgg taaaacatac 42720
 atacatctta ttttaacct ttttaaggat acagtgtctat aataagaaca ctatagtga 42780
 accatcacca ccatctcctt ccagaacttc ccggggaaag ctttgtacc attatgcact 42840
 aaccctcgag cctcaccttc actccacaag atagctttgt tttgttctgg tttggttggg 42900
 ttgggtttgg ctgctctgga gacacagtca tgcctacag tcaacatggc ctcaaattcc 42960

agaccttctt gcctctactt cccaaggctg ggattgcaga cacgtgtgac cacaccaagt 43020
 ctgataacce ctctcctgaa gatcaacagc atcatgaagg ctcaaatag ctggaacaca 43080
 gcatacgcta gtectacagt acacttcaact caaaggaact aactcagcag gcaacatctt 43140
 ctccccaaaa actcactgca tctaagaatc tgcaccaagg cagggcagcc caggcccagg 43200
 aaacagggag gcagggggtg caagcacctc ttggaggttg ctggtccgca ggaatccgct 43260
 ctctctgtaa atggaccagg ctatctctgt gtcattcacg ttcactctggc agccataggt 43320
 ctcgaggtag actgcaatga aaggagatt gagtaggcag agggccatgt ggtcttcag 43380

 cctccttccc aaagtgctca gagacacctg aggcaacttg tcatccaca agtcccctgc 43440
 tgccttgacc ctaaaatacc atcagctgcc agatgtacc ccaaattaat aatagccttt 43500
 tagaacaag gaaacacaat atcgtataca cacacctata ataacaggg tgtttaata 43560
 caggggaaat gtcccccta agaaataagg gcatagggt acagaaaca ttagaacagg 43620
 gaagactaac gatcattttt atccatctga gaaagaacta aattcaaact cccgtattac 43680
 agtcctccct ctaacaaga ggtcctctaa cctctgggag cagcagcact gaccagaggg 43740
 tacagacacc acagactaaa aaaaaaacga aagcagacac ggtcatatta tgaagtaaaa 43800

 atacaaattt acaccaagtt ccaaacacag gatttcacac tttgtagac ctttcaaat 43860
 catatttcta gttacaacce cattaccatc agaaggctat tattccaact agaagcaggg 43920
 catggggggc caaggcagga ggattatcat gaacttgaac ccagaatgag ctacacagtg 43980
 agctccaggc aaacctggac taaagagact gattctttct caaaaagca aacagaata 44040
 ggaaacatca gctcttcttt ttttaagcc aggtctcac tatgcagctc tggctagcct 44100
 agaactcact atgtagacca ggctggccat gctctgctc tgcctgccc atgctgagat 44160
 aaaaggtatt taccacgggc ctagataatt ttttatatac tttggaagg ggggtccat 44220

 atgccatttc agaagtcaaa ggacaatttg tgtagtaag ttctcccctt tcacctgtg 44280
 ggttcaggg atcgaactca ggtcatcaga cttggtggca agcaacttct gatttatctt 44340
 gccagccca agaataaaac tctaatacag aagtatgac agacatcagt aattccagaa 44400
 gttaaagggc tgaggcaaga ggattatgag ttttacta acctgggta cagagcaaga 44460
 cccagattca aaaggaagg ggcagagttg agcaagatgg ctcaatggtt gaaggcttct 44520
 gccaccaagc ctgatgacac atggtagaag gagacaacca tctctcaca gttgtcctct 44580
 gacatccaca tgtgccacac acagagacac atagagtaaa tgtgaaattt aatggaact 44640

 ttaaaaactg taattagaac acagattata gtgtttcca aagcaacca agagaggact 44700
 ccaattcctg tgtgcacagc tttgagttct agtttctt ttgaagtgtt gaggtgaag 44760
 aacagagctt caagcacgct aggcaatcac tgaacacac aactcttccc ctgcccaacc 44820

tatgagtttc ttiacagcaa tgctgcttgg gagagcctga tgattctgta actgagcaac 44880
ctgccacac tgctaagaca gtagagccac agaggctgcg acagagaaag gaaggaagcc 44940
aaagggaagg gagaagtaaa actaaccttt tctctgcctt cctagaagtt catcccctgt 45000
gagatacggg ggigggtcct ccacttctgg aaaagatggt ttctcttgaa gaaccgaagc 45060

acttcttaaa aaatgctgaa aagtgggtcc ggcggctagc ctggagctga aatccttctc 45120
aacaccttct gagctctgcc cctctgaact aagacatgaa gagctgggga cactgctatg 45180
tgccctgcag gtcttgagca gcagccagga cacagagctc agtggccccc attttagaga 45240
cctctgtgct tggaggacac attgtaaggg atgcatgaca cctgtggtcc taaatctgca 45300
aaagagtgag gcataccaac atttactgca cactctatac aggtactact ctggacactt 45360
gcccctcaca aaagcagaag agaggatgct ttgggggtgg ggtgggggca taagaggtgt 45420
tgagacaatc ttagtattat cctgagctgg cctggaactc actatgtagt ccaggctggg 45480

gggggtctgc ccctaggttt tgtttgttca tttttgaga tattggtcta tagtgcagac 45540
cagcctcaaa ctctcatcc ctctgcctc cgtcttccaa gtactagaat caccagcata 45600
gaccaccata tccagttcaa aagtactctt gatagtttac cttaacccaa gcatggtaaa 45660
actgcagtct cagtgccttg gaaggataag gcaggaagat catttgagcc caggggttcc 45720
aggcctgcct ggacaaccta gcaaggtctc taaaaacttg gtctcgggct gaagagatgg 45780
ctcagcgggt aagaccactg actgttcttc cagaggctcg agttcaattc ccagcaacca 45840
cgtggtggct cacaaccacc ttaaatgaga tccggtgccc tctgctggca tgcaggcaaa 45900

agactataca aaataaataa ataaaaatctt aaaagattta aaaaaaaaaa acttggcttc 45960
tcatgctgga cgiggtaaca ctcgacttia atgccagctt ttccgaggca gaggccagcc 46020
tggtttatag agtgagctct aaaacaacca agccttcaca gagaagaacc ctgtcttaaa 46080
aaaaaaaaaa aaaaaaaaaa aaaaaaaaaa aaatggacaa gggacaagat ggctcagtgg 46140
gtaaaaatgc ccgaggctca agtctgaaat cctcagttaa gagctcctga acccacctg 46200
aatggaaga actgacagtg gagagaggaa tgactctgac catcacacgc tgtgcgcaca 46260
ctcacacaca cataaactt ttaagaagtg gggcgggagg ggaacgacce aaagaggcat 46320

actaagactt cagcaaccac tcatttacac ctcacacatc ttttcacagg atgggcctta 46380
agtaaagtea atgtgactgc tgccctggcca ggcaagcccc ggatcaggga gccttcttta 46440
agagcgttgg gatggggcag cgatcctctc tgtggaacct ggtgggggca tcaaatgcaa 46500
gcttaaaggt ttgcaccgca cagcgcaggg cggagctctt aatgtcagt aagggggcgg 46560
aacgccccc cacatccaag cacgcgattg ggtagatact ggtgctgggc gtggcaaggg 46620
ggctctgcgt gcacgccac gagaaccccc gcagccaccc agcaaggccg gtccgacccc 46680

catctctgca tccaagggg agaggctagg gctccgaagg acccggtagc ttggccaagc 46740

 gcatacagaa gtaggcagcg ggactgagct acattcgcag cggcctctct cggggcctca 46800
 cgccgccag tgacaccttc cccagtgct cctggctttt cggggacgcc gcgagcgcgc 46860
 ccacgccag gcaggtcacc cgcagcaagt cctctcaag cctctcacct cccacaaccg 46920
 cgagacccc cgtccgaacc ggaagctctg tccgtggtg aggtctgctc tcaggcgtcc 46980
 tcctctgcgc gccgaggcgt gcaacttctg ttccgccgtg acttccgcca acggtgttct 47040
 aacggaagtg tttcctaccg gcctggtaga ctcaagctac gggctttgaa aaatatttgg 47100
 gtgggaaacc caattattta tatgctaacc aaaaaatfff aaataaagct taaaaaccag 47160

 gtgggcca gcggtgggg cgcgcgtctt tagtcccagc actcgagagg caggagcagg 47220
 tggatctctg agtttaggc cagcctggtc tcagagagag ttccaggaca gccagggata 47280
 cacggagaaa cctgtctcg aaaaacaaac aggttgggca cgtgggcacc ctgagagtct 47340
 gcatctacc ttgtccaag aaaatgaggg attcttagga gtgttctgcc cttgaaagt 47400
 aggggtctta cctgtcacc cgtctgtcac atgtactcct ttctccttg caccaggccc 47460
 ttaatggaaa ggggccgatg gggctggtaa ggtggctcag agtgaagac acctgtgcc 47520
 aagcgtgagg acctaagttc gaacccaga acatacaagg tgaagaaaa ttgactcctg 47580

 caagtctct gacctcaca aatatgccag gggacattcg acaccccc cccaacacac 47640
 caacacacac aactcacac gcacgcacac tgtctcttgg cgaggtatca cactttggta 47700
 actcaacac tcaggtagca gagcctgaca gcctgagttc caatccccag aatccacaag 47760
 gtgaaagaag agaattgact accccaagtc ctctgacctc cacagataca ccatgggata 47820
 cgcaacccca cctccggcc gccaaacaca cacacagata catatacatt aaatgtctcc 47880
 tggcccagca tacttcagta atcccaacac tcaggaggca gaggcggctg gtctttataa 47940
 attcaaggcc agacagagat acatagtaag actcggctctc atagtaagta aatgtaaagc 48000

 aaattaaaga ggggtttctg tggtacctc tgaactgctt cacctttctt gaatctcca 48060
 aatggccttg gacagctcag ttattcctca ccagctcttt gcctgtcacg ttgctgggcc 48120
 ttgacactct cagccactct ccttccctg ttgttcatgc ctctagccaa ggtgcctctt 48180
 ctcccttaga cctaacctat agactccaca ctcaggaaaa tgctgagagc aggattcaga 48240
 cagaccagag cctgaggtg agaaccacce tgtgtaacat aggtgttttt caagctccac 48300
 cataacacct agttttaag tgtaaacatg ttgttgaac acaattgca tgtggaatgt 48360
 ggacagttta aattccaca gcctggcatg ataacagagg aaaggcggcc cctcctggca 48420

tgttctgtc actactccca ccaaaact cgttttgggt ggagggagg agaggggcat 48480
 tcccagcctt cctctggaac aataagtttt tgttttgttt tgttttgttt tgttttcac 48540
 tgtgttgtga atctgtgcag aaagtcagaa acacctctgt gtgggaagct ggaaacacct 48600
 ctgtgtggga agccaaaaac cccgtagcct ccaaccgaag ctagagtaac tggtttcttt 48660
 agtacggtaa ctctgaaaa ctgtgtaggg cattctgggc ctactctcc acctcattct 48720
 actatttcaa atatacagat agtgctatgg tctcaatgtg gtgtctccct caaatccaca 48780
 tattgaaact gtaaccttca agaaaatggt aataggagggt aggatctttg caaagtgatt 48840

 aggccataaa ggcagagccc tctctgggcc ttagcaccat cttgcttgca actcttgccg 48900
 catgagatca aagtggagga agaagccaat gtgcaggctg aagcacaagg gaagaaagat 48960
 gaggcagagg tccaagtaaa ctagctcatc cacccacgaa ggctgaagga gcagaagtaa 49020
 gggactctga agcctgggag gctggtacaa gttgttggac tgtgtgctac tgttgctgta 49080
 agtctcaatg gacctggaac atcaccatct gctcacagaa accacctgag acacttgact 49140
 gttgacatca caacaaaac agtcccctg gcctctgcc tggacctgtg gcattctgga 49200
 ctcatctgt tctcacatgt ggccaagtgt aactcgtaca caataaatca tctaagcctg 49260

 ttgtttccgt agtataagg ttatcatgtt cacctcacac aaaaaatcat ctttctcact 49320
 gtctcagctc aagaatcaaa aactaataa atggatagat agatagatag atagatagat 49380
 agatagatag atagatagat aaaggcagag ccctccctca tgcagaaaca gaggcaggca 49440
 ggtctctgtg aatttgagg taagtctggc ctatacatat ctagctcaa gccagcctgg 49500
 gctgaatagt gagaattgt cttgataaat aaataaactt tttttttgg ttttttgaga 49560
 caggttttct ctgtgtagct ttggagccta tctggcact cattctggag accaggtgg 49620
 cctccaactc acagagatcc gcctgcctct gcctcccag tgctgggatt aaaggtgtgc 49680

 accaccaaag cctggctaataa aaacaaactt ttttaaaca aaaagtgtat aaagaggtat 49740
 gctgcacatg cctataacag tgcttgggaag gtggaagcag aagaatcagg agttcaaggc 49800
 cagcctcagc tacattagga gttcaaagct agcctgggct acgtgtgacc ctatctcaag 49860
 aatttgatg tgtaaatcag cactcaggaa gcagaagcaa gaggtaggga attcaacgct 49920
 acctagacaa tatggtgagt tccaggcaag tctggagtaa gacctgtctc agaaaattcc 49980
 tttttgatt cataaaaaa aaatatatga gattaactca ttttacagac ttaaagatga 50040
 ggaatacaag agtagtcaca taaaaggct cacactaca gacagagctg tgcagtgtt 50100

 gggaccacc catagttcag tctgatcca aagtcctatt cttagctctg actaactcaa 50160
 cctcagactg gctgggttcc cgctggggt atgcttctga cagttggata accatggcca 50220
 actaatcact gctgactcca gtgtccttgc ctacaaagtg ccaactgtgt ggtgaatca 50280

ctgtggtgag gcatggggag aaaaagggtia aggaggggcc aaaggatcag aaaggcactg 50340
 gggctgtggc agtagtccag agatcaactg tggattccta ggccagtgtg ggatttgggg 50400
 cctgaagtt tgaaaaaata aacaaaacc tatgatttca ggagattggg aacctcatat 50460
 tctctctgct ttaggacctg atgttcatcc ctctttcacc gaattctact ggctgctgaa 50520

 agttctgata gcaagcactc gctcactcac tcaactcccc tccaccttac tgtgagcagg 50580
 gtgtgctctc ctctcactg ctgacaggca gatggcctga atgctctatg tgattgactg 50640
 ttcttcacac tccactggcc taccgcagga tgaggaacc caatcaacag ccaggagcaa 50700
 aagtaccctg ctctcagccc agttttaact agtaaaactg tagtctaggc acagccagga 50760
 cagtgaaat aaatgcctgt tgttatagcc atggagattg aacggggttt gtttggctgct 50820
 tgtgcccgag tgttctctcc ggagaaactg actgaagcgt gtttctataa gctgtccctg 50880
 cttcagtgtc tctacagaa atgagaccag ctgatgtccc accatcctct ccaacttactc 50940

 cctgtgtctg accaattgga atcacacatt tgattttgat ggagtttttc ctgctgagga 51000
 tagagacctg ctggttttac atcaccaaag actagcacia gatgtatcct agatacttgt 51060
 aggtgacccg tgggttgggt ggtgcaggag tgagatggat gggtaaagca gactggaaaa 51120
 tcttcaccta catgcatctc cccatttctt ggtgcctaata ttccaaacat gctaattaag 51180
 taacttcatg ggacaatttc ctcatgtaat gaaatttctt gagacttcaa acagaaataa 51240
 attcaactca ggcactctta gatttcccac ccccataatg aaaaacataa tgaatactag 51300
 ttgctttgag ctgctagatt gcacagtcgt ttgtcacaga gcacagataa agcctgtatt 51360

 cactttgagg cccagttctc cagaagggtc tcacatcttg gtctggttcc tcttgggact 51420
 gcagagccac ctgagatcc aaatgtcaag acacaaacca cagacataga gccaggccgc 51480
 ctctgtgtca caggctgttt attatccaag aagaaggagg agagagagag agagagagag 51540
 agagagagag agagagagaa gaggaggagg aagaagagga ggaggaagag gaggaggaga 51600
 agacagaggc cccctgggc tcaggagaaa gtgaacagaa aggttctct tcttctctt 51660
 gccactgacc agctgcagag atctcagggg tggcataggg gcctccagga ggctggcag 51720
 ctctgctgtt gactggagac agaatcccca caggggcagg tcccagggtc ggaatggctt 51780

 ctgtgtacac aaaatatctc tcttcaaaag gactggtgg aggtgagcag taggaaggct 51840
 gccccgtcgc aagccagacc cactgtccca ggtctgagtc ctattccca agacaaaacc 51900
 ggcttctctc aggtggtct gttagggccc tgttccctc ctctccctc cctcagacca 51960
 aagatgagta ggcagtggc agaaggacaa gtcaagtcac ggggtaagt atcctttca 52020
 gggctagtgc atctgacaac ttctaggeca agagccca gcggtgact ttggccgaga 52080
 ggaaggagt gatgataaag accatagttt taggacacga atgcaggtcc agctgctgca 52140

gagtggacag agaaaagcat caggggctct tnnnnnnnnn nnnnnnnnnn nnnnnnnnnn 52200

nnnnnnnnnn nnnnccggg ctgctcctgg ctcagctgcc cacagcgtga agcccttgtc 52260

gatgtgcaca gagaggttac agggacggcc attccacgtg cagcctgcag gagagcagtg 52320

aacacaggct gctctgaggc tacttcaaag atcacaagct ccaactcaact tcaaaagaag 52380

ccccagaat ctggcttgat ttccccaga tatgggaggc tcaactcttc atcacacctg 52440

aacaaccacc tgcccagtc cccctatect aaaatacaga agagcaggcc ttcagagaac 52500

ctccagctgc atctagcccc acttctagca catgtgttgg agaagcttgg gctggaaggc 52560

tctgtgagag aggattcagc taccacgtgc aaggtcttgg gttcaattct agcacaataa 52620

aataaacgag agttaatttc tgcgatgtac acagtttacc ccaataaggc acaggattgc 52680

ctggttaaat ttaaatctat gaaatttaa gtgggtaatt tagattgaca tataataaag 52740

tgttcattgt ttacctgaaa ttcaaagcta acaactggtat actatcttac ctatagcctc 52800

acccccaga cagattctca cagtgcagcc ctggcttggc tggaacttgc tatgtagacc 52860

aggctggcct caaaccaca gagatccacc tgcctctgcc tctgcctctc aagtgctaga 52920

attaaagggg cacaccacca tgtatcctta cgagcagaat cacaaggata acataagaaa 52980

gactctaaga aaaaatgtct ccttctctcc cagagcactt gcataccca aacagggacc 53040

tcttaaaagg cccaacctcc attccttatt cccctccaca aatgtcataa agaaaaaac 53100

aaacaaaca acttgaacgc ctctaggcac aagaggctcc acctggcaca cctgtagaca 53160

cttctgtac accttcggca gcccgatggc agccatccac cagctgtcga gtccaggctg 53220

ccagctcttg tggtagactcc acaactgaata gatgagtgtc cacaccgtga cgtgtgcccc 53280

tgcgcagggc aaaggagagt tctgcgtcat agagcactga gcccttggag gggcccagat 53340

gcaccagcct gtatgcagag cagagggaca agcatgagac tttgaggtgg ggtggggtgg 53400

ggtggggtgg ggccagggaa gtgacctgca tccttcagta tcttacagag gacaggaatt 53460

acagggggtg tgtctctcc acctccct gactcactc aaccttagtg gactcctcac 53520

agatactgtc cctccctat ctcccactgg ctcaactctt cacgtctgt ggatctttgt 53580

tcaaatatcc cctcctctga gaagatctgt ctaaaatagc tcctttgtca ctcaactggc 53640

ttactttca tcaggactgc tgaaattatg cattttgaat gcttttatta tttgagcagg 53700

gtctcactag gtagccttgc tagcctggaa ttcactgtgt agaccaggt gatcttgaac 53760

ttgccttga cctccagctt cagcctccta agtactagaa tttcaggtat gtgccccac 53820

actcaaatgt aattataat tttacttatt agtttcagta ggcttttggc tttttccta 53880

gaatgtctct aaaatagaag tttttgtctt ttttatgcaa cactatattc ccagcaattt 53940
 aaactgagca catagtagct gtttaataaa taattgtctt aattaacaaa tcaactgact 54000
 aggcaggcaa tccaaaacct gccacttgtc cactggccga gaaccaatc cagagagagg 54060
 agacatggaa caaggacccc agaccttgca gcttgattct catttgctgc tgtggcctta 54120
 ggcagttcac tggccctctc tggccagcag acctctacat tatggcctt agcaacctt 54180
 gtccctcact ctaccactc tgtttgcctt tagagcctt actaagtccc acactcctca 54240
 gacccaacag ccaccaagcc tctgagccac attccctatg tttccacata tactctggac 54300

 ctgactcagc atctcgttgc tgactcagca tcccattgaa cctcctccat aggcacctc 54360
 actccagacc cactgcccac accaacgcac acactccaaa cctcctattc atccaggacg 54420
 cctcctgccc tctcccatct ggcaagcact gagcctgtga gttcccacc atgcactttc 54480
 tactgcaaat gccatgattc ttctccatat gcttctcca cccctgctt cctcagccc 54540
 atgtctccca aagatgtggc aggctctcag ctactgcct cccctccca gcataagtcc 54600
 tctgtggcag gagtgcctc tagaatacag ctagtgcag tctcctgact tcccagctta 54660
 accctccag cgacactgct gggactgggg agatgcctca gtgggaaaag tgcttactgt 54720

 tcaagcatgt gaacctgagt ttgggtcct agcatctatg taaaagcaa acatggcagc 54780
 agacacctgc agccccagcg ctagggaag ctgagacagg ggtcactggc ctgtcagtct 54840
 agtcaaaaca agctctgagt ccaatgagag acctgtctc taaaaaagaa tatggagtgg 54900
 gcatgataac acatgccttt aatcccagca cttagagcag tccaaggtca gcttggcca 54960
 tgtgcaaat cctaaccagc catggataca tagtaagact ttgtctcaca aaaattaaca 55020
 taaatacata tatatacaaa tatatatata cataaacata tatgtatata tggtaaagcc 55080
 aatgtggtg gcatatatct gaaacctcag gactggaggg agcagagaca ggtggattgt 55140

 gtgaacttaa tggctagcca gtctagccaa aaataacaac ctctaggttt gatgaaagac 55200
 aaagtctcaa aaaataaggt agagctaat agagaaaggt acctgaatat gacttctggt 55260
 ttctatattt gtatgcactc acgtgcatgc acacacacac atacacacac aaaaaaaaa 55320
 aaaaaaaaaa ctgctaacac agtgttctt caccagacag cagctctgtc tetttcccc 55380
 ccagtcca tgiggattct gtatgtggt ctgccacatt tacaggctcat gaacatgttc 55440
 tagccctcca tgcctctgta cctctggcca cacctaagat gctctcctt gcttctcaa 55500
 aagctacagt tctattcat caaagtccat ttcaagtgtc accttctct taagtcttc 55560

 ctggccaagc cagacagcta agtgtctct ataaccttca atgtaatgac tagacataca 55620
 taatggttat tctgggtttg tctcctgact gactccggat tctcctgag ggcagtaact 55680
 attcatgtca ctgtgtgcc cctgaaccgt gcagtacaag atgaaggtat caataactga 55740

gtgacagtta gcacttcaca tttttctggt ctgagcctca actttataaa tgggggaaat 55800
 tgtggctgta gggagcagaa cttgcttcag atcacctggg aaatagctgg aggcagaaca 55860
 gcactggggt ttggggcttc tggggtccat ctggaacacc accctcccaa gtctgagtat 55920
 aacaccgagc gttcctgctc ttcagtacct ggtggcgatg agcggggcag tacgggctgg 55980

cctgctcagg gcctctcgag tttgggggag agagcagtaa aggagcaact ctttctctgt 56040
 cagcagggcc agggttgggg ctgtacctcc actgggcaac tgcaagcaaa aaggtaatga 56100
 ggacggatgg gatgaaagag gtcaaagggc cgggagggca tggggtgata aggtgtgaca 56160
 gaaatggggc ccagcaagca cctgttctgt cagccagcca atctgcttga tgtcctggct 56220
 cccagctgta cctgtggctg tcagcagtgc ctgcagctca tccttgacc aaggtatgaa 56280
 agtgctgatc tgggcttggg tggcacctgc ccatgacctt gcactggcct catccttggc 56340
 cctcaagaac agggatatcct ggccatctgc tgeccctatc tccagatacc tgaaggcaca 56400

atgggataaa agataggaca tgtcactggc cagctatcca tcccagacat ctagtccaag 56460
 aaagccacc actgccaaac tggaagaagc cacacaggct gtccatgaga gataaggatt 56520
 gtgtttaggc ctgaagagat ggctcagagg ttaagagcac tggtggcgcg ggcgttgggt 56580
 gcacagcct ttaatcccag cacttaggag gcaggggcag gtgtatcttt gtgagttcaa 56640
 ggccagccta gtctacagag caatttccag agacagccgc aaagaaatct tgtctcaaaa 56700
 aacaaaaag aaaaaagaaa aagaaaaaga gaaaaagaga gcaaccaggt gtgatggctc 56760
 ccgtctgtag tgtcagcaca ttatcaccag gttgggtata gaggcattgc agccaagctc 56820

agcaacctga ttcccatggg agaagagaaa agttgtctc cagccatcac acatacattg 56880
 tggcatgtgc acatgatgc acatacaaaa taaacaata cataaatgta attcaaaatt 56940
 ttaaaact gaactaccta aactatacag acccttctc gaaaaagaaa aaaagaaaaa 57000
 aagaaaaaaa aaaacaggtt gggaaatgag ataaaatggg tagagagaaa agaaacaaaa 57060
 agccatgcca tcaagtgtgg agggagagca acagtgatac tggaaagggt ttccaaaatg 57120
 ttttgtgttc cgtaaaagat tcgctccct ttggatttct gtactacaag gagtagggca 57180
 gaaaggggag gctactccca acacctagcc catccagctt tgeccctgcc ttcctctact 57240

gcagagctga aagcaaagga cttgagtcca tggattccct tgcagttafg ccagccacat 57300
 gaccagttc taacctctga ggctttgaca gaggtctctg gaaatcaaag gaaaaccttt 57360
 ccaaagacag accaaatcca cccctcgta cacacattgt ctagtctcc cagcacaagg 57420
 atgcaattca aaataccaga tgtgtagta cacctgtaa tcacaccact ggtaaagtga 57480
 aagcaggagg atcaagcaga agttcaaggt cctcctgggc tacacagcga aattgagaat 57540
 agctccagct acttagacc ctttcttaag aagaagaaag ccaagagaac caaggctgga 57600

agccaggttc ccaagttcct gctcacctgt taatttccca gaggaagatg agacaaaggg 57660

cagtgtggca cacaccttg atcccagcga gaagagaaga gaagagaaga gaagagaaga 57720

gaagagaaga gaagagaaga gaagagaaga gaaaacaagc agtgcatacc atcaccttag 57780

agttaagtca tgcgtccatt tgactcagtt gtgaagcacc tgcttcatgc cagcatggat 57840

gctggatga tgtttgtcac ttacatacaa cacagatata cttcgtttgt attatctgag 57900

tgctcccca ctccagcctc acctgggttc egggtcagtg ggcggtgcacc tccttgagac 57960

atatgccatc ttcaaggata tatgtttggc ctactgagg ttcctgggct ggggaccagg 58020

ggaagaaggc tgacgctgaa gaggtgagc aggaggtgag tcccagccaa ccgaggtccc 58080

gccagcagaa ttcttgaat acggtgagac ctcttcatg tatttaactg gcaagaagag 58140

aggccgctg ttaccattgc tgcataact ccatgtagca tatacaca ttgtcctag 58200

ttaataaaa gcttacttta tggagctgga cagatggccc agtggttaag agcactggct 58260

gctcttccag aggaccaga ttctattccc tgaaccaca tggcagttca caactgtctc 58320

taactccagt tccaaaggat ccaatgccct ctctgacat caatgggcca ttcatacaaa 58380

tggtacacag acataaatc aggtaaaata ctccaaaaca taaaatagta aatatgaaat 58440

aatttttaa atagtgcagt ccataaacag atgcaatcat ctgagaattg ctaacatcag 58500

acttgaacc cttacctaaa cataacattt gagctatcaa gcacaggtaa acacacactc 58560

tctctcttc tctctctc tctctctc tctctctc tctctctc tctctctc 58620

tcttctctc tctctctc tcaatttta aaattttta agatgatgtt tgatttaaag 58680

caaaacatct tccaggcatg gtgatcag acagaagcgt caggagtga ggtcagcatg 58740

ggtgatttag ctgacccca tctcaataat cctacttcaa ggccagcctg atctacagag 58800

caagttcaa gacaaaaag aaaaaaac aaagtaata aaataagcac atgactgtaa 58860

accaagcatt tgagagctag aaaaagagaa atcaggagt tggagactagc ctgggccgca 58920

caagcccatc tctcaaaaa aaaagggggg gggcaggaag tgactccagc agaatacgtg 58980

tcttccatgt tcagattcct gaggttcaatc cttggtaaca cacacacaca cacacacaca 59040

cacacacaga gagagagaga gagagagaga gagagagaga gagagagaga gagagaaaga 59100

agcaatgga gggggtataa gaaatgaaga cagagttgta tgatggttca cacctgtaat 59160

cccagaactc aggaggatgg ggcaggagga ttgacaagaa ttggatgccca cagagtgtgg 59220

ctctaaactg tctaatgct gtagccctt aatacagttc ttcacgatac agagacaccc 59280

ctcaatcata gaactattc attgctactt tataaatgta atttgctac tattataaat 59340

tgaatgcaa atatctgata tgcaggtag cctatatcca accctgtggg ggtctcgaca 59400
 cacgggttga gaaccattgc tacagtccag gcgtggtagc acctgccttt gatcccagca 59460
 ctccagaagc agaggcagtg gcaggggcag aggcaggcag agcctctgta aattcaaggc 59520
 cagccttgtc tatagagtaa attccaggat agtcaaaacc acacagagaa accctgtcta 59580
 gaaaaaaaa tttaaaaagc aataaataaa tgtaatatag aataaaataa aaagtaggaa 59640
 gaatgaaaga ggatggagag aaaaaggaag agaggaagga aggaataaag ggaaggaaaa 59700
 agaagagaaa aacttcact acattcttgg ccttttaatt ttcctttcag atttacttat 59760

 tttattttat gtgtatgaaa gttttgctca aatgtatgtc tgtataccac atgtgtgctt 59820
 ggtctcctta gcagtcagga gaggacacca tgaatgccat gtgggtgcta ggaattatgc 59880
 ccaggtcttc tgcaagaaca agtgctctta tcggatgagc catctctcca gcctgttgt 59940
 tggccttttt gaaacagagt ctcatactgt cctcccaat actggattgt aggcattgaa 60000
 gatcaagtcc agctaatttt ttttgagat aaagtttctc ttttagacc tgactgtcct 60060
 ggaactcact ctgtagacca gactgacct gaactcagag atctgcctgc ctcgccctag 60120
 gaatgaaggg gtgtgtcacc accatcccct ggcttacttt tattatcttt aaggcacagt 60180

 ggttaatggg tttatttctt acatgggcag ttagtatctt aagcagtata tgtgcccagg 60240
 gaccctggca gatctcaaa tactactgag agggtacagt ggacctctg tgatggttga 60300
 aatgtattgc tctatacaaa agagtctgcc tctggtcaca cactgcaatg agtacaatgga 60360
 atgagaccag tacaacaga attgcttaa agattgtttt ttttttatt ttatgtggct 60420
 aggcactgca tgggtgcaag tagccacaga caccaaaaga gggctcaga tcccctggag 60480
 ctggtgttac aagcaattga gagtcacct gatatgagga ctgggaacca aaccagccc 60540
 ctctacaaga acagcagttc tcttaaccac tgagctgtct ctccagtccc taacagaat 60600

 caaaaaattt ttactgetgc aattaaatt aattttagaa accaggtgtg gtggcccaca 60660
 aacctggta atctcagcac tcatcggaca aaaacaggaa ggtctgaagt tcaagtcac 60720
 ccttggttac ataaagaatc cagagccaat atgagttaa caagactgtc tacaacaagc 60780
 cgggtgctgg tgccacacac cttaatecc agcactcagg aggcaaagac aggcagatct 60840
 ctatgagttc gaggccagcc tgatctacag agtgaattcc aggacagtct caaaactac 60900
 acagagaaac cctgtctcga agaaggaaaa aaaataaata aaaaaaaaaa aaacttaggg 60960
 ctaacaagag gctcatcagg taaaggcact tgccaccaag tccaatgacc tgagtttgat 61020

 tcctagaacc catactgttg ggaggtgaga accaactcta aaagtcaccc tcttcctta 61080
 cctccatata aacctgtgt catacccaca tcctgecta ccagtaaca gtaattttaa 61140
 acaactagaa gtaactcaa atagtcacag agaactaagg gcaaccacaa tgggcaggac 61200

agtcctagaa tatatgcttc tctgacatgt gaccctaccc tacaagctgt gctagggaca 61260
 ggaaaggaca tctgagccaa aaagctgcca gactgggatc caaagagtgt atcctgggag 61320
 ttggatgcag gaggatccca aggctaagat tatatccagt tataaagcac attcaaacc 61380
 aggacctgtc tcaaaagaaa tagaaacaaa cctggatggt ggtggcgcac acccttagcc 61440

 caggactcgg gaggtagagg caggcagacc tgtgagttg agccagcctg gtttacagac 61500
 tgagtttcag aactcccaag aactgttaca gagaaacctg tacagaaaag aaaagaaata 61560
 gaagcaaagt ctigagattg gccaggcctg aggaattcag agtcatcctt aactatatag 61620
 ggaatctgag atcaatctgc cttttataag gagagagaag acagaatctt gaggaggcat 61680
 tgtggctcac acctgtaatc ctagcacttg ggagagtcta aggcaattga attgtcaaga 61740
 gttataggtt agcttgggtt acagaattag gcctatcctt aaatgactga aaaggggaaa 61800
 aaaaaaaaa actaaggaag ggaatttagc tttagttcag gggataagtg tgacactagt 61860

 gtctgggtct tactcttgcc ttcactgtca tagccacagg aggactgcca tagctcaagt 61920
 cgatcattcc ttatgtcaca aaatacaaaag caagaagaga ggagaccagc agaaaaatgg 61980
 ctgtttcctt gcatctgtct aacaggtgcc tgtggaggcc agaggtgttg gatccctag 62040
 agctgaagtc acaggtggtt gtgagcaact ttatgtggat gctgggaacc caactccggt 62100
 cccctgaggt cagtgttccc acctggagag aacctgtca gggcaagaac ttcattgtac 62160
 tcatctatgc ctcagaate cggttggtt ctcatatgct acatgctcag caaatgaaca 62220
 tttgtcaact ctgaagccaa agaaaccatt agagtcaccg ctcgtctggc tgtccctgaa 62280

 ccaggtcate tttctccatt cccacaggaa tgfactataa atgaggagtg ttctagctgg 62340
 tgccagaaac agagcttggg tttcacagac caagtacct ctcctgaat gagggaggaa 62400
 acctgggggc cccagagttt ggccataaat agcccagttc cgaagttgcc tcccactctg 62460
 atttctgcct gactcatttg agcagatagg gtgggactga ctacagacta tggcttctag 62520
 cactgagga catgactgtg gctggtcgcc agggtcatgg aatctatgac gttaggccca 62580
 gccagagtc acattctccc caggcaagtc tctggcccag aagcctggac aagctcacac 62640
 aggaagctga ggataatgaa ggaagccaga ggttagctct ggccccagga cacaggaaga 62700

 gattccactc aaggcattcc actagattct acaatggagc aaggccatac cctgcccag 62760
 tttactaag agcacagggt ctcatatgtc ttgctaagag gagtatttg ttttggctca 62820
 atgcaaaaaa tgttcagaat gcatcccagg gctcattaag tgcctgtgac taaatgtcct 62880
 gccttggat ctggaaaat ctgttggcta cgctcaacct gttccctgtc tgttcagagt 62940
 ggggtgttac ttcccctgtt gaaattatac tatggactta tcttttact aatctaagc 63000
 ctctctactc taatccaaat gtcaatactg tgaacagagg aaccaatct cattttccag 63060

ggcacacca gcttctacta gcatttgatt gacctacact agctagcaga agaataacac 63120

 aaaccaagtg tggtaatgca tgcctgcaat tccagcactg gtggctgagg catgaagagc 63180
 aacattaaga accacatagg cgggagcagt gtggcacata ccattaatcc tggcactcag 63240
 gaggcagagg caggtggatc tctgagttca agtccagcca ggtctacaaa acaagttcca 63300
 ggacagccag tactgttaca ctgagaaacc gtctctaaaa accaagaacc aactagcctt 63360
 aactctagtt cccagggctg tccctgccttc taaagggtgct aggcacacaa gtagtataca 63420
 tatgtttgca gacacaacac tcatatacac agagaaaaaa taaatgtcta ttaaaaaaaa 63480
 aaacttctta aaccaagtag tgggtgcacac ctttaatccc agcattgggg aagcaaagga 63540

 aggcagatct ctatgagttt gaggtcagcc tgatctataa agatagttcc aggacatcca 63600
 ggtctttgaa gaaaaacct gtggggggag gggggagtgg aaaccttct tccttctttt 63660
 aaattttatg tggctagta gtgcatgggt gcaagtagcc acagacacca aaagagggtc 63720
 tcagatcccc tggctacaaa agtgggttcc aggactgtta cacagagaaa cctgtatcag 63780
 gaaaaacaaa acaaaacaaa acaaaaaaaaa aaaaaaaaaa aaaaaaaaaa aaaaacccaa 63840
 ccaaccaact aaccaaccg ccaacctgcc aaaaataaaa taaaataaaa aagacaagta 63900
 tatattagca tglaaaaatg tttatgataa aagcctagac taaaaggaac tgctattact 63960

 ttttaattata tatatgcaca tgtatataca tataactaca tgtgcctttg gaggccagaa 64020
 aaggggtggcc tcctcttctg tagctgtggt taacagtgtg aacagcctgg tgtgggttct 64080
 ggaaactgaa ccaaagccat ttgcaggagc agcaagcttt cctagtact gggccgtctc 64140
 tccagctccg agaataagta atgtttctta agtccctgagc taagaagatt ctgactccaa 64200
 ttgaactgat ttctatctgt tacagaggcc actattgcct cagtcttggga tgatactctc 64260
 tgccatgctt tttccctccc aagattaaag aataatgcat gtaggctggg tgggtgtggc 64320
 aaatgttttt aatcccagcg ctagggagaa gggggcagta aagccaggca gatctctgag 64380

 ttcgaggcca gcctggtcca cagagcaagt tccaggacag ccagggttac atggagaaat 64440
 ctgtctcga accctcccc aaacagagta attcatgtaa agccaaagcc agccattca 64500
 taaggatgac attctgcatt tcaagcatct aggctagaag ttgttttttc cccagtgtg 64560
 gaatcaaacc cagggttca cagtcaggga cactcggaga aacctatct caaatatctc 64620
 aaaaacaaat cccaggcccc catgtatgac tggcaagtac tgtaccaccg aactattcct 64680
 ccaacctaga aactctccga gagcagaagc cattgtgtac ttctgagccc taccgcctcc 64740
 tccagggtg gcaactgagct ctgtacatgt tggatcttga ggggtgtgta agattgactg 64800

agggggaggg gggfacatct ctgacctttt gtactttttc cacaacgttc ctgattgcag 64860
 gtgtcattcc taaatcttta agaaggtctc caggctcatt ctggcttgtg aaatttgagc 64920
 ttttctgtta tgggtccttg gaactccgag gccagccaac tctgctgctc ctctaggaga 64980
 tagacactgc tigtatccc atgggatttg gctgcacatg ttaacagttt taaagtggat 65040
 gtagttaatt tttggttacc tattcagaag agctgagtat tctgcgcctc ttaggtgcca 65100
 gagggacttc tgtgcctgga acagacataa atggaaacce tgtctaggac tcccatgaat 65160
 gcaaagacct gttattctga ccattgttct caaggagaca ttttttggc tgcacactca 65220

 taactttgga tcatgtgact ccccacagac aaaagtggc ttaatccaac cctggcctga 65280
 tctgcacaac tcaattgaaa tgcttggcta ttcccagtga gatggctcaa taggtaagg 65340
 cactcactgt caagcctaata gacctgagtt cagtctcccc atgctggagg aagagaactg 65400
 actcctgcat gttcttctct gacctatgca catgtgtgtt cattcacata agcacgcaca 65460
 caatacaaaa aattaataaa aataattagg gctgggaagt agtacagtgg cagtgtttac 65520
 ttcccaaac catcacctct cccacaaca aaacaacag aaaaacttct ggtcttttag 65580
 atgaaggtta cttgcctaaa gtcacagttg cctgcctggc ctaattgtga gttccaggca 65640

 aggtagggct acagagttag accctttctc aacaacaac aaaaacaatt ctttctcca 65700
 ttattaagat cctaaaactc aggcaggaag gtggtggcat ccactcttaa tcccagcaca 65760
 agggaggcag aagcagaggc caaaggatcc ctgtaaattc aaggccagcc tagtctaaa 65820
 aacaagttcc aggacagcca gggctgttac acagagaaac tctgtctcca aaaaacaaaa 65880
 agatcctaaa actttagggc cagcagggcc agtgataggg ctcatcaggt ggtgagtgat 65940
 gacctcagtt caatccccac aacacacctg gagactggac tctaagcttc cctagggacc 66000
 cacaactcat gcatcaccaa aatcacactg acacacaaaa tcaaaagatt gtagaactct 66060

 gattctagaa ttctgagtt ggaaggggcc ttatttatgg atttctttat gtttttgtgt 66120
 gtagtgtgt atgtattat gtattgcatg catgagttgc ttctgcatca tgggtgacat 66180
 gtagaggtea gaggacaacc tggccattag attgtcaggc taggctgcaa gcatctttac 66240
 ctgatgaacc atctcctgag aaaaataaag ttgttttaaa aattaaaaag cagcatacac 66300
 tatccagaat gaaacaacgg ggaattaagg aggtcacctc atagtcaggg ctgagatact 66360
 actcagtggt ggagcgttg cccatacata ggaccttggg aggtggaggc aggaggagtt 66420
 caaggccagc ctgagctata tgtttaaaca acaagaacaa caacgcccc tccttccat 66480

 cccaacttca caatgataat ctctattgat atttttacat cggggaactt tatatgcttg 66540
 tgcttataag ttaaggactt gtaacttttt gagatggggt cttattatgc agccctggtt 66600
 atccctgtgt agaccatacc tggctagtct tagcaatcct cctgcctcag tcgccaagt 66660

gtgtcactat atctggcttt tttatTTTTat tttatTTTTt ttacagtgcc aggtatcttg 66720
 ccacacgcag gtaatatgct atgcactagg agtatttaag aacattgctt ctcagagatt 66780
 tgagctcaaa atttataTTTt ttatTTTatTTt atctgcttgt ttttgagaaa gtgtgtagcc 66840
 ttgacttacc tgtaactcac tttgtagact aggcaagtgt gaccttaggt aagtaacctc 66900

 acctgagttt cagtgtcctc atTTTcactc aaggggtgg cattgaggat ccaatgagat 66960
 gacatagga aggcacttaa cacagtgcct agcagccggg cgTTTgtggt gcacgcTTTt 67020
 aatcccagca ctcaggaggc agaggtaggc ggatctctgt gagtTCgagg tcagcctggt 67080
 ctccagagca agtgccagga taggctccaa aagctacaca gagaAACcct gtctcGaaaa 67140
 accaaaaagc ctagcatgct ttggTgtctt gtacatggg atgtcccat gctaaacaaa 67200
 tgtgctagtc cTTatTTct caattaaaat tTtaattatg tataTgtatg gttatgggta 67260
 tgtacatccg agtataagta cccatggagg ccaggggatt gaatcctgga gctagagtta 67320

 caggcagttg tgagctgccc aacatgattt ctgggaactg aactctggtc ctcttgcaaa 67380
 actgttcatg tccttaatca ctaagcccca tTTTTTTaa tTTTaaatt acaccttTgt 67440
 ttatTTTtga tgTaatgtg tgtatgatgt ttatgtgtaa gaatcactgt gcatgtgtgg 67500
 aggtcagagg acaactTgtg ggagtCagtt tcctccttcc agcatgtggg cccaagggac 67560
 tgtgctcagg tagtaggctt aacagccagc acctttgctt actgagctgt ctcatgggcc 67620
 ctctgtcate gtcgtgtttg tgtagcctcc ttggcatgat tacaggcaag ctctaccatg 67680
 ctaagttcac tcattcttct agcaaatatt tcctccttcc ttctggtcca ggactggatg 67740

 cagacaccag ggcacagaat gacatgcacc agtgagggcg ctacattgg tttgtgctgt 67800
 tgatgttcat cacagacatg catgtTgtcc ataggctctc acatcctaga aaacctgat 67860
 acgactctgt catgtaccta tgaatacata tttggagtgt ggttcatggg agggactact 67920
 gttagaagga agggTTTgtc tgccattaga atctcactcc tacccttcca agtcttctcg 67980
 tgtccattc actatactg cttctcaaac ccatgtctc ttctctata attaaaattg 68040
 tttatacaca aatgccctct atcaggcagc tgatccctac agaaaactga ctcggtTTTT 68100
 ttattaatta atttatTTTTt tatctgtgtt ttgcctgtgt gagggtgctg gatcctggag 68160

 ttacagacag ttgtgagctg ccatgaaggt gctgggaatt gaatctaggt cctctggaag 68220
 agcagccagt tctcttaaca gctgagccat ctctccagct ccagaactta ctcttcagt 68280
 agccagtaac tgctgtagc tcttcagtgg ggtggggcc ttctgaacct ttccccatcc 68340
 ctgttgccat gtcaactTgg tgtgtgctct aatcaggcaa ctgatcattg acagtTcatg 68400
 gtcacagcat cctgtcatg tccagaagac tetatctctg tagcaattcc ctTggtctc 68460
 tggttctac aatctTTTca cccctTTTTt gTTTTcctt agccttaggt tataggggtt 68520

atgttacaag tgcgccattt gaggctgggc acatcaaagt cacttagtct ctgcaccttg 68580

agcagctgtg gttctctgaa atagcccctg accatcacia aaggaagatt ctttgatgag 68640

cattatgtgc tgcacttaga aagcacacia gccagatggt ggtggtgcac gcctttaatc 68700

ccagcacttg ggaagcagag gcaggcagat ctctatgagt tccaggacag gctccaaagc 68760

tacagagaaa tctgtcttg aaaaaaaaa atagtccctc actgtgttgc ccacgatggc 68820

tctggctcta aatgctcaga tcgatcttct tgttcagtct catgagtta cgatttgctc 68880

cacctggcc atctttttgt ttatctttaa aagccataat ctctgtatta catgtaactc 68940

tcccacttc aataaagcac ttagacttac tttatgagtt tttactgtgc cttagtattt 69000

ttttattct atgtatttta tgcatatgag tgctccactt gcacatatgc ccacatgaca 69060

caagagggca ccagctccca ttatagatgg ttgtgagcca ccatgtggtt gctgggaatt 69120

gaactcagga cctctggaag agcagccagt gctctaaacc actgaacat ctctccagcc 69180

ccaattctt agtattattt ttcaatgaat gacagactca ctactgtcac tgtcagtatg 69240

ttcagccaaa ctggaaaacg aacgaaagaa agaaggcat tttccttgta ggtatccctc 69300

cctctctcct ctggcctggt ctctaagggc ccaggctagt cctggcatga gatctgcaca 69360

cacaatgggc ctctctaagc agcagacaga ggcatattgg ctgccagctt acaccaggc 69420

tctagtgaca aacatttccc tgtggctgaa aaaagcctca gaagatttgt gcagatccct 69480

gacttagcag aaaaaagct ctaggagaca tgctcgggtc tccaactcag cccaggagg 69540

gaggcctatt ggaaacct agagttcact ggtgacacct gtccttactg gacattctca 69600

gggatctat atccaccaag ccacctgcc aagtteacat ccaaatgaca gaccagcctt 69660

ccatggctca tccaagaaga cttaggagta ggttggggaa tggggaagtt gcaaccagtg 69720

actggctctc cagggaacct tggccctggc aagcccctaa gagccctggt tccaaatagg 69780

aaaaattgag tgcctaattc atacaaactc ctcaaagtct caaggaacaa gggcaacca 69840

gcatccatct gtctccagg cttttcaaat cactcctgca gtgcagactt gagcccagtt 69900

cctcaccag cctgtggtgc tgtctgaag gaaactcccc ctttccatga gacagttggc 69960

cagaagacca gctcaaaaga gacttcgggg ctgggaacag agctcagtga tagataacct 70020

gcctagcctt taagttcagc tctagcactc ccaccaccac aaaacaacag ggagctggga 70080

gagggaggga gagaaaatga gagtccaagt aagaaaaact ggaaagctga acatagtgat 70140

taagacatac aacggtggct cacaccttta atcatagcac tcagaaagca gaggcaggca 70200

gctctctcta cagagtgagt tccaggacac ccagggtac acagagaaac cctgttttga 70260

aaaacaaaa ggaggaggag gaaaaaaaaa caaaagacat acaatcctaa tagctaagag 70320
 gctagggcaa aaggtgggta aattcatcag cctgagctaa acagtaagac tctatcttaa 70380
 aaaaactttt ttaaggggct ggagagatga ctcgattaag agcactggct gttcttccag 70440
 aggtcctgag ttcaattccc agaaaccaca tggtagctca caacatccc ttatgagaac 70500
 cagtgcctc tcttggtgtg cagatataca tggaagcaga atgttgtata cataataaat 70560
 aaataaaatc ttttttaaaa actttttaaa aagacatata tgatggtata tcctttaatg 70620
 ccagaagctt gggcatctta tgtctgtgag tacaagacca tcctgggtcaa catgagacac 70680

 tgtctcaaaa aaaaaaaaaa tccagtcctg ggggctggag gggctagagt gagctctggc 70740
 agttcagagc tcatagtctt cttccagaag acccaagttc agtttcaagc acctatattg 70800
 aacggtaact ccagttctag ggaatctgac acctctggca tccaaggtca cctgcactca 70860
 catacacaaa cccatataca gacatacaca taactaaaga ttgatggggg atgtccttct 70920
 gtatatatat ttctcttatt ggttgatgaa taaaacactg attggcaagt agccaggcag 70980
 tctgtatagg tggggctaca agatgaggag aactctgggg agaggtcaca gagagaggtt 71040
 gcaagagagt ctccatggag ctgaggaagg agttaacagg tctggaccct tctccggtaa 71100

 gaaaagacca tgggaaata cttagattaa tagaaatggg ttaataatta agaaagagct 71160
 agccaataag aagcctgagc cattggccag ttataatta ttataagcct ctgtgtgttt 71220
 atttggggtt caaagagctt gtgggaacaa gtgggacaga aactccatct acaaagctac 71280
 agagaaacc tgctcagaa aaaaaaaaaa ttaagaatc caggcatagt ggcatagctt 71340
 gtaatccca cattcaaaag atgatagcag gagaatcggg agttcaaagc cagcctgggc 71400
 tacttgaac tacaacaaat aagcaacaca taaaatgaag gtgtgagggg agatgtttca 71460
 attaccttct ttgttagtat tctttgttt gttttgaga cagtctcact atgtaggcct 71520

 tggctgatct gaactatgta taccagctt tcctcaaac tcatggacat tcaactgcct 71580
 ttttacctcg gagtgtggg attaaagata tgtaccacta tgcccagctg ctattattct 71640
 ttttaataagt gtgtgtgtgt gtgtgtgtgt gtgtgtgtgt gtgtgtgtct ttatctgtat 71700
 gtaccacaga taaatgtgag gttgtctgtg gaggccagaa gaggacattg gatccctgga 71760
 gctggagtta taggcagttg tgaaccactg acctggagac tggcaactaa acttgggtcc 71820
 tctaaaagag caataaataa gtactcttaa cactgagca gtctttagg gagacacct 71880
 agccccgtcc aatagtctg ggacaggtac caggtggacc cgttacaatt ccccttttac 71940

 cctagcccca cccaatagtc ccgggtccac ctggtacctg tcccaggact attgggcggg 72000
 gctagggtgt ctacctacac agtctctcag atccctccct acctccctt accagatcca 72060
 ggctctccta gccaaagatg accttgaatt ttgatcttcc tgtctccacc tctcatcaaa 72120

tgtcaatcat tcaccttct cagaataatg tatgtgctat gataaaatata tatcatccta 72180
 aagatgagag agtatagatt aggaacaagg ctctgataaa attttgccat ctgccaggcg 72240
 ttgggtgtgc atgcctttaa tcccagcact caggaggcag aggcaggtgg atctctgtga 72300
 gttcgagacc agcctggctc acaagagctc gttccaggat aggctccaaa gccacagaga 72360

 aaccctgtct cagaaaaaaaa aaaattgcc tctatagaac taaggttttg aacagtaatc 72420
 caggtagagt ggtatgtgtc tttaatcca gcacttggga gcaagaggca gacagatttc 72480
 tgtgagttca atgccaatct ggtctaaata taaaattcca ggatagccag agtaaaacaa 72540
 aaagaccctg tctcaaatg aacaacaaa ttaagagctt caaatagcag aactaaaga 72600
 agccttagca tcaactgcaa tgttatccac ctgggtataa gcagtcccag gtgcatgctc 72660
 ccaactgcat aaactcagcc atatcttct gccatattt tactttatac cgtcaaacca 72720
 taagtttaa ataatccta taaatacaat aaaatgtgac gtttcaatta atgccatta 72780

 ttttaataca cgtcactggc tataaccatc aaaacaataa gatgtctgaa gtggaaagtc 72840
 tctctcatat ctataacatg tatgatccta ttgttgact gtgtgttaa atatgattga 72900
 taggagctgg gggatatac tcaactggagg aatgctgctt ggaagaccag aggccctggg 72960
 aatatgactt tttttttct ttttattagg tctattcatt tttaatgtgt attttgactg 73020
 tatgtggcta tgttgccac ttgcatgctt ggtgccccca gaggtcagaa gaggggtgtg 73080
 aatcccctgg aactagagt tctggagttt cagggtgttg taaaccatta tgtgggtgct 73140
 tggaatcaaa ctcaatctc cagaagagga gtaactgctg aaccatctct ccattccaat 73200

 ttcttattct tattctttt tgagacagga tctcattttg tagttctagc ttacctggac 73260
 ctccctatat agaccagact ggccttgaac tcacaaaggt cttcctgctt ctgcatcctg 73320
 agtgcctgctg tgattaaagt agacctgacc ttgattatat tactcatgta actgcttgat 73380
 atactttttt ttaaaaaaga gatttattta ttgtttatgt ataaagtgtt atgcctgcag 73440
 catatattcc tgcatcag aagaggcac cagatctcat tatagatggt tgtgatccac 73500
 catgtggta ctgggaattg aactcaagac ctctggaaga gcagcaagt ctcttaacct 73560
 cagagccate tcccagccc tgcttgatat acttttaacc ttttaaggat taacattcta 73620

 gactgagaaa caaaacta tgcacaatga aataaaatgt atcaatcca gttgtagatg 73680
 agcctaaaat atgaagaaa ataaaactgc atgggagttg aggtcttgaa ccacaaacat 73740
 ggcaaagggtg aggtctagg gcaataatag ctcaatggtt aagagtggtt taaaggagga 73800
 ccagggtact atacacatc gtagtcaca gacatgcagg caaggtacta tacacaaaca 73860
 tacagccag caaacacca ttcacatgag ataaaaataa gtctttgaaa gtgtcaaagg 73920
 tcaccaagg tcccaaagcc tctctacttc tgtggcgtct tggagacccc tgtgggaaa 73980

ctggcagga ttgagtctg ggactgagct cagcagcttt gctagccatg gcaactgtgta 74040

 tcagcccca ccatctctca gttccattc tgggcaagaa gccaaaaata cattcttcag 74100
 gccccacag gcgtttggag ctgacagagt ggagcttgag gaaagggtg agcaaagcag 74160
 aaacctcctg agagtgtcaa aaggcagata acaataacc acatcacggg gcttatgcaa 74220
 caatggagaa actgagacc agaaaaagt agtgtctcca agaccacaca tgaacaggtt 74280
 gtggagagag ccaccaatt aaggttctcc tcaaagcact tctctggtcc tcaactggatg 74340
 tgacgagtca ctacatatct caggatttga gggccacaga tgataaaga acctgaagtt 74400
 aatgtctca tcagccctt agcaaagaat ctagtgttcc tttccagtc cccattcttc 74460

 ctttccctt agcttccaa taggtgacaa atcctagtca caaccagag agcccggagt 74520
 tatgtccca ttttaagatg aatcaaggt tcttggaat gaagtattt gtccaagacc 74580
 acaactactag tgaatgagag acaagaata caaccagtg ctaactagct ctgtgcttct 74640
 cccccaggg tgacccagg taggtgctga ttctattttc atgccacat cccatcctc 74700
 aagaccaggc tggagccact tggtgcttgg ggtaacagg aaagaaatta caacagccct 74760
 tcccagccct cggctctgt tccctggtac ttaccctcca gcaccacctc cttgectgtc 74820
 ttcttgaggg cctgtacggc ttcatcatgg gtggcagagg acaaatcttc accattcaca 74880

 gacagatgg catcccaac aaagagtgc tccgtctggt ctgctgccag tcccttgaag 74940
 atcttgaaa tgagaatagg catctgttt tcccggcccc ctgcacaggc acagaaggaa 75000
 ggggaaactg aggcgtgtgc ttcaaatgg gaaacttacc aaggigaaat tgattctgac 75060
 tcagtctgg gaaaggaaa atgagcaaat agtgagaaat aaaggagga aacttaggag 75120
 ttgaccaca gccagactg gtgacatgca gccacaattc caacatttag gaggctgagg 75180
 caggaatgga gtgccttgag tgcagagtca ctcagagata tagcaagaca gacaaataat 75240
 atattttcta aatccataat gctatatttt ggttccctaga tcttctgttt aatgttttg 75300

 tttgttacc acttcactga tttttaaat gttttgatt ttaagcaatt ttctacagta 75360
 tgaaaattta ctgataacc ccatctagag tcaaggaaa agtagtggtt gctatggcct 75420
 gaagggacct ctctacaat cagcaagttt tagaatccag agctgggtgt ggtacacaaa 75480
 gcctgctatc ccagcactg ggaagttaat gtggggaagg ggggtgggaa gcccagaagt 75540
 tcagatcaac ctcagctatg aaggagttt gaggccggcc tgggatgtat acaaggccat 75600
 ctcaaaaaata aatagttaaa tgggctttac taaccaggat tcacactgga aaggaaggcc 75660
 ttaagtctca gaaattcaa aagtatatct gaatttcac tctgatctaa gaaaataata 75720

catttactg aactacttta ttgtttaaact ctcaaagtgc attttaaata attcaacatg 75780
tatttatttt gtgtcttatg cgtgtataca aatacacatg tcctatatag tacaatgtgg 75840
gagtcagagg acaacttgca ggacttgggt ctctccagga ccatttgggt cctggagatc 75900
aatctggctc gcagtcttga gagaagacat ctttaccctc tgagccagtg gttctcaacc 75960
actggatcac aaccctttg agggctcaaac gactctttca caggggtgga atcagatagt 76020
ctttatatca catctttaca ttatggttca taacagtgc aaaattacag ttatcttttg 76080
ggggggttca agacagggtt tctttgtagc ttggagcct gtcctggaac tactctgta 76140

gaccaggctg gtctctaact cacagagatt gcttgcctct gcctccaaa tgctaggatt 76200
aaagggtgga gccaccacca ccaccaggcc aaaatgacag ttatgaaata gcaacaaaaa 76260
taattttaag gtgggggtc atcacaacat gaagaattat gttaaaaggt caaagcatta 76320
ggaaggttga aaaccactgc ttctgagtca tctcatcagc ctcaaagtgc ttttgcttgt 76380
tttgtttgtg gttttgtttg ttgagaaaag gatcttacta tgcagccccg actggcctgg 76440
aactcactat gtctaacagg ctagtctgaa acttgagag atctacctgc ctctgcctct 76500
ggagtgctaa gattaaaggt atgcatcacc acaccagac caaatgtctc tttaaatagt 76560

tagcggggct ggglatggtg gtacatactt gtaatcgaag caccgaggtg acaatgaata 76620
aaggattact gcaaattcaa gaccaacttg ttccacatat gaagtttcag gacagtataa 76680
cagtcctcaa aaaagaaaaa tcaatgtega ctctatatag actcaagtca gaccctcaga 76740
tatcagttc ctgatccacc ctcaaagtac tgaagaagag agactgggtg cacagagcaa 76800
gaggtcattg tttcaaggtt atataaattg gtgacatctg agcctggaac acctcactcc 76860
caacccccac ccagccaac agttgtctcat ggcaactgcaa aaggcttgag gcctaggaga 76920
ggaaggtgtt tctatttata tccagcctct ccacctaat gtaaggcctt ccattccatt 76980

tgaagetatg accattccca gctgcctggg actcagetgg accccagaag ggaagttacc 77040
atggcaacag gagcccagtc ttcaatccag gaggaagtga atgaaattcc ctaaagtccc 77100
accaaaatat ctttcaatc acctggaagt acagatttgg gtagtgtctc tgtaccttgg 77160
taagacctg ctctcgaag agttagtctg tctgtctgct ctgacacacc aagtgtattt 77220
ttttattgct gtttccttag cctataccag agtttgggat taaagctggt gccactccc 77280
tgttctccc tttctcttt agactcttgg ggttactac ctgggaattt acccttctct 77340
gggaagaact gactccctgg gcagctttta gggcaataaa ggctctataa ttaagattga 77400

agtctggtt ctgctgtaca cagactgatc ctgggaaagt cacttttccc ttttgagtcc 77460
ttttagcact gatgctcaaa atgaagtaga cctgaaacta agcataatga acacagcgc 77520
tagcacacag tggcattcac caccatgccc acttcctaac ctgggcaaaa gtctagacaa 77580

ggtatcaatg aatacagtca gctcccagga ggcttgggaa tgtaccgaca cattcagttt 77640
 tttaaaaaag gctggcagtc tgttgagggc tgaactggt agacaaggca agaatggtga 77700
 acccagaagt ttaggatata catggatttt aagcaccaga agctgggggt gcacatggat 77760
 tttaaacacc agaagtcagg cccggtgttg gtggtgcatg cctttaatcc cagcacttgg 77820

 gaggcagagg caggcggatc tctgtgagtt cgaggccagc ctggtctcca gagcgagtgc 77880
 caggatagge tccaaagcta cacagagaaa cctgtctcgc aaaaaccaa aaaaaaaaaa 77940
 aaaaaaaaa aaaaacacc agaagtcagg gatacacatg gattttaagc accagaagct 78000
 ggtgtgcccc tggattttaa gcaccacatt cagctgattt gagagtccct cctggcctct 78060
 ctctctctca tccatgttg gcaagccctg ctctcagaaa catcctcacc atatagtac 78120
 caaacagat tcagagatag ggagtgactt gaccaagttc acacagagat ccagaactcc 78180
 ggttgagacc taagtgacct ggggaagcag tcagttggtg aagtgcttgt ctaacatgta 78240

 taaagctcta ggcttgatcc ccagcacaac ataacctat tttagcctca cattccagta 78300
 atcccagcac tctgggatta ctctgggtgtt atcctttgct acgtagtgcac tatgaggcca 78360
 gcctgggata caccagacc tgtcaaacag tcgttagtct tagaggcgaa gaactctcaa 78420
 gaaggaatgg cagctctggc tcaccctttc ccctgtcca tggtaacaat ggacagatga 78480
 ggagactcaa acctagtcat cgagactccc agtctaggca tacaaccttc tggagcccaa 78540
 gatatctagg ttcttactgg ccagcccttc acctgtgcac ttaggttgtg tctcagaact 78600
 tccccctct tgcctagta gtgtcccttt tcgccccgtc gtctgccttc ctgaggatcc 78660

 tcatgcctt gataacctata gctaccattt tgettcaaca cagaactacg aacctatgct 78720
 cttggtgagc ccgcacactt ccacacttgt gtctgctgag ctccctgtaa gatctccaac 78780
 tccccagcc ccttccgacc ttggtgttcc tcttctca ctctgttcc tctctccct 78840
 caagctctgc tccagctcag acagcagget tttggctatc tagtctcctt getctgccag 78900
 gccccgtgac ccctgggcac ttcgcagcag catagacacc acgaccccat gcctcagtg 78960
 cccccacct accttgatg ctgatgcca gcccgccggc nnnnnnnnnn nnnnnnnnnn 79020
 nnnnnnnnnn nnnnnnnnnn nnnnnnnnnn nnnnnnnnnn nnnnnnnnnn nnnnnnnnnn 79080

 nnnnnnnnnn nnnnnnnnnn nnnnnnnnnn nnnnnnnnnn nnnnnnnnnn nnnnnnnnnn 79140
 nnnnnnnnnn nnnnnnnnnn nnnnnnnnnn nnnnnnnnnn nnnnnnnnnn nnnnnnnnnn 79200
 nnnnnnnnnn nnnnnnnnnn nnnnnnnnnn nnnnnnnnnn nnnnnnnnnn nnnnnnnnnn 79260
 nnnnnnnnnn nnnnnnnnnn nnnnnnnnnn nnnnnnnnnn nnnnnnnnnn nnggcggtg 79320
 ccaaaggggg cggggcccgg gagagactga agagatgctg ctgggtaacc taaggatgct 79380
 ctgcccggacc gcttgagtg ggtcggagcc gcgtcgcggc gaggccacaa agtttagagga 79440

ggcggttgag gtgtggagta ctcagcgggg acataaaggg accagattct gtggatgagg 79500

 caaccaagg atcgggttct gtgtgccgtc gaggactgga ccgtagctcg tggagcagaa 79560
 ggacaagaaa aagaatcaaa gatccctggg cgagactttg ggagtctgga caggactgcg 79620
 tgtggcgggg agctaggctc cagggacttg gcagacagag ttaactggta agcgagctaa 79680
 ggaaggagat ggtttccctc gttttgtgtg ccatggggag aggactgtgg gcgtggttca 79740
 gcttcagggc acagtgtcta aagaggtagg cctgccacc aggaggagaa acgccaactcc 79800
 tttgagggct tgatcccagc acttataggt agaggcagga ggatctaca gttcaaggcc 79860
 agcctaggct acatgagaac ctgccttaa aatatacaaa ataaaaaatg cgtaaggagc 79920

 tgaagagata gaaggtccat cggctaagag catgcaactgc tcttattgag gaccagaata 79980
 aagttcacat catccatgtt gggcagcaca caaccacttg taattccaac tccatggaga 80040
 tctgacacca ctagcctcct tgagaacctg tattcacatt gcacacaccc atacacggca 80100
 cacaaaaata ataaaaata ataaaaagac gtgtgttaca tacacacata catacttgaa 80160
 tgccatttat tcagtgtttg catgacatat gagctggcta gtttacta tcattgttac 80220
 ctcatittga aattctgcat agcctataca ctattacat tttattgata aggaaactga 80280
 gacagaagta ctaagagcag acctctgtgc tttttgtttg ctagtttttg cttgttttct 80340

 tgagccagga tttctctgtg tagctccct gcctctgcct cctgagtgt gggattaaag 80400
 gcatgtacca ccatgccagc ttgctgacct gtgttctaac ttgggtcttt ctggcttcca 80460
 agttcatatc ccctactccc cttagcagca agggatggtt gcactattca cttaattgatc 80520
 actaactgga ccaacaaga tgccatacac ctgtaatcac agcactctga agactgaggc 80580
 agaaggttca tgagctaatt ctaggccagc tagggattca tagcaagttc caggttatac 80640
 attttaagt ttattttaa tctatcgaga ttggctcttt tgccctgtgtg gatgtctgtg 80700
 tgccacatga agtcctcaaa ggccagaaga gggcatcaga tccctggcac aggaattata 80760

 gaccattcta agctatcttg tgaattgaac tccagacgtt tttgttaaag actgaaggac 80820
 aagccaggcc tactgaggaa ggtctgcat ctcagatact caggaagctg aagcaggata 80880
 gtcacaagtt caagccagc ctgggcaatt tagtgagact cttaaatgtt taaaatacag 80940
 gacttggggt atatagctca gtggtagagc ctatcatgta taaagcccta cagtaaatct 81000
 caccactgta aacacacaca taagggggta aggattacaa gtctcatgct ttagtcaca 81060
 atactaggga gatggagtca ggaaaatcaa aagttcaaag gctagggtag aggagatggc 81120
 ccagcagtta ggagcactgg ctgttcttgc aaaggacttg gatttgattt acaacacca 81180

tgtggtggct cacaaacatc tataactcta gttccaaggc atcttacacc ctcttctatc 81240
 ttcaatgagt ataggggcat atacaggcaa aacactcaca tacagaaaaa aaaaaaaaaa 81300
 catgttttgg gttttgcact cataaacata aaaaaacatg ttttgggttt tgttttgttt 81360
 ttttgtgagt tttttggttg ttgttttgtt ttgggggggtt gttttgtttt ttgagacaga 81420
 gtttctctgt agctttgaag attgtcctag aatttgatct gtataccagg ctggcctcga 81480
 actcacaaaa catccacctg ttgtcatgtc aggggtggccg agtggctctaa ggcaccagac 81540
 tcaagttcag ctctctcaag agatctccct gtctctgctt cctgagtgct gggattaaag 81600

 acgtgtgcca tcaccgctca gctaaaaaac atgtttttaa gttaaaattc tgcatagtga 81660
 gaccctgact caaaaagaaa atagagaggg agggagaaaag gagagatggg gagagagagc 81720
 atacaagagt acatgagaga gggcacagac ccacacatca ccaagaactg agtcctttc 81780
 ccaagaccaa ggctagaatt agatccttaa aagtcccccc acgtagtgcc ctgtttaaag 81840
 aagcttaatg aagtccagcc aaacttctgg gaaggaacct taatagagag ctctccct 81900
 aggaaatgtt ctgaggacag agcttaggaa aggggaaatg ggcatctgta taccaagcag 81960
 ctagctgaga agggagaaaag tgtagagcca gaaaagggga gaggtgtcca tgattgaaca 82020

 gcatgagcag tgccaatcac cggcttctct gccagctgcc tcatgaacat gtagctggag 82080
 gaatactcta taccctca cttagtcagc tgtggccaga aattgatcac acacacacac 82140
 acacacacac acacacacac tggcctggct atctacaaa cgctgggca aagctcccag 82200
 agaaaaccag ttacagaag agataggagg gggaacctag aaaaggacga acacaaggga 82260
 actgcccagc atttacacac acaaaagaaa taataaaat tgaaaagtag ggtagttttg 82320
 cttaaagtca ggtgaaatca atcagccctg gtaacatatg aaggatctgc tcctaaatg 82380
 ccaagattta tgctaaaatg ctaacattcc ttactactaa attctaaaat ctacatttca 82440

 gatactctag catctgagat gtctgaatct agccaatc ctagagtagc ccaggaaaaa 82500
 ggttaaaggc ttgggatcca ggaatctgct gatttagcta ggctcaataa ctcatctcta 82560
 taatcacagc actcagacgg ctgaacaaga gtatcagtgc aggtttgaag ccagcctagg 82620
 ttacatagta aggtttgttt ttgttttttg agacaggttt tctgtgtgta gecctggctg 82680
 tcctagaatt cactatgtag accaggctgg cctcaaaatc agagattcac ctgcctcca 82740
 agtgctggga ttaaaggtgt atgccactat gccccacaag taaatcttgt cttaaaaaca 82800
 cataggccca gccatgcagt ggtggtgcac acctttaatc ccaacacttg ggaggcagag 82860

 acagctggat ctctgtgagt ttgaggccag cctggtctac agagcgagtt ccattgagtt 82920
 ccaagacagg ctccaaagct acagagaaaa ctgtcttga aaaaacaaaa agaaacaaaa 82980
 aacaaaaaac cctaataggc caggcagtga tggtgcatgc ttttaatctc agtgccccag 83040

aggcagaagc aggagagctc tgtgagttcg agaggccagc ctggtctgca gagtgagttc 83100
catgacagtc aagactacac agagaaacc tatctaaaa accaaaaaca aaacaaaaa 83160
caaaaaaca aaaaaacaga aagtgggcag gcaagattgc tcaactgggc caagcagtaa 83220
tggctcatgc ttttttttt ttttttttt ttttggtttt ttgggttttt tttgtttggt 83280

ttttttgaga cagggtttgg agcctgtcct ggaacttgct ctgtaggcta ggctggtatc 83340
tgaatcacag agatccgctt gcctctgcct cccaagtgct gggattaaaa gcgtgcgcca 83400
ccaatgccca gcttttttt ttttttaata aaaacaatct cacagcattt attgtcacct 83460
gataataaca taagggccac taaaacaata tgaataaatg tttcagactg tgctccaagc 83520
agaagaaacc tttaaaaaca ttgtacttcc tcttcagctt ctcgagtgcc tgagtttata 83580
gtcggaaaca ctttgagca gagtaataat gtctccttc agcatgatcc aatccagttg 83640
cttccttgac tttgttttag agtggatctc tctgtatcat ctaatatgag gttcatatac 83700

tcatcaaagc cagtaaaaca accctctatc cacatatctg cttgctcata tagccacacc 83760
tgaatccgag acctaatttg caaatatttg aagatgagtt tgatgggctg caccgtctga 83820
ccctggccgc agtatgccat agtgggaagc acaagacca cagcagtagg ctgcctcaga 83880
aagcgacttc cagaagtaag accaggaaaa accgtgtctc ctgcagttaa taccagaatc 83940
ttggaggcag atttctgagt tccaggctag cttatctac agagcaagat ccaggacagc 84000
cagggcaacg aagagaaacc ctgttgttga aaacaaaca caaaaaagat tgttcaatgg 84060
ttggaagac tttgtatag gcctgatgac ctgaattcaa tcgtccacaa ggtggcagaa 84120

gagaacctac ttctggaact cacacgaata cctgcgcaca ataaattgtt ttttaagttta 84180
aaaaaaaaa aaaaaaagct ggcaagctgt gtaaagaac ttgttataca atcttgggtgt 84240
cctgagtcc attccccagc acccacataa tgggtgaaag agagaacttc acagaattgt 84300
cttctgatct gcacacatgt gtcatggtac atactcccat acccacatat gcataatcatg 84360
tatacatgct cacacgcgag agcacacaca cacacacaca cacacacaca cacacacaca 84420
cacaccaca aggaagagaa aaagacaaga cagaaacaac ttttaagtggg gctggagaga 84480
tgacccaaag ttaagaacac tggttactct tccagaggac ccaggtcccc agaattcaca 84540

tagcagctaa caaccatccg gttccaggga atctgacacc ctattctggc ttctgtaggc 84600
accaggaatt catgtggcac acagacattc tgaaggcaaa aactcctgc aaataaaaaat 84660
gaataaatct tgccgggctg ttggtggcaca cacctttaat cccagcactg gggaggcagg 84720
ggcaggcaga tctctgtgag ttcaggcca gcctggtctc cagagcgagt gccaggttag 84780
gtccaaagc tacacagaga aacctgtct caaaaaaaaa acaaaaaaag aataaatctt 84840
ttattgtaaa aataaaagga accgggcagt gatggtgaaa gcctttaatc ccagcattca 84900

ggaggcacag acaggtggat ctctgtgatt ttgaagccag cttcaaagc aagttccagg 84960

 aaagccagga ctgttcaca gagaaacct gtctcgaaga aagagaagaa gaagaagaag 85020
 aagaagaaga agaagaagaa gaagaagaag aagaagaaga agagagatca ggtgttatga 85080
 catgtgcttt tattcctgtt aaatttcaa tggtttggc cagtacaaat ggctgaggtg 85140
 cccacttaac atatcaaac gaacctggcc aagctcaatc tagtcatgtc cactccgcac 85200
 tctcccagat gtcctgtct ctacctctgc tctcccatat atctataata aactttttcc 85260
 tccactgtac ctcagagcag tcatggcctt tcctttcctt tttatttatt tatttttttt 85320
 cattcaattc caagaactct tgaatcagag gtcagcctgt ctacatagtg aaaccaggc 85380

 tagccaggac ctcaaggtaa aacctatct caacaacaac aataaaacaa ggcatggtgg 85440
 tacatgcttt taatcctagc acttgggaaa tgggggcagg cagatctcta agttttgagg 85500
 ttagcctggt ctagaaatca agccagggat atacagaaaa accctggggg gcggggagta 85560
 agacaagggg ttggggtag gggagaaacc aaaatatccg acaggtcctc cctgtgttct 85620
 gatctggaat tccagcctgt gcaaggtaag tgaacagttg ttcaaagagc aagtgaagac 85680
 aagaaagcag cagatcaggc taatgagatc tttggaatga ttctaaagct aaaatgacaa 85740
 atgatagaat cgcaatgcag ttggaagact attcacacaa gccaataaag gagaatggat 85800

 aaaatgcaga cctgacatit cctaccaagt gttctctct ttttcttctc aattttgttt 85860
 ttgttttgaa atggggtttc tctgtatagc cctggctgtc ctggaactca ctctgtagtg 85920
 taggcaagca ctcatatata taaaaataaa agtctcaaaa aaaatttagt gcttctgcct 85980
 ggtgtgataa catcacctt tatttccagg aaccagaggc agacacaggc aaatctctgc 86040
 cagtttgaga caccagtcta cctatatgtt gagttccagt ccagccaaag ctacatttaa 86100
 tgcaggggga aaatgcttct aatatatatg tgatattggt gaggccatcc aagaaggtgt 86160
 agaaccctgt taagtagaaa taaatggaag acatgtcaag tgaatacaac ctacaatcta 86220

 aatagacatt cgattgtgtg atatagaata catgttgggc aggccagcga aatggcttag 86280
 tgggtaaggg caactgccat caaacttgat gacctgaggt tgatcctgaa gacacacatg 86340
 gcagaaagaa agaaccacc cttctgactt ccgtggagga accatcacag aagagcacac 86400
 acatacacag acacacagac acataaaaaa atataatgaa gaagctgggt gttggtggaa 86460
 cacactitaa tcccagcact caggaggtag aggcaggtgg atctctgtga attcagggcc 86520
 atcctggtct ccagagcгаа tgccaggaca ggctccaaag ctacacagag aaacggtatc 86580
 catgtgagag aagggacaaa agagaaagcg agaggaatga ggaagaagta tatgacatta 86640

aaactcttag tagcacaaga aaaagcaggc tcccttcatg atgatatgga gcattcataa 86700
 tacataaaat attttattgt tgggcatcag tcaataagcc ttctaagaac aaaacacttg 86760
 ttaatattac cagtaaatac tctggcactc ttgccttcta ctgcagatgg ttagattgac 86820
 aggttcatga ctctcaagaa tctgactagg tctactatcc tatgttccag actaatcagg 86880
 gtttcacatg gagaccttgt ctcaaaaggg aaaaaaagc agacaagcca gtcattgtaag 86940
 tttatatatg atataatfff ataagtttaa ttaatcgaag ttagctcaa gtcacctcag 87000
 catctttatt ttctaacaat tgtgggaaaa cgtaccagaa ggaatttgca acactttatc 87060

 tgttttaaca taatggactg tgcaatagtt ttatctaagt ttaaaggttt catcaaaggc 87120
 aactgtcttt ggcacaggta gtactgggaa gtgtcagtga tatttaagtt ggttttcaca 87180
 atgctcaggt agtgaggaac aaaacctfff agagaatgaa gcagacaaag cctgccaggg 87240
 taaagaatcc acgtttttta tggagtcaat ggaagccagg aaggtattca tgattcaggt 87300
 tctctttttt gtttgtttgt ttgtttgttt gtttcttttt cgagacagga tgattcaggt 87360
 tcttgatctg agcaatttca gttacagtgc aacacttcaa ccagctctgc ctgtcctgcc 87420
 agcccacaag cagtcaactgg ggaaagggccc tgtttagggg tccagacaga ctaatgctga 87480

 attcagccca cacagatcct gcctccactc tccatcccaa aataccagct gggcacccga 87540
 gcctgagtat cttttcctc aacctttttt ctaattaaaa cttttgtctt ggggggtggag 87600
 attccagcag ggggcagcag actgccaggg ctgcggggtc caggcagggc cctagccacc 87660
 atctagctca actaagtaac aaatggaaaa gaagtgggtt tctccttctt cttttttctt 87720
 cttccacctc ttcttgtct cccctcccc cttttgtttt ttccacacag gagctaccag 87780
 cataaccga gttagcctca agctgtaaat attccttctt taggtccca agttttggaa 87840
 tcacagacca aagacatctt acctgttctg tttggttctt tctttaacct tttttctttt 87900

 ttttctgaga cagagtctga ctgtgtactt ctgactaaca tggaactcac tgtgtaggca 87960
 ggctagcctg gaactcacag aaatctacct gcctctgcct cccaagtgcc agaattaaag 88020
 gcatttgggg ggggggtgag agaggttgtg tatgctatgt ctatgtgggt gcctcggag 88080
 gccagaaggg ggtgtcagat ctggagctgg agttatgggt ggttgtgagc cacctgaatg 88140
 ggtgctggga accaaactca catcttctga gagacacctg actcagattg tcaatttta 88200
 tctatttact ctttcattaa tttgtatatt acttagtggc cctgaagatt gaatccagag 88260
 ccttgacat tttaggcaag ggctatggaa ataactacta tttttgttgt ttgattgggt 88320

 ttttgtttgt tttattttt cttgcgagtg tafgaatgtt ttgcctgaat gtatatctgt 88380
 ttgccacatg tgtgcctggg gcctgtggag gtcagaagag gtcctcagat cccctagaac 88440
 ttgagttgca gatggttgtg agctattttg taggttctgg gaatcaacct tggctcctctg 88500

caagggcagt aagtgcctt aactactgaa ccatctctcc agcccctagt ctgttttttg 88560
aaacatgggt tctttgtga tccttggctt tcttagaact tgcittatag agcaggctgg 88620
cctggaacc agagatctgc tggctcttaa ctttctatta aaggcaaaca ctgctaccac 88680
caaggtattt gtttttgaga cacagtctca ttctgtagcc ccatccaact atatcaccca 88740

acctcgtctc aaacttgtg caatctccat gccttgactc ttgggcactg aaattacagc 88800
tcaggctctc tgaggttttg aagcactttc ttctgttctc catgtgagga aaccacatcc 88860
gtctaacta tcacctctc cattattatt atcatcatca ctctgtcaac cacacgtttt 88920
tagacaatcc tatccctatt tcccctccag agcgtggact ggagcggtag gaaaagaacc 88980
aataccgaga gagcaagtg actaggacta tagccctagc tttccattga catagtgtgt 89040
gacctcagtc agaacattca tctcttatt tccactttac acatctgtag aaagatggga 89100
atatgaaaat gaaaggttgc ctggcagtggt tggcgcacgc ctttaatccc agcactcagg 89160

aggcagaggc aggtggatct ctgagttcaa ggccagtcta gtctacagag tgagttccag 89220
gacagccagg gctacacaaa gaaacaaaac aaaaacaaaa acaaaaaaag aaaattaaag 89280
gtgggcaagg catggtgaaa cctgecttta ttcccagctt ctggaaggca gagacaggtg 89340
gatgtctata aataaaggcc agtctaactt acatagcaag tccagtccag ccagggtctac 89400
ataatgagge cttgtttcaa agggagtggg gggggggcat ggaggtctgg aaagatgtct 89460
cagaggttaa gagtgcatac tgctctagca gagaacctac attcgttttc agctgccata 89520
ctggatggtt cacaaccacc tgaactccag ctccaaggga aatctcattc ctccagcctc 89580

caaaggcacc tacactcata tgacacataat tacggggctg gagagatgac tctgtggtaa 89640
agagcactga ctgctcttcc agaggacctg ggttcaattc ccagcaccca catggcagct 89700
cacaactgtc tataatttca gttccagggg acccaacgcc catggcaaag caccaatgca 89760
cataaaaata aaattaaata attaaataaa taaatctcaa aaaaataaag aaaaggtagg 89820
ccagtgagtc agtgagtaaa agcacttgac tccaaacctg aagtccaatc tccagaacct 89880
atggtagaaa gacagagcta gcaccaagg gctgtcttct gacctgcacc tgcacactgt 89940
gaaacatgga catctctact catgcatgac catcaagcat atctacactg taataataaa 90000

taaaacttag ataagaaaag aaagaaggaa gaaagaaaag aaagagagga gaaagaaaag 90060
aaagaaggaa agaagaaaag ggctagagga cactaggaag aattgagttg ggtctgtgta 90120
agtacctggc atatgaagaa gcttcacatac attttaattc ctgctaagtg tactggttca 90180
catctataat cccagcactt gagaggctgg ggcaagagga gtagcatgca ctccaggtta 90240
gcctgttcta cataatgagt tccagaacaa tccaggetac agaagagaa cctatctcaa 90300
aaaaagttaa atgaaattgg gcagtgaggt cactcactca gtgggtaaaa ccctagcaa 90360

cagcctgtgc actatcctca gaaacacat gaaaggagag aatttgagca cggcgggtgt 90420

 ggcatactcc ttaattcca gccctcggca ggcagaggca gacaggtctc tgtaagtctg 90480
 agactagcct ggtgtacagg gcaagcattt ttctttttgt tttgttttgt tttttcgata 90540
 gagggtttct ctgtatagct ttggagcctg tcttggaact cgctttgtag accagggtag 90600
 cctctaacte acagagatcc actgcctttg cctcccaagt gctgggatta aaggcatgtg 90660
 ccaccacaag ctggcttcag caagcatttt ttaacacctt tttaaaaaat tattttttat 90720
 ttttatttct gtgcactggt gtcttgccctg catgtatgtt tgtgtgaggg tgccagattc 90780
 tctggaactg gagttacaga cagttgtggg tgctgtgaat tggacctggg tctcctggaa 90840

 gggcagccag tgctcataat cactgagcca tctctcggcc ccatTTTTgtt ccaaacactca 90900
 ggagacagag acgatggatc tcggtgaatt tgaggccagc ttagtctaca taccagttt 90960
 caggctagcc agagctacat ggggagacc tgtctcagaa agagaggatg aaggagcaa 91020
 aggactattc ttggcttca gaattttcct ttaacactgg aatttactgc ttgaccag 91080
 ccaaagtcag ggggttccca aggcctggaa aacctgccc ctgtttccac gcacagttct 91140
 cctttctgt ggtcctccac ccaccatgt gcttcatcgc gccaccttc atccagaaca 91200
 actcgttttc tttttctcac agatgttcca caggctcttt ttcctcagaa attccctcaa 91260

 aagcattcac tgtaatttt tctaaatca cagtaattac ctcattactt tgatattaat 91320
 agacctcact tggcaccagg gtgccaattg aaagcgtca ggcctgtgt gaggggtgga 91380
 gagggagcct gaagagcagc cctcctgaat gctggccctg ggacagccct tgtttgcctc 91440
 catccaagt tgccttcac ctttgctccc aggtgttctg atttcaaag agaactctgg 91500
 atccacaggc tctgagaaa tgttagctgc ctgaccagga aaaaggaaga taaaagaaa 91560
 tgatggaagc taaacatgg actccccga ggcctcaagt ctcacagagg aaagcagat 91620
 ggtgagagge caccctagac caccttccc ctttcttcc ctcagctaca cetaaggctt 91680

 tagcctgaag gactctctcc agttacacct ccccaggac ctctactggc ttcctacag 91740
 ctctgtaate cagtgtggtc tctacatctc ctggtcaata atttatttga tctcactat 91800
 attcttatta ttttttaata atatgtaggc cttgtatttc aaaatgcatc ttgaataaaa 91860
 tggggcaact gtattacggt taataactaa tacgtagccc ataatggtca ggatatattt 91920
 ttattagata gcccaaccagc aggcagaaca agccaaaaca gcagggaaaa gagagctccc 91980
 atgtgcgttc cctatctctt taaaccttta ccatgtcaac ctgacatcac cttgaccaca 92040
 ccctggtggg tgtggtcggg cacacctgta gccagccctt aggaggcgtg gttacggtgt 92100

ctccctacat aactgtcatc atttaacat tttagataag gaaagaacat aagcttgtaa 92160
ctgaggacta ctcagggttc tgggcctgca cctgacagct acagaagccc tgggacttct 92220
ctctcctcac ctggagtctc tagtagctct agtggattta atctgcatgt attgagtgtt 92280
ccgtcagggt acctgggtta tgctattgag atttgtcagg tgatttgctc cagagtgctc 92340
tctcgatagc tgatagctca gactgctaag cttatactct tcacctgac actctcctgc 92400
gagcatctcc ctctcaaggt catccagagc agtctctgag actgctgata caggcttgc 92460
gaaagtcagg actgaccagt ttgccacaac ccctacctga ttgactgtac tacctgactc 92520

attgcatcgg agtctgcaaa ccggttgtga ccatatggct gaccacgcta tgctggccac 92580
atattgcatc cctcagggtg gtagatatgt tttccaagtc caaggctctc cagcacactt 92640
cctgggaagt ttctctgta aacagaatgg gaagagtgat agtctcaaca gaaatccagg 92700
acagagagtg attgggcagc cagactagac tggagctagt ggggtgggaga ggggcagtat 92760
agaggatcct ttgttaggcc agaagctact aagctgcccc atccccacca tctggctcct 92820
gctgcagccc agtgatgcat gatggggaat attgggggcg ggtgctaggg gctaccacc 92880
tgctctgcct cctgggataa gctgatccaa gacctcccag acctatctgg tcaacacatc 92940

cccaggccct gaccaccct gggactcctt tagacagact gaaattggcc gggagtgtgg 93000
ccagcctgtc agggtcacag gtcaccgtta atctgccaga acaagggagg acaggcagg 93060
gggcaggcag gcggtgtggg cgaggccatg ggagtctctg ctgtcttctt agtgaccaca 93120
gagggagggt ttccccctt gggaggcagg gagaaggtta ttggactcca gggaaattgc 93180
tcattctcac acctagctgt tctagtcca gatgggaacc ctggaaactc tccttaata 93240
tgcttagggc atcatggaaa ctatgcatga gacagagaaa tactgggaa aatgtaagtg 93300
cccatcaaca ggaactgggt taatctaaag actgagacca acttcagtgt tactgaactt 93360

cttgggctga gaactgaggt ccctgtctca attgtctcta ggaatctctt gectgaaag 93420
ataagactat aaaccaacag ataactcac tgtttgtctc agagagtcc tgcaaaccaa 93480
ttctttggg caaacagttt gttcaacttg gccaaaatct ctcttctcag acaacagttt 93540
aacctcaate ttatatttt ggttgtaagc ctagccttta attgctgagg tattectca 93600
gcccttaact tcaatatttt aggagcataa aaatgggctt atactcagga ttccacctgg 93660
cctcaggctt gcaaacacca gcttctctt cccagtccag cctgcagtct gcagccccag 93720
cactaagctc ttctccaagc ttcttaccag tctgagcatg tgtggaacc tcattctgt 93780

ggatcagtaa gtagctcaac atcaaaactag cttacatctg agtcacagtg tctcatgtta 93840
tcatgaaac caacttcac agggactcag ggttccctct gtacaattgt agtgtgctag 93900
gaggacacac aactgcacct gcctttctca tttcttccct ggaaatagtg gaagttctt 93960

agatcattcc taggctatTT gggagatgaa agaactctat cccccattgg aaacaagatc 94020
 tatctatctt tgtatctatc tatctatcta tctatctatc tatctatcta tctatctggg 94080
 tttgtttgtt tgtttgtttg tttgagacaa cgtgtctctg ttgtgattta agaaaagcag 94140
 aatgagagag aaagatgtca tgagacttgc ttcaagcaga ggggtttttt attagggaaa 94200

 gggatcataa aaaaatgggg aaaggggagg gaggagactg gcctcctggg atgggagcag 94260
 caggaaagag gaaatggggg gagagagaaa aaagagagat gagggaaagg ggggatggga 94320
 ggtgggcaag gcccttttaa aagggaacat agtaaatatg cacagatgac gctcttagtg 94380
 gctgtagcta agggtttata ctgtcaaaac cccaaggaca ggccagtaga gatgcctgaa 94440
 tactaacagt ctctacattg ccctggctgt cctggaacct gccatgtagg tcagactggc 94500
 ctgtaactca cagagaccca cctgcctctg cctccaaagt gttgggatta aaggtgcggg 94560
 acacacacga caaaaagaaa atttatgatt ttttttaaag agacacttct tgatggacat 94620

 ggggtgtaca ctctttaat cccagcactt gggaggcata ggcaagcaga tcttggtgag 94680
 ttcaaggcca gcctggtcta caaagtcca gggcagccaa tgtaacacag agaaaacctg 94740
 tctggggggg gtccactttt cagatattta ctagtccaa actgttatat cacaaatTTT 94800
 gcccaatccc aatctgtttt ctgccttaag aggagctgga ctggTggTtc atgagttaag 94860
 atgtactgct cttgtaaagg acccgggttc tagtaccaac agcacatgtt ggatcaaaac 94920
 tataactagt tcaggggat ccaacacctt ccctggctt aaatgggcac cagacacaca 94980
 tagtacacaa gcatacatc agacaacac tcataaaca aaacgtaagg gggaaaatgg 95040

 tggTtacacac ctgcaatcct atcctttgag aggtagaggc aagagaatca ggaatTTatg 95100
 gctaacctca actaacataa tgaattcatg ggactcatct catgaaaaga aaaaaaatg 95160
 agacgggtaa agtggTttac atttgtaatt ctgactga aacagtagga ttgctgagat 95220
 gagagTtagg gagggTtaca caagatcctg ttttaaaca acaaaactca ctggatcctc 95280
 tttctttgtg agtattcttc tttggagcct tctgaggcac ttctgagact cctcaagaa 95340
 cctgactct ggtcagggt cagcagTtta ccctgatcc aactTggTgt atcactgagc 95400
 tacaccatcc ctattctat tttaaattaa tctattgaga cacagactct cgtagcataa 95460

 actttgatct cagtatgtag tcaaggatga acttgaattt ctgatcttTc ttgccttate 95520
 tctgagtaat tagttacagg tgtgtaccac catactcaag tgggcttatt ttattgtgat 95580
 ttcgaaaaat ttgtgtgtgt gtgagagaga gagagagaga gagagaaaga aagtgtgtgt 95640
 gtgtgagaga gagagtgtgt gtgtatatgt gtgtgtgaga gtgtgtgat gtgtgtgtgt 95700
 gtgtgtgaaa gagtgtgtgt gagagtgtgt gtgtgtgtgt gtgtgtcaga gagagaggag 95760
 ggggagagag agagagagag agagagagag agagagtgtg tgtatgtgtg tgcagtTgcc 95820

cagagaggcc agaagagggt gtcagattat ctggagctgg agttgcaagc agttgtgagc 95880

 tgcccgatac agggctgaga accaaagtgg aagagcaaca gctgaacat ctctctatag 95940
 tgtccaggct gctttgctga gacaggctct catgtagttc aggetggcct tgaacttcta 96000
 atcttgatgt ttcttaggta agttttctgg ttgattagaa ttccaagact tcaaagtttt 96060
 ctgagttaaa atttcacaac tagatgctgc ctgcttttca tcccagcact tgaagtcagg 96120
 agagttcgag gccagactgg tctactaagc gagttccagg acagcctcca aaactacaga 96180
 gaaacctgt ctcaaaacca acccccgcaa acaaaaattt ttacaactaa agaagctctt 96240
 gattagaatt ttatggcact ggagaaattg tgattaacat tctatcacca gacctttttt 96300

 tttttccctt ttctttttt tccaagacag ggtttctctg tatctcaaca gccctagctg 96360
 tccttgaact tgctctgtgt tctgttgacc aggetggcct caaactcaca gagatctgcc 96420
 tgctctgtgc tctgcatgc tgggatcaaa ggtgtgcact tgctcgcccc atcaccagac 96480
 ttttattact gaaaatttca tgacttgaga gctctactgt tttgaatgta gtggtatctt 96540
 agtgcttcag cagtgcaggc ttctccgcca agatggcttg gatctctgtg ctctatcact 96600
 ttcttggaa ggcttttctt gagctatttc tgtctactg ccatctgctt taattttctc 96660
 catgctgttg ataaacactt aaaaaaaaaat agcacctggc tatttacta caatgcaaga 96720

 agctccatta gggcagaaac ttatittgga atttctttt tttttgaga ctgtctcata 96780
 taactcagta ggatgacgtt tgtttaattg ttcatcctgc ctctctctac tttatgttcc 96840
 accatgtcca gtttatttgg tgctgggaat agaaccaga gctacctgga agttcctcat 96900
 ctttccagat ttccaatttt accattactt tctccagaaa gctctcctga gtggccagat 96960
 ttatttgctt ccattgtcaa aaatagttaa agttcttgta ctgttattca taaaactctg 97020
 tactattcta tctatttaaa atagatacag ctgggtgggt gtggcacagg ccttttagtcc 97080
 tagcacttag gaggcagagg cagtcggatc tctgtgagtt tgataacagc ctggtctaca 97140

 gagctagttc caggtcagtc agagaaatcc tgtctcaaaa accacctccc cgcccccca 97200
 aaagatagat gctatctgat agtctgtgtc cctgccccaa tctctttttg tgacagggtc 97260
 tcactatgta accctggcta aactggaact aaatatgtag accaggctgg cctcaaactc 97320
 ctgtctttgc ctctgagtg ttgagacgaa aggcaccacc actaactagc aactggctga 97380
 ttctttgata cttgcagaaa gaccatttac tttatactc ctgcctagac cagtgtttgg 97440
 caccagtag caaaatacca tattacactc ctgcaatcag aacgaaaaaa gaccctctag 97500
 ggctaaatgc catcaagaat cagaggatgc aagaaggaac caagactttg gttcacaagc 97560

tcccttctga agaaggcagc tatataaggg tgaacaaact actttttgtt ttaaaaaata 97620
 tttattcttt tacataatag aatgtttgct acatgcatgt gtgtgtacta ttgtgagcct 97680
 cgtaccatg gaggtcagaa ggcaactggat tccctggaac tggaattaca gaaggttatg 97740
 agctgccatg tgggtgctag aaatcgaacc caggctcctct gtaagagcag caatggctct 97800
 cactccttaa acttattatt gttttgttgt tgctgttttg agacagggtc tcactatgta 97860
 actggctatc ctggagctaa ctatgtagac caggctagcc tcgaactcac agagatctgc 97920
 ctgccattgt aatgtaactg taatttctta actatgatat aacaaagtca ctcatcatga 97980

 agggcctcca ggtccacttc aatttctttt tcttcttct ccttcttctt tctttctttt 98040
 cttcttcttc ttcttcttct tcttcttctt ctcttcttct ttcttcttct tctccccca 98100
 ccccagtcca aacaaggttt ctctgtgtag ctctgtctgt cctgggacca gaaggcctc 98160
 aaactcacag agatctgctt gcttctgcct cccaaatgct agtgctggga ttagaggcgt 98220
 gcatcaccac tacttageta aaactttttc attttttaaa agattcattt atttattgtg 98280
 catagagtgt tctgccagca tgtatgaggg catcagatct cattatagat ggttgtgaac 98340
 cacatgtgg gtgctgggaa ttgaactcag ggctctgga agagcaacca gtgctcttaa 98400

 cctctgagcc atctctccag ccctaaaac tactttttct tttcttctt tttctttgg 98460
 tctttggaga cagggtttct ctgtagcttt gtagaccagg ctggccctga actcacagag 98520
 atccccctgc ctctgcctca ccagtgtctgg gattaaagge atgcgccacc actgccttaa 98580
 aacttttttg ttaacacatt aaaaaacaag gtgtgcgctg ggaagtgggtg gcacatgcct 98640
 ttagtcccag cactcaggag gcagagacag gtggatctct gtgagtttga gaccaccctg 98700
 gtttacaaga gctagtcca ggacagcctc caaagccaca gagaaaccct gttttgaagc 98760
 aacaacaaca aaaataagct gtgccagcca tgtggtttgt ggccccctct gtatcacaac 98820

 tggcagggtg acatgtgagc cacagacagt acctggaact tgttcaagta aacttcttat 98880
 actggtttga cttttactta actctcccag ggacaaaaag atctggggac tctgcaatgc 98940
 agataaagct ttaggaaatg tgagggtctc agatggacaa gaaacacttt tttctcccc 99000
 acttcagtgg tgetgggaag tcccttaact gttcagagcc tggggctcct cctttgcaaa 99060
 cgggctacaa taaaagatct tggctccaa agcgatcatg aggattaact gagacaagcc 99120
 ttcaactcca accagggggg ctctgcatta cacaccgat tgctattgtt gataatgatt 99180
 attattacta tgaccagcgg gactttggga gtagcaaatg gaaggacat atgcaaatcc 99240

 tccagcga tgctgttac actggagacc tcacaaaagg ctcataactg cctgttttac 99300
 accctcatca cccccacatc ccaggtcatt tcacatagge tttcccagca tectttatgc 99360
 tcccccccc ccgccccaa tccattgca agatctcgcc acacaagcct cagcagagac 99420

cagagaaagt gccacaggca gctggccagg gtccgggaga ggacccggcg ccaagggagg 99480
 caggttccgg gcagaccct gtccattgtc tcaaccgcc agcccgcag ccagctgatg 99540
 tcttgggtcg ccgacaccag ctggttaggc cccacaccac ctctgaaagg cctcctcctc 99600
 cctggaccct ccctgtctct catcttgccc agtagcccag agagaatcct agtgtgatta 99660

 cagggcctgg gcttttgtcc ctcaaatcag tgactgattt gcattctttg gcaatttga 99720
 tagcccatte ttttgtggag ggctaggctg atgtagagcc cgcccagtcc tttgcgtttg 99780
 tttattccgg taattctatt tttgtagccc tggtctgctt ggaactcact atgcaactcc 99840
 tgctctgcc tccagttatc tgtgttaaca gggcgtgctg tccaatactg agccactagg 99900
 caacttgcc attaaaattt aagtaatttt agtactttgg tgcctcagtt ataggcatca 99960
 aacacatata taggactttt tttttggggg ggggggtcag ggtcttaata taatccaggc 100020
 tggctttgac ctttgcctat cagtcaaggc tgactttgaa ctctgaccc tccttctct 100080

 tctactactt gggagtgatg agattacagg ctttaccac agtacctggt tttatggcat 100140
 actggagaca gccagagctt gaagcaagca ttgtaccaag tgagctctat ctctggcctg 100200
 gcagccacat attaaatgct caggaggggc tgggagtgtg gctgtgttga agcatttgaa 100260
 tacatctata ggcctgaat tccactgtca ctgccacaca cacaaaaaga gagactgctg 100320
 ggcatggcag gacacatctg caatctcagc cctcgggagg caagaggatg gtcacatgct 100380
 gagaccagag tgttatgat agttccaggc catccaggac taaatagtga ggcccatcta 100440
 aaaataaaga aaccaaact atagggactc tcaaactaag cagtgtgggt ataatcatc 100500

 catctctgaa agttctgctg gatgaggctg attcaaacc tttaatctga ctcatctctc 100560
 tttctagtct agaggtcttc cttctacagc tcctctcctt accccaaca aggtaatgac 100620
 cttggtgagt aggtgttctt ttgttctcgg aagcgcaggc ttgcacctgg acagagggtg 100680
 gagaacaggt gtggagtgtt gccctggagc accaatgggg tgggctcaat tgttgttctt 100740
 acaaagcaaa caactgcact cagctctgtc tttggcctca gctggagcct ccattgcctg 100800
 gaggtgaatt agggaggaaa ggcttaggga actgtgaacc ctgtccccac caccactcac 100860
 cggcacttta aggtcactcc tcccctgga tgagtgtttt ccagcacagc tgacacctgg 100920

 ggaaggtgtg ccagatggaa tgcgctctga ggagcgggga tgggggagga ctggcaatct 100980
 gccaatggct aaggcccagc tgcagcacia gctgtggaag gcattgtcag gcttctctca 101040
 gcctatttca ggttataggt atcccacatg cactgtggcg ccacctcact tctggagagg 101100
 agcaagggtt tagcaaccac aacagtaaca tctttcatag ccatgtggcc atctcttgcc 101160
 atcccaaagt gtataccac gcctaaactc tgettctgct agtctcttag ctagtccat 101220
 ctcagcagac ggctactccg tgcttccaga tattccaggc ttcaaatctt ttattttgtt 101280

ttgtttgaga cggggtctca ctatagtttt ggctggcctc aaacacactg tacctctcct 101340

 gcctcgtgag aggtgagcca ctataccag ttactattct ggtgtaccac atataaatcc 101400
 ttggcaaatt ctgctgcctc taccttcaaa atatatetaa aatccactcc cttttcaaat 101460
 ctccactgcc gccatcctgc tttgagcatt actgtagcaa cattccacct ttgccttctc 101520
 cagtatactt ctctcccata gaggtcaaga tctcaaaact atctgggtgc tgcaacaatg 101580
 acttagaata aaaccaaagt ccttactagg gtgcaataag tcccacataa tetatagtec 101640
 ctttctaagt ctctggcctt ttaccaattt ccattgtgtt ctatgaatgt tctgcctca 101700
 gggcctttat ttcttctac tctctccaaa tttggcatct ctgttacctt cttcaggttt 101760

 cagtgtata aatgtcacct ccttagaaaa gtcttagcct ggtagtgggtg gcacacacct 101820
 ttaatcccag cactcaggag gcagaggcag gtggatctct gtgagtttga gaccagcctg 101880
 gtccacagag tgagttccag gacagtcagg ggtacaaaga aaaacgttgt ctagaaaaac 101940
 aaaaagactt tctttgctat ctttatataa aatcacacct gaaacacaac ctttgctccc 102000
 ctcccacctg ctcttcagac gagtgcctgtt actttttgtg gtttcaagga ttgagcacga 102060
 gtctcttatg acccctaggc aagctttcta accctagact atttctgcag getctaattt 102120
 gcctagtagt ctaggttttc tttagtctc ctgattattg gcaaatacag aattttccaa 102180

 tctttattat taattattat tattattatc tggttggttt tttgtttgtt ttgagacagg 102240
 gtctctctac ataaccctgg cagtattaga actcattgtg ttgaccaggc tgcctttaa 102300
 ctgacagaga tctgcctgcc tctgcctaac aagtgatgga cttaatltaa agacaaggac 102360
 aaccaatcct ggtccaatct taattattga cgataatltt cagatcttat actacaccg 102420
 aggattagat tacagaatga ccaacaatgg gtttaagagg ccacagggtt cagaggtgct 102480
 ttactgacag tagaaggcag ggagcagata gatgctagga gagttatggt atgtgcttag 102540
 attaatatta caactaatgg gggctggaga gaggcttcag tggtaagag cactggctgc 102600

 tcttcagag gacctgagtt caattcccag caaccacatg gtggctcaca accatctgta 102660
 atgagatctg gggcccactt ctggcctgca aggaatacat agatgcagaa cactgtatac 102720
 ataataataa agaaataaaa aaaattataa caactgatat tgccacagtt ccagcatggg 102780
 ctgttgaaga tctgggtgct tccagatgct aaattgagtg ggttggggga gtgtttcaca 102840
 tctgtaattc cagtatttga gagacagagc caaatgcac aaattctagg ccagcctgct 102900
 ggattatata gtiactacct ggccagacac aactggtaga ttctgtctta aagaaaaata 102960
 atgagatggt gtggtggtaa agtggtagtg ggggtggaga gtgagttcta ggcttactag 103020

gttccagaa aagataactt gagctggcctt tgtccagcag tccatgtaag ctaataacct 103080
 tgggctctg gggacagtca ggaacttgct tgtggatagt tcgatgatgg gtgaagtctt 103140
 agtcaatgtt aggaccctc ctattgtatg atccaggtga aggagtgtt cattctttgg 103200
 tctgggtgg ttgataactt tgtgggcctg gtttctctga tatagtcc atatatctat 103260
 gigtacaaat gtttctgatt aaatttgata aagcctatca aattaagtgg tagatagagc 103320
 aaggacatcc tgatctatctt ctcccttcc ttccttctt ctttcttcc ttccttctt 103380
 ctttcttct tcttttctt ctttcttct tcttttctt ctttctgtt ttcgagacag 103440

 ggtttttcta cagctttgga gcctgtctg gaactctctc tgtttaccag gctggtctgg 103500
 aactcacaga gatcctctg tctctgactc ccaagtgtg ggattaaagg catgcaccac 103560
 cacttctcag catgatctct attttacctg tggattgca actttgcaat accagcactc 103620
 aagagctaa ggcataagga ttaaaaactt aagcctaggg ctggagagt ggctttgtgg 103680
 ttaagagcac taactgttct tccagaggac ctgggttcaa ttctcagcac ccacatggtg 103740
 gctcacaact gtctcacaac tccagttcta ggggaccaa acatcaatgc acataaata 103800
 aaaataagtg aattatttaa aaagtcgagt ttagtcaggc agtgggtgta tatgccttta 103860

 atctcagcac tcaggaggca gaggcaggca gacctctgtg agttgagacc agcctggtct 103920
 acaagagcta gttccaggac agcctcctaa gccacagaga aacctgtct tgaaaaacca 103980
 aaaaaggaaa gaaagaaaa aaaaagtaga gtttaagcct agactgaact atgaaatgag 104040
 actgaagtca gcagcagcta tataatgaaa ctgtctcaag atgaaaacag aaaaaatgg 104100
 ggaggcgagg atttgaaac agggtttctt tgtggctttg gaggtgtcc tgggactagc 104160
 tctttagac caggctggtc ttgaactcac agagatctac ctatgtctgc ctcccaagtg 104220
 ctggaactaa aggcgatgac caccactgcc tggctatagt cttaccatt gaccttctc 104280

 tttattccca agatcaaaaa tttaaaaaaa atttttaag tgcctcattt tcttcataat 104340
 cttgttgagt tttgtctta atttggtttt aattttgctt atttgtttat tttgaaacag 104400
 aaacttatgt tcttcatca tttctcatac tgactcagaa ttctgatcc tctggtctc 104460
 tategccacc accagacaga acataatgtt cttttgttt tgtttgttt tgttttttg 104520
 aaacagggtt tctctgtgta gctttggagc ctatcctggc actcgtctg gagatcaagc 104580
 tggccttgaa cccacagaga tctgectgcc tctgectccc gactgctggg aataaaggca 104640
 tgcgccacca acaccggcc ataatgttct tgtataataa attttcatca gaagcatgct 104700

 cattcctgtc aaaattgtaa ataataatga attctaaaa tacaactaat gtccaagaac 104760
 ctcaactgtt cgtatcttct cctgggacgt cttagctcc ttctctttgt ttttttttt 104820
 ctctttccca gccatggttt ctctgtaaaa gtctggctg tcttggact tgcctttag 104880

ttcatgttgg ccttgaactc acagagatct gtaatgaggg agggatctct gtgattaagt 104940
 atggtttatt gaacagggtgc aaaatataaa atacactcac aatacataac aagaatcctc 105000
 tcattccaaa gagtgatggg gaagtcccca aaccattgct gccagcgaga cggccacagt 105060
 ccaagagagc atccatcgcc ccacctggc cttttattct gggtcacacc cccccagaga 105120

 agaccacact cattgggcca agccaccca atacaattgg ctgttggatc aaattcccac 105180
 accagatctg cctgcttctg cctactgagt gctgcgatta aaggatgtg ccactttacc 105240
 accaggctgc tccttttctt tgggagaaag gttttgttta tctaaagagt cacactcatg 105300
 gcaagtattt ctcaattaca gagataggtt tttgtcaagg gtgaaggagt tgagtacagt 105360
 ggaacacacc tgiaatattt caggggactg aaatgggagg aatggtgtga attccagacc 105420
 atgggtcaca tggcaagtag taagccagcc agagtttgat atatgtttat tatcaaacat 105480
 aataatgata ataacaaaaa tctgggcctg atggtatttc tataatctca gcactataat 105540

 agagccaaga ggatcaggag ttcaaagtca ttctctttct aggctacaca gtgagtgaat 105600
 tctagccag tcttaggtat aggagatcct gtctcaaatc cagtcaacga gccaatcaac 105660
 taccactacc accatcataa ataaataaat acataagtaa ataaagtgcc attggtgttt 105720
 caacaaggaa tattacttat aagaagttac acaacatgtc tttaaatggc ttctctcact 105780
 gtcagctggt ctggccttgg gattatcatt cattagagga agtggcatgg tttgggcaga 105840
 tggcaggcag catgtatttc tctctgctg cccatcttta ctcttctgt caccaaagac 105900
 aaatattggg ggggaacaaa aggaagaaga aaaaattcag cttgccacga tcatatttgg 105960

 aatcccagaa ttgggggagc tgaggcaagg gatttgttaa aagttgcagg ccaggctggg 106020
 tgggtgtgtc acatgcgttt aatcccagga ctggggagac agagacaggt ggatctcggt 106080
 gatttcgagg tcagactgtt ctgcctagt ctaggacagg ctacacactc aagcgttttc 106140
 catttccttt gttttatctg aacctgtaac tttctgtttg ttttttgaga cagaatttct 106200
 ctgtgtagcc ctggaacttg ctctgtagac caggctggcc ttaaactcag agatctgcct 106260
 gcctctctgc ctcctagtg ctgggattgg ggtgtgtgtg tgtatgtgtg tgtgtgtgtg 106320
 tgtgtgtgtg tatgtaccac ttcacctggc aaatgccgct gcagctcacc cegatggcct 106380

 ctgacttatt atcctgatga tcataacctt gaactgatcc tcctgcttta atgctgagtg 106440
 ctggtgtaca ggtgtgggcc accatggctg acctgtttt attgagactg ggtcttacta 106500
 tgtggcccag gtactggctc tgaatcggca gttcttttgc ttcagtttcc taagggttgg 106560
 gattacaggt gtgggctacc acaccaggct gcttcatttt agttattttt taaaaatgtt 106620
 ccttttaaat tttcttttat gtgcactggt gttttgctg catgtatggc tgtgtgaggg 106680
 tgtgggacc ctggaactag aactatagac agttgtgagc tgccatgggg ttgctggaaa 106740

ttgaaccgtg gtccttggaa agaacagtca gtgctcttaa ccagtgagcc atagctccag 106800

 cccctcatt tagttagaat tctgaacta taatTTTTga aaaattatga gtaattcttc 106860
 aaatataatt ttgagctctt gagaaacaga aaggctgtgt agcttaaagt aatcgtccta 106920
 cagcccaact acittctttg ttgctctgag ccccccccc cccatttaag acaggctagt 106980
 gactcatgtt tataatccta cttcatggga ggctgaagga ggaggaatgg tgagagtcc 107040
 agaccatcat ggactacact gtgtgttcta ggctagctag agatccaaaa cagacccttt 107100
 ttttggaaac aaaacaattt gtgaggcctg ctggtgtttt aaacacaacc tttgggagac 107160
 agaggcagga gtatggctta aggttcaagg atagcctagt ctaggtgagt gatttcaagc 107220

 cgcccaaatg tacattaaga tcttgtttca acaaacaaaa acatgccagg cagtgggtgt 107280
 gcttgccttc gcttttaatt cttagcagtc agaggcaggg gcagcagatc ccttgagtgg 107340
 gaggtcagcc tggctctacag agggagtcc agaagatggg gctgcataga gaaaaaccaa 107400
 aaacaacaa aatcagaac agaactgct tatatacatg cccctttccc catgaacaca 107460
 cacaaaacc ccacaaagct cttggtctaa tgcagaaact aataatgaca gctactagct 107520
 ttttttgtt gttttgttt ttttttgtt ttttgagaca cggtttctct gttttgcttt 107580
 ggaggtgtc tggcctctaa ctcaaaaaga tctgcctgcc tttgcttctc cagtgtctggg 107640

 attaaaggta tgcaccgcca aagcccggct ttttttttt ttttttttt tttttgttac 107700
 tagcttaaaa aaaaattaaa ttctatagct ctgaaaagag gaaggaatct gtgagatagc 107760
 tcagctggca aagatgcatg tcaactagcc tgatgcatga ggtgaagttt gatctgctgg 107820
 acctacaggg tggaaaggaga gcatgcccc aactgtgct ctgacattca cacgactcc 107880
 ttcgaatgta cgcgccaag cacagacag cacacatagg caataaatca atgtgaaagc 107940
 aaacaagtaa gtaaaggag taagaacaat ttaccacca aaacaacat aaaggcatta 108000
 aggctgtac ctccagctgc cctcccctg ageccccccc caggactccg cctcnnnnn 108060

 nnnnnnnnnn nnnnnnnnnn nnnnnnnnnn nnnnnnnnnn nnnnnnnnnn nnnnnnnnnn 108120
 nnnnnnnnnn nnnnnnnnnn nnnnnnnnnn nnnnnnnnnn nnnnnnnnnn nnnnnnnnnn 108180
 nnnnnnnnnn nnnnnnnnnn nnnnnnnnnn nnnnnnnnnn nnnnnnnnnn nnnnnnnnnn 108240
 nnnnnnnnnn nnnnnnnnnn nnnnnnnnnn nnnnnnnnnn nnnnnnnnnn nnnnnnnnnn 108300
 nnnnnnnnnn nnnnnnnnnn nnnnnnnnnn nnnnnnnnnn nnnnnnnnnn nnnnnnnnnn 108360
 nnnnnnnnnn nnnnnnnnnn nnnnnnnnnn nnnnnnnnnn nnnnnnnnnn nnnnnnnnnn 108420
 nnnnnnnnnn nnnnnnnnnn nnnnnnnnnn nnnnnnnnnn nnnnnnnnnn nnnnnnnnnn 108480

nnnnnnnnnn nnnnnnnnnn nnnnnnnnnn nnnnnnnnnn nnnnnnnnnn nnnnnnnnnn 108540
 nnnnnnnnnn nnnnnnnnnn nnnnagcggc cttggatcgc aggcctggcg ggcgcactat 108600
 ggactggccg cgagagaagt attgttttgt tttcgcggca tcggggctga aagtccggtc 108660
 ccgggaaacc gtaggcacgc cggatttggga gcgacgtgtg gtagatgttg gaagacgcgg 108720
 ggccggtgtt ccggaggggc ctgttgagt caggctctgg ggtcggaccg cctgggttca 108780
 cgtctggctc cccggcgtac aagctgtgtg accttggtc tccccgagtc tcagttgtc 108840
 tgtctgaaaa atgggctgtg aggaacgttc tctgaactgc cctgtagttg ggtttagtga 108900

 gttcagcggga acgccctgca cacacagttg cacatcacia gtgtgaaagc tcgctattgt 108960
 aattgcggtt tattaatcat gtgtgcacct cggaaaagtc cgaaattgcg atctggttgt 109020
 gtatttttta tttatttttt ttaaagatgt ctttgccaag tcccgtggg tgaccggtt 109080
 gtgttttcat tcttacctcc gtcttgccat ttcatttacc tgatgttctt tctagaatcg 109140
 taagatcttt gcaggagggt ttgtatcctt aataagaaca ataaaaactt aattgicatt 109200
 aaaatacagt aatagccaac attacttcag taccaggcat tttgcattcg atcatttaa 109260
 tatttattaa atcatctctt aagtacaaag taccactcca ggcccagagg atatggcaac 109320

 aaagtagatt ctggatttga gtttgagaga ggggactcat gtaactctt ttgtggattt 109380
 ttctgtttat gcagaatggc attctaaaaa caggtatttg aggcactttc aaggcaggtg 109440
 catctttgag ttgaggcca acctgatcta cacagccagt tcttggtaaa ccaggctctat 109500
 attgtgagac cctgtctcaa aacaaaataa aaagtaata aaaaactgaaa ccaggatatt 109560
 gagtatgtcc attgtgcaga ggataaaatg agaggatttg agaacccat gctctgcctc 109620
 cagaggggtt ttcttcagcg cttaaaaggg aggatttata cagctgcttt cttggactct 109680
 tattccacat tggactgaag aaatgcaagg tagatttagc cactactccc tttttagtg 109740

 ctgtgctctt gctgctcttg atggcttctt ggaggccgac caggtaaccc tgaggctctga 109800
 caaggatttc gttatattag gaaagtggaa aaacctttta tatgtattta aattcattta 109860
 cttatagcag tattgaggat tgaatttagg gccttgact ctatgctgta cactgaagtg 109920
 tatccccage ctttttcaga ttgggtctta ctaagttgcc caggcaactt gtaattctgt 109980
 ctcagcttcc cagtagctaa gaatacaggc ccgcgtcact aggtctacct gaccatgtct 110040
 tacattttca gttaaagaca ggtcccaaaa agttgagtat ggcgaaagcc tatatgtaat 110100
 tgcagcacgc aggaggttga ggcagaaaga tgtgagtttg aggtcaacc aagctatgcc 110160

 ctgagattgt tctggaaaaa caacaaaagc taagactttt tggtttgttt tgtaactagt 110220
 tttctttgca taaggcagtc tgtagtgttt agtatgcttg cttattgatt gatagctgga 110280
 ttgaactgag gacatgtg caaggcaggt gtccccccc cccccccag tgtttctcta 110340

agtagctctg gctgtcttgg aacttgcctt attgaccagg ctggcctgga aactgcctcc 110400
 catacctggc ttggcctctt aactcttaat cctgtctcag gtgcctgaat actagcatta 110460
 caggtgggca ctgtcatacc ctagtctact tttccttaag ttcagactaa taaattacac 110520
 tgaacttcgt tggtttgagt actttctttc attaagatag actcttacta tatccgtagc 110580

 ctaggccagt cctacctcct ggccctgactt cctcagagct ggggtgttac aggcattgtgc 110640
 ccttttcagt cagtgcctct gtgttgacca tttgctgttc agaagcttac ctacagtttc 110700
 ttgtttttct tgagtgtcga aggaacacag gccttagtgt atgctgggca agtgctctaa 110760
 ctgctagtgc ttttaactat attcctgggg aaagaagagt agaaaagaac tcaaccctga 110820
 gtctgctttc ctaaactgga aatttctaca tttccctggg gaaatactgt agcactttat 110880
 cttctgggtg tcattccatt aggatataat gctgagtttg cacacaatgc atgaatattt 110940
 gttttgtttt acacgttttt tgtctgtcag tactgggtcaa aatcaacca ccacaaccag 111000

 ggccctccat tcctatgca agtgttttac cattgagctt cattcaaacc ctgaatattt 111060
 tgtgttattg aaaatcctgt tgcctcaaa ctgtaacac tttctgcttc agccttttaa 111120
 atgagggatt ctagatgta gtctggctga atatttgttt taaatgttg tttaggtag 111180
 ggctgtaact cagtggtagt gtactcacc accatgggca aggcctggg tttgctgat 111240
 tgctcataaa taagtaacaa ttatagtcag actgaaaatt gccattttaa ggaataatga 111300
 gctaaaaatg aagtggacat gacagtattg tctctcaaa ccttgggtgtg atagtacta 111360
 gtcttgggag ggagaccatc atcttaagtg gatcttatcc cttgacttat taagtatgct 111420

 actcttgaaa aaaaaaaaa caaacacctt atttagcaga agtagaatgc agtgggtgag 111480
 tctaaacttt tgttgtctt ttgtttttt aatgtctct cactatcct ttttttctt 111540
 aactttttt ttatttgaat taggaacagg attgttttac atgacaatcc catttcctt 111600
 cgcccaccg tctcctac cccccccc cccccccc ccaattttt ttttttttt 111660
 tttttttct gagactgttt ctctgtgtaa tagccttgac tgtcttgaa ttccattgt 111720
 agactgtgct ggccaactca cttgcctctg cttctggat gctgggatca aaggtatggc 111780
 tttttacagg ctaggatgaa cttctgaaag ctaatgttt gtctgtctt ctttttgag 111840

 tcagtatctg gaacatgctg cagtctcct gtctctgct cccacccc atccatttta 111900
 gcattatagg catgctttac taagccagt ctctctgta aaattaaagg tagttcccta 111960
 catcatttgc ttttttttt ttttttttg agacaaggtt tctgtgtagc cctggctttc 112020
 cttgaacttg ctctataaga agaccaggtt ggcttcaaac tcagagatct gcctgtcgtc 112080
 tgctcccaa gcgccaggac taaaggcatg caccacatg gccggcctca tttgcaggtt 112140
 tattctgatg attagatgt gagagtggca tgtgaaatgc tttagcgta cttggcacat 112200

tgtttagctg ctgttagttg ctgaggatag tcacataggt gacttaggat cccacacttc 112260

 atgggggtcc tgcatagata aatggggaat ggcagataaa gtgtgtaaat cttttttcag 112320
 atttatttga ttttatgtga gaagtggaaat atatcatggt aataaaatga cagtgaattt 112380
 cagctggatt tgtgcctagg aagtaccaa tgacaagaaa acctattaca gaattcttca 112440
 tagccttgac gctctttctt ctcagatggt cttttctgtc tacttacctg agaatacaaa 112500
 ctgfcagact aagctatatac agggttatga gaatatcttc attttgaat tttattttgc 112560
 ctagcaaggt aaagtgtgaa attaataatg tgtcgaagag tatataaatc agtgaccctt 112620
 gtcgggcggt ggtggtgcac acctttattc ccagcactcg ggaggcagag gagatctctg 112680

 agttccaggc cagcctggtc tacagagcga gtgccaggat aggctccaaa gctacacaga 112740
 gaaaccctgt ctcaaaaaa ccaataaat aaataaataa ataaataaat aaataaataa 112800
 ataaataaat cagtgacctt tgaaagaagc ctaaacacat ggagcagtat ggtagtatac 112860
 gatatttctt acagtagaga ggttctgtgc attcattact ataaaaagat gtaagaattg 112920
 tcctcttgag aagtgtttcc ttatgtggca catagctatt agcatgataa aagagaaatg 112980
 gaaatgtacc agagagacct tgttgaggat aaactcatta cccctattt tetctctct 113040
 aggccacta ctgtctctaa ccctaattc tggttgactt agttacttgt ctgtatccat 113100

 gagcttctt tctctgaga tgatcaaat attttctgc tcctttttgt tggatttct 113160
 tctagtact ggattatctt aaactctac ttccagcata gcccatgctg atttcaaact 113220
 cctgattctc ttgtctctca ccttgcaagt actgagattg aaagcatgag ccatcatgcc 113280
 tggacaggat tgcataaat gacagtagag atgaagtgga aaagaaaatg caatattggt 113340
 ttaatagcac acacctgaa tcccaggatt tgggaggtgg aggcaggagg attattacaa 113400
 agtgccaagc cagcctgagc ctgggctttg tctcaaaaca aaacaaaaca aaacaaaaca 113460
 aacccccgt taaacaataa ctcttcgagg ggccagatct cgtttaagc catcctggac 113520

 tacagaatga gtgccaggac agccagggtc acacagagaa acctgactc aaaaaaaaa 113580
 aaaaaaaaa aaaaaaaaa ttgactcttg caggtcatgg tgtgtgcctg taattctgct 113640
 ttttggagg ctgaggtggg aggatgaaa ttttgaggtc tctctgtgct gtagatcag 113700
 actgtcttat aatggggaag ccaaatgaaa aactaaaagg atttgtttct tccttctgtt 113760
 tcgtattgct ataattttaa tttttttgtt tgttttctga ttcagggttt ctcgtgtagc 113820
 tttggagccc atcctggcac tcactctgga gaccaggctg gcctcgaact cacagagatc 113880
 tcctgcctc tcctctga gtgctgggaa taaaggcatg cgccaccaac acctgcttg 113940

tattgctata attaaacgca gaaatcaaag taaaattcag agtgacctat gtaaaattct 114000
 gaatttataa ctctggattg gcagacttaa attaaattag ttgatggcta caaatatgta 114060
 atctaacctc tctggtagcc caagftaaat gttactgtca ggcatgcaca cagcccttga 114120
 cacacacaca cacacaaacc accacacaca cccacacaca cacacacata nnnnnnnnnn 114180
 nnnnnnnnnn nnnnccctt tgactttttc tcttttaaaa atgttgccctc attcctttgt 114240
 taattttggt catcatgtag aggtcctgcc tgcctttaat ttttcaaac cacatgagaa 114300
 caaacattca catagcacag atttattcat ttaggtctca taaccctaga gcaataataa 114360

acacacccac agtttctgga aattcacaac actcctgacc actaccaccc cctgcccctat 114420
 aaaaactaat atgccagtgg tatttttctg cactataaaa atgtgacaag tttttattga 114480
 cttcagtgtc tttattttct ttctagaaaa agtactgtca gccttgagga gaggtgacgg 114540
 gcagaaacat ctcttttttt ccccttttta gttttacttt taccaggtt ggctgaaac 114600
 tcagaaattt tctgcctat gcctcaagaa ttgcaggtgt gaactaccac attcaacccc 114660
 ctccatctct gtctctctct catctctata tctgtatctt tatttttgtt tttcaaggca 114720
 tggtttctct gtgtagtctg gctgatctgg aacttgctct gtagaacagg ctggtctcaa 114780

actcactgag aacttcctgc ctctgctccc caagtgctgg aattgtttta attatttgg 114840
 ttatatgtat ggtgttttagt ctgtgtatat gtctttgtac tacatatgtg cttggggccc 114900
 agaagatggt ttctatccct tgggactgga attgcagttg agttgggaac caccatttgg 114960
 gtgctggaaa ccaacctgag tcttctggga ggacagccag tgagtctct ttaaacagcc 115020
 gagccatttt tctggccatt tgtttttgtt tccttttaca gtgctgatat gacttgagtt 115080
 tgtcaagtaa actaccactg aatgatagcc caggagaatc ttttttttg tgagacagaa 115140
 ctttctatg tatcccaggc tagtctggaa gtgactgtgt aaccaggtt ggcttctgtg 115200

tgcaatgate ttcccacttc tgccctcccag gtgttagggt ggctttattt tagtttttat 115260
 cttttttct ttcccaga cagggtttct ctgtgaaaca gtcctggctg tcttggaaact 115320
 cactctgtag atcagactgg agacaagctc tcaactaatg atctagactg atctctatt 115380
 tgtggactaa agtgatcctt agctgccc aaactggtat ttaggtata tactactgtg 115440
 catagctcct gattgtattt gtattactgt ttattttttt ttcattttta tttatttatt 115500
 tattgagaca atctatgtag cccaggctac ccttgaattc gttctgtagc ccagaactga 115560
 aactaaggta gtctattgc ttcagcctcc ctctgtagg atcaaagggtg tatgtgtgtg 115620

tgtatgtatg tatgtatgta tgtatgtatg tatgtatgta tgtatgttct tggttctata 115680
 atattttatt ttttaagtta aattttattt gccttgggtg gggatagatg tcagtgatag 115740
 aacaaattct gtatttgatc ctttgcatc acatgatgcc cccacattta gttttttgtt 115800

tgtttgtgtt tttccaagac agggtttctc tgtggctttg gaggctgtcc tggaaactagc 115860
 tggctctcaa ctcacagaga tccacctgcc tctgcctccc aagtgtgga actaaaggcg 115920
 tgcgtcacca ccacctggcc ccaagtttag tttttaaata cagtttttgt tttcagtttt 115980
 tttgtttgtt tgtttgttta agtttagggc tctctttgta gcctgtgctg tcttggaaact 116040

 cattctgtag accaggctgt cctccatctt acagaaatct gcctgtctgt gtctctgag 116100
 tgctgggac aaatgtgtgc aataccaagc ccagctgttt atattgtttt gaaagtgtgt 116160
 gtgtgtgtgt gtgtgtgtgt gtgtgtgtgt gtgtgagaga gagagagaga gagagccaga 116220
 tgcattggat ttctgtgtgc tgagaattag agacagtgt gaggtgcctc actgttagga 116280
 actgaactgg ggccttgag aagagctcca agtacttta aactttagg gcatctttcc 116340
 agcactctg tttattttt ttctgatta gaaaaaaaa acacataaaa attgcacata 116400
 cttgggtaac acgttttgat acggttttca ctgaagaga tgatcactct tcttctgagg 116460

 gtgggtggga cctgggacat tactgattta ggctaagaga gggagggtgcc tgctttggac 116520
 cagaataaca ttaacagtgg atgttgaat agtttcattc acgtatgtct accttctttt 116580
 tctttttct tttctctctt tctctctctt ctctttctct ctctctgccc cccctctct 116640
 ctctcacctc tctctctctc tctctctctc tctctctctc tctctctctg gtttttcaag 116700
 acaggaattc tgtgtataat cactatgact gtcttagaga tctgcctgcc ttaaaggat 116760
 gcaccacat caccaagctg aaattctgag tttttgaag gtagagtgg taggtgtcgg 116820
 ttcataaggt gttgtgcacc cccctttgat tgtgtgtgtg atgtgtacac ataggctcct 116880

 gtaccaaggt gtcttgtgg agattggaga acgacttga ggtgccagt ttgccctatc 116940
 atgtgagttc aggatatcca ctcaggcctc aggccttgca gtagatgcct tgacaagcag 117000
 aacctcttg cttagactgc tcttctactc ttttttattt taaataatgg aggtgtcacc 117060
 tgttgagagc ttgtttttct caattttaaa aattagattt attcaatttt tgttttatgt 117120
 atttagcctg tatctatgta tgtatgtatg tatgtatgta tgtatgtgca catgtgcatg 117180
 cttgttgtct ctggaagtca gaagaaggca tcagctctctc tggagccgaa gttcagatgg 117240
 ttgtgagcca cctgagcgt cctggaagt gagcctgtct tcattgtaag agcaacaagt 117300

 gttcttaacc attgagtcatt tctccagtt cctattttat ttatgtgttt tttttttct 117360
 tttgttgttg tgattggctc gggattcact gtgtagacca ggctggactt gaactcaaga 117420
 aattagcctg ctccagcctc ttaatagctg gagttaaagg tatgagccat catactcagc 117480
 ccaacttctt ttatttaaag acaggttctt ataactctgc tggctttgaa ctctctgtca 117540
 tctgaagatg gtcttgaact cctgagttgc caatatttgt ctgtggactt gggatgggga 117600
 caggggagaa agtcaaggca gtgctaaaat tattggttga ggttactagt ttaaaatcgt 117660

ttttttgttt gtttgttttt gtttttgttt tgtttttcga gacagggttt ctctgtggct 117720

 ttggaggctg tcctggaact agctcttgta gaccaggctg gtctccaact cacagagatc 117780
 tgctgcctc tgctctctga gtgctgggat taaaggcatg cgccaccaac acccggtgg 117840
 ggttactagt ttaaaattgt ttaaaaaaat tattcttatt tcatttgcac tggatgtta 117900
 cctgcatgta tgtctatgtg agagtgtcag atcttggagt tgcagacagg tataagctgc 117960
 catgtgggtg ctggaacttg aacctgagtc ctctggaaga acagccagca ctcttaactg 118020
 cagagccatt ctctagcccc caaggttact agtttaatac ttggagaata ctttagtagg 118080
 catgggtagg aaacacagaa tgtcagatgg gttggttgtg gggctttgag gaatatgtca 118140

 ccagaccag cccagcctaa tttcaattag ttaattaaat tttttatagg gtctggggac 118200
 atgaatgagt tggtagaatg catgcgacat atgcattaag ctttgagttt gctctagggc 118260
 acttcataaa tcaagcagaa gttcctagga aatagaggca aatcagaag ttcaaggcca 118320
 aaatcttact ccattacgta tcaaggttga ggccagcctg agatataatga gaatcttgtt 118380
 tcaaaaaagc aaagacaaca ttaaaaaaaaa aaaaaaaaaa aaaaaaaaaa aaaaagaaaa 118440
 gacaaaaagta gacaacaaag cactcaggaa gctgaggaaa tagttcagtg aagagtttgc 118500
 tgaggtaaag tttttgctgt gcaagcatgg gacttgagtt tggatcccca gcccataat 118560

 aaaaccagg tgtggtggct gatggggaaa caggtatacc ctggggccca gtagaactag 118620
 ctacagtata gtgagagacc ttgtctcaga aaataaggta gagagtgata gacaaacata 118680
 actgacattg acctcttaca tccatgtgta tacatttagt tgagtgacc tgcatacatt 118740
 atgtattatg tgcacacaca aatgcttagc aatgaagtga actgcagaaa gttaccattt 118800
 atcttatcac tgaaaaatta tatgctgaga tttttgtata tctttataca actataatac 118860
 ataaacatga tgtatthaa aatgaactt ttactacttt gcagctgta acctcaatca 118920
 gatgtaagt ctacaagact acatctttta ctatgattc ctcaatattt gttgtaagat 118980

 atctttaaag tgataatagc tttcctgtca gagaaagctg caaatgcact ggttctggtg 119040
 gcacatgcc ataggatttg ctgaaggagg cggagacagg aggatcaaga gtttgaggcc 119100
 actccaaagc aatgcagaga aacctgggg ggggggggac aaaaaacaaa aaaacaaaaa 119160
 aaaaaccaa caacaaaca aagagtttga ggccagcctg ggctacacat ttgccaggcg 119220
 gtggtggcac atgcctttaa tcccagcact caggaggcag aggcagggga acctctggga 119280
 gtttgaggcc agcctggtct acaaagctac acagagaaac cctgttttga aaaaatttaa 119340
 aaaaaaaaa aagctgcaaa tgactgtgta ataaaagcag atggttatct ggctgaccac 119400

ttcattgggtc tgicaagcag catttccacc cttttttctc agaaagtgtg aggttgtcca 119460
 tttcgggaatt acttgaatct agttgaatct gttatctctg gttttcatta gcagtagaaa 119520
 aagcaataa tgaagctgtg aagttctgtg agtagataca actgttcttg aagtgaatta 119580
 gtccctttct gccatttgac actgcaactc agatactttg ttccggcctc ccaagagcac 119640
 ctgcacacca tgctgtataa tctcccacac aaacacaaat aaaaataaaa aaaaaaatt 119700
 gggctggaga gatggctcag tgattaagag cactgactgc ttttccaaag gacctagatt 119760
 caattcccag catccacatg gcagtttaca aatgtctgtg actccagttc taggggtaaa 119820

 gaaatggctc agccgttaac tacaccatct tctctgtcag aggactgggg ttcagttccc 119880
 agcaccacaca tgacaggta cagctgtctg taactccagt ttcaatggat ctgacatcct 119940
 cataccaatg cacataaaat gaaaataact aaaaattaat tattaaaaaa ctccatttct 120000
 agagaatctg gcaccctcat ataggcatac gtgcagacaa aacaccactg cacataatat 120060
 aaacctaaaa caaatgaaaa aaatttaaat cttgccaatt tttatgtgac cactggtcac 120120
 catcaataaa atgaacattg actgcatttt tgatattata agatataгаа catcttcagt 120180
 gtttttctga tttgatcaat actttgattt tttacaattg tcaatgctga gaatgatata 120240

 taatatgtag taaaaatgc caaagtgtgt ttagaccaag ccaggcattg gtggcccacc 120300
 ctttttagtcc cagcactcag gaagcagagg caggcagatc tctgtgagtt cgagaccagc 120360
 ctggtctaca agagttagtt ccaggacagc ctccaaagcc acagagaaac cctgtctcaa 120420
 aaaacagaaa aaaaagatg gtttagacca tttcagaaat tgtgtcctag gccaggtatg 120480
 ctagcacatg cttttgatct cagcactagt tagtacatag gcagacagag ctcttgggtt 120540
 cagggtctac ctggtctata gaaggagtgc caggatagcc agggctacag agagaaaaag 120600
 ccctgtcttg agaaaacaaa caaaaaggga tttttcatt tgtttgtgtg tctgcctgta 120660

 tctgcaatgt gtatacagtt gccagtggag gccagaagag aacctgcat tecttagaac 120720
 tgaagttaat aggtgatgct gggacctgaa ctctgagaag caataaatgc tcttttattt 120780
 attttattat tattattttg ggttttgggt tttcgagaca gtgtttctct gtgtagtttt 120840
 ggagcctgtc ttggcacctg ctctgtagac caggctggtc ttgaactccc aaagattctc 120900
 cctgcctctg ccaccaccac cacctcccgg cctgctgaac tttctttcta ggacctgttt 120960
 tcctattttg attttgaatt tttggatggt gcatgttaga aatctacatt accacctcac 121020
 acattcagtt ctgtgacttc atatgggatt tgtgacagtt taatatgctg gtgactgtgg 121080

 cataaaatca tctgtcatcc atgagttttt aatttgcaca agaaataaat catggggctg 121140
 aagagatggc tcagctgggt ttccagaggt cctgagttca attcccagca aacacatgat 121200
 ggctcacaac catctgtaat gagatctggt gcctcttct ggcctgcagg gatacatgca 121260

tacagaacac tgiatacata ataaataatc ttcttcttct tcttcttctt cttcttcttc 121320
 ttcttcttct tcttcttctt cttcttcttc ttctctctcc tcttccctcc tctctctctt 121380
 cttcttcttc ttcttcttct tcttcttctt cttctatcgt ttttttcaga cagtctctct 121440
 gtagctttgg agcctgtcct agaacttgct ctgtagacca ggctgggttt gaactcagag 121500

atctgcctgc ctctgcctcc caagtctggt gattaaagga gtcacctggt aaataaataa 121560
 attttgaaag gaaaaaaaaag aaagaaatca ctggctgggt atagtgggtg acaggtttaa 121620
 tctcagcatt ctgatcatat taattgcagc acttgggagg caggggtagg tgggttttgg 121680
 tgaattgaag ggcagcctgg tctatgtaat gaatttcagg aagctgagat tacatagtga 121740
 gactgtgtct caaaaataaa taaataaaag tcaactgggtt aaatttgata atgtactttt 121800
 ttttaagtgt tgiatctgtc tgctagtatg tgcatgtgag tgcaggtatg tgagctgctg 121860
 cacatgggtg ctgaatctcc tctccagcct ctaaaattgc caatattgat caactttttt 121920

ttttttttt caaggcaggg tttctctgtg gctttggagg ctgtcctgga actagctctt 121980
 gtagaccagg ctggccttga actcacagag atcctctctg ctctgcctcc cgagtctggt 122040
 gattaaagge gtgccccac caccgcccggt ctgataatct tttaaaacct ttttttaaaa 122100
 agattttatt atttactatg tatatagtgt tttatctgca tataccctg ccagaagagg 122160
 gcattggatc tcatagatgg ttgtgagtca tcatgtggtt gctgggaact gaactcagaa 122220
 cctctaggaa gagcagtcag tgttctgaac ctttgagcca tttctccagc ccttaaaacc 122280
 tgtgggttgg ttctctctta ccacgcggtt ccaggggatt gaattcaggt catcaaattt 122340

gatgacaagc acctttactt gctgagtcac ctttctggca ctatgcctat ttttcttca 122400
 agacggggtt tctctgtgta gcatggctgt cctggaactc actatgtaga ccaggctggc 122460
 ctcaaaacta cagagatagg cctgactctg cctgccgaga gctgggttta aaggtatgcc 122520
 acccagcctg gctttaaaaa atgattttgt cttttatttt tatttctaca tttattttta 122580
 atttttaaaa aaggctctggc tatattgcc tgactggctc agatgcttgc tatgtgtacc 122640
 aggctggcca caaaagtta taggtaata agtaaagctt attgttacac ttcgagatta 122700
 cagtatttgi gtttgaaga taaaaagcct attttagtga tgattttggt ctttgtgcag 122760

acaataaaat gaaataactg gtttgggctt ggtgtcttta tagctagcat tgttctgact 122820
 ccatggagtg gatgtattga accaggtgtt ttacttcagc tgtaccatct ggggagcag 122880
 gtggacagat ccctgtcat caggaaaaca cagctggtga gacttagatc taattggttg 122940
 ctttctage tctttctagt cacatatacc tgaatgcagt ttacctcagt aaatgtgttg 123000
 attttggtta ggacattaac agcaaaagtg acaaaaaag taaaaaggtg tgagtatgta 123060
 tgtattgaga cattgcctgc tgccttggaa atagtattat cctgtctcat cctcccaaat 123120

tcttggattg caggggtatg ttactacacc cacccctgcg ttttggatt tatatcgaga 123180

aaaataatth aagggtttat ttattttatt atttatttgt atttaacttt gtgtgattat 123240

gttcatgtgt gtgcttatgc ctttggagac cagtagatgt tctttctgtg atgccattca 123300

ctttgattht gagagtcttc ctaacctcac tgataggcta gactggctgg ttagactga 123360

gttttttttt ttttttctg cctgttcccg cagccgttta gctccaaata aacacacaga 123420

gatttatatt aattataaag tgtttggctg atggcttggg cttcttactg getagctctc 123480

tcttaattat taaccataa atattaatct atataattct acatggcctt atcttctcag 123540

tagctacatg gaatctccct ggaagctcgt ttctgcctcc tctcaccagg attcccctct 123600

ggtagctccg ccaatacttc ctgcctcgt actggctaag tgttttattc atcaaccaat 123660

aagagaaca tatttacata ttctccatca agctggatc aaatcccagg ggtctgcctg 123720

ttccctcctt ctcagcgcac tcatcacacc agcatttttt gttgttatta aatgctttac 123780

caactgagcc atctttccag tgatggggga tgccttctg tatgtatgtt tctcatattg 123840

gttgatgagt aaaacactgt ttggccaatg aggcaggaag ataggtggga ctaaggacga 123900

ggagaattct gggaaaggta ggcagagtga gccaccaaaa gagaggagcc atgtaaggac 123960

caggaaggat gaatcagtg tttttcagca agataagacc acgtggaaat acatagatta 124020

gtagaaatgg gtttaattaag acagagctag ccaataagaa gccctagtca ctggccaatt 124080

aatatagcat ctgtgtgtgt atttggggct gagaagggtg gcgggacctg gtgggaaaag 124140

aaaaatccac caataccaga acctgattta tctttgtaa agagtgtgt ggggtgtgtt 124200

gggtgtgtgt gtgtgtgtgt tgggtgggag ccctgtgtg tatgggggtt ccaagtttg 124260

aagagaatat taggtattct gcttttatca cactttatct tagtccctc agacatggtg 124320

tctcactgaa cccaaaggta gcctgtgac tggcagggcc tcagtgatcc tcctctttgt 124380

caccaataca cagccatacc ctctctttt gttttgtttg tctattttga gtcagggttt 124440

cactgtagcc atgacaatcc taaaatatgg tatgtagacc agactggcct ctaactcgt 124500

gagatctgcc tgcctctgcc tccttgatg caggaggtat taaagtcag cactaccaag 124560

cccatgggg gactattht aattctttgt atcttataaa ataacttagc aatgtctca 124620

tagatgctta aaataaataa tcatggtgt gtcatcctt tgggtcgtc ggtgtagtgg 124680

tacataaagt gatagccacg tcatgcagt gtggcacaca ctttaatcc cagcacttgg 124740

gaggcagagg caggcagatc aattggaaaa taaagtgttt cttttcagt tctggagatc 124800

aaatctagga ctttatactt ggtaaagatg atctaaaacc aagttacatg tccaatcctt 124860

ggttttgtaa aatagggcct cactgtgtag atctagctgt cctggтата gctgtgttc 124920
 tctgccctt tttgggggtg ggggtggggg tgggggnnnn nnnnnnnnnn nnnnnnnnnn 124980
 nnnnnnnnnn nnnnnnnnnn nccaccacct ggcaggcctc ttttttttt tagattcatt 125040
 tattttatgt ttgtgggagt tttgctttca tgccattaca ttgcctgcct ggtgcccttg 125100
 gagttcagaa gaggggtcca gatcccttgg aactggggtt acaggtagtt gtgagccaaa 125160
 atgtgggtgc tagaaatgga acctgggttc tctgcaagag cagaacgatt ttaactgctg 125220
 aaacatctct ccagaccctt tccctggcc cccccacctc gtatttcaag acagggtttc 125280

 tctgtgtage tttggagcct gtccctggaac tagctctgta caccaggctg gcttggaact 125340
 cacagagatc tgctacctc tgccctctca gcctggctt attttttaa agctttttta 125400
 ggtagtgttt cattatgttg cctatgcagg cctggagctg ctgacccaa gcagtctttt 125460
 ctgcctcatg ctctagagtt cagaatacag gtttgagcta ccatgtctgt ttttaaaact 125520
 attatgtgta tggatgtttt gcccatatgt gtgtgtctgt gcacatatt tgtgcaatgc 125580
 ccgtaaggtt cagaagaggg cagtgtattc cctagaactg gagatgcaga taagtgtggg 125640
 tgctggggat tgaattctgg tccctggaaga gcagccagtg ttcttaactg ctgagacagc 125700

 tctccagggt ctataatctt ttgtttccgg gaggatcttg aattccctat cctgtcagag 125760
 tttctgaat gttgggggtg caggcgtcca ataccatgtc tggtttcatt attctttatt 125820
 atatatctt tctctctt tctctctact ctttttttt ttttttttt ttttttttt 125880
 ttttttctt ttttattaca gcagtcttc tgtctcagtc ttccaagtac taggatgaca 125940
 gaggtatacc accaggactg atttcatgcc tgtttctctc tcatggaaa taggctgctt 126000
 acataatatg tagtatagtt aaggacaaag aatcactgta cttatgtgcc tattcatgac 126060
 ctgattgttg gaagcatcat aaaaatttct atgggtcttt caggaaagta aagatggttt 126120

 ttgtttgtt ttttttcag gatagggtt gtttttatgg cctgactgt cctggagctt 126180
 gttctgtaga tcaggctggc ctggagctca tagatccacc tgcctctgcc tccaagtgc 126240
 tgagactaaa gttgtttacc accatgcctg gcttaaagat ttttttttt taaatagggt 126300
 gtaatagga tgaattaaag gtttggggtg tagcttaate acggagcact tgactagcat 126360
 ggtgctgac attcttggtc cagtccttag aactgcttca gaaaagatgg aattgagagc 126420
 aatgatttt agggactgtc aggggtgtaat gttttataaa cacttgttt gaaggaaggg 126480
 tatgatttca cagctaagct ggggatgat ggaaatgtca cagcagactg atgggggcca 126540

 tagttcaggt atatatagtg ttttaacaa agcctggagg tgggaaagaa ccagagacgc 126600
 ctgcagaata gctaccgttgc tcatttaaac cagagtgcac ctgagactgt tagaggagat 126660
 cctttcacc ttgtatttga ttattttgaa aggtattttt cttgaactgt tgccccgtta 126720

ttataaaaag agattctggt gtagttccac atcgaaactg cttcattctt cattccttct 126780
 gggccttctt aataatgctt ggagttacat tggacttcat gtgttcctgt gcagaacaaa 126840
 agcacatgat cattgaagcc tgtagcataa atgagaggct tgtgctgggt gtgtgaaagg 126900
 agctctccca gcctcacatg cctgggtggg cgagctacac taatagctcc cagcagttct 126960

 gaatcagaca ttgtggagcc aggagtctag cttttggaat tccattgcct gtgctaaggg 127020
 tctgtctttt atcctccaaa ccaccatttg ttaaatggca gtggacctgt tgacaagagg 127080
 gggaagactg gcaaagatca agttaaagg aggaaaaagt tcaaaggtag gaaaataaga 127140
 cgaagggttt agtcatgctt ttacctcccc tcccagcccc acctcccttt ggagacagga 127200
 tctcaatatg tagccctggc tggcctgcaa ctagtagacc aggttgacct ggaattcaag 127260
 agatgttcag cctgcctctg ggccgacaat gtaggttacc actctggctt ttttttttt 127320
 ttttaacca tctgttaatt atttaatttt aggattttgg taattcatta catagaattt 127380

 cattcctgaa agctgggctt gtgtgtgtgt gtgtgtgtgt gtgtgtgtgt gtgtgtgaat 127440
 atgtgtgtgt gtgtgtttct ttaatcccag cacttgggag gcagaggcag gtgggtctct 127500
 gtgagttcga ggccagcctg gtctacaaga tcgagtgtcc agaccggctc caaagctaca 127560
 cagagaatcc ctgtctcgaa aaacccaaaac aaaaaaccaa ataacaaaa aacaacattt 127620
 caaagcatgt tgaaccaagg ttgattctct gtgagaagac caatgagagg acagaggcca 127680
 tgtctctgtc atattttggg tgttttttag ttaaatgagc cagaacagtc ttcactttag 127740
 cttttataaa agtggacagg cagggtggag atgggtgggt ggatactgtg agtagtgtgc 127800

 tatagattga taaaatagtg agttacctgc taccaccttc taatttatgc tgccttctct 127860
 ttttcaagga ttctttcag ttttaaaccc attgttttca ctgtccatag atgttgtcca 127920
 tttggcttgt tttctgtgt tttcagatct aggtgtttct aattgcatgg atttttcagg 127980
 gatgcagtga tttttactgg tgctttcttc tgaagccttt ctttcttgca tacactttta 128040
 tattcttttt ttaagatttt atttatttat ttattatata tacaacattc tgcttccatg 128100
 tataatctga caccagaaga ggacaccaca tctcataaca gatggtttgt cgccaccatg 128160
 tgtttctggg aattgaactc aggacttctg gaagagcagt cacctttata ttctttatct 128220

 tgaaaaaata agagatafat ggccaaggat gaagctaggt tcgtagaatg catgaccacc 128280
 atctacaatg cccaggattt gatctccgc accacataaa ctgagtgagg tattgtgtat 128340
 ctgcgttata ttctgaggac agcttagagt ccatggctta aaacttgtaa tcgactcaca 128400
 ataaactata tatttcaagt gtataagtgg gtctagggag atgcataggt ggttagtttt 128460
 cactgtgtaa ctctagcttg tttggagtta gcgatgtgt acaagctgac tetcccacc 128520
 ccattatcta tattgtttat gtgtatgggt gtttgtgcac cacttgcag cttttcgtcc 128580

ttggaacca gaagaggta ttgcatcct ctggaactag agttgaaaat agtttatgag 128640

 gccgtggtgg tgcattgctt tagtcccagt actcgggagg cagaggcggg ccgaactctg 128700
 tgagttgagg ccagcctggt ctacagagat acacagagaa accctatcac gggggaaaaa 128760
 aaaaaagaga atagtttatg tgggtgctgg gacttgaacc tgggcctata gaagagcagt 128820
 tagggctttt tttttttta aatcattttt ttattctaaa aacagtcttt ctatttttac 128880
 ataccaatcc cattteccac tccctccct cctcctgcta cctctcttt tecccattec 128940
 ttcccctacc ctctccttag agagggtaa gcttccatgg gagtcaagga actctggcac 129000
 ctactttga ggcgcagtca gtgctcttac tcactgattc ttcttcatcc cagccctctc 129060

 ctgccttatg tatttttaaa attgttttag gggttcttgt atttgaggc tgggtctcac 129120
 caagtaactt ggcaaataga acaagctggc ctcaaattca cagatctagt ttcacttta 129180
 cacgtgcttc gattaaaggc atgcattacc atgtctggct ttaaattttt atttattcat 129240
 ttaatttta aaaatgtatt ttaggccagg cattgtggtt catcccttg atcccagcac 129300
 ttaggaagca gattcagagg atctttgtga gtttgagacc agtttggctt acataatgag 129360
 ttccagggca ttgtagaaaa gccctgtttc aaagataatc taaataaata agtaaatata 129420
 atacacaaa caaataaatt gtatgtgtag ttgtttgtc tgcataccat gttagtgtct 129480

 ggtgccaagg aggccaggag aggggtgtgt gtcccttgag actggagtta gaaagtttt 129540
 agataccatg tgggtactgg ggtttgaaac tgggtccttt gaaagagtag ccagtactct 129600
 taattctga gacatcttc cagtcctca attttaatt gttttattt actttttatt 129660
 ttattattat tttgtttat ttttagagac agggtttctc ttagtaacce tggctgtcct 129720
 ggaactccat ctgtagacca ggctggcctc caattcaagg atctgctgcc tctgcctccc 129780
 aagtgtggg attaaacgca tgagccacca atgctggta tgcctcagaa ttcactgtc 129840
 tatecaccta cctccctctc tccctcccta cctaattat ctagtctctt gagatagggt 129900

 ttctctatgt aaatctggtt gtccatagaat ttgctctata gattagactg acctcaaatt 129960
 caccttgatc tgaatgcctc tgccctccca gtggcaggat taaaggcatg caccatcgct 130020
 gcctggcctg aacttttatt ttaattatg tgggtttatg tatggagtgc agtgcccaca 130080
 gaggccagaa gaggatgtg gattccctga ggctagacta gatttacaag ccaactgggaa 130140
 ctccctgagt ggatactggg aaccaaattc tgcaagagca ccaagtgcaa ccccccccc 130200
 caaaaaaaaa aaaacagggt ttctctgtgg ctttgaggc tgtcctggaa ctagctcttg 130260
 tagaccagge tggctctgaa ctacagaga tccgctgcc tctgctgtc gagtgtggg 130320

attaaaggcg tgcaccaccg gtggcgccaa gttctcttaa cctaagtcac ctctcatttc 130380
 tgtttttggt ttgagacttc ttagggttgc ctttgaactc actatttagc tgaagatgac 130440
 cttagatgac ttaattactt gagttctgga attacaagtt tatgtatgac attccaccct 130500
 cccagctctc catcccaacc tcttttggtt atttacttat ttaacttatt gagacagtct 130560
 ctctaagctg ctcaactgac ttgaactcac catattgtcc aggatagctt tgacctggg 130620
 atactcctgc ctcaacttcc cacatagctt aactgtcac cagcccaggt ctcttaagtc 130680
 tttagacaca gctttcagaa gtctttggaa actatttgct ttctgatata aggagtttga 130740

 ttcttttctc tcctttgtgg ggagggcacc attcttctta acaagttgct tttattggga 130800
 aataatattt agaaccata atgttcatgc tagaacttac tatatagata agttggcctt 130860
 aaacttgctc tggtagccgg gctgtggtgg cacacactt taacttggga ggcagagaga 130920
 ggcaggtgga tctctgtaac aataaatctt tctgccaagc caccggagcc ccaactgccac 130980
 aataaggtcc caagtaacac agagagactt atattaggtc cagtgtgct ggccaatgac 131040
 taggatttct tactaatctt tattaatcta tatattttat aaagacttat ctgatcaagg 131100
 acgccggcgg catgcatcct ctcttgtctc aatcacatgg cggccatgac cctttcctac 131160

 atttccaga atctccttc tctcctagtc tcacctaact tgctcccctt attggccaac 131220
 ggtgctttat ttgtcaacca gtaagacaaa catatacgca gaagtacctc ttctcatca 131280
 gatctctatg aattccagga cagcctggtc tacagggtga gttccaggac agctagcgt 131340
 acacagaaaa gccctatctt ggaaaaacaa acaacaacaa caacaaaact tgagtgtctc 131400
 tctgcttca gcctcttgac tgttgctggg attacaggca cagttaaga gaactgtcct 131460
 tttcctttgt tagaagctaa acattaaaac aaaaaactaa acattaaaac aaacaaaaca 131520
 taaaacattt gagggtgga gagatggctc agtgtttaag agcatgactg ctctccaga 131580

 ggactcgggt tcaaatccca gcccacat ggagctcaca actgtcgtaa gtacacctgt 131640
 gtgagtacac cctcacacag acaacataa aaataataa taagaaagaa aactaactaa 131700
 ccaaaaaacc ctaaacatgt attatattat ctactttctg tgggtcttag ttccaatggg 131760
 tcataatctt gtactgagga ctggagagat ggctcagtgg ttaaagagta cttgttgctc 131820
 tttcagagga cccaggttct attcccagtc tctcttgtt ggcttataac tatttgtaaa 131880
 ctccagtacc agagtatctg atacctctt gatctctgaa ggcaccagcc actcataaac 131940
 attaaacaaa caatcaata aataaaaaga ttcttactt atatagtgac aagaaattgg 132000

 caagaaatct taattccttg tcaggtgggt ctgaggtgac ttgaatattt ccatgacttg 132060
 gtagtctcc agaatgagta atttagaata accccttgat tccctttcc ctccctccct 132120
 ctctttctcc ctccctctt cctccttcc ttctctctt tcttacttt gctaggatca 132180

gtaaatacta agcagtgtgg tgtgactgtt gcccaggctg gatttgaact cccagattta 132240
 cacaatgtag tccaagtag ctgggactac agttgtgtgc ccctgcatcc tgcttaagta 132300
 gtctagtctt gattaatttc ttaacttgata atattgtata gtactctggg taagaattca 132360
 gacatgccgc tgacaccagt caaaagttaa tatattigt ttttactttc cttgcaacac 132420

 caagataata atgtttacca aatgtgttct gctttattga ctctttgtaa caatcaagga 132480
 aataaaggta gtccttgata ctcatgtctt aaaataaaat cttgtctactg catcagttag 132540
 tgtttctgcc cactgcctct ggggggtgat ggcgagtctt cctttcttgt aaaatgtcat 132600
 gcttgtaggc ttcatttacc caaagtatgg tagaggcgaa aggaaggcat atctatttga 132660
 ttatgtatgt gaaggatctt cattcatttt gtttgttttt ccagacaggg tttctccgtg 132720
 tagctgtcct ggaactcact ctgtagacca ggctggcctc aaactcatgg agatccacct 132780
 gcttctgcct cccaaatgct tagattaaag gcctttgcca ccaactgcctg gcttagatct 132840

 tcattcttaa tgcatgttct tgtaaatgtt atgtagcata tatgttcatg taatagacc 132900
 tgggaagaag acaaaacccc tctccattt taatctttag tctaaaaaaa tatccacagg 132960
 aaatttaaaa agtatacaga gaagettaag acccttcacc cttttacc agtggttaaga 133020
 ttgtgataa taactggtag atgtcagct tcagatacc agttttcatg cagcagaaat 133080
 tgataagcat tgccttgat tagctcttgg gaagtgctaa ggattaaact tgttagtctg 133140
 gtggatctat ctcttctct agagctctca aataattatg tcaattttac tgtattcttc 133200
 agttttgaaa caaacttaca tacagttcta aatgttaatc atggggagcc tcacattcgt 133260

 gtttgcctgg ttttaaagct ctttttgtaa cttgtcttca tctttcactt acagtctttg 133320
 cagcaccaga accgtgttgt ctgcattgtc ttaatttcat cacgtgccat ttttgagag 133380
 caccagtct ggatctggga ggcagcttgt tgaatcatt tacatatatt tctgcttatt 133440
 cccaaaacta atttgcagct ttttattttt gatccaatta tacacttaa atgtgtttac 133500
 aatttatttt atgaagactt ttgtctcata gggtttaaaa accagtcaa agaccagaag 133560
 ttattaaaca atagcaaaaa cctacacaa atgtaggact ttaaatggtg attgttaaac 133620
 atttgattgt ccccaaaaat gtgagtctgt gtgctcatgt atgactatac atttattcta 133680

 ttagtgactg aaataaataa gttttgcaca ttattcttcc tgttattctc agccgtaaac 133740
 aaattacatg catttaacaa gttagtgtta gattggccag gagccactag gaggcgtgta 133800
 cttagtgaca tcagctggca aagtgccctg atagcagaga gggaggagg ggtagtggag 133860
 agagaggaaa caggaggag ggaggaggagg agggaggagg ggaggaggagg agagaggagg 133920
 agannnnnnn nnnntttttt ggggattctg gcaaggtaga gagctggtct gtttggcagg 133980
 accttcccat ctgggatcca tctgtgttcc cctggaatgg gacaggcagc tctagtcatg 134040

gagaaatcgc agatgtgaga gagctgacac atgtccagct aatgaaagga ggaggaaggc 134100

tggctctgca ttgggctttg aagattaggg ggagaaaaga gagcttttta atacctattt 134160
caagtagatt tggatatatt acgcgtctgg agtttttaaat ttggacattc agggtaatg 134220
tacattttaa ttiagtctg ggtgataaag tgcacaattc tgccattcca aagctttttg 134280
cttatctcga attgtgtgtt tatggatatt ctgtgggttt agtctctggtt tcattttgat 134340
gcttcatttg gttttatgtt tctatttaat ttttcattgc cacctttgca tttttgaatg 134400
gaaagttag ttaaaatcag atgtagttca taattctaca gttagaaaag tagtcctaca 134460
aatacttctt taagctctcc catattgaat acttctggca tattctgagg gaattgcttt 134520

ttcttaagtt atgtataaaa gcagtgaagt tatgtataaa gagaagactg ctacaatgct 134580
cttttccatt gtcagatttt atttcaaagt aatcagacat gtaactaaaa gagattgcag 134640
caaagetagt gtctctctg cattttattt acatcttggt atgttttctt cctatactat 134700
ttttctatga ctgaaataac atcaaatcag acttgaattg tgaattggag tgctcaggag 134760
tgtgctcaca acacacacac acacacacac acacacacaa cacacacccc tcttcaacce 134820
ctactatggt ctggagtctt tgctcagttt gatgcctatt ggttatttat atagtgttac 134880
taatttttga aagacttccc aatcagcccc ctacatgtag aacctgagtt tagtatatac 134940

tgtatatata ggttttattt cttagttttc tcatcttggt caatctgctg ctctgagccc 135000
catttggttt gtttgccttc ctgcctgcag ctcccttttt tctctttctc aactggatct 135060
tactatgtat ctaggtacac caggctagct tcccactcac agagatccac cctcccctgt 135120
ctccctaaag geatgtgcca ccacagccag ctgactecca atttgtgacg gtagtgggga 135180
aatgtgtcca gagcctttcc agcacatgga aggcagctta aaattttttg aggtatttat 135240
ttattttatt atttatttat ttattttatt atttatttat ttatttatgt tgttgtggca 135300
ggttcctaaa cccttttcac ttccatattg agctataact gtatctggtc taacttgtga 135360

tttcagggta ttattttgac tgcattgtga tctgtaccac acagatgcct gatgccca 135420
gaggccagaa aagatcccct agaactggag ttagagatgg ttgtcagctg cattgtgggt 135480
gctgggaatt gaaccagggt ccatctcttc agaccctgca cccacctttt agatagtttg 135540
tatttgtgt ggtgtatgtc atctttgcta agcctttcta tgactgtaga gtttgaaag 135600
cattctgagt ataaaatgca aatgtaataa atattccctt taactgcacc agaatagaag 135660
accttgaaa agtcaactta tccaagtga gatttgattg tattactttg aaagagcatg 135720
ttattttaaa aaatattttc tttttcttt tttttgaatt agaaagaaga ttgttttaca 135780

tgtcaaaccc agttagtcc ctctccctcc ttcccttatca ccccccaac taaaactcta 135840
 cctatcacct acccctcaaa aatattttta tgtttatgtg tctattgctg tttttctat 135900
 ccattgtgtg ggttccagga atcaaattha ggtcatgtca ggcttggtg caaagggcct 135960
 ttaccactg agccatctca ctagtcgtca ctatttaaat tgtacctggc tccccaaaa 136020
 ttctatgaca tgacaaatgg gagcttttaa aataacattt ctttttaaat aattttagt 136080
 attttaggtg tatgagtgtt ttggccgcat atatatgac cacctgcaag cctgtgttca 136140
 tagaagtcaa aagagggcat gggatcccct ggaattagag ttgcagatgg ctgtgtgcca 136200

 ctctgtgtct tgctttctca gaagagtatc cagagtctt aacttctgag ccatcactct 136260
 actcccctaat aacttttatt cagtaaagtt cttcagcttt ataccactg agcattttaa 136320
 ggaaactgta gtgctttttg ttgttttaaat taaagactgg gtgtctcagt atccctcagt 136380
 agctggaatt tgcttttagt gctctcttgg cctcagactt gtagcaatac cctgtgtgcc 136440
 tcctgggta ggagaacagg catgcacctg gctgtaatgc actgtaatgc agcataatgc 136500
 tcacattctc ttctctctaa aaaatggagt ttacctcca tttccctcaa gtagtaagaa 136560
 ctttttaaat ggattttgtt tgtttgcttg tttgttttt tcgtttttca agatagggtt 136620

 gctctgtgta tcaactgtag ccctggctct ctgtagacca ggctagcctc ggactcagag 136680
 atttgcctgc ctctgcctcc caagctctgg gattaaaggt gtgtgccacc atcatgcca 136740
 gctttaaatg gatcttttta gaaatttctt taatgtttaa ttgactgaat ttgtagaaca 136800
 aatntagaa gttttgatag gtgcagtgga cagcagctga gacttgtttg actatgtgag 136860
 aggctataat gtaacatcaa atttacatgg tcctccttca gtgaacagta ttgtatcttt 136920
 aggacctatg ttcttgaaga tgaatgggga gaaaaggact taatgctgaa agtgtagtgt 136980
 aggctgtagt ctgatatggg agagcctaaa aaggtttatt ttttaaaatt attactgcta 137040

 tatgtccatt ctggcaataa tgtttcatat ttgaggctc aggatttcat ctaagacctt 137100
 gtgcatgcta aaaaagcatg tgttctatca gctattagtg gctaagttcc tagccctcag 137160
 gaatacattg gtccaggttt ggcatagaac tatgtatgta gccagccag gtcttaact 137220
 aacagtaatt ttccagttag cctcccctaat gcttggataa caggttattt tatcacatct 137280
 gactaatata ataaccatg gaccccaaat aaaagtgttt gattaacagt cctgattggg 137340
 tgagatgagg ccctgagttc cgtgttcgct tgtgggtggg agtcccacct aaggctcagc 137400
 agttaaatac aaaaccaggc ccagtggcac ttgctgtcaa ttctagaact ccaggaatca 137460

 caaacaggag gatctctatg agttcaaggc cagcttgatc tacaagtcaa gttccaggat 137520
 gccctttgaa aagaagacc ctgtttcaaa acaataaac caataagatt ataccatttt 137580
 tttttttttt aagatttgtt accttttatg tgtgggcaca tgagtgaatc aagtgtgcac 137640

ttgcacaggc cciatggagg thtagtgggg ggtatgcccc ttggaacagg agttagaggt 137700
 gtttgtgaac tgcctagtagg gttggttgca gggttctttg gtagagcagt aagcactctt 137760
 taactactga gccatctctc caaccataa ccaaaaaaaaa tcttttgagt taaatattac 137820
 tgaggaaagt catagtattt tctgtggact gagaaagccc catatgtgga aaccagagga 137880

 cagcttgacag gagttagttt cttcttccac aatgagggtt tcagagatta agctaagatt 137940
 gctaggctct ttacctcaa gtcataattg tgggccagg gaaggttctc tttattttta 138000
 actttcattg attcttcgtg gatttcacgt cattcattct gacccactt acctctctgc 138060
 cccctcaaat ctgacttctg ccattgcagc cttttccca taccaaggtt cttatttttt 138120
 gtataatctt attaaatgca ttattatac ttaagctgag ggaatgaatg gtcacggtta 138180
 gagcattgcc cagtcatgtg ctagtttcag tctccagcaa ggtgcatgta tgaggaaggg 138240
 gagagaatcc tccctggccc catagttttt aataaccagt ggctgagctt agaatggtat 138300

 tctggatttc cagaatattc gtcgtactgt cttattttgt ctatctacct atttatttat 138360
 ttatttgaca gggcttccact gtgtagcctg gctagcctgg aatttacaga gaccctcttg 138420
 ttattaatc tggtttctgg gattaaaagg tgtataccac aacaccaac attttataaa 138480
 ttctttattt tatttttgag acagggtttt tctgtgtgca gccctggctg tcttggaaact 138540
 cacaagatc ctctgcctcc caagtctgg gagtaaagg gattatatgt gttcatgata 138600
 tcttgaagtt atttgaatt ttttcttagt atttctgat aaggttttgc cgagttgtcc 138660
 aagctggcca tgctttcaca ggtcctggga tttcagatgt gaaccacat acctagtttt 138720

 gatattttgg ggggtagaca ggggaagatg ttaagacagg aactcagtgc tagtatttga 138780
 attccttccc aggtagctat ggagtagctt aatggattta gaggatcctc atgtctgcac 138840
 ctcccaatgc tgtgattata gatgtgggtg tgaaccgttg tgcccagttt aggctttttt 138900
 gtataataat acatataatt attattatta ttattatttt tggttgtgaa cccagccttt 138960
 aacaactgaa ccatctctct agcccagact tttttttat ttaaaggatg gatcgtagag 139020
 gagataaatt aagaatgac aaaatcaata agttctagaa gtcattgcca acagagggaa 139080
 tcaaatcctt tggagaggag gtaacatttg atttggaaac cttgtgcttt attgggggaa 139140

 tgatgggcag atagaaat actagtttca gacggactgc tcttccagag gtccctgagtt 139200
 caattccag caaccacatg gtggtcaca accatctata atgagatctg gfaccctctt 139260
 ctgactagca tgcaggcaga acactgtata cataataata aataaaatct ttaaaagaaa 139320
 gaaagaaact agtttcaatc cccagcaagg tgcttgcag gggagggggg gaagaaagtt 139380
 ctccctggcc cagatttcag taccttaatt ttatcaattg catagttaca ctagtttttt 139440
 tcttctatat ttttgattgg gatgggggga tcttatgac tagactggtc ttgaactcat 139500

tatgtagcca aggctggctt ttagctccta atcttctga ttactcacag ctgctgagat 139560

tacaagtatg tgccaccata ctcagtagta tggatagcgt tttgttggtt tcttttaatt 139620

ttattattat tattattatt attattatta ttattattat tattatgtgc attggtgttt 139680

tgccatgatg tatatcttgt gtgagggtgt tgaatcatgg agttaccgac agttgtgagc 139740

tgccatgtgg gggtaactagg aattgaacca gggtcctcta gaagatcagt tagtgctctt 139800

aactgctgag ccactctccc agctccaact tttattttta aattatgtgt atatatcttt 139860

gtgggagcat cagcatgtga gtgcagggtc ccaaagggt caaaagtatt gaacccttg 139920

tagcttgtgt tacagggtgt tgtgagtcac cagatacgtc caaagaactg aatttggtcc 139980

tctggaagtc tcttaactgt ttaatgttct ccggtgcctt tgctgtgttt gaaatctatc 140040

cctttctatt gctatcttc agatccaagc acagttgttt gattgtaagg catttagcaa 140100

aatacatagc tatttttccc cttgaatttg tggtttattt ctgctccaag ttcaaatcaa 140160

taataaagg aattaatagt ggttgtgtct taaagaaaa aaaaactgct aactgggttt 140220

tacatagagt tactgactga tggactggaa aattttttaa agatttattt atttattatg 140280

tatacagtat tctgtctgca tatattcctg cagctcagaa gagggcacca gatctcatta 140340

cagatggttg tgagttgcca tgtggtttct ggaattgaa ctcaggtcct ctggaagagc 140400

agtgagtgct cttaacctct gagccatttc tccaaccccg acagttaact tttagaact 140460

atgttattaa ctgggcctgg tagtgcaggc aggccatac tactggcttc tcagtagaat 140520

caaaagtcca aagcctagca ggactacaga gtaggttcaa ggtcagcctg ggcaatttag 140580

tgagactttg tctcaaatg aataaaaagt gtctatggag actgtagtaa aaatgcatgt 140640

attaggtcct aggttcaagc catagcacca gtaaaatagt cagccacagg tcctgagtgt 140700

gtaaaggccc tgtgtttagt acccagcaat caaagtgtac acacacacac acacacacac 140760

acacacacac acacacacac acacacacac acactttggt ttgacagatt tattcgagga 140820

aattgaaaat gcatatgggt ctggttttct aaagcaagca ctcccatcc ctaggacttt 140880

ttgtgcttag tttaaagcaa ccattagtga aatgctgtt ttcttccat cctgagcagc 140940

ttgttagcaa ggigggttac agttctgtgt aaaacatgga tacatgctac ctgcagtgac 141000

atctcatagc tggagctaaa atgtaagtgg agtatgtgt ttctttttc tttgtttgtt 141060

agaaataggt tctctgtag cccaggctgg ccttgacctc tgtatagctg aggatagctt 141120

tgatctctg atcctcctgc ttctacctc tgcctctacc aagtaactggg attacaatca 141180

tgtagtacaa tgcttagatt tagacaattt tcaactgatt gtgtaagaa aatgaagaa 141240

agaaaattag tgtaagaaa aatgaagaaa gaaaattagt gtatgtaggc tttagcatta 141300
 gattaggttg tgtaaccatg agcgttgatt ctaacatcct ctaagcctgt ttcttcaact 141360
 gtaaaattgt agtaaaatga gttttaagca ttaaattaat atatgctaca tgaatactta 141420
 ataaagttaa tcttcctgtg taatttgtct ttgcccttcc aacattgata agtcatagta 141480
 atgaaaaaag ttaattgga atctgaatgt tttttaatat gtctcttttc agattgatgg 141540
 aactacctct gcttccttaa ctaattcttg tcacaagaga gaggggttca gtacagaatg 141600
 tagtagcctt aaaaactcaa acctgttgct gtgtgtgtgg caagctgttt agggaccttg 141660

 ccttactttg ctggaagagc tgggggatgg gccacttcca gggtgacaga tgtgtcctct 141720
 gctcccagca ccaggtgcag ccattgttgt ggctggcttc ttcacccctc ctgtctgtta 141780
 ctctgtctct ttagctcat tgtttctgta gaaattagc attaatcca tctgaaacct 141840
 catgtccctc aactgcaggt gactgttact ggccccagct gccacccttg cgcttgatta 141900
 ctccatag ggctgtgcaa agaagtagta gtcatctatt gattttcacc acaagcccc 141960
 gcctcaaacc ataataacct gaaatctatt aggcccccaa taggctgtaa ctcagtggc 142020
 aagtacaact gtgatgaaca ttttacaagc aaaactaatt atgtcctttt tcttccttct 142080

 tagtcacctc ctccctaat atcagatgga gaaaaaccg agttgtcata gtgcagtagt 142140
 aatttgaact ggctgcttct gagtagtca gcttgaagag tttggatgga ctgtctgga 142200
 aaattatagc cactatttta aatacttta tcatacctat agtgttcaag caagccaggg 142260
 tataataggt ccttaggtg gagatgttc tgaagggaca caaattttta tcacctgttt 142320
 cataaaatta tttgggtgt tcagtaaat taaaaaaaag gggggacacc tagtttaaaa 142380
 ggttgcttga aaattatag caatcagtat tagctaaatc cttgtgtttt gtatttattt 142440
 ccttgtttgt actgtggttc tagtttacct cagatactgc agtaagatgg ttaatgtcct 142500

 agacttcttc cttatcatg aaatttgtgt gtttcattct gggccttgtt atgaattgat 142560
 ttagtgagc atagtacac atccctgaga tcccagtttt tacaagcctg gagggctca 142620
 gccatgagc cagcctcaca cagtaagttc aagtctagcc tacctgtcaa aacaagatct 142680
 caaagaaaat ttgtaaaag gtgaattgga ttaaaagccc taaatccaat ttaaggaca 142740
 gtagaagtt gcttttggt tccaatgctt atgttgattt ttgacaaagt taacaccaca 142800
 ccaatgaaga gtatcctaat agcctgtagt ttcacagccc ttgaagtcaa gttggctgac 142860
 ctgacctagt agattttatc accaaatcct tagtttgtaa tattataact cagattaata 142920

 agccatttaa agcgacagtt tcattacttc aaagttagtt tgtgaaatgg ggaatatagg 142980
 accatttctg ttgaggat atctttttac ttcttttttc cccctgtttt ctttcttttg 143040
 gagtttaag aggttttaga tttgaaaaac tcttgtaac cggcacttta cctggcaact 143100

tctctgaagg tgagcctcca ggtaaagtgg ggtgaaccta gaatagtttt ttttttttt 143160
 ttttttttt ttttttttt ttttcgggc agggttttcc ccagagatcc gcctgcctct 143220
 gcctcctgag tgctgggatt aaaggtgtgc gccaccaacg cccagtttag gttagtgttt 143280
 tgagagcttt gaaatctgct tcttcatttt ggggttttgt ttgttttgag acagggctctc 143340

 actatgttgc tctggctatc ctggaactta ctatgtaggc taggttggcc ttgaactcat 143400
 agaaatcttc ctgcttctct gtgtcctcca gaatgctggg attaaaggcg tgaaccacca 143460
 tgtctggttt ttgcttcatt gtaagcataa gaaagatgga aagatttaga gatatcaggt 143520
 gtcttactgt tctactgctg tgaagagaca ccatgactac agcaactctt agaaaacatt 143580
 taattgggcc ttgcttacag tttcagaggg ttattccatt gtcactatgt tggggagcat 143640
 ggggtgctgga tctgatatag acttttgttt ttaaggttta tttattatgt atacagtgtc 143700
 cctgcaggcc agaagaggac accagatctc acctcagatg gttgtgagcc atcatgtggt 143760

 tgctgggaat tgaactcagg atccctggaa agagcagcta gtgttcttaa cactgagcc 143820
 atctctctag cccttgggtg ggacttttaa aaccttaaag cccaccccca gtgtcacact 143880
 tcctttaaca agccacacc taccaatctt tttcaagtag tgccactact aatcattcaa 143940
 atatatggtc ctatgggggc attcttactc taaccgccac atcaggaag agaaagagtg 144000
 gcatttgaaa ctgggtcttc tgctcataga gttgggtgtac attcatttgc aatttggaac 144060
 tagaataaac agttgggaca gttgtaagta caatattggt gtagctatta ctacttaaaa 144120
 actgtcagaa gacaggcata ggggtacatg cctttaatcc gaattgaacc atgctcctct 144180

 agaagagcag ccaatattct taactgctga accatctctc cagccctta taaaaatta 144240
 gaggttaatt tatttatgta ttttatgcat ttgggtatth tgtctgcatt tatgaatacc 144300
 agaaaagggc attgaaatccc atgagactac agttagagac agttgtgagc caccatgtgg 144360
 atgctgggaa tttaacgata gatctctgga agagcaacct tacccttaa ttgctgagct 144420
 atctctccag tcctctgac agtcaagcaa tcaattaatt aatctttggc ttttcaaac 144480
 agggtttctt tgtgtagcca tggctgtcct ggaactaact ctgtagacca tgctggcctg 144540
 gaactcacia gggttctggg aatatgattc tcatecttgt actttttcaa caggcacttg 144600

 actgactgag ctagtctctc agtactaaaa ttaatttttt gaaatactat gtagctatgt 144660
 atgatgtgtt atacctataa cccaacactc aagaagctaa gggagtaagg ctgcatgaa 144720
 tttgaggttc acctgggcta gaggtcccat ttctaataaa aattaataaa tgaagatcca 144780
 cttgcctttg cctccccagg gctgctttt gtcttgttta atttcatttt ttgaggttct 144840
 cactgtatata gccttggct ggcttggat tcacaaaaat ctgctgcttc tgcctcctga 144900
 gagctcaaag atgctaccat gccttgccca tgatttaaag tgtggtgggc attttgagtt 144960

ttcaaaatga agttagacaa ataaacttgg atactgtaca cccatatttt attagacact 145020

 tgggatggca aaattacttc tgaatatatt ctggcaatct cattttcatt tttatctgta 145080
 ggacaaaaaa atataaactt tttttctttc agtagaccat atggtgtttg cacagactgc 145140
 ttatgtgagg tggctgtgtt atttttcttt caggataaaa tgctttacct gatgccaatg 145200
 ttctgaaca tttatttttc tagtcattag tatgtgcagt aattattcta atcattctgt 145260
 ttttctttgc tectctcaca cctccttagg gtgtcatgta ttctaggcta gcctaaaact 145320
 ttctcaagct tagaatgact ttgaatttct gatcttctc tttctacctt ttgagtacta 145380
 agattacagt tctgtaccac acacataatt ttgagttact aagggtctaa cccagggctc 145440

 ccttcatttt aggcttagca ctaccagata aaccattgcc cccccccca aaaaaaaaaag 145500
 agctcttggc tgttcttgtt tttgagacaa tcttactgtg tgtccctggc tgacctggaa 145560
 ctcaatagt ggattaaact gactttgaac tcagagattc atattctca cctcatgaa 145620
 tgctaggatt aaaggaaga catgcctat cattcttagc ctataatttc ttttcttttt 145680
 ttcttctgga ttctacagtt aatgtgattc tatagtttgt gtagtgctta accctaattt 145740
 tatatgagct ttttaatttt ttaaaaagat tttatttatt tattatgtaa ttatgtatac 145800
 agtcttctgc ctgcatgcca gcagagggca caagatctca ttttaaggtg ttgtgagcca 145860

 ccatgtggtt gctgggaatt gaactcagga cctctggaaa aacagtcagt ggctcttaat 145920
 cgctgagcca tcctgcagc cccaagcttt ttaattttta aagttgtctt tttgggtcag 145980
 tgatacggct cagtgaataa ggacaactgc catacctgac caacctcagt tcaatcctg 146040
 ggatccacat ggtacaaaga gaaaaccagt tcagaagaa ggtgttggat tctctagaac 146100
 tgggtgtgca actgagtcac catatgggtg ttgggaacca aacttggatc gtctgcagga 146160
 acagcaagt tcagtgacc atctctgaag ctcccaaaga tctcctttg caataatagt 146220
 aactatgga cttacatgtt tactcagatg gcataggtgg ctatttgctc tgccaaagtg 146280

 ctcatctacc ttccatttat gttgcttggga ttcagtcct gctatattat aggctcatat 146340
 ttacattgtg cttttaatct ggaaaagctt tttatcccca taaaggcccc tcaggggcag 146400
 gaagtaaaag ctaggtgtaa tgtttttata gaggtgaaac ctgagaccac atcattctgc 146460
 tatcatttta gttcttagat aaggcttttt tccatagttg gactgcaaag agtgctttcc 146520
 aataggaaga acctccttca gttatgtgga tagacctgag tgctgctga ggaggcacc 146580
 taccaggagt gcctactggc acgaaggcag catggttgc ggtcatagag ctaacagtct 146640
 gacatctga agctacagct gtactgtttt gctacagtct gtctatattt ctgcttgc 146700

ttgtgaagaa tcacagaatc tggaagactg taagttaacc attccaaact tggagtttg 146760
 ctgtgtgtgg gggagtattc tgtactctgg agagctgtcc atgaaatctc atagttgata 146820
 ctgttctctc agttcattta ttgccatctt tagtttgtca ttctatgcc agtttttagtt 146880
 taatgccaga ataagattga gctatcatga tagatgaatt gagtgggtgc taattgtgtc 146940
 accggagtgt ctgccacaat tttctctacc tcatttggtt cttctattct ttagtttgtt 147000
 ttggtaaaaa tataataactt ggttacattt caggatattc tgagcagggt tgcttgttga 147060
 cctctctgct atcccactta acacaggctc tcagtaacta acccatcctg agtcctggcc 147120

 tcctattcat ggtgacattc ttctgcccc attctcccaa gtgccacgat taaaggtgtg 147180
 aaccatcatt ccaggcggtg tggtttgttt atttatgctt tagagacaag attgtgtctt 147240
 gtgtacctct ggttgcctgg taaccaagca actctgcagt cacactgagc tctgggcagg 147300
 cctctgttta ctttctgatt actggaatta caggcatgtg ccagtacatt gggtttatca 147360
 gtccctggaga ttgaaccag gactttgtgc tactaaagat gtattctacc aactgagcca 147420
 tattccaggt gtagtgtatt tgttaactat attttaaggc atatctgttg ctacttctaa 147480
 aaccagccca ttaatttgtt aagggtgaga agcccttttg attgtcaggg aggacataac 147540

 tgggctcttt taigtcatca gtgtcatttc tcttaaattc ctagtcaaaa tgtacaaact 147600
 tctgcttga tttgtgaaga atcacagaat ctggaagact gtaagttaac cattccaaac 147660
 ttggaagttt gcigtgtgtg ggggagtatt ctgtggaate ttacaataat tttctctttg 147720
 ttgttgtttt gtttttgaga caggttctcc ctaattagct ctggttgtcc tggaaactcac 147780
 actgtagatc agcctggcct agaacttaga gagatctgcc tgcacagcc tcccaagtgc 147840
 taggattaaa ggcgtgcacc tctcgttttg gatttctttt gttactagtt ctaggctcta 147900
 agtacaccac aactatcaac aacaaccaag caatcctgaa taacattatt tctgtccttc 147960

 agtttttggg taagtggtaa agaattggat atggttctgt acacctgttg tcccagcact 148020
 tgggaggtag aggcaatata ctactagct agaggttcaa agccgggctc aggtatatag 148080
 gctagcatta ggtaacataa gaaccaataa ataaaggaaa aaagaaaact atcttcttgt 148140
 ttgtatttct ttttgagaca gcctttcttg ctgtcctgga atgaattctg tagatcaggc 148200
 tggctttgga actcaagaga tcttctgcc tccgcttctt gagtgtagg attaaaaagg 148260
 tgtgactac cgagaattat ttctaaggca atttatgtat gattgagcca tttttcattg 148320
 agtaatgagt ctttttttt tttgtagtag tagtagtatt tcagtttttt aaatagccct 148380

 ctccccagta gtcacattga agtcagatct atggaaaaag acaatttgag cctaaagttt 148440
 aatgtggaaa taagataaac tgtttctaca tttttgtga aagaaccatt gttgacagtg 148500
 ggcgtttctt aaagaactcc tgtattcact agtactgccc cccccact ctccccttag 148560

tcactttatt gcaagctttc agagttgctg tagtgtgcag tgttccatgg ctggtgtaaa 148620
 aactcctgc ttgtaatgcc tagagctgtc atccaaggag accaaacaca tggcactaca 148680
 ctgcatttcc agatgtcctt ccctctgttt gggtgacttg gagctaagag aagggtgttt 148740
 gctcttgaat aggagaaaaa aaaaacattc cttggcataa ggcccaccct ggcaccattc 148800

 ccacatctgc tgttcattag aagtgaatgc tggtcagtca ggatgtcagg gtgctggtct 148860
 gattatcagg cccaggcttc aagaagaaat agggcaggaa aataaagggt gactcagcta 148920
 ggtctgcaga gaacctggaa gaccctttca taccgtggta cattcctgag tgctttccat 148980
 gtattaatca aaatgtctgc catatagaaa ctgcccttag aaaggaagga gggggagtgc 149040
 cgtagaaaaa aatTTTTTTT tcaagacagg gtttctctgt ggctttggag gctgtcctga 149100
 aactagcttt tgtaaaccag gctggtctcg aactcacaga gatctgcctg cctctgactc 149160
 ccgagtgcta ggattaaaga tgtgcattct ttacattaat attaatatct tggactatat 149220

 caccctccc taaaatatag aggtgttctt gaattttaaa tttttcttt ttataaaact 149280
 ggtagttata gtgaaaaagt tgcaaaacat taaattttct tgtttattta aagttggatg 149340
 tgtaggaggt tacttactgt gattgaaaat ttttttact ctttactatt tggggggcct 149400
 gccacctcac ccccaataa atacacagac ttattcttac ttatgaatac ccagcattag 149460
 cttggcttat gtctaaccag cttttctcaa cttaaatecc gtctacctt tgccttgggg 149520
 cttttacctt tctctatcta ttctatatac atttcttcc ttcttactcc gtggttgatt 149580
 atgtggatgg gtgactggtc cctggcatcc tcttctttc tctctcttc tcctttcttc 149640

 tatttattct ctctgectgg tagtccaact tatccctctc ctgcttagct gttggccatt 149700
 cagctcttta ttagatcaat cagggtttta ggcaggcaaa gtaacacaac ttcacagagt 149760
 taacaaatg caacataaaa gaatgcaaca tatctttgca tcattaaaca aatattccac 149820
 aacacaaaca atctaacaca tcttaaaata acattccaca acaagttcag tgccacagcc 149880
 cgttaattca gcacccccag tgcaggaggc ttaactgtga tgagcatgag gccagcctgg 149940
 gctacatgaa accctgtctc caaaaacgtt aaaataaaaa gagggtttag gattatctag 150000
 taggacctgg atttacctt aaaaaaagga aagcagccag ggggtggtgat gettgtgtgc 150060

 ctttgatcct agcactcagg cagaggcagg ttgacttctg agttcaagtc cagcctggtc 150120
 cacagatcaa gttccatgac agccacggct acacaaagaa accctgtcaa aaaacaaaa 150180
 aagaaaaaga aagaaagaaa gaaaaaaaac cccgagatac ttaagagtac tctttgcatg 150240
 taataaaaa gcaaatgigt ttgatattct gactggactt gaccatagt atgagggcaa 150300
 ttgtagtctt gaacctagct ctttgggttc ttaggacctg aggaacagag gccaacctta 150360
 ggaaacaaga aagcacagtg gtggatttag ggaactgtga tgtgaagttt tcagtgttct 150420

tcattatgta gttgctgata ggaatgctca gcatttggta ggtctctgtt tgaggggggtt 150480

ttggttgttg gatgttactg ttatttgaag aaaatatattc ctgaagtcac ggggtgtggca 150540

tggatattgg aatgaagggtg tatgtatgag tgtacacatt catggttttc ttcattggct 150600

gcttttttct ttgggttttt tgagacaggg tttctctgtg tagctttgaa gcctgtcctg 150660

gaactctctc ttagacatgc tggctcctcaa ctactgaga tctgccttta tctacctcca 150720

gagtgtctggg aattaaaggc atgtgtcacc tccaattggc ccttttctct tttttaactt 150780

aattttattt ttgcaatagg gtctcattat gcagtcttgg atgtcctgga actcaatttt 150840

tttttttttt gcaattcagg ctgggttttga actcaagaga tctgcctacc tttgccttcc 150900

atgagctagg attaaaggca tgcaccacaa tgctcagcca tatcttctga ggattgccaa 150960

cttaaaaaaa ttcccttttg ccgggttagtg gtagagcatg ccttatagtc tagcacacgg 151020

gaggcagagg caggtggata tctgtgagtt tgaggccagc ctgatctaca gaatgagttc 151080

caggacaagc cagggttaca cagagaaacc ctgtctagaa ccaaaaaaaa ttcttttcaa 151140

ggtccaggca tagttgtgca agacttcagc actcaggaag cagaggtaga taggcctcta 151200

tgatttttag gccatccagg atgatacagt gaggateccc cctctcttcc tectctctcc 151260

accaatttgt gtgtgtgtgt gtgtgtgtgt gtgtgtgtgt gtgtgtgtgt acgcgcgcac 151320

aatgatagg tactaggtac ttaggaagtt gaggcaggag gattgcaatt cctaggtcag 151380

cataggtaat ctagaagac ctggtttcga aatcaattaa aatgggctga gggccaagta 151440

aaaaaaaaa aacaaaggct tatgatgtta gccttgtgct aattttttgt gtgtgtgtgc 151500

taatgtttgt atagcaggag gaaggtcctg ttttcagtcc ttaaaggcag cacaaaataa 151560

attcaaaata attcttttga ttgatgtttt atgcttgtga ttggtattgt caaacagggt 151620

agatagattc tttttttta aataattatt taacttttat tttatgtgca ttggtgtgaa 151680

ggttcagatc cactggaact ggagttacaa acagtttga gctgcatgt ggggtgtctggg 151740

aattgaacct gggccctctg gaagaacaga cagtgtcat aaccactgag ccatctctcc 151800

agccctagat agattcttta tgttgcctc ttttgttttg ctttaatctc agggaactag 151860

agggtgtaac ctatgtttta aaactcacat ttggtagtga tacaacagc tgtcacactg 151920

cataattgct acatcattat gttagtcact gtcgctcact aatctgtagg tataaatctg 151980

tattctaaact acatgtgac gggaaaaact agttactgaa agagtttatg ctggatagac 152040

catctgctct ttatttccaa atccaaaatg aaaagttagc catagcatct gcaaatctgt 152100

taattaagat gtgtatagga aggtgagctg agtgaagtct aaagaggtaa ctttgactca 152160

tgaagcact gtgtggaagt ataaaatacg tagacattct ctttatttaa tggaaaggaa 152220
 tcttagtttc caagggcagt tgaacataa aacagtgttg ggaatgataa acacacatgt 152280
 gtggctagac ctggggagtc tgaagccagc ctgagctatg gctgtcaagc cccccccct 152340
 tttttgttg ttgtttgtt acctaccctg tgtctgtttc agtattatta actcatggca 152400
 ggaggactag aggttgagac aggattttat tgtgtggcct ggactgactt tgagctatag 152460
 gcagctgttc cgtgttgcc tcttgactga ctgttgggt catagcatg acccactgtg 152520
 ccagctcacc agttcatttt cactcttgcc atctagctat atcatcaact ccttgaggct 152580

 gggattatac cttcatgtta tccttagtgc ttagtgcagc acttgggtta tgctaaggga 152640
 tctttgtgct aggagtgaca atagtatttt agagaaaaat ttctattcaa attattgact 152700
 cataagctaa ctttgtctct aaaaataaaa ttaaaattta gttgaaaagg gccagtggct 152760
 catgcctgtc tgtacttggg aagcagaagt aggtggatct attgagtttg agacttagtc 152820
 tataactat gtttcagcc aatgagggt acacagtga accctgctcc taataaataa 152880
 atattttat aaaagaatta attgaagaac ttgaagctaa aaaatcatgc atacaacaaa 152940
 aatgagcct agataagggt atagactgtg acacagactg cagaaggacc aactgctgtg 153000

 taggcagaac aactttgtcc taatgactaa attaaaaca ctgacttcac agactagtaa 153060
 agtagttgtg tcctagaata aagatagtta gatagaaaca taagcaaatg aaaatagtga 153120
 tatattatgt tggtgaaaa tcacattcta gacatgttc tccgtacaat agtagctaaa 153180
 tatgcttcaa catagaaat gctttgatgg agtgagtaat atggagaaat cctaagacag 153240
 tttgtttgtt tgtttgttta tttatttatt tttttatta tttatgttt tgattatgtt 153300
 gtttttggtt ttcaattca gggtttctct gtgtagcctt ggctgtcctg ggaccactc 153360
 tgtagagcag gctgacctg aattcacaga gatccactg tctctgcctc ccaagtctg 153420

 tgattaaagg tgtgtgtgca ccaccacata tggctaagtt ttttctctt gtggtgaatc 153480
 atgtaataaa ttttttaaa taattaattt ttcaaaaaga ataattacat tgctctgtgt 153540
 tgtgtgcatt ctttaattgt tgatattctt tgtaattata attttcagt cctttacagt 153600
 tagcattgac atgctgttcc accatttaac cattcatcag cggaataaat tgaattttcc 153660
 cttgagctat tttcttaagg ataaattctc aaggatcaag gtcacacact ctgagagaat 153720
 gaatattttg ctggcaaagg aatgtgttg ttttttttt ttaagatttt atttattatg 153780
 tatacaatgt tctgcctgca tgtatgcctg caggccgaa gagggcacca gatctcatta 153840

 tagatggttg tgagccaccg tgtggtttcg gggaatcgaa ctgaggacct ctggaagagc 153900
 agacagggt cttaaccttt gagccatctc tcagcccccg tggttttttg ttttgtttg 153960
 ttttgtttt ttaaaccta ctaatttaat attggttaatt tgaatacgt tcattttgt 154020

tttttcttc tgactatac agtaattaga cactggcagt aatagaacaa atcacagtat 154080
 agatagtaca taaaagctt taacagccca aactggaaat gggtagctgt tttctttta 154140
 aaagtacca tccaattta ttgtatttg cagagctgtg gggactggca taggaaatag 154200
 cggaatcgg cattaaaact ttggctatgg taagtagaaa gtttatttta ggaaaaagat 154260

 tagctataga agaaaagcat aagtactgta tgatttgct tatgcattat aggtttaatt 154320
 atttatttta ttttatttt gagacagggt tttctctata cttggctgtc ctagaacttg 154380
 ctctgcagtt caggctggcc ttgaactcaa gagatccacc tgcctctgcc ttctgagtgc 154440
 tgcataatgt tttcttttaa aaatgtttgt ttttttgc atgtgtgttt ttaggtcaa 154500
 aggacaacct gcacagitta gttttctcct tccatcgagt gggtaccagg aatcaaactc 154560
 aaacatcagg ctgggtggca atctccttaa cctgctcact aaccaagtg taatcctttg 154620
 tcctttgcat gtgtgtctaa gaggtagct agctaattaa tgaatatggt agttgacagg 154680

 gtacagaaga accaccagtg tggttgcctg cagccctgtc agcattgtga ttaatggttg 154740
 ttgtctctgt tattgaaatg gagaaaactg aggttcttgt tgataattag ttgctgcca 154800
 ccaagtttga ggcccgcctg agctacatga gatcttctag ctactctgga gtctaaggtg 154860
 ggaggagttc ctgaggcca gcatctctc agatttatgc cttcttactt agatgctata 154920
 ctccctgctt ttgtttgtg acatcagctt taattatatt ttccttaagt ggatctttat 154980
 ggaaaatacc ttggatattt ccaagacaaa atttgaattg tttacatgc aatcatttg 155040
 aactcagtag ctgatcgggt ttgatattta aagccattaa ttctaactca cagatttctg 155100

 ttctcaagca aatgagagat ttcatgtctg gatcttttgt tacaacatt gcttctttt 155160
 ttttttttt ttttttttt ttttttttt gagacagggt ttttctgtgt tgctttggag 155220
 actatctg cacttctct gtagaccagt ctggcctcaa actcacagag atcctcctgc 155280
 ctctgectcc caagtctgg gattaaagc gtggtgatag ctcaagtgt aaagatgctg 155340
 ccatactga tgataccaat ttgcttctc cctgggtctc aaacagtgga aagaaagaac 155400
 acacaggtt tctcctgacc tctcatgtg catggagctg agatgatagg tgtgtaact 155460
 catactagtt attagctatg cctagaaatc acatagagtc aatgcataa agcttcatgg 155520

 gttttgttg ttttgcctg gcttctaga gttgaaggc atgtaagcag gacagtgagg 155580
 gtttgggtt tctctttga tttgatgtg taatgattgc ccatgtctc tctccattta 155640
 acagacaatg ctgtctttac attattgcag aaaactctat gtcagaagt ctgactaggt 155700
 gttggacagt tgggggtat gtccagaagc ttctcatcat ggaaacctc accagtcctg 155760
 aacctgaagt tctgttttt gtttgtttt ttttctccac ccgaaaatag aaacctgtg 155820
 ttcttggggg cacagggact cactctctct ctctctctct ctctctctct ctctctctct 155880

ctctctctct ctctgtgtgt gtgtgtgtgt gtgtgtccca cagggtttct ctgtgtaata 155940

gtcctggaac caggctggcc ttgaactcac tgagatcacc tgcctctgcc tcccaggtgc 156000

tggggttaaa ggtgtgtatc accaccaccc ctgcagggcc ttaattttcc aacattaag 156060

ggaccctaca ttggcaagct ctttcagagt ttgacaata aatatgtata aaaagaaatg 156120

aatatttgta ttatacaagc tgactgaata tgataatgtg agttaaact ttttcttggg 156180

gatgtagctc agaatgtcta gcatacacag cccatttttc catacgactt aagccaaacc 156240

aaaataaaga gcagtcacat gttcacatgg actagagttt gggggccaga tatgtgtcac 156300

aagccatgta gtgtatttat gttgttggc cattgtcatc gtcgtggtgc cccccccca 156360

atataccta ggaacaaaa aaaaaggat ttagatccct tgacaccgga gttataggca 156420

gttgtgagct gccattgtg ggtgctatga actgaactca ggtcctctac cagagtagca 156480

agtgtcttta accgctgagc catctctcca gccatttgt gaaggaacag gttacatata 156540

gccaggctgg tctagaactc atcatgtagc aaggctgcc ttgaaatcct ggttttcacc 156600

aagcatgatg gctaagtctt ttaattccag cactcttgag gcagagtcag tgggagaaaa 156660

gaactaactt atacatgtac ccatgtacac attcatgcat gtatatgtac atgcatacac 156720

taaaataaat gttacttta aaaaaattt gaggctggag agatggctca gcaattgata 156780

gcacttgatc tcacaaagt agagcaactt gggttcagtt cccagcacct gcagccggc 156840

ttacaagttc tgiaactcca gttccaggga atctaccacc ctttctgac atctataggc 156900

accaggtaca cacatggtac acacacatgg tacacacaca cacacacaca cacacacaca 156960

cacacacagg caaaacactc acatattatt attcaagaaa ttcagtgagg agcaggagcc 157020

agggtactggc agatccccta tgacttcaag gccaacctgg gttatgtagc aagttccaat 157080

ccagccagag ctacctgta agaaactgtc tcagagaacc taaataaata attaaagaaa 157140

gagctagtgg atgcagagac ccaccacaa acattagaca gaaagagaac cctggtcgga 157200

ggtctccatc gggctcttcc ctcccttgg agctcagga atcctggagg aagagggaaa 157260

ggaggaattg tggaagccag agggattgag gatactgggg aagcacggcc ttcaaatca 157320

actaagcagg gctcatatga aggcttacag aactgaagc agcaataatg gggcctacac 157380

tggctgagc taggtccat gcatgtgta tggtgttgg cttggtgtt tgtgggggtg 157440

actctgattc tttgctgct tttggaacce ttttctctt aatggggtt tcttggcagc 157500

cttaatgta aggctttgtg cctggtctta ctgtatctt tgctgtgtt gtttgatggt 157560

gctgggaggc ctgctcttt ctggcgtgag ggggtggtg cgtagtaat gtatctgaa 157620

gaggagagga agggaatgct atggctcttga tgaattgtat gagagactaa ataaaaatta 157680
aagaaatatc tagaaagatg gctcagtggf taagagcaca tactgatttt tcagaagacc 157740
taagtttggga ccttcccccc ccatctccct ccctctctta ctcctccct gcactgtaga 157800
tccaatccca gatccttaca tataccgcac aagcatccta ccaactgaaac acacctccac 157860
cccgcttca gacggggtct tgctgtataa taccaggct ggtctagaac tctggatctt 157920
ctctgcage cttctaagtg ctagattaca gaggcagcc acctgccta atgtatctta 157980
attaagtga ccattcattg gtgtttttia ttcatttgt tgcatagtca ttatcaccac 158040

catctccaga accctttcca tcttttaaaa ctgaaactgt ttccattaag tgtaactct 158100
ctcacagggc tggagaaatg gctcagtgia agagcactga ttgctcttcc catatgatct 158160
gggtttaatt ccagcacc acatggcagc tcacaagtgt ctgtaattcc agttctagag 158220
aatctggcac ctaatacag atacacatgc agacaaaaca ccaatgcagc ttaaaaaaag 158280
atgtaaatgg taacttcca acctggcctg ttgactctc tagaaacctt ataagtagaa 158340
tcatagcatt tggtttttgt gtctggctta tttcatgtag cacatcatta cacttttcta 158400
atgtgttaaa atttcttca aggctaatta gtactgcatt gtatatttgt atgtgccaca 158460

tttccctg ggggtgtgct gtttgggtt tgagataggg tattacatag ccagcttgc 158520
ctcaaacatg gcatataatg gaggctgacc tagagctctt tttgttgtt gagacagggt 158580
ttctctgagt agtctggct gtcttggaaac tcaactgtata gagcttgcg gcctcaaact 158640
cagatccgtc tgcctctgcc tcccagtgct tgagattaaa ggcgtgcacc atcattgcct 158700
gcttggcctt gaattcttga ttttctgct tctacatgc aagccctagg tgtactgaca 158760
atgtaccatt gcctgtctct gtttctatgt tttagctgtt gtgaacaatg ctgttaatgg 158820
gagtgactgt agtaataata atacttttc aagaggctgc ctttcagtca ggtgacagat 158880

aatttttaaa gtgagaaaat actcatctgt cccagggtt atatagctgg ttaatgatag 158940
agaaacaggc tglagctgga catggtagca ttctgtaat cccaggactc agcaagtgga 159000
gacagttcta ggggtcacct tgttatgtgt gagactctgt ttccaataa ataaataata 159060
agacaattgg gtcctaag tgattttgaa aatctgttcc tcttctccc ctctgccaca 159120
gaaggtctcc agaatgctta gcaattctag ataaaactgt ttaaagacc atgggtagta 159180
ctccagtc tgcattctgg aaactgagga aggaagattg atgcacgctc taggtcagcc 159240
tgggtacat agiatgttca gtactatcat gggatacata gtgaaacctt gtccagctctt 159300

tctcactaa gccaaagtaa agagctgatg ttttattata ggaaccgaa gaggccatta 159360
aatgagttt taaattcatt taaaccatt ttaggctta aatcagctag attggaaggg 159420
gtcagatag aatcagaata gttaggacta gttgtcattc atggcagagg ctacagtag 159480

atcagtaggag gagggatgatg ggataccttg tcaaatatatt gggagttgga cagcagacac 159540
 tatagtagac ttgtgtcagt ggctgggtgct tgagagacgt gaggttccatc ttaagagagc 159600
 tattaattag tgttatgtaa agttgacagt gctctgtttc agacagacag acagacagac 159660
 agacacacac acacgcacac gcacgcgcgc gcgcatgcgc gcgcatgcgc aaccaaagtg 159720

 aggaggattg tatgtgacta agaagacaag aactaactta tttcatgata gtaccgggct 159780
 gctctggacc ctgactgtgg taataagtgt tcagtttagga tgttaatact aattatgtta 159840
 aaagcttag atcagttaga ctgtggcaga ggtagcctct gagaaggcag ggtatttgct 159900
 atttctcacc atgtgaaaa tattaccttg gtggagactt gaaacagatg gtgtacagtt 159960
 ggagtagact ctgttattcc aaataaacat ttgctggaac tggggtacag caatccatat 160020
 ttcacttttc cctatttaca ttatcaggtc agctgtgttg ctgctgcttt tactagcatg 160080
 aaggttatca acaggctttg atgttggcag gctgattaca acatgtcttt aaatattaaa 160140

 atgattagca ctggaagaaa ccccttagtt acctactttc tatactcagt gcataaatgg 160200
 ctattagcac taggtaacag cgtgtgtgtg tgtgtgtgtg tgtgtgtgtg tgtctgtgtc 160260
 tgtgtctgtg tctgtgtctg tgtctgtgtg tggctcact ggaatgattt gtctcaggtt 160320
 ctgttgtatt taatcagcat tagaaccagg cttcaggcac atctttcaga ttcaagatca 160380
 gtgttgtctt ccacaggaaa aaaaaatgtg tatggttttg atctcatgta ttagtccat 160440
 tatagctcag acaccattg tagttgaaga cctcgaactt gtaattctat gtgtgtactt 160500
 gtagttaga tgaggtttct actgagctac atccctgtgc ctttcatgg ttttctcaga 160560

 tacctaaata tattaatttc cacttgcatg gtagccagac tggcctggat aggaagtctg 160620
 agctttggat taagactgt cagctgatca ggtggagggt gacatgaaat gccaaaggct 160680
 gctattagct actctccatc catcaaaaag acaactaata tcatggctct caagggggat 160740
 ggagctgga gctagctcag cttagatgca ttgagaaaga gctggttatg actgccaac 160800
 atccaccaac tccatttgc agcctggtga gtgggtggg cttcaggagg cgtggtctgg 160860
 ctccactcac ttcaaaactg agtattgtg tcccaccatg gttattctg ggcagcttgg 160920
 tatggacaac agccatggct gccacagaat tccgccggtc tcaggagaac ctgagggtg 160980

 gcagctccta aaccaagigg cctcatgctg gtaactggca aacctgcaag cctctttggt 161040
 atatagaaca aaaaaaaaa aaaaaatttg gaacacagat aatttttgaa gcttgagagc 161100
 aggtattttg gatgaagtga gtcaagaata ggtctgagga ctgagctcca ggattctaaa 161160
 ttttaagatga caaagaagat gctaaaagaa gtgcatgaaa atagcagcca gggatatggg 161220
 gatgggggtt gggcaccaca cacgaaaacc aagtcaacag tatcctttgc tggcctataa 161280
 gcaccggaag tglaaactgt agaaaccacc actactctga atgctagctg tttacagtat 161340

cataagggtc aggcacatta gtaatacata ccttcttaaa atttctgtgt aattctaccc 161400

agccgtctcc aggcagatga gactttttct ggtctcgggt ttttctagaa aagtggaggt 161460

ggagcagagc ctggaaatag gcttaateca ttgcttaact ggttgctctt ccagaatttc 161520

tgagttcagt acccagcact gacatgatgg atcataatag tcctctcttc tgggtgagcag 161580

atggcagata aaatacccat atccataatc aaaccttttt aaaaaataat ttattttaga 161640

ggcagttcac tctgagttcc aggccagcca gagatacata gtgagactgt ctgaaaatac 161700

actacactcc tcattttatg tgagtggtga ggttacagaa tgtattttct ctttgtacca 161760

ggtgggttcc aggagttgaa ctcagaccac caggcttaag acacagcagt aaaacgtatt 161820

tactttagaa ttiattgtat ttgtgtaata tatacatgta aatgtattta tgtgtgtgtg 161880

agtgttcaca tgggacatcc aaagtccttt attttattcc tttgggacag ggggtctcac 161940

caaacctgga accaggatag tggccagcaa ccagtgatcc tcctgtctct attccccac 162000

agctcctcct gtttctttct gtttccccac actcctatta ctaactttca cccgttgctc 162060

ttccatgtaa aggcacaggg aaatgctggc tgaattcac agagaaggtc ccagaagaca 162120

cactccccca cactcaaac tgcagcctcc agagttggta gaagtctctg ttgcttaaag 162180

gctccaggtt gtgtggcact tggttatgag caagctaatt gagcagaaag cattcccgtg 162240

aaaccggtta tgttcttttt ccagctctggg aaagtgacat cttgttcctt tttctttttc 162300

ttttttttta aattttattt atttgcttat atgtttattt attgagacag ggtttctctc 162360

tgcaacagcc ctgtaaagt atgcctact atcacactg gcctttcctt taaaaagaga 162420

tttattgttg ctgggagttg gtgggtgcacg cctttaatcc cagcactcag gaggcagagg 162480

taggcggatc tctgagttcg aggccagcct ggtctccaga gtgagtgcca ggataggctc 162540

caaagtaca cagagaaacc ctgtctcaaa aaacgaggag ggggggtaca tgttagtgtg 162600

ggcactttga gtgtacttgg tgcctgagaa agctaaaaga gtagatcata tccccgaaa 162660

ctcgagttag agaggattgt aagccacat gtgggggctg agaattgaac ttgggacccc 162720

taaaagaaca gcaagcactc ttaactggtg agctatctcc ccagcctcta caccctctt 162780

tccccctctc cctttcctgt cttattcttt ccttgtgaat ttgttgtctt aaaggggctt 162840

tggtttagag ctctggttct caaccttgct aatggtgaga tgccttaata cagttcccat 162900

gttgtgtgta cctcagccat aaaattatit cattattact tgataactgt aattttgcta 162960

ctgtaatgaa tggtaatgta aatatcta atgcaggaca tctgataagc aacccccaaa 163020

tgagttgcaa ctcacaggtt gagaactact agtttagctt gaaaatatga ctggaggtag 163080

ttaagtgtga gtttccagaa ttaggagctg gaaatgacag caaagacatg taaagccaag 163140
 ttttccatgg gacaattatg aacaaatttc agaacttgca aaatgattaa atctgggtgt 163200
 ttgtgaacat gttatTTTTc atctttggct ttgtgactta cccaaagtag gcttgaaaaa 163260
 gacaatttgt gtaaatagtt aaagctttct aaagggtact tagtatataa tacttaccag 163320
 ctatTTTcca ctgatcataa agtaaaagca ggaacaaaac aacaacaaca aaaacagaag 163380
 aagctgggtg taacagtaca taccttgcta taccagcgct caggcctgcc tgttttgttt 163440
 ttgtTTTTTt gttgtTTTaa tcagatctga ggctgtaact cagcaggagg atcagaagtt 163500

gaaggcttcc tctgttagat agtatgctct aggccagtct ggactcacag gatgtacact 163560
 cgtgttctct ctctctctct ctctctctct ctctctctct ctctctctct ctctctctca 163620
 aaaaaaaaa ttaaaattaa atgggtctga aggacatggc tcagtaaagt taagagtaca 163680
 tactgctctt gcgacaatca cagttcagtt ccacggctc tgatacctat ggcttctacg 163740
 ggcagaggag cacatactg cacatacaga cgtgtaaac aataaataaa ttctctaaaa 163800
 ataataagtt attgccaggc gttggtggca cactccttta atcccagcac tcaggaggca 163860
 gaggcaggca gatctgtgcg agtttgaggc cagcctggtc tccagagcga gtgccaggat 163920

aggctccaaa gtlacacaga gaaaccctgt ctgaaaaac caaaaaaaaa aaaaaaaaaa 163980
 gttatttctt ttatatactt gatttcttca tttttatgct agtaacttcc agttataaac 164040
 tgaagtgttc ttttatttcc aaacttctga attgaactac ctactaggaa catatatgg 164100
 tttagagtca gcacaaaact tattgtcctg cagggtggagt ggtgtacact ttcaatccta 164160
 gcactcagga ggcagagaca gatggatttc tgtgagtcc agaccagcct ggtctacaga 164220
 gtaagtccca ggacagccaa agctacatag tgagaccctg tctccaaaaa ccaaaacatt 164280
 aatgtccaag ttcctctcc tcaaatatac tctaccacta gtgttctcta tctgtgtcag 164340

taaccattc cactttggtg tgcacctca cccccgtcg tcttataac aaccagatec 164400
 tctgcatcct aatttttagt tcttgtttgt ttgtttttgt tttttgaag cagcgtttct 164460
 ctgtgtagct ttggagcctg tcttggaaact agctcttcta gaccaggctg gtctcgaact 164520
 cacagagtte gtatgctacc actgeccggc tcttaagttt cttaaatcca ctctctcatt 164580
 ccattcttac tgctttttca ggaaatattg tatgtcaca caggaaaact cacacataac 164640
 cattttgcat cacagtctca tcaattcccc atcaaaaaca gtgatctctt cttttccttt 164700
 cttttatatt tctcccacc ctctcccaca gtaattttta gagtaattta ttaatataga 164760

tagatagata gatagataga tagatagata gatagataga tagatagata cagatagata 164820
 gatagataga tacttgcatg catgtatgtg tgtgcattgc atgcctgggtg ttcattggagt 164880
 ttagaagagg ttgtcagatg ctctggaagt acagtttcag atgcaatcat gtcgttgctg 164940

gaaccaaacc ctggtaaca acaattgctg ttgttaactg tcttaactgc agagacagct 165000
 ttccagctcc tatttatfff tattgtatgt atataggttt tgcttgtgtg tatgtttgtg 165060
 gaccacatgt gtgttttatg cctgtgaagc caaaaaagtg catcggattc cctggaactg 165120
 gagttaaaga cagttgtaag tcacatgtg ggttctggga attcaaacc aggtcctctg 165180

 gaaaagcagc tgtgttctta acctctaagc catctctcta gttcctgtct ttgattttca 165240
 tagctttcct tctaggtgat ttttaatgic actcatttac ttgtgttgaa aaacaaggcc 165300
 ttgaagggtg aaattatttg ctaaatttta ttaggtcgt aagtaacaag gatgcatcaa 165360
 actagccctt tcaactctga tatctttatt actgtttgaa actaggaatt aacagtaatg 165420
 gtgctggttt atgggcagtg gattaaaca ggagttagta atgtggtctg tgaactgtgt 165480
 tcctgaggca gatttatcc actagctaag tttcaggag gtgaagcatg gagctcagtg 165540
 ttttgagtt gggtgacgc gtctttgtta cctggccaa gtgcttgaat gttaaaactc 165600

 atctatttga ctgctaagcc ctctagcctt tggcacctt gctgtaaaga caggtggtct 165660
 gagaaaaat gccctccaga ttgatgcaca ctatacataa cataacagtg cgagacaact 165720
 gtcagttcct tctactctt ctccctcacc cctccagaa agctgggccc cagatggaag 165780
 agctggaat gcgtcaactg ttctctgaag ggcatgaga aaacactggc aggaagaaaa 165840
 aggcaagcgc aacagctcat tagcccacta atcagatagg acgacatca ttttcacaaa 165900
 gaaagcatcc tgaccaggga cagcaagagt gtgaaatfff agcctcatgg ttacagaat 165960
 actgtaggtt ttgttagggg gtttgaaca tgggtgcttg acttccttga cactttttat 166020

 tcataatcc ctctctgaaa tagagccact gcaaaatgga acataaaaata gtatttgggg 166080
 acatctttcc taicacaaag tgtggtgaat atgctaagat gtgccttgtg gtttatatga 166140
 acatgctgga atagccatc tttataactg atcctacaag aaagctttga ttctacctc 166200
 tcatttaaac cttttttgtg gtctttgtac ttgaaatcaa aatcagttgc tactacagta 166260
 ttttaagttaa aaaaaaaaa aaaacaacc atacaatagg aattagtgag aggcatatag 166320
 ttcagtttaa aggtgagcct gttagccagg tactaatagg ttctcttttg tgagaaataa 166380
 tttatftaa atatftttg agtcatggtt ttgccacatt tgatccagaa tgttttatag 166440

 ctagagtgtg gctttgagct tctgatcttc ctgtttctac caccctggtg ctgggattac 166500
 agccactgtg ccaggtttta tttatttata attttttagat tttctttatg tgtgtgtttt 166560
 gcctccatgt atgagagccc agaagaagct atgagattgc ttagagctgg ttttagagct 166620
 ggttgtgagc taggaactgg acctctgtct tcttcaacct ctgagctgtt tctccgcccc 166680
 tcttacattt ttttcatgtg cattggtatt ttgcttgcac ttgtgtttgg ggggtggtgt 166740
 cgtatcctct ggaactggag ttatagatag ttgtgagctg ccatgtggtt gctgggaatt 166800

gaaccaagc tcctggaag agtagccagt gctcttaact gctgagccat ctctccagcc 166860

 tcctctccc caatcttaaa aggtcctttc caagccctgc aaggigttta ctgccaagcc 166920
 tgaaaacctg aatttgatca cccggaccaa catgatagaa ggagaaaact gactcaggca 166980
 agtttatctt ctgactgcca cacacatac atagtgtggc gtatgtgggc atgcgcgcac 167040
 gcgtgcacgc gcacgcacac acgcgcgcgc gcgcgcacac acacacacac acacacacac 167100
 acacacacac acacacacac acacacacac acacacaaaa tcaataaata tgtaattaga 167160
 tttttaaag gtcctttccc caaataaagt agtattgccg agctagatgt taggacatga 167220
 acatatctcc aggcagctaa tgttttacc cttgttgtaa gtatcatctt aatctctgag 167280

 tcctctagga aaataggttc agttccgatt gctgttgcta tttattatit atagagagct 167340
 ttgacctcct ttatititatt ttatititatt ttatititatt tctttgcagt tggttgtgag 167400
 aaaagggtgc cagcaatgcc tggatcgct gtggaagtga agatacagtc aagatcctca 167460
 cctccatca tgcaccctc cccaccaata aatcctggag gaccgaggcc agtgtccttt 167520
 actcctacag catgtgagac ctttaaatg aattcctgat tcagggtcat aatgtagatt 167580
 tgagtaactg gcttacatta aaccttcaat atacatcatt caacatgact aaaatataaa 167640
 taagggtata gtgatgcatt cctataatct cagcctgtaa tcccaggact cagaggatca 167700

 agagctctag gtcacccttt ggtgtgacac atgcctttaa tcccggcatg tgagaggcag 167760
 aaacaagtgg ctctcagtga ttttgaggc cagtctgac tatatagtga gttccaggcc 167820
 agctgagcta cttagtgagg gggctattc aatatgactc ccaacaatat ataaagattg 167880
 gcatggtttt taittctttg tgacagagtc tcactcacta tggagctgga tatattataa 167940
 tttgaagagt gtgaaaatag atcacacaat ttaattttaa aaggctgtaa aagtttatct 168000
 gtattgtccg gtggctgcaa gcatagtaat atctgtgttt tttgtgggg tgcttcaaag 168060
 agggcagctc tgatcaggat agatctttct gtggaacaa agatgaaaga tggttgcagc 168120

 taattttcta gatggtgaa attaagtgtt gagctatit tctgggagg ttttagtaat 168180
 ctctttgact ggaagataga attaccctcc ctctctctc agccattag ttttttatg 168240
 aattcaacac caitttctg aaaacctact gcctgttagg ggatgatgaa caaagcaaga 168300
 gaatatagat gagatagctc agcaggtgaa ggtgcctgtt accaagactg acaacctgag 168360
 tttgtctctc aggaacctg tggtaggagg agagaaccag ctctgtgag ttatctctg 168420
 acctccat tcactgacat acacacactt gagttcacat gcacacaaa taaatgcatt 168480
 ggtggtttac aaaaatctag taatgtttat gtgttaaggt aatatcttt gagcagctc 168540

acctggtgtg gtgacataca cttgaaatgc ttgagggaaa agggaagtag aagtctgagg 168600
 cagaaagaac tctagttcaa ggtctgtctc agaaagcaaa aaccaaacag aaagaagacc 168660
 agtctagcaa gtaattgcat aggtacaaag aaaagaagta aaatagtggt tgtgtgtgtg 168720
 cacatttctg gaactcattc tgtagaccag actggcctca aactcagaga tctaccttc 168780
 tctgccctg agttttggga ttaaaggtat acacaactac acccagcaca aatttattaa 168840
 atccattagg gtttacctg aagaaggcgt agaggtggag aagggaagta taactgagtg 168900
 tatgctggtc ttcatactca tgaatggcgg ttttattagc taagtagtgg ttaaaagatt 168960

 gttgttttaa aacagagcta atgtcttgac ttaattatt ttctgtactt tgttgcttgc 169020
 ttgcttgatt tttgtttgtt ttgggtgtgtg gtctcatgta gctcagagtg gtcttgaact 169080
 cttacaatc cagcatgatac ttgaactctt gatgtttctg cctccacttt ccaagtcca 169140
 gtgagatcat gggaaatagg ccccatgccc cactttgttt ttttaagata ggatctaact 169200
 ctgtagctca gactggcttc caaactagaa tcctcttaac ttgtctcctg agtgctgggtg 169260
 gcatcactgg tgtgagccca ctacacctgc cgtatttgtt tatttgataa ccctccctc 169320
 tggacagggt ctcactttgt aacctgact atcacggaat tcactatgta gactagcctg 169380

 gcatctaact caacagatat gtgccacat gctggccctt aacttgatta gatttttaag 169440
 catggatatg attaggtcaa atcggattga aacttaggtg ctaggtaatc ttgttttact 169500
 attcagtca agaggagact tctttttata tgtatagggtg ttttgcttga gtgaatgttt 169560
 gtacacactt gcatgccctc agatccctg caactggagt tacatacagt agtaagcagc 169620
 tgagtgtgtg ctggttacca cacctgagtc ctctggaaga gcagccagtg cttttaacc 169680
 ctgagtcacc tciccagctc tcataggaga attttttctt taatgccact gagaatgtgg 169740
 ctttagaac aaagtatata agccaggtgg tggcagcgta tgcctttgat cttagcactt 169800

 ggtaggtaga ggcaggtgga tctccatggt ctgaggeccag cctggtctac agagctacac 169860
 agagaaatcc tgtctcataa aaaccaaag tgtgtgtgtg tgtgtggtcc agtcctgagg 169920
 tttctacat taaaactacc aagaagtaac tactgataat agcaaaaaa cagaaatact 169980
 gattgtttta tcatcatttg ttcaaaaata aaggatggga ggtcctttat ggagttaaa 170040
 tagtgcctt tcccccttt cttcttttgg gtatatgggg tcttgataca ccgatgcact 170100
 ggtttcaact ttttgggcct aagtcactct tctgccttaa cctctagaat agctaagatc 170160
 actctagttt tagaaggat tttctgaat gatcaagact tttgcattat ttgtcgatct 170220

 gigtcaagat aagaggaaag ctactctaaa ggacattagt attttgaatg gccaaagaga 170280
 gacattttga tgcagaatta ggtcataaag atagaccctt aaaatatctt tgacgttagt 170340
 ataattctgt ttttctggta tttctcacat actaacttgt gactgattgc ttggcttcat 170400

tgagattttc agaaggatat ttgtaaaatg aacagaaaagc ttgatgtgtg gtgggtcaca 170460
 cctatattaa tagtattctg gaggccaatg caggagtatc gtagcaagtt caaggctact 170520
 gtgcaagacc ctatctaaaa aggaaagaag gaaggaaaga aagaaagggg tctctgagaa 170580
 agatgactca ggagttaagg gcacttttta gtcttgcaga ggacaggagt ttgttttcca 170640

 gcactcacat ggcagctaac aactgtctgt taactccagt tacaagatct gtcttctgat 170700
 ccccatgggc atcaggcata caagtggtag atagacatac atgcaggcaa gacattcatt 170760
 cacacaaaa ttagattttt ttttaaaaga ttttatttat ttattatgta tacaacattc 170820
 tgcttccatg tatatctgcc caccagaaga gggcaccaga tctcataatg gatggttgtg 170880
 ggccaccatg tggttgctgg gaattgaact caggacctct ggaagagcag ccggtgctct 170940
 taacctctga gccatctctc cagcccccaa aaaattaaga tcttaaaggg aaaaaaaaaa 171000
 taaaaaatg agtttcagtt agtctccaac tcaccttaag caccatggtg tctatagtta 171060

 aatgttcctt ctgtacctt tttttcccc ccagaagggg ctcacagtag ccagggttc 171120
 tagaactcaa tatctcctc caccctaatg ctgggattat gtgtgggcat cactgtagct 171180
 tgctttttcc tattcatagt gctccacgtt gattgtgtgt gttgtgtctg cttgtttact 171240
 ttgtaataa tgttcttatt tagtcttaa gaatttcctt caatatattt ttggtcatat 171300
 tcaactcct ccccaattcc tctcagatcc cccccageta tcaacttta tctctccca 171360
 ccccatctct ctctttctct cttgttteac actgttctct ttttccctt cctctccct 171420
 tccagtccag tttgtgatga ctgactactt ctgggtgtgg gacctccctg gagtgtggtt 171480

 tggatacact aggtattcct acattgagga aaactaactg tcagcaagaa aactaacagc 171540
 aagaatcata tgttgccagg catggtggct aatgccttta aatcccagca atcaggagac 171600
 agaggcaggg gatctctatg agttctagge cagtctcacc tacaattga gttccaggac 171660
 atctagggct gctgttacac agagaaacc tgtctgaaaa aataacaaa acacacaaca 171720
 acaacaaca aaaccacaac caacacacac acacacacac acacacacac acacacacac 171780
 acacacacag aatcaaatgc caatagctac ttggtggtgg tgggactttg tgcccatctc 171840
 tctctcttc tatgcttaaa ttttgtctgg cttgaacctg tgcttgcat cacaatctct 171900

 ataagtcaat atgtgcatct accttactat atgtgagaaa cagtttcctt gaagacatcc 171960
 accatctctg gattttatag tctttctctt agatccctaa gtcagtaggg gaggagtata 172020
 ataataatag acaccatggt tagggttgag tattctgaag tctttttctc tgcattgtga 172080
 ccagtgttgg gtttctgtgg ctatctgcta catgaagaag cttctctgat gaatgttgag 172140
 tgatgcattt atctatgcat atggaataa atcattagta attttattgc tatgcccatt 172200
 taacaataa cagcaggttt tctcttaggt ctcatgacct gtctagccat agtttctggc 172260

cccattgaca atatcacata caggttctgt cttatggagc aggcctgaag tccattcaaa 172320

 aagtgttggg ttactcctat gatatttatg ccaagcaggt ctttattgta gctcacaaga 172380
 gttctgggtt caaggttgat gacttatttt ttttttctc cagtagcatg catagcacc 172440
 ttttagtact ctgaacacta gccagtagag atgaagcttc tggttaagta taagctagat 172500
 tttccatata ttgatgactc ttgattggtg tctccatcag tagagtatta cagacaagtt 172560
 ctggagggtg acaaatagca ttggcaaagc ctttaatgtt tgggcttggg gtggtctctg 172620
 taactccatt atccaacagc tcaaaaagag gttaccaggt tttctttggt agtggcagct 172680
 atgtagtgg ggtcttgttc ccccatcata gagcatctct ctctctctct ctctctctct 172740

 ctgtgtgtgt gtgtgtgtgt gtgtgtgtgt gtgtgtgtgt gtgtgtcttc taaaatagtt 172800
 tgtgtgacct tttcaaaatg cccttaatgt tagttatcct tcccatgttc ctctctacc 172860
 ctctcttccc atttcccacc ccacttatgt acttagcact tatttacttg ctgtcttaa 172920
 atggaatgac acigggtcac taaggctagc ctcttatcc tgggtatata agatctttcc 172980
 attgcagccc ccccaccag tagccataac tacaacacaa gcacatatca ccatacttag 173040
 attttaatac ctgtacaata ttctgttgc atttttctg atagttgtc ttagtatgca 173100
 gcagtctctc tctctcttc tttcttctt ccttcttcc ttccttctt ccttcttcc 173160

 ttcttctt cctttcttc tttctttta gatagtttct ctgtgtaact tttgaagcct 173220
 gccttggaac ttgttctgta gatctgggtg gcctccaact cacaaagatc cacctgcctc 173280
 tcctcccaa gtctgggat taaaggcatg tgccaccact gcctagctgg tacacagcaa 173340
 tctcattgag ggtggaaatg agtgtgagtg tgtgtgtgtg tgtgtgtgtg tgtgtgtgtg 173400
 tgtgtgtgtg tgtgtgtgtg tgtgtgtatc cagagagaaa gtgagacaga cagacagaca 173460
 gacagacaga cagacagaca gacacacaca caaacacaaa cacacacaca cacacacaca 173520
 taataaatg ctttacagaa ttcaaaagag tagtgaaaga gactatatgt ataagtcaat 173580

 aaagactctt acattctata ctgagtcttc tgattctggc tttcttttag taagcaatgg 173640
 catcaacat tcccctcta ccctgaatgg cgecccatca ccaccacaga gattcagcaa 173700
 tggctctgcc tcttctacat catctgact acaaatcaa cagttgccag ctacttggg 173760
 tgctcggcag ctgcaagat tgaacgctt tctcactact ctgcaacagt ttggaaatga 173820
 catctcacct gagattggag agaaggctc gactctgtt ctagcactgg tggtaagtat 173880
 ggcttcacct tcgccagctg cctaagaagt tgtgatatat tctgttcat tcccaacca 173940
 ttagatatt ctggactaca ctagtgttt cacaatttt ttttaaact gtcaaattat 174000

agatttcata gcagtatTTA tttgtCAAAG aatctataat gtgtcttatt atctaaggtg 174060
 cggatttaat tccagtGAGC ggctttGGAT ttgtcttaaa cagctttcag caggcctgct 174120
 gaagtccaac cgagttaata gaaggttGTT tgtatgtcaa cataatTTAG taactagtgc 174180
 aaaccagttt taatTTTCAA aacaatattt tgtAAAATTA gaagtTTAAT ggtctaaata 174240
 agtagtttct atacagtTAT gttgttcagc tccatgtgca tagttttagt ttttctttct 174300
 atactaatca tactgagcct gcttataaag gattaacttt ctatgttgcc atctgggtga 174360
 gattgagtct tcicaattta tgagggaagt gctgccagtt gtcagtgttt ccagatgaaa 174420

 tactgtaaga tTcactcctg gtgaaagcat tgtattcttt cccacatgtt aatttatgtt 174480
 tatgatgaga agctgagTTA ttgtagtagt ccttacagtt gcattttctc tcaaaatata 174540
 atttaggaaa atccctgggg ttctccagta tactggatgg cagggtatgg aacacacttg 174600
 gtggagtgct tttctagtgt ccacagccct gggtacagtc ccagtattct gaatatctat 174660
 gcagaaagac tagacgtTCA aaattatcct gagttttaca tagtttcagt ctagcaagtc 174720
 agtgtataag atactgtctc ttaaccaaT acttaaaga aatctcctgt aggtcagtgg 174780
 tcttgaactc tgtgtagtct aggacctcaa actcttgatc gctgccct gcctcattag 174840

 tgtaaagatt ttaggcatga actaccatta tttgttcta ctgctttatt gtaccacagt 174900
 ttatacattt ttgcttctga taacatttga attgtttgca tttggggcat tgtgtcagga 174960
 gtccctaata ctgccgtgca tttgtagatt ggtttacct ttcagattt gacatatggt 175020
 ggtgctcaca gtaacatct attccagaaa agtcataaaa atacacagc agattgtaaa 175080
 ggagatacac atgggcagag tctggaggag tctgtgtgct ggcctcctta atgttctccc 175140
 catttcatga ttacacagaa cacactttcc cAAAACAaa gaaaatgtgt gcagtgtctc 175200
 tgcccaaaga gtctgtaaa gatgctgatt gttgctggat ctgttgacc atctatgtct 175260

 atcttctcct atatggaatc caatgcttta gcataaccag aaacagtaac agtgagccct 175320
 ttctactact tggagaaagt gtgaggtttt ttttctgtg cattattta ttagagcaa 175380
 atctacttat tagtcaaaat taaactatg ataggttagc attattaaat tgagactaag 175440
 ttagcttttt tttcaagac agggtttatc tgtggctttg gagcctatcc tggaaactagc 175500
 tctttagac caggctggtc ttgaactcac agagatccac ctgcctctgc ctctcgagtg 175560
 ctgggattaa aggcagtagt caccaacgcc cggcccaagt tagctttttg ttaagcttat 175620
 tttttgtgt atgagtgttt tgcttgata tatgtatgga caccatgtgt gtgcagtctc 175680

 agaggatgcc agaaagcatg tgtgttgggt cttttggaac tgcagttaca gaccattgta 175740
 aggtgccata tgggcactag gaattgaatt caggctctct ggaagagcag ccagtactca 175800
 taacattgag ccatctctc agctccaaga tgtatttatt tttattttat atgtgtgggt 175860

gtttcacctg catgcgtggt tgtgcaccac agtgtgtagt gctcaaagaa ccagaagtgt 175920
 tgtatcctca ggatctcttg cttgtgttta gtttgtcttc ctcagcccag agccttacca 175980
 gctctcactt gctctgggtc tgtgtctatg gcgcttagcg gttgtgagag cccgttttat 176040
 cacttttcgg tttatagtgc agtatgttgt cattgttatg ccatcgctgt caccattact 176100

 accactgcca ttcacatca gaactatfff tatctatttg gtttttctag attatgtttc 176160
 atgtagcccc agctaaattc actgtgtagc tgaagacgat ttattttatt atttgtttgt 176220
 ttgtttgttt gtttgtttgt ttatggcttt tcaggacagg gtttctctat gtaacagccc 176280
 ttgctgtcct ggaactcact ctgttagacc aggctggcct caaactcact gagatccgcc 176340
 tgcttctgcc tccaagtgc tgggattaaa gaccaccacc gtcccactga agatgacttt 176400
 taaatattta tttttctgcc tctacctttc cagtactgga attattatca tgtgccacca 176460
 tgttcagctt atgtattacc taggggtcat attcaggtct tcatgtatgc caggcaaaca 176520

 ctgtgctgac aaagctacac cccagacctt tacatgattc aacaatgatg taacgagtgt 176580
 gattgttttg tttttgtttt aagtcaatgt ttatctgtgt aacagtcctg gttgtcctag 176640
 aactcaattt gtagaccagg ctggccttga actcacagag atcccctgcc tetgagtget 176700
 gagattaaag gtaccactcc aggttgaaaa taaatgtttt taaaggataa ggcatattct 176760
 attatctgtg tgtacattta gtttaccat ttgtcctgta tgaggaacac tgggttgttg 176820
 ctctgcctt ttcagttagg gaaatfttta tatcatttta caagttttgc tatccacatt 176880
 ctcagatcag ctaatagtc acactttcgt gaaggcctgg cttttctttt cccttttctt 176940

 tctatatatt ttttattgtt ttaatfttta tttagtgtat gcatgggtgtg ttccagggtt 177000
 ctggtgccct ctctggcct ccacaggcac caaacatggt acatgtacat acatgtagtc 177060
 aaaactcata cacattaag aacaataaat cttttttggt ttactgtga tcagtgtgag 177120
 tttcatgaga tgtaacagt gaagatgaga gaaacggccc attgcatgta acctttctaa 177180
 gtttttaagt ttttttttt ttttaagct taaaaacgtt acaatfttat gtgaatgagt 177240
 gctttgcctc cttgtaggtc tgtgtacatg tcaaaccagt atgcttaact gcttagccat 177300
 ctctccatcc ctctaatftt gtttttgcaa ctttgttaga ctaatfttate tcaaagaatg 177360

 taaagctatg tatagttttg tcaataactc catcactcag taagctgttc tagaccagcc 177420
 ttagtgccat agaaaaagcc tateccacca acaaaagtgt gggggactat ctctgtcctt 177480
 gtactfttaat ctctaaagtc cattatagat gttcccctga gactaaatct accaatatcc 177540
 taccctttga atftttctgc tcccaaaaat aaccattftct gagcctftaa aaaaattatt 177600
 acatgcagag cctgatgtag taatgtatac ctttaatctt tgactctgg aggcagagtc 177660
 agatggatct cttgagttta acccagacaa tgctacatag tgaggccgtc tcaaaaatca 177720

aaacaaacag ataaaagaat tacatctatc taatgtaagt gtgtgtgtta cactcatgcc 177780

 actgtaaatg catggaagtt agaggacaac tgcaggagat ggaactctga tttaccatt 177840
 gagtcatctt actattaaaa ataaaaataa actttctagt atgctttcct getggactgt 177900
 gcattcttta gagagggaga aaaactaagc taacaagaa ttaaatagtt aagctctttg 177960
 tgatttaaca gttgactgaa gacagtctgg tatggcaact catttctctg agatccagtc 178020
 tgcctatatt tgcctaaaca tgcagcagcc ttgggtctgt tctgtggca tgagtcat 178080
 attctgtgct acaaatctgt attatcactt tgcctatcca tagggaaatt ttagatcatt 178140
 cttttggctt tccatataat gtaatctatt ttgctgctgt gccagtttt ggatgtttaa 178200

 cattatattg cttttcagaa ttcaacagtg acaattgaag agttccattg caagctcaa 178260
 gaggtacaa actttcctct tgcctcattt gtgattccat ttctcaaggt aattctgaga 178320
 ggcatcatt gtaatttacc aacagcatct cctcaaaatc tgcctgtccc tgcctctgtg 178380
 gatctcaggg cctcttactg tagttcactg tctttgttgt atttgggct agtagttaa 178440
 cagtatctac atcagcctca aacatgatga gaattgcagt gctttgagtg atttctgttt 178500
 gcaagcacta taatcagcat acaggagcaa gtgaaggaat aaagagggaa gaaaatgaag 178560
 aatccact aagctttgg agtgtggtct gaagatgaaa aatatgtgtt atctgagtgg 178620

 agaacctttg caaagagagg cttatgcagt tgtgtcagga tgggtgaga aggcagtgt 178680
 tgttttct caaacccag ataatgcagt ctaattaatg tctctagaa ttattgtttc 178740
 taaattatgg ttctaaatta ccatcttact ttctaaaag tgtttcatt ttgaagtaat 178800
 ttcatgctcg tagatgagct gtaagagggt acagtaagct ttcttatgg tctcaacca 178860
 gttttccaaa cagtagcact tcataatcat ttctatctt tcttctgaaa aacaaccccc 178920
 cccccccat gggggttctc tgtagctttg gaggctgtcc tggaactcgc tttatagacc 178980
 aggtggcct cgaactcaca gagatccgcc ttctctgct tcccgggtgc tgggatcaaa 179040

 acctgtgcc accaacgccc agcttcttct gaattttta aaaaagaagc ttagatgtg 179100
 atacatctaa atttccaaat ctagaatttt cttttcttgc tactagggat ccaactttgg 179160
 gcttgaagta tgccaacaa gtgctctttc aaggagtgt gtccagagtc cttaaatcaa 179220
 gacgttaaca ttacataac acttgggtgt taatgtacag acctattta tgtttacta 179280
 gtctcccaat aatcttcttt atacaaaatt aagcctttat gtgtgtgtgg ttttaataat 179340
 taatgtatga gggccttct tccataatc attcaagact aaagactgag gaaaattcta 179400
 aatcttcaa cctgtggctt actagatgat tgagcacaaa ttcagttaac tgatggctga 179460

gaggtgagat acagggagag agctagagag aatgcttgca taaagggttt tgaaggagt 179520
 aggattggcc tgggattggc atctgtccct gtctatgact cgctgtgtct ctatgtcttc 179580
 attgtccagg actcagtcac atggfatac ctaattacag cagaggatag aaaatctagg 179640
 ctagatgcta ggagaaaaga gcttgttaca tggctcatca gtttctgctg cagatgctat 179700
 tgagggtgtt ttcttttctt cttgtctact ggtcttctct cacacaactg aggtaggtat 179760
 ggggaggccc ttaagacctc ccactgtgga aataccttct tgtgcatccc actggtctag 179820
 tctgtgcctt tgctcttctt ttttctactc tgctaataa ttagtatctt gaaaagggt 179880

 tgagggacaa gtagtactg ataaggagca taacgaaaa atgtgacatg gcacaaaac 179940
 acacaaattg ggggttcttg tctgccaga gcaccagtcc tatcatgata gtagttcct 180000
 gcacttgatg ccctgaaaga gtagagcttt tgtgtgaaat acttggtact aaatgcttct 180060
 ttctgacatc tcagaaatgg agagagaaat acattcagaa agacttgttt tgttttgttt 180120
 tgtttttgtg ttttgttttt tagaacatgg tttcactgtg tatcccaggc tgcctagaa 180180
 ctactctgt agcccaggct ggccttgaac tcacagagat ccacctcct ctgccttccg 180240
 agtgctagga ttaaagggtg gtgccacat ggctctgctt ctttagtgac tgtggggcac 180300

 aaggtctggg tctatattta atcatggtcc ctcatggcat gtagtattaa tttgtaacag 180360
 tttctcaact ttaaatgagt attatagctt tgaataattt tatttttaac catgtgtatg 180420
 agtgtctggt atatatgtac atgtgattgt tgggtgcctg tggaggccag aggagggtgt 180480
 tggatccctt ggactagggt ctgggaattt aacttgagtc ctcatcaaga acagtgttct 180540
 ttaagtgtga gccatcttc cagccacaag agtgtcatga tttagaggat gctgattgta 180600
 aagaagctca gcttgcgttg ttctggaact ttctctcttt gaagcttaa gtcatttgat 180660
 atattttagt taagaattgc aggtaagctg ggcagtgggt gtgcacacct ttaatcccag 180720

 cactggggag gcagagtcag gcggatttct gtgagtttga atccagtctg gtctataaga 180780
 gctagttcca ggacagcctc caaagccaca gagaagcctt gtctcgaaaa acaaaaaga 180840
 agtgcaggta gtttaggta tgggtttaca tgcctataat cctggcatcc aagaggcgca 180900
 ggggcaggag tactgccctt cctagttaa ggccaacctg gtctatgtag caaattcctg 180960
 gctaactaat agtacctagc aagatcatct aaaaaaaca aaacaaaaa aatcaacaa 181020
 caacaaaaac aaacaaaaa gacaatata ttgtataaat aattatcata actttaaaaa 181080
 agggaaaaaa agaaaattgc aggaagtggg aacctgcag ggtggcccag gacataggca 181140

 gigattggtt ccatcataga taatgtcttt tctccccctt aacaatttag caaaactgat 181200
 tttctgcctt gacttttttc tataaaatta atatctctc tgattaatg attgttttcc 181260
 cacatggcat gtaaacaca gactgcagtc ctagtaattg agaggcttca ggtagaagga 181320

tcacaaatag tagatcagtc tgggctaaag aggtcctttc tcagaaaaa acaaaaaaca 181380
 aaacaacaac aacaacaaaa aaaaacaaca gaaaagtact actaggacct ggaatttagc 181440
 tcagtgatag aaaacctacc tgtcatacac aaggccctga gtaaattact accagtttaa 181500
 aacaattaat agtaaagatt actttcccat atgggaactg ttagcacatg cctttagttc 181560

 cagcactctg gagacagaga ggcagtgtaa tctttgtgag ttcaaggcca gcctggtcta 181620
 cagagtgacc aggacagttc cagaacagcc agggctgcac aaagaaacct gtcctgaaaa 181680
 acaaaacaac agcaaaaaga ttatTTTTT cctaataaggt aacatgaaca tgtatcagat 181740
 atttcattga gttgatgaag gcatctgtga gacttcacag tcattattgc ttaataaata 181800
 atattcatag gtcacaatta atatTTTTT aaatTTTTT aatggtgtgt gtgtgtgtgt 181860
 gtgtgtgtgt gtgtgtgtgt gtaaatatgc acttgagtgc aggtgctgtc cagataccag 181920
 aagcagtgtt ctgtgtgtgt gaaactggagt ttcaggcact ttggcaatct gaccctgttc 181980

 ccttgaata acagcaaata cctttagctg tggagccatc tctctagctc cacagttcac 182040
 agttacagat aatgactgtg taaacacaga actcattcta ataagtgga cttccagaa 182100
 acaattcatg tgaatatata cagttgtttt acttctgtca gctatTTTT agtcaactcac 182160
 agaatagctc aaaagaaatg aaagattaga attttgtgt caactagttt gaacaaatct 182220
 agcatacat ttggTTTTT aacactgaga atgctgtata cagataaaca tttgcagttg 182280
 acttaatgct gaggaatacc cacttgaaat ttaattaaac taaatattac ccccttctcc 182340
 ctgaaaaaaa ccttactgtt actttcatta gtagatttgt actacaaaat ttactatgtt 182400

 caattaacat attttgatt ttatTTTTT acctatgaga taaatcctta caattaatc 182460
 ttggtggctg aaagtactgt atgaccttg tcagccctgg agtagctatg ctgcttggac 182520
 cctggtgtgc tttgtcttgt cttgtcttgt ctgggctttt ttttttttt ttttttttt 182580
 ttttgtttt ttttttttt ttttttttt ttgttgttt atattgcaca gggtttttagc 182640
 cctggatgtc ctggaactca atctgtagac taggcaggcc tcaaacctac agaaatccat 182700
 ctgcctctgc ctgtcaagtg ctgggaataa aggcattgtc cgccaccacc taggttgtct 182760
 tttctttata tctgaattta cagacaacta ttcaccgaga ccctacaatt aaaaaaacag 182820

 tttatgaaat ttgtgtaac agaacataat taactatgtt tttcctgtat gtcaccaaag 182880
 gacacacgtc acaaatataa tgatttgaca tgtttccttt ttttaattaa gtttttgag 182940
 ttgtaagatt gcgattctag accagactta agaagtgttt catattgtca gattctctat 183000
 tcttaactgt gttatttga aaacagcatg aggtaggttg ttgcagcagc tttttggcta 183060
 gcatttgagg ttttgtcaat ttatTTTctgc tttaaaacag ctaactaatta tgggtcctgc 183120
 tcagtgaggg ggtgactact tgcattgatt aaaactttt atttactcat ttgtcccttg 183180

aggtaaaggc attcattata ggcccctccc tgaatTTtag ggaaaaaaca tacaactTTT 183240

 tgatatatat atatatatat ctgaagTTtg tgggTTTgTT tgctTTTtat cctTTgTTta 183300
 TTTTatTTTt attgcattgg tGTTtgcatg tattTctgtg tgaaagcgtc agatcttggA 183360
 gtacataca gttattagct aatatgtggg tGctggggat tgaatctggg tctctggaa 183420
 gagcaatcag tGctcttaac ctctgagcca tctcttcagc ctgTTTtGTT tGTTTtGTT 183480
 TTTTgTTTg TTTTttatc taccaaaagt tTctaaagta tgagaaggaa aaatagcaga 183540
 acataaattt cctTTtccag attacattat tcccagcact cctcttcaaA actgcatttc 183600
 cagagtaatc ctggTTTcca ggattccaag atctctccag agagccctca gagaaggTTg 183660

 agtgccacca tcagagagtG gttgtgattc agaagaaata aaccagagct tgtaattctc 183720
 cattttaggc agtagtaatt ctcttaactg gccagtcttc aagaaaatgt gtgtgtattt 183780
 tgggtgctgg atatgcagtt tagtaataga gtgTTTgtcg tGctccatt tggTctaat 183840
 cctattgcc agactTTTga aaatatatat tttatggctg gaaaggcaac ccagtggTTa 183900
 agagcgttG ttgcgTTTc agagaacctA agtatgatgt acagtaccaa tagtaactcc 183960
 agctacagga catgtgcact tacataccca aacacaaaaA cacaattaaa aataaaagac 184020
 atcttgaaaa aaaaagaaaa atgtatattt ttaaattctg tGttcaacaA acctttattg 184080

 tGctctgtat catcaggcca cggaagtagc taagacacag tccctttaaG aagattggca 184140
 tcttctttg gaagaaacag atcaaccaat aacttatata aaaatgcccc tttgctactt 184200
 tgatgtcatt ttacttgtg tagagggaga aagcaaagag ggctTTTtGt ctgcaagagt 184260
 tGttgagatg ctaatctctg taggtagggc tcagcagatg ggaaaactgc ctctttcttt 184320
 tcaaggccaa ctgcccctg ctgcagcgag aactgctgca ttgtgcccgg gctgccaagc 184380
 agaccccatc ccagtacttg gctcagcacg agcacctct gctcaatacc agtatcgcat 184440
 ctctgctga ctctctgaa ctgcttatgg aggttcatgg aaatggaaag aggcccagtc 184500

 ctgaaaggTg agcagagaag agatctgttc tattttcccg gagctactct ttgctttaaA 184560
 agaaaggagg tttggttggT ggtttgtagg cagatacatg tcttagactt tccaagatta 184620
 gcttcccttt gtcccagTga ctgttcaggt aactaactgc acattcctgt tgagaagttc 184680
 tGccctggag tttagacatg aagactcagc tctgtgatt gtccagtccc ttcagccaat 184740
 gacaagtctt aggttatgat tgtgaagaag caatatatg aacaatagaa agattactac 184800
 agttgaagct gagtgactaa aaccctacc aagtcataga ggctgTTTc tTcccagtag 184860
 ctgacctcta taatgacaga tttgaccttc agcattccta aacctgtca aacctgtcc 184920

cattcagttt ctctgtcct gtgtcatgat tagatggttc tgctttctgg acctctcttc 184980
 ttcacactgg aataaacaaa catttacata ttgtttctgg cccctgaaga cagttcggtt 185040
 catgcctctt gttaagccat tcttgagctg ggtacgggaa cacacaccag aagtcacagc 185100
 tattgcagag gcaactgaagt cagatctctg aagtttggct gacgaccagc ctgagiatca 185160
 tactgactta agggctgatg gtctaccagt atgaagcatg tgtgtagcat gtgggctgca 185220
 gcaccaaaaa tcaataacca ttctttgaag acttctctgct ttgtaaagta catagtatgt 185280
 gaaggttggg ttcctatga ggtgagttgc tgggaagaag ctgctgtcct gagacttgg 185340

 cgggatgtga catgagcact tcttgatagg cacctataag cacttctgat tcttctgcag 185400
 gaggggaagag aatagttttg aaagagatac aattgcttct gaaccacctg ccaagagagt 185460
 gtgtactatc agccctgctc cccggcacag tctgcctc actgtgcccc tcatgaatcc 185520
 tggggccag ttccatccca ctccaccacc tcttcagcac tatactttag aagacattgc 185580
 aacttctcac ctgtatcggg aaccaacaa gatgctagaa caccgagaag ttcgtgagag 185640
 gcaccacaat ctcagtaagt ggtcgcagca gcatgacaat gctttaatct ggagggaatc 185700
 atgggttgc tctattcag tgaagagccc agtaatatca tgattgcctt tttctgttaa 185760

 gatgatgttg tgcagctgga cgtagttcca catgcctgta attccaacat tatagaggct 185820
 ggagtttgat gatcagctca gggtcacct catcctcata aggagtttga ggctagcctg 185880
 tgctatagac cccccaaaa aagaggactg ggcatggtgg catacatatt agcagtcagg 185940
 aaaatagcgt ggtttacacg agtctcaggc cagtaagagt tgctttgact ctatgtgtgt 186000
 aatctgatgg aaattgctta gcctcttgag cctgagagtg ataactttt ttttttttt 186060
 ttttgccatt tttctttatt gagctataca tttctccac tccccttcac tctcctcctc 186120
 tccccttcca tttcttccc aatactcagg agatcttgc tatttccct tctaggtgg 186180

 atccatgtat ctctcttagg gtctctatg ttttctgggg ttgtggcctg taggttggtt 186240
 gtcttttgc ctatgtctaa tatccactta tgagtgagta catattatat ttgtctttct 186300
 gggctctgggt tacctcactt aggatggctc ctcttagttc agtccattg cctgcagatt 186360
 tcaagatgct atttttttt ttttttttt ttttttttt cccactgagt agtctccatt 186420
 gtgtaaatgt accacatttt ccttatccat tctttggttg atgagtacta ggttgattcc 186480
 aggttctggc tattatgagt aatgtgctgt gaacatagtt gagcaaatgt ccttghtaatg 186540
 tgagtttgca tctttgggt atatgctcaa aagtggatt gctgggtctt gaggtaggtt 186600

 gattcccagt tttctgagaa actaatatac tgatttcaa agtgactgta caagtttgca 186660
 ctcccaccag cagtagagga gagttccct tctccacat tctccagctt aagcagtcac 186720
 cagagctttt aatcttgccc attctgacag gtgtaagatg gtatctcaga gttgttttga 186780

ttcgcatttc ccigatgact aaggatgttg agcatttcct aagtgtcttt cccccatttg 186840
 agattcctct gttgagagag ttctcttttt agattatttg gtccttggat gtctagtttc 186900
 ttgagttctt tgtatatttt gaagatcagc cctctgtcag atatgggttg gtaaagctct 186960
 tttccattc tgiaggcaac tggtttgttt tgttgactgt gtcctttgct ttattggagc 187020

 ttctcagttt caggaggttc catttattta ttgttgctct cagtgtctat gcagctggta 187080
 ttataattag gaagtagtct cctgtgccaa tgtactcaag gcttcttccc actttctctt 187140
 ctatgatgtt tgatgtggtt ggttttatgt tgaggtcttt gatcattttg gacttgagtt 187200
 ttgtgcattg cgatagatag ggatctattt gcattctctc tcatgtcaac atccagttat 187260
 gccagcacca tcgttgaag atgctttctt tttccattt tataattttt gctttgtcaa 187320
 aaataaggtg ttcataaatg tgtggatac aaggtcttcg atttgattcc attggtccac 187380
 ctatctgttt tttatgcca taccatctg ttttcattat tgtagctctc tatatagtag 187440

 agtttgaat caggtatggt gctgcctaca gaattccttt attgtacata attgctctgg 187500
 ctatcttgc ttttttttt tttttttcc tnatgaagt tgagtattgt cctttcaagg 187560
 tctgtgaaaa attgtgctgg gattttgatg ggtattgcat tgaatctata aattgctttt 187620
 ggtgagattg ccatttttac ctgttaaac ctgcctatcc aagaacatgg gagatctttc 187680
 catgttgtga tgccttctc aatttcttc tcaaaagact taaagtctt gtcatacagt 187740
 tcttgaaggt aataactct gaaatgaatg aagatagtat taccatctc gctttttgt 187800
 taggtttgaa atgcctgaag cataggcctg tgtaactatt aaatttaaga ataaactc 187860

 ccattttaa aaccacagt cctaatttga gatcagtttt tgaaaagagc tttttgtcac 187920
 attctctttt gtaaatgaat ctttagagtt taactcctca gtatcaatca ggcagggaaa 187980
 taaacaaaga aacaaataa tgaaggctgc cgtcttgatg ggtttctggt gcattccatt 188040
 tgttaggggt acctggtaga aaacacatta actttttccc atttggacct aagctgacta 188100
 gcattttccc aaggcaaaaa cctcaccagg gcctcatggt ttatgcaatt ctactgaat 188160
 ggtaaaggcc atgagagcat tgtctccata ctttactga gtctcageta ccacaaatta 188220
 tttgatttag tctttccaga aggtctggac agtcattaat tcttcatac agaaaggatc 188280

 aaagcaactg tggccagigt cacataacta atgagtggcc ttgacaagat tcagttccta 188340
 agctgectga tgttgaggtt ggctacattg gcaacatgtg gtgatacata ccattcttag 188400
 tgccttcca tactgtctca tgccttttgt ttagcttggg ggtcatcaag atggctcagt 188460
 gaaaaaagt cacttgccat gtaagcctgg gtcttgagtt tgatgcctga agagaattca 188520
 ctccataaag ttgttctctg acctccatgt gtcacatag tcaacatcat catacacata 188580
 cagacacaga caataataac attaaattcg ttttcagaac tagtcttgct attgattttt 188640

ttctcttca tacacagttt ctgtccattt gagaaagaag aatggtgaaa gctaggtgtg 188700

 gggtttgaaa gaaatggcc cccaaaggga gtggtactgt taggaatgtg gccttgttgg 188760
 agaaagtatg tcaactgtgtg ggcaggcatt gaggtctctt ttgttcaaag attccctcag 188820
 tgtgactgtc agttgacttc tgtggcctgt atatcaagat gcagtcagca tgcagctctgc 188880
 ctgcatgcag tcttctccc cactatgatg ataacggact gaacttttga aactgtgagt 188940
 gatccacca attaaatatt ttctttataa gaattgacgt ggtcatgtca attgctctgc 189000
 acagcaataa aaacctaaag gcagtaggta taaatgtatt ttgttaaatt ttacttgtat 189060
 ctctaatagt ttaggaaaa ctatgtatct acatctggaa ttgtactttg agattgttgg 189120

 tcacctacca tgtttaattc accaggttca tcaaagattc ctttgttttc cttagaccta 189180
 ttaggaaatg tctgccctat tatactggtc catattcacc aatctatcac atgccctcc 189240
 ccctaatega atcagtaata agtccactcc cctttactcg cctgaaatga aatctgtggg 189300
 cacaatctat agcctacctt atatctctaa atttaggatc tatagtctat ccaaaatata 189360
 aaaaagtatt tacaataaaa tgtagtagtg cttagacatt agaagatagc aatgaaagat 189420
 agtgtttagg gtgtagctca gtggtaaagc aaacttgcatt gtgatagagt taaaggtgtg 189480
 cgctacaaca cttcttagtc agggttccct tgctgtgaag agacactggc cacagcagct 189540

 cttataaaaag aaagtcttta attggggcctt gcttgcagtt ttagctgttt ggttccatta 189600
 tcagcacagc aaaaagcatg gcagcatgca ggctaacatg gtgctgagag gcctatatct 189660
 ggatctgaag gcagcaggaa gggagagaga gccactgggc ctgactttgc tgtttgaaac 189720
 ctcaaagtec attccccagt gacacacct ctaatecttt gaagtagtac cactcactct 189780
 ctggtgacta aacattcaaa tacgtgagct tgttgggcc cttcttattc aagccaccaa 189840
 cagagtactt ctgatatttt atttccagg atgttgata tgaaaggctt atgtgaacaa 189900
 aggaaaaggg catageccct aataacttag aagatttgc atccttagaa ggtgtttatg 189960

 ctctgtctgt acttctttt ctgatatgac ctgttgtgtt tgttttctt ttgggatttg 190020
 tctttacaac tgaattgata agagtttggg agttgtgccc caaaagtctt gggaatggaa 190080
 cccaggctct agtgcattct aggtaaacat tctgtcactg agctgtactt ctagtccctg 190140
 gagttatttg atctgaatac taactcttta ttggttaaca ttaatggttg tgcattttt 190200
 gtgggtctca caccaggtat ggtaacttac tcccttggta gtgtgctcta agttgacata 190260
 actgtgttgt gtacacttga tagaattcag ttgctctgca ttctttaaat ataatttctt 190320
 gtttctaata gatctgaatg gaggctatca agatgagttg gtagaccacc gtctgacaga 190380

aagggaatgg gctgatgaat ggaaacatct tgaccatgta agaatctcag catgtttaat 190440
ttccctaagt ccttattact tttaaatctt tatagtttgt tttgcttttt gtttgtttgg 190500
gtttgtcgtg tatctgtgtg cacatgaaca tttgcatgca tgcacatttg tggacatgcc 190560
atgacttgaa tggaggagatt cagaagaaac tatttggctt tgttccttag cagaaaggct 190620
cctttacatt cttaacatg ttgcctgccc acttttgttt ttactttcct attcaggcat 190680
gcaccactgc atccagctct tttaattctt attgctacca gtagttcatg tgtgcttgaa 190740
gtgaacatga cttttgaaca gaagttgatt tgttcaccac ttctcaggtg aagagctgca 190800

cagtcactcc cagatcttgg tggtagactg gtcctccag ttctaaaac aggtagtctg 190860
ggaatagatg gttaaagcaa agattccagt tttgccactt gttgcctttg tgagctcaat 190920
aaattactct acctctttta gccttgattt ttttccttt aaaaataagg ttcagtata 190980
tggctctgtg ggcaaggca ctttgccata gtttgattcc caggactcac atggtgggtg 191040
ggggagaacc aactcttcac aagtgtcct ctgactttgc tcatgggcct tggaatgtgc 191100
acatgaagac acataaacac accactaaaa ttaagtaatc tttctcctct ttcaaaaaa 191160
aaaaaaaaa aaaagctggg cgttgggggc gcatgccttt aatcccagca ctggggaggc 191220

agaggcaggc ggatctctgt gagttcgagg ccagcctggt ctccagagcg agtgccagga 191280
taggctccaa agctacacag agaaacctg tctcaaaaa aaaaaaaaa gaagaagaag 191340
aagaaggct gataagggtg cttagtgggt aagagcactg gctgctcttc cagaggtcct 191400
gaattcaatt ctgagcaacc acatggtggc tcacaacat ctgtaatgag atctggtgcc 191460
ctcttctggc ctgcaggaat acatgaagac aaaacactgt atgcataata aataaatctt 191520
tgaaaggaag gaaggaagga aggaaggaag gaaggaagga aggaaggcac tgccattatt 191580
tgtaataaca cataaagtgt ttattatgga gtgtggcaca catggaaagt taacaaatc 191640

caagttagaa ttagtatgct gttctctttc ccatcagaga agagcatctc ttctcctga 191700
aaataggcag tgctacttg aaaattgcat attgtggttt acttcagata ttattactgt 191760
tactatcate atttgacct ggtccttacc tagggggtaa tgtattcatg tgtgtgtgtg 191820
tgtgtgcatg catttgtctg tcacagagac agccccagat tgtattatta tagaaacatc 191880
tagctttatc taatgatacc aggtattcaa gcctggtgaa aaattctaac treactgagct 191940
gttagcttac agaccagcag tttttctcat atatatatat ataaaataaa cgattatfff 192000
gtgtatgtag ttgtggtggt ggtatgttgt gccacaatga gtattcagga ttcagttctc 192060

tccttctacc ttgtaatttc cagagggtag caagtattcc ttacctcttg agccatgctg 192120
gcctgataa agactttttt aaagtcacat aagtatgtgg gtagatgtgc acaggatata 192180
tgtaaatgcc acacctttta tataaggga ttggagcact tgtgacttct agtgttctctg 192240

gaaggttcta gaaccaatac ctctgtagtt gtcccaaccc ttgggacagc agtctagggc 192300
 aagatatcca gtgggggaat ggtgacaaga gatgcaagag aatgaccaca agacaggatt 192360
 ttgatcaagt ggcaactttt attttttcca ggctagctta tatagtcagt agtatagggt 192420
 aaaggggagg gggagaagag gcctagagtc aggtgttagt tcaagcagga tgttagaaaa 192480

 ttatagaagg aggatattgg caggtaata agttcatggg tgggtgggag agggaggttt 192540
 acttaggtca gtggttggga cttgggaggg ttgcttaggt aagtgggcct gtggttagaa 192600
 caaagggttt gacgtctgga tcatgttgtt ccttctgggt gctcatgctt ctagaagcca 192660
 tttataatca aaagatagtt ctataaccgt gtggcgtgcc aagtttgcc taaaggttta 192720
 tgccaagctg tatggctccc aacataccct catggatagg aaaagatagc tgtatatata 192780
 aaataaaaag atataaaaagg gactcagtgg ttaggagcac ttgctgttct tgcagaagat 192840
 ccaggtctgc ttctcagcat ccacatggca gctcacaacc atcagtaact ctagtccag 192900

 gggatcctgt tcctcttct catctctgtg ggcaacacat aggcacatgc atttgtcag 192960
 accaaatact agcatgcata aaataaatta attttaaaaa gcaaggaata agaatgactt 193020
 tcaaagttaa cttttattcc taagttata aaatctgtga gtctccccct cccgctccc 193080
 agtggtttgt ccatcctga tcttactgt gccttgttta agtgtctcat ctctgcctca 193140
 ctttctctct ggctcaggcc ctgaattgca ttatggaaat ggtagagaaa acgaggcgg 193200
 ccatggcagt tctgaggcgc tgtcaggaat ctgatctga agaactcaac tattggaaaa 193260
 ggcgatttaa tgaaaacaca gagatagga aatctgggac tgagctagtc tccagacagc 193320

 acagccctgg gagtacagat tctctcagca acggttaagga tagaaagagg taccctagaa 193380
 ggaacagcaa ctttcattcc acttaaacat cagatagatc taagttcatt gttattctga 193440
 agcgttgtt tggtttgttt ttgagaatc ttactatgta gcttagacta gcccacatct 193500
 ctgctcag tttctcaagt gctgggatta aaggtgtgca ccacatgcc taactacatc 193560
 tatttagttg tglatgtgta ttgtgtgcc atgtttatgg aggggtgttg ttatttcac 193620
 ccacatatt ggttctaggg attaaacttc ttttttttt ttttttttt taaactggta 193680
 tgtgtgttg gggatgtcag aggacaactt acaatattca atattcttta tacacatgt 193740

 ggtttccagg gattgaactc tggctcttat cctctactac aaaggccgtt acctattgag 193800
 cctgacttct cctgccaca ttacatgcaa gtttgcaagc ctcaggttct tctattcatg 193860
 ttctgatctg ctgaatatca accatgcttc ccataattcc ctcttaggt ttgattgatt 193920
 tgctcaagct gctcacaggc tcaggaacc aagcttatct gttfacaat gacacacatg 193980
 aagagataca aagcacaagg tctaggggaa ggaacacagg gcttctctgg acctgccaca 194040
 ctcagaaatt gcacattca gctaaccagc tttctgaatc ctgtcccttg tggactcatt 194100

gcagttgaat tacagtagac tggatgggga agtcaaggaa ggcttgtgtg catcagtgct 194160

gttctgcagc actccttgtc taggtgatgg gggagaccca ccagtatagt atagtatcag 194220

acaagggtac attcaaacag ttttgttact ttagggttta gttttattgt gtgttttctg 194280

agatgcgttc tcaactctga atctaggctg acctcagact tgcacagacc ctgccttagg 194340

tgagattaca gcatgaacaa tcagcaaatc ctatggtttt gttatggcca gtcccaatgt 194400

agaaagcttt ggttggggga ggggggtgaa ggcaagagta agaggaggag aaattcaggc 194460

ttgtatggcc tccagtggag gaattgttag ccagaaacaa tgatgacatc taaactttgg 194520

tgactggggt gttgcttaat gatgagtatt tgcctgtctt gacctgagtt cagcatagca 194580

atagcagaga tcagcaaggg agaaagaaaa gagtaccagt tatgtatata acatctaac 194640

tagatacttt gatggctgca ctcaccata tcttcttga tggattcac cccactttgc 194700

tttctttcct caattaactc ccacttctg gtgcttctc tcaaaagatt agcttaggca 194760

aaactgggtt gcacatcttg atgcagcaga gatgagctta tatccaggaa gctagagtta 194820

tccccagaa tgttccatca cttttacca gaagctgaaa aggtgcccta tccaaaggca 194880

cagctgaatg acaggeccatc tgtgatcaca ctctctccac ccaccactt aaagtccca 194940

aatgttcac aaagagaatg aatttcttct tatgacagtg ctagcgtttt tcatagaaga 195000

cagctgttag tctcaaaagg actggaagag aattttgagg aaatgccagc attaataatg 195060

tgtgtcctat cctaaatagc taagggttac cactttctcc tttaatgac aggcgtggct 195120

cttgagccag tcatcaattg gcaccattt atataggata tctagtatat caagaaacaa 195180

tttacaatcg agcacacagc tttgatitaa aacgtcaaaa aacaaatgag gctaatctc 195240

gggtcactct aacaaatctg aaccttaaca aatattcctt aaagcaactt agagatcctt 195300

gactaaagat caacatccac agtcatacat tcttccatg agtatgcatg tgtgccgctg 195360

gggtggcaga gtgcaggcca gcagcactca gtaaaactct gctgtgctct gtacaaacca 195420

ctctaacttg agggcttagc agggacgacc catattgtct ggtgtgtcta ggacggtttt 195480

tattatTTTT atggtccatc aaagtcatta caagcacctc tctttcaaga tgaagacaat 195540

ttgatgaatt ctagtactc tagatttagt gtttcacgga ctctattaa gagtctgaga 195600

acattgccag cctgtctgat ttcagttgta tcatttgtct gggatacagt ttagttgaca 195660

tagtgtttac ttaacaggca ctaagccctg ggcttagtcc ctagcaccac aaaaactggg 195720

tgtggcttta gggcacactg tgcttacaac aagagtttca aaagttaatt gctagictga 195780

acttcatgaa accctgtctg aaaggaagga gaggaagaga agagaaaatg gcagggttaag 195840

ggctagagga atggctcagc agttaaanaat actaaatact tttccagggg gcaggacttt 195900
 aggtggctca caaccatttt tttttttttt tttttttttt tttgagacag ggtttctctg 195960
 tgtaggtttg gagcctatcc tggctcgctc tgtagaccag gctggtttgg aactcacaga 196020
 gatccgcctg ccctgcctc ccgagtgatg ggattaaagg cgtgcgccac caacgccag 196080
 ctttcaccac ttttaacttc agcttcagga aatctgacct acctaagcag ggcactcatg 196140
 cagactcaaa ttcatacaca tgtagtcaaga ctttttgcg ggaccattgg ctccccaata 196200
 atgatacaca gacttatgaa ttataaaaagc ttggcctata gcttaggttt gtcccactag 196260

 ctcttataac ttaaattaat ccatttctat tcatctacat gttgccacat gactcgtggc 196320
 ttttacctgt ccigcatgtt ttgctccctc tccgtctgaa tggcaactcc acctttcttc 196380
 ttcccagcac tcaatctgtt cagaagtccc tgctatacct cctgcctagc tattgactgt 196440
 accagtcaaga tagacgcac ttcacatggt gtaaaggaat attccacaat acaacacaca 196500
 cttaatgaaa atcaattata aatcttttgt ttgttttggg tttttagat ggagtttctc 196560
 tgtgtagcct tggatgctct ggaacttgct ctgtagacca ggctggcctc aaactcacag 196620
 agatttgctt gcctctgctt gttgagcaact aggattaaag gtgtacatca ccaactccag 196680

 gctaaatata aatcaagaaa aagaaaaata caggattggg tatgagtggc aatgcctctc 196740
 ctaaataag gaatggggta tttatatcat acagtattta aacatactaa ataatgtgtt 196800
 tctagataaa tagggtttat ttctctttca gtgtgtgtca gttttagaag gaaagcagaa 196860
 ttcacagggg ggactaaact gttgcaactgg agtgtattga gtgtattggt tgctttaaga 196920
 aagtctttgg ctggcatggt atatgacttt taatcccagc actctggagg cagcagagga 196980
 cagcctagtc tacatagaga gttctaggac attcaggatt acatagacct tgtctcaaaa 197040
 aaaacttttt aaattttttg tttttttaa aaaacgtgtg tgattgcttt tatgcctgcc 197100

 gggatatatg agggggggga ggggtacatg tctataaatt acctgtggag gtcaaaagaac 197160
 aatttctgag agttgattct cctttatttg ggctccattg atctaacttg gtttatcaag 197220
 cttgcatggc aggcagttac ctattgagcc atctctctat cacctttttt gtgtatgtga 197280
 cagggcctct tgcgtgtgaa accagttgat ttttttaagt gctacttttg tttgttttga 197340
 ttttgagaga ggtctctctg tgtagctcta gctagtctag aacttggtat gtagcccagg 197400
 ctggcttcaa actcaaattg atctgcctgc ctctccctcc ttcattgctgg aatttacaag 197460
 tgtacactac catgccaat taaatgctat ttacaagta attgcactat gaaaggtcat 197520

 atgcaacagc actctgaaag ctgaggcagg aggattttaa atttgaggcc ctctgagtt 197580
 gtgacatact aaaactttat ccctactcc aaaaaagccc agatcatata atgcaaaaag 197640
 ataaaattgt agaanaactt tctctctctt atttttctta tagattttct tatagggtca 197700

cttactaaca aattaatggt gtcttacaat tttttctatg ttcataatga acagagtcc 197760
 cccagttttt tattttgaca ttttcagtct aaatttggtta gcaaggccta taatcccagt 197820
 tactagagag gcaaaagcaa gaagatgagt ccaaagcttg cctgagctac agttcaaggg 197880
 cagcctgagt aacatgggaa cacttttttc taaaagtaac aaaagtgagc ctgggacttg 197940

 atctctagtc aagttacact gaattcatgt atataatgtc ccaagtttta tatggcccac 198000
 tggtagacce acccatttat catgaacaag ggcctagggt tgatccccag caccacaaaa 198060
 aatttatgct tacctactta aatataaagt tgagtatact gtttcataat ctgaagctag 198120
 ctcttattct gaatatgttt tgcattaaat aagcatacag gtttagatct aggttgtaaa 198180
 tgagaagtct gataagaaat tttgtgtcag ggttagagat tattcttaga gcatttgctt 198240
 agcttctata agaacttggg ttttaagtac tgggtaaaga aagcttctga ccccttgctc 198300
 tttatctctt atgtagattc tcaacgggaa ttcaccagta gaccaggaac aggatatgtg 198360

 cctgtggagt ttggaagaa aacaggtgtg tatctgtctg ttggaagca gtctgttctt 198420
 actagtttat gcaagttggg aaccatata ctagggaag gttcataacc agcttttaag 198480
 ttgtctacaa tgcctcctc atggaattgt tgccttetat tctccctctg getcgtctgc 198540
 acgtctcctg gactgaattg cctgctgat ccttggcagg tcaggagttt cgaatgggtc 198600
 cctctgggcc ttttaacgcc cttctacagg ctccattga aacatgaagt acctagctct 198660
 tctttcattt tgacaaaagt tgaatttatt tctgcttggg ctctttgctg atateact 198720
 gtgtctacat tgcacaaca tttgtgtaat tttgattttt ttttttttaa gttttcttgt 198780

 ttgggaagca gaaatagaag acttgccaaa agtttgaggc tagcctaggt tatatagtga 198840
 gaacttacta accctgcctc ctgaaacct actaccctcc aatgttggg gttgggaggg 198900
 aaaagatttc tctgccagt gattttactg ttgctttctt ccagaagaag ctgtgaataa 198960
 ggtgaaaatt caggccatgt cagaggtaca aaaggctgta gctgaggcag agcaaaaagc 199020
 ctttgaagtg attgcaaccg agagagctcg aatggagcaa accatagcgg atgtcaaaag 199080
 gcaggctgca gaagatgctt tcttggtcat caatgagcaa gaagagtcca cagaggtcag 199140
 agctatgctg ggctctgggc tgggctgggc tgggtggctg aaggggagca agcccatg 199200

 ttgctgctga ggtgctgggt ccaaagagtc cactagatga tgggagtttt agctaatacc 199260
 agacgacttt tttcttgatt gaagatacac caaataata aatcattttt ttggaatcat 199320
 tatagtctat cacatactca caatatattg cttcagcttc catgaaggca gaggtttgtc 199380
 ccagctgtag ttgtagtggg ctcatgtgtg gcagacagat acctagctat gtatgtatac 199440
 ttccttttaa tctcacagt aatctcatta ttagatgtt gattctcagt ttatagaagt 199500
 gacagataga tagactgcc aatgcctat ccagggccca aaattgggtg atgcttcaat 199560

acaatgaaaa atccaagtgg acacaatggt tacacacctg taatcctagc atttaggagg 199620

ctgaggcccc agaatttaga gttcaagatg agcctgatac acatagggga agatgggtca 199680

caaagacaaa aaataaaaat aaaaaattct ccaaccacc acccatctct cagtactggg 199740

cattaaattt atggccttgg gtatatttgg catcccaatc ttttcttgtt ttattttaag 199800

acatggtctc actgagttga taaactcagc ctctagagga gatgggactg tagatacatg 199860

tgttcagccc tagcactaga atatttgaat tcagtgaatt ttgttttatt tttttgcata 199920

taggatctct ctgtgtagcc ctgactattc tgaacttgc tatgcagatt aggctggcct 199980

caaactcaga gagatctgcc tgcctccaag tgttaggatc aaagatgtac gccaccactc 200040

actcccagcc tgiaacttcc atttagtctt gtcctttttg ttgttgtttt ttgttttttg 200100

ggtttttttt ttttgttttt gtttagtttt ttggtttttt tgaaggatgg tagatttttg 200160

agacaggatc tttttatagc ccagctcggc ctggctactat gcaatcctag ttgttatggg 200220

gagatcagtc cttttgcctc agtctcctca gtgcagagat ttatagatgt gcgccatcat 200280

gccaaccttc tcatgttagt cattctttag gtttaaaata taattttaag cagcaaaacta 200340

aaagtagtct gcaggtgaga tgaatgccag catggatcct ggcaaatttg cacttcaaaa 200400

ggaagaacag acatcttaag cttttgggtga gtttgcagtg gaccagaaac gctgattctc 200460

gtgcatttca agaaatactg ctaggtaa at agcagtttct ccatctcgtg agaagctgtg 200520

tggcacagga gaagcatgct actcctacct tctcttcaca ctgacttacc attaaggatc 200580

agttttctct acagagggta caactgctct gtccttttgg cctgataaat ttaggaaga 200640

taaactgagt ttacatatga tactattcag tgggtgtgtaa actacagcag ctcttactct 200700

tggctgcata gccctaggcc tgggttgcct tctctacctg gaaggttttt ttgtttgatt 200760

ttcttgagat agggtttctt ttttagcttg gctgtcctgg aacttgcctc ctgaccagg 200820

cttgccttga actcgcaggg atgcacctgc ctctgtctcc tgagtgtctg gatcaaaggc 200880

atgtaccatc accatctagc actctgcctg gaatggaggg ggggggagtg tcatctctct 200940

aacgaggcat gttctggcca cagctccaat ttttctggca aatacaataa attagcaatt 201000

gatcatgaag tggagagtcc tttctcctgt gggccagggc tgccaaaagt tttgaattga 201060

gatccaagc ttttgacaag ccccaggtaa ttctgataga ggttacctga gatgctgaca 201120

taacagtggc ctctcttaa caaaggagat cctagaatca taatcctgac ttctctaact 201180

agtgactcag gaggtttatg accttccac aataactata gaagagccaa gtctgtggct 201240

cagattttaa ggaatgctga tctgaaggtt gactaacag taaacatttt ggttttattt 201300

gggccaagg ttgttctg agatagggtc tcacagtcta ggctggcttt gaattcacta 201360
 tattccaag gcttaccta agctcctgac ttacctgctt ctgcctcca aatgcagga 201420
 ttaccctttg ttcaagaag ttgtcttact taccatattg cccaggctgg tctcaaatta 201480
 aatcttagcc tcccaggtag ctagaactac aggccagtgc cattccttca cccatgtcct 201540
 tccacactaa ccgtactata cctgcatact aggagcctat ctctgtaggc tacttacttt 201600
 gtctactat atttcacata gcatgaagat attgttgaat agtggcagtc aagatggaaa 201660
 tgttggtagc ttgtgttct gaccagggtc ttagatgttc ttggagacat ctggagttag 201720

 aggagcctg tagtagcaac ctgcataggc agctcctggc ttgttctca caagtctat 201780
 caactgttg aagtattgat ccttggcagc ctatcagact ctgagtgtg cctgaagatg 201840
 tgtaaatgta acataatgat tatgtctgtt ctctaattct gtcctatgat gctggtagtc 201900
 atggcaaggt ttactgcc ctatagtaca ctccaaga agcctgagtt aagagggatc 201960
 ttagtcttt tctgatgtgc ttgaagtaa gtctgtgtat ggagtatctg ggcttcagga 202020
 aaccaggtt ctctaggctt tgatgacatt ctgacctac cacatctggg cctcagtttt 202080
 cccatattac aatgctggga aggagccagt aggctgttt atattctggt caagcgtcct 202140

 ggttttagga agaaggctgt ctttctccc tagctagtac ttagtgcagg cttttgagat 202200
 ggaatccgc atctggtgt cctttaggc aagaaggcta gttgctctgt ccttgatagt 202260
 ttcccaaac tagaacctt caaacaagca acaaaacaaa aaacctttct ttgaccagta 202320
 ggtcctgaga gtttccgggt gtagaataat cacatgtcac tagtgattc ctcccagagg 202380
 tagcaaagga cttaggagtc agtggtaggg ctccacagcg gtagtgttt ttgattgttt 202440
 tgttttaat gctgtctttg ctcccagtca cctagagatg ttagtaagtt gtgtgtttag 202500
 tgacttgggt actgtctga tgccttctg gctgctcctt gagctcttat gttatatgat 202560

 agaattactg ttcttagctg gtactttctg ctgagcctca ggattatttg cccactctg 202620
 aataaatgta acaagcagta agaaaactcc ctgagctcca cttcaggtac ccccacagtt 202680
 cagtacctt gaccacagac tacagcttcc cctcagccca tctggaatgt gacatgacag 202740
 tgaaggaaat aggcacaggg acaaaggaag cagtagcaaa gccacctccc tettcaccca 202800
 tcctgattcc ctggcaggtt acttggggggg aaaagaaatc tgtttccta tatgccttta 202860
 aaaatatttg ttaagagatc aaatctagc cagatggtg tagcacacac cttaatctc 202920
 agcatttgaa ggcagaggca ggcagatctc tgtgagtta aggacaggtt ggtctacaga 202980

 gigagtcca gaacagccag ggctacatag agaaacctg tcggggccaa aggtggggtg 203040
 gggaggatcg aatattgca gtaaaagacg gtgaagatgg ttcctccatt ggttgcata 203100
 gaaaatgttt ggtcaagcct catgtgtgga tgtgtgtct tcagaagata gttgtgagac 203160

ccgggccagg tgacatgtgg ccatgatcct ggcatttggg agggagaagc aggaggatca 203220
 ggaattaaag gtcatcctca gaggactcac ccacaggtgt gtagctccac gacccttgtt 203280
 ctaccatgca gataacaagt gacagtggca agcctgcccc tcaagatata agcagccact 203340
 aactgatgcc tigtcttgc agaactgctg gaactgtggc cgaaaagcca gcgagacgtg 203400

 cagtggctgc aatattgctc gctactgtgg ttccttctgc cagcacaagg actgggaacg 203460
 gcaccaccgc ctctgtggcc agagtctgca tggccacagt ccccacagcc agageccggcc 203520
 actgctccct ggagggcggg gctcagccag gtctgtctgac tgcagtgtgc ccagcccagc 203580
 cctggacaag acctcagcca ccacctcagc ttcctcaaca cctgcctctg tgacagccat 203640
 cgatgccaat ggactctgag ccacagactc caccagccct gatgaccact ccacatggca 203700
 gaatgcttgc accagggagc tggcaattga aacaagtagc tgttgagtca tcagcaagaa 203760
 atgaattggc aggaagcatc caagaagcat tccacagctt ctctaggatt tgccacatgt 203820

 ccttgggaga actgggtgtg cattctctgc acacgaaag tagcttgagc ctctccatg 203880
 atgttctga tgtttctctt ccagctaaaa ctggcataac ctgcctctc tcagcgtaga 203940
 ccaccaggct cctccaact ccttgcatac gcagattgtc agtagtgtcc accagccacc 204000
 tgtgccccat accatccata gtagaggcat gaaggctgga agcaggctaa gggagacctt 204060
 tctcctctc gcctccaac agtttcttga gctgcatctt caccctcaga tggcactgat 204120
 cagtttaaca gactctagta gccaaaaagc agtactcagg actccttctc gagccactca 204180
 aacatgccag aaagaagcca ccacttcagt aaagtctcta gtaatggtaa aaattaaagc 204240

 agtctttccc aagcatcata gatcattttg gacaagattt tccaacctgg ccagctccat 204300
 tagcttggaa cccacctccc agctccagtg tttcacttga ttttgcttgt gcaaaaataa 204360
 tctccatcgc atggattggt ctgagagagg atgaaacct tgtgttagtc ttttctctga 204420
 gcatgctggc caaactgaaa tattgagtgc atcacctctt ggaaatgcaa aacctttgc 204480
 tgttgcttga ctgtttaaac agtcgtcttg ttccttgtgt ccttctgtct ctcactgtgc 204540
 atgtctggat cactgggggt gtctctggcc cataggttct gtttggcacc tgtcaagcta 204600
 cagtttgaac agtgctcctg atgctggtag attattcata cctggtttta tggcattaca 204660

 ccacttcatg ggtttatca ggtgaacatt ctcagcctcc ttttctatg ttatgtgttt 204720
 aatagcatcc ctacagctc agaaaggatt tgtgaagtgt gggaaccgtt ttgaaaagcc 204780
 tgaccagttt ttcttccat ctccaggggt tttccaatt acctgattct ccaaatagag 204840
 tatcatctgt acctatftaa caggctaagt actgcctctg acacctttc tactgctgtt 204900
 tgaggtttgt taggagtccc aggacctttc cctcccact cagtatcctc ctgacctgag 204960
 cagtcaatta gaatgagtca tcaacttga tctgttggct tttggaaact gtggtcacct 205020

tctgtacaat gaccacatct gaatattatt agcccttgcc ccataaaaagc atggatgtca 205080

ttgtccttgc ataatagttac agctgatttt aagatTTTTg aaaccctact tttttgaaca 205140

agaatTTTca gcttcagaaa cttagacttt taaaataatt tttcagcata caatacccaa 205200

gacctactag ttgtcagaca atctggtaca gcctggcatc cctggccaca tccccttcag 205260

cctgctgttg agtatectag ccaactaggga caactttgct ttactagta gagtcagtac 205320

cagacacaag gctgtgtcat gagaagatca caggcttctg ggaatctgag aatgtctccc 205380

ggtgtaacct gggttcgtta tttcattagt aaattggatg aacatctgag tgttaaatac 205440

ttggagccac aggactactc cagggtggtta gaatatagag ctagaactag aacactactt 205500

cttaccaggt tggagatcag ttcciacagc aaaggTTTTg gttaagggcc tggcctactt 205560

ttgtgggcta catggttgcc ctgacagatt ctgagtttct gtttttgttt gttttttgtt 205620

ttctgagaca gggtttctct gtgtggcttt ggagcctatc ctggcacttg ctctatagac 205680

cagtctggcc tcaaactcac agagatctc ctgcctctgc ctctcaagtg ctgggattaa 205740

aggcgtgtgt caccaacgcc cggcctagat tctgagttc tatagtctg tttgggaact 205800

gtttggcttc tgcctctca cagatttgc tatagacctg gacagggctg cagactagag 205860

agttcagttt tcagactgct actgtcttga cgctggctcag catcgtcttt aagtggcatc 205920

tgctgaggac tgacttttca cactccggga gctcccttcc gcacttctcc aacctcccc 205980

cagtcaggag aagcagcagc atctagggta gcagctggag tgagtcccgg ctcccactt 206040

gatttctagt ctgccaatc atacgatcca atacttgact ggaagtgaac ataaagctc 206100

cactcatcca ctctaagaaa agaagaaaca gctgagtcag gctgctcaga ggtctggact 206160

cccagcagta actatttggg gaacaaaaag atgaggctt tatcatcccc taccaggtga 206220

aagataaaat tgcagaagcc agacaacacc aaaagtagtg caactggagt tatgcaacca 206280

tccctcactc cagcaaacgg tgaagacttg gtaggtagga cgctgtggaa gttaaaggag 206340

atgtggctta tttgtagtg tggctagcat gcagaagccc tggattggat tcccagtatg 206400

acataaacca gcttatctat catctcagca ctggggagat ggaaagcagg aggacgagaa 206460

gtttaaggtc atccttaaat acatagcaat tctgaggcca acctgagtta cataaaacct 206520

atctcaaca aaagaatcac attgaagaag ggtcccttgt agctccatca gattggctca 206580

tgccagcagg tggccgtgag ggcataaaact gagtggcttt ttctgagtc actaaatcac 206640

gtgtggaac atctgcctgc ccgctcaggt ctgctcaggg cattggcagt taccttcagc 206700

agtgtggatt cttttacca tttggtcccc aggaggtgct tcacttcttg atgtcaactc 206760

tagcatcttt agcttcaga ggggatctt acattttagt ttgtatagcc ctgtcccaaa 206820
agatggaagt gaccatacc tgcttataga ggggaagac atttttctga gtggctctgg 206880
aagctatctc agcaagtatg tgaggactca acagaactgc aagtgtgat tagtggagca 206940
taaggaatga gcagatggcc atcgtcctgg aaactgcaga cgggattgtg ggttgaaaaa 207000
accattacaa ataggacaca tcttgaggc tttcttcaga actggactag aaccaaggtt 207060
tccaggctcc tggctcagaa gaccaagcca gcgtgctttg atgaatgta gctgtttgca 207120
gagaactggg tggtagcatg tttgaacaa atgtgagaaa agccagaaga aactgagctg 207180

gctagtgtgg gccaggtggc cagctgtgga agatccttga cctggcagct gcttagcaga 207240
gcctgccac tcaagtatat tccttgtaa gccaaaatgc tgaactacct gcttctgcct 207300
catgtgttga caccctttc caaagatgat ggagtaagtg tgagccagga agaagttgag 207360
atggtgggca atgatttgc cctcaatctc tccttcaca gcccaagagg taggtggtgc 207420
ttcccactca gacccatct tgtcaggcct ccagctgccc agtgtacact gtcaatgctt 207480
ataccaata gggcatgtgc agctggtgtc tgtcaggac agcccagtcc ctgccttcta 207540
gttgccaggg agaagctgca acaattgttc cagtgaatgg ttgaaagggc tgtttgatac 207600

aaggccttca ttccactct gtggctttcc aagtctctga tgaggctgca aaggctccat 207660
ccctacagaa aaccaataat gtaaatagaa agccaagctt ccaagcatgg ttgacagagg 207720
ttggtgatga atgtgaagcc acccacagga tacattttaa tctggttttt ctgtgctttg 207780
tcatttgact caataggaac ttttgtact taactctgtg cataacttat ttaatgtact 207840
gtataaatga accaaaactg ttaaacatgt atttagttt ttctacttaa agtagttaat 207900
aaagatgata tattccttt ctgactcaag ctggactagg tctgggcaag atagtatagt 207960
ggtggcaatg tgtgtccag gtggcctgtg gcgggcttta gtgtcatcgt gcaccacaca 208020

tggtgcatcc tctccatcc ccaggacttt ggtgaagggg cagcggagct gtggccaaaa 208080
gagcatgaga ttggccaaat caggaaggag gtgggctgct gaggagaaag attctagcac 208140
agaagtctct aagagcttgc aattagacc ttccatgaag ccagttgcag ccattctctc 208200
tatcccagga aggtctaagt gaccatgctg gttgcagtag attgccacca atagtgtaca 208260
gacatccttg gttcttctcc attgagtaat ttactaaga acattcagcc acggaatgtc 208320
cttaggctaa tcttttctca gcaacatttg ttattttctt acaaagtttc aacattaaca 208380
tactagagtg tigtgaaaatt ttgtcttttc tigtctagca ttaattctta atttactga 208440

tgctgtcatt ttaggctgta ctttacctca aagtctcatt cagcttact gtttgggtgc 208500
tggtgcctc tggaggacaa aatggtgct gctactctg cttccatctg agctaattcc 208560
tacctagggt gctcctctga ctgcttttgi cttttctgg tctttggcct tttctgagtc 208620

tgtctctctt tcccccccc cccccaccc atcttccaag atagggtctc tctgtaacag 208680
 ccccagctct catgaaatt gctttgcaga ccaggctagc ctcgaaactc agagatataa 208740
 ctggcatttc tgagactctc tctatcctat gagttcagat gatgatgttt tgggtacatc 208800
 agaagtttca ggagaattca ggattcagca tttttcttgt gctagactct accttgcttt 208860

 gacatccctt agacctcaag gcttagtagg ccttggcaca ctgtggaact gagtaaaacc 208920
 tgtcatcact gtcctgctt cttagctagg atactgctgt caagggatgc ccattttcag 208980
 tgcttccac acttgacagc aagtagcagt tggtagcagg gcaaagcatg caactgcctg 209040
 tgtgtctctc ctgtaacttg gggtagctagc attgcctact cactgggttg tgagggtgaa 209100
 atgtgatcgc aagagagcca agaagagcat gtggatattg tttcttaaat caatgataag 209160
 caagctgcaa ttcataagag cacggcagtt aggtttacag caagggatgg gatggggggc 209220
 agatagatct tattgggaaa gggaggttag aatagttatg gatggattgg tggggggtgt 209280

 ggaacagaag gatcaagggg agaaggatga gggagggaa actaggagag aggcagctaa 209340
 aattaagagc catttgaggg gtagtatgaa cctaaatata gtaggagctt ccaagtacat 209400
 atatgaaagt gatctaaatg aaatatcact aaataatgga gacagaacct gaactggcta 209460
 tctcatcacc aaatgaaact tatggtactg gaattgagtt gcatctaatt gagctgttgg 209520
 ccaaaggagt cccatgggaa tccccaaaca actcaggctg ttgcggagac tacagcacct 209580
 atgccaatca ttggacaggg agaagttgag ctgatggcta cgtaagagcc ttcacccta 209640
 ctggcagtgc tagcatcttt ggtacaggaa ccttctgta ctcggcatgc taacaaacga 209700

 aacaaacaac tcagctaaca accctttgat ctacagtggg gtgttaagga accacetaat 209760
 acctgacttg acttaaggtc cactccacaa gatgaaacc ataccagca ctgcttgggt 209820
 gaccaagaat ctgagattag ctaacacagg gacctggggg aaaaccaaata aaagtcacaa 209880
 caaatgatt cctaatgacc ctctctacct cagacaactt gtaacactca gecctaaca 209940
 ggatgtgtcc cctcagggt cagggaatcc catgaagagg aggccaaaag agtgcaaagg 210000
 ccagagagga tggaggacac caagaaatca aggttttcta tgtcaacatg atcaaagctc 210060
 atatgaacte agagattgaa gcagtatgca cgggtctgca ccaggtcctc tgcgatcta 210120

 ttgcagcttc cagtttagag tttttgtgat tctgagat gtgaatgagc aggtctcttg 210180
 attttcttg gctcttttc tttatgttgt tttgtccaac tcaaatgtat tagttttgtt 210240
 ttaccttatt atcccttaga accttgaacc cttgtttgtt tgtttggttt ttgagacagg 210300
 gtttctctgt gtaacagtcc tgactgtcct ggaactcact ctgtagacca gtttgacctc 210360
 tgctctgtc tttcaagtg tgggattaaa gacatgtgcc accactcctt ggctcctttt 210420
 ttgttttctt acaagaagca gaaagggagt ggatcaggtg ggaggagggt gggcaggaac 210480

tgggaggagc agaggagggg aaacggtatg ttaggggggt ctactttcaa taaagtgggg 210540

 ggcacagggg ttggaaggga gccaaacagt tatggtggca catggctgga atcccagcac 210600
 ttagaaatga ccacaggaaa attgaaagt ttaggtttata gtgagtttga agccaacctg 210660
 agctacatga gatcctgcct caaaccaggg actggagaga tgctcttcca aaggacctgg 210720
 gttcaattcc acagctcaca actgtcttta actacagtcc tagggatcca gtgcctcttt 210780
 ctgaactcta cagacaccag gcatgtgggt cacagacata catccagacc aaaaaaaaaa 210840
 aaaaaaaaaa aaacaaagaa cttctaacat ttttaagggt gtggagatgg ctcatgtggt 210900
 gagagtacta ctcttgcaag ggaccecaagt tcagttccca gcactcaact cacaacaac 210960

 tcctgagaa ccgaagattc tgacttccaa gggcacctac acacacacac acacacacac 211020
 acacacacac acacacacac acacacacac acacacaatt tttttgttgt tgttgttttg 211080
 tgtttttaat ctttggggct agagagctgg ttaagagcac ttactgtacc agaggacctg 211140
 agtggagtcc cctgcaccca ggtcaggagg ctcaaaatct ttatgggctt ttaagccggc 211200
 catggtggtt atgaggcaga ggcaggattg ccacaagttt gaggtcagtg tgctctacat 211260
 agtagatccc aggtcagtc cctctcatag tgagagtcca tctctacccc tgtcactacc 211320
 aagaaaagtg taatggcggg gttcaccta gctttggcca gacagctcct gttagcatgg 211380

 ctgtcacact ttctcccagc cagtctgac cctcgggtgc tcacctatcc ttgtctctca 211440
 catggaagct gtaggattta ttcaagtaat atctacttca agaatgactt tcctggttcc 211500
 tgggaagcaa aagcaagtg atttctgtga gtttctggct agccagggt acccctgcta 211560
 agaatgactt cttgacaacc ctactttaca gtcccctcat tatacttct caaaggctgc 211620
 atcaacagga gctaaagtg tgtgagcaat gggcactgtc cggattgctg catctggcct 211680
 gatcctaage caagccccag tcacagatgt aggcagttga ggatggtgga gttgctccta 211740
 ggtaaggagc cagaacactg gcttcaggat tcactcagcc caccacggcc tggttgctaa 211800

 cattcatta tcctagtg cctatcacaga gtagtctcc agtaacagtt gggaggtgat 211860
 gctgagtcg tgctttggc ttgctgctga aaggctgagg cagtgtttgt ctagagtagg 211920
 catcagtcg aggccaggga ggggtgacta aggcaaggga tggcccctca gcctgcatgt 211980
 gatttaggga aaggggagt catgaattgg gaggggaaa gatctcaaat gtcagaaaag 212040
 aatgctac aacagcgaag aaaataggag ccattgaagg gctctggcta aaaggatgc 212100
 ggtgaccata agaatgagca ttttagggc cccattccag tacagagtgc agcctgatga 212160
 agctgctgtg tcactgctg agctgtgtgt tgtgaagata caagacagag aagaggtggg 212220

ctgtgggagt acacatcatt aaaggcctca ctaccccgagc ctcagattcc tattgctaag 212280
 actccagatt catagcgaca ccttttggac cttgttactc caagacagca gtgcagctgc 212340
 ctgggtcctg gcctcctcca gtactctctg ttcactctct ccccttttgcg gcttttctgc 212400
 cccaccactt ccccatccac taagatcccc tgettatact tgaagagactc aaaccaagt 212460
 cctgtctcct agaggactcc cagcaggata gatactcct ccacctgcag tgcctctct 212520
 agcagttctg agccttcagc aaggagcaa ggatactcta aaatagagtt agttgcacct 212580
 ggtagcaaag gcctctaata ccagcatctc aggaggttga ggcaggggaa tcaaaagttc 212640

 aaggcctgca ttgaaaactt actgagatcc tgtcacctaa ctgaaagtta aaaccgaagt 212700
 cggacatggc agtgcacagt gaggcagaag gatcacccaa gtgtcacact gtctgcagac 212760
 taaggtaaaa catgaagagg ctgaggctgt agctctgtag aacagcgctt gtgtaacatg 212820
 tgaggtcctg gattcaatc ccagtgcttc tgaagaatac aaataatgac cccaacactt 212880
 gaaaggcaga ggcaggcaga tctcttgagt tcaagctaca tagtgaagac cctttctaaa 212940
 aacaaaagcc tcaaggccag gtctaagtgt aggcctatgt cccagcactt aggaagctga 213000
 ggcaggaaga gcttagcaaa ttcaaggctt atctgaagac cttgtgtctc tcagaagtga 213060

 actcagagtg tgaatagtca gattctgaat gttccccttc tgaggagact gcctggaac 213120
 tcgctctgta gaccagactg gcctcgaact cagagatcca cctgcctctg cctcctgagt 213180
 gttggtatta aagatgtgtg ccaccactgc ctggcggttt gaagcatctt aagataatgg 213240
 ggccaggtgt ggtggcaaga aaagcacaac ttccaagcta gcctgggcta cttacaaagt 213300
 aaaatcttgt ctcaaaaaca aagcaagggg ctggtgagat agctgtcagt aaagttttta 213360
 agaagacctg aggtcagtc ccagactctt atttttaaaa agccaggtga ggttagcccc 213420
 tcattactgg ggaagtagag acagatggat cctggggct tattggcaa ccagcaaac 213480

 ctcagcatga ttigtgtcat tgagacattg tctttaaaaa aaaaaaaaaag taccaccacc 213540
 tgaggaacca cacgtgaggt tgtcctctgg ccagtataca tacatactac acagatacac 213600
 agacagtgat gtgttttttt tccatttgtt cttctgtgga gccaaggtc tgtccactac 213660
 aagaatgtct actgcaactc atgcctgtag ttttgagagc ctgttattac tgttggtggg 213720
 gatgctgcca cacaggactg accgcaggga tcattcctcc cagactggtt ctttctctaa 213780
 ggagacactg aaaccacagt gtgggcaaca aacttctcca aggagcccca gggcccatag 213840
 ggaacagata ctggcagcac attctggagc ctgctgggtt cagatgctgg ccccaaagca 213900

 ttcaggcctc ttggttgagg ccccaaagga gaaccacaga aaagaccctg cctgcaggcc 213960
 atctctgtac tctgccagc agagatgttt tctggetat accccagcac ccagcaagga 214020
 tctggcagtc aggcacacgg ggacatgaat gaagcagctc tcagaccctg gccaccagcc 214080

ttggcttcag atctactgca gcctccagaa tgaagctctt ttaagggccc tgcctcccca 214140
 gctgcaccct ctgccttctt ccttccccct ggtctcagta tccctcttgt ttggcttccc 214200
 ttggttgact ggagtgggt atccctgccg ctcagagctt gggatcccca catgtgagac 214260
 aggtgacatc cattccatgc tcatgtgata ccatatgcct cctgtagagc atcacttgag 214320

 gagtccacat tagttacttc tcagcttctg tctgtaggag tectccgccc tgcaatggct 214380
 gctaggaagg actcctgggt atgctatttg gagacagtga tgaggacagg cttgcttggc 214440
 aggtcctggc atgagatagg tccactcagg aatccagcca agcaggctgt ttggaacacc 214500
 tggaaaggctc ttaggggta agctgagctt ggaccatata ctttctcctt tcccttccat 214560
 gcagggctct ggaagcaaga tctggggtat agccttgagc tgagaatgat gatgaagctc 214620
 cctcattctg ttaggcagct tcagcgaggg accaactgca acttcttcc ctgagtttcg 214680
 catcaatgtg gccaggaag cctggccttg ccaagagaga gaagagagac agacagacag 214740

 acagacagac agatagacag aggcaacacc acagatgacc accaacttta ttgcctctgc 214800
 ccaaattatt gctactctgc aaggtcttct tacgactctc atagtccct gagatgccga 214860
 tgggtgggt gaggtcatgc aaatgatatg caggtaacat gcaaaccaac ccaggatccc 214920
 ccagagggt ctggcacagc cactgatgct agaaattcta gggctgacc agaagggtga 214980
 tagacacca ggtttctact ctacaccaca gactatgagt tggcctagcc tcaggggtca 215040
 aggttccagg gtttgagagg ggtccctgag catcagccct ggttctgcca ctggttgagg 215100
 aagaacagaa acctaacccc agaacagcaa ggaaaagcag gacacccta ggcagccaga 215160

 gagggagggg atctgcctgg gacacagagc aaggcagaga ataaaggac cagaatctgg 215220
 acttctgag tcagtcagaa gccagggtgc ttggaagcta caaacattaa aataaacaag 215280
 caagcagccc cgtccctgat cctgtgctg acaccctcta ccagctgacc aggctaagge 215340
 ctgggaacag gcaggttct tggctttagt gtagagtgg ccaatgcagg aggctctaga 215400
 atgataggcg gggctggaga gtcaccagct taagcagacc cgactcagtt attattcaca 215460
 atccaccagg aggtgtggg tgagagattg ggggtcagg agctggggg ggtgcccct 215520
 catgggcccc agggctgttt ggagcacagg gatcacgcgc acctgggaag aacacagtgg 215580

 tgagggtgtc cgggacctgc aggtgatcaa tgagggtacg ctggaaggcc ttgctgcagg 215640
 gcgactgctg gtgctgaga gagccacaga atagacagag gctgcagcca tctgctctaa 215700
 gatcagtgct ctgggttacc caagattagt cctgctgctt ggactcagge accaatcctt 215760
 cctctactac ttttagcctc agtcttctc ctcaataaaa tgggaacaag gcacctacat 215820
 cactagactg ctgcaaggag taaatgaagg cacctagcac agggctcatcc acttgacgat 215880
 agtatatatt cattgagtgc ctctgtgca cctggcattg tattgagttt tttagagttg 215940

tgtagacag ggccttgcta tatagtccac actggcctta aatcattgat cctcctgcct 216000

 ctgccttaca acttctgggg ttttaggttt gtgccacat ggccaacttg tgttattcta 216060
 tatgtctgtt tgtctgtttg tttgtttgtt tttgagacag ggctgtgctg aatttctgt 216120
 gtagcccaat ctggccttga acttttgagc tctcttgccct ctaccttca gtgttgatat 216180
 aacaggcatg cactggatac ctaatttgca ttcatctttt acaaatcatc tcatctggga 216240
 cccagatatg ttaggtcagt tatctgaagt cacacagcca gtggacagga gagtaggact 216300
 tgaacctggt ccagacactt ccagaacca tactcagtgt cagacattaa accaccactc 216360
 accttctcca ggaggcttca tctgccaana actcatagag ggtgaaggta gcatggtcta 216420

 gcatcttctc agcagacaca ctgaagagcc aaagaggtag ccaggtttg accaccactg 216480
 cctacctgcc agtggctctg tgggagctct gcccgagta cccagccac catccctccc 216540
 tgctcacccc tcccacctc agccatctca ctgctagcc agggactcac tgcagacaat 216600
 ggctctgggc ccctgtcaag ttcatgtagc agcacagggc acggtgaaaa tccggcaggg 216660
 cgtcctttgc cacctgfact tgccctttgt ccacaaggat gtgctggcaa gagagcagct 216720
 cgtcactggg gtaggctagg cccagagtat aacttcacce ttcctaatat ggttcagatc 216780
 gccccctgtg gggggaggtc cccacagccc acaaggctc ccagcatctc tgactccatc 216840

 ctccaagcca ttgaccatit acctctctg ctaccacct cccactctgc cctctagctt 216900
 ccatccctac ttcagacctg actgtcagag agacagatcg gagaacagaa aaccaagag 216960
 ggtcacagag caagaagcag aaccagcac ctgcctacca ggtctgagta gacagccatt 217020
 accttcttc gtgagtactc cgtcccagc tcaccgagtc aggaccttg gcacagtct 217080
 ctcatgcag gggttccagc cggggtgcct gcaagggaca agaatatagg ccgagcctct 217140
 aacatgtatt ggtttgagca agtgcacag aatcccctc tcaggggcac tggccgcca 217200
 gctgcttacc ttgattcaa gctggtctat gagctcctgg aggcggttga cctgcagccg 217260

 ccaactgcagc tcagcctctg aattccacc tgacagggga ccaggaggac atcagccagg 217320
 ggcccctgaa cctgggagtc ctctcagggt aaactgggaa cagtggcaga gcaaagcctt 217380
 gagagaatag gagattcaac gtgttccccg gacctatgc agcctgtac aagcacacct 217440
 glatcgaagg atccaggaga gcagttggt gaccagctta tgcctctcag ggctctgct 217500
 cctgcccgc tgetgccag gaacctctc tgcacctca tttttcttc atccaaccta 217560
 gaaagtagaa gticatagcc tcaaggacta ggattccagc acaagaccaa gcttaggtgg 217620
 ggcaagacag gtttctggg tctctgaagc ccagccctca aaccacccat cccttctca 217680

cagctcacgg cctccctgtc caagaatgia gcctccagaa ggctgagtgg atcgtgacac 217740
 tgaggagttt ggaatgcaag aataaaaggc actcagaccc cggaccaaag gtcaacatcg 217800
 ctcacgtacc gctgaccacg ggccctgggcc tccagggtgt ctgatgcccc ctccaaggag 217860
 ctctgcaggg ctigttagctg attcacagtc tctcgaagca ggaaccgtgt gacaaactgg 217920
 tccaccttgg aggcctgttc atactcctgt gggcagggca gagaggtgtg gctgaaggag 217980
 gagcttacct tgetgtctgc ctgtgccttg cttgagagag caacagggaa tgtgaaaggt 218040
 gtagagcatg caggccctgc acaggctggt cactcacact ctagttttgt tttgagacag 218100

 agtgttacct tgtattcagg ctggccttga attcatgac ctctgccta tgettccca 218160
 gtgcctgcct tccgagggcc cccttcctgg tccaggctgg gtgtttttgt tttgttttgt 218220
 ttttcccat cctagcagat ttgaagctga gttataaggg tcacaacca ctggtacact 218280
 ggttttcctg ggtctcaatt tctctctttt gttaaggctc atcctcatct ttgccacagc 218340
 cagtgaggct cctgggcaca gccaggcagg gtaaagggtgc ggaactgtat ggccaatfff 218400
 acacttgggt caaaatgatg tgtggtatgg cctcttaccg acctgttggg cccaaactta 218460
 aatctacata tgcatttgtt tgttctttca ttattccatt caccaatctg tghtaaccaac 218520

 atttactgca tggactttgt gagacattac atatacaaga catccagggt actaaagagg 218580
 cacaacata ctccagccta cactaccage ctccccttga ttcctttaag gtaagcaggg 218640
 acagggagaa ttttgtttca tctgtggggg gatgcatttt tattttttga gacagggttt 218700
 ctctgtagtt tagagcttgt ctgtagacca gactgacctc gaactcacag agactcacct 218760
 gcctctgcct cctgagtact gggattaaag gcgtgtgcca ccaccacca gagcagagac 218820
 aggttgactg actaagcttc aggcctctgt ctgacatctt gggatactct cactcctcca 218880
 gctgcttttg ccttgtgcct ccgttttccc accgtaccga gttgaggttc ccctcggtta 218940

 ctgtctacat agggctaagc ctagtgcctg cagtcaagat tctcagteta gaaatgcaac 219000
 cactgttgtg gaacatacca ttagtaatct gccagctac acacctggac agtcaggatg 219060
 cccttagaag cccgcacccc caccacacac ccagacctaa gatgctggaa gtctctggga 219120
 gccatgaaga ccaggctcca cagcaacttc tatcatagge tcttgtctgt cacctgcctt 219180
 ggctcaacca agatggtacc ttctgaacca ggcttgtaac aaatgggaca gaatagtgcc 219240
 tgattcctgt cgtgaagttt gtgggttctg tttccatgac atctcttcag ttaacttcct 219300
 ttggaggat aaggtaactg atcagttttc tgetgtttgc aagcaaaaac cctggttggc 219360

 agaaccacce accccgtacc agcctcatcc caagaatttc atttaacat tataatttgt 219420
 aagaactata gttgattcca ctccatctct ggggccgaga gcttaaccaa ggttaagcac 219480
 ctaatcgggt gcagggcagg attcaaatca aagccacaga aattcccctc tacttacctt 219540

taagcacctt ataggtgctt tgttaaagca ctagccctgt ttcacagttg ggaattagag 219600
 accagaagag gtcatagacg gtgaatagag gccagattct caggggagga gcacagcttt 219660
 ggtgtggtga ggtcacttgt gagctcacia tgcagttcac ttagtggggc ggggccaaac 219720
 ggcacccctg ggiagagggc agggccgagg cagcatgggc agtggcctct agtgaccagt 219780

 cctaccatgg gaaacagcag ttcccacaag agaatcaaag caccagtcg gccagcaag 219840
 gacgggccgc ctgacatgga caagcccctg cacaagcagt tcttcagcca cctcaagcgg 219900
 aagaagccaa gtgtgagtat ggggatgcc gggggaggct ggatgctggg gtctccacct 219960
 ttagagccag aggcatagga ggggttagag aatctcttta gaggaggagg gtccctgaag 220020
 cccacacagg tggataaagg gaccagaag caaggctct ttttaaccag ggggcaggct 220080
 gggggccaca gacatggaat atcctttacc ccctctctcc agcccacagc ctcaaacac 220140
 atcactttcc ccttctttca atggcgagag gccctgatt ccgcccgggt gggtgagaat 220200

 ccccgatca aggtcggaa agtacgcagt ggatcggcct agggcggacg atgggttctt 220260
 gtgaggaggc aggttcccgc ccggggtgtg ggttgagcgg ccctgatgac accgtggggt 220320
 ttgggaggtt gggctctcca gatgcgcggg agtggcttca tgcctgtctc gggcgcgttc 220380
 tttccctcac aacgcgcccc ccccagacc aagatcgtac tgcttttccc gctggacaag 220440
 cggcagcagc tggccgaggc agcnnnnnnn nnnnnnnnnn nnnnnnnnnn nnnnnnnnnn 220500
 nnnnnnnnnn nnnnnnnnnn nnnnnnnnnn nnnnnnnnnn nnnnnnnnnn nnnnnnnnnn 220560
 nnnnnnnnnn nccgctgat gcgcatctgc tgacccatcg tgaggcctgc ggtgaaagcg 220620

 acccccgca ggagcagcca cgcaagcggc gccgctgccc tcgtccgagg cctgagtgc 220680
 ctggtgaggc cccagcgtc agggctctgc tcaataaaga gcacatagca acctggtcgt 220740
 ctgccactt tgcctggcc atcggatcca ggttcaaagc tgaggcccc gggtagtag 220800
 gaatgaaggg tactccaaa cctggagcta gggctgcttt tatcttatct ttgtggcaca 220860
 aaggccagct catgccagaa ccacagattt aagggtggtg gcttgagcaa tctatacttg 220920
 gcttgaggtc tccagagtc tcaacttca aaaatccctc ttagcggag ggagggtccc 220980
 aggtgctaa cagataccat accaggaaga agagtcagcc atggtggtgc ggaacctaa 221040

 attctgctg tgtaacaca ctcaagaaga gggccttgag cctctggtct ctaactcgtg 221100
 cccggcagtg ctcagtaact cccaaatatt caactccca aatgtaagg tcccttagtc 221160
 aaagcacttt cctcctgagg tacctacca gttccatcct ctaccccaca ttagccaga 221220
 agcttcttc aaaacctaa tctgtctaga gcagttcatt cccctgatc atagcccaca 221280
 ctgcttctc actaccccc aagcccagg ctaaaattgg gatgtgcagt cccagctccc 221340
 cagcctgtct tcctcagta cctctcagtg cttgctccct gctcttcac actgacatgg 221400

caccagtggc ctccaatgtc agtcttactic cttgcatcac tcctgagaga agcaacatgc 221460

tctgggcaga agcccactgc tggctttctt ggatcccaca cacggcttcc agacctaaag 221520
ctaccgtctc cagttgtagc cggctgagat aataccacca ctcaaaagga tggggtagga 221580
ggatcttgag ttcagtgcaa cagattgctt cagaaaacaa aatattctgc ctttcctact 221640
gcacactgat gaccaactca aaatgcttcc cctggggcca gtggtagcag gatgaaggtc 221700
tcagctcact agagccataa gccatggact taaggataca ttttgtcact gtccacaggc 221760
ttgaatcatg ctggaaaatg tgtgacccat gcacagcata ggtatttact tgagagctaa 221820
ttgctgtcac gtggttctct cagtaagtgc acacttggcc tacactggct ctatcatccc 221880

cttccccggg accataattg ggaactttaa gagaccttcc cagttaacca cagccctgtg 221940
gtcgaattct gttcctaagt cctatttctg ccttgtgatc cagaaaatat ccagtatccg 222000
tgtaatcctt attttagtct aaatgcatct gagtcttcta tttgcaacca atgtggtcct 222060
aaagagaata gtctgtccgg gaggtgaggc tcattgctat cttttggagg aagaaacacc 222120
agaaagatag atttggactt gcttaggttg atacctaacg ttcagaactg caggggtcag 222180
gccagacccc ctgtgtggct gtcggctaag cacaagaagt cctcattgta gctgtagatg 222240
tgtggttgaa acgtctatct ttagaactga tttagaaggg atagcgcata tgtctggagt 222300

acacagatac tccaagaatt tgggagaaaag aattagctgg ctgtgctggt ctaccaggcc 222360
tctattatgg gctcccaaat ggctgtcatc agcctggtgc gggaggaggg ggggtgagca 222420
ctgcaagact gaggtcataa tgagcccaat ctaagttcct tcttttcga accatttctt 222480
ccacctccac agccaggtaa ctctctagcc aagctaggtg acgtccaag agacttecta 222540
ggagtcccgg actctggaac cctaaggagg aattaagtac tgactaacag ggccacatcc 222600
cctctttggg gtggagccac aaaaaagaac cgctcccct aataggcggg gcctcgtagt 222660
cagaggcggg gctgagaact gagagctggt tatctgceca gaaggccac agggcttcgg 222720

ggcactga gcccagaagg tggcgtcggf gcacaggacc cggcatgtcc gcaggctgcc 222780
gtcattggac cacgttgagg tgggtgtaga ccaaggctcc ggcttcacca aggctggctt 222840
cgctggggag atccagccgc gcattatgct gaagagctcg agtctgatgc caagtggga 222900
ccggcctgtg ctgccgaag caccaggttg cgagctggcg ggcggcgtgg cgcgtgcgca 222960
ccccatcaag catggtgtgg tgggtggactg ggacgcaatg gaaggactgt gggaaacgct 223020
aatggtggga ggctgcagg tccaccaga gcagtggcct gtgctagtga gcgactcacc 223080
atcagacca ccggagggcc gagagaaggc ggccgagctg ctgttcgagg ccctgacagt 223140

gccccgctgc cacatggcca gcacggctct gctggcactc tgctccactg gagcattcag 223200
tgggctggct gtggaggccg gcgcgggctg gtgccacgcc acacccatct acgcaggtca 223260
ctcgtggcag aaggccacct tccgctgtaa cgtggcaggc agcagtctgt cgcgctactt 223320
tcgagaccta ctgatggcaa caagccctga tcttcagccg caggtctctgc cccgcaagac 223380
cgttacacat ctcaagaagc gctgctgcta tfgtcccta gatttcagg gcgatatctg 223440
taacctgcc cgcaccgga gggcctgttt ttgcctgagc aatggctgct gcgtgcacct 223500
tggcagcgag cgctttcgct gccctgaacc tctcttcag ccaagtctcc tagaccatcc 223560

tgagccagga ctgcccacat tggccttcca ggcaactgcag aagatacca taaagctgcg 223620
ggcacggctg gccaatacgg tggctctggc tgggtgttcc acccttttcc cggcctttgt 223680
ggagcgcgat aacctggagc tagaggcact gtgccagagg cttgggcacc cggccctaaa 223740
gctctgcctg gtggctcaac ctgggcgggg cacagctgtg tggactggag gttccatgat 223800
ggcctccttg cagtcctttc agtgccctg gatgactcgg gccatgtacg aggagtatgg 223860
tccttttctg gtgcgaaaag tgttcgattg agttttatat tgaagtagaa tgggtgccac 223920
caggggtact gcaggaacag aggtctgcaac tctgccctag caccgagaac cagataaaca 223980

gattgaagtg ttggagctg gcagggttat atgtggatgg gctgcccttt tcctttctg 224040
ggctaacct gaccctcatt ttgctttcat ttgaataccc aaaccaccac cagttcagag 224100
aatgtcagtc cagcagggcc aggtctaaaag aacaacactt gaaaaataa ctcttacacg 224160
agcgaactag aagccccgga cgcctaggct gtgtgctcag gtgatcctg acgttctcaa 224220
ttttcccttt cgtgtagaaa gtgagatcaa agggcagtga ctagctgtgc agtgcaaggc 224280
cttggggcct atcaagtacc aaaatgtatg atcaggtaaa gcctcagacc tgctcaccac 224340
acccccagaa gatccatgga catggggaga gggacctttt ccctctattt ttggagacgg 224400

gatctcaact atatgccag gctggcttct gtctcaagct gtectgactc ttccaaatgc 224460
tggggttaaa agtgtgaact acctctgggc agtgtgtgg tacatgcttt taatcccagc 224520
actcgggaag cggaggcagg cggatctctg tgagttcaag accagcctgg tctacagagt 224580
gagttccagg acggccaggg ctacacaaaag aaactgtctc caaaaagaaa aacatgtaag 224640
ctaccacata gtcttggcag atggttctta atacataaag ggagggtatt ttgtttgtt 224700
gtgtttgtt ttggtcacta agggctgga gctctgactg tcaaccttg tctatacatg 224760
ttgtaatata ggccaacaga catgcaggca gacacacaca cacacacaca cacacacaca 224820

cacacacaca cacacctgcc ttatcacgtg tctgaggtc aggtctgccc tcataggctc 224880
catgcacctg tggacatgca tgacctcacc tctatgtcc tagcccatgc ctgctaggtc 224940
ctggcttgac aacctcagc aattacatca ggccaacaaa aacctactat gttgcctgaa 225000

ttgttttggg tactgggaat atagcaaaga aaaaacact agatctctgc ctctcctctc 225060
 tcagcagggt ctactctag ccagctagc ctgaaactgg cagcgaatct tctgcctct 225120
 atctcctgag tattgaagat tacagtgtga gccaccataa cccacttcat tgttcattgt 225180
 cacctctggc ttatagatga ggaaaccgga ccaggagta aagggcagtc attaagtggg 225240

 aatatccgaa tctgaacca agttccattt caacagccag agccatagta ggcaagagtg 225300
 ccacagcacc aagccatctt ttcaggttcc ctataagccc ttccttgac ttaccagctt 225360
 ttagtgtcc atggcgggta gcaccgcacg gttcagtac tccagtgcag ccagcacagg 225420
 ccgatagaca cccaggtgtt tggagaaata gtctgtgggc agaacagtg ctcaggggct 225480
 ccagcccaca ccgtctctcc agcctggaat tcgccagctg cccagcctt cctacccct 225540
 aagactagcc cataaagcac cccttaccac acccacctgc ccaggggctg ggacacaagg 225600
 gccagcacag gcctactcac cacacagttt ctctgtttct aaattgctgt gagggaaaga 225660

 gaaaacatcc ttcagactct tagaacctgg gcctgaagaa ctgaacatag aagccggtgg 225720
 cccatcctt ttattcagcc tgacatggtt atctatttgg tggaggaagg ggcataggca 225780
 cttaaaggg tcagcccaag ctttgaagc ctggaatgct gacaaagtct cagctgtata 225840
 ctaaggggga gggggaggag aggggaaggg cagctgtgca tgttctggc gtgtgtccc 225900
 aagcagagaa gcaggaagg agtatccact tgaatcagat gtgtatatgt gggcacgtgg 225960
 gaagatgtgt attcctgcac ctacatccac aggcggagge agcagagccc agctgtctc 226020
 agacatctc tgcatgggaa tggaaagggt ggcacgggt ggtgactcaa gcctggttat 226080

 tctgggtcc cagctggaag cagtgtagca acaaggctgg agctgaagaa ggtgtagtg 226140
 ggtggataaa gtggcattg ggccctggcg tcttttccc caaccttct gcctccaga 226200
 aagagccatg acagcagggg acacagtggg ttggaacaat ctagccagge actgccacag 226260
 caagtactg ctctattgt actcactcgg tgagatgtcc atcgatgtg ctgaacagtt 226320
 cccgcagctc cgctgagctg agaacccat cagcaaagta attctggaat tcttcaatg 226380
 agagcttacc atcatctggg gagagacagg gcgtggagtt ggtatcctg agtcctggct 226440
 gcgtctgcc ccagatcta ggctcccaa aggcctgata gcattctcaa tcaactcagt 226500

 agatagccta ggttctgac tttagtgtg gcctgacta ttttgacaa aagtcccaa 226560
 aagtgtatgc tgaaggaac agggcccacc ttgtacaaga aatacaagcg accagccttg 226620
 gacacaccag agcatggctt gggacttaga agcacagtcc ctggccacat aaaatagcct 226680
 ttctcgggg tcacagaagc aggtgaagcc ttctaacagt ttgactctac catgcagcag 226740
 actggggaca tgtcaaaaga ggcagagaac agaggtgcag gatggttaa gatgatggga 226800
 ttcagtctgg gtgatgagca aaggtgggga ggcctgagc ctctgccaca ggatgtctta 226860

aatcaatggt cccaccagt ctgaagagg ccacaaaagg acaagtactt ggggacacaa 226920

ggaggctgaa acacacgaat ccgcaggccc agggagaata gaagtggagg ttgaatgggt 226980
gcctcaccac ctagtcagg gtctgcatcc cagacacact aattaaaggc ttagacaact 227040
ggtgtacttc ccigagcctc tattccttgt ccatgaaatg caatgaggaa tccccaccta 227100
gaaagctgtt gtaaggacat cacaaggtct tgtacaagca cccatcactg agctactgac 227160
cacttaacac aagccccac ccccaggctc gggtcaacce cattacctg cacaccatct 227220
gttctctagg caglatccct tgcttgacct ctcaaagaca tctctctagg ctgtacctcg 227280
aagtccttag ttctcttacc ctgcctcacc cccccccca atacacacac tgtgggacca 227340

aggggaagaa gccacactca ccgttcttgt ctgctcttcg gaaaacctaa gggacaaagg 227400
gaaatgagtg ggtgctgiga gtggagcctg agaggtagaa gtccccctcc caagccagtg 227460
aggccccage tggccagcca ggtcctctgc attgacttcc tctgctcag ggcagtctg 227520
caggagtctc cagcaaggaa gtacaggaag atttcacagc aagtccaac gctgactctc 227580
tctgctgca gggiggcttc acagtgggta ggtgctcctg gccagctctc tgtacctca 227640
cctccccag cctgagtca ctctgctgta acagcctttg gcatggctcc agcttgagga 227700
agcttgaca gatgggcca gatccatcct gaggagctgt ggaaacctca tcagaccgga 227760

accctactc ctctgtgtgt tgtctatag tgcacccct tttccatcca cctcactga 227820
acaggagctt cccttgtgcc tgttgaagac tggcaggcag tggctagccc tctgtgggtg 227880
ctttggttt cccagtagta gtgaggaggt agcctgagtt taaccctctc agggctgggg 227940
aagaggccat ctattgtaa agactggtca tctgtgcata cacgtttgtg tgaggggcaa 228000
ggaggatggc aagggtcagc agattttatt ttagaggca gggatgaagc agacacagca 228060
gcttccttaa gtctgcctc cctaggaact agtcttcaa agcagctgaa caaagagcat 228120
caggttcaag gtctggacag aacccccata ggccagggtc ctgaatgcta aactcttcca 228180

ccaagtccc tcagggtcac tggctaaac aactaaagta accctaacc ataggctgac 228240
tcagagaagg cctgctacta gactgggatc acgcagcagc tcagtgtggc ctggctgggg 228300
taatggggag ggcgggtgag acagaagagc taagcttggga atgaaggcac tttcatccac 228360
atcgttgtgt gccctgatt ccgtctgtga cctggaacat gtctcctctg acctgaagga 228420
ccatggtcaa gatgctgagt cactaggaca ttgaggaagg ggcatgacag cctccccac 228480
tggcaagtcc cgctggagta tgggcaggag agtgccagga ccagctgggc acattattga 228540
aaggtttaa aaaaggagg ggcggggggc tcagggcagt ggctgaggca ggtcaggatg 228600

ctctatagcc acacaagggg gcttcaatgc cacctgctgc taatgagagg cgtcctttac 228660
 caactgtaga actctgccac ccttgatca ggctgagggc ttctggggca ggacagagct 228720
 ctttctaggt ccaagctccc atgtcccac agcccagcag gggctgcaat ggagcaagca 228780
 ggtcggatgat ggctgctgtg actgagtgtt gacagcccct aagccccact ggccaaattt 228840
 ggggtggagg acggtaacac tattattgca gagacaagga gacacggagc ggcacaacgg 228900
 cacagacagt ataaggaaca caaaggcagg gggatgagaa cagcagggtc acggataatc 228960
 cgggagaggg actgaagcag aaccaacaaa tgaggagggg gagatggaga cacagaggac 229020

 cgagacctgg ggagcccctgc gcccaccac cgggtgcccta ctcacatcct ggaaaagcgc 229080
 gtgtcccga gcaggcgtgg ggtgtcgcgg aggctgagggc gcgggtggcc caagcaagca 229140
 cacagcgagc aaccagcgc acgcatggc tcagaagaag ctctgaagc tgcgggttgc 229200
 agttcccagg ccgctatgc tggctggggg cggggcgcgt gccatttgtt ccaagcgtgg 229260
 ccccccccc atctggcctc ggtttccctg cctggaagag gcttccaaaa ggggtgggat 229320
 aaggaacat ccaggggccc actggcaatg acagcctgcc agttctacag gaccaggtgc 229380
 tccacagtct ggtgtggaca aagctttaga tgcagaagcc attaactggt caaactcaca 229440

 agctcttcac ctctggatcat ctgtggagga taatgggtgc ccccccca gattgtcaaa 229500
 gggattgcag atgttcagct caaaggactc ccattgaggg tttgttaacg catgtcatga 229560
 ctttccagtc ataaccctt tctcccagat ctccagccac ctctttcagg aacctgtttt 229620
 tctcacttgc aaggcagggt taaagggagg aacacatgct gcaagtacag gacacataca 229680
 aacacacaca aaagcatcgg acacaaacac agttgactgt gtgttgcac tttactaatg 229740
 ctcagaaatg tccggaaggt gcacagcaag ccaactctaa cactcccttt tctgcaacta 229800
 ggtaaatatgc atgacttctt accagtcact gggtcatttt ctctctctca aatgggtaca 229860

 tcatagaaag gaaattaat cagataggaa aagggaatga atattccctc tgaccctagc 229920
 ctcacattgg catagagtcc caaaccagc ctaaacacca tcaaatatt tattaaaacc 229980
 aaagcaggag ggaacagaac tgttaagaaa caaagtgcag gctggagggt ggagaagaca 230040
 atggaggagc actccaacta caggagggac ccaccctcc tcttgtcca cctgtcagt 230100
 gaaggtcctc actcacttct cccatctca atccacctgg gtgcagctag ggtgctggca 230160
 caacttcta caaggggacc atttctcaa cccatccgtg gctgtcagtc tgtttccac 230220
 ctcccacttt cccaataat aaactgcagg ggcctcagct cctttggggg tggaaaaaaa 230280

 aaaaaaaaa caaacagct aggggacct gcccttgctc agagtatagg aagttggggt 230340
 attagcccaa tctcactcca acccttagct tattccccag gctggccaga ggcctcgata 230400
 aataaataaa cgctcatta aagcttcgat cgggaaacct ttaagcagtg ctattgctgc 230460

cctgcaaatg cagccagcca agctacccca cctggccagg ctgacacaca ggattctggg 230520
 agcaggcagc caccctgggc ctcaacaaggc ctctgcagca aggacaccaa aagtgcagtt 230580
 agagccccac cccccccca atgcgcacac atgaattcat gcacacatgt ggacacagca 230640
 ggatgtgtct gcagcacaca tacagatgtg ttcaccttca ttccccgta cacaacacac 230700

 acacacacac acacacacac acacacacac acacacacag aatacatccc aactacacag 230760
 tgcgcagtat ggggtgcaca tttgcgcatg cgcgcgcaca cacacacaga ccccacacaa 230820
 aatccttccc cttttgctct gctcaatctg gcagcagcca aaccccagac ccagaagcca 230880
 ctgcacagag aagagagtat aagtctgtct tttccaatga ggcaggaagg atggcccagg 230940
 gcaggaggct ccaaagctgc agacagggtg ggcatctcca gacaccctgg ctccctagac 231000
 ttctgtcaga aatccagagg ggtcaggtcc ccaaagtcac agtcaaagag atctctgatg 231060
 ccttcacctt cctcaaggcc aaagtggtag tcaaggcctt cttggggcgg ggaaaggctg 231120

 atgaactccc caggaggag ccccgagaag tcttctcga catgctccag gagtgagtcg 231180
 gcagccacca gcggtgacag atggtcttct tccatggggg ccctcaggtg gcccatccgt 231240
 gacaactctg gtcttgggga aagcatgcat tacaggttag agaaggccca gcaggaatgg 231300
 ggctgccatg actgcctgcc ccaataagca acaaaaacct acccctacct accttgctcc 231360
 aggcctagca gggactggct gggatccaag gttggggatg tggagggagg tgggtgtgga 231420
 ggccctgcag tgccagggtc agtggctctg tcttccccag aggatgtctc ctgggatggg 231480
 gtctcccag ggctgatccc ccctgcactc tcctcaggac acaggaaaac atcgatgggg 231540

 ccttgtttgc tcttaagaga gatctgaaat gtctgggtgg aggcatcagg cagggtaaac 231600
 ttaggccag gtgaccatca gccagccca cctgtcttg gtcaggcctg ggtctcagag 231660
 tctcacctcc gcagagtcca cagctttagt tgggtctca ggagggcctt tgatcactat 231720
 gaccatctgt tctgcagggt ccgctatgct acgaaggtcc tggcaggtca catagccag 231780
 ggttggggga gtcaaggacc atttgacctt tgaggagccc ctgactcagc ccacataaca 231840
 ggaccacac ctacctagtc actcctgttt ttactcttc atccaagge ctggcacaaa 231900
 gtcagtactc agagtctcat tccaagctt caactgccac atctgtacag tgggtatct 231960

 acctatcaa ttccaaacta atggctacct gtaaataact ccacataaaa tgctcaacag 232020
 atctccagge tgggagatgg aaattacttt tgacaatfff actcttaatg gtattcacta 232080
 aaaagacata ttctaatgaa gtttctttta actttcaagc tacaatcagg cactaatca 232140
 atgactaagg aaaggtttgt catcactggi aatagctttt ctcttggatg acagggtcac 232200
 actgtgtagt ccagtggcct gtgattatft gtatttagac agcctcacta catagtcttg 232260
 attggccctg attatgtggc agtgtctgcc tcatactgg tcctgggatt tcaagcacac 232320

accaccttac tgggcttttc ttctttgttt tattgagaga gggctctcatt gagtatcctt 232380

ggctagtctg gaaatatgta gacacggttg gcctgagttc agagatcttc ttgcctctgc 232440

ctcccaagtg ctgggatttt gaaggctgta cacacaccaa gccgggactt tagtgcgtgt 232500

aagtattttc ctigacatgt attctgcatg agtgttttcc tgacatgtat gtgcatctcg 232560

tttgtacctg ttaccttcag aggtcagaag agggcatcag atgcattagg actagactta 232620

cagagagctg tgagccacca ccatatggat gcaaggaatt gaacttgggt tctctgcaag 232680

agcaacaagt gctcttaact gctgagccaa ctctccagtc ctaggcttct tttaaaattt 232740

actaaaactt aatacttact ttgtgtgtct ttgtgtacat gcatatacat gccacagggg 232800

tgtgtgcaca cacacacaca tgcaggtcag agaacaacta ggagtcagtt acccccttcc 232860

accagggact caaacttaga tggctaagat tggccaaaag cacctttact catcaagcca 232920

ttgggttggc actttttctc ttcttttttt tttttttttt tttttttttt ttacaagagg 232980

ggtttttttg tglagccctg gctgtcctgg aacttgctct gtagaacagg ctgtcctgga 233040

actcacagag atcctctgc ctctgcctcc cgagtgtctg ggttaaaggt gtgtgccaca 233100

tcaccaggtt gttttctttt tttaatatgt acaattttgg aaatggtatt actattctct 233160

tttatagatg aaacttaggc ccataaaagc caagtaactt atcgaggcag tgggtggcaca 233220

catctttaat ccagcactt ggaagacaga ggcaggagga tctctgtgag ttccaggcca 233280

gcctggtcta cagagtaagt tccaagacag ccaggactat tccacagagg aactgtcttg 233340

aaaatcaaac aacaacaaa agccaagtaa ctgtttcagt gtccctgtgtg gagtaagtgc 233400

agagccagge ctgtctcca aagccagaat ctttcagaat ccagagccct agataagctc 233460

tatagtctca gtgtggfacc accatgttcc ctggccaatt caaggatc gctggctgtc 233520

tgagtctca gaaagcagct gcagctgtgt ggtacagatg tgcatcaggc ggtccaggtg 233580

ctgctcgctc tectgcagtt gctgtaggtc ccgggtcaag ccttcaagcc gettactgat 233640

cccaccatg gtgcggctgc ctctgtggga agccatgaag agttagcagt cctcagacce 233700

tccatccatc agccatggca ctcaaggcag tgcaccattg ttctgtgagc aagctctttc 233760

ccctctctgg ctctgtctcc cagctaggct ccaagttaga ctgacatgga cttatgcctg 233820

gtctgtcaac aaacacctac atgtccccag gtaaggaac aataacacac actgccatac 233880

aatgtacca agacacaccg acaagtgaag agaacgtaat acggaatgaa gaatggtcta 233940

tcaaaaacca agaaggcaga tgtgccagag agggcagcag gatgcctggg gagagggggg 234000

tacaagagag aaatcctaac aaaactaaaa catctgtaag gccaacctca gtgatgacag 234060

cacaaagctg gaatggtggtt tacacagtgg tccaaaaatg ggcaacactg ggagagggaa 234120
 caggaaacct tcagcaggcg tgtttatgtg tttattggat gggacacctt gtacagctat 234180
 agggagctgg atctgtaaga tctgtatata cctccctttc taccaccca gggaagacac 234240
 ctctcctcag aggcaggaag ccactgcagg cctggctctgg ctaccaccag cctacctgac 234300
 tggtcagtac ttacaaccac tggatatgat tcttggactt cttggcaatg agctggatgc 234360
 cctcaaggac attggtgatg tcatagatgc gccgtttctg cactttgagc acctcagccg 234420
 cccagttcag gtcaacaacc ccatcagctg agcggctcag cagctccaag aagcgtttgg 234480

 tggtcagatt taacgatgtc tcatatcgtg acttctcccc tggagatttc acacctgggg 234540
 ggcaggggtt aggctaggca gggctcctca aacactcagc ctgccccaa caggcctgtc 234600
 tccttagcag tgiagagtgt caggatgaag tgggatgcag agggctcctt cccttagtc 234660
 aggccaagca gaaaggccct gtgactgctg tctgccaacc aaagcattcc tctgtggctg 234720
 gggaactccc tactccaag gcccaaggaa gtcatgtcag ccagccattc cagctgcctg 234780
 ctggggcccc agagtttaca agcatgcca ccccaaatc tgggcctgag atgctagagt 234840
 catcaagcac ctttgctgg gtggcggcct ctgccccgga acggccact gctcccagcc 234900

 agatactgat ggtcagtttc cagatccagc ctccgtttca cctgtaacag aaacacagga 234960
 agatgccag taaccaggag tgagaccacc tcagtcactt attaggatgc ctagggatac 235020
 aagcagagac agatcctaag ggacacagca ttaggttata ctaccacaca taccattcaa 235080
 gtgcaagact gagtccaagt tttaggtcca acaggtggtt tttttgttg ttttttaaat 235140
 acatcaccaa agaacaaatc atggcagtaa tgctagagat taaaatgagg gttttgtgca 235200
 tactaacaca caatctactg ttagtctcct cagttcctac agcccagctt gtcctcaaac 235260
 atactatgta gccagtgatg acctgaact cttttctcc ctgcctctac ctcccaata 235320

 ctgggettac aggcacatgc caccaggact tgttacttct agtacttctt tcaaagataa 235380
 gcgctaactt ccttcccctt actagccaga agtgatggtg tccctctgag actggtcaca 235440
 gaggccctgg agcttctcct atgaggaagc aaggagcggg agaagagctg ctgcaccatt 235500
 ctctcatgtg gtctaaaga gaagccctgc tggcaaagag ctgagaactc caggtgagga 235560
 ggaacaacac aagcttagaa gcaaatccat ccagcagcct tagtcctgcc ttctgattac 235620
 aactagacag ttttctgtct gcaacagggt cccatcccag gcaaaagctc cagctgactc 235680
 tcctcaagt cctggcccac agagactaca taataagcca ccaaggaagg gtctaggtcc 235740

 cttgggcaag caagtcattt ctctagtttt taactcattt acccatctat aacctggta 235800
 gcagctgggtg cctttctctt ggcaacacaa tggctccact ttgcagatta aagcaacca 235860
 cattcaagat cacagtcagg aagtggcaga gacacagttc ctaccaggt ctgtgtagaa 235920

tgagcaaaag cggctaattc ccatgccctc tagcttaggc tagacatgca gagatggaaa 235980
 ggaccctgaa atcccacgga tagtcaagac accctaacgg gaccagactt gctgtcctct 236040
 caccagccac aggcccttct caactaaacc cgctttcaac ctggcccacc acctgtcaca 236100
 ttcatttggc aagaattcta cccacagctt ttatcacctt cccactggac agtccagctg 236160

 tccttacct ggtctcctc cacatctctg ccttagtaaa gccttccaac agcattcctc 236220
 atgtgaactg ctgagacgga cttctcccgga cccctgcctc taaggctcag cctatgcccc 236280
 tctcctccag caggaccctt agcaatcact tagagagatg ctacccttct ctctgtattg 236340
 actcagacce agccttctcc tacatccatt acaaacagct gcagaggtgt cagtcaagtct 236400
 tccccgcta cccctccaca ccagcaacag tgcactgga tccagtgaat ctctacctaa 236460
 gtgtcagtca acatgtgtg actctactcc acatcctcat gctgccacgg acttctggaa 236520
 gcttgaggaa gaggatcaca tgtgggcaga catcgtctat gctgtctatg cagaacaggg 236580

 tagtaactgc ttctcataca tttctcacc aaattcttgc ctgatagcag agcctatggt 236640
 ggtctccacc ttgggacgga tctgtagcga gggagaaaac caacatatgt accccaatgg 236700
 gctgaaaggg cctaccag agtaaacacc ctacgtacaa actagcaggg agtgcctttt 236760
 ccctagtact ctggcccttg ttgaccgaac cctaaagaca cacttgaag taagggtcctca 236820
 gacagatgcc ggtttctgtc actcctgtct agtcaaccct agcaatgaga tcctaaaagc 236880
 cataggtcaa gatattcact aatgaaaaca gctgaatgac tcaaacacc acccatagga 236940
 caagccacaa aaactgttta cttagcccct ggaacagcaa gcagtctcag tgaatactc 237000

 aggcaacca ggccaacgca gaatgctctc acagacacac aagtaacca ctgtgacaga 237060
 ctaatacggc cacaggagct gttctctagt tcagtttcta acagtgtgtt ttggaacag 237120
 gaccacttct gtgggagagc cagggcagac tattgcctcc tctgggcaat gagaatgcta 237180
 cactgtctga agacggacca gtttctcgaa tagcccaggc tggcctcaag cacgggagca 237240
 gctgaggaaa accttaact cctgatctc acacctctac tttgtaacta ctgtcatcac 237300
 acctggtca cagcaacttt tggaaactatt aaaataaat cctgaggatt ggcagagtgc 237360
 ttgttcagca tgcacgaaat cctgggttca atcccaca gcatcaagta ggcagtgacc 237420

 agccaggac acatataatc aaaaagtcac ccctaaaaca agagcccgga gctacaactg 237480
 actttctgct ctaaatctgt tttttacaga cctaatgtct ggtactacat acttctata 237540
 gtaaacatgt attatgtgca taatgggaaa atttagcttc tagttgttac tgtctttaa 237600
 cagggtcttt gtagtacggg ctgtatctc attcttgctt gcctgaatta taagatatgc 237660
 caataaacca ggatagactg ttggatattt gatataattt tatttaatta gttcactttt 237720
 taagaacttt gtgtctgtat gagtgtatgt gaccatgtgg gcatgggcag cagacaccgt 237780

caaatccctc gaagctggag ttacagcat ctacaacccc aatgtgggtg ctgggatcca 237840

 aactctagct gtcataatag agcaagtta ctttaaaaa gtaatttact ttaaggcaa 237900
 gattccacta tgtaacctg gctggtcttg aacttatggt aattctcctg tetccgcttt 237960
 ccccttacag gacacacaca cacacctgac aaggtagagg taggcaggcg gggcaaagag 238020
 gaatgtctga atcgaatgga gttctgtaca caggaagcat tcaacaagt cttactgggt 238080
 ggaagccaag cctgtagctt attgcaagga ctgcctcccc cccaccccc aatgccaga 238140
 gcaaagtcag tagagcaaaa tctggatttg cattcccggc ctttggctcc aggatgttgt 238200
 cagcctctcc cacagaaaat gtttctggc ccttaagtac catgggggca ggggacctg 238260

 aactatctct acacctagca tgcagtgggg actcactcaa ctggagtgag tggaatgttt 238320
 gatcaaacgc agactgtctg cccaggcccc aagctccaac ctgcaggcac aggcccctgg 238380
 aggacatgga agacaagcca gctgacctac caaatacaag ccgactgtca ctgggaggaa 238440
 gggccattaa caatcaggaa ataacactcc ctggctgaat gaggaaagt ccaccatttc 238500
 tgggcttcag cgtccccatc tcttaagaag ggtcaagggt caaaaagtca gtttgccaac 238560
 agggttaagt gggatgaagt cttagcacag agcctggcac acaaaacatc cttaaacaat 238620
 ggaagtgtct attgttatta ttattagcat cttggtgatt ccggaaggaa ggcagcactg 238680

 ggcactgggc caaggggct atgggccttc ccaagatgcc gcagggacca gctgccacc 238740
 aaaaccccat cagcagttga acagctagct acctgggtt ctgggcctg cccctccat 238800
 ttgctccaag cccctgctg agaaccctt ccagtccct ccacctcac aataaagctg 238860
 gtggcccaca cctgcgccc gccctcccgc ttggatccaa gttccaagct tccactctcc 238920
 actgactcag ctgccttttc taggccccca gcctaaactg gtcttgagct acttgacgtt 238980
 cagggttaagt gaagactttt tccagggatc tcctccac ctcttctctc tccaggaact 239040
 tgaggccct tccatagatc tcaggggcc agcccaacca gtctttcaga gtctccggg 239100

 tctgcccgcc tgattaataa agttccatgg caaccagggg ctggaagggt ggcagatgga 239160
 aggacaggca gaggaagggt tgcagcagct ggcccagcac cccgccccg cagagaaggc 239220
 ctcccagtca ggaggcctat cccagaggc cgggaaagt aggccagcac ctggcactcc 239280
 aacatcgagg cactaaggag gggctctccc aagtcacct tcttcacct ccacgtgcaa 239340
 ctgtgtctac taccaggag ccctaagttc tgtgcaagc cagcagacat cacttaaaat 239400
 accagcccc accacctgca gctgcgtgaa gcactcactt ccctgtctgg gcctcagttc 239460
 ctccctctgg cagatgggca cgtgacaaca cccagctcac agcagagttg agaattctgg 239520

ccacgatcct aagtgtgcc aaggctgggt gtgcactaag caagcaccag ctgaatacac 239580
 gtgaaccatt atctttaacg aatccgacac tctggtagg acgctgagc ccagagcaag 239640
 gcgcagaaaa cagggaagn nnnnnnnnnn nnnnnnnnnn nnnnnnnnnn nnnnnnnnnn 239700
 nnnnnnnnnn nnnnnnnnnn nnnnnnnnnn nnnnnnnnnn nnnnnnnnnn nnnnnnnnnn 239760
 nnnnnnnnnn nnnnnnnnnn nnnnnnnnnn nnnnnnnnnn nnnnnnnnnn nnnnnnnnnn 239820
 nnnnnnnnnn nnnnnnnnnn nnnnnnnnnn nnnnnnnnnn nnnnnnnnnn nnnnnnnnnn 239880
 nnnnnnnnnn nnnnnnnnnn nnnnnnnnnn nnnnnnnnnn nnnnnnnnnn nnnnnnnnnn 239940

 nnnnnnnnnn nnnnnnnnnn nnnnnnnnnn nnnnnnnnnn nnnnnnnnnn nnnnnnnnnn 240000
 nnnnnnnnnn nnnnnnnnnn nnnnnnnnnn nnnnnnnnnn nnnnnnnnnn nnnnnnnnnn 240060
 nnnnnnnnnn nnnnnnnnnn nnnnnnnnnn nnnnnnnnnn nnnnnnnnnn nnnnnnnnnn 240120
 nnnnnnnnnn nnnnnnnnnn nnnnnnnnnn nnnnnnnnnn nnnnnnnnnn nnnnnnnnnn 240180
 nnnnnnnnnn nnnnnnnnnn nnnnnnnnnn nnnnnnnnnn nnnnnnnnnn nnnnnnnnnn 240240
 nnnnnnnnnn nnnnnnnnnn nnnnnnnnct cgatgggtgg cggggtctgg cgaggggaac 240300
 aaacttcgta cttggttctg cacgttcgc agtccccat gacacatgac ccctggactc 240360

 ccaacctgtg gcctccacc cctcagctca tattccagaa actgtctctt ctgcacgctc 240420
 aggtcacct ccaaagctcg cttcagccac atctccggtc ctgctccatt tgetcacaga 240480
 tcatgggccc ttcctatcc ctgtcaccta gaagccacgc ccaagagggg gtgccagtaa 240540
 ataggttggg atgtctggt ttgatctcaa actgatttta gctgaaatc cttcagtagc 240600
 tagcggccag tttgcgttca ttcatttgc tacttcacac gggctcctc ctgccttcaa 240660
 tgccagcact tgaggagaca gaggcaggcg ggtcttcagg ccagccaggc aggactacac 240720
 agtgagacc catctgagag cctgttcagt gccccatcct cagtccagac cttactcctg 240780

 ccagtgaaaa gaaagaggg aaacaggcag cagaaactc caatgtgaag agactcgacc 240840
 attaaattaa ctctacgta gacctcacgt gggcggttag ggccgtgcaa gggcggtgag 240900
 gatgcctgtg gatggatgcg cgtttactac tgaggccctg ggctatctcc gtcagcattt 240960
 ctcatgtcte aggtcagccc atctgaccag tattgtecte tctgctaggc attgtgccaa 241020
 cactgggaac agagattcga aagattaac aagacctaca agcttctgc actggggcgg 241080
 ggcgaccaca agaagagagt agctgacaac attcaagtc ccaagtccag tgcaagcatt 241140
 gcttctcga gggagctctc aaccagggt tgettattcc attgectcat actactttt 241200

 cctctgctc aactctgacc aactgctct gggtgcctc agcggggct gtttctcaca 241260
 cctttcttg gtatgacaga aatgagctg agggcagagg agaaccggaa agcaacaagg 241320
 aggctgtgat ttccaagctt tctgaaatgc cagggcacct gttaactttg ggtcacccca 241380

gctggccaat ttacaatcaa tccctaccic ccaccaatg cccccccac aacctcttgg 241440
 gtttttttgt ttggggattt gttttgtttg ggtgatttga gtttgttttt tggtttggct 241500
 ttgtttgtgt tgtttagaga cagggtgtca ctatgcagct ctggctccct ggaactcaca 241560
 atgtagacca ggctggcctg aactcagaga cccacctgtc tctgagtctc ccaagtgtg 241620

 ggagtatagg ggtgcaacac tatgcctggc tcacccttg gttttgttt gtttcttttc 241680
 ttaagagcca gtatcttct gtgtagccca aactgaatca aggtaatctt cctgcatcag 241740
 ctctctgagt tacaggtatg tgcttctctg attacaggta tgtgccacca caccaggac 241800
 cagtttagaa tctttatgag ctcaggaatg tgcattttgc aatagacttc ttcttcttct 241860
 tcttcttctt ctcttcttct ttcttcttct tcttcttctt ctcttcttct ttcttcttct 241920
 tccaagcgac ttcttaagaa atacatttgt atttcagta tttagaaggc cgaggccaga 241980
 agagcttaag tcccagggca gcctggctctg tatacagcaa aaataataa ataagataaa 242040

 aaaaacaaac aagaaatttc tggacagtgg tggcccacc ctttaatccc agcactgggg 242100
 aggcagataa aggtggatct cagtgagttc aaggccacct tggcttaca atcgagtcc 242160
 aggacagcca ggaccattac acagaaaaac cctgtcttga aaaacaaaac acaaaacaaa 242220
 accccaagga aactttgtat ccatcccaga taatgtgtta atcttcaaaa acaaattggt 242280
 atacctttat aataaacatg tggagtggag ccaaaaatta cagtttctac agctgaatat 242340
 agctgcttcc acctgtgacc ccagcagata ggtgcagaaa gaccaggagt tctagacat 242400
 ccttggctac ataggcagcc gggactacat gcaatcctgt cttaaaca gcatattgaa 242460

 gctctcagtg atggttttca gctcagtttc ttgtgaaag tggacaceta gatcttgct 242520
 tggccacttc aagttttctt gagatgaagg cgcaaggac tagacagtac tctatagact 242580
 gtgaggtgct ttgaaaata gcaagggtgt ctttccatcc ccctctcatg agcagtttgt 242640
 gaaattactc attgcagatc ctggaatgtg tcagagetgg gaaggacat gagagcacac 242700
 gagcccttgc tglacagatg gggaagtgag gctcatgcag ggttagtgct tgtgaacca 242760
 gctagtgaca gaatctggcc cacatcagat cctgtcccca cgtctgtgct gccaccccc 242820
 caccacag tagagaagcg aaggctaga tctcattcaa cataaccaag ccagacactg 242880

 acggagggtg agagaggtg gcacattctc gttccagatg gagtgttcc ctctctggg 242940
 ctctctaagg ggccattaa caatgacact cgttttgaa aagccttctg ctactcaata 243000
 gtcattcaac aaacacttac tgaacatctg ttatatatca aggatcaaga tggttgctgg 243060
 aggggaaaac ataatatgt cccattttat gatgattaaa ctgtgcttac ctagttagct 243120
 gaaaggctat actaccaag gttggagagg ccaagaccag ggctttgct aggcctcacc 243180
 ctcccaaat attcaactat acatctaca caagcttaca gtcacaagtg ctcaggaggt 243240

tgccacagat cacttgattc tggggattca aggacagccg ggccacagag ggaaaaatct 243300

 taacacccca ttataaagag ggggtagatc ttattatggt aggcaaggag ttgcacacct 243360
 ttaatcccaa cactcaggag gcaaaggcag gtggatttct gtgaattcaa agccagcctg 243420
 atctacatag tgagtcttag gccagccaga gtttcatagt aagacccttt cttaaacaaa 243480
 caaacaaaaa acccaaaaaa ctcaagttca tatccaaggt gactgagga tactaattcc 243540
 cactagccct catgtcctga gtagcagaaa ggagtatggg gtgaagacca gaattccctg 243600
 aagggaaatg aggataagat aagggtctgt ggatctgtta ataatagtg ggcagctgag 243660
 aagggcccga gagatgggcc ctttggccaa gacctgaag atcccataa ggctgttctc 243720

 aatgtcagca ggictcctga ggcccaccag catccaaaaa ctaatccacc atcactgggt 243780
 agtcactgca attagtgtct ctttcaacc ttataatccc ataagtgaag cttgtttatc 243840
 tgcaggatgc gaaaggaaa aggctcagag agggctccctc acaactcaag gtcacacagc 243900
 aaactgaggt gaaaacttag cctgttctc tgcaaaaatc cagggtgcc cttgatattt 243960
 gtcatctctc attaatgtcc caggaaccag gatcaggata taatgtgtgg tttccaaagg 244020
 gtattagga ggagtctgtt ttggtagta ggtacctata tctaccacca tetataccaa 244080
 cctcatctaa aggattccaa ggaagtggta gctcctggcc ctgtgtcttc tcctggaga 244140

 catcttgctt ttggttcttt ctgagatgaa aaatgggcca ggcaagtgtg gtgcactcct 244200
 ttaatccag cactccagaa gcagaggcag gcagatcttt gaggttgagg ccagcctagt 244260
 ctacagagtg agttccagga catccaggc tacacagaga aacctgtct caaaaaacaa 244320
 caaacaaaca aaagagatgc aaagtgggt agtagtaagt ggccagacct ctactctat 244380
 acattcagta gacagacata agcaggaatc ctgggctgtg tgaccaaggt tcacctatt 244440
 tcctcaaaa tgcactcatt tacacctgg atatctactg aacacctagt gagtgttgc 244500
 cattgtagga gctggggaga cacaagcaaa gcagatgcat ggagacacct ggagcctgca 244560

 agctgtgcaa gactgaagaa taacttccat ggacctgaac aatatgccca ttaagaagt 244620
 tgacaagtga cagagataat ttaaagctat ttattccaca caaacctccc ataaatatac 244680
 attcttagct tgaaaaaaaa cctctaaaca cgagtgtccc atcattacaa ggaatacata 244740
 attaggagaa atgtctctat ggtgacttca tgttattaag ggcacagaga catccattgt 244800
 tgagtctgg cagaaggcag tggggaattt tgcactgcg attcctcgtt cctcttgagt 244860
 gatcccagga tgctacctg actggcagtt tactgtccct agagatgttc tgtcaccatg 244920
 ccagctctag ttgagtaggc ccctacca ctggagaggt agtctcatal aatgctggcc 244980

ttcagagcca gcagacccca gctcatccct gctggaaggg ctatgcgtgc ccaagccctg 245040
 caatgtgggc taacagtctt aagacagggt tcagggtcga atgaaggaac acagcaagga 245100
 gagttttcaa actgaccctc aggatggttt aattttaaaa atgtaagcac ctggttttct 245160
 aataaaacca gcaagagagt ctggggctgt aactcactgg tgagcatgct tgcctagcat 245220
 gcacaaaacc ctgggctcca tctccatctc tgcataaac tccttatggt ggtacacacc 245280
 tgtaatccca gcaactagga ggcagaggca gaaggatgaa aagtgaagtt atccttgggt 245340
 atatagcaag ctcaggggta gcctgggcca catgcaacc tgtctcagac aaaattaaac 245400

 aaaaacaaaa tctgtcatag ttggcaatat taaccaggcc atcaaggcac taatcagttc 245460
 ctgtgtcatt gtctgtgtc ctccccactc ccatcacat actcacttcc tggcttgctt 245520
 tgctccatga ctgtgacct acttgccctg atgtccaag tgagtctgca actcatagta 245580
 gtgccttgtg ggatacagag taaatgtcac aatactattg atacaatgtt gaatgggcac 245640
 caactggttg gticcagcac agcttctctc ctcggtgtgt catgaaggac aaggtacaga 245700
 tatggtagga tagggaagga aggcatttct ggggtcactg tgcagctctg gccatcagtc 245760
 agcccttatg ttcagtggga taaacttctg aggagacagg gaaaaccata tacagtgact 245820

 tcatgtttgc ccgaccaca ctgatgaggt aggagattct cagagccaat ggctctgatt 245880
 cttcatctgt aatggaggt aataagataa tgataataag aataatgttt ctgatagggc 245940
 tgttgccata gtgaatgagc agccggatgc gtcaaacagc acctaatgtg tgaagagtgc 246000
 tcagcgaat gtcaactgct gttaagtatg aagataaaag ccgggcatag gtggcacaca 246060
 cctttaatcc cagcactcag gaggcagagg caggtggatc tctgtgagtt ccaggccagc 246120
 ctggtctaca gagcaggttc cagaacagct agggctgtta cacaaagaaa ccctgtccag 246180
 aaaaacaaa gcaacaagt atgtgctact ctccagagg acttgagctt ggttctcggc 246240

 acccacttag ttaggtcttc tcgctgtaac tccagctcta gaggatccag ccctctgtga 246300
 acacctacac ctacacacac acacacacac acacacacac acacacacac acacacaaat 246360
 aaaataaaaa aattgagaca gggatatcaa atgttcatac acacaaaata aaataaataa 246420
 atctaaaaaa ataaacctcc aaaagtaata aaagaacgga gatgaggcca gtgaaatggc 246480
 ctgctgacaa gccttagaac ttgagctcag ttagcagaag ggtccctaga acccatatga 246540
 agaaaaaaag aagagaatat taaccacaca tacacacccc acccaaaaa taagtgttaa 246600
 aagtattttt tcaatggttg tagtggcagc actcaggaga tactggcaga aagatttcta 246660

 aaaatttgag gccagtttgt ctacataatg ggctccaggc caatgaagc tatgtagtga 246720
 gtctctttct aaaaatagat gatagagata tagatatatg gctacggatg aataaaatgg 246780
 agatgagcca ctccaatgg aagttagga gacggtgcac atctgtaatc tcagttcttg 246840

aaagacagag gcaggaaaat cagtaggtca aggacagtat tagctacatg ctaaattcag 246900
tgccagcatg ggctgtacgg gacccaaact caaacatgaa ctcatgtcta cacacacaca 246960
cacacacaca cacacttact tggtaggagac tgagacagt tctctacctt ctcatittga 247020
ggtttccata aagaaaaaga aaaactactc ttgtccacct ggagaacagg agagttgttc 247080

aaagtagccc gatcctacct ctcaaaccct gtgagtcaga caggccaga gacagggagg 247140
gggaaatata ttggaggac aatggagtgt ggcaactgaga tgaaccctat tccactgatc 247200
ctgggtcttt tcttgggggc aggagagaga caaagggttt tatgtagctg agtatgacct 247260
tgaattcctg attctctggt ctccctgctc ctaagggtta ggattttagg catggacacc 247320
atacctgggt ccgaaacat ttcatattt taacatctcc agcccaagct atctctccag 247380
ccccatattt taacatctct gaaattcttt atctccctc ttcctttctc tctcccacc 247440
tcctaatact tccactcct cctctcaact caccctctc taataccac accctcccc 247500

tctgtcttt tggtagctgag aataggaaac cctgtgaata ccaaatggga gacagtgctc 247560
tgtaactcag ctatactcc agcccctctt ttccttttta gggagtcaa ataatgatgt 247620
actctagatc ttgaatggct tcttagaggt ggttagctac agttcacatc agtgccaggt 247680
ggggctggga gtgacatcag tgggagaagc catgctcgc ctacacaaga tctgtgttc 247740
cattccctgt gcagggccag cacttgccat gtcataagcc cttagccac caccatggtc 247800
ttcagcatca atgtaagccg gccacagtgg agcaaccage ttttctctcc tttttagct 247860
gacacctgca ctgggctcca gatgtcatag acgaatgaca cctgcagcta cgcaggagag 247920

gggagagcag ggcaggggga ggaaaacact tcttataatt ttatattaat atattcagag 247980
gaagagccag agccctccag cccccctcc ccgccacac actattttta aataaaaaa 248040
aaaatcctct ggaagccaga gttatataa tgccaaacag gccaggaaac ccagcagggc 248100
ttctggggct gtcaatgaac cgaaacaggg gcattgtgtc caggccactg getggctgag 248160
ggggcatgt tagggcctgg cctcgtctgg gaagagggg gtgaagaggg cagggggagt 248220
gtgttccat gactccctgg ggagcaatga caatcagggc cagctgcgaa gcctggcatg 248280
ccagggcct ggtaggcggc tggcctcaa agggccatga agggcaggag aggattgcag 248340

aggaacaggg aggggcaacta ggtcctggga ctatctctg gctggaggca aactccaaag 248400
cagagagaca tgaggttat tcactacacc ctctctctc tcaccctcc tgagcattgt 248460
gccattctcc aaggacacc cagatcctc cactcttct tcaccctgt ccaggacacc 248520
cttgagcgc tcttctggt caccctgagc tctgtgttc tgttctcat tggaaagtag 248580
aaaagcttt cccaaggta actaacatca cactgcattc ccttgccttag gtccagtgt 248640
ctccctaagc atgtcatgt caccactgt atccagggtg atggttaggc tcatcatacc 248700

ttttaagtcac acaagggttaa aatgggtgat ttaccaatac gtagccaggt gaagattaaa 248760

 gtatttaata gggagatgcc ttacttactg agcaacctag ccagccggct gggatcaaag 248820
 taatatagggc aagcctataa ggcagggaaa agagagagca taccatgtgc attccctaac 248880
 ctttaaacct ctcccatgac accctgacat caccttgacc acgccctgat gggcgtgatc 248940
 gggcacacct gtagccagcc attaggaggc atggttactg tgtccccta atacaagggt 249000
 ttttgtttt ttggtttga tttttgttg tcgttaaaaa aagggtcac tatgtagtc 249060
 aggcctgtaa ctactatgt cttccagcct agcctcaagt gtgtggctct gcctcctgag 249120
 tgttggggtt acaagttcgt agcaccatgc ctgggctttt ttctttcttt tattattttc 249180

 tagcttattg gcigtttttg ttttctaca taggttctta tgtagagtgg tggttatgca 249240
 cacctttgat ctcagcactt gggcagaggc tggcagatct ctatgagttc aaggtcagcc 249300
 tggctctacag agctagtcc aggacagctg ggcctacata gagaaactct gtctcaaaaa 249360
 acaaaaaaca aaaacaacca aaacaaaaat ctaaaaaag gaaaagagat aggacctgac 249420
 tactggcatg ctatggcctc aaatttgtga tcctcctgcc tcacctgag gtccctaggat 249480
 tatgtataca tttttaaga ttttgtttg ctttgtttat atttgtgttt ttgggatggt 249540
 gtctaattat gtagctttgg ctggactgga acttgctatg tagtccaggc tgctctcaaa 249600

 ctgacagaga tctgccttc taaagactg ggtcactgct ccatgcctgg tgatttattc 249660
 ttttcaatta gtgtatgtg tggggcggt atgtacgtgc aactacaggt ggccagggat 249720
 gtcagaagca ccagatcctc tggagctaga gttacaggtg cttgcgaatc acctgatgtt 249780
 ggcactagga attgaactg gatcccctgc aggagtaata catgctccta acagctgagc 249840
 catctctcta gtctgagtc ctgagattat agatgtgtgt gacagcaact actagatfff 249900
 atttaatgca aaggaggaga agggggaaga ggaagaggaa ggtatattgt gttcaactat 249960
 aatccagctc ttgggagaca gaagcagggg gatgtctgaa ttcagggaca gtctggtcta 250020

 acacactgag ttttagatca atcaggttta catagtgaga ggctcatctc gaaataccaa 250080
 caacaatgat aataaactaa aataataaaa ggaatatgta ttcataagtc acaactggtt 250140
 agacaagtga caagttctat accactgagc tcttgcccc gcccccacaa aagaatfff 250200
 ttgttttat tgtttttgt tttgagacag ggtctctctc cacagccctg gctgtcctga 250260
 aactcactat gcagactaag ctggccttga attcacttc cctctctcca ctgaatgctg 250320
 ggatttaaga tigtgcat gcatgactcc cagccctcaa aatattttat ttttaatfff 250380
 gigtatgtct gcgggaaggt gtgcctgtga gtgcagttac ttatggcatc aggtgtgagt 250440

gctgggaatc gaactcaagt cctctgcaag agcagtgtaa gctcttaacc actagccccc 250500
 cttgggtttt gttttggttt ttgagatggc cttatgtagt ccagactggc tatcctggtt 250560
 ggtttttttt gtcaacttga cacaaaccag agttatctag aaagaggagc ctcagttgag 250620
 aaaatgcctc tigtacattg gtctgtgggt gtgtccacag ggcatatfff cttgattaat 250680
 gattgacttg ggaggggcca gtgccatcct tgggcaggca gtccctgagt tatgagaaaa 250740
 taaactgggc aaactatggg aagcaagcca gggggagcaa gccaggggca gcataccttc 250800
 atggctttcc cttcagtttc tacctttcat tctgcctga ctacctctgt gactgggtat 250860

 gacctaahta gttgttagat gaaataaaca ctttctccc caagtcgctt ttggtcatgg 250920
 tgttttata ctgaaataaa atctatgaca ctggcctcaa attcactgtg tagtagagga 250980
 tgataatgaa gtcacgattc atcttacttt acctcctgaa tgctgaaatt acatgggcaa 251040
 cagaacttac agctcttcca ggactgggga tggagctcag atggtagact gcttgtcttg 251100
 caagtacaag ggttcaaacc ttagcactgc attcacaat aaaggaactc acagctctgc 251160
 ctacatgtcc cttgcttgct gccttatcta agacactgct tgtgtttatt gcatctttga 251220
 agcatagtt tttgaatatt ctattagatc ttagtatfff tttgttttat tttgttttga 251280

 ggggagtgtt ttgtttgttt gtccctggctc tgtgtacttg cttgcatggg ttttgaaac 251340
 aactctgtga gaggggatga caggctccta cagatgccag aggaattcat gacataaaca 251400
 aaggcactcc aagagaagta tctaaagagc tgatgtggcc tggccctggt cctgactctc 251460
 agctgacacc cagcccacac ggagaagaa gcctggaaga gtgaagagaa caaagattgt 251520
 gacactcacg ccaggagcca catgcagccc tgcttcttt ctatcttagt cacgacttcc 251580
 gcaggagctc ttgagcagag tcttggtgca gaaaaaccag gatgcctgtg tttagaagct 251640
 ttcttaaac gacactcaga agagagctct gcttcccttt gtccctctgc tgggtgtgtt 251700

 tggcctcttc tgctctgtt taactcaaa actctcactc caaaatgccc ttcaaggctg 251760
 aagtaagaca ttctctcctt aggaatctga aacaagaca gggaaagggg aaaactttt 251820
 tctttttata aatacgatct aatttgtaa agaaaaggac atctgaagcc acagtttgtc 251880
 gtgacatggc cttccttctg ggaggcagaa catggtgttc tagtttagga gaccagaggg 251940
 ttcaaagcct gcttcttata aaccaaacgc acttccagag cggtaaagga acagtgtgaa 252000
 aagagaggct gttgccagga ccttttctgg agcctgggag tggagtcttg agaggaaagg 252060
 atcaaacacg ggcagcttct tggcatctca gtctgcacat tgttctctc acacgggctt 252120

 acttaacaat ctctaactg ggagtggaga agcagaaggg tcccaatta acgtcagcct 252180
 tccccttca tttggaagtct tgagagcctg aattttggga actgtctctg ataaggccca 252240
 gggtatctgg ggtggttctt tattgtctcat catagtatgg ccttctcaa ggtatcagaa 252300

aagtggagct gggtagagta aggtacgggc tcaaagaatc acttaaaaag atatTTTTTT 252360
TTTTTgTtT ttttagaca gggTtTctct gtgcagcttt ggagcctatc cttagcactca 252420
ctctggagac caggctggcc tcaaaactcac agaaatctgc ctgcctctgc ctcaacaagt 252480
ctgggattaa aggtgtgtgc caccaacgcc cagccctttt cacaatTTTT aagagtTctc 252540

ttggatagct ttctgtctag gctgtttctt gtgtgtgtgt tggggggggt tctcacagaa 252600
gcagctctatg tcctctttc ttaactctaa ctctgcagtc atcgatacta ctgcaaaagt 252660
agcttccctg ctctttatag tcaatggaag catggatcat ggacttcccg tgatttcttg 252720
tgacaacacg gaccatggat atccacatgg tgtctggcat caaaaagtgc cacagacctc 252780
agcatggtct tctgtgggg tacagaccac agatactaac atggaccaca gataaatca 252840
tagcccttag tggcagcaca ggtcaaggat atcaacatgg cttctgggac aacagggcc 252900
atagacacca atatggtccc tggtagaaaa aaacatTTTT tatagctatg ggtatatgtt 252960

ttatagctat gggTgtatgt tttatagtA ggggtattat gtctgtgtag taatgcctga 253020
gagggccaga agagggcgtc acatcccctg gaattgaagt aaaggtTgtg agctatcgtg 253080
tgagtctga gactcaactt gggTctctctg aaagaccagc cagtgttttc aaccacggag 253140
ccatctctcc aaccctcaa tggctcactt tctatagaat atttgtTgt tttaaagcca 253200
gaggTttttt tgtTgtttt tttttgttt ttttttttt cactgtgtag ccctctggct 253260
gtgtggaact cacactgtag accaggcttg ctttgaact cacagagatc cacctgcctc 253320
tgccTtcaa gtctgggat taaaggcgtg cgccaccact gcctggctag aatattaatc 253380

agaaagaagc caaacacaaa tatgaggatc aacgtcaaaa aagtcaagat taatgcaaca 253440
taaaggttta ttttagaca gagttagat catacgtagg acacatcaga agactgtgtc 253500
gttcagaaag tgctagaacc cagggtggg gcaaagggtt aaaggatgac tcagtcggtt 253560
aggagcttgc atataagcat gaggeccaaa gtctggatct ccagcatcca tgtatagcc 253620
aggcacagta gtgtgtgtct gtaatccctg ctctaaggag gagagacagg gagaagcctg 253680
gagctcactg gccggctaac ctaactgaac cactgagaaa gagaggctcc acctcaaaaa 253740
aaaaaaaaa aaaaaaaaaa aaaaaaaaaa aaagtgaag gccaggcttt tgtggcacac 253800

aactttaatc ccagcactca ggaggcagag gcaggcggat ctctgtgagt ttgaggccag 253860
cctggctctat agagtgagtt ccaggacagt caggatata cagagaaaca tgccgtcccc 253920
cgcaataaaa atggagagca actgaagtag gcaccgaatg tagacctta tccccacat 253980
gctgacacac acacacacac acacacacac acacacacac acacacacac acacacacac 254040
gcatgcatat gcagactggg gtaggtattc ttatagctcg tttccctggt actcaggacc 254100
cagcttaggt ataggagaga gtcaaaactc tgtaaacag cttgatgttt gtttgtttgt 254160

ttttgTTTTg tttgTTTTct aagacagggt tattgtgtat ccctgcctgg cctggaactt 254220

 actatgtaga tcaggctggt ctccaaactc acaggcctgc ctctgcctac caagtactgg 254280
 gactaaatga gtgcaccaac ctttgagttt tgtactaagg agggaggggg tgctTTTTga 254340
 gacagggtct ctcatgcagt gctggcttct gcctctgaaa aggaggatga caggaacgta 254400
 caggaataca ctgccatgcc taactttggc tatacagtga gttgcaggtc agcctgggct 254460
 atagagtgag actgtgtcaa gaaaaaaca aaaagcccaa gcaggatgac acatacctgt 254520
 aatcccagca ttcagcaggt agaagcagaa ggatcaggaa ttcaaggcca gcctcagctg 254580
 catattgagt tcaaggctag cctgggctac atgatacccc gtgTTaagaa aacaaaacca 254640

 agactcccaa aagggagaaa gTTaattaaa taataagata atTTTTaagt cggcatgtc 254700
 aaaagactcc atacaaatgt ggcaggcagT aattgcagat ttatctacct tgctgtttca 254760
 ggaagTccca ttcaggaatg gcagtagctc ctccgtgtat gccaatggtt ctttagcatt 254820
 tcctacatat agatcataaa aatggaggct tagctaggga agagtgaagc tgggctcttc 254880
 ccaaagctgc tgaagacagg atctgtctct ctctgtgggg accaccccgc ctTctcct 254940
 ggagtgtgca gttggaggca ccagatgtc tggcaagatc cagagagatg ccatctgCGa 255000
 gggaagccta ttcttagaga gcagaaccag tcagtTgtgg agccggccac cccccgagc 255060

 agagggggga tgtcagggca ggaggccaag gctagctggg gagaagggca ggctaaacac 255120
 agggcacact tatttcttac aaccagctcc ctctgcatt tgctctattg gaaataagag 255180
 caatgtttgt tgaatgttca cttgtatgta tcaactcaaac cctccagaca ccacaaggtg 255240
 tgtgtcatca caacgcctct ttacagatga ggcacagatg gctacgtcac taataggtca 255300
 ggctcaagc ccaggcatgc tggTtccaaa gcctTgtct cttgcaacca tgtatactgc 255360
 ttctcagTgg ccaattTtag tttgggttac ccagataata aacccaagT tgaggattTg 255420
 aaagcaagTg ctTtaagtga gaagtTgtcc caggatgcaa aggetgaggc atgagggaga 255480

 tagtttccat gggctcctga agcccaatcc ttctggagct ctagcaagca gcacacagag 255540
 tatatggggg ttatctctc caagggctgg gaggtgctca tgatggctct tctcagTgct 255600
 gggTtaatgc tgctcaaggg gcatgtcagT ccctaaaact tcatgcctgc tgcagagTgg 255660
 taaagcaggc cccagTggTg ggagTctca gacagggaaa cacaggagTg gcaactggag 255720
 aagTcgggtg ttcacgcaga gagaatggca gggctcccca ccatctgcta taataaacct 255780
 gcctggcaat ggtcggcctc cccacagTct cgagTttgct catcaagcac agTaaaagc 255840
 tcttccaaat ggtctgcttt gagcttacag tgagctgcag ccgagagcac tgggaagTca 255900

gacaaaagcc acctccacca ccccagagat acctaggata atgatgcttg gccctgctgt 255960
tcaccactcg ctcagtactc aggtctgggct catagcacag cacttacagc ataggaacct 256020
gttagctata atagtccaa aactattcca caccctaag tcagaattta tattgtgtcc 256080
atgtgtgtt tatttttgag acagggctc acatgggcca ggctggttcc caacttgcta 256140
tgtagcggag tataacctg aactccatc ctcttgctc cacctcccag gtgctgtgaa 256200
tatgggtgtg tatctccatg cctggccata atctacacac taataagatt tccagtgact 256260
catgtagatt tctaccagtc atttcaaaca cataaaaaca caggggagga agggcacatt 256320

aaagtaatgt attgactaa accaagggtc tcagactggc agcctctgga ccaggctttt 256380
ccgagagtgg ttttgtttta aaaattctgc ctgcagccgg gaggttgggg cgcacacctt 256440
taatcccagc actcgggaga cagaggcagg cggatctctg tgagttcaag gccagcctgg 256500
tctccagagc aagtgccagg ataggtcca gagctacaaa gagaaacct gtctcaaaaa 256560
accaaaaaaa aaaaaaaaaa aaaaaaaaaa aaaaaaaaaa aaaaaaaaaa aaaaaaaaaa 256620
aaaaaaaaa aaaaaaaacc cctctcaaaa aaaaaaaaaa aaaaaaaaaa aaaaaaaaaa 256680
acctgectgc cacacaacca cacaactctc tagttcactg tgacacattt cctcctatgg 256740

catagcacct caagaacatc catttaggag tttgaatttg tggctgagct tgaagcacct 256800
ggaagcctag tctgccaagt tgtcgcagac gcttctagag aattaccag gcattcatgt 256860
aagcaggaat caagataact acagtgtctg tcctgagga ggatttatgt cactataagc 256920
aagtagttgt tcgatgcat cctgagaaca caaaagaaa ggcagttgtg tcccacaaag 256980
tggttcatgt ttagataaa catatactcg cttttgatcc aaaacaagaa gtcagttttt 257040
tcaagaaaag aaaactacaa attttgatat tactaaaagg caaataaag atcttaagtt 257100
tgtatttgat gctgtttttg atgaacatc aactcaatg gaagattttg aacatactac 257160

taaaccaatt ctcatagtt ttctgaatgg agacaattgc acagtacttg cagatggtac 257220
cactggagct gggaagacac acatgatgct aggatcagct gctgatcctg gagtaacgca 257280
cctaacaatg ttagaccttt tcaaagccat gcatgagcct aaagaagaga aagtgtgtag 257340
tactgctgtt tcttatttgg aggtgtataa tgaacagaat catgacctct tgacaaattt 257400
ggggccactt actgtccagg aagatgcccc caaaaggagt ggttgttcaa ggtctcactt 257460
tacaccagcc caaatctca gaggaatat tacagctact aggcaatgga aacaaaaaca 257520
ggacacagca tcccactgac atgaatgctc catcttctca ttcccatgct gttttcaga 257580

tttatttgtg acaacacaaa taagaatcaa tcaaatatc tgtgtagcca aatgtcact 257640
cattgacctg gcaggatctg agcaagccag aacttctggt gctaaaggga catgatttgt 257700
agaaggcaca aatattaata aatcctgttt agcccttggg aatgcatca atgccttagc 257760

agatacaaaa agaaggaatc agcatattcc ttacagaaa tattaagctt gctcgttat 257820
 tgaaggattc tcttggagga aactgtcaaa ctgtaatgac agctgctgtt agaccttctt 257880
 ctttgttctc tgatgacaca tataaacactc ttaagtatgc taatcatgca aaagtcatta 257940
 aacctttaa gagtgatgtc cttaatatgt aaagatctgt aatgtgcaga aaacagagat 258000

 tttaatgctg aaagaaaaac taaaagccta tgaagaacag aaagccttga ctgacaaaaa 258060
 caacagtgta aaatcagtac atcaaacact caagacaaag aaattaaaag acttcaagaa 258120
 attcggaaat gcttgttcca gagtcgagaa gaaatcaggc aagaatatct aaagttagaa 258180
 atgttgctta aagtaaatga actcaagtca ttctatcaac aacagtgcc taccacaata 258240
 gagatgaagc attcagaaga caaagtagaa aaggccactt gcgcccagtg gtggtggcac 258300
 acaccttaa tcccagcact cgggaggcag cagctgctgg atctccgtga gttcgagatc 258360
 agcttggctt acaagagcta gttccaggac agcctccaaa gccacagaga aactctccc 258420

 ccaaaagaaa aagaaaagaa aaggccactt gcaatcgaga tcacagactt caaaggttga 258480
 aaactgttcg ctgtttccta gagaaaaaga aggaagaggt gttgaaaca ttgacgaga 258540
 ataccaattg gctttcttag gtcaaaatgg tgacatecca gagtactca ttaaagatct 258600
 tcattgtcac caatatact ccagacaaa gacctgaaa cacaatggc acacatgaag 258660
 gctctagcct gtctccaaga gcagcagcac agtcagattg aggcagtatt gaatgttta 258720
 ctccagccc taagaaaaac gtatttcatg tcagaagaaa ctaacctgtc taacgtgct 258780
 tttgattctg acttctgact tcaaagatat tgagcatttg gtagaaagga agaagtggt 258840

 ggcttggact gaccaaacta ctgaacattc aaacaaaat gatgttccag ggatttctct 258900
 tctttttttt tttttttttt ttggtttttg gagacagggt ttctctttgt agctttggag 258960
 cctatctgc actcgtctg cagaccaggt cagcctcaaa ctcacagaga tccacctgcc 259020
 tctgcctgcc gagtgatggg attaaaggca tgcgccacca acgccaacg ggatttctct 259080
 tcttatgacc ttcccacagc ttggaccaat gcaatctatt ccttgttgca tgcctcaaa 259140
 tgacctgac ttgcttaaca ttactcaca aaaaagaacc agaaggaaat taacaccatc 259200
 ttctttgaaa gtaaaacata ctgagaagtc tccactgtct gaaagtaca getcaatgat 259260

 tctttcagca aagaacttga gcctattgct tataccccag aggactacag aagacctttt 259320
 caaaacccat cccagcctt aataaaacct tcatcacata ctacaataa tcaatgataa 259380
 ttctcatgga aactgggat aaaacaagt ggagtgtgag gccctggct ttgagaaggc 259440
 aggatcctcc gtgagggtgt gttgatagaa ccacactctg agcagcagct cacactgcct 259500
 ggaagctgtc tgggcagagg agttccttaa gcacctggg ctgtgttact tggaggggcg 259560
 gctcttgttg aagatgagga agtctgagat gtcatgccac acgttctgt cctcgtagag 259620

gtaggtcatg gaggactgca gtgagggctg cagagtgggc cggtgatact caaagagcca 259680

 tagcacaagc ccccaaatca ctgctgtgtg caaggggaac ggggccagc tgagcttagg 259740
 gatgtagccc ttctccacac ccaggcggca caaggcaaac aggacgcgtg atgtcaggtg 259800
 catgttgatc tgcagggagg gaatgctgag ggttactagt cagcatggcc actgggaacc 259860
 ttcacctgcc cacccaacce taggcactgg gcattgctgt gcagcggctc tgtgattttc 259920
 aaagttaacg tgcaagatga ttgaggtggt atgcagcaga cattttaata tttctattta 259980
 tgtgtgtgtg gtgcgtatgt ctgtgtaggc gaatatcctt gtgtgggttg ggtgcttgtg 260040
 tacatgtggg tatagagact agagactgca attaggtgtc tctctcagtt ctttctctgg 260100

 cctaattatt tgttttgttt ttgttgtatg gagacagggt ctcctatta tntagctttc 260160
 ctagaacttg ctatgtagac catgctagcc tggaaactcag agagatccac ctgcctgtct 260220
 tctgagggca gggattaagc gtgtgagctc ccatgccag ctcagccag gtgtaattgg 260280
 tcaggagtgg tggcacatgc cttaaagagga ttgagggcca ggtgactgtg gtgcacacct 260340
 ttaattccag cacttgggca gcagagtcag gaggatctct gtgagtctaa ggccagcctg 260400
 gtctacagag caagttccag ctgaggctat gtagagagac ccagttttaa cagcccctcc 260460
 cccaagaaa ctttcaatt tacaactgtt ttctcttttt aaagatttaa aagcactctt 260520

 aatctttgag ctataggfcc attctgcccc ttaccaatt tgttgagacc acagtttctc 260580
 attcaacacg gagtgcacca atttggctat gctagctgac tacagagttc caaggatcta 260640
 cctctctcta cctcccaat actgggatta cagacagatg cttctgtgct tggctttaa 260700
 agaaataggt aataattatt atttatgtat ttactttgtg tgtgtgtgtg tgtgtgtgtg 260760
 tgtgtgtgtg tacttactta actgtttttc ctcagaaacc attcatcttg ttttttactt 260820
 tttttttttt tttttttttt tttttttttt ttttttagac agggtttctg tgtgtagctt 260880
 tggagcctat cctggcactc gctctggaga ccaagctggc ctcaactca cagagatctg 260940

 tctgcctctg cctcccaggt gctgggatta aaggtgtgcg ccaccaacgc cccggcgttt 261000
 tatacatttt tttatttttg agacaaggcc tctcatagcc tggcactcac caatctggat 261060
 agagtggttg gticcagaga gcccaggctc cctcctgcat ctgcctcccc agtgctgtga 261120
 tttcaagtac catagtggtc ggctttctat gtgtgttttg gggatggatg tcaggtcttc 261180
 agtttgcttc ataagtactt tgccaacaga acgacctctc tgttcccttt ttagaagctg 261240
 tggttttgtt ttgttttgtt ttgtttcaag acaggatata actatgtagt cctgactgtc 261300
 ctggaactca ctaagtagat caagctggcc caaaactcag tgtctttgtc tctgagtgtc 261360

gggattaaag gtgtacacca ctatgcttgg ctccctttatt agaagttttt aaaattgtac 261420
 acagttcaaa attttaaaaa atgatccata agaggaaaaa taatatTTTg gatttccttg 261480
 aaactcattt tttctatgtg aagccagctg ggtatacaga ataaattcca ggccagttgg 261540
 ggctacaagg caaggcctta tctcagagaa aggaaggcta caaggagagc cattcacaat 261600
 acataTgtgc aaagcatcag catgtaaatg tTctgaaaag tgtcctcagg gctcacaagt 261660
 aaaacatgaa acattccagc Tggaaaatga gcaaaagata tgaatgtTtc actcgatggg 261720
 tagcaataa gtgataatga ggaaaatttc aacatcattg tTcatcaggg aaaggtgaag 261780

 tcaagtcaca atggatagga cagggtctgtg gataggtttt aggagctgag ggcacttgca 261840
 gcaaaaagtct aacaacctga atttgatcca cagagcccac agagtTgaag gagagaacca 261900
 atttccaaga gctaacctct gaatcacatt cataccat ggccaggtgca cacctgcact 261960
 tataaacatc acacaccac ccaccatac atcccaaac ctttaaaaca tagataaaat 262020
 aaattTgTaa gcaaaccaaa Tgttaatagg atatggagaa actagacact cctatatttg 262080
 Tggtgagaat gaaaaaaaa aaaaaacct agtcactgga aaacagcttg gcagaggttt 262140
 gTcagttTct tTctttcttc tttttTggca ggtTgtttta aaatcaagca Tgcatgtacc 262200

 atacaacca caattacact ctTgggcttt tatccagaa aaatgaaaac ttatgttcac 262260
 agaagtatct atacaagagt gTtcttcaca gctctatttg taacacccta aagctagaaa 262320
 ctgccccaaT gtccatcaga ggatgggaaa aaaaactgat ggtacttcta tactacttag 262380
 gagtaaaagg gaaaaatTaa gccagggtgg ccatacatga ctataacccc agtgctcctg 262440
 aggctcgggg ggaattgcca aggctcaagg ccaactTggg ctacagagca agacacagaa 262500
 aaaaaaaaa aaaaagctgg TgtTggTgg catgtgccta taatccaaac cccggggaag 262560
 tataggtagg aattcaagtt cagactcagc tatagattga gTttgagtca acctgggcaa 262620

 catgagacce Tgtctcaaga aataaaaggg actggaaaga Tggttcagag gTtaagagca 262680
 tttgctgctc ttgcagagga ccaggctTgg Ttcccagcac ccacacagca gctcactact 262740
 tTctataact catgtTtcag gggatccaac accttctTct ggctTctcca ggtaccagge 262800
 atacatatgc Tgcacacaca tacatgcagg caaatactca ggctcataaa agaaaaaaaa 262860
 atgtttTaaa agaaaaagtc aggctgtcct Tcccatgtga ctctggcatt tttttTccc 262920
 caaagaagtg gtctattttt Tgtcagccaa gTttgcaaaa acagaattag ccataatatt 262980
 ccatagcttt ttattttttt ttttttttt tttttTggtt tttTgagaca gggTttctcc 263040

 gTggctTtgg aggctgtcct ggaactagct ctTgtagacc agaccaggct Tgacatgaac 263100
 acccaaatct ctgctgct ctgctcccg agTgctagga ctaaaaggcat gcaccaccac 263160
 caccagcca atattccata gctttTaaa tctacatttc atttactatt attttatttt 263220

agaggTgcag ggaaaatag tgatagcatg tgtaaagcag tcagaggaaa acctttgaga 263280
 cttgtttctc tctttccacc atgtgggtcc ccggaaccac actaagtcac cacacttaac 263340
 ggtaggcaac tttacctgct gtgccacctc acaggccctc agtgcttgtg ctttttatct 263400
 ttatTTTTgt gtttgcttat ttattattta ttatttattg agacaggTtc tctctatgta 263460

 gccgtggctg tcttggaaact cactatgtag accaggctgg ccttgaattc acagatatcc 263520
 tcttgcctct gcctctgcct cctgagtaact ggggttctc aaggcctttt aatatacaca 263580
 agacattaaa cataaccctt gtatttccag tatgggtaaa agtctttgga ggtgatgctg 263640
 gggtagaggc ttatagattc tattcatctt taaaacaaaa caaaacaaca acaacaacaa 263700
 aaagaacggc ttctctcttt caatttccca atttccattt cattgagTtc ttcttgtctg 263760
 ttttgagatg cagcccaggc tggcttcaaa tatgtgcctt agcctctcaa tgtaccacca 263820
 caccaggtc aaagtgcatt aaaaaaaaaa tcctaaactg gagagatgac tcagcagTta 263880

 aaagtacttg ttgctctctt gcacaggacc agagttcaat tcccagcaca cacatagggt 263940
 ggaacataag ttctgtaac tctagctcca gaagatataa caccctctc agccctccac 264000
 ggacaccac acacaggTac acatgatgc agaggcacac ccacatacat aaataatgta 264060
 aaaatggttg taccacaaa ttattgatgc atatgtaatc tcagcacttg ggatgaggca 264120
 agaatatcaa gatttcaagg caagcctccg ctagctacat agcaagtTca aggcctgccc 264180
 aaacaagatg aaacagtctc aactaccacc accaccacca ccaaaatcct tgccccaag 264240
 agcagcagac aactgatgt ggggagTcct gggattccaa ctgtggcttg gtttacaagt 264300

 gggaaaacgg agggagaagt gactttccca aggtcacaca gggactggtg attcttggac 264360
 ctCagacaca gacagcagcc aacagttcat ctttactccc ctgtccctca actaaagggc 264420
 atcccactgt cccatctcag gaaagtcttt acctggctat tgatgttatt gtcttctcta 264480
 aacaccagga ggccccgat gaaggctgcc aggaaagagt gcatctggtg ggtctccct 264540
 tgcacatggg actgtagggc acagagactc ttatagatga acacaaagca agccaggTtc 264600
 cgagagtggg tgtactggc tttcaggatg gcctgtagct tctcttgag actgcacaaa 264660
 cagaaagccc catgagtgca ggcccagagt acatatagct ctgaattagg caaggagctg 264720

 tagcccatcc aattcaaac ctctgtggag ggtgccccat gtcctcaggg gcactgcct 264780
 ctCaccagac tggggccttc actcagtgtc accacctcag ggatcactcc ctgacacctt 264840
 gcattaaataa gtgccccatcc ctttctcat ttgtcttttc catcatggct ctcatggcca 264900
 tttaacattt gtgagctgat ttatcaagtT ccctgtcct cagtataagt tctgcagag 264960
 cagggtctag attttgcTtg ttcacctaa gggcacagaa tggggcctga cacacagtag 265020
 gtgctcaaca aatgggagag gtgagtgaac agtgaacaga tgaatgtgtg cctgctatga 265080

gctggagttag cagataaaat cttgagaaat ggcaggctctg ctttctacat ttgtggggct 265140

tatgggcgag ggaataattg ccaaggcaag aatcagacat tgactttgat taagaggtgg 265200
tcctggaate tgaaggattc caagcagaag actcatcacc caaaaggccc caaggacagg 265260
cacagaaatg gagccaagca atggagagag gtcactgctg gctctgagca gggactgtgt 265320
gtggaggcca gtgaggaggt cagcaccag ggcctggtctt tcttttgaga tgaagaggag 265380
ctgattcaat tcacctttc cttaaaggga gagagagaga gagagagaga gagagagaga 265440
gagagagaga gagagagaga aagagaaaga gagagagaga gactctatgt ctgtgggtac 265500
ccacagagcc caaaaggagg cattggattc cctggaactg gacttatagg cagttgtgaa 265560

ctgtgtgctg ggaactgaac tctagtctc tgtaagagca acaagcactc tcaatagttg 265620
agccatctct atagtccac taggggacaa caagataac tcaggagagag agcagagtat 265680
acctctcaat tctgttactg gctgatggac ttcaagaca gtttaactttt ttttttttta 265740
agatttattt attcatttat catgtataca gcattctgtc tgcatatatg cctgcaggcc 265800
agaagagggc accagatttc attacagatg gttgtgagcc accatatggt tgctgggaat 265860
tgaactcagg acctctggaa gaacagtcag tctgtttaac cctgagcca tctctccagc 265920
ccctctgct attttaaat ttgattttt gctgcctcct gctagaagat aaacctagg 265980

agggcagga tcttgtctg tcttgtccac tctgtatca ttagcagcca caacagtgtg 266040
tattatataa tagatgttca ctgaacactt ggagactgaa tgagttaagt tgggttttaa 266100
agaatgcttt tggacctgt ctcaaaaata aaacaaaaca aaaatattg gaaggctgg 266160
gcatatagct cagtgccagt gtgcttgcct actgtgttcc aggetcaggg ccagtgtgct 266220
tgcttccaa tgtttctcac tctgaaaga gaaagaaagg ggagaagaga aggagagaga 266280
agggaagga aaaaaaac aatttggagg gcaaaaatcc ccaacatata taacaaaat 266340
aaaactgcca aaacagaaat cttttttaa aactcaatct cagaagatgg acaaacaga 266400

aatcttgcaa ttggacttg gcctaccctc ttgtattct tcttctctt cttctcttc 266460
ttcttctct tcttctctt cttctcttc ttcttctctg atttacttat ttatattta 266520
tgcatataag tgctttgctt gaatgtttgt gcatcaccta tgtgcttagt gctgcaaag 266580
gtcagaagag agtgttggag ttcttgggac tggagttaca aatgattggg agctaccatg 266640
tgagtctgg gaaactgaact cgggtcctct gaaaaagcag caagtgtct taaccaatga 266700
agtcactctt ccaatctctg tatacaactc tcataaacta caggtgtgtc tataaacatc 266760
agactgcaag gtgtttaagg ccttgaagga agggactcag gtcaggacac agagcaggag 266820

aggagagatc agagactgat ttccagagac tatgaccagc aggactggac aggtttctgg 266880
gaggaaca gaagctggct agaagaggat agctccctgg aagcgggtgt gcacaggcca 266940
atgagtggga gtgaagtatc acagcctgca tggaacaggg cctgtgtgcc acggaagccc 267000
aactggaca ctgtaggggt tagctgtgtc acaccgcaga gggttaggtc tttgtggagc 267060
atagtgagga gccacaggca tttccatag gtcagagctg gactttagga agcacaggga 267120
atcgggaagc cagtcttagc ttggaaacta ctacacccat cctggcctga gggctgacca 267180
cattgtctcc caattggat gcagagaggg taggtacctg ccactcctga agagaaaggt 267240

catgaccaat gcatgaggtg cccgatttt gactccatag ctgtagaac agagacaaac 267300
agttactaat ccatcactgt agcagtttcc aggaccctgc cccctttgg ccctggctcc 267360
tttctcctt cccagttct gatacatga tgggagaaaa ataagtgtgg ctttccagtt 267420
acatctgggc tcaagttctt gaggccctg gtagagtac ctttgctta gcttgacct 267480
ctctgagctt cagtttccc aaaaaggaat gcaaaacccc agaggctgg gtaaatggtt 267540
cttgtggaca aaaatgaagt atgcaaaagg tgcactat tcctacctg cagaaatgct 267600
ctctccactc cttctgacc tgtctattat agttaggctc atcttgatt aattttaaat 267660

ttgatttatt attactagta ctgtttgtt ttcttttaaat tttctgatg ggcattgaaa 267720
tcaggattca ctgactctg tatagtggag ttatttaggg gaaaagaac tagacagaaa 267780
acaagaggcc ctccagctct aggaatgcag gtcctgccac cccgtgctc tccatcactg 267840
aatgggcaa gagagctcca agcccaaac ctaatcctaa tcactgatcg catccatccc 267900
cacctgtgac cagcccaaa aggcgtggtc agtctacag gcttgactg cagtttcat 267960
tacattcatt catagacaaa gaatcttact gtgtagtact agctctggct ggaactcact 268020
atgtacacca ggctggcctt aagcatgtcc taactctgg gagcagagg caggtggatc 268080

tctctgagtc caaggcctgt ctggcttaca agtgagtcc aggacagcca gggctactta 268140
gtggggccct gtctctaaaa atgaatcaac aacaacaaca aactcacaga gctctgcctg 268200
cctatatacc cctgagtgtt ggaggagtgt gtcaccacac caagaatttt cattttattt 268260
aactttattg ttgctattgt tttgggtgat ttaaaaagtt attgaagtaa tttattgtg 268320
tatgtgtggg ggcattgtgg ctgactagt ttatgtcagc ctgacacaag tgatagtcag 268380
ctgagaggat ggaactttta ttgagaaaat gcctccataa gagcaggtgt caagtcaggc 268440
gttgggtggc cagccctta atcccagcac tgggaaggta gaagcaggtg gatctctgtg 268500

agttcaagac cagcctggtc tacaagagct agttccagga ctggctcaa agctacatgg 268560
gaaacctgt ctgaaaaac agcaaaaaca aacaacaaa caaaaaaga aaccagactt 268620
caagtgggtt ctgaaggcag tagtgaatgc ctttaatccc agcgtcagg aggaagacac 268680

aggtggattt ctgtgagttt gaggccagcc tggctctacag aaggagctcc aggacagcca 268740
 gggctacaca gagaagccgt cttgaaaaat caaaacaaat agaaaacaga tcaggctgca 268800
 ggtaggcaag cctgtgggga attctattta tttatttatt tatttagaca gggtttctct 268860
 gtgtagcttt ggagcctatc ctggcactct ctctgtagac caggctggct tcgaactcac 268920

 agagatccgc ctacctctgc ctcccagtg atgggattaa aggcattgtc caccaaggcc 268980
 ctgtgaattt tcttaattag tgattgtttt gggaggaacc tagccattg tgggtgggtg 269040
 gtgttacctg tgggctagtg gtcttggaaat ccataagaaa gactgagatc agctcctgcc 269100
 tccaggctcc tgcctccagg tacctgccca gtctgagttc tgccttggtt tcctccatg 269160
 gactgtgact tgagatacgc aggcacata aacccttccc tctctaagtt gcttttgata 269220
 atagcgtttc atcacagcat tagtaacgtt gactaggaca gcatgcatgc cacagcatgt 269280
 atgtgtgta gagaacagct ggtagcaatc agttttctcc ttccccact tgaactggg 269340

 gatcacagtc tctctggctt tcttcaggct tgggtgtaaa tgctgttacc tgctgagctt 269400
 caccaccaac cctggctttt tttttttttt tttttttttt ttttttttg gtaaggatct 269460
 tgtgtaggca agtctctata gctgactgag tgactgaggc cttgaactcc tgatcttct 269520
 cccaccacct ctigaatgct gagattgtag gtgcctgcta ccttacctac tttaatatat 269580
 cattattatt tcatgtgtgt gtgtgtgcct gcacacatgc atgcatatgc atacatgta 269640
 cctttggaat ctagaagagg tggcaaatcc cctagagctg gaggttacagg tggctgtgac 269700
 ctaactgctg tgagtcttgg gaaccaaact caagtcctct tcaagagcaa caagtgttct 269760

 gtctctgcct cccaaatgct gggattaaag gtgtgtgcca ccaccgacct gcctttctta 269820
 tttttcttta tcagacatct tatgtctggtt agttttatgt cacaggctag agccatctga 269880
 gaggagggag cctcaactta gaaaatgtct ctataagttc aggcctacagg gaggcctata 269940
 gggcattttc ttcattagtg atttataggg gagggccaag gtcattgtgt gtcataccac 270000
 ctctgggctg atggtcattg attctataag aaagcagact gaggtagcca cgatgaacaa 270060
 gccagtaage agcctctctc catggcttct gaatcagctc ctgcctccag gttcctgcct 270120
 ggtttgagtt attgccttgg ctteectcaa caaactatga cacagaattt gtaagtcaaa 270180

 taaacccttt cctttccaag ttgcttttgg tcatgttatt tcatcatagc aatagtaacc 270240
 ctaactaaga taccttcacc ttcatttctg cagctgtgtc aaggcttttg aagcctaaaa 270300
 tctcttgaag gccttgagac aatgtttatg agccaatfff gactgtcact tgaatatata 270360
 ggaatattca ctgcaggttt caaaaaagag gggctcccat ggcacacacc attagtctgg 270420
 tacttatatg aaacaacaaa tggccagaat caggcactgg gtagacagct cagaaagtaa 270480
 agttgcacag taagcatgag gaccacgga agagccagta cagtggggca cattaacaac 270540

cccagaccgt tgggacagag atgggcaggc agagccttgc agttcaccag tcagccagcc 270600

 tagccaatgg atgagttcta ggctcagtga gagacactgt cacaaaaacc aatacaaaaa 270660
 atgacagagg ctgggtgaat ggtggcacac acctttaate tcccagcact cgggaggcag 270720
 aggcaggccg atctctgtga gtctgaggtc agcctggtct acaagagcta gttccaggac 270780
 agctaggcta cacagagaaa tctgtcctc aaaacaaca aacaagcaag caaacaaca 270840
 aacaaaaagt gatggaggaa gacaattaat gtcacctct ggctccata cgctcacca 270900
 tgcacatc tgcacgaaca tgtacatgag agagagacag agacagagag agacagagga 270960
 tggctcctc tctctgtttt cattttaca cagagaaatt gaggcccaa gagagtaaaa 271020

 gagggcactg agctgagtg ggtggctcac accttagtc ccagcactg gaagcatagg 271080
 caggcagatc tgtgtgagtt caagccagc ctggtctaca caaggagttc caggtcagcc 271140
 agggctacat agagagactc tgtctcaaaa acaaaacaaa acagaaaact aatttgggac 271200
 tggagagatg ggtcagtggt taggagcatc atacctctc tggcttccat gggactaag 271260
 catgtacata gcaactaac atacatgtag gcaaagcatt cacacacata aaataaatgt 271320
 atcttccag gtgtacac atttaatecc agcactcagg aggcagagcc aatggatct 271380
 ccttgttcaa ggatagcctg tcttcagac aagtccaga acagccaaag ctacacagag 271440

 aaatcctgtc tcagaaaaac atcaataaat aaataataa ataaataat atgtcttaa 271500
 agtaattaat taaaacaact ttttactctt ctttctaca gtacatcctg agtgaagcct 271560
 cccctcttt acccctctca ctgctctcc ccagatcca ctgctctcc actcattaa 271620
 aaaaatgggg gagaggggt catgatgagg gacatcttc tgtgtatag tttgtctat 271680
 tgattaataa ataaagtact gttggccaat aggaaagcaa gataggtggg actaggagtt 271740
 gaggaggatt ctgggaaat tagtaaatg tttgatcca ggcaggaagt gacatagcag 271800
 gcagactcag aaaataagca ggaacaagca ggaagtcgcc ctctctctcc tgctctctgc 271860

 tcaggagctc ccatgtgacc actaggaaga caggaccaa ggccagtggc atcatctata 271920
 agtcttataa atatatagat taatatagat aaaaatatca tagtaataat gataattaag 271980
 actgagctag cagatagaaa tcttagttat tggccagcag cattgtaatt aatataggtc 272040
 tctgtgtgtt attggggccc taacatgccg gcggaactca ggcggctggc agtaagactt 272100
 attgttacag ggtcaagaca gggtttctct gtgtatctct agctgactg gaacttgctc 272160
 tatagaccag gttggcttca aactcacaga gatccctctg cccctggagt gcttggatta 272220
 aagtcatacg ccaccatgcc tggcttaatt taaaagaatt ttaaagaga aatggaggt 272280

cagaatagat gaagagtcac tcaatattca gaataagaac attaggattg gagtacagagg 272340
 acatgaccac agaaagtgcc atgggtggga gggttcacag aggatacagg gagagctgga 272400
 atcagaaagg attacaaagt cctcactggg aatgcctgc tggctctgga gctaagtctg 272460
 tgggatataa aagaacaagg tgggaaagtg ggagcagaga agcaaaaagt gtaaggtcta 272520
 acattattcc aaaagaaaaa cattaaggt gtggggggga tgagatgcct ttgtctgtat 272580
 gtgcacacag cctctctctt ggaagacaac aagagagtca tcccaggact atctccatgg 272640
 agagggactg gtgactgagg acattatgia actattttag agtccgggat ggacctcagg 272700

 tcctcttgca tgctaagcat gtgctaagca cgtgctcttc catggagtta catgcctggg 272760
 tcagcagtga acitttataa cttttgtgaa tgtgttacct aacttttaaa aaaggaaatt 272820
 aaagatgatt aaaataacta acaacttggc tggcgttggg ggcgcacgcc tttaatcca 272880
 gcactcggga ggcagaagta gttggatctc tgtgagttcg agaccagcct ggtctacaag 272940
 agctagtacc aggtcagcct gcaaagccac agagaaacc tgtctcaaaa aaacaacaac 273000
 aaaaaacccc ctaacatctt aaactgtgtt tttgttcag aagccagtct gctgctgtcc 273060
 ttatcatctc ctctgcctgg cagtgtcagg cagtcccat cctcgtgcct gtggcccttc 273120

 ttccccagta tcctagaac cttatctcct tcttctgcat agagagacct tcagcctcct 273180
 ccagttagcc agggacttcc tttagcctag acacaagcag actgtcttca agtcctaca 273240
 tctgccagge cttttctcag agtctcaag ttcagataag acctgttaca tcacacctgt 273300
 aatctcagaa tttgggtagc ttagacagga ggaccttgag tttgagtaca acctaagata 273360
 gacagtgaga cccccTTTT attaaatgg gggctagaaa gatatcttgg tcagtaaaga 273420
 gcttgccctg taagtgtgat gacctgaatt tggatctctg gaacctatgt aaaaatcaag 273480
 gcatggtgtt gggcactata ttccaaggca tctgtaggta gagggcagag caggaagagt 273540

 ctgggagctg gatggtcaag tagcctagcc tacgtggtga agttccagt cagagagacc 273600
 ctttctcaaa caaaaagtga aaggagagt cctaaggcat gatggcaggg ttgtcttggga 273660
 ccgccacata tcttgccatg catgtgcaca tatacatctg tgtgtgcaca cacgcatgta 273720
 aaactcttga acatttgggg gtgagtcaaa tgttcaactaa ggtcaaacat ctcagtcac 273780
 cacattgacc tcctaaact aatgacctct cttcacaat acagcaaatt tttctccacc 273840
 tccaggcctt tctgaatac attttcatgc ccagaatgcc ctggagaact ccaacttggc 273900
 cttcagaata tcacatcac tccctctgaa aagaattcct gaatactact ttgattgat 273960

 ggggtatttg ggittgttgt tgttgttgtt gttttggtg tagactcttg ctattcagtc 274020
 caggctagtc tcagactccc aatccacttg cctctaaagt gctgtgatta caagtgtgtg 274080
 ttgccacgcc aagccctgtc accgtagttt gtgagacttc ctttacact tatgatcctt 274140

atagatgggc agagtgtcaa tgccactaac aagtaatgat gtccatgcct tggagattcc 274200
 ggaatggctg agtttacagt ttttaatttta cagaggagga aactaagacc agaagagact 274260
 acccagtttg tcacagtgga agcactagga ttagagccca aacacctgac cctaaaaatg 274320
 tctgtcctgg ctggaaggat ccagtgagaa gggcacagag agaggtgggg tagggggagg 274380

 tgtacaaagc ccatattggg caacacttgc tgtgtccagg ccataactgg caaaggggct 274440
 actgatgtaa cctcagggtt cattctgtcc tgatcaaac atggctgata tgatctggcc 274500
 agatccagca ggaagcagtt tctacctgac ggagtgccca ctctgagtct caatcctgac 274560
 ggtaacctga cttgacatgt gcaggaacaa tcagcatacc tccccgagtc actaacgatt 274620
 caactagaag gtagagagat aagagtaatt cctagttttc aaatattcat tcaaaaaaaaa 274680
 ttgaatgcct ataaatagag ggattaccag gatacataga gggacaatta tcggtaaaaa 274740
 tgtgtgttcc tgtaaagcac attttgtcat tgttgttgac agagggtctc aactatagc 274800

 ccaggatgac ccagaatgca ctatttagca caagttggtc ttaactcac aataatcctc 274860
 ctgttccagt ctcccatgta caccaccca ggctgatfff tactgagaga catggactat 274920
 gaaataagat tgttcagtg ctattgataa caagtgtctac agagaaagaa acagggagga 274980
 aagttcagag gctgctcgtg gggaggtctc cgtgcaggat tagtgaacct gtgacaacaa 275040
 ccatcacatg ggcacacaca ccagattgt gctctgcatt tcacacgact gaccagtctc 275100
 caaatagtac catgcaagtg ctctggggaa ctctgtatcc agaaagtgag gctctgaaag 275160
 gccaaatgat cactcaagg tagctgacat tgggttttaa accgtggcag ttcacacact 275220

 caacaccgtg ccacacactg ctacctggat gccaaccgta gggactttgg tttcttctct 275280
 gagtcattgc tagttctggc acagcaacc ctcaataact gtgaaagcct gaggtttcaa 275340
 gaaggtggag ctgccctcca ggcacccatc gatcaaatg gccctaagac ctctctctct 275400
 acctglagga gtgagtgaga tcaatctgtc cagcaaatat tagctgcctt ttcttacgtt 275460
 tactgtcact ttccatgagt ccccagtga aaacgagggc tgggtgaag tcatattgat 275520
 gagaaacagg atgtgaacct gttagcaact taatagtag taggtgacca cctgtttgct 275580
 aaaggacaga gtccagtttc tttggtgcac acagagacac cgaagccaaa tagggcaaag 275640

 tgcacacggc aagatgaggt gaactggacc caaatgaggg gccacaggtg ctggcatatt 275700
 aggcaactat gtcaagagtg ccagattgta aagcacagag gacctagaag agggacatgg 275760
 gaagccccag ctcaaggctg acaagtgac aggaaccag aacccactt cactacacc 275820
 agcaggacac cggaatctaa cctcagagct ccttagagag tgcacagcga ggtgacaagg 275880
 ggctcgaac ttgcgacccc ggctaggecc gtccctcaac cctgaccaga ctctgcggcc 275940
 cactcacac agccccgttc cggaagccct taagcagggc caacacagcg tggtagcggc 276000

gctttcgag cagcgtgtg acagcctgga gaagagcctg cagctgcggt ggggaggcca 276060

tggcatcgga gaactcgggt gaggaacccg gctggacgcg tactgacagc cctgggctcc 276120

ggctgcaaag cccactggca caggagacac cgccccgtcg ttgtatccat aggctgagtc 276180

tgccgtcact cattcagcag agccagtcac agagcacact ggtctgcaag ggctgagcc 276240

gctcgcactc ttggactag ctgactgatt ggaagagaaa ggagagtcgg taaccaatca 276300

ccgggactcg gaagagctca cgcaggattc gcccaatcag aaggcagctt tcccaggag 276360

aagtttgggt cattgagagg cttaggagga gtttcttgcc ctccctggag ttgaaatgga 276420

tgacttcggg ggagctgacg ttggctttac ctcacacaca ctttcgatgc ctacagatg 276480

tgcagctaa ctctcaaga gcataaatca catgccactc ttgttgtctg gtgttttgag 276540

acagctttct catgcaacc aggcgggct tgaactctga ccactccctg cccacttccc 276600

acgtgctgga attgcaagcc tgtgccattt taactgcttt ctaactactt ttaaaataca 276660

aactctttct cgggcctccc aggaacagac gcacttagtg tttgctggcc ctacgctctc 276720

gtcccatatc ctcccttttc tccaacttgg ttggcttgggt ttccttctct ggagtagtcc 276780

aagagcgctt aggacttga cctgetattt ctctgttaaa atttattgcc cettgaactt 276840

tctatggctg acttctctc agtattcagg tgcagctca ggtaccacct aatcagggaa 276900

gcctgcagg atatcccaca gacagtaagt agcactgctc acagccaact tattagctca 276960

ggtttttgtt gttgtttgt tttttgttt tgtttgttt tcaagacagg gtttctctgt 277020

gtagccctgg atgtccgtaa actcactttg tagagcaggc tggttcaaa ctcatagaga 277080

tctgcctgcc tctgccttcc cagtgcctggg attaaagggt tgcaccaacta ctgcccagca 277140

gacagcccag gctttctgtt gttttgttt ctgttttct ctctagaatt cttcacattt 277200

tctaattgtt attacatgga ctactactt cctggagcca gaaagtgtt tgtctagttt 277260

tctactatga ctccagtagc caatgtaagt ttccaaaatc actaagatgt taaattatca 277320

ctgctagaca attaatgagt gacatttaca cataatgtta ctgtgtgtaa aggtattaga 277380

taacacacat tgaatgggtg ctgtatttgg gaggttgttc cctggacatg tgatatttac 277440

ttgtgatatt gactgggcta gtatcagagg tcagtaaaag aagtcaactg tgttgaacct 277500

acctgttcca tcacaaaat tggctctctc tctctctctc tctctctctc tctctctctc 277560

tccctctctc tctctctctc tcccgtttat tctgtagtc ctctaaaaat agtttattag 277620

aaaacagaat ctctaggcta gggatgtaac tcagttggta gagtgttctc tagcatgcaa 277680

gaagccccc gcatggtctc caacatctcc tcaactggct gtggiggcat tcacctgtaa 277740

tcccaggata aaggaggatga tacaagtatc tcagaggttc aaggttacat acaatagcga 277800
 gttcaaggcc agcttgagat acataagatc ctgtctcaaa aggatatgga gaggctgcca 277860
 agatggctca gtcagtaaaa tggttgctgt ctaagcagga ggacctgaat tcaatcctca 277920
 gaacccaagg aaaaagctga gtgtagtatg tgagcttgta atccagtact gggaaagcaa 277980
 agaccggcag atccctgaag ctactggcc agccaaccta gcttaatggt tgggcctggg 278040
 gtcactgtga gcaaacctgt ctcaaaaaga caaggtagac agcttctgag aatgacatc 278100
 agtgattgac atctggcctc cataccata tggatacacg tgaacccatg cacacgcgtt 278160

caacccata aattcaaatg cacatacata tatacacaac gtatgtatac aaatagtgat 278220
 tgtgtttag aaatgtctc tagtctcca cgggatgccc acatactct gctgtcttcc 278280
 ttaatgttga gaatggatga ctttacttgg tgaccaagtc tccagtgatt gccgagaagt 278340
 tccgtcacat tttgctagta ctacagacca gcaactgctga gcagcacggc ttgacctttg 278400
 ccattactga tatgaagggt gtggagcaaa gggctctctc aaatggcatg gaggtctgca 278460
 gaactcatgg atgaggcatg aaacctgtga tcacagccat gcagattcca caccagatca 278520
 agacctgac ttgaacacaa gaaagataag cagaaaggaa tctagccagg ctctggccag 278580

tgtctacata tcaagttctg tcaagacctt ggatacctaa tgatgattga gacccgtgca 278640
 atactgaagt cacttccggc acatttatgt ccaaggcccc cacaccaaga ccattggccg 278700
 ataaggctac agiatgggta aatcttcagc catatctgtt aataaatagc caatatgcct 278760
 acttatataa tatattgttt tgtttttttt cgagacaggg tttctctgtg tagctttgca 278820
 catcatgctg gcctcgaact cacagagatc cgctgctc tgcctccca gtgctgggac 278880
 tagcactcgg catgtgccac caatgcctgg ctatataat attcttaca acacagaaat 278940
 gctttaaagt gtgaggaatg tccagaccag ttatgaagtg aaaactagaa actagacagt 279000

taacaagagg actcataagc tggaaacca aaaccaetta tgacatgaga gccttggcaa 279060
 atattgaacc tglgaatttc aattgacaa ctacactggg caagagatat aagagtgaag 279120
 gtccagggcc tgtccaagt gaagaggctt agagcagact cttcaagtca agctgaagaa 279180
 aaaggatttc acattccaag ctaatgtgac acaaaactac tgtataacce ctgagcccca 279240
 aggaacccca gagaatgctg ctgcagagct aaacaccaca gttcaaagaa gaggaaaggg 279300
 gaattccctt taaagctctt tcttgaaag tgtggctgat aagcttttt gcactcctcg 279360
 gagtagagct tggatgtca agaaattca agctatgcca atttgtgtgg cacacaccag 279420

caatctcaat cctgtcaaag cagaggcaga aggatcatgg agttgggtcc agcctgcgct 279480
 atcctgtgag atcctgtctc atccagctta ttcttattta aaaatgtttt actgttgcta 279540
 agtgtgtgtg tgtgtgtgtg tgtgtgtgtg tgtgtgtgtg tgtctgtctg tctgtctgtc 279600

tgtctgtctg tgictgtgtg tgtttgagtg taggtaacca gggatgccac agtcatttgt 279660
 gagctgcccc gtgtgggtac ttggtaccaa acttaggtcc actgcaagag catacgtgat 279720
 atttatttat gagacagggt ttctttgtgt agctttggag cctgtcctgg aacttactct 279780
 atggaccagt aagagctggg gttaaaggag tgtgccaaca ccacctgag tgttcatgat 279840

 cttactgct gagcaattgc tttctccag tcctgaaaa tctttcttt aatataaaaa 279900
 taaggaagac ctctcaaaact atgaacaatt gatgtctcca caaccttgca gaaatcagat 279960
 tcaggagcgg ggagtcagct aggtgatagt gtttgccttg ctagtttttg atggcctgag 280020
 ttggaatccc cagaacccaa gtaaagagtg ctatttggga ggaggggagg gaatgggaac 280080
 tggaaattgt atgtaaaatg agaaaagatt gttttaaata aatttttta aaaggagagc 280140
 aaaaaagag tgtttgtcta gtgggtaca gttgatggc tcacacctt aatcccagca 280200
 ctcaggagga aagtatctg gctagccaag gctcataatg aaaccttgc tcagaacaaa 280260

 caaacaatg acaacaaaat aataataata aaaattaatc tgaagaagag cacgtctgct 280320
 tttagtttca caggtcacca gagataatta ggctcctaag agaacatgaa aatcaacag 280380
 ataagcagag attatagttg caattcaggc acaggctttc aagaaaaaaaa aaaaagacac 280440
 aaaatttaa gctagaaagt agctatagag aacttaaaag tattatttaa aaattatgtg 280500
 cacttatatg tatccgtgtg cgggatgtgc atgtatgtgc cagaagtgc ccatgtccct 280560
 ggagctggaa ctacaagttt tgtgaacttt ctgatgtggg tgcctgggaac tgaatttga 280620
 tcctccgaaa aagcagtgtg tactctaac tactgagtca tttctccagc cccagaaat 280680

 atttttttta atatagcaaa ttaggtgatc ctagcacttg agaggtagaa gctagagtca 280740
 ggagttcaag gccatactca gcttcatagt gagtttgaag ttgcctaggc tacaagagac 280800
 ctgtcacia tccccaccc caaccctgtg gtctgtctgt gtgtgtgtga gagagagaga 280860
 cagagagaca gagagacaga gagacagaga ggacagagac agagggagag agagagacag 280920
 acacacacac acatacacac acacacacac acacagagag agagagagag agagagagag 280980
 agagagagag agagaatgtg tgtgtgtaat ttggaagaac aaagctgcta gaaatttcac 281040
 ctgtaactac atggagatca gtctgagttg tgacatatgg cccagtgttg ggagcagata 281100

 tttggaaca attctgtttg gcaggtcttc ctgtatatta tcttttgta aggcctttct 281160
 taggtagatg aataagtttc taccttcca agectctaa tgtgctaaag gcaaaaatcc 281220
 attgccacaa tgagagtatt tattacctag tgaccattt tcattttgca caactctaag 281280
 tcctcagggc acaccattta tttaccttg ccagaaaaa aaattgact acatgtgcta 281340
 tctatagaat actaactggg tatcagtttc ttgcatgcct ttgtgtgtgt ggtgctgggt 281400
 gtcaagctaa ggggttccct gccacagaac tacatgcaca gcccttgaat actttgttac 281460

tagtcttgtt cttatagaaa gtctgcaagg taagtgtat gaaattgtca gctaacttac 281520

aggaaacaga ggaacacaga ggccaagtca cttgcccaag atacaatagc tgttgaaggc 281580

tagaggaggg atttaaatcc aggccacceca gcttgcctct gaagattgtg atcttagcca 281640

tatattagtt tgttagtact gccatgccaa agtaccacag aaatctattg taacagaatc 281700

ctggaaactg gttgttaaag accaaagtgt tgttagtagg tttcatctct ctggagatct 281760

atctcccttg tttttaaaga aagtaccttt aaggagaatt ctcacgtggt cacccttttt 281820

aaaaactaga ttcttaggca gctgtagtat gtatctttaa cctcagcact ggggaggcag 281880

agaggcaggt ggatctctga gtctgagttc cacctataac cagagctata gaatgagatt 281940

ctgtagctaa ttctgtctct aaaaaaattc ttaaaaaaat aaaacattt atatattat 282000

atgagtggag catgtatgtg tgccactgaa tgccactgga agttccagaa caacttttag 282060

gagtcagttc tctgtaagca tgagttttct gtctcgggtc tagtgaaata attacatcct 282120

tgccctcagt tctctctcc accacttagg tccaggggat caaactccag tctggaagct 282180

tagtggggga cacctttact cactgagctt tgtgcgtgcg tgcgtgctg cgtgcgtgcg 282240

tatgtgtgtg tgtgtgtgtg tgtacatgta tatatacata cacatacacc caggtcctct 282300

taatcactga tccatctctt tagtcccat tttcttcac tgattacatt gtaatttcat 282360

ttacttcctt agtgcataata tgaacacttg caccacaatc acgtatggat ttgagaagat 282420

agctggcagg aatcagctct ctctttcag ggcaagtgtc ttcttcccgt gctgagccat 282480

cttgtcagcc tcccgcaccc ccgccccac cccacccca gttctcaagg tgctctcaaa 282540

ctgactctat agctgagaat gacttgaagt tgcagtttc ctgcctctac ctccctagtg 282600

ctgggattat aggcaagcta ccatgccat ttatacgggtg ctgaggatcc acttggagct 282660

tcctgcttgc taagaaagca ccaatcaaac tataacccca gtccccacat acagaagaaa 282720

catactggac tgggcctaga aactcctagg atggggcgg gtggtgaaag agaatacacc 282780

attctgtctg taacaactgc caggccttgt ttctcctac gaacaccaa acgtaaggat 282840

gcaacattgc ttgacacaca ttcattttct cccctcaacc taggaccag atgtaagttt 282900

tgtcattctg ggggtaactg aagtgtctac tgtgaagctg gtcattaaaa gtttctcagt 282960

cttttccttt tcctagtgt gcccaatgcc tggaaact acattagtgt cttcagaggt 283020

tcagtccaa ctaggtagcc ccgaggaggt aggacatggg actgctagag attgtgatgg 283080

aggaaggat ggtgggaaag aacggaaggt ctgtagagga agcagtctga ctgggggaac 283140

ccatcagtgt tagggcttgg catccccgaa ggctcatgga cctgttccac ccagcaggcc 283200

atcggtaag cacttcttgg tagcctctgt gccaaagcctt gaggtccaac cagaatggat 283260
 gcagtaactt cctgatttgg gtttggaaaa aagagctaac tgccaatagc aagaaatgat 283320
 tacttggcgg ggatagtgcc agctactgtg accgcaacaa agggttctgt tctaccctgg 283380
 gaggccacag acaatctctc aggggagcaa gcaggcaggt tcctaagttc catggaggac 283440
 aggaaaactg cccttttaga agatgggaca gcaagcagca cagggtgtgca cgtgccctgt 283500
 gtggagagaa ggagctggag agctgccatg gctgtgctgc cttgtgtttg tggagctttc 283560
 actgtctgtc actctcagaa caaacctaaa gtctcacata gtctcagctg cacttttaca 283620

 attcttggtc ctgagtgtg cgggctagaa aagggtgggg ctgcacaaag agccttgcca 283680
 atgctaagca ggttagctgc ccttggcctt taatttggac ctcagagcct ttgtatttgc 283740
 cattctctcc agttccctt ttatccttc aaaaagctga ctccattgcc tttcttgggt 283800
 catccacctc ctcagagagg ctcttctga cccaccctga ataacatagc ttctcttcat 283860
 accagaataa agaatgatct gaagtcatag cctctctctc tcctcattcc cttatttact 283920
 tccttgtcta caaccatctc tcctgtgga ttataactgc acgaagaca ctttttttgg 283980
 tctttttttt tgagggggtg ggggcttgtc caggtttcta aaatctagaa caagtcttgg 284040

 catacagtag ctgcttagca aacaaggtaa attaaatgac cagttatatt aaaaggtaa 284100
 tagtgataaa aagctatgct gaacaacct ttaaggagag atcagaacct gaggccaatg 284160
 ggttaatgaa taigttaaag ataggaaaga aggaattctg gtcttactca tgcaaagggt 284220
 attggaagg aggcctttagg gctctggatc tccaagagtc ccaggaaaag gattggcctg 284280
 tggagtctct gaggagtgtt tttgtggtgg tggtagctgt aatgataaat aaaaaagaaa 284340
 ggcaaagtgg gtacctttcg gtggccctg ccaaggtatg cactaagga aacatgtccc 284400
 tcaaaacaga ggtagagcaa gaggtttatt ggtggggggc gtgaaagact gataggctat 284460

 gttagagtag ggacaagaag tggcaagaga agaaagagga aacagagaga ggaaagagga 284520
 ggcggagaga ggaaagagga aacagagagt ggagagaggg ggcagagaga ggaaagagga 284580
 aacagagagt ggagagaggg gacagagaga ggaagaggg gacagagaga agaaagagga 284640
 aacagagagt ggagaggggg cagagagagg aaagaggaaa cagagagagg agagagggga 284700
 cagagagagg aaagagggga cagagagaag aaagaggaaa cagagagtgg agagggggca 284760
 gagagaggaa agaggaaaca gagagaggag agaggggaca gagagaggaa agaggggaca 284820
 gagagaagaa agaggaaaca gagagtggag agggggcaga gagaggaaag aggaaacaga 284880

 gagaggagag agggggacaga gagaggaaag aggggacaga gagaagaaag aggaaacaga 284940
 gagtggagag ggggcagaga gaggaaagag gaaacagaga gaggagagag gggacagaga 285000
 gaggaaagag gggacagaga gaagaaagag gaaacagaga gtggagaggg ggcagagaga 285060

ggaaagagga aacagagaga ggagagaggg gacagagaga ggaaagaggg gacagagaaa 285120
 ggaaagaggg gacagagaaa ggaaagaggg ggcagagaga ggaaagagga agcagcgaga 285180
 ggagagaggg ggcagagaga ggagagaggg ggcagagaga ggagagaggg ggtagataga 285240
 ggagagaggg ggcagagaga ggagagaggg ggcagagaga ggaaagaggc aagagaaaca 285300

 agacacagag aggtaagaga agaaagtggc aagagggcgc tgtccctcaa gaggcactttt 285360
 aagggtgcac attgttcagc tgggacctcc agctcccttc tgecccatcc ttgcctctcc 285420
 aaacctgtc ctcttgaaa aactgcaaaa aagtccgca ttcctgcggt tatggcagct 285480
 cctccctga agccccagc tcccgaagac cccaccagg caccatgctt gggcattaac 285540
 ccagcttgtg gcagacacat catcacccct tgactacagg gcacataaac gcctggcttt 285600
 agtttggcca tigtattttt ttttctgc ccctccctt tccaatct ctggggactg 285660
 gaggagtac tctcaagtg cttcaccaaa ataacctgg tcttttctt ttttaattct 285720

 gcttgatctg gcatactgag ctggcggaga aacctataat caggatatag gaagcctatt 285780
 acacatgcc catagatggc ggtggaagg cacctggtga caggatga gataactgct 285840
 tgggtgcaga ggcagctgc tgttcggca gaaactaaca ttcctccctt ttgttctta 285900
 taaaagggtg aggaactggg aagggttagc agtggggcag gaatgagaag atcgtgttct 285960
 tgagactgct tctgttgcc tgggggtgtt agcatctgc ttagtggcat accttggcag 286020
 ggcccactga aaggatcca ctttgccttt cttctttatt tatcattagc ttgggtgcga 286080
 gactcacata cgctctctg gcatttggc tggtcaggct gggatcatac acctccacc 286140

 ccacccccgc tccacctaca acaaatctgc tttctagttt accgctggct ctgccttcca 286200
 ttcaactg gcaattggat ctctggccag gctttccacc tcagaccatt ccctggatg 286260
 tgaggctttg tttctgagc actatcctg cttctgact tttctgaag tctgtgttac 286320
 cagggtggctg tgttgcactc ggtctcttag cccttgggcc ctgttcttgt atgatgactg 286380
 ctctgtttgg tcttctctg agtccaggga tgcccaggc tctcagttt gggacttctc 286440
 tctgcctcat ctttgggga tctgtatca tatacctcac tcatcgccc cattacgatg 286500
 tcttttggag acctcttac cactctttc aatcaaatc tagtctact atacctgga 286560

 ccagggtggtc agagaatgga gaaagaattc ttactctct tctttgctc caagacctac 286620
 tcgttctgt ctgctctct ctaaatctg taaacgtct gtctgtatgt ttgttgaac 286680
 gtgggagtca gagatggaaa ggccggcttc tcttctca gcacatgcca gttctcttt 286740
 gcagtgtctg ctgacctaac cctcagtaag acagacatgc cagctccaag cagctctctt 286800
 atctctcca aagaagat tttggcacag aagcttgatt taaataggc aacgctgacc 286860
 actgggcaaa aaacaaaca acaaaaaaaaa ccccaaac tgccttttac ttcaactgct 286920

gccaagacc tgcctatatt gtggacaagc agaccaggac attgggaaat caattgcccc 286980

cctttgcta gacaaggtag gctgcttgac cccaagttcc taatccacag gaaagtctgt 287040
cagatattct gggcctggta gccgaagact gatgctgccc tgagactctt cccccaatga 287100
ccacattgga acctggggta ggtgtctagg tcaccagtaa gtctctctca ttttaaaaat 287160
atattttac ttagtatgta tacagcattc tgcctatata ccaggagatg gcaccaggtc 287220
tcattataga cggttgtgag ctacatgtg gttgctgtga attgaactca ggacgtctgg 287280
aagagcagcc agtgctctta actgctgagc tattgctcca gtcctgtct ctgttatfff 287340
taatagattc agaagctgct tggctctcac ttctgcttac ttgggtgaaa tttatccttc 287400

tcagaactct aacagtatff gatgaccagg ctaatgatag ctttgtcagt ttaactacag 287460
caatcatgga ttcagctggc ttctcaattc tctttgtgtg caaaattcag gccacaggcc 287520
tcactttcct agagctacta ttaggtctag acacagtffa ctttgttacc aggctctgaa 287580
aagagataaa ctcaaaaa tagatttcaa tgtttttact attcctttgg ttttactatt 287640
cctttatffa ataaaactca ctctacaatg actgctctca gtaatcaacc acctgtttcc 287700
cctggtaaat gcttagatag aaaaaaagtg taaagtttat gtgaagatac gaagcttaa 287760
gttgaagga tctaagaaaa cgatttaggg cctaaggtgt ttaagatgt ataaatccga 287820

attataaagg tctgaggaga cagggtttct ctgtgtagct ttggacccta tcttggcact 287880
cgctctggag accaggctgg cctcgaactc acagagatcc acctgcctct gcctctcaag 287940
tgctgttatt aaaggcgtgt gccaccaatg cctgcaaggt ctgaggatgt aatgcttaa 288000
atggtgattt ttttttttt agaaaagggt acttaagatg tatggaagga tgaacgtgt 288060
taggcttctt tctgtggctt tctactgtta tattaagact ccagaagttt atagtcttaa 288120
cattaatcaa tggatttcag ataagctgct cctctagctc tggtaagca cactactat 288180
atcatagtca caaacccaag attttaagtc ctctttgggt gttttctaag tatagattta 288240

aaagtgttc tcatttgcta aaaacttctg tgaatctat atataccag tcttctggat 288300
agagtaaga gtaggaatgc ttttaaccag aatcattttt gggcccccta tgaatcaaag 288360
gcgtgagtct gccttttcta caatgtggac ttcagtatag attacaaaca atggaaatgc 288420
taatgtttct aaaactaatc tctttttgta aactcaaaaa aaaaaaatcc tgtaagctcc 288480
agggagtcaa agtagatcca cctggaacag gcgaaatgaa ctccaggtaa gfactgtcaa 288540
tcaacagctt aaatttcccc acctactgct tgttctgag ggtgggatct cccccattt 288600
tcctgatct tgggattccc ctccctcaat catcaggacc taagaaaaaa aatccccctg 288660

gaactttgta gcittatctt ctgctctgcc agcgtcctgc caggfccagg tgtccctca 288720
 aaacctgcat cccgggacag cttcgaagtg cctagcgcca agtggtctaa cctcacagac 288780
 tgcttcaact aggccctgcac tttcctaact cctagcgctg gagatgatcc cacaaagcct 288840
 ggacaatgag caaaacagcc agctttctca ggtcccccaa agatgctttg cccccagaca 288900
 acaggaagca gtccttatcc ctgcctcaact tgctaactct tcctagttcc tgatcttttt 288960
 ataatacaca atagggagga atgttagttt ctgcaaggca gcagcctgcc tctgctgcca 289020
 aagcagttac atcatcacct gtcacatca gctattcaac atgtgcaccc cttaaaagta 289080

 ccctccaggg acagctcaact cgcttgctc ttactcctct ctctgctccc ccattccttt 289140
 ctgccccccc ctttctctc atgcctcttc ttgtcccccac tctgacatgg cctttcagtc 289200
 tttcacccaa gtccttcccg aaataaccct cttgcacaga ctctgttgct tgcagcatgc 289260
 ttgcttagtg gcagacctg gcagggcctg ttgaaagtga cctacttcac cttccttttt 289320
 atttatcggg acagtagtga tggctttttg ttgtttgtgt tctgtttgga gacagggtct 289380
 cactacgtag tcctgacatg catagaactt tctctgtagt gtccaaaag agaggagctt 289440
 taggtgcatt tcttaatttt aggagtttag tgaagagagt gaaaattgtg gtttgtattg 289500

 atgttccctt tggctgaggc ttaactgtgg gaagcaagga ggatatttgg agtcaaattc 289560
 atggtagttc agtcttagaa caacatggct atgatcatag agaccatcca ttgttgatgg 289620
 catctctctg tttctcttt ccctgtgtgg gcttctcca acattccctt gttgtccaag 289680
 ggcaacagat tgacatccct actgcacatt gtagttaaat attttttaa gattttattt 289740
 attatgtata caacattctg cttccatgta tatctgcaca ccagaagagg gcaccagacc 289800
 tcatgaaaga tggttgtgag ctacatgtg gttgtctggga attgaaagca ggacctctgg 289860
 aagagcagtc ggtgctctta acctctgagc catctctcca gccctttag ttaaatattt 289920

 ttaattttta atgatttatt ttcatttatg tgcattgtta ttttactgca tgtatgtctg 289980
 tgtgaggggt tcagaccctg gaactggagc tacagcaagt ggtgagcttc catgtgtgtg 290040
 ctgggaattg aactcaggtt cttttggaag agcacccaat gctcttaatc actgagccat 290100
 ctctccagcc ccatagttaa atatttttaa agattgaatg tctataatat caaactacc 290160
 tctaaattcc taactttcta cccataggtt aacgcatctc tcagccatca tcagagaact 290220
 ctttgtgtaa tggatggcag ttaaccaga aactcacaac tggttaaaat gtcagtgtg 290280
 tgcccagcca caggctggaa ggacctctat ctctatctc tteccactac caagactcat 290340

 ggatgagggg ggtggaagaa tattctaaga gccagaggtc gggaaggact ggggtgaaag 290400
 agtgtctcag aaatgacagg cctatagcac ttacaaactc agaccagctg cagttttgtc 290460
 tgcacaggat caagctaatc agcattccag aacgcctgag ggaggagctc actattcca 290520

ttaaggctg ccttgggagg gatagtcagt ttcttttaag ggtgtagtcc ctggtagacc 290580
atgttgcaat ggataaccca acaccaatca atacactggc agacacatta gactcgggtg 290640
attataagga aaacaagaga agccttagag atggctcagc tggtaaaggt acttgctata 290700
gagcctgtgt tcaattccag ggtctcaaat agaaggagag aatcgattcc tgaaggttgt 290760

cttctcatct tcacacatgt actgggtgtg tgtgtgtgtg tgtgtgtgtg tgtgtgtgtg 290820
tgtgtgcaga catttgccat gtgtgtgctc acacacacaa ataaataata aatgtaaaaa 290880
gaggacatga ggggttggag agatggttca gtggttaaaa gcattagctg ctcttctaga 290940
ggacctggat tcaattccca gcaccacagt ggcagctcac tccaattcca ggggatccaa 291000
cacctcata cagacaaatc accaacgcac ataaataaac aagaggacat gaaattggac 291060
gtgggagtgt gttatgataa agtgtgtggg gacccctggc gaattccatg gcagatgagg 291120
gtgactggag gggggggggg cgacaaacat gccaggcaga cagagctttg tgagaggttt 291180

tattagaaag ggaaaagggg ggaaggaaag acaaaagagg tagagacaca gagacagaga 291240
gaggacagaa gagggagaca agaaaagtcc tgctgccccca ggggcagaaa aacaataagt 291300
ggcggggggg ggggggggtg tctttctttt aaaggggtcc tttgctcctg agtgcagacc 291360
acaccacat ggaaccctgg gctgtccaga gtactgcgtg agtgcattct gccaggtgac 291420
aggagcagge cagcgtaatg actgaatcct tacagggtgg atccccacga acttgggata 291480
gggatgactg agatgggtat aaggctctgt atggcaatgg ggtctcagag aatcagggtc 291540
gagggatgtg aataggagtg gaggtcccct caaagctgga aatcggggct aagaagagcc 291600

ttaaggaat ctaagagata atgaaagatt gacaccaggc agagatgaaa atcgttttga 291660
caaggctgct ttccaactta cgtggcacag ttgcgggtg tgggtgtca ttttacagtt 291720
gggtaatgcc ggtgaggtg gttgtgtgtg caaagtggga gaactgtg tgcagcgata 291780
atgaatgggg ttctgtttc agaactaggg ccggtgtcgg ctctcggagg nnnnnnnnnn 291840
nnnnnnnnnn nnnnnnnnnn nnnnnnnnnn nnnnnnnnnn nnnnnnnnnn nnnnnnnnnn 291900
nnnnnnnnnn nnnnnnnnnn nnnnnnnnnn nnnnnnnnnn nnnnnnnnnn nnnnnnnnnn 291960
nnnnnnnnnn nnnnnnnnnn nnnnnnnnnn nnnnnnnnnn nnnnnnnnnn nnnnnnnnnn 292020

nnnnnnnnnn nnnnnnnnnn nnnnnnnnnn nnnnnnnnnn nnnnnnnnnn nnnnnnnnnn 292080
nnnnnnnnnn nnnnnnnnnn nnnnnnnnnn nnnnnnnnnn nnnnnnnnnn nnnnnnnnnn 292140
nnnnnnnnnn nnnnnnnnnn nnnnnnnnnn nnnnnnnnnn nnnnnnnnnn nnnnnnnnnn 292200
nnnnnnnnnn nnnnnnnnnn nnnnnnnnnn nnnnnnnnnn nnnnnnnnnn nnnnnnnnnn 292260
nnnnnnnnnn nnnnnnnnnn nnnnnnnnnn nnnnnnnnnn nnnnnnnnnn nnnnnnnng 292320
ccctgacccc cgaggacttc tgagaccac tgtgtcccta gagctgcggt gtggtcctac 292380

taaatgcaga gcagggaaagg agacgccgcc tgtgcgca gccgagtctg cagagaccac 292440

 aggcccaagg cagtgaacac agggcaccgg tctgtgctcc cgagtcagaa cccacgacgc 292500
 cgtgagcctg cacgggccac gccgctctct gatccgactg gatcctgtcc cgtgatgtgc 292560
 aggctcaccg aggtggctgg gcctcgggct ctggagaaag cgagctctga gcgccacct 292620
 gtgcaccgcg tggagttgag cgagaaagga tagctctaga gacaggagtg gagctgggca 292680
 cggaggtcgc cgcgggggtg cagggtcggg tgagccgctg gagtagacac ttgtggacag 292740
 ggccggcaga aggaagcggg gacttgcact tctctagatc tcagccagtt ctaccacgg 292800
 aatgatgagg ggtgcctttt gctatcgacg ggtgtcgttt cagtgggtct cactgaacca 292860

 gactccgagg ttctcacctt ccctcattat taccccatcc cactcccgc tccaaaactg 292920
 tgggaaagaa tagtaaaaga aggtagctcc tcagccagg tgtggtggtg cgtgcccga 292980
 atctcagcgc ttggaagggt ttagcttcgg ctacataatg agtttgaggc caacctgagc 293040
 accgtattcg cgcaattaca tttttctta cagggtttct ctgtggcttt ggaggctgac 293100
 ctggaactag ctctttaga ccaggctggt ctcaactca tagagatcca cctgcctctg 293160
 cctcccaag tctggagca attacattt ttaaaggcc atgaatatga aggagagtgg 293220
 agaagtata taggaggga atcgaaggga atatagtat caaattata tctcaaaaat 293280

 aataaattat tgggggttgg agagatggct cagaggttaa gagcactggc tgctcttcca 293340
 gaggtcctga gticaatttc ccagcaaccg catggtggct cacaaccatc tataacgaga 293400
 tctggtgccc tcttctgctg tgcaggcaca cattcaggcg aaactgga tacataataa 293460
 ataaatcttt taataatatt aaaaataaat atcttcaga aaacaaaaca gacaaaacca 293520
 caaaacaaga acccaaaaag aagatggcaa agacaccca actgtgtgtt ctgtgaagaa 293580
 aatagcagg atggctgaa tctgggtagt ggggttatgg gtgtccctc ttggagggca 293640
 gtgggtatt gcattgttc agtgttcatg cgtttgtgta ttggataatg agaaaagaga 293700

 gaaatcggga agttagctt cactggcctt ggaaggtctc cagcaccaa ataaataaaa 293760
 tttccgagt agagaaggac agcaggtgtg cattgatcca atgggagggc aaaaggacca 293820
 ggtggtgaa gtggcatttg caaagccctg gggagagcaa gatttcccgt atctcagttc 293880
 agcatataac agctagagaa aagacctca ctgattgat gatgctctg aactttatct 293940
 tgggatcagt gtggtgctaa gaaaaggtt tcatcaaggc agccttatca tctgatgat 294000
 gttttataaa gttcactctg gcttctgggg attggcctgg agggggctga atggcagcag 294060
 ggagggagtg aggagctagg ttaggcaact gaggggaagg aaagagtgga tttcaaatat 294120

atttgggaga cagaataggt tagatttggc agaagtctag aaatgtcagg aaggaagcag 294180
 tggatgagat ttggtggggt gcccttaggc tcttggcttg gaaggacagt gccttctgt 294240
 tgtgcttgta gtgatgggtg ttaccagaag agacagaagt ggaggatagc ctgtttaatt 294300
 tggggttgta tttttatcc tttttatgt acatacatat gtcacagcat gcctgtggag 294360
 gtcagaggac aacttcagg agtcatttcc ctcttccac tgtctagtc ctagaaatca 294420
 aactcaactt gccagatgcc tctacccaact gagccatctc acaggcccaa gtattttatc 294480
 ttgaaaaaca ttttttttc ctctgaaat tctaagacaa tatggagtgg tccaagaac 294540

 tgatttccc cagcttgtgc ttttatgctg atattatfff aactagtga ctctcaccta 294600
 tcagtgtgga agaattccat tgctatgagc tgatcggttt cagggatcca agatcctagc 294660
 tggctcttcc caagccacat tctgcatccc cccccccat tctcctgca tcctgacta 294720
 ctggcaagca cgaatctatt cctcacctat gagatgtcgt ctttgcaaga ctattatgta 294780
 agtggatctt gcctttgaga catatatttt gttcatcaat tacctcaagg tgcatttagc 294840
 tgggtgtgtt gttggtatcc tggaaactctc tttgtagacc agactggcct ggaactcaca 294900
 gagatccacc tgtctcttct ggtattgaag gtgtgtacct ccaccatctg ccttaactgg 294960

 ggtttctgtc tgcaggaca gccactactt cccttcccag ctgttgatgg tcaactgatg 295020
 gaggcaaagt gcatctagtt cccattaac cacaaaagcc ttcactcaact caaagagccc 295080
 caccaccctt geataaagtc cacttgctt cctgccagga tgcgctctg tgctctctga 295140
 ggcagcccag cactttgtcc cctagtaaaa ctgtcttctt aactatggag ctccccctc 295200
 acagatactg acctgcaactg tactgggaca ttgcagacag gatttctcac ttgggaagtg 295260
 aggtaacatc aaagggtatt gatgctaagg ttttggtagc aggtacatcc tattccccac 295320
 cctcttccct ggactcctgc cgtaaatctc ctccccgggt ttacaagggc atgagaacag 295380

 agctcacttt tgetacacgg gcaactgattc tcttcacact ggacaccgtg ctatctgtct 295440
 cagattctgg tgctgaagt ctctcagag ccctgcat cccattggcc ctctgtccat 295500
 ggtgttagta attcttctca taaactactt agcttttctc tctgttctct ctgaaacctc 295560
 ctgactccat ccaaaacctc acaatagaaa agggttggca gaagctgtgt ggcagagcat 295620
 gagccccagg cctgtacctc ccaagatgtg gaatgagacc actggggact ggctagaagg 295680
 tgcaatctaa acagaaggaa tgctcaaaa tccagacaga aggaacacct caaaacagct 295740
 gcctttgggg gtgggcagta gaagactgga aagaaggacc ccagcaagta gaagagatcc 295800

 aagaagggtg gctcctggag tagggggtgg ttcttgggtg ctcaggcact gttgggtggc 295860
 ccttgggtgga aggtgagagc ttgagtgtca ctagagggaa tagagatgat ggaagtggc 295920
 aagaagatgt gggcacaggc agatattttg aagagtcaac atcgatatt tgatgttgg 295980

gggacagaga tgaggagaaa gaatgcaagg aaccttgtgg ggtgtgagtg aggaggacca 296040
 gcgaacggga tttccaaagg gctctgtgac tggttagtct ccagcaatgg ctttgagaca 296100
 ttacaaaatt gtagaaagta caaaggacgg tgatctaggg gtgccacttg gcccagaaga 296160
 attctcgatt tttttttttt ttttgatgga tgggagtagg tcctggacct ctgtacatac 296220

 taaaaccttg tacatgccaa gcatgtgttc tgccatgagg catgctctca gtttcttttc 296280
 ccagcttttt tigtgtccag tccttagagt tcacctcac gatcaagggt ggtgtgtaga 296340
 cttccatgtc ctigtctcgg gaagcagagt tggggattgg gtaaagaagg gcactacgta 296400
 ctacgagctt ttaagacatc ttaagatggc tcagtaggta aggctcttgc caccctaatt 296460
 atctgagttg gatctctgga acccacataa agacagaaag agaactaatg tcacagagtt 296520
 gctctctgac ctccacgtgt actgtggtac aaacaaatct cttggtttga ggatgcagct 296580
 caggtggttg aataacagct cacacccaca cccacacctc tccccctcg caccaaagcc 296640

 ctgggtccat tcaccaacac cacataaaac tggttgtgga gatgctcacc tgtgatccca 296700
 gcactgagag agtgaggcag gaggatcacc ttgaactcaa gagcaattta acccttcata 296760
 atgagttcaa aggggctgg agaggtatct cagaggttaa gggcactgac tgctcttccg 296820
 gaggtcctga gttcaattcc cagcaaccac atggtggctc acaaccatct gtaatgagat 296880
 ctggtgcctt ctctggtgt gcagatatac atggaagcag aatgttataa atatgataaa 296940
 taaaatctta aaaaaatgag ttcaaaggcc agcttgact attagagtga gaccctatct 297000
 aaaaaaaaa aaaaaaagaa aaaaaaaaa gtgggtaggt gatccttga gaagctttct 297060

 tttttgttct tttgtttct gaaacaatgt ttctctgtgt cgctggtg tcttggaact 297120
 cactatgtag accaggctgg cctcgactaa tagagatcac ctgtgggtcg tgacctttt 297180
 gggggtcaaa tgacctttc acatggagtc ctaagacaat tggaaaacag agatatttac 297240
 attatgatte atagcagtag caaaatgaa gttaggaaga aacaacgaaa ataattttat 297300
 ggttggggtc accacaacat gacgaagttt atattaagc gaagtttata ttaaacgtc 297360
 tcagcattag gaaggttgag aaccactgat ttagccctag ctgttctggt gctatataga 297420
 ccatactggc ctcaaaactca cagagatecc cctgcctctg cccctgagt getggcatta 297480

 aaggcgtgta ctactacacc tggttttgag aaactttcat gtaatgcctt ctgccccct 297540
 tgatagcacg tagcccttc ctagecgcaa gagaggfcta ggaagagaat cgttactctg 297600
 aggccatggt tccagcttca catcctggaa tctgttcag tgaagtagag agaacatatt 297660
 ttgggttttt gtggtagatc tggcttgtga gggtaaggt gaagtgaag ctgggcccac 297720
 ttctcagac gctgcatttc ctgtttcagg aatggacaat cagaccgttt tggctgtcca 297780
 gtcattgttg gatggccaag gggcagtcct tgaccaaca ggacagagtg tcagtccacc 297840

gcctgccatc cagccactgg gtgagtatct gcctgccca taagtagagg gtaaatgtga 297900

ggttcatggg gcacgggaga gaactgcctt tfgctccca gactatcctc tgggtctga 297960

attctctccc tttctccttc atgcacctgc ccatgccttt ctctgcccc tgcttagagg 298020

atgtggggag tggcatccat cttttgggag tgcceaagag ccctgatgtt ttgcaacctt 298080

tgccctggaa gtcatgtttc agcttccatt ctgtaaaaag agatcaaacc aatttttcca 298140

gtttatgggt caagcctctg acacttagag aggggaaagg acttctctgg aagtctctgt 298200

agtctttatt aatttatttg taactaattt ctttattttt ttttaagacc aagattcata 298260

aagcctcaac tggcctcaaa cccgttattt aaacatgatg gctttaaact cctaagtagc 298320

tctctctggc ctagaacttg atatgttgat gtggctgggc ttgaaatcac acagatctgc 298380

ctgcccctct cttcctaagg tgtaggttct tattcccgta gttcttagct tcaaaagcta 298440

agagaatact atgagagtc ttaagacttg ggccttagct gttgtatata agaatggaag 298500

tttctgctgg gcgttgggtg cgcatgcctt taatcccagc actccggagg cagaggcagg 298560

ggattttctgt gatttcaggg gcagcctggt ctacagagcg agtccagga taggctccaa 298620

agctacacag aaaaacctg tctagaaaaa acaaaacaaa acaaaacaaa aaaaaagaat 298680

ggaagtttct gatgtcagca agatggctcc gtgcataaaa gtgctggctg ccaagtcaga 298740

tgacctgagc ttaatacctg gaactcacat gctagagggg gagaaccac tctgcaata 298800

gttctctaaa ctccatgtgc aagccatggc acaattatac acccactcac taaaatgttg 298860

aagaagagga ggaagaagca gcagccgcca cttttaatcc aagaagtgga gacatgtagg 298920

atctctatga attcaagttt gaggcttaca tagtgagttc aggccagcca gggctgcaag 298980

ctaagatctt gactcaaaca agcaagcaag caagcaagca aacaacaaa caaaaaacaa 299040

aacaacaaca acaaaaaagc agcaacaaca aaaagcctaa tctaaccbaa gaaagaaatg 299100

gaagcttcta ctagcttctt cacaaatgaa gctaatgttt ctctccctga agccctgact 299160

gcccctctgt agagctgctc tgattttgcc tacaccctgc agtccagatg gacgttcctt 299220

gttcccactc tgattcccat cttttggcca acatgaaggg ggagaaagga ggatgaggaa 299280

gtcataatcc attccttttt tattttgttt ttttttggc tttgtgattg ggacttcata 299340

tgtagtcaa gctggtctag aactctagat cctcctgctt taacatcctg ggtgctgaga 299400

ttataggtgt ataccatat gaccagctac acttttctct ttaagagaaa tctgcataga 299460

tattacatt ctgtcttacc ccattgggtca gaatatagtc atgtgatag ctgcctagca 299520

gcaaagcaat ttgggaaaaa tatacttaag taggtaatca tgccagatat tgtggtgata 299580

ctcatggttg gttggttgg ttttttgat ttttgggtt ttgagacagg gttttgctgt 299640
 agctttggag cctgttctgg aactcacaga gttccactg cttctgcctt ccgagtgccg 299700
 ggattaaagg catgtgtacc aacaccactg gcatggcgat gctcatcttt aatcccagca 299760
 ttctagaggc agaggcaggc agatctctga attcgaggcc agcctgcttt acagagtgag 299820
 ttccaagata gtcaagatat acagaaaaat cctgtcttga aaaaacaagt tgtggggcag 299880
 tggttgctca tacttttaat cccagcattc aggaggcaga ggcaggtaga tctctgtgag 299940
 tttgaggcca gcctggctca tagagtgagt tccagaacat ctaggactgt tatacagaga 300000

aaccctgttt ccaaacaata aacaaaagga aaaaaattha aaaagcatga agtcatgttt 300060
 cccactaaaa tctgtactag tttataagaa gaatacaatg aatattgatg cctggtttgg 300120
 ggatatatca gtggtcttgg taactaataa cacacacaca cacacacaca cacacacaca 300180
 tacacaaatt gtgtaataat tggacaggtg agctacagtg tgctttaaga cagcataaat 300240
 ggctgctgtt agctatctct actttaagtg gcttttcatt tattcagcac acaccctttg 300300
 agggccttct aggtgccag gttataccac agccactctg ataaataaaa caagtttctt 300360
 tcccttagag aacacacaat ctgggtgctag tgagaaaatg gtattgatgg ggccagccca 300420

gaatcaggaa ctgtggcccg agctgtaaga agattgcctg ggtatgggtt ggggagatga 300480
 ttcccagtta agagtgtttg cacaggacct gaattctagt cccagcacac acataagatg 300540
 actcacaact gectactgta aatecagttc ctctgttgc ctcttctggc ctctgagggc 300600
 actgcactta tigtgtggta gacacacata cacacacaca cacacacaca cacacacaca 300660
 cacacacaca cacacactta aagcatacaa acaaatcttt atgaagactt cctagaactg 300720
 atgagccttg cagcatgagt tgaactgaga tggaccggga ccagggtata gtggatgcag 300780
 aggtatgaga agtagctaca tgaccactg gagactgaca gtcaattcag tcaagataga 300840

gtctgtatth ctcaactttg gagtgaagtc actgtaactgc ttccatatgc caaattatth 300900
 gatgcctgtc tgcacatggc tggctcttcc tgaaggttcc tgttgggctc tgaacgttcc 300960
 taggaagcac atggttgggt ctcaacacct gcatggcaag gcacacagtg ttttcagact 301020
 tgctgttcag atgccagctg tggatcgcga ttcttactg tgatcccccc tgactcattc 301080
 ttgctttttt cattactcca ctccatgtgt ggcccaccca actactggcc taaccctaga 301140
 tgacgaggat gtcttctgt gtggaaagtg taagaagcag ttcaactcac tgccagcctt 301200
 tatgaccac aagcgtgaac agtgccaggg gaatgccccg gccctggcca cegtctctct 301260

agctaccaac agcatctaca caccttcagc agcaccgct accgtccagc aggccccgcc 301320
 tcctgccaac cgccaggtag ccttttgttc ctttgtttgt tgattccttt agaaggtctc 301380
 tttctgcaca cactgtccta agtcttggag gaatggtgct gggcaggact gacgatgat 301440

ctacgttgtg gtgttggatg agatgcacaa agatgggcat gttttgctgg gcatggtggt 301500
 atatactgc aattctgaca cccaggagtc tgggccagga ggatcaagag tttagaggcca 301560
 ccctgggctg cagcttgcca ggtggcagaa acgcgccttc ctgagtctgc ccacttttct 301620
 aagtcaattca gaaaagtata gattcttttc ttcactaatc ccttatctaa gtatgctttt 301680

cacaacatac ttagataagg ggtttcctta ttcttgctct gatgcttcgt ttccaccatg 301740
 tggctgcttg tccgcegtgt gtctgatctc tgtgctgact ttagtggtat gttttgtttt 301800
 attcttcttt cctccatttt ctcttcttaa caagttgctg atatttacag ttcacctgta 301860
 aatgtgggcc ctgtaggctt tttcttctc tttcttctc cccgcttctt gatgttgttc 301920
 ttctttttgg ttttttagt taggatttct ctgtgtaaaa ggtttggctg tcttggaaact 301980
 caccttgaac ttgcagagat ctacctacct ctgcttccca agtgctggga taaaaggcat 302040
 gtgccatcaa ctgcccagca aatctctaaa taaataaata aataaataat acttttcccg 302100

gggctggaga gatggctcag aggttaagag aactggtcgt tcttccagag gaccaggtt 302160
 ttattcccag caccacatg gcagctcaca tctgtctgta cctccagttc cagtggatca 302220
 aatgccttca caccaatgca cataaaataa aattaaataa attatttaa aaaaataata 302280
 cttttcccag tctattaat gctgagatgg ggtgggagat tttaccatat tatgtgtggt 302340
 atttggagca gaactttgaa gaagtgacat gtgaccagag gttcaagagg cgagggagtc 302400
 agatatatat attgtgttcc tgcaaaggct ctgagattga agtgtactga ggtgttccaa 302460
 gagctgcatc caggagatga cagggcggct gggcctgagt gagnaaggga ggggtcagat 302520

cacgtgggcc ctgagtgagt aaggaggagg tcagatcacg tgggccctga gtgagtaagg 302580
 gaggggtcag atcacgtggg ccctgagtga gtaaggagg ggtcagatca cgtgggcctt 302640
 gtaggctttt acttaattac aggcgccatg gagagtgtg agaagaggga cctagactga 302700
 cctacacttg cctatgcag actgctctga gttcttgctt ccctagaaca gaaggcagga 302760
 attttattgc tggaccaaag gtctgtgcct ttcagagaga tgtgaccct cctcattggt 302820
 agatgactaa ttggagtctc agaaatgtag actggcttgc caagagtcaa gtgatgggag 302880
 cagctagggtg gaaaggctcc agaacctgga tttttcattc tgtggtccat getttttctt 302940

tttattttgt gtttttagt ttattcgttt tttttatgt gtgagtgtt tgctgtgtg 303000
 tatgtatgct tgatgccctt ggagatcaga agagggcac aggtcctgta gggagagact 303060
 ctgaatactt gtaccactga ccaccccaa ggtatggaga ggggtaggat aaagagcgag 303120
 gaggagaggt gctcactctt tgcaggttca agccaggtct cggagtgcgg agtgcgtagt 303180
 acgtctgaga ctgggctgct cggagtgcta atctgattat cggetacacg tgtgagttgt 303240
 tttcatgggtt attatttata atatactatt aataaccgta tcttgcatat cctttgggca 303300

tggtcagcag tacaggtatc cagggctctc cctacaagg tcccttgaa ctggaattac 303360
 agctggttat ggaccacat gtgggtgctg agaatcgaac ttgggttctc tgcaagagca 303420
 gggagtctt ttaaccactg agccattttt ccagccctt gttttgttt ttaaacacag 303480
 tcttctatg tagtcccggc tggctataaa ttactgtgt aatatgttaa cctcaactc 303540
 tcagacattc tctgcttcc cagggtctag gatttcaggt gtggacccta tgtgtggctt 303600
 gaacttaggt cttcacatc actcttcagc ttccttatag agcctcagac atgctcccc 303660
 ctctcttct catctagatc tccacgtaca tcacagtcc cccgtcccca ctgatccaga 303720
 ccctggtgca ggggaacatc ttgggtgagc atgatgtct catgtctgcc atgtcagcct 303780
 ttacatccct ggaccagcct atgcctcaag ggccccacc tgtgcaggta aggtggtggg 303840
 tgcttctcat aggggtcttt tttttttcc ttcttgcaat gctggggact gaccccaggg 303900
 ccttatacat ctctcaagat ttctatcca aatctgcaaa ttaacgccta tgaatcaga 303960
 atactgtaga agaaaatgc tttagctcca gctctctac atggaaggga ctagtgcct 304020
 actctggcta gccagctga gcaatggagc cgtgacaacc acgtccagct attctgagtc 304080
 ctgtttttat tcatggtcca ttagaaaata tagtggtccc ttggaatttt ccagtacaca 304140
 taggtgacca gccaccaaga ccagatttca ggcttccaga agggaaggag ctggtccct 304200
 ggaccccc tatttgaaca ttctagtaag tggctgctat gtgatcagta tcttgggaaa 304260
 tgtcccaaag tcagtcttga gtcaccaatc aagagccagt cctgctttac aaacttttt 304320
 tctttttctc aatggcctt ttagacctc tgggtgaat catgtgtgcc caaggcaggc 304380
 tagcttagag aagagggagc gaagccccag gccgacatcc cttgacatc tcccaggct 304440
 ttgctcctt ccctgtccca gtaactgtct ctgagctgcc cggtagtgc ctgtccctc 304500
 cacatgctga ctaaagcct tcaagtgat gaaacagaca cttcaatgct gtcattttct 304560
 cttctgattg cagaacagct tgaacatgca tccagtcccc aactacctca cccagctcc 304620
 accgctcct cggccccct cacccttacc cccacctccc cagcctcac ctctccgcc 304680
 ccagacccta ggcccttctg ggcttccaa ccctgttggg aacagtgtgg tggaggtgta 304740
 cagtgtgct gcacccatgg caggaaatgg aacagtggag atccaggctc tgggatgca 304800
 gccctaccg ccctggagg tgagcagagg cagcgtgtgg tggaaactggg cacaatcgtg 304860
 ccagacactg tgtaaggcc actgtgaaga tcaaaagcag acccagcctt ctcatgagtg 304920
 cctgcgtcag ggagaggagg actttacca aagcgggcag tctacagatg ggacacgcaa 304980
 accgtgttag ggccctgag gggcgtgtaa cacagtctgg gtttaacc agacagctga 305040

gctacaaagt tacttcatga agtttgttct gtttctccct ccctccacce ccctctcttt 305100
ccctctctct atgtgtgttt gtatgtgagt gtgtgtgcat ctctgtctgt ctgtctgtct 305160
ctcttctttc atttagtgga tgggggcata tgtgtggaag tcagaggaca atttgtgaga 305220
gttcagtctc ctctacccc gtgggctctg gggattgaac tcaggatcatg aatctcggca 305280
tcaaagacct ttaccactg agctatccta ttggcccagt tcatgaagtt ctaaggggtc 305340
ttgggagatc tgagtgagcc aggtgcaagc ttatgtgata atggaatgtc agtggttgaa 305400
cacagctagg gctacagtga gggtcattia gggtcacctt atcctgtccc ttctaaggct 305460

tttcccctca cagtgtctatc ctcttaggtg ccaaaccagt gtgtggaggc tccggtgtac 305520
cccacacccc cagtgtacag ccctggcaag caggaattca aaacaaaagg acccagctcc 305580
actgccccaa tgaccagtgc aactgggagc acagtggcca cctttgactc cccaccaacg 305640
ctgaagacca gacgtgctaa aggtgccagt ggactcccag aaggttggcc acccacctc 305700
cctgggcatc tttccttggc actggcctcc ccacaggctg cttgggtcta gtctttgctg 305760
ttaagatgag tagggttgtt tgggtgtgtg tactggaaaa cgtaactag cattgacttc 305820
agaatgatag ggggtttctt tccttagacc aggagcagaa actctggaat ttctgcagtg 305880

ccgtctgcaa atagccatat cacttctgtt ctccctttc tctgtcccta gagcatggct 305940
tcattttcag ggtgccttgt cacctgaggt ggttctgtaa atgccagtca tcaatttcat 306000
attctagaaa ataagaaagt agaggaagag aagggtaaag ggggactctc ccagcttctc 306060
gaagtctat atagtcaaga ctttcttcat atatagtcag gtggctacgc tagctacaag 306120
ggaagttagg aaatgtttgt cttagccagg agcaggaagg aggcaaaagt ggctaccagt 306180
tacaccagtt gtggtcttcc cccttttaga gatgtgaggt gtggaatcag agtagaatca 306240
gaaccagga atagatgtgg ggaaaggaac tgggaatfff ttttttttc aagacagggt 306300

ctctctgtgt agccttggct gtccctggaac ttgatggcct caaactcaca gagatcctgc 306360
tcctctgcct ccagaatgc tgggataaac ggcatgtgcc accactgcbc agctcaacta 306420
ggaatgtttt aagagcttcc ctttcgacce cttctttttt ccttcttctc acaatacac 306480
attaacacca gtgcatcacc tacttgggat ttaggtcttg gttcaggatc tectctctg 306540
tcagtcactc acagtttaat gggagagatg gtaggaaat aagtgggtat ttatgagttt 306600
ctccaggag atcacagggt agaaaaggac acagcttacc tatctggaca gaaggaggtg 306660
gtcctgtagg gactgaaagg caagctttcc aggcaagagg agcagcaggc ataaagtct 306720

gagctgagcc catgcttggg atcatcgaga ttagcaagga gtccattgca ggacagaggg 306780
agctctcaag ttggcagata cagaggacat ggagaggtgg tggatttcac catgagcaga 306840
gaaagcctct gagagagttt tgtctgactt tcctcttac actgtctaca cataaatgga 306900

gatgtcccag ggcgcatgct gtctggcccc aggtacaggg gagaatggt tggaggtttc 306960
ccctatctcc tcagctgggc ctgactatcc ctctccttgt ctttcagcta caggggaagcc 307020
caaagcccag aaactcaaat gtcctactg tgacaagtca tttacaaaa actttgatct 307080
tcagcaaac atccgaaggt acaggcagcc ttgggggccc ggctccagca cagcgccaac 307140

taggggccac ctgcatggaa gtgaggcccc ttcccaggct ctgtgccat cttcaggcct 307200
gcagtgccca ggaggagggt tcctcacatt ctctcaaat ccaagggtg aacccgcca 307260
ccgagacaga aaggttgga tgtctgtttg gatgggtacc cttgaactga gagcggcttt 307320
gcacacacac aaggctgct gtctccaac tgcagaaggg ttagcctgca ggctgccgc 307380
tgtgccagga tagctaacta cagagggtcc ttctccca agaatgtgga gtccatctgt 307440
ggaatggtgg ggtgggcaga ctccgacct cttcacagtg ggatcgtta gtatgtaggg 307500
gacttaggt cagtcatggc tctggtgtg ggaatttgg aatggtgtg tgagatgatt 307560

tcaccttaag tcctaaaga gtcaatggag gaagtctcag ctttggacta atctgtctc 307620
aacacctgtt ctttctgag agagaatcaa gggccagtcc acacaagcac acgacatcta 307680
tctagatcag ggtctccaa cactgcatta ttgggactcg ggcttgggt caagtctgc 307740
tgactgtgct ttgtggaata ttcaaaatta tccttagctt ctgacatag atgctaccac 307800
cacctctcc acagctgta cagccaaaaa tgtttcaaa cattgcaaa tgttgctagg 307860
agcaactgg acctcatctg gcatacattt ggcaatacta gaaatgtcca aattggaaca 307920
gttaaccttt catggctgtt aggacttggc tagtgcagct gagaagactt tttttttt 307980

tcccaatgca aaagcaaaga gtcttttatt gtttaatgag ctaaccacat tagctcaggc 308040
ccagctcggg ccctttacc gtttatcgca gcaggtggct ggagaaggac ctaagaaaca 308100
gacttttaa ttcactgt aatgaagca actgtgactg gtcccacag gctggcgtct 308160
gccttaacac ggttgggtgc caccttactg ggtgggtgcta ctttggatct tcaatgacat 308220
tgttttata atcactgaat tttccatta ctctttttg tttgtttgt tgtttgttt 308280
ttcgagacag ggtttctctg tggctttgga ggctgtctg gaactagctc ttgtagacc 308340
cattactaca tttcaatac atagggagtc ataaaaaat ggttttcat attcaataac 308400

aaccaatggg gaacttctca aaattattt caaagctggg catggtagca cctacctta 308460
attccagcac tctggaggca gaggcaggta gatctctgtg agtttgaggg cagcctctct 308520
ctctgtctct ctctgtct ctctgtctct gtctctgtct ctctctctgt ctctctctct 308580
ctctcgtct ctctctcaca cacacacaca cacacacaca ctttcttagg gttctgtcc 308640
taccaggtcc tgetcttca gttccaaatg aacacagcaa cactatatta gttattaaac 308700
tgttggccaa tggctagggc ttcttattga ctagctctgt cttattatt aaccatttc 308760

tatcaatcta tgiattgccca caagactgtg gcttaccag taatgcccca gtgtgttgtt 308820

actccttcag cagcatggag actctgtggc ggctccctc tgcctacctt tcccagaatt 308880

ctccttgtct cctcgtccca cctatcttcc tgcctcattg gccaaacagt attttatca 308940

tcaaccaata agagaagcat atgtacagaa ggacatcata catcatacac acacatgcaa 309000

gcacactgac acacacacag tttgttctct acttgatgcc ttaaaagtta ggaaatctgt 309060

gatctcagat gtgaggtggc caaggagaag ggctgtgac tgagcggctc aagaacaggt 309120

ctttctacct ctggtctatc tgccacattg ggagaacaag tcctagtgtt gttgggatga 309180

tggccagcag cgtctcttgg ccttcttggg ggctgtgatc tcctgggtag aggccatgac 309240

cctgtttcta tgaaggaatg acaataact gtgttccac agccacacag gggaaaagcc 309300

tttccagtgc attgcatgtg gccgggctt tccccagaag tccaatgtca agaagcacat 309360

gcagactcat aaggtgtggc ctccagggcg cagtgggtggc accatttctc gaaactctgt 309420

cacagtgcag gtcatggctt tgaaccccag caggcaagag gaggaggaca caggtgagtg 309480

aggtgggagg ggcggctctc cccactcatc cctctgaag tcccaaaggt gctgtctgac 309540

tgtctgtgtt actggggacc aaaccaggg tctctgact gtecccagcc ccagtctcat 309600

tgggtgtgtt gctagtggg tggcttccat gacttcgctg gattcagcc tactttatct 309660

gtaaaatgga acctaaagag atgggtgtga tftacatgaa tcattcagct ttggtagacc 309720

caagacgggg gaatcaaggc ctgactgccca catagtgagt ttgagtccag tctgtgctgt 309780

acagcaggct ctctaaaaag ggacatgggg taaaagcaag gatgagagta tgaagatat 309840

gtgacattag tctaaactg tccccaggca gacgtggaca tcaactacta attagtatt 309900

atctctttct ggctgagcct ggatccatat gagaatcaa ttctttctc ccttctctc 309960

cctgcacccc ccacccccca cccaggtct catgtagcct gggtggctt ggaacttct 310020

atgaagctga gaatgacctt gaactcctga tctactgcc tctgcctctc gattgctatg 310080

gttacctcag acctgagcta ctttaccag tttatttgtt tgttttggct tttttgttt 310140

tcaaggcaag ttttactgt gtatctctgg ctgtcctgtg actgtagacc aggtggcct 310200

caaaactcaca gagatctgcc tgcctctgcc tcttgagtgc tgggattaaa ggtgtgcacc 310260

accgccgct ggctatttta cccagttctg tftgggtcca gatgttgaat gcagggcact 310320

gtttgttctg ggccacaggt gggcccttct tftcaagctc tftcacttgc cctcagaatc 310380

catttccagt gctccaggca gttctcttag ttgatcagca cttgaaacct ttggatctcg 310440

gtgggcagct gctcctcaga tftcctgcag gttctcattc atccaagtct tcaggggctc 310500

ctgagccaac agtcctgtcc caaatgctgg ttagttctcc cacaaaggag ttagggactt 310560
 accaagtga taaacagaac agtcattgga gattcaacat gaggaccata atgtaattga 310620
 agttttttta gtagtccagc atggtttgta gttctagtgc tccagaggct gaggtaggaa 310680
 gatttgaat ttgaagccag cctaagctat ataacaagat cttgtctcag aaaaacaaag 310740
 caggaggctg tagagatggc ttagcagtca agagtacttg ctgttcagtc atgaagacca 310800
 gagttttgat gcccgcagat acaacaggtg gcttacagat atctgtaact acggctgcaa 310860
 gggatctgat gccccttctg gctctcaacg gcacccactc atacagacac ataggcacac 310920

ataagtgaga taaaaataaa atttgagata gacttcatat attttactga acctgatgca 310980
 ttcttgcttc acaaagtagc ataaaggact tttcctttgt ggagctgggt gtggaacctg 311040
 gggctcctct gttcttctac agagccacac cctgtaaatg gacttttctt tgggctgcca 311100
 gcttacaaaa aatgacaca gaggtttctt ataatatg aaagcctggc cttagcttag 311160
 gcttattcct gattagtct tacaacttaa ataacccat atcctttaat ctacattctt 311220
 ttacggttac ctgtactctg tactgcccac cctgcttct ctgcgtctaa ctggtaattc 311280
 cacctttttt cctcccagag ctctctctgt ccagaagtec cgctatgcc tectgcctag 311340

ctgtggctgt ttagttttaa aaaaaaaaa gattttatth atttattatg tatacaacat 311400
 tctgcttcca tgtatatctg cacaccagaa gagggcacca ggtctcataa cggatggatg 311460
 tgagccacca tgggtttgt ggggaatftaa ctgaggacct ctggaatagc agccagtgtt 311520
 cttaacctct gagccatctc ttcagcccc atttagcttt ttattaaacc aatcacagtg 311580
 atacatctc tcagagtga aaggaatgtc ccataacatt tcttctttt gtctaaataa 311640
 aaaagaaaga ttttaactct aacacagtaa aactacatac agtaagaata attatcagca 311700
 gggtagtggg ggcacacacc tttaatcca gcaactcagga ggctgaagca ggtgggtctc 311760

tgtgagttcg aggctcactt agtgcattgt actggaggct ccagcctgca agcagcagtg 311820
 gtagctgcac ctctatgcc ccaagcacca gctgcctga gagactgcag gactaggaag 311880
 ccacatccag ctctttgtgc agagcttttc ttagctttct caggctatat gtttagatat 311940
 ttgagccctg acattggatg ccatttghta acagatfttt ctttgggttt ccagctcaca 312000
 aaaaaaaaa aatgacaca gaggttatt aattatgaaa gctcagcctt agcttagact 312060
 tattcctaatt tagttcttac aacttagatt aacctatc ctttaacta cattctttta 312120
 catggctcgg ttacctgtac tctgtactgc ccactctgct tectctgct ctgactgggt 312180

attccacctt tcttctccc agagctctct ctgtccagaa gtcccaccta tgectcctgc 312240
 ctactcttg gccgttttag tttttattaa accaatcaca gtgacacatc ttcacagggt 312300
 glaaaggaat gtcccacaac acacaacacc ccaaagccat atggaaatat tgtgtatatt 312360

tgtttactga atttttggaa tttacggcac acctgcactg gcaactggcta tcttctagat 312420
 cttgcatgtc acccatgact gtggccattg tftaggacag tftagagcca gaaccacagt 312480
 tcttcctacc caagcagggt gaggagcccc ggccacatgc cagctgctga agagcctttt 312540
 gttgggctcg tgcccagga ctgcttttat ctgacacacc agtgcctctgt tggagccagc 312600

 cctcttttgc acctgggttc ttgctgtctg aactcctgcc cagcaactgga ggccactcat 312660
 taagcataca ttftagagcc tattgtgtgc tggccatggg ctacagaggt gaaggagcag 312720
 gccctgatg tcaggagag tggggatgg cctaattagc aaagaataac aaagcaaagg 312780
 taagtgtgt ggttagaaag gcctgagagg cgatctgact atgcttggga atgttcagtt 312840
 tctaacacce atggagaggt cacagtatct gagtgaagat agggagtgtg acagaggtca 312900
 ctagctgtct ctcagtcaga atgtatttca gggcctgtgg atgtacctca ggatagagga 312960
 tttgccttca cacaggatgc cctgggttca gtccccagca ctacataaat tcagcatggg 313020

 ccatgtgggtg gtggcgtaca actttaatcc ccacactcag ggaggcagag gcaggaggtg 313080
 gatctctgtg agttttaggc cagcctggtt tacagggtga gttccaggac agccaaggct 313140
 acacagaaaa actctgtctt gaagaacaaa aaaataaaac aaacacaaac aaaaaaaacc 313200
 tcatggagct ggagagatgg ctcaagggtt aaaagcacca gctgctcttc cagaggtcct 313260
 gatttcaatt cccagcaacc acatagtggc tcacaacat ctgtaatgag aattggtgcc 313320
 ctcttctggt gtgcagatat acatggaagc agaatgttgt atacataata aataaataaa 313380
 taaaatctta aaaaacaaaa acaaaaaacc tgagcatggt ggcacagact tgtaatccta 313440

 gcacttagga gatagtggag gaggatcaag agttcaaggt caccctcagc tacatagcat 313500
 gttttaggcc agcttggact acataagacc ctgtctgaaa ataaaataaa aaagaatgta 313560
 tgttagtgtt ttagcatctt gtgcatatgc taagtatagt cctaataca gcatgtgata 313620
 gcaagtctac agtaggtgtc ccaggagccc tcatgcatgg agtggctcct gtctgcctg 313680
 actcaaaacc ttctctgac tttctctct ctctctgact ttttctctt tctgcatagg 313740
 attgggcca accctgtcca gcaccacaca gccccaggcc ttggccacgg caggtgagga 313800
 tgaaggtggc aagccagagg ccaagcaggt agtctctatt gacagctcct acctgtgtca 313860

 gttctgcccc agcaagtcca gcacctactt ccagctcaag tcccacatga tccagcacia 313920
 gaaggagcag gtgggtgggt gtgaaagcag agggcacagc tgctcactta caagcctcat 313980
 ggcaccgggg tcaccagtgc tgcctggaga gggacaggaa ttgggccagc ctttccatg 314040
 gctctttgtc ctgaagatag gttctctggag ggtcaataca cagttgggtt atgaggtttg 314100
 tcatctgaca tagcaggagg ctgagccagg gcaagcactc agctcagatt caagggtttt 314160
 gtgtctgtc tcaccagctc tagtggctgt gttcataagg tgtggccttg tctttcatca 314220

tggattccct cctgcttctt gggaaacctg ctgactggaa ctggctatgt agagcatacc 314280

 agcctcaaat ttgcagaggt ctgcctgcta ctgcctcctg agtgcctggga ttaaaggtgt 314340
 gcaccacat gccctgtgct ctatttctga cctttgttgt gtgtgtgtgt gtgtgtgtgt 314400
 gtgtaagtgc cgtggaacat atgaaggcca aaggacaact tgtgggagtt ggttctctcc 314460
 tcttaccatg ggagtcccag aaattgaagt ttaggttgtc aggttcagtg gcaagagtta 314520
 ctgtcagggt tactctttgt agaaaaacca gtcatagtat ttctcatgag caatggaaac 314580
 ctttctaga attctctaat cttttatgga tcagagacag ttttgttttg tttttgtttt 314640
 aatccgggct catggggcta gagcttcggc tcagtggtta agagcaccga gttcatttct 314700

 cagcaccac atcagatggt tcacaacttc cttttagtcc agctccaggg gatgacaccc 314760
 tctgctggcc tctgaggcca cctgtactta cgtgcctgca ctgatgatga ccttggagtt 314820
 ctgtcctcca agcactgaaa taggcttca tacatgetag gcaagcctgc taccaactga 314880
 gctgaagact ggccaacagt tagggtttta tttctctct atcataacag gcctgaatt 314940
 aacagtgttg ggcttctca acaggctagg catgtcatct aaggccagc tcttgcttc 315000
 ctctctagt atccttagct tgtagtattc accctcaatg ctgcagaata gttgctgtgt 315060
 ctccatcaca tttatctccc agtcaagata aatgcaaaaa ttagaaggga ttctgctag 315120

 caggcttttg ccattttgtt ttgggaggta tggtcgcccc aaagatggct gcctgcatat 315180
 cattgccaag aaagtaacaa catactagat tcaaggctgc caggaggacc cagtctgttg 315240
 ctaccctggg caaattggag ttgacttcat taggaataaa gagggtttga cactgtgtaa 315300
 gcacctgagg aatattgatg actactggaa ttttcaaat atcaaaagca tatttctttt 315360
 agaaatgaga ccagacatgt gtcagaatgt cacatagatc atgaaagaaa cagtggaaat 315420
 gatatgtgtg acacatactt cctgtgtttg actatctcca catcagactg ccaaagtaga 315480
 cacagatttc attaatgtct catctataac ctttggagtt acccttcta tetaacaaca 315540

 acagtggcct tgagttatat ccgtagcatc acacataaat acacaaaaat catttatact 315600
 ggattttttt ttaacaacac taacattgaa cttgagagtc tgggtcctaa gtcaactacta 315660
 catagtcaaa attagtcatg tcccgaagga gcaagaggac cctagggag tttgtttggt 315720
 agtaactcca acaatgatct ccagacttgt catctgagaa ttctactag gtgtaagtaa 315780
 catgtttggg tcacaaactt ctgccaaac agatactctg gtggtgatgc ctctcaagtc 315840
 ttcttctctt tcttctctt cttctcttc ttcttctct tcttctctt cttctcttc 315900
 ttcttctct tcttctctt cttctcttt gatatggagt ctcatgtagc tcaagctagc 315960

tgtaaac tca ctatgttgct aaggat tttt ttttaatttt aaaagatttc tttattctat 316020
 ttttaagtga tgagtgtttt gcctgtatgt gtagtataat catgtgtatg cctgggtccc 316080
 tggaggtcag aagaaggcat tagatttccct gcatttggag ttatggttat gaactacat 316140
 atgggtgctg ggaattgaac ctgggacctt gcaagagtga caagtgtcc taaccgtcct 316200
 aatggctgag gtattgttcc agccccacca atagtgatat tgaactcctt ttcttttttc 316260
 ctcttttttt tttccccaaa tgctgggatt acaggtgtgc atcaactgcca tcagataatg 316320
 atgggagcca cattagaagg gtatagtgtc atcccctcac tgtacttcca ggtcttgggt 316380

 aat tttt tgtg tatacatttc ggcttcacca agccttaggg aagaataact ggtcaagaga 316440
 agagaacctt gcaatcttag tggagccagg aactgagcct ggtgccacac agcctgtgat 316500
 cgtcaggaga cttatgcacg agcatctcaa ttcaagactt gactaagcta cagagtgagt 316560
 ttaaagccag actgggcgaa cttagtgagc acctgtatca aaataaaaag taaaagaga 316620
 gctagagata aaactcaatg gtagcctgct tgcccagcat ttgggaggcc ctgttttgtc 316680
 ttaggggagc aggagaacag ctggcagggt gttcacagta gtgtgtatag cctcatgcca 316740
 gggccacagg gtaggggtag ccatcgaggt gatcccacg tctctcacct cccagtgtct 316800

 cctccaaggt tglacaagtg cgtggtcaga agctgtgccc agatgttccc caagctggac 316860
 acctttctgg agcacatcag aagccaccag gaggagctga gctaccgctg ccatctctgt 316920
 agcaaggact tcccctcatt gtatgacctt ggagtgcacc agtactecca cagtctctg 316980
 ccgcagcaca gcccagaagaa ggacagcacc gtctacaagt atgtgtgcat gccacctacc 317040
 ccgctggacc agtgggcagg gagcctggcc caggctgctc aggatcagta acaaattgca 317100
 aagggaaact gaggctaaaa actgggttcc agcctagagt gtttgagtgt tttggcacct 317160
 gtgggaaaaa atgatactga ctcttcttag accattcttc acttctcagg tatttaccat 317220

 ggaaacagca ccttaaaaag ggtaactagg ggccagaaag acggctcagt gagtacaggt 317280
 gcttgctacc aggcctcccg gcctgggtgt gattccaaag acccagcatg gtggaggaa 317340
 agaactcact tccatttatt tttctctcat ctccactggc acacgcacac acaaaataga 317400
 taaatacaaa tgaaaaggaa aacacacaca cacacgttag ctgggcattg tggcacacgc 317460
 cttaaatccc agtactaggg aggcagaagc aggtggatct ttgtgagttt ggggccaacc 317520
 tggctctatag agtgagtgcc aggacaacc tgtctcaaaa agacaaaaaa gagggtgggg 317580
 gggatattga gggctagaga agtggttcag tggtaagggt tgtttgcaga ggacctgggt 317640

 tagttcacia cccccactg gtggttcaca actgactgca atagaagagg gatctatggt 317700
 gccctcttct ggctctgtg ggctctgca agcacaaggt atatataaac tcatccaggc 317760
 tcacacacat aacacagaaa acaagttttt gtttgtttgt ttgttttttg ttttgttgtt 317820

gtttttcaat acagggtttc tcagtggcct tggaggctgt gctggaactc gctttaggct 317880
 ggccctcaaac tcacagagat ccgctgcct ctgcctccca agtgctagga ttaaaggcgt 317940
 gtgccaccag cgcccaacca gaaaacagt ttttaaaact agtgttctag ggctggagag 318000
 acggctcaga tgtaaaaggc taggctcaca accaaaaaca ctgggtttct gtattctctt 318060

 gtgagaaatg tgattgccac atatatcttc aactttttct ccctgaagct gtctctctg 318120
 tcatcactcg tctatagagt atctccctgt tttctgggcc tctctagat tgggtgtgtt 318180
 ctgtagatag tcaccatcat gcttctgtcc tttgggcttt tcttaccat ttgctggctg 318240
 ctggttgaga gcaggtgttc caaaaacagt cccgagccta tggggacagg tgggtgacagg 318300
 tatctgtctg ggacatcttc cacatgttgg gattgcattt gtacttcata caagtttata 318360
 cctgtaggga ctgtctgtt gacctctgtt acttcagaaa cttctgggtg aggcttctgg 318420
 gattaagata agtaaatgcc aaaatcactg ttgcttcagg gagacaggtg tgtaaacaaa 318480

 tgctttttgt aactgtaat gaaatgctgc cagcctgcc tcaaatatag ctgaggaggc 318540
 agctgcttca gggttccctg agggtaaaga taaggactgt ggagccacct gtcagtgtt 318600
 gcatccaag ctgacttggg ctaattcctg actttggaga aagtattgaa ctgtcattgg 318660
 cctcagttcc cttacctgtg gtaagagatc ctgatcatgc ttagcctgtt agaatagggc 318720
 catccctgtg treactgcct ccccatcaat attttatgta gtcttggtg atttcattgc 318780
 acagccaagg atgaccttg atttctttgt ctccacttct cteaagtact cctatgtagt 318840
 ccaggctggc ttgaaactca ctgtataggt gaggataacc ttgaacttct gatctttctg 318900

 tcattaccte ctgagttctg ggataacatc tgttccacca cacctcactt atgcagtgtt 318960
 ggggaccaa ccaagagcct tgtggatgtt aggcaagcat tctaccagtt cagttacatt 319020
 cctagaccte actcctcctt tgtttgttcc cacttagggt ctccacaggt aaccttgaat 319080
 tcactatgta gctgaagtgt gtattgactt tgaagtgact ctcttgctc agcgcttga 319140
 gtgctgagat tataggcaa taccctagg cctagcttcc tctgaattc tttgtaaagg 319200
 tcaagtaaga gcatttacca aggggctgga gaggtgctc agtagttagg agcctgattg 319260
 ctttttcaga gatcagagtt caattccaag tacctatag acagctcaca actgtctata 319320

 actccaggat ccaaaccta cacatagaca tacatacagg caaaaacacc aataaaataa 319380
 aaaagagaat ttaccgagca tatagacatg gtcttggaa cacaagaggt acccaataag 319440
 agatgactac agtcttttt gctgtattat tcagctgtat gcagaaacc caaatgacaa 319500
 tgatacaagg gcaggtttac ctctctcagt aggtagattt agcttgtgtg gtggtcacat 319560
 catgttttta gaggttggtc catgctttga cagttggttg ctgtgtgtcc ttggagtga 319620
 gtggacttgg cctgcctatg gaatgtctcc aaccactgaa gtgactctgt attcggtttt 319680

gttttttggt ttgttttgtt tgtttgtttg gttttttgag acagggtttc tttgtgcaac 319740

 atccctggct tcttggaaact cagtctgtag accaggctgg cctcaaattc acagagatcc 319800
 gcctgcctct acctcctgag tgctggaatt aaaggcgtgc accaccccga cgcagcttgt 319860
 attcattttt tgtttgtttg ttttttcttt tttcttgttg ttgttgttgt ttgagtcagg 319920
 gtgttgctac acagccctga ctggcctgga gcttggatg tagaccagac tgacctcaga 319980
 ttcacagcaa tectcctgct tctgctcgac gggtgctgga ttataggcct atactatcac 320040
 tctaccccc actgccttat tttccttttg aaaataagat ttatgcctg gtgtcacagc 320100
 tcatgtaac ccagcacttg ggaggtagag gcaagaattc aaggcttttc ttgttcacac 320160

 agaagtttga agccagctta ggccctattia ggcactgtct caaaaaaatt tttttaaaaa 320220
 agatttatcg atgttatttg cttcctaatt acaaaatgca tttttgttaa atacagagaa 320280
 aatgattctt tttccttaat ttgttactgt tgtttgcca tggaagccag aagaggtgat 320340
 tgagtccct gaaactagag gtggttgtga gctgccatga gggtgctggg aatcgaacct 320400
 tggctcctcg ggtgagcagg cagtgtctct aaccaataag ccatctctc aaccctgatt 320460
 ttcattttta aagacgtctg gcttcttagg aggataaggg acttcagggg tcaggaggag 320520
 gcaggaagc cagagaggct cttacacatt tctcagcagc tcagcccatt gtggagaaaa 320580

 tcagagaaga atggacacgt ttgagaatgc atttcatgta ggatttttgt ctctgaggt 320640
 tggatttggg gaagtaaggg gaaattccat acttgctaga gctcatctct ctcttcctc 320700
 ccacttaggt gtgtcaagt gtgcaataaa tactccactc ctgaggcctt ggaacacat 320760
 gttcagacag ccactcacag ctteccctgt ccacactgcc agaaggtagg tgtcatagca 320820
 tcttctcac aggagtcccc gagagggaca gtgacctgac tgaagacttt ggatagccag 320880
 gtgtggtggc gcacgccttt agtcccagca cgtgggagat agagacaggc agatagatat 320940
 ctgtgagttg gagaccagcc tggctctacag agtcagtcc aggacagcca gagctacata 321000

 gagaaatgct gtctcaaaat acaaaaaaac aaaaacaaca acaacaaaac agacttggct 321060
 gatcactcag aggcagaact tgagtgtct aacatggcat cagagaatta agaaggcttt 321120
 gcagagaggc acggacacct gacttgggtc ttgagggatg aataggagt tatgagacca 321180
 agaaagaaca tctctgtgt aggagaccag cctgggtggc aactcacagg gaatgtgctt 321240
 tggctgggct catgagtgt tacagaactg aggggtctgg agggctgggt ctgacacttt 321300
 ggctccagc ctigtggca gatgggatga tgtttccaag gagctcgaac ccagagtcc 321360
 tgagctcaga aggtggaagg tggtagggc aggggtctcg gaagctgacc tgctgtgatt 321420

ctgtcttact ccaggtcttc ccctgtgagc gctacctacg gcgtcactta cctacccatg 321480
 gcagtggtgg ccggttcagg tgccagatct gtaagaagtt cttccggaag gagcactacc 321540
 tcaagctgca tgcccacatc cactcagggtg ggcaccctgc ccaccctcc ctctctgtcc 321600
 tgcccttctg tcgcttttcc atttatactg gctcttctcc attgaattcc tcttctgcc 321660
 ctccatactg ctctcactc acctgtctc acctgtgaac atggggctcc caacatcttg 321720
 aaagcagaga ataagatggg tggtagcgat cattataaga attcattggg ccaggcagtt 321780
 gtggcgca caaccttaat cctagcactt gggaggcaga ggcaggnnnn nnnnnnnnnn 321840

 nnnnnnnnnn nnnnnnnnnn nnnnnnnnnn nnnnnnnnnn nnnnnnnnnn nnnnnnnnnn 321900
 nnnnnnnnnn nnnnnnnnnn nnnnnnnnnn nnnnnnnnnn nnnnnnnnnn nnnnnnnnnn 321960
 nnnnnnnnnn nnnnnnnnnn nnnnnnnnnn nnnnnnagcc tgttgtaca gagctagtcc 322020
 caggacagct tccaagcct cagagaaacc ctgtctcgaa aaaccaaaaa aatttttaa 322080
 aaaagaaaag aaagaaagaa aaagaattca ttgggcaggg cagggcagtg gtgtgcaca 322140
 cctttaatct gactacttg gagacagagg cagggtgtatc tgtgagtagg aggccagcct 322200
 ggtctgtaca gactgagttc caggacagcc agtgctacat agagaaacce tgtctcaaaa 322260

 aagcaaaaat aaaacaaca agggagggag gggaaggggg gataaggaga aaggaaggaa 322320
 aggaaggaag gaaggaagga aggaagaaag aaagaaagaa agaaagaaag aaagaaagaa 322380
 agaaagaaag aaagaaagaa agaaaagagg gaaaaagaaa agaaagtaga ggtgagcccc 322440
 agaggcaggt aagggggact tgactccgct ctctgggtgc cagccctgct agactgggtg 322500
 ttggatgact gtctgcaaa ttctacccc ctctcatagc ttcccagctt gaggtgtagt 322560
 aaaagtttt ggattgttaa agttttatgg aggagaaaga gagatggtat ctccatagc 322620
 caaggctgat ctgcactcc agacctcct acctctatct cctgtgtgct gggattacag 322680

 gtctgtgctg caggattcag gtgtgtgtgt gtgtgtgtgt gtgtgtgtgt gtgtgtgtgt 322740
 gggggggtgt gggggggggg gggagagaga gcgcgnnnnn nnnnnnnnnn nnnncaggtg 322800
 tgtgtgtgtg tgtgtgtgtg tgtgtgtgtg tgtgtgtgtg tgtgtgtgtg tgtgtgtgat 322860
 gggtaigcac atggcataca tgtgtggcca aatggcagcc ttgggtgtta gctcttactt 322920
 tcagccttgc ttgaggcagg gtctctgttg ttactgctc tgtacacaga tgagctttgg 322980
 cctttaagt cccagggatt gtctgtctc cacctctcat caccctttag cagtgtagga 323040
 ttacagatgt gacttctggg aatttggact caggtagtca cactttgcag caagcatttt 323100

 acccaccgag ccatttccc attccaagga ttcggttttt atcttataaa taagtattag 323160
 atgggtgtgg tgtacacctg aaatctgac tactcaggag gctgagatgg gagggcccca 323220
 gggtttgaga taagcctggg ctatagtttc tgtttcaaca caataccaga caaaaacaaa 323280

atccttaca gctagaacct gcaggtcaca gcttacacgg tgctcccaac tcctccata 323340
 gtaactgtgg ttactgccta gtttgggtga cagattagaa aagaatcatt tatgtgtttg 323400
 tgggagctta tgtcatgtgc atgaagtacc ctacagagacc tgaagagggt ggtatagaaa 323460
 actgtgaact gcccttctga aagagctgct gcaagctctc ttaactgctg agtcaagtct 323520

 ccagaccctc tggttttata ttttgtctgt tcgacacact ttcttacttt cacctaagtg 323580
 agcacatggt gtaactatat tatctgctta tttccttctt tttccatagc tgcttagtat 323640
 tgatctgttc cctccctatg agtgaacttt cctgtcatca tcatcatcat catcattgtg 323700
 ctgggaattg aacctegggc ctcatctagg ccagataagc cctattactg ggctatacc 323760
 ttccccctag atccttcaat gagtttttca gccattatta ttattatfff aagttaggtg 323820
 acatttcagg gtatagtcac tcacctttaa tctcagcact caggaggcag aagcaggctg 323880
 atctctgagt ttgaggacag cctggtccac agagagagag agttccagga ccaaaaaaaaa 323940

 ggggggggga agaaaacttg tttcttttgg tactgaggtc tttttttttt aatacatttt 324000
 taattaaaat agaattacat gacagtcttc cttccctcc ctccagctct tcccagatta 324060
 gttttatggt atagatagtt cagtgtgttt ttttttctga caagctttca gaagttgggt 324120
 tgtgtggctt gttcttaaca gtgtgttggg ttaaaacatg tatttaaagc ataatttctt 324180
 tttgggatga tgaagattct gaaaggcaag gcatggtagt acacacctgt aatccaggcc 324240
 agcctggtct acatagagag gcactgttgg aacacactct gctacctttg gctgtcacat 324300
 tcaggcccat acacacacac acgcacacgc acacgcacat gcacacacca gcaacacaat 324360

 aatgacgagc ctctggettc cctgcaatgt tattatfff tggcctagaa aggcaggtgg 324420
 ctataccaag ctgctgcccc agcatgtcca gagatctttc tagagcagga aacaaaatga 324480
 cttcagaact tttttgttta tatgaggcag ggtcttgttc tgtctctcag actggcctgg 324540
 aagtatgagt caatattcag gcaacatata aatacctgt ctctagaaa acaagccagg 324600
 cgggtggtgaa gcacacattt aatcccagta acctggaggc agaggcaagc agatctctga 324660
 gttcaagacc agcctggtct acagagtgag ttccaggaca gccagggcca cacagagaaa 324720
 ccctgtctca agggagaaaa aggaagctgt gggtaggggt tgggtggaga gatggcttaa 324780

 cagctaagaa cactgctgtc ctttcagagg acccaggttc aattcccagg acccaaagtt 324840
 tggctctcaa ctgtctataa ccgtgttcc aggggatctg acacctctt ctggcctctt 324900
 tgggcatcag gatcgacat gtacatggig tacagactta acatgcaggc aatgatgtc 324960
 atacacataa aaataattat atatatgtaa tttaaaaata tattgtaaaa ctggggttat 325020
 ggtgtggtgg tgtgttctt tcttggaag caccaagcct tgtgttccat ggtgacacat 325080
 tcctgtaatc ttagcacttg ggaaggatga ggcaggagga ttgaatactc caatccagct 325140

tgggctacac agggaaaacc tgtccaaaaa aaaaaaaaaa aaataccctc caaatctct 325200

 gtgccaagtc aggagaaata agaaaagctc ctcttgagg attcagactt gtcctcatgg 325260
 gattcatgag gtgttcccat gtccccacag gtgagaagcc ctacaaatgt tcagtgtgcg 325320
 agtctgcatt caaccgcaag gacaagctga agagacatat gctgatccac gaacccttca 325380
 agaagtacaa atgtcccttc tcgtaaggag gggctgcctt atttatgggg aggggagttg 325440
 gattacccca ggggggtcta tgtggaaggt tagactgagg gcctctctcc ttgggccta 325500
 ccggaccctg cctggctcat tccccact actcctttgc ccatcccttg gcttagaaaa 325560
 gctggtgcag gccccagtga gagggttcat gctcctgttc tgtaactgat ggctttgggt 325620

 tccaggatgc acacaggctg cagtaaggag ttcaaccggc aggacaagct gaaagcccac 325680
 attctctccc acgttgtaa gaggcttagg acccattgga gggcctggct aagacaagtt 325740
 ccccgagaac agctattggg aggaagagca gcacttgcac gaggcataat gtccaggcct 325800
 ggtctatcca gccagtgggt ttctgcacat gtgttcatgg gagctagaag ccaggctgtg 325860
 gttggggctc ttggcacagc agaggcaaat tccatgcaac tccagtcca ggggaagtag 325920
 atgtaagcag ctgaaactaga ttgtgtgcag taacacagag gtgtgtgtca gtgcatcca 325980
 agatgtgtcc aagggatggc ctggaaggc agaagggaca gaggtctcta agccaccttc 326040

 ccagggcaaa caagagtgtt taccagcacc ccatcacta tccatgcaa ccccatccac 326100
 tgtccatgcc aaccccatcc actgtccatg ccaaccccat cactacca tgccaacccc 326160
 acccactgtc catgccaacc ccatcacta tccatgtcaa ccccatccac tgtccatgcc 326220
 aaccccatc cattttcatg agcacccac atccatgcta tttcagtgtg gcatctccc 326280
 cttagtgtaa caatcaaaaa tgtccctac aattcacctg gagataaagt tgcttctgtt 326340
 aaaagcttga aaatgggagg gaagactggc ctagcatgca taaagccctg tggtttgagt 326400
 cccaagtaaa cataaactaa gcatggtagc aaaaaataa acaaaaaacc tgaacttcca 326460

 gtacttgggg gccagagaaa gattcaagc tcaccttgg cttcatagca agttcaaagc 326520
 cagcctgagc tatatgatg gccctctcc tttttaatgg gaaatggggg agggctccatc 326580
 agggaatctg acatcttggc tctgagcctt agtgtacca gcttcttctt ggggtgtctc 326640
 agggaagtag ctgctcattt tggccccaa cccagaggc ctgaagagt aaggcattta 326700
 caaaaggggc ctggcccagc agggctgggt tgagaatcag gaaagtctc cacagagctc 326760
 aggcctgagg agagagaaga gcgagaaaag agagaacaag aggaggcccc atggataagg 326820
 aaggaccaga ggaaggagg gccagagcac agggtggagg aggggctggg cagaccacac 326880

cctgatttgt aggaaacacc tcagagcaga atttgggcac cagggtcttt actagtttgt 326940
gctttacaaa aacatctctc tctgccattg gcaatggcct gaggggcaca ggtgaggcca 327000
gcagcccaga ggagtggct gcatgtggtc atccaggag aggttgatg acctacagag 327060
tcaccaagg cttagaatt aagcagatta ggggtggag atatggctca gaggtaaga 327120
gcaccgactg ctctccaag ggtcctgagt tcgattcca gaaaccacat ggtggctcac 327180
aatcatccgt aatgagatct ggtgccctct gctgctggg tgcatatata catggaagca 327240
gaatgttga tacataatan nnnnnnnnnn nnnnnnnnnn nnnnnnnnnn nnnnaattaa 327300

gcagattatt tcaggcatgg gacaagcaac tgcaaaggcc cagggtctgg aggaggcaca 327360
gtgtggtaga gtgagtgacc cggaaagtga acgacgataa tggagccagc tgaggcctga 327420
ccacacagat gcctgtcaga acagaggctg ggtgggacag gcgcgggggg aggggatgtg 327480
cctctccctg acagcctctc actccccagg cctgaagctc cacaagtgtg ggctgtgcag 327540
caagtcttc agccgccggg cccacctggc tgagcaccag cgtgcacata cgggcaacta 327600
caagtccgc tgcgcgggct gcgccaagg cttctcacga cacaataacc tcaaggatca 327660
ccgtgccgc ctgggcccc cgaaggacaa ggacttgcaa gcccggagac ctccccggag 327720

gagagcagcc ccacgtggtg gaggcagcat cgttgagtg cacaaggagg agagcccgtt 327780
gcccgacca ctggggtctg aggagctgaa ggccgcaggg cctgcaccg aggtgctcc 327840
tggaagcca ccttcgagc aagacgcegt gctgtccatt gtggtgggtg gggaccgga 327900
gctggtggtg cccgggcaca ccgagggtct gggctccaac ctggcactgg ccgagctgca 327960
ggctggggtg gagggagcgt gtgccatgct tctgtcccg gtctacatcc aggctcaga 328020
atgaccagc tggattttcc gggggagcca ctggcacaag ccttttga aattactgta 328080
tcaaccaat ccatgtctt cctatgccct gtgatcagct ggggagccct gcagactca 328140

cagggtctga ggcattgacc gtagctccag gacatagcag tgctaagaga gatggccaga 328200
aatgagggt cccagagact ggctgatgga ggcttgtact tggcctcct ctaaaagaag 328260
gcccgggtgt tctacctggg tggcctcaga ctgtgctact cattatactg gcggggcgtg 328320
gtcaagtctt agtgtgtgga accattacca gaacacttcc tgatggcgtc ctcaaaggac 328380
tgtgggtga gtatgtaaga ggcactcagc ctgggcttag agttagctg ccagccagac 328440
ctggcttcag atttaccagt gtgacctega gcaaggcact tcacctttt ctgctccatg 328500
ttctcacct gttaacagg acttaataata gtactacctc ttagagtgtc ctgaggacaa 328560

agtatgtga aattcgaaa gggccgcgca cagtacccat ggcttgaaa gtgctcaata 328620
aatctcaata aatgttttta tcaatgatgt ggtccaac agctcaggcc tgggcttag 328680
tgttctcttg cttagcctga agggacaaca ctcccctcta aaccacagc tgagatgccc 328740

tgtagtcctc acaccacggc cagccaagga gaatcacaga ggtgcaggct cgcccagaca 328800
 gccggaact ctaacagtct gcgacactca agaagctgag gcaggatttt gagcttcagg 328860
 tcagcctggg ctacaggcta ccaaccccct ctcttccaca agtgcagacc tggggctccc 328920
 cagatgctat ttacacatag tctgtgcaaa tggcccctgg gagagtttat acttgtgtgt 328980

 ggaacttaag aatcctgggc cttccacccc tccccatgct atcaattcag aagctctgtc 329040
 gacagaagcc cctcccttcc cagctgggtcc aggtgggagg caagccaggc catgtgagag 329100
 gcaggataga gaaagggccc ttaactcatg ttttccatct cttcacagcc gtctctctg 329160
 tcacgttgtc tctgttacag aaagggaaac tgaggctcag aaaaggacca gggcaggaca 329220
 cagtagagtt gactgtttga tggctgagtt tcctagaagc ctgtcacgat cttcagacct 329280
 ctgtgtggag acccaaggct ggagctgaga gccatgcctg acttcccaca tgttcgagga 329340
 ggatgtggtg gtggctgtgt gtgtgtgggg ggggggtgct gtaggaagga cgaagacaat 329400

 gaggataggt gagggtccaa gtgtcctgtc tgcaaaaagag atagaggact catggggacg 329460
 gggagttttg gaagagatga catttgagct ggggctttgt tttggttcac ttgattggct 329520
 ggctggttga ctacaggct gattttctga caaggcctca ctctgtagct caggctatec 329580
 tgaactcaat atatagtcac gcctggctcc aaactcctga aagccatctt gtctcagcct 329640
 cccaagtgtc ggggttacag atgtgggcca ccacacctgc tgccacagag tgctctggtg 329700
 ggaagaccag agaaggcaat taaggaagca ggtatgaagt ctgggctggt gaaccgcca 329760
 ggtgactaga gatgggagg aatactgaa aggtgacggt tgctgattct ttaagccttc 329820

 atgtaatggc cactgctaag caattcatgt cacattgcct cagtcatcag gtgtgcgcta 329880
 ttgctttccc atgccaagc tcacacagcc tacaagtgc acagctggga gtcaagccag 329940
 catggccac ctccacatgc tctagcctc tctgctctat tgaatatga gttggtgatg 330000
 aattagagag aacataggtt attaagaaaa ttggctttta ttctctacat atcagaggaa 330060
 tcttgggaga agtcctgttt gagattggag catgaacatt cagggaaatg ttaaaacatc 330120
 tgcttctaca ctacgtgtt cccaacagca ctcacatgta cacatatttt ccagaaatca 330180
 tgaaaaaatca ctcaattgtc ataggcttat catggtttca aattagggac tgaattcagt 330240

 ttggaagctg agataaggca atgggggtat caagggttat caggccaaag ctgcagagca 330300
 ggtaagtggc agagacagat cacagaataa ggcagatttg gcataggact gtgtgtctag 330360
 agaagcctga cactcttata gtctgaatgg cacatgttag caggtgggag actgagcccc 330420
 agagaaaaga aagctcttca tcatgggcca cagagaatca atggcagagg gcccaaagca 330480
 ccttgaatag ccccaagtt gcagaacaat gtagcattga gaggtgaac atccagagag 330540
 aacacagatt ggtgtcaggc agggctgtgt ttgaatcctg gctctgcccc ttctgtggtg 330600

aatgtttctg aatctcacct ttctcagctc atagaatagt atctgtctta gttagggttt 330660

ctattgctgg gaagagacac catgaccacc gcaactcttg taaaggaaaa tcatttaatt 330720

gggggtggct tacagtttca gagggttagt ccattatcac catggtgaga catggcagcg 330780

tgcaggtaga catggtgctt gagagtttca tgtcttgacc agcagacagc agaagcaact 330840

gtgacactgg gtgtaacttg aacatatgaa acctcaaaag ccgccttcac aatgacacat 330900

ttctccaag gtcacatcta atagtgtcac tcctaggggg ccaagcatcc aatcatgagt 330960

ctaattgggag gcatttctct tccaacatcac cacagtatcc tacctgatga ggttgatgct 331020

gtgttttggg gggagggagg gtaaaatagg taaactggag agcacagact ggcaactgct 331080

gggttgaatt cagttaatat aaagaaaggt gttcatcatg tgagaaaaag agaaaaagag 331140

ctgacattct caaataatga tactgagact gaaggtatag ttgtgtgta gagcatggtc 331200

ccgttttcaa tctcaccac tgcacaagaa ggtgaataaa tggataaata ccagaagggt 331260

ggtggtacac agctataata ctagactctt ggaggctgag gcaggaagat cacgagtcca 331320

aggccaaact tggcctctga gtaagtcca atcctggctg agctgccata gcaagactgt 331380

gtttcaaca ggcttgatg gaataactttg tatgtgtgtc tgtgcgtgtc tgtgtgtgtg 331440

tgtgtgtgtg tgtgtgtgtg tgtgtgtgtg tgtgcgtggg tgttgggtgt attcgggtgt 331500

gtgtgtgtgc atcatgtgt gcatgtgtgt tgtgtgtatg tgtgtgtgtg cgcgcacatg 331560

tctgtgtgtg tgggcttctg tgtctgtctg tgtgtgtgca ttagtgtgtg tgtgtgcatt 331620

agtgtgtgtg tgtgtgtgtg tgcatctctg tgtgcatggg tgtgtgcatg ggtgttgagt 331680

glatcgggat gtgtgtgtgt gcattcatgt gtgcatgtgt gcacgggtgtg tgtgtgtgca 331740

tgtgtgtgca tgtgtgtctg tgtgtgtctc tttgtatgtg tgcattcatg tgtgcaattg 331800

tgtgtgcatg ggtgtgtgtc tgtgtgtgta tgtcttctat gtctgtgtgt gtgtctgcat 331860

ttgtgtgtgt gtgtttgtgt gtgtgtgtct gtgtgtgttt gagactgggt ttctctgtgt 331920

agacgtggct gtccataaac tcattatgta gactaggctg gccttgaact cagatctgcc 331980

tgcttctgcc tccaagtgc agggatgaaa ggcatgggcc accactaatg ctttagtccc 332040

agtacttggg aggcagagggc aggcaaatct cagagtcca gccagccag gcttatatat 332100

caaggccctg tttcaaaaa tattactaat agcctgggtg ggcacatgcc ttaatttta 332160

gcatttgaag ggcataaggc agtgaatctt tgtgagttg agccagcct gctctacata 332220

glaagtctca gtccagaaag agctatactg tcagaccctg tctcagagca ggggaggggg 332280

aggaagaaaa aaaagctgga atgttttcac agcatttgtg aagctcgggg ttcagtcacc 332340

aatacttcat aaaaccaggt ggtggtgcac acgtgggaaa taaaggcagg agaattagaa 332400
gcttgcggtc attactaggt atatagcaaa ttggaggcca gcctgcgata catgaaacga 332460
atctcaaata tgtaataaat aagtcataat agtgaagttg gaatgaacta caaataaaac 332520
aacaatatg gcaaaaatgt actacagtgg gaaaacatat ggtaggtttc ttttatgcca 332580
ggattcatat taaacattca agcatgacag taggggtctg gccagagcaa taaaacaaga 332640
aaaggaaatg ccataagggg ctcatggaat gactcagggt aaaggcccct gccaccagtt 332700
cctgacttcc acacatgcac agtggcacac ccacacacat acactcatgc tfaataaat 332760

gttaaaaaaa aaacagagaa cagaacacta caaggtttag gcagggtaac gtaatagtga 332820
gatagatata tacaatttc cggatcttca gtagcaatta aaaacatgc cctggattta 332880
tgccatgcag cagctttgaa tgcttgggac agagttggag aagtaggaaa ggaaattgag 332940
tcatttacta aagtataca gggccaagg gaaaccttca tgcagttctt acaaagattg 333000
acttagcagt aaatagaatg ataccaaatt cagaagctag acaagtaata attgaatctc 333060
tggcttttga aaatgctaag gcgcaatgaa aaaaggtaat taggcaatta aaggcaagat 333120
cagcacctt ggaggactgg gtgtgagata caatcaatac tgaacctcat aacctgatg 333180

atgcttggat aggagagtg atttccaggg ggttgaagaa aaataaaat gtcaagtgtt 333240
tcaattgtgg caaacaaggt cacctaaaaa gggactgtaa acagggcatt cctagaacaa 333300
tgtttttct aagcataatt caatagaatg ccctccctt ctggattagg cagaaagtgt 333360
ggcaacggca ggcattgaac taatgaatgt agatcaacaa ggaacagtca aggtaaccct 333420
ttgccattgg gaaatgcctt aggggactct tgaaggcccc catgccaat tcagtttgg 333480
tgtctctgt aatcatggaa gaaactcctt gccagagaaa ttaaagaacc taatgcctat 333540
tgaagaaac catactgttc tggatgatag aaaatctata gaagagagaa caaaaaatca 333600

ggagtaattg taaagcaaat attttgcaa acttctataa ataaagacca aaattaaaaa 333660
tatgaataaa tgatattgtc attgaaggct ttatagacac aggtatgcat gttataataa 333720
ttgcaccaga atcttggcat ccaaattggc ctcataaatg ttcattttt agggattgaa 333780
actttatctc aggtaaaaca gagagtgaag tgggttgaat atataaggcc agaaggacag 333840
agaggaaaat aaaagccaca tgttgctaac atagcaatga acttataggg acatgatttg 333900
ttatagcaat gaaatattca gattaacatt cctccaatct tagaacaaca ccataaatta 333960
acatatgttt ctgggaaaaa tattagaagg tattataaag aacagtcacc aaccattcag 334020

gttgtaaaaa aacaggaac aacagctgct gatctttcaa aggcaccaac aaccgtacct 334080
ttaaagtgt tgatggacaa acatgtatag gttgagcatg acttttaaca acagagaaac 334140
tgcagtcctt agaacagctg gtacagaaac agctaataatgc tcttcatatt gaagaatcaa 334200

ccagcccttg aaattctcct atatttggtta ttaaaaagaa atctggaaaa tggagaatgg 334260
 taacagatct aagagctggt aataaggtga ttcagccaaa tggcttccta tggcttgaa 334320
 ttctctgcc ttctttatta cttaaaggat ggcctcttat aattattgat ttaaaagatt 334380
 gtttcttcac tafacctta caagaaaaag tcagcgaaaa atttgccttc acagtgccta 334440

 cttaaaataa ttcttagtct attaagagat atcaatggaa ggttctcca cagggaatat 334500
 taatatagctc cacactgtgc caatattttg tatgacagct gttggaaatg atacgtaagg 334560
 aatttctca atctatagct caccattata tagacgatat tttactagct gattcaaatg 334620
 tagatactat agagaaaatc tttgaagaag aaaagtttgc cttgttggag aatacaaat 334680
 gctcatgaaa aaatacaaaag aggagagtct actaattatt taggacataa aataagtcta 334740
 caaaaaatta gaccccaaaa ggtgcaagt aggagaaata catttcagac tcttaatgac 334800
 tttcaaagat ttaggaaac atttctatc tatggccac tattgggata caaatgata 334860

 aactgagtaa tttgttcaa ccttagatgg tgacaaggac ttaaatagtc caagagaatt 334920
 attatagctg aagctgagag agaattgact ttgatggaaa agaacttaca ggatgcacat 334980
 gtggatcatt tggatccaaa acttgattgc attttggtta ttttacctc taagaattct 335040
 tctacaggaa tattaatgca gaaagaagat attatctca aatggatctt tttactacat 335100
 aaacagacta aaaatntaaa aacttatgtg gtaatgtctc tgagttgatt ctaaaaagaa 335160
 aattaagact teatcaagta ttaggaatat atccagcaga aattatagta ccctttacta 335220
 atgatgaaaa tcacaaatta tgggcagaca gtgaaatttg gcaaagagct tgcagtaatt 335280

 tgggggagaa attaacaaaa aatatcccaa aatcaagaga attcgattta taaaggaac 335340
 taactggatc cticcttgca ttgtatgggg aatacaata tctgaagccc ctacattcta 335400
 tactgataca aaaaaattg gaaagtcagg atacaaataa gaaaattta cttaaagtggc 335460
 tcaacacct taatagtctg cccaaaaatc agaatttatg ctattcttat ggtgttaatg 335520
 gatcataaag aacctatna catagttact gactctctca gtatctgaa agagttgttt 335580
 tacacactga aacctgca tttattctg atgaatcaga attaactttg ttatttatc 335640
 agttacaaga aataatcagg aataggaaac accctttata taacacacat ccaaagccat 335700

 atgggtctgt gagacctct agcataaggt agtgaaaaa ctgatcaact attgatagta 335760
 aatgtgctaa aggctcaga atttcataaa aaaaaatcat gtcaatagca aaaagttctc 335820
 cactacttg caacaagcca aggaattat aaggaaatgt cctacttgtt ctttatcaa 335880
 ctccaccacc tgcaggaagt aaccctaaaag gtaatcaaag gaatgaatgt gttttatgga 335940
 tgtgtttcat tttgtagaat ttgaaaaatt aaaatatgta cagcacacca ttgatgccta 336000
 ttcagatatt caatgggcaa ctgctttgag tttggaaaag gctgattctg taatcacaca 336060

ttgttagaa gttatagcca ttatagctat acttgtaaaa attaagcaga cagtggctgt 336120

 agagatggct cagaggftaa gagcaccgac tgctcttcca gaggttctga gttcgattcc 336180
 cagcaactac atggtggtct acaaccatcc gttatgagat ctggtgccct cttctggtgt 336240
 gcagatata atggaagtag aatgctgtat acataataaa taaataaaat cttaaaaaaa 336300
 ttaagcagac aatactccag tatatgactc tagtaaaatg aaaggTTTT gcttattaca 336360
 atataaagca tattacaggt ataccacaca atcctacagg acaagcagtt atagaaagat 336420
 cagatcaaac tctaaagat atgctaaat aacagaaagg aataaaaatg acccccaga 336480
 aatagagtgc ataagtctt ttttaaaaa ataatttatt ttcctcagt tttatgaaca 336540

 ttggcatttt gcctgcatgt atgtctatgt gagggtgtca gatcttgag ttatagacag 336600
 ttgttagctg ccatgtgggt gctgggaatt gaaccaggt cctttgtag gacagttagt 336660
 gctcttttaa gatttattta tttatcatgt atagttttct gcctacatgt atgcctgcag 336720
 gccagaagag ggcaccagat ctattacag atggttgtga gccaccatgt ggttgctggg 336780
 aattgaactc aggacctctg gaagagcaga cagtgcctt aacctctgag ccatctccc 336840
 agcccagaca gttttggtt tttttttgg ggggtaggg ttcgagacag gttttctctg 336900
 tggctttgga ggctgtcctg gaactgtctc ttgtagacca gtctggtgtt gaactcactg 336960

 agatctgctt gcctttacct cccagtgct gggattaaag gtgtgcgcca ccaccaccac 337020
 caccaccacc accaccacca cccggctcag ttagtgctct taaccactga gccatctctc 337080
 cagcccacac aatgtttat tagctttaa ttcctaaat gctaatgaaa aaggaatgaa 337140
 agtttgggag agacattgga taatagaaaa aactatggaa ttaaatcagc aggtatactt 337200
 caaagatctg ttggcctcag aatgaaacc aggacatgtg ttacgttggg gaaggggttt 337260
 tgctttgtt tccacagaag aagaaaagct atggatacca tcaaaactga taaagactct 337320
 tttgaacagg agaggcatat taattagaag agatcatagt tcatcaaaca tcatggctgt 337380

 tcaatctaaa ctaacctata aaactaaca atgcttttca ttgatcaga tataacttgc 337440
 caaaagagag cttcccaaaa attagggttg gggaagggtt ctgtttctgt tttttcagg 337500
 agaataaagg gatccagcta aagaatcaa agaccactgc acaaatgaga catctgaaga 337560
 aaaaggacaa atcaactaga aaaatgtcc caagaaaagg agcaaattgc ctattggtat 337620
 atcacgttcc caacaggata aaatttcata aatcttccca aatgtttgtt tctgctgttc 337680
 tctacagaca tataatgcaa atggctttt ttagtccta gtccaattaa aaattaaagc 337740
 tggttttgga gttggagtgt ggctctctcc ttctctagac ccaagcattc ttgttaaagt 337800

aaaatccaaa atctctgtgt catgtcagaa aagccacctg atttgagaca gaagaaaaac 337860
 caaaattaag gggctattct attgccacta atctcataat actttggttt tattttgact 337920
 ttttaaaagt tttctttttt ttttttttta agacagggtt tctctgtatt ggacctgtc 337980
 ctggaactta ccctgtagac caggctggcc tcccggagtg cgccaccact gccaccacca 338040
 cccagcttaa agcttttctt aatgtctaaa tattacctca aaatgataa gaataatata 338100
 tatgcatata ttttaaaact tctgtcatga tattaacggt catatagagt actaactaat 338160
 tttagaaga ggcttcatct accttctgt aaataattc aggtttgagg ctctgtcagt 338220

 tttctgcagt gaacaataac catgcctaac actgacctt gaagtctcca aaaggaagat 338280
 ggggcctac aataatgatt ccaccaggat tatgataact cactaagct gaaaaacacc 338340
 tcctaaagat cagctttgga ttacaaactg ctcagaacaa tttcgaggtg gctagctgag 338400
 atgatccagt ctacagacg actccagcca ggacttgaga caaacctac actttccat 338460
 tacacagaga ctggacaaat catacagctt tctctcccag gacttgacaa ttaacctgat 338520
 tttttcttt tcaggatccc ctagagttgt cgtcaccccc cagacagcag gaataaatt 338580
 taagaacatg aactttacat tccaagaaa tgggttgggt gggtttggtc atttaattgg 338640

 ttatgagtat ttgtcattgt ttaggtact tggttacaag tttttattga taatggtcag 338700
 gaaaaagcta aataggagaa attagattca gagtcttgtt ttgaaaagaa aaatggggga 338760
 gggggactg ggctggagag atggctcaga ggtaagagc actgtctgct cttccagagg 338820
 tcctgagttc aattcccagc aaccacatgg tggctcaca tcatctgtaa tgagatctgg 338880
 tgcctcttc tggcctgcag ggacacatgc tttctattt gtatttctc caaagccagt 338940
 gggaggtaac gacctgtgta agcaaacagt gtaactaata aataaatctt gaaagaaaga 339000
 aagaaggaaa gaaagaaact ggggggtaca gatatgatag gataaaaagg gcagatttca 339060

 actctgaaaa gaaaaaagga agggccgggc gttggtggct cacgccttta atcacagaac 339120
 tcaggaggca gaggcaggcg aatctctgtg agtttgaggc catcctggtc tacagagcga 339180
 gttccaggac aacctcaaa gcaatagaga gaaacgagga aaaaaaaga aaaaaggaag 339240
 gatataagga tataggatg ataagataa aaggtagggt attgaatcta cttttaaaaa 339300
 gcaactaata gttttaata ttttacattg gattgtactt ttgtatatt taacaaatt 339360
 ttgtatattg aggggctgga gagatggctc agtggtaag agcactgact gttcttcag 339420
 aggtcctgag ttcaattcct ggcaaccaca tggtgactca caaccacctt aatgagatc 339480

 tggtgccctc tctgacatg caggcagaag actgtataca taataataa ataaaatctt 339540
 taaaaaattt gcatattgat gcaaatitga gaataatttt gttagaacat actgtacata 339600
 gatactgtac atagatttct aatattgttc aaggtattat accttacag ctcatttaat 339660

aatgtaatgc aagttcctag gtttttttga gggggagggg cggggatggg gggtaggagga 339720
gtgtttcgag gcagggtttg tctgtggttt tggaggctat cccagaacta tgtcttgtag 339780
accaggctgg tctcgaactc acagagatcc tctcgcctct gcctcccagag tgctgggatt 339840
aaagtgtgca ccaccactgc ctggcctaaa attttagttt ttgaaaggta ttattaccaa 339900

ctatttagga taataagtaa tgcagattag taattagtca ctttttaca ttatagtcac 339960
attaggtatg ttttcaaggt caaaagagag atagtttaga tggacaagtc atcttcaaac 340020
acttcagaga tctacagaat atggcattta agatgtttta atgacatagg ttcttttttt 340080
gttttttaag acaatgagac atgtctgctt ctggcagcac caatctaaat cagagaagat 340140
gatggacatc aaagaaactt cacatggagt ttactttctt tgtggcaaaa attagccact 340200
gggcattaaa gtgctcttgc cttgactact gacagtatgc tgtccagatt ggacaaacag 340260
gactcaaaag acagcgactg ctaaaacaag gcagggcagt ccttcagaat gtcgtgcttc 340320

acagaaaagt ctgttgaata ttctaggcct gtaggtggaa gacggatgcc cagcattgca 340380
gaggaaccct gggtagcttt ccaggcagcc agctgtttct cccatttctc acactttttg 340440
gaagtcaact gcttgcactt tctgettact cagttaatgt tatgtacttc ctggatctct 340500
gagggagtgg aagactagat agttatagct ttctttgttt accagactca gaaaagaaac 340560
tcattaaaga ggtgtaatgt gtaaaatgtt gagagacata gaaatataat tttgagttgg 340620
taatgcaagt tagaatagaa agtgaattag gtacaacact tttggactca ccaagataga 340680
tatggagtat tttctctgaa tttgacaaat gcaaatgaac tagacattgt tgatgtattt 340740

atgacctgta tatattgat atagttatta tacatgtata gtttttctta tattagttat 340800
gtttcttttt attttagaca aaaggggaaa tgtggtgata ttttgtttat gatctaacia 340860
ataaagcttg cctgaagacc agagtgcaaa gctagccaca ctagaatctg tgctccttcc 340920
actgtctggg atccagggat ggattgtagg acgacaggct tagcatcgag cacttttatt 340980
cactgagcaa tcttgataga cccaagtttc tgtatatttc aattcatttc tttcctttcc 341040
tctttttttt cccctctcc ttttccctc cccatecctt ctctgctg gaacacctgg 341100
aactcacaga gttgcttagg tccattttaa ctgtcagcaa tgctgctgac ttggtttccc 341160

ggagggtaa attattgatt atgagctgcc ataccctgat aacctcagtt tcttcttttt 341220
tcttttttgg gttttcaaga cagggtttct ctgtgtagca gttctgactg tcttagaact 341280
cactttgtag accagggtgt cctggaactc actgagatcc acctgcctct gcctccaag 341340
tgatgggatt aaaggcatgt gccaccatgc ctggctaata ttgtcttttt atttatataa 341400
ataaaattat ttagttttat ttatgtgttt gtgtgtgtgc catacaagtg ttgggtgctct 341460
tggaggtcag aagcaggact cagaccccct ggaactgagt taatggtgat tgtgagccac 341520

ttgatgtgag ttctgggagc tgaactcata tcctctagaa gagcagaatt cactcttaat 341580

 ggctgagccg tcctccagc tccacacca gcttcttata taggtgctaa gatccgaact 341640
 caggtccttg tgatggcatt aaatcagcag aaccatctct tcctcctttt gtttatttga 341700
 gaaagtgtct cctagatgtc tgagatgtag cacaggctat ccttgaactt gctatgtagc 341760
 ttcagataac gttgaaccta ctgcctccac ttccaaggg ctgtgccacc actgtacctg 341820
 acattccttt atggtttgtt gtccctccttg aaacaaaagc tctatgaaag ctaatggctt 341880
 aatggtttct cagttgggct gagaactgg ggaggaaagt tggcttgctt gtgggctatc 341940
 agtagaacct cccccctcc cctaccacc ccccagaaa tcttttgact gatataccaa 342000

 cctctgttag tatttacctc attgagagia cagaggaact gatattaatc ccaccaatca 342060
 agaataagat cactgccagg tggctttggc acacccttt aaaccagct ctgggaggc 342120
 agaggcaggt ggatctctgt gagtccaagg ccagcctggt ctacaaagct acacagaaaa 342180
 gccctgtctt ggcaaattaa aaaagaaaag gaagaagaag aggaggagga ggagcagaag 342240
 gaggagaagg aggaagagga ggaggaagag gaggaggggg aaggaggagg gaggagaagg 342300
 aggaagagga ggagggggag gaggggggag aaggaggagg aggaggagaa ggaggagaag 342360
 aagaaggaaa acccataatt cattgtattt cccatcaggt tcaatcaagg gcatgcatat 342420

 gtctgttgt acttccagcc tataccaat cagaggcaag catacatct gacctggcta 342480
 atattgtctt tttatttata taaataaaat tatttagttt tatttatgtg tttgtgtgtg 342540
 tgccatacaa gtgttggtgc tcttgagggt cagaagcagg actcagacc cctggaactg 342600
 agttaatggt gattgtgagc cacttgatgt gatttctggg agctgaactc atatctctca 342660
 gaagagcaga atcactctt aatggctgag ccgtctctcc agctccacac ccagcttctt 342720
 atataggtgc taagatccga actcaggtcc ttgtgatggc attaatcag cagaaccatc 342780
 tcttctctt tttgtttatt tgagaaagtg tctcttagat gtctgagatg tagcacaggc 342840

 tatccttga cttgctatgt agcttcagat aacgttgaac ctactgcctc cactttccaa 342900
 gggctgtgcc accactgtac ctgacattcc tttatggttt gttgtctctc ttgaaacaaa 342960
 agctctatga aagctaaggg cttaatgggt tctcagttgg gctgagaaac tggggaggaa 343020
 agttggcttg cctgtgggct atcagtagaa cctccccgc tccccctacc accccccag 343080
 aaatctttt actgatafac caacctctgt tagtatttac ctcatgaga gtacagagga 343140
 actgatatta atcccacaa tcaagaataa gatcactgcc aggtggctt ggcacacccc 343200
 tttaaacca gctctcggga ggcagaggca ggtggatctc tgtgaggtca agggcagcct 343260

ggtctacaaa gctacacaga aaagccctgt cttggcaaat taaaaaagaa aaggaagaag 343320
 aagaggagga ggaggagcag aaggaggaga aggaggaaga ggaggaggaa gaggaggagg 343380
 gggaaggagg agggaggaga aggaggaaga ggaggagggg gaggaggggg gagaaggagg 343440
 aggaggagga gaaggaggag aagaagaagg aaaacccata attcattgta tttcccatca 343500
 ggttcaatca agggcatgca tatgtcctgt tgtacttcca gcctatatcc aatcagagcc 343560
 aagcatacat cctgacatat ttctgcctg tgaacctcct gaccacatgc aatcaaatac 343620
 atctgtata gatgggcaa acaaaattgt ttaggaaagt gaaaatatgt gacttgttat 343680

 ctctcataaa caatggcccc cagcatttca ggagctatct gtctttaggc aaggaagggg 343740
 cttgtagatc agcggcgttt tgtttcatgg atctcttaga catggtatt aaaacttaaa 343800
 acataacttt ggctctcaca ctgacctaca aatgttatct tccattcca aagtcccct 343860
 ttccacctaa taaactcct aagcctccac tactgcagga acaattctgt gtagagggt 343920
 gtaaagagtc ttctctgtc ccaccattca gctcccaat aatgacatgg agatttgttt 343980
 atacatata acatttgttt atacatacat acatactcac agagatccgg ctgcctctgc 344040
 ctctggagtg ccaggattaa aggtgtgcgc cccaatgcc tgcttagact tgttaataat 344100

 taaagcttga ccttagtita ggcttgttcc actaactctt ataattttaa ttaaccctt 344160
 tatattaate catatttgc ctcatggctt ttaccttc tttcattctc tacgcacaac 344220
 ttctccatg tcctttggc acttggattc atctctact tctctttct gcctagaagc 344280
 cccacctata cctcctgct ggctattggc cattcaactc tttgttacac caatcacagc 344340
 aatacacctt cacacagtgt acaaatatcc cacaacagag gttagtctct gatttcaca 344400
 tcgcctccat caatcccatt ctaacaaagg caaagacatc cacttataga cctatctact 344460
 atgcctaaaa ctgccagga attcttcagt taacatctgt gaaataaaca acacacttta 344520

 aaagaccacg acgcaggttg cctgtcctct cctctacca cagggcagct gagtaacttt 344580
 cctcaggtag attctgctat gtgggcttag ccatgtgtga gagaggacag tccactggtc 344640
 tgaaggtagg gcagaaacaa tctgggaaaa tgactgaagc aatagcttgc aagtctcagt 344700
 tgactgagca ggtccctgtg gcctaggaaa acaggttggg ccagttttgc cccacccgc 344760
 aggaagaag gaatggaggc ttcaaacaca ggtgctcca accccatag cttcaaacc 344820
 tttgtccagg ttctcaggtc ctgcacaatt tgaatcacag aggttgacag agtctgact 344880
 catggttaag ggtttgacat tctatagggg tatttgggtt acatttaaga gcctagccc 344940

 gggtagcaaa agaccaaagt cttgcccctt tgtacagtca tagagaatgc actctttggg 345000
 aggaaagatc actttccaag gtctcacttg gggcaagact cccagatcat cctacctct 345060
 gtcccttcat taatccattt aaccaatact ttctagctt agaagataac atcacgaaca 345120

caatgatttg taigatcctt tgtggagatt aaaaaaaaaag aacacagtaa atacaacaat 345180
 tatgtggttt gttgtaaagc agaaaagaat agaaagggga gtgtgtggag tgaagtgcct 345240
 ggaggaagag gccaggggga agggaggctc atccctcccc gctccccttt ctgtgtgtgt 345300
 gtgtgtgtgt gtgtgtgtgt ggtgtgtgtg tgtgtgtgtg tgtacaggtc tttacctact 345360

 tcgccatccc tccccgcccc tttctctctc tctctctctc tctctctctc tctctctctc 345420
 tctctcggtg tgtgtgggtg tgtgtgtgtg tgtgtgtgtg tatacacagg tetttaccta 345480
 tgtggccatc cctccagccc tttctggatt cttgtgtctg catttcttga cttagccttt 345540
 cttcactttc aaagccagga ggagcatctt gcattctgat cctctcctt tgattacacc 345600
 atgtccaact ggataatcca gaatatcctc ttcctctcaa agacctttaa ggacattctg 345660
 ggtatagggc ataggtatct ttggaaagt actgtgtggc acacttcagg gagctactgc 345720
 caaaatcca gcatgagata gataatagt acctggaggg aagtgacagc agtgaagagt 345780

 gacagatgct ggggctctgg ggacactttg agggctcagc cagcaggatg ttctaaggca 345840
 ttggacatgt gtaattcca caaatgaca agacaactac aacttaaagc caaatttga 345900
 agcaagcttt aattaaatac tggccccgtg gttgggetct ggccaggctc atacctaggt 345960
 tcctgggaaa tggccccatg tcactgtttg cagtggctta aaccataa tcatcacat 346020
 ttcccatcag gtccaatcaa gggcaagcat gtgtttctc ctacccaaag gggatcaagc 346080
 acatctgggtg cataggggtc aaacaacat atgaaaaaca tgtggcttct tatctcccat 346140
 aaacaatatt tcaggaacta tttgtccttg agcaagaggc ttgcagatca tttttgttc 346200

 atggatctct taggcatagt attaaaactt aaaatgtaac tttagctctc ccacatggac 346260
 tttccttcca tctatctgga cttggaagca gacctcctt tctgtgagag agagtaggcg 346320
 cctctataaa ggtccagga gtgatcactg gagcctgtgt gccccctca atgtgttgtt 346380
 actgttagca ttcaggcatc tgtaactggt tgtccttggg gttctgacag aatatgtcct 346440
 cagctgcagc cactaagagc acattcacta tgttccttt taaaagggcc ccaactcca 346500
 tctctcctc cctctctccc tccctcctc tctgctgtc tctcttctc tcttctctc 346560
 ctgcctctc tcttctgcca ctctgtccc cagaggecag tctcccctc ctctctctc 346620

 cttttgcat tcactttctc ccaattaaaa aaaaaaac aacctccac ctcttgttc 346680
 taattcaaat taaaaaaaaac aaaacaataa caacaacaaa aaacctcca cccaagctc 346740
 attgcatggc atctttaca cagtcacttg gttacatag actcagcgga acccaccatt 346800
 gctcaagta gaggcccat ccagcacaca tctcctctc acacctca ggttgggtct 346860
 gctttatctc cattgctgaa tttgccaga tttcactaag tagcctgtg tgacctagaa 346920
 ctggatatgg agactgcct ggccccaac acacagggat ccactgcct ctgcctctg 346980

agtactggga ctgaagatgt aaatcagcat gtctggtata aataaataat tttagatgaa 347040

 aaagaaaaaa gggttgtagg gtgtggggat ttagcttagt aggaaagtgc tttcccagcc 347100
 catgaaagge cctgggttca atccctagca ctaaaaaaat gaaagaaaaa agataactcag 347160
 caggcatag tggtttgtgt ctgtaattcc agcacttgag aggcaaagc agaaagactg 347220
 ccatgagttt ttgtgcctag cttctttcat tcaaggtaac acatactgtg cttattgttt 347280
 tcacatggct tcaacacttt cgtttgtttt gaagacgggt ttttctatgt agccctggct 347340
 atcctggagc tcacagagat ccacctgcct ctgcctccca agtgctgaga ttaaaggcgt 347400
 gcgccatcaa tgectggctg gctttaacaa tttgtttgt tttgttttg tttccccgag 347460

 acagggtttc tattgatgcc tctgggacca gcctctaggc agctcagggt tctgagagaa 347520
 gccaaaggcaa tggigaagct aagacctttt ctatctgaga gggtaggga gaagacattc 347580
 acattttctt catcatttcc ttttttattc attaacctct tctgatactg aaagaccctt 347640
 ggaggctcag gccccagga tgttggcca ggactgaggt ggtggcaaaa acttgatgca 347700
 aacagcacga ggctttatta tagtttttta acgagctaac cccatgtag ctggctctt 347760
 tcatccacce accatggctg atggetagga aagacagctc aaagtgtctg catagagatc 347820
 ttatagggca gcgtaagggg agtgtctagg ggtacgcaca ggctcaggat tgggtggct 347880

 tcaggcttgg agggtttgcc ctgtgtgat tggtaactg gttgttatgg accataggcc 347940
 ctcccagggc gattgctatg ctctgcgtgt cattgctgtg cacctgtcca agaagcacac 348000
 ccagagccat aaagcgtagc accaccagct aacttctgat tggttctttg ccacaggca 348060
 ggcatctgac ctctagtga ccaaggcaag gtcaggcaag cacgtgctag gctgttatgg 348120
 ctgccgaaat ggggagctgg aaccttcaat aactctctg ggctggatct ggctgttatg 348180
 tttttgttta aattagatat aaaaagaggg gacgcgaagt tgagacatat tagccatfff 348240
 attataagcc cggcagagta gggagactaa gagagaagag aaacggggtt aatggctgac 348300

 cgccatggcc ggtagccata gagagagaga agagaagcag aagcaaacag agcgaagaag 348360
 cagcagagag agagcgcaaa gcaaagaagt tggaactttc aaaggaaga ctgtgcatac 348420
 gcactgaggt tccacgcatg cccagagtcc tcatgtaggc tgtaaatgca tggtaggtga 348480
 tggcacgtcg catgccctga ctgttgcag gggcggggt ctgtctctca aagagtaga 348540
 gctgatcagc attaaagcct gaacctttca ctggccaccc ctttaaaact gcacaaaagt 348600
 gtatfttttg tttgtttgtt tgtttttgga gacagggttt ctctgtgtaa cacccatggc 348660
 tgtcctggaa ctcatgctgt ggaccaggct ggcctcgaac tcacagagat ccacctgctt 348720

ctgtctctag agtgctggga ttaaagggtg gtgccaccac tgcatggcct tttcttttct 348780
 tttttaaaga tttatttctt tactatgtat atcatgttct gcctgcacac caggagagga 348840
 caccagatct cattacagat ggttatgagc caccattcaa ttgttgggaa ttgaattcag 348900
 gacctctgga agaacagcca ggactctttt attccccctt cccccctt gcccgaaac 348960
 cagaacattt tattttaiga ctgactgaaa tcctcaagat gaactggatg ctgcaacagc 349020
 tgccctcttg ggtttagggt ttgtcccttc atggaatcca tgtttgaatc ttcgacaatt 349080
 tttagggtgc tcagccacc agttccgtca gtgttttgtc tcttagcctt ggacacaccag 349140

 ttatacttct tcttgcgctt ggcagggtag ccacatttgc cattctgaag ttggtaggcc 349200
 ttagagccac agcggcagca caatgcttct caaaggatga tgttccttct gtcattctgc 349260
 ttctacagct gaggccaaag agccagccag tactctaac ctctgagcca tctctctagc 349320
 acaaaagtgt atttatcaat tgttacacaa agcatttccc aattccaagg ttccccatct 349380
 taatctacat atcttattga agggagcatc acatgtctcc atgactttca tccttcatta 349440
 agcattgtgt acaatacaca aataatacaa gacccctctg tgtgcctgag gtgtcctgtg 349500
 agcaaggtea tgggatggca ccctcagtaa aacaatcatt ggtctccgct tggattctct 349560

 aagtcaaagc actcctaaga agcatctgtt tactctagtc tctatcccat atagtgattt 349620
 tgctaaatc ttacagagta cattcatctt acatgactaa tgaagtttct gcaccccgat 349680
 tagcctctcc actgatcgag caatccaaat cagaccaaat caaactgaat tagaaaaagc 349740
 ccacgttgaa tggataaaaa acgctccac atgactttcc aaactcccag ggaggagact 349800
 gaaaagagag actagaaaac cacatgtcta ttttctgggg gtcagtttaa atacctgtg 349860
 ggagtggctt tgagcatctc tgggggaggg gtcattcatt gtcgggcttc tggagatatg 349920
 gcagggtttg gagagagatg agggaggggg tttgaggtgg aacttccatc agaacattcc 349980

 agactctcta ggtatatggt tgccaggggt tgggatgaag cttctaccag aatatctaat 350040
 aataaaatca tccaataaa tctcaagaaa aaaacacaaa aaacaaaaca aaatttatcc 350100
 caatacceca tatacattta catcttgaag ggaccagctc cccatttcgg cagccataac 350160
 agctgaacac gtgcttgtct gaccttgcct tggtaactaa gaggtcagat gectgcctcg 350220
 tggcaaggaa ccaatcagaa gttagctggt gggctatgct ttatggctct ggtgtgctt 350280
 cttggacagg tgcacagcaa tgacacacag agcatagcaa ccaccctggg agggcctatg 350340
 gcccataaca accagttgac caatcaacac agggcaagcc ctccaagcct ggaggcacac 350400

 caatgctgag cctgtgcgta ctctagaca ctccccttat gctgccttc aagatctcta 350460
 tgcatggtt tgcagctgtc tttcttagcc atcagccatg gttggtggat gaaagaccg 350520
 agctaacatg ggttagcttg ttaaaaaact acaataaagc ctctgtcagt ttgcatcaaa 350580

ctttcgaatc cacctgggta ttgggggtgac catggtcctg ggaaaagatc ctggaggcct 350640
 gagctttcct gaggtcttac aatctaagta acttattgca gatcaataga gcataagcag 350700
 acagaaatcg tctctttaca gacaactctc ttgcttgctg gcagggtcta ttcaatggct 350760
 acaaagaatc agttattcta ttgtctatct agaaagttaa ttttttaat ggttttttga 350820

 gacagggttt ctctgtatta ttttggagcc tatcctggca ctactctgt agagcaggct 350880
 ggctcaaac tcacagagat ccgtctgcct ctgccttccc agtactggga ttaaagggtg 350940
 tcgccacat gaccagaaac attttttaa acaaatctt ttattgtaag agcattttgt 351000
 ctgcatgtat ttgtactaca tgtgtgtctg gagtctgtgg aggtcagaag agggcactgg 351060
 atctctgga actggagtta cagttgtaac ccatcacatg agtgttgaga actgagcctt 351120
 gcaagcaaca agtgctacac ccctgttttt cacagagctt ttaaatgagg taatagtagt 351180
 tgcttaaaaa tttaaaaggg cctgcactta ccccaaaggc cagaacaatg aagcccaggc 351240

 tttctggtat ttaaccaatg tacactgtga gtcttgccat ggcagttaa tctcaggcg 351300
 agatggcagc cacccatgtg tcacatgag gtattccaca acctaagcag acatcatgac 351360
 ttgctctct ttttttctt cttttcttc tttttctt tttttctt cttttcttc 351420
 tttttctt tttttctt cttcttgaga ttgagaatta tgctatgaag gctaagctgg 351480
 cctggaactt gtggtctct gtgtcagtct tccaaggcca cactgtagac aacatactgc 351540
 acctggcttt cagcacctt tcaaaaacag tgccagggta ggatcaaat tttttctgg 351600
 tgaccaatat caattgtatg ggaacagcac tcaaatgtga gttttctct gtgattccc 351660

 cacaagatga ttttctggac tcttaggggtg tctcagttgg ggttactatt gctgtgatga 351720
 aacagcatga ccagaaagca agttggggag gaaagggttt atttagatta cccttcata 351780
 tcaactgtaa tcaatcaagg gagtcaggac aggaactcaa acagggatca atgcagagc 351840
 catggagggt gctgcttact ggcttgctct ttttcatgg tttgctcaac ctgctttctt 351900
 tctttcttc cttcttctt tttttcttt ttaataattt agttattttt atttgattg 351960
 gtgtgggtgcc tgcatgcatg ttgtgtgagg gtgtcagacc ttggagttac agacagttgt 352020
 gagctgcat gtgggtgcta ggaattgaac tagggtctc tgaaagagct gtcagtgcct 352080

 taaccactga gccatctctc cagatcctca acgtgctttc ttatagaacc aagaaccatc 352140
 accccagggt ggccccactc acaatgggat ggacctccc catcaatcac taatgaagaa 352200
 aatgctctac aggttgctc acagcccagt cttactgag gttccttct ctccaatgc 352260
 aagtagtgc aagttgacat aagcttatta ggacacagtc aggacacaag gactctgctg 352320
 tcaacctggt tagctcaaca gcagtgtgag actggtggtt aagattgtg gcactctacac 352380
 tgggagggtg tggcacacgc ctttagttcc agcactccgg aggcagagc aggcggatct 352440

ctgtgagttc gagaccagcc tggcttacia gagcaagttc caggataggc tccaaaacca 352500

cagagaacc aaaaacaaaa aagaaacgaa accctggaac ggcattaact atcatacact 352560

gattatgaaa atcaaatgtg atcatgtgct ttgggggctg ggaatttaac ccaggcctct 352620

accacggaat ccctctctgt aatagttatt tcgctccctg ttcttccgtc tctacggagc 352680

acattccaag gagactacgt cttccagcat gccacctcac cctttgacct cggcgcgact 352740

aaaaagggtgc gccatcgtac gccatgagcc ggaagactcg gactcccggc atgcagcgcga 352800

cagtcctccc ttagacaaaa tgggctgtgg gcgcgtnnnn nnnnnnnnnn nnnnnnnnnn 352860

nnnnnnnnnn nnnnnnnnnn nnnnnnnnnn nnnnnnnnnn nnnnnnnnnn nnnnnnnnnn 352920

nnnnnnnnnn nnnnnnnnnn nnnnnnnnnn nnnnnnnnnn nnnnnnnnnn nnnnnnnnnn 352980

nnnnnnnnnn nnnnnnnnnn nnnnnnnnnn nnnttcggga cacggaggag atgctaagta 353040

agaagcagga gttcctggag aagaagatcg aacaggagct gacggctgcc aagaagcatg 353100

gcacaaaaa caagcgcggt gaggcggccc cgaccccatc agactctcca ctgcctctcc 353160

taaggteccc caggctcgga ctccactttg tctgactcgt ttcgggtctc cttcaacce 353220

tggaactctt cggttagact tcttccggtg cctctcccgg cccgggacca cttccacca 353280

gactcctgtg tctccttgag ccggtcact tccacatca gactcccttc aaactcttc 353340

ctccctatc aggcctctct tgaccagat ctcacagcac ttaaactccg tgctcagtct 353400

gttccactct gttttactgt gttctcgctt tgacctcacc caccttcca gccactgcct 353460

ccacccccac ttggctcat ttctttctt catctatca ttttgtctct ctcggttcac 353520

ctctgcctc ctccgagccc ttggggagt ctgagctgcc ttcggcctct gacttaggag 353580

tcttttgaa aagcctcctt tatggagaga aaagaggata ggggagtga gagactctct 353640

ggtaccgct ctgttactt gtgaaattga acaagttga gaccttggt tccgcatcca 353700

ctagctcgga tctggccgct gtgaggccca agatgtcact agcctatga ttctcttttg 353760

gttgcccat attcaggcct tcttgagct tccgtattgt cagccttacc cctgtgact 353820

caccacttc ctgtcctctg ctgaataagg agatttgtcc agtccagtct tgatgtgaat 353880

tgatactact tctgtttgtg agtctgtcta ggaaagtgcc ttgtagtttt cgtaaggga 353940

atgaatgtga aaatgtttta gtgactgtaa agaaggtttg cttttgtca cagcaacgtg 354000

agtatgaatc atagcgtgga gttcttctt tgagagtgga ccaaaggtgg gaggggttta 354060

ggagtcttac agacaaatat tgaactcaga agccagcag ggaagttgt tctgggattg 354120

tgaactagtg gatttcctt tctgaaagga ttactaatac ccagcacata gtaggaactt 354180

aactaacatt gtaaacatct gcttgatgta ttctcagaat ataaaatggt ctatcctgat 354240
aggaggtggt ggcgccacc tttaaacca gactcggga ggcagaggca gatgggtctc 354300
tgtgagttcg aggccagctt ggtctacaga tcgagttcca ggacaggttc caaagctgca 354360
cagagaaacc ctgtcgaaaa accaaaccaa acaaaaagat ggtccatccc taggatgctc 354420
cttgataata gcaaacattc tggaacttct ggttaccag tgcattccagt cacattcata 354480
gaggggaatc agacagcccc cacttcaagc agagagacag ataactggctg tgtgtgtccc 354540
tgtagacctg tctgtaaccg ggcactggga ggtagaggtt ggagggtcaa ggccatcttt 354600

gttgaggag caatttcatg gccaacctgg cctgtgagag actctgtctc taagagagat 354660
ggtgggggca ggcaagatca gagtaagtga agaagctagc catttaggag gtgtcattga 354720
tgagcattaa acaaggaana gttggtcata gtgaggggga gcggtgctat tttgtagag 354780
tggtcagga tagcctcttt gaaaagttaa agtttgaact gagtcttttg aaaagaacca 354840
gctttcgggg gcttttctt ggctgggaga acagcataag aatggctgga aagttgtcaa 354900
gattaaagaa attgaaagac ctctgtagt attgagggga gagcagagta aataaaagga 354960
gggtatagta ggtaattacc aatacggagt caggtagaaa tataagggtt tttaataggg 355020

aaaagccta ctacagagc gaaccagcca gccggtgta gtctgtacag caagaagcaa 355080
agagagagac cgaaacgaa aacgcagtcc ccctactcat tctgaccacg ccctcataag 355140
ccctcagga ctctgtagc cageccctaa gaaggcgtgg ctacagcttc ccctacagga 355200
gggggacagg cctcgaatgg ctgacagttt ggattctaag tggatggaaa gcttttgaag 355260
ggtactgttc agaagcaagc cctaatcatt ggtaaagatt ttaagcatct ggctgtcttc 355320
tggagagtgg gaggggcatt cgaggaagtt gcaggcatcc atctgtggac tggacaccag 355380
ttgtagctgt ggagaagaac agagctgtgt tcgttaatca gctcttttct ctgacaactc 355440

tcccttaate agggtectct ttcaccagcg gtaattagtc ctggtttttg cetatctgca 355500
tgtttgaaag ctigcccttt cacagtggag tggaggaggg tgtcactgca catcctctcc 355560
catgccacag gacccaagc acaactgtct ccacacggta agagagcaat aactcaggtc 355620
tcttggtcta ggctagctt agtgtctgcc gttgcagagg taactgaatt ggctttcaag 355680
atgctttag agacaaagct gacacactgg agaagcaacc ccagctgtaa taactttgtt 355740
caaagtgat tctgtctttt tgagtttacc tgtgagggtc cacgttcttg tctttcttat 355800
ggtectaagg tcaaatagtt gtgtttgtct tgccttagca cctaacctgc ttcctccgag 355860

gctgctgtga gtttctacca ttaccacatg cataccactt acttaccac ccagactgtt 355920
gagactctga gcatcagaga tgagaaaaca ctgccttctc ttcctgggag aagccaggat 355980
tggaatggg ggtgaggag gtggggaggg ccaggagtaa ttttagaagt cagtggtgaa 356040

gtgtgtttaa atggttgagg ttacagaggg ggaggttctt gtctggaggg aaggtaggga 356100
 ggaggctttg tggaggaagg agaatcgggt gggccatcag gggtttagtg tttgaggag 356160
 cagtgtaac ttggagggtg acttctagct ttggatcttg ccctggatat gttggagagc 356220
 tgttggtggg agttccagga caggctccaa agctacacag agaaactctg ttgggggagg 356280

gggtgggggt ggattcgaat cttacagatc agggtttgag ctataccttc tttactgact 356340
 agctatgtgt ctgggcagggt tactctgcct cccgttcttc tgtaaatatg agtcctatca 356400
 acaggacaga ataaggtatg tttgttgtgt atgcaaagtc agcacagagc ttgctgtatg 356460
 gtaaaagatc aataactgct agacattaac attattacac tgatactagc agttattcgg 356520
 gtgggaatta agggcctaga atagacacat ggaaaatggg caaagatata catgtccaag 356580
 acttctaaag gagagtcaga agaagcttgg tggtttgta gggttattgg cagtagcatg 356640
 atgcagacag gaggaagaca ttcccaggct ttcagctggg gcagccgggt acatggtgat 356700

gcatggataa gttaggaggt aagtggcatg tcatagtga atcctttgaa atttgtaaaa 356760
 gctttctgat gagtattaca gcgtctactg aaactatggc tccttgaggt gggattttac 356820
 agaaatgttc actgctctat gccacagcagt atctggetta cggttaatgt tcagtagata 356880
 tttagtcatg aatgagaatt gatttatcta tttatttgtt tgtttatfff tggttttcca 356940
 aggcagggtt tctctgtatc aacagctctg gcggctctgg aactcatttt tgtccaccag 357000
 gctggccttg aactcacaga gatgetcctg cctctgcctc ccaagtgctg ggatcaaagg 357060
 cgtgagctgc tgctgccccc tcggccacct ccaccactg gcaaatgagt atttattata 357120

tgactaaagc caatcttggg actggagaag tggctcaatt ggtaaagtac ctgccataca 357180
 agcatgagga ctgagttca gatccccgca ccaggtaaa ggggctcatc agtatgccca 357240
 gctgtaacce cagcactggg gtaaggcaga gacaggcaga ctcttagat ccgtggccag 357300
 acagccttfc ttaattttat agcttcagggt tcagtgagtg atcctgtctt aaaaaataaa 357360
 atggagagta atagaagcta tttactttg acctttcaac cttgtttgac ctctagcctt 357420
 aatatgcatg tgcacataca tattcataca accacacaca ggtacacatg aaaagtatct 357480
 ggctggtatg ttcttttatg cccggtgtaa agggaggaaa atgaggcgtg ggaagtgatg 357540

tgtctcaact cagagacttg ttcaaggac taggggcatc atattggctg attccgtgac 357600
 tgccagagge ttcacatggc tggcattgtc cctgcactca gtacataacc ccattttatgc 357660
 aaggtgtggg atgagagggg ggaaagtgag acagcaccaa attctgccca tcagaatatg 357720
 tatccaaatt cagaagccat cttggtgata tacacattgc aaagatggtg cactgcctt 357780
 tggaaagaaa catgaaagcc agattggatt atttgcactg tgtcccgggc agtggctcca 357840
 gtcagatgaa gagagcaaaa tttgggtcac atatttttt tccagttcct ttttgtttcc 357900

tttaatcata tatttattct catgttctgg ttctgggcc tttactcagtg ctaagaatac 357960

 agaccaggac atagacctg ctacacagga gacttataaa cttatcttca cttgtgaaat 358020
 atctacctgg ctgaggtag gattacctaa gatatgtatg aaagaacaag atatatggca 358080
 cttgtctgat agttaccgt gatcagattt atatggttta attgtaata gaacaactt 358140
 cagatcgagg cctaccaaca agaaccatcc aaatTTTTcc tgggcacctt ttagacagt 358200
 actctgttag tttcccaaga aaggtagaccg tatgtctcag attctcttct tgttctctct 358260
 tttttccct tcttttcca acgcccacct ccttgggttt tgtttttgtt gttttgtttt 358320
 tgttttttg tttttgttt tctggagaca gggtttcttt gtgtaaccct ggctgtcctg 358380

 gaattcgctc tgiagaccag gctaacctcg aactcagaga ttgcctgcct ctgcctccca 358440
 ggtgctggga ttaaggcat gtgttactac catctggccc ccaaactct taaaagaga 358500
 tttatttact ttttgttat gtgtatatgt gtgttctgt gtgtttatgt gcaccacatg 358560
 tgtgcatgtg ctttgggagg ctctagaact ggagttacag gaagtgcga gctgcctgat 358620
 gtgggtgta ggggaacgt acccaggtcc tctgcgggag cagcaagcaa tgagtctct 358680
 ccacctttt tcttcactt aaaattaaat tgttattgtt gttttatga ttatgattat 358740
 cactgttgtt atcatttggg ggcactcaa gcacagcaca ggaagaggtc agaagacaac 358800

 actcagaact tggttctctg cctctacttt tctgtgggtt ctggggctca aactcaagtc 358860
 atcatagcaa gcaccatctg aaccatcttg ccagttcctt gttttatttt ttaagggga 358920
 gtatggcgag tgagggtgtg ggacttgcta tgtataacc aggctacct tgaacttgtg 358980
 acccttctt tgcctcagcc tgcctgattgc agggattctg agttacacat gtgtaccacc 359040
 acacctttat ttttagtgt ttctctgtgt aggacagctt gatggagtgt gttcttctct 359100
 tctaccatgt gagtgggggc tgggtgaac tcaggtttcc aggtttccag gcaagtccc 359160
 tttttacctg ttgagccaac ttactgtecc agtttctttt cttttatgg catggtagct 359220

 aattaaggaa gtatctactt taggtagttc agattttctc ttttcttatt ttaataaaga 359280
 ggaagagagt ttgtaggaag ggtaggttt ttagttacac acattgtgta agattaagca 359340
 atggggactg tggtcacacg tgtacattc ttagatcat ggaagcaacc agttcgttta 359400
 ctgttaggtt ctgctgagaa tgcgggagtc ggaacaatgc agaggccagg agcttatggg 359460
 aactacatct tcattaaatt ctgctcattg ctgagaccag gtagcatcc tcatggttaa 359520
 taaagtcact aaatcatcag catatgagac ggcactttc taaattaaat ggatagttaa 359580
 tgtggccttt tggttcttga taatcaacat ctaaaaacta cagtatcttt tattttttc 359640

agacagggtt tcctctgtga gccctggctg tcttggaact tacagagatc ctgctgcctc 359700
 tgcctcccaa gtgctgggat caaagacgtg gaccaccaac gcctggctca aattacagta 359760
 tctttttttt tttttctctc tctttttatt attattaatt caagttaggg aacaggcttg 359820
 tttcacatgt acttcccctc ttccctctcc tctcccaaat tacagtatct taatagtgtg 359880
 tgtgccagct ggactgtctg tcccagaggc ccttggatgg aaaacttgaa acctatccag 359940
 gaactaagca gtgggatttt cccttgggtga cactaatgt ttgaggacat agttttattt 360000
 atttcttaag acagatgggg tgtcagaaag gcctgtgtg ttgacttttt aaacatactg 360060

 gtgtcttcaa ttcaaatgaa aaaaatccgt ttttgtaag attgcatgca catgtatgca 360120
 cgtttgtgaa gttttgcata tgtggaggcc agaggtaaac actgagtgtc attcctcagg 360180
 aggcatctgt cttattttat gagatagtgt cttccacctg gcctgcctgg cctgtaagcc 360240
 tcaagggttc ctctctttct acttctctag tgatagaatt aaaaatatac ttcacctctc 360300
 ccagctttgc atgctgatgc tgggactgta actcaggctc tcatgcttgc atagtaagca 360360
 ttccactggc tgcattgacct gcacagcctg ggtgtgcatg tgtgtctgtg tgggggtggg 360420
 gtgtggtgtg tggagagaga gggagagaca gacagatacc cacctatgtt tgcctcctga 360480

 gtgctggtac taaaagagtg ttccaccacc tactgttttt aaaagagaaa gctgaatata 360540
 atggtctctc tccacctgtg attccagcac ttgaacggta aaggcagaag tttccagcta 360600
 gctttagtga gactctgctt ttaaaaaaag tgtagaacag agaggaagag aatattcaaa 360660
 aacaacttta gtgctccatg catgtgtgcg tgcacacaca gcactcaggc tgaaaaagga 360720
 tttccatgag tttgaagcca gcctggacta catagcctgt tcaaatcaag cctggactaa 360780
 accaacagat gcitttaggtt agtcattatt agtcattgaa gatggatgac tatatctgtt 360840
 agttgttgag gatgggtgat tatatttga aggaaaatct gagcacattg agaagaaca 360900

 tcaatcttag ctggcatcta aggcagtggg ctcaagtcag cagcatctat tgtgttcctt 360960
 gtagaagtcc acatagtgtt gtaggtggat agtccctgtt ttcattgctgc ttttctctt 361020
 accatcagt ccttgaagct tactcacctt gactctcttt tctttgtaa aagggaatgc 361080
 tgtgacttcc ttcacagggc tcgagtagaa acaagtcagc atgtctgcag gacagaggac 361140
 agaggccagc acccgaagag atgtgtttcc tccttgggtt ttccactcac agtcttgagc 361200
 tctgccttct ccttctatg gggattcata actctgcaag gacagacat gaagtagcag 361260
 aggaaaacag caggagagaga tgactctcct ttggatttgg ctggttcatt tcaccagcc 361320

 acctatccag ggcccagatt tcttttctg cattctgca ttctgctgc ctatcgatta 361380
 gcctctatt gaatcacccc aaccttggc atcaggattt gcgttaggat ttctggcctg 361440
 tgttatagtt tattttgtct tggacagctc tgccagggt gagagctgtc ttcccgaagg 361500

cttacgttgg atcagggtgg atggcttct gtggtgaagc agcctgggct gaagtcaag 361560
 agcttggggg ctgatactag acaactgtga actggaaagt ggggggtggg ggcaggtttg 361620
 gcaccctcgg gccaccgagg acaggtctgg caccatggct gatggagaaa tctggtgctt 361680
 atgtttcaag tctgcacttc ttgaggacag acaaatgttt ctcttacct ttgtggatgt 361740

 tcaccattc aatggtgggt gcctcagaat actcagaata gtccagcaga aatctgaaca 361800
 gcatagctca gaacatgcag ggtcatgcca ttgcttagg gatttagtac aagctcttga 361860
 gccaggtaat tcccctatcc ccaagccaga tcttcttctc aaaattgtgt gtgggtgtag 361920
 catgtgtgt accattgagc taaatcccta gttcccttct agccctttaa ggagtattag 361980
 ctaaaggatg gatgattgaa atcaccatga atacctggct ggcttgattc tcccatagct 362040
 ggtatttcca gctctacctc ctccctcttc cttgtaggac aaaggaaagc tgtacatctc 362100
 tttggttgt gtgtttatat cagaagattg gtgaggtggg ttagtggcaa cggtgctagg 362160

 tttgcagtca gaagacctag gttcaccatc tgcctttgcc tctgcctctt ggtactctgg 362220
 aatcctgccc aagtttcctt atctttatga gcgttggctt cttcagttgc aaaattcaga 362280
 atacagtate tctatactt tcttgggtgt tgatgtggca tataggaaca tgttgggggt 362340
 tgttagaaat gcatgatatc tgggcagtgg aggcgcacgc ttttaatccc agcatttggg 362400
 aggcagagac aggtggatca ctgtgaggtt gaggtcagcc tggcttacag agcagattcc 362460
 aagatagcca gggtctctc caaaaagcaa aaataaatag aataaaataa accagacaca 362520
 gaggccacat ctgacttct taaagcagaa ctgttgtttt tgtggaattt ctctgtagtt 362580

 tgtatgttcc ttgaagtttg aggggtgctc aagtgtgtat gtgtacacac gtgtgcgtga 362640
 accacgatgc ttgtgtggag gtcagagggc aacttttggg agtcattttt ccctctgcat 362700
 gttgaggctc catctcctg cttgctatgc tttctgtgt gctggcatac tgcaggetag 362760
 caggcatgtg acttgtggtt attgtgtgt ctccatctac tgtgggatta tagatgtttt 362820
 ctactggctt gtttttagt cccagggatt gggactgaag ttactgttct tgaatggcaa 362880
 gcgcttttac ccacaaacta tcttgccttc cttgtgggat ttttttgggt gtgtttgttt 362940
 ttgagacagg gtctcacttt gtagectagg ctgacttcaa attggtgatt cttctgtctc 363000

 agtcttcta gttctgggat tactgatttg tgccaccatg tctagaaagt ttgagggatt 363060
 tcaaaaccaa tttggctatc atacatcttg ggggaactct ggtttttcca tttccatttg 363120
 agactacact ctgttaactc agctggcctt gaactttgct tctacctccc aatgctggg 363180
 gttacaggca tgccccatct tggcccagtg acattccaag tcttgttgat ctgaatactt 363240
 gatagacatt tgtgtttaat ttcaaggact ctatttttaa gtgctaaagga ccaaactcgt 363300
 taacttatgt atgttagcta aacacccac cactgagcca cactcttagc cctgtttgta 363360

gttggatfff tctttgggct gcaaacagct cccaaataaa gacacagaga cttactatt 363420

aattatgaat gctcagcttg agcttaggct tgttccactt aatfttaact taatttaaca 363480

tatftttatt tgtctcaggg ctttgtttta cttgtatgtc ctactfttctt gettcttcca 363540

tgtctgtctg tctggcatct ccctgttgc tctfttcttc tccftgagcc taaattcctc 363600

ttcctactta ctctccctgc tcagaaatcc tgcctfttacc tftctccctg ctgttggcca 363660

ttctgtttt tattcaacca atcaggtaac ttaggcaggc aaggftaaac agcaacacat 363720

ctttacataa ttaaacaaat gcaacaaaca catcattatg ttgttaaca aatgcaatga 363780

atctgcatag ttaataatc cacaacacct gtttgttagt ttgtftttga actcctggtc 363840

cttctgtccc tgcftctggg gtgctaggat gacatgtacc ctgattftatg ggtgatgagc 363900

cttaaacccc agtcttgtgc attactcaag cactctacca actgagaaca tgcctagccc 363960

aaaaggtccc cccccccag ataaggttca ctacattgtc tagattgacc ttgaagtgt 364020

gatcctcaag ctccagaaga cctgggattta cagatctgtc ccatgtgttc tgctaatgtt 364080

catcttaaca agaaagcact ggggaccagt tccattccta tgtgggatga gcaggcatgt 364140

tttagtggga gaggtgtgct gatactgtct agttgctagg cagagtgcag gcaacagatc 364200

attgttctg aggagtgtac aatctacttg aggtgataaa cagatagtca gggcacagga 364260

tgatctgttc tagaagcatc ttcagaagtg cttggcactg gcgttgtggc acagtgtcca 364320

gcacttggga ggcagagcca ggtggatccc tgtgagtttg aggacagcca gagctgttac 364380

acagagaaac cctgtcccga aaaacaaagt aaaaaaaca aaataacccc tcaaccccaa 364440

aaaacaaaca aacaaaagaa gtacttggta atgcagtggc aggagctaaa atagaggaga 364500

ggggagaaac cttacattt atgtftttgtt ttgtftttgtt tfttggfttt ttgagacagg 364560

gttctctgtt ggcftttttag gttgtcctgg aactagctct tgttagaccag gctggctca 364620

aactcacaga gatccgccag cctctgcctc ccagagtgtt gggattaaag gcatgcgcca 364680

ctaacacccg gctacattta tgtftttatta gatagttatt atgaaatctg atggaattta 364740

agatagaaag gaatatttaa gtgtttgaat ttacttggaa ttaataagat tftttattatg 364800

tatatggctt atftttatat gtatgggtgt tttgcctgcg tgtatgtctg ttgctgtgtg 364860

caaacatgga agtgtatgct gtgttgtgtg tftgtgtgtg tgtgtgtgtg tgtgtgtgtg 364920

tgtgtgtgtg cacatgcgcg tgcacgagca tafcttggc tgtcctggat caaaggtgtg 364980

caccaccacc acccagctat gtgctgtgct tfttaaaagc tftgtctgag tcagaagtat 365040

cagtgatgga aaggatgtga gaatggatcg atgtfttaact ctgtfttagta ataaaataat 365100

taatactggg atctatgta aggtgttgtt tgttctgatg atttattagc ttcagaacat 365160
 taattcagtt agatcaatta atagcagttg ttttacttcc tataaaagga agtaggaaca 365220
 gccaggcgtt ggtggcacat gccttttttaa tcccagcact cgggaggcag aggcagagga 365280
 tctctgtgag ttigagacca gcctggctca caagagctag ttccaggaca gcctccaaag 365340
 ccacagagaa accctgtctc gaaaaaccaa aaaaaaaaaag aagtaggaac gaagaacct 365400
 aggaatggat tctttgctat tgtctctggc cctgctgctc ttcttgttca gacccagaga 365460
 ggaagggctc ttiagacagg ctgcctagaa gatgtttgct tgagacctca cactaaagtg 365520

 agaaatttga tcataggact tggagatgat ggctggcaag gctgacatta aaaaaaaaaa 365580
 aaaaaattgt tttctctctg tgcatctacc tgctgcctg ccatgtgtgt ggctgtcact 365640
 agagaccagg agagggagtc agatgccctg gacgaggtgt tacaggcaat tgtgatctga 365700
 aatgggtgct gggaactagg gttctctggc agagcagaaa gtgctcttag cactgagct 365760
 ctccagcccc agggctaact ttttttttt tttttggttt ttcgagacag gttttctctg 365820
 ttagctttg gagcctatcc tggcactcgc tctggagacc aggctggcct cgaactcaca 365880
 gagatccacc tgctctgccc tcccagagtgc tgggattaaa agcgtgcgtc atcaacaccc 365940

 ggctccaggg ctgactttta aaagcaaaat gattgctaata ttcctaattt tttcctcggg 366000
 tggacctgtt gcttttacct ctccggagca ctttcccat aagaattgta gataggtagc 366060
 tcattgtcac tgattgtttg acaagtccag acatcaagtt gcaatgctgt tgatagatag 366120
 ttttctgtgt cttagcattg gtaacaatct gcctgctgtt taccttgttg ttcttaggga 366180
 aaatgtcctg cactttacag atttgatcac ttttttggcc ttttcagcaa ccccatgcat 366240
 tgcattggtg ctcccattct agagatgaga aagctgaaac ttggattaaa tggactcctg 366300
 gctgccttgg gtgttctgag gtggctgaat cacagtggct ttggtatctt taatatctc 366360

 ataagatcag aactttgaac actcatatac tcataaatta taaatctaata tggaatggat 366420
 ttttttttt tcaagacagg gtttctctgt gtaacagccc taattgcctt ggaacttgct 366480
 ctgtagacca ggctggcttc aaactcaaaa agatcctcct gcctctgctt cctgagtgtc 366540
 gggactaaag gtgtgcacca ccaactgtcca gcctgggaat ggattttttt ttaataactc 366600
 cttcacagt gtgagacct acaagcaact acagggtttt gtggcatcca tagcactgtc 366660
 aaatacataa ggtaaataga gcggttcaaa cccagggtct tgagcccagg gccttgtaca 366720
 tgctaagcaa atgctgtact gttgagccat caggttgtga tttgattttt atccatccat 366780

 ccgtttatct tgctatcttt ctgctatct atctctatct atttattaag acagaattac 366840
 actgtctate attgggetgg cttgaaactg ctgtgtagac catgctagcc ttgaaactcag 366900
 agatctgctt gcctctgctt tctgagtact gggattaaag gcacctccac tatgcctggc 366960

ctaggttgtg atttttagcc tgattgtgca gaagaagaaa ctgtttcagc cagtgttctt 367020
aatcactgag ccattttctc agccccaact gggacccttt ttaaagtgt gatgaccagt 367080
ttctaaatta aaagttatta gtaacagtca ggtgataata gttgtgcctt tagtaccata 367140
gatactaaat aaatgcagtt acaaaatttc tcagctagta cgcactaagc agcccttga 367200

ctgtatctgg catgacagtg ggaagtgatc aggcagaggt gttcgatta aggtttggtc 367260
atcgttagtg tgcaaacagt gcttgtgagc acagtcagag cattagagcg ctaactgaat 367320
gctgtggact ccigaatgac ttttaccagg aactggaga gcatagcagg cctgaaactc 367380
aggcttccct gaaaccgtga actgtgtcca cacttgggat ggaatccct gcactctgga 367440
aatgcagagc cagcaggcta cccaggagtc ctctcagtcag ctctccccac tgccacacac 367500
tggggtattt gtgatgaaag aagaggcgtt tggttgaaa caggctgagt ttctagcatt 367560
agttggtaag tggcgcacga gtctaaagag ttgaaataa cggccttgaa gttgagaatc 367620

tgttttaga gctgctcadc tcaaaacact cagcttctct aacaagagcc gttattctta 367680
gttcagaggt aagaggcaga gaggccaggc caaccaggc cacacagatc atcccagaaa 367740
acgagctage cattcccaga gctaggagct gaggctctctg gatggcatcc cagggtgggc 367800
tgtttatttc tgttagatga tgatggcaaa gaaatgaggc tgatggtttt aagtcctacc 367860
cagttctgca aacattttga gcacactgtg aaactgtctg caagggccat ctgggacaca 367920
gttgttactc tatagaggcg tccagctagc tctagttcac tgccattggt attcagtcac 367980
agtgtggcaa gagaagggag actttaaact gggagagtca gtgccaggga gtatgcattt 368040

gtgggggtgt ttctgagctg ggccttggca gatgaatggg gcgcagaaga aacttaaggt 368100
agaggttgtg gaagccaggg tgcaagatg agcatatgca tgtggaagat gttgggaggg 368160
tgaggagagt taggcaggct acagctgcc tcagaaagcc ctcggtgcta agtcagagag 368220
cttgagttgt gttgagatc ttaaggagga actttgtaca cccagacttt gtgaggacca 368280
acagttatct ctgcagcact ctgaggactt tgttttatcc atcattgcct gtgaggacag 368340
gataggtaga ggaagggag tcctatcggc caccactctt tctctgtta caactttgcc 368400
ctggttttcc ttgtgccag catatcctgg gcagtagaac aaaggaagaa taccaccccc 368460

acccccacac aactctgag cttgccaaag gtaaactgcc ttgaccacc ctcatctaac 368520
tagcaggctc accacttctt ggtgtttatt gttggtctct ctttcagttg cctgactgat 368580
tgaccagtt cgcatgac tttggaatta tttaatctag ggctagagag agcacttagt 368640
gttcaagata atccaagcca gtaccaaca cccactttat aagctcacag cctcatgtaa 368700
ctccaactcc aggggaatct acaacctttg gcacctgctc ccatgtacag gtacacacac 368760
aattaaaatt agtaaaaata agccaagcgt gctggtgcat gtccttaagc tcagcacttg 368820

ggaagcagaa gtagatagat ctctgtgact tcaaggctag tctggcttc atagcgagt 368880

 ccagggcagc cagggtacat agagagacc tgtatcaaag ggggtgctgg gcatagtaat 368940
 ggatgccttt aattccagcc cttggaaagc agaggcaggt gactctctta gttcaagata 369000
 gtatagcctc cagagtgagt tccaggacag ggctacacgg agaaacactc aaacacacac 369060
 cagagccagg gatacacaga gaaacactgt ccacacacac acacacacac acacacacac 369120
 acacacacac acacacacac acacacggag gacatggaca cgctccagag cacatttggg 369180
 ttggggaagg ttigtggag agatggctca gcagttaaga gcactggcta ctctccaga 369240
 ggtcttaggt tcaattcca gtgccatata ggcagctcac aactatctgt aattccagt 369300

 ccagggaatc tgacacctc atacaggcat acacgaaggc aaaacactgg tgcacataaa 369360
 ataaaaataa tttattaa tgctttgaa attatacatt ttatttgcg tatattgcct 369420
 tatgtatata tgtaactatg tgcaactgtg gtatatctgg tgctcacaga ggccaaaaga 369480
 ggggtgctgga tccttggaa ttgggttac aggtgggtgt gagctgcct ttagaaatta 369540
 tttaatctc ctittatct tttttatcc aagacagaga cagtacttc ttgaatgaca 369600
 atgacctgt tctaaaata tacattctg tcccgcgcgc tgtatgtct cgccgcaag 369660
 aaatacacgc aggacactcg gatcctactg cagacaagct ttaatgcatc ttgagagcga 369720

 gagagcataa gcttaccaga gcggagactc tgaaccaaga aacctatccc ttaataaagg 369780
 ctggcaagca gccgcctggg acgtgttacc ctatgaatgg cttcagctcc tcaggccaaa 369840
 tgagccacgg gatagccaga gatcaaagga atggaaatta cccagcgcct gtgaannnn 369900
 nnnnnnnnnn nnnnnnnnnn nnnnnnnnnn nnnnnnnnnn nnnnnnnnnn nnnnnnnnnn 369960
 nnnnnnnnnn nnnnnnnnnn nnnnnnnnnn nnnnnnnnnn nnnnnnnnnn nnnnnnnnnn 370020
 nnnnnnnnnn nnnnnnnnnn nnnnnnnnnn nnnnnnnnnn nnnnnnnnnn nnnnnnnnnn 370080
 nnnnnnnnnn nnnnnnnnnn nnnnnnnnnn nnnnnnnnnn nnnnnnnnnn nnnnnnnnnn 370140

 nnnnnnnnnn nnnnnnnnnn nnnnnnnnnn nnnnnnnnnn nnnnnnnnnn nnnnnnnnnn 370200
 nnnnnnnnnn nnnnnnnnnn nnnnnnnnnn nnnnnnnnnn nnnnnnnnnn nnnnnnnnnn 370260
 nnnnnnnnnn nnnnnnnnnn nnnnnnnnnn nnnnnnnnnn nnnnnnnnnn nnnnnnnnnn 370320
 nnnnnnnnnn nnnnnnnnnn nnnnnnnnnn nnnnnnnnnn nnnnnnnnnn nnnnnnnnnn 370380
 nnnnnnnnnn nnnnnnnnnn nnnnnnnnnn nnnnnnnnnn nnnnnnnnnn nnnnnnnnnn 370440
 nnnnnnnnnn nnnnnnnnnn nnnnnnnnnn nnnnnnnnnn nnnnnnnnnn nnnnnnnnnn 370500
 nnnnnnnnnn nnnnnnnnnn nnnnnnnnnn nnnnnnnnnn nnnnnnnnnn nnnnnnnnnn 370560

nnnnnnnnnn nnnnnnnnnn nnnnnnnnnn nnnnnnnnnn nnnnnnnnnn nnnnnnnnnn 370620
 nnnnnnnnnn nnnnnnnnnn nnnnnnnnnn nnnnnnnnnn nnnnnnnnnn nnnnnnnnnn 370680
 nnnnnnnnnn nnnnnnnnnn nnnnnnnnnn nnnnnnnnnn nnnnnnnnnn nnnnnnnnnn 370740
 nnnnnnnnnn nnnnnnnnnn nnnnnnnnnn nnnnnnnnnn nnnnnnnnnn nnnnnnnnnn 370800
 nnnnnnnnnn nnnnnnnnnn nnnnnnnnnn nnnnnnnnnn nnnnnnnnnn nnnnnnnnnn 370860
 nnnnnnnnnn nnnnnnnnnn nnnnnnnnnn nnnnnnnnnn nnnnnnnnnn nnnnnnnnnn 370920
 nnnnnnnnnn nnnnnnnnnn nnnnnnnnnn nnnnnnnnnn nnnnnnnnnn nnnnnnnnnn 370980

 nnnnnnnnnn nnnnnnnnnn nnnnnnnnnn nnnnnnnnnn nnnnnnnnnn nnnnnnnnnn 371040
 nnnnnnnnnn nnnnnnnnnn nnnnnnnnnn nnnnnnnnnn nnnnnnnnnn nnnnnnnnnn 371100
 nnnnnnnnnn nnnnnnnnnn nnnnnnnnnn nnnnnnnnnn nnnnnnnnnn nnnnnnnnnn 371160
 nnnnaatttt ggacttcttt aagattgtta caacagtgag aaaggtcaaa atagctccta 371220
 gtaaaagcac agaagcctct atattaacct cccaaaatag caacattccc aagccaaagt 371280
 ccagaaaaaa catacctctc cgaatttacc acctgcagt tctgaatccg ccccgtaga 371340
 ggggtctccg cggtgccagc gatgttaaca aatcccgagg tttcggcacc atatgtcccg 371400

 cgcgctgtat gtctcgcg gcaagaaata cacgcaggac actcggatcc tactgcagac 371460
 aagctttaat gcatcttgag agcgagagag cataagctta ccagagcggg gactctgaac 371520
 caagaaacce atcccttaat aaaggctggc aagcagccgc ctgggacgtg ttacctatg 371580
 aatggcttca gctcctcagg ccaaatgagc cacgggatag gcagagatca aaggaatgga 371640
 aattaccag cgectgtgaa gtaatttaca ttttgggtgc ttcaggcacc attattgtaa 371700
 tggagaatgc aggaacggct ccctacacat ttccaattaa gtccagactt ttatgtcact 371760
 cacacaaaaa aaatctgggt tcttagcctt accttaaggc cttggggtct caagacagtg 371820

 cactcagggt ctggttgtaa tactgtgtat tttggggtaa gtgccttctt atttttgggc 371880
 cttattttct cagcaataaa aggaagatgg gctaaatgag tgctgagact cttcatgct 371940
 ctataattct cagagtcaac aggtgccaca ttactgtaac ctccagagag ccagggtgtg 372000
 ctccaagcag tttgctgtg taaaaagatg aagtaagtca gccttcattt tgttggttga 372060
 cagcttggtc agtctagggc agccacagct gttttgtaga aggtgctgag gtttttcca 372120
 tttcagttec tagtttagag gctagagctc ttttggctgc tcccctgatc caatccaggc 372180
 agtagcaciaa ttcagatagg catttctcct ggctccaag ctttctttgg atccataaca 372240

 acctaacat ttggtgaatc aaacacagat ttctttttgg tctgagcaac ctaaggtttt 372300
 actgaggaaa aatctaacag ggaccagtta agccccagag atatatccct tgataggatt 372360
 ttacttcctt gctgaccacc tatgaggtca tcagggtgtag aggatttgtc tctgtgtaa 372420

ggataatgga gaaagggacc agttgttaag ggttggccta ccttgagtat tttgtattaa 372480
 gtgtactcta ataactctgtt ggtgactgag acaccatctc tgctgggatg ctgggaatgt 372540
 caggaagacc agctggcttc tctctgaagg cctcagtgtt gagtgtaatg cctggcccca 372600
 ccatgagcag ctaagcctct taatatggaa aacactctgc ttctaataa ggacttttaa 372660

 acctcaagtc ccaagttgtt cccattctag tggtcactc ctttttattg actcccacag 372720
 aacattgttg tctcctaaga aactttggaa agccagagaa ctccagagct cattttgtca 372780
 cataggaggg tatcccaggc ccaaagaggc tagatggctt gttaacagtg acacagctca 372840
 ctgcagacaa aaaggaatgg aaccctggtt ggaacacgaa gaaataaaag acccagagac 372900
 agatattggg gticcaactt caagcagaaa agcaaagcag ctggcattag cttcttacct 372960
 ctacctcagg ctgaatgggc tgatcctgtc tccatgagct ttcaccaagc cacagtttgt 373020
 aacctctcct cagcatggct ggagaatgca tgccttctac ttaatgtttg atactgactt 373080

 atataccttt catgagtcct gggattaaag gtgtgagcta taattttctt ttagactgtt 373140
 tcaactttgt gtagatctgg gtggccttga acccacagat atccgtctac ctcttaatcc 373200
 tgagtcttag gattaaaggt gtgtgcctga cttctatggc ttgtggctaa ctttgttttc 373260
 tgaatcctca ggcaagcttt aataaattgt aaataatata tcaccacacc atgggtgcctg 373320
 tctccttgtt cagtgcagtc tgccttgatg ctttctgaca gacagactag cactgtggct 373380
 caatgttgcc aaccctgcca ggatggtttt gaaaatagct ttgcggtgca gaaagccagc 373440
 atggaagaga tgaatgaac agttgctatt ttgaggtttg ttttctttgg agttctaagt 373500

 ggctgtaggt ggtttggcca gctggcacag cctgggtgga ggatctcaa ccccagtggc 373560
 tgctgtgctt acatttttac tccgtgataa ggctaagaag acattagctt tcaactgtta 373620
 cagtttctc caatgcaag gatcagacta attctccctt ttcaccact taggatttag 373680
 gaggatttag agacceaga aaaagtggc atagaagtat ataggagttt ctttttaat 373740
 ttttaaaaat gatttgctta tttttattc atgtgcattg gtgttttggc tgcattgatg 373800
 cctgtatgag ggtcccagat cccctagaac tggacttaca ggtggttata agctgccata 373860
 tgggtggctg ggaattgaac ccaggtcctc tggaaagagca gccagtgtc ttaaccattg 373920

 agccatctct ccaacctga ctgtgtgtgc gtgtgtgtgt gtgtgtgtgt gtgtgtgtgt 373980
 gtgtgtgtgt gtgtgtgtgt gtgtgtgttt ttaataaaaa atgtatctga aatgtagcta 374040
 actttacca atatgtacct gtgaaaactc ccttcccctt ttaagctgtc tgaagctcc 374100
 acctttgta gtcttgacct tatagccagc cactcaggac ttagaggaga cagtgtttat 374160
 ctcaacaggt gcttccaac ccttgcaagt caggggtgcta ggtattgtag ggagatcaga 374220
 aatgatcagt ggctgtctgt tgtctctcac ttctagcaca tccgggtttg accatagtcc 374280

aaggagaaa tccaggactg agagcttcta gaagagggat tactgcttac taggagagga 374340

acgggttag gatttatata gacatgggtg ttgtccttcc agtgtttgta aatactttca 374400
gcctcttgcg actggttctc cccctactta aataataata aatactaatt ttattttgca 374460
tgtatgggta ttttgcctgc atgtacatct gtgtgccaag tgcaggtagt gcctgtggag 374520
gccagaagga gggctttgga ctcacaggag tctatgctct taaccactga gctgtttctt 374580
caggttccag ctggttcttt gcactctagc tcctatgga gaggagcagg tgctgcctca 374640
gagctgtacc ttctccctgg caggcacaaa acaagcagtc cctctcttcc tcttcagccc 374700
aggatcccat aagctgacct gtgttttcag agtgtacgac cacacatctg agatgatatt 374760

ggcttaagtg tcctgcttt cttcggttgc atagtttaga aacaggacac ttcctttttc 374820
ttaagtgaag acagaatcaa gagcaagttt tccaatcctt tttttttttt tttttttttt 374880
tttaaatttt gaagtacagt agaggtttta actgctaaca ggacgtatgg ctctctggtc 374940
aatgggagtg aggaaggcca tgtccaaat aggttcctgg tgaccactt ttataaaggt 375000
tcctaaggtg gagtcagtgt ggagaggcaa cacctggat gtctgagagt tgtaatctcc 375060
tcactgctca tgtttagacg gtagataggg aagaaggcaa cgctcagcc tggctcgggt 375120
tctagtgagt ccttgactct tagaaataga aaccagggat tatttgagtt tatccccatt 375180

tacagataag agaaggaagg cttgtggcca gagccagata tggagtcatg gatggaagag 375240
ggtgtagcg aggagaaggg tggatagtat ggcaggagca cctccagtgt ttggagccag 375300
gaatagccaa gggctaagga ggtagggcag gccaggaagg tactgactgt cagctgtctg 375360
aggggcagge caaggagacc atagacattc tacaccagtc taaagattc gaatggctgg 375420
aggattttca tggctaacc tcttatatt agttagctct ggccgcccta acaggatgct 375480
gtgcaccggg tcgcttagca gaaagcagct ttcccacagt tccgagattg gaagtgaag 375540
atggagtgg gggatggcct tcttggcttg ttaatggcct ctttgtcctt acatggcctt 375600

tccttggccg ttgccatcac ctgtgtgtgt gttggtggtg gtgggtggc atggggaatg 375660
gggatcttga cagctagcca tttctccagc ttcctaatt acctctaaa ggctccatct 375720
ccaaatactg acacatcaga ggttagggct tcagcctgtg aacggggaga caaaagcagc 375780
ccatagctgt ttttacttc tgatgaacta ctttggctt ttagggtag gggatattcc 375840
tcttgaagge agcttgtttt cctttttct tttttcttt gtgtgtgtgt gtgtgtgtgt 375900
gtgtgtgtgt gtgtgtgtgt gtgtgtgtgt gtgtgtgtgt gtgtgtgtgt gtgtctatgt 375960
tttcatgtgt ggccatgiga aggtccacgg ttctccctt ttcattcttg tggcaagtgc 376020

ttaccattg agccgtcacc ctaataccic tcccccttta agtatcttta ttatgtcctt 376080
 taatcatttt gtttgttttg ttttgttttg agacagggtt tctctgtgta gctttggagg 376140
 ctgtcctggg actcactctg tagaccagge tggcctcgaa ctcatagata cacctgcctc 376200
 tctgtccttt aatcttttaa caattatatt gtagttagtg atgtatgtat gtatgtatgt 376260
 atgtatgtat acaggcacct gccacagtgc atgttttagag gtcaaaggac acatgttaga 376320
 gttagtctg tcttctgttg tgtgggtctt gtggatggaa ctcaggatcat tagtctttat 376380
 ttactgagct gtctcatctc ctacctcttg tttttgagat ggtgtttaac agctcaggct 376440

 ggcttgaact cactatataa ctaaggatgt ccttgaactt ctgattgtcc tgcctctgta 376500
 ccttctgaga ctataccat attgctaggg atctgcatca caaacctcaa tttatgtgat 376560
 ccagaagcta gaaccagta cttcctgtgt gctaaaactg tgcctctac catctaaact 376620
 atatcctcag cactcttctt gtttgtctta cctagtctgt ctttgccttc tgagtctaa 376680
 gattgtaggg gcaacacatt gtgctcaatt aagaatcctt tcttttcctt tcctttcctt 376740
 tcctttcttt tctttccttc tctttctct tttctttct tctctcttt ctttttgaga 376800
 cagggtttct ctgtgtaaca gcactggctg tctgaaact caattttag accaggctgg 376860

 cctcaaactc agaaattcac ctgcctatgc atcccaaatg ctgggattaa aggtgtgtgc 376920
 caccactgcc tggcaggaat cctgctttct gatcactcc tactctatc tttttttat 376980
 agtactggte tacaatctag caccattgtg actttattga agggagcagt gattatttc 377040
 atccaatgtt tgaatttctg ataattctgt gcagtttga gtttgcctc cagttttgtt 377100
 attctcacat atatggcatg ttttatctac tgtgtttcca gggaagatca ggtggtgagc 377160
 tcctgacctg tctgctattg ggttttagtc tggagattga acccggggct ttgtgaatac 377220
 ggaccagca cttccagcc tcagacttgg aatgtagcca acaataaaca tgaactcag 377280

 atcctcctgt ccaccttcta aggactagga ttataagctt gtggcaccat atctgatttt 377340
 tgcaatgctg tggatggaac tcaaagcctt tcaaatgcta ggcaaaact cttgatctga 377400
 gctgcatctc tagcctcctg ttctgtgttt taattgtgtt aaaatatata tgacataaaa 377460
 cacaaaactt gccattttta tgacttgtaa atggctttgt gatattaagt atacttatac 377520
 tgttaaattg ctctatattt actgttttta tgtgcatgg tgtttgcct gtgtgtgtct 377580
 gtgtgaggtt gtcagatccc ctagaactgg agttacagac agttgtgacc tgccatgtgg 377640
 gtgctgggaa ttgaaccag gccctctgga agagcagtca gtgctcttaa ctgctgagcc 377700

 atctctccag tcctgcgtt tactcttaag caaacctgtt ttttgtttg ttttgtttg 377760
 tttttgaga cagggtttct ctggctttgg aggctgtcct ggaactagct cttgtagacc 377820
 aggctggtct caaactcaca gagatctgcc tgcctctgcc tcccagatgc tgggactaaa 377880

ggcgtgcacc accacctccc ggtacaaaacc tgttcttatg tttagttctt tctgctatt 377940
 aagatgagct gtttctgaaa cagatgggat ggcagaaggg ttctggagt agaggaactc 378000
 agctggaatt caggctccct cacttgctac atgcagttgt tttggtttgc tgttgagtgt 378060
 tcagtacttc aggcagactt ggagcacctt gagggtggcc ttgattaaga gagtctcccg 378120

 agaaccagaa ttgcaagcag agcctgctgg ctttagttag ttactctgca gcaaaggagt 378180
 ttattggccc acaggactgt gagaacagtc aggggtgcggc tgaactctct tetgccagtc 378240
 acctccattc tcttggctcc ctctctaaa cctagtcatg acagctggcc tgtgtagttt 378300
 atagtttttt tcttgggaagg aaaattcttc ttacctctt tectctccca ttagagttag 378360
 aaaactcaca gaaaaggatc ctgatgggct actggagtca tgtgttcag actagccaat 378420
 cactacaagc cagaggatgt caagtctgtg gataacaggc ctgtcccacc ctgtgatagg 378480
 gaagcagtct ctttccaag gccagggctt taagggactg tcttaggaa aacagttgtc 378540

 caccttacct taccttctt gcttctgat ctggcttatt gccctgctca ggtgtttttt 378600
 cccagcccaa gcagggtctg tagggaggca ggagacacac tcttctactg gctgcctatc 378660
 aggatctgct gaacacgctg cccagggtt gaacacttgc tgtgtatagg gatcctgaga 378720
 gagtggcaca cattctagt aaggctgcac attttagtta agctgcatgc agagtaagg 378780
 gagacatgca tcaggattcc aggactctga ggttctgtgt cctatttttg tatggccaa 378840
 gaaaggttgc cttttctcaa aagagagcct ttttttttt ttttttttgc catttccct 378900
 gctgccgttt ggacagggaa atgctgtggc tctgcagccc tctctctccc tgtgactgac 378960

 tgactgactg actgactgac tgactgactg actgactgac tgactgactc gggaagggca 379020
 ggctgctttg gtctcttct ctacttgact aacagttgca cacactggaa gcattttctg 379080
 ctgacattcc tctttccca ctccacata aatgtccca accccagct ctctgttgc 379140
 acctcagttg ccagggcact catgettget caggcagaag gggttttgt tggcatggat 379200
 tcagttgga gcaaggaag aaaagccagt tggaaaagaa acagtgacc ccagcctggg 379260
 aacagaaacc aagagcaggc agtttccctc tgtctcaggc taagggtgtc tagaccaggg 379320
 cctggcatgt aggggaagag catcatgctt ctcttctctg tggacaggac cagaccacac 379380

 agctcaacac agagaggtac tgaggaaaag tttgcagcct tcagtgtagc tgccattctc 379440
 tctgcaagaa attggctgtc tttttttgct tgtattttt tctgtttaga aagttgtata 379500
 aatgataaca acttgaaaag taccttgctt ggctaccac tcttcccagc attcccaggt 379560
 ataagacca aaggtgggct ttgagatact gacaagcctg tgcgttgtga tatacatacc 379620
 cagatatggt aactgttagg aactgttga tctgtgctc ttagtagttt tactttttta 379680
 tttttaatg gatttggatc aagcatgtga cacacactgt agtcttagca gtcagagggc 379740

aggaggatca caaatgccag gccagcctgg tcttcatagt aaggctgtgt tcaaacagaa 379800

ctaaacaaaa caaaaaattg ggggaagtcc ctggattaca tcttcattaa atggatttag 379860

aaaatgtgga tttaaatgtc agctattggt tgaatttaca gaaagacctg aaaatgcttt 379920

ccccctcaa gacctatctt gtcttctctg agtcactggg ctgagaaatg ttagtcatct 379980

cctcacctgg ctccccatta gcaacctgtg atccccctcc ctttctctcc tgctgtgggt 380040

tcagacaagt ggggtgatac aggccaggg gatcactctc ctggctgggc ctcaggttca 380100

agcaagccct tctctcaaaa cctccagttc aggccttga aatccaaacg ctccccgttg 380160

ggtcaccagt gccactccc cacatcagcc aagccatcct tctgcactgt agtctgtttc 380220

tgttctgttc tgttcttttc tgttctgagt caccagtag cttccaatg actgggataa 380280

agtccagcgg cagcgcctta acaaagatgt ttttccagct ctctcacacc tctgggtct 380340

cctgcctgag attccagccc ctgtctcttc ccttctgta gagtatgtgc taactacctc 380400

tagaaaaatg tcaagaacaa gataaaagtc ttgatgtaat agaaagaatt tgtttatttc 380460

atctgagttg tgtaactcat tgacttggag ttgttcgtaa cagtccctta ccctttaat 380520

agcgggtggga tctgtagga atcccacatt tcttactcct gctgtttatc atcttttatt 380580

tccttgtcta gaagttcagt ttgtttgtt tttcatggca gggtttctct gtgtagccct 380640

gcctgcctg gaacttgtc tgttctctg taggccagge tggcctcaa ctcacagagg 380700

tctgtctgcc tctctgctc tctgctctc tgcctctctg cctctctgcc tctctgctc 380760

tctgctctc tgcctctctg cctctctgcc tctctgctc tctgctctg cctctgctc 380820

tgcctctga gtgctggaat ttcatgcgc ctttgtatgc ttttaagttct gtattatfff 380880

tgagtcttg aatttcatgc gccctttgia tgccttaagt tctgtattat tttgttgttg 380940

ctcatcaaga cttaataac tgaagtctat acgtggttac ctatgtatff gtcccttcta 381000

atgctcttca tctcatacct ttatataaat ctgtctttca tctggtgcca ttttctctc 381060

gactcaaaga gtatgtgga tgaggaattt tttcagttt tctgtacctg atgaactcta 381120

ttttaccctt gttttggga aattttctg tatttagaat tctaggtga cacaatttta 381180

tggactctc ccccccttt ttttttatt aagaatctga ctctatagcc cagactggcc 381240

tgaaattaga aatcttcta tctcagctc ccaaggactg aggttacaag catgccccac 381300

aatgcatagc tgtttctggt actttaattt ttttaattaa aattagttg tgtgtgtgtg 381360

tgtgtgtgtg tgtgtgtgtg tgtgtgtgia tgtgtgtgtg tgtgtattcg cgcacgcgcg 381420

caagtttgtg tttgtgagtg ctggtgcca tgtggtacag tgcacaagt aaggtcagag 381480

gacatctccc aggagtatgt cctctccttt ccaactgtggc ttcctgggac acttctgtta 381540
ctttaagac tgctccagtg aactgtgggt ggagcccagt ggtggagcac ttgtctaaca 381600
tggttgagac cctgcattta gcctccagca gtacaacaaa tgaagacgtt gttccactgg 381660
catctttttg ttgttcttaa aacaggggtg caacaggcag tggcggcact tgggaggcag 381720
agacaagtgg atctctgtga gttcaaggcc agcctgggct ttataagaac cagaggctgg 381780
agagatggct cagcagtcaa gaacattttg gcagaagacc cggetgggtt caattcccag 381840
cactcatggc agctcacaac tgtctgtgac tccagttcta ggggacctaa tgttctctc 381900

tgacctctgc aggctccggc atgcatgtgg tatacacaca gaggcacaca catacacaag 381960
tacataaaaa taagacaaat aaattagaaa tttaaaaaaaa ccaatctaag aacaaaagta 382020
tcttctaatt ctgacatttg tgttcaagt actttgtgac ttgagtattt cttatgttat 382080
ggttattacc tccccctct tacatgatca gaaacttttg gttgaatctc aaatgtaaat 382140
ttttccttgt tgaatgctat attcctgtat tttttgttgt tgtttttgtc tttttgagac 382200
cgggttctct gtgtagcttt ggagcctgtc ctggaactag ctctttagc ccaggctgg 382260
cttgaactca cagacatcca cctgcctctg cctcccaagt gctgggacta aaggcatgca 382320

ccaccacctt ccgctatat ttctgtattt ttatagactt ttttcttgg gaacagtttg 382380
tccttttaag atttattagc tatggctgac aatggtgga caggtgacta atgccagtac 382440
tgaagcagaa ttgtgagttt gaggccagcc tagactctat gttgcgtgtg gacttatttt 382500
aaaaatccc acagtgggta tatgtatagt tgtaatcca gcaggaggat gacctggagt 382560
tcaaggctac ttgagaacct cttaaactta agaaaaatgg ctagggttgg aggtatagcc 382620
tggtgctaga acatgtattt ctctatgagt tattgggttc agttaccagc acaggagga 382680
gcaaaaagca aagaaagaga tggccttggg gcaggggagc catgctaaag aacctctgag 382740

caggggagga acttagaagt taaggagatg gctggagggg tcttgactgc agttcttccc 382800
gagtgacatt tgggccagc attaaacctg ggcactgact tcctctgcc agctggagta 382860
gctgagttca gaggccagca gaagtctctg atctgtctga cacaggttgt gaaaccagtc 382920
aagacgagag agctgctaa tgccccacac agaataactg tgattatgtg acatactcag 382980
gaagtgacat gtggggggg ttaattaca tttcaggatg atacacgtcc atcaggagag 383040
ttttacctt gtgtttttgt tagtctgtta gtgaaatct caaaattcta tgagctccta 383100
tattttttaa gttggaggaa gactaaggga aaatatgttc cccactecca tgcttttct 383160

ggggaggcca agccatgaa gatgtgagg gctcttactt gtgacataat ttggtgatga 383220
catagctgga gctagattcc atatacagaa ccatggggtg tgtatgacag gtgctgtcag 383280
gaccaagta tctctcagag agtagagagt gctgtccatt cagaacacca cacttaagat 383340

tcttgtctgt taictttaat gctgtgacct caagcaaggt attgagcttg ttttcagttg 383400
gatatagctt aactgcctga aggcaagctg ttataccaag ataattcttt ttggtttccc 383460
ccagaggtaa gctgaatgtc caacactgtc aagtagcaga tgggccgtcg taggctctat 383520
ggtgacctga aaagtacact atgcctcttt taaagctgga catggatagt gcacacctgt 383580

aatctcagtg tgtaaaggct gtaaggcaag gaggaccaag aatttaaagc cggccagggt 383640
tacatagtga ggccaggctt taaagcgaga gatagataga tagatagata gatagataga 383700
tagatagata gataaataga tagatcaatc aatcaaaggg atgctggctg ctgcttagct 383760
ccagcaggtt ggtgctgcag agtgggccct gtgttgccac atagtcggca tttacagagg 383820
aacccccaaa tgtggatttg tgggtaaaat atataaatac catatcaccg gttaagacct 383880
tttgtctggt tatttaccta ttcatTTTT tttgtttgtt tttgtTTTT tgaacagag 383940
tttctctgta tggctttgga gcctgtcctg gaactcactc tgtagactag gctggcctcg 384000

aactcacaga gatctatctg cctgtctctg tcctcaagt gctgggatta aagttgtgtg 384060
tcaccatcac ctggTTTTA ttttattttt tgagataggg tctcatatat atatatatat 384120
atatatatat atatatatat atatatgcca gactggtttc agtccatgga tacagccatt 384180
tttatgaatt tgttttctt ccttgacagt ggatctcact tttgaagtgc acaccagctt 384240
ccaactcaaa atcttctgc ctcagcctca tgagtgtgg gattacattt taattaagac 384300
agaacttatg tgtggactat actggttctc agtttgaact ttgagagcca ttttaagtggg 384360
attcagcctg gctggtaaac agaaaaagac cttggctttg ggtagatcct caacagcctt 384420

tcctaaggte cctggcctgg cctgagttat caccgatgct acttctggt tgcttctgt 384480
gtttgtgaat tgaaggaatc ctagtgggca ttgacaaaag tgtgtggaca aatgacagtt 384540
tgagaaacaa tgttgcgata aatctttctg ccaaaagcca cctgagcccc actgccacat 384600
gggtggtcta cgccagctgc ctgcctgagt tagggcecca attaatgcac agagagactt 384660
gtattaggtc tctctgcttg gccaatgact aggattctca tctgttagct cagtctccat 384720
tatcataaac ctatatattt tataagactt atcttataga ggatgccttt ggctggcacc 384780
ctctcttgcc ggtggctcac atggcgccgc tggaggagga aggggaaaag ggggacactt 384840

cctgtttctc cttgctaaat atgagtctcc ttgccatgct acttctgccc tggatcacca 384900
cttctctact acatttccca gaatctctt tgactcttag tctgtctaa ctigtgtct 384960
tattggccaa acagtatttt attcaatac caataagata aacataaaaa gaagtacatt 385020
ccccatcacc tctcttttc tgtctaaata aaaaggataa cttatctttt ataataactg 385080
aagaaaacta taactataac tatctgtctt caactctatc aaaaaccaca gaaggaaaat 385140
atataaactc tagaattgac agacacatct cgatacctgg acagtcaccg aagttctctt 385200

gtaacgttgg ggcacccatc ttcagcctat aaggccacag tgtgtctggc acacttctcc 385260

 atttcaacaa caaccgttca gtactgtctt gttttgtaag ttcagcagtc actttcttgt 385320
 gggctctgca tgttccagtt tatacagcaa caaacagtcc aggcaagagc agtttcttgc 385380
 ccaaatggct aatcttgctt tgttgaaagc aaactccata acaagtttct tcgataccca 385440
 tcctccttcc tgacataatt ggtgtcccag gacagctgtg gtctcactgc caagaaaaac 385500
 cctaaacat ttaaatgcca tatttctgta ggtctttgaa aggtttgaag aatacctatc 385560
 catctcaaat acatctctgt atatctagaa aacctaacta acctaattat aagttctgac 385620
 tatcataggt gactatataa cctgtattta attatgtata tcattttaaa agatctgtat 385680

 aaacacaata tciaaacaag aggagacata tacatatcac aaaattgacc ttaaagtgt 385740
 atcaataaat gaaaatctat accaatgcaa agtattcatt cctatctctt aaaacataga 385800
 aatctgacca agtcttctgt ttcatagtct gaaaggetgt atcgtctcag cttttttgga 385860
 ttaggatca gttgggtcac tgcctcgggg gtcttgcttg atcaaaccat attagtctgg 385920
 aaggaatcca tagcttttta ttttctgtgg aaacacaaac agaaattctt tttccaagta 385980
 gcctgtcctt agacttaaat tttgaagtca aagtattttt aaaatttata agttggatta 386040
 atttagcagc atttataatc aatgtattt tagcagcagt aagtctttcc tcagcaatca 386100

 aacaatttaa agacaacaat atggcatata gtatccagat tctctgtgta ttttccatct 386160
 ttatgtgact tttttatta ctttattttt actttctttt gtttctttt tcccctgaga 386220
 cagggtttct ctgtggaat cgcctgcctc tgcctcctc agcaaatcct actggtgtgt 386280
 accaccacaa cgggctactc tatttctctc tctatattt tctctcaca agcctacata 386340
 tatttttaaa cgcagtgtaa accttagag gtttttctt atctggattt gtctttatca 386400
 tctcagaagt gccgagtcca acgccaaga gcgccgggag ggcgtgagcc tatggaagct 386460
 tctctgatgc ctctgagcgg cccgacaggg ccggctgtgg cggcaggtt tectctttct 386520

 ctgggaacct tggggcaggg ggtcatcccg ctactgaca ccattctgtt acgataccgc 386580
 ctgaacccca ccaccacgtg ggtggtctac gccagccacc cgcctgagtt agggcccaaa 386640
 ttaatgcaca gagagacttg tattaggtac aatgctgctt ggccaatgac tagcattctc 386700
 atctgttagc tcagtctcaa tgattataaa tctatatatt ttataaaact tatcttatag 386760
 aggatgcctt ttgctggcac tgcctttggc ggaagattt atcataacaa aacaaagttc 386820
 ttccaagag cctttttccc aagcaaaggt cttttcggg ccggagataa gtctagggac 386880
 cattaagggg tgagaggaca gaagacactg acaggcaaag gtaagatgca gctgagttgg 386940

gcacctgctg ccttcatgct ttcacagggt tctgctgtga ggagtctagg agccgaggat 387000
 ccgactcgg ggaagctatc tttcttttcc ttggcatttg caaagcacct ccttggtagc 387060
 ccggttctgt ggggtcacta acctatgtgg aaacatgcta acatagtgat ttttatcata 387120
 tatgttttaa aaaccagttt aaaatccact gggaaataat tttttgtcca gtcagagaat 387180
 ttactgcttg tcatggttgc cagctggttag tttctgggca gactgagtcc cctgatgcct 387240
 ttggtgccaa actgttagct tgcaaagttg ggggtgcagaa ggacagagcaa taggctcaaa 387300
 cggaagtagg ccagtgcctg ctgctcttca gagagagggt gggccctgca acaggcagcc 387360

tgatattgag ccttctgct ccttttttaa aatattaca ctggggtgtg tgtttgtgtg 387420
 tgtgtgtgtg tgtgtgtgtg tgtgtgtgtg tgtgtggtgt tccaagttgc tgagaactga 387480
 acccaggatt tagcacatga taagactatg ctttaccact aacctacatt ccccgccca 387540
 gaatctcttg ttcacaaatt gttaatattc atgcgtgcgc gtgcatgcat gcatgcaagt 387600
 ggacgagtgt gcgtgggcac tcacatgcca cacacagtgt gctaagagat cataggacaa 387660
 cttgtaggaa ttggttctcc ttttaccatg tggagttagc aggttgaact cttttcatca 387720
 gcttgagagc aagtgtcttt acctgttggg tcagctcacc agccaggcgc catccctac 387780

cttctaact gcctctgacc tgggattaca ggccctcact ggtttctgtg cttctgggga 387840
 tagaaccag ggccttctgt gcactaggca ccaagctgca tccctgcctc tgtgtgactt 387900
 gggcagatga tgaactcttt gcgcctcagt attctaagt gttaaatcag acaataataa 387960
 tacctaccta tggggttgtt gggggatggt agatgaccaa caacctcaa acaaaaaaaaa 388020
 agccagtcat aataccatc atcctgtaga gcatgttgtg caaggcaagg aaagaggcag 388080
 aggggaaaga agcaagcaga atggagtga cgcctcaatc atccagtatt cctgtgaaga 388140
 ttatcttccc ttctgcccac gaaggtgcta gtaacactct cactttgcat ctgacaaaac 388200

acactgagag aggtgtaata acttaacctg cctcttgctc agcatcaggc ccagaattct 388260
 gtccagtctt gatagtaaac cccattgtag gggctactct gaccacacc tagcagaatg 388320
 accctacct cacccatga tctcttctc tatgtcttag agctgattgg cttcagccaa 388380
 gggttgggga tgactaggct ggcattggct agagtgataa aatgcttttg tatgcgatac 388440
 atgtatgagt gtggctgtgg ctgtgtgttg gactgtgtgc acaggaatgt cgaggccaga 388500
 gatcagtgcc aggtgtcttc cttagtcatg ctctacctta tttttaatg tagagtctc 388560
 actaagccga gagcgcactg atccaggaag gctagctagc catgggatta caggtaatct 388620

acctggcttt ttacatggtt gctggggtca ggaagcactt gttttcca agctggttta 388680
 ttttgtttg tttcaagata gaatttctcg gctgggagag atggctcaga ggttaagagc 388740
 actggctgct cttccagagg tctgagttc aattcccagc aaccacatgg tggtcacia 388800

acatctgtta cgagatctgg tgccctcttc tggggtgcag atatacatgg aagcagaatg 388860
 ttgtatacat aataaatgaa taaaatctta aaaaaataa aaagatagga ttatctgtg 388920
 tagtcctggc tgcctggaa cttgctctgt agaccaggct ggcctcaaac tcagagattg 388980
 cctgcctctg tctcccaagt gctgggatca agtgtatgcc actaccaccc ggctccacac 389040

 cgtgttttgc agatgttcat gtgtatacgt ctgtgtgtac acatgccacac tggttgtttt 389100
 gttgctgttt ttttgttgg ttttgttttt aaaccttggc actggtgatt atattttcct 389160
 attaaaatca attctgtcca gaagtctgt agttacatag accagtgaca gacattttct 389220
 gagcacttat ttcattcaga ctctgcatgt cacatacata actcattctg atcagcacia 389280
 taacctcttg agattgggtg tgtcacagta agggttagtg aggttaggaa attggctcag 389340
 ggcagtaatg gtagagctgg acttggtagc tggccaccgg gacttctaa accactgtta 389400
 aaacatgctg taaccagca gatcctaagt tttctggacc atgtagggtg ctcttctagt 389460

 tgttcataga acacactgtg tgctgtttca gtgcttctgg gtggctcagc attctgtgaa 389520
 gttgttattg tggggcttat ttctttcacc tttgtctgtg ttacacagat aagaggcttc 389580
 tttttctcta gaatcttct ctgcagagag tactgtactg cctgtgtact ccctgtgtgt 389640
 ctgctgatga agtcagcagg gtttcagact cccatttctt ggtcatacac aagtacttat 389700
 tttaccatct ctaaatggag tacattagct cggggccacg tagagcaaat tagggagcag 389760
 ggagatagat cacgagaatg aggcctgctt gaaaaatgtg ctgtgcttct ggcctgaact 389820
 ccctagctgt gtgggaataa atacagtgat gttggggtat catttcaagg ctgttcaga 389880

 atgagactgg ctggtctaca ggtgatcctg aaacaaagca acctgtcttt atagggtcct 389940
 ttttcttctt gggaacttta aaaaaatgta ttacatttat tttagagagg tgtgtgtgtg 390000
 tatgtgtatc agaggacaac ttataggaat caatatctct cctaccatgt ggatcctagg 390060
 gatctaactt gatcatcatg cttgctggca agtgcccttg cctgctcacc atcttatccg 390120
 tcttactgga cctggtttct gaggagtaac taaagcccaa gctggtcacg ctgccttcat 390180
 acaggatagg aaaaatgaaa ctccaccctg acccagctgt aggcaagatc acagcaccta 390240
 ctcagagaaa atacccttga cctgggtcaa cgtcatccc cccccccac ctccctccct 390300

 tccttcttct ctctctctct cctcctctcc ctccctcccc ctctgttgc tcaggatgcc 390360
 ttattctgtt gctcaggatg gatggcctgg aattgcagat ggagccacca tgctgacct 390420
 ctttttcttc tgactgagga ctagaagagc aactgtcat tttcagctc tttcatgggt 390480
 cagcacaagt ctcaacaag atttgcaaag ggcagagttg aggactgaag tgaaaggagc 390540
 tgggacatgg ttccacagtt gagaatgcca ctcttgcaga ggacctagag ctcagttccc 390600
 agaacttaca tgggtggctc agaccacat aactctagct caaaggactc caacaccctc 390660

tcctggctga tagctgctcc tgccaacaga ttggcttctt tagtttcatt taactgtgat 390720

 ttgactttg tgccttgtct tgttctcata cacaggacag atgacagatg agtgcctgtg 390780
 tctgtcttgt tctcatacac aggatggatg acagatgagc gcctgctctg cttccagcac 390840
 atgatcagtg gcttcatgcc tagttgtggf catggttctc cagaaatctt cattcacagc 390900
 agaatgagge aagagccctt gaaagatggc tagaggcagg tgaatcaagc cccctcatct 390960
 gcctttggct cactgcctgc tgtggtccta ccatgcatgc ccacgccact gagggttctt 391020
 catagtctta ttaatgctgg aggcgcagtg ttgccttttt gagggaaata gcctctggag 391080
 tgtgctggtg tttgctgtgt ggtttatgct gattaggaag gaagtgcaca caccctcac 391140

 ccgcaacctg tcatcacttc tgatgtttgc tttcagttgt aattcatggc ttttgaagg 391200
 actgcagaca ctgccattca cttctgtgag agctggttcc tgcctcctt ttccatgctg 391260
 gggctctccg tgcccatagg gagtgtgcag atatgctttc tteaagtcca ttgagatgct 391320
 ttgagctatt ttacactgta ctgaatgtgg ggcacatcac aaccttaga cctctcttct 391380
 tccaggagaa tctagttgat cttggtctac aagaaaggaa atcttccta gttacatcca 391440
 actgacgcat cctctgttgt cactgtcaga tgcctttag aaggagtttc cagtctggg 391500
 tgaatgaatg tttccctac tagttgctct gcttcttggg gtgtctcttg catgctgtct 391560

 tttaaatagc tgttaggagg gtctaataa gcaactgtct ggagaccaat gtttatttca 391620
 acatggttgc agttgctttt gcttcagctt tcagagccaa taaagctggt tattagattc 391680
 tgtaattgct gctgtaatta ctctcttggga actggcaaag gcataattaa atatggagat 391740
 ttacagact ttttctcacc taaaaaac ctcgtaaact tctgttagca gggttaaatt 391800
 tctgctgcta aagccagtga atttacaaat gacactgagt tttgtggctg aagatgaatt 391860
 tctttggata ctatttcttt gaagatttgg cttttagtaa cagctgttat tagcctggaa 391920
 gctatttctt taatacaacc acccagaatt tgggaagggt ggcaagtctt tacaagctag 391980

 tttgcattta tttatglaaa tactgggttt gggctctgtg gactttggct acttaggaaa 392040
 acgagtctgg ttggaaatct ggttagagct ggtgtgtgtg gctcatacct ataactctag 392100
 cacctgggag gctgagtatg ctgattgctg agagttcagg gccagtctag actacagtaa 392160
 attccaagcc tgctgaact atagtatagg aaaggccttg tctcaaacct tccaccccag 392220
 gtagacatcc ctgtgggaag aaggagttt tacgtggaca gtgttcagag ggagcatgct 392280
 acgtgacccg tgggagcacc tgcttcccct aagttatcct cactgtagtg tctcacatct 392340
 gtatggtgta gggagtgtct tgatacttgi gttcacacac atccttgtgg accagatggc 392400

acttttcatg gttacagggg tttattttgg tgttttgttt tgtttcaatt ttggtttgg 392460
 gttttgtttt gttttggttt ttcgagacag gattttctcta tagcttgaac cctgtcttag 392520
 aactcactct gtagaccagg ctggccttga actcacagaa atccacctgt ctctgcctcc 392580
 cgaatgctgg aattgaaggt gtgcaccacc atggcctgtc agggttactg ttgtttgaa 392640
 acatatttta ggggttttctt agaatgtgtt ctttcttttt agagatgtca gtagttgaa 392700
 aaatacaggt taaatatgag gtaagaggaa aaaatatcca tagtccctac tagacaccag 392760
 cctggggaat ccaactgcttt ctgggatgaa actttataaa cccacagcag gagggtgacc 392820

ctgggagacca gggatatttc tggggacctt cccctagctt ttgcatgttt accttacagt 392880
 gatgggcttg caaaagatgc tattgtatga accaagaaaa aggcaggaga ctctatata 392940
 gaacatatgc tcttctggtc acgctgataa gccattgta aatggacagt attattaat 393000
 aaaaaatgca gcacacctta catagctacc ttaagtgcta ggatgggaat atttgtgtat 393060
 gaaaatgcat ggagttaaaa gattcaactt ggcatatatt aactaactgc attccagctg 393120
 acgtgttaga tagatatgg tctgcaaaga tgcttagtag ccatcattca ttcactggag 393180
 ctgtcttctt tatttcctg gtgtattggc atttgtttcc aagtattta ttcttggtgt 393240

gtgtgtgtgt gtgtgtgtgt gtgtgtgtgt gtgtgtgtgt gtgtccactt gtccctgtgc 393300
 ctgtctgtct gtccatccct tgtactgggg attaaacagg tgctcagcca tggagctctg 393360
 tttttttttt ttttaagatt ttatttactt attatgtata caacattctg ctccatgta 393420
 tatctgtaca ccagaagagg gcaccagatc tcataacgga tggttgtgag ccacatgtg 393480
 gttgctggga attgaaactca agacctctgg aagagcaggc agtgctctta acctctgagc 393540
 catctctcca gcccagctcc tgactcttgt agacaggttc tgttctcagt tgagccctgg 393600
 gtggtgagag taggggagtc tgagaaagaa cactcacgag atgtagggtg taacgataac 393660

tctttccgcc atctgtcaa gccctgtctc cacgtgggcg cccaaaatac acagagatta 393720
 acattaggca caatgccgt ggccaatgac taggattcct tacttactac ttcagtctta 393780
 attatcaatc ataattatta atctatatat ttacaaaga cttatcaagg acacagggtg 393840
 ctgggtctgc cctttgagtc taagtcagag cagagtcagg gtcttttcaa acttttaatg 393900
 aggggcagta gtatattgct cttctcatct gtttcggatt ctcctattcc agtggttctc 393960
 aaaccttccc agtgctgtga tcttttaata cagttcccca tgttgtgat ccaaccataa 394020
 aatcatagct gcaattttac tactgttatg aattgtatag taaatatctg ataggagacc 394080

tcaacagggt cgtgaccctc agatggagaa cttttatctt cttcctcagg ctgggggagt 394140
 tggattttct ataatttag tggttgaacc caggattgaa ctatactctc agtcctaacc 394200
 aatttaaatg ttctctttca aagatctaaa tatgctggtt atgatggcac actcctttaa 394260

tctcagcact tgggaagcag aggcaggtgg atctctgagt ttgaggccag cctcgtctac 394320
aaggaatc cagaacagcc agggcaacac agaggaatgt cttgaaaaac cgaagaccg 394380
atgcctaggc taatagtcag gtgtcttcaa ccttcagacg ttgggcacaa tgctgtcatc 394440
tacagactcc tcagtggaga agtgtacagt tgagttgagt tacacaaata actttacagt 394500

ggttttatgt tgggtgttga tagctatcct gtggatcatg tgcctgcag gttgtaggat 394560
aggcaactgc aagtggaagg acagacagaa accacctctg tagaggaggt tgtcgtgacc 394620
tcagctggc atgggtggca ctggcgcaca cctcctggat gaggacgtgt ccatgcatga 394680
gtgcatgtat gtgcagcttc cctgaccag cccagcccag tccagctgtt ctttctgct 394740
aagcctgctg ggctacctt ctgagattgt aaaggaagg agcctacatt tgagcgggag 394800
ctgtatatag ttggctcta gctttgccac agattgatct tattgaaatg cttgccttga 394860
ctggatctca gacaaaatga tctctcttc cccccacagg ctgagaacta acagagcaaa 394920

tgccattgat ttactaaat ggttaaactc cagatttgtt catggcagga gccgcgtctt 394980
cagttgtgtt tgtgttttct atgttgact agccatcatt aggcataaag ctttctggtt 395040
ttgttcagtt gattttcaga cagaaattac tggctcagag agtgaggaga catctttatg 395100
ctatgtcca ttccactgt acgttcagaa ccataacaat ttgcagaact gttggctttt 395160
tgtgacatag cattttaacc aaactgatct aatgcttgtt tattatttt gtcatttagt 395220
tgggtggaag tggactgca atggctctt ataataatta gagccagcag ggttttttt 395280
ttttccggt gtgctagcct ctttgctaat acgctaggct actctgtatg ttagcacatt 395340

tcctctcac agtgaaceta gcaggaagc taagccactc acctctgtct gtgagcgacc 395400
gtttgacccc agaaagcatt cttccttgg gacccatcc atactttgat ttttgcaaca 395460
gatgtggtta ccagagaatt taaactgttt gtgtgcttcc ttctgtctg cattgtgggg 395520
tgtgtgaact ttggcatttt cttagaaaac tgaatgtgct cctgggagaa gttgctatta 395580
gctttcttac aaaggaggca gcagcagagg tgcatggagc acatttgggg gaaggctcg 395640
gtgtcctctc accacacacc gtgccagaca tgctcaagtc tccttctcc ctgcagcggc 395700
cctgcaggct ttgaaacgga agaagcgata tgagaagcag ctggcgcaga tgcagggcac 395760

cctgtcaacc atcgattcc agcgggaggc cctggagaac gccaacacca acacagaggt 395820
gctcaagaac atgggctacg ctgccaagge catgaaggct gcccagaca acatgtcgt 395880
gccgctgctg gggggaggac tctggaggga ggggtgctgct gaggccacgg cctcattgtg 395940
gtcggctccc tctttgtagc ttctgaggga actgtggcct gctgcctttg tttctacgag 396000
agctcagggg tggaaagaga aattgtttt cctggttcta gattattgtg acagccttag 396060
ttccaagtgt galagtcctt agaagaaggt cttctcagtc accgatgttc atcagactgt 396120

cacagagatg gtggcagcct atgctgatcg aggggtgggat tgggccatag catgtgtgct 396180

ttccccagg gctttgagtc tgttcttaag tccgctttgg gggacctttt tgtcccggct 396240
gccctctgct tctgttctca gcagtccttc cttccctgtg gatgcttcta tgccagtggc 396300
ctgagaacta cacactcacc ttggctccag ctgtaaagaa caagggtctt tccatgaaaa 396360
aaccttctat ttatcttagt tctttgatgc ttcagctggc cctgaggggt acttgagca 396420
tttgctgctt tggccacctt tggccttcca tgtatagcag ccatgtcctt catttgcata 396480
ctgtctggag ctgctcagtc tttataaata acattaaaat atttatcagt gggctgggga 396540
aatctgtac tctttgctct agagacaagc ggtgcggaag cattgcctga catacatgag 396600

gtgtgggagt gcactgtcag gcgaaggctg catcctttaa catttagaac aacagatagt 396660
aagtagtgtg tatgtttgga agtacacaga ccatcttgaa tatctgtgtg acacacagtg 396720
tttaaaaac aggcatttc ctttcccttg ggacttcata gatgtttaag tagggaaggg 396780
cctggctcag ttttgtggtt tatgattttt tgtttggttt tgtttttcga gagggtttct 396840
ctgtattggt ttggaggctg tccctggagtg gtttgtgatt tttaccacct cctgtttaga 396900
gttgctttgg ggcttgaaga agacttggtc ttggcactag agttaaagtc ctgtggtctc 396960
aaatctgttt acagatctgg ggtagagggt gagggctcctt gactccacc gatgctaagc 397020

ctactttcct tcagtgtcgg actaaatgat gtctaaggac ttccatcttc gtgattctgt 397080
gattttcaat ttiacattta ttttgagtgt gtgtgccctt gcctgtgtgg atgtaggggt 397140
cagaggacaa ctttggggag tcagttcttt ccttccacct ttatgtgggt tctggggcaa 397200
agtactctgg tcaccagctc atgattccca gttctgaagg gaaggaagaa ggcaatgatt 397260
acaggcagtt tcctaaagga gagtiactgg gtgctaagaa gcagagggtt tgtgcagggc 397320
ttctgttcag accagtctta gctaaagtga taacctgttc atttcatttc aaggacatt 397380
gataaagtgg atgagttaat gcaggacatt gctgaccagc aagaacttgc agaggagatt 397440

tccacagcta tttccaaacc ttaggcttt ggggaagagt ttgacgaggt gagtgtttc 397500
ttgaagatca catgggtctc ataggtgaca agcctcagge tcaacatagt gtgtcaactc 397560
cagatgtcaa caggcatagt gtgtacctcc ttggattctg aatTTTTTTT ttaattttt 397620
aatattattt tgtgcttgcc atagtggcat gtgcctttaa tccattatt caaaaggcag 397680
aagctaacct ggtctacata gagttttcca ggacagccag tggcagttag acccagtttc 397740
aaaaaagaag aaaaagagaa cataattttg attttttct ttaagggtat tttgcctgcc 397800
catgtatgtc tatctgcgca ctacttgcac gccttctcc cctggaggcc agaaagaggg 397860

tgaagcact cacttggcag ctagcaactg tctgtaactc caagtccttc tgttgggta 397920
 ctgtatgcac atggtgcaca gacagagatg tgggcaaagc acccgatac gtaatataaa 397980
 atctcagaac aacggcaaca aagaggatgg tgcctgggttg atggtgcagg ctgttaacc 398040
 agcagctcag gagtttggag caggagaaca agcagcctgg accacaggaa gtgtaaggct 398100
 ggcttgggca acagccagaa accatctcaa aactttaaaa aggaagaaaa agagtctggg 398160
 tatgtagctc cgtggtagag cacttgccta gcatatgcgc ggtcctggtc caggtcccag 398220
 tatttcccc tgcaaagacg tgaaaagata cagcccctcc acccaagaag ctcgtagcag 398280

 ggaccccaga tgcatacata tgccagtggc ctctcagaa ggttcaccgg gcatcaggag 398340
 gaggaatggc tgcagggagg gtttcaccac acttcctttt gcaggatgag ctcttggcag 398400
 agttggagga actcgaacag gaggagctag acaagaattt gctggacatc agtgggcccg 398460
 aaacagtcc actaccaat gtcccctctg tagccctacc atccaaacct ggtgagtctg 398520
 cccacagtgg ggacacaccc tggcaccatg agaagggggg gatcgcattg tcagttgact 398580
 tcggttggg ttctgagcca aagaggatct gttgtgatga tcacgatgcc aatgtcattt 398640
 gcagaacaga tttcgaacct cagcaactgt gacatggcca gataattcca aggcttgcag 398700

 tggggctgtc ttataggata gccctgactt ctctcacca gatgagcagc cgctgcctat 398760
 gatgtcttca ggcattgtc tgttctagaa tgattttct tatcccctaa taaggaaag 398820
 ttctaggcac tgtcagagg tgtgagaact taagtcttgc tccatccagg actctgtgct 398880
 atgtgtctc tggaatgaac cagctctggc tggtttggag acctgcttg taaaaccatc 398940
 atttccttgc ctgcatttc tccctcttct cccacgtgct ccacacagag ttcttagaga 399000
 gacaaaactg cccatctgga tgggagacaa gggcctgcta gcagggtgtg aacagggtgt 399060
 gaccctgtcc ctctgccatg gtaaagagag gccctcacc aatcagtac taacagaggc 399120

 agccttgcaa agcatggctc cagcactcc aaatggagtc gacttggcaa ggattgcac 399180
 tcttgggagg gatggtcttg cttctcccc aaccctgagt gcttcaggag taagggacc 399240
 ccagtgtaaa acaggccctc ctggtatggc tgcccctgct gagggtgag gggagtgtg 399300
 gtggaagggtg tgcttggtt cctgaatttg cgtggcagct tgtgggcca aagagcagta 399360
 tgctgtaggc ctgagctggc tgcaggacag ggctgtgtgc ttacacagcg gagcacagcc 399420
 ctggcttcca ggcaccctc aaaaatcacc ttttctgtct ccacacagtc aagaagaagg 399480
 aagaagaaga cgacgacatg aaggaattgg agaactgggc cggatccatg taactggtcc 399540

 agcataggct ggggccagac agactctggt ggcctgtgcg acgggcagc gtgtgctgc 399600
 gcagggcagg caggacgcgg tgcaggcagc ctccatcgt cagctctcac ccaaagcagt 399660
 aggcccatc actnnnnnnn nnnnnnnnnn nnnnnnnnnn nnnnnnnnnn 399720

nnnnnnnnnn nnnnnnnnnn nnnnnnnnnn nnnnnnnnnn nnnnnnnnnn nnnnnnnnnn 399780
 nnnnnnnnnn nnnnnnnnnn nnnnnnnnnn nnnnnnnnnn nnnnnnnnnn nnnnnnnnnn 399840
 nnnnnnnnnn nnnnnnnnnn nnnctctgct gtttataatg ttgaatttct gtaaaataaa 399900
 ctgtatttgc aaatccaaca ttgagcttct ggactacgct aactccactg ctgaatcctc 399960

 catggaagg gtcggccgct tgcagttgaa acgatccgga aatgtagccc gtgtccttta 400020
 agtcagctga cttgtcgcac atctctgtaa gacgtgtatg gtaactggcag aaaagtcgtt 400080
 tttttaaag ccatagatag gcttttctc gtccttagct gtaatagcac atctgatttt 400140
 ggtttctca agagctgtgt ttctgtctgt cacctgtgta ctgccccca cccctgtgtt 400200
 taccacctg gcccttgca ctctgctcc cctggctttt ggagtgtgc cacggatctg 400260
 aaatggatgt atctcttga gaacaataa gattgttaga attaatccc agctatccag 400320
 ttttctaaca tagctctaag gtccctattg ctgttttga tgactgatag ataactcact 400380

 gagaacatgt gcatacattt atattcagat gaaattatgg ttgcaactgt ctattaaata 400440
 tctcgattta atttcacac ttgctgttgt gttcagtcaa tctctccct cccctgggaa 400500
 ccgacctct cccgtccagc tctggtccag ggtcactggg gaaacatgaa ggacttttga 400560
 agagcagctt ctttcttct acaacttcc agcttctgga ggccactgag ctgtggccac 400620
 tacttaacct ggggacctct gggctatac ttagtgagtt gattcttgtg cagccccaga 400680
 atcttccate ctigcctgc aacacctagg gaagtgcctc tgggagcctc tgcctggtgg 400740
 aaaccacggt gccacatga tacaaggccc agccaggcag cgtgtttcat agtagggaag 400800

 tgtattgggt agggactgag gactgagggc acaaatgctc ctttggggtc tgcccagtct 400860
 gtttctcttt ggccaacac ttccattctg cactttatc ttgtgccctc tttagaaact 400920
 gatggatgct ttggacctt gtatccagct aagtagatct ccacatacgt ttgtccctcc 400980
 tgcattgtctc aggattgagt agtcacccc atccccctag cttctttttt ttgttggggg 401040
 ggagaggttt tgagacaggg tttctctgtg gctttggagg ctgtcctaga actagctctt 401100
 gtagaccagg ctggtctcga actcacagag atccacctgc ttctgctcc caagtgttgg 401160
 gattaaagat gtgtgccacc aacacctggc cccctttagc ctcttaaggt taaaagcaat 401220

 ctgagttcac agtgggatat tgtcatgctg gcagtatccc cagagcaagc tgccatggtt 401280
 cctgtctttc aactgttct gtttctgctg aagagacaca tggcaacttt taaacgtttg 401340
 ctggggcctt gcttacagtt tcatagtggg agtccatgac cattgtggca ctgtgctgga 401400
 gccgtagctg agagctcaca tctttgcaag ttgaaagcag agagagactg agcatggcaa 401460
 gggcttttga aactcagag cccaccccc ggggcacacc tctccaagg ccacacctec 401520
 taatccttcc caaacagtt ccaccaacta gggaccaagc actcaaacac aggagttagt 401580

gggggcccct ctcaattcaaa ccccacagct ccttgggtct catattctcc ttgcttgtg 401640

 ggaagctgtt catgccctgc tccgtatccc ccatgactgc tacactcaa attgggactt 401700
 gatgatgggg ttgaaaattc ctggcttggg agagatgggg cttggctgat gtcacaagtt 401760
 atgtacacct catgaagaat ttagtggtag cactcgtgg catccttctg ttgcttcta 401820
 ggaccctttt ggtgtgagat tgccggagtg gcctgtcttg agtcttacca gctgccttgc 401880
 actctctccc taggactgag tgagtagagc tgccagatcc cctcagctc tgacaggcaa 401940
 agagatcaat ccaggccagt atcacacacc ttgaacctgg gactgtgggg cacagggctc 402000
 accagtgcc agaccctttt ctgtccttag gaaggtctca gaccttga gacataacta 402060

 tgtctcacat agccgttttc ttggataca agcaacagaa gactcaacca acacatagac 402120
 acgacactca ctattctaa atttattcag gtatTTTTTg atcacctact atgagcaggc 402180
 actgagaata catgcaacag agtccatgcc ctgtgtctgt ttgcaggctg gtctccgagg 402240
 gacaggacat ctgagccga gtgctggggt tctgggttg aagtggctc cagcaacctt 402300
 ctcaagagca aagctcttgc tgggtgtgat gtacacagct aattccagca ccaaggaggc 402360
 tgatgttga aggatcaaca ttcaaggcta acttgtatgt agtagtgaga ctgtctcaa 402420
 atacaaccag ccaagatgtg gtgtactcag gagacagaga caggagaatc cctatgaatt 402480

 caaggecatc ctgatctata taggtagttc caggacagcc agggcttctg agagagacc 402540
 actctgttga taacaacaa gagtgggga gatagttcag tggtaagag cacttgcttc 402600
 gtgtctggg cattggtggc actcccagca ctgggaggc agaggcagaa ggatctgtgt 402660
 gagttcgagg ccaacctggt atccagagtg agtgccagga taggctcaa agctacacag 402720
 agaaacctg tctcgaaaaa ccagaggacc caggtttgat cccagcacc cacatggcag 402780
 atcacaactg tctgttactc cagttccata cagacatata tgcaagcaga acaccgtac 402840
 acataaataa aaataaaaat caacaaaat gcttctgct ctgcctagc acatggcct 402900

 tttccttagg ctactactat gtctctggg ccatgactat tacatggctg aaaatggagg 402960
 tttctgttcc acccagctg gctgtgtctc aaataaacac atggacactg tattaattat 403020
 aaaactgtt gccatgggct ggagagatgg ttcagaggtt aaggcactg gctgcttctc 403080
 cagaggctt gagttcaatt cccagcaacc atatggtggc tcacaacat ctgtaatgaa 403140
 atctggtgcc ctcttctggt gtgcaggcat acgtggagc agaatgttgt atatataata 403200
 aagaaataa atcttaaaaa aaattgttgg ccaatggcta gggcttctta ttggctagct 403260
 ctgtcttaat tattaacca taactactaa tctatgtatt tctacatagc ctatcttac 403320

cagagagcca tgcctatct tcccagtttc tacatggcat cctcctgca acttcctct 403380
 gctttccttt tcccagcctt ctctgggtct ggtcaccccg cctatgctac ctgcctgact 403440
 attggccaaa cagtgttttt tgttcatcaa ccaataagag aagcatacat gcagaaggac 403500
 atccccatca gatggctggt tccagagtct actaggattc cccttaaggc tggagatggg 403560
 ctctccggtc ccagagtgtt ttaccgtctg cccttcaga gcctagagaa gctggggcaa 403620
 agtggcgcac atcttttacc tcagccctag gaggcagaga caggcagatt tctgagttca 403680
 aggtcaacct gcctcatctg tgtagacaaa acttggcttc tgttaccagg aggaagcagc 403740

 tcattgccaa gcaggcaacc agaaattcgg acaccaaaaa tcagccacat ggctaataatg 403800
 gatttaaaat gttttaatgg ttatittatg tgatgagcg ttttgcttac gcgtgtacca 403860
 ggtgcctgag aagggcaaag gagagtgtca gattccaag aactgaagt agagaaggtt 403920
 gtgggctaca agtgggtgct gggaatcaaa cctgggtcct ctggaagagc agccaatgct 403980
 gccttctcag ccctaaaag cagatggagt caagacactt ttgcaaatct ctcaatccct 404040
 ccagattcca gttcttaaga gcccagaat agctgagat ttaatcttag gaggcagagg 404100
 tgggtgggac tgtcagttgg aggccagacc acccttgtct atagggttcc aggccaacca 404160

 gggctacaga ctgagaacct gtcaaaaaca aaacccaga acagggtggg ggatctgaga 404220
 cttcagttta gcaaagtctt tggtaactat cgggacctgt acttaactcc agaaggctta 404280
 aatcctcagg aaagcatatg tggtcacttt gtgacctggt tccatgctca tettecagct 404340
 actgttacc acaattcctg gaatgggagt tctagtagcc cttgggcctt gcctcccact 404400
 cctggacaca gccctctct ctccctctcc cctctctcag gtgtgtgtga gtacctgct 404460
 cactataagc ccaaccctac aaatacattt tttgtttgt tttgttttt gagacagggt 404520
 ttcatgtgt agccctggct gtccctggaac tctctgtga gatcaggctg gcctcgaact 404580

 caagagatct gcctgcctct gcctctcaaa tactaggatc aaaggcaagc accaccactg 404640
 ccggcataca aatgaatttt gagtgtctgc cctctctaat gaaattctgg tttggtagga 404700
 aattgaggaa ggtagctgcc atcactcctt tctcatgcc tccaggctct gagtaattga 404760
 tgtgaaacac atgggaaaga acccacccc tcaggagtgc tgatgggaag gagcagaggg 404820
 ggaggggagt gaggaggact aggggtgggg aaggagaaga caggaaactc caccttgaag 404880
 catgagcagg gtcaatggct gccccgttc taagtgatgg cagagtcaat agacctgcag 404940
 taaatattta tgaatgaatt acagatgagg aaactgaggc accagggtgt ttcaaacctt 405000

 agccagccct aaaacatggt ctcagcgcc ttcttccat ccagacttca ttcaatatgt 405060
 ctatgtate catctaaca aaacagcttc ctctctgct gccaagttgc atcctggcct 405120
 tgctggttcc ttctcagca gaagtgtgt ctctggctca gaggccaca ggccagaacg 405180

attcagtttt cagtaggaac agcagctcca cggggcatca aactcagaaa acacagagcc 405240
 atcatttcat tcaacctcca cagagcatct cagaactatt tgcctgtttt acagctctgc 405300
 aagcccaggc acaacagggt taagatttgc ctaaggtcat agggcatttc ctgtcaccat 405360
 agtgaggcag gggcagattc acagaggcat gttcctgttt cagaaggtgc caatcctgaa 405420

 tgtgatcaaa tgctggggtc taaagatcca gaaatgaggg ctgccactct catttttgc 405480
 tcctgctgga gccaaaaatc ttataagcaa caaaagccag aatcatctag aagacacgaa 405540
 atggagcaat gggatcagag ccatgcaata atagttggtc tcctgtgtcc ttctataatg 405600
 actgataaga tggggaccct aagactgggc cctcctcca acctgagacc ttttctctta 405660
 tccccagaca ctaatctgtc tttctctc cctctcttta acttggccat ttggggacac 405720
 ttggttcctt cacagaaaga gtggacaaag ctaccaaggt gtatgtgtgt gtgttacaca 405780
 cgttaccaag tcatagttgc catggttcat gattcatgta tggaggtcag gacaactttg 405840

 tgtgttgatc attgccctcc atgctgtttg agagagtatt tttgttggtc cctgttgcat 405900
 gcaggctage tgacctatga acttttgggg gttctctat ctcagcttcc catctcgggtg 405960
 tagtaccatg cctacttttt taataaaaaa atttatttat tatgtataca gtgttctact 406020
 tgcacatttg cctgcacatc agaagaggga agagggcacc agatctcatt acagatggtt 406080
 gtgagccacc atgtggttgg tgggaattga actcatgacc tcgggaagag cagccagtgc 406140
 tcttatagcc tetgagccat ctttccaacc cccccccccc cgtgtctacc ttttatgtgg 406200
 gttctggggg ttcaaatcca ggtttnnnnn nnnnnnnnnn nnnnnnnnnn nnnnnnnnnn 406260

 nnnnnnnnnn nnnnnnnnnn nnnnnnnnnn nnnnnnnnnn nnnnnnnnnn nnnnnnnnnn 406320
 nnnnnnnnnn nnnnnnnnnn nnnnnnnnnn nnnnnnnnnn nnnnnnnnnn nnnnnnnnnn 406380
 nnnnnnnnnn nnnnnnnnnn nnnnnnnnnn nnnnnnnnnn nnnnnnnnnn nnnnnnnnnn 406440
 nnnnnnnnnn nnnnnnnnnn nnnnnnnnnn nnnnnnnnnn nnnnnnnnnn nnnnnnnnnn 406500
 nnnnnnnnnn nnnnnnnnnn nnnnnnnnnn nnnnnnnnnn nnnnnnnnnn nnnnnnnnnn 406560
 nnnnnnnnnn nnnnnnttgg tttgtgtgtg tgtgtgtgtg tgtgtgtgtg tgtgtgtgtg 406620
 tttgtgtgct ctggctctgg aacctatggt cttgccatgc taggcaaata ttctaccact 406680

 gagctacact cccagctttt tacatagtgt tcagtaagtt gcaagtatga attaattcat 406740
 ctggtctctg aacctgtatc aaaagattat tttgaaatag ctgctatatt ctgtatttat 406800
 aaattctata tacactgctg tgctagattg tatagcaata tacatgtaac tgcctgaagt 406860
 ttttaaagg cagacacata agaaacacgt ataataaaga cttgtagcac tcttctaca 406920
 ctccaaagga ataaaggat ttacctctaa agtctgcccc cccccagtca tttcttttct 406980
 ccatggaaac ttctgcactt gcctccctt gtcttctctt cctgctgttc acctgtcca 407040

ccacgctcaa acatggtggc ttttacctgt aatcccagca cttgggagga agatgcctgg 407100

 ggattgtaat ttcaggcca gcacggataa ctcaacaaga tcttctcttt taaaagagaa 407160
 aaaagagcgg ggcaagtgtg gtgcacacct ttaatcctag cactcaggag gcagaggcag 407220
 gtggatctca gtgagtttga ggccagcctg atctacagcc tgaggtccat gacaggttcc 407280
 aaagtacag agaaaccatt tctcggtgtg tgtgtgtgtg tgtgtgtgtg tgtgtgtgtg 407340
 tgtgtgtgtg tgtgatttc cccctaaaac atcggttctc aaccttccca aagcttcaac 407400
 cctttaatac agtttgtcat gttgtgagat ggatgatccc aaccataaaa tcatttttat 407460
 tgctatttcg taactgaaat tttgatactg taatgaattg ttatgtaaat atctgtgttc 407520

 tgcgatggtc ttaggcgacc cctgtgaaag ggtcgtttga caccccccc caaggggttg 407580
 cgactttggg ttgaaaacag ctgctctaaa acttccctgg aagacacagt ttccaggttt 407640
 cagacagaat ctgcctctct ctgtctctgt cctttgttcc tctttgtctc tgtctcttct 407700
 cctcttacac acacacacac acacacacac ttccaaggc cttgttcaag gttaagtcag 407760
 actcagggct aagcacctcc aaggaatatt tccaaacttc tggatccgca gaccttttg 407820
 gagtcgctgg gaccgagctg tgtgacatgg aacagaaagg aagcaggcta ctccgaggag 407880
 cagcgtcggg cgtgaggcca gcagcgtctc aggcggcctg caggtggcgc catctcccag 407940

 acagtgaagc aactctgggc tcttcccgtg ctgaccacag atctctgggt gcgaggcca 408000
 ataggagccg gcctcctctc ctgcacccc ctagccatgc ttcttctgat ctcacctca 408060
 caccgtcacc gttgcctgct gtcgcagaga tgtcccaac agaggttgat ggataagagg 408120
 accgcacagg ggcgggcagg ccatlgcaac agtagtaatg gtgatcaca tactttccct 408180
 ggctcatttt gcaggggtcc tccgtggagg cctgggggag gggccgctga ggctacctag 408240
 aaagtctgc cagctaccta atagtgtgag atcctgcctc aaaaaacaa aacaagcttg 408300
 gttcatgctt tgccaggaaa ctcaggagt cttatcctc ctcggataca tagcaagttc 408360

 aaggtcagct tgggctacat gagacgatgt ctcaaaaaa aaaaaaaaa aaaaaaaaa 408420
 aaaaaaaaa aaagcaaatc aaacagggga acaaaaaac aacaatgct cacagagaag 408480
 gactgggatt taictcagta aagtcttgc ctagcgtaa tcaagacttg agttcaagct 408540
 gtgtaggctc gcgtttaatc ccagcacttg gaaggcagat ctctgtgagt tcaagctag 408600
 ccttgtctac agagagttca gaacagccag gactacatag ggaaacccta tcttgaaaa 408660
 gaaaaaagaa aaagacgtgg gttcagtctg gtactgcatg aagctgggtt tgggtgtaca 408720
 cattataaaa cccagcactt gggagctgga ggcaagaaca gacgtcaag gctgtcttca 408780

gaatcagcaa gtttgagttc caggctctggg atacctaaaa ctttgtctca aaacaatata 408840
 caagaaaaac caaacaaaa caagagtta aaggcagtga gtcttaatta aaggtgagta 408900
 ttgcatagcg agggccctgt gtagctgcaa ggattgaata actatggcac gtaactggcc 408960
 cagccccacca gcatctttgc cagccatgac ctccaccccc tctgtctgtc tgcctgacct 409020
 tgcacctcgg tctccaacag tcagtcaggg gagcattgta gcatctagtc caggctctgt 409080
 cgcttttcca ctggacactt gtctttgaga gctaggggaag agctagggag actgctcatt 409140
 cagaaaagtg tigtatcatgc atgcctaaag atgaagttcg atccccagca accaggtaaa 409200

 aagtcctgaa acagggcact gaaacaggaa gatctttggg ctcaactcagt cccagatcac 409260
 acacacacac acacacacac acacacacac acacacacaa gccaggacta ggcctttcag 409320
 cttggctctt ggctcttcta ctctgaactt tgagaactct ccactagtat gtctcttagc 409380
 ctggcttgcct catcactgta gaaactttac attttcttct tcagtgctta tttctccttt 409440
 cagaccacaa gticcatgag agcaacagct gtgatattct catgccctgt gagtagtctt 409500
 ctactgaact gaactaatta acgaggacag ctggacctgg gcaggaggct ttggtaacag 409560
 catcatttag acaataata tcttcatgac atcaaacagt gtatctgttt agcctgccac 409620

 agagtcaagg gaagggcagg ggactgtagc tctggctctg gattccacac actgcagaac 409680
 tgtgaaaggt tgggtgacgg ttactgttac ccaacggtga cagtaaccgg tgacggttac 409740
 tgtcatctga ccttagcccc actagtctctg ggtcaatgat ctgctatatg ttcctgtaag 409800
 atagattctc acctcagcta tcatgttgct gtaaaccag atggcattca tagctatccc 409860
 cttaccctc tgtgtgtgcg tgcccgtgcc tacatgtgca gatcattctt ggccaccctg 409920
 ggctctgggg acagtggccg ggctgagtca cacagaggat ttggtgtcct gtggagagtt 409980
 tagggctcag tcccatatgt cagacagctt gctatcacac tccagttgtt atgtgcaact 410040

 ccttttaacg gctctaac tctctttaac aacagccagc atgtactagg cctacctgg 410100
 atgccacg tgatgtggag ggcattctca aaagattctt aggggccctt atcatgttca 410160
 tcattgttca tatgaaaaa tagagtccac gaggaggaat gatcagctca agatttacag 410220
 tgtgtgttcc agggttccca ttcaactgac ctgtgcacag tggggcacag aacagctctt 410280
 aggacaatag gggacgcaga accagtacct gagctgatgc tctggcctgg tatgtattgc 410340
 aacagggaac aaccatgtct ttctaggac gcaggatggt taagcaggtc aggctcaggc 410400
 tggccaagc tggagttgca gcagaaagat ggcttctctgg ccttacttcc cagccaagcc 410460

 agcagaggac aggcgtcagt gccatctac ctgggttggg gtgagtatgt gaggagaagg 410520
 tagctctgat cctgggtcca tctgacaata gagacagaga caaagtcccc tggggacttt 410580
 cctgtccttc cctagtggag tccagagcag acctggtgg tgcctgtgct gggcatttct 410640

gagctgcaaa caccacctgt tgggtcccag cccccacggg gtctctgaga gttgcttgtc 410700
agccaatacc cacaggtgct tctctgtgtc tagtctctggc ttacagcccc ggcctcaccc 410760
cactacacct gggaaaacac gagctcttcc tccacgagct cttccacctg gggtttttcc 410820
actgtgctgt aagtgtatat aaggctgctc tctccctgga caacggcaga caaattaaga 410880

tgcacatagc acgggtggcc agacgtctct gcttttaact aaatctccag gctttcgctt 410940
gatactcgga cttagtcttg gcaagacgac acaaccaccc actcactcag ctctcattg 411000
gggagtgact aggtgagtggt ggttgggttc aggttctcac cagtctgagg catcagggtta 411060
cagtgcгааг gcagttttag gcaggctgga ggcatcaggc ctttctctgt ggagatgagg 411120
ggctagagct gttttcttag gcctccctag catcaccaca tactggctta ccacagtagt 411180
gagtagacac acggcctcac agttcaaac gtcattaaac agagatgtat ctctatatgg 411240
ttcaagaaac cttatgtaat ctgaagttga ggtgggtggtg acctaggttg tgggaagcgg 411300

gcctcctagg gactgtggcc actcttggct gtccctggct ctagtcccag ctctgctgca 411360
tactgacatc agtgccatta ttatcttctc ttgtctctta taaagatgct tgtcattggc 411420
atcagaggtg acatcccaaa tgacgacacc ttaaaacctt caaatctatc tgcaaagagc 411480
ttttatccag gaatgtcaca ttcacagggt ctggtgggga cacatgttct ggggtatcac 411540
tcttcaccta cccaaggcta ttacaaaggt gagttcagag gacccttga ggactgctct 411600
ggcagcaggg acacctctc tgctaactct ggaggataca gggcaggcag gccttgggta 411660
aagaggcattg tgccttgtgc agcaacctg caccacggc cctgctctgg caaagcacta 411720

tcccaaaaca tattttactc ataaacgggc caattaagaa ggcaaatgtt ttcaaacagg 411780
aggatttatt ggcacagaga gtgccatccc tctagcacia ggagtgggtg tgtgtgtgga 411840
gccaatctgga ggggctattt gtcattttta tttagttaca agttgttgga ttgttactgg 411900
cggggtttta tgaggtctga gcagggatcc ctagaggtgg ggaccacagg ctgtgtgcac 411960
atgtgtttca gtctgtcagt catgtacacc taatgtctga gtccatgtgc atgcatgtgt 412020
gtccctgtat tcttttctc tctgagtgta tacatgtata cctctgtatg aaagagtatg 412080
tatgtgtaca caggataata tgttggcctt tccatatgtt ttaatatgca cacatgcata 412140

catatgcca tgtacctatg ctgtcacatg cctgcatgca ctttctgtg cctttgcatg 412200
tatgtgcctc tgtgtttgaa agggfataag tctacagtcg tatgagggtc tgcatacatg 412260
actagtagat gtgcatgtac acatgtgcac actcttccat gccacgctg gagtatgctt 412320
gcatgtcaca cccccgagc acaccgtacc ctggcagcag tggacaactc ctttatgccc 412380
ccatccctgt caccacctct gtgaactgtcc ttaaatctcc cttccctgtg tgccttctc 412440
ttttgagtg gtttgaatga gaatgacccc ataggttcat atattgaaat gctggtagaa 412500

ctgtttggga aggccttagga ggcgtggcct tgttggagga ggtgtgtcac tggggccagc 412560

cttgaaaagc ctatggcatt cccagttagc tttctctgct tcatgattgt ggatcgatat 412620

gcaaatgacc agctccgagc taatgtgaac tgetgctgcc atgccctcc ccccatgata 412680

gccatggact ctaatcctct gggaccaaga tcccaaaatt aaatgcttcc tttcataagt 412740

tgccittggc atgatgtttg atcacaacaa taaagatgta actacgacat cttttgtct 412800

ttgtttggac caggagtccc cagtagcaag tctcttgaat gacagaaaag ggcctgacct 412860

ggcctagatt tagatcctgt cttggtcttg ttttgcctgt tacaaggact tgtcttgga 412920

aagaactatg ctgtcttgtt ttgattgaaa caagcaatcg tgtctctctg aggccactct 412980

ttgttcccag aagctgagtg aggtgtagcc atagaaacc cagcatgtgc catggctcct 413040

gacacacagc ctctgcttgc agggatgatg agtacaggtg cagagcatgt atcctgtccc 413100

actggtgacc agccacagat ggctactgtg gaattttcca gcctgtatit cccaaaacaa 413160

gctcaaagat tttgtacagg tcaaattgag tttgtgtagt agggggatcc tgggaccacc 413220

cactgtggct tcccacagcc acagtcttgg catattgtca aaaggctaca cttcctgtgg 413280

gtcccacat cagccctgga gactggattt caagcatcat cttctctccc tccgtgagat 413340

ctagccagcc actcagtct gtttactagg cccccaggt atttctctcc agtctttgga 413400

actctgtggt ggcttactct tgcttccagc ttgtggcaag gtccttaaaa actctttgtg 413460

tctgtcctgt cacatccaac ctcatcaaga cctatcccat tggatattaa agctgcagca 413520

aagccgaact acttttactc tatctgttgt ctcttggctt tcatatgct gctcccattt 413580

caggtaaac ctgtccaggc ttttccactg cccattactc ctcttcatcc tttgaagccc 413640

caagggaagc acccttgaag gggcagaaac tcctattct taggattttg taaggttatg 413700

gtatggagaa ggctctcaat cagtgggcac actttctct tgaaccacca gcttcttcag 413760

ttgctgtgga gggcggacct tgggcactca gtggtctgag agattggaca gtttgactca 413820

ggcaggagcg acctcacagc cttccccagc ctcggaacca gccacaact ctcaaatgac 413880

atcagctgca gttcctccag cgtgtggatt tttctcaca gaggccattt ctctttaat 413940

cggcatttta ctgctttccg tgggactgtg ttggtcatgg agaattctga attttacagc 414000

cccctgttgt agagtgtgac attctgggct ataaagatat aatcagctct cataagagat 414060

ggtttcttca gcactcaggt ggtgggaggt tgggtggcgg cagcatgatt ggaaccctta 414120

agtatctaaa gtgactgttg caagctccgg gagccacaat tcaatcagcc tctaaaacat 414180

gaaattcaac agagagcggg aaaaagatgg cagaggacga aaatgagaaa agaaaaaacg 414240

ctcaggctgg aattgaattc tgacgtcact tgatggaagt gttgaaatga gcagtcaccc 414300
ccacccccta cacacacaca cacacacaca cacacacaca cacacacca cacatatata 414360
caccccacac actctatata caagctccct atgcacacac ccaccacac accctacaca 414420
catccctccc acaccttaca catacacaca cacacacaca cacacacaca ccctaccac 414480
acatcctgta tacacacaca ccctacacat accccaccac accctacca catabaccct 414540
acacatacac acaccataca aacaccaca taccataca tacaccctac acacacaccc 414600
tacacataca cacaccctac acacaccac atgcacaccg tacacacaca cacacacaca 414660

cacacacaca cacacacat gtgtacctc tccagctctg ctgaacagaa ccaggattgc 414720
ttcctgctgt tctgaaagaa ccaictcaaag tttcttctct ctctctgtct ctctctctgt 414780
ctgtctctct ctctctctct ctcttctctc tctctccct tctcaccgc cccatcctc 414840
cttccatgct tctgagtag ccaactgtgtg ccaggcacca ctttagggac tggaggtata 414900
aactgaaca gtcagatgtg gtcctgattt ttgggggtgg ggggtgggggt gctggggaac 414960
agggtttctc tgttagccc tggctggcct gcaactcact ctgtagagca agctgggctt 415020
gaactctcag agaactgect tctctgctt ccctagtct gggattacaa atgtgtgcca 415080

ccatgcctgc tctccccagt ctcagcttcc ctactgtta ggcaccagag ctgcttctctg 415140
cattggtccg acaattcatt tttcttgtga ccagcatgaa gtgtgacaat gaagtagtga 415200
ctgaggccaa gcaaatgcat catabcccag ttttgtttgt ttttgtttt cgaggcaggg 415260
tttctctgtg taacagtctt ggctgtcctg gaactcactt tgtagaccag gctggcctcg 415320
aactcactga gatccgctg cctctgctc tgatgtgctg ggaccaaagg tgtgcacccc 415380
cagcttcaca tcccagttct aaagagcaca gtttaattgg gcccagacac accctacaaa 415440
atctcaaac cgcagagcca cacttctgc tctccaacca ctctgctggc tgagttcct 415500

tcttgacce catcaacata aaacagcaag agacagtgag aattattgag tcataactec 415560
ttcgaggag ccatttgcta tccatctttt tggggagggt ggtcttcaa gggaccactt 415620
acagagatag agatgcctag gaggacaagg ggtctctgtg caatgtgggt agtctgctta 415680
ggcagttgcc tggcctctgc cctctgactg gacagaagat atgggcgggc agcaggaag 415740
tgtagtcaag cagaccctgg aggagactga ttgaggccac gtgctggaac aaggatcag 415800
gggcatcagt aggggtgtgg gaacttagca atgagtcacc agcacaagt agttgctcat 415860
tacgtgtgtg tgtgtgtgtg tgtgtgtgtg tgtgtgtgtg tgtgtgtgca cgtacgcgcg 415920

cccgcgatg ctgtctgtg aattttcaca tgcattggag acaggacaac tttgggtgtc 415980
ttccacagga gccaccaaga acatgggagg cagcctctgc tgcgtaccga gtaccagcc 416040
agcaaggcct aatcaagggt ggagaagaca gacctgggaa gcaggggcca gacttgaaca 416100

aggtgacaaa ggcagaatTT ctgggactTT gcctcactta acatggactg gtagaggcag 416160
 gaaggggcag gacagctgt ggttggTgtc agaccctgt agaggTgaga catcaggga 416220
 caatctagaa gctgcagacc cagtTgtgtt agaatatTTT tTTtaaggTg tgtgactTTT 416280
 gTTtatgtgT catttgtTTa actatgtgaa gctgtgattc tTtgctgtc taaaacacc 416340

 gatgctctaa taaagagtTg aagggtctaat agcaaggcag gaacaaggat aggcagggt 416400
 gccaggcaga gagaattaaa tagaaggaga gacaaggaag gtgtaggag agaacaagga 416460
 gaggagggtg tcaggggcca gtcataaaga aggaaagtaa gatgatgcag aagcaagaga 416520
 gataaaagcc cagagaggaa agatgggtta atTtaggta agaaaagctg cctagaata 416580
 agtcaagcta aggcTggcca ttcataacta atcagattcc ctgtgtgatt tattTgggag 416640
 ctgggtggca ggccctcaa aagacccaa aagagccaaa gagtaaaaa caacctcaa 416700
 cactcagtgg tctggagaga ctgggtgct gaaacagcat ggtggtctgg gaaggagcca 416760

 ccatggctgt gtcaggggc agaagctctg aagaagtaga gcaaggagac acggaagctg 416820
 ttagtggaca gaagTctgg aggaatggga cTTtatTTa gcttaggcc tctgaccgt 416880
 tcattgtcat cataattaaa gctatccatg tttacctgaa aataaataga attTggagct 416940
 ggaaagatgg cacagggga actTgtgcaa atgtggagac ctgaattctc tctccagagt 417000
 ccaggtaaag gcagcaggag aaaatgacac cacaaagtTg tctcttacc caacatgtat 417060
 gacgtggcat ttgcagcccc ctaaataatg ataataaaa tggaaataga attaaacatt 417120
 taaatctTTT tTTTgtTTT tTtgagacag ggtTtctctg tgtagctTtG gaccctatcc 417180

 tggcactcgc tctggagacc aggcTggcct cgaactcaca gagatccacc tgcctctgcc 417240
 tctgcctccc gagtgtctggg attaaaggca tgtgccacca atgcctggcc catggcaact 417300
 cttataaagg aaaaacattt aattgggggc tagcttacag tgtcagaggt tcagtccatt 417360
 atcatcacgg taggacatgg tggcgtgcag gcagataccg tgcttcagaa gtagctgaga 417420
 gctctacatc ttgcaggcag caggaagtga tctgagacac tgggtggtat cttgagcata 417480
 tgagacctca aagcctgact ctacagtgac acacttctc ccaacaggac cacaccact 417540
 ccacaagccc ataccttcta atagtgccac ttcctttaag aacctattc tgggctggag 417600

 agatggctca gaggTcaaga gcaccgactg ctcttcaga ggtcctgagt tcaattcca 417660
 gcaaccacat ggtggctcac agccatccgt tatgagatct ggttcttct tctggTgtgc 417720
 agatatacat ggaagcagaa tgtttatatac ataataata aataaaatct taaaaaaaa 417780
 gaacctattt tcttcaaac caccataagt agtcacccta aagggtTgtg cagctgcccc 417840
 taacttacag aggtgggaac tgaggtTggg gagatgaatt gcgttagctg tgaggcagat 417900
 gtgggactga gatggTcaaa tgcacacctg ccacgttcca aagcccaggc tcttgttcag 417960

tttcacagct gagaacaatg accaagtttg ggtgatatta gagggctctg agagggtcta 418020

 gacctcttgt tccaatttgc agaagcagga gctgggtccca gggctcctgg cccagccagg 418080
 tcatcccagg gaggagatgt ataaggaaga tgtcagcgca aggggccaag tccgtgctct 418140
 gcttacctg agctgcacac agtactcccc tttatctccc ctccaggctc ccacaccca 418200
 cctggcagct gggagcctaa aactgttgct cagaactggt ggccaaacc agccaccagc 418260
 aaggggctga gctctgcacc gaagaateat gtccttcate ttgtcccctg cattttacac 418320
 cacatgtaa aaatttccat taattcctca gaataaaatg tagtggctgt taattttcaa 418380
 cgctgggaa gtagccagct gaatgccttt tttatgctg aaactatfff ccactattag 418440

 gaaagtgtaa taaaagtgt cctttccttg atttatfff ttaattaagt gggaagtctt 418500
 gggcagccct gctgctggcg ctgtggcctg cagcctgcag actaaggaag tagcagagaa 418560
 aggacacaag ccagttcacc ttcccaacac tgtttccaca gccaggcccc aaccctcaga 418620
 gccagccagc agcgtggcc tggcccagat cataaagaac cctgaatcct ttttgtgttc 418680
 caagctgta ttaggtagt tgtgtttgag tgagggtgtg tgtacatgt aaggtcagag 418740
 gccagccatg ggtgtacttt ctcaagatac catttgaat ggctaagaa actccagttg 418800
 gtgctaggca tccatctggg tacctgatag ccatttgtct ctaattcaag ttctggagg 418860

 taagtccag gcaaccctga cgcttggct tccaccagg aatgtacagt tgtgacatgg 418920
 acagttgta tgacaaaacc tggttttggt tctgttaact tatgcagaca ttcaaggact 418980
 attcaagtc agaggtcact ttgacctct aatactggca aagcagaaca gctcttgtgg 419040
 ttttcacctt taaaatccct tctgctcct gcatgacaca tctctgattt gtgctagaga 419100
 ctgtggccct gctagaagtt ttaataaat ctggctaatt ataactgaa ttgagcttg 419160
 tattcccc ctcgggtgt ctcgaactcc ataacacact caacttgctt tttgagtcag 419220
 gtttctcact ggcctataac ttgctgactt ggccaggctg gctggtcaga gaccctcagg 419280

 gatctcttca tttgtcctt ccaagtttgg gattataaac tcatatcacc agggctggag 419340
 aaatagctcc acacttagca cttgtgctt gctctccccg aggactctct ttggttccca 419400
 agaccacac caggcaattc acagctgtaa ctccatatcc aagggacca attgttgg 419460
 aatattaac tgtgtaaaga tgtgctatat ttgtttatgc tggggaatat tactttatgt 419520
 gaaagtgtgt tacatttgt tctgtaaca tttgtttttg ttacatttgt ttctgttaac 419580
 aatgaaaaga tigtttatat ttgtttgtgt tgtatttgt taattatgaa aagatgaatt 419640
 ccatttgttt catcttgctt gcctaaggca tgtgattgat ttaagataaa agctgaatgg 419700

ccagtaccta ggcaggagat ggataggcag ggctgacagg caaagaaaat taggaggaga 419760
 aatttcagct ggagaaaaga ggagaaaaga acaagggaga aagagaggga catgtctggg 419820
 gccagaagcc aggtggccac cagccagcca gacacgggaa gcagtgaaag ttacaagtga 419880
 aagtaagata cactgagaaa agaaaggtaa aacgccccag gcaaaactta gatgaagaga 419940
 aacagggtaa gttctaagag atagtggggc aagcataagg ctgagcattc ataactagta 420000
 agtctctggg tcatgatttg ggagctgggt ggtggcccaa aagaaagcct gttatattca 420060
 gtgcctctt ctggcttctg tgggtaccct agcccagcat ccgcacacag gcacacacag 420120

 agaataataa aaataaatca gggaggagaa caaacagtta agagcacata ctagtcttgc 420180
 acaggacccc atgtcgtaca gctcacaacc acctctaact ccagctctag ggagatccta 420240
 tgcttctgac ctctgtgtgt ggctgctctc ccgtgtctgc atacacacac acacacacac 420300
 acacacacac acacacacac acacagagct taaaacaata aaaaattaat ctttaaaaaa 420360
 tgtcataggt ttgctgagtg ttgtggcatt ccaaggagag gctctgagag ttccaggaca 420420
 gccaaaggcta tgtaaagaga ccctgtctgt ctcaaaaaac aaatcaaac aaacaacaa 420480
 aaaacaccac taccacaacg acaaaaaaca aaacacaaaa cctccaaaac aaaaccaacc 420540

 aaacaacaa acaaaaaaa aatccacaaa aacaatagga ggctggagt acagctcagc 420600
 agttaagagc tctgactgct cttctggaga atctgggttc aacctccagg gagtctcaga 420660
 gccacttgta gctctagtc cagggateca gtgccctctt ctggcctctg caggcactgc 420720
 acacagttag tacacaggt tacatgcaga caaaatacat ataaaaata aggttaaaaa 420780
 atattcaaaa taaataatc ataaaaata aatctaaacc ggggtttggt gatgtacctc 420840
 attaatccca gcaactcagtt ggcagaggca ggcagatctc tgagttcaag tccagcctgg 420900
 tctacagagt aaaaccctgg ctacacagag aaaccctgtc tcaaaacaaa acaacaaaa 420960

 accaaataaa cagaaaacaa aacaaaaagg caaaaatgta cgctagaatg agcacctaaa 421020
 caaaaagaca gcagcaacaa caaaaattat ttactaact aaatcatctc cccagctcca 421080
 gagcctcaaa cctttgaaca agttctctct actgggctgg agagatggct cagtggttaa 421140
 gagcactage tgttcttcca gaggaccag gttcaattcc cagcattcac atggcagctt 421200
 acaactgtct gtaattgcag ttccagggtta ccgacacctt catacagata tatatgaagg 421260
 cataacacca atgttataat aataaagaaa gaaagaagtt ctctctgctc tctgggcctc 421320
 ttgattgcct caictctgag cateccagga ttgttaatca atgcactgaa tgagtaaagg 421380

 aatatgggtg ctggctctca gtagccatca ggaacaatga agacaaggga tgtagcata 421440
 aagggggtct ttttttttt tttttttgag acagggtttc tctgtgtagc tttggagcct 421500
 atcctggcac ttgctctgga gaccaggctg gcctcgaatt cacagagatc cgactgcttc 421560

tgcctcccgg gtgctgggat aaaaggcgtg cgccaccaat gcctggccat aaaggggttc 421620
 ttttaagctag tctgggggtga caagcagaca gaagggatgt gccaggtgaa ggctgaactg 421680
 gatgagattt accggacctt gtcatggaaa gaggacagaa gagcagagtc tgatggccgt 421740
 cagtcacagt gcccagtgac catttgtgga tgaggttagt gtcaatagtt ggtgacacta 421800

 aaggaggaca cccttgggta tatgggatca ctctttccta ctgagcctga ctcatacatg 421860
 gaaggaagat ggaaggcagg ggactctggt ggtctgtgtc cctgcgttct tgttctgatg 421920
 aatttctgtg tggtagggcat gtccagtgag tgccttggg tcatgtgggc catatcacc 421980
 aggtggagat tttatttgc aagggtttca tccagcgtct accaggaag aactccca 422040
 ctaactagag tgiccaccta gagggggatc tcagagtca gggcttctgg cttcttctg 422100
 ttcccttacc tctgcctcca gtctgggacc ctggtcagct atctcttca taaaggggat 422160
 cggctattct tgtcaggaca tgcacgttcc aaggtttatg aaagtcacat ctgtgccagt 422220

 gtgaccttgt ttctggaaa tcccaggcc acggtgcagc acaccattaa gtgacacaaa 422280
 gtgttagccc tgctatcatt aacctcacat ctttgacaca aacctgtc acagccctgc 422340
 tgcctcagag ctaccctcc actcttccc ctctttccaa tgtgctgtat gactctaggt 422400
 ttctacagtc aaaccaagg agctgaagac ggagctgagt ggtagatggt aaagctgtgg 422460
 cctccatttg ctcatgtgcc tgccttcca gggctcctag ctatgttga agaaactccc 422520
 tttattttt tagaatggca acatcatct ctgaatgtct ctgctattat tttattgat 422580
 ctctctaggt ttctttatgg ccagaataa ggaatccaat ttgattaggg actgatttgg 422640

 cctccaaggt aagaagcadc aatacaacag ctgagaatca agcagatgcc aatttggta 422700
 gagttgatta gacgcattta gggtaggtacc atggcccacc catgccttcc aacctccct 422760
 tccagctgtc agctgcccc tcccttccct gctgactccc agtggggact agtaaaaaga 422820
 gaaacacaag gtctgcca gtttgggagc aatttacctg tgggtcaac ccagacactc 422880
 ccatcctcta ggggggtgtg aagagatgtt tatatgctaa ttttggagtc ataccaactt 422940
 gagttcaggt ctttccaca agccccagg aaaggtcatt taccttctaa gcctctatc 423000
 cctcatctgt taaattcgt aattatttg gaaacctag gggctgggga atccacctca 423060

 gttgtagaa tgcttatcta gctcactta acccaatac caactctgag cctttaatcc 423120
 caggttagca gaggcaggca gatctctgag ttccaagcca gcctggtcta cagagtgagg 423180
 tccaggacag ccagggccac acaataaac cctgtctgga accctcactg cctcccatac 423240
 agagtcacct ctgccttcca gagccctgaa accaatgtcc cgtgtcttcc aacagcctgc 423300
 tgcttcttt gtggctcaac tatttcatag agtcccacag ccctaattct acaaaacaac 423360
 aatggacaga aactgactta gaactaccag tgtctacat tttacagtc actcatcact 423420

gttaaaaaaa aaatgttgcc atttttaaaa ttgttaattg gttattgatt aaccaatgag 423480

 ttgctggct ggctttggtc aggtgatcat ttctagcctt acatctctgg tctcattccc 423540
 acctcaacac ttggtctgca acctcgtgta cttcttacct gatctcctga tccatgctac 423600
 agaggggctg ggcaggggct gtcagcccca tccaccaggg ttgattcat ttggcccag 423660
 ggaacaatgg ttggtgatg cagctcaggc aacagaggag atgtctacta ttcacccctt 423720
 gttaaatfff aaagactfff gtaaagctct ctctctctct ctctctctct ctttctctct 423780
 ctctctctct ttctgtgtgt gtgtgtgtgt gtgtgtgtac caagcaggca aggtcttgtt 423840
 ttgtattctt agctggcctg gaacgtacta tntagaccga gatagccttg aatgcacaga 423900

 gttctgactg tactgccctt cctcttgaat gctgggatta agggcattta ccaaacctct 423960
 ggaattatff tttatfffta attatgtgta ttgtatgag ggtgtggcat gtgccttgaa 424020
 gtacctgtgg gggctcagagg aaggcaccag atctcctgga gctggagtta caatcacttg 424080
 tgagcagcca gactgtgggt gctggagacc aaactccagt cctttggaag agctgcaagc 424140
 actgctgttc ccatcattca ttcttttgg atgtctgtct aggaatggag ctgttagatg 424200
 gtaaggcagg tgcacactcg tcacctatat attcttttac ctctttatac tattgttgtt 424260
 caaggctagc ctctgagctc aacttctacc atcttcaggc ctgctcaaaa agatcctcac 424320

 aactaggcct gttgactgct tatctccccc agatggggg agtatccacc catcccttat 424380
 aattcatcct aatgtcacat gtcttcaggc aggggctaga ggatttactt gaaaaaggat 424440
 gagcggaggg gggttgatcc ctactgtgtg ctgacctcca agaatggcta ctctaaggtc 424500
 acctatgctc ctacacataa ctccctcacac agtgctctgt aaataaggct agtgacatca 424560
 ttggttctcc caggggtgga ttgaagctta gttatactt gggaccttct gagaaaggta 424620
 gacattgttt ttctctccct agtgaaggca ttttagtaac aagtgttttt ctctctccct 424680
 agactetaag ttctccaaag gtaggaacaa acctgttgtt cacagttata ctccctgcat 424740

 attcatagca tattacctgg aacatagtag gtgctcaata agtatttttt gaggggtggg 424800
 aatgtaattc agtggtagac cacttgctct gtgtgcacaa tacactgggt tccatcccaa 424860
 gtgtgtgtgt gtgtgtgtgt gtgtgtgtgt gtgtgtgtgt gtgtgtgtgt gtgtgttggg 424920
 gcacattgaa aaaaaaaaa caagaacaaa cccaagctgc tttcagttca aagagagttg 424980
 tgacaactcc aggacaagc ccaggacctc ccacagcccc cctgcctat ctactgagac 425040
 aaaagcccag ctgactcata aagagccagc agttcaaggg ctgcttgatt tcagcatccc 425100
 ctgtttcttt gaagaaagag catccccctc tcctctctt ggtctgcatt gtcacagctt 425160

gaaatattct tttgattatg agaacatttc ccattaagtg tgtgattcca gctcctcccc 425220
 acccccaccc cccagtatTT atgaccccat aactccaggg tctgtcacia ctggttctgc 425280
 aaaagtgtat ctgagtgtaa tgaataaatt ccatgaaaat catggtgaga ggctgtcggg 425340
 ttccccgcc ttatgagcaa gccatcaggg gatggggtat ataatcaca gcctccctta 425400
 attaagtaaa acattttaag gaaaaaaaaac caaattaatt accacttcat ggcaccaccc 425460
 cagcagatta cgcaaatggt tcacattcca taaacctga ctgaatttag aactaattgt 425520
 tgctctttgg gtttgtttat gctttccac aactgaaga tctgtttcca aagtggtagt 425580

 tcgggaaggc tctccatcc aaaatgatgt aagtgtcat aaaatcaaga atcatggttt 425640
 tctttttctt ttttttttt aaattgttgt tgtgttatgc aagctgaaaa cacaggctgt 425700
 tgagcatgt aattgaagta tccacacctt tgggtgtgggg ccttggcttg gccaaagtcc 425760
 tgagtctgt gtgagttga acaggaaccg ggtgtctctg tttttttcca gtcactggta 425820
 atgcacaggt cactatgcag gcagcctctg ggctgtcca acaggagggt atggtcacct 425880
 ctcaacttc tacagtctaa tctgatggc cgttttttt ttttttttt ttttttttt 425940
 ttttttttt ttttaatga gttagggtt gaactcaggg cttcctgaat tctggacaag 426000

 ccctctgctg catgccagc cctatagcaa tcattctga actcttttt tcaagctaaa 426060
 ttttaaaaat agatggctct agtgactcct ggatgttggg atctagttg gcagtgtgg 426120
 gtctaaaga gtagccaaat gccaaagata ctgagtgtaa tactgtcatt gagttttcac 426180
 aaaaaattag ggataattta gctctccagt ggggtttcag ccagagcagg gatgagtctc 426240
 aataggaagg gtctggccac attccttctt gaggacctt caggccttag aatgctgctt 426300
 aattccacct cctgggtttc aggagctga gtgctttcta aggatcagtg gccatttgtt 426360
 tctgtttggc tctgcccgg actctctta gatttcaagg ctgaggcaag agcctatgag 426420

 ctgctccctc caagttatct gagaggttgg ggtgggtggct attcttgggt gccaaactga 426480
 ttacatctgg aattaacaaa actcaagcag ctgggtacac ctgtgagga ttttttttt 426540
 tttcttttgt gggggagctt gaggcaggtt ttctctgtgt agctctggct gtctagaaa 426600
 tcactgtgta gaccagctg gcttccaact cagagatctg tctgcctctg tttccagagt 426660
 gctgggatta aaggcgtgca ccaccacaa acagcaggat tttttctta attaaataat 426720
 ttgaagtggg aggatccatt cttttcttt ctttctttt ttttctttc ttttttttt 426780
 tgcttgtttg tgttttgtt tttgagacag ggtttcactg tgtaacagcg tggcttctt 426840

 ggaactcact gtggagacca ggctggcctt gaactctgcc tcccagtgct taggattaaa 426900
 tgtgttcate agcaccaact gtctgggaag acccattct aatctggatc ttttgaggtt 426960
 gattcacctt tagtctgggc cacacttct gctggcatct tataaaagg acatggaaaa 427020

aggaaacttg ctctctttgc cagcttcttc tcaactggcaa gtccattcct tcaactggcat 427080
gagagcctgc ttctttggaa ttctgatgta tactaaagtc catctgagac atccagcctt 427140
gtggacagaa caactactgg attcttagac ctctctgttg tagacagctg tcttagtggt 427200
tctattgctg tgaagacaca ccacaaccaa ggcaactttt ttttaaga tttatttat 427260

tattatgtat acaacattct gcttccatgt atatctgcac accagaagag gacaccagat 427320
ctcataacgg atggttgtga gccaccatgt ggttgctggg aattgaactc aggacctctg 427380
gaagagcagt cagtgcctt aacctctgag tcatctctcc agccccaag gcaactctta 427440
taaagaaaa catttaattg gggctggctt acagtttcag aggtttggtt cattatcatc 427500
atagggggac atggtggcat gcaggcagac atgctgctgg agaaggagt ttacatcttg 427560
atccgcaggc agcagaagga gagatggagt actgggcata gcttgagcat atatgagatc 427620
tcaaagcca cccatgtagt gacatacttc ctccaacaag gccacatcta ctccaaaaga 427680

ccacacctct tcatagtcc actccctatg ggtaagcat tcaacatat gaatctatgg 427740
gggcatatc tattcaaacc accacaacag ccattgttag accggctgga ccacagccta 427800
taagccattc tgataaatcc cgtgtgtgtg tgtgtgtgtg tgtgtgtgtg tgtgtgtgtg 427860
tgtgtgatg tgiattcatt aattctgctc ctctagagaa gcctgactaa tagaggagga 427920
gtggctctgga taccatcttt gggatgtcag caagtaaagt gagtacctag catgagacta 427980
tccatttgaa atatctctt gtatatntag aaaacctaag taatataagt ctgactatt 428040
atagtgact atctataatc tttatttatt tatacattaa aatttaagta agctgtataa 428100

acacaatacc taacaaaaa tagaaatata aaaaattga ccttaaactt gtaacaataa 428160
acaaaaacct ataccaacgc aaagtattca ttctatatc atattccctt ttttctctt 428220
agaaagtgat tgacttgtga tcatgacca ttataacca actccgttta aatgaaaaca 428280
aacatttata aataataatt aggaatttgg ccatagtctt cttcaaatg tttctgctg 428340
ttttggggg ttgtcaatcc ccaggggatc ctgagaaatc ccagaacat ggccaaatcc 428400
tgtctgaaat agtctgtgag actacatctt ctgagctgtt ttgaatgttg gatcaccagg 428460
gccattgctt caggggatct tgtttagaag ggatccaagc ttcttatctt ctgtggaac 428520

aaaagcagaa cttttttcc aaagtaacat gcttttagta acatgtctta aattttgaag 428580
tcaagtggtt ttcaaatat atagttgga ttaaccagc agcattgata atcaaatgct 428640
tttcagcagc tattgttctt tctcagcag tcaacaatt caaagccaac acaatagcat 428700
acagtatcca gactctcctg gtattttcca tctttatag actttttatt actcaatttc 428760
tttcattttc atttatttat ttgcttgttt tgagacaggg tttctctgtg aaacagtctt 428820
ggctgtcctg gaactcactc tgtagaccaa actagtcttg aatcatagt gatccacctg 428880

cctctgcctt ctgagtctg ggattaaagg tgtgtaccac catgcccagc tattataatt 428940

 ctttcttaag gactttctct atccttttcc ttttctctcc caagactatg tatattttta 429000
 aacacactgt aaaccgttta gagggttttt tcctctggat ctgttggttac tgaatatctc 429060
 tatttttttt tttttttgac cacatgagtc tttattctac taaactgcaa actgcccagc 429120
 tagcacagt ggtagagcat gagactctta atctcagggt tgtgagttta agccccacgt 429180
 tgggtgccac atgtaggcag aggtttctgt cccgcctggt cccacaacta tttaatcaca 429240
 aataaacaca tggaggcttt tttttgtttt ttggtgtttt gagacagggt ttctctgtgg 429300
 ctttgagggc tgcctggaa ctagcttttg tagaccaggc tcgtctccaa ctcacagaga 429360

 tctgcttgcc tcigcctcca gagagctggg attaaaggca tgtgccacca gcgcccggcc 429420
 acacggagge ttatattgat tataaactgt ttggctgatg actcaggctt ctcatggct 429480
 atctcttaat tattaacca tttctattaa tctgtgtatc tccacatggt ctggtcttac 429540
 cgggtattcc tgggtctttt gcttctcag cagctactg gtgtctccct gactctgctt 429600
 actaccttc tetatccctg tttggatttc ctgctgggtt aaattctgcc tgtgaattgg 429660
 ccaaaagcag ctttattcat caaccaataa gaagaaaaac atatatccac agtacacaga 429720
 aagacacccc catcattgag gactgagcag gaccaagtac caatggcctg aacttcaatt 429780

 ttagctctgt ccataaact gcaaccttag actgatgtca ttctcttgcc ttaattttct 429840
 ctgtacagt aaagtagctt ttttgagac tgagatggat ctatacatta atgtttatgg 429900
 cataaagtga ggactcattg tctccatcac cactgtcatc actgccatca tccataatac 429960
 acagagaaac tgaggaccag aaaggtaca ggatgacca gaggtaacaca gtaagccata 430020
 tgggtacagg gaccagaagg acagctgtgt taccacttg catagctggc tggcatcctg 430080
 cccaatgtt cagttacagg atgaggaaca gagcaggaca gatgatctgg ggcatttgcc 430140
 tcctgtccct gtaactctc tctgtctctg ttcatctttt taggggtcca gtcaggacct 430200

 ctttctttt ttggaaagac actcctggat tcctgatgtt aggatatata tctcctcacc 430260
 attttcaat gtcacctgtt ctttcttgta ccctagatac ttgccatata tgaagccacc 430320
 tggatgattg tgacaccccc cccccacaca cacacactgc tgcttgcccc ctctactctc 430380
 tggggaatt gttctaaagc acagatctct acttaaaccc accaaggtgt aactggatca 430440
 ggaaaatgtt atatgatag aatggaacat tatccaagct ttaaaaggga aagctggggc 430500
 agagagacag ctcagtgggt aaaggtgctt tcattaagtc cagtacactg agttcagtcc 430560
 tgactcttac atggtggaag gaaaatgact ctcaaatgtt gtcctctgac cgccacatgt 430620

gcatcatggt acatgcactc atggatcctt agagagagag agagggagag aggaagagag 430680
agagagagag agagagagag cttgcttcac tggacaatth tgaggattac atgttactgc 430740
ttgcataaaa agtattacc ccatgcactg gagtccgtat cccacttgg tagtggtttt 430800
atthgtttgt ttgttttggt agcaagttct cactatgtca ctctgactaa cctggaactc 430860
attatgtaga ccaggctaac cttgaactct cggagatthg cctgcctgtg cttttttgag 430920
aggthtagag atthtaggag gttgcaggtc accaggggtg tgtttggtcc tgggtccctg 430980
cctctctttc agcttccagt ccaccataat gtaaagaaac tccttttcca agaaccagat 431040

cacacacact ctcccaaag ccttccctta gtcctgtcc tectgggagc acgatgccag 431100
agcatgtacc cctgtgcccc caccacttcc ttccggatag cthaatgggg ttcactatgt 431160
gcagatgagt gtgccaaca aactccagtc accgggatct tgatgaatca ccatgatggt 431220
cctgcaccgt ctgcatttcg caaatgtgga atcgaggctc agaacaggag tatatcacat 431280
aactagtaag ttgtgtcccc aagacttaaa cattctgaat tccagagaaa aacttctgac 431340
aacttgttac agtcagctth ctgtgactat aacaaatgcc ttgatgaat caaccagaa 431400
aaaggaaggt ttgttctgct tcacagttgt agaggtttca atcaatgata aactggcccc 431460

atgtttttgg gctgtggtgg tacagtccat cacaacaaga atgtgtggca caggggtca 431520
ttcacttate tcacagtaga ctataaagag aggaaaaagt cagagttcca ttatccctt 431580
taagtcatg ccccatgtc cccagtggct ccaaatgtcc cactagaacc acccttaaa 431640
catttcatca ctctactt tggaatttaa caaattaatc tttgaggac atatatcaa 431700
atcagaggac catttgattc tgttcccaa cccccctgg accatcacac cacctatcta 431760
tcatttctct tcactccct ccagtcccag tgaggggagg gctgtggttt agccatccca 431820
gagcttggca cagagcaggt gctcattttg ctgacttttg tctgtgccc tgcagtgagc 431880

cactatacac acgcaatgct ctaattctgc ttccgcaact atttccctc caggaattgg 431940
caggttggca attgccaaag aaacatcttc agccaatcaa taaataataa tgttgagaa 432000
tttaaaataa gaatctggat tattaagtt acaaatctth ggtctttatg cttcaataa 432060
aacatgcatc tattaataat gaatactggc tcgggcctgc ttaggctgaa aaggggagga 432120
aaaaaatgac cagtcaaaag atgctaata ttttctttt taccagctt ggttgccaag 432180
cactgtctc catgacaat tgttcgcat ttgaaaggt taaaagttt aacagcacia 432240
aagggaaatt ggagaccaa tgtttagcct tgtaacctt catggtctth chtaagttt 432300

tccgtccat ggactcgtc tcctggttt ctctcttaga cccagtagc cccttctct 432360
gtttactctt ttttccctc cagcttctt ctctctctc cteacctcc acctgacctc 432420
atccactcct agtattgaag agtctaggt ccatccccag cactgtgtgg tggtcacaaa 432480

cctgtaaggc cagcacttgg gaggtggagg cagaggacca gaacttaacg tcgtcctcaa 432540
 ctaactagtgt gtgagttcaa agccaccctg ggctacatga gaatcaatca gtcccaatct 432600
 ctgtctctct ctgtctctct ctgtctctgt ctctgtctct cctctcccct tctgtgtgtg 432660
 tgtgtgtgtg tigtgtgtg tgtgtgtgt tgtgtgtgt tgggtgcct ctctttctgt 432720

 gtgtgtggtg tgtatgtgtg tgtggtgtgt gtggtgtgtg tgggtgtgtgt gtgtctctct 432780
 gtgtgtgtgt ggtgtgtgtg tgagtgtgtgt gtgtgtgtgg gtgtctctgt gtgtgtgtgt 432840
 gtgtgtctct ttctgtgtgt atgtggtgtg tgtgtgagtgt tgtgtgtgtg gggatctgt 432900
 gtgtgtgtgt ggtgtctctg tgtgtgtgtg tgtctctctc tctttctgtg tgtgtggtgt 432960
 ctctctctct ttttctgtgt atgtgtgtgt gtgtgtgtgt gtgtgtcttt ctgtgagtgt 433020
 gtgtgtgtgt gtgggtgtgt gtgtgtgtgt gtgctcgac atgctgggag atagctaagt 433080
 tggtaaagtg cctacatcac gagcatgagg atttgagttc agatgccag cactcatgtg 433140

 ctggtttggt catgcacagc tgtaatccta gcattgaggg gtagagacag gaagattttc 433200
 agaatcggtc taaccagtca ggaagtgtt ggttcagtga gagagcttgt cttagagaga 433260
 cgggtggagag ggatctgata ttgacctctc acctccacat gcacgtgtat aatgtgcctt 433320
 caccgtata tacacagtca cacacacaca cacacagtca cacacacaga gtcatacaca 433380
 cacagagtca cacacacaga gtcacacaca cacagtca cacacacagg ccgttacaca 433440
 gtcacacata catacacaca caggcacaca gtcacacaca cacacacaca caggcacaca 433500
 tacacacaca cacagtca cagtcacaca cacacacaca cagtcacaca cacacagtct 433560

 cacacacaca gagtcaaca cacacagtca cacacacaca cacagttaca cagtcacaca 433620
 tacatacaca cacagtca cagtcacaca cacacatgaa ggaaaaagaa tggagggtgc 433680
 aggacttga ttttaggac ctgaaggcat atgtgtgtta gcaaggcaga aactttctgc 433740
 tgtcattagt tccatctct tggtaagtca catacagttt atgtgccttc tggtttgttg 433800
 atgttctagt aggacaacac ttaaccacag tagcaccaca ctaagtggtt ggccagtgtg 433860
 attcatcgga agggactgtg agtgaagaca gacaaatggt ttcttctcac ttacagtat 433920
 ttcagcacag ccaactgacc ttcttccttt atgcccata ttttgacgt gagtccttc 433980

 ttagcagcac cacaaagtct acatgagatg aagggggttt cattctgaat gtagcaatca 434040
 aagcatgtca ctttctagt acttgccagt gacatccatt tgcagacat tctgaaaatc 434100
 tttacgtgtc tttttcttt ttaaaaatct ctgtgtgttg tctgtgagta tgtgtgagtg 434160
 caggcttga ccgtgctccg tgagtggagg tcagggcac tgggtgcca gtccttgccc 434220
 cccaccttac tagagacagt ctctgtctgt gcttgcctggc ttgctgtctt ctggagtttc 434280
 tccacttccc agatcccagc gggagtgtg gagattcaaa ctctggtcct cacacttgaa 434340

gggcaaccct tcacacactg agccatttcc ccagccccaa ccttcacact ttctgtagta 434400

 accaaagact ccatctgcag catgatgaca atcatttttt ttcctgtaa attgttttgt 434460
 gatttggaaa ggccttttat tttttgttga gacaggatct tgcatgttaa cttaaactgg 434520
 cctcaaactc aciatgcagg acagtctagc tttaaatag taatcctcct gcctcagctt 434580
 cttgagttct tggattacag ctgtgtggca tctgcctga ctcaaacac agtcaaatg 434640
 ctgtggagcc tggtaagagg cctctcagac atgagggtat gtatttgaac gaagctataa 434700
 aaccctatcc ctctcctt gtcaagtcta ctctagaag ttcttctaca gctagaatg 434760
 ccatagtctg atgagagatg ctggcatcga agagctgacc ctgcctggag aaccagggaa 434820

 caaggtagaa gtgcatgga gcttgctggg ccttaagaag aggaataggg gaaaagagaa 434880
 caaatgccgg ttccacatg ggaagcggca ggtactcgtt ctagcataca ttttactttt 434940
 taaaattgtc tctttttttt tgttttatct tctctttcc cacaccteta cattcacaaa 435000
 cacactgaat aaccattagg attcttgcct gcaagtgaca gaaaactcgc cttcatgagg 435060
 ctgaaagcat aggagtcca gcgtttgagt cattaaaatg tctgaaacct cactcaaacg 435120
 ttcagaccca gggacggaac aatggtgcca taacacggcc tttctccgag actaaggtct 435180
 tagcctgctc actccatggg acagaggagg ctgctgtcag caccaggtct gccatctcaa 435240

 tgcagttaat ggatttcggt agagttgcag tcggattctt tgtaaagcat ccagtccagc 435300
 aactacgagg aagcagttct cttgcagaaa gtagggcaga taaatgggcc gttagccaca 435360
 gaaactgcac atgtctgttt ccatggagta gatgccagga agatgtaagc tttgaggatt 435420
 gaagagcccc caggaaggat agaacttgag cccaagacg caagatgggg aaggcctgag 435480
 aaacacagag ctcagaagtc acccagccct ttactaggc aaatgaagtc atgtagacca 435540
 gaaaagggcc ctgtccagg tcaactaa ctgaatcaga gtttagattc gaacacaggt 435600
 gatgtgaagg ccagaacaa gctctgtgga cctggcagct gccacattca ttagctccct 435660

 cctatctgct tgittcccag tatatttta caaggctgtt aattactagc cataaagctc 435720
 ggcaaacatt ttgataggct taaaagctc atgaaaacca cattacattt taaggcatgg 435780
 ttccctaatt aaccaatta gctgicagac tcatatcctg ctggtttcca gatgaggcga 435840
 gcctgcctc tcatcccca atccagcccc atggacagg gcctggagtg ttctgtcaa 435900
 gatctctctg cagtacaaag acactggctt agagatgccc gtgcaaacia gtggtgctg 435960
 gccagcttag cttaggacca aggctaaggt ataggcacaat gggggcttcc ccagtgatgc 436020
 tgccatccct gtctcattc atagccttgg ccattttgtc atgcttcct caacagctga 436080

tagacacaga cggacacctg accccaaata gctcagttct gaacctgac atagctcaaa 436140
gacatgggcc aacttgaggc aactcaggag ggagacaagg gaagcaggtg tgatgtatta 436200
atctcttagg gctgccatca caacagcctg gagggcttca aggcaggaac atattgctta 436260
cagctttgga gactagaagt ctaaggtgct ggtagggtgt cgcctgacat ttcttgcctt 436320
cagctttgta atggctacce attcctctct cttattctca atacctctc tggccatgta 436380
ttttatggct atcagcactg ctgaatgtca agtctaaggt tcaaagttag accctttaa 436440
taaggaccta aaagttagaa gtctttcagg aaacttggac ttgggttata aattgtactc 436500

ttaaacttaa atgctcgctt cttgagttct tactatacaa tttcttagat ttttgcctt 436560
ataggagcag gatgttctcg gtagagtctg gggtcagaga ggagtagatg aggcaacaga 436620
gatgccaatt acatatgggc ttgtgccagg tgatgggaga taccttaaca ccaggactgg 436680
agggatggct ccagcagtca agagctcttg gtggctcttc ctgaggaccc aggttctatt 436740
cccagcaacc acatggcagc tcacaattgt ctgcaactcc agttctagaa aatgatgcc 436800
tcttctggcc tccacacgtg tggtcagac atgcaggcag gcagaacgct cacacacatt 436860
aaataaaaac aaatgaacat gaccaccagc attccagccc cagggtcaag gataaagaat 436920

aacatgattt tataataaag atggcatatt agttactttt ctcatcacta tgacaaaata 436980
caccacacag gcgagtttag acttatcttg gctcacagtt tgaggagaca gatttcatct 437040
ggaagttgag gcagccaggc acactgcctc cacagcagga agcagagtaa gatgaacact 437100
ggtgctcaag tgctcagccc ctttctctt ctttttattt ctctttctc tctgaggtc 437160
tcagccaatg gagcagtgcc accctcattt aagatgggtc ttctgtctg gattagcatg 437220
atctagataa tcctcttgg aagtttgtct cctaaataat cctagatctt gtcaagtga 437280
ccgatggtga ctgtgaccac aatcacacca tctctatct acagaaaaga caacttact 437340

ctccactggg ctgagtgtga agtccaagaa taacatcaga ctcagtggc agactgggag 437400
cagctgggaa atgtcctatt tgggtcaggg caggctatct ggtagtgagg ttgagaacac 437460
tgtaaggagg tcagaagcca tctgggggtt aggcctatgt gggaaagggc tagttctggt 437520
gcccagatgc ccacaggact gagcaggacc atccttcag tggttccat ccagtccca 437580
tctatttgac atacctgatg tatttcaatg gatgcctcaa cactgcaaat ctgagcctg 437640
cctcttctc gtccactcac cttcgagaac ctaatgagtt tgcctaggtt aaaatgttt 437700
attgaagccc agtgatggtg gtatcactga gggaataaat cctaaactaa taaaagtga 437760

gigtfaatca aaatagcaat taatctctgt tgtggagaat aagaaaaatg aacaagccat 437820
gtttgaata tttattagcg agaaagacgg gacagatgca tttgttctga atgggtgttg 437880
cttgggtttt tgggttgtgt ttttgtttt gtttctgcc tctgtggtgt gtgtgtcagt 437940

ctgtgtgtgt ctgtaggcac acatgtgcac acttttcagg tgcacaaatg tgtacaggta 438000
 catgtgtgtg tttgtgtata tgtgtgtgta cttttgtgtg aagtcagagg tcaaacttgg 438060
 gtattattcc tccagaacca tccttatttt ttttgagaca gggctctctaa ctagcctaaa 438120
 gtttgcccag tagactagge tgtctgggtca tcaagcccca gggatctgcc tgtctccctg 438180

 gaactagaat tacaagtgtg tttctccaca ttcagctttt tttttttttt taatgtgggt 438240
 tctgggggtt gaacacttta ccaatagact gagctatctc cctagtccce tgctccattc 438300
 ttaaatagag gcggagtaga ccgagggatg actctagagc atacagggtt caagacatat 438360
 gatctgaagt taaaaggcct tgtcaattcc taggaattat gggttttccc ctacaaatgc 438420
 tagatcactc ctgcgtatag cagtactttc tccttgggac caccagctta taaataatga 438480
 cacagagact tcttattaat tataaaagct caacctagcc aggcgttggg gacgcacacc 438540
 tttaatccca gcaactcgaga ggcaaggca ggcagatctc tgtgacctcg aggccagcct 438600

 ggtctccaga gcgagtcca ggataggctc caaagttaca cagagaaacc ctgtcttgaa 438660
 aaacaaaaaa agaaaaagaa aaaagaaaag ctcagtctat agcttaggct tgttctaac 438720
 tagctcttat tacttaaat aacctatta tattaatcta cgtcctgcca tatggcgtaa 438780
 cctctcttcc atcttgacc tctgttttc tctctgtgc tcttggcttc cctgcacac 438840
 ctagattcct cctcctctc ctttctctcc cgggaaatct cacctatacc tctgcctag 438900
 ctattggcca ttcagctttt tagtaaatga atcagagaaa tataccttca cataatgtac 438960
 aaatatctca caatatacc tgtatagatg gaagttttgg tcccactgg tcccacagtc 439020

 gttcagtccc aaataaacac tcagaggcta tattaattat aaactgtttg gctgaatgct 439080
 caggcttctt attggctagc tctctcttaa ctatgaacc atttctatc atctgtgtat 439140
 ctctactggt tcttggcttc ctagtgttag tgatgtccag acctctggtt ccttggcage 439200
 tacatggtat ctcctggct ctgcctacta cttttctat cctgttttg atttccacc 439260
 tggctaaatc ctgcctgtcc attggcagaa acagctttat tcatcaatca attaggaac 439320
 catattcaca gcacacagaa ggacatcccc atcacacctg caggaaacac ccaccaggca 439380
 cctaagggtg gcacctggaa ggcaagggtc cagagttttg tttccaagg gtggaacatt 439440

 gcttctgaag atggccaccg acaattctc atgtccctag atacacttgc catttctct 439500
 cctcagatc tgagctggcc ttgtggatgg ctgagctgta agaagccaag aagcatctac 439560
 tctctggcag ccctgagcca ctggaaggaa gtgctgcaga ataggacca tggaggccac 439620
 cctccctcat actgtagcca cctcttccga aggctatcaa ggagaggggc aggtgaaggg 439680
 aacatagcag gacaataata caagttgaag gctgaagtig gagactgagt gtcttgggtg 439740
 ggcaggggct gtccaacatg tggcatgttg ttgattttgt cctggggatg aacctatggt 439800

cttgtgatg ttaggcaact accccactaa gctatatccc cagatctgtg ttttccattt 439860

tgagacagga gttaccaaat tgcccagact ggccttaaac ttaccctgta gcccacatag 439920

gccttaacte atgatectct tgctttaacc tcacaagcaa tgtgtttata ggcatgcacc 439980

atcaagcctt atatgtgcct tgggatgtag tttagtgggt agaatgtttg ctactttaa 440040

tatgtcaaaa acaaacggct ccaggtcaga ctccagaagt ttgaaccagc ccagttaagt 440100

cacgctgaac agggtttctt tcttgtctct cacagtttct cttccagctg tagggcttgc 440160

aagtataac aatagagtaa cattagacat ggaaaatag tatgaatgtg tggtagacaga 440220

tacaagaatg ctctggtagc tttgtttgtg atgtggtgtt atgttgaaaa gggctaagtg 440280

gtaagagca ctigccgttc ttgcagagga cctgggtttg attcccagca cctacatggc 440340

agctcacaac catctgcaat tccagttcca ggggatctga tgcctcttc tgacctctgt 440400

gggcaccagg catgcacaag tggtagcagc agacaagcag gcaaaact catgcacata 440460

aaataaatta aatttaaaaa aaataagaaa ctggaaagag gttgaggatg tggcacagtg 440520

gtagaccatt tgctgtcac acacagatcc agggctacag cccaacacc aacactaagt 440580

gggaaggaa tttggaatgaa tctacacatc aagcaacagg aaaacggtcc acatatgatg 440640

ggggtcctta tcataaaaagt aaagaagtgc cgggcgttgg tggcgcacgc ctttaatccc 440700

agcactcagg aggcagaggc aggcggatct ctgtgagttc gaggccagcc tggctctccag 440760

agcgagtgcc aggataggct ccaaagctac acagagaaac cctgtctcaa acaacaaaac 440820

aaaaagtaaa gaagctaaaa gaaatgactg agctacatga cccatgagt aagagtctta 440880

gagacgact aaggttgtat gctgatatat aaatcaacct cactacagac ccatcaaagc 440940

atctcatagg agatatgtaa ctatatgctt aaatgtgtgt aagtagtga tggaaagtact 441000

ggggttggaa ctcgccatc gcgctgggtt agcattctac aactgggcta cactcacaca 441060

aacctgcaat atacacaata tatctatatt atatgtaata tatttaagt aaaatagcat 441120

tttatttatt taitgtatat gtgttgtttt ggaggcagac tcctttttta aaaaagatta 441180

tttatttatt taitttttta tttatttatt tattatgtat acaaatttct gcttccatgt 441240

atatctgcac accagaagag ggcaccagat ctcataatgg atggttgtga gccacatgt 441300

ggttgctggg aattgaactc aggacctctg aaagagcagt cagtctctt aacctctgag 441360

ccccgacaga ctctttttat tttgtttgt tctattttat ttttcgagac agggtttctc 441420

tgtgtaaaa ccctggctgt cctagaactg tagaccaggc tggacttgaa ctcacagaga 441480

tctgcctgcc tctgctctt aagtgccgaa attaaaagca tgtgccacta tgccaggctg 441540

gacacagaca cttgctagtt caagactcct ggggtcaagt gattaccgta gcttcccagg 441600
tagctacaac tgcactcagc tttatTTTTG cggttgtgag gacactggtc ttgtggttat 441660
ttgtttggc agctctagga aacaaatgta accctccagt acctgcatcc atgaactttt 441720
ggattttgtg tgggctatgt gaagcccaat gttactgaga accatgtttt gctgaaaatt 441780
tggtttaggt ctggaagggt ctgaaaaggt cctgtgtcag ctccgcactg ttgtaaagtg 441840
gaggaacctt tgagaggcac atcccagtgg gagcttttag gttttcagga gtgtgacttg 441900
aagaggattg tgggatgcca gcctcctcct cactcacctc ctgatcacca tgaggtgaga 441960

ggctttttc atcctttgct tttcgttatg atacgtgcc tcatcacagg cccagaggca 442020
atggggccaa gccacatgg agtgaactg ataaaaccgt gagccaaaat agactgttct 442080
tcctgcaagt tgattaactc gtgtatTTTg taatagtaat agaaagctga ctaacacagg 442140
caaacagaat aagggtcctt gaaccacaca gcagactcta cttagaaaat aaggtcacag 442200
atttccctta ccaggccttc cctggcaact cctgagtttt caagacttga gtgataatct 442260
ggggttagg gcatctccat gctttcagtg ctaccactg agggaactag aaagtctagg 442320
agtcatctat aggcactgca acatgctgtt gctgaagaca gattctggtt agttccaagg 442380

acacttggtc attgccatcg ggtgtccttg ctgagtgttt acctgctgtt gtctggctcc 442440
ctacagagta taaattccac gatgcagctc atgtctgctt catgcaacac tatttggggt 442500
ttaatattgg ggtttaataa acaccagtca agtcatgca tataatgcatg aatgggtaaa 442560
tgaaaggagg tctctaaagc aatggagatg agagtttcag agaaataatc taaccctccc 442620
accacccca ctcctcccc tggagagcaa gaaatagcaa atacttgcca cacaaaagct 442680
tctgtcactt tccgagggtg gagacgggtc ccaaattctt agtccagtgg ttcagccatc 442740
ttttgcaata aatgcaagga agataagaaa atggaacttg atagtaacag gattgaggtg 442800

gttcagagag ggttcttatg gtggccattt taaaatacaa ctctgagcca tgactttaat 442860
cccaggacta gtgaggcaaa gacaaggaca gtctgggcta cagagtgagt tttaggacag 442920
tcaatgctac attttgcgat tgctgtctca acccgtgctc tgccccccg ccccaaatta 442980
aaatacaact ctggaattct ctgccatecc tctacagaa ctgtagtcta tgactcctec 443040
tcttgagtct gcatacttga acaggggaat gtaacaccaa taataaaaac ccagagacag 443100
atatggggtt caaactgaag gtcagagaag cagagcagcc aagccactaa agagctctta 443160
tctcgaccaa ggctggaagg gatcctgtcc tcaatgtggc tggagactaa ttgtcagaga 443220

ctgaactatg aatgccttac tctatctta tatacctctc tagtctgag attaaaggca 443280
caagctctgt ttctctttta gaccgattca ctctcatgta gccccactg gccttgaatt 443340
cacagagata cactgcctc tgtctcctga gtctgggat taaagatatg tgcggccact 443400

gcccagcttc tatggctgtg gctagctttt cattctgac gtcagtgact ttattagatc 443460
 attaacaatg tatcagcaca ggaaaatatg gcagaaatga tgctatgtgg gtttctagga 443520
 actgccaact tgggcacagt ggcacaagtc tttaatcaca acatttggga ggagacagag 443580
 gtaagtggat ctctgtgagt tcaaggccta cctggtatac atagcaagtt ccaggcagcc 443640

 agggctacat aatgaaaccc tgtcttaaaa agaagaagaa gaagaagaag aagaagaaga 443700
 agaagaagaa gaagaagaag aagaagaaga agaagaagaa gaagaagaag aggaggagga 443760
 ggaggaggag gaggaggagg tgggactgga gaactagctc ctggctcctc agttaagagc 443820
 acttgttgct ctgaagacc tgggtttgat tgccatcgcc acatacagct gtctaactga 443880
 agtcccaggg catccaataa gcttctcctg acctccaagg catgtaggca catatattca 443940
 cacaggcaaa acactcacat acataaaaat acaaaaataa tttcagaaaa aagggaagaa 444000
 aaactcttgg cttcttttgc ttgtccctat acagccccgg ctggttttga actggctaag 444060

 tagctgagga tgacctttaa cttctgatct ttctgcctcc atctccaag ggttgggact 444120
 acaggcatgt atcacatgt caattcattc ttgctctttt aaatgctttt tatgttttct 444180
 tgttattttg gtttttagtt cttatttgtt tattattttt tatgtgcatg tgtttgagtg 444240
 tatgtcatgt gtccaggtag ctgtggaagc cagaggcatt tttctcctgg aactggagtt 444300
 acaggcaatt atgagctgct tgacataggt gctgggaacc aaactcagac tctctgcaag 444360
 agctgcaagt gctctcaatt gctgaacctt cgatccagaa ccctgtgggt tgtatgtatg 444420
 tgtgtgtgtg tgtgtgtgtg tgtgtgtgtg tgtgtgtgtg tgtatgacag gcatttacca 444480

 tgtagcccta gctggcctga agctttctac gtaggccaga tctatctctg cctcctgagt 444540
 actgggatta aaggcctgtg tcacatgat gccagcctg tcctattgat gactacaaat 444600
 ggaatcagag ataggctaat aaccagtaat ttattagggg atatactcac acaagggaac 444660
 cagtgaccag attagcacc caagcaggtt gggcccagaa tgcttcccag taccggctca 444720
 gcctagagag agaccgtgtg ctggccctcc ttgctcttat acaccctgct atgtacctgt 444780
 gaccacgccc aagtgggcgt ggtagtaggt acctgtaac agggctctct cttacactgt 444840
 cttttttttt ttcttttttt cttttttttt ctttttttgg ttttctgaga cagggtttct 444900

 ccgtggcttt ggagcctgtc ctggaactag ctctttaga ccaggctggt ctgatctca 444960
 ctgagatctg cctgctctg cctcctgagt gctgggatta aagggtgtgt ccaccaccac 445020
 ccggcttttt tttttctttt tttttctttt ttttaaatgt agaactctgc tttgtagtgt 445080
 aggctggacc agaacttgtt ttgcagccta ggttggtttt gaattacca ttctcatgtt 445140
 ttagcctctc tagtatgaac agttattctt gaaactcagc catcacactg tgaggaaatt 445200
 ctactgcttt gagaagagac ccatatggag aggtaccagc agccaatttg ctttagtggt 445260

ggacgaatcc tccagtcttg gtggatacat tgcacctgcc atggcacaag caaaaatgag 445320

 ctgtctctct gaatcctgcc caaattgagg atcctgagaa aagcaaatgt tttctgtcct 445380
 ctgttactaa gttgggactc tcagetcttc cgtctgtcct agtctctaca gtcaaggctc 445440
 gtctcccttc tcigccitta ggcctcctga tgggactca gcctgaagag acagctcaca 445500
 ccccatgaag agatagctca tatctgcacc agtgagatgg agtgagggat tttcctctgc 445560
 cccatgttcc tgcaggagga ttgcttagcc taaggaccac ccaccacctt tcacctccc 445620
 agcatccatg tggagatctg gactgaaagc ttcacagcca aggggtggctt ctggatgtgg 445680
 gaatgacgtg tgggttttgt tgaagctatt tcccatttct ttcacccctg tggctgttta 445740

 ttaacctcat gcactggctg agaaagtga atgccgcac tggctcgtgg cttccctgtc 445800
 aagtcctgtt gctccttctg aatatatact ctctgaactc ggggcaaccg tctctgaagt 445860
 tgctgctaag tggttctgaa acatgtttag ataccattta gctgcttgaa tgaccacgtg 445920
 gctgccacat taacctgata aactgtagga agccacttgc ctgctttctt cctcctggca 445980
 ttaggcagtg ggttgaaccg accctcacct caaggacact ttggacttca ggaggccaag 446040
 ggggcctcct aggcagagac agatgtgatc tcaattttaa tctctgtgac atagtctcat 446100
 attcttatga ccttcgacaa aaaatgacag ctgcctggct gaggggctcc acgtctgttt 446160

 attggggaca atgataacct cagaaagggt attttacttt agattttaaa atctttattt 446220
 agtttttgtt tgigtgttta cttgccggta tgtgtgcat gtgcatgtag atgccctctg 446280
 aagccagaaa aggacattgg atcacctgga actggggtcc aagtattga acataggtcc 446340
 tctgctggag cagcaagtaa agagtgttt gaagggtctg agatgaggta cacaatccac 446400
 acgttaactg aactcttggc cctgtgagat caacacaaga tgagttcaa cacaccactt 446460
 gcaagttaa tgcctgttaa ggggtcagga caatgtccat acaaagtcca agttaacctc 446520
 tgggcctcag ttttattatt tgcaagtaga gatataataa acacctcctc aggctattat 446580

 gaaaatgaag gaagtaagtg cttagtaaac acccacaaca gacagcgcta caatcagggg 446640
 cagctgttag caccctgtgc ttcgtaate cagacgtgaa atctaataca tttcttattt 446700
 ttcacatcaa ttttgcctcc cgccaatata tgaactgctg tttagatggt accctgttga 446760
 ttcgtacatc ttttatggtt gtacatgcta ggcaaagata agtttagaag tgtaaacata 446820
 caaaaataaa gaacaaatca aagttaaaaa aaatggaata gtagggttta caaaacgcgt 446880
 ttggatgcag tagtggagaa aggagtact gtttgctaca tgaactgttt aagttgactt 446940
 tggcatggca actcttgttt atttccttat tgtgtttatt tccttatgct atgtgacgtg 447000

tgtgtttgtg tggcgcgctg tgcgcgcgca cgtgcaaagg cctaaggtgt cttcctcagt 447060
 tgctttccag catatatgt aacacagggc ctttcagga actggagctc attgttcage 447120
 ctacctgac tagccagttt actccagagg ttccctgttt ctgtcgtggc tcacaggcaa 447180
 gcctcgtat gctcacctgg cttttctcgt gggctcctgg gtccaaactg cagcctctgc 447240
 acttgtggag aaagtacttt acatggccat ccactcctcc agcctatfff tgatttagtt 447300
 ttttgaagga agggctctca gtggcccagg ctggcctcaa actcactatt tagttgagga 447360
 taatcttgaa ctctagctc tctcgttct tctacctctt gggggctaga attgcaggca 447420

 agtgtcatcc tgctggattt ttttttttt aactatagta ctggagaagg tgttcagggt 447480
 ctctgaagg ttagatcagc cccaccagct gatctaaagc tctaacctat agtaagagtt 447540
 atttatgtaa tcatttgatt tcttcttctt cttcttcttc ttcttcttct tcttcttctt 447600
 cttcttcttc ttcttcttct tcttcttctt ctttaaaaa agacagaatc tggatatgat 447660
 agcctaggat gattttgaac ttactgtcat catgcctcag tctcttgagt gatgtgccac 447720
 caaagctcag gggctataga cccttgtctt agccacaaac aggaaaattc tgaatatctt 447780
 taaaacattt atatttacta tgcatctgag tttaggagag gaaaagaaaa atctctctaaa 447840

 tgtctgaaaa caggagtgat ctgaaacaa ggatacaaac tctaagagga tccatgtgct 447900
 tctctaagag gatgttgcca cagcccctgg gaggacccat ggtcttcagg gattagatgt 447960
 gttagcttct tgttctgca gcaaaacacc tgcgacctc aacttagaaa gaagaaaggt 448020
 ttatttggcc cacagttgga ggtttcgggt tatggttcat tgactttgtg ctttggggct 448080
 gtggtgaggg agatgatcgt ggcaggaatc atgtgtcata gaaaaatcat tcatttcatg 448140
 actggtagca agacaaaagga agaggaggaa ctaaggtcct atcagtccca tgggtccagt 448200
 gacctagac actcccacac ccctctatgc ccactctgta aattttccat ttcttccaa 448260

 gggatgcaaa ctaggagcta aacctgaac acacatgcct ttggaggata gataacaccc 448320
 aacgtataac aaaaatgggc tagagacagg gttgtaatag ccctgtggtc aggagatgat 448380
 gcccaggggg catgagaaaa tgatctagaa ctaatatcaa tttaaaccag agctggagcc 448440
 tgggaagaaa atctttccc tgaaaggggt ctagagtctc tcaagtttgg geccagatct 448500
 gaaggcctaa tgtctgaggt gaaactggaa taggaatcca gaggtcaaca tgagccatcc 448560
 atcagggccc gagcagacag aggcagagag tgataatgag gataacagt gccactcgtc 448620
 atgagccac tgtgtgcaca cactgtgcct agcacttcac atttaactct cacaacttac 448680

 caaggtagat gccattatg tcacctaatg gctgtgttta cagatttggg caattaacag 448740
 atgaaaaaca aatagctctc catagactca gaaagctagt gagaaaggca ttctagaggt 448800
 ttttgtttgg ggtgaggggt gaatgggggt gggtaggggc tgtgcttgtc acagcacaag 448860

tgtagaggtc agagaacaac ttctgccatg ttgccccag aagttgaact caggctttat 448920
 ctggtttgat tgcaagccct ttcactacca agccatctta ccagccctat ttatttattt 448980
 ttgagacagg gtctcatgta ttctgcttg gcctccagtc cactttgtag ctgagaagga 449040
 gtaccttgaa tcigatcctc ctgcctccat ctctctaaatg ttgggtgtgg tgttgtgggt 449100

 ctgtaacccc agccctagag aagagtgaag acaggtttca gaagcttgct ggccaaccaa 449160
 tctagttgaa tcagcaagct ccagggtcag tgagagaccc caggccaaaa aataaggtgg 449220
 agagccattg aggaaacatc aagtgatgct ggctctggc ctacatgcc atagagcct 449280
 gcctacccat atgcacacat gcacgtgagg atttacacac acacacacac acacacacac 449340
 acacacacac acacacacac acgcatgcat gtacacacgc aaaaatataa tcggaagaat 449400
 gccatcagaa aacatccaag agccagcact tgggaggcag agacaagtgg gtctctgtga 449460
 gttcgaggcc aacctggtct acagacagaa ttccaggaca ggctccaaag ctacagagaa 449520

 atcatgtctc aacctgctg cctccccaa aaggctacag tattgaggct ggagagatgg 449580
 ctcagtgggt aagagcactg gctgctcttc cagaggactg gattcaattc ccagcaacca 449640
 catgggtggct caccacagtc tgtaattcaa gttccagtgg atctgactcc ctcataaaga 449700
 catgcaggtc aaacactaat gcacataaaa ataaaaaaca aagtatattt aaaaaaaag 449760
 gaaaacatcc aagactttcc cactttgctg taaatctgcc tatgtgatat ttccatcaat 449820
 atatttgaaa aatgtcttga tttataattt ttctctgtgc tgttctata aaaacctcat 449880
 gaaactactc ccacactggc acatgggatt tgagctcatc taaacatgta tcctgggtc 449940

 atggtcacgc atattcagca ttggagtaaa tgatctctta ttcctttga ggtgagagct 450000
 gtgctttcac atigacaaag gtttctagct gaggctttga cctgtctcct tcaatcagag 450060
 cagggacttt ttgtctgtt taagggttgg tttttttgtt tttgtttta gttttttatt 450120
 tttcaagaca gggtttctct ggagccttgg agcctgtctt ggcaactctct ctatagatca 450180
 ggctggcctc gaactcacag aagtcactg cctctgcctc tgcctctgcc tctgagttc 450240
 tgggagtaaa ggctgagcc accacgcca gctttgtatc tgtctagttc acttgaggca 450300
 gggtctctca ctgaacttgg agcttgtcat tttggttacg ctgcctcttc cegtcacat 450360

 tttcatctgt tcatactgtg cttctccctc aggagactca cttactgtt aaacaagtaa 450420
 taatcaaact ataatacagt aaaagaaaac aaaacaagaa tccacaaaca ctgcagtcaa 450480
 atagaatgtc tatttgctgc cagtcaggig ggtcctttcc ctcacagcat cccatgatgc 450540
 taattgtgcc attagcctt ctctccaact tctggatggg cactgtactg agtctctgtt 450600
 taggaccatg tcagcatttg gctcggagga aatcctctga cctggaagaa ttccttgget 450660
 cacctaggag gtcaaggggc agagagactt gggggctggg cacacttttt ccaggatgta 450720

ggctgtttcc tggctctggg gctcctctcc cacagcaaga ataagaatcc atttctgtt 450780

 cattatattt acctgaaagg taaaacaggt tctgtttttg gaagcctctt gattgcagcc 450840
 ttataaagaa gctccacatg cagaataggg ggaattaat tggctttcca gggagcagct 450900
 gaacgaagtc tggtaattga atttcacaat gaatgcctcc ctctgggtgg cccgagtgtg 450960
 atctggaatg gatatttgaa gttttctctg tgtaaacggc ttgggctcct caatgtttat 451020
 atttttggtg ggcatactc attcacactt tcatcaagaa aaaagaaatg tacatttctt 451080
 tacaactct gaaatgatag aaaggggaaa aagaggggga gggggctggt ctcatctgga 451140
 gacacaattt ggcaggctct tcgcagagac tggggaagag ccaactgaga gaataaatta 451200

 ttgcttgaac acaggctgtg tcagagtgga gctgcagacc cagctgctag gtatcagagc 451260
 agcctcaggg ctccgttcca aatgagtta tgcttgggtg ggtcgggagc cggaaagaac 451320
 acatgaggtc atgatgccaa tcaatacctt gaactggtgg atgcggacta aactgcctc 451380
 ctcgagattt aactcaccca gctgcccagc aaagacttaa ctaactgtgt gtttctgtct 451440
 cgacagaata gttactagtg aattaccttg gccttgggat agccatgga gacatgcaac 451500
 ctcaaccctg ggtgggtaac agaccttttc agctcctgaa gtcaggtta gaatcagcaa 451560
 tataaaatat agtcagctgt ctgatctgt ggattcaacc aactaggaat agaaaatatt 451620

 aaaacaataa cgcacctcc caataaacct caccttgta atattgagca catataggct 451680
 atttttcttg tcatgattcc ctaagcaata gtcttgcaaa tatttacata gcatttactc 451740
 agtatgaggt aggggaagcc acctaaact tctgaagtca ttaagaatg agaggatgtg 451800
 tgggttatat gcaaacaccg tggcgttttt ttatttttta tgccgagcat tgagcccagg 451860
 gccttgttca caccaggcaa cctgggagtt acatccctag ccctgttgtt ttacagagga 451920
 cgaactcttg atttgatat ctgacaggtg tatatgtgtg tgtatgtatg tcctggagtc 451980
 aagcctcagt gtatactaat ggatggttat atactactag aaatatatag aataaatagg 452040

 attgtgatgt gaaccacaaa tgcaaatcac atatgtaatt taaaattttt tagaggctga 452100
 agagctggct caggggttaa gccagttac tgctcttcta gtggacctaa gttcgttccc 452160
 agcatttatg tcatgataac atgacactg gggtttaatg gccacaatc taatggtgag 452220
 agacctgtc tcaaaggagt tgttttaggt ctaaagcctt ctccactcac cccaaatagc 452280
 agtgctggtg aactgtccc aaacagaagg acttgggcca gtaaacagaa gaattgctgc 452340
 tgggtaacaa agcctaaaaa gagtttttgt ttacaagaat agaggatctg ctatagtggg 452400
 ttctaatct gcagagagag gtggggcttg cctataatcc ccagaaggct ctgcaggagg 452460

atcataaatc tgaggcctgc tgggcattgt ggcgcatgca cacctataat ctagcactc 452520
 tagcggcaga ggcaggtgga tgtctgtgag tcccaggcca gccaaagcta cagagtgaga 452580
 cactatctca ataaccaaaa tctaataata ataataaaag aagtctgagg tctccctgga 452640
 ctacatgatg agactttgtc cccaaaagaa aagtaggaaa gaagtcacta ctgagatgaa 452700
 tcaatgaaag aaaggaagtg aacaatattg ttgcatctca cttatggaac tgaatttcc 452760
 aaaaaacaaa cttgaaattg ttagaccccc gaaaactcaa gtatcgggat cccaggccac 452820
 gttcgaggtc accccaatca ccagggtgcat tcgagagctt gctgcaaact gcacaggct 452880

 ttattgtaat ttaacgagct aacctatgt tagctcgggt ctttcacca cccgccatgg 452940
 cggatggcta ggaagacgg cttctagggt ctccaaaag atcttatagg gcagcataag 453000
 gggcgtgtct aggtacgcac aggcttacgc acaggctcac gattggtgtg cttccaggct 453060
 tggagggctt gccctgtgtt gattggtcaa ctggttgta tggccatag gccctcccag 453120
 ggtggttgc atgctctcta cgtcattgct gtgctgtgt tcgtaagca cacccagggt 453180
 cgtaagcat agcggccaca gctaacttc gattggctcc ttgtcacgag acaggcatct 453240
 gacctctaag tgaccaaggc aggtttatgg caagcacgtt ttcggctgtt atggctgcca 453300

 aaaggaagc tggttccttc aaaatcatta aaaaacaaa gctgtccacc ccacaggaaa 453360
 aaaaaaaca aacacattcc tgactggggg aggaaacctt ggaccagaat attttagcag 453420
 agagagtaca gagaccagc tcgctaagaa agccaggact cagcagccac agagctctgc 453480
 ccctggccac cataaagttc ttgaaccaat aatggcagaa aagacacca aggcagctct 453540
 ttggctctat ttcaaaggag aaaacaaact gattttaatt gcagagggat aaggattaag 453600
 ggtgatacag agaaaataca agtcaagaaa atgtgagcaa ggtacaagga tgggttagca 453660
 tctctctgt tctttccgtg tgtgtgtgtg tgtgtgtgtg tgtgtgtgtg tgtgtgtgmn 453720

 nnnnnnnnnn nnnnnnnnnn nnnnnnnnnn nnnnnnnnnn nnnnnnnnnn nnnnnnnnnn 453780
 nnnnnnnnnn nnnnnnnnnn nnnnnnnnnn nnnnnnnnnn nnnnnnnnnn nnnnnnnnnn 453840
 nnnnnnnnnn nnnnnnnnnn nnnnnnnnnn nnnnnnnnnn nnnnnnnnnn nnacaatgac 453900
 gtagagagca tagcaaccac cctgggaggg cctatgggcc ataacaacca gttgaccaat 453960
 caacacaggg caaacctcc aagcctggag ggacaccaat cgtgagcctg tgcgtacccc 454020
 tagacactcc ccttacgctg ccctataaga tctnnnnnnn nnnnnnnnnn nnnnnnnnnn 454080
 nnnnnnnnnn nnnnnnnnnn nnnnnnnnnn nnnnnnnnnn nnnnnnnnnn nnnnnnnnnn 454140

 nnnnnnnnnn nnnnnnnnnn nnnnnnnnnn nnnnnnnnnn nnnnnnnnnn nnnnnnnnnn 454200
 nnnnnnnnnn nnnnnnnnnn nnnnnnnnnn nnnnnnnnnn nnnnnnnnnn nnnngtgtgtg 454260
 tgtgtgtgtg tgtgtgtgtg tgtctgtgtc tgtgtgtctg tgcgtttctg tgtctgtgtg 454320

tccgtgtgtc tgtgtgtgtg attatgtgag agaaagagtg tgtgtgtctg tgtgtgtgtg 454380
tctgtgtgtg tgtgtgtctg tgtgtctgtg tctgtctgtg tgtgtgtgtg tgtgtgtgtg 454440
tgtgtacatg ttgttctagt ttcatctctgt ttctgtgaca agtatggaaa gcagtttagg 454500
gagtggaagg tttatttcag cttacactta gaggttacag tccatcattg atgaaagtca 454560

gggcatggac ctgacataga atccatggag gacactgctt ggtggctcac tcacaggctc 454620
atgctcagct ttctttctta tgtagccgag gaccatctat ctatctgcct agggaatggg 454680
gctgcccaca gtgggctggg ccctccagga cagtcccca tagacatgtc cacaggccaa 454740
tctgatctgg gcagttcttc aattgagact cccttctcag gtgactcgag gctgtgtcaa 454800
gtcgacagct gaagctaact agaacatggt tgtgaattct cccccccc ccaatcaaaa 454860
gtagtataac tgcagacctg catggaaga aacaaagag acagatgaaa attgttttat 454920
atttcaaaaa catgataaaa ctatagttaa gttcaattaa ataatttttt tgcaggtcta 454980

ggcattgaac gaaggacctc acgtattcaa ggcaactacca ctactctata tgcccagtcc 455040
cttaatttca gttttcaaaa gaacacaagg taagatgcca aatagatgga tggaacccaa 455100
ggaggccaat tgacagccca aactgcacca ttatgattaa taaatctaaa accacagaga 455160
acacacttct gacaaacaca aatgctaaca caaaggaaag agtctagatg accgttatga 455220
gctttgagga aaggacaca ggcttaaac tagagaggct gtcagaaggg ttcagctggt 455280
gaaggtgctt gttgacactc ctgctgceat gctgctctt gcccaagtgt gatgtctgca 455340
gtctatggca gaaggagaaa actgactcct gcaagtaata cacacagaga gccacagaca 455400

cagatacaca cacacacaca cacacacaca cacacacaca cacacacaca cacaccattt 455460
aacaagaaaa agcctggatg gtcatgatag aacacacctt taatcccagc gcttgggagg 455520
cagaggcagg cagatctctt tgcgttcgaa gccaaagctg gtctaccagc tgagtccagc 455580
ggtagccagg gatacacaga gaaaccttgt gtcaagaaaa acatggcccc tcaacaccaa 455640
caaaaaagtc tagcaggcat gggaacaaa gattcaatgc aaagaaaata gacatcagca 455700
agtaaaagac aaaggaagac aaaatcaaaa tgataaaatg aagagatttc tcttaataaa 455760
acaaagcaca agccccagta tatagaaata tgggtgttctt ggaaacttta attaaaaata 455820

tctcactg aaacataatc tatcatgaga attccagaac attccacgag gaaagatggc 455880
aatttcaaca gtgtctagag aacacgaaaa ggaatagagt tgaactccac ctgcccatta 455940
aatcaactt accatgaagc aaactcctag agataagaat taaaactatt acattcttag 456000
aagaaaaaat aagtgaaaa tctttgtgtt aggtaagtct tgtaaatgta acatctcaaa 456060
catactagat aaacaggacc tcaccaagt taaaatgttt gtgctgcaat agcccacaaa 456120
acaagagaag ttatctgcaa atcatgtgcc tgtaagaatc tattttgaga tcatataaag 456180

gatagttaac aactcagaag agaagaaaca aacagcgctt ttaactagca ctctgaaagc 456240

tgaggcagga gaatcgtgat tttgaatttg aggctagttt gtgttatata atgagatcct 456300
gtctcaaca aacaaaaaaaa tgcatacaag caaacataaa aatgggcaaa gtagtttggg 456360
tgacatgcct gtaatttcag gtattggaaa ggctagagca ggcgatattg agtttgaaga 456420
cagcctagge aacacagcag gtgctgcctc aaaaatcaat tagaagatgg ggagtggata 456480
ccaaatagaa aatatgtaac tgtttttttt gggttttttt tttttttttt tttttggctc 456540
tttgagacag ggtttctctg tgtatccctt gtctgtcctg gaactcactt tgtagaccag 456600
gctggccttg aatttatgga gatccgctg cctctgcctc ctgcatgctg atattaaagg 456660

cgtgcaccac cgatgccat caataaataa ctcttaatgt taatggtctc aacttcctaa 456720
taaggaaaac aactaattaa ttaaataatt aattaaatg aatggacatt tctctaaga 456780
gagacaaatt gccagaagac acagggacag gtgttcgcca ttagccgcta gggaaatgca 456840
aattaaaac acaaacagt caatagtgtc agggagaaat tgtaccctca taaaattgct 456900
gctgggaatc taatatactg cagttgccca gaaaacagct tggcaattcc ttgaaatatt 456960
aaaaagagac tcagggacc ctcctgcaca tgcattccaa ggaactgaaa acatgtttgc 457020
agtgaaattc attccgatgt ctggacaaca ttcttcattt tagtctcaa ctgaaaaca 457080

cccaattggt attcatgat gcttgttgac acctgcattg tgatggttaa tcttgttaat 457140
caccctgacc cactgccag agtctgaac cgaataaaaa ggagcaatca agcagggtgt 457200
tggtggcaca tgccttfaat ccagcactc gggaggcaga ggcaggcgga tctctgtgag 457260
ttcgaggcca gctgggtctc cagagcgagt gccaggatag gctccaaagc tacacagaga 457320
aacctgtct cgaaaaacc aaaaaataa aaataaaatt aaaaaaaaa aaaaaaggag 457380
caaccgagt gaacaccagc gtccatgcct ctgtgtttcc tgagggtgca atgtgaccag 457440
ctgccttaca tcctgtggc caggetttcc acaccaagat ggaactgatcg tcagaatagg 457500

aaccaagaca aatccttct tactcaagt gcatttgcca ggtgttttgt tacagcaatg 457560
aggaaagtaa ctaatacaca cacacacaca cacacacaca cacacacaca cagcagaaa 457620
tattatttac cctgacagaa agatgggatt ctgaaacctg ctatgacatg aatgaacttt 457680
ttcattttta tttatctgat tatttgatat tatctattta tttttgctaa gtaaaagaag 457740
ctagecctec ccaccccc ccaacaaca tgetgtctga tttcatttat atgaaatgct 457800
cagaatggga cgaatgaga caaaaataat acggataaca acaaccagg aaaaccagga 457860
agtaaaagaa gaggaggaaa gtctgttacg atttcaaat gatcagacaa ataaaaccag 457920

agtghtaatat aagaactaac cacaaggcctt tgcaacctca agtcacaaat ctaagatggc 457980
 tattataaaa acaatctctt gaagtgtgcg actatatttatt ttgaatttca atattttatt 458040
 tagttttctt agttcccttt tcttctagta aatggtaaca aaatatgcaa aaagcaatac 458100
 tattcattaa aatttgatt tacagtacaa ctccacctta atcaagtatt ttgctagttc 458160
 tgtgccggca cagagcaatg tttacaatgc tgtttctttg gtgtgaggtg tagatcctgg 458220
 tgtctgggtg gatttcttcc cttacctctt cttcttagca ttattgtatt cttcataaag 458280
 attctatcat tttcccaaa acaataggat taattttcta agtgcctgaa aaaaaaaaaa 458340

 aaaacatgcc gggattcaac atgacagcat atggtttggt attttggtag tttttatttt 458400
 tctttatttt taagatttct gctcctatcc cttgctatga gccgcactgc ttggctgggt 458460
 cctggcaacc tgactggatg atgagggagt gaagaaagga cagacacaaa gggtggaat 458520
 tgggtgggtca tggccttggg tggagtgggc catggctttg gatggagaca tatcagcagc 458580
 tgggaaacag cacatttatt acctacctct gagaggagat gagtctattg tatacagctg 458640
 aacaagcagg tagatttagc tcatctgggt aggcagtctc tacaggggtg cagtctcagt 458700
 ctgtaatcag ccaggaggaa gctgccaggt aggtggattc tttgtgtcaa catccacac 458760

 tgactggggg aaagctttgt cattttcttg agcctgctg cagcaaggct ttactattcc 458820
 cacgtgtctg aggcattccg gtccttgaca tgtctgtgtc cacaccaaca atatacttc 458880
 actcagcact teatccattg ccacaatect tctgcaggag actgactcaa tctttagaaa 458940
 aggctgaaag gaactgcgtt ttgtagctgg ttttgggac atacgctgt catctcagga 459000
 ctctggaggt taagacagga gggttgctgt gattttgaga ccagcctggg ctggtcagtg 459060
 agtcccaggt cagagctaga tggtaggct ctgtttcaaa acatcaaaca cacaaacacc 459120
 cactgcctaa acaacaaca aaaagaaata cagaattgtg gattctttg tttgtttctt 459180

 tagtagagaa aaggtatctc aatagctttg gcttaagtcc ttcctctaag gtatctacac 459240
 tcttgatgag gaaggcaaga tgcaagtgcc ctgacttgag tgtctgggtg aaaatgtggc 459300
 cccagaactt ggaagagac tctttcaaa gaccataata caagcttaga ccagggacta 459360
 aaaagatgtt gccacagcct ggaccagcag cactcaaaga cctgtagggc cacagtgtga 459420
 tagtgtgctg actgctggag gggaagagtg acaatagtaa ccatcctgca atcctgttct 459480
 tatcactttt ggacttaag aaataaaaga gccctttgat cccagcactc aggaggcaga 459540
 ggcaggcctc cctagtctac agagtccag gacaggcaga ggtacgaga gaaactgtct 459600

 caaataaata aataaataa taaataaata aataaataa taaataaaga aaaagaaca 459660
 aaagagaaac aaataaaaga atctctaaca attacttctg agagctaatg aatggttcac 459720
 tatggttctg tatggagcct tagcctgcaa gttgactgtg ttttaaagtt accgtgtgtg 459780

tgtgtgtgtg tgtgtgtgtg tgtgtgtgtg agtgtcattc ccagagactg ggtcctgaga 459840
 cttactgatt aggctagata gacaggctgg ccagaggatc tatctgtctc tactctccag 459900
 caccagggat tgggattaca tatgtactcc acctggcttt tatgtgggtg ctggagatca 459960
 aactcaaadc ctctgcttg catagttagt gctttattag gatggttagt ttaattggt 460020

 aacttttaat tgtcacctgg aaagtgtggc tcagtgagga attgcccaca tttctcatta 460080
 tgtgggcagg ttgtaacagg ttgtcttgat tactgtggta gcttgaatgt aattggcccc 460140
 cataagctca cagcaagtgg cactattagg agatgtggct ttgttggagt aagggtagct 460200
 ttgttggagg aagtatgtca ctgtgggggt gggctttgag gtctcatata tgttcaagag 460260
 acgcccagtg tcttacacca ctttcttttg catgcaaatc aagatgtagg actctcactc 460320
 agctccttct ccagcaccat gtctgtctgc acgctccat gtaccacat gatgaccatg 460380
 gactggacct ctgaaccgta agccaccag ttaaatgttt tcctctataa gatttgcctt 460440

 gcagtgggtg tggtaggcga tgccttgaat ccagcactc gggaggcaga ggcacgtgga 460500
 tctctgagag ttcaaggcca gcctggctca cagagcaagt tccaggacag cctccaaaac 460560
 aatacagaga aaccctgtct cgaaaaacaa aaacaaaaac aaaacaaaca aacaaaaaaa 460620
 gagttgcctt ggtcatggtg ttccttcata gcaatagaaa ccctaaagaca gaagtggta 460680
 ccagagactg ggatattgct gtgatagacc agttttgttt ggaataatat ggacttggg 460740
 agtttggctt aggaaagcaa tagaatgctt taagtactgc ttaatgggcc atgctagtag 460800
 aagcatggaa gacagtgaca ctaagaatta ctggaactgt agggccttgg ctcaagaggt 460860

 ttcagaggag aatattaata tgtggcctag agactggtct tatgaaattt tggatgaatg 460920
 gactgtcctt tgccttgtc caaagagtct gcctgaggct aaagtgagag ttttggatta 460980
 attccattgg cagaggaat ctcaaacag cctagtatag acattgttgt gcagttacta 461040
 gtgttaacte taacgaagat ttataatgaa aaggagaaga ctgagcaggg taaatgacaa 461100
 tgtacaattt gaggagaaaa ggatcaccag gaagtggaag ggagctaat cctatgttca 461160
 aagagatgaa cagattaaga agtgaataa agggagtggg gacctcgggg caagaatcca 461220
 cccagctaaa tttccaactt atgaaaagga attaaagaaa agcttagagt caggtatgat 461280

 ggtacacacc ttaatccca gcactcagaa ggaagaggct ggcagatctc tgagtttgag 461340
 gccagcctgg tctacagaca aagttccaga acagccgcgc ttaggcaatg aagtaaatca 461400
 tggaaaacag aaagctggtg aagaatatat tgaatgaggg gggcatggtc cagccccagc 461460
 aagcagcaga gcatggaagc tttgtccaca tggttctctg gctctagagt caaggatagg 461520
 agaaaggcat tatggaacct tcctctgtaa ctaaggaaag ccaactgaggt gtcaggggtg 461580
 tcctgaatg gaggcccagt agagaagccg gtgctcgaag ctgtgaaggt gaagcctgca 461640

tttccttggg gaatgtaaga tgttggagat gccagagtag tgggatacct gctgaggaga 461700

 gctgctagca gggagtggaa ccagcccag agagaaatgt gttgcagtca acaaagctga 461760
 aaggagtgg agatgccagg cgggtgggac acacaccttt aatcccagca ctgaggagc 461820
 agaggcaggt ggacctctgt gagttcgagg ccagcctttt ctacaaagct acacagagaa 461880
 acctgtctc aaaaaacca ccaaaaagaa agaaagaaag aaagaaagaa agaaagaaag 461940
 aaagaaagaa agaaaggagt tggagatctg aagaccatct tgacatcaga ctggagacac 462000
 agagtttggg gttttccag taggttttca gtcttgtttt ggttcaatat ttctcacta 462060
 ttctctttcc tacattttgg acaggtaatg tttatcctgt gctattatat gttggaatta 462120

 tctaattatt ttttgatttt atagaggatt acagttaaga gattgcatga atcttagaaa 462180
 agacattgaa ctttggactt taaaacattg ttgaaatgt gataaatgat gggaactttt 462240
 gaaattagaa taaatgcatt ttacattatg atattgttac aagcttacac ggagtggaat 462300
 gtggtagctt gaatgtaatt ggccccata agctcatagt gaatggcact gttaggagat 462360
 atggctttgt tagagtaggg atagctttgt tggagaaagt gtgtcactgt gggggttagc 462420
 ctgagggtct catatatgct caagccacat ccaatgtctt agaccacttc ctgttctgctc 462480
 agatcaagat gtagggctct cagctacttc tctagcaaca cgtctgccta tatgtacca 462540

 cctcccacca tgatgacaat ggactgaacc tctgaactgt aggctaacca attaaatgtt 462600
 ttctttttaa gaggttgctgt ggttatggta tctctttgct gcaatagaaa ccctaagata 462660
 attaccttaa attaatfaat gtagggagat ctagcctagt gtgggtggca ccatttccta 462720
 ggcatgagac ttttggagag atattcagcc acagaggccc ccaggggaat gtgaatcagg 462780
 tattcaaagt gggatctgtt gagaatcatg ggcttgctta ttgtgaattt tctcttcatt 462840
 cctaattcac caaaacttc tttgcttagt gctgtttatt attattatta attattatca 462900
 ttattgtctt taaaaatagg ctagectgga gctcacatct gactcagtgc tgattttaa 462960

 attatttttt tctcatgctc tttttttta aaaaagattt atttatttat tatgaagaca 463020
 gtgttctgcc tgcatgtaac cctgcaggcc agaagggggc acaagatctc attacggatt 463080
 gttgtgagcc accttgtggt tgctgggaat tgaactcagg acctctggaa gacagggcag 463140
 tgctcctaac ctctgagcca tctctccacc ccccttttca tgctctttca ctctctctaa 463200
 atgaatgtat tttgagactg tctaagtctg attaggctag ccttaaaactg gctatgtagc 463260
 caaagatgac cttagacttc tgatcctcct gcctcccct ctcaaagtct gaaattatag 463320
 gcctctatac caggcttctg tgggtacttg tgatagagct ctggacattg tgcatgccag 463380

gcaaacactc taccacaga gctagagctc cattctcagc ccaccacatc tgtcttttca 463440
tcaactaata ttcatctctc agtcatttcc ggaaagggtc ttgaaatac gtggttttat 463500
ggtcatttca gagaaagtta tctacatcag gccctgacca tggatcctgg aaaatcagca 463560
atagaacagc aggcctttgt attgttttgt ttcttaccac tcaactttatg agacctgctc 463620
atcaaagagt caattctcga tgcaattaca catgtaacct atatgtcccc cagtggctct 463680
tgctgtgagt gacctcagca agatgggctc aggcctcagtt ccatggcctg taggcccaca 463740
ggttcctcct cagggtgccgg gagccccag gggactcctg ctcaagtaaaa cctgccttcc 463800

agagtctga ttctggatg aatctcagtg acccagatgt gaaactcagc cacacacaca 463860
aacaactcaa atcacaaaa gcgttcatgg gtataattag atttccctc agttgataaa 463920
aattttaaat acagacaaga acagagacta atctaataag tgtctgtgcc ctccaaatca 463980
gaatttagtg ttatcacttt acaatgtttc ctcccggttt aaaaaaaaaat gtctaataagg 464040
atataaagtg aaatctctca ggcacaccca cctccctaaa gatatatgca ggcatttggg 464100
atctgccctt tgaaaacttc ttctcatata tctactgtat cataaatgcc tgtcttgcac 464160
ggttttaaga tccacataat tgtatcatal ttatttttct gcaacaggct tttaatgcaa 464220

taatgtgttt ttaagagcta tctttgatga tatatacata tagatagatg cagatatata 464280
cagttcattc atattaactg ttatgtagca tgaatattta taaatttgtc tatgcaaaac 464340
tctacttgta gacagttaag atttttacaa agttccctct gtgacaaaca atgcagcaaa 464400
aagctattat tctgtatat attttatgtg tcagagtttc ctttaaagtt tctagaagta 464460
gaattactgg gtctttggg cctctgtggga tattctggac ttgttctcag gtgaacagca 464520
ggctctctaa aacagaagcc tgcagagttt ctgggtgtctc aggcctcagac tggcataatg 464580
gtttctgcct cgttctggg gcccaactctc gtccagtta gactcaagga atagattagt 464640

gggcaggaga taaggctcag tggttaagag aactgctgct cttccagagg actggggttt 464700
gatccccagc accccatag tggctcaca ccaaccataa ctccagtact aggggatttt 464760
ctgatctctg ttgacaatga tgcacacaca cacaaacaca cacacacaca cacacacaca 464820
cacattaac atcatacac ataaaatagc aaatacatat aagataaaat aataatgtaa 464880
aaaaaagtgt ttgttgcttt ttttttttt taagatccaa gttctgttcc cagcaccac 464940
tattgtctca tagctccagg gtatctggg ttgtctctg acctccattt acctgttttt 465000
atatgtgcat accaccctgc aacctcccc caggcatata acataattta aaataataga 465060

accgggcaat atagtaacac acgcctttaa gcccagcact taggaggctg gcttaggagg 465120
cagatctctg tgagtttgg gccagactgg tctacagagg gaggttccaag acaggetaca 465180
aagaaacct gtcttgggaa aacaaaaaac aaaacaaat accactgaac tggcactagt 465240

ggggctggag agatggctca gtggttaaaa gcactggctg ctctttcaga ggaccccagg 465300
 tttggttacc agcaccaca ttggtagctc acaaacctct gtaactccag ttccagacac 465360
 cagtatgcat gtgacacaca gacacacatt caggaaaaca ccccatatgc ataaaataaa 465420
 taaaataact tttttttttt ttggtttttt gagacagggt ttctcggtgt agcttttgag 465480

 cctctcctgg cactccatct gtagacaggc tggcctcgaa ctcacagaga tctgcctgcc 465540
 tctgcctccc gagtgcctga actaaaggca tgcgacacca tcacctggct aataaaataa 465600
 cttttaaaat taaaaaaaa agttggggat ggacagatgg cttagcaatc aatagcactt 465660
 gtcttgaag aaaaccagg tccccactac tcatgtggtg gctcacaact atccatcatt 465720
 ccagttccag gtcaaccttc ttctgacccc tgtggctaac aggcactcac atggtaccta 465780
 tacacacatg caggaaaaaa aaaaacattc aaacacataa acaataatt ctacagtgtt 465840
 ttaagaagcc cagtagaggg cctgagaggt ggctcagagg ttaagagcac tggtctctct 465900

 tcagagggc ctgagtttaa ttcccagca caccctgca gatatacatg gaagcagaat 465960
 gttgtataca taataaataa ataaaatctt taaaaaaaa acttacatac agaaaagtaa 466020
 atttaaaacc aacccccccc ccaataattg ggaccaatgc tggatgtggt agcaaattag 466080
 gataaaaggc gtgagctacc accaccagc tgcagttca gttttacat acaatgtaat 466140
 ttactctaca gatagcctt aagcattttt gggtcttaca ttgaatgagt tgtggtaga 466200
 atgtagagat ttcatgtcat cacactgcta agtgtcctct tgtaactggc ctggcaggca 466260
 taaagatatc tggctatctt gacacaagag accccaagaa actggaagtc ccatgggaaa 466320

 ctcatgctgg tagaagaaaa tgccagccat agtggtaact ttaatccagt aaataaattt 466380
 acaatttttt tttaaagatt ttatttattt attatgtctt ctgcctgcag gccaacagag 466440
 ggcaccagat ctggttga gaccacatgt ggttgctggg aattgaactc aggacctctg 466500
 gaagaacagt cagtgtcttt aaccgctgag ccattttccc agcccctaga tttacaattt 466560
 ttcataccac ctigtgtaa taactgcagc ccagacaatg atgggtggga ccataactg 466620
 actgtgactg gagactgtg atagataatt ctgacctga cttacacctt aatttcattt 466680
 cagggtcctg aaaatgggtt tttgggggat ctctggttct ctttgtcct ctttccatg 466740

 tggccacatg gaacacataa cttttttct atgtttccct gttaagtgtc ttatcgagga 466800
 tgggggtgag acctgacttg ttaggtcaca ggctgtgatg ctctgaactc tgctgtcatg 466860
 atttccattg ctcaacttg tagaatcatc cgctcagaac tttaaagggt gaagagaact 466920
 ttgcttctcc tatgtgagat ccaggcaaga ggcaagaaca gtttcaaacc aggttaagac 466980
 atcaccagga cagccaaggt ggagacattg ttcccttagag ttacagagga gaggggagca 467040
 gagattggag tcaggatca cccacaggt cctcgggcag gccagcaagg agtttgctg 467100

aaggatagag ttgtgagagg acaaacggac caagggaggc atttatggat taaagaaaag 467160

tgtttcaaaa cagcccttca aacctgggcc gatattctgt atggaaaagg gcaaattgct 467220
tgtacagcag aattcctggg gagttctcag atcatagtgt gaaaagagg atggagaatt 467280
tggttcact tgcaacaag aatccttgg aacacagaaa aggccagcat tttgaaagg 467340
gaaggctttg aacttcattc acatggagtc tgtcagaggg ataaactgtg agggcgggac 467400
aaaagtgat ggcagaagat ggaactagtg aggggtgtctt tctcagtttt aactgtcaac 467460
ttgacacaga ctagtgtcat ctgaaaaggg ggtctcaact gaggaacagc ctatatcaga 467520
ttagcctata ggcaggtcta tgggtggaatg gcttcaacta attatgtagc agggcccagc 467580

ccactgtcaa agiaccattc cctgggcagg tggcctggc ctatagacaa aagctagtta 467640
agcatgagct ggtgactgag acaaggagga gtgttcttac agggtttctg cttctccaac 467700
gctagggttt ttgactttct tcagtgacat actatgacct gaaacagtaa gccacttttg 467760
ctcaaagtgt gttatcacag cagccgaagg aactagaac agtgggggtg gtaaccagg 467820
agaactcacg tgccctgggc cacgaacaga gcagaaagct gatctggagt gcttgagtga 467880
taagacaaga gcatacccc ctgtttagct cctcagagct gccctcagtc tcttcaccag 467940
gtagcactat gccaggggc taaccaggag tcttgctctc tgagtttttg ttgccctgag 468000

gaagacttgt agggtatgag gaggcaggag cgagtaatga agctgatttc ccccagcaca 468060
ctcttcaactg gagccaagcc ttgcaggcca ctcttcatcc tagtcagttg gtttcatagt 468120
cccataagca ccctttcttc ttgtccctac aggccaggac tcttccccct tcctcataa 468180
tgttgcaacc tctgggatgg cttcacagca ctgctgaacc cctttagccc tgtctacact 468240
ttaatgtttg ccttgttggc tccaatctag catcatctac ttcctgatgg gactcagtaa 468300
caaccatgtg aggcagtttc tttaaaaggg cacctgtgaa tttccaggga ttattgttcc 468360
tcttggctac ataggcttag aaacacatcc ttttgtctgg agtctttctt cccagaatga 468420

gtcttggtag gaagtagagt tttctactca tgtagaatgt gaaagtctta gcctcccttg 468480
cagctagggt ttggatatat gaccaagct ctgtcaatca gaggcacaaa ctagactttg 468540
gataaggagt ctgagacaca gggacattga ggaggtaggg ccagtgactg ttctcgaat 468600
tctgctctga ggaaccatta aggcctggtg aggactctag ctagcatcct gcattgtagg 468660
acacaagact gccatcaggt tggccctgtg tttctgctat cacactgtcc aggtccaagt 468720
tcctctgcct cccagcaggg tcaaagctct ctagtctctt gtcctctgat tcctactctg 468780
cttagatttg agtcagctta taactgcat ttatgaattc cagctagggg aggtttccta 468840

cctcaaatgt agactgtaat cagtgcttac ctctgcctct atttttgggtg cttcctcagt 468900
catcccctgc ctccaggtag ctgtcatttt ctttcagct gtgcagtggg gaagggggtg 468960
atattttgac acagggctctc atgtagccct ggctgaatga tcttgaatct cctatcctcc 469020
atgtttgctc cagctgtact tctttattca cagaaaggct gtacagtctg tgagttagga 469080
gacatccact ttaatggatc aaaatcccac acgaaaagct ttctcactgt gaggctagag 469140
tcaagttatt gcacctctgt gaactctctt gtctccttat ctatccaatg ggagacatct 469200
tgtttgagg actgggtaag agaacttgtg tgtgaagtct ccctaggctg cctggctcct 469260

agtcaccatc aataacagcc gctattatct ttatacacgc cattatcatc accatcaaca 469320
tgattcaaag gccttatgga gcctacttag aacaggcatc atcaaacca atacctgcag 469380
gaggcaggca ggcagcaagg acaagtgtg aagagtcatt tataccaaca cattggcaca 469440
aggtgggagc tagagagaat gagagccagg tctgtctcaa gggggaagcc actgctcagc 469500
aatagccatt tactgccaag tgaactgtga gccagatgat gccaggcttc aactatttc 469560
aagcaaagcc aaaaattcag atctttatag aaagcttggg gcttcatgaa aagctacaca 469620
aacactgcac tgaggtcaca acagactgag gaggccagtt cgtgtttctt catgtgggac 469680

tctaggtcca ctttcaattg ccaggtgaca acctgcttgg gttgggttca ttccatcggg 469740
acagtcattg atagctaaca cccctgccta cccagtagag aatgtgagag acattcctg 469800
acacaggtgt tggctctcagg cacacttaga gaggagaagt aagaatttca ggtgtcctcc 469860
aacagttact tttctgtggg tgtcaggtcc actgagggtg aatgcttcag gatgtcagtg 469920
agccccagc aactgcccga ttaccacagg ttcagattct cttatgtatg ttatcacacg 469980
tccagaggtg tgaagaacag gaccaggaca cagattaaat gtatctacag gatttcaggc 470040
tttttccatc ttttctcagc atggaaagt tgcctcagt ggttcagga tagctacaac 470100

cacacctate atgattatgt tctaggcagg aagaaaagaa tatgataagg ggtggtcctt 470160
atactaaaat ttcccagaaa cctcagcgtg tttccttttc tatttcattg gccagagctg 470220
ctgcccatc cagtacttag tcacaaaaga aacgagatgg gatattttta gatggttaca 470280
cggaccatcc aaacaacatc aggtttctgt taattggaaa caaagtgaga actgagtgag 470340
agtaagcaac ctttagcctc tgcagcctcc tctgaataca gactacatgt cagaccccag 470400
ccaagtacta gagacctcag ccttccttgg atctcagcca catgaacaca agtgattgga 470460
tctcagtttg aaatccaaag cctattcagc agaaagatat gggagtgggtt ttaaaactca 470520

accaagccac caagtccaat gctgggacag cagctctggg tccctccctg tctgttctc 470580
ccataccct ctctgtcccc acccttctg tctctgtggc cccaccagg cccaaggatg 470640
gtggggagac tgttgatta acaccactag cagtttcagg aggcacccaa gagagacatt 470700

ctgagagaaa taigtccgcg gcacagctgg ttataatgt gtattaatcc ctgacatgta 470760
 atttgagtaa tatatglaaa gcagaaagt caggcgctga tttaggggcc ttattattac 470820
 cctgtcagca gaattcatgt tctatttga cagtgtctg ggtccagcat ctcatcctgg 470880
 gtgacagaag gaggaggtt cctgatggag acagctgata gcgggggtat aggtggatcc 470940

 tgatggagac aggtgtctg tcaigtcaagt gcttagagcc cccagcaggg ttgccagta 471000
 cctacatage ccaggagct atggaacaaa accaggttcg tactacttgg cctggaagca 471060
 gatccatgtt cattcctcaa gagggccata actgtaagtc tagaaagtca tggtttggaa 471120
 ttcaaagcca actaggccac ttattatca tgtgactttg gacagtttc ccagttttt 471180
 gatggttatt ccatatgtgc aagtgggaat cagaatagca tccatctaac tgaggcttaa 471240
 aaacaggttc tgagcactta tgaaggacta cagtggaatt ctaaatgttt gacatgttt 471300
 ctcaacgaat ccccatagca acctaataag atggatgtat gatgcccac cttagagttg 471360

 aagaaaataa ggcacagaga ggtgaagtaa ctattcaag gtcacacagc aaatgactga 471420
 tagagcttaa agttgccctc tgagatcaa tggaacgttc tgtcataata gaaatgcttt 471480
 ataattctat gctgtctggt aaaagateca cttgccacaa ttggccattg aatgtttgaa 471540
 tatggcgatt ttgacagaag attctaactt ttattttaac tgtagctact ttaaatatag 471600
 tggttggtgg atatgcagct ctagactccc cagtgtctc tgactacact agaggctta 471660
 gctttgacaa ctgttgccct agaaccccag gaagctccta tgttagcaag gcttccgaaa 471720
 aaaggaccac atagccatga tggcacactt ataatcccag cacttgggag gcagaggcag 471780

 gtggatctct gtgagtttga ggtcagcctg gtctacagaa caagtccaag gacaggctcc 471840
 aaagctacac agagaaacac tgtctccaac aacaaaacaa gacaaaacaa aaaaaatca 471900
 aaaaacaaaa caaaaccag tgctagagaa gtggaacaa ctggattgct ggccagctag 471960
 catagactac ttaataaatt cctgtaagag acctgtctc aaaaaagggt gaaggtcttt 472020
 gagaacaac acttgagatt atcctctgac ttccacagca tgtgcatatg tgtatacaca 472080
 tatgtatgaa aacacataca tgctcacaca taacaagaac aacaaaacag gatcatgtaa 472140
 gggagaaaga gatgaccagc gtcagttgtt atgtctttcc ctgtccatg cagaataaat 472200

 gctgctcctt taagatgagt ggggtttatg gtgtgaacat tgagttcct caaaattcat 472260
 cttgaacctc ggtgccagg caacagggaa gtctaaaaag tgggaccttt aagaggtaat 472320
 tgggtcttct taaaaagct caagcgggca tgttcatctc ctccatcctt tctgcagtgt 472380
 gagggctcat gtctcatctt ggcagcaaca aggtgctgtt ctagaagaag gaaacagcct 472440
 ttcccagagt ctactctgc cagcaccttt atttcagact tcccacctc caggttgtga 472500
 gccaatagtt ttctgtctgt caagaacaca ctgagctggt ggggttccg ggtgtcaggc 472560

tggggttggg gagaaagcct agtttgggtga aggtcttggc atacacacgt aaggaccagc 472620

 tcccaactaa aaagcttggc atgggtggcat gtttgaatc ccagcactga gaaagtggag 472680
 acaggaggat tcttgggatg cactggtcag ccagtttagt gtaatgatga gttccaggtc 472740
 ccagtccagag atcacttcaa aaaaaaaaaa aaaaaacaaa aacaagatag atgccctgag 472800
 gaagggcacc caaggttaac ctctgggtctc cacatgcacg tgacctgtac acacatgaac 472860
 ttacatacac acacacacac acacacacac acacacacac acacgtaggg gaagctgtag 472920
 ccacgcctgc ttaggggctg gctacaggtg tgcttgacca cgcctgcgag ggcatggtca 472980
 ggggtgatgta gagtggaggg cagtcaggtg gccgggttca gtttctgttt tgctttcggc 473040

 ttgctgtaca gactgctgcc gcaccagctg gctaggtcgc tctgtaagt gtcgtggccc 473100
 ggcttgtctc agctttaacc catgacagcc atgaggttct acctgagtgg ggggtgtgtga 473160
 acttgggaagc gtctaggaac gcaacgacga taaagaccaa acataggcat ctgtcatct 473220
 ttagagagct ctcaattcca tgttttggaa cttagagccat tagtttatta accatctttt 473280
 ctgggtgtccc ttaacatcct gctaacacta cgaggcagcc atttctctct tgttctctct 473340
 ctgcttgccc acttctctcc taaccttctg tcttaactca cataccacca acccctctcc 473400
 taaccttctg tcttaactca cataccacca tccccttctc ccaggtgagg gcctattcag 473460

 atgctaggca catacagatg caaaataaga ggcatattac cctcaggcca ggtaaacagt 473520
 aacagcctgg tgtaattaa caatacaata gcgggccata gtttcttggc ttcacggctc 473580
 ctgacagcca gaacctgggg cccaatattt ggtcctccac agtaagtaag gctttttccc 473640
 tattaanaac ccttgtatit ctacctgget ctgtattggt aatttccaca ttacacacac 473700
 acacacacac acacacgcat acacacacac atcctaggcc cttcagagag ccccaggatc 473760
 ctagatactg tctgccagtg agctaagatg acagacacag gctctaactct tctacttttg 473820
 gacctggcag tctagtagag aagatgatgt taaacaaatg gccactcagc taattatagc 473880

 tgacttgtga ttttttgact ttgcgatggg tttgttgggt cataacctca tcataaatgg 473940
 agtaatgtct atatttataa cagtttaatta aaggccatc tgagtgcag ccaataaagc 474000
 aaagtgatca aacggcagtt agagaaagt gttggagaag cctaaccag cagttgtgtc 474060
 tggggcttta ggagatggtt tgtctcagat atgttgagaa aagaggagg gcttgaattt 474120
 agtctaaaag agttagaagt tgtagccagc tftagtggcc catgcttatg agccagccta 474180
 ctgaggaggt caaggcttct gtccagcttg gataacatgg caaactgcta gctcagacaa 474240
 ctggggctctg ggactggiga gatgagtcac tgggtaaaaa tgcttctgt gcaagcctga 474300

tgcctggagt taaatatcca aacccatggt ggaaagagag atctggttca tccaaattgt 474360
 cttctgatct ccacatatga gcatgtcttc ccatcatgca catatacaca gtcatcacca 474420
 tcatcatcat caagtcagat gctgggatgt ggctcagttg gtaaagtact tgcccaacat 474480
 gtgtgaggcc ttgggttcca aaccagcac gacacataca catacacatg catgcctaa 474540
 ggcatgcgcg cgcgcgcgca cacacacaca cacacacaca cacacacaca cacacacaca 474600
 cacacatcca caaggtagag aaaaataggt taacatatca ggggatgaga ggctggggag 474660
 atggctcatt ggtaagagc actggctgct cttccagagg acctgggttt gattcccaga 474720

 acccatttta cttctcaca tcatctatta tttcagttcc aggagatctg atgctctctt 474780
 ctggccctgt ggataccagg catacatgtg gtacacagac atacatgcat gaaaaatacc 474840
 cagatacata aaatgataaa aaatattaaa aatattttaa agtacacca acaagctttc 474900
 cagtagcagg agcagtgtgg gtgaaggcat caggagacag agtccttcag gtcctgacct 474960
 caaaatacac aatgactggg agcactggtg aggtagcctt gggaagatga tgtccctacc 475020
 cccttgccct cctccattgt gaaattattc caacttacac tgaattgttg gctgttacc 475080
 tgaagtgatg caggtttctg catagggaca ggtgtgagtt ttgtcttcaa aagcaattca 475140

 gctgtattga agagtataca attgggccgt tttctagcca ggtaactgtg acattccttt 475200
 aggtctaaca tcaactctgg gccatccaac ctactttcca cagggaaact tcagggatct 475260
 tttcagggtt tgagtttttc atgcagttaa aaaagccaaa ctttttagaa agttcatctc 475320
 tcctgcctc tccattttta ttgttgggg ttttgtgtt gttgttattt gttttgcttt 475380
 aggtctcat gtaacctagg ctagtctgga actcacaatg tagatgagat gaccgtcaat 475440
 ttctgatctt tctggttctt caaagtctg ggggatcca gttcaggatc ttgtacaagt 475500
 tggcaaacac tctaccaatg agttacattc cagtctctg tcccctctc aaggaatcac 475560

 tctgtctate tatccatcta tctatctatc tatctatcta tctatctata tatctatcta 475620
 tctatctca tatctatcta tctatctatc tatctatcta tctatctatg gcatgtaaca 475680
 taggaagga tcaacttaat tagttttttt ttttctgttc tcttcaccag acttttctgt 475740
 acattctatg catggaagt accccacatt cttgggaaca tttctctc atctctgctt 475800
 ttgttgtag taagtgtgtg tgtgtgtgag agagagagag agggaggag agagagagag 475860
 agagagagag agagagagag agagagagag agagagagag atttgtttag gtgctcgaaa 475920
 ttgtaccag gggcttacac atgctatgca agtgccttac cactaagaaa tgactccagc 475980

 ctccaaaagg accctgctgg ttgtcctctg acctccacac acatgccaca gcaatactta 476040
 cccatgaaca cactcaatg gtaaatgagt aaagaagcat atagttaaga agcatgcagg 476100
 taatgaagt gtgaactgct ttaactaaa ctgcatgagt gctttgttca gatttccata 476160

tggatataag ccctcatttc tcaagtataa atgcccaagt acgcaactgg gttgtataga 476220
 gttacatatt tagtagtaat aaaatgcaca taacatggct cagccttta atccctgcac 476280
 tcaggaggca gaggcatgtg tatctctaag ttgaggcca gcctggttga tggaatgagt 476340
 tccaggacag tcagggtctac acagagaaat tctgtcttga aaaacaaata catgctatag 476400

 atttaccctt ttaagcattt taagcgtaca gtccatggca ttaagcacac tgacattggt 476460
 atataacat caccatcatt tgttgccaga tctgtacca ttcaccacac agcaacgtcc 476520
 tcttctccc tctcctagac tcttataacc acctataac gcaagcacat ctatgtgtct 476580
 acatatcata cacatacaca catacatata tatagagaga tatagatata tagatatata 476640
 tgaaactacc aagttttat aggtcagcct cagtatttaa cattctcata gctgacatag 476700
 gaatgctcca gttccatta ctccccattg gcatttaaca ctgtttttt gttttgttt 476760
 aaccattctg atgtgtgcac cgacaaaagg ctttgtttac acatctagat tctcattcta 476820

 cagatacgtg aattgcaaac attttctcaa cagggtcttt cacagagaaa gtgttttgat 476880
 tatttttatt atattagtg atgtgtatgt atgacgatg tgtggtgtga gtgtgggcat 476940
 gtatttgcca caacatgttc tcttetteca cttttatgtg ttcagaaat caaactcaga 477000
 tcatcaagct tacacagtg gcatctttac tcatggagcc atctcaaaga ccaagagaaa 477060
 atgttatttt gtattgtttt gttttccac agggtttctc tgtgtagccc tgactgtcct 477120
 ggaaatcgct ctgtagatca gactggcctt gaacttgcag agatctgcct gcctctgcct 477180
 tccaagtact accccacca gcccaaatg ctattaattt taataaagtc cagtttatca 477240

 attttaccct ttattgacca tacttcttct ggggtcaag tctcataact atttgcaat 477300
 ctgttttgag ttagtatttt tttgtttgt ttggttttt tttttttgg tttttcgagg 477360
 cagagtttct ctgtggcttt ggagctgtc ctggagctag ctctttaga ccagctggt 477420
 ctggaactca cagagatcca cctgcctctg cctcccagat gctgggatta aaggcatgtg 477480
 ccaccactgc cctacttgag ttgatatttt tatgtgtcag ctttaggttg gttattttcc 477540
 tttcccttga ttctcttctt ctcttcttt cccccact tctcttctt gttttccctg 477600
 tgcgatgata gttgctgtc ctgcaccatc tgtttaaaag acttcaaag caggcacggt 477660

 gccacacgca tggaaattcta gcattggaag gtgcaagcag gaggactaga agctgaaggc 477720
 catttcaat ttccatcttc aaaaacgggg ttggggccta ggtggtggtg gcacacgcct 477780
 ttaatcccag cactcaggag gcagccgag ttgaatctct gtgagatcga ggccagcctg 477840
 gtttacagag caagctccag gacagccagg gttcacaga gaaacctgt ctcaaacaaa 477900
 aacaaaaaaa aaacaaaaa aaaaacaaaa caaaacccca aaaccaaacc aaaccaaacc 477960
 aaaccaacca accaaacaaa caaacaaaa aaaaaaacag ggcaggagca ggagctgggc 478020

attggtggtg cacaccttta atcccagtac tcaggaggca gaggcaggcg gatctctgtg 478080

 agttagaggc cagctgagtc tacaaagcta cacagagaaa ccctgtctag gaaaaaaaaag 478140
 agggggggtg gaggtggggg tggagacat ccttcttcca gttgaggact ggagagatgc 478200
 tcagaggtta agagcactgg ctgctcttcc agagggcctg agttcaattc ccagccacaa 478260
 catggtggtc cccaaccatc tghtaatgaga tctggtgccc tcttctggcc tgcagtcata 478320
 catgcaggca gaatgctata tacataataa ataataaatt cttaaaaaat tctttacaac 478380
 aaacaacaa acaaaaaaca tactcctact ggcatatgac aacgttactg tggggttacc 478440
 agtcttctag ctgggcttat tgtctcccat ctttctggaa ccacaggtta aactgagctt 478500

 atttaatggt tggagatgat gggattgcaa gagaatgtac ccagcgggtc cagcatattt 478560
 cagaaccttt tgttcatgtc tggtgacatt ctatcagcca aagcaagact cttggccaag 478620
 ctcaaagtta aggcaagaaa attaggcaca gtctatggag gtagagtcaa gagaggcctg 478680
 gcatcagtag aatctatcac ctaacaaaag caagaggttt ctcttcttat aacggctttt 478740
 attcacatgg gacctcaagc tctctttata aatattccct atgttccctt ctattctaaa 478800
 gtaccacagt acaattaacc ctcaaaataa tgaatattca caatacttcc tctcttacc 478860
 tgacagaaca gggttttaga aaaattcaca ctcatTTTTT taattagcca gcatctcttc 478920

 ccaacaataa agaatgaga cattgcaaca ttgactccga gtttctatct ctacacttcc 478980
 tcctctgccc agcaggctga ggctgctgct tcttagagga ctgacaatag cccagtgggt 479040
 tctgctcagg cttttacatg cacacaaggt cttctgtttg agaggaattg tgcattgtgc 479100
 aattcttcat aaagaatggc tttgttctag tttttaaggt tataaaggt tacaaaacat 479160
 aataaattaa ttiagaaatg atccaaaaag gagagagagg ataagagtca gaacaatcgc 479220
 taagactctc actttctttg ctgcttctgt tggttgaaga gaagagactt agagatttaa 479280
 caggaagtt atgcagtatg gcatgtgacc agggaatgtt gccctacctt aatacctttt 479340

 cctaattttt ttttccctt atcactggtg tgtgtgtgtg tgtgtgtgtg tgtgtgtaga 479400
 ataatttggc aggaggtatt gcattcctag aggtccata caatattttt atgtgcttga 479460
 cgaccacca ttgtcagcca cggttaaagt tctctctcat cccactcaca ctagtggaca 479520
 ggtgaacatg tgttgccatg gaagcctct ggaggtgtct cttatatttt ggggaatata 479580
 tgaatcggtc aagtattctt tttggaagag atagacagcc agttgctact agtttgagca 479640
 agatgaggat gtattattgg tctatatgtg gcgtatatat ttattggtct atatgtttag 479700
 ggcagagcag atctgaggga tacttgatt caggaatcca aacttctcca ggttcttctt 479760

ctctccaag ggagatgaat aaggacaatg gagactccag aattacagcc ttgggcttt 479820
 agtaacttct ggaggacaga aaacatatca cctttgtac agtttggatc ttgttataaa 479880
 aggaaatgac cttactggc ctggttttaa tcacttgttt atggcctgga ccaatcatta 479940
 gcagaatata gatgaggaac actggggaaa tcacaggaaa ccatgaaatc ctgtgttctt 480000
 tatgagacca gaactgtgag gcaagtggaa aacagcctgt tacttttctt tctttcttc 480060
 tttcttctt tctttcttc ctcttctctt gccttctttt ttttttttt tttcttgaga 480120
 ccgtgtttct ctttctagtc ctgaaactca ctctgtagac caggctggcc ttcaactcac 480180

 agagtccac cccctctgt ctctcaagtg ctggaattaa aggagtgcgc cactatgcct 480240
 ggcccttagt tacttctctg ttgctgtgat aaaatgccac gatcaagaca actaatacaa 480300
 ggaagagtta atttgggagc ttccagtcc agagggatag gagtctctta tcaccatcat 480360
 ggcagaaaag cattgcagca ggtggcggac acggtggctg gagcagtggc tgggaactca 480420
 catctccaac aataacagga agcagcgaga acaaaactcaa acggtccaag tctttaagct 480480
 ctaaaaccac cccagtgaca tccctctca gcaaggccac acctcctaag cctctccaac 480540
 atggtcaaca actgaggacc aaatagtcaa atatcagagc ctctgggggc cactttggtc 480600

 aaagcaccac acaccctccc ccagtctgca ctgtaggagg ttggcgttac attgtattgg 480660
 aggggttgt gatctggaag ttcttcccgc actgacatgt tgtaaccctg atgtaaaata 480720
 acaactatca aggagacagc tccctctcaa gatgtctttg gtggcccttc agatttggtc 480780
 ctgtagatc gttgcctagg gcaggttaa tgctgtctgag gtggctggac ttggatgaca 480840
 aaccagtag caagtccca gctttctgag atgtcacttt tggaaacacg aaaacacatt 480900
 gacctgacc cctgggaga accgattcct gtctgtcttc atagtatct ctgtttgggg 480960
 tttggcaaat gacctgaca ccagggttg gccacaacag ccccgagtgc taattctaga 481020

 tctattttc gggttctgcc ataccactga tcaaatcccc ctctgtcacc tectgtatc 481080
 ctcttaagc ccccccca catcttact cactcagaag ccttaatgag cactgtagaa 481140
 ctttcttaag attggccaaa ggtattaaga ttgccaagta gctgaagcag ggggatcact 481200
 tgagccaagt ttaagacaa ctgggtaaca caggggattt ttttttctt caaaaaataa 481260
 tcaacaagc tigtgtgtgg tggcacatgc cttaatccc agcactcagg atgtgtaatg 481320
 ggggtgagg gtggaggtgg aggggagcca agacaggtgg atctctgtga gtttgggcc 481380
 agtctgtcta tagatggaat tctaggacaa ggagattata cagagaagcc ctgttcaaa 481440

 aaattactac caccaccact actactaatt aaacaaaagg ttggcacata accacattta 481500
 tctattttaa aataaactaa aaatgtttaa ggtgtatatg tatcatatgc ttgatgaatc 481560
 cacattaac tagtttgtg aatgacagac agtatctgcc ttgattctac catattctta 481620

ttgcctatta gccccccca cagaatatat aatggatctg atattttaaa atattgaatg 481680
 atatcttagg gtatcttcag ataagaactg gatataaatg taggtatggc agtgtgggcc 481740
 tgtagtgtct gctacttggg ggctaattggg ggaagatgct taaggctggg agtctaagc 481800
 caacctaggc aacacagga gacctgtca aaaagaacaa ataacaaaa caaaacaag 481860

 caaaccccc caaaaacaac aaaacaaca aacaaacaaa caaccacaaa acctaaactg 481920
 aaaacaagta gtttagttgg tgggatggat ccaaggaacc agtttagtaa ggggtggggc 481980
 aggaaagaaa gtctgccgat aagtgttat tttccactga aagcaactag gctcaattct 482040
 gctgagggcc tctgggagac agtcaacaac gttcctcaga gttatctat gcagtgggaa 482100
 aggctatgga ggtcaccgtc acttcaccac ctgtcatagg ctgatggata tatctgtggg 482160
 catttcatct ccggtcctcc actctggtct cctgagtata ccaagattgc tcttacggct 482220
 gggaatacc ctcagctgcg tctggttgc agtaatcatg tctgaagtgt ccagtcagt 482280

 acaagtgaat tccactctc taaacctatg attattggct ctgtctactc cactggatca 482340
 gtggggaggg gagaggggaa ggtgaatcac atgtggaagt ccatatgtca tccttggctct 482400
 ctggggataa tataaagatt tcccagagac accagcttga gtagaagggc tggggtatgc 482460
 atacagactc ttgactcaa acgtgatgga gggctgctga gatgactcag tggctacagg 482520
 caacctgagt tctattactg ggacctcat ggcagaagga gagaactgag ttcagaaggt 482580
 tgccccatga gtcctatgcg actggaatga cacatcagaa gcattgtgt atgcactcat 482640
 acacacacaa atcaatggac tagacatggt ggtatagtct ttagtcccag cactcaggag 482700

 acagagtagg cagatctctg ttagttcaaa gccatcctgg tctacataga gaattccagg 482760
 tcagccagga atacatagtg aagctctgtc ttgaaaaaa agatagataa ataaataggt 482820
 aatgtaat ttaaaatatt gtcaaaaagt gataagggga ttgaaggat gactcagtgg 482880
 ttaagagcac tggtgcct tccaaaagac ctgattcag ttcattaggac ccacacaaca 482940
 gcacatacac acacacacac acacacacac acacacacac acacacacac acctgctat 483000
 cctcagactg ctgaatttga ggcatacaaa ttggcaacc gatctctctg gcacacagct 483060
 ctctcatcta agcgggaata ataacaactc ttctcaccgg gttacttca ggattcagca 483120

 gagtgggatg tgggatglat ttagaactgt gtcagctctg agtaaatggt tgtcattagg 483180
 acaacctgta tcaactgaac tttagccca cctgggaag caatctgcct tccatcgatt 483240
 ctaactgag ggcagtaatc tgcatggcat aggtggttgt gattctgaaa ggagacacag 483300
 gtaaagcaac aatagctaat gtttactgag cacttgaatg agctagctat tatgctgtta 483360
 tgagtcaaaa atgtatttga catgaagaag caagattcaa aacagcagca caaacactgg 483420
 agactttctt tatctcatat aacaagaagt ctaaagaatc tgagctttgt atttcttccc 483480

tgtcaggttc atcaagtcaa ttcttgcct caaggtttca agatggctgc tatacctcag 483540

 tgtatcaaat ctgtgttcca actaatcatg aagctagtga gtggaggatg aatgaaggg 483600
 acaatgaggg catcatgcaa aaggetaaag gacaccagct ggatcttgc taaaagccaa 483660
 actcaaagcc aggcagggtg tacatgtggc ggtacacatc tttaatctgg gagacagatc 483720
 tctgaattca agactattct gatcccatg gtgaattcaa gactagtcaa taggacctg 483780
 cctcaaaaca aaacaagcaa acaaaaccaa gaacttttct agtaacacca gacttgcac 483840
 catggccaac cccacctgct agacagccta agaaatggag ccaggttttg acaagggaga 483900
 ctaaatttgg atgcagtcag tttataatat atgccatcta tgcattttcc tgtttaatcc 483960

 tactcaagat tgagtgagta gaagcacat ttgttataga tgagtgaact gaggccggga 484020
 gagacaagaa ctagccaaa gtacacagt cacaatcagc agaatcagat tagaaccag 484080
 gtctggacce ttctccatta aatcatgtta caaagtgtta attcatttcc ttgcctgcct 484140
 ctctatgag gtccaccag ctgtatgctg ctgaggctgg gcttctgcac cctgtcccta 484200
 cagtcacagg gacaggagag ctggagataa gaatccaaag aaagaatgaa aactaccata 484260
 cccaaagatt ctctggtctt taggccttgt gacctagtg agcttataaa gttgggacca 484320
 ttcttgtgtg tlaggacag ggtgggctga gtgattatct tttgatatgg gcataaatgc 484380

 tagcagagca ttttcaata atttgggtca gcatagtcag ctaggcagtg atggtgcatg 484440
 cctttaatcc cagcactcag gaggcagaca ctggtgaatc tctgagtcc aggccagcct 484500
 ggtctatgta gcaagtccca ggacagccaa ggatacacag ataaacctg tcttgaaaaa 484560
 ccaatccttc ctgctcccc aaaaagaaaa aaaataatgt gattaaaggg tttcagatca 484620
 gcaccctgca ggctaaacg actttaaatt tttcagacga attaataata ttttactgtt 484680
 tggaaatttc acattgtaa ctaagtttcc cgtttctcta ggggaaaaat agcaaaacaa 484740
 aatagttaac tgggtcacat gggaactagg atccacttag tgacccttg ctggagcggg 484800

 gcagtgaccg aaccttttca gggatcatgt ggtcaccatt acagtactca cccacctac 484860
 ttcccttgc tgtgccaact gctggtcttg aagactggga ctgtaagagc ttgagttgct 484920
 tatgctcata cagccacaga atggggcaac taggaactag gtcacggtga cttccctag 484980
 tgaccttcca ccatagctgt ttctgagggt cttcacctgg gtgggagctc taccctgct 485040
 tggccatagc ttctcacct ataaaaatgaa gacattaaca atatcattct ttcaggaggg 485100
 agagggtttt ttgcttgttt gttttgttg cttttgttt acaacaacaa aaaactgctc 485160
 ttatgtatgt gtctttacca cagaagccag aagaagagtg tcagttccc tggaaattgga 485220

gtgacagaca gttgtgaact gtcatacagg tgctgagaac tgaatcaggg tctatcttca 485280
 agagcaggag gtactcttaa tcaactgagcc atctctccag gcccaaatga gaagctgaga 485340
 gctgaggagc taggcaacat tactgaatga ctattgtctt agtggcttat tgctctgtaa 485400
 taacaaaagc acccctcctg cagtttggag gtttaaaata ctacatgatt tgctcaagag 485460
 gttttcagtc tgggctgggc tcagctgagt agttttacaa ctgactttgc tcatgagctt 485520
 cttttcttgt tatttttttt tcttactttc tttttggttt ttcaagacaa ggtttctctg 485580
 tgtagtcctg tgcctagaa ctcaactctgt agaccgggct ggcctagaac tcagggacct 485640

gcctgcctct gccttccag tactgtgcac caccaccttc ccatttatga tcattctgtg 485700
 tgcattgggt gagcactggg ctcaagcagg aagctgcat gattctccac atggtttaag 485760
 aatctcttct ccttatgtat tttctcata tggctctctc atcagggcag ctagacattg 485820
 tctagggttc ccaattccag gaggacagc tttgatgtgc aaacacttgt agtgcttctg 485880
 catgacttat gcttgcctgag gtcccactgt cccatccttg gctgacatta gactctgagt 485940
 gccaggctga agatgtcact cagtggtaga gacctgtcta atacatgcaa ggcctgggtt 486000
 tcgaacctca gcatacaaaa atggaccatg atactggagc atggcactgg aggctatcag 486060

aataattgtc tccacatcat tttcatgatg tataatgggt agaaggaggt tcacctcac 486120
 ttttagggtg aaattggata gtctatgtca ccttttcag agctctcttc tctgaaccag 486180
 ctcaatcttc aattttcag ctctgcctag aaagttgagg gtgtcagaga accagactaa 486240
 gtttgaacta gtttttaatc acttggattg ccatgattgt gttcctgtgg agaagggttt 486300
 cactgtgggc aggaggacaa ggcctaaatc aggcaccatc tgagtccctt ggctgggttc 486360
 aaaactgaga aggttttcgg ctacctggtg aagaactgct gaagtgcagc aaataaaacc 486420
 atctgagacc aacatccagg catgaactct cttaaaataa tatgaaaaag tgggtttgga 486480

gaagcagatg gggaatatag cgcgtgagc ctgctgacac gcacatggaa ggtgagggca 486540
 gaaacgaagg taactggaaa gtttctggtg gcatttgcac ctcttctgaa cacaagagtg 486600
 gggttaagggt ggaaggacct gtgtagctgt ctttctctgg acattcagtc ttttatttat 486660
 ttttttaata agatgcttcg gaaatgggtt ttctcgttaa aacaaatgct accgaatgca 486720
 gtgtgtcgat gtttatattc cttctaattg gcttctgctt gagcaagcaa gcccttaatg 486780
 tccgtttcaa ttaatgcggc tgccctgat ctgggtgctg ctgctcttgg atgcaatgca 486840
 ggggtggggga ggtcactggg gtgtgggagg cagtgtctgt cttgtcaggg cccttagagg 486900

cccttgcaa agaagggaag atgtggaatg agtcaactgcc tccttagtga agaccatact 486960
 ttaaagatgc cagcctgctt gctgcttgat aaaaaacgag cgtggagacc attggcaagg 487020
 cagagaacag agcaaaggct ccgagagccc agccagtgag gagcttgact gaggagaact 487080

gtccctccaa ccctgagact ccagcaacca gccacaaggg tggagtctgt gagctacaag 487140
 ttgctatcc tggggtgcc tgattctgcc acatacact catgtcatga tgggtcatg 487200
 acatgatgac atgtcatgat ggctcagagc tagtggcttc attccagcag gctgtccggt 487260
 ggctgaggt caggatgtcg gtgtgagtgg gctgggctga ggagcagagc aagctttaga 487320

gagaaacagt cacaagctgc caagccttcc tccttctctt ccttttcct tctatcatcc 487380
 cacaagatgt ttaggaaaag aatatggatt tatattgtcc cagagtcaag cttcagaatg 487440
 agttccccct gtagtaagtc agtgctcttg cttttcatct catgacaatc tttgttatg 487500
 ccctctcacc ggagaacacc tgtgtgtcag gtgataataa acacattatt tctagttttc 487560
 caaataactt tctaggtaaa tgttaatgtg tccactttat ctatagaggg caaaattggg 487620
 gtgcacagaa ccacagaagc ttgtcccgta agtagcagga ttggggtttc cagaggcctg 487680
 ctcatttcga tttctggctc cagtgtcacc aattattgag cagcaggag ggccaagtcc 487740

ctggctaagg ctigtctaatg gatgcatctg aaatgagaaa tatcttcaag tttcagacat 487800
 ttacagtgac aaagattcaa cacagactag cctgcatgt cctaggagtc aagatgtgaa 487860
 gctcttgccc tgttctgtta attcttctga tatgcagctt tcagtctaaa tgagtctctg 487920
 tctcaccatt ggtacttgaa ctgaaaaag aagaatgaga acatattggc gtagaaatag 487980
 aaggagggtt tcccagccca aaccacatga aacagaagat gatcagcct taaatttata 488040
 agaaaaaaca aatcagggaa tagagagatg gctcagagat tgagagcagt gactgtctct 488100
 ccagagaacc cagcaccac acgtggctag caacctctg cagctccatt tccggggaga 488160

tgtgaggctc tctttttgcc ctccaagggt attgcatgca catggtgtac agacaaacag 488220
 gccaaacact catacaccca taaaataaat gtaaaaacag taacaaatca ctgctttaag 488280
 tcaccaagtt ttgaggtcgt ttatittgta gcaacagata acataaacct caaaggtgtc 488340
 tgtctagtta cagactttaa cagcgagaga ctgccagttt ttagaccaca acctacaatt 488400
 attggtttgc agacataatt tatttggctt gcatagggtt atttttcaa agatgatctg 488460
 atacttagaa actgggagat ttcatatgag aatccctatt tagagggtct ctgggaaaac 488520
 ctgcatctc acacctgct cctagcaaca gctggctage tgtcacctat ctgtgtgtgc 488580

actctatagt ttaccacagt ccctccactc ctgttatct tgccttaac atgctttctg 488640
 accctgcag gcatttgaat ttttgattca tctgtttggc atggcaatgg gaaggcactg 488700
 gaggtctctg aggagaggag aaaggataag agctgaacag tgagtaacgc attggtgggg 488760
 gcgactctgg agcatgtgta gtaagaaaag aaaatctatt cttcagtctg tccagagcca 488820
 tgaactccat cttttgggaa atgctccttc cttttctctg attgtaaggt tetaattgag 488880
 ccgctgagag ctccctgtat ctcccacttt ccatacagc aggatagggt aatgaatgac 488940

actcagagtt ggggagagaa agtggctgaa tglatgccac agggctcaga tagctttggg 489000

tttaaatcct ggctccctca cctaccatct gtaagaggct ggccatgtca catttcctca 489060

tccttgaaat gggggagaaa ctgactttgt agggttgata cgatttaaaa ggacagtga 489120

ataaaattaa tttttacatg tttcccaac cttgacactg taaaaacctt tttttttta 489180

tccagttgaa tgtggaaacc agtctctaga gcttgtctat tttttactct ttttttctc 489240

aactcgtacg ccaactctca gagecctgta gctcttttat gcccatcttc acatttgctt 489300

ttccttctgt gtggcgtagg cagacttctg taaatgaaat ccttatgaaa aatgtggacc 489360

ctattgggtc ctactcatct ttggttagtt ttagttagga aattgcagct tcaagttaga 489420

aaaactactc aaactagga ggtgcatttg ttatagctga agtccagaaa tgggctggga 489480

agatggttca gtcattaatt agtgtgcttg ccatgaaagc ttcctcttcc cataaaaagc 489540

tgggtactgg tggcacatgc cttaatecc agcattcagg gaggcagagg caggtgtatc 489600

tctgtgagtt caaggccatc ctgtctacag agtgacttcc aggacagcca gagctacaca 489660

cagaaacct gtctcgtaaa acaaaacaaa acaaaatctg ggcataatag cacacatctg 489720

taattccagt gctgggagc aaagactgtc tagctaaatt gtgagttcca ggtcaagaaa 489780

ctctatctca aaaataagg tgggggacgc tgaaggtggc ttacaggtta agaatacgag 489840

ctgtttttcc agaggaacct gattggattt tcagcacctg tatggtggct agcaaccatc 489900

tgtaactcca gticcagggg atctgatgcc ctcttctagt gtctgagggc actgaccaca 489960

tatagggcac agacacgcaa ggagacaaaa taccacaca tataaaatag aaataaata 490020

aatcttttaa aaaaggttct tctacagtgt aagtggccg aggtgacctg tgaatggtc 490080

tgagaccctc ttttttttt tttttttct tttttggtt ttcaagacag ggtttctctg 490140

tgtagctttg gagectatcc tggcactctc tctggagact aggtggcct cgaactcaca 490200

gagatccacc tgcctctgcc tcccaaaggc gtgcgccacc aacacccgac ttggtctgat 490260

acctcttaa ccaaggaac actacaaact caggcaaatc aagtagttca aacttccatg 490320

catatgacaa gaatacctgt aaaactgccc aagcaggtgg tcaatgtaat gcataattga 490380

aaagccacct agictgaaag atgtcactta aagaagcaac ctgtgtcatt ctgtcagtat 490440

aatggtagaa ctgggtggtg tgtcaaggcc aaacactatg tctggacatg atggcctgaa 490500

aaagggttg agcttttttc tggacatgct taaaaatgca gacagtaata atgaacttaa 490560

ctatttgaat gtggattctc tagtctttga acacaccag atgaacaaag tacctaagat 490620

gcagtctga atttacagag ctcacggaca gatgaacca tacacgagtt tctagaacaa 490680

agagttccca agcaagaaga aaagatatcc tagaagaaat gaaaacctac agtatgggaa 490740
 taaatacagc gtaaaagcta gggagagatg gcagagaata cccatgtcaa cttttgtaca 490800
 cacacacaca cacacataca cacacacaca cacacacaca cacacacaca cacacacaca 490860
 cacgtaaac caccaccaag taaaaagtgc agaagtgagt gtatcttctg aacagtttct 490920
 ttaggttttt ggctcaattt ttcagaaatg ttttctaggt tctgtcttcc aaaacttcta 490980
 catcttgtct tttgactgct gtctctcatg ataactgaga aaaaaaatc tcttgcgatg 491040
 gtaggtattg ttagaccccc agaaaaactc aggtatctgg ggtcccaggc catgaccccc 491100

 gtcaccccaa tcaccaggca gattcgagag ctgatgcaa actgcatgag gctttattgt 491160
 tttttaatga gctaacccca tgttagctcg ggtctttcac ccaccgcca tggcagatgg 491220
 ctacctagag atctttagg gcagcttaag gggagtgtat aggggtacac acaggctcag 491280
 gattggtgtg cctccaggct tggagggttt gccctgtgtt gattggccaa ctggttgta 491340
 tggccatag cctccaggg tggttgctat gctctgcaag tcataaagta cacctagagt 491400
 cgtaaagcat agcgccacta gctaacttct gattggttcc ttgtcacgag gcaggcacct 491460
 aacctctagt gaccaaggca aggtcatagc gagcgcgtgt tactgtcatg gctgccaaaa 491520

 tggggggctg gtcatttcag tatcatagta gactatgcta tccaggaaaa aaaagaata 491580
 tctcttcttc actcatcctt tttattgagc aactaccctg tttttttgt ttgttttag 491640
 tttttattha tttatttga gacatggttt ctctatatag cctgactgt tctggaactc 491700
 actatgtaca ccaggctggc ttcaactca cagagatcca cctgcctctt gaaggaaccg 491760
 gcttcccttt tggcagccat aatggtcgaa catgggcttc tatgacctg acctagacac 491820
 tagaaagtca gatgcctgtc tcgcgacaag gagccaatca gaaattacct ggtggcgcta 491880
 tgctttacga cctgggtgtg gctttatgga caagcgaca gcaatgacgt agagagcata 491940

 gcaaccacce tgggagggcc tatgagccat aacaaccagt tgaccaatca acacagggea 492000
 agccctcaa gcctggaagc acaccaatca ttagcctgtg cgtaagcctg tgcgtacccc 492060
 tagacactcc ccttacgctg cctataaga tcttttggga gcccttagga gccgtctttt 492120
 gctagccggc cgccatggtg ggtgggtgaa agacccgagg taacataggg ttagctcgtt 492180
 aaattacaat aaagcctcgt gcagtttga gcaagctctc gaatccgctt ggtgattggg 492240
 gtgaccgca acgtggcctg ggaccccgaa tacttgagtt ttcgggggtc taacactctg 492300
 actccaagt gctttgatca aaggtagca acaccactc ctggccctgc cctgggtttt 492360

 taatagttha ggaagactgg agatccggtt cagcaattaa gcacttgttg cccctgaaga 492420
 ggatctgagt tcaatttcca gtaccacaaa ggtgtctcac aactatatgt aactccagtt 492480
 ccagtggatc tgatgcctc ttctgacccc ttcagacacc aggcattgat gtagttgtac 492540

atatatacat acagtcaaaa tactcataaa cataaagcaa gtgttaaaaa ataattaggg 492600
 aggacatatc atattcatta agcatgtgga ctctaaaatt ggactccatc attttctagc 492660
 tgtatgattt tgggaaagt aacttctttc atgactgctt gctcctctat ggggatTTTA 492720
 atagtacata tttcataagg ctgttaggga gattatataa gcttgaaaag cagtcagttc 492780

 actgcctggc aactagttag tgctctataa ctgttagcta gtgttgccag catatttctc 492840
 tagaaacatc ttctttcaaa ttctcatctt attagattgt tttaggcatt aatgtctttt 492900
 tgacatttct tggttgaatt tgttatagtc aaccataaaa caaacattaa atgaggggggt 492960
 ctactatTTT atgcactgaa gagcaataa aacagacaac gtctgtcctc tatgttgatc 493020
 atactgtgtg gaaagtgggg tgtagcagag agaccataag caaatataca gatttcaggt 493080
 ggaacattgc tatggagaag aatccatgga gaaagggtgt aagtagtgaa gggctgctat 493140
 ctaaaatgtg gacaggtaa acttttatgt gtgtgtgtat gtatgtatgt aattatatac 493200

 ttctttaaag atagaatttc agtatagcct tggctggttt taagagtTGG tatgtagacc 493260
 aggctggccc taagctccca gagatctgcc ctgccaggt gtggggacta aaggcatgct 493320
 ccaccactcc tgtccatgta agacttcttt ttagaaaagcc tgaagatggc tgtccatagt 493380
 ggtgtacacc ttaatcccag cactcaagag gcagagaaat ctctgggagt ttgaggccag 493440
 cctgacctac atagtgagtt acaggataat tagagagcta catggaaaga tcttatcacc 493500
 aaaaaaaaaac ttaaaaaaat acctaaaaaa aaaaaggaag aagaaagTta aaaaaaaaaa 493560
 agaaactgtt aagatggcga ggagtgaact tgtggtggta tcttgcttgt acaaataaag 493620

 cctgtctgga ggtcagagaa tggagcttgc cactagctaa ccatagaggt ctggagctct 493680
 gtacatacag acaggaagtg aggtagctgg acagaaacag gatgtaagca gggagaaaca 493740
 ggaaatctgt tgtcttgtct gctggatgct aaggaggtaa ggtatgctgt ggcttctccc 493800
 ttctctgate tctcagcact tccctctgta tctgactccc gcctttttat tatctagacc 493860
 atttacctga gccaatcaat atctaggaga agactatttg aggccaacac aacagcaaag 493920
 gcaaaggccc agaaggagca gtatgttaga ccaggaaaa gaccataatg tagctagagc 493980
 aaaacagcag actgaaactt acaccatgtc agaaagggtg accagtgata agttacacag 494040

 gacatggaag aacgtgaaca ggattgttgt gcaatttttt tcataatgga agccatgaac 494100
 agagtggggc aacagctgca acttgccctag tagtgggggt gagagatcag aagaggtggc 494160
 tcttgagtTg agtattagat gaactggagg tatctggaga gaagtggaaa agtgaaaatg 494220
 ccacaacaca aggtgttaag ggtggtggcg gtggcgca cctatgatcc cgggagagag 494280
 agagagagtc agagagagag agagagagag agagagagag agagagagag agagagagcg 494340
 tgtgtgtgtg tgtgtgtgtg tgtgtgtgtg gaagcaggat ctctaaggcc agcctggtct 494400

acaaactgag ttgcaggta gccagggcta cagagaaacc catttcaaac aaacaacaa 494460

 aaacaaaca gacaggtaca ttcaagcaa tatggtaga ctagtgcaca gagaaggaag 494520
 aaaaagtagg ctggaccgat ggatagaagt gtttattgaa cactagacat ttcttacttc 494580
 atctgtgaca ggcattgtac aggttcgggg aacgcagtaa tattaaaaat tatcagtaaa 494640
 gaattctcgg tcttggcgt ggagagatgg tttagtggcg aagagtgggt gtctcgaag 494700
 gctgagaacc tgttggatc atccattctc cacctaaaac ggctggcat cgctgtgatt 494760
 ccagcaggta gaggcaggag gatcaacatc atttttggct acagagcaag ttcagtcca 494820
 gccttagcta catgagtccc tgctcgaac aatcacagg tctgcaggga tggggaatcc 494880

 agtcttctgg gagctcagta gttagagcag gcaatggtcc tgcttgtgct cccagacctc 494940
 tgattgtctg gagaggccag agtgtgatg tggatgggag actgaaacat tgattcgaac 495000
 gggagatcct gacacaagaa ctatttaaga gggagaacca acaccaggt taagtaagaa 495060
 aacatttcat ctcgatggg caaaacaact cgactaagct tctttatat tcctttgag 495120
 gaacggcacc cagaccccg gacacgaagc ctctccgcc aaccctagtc ttggcagagt 495180
 ggcagcactc tactcttaa ttectagaaa gtgaaataac cggctccaa ttacttcagg 495240
 gcctgccc catcggccac ggctaaccg cgggggccc atctccaggc ctgcccact 495300

 caagcaccac cccgtcctc ctcttccgg ctctgctca gggttacct cacaccctc 495360
 ccagctcctg ctgctccag gcccgcccc ttcaggccc cggcaacctc gcgtcttctg 495420
 ggtttctctt agcaccgct ccgctcctt agccccgc cggccctaa gtcccctct 495480
 ctgggcacgc tctccgtn nnnnnnnnnn nnnnnnnnnn nnnnnnnnnn nnnnnnnnnn 495540
 nnnnnnnnnn nnnnnnnnnn nnnnnnnnnn nnnnnnnnnn nnnnnnnnnn nnnnnnnnnn 495600
 nnnnnnnnnn nnnnnnnnnn nnnnnnnnnn nnnnnnnnnn nnnnnnnnnn nnnnnnnnnn 495660
 nnnnnnnnnn nnnnnnnnnn nnnnnnnnnn nnnnnnnnnn nnnnnnnnnn nnnnnnnnnn 495720

 nnnnnnnnnn nnnnnnnnnn nnnnnnnnnn nnnnnnnnnn nnnnnnnnnn nnnnnnnnnn 495780
 nnnnnnnnnn nnnnnnnnnn nnnnnnnnnn nnnnnnnnnn nnnnnnnnnn nnnnnnnnnn 495840
 nnnnnnnnnn nnnnnnnnnn nnnnnnnnnn nnnnnnnnnn nnnnnnnnnn nnnnnnnnnn 495900
 nnnnnnnnnn nnnnnnnnnn nnnnnnnnnn nnnnnnnnnn nnnnnnnnnn nnnnnnnnnn 495960
 nnnnnnnnnn nnnnnnnnnn nnnnnnnnnn nnnnnnnnnn nnnnnnnnnn nnnnnnnnnn 496020
 nnnnnnnnnn nnnnnnnnnn nnnnnnnnnn nnnnnnnnnn nnnnnnnnnn nnnnnnnnnn 496080
 nnnnnnnnnn nnnnnnnnnn nnnnnnnnnn nnnnnnnnnn nnnnnnnnnn nnnnnnnnnn 496140

nnnnnnnnnn nnnnnnnnnn nnnnnnnnnn nnnnnnnnnn nnnnnnnnnn nnnnnnnnnn 496200
 nnnnnnnnnn nnnnnnnnnn nnnnnnnnnn nnnnnnnnnn nnnnnnnnnn nnnnnnnnnn 496260
 nnnnnnnnnn nnnnnnnnnn nnnnnnnnnn nnnnnnnnnn nnnnnnnnnn nnnnnnnnnn 496320
 nnnnnnnnnn nnnnnnnnnn nnnnnnnnnn nnnnnnnnnn nnnnnnnnnn nnnnnnnnnn 496380
 nnnnnnnnnn nnnnnnnnnn nnnnnnnnnn nnnnnnnnnn nnnnnnnnnn nnnnnnnnnn 496440
 nnnnnnnnnn nnnnnnnnnn nnnnnnnnnn nnnnnnnnggc tttccagtc ccggccagctc 496500
 ttggtgttct cttaggcgca cagatttgggt gtccccccct ctccgcccc ccagtggttt 496560

 tatcgcttc ctgcccacc ttgccaatcc ttggtcgtt gtcacctggg gcgccggagg 496620
 ggccaccagc cctggaactg gtctcacact ttgtttctgt cctcttagcg gccgagcctc 496680
 agttttctcc tgggtgaaat ggggtcaaga aggaacgcag cctcgcaggg tgttagtgta 496740
 ttcagggagg gaggtagtac atgacagaag cgttacatgc caacaggtca cgttcaatta 496800
 gactgacca ggaacttctg gaatgtatcg cctaattgcc acagctgaat tccagagttg 496860
 tccctactca aagcagcaga aatccagttg cagagaaatg aaatagccgt agaagtcaa 496920
 agctgttagt aacttactta tttctgata tgaacatgtg tcatctcttg ttcagagggc 496980

 attttgattt accgttagga ttaacatcat atagttaaga agaaacgtaa ctccgggttc 497040
 ctccctgaga cattgacctt tctgccacag ataaaatccc cctttgttgc tatcagaact 497100
 ctgagggaaa ggtgattagg attaatttgt ttgtcttggg ggtgtggta gaggeatcca 497160
 gagatctcca agcctccaat ctaaatgaag tctgagctt aaggacctca ccaaagtcca 497220
 ccttctgctt tattgcatgt ctctctcttc tccaaccgc aaatcttgta ttctccatgt 497280
 tcgtagttag aaggtcaggg gtgtaggtag ctcaagttaa ctgcctcaac tccctgcctt 497340
 caaatagtgt tattctttgt ttccagtgga ggcttagagg ggttaaagtg aactaaaatg 497400

 aactttggca attgtttct gtggtcagta tgatattgggt tgtggggatc atctgagaaa 497460
 tcagacaggg ccaggtcttg aggctctcat gtttgatta gttttcaac ctgtaggtct 497520
 gctgtgcttt catccttaag attctagatt tggtagtggg ggaatatacg agtggatggc 497580
 tcaatagacc atcccttctt tgcttttaac tgatccttga aaggggcagg ttgtctaaac 497640
 cttggtgatt actagaattc ttggtagcct ttcagtctag tgtcatcccc ccctcccc 497700
 agtttggta atatgatcta cttttcagc cctcaagatc aggagtctca aaagacctg 497760
 tgtagtctca gccactttct gtgccccat gtctaaagag caggtgtctg tattttaaat 497820

 taacacattt gtttagttt cctaacaaca ttggttaggt actctctga tttctaattt 497880
 attgtgaagt agtttcagg gcttgattta tgcctttgta gtgtcaggca gtagagacag 497940
 attaggaagg acttttgctt taggatcaca ggatttaacc agcgttgact tctacaagga 498000

gctgagccat tcctttgagt ggccctttga gtctggtttt tccagacacg gttttcctgt 498060
gtagctttgg agcctgtcct ggaactcact ctgtatacca ggctggcttc caactcaaaa 498120
agatccacct gcctctgcct cccaagtgcct ggcaagtctg ttttcttatg tgtaaagtct 498180
cataggggtgc tgggagaca agaaaatgat tgtgaaaatg cttgttgacg taataatagc 498240

taacatctat taatcagtgc taggactgaa gatcatctat taatcagtca taggactgaa 498300
gatttttagt ggactatgct atttgatact tggacaataa tgaactaagt attatccctg 498360
ctttacagaa gaaactgggc ttaaagaaag attacatcaa ttggccaagc tggattcact 498420
ctgcagacag taacagtaaa atcagattct ttgagaagtt gtggtgccat ccatgtatgt 498480
catattttaa atagttggca atgcaacagt ttacagtgt gcaattctat gggaaatagt 498540
atattttata ttgtgtaca gctgatatct ccaaattacc ttacctttcc taactgaaat 498600
tctcctggtc aaacactttt aacttcttgt tgaagattct tggcaaacca ttctgttttc 498660

tgctgtaaat ttgactactc tagaaccttc acggtgaagt gaaataatc aatctttgtc 498720
cttgccaaag ctagcattac ctgccttcat ttcagttttc ggtaaatgca gaatgatata 498780
ctagtatca tctgtggcag agaatgacat ccttagatca ggaatccagg cctggttgtg 498840
tctctgaaa aagccccctt ctccacacta cagttgaagt tgattgctga aaccagttag 498900
ggaattacac tagccccgt attttcagag ggagaccttc cttctacct tgaaccagaa 498960
cccagactac tccatggctc ctgtgcatgc ttgtttggcc attcagggtc tgggtataca 499020
gctgtagtga tcaggaatag cagactatga cagcagcttg aattaaatt gtacagctgat 499080

taggtggatt aattacctca atgacaagct cttttttgt gtctctcctt ccataaaggc 499140
acacagaaag gattagagtt tggagtctgg agtcttagat gatcttagat gattcttact 499200
gctgtaggtg gttagggtga ggttagggtt acattgagct tttcaaaatt cactttagtt 499260
aatctgtttc tgtgtcttgt agtgagattt ttatttatgc aagtgggtg gaattttgtt 499320
ctgatagtaa tgggctgtt ccagagatgg ggactaggac aacgaacatg gttatgttgt 499380
gctctctaaa aatctgatag cccacattgc ctatatacta aagtcagtgt gttgaatagt 499440
atgtttggta aactgccatt tttcttttt ttttgtgatg cttgagattg aacatggatt 499500

tgtttttatt ttatgtgat ggggtttggg tctgcatatg tgtctgtata ccaagtgtat 499560
gcagtccca aggaggccag aagatgatgt cagattccct agacaactgg agtttcagat 499620
agtttgagc tgccatgtgg gtgggggag ttgaaccag gtcctctgaa gaatagctag 499680
tgctctaac cattgagcct tttccagacc ttggatagac cttgataggt tctgcatggc 499740
tatttagacc agacttcttt tttagcattcc agataactac ttgtttcagt ggacacatca 499800
ttattggaaa atgttttcat ttactgaatt aaaacttttt ttttttttt tttttgagga 499860

agggttttac tatatagcta agactgtcctt agaacttggg gtacttctcc tcagcttggg 499920

gttacaagaa ggatcactga tgatgccagg cttcatagac cagttttaag gcatttacta 499980

aacatactac gaggctcgag gatttgggta tatttaataca ggcaaagaag caggcatatg 500040

aaaagtgtg actaggccag gaccttgaag gcatagacag atgacgtcta acctagcatt 500100

gttgggtcaa gaggcatcc ttgaatttgg ctaggcctaa acataagcca ggaaaatgaa 500160

atitgggaag ccacagtaga ggcagagaca ggactattca aggcagaaaag aactgtaatt 500220

ggagcattgg taatgatgtt atatgagact ttgtttact tattgtatta ggtacagttg 500280

taggcattta acatttgta gcttcttctc tgagaggtag ctaaaagtat tgccatcctg 500340

taggtgagga aagcatcttg ggaattaaat gaatttctca agattctcag gtcaagtgtg 500400

aagcctcagc tgagtggatg tggtgataac agaattggca aggtaggag aatagaagtc 500460

agctcacaga aggtactgtg tgacctgtg aaggactttg gacctatct tgaggttaagg 500520

gggtctatgg tctatgattg tgcattttt ggaggctatc tctgtaata ttctagggga 500580

atagactgag agctagagca ctactggtag agaccagtta gccaggtgca gtatcattgg 500640

cccaagattc tgggtgttca ggtgacagaa atcacagagt atgtatacat gaaaaaaggg 500700

aaccaataa gattgttggg atggagaata tggaaagaag cacattttaa tctatcatat 500760

agaagagttt ggggtgtgtg tgtatgtgtg tgatttgtt ctctatgtaa tagctctggc 500820

tgtcctggaa ctactctgt agaccaggtt gaccttgaac tcacagagat ccacctgcct 500880

ctgtctccct agtctctggg ttatagcat gtgctaccag tgtccggcta gatgagttt 500940

taagtgggaa ccaaacagg gaatatagaa ggaagggtg agaatttctc tgctttcatt 501000

aatctctgtt atagatacca gttctgtatc agagctgggg acattggtga agggaggtgg 501060

gggttagttt gacttcaaaa cctaatttgg ctaaacaccagc agttctcaac ctgtgggtca 501120

tgaccatcag aaatatgtct taggaactga gacaccacta gaagcaaat tagttatgaa 501180

gtagcaacga aaataatttt atggttggga tcaccacagt atgaggaact gtattaaagg 501240

gtcaaagtgt taccaaggtt gagaacagct ggcctaaact gagtatgca aactttggaa 501300

aaatatttcc ctttggaaag ggaaatatta gttgctaggc atgtgggttc tgtacagctg 501360

caaaggaaga ctgcttttgt taagccagga taactttgta ttttctctag tcggcgtctt 501420

gtaaacctcg tgttccagtg tgccgctctg taagtattgt caccttagct aggcaccaga 501480

aaacaaaaat atgagtaaag gagcccaggg aagtccttt ctagaagagc aacagatctt 501540

agtgactttg atagaacaac aggggtggaga aaggagaggg ttgtgggatt gacagggaca 501600

ggacaggggtg ggattgcatt ggggactggt tttattaggg ataggagtct atcctaataag 501660
 acctgttttc cagatttctt attaggtggc aaatgttcag gtttgttcat ctgaataact 501720
 aagatccctt ctacgagtaa cattttatga ctaaataatt tagacactat atctccagga 501780
 gaggtatttc ccttccagac atcttaggca gtcttagggg ttaggttaggg gaggaaagat 501840
 agcaagaggg ctttcacatg agtgctttgt gtttaaggaga gaaaaggaaa atttgagatc 501900
 tttgttcagg atagatagtt agggcagaga gagtcgtaaa ttggatgatt agtagcctga 501960
 ggattatctg gtctgtttct ttgatcctaa gtgggttggc tagaacaggc tatttttatt 502020

 cactgatggt gttttcttca taaagtaatc taggaggttc ctgagagtct ataaaagccc 502080
 aaagactaga gataggaagt ggtgacagaa caagattgga ggtcccttcc tactctccct 502140
 ccctcttttc ccttaggtaa atacacagga ctatgccag gcaccattgt taactttct 502200
 cattgtttcc atggcacttc cttttcttc catgttaagt ttcttgtcat ttcataattg 502260
 ctttttagt aaaacatgtg aggtaccttt tgggaggaaa aaaaaggaag atgagatgtg 502320
 gtccctttt ttagttcca tttcttagaa gaacacttg agctgtctac tgtgtcctgc 502380
 tctggatgga agggtaagaa gtcagggtt ggctgaata cataggttc ccagagggcg 502440

 tgtgtatttg gaatgtttag agttgatgaa agtgcaaatc tagcagtcct gtcacctgt 502500
 ctagtgagtt ccattaggtt taaaaacata tctgatgggc ttttgatgct gcttgaactc 502560
 agtgtagtt ggaattactt aggactgcaa ttttagtctt tcttctgaaa aacaaggtga 502620
 tagtactaga taatcttta atttgttat ttactattgt gggatataat aggagtatga 502680
 tgtatgtgtg tcagttgggt ggtctgtgtc atgctcgagt gtggtgtttt ttttttttg 502740
 ttgttgtgt tttttgagac agggtttctc ttagctttg gagcctatcc tggcactcac 502800
 tctggagacc aggtctgacct cgaaccaca gagaccgcc tgcctctgcc tctgagtg 502860

 tgggattaaa ggcattgtcc aacaacgct ggcccaagtt tgggtgtctt ttgggagttg 502920
 attcttctt tttaccctgg gttctgagga tccgacctg tcatcaggct ttgcattgca 502980
 ggtactttga cttgctaagc catctagctg aatctggaat aggatctccc cccacccac 503040
 ccccccaaca gtatttctc tgttagctt tggctgtcct gtaaccgaa gagatctaa 503100
 tctcctggat gctgggatta aagggtttg ccaccactgc ctggcttgca atagataatc 503160
 ttttttttt ttaattttt aaaatttatt tagcatgtat acagtattct gcctgtgttt 503220
 ctcttcatgc cagaagaggg catcagatct cattacagat ggttgtgagc caccatgtgg 503280

 ttgtctggaa ttgaactcag gacctttgta acaacagcca gtgcttttaa cctctgagcc 503340
 atctctccag ccagaatag ataacttaa atgttgttcc tactacagtt ttatggaagt 503400
 ggcttaagaa tttttctctg gaaggagaaa ggggtttacc taaagcatta aatctctcag 503460

ggttaaattc tggggtcatc aaataaacct ttactatat aaaccgatgg atattgcttt 503520
 taaagagtag acaaattgct gaagaaaatc ctaggttaat ttaccaaatt atctgctgag 503580
 tticattata atcttggagc tgaagccctg tgggcaaact tgggagccta agactatatg 503640
 gaacattaaa tttaaatatg tgacagactg tctgaaaaat cacataatga aagtagaaac 503700

 agtaggagtg gaaataacta gctccaaaac atttcttgtt gttgtttttg ttttttttg 503760
 tttttttttt tgtttttgag acagggtctc tgcagctctg gctgtcctgg accttactag 503820
 gcagagtgct gtccctaac tcacagtcc atttgcctct atctcctcag tgctgggatt 503880
 aaaggtgtgt gcagccatgc ctagecccca agcaaagagt ttttcagag cttttagcct 503940
 tatgacgtaa gtacccttat ttcaagacac ctggtccttg aaatggcatc tatagagaat 504000
 aagtagttca gtttgtcaag ccaagaatga ttgctttact ccaaatacat attctctttt 504060
 agaaggccaa gttgagcagc ctaatgtttt tggccaggct ttcttcatcc tggagacatt 504120

 tatttggat ttagctgtct ctgtttatt gaagattttg gtaagcttag ttaaagtgta 504180
 tgtttgcatg gcttctcttc atctgtttgt ctagtttctt ttataattct ttgtgctagt 504240
 gaaagcaage ccggcagtag atttaaaagg gtcatttctg taactcatcg tttttaggt 504300
 ctaggtttcc ctigtgttgg gtctgatcac gctatactgg gaagtcaaat gttgcctgtt 504360
 ccccctaaca gaccatttcc aggccttggga ctttgttctt ctagataact gtaggctacc 504420
 actgaggaat ggtgctgtca atataatgag ggatgtgcat gagtattgg aacacaagag 504480
 taacttttct taaaacctta taatctcacc ttaaattaat ttttcaaac aattaaata 504540

 gcctttttat agttagggtt gtaaatgagg ttagtgttac cttgatggtg taatacaatt 504600
 acgtttggaa cagcctatct tccatccctg tgctcatctg gtcattgagg caatttgtgt 504660
 gcctactgtg tattctcctt gtagaattc tatctgcagt ttttttcaa tactggaggg 504720
 aaacaggtaa acaaatcagg gtagctagat ggttactgg ataaggaaat ttaccgctga 504780
 gcctgatgac ccaagtttga ttcttgggat ccacatgtgg taaagagcca acccctgcag 504840
 attgtccttt gacctcaca tgagctttat ggtgagaaca ctgtgcacac actccctaaa 504900
 taaaactgaa acaatggcc atttgtattc cattectacc cattectacc tgtgcttctc 504960

 ttggcccaga tacctgagtt gtgagttcat actggcatta gcataattga tgctaataat 505020
 tcatagcata ccaatgaa agaaggcttt ggttgtctga cttctaattgt attgatctgt 505080
 ttttggattt ttcttccctt ctccttttct tctgcatgct atccagttgt tgatctttcc 505140
 tgtcaatgt gcccggtccc tagcaagtaa agtcaagaac attagtgtaa gggagaacac 505200
 tgatcttgtt gaaggtgcag ccatccacct agcaccttct ctaattctta tatcacttct 505260
 ttggctgact tccagaaaga tctttcagag ataagattaa gaagaaataa ggcccggctg 505320

ttggtggcac acacctttaa tcccagcact tggaaaggcag aggcaggcag atctctgagt 505380

 tcgagaccag cctggtcagc caggacagcc cccaaagcca cagagaaacc ctgtcttggg 505440
 gggaggggga gaaagaataa ggagaaataa gtttcatatt gaattactac tttcttttga 505500
 tataaataag tcctctgtttt gcttgcagta gatatttgag ttgtgttttt tggaaatcga 505560
 tcaatttgta gtttgcctgat tctcaaagct catcactgtg actgccttct ttaagtgctt 505620
 tgctgcattg agtcctaaaa aatggaaata gaaatgaagg gaacatggag gtttccctca 505680
 tcttgaagaa ctcttttctc ttaagggaga aaagtcactt agggtaattt atttgtgtca 505740
 tgattttttt caacaattta gccttgcctg aggggtttta aggactaagt gggttcttga 505800

 gatagttcag tgggtaactg tacaagcctg gtatcctaaa ttccattgcc atcatgtaaa 505860
 ggtttaagga gagaaccagc ttctagaact ctctctcccc tccctgtccc cccccccag 505920
 cccctccag agatggctta gtggctaaga atactgttgt tcttatagaa gaccaggttt 505980
 gattcccagc acccacatgt ggttcacagc tgtctgtaaa tccagttcca ggggattcag 506040
 tgcctctttt tggccttttc gggcaccagc atgaaagtgg tacacaagca tgcaggcaaa 506100
 atactcataa aatacaataa taaaataatt aaaaaattaa tatttaaat actttttttt 506160
 tccaaaaaag attaagaagt atgcctttgc caaccctga agattagga taatgtaag 506220

 ggagagggcc aaactagagc ctattgttga ggtgctcttt ggtcttcagt gatgttatat 506280
 tctctgtggg ggagataaaa aagctgataa tgaggtaggt agtgtattgg gcagtgaaac 506340
 ttgggacagg aagctctact cttttatggc actagcaaac tggagaaata attttctct 506400
 actgagcttc actttctcat ttataagatg gggttaatat tctgtatctt gctttcctta 506460
 ccatgtaagg ggaaaattag ctaatgttac taaaagtaca caaagtaaaa tggtaggca 506520
 gttttacttc atgagtcatt tgtcagaagt aataggtaac tggcaagggt ttccatagga 506580
 agggaagtct ttgggctgca gtggtagca agagtatctg agccagtctc tagaatcaag 506640

 agacatccct tgaatgtctg agctggtttg gtctttagt ataaggatag taactattgt 506700
 ttgagtgtt cctcatttct aatattctga ctgatttctg cttacaattg attaaatgcc 506760
 agtatttctg tttctggact atattacca gactccacc agaagcaaca tgcaaacacc 506820
 ttttctcagt taaaggaat cttttcttc cttctacttt tacagtttct attcatcacc 506880
 caggaagtca gggcaggaac ctgaaggcag gaactgatgc agaggccaca gaggaactta 506940
 tcagcttgct cccattgact tgctcatccc gatttctttt ctgcttttta gttccaggag 507000
 agctagggct acacaaagag aaacactgtc tcaaaaatcc aaaaatatat attatgtttt 507060

gtgtatgact gttttgcttg cgtgtatatg tatgtgcact atgtgtattc atggagatca 507120
 gaagagagta aaggactttc agatggttat ggaccacgtg tgttcagagg atctgaatat 507180
 agattctctg caagaataac aagtgcTTTT ttttaactgc tgagccatct ctccagcccc 507240
 aagcctgctt tcttacctat ctaggaccac ctgcacagag tagcatcacc cagtgagctg 507300
 ggccctcttt catcagtcac taatcaagac tgcctatagg tccgtgtaga tattttctca 507360
 gttaagattc cttatgtatt aaagggttca ttttctttta aagctgagga ggaaaggaaa 507420
 cactgacacc taaagactcc agtctctcag ctcacctatt acttgtgtat ttgctcaggg 507480

 aaaaatgacc atttctttgt tagcttttat cctgccagtg gaaccttgct ggggtgtttat 507540
 tttctgtagt tttaccaaact cactttgaag gctggcatga acatagatca tgtcttagag 507600
 cctttcttct ttgttctata agcaaataat agaaaatgta ccttaaatta acctggttgg 507660
 gggaaataaa tggctctggt tgttccttaa tggtaaacad tagtcagctc ttgagctctgt 507720
 gtctgtaggg cgtttgtaa aagaatctgg ggggtttgga gcttccacta gagacattga 507780
 tcagagggct attaggtccc tggtaattc gaatattgt tggaaaagat ctggcctggg 507840
 ttctgaatct gccctcattt taatagctgc agtgaattat gtgtctgttt tgtaattatg 507900

 ccatatgtgg taccatgtat ttgtgttagt agagctgata ctcaaagcta tgtgctaagt 507960
 tttaaaaatc ttttagatc tactacagtc tttagaggta gattctattg agtcctataa 508020
 acctctctct ctctctctct ctctctctct ctctctctct ctccacaca cacagtgtgt 508080
 gtgtgtgtgt gtgagagaga gagagagaga gagaggtaga gagtagaga gagagagaga 508140
 gtgtttctgt gaccataaat atagctaggg aaacctagta aataaaaaac aaatgttttt 508200
 ctagcaataa accttctggt gattgagtta ctatttcatg ggtaactaat ctcttctggt 508260
 gcaaagggtt ttttgcTTTT gtggaatat tgaagaaatc cagaggcagt agaataatgg 508320

 agtgccatcc tgettcaagg gatagcaaac atttaggtgg gacagtgttg actcccagtg 508380
 gcatctcatg aggacagttt tgttattttg caaagaaaag aaaattttag ttgtgaacta 508440
 cagagaagca gccctttga gagaaaacag ttcctttaac gttggggaca accaagtgtt 508500
 ttctcttcta gatctcttca cagcatctta ttctctagat cagagatgaa aaactggcag 508560
 ctgctgggtt ggtaggccct gactacatgt tgcctttgac ctgaggtgtt ttatttggag 508620
 ttagaccctg agatagccct gctatgtgtg ttacaagagt gactggtaac atgtgaagag 508680
 agattttgtt gttgttagta taaaagtaa tgaatgggtt tcattatttc atttccatac 508740

 atatgttga atttattctt ttatttttat tttattttat tttatttttt tcgagacagg 508800
 gtttctctgt gtagttttag gagtaattta ttcttatccc actttcttac tgcctttctc 508860
 tatgctctct gccctccttt tactggtcct tgcctttcc ccaaaatccc catttcttct 508920

ttcttctctc ccctgtctct tccagtcctc tccagtaag atctcttggg ttttctactt 508980
 ttaacacaca cacacacaca cacacacaca cacacacaca cacacaccct ccctacctct 509040
 ctgtctttat ataagataaa atgtggttat ttcactcact tatccaaacg taatgctctc 509100
 cagttgtagc cttttttac tgcaaatgtt atgattttgc ctttcttttg tgactgaata 509160

 aaattctatt gtatggccag gcgggtggagt ggaggtgcac actctgaatc acttggcaga 509220
 ggcaagtggg tctcgggtgag ttcgagacca tcatggctca caaaatgagt tccagaacag 509280
 ccaggactgt tacacagaga aaccctgtct tgaaaaacaa aacaagacaa acaaattaag 509340
 aaaaattcca ttgtgtgtat gtagcacatt tcttttatcc atctatcagt agttaggcta 509400
 gtccatttc ctggctaatt ttagittgtc accaataaac atggatgctc aagtatcttt 509460
 gtattatgtt aactttgggt gcatatctaa gagtgatata gcttgggtgg tctattttta 509520
 agtttttttt ctaccctat ggaacctcca tgcctgactct ttgtcaatta ttattattgg 509580

 aacctttcag gaagtcattg tctctgccca tatcttgaag tcaactatg tttttagagc 509640
 tggaaattgt tcgaacacgg cacctacaga ggatctattg gagctggagt tgcataccct 509700
 ggggagctgt ctgatacata ggtgctggga tagagagtag caggggctgg tgtctgatat 509760
 gaaccataaa cagttctagt tacaatagtg ggtctaggcc ctggctgttc ttcagaaggg 509820
 ttcatctctt tgatctcca ccagcttcc tgtcttga ttctttatta ccttgectgt 509880
 gtatatttc acatggcttt tttgggacc tgtgactgtg ttctttggga aatcttctgc 509940
 agcatcacc taacatggaa gaatcctga atttacaact aacaatcttc atatttctc 510000

 ttaatgcttc catatgggta agcttcttta gatagtaatg tattgttct caagtttgtt 510060
 agagccacac tcaactactt gtctcattga taaccaagct gtgtatcagt tgctcttttt 510120
 gttttcttc cttttatctt tgaaacttgg tggattcatt ttgttaccg tttgacctct 510180
 gatttgcttt attgccaagg ataatcctga actttttatt ttttcttgc ctctactaag 510240
 tgcaaagcta ggattatggg tgtgtctgcc tgaactcttt aacattaaag agacttcagc 510300
 taggtgtcgt gctgctgaat ctctgagcg taaatgaggt ctctttattt tatgaggaac 510360
 cttcagctgc cactattgac tagtcagttt gtgtcctgac ctgtcataag acttgcaaaa 510420

 aaatagcaaa ttagccaagg cttagtaggt cttatctttg ttaaagttgc atttcttacc 510480
 cctaataattt gtaaaactggg tgtgtatagt ggtggaagta ggactgatgc catgattaaa 510540
 gctggttttc ttaggagtta gtacctgtt ctttttctcg tagttgcaaa tcctatttgt 510600
 gaaaagtagg catcttctgc gcaagacct tcttgaagtt attgtaacat ggtcattgta 510660
 ggtacctgac aaaaagctg tcaatatgtg tgtgtaactc agaaggtatt taagttctta 510720
 cgatgctagt ttctcagatt gaggcacatg attgcatgtg ggaagtatgt aaaatcacia 510780

catacccaaa gtgtcgatgc atttggattt ctttttgat ttagaactgg caattttaa 510840

 gttctttttt gaaacagaat ctcttttgca tagccctggc tgtcctagaa cagaccaggc 510900
 tggccttgaa ctcacagaga tccaattgtc tetgcctctt ggcttttggg attataggca 510960
 tgctccagta tgcccagcta aagtttgctc ttaatatcaa tcacacagaa agggatctgt 511020
 gtgtgtgttg ctgaggatct gacttaaggc ctgatcatgc tttatcatgc tttgtcactg 511080
 aaccaaaca gcccctacc cattectaaa ttgtatgagt ggacaataaa ttgggtgtgca 511140
 ttttttaaaa aatgcatgtg tatgtgcaca cacatgtacg ccttgtatat atgaggttgc 511200
 atgcatgcta tagatttatg tggaaacagt cagtttcctt ctactgggtg tacagggttt 511260

 cagagagggtg tggtgacaaa cacctagtca ctgagctgcc accagcctaa gaaagatgtg 511320
 gttttttgtt ttaaggttaa atgagaagac atcaaagaaa cagtagatta tagaaagcct 511380
 tctgatcttc cagtggatct aatgttacta gatcttgaca attaaaagaa tagttggaaa 511440
 aaattttaa agaacagtct gaatagctct agttggcctg gaattccctg ttagatcaa 511500
 ggggtggcttt gaactcacac agatccacct ccagtgtctg ttcctgagta ctggaattaa 511560
 aagagtgttt taccttgcct cctaatttta aaaagcatga tctaattttt aacattgca 511620
 actaatctgg gatttttaa ctggatttgt atggatcaga catacctttt ttagtgacct 511680

 ataaaatata ttactggtct gggaaggaag tagactttgg acatggctaa ataggtaatg 511740
 gtgtcagaaa tggcaggcaa ttactggaac cctcgccag aagcctggct ctggcttga 511800
 acacttgccc ccacaaagag aaaaatgaca taaaacttat aaaagacaaa aaaaaatgt 511860
 acagtttgtg tgcaaaactgg agacaaagcc attctcaact taatctgttt tccccagaca 511920
 aatttctaaa tttatagaa aagataaagc caggaaatag gcttatgtag atttatgtgg 511980
 ttctcattga gttgaagggg gacaggtgtc agtcaactaga gttctaattc tatttggttt 512040
 tcgtgtaacc tactcagggc ttctgagcag gctgtctctg ctgtcagcgt catgtttctt 512100

 acaggagacc ggggctgaga aagccaatta acattttttt ctttttagtt ttgaatgagt 512160
 tccattatag aaggaagcta agagacttga taagtttaga cagattgtta cattaaacgt 512220
 caccctcttg caggctgtcc tcgcttcttg tgcattgcagt gacacttctt cctaagcccc 512280
 acatcccaca ctcttacac tgaggtgcaa ctattctctt ccttgatttt tgtctatctt 512340
 cctacctttt tttctcact gtttaaggaa tttttattaa agcaagaatt ttataatcca 512400
 aattatgttt tccttgctca gtccatcagt tatacaagtt gaaacagAAC tgatatccca 512460
 agctattcca cagtaaagaa ttacaaaatt aaagaaagga atgctttaa tttttatct 512520

ttgctgaaaa ttcttttccc agggctctata aaacattaat ttgtttttat attttactat 512580
 tttttttgta ttttttgta ttttaaatca agtaatcagg actagcattg tttgctagag 512640
 ctggcatttg cttggactt aaggttcaaa gtttcctttc cttttttatt tattttatat 512700
 tttgcaatgt tttttcataa tatttaaat tttcgatfff tagatatttt ttccttcggt 512760
 gaagcacgag tttcttttcg tggtcctga taaatttaaa cagatggaac tccagcggca 512820
 ctgttcagat gtttagatat ttttttctcc ggtgaagcac gagtttcttt tegtgtccc 512880
 tgatcagttt aaacagatgg aactccagcg gcaactgttca ctgccttctg ggcagcctct 512940

 tttgcttggg gggcctgtag tacagctata gcttcatcaa cctttgagcg gagagactcg 513000
 ggagactcaa gcatgtgcag tagttctggg ttatcaatct ccaacagcat gccagtgatt 513060
 ttaccagcca gagggggtg catggcttga ataagaggaa acaaccattc acccaacatt 513120
 tgcttttctc cttgaggagg ggcagatgcc aacatggaag cagttaaagg tctttgacct 513180
 tgcacatgaa cagcaggctg ttgcatggta acttgtggct gtgcattaag ttgttctgg 513240
 gggttgtgga ctcccgcagc atatttatac tggggaacgg tggggacagc aggcgtggct 513300
 gcagcagcag cagctacagg acgtggacce atggtcctg ttgaagtgtt agcaacatgc 513360

 tatgttgaca tgactcatgg aacctgtgag gatgctggc tcatagtact aaatggtgg 513420
 ctaggagcag ctgggcggat agcaccgggc atattctgga atggatgagg tctggcacc 513480
 tgagcagtc agcagaggact tgctcttagt tgagcaattt ggctaggagg atagtatgca 513540
 gcacggttct gactctgagg gatggctgcc atgaagtaac ctgaaggagg tgctggctgg 513600
 taggggttga tcacagggtt gggcacagct tgcacacttg ccattctctg catatgctgg 513660
 ttagtaagggt gagcctggcg ctcttctttg cgtgagcta aagctacata gaatggcttt 513720
 gtggccacaa ttctgccatt catttccgta actgcttttag tggcttcttc aggagatgag 513780

 aaacacaaaa ccaaactgtt tgctcgcacc acctccatc ataacctttg cactggtgat 513840
 tgtacaaaat ggagaaaact cgttccggag acgttcatca tcaagatttt tcacataaat 513900
 gttaacacce tagtatctgg tgatcctatc ttgcttcatt tgctcaaatt tgcgcttaag 513960
 ctctgtctgt gtttccattt ttttctgagc tcgaccaaca taaatctgtt taccattgag 514020
 ttcctttcca ttcattctat ccacagcttt ctgtgcatct tcatgcttct caaagcttac 514080
 aaatccaaat cctttggatt ttccactttc atctgtcatt actttcacat ttaaggcagg 514140
 cccaaacttg ccgaagagat ccttaaggcg ctctcatcc atgtcttctc caaagtcttt 514200

 gatgtaaatg ttagtgaat cctttgccct ggctccaagc tctgcttctc gttccttgcg 514260
 agacttaaat cgtccaacaa acacttcggg catttagaag catccattc attttctcaa 514320
 tagctctttc tacagcttcc tgtgtttcag agtgtacaaa tccatagcct ttggagccat 514380

ttatcaca aaccaccta catgagagga tgtttccaaa tgcagagact ctaatatcct 514440
 tcatccattg tacctagcag actttttaa attaaatfff ttttctcct gagataggat 514500
 ctcactttag ccatcaatgg cctggaccta gcagacattt gaatttaaaa aaaattaggg 514560
 ctttttgttt gtttgttttc tttatfffft tttattagtt caaattggga acaagcttgc 514620

 ctgagatgic aatcccttct cctctcct cccctcccc ccaacatccc atctgccct 514680
 agccattccc cctctattcc ccaggcaggg tgaaggccc tcaaaagggg ctcccaaaag 514740
 tctaccacat catcctgggc caggcctagg ccctactcca tgtgtccagg tcaagagagc 514800
 atcccttcac aagggatggg ctctcaaaat cccttgtttt ttttaagac ctacatatt 514860
 taatacagtg cgttacctct gtacaaatgg aaaaaaaaa taagtcaac atttctagac 514920
 caatatggct gtaatfffft gtacaatgcc aactcaacac agtaaacctgg gatttgtttt 514980
 ctgtttttgt tttctgtgt aacagctctg gctgtcctgg aactcacttt gtagaccgg 515040

 ttgacctga actcactgtg atccacctgc ctctgcctca agtgcctgta ctaaaggcat 515100
 ttgacaccac tgcccggcca aaaactagtt tttaaaagaa atgcctactg ataacttagt 515160
 ggattgcttg tcatfffft agtagattgt ggactatttg tgacatcttt tggaaataag 515220
 gtagaggaaa cagaagattg ggttagaata gcagttttca acttgtgggt tgtgaccct 515280
 ttggaagtcc ccttcgacag gggtgccata tcagatagcc tgcatatcag atatttgcac 515340
 tcataatag caaaattata gttaggaagt agcaacaaaa ataatfffft agttgggggg 515400
 ggtcaccaca acatgagatg tttgggtcga aacattagga aggttgaaaa ctacagcact 515460

 atgtagatca ggetggcctt gaactcatat gctgtactt cccaagtgct ggaattaaat 515520
 tcattggcca ccacagtga ctgctttagg agtaatttaa cccccccc ccaaatctca 515580
 ctagtctcca gtgggcaggg cattcaaga cattcaatag aggcctgcta gaccctgacc 515640
 tgtcagaagt gttgcagtgg ttccctaatta gaaatggatc tatacgggct tgtagccaga 515700
 gctggggaga ctcttgatta ccatgaaatg gatctggtaa ttgttagcac cgtggttctg 515760
 aaagtgtggt cctctcctgg gatcagtggc aggcagcact gccctgaaca aattgtgaaa 515820
 aggttggatga acttgtgttc tccattatff tctctcact taataaaatc atgctagtgc 515880

 ctagttagag accacttct cagatagaag tcacttattt aatacttcat aatgttaaa 515940
 tactagggta agctcttttg catgtttatg tcttctaagt taccagagta ggttagaaaa 516000
 ggaaatggaa gctgagagaa gtgaaataat aaatacttga ctattcattg ttacatagca 516060
 tattgtctgt ggtgatgacc aacattcgag acataattgt aattccaact actgaattac 516120
 tttgtttttt taaaaatcag ggcccactt tacctcata aatattcaat tgaagatcag 516180
 gcctgtcct ttagccctt caaagactgg agaaatffct tttaaaacca gtggtaatat 516240

agttattagt ggggagctct gcttgctttt gctttctcat ttccttttca aagtctaagg 516300

aatgagcagg ctctaattgg agagatcagt catcatttgg gatcaatgga aggtctttta 516360

gagcgatgct gaattgaagg aggagaaaag gactgtggat atttctatgc attgagaacc 516420

tgaaggctta gcatgttcag ttacctatgt tgcagaccc tgttactcct attgttggtc 516480

attcaacaaa tattggatga gtgttgcct atgtattaag acttttgcta gtgctaagga 516540

ttcctagata acttcacaat ctagcatcat ttagggaagg atgccaacca tagtagatgg 516600

tgtgtgctct ttaataggat catgtataag catgaaaatg ggctttcctg gggaacataa 516660

atgatttgtg ctgttgtttt tttttttttt ttttttgaga taatctcatg tagtccaggt 516720

tggcccaaaa ctctcagtc tccatccca cttgccaagt tctgggataa caagagtatg 516780

ctacctgttt tgtttagga ttttacttat tttatgagca ttggigtttt gtatgtgtgt 516840

ctgtgtgagg gaatcagatt ccctggaact ggagtttagat ttgttagctg ctatgtgggt 516900

ataggaatt aaatgaggat cctctggaag aacagccagt cctcttaact gctgagccat 516960

ctctccatcc ccatagctct cattctcatt ctctatcttc tcccctttat ctccccctc 517020

ccccctctt ctcttttct ttttggaaact ctctcatgtag accaggtga cctcgaactc 517080

acagatctgc ctgtctctgc tttctgagt ctgagattta aagggtgtgtg ctgcatgcc 517140

aggctttact tgcgattga aggtaaagt aagagttaag gtagggaagg aaccagcaca 517200

aacaaaagca taaagtata ttcaagaacc cagggtaaag aagtgacat tagagtgtt 517260

cttcatatag caaatcagat tgagcccttg ccctttgcca ctttctact gtagcctttg 517320

gatggcagt atgtaggact ataggtgtg gaagaattag atctgtaagg aggtaccatt 517380

tgaaatttct agaattctgt agagggaagg cggaaggaaa ctgaaaacca gcaatctttt 517440

ggaccaagcc tgccagaggt gctgagttct tcacagtat ttgaaaattc tggcctgggc 517500

aaattggttg gttttctgg caaaatccca ttggctecat atagtctgcc ccccccatg 517560

cttttaaaa aagaaattaa tgggatctgt tcaaaatact tctgaaatga aattacattt 517620

ttaactctaa ttacctaat taaaacttga cagccataat cctgaaatga cagatatagt 517680

aagtaccca ggctgtgac aggctcattt acccagatga aatgtcgttt tgttttgct 517740

taggaaaatt cttttatctt tcttatcagc agcttagctt ttgctccat agctttacca 517800

agctagggga gctgtagtgg tgggctacag gcttaccctg gacataatct cagtagaggt 517860

gccatcaaga tggttgttac cacatatac taagtctttt tcttcagttc aaattggact 517920

taagccttg aatgaaattc tctgcttga aggtgaagga aatggcattt gttagaacc 517980

tgttgatctg gggatagacc ttgttcttgg gtaagtttat gactagtatt aagggcactt 518040
 taacatctg tggatgaa cacctgtaa tccttgcact caggaggctg gtggcaagaa 518100
 gatcaccaat tcaaggctag tcaagacctg tttgaaaggc aagcaacaa aacctcaac 518160
 agtttgaggt taggaacaag aaagctgaa aatagaagtc ttttcatata tctccaattc 518220
 ctctaacttt gtacaggctt gatggtgcc tagtctaac taattacttg gctagcctta 518280
 aaatatcttg gggtagggac taggtccaag tccatgaagc taactgaaga attggtgat 518340
 accaagtcaa gaattctaga atcagaagcc ttttaaagtc aatagacact ggctgctatg 518400

 ttttatgcta attactagag agatagttga gtaagacaca gtcctgatc ctgagaacct 518460
 tagaattgtg gtgaggcagc aataggtaag gaatagtcac tcatatatga caaattatta 518520
 agggcagaat aaaccttatt cagtgttaga aagtctcagt gccttatgta tatgaggtag 518580
 tgaatgagt acataaatat ttcagataca ggttctgctt tgaagagtgc ctagtaaat 518640
 aagacatgta gacttgtgaa aagttgattg taacactcaa catgtagatg atatctgctg 518700
 gacagattta cctggagaag agaggctggt caggaaagtg agaaaggatt agttttcca 518760
 ctggtcatcc acaaagattt accacagcct ttttcattga gcttgcctt gaatagggag 518820

 taatggagga atgaagaaa acactgtagg tgttaggaaa tagcttgacc aaagttagga 518880
 tctgtcaggt gataggtgtc tgatgtgatt tgagtagtat acagggaaag ggtgtgtag 518940
 atgatgaggg taaagtttaa actttatccg gacagcaagg caatcaaatt cattgagaca 519000
 gtgtaagact gagatggcag tgtatatggt gtattctctg atagatgtga ttggagacaa 519060
 gtagattagt taaaacaagg gtcagtaaat tacgatcata gggatgata cagccactga 519120
 cccacagaac ctatgtatgt ttttgcattt cagtgatatg ttgaatacta cagagatttt 519180
 gctgctgtag ccctcaaagc ctaacagtct agctgtccag ccctacacag aaaagattga 519240

 cagatacctg agttaggtaa ttatataggg tatgtaagaa aaaataaatg ttagaactaa 519300
 gtctgaaata ggttggtaat actgaaagaa gttagcaatg cgatttaaca ggtaacactt 519360
 gtctatctg cctctcaagt ttgtaaaaag gcatttgata ttaggcaag tactggtgtg 519420
 cttttattag ttgcatagct ttggtccagt catctaactg ctcagaggcc cagatgaata 519480
 taatgtagta agtaggataa agagaagcct caccagcttg attcttcctt acggattttt 519540
 gtcttgtttt gatgttgag acagggttct tctgtgtagc tctggctatc ttggaactca 519600
 ttctgtagac caggctggcc tcaaacttac agagatctgc ctgctctgc ctctgagtg 519660

 ctgggattaa agcctgtac caccacatgt gctgctcagc tcttagggaa ttttgaagt 519720
 catctagttg gaaagacaga tgcctagaa aatggagtta tgttaggggt tgtgggtgtg 519780
 ttgtcacctt taatccaagc actcgggagg cagaggcagg tggacctctc ttgagttcaa 519840

ggccagccta gtctatgtag taagttccag gccagacagg gatacacaat gaggttccat 519900
ctctgaaaaa aaacaaaaac caaaacaaaa caaaaaaatt atgaaggtga aaaaaaattc 519960
cctcctaccc taaggcctnn nnnnnnnnnn nnnnnnnnnn nnnnnnnnnn nnnnnnnnnn 520020
nnnnnnnnnn nnnnnnnnnn nnnnnnnnnn nnnnnnnnnn nnnnnnnnnn nnnnnnnnnn 520080

nnnnnnnnnn nnnnnnnnnn nnnnnnnnnn nnnnnnnnnn nnnnnnnnnn nnnnnnnnnn 520140
nnnnnnnnnn nnnnnnnnnn nnnnnnnnnn nnnnnnnnnn nnnnnnnnnn nnnnnnnnnn 520200
nnnnnnnnnn nnnnnnnnnn nnnnnnnnnn nnnnnnnnnn nnnnnnnnnn nnnnnnnnnn 520260
nnnnnnnnnn nnnnnnnnnn nnnnnnnnnn nnnnnnnnnn nnnnnnnnnn nnnnnnnnnn 520320
nnnnnnnnnn nnnnnnnnnn nnnnnnnnnn nnnnnnnnnn nnnnnnnnnn nnnnnnnnnn 520380
nnnnnnnnnn nnnnnnnnnn nnnnnnnnnn nnnnnnnnnn nnnnnnnnnn nnnnnnnnnn 520440
nnnnnnnnnn nnnnnnnnnn nnnnnnnnnn nnnnnnnnnn nnnnnnnnnn nnnnnnnnnn 520500

nnnnnnnnnn nnnnnnnnnn nnnnnnnnnn nnnnnnnnnn nnnnnnnnnn nnnnnnnnnn 520560
nnnnnnnnnn nnnnnnnnnn nnnnnnnnnn nnnnnnnnnn nnnnnnnnnn nnnnnnnnnn 520620
nnnnnnnnnn nnnnnnnnnn nnnnnnnnnn nnnnnnnnnn nnnnnnnnnn nnnnnnnnnn 520680
nnnnnnnnnn nnnnnnnnnn nnnnnnnnnn nnnnnnnnnn nnnnnnnnnn nnnnnnnnnn 520740
nnnnnnnnnn nnnnnnnnnn nnnnnnnnnn nnnnnnnnnn nnnnnnnnnn nnnnnnnnnn 520800
nnnnnnnnnn nnnnnnnnnn nnnnnnnnnn nnnnnnnnnn nnnnnnnnnn nnnnnnnnnn 520860
nnnnnnnnnn nnnnnnnnnn nnnnnnnnnn nnnnnnnnnn nnnnnnnnnn nnnnnnnnnn 520920

nnnnnnnnnn nnnnnnnnnn nnnnnnnnnn nnnnnnnnnn nnnnnnnnnn nnnnnnnnnn 520980
nnnnnnnnnn nnnnnnnnnn nnnnnnnnnn nnnnnnnnnn nnnnnnnnnn nnnnnnnnnn 521040
nnnnnnnnnn nnnnnnnnnn nnnnnnnnnn nnnnnnnnnn nnnnnnnnnn nnnnnnnnnn 521100
nnnnnnnnnn nnnnnnnnnn nnnnnnnnnn nnnnnnnnnn nnnnnnnnnn nnnnnnnnnn 521160
nnnnnnnnnn nnnnnnnnnn nnnnnnnnnn nnnnnnnnnn nnnnnnnnnn nnnnnnnnnn 521220
nnnnnnnnnn nnnnnnnnnn nnnnnnactgg tcatccacaa agattacca cagcctttt 521280
cattgagctt gtccttgaat agggagtaat ggaggaatga agaaaaacac ttaggtgtt 521340

aggaaatagc ttgaccaaac ttaggatctg tcaggtgata ggtgtctgat gtgatttgag 521400
tagtatacac ggaagggtg tggtagatga tgagggtaaa gtttaaactt tatccggaca 521460
gcaaggcaat caaattcatt gagacagtgt aagactgaga tggcagtgtat tatgggtgat 521520
tctctgatag atgigattgg agacaagtag attagttaa acaagggtca gtaaattacg 521580
atcatagggt gatacacagc cactgacceca cagaacctat gtatgttttt gcatttcagt 521640
gatatgttga atactacaga gatthtctg ctgtagccct caaagcctaa cagtctagct 521700

gtccagccct acacagaaaa gattgacaga tacctgagtt aggttaattat atagggtatg 521760

taagaaaaaa taaatgttag aactaagtct gaaataggtt ggtaatactg aaagaagtta 521820

gcaatgcat ttaacaggta acactgttcc tatctgctc tcaagtttgt aaaaaggcat 521880

ttgatatgta ggcaagtact ggtgtgcttt tattagtgc atagctttgg tccagtcac 521940

taactgtca gaggcccaga tgaatataat gtagtaagta ggataagag aagcctcacc 522000

agcttgatc ttccttacgg atttttgtct tgttttgatt ttggagacag ggtttctctg 522060

tgtagctctg gctatcttgg aactcattct gtagaccagg ctggcctcaa acttacagag 522120

atctgctgc ctctgcctcc tgagtgtgg gattaaaggc ctgtaccacc acatgtgctg 522180

ctcagctctt agggaatfff gtaagtcac tagttggaaa gacagatgc ctagaaaatg 522240

gagttatgtt aggggttgtg ggtgtgtgt cacctttaat ccaagcactc gggagcaga 522300

ggcaggggga cctctcttgg ggacaaggcc agcctagtct atgtagtaag ttccaggcca 522360

gacagggata catagtgaga ccttctca agaagaatt gggcaaaggg tttggtgact 522420

gtgtctggag gtataggga agtaattca aaataccaca tacccttct cttcattaat 522480

tcagacgttt gtttagcca tattgaattt gtttctatcc tcaactgcc aaaaacaaa 522540

ggctggattt atccctagcc agaaacaagc ataagcaca atgtcaattt gtattgttag 522600

catcagttgt cagtcactg acaggagaac ctcagttgaa gaattctca catcagattg 522660

gtttgtgga gattgtctta ttaattgatg caggaggat cagctacca aaagctctac 522720

caccactaga caggtgttcc tgggctttt aagaaagcaa ttacatatga gccagaggga 522780

gagtcagcaa gcagcattcc tctatggttc tggccctgac tttctcagt gatgaattgt 522840

gacctggaag tataacaaa taaatcctt tctctctgt attgcttgca tttagtcagt 522900

gttttatcat agcaacagaa gaagactagc tcaacctaca aaggagcagc ttaagatagg 522960

aagagttcat tttgctaac atttgaaggt acatccatc atgaaaggt tggactgtgg 523020

aagtggctct gagcagagca gttagagaat glaagtagta accatactaa gcctcagggc 523080

ccacatcaca gtgacctca tctatctagg ctccacctc tgaagattcc caaaatccc 523140

ctaaacaatg tcatcagatg gggaggatca ttgtgaggt tttttatat ttaagaaag 523200

agggtggag agatggctca gcggttaaga gcaccgactg ctcttccaaa ggtcctgagt 523260

tcaattccca gcaaccacat ggtggctcac aaccatcctg tatgagatct ggtgcctct 523320

tctggtgtgc agatatacat ggaagcagaa tgttgtatc ataataatta aataaataa 523380

taataaata aataaaatct tttagaaaga aagaaagaaa tatagccagg cattggtggc 523440

acacaccttt aatcccagca ctggggaagc agaggcagga ggatctctct gaggttcaagg 523500
 ccagcctgtg agttcaaggc cagcctggtc tacaagcga gttccaggat aggctccaaa 523560
 actacacaga gaaaaaggac ctgtcaccaa aaaaaaaaaa aaaaaaaaaa aaaaaaaaaa 523620
 aaaaaagggg gggaggacgc agaggaagag gaaatatagc caggcatgat ggtgcaggcc 523680
 tttaatctca gcacttggga ggcataggca ggtgtatctc tgagttcaag gccaatgtga 523740
 tctacaaagc aaaaatccagg ctagccaggg aatgtagac agagaactcc caccaggaga 523800
 gggaggagga aagagtgagg gagaatatc tctgataac ttcaaaagcc tttgtaagtc 523860

 caaagtctca tttgagccat gagccatgct ctgagctgtg agcacttgtg attattaaaa 523920
 agcaaagtta taagtgtaga ttcttccagt ttgagatgta gcatggctct cttggattac 523980
 aactgctgct tctattcttg atgggcagga aacacttccc taagtgaact taggacaggt 524040
 ttgccagag tctcaatag gttgagtcct tcaactcaagg tacctttctt attgtcccag 524100
 tgcagagcat gaggtttctg tttaacagtg ctaatatatt ttcttttatt attatttttt 524160
 aaagatttat ttattttatg tgtgagtgtt ctgtttgctt gtacacctt atgccagaag 524220
 agggcatcag atcgcactat agatggttgt gagtcccat gtggttctg ggacttgaac 524280

 tcaggacctc tggaagagca gccagtgatc ttaacctg agccatctct ccagcccaa 524340
 gcgctaatat tttcaacaat tgacagctac ttgttcaca ttaccatgtt ctcaacttga 524400
 accagattca agctctttt ctcactttcc agcttttttg ctttactcat tgctttttct 524460
 tgctgtaaac ctagataaat gcagcaagca ataaccatac cacagcctga ctgttctact 524520
 gtcatgaaat ttcttcacc aaattagtct gttaccttta aattcaccat attcatgtct 524580
 tttaggacat agaatgcagc cagtttcttt accagagtga aacttaatgg tttctagtcc 524640
 attcctgatg gagatagcta gtcttcgttg tcaatttggg atttagaatc accatgggac 524700

 atatctctgg gtttgtttat aaagtggtt cagaaagact taacagcaga gaagaatgtg 524760
 gatggcatga tttcataggc tgaggtcca gacctaagca ctagtgtcaa tctcaacct 524820
 gcctgctgat tatggttcta gtgtgtccag ttgctcatg ctctgctgc agtgtctacc 524880
 ttgaaacttt gaacaaaaat aaattcttca aaaccagaaa aatctattta tttatttatg 524940
 gaatgaagaa tggaatggg ggcaggacac acatgtgcc atagtcaag tgtggaggtg 525000
 agaagcagct ttgtggagt gattctgtt tccacttta tgttggttct gaggattgaa 525060
 ttttgagtta tcaggcttat gtgtcaaatg ccttgcctac tgaatcattt gcctgcct 525120

 ctattcttgc atttgtggtt ttctttccag tctttggagc tcaatttaga atagccctcc 525180
 acagtgacce attaaagctt ctttatagt ttcagttctt tttccatgt gggtcagatt 525240
 taatgcagca atgattcctt ttggttttta aaaaagatta tttttattta tgtgtacatc 525300

tatgtgtgtg taigcacata tgcatgcggg cacccgtaaa ggctagacga ggggtgttga 525360
tctcctggag ttgaggttat aggtggctgt gaagctgccc attatgggtg atgggaacta 525420
taagtctggt tctccagaag atctcttaac tgttgagaca ttgcctcagg tttttttttt 525480
tttttctgt tagtttttgt attgctgtca ccaagtagct gacaaaaaag taacttcagg 525540

gagaagaggt atattttggc tcatggtttt agattacagt cgatcatggt ggatatcttt 525600
gtctcttgta agttccagta tagacggcct cttttggaac ttgggatttc tcttcaaggg 525660
gtcagtgta aaacacatcc tttttcgttt taaccttttc ctaaagtcc cctctccttt 525720
cagtgtagag gatgagttta tgcatgcacc ttcattgtct tgaaatccac cacctttaac 525780
tgtgaagact gtagccatct gtaactgttc ttaatagtca aacttcattt tatagtttta 525840
tcatttgggt tagacagtca ttttcagtga ttaactcatt gagagaaaag aatggcaga 525900
ggagatagac aagaaaacaa gagtgatcaa agccctgcca ccagtttggg ctcaaacga 525960

catctatfff ctigtatfff cagctgtatt ttgctgcctt ttcttataag agcttgggat 526020
aggaatgaac tcagtggaaa tggtagcaaa tagatagcct ttggagactg gccattgggg 526080
aagcctggcc ttgggtttag agatgtgctt ttgtcttagg aaggacctaa gttcaagta 526140
gctgacaaag gggctttcaa atggacctga acctatftaa gtagtaaac ctcatggtca 526200
gctgactgtg tcttgaatgt ggctgcaaga gctccacaag atcttgcct acagctagcc 526260
tagtgaaga taacaggag aaaaggftaa ttcccaggcc ttatcaggag gggaagaaat 526320
cacaatttgt ttgatacac gatttaaat tttcagtctc aatttgaat gataaagcta 526380

tggtagctag aacgaggaag gaaatgagtc tcaagctaaa aagcaaagca cccctctcaa 526440
caaaaacaaa aaagccaagc tttgttaaat tatataactt atcccactta aaccctftaa 526500
ccattttctt ctggcatag tatttftaaa cctggagctt tttcctagag actgtgtcct 526560
tttcactgac catggctggc tctgagctat agtgtctttc agttatctgc tttacctttg 526620
actctgatct gtgaagcttc tgatagtttc ttcattcatt tgggaacaag cagcctgaga 526680
tcctactgta gatacctag tgtcttacta tgcctttgat tcttcttcc tftaagctaa 526740
tctccccttc atacggatga cctgaatecc aactaaaac cacacatggt ctttttaatt 526800

tttftgcaac gtttctatfc tctgtggta ttaatttggg ggagtttatc attgtctcag 526860
atcctggctt tccaccagc gccttggttt ctgggttga gttctatct acataacatt 526920
gttattgcta gttcaaaact gacacgaact taacctgcaa tctcagcctc cacattgagg 526980
gaacaccaca ttgattctac atcaaaaagt ctagataatg tggaaagcac actggttftg 527040
gataaggagg cttatttggg ccttgcata gactttgatt ttggacagaa ggtctgacct 527100
gtcctttcag gtggtacagt ctttctagt gctgctctca ttagggatag gaaagctatc 527160

ttctgtgtag tctcagttgc acagagcact gtctggcatg agccttgggtg tgttggtttc 527220

 tgattgtaaa gcctgagatt cccctcctag ctctagaggg gggaggggaa ccatccaact 527280
 gtctcattag catggagaaa agaaaacagt aattacttgt gcctcccttg ataattctgc 527340
 agggttgggt cttaggggaag gaggagggga aactggaga cagcttcagc tgaggaagga 527400
 gaaatgttct tacttagttc ccagaatatg caaaagcaag aattgcaca tctgttgat 527460
 tcttaggaca ttctccagg caggetggag actgcctgga ttgaatttca atttttgtgg 527520
 catatattaa tgttcttact gtctgacatt aagtactgg ctatgctagg tattctgata 527580
 ttgcctttg ttaaggagta gggtagggatt ttgctggagc actttgtgac ctggctgaat 527640

 ttttatgcta tgagatcttc ttgaagcaac acaacatttg gatttatttt tctagicaag 527700
 gttaggtgtc ttgtaaatg ggaggagtct tggaaaacga caagactgta gtgttctgtc 527760
 aagtctaaga aaagcaggac tcagaaggct tgaagtgagg aagttaggaa cagctggaac 527820
 agaattagca aatcaatatg caagcttggc tatggacaat gactgtttgc tctgtgttaa 527880
 tctttcattc cctgtgtgga cagttgtgag ccagaagta ctgattgtag cagaagcgga 527940
 ttggagaatg tgctgtgctg gtgagcgttg ctggggggag cttggagcta gtaggttctt 528000
 ctgttgctgt tctcctgctc tggttgctac tccaggcaa gagaacaact ccccccccc 528060

 ccccccccc ccccccccc cctcccccc cccccctct cctctccct caggaagata 528120
 gcttcagtac ctctttcat gtaaccttcc tttagacttt ggaaatcatt tattgtaaac 528180
 aaccaaggca tctgtaaaga catgtttaa aatttgttta caaatgtagg aatgattgt 528240
 ttctgtcagg tttatattct tctaccctt gaagtattcc cttttccct cctgggcct 528300
 tttgcttgat tagtctgctt ttgctgtcca ggttccaatg ttccttagc ctctaggtat 528360
 atattctgc tttccttata cttttgtaga atctgttccc tatgtttaga tggaaatgctc 528420
 taaatagcat ggcctaaggg aggagtaatt ctcttcagcc ttaacttggc agttaattgg 528480

 gccatagtaa tgggttccc aggaatacac atccaggaca cagtaaatgc tgattctcag 528540
 aaaggtctcc atatcattat ataaggtact ttgatcagat atttcaggac aggctactt 528600
 gtaataatc tcaaccctta gaatatagtc tccagaggct gaggtggag aatggctta 528660
 gtgattgagt gactgacaat agttgctact ctgaaagagt aaggccccta gcaccacat 528720
 ccagtggctc acaactacct aaaactgttg cttcagggga tttgatgttt tctggcctcc 528780
 ctgggtactg cacacatttg acattcattc acacaaacc acacagaaac acataaaga 528840
 aaacaaaaa tcatactct ttatgatttt atttttgtgt gtaagattt atttttctta 528900

tttttattta tgcattgtta tgtttgtgtg agggaatgcc ctgtgtatgc aggtgtccac 528960
 aggggccaga agagggcctt ggagctgcat ttgacaagtg tttatgagat agatgtctga 529020
 tgtgggtgtt tggaaacaaa caggctctct ggaagagcag caactaaaac tcttaatcac 529080
 tgagccatct ctttagtccc caaataaaaac caatctttaa ttgttgggtg tgggagggcg 529140
 taagatgact tagagggtaa aggaacttgc tgcacagtgt gacacctgag ttaataacct 529200
 gggaccacaca gggtagagg agggaaactga ttctctaaag ttgtcgaaga tatggcccag 529260
 tatggtaaaa gcctgtgttg tggtttgaag gtaagtgtc ccttgtaaat tcatgtattt 529320

 gaatactttg tctgagctg gtgggtctgt tttggaaggg agtagacct tttggatctg 529380
 gagcctacct agaggaagca ggttactgtg ggacagcttg aggttgaata gcctagcccc 529440
 atttccagtc tgcctctgc ttcctgacat ggtgtgctgt tatgcccccc tctctctcca 529500
 tgggtgacta tctctctct ccttacttct ttctaattt gacttactaa tttagtgtg 529560
 tatgtatgag tigtgtagg tcagacttac aacctcttg gtaattcagt tctctctgc 529620
 ctttttggc ctttggatga aactcagatg gtcaggctca gtgaagtgcc tttatccact 529680
 gaaccatfff gccagtcctg tateccttat ctgtctctct acctttcttt ttttttttaa 529740

 attaacffff tttatgtgtg agaattttt gcttgtgtgt atgtctgtgt atcatatgtg 529800
 tgccaggttc ctgcttaagt cagaagaagg ttttggacat gatttatgga tigtgtgtgtg 529860
 ttacagtgtg ggtattagga attgaacctt ggtcctctgc aagaaaagtg tgcttaatta 529920
 acctgagcca tctcttctg ttcctctatc ccatctttaa accaaagtag actcttctc 529980
 ccataagtga cttttaaaa atatttttt tcattttatg tgtctttgtc tgcattatg 530040
 tatgttatg tgccccgtc ctgcagaggc cagaataaaa gggcattgga tcacctgcaa 530100
 ctggttgtaa ggtgtcttgg ggggtggcagg aactaaacac tggctctgta agagcagcag 530160

 caaagtgtt ttaactgctg agctttctct taagtggctt tttgtcaggt gtttgcaca 530220
 gaaaagttag taagtggta tagcaaagta actaatgtac ctttgtgaac tccttatgta 530280
 acaataggct gacagctggc tggctctacag aggtctcttt agtcttgca cttgggaggc 530340
 agaaacaagg ggtctctgt gggttcaaag ccagcctggt ctacaaagtg agttccatga 530400
 aagtcaggac ttttacacag aaaaacctt tcttgaaaaa tcaaaaacag gggctggaga 530460
 gatggctcag aggttatata agcactggct gctcttccag aggtcctgag ttcaattccc 530520
 agcaactaca tgggtggctc cagccatctg taatgagatc tgggtccctc tctgtgtctg 530580

 cagggttaca tgcagacaga atacctgtac atatgataaa taaattaaa aaaaaaaaa 530640
 agaaaaatca aaaaacagca aagaaccaa ccaaacacca aaaaaaaaa aagtgtcaaa 530700
 aacaataggc tgacagcacc acaaccaggg gtgggtgtgg cgcatatcta tcctaacca 530760

gggttggaaa gtggaggcag gaggatcagg agttgagggc catccttggg tacataatga 530820
 attgaaacce agcctgagct tcaagagatc ctgtctcaaa aaataagtaa gatttatgta 530880
 atgggtcatt acggctattc ttttaaaaag aaaagccctt ggtttttccc actgtgctct 530940
 catggcatcc ttigaaagge tttttgtgcc attttattta aagtagattc tactcttact 531000

 ccttgtttta tttcgtgact gtttaaatth tcttcctaat actcaacatg gctgaaatg 531060
 atagaaacca ggattcaaaa tgtgtaaggg ttaagaccct tgacagacct cttttctctg 531120
 ttacaggtga gccctgattc tagagacagc tgctgctgac cctgtaacce taaggactaa 531180
 gtagctggct aaactcattc ttggtagagg tgagtgaggg tattcaggca gatttgggta 531240
 accatgggct aagataaagg gtaactagtt tagggattct tttcagcttt tgtactgata 531300
 tcttacaatt aatatttttt tttctaggta ctggaatatt ctagagatgg gaataatcta 531360
 ccagtgagcc ctaggtagcc tactggcctg ggaggaggat tgaggtcact ttcttggagt 531420

 tgccataagc atgtttggga tcatttgtca gaaaaagggc ttcctttctt cttgcttttg 531480
 tcagtcccgg gggcaagggc aaatataagg acctagagcc tataatccca ttggggatct 531540
 tcttgacttc agcctatttg acctactaag cccaggtta gcataaggaa atcttaagtt 531600
 ttctctgttc tgcataatgt gatcatgaat ggataaggat gcagtgatcc agcagagctg 531660
 tgtgaaatgg gtgaggatgc agtgatccag cagagctgtg cgaatgggt gcggatgcag 531720
 cgctccagca gagctgtgtg aaatgggtaa ggatgcggtg atccagcaga gctgtgtgaa 531780
 atgagtaagg attgcagtga tccagcagag ctgtgtgaaa tgagtaagga ttgcagtgat 531840

 ccagcagagc tgttgaaat gagtaaggat tgcagtgatc cagcagagct gtgtgaaatg 531900
 agtaaggatt gcagtgatcc agcagagctg tgtgaaatga gtaaggattg cagtgatcca 531960
 gcagagctgt gtgaaatgag taaggattgc agtgatccag cagagctgtg tgaaatgagt 532020
 aaggattgca gtgatccagc agagctgtgt gaaatgagta aggattgcag tgatccagca 532080
 gagctgtgtg aaatgggtga ggatgcagtg atccagcaga gctgtgtgaa atggatgagg 532140
 atgcagtgat ccagcagagc cgtgtgaaat gagtaaggat tgcagtgatc cagcagagct 532200
 gtgtgaaatg agtgtaagc agcccagaga ggaagggaaa tcaccacatt gagaatttat 532260

 tatgctagct ttcctttat gtagacaact acattttata gacgaagaca ttgagacaaa 532320
 caatctagga acccataaag ctgatcttag aatcagctca ctgtgaatac cattatgatg 532380
 tgacagactt ttcaggagc tgcttgaagt ttcctggaa ttatgctgtt tctcttctct 532440
 ctctctctct ctcttttttt ttttttagga aatttaagga gctagccctc ctcagagatt 532500
 tgagttatth gaggagccca gtaggacagg gaggaattag ggttcattgt gatcaattat 532560
 atgatcaatg aggatcagag agtgaagac aggaagatct taagcaggaa gtagcttadc 532620

taactaactg gaagaagaaa ataccagaa gtgaaggat ctaagaagt ggctgacag 532680

 gagttaggaa cctggacagc tgggtgaca ttgggaaaca gagtttctct gtgtagccct 532740
 ggctgttctg gaactcactc tgtagaccag gttggcttca aattcccaga gatcagcctg 532800
 cctctgagtc ctgggattaa aggcctgaga tacctgaatt ttaatctta tctctcagtg 532860
 tgccittgga cagtcttcat taccceaat tgtaaaattg ttacttctctg cttccctgca 532920
 gcattgtgtg tigtgtgtg tigtgtgtg tigtgtgtg tigtgtgtg tigtgtgtg 532980
 tgcgctgctg cgctcgctcg ctactcaca cacaggactg aacctagggc attgtattg 533040
 tttggcaagc actctactat caacctaaat ccctatctcc ctgcatatg tigtgtacaac 533100

 cattcagtaa tgatgtagag aaccaaata gaaatctaag aaaagtttg caaattaata 533160
 tgtaacatga atgaaagaag aaaagtcaga cctgtttgtt atcctactcc ccaaagtaa 533220
 gagtgagggt tttccttagg gtatctctgc tgaagtctt tccctgcac tttctctctt 533280
 ctctgcagg acctaccag agcagtgtt tatcacagg aaatgggtc cagagacagg 533340
 tgacagaaca tccaactctg gcagttgtg tttgcagcat gtgctctgca gagttaggtt 533400
 taaattcact caggtgccca ggcttcaagg cctctgtgg agggtagatc ttaaagcagc 533460
 tcttttaag aaccatttc agcactaac agctcagtgc attgttctc gttgcctcag 533520

 cagaatagcc tactaccaca cccactggta gtgaaagaaa gggtacctat gttgaaattt 533580
 catcattcca gtttctact tgtcttgctt ttttccctg gccagtgatt taagctgttt 533640
 tttttttt ttttctctg tctactgaa gggtcacaaa gggatagaat gctcacatgg 533700
 tgctcttaaa tttagtgtg acaagtcca gttttcttc ataactgaa tcttcaggtt 533760
 tttattaata ctttgtgtc ttgggatct aagttccaca gattctgac tttccatggc 533820
 ttgtgtgcca aggttagaac ttaactgcct atgaaaacat ttactgtta cttaaaaatg 533880
 tgagtggttt cttgtaata agtgtgtaat atacagatg atgtataata gtttatttat 533940

 ctagcagtct catgttctca gagcccaact gaaaaacagg gaagcaaagc attgctatcc 534000
 ttaagccttg cataataaca tattttaaca tgttattata agcttagctg tcttgctttt 534060
 aaacttctgc aggtaaaagt aaaagcaatg agaaaagctg tgctaatatt aatgacaact 534120
 agaggtaga ggcgaaagct ggcagtaatg aaaagggtga aagaaaaatg atactatatt 534180
 taaaataata gactggacgg cattgaaata gaggtgggta acagccctac aaataaatac 534240
 ctgtgtgctt tactaagata ggggtggaac ttagggaaat aggttaagttc tgaggttttt 534300
 attagaaaag ttatttggg gatatactat attactaggc acagagtcta tgtaaattha 534360

tttcattttc atagcaactt gagaggtatg tggatgatatt cttgttttat aaattgctga 534420
 gacctagaga aggcattgat gcattaattg gaagagctaa gcttagaata tagtagaatc 534480
 tgggtataga gacccaagac ttttctgtta tacttgggtt tgggttttta gattgttgtc 534540
 ttttcaggct ttiggatcaa taatagctcc cctttttgt tcatcccact atataaattt 534600
 tctgttttga agaaattatt attcatctgc ttagtgctta ttggtatttt ctatgcagca 534660
 tgcattggtt caggttttga gatctaacag tgaataaaat agtttgatct cagccgggca 534720
 gtggtggcac atgcctttga tcccagcact ggggaggcag aggtagatgg atctctggcc 534780

 aggtctgtta aacagagaaa cctgtctcc aaaaacaaaa agaaaaatag ttgatctca 534840
 tgtttacata ttagtggaag aaagcagaag aatgaataaa tacgaagaaa aataatgtag 534900
 gataagggaa taaggagaac tatagattaa agaaggtctg tctgagaaaa ataaggttg 534960
 tgcagaagct gaagtattga actttgtatc ttaactaac attctaggca caaggattca 535020
 gcaaggtcag aagtcctgaa acaagcatat tggttgtgtt tgaagaaaaa ggtgtcctta 535080
 gtgtatagag aggaagtaag caaaggggac attagactat gcagaagttg tcttaaagag 535140
 taaggtcagg ttatgtaaga ttttgagagg aatgttgtga ttaactagct atctttaaaa 535200

 aaaaaaaaa gtctgcatg gcggtggtg cacacacttt ttattaattc cagtactcgg 535260
 taggcggagg caggtggatc tctgtgagtt cgaagccagc ctggtcaaca gagtgaattc 535320
 caagacagcc agggctatac aaagaaacc tgtctcaaga aaagaaaaa aatcaggctg 535380
 gagagatggc tcagaggta agagcactga ctgctcttcc ggaggtcctg agttcaattc 535440
 ccagcaacta catggtggct cgaaaccatc agttatgaga tctggtgcc tcttctggtg 535500
 tgcagatata catgaaaaca gaatgtgtg tacataataa ataaaatctt taaaaagaa 535560
 aaaagaaaag aaaaatcctc ctgaccgact ccaacagcta ctacctctca ctctttatgt 535620

 agtgtggaat tgcaaagaac tgtgagagca ttacctgtt ccagttctca tttatttatt 535680
 ttacaatgta gtattcagtc ttaatctgtg ggtggcttac tataagaaaa ttctctttta 535740
 ctcttaggtt tactgagagg ttttattatg actggttata ttctgtcaac atggtattac 535800
 attgattttt cagatgctaa accaaccttg ttttctaga ataaatccca cttttagta 535860
 atgtataatt atttttttt aatgcagtgt tgattttatt ttttaagatt tatttattat 535920
 gtatgcagtg tctgtctgc atgtatgctt gcagaccaga agagggcacc agatctcatt 535980
 acagatggtt gtgagccacc atgtggttgc tgggaattga actcaggacc tctggaagag 536040

 cagtcagtgc tctaacctc tgagccatct ctccagccca tgtataatta tttttatgtg 536100
 atattagatt cgattgtatt tttgtgatgt ctttgtttgg ctttggatc agaataataa 536160
 tagtgcctc aaaggctaaa cgagaagtag aatcatggtc ttttctgtag tctgaaaatt 536220

tggaaagaat tatattatct ctttagaagt ttgatagaat ttaccactga agccatgtgg 536280
 acatgaaatt ttctaaaaa tcttagttac taattcatta tagaaatggt ttagtTTTT 536340
 cttacagtaa tgcttagatt ttctatttcc tttttagtca cttgataatt tgtgatttct 536400
 agacacttgt ttataagttg atttgttcac ttaaaattat ttgtagtatt ttcttatatt 536460

 cttttatata aaaatcagca gagcatctgt gtgcctggtt ttagtaattt gtaacctcat 536520
 cttttctttg tattggttta tacattttat aatTTTTTTT caaaaactca attttagtt 536580
 tcattagttt gtgtttgga attgatgttc tactttaat ctttattatt tcccaacctc 536640
 tgtttgcttt atatactttg tttctctctt tctggttctt aaggcttagg cactgattt 536700
 aaaattgtat ttatttatta ttactatgtg tatgtgtacc ctaacctttt tcttgittca 536760
 ttaaaactaa aaatgttctt tcttactttc ttactgaac agtgggcaga gacgaagaca 536820
 gctaagcaag agagaggtac taataggtcc tatagatcag atcagttaga ggtcacttct 536880

 agaaacattg gtggcaggga gtccctgagc taagaatatt gccaagaaat cagagtctaa 536940
 gtcaggaaat tggaaacttc agttcaggaa accaaggtct gtttagtagct gtggtgctag 537000
 gattatgtga taaagctagg cctagtggca caggtttata attccagcta cttaggaggg 537060
 cgaagcaagg ggttctcggc ctgctctggc tgttgaatg cagtgtcagc ctggacactt 537120
 ccatagacct tttctcaaaa aagaaagaaa aaggaaggaa ggaaggacgg acggatggag 537180
 gcacaggtca cttcatttta gcttcaaaac tcagttgtga tagacagatt cttgagattg 537240
 glaagagata ctgtagggaa tttactaat ggaggttagg tggagggagt ggtaaaacct 537300

 attttaaaag accccattaa cacaaagcag agagcaaaga gctgggccta gtggtaaaga 537360
 gctatagtcc tagctactcc agaggctgag cctggagggg aaggaatagc atacaagagt 537420
 ctctgtgctc ctttgggggt gtgtgtggct ggcatttttg ttttatcttg agtttctatt 537480
 cttttacctt tatcaccatt cccttatatt tctgcagtta gctgagteta tcaagagcta 537540
 ccttagtgcc tagggcaaga gacaaaagac tctaaagaca tcaactgttg ggtaagtta 537600
 gtgtttcttt ctactcttc aacctgaaa ctatatgaca ttaaaggagt cagatttgta 537660
 ctaagatttg agtctttgct gtgacgttta tctcctgtgt gactgacttc actgacctgt 537720

 agttttctc atctgcaaag ttagatctta ttgtggttat tgtgatgcta atggaggatg 537780
 gaaaaatacc aggctgect aattggaggg agtctgtcac tggatatacc gcttttagac 537840
 tgtatatect agggcccat attcactttt tctctgcttc ctgtctgccg tgggtgaaac 537900
 tctgccatat tttctttac caagatacca acctaaatc aaaaagcttc ttctccttg 537960
 aaagataaag aaggagtag gaagagcctt ggtatagagt agggttcacc tatcagtgac 538020
 tgaataaat tcccaacca tgtgttacat aattagattt aaaaaggga acctggtagt 538080

tcaggttctg aacttttagt ctggccaacc tcaggaaacc aattcattcc tgagtttcac 538140

tttcctcagc tataggagga acaaaggcag aaagcccatt atcttgttct tagctgtttg 538200

tattctggct ttgcccctg gttgagagga tttcatctgt gagaaggctt ttcttttctt 538260

tgtatttatg tglatgtggt gtatatgcca ggtgggaact ggagtgtga gctgcctgat 538320

gtgggtgctg ggaaccaaac ccaggtcctc tgcaagagca gcaagcacta tttagtacgg 538380

aatcatcttt ctagcccctat gagaaagctt ttcaagagtt gaggtttagg ggctggagag 538440

atgacactgg ctgcttttca gaggtcttag gctctctttg tcctctgctc atattaggca 538500

cacaagaggt acgtagatac tacatgcagg gaaaacacct gtatacgggt tttttaaaaa 538560

aggctttgtc agccggacgt tgggtccaca tgctttaat cccagcaccc tggaggcaga 538620

ggcaggcggga ttgctgtgag ttcgaggcca gcctcgtctc cagagtgagt gccaggatag 538680

ggtccaaact acacagagaa accctgtctt gaaaaacaac aaaacaaaaa aaggctttgt 538740

ctagctgggt gtgggtggca cacgccttta atcccagcac ttgagaggca gagacaggtc 538800

aggtggatct ctgtgagttc gagactagcc tggctctgcaa gagctagttc taggacagcc 538860

tccaaagcca cagagaaacg ctgttttgaa aaaccacaaa caaataaata aataaataaa 538920

taaataaata aataaatagt aagtcacttg ctgagaccag attccagatc tcttctgtct 538980

cattccaggg ttttctttc tagagtcaaa ccacatata gtaaacaag catttcagct 539040

ttcctaacat ctccatcaac agccttctta ggtcccctgt ggtgtgtgtc aataatacag 539100

gctgtacttg tttgatttac tttggctggt acaagatcca gatgctttca gaatagcaca 539160

acagattctc taaatctgcc cattccaat gtgctgcact ctatcaactg gctggggctt 539220

gtcccctgagt cctcccctacc tgtcatgtca gtcacattgt tttcttttgg tagtttgccc 539280

tttcctctt aaatttttta aaaaattatt tctgtgcata ggtgtatgca tgttattaga 539340

aataagtttg caaagaaaga gactaccatt ctagtaagag tctgagcaag gcaaaatttt 539400

acttttggtc ttgtcatgg gaataaacta ttttacttta gccattgtct tagaactacc 539460

actttgtgca gaaagtaagt tgctagtttt ccgctcttaa ctcatgctac ccccacactt 539520

aaaactagca gtcattctc ctctctagtc aatgttcaga attgtttgaa gcctggctcc 539580

attcttaacc tccacggaag caattggaag agaattgaga tttgaagttg actatttctg 539640

gatttgagcc ctaggaatag cgtctccgtt ttccttagtt aattaccagc taatattaga 539700

taggagtctt taggtactca ttgcttcgag catgtgactc tacagctaat tcaacagtta 539760

atttttaaaa atttctttat tagcatatac tatatattat attgagtttt atgacatatac 539820

catgcatgta tataatcata tatttaacca tattcacgtc ctatcactat tttgtttcct 539880
 tcctactttt gctgatctcc ttctcttct taagcagttt tcctactcca acccattgt 539940
 caaatcagag taggattact acaggagcgt agttgagaat acaggcaaca tagtgtggct 540000
 acaccactgg agaaacttgg aaaagtggga agttggaaaa cttaaaaagg aagcatacac 540060
 acacacacac agaggtacac atataaatac atataaata cataaaaca catggagaga 540120
 agtcctgtag aagttagaat tctgcatgta tctactgtat aattgttgc tagtccccct 540180
 ccccccttt gcaatgtaaa tttgaggtct tctgcttttc ttatcagagc cctaaaattc 540240

 agcctcatag ccatttggaa acctgatttg attatgactg ctcacatcaa aacatttctg 540300
 atgattgaac agtagtaatc caactggcag tgtgccactt ggagagagca ggatgggaaa 540360
 tgattatctc gatgaatggt aactgttaat ccatgactag aaatgctcca caaatcaact 540420
 aaagatttct aagacaggat ttgggggtgg tgggtttcta atcttataat ttaaattaac 540480
 ccatttctat taatttactt tctgcctcgt ggctttatta cctttactct gcccatgttg 540540
 ctttctgct tcttccatgt ctggctgatg actcctccca actctgcct tcttctccc 540600
 agtgttctct ctgcctgaa agtttttct agctattggc catttagatt tttattaaac 540660

 caattacaat gaaatatctt cacagtgtaa aggaatattc caaacataa acagttgcac 540720
 attttccat atacttgtat aaaagacagt gaattgacaa gtgttcaaat gttgctgagg 540780
 ctgcttagag gccacctcg ccattctgaa catcattca agtgtctaaa caagattatt 540840
 gtaatttgat agaacctctc ttcataatta cacagattcc tatatgcgtg tttactaatt 540900
 atgttcctag gttagcactt tccctcttaa gaacatcagt ttttatgcct aataatgata 540960
 gtactgttta taactacttt tgagattgtg gtagttttta gatatgaagg tatggtgggg 541020
 ggtcattccc tgctcccca gtgatttgat gctttggttc tctagatggc actattgagg 541080

 tgcttagacc atgaaggatga tgacttcac aatgggttaa aactacccat agattcatac 541140
 taaatgggct ttagaaaagt aggcctgatt ggacgatgta ggtcaattaa gacatgattt 541200
 tgaaggataa atctggtccc tctgtcttgg ctactcgtat gccatgaggt gaacagcctc 541260
 gttggtctca ggcccatagc agtggagctc gttagccacg gaccgaaacc atagacaaaa 541320
 ataaatcttt gtcccttta gttgactttc tcaaatgatt tgtcattgtg ataggtaaac 541380
 taacagatta gtatgagagt tcaaaatact tcgtaaatat cataatctac aaaacttgct 541440
 tgagtaaagg ctaaggcata ctgatctggt tttgttagct atttgaagac tccaggagat 541500

 ggcagtaaaa tcagttcttc tctaaccacc cttatcctaa gaaatgctgg gtctcatttt 541560
 ctctctgccg ttcatggcc cagaggactt ggtaataaaa agagccctc aggtcatgca 541620
 tgagtaacca ggacagttat ctagcagata ccaaggcag ggcaggtagc tcaggaagca 541680

gtagctgatg aacaaaaggc tttctctctg ttctaataa attggtcctt ggagatccta 541740
 gctttgaaat tctaattgac acaggaggaa aagattcatt agactctgga ctcatataaa 541800
 tgctctgctg ctcacctca atttattctt ggcagttggt cagaaggaat taactaaact 541860
 gacagctctg gatgctgctg acagcagagt cctgtgtgct tgggtgtact gggggctgtg 541920

 ggtgttgggt gtgcctccta tattctatgg aatatataga tggtttgaag agcacatcat 541980
 ccctaggact tcatgagctt aaatctcaca tatctttagc actgaaagga ccttctgaga 542040
 tcataagga taactcattt acagatggc cagagaatga ctagtgcttg ctctagtctt 542100
 aagatcttaa gatcaccaag caatttaag gtgaaattat ggtcacatag cctgactttg 542160
 ggccaagaat attttccct tggaccatt ttgaatttta gagtacagaat gtcattaatt 542220
 cagttatgaa acatattatt ttatttatgt gtatgacat tttgccttca tgggtcttga 542280
 agagaccaga agagggcata gaattataga cggttgggag ctgccatgtg tatgctggaa 542340

 ttgaaatcca gatctctggg ggtagggtgg ggggaaaatc agtgtttta accacttagc 542400
 catctctcca gctcttaaaa tataatacac attttgtgtg ccaagattct gtgacagaat 542460
 acgatgggg ttggaggagg atagaagaag ggagtcatgt acctttccca tattagaat 542520
 tagaacgacc accacatgga ctgaagagat gactcagttg gtaaagtact tgccatgtaa 542580
 gcatgaggac cccaagtta gttccccaaa ccagagttaa aaaaatacct tgctggttga 542640
 ggccagcctg atctacagag aaatttcagg acatcaaggg ctacatagag aaacctgtc 542700
 tcaaaaaaac aaaccccc cccccattta aaaaaaaaa agaccttgct gggcatggtg 542760

 gccatgcctt taattgtggg cagggtagg cagatctctg ttaggtcaag gccatccagg 542820
 tctacataac agcttcaggt cactcaaggc tacatagtga gactgtctca aaaaggctat 542880
 aagtaagtaa ataaataaaa gttgattgtg gtggcatgct cttataatct caatgctagg 542940
 gaagtggaga tggtaggtc ctgtggttca ttgaccaact tggtagatg cctgtttga 543000
 aaaaggcaaa caagatgggc agcttttga gaatgacatc taagattgac ttctggttgc 543060
 cacactcacc tgtgtacaac catttgata ctagcttta ttcacaccta catggacaca 543120
 tttcacagaa agaatgacaa acaaaagaaa aaggaatgat tactgctaag gaggaatttg 543180

 ttcactagag aagcataatg ggaatatgaa ggctataggc ccagcgaac tggcttctgt 543240
 atcccaggtt tgagattaga tatagttcct tcattaagaa tacagactta gactatgtca 543300
 ctgttcccag ctagggccta gattcaagaa tgctttgcta tagtttttgg cattcgttgc 543360
 taaaagcatg ggagaacaga tggccatctc agcagtttgg atcatgaggg tatgatctga 543420
 gacagagcta gaagatacat tgagagctct atacctagtt actgctgttt aggcccctec 543480
 caagctgttc tctatctcag aacaagcaa aattagctaa ctctatttct catctctagt 543540

cttccactcc cacccctatc ctttctctc gtcccatata tttatgctgt actgacctca 543600

gtgtaagggc tactgggagc tgctatccta aatgaccctt tgaacctatt tcccaggcat 543660

gtctcaagat gaagctcatg agtctgggtcc cacagccctt atggcatcta ctttatttag 543720

atcattctag ctgtaggcct cctaccaggc tctcttctca tccactcccc tgttttcatt 543780

cccaactctt aagaattaga taatctgctt agtatgactg cttagcttaa agaataatca 543840

atactgagag gaaactgatg gttcttgatt atttaaaatg ctgttaaatt ttagtaagta 543900

ttaaggtgca catgacttgg aatccctgaa agagtgtcat aatTTTTTTT tttaaagatt 543960

tatttattat gtgtacagtg ttcggcacca aatctcatta cagatggttg taagccacca 544020

tgctgtgct gggaaattgaa ctcagaacca ggcagtgtc ttaacctctg agccatctct 544080

ccagccccga gtgtcataaa ttttagaaaa agaaaagata acaatattta tttatgtcat 544140

ttcagaaatt tcttaatatt ctgacttttg tacctgtttt tgtctttgag ctatagagaa 544200

actctgaggg aaataatgca aggatttctg tttctgcttg gcatttatgg aagcctaggg 544260

aaggctagtg accatttaat aatcttaatg gcagagccca aatagaaata agatgtggaa 544320

gataaatggt tatagacttg aaacaaggca ttcatacactt tctagtcatg tgactctgaa 544380

gaagttatta aacttctctg agcctgtttc tttctgtgtc atatgaggaa aacatgcact 544440

taatatagtt gctttatgtt agcacctac agaagaaata taagaactca ttattgttcc 544500

tatctcagtg gttttttcc cagagattta ttcaacttgc ttttaatttt gtatgtacac 544560

ttgtgcagca acatgtgcat gtgtgtgtgt gtgtgtgtgg ggggtggct caaggctgta 544620

agtctaacat gtactgetga gacatctcca accccttatg gtttggtttt ttgtttgttt 544680

ttattttgtt tggagacag ggtctcactc aaggttggcc ttgatcttcc ttctggcctc 544740

tatttcagt ctttaaatat gtattattta ttgatttttt ttgaaaatag attcttttcc 544800

tcatatgata tattctgatt ataattttcc ctcctctgc tcttcccagt tectgccc 544860

cttcctccc ctccagatcc actcccttc tgtttctcat tagaaaagaa caggcttcta 544920

agaggtaaaca accaaatgtg acaaaatgat gtaaaagcta tcttattgaa gtcagacatg 544980

gcaacccgaa aggaggaaaa gagtccaag agcaggaaca ggagtcagag acccacttgt 545040

tctcaacagt taggcgttcc ttaaaaatac taggctaata tctataatat atatgtaggg 545100

gacctagtgt agacctatgt aggetctatg ctgtctgtt cactctctgt gaggttatgt 545160

gcaccttget tagttgattt agtagaggc cttgttctcc tggatcacc catcccctct 545220

ggctcttaaa atctttccat cctcttctg caggattccc tgagtgtga cgggagggat 545280

ttgatggacc tccaatttag gaccttgaca acccccaccc caccctgct gaaggctct 545340
 gcatttgggt cccttctgct gccaggaaa gtctctctga tgatgactgg acaaggcacc 545400
 gatctttgag tatagcagaa tattattagg aatcatttta ctaatgtttt ttgttttaga 545460
 gagccatcgt gtttgatttt acccctaggt ctctgggcta tctagtctct agttcttgg 545520
 tagccaagca gtgtcagggt tgagttcctt tagacattgg ttggctactt ccgcaagttc 545580
 tgtgccacca ttgccctagt atattttgca ggtaggacag attgtaggtc aaaggttttg 545640
 tggctgggct ggiatccatg tttcctttca gtgcctgca gagiaccttc ctacaccaga 545700

 gaatagaacg tggtggtgaa gcttcgtgta ggcaccagct caacctaccg atgtcagtga 545760
 gttgtgtggg tgggtgttctt ggcagctgac agtttgctaa gaacaacat ttgtctaac 545820
 aacagtttga gttgtttgag ggtttccttg ggactccttt aaccaccaac tcaagtgaat 545880
 ttcaaccag tccagccacc gaagcttgc ctgacaagaa atggccagtt gagtctcat 545940
 caggatcacc ttcagagact ccaggacgtt tccactgcag taggtttcca cagcacctc 546000
 caaatgcacc ccatttcac tcttcctgc acttctccc tctacccat ctctcccct 546060
 ttcctgac tccatcccag tccacctata aaatttattc tattttccc tcccaggaga 546120

 tccatgtgtt ccctcagacc tcttctctct gcccaaccac tgggtctatg gattgtagat 546180
 tggttatcat ttccttaatg gcttctttat caaaaatcag gtgtccatgt gtgtggattt 546240
 atgtttaggt cttcagtcca attccattga tcaacttgc tatttagctt tgtaatacaa 546300
 cttgaaatca ggaatggctg aatgtccagc agttctttga ttgtttatta ttgtttaaa 546360
 tctcctgggt tttttgtttt tccatgatga gttgagaatt gtcctttcaa ggtccagaaa 546420
 gaattgtgtt ggaattttga tggggattgc tttgaatctg tagattgctt taggtaggat 546480
 ggccatattt actatgttaa tctactgat ctttgagtat gggagatctt tccaacctct 546540

 gatatttca gtttctttct tcaaaaactt aaaattttta ttttacaat ctttcatatg 546600
 gttggttaga gttacccaa gatattacat acgattttag gctattgtga aagggtttat 546660
 ttcctgatt tctttctcag tcaagtctt ttgtcattg tatagtaat tgattttttt 546720
 ctgaattaat cttgtatgca gtcaactgaa aagtgtttat cagctgtagg agtgtcacct 546780
 acacttcag gtagaacttt caggattgct tatgtataca atcatatcat ctgcaaatag 546840
 tgaaactttg acttcttctt ttcaatttg tatccctaa ctctccttca gttgtcttac 546900
 tgctctagct agaactttga gaactatatt gaatagataa ggagagagtc cttatgaggg 546960

 aaattggttt gtaaatttct tgcctgtcc ctgattttag tggaattgct ttgagtttct 547020
 ctgtatttaa ttcgatgttg gctataggt tctgttaaat tgcctttatt atatttaggt 547080
 atgtccttta tatccgtaat ttcctcagaa tgtttatcat gaagaggtat tggatttttg 547140

tcaaaggcgt ttctgtatc taatgagatg atcatgtgat tttactcttt aagtttgttt 547200
atatgggtgga ttacatttac tgatttttca tattgaaaaa tgaaaaattg aaccatccct 547260
gcatctctgg gattatggtg aacaatcttt ttgatgtgtt cttggattcg atttgcaagt 547320
atthattga gtatthttgc atctatgttc atgagggaaa ttggthttgta aatthctttg 547380

ttgagctttt atgtggtttg ggtatcaggg taattgtggc ctcttagagt gaattgcgca 547440
gctgggcaag ggtgcatgcc tttgctccca gcactcagga ggcaaggta ggctgatctc 547500
tgtgagttca aggccagcct ggtctacaaa gtcagttcta ggatagtcag gaccgtaag 547560
cagacaacct gtcttgagaa aaacaaaaca aaataaaca caaacaaaaa ttatgcagtg 547620
ttccctctgt ttctatthttg tgtaataaatt tgaggagtgt tgacattagt tcttctttca 547680
gagctttgta aagttctgcc ctagaacatc tggctctggg gtgaatttgt tctthttgtht 547740
gtthttttga gataggttht tccagacttg cctgtcctgg aatctcatc tntagaccag 547800

actagccttg aactcaagag atcctcctgc ctctgcctcc taaatgctgg ggtcagaggt 547860
atgtgccaac aacatcttga ggttgggaga cttaattggct gcttctaggg gttatagctc 547920
tattthaaatt gthttatctga tcttgagttta tctthtgtaag tgatgcctat caagaaaatt 547980
accctthtct thtagattat ctgatatggt ggtataggth ththaaagtat gtcctthaatg 548040
atthtctggg thtctctggg atctgtthtt atgtctccct ctththaacctt tgatthttgtt 548100
aattthgaata thtctctccct gactthttagt thgaacaagg atthgtctat thttgttgatt 548160
thtctcaaaa aaagacacca tathctattt atatgtthtt ththththttgt agthtctgtht 548220

ctatthttatt gaththcatct cagthttgatt atthtcttgag gctctactct thttgggtggc 548280
thactththtt gthcaggtat gctcthaagth cctggatga gatactctth thththththt 548340
tctthttccag acaggtthtct tctgtgtagc thttggagcct gctctggcac tcaactctgta 548400
gaccaggctg gctcaaaact cacagagata cgcctgectc tgctctccga gtgctgggat 548460
thaaaggtgtg cgcaccaaac gcccggctga ggtatccaat thththacga gggcatthac 548520
agthaaactth cctactthca ctgtgtccca thaatthgga tatgtctat atthctthtct 548580
atthctthtat thttgtcttg atccacttht ctthtagtag aattgtctg thtccatgag 548640

thttgcaagct thctgtthtt tctgttgata cctagctthta atctgtgggt gcctgatagg 548700
aagcaggaag thattthaaat thtctthgtat ctgttgagac thctthttgt ccaaatatgt 548760
ggacagthttt ggggagagtht ccatgaggth cagagaagaa agtatatcct thttgtthttg 548820
ggtgaaatgt tctgthaaata tctgttaggt ccattthtct tctgtthttgc thttgtccgg 548880
atggctthtct tgtthgtggg gtgaaggatt gaagtctcgc actggcagth catgaggctc 548940
aatatgtggt thaaagthta gtagthattc thgtacaaac thgggtgctc thttgtthttg 549000

ggcatagatg ttaagaattg aaatatcatc ttggtggatt tttcttttga gtatatggtg 549060

 tccccccctc tctttttaa agattttatt tttttattc ttatgtatac aatattctgc 549120
 ttccatgtat atctgcacac cagaagaggg caccagatct cataacagat ggttgtgagc 549180
 caccatgtgg ttgctgggaa ttgaactcag gacctctgga agagcagtca gtgctcctaa 549240
 cctctgagcc atctctccag cccctccca tctcttttga ttagttttgt ttgaagtctg 549300
 ttttgttaga tattaaaatg gcaataccag cttgcttgtt aggttcattt gettgaata 549360
 tctttttcca accctttacc cttaggtgat agacccttga tgttgaagtg tgtttcttgg 549420
 atgcagcaga agaatggatc cagtttttca tatccattgt gtcagtctgt gtcttttgg 549480

 tggggaattg agaccattgg tattgtaatg tatcaatgat caatgattgt tgagtcctgt 549540
 ttttttgggt gtggtgggtg tgggtgggtt ggtatgttgt gtgcttcctt ttgatataca 549600
 ctggtgagat tatttccatg gttttcatgg gagtagttaa cctccttagg ttggagtctt 549660
 ccttctagat acigttaaag tttgactttt ccatggaata tattgttttc tccatctgta 549720
 gtgattcaag gttattctgg ataacagtag tctgagctgg catctgtggt ctcttagaat 549780
 ctgtaggaca tctgtccagg ccctctggtt tttcttggta ggttttaata ctctttcttt 549840
 gttctgtacg ttggtgtttt tgattactat gtactgaagg gtctttcttt cccagtccaa 549900

 tctatttgggt gttctgcttg cttctgttac ccgtatagge atctccttct taggttgggc 549960
 ctttgagtgg aatttcttct ccttctctca tacctattat tttggtttgg tcttttcata 550020
 gtgtcccaga cttcattgat gttttgtgtt gggggttttt agagttgata ctatctttga 550080
 ctaacatata tatttctctc atcatatctt caacacatga gattctctct tccatctctt 550140
 gtattctgtt ggigaagctt gcctctgtag ttcttgttca tattcctact tttcatttct 550200
 agaattccct cagttttttt tgtttttgtt tttgttttgt tttgttttta tcaattccat 550260
 tcccaatfff gggctcttga caatfffatt tatttcttca tactgtattt tcttgtgttt 550320

 ctttaagga tttattaatg tccccttaa ggagctctgt catatttata aaggctgttt 550380
 taaggctctt ttttttctg cttcagccat gttggaatat tcaggacctg ctgtggtagg 550440
 atagctgggc tctagcagag actttatttc cctggatgtt attgtgtttt atttatttat 550500
 tttttatfff atgtgattg gtgttttggc agcatgtctg tatgagggtg ttggatcctc 550560
 tggaaactgga gttacacaca gttgtgagct gggaaattgaa tctgggtcct ctggaagagc 550620
 agccggtgct cataaccact gagccatccc tccagccctt attgattgtg tttttatggt 550680
 ggtgtctcag tatctggggt tggaaatgatt ataggtctgg ggalcatttc tggatttgtc 550740

ttgttgggt ggttgtattg ttccttgggt tctgcttctt tggattttta gagagiatga 550800
 tggcagtttg ttgctgttt tcttggcatg ctgagctggg gtaattcacag ggaatgcctg 550860
 ctggtgttgg aggatgggat actgggatga gatgggggaa ggaaggttgg aagagagttt 550920
 ctgtgatcct ttgggaacat gctcagctag gaaagggaga ccacagcagg tttcctgcta 550980
 aagagctggg gatgagactg ggggaattgg atattaggat ccataggaga gatgtgcctt 551040
 tcagcttact agttgcctg tgagaagtgg cctttgtta gccaggggtg cctgctggag 551100
 ttgggttctt ggacaaagca acacatggag gggagtgagg gtaggagggc agtctatggg 551160

 gtcacaggag atacaggtgg tagagaagga acaccagga tgagactggg ggagtggctc 551220
 tgcggaacag agaaggtctg tgggcagact acctggtttt caggtatgac ctatggttta 551280
 ccaggagtg tctgctggag tggggctgt gatacagcaa caaattgggg gagaaaggtt 551340
 tggagtgggt gaagaagctg accagaagtg gatgagatgg aatgtcaatg cctttttgat 551400
 attaggcctt ttctgagga atggcacctt gtgtgttaaa gggcattact ttccattgaa 551460
 gaattaccgt agaactgatc ttgtcttgct cctttgtttt cagggtcagt tgggtaaggt 551520
 ttgcaattga gcttttagac ccactattta tataaagatg ggggaagggg gcaactcctg 551580

 gaccgcagca ttattgtac tgcatatcc ttcttttct aaccagcaga tgttgaatt 551640
 atagacattt ctgtagtac taatcaaagc acattgtttg agcatcaagc tttctgtttt 551700
 gacttgtttt ttccagcagg aaaataagta aacagcagat ttaatggcca ccaaagtgtt 551760
 ccaaacagtt gaagaactag agtgtcctgg tcaagtaatt agctttgtgt ctgcaaagtt 551820
 gcatctaact cacaggctgt tttctctcat cattgtcttg cctctcttc tgcctacta 551880
 agctgcagag tgaaggactt gggcacattc ggttcttctt gtaagtttag attgcatccc 551940
 agggatctcg gggttccacc atgcagttcc caatgcagac cactctggta tcaataatta 552000

 taacaccact aatttgaaga gaatetacca gttttctgct cctttgttgt catctctatc 552060
 atgaagttta tagggtatgt gttttggggg tccatctgc cccagcccc aggatttcac 552120
 tgtgtagctc tgactatcct agagctctgt gtatagacaa attggccaa actcacagag 552180
 atctacctgc atctgcccac caaatgcagg gattaaaagt atacaccact atgcccactt 552240
 gttcttttgg attttatcc agccccggg agaagttgct ttggcagttg gtggggactg 552300
 tctttatagt tttctaagc tcttaggttg gatttagtta gcaggtcagt ggtggcatac 552360
 accttaate ccagaatttg tttgagacca acctggtcta caaagtgact ttcaggacac 552420

 ccaaggctac acagagaac caaaaaacca aaacaaaatc tcccttatat tgtctctcca 552480
 aagaagagac tcttgaagc cttttttcc ctttaatttt aaatttattt taattggttt 552540
 ccttgacat atgtatgtg gaggtttag ggttttctag aactggagtt acagagaatt 552600

gtgagctgct gtatggatgc tgggaattaa acttggaccc tttgaaaggg aagtcaatac 552660
tctcaaccac tgagccaggt ctctagctcc aaacctatct tatgttcaa aaagcccagt 552720
gacattgaag ttattatttc ccttgtcata ggccattgag gtgggaaaag gggatgatcat 552780
ttataggtag gtttactgtt atcacacagt tgcttagtat gagcttgatg tgtggttaat 552840

gtccaagaag tggttagtag ttggaaaacc attacagtct gaggaatgaa gttcatgcct 552900
tttaaaaaca atgctttgta tttgtttctc catgggtggga cactgtatag tatattgaag 552960
atcactgggt aatacagaga ggaggctgg gtgtccttct ctttgttggt tgctgataga 553020
taggtgtttt ctggctcttg ctattctgct tggatgaagac cttgtgcac tttctaccac 553080
agaaaagctc gtatccagaa gtctggtctg aatattcaac ctctctttt tctttgctca 553140
aaataatgta atgaactcag cttatcttt tgctccaact ttgttttctc tcttactgt 553200
cttgtctccc tctttctac tgaaggtaa aggacttgag tatacttaa taactacagc 553260

tatatattta acattaaaga atttctctgt caggaactgt gaggaatcat ttattgtaac 553320
aggacttggg taggattcta aatgaaaag acagggtctc actttgtagc cctggctggc 553380
ttgaaactca ctatgtagaa cagactcttg agctaccaga tatatgaatg ctgggattaa 553440
agacatgtac caccatgccc agctttggta agattcttac acttatttgt tgccataaat 553500
ttcagaaaac acttgcctgt ttcattgtag tagcgttggg gccaggatt gcagtatga 553560
atgcttttag agtttagaat ttagtatagg gaagcagatg tgtaaataga gaagtgcagc 553620
agcagataat gcagctggag ttcgggaagg aatttcagaa tctcaagaat ctgcatgaga 553680

ggaaacaaag gtttttctt gaagagtctc atcaggacta tcagtcacat taagggattt 553740
gtacttggaa aattcctttg tctcagcag ctttcgtcac cacatctgag atcggctgca 553800
gtcctgtttt atagatgccc aggtctctct aaccccagtc agtactaata ctgtgatatt 553860
ggagccatct agtaaatggg agcaacagta attttacta aaaacagtgt tttttattta 553920
gaaaattccc ccaatgctta actttctct ttttttaatt aattatttt ctcatctact 553980
ttatgtatat ggatgttttg tctgcatgta tctctgcaca gtacatata gcattgtgct 554040
ccgagaatct ggaaggtgct agatctctc agaccgactg gagttacaga cagttgtgag 554100

ctgcatgtg gttgctgggg attgaacca ggtgctctgg aagagcagac agtgctctta 554160
acctctgagc catctctcca gcccccaat gcttgacttt ctaatatttt actaaattct 554220
cccagtgaca tgiatgagga agatcctata atatttccat ttttcagata agaaaactgg 554280
actgacaaga tgcttagca gttaagtcac ttgtcaagct tgatctgagt tctgtcctca 554340
acgatggta gaagagaga accaactctt gcaagttgct ctttgactta tgggtgacat 554400
atgtgcttct tcccactct taataaatta atatgtaata aaaataagaa agttaaggca 554460

cagagagatt aaatcactta cttagcatcc taacacttga tacctgagga agctcatctt 554520

 gtaccaggt cattgcctta aaacggcccc aaggtgtgag catggtgtag caagctacac 554580
 ctgcagtttg aactgccttag aaggetcagg ttgtaggatc atttccactc acaagttcaa 554640
 actagataac acaggcctgc ctcaaaaagg aaaaatagat gcctctacct ccacaaagga 554700
 cattgagact gttagtataa ttctttcttt caagagttaa aaagtcaggg ctggagagat 554760
 ggcttcatgg aaaaaaata ttgtaaagct gagaagttaa atatttaaca aagttaaagt 554820
 ggtgtttacc accttagtgg gcagcatgaa cctggaagag cagggactaa aatgaagtg 554880
 gcctaaagtc tcatgcagta gccaaactttg ttggaacat caggcagttt atactctgag 554940

 agttaagaag agtcacccaa ggaaggtata taattactag gataaaccac gggttgcaaa 555000
 aatattttcc cttagagata tataaacaaa taacaataga tatctgtaat gaataatcta 555060
 aagtcaagtc actcctatat gctatactgg gaggggcatg aaagcacatt ccaagaacaa 555120
 gtccatgttt ttgaagaaac ggaggtcaca agattcatga ctttttttct ttttctttga 555180
 aattttctta caagtattca gaatcccccc cacacacaca cccaccattc ttgtactgtg 555240
 ttctgacaca tgataagcag taattattta tattacaaga agtgattcct aaaggetgat 555300
 atggcttgct tgaacttttg cacagatgtc tccacatfff ctctctcctg catctttggt 555360

 tcttaaaagg caggcatagg gaaaggagag acgtagaggt gattgtgcat ggttttttagc 555420
 tcagttcagt tcaggagata gtccttgagc acctactgtg ggtctctcct gacaggcagt 555480
 gaggatgctg agataaaata gatggtgttt gctgttgtat taggatgaag acaggctagg 555540
 aagaggtgac actgagacat cattttgata atggtctcct cagatggact tcagccagca 555600
 cattagacct acagtccatg cctcatacca cagccagcaa ggcatcata ttaattgtta 555660
 aaataatcac ccatatcctt gtctctctta aggtactgtt attaagttag aaagcagtaa 555720
 taccttaagg tattatttaa gtcttctcaa cacttgaatt ggtaaattct attttgatgt 555780

 tagaatgctg gtaaggctga ggagagagag tccttgtgct gagaactgtg ctttaggaaa 555840
 ggatttatgt ctccctagge ttctgtctg gttatctgat gggcttctta gttatcacat 555900
 actttatagt atcttgacc caagcaattt ttctccctaa tttggcagaa tgaacaagaa 555960
 atgggaagat ttctgaggtc agacaatgaa ctgagtggtt tctaagatta gaggctatgc 556020
 caaggcaatg agggcttatt gagtattatt gtataggaa cttgcaaata gtcagtctgt 556080
 gtctgtgagc attagcacc ctgctgtgtc tggcaatgtg ctaagtgagt ggaaaatagt 556140
 agaaaagttc tgtctgttt ggtgagagaa gacttaactt gagagaaaga gaagtcagca 556200

tgagaacagg atactctgcc cagggatfff aattgggtggg ttagactctg aagagcactt 556260
 aaggtgtgcc tccttacaga acattgtggc ttgtcacaca ggaataaata ctggctctca 556320
 tgcaacaaag tcttctgat atactgtcat ccagttctct ggtgtcattt tctgcagcat 556380
 gaatccttat gtatcccaga ttatgtactt attatfffca agctacaagg caagttaagc 556440
 cttaaacatt tgactgtttc cacttcccct agatgtggac tgacttcatt ttgtccctct 556500
 taacaagatt agaatfffct gatgattcct ttaaggagtg cacataggca ttagatacta 556560
 tagtcctgga gaactattgg gttgtgagct gtctgaggtg ggtgctggga atcaaacctg 556620

 cattctttgc aaaagagtat aaacattctt aaccctgac ttatgtcttg cccaacaaa 556680
 tgctttcttg ataatcagt aaataaatct tttgtttgt cctttgtctg agaaactata 556740
 attatfffct ttagcattc aaaactctgt gaagaaaaaa agccggtaaa caaatcaga 556800
 agactattca ttttcacctg ggcagaacaa cagatgagaa tttgttttcc cctaattcac 556860
 acagttatac ataagcacia tataatata gatcctgttt gccatgaaag tggcagtcac 556920
 tcaagatagc actgtaaatt gttacagcca tttgggaaag caataggct gcatactca 556980
 aactgtaaaa atgttcatac atatgaccag taattctgct tctggcaatc tatccaaga 557040

 aaatatatag tatctagaat aaactttccc tcagatgata ttatffat atffataata 557100
 ataatatgag aagttagaaa aagctgcaaa gaataccagt ctagactatt aaaaaattca 557160
 tttagttatt aaagcagtag ttctacagac tgatacttat tgaaaactat gaacaaataa 557220
 agatgctatt atatatactg tctaattatg ttaatttggg aaaaggttat actgggcata 557280
 gtttgtttat gcatgtagtc tagcattcat gagagcaagg caagaagatt gagtfftagt 557340
 ccatcttggg tgacagtga agaccatgic tcaaataga acaaatfata caaatgatct 557400
 aactctgtaa tacacaagaa gaaaaacact ggaaagaaat aatagccat taatatacta 557460

 taagaaaagt gggggtttat atggttttgg ggtgacaggt tgtatggtaa tffaaaataa 557520
 tagtcattaa atgaagcaaa ttctactca aatggccata taggcattta aaaataataa 557580
 agtacatttt taaaactctg atttctatct taaacaagaa acaatgtggt aatactffta 557640
 gtggcaatag aggattaatt ttaataatta ataatagagg tggtaatggc ggtggcgcac 557700
 gccttgggag gcagaggcag gcagatctct gactffgaga ccagfctagt tgacctacag 557760
 agcatgttct aggacagcca agactacaca aagaaacct gtcttgagat tccccacc 557820
 cgactcccc aaaaaagca acaaaaaat ggaaggcaaa ttacaaaaga actattactt 557880

 aggcaggtgg tagtffcac acfftaatc acagcactca ggagccagag gcaggtggat 557940
 ctctgtaagt ttaggccta aagacaacca tagcagagtc ctaaatfata tffagtcac 558000
 caccatata tccgcctgaa tgtgggaaat aaaaaagcc atagccagtg agtgcatttg 558060

ttgtctttag aatcaagcct tttgtgaggg atggtggtca gaattttcaa ggagaaggat 558120
 tgttgtaatg aggaaaatat agatttctact tgaaggatt ttgatcagcc cgtatacttg 558180
 agaggcaaca cacttggttt gcaatgccaa tttgtactat cctgttcttc cgactgatta 558240
 tctgcctgtg aagattttcc acccttaggg ggtcttcttt cgtgcagcta catagcaaac 558300

 tcaggtaaca cagcatgaaa tctccctcta tcttcacaac acctatattg cacagggaca 558360
 ggacagaaat tttatttctc ctttacaggg gggaaccttg agatttttgt tgttttgaga 558420
 caaggtcaca cagtgtagct gggctctggta atctgcctgg cttagtcttg agaggtagg 558480
 atagggatgg gggcacattg ggattagagg tctgcactac cccacctgct ggggaacctt 558540
 gtgctttgaa gaagtaaaat acctttccaa ggtctctcag ctagtagagt tgggattaac 558600
 tttcagcccg ataagggatg ggctaaacac cctctctggt attctttatt ttctctagta 558660
 tagatccaaa aagggttaata tgtgcacaac cgtggcacag ctctatgcag tgattggagt 558720

 agccacagac tatagagatt ccagcagatg cagtatactg aatgaacagg gatgacttaa 558780
 cagtttcage cctcaaggtt tacttgtcca tatagagatt aatctgtgtg tctggttctc 558840
 acggcataag gaagcttttt gggggacctt gccttaaggg ttctttttct gttctctca 558900
 ccttggattc ttigtatgtt caatagactg cttttttatt ccagataccc attcattatt 558960
 tatttattga gcacttgatg gacaccaggt cctgtgacct tcagaatcat ccctgtggag 559020
 ttaaaagaca agtctttact agaatttggg gaccatttg aagagtcttg attgtatcca 559080
 gtgattgtac tgttctcttc atcatagttt gactctaggt tattgtcaaa gtagagctga 559140

 ccacctgtct cattataacc tcaaggaaaa attttttaag ttctagcagt aataatcatg 559200
 gtaggaggag ctaatatatg catgctttgt ttgcattga gtgccaggat tagaggcctg 559260
 ttctacccaa ctaaacctta tttgcgtgct ttggaatgtt ttagaagtgt acatgaattt 559320
 agttgtttta tcttccaata accctattga tatgaatagc tgcctgttt taagatgaga 559380
 tatcttcaca aatgatgtat tttggaggct agaaagatag ctcagtgggt tagaacactt 559440
 gttgctcttg gacaggacca gggttgagtt cccagtacc ccatgtggtc tcacaactat 559500
 atgtaactct agttccaggg gactcaatac catcttctga cttctgaagg catcaggagg 559560

 tacatggtac acatacatc atacatacat acatacatc atacatacac acacacacac 559620
 acacacacac acacacacac acacacacac cccactaata catataaac aatctaaat 559680
 aaaaaattta aaaagataga gttagcatat ttcatgaagg ttacatcaca caactagttc 559740
 agtaatggga tgaaggatg tggtttcaaa gattatttat tctcatgact acagtcatg 559800
 gtctcttaca agggaaagat attcaagtgc tgacttttgc ttgatggcaa gctgtatggg 559860
 ttttttgtgt tgtttgtttg aaataggatc tctccactta gcctggctgt cttggaactc 559920

aatatgtaga tcagactcac ctcaaactca cagaggctctg cttgcctctg cttcctgctt 559980

 tgcttgactt aaaggtatac accactgtgg ccaacttatt ttgtttttta aagtgtattt 560040
 ttttttaaag atttatttta tgtgttttgc ctgccctttg aggccagaag aagacattgg 560100
 gtctcttgga aciggagtta acagtgttta gctgccttgt gggtactgga aattgaacct 560160
 aggtcctctg gtagaggaac caatactctt aactgctgag tcagtgaac tcaggccatg 560220
 catttaatgc caactcacag caagtgtttt ctttctctgt aatgcgtatt gttagtctg 560280
 cttgtactaa aaataacact aggtattctc ttttcggggg aggggcaagg tatagtgtg 560340
 agtaccagga cagccagggt tacataaagg gatcctatct ttaaaaaggg gggtggggtg 560400

 gttaaaatag aaagaagttt gtacactgaa aathtagctg tgcataaata aggtacaaaa 560460
 acgtcaggcg ttggtggcac acgcttttaa tcccagcact gggaaggcag gcggatctct 560520
 gtgagttcga ggccagcaga gcaagtctc aaaagcaata cagagaaacc ctgtctcaaa 560580
 aaacaacaa acaacaacat aaataaataa ataaataat aaagtacaag gtatacaagt 560640
 agctcttgta tgcattctca gctagccaca gtcttaggta tgtagtcttt tgggggaatg 560700
 aatttgttat ttctgtfact cttaacttcc tagatgaaaa gagaggctga tgtataaaca 560760
 gctacaatac aagactgaac ataataagag gggttagaga tgtttcagtg gttaaaatac 560820

 ttactgtgca agcacaggca tcttgtgttt ggatcactga tgtccacat gccagatgca 560880
 gcattccatg ttigttaact tggttcttgg gcaggggctt gacataggca gatcctgaaa 560940
 tcattatagc agacctgggt ttagtctcaa aaaaactaag gtagccagca atagagaaag 561000
 ctacctgaag ttgacctcca ccctccacac ataaacacat gcacaagcac tcatgcacac 561060
 acatgtacac tcacacaaat agtaacaaat gtaggacatg gcttttcttt tcattttgtt 561120
 tgtttgtttg ttttgtttt tttttttgag acagggtttc tctgtggctt tagagctgt 561180
 cctggaacta gctctttag accaggctgg tctcgaactc aaagagatct gectgcctct 561240

 gcctcccag tgctgggatt acaggtgtgc gccaccactg cctggcctct cttctttctt 561300
 ttttctttt tgggtgaatt tctttattt ttgtctttt ttattttta ttttaattag 561360
 attattattt tacatgtcaa ccccaggctc ctctccctcc cctcctccc tgctcccaca 561420
 attaatacc tacctatct ataaccttc cactccccag ggagggtgag gccttatgta 561480
 gggggcttc agagtctatc atatcctttg ggatagggcc taggcccacc ccttatgtc 561540
 taggctcagg gggatttct ccatgtggga tgggctccca aagtccattc ctatgctagg 561600
 gataagtact gatccactac aaggggcat aggtttctga ggtcttctca ctggcactca 561660

cattcagggg atctggatca gtcccatgct ggtttcccaa ctggggaggt cagctgtttc 561720
tgtgggtttc accagcctgg tatggacccc ttgctcatca gtccctcttc tctgcaactg 561780
gatttcagtt cagttcaagg tttagctgtg ggtgtctgct tctacttcca ccagctgctg 561840
gatgaaggct ataggatggc atataaatta gtcacatcagc ttattatcag gggagggcat 561900
ttaaagtage ctctcctctg ttgcttagct tgaagtggc tatcatcttt gtagctctcc 561960
gacatttccc tagtgccaga tttctcttta aatctataat gtgtccctct attatagtat 562020
ctcttacctt gctttctctt gtttttcccc caactcaacc tccctgcccc gtcacatgct 562080

cctcaccctt cctcttctcc ccttctcatt ctcttagatc cctctcccc ctaccccat 562140
gtcccaatt tgetcagatc ttgtctcttt gccttctcc aggggacat gtgtgtctct 562200
cagggtctgg atatggcttt tcaatcctgc ttggtttctt ttttcttttg gtgtatagaa 562260
agacaaacca ggaatatcat tcttctggaa tatgtcctct tcttaggcct ctggcaccag 562320
aagtttgctc tagttcttgt taaacctaaa tcacttcccc ttgtacatga tctacagagt 562380
agataaccaa gataaattac ccctagaaga acatatcctt ggctgccta ttctctttgc 562440
tcttaaaagg atggtgggtg caatttttag aaagtagtct tgacatcaaa gtctaaaaaa 562500

ttcaagctaa atgacttaat gacttgaag aatgaaatt aattgttttg ttttctagt 562560
tttgataggg cagggcctgg aacctatctg ttattgctag ttcactctaa gtatgaaaaa 562620
ttgagagtaa atatttagaa accttgggtg ctggcattt tcttctatca ggacttaggt 562680
gtgataaatt agaattttgc actcgggagg cagaggcagg cggatctctg tgagattgag 562740
gacagcctcc aaagagaac cctgtctcca aaaaccagaa aaaaataaa tagattagaa 562800
ttttaaaaa caaaaaacta atccttcatg aatagttttg agaaatactg gcttacttgg 562860
ttattattag tatgataaaa tagaaaagaa cttcagctt ctggctctatt aaacaatcaa 562920

tacctaccte aaagaattgc tttattgatg atttgatgt agatatttg gttacttaat 562980
atactgttc acatcactta atcctacca ccactaaa gcacattttt tctgagactg 563040
ggtacgttat agggctgtaa gtgaatttgg atctgcatgg agctatgctg ttttctgcat 563100
agagtgtgca aaagaactct tccttgtecc gtagttagg ggatgctgta gccacgctg 563160
cttagggct ggcttttcta ccatggtagc tgggtacact aatggcgtac gagaagcaac 563220
cttagaagaa tagtcatgat agctgggtgg agtaggtgcc tcagattgga gtgattctgc 563280
ctctgaggca tccaatgat cttaagcct agtaatggca tccttatgaa aagtttcaat 563340

ctccttaate ataaaagatt ccaagcatgt tagtgaatct gtaaattgct ctaactgctc 563400
ctctacacat ttttctaggt cttaatacag gtagtcctta ggcaacatct ggatagtatg 563460
gaaactgcct tctaggtatt tgagtctaga ttcgaggca tgatttgctg attttgagtc 563520

ctcagcaatc gaccatatgg acctatctaa tctgtcagtc ctgtactgta gtaaattatc 563580
 ttctaacaat tcaaatatag actcaaatit gtgatctgct accttagatg cttcaataat 563640
 tgatggaatg gcattgtcca gttcttcaac cctatcctgg gtattttgca cctttgcatc 563700
 tagtttttgg gtaacagtgt ctatctgagt ttctagctgg ctacagatat tctttagttc 563760

acatggtcct ctgacacct agcctctaac gcctcagaca tggaggatct ctctgtgttt 563820
 atcttatcat taatatgctg catctcatct tgggtaacag acaactctgt ctttagcgt 563880
 ttggacacag agccaagctt atcatccaat ttctgttcca cttgctgcac aattgtgatc 563940
 tgacctaate tgttctccaa aacctcattg cgtaaagctg ttatttcttg caagcaggtg 564000
 gtgaggttat ctttgcctt gttctgagc cctctggcta gtaatattac ttgtatcagc 564060
 aagctaactg ccattacggc ataagtctgg taattggcag attagcatcc tcctcaaca 564120
 ctgaattcac gtaataagca aaaatattat caattttagc aatgataaa tattctgcca 564180

taattttacc tgatttctac tccagatgca gtaactatct ttgaccagca ggtggtgcag 564240
 gcattcagct actcagcacc gcttttggca gtggctggtc aggcaagatg gtcacaaagg 564300
 tggaaagagg tcacaaaagt ggctatgctt atcttagaga gtatatggcg ttggagccgc 564360
 aacctctgaa agagatgtgg ctttaagca gcagcaaggg gaagagaggg tggggggctg 564420
 ctgaaagcca aggcctactt ccgaggcctc tcggctaagg gcaggaagcc tccgggcatg 564480
 ggtaggctgc agtccgagct gttctgggtg ctgcagctag aaacttcgac agtaacctg 564540
 gggaggtctg tggaaatttc cttagctggc tgcggttct cagcagctta tcagcagcca 564600

gaaagcgctt gtgtggtgcg gcgggtaggc tgggagcacc tgtggaagga gggatctttc 564660
 cctgcctagg ccgcagtcca ggtgggacct gcaggctgtc ccaaatggag gctagattta 564720
 caatatccca ctctgacac cagataatgt gggaaattac caatatggag ccaggtagaa 564780
 atacaagga ttttaatagg gaaaaggcct tacttacaga gtgacctagc cagctggtgg 564840
 gcagcaatct gtacagcaag ctaaaagtga aaccgaaagc aggctaccac gaaagtgtcc 564900
 ctcaactac atcacctca ccatgccctc acaggcgtgg tcaggcacac ctttagctag 564960
 gccctaagca ggtgtggcta cagcatcccc tataattgct taggggctgg ctacagcatc 565020

ccctacacag tagagtcca attctgtcac taacctact tagtttttga ccttaagcaa 565080
 gtcactttgt ctggttctta atttctcat ttacttgcca tgattgagtg accatatttt 565140
 atcatcttac attccttagt atctagcatg atcaggcctt agcgtgttaa tgggtattga 565200
 atactgtggc cactgattgt aatagaggtt tcagtttgt tttatctgaa catcctaggt 565260
 attttatctt atgcctttcc tctagaggat catgtttcat attatttacg tgtgtgtgtg 565320
 tgtgtgtgtg tgtgtgtgtg tgtgtgtgag agagagagag agagagagag agagagagag 565380

agagaggaga gtctacctg catgtatcgt gcaggccaga ggagggcacc agatttcatt 565440

 atggatggtt gtgagccact gtggttgctg ggaattgaac tctcaggact tctgaaaag 565500
 tagccagtgc tcttaaccac tgagecacc atctctecag ccccatgaa tgaatgaata 565560
 catacatac tacatacata catacatac tacatacata catacatac tacatacga 565620
 taatgttact tctcatgct tatttttagc aatctctaac ctgaatactt tgagataacc 565680
 aatatggcac tatgggatgt gtctaaagta aacaaccagg gttattataa ggtaaagta 565740
 gaaggggccg gctcaaaagt cagaaaaagt actcttgtct attgttactc tatggggctt 565800
 gggcctgggg cagccctgcc aggcctgagt aatggctgca gcctggagca aggttttctg 565860

 tgcactgtat tggggtctcc agtaattgga acatggcact ttccaactta taatggatag 565920
 cagaacaaga ggggcatttg tcactgcctg acttcctac aggaaaaaag ctcataagtc 565980
 acagctgaca aacccttga tgatttttaa acttcattta cagcaaagaa tagctataat 566040
 caagcaacag caagcagtga ctaatcttgc tacattatca ctgtgaggag ccagcctcgt 566100
 gaggtatgag aagtgggagg ggtctgtttt gcagtttcat agtaattgtg gattggctct 566160
 tgggcttgtg agtgtgctct aggaaagacc acatgaattt gcctgaagga tcagaagctg 566220
 accaacgta gactcagcat tgaagccatt gaactaactc ttgtctggtc tcaactcagat 566280

 ttgtgccacc tctggcttca gtgggacacc atcatctgct tcagtaagag gcttaaaaga 566340
 taaaatagtt gaggtagata gtaaggactc tttatgattg cccatgtata cagacctgga 566400
 aggtctttt gttgtctaaa atctaatgtt ttgtgttcca gaggatgacc tatggcagcc 566460
 atattttggg ttttgaacaa atgagctaag tatatagcac ccaaaataaa agaataaata 566520
 tggccgggc aggagtggtg caccaacctg gtctacaaag agagtcttag gacaggtcctc 566580
 aaagctgtag agataccctg tcttcaaaaa ccaacaacaa aaaccaaaaa aaaaaaaaaa 566640
 aaaaaaaaaa aaaaaaaaaat atcaaatgat agatagatac acagatagat gatagatagg 566700

 caagcaaagc atcatatcaa gttcttaaaa catccagcag aaattcactg ggggaagcct 566760
 cttaagtea gtcaaatcag cttagattcc caatagttag tcctagtag tgtccccctt 566820
 gagtgagggt cccaagtaaa agaacaataa gcatagtacc caatttgata ttttctccat 566880
 ggctggactt tgagcttttc tttaccactg taggtagttt tatattgtgg gaaaaatgat 566940
 agcattttta ctttttagct attctcaaat caaatagctt tactttgggg ttattttggt 567000
 gtacttttcc tcctgtcag agatttgaca agacaaattt gaaagacacc acccagttaa 567060
 gaggaccaat ttatcttag ataaggggcc ttggaggata cttttgagac aaacatgctt 567120

gggctctgaaa acagcaaggg aacctgatt cgaggactag tttctcagtg agttcaagta 567180
 gcacaaggca gtttaccagt ataatgtata ttgtatagat tataatggaca ttactggtaa 567240
 aggcaggatc attcttatgg atggagaaat cactgagagt gatctcatgg agaaggaaga 567300
 acataaatga tcaaagttgc attagtcttc tctactctaat cagactaatt actgtggctc 567360
 tctgagactc ggttgcttgt tagtttttta aatttcctcc tttgtggtac agaggagaga 567420
 acccaggact tcatgcatgc taagcaagta ctctactact gagctacatc cccagccaga 567480
 gacttggctt ttaaatctgt agaatgatgt ggataactaat ttcattaggt tgatcaggat 567540

 cctaaggaat cctgtgtata aagcttccat gcctctccgt taaagtgct gtgtattgtg 567600
 ttctccttca ggacaagaat aagtgtgcat ctatcaaagg aatagaaggc cataactgag 567660
 gtgttgtccc atttcaaact tttgccagcc tactctgtag gtccatttac agaagcaggt 567720
 gaggcagaca agatacagac ttccatgtgg aactgagaa ttggatttgg gtccaccaga 567780
 agagcagtcg gtactcttta actgctgagc catctcaggc ttggtggcaa gtgccattat 567840
 cagctgagcc atctcactgg cccctgcaa actatctctg gccatagcag aatagcttta 567900
 attctgcttg ccagttgagg attctgaagc cttagcaagt ctagggtga gctcataagt 567960

 tgacaggact agatttgaa ctcagtccta cctgattcta aagtttatgc tgttttctg 568020
 atttcatcgt gtttgggggt ggggtgggaa actaacaaca gtaacaaact ggattcccaa 568080
 aatgccttt ttttttttt ttcttttctt ttcttttttt tattttgaga caggatctta 568140
 actatgtagc cctggctggc ctgaaactat ttagactacc ctggcctgga cttgcagaaa 568200
 tacacctgct tttgccttcc aagtctctggg attaaaggcc tgtgccacta tgtctgtcga 568260
 aagagagctt cttgacaacc aagagagcag tctctacttg gtttctcagc aaggccagta 568320
 ttggaacac taaaagtgg ttgttgaatg tgagggatag taattgggca gtaagagaaa 568380

 taggtataat cctatatctt ttcattaatt tgttgcagat acaacagagc actttcacat 568440
 tggttagctc atttgcacac tgaaaagata gagggagatg ctttctgttt tcagaataag 568500
 ggtgttgttg tttgtagaaa tcacatgact tgtttcaggt ggtatgaaca gccaaagcaa 568560
 agtggagcct tatgcgtcta tagccagttc agcttgtact ttcattgtctc tagaaagcct 568620
 tctgtggttg gctagttgag agctgggggt tctcatggga gtggaaatgt cagtgtact 568680
 tgggaaatta gtctgtctg gccagtgatg atcatttggg cagtgttaat gtagtggggc 568740
 ctgaagagtt taatgagatt aatagatggt ttgtcaccca tggtgcctg gtaactaggt 568800

 tctctggact gaggagtcc taaacactga tccatctaat tgcttggctt cctccagga 568860
 tagtctccta tcaactgacg ctctttacta ctgtctgccc tagggttata tgagggtgta 568920
 aaggcaggaa aaaaaccaa agtaaccaa cgtgattggc taaaactaag cagcattggg 568980

gcaacaagac caagagaagc agctcctctt tggaagtaaa cattccatga ggaacaggct 569040
cagtcctagg caggtttaaa cagcacttaa ttcaatctga gaggcaggat tggaagccta 569100
atgagggagg catgacaaag ttagagtcag gtttacagtg gataagtcta gactgtgtaa 569160
tgtcaggctc ccicaatagc tgtttgacct tacataaatc atataacttc aaaaaatctt 569220

cagcctttaa aagggatagg gggatgacca gcaatgatat tattttagcc ctttttgatt 569280
ctatgacaaa attgctgttt tattagcaat aaatttattt attcaagttc tagagttcaa 569340
aatgaaggca tctggttaag tgtgcccatg gttccaggac aggtcttttt tgttgtgttc 569400
ctacattgta gaaagaaaa gatagtctcg aagaggctct ttatttttat ttattttttt 569460
attatgtata cagtctctcg cctgtatgcc agcagggggc accagatttc attcaaggtg 569520
gttgtgagct accatgtggt tgccgggaat tgaactcagg acctttgaa gaacagtcag 569580
tgctctaac cctgagcca tctctccagc cctcaagagg ctctttatat tataaaggta 569640

ctaacacca tttatgcaga gttggttctt atgacctaat caccttctaa agactctgtt 569700
gccttttgcc cttagatacc ctgggggata tctgagtggg ttgaaagaa tgttgctatc 569760
aaagataaag acaaccattt ctggagaagc taaccagttt ccccaaagta tetactacct 569820
ccttggttca ccigctcttg gttaccaggc agctagggat ggacagaagg cctgttgatc 569880
tctaagctca ggctaatacg tgttcatgtt ggaaattagg tttcaacgta gaatttgacg 569940
gaagaatgca ggcctgaca gagatccatg gcattcataa aagtcctgtg caaattgaag 570000
aattgtagaa aggggaagga caaggagggt gtgtgtgttt gacacagatg agtatcttgc 570060

cctagaaact attacctgg gaatttttgc acacacaatc tggcccctgt ggatgcctgt 570120
atgtgtttgt ttigtgtgtt tttagacag acttgaattc catttgtggc ttgtctttat 570180
taacttatta cttgtctca tcttctatt taaagtaaat cttatgtga agattaatgg 570240
gaagagatgc aggaagcact ggtactcaga atcagaggct ctttttactg taagaggttt 570300
ttgggaagat tctcaattac ccaaaattta ggagtggga ggtacctttt aagactttta 570360
catttgcaaa gctctttggt ttttttctt tctttctagt gttggctttt gtgttctaga 570420
tcataatttc tatatgaaat gtttgaattt gggaaaatgg tttgtgtttt gccaaatttc 570480

ttactaactt ggagaagttg gcccatcct tcagctgta attacattc aaagcttttg 570540
tccttgggtg ggtttaatta gtttaaggct ccagcttttt agcagttgtt tatctagcaa 570600
gtgcaagtga agacattggc ctaggaggca gcctcctgta gttttctcc agcatagcag 570660
tgtttttgag atgctgtctt tgttttctgc tccatgtttt cctggatgcc catctcactt 570720
aaaggaaaa atataatata aaaatcctga tttttagggg tgtgatagcc taggcctgtc 570780
attttacttg ggaagtggaa gtagggagat gaattaaagg ccagcttgag ctacatgaaa 570840

ctcttgtgtt taaagagaga ggttgggaga gtgtgggggg atggagaggg agagaggata 570900

ctgaagggca aaggcaaaaa acaacaacag aaaacctaga ttagagctag aggacacctc 570960

aaacctgag gtttatggac catggtatcc tggccagggt ctgctcctct ttttttttgg 571020

gggggggtct cagtaagaac atatcaccaa agaccctgct aatctgacgt tacagatatic 571080

tctaacaaca catgtggttg ctgtatgacc tctgcctcc ccaggcctac cacccacctc 571140

tcctcagctt attgttaagc ataaaaacct ctggagtgtg tggtaacctg ctcttagtta 571200

cacaatttat aaagcaaagt ttggctggta gtggggacta gcttatcaag ttagatagtt 571260

tttgcgtaa aggatattga tatttttagga cccccactct tgaaaaattc agaaagaggc 571320

tagatgtggt agcacatgct gataatccca gcagttgaaa agcaggagga tcaggagctt 571380

aagatcatca tccttcaggc cagtcttagt tatgtgctac tttgcctttt tctaaatggg 571440

ggaaacaaaa tggggtgttt attaaagtgg ggggtgttgg ttgtgagggt gggcatttgg 571500

atcagactag aaaaccaggc ctgaaagctc gtacgtatgg catacacctc ttagcacca 571560

tttgagggtt ccacaactcc ctgacgtgc gtctctcttc ctgggcttag ggagtctaca 571620

gagtaacata cagcctatat gctaaagcat catgcaagac ttaaaagatc aactgggagg 571680

atatagattg ggggtttggg atttggacac cagagcatgt tccatttagc aggcactgctc 571740

atatacttgg tcttctctat agatcagaac aggggtgacaa ggttgactct tcttggatc 571800

ctaagaatgt gctccagctc gatcatgact ctaatctaga gtggccccac tactggtggt 571860

attaatagaa gagacaaata catagaatta tactaatagt ggatcttcta aaggcctcca 571920

cagtttgcaa agttctttta tatttattgt cccaaagctc aagtgaggag agaaatgatt 571980

ggcagagcca aacctgaaag actgttctcc agcaagccag tgagtgtctga tcctacaca 572040

gtactacaca aaggagctca gtgaatgctt cctactcagt tgtgttagag gctcctaaca 572100

gtctgaggga atccactact gccctgtctt tgcataata atggcagagc cagcagcctg 572160

gttggttccc tctgctgaa caaaatggca tctttctgta cagttttgag caggatcagt 572220

catctagtgt catgtaggca ccttaaaaag tttctttcta ttagtgaatg aacaaggaat 572280

taaccattga atgaatccag ataggaggat ttttgtaact gaaaaatggg gagcattaaa 572340

tatttcctat gcttatggag agtatattgg ctgtgttctt gggtatctcc ttgtgtcctt 572400

cactgcttta taaatgttgg tgtaagagta aacctactaa caagaacctg tcttgtccaa 572460

gttagttcta aagctcatat cagcctcttc attagtagca gcaagttaaa ctctgagccc 572520

ttgctttatg gtagtacaaa aagataacac atttctccaa cttgcattct tacttatttc 572580

tctgaaatga aacccccaac ccccagccct gtattaggta gaataaacat gcaggttgat 572640
 gaaggttttt ataccttctg cttggagggt atttaatacc ttctgaaact gccttaggag 572700
 ataagattca agttgcactc cgaacacggg cctagtaagt acaaatgcca caaccagact 572760
 gcaaaccttg ccigtggaa ttaaacatcc tctttccttt ctcttggggc ttatgccaag 572820
 gtacaactgt tctgcagaga gactctgtag gataaaatgc cttttttttt tttttttttt 572880
 tttttttttt ttttaaagcc agagccagag tctacctggc tgacctgaag aatttactat 572940
 gtagaccagg ttggtcttga actcacctgc ctctacatcc tgagtgtctgg gattaaagc 573000

atgctccatt gtggccaaca gaacatata tttaaaaagc caagtatagg ggcattgact 573060
 tgtaatacca gtgctagaga aatcatgggt aggcttgctg gctatccatg cctgcttact 573120
 ggacaaaaga acaagcgggt ggacttggta ctctactga tctgcgtata gacacacata 573180
 acaagagtag ttgcaaactt gtttataagc cgaatagatt ttgagtctgt ataaagttaa 573240
 taactaataa attaaattac taacgacat tctcaggtaa attcattatc ttaactattt 573300
 aaattggctt taactctagg aagcagtgat gaagctgaca gaaatgggct ttaaaagtgt 573360
 ttaaatgcct cttattagca agttaacaat cttaacaaaa aacaattagc agagtctcag 573420

tttctggtaa aataatctgt attcatccac gagttcttgg gatcattcaa tatttatgc 573480
 tactctttag ctacagttag tacctggtaa gtctatgtaa gcacacgttt ttgcagagtg 573540
 gctggcacag taaagacttt actggctggg ttagtaaaga tgaagtatat ctagatcaga 573600
 caaagcaatt ttataatag gggactgttc ttgaaattac catgtgttct ccttgttatg 573660
 gttctgcgtt gaaggaacag aaagaaaagc tgtagaaaat tatttagttt taaaatgggg 573720
 taacattgtg atttttttt tttttttttt cttttttctt tttctttttt tttttttttt 573780
 tttttgagac agggtttctc tgtgactttg gaggctgttc tggacctcgc tctaggctgg 573840

cctcaaaact acagagatcc gcctgcctct gcctcccga tgcctagatta aaggcatgcg 573900
 ccaccaatgc cggctcatt tgtgatata ttttaaagat ataaggttaa aaaaaatgc 573960
 aatcgaggct ggagagatag ctacagcagt aaagagccct ggggtgttctt ccaggggacc 574020
 tggattctat ccccagcacc ctcatgggtga ctcaaaactc tctgtgactt ctagtttccc 574080
 actgaaaaaa caccaataca catgaataa aaataaatat tttttaaact tggagttaag 574140
 agactggtta atcccagct tgcgttgac tagcattgtg actttccagt gtagggtttt 574200
 cctgtgtaca gtatcgtgag taccaaatga gggaatgtt taaagcacct agtgaagat 574260

tagcagccag gaagtggcaa ctcttgataa tgcaccaga aaacaggatg ccagaacagg 574320
 gagaatgggt accatagggt tgagaatgtg tacaaggca aggagcaatc caggtttagtc 574380
 aggttatcta ttggcatga acattccccg agcctggcct gggaaccag cttcacattg 574440

gcgttatctt ttcagggtga caccatgtcc ttgaagattc agaccagcaa tgtaaccaat 574500
aagaatgacc ccaagtccat caattctcgg gtcttcattg gaaacctaaa cacagctgtg 574560
gtaaaaaagt cagatgtgga aaccatcttt tccaagtatg gccgtgtggc cggatgttct 574620
gtgcacaaag gctatgcctt tgtccaatat gccaacgaac gccatgcccc ggcagctgta 574680

ctaggagaga atggacgggt gctggctgga cagactctgg gtaagttaac ctcttctgag 574740
tagctactgc ctggaatfff atgatttcaa cagataaaaa ttatatttgt aattctttaa 574800
tgagtccaa gaggagaaca catggttata gagggccctt ttctctgtc cttgctttcc 574860
caattctct attaaaaaa aaaaattatt tgtttctggg cttgatggca tgtgctatta 574920
atcctagcac ttgggaggca agtggatctc tgtgagtca gggccagcct ggtctacaga 574980
gcgagtcca ggacacctag ggctacacaa gggggctcct gtctcaaaag aaaaaaagt 575040
gtttgcatac atatatatgt gtatatgtca accatggttc ctgttagag gtcagagggc 575100

tagagtgggt tctctttcca cttttatgtg ggttcttaag aattaaactc gtgtcatcaa 575160
gcttatgagg caaacacctt tccccccga tcttcatagc ctctctccc caccctta 575220
aattaaaaaa attcttaaat acaatatatt ttgaatattt ttttcttccc taactctec 575280
cagatcttac ctacccatct aattttgttt tccccctcc ttctcaaaaa aaagagaaat 575340
gaataaaaac aaggaaaatt aaataagaaa gaaaaaaaa agataaaagt gccaaacaaa 575400
agccccccc caaaaaaaaa aaaaaaaaaa tgggtttgggt ttttctgtgc caactctec 575460
tggatgtgg ttgatagacc cactggcacc ccattggaga aaactgattg tccttttgcc 575520

tacagatgtc ggttgcaaat agcttcttgt ttagggtag gacccttgt ccaacttaact 575580
ccttttagtg ctgcaacca gttagtcttg aacctgtgtt ggtcctgtgt gcgctgccac 575640
agcctctgag ttcatatag cattagtctt gtgtctggaa gacaccattt cttttagtg 575700
ttcatacca cctctgctc ttacagtttt ttctctccc tcttctgcat agatecctgt 575760
gccttgaggg gagtggtttg atgaagacat ttagaactga ttgctacaaa gtatcacaat 575820
gttcagttct gggctctctg taattcctgt ctattgcaag gatcagcttc tcggatgtgg 575880
gttgagcagt gcaactcctg atctacccc atagcctctt aataacaagc tttatggttc 575940

cagctaaaaat ccaggttctc cgtagaaagg gaacaaaatg aactaatata gcctgttacc 576000
ccaatctaca gaagatatga gttagaacce ttctaaaag ctatgaggag ctgtgaatac 576060
aaggactaaa gggaagatgc gtgctcttgg cattattgat tacatacata tgaatgact 576120
gttgggtgtc accttacagt gtgtgtgtat gtgtgtgtgc atgtgcttga ttgctcatat 576180
acgtctttgt atgtgtttta gaaggtatat ctatatgtat gtattagtga atataagata 576240
tgcagatgtg attgcatttg tgagtgtggg agcagatgtg cttgcttttt tacttaatag 576300

tccttgatct tataggctat gtatatatga gggatatagat gtgttcatat atacccgatt 576360

tatatgaatt tacttgaaaa tatgtattta tatggtatgt gaagacttgt gtatatatct 576420

gaatgtatat gaatatacaa ctaggcagat ccatatgatg tcctggatt cttgtaatgt 576480

ttgaaaatta aatgtttaaa gacctttggc tacctcagtc ccatgtgtac actgtgtaaa 576540

tacacagagg catgatggg atgtgtgttg gcatactgct gtcagttag cattccaact 576600

ctgcgtcttc cctccacaca gacatcaaca tggctggaga gccaagccc aatagaccca 576660

aggggctaaa gagagcagca actgctatat acaggtgagg ctctgtgttt ttttttttg 576720

ttttttgttt tttgtttttg tttgttttgt tttgtttttg tttgtttttg tttgttttt 576780

ttggctcga ttggttgggt ccctcttttc acagaggag taaatgctga tagtgacagt 576840

gtaccaagct tagaatttag gaagattttg gagatgagga cctgtggaga agtgggctga 576900

gtagccatct ccctttgttt tcccagtggc tacagctttg actatgatta ctatcaagac 576960

tacttctatt cgaggtgagc aggggaagggg catgtcaagg cattaaatag ccaaactgga 577020

agggctctaa gagattgctg gtgtggctca taaagtcctc caattgggaa ctgaaacaca 577080

gagatgtgag tgagtctttg cttcaggggt gcttcacaaa tcaggacag tgctaggact 577140

aggatcccat tttgtaagtg ctcaggccag agctcttact gtcacaccaa actctcatat 577200

tctgactacc ttgcttcttc ttagttctat agcgtagggg agtgtatagc taaagggtga 577260

acacacctgg gcacagtgtc ttcacaggta gtgccataa actctgttca gcttttgtct 577320

ctgtaaggtg ctactcagc caaaaaagtc agacctacag atagtttggc ctgactctta 577380

tgactaagaa gtccatgta tttggaagcc tgcgttagtc catgatgagt tgtgatctgc 577440

cttctatctc caatctacc tacacttcaa ccttgaagtc ttctagagc cccagccaca 577500

ttgtttgtt gagaagtttt aaaaactcat tatcctccta tatctgctg ttgagtgcag 577560

ggattacaag actaaacaca atgccagctc ctggctcatgt gcttgactag aagttgtgg 577620

gacgattaaa tcaaaagtc tccttccttg tcagacagc ccagggaaaa gaattcttct 577680

gaaccatttt ctctgctgta agtgttaagt gtcataatct ggaaattcag gagactggat 577740

gctaactctg gccgtgacac tgaataggig tatctatcct tgggcaaatt ctctactcc 577800

tagtcagtga cataggctta taccaaatga tctctcggga cttctgaagt tcttgagatt 577860

ccagggtcag agccatcacc tccccttggt ggtcaaacg aaggatcggg gattgcattc 577920

attcccagag actgatcact agttgccacc acctgcagga ctctttgaac aggagtacca 577980

agaagcagga ccttgagtat cctagtgggt gcaggtaccg tgactcatca aaaaagtagt 578040

thtagagtat atccctgac aaggctgtgc ttcccttcag aacctggtc attgcacagg 578100
 tggtaggaga gtccctgct cagccttggg tctaatttag ctgccatcc tcgaaataat 578160
 gttgagcact tggcctatat atctctggag aaaaagaaag gtgttgaaat ggtccaaaag 578220
 aaaaaaggag ctiagaagtc tgaggccatg ggttcctcat gagtgcttca gtgccctagt 578280
 acccagcttt tgittgtcaa accttcttaa gtgttttttag tgaggttctc atgctctacc 578340
 ctctctgcat actcaggtag tcagtgaact tggacagccc tcttcattaa gtagatggga 578400
 aaactaaggt tcaagggttg gccacccatt ttcaaacctc tctgtttcca ggtggagact 578460

 ttcactgttt tgatttttac agtatgatca gatgaagtg ggggtattat ctgagtagaa 578520
 ggcgggtgctt tcaggaaagg ctccctttta gactgggctg tttgtcctta tactgtttct 578580
 cctagcatgg ctggggataa atctgtaggt gcaaacagta aggttttctt tcattagcct 578640
 ttaggatctg gaaaaccctt tcatcatac cagggttgt tggaatcatt cacttcttcc 578700
 ctggcccttt ccggtcacac aggtgaagtt agtatttag tgcctcctgg tggtcacagg 578760
 ccatgctgca gcctctggtc tgtttgcctt tgcaggctgt ttgattatag aggccgcctt 578820
 tctccagtgc ctgtgccag ggcagtccca gtgaagagac cccgtgtcac agtccctttg 578880

 gttcccgctg tcaaaactac aatactgtc aagctctttg cccgttctac agccatcact 578940
 actggctcag ccaagatcaa gtgtgagtga cttttgtgt tgttggtttt tgttttttga 579000
 gacagggttc cactgtatat ctttagctgg cctggaatgc actatgtaa tcagactgat 579060
 gtaaaattca caaaaattct tctacctctg cctcctgggt gctagaatta aagatgtgta 579120
 tgccactaca tctgatgac gtctttcaat ctttctagat ttttgaacce ctttggggtt 579180
 ggatatcaga tatttacaat tcataacaat agcaaaattg cagttaaaaa agcagcaaca 579240
 aaataaactt atcgttgggg gtcaccacac cagagggtc gcagcatttg gaaggttgaa 579300

 aaaccactgt tcagatggt ttgtttttta ttatcactaa aatgatagaa tcacattttt 579360
 taacaactga tttttaaatt gttaatcttt gtttttattt taagtatgtg gtgtttgcct 579420
 gcatatgtct ctgcaccggg tatatgcagt gccagtggag gttagaagtt acagttttga 579480
 gctgtcaatg tctgtgcttg ggatcaaaact cgggtcttct gcaagggtaa ccagtgtctt 579540
 tagcctctaa gccatctctg tagcctccag aatcactatt tattaacact gagaaaggag 579600
 taaatctgta gttgaagtta ctcttaataa tcaagtgttt ggatgcattt ctaaagaaag 579660
 tccagtgtg tggtatgata gtgttttttc tctagtaagg ataagttcag atttattctg 579720

 gtctttgtat actgcagtca gacaccagg aaatctaatt gcagaagacc tttttgtac 579780
 cttaaaaaac ataccacatc ctgtaacaca gctaaaaaga cactccatta cttaggtgtt 579840
 ccagaacac accacagacc tacattgttt ttctttttga gacaggctct cagaatttaa 579900

accagattaa ctttgaactc acagtatccc tgcattagcc ttccaagtgc tgggattgta 579960
aatgtatgac ccacatggcc cagtctata ttctgtgta tttgagctcc ctataggatg 580020
ggagctctag ggcaaatgac aaggatcgga ttatgaactg gtcaccctg gggcccgttg 580080
gttctctcaa gaagagacc ttttcttgg caggaaaaga accaaaaagg aatggcttcc 580140

ctagttgata gaatgaagct ggggttttgt ttgcattgta ccctaagtg ataacctgt 580200
ctcccctcta ctcccagtga agagcagcga actacagacc atcaaacag agctgacaca 580260
gatcaagtcc aacatgatg ccctgttggg tcgattgga cagatcgctg aggaacaaaa 580320
ggccaacca ggtcagcttt gagggcagcc ctgggaaga tagtgtgcc caagggttag 580380
ggatttgaag ctccaggccc tgagacttga tatgtagtga aagcccaact ttcacgaagg 580440
tgtgctgcat agctgctcca gctgatttct agtctttct acttcttta cctcaagat 580500
ggcaagaaga aggtgacag cagcagtgtt ggaggaggcg gcggcagtgg tgggtggcggc 580560

ggcagtggca atgctggagg cagcagcggc agcggaggca gcagtggagg tggcagtggc 580620
agctgcagca gcagccggcc tctggcccc caggaagaca cggcttctga ggcaggcaca 580680
ccccaaggag aagtccaac tcgagatgat ggcgatgagg aaggactgtt aacacatagt 580740
gaggaggaac tggtaagggc ctggctagct atgtgactcg gaagggttag agctgtcccc 580800
ctctgagctc cttcctttct gctttccaga gtgccagtcc tatgaggagt aggaagaat 580860
gagcagcgtg tagttcattg tttgagctgc tggccgaag tcccactcaa tactagacag 580920
acctcagcaa agcccagggc ccagtgcacc ttctactctg ggtgtattaa agaggaggag 580980

aattacgctt aagagttgca cacacaacct ctcaggaatg gttggtgttg atgatgaaag 581040
ccatgagaag atgggaattt taatttcaca tgagaatfff ctaaaagcca tgcctttca 581100
agcatctage agctgtctc ttaaaggagt aaactcctgt atatatggga agtattcagg 581160
gtgaggttag gagccatgag agggcctaaa ttgagtgaaa aggtctgatt tctttcaaca 581220
ctcaagatgc ctgctacagt gtttctgct tgtttagtga aacttgagt tgaatcac 581280
actttaacct taacaataga ttagattaga atggccacat ttaccttga gaagctgaag 581340
ctcaaagtta ccaggtacct tgctcagact tggctctgta taggtgtaag tectctatg 581400

ccacacttgt tttcttttc tttcttttt aaagcctagc ctggtacttc atcttattct 581460
cttaggcata gtactctcag taaaagctct aaagactctg agttgggcag accactgatc 581520
tatatggctt taagctttgc tgtagtccat ggtctttcca tgcatagaat gtgtccctgt 581580
tacactagca aatcccagga ctggtccctt aactttggga tcttcagata acctctcag 581640
gattctaage cagttttatt ggttggttcc ctttagttgg acctccttc cagcagctct 581700
ctgagccaca ggacattcct gaacagatag cgcagggttag aacttgtgac ctacggtgaa 581760

tgatttgtgc ttgtcttct cctctcagga ccacagccag gacacagatg cagaagatgg 581820

 ggccttgcag taagcaggta tggggtgcct agggagcaca ggaaatcaat gaagtgattt 581880
 cctgcaattt ctctctgatg tgggtctagg gagccatact gtgccgaggc tgaaggtcct 581940
 tacatgcagc ctactgcag tgtagtcaca caaatcagga aactcagag agtgttctct 582000
 tgggagcagg atgacaagga aggaaaagtg tgaactggag tgggtggaaga aatgctgtgc 582060
 agcttagtct gcctcttagt gagggagaag cattccatag ggggagagaa cagacagcct 582120
 tattggagca cagcattgtg acagtcttta aggacaagag ctgtctgttc ttagccag 582180
 ccctgcaagg taggggaaag gtgccatttg ttttaagagg ggatgactag aagtgtctca 582240

 ttccccctt ccctcgtag gtgttcaact tgatcctgtt aaggggagga gacgcctgc 582300
 aagcttttat ggcaggagct gttaatctga tctcttctac cctgcaagat taggattgtg 582360
 tgtatctct agaagtggga atgcagatgt tgaaggtag aatgaaacat cagcatgtct 582420
 catgagattc caagatagta attgacgctt aaatttgaat tcagtaacat gcagcccaa 582480
 agctccact ctggccactg tctgttatcc tgttattccc taccctagag gaggttacag 582540
 gtgacagaga ggtgcttgg tagataaac acatttgaata taggatctct attagttaga 582600
 gcttcagat tagttcagaa atttctcat gtaagtcttc cctctgaaa cttaatatt 582660

 ttttaccag aagactatit atatatttg cagctagttc atgttaggtt ttaaaggctc 582720
 aggtggggag atcgctccgt ccagggttg agcctttccc acaattaatt acatgatcag 582780
 aaaattggga aaggtgcaga catagcaccg caccctttt cttaccct atgatcagag 582840
 tttgtctcag ccttagtttc ttcttgcct tgacaggaaa aatggccacc agcagaagaa 582900
 gggcatcact gtctcagcc tcaagtcagg cacccatctc tggatgccag tttgtagtgg 582960
 gtaccagggg aaagctgcca gnnnnnnnnn nnnnnnnnnn nnnnnnnnnn nnnnnnnnnn 583020
 nnnnnnnnnn nnnnnnnnnn nnnnnnnnnn nnnnnnnnnn nnnnnnnnnn nnnnnnnnnn 583080

 nnnnnnnnnn nnnnnnnnnn nnnnnnnnnn nnnnnnnnnn nnccttccc caggcatcc 583140
 cagccagtga gtgctacgct ctttcaagt ggagttactg gcctaccctt acccatgca 583200
 ctcttctgt ctgcactgcc tggccaagg ggcagaacac attctgcct tcttcccag 583260
 ggaattccca ggcttgatt tttctatagg tttgagggg gtgggggtgg ggggtgggtt 583320
 ggtgggtgag gggaaaatga caataaagag attggatcca aataggtca gatggaatgg 583380
 tttgcttatt tggttggtt tatttaccatt gttattgtgc atgtatggtg tggggtggga 583440
 tacatttga tgcacacca tttgtggagg tcaaagaaa cttcatggag acaggcttc 583500

gaaggaaca cttaccac tgagccttct cactgtctct acttctatga taaaacacta 583560
 tgacaaaag caagtgggg gaagaaaggg ttaattttat cttctacttc caggtaatag 583620
 tccatcattt ggggaagtca gggcaggaac ctggaggcag gaactgatac acaggccatg 583680
 gaggattgct gcttacaggt ttgctcctca tggtttgctc agcctgcttt cttacagtgc 583740
 ccacattgga cttgacctc ccacatcaac ctgcaaatca agaaaaggca gcatagccca 583800
 gtctgatggg gaaatttct cataattaag cagccagcac acaggcctgt ggtttttctc 583860
 acagtggat ttiagcctc tgcctatcaa aaagctggta tgctcaacce ttctgttctc 583920

 ccatctccag gaaacactgt ctccagtgtc caatactgat ccatttgcac cagcactcct 583980
 ctgctaaaat gattaaagtt aggtgtgatg gcacatgcct atcatccaag cacttaggga 584040
 agtggaaagca gaaataccag ttcatgactg gtcaggactc catgagacct tattttatct 584100
 caaacacaa aaaacaaaag cccacaaatg tatctgccat ttttggagta cctatgcaaa 584160
 cactagaatc taaatcgctt taagcaagaa gtagctttat tcctttccta atagtatgtt 584220
 ttaggaatt ttaaatttta agcttttctc ttttttgta aacttaagcc atctgttcta 584280
 ccctattact gccgtttttg ggttgttaaa atgttaaaat gacactcaag tcgctgcttt 584340

 gacctggctc cttttccgt ttttggaaat gcagccttga ttcagctgct gttctggtca 584400
 tttcagggat gtttcagtac tagttgattg ttcttaaaga actaactgtt accttcttg 584460
 aaaggcctca cctcaggaca caagaccatc atctaaaagg gtgggggcct gggttcttac 584520
 ttcgtttgca acctgcctc actggattcc ttattgaacg ctaccagttc tagccaccag 584580
 tcatacagca gcttctgctc gggttttgac tccaagttt tggtagagc caggtgctga 584640
 aggtgggaca gtgctcaggc cccctggat atggaaacc ctagaaagt gctcacatcc 584700
 cagcaacact tgtatgagt gggcttttta ggttgtcttt gtcagttagc ccatgctgtg 584760

 ctggaagtc tgcagtgcg ctgaatgctg ggattacagg aatgtgcctc acttttgttt 584820
 cagctatact cttttgcagt attggctatt tagagggtgt ttgttgaagg gaggatagag 584880
 atttcacagg tgttctgcta aattcttttt tgtttttcaa gacagggttt ctctgtgact 584940
 ctggaggctg tectggaact aggtcttgta gactaggctg gtcttaact cacagagatc 585000
 tgctgcctc tgctcccca gtgctaggat taaaggtgtg cgccaccacc atctggctct 585060
 gctaaattct ataaaaggta ttgtttatcc cctacagtct cctagaagt gtgatagatc 585120
 atctgttaa cctactggaa actgacatat ttgtccaaac tcatgtcact tgaattatgc 585180

 aaatctccac ttgcaattg actctgaagt actgctcctg gatittgagt ctcttgggct 585240
 ttctcttct gtacattgcc agtgttcttt gacttctct aatgcccgtg cctctaccct 585300
 tttcctttat ggaaccttagc atatggcatc accatactct gcagcagctc cactgtacta 585360

tcttcagtga ccagagtcac cctacacctgt ccagccccat ttggtctttt tcttcatgaa 585420
 tcctaacctg gacaatggcc atcattccct acctgcca tttagtccac atcttctact 585480
 cctaattttt ccatagtagt ctgaacttta actcagatat gttcaacttc ttgacattct 585540
 aacaagaggt taccatctat aaagaactat gtgattaagt tacataaagg gaaataatca 585600

 tgtttttaaa gtaagcttgt aattttgttg taccacattc acagccatct ttgactggct 585660
 gcttgctggc cctttttcat attactttga tttttaaaaa gtttcatggt tactataaca 585720
 aatatacagt ctctgaggac aaaagagggc attgggaact ggagttagat agttgtgcgc 585780
 tgccatgta gtaactggaa tcaaaactga gtccttttcta aactactgag ccaccttacc 585840
 ttttcagccc tagactctac attaactctgg tctctttcat attatgcacc agggcittgc 585900
 tgttctgctt tcctccatt ttttgagatg ggtctgtctt aaaatcaatc tgtctttatc 585960
 tattaatct ataccatcta taccaggct ggctatgggc tcttgatggt attgcttagg 586020

 tctccaaagt attgagggtt acaggtatgt gctatcacac tcagttcccc aatggtcacc 586080
 aatatgaagt tgaaaactat cgtttaaatc actagcagat accaaccagt catcaaaatt 586140
 gccccatacc atccccaaag gaggeccacc aagaaaagaa ttggacagaa catacataaa 586200
 cacacaaaag taatggagca ctagttacac aagaggcact gatccttgct ttattcatga 586260
 aataataacc aacattggga attaggggca gaggtacaaa agaataaaaa aaagaaaaag 586320
 aaaaaattgc agtcataaca gtttgtatca acatggcagt gagggtggc aggcagttca 586380
 gccagcgtat ggcacgtctc ttgacctact tggccaaggg gaagtgcctt ctaccatttc 586440

 acagccaagt tacttggtaa cacctggcct tacttgaacc agggtcacag taattaaana 586500
 taacattgtc ttggctgagt ggctgttctt gggatgttta gcaagattaa cagtctgatg 586560
 gcaggaaagt gaggagcatc atgtatgtcc ttatcctggt ggggtcaagt aaggcagatt 586620
 atagcacaga cccacaaggt ggacctcct gtgcaccgat ggagaatacc tcgctagctc 586680
 agtcctcaga agcagagctg gagtgaacag caagaccaca cacgcagcag catctcttgg 586740
 tttcacagcc acattcaagt tagtttagta cagaaaagca tttgaggggg gtcttttact 586800
 gacctagaac acaggttga gaagcttct taggtgctgc tacttagacc ctaagatttc 586860

 tctgtactac acaagctttc tcaacaaact aacattagta tgtcaggtat aggatatact 586920
 ggctgtaac aagaattcca aagacaggga acctagcacc tggtagttcc cttagtgac 586980
 aacagctgaa gtttcagctg aagtcggctc caactgttgt cacaggaggg aatgaggaa 587040
 tcggcagtga ggtagtaaca accctcacia aaggaaagaa aactttcatt ctaaaaacag 587100
 gctgatcttc cagccaacta agtcatatct gctctagcca tgtaactcaa gagaagtga 587160
 aagggaat ggctgccag ttccagtatt tgccaactact cagtttctga ggacaggag 587220

aacttgccaa agtccaggaa ccaagttggt tgttttgtat tttgctaaat tcaacgagca 587280

 tttttattat agaaaaaaaa aactgaagga cagatcaaat tgaaagaatc agttataata 587340
 actttaatth atcttgcaat ttacagaagt ctatgaacga ttttaaaaag cacctcctta 587400
 ccccatcacg ttigacagtt gttaaagtgg gcaatgagta tgtcaacagc ttgagtgtcg 587460
 gcatcttgca agggtttcag atcaatcact tgccaaagaa cttggcagct tttctatctt 587520
 gtgtttcaac tcagtggtag gtccactctg atggtaacct gtcagccaa atctccacca 587580
 cacattttgg aaaaatcaat ggtgattagc aaattagtta gctttggcac ggagctgtgc 587640
 tcgcttgccc gtgacagcct ggaagccagt tttgatgctg gcaacagagc atcgagaatg 587700

 acaagtttca cactgtaaga aatagagtgc ggtgtccttc tgtaggattg tgtccggtga 587760
 tcggcatgtg tgacaagiga cgtattcttc tgcaagaaaa acaacacagc attatctgct 587820
 agatacagta aggcagaggc tcctgcttgc ccacagaaat gcacctgtct ccaagtaata 587880
 gctcagagga cagtttacc tagccaggca gggaagccta gctaacacgc tattctaggg 587940
 gtaagaaaaat gcaactaag ctgtctgcca tgttttttgg cagtatgata caagttgaaa 588000
 ggacttcaaa tgetccaatt aggggaagttt gccagatgcc cattcttgggt getatctatg 588060
 gataatccac ttaagcctta ggtgagaaca ggcaaggcat gccaatthta aatgthttga 588120

 taacaaaaga ggctgaggca ggccatgcca taaccagagg caggthttta gccccagaat 588180
 cagtcagcag aggtctgcat atcttggctt tctgcctcct cctcactatc atthttctgtc 588240
 thtcctcca gggthttctt atgtagacca ggctggcgtc aaactcagat ctcttaagta 588300
 ttgggactaa atatgtgtgc taccaggtgc agccccattg cthtcccagg thcattacaa 588360
 ttggacctcc tcaaaatacc agtctcaaga gaacattcag aatgatacga taaaattcaa 588420
 ttatacactt actgatafat cthtcaaga caththctat ttgtthctgt tggaaatctc 588480
 cthtgattac aagctggthta thaccatcta tagaaccact atgaaagaaa acaataaac 588540

 ccattacact ttgthtcatt thcctgaagg agcccaatc cagcacctc atacttaatg 588600
 aactthaaac atgtthcaatt gtgtaggata atthctgggg tgtgtthctg gthctthcaa 588660
 thttatthct atththtagc gacaggaatt ggtgtgtcct aggcctggcct ctgcctthca 588720
 agtgthtaaca thacttgagt gagctgctat acttggcctc aaathththt aaataththct 588780
 atctthtgca aagaththat ththtaattat gtgtgtgthta tctgtataga gthtatgtatg 588840
 tgcattggag tgetggthac thctctthaac tgctgagcca ththctccaga cactcaaaat 588900
 thattgagatt ggaththcctt gagtagtcat ggtgtgtcctg gaactcactc agthattctca 588960

aattggcctc agagatccac ctgcctctgc ctctgagtg ttgtcactat caggcttctc 589020
aaaatttctt actttaatga cgtactcata ctctttttt tgggggggag ggggcagctt 589080
cgagacagga tttctctgtg tagctttgca gactaggctg tccttgaact ctgagagatc 589140
tacctgcctc tgctcccaa gtgctggcat taaaggcgtg cgccaccgcc gccgccacca 589200
ctaccaccac ctccaccag ctgatttact caggtttctt aatatttagt ccaactttag 589260
acttgaatt gactttatgt ccaaagcaaa ctgatccctt aactgtgtag gtttgattgc 589320
ctgttcaact taaaaaaaa aaaagaaact tattgaatgc ataccaactg caaatatgag 589380

ggaggtataa acataaaaaa gttgtacatt attttataaa ttctgaagcc aagcatggtg 589440
gtgcatacct gtaatcctgg catgtaggag gcagaaacag gaggactgcc actggtttac 589500
tggtttaagg caagcctgaa ctacatagtg agaccctttc tcaaaaatca atataaat 589560
aaataaccta agccagacac agtgggtgta accaataatc ccagccatca agtagctcag 589620
acaagagagc actacatgag ccgagcctat gagtttagag cctggttggg taacatagta 589680
agaccctatc acaaaaatac ttaaaattaa agcactacag tttgatagtc acatacaag 589740
gcacagctga aaatatactc aaattgtgag ctgtatgtca aaaaactgtt acccaaaaaa 589800

glaaaactga aatcatggt acaaaactgtc agtgataaac tcaatgatta aagcagctga 589860
caaacacttg ggaaagtaaa gttagacatt gtttgttaa aatgataaat caagcaaac 589920
aaaaaaaaat aaatcacaac gtaaaaacaaa attaaagtctt acagttgaat ttatattgt 589980
tcctatctta acataaagtg gatTTTTGCA gaaactgatt ttctgagga ttactatca 590040
cataccatga attgtaatcc ttgatccctc cctatctagg ctaccctgac tccaatgtag 590100
gacatTTTTc actgtccatt aagaaatggg aattttgcc aactttaaaa tatttaacc 590160
actgaccttt tgttcacct agtcacaacc tgctagaatt accacacctc tacaccaagt 590220

gcaggttatt ctgagaagta aagaaagact tggctagctt ttcttatgct taacaatga 590280
gtataattaa aaaccattac tgtaacaatc ctctgataat taagatgaat tttttctg 590340
acacaaaagt agttctctg aagtgtcaaa tattactctt ttgacacaca gtttcttacc 590400
ttgtaccaa ttctgccaat aaaaatgcga ggagatgtt gggttgacga tgtaatctaa 590460
aaagaaaatc aaatacttaa aatctttctt agaaatccta aaacaaagca gaaccatgc 590520
tgttcattat ttcactgta ttactcagtt attaggagtc tcagtgaata gctcacttgt 590580
gcatagaaat aagtagcact ggctataait tcaacacca agagactgaa gcaggacgat 590640

caaccttaat ttcaaacca gcctagggca gtgagtgcc gtttcaaaa caaacaggct 590700
ggagaaaacag ctgtagtatt aagaaaatta gctggaaaaa aaagagaaaa aaaatttgc 590760
gttcttcag aagatgaagt aggtttgatt ccagcacac acaaggcagc tcattcatct 590820

ataacttcag atccagggga atctgattcc ctcttctggc cttgtaatca accatgcatg 590880
 ttgtacacat atatacagac aaaacacctt tacacattaa aaaaataaaa accaaaaaaa 590940
 taatatatgc tactttgtag tttggtactc ataaactatt tattacatgc tttttctggt 591000
 tttgtttttt tgagacaggg tttctctgtg gctttggagg ctgtcctgga actagctctt 591060

 gtaaccagge tggctctcaag ctcacagaga tctgtctgcc tctgcctccc gagtgtctggg 591120
 attaaaggca taagcctaaa tatctaaaat cgtgaaagca taactttaag atcatagtta 591180
 agctatgatt atctacctaa gtgaatttac atataacctt tcatttttgt actgtatctt 591240
 ttctaatttc tagtgaatat atactattgc tgccatcaaa aaagtaaagt atgctgagta 591300
 ataaaaatgg attacctagc cgggcgttgg tggtgcacac ctttagtccc agcactcggg 591360
 aggcagagac aggtggatct ctgtgagttt gagaccagcc tggctctaca gagctagttc 591420
 caggacagcc tccaaagcca cagagaaacc ctgtcttgaa aaaccaaag aaaagaaaat 591480

 ggattacctg ttctgtaaca agcaagtatg atttatgaaa ttgaaaaacc aacaatagga 591540
 taaagtgggt ggctggagaa aacttgccag aaagggcagt aaccccagcc cagggtgcaa 591600
 tggngaataa aaactaaaaa tctcatccac tgggtcctaa caatccagga agcttcaatt 591660
 cagcttagag ttcactgctt acttggcagg acaaccctg gcttgagaat tatatccagt 591720
 ctcttcattc ctgactctgc ttaggagcta ctccatcccc aaccacat gtgtgttcag 591780
 gtgttttggc tgcatatcat atccctgga actagagtta tagacagctg tgagttgcca 591840
 tgtgggtgcc agagtcatct ctccagcccc taggatctac tctcattatt cagtattgac 591900

 ttacctttag atgccaatat aaaatgagct ctgataggca gacatgaact gtgacttccc 591960
 tcaatctatg ccctatgtac ttttatgtac tttttcaacc tacagaaaa atgaccataa 592020
 aaaagaaaat gtggtattcg aatgaatgg tctccactag ctcaactaca gtttacagat 592080
 atctgtaaaa ttgacaaaag aagttttctt ggttccact cggacaacct gtggaggttt 592140
 catacaaat ttctcttct ctccagcaac catatccgga ttcttttctc tcatgatgtt 592200
 gaacactcgg ttcagcaact ataaggaatg ggaattcaat cacatcctta gtaatagcaa 592260
 gagcataaaa ctctatttg ggtcaatttg ccttaataaa gctattgaaa gcagcagttc 592320

 attacttact aagatctggc ctttatggat gatgctcagt tactctactg attttacagg 592380
 aaagcatgtg acacagggga aaaactgaag aaaccacaaa tgagcaaact ccagactacc 592440
 ctgacctcaa agiggacact tgtaccaag gtcccactga ttcccagagg gctccatact 592500
 atagtacag ccacactctg agcaggctgc ccataagtt ggtatcagga attgccatgc 592560
 actggccaca tggcctacta taatctgggt tatctccaat ctgtatctca gtggctcttc 592620
 caatgcaggg ggatctatac ctacttttct ctgagctcaa atgatagcca aaaagaaaa 592680

gaaaaaaaaaaaaagattt tgtctcacct cctcatatgt atagtctctt tctgagcctg 592740

 cccaagcagg ccagctcgg ttactgaatg aaatgccatc gtcttttttg ctgtcttcat 592800
 ctctaaage tagagataac aaagagtacg aatgagcagt ggctttgat ccaacaaggg 592860
 ggagttcaga actagagaat gaaagctaca gaaacttccc ttcctttca aagtgatagc 592920
 tgcagtagct tcaagtacaa agggaccaca cagagaagcc actttcctt atagacaaaa 592980
 atattacact tcacacaaga tctttaatga gacatccatg ataacagtga aatgtttctt 593040
 gacaaataca agacaagaca ttaagtactt aaaggagagt ccaattgttt tcaaaccttt 593100
 gagaaaattg tatatataaa acccatctgt ttaactatgc taaaaaaaaa ctttttaaaa 593160

 acctatagca tataaaacta taacattaa aaatftaaa tacttaaac tcaattacac 593220
 taatfttct gtgigaatca gatgatttt ctgtatcatt tttatcacac ttaataaaaa 593280
 tgaaattgtt tttgtctagc attatcaagt taagacactc ttgtcagatt tcattatcat 593340
 gcagtggaaa taaaaggcaa gacaagtatt ttctaaaagc tcctcaagct agtcaaggag 593400
 acccagatca aaggcttatg taacttaaaa acaggatgtt gagttccca cattaccttc 593460
 gtcttttct agtatttcat ctctatctgg gaatttgaca ttcttcttt tcttctttt 593520
 attgccaagc ataatatcca ggtcatctc tggctcagct ggctctggag catcacttc 593580

 aatcttaaga tectaagaaa ttaaagtacg tctcaatatt ttgatagtag atttttgtt 593640
 gttgttttt gagacaggtt ttctctgtgt agttttggag cctatcctga cactcgtctt 593700
 ggagaccagg ttggcctcta actcacagag atccgcctgc ctctgcctcc caaggctgg 593760
 gattaaagge gtgtaccacc aatgcctggc ttccatctg tattttatc aactaaatg 593820
 tttagaatag gtaaatctac agaggcagta gattagcagt agctgaggct aaggttgggg 593880
 taactgagaa gaactagaaa gtgacaaaaga tcatgggctt tgtttccag aggatgtaag 593940
 tcttcaaat tatgacagtt acagaactct gaatctgcta aaaatcattt actttaaatg 594000

 gatgaattat atgtaagtg aattatacct taataaactt tcttgcttca aagtgtggt 594060
 ttcaccactg catttgagg tatacttgtt ttgccctcaa cgttctcca tccctttaa 594120
 tttctaaata tgacagtgaa tggaagcaat tttcctgaca ccaatatat aattatftt 594180
 ttgcacatt ctctaactct gaaatacaaa gtaggtataa tacttattac ttggaataat 594240
 taatcagata ccctatgtt aaaacttggc tttatagttt aagggtttc acttcagaca 594300
 ctagtagttt cacctacact tttgctaagc tataaattca aagacctca gcctatattg 594360
 agtaatttgc taaaactcac agctctcagc aaagttttat tgatataat atataatat 594420

tgaggaatag ccaaatgaaa ataatgcata gatgaagcta tgaggagtag ggagttgaga 594480
 aggaatcaag aaaagccaag tatctaaca cgctacccta tcatcacttc tgtgggtta 594540
 ccaacctgga agttttgtcc acattgtcca tccacagaag tagcaggggc cattcaaagt 594600
 tccaaacctt aataatggat cttcctagtg tctaaccatc ccgagagact atacggacac 594660
 cagatttctc aagagcaaaa gatatgtatt acctttgaag actgcaaggt tttcagaatt 594720
 gaacgtgggg taccagagct aaagacctaa ttacttttta ttatatttat cacatcagct 594780
 tagaaccaaa ctatgaagaa gttaccgggc atcagttcaa tagatgatat catgaaagag 594840

 ggaaagacac aactcatggg gaatcagtgc catgtgacga acggatagac atgatacagc 594900
 ctgactccaa ggttacttgc ttacttgcctg taggcttgaa tgtgaaaaag gcacattaag 594960
 tcctaagaga tgaatcataa gctccacaaa agaacagagg ctgagcctgt ttcttgctt 595020
 ctagtctctg accagcttat cctgctcctt aacccaacat gatcacaatt acattttttg 595080
 tgtgtctatg tcttgaatga ttatttacia tggctatagt aataatttca cagatcttag 595140
 cagataaact caaatagaca gggataagta aaactcaac atgatatctt aaatctagct 595200
 gtgtagtttt agtgccatat taattaacta cagatactg tataggagat caaacagtga 595260

 cctagtctct gtgatgatga tcagtaaata catacatcag caaggctgta gtcattcaca 595320
 ctgtctaact aggatacttg taacatcctt ttaggtata acccagaag cagagaaaag 595380
 agtatcacag catttaacag aaataggaac ccatcagtaa ccttttggga caaaagctac 595440
 tggaggaaat caaccaaaa aagtattaac caagattaca atcatttaac accaattcta 595500
 ggagagtgga tgcctcttc cagcctctga agacactgca tgaatgtggt aactatcac 595560
 atcaaacacc catacatata aataaaataa tcccccaaa atatttttta aatagtctaa 595620
 attatccttg aaatacact ctgggggaaa aataaaacaa acaaaaacca ccaataaaaa 595680

 aatcttactc atttcaatgc aaagtaagca cacagactca atttctgaa tggattgtca 595740
 tctaaactac gaccttggtt ccaaacagat tactgagtaa attacttatt acatgcaggc 595800
 aatacttcac ttacttgggt ttgagcatct accaaagaaa aacttcagta catacagtaa 595860
 aacagagccc ttgatatgtg actgttttct tttcaatatg aacatatttt gtgaatacac 595920
 agacacatat acacacaaaa ttactatatg ctcatittat aaataaatgt gtgggctttg 595980
 ttaaagtgat ttctgcatag agcctctgtg tatgtgtgtg tatatacatg tatgtatcag 596040
 tatacacttg tccatgtttg tgtgtagaga gaggcccag gttgactttt ggatattttc 596100

 ctcaattgct tccccatgtt attttttga ctgtctggac taacagtcag tgagtccagg 596160
 gaactacccc tttcactct gcccggttc agggttacag gtgcatgctg gcaggcaggg 596220
 ttttatgacg gtctgtgta tccctcatgg ttgccagta tctttaaata ggtagctctt 596280

gagcaaagaa gaaccatctt tcagctactt tgtttatcca tctaccctcc tattcacctt 596340
cctacttaac tacctacatt ttattcaaat aattttcaga ttttgattg gaaatcaatc 596400
taagaggatg acaatcacag ggaatcaagt ccttacaaga tcatatcaga gcactctcca 596460
cagaatttcc cagagaagcc taattttctt attgaatctc tgccatcagc taccaacttc 596520

tgcactgggg gacattcttt gctggtacta aaatttctca gtcacagaga cacctttcct 596580
tagctcaaca attttaacat gggttaaaaac aatgtgcatt tcttgagtcc attttaatga 596640
cacaatacaa taagacctaa atccctctga acacagacac gcacgcacgc acgctttttt 596700
tcaaaacagg gcttctctgt gtagccctgg ctgtcctgga actcaatctg tagaccaggc 596760
tggcctcaaa ctgagagatc agcctgcatic tgcctcccaa gtgatggtga aggattaaag 596820
gcatgtgcca ccactgcctg gctcctatta taatctttta taccatgtag tcagatacat 596880
tcctaggaaa attaccttaa tagtggctaa atgctaaaca accaaagcaa agctactaag 596940

agatgagatg aaggaggaaa cagctattag cagccittct agaattccaa ttttaccttc 597000
aataagaaag ctacactacc tttacacctt cttcagcttc atcaatgtca aatatctttt 597060
ttgttttttt cttctttttc ttttgattaa agaagttcaa gtcacccaag tcatcagatg 597120
catctaaaaa tagattaac agatttccag ttattaacaa ttagaaagca aggcacaaaa 597180
ttatgagtca caccaactct tttcatgtat tcttatggtg tctactgct accaccaaag 597240
ttatggttct gaaaacaatg acaaatcaac tcaaagcttt ctagaaaaat tgttaggggc 597300
cttggctgag aacatcaaac tcaataatct gaccatgtaa tgacagaaag tgctctctgg 597360

cacaatctcc agactatcca actgtatctc tttacttccc tctgttctca cctccttct 597420
atccctcaat ctctggctcc agctctacca aagcagtgga ggaactaagg cttccacaac 597480
aactgtgact gacacaacta ctcacccttt ttctactgt cttcttctc agcttcaca 597540
tctttgtctt cagttggttc tggctccaact tcttttgttt ctgagggtg ggtttcttct 597600
gtctgggcat caccttcttc atctaacata aaaggcttct tcttcttctt tttctttttg 597660
ctcatagtag gatcaaaaat catctgttta aattaaaaaa gaccaaggga ttattttcaa 597720
tgatgctcac attccaaata tgctttattc tttttcttct tcttttttc cccccaaga 597780

cagggtttcc tgggtgtagt ttggagcttg ttctagaact agctcttgta gaccagagat 597840
ctgcctgctt ctgcctccca agtgtctggga ttaaaggcat gtgccaccac cgtccagcta 597900
tatgctttat tcttaaaaaa ctggatacat taaaatccca aaaggggtg ctgggaagat 597960
gccttaaatt ataaagccac ttgcccccaa ccaactgctt gtttgcacac tttctaattc 598020
aataaaagac aaatacagat aaaagacaaa tacagacaac aaaaatacaa acaaaaatag 598080
attcaaaaa agtccatcta cctcttttta cattattaga catggggagt acctcacaca 598140

tgtcttctaa tttataagtc agcacaagct ataaataact tcatttttat tttcatgagc 598200

 aaatttggac ctgaatgaat catgaagttt agggaaagga ccttagcaat aacctatgtt 598260
 gcatttctga ttgatgggtg agatcaacaa tgtctaggca gataatctag agtgactaag 598320
 accaggtgac ctgagtctta gtttttaaaa tttttatctg ctgagtagtg tttggaggag 598380
 ctggaggtaa atacaatcaa gatataattg aacatatatg aaattgtcag agagtctagc 598440
 agtggaggca cactccttta atctcattac tcaagaggca gatctatgtg agtttgaggg 598500
 cagtctgcag agtctacaga gtgagttaca gaacagccag gactacacaa tgaaacctg 598560
 tctcaaaaaa caaaaaggag gggatggaga gatggctcag tggttaagag cactggctgc 598620

 tcctccagag gtctgagtt caattcccca caactacatg gtggctcaca accatctata 598680
 atgagatctg gtgccctctt ctgggtgata ttcatatatg caggcagagc actgtgtaca 598740
 taataaagct taaaacaaa caaacaaaaca aaaaggaatc aaagagtaaa taaaatattg 598800
 aagttcactg caattttaac ttttaagaaa acctaaaaac accaggcagt ggtggcgcac 598860
 acctttaate ccagcactct ggaggcagag gcaggcaggc gggctctctg gagctcgagt 598920
 acagcctgat ctacaagagc tagttccagg acagcctcca aagccacaga gaaacctgat 598980
 ctgaaaaaac caaaagaaaa aaagaaaaag aaaacctaaa agtaagaaaa atttatcaaa 599040

 ttctaataac ttttacttg taagaaaatt tcctttattg tttttgttat ggaatgtgaa 599100
 atgttcacaa gciatagaac aagtgaaaaa ttaatttcta accagtagat tgtttgcaat 599160
 gatcccttga aagagtttga acatataggg catattcctg ctattgaaga aagcaaagtc 599220
 tttaaacaga actgaatttg aatacaattt tttttttccc ttccatgctt aaacttagca 599280
 gtttgttcat cgigtatgg ccaaaagcac aggtctggag cctcattacc ttgagtccaa 599340
 tcttgtctca aaacagtaaa actttaaaat ttttgcttg aacatttctg aattcctgac 599400
 accattaggg aatcttcccc ttctcatcaa ggaacattca cattcctgtg acattttaa 599460

 ggtaatgctt ttgctaggct aaaaggaatc atgttttact gagtttgggg cttaatctcc 599520
 ctgtgttttt ttttaatgtg tttactttat atcaagaaat catttaaaga aaagctactt 599580
 tttaaaatag acicttatc tctatcctgc ctaccagtca gaataatcca ttctaagag 599640
 atttataagt cacttccaag tacagatttt cagttaatcc ttaagttggc agtcataagg 599700
 ggtttgctg tgacacttct ctagtcaaag cactaggtaa accagaatca catcccatgt 599760
 tcatccccc tcictatcag taaattccac ctgagaataa agccaaagga aagggttctg 599820
 gtacccttca atttactgca tggcctaacc tccttgggcc ctaattttta atttataagt 599880

ctaaggatca agctacatac tttagatfff tcaagagact gctgctggta tgaagctgt 599940
 ttccaccatc tctgcttgat caaatcatgt tcattctcta gaaatgaatt cttacccac 600000
 acctttcaaa agatctcatt ataccaaaaa aatgacctct caaccccccc ttcataccta 600060
 caggtgtag ctattacctc ttcctacata caccacaagc actttgcat agatcgaata 600120
 cagcagttta caggcagtta ttttaagt attaagttg gaacatgagt agaaagaaaa 600180
 caagggtgaa acacttcctc tcagaacttt tctaatacat acataataca gcagctaaga 600240
 gcaatgtcta ctatctcttt caagcaagaa tcactatca tctccttcag actgaactac 600300

 ttagtaagct tgtgagagcc tcttggcca tttacatgga ggcagtatcg cacagatctg 600360
 ggattgtact actggctcag ccacttggaa tttgattata ggcatctac aactctagtt 600420
 ttctcatttc taaaatggac cttatttaa ggaactgtaa aatcaataa aaaataggat 600480
 ttctttctt ccagaatcaa tctcaaatc ctcaatgcag ttttctaagc cctccatgaa 600540
 ctacgctgtg tctgtttcaa ccaactggt gaatactca ctttcttaa gtacttttc 600600
 ctttctgac cataaatgcc ttgtaatcca ttttctcact ggttgagaaa atcctgatcc 600660
 tctctagagt ctactcaaaa gcccaactctg tagcgagccc ccaactgttc ctcttgcccc 600720

 tccaactgta acccctttt aagtcgttta atttatgtg aactaggata aatcttgag 600780
 ggcaaaaagt taaaacagga aagggggctt gattcaagcc cggaggagaa aaaccagtc 600840
 agcttcaag cggacttcc ctgctcgtt cgcgtgtaa aggaaactta gggactcgg 600900
 cccgaaact ttctggaag ggtggtcacc ttttaagact aaaatatctt ttctctggc 600960
 cctcacaccg tgtctaagaa ttaaagtctc gagcgaggaa agggaacgag attcgcccg 601020
 aaaggccagc cgacaaagt ttaaccacg gtactccacc ggaaccaagg gaagcttctc 601080
 agggcacctg agcactgggc aatgagagct gcggcggcag tgtctgaaaa gatgccggg 601140

 ccgccggccc taactgggtt taatcgtgga aactaactcg gaatccaac cttttcagag 601200
 agggcgactc aactgcttc ccattccgaa acgccgatca ccgtaggagg ccggcctcga 601260
 cgctctgcc ctgaggagag ctgggtgctg ccaaggccga ggatccggag tctcgtcgg 601320
 ctccacagct cgggcccgt taggeccggc tctctctcca catggcggcc geccaccgt 601380
 agggcgcagg cccggcttc cacaccgtg tgggttcggc ttctgcctc agtctcagc 601440
 tctagctcgg tctcaggct ctcactcgt ccccgacat ggctcgggt ctagtgggtt 601500
 cggcaagggt gggactcag accggtcagc ttcagacccc ggactcggcg aagctctac 601560

 cgacagctct cccaggcccg cgctaggctc ttgcatcagc gaaaggaac gacaccccgc 601620
 cctctccca acgtttgtaa gtgcgctgc gcagaactcg ccaacgcgca ggctgctggc 601680
 agagagaacc tgcggtgtg cttgtggcgc gagttaccag gcgacatccc ggcgccgggc 601740

atgctgggac tttagtttg cctagaagaa aagggcgctt gagctacagc agtttccgag 601800
 gccgtgagcg actgttttag cgccagtcag gaggtgcggg ttcttgtgcc gctggttacc 601860
 tcagcggttc gggaaagcgt gaattgcttg tagagtggat ttggggccat tcttccggag 601920
 ttaggttagt gagactctgt aatgtgaacc cgtgggactt attgcccaca tgcccctggg 601980

 gtgttctggc attcgaggaa ttctaaggga gctggaggca tgcacctcat taaaggcgtt 602040
 ttacgtcgt gagcagtttt atgttctggg ctttttactt cagaagtatc ttccctggtt 602100
 ccctgaagt aaaccgagaa acagccctgt cagtctgcca ggaagcttcg aaatacgtca 602160
 taactcgtt aaggaagga tatgttgaga aatgtgtaga gtagtaatt aacttgttga 602220
 tgaacctcac accacacaag gaaaaaact acaatgtcct ggtagatata atctgggacc 602280
 gtggttttat gtctttttg gcaaaagctt cttggttttg ttttttggtt tttgttggtt 602340
 gtgttggtt ttcgagacag ggtttctctg ttagttttg gagcctatcc tggcactcgc 602400

 tctggagacc aggctggctt cgaactcaca gagatccgcc tgcctctgcc tcccagttc 602460
 tgggattaaa ggtgtgtgcc accaacgcc ggccaaaagc ttctttacat gcatgactac 602520
 ttgtttatga agtctttgt agacaattct ggatgcatca cccaatttcc ctggggagat 602580
 acagctgcca cttagagagg tctcattatc tccagtcca tccagtcaa gatcatggag 602640
 ggccaggcaa tgggtggcgt tgcctttaat ccagcactc aggaggcaga ggcaggcggg 602700
 tctctgagtt caagcctgc ctggcttaca tctcaagttc gaggccaaac agaactgtta 602760
 cacagaggaa accctgtctc aaaaaccaa gatcacagag actacccttg tagttagaca 602820

 aatcaggctt gtgatcaaa gaaacaccaa agcatcactg tctgaaagaa tgcagtctgg 602880
 acttctcagg tgattgagg gatttaagca agcagatgct atcaagaggt gggagtaatt 602940
 gttggggtt taatgcttct gcataagagt caagagagga ttggtgaaaa ccctcatag 603000
 tacacgggga atatttagtt atttttgtgg ttggccetaa tattcttggg tttatttctg 603060
 tattcataca tgattacagg gtttgttct cttctctct ttttagaga tttattatg 603120
 tatacagtat tctgctgca tgtatgtct caggccagaa gagggcacca gatctatta 603180
 tagatggttg tgagctacca tgtggttct ggaattgaa ctcaggacct caggaaaagc 603240

 agccagtgct cttagcact gaaccactc tccagccctt gcttttttt ttttttttt 603300
 taatctactg aaatcataga gtggtctgtc taagtttggc atggtagcac ttaccgtcgt 603360
 cgcacttggg agataaaggc aggaatgact ctgcatgacc agcagagaga gagagacaga 603420
 cagacagaca gagacagaaa cagagacaga gagagacaga agaaaaagag aagaataaga 603480
 aaaagatctt cttagtgtct tttacaatc actttgctat gcaactaaact taccctaaaa 603540
 ataaactgaa ttgaaacagt gttctatgaa attatttaat tcagcacacc ctatagata 603600

atatcagcat tcccccccc cactatccaa ggctattctc tttttcgta tgatccataa 603660

 tgctttgggc tttaaaataa ctgaaataac ccacaaatat ttagtgcccc ctaagcatag 603720
 catgtccttg cctcagaaga gctataattt agtgagagag atattttatt agtttccttt 603780
 tttggatgaa gaaactgctt ggatagcata ggaaaaatta tccacactta tatatacaga 603840
 caacaaaaaa gagaaccag gacaatttga tactgggtggc tgctcattta ccttgaggat 603900
 ttgagttgct gctgcatag catagtcttc tttagctacc agcatctatg tgtgccagga 603960
 tttcttacca gcaacactat tagcactttg gaccagacaa ctctgttata ggttgatggt 604020
 ctctcactg aggacattca gtgcctggtc tatattcata gatcctagta gcacactcct 604080

 tccagtcatg gcattgccaa atgccaatg ccacctctg ggaggtgggg taaacatcac 604140
 ccctgattga gagctactca catctgtct ctctctgggt tgttgagcta gaacaagtat 604200
 tcttgctag tectcaacag agttgggagg ccatgaagaa gagagaagca aactggacta 604260
 agtttctgaa aagcctgttc attcaatgat aaaaactgaa aggggaaacg aaaggaaaga 604320
 tgatagaaat ggagaaaggt aatttacagg aagtcacct ttcattgattt agttcatgaa 604380
 agttagtga tcttaaaaa tatactaagg tggttgtgct atccagtta aggtcaactt 604440
 gaccaagct agaatcatct gagaggaagg aaccaactg agtaataact cctaagatta 604500

 ggctgctagg caagcctgca gagattttct taattagtga ttgttggtgg agggcccaaa 604560
 ccattgtggg tgcaccctt gggctgggtg tctgggttc tataagaaag cagattgagg 604620
 gctggagaga tggtcagag gttaagagca ctgactgctc tccagaggt cctgagttca 604680
 attcccagca accacatggt ggctcacaac catctgitat gagatctggt gccctcttct 604740
 ggtgtgcaga tatacatgga agcagaatgt tgtatacata ataataaaa tcttaaaaaa 604800
 aaaaaaaaaa aaagaaagca gattgagcaa gccacatag agcaaagcag taagcagcac 604860
 tcccctacgg cctctgcatc agctectacc tcaaggttcc cagcctgttt gagttcccat 604920

 cctgacttcc tcagtatga actatgatgt ggaggtgtaa aacaataag cccatttctc 604980
 ccctagtggc tttggtcatg ttttttcac atagcaacca tagtactaag tatggcagca 605040
 gtcttcatca ggccttcttg tccctccact ccctatttgg gagatattgg tatacatagc 605100
 aaatagtcaa atcactttgt gaaaaagatt ttctttcag catgatacc agtgtaacta 605160
 tctcactg tccacttgaa ggaaatcttg ctccagagat ttcacttttc ttccaaggag 605220
 tttgctttcc aagaaaagcc aggatcccct ggtgaactag ccaaagtcac caagcaatga 605280
 tacctaagct tttccagttt tctaagagat agaaccatt tggcatcaac acaaataatc 605340

attgtaattt tatagcttgt tttattttagc aatcactata aaacgtataa aacacagccg 605400
 ggcatctggg gtgcacacct ttaatcccag cactcgggat gcagaggcag gcagatctct 605460
 gtgagttcga ggccagcctg gtctccagag cgagtgccag gatggggtcc aaaactacac 605520
 agagaaacc tgictcggaa aaaaaaaaaa aaaaaaaca acatataaaa cacttggtaa 605580
 ttttcaattc atacctatga gggaaatcac tafagatfff ctactttcta aatagagaag 605640
 ccaaattatg gactctacaa aagtagtgag aagtcttgaa gtagtctact gggctcttta 605700
 ctctggacca ctctttatgc ctagtgtcaa cccagttctt cagctactga atggtaagtt 605760

 aatgggtgata tttaatcaac cctatactaa agtatgtfff taatgccctt ggaacagtcc 605820
 ttatattatt ccagatcttg gggtagccccc caaaccacca tggagtctgt actcatatgc 605880
 aaaagcaaag agcctttgtt caagctcaag gttggactct ctgtctgtcc aatgtcgtgg 605940
 ttgagagcag aaagtgccca gccccaggctg ggttaaggtgt ttatgatagt agaagttgag 606000
 ggtgaggtga ttgggttcaa ggccctgatt ggctgacaat tgtctagggg tgtcttgggtg 606060
 aaaggggaat aggtgtgtgc tgggcttgag aacatttggg gatcttatct aatggttggg 606120
 atgtttggat gctgaccctc tcttgatggt gtcagcttat gccttttctt ggaacctggt 606180

 gctgcctgcc aglaaactga aactcatgcc tacttttcag ctactttta ttaagcatgc 606240
 catgacagca atgtgccaa gctcattggg ctgttctggg ctccacactt attctcttga 606300
 gttgaccggt gtagtatagc tattttctcc aacctgaaac atgcccttgt agatgagtga 606360
 gtgcaagaag ctcataggac ttgaggagtt caggaaaaat acaagtctct gatagcacta 606420
 caaggtacaa agccccctcc acaaagtat aaaagcaagg aatcatttct ggggagagga 606480
 aacttactgt gactccaagc tcttcaggga gctccaagga tatagctfff gtgagtgcac 606540
 accatgtfff tggtagtctt ttcagtgaca cagctgccta tgagtcaact acattcttgt 606600

 aaggaacgtc aatcaactta ttggttcaac aaaccaataa gtgtgtgatc atttcttgt 606660
 tctgtcattg gagcccattt ggattgaata gacattgttc atgtctctcc aggaaaagtt 606720
 acccaacaca ctcaaaaaa tagcaggctct gtagagacta tgacttcaa ttgtgacagt 606780
 atttgaatta gaaccaagat cttgggaagc ttgctgggtg tgggtggttg aataagaatg 606840
 atccctagca gggtagtggg ggtacagcct ttactcccag cagggtgggtg gtggtgcagc 606900
 ctttactcac agcagggtgg tgggtgaagc ctttactcac agcacttggg agtaagtaga 606960
 tcactgaggg tgatctggcc tacagagtga gttctaggac aaccagggtc acagggaaac 607020

 cttgtctcaa aaaagcaaac aaaacaacga aaaagaatgc ccccccata ggctaataat 607080
 agtcattagg gagtggaatt gtttggagg attataagga ttaggagatg gtggcttttg 607140
 tggagtaggg tagcctttgg aggaaatgta tcactgggga tgggtttgag gtttcaaag 607200

tccatgccag gccagctctc tctctccctc tctctctctc tctctctctc tctctctctc 607260
tctctgtgtg tgtgtgtgtg tgtgtgtgtg tgtatgtctg actctatgtc tctctgtctt 607320
tttctgtctg tctctctctt tgtctctctc tctgcctatg gattagtctg taactctcag 607380
ctactgttcg agcaccttcc tgcattgccac catgctcccc accatgatga taatggacta 607440

aacctttgaa attgtaaaca agcccctaataa taatgtctct ctcttataat agttgtcttg 607500
gtcatgggtg ctctgataa caacagaaca gtgactaagt cattgggcaa actaatcacc 607560
tgagtccaag cciggaactg actcctaaga ctagtctctc gacaaaaagt gcactatggc 607620
acatgggtga cccccacaa taatagtaaa taataataaa ttaatttaa acatggtttt 607680
tagtctatct tttgcttagt aagtaaaaag gtttttggtt ttggttttgg ttttttggtt 607740
gttgtttgtt ttttttttc tctgagacag ggtttctctg tggctttgga ggctgtcctg 607800
gaactagctc ttgtagacca ggctgggtctc aaactcacag agatccacct gcctctgcct 607860

cccgagtgct gggactaaag gcatgcgtca ccaatgcca gcagtaagta aaaagttaa 607920
tatcacccac acatcttaga aataatggca aacataaggt agtgattcta ccccatag 607980
aaatctagge ctatttacct cattttcatt gtgaactctg cattgtatgg ggactttaaa 608040
agttagtgtt ggtgagaaaa gaggaaagtc actgaaacat gaatggaaa catctttaa 608100
ctacaagatt aaattaatct ttgggttgat ctgacagaa gaaaaagtga ggctcctcac 608160
aagaagcctt ggataaggtt attttatttt tattatctat ctatctatct atctatctat 608220
ctatctatct atctatctat ctatcatcta tccattcatt cattctggtg ttttgagaca 608280

ggctttctct atgtagccct ggatgacctc taactgttct gtagaccagg ctggctttga 608340
acttggggat tcacctgect ctgcttctgg agtgcctgga ttaaacatg taccacatg 608400
cctggcatga atgggattac cctgagagaa acacatgaat aggaattaat tcttgttct 608460
tactttggct tgtttgttta ttgatacagg gttttactat gtttcctaaa atagcctcaa 608520
accatgatc cttcagcttt taccttgaat tatttttaa catgtttaca tttattcact 608580
tactgtgtgt gggggtgtga gtacatgcca tacatatgtg catagagtc aaagaaact 608640
tattccaag gaggggataa aaatecattc ttctattact ctatgcagc cettatctta 608700

tgatgggtga cctatcttg aggtcttga ggacaggatc tgtgtactac tcatttctc 608760
ttgttttccc atagacagca catatatgtg aatgaaaaac tctaagagg tgatagatat 608820
gaggactcat aactaaatca ccaggactct tagattcttg aacacagact aatttctaag 608880
acgcagtggg gagcttcag ctgcttcta tttggaataa ttgagtgtga atgtagtcaa 608940
gaagaaagtg tgttttacct cctcccttca tgactcattg gaaaaggac tgataacatt 609000
cgtaacagac cagtgggctc tggaggaggt ggttcagttt acctgtaca cactcggcac 609060

cttagattgt cactgttcat agctcacata gctcccttgc ttttgattgg caacccccag 609120

 actctacaca ctgcccagta tgtattagga attcagtgag tggaactgaa agaattgtca 609180
 aattaataag tggaataaag aatttcactt tctcttatct taggtcattt aagcctacce 609240
 tctcaaatg attttaggca ctagtccctt ttatagctct ttccttatca acccagccta 609300
 ccacaatttc acccttttct gttatgattt aatattcatc aatattattg gataggcatt 609360
 ttaattcttt ttgcaatttt ttttaagag gctctgtctg tgtagctctg getggcctag 609420
 aaccactat gtagagtggg ctggccttga actcatggat aatcctcca agtactggaa 609480
 ttataggcat gtaccacaat gcctaaccaa tgcattatta ttttagactc atctgtctct 609540

 tctttccaac aaggttataa aattctctta ttttcttctt tagtTTTTTg aggtagagt 609600
 tcatgtgtca aaagtatgcc cctgaagtg tcttaaatct agtaggattg caatgttata 609660
 aatagtggg agtateccagg gctacttaaa gttttgctat cttagcagat gattTTTTTg 609720
 tttgtttgtt tgtttgtttg tttttgaaac agggttcttc tgtgtagctt tggagcctgt 609780
 cctggaactc actctgtaga ccaggctggc ctcgactca cagagatcca cctgcctctg 609840
 cctcctgaat gctgggatta aagatatgtg ccaccccc caccaccctc tettecatct 609900
 tagcagatga ttgggtttt ttgggggggg agttcgagac agggtttctc tgtggctttg 609960

 gaggtctgtc tggaactagc tcttgatac cagtctagtc tcgaactcac agagatctat 610020
 ctgcctgcct ctacttccca agtctgtggga ttaaaggcat gtgccaccac cgcccagcca 610080
 gcagatgatt ttttaataaa acacaataag attctccctt atagtcatta gaatgtcac 610140
 tatgaaatg aaactgaaag actcacacac caaaaaatga caagtctag cgataaatg 610200
 gagaaactgg aagccttgta cactgttgat aggaaggcaa aatgccgagt ctactatgga 610260
 aaacagtaag gctattcctc aaaaaaaaaa aattaaatag aagtaccaca gggttcagca 610320
 attctgcttg tttatatgta tccaagagaa caaaagcag agtctacacc catgttcata 610380

 gcaacactat ttacaatagt caaaagaatg aaacagacat tccatcacca gacaaataga 610440
 caagcaacaa tgttggtgat gcttatagtg gaatatcact gagctttcaa aaggaaggaa 610500
 attgtgctgt atgtgacaac atggataacc ttgaggacag tctgctaaag gacacaagcc 610560
 agttataaaa agacaaatc tgggtgtctg gagagatggc tcagcagttc aaagcataga 610620
 ctgccttgc agaggacctg agttcgtttc ccagccccca tgtcaggtgg ctcaggacta 610680
 tagataaact cagctccatg gcatctggig ctctgttctg gacacacaca cacacacaca 610740
 cacacacaca cacacacaca cacgcgcgcg cgcgcacaca ctaaattttt ttaaatgatt 610800

ttttgaatt atattataat tacataattt ccccttcta tttctcct ccaaactgc 610860
 ccatatgcta ccatccccac tctgctagct ctcaaattta tggtttcttt ttctttaatt 610920
 gttacattat tatgtgtgca gtttccctaa atacataagt acagcttgct cattcagtat 610980
 aatgttattt gtatgtatat gtttcaagg ctgaccattt ggcatggat aactaattgg 611040
 tatgctcttc tctggagaag acctgtttc ctgctttcag ttttcttag ttgcctgtaa 611100
 ttctttgtct aggattgaga ttccaccacc cacattagct tgtccattgg tgccctcctt 611160
 attcaggtca tgtttaaagc gtcattattg tgagacttca tggatgtaac ttctgattag 611220

 atatagatat agatatagat atagatatag atatagatat agatatataa gagatacaat 611280
 atcacaacaa attccctgtt cctctgggtc ttacaatctt tctcacttct caatgatttc 611340
 tgaacttcag gtacaggagt tgtgtggtag atatatcagt tgagactggg gctccacaac 611400
 cctgcatttt gatcagttgg ggttttctgt aatggtctct gcttgtttaa aaaggaagt 611460
 ttcttaaag agggcgagg actacattta tctgtgggta taagtaatgc agttagggat 611520
 tatgcaggtt cagtaaagtg gttgtagggt cttcaagatc catgactcga tagtctagg 611580
 tagttggcca actttccagt accagcatg atttcttct tgttgagtgt gcttaagtg 611640

 aaaccagagg gctgtagttt aactccaag gcatgaatgc cactatcgta cccttagaca 611700
 cagtgccag agtccccaa gctggatatg acacgatagc tttctcaagg actgactagc 611760
 tttcatgta caaaaggta ccatgcaagt ttccaaagga gagaagcaac caacagtcct 611820
 acccgctat gacaactatg aaccataaca atgacgagca cagtgtgata acaataatc 611880
 ttttaaagg acaatatct tcttgaacct ttatatgag ttaccacag taataaagt 611940
 catattggtt gccagggtt gataggatag gaacagtct agttaagata catagaattt 612000
 cagtatgtag gatgaaaaga gttctagaat ttggataag aaaactaac tgtgcacttg 612060

 aaaatggaca agatgatata gtatgggtat tgtaaaacat taaaaatca aatttat 612120
 atcattgtat tattgtatat ccatgtatga tgtgtgtgaa ttgtgtaaat tcaggcatgg 612180
 atgtgccaga gcaggcatgt gacagaggac aattttcagg agttggctat ctcttccat 612240
 ctttatgtgg gtctgggga ttgaacttag gttattagc ttgtatggca agtacctta 612300
 cacactgagc catcttgctg acccttaaca ctctcaaag ggcacagaac aagaggctgg 612360
 aaagattgct cagtttttaa gagcatttgc ttctctgca gaggaccaga gttcagttcc 612420
 cagcacctac attaagtagc ttacagttgc ctgtaagtcc agctcccagg gatctgtgag 612480

 tgtccagcac ggacacaatg tgtgcataca cacagaggaa tgaattatat atgtatatat 612540
 aaaattatat acatgttata catataattt taaaaggaca cataacagga tgtcaaaaaa 612600
 ccacagtttc agttcttgg tttccctc tctttactca gtgtgcctgt tgcttcaact 612660

aaaatcagga taatatgcct gacagtcttg gtttttataa agatcatata aaaacaaaca 612720
 aaaacaactc ttatggcaat gttttgatta gtagttttta cagcattcca gcatttctag 612780
 tcttacctc aagacaagtt tcgcgtctta ttccataatg caatgttcct aagggtgcct 612840
 cagccaaagt ttatgaccac ttcaaagaat atgcatgccc aacccctca atttgggcta 612900

 tacaccttat aatttggctc taggacagca aataaacagc ttttatgaag accattgatg 612960
 atctaagata ctaattatca atgtggttta gcattaattg aggaaatata aatccaggat 613020
 tctcatgta atgttcaaag agctagcccc aaattaggag gctaagagaa agaattaaca 613080
 tctgttgaat ggcagttaag tgtcagggcc cagagcaggt atgctacctg tgctatttcc 613140
 ttttagtagcc aciataatct tttcaggttg gtaaaacagg gaacataaag ttgagagagg 613200
 ttgtcactaa ctcaacaatg aacaagaggc agagatggac ttaggattta ggtccaatg 613260
 actgaagcct gcactcttcc tactatctta cactgcctct caaaatata tctctatcc 613320

 ttagttacat agagtccatg ataaatgata tgtatttgtt acacatttat gtcaattatc 613380
 tgacttggtc aaacaagtaa actagactgt gggggttgat tagcactgct ttagaggatga 613440
 ggacacagge agtcaggcaa gcagtaagca atcagaactt tccttctctg aatcagcctc 613500
 ctgggagcag aatttcattt ctgtgtttca ctctagtttt ttaataggca tgaagtctaa 613560
 gtgtcttgaa agccttgcac tcttacggtg tgtgggcaga acaacacaca aactgcttct 613620
 tgcttatact cccaatcat taaaatagct gtgaatgaat atagtttttt ttaatattta 613680
 gtttttagcc atgtgggtgt ggtacagtta ctataagat agtggttaata agagtggaa 613740

 ctgtctatgg agaccagact agcatcggac ttacaaagat ctaactcactt ttgcttctctg 613800
 agtgctgata ttaaagggtg gggacactat gacagcccat ttttaatttt ttttttttga 613860
 gacagggttt ctctgtgctt ttggaggctg tcttggaact cactctggag accaggttgg 613920
 tctcaaaactc acagagatcc gcctgtctct gcctcccagag tgctgggatt aaaggcgtgc 613980
 tccaccaacg cccggccatt ttttaagtttt ttaataatga gtatatgtgt gtctgagtgt 614040
 aggtttgtcc actctagtgc agtacctgaa gaggccagaa aggcattgga tcccctggat 614100
 ctggaggatga ggggtggtgt gaactgcttg gatgtgggag ctgggaccag aactccggtc 614160

 ctctgaagag cagtacagct tctttactgc tgagccatct ctccagcccc aagagtgtg 614220
 tatttcttaa cagtgatatt ggtcaccagg agacaatgaa gcaagtattt tcataatttt 614280
 gagaggaaaa ttgtattttt aacctagaac tttgctcagc catatgatca gtcaagtctg 614340
 gggaataaag atcttttcag gcatgcaatg actttaaaaa gtgtctctc cacatacata 614400
 taacttttct ttgggtactg ctgaatgatg catttcta aaacaagata ggaaggtaaa 614460
 gacctcaggg aacaggatga acctagggaa gaatgaaaa gcaagtcctc aagatgacat 614520

cctcacgggg acagtacagt cagcctggag gatgaacacc cctggggaag cttttgatt 614580

gaacctatg gaatatctgt aatacttgac tgtattgaaa atagcttaag catttttttt 614640

gcttaagcat ttttacattt ctctttcaga gtctgaaaga attaagatt aataacatta 614700

aaaaatggca aatcaaaaac tggggtattt attctaagaa caacagagta ggaaataaa 614760

tttghtaatgt gaataattca tgtaaaataa gccacactta taaagtcata ggctagaaat 614820

atcagcttaa taaaaacatt aaatattaat attgggaggc taaaggaag gaaatacaaa 614880

attgacttct ctgttaggtc ttatttaaca ttgaaaatc cataaattgc agtataagaa 614940

attttcttga gacagaattt cttgtattct aggctcacat caaactttct atgtagctga 615000

ggatgacctt gaactcctgg ccctcctgct tcctttccc aaatgctagg gttacagtca 615060

cgcatcacca cacctggttt atgtggcaat ggggatcaac cctggggctt gctctgtgct 615120

aggaagcac tttactaac cacaatagtc cctataactt taattcatag gaaaatgaac 615180

agaagcaagg aagcatttca gaggacactt caggctttgg gagcccctcc tctgcctca 615240

acctcccc attccccaac ctcatccctg ctttaaaaaa atcattatga gcatgaacac 615300

ggtagttgtt ctacaagcgc tttgtatgtt gataaacatt taacatatca aagaaacagg 615360

agagagaatg aatgccttga gtatctttct agacctatga tatataatgt gatgatatgt 615420

atatgtatga attatatatc atcacattta tatatacaca tgtatgtcat cacatcacat 615480

atacctcagc tatcagaaaa taatacagta ctaactagac tgttttattt gaggcatcac 615540

aaataaaatt tgtgtttggc ttaccacaag cattgacatc ccagagaagg tggcttgaa 615600

agtgccagtc cctcctcagt ctcttgactc atgttctaaa actgtgaact acatcaatgt 615660

catagaggct ctggaacctc aataggatgt tatcttgagg tcagtgctct aagactatct 615720

tctatgtgga attaagaaat ttagctcct tcttttact tactggccag gtgtctccag 615780

cctcccattt ctctattta tcacagacgt cattatatag tgaataatat ccaaaatgaa 615840

ctgcctccga taaatgcct ctcagttgca ggtacgtccc agtgtactta ttaggaatga 615900

ttccatcttt tattaaacta taaaaacttt aaaagcacca actttgtttt tctgaagttt 615960

cccacacact gtgactgctg tgctctactt ttagtggtca ctacataagt gatgcttatt 616020

tgttgattgg tatcgtggca aggatgtcat tatatatct tgaattccc tttttagaaa 616080

tgacgaaaat tccttattct ccaggaagat actattttga tagaaaattt ataattaatt 616140

aggacaatga agaaagtttt ctctctgagt ggttccttaa tgatttacag ttctataaaa 616200

agttaagatt ttctttgiga gacaggtttc actatgtaga tcagggtggc cttgaaatca 616260

cagagacct cctgcctctg gctcttgtct tagttggagt tactattgct gtgataaaaa 616320
 aaaaaaaaa aagacaaaa gcaacttgag gaggaaaggg cttatttggc ttatacttcc 616380
 aaatcatcat ttattatagg aagtcaggaa ctcaagcata gcgggagcct ggaggcagaa 616440
 gctgatgcaa aggccacaga gctgcttact actggtttgc tcatcatggc ttgctcagtc 616500
 tgcttcttat agaaccaga gcttacagcc taggaggcag caccaccac aattatcgt 616560
 aggaaaattt ccaacaaatt gtgctgtgct taaacactgt tctgtggggg gtgggtgggt 616620
 gggatgaaca gtgctcagact cctgtgggtt gaatcaacac tagctactta gttgtattga 616680

 actgcactgc cttcttgcct ccatggattg tttctctgct ggccatggtg tttacacaca 616740
 cacacacaca cacacacaca cacacacaca cacannnnnn nnnnnnnnnn nnnnnnnnnn 616800
 nnnnnnnnnn nnacaccac acacacacac acacacacac acacacacac acaaattccc 616860
 gttctgtag aggccagagg tgtggaatcc ctggagctgg agttacagct gactgttgtt 616920
 agatttctga ggcagcataa aaacacagaa ggcagaaaag agataagggt ctgacttcca 616980
 acagacagaa ttgtgcttat tagcagacat agtgaggggc agactcactc ccaaggaag 617040
 tggagggggtc tgctggggaa aaaagctggc tgcaaccctt tagaggggag gatgacgggc 617100

 tcaggaataa gaaagtgtc gtgcctttcc tgagtctctc tttcctaaaa ttgtttgcc 617160
 aaggtaaagc aggtgttcc aacagacatt ccttcaaag acaacgaata aggatgggca 617220
 aagagtctta taggaacctt gttttaccac caaggccctc tatcagttgt gagccaccag 617280
 acctgggtgc tggaaaccga gctaggatcc tctgccacag cagtacgtgc tgttaactgc 617340
 ggagccattt ctccacctg tagtcatcaa aaataaaaac tcttgcctc taagccagtt 617400
 cttttataa atgttactgt cttagttagg ctactagtg gctatgatga ataaaaacac 617460
 attaactaaa agcaagtgg ggaggaaagg gcttgtttgg cttacacctc cacatcatag 617520

 tccatcactg aagaaaatca gggccagaac tcaacaagg caggaactga tgcagagact 617580
 atgaggagtg ctgcttctg gcttgcctcc ccatggcctg cacagcctgc ttcttataga 617640
 acccaggacc tcaacaggaa tggcaccacc cataatgggc tagggcctcc ctcatccatc 617700
 actaattaag aaaatgcctt acaaccagat gttataaagg cattttctca actgaagatt 617760
 tctcctctca gatgactgtg tcaagctgat ataaaactag ccagcatagt tactaagagc 617820
 agagtaatat tttaaagaaa atcttgttgc tgtaggcaca gagaattgga ttctagtttt 617880
 acattatfff aaccctagat aatcccttag gtaaatftac atttgaaac atctattaag 617940

 aaagaaaaag aagccacctc aagtatgttt gtaaaaatag cataaggcat cagccatcta 618000
 caagcagcca gaaggttggg atgagggagc tgggtcactc aagtcattt gccttcacat 618060
 tgtcagacag agaggccctt agtgttaggg ctttacagga gcctgagcat ctttgggagc 618120

tagagcagga acaggaacaa gagctcaagc ctgggcctgg gcctgggcct gggcctgaga 618180
taaagctgca gcaactggct tgttttgggc ctttgtcttg ggctggcaga gcctttcact 618240
tttggattg caggcgtaaa cacaattccc agacttgggg tgggcaatga aaacaactcc 618300
atggtgtaga gtgaccaacc agcagtcaat agggtaaga tctctttatt cggatacacc 618360

agcgcaggcc aaagtgagga ggaaggagcc gggaccaggg ccaaagaag ggatcatcca 618420
cgtgtcggag gtccttaag aagcttccca aggtcacctt agacttcccc tcaccacgcc 618480
ctcacgggtg tgttctggca cacctgtccg ggctactagg aagcggagct acagtgtctc 618540
cctacaccgt ggagcttga atcatgcca ttgtgatctt aggtttaacc tcagactgta 618600
caaggacctc agcatgggtg ctcatggcct tcacattgct tttctgaact ctctcaggct 618660
ccttgtcag tacttggaaa aaaaatgata ttttctgag gaatacttgg gttgaaccc 618720
cttaagaaat taatatctt gtgatcaggg tttcttgatg ccatttctgt actgtacatt 618780

tgcagaactg gttgatgta ctttggttct tgaattgac catgtttaca tggaaaccac 618840
agcttttct agagggaag agctatctt aaacatctt aaaaatttt tgaatatagc 618900
atcaatgccc attaacagac ttgtgaccag gtgtgtatat gtatttcaat tgaccattaa 618960
aagatatcag cctgccaggt tgggtgcata tgccctttaa cccagcactt gggaggcaaa 619020
ggcaggtgga tctctgtgag ttcaaggcca gcctggctca caaagcgagt gtcagggtc 619080
ccaaagctat atagtaagc ctgttatgat aaatcttct gccataagcc gccgagcccc 619140
actatcacat gtgcgcttta tgccagccgc ccgcccgagt taggccc aaa tgaatacaca 619200

gaaacttga ttaggttcaa tgctgcttgg ccaatgacta ggattcctca tctgttagct 619260
cagtcttaat tatcataaat ctatatatt tataagactt atcttatcgg acgtcttatt 619320
ggcatccctc ctgtctggg gatcacattg tgggtctgga ggagcaagg gaaaaggga 619380
cccttctgt ttctcttct ttaaatatga gtctccctgc tatgtcactt cctgcctgga 619440
tcaccacttc tctactacat ttcccagaat cttctttgac tcctagtccc gtctaacttg 619500
ttgtctcatt ggctaaaaca gtatcttatt taaccatcaa taagataaac atacacagta 619560
cattcccatt catctctct tttctgtcta aataaaaggg taacttgtct ttgataataa 619620

ctgaagaaaa ctataacat aactatctgt cttcaactct atcaaagacc gtagaaggac 619680
aatatataaa ctctagaatt gacaggacat ctagctacct ggacagtcac ccaaagtccc 619740
tctgtaacgt tggggcatcc atcttcagcc tataggccac agtgtgtcta gcacacttct 619800
ccatttcaac aggaaccctt cagtactgtc ttgttttga aattcagcag ttactttctt 619860
gtgggtcctg catgtccagt ttatacagca acaaacggtc caggcaagag cagtttcttg 619920
ccaaatggc taatcttgcc atgttgaaag caaactccat aacgagtttc tttgatgccc 619980

atcctccttt ctgacgtaat tgggtgcca ggagcagctg tgtctcactg gccaagaaaa 620040

 agcaacaact atgtaaatgc catatctctg taggtctttg aaaggtttga agaataccta 620100
 tctcaaatc atctctatat ctagaaaacc taactaacct aattataagt tetgactatt 620160
 atagtaaaag atctgtaaaa atacaatact taacaagag gagacatata catatcacia 620220
 aattgacctt aaagttgtat caataaatga aatctatac caatgtaaag tgttcattcc 620280
 tatatcctat tccgcttttc tttctttaaa aagagattga ctatgctcat tatcatttat 620340
 aacctactcc atttaaatga aaacaacat ttataaaca tatttgggga tttgggcgctc 620400
 attcctcta aactgcttcc tgatgattgg gggcgatgtt catataccat ggggatcatg 620460

 ataaaacata gaaatctgac caagtccttg ttttcgtagt ctgaaaggct gtatcgtctc 620520
 agctttaggg ggtcttgctt gatcaacca cattagtctg gaaggaatca acagcttttg 620580
 attttctgtg gaaatacaag caaaccttt atttctaagt agcctgtcat tagacttaaa 620640
 ttttgaagtc aaagcatttt gacttcaaat gtgtaagttg gattaattta gcagcattta 620700
 taatcaaatg tatggcatat agtatccaga ttctctgtgt attttccatc tttatgtggc 620760
 tttttattac tttattttta ctttcttttg tttctttttt cctgagacag ggtttctcta 620820
 tggaaatccg cctgcctctg cttccttctc tcacaagccc atatatattt ttaaaccgag 620880

 tgtaaacctt tagaggtttc tttatctgga tctgtcttta tcatctcaga aatgctgagt 620940
 ctaaacccca gaagcgcgag gatggcgcaa gcataatggaa gctgctccga tgcctctcag 621000
 cagcccaaca gtgccctgtt gggctgtggc agcaggtttc cctctttctc tgggaaactt 621060
 ggggcgtggc agtcatccca ctctgacac cattctgtta cgataaatct tctgccata 621120
 agccgctgag cccactgcc acatgtgtgc tttacgccag cgcgccgcc gagttaggcc 621180
 caaatgaata cacagaaact tgtattaggt tcaatgctgc ttggccaatg actaggatc 621240
 ctcatctgtt agctcagtct taattatcat aaatctatat atttataag acttatctta 621300

 tggagctct tattggcatc cctccttgct ggtggatcac attgtgctgc tggaggagca 621360
 aggggaaaag gggacccttc ctgtttctcc tcctttaaat atgagtctcc ttgttatgtc 621420
 acttctgcc tggatcacca cttctctatt acatttccca gaatcttctt tgactcctag 621480
 tcccgtctaa ctgtctgtct cattggctaa acagtatctt atttaacat caataagata 621540
 aacatacaca gtacattccc catcaagac cctatctccc taaatgagcc ctgattctgt 621600
 taaaagccta gcaaaattaa caggaacag aacacattaa attattattt tttaatgcta 621660
 gccctcttta aattttatta aaagcagttc aatattctta gaaagtctaa ttgctctgaa 621720

tataaagtat taaaaatatt aacagcattt ttattaaagt cacitttaatt acatataaat 621780
 aaatcttttt gtctggata tttctctgta aacctcaaaa attatggata gcatttatag 621840
 aggtgatcac tatgtattta ttaaaaacat aagtgggtcc tggtaggcac aggccgttaa 621900
 tcccaactgc ttgggtgggt gaggtagcag ggtcacaagt tcaaggcctt cctgctcata 621960
 cagtgagttc aagtttagct tgagcaactc agtgagactt gtctcaaaa gtttttttaa 622020
 gatgtatttt atgtttatgc atatgtttgt gtgtctctgt gtgcatatca tatgtgcagt 622080
 gcccatggag gccagaagag ggtgttggat tcctggaag tggagttaca gatgtttgtg 622140

agccaccag catgggtggt ggaaaccaa ctcaggtcct ctgcaaaagc agttattgct 622200
 gtaaccact gagccatctc actagcccct caaaaagttt taaaagatta tgggtctagg 622260
 gagatagctc aatcgaaaaa gtgcttgctt gatttcaatg accagagcct atatgtaaaa 622320
 aggtgccagt tgtgggtggt tgtgtttata acacaacact ggagacaagg ggacaggtga 622380
 atctctgggg tctgtggctt acttaacaag ctgcaggcca gtaggaaaca ctatgcaaaa 622440
 aagaaaaata ggctggctca cacctttaat ccagttactg gggaggccag cctggtctac 622500
 atagagtcc aggctaaaca aggctatgta gtaagaccct gtctcaaaca aaaaccagag 622560

tggatggtgc ctgagaaatg ctatctgagg ttgacctctg cttccacaca cgtatgtaca 622620
 tgtgcacctg catgcacaca tgtgaacatt acctctcata catgaagagg ttttggaatc 622680
 tagtgggtg gtgcagcatt tatatagtat gctgaaaaag aaagaagaga aaaataacaa 622740
 aaaagaacac tcatttgaaa aaccatacaa aataaagtct ccaatatttt catcatgttg 622800
 catctgtcag tgacttagac atcattattc catgtagcat atcacaagaa cactttttgt 622860
 tacaacacaa atgttgtgtc taatggccca atgaacagag agatatagct caaactttct 622920
 ttttgttagc aattctgggt tcacctgat aatttcacaa tgtacataca taccaattta 622980

aaaactatte aatagctctg cattacaaaa tgfactatct cctgtaatg aattaatatt 623040
 gagggacaac tttattttt caagagttaa atcagttcat ctcaacactg aaaaagaatt 623100
 gtaatttcac atggaacaaa tcccagaaac catgcaaaag tttctgtatt tataagctac 623160
 tcctaaatte atttctaaa attatatttt atttgcttga taaaaaatt gggagcatct 623220
 ctgaattttt ctctctttt gaacaagcct tgattttcat catgcgccct cagattcttg 623280
 gctctctgac tctcggtgtg cctccaacac ttccctgtga tttctgcttc tcaagaagga 623340
 acatgctcaa cctgcacac acagcactat tgcaagccct cccgactgct tctctgtttc 623400

agacagctc acagggactt taaaaacca tccaagtctg cctgggcaca caccatgctc 623460
 agattttcat gcttccccca caaccttctt ttataaagg taaaactatc ctcttgccag 623520
 gggttcaaga cacctagttt tgctagaggt tgaattgtag gaaaacctac aacagtatgt 623580

cgaacgtagg accatcccaa gtgcctctaa gcaactgtccc tggaagacaa aatttctgaa 623640
ctttaacaa aagagatfff atttttattc gcatgtaa atgtgtgagt gtgcaattgt 623700
ggattcgaat gcagtacccc cagatgccag tagagggtgt cagatcccct ggagctggag 623760
ttatgagcca ctigtcttgg tcatgggacc tgaactcccg tcttctgaaa gagtggata 623820

tgcttttaac cattgagcca cctctccagc cccatatfff aataatttaa tcacccttta 623880
agtgcaagat ctggcaagc tttctttttt ataagactff atagcatagt cctttttcta 623940
atacacacag ggtaagtcca cctagatcct gaatgttacc cattgtgcag aatgaatctc 624000
ctataatttc caatatgaaa agaaaattta ggataaacat catatctgac aaaatatcta 624060
taattgtata tgiatcacag ccttaatttt aaaatttcat gtttatgaat atttgttgat 624120
atattattcc caggagacaa acacatagga ataatcta aagaggtfff taatgtccat 624180
tagaagtatt ttggttaata taaaacatgt catatcatct catfffcttt taaatttgac 624240

aacttagaaa taaaaattaa cctcttttca gaatttgttt ttcaagaaaa tgctaatcaa 624300
aataaatgta gccaatcacag aattagtagc taataggctg tggatgatgg ttcattgctgt 624360
aattccaatt aggaagtaga atttaagtct atcctcagat acacagagag tcaaagggta 624420
gcttagacta taaggagccc tatctcagca caagaaaaac agcaaatgt atgactaac 624480
aaaactttta tcttataatc ctgagtaatg ctatfffata taaacaaatt gaactttcag 624540
tcaagcattt tagcattgtc cctffaaaac acttgtffta ggggctggaa agatgactta 624600
gcagttagga gtgcttctg ctcagtcag aggaccaaca agagtttaga ctggcaatg 624660

cttctaacte cagctctggg gaactttaac acctcttct aggetactgg tgtgcacctg 624720
cacacacaca cacaaacaca cacacacaca cacacacaca cacacacaca cacacacaca 624780
caggaatctg tctgtctcta cctcctagc atgaagtat aggtgtgtgc tactgtgcct 624840
gagaatccaa actcaggtct tcatffffff tfffffffff tfffffffff tfffffffff 624900
tfffnnnnn nnnnnnnnnn nnnnnnnnnn nnnnnnnnnn nnnnnnnnnn nnnnnnnnnn 624960
nnnnnnnnn nctcccgcct cccgagtgct ggtgtagag ttatgtgcca ccaatgcct 625020
gcctcaggte ttcattctg cataaggaag tattttactc cctgaaccgt ccccatagtc 625080

tgtcttcag ctgtgttcca agaaacatca atagacccta gcttcccttt taatagattt 625140
caaagaaatt aagattaat agacttataa gtcagtatat agatttatca gtgtttaaac 625200
actcagttaa gtctgaacta tgtttatgac taattaagat catcttattt tattttaaat 625260
ctttgttata agtcatttta ctcttgtaa atctttagc agttatfff tttatcagct 625320
tcagttffta gaattaatat ttgaaagcac ggaatcaaaa caagcccagc accagaccag 625380
gaacattcag ccaggaaact caaaattaat ctttttatat ctacattttg gtctttcccc 625440

agccatctgc catggtgggt ggatgaaagg cccgagctaa cttggggtta gcttggttaa 625500

 caactgcaat aaaacctctt gctgtgctgt ttgcatcaaa aaaaaaaaa atctacattt 625560
 tagttaggcc tgaatgagac aaagtcctgg aaccactagt ttttctttct tttttttct 625620
 gtcccaaatt ctatagttaa tgcctacatt tttttttaag ctaaccacct tttcaaagga 625680
 agagaggaaa aacaacaga catgaacagc tcttctgcgt taatagagcc tccaaatcat 625740
 ccctaacaca cacacacaca cacacacaca cacacacaca cacacacaca cacacagagg 625800
 agagagagag acagacagag agagagagag agagagagag agagagagag aatactttaa 625860
 attagacatc taaataaatt taaaaatggc agaagtttca gtcatttttt tcttggaac 625920

 cctaagggtg gatgccatt acacatgaaa acaactgcat tgattcagag tactctctta 625980
 gatacatacc gtaagtttac aggttcctctg agggagaggg gtgcacacta agatagtata 626040
 gataatatac tacacaatta aaatagaagt ctctcaaca ctcttgtttc tctgggttcc 626100
 aaatagttca ccagaacccc aatagctcag atgagcctca aaagaccaac acattccaac 626160
 ctccctggtt atacagcaaa cacctgaaca gtttatttgc tgaatttgc caagcttcca 626220
 gattgacaat attacacata ttgacctaaa tggttcaaca gagccgactc ggctctaattg 626280
 agcagcttcc aaatcaaaga aagtcaaagc tcaaggtgca ccgagcaagg agacttcagg 626340

 gcctgtagag tccaaatact cacgtctcga gtctccactg taccagaggt agaaagtagc 626400
 tgctgccaac taaagtggaa aggtaagaaa aagcccctgg aaaaaggtga ttccagcagc 626460
 tgtgtggact gttgatttgc tcttctctt ccagggtaga cctgctaagt ggctgatacc 626520
 caaatgtgt cttttctta ctggagtttt tagaatcaaa accgaggtcc tggtagttcc 626580
 aacaagtgtg ttgaccctc tgtctcaaa acaccataat aaaaagcaga gaaatgagat 626640
 ctatttaatg tgaccctaa gtcaggatgc taacatgata tttggcttaa ctaggagaca 626700
 aggaatacag tctggttag ggtaatgtcc tgeccatcat taaccagca cectcttagg 626760

 ctctattctg tccggcaagg tggctgatt tgttagaatt gtgtgaaatc cttcccagga 626820
 agtcgggctc ctctctggc tgatactagg attcagcct ttcttatccc cttgcatgag 626880
 gttcttgggg aaatgccaat tttgggggac gatccattgt ttctcatagc caaaggaag 626940
 ggtgtaagtg tctctttaga gtatctacat tccttcaga gctatgaatg gctgtgcct 627000
 tcttctgtc tttttccta aattgtactt cagttccctt tcaatggat catactcatg 627060
 ccagtttaa ctattccagg tggaggcttc tggccttgc ttttctctg tgcattcaat 627120
 gacaccagtc tctctttat ctcatgctt tcttctgtgc atgcaatgac atcaatctcc 627180

tctttatctc atgcttttct tctgtgtgtg cagggatgcc tcttctttgt ctcacgtctc 627240
 tcaggttctt gatttcccaa cattcagtat cactgttctt ctagtagata ttcttctaaa 627300
 caaaaatgaa atttcagttg ttttaattctt tttgagtgtt cttccctttt cctccatcag 627360
 gtccctttt ctcgtatacc ttcaatagga cagcattttt tctccaccaa atttccatcg 627420
 aatatttatg atctctttat catttgtgtt aatgtcttca gcatcacagt tttcctgtcc 627480
 tagttacaga gcaaaactcag ggtctgactc acaaatggcg tagtttttat tgcacatttt 627540
 tcactttaa gttatgtttc ataatattia aaagctcatt aaaatttttt tctgtctggg 627600

 cgttggtgac acgtgccttt aatcccagca ctcggttaggc agaggcaggc agatctctgt 627660
 gagttcgagg ccagcctggt ctccagagca agtgccagga taggctccaa agctacacag 627720
 agaaaccctg tctcgaaaa aaaaaaaaaat ttttttttcc tatgtgtagt tgaaagtttt 627780
 ctgaccctcc tgtcagttcc cccagctgct tatgaaataa cactctgagc cttaatatca 627840
 attgtttggc caatgtctca gacatattac tggctagctc tctcttataa attaacctat 627900
 ttctactaat ctatgtattg ccatgaggct gtagcgtact ggtgatgctc tggcatgtta 627960
 ctctttgggt gctacatggt atctctttga ctccatcttc ttttgcteta taactctgtt 628020

 tggattttcc acctagctat attatgcctg gccattggtc aaaacagctt tattcatcaa 628080
 ccaataaaaag caacacatat tcacagcatt cagaaggaca tctgtatca tctcctcttt 628140
 tctgtctaat taaaaatgaa agtttttaatt ttaacatagt aaaatataat ataacaaaac 628200
 ttttcaagca agaattacag ctacaatatt tagtctatctt gtatttgca aaattaaagg 628260
 aaatactcta tcatctatcc tatctttgtg aatctaaagt tttatatcta atttatcttt 628320
 tatcataact aaggaaaaact gtaacaataa caatttgtct tcaactccat caaagacccc 628380
 agaaggatat attacctagg taaacaggaa gtgcattgca agcagcttcc aaaattttag 628440

 aatgacaga gacatctggc tgccctggaca gtcacccaaa tttcctctgc ctgtcattct 628500
 ctctgaagta attggtgatg ccaggagcag atgtatctca ctgtcaagaa aatctaaagt 628560
 tcttaaaata ttttaaatgc catattctat aggtcttctga agtattacct attcatctga 628620
 aatatactc tgtatatcta taaaatttaa catgactaag tttgactatt atagatgact 628680
 atctattaat atgtatttct taactataca ttacattttt aaatgggcta cataaacata 628740
 atacctgaaa caaaagcaga aatatacata gtataacaaa actggcctta aattttgtat 628800
 taataaacca aatccatac caatatattc atttctgaat cacctgtgtt atttttattt 628860

 tgtgtgtgta tatatgaagt ttgcctgcag gtagtatgt gtaccatgtg cattcgggtgc 628920
 ctaaagagge cagaagaggg catcagatcc cctggaactg gagttacaga cagctgtgag 628980
 cctccgggtg ggttctggga actgaccctt gatcctcttg taagatcagg aagtgtctct 629040

aaccaatgag ctatttatct ggcccctaga gagttaatth taatacagtt ttatcagtg 629100
aaatthctg ttatctgaat taagcatatt cctccagaaa ggtttgctat ttgctcttaa 629160
gaaatggcat catatacggc taactthtta gthtaatgtg ttggggaggt ggtagcattc 629220
thtttgggtg thtthtttgt thttgthttt thtgtgtgtg gthttgagac aggtthtcac 629280

tgtgtagtht ggagaccagg ctggccttga actcacagag attcacctgc ctctgccttc 629340
cgaatgctgg gattaaaggc atgcgccacc actgcctggc ggtgthtttt thtthttgtht 629400
tccaagacag gthttctctg tgtatccctg gatgtcctag aactcaatct gtagaccagc 629460
tggcctcaaa ctcatagatc tgcctacctc tgagtctgaa gtgctgggac taacggcctg 629520
tgattgatga cacagccata gggagatgtt gctthctgt acagcaagag tatgagacat 629580
gtgctctct catatgtga ccatggtaga aaaggtctag thcattctct gaccaaagt 629640
ccatgttctt cctgggcatt catccattc ctgcttcatt thctgtccct gtattthctt 629700

gattatgtt thtttgctth thtaaaagaa tataththt thatactatg acagthtaaa 629760
acacccaaac atcaggctct tgattactgc ataacctcca ctctctcacc catccagtht 629820
caggaccctg tacaththtc atccttgagg agagaaaagag aaagacagat agaagtaacc 629880
tggacttctg ctthcttaca agthcagtg gcacttaaaa tagtgctatg gtattgcagt 629940
aaacgatgac tgatgttctg tagcatgagg gthttcagac aatctagatt tacatgttgc 630000
tggatacage gtgacaaaac thtctgtgct catcaaaacta thcctthctc atctthccac 630060
agccctcccc tggcctcccc caccctctgg gagaaaatgt gggataaaga tgtgagacgt 630120

ctccagtcac acagactcg atgggatctg aagagactga acagtgtatc ataacthtc 630180
tcaataacat thtththatt ctthgaggat ththththta catttggtth thcttaattt 630240
taccacatc ctththctca gaaatgagca thatgggggt thaatggct thtgaacat 630300
caaatggctc ctaaaagtaa ccatgatgga thgagtgtga atgaagcaaa caagggtaaa 630360
atthctctg aattacatat ggatttaata attagcaaga aagctctca taattagaaa 630420
aaactgthta ggggataatg thcaagatgc thgagaatgt gtactgtaca gtcttgctgg 630480
aatgccgatg ccacagctag aagthaacat thcaacca gagtgagatg cgtagtcagt 630540

thctggcaca taagcaagga cagagthggg gthttgtgtg thctththta aatthtgatt 630600
tathththt thaaatatgt atatgtgtat thtgtgtgg thgtgggggt atgtacacac 630660
gagtgagggt actcacatag gcagaagggt gcactggatc cccagagct ggagthacag 630720
gaaatgtga atctcacaac atgagatcag caacagthc acctacaaa acagthggca 630780
ctcttaacca cagagccatc thcagccca gaththctth ththththth ctctctcccc 630840
ctccccct thatgtatc thgtgthth ctthcatgta thtaaatgta thctacatg 630900

ccgtgccctt gtaggccaga agaggatgic tgatcctctg gaattggagt tacagattat 630960

 tgttagtctc catgtgggtt ttgggaactg aactcaggtt ctctggaaaa gcatccagta 631020
 ctcttaacta ttgaaccatt tcttcaacce caggaatatt ttgtttttgt ttttgttttt 631080
 tttttccag acaggatttc tctgtgtagc cctggttgtc ctggaactca ctgtgtagac 631140
 caggctggcc tcaaaactcac agagattcac ctacctctgc ctccaagt ctggaattag 631200
 accctgagtg ctgggattaa aggcatgcca ccgtgatgcc aggcctccct gtgttgaag 631260
 tctccatfff gcaaaactatt tagttctgtt gttttgcatt gcatgtagcc caagctggcc 631320
 tccagcttgc tatgtaactg atgacggcct tcaactgctg gtctctttgt gttcatctcc 631380

 catgtgttgg attacgaggt tgtgtcattt caggctctttg ttgttttgag aacctatct 631440
 agggcttctc cattccaagg caggcacttt attatacatc cccagcatca ttttccaaat 631500
 gtctaaacat ccagagttta tttctatgaa agaaagtct ttcatacttt cttttgagag 631560
 ttgccactat tglaaagaag tcaatgtaca aagcaataaa aacaatagag tattctgggt 631620
 gtaaaggaca gaaagtcagt aaagatggct gtattcctca cgcattatgg cactgaataa 631680
 gaagaaagct tcttgttcgg tggagtttga tggacagaca ggcagccct gtaaagactt 631740
 gaaagtgttg aagaggagag ggtgcctga ggaatgggct gtacagccag agcctgggga 631800

 ctgttgtgag ctctgggct ttatcctgag atgtcagttc agccctcag tgcttgttat 631860
 atacagatat attgtaata accattaagt ggatctgttc atgtgagtgt aggcctgaga 631920
 ctggtggttg ataatgata catctgtgaa atcgtaccg ataccactca atctccagga 631980
 ttttaccatt acctacatc tttgcttatg gctgtctaag gctaccttt gcacacttc 632040
 gggaaaccag tacaattgtg tcttttctaa agattctatt aaatggagcc acacagtatg 632100
 cggtttgtgt ctgccttctt ttgctcagct tgctgttgtt gaagtttact caggatgaaa 632160
 ggcttactcc cttttatgct gagctttcat tgggtttata taacagacta tttatctccc 632220

 caccactga ccggacattt gtgtgtgtct cgtccagatt ctggctgtga taacatgcta 632280
 tgaacatttg tgtgcaggcc tgtgtcagca ctactgcaa catgtattgt agctaataag 632340
 tctaggaaga caccacgccc atccccctag ccagagtata tgtgttttgg actgggagca 632400
 gaggaggaag aactgcctc agcactggaa aaacagagtc tctcttctc ttgaaagaaa 632460
 agcagctggt aaaaggagca gtcttgtgag gcaagaatgg tgttcagaat ctttttctga 632520
 agtgaggatt tgttgttct cttgggatac tgaatgctg ccatgtaaac ctggagctgc 632580
 catgcctgtc taccctggtt acatgaagga aagttttggt ggtggtgttt tggttgtatg 632640

catgccaggg acagagagag agagagagag agagagagag agagagagag agagagagag 632700
 agagagagag agagagagag agagagggag aggggtggaat gcacgcagaa cttggaatcc 632760
 aaagaagtca gtgagtaaga gaggccccag ggggaaggac atggcagaga cagttcaact 632820
 cttaaagtct caatgtccta gtttcacag gccagcctt tccttaaacc tgaggigaga 632880
 caagtgcta gcttgagatg gttacagagg ctcttcatct gtgaggaaag aaagacagaa 632940
 aatggtttcc ctgacatttt aaacaatat tttatttatt tattatgcat acaacattct 633000
 gcttccatgt atatctgcac accagaagag gccaccagat ctcataacgg atggttgtga 633060

 gccaccatat ggtttctagg aattgaactc aggaccgctg gaagagcagt cagtgtctctt 633120
 aaccctgaa ccatctctct agccctttcc tgacattttc tcttctgccc atgcttagtt 633180
 tggcttgaca gatgtgatg gacatgtgcc cgttattgtg ccttgcgatg gaacctagg 633240
 ctaggagat gcctccaac agaggaggtg aagctcgtgc tgcctgggct gagggcagtg 633300
 gagactgaga cttagaagat aaagtgagaa gcagatagag cacagtagga ctcaagacac 633360
 attcagtgtt ctagatggtg tggagaaagg tggggacatg ctggagatgc cacttgcaaa 633420
 gcaggatcag ttaggaaagt ctctgaatgc caggttaagc ttatgttgta gacctgaaa 633480

 acttaacaag tgttacaag caccagaggc taggtagggt gcttcaaca tagaaaggtt 633540
 tcttctcact agtgtgagaa tttgatggca gatttggttg cttcagacgc ctctttgtg 633600
 ttctgtgtct ceatgtctc ttcctctct gtttgtaat gtctgcatct cttttctat 633660
 aaagacatca gtcagaatga ggtagcattc atccttctga cctctttta acttaatttc 633720
 ttttaattgc ccaatattga ataccgagtc attctaagat actgggggtt ggacatctgc 633780
 atacaaattg ggagcagcac aatttagccc acaacaggag cattaatga ttttaagagg 633840
 ggaaggacat gaacagattc tactcttctt ctctctggta accatgtgaa ggacagattg 633900

 aaggaggaca agaccagaca tctgaatgtt tgttcaaggc tttggggatt gtccaggcaa 633960
 ggttgttaca ctacaacaa catggaagat gctgtgacc gacaacatgt cgggaattct 634020
 tgctacatgc ttgtgtaca tctgcagta gcagaatcag ctacatgacc tcatttagtt 634080
 gtgagacagt caacctggag acagcacctc ttgacacagg ctgagggcac acttctaagt 634140
 gtccccatca ctcacacact tcagatgtca gttacaagtc ctaggttggtt tccttgtgg 634200
 ctctgatgaa tcagctacat atggaggttc ccacaatcct ctgcttgggt ttgattgctg 634260
 agtgccagga gccacagaa cttagaagga cacttaaatt caccacttta ttatagagga 634320

 catgacaatg gatgtagatt aagaaatata tgcatgaaga tgtgggcaga gcttccatgc 634380
 tgtctctagg cttgtcatca agataccaca tgttgacta tccaaaagta ctcttgacca 634440
 gtcttctga ctttatatgg agacttactg cataggcatg gtttgtgaata cacagaacaa 634500

ggagacctag caagcctgt ataaccacgt tctccttgcc ctctctaaaa cattcctttt 634560
 tcctggatac ttttaggatg aggagggtct gatgacctat tgtcatgcaa ggtaggttag 634620
 agaatttaat tatgatgaat tgaaggcagg aaagtggggg aaattaaagt tgctgtagcc 634680
 ctccacaggg aagaaaactc tagtgtctaa aacctcccca gagaacggag tttataagtg 634740

 aggaacctg agcaaaaact aaaataaaaa tgatgtcact gagatcttga aagcctaate 634800
 ctgatgctgc ctgattagaa aataactcac tcaagtgtaa actgcttctg agcagctgct 634860
 gacttccaaa agatgcttct ggatattctc tcagagaaag ggagaaagat actgtggggc 634920
 agaagaggtc taggaagggt tgaactgcat taccactttc ccaaagcctt ctaggttctc 634980
 agtgtagaaa ataatttgtt atttgttaca gttctacgtt cactctgatt tttgtaatgc 635040
 agaactattt ttggtgtagc ataatgaaca gatcatatgg agatgggctt cttgaagtgt 635100
 actgggtggc aattaataga tggatggttt gggtaatttt attttttgaa cctcatcttc 635160

 cttatgtgta actaaggatt aaaatagtaa cagcacttgc cttccaagtg tgttgaaga 635220
 ataaaatgag atagagaatg agatttataat tttgtttttt ttgattgttt tgttgtttga 635280
 aatgaaattt cttttagccc agactggctt gactctctcc atgtaggcta ctgatcttcc 635340
 tgcctcttcc tcccaaatgt tgggattaca agtgggtttc accccagcca gtttatgtgg 635400
 tgttagggat tgaaccagg gcttcatgta tgctaggaaa gaactctact aactgacct 635460
 tatccccage taataact aatttattgt tttgtttgt ttgtctgttc aaagacaggg 635520
 tttatctgtg tagccctggc tagtctgtgt agaccagact agattatctg cttgcctctg 635580

 cccctgagt gctgggatta aagccttga ctaccactga caggcaataa agcattttaa 635640
 agagtgtat agctaact tattgcactt ggcacccttg aaaactgcat ttatgctctt 635700
 aggtaagaat aggaggcaga taatttttac agaacaaact attgagtgtt gcctgcggcc 635760
 gctggtctgt aactctcatg tacctcttcc tctgttccc agatcacaga gcattgttgg 635820
 ttcttatttg tatcaacaca tgagaaaaca ggactcttct ctgggctgtt tgaatcaaat 635880
 taccaggaaa ggaaaaagaa aacaatgaag cttgatttca gtaaatgctg aaatctgggg 635940
 agcatgtgta atatcacaca gacaaaagga agggatcgag tagacaaaag cagaggaaaa 636000

 gatggagaga aagccagagt ggtcatatga aagcagaaga ccagatcaga aaaacagagg 636060
 ctttcccga atgtcttatt tccatgtag tattcctgcc tgattttctt aagtgaaga 636120
 accccggggg agaagggaga agctgtcctt tgtaacatca tttgagtttt atgcctggtt 636180
 atcatcaact cattattaat aatattgttg tttgcaagaa gtgactctaa gaagttttga 636240
 caggttcate atcatttata atattttgt gaatgctgta gctcacttgg gtctatcaga 636300
 tgcaggaata caatgcaatg acctttaaac taaaacctga aggctgagta agccttagtc 636360

ctggcaagaa tgggcaaaga atagtcagg ctgaggaacg agttcaactg tggatttcaa 636420

ggcaactact ttttagtagg caacattcag tacaagagat acttctctct caagtcctca 636480

aagttcacac tgatagetgc taagtgtctt ggtcaggac agggctgaaa ctattgtcaa 636540

cagttgggcc agtgttacc aggaggccag gcctcccca gccctggtat gagaacagac 636600

tctggggacg tgaactgaac tgtaggagcc agtgtagctg aagtgtgttt agttgccctt 636660

agagatggat acttcaatgt aattgtctag atcttcttga cataccgcca ttgttttca 636720

ctgtgcaagt ttgggggtg atttggtaac ctgtcathtt actgccccac cccaccctt 636780

tctgtgattt ctctgtctgc tgccatctc atctcaagg acattttcca ggccagaagt 636840

gtcagggtca ctctccacc atttgtcagg agcaatagat ctaccctggc gctgtggctt 636900

tggtgattga ttctctggc cactgactcc cctgttctgt tctctggctc aggcctcacc 636960

agctcaatct gtccctcagc tctgtcaca ttctattctt tgatgtccat cccaattctt 637020

ccatccctaa gcgccaatg tatttctctg taaaggaatt ccataaagc tggtcatctt 637080

tagatctcag gaagcagcat cagccttctg tctgttctg tcttctctc tcaccagcca 637140

ctcactctct cgccatcttg attctacttg ttccagtgc ttaaggtgtt cctcaattca 637200

ctcattcatc tattaataa atatgaatca aatgtctctt atatgttggc caatgaggct 637260

ctgaagatac acagtgagaa gggaccctgt ctctgcctt gtggagccta catgttcaca 637320

aaatttgcca gaattttaac caaaggacta tatcaaacca atggaagaca gggagatttc 637380

tccaacacca gattagataa atttctaagc ctgatactg gtgttccca tcagattgtt 637440

aaaccaatag acaaggtatt catcataggt ctggagaaag tagtgggaaa tgaggttgg 637500

gacatttaga actcttatgg agtcttgaat gccaggatta caagtttctg ttgtttttc 637560

atttttctt gactccaagc aacctttatt tatcagaata caaataatat atcacacaac 637620

attttccact tttgtctaa ataaaagcct attagtttat gccacaggca ggcccttcta 637680

acatccttac tgactctctt aaaacgactc ttcaaagtac ctaagaagca aagattccat 637740

atttttctgt tcatcttgac acattcatag aattatcttg gcaaatatat caggactagg 637800

aaaccaagct ctatttaatt gtcctaactt agatcagtta tttcccagac agaaatcagg 637860

tatgactggg aaagtaagat catttagcc taagaagaca ggcaatagaa gaaagggtgg 637920

aactctatca cctattccta ctttaggata ctactttgtt taaaactgcc tggctgcaca 637980

tctcaagaga acaggaacac tgttgcctt gaacttgaca gcagggtgt gcttcatctc 638040

tctcacagct cacatctggg aatccccatt ggaatctct ttgtgctgcc caccttcttc 638100

ccagccacat ctgctgtgga gggcagatgt ggatgaagtc aagtttctaa gcaagtgggg 638160
 caggcccaga aacaacactt caaagtacag gctgcatcct ttctcctcat gccttgaggt 638220
 ctacagactt aagctctgtc ctctctggaa gctggtgccg gtttctccc atccagaaaa 638280
 gctgtgactc ttcaaaggga tgtggaagt cttgctgact gacagccatc tgaggagagg 638340
 cggcctgtct tgaagcagg ccaaacatct gttgatgctc tctgcctcct ccaggataac 638400
 tgggctactg acagctcccg ccttggtcct ggggtaaatc agagagacat tagaggacaa 638460
 agaaggccct taagaaggcc cagcagaaaag ttgatatttc tgtgtttcta agccttctgc 638520

 catgttttcc ttccccagcc ttgctgaagt ctgagtcttt ggaactgtgg ggaacagggt 638580
 aattcgactt ttctattaaa cctcttccaa atgtgtgcag gagtcaggta tttgctcttt 638640
 atcctttttt aaaaaattag gttgatttat tttatgcata tgagagtttt gcttgcctac 638700
 ctgtatgtat atgtatcact ttgtatctgg tggctttgca gtcttttttt tttttttttt 638760
 ttttttgac tggtttagtt atttgttg tatacagtgt tctgcctgca tgtcagaaga 638820
 gggcaccaaa tctcaatata gatggttg agccaccatg tggttgctgg gaattgaact 638880
 cagacctctg gaaaagcagt cagtgtctctt aacctctgat catctctcca gcctgcctt 638940

 tggcagtttt aagaaggcat tgtacctctg gggcctggag ttacagatga tagtaaaaca 639000
 ccatggagtt gctcaaactt attctggacc ctctgcaaga agtactccta actatctctc 639060
 cagatccttg ctgtattctt tttgtttaaa aagaagaaaa gagaaatatt gagacagaca 639120
 tgagacttaa gactataagt ttattataag gcgcaacaga atggataaac taagaagagg 639180
 aacagggtaa tggctgaccg ccatggccgg tcgcataga gagagagagc ggggaaacag 639240
 agagacggga aagcacatag agagacaggg agagagagaa agagagagag agaaagagga 639300
 gtaaaggggc aagagcctat cttttaagg ggtcctctgc acctgcgtac agacttcttt 639360

 cccatggaac ctigggetga ccagggtatt gcctgagtgg attccaccag gtaacagggg 639420
 caggccagca taatgcctga accttctatt ccacactcta cttattatta aaaaaggtg 639480
 ggggtgtttn nnnnnnnnnn nnnnnnnnnn nnnnnnnnnn nnnnnnnnnn nnnnnnnnnn 639540
 nnnnnnnnnn nnnnnnnnnn nnnnnnnnnn nnnnnnnnnn nnnnnnnnnn nnnnnnnnnn 639600
 nnnnnnnnnn nnnnnnnnnn nnnnnnnnnn nnnnnnnnnn nnnnnnnnnn nnnnnnnnnn 639660
 nnnnnnnnnn nnnnnnnnnn nnnnnnnnnn nnnnnnnnnn nnnnnnnnnn nnnnnnnnnn 639720
 nnnnnnnnnn nnnnnnnnnn nnnnnnnnnn nnnnnnnnnn nnnnnnnnnn nnnnnnnnnn 639780

 nnnnnnnnnn nnnnnnnnnn nnnnnnnnnn nnnnnnnnnn nnnnnnnnnn nnnnnnnnnn 639840
 nnnnnnnnnn nnnnnnnnnn nnnnnnnnnn nnnnnnnnnn nnnnnnnnnn nnnnnnnnnn 639900
 nnnnnnnnnn nnnnnnnnnn nnnnnnnnnn nnnnnnnnnn nnnnnnnnnn nnnnnnnnnn 639960

nnnnnnnnnn nnnnnnnnnn nnnnnnnnnn nnnnnnnnnn nnnnnnnnnn nnnnnnnnnn 641880

 nnnnnnnnnn nnnnnnnnnn nnnnnnnnnn nnnnnnnnnn nnnnnnnnnn nnnnnnnnnn 641940
 nnnnnnnnnn nnnnnnnnnn nnnnnnnnnn nnnnnnnnnn nnnnnnnnnn nnnnnnnnnn 642000
 nnnnnnnnnn nnnnnnnnnn nnnnnnnnnn nnnnnnnnnn nnnnnnnnnn nnnnnnnnnn 642060
 nnnnnnnnnn nnnnnnnnnn nnnnnnnnnn nnnnnnnnnn nnnnnnnnnn nnnnnnnnnn 642120
 nnnnnnnnnn nnnnnnnnnn nnnnnnnnnn nnnnnnnnnn nnnnnnnnnn nnnnnnnnnn 642180
 nnnnnnnnnn nnnnnnnnnn nnnnnnnnnn nnnnnnnnnn nnnnnnnnnn nnnnnnnnnn 642240
 nnnnnnnnnn nnnnnnnnnn nnnnnnnnnn nnnnnnnnnn nnnnnnnnnn nnnnnnnnnn 642300

 nnnnnn gacc aggc cccccc gccggcgcc gcgccccggg gctggggcgc atcggggaga 642360
 gggcaccccc gcccccacgc cccccgatg gggaaccttc gtccaaggt cagccacctg 642420
 ggcgctgagg gaggaatcaa gtctgttgta ccagacacca gaccttgaga atatgctgat 642480
 ctggaatggc tctgtgcctc atttgaacca tccaatagaa tccctgttcc tcgcttgtgt 642540
 ttttttctat aaaaaggcac ctctcccttg gctcggggcg cttggcctca cagaagctaa 642600
 gtgccccggg taccctgac tccaataaag cctcttgagg ttttgcaccc aagattgtgg 642660
 tctcgttggg tctgagtac gggggtctcc tcctacgaaa gtacctcttt gggggtcttt 642720

 cactggaact ggctcttgta gaccaggctg gttgtgaact cacagaaaag tgtctctgaa 642780
 tggacatttg ttigaaagac ttaticatca tggtaaaaga acagcttaca ttttcacacc 642840
 ctcatcatta aatctaaagc tctaaattaa ggaattatac atttgtaaat ggaaggtatc 642900
 tttggtaaat tgccaaaaat atgggctttg gagtaatggt ttaattgcaa ataactttc 642960
 agaagtacaa gaaaatcctt cccgaaagct tctgtgggaa agaacatgac taatccttat 643020
 gcttgagacc aatctcaacg cctttgccc ctacagcct gaactcca gaagcacagc 643080
 cagtgttgcg gctgctgtct gtctacggcc tccattcctt ttectgact actgacagaa 643140

 actgggaaaa cacttgctat acttggctca taaaactgtg gctgctgctg ttaccaagc 643200
 ttctggaagg ttgggactga ctttcttctc tactgtgctt actatacagc tcaatgtatg 643260
 ttttcactg aatgaaaatt tcaaggtaa ttattcttat ttaataacag cctaaacacc 643320
 cgttggttg tgacacactc atataaccag actgaagaaa ccctatttat ttcagaaac 643380
 aaaaaaatc tcattatcaa gtattgcttg ggctgaaaca tgctttgac ttgattcctt 643440
 ttttaactct ttgactttcc tgaggcaaat ttattaatc ctaccaacag tattcactaa 643500
 tggacctcag ttttggggg ttagtgcttc tcatttggg gttttgtgaa tatataataa 643560

ttacctcttg tataaatgaa tadcagatat gctccaattc cacagagaaa agagctctct 643620
 tgatcattgt ctgaagagac aatcactgag actacgtata ctgtccacag ataggaacat 643680
 attttacctt ttgttcacag ggtatcatgg tctgtatgga gagcccagag tccatccact 643740
 gccagtagag ttgtgggact cacccatctg aagggaaaag gcaaagtcta gggttttata 643800
 aaataacata gttaatgttt aataactaact gcattagtag ccatggattt tcattagttt 643860
 gtgtcaaagt taattgaatt ataaataata aattttaata ttttattaac ttaaaagtaa 643920
 aaacaaagt ccaccttata aagttggaga cctactcttg gtgggaggga gaaccacaca 643980

 tagagtata ttatggccag cagactcatg acatgtattg cgtgcactca aagatgatcc 644040
 ataatgctaa gatttctttt tttgtttttt cagcaaaata aaattccggt ttattgttgg 644100
 acattgtttc acacatacat caaacaggac aaaaaataa aacagcaact tcataaaaa 644160
 aaaaggaaga aaaaaagaa accctttatc tttggccttt ttaacatct catacaaacc 644220
 aactacttat agtacagcta ggtacatata caaaaaagt tactggaatg ctcggaataa 644280
 gattggtttt tgtgtttttt gtttttttac aagttttttt ttctcctttg agattataat 644340
 gaacatggtc acaccacaaa taaggtcaga agtaggacag aaaacgctct gaaggctggt 644400

 ttggtcacc gttatcatta aaaatggctg acccttaac aatatgtaca aaaatataaa 644460
 atgtaataa aaaatacaaa caaattttcc ttttaaagta ttttaagaa aaaaagcagg 644520
 gccttggag ttttggttct ttttcctcc cctgttgcaa attcatggtg tggttttggt 644580
 ggggtggagg agagcgcag tcatctgtgg gtggcactgc ccgctaaggg cggggcctgc 644640
 tccttactc gaaggtgacc acgtttaa tctgagaccg gaagtggagg gtgactaggt 644700
 cacggtggcc ttaagtttag cttttccttt ctgctgtcta gtcactctca tcggccttct 644760
 gcttcttggg gtcaacatcc tcatcatctt cagctaccg cttgcccgtg gtagcctcag 644820

 ctctctate ttcactcca tctcttct cactgtcacc ttectctcc tectctccc 644880
 cacttcttt ctctcttca tctactcat tgcagctc ctgctccga ttttctcat 644940
 tagcattccc attggcaggc gcgtctctc cattctctgc ctctccaca acttcttct 645000
 tctcttcaa gtctggagg actctggcga gagagctgcc agagtctgcc cgggaggagg 645060
 ggggggagg ggctgcagc cagccagtgg agcatgctaa aatttctta tcagataaa 645120
 caaacctg acacagtagt agctcaggc tactaggagg ccgggctaca gtgtctcct 645180
 acagacaagt taaagttat cgtgagcata cccagtttta ctcataaaa gtgttgaaga 645240

 tgtgtgtcct ttgaaaaat gtgtgtgtgt gtgtgtgtgt gcacgtgagc gctcgaact 645300
 tgtttataca tgatcagctt tctgaattaa gatTTTTTTT cccaaaaata gggtttctct 645360
 gtgtaacagt cctggaagt acattgtaga gcaggctggc cttgaactct cagaaatcca 645420

cctacctctg cctcccaagt gcctcccaag tctgagatt aaaggcgtgc tccaccgccc 645480
caccaccccc gcctgaatta agattttctg gttctttttt tttaaatata tatattttat 645540
ttttattttg tgtgcattgg tgttttgcct gcatgtatgt ctatgtgaag ttgtcagatc 645600
ttagagttac agatagttga gctgccatgt gggtgctggg aattgaacct cggcttctctg 645660

gaagagcagt tagtgctctt aaccactgta ccatgtttcc agccctaagg ggtttttttt 645720
ggttttgttt ttgtttttta ttacatatac agtattctgc ctgcatgtat gcctgcatgc 645780
cagaagaggg caccagatct catcacagat ggctgtggtc accacgtggt tgctgggagt 645840
tgagctcttc ttctggaaga gcagctaata gctgctctta ctgctgagcc atttctccag 645900
ccccctcaga ttiaaaaact tcagatttcc atctgtcctg atggttctgg agagatgggt 645960
catcagagaa aggtaatgt agctaactct gatgagtgcg atcccagtgt ctccatgggt 646020
ggaagcagag aactgactcg cacaagttgt cctcagactt ccacacatgt gcacatacat 646080

ataaataaaa gtaatgaaaa ttattttaaa gtgaaggaac cagcttcctt tttggcagcc 646140
ataacagccg aacacgtgct tgccataaac ctgccttggg cacttagagg tcagatgcct 646200
gtctctgtag aaggaaccca tcagaagtta gtcactagaa agtcagatgc ctgtctctgtg 646260
acaaggaacc aatcggaagt tagctgggtg cgctatgctt tacgaccctg ggtgtgcttt 646320
aaggacaage gcacagcaat gaggtagaga gcatagcaac caccctggga gggcctatgg 646380
gccataaaca ccagttgacc aatcaacaca gggcaagccc tccaagcctg gaagcacacc 646440
aatcgtgagc ctgtgcgtaa gcctgtgcgt acccctagac actcccctta cgctgcctta 646500

taagatcttc cgggagcccc taggagccct ctttgcctagc catccacat ggtgggtgga 646560
tcaaagacc aagctaactg ggggttagct cgttaacta caataaagcc tcatgcaatt 646620
tgcaccaage tttgcctcc attctgtgat tgggtggcc gaggtcctgg gctaagatc 646680
tggaagcctc agctttctga gggctttaca aaagtacata tttttaccc taaatgagaa 646740
tcctaggtca aaaaaatag aaaattcagg ttgcctgagg aatgaaaata ataaagtttt 646800
attggaatc atttgaaaa tctggtgtat ttacagcttg ttcaatatag ctcaaaggca 646860
gacttgaaa atgttaattg aaatatcttc ctgacttcta gagcatatc ttgcatatc 646920

tttaaggggt aatttggtg aaacagatct cattgtcttg ctttagccgt tcttgagtca 646980
gttttgttt tcctggagt tctttgttt ccaaatcttt cacaaatcaa tgggggtcaa 647040
ttatcttcta tgcaataatt cagatagttt gcatgcagct ggttctcctt aatcttaagc 647100
atctttcaga gtcgttttgc ctctaacca aagtctctta cttctgtgaa ctatatagga 647160
ttcttgacag aattttacag ggtatacagg gttcttgagt ctgaagtgtt taaggacagc 647220
tgctttgctg ggcattgatg gcacatgcct ttaatacagc actctgagag gcagaggcag 647280

gcagatctct gtgagttcaa gaccaacctg gtctacagag caagtgccag gataggctcc 647340

aaaactacac agagaaaccc tggctcgaag aaaaaaaaaa aaaaagaaag aaagaaaaaa 647400

agaaagaaag aacagctgct ttacattggt tagaggtagg aagctggtct cetatctctt 647460

tgtgctctat taccatacat atacaattct aataaacatg aattgcttat tgtttataca 647520

gatgtgggaa gtgagccaca aatgtcaata aacgaaaggc acgcactcat gtgtgtatgt 647580

gcgtgtgtgg tgtgtgtggt gtgcttttac atgtgtgtga aggtgtgtgc ctgtaaatgc 647640

tcatgtgaag ccagaagtca atattgcata gctttctctt cactttccac cttatTTTTT 647700

gataccagtt ctcttactga acttggagct tgccatattg actacactgg ctggccagtg 647760

agccctcagg aatccatctg cctccacctt tcccgaagct aggttattat agatgttggc 647820

ttccacacct ggttcaagac ctgcttgggc tttgtgagac ttttcttga aaaaaaaga 647880

caggtgctag agagatgtct cagagggtta agaatactga ccactcttcc agaaagccca 647940

gcttgatgcc cagcacctaa tcagcagctc cagggatctg agcccttctg gcatcctcag 648000

gcaccaggta cacaagaggt gtacagacat tcatgcaggc aaaacacca tatacataaa 648060

ataaaaaatag aatataaac gaagaaaggt tgaatttgt gctttagagg atataaaaa 648120

tgtcaagaca gaccacagaa tgagaacaaa tagttacaaa ttttctatct tctaaaggtc 648180

tagtatttag aataccaga ttagcataaa ggcaaatac ccaattttaa cagatgcaaa 648240

aattctccac atcataccca caataaaatc cagtgttata ctcattagga ctaaaataat 648300

ctttaagga ctgtagcaag tattgacaaa gatgtggaga agtaggagcc attataagtg 648360

aaggaaacac tggcaaaaga aaggaaaaag tagctaaaca gaaagtcatg gttggaggtg 648420

tctgcacctt cctcttggaa atggaaagat tggagagtca cagaatcagc cagaaagtgt 648480

taaatagcaa tgtaaacga atggacctga ctgcatttat tgagtctcc accccagact 648540

gaaaaatgca cattgttgcc taatatatct ggattattca ttaatatgtt tgaccataaa 648600

aaactcaata tatttaaat attggaataa tacagtgtac catttcatag cctaaaaatt 648660

gttctaattg ctttactgta atataagtta attaaataat gaaaattatc tgactctcca 648720

aatatTTTga aattaacaa atgtgctagt ttagggctaa aaatgatcta taaccttgag 648780

TTTTtagcat tcccctaac ctaaacatac tcgtgaacct atcagagaac tttgtttact 648840

gagaaaaaga aatctttaac ttttaacctt ataacagatt acagagtttg gctacactaa 648900

ataaaagggg ccatttctg gcaacctcta gagatataac ttgagagcct ccaacttaat 648960

tgtaactctc ccttgaggaa gaagcccaca cctgtcctat tggatcctaat atattcacct 649020

tcatttcaga tttggctcgc cttgaaaccc atttcttcga tgaactgtg aattgcagtt 649080
 ttgcttgggt ggaagtctct aaaagaactc ggggagctgc cagtgtgta cagagatgtg 649140
 ttctctgtac tgggtgacagt ttgacagtct ccctccagca tcagagaggc agcacaccat 649200
 ggggctctgt agaccaccca gtgcacagcc aggcgtcatc gtaagaatgg ggccaatggt 649260
 ttgagactga gctactctga ggatctgaaa ccaaagaata atcacaagtc agggcggatg 649320
 gggacacttg cccacagtgt ctgggtggaa gacagccaca agaagcagtt gttgtgttg 649380
 ggggtgtgct gtatgcagac cactgagagg ttgggcagc aaggggctca ggctgtagac 649440

aacatggtgg tcaagtaccc cgacctttgt ggtgaggaat agtcccataa actgtggatt 649500
 acagtggaaa atgacagctc taagatcata gcagggataa ctcaattcca catctgtttc 649560
 ccttctataa tgtggtttac tgtgggctg gagctgagag agctaagact accacgcaga 649620
 gcacttggct tcatgagttc tgcactgcag aattcagtgc ttttatccca ccatctgata 649680
 cataatagga acacccttg gcctagattt ttgctgctcc tttatacata aactaaagga 649740
 ttctggagta aacaggaata ttctgacta taaagctcat tggggacagc agcaatgacc 649800
 agtaaacaaa taaaatatag gtgctggaga gatggtcaat agttaagagc aatgaatact 649860

ctttcagagg acccaagttc aatttccagt acccatatgg cagcctaaa ctttccaggg 649920
 ggtctgacac cctcacactg gcatacattc agacaaaata ccaatgagag aaataaaaat 649980
 aaataaatct aatgaaatc agtccagatg ctgactgat ccagtcctg acccacatat 650040
 ggtactaact tctacaatgg aaatacaaag gaagatcaga agttcaaggt tgtctttttt 650100
 tgtttgtttt ttttgagaca gggtttctcc gtgtagcttt ggaggctgtc ctggaactca 650160
 cactgtagac caggctggcc ttgaactcac acagatccat ctgcctctgc ctcccagtg 650220
 ctgggactaa aggtgtgtgc caccctaggt tcaattccca acaccagcat gatggcctac 650280

aacctgtga agactccagt tcctaaagat ccaatagagt ctgccagcct ctcttagaaa 650340
 ttgtgtgtgt gtgtgtgtga atgaacaag cttcattaca aaagatagct taaaataaga 650400
 gaggaagggg tgtgctggct agttttatgt ctacttgaca caagacaaag tcatttagga 650460
 agaggaacte tcagttggga aagtaagatt ggtctgtagg caagactgta atgttttctt 650520
 aattagtaat tcatgtagga gggcctagcc cattatggtt ggtcctgggt actataagaa 650580
 ggcaactaca aggaacaagg tagtaagcag caccctctg agacctctgc ttcagttcct 650640
 gtcttcaagc tctgcctg acttccctca atgagggact gtgatgtgga actgcaatct 650700

gaagtaatte ctttccact tatgctgctt ttggtcattg tgctgtatca caggaaaaag 650760
 agacctage taagacaaga ggacaggcct gtgacctaac aaccccccc cacacacaca 650820
 cagtgaagc ttcccaaaga agcaaaagat gtgtggaagt ttgaatggaa ttggcctca 650880

taatctcata ggaagtggca ctattagaag gtgtggtttt gttggaatgg gtgtggcctt 650940
 gttggaggaa gggcttttag ggggcaggct ttgaggtttc atatactcag gaaactgcct 651000
 agtgtcaact tctgtttgcc tacaagatgt agcagttcta gctccagcac tgcctctttc 651060
 tgcattgccac taigttaatt gactgaatct ctgaaactgt aagcaacca cctcaattaa 651120

 atgttttctt tgtaagagtt gccatggcca tgggtgtctt tcacagcaat agagacccta 651180
 actaagacaa gatgtcagaa gtcaggtttag tggcagtcct tgggacaaca agaacctaga 651240
 agtagggaaa agagggccta tcagtactgg taatttccat tttctgtttc taggcctagg 651300
 ctttgttttt ctggttgggt cacagtgttt atctatcaag ctgaacctt tttctgtgtg 651360
 ttttctcaat taaaaagaaa tgttacttac aagaaaatac aagctgggca tggtagcaca 651420
 caccttaag ttagctgtcc catcctgtaa ggtctgaatc cgtttgtcct tctcaactg 651480
 aggcagagtc tttctgtctt tttcttaact acaagagagt cctgtctggg agaagaggct 651540

 agtctgtttt gccagcagat gtggagtcaa tgatggaagc ctgggcaggc catgttatcc 651600
 ttaaaagtaa tgagacatgg agaacagtaa cctttgatac aggaaattta ggggtatctt 651660
 tgagtacatt agagactttc tcagttctta gtgagcttag cctggaggtc tagggctcct 651720
 gaaaactcaa cagccattca agccaccctg agctagtagc ttttgagttt ttgtccagag 651780
 aatttgaaga atgagattca taaactgtag cgtatacatt ttagagaaga gtttcttata 651840
 gattacaagg agggaggaaa ggagaggagag agagagagag agaaccatg tagcaagagt 651900
 actaagtgga ggcttttctg tcccaccccg tctgcagct gcttttaaaa taactactca 651960

 gaggttaat attaattaca aactgtttgg cctattgctc aggetttgtg ctaactagct 652020
 tttaaaactt aaattaacc atttctatta atatatatca tgcattata tataataggc 652080
 aatacttgtt ctctagtata tcttgggtct caggcagctg ctggcatctc cctgaccctg 652140
 ccttctccc tgtatctctg ctttgatttc ttgcctggct gtatatectg ctttctata 652200
 ggccaaagta gcttctttat taagcaatgg taataacca tattcatatc atacagaggg 652260
 gtcccagaaa tagagtatca ctaagcttct agtccaggtt tgtttttttg ttttttactt 652320
 ttctcttttc ttttttttt aagtcttaag agtaaaacat agggagggggg ataagctggg 652380

 aggccagtt ggtctagcca gatgtccagt tgctgtctc cagttttggg cacatcctca 652440
 tgtattatag ctcccaggca aggacaagag ataacaacgg actaggaact ggaactgtct 652500
 tttgatattc caggtctcca gcaggacat ttgtagagct gattcgttgg ggtctgtatt 652560
 agttactttt ttgttgcgtg tgttgtgcag taaaacactc taataaaagc atcctaaaga 652620
 agaaagctta tttagcttg atgtccacaa tggtagggaa gccatgctgg taggagcagg 652680
 atgctaagaa atcacatcaa cagcacacag gaagcaagaa aagcaagaac aggaagtggg 652740

tcaagacaat aaacccttaa agcctacctic caatgaccta tttccttcaa caaggttcca 652800

ccttctaaag gttacataat ttccccaac agtggcagca actgagagac caagtgtgat 652860

tccaactatg actgggtcct ttccetaagt gactggtttc taactcctat ttccccgacc 652920

taggatccaa ggcttaaaaa agtcataggg ttgagcaaag tcttgcccag gtcctaatt 652980

atagtaatgc caaggttggga gagagcattt taatgtattt aatattttaa ttggcttgac 653040

atagatacca agccagtgtt cattgcagat gctgctctag aaacaatgg caagaagagc 653100

tgctatagga cataaggaaa caattttaa taacgatttt tccccctctg aaagcccgcc 653160

tactgactgt tgttttgaat gagtctgac ggccctggag agcagaataa gcatgggaat 653220

cagtctacag aactatttca gaataaggga gaagccacac ccttcaccct ctcacaccc 653280

cagcaagatc caaatgatta attagaacat ttcatattta ggactttccc cccaaactga 653340

cacttcttaa aaatacccat aaaggagagg aataaattct ataagaacaa ctttgtgtgt 653400

ggggggcagg tgaagattga gcagctggat cccagcagg caatttcaa gcctgacac 653460

agaatgagtg tcaccacact gtaaagaata gcagcctatt aaaaccaatt gtctccattt 653520

ggctgctgt tttcttattt ctgactctgc aagggtctta aaacaataat gtcccatgtt 653580

tgggttctg aacacacaaa attctgcttt ggaaagcctc aacctgaaag aagctgaaac 653640

caaatacttc cacctgcaat ttacttccga gttaagagtc agtctctttt ctctcatctgc 653700

ctgaccggat atiggaggaa ccaaatcaaa gggtataat gatccccatt tccaccta 653760

tgccittgca tgggctgtcc tgctacagac tgtgtccaaa gcaaagccac cagcgtact 653820

gccctcatga tggagtcccc atgtcttcag aggatgacac acagacactc tgtacctca 653880

gtgtgggct cactcttcc ccttatttca cagagcagtt ggaggctggt tggatttctg 653940

atgtcaggct tccaggtgtg ggtggctccc ttcccgcctg ggtttgctct tctgatggc 654000

cgtgtgtgtg gctttgcaac atggetgac cctccataag ggaccttctc ctttcccat 654060

glatctcagt agggctctgc attctgccac ggggtagggt tcaatcctc atccttctat 654120

tttctggctg tgttttggct acctgcctgc aagatgtgct ccatggccag ctgtctttac 654180

aatgatttaa gtgcttacat attttgggaa cttttgtgcc caaataacac ccagaaagt 654240

tgattctgga attctaataa acagaatgca ccaggcmeta ccatctmeta cmetaactgg 654300

gggaaagttt tctacaggag aagcaagag gmetaactaa attaatgga metaaaagag 654360

ggagaataaa cctgaagaag taagcaactc atgcattgct tcatcatatc tattccacag 654420

cataaaactg ttgagacgag actgtggaag aagtttctc tcttccact ggggtgggct 654480

caactatcat tatacaggac ccggtccttt ccttttaggt gcttttgat tcagtaacag 654540
 ataattccag atgtaaagaa aggatccaaa atcaagatgt agggtttttt tgtttttgtt 654600
 ttgttttgag acagggtttc tctgtggctt tggaggctgt cctttagac caggcttgtc 654660
 ttatagacca ggctggctcg gaactcacag agatccacct gcttctgcct cccaagtgct 654720
 gggattaaag gcctgtgcca cttacacttg ctttcttgtt gttcttggtt tggttttatt 654780
 gttgtttttt tgaatatgg tctcatgtaa acctagactg ctctttaaata tgctgtgttt 654840
 ggtgaggatg atcttgaatt cccaatgatg cacttgcttc catctcccaa gtgctcagtt 654900

 tacagacaag tgttccagct taaaaaaaa aatgttgaag agttatgaat agtcagaagg 654960
 gattggacaa acacctcaac agtctctggt tcctgtgtg tttagctggt aacaggcaa 655020
 gactctggct ttgctcacag tctaaggact aaaattttga aactcaccaa ttcatatgag 655080
 aaaattgaaa atcccgatg gttaggactg aaagtgagct cccttcttgg ctgagcttcc 655140
 tgctcccagt gtcactgatt cctggctctg cctcaactta tagtcagaag caacctgg 655200
 caagaagccc ctgctcagtc agccacagct aagctgcctt tcctcaggtt tctctccag 655260
 ggagggggag ctcaggtgtg ggctgaaggg cagccaagtg agctgcagcc taggaagatc 655320

 tggttttcct catcctagcc ccacagcaag ttaaccccag gagagctgcg atggctgcag 655380
 aagagttttg ttagctgtct aatgcctgaa tgttacctgc cgggacggtg aagctgccag 655440
 gcactgatat gctcagatgc aatgagatcc tcaactgttt aagatagttt gagccgcaat 655500
 cgtttcctag aacaatttca aaacaggtgg aggccctacc actgcaagta agctcttggg 655560
 aagttgtata ttagagtgca ctagcagaca tcatttacct gtttaataaa gttgtatatt 655620
 agattgcact agcagacatc atttacctgt ttaataatgt tgcttatgca aacaaagcac 655680
 tatttggccc agatgttttt acccagaaga gaaggaagca atgctctcca catatccttt 655740

 gatgagatga aaaacaactt tgttatgata aatctttccg ccaaaagccg cccaagttct 655800
 actgccacgt ggggtggtctc caccagccac cggagtccc agcgtggatg gacaaaataa 655860
 tacacagact tetattaggt acaaatgttg cctggccaat gactaggatt ctcatctggt 655920
 agctcagctt taattatcat aaatctatat attttataag acttatcgga caccttccat 655980
 tggcctcctt gctgggtgat cacattgcac tgctggagga ggcaaagggg aaaaggagat 656040
 acttctgtt tctccttgtt taaatagag tctccttgtt atgtcacctc ctgcctggat 656100
 caccacttct caactacatt tcccagaatc ctctttgact cctagtctg cetaacttgc 656160

 tgtctcattg gccaaccagt attttattca ataataata agataaacat acacagtagt 656220
 acattcccca tcacaacttg tttgtctctt gaattgaaca aaagaggagg aggaggagga 656280
 gaagaaaaaa atacaaaatc aaactcaaca tctggatgga atttagtatg taccttctgg 656340

gatccccggc tcctgaatgt ttcggctaaa gactccctct tccgaggctg cagaggctca 656400
agcctggtgg gaaatggtac tttgatgcca gttcctgcaa gttggtttaa ataggttgtc 656460
gggatgctgt agccccaacc aaacctgct gagggggagg ggagcaaatg ccttgcaggc 656520
atgcttactt gtgtctgggt ggacacctag caaggagggtg atttgtcact tgtgtctcca 656580

gacctggaag tgctcttcta tgtttatgg taacaaagga agattctagc tgggaagagg 656640
aaaatccac aattataata tgagcccgag ggaggagtgc catgatttcc ttgtcccct 656700
ctcttcagc caatctcact gaaagaaagt cagcattgta accctagtta tagtgaaagc 656760
attaatccc ttaagttagt tctcacttca catatcagag caatgatcac attcaaacac 656820
acacaaatag tattagtgtc atgctttgaa atggttaaggct ctaccagct acatgctggg 656880
aaaggaagga aggtattaca tctataaagc ataaaagtgt acgttatttt tagccttgtc 656940
aaaaacagtc ctgccaacct agccaccttc tggaaattgc tgtctagttt agttattaca 657000

atgctttact ttaactgag ttatctgtat ggtattacaa tacaatacct tcaactgcgt 657060
tatctgtaaa gaaaaagggtg tatttttagct tatgggactg gaaaagtga agtatgaaga 657120
aagcttcagt gaggggtgtg tgccagaaaa ctctaggag aagtgagcct gtgtgcagga 657180
gcatggtgaa atgggacagt accagtctca tcttatgata gagaggctgc tcaacctgt 657240
agttccagct atttaggaag ctgtggcagg gcttctaact tgagtgggat gatttacta 657300
ttctcatgag aactacagta atgctttctt gcaggagaat ccaacactat tatgttacac 657360
tattaggaat tcacaacatg aaatttgatg caggcaact gtattcggat catagcagga 657420

gtttatctag aatttgtcc tgttcagca gctgataaga atgaactata gctgggtggt 657480
ggtggcacac gcctttaatc cagcactcgg cagagcctgg caggctctctg aatttgaggc 657540
tagcctggtc tataaagtaa agcccaggac agccagggtt gttatacaga gaaatccat 657600
ctcagaaaaa caaaacaac aaacaaaaa ccatgatatt gtaggattaa acttattcta 657660
aaaaccagcc ctigggttta gtgggtagt cttaaagctg agatataaca ttgggagata 657720
aataaagatt ggctccagct tttctaatt gcctgcaaga gttgaagctt ctagaactag 657780
gcccatgttt ttgtgaaca gaattaaaga acctgtttgg aaccaaagga catcaggagt 657840

ttgccccctt tctgatcata ttatatagca gagcaagtca gtggaggtag gaagcacaca 657900
ggtcttgtct tgatcttggg atattatggt aactccaatc ttgcaacttt ggggagactt 657960
gagacaaagt cccacataca agtcacatac tctagcggga ataccctaat tggctttctt 658020
ttgcaaggat aaacatcatg actggaagca acttggggag aaaagggttt atttcatctt 658080
acagcttaca gtccatcatg aaggaagtca gggtaggaac tcaaaggcag gaaccaggag 658140
gcaggaactg gacagaagc catggaggag tgctgcttac tggcttgttc ccatgacttg 658200

cttaatattgc tttcttataa aactcagggt agcactgtcc agcagagtga gttggatcct 658260

 gtcacaaata tgattgatca agaaaatgcc ttataggctt acctacaggc caatctgatg 658320
 gaggaatttc ctccattgct gttccttctt ctaaagtaac cctagcttgt agtaagttga 658380
 ctattcagca caaggaatag tctcttaatt agatacttta tttccttct taaaacatgt 658440
 atgagaaagt gaaggaaccc tgtgtttgtt gttttctctt tttctttttg acccaaaaca 658500
 tttcgtactt ccctgtgtc cttgtttgat tctgtctgct actctaataa aatatcctga 658560
 gggcatagt tactgttcta ttgctgtgaa gggacacccat gaccaaggca actctgataa 658620
 aataaaactt ttaattgtag gattgcttac aattttagga ttagattgtt atctctgaga 658680

 tgctgagacc ccggccttcc tgagagtac tcttgtgtca ctatgacaga ataccagaca 658740
 taataaaag ggaagaattc tttactttga ctcatggttt caaaggattc cgtttgaagt 658800
 acttatctcc actgtttctga cctcatggaa acagaacatt tatgagccac aggattatgc 658860
 agtaactatt cagccatcat tttataaggt caacccatca gaatgaaaga ttctgttggg 658920
 ggattaaacc aagatgtaag ctgtgttggg gtttaattgcc ttttgaatga actggcttcc 658980
 ttgctgtagt ttgtttccat ctgttacaaa ttttggattt atttccacag tttattacta 659040
 tttgatcatt tattgggcac attttcccct atgcatttga ggtatattga taacaccccc 659100

 tagttatgtg tgaaaacagt cacacagtca aaaaaaacct gcttcccaca accaggtctt 659160
 tgttcctttc tccaatgtaa acgcagagat ctgccttctt gcaaatatct tcattggcag 659220
 gcgtttggtc agtgctaagt gtccaggcaa agtatttcaa ggacatagaa ttactacatg 659280
 cctaaaagta ttgattcata gtcacttaga tagaaataag catgccttgg ttttacctcg 659340
 attgcaggta agagaagtga tagcctaac taacctcaca ctaactcctt gcacttacct 659400
 tcatctcgat ttattaacce aagattttag ctgggagatt tattgcttgt gttaacctg 659460
 agaaaatagt gagtttgctc atcttcagag gagaagtaaa ctatctacag acctgctgaa 659520

 catctgcacc tccacagtca gagggtgctg gaggtgccag gttccgttcc ttgtgcaagt 659580
 taagcttaaa tctctctttt gttctataac ctttaagcaat agattttttag ccacacttaa 659640
 agaatgtaga taagcacaca atttctccca tttagactcc cttgttgact taatccctgg 659700
 aggagccttc attaactact cttaccgggt gccataaatg atagctgaca gttattctct 659760
 gtgtgtgact cttatctgcc ttggtgacce tgagaaacte aagcctcaca ttgcattgcc 659820
 agaagaatta ctgttgtaag tgtatttata ccagtacct cactgtagaa gatttttttt 659880
 tttttagaaa caatgaagag atggatagac agaacatggt gtgagcagat tcttgcctt 659940

agccctcaga tcttagttcc ttcacttatt gtaatgtctc ctttggaccc tgaagggtt 660000
 tttaggctg gcccttataa gccaccaata gaacagcatg gtagcagaag cgcagaaagt 660060
 cagggaaaga aggtgctggc agcaggcaca attatcaaag gaccagtga ctcccttctt 660120
 ccaactaggc cccactaact taaacactgg aacttccaaa gtaataccac tgggctaggg 660180
 accaaacatt caactcgtga acctgtgtgg gactttctg cttaaagctg acattttcaa 660240
 aacaaacac agtattcatt cacctcatag gagtcaagag agagtttatc agaaacagaa 660300
 tatgagtgac tatggcctgg gaacacaggt ttatatcacc ccaccccacc cccaaacaca 660360

 tatgttacia taagtaaca atttcatgaa ggttttatag taacaaaaca gagaaagtta 660420
 taaatgaaga cagtttttaa agacattggt gggaacagca ggcaggtgtg ttacagcaga 660480
 gcaccatctc ctgcctgtc agcctcagat ggtgtctgag gacattctta gcttttgagt 660540
 tgggtggactc tgagcacctg tttgtacagt tcaaaaggat ttaccaata gtgacacaga 660600
 tgttaggtca cacacagagg tgggcaatac acagctaaga tgtttggctc tggactcggg 660660
 acattccagt cactccaca tcacagaagt tctagtcagc caatcagctg ttgtttaga 660720
 atgttcaatg taaatgtgac tccaggaact taggttcata gttcccttgt cattcaagca 660780

 ttatgttttg tgcatgtggg ggctagatat tatttcatgt ctcaacattg ctaggatggc 660840
 tcattggctg gatctgataa agatgaggca gagtgggcag gaaatcagtc tttagaacia 660900
 aaacatgcc tggcttctg tttgagcagc aggacatgga tctgttccca caaacgctac 660960
 cttttgcttg gagccagtgt agcagatgga tgggtgtagg tgggtgagc agaaaggcct 661020
 ctgtagacct ggcgtactgt gccttactcc aaccaatgtg cctaaagact atctttgctt 661080
 ccttgcagt aaagacggga actcgtagt tctaacataa gcactggcat ttaaagtccc 661140
 caggcagaga ggctcaatgg ataaaagtgc tttctatgcc tgagttttat tctacacagt 661200

 agaaaagcaa gtaagggact gattgcatat tatttctggg gtttgtcagt ttattaaata 661260
 agaaaggcat tglgtgtggc aggggtgggg cggcatctga ccaggaagac gtaggggagc 661320
 gtgatgttc agagaacagt cagtctcacc ctttcagcct ttattgtttg aaccttccac 661380
 tagtcggggc ctcaggagag tccagctggc ccaagggtgt aataggaatc taaggacagg 661440
 gaaccctgg ggtaggaggc ctgactgtt cgtaaataca ggcatgccag gatcttact 661500
 ccaaagagt gtccccctg ctggccctcc tttcttata ttttcagct ctgtgatctt 661560
 tactgtaaag caaacatat ggtttcgata tgggctctg gcttactgaa agcttttcat 661620

 gctccagca ccaggatgct ctttagcccc tttaaacaac cacttgggca tctaagatct 661680
 ctccaccgt ggggtgaaga gccactgga cagcactatg tgggttacag aaaggggggt 661740
 aagaaattat ccatgtgggg agatacatct gggattcaca gaggtgagca cctggctcag 661800

tcacctgca gtgtcaaaat agggggcagg ctttttcct ctccatgctc cagctagatg 661860
 tccatctgat tcctagtgtg acatggcctt ttctgaaga gagcagagcc cagaccttct 661920
 tgaagaaatt agggaaggag gtattatctt aataaaggac catacaaaga tccaacccca 661980
 taaattggct ctccagtcac caagatcaga ttaagggatc aggtacttgt tggacgacca 662040

 atgagattca ttcaaagaaa actgtgattg gagcagtgag aaggtgaagg atcagccatt 662100
 tcccagaagg ggtcaaagct actaagggca ccacgaaggg atgatggaaa gataaggaaa 662160
 acaccaagc aatctctatg tagttgcagg ttccattgt cagtcagttg ttcttattca 662220
 gggccagtgt cctgtttac cctctgcaa ggaagccttt cttagcatat tcccatatag 662280
 ctggaccctt gcctccaaga ttccgtcctt ctctgtatca tgcaatctcc cttccttctt 662340
 agaactcgta gttgttgaat ttaccttgtt tagttgtttt ggtctcatgc tctaaccata 662400
 gtgtaagtgc taggaaagtg tcccatcaat gctgccggct cagggtctaa aatgtcacc 662460

 acggctcagg gtctaaaatg tcaccacagg agcagcagg ttaggaacat gctcaacagg 662520
 gaggggtgtg agcagagggg gaggaggag agctgacact agaaagccag atgaaactgg 662580
 gatgggatc atatggccag aaggactata aatgataagg agaacaacca cattttgcct 662640
 gatgtcttc agttttgatc atagccaaca gggctgaaca ctgaacttcc ggtgtgcca 662700
 gtgttatgct aagaactaca gctaaaaaga cagatgaagt cacaggctta gataatgagg 662760
 caaaagtaaa ctggagacta gctcttctt gagtttttaa tccctacact gaattgatca 662820
 tctaattggg aggagacaca tataaaaagc tcagctacat gaaataggaa aggaaacatg 662880

 agagatgca acgagcttca aggggaacat attgagggaa ctataagaga aagttttgt 662940
 ttgtttggg gttttgaaat ccaggctggc ttgaacttg ccatacagct ggctttgatc 663000
 atcttctc tatttctaa gtaactggaat tgcaggtgtg taccactatg cttggctgga 663060
 tgaatttca ttttgatgc aaagatgagt gacgagtca ttgggcagag acaggaagtg 663120
 tatttcagat gaagtgacca catgagaagg ggcatggaaa cctcagaata cttgctacat 663180
 ccagagaaca acaagcagcc attccagaaa agaaagaaaa aaaaagaaaa gaaatcagca 663240
 ggactttgt ttctaaaaat catcccaggg ttttagaact ggaaactgtt tttgactaag 663300

 ggaaagaagg gctcttaagg ttaaaggaat gcagtgaaga aagaatttcc cgtgctgggc 663360
 tatgagatgg tctggagaa aggtgtgtcc ttgtgaggct aagtcccagg gcagcagccc 663420
 tttcacagac ctctggggtc acatggcatt gaatgggtg cctgtgtact cggaaaggcc 663480
 agtgaaggca ttgctgttg gagcctccac ccagcctc atggctcaga cagacctaga 663540
 gaagagtctt ggtgtaacca ctgggaatgg agcactaagg acagcaggca ctgactcaga 663600
 ctgtctcctt aaataattaa aagcttctga aaggggcca agatttttt ctatccattg 663660

ttcataaaga gcccaagagca gttagaaaac taagaaaatg gggcatttgt tgacggtgtt 663720

 taacaccage cttcactctt acctttaaata cagtgtgtgc tggcccaaag atgcctccag 663780
 ccttattcaa gtctgcctct taaattggag ccttgacaca ttccagggtg tgtgcatatg 663840
 gatgtgcagt ctcccggtg agtaagcctc acccaggcct cagattccag ttctccggc 663900
 aacaaccag tgaggactga gacaagggtg aactcagacc atgagctcac ttgaagagaa 663960
 agggaaagaa actggcagaa ctgacataga atcgggggtcc ccacactctg ctgtgaaact 664020
 tatccacaag actgcactgc cccagggtgg ccacagcact cttcatgcct gacttactgt 664080
 gccagtcttc caggtggatc tcttcccaga ctccagggtg ggaagaaaag agccaaaacc 664140

 ttgtatattc ctttctgggc ctgtgctgtg ttatccactg tttgtctccc tcccaccgca 664200
 ctctctatct atctacctc ttcccttctt ccttaggagt cagttttctc ctttcacat 664260
 gtggtgaaag gttgtcagcc ttagcagcaa gcacctccac taattaaacc atctcactac 664320
 ctgttaacag ttttctatc catcttctta ggtgtgtgtg tgttatacac atgatatgca 664380
 ggtgtgtctt cacatgagta tgggtgtgta tggagtctag agctaagttt tgggtacctt 664440
 cctctattac taccacatc attttttgag gcatagtctc tcattgaacc tggagtgtc 664500
 atttatgcca aacaagctcc cagaatttgc ctgtctctg cccatctac agtgctgtgg 664560

 ttatagacat tcatgggctg ctgcacttga cttgatatgt aggtgctgga aatacaaact 664620
 caggtcctta tgctgcccc gcaagcactt agccctctga gcaagagtgg gagtgtgtgt 664680
 atactctt ggtaagagc atggctggcc tatgtctacg ggttaggaag actgttggag 664740
 ggggctggag agatgactca tcacttaagg gtactggctg ctcttcaga ggacccagct 664800
 tcaattcaa gacccacat ggcagtttac aactgtctgt aactccaatt ccaggggctc 664860
 ttatacctc acagacatac atgcatgcaa aactccagtg cacattaaat aaataaataa 664920
 gaaaaagaag gaaggaagaa ggaagaagaa gaagaagaag aagaagaaga agaagaagaa 664980

 gaagaagaag aagaagaaga agaagaagaa gaagaagagg tttgttggag tagtgacagt 665040
 gctgacagga gctctccagg ggctcatct cctgttctgc ctgactttac acgcctgaa 665100
 gacagcagct cagtatcccc cacttaggac actttcagac acaaaaatga tacagcaaga 665160
 gtccctgctc cccctcagt tctgggtctt agtgggagac actggccacc ctggccttat 665220
 gaacatctgt gggacatggc aggacggaga gatgggtgct tctaggtgac tgccattcat 665280
 gcggtagagt cctcacttcc tctaaattcc tgggctcacc taatctgcaa ttttccagtc 665340
 tcaactgact ttatcgtact ctgcttattc acacgttcc tgggattcct catgcgagtt 665400

ctccaggctt tgccccacac ttagaggaaa caggtagatg accatgaagc agaggttatg 665460
 agtgccagag ggagaaggatg atgtgggaaa atcttggtc tggctctcat tgatcgaatg 665520
 accaaatgta agttattggt ttttaaaaa cacacataaa acaaacaaaa aacccccact 665580
 tttctgaggg gctgaggaga tggctcagtt ggtlaagattc ttgccaagca agggggacat 665640
 gagtactgt gatccacagt acccacatca gacaggcagt gcctggaatc ccagtactga 665700
 ggagcagaga cagggtcatg cctggggctc tgtggccagc cagaaaaaaaa aagggggggg 665760
 tgacaagtgt taaaggaagt caccagtggt ggatctctaa cctacataga catatgcaga 665820

ttaccagag caaagctccc tgagttcca tttctcacc tggaaaatgt cccatagggt 665880
 tgttatagga gaacatactc agaaagtcca aataagtggc aggtttcata gcatcattgt 665940
 tataataggt tcactctca caattgcttg tcctacttat ctttaaaaa aatgtcccac 666000
 cattaaga ttcttattag gttcaatatt caaaagccct gtccactgta atctcttag 666060
 ggagaaatat tattcctacc cattattact cactgtcatg atcctgaatc agttcaggtc 666120
 aaacaggaca ggaattggtc acaagcacta atattgtgtg ggcaggaatg aggaaaagaa 666180
 atgtttacta aacctgggat aaggacttca gtcatactc catcatcatc gtcgtcattg 666240

tcatcatcat caccatcaat ttggtttgtg tggatgtgaa tgtggacatg atcagagaac 666300
 aactttggga gttggttctc atttaccacc gtagtgtctc tttgtgttc acactccagg 666360
 ctagttcgtt caagaggttc tggctgatta cagatgtgtg ccaccacatc tggctttctg 666420
 ttgttgcat tttttgtgtg tagaagtggg ggtgtatgtg ttctcagagg ggctatgggt 666480
 cacacgcaga ggtcagagag cagtttatgg gattgtttc tctcctcca ccatgtggtt 666540
 ctgggatgg agctcaggtt gtcaggcttg agcaagcacc tttactcact gagacatctt 666600
 gctgaccct cccctcaaa tccaactttc tgagtgggtt ctgggtcaa attcaggtt 666660

ccaggettat gtggcatgcc catttacctg ctgagctgtc tccccagtcc catattacta 666720
 attttaata atatattatt gttttgtctg tgctaagggt tgaacttagg gtctcattca 666780
 tgctagtcaa gcactccacc actgggatat gtcctgctc cacctaatac atattattgt 666840
 ttactggata ttttaaaac ttaaggacat tcaagtacaa agggaaatgt acgttatcta 666900
 tctgtgtcat ttttcataa tcagaacata attccagagg gaaaaaaca gttgttaaat 666960
 tctaaataat tactgatacc ggaagtaaac attttctgat ttaaatgaa gtaaatgtt 667020
 gcatctggta atagtgcac aaacctgaaa gtgatgttt ctagatgtaa tccaagctgg 667080

agagcaaact ggagaggcac cttgctttct catgaggata taattattg gaacacctc 667140
 tctatctttt tatttttaaa ttttatgtgc attagtgtt tgccatgggt gttgggtccc 667200
 ctgaaactgg agttacagac agttgtgaac tgccatgtgg gtgctgggaa ttgcacctgg 667260

atcctctaga agagcaatca agtggccata actgctgaac catctctcca gccccacct 667320
 tctgtatctt atacatctca tacatgacct gcacttttgc aaacaaaaga tgggtgtatt 667380
 agaataaatc aggccagggg gctgggcata gtggcacaca cctttaatac tagcacttgg 667440
 taggcagagg caggtagatc tctgtgagtt tgaggtcagc ctagattact agtgagtttc 667500

 aggacaacca gagatacata gtgagacctt tgaaaaaaca agacaaaaaa caaaagaaag 667560
 aaaaatgagg tctgaggaat gggcctgagg cttggaggct atcctcacct gtttagcaat 667620
 ctagtataag acttgcattt ttgcagtacc tttgatgaac aggctagatt ggcacataca 667680
 acacgtgttc aataaatagc tggagactgg cttcatgaat taactagcat tagactaact 667740
 caatccaatt ctigtctctt gggagccaa gaagaagata cttttctga atatgctctc 667800
 tcaactaccg tctacaccag taacagactc agcctaaagt ctaagcaggt taccaacatg 667860
 ccacaggcca gcatatcaga atgggttcta tgcgccaac catacaaata acagtctttt 667920

 ctctctttc aaacttgggt atatgacttt cataactgca tttagttttg gaatggtgtt 667980
 acccactaa gcaataagat aattccaag taacctttcc tcttaaaaa tgtgttttat 668040
 cattacattt gtttatttat gtatgtgtcg ggggcatata ttcagaagat aacttgtggg 668100
 agttggttct gtctccctt atatgggctc agaaaccaaa ctcaggtcat cagcttgtgg 668160
 caaatgctg atcttctga gccatgtcag caaatctata acttgcctc tttttttttt 668220
 aaaaaataa cctctttttt tttcttttta agattttatt tatttattat atatacaaca 668280
 ttctgcttcc atgtatatct gcacaccaga agagggcacc agatcttata acagatggtt 668340

 gtaagccacc atgtggttgc tgggaattga actcaggacc tctggaagag cagtcagtgc 668400
 tcttaacctc tgagacatct ctccagcccc ctataacttg ccctcttaag cgtcatttag 668460
 agaaagtgga gtgctctatg agtgtgtctt aactgaaat aaaccacact actgatccag 668520
 tctctatggt tgettgccaa gcacctcacc cactgagtca tctcaccagt ccttttattt 668580
 attttgtggg atggagggtg gggcatgcct tgctacagtc tgcatgtaga ggtcagaagg 668640
 caacttgtgg gaaatgggtc tcatcttcta tcttgtgggg ctgggaattg aactagatcc 668700
 accaacttag cagcaaatac ctttactcag agtcatctcc caaagtcccc ctccattggt 668760

 tttctcttc ttctctctt tcttctctt cttctcttc ttgcacctc tagctactgg 668820
 gttttctggg tggattttgg gggcagttgg aactcagcac aagtttctt agtgtaaatt 668880
 ctctttttat ttgttttggg gtttgttgcg ggagttttgt tgttattggt ttgctttggt 668940
 tttttgttat ttaagacat gacctacta ttagaccag gctggcctca gacttgtgcc 669000
 aattctctg tctctacctc ccaggttata gcattataag catatgcaac cacaaccagc 669060
 ctggtgtgag ttcttttggc tatgaaaact tagttgttac acttccaatt aggaaacttc 669120

ctcaaattac ggtgcagatc actaattgtg gagaccagag gcatttgggtg ccattgaact 669180

tccaggcagta tgtgggtctc tgtaagtcc agtctgcttg tgtgggaaca cctgctcatg 669240

ttttggagca gtctggcaat ttgaaatgtc tcttaggcat ggcagacctc aggtagagct 669300

gacagatctc tgaactggga caccattaac tgcattgcc catatcagaa ccatggcttt 669360

accaattata aatcagggga cctgagtcaa gttaattaac tttcttgggc ttcactttgc 669420

tcatctgtga agtggggaag tgatagttaa ttacagtac taaagtgaac ttagatgag 669480

atataagatc tcatgcaggc agatgctttg ttatattgag ttccttcaag cctatcttca 669540

acactctaga gggaatgtat tcacttgcct tcttttctt atgctttata aactggaggc 669600

ggcttgagct caggaactat tactcagagg caggttcaga aagggtgaat accataggaa 669660

gccaaagcaa tggatgcctt tcttcttctg atctcagcat acaatgttaa gaacaaaatg 669720

agttctcacc gacagggtg accaggactc tctcttaaca tagctcaacc cggaaattca 669780

tagactgatt tttttctgg tgctgggat tgaactggg gccttgtatg tgcagggcaa 669840

gtgtcctaca ctgacctgtg tgcccagctt gctaattgaa gtaataactt tgtctctgca 669900

gcctctctc catcccttga acatatacca agctagttaa agctggccaa tgtgtggaat 669960

gtgggatact tttttcttt tctttttct tcttttctt tttttgttt tgtttgttt 670020

ttagacagtg tttctctgtg gctttgaatg ttgtcctgga acttactctg tagcccaggc 670080

tggcctcgaa ctaacagaga tctctctgcc tctgcctccc gaggatggg attaaagggtg 670140

tgtgccacca ttgcccggga tactttttc tacgtgatac tagggatcaa attaaattaa 670200

aaattaaaca ttatattaa aatgaactga aaattgctca caagtaaggt gcagagtgac 670260

acacagacac acacacacac acacagagag agagagagag agagagagag agagagagag 670320

agactgaggt agatatctc tgtacaccag gctttgctcg cctaactctt atctgtggac 670380

tttcattata tgttacaag ttatcactat ctcatgtgg gaatatgtgc tattggataa 670440

ctgacaataa ctgggctaaa cataatggtc ttattcctgg agccatgcct agtcagcaga 670500

aatgatgcc ctctactcat gagacaaat aggacaattg tatgccactt gatattcagt 670560

actgccacag gaataggacc ctggctcaaa cctcctcagc atgggaagaa gggcataaga 670620

gaatttaagt tgcaaggcag ctgtcagatg tctcctctgt gtttcatcat tgcatttac 670680

ggaatagttg ttgatataat gcctttgtat gatTTTTTcc cttctgtaac aactgaaatg 670740

gaagtgttcc aaactgagga aaaggagaga aagtgacttg atcttggatg gaatatttat 670800

aaactgatga ggaattgttt tacccttgg gttttagctg tgatggtcag gctgcgtctt 670860

actcatctct gtgtccctat tgtagaggaa gttcagtaaa tgcttattaa taaacaggtc 670920
 agataaaacg ctgcaaagta tgaagtggt ggtgccagta ataagcacta gagaagcccc 670980
 caaaagaaga gatcagtggg aatctaggaa gggaatctag ctaggaaggg atctgtggga 671040
 aggggaggag ttcagggaa ggactgcaact gtttggcag aaatggatta aatatggaac 671100
 gatcacagac ttccaaacca cttaactca atgagcctca ttttctcacc aaagcagcac 671160
 aagtgtgtgt gggaattttg tttttattt aattttaatt atttttgac agggctttc 671220
 cacatgcccc agctgtcctg caactaactc atggtgtctg agttctgggc ttaaaggcat 671280

 gtaccacat gcctggcaat aaagaaaata aacttacatc ataggcaaag gagaaatggg 671340
 atccttgtag gagggattga tgcagaattg gtcatttttc ctttcttggc atatgtagcc 671400
 attccactga ttigaacatt ttctgacag agttctggag ttcttaggtt gctgagattc 671460
 tagtcttcag tttagtgtat ttctgtctt cctacctcac agcaagcatt ttccagaaaa 671520
 tgtcagtagg gacatgggaa gcatccaacc acttccctgg acacacaata taataaactg 671580
 gggaatcttt gaatgctcct cttctgtttt tgtgtttctc ctgttttagt tagttgcttt 671640
 gtttttaata tgggacctca tgtagcccag gatggcctca aacctgtgta gcttaggatg 671700

 acttgatcca ctttctgca cctccccagt gtaggatta caggcatgca ccacaatgcc 671760
 cagctcaage ttcttccag cgggagtctt ctttgcctc actgggttcc cccaggttca 671820
 gatgctgttc atgtgtctca ggccacatca gaagctccgt tcaactgca tcagctcggc 671880
 tgaggactct tgatttggcc aaaactga caaacactg agggccaag aggacaggt 671940
 actcgtctca agatcacaga gtctacgagg ggcagttaga tctgaaacca aagctttgac 672000
 cctctggtec tctttcttct gtgccttggg tgccagaaa cacaagccag aacaggagcc 672060
 aaggatgac tcccaaagtc atgagcacag tcaggacttt aagacctgca tgaggtaaag 672120

 ccaccataca acacagaaga gcacttccag gtctggagac acaagtgaca aatcacctec 672180
 ttgctaggtg tccaccaga cacaagtaag catgcctgca aggcatttgc tcccctccc 672240
 ctgagcaggg tttggttggg gctacagcat cccgacaacc tatttaaac aacttgcagg 672300
 aactggcate aaagtacat tcccaccag gcttgagcct ctgcagcctc ggaagagga 672360
 gtctttagcc gaaacattca ggagccgggg atcccagaag gtatgtacta aattccatcc 672420
 agatgttag tttgattttg tactttgtct tcttcttctt ttctccta atcatactta 672480
 aagagtgaac aaattgtttt catgttatca aacaatgtag gagaagaac atggttcctt 672540

 ctttctggg caggtctaca ccgaataaat gaacaagaca cttacagtgt ctgggttaca 672600
 cagacaagca tctgaattcg aaattagcat tctgtatatt cagcagaatt accaggtgga 672660
 tggactgtat tgcaaacact tcagtaaaat gcaaccagca accgcaagtc ctctgtactt 672720

tacagcttcc agaacaatth acctgtgctg tagtgagccc gtctatthttt aaatccttct 672780
 agaaaactac tgttgtacaa gtactgttgt acaagtagat ccaacagtaa aatgtacatg 672840
 ttactttatt agaaaggag actaaatgaa actttctggt ggcatctgag catctcagtg 672900
 cctggcagct ttaccatccc ggtaggtaac attcggacac aaaactcttc tctgtctgcc 672960

agcacagctc tctgggggtt aacttgctgt ggggctagga tgaggaaaaa cagatcttcc 673020
 taggctgcag ctcaacttggc tgcccttcag cccacacctg agctcctccc ccttgaaga 673080
 gaaacctgag gaaaggcagc ttagctgtgg ctgcactgac aggggcttct tgccagtggc 673140
 tgcctctgac tgcaagcggg agcaggacca ggaatcagtg aactgggag caggaagctc 673200
 agccaagaag ggagctcact tccagctctc aagatatggg atthtcaatt ttctcatctg 673260
 aattggtgag thtcaaat ttagtctta gactgtgagc aaagccaggg tcttgctgt 673320
 ttaccagga aacacacaag gaaacagaga ctgttaggt gthttgtga actcctctg 673380

attatthtg gcttcttca acaatgtht ttgttgggt thttgttht thtgtthtt 673440
 thtgtthtt ggtacttht aatthgatt aactctcag tggaaaatag gthttaaaga 673500
 aaaacaaac ggagccacc actgcacttc ggtgcttg catttgacc cagccacag 673560
 aatgattcgg aagaatctct gcagacctc aagatcctg aatctatat gaaggacct 673620
 agatgtgaaa actccgtctt catttcagt ccttcttht tactggaat taccctcact 673680
 gaccatagag agcagthact gatgaactc gggacaggc ctgtgcagt agaggtgagc 673740
 gcatctgga gaagaaatth attccttca gcgagttht taattaatat tgtgtctata 673800

ctgtagtht atagctaata ggaggcataa thattctth thtattgtca agtctctca 673860
 accttctca gtatthaat tagthttgcc tcttgcttc tctttagaa aactthccc 673920
 cagthttgt thtagatgt ttgccctgt gcattctgt tattagaatt ccagaatcac 673980
 actthctggg tgtatthgg gcacaaatgt tccaaaata tgtaagcact taaatcattg 674040
 taaagacagc tggccatgga gcacatctg caggcaggta gccaaaacag caccagaaaa 674100
 tagaaggatg aaggattgaa ccttaccctg tggcagaatg cagagcccta ctgagataca 674160
 tggggaagg agaaggtccc thtggaggg atcagccatg ttgcagagc aacaacagg 674220

accatcagaa gagcaaacc aggcgggaag ggagccacc acactggaa gcctgacatc 674280
 agaaatcca ccagctcca actgctctgt gaaataagg gaaagatga gccccact 674340
 gaaggtacag agtgtctgt tgtcatctc tgaagacatg gggactccat catgaggca 674400
 gtagcgtgg tggctthgt ttggacacag tctgtagcag gacagccat gcaaaggcaa 674460
 thtaggtgaa atgggatca thtagcct thgattggt tctccaata tccgtcagg 674520
 cagatgaaga aaagagactg actcttaact cggaagtaaa ttgcaggtg aagthttgg 674580

ttccagcttc ttcagggtg aggccttcca aagcagaatt ttgtgtgttc aggaacccaa 674640

 acatgggaca ttattgcttt agagcccttg cagagtcaga aataagaaaa caggcagcca 674700
 aatggagaca attggtttta gtaggctgct attctttaca gtgtggtgac actcattctg 674760
 tgtcagggct ttgaaagagg ctctttcagg ttccacaaga cagtctggag gaatctcaa 674820
 gtagaaagaa ttccaacatg ccttatgtca ctgacacagg gacggtttct ctctatcaag 674880
 cactgatgcc tgtggttaag cattcaggca tcaggcaaac ttgccagagg ttacagtagg 674940
 actcgggaag cagaagagcc aagcagactg gacataagta gctgagaacc agagccagga 675000
 tgaaatattc ctataggaga gaaatggagc taggaaccag caagctccga tgtctgccac 675060

 aggggttcag tccatgtggc acctttgtcc gagtcaagaa gagctgaact ctagaggaaa 675120
 ggtttcacag gcacgggact tctttccacg ggggtgggaa gacttattca gctttggggg 675180
 aaaataagaa agctgcacag ccagagtctg catccaatct aaatacctgt gtagctgget 675240
 ctgcgcaat ttgtggaacc tgtcaggac tgctttgtgc tcacaggcag ctagcttgag 675300
 gaaaaagcag agggatgggc actgcgacag gggaagggtt cgatccactc actccttgac 675360
 tggcctcage aaaggtagag aggatcccat taaaaatcgc ctgctgggga gectgggget 675420
 cagtcttcac ctgcaccctt acaatattgt tcttatagaa tttcaattcc ttcctctct 675480

 ttatgggcat ttttaggaag tgtcagttg gaggaagcgt attaagtatg aaatgttcta 675540
 attcaccata tggatcttat tacacatgtg tcgggatgcc aggtgtgaca ctcttggat 675600
 ttaaaaatag tttgactg cctctctacc tctattgcc tgtgaggctt tctgcactc 675660
 attgacctgc ccagcctcc atctttgtct gcatcaagtg taaagtaaaa atgagctgct 675720
 tctgctggca gggattcatg taggtgagat gagagcagaa cgagaatctg tctcagctgc 675780
 aagagacgga caagttccca cgctgttggg ggtgacaggt ggttattcta caatcactta 675840
 attttaaaag ccactctctt atcctgccac ccccaaacct ttaaatattc tgagaatag 675900

 tagactttct ttttgtttt tactttgaga aatggtctta tttggccag gttggcctgg 675960
 caactctatg acctgaatt cttggtcccc tggacttctc ctgatgagaa atgtgcagat 676020
 taaattgtgc aaccacact tggccatgct ttaagtaaaa aacttattga gagaaacaca 676080
 cagtgtttga ctaagtgaat tttcactgtg actcctccca gaaaagaga acctaggcct 676140
 agaaacaaga atgataagc atggagaacc ctctctctct ggtcaagacc cacctctctc 676200
 taagaatagc cataaccac ccagagtgtt tgggatctgt ggtgtgtgtg tgtgtgtgtg 676260
 tgtgtgtgtg tgtgtgtgtg tgtgtgtgtg tgaagcgca tgtgtgcatt tttatgaatg 676320

gcttcatgtg atttttgcaa cacatcagcc ccatctcatt ttgtgcttta tatattggaa 676380
agttcaactc aactttcctt tatattagca aaataaggat tcaggcattc cacattttgg 676440
tggatataat tcaactaaatg tggcatctat gtggaactgt tggcccatat aacaaatgac 676500
tgaaggatc aaatgattaa tataagacat tccttctcat tcataatttc agacatataa 676560
tgctcttaat tccagcgcgt ttcttgtatt tcagtacatt tatttggggg atgagctctg 676620
agtttagagg ttcgtacatg ttaagcactc tggcctgtgt atcttaatac ttcagaatca 676680
ggcatttatt cccatgataa tttttttctc agctcatgta tcagatcctt ctaaaaattt 676740

ctagggcact tatacatatg aaatggacta aaggaatag ttctctact gtttctata 676800
tccactgaag aattactgcc acccttctac cctcagaagg tggttcattc tttcaaccaa 676860
cagtatttac tgagtgcctt ctatatgggt gttctattcc agaccatagg aatacagtgt 676920
tttattttca gacaggtttt tatttatgta gctcatgctg gtattaaact ctcaacagtc 676980
cgtctgcctc aacttctca acatgaggac tatggggatg cccaccatcc tcagcttaca 677040
attcagtgtt aaagaaagaa aactcggggg tagactcagt tagaaaagca ctgcccatac 677100
aactgagcct gcacataaaa atctcagtgc cggagaagca aagacagcac gatctctggg 677160

gctgaagttc aggctcagtt agagaccctg cttcaaaaaa taaggtagaa tgattgaaga 677220
agacacctga tatccaccta tgggtgtgcc atgtgcaagt gcgaaagagt gaggttgaaa 677280
gagcgttgt gtcacaca caacacacacacacacacag aatgcacact tgcataacat 677340
acacacaact tgcacacgag gtgtacacac agaaacatgg acatatgcac aaaaaagaaa 677400
gcattgaaaa tggaatgtaa atacatata aactagtga caaaatctc aaaaaattta 677460
aattaaaaaa aaagaaaaa tgaagaacaa atgacacagg gcaaaattta acagataatg 677520
acagtctaa aatggaaata aataagataa ggtcaaaggt taactggaag gtacttactt 677580

tggagggggc aggaaaactc tgagtaatg tatgggaata agacttgagg aataagaacc 677640
agctaaggaa atggcaagtc ccagggctag catgagaaag aaagaccagt gtggctataa 677700
gtctactagg aggataagaa tgaattatcc tggaaaagac agttagagc cagatcatat 677760
aggcccttat aagccatggt gaagaatttg gacctaggca ataaaaatca tagagttttc 677820
aacagtgtc caatgtgtc tcagttttcc ttttttttt ttttttttt tttttaaca 677880
tgcagacaca gttcacaggt aggggacaat gtagattata tgtgtgagta tgatgggtc 677940
tgacagctgc acaggcagtt ttccaaaatg gctaacattt ttattgtcac tttgagtcag 678000

gttcttatgt tgctcaggt gacctgaaac ttctgatctc aaggatcct ggtctccaag 678060
taaccagtac aacaggatcc tactgtgcc tetggctaca gtatattttt aaagtctgt 678120
cagtatatgt taagaattct cttgccaagt atgttagcag agactgggat gagggtaaga 678180

ttttgaggca aacctgagct acataacaag aatctgcctc aaaaaaacia agtaatacaa 678240
 aaagcaagca agcaaacaaa caactcaaaa ttctcacaaa catttggtaa tcagagattt 678300
 ggggtggaag tgttttgttt gttgatgttg ttatttattg tttgttttag gtatttctaat 678360
 ggatacaatt gatgtctcac ttggctttgt ttctttgctg cataattttt ttttttgctt 678420

 tgtttttggg gagagagttt cttgtgtagc ttgggagcct atcctggcac ttgctctgga 678480
 gaccaggctg gcctcaaaact cacagagatc cgcttgctc tgcctcccga gtgctgggat 678540
 taaaggcatt caccggctgc tgcataatgt ttattggtca tttatgtatc atctttcact 678600
 gtccctgtcc caaggtttag tactttaaaga aaattgtgtg ggcacacatg catgccatgg 678660
 tgtcatcgtg ggcgcacatg catgcaatgg tacacatgtg gaggtcagga ggcagctttt 678720
 gtgagtcagt tctcaccttc cacctgtaca tgggtcccgg gatcaggtct ttaacttac 678780
 acaagtgggg ttaccagtgt agccctctca ctggccctgc ttgtttgcaa agataggatc 678840

 ttgctgtgca ccctgggggtg ggttcaagct cctcagctta agacattctc ccaactccgc 678900
 tttctgagta cctagaacta caagcatgca ccatcacacc cattggagct ttaaaaattg 678960
 tactgtttg tctttttgtt attgaatggg tgttatttgt atatagaggt ttttatttca 679020
 tcagacattg tigtgtttaa atattttctc cagggtatac tttgtgtatt tatcttataa 679080
 cagtatattt tgagtctgag aacaaaacag aaataagcaa ataaacctt gtagttagaa 679140
 ataattttaa aattattgaa aaagtaaatg cagcattctt tgtgagttga cctttttata 679200
 atgcaatacc tttgtttctg ttagttcctt ttctctgaaa tctactttgg ttgctattga 679260

 ttcaaacatt caattgtaa tagaattctt aattggicta agtaaaaaga aaaaaaacct 679320
 gcaagatata accacattca attttgtttt gttttgtttt gtttgcttag tgttttcatg 679380
 ctatgaatt taacctaaact atgacattac atttgaggtt attattatta ttattattat 679440
 tattattata gataatatgt agttggttca tttaaaaaaa ttctcctggg gcctttagaa 679500
 atgactcagc aattaagagt acttgctgct cttacagagc acctgggttc aattctaagc 679560
 acgcacattg atgattcaca accatctgaa actccagatc cagggaatct gatgcatata 679620
 tatgtatgtg caggcaaaaat acacataaaa tagactttaa aaaatcccat tetgacaatt 679680

 gtgcacttcg tagtgtttga tataataatg tafgctagaa ttaaggtcta tggctttatt 679740
 tttttctcgt attgaccttt gtttctattt cagtttctta tgtattggtt tatcatcttg 679800
 ggcagttttg gtgagtgatg aaggattat aacatatata tttaaaattg cagtctgtgt 679860
 acaatcagtg tttcaatcag gggagtattg gaacatacca ttagtatgtt ttttttcctt 679920
 tacttcccac tttacaatgc aattatctgt attttttttt tacacttaca catagaaaac 679980
 cccaacagag aaaaatcata gcctttgctt ttaatcctca agcatttttag atgtttttaa 680040

attatgttta ttttgggagg agacatatgt gtcatagcac atcagacgac agcttgcagg 680100

 agtccgttct ctccttcac catgtgagtt ccagagattg aactcaggtc atcaggattg 680160
 gcggcaagca ccttccctg ctgagccagc tcaactagca tcaaacagtg ggaaaacctc 680220
 acagagtagg aactgagaag tgtttttacc tggatagttc ccattctgcc acttctcctt 680280
 cctccttctg gcatcatttc ccttctctct gaagaaacc tctctcagca gctgttccag 680340
 agggagtctc ctaacagtgt gttctcattg tctcctgcta cctaagggtg tccttatctc 680400
 atggtcattt atcctggcta tagtcatcat ggcacataga attcaggag agcgtttgtt 680460
 tatcatgtta aaaatgtttc acttcatttt ggtgtcaatg gttgtgtcgc agaaatacac 680520

 agccattaaa tcagtttgcc tgtcagtaac atgtcgtttt tgtgctgtcc aatttctttt 680580
 gttgttgttt tccattttaa atttttatct tattgtatgt ttcctccgtg ttgtgtgtgt 680640
 gtgtgtgtgt gtgtgtgtgt gtgtgtgtgt gtgtgtgtgt gtgtgtgtgg tgttgtgtgg 680700
 cataaagtga ggctggaaaa atggcctcat ttcttagaga acatacttct tttccagagg 680760
 agtggggttt ggctcaaaga caccagaggg ttacagctt cctgtaactc cagctccaag 680820
 ggactgatcc agtgtctctg gcactcttca gcacccaac tcacatccac atacctgtgt 680880
 gtgtgtgtgt gtgcatgtga gtgccttcat gtacacacac acatacatac acacacatgt 680940

 acacacacgt acacacgcac acatacatac acacagagtt aaaataagt ttttttaaaa 681000
 agtaccattt tccttcaaaa cactgttgca tgcacaacc actcatgtca atatgtggtt 681060
 tcaattattt ttcctttcaa gtagtttcta ttttggacc tatggattgt aagagacagg 681120
 tgtgtttgtt ttcaagacat ttggagaatt ttccaaataa cttttcattg tggttcttaa 681180
 ttaatactg ttgaggctct atcagactct gtattatttc agtcttttaa aatgtactaa 681240
 gattttttta tggtaaagca tatggcttac attaatgaat agtccagcta tatttgaaaa 681300
 gaatgtgttc ttttcagttt ggagtagagg attcaatagc ggcaggcagg tccatttggg 681360

 ttacattgca ttattcacia tttcctaact gattgtgtga ctgtccaatc catctagttc 681420
 caggaggaag gtgcagacac tggagcagca gctgtgtatt cacctacttc ttcctttcct 681480
 ctggcaactt ttacttctta ttttttaaaa ctctgttgtt acatgaatat gtttttagaa 681540
 atgttacgtt tttaaaaaaa ttgtttgttt ggcagtattg ggaattaaac tcaggcctc 681600
 atgcatgcta ggcaagtgtc ctgcctctga gttacagtac aagactaaaa tgctattgtt 681660
 taaattacac acicttctat catgaagaaa tattccccgt acctatcgct gtgctcctgt 681720
 gccctcaggt tactttacgg gtgtttgtag agccacttca gctttcctgt gactcctcag 681780

tacccttctc cttttactg cattagcatg agcctttctt gagagcaaca tccagtttgg 681840
tcttgctttt tcatccagtc tgggactgta ttgatattag agttctattg ctatgcaacg 681900
aaagactgtg aatttaggag ctgttaactc tcagtctttc gtcagaagtc tgacctggtg 681960
tatgtagtct ggctcactgc tacgggtcca acaaagctga aatcaagggtg gtggctgctg 682020
gtgttcccat ctaaaggaag gttctactgc caagttcgtt ctggttgca gaattcagct 682080
ttctactat ctcaattgacc attggctgct agtgacttcc ctcacctcaa gagggctgta 682140
tgcataaatc ttcttgtagc cttccacaa catagtagca gcagaatctc cctctcaacc 682200

aatccctctc aacctttgaa cctctttgac ttctaccacc aaaggagaa aatgcttctg 682260
ttgctcctgc cacctgaaaa gcatecttat ttaacatca attgaatggt aatactgatg 682320
gcaagcagga agtccttagg gggcaaaagt catgggacca tcattgaatt ccacctacta 682380
catcactcct atttttaatg tctttttatt ttgagataat ttaggatatt tatgcatgtg 682440
tgaagtatgt gtgtacctgt atgtgtgtgt gtgtgtgttt gtatgtatgt acacatgtac 682500
gtgtttgggt acagaggcca ggtgttgatg tcttctcta ttgagctcca tcttactatt 682560
tgagacaatc tctttgctga acctagacc gatcaatttg gctaggctgg ctgaccagct 682620

aatgagcttt agggagcctc tectctctgt cttctcagta ctggggttac cagcttttat 682680
atgggtgata gggaaaccgaa ctcaggcttt ttcaacaggc ttttgaccta ctgaatcacc 682740
cctgtggccc ctaatttata attatttagg gaaagctgca aagctttcat ttctgcacac 682800
ctgtggctct acitttccat tgttctctgt gtgtgcatgt atgtttctgt tcgtatggag 682860
gtccaaacgc aaccttgggt tcagtcctcg ctctgcttct tgtttgagat gggctctctt 682920
gtctgcatct gggaacacca ggataagtga ctcatgattc tgtggagtct cccatcctg 682980
ccttccatct tgttgaggga acctaggat gacagcagac actacctagt ctggcttttt 683040

atgggttctg gtgctgtgga atattgtttt aactgtgtaa aggtgtgcta tatttttctg 683100
ctgcttttgt taacgatggg aagatgtgtt acaattgttt gattaataa aattaatctg 683160
gggtcagaag gctgagtcag caactagctg acaggaagtg gtagagagga attaagtgtg 683220
ttgagggctc tttagtgggg cttgagccaa aggacacctt gttttgggga gacacagcaa 683280
ggagaaaagg ttaactactt gctcttcagc ctctctgagc aagcaaaatt tcacctcaac 683340
ctttgactcc tgagttctat agacatatag aaatctagat aaagtttctt ctagtggcca 683400
caatagagat gtgcctgaag gaatagagtt cccacatggc tgcggccagt gtggtggaag 683460

tgctgctggt agctgcagag atgaaaacaa tgccttgggg atcatgtttg cttggcaage 683520
actttactga gatgtctcgc agctctgttt ttgtttgttc tcagctctgg gaattgaacc 683580
aaggatgatt ttgttttgtt tttgaggcag caccttatta aacagcccag gctggtctgg 683640

aactcaggct cciccagttt cagtctctca acttctggga ttacaggcac gtctcaccac 683700
acttggcgtc gtttccitta atattaacaa cttacagaat catagcatag tgatcaaagc 683760
tagcacgttt gtattgaggg aacagtgcag tcagtgcagt tctatcggat ctccaccggtt 683820
tttctctccg acatcatttt cataatctga gagctggttg aggtttgcat attgccttta 683880

gttgtcatgg tacctgttat cctcttaatt ggtacatcct ctttaattaat acagttcctc 683940
tggaattttt ttgggggggg tctcttctga catgaatctt tgaagaatac tagccacata 684000
ttttataaaa ttttctgag tttaggtttc tctgatgctg cctcaacatt aggttaaagt 684060
tatttttagt aaggacaaca cagaagtgat gatggcctt ctaccatgga atccatagcc 684120
tattgtctta ttggtgatat taatccaaaa ctcccagtta gttagatttg agaaatccga 684180
gtttctcaac ttggaatta ttattattat aacctttata atagatattt ttaggaata 684240
ttttctttct ttctcttttt gggggcgagg tgtttcgaga cagggtttct ctgtgacttt 684300

tgaaactgaa cccaggctct ctgcaagagc agcaagtact cttaacctca gagccagctc 684360
attcctttta tttttatttt taaaagagtt attttatttt atttttgtgt gtgtctaagt 684420
tataatgta tgccatagt gtgcaggat ttaccggagtc caaagaaggc attggggccc 684480
ctgaaacttg tgagctacct aatgtgggtg ccaggaacca aaccaaagtg ctcttaactg 684540
ctaagacatc tctgcagcct gaaaggaatt ttaaaatgag aaatagttcg tcattgcttg 684600
aaatattgca tttatttttc ttttctaaaa cccatctctc tctctatcta tatatctata 684660
tatagatata tagatatata gatatataga tttttcatt ttaaaaaat gagtataaag 684720

caacattttc tcaaaccag aggtgttttg gggctgcaaa aacagagcaa ttaaacctgc 684780
tatgaaaggg aagacctga aaacctttct ctgggtttt gatttacaag tgcacttgcc 684840
ataggactgg agctttgggt aagagagaaa gggccctgc aaaacgccg agattaagga 684900
gaaacagctg tagtaaaaag catttgactt taattgtgtg gaagataatt gggcccgttt 684960
gatttctgaa agatttagaa acagagggtc ccagaggaaa cagataatga ctggagaatt 685020
gcagtacagg accgtgagct tccagcctaa gttatcctaa ggcggattgt ctgcaacta 685080
agaaaacact tcaattaaca tcttccaaat ctgtcttcag gctttattaa agaagctata 685140

aataatcag attgttcaga atggctcca ataaaacttt aattattttc ctcataaaca 685200
gactttatgt cctgggttct tttttgtgt tttgttttt caagacaggg tttctctgta 685260
taacagccct ggctgtccta gaactgtctc tgcagaccag gctggcctcg aactcacaga 685320
gatccgctg cctctgcctc ccaagtgtg ggaataaagg catctgccac cacgtcgagc 685380
atgtcctgtg ttctttggct taagattctc atcatttaca tgtcagaagt tctggagatc 685440
tttttttttt tttttttttt tgcttctccc tttctcagt ccttctgac agaacaaagc 685500

cttagttaa taccaaacta ctttggactc attgcaagcc atattcaatt atgacacgca 685560

 agacaccagc acctgcaggt ctcagtcatc catttttaggc aaattcccc tggaaggcag 685620
 gggctcctc aaagctgggt attctgcaa gataaggaaa catttgcttt agtgacctct 685680
 tcttgctcag atccctgcag ctaatttttc attttgattt cacgttctct tacctacaga 685740
 aagcttaca aggcattgaa gcttcagaat ctatgaaacc tggatctgcc cctggactca 685800
 ccaaaaagcc cagcactgag tttttattgc caaatcatct gtcctcact atcccatccc 685860
 agttgtgatt ggtcagtagg cttcattcta ttattctgat tccgtcttc acaggacaaa 685920
 tgtataaata tttagattct gtctcttctc ctatttagag agttaactta gtcagagggg 685980

 gcctttccca gtttcagggc tcatcctgic tggcctctta ctgacatctt gcccatcttt 686040
 tctctctct gcttccattc tttttaaac tattctgcc tgtcagtggt ggcacacacc 686100
 ttaatccca gcactcgaga ggtaaaggca ggccgatctc tgtgagtctg agtaatctac 686160
 agagggagtt ccaggacagc caaagctaca cagagaaacc ctgtcttgaa cctcaccccc 686220
 aaagtattta tttttcaca atttcataca tatataatgt acttcaatca tattcatctc 686280
 cccattatt ctctcatgcc aagtecttct tcccacaaa ctccttgca ctttctgtc 686340
 ttctgtgtgt gcaggtgtgc acacactgag taccactgc atttaattag gagtgtctgc 686400

 actaacacag gtgaggttat gtacttgagc aagggcattt taccagtggc tactctacct 686460
 aggattatga ctccataccc cagcaaccac taactcccta tagctctca gggaggaag 686520
 gggcctcaca agccctcaga cttcttttg gagacagaac atctctttg cccttagact 686580
 tgagatttaa aaagaacaat tagcagaata aaccttttc gtgactatgt aaattagaga 686640
 aatcttatga ctactgtttt gtttgtttt ttttgtttt ttgagataga gtctcactat 686700
 atcaccttg ctgggctaga actcactaag tagatcaggc tcactcaca ctcaaaaga 686760
 tccactgce tctgtctctg cttctgaga gctaagacta aaagcatgta ccaccacacc 686820

 tggccatgg ctacttgcta tatgtaaac atcttaattc ctagtccatg tcttctctc 686880
 tcacatgggc atactctaca aactaagtca gtgaatggat cagcattctc cacatatgac 686940
 tgtaatacat gtcttagga tctcattgct gggatgaaac actatgaaca taaatgactt 687000
 gaggaggaat gggtttattt cagctcaca cctcaagca ttatctaact ttctgttaat 687060
 ctctccagca aatttcttt ttctctttca ttctctctc ttaatttat tttttacaag 687120
 gaatcactgt gtaacctggc tggcctggaa ctaccattg gtaatttat cagggatgcc 687180
 ttcatgtac aaatacaat gtaggtcacc ttaatttga gcttcatatt taatgatgag 687240

ggtgtgggaa tgcaagctgt tcctcagctc tgataagtct ttcaaaccac catacctttc 687300
 agagacactt tgcttcgcat aagaataaag agaaaatagc tggctcctgt gctcatttga 687360
 aaggggtttt gtagtagcaa agctgagtta ccctgtgtga cagcagaggc tgtgggctgt 687420
 gaggcactca catttaggat gtccacatga gatttgcctt ttgaatatgt ttggtttatt 687480
 cacacaagca ttctttacat taccatgctg ttgtagagat tatggaagtc tcttgaaaac 687540
 aggctttggg ggggggcggg gggaggtag gaaatcctgc aggattctac tagggagtcc 687600
 tctccagtga gagcacattg ggaggaagct caaccagcat cctctgggag gcccttcagc 687660

 tgtggaaggc caggatgatg acactgtctg aagtgcacaa ggtccttgag agcattggac 687720
 agtggtagc actgatttca gaacattgcc aggaaacttg actgtcacta gtcactaaag 687780
 ttagagctac agttgtcagt ctcaaatcc tgttaccagt agggatcatt gcagaggttt 687840
 aagaagccat atctctgaag cctgtagag ccatacctagg gctgcctcca aagtttcagt 687900
 ttttgtattg ttcccatgag ctttaagctt tgtattatct tggctcacag ataagagttt 687960
 atttattaac aaatgagagc caccttgggt ggttcattga catacagag catgccttag 688020
 gcttggctca tattggaact gcctttagt tcactcctta cctagaaagc attgcattag 688080

 ttctagatac acaaaatagt tttcaaggta caaaacaatg gttccactta tgttactaac 688140
 acctgttct ccaccaacta cacatatttc caaagcctc agacttcagc aaggctgggg 688200
 aagggaaaaca tggcagaagg attagaaca cagaaatate aactttctgc tgggccttct 688260
 taaggcctt ctttgtcctc taatgcctct ctgatttacc ccaggaccaa ggcgggagct 688320
 gtcagtagct cagttaccct ggaggaggca gagagcatca acagatgttt ggctgcctt 688380
 caagacaggc cacctcctc cagatggctg tcagtcaata agaacttcca catccctttg 688440
 aagagtcaca gcttttctag atgagaggaa accggcacca gcttccagag aggacagagc 688500

 ttaaactctgt agactccagg gcatgaggag aaaggatata gcctgtactt tgaagtgttg 688560
 tttctgggcc tgccccactt gcttagaaac ttgacttcat ccacatctgt cctccaaagc 688620
 agatgttgat gggaagaagg tgggcagcac aaagagattt ccaatgggga ttccagatg 688680
 tgagctgtga gagagatgaa gcacagcccc gctgtcaagt tcagggacaa cagtgttctt 688740
 gttctcttga gatgtgcagc caggcagttt taacaaagt aggatcctaa agtaggaata 688800
 ggtgatagag ttccaccctt tcttctattg cctgtcttct taggctaaaa tgatcttact 688860
 ttccagtc aacttgattt ctgtctggga agtaactgat ctaagttagg acaattaat 688920

 agagcttggg ttctagtcc tgatatattt gccaaaacaa ttctatgaag gtggcaagat 688980
 gaacagaaaa atatggaatc tttgttctt aggtactatg aagagtcatt ttagaagagg 689040
 cagtaaagag gatgttaca gggcctggct gtagcataag ctaatagacc aggttagaga 689100

acagaaaaag aggaggctca tctacacact gcttgaggc agctttctaa gtgactcctc 689160
 gatatttgag gtccattata tgatcagtgg atattttaaa ctgtgtttaa aacttataac 689220
 cttagcattc aagaccccca taagtgttct aaatgtctcc aacctcattt cccactacta 689280
 actttctatt agttgatgaa taccctgtct attggtttaa caatctgatt gggaacacca 689340

 gctatcaggc ttagaaatth atctaactth gtgttgagaa aatctccctg tcttcattg 689400
 gcttgatata gtcctttggg taaaattctg gcaaatthtg tgaacatgta ggctccacaa 689460
 gggcagagac tgggtccctt ctcaactgtg atcttcagag cctcattgtc caacataaa 689520
 gagacacttg atccatattt attaaataga tgaatgagtg aattgaggaa caccttaagc 689580
 actagaaaca agtagaatca agatgaccag agagtgagtg gctggtgaga ggagaagaca 689640
 gaacaagaac aaaggctgat gctgcttctt gagatctaag atgagccagc tttatgggaa 689700
 ttcttttaca gagaataca tttggcgctt agggatggaa gaattgggat ggacatcaaa 689760

 gaatgaaatg tgacaggagc tgagggacag attgagctgg tgaggcctga gccagagaac 689820
 agaacagggg agtcagtggc cgagagaatc aatcaccaaa gccacagcgc cagggtagat 689880
 ctattgtctc tgacaaatgg tggaaagagt accctgacac ttctggcctg gaaaatgtcc 689940
 ttggagatga ggatggcagc agcaggagaa atcacagaag ggggtggggg ggggcagtaa 690000
 aatgacaggt taccaaatca cccccaaaac ttgcacagtg aaaaacaatg gcggtatgtc 690060
 aagaagatct agacaattac attgaagtat ccatctctaa gggcaactaa acacacttca 690120
 gctacactgg ctctacagt tcagttcacg tccccagagt ctgttctcat accagggctg 690180

 ggttaggcct ggctctgtgg gtaacactgg cccaactgth gacaatagth tcagccctgt 690240
 cctgagccaa gacacttagc agctatcagt gtgaactthg aggacttgag agagaagtat 690300
 cccttgactt gaatgttggc tactaaaaag tagttgcctt gaaatccaca gttgaactcg 690360
 ttctcagcc tggactattc tttgeccatt cttgccagga ctaagcctta ctcagccttc 690420
 aggttttagt ttaaaggthc ttgcattgta ttctgcatc tgatagacc aagtgagcta 690480
 cagcattcac aaaaatatta taaatgatga tgaacctgth aaaacttctt agagtcattt 690540
 ctgcaaaaca acaatattat taataatgag ttgatgataa ccaggcataa aactcaaatg 690600

 atgttaciaa ggacagcttc tccctctcc cccagggttc ttgcacttaa gaaaatcagg 690660
 caggaatact acatgtgaaa taagacattt cgggaaagcc tctgttttc tgatctggc 690720
 ttctgcttc atatgaccac tctggcttc tctccatctt ttctctgct tttgtctact 690780
 cgatcccttc cttttgctg tgtgatatta cacatgctcc ccagatttca gcatttactg 690840
 aatcaagct tcatgtttt ctttttctt tctggtaat ttgattcaaa cagcccagag 690900
 aagagctctg ttttctcatg tgttgataca aataagaacc aacaatgctc tgtgatctgg 690960

gaccagaaga aagaggtaca tgagagttca cagccagcgg ccgcaggcac cactcaatag 691020

tttgttctgt aaaaattatc tgcctcctat tcttacctaa ggacataaat gcagttttca 691080

agggtgccaa gtgcaataag tattagctat acaactettt aaaatgcttt attgcctgtc 691140

agtggtagtg caagccitta atcccagcac tcagggggca gaggcaagca gataatctag 691200

tctggctac acagactagc cagggtaca cagataaacc ctgtctttga acagacaaac 691260

aaaacaaaac aataaattag tattattagc tggggataag ggtcagttag tagagtctt 691320

tcctagcata catgaagccc tgggttcaat ccctaacacc acataaactg gctggggatga 691380

aaccacttg taatccaac atttgggagg aagaggcagg aagatcagta gcctacatgg 691440

agagactcaa gccagtctgg gctaaaagaa atttcatttc aaacaacaaa acaatcaaaa 691500

acaacaaaat ataatctca ttctctatct cattttattc ttccaacaca ctggaagge 691560

aagtgtgtt actattttaa tccttagtta cacataagga agatgaggtt caaaaaataa 691620

aattaccaa accatccatc tattaattgc caccagtac acttcaagaa gccatctcc 691680

atatgatctg tcattatgc tacacaaaa atagttctgc attacaaaa tcagagtga 691740

cgtagaactg taacaaataa caaattattt tctacactga gaacctagaa ggctttggga 691800

aagtggtaat gcagttcaac ctttctaga cctcttctgc cccacagtat ctttctcct 691860

ttctctgaga gaatatccag aagcatcttt tggaagtcag cagctgctca gaagcagttt 691920

acacttgagt gagtatttt ctaatcaggc agcatcagga ttaggctttc aagatctcag 691980

tgacatcatt tttatttag tttttgctca tggttcctca cttataaact ccgttctctg 692040

gggaggtttt agacactaga gttttcttcc ctgtggaggg ctacagcaac tttaatctc 692100

cccactttcc tgcttcaat tcatcataat taaattctct aacctacctt gcatgacaat 692160

aggtcatcag accctctca tcttaaaagt atccaggaaa aaggaatgtt ttagagaggg 692220

caaggagaac gtggttatac aggcttgcct aggtctcctt gttctgtgta ttcacaacca 692280

tgccatgca gtaagtctcc atataaagtc agaaggactg gtcaagagta cttttggata 692340

gtgcaacatg tggatcttg atgacaagcc tagagacagc atggaagctc tgccacatc 692400

ttcatgcata ttttcttaa tctacatcca ttgtcatgct ctctataata aagtggtgaa 692460

tttaagtgtc ctctaaagt ctgtgggctc ctggcactca gcaatcaaac ccaagcagag 692520

gatttgggga acctccatg ttagctgatt catcagagcc acaaggaaaa caacctagga 692580

cttgtaactg acatctgaag tgtgtgagtg atggggacac ttagaagtgt gccctcagcc 692640

tgtgtcaaga ggtgctgtct ccaggttgac tgtctcaca ctaaatgagg tcatgtagct 692700

gattctgcta ctgcaggatt gtacacaagc atgtagcaag aattcccaac atgttgcgg 692760
gtcacagcat ctccatggt ggtttagtg taacaacctt gcctggacaa tccccaaagc 692820
cttgaacaaa cattcaggtt attctccttc aacctatcct tcatatggtc accaataatg 692880
tttcagaagt gtagaatctg ttcatgtcct tcccctcttt ttttaaaaaa ttatttattg 692940
tgtacagtgt tctgcctgca tttatgcata tcagacaatg acaccagatc accagacctc 693000
agtatagatg gttgtgggct actgtgtggt tgcctgggaat tgaactcatg acctctggca 693060
aagcagccag tgctctaac ctctagcctg cccttctcct cttaaatca cttaatgct 693120

cctgctttgg gctaaattgt gccctccca attttatgca gatgtccaac gccagtatct 693180
tagaatgact cagtactgaa gattggtaat taaaagaata attaagttaa aaggaggtca 693240
gaaggatgaa tgctacctca ttatgactga tgtctttata agaaagaaa tgcagacatt 693300
gatgaacaca gagggaagac agcatgaaga cacttggaaa gcacagccag gtacagaaca 693360
aagagagggc cctctgaagc aaccaaact gccatcaaat tctcacacca gtgagaataa 693420
atatttctgt tgitaaagca acctacctaa tctctgggtc tttgttatgg tagcccttgt 693480
taaggtttca agatctaca cataagctta acctggcatt ccaggacttt cccaatgatc 693540

ttgctttgca tgccccacc tttctccaca ccatgtagaa cactgaatgt gtcttgagtc 693600
ctactgtgct ctatctgct ctcactttat ctctaagtc tcagcctcca ctgccctcag 693660
cccaggcagc acgagcttcc cctcctctgt tggaaagtat ctcctatcc gcaggttcca 693720
tcacaaggca cagtaacggg cacatgtcta tacacatctg tcaagccaaa actaagcatg 693780
gacggaaggg aaagtgtcag ggaaaccatt ctctgtcttt tttctcata gatgaagagc 693840
ctctgacct tatgtacca cctcaagctc acacctgtc tcacctcagg ttaaggaaa 693900
ggctggccct gtggaaacta ggacattgag aacacaactt aggagttaa ctgtctctac 693960

catgtcctcc tgggacctcc actctcttac tcaactgactt ctttagatc caagtctgt 694020
ctcaacaagg atgctgctgt caagggggtt cctgggggaa gaagggatc tctctctgtc 694080
tctctgtctc tctctctc tctctctc tctctctc tctctctc tctctctc 694140
tgtctctctg tctctctc tctctctc tctctctc tctctctc tctctctc 694200
tgtctctccc actccttggc ctgtatacaa ttaaacaac aacgtttaa cttctctcca 694260
tgtaccagg gtaaacaggc atggcagctc caggtttaca tggcagcatt tcagcatccc 694320
aagagaacaa acaaatctc acttcagaaa aggactctga gcaccattct tcctcaca 694380

gactgctcct tgtgccagct gctttcttt caagaggaag agagactctg tttttccagt 694440
gctgaggcaa gttctctc ctctctctc agtcccacac acatctactc tggctaaggg 694500
gatggcctg ggtcttct agacttatta gctacaacac atgttgcagt gactgctgac 694560

acaggcctgc acacaaatgt tcatagcatg ttatcacagc cagaacctgg acgagacaca 694620
 aatgtctcgt cagtgggtgg ggagataaat agtctgttat ataaacccaa tgaaagctca 694680
 gcatagaagg gagtaagcct ttcaccctga gtaaacttca acaacagcaa gctgagcaaa 694740
 agaaggcaga cacaaaccgc atactgtgtg gctccattta atagaatctt tagaaaagac 694800

 acaattgtac tggtttctcg gaagtgtgca agaggtagcc ttagacagcc ataagcaaag 694860
 atgtaaggta atggtaaaat cctggagact gagtggtagc gatttcacag atgtatacat 694920
 tatcaaccac cagtctcagg cctacactca catgaacaga tccacttaat ggttatttac 694980
 aatataatctg tatataacaa gcaactgaggg gctgaactga catctcagga taaagcccag 695040
 gagttgggaa tagtcccaaa ggttctgggt gtacaggcct tcccttatgg tggcatatta 695100
 tttatgattt attaaagttt gcctgaggat tcaaaaagca aagtcagcct caagctatag 695160
 agatcaggca gtggaggcac acatctttaa tcccaggact caggagacaa aggcagatgg 695220

 aactctctga ggtcaaggcc acccagggct acttgagact gaatcagtca aaaagagtaa 695280
 cagagctcac gcctttaatc ccagcactag agagatataa aagatagaag cagattctta 695340
 aggattcagt ctcaggatc tccagccacg ttgaggagaa catagtagtc tggattaca 695400
 gtctgtgtt tggtaggacc aggatcccct ttcagtctga gatagagata agagctagt 695460
 gctggctcct ttgcttttct ggtcttcagc ttaaagcttg aagcttgaag cccaatcgc 695520
 gtctctgggt catttattt tcatgtaca atccctcagt gctcccttgt cgtcttcagc 695580
 actttggcac catgataatt acagtcttc agcacttcta agctgcctgt cacctgagtc 695640

 ttacagggg ctgttctgc tgctcatcgt agtccactaa gccagaagct ttcttcttat 695700
 tcagcccaaa atcttgagg aatggaagca tctgtctgc cttctttaag cagaatgcaa 695760
 aacctatccc ctttttctc ataacaggcc acaaatgttc tctttttaa atttcttgt 695820
 gcattgacta caatagtga aacttctaaa gacaagcgtg aaagaaattt cttccacaga 695880
 aataaacgtt ggctattga agtaaacatt tggaaaatgg gaattaagga aaactcctta 695940
 atgacttacc ctgtgcctca gtctgtacta tcattctta cctcccgtc agaccaatga 696000
 catcacaatt tcagaggaaa gctgaggctt ggcacaatta tggccagga cattctccc 696060

 ttctcaagca tcttaacaa tattctcaa cgtttattct aattatgaac agtttctctg 696120
 ctaattatta aatccatag tattccaaga gaaattgaat cctggtttgc ttcattcaca 696180
 ctcaatccat cacggtttta ctttcaagag ctatttgatg ttcaagaatc cattagagcc 696240
 ccataatgcc tcttctgag aataggata tggcacaat taagcaaac caaatgctca 696300
 caaaatcctc cgagattaag tagaatctta acgaggggaa ttatgtaca ctatttctg 696360
 ttcggactct tcagactcca aggaagttag tgaaccgga gacgtctcac atctttatcc 696420

cacattttct cccggggttg cagggggaag gggactgtgg aaagatgaga aaaaagagta 696480

gtttgacagg atagaattat ttgacattct gtttccagca gtatttcagt ctagaatttc 696540
tgaagacttt ttgatatgaa acatctaaaa ttgctaacct tagtatcacc aacattaaaa 696600
agtaaagtag aagtcaggga tatcttcccc tcaactaaat agctaaaaaa cacaaaggga 696660
gataagactg ggagaaaacc aggagttagt cctaagcagg ggtagtaaag gatggctatt 696720
agtcaacagt gaaaggctcg cttctgggcc tactcttggg tgtgtactac tgtgtttgat 696780
atgtgtgatg actactcttg attgtcagct gctgggattt aaatcacctg gcaaactaac 696840
ttcgggcaag cctgtgaggg ggtttctagg ttaggtagtt gatgtgggta gaccaactat 696900

atgtgagtgg tgccagtccc tgggcagggg tcctggactg gtaaaaaaaaa aaaaaaaaaa 696960
aaaaaaaaag gagaaagaca ggtgagatgc agcattccct gacctctgct tcctggctgt 697020
ggacacagta tggccagctt cttgatattc tagtgctata acttctcca caaatggac 697080
tatatcccc tgaactgcaa ccaaagtaa ctttctctc ctttaagtac ctttgtcaga 697140
tattctgtca tagcaacaag aaagttaact aatataatag taaattagcc aatccaaaaa 697200
aaaaatgata atgcatgcat tctaggagcc actgtcttct tcttccatca tcccaggatc 697260
atgtgaccaa gaaccagtct gtagcttaga gcttgcttag actattcaaa gtagccaacg 697320

aactgcatcc tgccttctc ttcctctgca ageccccctc aaaggctctt ccctaact 697380
ttccccttgc ccctctctc gcacctgag aacctgtgt atttcaaca aggctcctgg 697440
ttctaggact gtgtccctga ctctctctt tgtctctca tgagctgac ctgactgcc 697500
accacattaa aaaaatccaa acattctcta acacaccatg ggacaacaca ttgaacatac 697560
cataagatat tgaacatatt ttgtgttga aataatattg aaaaatcaat tttatgttct 697620
aatltgcta ttttccaga ctttatggcc cctgtctgtt atgcaatltt aatagtaata 697680
agatagatct gttggtactg gcatgggaaa aaaaccacaa tttattaact gaggaaagta 697740

ttgactaaaa tgtatcttat gatgacagtc tcataaaaag aaaaaacaca atctgtgtgt 697800
atltgtatgt acataataaa attctggcag agtttcattt cttatltctg tatatgttc 697860
cattlttatg agictlttatt ttcctataa caagaaaaac aatataaatt tctagttaga 697920
gaatcctgaa taagcaatag gcaagaccac acttggggct gagtgaggat gtgtgatcac 697980
tgtaaagtgg ccaatgcttt gteccaagcc atctctctcg gtgtctcaac ttaggcttag 698040
gggaaagagg tactagtgtg ggtgaaagac ctatggtltt catggaggaa agagttagag 698100
aagagaaagt gcacacttc tctctctcac ctctagtag tagagccaga gtatggagaa 698160

cataggtcta cctggaaaga agacagcact acaaggatat taggttatca gatgatgta 698220
 acatgagtct cttgggtgta ctgttgcac catccctctc ctccctccct tccttctttc 698280
 atttctctcc tctgtctaata tacatgaaaa tcttgctaaa aggtggaaga gatacagctg 698340
 gctgacacct tcattctact ttatatgttc cgatccagac tcaggactaa tcagatatta 698400
 gctggtgaaa gaaatgagat agtagggaga tctcttcacg gcctccccag tgatcatctc 698460
 agatacgtct gtgtagtcag cagggaactg tctggtacag aagtctgtaa ggactttttc 698520
 agcctgttcc tctgggatcc atgagggttg ctatcccatc ccaggcaacc acttattaag 698580

 agaaggattt atttgacgt cattcacacc agatcctatt tgtaatttaa cagcttagaa 698640
 ttagaataat aaatttcta tctgcctaag ttctctgtgt aactcctgt gtaacttctc 698700
 tgggattttt aatcatgtg tcatctacaa atgtagtcaa aatgcagctc attgtctaga 698760
 taaaagtaga ttttctatg caataatacc aggtgtgtgt gtgtgtgtgt gtgtgtgtgt 698820
 gtgtgtgtgt gtgtgttata atctatggat ttaagactat ttttgaaac aatgtctcac 698880
 tgtgtaactc gggctatcct agaacttact atgtagacca ggatagcctc taattcacag 698940
 atccacctac ttctacttct tgtgtgctgg gattgcaagt gtgtgccacc acatccagct 699000

 ttagtTTTTT gtgtttgttt gtttgtttgt ttgtttgttt ttagtttcat gtagcatagg 699060
 aatgacacaa atttgctagg taggtaaggc tagccttgca ttcttgttgc ttctgcttct 699120
 gcttttcaaa tactaagatt acatagggtta gctgccatgt caagacacag agtccaactg 699180
 ttggatagta aactggctga tttgagacta aagaaagaca aaagcaagga aatggacaag 699240
 tgtataatcc tatgactggg aaagggttag ggggtgtctc aatgcttatg gacaagctga 699300
 aaagtagaat aggaaggag agtaaaactta ttctaggctc tatgaatgat atcttcttcc 699360
 atatgcttat ctaatgaaa tgcataaaga aaggaattta agtattttag ctgttctgat 699420

 agctattact gtcataaat agtccagatt ctctccctgt tatcttcttc cetgtcagag 699480
 gattgtgaat tctgccctag tgaactccta aatgaaccta tgtgttagtc aactgctat 699540
 gtaacatatt attctaaaac ctagatttga gaaaacaaat tttatcaggg cagtgatctc 699600
 ttgtttactg gtgtattcta ctatcaagaa tagtacctgg cacttagtaa gagctcagtg 699660
 gtgtttactg aatggtaaat cctgcttctt attttctccc attaaccag tctagtttgt 699720
 ctacagatth tctgaatgtt tttggtttag tctgatcagc acagcagttc ctaagtaatt 699780
 ctgacctcag aagttaaagtg tgtctgttgg ctctgttctt cattgctgtg acagaatgta 699840

 tgacagaagg aactaaagag agggagaggt aacctggct catggtttca gggcagatag 699900
 tccattgtgt gtggggagtc atggaagact tcattgcagt gagtgggaagg aaacaaatga 699960
 gcttcagaca ggacaggctt tcagccaagg cctgttctca gcaacctact ttagctagct 700020

ggacacaccc ctgaaatgtc ccacaacttc cccaaacagc tggggacaaa gtgccaagc 700080
 atggagcctg ggaggctcat ttgtcattca aagtgtatth ataagctcta actgaactct 700140
 tcagtaaate tactggatct ggtcaatatt ttcatgataa tcttctggtt gtcactagtt 700200
 gcaagttgta acagaaactt ccacattctt tttagatata tctctgctgt ccttatatct 700260

 atttttattc tcccagggtt gtgaaattat ttgagtactt gtgcatttta acaagcaact 700320
 tgatacaga taattaaaat aaaagtaagg ctgggtggtg acacatgcct ttaatcccag 700380
 ctcttgggag gcagaggcag ttggatctct gtgagttcga ggccagcctg gctacaaat 700440
 cgagtccag gacaaccaga actgttacac agagaaaacc tgtcttgaat aaccaataac 700500
 caaaaaaaaa agaaagaaaa gaaaagaaaa gaaagaaaga aaaagtgagt attttaggca 700560
 acagagtaga ttcttgagga aatatgtct agctagccat gtcacctaga agagacagtg 700620
 gcaacacttg tctgtctgac attcactagt tcttagagac aacacaaaga tgttgcaat 700680

 ctgtccctga gctttatata ggatacttta atgaaatata tcttccattt attaaatag 700740
 gttttacaga gctaataaag aaacattaaa ggcaaacctt ttttatatcc aataacactc 700800
 aagagtggga tctgcctttt ctccccaaac aactgcttag ttaaattgat ttgtaaggag 700860
 aacagagcct agagaagact gtgttctgtt tactgacacc cttagtaatg actacagcct 700920
 gtggagaatt tatggccatc cttggagctg taacaaggaa tggaggaaga taaaacaata 700980
 tacaatgaag tcagtgtatt agagtgagag aagaaaagac tagaaatcta agatctgcag 701040
 tctggtcctt gctttgccgc tacatgtgtg gcatgagcaa attgcctgtc ttgtccagat 701100

 ctgattttct ttataagggtg ttaggttttag aatggatggc tcagaaaagtc ttttacatat 701160
 tagtgtgaat gtgggcatgt gacagaggat aactttcagg agctgcttcc ctcttccac 701220
 caaggattga acttgggtca tctggcttgc acaaaaagtg cttttttttt ttttttaaga 701280
 ggactgtgta gctgtctgtg tagccttggc atggcctgga atttactatg gttgtataaa 701340
 ccaggatgtc cttaactca ccaagatcca tctgcttctg cctcctgagt gctgaaactg 701400
 aagacatgag ctaccatgcc acatcaagtg cttttatctg ttgagtcacc tcaactggatc 701460
 tctgtttgtt attggtatta ttacataaat cactttatta taatgaactc tcaaacaaaa 701520

 gcatcacacg gctagagtaa ggtaagcact cacacaccaa actctgtccc tctcagtga 701580
 cagctataca gtcccagtg ccatctgtaa gcaatggagc ttatatacac atctctggta 701640
 tcagaaggta tgggagata tgcctgatta tcatctaaaa tcttataatt tctgggtctc 701700
 ttggggaaac acgtgcaaca aaaatggcat agctgtttcc actatggtca gttttccttt 701760
 ctttcattct tttctttggt tttcaacta ttaatagccc actagcaaaa ttcctgagac 701820
 tctaaccaga agacaatgag agcaggctgt tgaatatcac tagacacca tcaactccact 701880

tatttaattg acigttcatt cattccctca gcaaacattc tgcgtttcct atgtgcaaga 701940

cacgaaacaa aatagaatac ataatggctc ttgtcccca ggggctcagc ctctaataaa 702000

cagaaaaata acacagataa gtaacaaacc aaagaaaaca agacaaacaa tataaataag 702060

atataaataa aagtaattaa acattcatgg acaaaaaaga atatttccta ccgaggttat 702120

atggggtcct tgacaggagg aaaagagaaa ttcaaaagga actggttatt ttaaggggat 702180

ttgttttggt tatctagtag aacgataaca ctattttagg aaaacaggaa ccggaagaaa 702240

aaaaatgctt agaggaagct agagataaag aggccaagag gcggttatat acctggaaga 702300

aaaataaaca ctaccgggtg tgaagctccc ccacaacctc agacctgaac aagccgacca 702360

gcactgaaag ggcattggaa tgcagtttag agaaggccat ttgagagtca ctccaatgg 702420

gigtagttag ttctttagaa tttcatcca ggcttcttaa gggttttacc aatgagattg 702480

tagatttgct gttagtaacc cccagggtag agacaagaaa acatggccac attttcacac 702540

cttaaaaagg gctagcctgg taagtaattt gcattctgat caatattcta aaatccagcc 702600

atcatttatg agcaccaaga gaaatgtgaa ctatagaat gaaccaaagt gaagtaagc 702660

cagccacatg agataacctg catttccttg attgctgtgg ctggggaagt tggatgaaaa 702720

acatcctcca gaacctggac aaaagttttt atgaaggcca tgtacttggc cttaccactt 702780

caacagcttt ttaaattaat gttggcaata tattcttctc tcataaaaata catccctgcc 702840

acagtttccc ctccctctac tcttcccagc tcccccccc accccatttc cctctcccct 702900

agatccactc atcatccatc tcccttcaga aaagagcagg catccaagag acagtcaaac 702960

atgacaaaac aacatacaat aaggcaaggc aaaagcctc acaccaaggc tggacaaggc 703020

aacccaatag gagaaaaaga gttccaagag cagacaaaag agtcaaagac acatcactcc 703080

acagtttaga gtcccacaaa aacaccaagc taacagccac agcatacaca tagagaacct 703140

ggtgcagacc ctgagacaca ccatgcttgc ctcttcagtc tctgtgacct catatgttec 703200

ctgcttagtt gactcagtgg ccatgctccc ctggtgtcct ccagcccctc tgactcatac 703260

agtctttctg ctctctctc catgagattc cctgagctcc aagaggaggg acccaattga 703320

gacctcaag tagactctct ccgtaacat ctgactgtgg gcctctgcat cactctcat 703380

ctgctgccag aggaagccta tctgatgatg actggacaag gcaccataa tgtttgtctt 703440

tctggatctg ggttacctca ctccagataa ttttttcta gttctatcca ttgcttaca 703500

gatttcatga taicatttcc ttaaacagct gagtagtact ccattgcata gatatgtacc 703560

acatttctct tatccattct ttgggtgggg gacatctagg ttgtttccag tttctggcta 703620

tcatgagtaa agccaaaatg aacatcagtt gatcaagtac ccttgggta ggatggagtg 703680
 tcctttgggt atatgtccca atgtagtata gctgggtctt gaggtagatt gattcccaat 703740
 tttctgagga accaccatat tgatttccaa agtagatata caagtttgca ctcccaccag 703800
 cagtgcagga gtgttctctt tgttccacat cctcgccagc atgagctgtc acttgtgtta 703860
 ctgatctcag ccattctgat aggtgtaaga tggaaatctca aagtatttt gatttgcatt 703920
 tccctgatgg ctaagtttgt tgaacatttt gttaagtttg ttaagtattt ctccagccatt 703980
 tgagattctt ctattgacaa ttttctgttt agatctgtac cccatttttc ctctttaatt 704040

 attctgtgtc ttttatacca tgtatcttga tcccattcat tcccctatcc ctttgcatec 704100
 accctctgcc tctgcatccc cccccaaaa aaaaaataa agaaaacaaa atttaagaga 704160
 aaaatgaaag ctgcagcgtg acatagaagc catagtgtga cacaggtctg gttccaggcc 704220
 tctggtttct actacacat caatgctggc cctcaactggg catcttcttg gacatctat 704280
 tgttgcctg tgttgtggag atcctgcagc tttgggtctg tgagtcaggt cctttcactt 704340
 gttccagtag atcgcatag ggggtgatgt tgggacagcc caagtcctaa ccctgggttc 704400
 tgggcctggg cagctgcagg gttggtctga ccaccagttc tcccctggcc tcaccaccag 704460

 gttgggctct ccagcattgt tctggctgat tcacttttt tagaaatgag tgaggggtgg 704520
 agccagttct cctgctttta tatectcagg gttagctctg ccacacctat ctatactgtg 704580
 ttgcctggc gaggtacagg atctatgtc cagagtctg cagctggtga ggtgctgaac 704640
 aaccctctgt tcttatggc ccatggccag ctctccacc tgttcaggc actgatggc 704700
 agaggtggg ggtgaggaa aggttgtca caacatcggg cctgggtcac catctggcca 704760
 gctctgttc ctaggcaagg ggcagggccc gctttctga gtgctgcagc tggtaaggtg 704820
 gaggatcagc tctttatct gttgcaggca glaagaggca agggggagtg caatttccc 704880

 ttaccatac cgccacatga cagacaggta ctgggaaagg ctgacctatg cttacaactt 704940
 tggggtcac tcacacctcc accgcaggtt gactctattg tgttaccag gtgaagtca 705000
 gggcctgctc tccaagtgt tacagctggt ggagagttag gacagtctg ctcttgtgac 705060
 ctccagggcct gttctccac ctgcctcagt ctttgatggg tgggagagaa agggcatctc 705120
 tccccagtcc atgccccgt ttggcagatg agaggtgggg ccaggtctcc tgtaatcact 705180
 actttcgggg ctgactcacc cacacctctg tcaacagggt tggctccata gtgttgtcca 705240
 ggtgcagtgc caggcgtgtg ctccaagtg ttgcaactga tgagggtcag ggacagctct 705300

 ccagtataga ctgagttttc ctctctggc agccactccc aaataaccaa catagagact 705360
 taatatcaat tataaatgct cagctgatag cttagcttg tctccagcca gctcttaca 705420
 ctaaccac ttagattcat ctacattctg ccacatagca ttacctctt tcatattgt 705480

acctctgtt tctctccat gtctggctgg tgactcctca gactctgccc ttcttttcc 705540
 cagaattctc tctgccccca aaattctgcc ttgatatcag ccaatcagct ttttattaac 705600
 agcatgagca acacattttt acaatgtaca aaagaattat tccacaacac tccagttctt 705660
 atgcccacag gagcagcttt cccgttgcct caggcattga tgggtatggg gaggttgtac 705720

 ccatttttaa ttggatgatt tggggggttt ttgatatcta gtttcttgag ttgattaatc 705780
 ttctatctgc tgtggagatg gtaaaaatct ttccccattt tataggctgc catattgtct 705840
 gaatgacagt gtcctttgcc ttacagaagg ttttcagttc tataggaca catttattag 705900
 ttgttgatct tagtgcctgt gctattgggg tctgttcag aaaatcatca cccgtggcaa 705960
 tgagtttaag gctattcctc actttatctt ctatcaggtt cagtgtttct agttttttt 706020
 ttcttattaa aaattatttt tattagttca agttaggaa caagcttggt tcacatgtac 706080
 ctccccatg tgtccagggc cagagtgtat cccttcacgt gggatgggct ctcaaagtcc 706140

 ctcttacac cagggaaaaa tgctaatcca ctccagagg ctccctggag tgcagaggcc 706200
 tccttattgg catccatgtt caggggtctg gatcagctt gtactggcct ccccgacagc 706260
 atctggggte gatgtgctct cccttgttca ggccaactgt ttctgtgggt ttctccaacc 706320
 tggtagacac cccttcaatc ttcatctc cctctctca actaagttcc agatttcagc 706380
 tcagtgtata tctgtggatg tctgtctctg ctccatcag ccactggatg agggctctag 706440
 ttcttggtca gtcggcggcg gaatccagtg tttctagttt tacagcatct ttgttaaca 706500
 aatcagagaa gccaatataa cctatgcctc agaaataatt tattgctcaa aagtagaaga 706560

 catatctaaa atagtgagta gcagaacagg aaaaaatgct ttcagtagtg tgatacaact 706620
 gtgatgaaaa gaaaaaagat tgtgaaatac attgtaacat tcaagaaccc atttgaagtg 706680
 taatgtttaa ctacttaatc tctttgagcc attctcctat ttatagtatg gagataactg 706740
 tagtgactaa tggtagaaaa ataggatcat gtattaagga actagcaaga gagctaggaa 706800
 gaggtcttgt tcatagcagg agagttaggt agatgtctca gttaatgtct ttcagtgcaa 706860
 gtaagaggac ccgcgttcat ttccaggcac ccacatggcc ctccataact atctgtaact 706920
 ccagttccag gggacceaac accctcacac agacatacat gcaggcaaaa caccaatgca 706980

 cataaataa aataaataa ttagctgggc agtgggtgtg cacgccttta atcccagcac 707040
 ttgggaggca gaagcaggtg gatctctgtg actttgagc cagcctggtc tacagaatga 707100
 gttccaggac agcctccaaa gctacagaga aaccctatca tgaaaaacca aaattaatta 707160
 attaggtgca aataaataa taaaaatgaa acaaggagct tagctatagt aactgttgtc 707220
 tgtggaage agaagaata ggaggactag agacaacagg ctcatgccac tgtgccgaaa 707280
 tttgtgcagt gttggagact gaaccagggt ctctgttcag cctagtcaa cattccagca 707340

actgagctcc atccccagcc ctgctaagta ttgcttacga attgtctcat gtcgtttcct 707400

cttaccacaga tcacagaggc tcttgcttat caggcttcat cttccttggg ataattttct 707460

ttgtttaatg accacaaaatt atattgttca tactaataag aacatgaata gaagtaagca 707520

taggaattca aatgtctaaa tctatgcccc agatttactt ttcctgtact ttgaataaat 707580

tttttcttt tataaaaaat ataaatcatt taagaagttc tttctttggg gagaaaatag 707640

atcgttttgt tttcatgita ttgtttagct ccaacttact cataaattta acaatgaaaa 707700

tagaattttc ctggagccaa taaagtctcc tgcattcca gaaaagtgga gggaattata 707760

agaacatata atgagaaaca ttttctgat attaacaatc aataaatctc aggatcattt 707820

attingtgc caattagtag cagaacaata acaaggggtc tgggaagttt cagaggcaaa 707880

gatggagtgg gtgattttca agtacacaca gtttaatagg gactgagtta tccttagcaa 707940

gtacgtggg agaacatgtg cagttgagaa ggaggtagcc agagcagctc tttttagaca 708000

ttgttcaccg caattagctt ctggggtgaa cagaggaaat gggagagaca gagaaaatag 708060

tagagttaa gtcacagagc caggaagtgg tgggaaggag atttaaacgt agatttttct 708120

aggtccatat gtaagatagt ctcatgacat tctcttgagg aaaacatctc acagatggtt 708180

caaatatct ccgatgttaa ttgaatagac attttaaaaa gttgtgttc taattcaaat 708240

aaaaaagttg gaaaaaaaaag aaataaaaaa tccatatgca atatctcctt tgcatttgtg 708300

aacacatatg taccacaca catgctcaa ataaaacttt taaataaagc ctgtttaaaa 708360

aaaaaaaaagt caggtactgt gactgagtag aaataaagca aacaacaaca aaaaccttct 708420

agtcccggcc ccccccaat ttggggactg gtaggacttc tgaaacceca agctcaccat 708480

gatgcctcaa agaaaatggc ttaaatagtt gggattttct catcctcaga caactctcta 708540

atattcttcc tgaagtctc tgtaaaggac acttacgaag ggctggagca atgcctttgc 708600

tactttttca gacaatctga gttcagttcc cagcaccac agaaaaagga cacaattccc 708660

ttctacctcc agacagagac ataaatatac atataacatt aacaaaagtg aaaagaaagc 708720

tcatgttact ctatattgta ggtctggtag atactaaatt tctctaatgt ttattgagat 708780

aattcttgca aatatttttt aaaatgtatg tgggactatg atgaagctgc aataaaaatt 708840

actggagtat attttaacac acacacaaac acaaatccat gaaacacaca tgcagacttt 708900

aaaggtgagg gaacagtgtc ctccccaaag cctgaaacac cctgtgagac ctttttactt 708960

tcttctctca tgtttgccag ctttttccca gataaaacca tttgccacca ttttgitatag 709020

acattttaag catttagggc tgccatccat ctigaattga atgttgtata tggggcatag 709080

gtatctttcc cacagacacc cagttgttga agcatggatt attaaataag ctttcttttc 709140
 ctcatgggac tgatgaggaa gctggttcat aatcactcaa ctgcatacgt gtgtctaact 709200
 acgaacttga tctgttctg ttagtctatt tacttgtgta gccagtaata aatcttgaac 709260
 tcagagaggg tattctttgc tgttttgggt gctcagtggt ctttgcattt ccatataaat 709320
 tttagagcca cacactgtca acatcttaa aagaacctac tgagctctgc agatgatatg 709380
 aaattctaga tcatggaagc tgtceccaga gagaacttac ttgtgtttct accacttgaa 709440
 gaggtctgag aaactcaaag ttgagcttgt gagagcgggt ctactgcagt catcctaatg 709500

 cccagggtgg agccagtct agtaactatg gattcctggt catttgcata gcccttcac 709560
 ttctcagcct ctttctggag gtatctgtct tgatggtcag gccaggacat gccagagat 709620
 ttttgtgagt ttataactgt caattacct cagggatgaag ggtcccaaa cattagcctc 709680
 acctttcttg gcttcacttg tcttctagat ctggaactag caatcttcac tgatttggtg 709740
 gctcctcctt gatgtttaaa aactataatt tgcacaactt ttctaattgt tctcagcaag 709800
 aggtttttct gaaacagcct aattagccag gatttgctga aaatggcacc atagcataca 709860
 tttcttaaaa cttaagtcc attaaagtta actttgtttt ggaaaaatat gttcagactt 709920

 ccctaagat tctggaaaga actggaatt cctcagagga gtgggtattg ctagcatgga 709980
 agtttggttt tagtattgtt aaggagaaaa actaccacag acctcaaat tagagagaaa 710040
 gagaccacag cagaacatgg tcttgggagc tgcccacaa ggctactctg tgtgectcct 710100
 ggatttactg ctcctctcc accatttcac cctcaaagag aggctgggaa aatatcccc 710160
 ttgctcgta caccatcca gtcccactga ggcaaagcgg cgtcatccac tcatcaattt 710220
 tgattactga gctgtagcca catgtgggtt ttacaggctc caaacatgic catattacat 710280
 gtctaagta tctagacata aactcaaagc tcctaagaaa tgggtcatat aagatcagga 710340

 ggctaaacct tatgttcaag tagacagtgt tatataacce tattgaatgt tgtacagaaa 710400
 gaagtgacc agatgacact ttagaaagaa cagaaccaag aaataagacc caactttta 710460
 tgatccttat tatgaaccac atatgatgct aaggcgtcat taaagataat tacactcatt 710520
 tattttatgg gcaatagggg atgtgtgctt tctctactat gttggtcca gggactaact 710580
 cagactatga cttaacagag agcatcttgi cttagttagg gcttctattg ctgtgaagag 710640
 acacatgac cacagcaagt cttataaagg aaagcattta attggggctg acttacaggt 710700
 tcagcacttt agtccattgt catcatggca agaagcgtag tggcacacag acagacatgg 710760

 tgatggagaa ggacctgaga gttctacatc cagattggca ggcatcagga agagagagtg 710820
 agacactgga cctggcttga acttctgaaa ccccacaacc cacctgagt gacacacttt 710880
 ctccaacaag gacatacctt ctaatagtgc tactccctaa tgaccaagca ttcaaatata 710940

tgagcctgtg ggagccattc ctcttcagac caccacacac ctttaccac tgaacctct 711000
 tgctagccgt aaggcagctt ataaaggcag agaatttcta agatctgaag agaaagcagg 711060
 gtagagggca ccttatattt agtcacatgt tcagtcctca taatgattgt cttttttttt 711120
 tttttttttt ttttttttgg aacaggctct ttgtgtgtag cgcaggccag ctctggttac 711180

 aatcctcctg cctcagcctc ccaaataccc attctaaatt taaaaacat agcaaaggtc 711240
 tcagagctgg tgccttgtag tccaaagatt tgaatccagt tcttccagat cccaagcctc 711300
 tttgaaagtg tgaagagaa ggaaaggatc ttatttaaat gaaatcctat tacagtcccg 711360
 ggacagaggt atagtcatgc atgggttttg tttatagttt ccccttcacg ggctcatcag 711420
 cattatttac tggaacaac agtctgctga aacttaacc aaatcttcca tctgaggtt 711480
 ttcaccagtg agggccaggt tgtcacagt catgagagcc ataaacta gcattcaata 711540
 actttttcca tcaattacac attcacaata caaagaagag atgtgtaaaa tacagttcct 711600

 attattcaaa tctttctttt cttttcaag acaaggtttc tctgtgtagc cctggatatac 711660
 ctggaactca ctttgtagat caagctggcc ttgaactcac agagattctt ctgcctctgc 711720
 ctctgagtg ctgggattaa atgcatteac agcatttttt ttecccaaaa agatecttea 711780
 atctagacat ttggcaattg tttatctatc atgcacacaa aatttttatt cctgtaaaag 711840
 gtaggaagaa tataaaataa gtaagcctgg accttaccac atgaaactgt gcaaaggatga 711900
 attgggctca taaatggata ttctcattat aagagcatag ggccagtggg atggctcagc 711960
 aggtaaagac actgtggcac aagcctggac aactgatgta aggctggaag agaggagtga 712020

 ctccacaaga ctgtcccta acctetacaa actttgtagt acatgtgcc cccattatat 712080
 gatgcacata cacaaaaata ttttttaaaa aatctttaag taaccacagt atgatagtta 712140
 atgtggattt ttggcttgac aggatgtaga aggcctagg agacaagcct gtggcatgct 712200
 tgtgatgagt gtctcaatta ggttaactga ggtggaaggc tcaactaagt caggtggcag 712260
 tagcccgcag actgatggcc tacaccgaat acgaagaaga cagaagctaa gcgaaatctc 712320
 cctcctttct gtggatacaa tgagactgac ggcctctgtg gccaccatat gaacaaaag 712380
 gagcccttcc tcctaagtg cttgtgtcag gcatttgcag cagcgatgag aatagtaact 712440

 aaggcacaca gggatcaca gaaactagaa ggggaccaag gaagcaggag caaacacc 712500
 ctaggccaac atggggaggc agtgtgctg gcaggaaaca ctaacatcag tttgggatgg 712560
 aaccacatga tacagcacta cagaaagtcc aatggtgtgc tgagacagag ctgggcccag 712620
 aatacttga gtgactgtag tcgggccacc aacctttctt ctcttgcct ggctttgcag 712680
 ctcccaaaage tcttctcttt tgtgagtttg ttttgggttg ttgaggggaa gggaagtat 712740
 ctgttatttt ctatctttta aaaatagtg tgtatgtatt acgtatgtat gtgaagggtg 712800

tgtgtgtgtg tgtgtgtgtg tgtgtgtgtg tgtgtgtgtg tgcatttga tgtatcaata 712860

 cagtgcacac ttgccacagc atgtacttga ggccagagga caacctcagg ttttggctct 712920
 cgctccacc ttttcgagac agggctctct ttttggctct tgtgtataac aaggtagctg 712980
 gtccacgaac ttgcatgggt tctgtctccg cctcccatct caattgtaag agcactggga 713040
 ttacaggttc cagcaaccac actggctttg ctggagagtc taattcaggt tcttacacct 713100
 gcacaacaaa tgcctcacc actgagctgt caccagccc ctctctctc cctttatctc 713160
 ttttcttcc cactccccgc cagtccagcg gttgaggaaa tgggtaacct taaagcagac 713220
 tgtgaggctt gaaggagctg tgggatgga aactgttgc tcagttggcc gcaatcttgt 713280

 ctttgccact ctgtagggac actgaagtac atctaccct aagttaaata caacaggaca 713340
 tgtctgcagg cagtaaatgc tcagtcata tgtacattg tgggaaataa atccagtaac 713400
 aaaacagaat aatagatgat aaaggacttg gaaaacagag acatttagat ttatgactgt 713460
 tctttaaatt attatttta tgtatagatg tgtgtacctg agtgtatgta tgcatagtt 713520
 ctgaatgcat ataggagccc aagcagtcca agctttgatt ccaagtacc acaatgact 713580
 ctgttccgg gagateccac actctctct gatctccagt ggctctgca cgcattggta 713640
 ggcatgtaca catgctgca aaaactca tacatatcaa aaattctatt agcatttttg 713700

 tttatttatt ttttttgt atggggcatg gttcttgggt gtcagggtac acaagtggag 713760
 accaaagaac tcctttcaag aatcggtctt ctcttttac atgtgggttc tgggaatcaa 713820
 actgaggtea tcaggcttgg cggcaatac ctttacctgc taagccacct cactggtccc 713880
 ctggaagcac cttttcaaa accaggtatg aagctcaact cagaacct gcttagtggg 713940
 cagtgtctat cagattgtgc aacctgaac actagagaga gaaacagtgc atatgtaaa 714000
 agcagctggt ggagggcacc caggaatgtt tggcaagctc tgaagtgatg gcaatgaaaa 714060
 aggtactcca gagacctcc caaacatcc agggaaagggt gagtgcctc aggggttget 714120

 ctgactggtg ggacttgtgt caggatcca gtggcctcac cctaccagc ctgtgactgc 714180
 cagactctc ctgtctgcca tcaaacatt cagccccagc agctctcatg ttccaggaga 714240
 acagttcaca cagactcact gactactctg gagccattta gactccagag agttcatgaa 714300
 aatgatccta acagcaatga atcagaaaca tcatactc tctttaaag accctgtggg 714360
 gctggagtga agagggacgg gactgcccag atcgagagc ctaagcagaa tgggtctct 714420
 ggcaagcaaa gctccagaga ggtctctgg gatagtcca ccaggacctc tgaggcaact 714480
 ctaatgagat gatttagcag tgtgtggac cggcctccat gcctcccaca ctgacctaat 714540

cccagttgaa attgcacaag ggtgagctga caaactctgg ttacacaaag caagggctaa 714600
 cattcgaggc ttgggaaacc tgtccaagac atttttttcc ctttctttaa aatttttata 714660
 gttaatTTTA tgccccataa gccagtgagg ctttttattt cgtgctagca actgtatggt 714720
 gctcaacctt cttttagat tggagctgag ctccTTTTTT tctccttatg ccctcttcag 714780
 ccctggcatt cctctgtttg ttatgtagga cagtcctcat gtcagtgagt ccatctttag 714840
 atgtcatggt tctatggacc tactctagtt catTTATgta ccatgcaatt agggttactg 714900
 cagttctaca gtTctcactg gcttctgata aggtgtgctt gctatcttac tatcattctt 714960

 ttaaaagtat ccctggttct tctcacagct tctctcaagt tagctctaga gacagttttc 715020
 aaaagaatca aaatgatgcc tgggtgctg cTgtgcagct gtaaggccaa ggcaggggga 715080
 ttgaaagtcc aacagtagcc tgagctatgt ggtgagacc tgcaaagaca gaaagcaagg 715140
 gctggggaga cggctcagtg atttaaatgt ttctgataca agtataatct ccagaacct 715200
 ttagatagct tgTTTTtagtt cccctactca acttcattaa caagaaggat aatcaagaca 715260
 ttactacc atctaccaag agcattcact gccagatact tagaaacct cacaacctg 715320
 aattctgccc tagagagcca tagccacggc tttccacaaa tcatgtctct gTcaatatct 715380

 tatctgcca attcttggat ccaatgggag agagtaaagg acccagaaac aaaaatgtgt 715440
 agtactacc atgtgattcc cagcaaaggT gccaaaagca caaactggaa aaagacaaca 715500
 agaaaTgta ggaagctgg ataccacga gtagaagact gaaactacat ccgtatctca 715560
 ccttgcaaga aaatgagTcc agtatggatc aagggcctta acagaacacc tgaaagtTtg 715620
 aaagtTtca aggaaaacat taaggaatct agacagaggT gatgactTtc ttcatagatc 715680
 tccaatagct tagaaagcag caagaattga caaagggggT cacatttaa aattaaaaac 715740
 aacactagaa acaattacca caatgaaaag atagcccagc agggcaaggT agTcatgcc 715800

 tgcaatccta gaacttgaga ggtggagTcg ggaagaatgt gagactcagt ccagcttggg 715860
 ttgtacaaga tctttagaa aaaaaggaaa aagagggagg aggataatga gaaaaagaga 715920
 aagataagaa gtcttcagaa tgggagaaaa ctttTgacta aggaataaga cccagaatat 715980
 ataagaaatt caaagactta aaatcaaaaag ggcaaataat cctaccagca aatcggcaca 716040
 tgaaactgcc cgatttcaa aaaaaagga cagatggcat gaaaaggaat ttcaacatct 716100
 tttgtcatca gtgtatcaaa actacactga gattctatat cccccagTta gatttacaat 716160
 tgccaaagag gaggtgtaaa aaaactcaa gcaacagcca ggtgtaacga cacaaaaatc 716220

 ccagcacttg ggatatagag gcaggatcag gagtTcaagg tcatccacag ctacaatagt 716280
 gaattctcat gagcctgagc tacaggagat cttttcttta aaaaagaaaa aaaaaacttt 716340
 tgaggatggg cagtggTggc acatgccttt aatcccagca gagaggcaga ggcaagcaga 716400

tccatgtgag ttcaaggcca gcctggctca caaaaagagt tccaggacag ccagaactgt 716460
 tacacagaaa aaagtagtag tataccactc tggaagtcag aatgaagatt cctcataaaa 716520
 ctaaaattag aactcccta agattcacct ggaccactcc tggatgtaca cctgaaggaa 716580
 ccaaagtcag cticctgtag tgatatgtgc acaccacat atcactggat tattgcggtg 716640

 tttattgagg cattattcag aaatgcaaag tcatacaatc agcctaaatg cccataaaca 716700
 gatgaatgaa gaaagaaaat aaggaatgtt acgctgcat aagaagaag aaaattatgt 716760
 tttctgtagg aaaatgggta gaactggaga tcatgttaag caaataagt cagacacaga 716820
 gagatgagta tcacatgttt tctcatgttg tgtgatatcc aacagagaag actgcttaga 716880
 caagggttta agccaataga aaatcttcat tacctgggtg tttgggatcc tagtatagca 716940
 ctaattggtg agtttttaa cacaaaaacc atgttctggg ttgacatact tcagttaaca 717000
 agaataacta gcaagaagta gaacaactac agataccaaa aagcaaggtt agtacattta 717060

 gaggcattcc cagaactttg gatthttagt gatttagtct ttgttttagt gttggcaggt 717120
 ggtactgtct ttgtgctgag ttgacagcc tgaatggtac ttccatcatg gagtcagttg 717180
 tgctaaggte tcaggatcta ctaagtctgg ggcctgtta cagtatccaa tccatttgag 717240
 tgctgaaagg gtcatgtgga tggccagga ggatatgctt catgcagtag attacattat 717300
 aggaaggag ctgggaaac ctgccagttt ataataagca ctgaagcaa cctggttttt 717360
 atcccaaaga gtaacaatac cacaccactc aagcttgctc acagcaaaca agcacagtec 717420
 tgaaatgac caggatagat ggtagtcagt ccttcgtact cttggcacac taagccagat 717480

 aacactggaa gaatgtctca caacaatata ttaatgaaat aagtgcaaaa tgggtgcagt 717540
 cactctgaaa atgtcagtt acctagatat gctttgtata cgaccagcc attcttctcc 717600
 tatgtatcta cctaagagaa atgaaagtat atatctatac aaagtctctt acatgaatat 717660
 taatagcagt tggaggatga aaggagagag aggaggaagg aaggggaata cctcaataaa 717720
 aaaatagcac tttatttga acagctaaaa attaaaaatt tctgtgaata gtatatggat 717780
 gaacaaatgt aatatccatg caggagatta ctactcggcc ataaaatgta atggatgtg 717840
 acatatgcaa caacacagaa agactatata tgctaggcaa gcactctact actgagtatg 717900

 tccccagctc tttaaaaaaa aaaattagtc ccagtgtggt ggcacacacc tttaacacca 717960
 gcacttagaa ggctgaggca aatggatctc tgtgagttca aggttagtct ggtttacata 718020
 atgagttcta ggccagtcag gacaaagaaa gaaaaaaga aaactttta aaagacagac 718080
 aggagctggg catgaaacac tcttttaata tgaggaagtg ggcagaggca gatggatctc 718140
 ttgaattcaa gaccaacccc agtctacata cagagcaaga tccaggacag ccaggactac 718200
 acagagaaac cctgccttga aaaaaccaa aaataataa ataaaaataa tgatagctgg 718260

ggaacctggg gcatgaggac ttggctcatt tgctacctta ttcactgagg tcataactga 718320

 attctactga ttccaagca taaattctga gtctctcaat atactacact attccccacc 718380
 tatattatga tgttcccct cttttttttt aagggcataat gtggtgcatt gcataggaag 718440
 caaatttaga agaaaataca ttcaaatgat catatgtttt gtggttagtt atagatatcc 718500
 aatttctaga aatcaatctc tctccttgac tcttgtgtgt tttaaaaatg aacatatata 718560
 atattttagt tgttctaagc aaaaagaaac tcactttgtg gactaaaaag taaagtattg 718620
 aacttctctg attatgaaat actgtttatg agaaaaatct cagggatgct gcctaagttt 718680
 gaaccagct ctatcaattt tccacctgta aaattctgga gctctctaaa ttccagtcc 718740

 ctctctgta aatagctagc atctagagct agtgtggagg ctgagtgagg caatgcacaa 718800
 agagggttta tcacaaagct ggatggacat atagtgaact accaattgat attaattata 718860
 ttatcatcat tgttctgagt ttgacagcca gttgtctgac attgatTTTT taacaaatta 718920
 gaacatcatc ttaaacacag gatctactta gttattagag aaaaccttgt atttacagta 718980
 ggttgaaaa aaaacttttt gtgaacaaaa tcaaaaagtc agacacatag cccagctcaa 719040
 gaatctcagc acttgggtgg tggaaacagg aggatgagtg caaggtcagc ctataccaca 719100
 tgagatcctg tctcaaaaca aataagcaaa acaaaaagaa tcagttcaat atgaaataac 719160

 atattgtagg aaggaatgct ggaggactgt tctgcccact ataatttctg atcagtgcaa 719220
 tttaaattaa attaagttaa aataatttta attaattaa aattgctgat ctaaaacttt 719280
 ttaaacacga gtacaataac ataaagaagg aaagatttaa gaggactagt gtgagcttc 719340
 accccaccac aattatgtgt gacgatggca agagcccctc aattccctgg atctgttccc 719400
 tattccattc aaactaaagg gttgaacaaa accaacttgg aagacttctc aattctttaa 719460
 cccaataatt ctacatcac atatttactc atctttcact ggccattaat tcccatttta 719520
 gggccaggcc ctacactagg acctggagaa tcaacataat taaatgtctc agctcctgtt 719580

 atgaagcata cactctaaaa aggaaataca agttgcgccg tgtgtgagtg cgtgcgtgcg 719640
 tgcgtgctg cgtgcgtgcg tgcgtgtgtg tnnnnnnnnn nnnnnnnnnn nnnnnnnnnn 719700
 nnnngcctgt gtgtgtgtgt gtgtgtgtgt gtgtgtgtgt gtgtgtgcat gaggggaaga 719760
 gggagccctc accagtgcta agatgtatta aagcagcaac tagacaagca ctacttatgg 719820
 cctatctgtc ccaacctata gctaagtatt caagtaataa acagtagcat tgaaccacac 719880
 cacaccacc ttgaacatct ccaaaaagta cacaagtta gaagacccat gaaaagtcca 719940
 gggcagtggt gttcctatta attaggcatt gctaaatctt tcagcaattt atgagccagt 720000

taggtctata aaaacaagga aatggctgtg gtgggataat ctgtcatatt gtgcctcaaa 720060
tagatggccc ctactccag cagtctgcg atggcatgaa cctttccta agcgttttct 720120
tctcattatt gaaaacagat gctttcttat actctcagat tcaactcaaa ccctgtgaaa 720180
ctccaggttg tagaattcta aggtgggtcc cccaagatct catccattgt ttttagacaa 720240
aatgaggcct ctggggttca tggcctcagg ggagatggag cagaaatgaa gctaggactt 720300
ggggcagagc tggagtctcg ggattggtgc tgactgcccg ctggacagct ggagggccta 720360
catcttgacc ctgactcatg aagtgactca tcatgccaat catctctgcc actctctgca 720420

gttgaatgt ttgctgact cttcctggaa gaaagatgag ctcaaaaagg aagaaaggag 720480
gaaggaagga agggaggaag gaaggaagga aggaaggaag gaaggaagga nnnnnnnnnn 720540
nnnnnnnnnn nnnnnnnnnn nnnnnnnnnn nnnnnnnnnn nnnnnnnnnn nnnnnnnnnn 720600
nnnnnnnnnn nnnnnnnnnn nnnnnnnnnn nnnnnnnnnn nnnnnnnnnn nnnnnnnnnn 720660
nnnnnnnnnn nnnnnnnnnn nnnnnnnnnn nnnnnnnnnn nnnnnnnnnn nnnnnnnnnn 720720
nnnnnnnagg cagaggcagg aggatctctg tgagttcgag accagcctgg tctacaagag 720780
ctagttccag gacagcctct aaagccacag agaaacctg tctcaaaaaa caaacaaca 720840

aaaagcatat tgiattttac tttagctttt tcattcatca aacttaacac ctactaaacc 720900
aagagtaata tgagataata cctgacatg ttattgtttt ttaaataaca attaatagag 720960
ttgtttgtaa aaatttcaga cctccactaa tgatcagcag ccaagccca gactacagga 721020
gggcaagatg gtttatgaac tctacaagca gctagatgca gtagtacaca cttttaatcc 721080
cagcacttgg gaggcacagg aggtggagct caagttcaag actatttggt ctacgtaaaa 721140
gaattccaga gcaatcaggg ctacacaatg agatattgct ttaaaaaaca aaacttcaag 721200
cattgaagta tgaatatgtg ccaaagcaga cagtgaagag tctatatgca agtatatcaa 721260

ttgattctaa ggagtctaac aaaagggtac ttggcaactc aagaagaata tagtcatcct 721320
ggggaggtgg tcttagtaca gttagatacc aaaggttctt agcatcagaa gaaatcattt 721380
cttccactgc catgagtttt caataacctc agagttgctg gaaacatga gaacaatctc 721440
tgggattgac agtcgtgtca aacaagaaac agacctctgt gcaaaaaagc tgggcacggg 721500
ggtgcacacc tcacaagtg gaggcagggt gatctctctg agttagagc cagcctgatc 721560
tacagagtga gttctaggac agccagggca acacagagaa acccaatctt gaaaaacaaa 721620
acaataacaa caacaacaac ccccccaaaa aaaaacccta gatttaaagt cataggggta 721680

ctgagcttgc cacacaattt ctggagcagg tgtttgtggc cccagtgact ttttattccc 721740
atggcctcag tattcccaat catctggctg ggatcctttt gctctgcca ggtaaacaag 721800
ctctgaaga gttggcctta ggtctgggtg tgctttacgg acaagtgcac agcaatgact 721860

cgcagagcat agcaaccacc ctgggattgg tcaacaacca gttgaccaat caacacaggg 721920
 caaacctcc aagcctggag cccaccaat cctgagcctg tgcgtacccc tagacactcc 721980
 ccttacacgg cccgataaga tctctatgca gtcacttoga actgtctttc ctagccatct 722040
 gccatgggtg gatgaaagac ccgagctaac atgggttaac ttgttaaaca actataataa 722100

 agtctcatgc agtttgcaaa aaaaaaaaa gagttggcct tagggctcta ctgtttccac 722160
 tgcagcagta agcaggtagg aactgcagca gggccgaacc ccacatacca gagttctcca 722220
 gcaggcctca gaccataact cttgcctaca ttacagctcc tgtataggtc taggaagcta 722280
 acagtcctca gctcttagca ctagtaagtg ttaaagctct tggcctggga tctgatggcc 722340
 ccaaagatgt ggcaaagctt ctggtgcca ggacctacag tttctcttct ctggttcctt 722400
 acgtcgtggc tccccagctt ctctctgctt ctgttgccct tccttctctg gctgctactg 722460
 aaccattcag ctgcttcttc agctgtcaag cagctggctg ctgtgttact gactgctcag 722520

 ctgtcactgc cactgccctg tctgtacca ccctcattgt gtccttgtct cttctttctc 722580
 tgtgttatag aagaagaaag gagcactgga ggggagtitt ttgttattgt tgttgttgtt 722640
 ttgggtttgt ttttttgctc ctaatgatac aataggagaa gcagctcagg agagcgtctc 722700
 tcagacactc actaagttag cctggatggt gcacttctat agccggagaa gaggcctttg 722760
 gatcaacaga taaattttag cagattttta agtgcctagc agtggcccag tgccccacgg 722820
 agaagtgggt ctctcttacc tgtctcatca ggactcaagt ccaatgttac agaaataact 722880
 ataatttgta taatacatct tcagattttt tttaaacttt taaatcagat ttgttaactt 722940

 aattttatgt gagtgttttg ctttcgtgta caggctctgtg caccatgtgg ttgctttgtg 723000
 cttcaggagg ccaaagaca acatcagatc ccctggaact ggagttacag atggctatga 723060
 gccaccatat ggggtgctggg aattgaacct ggctcctctt aaagagcagt cagtactctt 723120
 aaccactgag ccactcctcc agtccatgcc ttcacaagge tttatgactt tgctgtaagg 723180
 atcctaaacc ttaccgtgct ccaggtgtct ttgaggtgct tgctttagct gcaggatcca 723240
 tcacctgga gatgtagagc ctagacaaca acacattcta caatgcttgc ctccacacca 723300
 tgccaccagt gcaaactcag agtggagaga actgctattc agtgtttgag ggtataacag 723360

 cctttgtatc ttattttgaa gtgccttgaa ctfgacatca taaagtcatt aagcaaattt 723420
 caaatacatg aaagatgata aatgctgggc ttggtagggg cagaaggaat gtaagctcat 723480
 tggctacaag agtgagtcca aggctagcag ggacaactaa ataaaacct gtcctaaaat 723540
 gaaaagtaaa gagagggctt gggatgtagc tcagtcatag agctcttgcc taatatgttc 723600
 aagagctgga gtgctatcca cactatcagg ggacaaaatg ctgataaagt ctgggggaca 723660
 tcagggctac agagatggct cagcggtgga gtgcttgcta ctctccagg agaccagggt 723720

ttggttccca gcacccaggc caggaggctc acaaccactt gtaactctaa atcccatagc 723780

 tccaacactc tcctctggcg tcctctggca cttccattca taaacacaca cacacacaca 723840
 cacacacaca cacacacaca cataattaaa gataaaatgt tttttaaac tttgggaaaa 723900
 tcatgtttca gtataatata ctctatgata aagtaaattc tgttcagatt tacttttaggc 723960
 tttgggtcca gctagatagt gaatatttag gatatagaaa taaatcacct tcacatctct 724020
 ctctcagta cttaacataa tgcctgtgaa cagtagaatt tatgtaaag ggttaccag 724080
 attttatgct gttacaaca tttgtaaac aactgtggg aattaggtt gctttattat 724140
 ccccagagat ggcttggggc taggattggc ctctgtttct taacttctga tgcctttact 724200

 ctgcaaac caaaattat tattctgttg ctgttctgg taaaattatt cattatagtt 724260
 ctgactttt tccagtgcac agttgacatt tgatataaag ttgctatgtt gcatcatgat 724320
 gtttgtttta aaaataataa aactttcttt ttactatca agataaaaaa atactctgtc 724380
 aattacaaga caatcagggt actgagacct ctgttatggg agtgccatct ggggcaaggc 724440
 actagccaat tacagtgtac tctaagctgc ctttaattat atgccacct ctctagaatt 724500
 ccttctgtgt tttatactc tgggcatgc ccttgetcc cctatgccac tgcctaaacc 724560
 tgccttcaag ttatactccc atcctttccc tcatctcatt gctatcatca acccaatag 724620

 agtctcactc tttcaaatct ataggacctc tataaaattc agaatttatt caaacttta 724680
 agtctctagc atttagctaa gttactaaat taccaatact tctctcttac agcctgtcca 724740
 agccatgctt cagcctctgt tttcatacct tcaatactgg ggtgggaagg tgggactga 724800
 gtgagttcaa ggccagcctg aacaactaaa taagaccctg tcttaaaatg aaaaacaag 724860
 ggagagtttg ggtgataatt caacagtaga gctcttgctt agtatattg atatctggag 724920
 tgaatccac aaaaccaggg agcagaatgc tgatggctca gcagtgaggt gtttctctct 724980
 ctttccaag gaccagctc cctgaacagc ccagccatc ttgggacagt tttttttta 725040

 tcataaattc ctctgtata ctgtaaattc tctttccttg gagatgtatt aggaactggg 725100
 taataaggc aaatttctac cactctgat ggtgagaact ttgacgtctg gcatcccaac 725160
 tactgtaag aatataaggg agcatcaatt tcacacacct ctgtggggtt caaagttact 725220
 aaaagtgctt taggagagca atttggttat atctaataaa gtttaaagca tatgcttacc 725280
 ttccatttct ggcagcactc caaattagta aatatccagg gcatgaactt aagagaaata 725340
 atagaataag cacaaagaaa gaaaaaatta atataaagg agtcaattaa taaaaagaaa 725400
 ggcaataag ccatagagga gattgacaaa gtcagaaact gatgttttaa aaatgtctct 725460

aatgcaatta agttaagaga gagaacacaa ggctctggat gctgtgcagc agcaggtgag 725520
cgcttgccca gtgtgcaccg ggcctggctc tgtcccagc accacatggt aactgttcta 725580
atgttctttc ttgctgctgt ggtaaacact atgactaaaa gaaacatggg gacagaaagg 725640
gtttacttgg acttacagct ttcaggtctc catcattgag ggaagtcagg gtgggaactc 725700
aaacaaaaac taaacagaaa ctgcagagga atgcctgctt ggtgattgct tcctctgttt 725760
catgctcagg taacagtgtc acccacagtg ggcgggctgg actcgccac atcagtcacc 725820
ggccaggtcg gtgcccata gacctgcttg cacaccaatc tagtcaagaa aagaaaagct 725880

ttctgcccgg cgttggatg gacaccttt aattccagca ctgaggagc agaggcagac 725940
ggattctgtg agttcaaggc cagcctggct tccagagcca gtgccaggac aggctccaaa 726000
gctacacaga gaaacctgt ctgaaaann nnnnnnnnnn nnnnnnnnnn nnnnnnnnnn 726060
nnnnnnnnn nttccattgg gattctctct tcccagagac aaaaaactaa ccagaagatt 726120
ggcgcaggcc tgtaattcta gcactagaga tgaagtaag agggccagaa gttgaagaga 726180
atctgaggcc agtctgggat acatgagatt ctgcggggga ggggaacaaa aaataaatat 726240
aacatcaca tctgtaatcc aagcacaggc cagccagtgg gttctagaat ggcttgggtc 726300

acagaatgag acctgtttc acaaaacaa aatcaaaca acaaaaacc tcttgcccga 726360
tgcgtgttac cttttgctgc cagaaatcct atggcaggta ataaggaggt taagtaagac 726420
cagtgcaaac aatctcaggc caacacattt ggaaggagtc caaatagaaa gaagaatgaa 726480
gaaccttaaa ttgttttatg acaataaaat agagtaagag gataaaatat ctactatat 726540
tctaaacaat gcaactctgat cagcctagat tgatagtcct actaaaattt caggaaagaa 726600
aaaatcttac atacatatac aatctttaca tataacaatc ataataaca atatattcat 726660
aaactgtt tccggggcct ggggggagaa tgtaaagaaa agacaggac tgctgaggtg 726720

gctcagccta taggaaagag tgctgctctt gcagagcacc cacacaggc agctcacagc 726780
ctcctattac ttcagcccca gaggtagcag aactcagag ggaacctgca ctcattgaca 726840
catgcccaca cacagacaca taattggatt taaaaaatct ctttaaggag ggacaagcct 726900
aggaaatcag cttgggtgtg aaggccttac cttgcctcca acaaagcct gagttccatc 726960
ccaatcatga agtgaggac atttagctca ttttatgaag gtcacataac tttgagacca 727020
taataacaaa aatagtaaaa taaaggaaac catgtgtgtt ttccactcat gagtagatga 727080
aattattttg aatattagac aatgagatct atcaatctat aagacaacat tacactcttg 727140

agtttgtatt aggaatgcaa catatgttta gtaaaggaaa tcaaattact ctaattcaca 727200
ttaacagatt aaaggaaaac aatcacatga ctgtaccaac tgaaaaagaa aatataaca 727260
tccatttgtg attcattttg tttttgtttt tgttttttta gacagggtt ctctgtgtag 727320

ccctggctat cciggaactc actctgtaga ccaggctggc ctcaaactca gagatttgcc 727380
 tgcctctgcc tccaagtgcc tgtgattaaa ggcaactgcc accacaactc agccattttt 727440
 ttacatttat ttgtgtgttc gtgtgtgtgt gtgtgtgtgt gtgtgtgtgt gtgtgtgtgt 727500
 atgtacactc gaaggagtgt gtcatgacat ggatggggat gtcagaggac aactagtagg 727560

 agtcagtttt ctctctctac catgtgggtt gaggaatcaa actcaagatg tcaggctcgg 727620
 taacaagtgc ctttccacc tgagtcaatc tctctggccc ccattcgaga tttttttttt 727680
 tttttttttt tnnnnnnnnn nnnnnnnnnn nnnnnnnnnn nnnnnnnnnn nnnnnnnnnn 727740
 nnnnnnnnnn nnnnnnnnnn nnnnnnnnnn nnnnnnnnnn nnnnnnnnnn nnnnnnnnnn 727800
 nnnnnnnnnn nnnnnnnnnn nngtttaggg caagcacgtg ttgggctgtt atggctgccg 727860
 aaaggggagt tggcccttc acaagttagg caggactagg ggtcaaagag gattctggga 727920
 aatgtagtag agaagtgggtg atccaggcag gaagtgacat agcaaggaga ctcatatttg 727980

 agcgaggaga aacaggaat gccctcctt tccccttct cctccagcgg caccatgtga 728040
 gccacaggca agagagggtg ccagcgaaag gcatcctcta taaagataag ttttataaca 728100
 tatatagatt tatgataatt aagactgagc tagcagatga gaatcctagt cattggccaa 728160
 gcagctttga acctaataca agtctctctg tgcattaatt tgggccttaa ctcaggcggg 728220
 aggctggctt aaagcgaca cgtggtgggtg gggctctgcg gcttttgga gaaagattta 728280
 ccgtaacaca tggagtttgt agatagattt ttctttggaa cgacagctca caaaaaaca 728340
 catgggaact tattattagt tataaaagct cagcttatag cttaggtttg ttccactaac 728400

 tcttatacct taacceattt ctattcatat acatattgcc acgggactta tgacttttac 728460
 ctctccttct atatgccttg ttcctctgca atccagctgg caactccacc tttcttctc 728520
 ccagagctct ctctgttag aagtctctgc tatacctcct gccttgctat tggccagtta 728580
 gctttttatt aaatcaatca cagtacaca tcttcacaca gtgtaaagga atattccaca 728640
 actcttaate tgactttttt attatcctaa aaagtttga aaaataactt tcaaggatta 728700
 gaaatttaca ttacattgtt aaataagctg cataggtaca ataccttaa caagagtaga 728760
 aatatatgta tactatgita tgttcttttt cttatttaaa aaatattttt cattttacat 728820

 accaacccca gtttccctc cctctcctc tcctgcct ctgcctctca ctcttcctaa 728880
 ccccatcca ctccacagag caggtaagge ctctctggg gagtcaataa agtctagcat 728940
 accaagttag gacaggacca agcccctcct tcctgtatca aggctgagca aggaatgggc 729000
 tccaccataa ggaatgggct ccaaaaagcc agttcact cctgggatgg atcctgggtgc 729060
 cactgccagg ggccccaca gcagatcaaa tcacataact gtcaccaca ttcagagggt 729120
 ctagtccgtt ccatgcagg tccccagct atcagtcct agtcctctag cttgggtcag 729180

ctgtctctgt ggTTTTcccc attTgTgtct cgacccccTt gTtcatatga Tccctcctcc 729240

ctctcttcat cggaactcca ggagctcagc ccagcacttg gctgtgggtc actgcatctg 729300

cttccatcag ttactggatg taggttctat gatgacaatt aggttagtca ctaatccgat 729360

taaaggggaa ggaccgttcc aatagcctct ccattattgc taggagtctt agcaggggtc 729420

atcttttgTg attcctgata atttctctag ctccaggttt caagctttgt ccctaactcc 729480

ataatgttcc ctctattaag atctctcttt cattgttctc tctctcttcc ctccccaac 729540

tCGgtcttct tgatccctaa cattcccatc ccccatcccc Tcccttctac ccctccag 729600

tttaccagg agatctaac tattttctcc Tcctggggcg ctccacgtat gTccctttta 729660

tggttctcct tttTacctgg ctctctggg ctTgtggatt gtagcctggt tagcctttgc 729720

tttcatctata atattcactt atgagtgaat acataccatg tttgtcttTc Tgggtctgag 729780

ctacctcact caggatgttt tttttttttt tttctagtTc Taccatttg ctgcaaat 729840

tcaagatgtc attgtttttt aacactcagt aatataTtcc attgtgTaaa Tgtaccacat 729900

tttctttatc cattcttcag ttgagggcat ctgggtTgtt cccaggttct gactattaca 729960

aataatgctg ctatgaactt agttgagcaa atgccctTgt gttatgattg Tgcatcattt 730020

gggtatatgc ccaagagTaa tattgtcagg Tcttatgata ggTtaattcc caattttatg 730080

agatgctgcc ttactgatta ccaaagaggt gTgttctaac aaaaataacc tTaaattTgt 730140

attaatgtac aaaattccat accaatataa aatattTgag actTgtggtt gTtcaaaagt 730200

agactcaaca atccaccctt ttattccatt atttctattc tataatcccc ctTttccctt 730260

cagaaacaga Tccctgaacc taatcctgtt Tgtttagctt tttccctgac catgatcagt 730320

aacaattTgt aaccaacTc ccaaatgatg acaaacatcc ataaccact gaacaaccaa 730380

aaccaccca caccactct Tgggaatgtg gTgtcatgtt ctctagactg ctTcctgtTg 730440

tctgaggcat ctTtggggaa ccctgagaaa atcaagataa Tggttgaat agTctgcgag 730500

gctgaaacat ctcagccagc agcctTgaaa ctgttctgga Tgcagaactc Tgaagaaaca 730560

gcaacagagg cattctgaga ggctggatca cctgggccac ctgttttcat Tggtgtctgg 730620

TccccTgtt ctgaaaacac ataaactTtTc aaaggtcata tatactgca tTaaacacaag 730680

tatggaatgt gcaatgtgta caagtcaatt aaagatgatt tttTgtttta Tgcggttttt 730740

ttttccaga caagctTtt ctgtgtagcc ctggatatcc Tggaactcac Tctgtagacc 730800

aggatggtct caaactcaca gagatccacc TgcctTtTgcc Tcctgagtgc taggattaaa 730860

ggcatgtgcc accactgcct agctTttTgt tttatgtTg agcaggtaaa atgtacatct 730920

cctgttttgt agttttatta ggtttatfff tttatgtttg tagccaggat tttcaggggg 730980
 tccttcctga tcaaacctgg tctatatcaa ctttgatgga atcctcagcc tttcattttc 731040
 tatggaaata aaaagtataa cctcttcccc aaagcaatac attttctgac ttccatttta 731100
 aagttaaggc attcctaaaa taggctgggt taattcagca gtctctctta caatcccatg 731160
 tgtctcagca gctgtcattt ttccatcagt aatcaaaaa attgaaagtc aacaagacac 731220
 catatagaat ccagactctg tataatfffcc ataatacatg gcttatectt tttatattat 731280
 tttatttgc ttttagagac tgtatttcat tacttataaa ctatfffcc tatgattgtc 731340

 tataccatt tctffftha agtctatgta catffftha catattgtac ctctttatag 731400
 gttttctgtg tctggacttg gctttactga gtatcagcag gattctggga ttgtgaaga 731460
 caaatcttaa actgtcatgt cagccactgg tccagctcag cttagggaat ggcacttagc 731520
 acatggctct ggcagctggc tccagaccac aggcagcagc cagtggctgc acctffftht 731580
 gccacggagc actggcccac ctgggagact gcaggactag gaagctacat ccgactcctt 731640
 gtccagaacc tttcttacct ttctcaggct ctatgtttgg atattcaagc ccctacattg 731700
 gatgccatat gtagatggat tttcttttgg gccgacagct cacaaaaaga aaaaaaaat 731760

 ggggacttag tcttaattat aaaagcttgg cctatagctt aggcttgtcc cactagctct 731820
 tataacttaa attaacccat ttctattcat ctacctgttg ccatgtgact catggctfff 731880
 acctctctc ctgcatgctt tgcctctctt gcctctggct cagactctg tctffftht 731940
 ttccagagct ctctctgtcc agatgtccct gctatacttc ctgcctagta ggtattggcc 732000
 gtttagctct ttattaagcc aatcacagtg gcacttcttt atacagtgt aagggaatatt 732060
 ccacaacagt ggggcgataa ggagatagtt gtgcaagtgg agcacccatt taaagctggg 732120
 tgtattgac catggcacat ctattaccgt ggatactttg gaaggcagaa acaagaggat 732180

 ccctggagct tactggccag taacttctag ctgaactggc aagattagtt cagtgtctca 732240
 aaaaaaaaa aaaaagagtg aagagagata aagacatctg ctctccacac acatgtgcac 732300
 acatagctgt gcacttactc tacacacata cacacagttg ttaaagagag ctgttcacat 732360
 aaaaacatac tgtagagaca acatfffct catgctactt acaattataa aatgttgaaa 732420
 gcattctctt tgttgaatt aacacacata cttcatttta ttttaacagc atactggaga 732480
 tcctagtatt gccataaga aagtaacaag aaataaaatt gtaaggattt tgagctggag 732540
 agatggctcc ccagtcaaga gcacttgcia ctcttgcaaa ggacccaggt cagttcccag 732600

 ccccacaagg cagctcacag caatccacaa ctagtttcag gggatctgat tccctcttat 732660
 gacctctca ggcateaac acaacatggt acacagacat atatgcagac aaaacactca 732720
 tatgcataaa ataaaaata gaaaggaaag aaggaagaga gagagagaga gagagagaga 732780

gagagagaga gagagagaga gagagagtct tcagactgtt tctattcadc tagagccaga 732840
tcgtttgtat tgctgagttc attgtgtcc tcattgtat tctgaaatat tagaagttgg 732900
ttaagtcac ggggctaggg agatatcttg gtagtaaagt actgtcagag caaacatgac 732960
tatccaagtg aaaagtaaaa agccaggagt atataacgtc actctcttgc ctccatgaat 733020

gcacacttga gaacatgcac acacacacac acacacacac acacacacac acacacacac 733080
acacacacac acacacacac acacggggggg gggggggggg agagagagag agagagagta 733140
gggggaatcc tcatgtcctt tatttgaact ccacttttaa atttgtttga atttattgtt 733200
ctaggctcct gataaattac ctcaaccttg caaacaatt tttttttta atccacatct 733260
ggcctttggt gatatctgta atcccagcat gtaggagta aaaaagcaag atcaggagtg 733320
aaaagccact gttgaccag cctgagctgc aagagacct gtctcaaaa acaacaaac 733380
aaaaagatt cacgtcatcc aggggcataa attgtgacct tataaattct agctgattca 733440

aagaaaaacc aagagaagag agggcagccg cagcctaadc ctttccggac tcggctctgg 733500
aacgcctcct tccggtgctg aaaattggta gaaattttaa aattatgaga ccaatattga 733560
caatccccca agagagagcta ccaattgggc aggccaggcc tcagctgtct gcctatctag 733620
ttgatttagt ttctctacca actgtgtctt cgcccacca gaatctcca gagaagctca 733680
attaaacctt gccttagtgg gatttgtttt tccaggtaa atattaggcc taggtttctt 733740
ttgtctcccg gtgttaattc tgaattaaat cctcattaac tgtgcctatg gagtaacctc 733800
atcggaacca ctctcttcc atcctctcct aacctccgt gtcaacacca atttcattc 733860

ctaagactct ggagaaatat agggtagca gaccacaaaa cttgcagcca ctgggatgag 733920
tctgaacca cggcgtttac tgggctaagg gtaaatgg ggaaggcagc taactaccgg 733980
gggctttggg ggcttataaa tgtctcacia caactccttg cctctgtac ccaaggacag 734040
gcttctcctg ggagctgat tccgagctga gtcacttga ctgtaagtag gtggaaactg 734100
atctcttat tctactgct tccaggactc tatctcttc tctgggttcc ctttcagaca 734160
gcctgggctg ctggagacct ggctataaaa ttaaaaaaaaa aaaaaaagtg tccttcttg 734220
ggctgcttct ggagattctg ctctctctt ctgctctcgg ctgttccgct gatgaagctt 734280

cacctcctt ccgtgtggac agccggtacc ttgccctga gacagagtga agtttgagat 734340
cgtgtttata gtaggccag ttgttttctt gttcttata tttagatacc aaacaagtgt 734400
taagcttct ctgttaggtg gcctccactc tttggtggag tgcagatgag ttctgttggc 734460
aactttatct gcttccagg caagaaaaa ctagttggc caccatttc ttggaaagt 734520
aaacaaatct atttgattca gaggtaagg tcagagctgt caagatatta acataaaaga 734580
tgcaaagcag cttttgttg actagccttg tattgtcccc agttctctt acctgcttt 734640

tgccatcccc tagccggtaa aaacataaaa agcaatttat tctaagaagt actccaaagt 734700

 gtcagctttg acctttgtca acttttgaca tgtgaatgct ttagattttc ttcagagaat 734760
 ggctttgtggg atctgagttc aaccactca tacagtgcaa aattgagagt ttgggaatec 734820
 atctgtgtgt aaatcacttc actctgtatt cactagagtc aaaccagga accaacaatgc 734880
 cgtttattcc aaccttctt ttcctttatg tgtgctgagt gttttagagt cgataaccag 734940
 ttagcctaaa tgcactag atggatgctt gggatgatc tgcaatttg gatgagtgct 735000
 atgtttcact gacattggat atttgttctg atgcttctg tggagaggct gtaggaggct 735060
 aatggatgg cacactttt ctttgtttga ggaaggcctt aaaggatcaa gagaatctcg 735120

 gccactccc gaaagcactt tacagtgctt tgggaccctt ctgcttcac cagttgtctc 735180
 atgggtattc tgaaggcttg ctcagctgga ttttccagg ctatgacttg attgattctt 735240
 tctggcagga agctgctgca tctgacatga aagcgtctc ccctcctttt gctgtaaacg 735300
 ctggggagct gagaagagt actcatctc cttcgccac actgaggaac aacactcaa 735360
 gtacacggaa ttcagagagg ctgtgatgta tttcagtga tagagtgtt tgctaacaatg 735420
 catgaaacce tgggtttgtt ccctagctct acataaaact ggacatggtg ccgggcatag 735480
 tggatcatgt ctttaatctc agcactcagg aggcggagtc aggtagatct ctgtgagttc 735540

 aaggctgacc tagtctacat agtgagtcc agccagcca aggctgcata gtgagccct 735600
 gtctcaaaca aacaaataaa actggatata gggatcatgc ccaaacccc aacacttgga 735660
 agggagaggc aggaggatca gaagtcaaa gttatccttg gctttgagac gatctcaaac 735720
 aattaacaa ataatggaa ttcagaaaat caggagatag catgtctctt gggaaacaga 735780
 agtgggaact ggtttcaaaa gatgttagt aagcagatgg aagggagt ag tgtctggagt 735840
 gttggagtgt ggtcattcca tcagctccta cctgtagtat attactgta ccataggaat 735900
 gagcgcctgg gacctgggag gcagccaca ctaacaagca gctgcctggg caacaggcat 735960

 cattcaaac ctctctgca ctttgaactc aggtgccttt aagccatact tgggcctcag 736020
 gtgaattctg aatccaaacc acctgaggac ataggataaa ataaccacag actcattttc 736080
 tcctgttcac atgctcaaaa accaacagaa gacttgagtg acagatgtgg gtgctggtct 736140
 ctgcaatac caagcatgct tacaattcga aagcagatgc caactgggta tcctttaact 736200
 cagacagtgc caggttccac attaagggca tgcagatg tcatactac atctcagagt 736260
 gttttgcccg gcttctaacc atccattgat gatttggat tttcacaacc ctctcctcag 736320
 aactcagggg tgttattaag gtatattgca gtttatcata caggatactg gtgggcagac 736380

tatgaagaga tgctggggc aaggcttagg gcagagggg acacagctac cgtctgggaa 736440
tctccatgtg atcagctgga cagtctctg caccctgcct tgggagcttt caatacatca 736500
gaatgagtga ttaactaatt ggccagctcc tcctttagcc tcctttccct ggaggatgga 736560
gggcatagtg ccaaagaatt caacaaatag actcctgcct tggttcttcc ctgaccagct 736620
agcactgaga ccagaggttt atgtaggtat ccaatgtagg ttttacaacc tcaactatcag 736680
gttttgagca ggaagaggag caagaattca aaagagaggt acggggctgg acagatagct 736740
cagaggttaa gagcactggc tgctcttcca gagatcttga gttcaattcc cagcaaccac 736800

atggtggctc acaacctct gtaatgagat ctggtgtcct ctgctggtat aaatgtatgc 736860
atgtagatag agcactgtat acacagaata aataaataaa taaatctttt taaaaatta 736920
aaaaaaaa gagtggact cagccgagtt gtcttcaggc aatagactta ctaatgttga 736980
agctgttagt ataacagggt ctgaaataag aatcttcaat gttgcttggc agtgggtggtg 737040
cacgccttta atccaagcac ttgggaggca gaggcagctg gatctctctg agtctaaggc 737100
cagccaaagc aaggtgtcta ctctttgtgt gtgtgtatat gtggtgtttg tttatttgtt 737160
gagacagggg ccctgtgta gccctgactg gcctggaact cactatatgg accttcaact 737220

cacagagatc ctctgcctc cgcctccagg tgtaaagggt tcaactcatca cttgacaagg 737280
catcttctct tagaggtttc tgagataatc aagatcttgc atttggggaa gcaggctgag 737340
ttaatgtgac ttatgtcacg tggtagaaat agggacgagg tccagatgtg acttaggcta 737400
tgacaggagt cactctttct ctgggtagca gtgtggggct tggttaacat gtgacctatg 737460
tcaagctgcc tttgactccc aggcagcagg gattgtatg catttccatc ctgctagagg 737520
ccctctctga ttagggccta ttagictgta ttctccaata atcatatcac ccatcagcat 737580
atcactcctt ttggcgtctg ctaggcacia tgattagtca caatttaac tggacataga 737640

gatactgctc aagagaccac aaataatfff aatggttga aagaaaaaaaa ttaagttttt 737700
acttaaatgg taagaaagag tttatccaat agtatttcag tctggaccgc atgactaagg 737760
cctataatcc tagatattcc agaaggtaag ataagaggtt cacaagttca aggtcagcct 737820
gggctacaga ttgagttcaa gtactgccta ggcaactaag taaaaccctg tectaaaata 737880
agaaaaaaaa aaaaaaagag atctggggaa tgttatgtgg taatagagtg cttgcctggt 737940
gtatccccag tactaacaaa aaaagtactg ctatagaaga ctctgaacac agcaaaggca 738000
attgaagaga gcagagtaag gatgatgatg agatgggtag gggaaaaaaaa ggcttagagc 738060

agtggttctc aaccggtggg tcacgccct ttggagtca agtgaccctt tcaccagggt 738120
caactaagge catcagaaaa cagatatttg tattactatt cataaaagta gcaaaattat 738180
ggttatgaag tagcaacaaa aataatftta tgtttggggg accatcacia cataaagaac 738240

tgtattaaag gatcacagtg ttgagaacca ctgccttaat ggaaacacca attataaggg 738300
 gattcatgtg atcataatgg agtatttgct acaggcaggt caaaggggct taggaactta 738360
 gatattggac agtgaaagt gctaaattga cttagcagga ctgttgctaa aactggacca 738420
 gagggcaaga tcaaagccta gctgagaatg gtttcagagg aacctaactg aagtttgatc 738480

 agggagaaaag tcttgttttc cttcccactc tactgtacca gctcagctac aaaagagga 738540
 gaggtctctg cttccttcag ccaacccctt cctttttccc tttttcccag actctctct 738600
 tgtgaagagt gagaattggc agactccaaa ttggcctct caataggcag acttatttct 738660
 gactcagtct agccaggaa gcttgcctcc cagaagcaga gccccatccc tgacagcccc 738720
 actggcagcc ttagtcaaca aaaatggaac tagagttaat ttgctggctt ctcttcagtc 738780
 atctactgtg tgaatggagc tgaaggaatc ctaaatccag gccttaggac cagaacagct 738840
 gtcccggttt tgttttgttt taattttctc cataacaagt tagacttggc caggacagca 738900

 aactacagtc catggaggtt ttggttgtt cttgttcttg tctttgagac agtgtcatgc 738960
 agccaaggat ggctttgaac tatatacagc cttcacatgc tgaatcctgg gattacagag 739020
 ggttctttgg cagcttgctt tgttttgttg tgggagactg ttctttgttc atatgtctta 739080
 tttgagactg tagctcataa tggcttcaaa cttgtgagcc tcttgccctg cctcccaggt 739140
 gctggaattg catgcaggtg tgcaacatta agagtcaagg gaatagcttt gaggagtttg 739200
 gcatacceca ccaaaagaaa gcaccaagtg aactcaaaga aaataacaag atcttatagg 739260
 tgatgtgaat ttccttcag gaacagtggc aaactagttg ggtgtggtgc ttgcaacccc 739320

 agcactcagg aagggaaca agaagatcaa gatttcaacc ctagtgtcta aggaatgatt 739380
 ttgagccag cctgagatac atgagacact caaaaaatca aaaacacctg ggcataggcc 739440
 tttagtctta gcaactcagga ggcagaggca ggcagatctc tgtgagtttg aggtctacgg 739500
 aggtctacag agtgagtcc aggacagcca gagctacaca gggaaacctt gtcttgaaaa 739560
 acgaagaaac aaacaaaaat aaaaaacaaa caaaaccac aaaaacaatg agaagtctaa 739620
 aggtttgtaa gcagaaagta atatgatttg aactgtttca ggaaaaaaa aaccactat 739680
 atgaatggac aggacaagac agaatggagg gtggttgaag tggcattcat ttgccaagc 739740

 aacagcaagg gtggctcaac ctagggtagt tgtaagtttt tggttagtgg ctcagcagca 739800
 ccttctagga ttgggctaac caatgacagc aaatccacaa gctcagaggt tgacaaattc 739860
 ttcattgctta gtggccttg actttctaact gttcccctc agtcatggct taggctggtt 739920
 ttaaaactcc ctcagcatac tgggctcagt gctttgagct gcctctctgc agaccactc 739980
 taaaggagtt agtcttgaaa agtgagcaaa atttacagcc agggcttctc ctttttgtea 740040
 gtcctttctt cctttaaatg ttctctccc aacctctgca gaattgtcc tctgacacc 740100

atttctcag aatgctgctc ttgggaaaag gggaaagtaa tcaagtgaca caaattgcta 740160

 ccagcttaac cgtgtctgag gtcatttgtt ctattacttt agtgacctct aagacatgat 740220
 gtggtaactg cgtaaaataa ggtggctatt ttgaggtggg atggatggcc tgaattcca 740280
 ttttactctg gggacatagc tcagtgggag ggtgttctct ggtgaggact ttatctagaa 740340
 tgaacttggg ctactgtagc ttgactcaca aagtagcagg attcaaacca catacttggg 740400
 cctggtatte cactgggatc tcaggaaga tcttaatfff ttcctgtcag ctctagccca 740460
 gaggtgggct agaggacttg aggaggctcc ccaggggaaa ggtagaactg agaaatagag 740520
 acagaatagc catgacatcc tagacaagtt aaagagagtc tcattggtaa actggaagct 740580

 actaaagcag aattgcagag ctctgcccc agcttgtccc tactgcccag caatgattgt 740640
 agagtgtaac cttacaataa aacattacct cacatctgac aacttattct aaccaatgct 740700
 gactgatctc gatttttttt ctccccca caatttctt tctacctggg caggctggag 740760
 cccacttaag ggaagcaac atgaaatcac aatcccttgc cttacaggta gggaagcat 740820
 gcttcatttt gctttggta catcatcttt tcatttggg tgttctcaa tccacagatg 740880
 ctaattaact tcacactgaa tcacttttgt ctccacact ggatagtctc taattcttct 740940
 aagcttattc atctgtattt gcaatgatta tctcaggtct ttccttggg ataactctgc 741000

 atagtcttc aggagtgtat gatctctgta gctttaaatt attagtgtca taatggttca 741060
 attaggctc tcgtgtgtgt gtgtgtgtgt gtgtgtgtgt gtgtgtgtgt 741120
 gtgtgtacac gtgggtgac atgtgtgccc gtacatgtgg aggctagaag tcaatgtctg 741180
 gtttcttct ctatcattgt ctacctaat tttttttct ttaagacagg ctttctcact 741240
 gaatccagag ctctctgatt ccaactagact aactggctag caagccaag ggatccagct 741300
 atctttatct cccagcact gagattacag gcacagctg ggtgtgggac tccaaactca 741360
 aggctcaca tttgcacatc aggcacttta ccaactgagcc atctccccag accacaagac 741420

 agagtctcct taitcagctc tgacactgct gtatagccta ggctgacctc aaagtcaaat 741480
 caatcctcta accaacacaa cacagccctt gctgggatca caggcttgac tcatcactcc 741540
 tggtttatat gatgcttttt cttgtataac tattaagttg cctctgaaga tatgtctgaa 741600
 atccaaagat attttaagca acttgcaaca ttacagcaaa tttatggcct ctcaagcttt 741660
 atagcttagg gggaaagcac tcaacttgac tgcacaatt ttggtttcat cagctacaaa 741720
 ttatgttatt tciacaatta aaaaccccat gatttaggcc acacctggt tgttttttt 741780
 tttttcttt ttaagcaaaa gcaactgctat tttaccaga gtagtctgca aatcattatc 741840

taggtccaaa aatcgggttt attgtcagag agggcaaacc cttgtcctca aaggaaggc 741900
accatgtatg atgaaatcct ctgagaaacg gaagtaccgt tagccattg tgcagtgtct 741960
gtgaccactc tgatgacaaa gatctttctg cattacaagc tgttcagagt aagtcataaa 742020
catgcacttt ggctgcacca tggatggggg tggagggtgc tcattggcac acttagaggc 742080
ccaagttaa catabaactag tttttggaag agactggagc tacagaataa aatttaaat 742140
acacatttaa ccgcatgcaa ctaattaaaa atattttctg atagttagat tttatatgta 742200
gtctaaactt tgittaggcta aatctttata attctatgca gcatgggcta actgaaagct 742260

tccgagcatt atgccaagta ttcattgatgc agatttagtt taccctaaca atccacactc 742320
accggtcctg atgtgcatct cattagaacc caaccctgca ctcatctgaa gtctgatata 742380
ttaatgagaa atattactgg tgacataatag cacaagtcac ctttctaaga tcacatctgc 742440
cttatttatt tttgtttatt tttgtgtgtg tggtgccaga ggttggattt agttgtcttt 742500
ttctactgct gtctgtgta tcattactgt tgggaagat agttttgttt tgtttgttt 742560
tgtttgacag ggtctcatgt gtagcctgg ctggcctggg actcactaag tagacaggct 742620
gacctcagac tcacagatct acctccttct gcctccaag tgcagaaatt gcagggtttt 742680

cctactacat gcagattcta ccttagtggg tctcacttca cctggtgctt gccatctgtc 742740
tggaccccaa tgccttacct caggcttaca ggcaggctcc cccaggcttt aaggggtga 742800
tgaggactga acctcaggtc ctcatgcttg cagagcaage actttacca ctccccagct 742860
ccttgcttat ttatgtttag atgtcatttt attattatta ctgggtgagc tgtctgtgcc 742920
acagcacaag tatggaggtc aatttctctt tgggtgcagt tctctctcc cacttttatg 742980
taaaacttgg ggatcaagtt ctggcctcta gacttgcaaa ataagctcct ttatccaggt 743040
cctctttatt tttttttga gacagggtgt catgtatcct agactggctt tgaactcaa 743100

atgtttcaga gaaagatcta gaccttctaa tctcctgcc tccacatcct gagtgtgat 743160
attataagtg tgcacatttg tgcagtggga ggtggggaaa tccaagctgt ttgttaggca 743220
agcactctcc taactaagtt acacctccc acacacatct gccttttagt gtgtgttggg 743280
caggggttga gcacatgtgt atgcttgcac ggcagtggct tgtacagga cacaagttac 743340
aacatatgta ctttcgacc ctgtttaaga cagggttct caccacggag tatgctaggc 743400
tagctggcct gggagcgtct ggggattctc ctgctccca tctctccaca gtgtaggct 743460
aggatcacag acacttatgt ttctgtgtct cactttcaca tgatttctgg agacccaaac 743520

tcagtttgc aggtttcat gacaagtgt tttatccact ggccacatc cccagcactg 743580
catctgcttg tttgtttgtt ttgtttttg tttgggggg acagggttct tctgtgtaac 743640
agccctggct atctgaaac ttgatctgta gttcaggctg gccttgaact cacagagatc 743700

cacctgcctc tgctcccaa gtgctgagat tagaggcatt caccaccacc gggttatcac 743760
atctgctttt taattagtaa gggctcatcaa tatctttacc caaaacatca attaattatg 743820
ccataattta atacataccc atagaacgaa tatgatgctc ttaactaagt atgagaccct 743880
gtctcaaaaa aagggagtaa aaaaacaagt ttaaaagaaa aaagtgggaa gaatggcttt 743940

catacagggg ccaggaagca gctaagcttg actggaatgt atacttctgc atactcactc 744000
agtttcagtg aatgtatggg tgggtgcacg taaaaaatga acagaggccg ggtgggtggtg 744060
gtgcacgctt ttagtcccag cacttgggag gcagaggcag gcggatcttt gtgagttcga 744120
ggccaacctg gtctataaga gttagtcca gaacagcctc caaatccaga gaaaccttgt 744180
caaaaaaaaa aaaaatgaaca caggaaggct aaggctagaa agatggcccc aagtctgaa 744240
gcaatgtcct aatgttttc ctctcttta ttctctttc ctccattcc cacagcctcc 744300
agagcgattt ttctacatg cagatctgat taaagtctt tttctcatcc acactcttca 744360

gtcattttca gtgaagata ttgctcaaac tgcttagcat catttgcaag tctcatctc 744420
ttgtgtctac ctgccatctc agcaaacctg tagcttctca aatgcagcat cctctctgcc 744480
ttagatttcc ctaccccct atatatctta acagtccat aatttacttc tctcatccag 744540
atagccaatt gtcttgcac tactttaca atttattgtt ctttgtctga agaataaaa 744600
agcaccatgc ttgggcatt tcttcagact tcattctctt gtgaacatcc ccatatacat 744660
gtaaatftaa taaaacttta tgcttttgcct cttaataate agtttttata ctaattgggt 744720
tcctagatcc agccaaagag cccacataag aactaagagg gggctcagag aacctcttc 744780

ccctctacat tcatataatt ggtaagtgat ggagtacgt atgtctgacc acagatccaa 744840
catcctttca gcttcaactg cctacctact ttatacaaag aactgtgtct aactgatgag 744900
aatagcccct gtgaacaatt aaagaacaat gaagtactga acaatgtccg tggatattgaa 744960
gagcaaaggg gggttcaaaa agggagagca tattatttgg gctgcctggc tggagaagaaa 745020
acgtgcttag aaccagcctt tgaacaggcc ctggaggaag ggtgagacag aaccaggagt 745080
agtggagagg atgatatgag agataagcaa gatgctacat aagcaagaga aacatggcag 745140
ggggtggggg tgtgtgtgga tggagtcatg atgaagcttg ttccgttggg ggtgagtctt 745200

tggagccttt aatcccagca ctcaggggca agggcaggtg catctctgag ttcgaggaca 745260
gccaggggatg cacagagaag ccccactca aggaagaaag aaggtggagg gcggggggaa 745320
gaaagtgagg ctggggtaaa agacaagggg ggatgcttga agggcgcaga aagtaaaact 745380
tggtagagaaa aatagaaaga tcagggagag agagagagag aaagagagag agagggatac 745440
caagattctt tctagggaa ggtggtccct ggaggaaggc ctacaagaga gtcaagtctt 745500
gcacacactt gccatattga aagccacctc tgcactgtga gtgaggaag ctgaagccag 745560

gagagagggtt ttctgctagt gtagatgatt ctgctcaatg tcctacctgg agagggtatt 745620

cagggaggga aagaaagagc cacatgtctg ctgagccagt ctcccatgct atctctttct 745680
gtcagtcctc tgctatgtaa gctgtgggtca tggcattcaa agaaaaggaa tgtttttca 745740
agtatgggcc ctggaggctg cctaataatag actatcttat tctgctgaag attgaggggg 745800
gtatcagagg aaagacagga agagatgggg aagggagaag aaaatatcag ccattatttg 745860
ccatgttggg gaaaatttga actctgactt ttgtttttac ttgaagtctg gettttagtc 745920
taaaccactt gtaagagaaa gccctattgc agaggacagg gaagcacttt tgagggtgcc 745980
ttggggtaaa agctgggtat ggtggctcat atctgtaatc ccagcacttg ggtgttcgta 746040

tgcttactac aagctcaagg tcagcctgga caacattgtg agttccaggt cagcagggac 746100
tacacagtga aagcttgttt gagaaaaaga aaatccaaaa ccaaaacaaa taacaacct 746160
acacacacac acaagacttg ggttgagaag aaaactcaac tcctactagc ttaaaacaag 746220
ggaaacatta gtttatatgg aagtccaggt ataaaatgg cctcagatga gacataatct 746280
agtggcttct gtgttacc aa tttgtttgtt tgcttgttta ttttttagcc aggggatgtg 746340
gttttagtaa caaccagac tgagcctgaa catactatgt agccaaggat gaccctggat 746400
ttctcattct ccgattgct aagattatgt agttgcatac tactaccccc ggtttatgta 746460

gtggctagga attgaacceca gggctttgtg tgtgctagge aagcgtctg ccaacagagc 746520
tacatagccc cgttttacat attctgtcac ttgttttgaa gagttagcct gcatatgggt 746580
gcaaaccact gatatagtc attctgtca cttaccaga agagaaattg aagcctgtca 746640
aaaagagcaa ttttgcccag agttgtacat ctcttttaat gctgagccaa ccctaaaaac 746700
acagtggttg ggccagtgcc cgctctcaac taactaggct ttgtgaaagc aatttgggtg 746760
tgagtttatg acaggcagtt cccggtgatg aaaaggaaga cttgagggtga tcagaactgg 746820
cataccggtg ggtggatttc taaaggtcag gaccateccc tacaacttca cgaagatcgg 746880

aagggttggg gccagttga ttgggtcttc tcctgcaatg taacacacat gcagaaagcc 746940
tggtgtcaac catgttagtg tctctatgct gcattagaac accatgacca aaagcaactt 747000
ggcgaggaaa gggtttattc caggttacia cttcaggctc atagtccatc accagaggaa 747060
gtcaggcagg cacctggagg caggaactcg atcagatggc atggaggaat atctcttact 747120
gtctttctct tcatggctta ctgagcgtgc tttcttacag cacccaagac gatcaacca 747180
ggggtgggtc tgccccctcg tgagctgggc cctcccat caatcatcaa tcaagaaatc 747240
gcaccacagg ctgccacag gccagtctgg tgtgggcagt ttctcaactg aagttcctc 747300

ttcccaaatg acictgactt gtgtcacatt gatataaac tagccagcac accaactaaa 747360
 ttgagagtgg agaggaggag gctggagctg gccagacagc tgcacagga gccagcagtg 747420
 ggtaggatca ggatgagcaa actgttattc tcttctctct cacagcactt gtgtattggg 747480
 tggagggaac ctiggaaatg cagacctagg cttttccaaa acaagagagg gaaacggggc 747540
 agttgggtag ggaggggtgg ggatcccata gtgacagaag gcattcaagg gaagaaactt 747600
 gctaaaaatc catcagcccc ttcaaactcc aactagcaaa ttaagaaatc catttagctt 747660
 atgttgccat acctgacac agtctgatct gtgtttgttc cctctagatt agcagggaat 747720

 ctggtatgag atgatggcca cttgcctca ggaggctttg tcccttatcc ctctcactga 747780
 gccgtaacat gtactctctt taccttagta agacttctgc cactgtgagg cactcctggg 747840
 ggggggcact ttcaacagct ctgcccaggc ctaaggtctc ctgggaccac tgcttataca 747900
 ggaacaagaa aagaaatgga aagagtcatg actccgccct ctggacagca caaaccaaca 747960
 caatgcattc ttgtctctt tgcttcaacc tcctcctt tctcgtcttc tctcttctcc 748020
 ccatctctcc tttctgtca tctcctata tcaacacccc tgcctcagt tttctagac 748080
 atccggcctt gctaagacac ttgtgtggcc gagtacagca gccagcccaa aggcacatcc 748140

 tcctctacc accatcttct ctctgaactc accacggacc gccttctctg tccaatttag 748200
 gcttctcagg atggatgtca ctgcctact cctggccacc ctagtgggct tcttatgctt 748260
 ccttgccate tacagccaca tggtagctga ggagacactc agagatgaca ggagtctgag 748320
 gagcaactcc tccatgaact cattggattt ctcttctgtt tctatcgtgg gtaagtagcc 748380
 tggcctggga cctagcctct aggctgtgac ccatgagagc aggtacagta tgtcaagcct 748440
 gtgcccagg ctgccaccag catagctatg gctctttctt gctcattcct agggaaatac 748500
 agagtcttg agtcattggg tttgggaaag cttggcatgc caccaagttt tggtgtgtca 748560

 tagatctgaa gaagcctcaa gtcgagaaga tcttgggtgg gcttagtita acttagcatt 748620
 tataaactta atgaatcaca aaactcaaca aaacaaactt taggaaaacc atggaataga 748680
 actaagtcta caataaacca gtctcacatc aggatgcac aaagtctgac attggggatc 748740
 ttgtggtttg ttctcacttt ggaccaggga tgaagcacia agtcagagcg gatgcttagc 748800
 aggcataatg cccggatcca gttcctggaa ccaaaataaa aataaacgcg caaaggtttg 748860
 ttctgtgagg tggtcttga gttttatctt tatcttacia cagacaaaac tggagcttac 748920
 tgacattagt tctaattggg ctgaaccaga attcaaacag cagccaatta tacatgtaag 748980

 ctcaaacctc tgtgttgact ggcatttcaa tggacacaga aagatggtct agagcagcag 749040
 ttctcaaacct tctaattgtt gcaaccctta ttaatacact tcttcatgtt tgggtaacce 749100
 caaccataaa attatctgtg ttgctacttc ataactgtca ttttgctact gttatgaatt 749160

gtaaagaaaa tattttttga gatagaggtt tgccaaaatg gttacaaccc agaggttgag 749220
 aactattggt ctatacatat cagagaagtc aaaggaggga aaggaggaga caccaacatt 749280
 ccttaatcac cattgatatc tcagactttt taaaatattt tactttttatg taaaggggtg 749340
 ttctgccttc atgtatgtct attctctgtg tgcagtcctg gtaccctcag aggccagaag 749400

 aggatgccag agccctgaa actggagtta ccatgtgggt gctggggcac aaacctgggt 749460
 cctctgcaag agcaccaagt gctctcaaca gctgagccat ctctccagcc ccatgtcaga 749520
 ctttttgttt tataaatata ctttacatga tagaaccttt tgtaaatgag ggaactgatt 749580
 gtccaggaga agatcacaca gctgttataat ggattcaagt caggcatagc tggcctgag 749640
 ctgaaaatta aagaaaaaaa aaagtaacac agatgtgtcc agtaacaaaa ggccaagttc 749700
 atttccagag actcatagtg ctcttgcacc tgcacggtta aaggctaaaa caggggcacc 749760
 tatggtgatc aagggccaca cagtcaaaag accaggaagg tctctgacag aggccacaga 749820

 caggtccccg gtcctcttg gatttctctt ttgccttccc tgggagcacc ctgctcttag 749880
 gtctgatgcc aggctaataa gaacctgctg gcttgatttc cataatgtgt tccatcctgg 749940
 agtccctttt tctctcact ctgagacttc ccatageccc tgcctctccc acttcataac 750000
 tcaggcccc agaaacatct ggctttgctc gttctgtctt tctttgaagc actgaacaag 750060
 aatccaaga agatcaacag aaaagaagcc gagaagcaga agagatcgtc caaggtaggc 750120
 ctgggggttc tcacagttag ggtgggagat ctgcaagcca tggctgagaa ctaaatgtaa 750180
 gatatctcca agcctacatg aatgactga aaactaccta aaggtttctg gcctagagcc 750240

 ttgaggcaga ctccataga agccaggag cctaagtcca ctgaacaaaa cagctacctg 750300
 attaaaaaa aaaaaaaaaa tttccaatgc aagcatcccc accccttctt gaaagctggc 750360
 actcaatctt ttggatattt acctaaacce caactgctgc agaaccactc ttgctatacc 750420
 tgagtttctt cctgcceccc cttttagagg cctgtgcaag gtaggcaagt gttccaccgc 750480
 tgagccatac tctcagccca agattatttg cagcaagctt ttgctatgta gtacaggctg 750540
 cctgtgaact accaacctc cttatccaga gctcaagtgc cgagattaca ggtccaggct 750600
 accgtgcccc gctgtctcac ctgtctgaca atcagaaaac gtaagaata ggaattagaa 750660

 gttgggggtg gtggcacaca gctatactcc cagtatttgg gaggtggaag cagtaaggtc 750720
 aggagttcac agccacceca aactacatgc caagttctga atgacctgg gctgcacaac 750780
 cactgtagct agagtaaaaa cctcaatgaa aataaaacac tggtagcaga gcctagcagc 750840
 acaggctttt aatcccagct gcttaggaga ctgagagagg accctcagtt caagggtac 750900
 tggagctatg cagcaaatc aaggtctgcc tgggcaaac gaaacagtca caaaaataaa 750960
 catttcaaag ggggtgggat atagtgaagt agtgaagctt gcctgtaaca aacaaagccc 751020

tgagttcaat tcccatcagc tggatgttat tacctgctaa aggctctaaa tctcgctttt 751080

 ttaaaaggca gttagacctt aagtacatgt gccataccag accaaaatta gagttagaat 751140
 tataactggt aattgttact ttcaacaagc agtctagata agtctagcaa gtcagacaga 751200
 aaatgcttga agagacaagc aatttggaga aactgttct acagaccca aaatggtcta 751260
 ctttcttcta ttacatatat atatatgtat atatatattc ttaaaccattg ggcttgttta 751320
 ctaacaaatg cattcattaa atatatattac taagtattta aaataaggac aaaaaagcag 751380
 tgaccgctct ccccgcccc ccacaaaaag aatgtgttgg aaagcaatta aggacatgct 751440
 atcaccaaac acaagctaaa acagaaaaaa gaatgccttc tctaactagt gtttaaggatc 751500

 atttaacgtt ttcttacctc ccacctaaga tcatactgcc atgatacagg ttcccacaat 751560
 ttgataaata ccagattgaa gcattgttga aattcacaca ctattcctgt ttttgtgctt 751620
 cagctaaatg gatcaaccgt aaccagaaca gggaggacag aacaaaatac atgtatgtgc 751680
 taggtgctgg gaacacagca gtgaacaaga ggttactgat gtgtggagct tacacctgtg 751740
 tgggaaaacc aggccgcaag taaattaata aacaagtta aatttttaga tgacacacat 751800
 tgtgaagaaa ttaaagcagc gtgaaggcct aagtgcattt aaatgaaaaa tatagaaatc 751860
 tagagtagcg gtctcaaca tggatatttc attatgattc ataaaagtag caaaattaca 751920

 gtggggtctc ttaagaaaag gccaggtcgg atctaggtga gctttagat gaaggcggcg 751980
 tgcagggtgg ggiggcgcc agggaccac taggatggcc tgtgcgttat gagtagaggt 752040
 gggcaccgcg gcagaggttc tgggtggcaga cctccacagc agaagaggac gcgcgggacc 752100
 agcgtggccc gctcagcagc cctcgacgtc tttcctacag aaaaaggcct cgacgaagaa 752160
 ggtggcacgg cccccccac ccacgccctg cgtggccacc cgagacagct gcaagccgcc 752220
 tgcaccgcc tctcagcacc cgtgcgcctc ctgccagtgt cgcttcttc gcagcgcctg 752280
 cacctgccgc gcgctcaacc ccaactgctg aacgcacttc cgcgctgcgc gcgcagcctc 752340

 cgagatgggt gattgggcgg ggcttcaagg ctgaggagg ggtctcttcg tgggtgggcg 752400
 tggcttaggg tgggtgggtc tttccgatga caggtgttca aggaacccta atggaagcta 752460
 aaatcagaat acagtatctt tccgctgctg ggaaagtgtg gctgtttctt taaaagagcc 752520
 gaaagcttcc ggccccctta ccgagctctg atccttgcgg agaccccgag gatcgcgct 752580
 ggctggtacc tttgcttcta gcagtaggca cgatgctgcc cggttcttc cagactttca 752640
 gtaccggctg cctccagctt aggagaaaag gagctttagg gaacggcctt ccagtatctt 752700
 caacgctctc ctcccgggga ggagtacaaa tatcccaggc gagctagaaa tccacaggca 752760

gtctcagccg ggtagggcg gggtagtgca tttgttgg gtttctaaag ccagaaggat 752820
 ctgggttag gatcctagaa cttttaagag tctcccaaac aaaggcacta atgaaacca 752880
 ctctccctt cctcccaagg gcatacagat gtttgacca taagaatfff cgggcatta 752940
 gtcccatgc atttaaaatt attattctaa taccttagag tttgggctcc taaagaagca 753000
 aaaatgtaca cagccttct tgatcttcc ctagtggcc ggtagaag ctgtagggt 753060
 tggggggagc tggaaagaag cggcaatgc actaagtat caaggaccta ttgcaaaaa 753120
 cgtcccagac tgtccctga aattccacag agtctcagtt tgtgagaagc tgagggtctg 753180

 cgttgaact ttggaagaac cgtgggagag agagcaccta gagaaagtga agagtttgg 753240
 gcgcagattc tgtaggaag gagcagcagg gagagcga atggagggt ctagatagt 753300
 ccatctactt gtcttggctg gggcaccgaa gggagaaagg ctgagaagag ggctcacagg 753360
 gctccctcgc ctagcctgag ctgccccaa ccccaatta ttacatgca gtacaaaag 753420
 aaaaaggct ttgcaaaaa agattccata gagaatctct attgggctag ggagatgaag 753480
 acaggtgtaa ggtctgatac aggtgtgacc agctttcgg gcctttgtgt ctatttcta 753540
 ttgttctctt tcaaatgctg gcaagatggc tcacaagcct gccaatctga gttcaatccc 753600

 caggacctg taaagtaag agaaaacaga gcctcagag ttgtctgtca cagtacacag 753660
 gcacctcaa actcacatca catacaataa gtgtaataaa tgtaaatcc actccctcaa 753720
 acctctctt ttgcccgtaga ctttttcca aatggagacc caggttgtgc ttttgggtcc 753780
 atacttacct cgaatggata caagaggcaa acacctctgc ccagtcacca cctagacagg 753840
 gcacaagaaa aggcaggtgc tccaggcaa gctattcaca cagtctgac actggacaag 753900
 tccttatgct tgctctctt acttatctt aaaatgagaa ataattccag ctgttcttgg 753960
 taaaaatcca ggaagtgtg atttctcaat gcctttaatg cagcaccacc acacaccac 754020

 acgatgctc acccacacc atgctgccc acatgcactc tcaccacat ceatgetcac 754080
 ccacatgcat gctcaccac acccatgctc accatatgca cgctcacca cacccatgct 754140
 catccacag aatgctcacc cacctgcag ctaccacag gcacgctcac ccacatgtac 754200
 actaacccac acccatgctt gcccacatgc actcttacc cacacccatg ctgcccaca 754260
 tgcacactca cccacacgca tgctcacaga gaagctgccc attgtttgct ttgttctctg 754320
 tcctttagge tgcaagccca caaggcaaga acatgttgtt cttgtaccac agctgctgct 754380
 gagtaaatgt catcagtaat gagaatattg ggaacacatt gcagcaactg ctctgtatt 754440

 tgccagacac tgttactca ccaggtacta tttggcggc agcagtgaag cagcataaaa 754500
 aactgaacac tcagccagtt tgttgtgtt gctatgtgcc ggtttgttt tgatattgtt 754560
 tttgagacaa aacatcacta tgtgtagctc tggctggcca tggactcata gaggtcccc 754620

tggctctgcc tcccactgct ggaaactaaa gaagtgctac caccctgca gccactagc 754680
 acaaagccat tgagttactg gatttagaca atgcatgga aggcaagccc aggggttcac 754740
 tcattcagct tgtgtgttgg ccacctgctg tatactgggt actgtaagta ctctaataa 754800
 aaactccaat atgggtattg tccctacaga ccttaatcat tcagtgggcc tgaccactgg 754860

 ccctcataag aggcaagaac aactgttagc ctgtggggct cttcctcaca cttaatcttg 754920
 ctctcttga ctgagacccc ctagttagt actacctgcc caggttttcc ttcagctttg 754980
 agatcctgag ttgttctatc ttttcagaat tcctctgtaa gctttagagt cctaagatca 755040
 tagcccactt tgggtggccag aactaaaact cacgtttata ttgtatgttc tgttatgagg 755100
 atatgagtgc cttagcccat cccacactia ttacacacac acacacacac acacacactc 755160
 tctctctctc tctctctctc tctctctggg taaactttgt cctgtaaagg tttgctccgc 755220
 tattcatcct ttcttccac agccattgcc ttaaacttgt gcaccgaag ttctcataat 755280

 gtgaccttga acacgtctca agtttgtttg ttttttttt ctgtcatggg ggaggggggtg 755340
 gtctcatgta actcaggctg gcccaatctg cactaacttc gaacttctga tcctcctgcc 755400
 tctatgttct aagtctaga tgacatggat gcagaacct gtgtggttta tgatatagta 755460
 ggcaagctg ggatccacc caggccttgg tgtttgctaa atgaactcta ccaacctcc 755520
 tacctcctca gctctggaag ttgaagctc aagtgagaat ctcatcatac agtacacatg 755580
 aaagcatctt tgcaaatatg ttatatatt gcacacaaaa ttgaaatcag cgagtagata 755640
 acagtgccc tcctaatta gcccaccag ccagtttgtc tgttagttg gttttagaag 755700

 aaagttaaa tgaccaggag atgtaagaag gtttttaaca gctcaccctt tacctcatac 755760
 agcctcctaa taaatggaaa cagcagggtt tatgtcagaa tttggccag gtggttttgc 755820
 aacaggttaa ctttaatgc atagaagat taaacatgta tgtttttatt acatctttt 755880
 aaaaagcttt gatattttta aaagaaacta aagcttatga tttcacaaaa gcagtatact 755940
 tcaaaaactc tglagtctca gaggcagaaa gcccagggc ccagatgtc ccagactgtg 756000
 gacgtaaggt caatctaact ggcaatcact agtcctgat tctaattct tccatctgtt 756060
 tcagcgagca cagatgtgga ccaactacca ctgacaggaa attaccttc tcaaaaagga 756120

 gctttataaa gaaacctagc tcccggggcc aattcccatg tgtggaggga acaggataag 756180
 tgaagaataa gaaagtgatt tgagccaaat tagccaaacc atctgtagta actttcagat 756240
 ctagagtaga ctttactct ttttctctt ccatgaacta aaggataga catgtgtgtt 756300
 gaaagagaag gcagctgaaa aggaatttct ttgtattgt tttatcaagt aaaatattc 756360
 aaaatagtaa aaggctgtat tccagagggg agttttctcc tgatagcctg gagaaaaaca 756420
 glaactactt gccaaactcc ccagccagat ctgtgagttg tatctgggag gtggctccag 756480

tgggtgtaat aatgcttatg cttggccttc ttcttgtcgg gggagccctt ctcaatgagt 756540

 cttaaagggtt ttcacacctt ccaaactcct ccttagaatt cctatgccca gtggctgtgt 756600
 agactactgg agcaacagta aattacagct actttttaag cccatactca gettccgaag 756660
 caagttcatg gctcgtctct cactgcacca gatttctagc aaaatcccta cgccttgtg 756720
 ttgcatctg gaccaacctg aatcacgtac ttattcttaa accaatttgc agagttgatt 756780
 gatgaattga ttgaagttag ttggetaagc ctggattaca tgagcacctt gattgcctca 756840
 agcaggtctc ctggaacagt gctgagctc tggggtgaga atctggcttc ctgggacttc 756900
 agaccaccaa agcagagcta agtactcact gcctgctgcc cccagagttt tcaactgctat 756960

 tagtgggccc tggactttt cctgggtttt aacgatgct tcctccagcc ctctaagctc 757020
 tcattactat tcagctaaga cttgggagtc tcccccaac agcctgacac ctggcggcag 757080
 gaagtaccca gcctgcaag gggacttcag ataaatagct gaagctctgg ggaacaatca 757140
 ctccatgtct gaacactgac ttctacttta gtaatgctct aagatattta aggttccagc 757200
 agcctgtggt ttataactg aacttgacac aaaggcagac accacacact ttaaaccgggg 757260
 ctttttcag agccgacaat ctaagaagat gttgggttac catccctaaa ctctgccttc 757320
 catctcatcc ttagccagca gattacactg gaagggaaac acaggcagtc agtcactcca 757380

 gagttgagcc ttgccctctg ctcagatggt cagtgtcttc caaagattat cgccccact 757440
 ctgtaacagg ggaggatttt ctttcctct ttatggtatc tgtgaacatg ggagttgta 757500
 tacaccaagg ccattgaatc ttgaagtcct cccccagagg ctglttgac aacatgtaga 757560
 tggagatta actcctataa gcaatgtggg cagaagagtc cttactacag aatggagtaa 757620
 ggatgtgctt ttctaaaata tgggaagtat tgtttagatc tcaaaagtct tctaaactcc 757680
 ttacctcca aacaactctc tccccaaccc ctggccttaa aacttgacat agaactttaa 757740
 gacaacaate tgaggtatit gtcactatcc tgagtgggac tcaggtcttc tecttaacce 757800

 gcagatcact gccccacaac cccccaggcc tcactttgtt ttttcagcc tagatgggaa 757860
 gcacagtggg ggccaggcca gatactgtgg gagcctcagc tagttcttcc tcatgaaact 757920
 ttggcaaaga gcgtgggaga aggcccgaga cacatcatcc tttattgtgg atacctggtc 757980
 attgtcacac ctgtgataga gtagcacacc tgagtacaaa cctacacctg agaccagaag 758040
 tgaaagtttt gtttttaatg aaaaggttct gagagcaaga gaacatctcc aaaaaagga 758100
 aggtaacggc cagggttaaca aaagccaggt taggactgca tgggaccctc accaggggac 758160
 agcttagggc tgcatgggac tctcacagat ggaacacctg gaaaggcact tgctctatct 758220

ttgtgctcta tciatccacc ctgagctggt ctctttggag ggatcagcat agccactgct 758280
 atcaaggag caacactcag aacagcagtc tctgcaagtc aggggtgggat gaagatgggg 758340
 tgaagcaacc cccactgctg gagccttgc tttaggaacc taagttccag tttgagttac 758400
 ttaacctaat gtttaaggagt ctgaaacctc gttccctccc tcctaaccct gggcctatgg 758460
 tatagaaatg tcttggattt tggttccagg aatccaacct agtacaacag ctagctcatc 758520
 caaatggctt ctctcagct gagtccaaga ctctagcaag ttctcgtgaa gaatgagtaa 758580
 gatcctaaaa agtgccttt tgagcaacag gatgcaatgg ggcaccctc tgtaatacca 758640

 gcactccaga aattgaggca agatTTTTat aaatgtgggg ttcagcctgg gccaaaggcca 758700
 tctcaaaaca aaggctTTTT ttggttcaac cttgaacaca attagtgtgc aagaaatagt 758760
 acaagagatg tctctcctat ttttcaaga attaggattg cttttatTTT aatactttgt 758820
 acttttactc attaatTTTg atcctatcca tctatcatta cctgttggag acagctctga 758880
 catagctcaa gctgttctca actccccctg tagccaagga tgaccttac cttctgatcc 758940
 tcctccctcg gctcccacag ggcagggact gcacttcct ttcagtctat ttaccattt 759000
 catgattagt tgagaagtgg ggggctggag agatggctca gccgttaaag gctaggctca 759060

 caacaaaaa taigagaagt gggcccttgg catctgaatt taccaaaact tattttcagc 759120
 aaagtcatca tatactcatg tagtttacac accttcaact acatgtactg caggagaga 759180
 aagtaattac ttaagggcca acgcctaagc tgggatgaac attctcagtc ccttatccct 759240
 gtgacactgg actgctgaat gaccaaggg tttgtttga aatctttaa actttgagga 759300
 actgggaatg gagatgaatg attggctgtg taagcctgag acctgaattt gatccttaga 759360
 aaacacatga agatggaagg agagaaccaa ccctaagag ttgtcatctg acatactgta 759420
 ttcacattac actggcagga agatcagaaa ctgagtcacc tttagctata tagtttgcca 759480

 gcctgggcaa cttgagacca tgtctcaaaa acaacaaac aaaaaacct acttttctec 759540
 aaagtctttt caagcactac ctcttctcca atgctttct cctgctgcca gacatggaat 759600
 ccaaaagctg ggaagaaaag gggaaggggc aggggatggc agagctgttc ctgagagAAC 759660
 ctatctttac ctgacatcc cagecatctg tgttcagcgc tcacacttac accgggctct 759720
 ccattctggg gagggcactc agaatgtcat tctgtacatt tgggttgctt ttagttgact 759780
 tcagggttaa acgggttac taaatgacca ctggacaaa taacagggag ctcaatttct 759840
 catacgtttt tgiatgactc aagttatgag atctctgact ttacatttct gagggactcc 759900

 ctgaagagat ggctgagtgg gtaagactac tttacacttg taaaaagct aagcaaagcc 759960
 atgtctact gtatccccg tactggtgga cgggggtgg ggagagcaga aacagaacag 760020
 cctggctcca ggttcagtca gagacctat ctcaggaata cagaagagag tgatcacaca 760080

cccaatgtcc tcctccgggc tccatgacca cagaacacat acctgcacac aaatgcacac 760140
 ataccacaca cacttaaaaa ctggcataca tggatgatcga catggtagtc aatatcttat 760200
 ataataaaaag gtcaaaatit ctttaggcac cagaaatitit atttaatcca ctttcctttg 760260
 ttaacattct agacactata aatcaaatta gtctttttgt gaccaggct tgtcacaaaa 760320

 ccatcaatta caagacagt acagacctta gcctatttgt tttttctggt ccctttcaat 760380
 ctctagctgt cacttttctt ttcttgggta tctcttaate tattctaacc cegtgaaca 760440
 gggaccaaaa gtgccaacct cagtattctg aggtttaaga gacggcccaa tggtaataa 760500
 gctctgagga agccctcca aactccagt gctcctgcc tgtccgggc tgagaaacta 760560
 agcacatgga tctaaataag cccaagtgag ggtctggatg gtaagatgca tgggcttgtg 760620
 accaccacta gccacatcca gcctcaggac ttccaagact ccgaagctcg tgtccctgt 760680
 ggatcgtcc caggtacctc ttatcttgac tggagactct cagttccct caccacacct 760740

 agaacagtat gaaggacaca acagagacca gccagagtaa ccagcctcag cgggacgaac 760800
 actggcgaag caactgcaaa gttggtgaca tgtgctcttg ggaaagagag gtagggcctg 760860
 gagtaaggat ggcagctgga aggtgaagga cagtctgtc tctcagtagc ggtagtgtc 760920
 aggcttgaag gggccatcaa tgggcatgcc cagatactgg gcctgcttct cagtcactt 760980
 ggtcagcttc acattcagct tccccagggt ggcttcagcc actgcctcat ccagctggag 761040
 agaaacagaa acctggagtt agtgcatac tctagtagcc ttagcctcat ctaccecaaca 761100
 gaactgctct ggggaggagg ggggttactg gcaagtggta ctaccctcag cacagagtgc 761160

 ttttacattc ctaagcagtt ttatgttccac tgccttaga acttcacaaa cattcctaag 761220
 aagtaggaag gggaggacaa tgcctacact aaagaaatga ttatcaggtt catagatgca 761280
 agtaaaggca agaagggctt aacctggaat ctgtatcaga agcagaatga aggtctccta 761340
 tgcctggcca atctagctca ggacgcctgc ctctcaggg ctctctgtac cagtgtgcca 761400
 cataatgggt gaccatctgg gcagtagcag ctggattccc agtgactccc aagagtacac 761460
 cagcctctaa accgtggttt cctcacttgt aggacacaca taataaatat atcctatgtg 761520
 gccatcacia agatcaatga cattcagatt tttagttaa gggggtgatt tatttagtca 761580

 atagtagcta ctatcatcat taattaaggt acctaatagt gcttagacag tatgcatctt 761640
 acagacatgc ctagttgacc cacccaagta ccagggatgc agctaaggga tattttgtgt 761700
 agcatgtatg aagacctggg ctccatgtcc acaaaatgaa caaacaaaaa tttcaagata 761760
 agcatggaga ctcttgctt taatcccagt tctcgggagg caggaacagg cagacctagg 761820
 agtcaaggcc agcctggtct acatactgag atccaggcca atccgggcta taatgagacc 761880
 ctgtctcaaa accaaacaga tgaacaaaca aagtaaatgg gccatccat tttttaact 761940

acaatatggt gcttatattt taaaattatt tcataccaag accttagcat atggcttctc 762000

ttcagagctc agaagctttg tccactggag ctgtgtcctg ggctggtagc agctgagtgg 762060

cagccacccc ttatctgga gcatgtattc ttcaactttt cacttcccaa ccagectact 762120

ttaccaacta cctcgccatt attattcaga aacatattct tgccttcacc tgacaactga 762180

ggaatggaga caaagctcca aacctgggtga gccacacttc aaagcccatg ccactatggg 762240

tgtgctctgg aggattctgg aggacaacta agacagtagg caaacaacat accctgccaa 762300

gcccacacag ggagcccagg aatagcacag gagccttggc ttgtgggaaa gtcaagagct 762360

taccttctta ggcaagaagt gaaccccaac ggggtattta tctgggtggg tccacagctc 762420

aatctgggcc atgacctggt ttgtgaagga gttgctcatc acgaagctgg gatggcccat 762480

ggcacaacce aggttgacca gccgccttc agccagcagg atgatcggc gccattctt 762540

cagcctgtag cggctccact gcaagtcccc gtggcaacag taagggtgg taggcaccac 762600

ctgtctctgc ccacctccta ccctgcacaa gatagcctga aatgccccca acctacaga 762660

gctagcacac acaattaaga gtagcaaat acctcaccag cctgttgtga gaacttaatg 762720

aattcagatc tataaagcac ttggaatacg gtagtaggtc ctgagaaggt agcagctagt 762780

actgtcatta ctgccacata gtgtgtacat aatcctttac ccacataagt atcatttttt 762840

aaaatttatt ttgtgtgcat tgggtttttg tcatgggtgt tgcattccct ggaactggaa 762900

ttacagacag ttgtgagttg ccatgtgggt gctaggaatt gaaccagat cctctggaag 762960

aacagtcaat gctcttaacc actgagccat ctctctagcc cctcatgact atcatttaag 763020

tgcttcagca tcaccttttc acaataaac tgaagtctac aaagctgagt catttgttca 763080

gagctacatc taagaagtgg ctgcaatttg agccttgaca atttgaggcc aggtctcatg 763140

ctctcaattg ccattaaaaa gttgaatgca ggatgggtgag atggctcagt gggatgaagt 763200

gttgcctgcca aacctaaatt taateccccg gaaccatttg gtggaaggag agaatcctct 763260

gtgacaggct gtctctttac ctccacatgc aagtatgtat gtacttagac atacgagcat 763320

gcaaaatgat taagtaaaat gtaattgtat gtgtgtgtgt gtgagtgaga aacagaaaga 763380

gagagagaga gagagagaga gagagagaga gagaggatac ttatatataa ggttggatgc 763440

aggactgagg acctgactag cttggtaaca gtgcttgctt agcttacaatg aagcactgga 763500

tttaatctcc agctgtacaa ggcaaaaaag agctcttaat gtacaaagcc aaaacctttt 763560

ccaggaacat tgcttttata accaggtaag aaataaaaag ccagcgcctt taatccaac 763620

actcaggagg cagagacagg tggatctctg tgagttcgag gccagcctgg tctacagagc 763680

aagttccagg acaggctcca aagcaataca gagaaaccct gtcataaaaa gccagataaa 763740
agttgcatgt actccaaagg aactatctct caatgccttg cagcaaagcc accctttctc 763800
taactcaata atgatggcct actttgcca gagcaaagac agaaatgcag tgtccctttc 763860
cagtcctccc ccatcctgac cctgctgcca gttcagccca cacacctcag ctgccagcat 763920
gcctgctgg ctatgagcac cctcagagcc ttgtctcttt ggccaccact gtatacaaaag 763980
caatcttcaac tcccaagtac atagtgcct gaagcagcca ggtcaccacg ctccacacac 764040
ctgctgacca actctgatac ctcaaaccia actctgaaat gaggcttata caacacacac 764100

agcactctcc aggttataaaa agtttccatg agaggcatcc tccccgcct tcaccacat 764160
ccctgcggga aaggctgggg cttctcacct ggggcttgat gttcaccttc tccacagcgt 764220
tctcattgag ccacttcaca tcaatctcca cgtcaaagtg tccaatgtta cacacaatgg 764280
catcgtcctt catctgttca aagtgcctat gagggagccc aacccctga gagaccagag 764340
accaagaaca gcccgaagcc tgtgcacctt tgcacctttg ctccctagga ttcccacgtg 764400
gtacctaccg gccaaagaatg atatcaacac agcctgtggt ggtgacaaaag atattgcct 764460
ccttacagge ctctccatg gtggctcact catagcctgc gcagacaccg agcatgagtt 764520

atcaaagggtg gcctcagtc tctctagcc ccaacagcca gaccttgagc tatcatacc 764580
tccatggcag ctgtagtgc attgatgggg tcaatctcgg tgatgatgac tcgggcccga 764640
aaacccctca gggcctgggc acagcccttg cccacatcgc catagcctgc caccaccgce 764700
acctgcccc caatcatcac atctgtggct cgtttgatgc catctatgag ggactcccgg 764760
cagccataga ggttgtcaaa cttgctctga aaggagaggg ggttaagggga tgaggggcag 764820
gcaaagcctt ggctcaaaag catcccacag gcctgagact tgagccctgt cagcctggct 764880
gaccacctaa gaatcttctc cactagacaa tgccaacatg acccctccc catcagcctc 764940

aagactgtct ctctagcagg tctctgctgc tctagaagca gccagggaa gcaatgccc 765000
ggacaggtta ctgggtcaaa gaatgtgctt aactttaag ctcttgataa tcaaagccac 765060
aatgttccc aagcagccat gaccactgt gcaggctctc cttcaatgca ctctccacc 765120
tcagcccctc aggttaagggc ttcatgtecc aggccatacc cttcctggac actcttcaga 765180
gatccactcc tcggctcact gggcagcaac aactggagct gacactacc cagggtcac 765240
cttgggtgaca gagtcttga cattgatgac aggcaccttc agtatccat tggccatcat 765300
cttgtagagg ttgtggacc cagtcgtggt ctctcagag atgcctcgga tgcctgaaca 765360

agagagggag agcatcagag aacacatctc taccaaagc cttctcact cccaagtgc 765420
cccctctctt ttatcccat ctctgtacct gaccgtaaag tctaccaagt caccaaggec 765480
agtatcatct gatgcctccc atataaagtc ctaccaggec taatgactca acttcccaac 765540

accttctcc caccactgtg ctagttagtg cctgacacta ttcttcatcc agttgtccta 765600
 taatactttc aagagatggc ttcttcattt actagtcacg ctagtttttg tatagtcaat 765660
 cttttttctac ctcagggect tttgtattct ccaccctcca tectcctcct ccctgtcaca 765720
 cagtcaacaa ggctgcttct ctgcaacat tcttagcact gccctacatt agccttggct 765780

 aatgagctca gcaagctctg gctctacccc gttaccctgg cttcacagca caagtcagaa 765840
 ggcagactcc atgcctgcag gaacctcctg tctccaggc ctatggagaa tetgggcgtt 765900
 ctgccaggcc cattgcctca ggtctatgaa ggggcaggct cccttcaggc cactagtgcc 765960
 cagcccagct gcttacctga cagaagctgt gggacttgg tatggatgag gttagttaag 766020
 tcaccacat catccagaat catgttgaga ggtccatctt tgaagtgcag cgtctgctca 766080
 atgcaccaca ggtactcttc gtctgtctcg cccttcagg catacactgg agggtagtg 766140
 gcacatgaga agctggcagg gaggtccag aaacagagcc aattctgtcc ctttctaat 766200

 tcccatccct atgtatgtcc agtctataga aagcaatggg aagtatacag cttgaagcta 766260
 gacagatcta agctcaaacc ctggctctga actttccagc caagtgactt tgagaaattc 766320
 actttaccag tttcctcttc tataaatgag gcttcagta atataaatca ctgacacaga 766380
 agccacacac agccctagac ctatgtgtct agaaataatt attccctttt gtatttcctt 766440
 cttccaggga gtaggtact ggactacaaa aataggact ctaaccaga agggcatcct 766500
 tctcactggg cactgtcagg taggacctg gatttgttca ctgaaaggtc ttgaaggcct 766560
 ggcagtctcg gtggtgggta atttcagggtg atgcctggtc aaagtcccc cagagaagct 766620

 actaaagacg gagcattctg tgtcaggtag tftaactgct ctgtgccat ttgagtgcc 766680
 tcacaaaaac ccataagga ggcactgcca tcaccactca caaaaacctc aagagagtct 766740
 aggaagtgca gactcagca cagcactgga gagcagcacc tgaaacaggg gtgctggctg 766800
 ctggccttgg tctcccacc gtgtggaacg ccacaggtgt gggttcaag actctcctgt 766860
 ttgcacagga caccagcaa gcagtcggct gcctccctcc ccacaactgt agaagataat 766920
 gctgtcaaaa gcaaagcctc ttttgaagga gggctgccga gcctcactaa ggtgggagct 766980
 gctgacagge actcagcct gtgaggctcg acaggagccc ctccaatgc ccccgtacc 767040

 tatggctgat taagatctcc ccccaccagt cgggcgttgg tggcgcacgc ctttaatctc 767100
 agcactcaga aggcagaggc aggcagatct ctgtgagttt gaggtcagcc tggctccag 767160
 agcgagggcc aggataggct ccaaagctac acagagaaac cctgtctcga aaaacaaca 767220
 aacaaacaaa caaacaaaa gatctctccc accacatgtt gagtgtttg cctatgaata 767280
 tgtctatgta tgatgtgctt gcctgggtgc tgaggaggcc agaaatggat attggatttc 767340
 ctgggtctgg agttacaaat ggttgtgagc tgtcatgtgg gtactaggaa tcaaactgg 767400

gtcctctgaa gagcaaccag tgttcttaac cactgagtta tctctctagc cccttgtaa 767460

 aaattcttgt atattctatt taatcacat tgaacctaac acccccaac cccaccactg 767520
 agtccagaca gacatgtacc actctgcagc agctgagaca aagtctttgc tctttaactc 767580
 tggctctttc acatactcct aaactaccac aacacctcag ccagtgcac cctgagattc 767640
 cagctctgcc ttacactgca ccagtttgtt ctttagtaaa tgatcaagag tcctctaaag 767700
 gagcttccct atcctctgca ccatggagct cccaatetta agattcttcc actagagacc 767760
 acataactca gtgggtagat aggtatcttc catgggatct gagatgaggt aggagggcaa 767820
 aaaagctctt tattgtaagt caatgggata aggggctctg tctgcttatg gaaacctata 767880

 ctacaagagt cagtaagaga aacacgaaaa agcaaagtgc tttatccact cccacatagt 767940
 ccacagtgag cccactcacc tggaatgcc gccttgcaa tggcagctgc tgcgtggtcc 768000
 tgagttagaga agatgttgca gctggaccac cgcacctaga aggaccagga aaacaaggt 768060
 gttggtcacg ggtggctatg aagaacagg gaaaagaaag ccctgaggcc aagagtaaaa 768120
 ggctggtact ctgggcaagt gaatagctag aagccaaagc agtaaaaaga taccactaga 768180
 actttaaaaa aaaaaaaaaa aaggcaataa atcactgagc caggcatggt ggcataccta 768240
 taatcaaaaa actcaagata taaggcagga agatcagagt tcaaggccag cttgggctat 768300

 aggagaattc cggccagcc cgagttatgc agtgagattc tgactcaaaa cacatacaaa 768360
 taaataaaca actagagaga tggctcagca gttaagagca cttgctgctc ttgtagagga 768420
 ccctggtttt ggttcccagt atccacagtg tagcttacia ccagtacctt ctctgggct 768480
 ctgtgggcac caggcatgta tgtggtacac atacaaacat gaaggcgcag acgaaacct 768540
 cacacacaca aaattaaata aataaaacgt tactctagtg ctatgtgaac aaggagacag 768600
 ggaaggatct gctaaagcag gctgcagaga agaatacag cagcaacggt ggaagtgatg 768660
 tgtggtctgc aaatactcca ggtctctcat gcaggagaa tctccaggt agacttgcca 768720

 tttagtgatg gatgtagcgg acttcaggat gcagaggta gaaagtttgt ttggacttgt 768780
 tcgacatggg atgtgtactt gatggccaag aggcttacat caatacttag atgtgagagg 768840
 cttgtacatg agicatcacc acacaggcag tatttaaagc catgaaatca gatcaccaac 768900
 aaactgaatg ttgaaaataa aaagaatggg agctagagat acagtggttg agagcactgg 768960
 ctactcttcc aggacctgag ttcaattccc agtcccacat ggtggctcat gaccaactgt 769020
 aactccagtt gtagggaaaa atgacaacct cttctagcct gcttgggcac tgcatacaag 769080
 tgggtgcacag atgtacattc aggcaaacat ccatacacac aaaataaaaa caaatctaaa 769140

agaaaggcca atggaagtaa aatcccagta cttggaagcc tgaggtagaa agatagcttg 769200
 agccttgccct gaacaataca gtaaattcca ggacagccta ggctacagag tgggatgcta 769260
 gctcaaaagc caaagaggcc ctcaagtffc tctgccacag gtgttagcag tgggaaatgg 769320
 agagaaaacc agctaggctc cccaaccagt cctcttccat ggctgaacce agagaggcca 769380
 agggactcaa aggagtcaaa cggctgtgga cctcacctcc gcaccaggg ccacagagat 769440
 ctcaatgagg acagccgtct ccacagtcac gtgcaggcag ccagcaatgc gagcacctt 769500
 cagcggttg gatgccgagt acatctcccg catccgcatc aaacctggca tctcattttc 769560

 agctatgtcc aaggcctffc gtccccacgc agccagtcca atgtccgctg caggaacaag 769620
 atggagagag agttacacaa gccacctcct cccatcaacc atgaagcacc atccccgtgt 769680
 aaagagtgat ccaagtgtgg ccctatagcc cttaggctga gcaatctgcc acagcattct 769740
 gtgactcaca acaagagaaa gcacaaatgc ctcttgaaa aacagctgag actgaatccc 769800
 actgtcaatc gttttactg gtgtaccaac ctcaaacatc gatcccctgg gaaaactcaa 769860
 atccagcaag ttagtagga tgggcctggg gttcatggtg agattgttt taactattat 769920
 tttttaaatg aaaggacagt ggtctttctt tttatgtatg tgcattgata tagaggtcag 769980

 aggccaatgt cagtgtcttt ctcaatttct gtcttatttt ttgagacagg atctcactgc 770040
 acctgaagct cactgatctg gctaggtaga ctccccctcct gcctttgcct catcagtact 770100
 gagattatag gtctttcagc ctttacatga actcaggttc tcatgtttat aaagacaggc 770160
 aaacttgcca attgaacct ctccccagtg tgtttacctt tggggagctt aggtctcact 770220
 caccctagga aatgaagggt gaaggagaaa gaaggctgtt acagaaatct taataattta 770280
 acaaatagtt aaacatgcca ggagtgggtg accatactg taattctggt acttgggaga 770340
 tagaggcagg aaagtcatcc ttgactacat agcaagtca aggccaacct gggtacatg 770400

 aagccctgtc tcagacacta ctgctgctgc tactactatg aagactttat tattattctg 770460
 cttcctacac tgcattaat aatttcaaag gagcagtgac aggggtgtgc caagaccctg 770520
 atctacccta ccaggggttc aatcagcaat atacacagct cctcatctct ctctctctct 770580
 ctctctctct ctctctctct ctctctctct tctctctct ccaggttate atctggcatg 770640
 tcttccccct gtacattccc agctccaaga gggaacagct cagactctac accactgatt 770700
 tttatcaatt tctagtgtct tttaccatgc ccccttcagc atctcaatt ctcttctcca 770760
 gtttaggata ccctgtcca tcccctgctc tcttagcctc tgagacctca cttagcaaaag 770820

 ctcatacca aagcttgggt ggggtggcttc atgctgtaa tcccagcact agggagctg 770880
 aggtaagaag aattgagttc atctgagct tcacagagac ctagtctcaa aaacaaaaca 770940
 acagcaaaag ccaagtttc ctctagtta gagccagctc ttcaatgtag ctaaggcctg 771000

aactggcagg agaatcaaca ggcatgggac aacagtcttg cctactatca acataaaact 771060
caagggacac ctggcacatc ccagcaacc tactacattt tcctaataag tttatccct 771120
tctcttctcc ccagtcactt ttctcatcg actgataaca ttacttgaca atttactttc 771180
tgtccacgga ctccatctc atctgtagt agactaggca ttcttgtctg tcgaaaagga 771240

taagctgtcc ctggccctg attttctcat cccttaccgt tctattctgg gtacccttg 771300
ggtaattatg ctgaggttc tcacaggagc agagacctcg ctaacgactc catcatttct 771360
gaaatgtttg ctttccctg gcatctgatt ctctcttctc cctccttct tcttagctgc 771420
tcttcatctg acacattcta agagcccttg gggaccatc atcgctctc tccaaactcc 771480
tgccaaataa gtctattca gatgactgtg aacaccttc ccatggtgat aactcccagg 771540
tattgacctc cagtacaac ttctcccagg aatttgagag tcacataatc taactgctga 771600
ctcagcaact ctagactggt gtccaactgt ttacccatca agtatgagcc ctcaagactc 771660

cttagccaca cacaccagt ctccattt taggaaatga aaccaccatt caatcaactt 771720
gctggccaaa agcctctaag attttatttc catttttctg tgccatcatg tttttttgt 771780
ttgtttagt ggttttggt tctttgctgc tgttgtgta ctgtttagg gttttttgt 771840
ttgttttgt ttgttttgt ttttgagaca gggttcatta tgtagctctg gctgtcctga 771900
aacttgatat gcctcctggg tgctggggtg aaggatggg ccaactcaaca tgttttgact 771960
gagtaictca ccttgtcta aagcacttct cagggtggcc gacaaagcaa ctccatggtc 772020
ccctctgttc ccacattca ttacagacca gtgggaaacc taaaatttt aaacctaata 772080

cctgacctgg gcttcaggcc ccaccgctc ctatctccac cttgttcccc ttaccagctg 772140
ctcagccaca cagggttta acacaagtca actcatcaga tgcagtacct ggctcagtct 772200
acgctcaaaa cacctggaat tggaggggct ggagagatgg cttaacggtt ctcccagag 772260
taacgggatt caattcetaa cagctcatgg aactggcag agacgctata actccagtec 772320
caggggatcc agcactcgt tctggcctgt gtgggcagca catacactg gtgtatagac 772380
atgcaggcag gcaaacacc cacacacaca tcaggacat taagatgaat cgggacttca 772440
cttgtagcgg ggtcggctcat ctageittca aagaggtatt tattatccc tgaccagatt 772500

tgtctttca aagatcccac tggccaacca taatgacatg tacctataaa aacagtctg 772560
tggaggataa aggaagatct tgaggcccaa aaaacaagca aacaaaatgg tagcatgagg 772620
accagagacc tgiaggaga gatgagaatg ggggctgta gcatgaagag tgaaaagtga 772680
cagatctct cacacaaata gactatgcta cactacatag gcctatctgt cccaacctg 772740
tacctgggct acttttatat ctccagtaac cagcagggcc tggcatagag aaggaaatca 772800
gaaaatgtta actgaccata tcatctgcta aaactgattg agcaaagatt cacaaagggt 772860

tgaaacaggg caaggatggt gaaagaaaga aagaaagaga accccagcat ttatggtttc 772920

 cagtcagagg cagggcagat ggtggtcgag gctgctctca aggccttctt gaaaaagacc 772980
 ctgggttttg tgccttcttg cttaaactcc accccatcta ctatcgcttg tccctctagc 773040
 tagaaatgac tctttcaatg gcattgtggc agctgtgcca gttccagagc tctcagtggg 773100
 actttcactc cagagggaca ggaggagcta gtgtacaaaa ctctggagct tttggtgcca 773160
 agagaaccag agggctaccg acacctgtca aaagagcaag ccaaaaggcc tgtgtgaccc 773220
 ttctgaacc tgcttcatta gactaagaat aatcagcctg aaccttactg tacaccaag 773280
 gattatagaa aacaccaagt ggacaaggtc tggcatacag catgtccttc ttaatggatc 773340

 tccaccccca cacagccaag aaccagggtt ccaaatccag ccttatctct agccactcaa 773400
 catatggtcc tcccaaccc ctccacagta tgacaagcct acattctagc tgttccacca 773460
 agacaacact aacttaaacc tttctgggccc tcagtttcag tatctcccca atagagacaa 773520
 caatctactc tgatagctga tgaactccct taagttcttc ctccctataa tgggatagca 773580
 tccatcatcat gctggtgact ctctccaacc taatggggtc ttgaaatgat tttaaaagct 773640
 agccagactg aattgctttt ttttgggggg agggggagtg attggtttgt gattttgttt 773700
 tgatagtgtc tccttatttt gtccaagttg gcctgaaatt cactgtatgc ccaggctgac 773760

 ctctgatgga tcctcagcc tcagaagtga gtgctggatt acaaacttgt gtcactaatc 773820
 ccagcctgaa ctgaatttca ttagtgtgtt cccttgcata cagacagcag tgaaagggat 773880
 gacgtattgg gtccaaatc taggtaagca ctcccagtt gcaagattct ggaaaaata 773940
 actccatac ctctgaattt ttatcgtaaa aggagaatcg ttctttcccc agggagctac 774000
 agtaataaaa cggattagtc tagaataatg gcagtgccca tcccattgta aacgctcaac 774060
 tgaacgttgt ttactcagtc agccttctat cactggaaca aaacgaaggg taatttctaa 774120
 ccactccaaa ttttctctg gccttcacc agacaacccc acagactgag ctggcccaca 774180

 gtccccagtg caccagggtt tgtcttcag gcctctctc actagcacct ggagcacagt 774240
 gcgctctccg gccacctca aggccagaa ggcggtggac ccttgttggg agccacacag 774300
 accaccagac gccagcga gaccgagcag ggcagcttcc caaggccag tctctcaacg 774360
 agaagcacgc tgccgaagca aggatcatag cccgcgccg cgctcggggc gcctgctgcg 774420
 gggcacgggt ggactttag tccgtggctg ctcccacag ctactctct gggcgcgctg 774480
 gactccaacc cccaggcacc tgcaccgcca ggccagcag tctaggggt cccggcgccc 774540
 ccgaggccgc ttctcgacc agacccgat tggtagggc aacaaccca gggcaggag 774600

tcgagtcgcc gcggaggcca gcacctggg actcaccgac tttgtaggc agtttatcag 774660
 acatgttggc ggcgcttccg ctaggaatga cgaactcagc gaatggggcc ggacggcgcg 774720
 aggcagggat ctacgcctgg cgccccgctc tttaaatata ttcttatttg aatattcatg 774780
 agtcccgcta gggctgagac ttggggggcg agcctagctc gaggtgaagc gctgagccgc 774840
 cgcagggctg gacttcgac cctaccacag aaattatagc ttttatgctc ttagccttt 774900
 ggacctctgg cccccgctg gaagggagca tggagagagg cagtcttct cccagcaagt 774960
 gaaccagagg tcaaaaata gcagaacttt caggctctag gcaatttact tctgagcct 775020

 tatttcttaa ggtatcaatg ggctgaagac tgactaccgc actggataca agtaaagagc 775080
 tgtgatacat gcctgtaatc ccaacactag ggagacagag ccgggaggat tgccacaagt 775140
 tcgaggtcag tctggctgac agctagtgg ttccaggcca gtctctccc tcttcttct 775200
 ttcttttctc tcttctgta tccccctct gcccaagcca ttatgttgc cagactagcc 775260
 ctgtcccact tcaaacctga gatcctcctg cctcagcttc tcaagtgtg agattacagg 775320
 cttgggccac catactgggc taacctttc tctagtaaa ttgattgtct ggagtattt 775380
 gttatagcta tggaaagctg actaacacag aagtattcct tcttctgttt tctagatgag 775440

 actatacaga acacctatta actcttttaa aaactttat ttgtgattat aggggtgcgtg 775500
 tgtgtgcgtg cgtgcgtgcg tgcgtgcgtg cgtgcgtgcg tgcgtgtgtg tgtgtgtgtg 775560
 tgtgtgtgtg tigtttttat gtgcaccacc tigtgtgcage tgccttggga gtccaaaagg 775620
 gatcatattc cctggaattg gaagtacagg gagtgtgag ccacctaat ctcaaatgga 775680
 agtggaccaa cctagaactc caaccacgt cctctgcaa agcaataacc actcataaca 775740
 actgagcctt ctctccagtc tctaactaact ctctaactt tttgttttgg tttggtttt 775800
 gttttttccc agacagggtt tctctgtgta acagccctag ctgtcctggc actccctctg 775860

 tagaccagge tggcctggaa ctcacagaga tcagtctgcc tctgcctccc gagtgtctggg 775920
 attaaagacc tigtccacca ctgcttggaa actctctaat cttttgaagt attccccagt 775980
 aaaactatth aggccttgggc atttctttat cgagagtgtt gaatataca tcagtthtat 776040
 tttttacaat ttatthatt atgtthttct gtgtgtgcag gtcacacag cttgcatgta 776100
 ggggtcagag gacaactgag ggacttgggt ctctccattt acttctgcgg gtcccaggga 776160
 tcaaacctca agcatcagc ttgggtggcga ttacctttgc ccaactaagca gccatcttgc 776220
 tagcctatga ttcgagtctt tttttcttt agagagacag ggtttctttg gctgtcctgg 776280

 aactcactth gtagatcagg ctggccttga acttggaaat ctgcctgcct ctgcctccca 776340
 agagctggta ttaaagatgt gtaccaccac tgectgttct ttaattthatt ttttaataaca 776400
 ttttaacata ttttaacat ttaaagthtt gctattatta ttatthatt gtgtatgta 776460

tgtgtgtgta tgggtacaca tgccgtgtagc tggaaattttc tgtcctgcca gccagctccc 776520
 aaataaccac acagagactt attaattata tftgctcagc cagcagctta ggcttgttac 776580
 taactagctc ctacaactta aattaacceca tagttcttat ccacattcta tcaactggct 776640
 cggtagcttt cctcagcgtg gcatgttcat cttgtttctc cccagtctcc tagtgaccct 776700

 gcccttcttc atcccagagc tctctccctg tccacaagtc ccacctaacc tcttctgccc 776760
 tagctattgg ctcttttagct ctttattaaa ccaatgagag caacacatct tcacagtata 776820
 caaaaagatt gttccacat aatccataac tgcatcctaa atatttatcc ttataccac 776880
 agattgggtg agttctcacc cctcatggag gaatccttac aaaagacaga gaccactaca 776940
 gaaaattaca accgatggaa atgaagagct gtagagccca gtccatcagc ctctcactcc 777000
 tgcacctgag gctcagggtc atgaaggagg gacgaggacc ttttgtttgt ttgtttgttt 777060
 gtttaagatt tatttatgta ttgtatatat aatgctctgt cttcactcca gaagagggta 777120

 tcagatctca ttacagatgg ttgtgagcca ccatgtggtt gctgggaatt gaactcagga 777180
 cttctggaag accatccagt gctcttaacc tctgagccat cctccagca ccggaagaaa 777240
 gattttaaga gccagagaaa caagaagttt ggtgtgctgac tgtgtgtcat aggaatgtca 777300
 gaggggctgc agctatgtaa tttcagcaac atagctgtct aaacatatcc tgaagaggaa 777360
 tgacacaaat ggacatgcta acgtggaagg ggggagctca ccaagtctca gccttagaca 777420
 aagaacagge agctaaggaa ggcagagacg aggagaaaata gtcttccca ggaaaaaaca 777480
 tgtcattgct gcttatctga tatcaattag tcagccctga aaacatatgc atacaagtga 777540

 cattatatgg attgagtagg ttgtattttt gtattaaaaa aggaatatat atgtatatat 777600
 gcacgtatgt atacacacac atacacacac acacatacac acacacacac acacacacac 777660
 acacacacac acacacacac acacgtcacc aacaattaaa gaaaaaaagg ccatgaattt 777720
 gaagggggtg gaatggcagg tggcttcttg gtaggttag agggaggaaa ggggaaggcgc 777780
 aatgatata attatagtat aatctcaaaa aataaatcaa taataaaaag attctcaagc 777840
 cagacatggt ggcacacatc tttgatccca gcaactcagga agcagaggca cgcggatctc 777900
 tgtgagtttg aggcctgtct aatctacaga gtgagttcca ggactgccag ggctacatag 777960

 agaaaccctg tcttgaaaa aaaaaaaaaa aagattctcc tgtggttcag taacttaaag 778020
 ttttcaagta accatatagt accacacaca caaaacaaaa ttatagtggtg tgcgatgctg 778080
 tgcactgta ttcccagcac ttctatggca agatgggagg tggagacagg aaaatcccta 778140
 caaatttgtg gaaatttaca aagcttaagc agaacaaaa aaaacaccct gacataaagg 778200
 tagtactgaa agttgtctgc tggcctctat atgtgcaactg tggcttgtgt atactggcac 778260
 acatacacia gcatatgagt gcacacaata ataacaaat tctctgaggc ttcttgttga 778320

ccagtgaact atttagacat gcgttgttta gctttgaaag gttcagacat tttccatta 778380

ttgtttgtc attggtttct agtttgattc tattgtggtt aaagaatata ttctgtatgg 778440

ttttgttttt gtttttttgt tttggttttt ggtttttttt ccgagacagg gtttctctgt 778500

gtagctttgg agcctatcct ggcaactcgt ctggagacca ggctggcctt gaactcatag 778560

agatccgctt gcctctgctt ccttctgtat ggttttaatg catttcaatt tgtggagatt 778620

tgaccacat catggttagt gtctttgagt ttctgttctt gtgaagagac accatgacca 778680

cagcaactct tagaaaggac aacatttaat tgtgggtggt tcagtcagat ctcacaggg 778740

cgggacatag tgcaggcaga catggactta gagaagtaac tcagagtcct atgtctttcc 778800

aaccaccacc gtggcaatth ttactttgaa accacttggc agatgaacct ttgggcatgc 778860

atatgagggg ctatthggat tacattggtt gaaatcagtt tgggaaaacc cattthggtt 778920

gcaccattcc ctgggcaggt gtagcaagaa aaataaaaga ctggagacc gatattgagg 778980

ttcaagcttc aagcttcaag ctgaagatca gaaaaacaaa gcaaccagca ctagctctca 779040

ctctacctca gattgaaagg cgatcctggc tccaccaaac ctctgacagc tgcctctcct 779100

cagtgtggct ggagaatcct gagaattcaa tgtcttecta tcttcaatgt ggctggagaa 779160

tgaatcctga gactgagacc ctgctcctgt cttatatacc tccctaatgc tgggattaaa 779220

agcctctgat cctaggtgct gaggfcatct tttgtgagc tgtttctctt ttgtttttca 779280

agacagggtt tctctgtatt gctthggagg ttgtcctgga actcactctg tagtgctggg 779340

attaaaggca tgtgccacca acaccagct gtttctcttt aggactgcat caatcttgtg 779400

tagatctggg tggcattgaa ctcacagaaa tctgtctacc tcttgaatcc tgagtctgg 779460

gaataaagggt gtgtaccacc acttcttagc ttctgactgc tgggattaaa aggtatgtgc 779520

ctggcttcta tggtttgta ctaactttgc tttctgaatc cacaggcaag ctttaataaa 779580

gcataaataa tataccacca caggcaggag gcctggaac tgtgtaagat gaaggatat 779640

tagcatgcat gcactcctct ctctcactg agagctggat attagcgcac tcgctcctct 779700

gtctcaccg tggactgat gtggctgctg atacaaagct gccttgactt cctctacatg 779760

acgaactcta cctgaaactg tgagcgaaaa tgagcccttg atgtttcttt ggtaaggatt 779820

tcttctatca cagcaaaaaa caaaggacaa caaccagga tgaggtcaat ctthgtgcac 779880

gttttgcaag cacctgaaac aatgtgtgt tctgctgttg tttagtgaat cagcgagatg 779940

ccaaagacat gcttctggct aatggtgatg cagaactcta tactcttgct gattttatgc 780000

ttagccattc ttccaaacga aagagctatt gaaatttgc ctttccaatc catcagcctt 780060

tgcttcatac attttacaga actgttcttt ttgcacatac acgttttagga ccgtttgat 780120
 gtcttagggg ttggctcttt tgcctttca taatggaaag gaaagatatg agggacaggg 780180
 tgtctcacta gtgccctatg ggagcggaaa gtctaccact acattgatgt gatttgaaaa 780240
 aaggtaatat ttgggtttct tttctttctt tctttttttt aaataagatt tatttatgta 780300
 tccagtgttc tgctgcaag tatacctgca ggccagaaga gggcctggg tcttgaagga 780360
 tggttgtagt tgctgggaat tgaactcagg atcactggaa gagcagccag tgctcttact 780420
 tgctgagcc atgtttttaa atgtgactgt aactgttgg taaggcttta gggaaacagc 780480

 cccccccaa gacatagaat gtagaaactt tcataaacca cactctggta actgctgaca 780540
 agatagcaaa ctacatacc ctttgaccaa atagctccac tttgaggaat ttaacctaaa 780600
 gatgcacata tigtgtaatg atgatggtaa aagtcagagg ctggaaaagg cagacacagc 780660
 cttcagtaga tttgttaagt gatggtacaa tccccagga gaaatatagt aagatggcta 780720
 tttttaagt ttttttttg tgtgcacgta cacatgtgtg agtgtgtgtg tgtgtgcacg 780780
 cacgctgtg tgcatgctg tgtgctgctg tgcgtgtgag ggggggtatg agacacagca 780840
 ttcatgtgga agtcaagga caattttag cagtgagtct ctcttccac catgtgcgtt 780900

 ctagggattg aactcagatc attaggcttg gtggcaagta tcatcacca ttgaaccatc 780960
 ctataaagac tgccagtgtt taatgggaga tgtttattaa tatcgaattt caaggtgtgt 781020
 tacataaaga atcagaaaca acaatgtaga gaacaagtga cctataatgc tattatttat 781080
 gtaaaagaaa agggaacaac tgggtctggc agcacaccg acacttgaga gtgagaggca 781140
 ggaggatcag aagtccaagg gcatcattag gtatataaca aatctgaggc cagcctaggc 781200
 tacttgagat tctgtctcaa ggtgaggagg agagggggag acacagacaa actgggattt 781260
 acctataatc acacatgtac caggctagat acaagggact gctaacaatg ccaggaagt 781320

 gggacatggg ctccagtga aagcataatg acttagactt cttctctaa atctgtgctc 781380
 cagggatgcc tctggcaggc tgctgggctc ccaaccctg ggcagaggca agctgcccc 781440
 tccaattgcc ctttgaccc ctttccctg tgtgcttttt cagacactga gtcctctgtt 781500
 ccaggggtgg ggagagcagg atctctgcta ttggttaagg gctgttccag gccgtccact 781560
 ccaaagcacc ctcaactgcc ttctatgct ccagcctctc tctcactgtg ggacaaaaca 781620
 agggaatgag gtccaagtgt tgaggacacc tgctgacatc aggagacggg ctgaactctg 781680
 acctctgag atgacccacc caccaccact ggtctatccc tgtccagaga cctctatcac 781740

 cttctccat gaccctcct ccaggtcccc tctgggtgt aaacacctc tggggtctgc 781800
 cttgaggtgt ctgatgcat gtaaccatct tccagtctt gaaatagtta ttctcctec 781860
 tactcagcc cttctctcc cagattgctg taggtgggtg accagagttc cagaaactgc 781920

ctttacaggg ccagctacag actcaaccgc tgggagacca cactcctctc ctcccagtct 781980
gagcttcagt ctgtccacct gcaaaatggg tatagacgta acggtgtctg aactgtgtat 782040
atggaatgta tgggggacac tttcgtaact tacccaatga catgtttgtc ccattagcag 782100
aaaagtcaga aatgtgtcta gtttggccaa atgttcattc tccaagggtc agttcagcgt 782160

gtgatacacg gtgttttga aatgactctt cctgaccatt gccccagcct ttgcgcttcc 782220
ggtctgatct caggtgttcc tcgagttggn nnnnnnnnnn nnnnnnnnnn nnnnnnnnnn 782280
nnnnnnnnnn nnnnnnnnnn nnnnnnnnnn nnnnnnnnnn nnnnnnnnnn nnnnnnnnnn 782340
nnnnnnnnnn nnnnnnnnnn nnnnnnnnnn nnnnnnnnnn nnnnnnnnnn nnnnncggag 782400
ggagggggga aaagggaaat tttgcagcag aatcttctgt agctcagact agtctccaac 782460
ttagtaggca gctgaagggt gccttgtact ctctacaga tacctggctc tggcacaggc 782520
tgagaggctc atcatggctc ctgcagcaat gctgccatcg gtaggctgcc cccctcctc 782580

acttctcagg cgacaacct gcaaaggagt gcactgggga tttggaacaa ggggcttggc 782640
ccagtttgat gggcaaggcc gtctctagaa cgagtttaga gggaagaaaa aacaagaaag 782700
caggtggctc ttagtcggga agctttaaaa ccatccctt cagcctcctc tgccttgccc 782760
aggctcctta taaaggagac accccgcgct ggtggcgccc ttgcacctgg gaggtcagcc 782820
ttcttcagge tggagtcacc tttaccctac tccgccaggc gagggcgctc tgcaccatc 782880
tttgcttct gacggaggca aactcctctc tctgacaag tgcacacata gcttttcatg 782940
gcctgtccca tagaaaaat ggaggggtgg gaaaaaagg atggccctc cttgtcaatg 783000

acctttaaac ttgttctgaa cgacttgggc agaaccaggc actgattgtg acaccagtta 783060
tagttgtcgt ttgttgata catctttgct ctccacgttt ttttgtgttt tttgtttttt 783120
cttttttgaa agaggatctc aatgtgtagg tcggctgccc tggaaactgac tatggtgtaa 783180
accaggctgg cctcgaactc tcagagatct gctgcccaca cctgcctctg caggtaccgc 783240
cagactctgc cattctccac ggttctaacc tctttagtct gtttgaagg tagatgtacc 783300
catttacaga tgaaaaactg aggccacag tggatgattg ccaacaagta agaagcacc 783360
acaggcgtgg gggtagctag agagatggct cagtggttaa gaggactggc tgcttctct 783420

agaggtcctg agttcaattc ccaacaccta tafggtgact cacaatggtc tataactgta 783480
gtcccatgga atccaatcct ctctctggt gtgaagatgt atgtgcagac aaaacaccca 783540
tatccataaa atatgtaaat aaagcaccca ggaaccaag tgtgggggcc cacaccttta 783600
atccccgaa cactcaagag gccagcctaa tctatagagc caattccagg acagccgggg 783660
ctacacagag aaacctgtc tccacaacc aaaataaact gattagttaa ttaattaaaa 783720
caataaagga ggcacccatg ctgtttgacc ccagagtcaa acagtcccag ctaactcact 783780

ctgctcctca ctctgccatc ataccatata attttcattt gaaactgtca gatgcaaaga 783840

tgtaaaagaa ataagacaaa gtccctgttc cctggacatt tttttaaag actttattta 783900

tttattatgt atacaacatt ctgcttccat tcttccacca gaagagggca cggacctcg 783960

tgacagatgg ttatgagcca ccatgtggtt gctgggaatt gaactcagga cctctggaag 784020

aacagtcggt gctcttaacc gctgagccat catctctcca acccattccc tggacatfff 784080

aacaaacacg tgcattfaca cataggaaca ctacataaa actcccttgc tcattcatag 784140

acaaggttag tccgggatct gcccttact atcagcctgc ttactttgct ttgtttgat 784200

gtgatgtgtg tggatgatgt gtatgtgtgt gatgtacaca tctgtgtggc tatctgtgtg 784260

tgcccagcat gtggaggcca gagggggcat cctgctttag cattatgcct tagtctcttg 784320

agacatggtc ttcacctgga gtccccgac cccttttct ggcttggttg gctaacaaga 784380

gctagcagtc ctctccatga cttgccactt gctctgtagt tgcttcagat tctcgtgtgt 784440

gtgtgtgtgt gtgtgtgtgt gtgtgtgtgt gtgtgatata tatattctct ctacacctga 784500

ctggggctga tgctggcagg catcatctct acattcttgt tttgttttgt tttgttttgt 784560

ttttttgttt tgtttttggg gggttttgtt tgttttttg tttgtttcga gacagggttt 784620

ctctgtggct ttggaggctg tctgaacta gctctttag accaggctgt tctccaactc 784680

atagagatcc gctgccect gcttcccag tctgaggatt aaaggcatgc gccaccaacg 784740

cccggctcca tctctacatt cttaagaccg agtgcccca tgcctcttgg attcagtgtc 784800

accaaggaaa ttctgatct gccaaagaac tctccgtaa ataaaacca cctctaacga 784860

tggatattgt tggtaggggtt ggtagtgtg taaaatgtat ggtacatgcc tccagattcc 784920

tactctgagt ctgatgctca aaaggctctg aactccttca gaccagaacc caaaccttgg 784980

ggcatctctt catcactgta tccagcagag ctaaccagg acagctacct ggtcaaggct 785040

tgtaaatagg aatggatgac acatagattg agcagaggtc gtagcatagt ggctgttggg 785100

atgttggccc catagttgtt ctctaattgt gtgggcaagc ctgcaagctt ctttctctgg 785160

tgatacataa ggtctctagg ccaacatcag cccccacct ttgtatgcct atataaacc 785220

ctaccaatg ttcttgcaag atcttagccc aaccacggaa ggctgagctg ggtctgagga 785280

agggtlaagt tactgctcac ccgttccta gccttcagg atcccagaga caatcagatt 785340

cagcagggag cctagtcaag caggaacttg tttattgtgc cccactgcaa gcattttta 785400

aagggaaaaa accacagagc atggaaaaca gccaaataat aactttaag gtcaacctat 785460

catgagtcta ggcgtcctat gctttacctg gtggacacga gctgttcatg tagtgtctca 785520

tctggttcaa tctaggcaac caatcatctt tttttgtaa ccaactcaata ctcacccatc 785580
 tgactttccc tcaagtccat ctttgactgg ctctgtgcc ctacagttct ctctgtggcc 785640
 cagaatcadc ttgatgaaca caggatggca ctctcatctg catggtacca atggagctct 785700
 ttgctcctgt accagatgtc accatattgc agaattcctt gtgttagtat gatttgccca 785760
 tcttctgtt ggctgtcact ctgtttacca gcaagtcacc tctcattttt tgctccttct 785820
 ctgacaaagg ggagcctgct caatcaaatc tcaaagtagg ataaatgaga cctgtatgg 785880
 ggaaccactg ctaataccaa tttccaggaa ccaagatgat ttctagactt gctctggaaa 785940

tacaggcagg gatggtgttg tgagttcaat ggtgggcctc tgcctaaaga tgcttctagc 786000
 atttgtgact gtgactttac ctgggagaaa aaaacctaaa tccaatttaa atgtccttat 786060
 aagagaagaa aaaggaagag tcacacagtg aagaagacag agggaggttg gagttagca 786120
 tccacaggca aagaatgcca actatatcag ctacttgtga agctcatcaa ttcctcgtct 786180
 tttttttttt tttttttttt ttttttgggt tttttttttt tttttttttt aagattttat 786240
 ttgtttatta tgccttctgc ctgcatgcaa gcagaggta ccagacctca ttcaaggtgg 786300
 ttgtgagcca ccatatggat actgggaact gaactcagga cttctgcaag aatagtcagt 786360

gctcttaacc actgagcaat ctctccagcc cagatagggt ttctcactga accaggagct 786420
 tgctaattca gcttttctgg ccagccagca agtcttgggg tctgtttctg cctccctggt 786480
 gctggtatta taggcatgaa ctccatecc tggcctttaa tttaggtttt gtttgtttgt 786540
 ttgtttgttt tttatttaat gtatacaggc gttttgtcta tctgtatacc atgtgcatgc 786600
 ctgttgctg cagagctcac cggggacatt tcagaaccaa aaagtaacac caaggcctgc 786660
 caacagtgc cagaactagg agagaacctt gggacactat actactccta cacatgattg 786720
 tggacttaca gtctcaagaa acgtgaaggt agtgggcaat ggtggctcat gcctttaatc 786780

ccagcactca gggttaaaga gacagaggca ggtggatctc tgtgagtttg aggccagcct 786840
 ggtctacaga gtgagttcta gtaagtcaag gctatacaaa gaaacctct tttaaaaaa 786900
 ggaaaaagaa aaaaaaacg tgaaggtata aatttctgct attttaaatc accagggtctg 786960
 tgggctttat cttggcagcc ctagaatct aacctgctg ggaagtgggg agtcatgggt 787020
 agacaaggag gaagctaact ggtgactggt gattcagtgt cgcttgttct gtctcttggc 787080
 accattccc gtaagaaag ctaagttgat ggaggctaca gtgagacttg ctatgtcatg 787140
 ccaagttcta acctaggat tccagagcct cctgggctgt gaatcacca tgagctgtgg 787200

ttttgcttta agcaactgtg aggaagtgtt gtcataaggg cggcactctg agaaagaggt 787260
 aaatctccag gccctgctag tggaggtgca catctggcat tcattccaca cagggtgcct 787320
 ggggtccttg tagttgcttc ttccagagga agtaagact gaagcattga cctggaagaa 787380

caaagagaag gaagtaagcc tgggggtgtg ccctaagcc aaaaatgatg agagagggtt 787440
 ggatcccga tctaaatctg ccagttttct ttgtccctt gtctatctaa caggatctcg 787500
 tgataacagg gttgcgttaa taattcatat ttcagtttcc cttttctaag agagcaaagc 787560
 tgtgaagtgg agaaagggtg acaaaaggcc gtggagaagg aactgaaag gtcacccaga 787620

 agacctggat cccgaaatgc aaacatcggc ggtctcctta aatccacgca tccaggaagg 787680
 tgttcataac ctcttctcaa gtggccagag ccaggatcat acagcataag gatgaagctg 787740
 ccctctgagc atgcccataat acttttcttt ctggctata ctagggatcc atgctagccc 787800
 aatgcaaat ctgtctttca ggagccattc cacctgccac aagtcatttt tttccaggtc 787860
 taaagcagag gtggactctc tgggttcatt tccacctttg gataaaggac agtagttag 787920
 acccctagtg ctgctgagta agtaaatgaa atgatgaatg taaattcttt agtgcccat 787980
 acatacttgg tattccattt tgaatcatta ttgttgaggg gagtcccatg aaacctctct 788040

 atagagggtt tttccgaaat tacttactcg tggcagggtt gtgaaaagta agtgcaggtc 788100
 agagaacaac ttgcaggctc caggacttga accccggtta tcaggttgtc actgaacat 788160
 ctgtatggcc ctgtctatag gatttttgag ctctatatta gtacagagcc tetagcctec 788220
 ctccaacagg gaaatacaaa gccacgctgg acaggttgtc tgagagacga catggttagca 788280
 tttccaggcct gcaactgcata tgggtcctgc ctgttcccca gtgtgggtga tgcaggtcct 788340
 aggatccatg aaaaatgac agctgagcac ccagagcac tttgtctgcc agaccaagt 788400
 ccagagcttg gtcctagac tcactcacct tatctggaat gagtatgtgg tggccaagca 788460

 acaccacctg acctcatcaa cctagcagtc cagagctcac tgtggtggca gaggaaggtc 788520
 agaaggaaaa gaagttcaaa atccagttct gcaggggctg cagagatgac tcagcagtta 788580
 agagcactgg ctgctcttcc aaaagacctg ggtcaggttc ccagcacctt catgatggtt 788640
 cacaatcate tgtaactcca aagggatttg atgcttgttt ctgtgtttct gttggtttgt 788700
 tttgtttggt gtgtgtgtgt gtgtgtgtgt gtgtgtgtgt gtgtgcgta tgcacgcact 788760
 ggagaccaga ggaagaaatc tgatgtcttc ttctatcagt ctctacttta ttcctggag 788820
 acaaggtctc tcaacttctt tggcactctt ccaggtttgg gctcagatgg cagtcagcaa 788880

 gccccagaga cctctgact ctccacctc agagtgttg gtttacagga gcaactggcca 788940
 tgcattgggtt tttgttgtg tttgagcgtg ttgaggcaga gtttactat ggagctctgg 789000
 ctaacctgga gtcacatctc tctgtctcc gtcggctact cagctgggtt tacagtgtg 789060
 cactattcta cctgacatca actgcttttc attctttaga accaaaatga tctaattha 789120
 tcccgtctcc ctctecat ccaaacgcca gctctttaca gctctgtact attcagtgac 789180
 tttccctctt gcctgcctc tctggcctc ctcttcattt actgcagact ggctcctgcc 789240

ctgtgctctt cttgtccctc ctaagccctc ccatccctt ggacaattgt catttcatga 789300

ggttgaccac tcctacctt ggcccttga ctctcaact cctgaccacc ccttgacct 789360

caccgccact teatatcacc ccctgtctc agtggccaca ccttgacct tatcctttct 789420

tcactgacac agaagtttc tacaattgc ctaaagtcca actglagaag gactcagcaa 789480

tagaaggatg tcatttccc agatttaca gaatcagtac ttggtgggct ccaggtacat 789540

caattcagtg acatgtctgt aactcaaca actaccagg ttcttctatc tccttttct 789600

gctattctca ggcatgtct gggcatcag actggcttct cacatgctca gcagatagtt 789660

actgaaactg aaatacctta tcgttaggac tgtgtccaaa ggcaggaaca agggcctcat 789720

ctttctctg cacttttga acaaggaagg aaaatctcca agccagcata gaggtgcaca 789780

ctcatgatcc cagagagtca agagtacaag gtattcttg actatatcta gttccagaac 789840

agcctgggct tglatgagac ctaatttcaa agaaaataaa ttttcttga tgttttctga 789900

ctccaactct gactgcctat attattatat gtgtgagtat tttgtctgta ttagtatgt 789960

atgtgtacca catgtgtgca gtgccatgg agacagacca gaagaagatg gcagatcac 790020

tggccaaga attatagatg gttgtgttg tgggtatcc accagaaaag actgctagga 790080

catggatgta agataataga aagtctttat tagcctgcct atgtgttcag gatcccagtg 790140

tagccccaag ctttctcag agtgagatt taagcacaaa accatatcct gagttgacat 790200

atatcagtta acaggaacag ttaaccagaa gaggaactac agaggccaaa aaacaaaatt 790260

ggtacattta gagacttcc cagaacttc tcaggcttg atgaattggg tcttttagtt 790320

ttggcaggtg gtactgtcta cgtgtgagt ttacagctg aatggtacct ccatcatgga 790380

gtcatctatg ctaaggctt ggggggcttg gtaggtctag ggccctgtta tagttgtcag 790440

ccaccatgtg ggtacagtga accaaactca tcaggctctc tggaagagta gcaagtactc 790500

taaaccatct ttctggetgc tctctctc tctctctc tctctctc tctctctc 790560

agagtcttat atagctcagg ttggcctcca actcacaatg tacctgaaac tggcctgaa 790620

ctctgatcc tctgtctct acctcccaag tgctaagatt ataggtgtga tgacctgcc 790680

cagctttcc tatttctcc ctgctagagc tggttttct aagaagccca ggctgaactc 790740

aaaactctaa atcttcacc cacatatccc gagtgtgag attataggcc tgtgtgtctt 790800

agtcactgtt ctattgctgt gaagagacac catggccatc aaggcaactc ttataaaaga 790860

aagcatttaa ttgaggcct gcttacagtt tcagaggtta gtccattatc atctatcac 790920

atggtgagga gcttggttgg aaaagtagat gagacttcta catcctgatc ttcagacagc 790980

agaaagagaa cctgggcctg tcatgggcctt ttgaaacctt gaagcccacc cccagtgaca 791040
 cactttctcc aacaaggcca cacatcctaa tccttctaata tttttcaaat agtgctactc 791100
 catagtgatt aaccattcaa atatatgagc ctatggggac cttttttat tcagaccatc 791160
 acaccatgct ctatgcaagg atatatagat atagatatag atacatgaac aaatgaccaa 791220
 agtcatgctg ggtatgttcc aaattttata cttttcatga acacactaag atctccagtt 791280
 ggcaagatga aagttagaaa gagctttctg cagctagaga agtaattcaa caggcagagt 791340
 gcttgccatg catggtcaca tatagataat taacagcaaa ctcaaggtca gtctgtggtg 791400

 cataagacc catccaatgg gtgctgcaca aatgctcagc agttaagagc accagctgct 791460
 ctgacagagg acctgtataa ggttctcagt atctacatgg ctgctgggga tctgatgctg 791520
 tcttaggctt ctattgctgt gaagagacac catggccatg acaacaggag cacatttaat 791580
 tggggctgac ttttaagttc tgaagtttag tccattatca tgacaggaag catggtggca 791640
 tgcgggcaga catggtgctg gagaaagtag ccgagagttc tagatcctga taggcaggca 791700
 gcagaaagag tgacactggg cctggcttga gcttctaaaa cctcaaagcc caccacat 791760
 gacacatttc ctccaacaag gccatactc caacaatgcc actccctttg agtctatgcg 791820

 ggccattttc attcaaacca ccacagatgc cctcttctga ctccatgagc acttcataca 791880
 tgtactgtaa agacatacat gcaggcaaaa caccaatata cataaaatat aaatatataa 791940
 accttaaaag acaaacagaa caaacagca aaccaacttt ctagaaaaat attggcaact 792000
 tcagtatata agaaaaggag aagaaaaagg aggaggagga ggaggaggag gaaggaagga 792060
 aagaaagaaa gaaagaaaga aagaaagaaa gagaaagaaa aggtaatgat tccttagctg 792120
 gatggcgggt aatcatactt ttaattccag tactagggat taaagaggca gaagcaggta 792180
 gattgctgtg aattcgaggt cagcctggtc taaaagcta gttctaggat agccaaagct 792240

 accaaagaaa cctgtcttg aaaaacaaaa acaaacaaaa aaggtaatgat ccctacceca 792300
 gtgcaccatc acagcctgcc ttaggaaaca tccatgtaga tataaagtag tatgtacaag 792360
 gatgtccact ttaataacat tttttaaata tttgggtttt tttgtatft ttttaagat 792420
 tttatttatt tttttttta ttatgtatac aacattctgc ttccatgat atctgcacac 792480
 cagaagaggg caccagatct cttacagat ggttgtgagc caccatgtgg ttgctgggaa 792540
 ttgaaccag gacctctgga agaacggcca gtgctctcaa ctggtgagcc atctctccag 792600
 cctcaataac attttttaaa gggggaaaga tgggcaggaa cctaaataca tgccaggag 792660

 gaagaaatga acaaattgct tccattttca aagtcactta ggtcaaaagt gaactcagtt 792720
 caaatgctgc tccaccact agcgagatac accatcttc atttatttgg cagggttgea 792780
 tcctgagaaa ttcatcattt ggcaattttg tcattgtgca aacatcaaag ggtacttatg 792840

caaacatata tggcatacat atggcagcca cgcaacatgg cctcttgatg gagttgagac 792900
 attatagaaa caagatgaaa gaggctttgt cagtgtaca cagtacagtt ttgtttttcc 792960
 tgtttgtttg gttggttttt tgtttgtttg tttgtttgtt tgtttgtttg tttgtttgag 793020
 acagggtctc atgtagccca ggtagcctt gaaatcacia tgtagctgag gatgacttta 793080

 aattcctgat ctctctctct tcaactccca agtgcctgga ctgcaggcct ttgccacaac 793140
 gccagcctac agcctttgtt gagagcattg catgacagta cccaccaatc accagagaaa 793200
 ccaggaatgt taagcacaca ggattgtctt tccaatggga aagatgaaaa acctgttctt 793260
 ccaccagaa agctgagaat tggaaatgat taacaacctg atgatctgtg ttctctgttg 793320
 ggccaggcca catcaagctc ttacaaccaa gactgggagg tagctagtaa tctaatgac 793380
 cctgatatcc agaggttccc ccaagctccc aactaggac cagaggtggc taataaccaa 793440
 aatgagctct acattagcta tatgaccaag accaggccag acccttaggc tgaagctcg 793500

 tttgggtagc ctatctccag aacctatctt ctggaagaa atgacatata ccccgagggg 793560
 agtttcaatg taattacact tctttgtgca ctaaggattg tattatatca ggaaactttt 793620
 tacccecaaa ttgccctgta cttaactatt gggaaaaaaaa aaactgtctg ttagtagaca 793680
 ccccccccc gaagtctgat ccaggctgat gaagtcaatc tgcacctggt ttttattctt 793740
 gtcttttctt gatattcaat tccccgtatg acacctgcag ggaccccat gagcattctc 793800
 ttctacagtg aatctttttt gttttttttt tttgtttct gagacaggtt ttctttatgt 793860
 atccctgctt gtcttgaac tccatgta gaccaggctg gccttgaatt cacagagatc 793920

 ctctgcctc tgetteccga gtgctgaaat taacaatgtg caataccacc tcccagatac 793980
 agggagccct tttttaata agattttttt aaaagatttt ttattttttt attatgtata 794040
 cagtcttctg cctgcatgcc agcagagggc accagatctc attcaaggtg gttgtgagcc 794100
 accatgtggt ttctgggaat tgaactcagg acctctggca gagcagtcag tggctttaac 794160
 cgctgagcca tctctccagc cccttataata agatttttaa gacctaggt ttattgtctt 794220
 tatcatgtat tgtgtactac acacaattgt actgctgtaa tgttttatgc tggcaatgca 794280
 gtggatttac aacaggaata gcacaagaac agagcagtcg tgaacagta acaggaacta 794340

 cagcatccct gggaaatggg aaatttccag ctctcttata attttaaaat attttagatt 794400
 tgttcatttt atgtgatga gtgttttgc gacatgtgta tctgtgcacc gtgtgagtcg 794460
 ctggtgccca tggaggtcag aagagggtat cagatcccag gtcctctgta agaacaaatg 794520
 ttcttaacta ctgagccacc tacctctcca gctccaacta tataatgata tgtattgaga 794580
 ttaggccttt ctatgtagtt cattgtccta gtttgccttc tattattgta atatttggtg 794640
 accaaaggca acttggggag gaaaggattt atttcatctt tgcttgtttg ctgtctgtt 794700

tgtttttgtt tticgagaca gggtttctct gtgtaacaac cctggctgtc ctggaactgg 794760

 cttttagac caggctgaaa ctcacagaga acctcctgcc tctgcctctt gagtgtctggg 794820
 attaaaggca ggtgccacca ccacctggct agcgtttatt tcattttaca gcatccatca 794880
 ctgaggaag tcaggacagg aatcaaggc aagaacctag agacagaaac taaagcagag 794940
 aatatggagg agtgcctgtt gctctccatg gcttgctcag cctgctttct ttattattat 795000
 tattatttat ttgtattttg tgtacattgg tgtttgcct gtgtaaaggt gtcagatccc 795060
 ctggaacagg agttagatac agttgtgagc tgcatgtggg tgctgggaat tgaactcagg 795120
 tcctctagaa gagcagtcag tgcctttaac ccaactgagcc atctctccag ctctcagcct 795180

 gctttcttat accagatgac cctagcttgt gtcaaattga cataaaacta accagiacat 795240
 ccatgctgct ctaaaactgg aatctccag cctcagcttc tcaagtgtg gattgccacc 795300
 atgacctgct ttctttata attctaaggg accactgtca ttttcttcat tggtaaaaat 795360
 attgttatgt aatgcatggc tataaacctc tcctcttcc cctcttccc tctctctctt 795420
 ctctgctgce ttctctcct attctcct cccccctcc ctcctcccc tctctttctc 795480
 atagtgaaga ctgacctgt taggcaagtg ctctaccact gagccatata tgcagccttc 795540
 ttcacttta aatgggtaa aatgatagt gaccagttga tagcgttgaa atgagacacc 795600

 catgtgaagc agataggaag gaaggggtct cataagcatt gagtatattt tcacaacccc 795660
 acatagtaag gaatactgag tagcaattta aaaggtatga attcaagggc tggagagatg 795720
 gctcagcagt taagagcact gaatactctt ccagaggacc tggaagtacc cactgtacac 795780
 acacacacac acacacacac acacacacac acacacacta attcaagctg ggtggtggat 795840
 ttctgagttt gaggccagtc ttagagcгаа ttccaggaca accagggcta cacagggagt 795900
 ctttgcctca aacaacaaa caaaaagtac tacacctta gtcttagcac tcaggaggca 795960
 gaggcagagg cagaggaggc agagaggcag agaggcagag gagaggcagg agacaggaga 796020

 cagaggcagg cagatctctg agattgaggc ctggtcttca gagtctattt cagaactaca 796080
 cagagaaatc ctgtctcaa agaccacaca cacacacaca cacacacaca cacacacaca 796140
 cgcgcacgcg cgcgcacaca cacacactat tgiactgccg cctgctgcct attgggcaga 796200
 gatggaatta ctttctctt tgctctgtct tttctttcat gatcctaac aatctgtttt 796260
 agaaaaggat ggagctcctt ctccacaatt cctatagggc ttaatactag ggagaaactt 796320
 agaaaactaa aggattatgg gggttggtaa agtgcttgct atataagcgt gaggacctga 796380
 gttttcgtat cagcgttcac agtaataaaa cccccagct gggcagtggt ggcacacgcc 796440

tttaatcaag cacttaggag gcagaggcag gtggatctct gagtttgagg ccccccgatc 796500
 tacagaatag attctgggac agccaaagct acacagagaa tccttgtctt gaaaaaacca 796560
 aaacaaaaaa caaaaccacc aacaaagtag tactcatcag tagccccagc acatgggcat 796620
 agagacaggt agctccctgg gcacacttac catcaagtgt aactccagtt tcagcaagca 796680
 actttctctc aaaaaataag gtgaagaaga cagagaaga tacttgacct ctggcctcca 796740
 tatacatgca tgggtgagtg cacgcatatg cacaacacac acacacacac acacacacac 796800
 acacacacac acacacacac acacacaaaa taaatcttta aaataatgat atgggtcctt 796860

 aagtactgaa attggaagcg gcaccacac cccaatgttt gcagaatgtc actggactac 796920
 ggaataaggg taaagggata ttccatgc taattatfff gaagtgtfff ttcgggggac 796980
 agtaaatgtc aaattctttc ccttaacct cctgtctcc tttgttctt tgcaggggct 797040
 gagtgcacct gttgggtgac ccaggcctgc ctagggggag ggaggaagct acacaactaa 797100
 gtccittgag ccctccct gtccagaggg catcagcaat tggaaaggag cccagcttta 797160
 tgggcaaaca atggtgccag ccagctgcag ggctcaacag cctggctaata ctgggaggtg 797220
 tccagaaggg tgccctcat acctgaaggg tccacttcaac ttggagacaa atatccacca 797280

 atcaggaat aggtcacgaa gcagtttggc aagggtggg gagagtcagg gaccattgag 797340
 agggaatccc tcagcattcc tggatgaacac ctctcaatat gaaattcca atctccctgc 797400
 taggggacct cagtgttctt gggattgaac tattctggca tatgggggga gaaagcaaag 797460
 gatccctaag gaactgaaag ttgtttgagg tcccatagga aatcaaccac aaagctggga 797520
 ctaaaatcca ggttcccttt gacacagcaa gtccacacca ggaagtgatg ttgcacaac 797580
 tttatgagca tgctcaattc tgtgtctttg ataaatgtcc atctgataca gaagatagtg 797640
 tctgatcacc tgaccactgg aatccgaagc aggatcccaa gcctggagac ctcatggaca 797700

 agagcaatca gcagcacttg cctgtctgac tgtcaaggct gtaatttggg aattgccttg 797760
 agttcaaagc ctgcctcaa aggctaggaa gatgccaggt gggtagaggg attgctgtac 797820
 aagcatgagt ctgagagttc gaactccag aactcaggaa aatccaggt atggtggtga 797880
 gcctctggaa tccagctctt gggagggagt agactcaggt ggatcctgtg ggtggggctt 797940
 tctagccagc caatccagtc caaacatct agctcccagt tcaaggagaa acctgtctc 798000
 aaaaatcaag tgcagaagca attaaggaag acactcactg ttgacatgag gctttgacat 798060
 acactcatat gagcaggcac acccccagac acataccaca caagcacaca caacctccaa 798120

 ctaacacttc ctatgttgt cacctgctat gaattagttt gttgctgtgg tagtgctcc 798180
 aagatggcca tcaatgacc tgaacctcag gggtctatcc ccttatctag acagttcctg 798240
 tagtgtatct ttttcttct gtaggcagtt ccctcaatgg ccctgcctc agggtagcta 798300

tccccttgtg ttggcagttc cttctgcgtg aatgccactg acttctgtaa ccaactggagg 798360
 actgtagaag taaaagccca acttcagaga aaaaaaaaaa aaaaaaacac tggaaaggtct 798420
 atcttctctt cttgaaccac tgtctatgtg gggagggcat cagaggctgt gtactacaga 798480
 caggtagaca ggiagcccaa tggaagaacc cacacagctg tgtgttgctg taataccaca 798540

 cattatgcta tgaagaagtt taactggctc aaagtccctca aggtcagaga gtctgagact 798600
 gaaagcccag ttctgctgag ggtcttcttc ataattcagc aagagaagtc atgtggccaa 798660
 gaagcttgtg caagtgttgg aggcaggggg gaggtggggc tggttttgct cttagagcaa 798720
 accccggctt ctgaatatca atccactccc acaatgttgg ttttagcctt cctgacctaa 798780
 taaactactt gacaatccct ggaacctctc aacacaatca gagtagtaag taaacatcaa 798840
 tgtgagtttt agaagggta ttcagacat aagcaaattt ggagaccct ccaacagcca 798900
 actgacttgc cagccatttg catgagtccc ctgagaactg gatccggaac cctagcccca 798960

 ctcagggtc tagaagcctg aagcccgtgt tcacatcttc actagaccct caggacaatt 799020
 ctagagattt catgttttaa gctgtcagtt ttgtagtaat ttcttatgta gaaatgatga 799080
 atgcaaacat tttccttctt tcctttatct ctttaaattt aaattttacc agaaaatgat 799140
 gtgtgtgttc cattttccaa taatcaaata aagtctataa atatttgc cagttaatat 799200
 aaaataaata aatttaaatt ttattagctc attatcatgt atgtgtataa agtgtgcacg 799260
 tgagtgtgcg cacaggcagg ccatattgcc catgtggagg tcagaggaca actgccaaga 799320
 gtcactctc tccttcatt ggatgggttc tggatatcga actcagattg gcaggcttag 799380

 gagacaagtg cttttccca ctgagcatct catcagcttt ctttatttaa aagtgaaggt 799440
 gagtatagcg tcigtctcat acacacagaa tgcagatcca aacagatggg ggcaatgttg 799500
 ctacattatt aggtagtatt tagtcagtt aacttttgtt tatttattac tgcgattgtg 799560
 tgtgtacacg tigtctcttg agtgggcaca cccttctctc cttccacctt aagttccagg 799620
 gattgaactt aagttgtcaa acttgcagag caactacttt taccactga gcctatcacc 799680
 agccccatgt ggtttttatt aacagagaga gagcatccag gtagggccaa aggggcagca 799740
 gcacctggcc tcttcatttt ttctagcaat ttcattccga gttcgggtct gaaatacccc 799800

 ccaaaccxaa gcacaaggac aaatcctgca gggactctgc atcccctctc tctcccctga 799860
 aggttccagt ttctatcgcc ccaccccaac ctggaactta tcaggtaat cttggtctcat 799920
 ctgctaggag gtctatgttc aaaaaatttg ctccatctca gcacttttct gggacattcc 799980
 ctgaccctg ggagctgccc agctaaggat tgttttgctc cttaatccat ctctgggaac 800040
 cgggtttaaa ttttaactgt actgcagatt tcacacttg aaaagtttct caacctcgtg 800100
 aacccattt cttcatctgc caaacagaga gagtgaattc tgcctcctgg ctgctgggga 800160

aagaaaatag tcaggtatga aaactgcaga gtaaccacaa gatccagcag ttccactctt 800220

aggcatatac ccaaaagagc acattcatac aacaaggaca tctgttcaac tatgttcata 800280
gcagcactat ttgtaatagc cagaaactgg aagcagccta gatgccctc aactgaagaa 800340
tggatagaga aaatgtggta catttacaca atggagtact actcagcgga aaaaaacaaa 800400
acaaaacaaa acaaaaacac acacacaaaa aaacaatggg atcttaaaat ttgcaggaaa 800460
atggatggaa ctigaagaaa ccattccgat cgaggtaaca caatcaccac aagacaaaca 800520
tggtatgtac tctctcatat gttgatttga gacatagagt aaagtattat cagcctaaaa 800580
tccacactgc cagagaagct aggaaactag gaggacccta agagagacgt acatgttccc 800640

ctggagaagg gaaagggtc acgatcccct gagcaaattt agagcacggg aagaggaggg 800700
agggagctac aagaatgaga agggaagaag aggaaggatg cagaggtcat gagggagcag 800760
aaaggttagc tcaggggaag aatagaagaa agggatgtg ataggtaggg ttttagttgg 800820
ggaggggagg ggaggacggg agggagaagg gaactgggac tgtcatgtaa aacaatcttg 800880
tttctaattc aaattaaaa aaatctgaaa aaaaaagaaa agaaaagaaa aagaaaactg 800940
cagagtaaga taaactggaa gccccctgca gctgtcaggt acagccccgc ccagcatctt 801000
ctcctcacag tgggagtgc ttaactca ggctctgcca tgctttgtga tacagaccag 801060

ctttgtctct ttgacatgg gactttcaat ttctttatta ggctttcagc agaactgca 801120
aacttattcc agiactttcc ttcagcagct aagccagggt aagaagaagg gcttgctgtt 801180
gttctgtttt atttttgttt ttcagacag gctgtagctt tggagcctgt ccttgaactc 801240
gctctgtaga ccaggtggc ctgcaactca cagagattca cctacctccc gagtgagggg 801300
cttaaacgtg tggccaaca ctgccactt tgttttgttt tttaatgggc taacatttga 801360
tagcccagc agacctaaa ctcatgatct tccaggtca gacttcaag tacaggcatt 801420
acaattgaaa ataatgatt attattagt tttgtatgta tgggtgcttg aatcaaacta 801480

aaggttcag gtatgctaga cagacattct actactgac tatacttttt tgtttgtttt 801540
ttgaaacagg gtttctctgt gtaacagctc ttgttatcct ggactctgt agaccaggca 801600
gacctcaaac ccacaaagat cctcttgctc tgccttcaa atgctgggat taaaggcctg 801660
caccaccacc accttctggc ttttttttt tttaatgggt ttagagatc ttaattcagc 801720
tactcacatt tgtaaggcaa gtgacctacc aactcccagc tcccaataa attacttata 801780
agtggaatct tattagatat tattagtcc taagtttggc tgcatgttgg aatagcctaa 801840
gggtttaatg tacatactc caaagatcct gatttagttg tctatcagg attcggcctg 801900

gacatcaaaa gcattttaaa accttgttcc cctgaagtta aaggactgg attatctagc 801960
catctgaaaa caagaatggg attaaatgaa acaattcaaa tagggatcaa gtagtgaagg 802020
aaagtgacct ctgggatgga aacaaatgaa aaaagacct ggtgatggat ttttctttgg 802080
gccatcagta cacacacaca cacacacaca cacacacaca acatagagac 802140
ttatattagt tatgaaagct cagccttagc ttaggcttgt ttctaactag ctcttataac 802200
ttaaactaac ccatttctat taatttactt tctgcctcat ggctttctta ctctatctcc 802260
ataccgcca ccctgcttcc tctgcatctc ctggaaatcc tgcctcgcta ttggacattc 802320

agctttttct taaaccaatc agagtgcac atcttcacag tgtacaaaga gtagtgcga 802380
caagatttcc acaagttacc atcaagacag ttttcagaat tcccacaaac taccgtcaag 802440
acagttttca gaattcccac aaactactgt caagacagtt ttcaggtcat agaatagga 802500
aaggaaatct tgtggagtcc cgcagactct ggggggaagg aactaaatct gaggagactc 802560
cggagcaggg ttctcaggag gactgcttcg tggatagtgc tattcaagca ttcagccaag 802620
cactcaaggg tatgtgatg caaggaaact accttaagat aaggggaaa taccccaaga 802680
gctggcagta acagtgttcg gggctcacac aggccagga acacatccgg gccctccaag 802740

atgactaaga agcctcgtga ttccccagga atttggtaga gtacacagaa gtgtaatfff 802800
cctcagtact ggaggaaaat aagcccaaaa ttaagaagtg ccttgatcac acttaatgff 802860
aaaatcaaga cccccccc aaagatcgtt tgatctttcc aaataaatta ccttaccag 802920
aagaaggtaa tacctaaagg attacaaaat tatctagaag ctggatgffa gtggtgcaca 802980
cctttgatcc cagcactcaa gagacagagg caggtggatc tctatgagtt tgaggccagc 803040
ctggtctaca gagctagttt ggagacagcc aaggctacac agagaaacc tgtctctgaa 803100
aaccaaaaac caaccaacca aacaacaaa caaacaaaa atatctagca cttactaat 803160

ggaactcaca tgtccaatat ccaattttaa aaaaataaat caggggccag gaaagatggt 803220
ttagtgggta aagacgatca cctttaagcc tgataacctg agttcaatcc ctgggacca 803280
catgacggga gaaagtgc tctgcaagc tgcctctga cctccatctg tgtgctatgg 803340
tatggtaaca tgcacacaca caaaccagc ttttacagga tgtctaaatt gttaaaatat 803400
gctttatgff tctttttgt tttgttttt ttcaaaaca ggtttccctg ttagcttg 803460
ctgtcctgga actacctctg tagaccagc tggcctgaa ctacagaga tctgcttgc 803520
tctgctcca aatgctggga ttaaagacct gtagttacc actgttcaat ttaaaatag 803580

ctttttctta aatggtgfff tatttagaga cagggcctca ttagcccaa gttggccaca 803640
aactcactaa ctcaggagtg ctgagataac aggcgtggcc tccatacctg atttatgtag 803700
tgctggagtc caagctaggt tttgtgatg agaggcaagt gcactattta ctgaacaaca 803760

tcctttgtcc ttaaaatgca actttatctc aaggatttcc taaggtaaaa acttagtgca 803820
acaatgtaaa acttgaacaa attctttgtg tctaaagaaa caaggcttcc tcaaaagtat 803880
tgccttgtt tcagtgatat ttacaaagag gaattagctt agaggacaag attttatgtt 803940
ttaagtaaat tgcttgtgtt ttctgctgat ttcacaggt tttgactat ggaggaaaca 804000

atattaacaa aaccaaggtt cattcaata tctacttctg ttaaggtctt ttaaataacc 804060
atttgaacaa acaactgact ccaagcaatt ttatttatat attttatgtg tatgggtgtt 804120
ttgcctgatg taigtctgtg tatcacatgt atgcctggta ctgaggaagc cagaagaggg 804180
cacatgtggg tgctgggaat tgaacctggg tcttctgtca gagnaattgg tgcactaac 804240
cgctgagcca tgctccagc ctttgtttta gtctttatta catttagtaa gtgcacacta 804300
caggcgtttg tgtgcgcgcg cacacacaca cacactcagt gcataatcgg ggcagagaa 804360
caacttgtgg gaggttgactt tctccttgca ccatatgggt ggcaaggatc aaagtcagag 804420

cattagataa aggaattaat ccgaagagcc atatttctgg ccccttaggt gattttagta 804480
catttaagac cctgtgtatc tgtaatgtct aaagcaatat gtctaaaacc tattctgaaa 804540
aactttggga agttaaaggc acatgtttta tacatgttta ataccacaa gtcagggct 804600
cactgttatt gaggttttat gttatatac ttagactgtt gacacatgaa atggccttga 804660
aattaaaaaa aaaaaaaaaac aattctgcta ttacaatca ggagcattaa gataaaaact 804720
tgccttttat gctgagaatg gtgactcagg cctgtactcc cagcacttgg gaggttggaag 804780
caggaaagtg atgagttcaa ggtcatcctt gactacatag tgagtttgag gccagctggg 804840

ctacagtga accctgtctc agaaaacaat aacagctcac caccgggcag tcttctatt 804900
tcaacccag cctacttctg tttggcttgc ctagtaggca tgttattatt gaggatgtaa 804960
agtggtgtgc tgtgtttgtt gtatgtcaga taatgagccc gatcacag gcaactgttc 805020
ctaaatctgt aaaaggtcca aagtctttat tttgtctgc attggagacc tattatctta 805080
cccagccaaa gattccaaat tttgtttcag aagtaggtaa cacattaaga actcacgaca 805140
gtagctgac atggtgccac ttgcctttag tcccagaact taggagcag gacagaggag 805200
agctctatta gttcaaggtc aacctgatct acaagcaag tttcaggaca accagagata 805260

caaaaaatga aaacctatct caaacaacg aaaaagaaaa acccacgatg ctacttgtgg 805320
ctggcttctt tatatggcaa ctgcctttat gctccccttg tattattggg gcttcaaac 805380
acgtggcccc tcaaagcacc ctttaccaaa ctgatgcctt ctaactaga atcgtaagg 805440
gtgataacct tgcttagcta tcttagggtt actattgcta tgatgaaatg ccatggccaa 805500
aagcaaaactg gggaggaaag gggttatttg gcttacaatt ccacattact gttcatcata 805560
ggaaaaagt aggataattt aaggagggca ggaaccagga ggctgggact gatacaaaag 805620

ccatggaggg ttacttctta ctagecttgtt ccttctagtt tgctcagcct gatttattat 805680

 agagcccagg accaccagcc caggaatggc tgggctgggt cctccacca tcaatcacta 805740
 attaggaaca tgatctacaa gattgcctac agaacaatct tatagagata ctctctctca 805800
 gatgactcta gcttgtgtca agttgacata aaacacacta accttgcttc taaccaacta 805860
 tgctatcat ctttttgtat gtatgtatgt atgtatgtat gtatgtatgt atgtatgtat 805920
 gtattaacag gcaaggcttc cttcttcagc ctttttggac taggctggaa ctccatgtgt 805980
 agcctaaatt ggcttcagac ttatggagac cttcttcca catcagcaag tactacaggc 806040
 ttcggtgtg tgctcagcat gactgtgctc ttttaagcaaa gataactaga catgtcctaa 806100

 cacagtgtac tcaagaagt gccccagtga cttttgtttg tttgtttgct tgcttgttca 806160
 tttaactac taagaactga acccagggcc tcaaatatgc cagatgagac ctctctcact 806220
 gactgtatcc cagaccctc cctttaacct cagctcaagg ttcaggtcct gagacgggaa 806280
 ggggagtcca tgcaaggaaa acttctgacc accaagtgga ttgactcaa gtgtcccaa 806340
 atatctcagg ccatctttgt ttactctaa acaaagtfff tcttaccagg attacatgaa 806400
 cagttttatt attgcttct atttttgatt ttaagaaata caacataatt taaggaatac 806460
 atcatgatcg ttatgaaagc tccattgtt cccattatgc ttcctcaaat acacctccc 806520

 acccctaca taaccttatt ctgacctag agttcagaat ttttacagc ttaactaagt 806580
 atcaagccag acacatccta ctcttgagc gcgcttatgt cagctggtag ctacttgtgg 806640
 ttacaaagt aaaaagtaat agacatagcc acaatgcttt aaggacaaca atattcaaac 806700
 ccagacaatt tctccatgtc tgcaatata gctttcatgc agttcccttt tctacaagag 806760
 ggtcccggt ctcaatctct gtagaaggca gaccttgaca gggcactctg ttcctgtccc 806820
 tctatgcat aattcttcca ccagtgtaaa ctctgtgta tggtaaagat agatctacce 806880
 atccacactt tgcatgtat tgtttccct tccagcatac cagatccac caatgattct 806940

 atgtgtggtg tccaggaac atactctca cggttggcac tatgtgtatt cctgagactt 807000
 tttccctatt cagtgtatgc ctgcccact ctccagaact gtgaaacatg gctaatgttc 807060
 caagtgtgt tttctcatat gtacctact tctccattaa gtaagaaaag tccccagggt 807120
 taggagtgt agttagtaat ttcagataag agatttgaga aagaatagcc ccctgttgaa 807180
 tctcaggaga aaatattcga gaaacagcag aatttccagg gaaaattaca gctattgcat 807240
 ggaggactga caaagtaaaa ctaaaaacca cccaagagg gatggagaga tagctcagag 807300
 gtaagagac ctggctgctc ttccagagat cctgagtca gttccagca cccacatggt 807360

ggctcacagt catccgtaat gctgcctct tctggcctgc agatacacat ggaggcatct 807420
 gggcagaatg ttgtatata aataaataaa accttttaaa aaataccga gaaggattaa 807480
 attgttaaaa aaaaaaaaaa caaagaatca gcaagagctt gcaagctgca cagattttgc 807540
 aaattcctat gcccaagtgag aatctgtttc catagggtgcc ttgcccgaag gaaactcgtt 807600
 ggacaggtag tcccatgctt atccaagact aggctgcaca gctcctgaca cctcctcctg 807660
 atggaaagac actggcatgt catacatcct aaatcttgac tacatctgta agcaaatgca 807720
 ttctgcttta ttiggaaaac atgcttattc tcaaagacaa aaataactag gggcttgtgg 807780

 gctaaatgtc acctagtatt gaaaactctt gtcattcttt agactgaaaa aaaattgagt 807840
 gtatttctga aagagagaaa aagttatgat ggtcctaact aatgctgtca atcataatta 807900
 ttttcctgaa attctattca caatgaaagt aactgcacag catggttgat agccaaactt 807960
 tctgcaaat tctgaaatgg ctgttctgag tcttgtcaac catagatgag atccattgg 808020
 aacttattta tttattaata ttattgtgta tgtgtgtatc tgtgtatctg tgtatctgtg 808080
 tgtgtgtctc tgtgtgtgta tctgtgtgag tgtgtatgta tgtgtgtgtg agtgtgtgtg 808140
 tgtgggtgat ctgtgtgtgt gtgtgtgggtg tatctgtgtg tgtgtgtgtg gtgtatctgt 808200

 gtgtgtgtga gagagtgtgt gtgtgtatgt gagtgtgtgt gtgtgggtga tctgtgtgtg 808260
 tgtgtgtgtg taaggacaaa ttccctccagt tggttctctc ctcccacctc tctgcaggtt 808320
 ccagacatcc agtgcgaagt gctcactggg ccaacttact agccccttca tccatttcta 808380
 aagaatttat ggcaggggag ccagttgctg gtatcacaca cctttaatcc cagtactcag 808440
 gaggcagaag caggcagagc cctgtgagtt tgaggccatc ctggtctcaa attgagttcc 808500
 aggacagcca ggactattac acagagaaac cctgtcctaa aaaaccaaaa aagaaaaaaaa 808560
 aaattatgtc cacgttttgg ggtgtcacc tttaatccca acatgtagca ggcaggggat 808620

 ggcagatttc tgtgagtttg aatctagttt agtctatata ataagatcca ggccagccaa 808680
 aactacacag tgagaccctg tgtcaaaaa agaatttatg atcaactca taaaaattac 808740
 tataacaagt acttattttt aaatctagta tttttgtgt cttgctttgt tttgagcat 808800
 ttcttgctgt ataactctgg gtggcctgga atttgctatg taacatatct ggccttgaac 808860
 acttgatgac tctgctctga ctcttctctg actattggag ttaacaggag tgtactgctg 808920
 tgcttggtac aaagctgcat tcttaaaaaa tgttagggct ggtgatatgg ctcagtgggt 808980
 gaagatgctt gttgtcaagt ctgacagcct gtgttcaatc cccaggtccc acgtggtgta 809040

 aaagaacagt ctggaagtt gtcctctgac ctctacacat ctgccattgt acacaagccg 809100
 tgtactcgaa tcatgagcac gagtatgtgc acacacactc acatgcacac acacacatcc 809160
 cttaatagta aataaaatc atatttctaa aaaatgtatt tatttttatg tgcacgggtg 809220

ttttctctgc aggtatctct gtgtgagagt ttcaggctctc ctggaactgg aattacagat 809280
 agttgtgagc taccatgtgg atgctgggaa tcgaacctgg agcctctgga agagtagtca 809340
 gtgctcttaa ccctgagcc atctatctcc agccccaaaa tatatacttt cttgaaacag 809400
 agtttcacta tgiagccctg attggcctac aagttgctat atgatgtata attttggatg 809460

 ttcattgtaat attgggaatt gaatgcaggc ccttgtgcat tctagaccg tctaccactc 809520
 agctgtgtcc cattggagat tttagtaagc tttcacaat caccatattgc gtatttcctg 809580
 gcttttgcct cgcttccct atgaacttgc cccttttcca taatattgtg ctggtactcc 809640
 atgcttgttg cagaattatt tgtttacatt gtaaagatgt gtctctgcct aagatgcctt 809700
 ctgattgggtg taataaagag ctgaatggcc aatagctagg caggagagac taggtgggac 809760
 ctctggagaa ggagagaaaaggaggagga atttaggcat gcagattttg ccagcagact 809820
 cagagcaagt cagacatgcc atactgacga gaggtaattg aaccatgtgg cagaatgtag 809880

 attaaaaata tggattaatt aagttataag agctagttag aaacaagcct aagctaaagg 809940
 ccaagcttcc ataattatta ataaatctcc atgttgttat ttgggggctg gcgatccaaa 810000
 gataatctaa caaaaaaaca acaaacaaac aaaaaacttg gtatacatga tggaatgaaa 810060
 gtaggactct ctctctccat tttgggtaag ctataaataa atccattttc tttattagtt 810120
 tgcttttttc atttctttta aggtacactg ggtatttata cctacaataa tacgaagcag 810180
 gaaataaaca tgaanaataa ttaaaacaa tccagaaatg gaagttttaa tcagcaaaaca 810240
 aggatgttaa agcaatggtc ataactatag tatatattac ccaaagttaa gcaaacacat 810300

 agaagatata aaagaagtca aaactctaga gatgagttag agtaaaaaca gactggagac 810360
 aggagagatg acttggaggc taagaacgct gattgctctt gcagaggacc tgggttcaat 810420
 tcccaagcac ccaacttgga gtttatagct gcctgtcact ccagtcccag gaaatccaat 810480
 gtcatctttt agcatccatg ggcaactaggc atgaacaagg atcacagatg tacattcaaa 810540
 caagcactca tacataaatt aaattaaaat gaataaactc tcaaaataaa atcacggatg 810600
 gtactgacca catttaagat gggtcacctc agaaatcctt agagacacat cagaggttgg 810660
 tcttctctat tattctaagt cctgtcagtc tgaanaatcta tatataccat cacaccactg 810720

 gagggttcac aattggcata atagctgctg agacagggtt tctctgtgta gcctaacca 810780
 ggctggcctc aaacttacag agatacactt tgcctctgctg ggggttaaagg catgtattcc 810840
 cccccccat tttcttttct taaatttaa gtgtatgagt gttttgcttg tgtgcatgct 810900
 tgtgcatcat gggcatgcat agtacaaca gaggccataa gaaaatttca gagctcctaa 810960
 gactgaagtt acagggagag atgaaccatc aagtaggtgc tgagaattga accccagtag 811020
 gttggaaaaa cagacagagc tatttaacta ctgagccatt tttccagctc catttatcat 811080

tttcttaatg gtgacagatt ctctatccac ctgttatcta tcatctatct gtccgtctgt 811140

 ctgtctgact gcctgtctgc ctgtgtgtat gagaaagcga gtgcttgatg cctgtgggtg 811200
 tgcacataca tatgtgtgtg aatgtggaga aaagaaatca gtctcaggaa tgctaccac 811260
 cctcctattg tggagtgtgg tgtatgtgtc tgtatgtgtg ggtatgcaca tctttgactt 811320
 gcagaggtea gaagaggaca ttggtcaaca ggcattatca gtctctatc ctttttaaga 811380
 cagaatgaat tgctcactga acccaaaggg aggccgatgg ccctcaggcc ccagctatec 811440
 tcctgtctcc acccctcaca gcagtggggf tacaggggag cctgaggcca agtctgactt 811500
 tatgtgtttg ttctgggata tgaactcagg tccctgtctt ggagggcaat cactttactg 811560

 agccatctcc cctccttat gggctctgatt gaacccgggt cattgtctac cttagtctgg 811620
 tgttctaaca caaaccacag ttccagctct tttttgttg tttgtttgtt tgtttgtttt 811680
 tgttttttga gacagggttt ctctatgtag ctttgagcc tatcctggca cttgctctgg 811740
 agaccaggct ggctcgaac tcacagagat ccgctgcct ccgctcccg agtgctggga 811800
 ttaaaggcat gtgccacaa cgcccggcca gttccagctc ttaatgatgt cttctattta 811860
 atcaaaactga aacccatata atgtaaaatt gagcatttaa gtgaacaatt cactgtcttt 811920
 ttaaaactaa aagatttaat ttaatttaat tttattttat tcatgttttg cccacattca 811980

 tgtctttgtg aggggtgttg atcccctgaa gctagagtta cagacagtg tgagttgcca 812040
 tgtgggtgct gggaaattgaa cccaggtcct ctggaagagt agccaatgct cttaccact 812100
 aaaccatctc tccatttcat tgtcttttct ttttttagg taaggtctca tatagctcag 812160
 gctggcttct gaactcacta aatgtagccg agattgacca caagcttttt tctttttgag 812220
 acagggtttc tcaatgtaac agtcttggct gtcttggaaac ttgttctgta gaccaggatg 812280
 tcctcaaact cacagagatc tgcttgcctc tacctctcaa gtgctgggct gaccaccaac 812340
 ttgtgatctg tctacttctg cctcctgagt ggtgggatta cagacatgca ctatcacatg 812400

 tggtttatat ggagctgggt actaaggctt catgaatgtt aggcaagcac tctgttaact 812460
 gagctaaatg tctagcccaa aggtttgtat ttttgaggta tggtttcaca tagttgagc 812520
 ttgtcttgag ctgaccctcc cttccacct ctcaagagct gatattatag gcatgtgcca 812580
 ccatcacagg tttatcatg gaaaatgtta taggaagttt tgtatttttc ttttttcac 812640
 gtggggaatt agatccagga tctcattaat gctaaggaca tgctcttcca atgagcttac 812700
 atccgcagca gtaaagattt tatatgttca ttcattggctt gatgtaaaat catcttgtgc 812760
 atatccacct ttgcacaact ccttaaaaga cactggctta acctggtgga gtgagaggac 812820

tctagaattg ggagggccag ccctactact gatagtcac agctgatctc gagttagctg 812880
gctgactgtt ctgggacgca gcctttttat tgcacccttg gacctaccct gtgctttgcc 812940
ttctggtttc atctttccca tgagcctaag aggtatgcaa gataccacca ctagtctctc 813000
ttcacagatg aagaacagct ctgaatgcag ctgactagac cagttgacct tgtgggacct 813060
gtctctctc cacccaagcc tagagactcc cctgggattt agcagaaaagc tttctcattg 813120
cacctgtac cacctgcaga gacgtctgcg tftaccaggg tgagctctaa gattccgggg 813180
agtctttctg tctgacacct tcccagctta tgtaaagtga cctggatgct tgctgcttga 813240

ttctatcttt gcctgaagaa ttttaggtg tgactttagt ctgcattttt gttgttgttg 813300
ctgttgctac tgctcttct ttggattgca gattctggtt taggacagac atctccagtg 813360
agcattctag gaaagaaaa tattctggtt tgcaatgat agaggttggt cactggaggt 813420
ttcacaggct aaagctaaca ttaagtttga aagcaaaaaa ggagaaaact tgtgggggct 813480
gtaccaggat tcccacccc aacacttcac tatgaaagca tttaacagg tagaactgta 813540
tacaatggaag agactgaata acaatacac ttagattcta tattatcaa ctgattgctg 813600
tttgcctctg cacacattcg tttattgacc cctcattgtc tctgcccatt catctcaatt 813660

ttttgacaac ttcaatgaag ctgtagagtt cactccacct ctaagcactg tagcatgact 813720
atcattaact agcattcaat gtttggcttt gcttatgtta aataatatac aaagcagaca 813780
ttgttttaga ttgagctctt aaactaggcc caacagatca aacaaaaact aactcatct 813840
aaattgtaag tctctttttt gatgtttttg tttttggaga catggtttct ctgtatagcc 813900
ctggctgtcc tggaactacc tttgtaaacc aggctggttt ccaacacaca gaaaccgct 813960
tgctctgca agagattaaa ggcattgtcc accactacct ggctaaatct cggattatta 814020
attgttatgg taaaagctc accctagagc ctgccacca tatacccaa gagtctgga 814080

tgttatgttg ggagctccac ccaagccct cctctatctc tctcaaacc ctgctacac 814140
tcagaaagcc ggacaaatga tgacccttc ccagatata ctcaaacca ctcccacagg 814200
gtatttaaac taccaccag aaaacagatt gctggttttt ctggtctccc tttctgtct 814260
cctctttcga ggactggaag gctatccagg accatagtat ccattaaact tgggcttttt 814320
ctttctttct ttctttcttt ctttctttct ttttaagatt tattattta tttattatc 814380
atgtatacag tgtgtgccag aagaggacac cagatcacat tacagatggt tgtgagtcac 814440
catgtggttg ctgggaattg aactcagaac ctctggaaga acagtcagtg ctcttaacc 814500

ctgagccate tctccagccc ctctttcttt ttttaataatt ttttcattt agaaacaatg 814560
ttattttaca tatcaatccc tcttctctc tctctccat ccttccaagc ccttaccga 814620
ccccccaac ctacccccc cactcccta aggatagtga gacattccat ggggatcat 814680

aaaagictgt cacatcattt tggagaggcc ctcccttgtg tatctgggct gaaacagtat 814740
 ccctccataa ggaatgggct cccaaaatcc attggtgcac aagggataaa tactggttca 814800
 tgtgggcttt ttctaattcg gtttgatttg gtctgatttg gattgctgca tcggcggaga 814860
 ggcttgtggg gtatagaaac ttttcattaa tgtttacaag aaaagtaatt ttgaagtgat 814920

 tagctcacct tccaatcact gtttctgctt tctctagcca cttgccttgg gccattgaca 814980
 tggctagcag gtaaaatcac ttgttttgca agcctgatga tctgagtttg agcctggaaa 815040
 accacctaag acattggata tgatggata catctgtaat cccggctctc ctttggtagag 815100
 atgggaggca gaggttggag aaccgggaac ctctcaggcc agtagcttca ggtatgtagc 815160
 atagaaagtc tcagacttct aaacttgcct tagtttttcc agtgataacc ccatcccaga 815220
 gctacctagg ggccgccagc catcagttga ctcaacatac atgaagacac ttcttacttg 815280
 ggaggatttg agaattttta gaaactgcat gtcagaaatc aggacatatc aatatctgtc 815340

 atctatctac ctacctact acctacctgt tatttatgta ccctctacct attttcatt 815400
 tatctgtctt tgatgtatg tacgtatgtt ttatgtatct atcacctgtc tgtctgtctg 815460
 actgttcttc ctgttggcct acctacctac agaccacct atcatctttg tatgtatgta 815520
 tgtatgtttg taigtatcta tcacctgtct gtctgtccta cctacagacc cacctatcat 815580
 ctttcacacc atcctacttt gtaactgtcac aattcattct ttctttttgc ttacttgtat 815640
 tccattgtct ggatgaatat ttgacagttc attaatctc ctgtataaaa catcaccttg 815700
 gattggtttc cagtattttc ttttaattt ttttttgtgt tttggtttta tttattttta 815760

 ttttttgttt gttttagttt taggggactt ggtttttcaa gacagggtgt ctctgtgtaa 815820
 ccctgactgt ccitgggactc actttttaga ccaggctgaa ctcaaacaca gagatgcacc 815880
 tgtctctgcc ttctgagtgc tgggattaaa ggcattgtcc accattgcct ggcttctttt 815940
 taatttgtaa agattggttg tcatttattt atgtgtgcgt gtatctgtgt gttaatattc 816000
 ccacaagcat tcagtgccca aggaggcctg aagaaggcat tgggtccctt ggtaccagag 816060
 ttatagacac ttgcaaatat ttgatgttgg tgatgtaact gaattgagat cctctgaaag 816120
 agcaggaaat gcttttaact gctatgatgt ctctccagct cctattttaa aatttttat 816180

 tggagacagg gtctcacigt gtaaccaga ctggcctcaa attcactttt gccgtgtgtg 816240
 tgtgtgtgtg tgtgtgtgtg tgtgtgtgtg tgtggtgtag gccagatgac aactacgaat 816300
 ataagtcctt gcctttcact ttgtttgaga cagggtttct cctttgctat tgtgtaggcc 816360
 aggctgacct ttgagattct gggcattctc ctgtgtctgc ctctcatttt ggcattggaa 816420
 tgttgacta tcttgcctca aagaccagge tgcctcga ttcacagaga tgggcctgcc 816480
 tctgccttct gaggctgga attaaagggtg tgagccactg cctctggct ccacctgtc 816540

ctggcttacc ctgtctatct ttatgtgaat tcttagaagc tgaacttatg ccttggagca 816600

agtgccttcc tcattgagta tctccccact gaccatgagc tctgcctcc tgactccatc 816660

tccttgggtg tgggattaaa ggtgatgtc tcctgttgt tttgttgtt getttttgtt 816720

ttgagacagg tatttctcta tatccctgic tggcctggta ctcataatgc agtttaggct 816780

ggccatcagc ttgcaagaat cctcctgcct cagccttcca agtgcctagca aggcctgaca 816840

gtttttgtat tttacttgg ttagectaatt taatcccaa taactactaa tgcagatgca 816900

ttactattcc catcttatag ctgaggaaac cgaccaccta ctgaggttgg aatacaagtt 816960

taatgacata gtacatgtga aattcttagg gcaagattta gtgattaca tgtaagaagt 817020

gtatgttagt gattacagtg cagagtaacc attaggaat ttttatttta cttacttgg 817080

ctttatattt actacccttg attattagta ggaagcaaag ttgcaaata ccatatagga 817140

tgcccagtta aatttgaatt tttggaatta aggagcaaga gggagggcag tagagaagtg 817200

aataaaaaca aatatttgg atatatatat atatatatat atctgcatgc cgcaataaaa 817260

tactgtactt tgtatgctac ctacaagtta attatggcca gagagctgac tcatctggta 817320

aaggcacttg tcaccaagcc tgactgaagt tcagtccctg ggaacatgt gatgggaaga 817380

gaaaagcaac tcctgcaaag ctgtcctctg acctccacac acagcatggc ttgacataca 817440

caataaatta ctaaatgtaa ttacaatttt aaaataaaat aaaaatattt taaattttta 817500

aaagttttga atattagcca ggtgtggtag cacacgcctt taatttcagc acttgggagg 817560

cagggacagg taaatctcta tgagttcaag gccatttgg tctacacagt gagtcttagg 817620

ccagccaggg ctgcacagta aaacctatc tcaaacattt tttttttgt atcctagata 817680

atgaaaaaca aatagcgtaa gtcagtcaca tgcaattttg actgtaaaaa tatgagtgtg 817740

gtgacggtag catacacctt taattccagc ctttctctgt gtagcctgic ccggaactcc 817800

ctctggagac caggctgacc tcaaaactac agagatgccc ctgcctctgc ctccaagtg 817860

ctgggattaa gggggttga gtggttcaa tgcaggtttt aaacaggagg gttctgagga 817920

ggaaggagct tgtgaaagaa ataggatact tggggagaac atgggcttgg gctgctcaat 817980

aactgtgtat acagcattct ggaggccttt gaagctattg tctttaaagt gttgctaaag 818040

aatgagatgc taatgagatg acagtgtgtt tcctgggcc atctgacagg gggacaattg 818100

ataaggaaaa aatctagat cacaggaatg caggttagaa gatatttatt gtaagcaagg 818160

tgaacagcct tgcttgggg tttccagaa agtgtctggg agaagaacga gagacccttc 818220

caaggtcata tgctttcagg cctggagctt ggttcatctt tattttaaca taaaatatct 818280

ataacaataa gaaatatctt tgtatttgca accttctcag taaacactgt taattgtgct 818340
 tgactttctca gctgtcgaga gacttcaacc tcattctgtg gaaggtctta gttttcttct 818400
 ctggctctca ggatttccct tgtcttttat ctgactcagg agcaaagata gaacctgtat 818460
 aattcattct gcagatgtgg aaacagcctc aaagaaagga aatgatgtag ctatagcctt 818520
 aggtgtcccc cttcacacac tccaggttcc caggtagctg aggctcacct ggagctcagc 818580
 atgtggctga ggatggccat aaactcctgg ttctggatc atctttacc tctctgggtc 818640
 tgggattaca gggatatgcc aacatgccca gcaaaaggct gagtttcagt gttttagtgt 818700

 gtgtgtgtgt gtgtgtgtgt gtgtgtgtgt gtgtgtgtgt gtggatgctt gtgtatcaag 818760
 atgcaccata tgggaaatc aggacacttt gtaggagttt gttctctttt ctcttaggca 818820
 ttaatttag gtgattagaa atttgtaggc agaagtttct gtccttcacg ctgatctcaa 818880
 ataaccacac agaggcttaa tactataaat gcttagccaa tagctcaggc ttattactag 818940
 ctaacactta cttttcaat gaaccatata ttttatctat gctttgcctt gtagcttggg 819000
 acctttctc atttcagcat gtccatcttg cttctctctg tttctgcttg ctactcctct 819060
 gactccacc tttttccaa cattctcaga ttggcttcc cacetaactt tatctgttc 819120

 agctattggc cagtcagctt ctttattaaa ccaactacag tgacatgtat tcacacagtg 819180
 aaaggaacat cctacatttc cccctatttg cctaattaaa aaagaaggct ttaactttaa 819240
 catattaaga ttatatacaa caaacattt attaagtaag aattatagtt acaatatagt 819300
 tcatttgtat ttggcaaat tagagaaaat attctattat ctattttacc tttgtgatat 819360
 acctaatat acctaattha tcatctcatg gccccgctc cactctttta ttttcacaga 819420
 tgaggctcaa tgiacctcag gctgtcctca aattccctat gtagtagcca aggatggctt 819480
 tttttgttt gtttgtttgt ttgttttttt ttgttttttg ttttttgag acagggtttc 819540

 tctgtgtage tttgaagcct atcctggcac tcaactgga gaccagtctg gccttgaact 819600
 cacagagatc cactgcctc tgactcccga gtgctgggat taaaggtgtg tgccaccaac 819660
 gccggctca aggatgtttt tgaagatc atcctcactg ctgggattac aggcactac 819720
 tgttactcat ggtttatgtg gtacaaagaa tgaagaagc ccagggtctc atgcatgcaa 819780
 ggcatgcact ctaccaactg aactacaacc gaaggtcccc agccatctc agctctctga 819840
 agccctatca agcatctgtc tccattaaca cagctattca agccttccct gtctgtggca 819900
 attaaaagtg gagcaaatcc atgacagaga gggacagcag catgactaag tgttctgttg 819960

 ggagagccag taaggacag gtggcatgtg ggccagtggg gtgtcttttt caactccttt 820020
 ctgaaatggg tttctgtctc tccctcttc cttctccct ctttctctt ctccacttct 820080
 ctccccttg tctcttttt actctctc ctcactctcc tctgtctct ccccttcta 820140

ttatttgagg cagggtctta tgttctctca gctgtcctca agctcactat gtagccaagg 820200
 aagaccataa gctcttgatc ctcttgccctc catcttccaa gtgcaggat actgacatgt 820260
 agccccacgt gcatctgggt accaccttcc cttgcttata gccagctctt tcagacttca 820320
 aggttttgct gcacaagggc ttttgcttct ggctaacctg gtgtcctaga cagaaggaaa 820380

 atgaaagtgg tttgaggttt tattagccac tgtttctgca ttttaatttt ttcagtcagg 820440
 ccaagactga ggtagttctg actcaagaaa actgagagcc agaaccacac agtgtgaaag 820500
 aatgaggaaa tgacctagct gtgatttgct gccttgcca acacagcttc ttggagaacc 820560
 accaagtacc tattttatat ctgcctgaat cttcacaata tcttgggagg tgggcttgta 820620
 accattctgg caggaatgaa gacatcaaaa gagatactg tgctgttcc tacagctatt 820680
 gttgtttgct attgggacaa ggacccaag aaattagaat cttcccacga gtctcattct 820740
 ggtgaagggg aaggccttgg agccaggcag aagagaactt tctcccaaaa aagatgccac 820800

 aaagtctga taatttaaat ttcaagagag actggagccc aaacaatgac ctcaccttat 820860
 ccacgaccac ttagctatgc atacccttg ctctctatgt aaccctaage cttgtgtcag 820920
 gaccetaaat ttggacttga ggggttact ggacctcttt gttgctcttc tcaatgtgtt 820980
 catagtgc atcaatctctt tattctgcgt gtcaatatta ctttctctct tttgttggt 821040
 ttttggggga tagatgggca agtccagctt gtcagcactg tcgggccctg gctctgacac 821100
 tcacatctct gttgcaggat ctaatatttt cgtatggtga tttggttatg ggggctcaga 821160
 tgaccgtgct tggacttag aaagcaaagt gacattggct gctcacttga gtgtctcct 821220

 tggctcagtt actttttgtt cccctccctt tgetggetat ttgaaattct cattctaaat 821280
 cccagtttt acttggatta agacgataac tgtaagtaa tcttactgta gatttacaga 821340
 accttgacct gcatataaca taagaatgtg tacttctcc cattccatat tctttgatc 821400
 tgggcatcag ataacataaa acatataagt tgetatgatg ttttaacttgt agaaagtagt 821460
 tttgttcta ggaggcctgc ccattgccac tcccctctt tccctttctt ataaaagccg 821520
 tctgttgggc tggggagata gcttagtagg tagaatgctt actgcacgag tgtgaggtta 821580
 tgattcccag cacccatgtg aaaaactggc cttggtggca cacacctgta atcccagcac 821640

 tggggaggcc gataggggag aatcctgggg tttgttggcc agacagacta gctgagtcag 821700
 tgagagcttg gtttagtaag tgacctatc tcagaaagta gtgattgagg aggacacttg 821760
 gcaccaacct ctgcccactg tgccccctcc tcaaagacac acagacaaac agacagacag 821820
 acacatatgc atacacacac acacacacac acacacacac acacacacac cacaatttgt 821880
 gccctcaagt ttcttagat gaggttctga ggcaatagcc cccatctct caggacacca 821940
 gtctctgaat aaagctgact ccctgtttac ccagtctccc acctctagag gagggctggc 822000

attcagtggc aagcagttgg acatgggttc agtaacagca agttattggt agaaggattg 822060

 gatttttatg tttctctgaa gtccctatta ctaattcttg gcattcctgc ctcataaatc 822120
 agggatagtt tgcctgttg acactggcaa gaagcttaag gcagcacagt tcaatggtea 822180
 caaaatatga ctctggggg tcagcatcac ctggaaatgt gttagaaatg cccattcctg 822240
 gcctcattct agaactttta agaacctcta ggggttgggt acagctgaag gacacagcat 822300
 acacctagca tgtgcatctc ctacataaaa ttcccagaac aataattttt aaaaaagaca 822360
 ttcttgggga aggttttagag tatagttttt gatttccaac acctagttt tacctactat 822420
 gatagaatct taaaattatg ggtctggcca agtaacctac aaatctgact tcttgagttc 822480

 cattcttgc t gatacctgg atcccacaat gggaggagag agctagtcc t gaaagtgt 822540
 cttcttacct ccacactaat aataatcaat aaaacagaat tgaaaataaa catgcagaca 822600
 cattgagtgt ggtaatacat gcttgaatc agtcccagta ctgggaagt tgggggtgaa 822660
 gaagcctggg ttgaggcca gcttcagct catagt gaaa atttgtccc caaataaaga 822720
 aaagtgttag ataaagactg tctggaagga gatggtttgg ctcttttctt agtgttcttg 822780
 ggccagttag caatctctt tatactcgg ttttttctct ctctctgtat aaagtaataa 822840
 aacacttaat attttatagt atgcctgggt actagaatca tctaggatgc tagttagaaa 822900

 gcccagattc cctagagca caccactctc tcaatactgg gaatagaatc ttgggcctca 822960
 tcaatgctag gcaagtctc taccagt gaa caacatccct acctacaac ataattccca 823020
 acagggcaaa cattggttg aagagcagaa gacttttaaa tacttcaaaa ccaaaccaaa 823080
 caccctaaaa ccagggttt taccatgtaa ccctagaac tctcttttta gacctggcta 823140
 actgtgcact tccagagatc cagctgtctt t gctctctca ctgaacctga aagcttgctg 823200
 tgtggtcttg gctggttaac tagggagctc ctatctctgc cccagggtt ggggttgggg 823260
 gagtctatgt ctgcttttac atggacctg gggattcaat tcaagtcctt gtgcttgagg 823320

 gcaaatgctc ttacctactg agccatctc ccaaccaga attttttta ataaactctc 823380
 ctacacata atggagaata tgatagt ttc aaagtgctc aaaaaagtgt aagtgactgg 823440
 atagatggtt tccttgcgag accaacaat agtggcaaag atgggtaatt accaagtgct 823500
 tgagtagtgc ctctgttgc acagcctatt aatcctcaca aaccttcca agggaggttg 823560
 aggataggtc tcatggatt tgcctgggtt tcttatecta catacagctt aatttaagca 823620
 tctgaaaaag gtaacaaatg gcgttttct catagttttg tggttaaggat ccagaagtat 823680
 gcttttcatt ttttttttt tagaactcct gccactgtca agctgtcacc ctccaagaa 823740

cacctgtca aaaaggtgga gaaaagagaa ttgaaacca atcagtgtaa tcccagaaag 823800
 atagaactgg ctcagtatt gcggaattgt gatccctgct gtcagttagta tcgctagga 823860
 acttgftaaa aatgcaaatt ataaaaact cccccccca tcccagatcc actgagtcag 823920
 aaactggcgg tgggggctca aaagtcgtt ttcaaaagct gttcgaggaa ttctaaggca 823980
 cgctagagtt tgggaacagt ctttagaggt ttggcgggg gtggggagt ggagtggggt 824040
 agggtggggt agagggtgt gaggagaagt gtaaaaaa ggaagaaagg aatgaaaaa 824100
 ggaagaaggg aagaaaaaga aggaagaaaa ttaaaaacaa aacaaaacaa aaacaaaaac 824160

 tctggagatg tggagactgg gtccacttca cctgaagtg aggaaatgc ttagcaggc 824220
 tggcgcgcaa gggctgctgg ggtctgtagt cccgactgcg ccttagggga cgcgcctgcg 824280
 cactggttgc gagctcgctc tagtcgctgt agtcgggct cgggaccggc tgccatcgta 824340
 gtggagggac tgaggagtgc tcgcccccc gagtcccggt aaacaccgc gggccgactg 824400
 gggggcagct ctgtggttag gagggagctt ggcatggggg aaggcacgga gagtgcgaag 824460
 ggtagaagag tgcggcgcgc gagtcggaac ccagagccga ggctgctctt cgcgcagccg 824520
 gtgtccgtgg ggggcgcccc gagctccggc tggtagcccg agccgggagg agggtggttc 824580

 agcgggacga gccgggctgc tagtgcctgg cgcaggcgc cggagcccg ggccccgca 824640
 accccaagtt ggaagagagc cgagccgagg cggacgtggg cagggtccag cgcgcgccc 824700
 cgctgtcgcg cggggggct ccgctccgc ggctcggcct acgcggggg cccggtggca 824760
 gcggcccccc cgagcgact ggcccttga ggggcggcgg ccgggcccac ctgccacctg 824820
 gcaagctctc ccgagacttt tccaggtcc cactcgcgga ggaccttctt ccgtagcctg 824880
 ctecccttc tagctttca ctccctcct cctccattg tccccactca tgggtgtctc 824940
 ggcccaggcc ggcgcccg acttttgcgg acgtggagct gtcactgtct ttctttcaa 825000

 gagcgtactt ttctttagca aagaaaaag tagaggtag cgtagtgaa ggtcgaagc 825060
 ctgaaagaca tggctttaaa gtagaagact cgagtttca gacatggttc tctgggctgc 825120
 aacttcaaaa gaggaata agggtcagt caccaggt aggcattggg ctaaagtta 825180
 ggtctgtgac caggtgaact ttgcagtac ccgaagctga cggttccca gtcactgtt 825240
 tttcttggt gtgttagaat cctcctaac ttgaatttc tgcttcgctc tagctgtgt 825300
 agtgaacttg gctgaagga ggagtgtga gaaaagagt aagagtttg gttttttcc 825360
 ctcaagtt acagaacaca acctagccac ccatcattgt gctcttaagt gtgctgcttc 825420

 tcctggatcg gtgagalctt atgaaaatag gtaaaggcca tgtgtgttca ctctcagggt 825480
 tggcaactgg ttggttctc atctgaaata aagtttttt ctggggggcg gtggcaaatt 825540
 tgatgagatt cagccttga tatcacaggt ttacttaagg cttaattttt cggggtttta 825600

gaaaagatgc aattctcctt gaatagttag tgtactttgt gtgtgagctc atgaattcag 825660
 actttagaat agacctcaac aaggatataa tgtgaaacca aaagcatgta ttctagagtt 825720
 gtttttattt tattttgaga caagatcttg ctgtatagct ctggaataca ctgtgtaaac 825780
 ttagactggc atcccactta attgfatcct cctgtctctg cctcctgagt gcttcagtta 825840

 caggtacatg ccaacacgat aggcacagga gaaatthtag atthgttgat ttgtgtgtgt 825900
 gagcgccatg actcgagttg gaggtcagaa ggtaacctc aagagtgttt cctcctttta 825960
 ccctgtggct tccagggatc aaactcagat caacaggctt gcatagcaaa tgcctttact 826020
 taatgatcta ttctgctgaa ccagaattht ttttgggggg cgggggtgga cagagtttct 826080
 ctgtatagcc ctggctgtcc tggaaactcac tctgtatgga gacagagatc cctcccaggt 826140
 gctgggatta aaggccttca ctaccactgc acagttcagg agagatthtt ttgtttgtt 826200
 ttgtthtttg tttttgttt tgtttgttt ttggagacaa ggtthctctg ttagactttg 826260

 gagcctthtc tggcactcgc tctggagacc aggtctgcct cgaactcaga gatctgcctg 826320
 cttctgcctc ccaagtgtcg ggattaaagg caagcaccac caatgcctgg cccaggagag 826380
 atthttaaaa gtagagtgtg cagctcagtt gttagagtgc ttgcttacca tatacaaac 826440
 acagaattht agtctcagta atthggaggt gaggccaatg ctacttgaga cctthttgga 826500
 aaaaaagga gatgttctca ggtthcattt ttgagattga tttgtagttc agaattggtt 826560
 tctaccagtt tatttgaaaa tctgtctcag gtatthgggt agtcttgga gctactgagg 826620
 taacaatag tatggctata ccaaggacag ctcaaaaagc tttgagatag aaaaggaagt 826680

 ggaagtgact agtgtgggaa ttattgaagg aagtggcagg actggtctct gaaggctagg 826740
 cttagtggcg taccaactca aggtcagcct ggtcaacata gtgagttcca ggccccag 826800
 agctacatag tgagaccag tcttaaaaa aaaaaaaaaa ttgcctatcg tctgagttct 826860
 gcctagagca ttggthttca accctthtga caaacgtcta tcttcacaaa actthacagt 826920
 agcaaagtha cagttatgaa gtagcaaaaa cagthttatg gtgtgtgtgt gggggtcagc 826980
 acgacatgag gaactgtgtt aaaggattgc agcattatga aggttaagaa cactgtctct 827040
 aaaggataag tagcaatgtg gcagaggcga ggaaggga ggcagtgagc aaaggaaata 827100

 ctcaaggctg tgtgtcaatg agaccgaatg tgggagaaaa agagttcagt gacaggaag 827160
 cagagaggag gacagcattg tgggactcaa ggccagaaag gtaaaaggag ctgattctag 827220
 aaaacttctg tgiatagtht tgaatthttat gttgttagag ataaagthtt ttgggaaagg 827280
 cagtgatgtg agthgtgtct tgtthtaaaa agatggctct gggataaaa tgaaagggtg 827340
 aaagtgactg ttgcagaagt ctcccattata agtgacagag gctggccttg gaggtgggac 827400
 taagggttg ccatgthttt tgataggatt gthttagggc tggctgtgtt aaagggttcc 827460

ttttctctaa ggatatagtc attagcatct ttgagaaata agagctagat cagatgcaat 827520

 ctggaagtga gcttgagttt tggactatgt gactgtcaac acatcaatcc atgtttgctc 827580
 aatgtgtttt ccttctagtc acagaaactt ggtacttgag ttttacagtt ggaagagatt 827640
 gtctactgta tagtggcaaa tatgttttag gttgcaggcc aactttggtt ggaaatagct 827700
 tctggaagta cttactgtta aggaggatcc gggcaatcta tgcttcagtg tgaggtcctc 827760
 accctccacc ccacccccac caaaaagagt ggattctggt tgtattagtt ccctggggaa 827820
 gtagtctatg attaggact gatatctcta gtgaatagtt atctagtagg tagtctgtgt 827880
 gtgtgtgctt gcacacacat gcacacacca cgtacatact attacactgg cccagtctct 827940

 tagctttctg tttctgtttt tgatgacagg gtctcagttt gcagactagg ctggcttga 828000
 gctcgcagag atccatctgt gtggcctaca tagctagttc caggtagct agatgtatgt 828060
 agtgagagct tgtctcaaaa gaagaaaaag atgttttgcc taaaactagt tttagtcaga 828120
 actagaacca aatgctgtaa ctctggtact ctccagtta ccgaagtgag tgtattgcca 828180
 ctgtacaaat gttgtcatag taggaaaaaa aatacttcta cctatgccta tttactgtat 828240
 agacaagata ttaatgaatt ttcacctaga aaggagtta gtttactcct tttgactcag 828300
 gaagttgagt tagtactaac aggaaactgc cagtctcaag gctcccttc tttcttgtgc 828360

 cttacctctc ttagtttggg gatttggtat aagaactaag gtaaaagtat ttaagttgt 828420
 ttttctttc tgiatttata gtgcttagca aattatggtt cataaaaagc attcagtaaa 828480
 gacatgctaa cttttgtct gtaaatgata ctgatgtga gtcagtatag atcagtaaag 828540
 ggccctccct gatgtggtgc cctcatctga aaatattaag ttgcagcttt tttttggggg 828600
 gggggggttt cgagacaggg tttctctgtg tagctttgga gcctatcctg gcactcgctc 828660
 tggagaacag gctggccttg aaatcacaga gctccactg cctctgcctc ccaagtctg 828720
 ggattaaagg catgcgccac caatgcctgg catgagtagt agttctaag agaagctgcc 828780

 cctggcctg cctcctcct cctccagtct agtagtgacc attgttgag agctgctgcc 828840
 aggttgactc tattgctgct ttttaactca gagtctcagt gcttccccca gcctgtgtct 828900
 ctaggagctt ctgacttga ggaatccact ttacagtac ccttatggag agaatatgtg 828960
 tatgtatgtt atccttagtt tgcaaatgtc catcatatcc aagtggattt tatccatac 829020
 tgtgcaggag tcatttcctc agaagtttta tcttctctgt tctgtataaa atgtctttct 829080
 thtagattct tctttttggg ggggtgggag gctttatgct gggcaataa agacactttt 829140
 tttcttttg gatttccca aggttatcac agatctggtt aaccagagta ctttgtaat 829200

ggacccttct tcctttcag gtaacatgca tttcacagtg gccttctgga aacaacgcct 829260
 taacccaaag aagtgactca accagtgaga atttcagtg tggtgacatt cctgtgagag 829320
 acatttgggg gcagtatgga gcagagggca agtcctggtc acataactgc tgtgaagagc 829380
 tgtgtgggag aggatgttag ttactgggta catcaattgg cttttccac ttgtgctgtg 829440
 ttataaata tttcttctt aaacatgttc aaacatatac atgtgatggt taagaagtgg 829500
 agaaattgct ggggtgggtt ggccacacacc tttaatccca gcgctcagaa ggcaaaggca 829560
 ggtggatctc taagttcaag accagcgtgg tctacagaat gaggttcaag acagccaggg 829620

 atatacagag aaacctgtc tatagggagg gaaaaaagta gaagaattcg taagaatgca 829680
 gcatagtata gttagaaaa cagaaagatc tgggctctga ttttgactg acagtctgtg 829740
 ttacttttgg taattttctt aattctgtc gcctcaggtt atctatctc tatatagata 829800
 tattgattct tttctacct cctgggggta ttgtgaggac caaataaac aatacatatt 829860
 aaatcttcag aatcgaaaat aaggggctgg agatttagtt cacttgcttg cctaacatgc 829920
 atgaagccct aaattcaatc cctagtgatg aattaattgg gtgtagtggc acaagcctct 829980
 tatctcagga ccatcagcag ttcaaggttg tctttggcta cataatgaat ttgaggccat 830040

 cctgggttac atgagacctt gtctgaaaa aaggaaagta agaaaatgaa tttatagttt 830100
 aagacatcta gatctataag ataggatcag ttgatactat tattataagg aaaacattac 830160
 aagatagact cattttaaga ggccaagaaa ggggctggag agatggctca gaggttaaga 830220
 aactggctg ttcttctaga agtcctgagt tcaattcca gcaaccacat ggtgactcac 830280
 aacctctat aatgagatct ggtgcctca tggcatgcag acatatctgc aagaagaaca 830340
 ctgtatacct tataaagaaa taaatcttta aaaaaaatt gaaaaaaaa aagaggtcaa 830400
 gaaagagtag agctgtgtgg atagttgcac aagcctttaa ttccagaggt agaggcagtt 830460

 agatctctgt gaatttgaag atagactggt tacatggcaa gctccagatc aaccagtatg 830520
 acatagatag acctgtctc tttaaaaaca aaacagcaga gaaagattag tgggccgggg 830580
 gagatggaaa cacacacaca cacacactga agtattgcat gtgaaactga actattaggt 830640
 gaggaaactg aaaggaatta tagtcactac ctctgagaaa taccttcatt getataggtt 830700
 tattgcagta ttattatta ccatagccaa gataatagaa acataaacat gtctgttgat 830760
 aggtaaatgg gtaaatgta actatattta tattttacac acacacacag tgatgtatat 830820
 gtgtaatagg aagtactact tggcctttaa atagaaggaa atctgtccat ttgggatagc 830880

 atagatgaat ctgaaggaca ttatgtcagg taaattagtg cacagacaga tgtaccatct 830940
 cacttatata tagactaaag tcacttttag aaatggagag aagggtgcta ccaagaatta 831000
 gatacagaaa atggggagat gttagtcaaa ggatacaaac ttagaaaatg aataaaattt 831060

gaaaacctgt tgggcatagt ggctaataac taatcccagc tcttgtaaga ctaaattagg 831120
 aagctttgta atttgaggtt agcctgggct atttggcagt gctttcttcc cccttatcct 831180
 cttaaacc cagtaataat aagagacttg aaattcactg taagagtaaa atttgagctg 831240
 tgggaagtggc ttgtgtggta tagtgtctgc ttacaagcat gaggacctga gtttgggtca 831300

 ccagaacca cctagaagct atgaacagtg gcatgtgect ataaccacct cctccccc 831360
 aaactgggga gtgtggacca gggagacaaa tttctaaact cattcgatag tetgcctaga 831420
 agaatcagt agagacagac cctgtctcaa aactaaaga tgtaaaactg aggagagagc 831480
 tgggcagttg cttatggagc taaagccatg tagctgtgtt aatgtgccc tcttctctga 831540
 gtcttctctt ttgtcttat ctcttctaa agcatgcttt tcttctctc ctctctct 831600
 tcttctctc ctctctctc tctttttttt aagttacaat tccctctcg atttatcca 831660
 tgctgtgat tgtccaccac atgtctaacc tccattgctg aacatgttgg tttaaatggc 831720

 atggcttttc tcttctctt tgtcatttcc cttttgacag atgctgaagt tgcagcttg 831780
 ttctgggatt tttcttttta aattctaata aaattaccct taggcttaa gatagaaagc 831840
 aagcaagctg acatctgtct acctetagcc gctatactca tgtacacaaa gtacatatat 831900
 catataccac atgctgctgc gcgctcacac acacacacac acacacacac acacacacac 831960
 acgggggggg ggggagcgt accagtgaga tggggcagca agtaataagc acttgttgaa 832020
 caacctgat acctgagtta gattctctaga acccatggtg gaaggagaga actgactccg 832080
 agaaattgct ctctgacct cttatgcaca cccacactca cacatattca tgcacaatga 832140

 taatactttt tttaaataga aaagctgggt gttgtaacat actccttct ttaatcccag 832200
 cacatggaag gcagacgctg gcagattttt gtgagttcaa ggtctacata gtgttctagg 832260
 acagccaaag caggaggatc tagagtgtaa ggttatcctt gtatcatagc aatttgaggt 832320
 agtctggact acccaagacc ttgtctcaaa aagacacaca tacacacca aaaagaaaaa 832380
 aaaaaagga aagaaaggaa gaaggaaaga gagaaagaag agaattgaaa agaaatcgt 832440
 ttctgagga tcagtgcccg accataaact ttaggctatt agttgccagt caccatcctc 832500
 accatgtctt tgcaaacctc ttcctcttt gtctccactg tgagcattaa tgtttatcat 832560

 tctctacct ttgatttag ttgtgtttg tgttaactag ttgcctata aatgcttaag 832620
 acagaacaag gctttgattg gcttatgtaa aggagtctca tttgctataa tcagatgctt 832680
 gcttaactgt gctttttttg atagcatgg agagaaagga aggagatggt gatgtgattt 832740
 gtgaaagata atagaaagga aatgagtaca agggagagca gtttaagtgag attgcaaaga 832800
 agttgtttca gattgttaga aggcagaaa atgaaatag tacacttcat aagaagctgt 832860
 tatctgcaat aaagaagcaa atcagcttcc attccttcaa tgatggccta tcttaccaga 832920

aataaagaaa tttcctcaaa aagaaatgia ttggaaaaga ttgtttctgt ttccaaatat 832980

tttcaaatg ttctcagag tagccatttc accccagttc ccaaagcagt tctttttgga 833040
gagatacctg cgagacttgt gttgtagttt ttatattctg taatcttggg cagctgattt 833100
aaatctctca gagttttata tccccccac cctcaaaaa aaaaaaaaa gatagggtag 833160
ctgaagctgg ccttaaactc actgtagcta aggactatct tgaatttga tcttccaag 833220
tgctgggatt ccaagggtgc cccctccat cctgtctac tgaagtttg cctgtgtcct 833280
ctcagatgcc ttcttttcca gtctctgatt atactttgtg tttcatgtgc tgagtcacta 833340
cttttgggtg tttgaagaca gggtttctca gtgtagcttt gtagaccagg ctggccttga 833400

actcatagag attgcctgc ctctgcctcc tgagtgtctg gattaaaggc atgcgccacc 833460
accgcttggc tgagtactt actaccttt tagtgctttg ttttctcat ggtataggac 833520
taatacagt aacataagat tttctagtat ttactgtttt acaaatgaga agccagagcc 833580
agctgtaatc ctagcacttg gaggtagagg caggtggata tctctgagtt tgaggctagc 833640
ctagtctgcc tggttacct agaaagacc tgtttagca caaaaataaa agaccatag 833700
acaaatcttc aagcttcaag ctgaagatca gagaagcaag gcagccaagc cagtagatct 833760
tacctctacc cagctgaat ggcaatcctg tctccacaaa gcctcagact caaaaggctc 833820

tcagatcctg tctctcctg ctttttattc ctttctccc cagccacata actccttatt 833880
ccacctgcct attgctggca ttaaaggcat gtgatgccag atgctgagat cacctttggg 833940
tgagctatth cttttaggac tgcatcaatt tctgtattc tttggcctta aactaacaga 834000
gatcagtcta cctcttaatc ctgagtcctg ggattaaagg tgtgtaccac caccttctag 834060
ctctatggct gctgggatta aagggtgtga tcaccactgc ctgacatcta tagcttgtgg 834120
ctaacttttg ctttctgaat cctcagtcaa gctttaataa atcataaata atatatcacc 834180
aaccttgcct aaaaaaaaa aaaaaggcca cgttgtcttc tgctttaaac tttggcacia 834240

agactggaag gaaacaaagc ataaaaatgt tagtgggttt tgttattggt tttgaaagag 834300
ggtctcatgt aaccaggct agcctcgaag ttgctatgta gctgctctca tgagcctcat 834360
acatttacc cccagtctg ggattacaga cagggaccac aacctgctt taaattgata 834420
atacttagca agcgtttgtt gagctgcttc tatattaggt ctcaaggatc ctctgcttt 834480
aaggactttg tcagtttttt ttttttttt ttttttttt ttttttttt agaaaaaaaa 834540
aaaaaaaaaa agctacttgc cagcaatcac acttcaatat taaaatttaa gatgtttatg 834600
tcatgtttcc tggtttcttt ttttttttt aagattttat ttatttttt attatgtata 834660

caacattctg cttccatgta tatctgcata ccagaagagg gcaccagatc tcataacaga 834720
tggttgtgag ccacatgtg gttgctggga attgaactca ggacctctgg agagcagtca 834780
gtgctcttaa cctctgagcc atctctccag ccctcctgg tttctttaaa ataactagat 834840
atattttaag tgccattctg ctaagtacca acctaggcta tatttaaaaa aagaaagata 834900
gtgaggtgtg ggtctgggag tgtagatgga ggaccaccta gcattgtgag gtgtgggtct 834960
gggagtgtaa atgggaggac caccaagcat tgtgaggtgt gggctctggga gtgtaggtgg 835020
agcactactg agcattcaca aagcctttgg tctgccccac aacatggcag gtcacctac 835080

ccctcaggag ggtcagaaat tcatcgtcat ttccagtat atagcaagtt tgagcctcct 835140
aggtctacat gagacccttc tcaagagagg aaaggaagag agataagcaa gaagaaaatg 835200
cagtgtttgc caggaagaaa cttggaattc ccacatctag aaacattcct ctaatattha 835260
gatatTTTT tgttccagaa aagagcagca tttcatacc ctaccactta tagtaagaac 835320
tcttcaata ttgagcttag ccacagaaag actaacagtg gctttttttc ttttttttt 835380
ttttttttt tttttttgt gtgtgtgtgt gtgtgtgtgt gtgtgtgagt gttattgttt 835440
tgtgtgtgtt tgtgtatggt gaatgtgcac atgtgtgtgt ctatactcaa aggacattgg 835500

gcattgtatc actctgcacc ttatgccctt gacatagaat ctgtcactga acttaagagc 835560
taggtctggt gctagcctca gctatcctct tgctgtgct cctcacaaca ctggtgtttg 835620
aggcatggtc atgccaggct ttttatgtgg gtgcttgtgt ttgaactcag tttccattc 835680
atgcttgtgc acagcaagtg ttttatcctc taaccttct tcagccctac aataaagttg 835740
ttttctgagg aaatagatat ttttattggg tttcacattt tatgagagaa atttttttt 835800
ttttctgag acagggtttc tctgtgaaat aacctggcc atgctggaac tcaccctgta 835860
gacctgactg acctcgaatt cagagatcat cttgtgtctg ctgtctgctg ggactaaagg 835920

tgtacaccac cattgccga caaaactttt ttttattacg tgtatttatt tgtgcgcgcg 835980
cgagagagag agagagagag agagagagag agagagagat gtgtgtgtgt gtgtgtgtgt 836040
gtgtgtgtgt gtgtgtgtgt gtgtgtgtgt tcgttcgagc atgcgcacag tgcattgtga 836100
gaggtcagag tataacatgc aggagtcatg tctctcttc caccaggtga gttttgggga 836160
tcaaacttga attgtcgggt ttggcagcaa gcacctttat ctacatttgt ctacatttag 836220
gcagactatt ttgcttggcc ataaggtata catgaagtgt atatacatc atacatgcag 836280
gtaaaaggcc cataaataaa aatagaaata atactttatt aaaataaatc agtgtcagga 836340

atgaagagca gtagtcaaga gtgcttccc tagtcaggca gtggtggtgc aactgttaa 836400
tcccagcact tggcgggcag aggcaggtga gtctctgtga attcaagccc aacctggcta 836460
cagagtgagt tctagaacag ctggggctac acagagaatc cctgccttaa aaataacaa 836520

acaagtaaaa ttgaaagaat aagtgaataa aatgaaaaaa actttggaaa gcataagtta 836580
athtagcagc cagacatgct ctcttcagta gtggtatata ctctgaactg ctaaattttt 836640
tttttttttt cacttacaag gtttcctact ttctattttg tcaatgatac tggtcagttt 836700
tctaggttat ttttagcttt atagaatttc ttagttttct aggaagatac tgatattgtt 836760

tgtttcatat tttatttttt aattttgttt ttactgtttt gagacagtcc tagctgtctg 836820
gaactcactt tgtagaccag gttggccttg aactcacaga gatccatctg cttctgcttc 836880
ctaagtgctg ggattaaatg catgtgccac tactcctggc tctccattaa tttttatatac 836940
tggctttaat tttttttttc tttttgagac tagagtcca ttagctcag gctagcttct 837000
aactggttac atagctaagg ataaccttga acttctgata cttctgcttc cacttttggg 837060
gtccccggat tacagtcagc aatcacatg cccaagtttt atgcagtgtc gggcttgaat 837120
ccagggttc atagtgtcta ttcagtctct ctgccaattg agctataccc ttagccctca 837180

gttctttttt ttctgttctt ttgctttgtt ttcttttttt catgaggaat gttgaactat 837240
aatagtagct taagaagaat catataaaat aaggcatcat atgaaggaaa tagtaatgag 837300
taaaaggaag aaataaaatt taaattacaa gattttctac ctactccac ctatcttatt 837360
ttttaagatc tcaaggactt ttgcttcttg agtacttctg tatttctga ttgatttttt 837420
tgtcatagat ctgtgttaaa tatgcttttg gatattgagg actagtaat aaactacaga 837480
atgatggtga tgtttctaag ggtcttttgg gaatcagata gtagcatcat acaatgcaga 837540
gttgaaactc ttacattata tctcatttct ctttaattta ggtgactact aatgatttta 837600

agtgatatat ttgttcaga atgaaagaac tctatcagta gagatactta atttgaaggc 837660
aggttggaag caaataaagg aaagtgtca agaatgactc cacagttttt aactggaaca 837720
tctagaagt t agaatcaaga cctactgatg aaaatactca gagagtagag gtctatagaa 837780
aagatcagga gttgagtgtt tgtaagcaca gaaccatctc tttagcctca agaaaaggaa 837840
tctttaaaga gactgagaag aaattaacca gaagaccata aacctagaaa atgtgtcttg 837900
ggaactcaag ggaagatcgt tgtttatact agaggaagaa attgaaattt tactgataat 837960
agaatgaata ctagaattga aaattgtgtt tagcaatgtg agtaccatat attattatga 838020

agcttttagt atgaaaggcc agactatagc tatttacata ttcttttttt tttaaagatt 838080
tatttattta tttatcatgt atgcagtgcg tgccagagga ggacaccaga ttacattaca 838140
gatggtgtg agccaccatg tggttgctgg gaattgaact cagaacctct ggaagaacag 838200
tcagtgtct taaccctga gccatctc tagccctat ttacatattc ttaaatggaa 838260
aattttgatg ctaatagat ttcatttgct ttgttttcag gtttgctgtc ttattgatga 838320
tatgtctgac agtggatcac agcttcattc agtgggtagc ttgacctga aatcacaact 838380

tcagatcact ggtaagtttt ttttttgaat tttatgtgta ttagtgtttt gccatgggaa 838440

gtttcaggtc tcctaaaact ggagttacag acagttgtaa gctgccatgt gggtgctgag 838500

acttgaacce aggacctctg gaagagcagc tggtgctctt aactgctgag ccatctctec 838560

agccccatt agtaagtctt aaaaaggtag aataccttat atctctgact ctctattaa 838620

aaataatctt ggtgactgga gaacagttaa gagcagacc tttgtcaggt tccagtacc 838680

atatcataca tggaggctca caacttcaac tccagaggat ccagtaacct ctctgacct 838740

ttgaggatat ctacagctat atgtggcatt catttacata cacatagatg catctaaatt 838800

ttaaaaaaaa gtctaaaatt tttctttttt taaatctgag aacaaactct ttagtggaca 838860

ttataggcag caaatcagta tttgatgaat acatgaacag aatgttgaga tacataaaaa 838920

taattttgcc tcaagacatt ttatagattc attctccttc attaaactgg tatctaggt 838980

attactcttg gttattaata attttattga gttataaaca gaattgatcc attatcacca 839040

caaccaatth tatttacct ttaaaattht aatthtgaga atttcataca taagtactgc 839100

atttccatca tttccatccc tctccctcta actcctgtgt tcttccctac tcaaatgat 839160

gacctcttct ttaattatgt ttttttacct acacacacac acaccacaaa acacacacac 839220

acacacacac acacacacac acacacacac cccacaaaac acaccctact gagaccactt 839280

agtgttttgt tgttgttggg ggtgatgggtg tgtgtgtgtt tagggctgac tacttggagc 839340

tggataactt accagggctg ccttccttag agaagactga ctttccctct cttaggtcat 839400

taattgtcta tggtcttca tctacgggtg ggtcttggaa gatttttccc taaccacatt 839460

ggtgttggct gatattgtca ttgtgaagct tttatttagg ggacaatatt gttgagattt 839520

catgggtaca atttctgtgt catatataga agacactgtc ttgcagctga agttcacttg 839580

tctggctttt caaatttttt tgctctctct tctgcattgt tctctgagtc ttaggtataa 839640

ggttgtgttg tagatgtagc aattggagtt gggcacecta tgattaatta ttctctgaat 839700

tttgaccagt tgggatttc tgtgatggtc cctatatgct acaaaaggaa gctacttttg 839760

tttatttgtt ttttgtttgt ttttttgaga cagggtttct ttgttagct ttgtaaacca 839820

ggctggcctt gaactcagat tctgtctgcc tctgtctccc aagtctggg tgagtctgg 839880

gattaaagc tttgccacc accacctggc tgaagctact ttgttgagg gtgaaaata 839940

catttatctg gatataagga taagtaagta cctagaatgc aatatggatt tcaggaaagt 840000

tatagtagta gtaggttttc ctctaggctt catgacctca ccaaccacag gtagttggct 840060

gggtttgtgg tagcaggcat gaattctctc caattgagtg ggccttaaat ggctgttagt 840120

taccctaag atgtaagtgt tactattgia cccttgtggg tatctggctg tgctggcat 840180
 tgttatggtt caaaggcttt acatcagggt aggactgttg attgcttttc tctcctagca 840240
 gcctgcttat catcttttga tactatgaga gctagtccat agggaggaga cttccaggtc 840300
 agttccagct tgattcttcc aagtccctgig tccaaagtga gtgtaaggtc ttgttttcaa 840360
 gttctgagag accagttaga gcaatggcaa cagcccttac tgttttggga gtccttggga 840420
 ctcttctgac caacagctga aaaggaggtt ttctatgttt ggtctgggac ttttgttaga 840480
 tgtctattgc tcttaggggg agcattatca ccctaaaggg cataatttca tttagaata 840540

tgtttatgta tgtacataca cttatatata aatgtacata tgagctatat gtaaatactt 840600
 agttatatgt gttatatatt aagtcaacat aaaatgtttc cttatgactt tctcaaatct 840660
 ccttagtctt attatccct tcctactta aagtgctttg ccttctttt ttctctcatt 840720
 tcctgtccca tagaacccat gtgctactat tctctcttt agagctcttc ctaccactc 840780
 cacccecatg atcccttga ctttcttggg ttctgcagct acacaaaaa ttatatactc 840840
 atatctaaaa attcagagat ggatccacaa gtaagagaga acatgtagct gtcaccttc 840900
 tgggtctggg ttagctcact caggatgatt gtttaaagtt ctatccattt atttacttgc 840960

aaattgcatg tcttttcttt gcagtgaata gaattctatt gtataaatgt acaacgtttt 841020
 cattatccat tactcagttg agcatttaga ttatctccat tttcttggta ttgtgaatgg 841080
 agcagcggtg aaaaaggctt agcaagtatc tggaaagtag tttgtcaaat cctttgtgca 841140
 tatgccaagg aataatacac cttggctcta agatatactt actttttagc ttttagagaa 841200
 ttctctatgc tgattttcat agtgggtggca tcagtttga gtttcacca caatgaagat 841260
 tcctctttac ccacatcttc cctagcattc gttatcagtt gatttgtttg tttttgtttt 841320
 attttagtgc ttgtgattgg ggttagaaat ctcagagtgg ttttagtttt catttcccaa 841380

attgctaag atgctgaaca ctctccctt cctcccttc tctcccttc tetcccttc 841440
 tcccttctc tcctccctc cctccctcc tcttgatgga gtttctctgt gtagctttgg 841500
 agcctgtcct gccctacgtt ctgtaaacca ggctggcctc aaactcacag agatctgcct 841560
 gcctttgcct cccaagatgc tgggattaaa gacttgagcc accaactcct agcttgatec 841620
 attttcaac ataggtgctt agagtataa acttccctct tagaactgct tttaatgtgt 841680
 cccaaggtt ttgttgtgt ttctttttca tttaatatga agaaatttt atttctttct 841740
 agatttctc ctaaactgct tctttgactg atccatcatt cagtaatctg tttaaectec 841800

atgaatttat gcaattacta gagaaccatt taatgtttat ttttagcttt attacattgt 841860
 agtcagatag tatccacaga gtctttcagt ttttctgaat ttgttagcat ttttgtttg 841920
 tctcctgagt ggtatatttt aaagaagat ccatgggctc ctgagatcat gttctttgg 841980

gttaggtaga atattctgta gatatgtag gtccatttga tgtgtcatgt tgttttttt 842040
 ttttatttac tttgtgttt gttttgttt ctttgacaag gtctcctagt tcagtctggt 842100
 accaaatatg gtttgcaacc aaggatgacc ttgaacaggg gttcttttgc ttcctccta 842160
 agttctggga ttggagacat gctgccaagc ctgctttagc ctttttagaa tgatttttgt 842220

 ctctccagaa agaatectta tgtccattag catcacaac catttactct tgtgaatagt 842280
 aaccacaaat ctaggcagcc acttaateca ctttttggg atttggatct cttttaatac 842340
 aatttgtgac cttttgtgtc ttctttcgct tagcatgttt tcaaggctca ttcattgtgt 842400
 agtatatac agcacttac ttctttttac tgctaaataa cattccatta tgttaatgta 842460
 taatatttta tgiatttctt actttagtga tgtttggatt gtttctgctt ttatttatt 842520
 ttacattatt ttatgtgtgt gtgtgtgtgt gtgtgtgtgt gtgtgtgtgt gtgtgtgtgt 842580
 gtgtgtgttc atttctatgc ccatacaagt aagtgtgcat atgtatagaa gccagtggac 842640

 aatggttctc tcctccacc atgaggttct ttggatcaaa ctgaagtcct cggttaagcgc 842700
 ctctgttctc tgagccatct tgctagagt ctatttttta tctattatgg ataatactct 842760
 ataaataatg ttacgaacat ttgtacagt tttgtgggg tgtgtgcttt cttcttactt 842820
 ggatgtattc gtaggagttg aattgtttgt tcatatagta tccatgttta gcattttgag 842880
 aattctaggt tgtttttcaa agcagatgca ccattatgta atttcatcag caacataata 842940
 ggtttcta at ttctcatc ctteccaata ctgtttgtct gtcattttga ttgtacctat 843000
 cgggttagct gtggttttgt tttctgata gctaataatg ttcagcatgt ttttgtgtac 843060

 ttgttggcta cttttatata tgttttggga aaatggctat tcaaatcttt tggttcctgt 843120
 tgttaagtaa catcttactc tttgtttatc cttttagcca tactgtatat cattttaaga 843180
 ttaataat ttaacatgcc cccttaggtt atgtttctgc tcagaaacct gcattgcttc 843240
 ttttcattga ggtgtagaag ttttttagtc tttgctatga tttttctaca ctgtagctec 843300
 atgtggtcaa gatgagatgc tagatttttt taaggcaaag taggtacctat tagatttatt 843360
 atacagtgat cccagtcctc tttcccttta acatttgttg attatagaac actccacacc 843420
 ctggtgtatt acttagtttc tgctattcct ggtttatata atcttctaga ttgtgaatgt 843480

 gttaggccac aaaccgtatc cttttttaa aattgtgtgt ttatgtgtgt ggctccaac 843540
 acatatttta attgctgcat tcagtcctac aaaatctgag ggcaaactgg gctacagtgt 843600
 cacatgcctt taatcccagc attctggagg cagagacagg tggatctctg taatttgagg 843660
 ccagcctgat caatagagtg agtttcggta cagcccaggc tattgatatg aagaaacct 843720
 ttctgggggt ggggtgagg gggagtaact tcttgatgat atcacagtta ttgtctctag 843780
 ccattttaat cttttgtcta aaagttcaa ggatactcaa atacatgact taaaaaaat 843840

gagcaaagca aacaaatata ataagggatt gggaatatgg ttcaatggta aaagtgcctg 843900

ctatgcaaat atgaggactc tggagtctt ttcccaaga gatccaagta aattctgggt 843960

ggctgtggta gcctgcctgt aattcaagcc ttggaagggt gagaagttag caagagcagc 844020

catatcagtc cactgtttaa ttgagagaac ttgctttaat gcataaagta gaggagcgat 844080

caaggatgat ttccatcacc aaccttgagc cgtcaaatgc atttatacac acatgtatag 844140

ttaccacat acatgcaaaag acctatgctt agacacttgc acacaccaca cacaagaaaa 844200

atggaaaaac aaaaataaca gataaaatta ttttcagcaa atatatcatg tatttttcag 844260

ctttctaata ctgtaacaaa tatctgagat aatgaattta taaaagaaa tggattgagc 844320

cagtgatggc ttagtggtaa aggcacttgg ccatgaagcc tgggatctg agtttaactt 844380

atagaacca catggtggaa ggggaaaact atttcctta agttgtgctc tggccttcac 844440

acttgaccg tggcacaac actccttcca acaataaat ataatgtaa atgtaagtat 844500

atatatatgt gaaatataag taaatgtaca tgcattgatg catacatgca tacatacata 844560

catacataca caaacacatg ggttttaaat ctactgtttt agttagggtt tgtattgctg 844620

tgaagagaca ccatgaccat ggtaactttt tcttttttga gacaaggctg tctgtgtagc 844680

cctggctggc ctggaactcc tttttagac caggctggcc tgggaactcag agataacct 844740

gtcttttggc cccccagtgc tgggattaat aaaccttccc cgcttgatca tggcaagtct 844800

tataaaggaa gacatttaat tggggtttgc ttacagtttc agaggttagt tccattgtta 844860

ccatagtggg gaggtagggag catggtggca cagaggcaga catggtgctg gagaagtagc 844920

tgagagtctt gtattcagat ctgcaggtag agagagacc tgggcctgaa atggcctttg 844980

aaacctcata gcctgcccc agtgcacat ttctccagt aaggccatc ctctaatcc 845040

ttctaattct ttgaaatagt gccacttct gtgactaag cattcaaata tgtgaaccta 845100

tggggccat tttattaaa aacaccatc catgtccat gccagcttg tgtgtgtgtg 845160

tcatacacac acacacacac acacacacac acacacacac acacacacac tatattagcg 845220

gaaaacaaat gatttgcca tgctagaaaa ttatttgatc tgtgggaagt cagagattta 845280

tggcctccc ctggcctgt gtttctctg ttagagtga tgttgctg cctgggctat 845340

aaactcattt tggccaggca tgggtggcat gctcatggc ctggcactgg ctatgggggt 845400

ggggtgggt ctcttagat ttgtttgagt atctgatgtg tagaagtctt aagtgtatat 845460

ttactaagat aggaaaatc aagaataaa aatattataa ataataaaa ttaataatat 845520

tttagaaaac agctgcttct aaataaaaat aaccagctaa atctttaatg aatggcatt 845580

aatcaaggaa taaactaata tttcagatgt taaagtatct tctcttttct tttacagtca 845640
tctcagccaa acttaagaa aataaaaaga attggtttgg accaagtcct tatgtagaag 845700
tcatagtcca tgggcagtca aagaagacag aaaaatgtaa caatacaaac agtcccaaat 845760
ggaagcaacc ccttacagtg taagttccia tacttatata tacatgatac ttgtatgctt 845820
gtttatacat gagcagagat gtgactccaa tafgcctgtt tctttgcatc cccttttctt 845880
ttttaccttt cccacctgct cctaggactc gttcctctag tttacttttt gtttctcttt 845940
agatggtttc ctgtctcttc tggctctgtc tcatctctc cagtttagtt ggtgtgatgg 846000

tatactgta gccattgaag acaagtggga agaactcttt ataatactg tctctcttaa 846060
ttttagtttt gtaaaaaagt catacattaa ttagtattat atttaccatca ttataatagc 846120
ctttaagaaa gattttattt tatgtgatg tgtgttttgc ctgtgatgt ggctatgcac 846180
caaatgtgta tagtgccta ggaggtcaga aaaaggtgtc agatcccttg gaactggagt 846240
tacaatggt tgitagccac catgtgatg cttaggaagag aatccagttc tctgcaaaa 846300
attagcaaat actcttaac cctgagccat ctttctagtc cttagtagcc ttttcttaga 846360
ttggggctga atcaggttca gagattaact cactggtttt tttgttttgt tttttaaaaa 846420

aaaccttttg tttgttctg ttttgagaca gggctttgct tcatagttca gatttgcctg 846480
gaacttgctt ttagctcag attagccttc agttctttat cctttaact caagcctcct 846540
gaatgcctgt gcttctgtgt gtgattctat gtgtgcttct gtgtgcgctt ctgtgtgtgc 846600
ttctgtgtgt gcttctgtgt gcgcttctgt gtgagcttct gtgtgcgctt ctgtgtgagc 846660
ttctgtgtgt gcttctgtgc acagcacttg attatttctg ttttctttt tgagacaggg 846720
ttcaatgagt gctcaaatgt gtcaggttgt actaccaata tctgacattt tgtcagtaag 846780
tattgaaat gagtgctatc ttatttttat gaatttattc agcacataaa aattaccagc 846840

atacatgcac acgaatagct ataaattata caagcctagt accttaatat tagcagctat 846900
tagacgacaa ctactatagg acagaaatta catacctaca taaaggatat tagatgtgta 846960
tacactcage tgcaactgta accacgatat gattatataa aagcagagtt ataggagctg 847020
gaaagatggc aaagaatgta aatgcttat agtacaactc cagcgatctc tgagtttagt 847080
ccctagagcc cacaagaaaa atttggctct acaaagtgt gtcctaactt catgaatacc 847140
acagcatgca cccctcata aacacacaca aaataataac aaattaattt aaataaatta 847200
aaataagga cagaggttca actcttaaaa gactaaacat acttcaaagg aacagagttt 847260

gattccagct ccaggggatc tatggctctc ttctggcatc tgaagttacc cacaccaca 847320
tgcatacaga gatgcacata cacataaata aaaaaattaa aataaagtat tttttaaatt 847380
aaatttaaat taaaaataa taaaacaat gctatagaat aaaatatatg gtataacttt 847440

ttgtcatata taatatctta aaaatataac aaaattaaat tttggtttgc aggggcacta 847500
 tgattgcaca atacaaaact atttcttttt ttaagattta tttatgccag gcattggtgg 847560
 cgcacgcctt taattccagc actcgggagg cagaggcagg cgagaatcgg gagttcgggg 847620
 ccagcctggt ctccagagca agtgccagga taggttcaaa agctacacag agaaaccttg 847680

 tctcaaaaa ccaaaaaag atttatttat tatgtataca gtattctgtc tgtatgtatg 847740
 cctacatgcc aaaagaagac accaatgtca ctatatatga ttgtgagcca ctatacatgg 847800
 ttgctgggaa ttgaactcag gacctctgga agagcagcca gtgctcttaa cactgagcc 847860
 atctctccag cccacaaaa ctatttcttt aaacagtgtt ttacaatgtg gtccaggtat 847920
 gcctaatact tgtaaaccce ctatcttagt ctgagaagtc tgggattgta cgcattact 847980
 gccacacca acttatacat gcatacaaaa ccctaattta aaaaaatag agttgtgggg 848040
 atggtggcgc atacctttaa tcccagctct caggaggcag aggcaggtgg atctctgagt 848100

 ttgagccag ccgggtctac aggggtgagt ccaggacagc cagggttaca cagagaaac 848160
 ctgtctcaaa aaagaaaaca tcagtaaca caacaaaat gcaaattgtt tttattacct 848220
 gatatttga actcttgatt ttgtttcatt taataatta aactagcgac tagtaaaaaa 848280
 aaagatttct ttaaatgtc aagatgagaa actataaggt tttctctca aacaataat 848340
 tttacttggg tatatttatt cccagtaaat atcaaacca ttgttatacc tataatatga 848400
 atgtctgaag tcttaggagc attttgatgt gtctaagat aattttaaga aaataaataa 848460
 agtttaaaaa ttacatgcat gtgatcttct taggaggatt taaaattca gaccagccag 848520

 gtctacatag tgagtaactag gccagccagg gttatgtaag tggaccctg tcttaaaga 848580
 caaaagagat aaaaataaaa ttgaattaat aagaatttac tgaagaaca tttagatttt 848640
 gtttgcaaa tttcttgat cttttaattt atgttgcctt ggaacagca ttatagagta 848700
 cattctttat ggtgtgcttt tgccaagcat gaggtatgtg cttctgtctt gagacagggt 848760
 ctcatgtgt tgttcagctc tgcacatctc tatgttatgg ttatcctggt gactttgcct 848820
 ccagaactgt gaagctttgt gtatctgttt tagttttcaa aatgaatgat ggctgtgga 848880
 acttttggg tattccagta gaatttagtt cagatttgag ctacttact agctggatga 848940

 ccttggcagt ttgctcaact tctctgaggg catcattttt agtattaatt ctcatatgac 849000
 aacttactg tttgattaa tgaagttacc ccaagttcag tgaatgcat ctcataagta 849060
 agaattcaat ttgtaattc actaacttca aaaaatgaat ttaaaaattg acatgtaaag 849120
 ttatgtattt tctggagca tattttattg tttactaaa ttcactcctt taatagtttg 849180
 ttacctata agcagttttg tttctgtgtg gtgtgtgtgt gtgtgtgtgt gtgtgtgtgt 849240
 gtgtgtgtct gtgtctgtgt ctgtgtctga tcttacaggc cagttgcatt caaacagg 849300

tttcttgagg tttcagggca taggccacct ggctaatagt aaactttaag aggcccagtg 849360

 agggactgcc tacatagctc agtaggtaaa ggtgcttgcc tccaagactg ataactggag 849420
 ttaggtccct gagacctact gggtggaagg agagaaccaa ctectgcaag ttgtcctttg 849480
 acccccaca tcccactaaa taaataaaca taatttattt taatttaaga aaaagaggta 849540
 caatgaaaag attttagatg ttaaagcttg attgtaactt attaaggatc tcatttgtat 849600
 gttaaatgaa aacaatgttt ccctgttttt ttattttcag tatcgttacc cctacaagta 849660
 aattacattt ccgtgtgtgg agtcaccaga ccctaaaatc tgatgttttg ttgggaactg 849720
 ctgcattaga tatttatgaa acattaaagt caaacaatat gaaacgtatg tatgtaagag 849780

 ttacgtaaaa tgiactgtgc ttgtttttgg aagaaatgta tgtcagagta acataaaata 849840
 tactttgttg gtttttgaa gaaattctta tgttaaacat gtggaacagc tcacatcatt 849900
 atttgtctta aaatttaaat gattattgag ctgggggtgg tcgacacact taattgtagc 849960
 atccaggaag cagaggcaga tggatctcta tatatatga gttccaggcc aaccaggtct 850020
 acattgtgag atcacagtaa aacaaaacaa ctacaacaaa tatccatgtg gttttaagga 850080
 gtgacagaaa agtgtaaaaa ctatttaaag cattccaat aatcttggtt ttggtcattc 850140
 attttgaga tactatttta gtaaatattt atttcctaa gtatcaataa agtaatacat 850200

 agtaaattat agagaaacta aaagatttaa agcagtcag aaggaaaaaa atagttgaga 850260
 aagacaaatg tgctgttaaa gttataggta gatttctcag catttgtttc tgctgcttaa 850320
 ttttgaagtt tccttgtttt aggtggttgt tttattttca tttataaagt cataactcat 850380
 tttagttaga tctcatattt taaatgtgaa ttgttttttg agcccttgac ataattctaa 850440
 gaacttgttt ctttatttag atctttatga tatataatcg atttttaaat tatgttttca 850500
 ttcaatatag cccaagttaa tattgataaa tgatctttgt ttttatgctg gtttgattta 850560
 tactattgtt ttttcaaggg gggatgacta taataaacia tatggactat atttcttgtt 850620

 atatatgttc tattaagtat tatatatatt ggtgaagttt attttcttt taaaaagtaa 850680
 tgttctggtc tcaaaggfcc ttaaaccctt gtccagtaaa acagtttacg aataattgaa 850740
 agtgtgatgt ttcttgata atttgttctt tttcagttga agaagtagtt atgactttgc 850800
 agcttctagg tgacaaagag ccaacagaga caatgggaga tttgtcagtt tgtcttgatg 850860
 gactgcaagt agaagctgaa gttgttacta atgggaaac ttcagctcg gaaagtaagt 850920
 gattactttt ttgttgtgt ttttcatga aaaagttcc ctgtgtagcc ctggctggtc 850980
 tggaacttgc tctagagacc aggtggcct caactcagaa atctgcctgc ctctgcctcc 851040

agagtgcttg gattcaagggt gtgcacctcc acagcctggc taagtggtta catttcccct 851100
 cctttttttt tttttttttt tttttttttt tttttttttt tnnnnnnnnn nnnnnnnnnn 851160
 nnnngttttt aagacatggt ttctctgtgg ctttggaggt tgttctggaa ctagctcttg 851220
 tagacaggct ggictcaaac tcacagagat ccacctgcct ctgactccct agtgctggga 851280
 ttaaaagctt gtgicaccaa tgtccagctc cacctccttt tttaaagata gtaatatatt 851340
 gtgaagacaa ggcctggttg tctctgtctc tctctctctc tctctctctc tctctctctc 851400
 tctctctctc tctatctatc tctatctctc tctctatctc tatctcttcc gtgtgatgag 851460

 tgggtgggtt agtacactta cctatgcata catcagtggg tcccaaagggt tgacatcaag 851520
 atgtcttccct cagtcatttg tctgccttta aaaaaaatat ttttaaatag atgtaagtgt 851580
 atgtttgtct gtaagtgtat gtaatgtgtg tgtgtcccct gagcaatctg atggagctag 851640
 gtggttgtgg actacctgtt gtggatgctg ggactctaac tttggctcct gcaagagcaa 851700
 tatgtgttct taattaccaa gccctctctc cagccccctgt ctgcgctctc tctctctctc 851760
 tctctctctc tctctctctc tcttctcttc tctctgtgtg tgtgcgtgtt ttgagacagg 851820
 atttctcaca atcctacttt gtctaggggtg tctaaccaga gagccccagg atccactggt 851880

 tccagccttc ttcttactgc tgggaatata agcatgtgct gccacaccag gtttctgtat 851940
 ggatgctaaa aatctgaacc tgggtctcca tgcttataca gcaaactctt taccactgag 852000
 catctcgata gtactaggtt ggtcttgaga tcccatctct tgccttggcc ttcccagctc 852060
 aggaattata ggtagacaca ggccagaatg cccagttcag tcactacttt gtggtaagg 852120
 tctcttatga ttcttctgac aaacaatagc cagtgtggta tttgtaatta ttgttattac 852180
 tgttcttttc tccagagggg aaaaaaaaaag tattttttt cttttttaa aggtattggt 852240
 ctaggaaat agcttagtgg tagagtgtt gcctagcatg tatgtgacct taaattcaat 852300

 tcccagtatc ataataaaat acataataaa tagataccga tcatatataa tactttgttt 852360
 tgttgcaatg ttctataaa ttttttaaaa aatttcaagt taaaaagctg gatgaataaa 852420
 agttgaatca cactggacag tgggtttgca tgcttttaat cccatcactc aggaggcaga 852480
 ggcaggcaga tcttggagtt tgaggacagc cttgtctaca gagtgaatc caggtcagcc 852540
 aggatatacc tgccttgaaa aacaaaataa cagcaacaac aaaaacccc aaaatcccag 852600
 gcaaaatatt tttgtgctgg agacatggcc cagtggttaa gaacactggc tgctcttcca 852660
 gaggacctag gticaattct cagcacctat atgatagctc acaactgtct gtaactttaa 852720

 ttctggggaa tcttacacc tcacagcaac atacatgcag gcaaacacc agtgtatgta 852780
 aaaaatagat ataatcatt aacaaaagtt gaatcacagt tggctctgta ctattgaact 852840
 gattgataaa gtatctctg gatgctattc atgtcagcta atatggtctc ctccattgcc 852900

agtgggtgggt ttgtgttgcc accccgagca gtggctgctt gagtttaaat gactccagtc 852960
 ctgtagtact tgacagtcag gacaagctgg agtccatttg ccatttcac tccattctg 853020
 tgagccacac ttcacagga tatcttctgt gttattatag ttaaagcct gattcatttt 853080
 acagtttga gggatataccg gtttgtgtta aagtggagtt aacatagta aggaactttc 853140

 cagtaacacc ttatctggta ttgtcttaag taaaacttct ttccagtttt tttttttaa 853200
 taattttttt agatttattt atttattatg tagtattctg catgcatgta tgcctacagg 853260
 ccagaagagg gtgccaggtc tcattataga tggtaatgag ctacatgtg gttgcccgga 853320
 attgaactca ggaccttgg aagagcagct agtgcctctaa cctttgagtc atctctccag 853380
 tctccccac caccacceca gtttattctt aacagatatt tctctcattt agtaataac 853440
 taaattattt taccatttta aaaattttaa cccttttctt gcttcttctc tgcactctat 853500
 tctttttctt ttctctatc ctctttttta aaaatttatt tatttattat gtatacagtc 853560

 ttctgcctgc atgcctgcag agggcaccag atctcattag gtggttgtga gctaccacat 853620
 ggttgacagg aattgaactc aggacatctg gaagaagagt cagtgccttt aacctctgag 853680
 ccatctctcc agtctctctt tttttttttt tttttttttg acaaggtctc actatatagc 853740
 tgtcctggaa cttaactgtg tagatcaggc tggcctttaa ctacagaga tccacctgcc 853800
 cctgcctcct aaggactggg aataaagggtg tgcgccacca ctctattttt agaaccaaat 853860
 taatagtttg gtatttggc tgagaaagac ttgtttactt agaactgaat tataaagtag 853920
 ttccggtgtg acctctgtt gcttcgttgg tggaggactt tctctttagc acaacttttt 853980

 ttttacagca ggaacttga gatagtctg aagaattttc tacactgttt ttaaattaca 854040
 tttttcattt attttgtgtg tgtgcgcgtg cgagtgtca gtgagtgtgt aggagtgtt 854100
 gtgccatagc atgcatttg aatcagagg acaaacgcat gagagtcagt tctttacttg 854160
 taccatgttg gtctgagca ttgaattcag ctcatcagc ttgatggcaa gtgcctgaat 854220
 ggactgagcc gacctgtgtc ctgcctcttt tttttttaa gaaattataa agtagaagga 854280
 aaattcagaa ttgattatac tgcttccgaa tttgaatgtt attaacagga tctgtaatag 854340
 ttacattgac atacacacac acacacacac acacacacac acacacacac acacgaacga 854400

 taaaatagc ataaatcata ttgctaagct tggatcaag cccaggttct ctgcaagagc 854460
 aacaggttct cttgacct gagccactt tctagccct atagtcttg ttttgatttt 854520
 tcaagacaga gtctttctac attgccttag ctgccctgga actcactaag tagagcagac 854580
 tgcctctaa gtcagagatc cccatgcctc tgcctcctga gtgctgggat taaaggtgtg 854640
 tgccaccaca cactgctctt ttaggatttt ttttttaagt gacttacgtt tcagtatttt 854700
 tatgtgctca aaatattagc taacttgcct tccccaaag gacaacagaa ttctttgtc 854760

attgttattt attttatttt atataagtgt ttgacctgta catatgatg tgcacctgtg 854820

 tgtgtctggg ttccacagag atgagaagag ggtgttggaa ctatgactac catgttgggtg 854880
 ctggggaatg gaactcaggt tctttgtaga aacaatatgt gctctaaact getgagtcag 854940
 ttttcctgct ccigtgttta tgtttttatt tgacatgatg ggtggfacct taaaaattga 855000
 agcagttagg ctgtggfcat attttttaag taggacttgt accatattca ttaatttttt 855060
 tcaatttaca aagcacttgg atttgcattc tcctatttag tatgtgtttg aggtctaagc 855120
 ccacattata aaataaacac tcatgaaaac taccacacag tctatatatt aaagacataa 855180
 acagtgtcat tgaatatatc tgtatttttc cttctgtatc atttcttatg tttttttgta 855240

 gtaataattt ttctgaattc tgagttaaaa aataaacagt atattacttg tggtttttta 855300
 atcttgttcc ttttgtttgt ttgatgcttt ttttttgttt gcttgttttt tgagaccaca 855360
 tctcagataa gccagcttg gcttcaaaat cactattaca gctgagctg gattgaattc 855420
 gttctcctct tactactct gcctacattc tggggttata ggtgtttgcc tccacaccta 855480
 agtatttctt gagctatata taatatcaat attatttttt gagtttatgt attgttgttt 855540
 ctgagctcat ttatttttcc tgttttataa aatttgttag gtaaacaatgc tagagtttta 855600
 tgtcaaatta tgtttgggtt ttttaagttt tgctgttata aataatgata tagtagatgc 855660

 ttcttgaata tctattgata agctttctta gagattatat ccttaataaa acttttaggg 855720
 tttaatgtta agtagaatga actggatgt tcatttacag cttataatat ttattgcttc 855780
 ttcaggtatg ttacttttta ttgttttaggt gtttttaaat taggtgaaat ttatatatca 855840
 tgtagtatc attatcaaga gagtatgttt ggcatctctg tacattgaaa actggaacce 855900
 tagaacaata ctgtgcttcc tccittacc agtccttagt aaccttactc atctgttttt 855960
 ggtttctgga tttccacatt atgagaatat attatacata ttatttactt ttctcatgag 856020
 tattgacaga atgtttgtca taaacaattt aaaggaggat tttcttattt tagctcctgg 856080

 tttcagaagt atatgtctac cacaacaggg aagactatga cagaacagag taactcatat 856140
 tatgggagtc aggaattaaa gagaaagaaa aatagggaaa ggtcaaggaa gcacattatc 856200
 ccaagaatct ctgtgctcca tgacctacct cgttcaagta atcccatta cctgcttccc 856260
 gccacctctc atatcctcta tatccatcaa gggattaatc aattcaccaa gtcagatgag 856320
 ctcatcatct ttggaaatgc catcatttgt tggfacctta ctagectcat aggcatttct 856380
 taatccagtt aagctgacaa tgaaaagtaa ctgttgcac atattaaatc atagctgaat 856440
 ttttgtgagt gtatgtgatg tgtgcacata tccatgttgg tgtgttcagc tgtgcacatg 856500

gcagctaggg gacaacagtg tttgtcctct atcatcttgt cttgttcttt gaggcaaggt 856560
 cttccgttat acttggagct ctggatattt ggctaactga ccaccagtca tgtgccacca 856620
 tgatccatac attgtctttt aatgcatgat tttcctctgt atttttagtt taataattct 856680
 actatctaaa acctgtgggg atagaaatga ttttaaaagt tcttgttgtt ttcagagtct 856740
 tgatatatag tactgactgc cttggagctt actatgtaga ctaccaagat ggcctcaagt 856800
 ttgcaatagt tttcttgaat ctgectcttg agtgcctgagt gctaaaatta taggcatgca 856860
 ccacatggt gacttagaaa tggatcatgc tttcccttac tggggctcat tttgatTTTT 856920

atTTTatgTT cTTtgattgc cagTTtccat tttatcttag tctaccagaa ttttaaaggc 856980
 ttaatttggg aattctttac tttagagaaa atgtcttttg ctttaggtag tgccagggtt 857040
 tgctgcaacc taaaaagtt ttatctgctt tctgctggtc ctagcttaat gttcagcact 857100
 tcccaccttg ctgctgggct gagactctct gatccacctc agatctggca actgccacaa 857160
 gataaaaatg ttttcaaggt gcttctagtt tggatataca gatcaagttt ttgttcagtt 857220
 tggagattgt ctggccacca aggaatatga agtgcgttaa atttctttag aaaccagttg 857280
 ttttgggtg ggagtgcctt tgtaatttag ctcactgaga cgaaatcttt gtagcttttc 857340

cagattttcc tggggtaaa acatgttcag ttagaatttt gatatggttt tcttgcacc 857400
 ttacccttct ccaagtgacc ttatttatgt attatctatt tattgtgtgt gtgtgtgtgt 857460
 gtgtgtgtgt gtgtgtgtgt atgtgtgtgt gtgtgtgtgt gtgataagca tatgctgcag 857520
 tgcattgtga gagtaagta gtatagaaga caatttttgg agttggtttc atctgctgcc 857580
 tagatgagac aggacttctt ttggctgcta tgcctgcacac tccaggcagc tggcctgaga 857640
 aattctagge atttctgctt gcctccatt gtgctctagg agtgttggat tatagatgca 857700
 caccactgtg tcttgatttt tcatgcaggc tccagaattg aaccaggtt gggaggtttg 857760

gcaaatgctt ttacctgctg agctaccctc taccceccat tcccagtgc ttttttattt 857820
 gtggaagaaa tggaaactg atttgattga ctattgaatg ccatataac attttttgg 857880
 atagttttct cattccactt atgtctaca tatcaatcaa tcataagaaa gtatacataa 857940
 aaaacattgt ttaattttat tttggtacag tttcactctg gagctcagac tgacctgtaa 858000
 tcttactgtg tgcaccagac tgaccttggg tcatggcag tctcttgggt agataactga 858060
 tgtgaatttt tgcacctggt gtgtacagtg ctggaactca gactcagggt tttatgcatc 858120
 tttaaacaag cattttacca aggtagtttt aagcattcta ccaagtgagt tttgtcctaa 858180

actctgtttt ggtttggctt tttttttttt ctttaagatt ataaaactcg tctttaatca 858240
 agcttgaac atgtaacaga attgtcagat aaactggaaa gtttccaata tattgaaaca 858300
 aaccataag tcaccataaa tacaatacc aaaataggaa aaccacaaca acaaatcat 858360

acttgctctg taacagccat gaacaatcca gacactttct cagtgtagca gatgtggcct 858420
 gatggatag gaccacacta tggctttggg gtcacacata tctgatagca ctgtggcatt 858480
 gttggcttga ctcatgaagc aatgcaggtc ccagcacatt caaacagtgg attgaatatg 858540
 ctttaaatat tgaagtgaagc aggaaagcaa cataatcatg ctgtcagaaa gatattagag 858600

 agtaaggaca gctgtgtaaa gcttgaggct gagaggtggc tcacagcttc atttctttga 858660
 ctctttggat aatggctgcg agaacagtaa gatgtgaggt tctggttcat gggtcaccca 858720
 ttctgactg ctgaatgcca aaatctctcc agtcagattc agacatcaca tgggttctag 858780
 gaaccagcat ggctatgtct ttgggcaaac tgacatgctg gtatttgaac tctatctatc 858840
 cacatgctaa atttgtttgt actgtgtgat tgctctgtgg aggtcactca accccctacc 858900
 atcaacttcc agagaacact atgtcatgtt ttagagatc actttaatac tttattagac 858960
 tacattttat atgtcgtaag ggtcaccatt tcaaatgtgt aggtaatgac tttttataga 859020

 aatcattata tttattacat gtgcttgtat gtatgtatgt agatgtatat agtgagagta 859080
 tggaggttag agaccagctt ttgtgagttg gttctctcct ttgatcagat gggttccagg 859140
 aatcaaacte aggtcatcag gtttggcagc aatcaccttt gcctgtcacc ttgccacccc 859200
 acatttaaca tttttttag ataacatgtg ttaatttgtt ttaataactg tagattttaa 859260
 tgcagttca attacaaagc actccacaat ttatctattc cactatcatt tttaaatgtg 859320
 tttttctate atccccagta cttataaaaag aaaaacagta gacttctaca acccttgata 859380
 gatgtggcat ttggttatgt gctgtggat tgcgtactgt gattttatta ttgaaaccgt 859440

 ggctgcgtct tggggatttt tttgccagtt gcgcttagac tgctcaactt gagttgttaa 859500
 acagttttca gttttccttc tctttctgtg aataaaattg gaagaataca tgaatattaa 859560
 ggcatattat tgggcctctt tgaacttga ttagtttttt tttttttttt tttttttttt 859620
 tttttgcgcg gggttttctt tttcagacgg agtcttctct tcagagagtt ctttgtgtct 859680
 ttcatttct cggaggtttt tttttccag ctcttttata taaagagtta ttattggctt 859740
 tgctatttca gagttgtttt atattgactg ttctgttatt gattagtact tttctccat 859800
 atttcagata aagtaagtag taaaaaggtg tnatgaggg tgtacaacga gactgaggca 859860

 ggaacatgag ttcagtcca gcctgagctt tgggaaaatg gctaattact gggtttgaat 859920
 tggagcaaaa aacatttcaa aacaaaaaat gcagaagtag ggtatgagta atgcacctta 859980
 actaatctct cattgaataa cgatatatat agaattgaat ttgaacattg ttctattttc 860040
 cctttaaata ttagtttgg atattccata ctagaaaggt ttaatagttt agtataaggc 860100
 tttttttttt gtttcagttg aaaattactc tcttgaatct cattttgttt aaattttattg 860160
 ttcaaggtag ttcacagaat gatgatggct gcagacccaa agatgaaaca aggtaggagt 860220

tcactgattg cttatcacag aatgcagaaa gaattaactt gtgtaattc atttaacttc 860280

 aggtttaggg ggttggaaag ttggctcagg agatctaag tcttctggct ttcagacact 860340
 catctgtaca tatctataca tacacacagg cacacataca catgaataaa taagtaccaa 860400
 ttttcagggt cagactgata aattgtgggc caagtatgct gactttcctg tgtgatccca 860460
 gcatttgggt ggttaaggca ggaggctatc tgtgagtta aagccagctt gggctgcatg 860520
 tagatttggg ctagcctggg ctacaaagtg aggaaacct gtctttaaaa aatcataaaa 860580
 agttgagggt gttggtgcac acctataatc tagcattttg gagaaggtaa gattaggaat 860640
 gcaaacctg ctcgagttat gtgaaatgta gtctcaaca aaacctgaa aagggtgcta 860700

 gagagatggc tcagcgacat aaagagtaca tgctgctttt ccaaaagatc cacattctgc 860760
 cagggtcat gtctggtggc tcatacactc cagttccagt gatccaacac ctctttggcc 860820
 tccgtgggtg cctgcataaa tgtatgtgcc tacacataga cacaatata catacaata 860880
 ataaatcttt taaaatttaa atgggagaat caaaagcaat gtcacagatc ataagagata 860940
 tttaccaga agtgcattgc atactattgc attgctacag ggagaataga tgacttagac 861000
 ccaagcacag gggaacatac ctgggatecc agcattgggg aggtagagtc aggagggtca 861060
 aggacaaaga ccaacttga ctgcttgagt ttaagactag cctgtgctag taaagggaaa 861120

 tagagcttaa tattatggtt tggaagttgg gcagactagt acaagcttc atgttaccta 861180
 tctacttctg taatgcgtag aaattttcgt agtaaaaata ttttaagaa cagtgttggga 861240
 acacttggcc agtgtgccca aagccatgga ttccacccc aaaagggcaa aaacaaatga 861300
 cacatagttt attaaaatcg tcaggaaaac caaagtcata atgttctgtc aaagcaaata 861360
 gaactctaca ttctttgaat cacagtatat taatctacaa gtatactctt aggtaacttc 861420
 ttactgagaa caattactta taatggaaaa gtagttttaa tttcacatac tttctctgtc 861480
 cttaaacttt gttttagtc aagactgggc tcaaatcccc taatcctcct gtttccattt 861540

 cctgagtgct gtgtttacaa acatgtgtaa cctgcctgg ctagaaaagg tttgctaaca 861600
 tagatggaag cctaacatta agggaggag tcacttagga aaaggccagt acacacccaa 861660
 tcatgtatga ttttgggtcc ttcagaactt gtttaaaggt tcactatggg aactttttaa 861720
 taaatgacat cataaggigg tttctaaaa acattggact ttaattaaag gtgataagag 861780
 aaaactgtag gaggctggag agaggactca gcagttacaa gtactgactg cttttctaga 861840
 ttaccagggt tcaattccca gaatccatat ggtggttcac aactgtctgt aactccagta 861900
 cctgggatcc agcaccctt tctggctgct gcaggcacca aacacctgt ggtgcacata 861960

cgtatgtgca gggaaaacat gtatacaata aaatactaaa aaaaatttta aaaagataaa 862020
 accataaatc aaaagggtaa aaaagagtca tataaagtta tacatttggt tggctgtaaa 862080
 catcttgttt acatgtcttt tcttacactt gtgaaaccac tntagccatt tgtttactaa 862140
 gttctttctg tcttcctagg tcaataatca tgatcatagt ttctggggac agtgccttct 862200
 gggtttttgg gcttgcttac agagatcaag tggggtgtgt gcgcgtgat atgtatgcgt 862260
 gcgtgcgtgc gtgcatgcgt gcgtgcgtgc gtgcgtgtgt attggggctg attctcttgt 862320
 tctacatgt gaattccaag gatgcaactc cggctctcag gctttccccc acgcatcttt 862380

 acctgctgaa cgcacctct aacctcaaa aatgtatgta gtacatcaga ttcttcccca 862440
 gggtttgata aagtacagat tgctaggctt cattctcatt ctttactac ttgggtggga 862500
 aaaagtttc atatttaaca agtttccagg taatgttaat gctcttaggc tagattgggc 862560
 ttacataacc ttgagatta cagctgtacc agaagtttg cagtttcata atgtagtcaa 862620
 tttcatagaa accctagttt actggaaata atgtactca ttttaacttt accctctttt 862680
 ttttttttaa gatagttgaa tcttacttgt cttttgaaat ttgittgtgt ttattagaaa 862740
 aagcatacaa tcttaaaatg tttaaatgta gtagtattaa cattaaaatg tatagtcatg 862800

 gaaaaataac gtttgatgta agtcttgatt gtgatataga tatgcacatc ttagaggaat 862860
 tgtggagaag gaggaatttg aaattgaagg aagaaaaaaa tagcatggag gtagagagaa 862920
 actggttttt taatagttaa tgtttgatca cagtgtttga ctggagatag gatatgaggt 862980
 ggtttgaata gatatgggc ccttagactc atgtgtttga atgcttgccc tatttgtagt 863040
 ggcaatatta ggaggtgtgg ccttgttaga gtaagtttgt cactgtgggg gtggacttta 863100
 aggtctcata tgctcaaaact atgtccagtg tgggatatac ggttcacttc ctattgcctg 863160
 cagctcctcc agcaccatgt ctgcctgcat gctgctatgt tctgcatga tactaatgaa 863220

 caaaacctct gaaactgtaa gccagcccca attaaatgtt ttcccttata agagttgcca 863280
 tggatcatgt gtcttgctta ttcatagcaa ttgcaacct aagatgttta aaagaaaaat 863340
 gcagttggtc agattcagag tagaattgga gttaacattg tttcttatgt gccatctact 863400
 atgctgaaag tgatgaaaaa tacagaagga ggaaggaact tgccctgagtt tgtagtgtat 863460
 tgggtataga tgaatatagg aactgcttaa tcttcaagag cctgaactca taactgtcat 863520
 gctttactac cacctaaagc tgggtgtaata ttacataagc caatgtttag tcattattac 863580
 atgtgaacce ttttattgtt ttttgtttat taagatatga tctaactatg tagctgagac 863640

 tggcctgcaa ctcagaagct ccttacctt ttctcttgag tgctagaatt aaagatatgc 863700
 actaccacat ctaattgtta cttatttcaa tttttatttt atgtatgtat tattactcaa 863760
 tcctttctct accttagttg ttagaaaaca ggatttttca ctaaactgga gcacactgat 863820

ttggccagac tggctggcca gcaagcccca ggcaccttc catctctgcc ttcctagcat 863880
 tctctgtagg tgtcaactact gtgcctggca tattacgttt ttttgtggat tctggggacc 863940
 taaactcagt tctcatggt tatgcagaaa gtcttttact aacagagcca tcttcccat 864000
 cctgaatatt atttaagtat taggtagatt gttatatggc taaatagagg tttaaagata 864060

 ccccttggga ggatgtctca aaaaatattg gactgggatt gatataatca gaattctata 864120
 agaaaattaa ttttatttgg caatgggatg tagttagt ttgtgttatgg gtatgtcagc 864180
 aatagcaggg agataccccc atatgccact agctactga agagtctct tctctcttag 864240
 ggatttccat acagttaagg ccccacctg agtataaagg gtttcaggat gagccagggt 864300
 gaagtggagt tagttggga ctgcttagac gtataggaaa aggaacagaa tgtaactcca 864360
 aggtgtgact atggcctct tgagatagag ttgtgcttac atgtccttac agtagctttg 864420
 tatatgatcc tctggcttcc caagtctcat tactcaaagt atataactta ttagcaaggt 864480

 ttaaaattaa gtaaagctta aaatttaaat aaagttttaa aattaggaca actagatgac 864540
 ttgacaggtg agaaacattt ggtgttttt tactctgaag acttggattt gattcctaga 864600
 acctggataa aataggaaga agagaactca tccattagg tgtcctctga cctccacaca 864660
 tccagacgtg ttctcccca catgcctag gactcggacc tacccccgcc acaccaatg 864720
 gcttggatgc acctctcccc acatgttga cacacacaat aataataaaa tttaaaatct 864780
 ttaattaaa taaaacaca tgagctgggt cacacattc tctcatctta aggactctta 864840
 aatgaacct gtaaggtgt ttatagttta tgtactgtag attcaggac aagaggggaa 864900

 catttggta aagctcatag ttataaacgt tctagtctc gtaagcatag tgcatttgtt 864960
 gtttctaata tccttttaag atatctttag gaaaacacac attatctctc aaagcaatgt 865020
 gggctctttg gtttgtgtt aagtttctt actaatcaac aggcaaggta aagtagatct 865080
 caggatgaga ggcccccttg ccttcttctg tctctttta agtttcttt ttatattgcc 865140
 tccagtgaag atgggggaaa ggaatcaata tagtagacta agaggtagat gaggtgggtg 865200
 tgggtgaaga gtagaggaga atatgaaagc agtatcaagt ggacttagaa attaacaaca 865260
 cctagaagga agaatgacag agttagagag ctgtatctc tgcattttgt gagagagtc 865320

 cactaattac agaaattctg atttggagat aatcttcaga attatgggat ttgagatcct 865380
 agagaaaaat ctgaagaaga ggaagaatca gagggtgatt agaaatctaa gtacaagatg 865440
 ataaaattag agtgacaagt tagagaaaaa tgccttctaa atatggcatg atgggctgg 865500
 agagatggct tagactaaga gtacttcaa aagactcagg ttaaatttcc aacacctaca 865560
 tgggtgctca tagccatcca taacctcagc tctcagggtc caacaggcac acattcatac 865620
 acatagatgg atgtaggtaa aacattaata cacataaagt aagataaatc caatctagaa 865680

atctacaaaa aaaaaatcta atctaaaaac aataagatga gctagctggg catggtggct 865740

catgccttta atcccagtac ttgagggaca gaggcaaggg gatctctgtg agtttgaggc 865800

tagcctgate tacatagtaa gttccaggca gccaaggcta caaagtgagg ccctatctac 865860

ctccccacc ccaacaaaga gatgggatag tactggtttg atggcataat atattttag 865920

ttctgtact tgggaggtg aggcaggaaa tctttagttt gaggccagcc tgggctagtt 865980

atgagacaaa gaccctccct gtttcattaa aacaaagcaa aacagtaaca ataacagcaa 866040

caaaaagccc aaagtattta atgacattgt taaatgtctac agaagtcatt atgatcatag 866100

gtagttaat attctaggaa agctggccat ctggcaaaag aaaaatctag cctttgtccc 866160

aagacaagag taaatttcaa gttgatttta aatagatttc aaaaaatgaa gctataaaac 866220

cattggaaga aaatgtggct agttcattgt ctagtccaag tcccagcaac cacatattct 866280

aattacatag aaatatgaaa ctgtctactg ggcgttgggt gcacacgcct ataatcccag 866340

cactcgggag gcagagacag gtgaatctct gtgagttcca gaccagcctg gtctacaaga 866400

gctagtagga tagcctcaa agccatggag aaaccctgtc tcgaaaaaca aaaaaacaaa 866460

aaacaaaaa aaacaaaaa aaaaaacaaa aaaaagaaat atgaaaatg catatttaaa 866520

aatattatca tggagctagg ctgtggtggt gcatgcattt aatcccagta ttcagaagtc 866580

agagagaggc aggtggatat ctatgagttt gaggtcatcc tagtctacag agcaaattcc 866640

agggcagctc aggcatfaca cagagaaacc ctgccccgaa aaacaaaat aaataaataa 866700

tttatgttaa ttatataata atataaataat ttagatata taatataaat attatataatg 866760

tatgtatata gcattgaaag caaaaaggag aagccctttc acaccagtgt gctagataag 866820

tagccttggg ttgtttggca ctcttataga tggtagcttt cctagtaaaa aaatgtggag 866880

gggtactcat atgcttatag gcaaaaagat ttggaagaac ttgatttcat tcctgcttat 866940

acaaggcatt ctgaagcctt tctaaagcca tacctagtaa ttttgaatga getcaagttc 867000

gaccctttag tgacttctca ctgtctgtgt caggttgta ctcttctact gctgtgaaga 867060

aacactgtga ccaaggcaac tcttagaaaa gaaagaattt aattgggggc ttgcttacag 867120

tttcaaggag ttagtccttt atcttaatgg tagggaacag gcaggcatga cactggagca 867180

ggagctgaga gctttacatc ctgatccata ggcagccaga ccgagagaga ctgggcctgg 867240

catgggtttt tgcaacttca aagtcacct tcagtgccac acctactcca gtaagacat 867300

accttcta at ccttctaate tttctcaaat ggttccactt tctggtgaca aagcaatcaa 867360

gcatatgate ctatggggca attctcattc aaacctccc aaggaattat ataagattaa 867420

cctgtggcct ctttatttga taaggctgac ctgaaattag aaaggaaaa agacaggctg 867480
gagagatggc tcagaggtta agagaccgg ctgctcttcc agaggctctg agttcaagtc 867540
ccagcaacca catggtggct cacaaccatc tgttatgaga tctggtaccc tcttctggtg 867600
tgcagatata cacggaagcg gaatgttgia tacataacaa ataataaat aatctttaa 867660
aaaaaagaaa ctttaaaaga ctatttctca aattcctaaa ataccaaatt ttgggtttct 867720
tgggtttctt aatgaataa ggaacattta ttttgttccc ttctctctc cctccttgc 867780
ccttcttacc tagagtgagc acaaatggat cagatgaccc agaggttgca gtattggggg 867840

aaaacaagag ggcaaatggg aacaactctc catcccttcc aatggtggt tttaacctt 867900
ctagacctcc aagacctcg agaccacctc cacccacccc acgaagacca ggtatatatt 867960
ccagctttca gtgctgtttt aaaataatgt tcctttggtg ggaagggctg acaacacagt 868020
ctccagaagt tgcctatgtt agcctcaaat gcttcttag cccagctggg gtcagtagtg 868080
tgtactacca tgcttagtgt tcttaataa tgttctgttt gggaaactgat cgacagctga 868140
gtgtcaggtc attggtgttt tgtttaagta gaatctgta acataggctg gcctcaaacc 868200
tagaaatcct tctgcttcag ccctcttaag tgcctgggatt gcagatgtga cccaccataa 868260

ctggcttata gctttgtttt tacatttaa aacttgacca agaatgatct ttgcataggt 868320
gactaagaac tgtttttct ttaagtttcc cttccaggaa tgaagttcca tgtgagagtg 868380
ctttattatt aagaatgaaa atcatgtgia ttatataaag tatgaacagt acagttcagt 868440
tagattgaaa catctttatg tggttggcaa ctgtgacata tcttatagtt aaaaatttg 868500
tttcttagtc cttttatct tttaaaagc tgagtggggg cctaaagaaa aggactcaac 868560
agttaagagc aacaactgcc ttaaattccc atcaccaca tggggtttac taccatccat 868620
aactcctgtt tctcttctg accttgcag gcaccaggca cacatgtggt gcacagacat 868680

acatgcagge caaagacaaa atataagtga atagattga caaaaaatt gttttaagga 868740
tttattatt atgtatactg attctgcctg catgtatgtc tgcacccag aagaggcac 868800
cagatctcat tatagatggt tgtgagtcac catgtggttg ctgggaattg aagtcaggac 868860
ctctggaaga ggagccagtg ctcttaacct ctgagccatc tctccagccc ccatgctaaa 868920
aatttttga agcttactgg taaatgatga tcagtttta aacaacaaa aaaatcatta 868980
aatgaacata tttcatgtag taacaatata aacattatat agtagcattt atatagaata 869040
tctattttct gatcagtagc attaatact tatcaacaac atcaaaaatt agccttagac 869100

cttcagggtc acatatagaa ggcagtttta aggacctgga aagtgttacc catggtttcc 869160
tattctgaag gtttttactg ggctacaagt ttaggtcag tcagagtact tgcctattgt 869220
gcatgaggtc ctgtaccat aaaaatcaaa ctaagtagtt agtttatatt tttatgaatt 869280

gagaattata tatgctatgt aatttgatga gacctgtgta tctacatcat aggttttact 869340
 tgttatgtac ttttaaattc ttaaattaaa atttgatcat gatittagat ttcagaaagc 869400
 aaaagattct aatattttcc ctaaactctt catagcatct gtcaacgggt caccatccac 869460
 caattctgaa agigatggat ctagiacagg ctctttgcca ccaacaaata caaatgtaaa 869520

 cacaagcaca actacatctg aaggagcaac atctgggtta ataattcctc ttactatatic 869580
 tggaggctca ggccttaggc cactgaatac tgtaagtcaa gctcccctgc cacctgggta 869640
 agtaactgct aacatttgct ttcagctttt acatgtattc attaatttta aaaagatcat 869700
 gctacattct ttcattaatt gtcttttaag taattgattt ggggtgggga gtatggaatc 869760
 caagaaagt ttcattttt taaatactac ctcttcattt tttgggaagc agaaaaaaaa 869820
 ttgagctggg tatgttagca catgcctata atctcatcat ttggaagtct gaggcaggag 869880
 tattattatg agttccagat cagcttaggc tacaacatga gactatgtct caaaaacagg 869940

 ttttttgtt tgtttgttt tggtttttt tttttttatt tttttttta tgtgtgtgtg 870000
 tgtttcaagg cagagtgtta tatagccctc attgacctca aactcactat gtagatgagg 870060
 atagccttga actactgac cttctgctat ctatttctca agtgtgaatt acaggtgtgt 870120
 accattacac ctgaaaaca aaataactct tgaaggactc ctactatcac ccatagaaag 870180
 ttaatgaaag tcaagtaata acatagtcac gtgactaagt ggtgcttctc taggtagggga 870240
 aaaagcaaat accttttaa aatattttta ttataaaatc atcatagcaa gtaatagttt 870300
 aaactgataa attagtttca taatccatt ttaatttga cttaaattt ttaagaatt 870360

 gtgtgtgtgt gtgtgtgtgt gtgtgtgtgt gtgtgtgtgt gtgtgtgtgt ctactcacct 870420
 tctctgatg tgiaccacac gtggacagtg cttatagcat agaagaggac attggaagcc 870480
 ctggaacttg agttatagc agttcagatc catctgatgt gggttctgga tattgagcca 870540
 ctgttctctg taagaggagc aagtgttctt aactactgag ccatctcccc aaccttatt 870600
 tttacatta atactttgat caaattaaa gctcagtcag ggctaaagat ttagcttagt 870660
 ggtagaacat gtctagcgtg cgtgaagttc caagttttac cttcagtgcc acacacataa 870720
 atcaaaaaca aaattcatgt tcagggtcga gaatgccagc caaagttatt tggctgactg 870780

 gtaaattaat aaactcatag tgaacatttt aactacggtc acagattata cttattggta 870840
 acttaggcca tttcttttg gaaagctata tggctttta gttactgtac taaatagtgt 870900
 gacagaacct gacagagcca cttgaggag agattttgac ttggtctctt ttgttgggaa 870960
 ctgatcttaa tcaactgtgc agttcgaag cagggttaa gtagaagcca gccgggttac 871020
 agccctcaac aagacctac cccagcaacc ctctccctct aggtagaatc tgtatcctaa 871080
 aggttcaca accttccaaa agaatactac tagctgggga ccaagtattc aaagacatga 871140

gcaggatag taggtggggg ggcaagatag gaacggttta tatccaaact gtactacatg 871200

gcaagctaaa ttagaagatg gtttgtacta aagaacacat gatctggggc tgagagatag 871260

cccttgctac tcttgacagag ggtcggactc agccacctac agtggctgga aaccacccat 871320

aactccagtt ccaggggatt ctgtgccctc tctgacctc tgtgggtacc aggcattgac 871380

atggtgcacg tatacatgca ggcaagatac tgacacacat tcaataaaat aaatgttaaa 871440

aaaaaagttt ttaaggtatg gaacaatggc ttatcagtta agaacactgg ctgctcttca 871500

gatgacctgg ttttgattct cagcaccttc acagctgctt aatgttgtct ctacctctc 871560

tcttagggga tccgatgcc tcttctggct tctggttac taggtacaca tatggtatac 871620

aggtatacat gcagccaaag tacccataca cataaaaata aaaaatcaag taatggttaa 871680

aataacaagc tgtgagggtt tactgctatt ctcttctctt tggcaacaaa cctgctcaga 871740

aaactagagt acttacagtg gccagtctat aacctcacc ctgtaatac tgataatgac 871800

atgctttgat ttcagttttt ctagaatgta atcagaatgt tgcttttcat ttagctcagt 871860

ttttgagggt tcagggcatt gacactttct ttttctctca aattctcaag ttctgagtat 871920

agtttgatca gattgagaaa tttggtcttc tgggtggatg gtctggcttt aaaaatgcatg 871980

ttatttcag agcaaacact taggaaaaag aaacctcatt cactgtttgtg tgtgtcactc 872040

ttggggcttc ctctctctt tttaggtgat aattcttgc tgcattttaa ttctttttt 872100

ttttctttat agactaacag gctgattttc tttagttaca taagatggtc atttacagtg 872160

aaaagatgta gacaggatta aaaagccaaa ctaatacaaa atgctcttac tagtctttga 872220

tttgatatta aggtgggagc agagagtaga ccagcatggg cgtgtttact atgtagacca 872280

tgttgaaaag cgaacaacat gggatagacc agaacctcta cctcctgggt aagtgtatga 872340

atttaaaac aagtttatcc agaagaacaa attgtatcca taccagtgt tcctgtagt 872400

cctgctctcc cctccttcc tattttgttt tatgttagac acagactaga aagaagagag 872460

ctagagagct gactcccagc atgctgaggg tgttgctggt gtgactgatt ttgtttttgg 872520

agaccggagt gtcactgct atcccaggag gaactcagct tttcagcctt gcaagttctg 872580

gggttacatg cctatgttcc atactgtgac gaatgatttt ttgcttttaa catttctaat 872640

ttgaagaacc aaccacagt tcttattgtt tgtattttca tatctgagtt gttttccag 872700

ctgagagcca ctgaatttta aattagtttc tttttgtttg tttgtttgtt ttttcgagac 872760

agggtttctc tigttagctt tggagcctat cctggcacta gctctggaga ccaggctgga 872820

ctcggactca cagagatag cctgcctctg cctcccgaat gcttcgatta aaggcgtgcg 872880

ccaccaacac ccagctttaa attagtttct ttaagaataa tcatttaact aaataagagt 872940
 tataataacc aaacatggtg gcatttgcct gcagtcttag catttgggtg gtagaggctg 873000
 gagaatcagg atgtcatgtt agaggccaac ctgtgtttaa acctgtctca accctccatc 873060
 ccaggtaaag agttgcagtg cctgctatat attaagataa aaatccttgt tattaanaact 873120
 aatatatatt aaaaatcattg caaatggttg agaaaagtaa gaacatgttg gtaacatgg 873180
 tattaagcat ttaatgtgta tatcatataa aatgaaagaa aatacttttt taacccaaag 873240
 ggaatatata gcaaacacag ggagtgtagt ctctctgag gttgaagatt gctcaaaggt 873300

 taaggtgttc gctgctcttc taggggttgt gagtttgatt ctgagcacc acaccagcca 873360
 gtttacaac tgctataac tctagctcca tgggattcat ttcctcttc ttactctgtg 873420
 atgaccagca cacatttga catacacaca catacatata aatacaaatc tttagaaaa 873480
 tattgccagg cagtgggtgt acacaccttt aatcctagca cttgggaggc agagtgtccc 873540
 gacctgcagg acatcaacct ggggcaagag agtcagggat agggaatggg gtcaagagac 873600
 acagaaagaa cgaccacaag acaggattct gatcaagtgg caaactttac ttttctgaag 873660
 ctgacttatg tagtcaggat atggggaggg gcagaatggg ttgtttgtcc cccaggtgtt 873720

 agtgtaggca ggatattagg aagccacaca gaggatgttt ggctgggtaa agagtttatt 873780
 agtaagaggt ccagggaggg ttgcctaggt gacggagcct gtgggtggag gactgggtca 873840
 agctgtttct tttcttgagc tgaggttcta agagctgcta tatgtaaagg ttaactatgt 873900
 gccctgcaa gcatggccta ggatcttttg ccaagcctgg agatttggct cccaacagca 873960
 gagggagaaa gatctcttga gttagtatcc agactggtct acaaagcgag ttctaggaca 874020
 gcaaggctac acagagaaac tctgtctcaa aaatccaaaa gaaaagaaaa atattagtct 874080
 tgctagctat taactagcat taactaacc ttaaagaat atatacctaa aaaatgtggt 874140

 ttgacttgtt aaattagcag gtcatattaa gtgtggatga ggaactctaa ccatagtaat 874200
 gctggcaata gtgtaatttg aacctactat aaaaatcttt gcagatagat atagatcaat 874260
 atatataagt atgtggata tatattttct ttgtaatct tacattatga aataacttga 874320
 agaaaaaact ttgtgtctt gaaattatca ttttactaca agtaagtaaa aaggtagtac 874380
 agattgcttt ttctctgtg aaaatttctg tatataactg atgtctcca tgatgtttgc 874440
 aggagtgtaa aggtcagtg gggagaaaaa agaaaacttt ttcctttgag actctgaata 874500
 tgtattacat ttaaagact tcattgatat gtgtcacaga tttttaaag acaaaattgt 874560

 aaaagcttca aagttcagtt tataaatatg aatgaatgag ttcagataaa tcagaaagag 874620
 ctaaggatgt ggctcagtg tagagcactg ataagcgtgt gcaaggccct ggatttggtc 874680
 ctaagtacac agagaaaaat acttagtagt ttctccaggt aaaatttctc ttacatgttt 874740

ttccgcagat atttcttaaa ttagtgtcct cttttctggt ttagttggga acggcgtgtg 874800
 gacaatatgg gacgtattta ttacgttgac catttcacaa gaacaacaac atggcagagg 874860
 ccaacactgg aatctgtcag gaactatgag cagtggcagc tacagcgtag tcagcttcag 874920
 ggagcaatgc agcagtttaa ccagagattc atctacgggg taagcagcct attgatttat 874980

 tggttattgt aactaacaaa gatcttcagt ctttaagaac tgccctgatg tgtcatgaaa 875040
 agcaccacaa aggttacaga gtaggggtgc aagtcagttg ctgctgtagg taggtattgg 875100
 tcttgtgagt tigtctttt ctgtaggtgt taaaaataaa caaaaaccaa gttagagcaa 875160
 tttaaaattc atggacaagt ttggaagaa ttaaaacaat tctaaagtag aactgcctat 875220
 aactcactag aaaatttga tttctagtgg ttaaccaac ttaagtggtt gcatagaaat 875280
 gacagtgagg ttgaatcact gaacacttac tgatgaaact actgaccgaa ttctttggtg 875340
 tgttactcta ctgaagagtt ttcatctctt atagtaatat actatacatg tttatatcat 875400

 glatgtttat gaagtatctt ctttacaag ctggatgtga tgggttcat ctattacctc 875460
 agcatttggg aagttgaggc agatgactca cttgagctca agagttcaag gccagtcag 875520
 acagtgaag acacagctca aaaacaaaac ataaaaataa aagaaataa gtaaaactgcc 875580
 cagacatggt gglaaatggc tttaatcca gcactcagga aacttgggag gcagaagcat 875640
 tcggatctcc gaattctagg ccatcctgga ctatatgtg agttccaggt cagccaggac 875700
 ccatggggca gggtaggtg gggatagaca aacaaagaaa aacaaaatac ataatttctt 875760
 tcagactgat acaatgataa atgtattagt gctttccttg ctgtgtgatc tgggaatfff 875820

 gtaagtcata atgtatcaca gatctgtctg agaaaagtaa aatggtccat gccaaaataa 875880
 gttggtttgt tggagtagta tttagaacta aaccaaagaa aaccagtact gccagaggcc 875940
 tgaaaaacct ggcactctcc attgcaattg cctcagtgtc atgtgatctt ccctttagaa 876000
 tgcaccaggg taaaacgtct ttacttttat tccttagaca ttacctttcc tecatittec 876060
 tgctttttct ttaagtttt tatttttatt ttgtgtgtgc cagtgcctgg atgtatgtct 876120
 gtgcaccaca tgcatgact cagcagaggg tgcagattc caatgggtg gactgaaatc 876180
 acagctgcaa gagtgatcag tgttcttaat cattagecat cactccagac tetcttgag 876240

 ttttctccga tctcattgtt agaatagtta ccaattactg atgtgacaag ttcgtcttta 876300
 tatcagcagc ctctcttca ctgctttgtt atcatcaaga cccctttcac tctagtaagt 876360
 gttttcccca cactgcttc tggaaacgic actatattcc ccttcctagt gttacatagt 876420
 gctagggatt aaattagttt ttggtgtgtg tgtgtgtgtg tgtgtgtgtg tgtgagagag 876480
 agagaggggg ggggagggag agggagagca ctttcatggg ggtgattact gagagaggat 876540
 atgtagactt agaccttgca tttcttgtgg ctgccaacac tctactcagc ttcttgact 876600

ccccgggca tggatgtaca ccccttttgt gtccttagga acctctgtgg cagtgcacatg 876660

gtgcaactgct cataaagcac aaaggcacaat actctccaaa tcatgcacca cacaaatgtg 876720
gtgtgcttgg tgaggtgtcc ccagcactgg ccttgccetca gccttctccc cetctttatc 876780
accttctgtc agttagggcc cagtgtgtat gggggggcag tgcagagcca ttgttgctgt 876840
cttcaaggct gtcttgctg ccctagtctt ttacatttt attttgagac atagtttcac 876900
taaattccca ggetggcctt caacttgaga tcttcttggc taagccttct aaacaactag 876960
gattataagc ttgtgccagt catatcctgt ccattttctt tttaggctctg ttctgtggtt 877020
ttacatttta gtttctgtgt aaattattat aggcaaattt cttctaggta tggatcctta 877080

acttggccac tttttccaac cctagtctca catgaatctc caatggcttt ggagtccagt 877140
acatctagtt cctatccact gttactttga gtaattttgg atgagctgct taacctcacc 877200
aggaatcatt taccttttaa gtgaaataga catgcccttc attaccttga tgggtgtttg 877260
ttgttatctc tgiactccca actctcttct atagtttata tactatctta attttatata 877320
acttttaagt gttatataat attacatagg gttttcaaag atttttttt ttttttttt 877380
ttttttttaa aaaaaaaaa atttttttt ttttttttt tttttttta ccaaaaatag 877440
aacttttcta agtgtgagtc tgtaagaaaa tgttgtattg tatatagcag agaatccata 877500

ttggaattca tacatttctc ctgaaatgat gtatttgttg tgaattattt gtctaattat 877560
tcattttttt tattcttttt agaatcaaga tttgtttgct acatcacaaa ataaagaatt 877620
tgatccctt ggctctctgc cccctggatg gggtaaagcac atcagtttta atttaaagtc 877680
tgttatttag aagattggcc tagagaggca gcttagaatg ttggtgaaac gtgggcagag 877740
ctctaggttg agtcactggc actgcaaagt gaaaagaaac agatcattga tacaacaatc 877800
tggcaggacc tcagagatgc tgggtgcttag agaagataat ctgtttcaca agattgcaat 877860
agtcatgtta actttcgctt ccagtttcta ttactatcac caaatacttg aggcaagatc 877920

ctttataatg aaaagaggct ctgttgggga aatggctcaa gtcagaaagt tgttgccat 877980
gcaaacagga agatctttaa ctgaattccc agaaccagg taaaaagcca ggcatgatag 878040
cacatgtctg caatcccatg ggggttgaag agaccaacag atccctgaag ctcatgtgtg 878100
cagttaacct agtcagattg atgacctca ggttcagcaa gagacttctc tcaaaactta 878160
gggaagccag acatggtggt agatatataa tccattttga aaaatcccat tgttttctcc 878220
ttaaatacat gtatactatg ttggcagagt tttccatctg gactgcttgc tgatcagctc 878280
tgttccacca gctgctcccc aaataagctc acagagactt aattacaaat gtttgctgg 878340

tagtgcaggc tcatttttta gctagctctt gtaacttaaa ttaaccatt tctattgatc 878400
tatatgctgt cctgaggctt gtttacctca tctatgtact tttcatccgg ccaaagctgt 878460
cagaaaaatct gactcaacta aataaaggca gagggatagt cagtaaagtt gttgctgttc 878520
aagtatgaga agctgagitt actgigtgtt gccagacctg gataatcttg gagatacttg 878580
agaggatccc aggagtttgc tggctgacca ggctagctga atcaagtgag ttgtaggcca 878640
ttgagagact cttgtctgaa aaaaaccaag gtaactggta cctgagaagg agcacaggtg 878700
aggttgcct ctggactcat atgcgtgtgc ataatgagct tgtacatgca catccacacc 878760

cgctagtggg gtggaagaaa ggcatatgtt cagatgctaa gcttttgtgt gtgtgatatg 878820
acacagaaat tataaaattg tagtactaa gtggtcagct ttattttatc ttagtttgag 878880
gggaaaagac taitccagca ttaactactgt gttttcattt tgtttaataa agagaagaga 878940
actgatagca atggcagagt gtattttgc aaccacaaca ctgcaattac acagtgggaa 879000
gaccccagaa gtcaagggtg agaacttcat tgtatgtgtg gcttctagag attgcctacc 879060
tacttttgac tcatttatgt attctttcct caaaaacctc aagcactaat catctacata 879120
ccttggaaga agaaaaaaga ttgcttttat gtaatgaaaa gcttgagttt catgagaatg 879180

aggtgggaat gagttagtac gactcactgg ttttctgtt tctaaaccaa tagaattaca 879240
gaactaaaaa aatactcttg tgtttgtgt agactctcaa aatatgttta tgtggtatat 879300
ggtataaata tttttacatt ataagaactt gctggttaac atactaagaa atattatcac 879360
aagtttgctt ttttgatgct ttgatgacag tatacaatga tttatgttat tctgtgtacg 879420
aaagttagct aaggccttgt taaaaaaaaag accactcaaa caaaataatt ctgagccag 879480
acatagtagc gcacaccttt aattcacca ctggggaggc agaggcagac agatgtctat 879540
gagcttgagg ccagccaggg ctacatagtg aggcactgtc tgggggtggg ggagattgtc 879600

tgtttctgtt ttcaaaaaa agcttacagt ctagagttc tggaagctgg aagtcagaaa 879660
ccatggtgtc agcagactat atgcctctga tggccagggg gaagaggtgc tccagttctc 879720
ctaacctagt ggtccacttc ctctcttcc ctgtcttgtt ttctgaggtg aggtctctcc 879780
atgcagctct tgetgtctg aaactcactc tgtagcccag gctggcctca aactcacaaa 879840
gattcacctg ctctgcttc tcaagtgtg ggattaaagg tgtgtgcaa caccgcccag 879900
caaatagctt agcttatggc tttttttttt tttttttttt tttttttttt tttttttttt 879960
ttgagacagg gttttactgt ggctttggag cctatctga aactagctct gtacaccagg 880020

ctggcctcga actcacagag atctgcctgt ctctgcctcc cgagtgtgg gattaaaggt 880080
gtgcaccacc aacgcccgc ttagtttatg tttttaaagg tatgctttga atttgaaata 880140
cctgtttcta agtaccagca aatattaatt tttatacaa ctattatatt aacttaata 880200

tgttcacttt cataaggatg ataaagagct ttaaggataa aacatttgat tccccagtaa 880260
 aattgtatct gggctgcaca tgaagctcag tgatacagtg cttgtctaata atgcatgatg 880320
 tcagcatttg atatctaaca tcaaatccat ggctttgatc cccagtaccc ctgggtcagg 880380
 aatgaggatg tcttctcttt caagataaac tgaacaagtc acctttctgt cacttgttgc 880440

 tgctgttgtt ttgtcccttt tggacttgat aaagttttag agcttaaatt agagtcattt 880500
 catgaactag tgaccaagtt ctaccagttc atttgtttaa aatactttat ttaaaaagag 880560
 gtgcttatac cccttaatgc attaactat tgactgaata gcataggata atttaccat 880620
 accatagcc aatttctctt agtttgtttt taagacactt gggttattggg cctatctagc 880680
 acctataatc acagtggaag tgaataacct tttttatatt tttggttagt cttccctgac 880740
 atgtgatagg aattatatga ataagactaa atattcttaa cttttgata gtttgtaaaa 880800
 ttgatttaag gcagtgttct tctaaagtac acttgaagaa aacaacagtc caaactaata 880860

 gtgtttctct ataatagta gcttgactat ctccagatct ctgcttttct tcttgttga 880920
 tataaacttg catatttcca gtgttccctc ataccaagcc cattagataa gagacttcaa 880980
 gctataaaac caggagttag gggggagggc atagctcagt tggtaactct gtcagcctct 881040
 accttgcct ctgccactcc acctctctat gcctctgctt ctgctcttct ccacctatgt 881100
 ctctctgccc cgtctctctg ttcctctggt ctccccctct gccctctct ctctgacccc 881160
 tctgctctc tctctgccc actctgcta acctccctgc ccgctgggc ctctgggccc 881220
 cctcccctac ctctgggta ctgagataa agtcatgtac caccatct ggctgttgac 881280

 tacattttat agataaaaag cctgaagttt aaagttttaa gagttttcag gcataaagat 881340
 agatgttaag gaagaaaata gggatattc ataatgaact ttaagttgc cttaacagag 881400
 atgatagatt tgcagtgagg ggaagatgcc attcagaact gttacagata tgacttgttt 881460
 gagaacatga tcaactggaga aatctcagga ttcttgagag ggagtctaaa agagaaactg 881520
 agttaatgag aggtctgttt tatggagatg ctctgtcaac aagattgata ttaggcctg 881580
 agtgagtcta ggagcagcag aactatgtag gtatctgttt ggaaagtta gatgaagaag 881640
 accagaataa cgggtgggaat caaagacaga gtgggggatc ttaggtacca tggctatttg 881700

 aggtgagtca ttaagtagat gggagagtaa tataatagtg attcattttt aatgttgttg 881760
 atgattactt taatgtgttt gtagaatgcc taggtagaga tgtctattat ctgaaaatgt 881820
 aggaccatgt agattttctg aaagatttta ttctgtttac aggtatttat agtttctgtt 881880
 tttggcaaag aaacaagtct ttaatataat tgtttatatt ttctctgta ttttatagtc 881940
 aattaatga aaaacctta ccagaaggtc gggaaatgag atttacagta gatggaattc 882000
 catattttgt ggaccacaat aaaagaacaa ccacttcat agatccacgt acaggaaaat 882060

ctgccctgta agttttctaa acattactag ttaaaagcac aactaagttc ttggattttg 882120

acaaagattt cagtaagcaa agattggagg tgtgcttgag atgacttgtc cataggtctc 882180

tgaatactga atcttgttgg ttttatttgt ttatttgggt gtggggcatg gtggggaaca 882240

ggttctctcc ttaaagctct ggctgacctt gaattcactc tntagactag gctggccttg 882300

aacttacaga aatcatctgc ctttgcctct actagtatta aagaggagta ccactatggt 882360

cagcttaaga gttctttata tactggcagg agtcacttga tacattatga gaaaggcacc 882420

attgggtgag cattgaagac tatgctttca caagcgtaga tggattaagc ctgctatatg 882480

cctagactat atgcatgta ttacttagcc taggtatgat ctagtattcc taaaatcgtg 882540

atggcccaaa cacaagatta aataaagcac tggaagaaaa tgatgcaatc aagatacaca 882600

gtaagcacia agtgtgtgat gtttagcctg tataatatgg ctgcttcata gtaaaccttg 882660

ttgttgttgt tttgtttttt tttgatcatt tgagacagtc tgactatgta aatctggcag 882720

tntagaccgg gttggccttc aatttacaga ggtatctgcc tctgctgcat aagtgctgga 882780

attaaaaagt gttccttadc gtacttggct gaacttttta tgttagtaga agtatactct 882840

aaaataatga ttaaaaatgg agcactaagg gctggagaga tgactcaatg gtttagagca 882900

ctggctgctc ttccagaggt cctgagttcg attccagcaa ccacatggtg gctcacaacc 882960

atctataatg agatcttgtg ccctattctg gtgtgcagac agaacactgt atacataata 883020

aaaattcttt aaaaaaagg gggggggcgg cactaagccg gatgtagtgg tgcattcttt 883080

taataaccagc actagggagg caaaggcaag tggatggatc tgtgagttta aggccagcct 883140

ggtctacata gtgagttcca ggacagacag gactgttata cagagaaacc ctgtctcaag 883200

aaaccgatat atatatcagt ggggtgtgtga gagatgacac acaatgcctc agtgggtaaa 883260

ggcacatatt gccaaagcaa aggacctgag tttgatatcc gtgatccaca tggttgaagg 883320

agataactga ctccacaag ttgtectctg aactggagc actatggtat gagcatgact 883380

atacacacia aataaataaa taaataaata aataaataaa taaataaata taataaacat 883440

gttaaagaga gggagagctg ggactatagt tcagttggta aataagtaag tagattgaat 883500

tgttttttct ttttcatttt attggaagaa gattgagtac acttccagtg actaaatagt 883560

aacaaagga ttagaggtat tgctcagtta gaataatgca tgcttgcctg catgaagccc 883620

ttagttcagt ctccagtadc acatgatcc aggcattggtg gcacatgcct ataataccag 883680

catttgggag atggagatgg accaaatatt aaggccagcc tgggctacat aagaccttgt 883740

ctcaaaacia aagtacaaaa agattccact cagtaacaag agtactgccc tgcagccagt 883800

tatgtggttt tcttcatttc tcttcagat tcattgttaa tgtgtagaca tataactaat 883860
aatgtgttaa catattctga tactttgttg aatttctttc ttaaggaat tttcaatttc 883920
tgcataaag attttattat ctgaaaacaa atcattatgt attcccagtc tgcctccttt 883980
ttcttgccta gttattctag ctttaattcc caatactaga catccttgca ttgtttctga 884040
cctgatctta gagaggtttt cataccttaa ctattggttg taatattctt gttagatttt 884100
tctcctttct ttttaactaaa aaatatTTTT cactttgtgt ggtattgcac acctttaatc 884160
ccagcacttg ggaggcagag gcagacatat ctttgtgagt tcaaggccag cttggttcac 884220

atagccagtt caaggacagc taagactaca tagaaagatc ctgtctcaa aaaacctctg 884280
tgtgtgtgtg tgtgtgtgtg tgtgtgtgtg tgtgtgtgtg tgtgtgtgtg tgtgtgtgtg 884340
tgtgtgtgtg tgtgtgtgtg cccgcgcgcg tgtgcacgca tgcacaagag agacagagac 884400
agagaccatg gagctggaat tacagacatt tgtaaaccac ctaaccagtg tgttaggatc 884460
tgagctctgg tctctgata gcacaggaac ttcttaacca ctgagtcac tctggccctt 884520
tttgttatgt ttacacttga ttgttacatg atttcatatg ttgaactacc cttccattct 884580
aacaattcc atgccgtatg tgatataaag gattaaaaca tcaatccttt aatattctgt 884640

caaatcctt ttgcatatat atatgtatat atatatatgt gtgtgtatat atatttattt 884700
atTTTggttt ttcaagacag ggtttctctg tgtaacagct ctggctgtcc tggaaactagc 884760
tctgtagacc agcttgctt cgaactcaca gagatctgcc tgcctctgcc tcttaagtgc 884820
tgggattaaa ggtgtgcacc aacaccatgt ggcagctaat aatatttgac tgagaatttt 884880
atatttctgc atattaaaag cttgctgtt tacacagaaa ctgagaaatc agtccaatta 884940
ggcaccaatg aaaaattata gaggtaatcg agctgtgcca ataaattata agtagataat 885000
atagttacaa ttaagtttgg gtgcatataa cagaaagtcc tacaacaata ataccttata 885060

tttgaatagt agtatatttt tctacattat ttaaaaataa cctggaccag ataatgatgt 885120
tttctgttaa tcataaccac ctgtaactca agctctgtga gattcagtgc cctcttctgg 885180
cctcctctgg cacatactcc ctcccctaga taattaaatt taattaaaaa taaaagtgtg 885240
actcaccata aaaatagaat agcagaggaa aatgtatgac cattatgtct cagtagttaa 885300
gagcacttgt tgcacttggg gagaattcta gttcagtttc tgtcatccac atggcatgga 885360
acaataatct gtaaatcag ttccagggtg tccagttcct tctcagccct cgttgggcat 885420
tgggcactca catggtacac agtcacacat acaggccaac actcttacet cttttaaaat 885480

aagtcatgat cttttatga tccacttca cctgccgtgg aaatgttctt acctacgaaa 885540
ttacagacaa aagcctcagt cagcatcata tttaatgatg aagtaattcc tccacaagaa 885600
caagggtatc tatcagcatt actgcactc atcatcatic cggcaatcaa gtgtagaaga 885660

gacagctga gccagcgttg gctgcgcata cctttaatcc cagcactcgg gaggcagagg 885720
cagcgggatc tctgtgagtt cgagccagc ctggcctaca gagtgagtgc caggataggc 885780
tccaaagcta catagagaaa ccctgtctca aaaaaccag aaagagagag agagagagag 885840
agagagagag agagagagag agagagagag agagagagaa aaaaaaata aacagtcagt 885900

cagtctggag aggaggaagt catactgttt ttaagaatca tatgtagtga aagtaaagg 885960
gaatatagag aaaaccacta gagctagtaa atttccaag attgcagggt acagaatcag 886020
atggaattcc tcattgaaac accagacaga ggcttccggg gatctggagt tcttgttcta 886080
cagccctaga gcagggtttc catctcatt gtgcttgca tttggagaaa ggccacactg 886140
gaatgggaaa cagcaaaacc ctgaaccaat gtctcttctc ttttaaaat tgacttgttg 886200
aaagccccta cagcagttgt cattagaggc ccttagacag acccgaagtc tcacacacac 886260
actaggtagc atccactgg ttgaccgtga gtctcagtta aggataaaag gatagagtag 886320

taaatgtgat gggttacatt tttatgtagg agctctttta tccagccctg ttatattcac 886380
ctacatatag aaaaaactcc cctagcagta gcgtcaacaa gatttagta aaaatagtc 886440
tgaggaaaca ttcaaaacag aaaagagttg tattaggaat atgctctgcc tggttccttt 886500
gtatttgtct gcigagtaat gggcaaac aggggtgggg agtggctgtg tttgctttcc 886560
tgcagcattt cttttacaag cagttgcatg tgcattgta atctctgttt ttccagagac 886620
aatggaccte agatagccta tgtgcgggac ttcaaggcaa aggttcagta tttccggttc 886680
tgggtgcagg ttagtgttgg ctctgtgtct ctaaactctt ttgtttgttt gtttgtttgt 886740

ttgtttgttt ttctagacag ggtttctctg tftagctttg gagcttatcc tggcactcac 886800
tctgtaggcc aggttgccct cgaactcaca gagatccgtc tgcctctgcc tcccagatgc 886860
tgggattaaa ggtgtgcgcc accaacgcc agctctcttt cctcatttta cattgcttat 886920
gttataccgc ggttctgcaa atatgtattt acaagaaaaa tgtgaagcat tggactcatc 886980
catttttagg acaatgaaat atagtttca attagataat tgtatgcttt ggacacaaag 887040
attgagctag aaatcatttg aattgagaac atttgacttt tttcatcag tactattgtt 887100
ttcaagttgc ataatctag caacaaaata ttttctgata aacagattgc aattggcccc 887160

ttatctaggg tgtgtgtgtg tgtgtgtgtg tgtgtgtgtg tgtgtgtgtg tgtttgagac 887220
aggacaactc aaatagccca tagtggcttt gaacttaaaa tctcctccc tcagccttct 887280
gagtgtgca attataggtg tttgcctcag ccataactcc atgtagaatg tttgaaatgt 887340
ctttgataag tacacatgtg atcatttaca tacaatata tattcagtgt tttttctga 887400
tgtctaaaga ttttctgat gggttctaaa taaaatgagt gcattaattg aactattatg 887460
ttaaatactt aaattcaat ttttataat aactgggaaa cataattctg gattaaaaat 887520

tgaaaattaa agacttactt gagtccttaa ataaatactt tatatatctg attttcatac 887580

 tttacataca gagatctgat tttcttttta ctctcattga aaagaatcaa tgtgagtgt 887640
 gacagatgtg ttggcaatca tggatatacat tcatattcaa aatctgtttt tatttgcaaa 887700
 gttaaagta agtaaaaatt tccttttggg tttagctagg ccatTTtaat ggtgagagt 887760
 gatttaaat gtctttacat aaggagagg ggaggggaagg ggaactgggg aagtTggcat 887820
 gtaaaatTTt ttttcaaata aaaaaatatt tttaaattgt tcttacattt cagcaactgg 887880
 ccatgccaca gcatataaag atcacagtga caagaaaaac attgtttgag gattcctttc 887940
 aacaggtatt gtctcgttca ctcagtaatg actaccttct gatattgatg atttgctctt 888000

 aatagtttag cttataactt tagtgtttgt gtgtgtgtgt gtgatatgca tgctcatgtt 888060
 catgcaagta caagtgtgga ggccagagac gtacgtcggg gtctcactcc ctcaactatct 888120
 accttgtatt ttgagacggc acctcactga acgtggagct gacatttggg ctagagcagc 888180
 tagccagcaa accttagga tctgtctgtc tttgcccttc tggTgctggg gttacaggca 888240
 ctgtcacaac aaacttctac atgggttTct ggagattTga ccacgggtcc tcaagctTgc 888300
 acaggaagca cttactctc aagccatctc cccagtcctt attcttgatt tttcagttca 888360
 atttgttgc cagctatctt agtacattgc agttgggagt gtgcaaatgc tcttTgcag 888420

 ggTTTTctgc ttctcagtgt aaatgatgac tgagttTcaa gttctgtTc taagctgcta 888480
 agggTgtgat ctgaaatgat acacagtaaa attacaatcc gtcaactagaa agaggTctgg 888540
 aaatagccat gtgcacatgt gatgagtagg gagaagagtg aagagttTgt ttttacactt 888600
 Tgtattactt Tggattttt tttgataaac attTgtttct cttagaagta atatatTTa 888660
 agtaggaaag aaattagcca ttggttTcta agttttcatt ttcatcagtg aatgagtcag 888720
 ttcaactatct ttatactgca tacatcacta tcaagccaag tgcaattaag Tgttagattg 888780
 tcttagaata aagaaatgga atttttTaaa cagcatctTg ctggTctttg tcttactact 888840

 agatTggaa aggatggTtt tccagcacct gcagtacatt gtgataggTg ggtTcctgag 888900
 cactgaacta agctgaaagg aagaaaggTt caatccattg gcctTactg gctgcttcat 888960
 ttcaggaaga gttttgtTcc tttttTaatg gaaccttagt tattaagag acaagTcagT 889020
 Tgtcatcctg ctatatagga attaactgag gtacttagag aattctgtgt atactcatgg 889080
 cctgatgtat gtaagcctcc atggccatcc tcagcctagc gcttactcat tctagTcct 889140
 catactcatg attgtttttt tttttTgtca cttttttatt tttttcaatt acaactcctt 889200
 agtagctgta gtaacaagat gcagaccatg cttaagcaag ctttttatct ttatgctctt 889260

acaactaaag acitttgcag tgacttgatg atgtgctaga acatttaaaa ctcattgtag 889320
 atttgacatc caacaaataa atgggcactt gtaagagaaa atatggttgc ttaaaggtaa 889380
 taaatctgat atcaaaataa gatgtaattt aaaagttagc aacaggcttt cttcatagat 889440
 gttggataaa atigtgttaa atggigtttt ttataagcat agtacaactg tttatggtgg 889500
 aatgtgtaga agaaaaaaag tcccttccca ttagcacttg ttaaaggaa ttgttcaaac 889560
 tagttgtaac cttgtgacat ctctcaagtt ttagccaag tgcctagttc atggcacatg 889620
 taggggtgtt atcataacca tgcagtcaca accactgaac tttttgtag aactggctgt 889680

 actatittga gtgtccgtgt ctctttcgta gggaactgag agaacttacc aatcctcttt 889740
 ggatatttat taacagttaa ttcttatcat gtgataaagt atagatatca tatcaacta 889800
 tcccttgtag gccctatgg gattctcta agcagaatta aataattta gcgaaggaga 889860
 aacagattga cctatctact gtagctttgt aatgctgctg cccttgacat ctaaaaatga 889920
 cactgttacc caccactgt gggaggcaaa ggagtagttt tctgtataat tatatactcc 889980
 ctctgtgtct gtttccaaag ataagtaagt ctgcagccac tgttaattag tatatgtatc 890040
 ttttgactgt gaaacaaaat caaagctaac cagtctact gctcttcct atgttactgg 890100

 aattgaagga aaatacceaa tccatgccta gagttacttt gtactactaca caattgatag 890160
 aacaacttat aagtttcatg tagaagtga ataactgta taaaaatag atgcttatcc 890220
 taagtatatg aaacattacc ataagtatt tctatatatg tgtactatga attagattgt 890280
 aaacattctg tttcatgtgg aatttaagtt acctataatg gagtaagtgg aaagtgcag 890340
 tgatgtttcc acagttgcag ttacagttct ctactttgt tttgtagata atgagcttca 890400
 gcccgaaga tctgagaaga cgtttgggg tgattttccc aggagaagaa ggtttagatt 890460
 atggaggtgt agcaaggtag tgatatatga atactcagaa cttagtcctt tcttccaaag 890520

 gtatcattac actttgttca cagtgttatt ttctcaatct aatatttcag gaaaatgaca 890580
 tatagaaaac cattgtagct ttattatgct gcaactacag aatttcaaca aacattaact 890640
 tagtgccat tttctaagaa ctgctggttg atggcaccta catcattcac atgtctctca 890700
 gagtaactct atgggatagc attttacaga tgatgagatt tagagactta tetagggcac 890760
 ataagttgta gccagatgta agttttcatt ttctcaaca gtgtcagtca accaacttct 890820
 gtctgttcca tgtattacct agagccctga agtgcagt ccttctcact agaatactga 890880
 gaaagttgat agcgactcag ttcctacctt ggattgactt agtgcagaga acatagagga 890940

 ctatgagaaa attgctgaat gtctttgttc tgctctattc atttggagc aactattcag 891000
 actctagaag acatccttga gcaagagata gctttgctta tcccatgaca gtattacacc 891060
 agtttaaaat ttaaaactag gactaggcag aagtgggtgca catctttaat cccaggcctg 891120

gggagacaga ggcaggtggg catctgtgag ttccaggcca gcctggccta cagagcaagt 891180
 tcctagacag actccaaagc tacaagaaa cctgtctca aaaacaaaa aaataaaaa 891240
 ttattaacta gggccacatg atggctcatt ggataaaagt gctttctaca caacctggca 891300
 acttgagtgt agttacaaa acctacagaa ggagagaaac cagttcctca aaactcttgt 891360

 gtaacctcca catgcacaat atggcctttg tgtactatga cctgcacata catacataca 891420
 tacatacata catacataca tacacacaca cnnnnnnnnn nnnnnnnnnn nnnnnnnnnn 891480
 nnnnnnnnnn nnnnnnnnnn nnnnnnnnnn nnnnnnnnnn nnnnnnnnnn nnnnnnnnnn 891540
 nnnnnnnnnn nnnnnnnnnn nnnnnnnnnn nnnnnnnnnn nnnnnnnnnn nnnnnnnnnn 891600
 nnnnnnnnnn nnnnnnnnnn nnnnnnnnnn nnnnnnnnnn nnnnnnnnnn nnnnnnnnnn 891660
 nnnnnnnnnn nnnnnnnnnn nnnnnnnnnn nnnnnnnnnn nnnnnnnnnn nnnnnnnnnn 891720
 gaagaaaaac atatntaaa ctaagtaggt aataaaaattt taagcacatg actaatccca 891780

 gcactttgga gglagaagta gggaggatct agagttcaag tttagcctgg ggtacacgag 891840
 actcgttctc acctaaaatc aaataaaaat aaattacaaa gcagtagcag tgtggaaggg 891900
 caagaatntt aaggaaagc agcttgaata tttttattat tttgagcaaa tacctgtttc 891960
 tagattatta tgaagggtag aaatntttt ggtntttgtt ttgnttttaa aattcttttag 892020
 atntntttat atntnttatg tacttgagtt ttgcctatg tgtatgtatt tgcttggtgc 892080
 ccttagaggt cagaagaagg ggttgctttc ctggaagtgg agttagagac agttgtgagc 892140
 caccatgtgg gtgctgggaa ccaaacccaa ctctccgaa agagcagcca gtatagatag 892200

 atagccttgg ctgtctttaa ctcacagata tctcctgtc tctgcctgat cttctgaat 892260
 gctgggatta aaggcatgtg acacatgcc tgactgaaaa tactgtcttc aagatntttt 892320
 tnttaaatat gaatctttgt atatgctaac tggtagtac atcttactag tcaatntttt 892380
 tntaaagatt tntctgtaat tntttgtgta tgtgtgtgtg ggatggctac ttacacatat 892440
 gaccgaagt cttaggaat ccagaagaca gcattagatc ccttggacga aagttacagc 892500
 cagctatgag ctgcctgaca tggctctggg agctgaactc tagtctctg gaagagcagc 892560
 tgggttctt aaccactgaa ccatctctc agccagagta atntntnta gettaataaa 892620

 ttctaaaatg cagntaaact atntaaaaat acatgaagta atctgaagta ataaatgtaa 892680
 acaagtaata aataaaaata gtgtctgcag acagacactt agatcattta ggagacagcc 892740
 aaatcactca taatcagaag aatgccagc agtntntata tntgccacat tctcaccaaa 892800
 ggttgtgcgc taacaggaca agaggtctag gatacatgct gatggcgcaa tatattgggc 892860
 cagatagacc catccgtgtt acatagtggc cataacttgg tgtnttcaag tcaattagat 892920
 tagagcttca ggggtggctgt gagatgattg ttgcacaaac ctgtcgacca gagttcagtc 892980

cccagaaccc acataaatgt agaaggagaa ccaactttga ctctgaatt tatgtgcctg 893040

 tcctcctct ctctctcctt ccctctctgt cacagcaaga ataaacttct cagggcatta 893100
 ttctaataga tgagtggctg gaataagtgt tttccctatg aaaatgaggt gtttggcata 893160
 gtggctctcc ttaagtattc tatgagactt aattgaagat ggaatcagaa ttgtaattca 893220
 gctgctctaa ttacctgggc caatagtaaa ttttaaactt gactatataa aattttatca 893280
 actaacaatt ttcacatfff aatatctttg aagttagggt gcatattatg attgtgatta 893340
 gaaaaacttt agtgggcaat caagtaaggg tctttaaagt taatgatatc ttagatcctt 893400
 tgaaatttga gagcatataa atatctctgt taacataatg tagtttgaac agaatcaaga 893460

 aaaatcaaca agaaattaga aaagcattgc agttgaggca ggcagattcc tgacaactct 893520
 ataatgctgc tctgttattt gttgacttgg tttcctacaa gacttttcat cctgagtttt 893580
 cttttgattt cagagaatgg ttctttcttt tgtcacatga agtgttgaac ccaatgtatt 893640
 gcctgtttga atatgcaggg aaggataact actgtctgca gataaacccc gcttcttaca 893700
 tcaatccaga ccacctgaaa tatttccgct ttattggcag atttattgcc atggtaagta 893760
 caggtgtaac actgcactta ctcatcagc aataactaat ttttgtgat tacaacagat 893820
 tatgtgacag agtccccctc cccctttttt tttaatattt tttgtttttg tttttgagat 893880

 ggggtttctc tgtgtagecc tggtgtcct ggaactcaca atgtagacca gactggcctc 893940
 aaattcatag agatccacct acttctgcct cctcagtgct gtgatcaaag gcatgtgcca 894000
 ctaccacccg tcacgacaga atttaaaatt tttattttgt ctgctgggt gttttgcctt 894060
 cgtgtatgtc tgagcaccat gtgaatgctt ggtgcctgtg gaggtcagga gagggaatga 894120
 gatcctctgg tacctgagtt acagacagta gtgagtcacc atgtggttgc tgggaattaa 894180
 acctggttgt ctggaagagc agccagtgtc cttaactgct gagccatctt tctacctata 894240
 gaggttttag agaagtgagg tcttcatcgt gtgtgtgtgt gtgtgtgtgt gtgtgtgtgt 894300

 gtgtgtgttg tgtgtgtgtg tgcgctgctg tgtgctgctg cgtgtgctg tgcgtgtgca 894360
 tgagcacaca tatgtatttg cttgtttgtt ttgtttttga gggaccacct ccatacatag 894420
 ctttggctgg ctgactatc actgtgtagg ccaggttggg ctccagttcc tggagatctg 894480
 cctacctatg tcttggagtg ctattaaaga catgtgccac cacaccagc ctcaacaatt 894540
 ttttgaatgg aacacttate taatgttttg atgtttaatg acttttatat ggttatctta 894600
 tacagtattg cticcttctt gtataggctc tattccatgg aaaatttata gataccgggt 894660
 tttctttacc attctataag cgtatcttga acaaaccagt tggacttaag gatttggat 894720

ctattgatcc agaattttac aattctctca tctgggttaa gtaagtttct ttttacattt 894780
 attaaaatac aatccatgtg ctttcattgt ggtactagtg aagttttcca cattataacc 894840
 atgtcattgt tttatcgaat ttaaatgata tggacatcaa acctttctca tgttcagtat 894900
 gataaatttt atagaagtg accctaggtc ttaggtaata tgattctaata attctatttc 894960
 tttgaatttg ttgtcataat ttaagggtta ttacttaaat tcagaagggtg aatttaatta 895020
 aacttttgaa ttatgattga tatgtacata taaaaataa tgcctatttc aattgtgcag 895080
 agaaaacaat attgaagaat gtggtttggga aatgtacttc tctgttgata aagaaattct 895140

 ggggtgaatt aagagtcatg atttgaacc caatgggtgc aatattcttg tgacagaaga 895200
 aaataaggag gaatacatca ggtaagagca gtgtccctaa aaggaggcaa gaagagtgg 895260
 gcaaacgggg atggctcaac agtgaacagt acttgcttct cttccagagg acctaaagt 895320
 tgttcacagc actgacatca gacggctcac aaccatctgg aactctagct ccaggggatc 895380
 aacacttctg tcctctggac actaacacac atggcataca caacatacac acaaaaataa 895440
 atattctttt ttttttttt ttttttttt taaaaatga ggcaacgttc ctttgacaga 895500
 gtttagcctt tttgttaatg attgttaaat aatagttaaa aggtgatagt caagcaaagc 895560

 tcactaggcc tgtgtgtgtg cttgcgtgtg tgcttgctgt tgtgtgtgtg tgtgtgtgtg 895620
 tgtgtgtgtg tgtgttgggg ggagcctcat aatagatcag tagattaaaa acaaacgtg 895680
 agcctttaac gtgccaatca accaccttga ccaaatgct ttttctct tgtttttcta 895740
 cttgatactt ttgggtcaga gaacattctt taagatgaca ttctgtttg aaacttgtgt 895800
 tataagccag tatgtggtct gtcttttgca catatgtct tctatttctg ggttagttat 895860
 tgtcaagaac tcaaatacct aaaatataca cttttgttg cttgttaaaa ttgttttaa 895920
 agaaaatatt ctgaacaaa ataaaattt tatatgatt taactgttga aagatgtaga 895980

 taagaattga aatctggggc cgggagttgg tgggtgcacac ctttaatccc agcactcagg 896040
 aggcagaggc aggcagatct ccgtgagttt gaggccagcc tggctccag agccagtgcc 896100
 aggataggct ccaaagctac agagagaaac cctgtctcga aaccacccc cccccaaaa 896160
 aaagattgaa atctgcaaaa ttttttggta aaaagagttt aaagaaaata attcctcaa 896220
 aaaaaaaaa tttttttcg ccgggctttg gtggcgcacg ctttaatcc cagtactcga 896280
 gaggcagagg caggcggatc tctgtgagtt cgagaccagc ctggtctaca agagctagtt 896340
 ccaggacatc ctcaaagcc acagagaaac cctgtctcga aaaaacaaaa caaacaaaca 896400

 aaaaaaata tttcaaacat ggcattgtga tgcttacttg ttatcatagc cattgggaag 896460
 ctgagcgagg aggattgct tgggcttgaa gccaggctgg gctatgat gatttacagg 896520
 gcagcctagg ttacattgtg agacctctt tcaaaaaaaaa aagacgttca tgctactcta 896580

atttttatgt ctatctcagg gttttagaat aatgtttaca attttaattt tatatgtaga 896640
 acttaaaatc ttaacttctt aatacaattt ccattcttac ttgccaggat ggtagctgag 896700
 tggagattgt ctcgagggtg tgaagaacag acacaagctt tctttgaggg cttaaatgaa 896760
 attcttcccc agcaatattt acaatatttt gatgcaaagg agtttagaggt aatgagcctt 896820

 tcttttcttc caacacgcta gtgaatgcc tgggtatct attttaaac cagtgttttc 896880
 atctttctag tggaaattgt gtttttttac gataacagggt gtttgaaacg cccttaattt 896940
 atactgaaag aaagaagaac attacctgag aaaaaactgt tgttgcagct agagaggatga 897000
 caaagggtta tgtgccccgc ctgctcttca gaggacctga gttcagttcc cagatcccag 897060
 ggtaccaggc tgictagaag tgcacaaaca cacatataga caaacatcca tacacgtaaa 897120
 ataaatcaat aatattttta aaaagtctta acattagggt tttctgcaat tcagtaacta 897180
 tttctctcaa tatgagacc cacacatggg agctgtcctc cctgggtcgt gactaggact 897240

 ctgagtcaca tggataggac atgggggttt gggtttactg agacttgctt agtgtatctt 897300
 cagtcactgt ttcattggcag tcttatttag gagaaacaat tttggttacc taaagtaaca 897360
 acttgcctttt tgtttttgtt ttattcatal aggtcctttt gtgtggaatg caggagattg 897420
 atttgaatga ctggcagaga catgccatct atcgtcacta cactaggaca agcaaacaga 897480
 tcatgtggtt ttggcaggtt tgtttctaaa tttattttta tagacagaca cagtatacat 897540
 ttgttttatt ttttttttag aatttacc aaataagtgac ataacaaaat gtaaattttt 897600
 gtcctaaact gtgcattaca gtaatatgtt ataatgagtg agtgtgattt ttacagaatc 897660

 ctctaaagac tgttactgag taacacgtac cttgtacttt tgccagagta caagctaatt 897720
 tcagaagata tgattcattc atttaggggc tagagagagt tccattggta aagagcactt 897780
 gttcttgcag tggttcccag cactcatacg atgactcaca accatccata gccgtgtgtt 897840
 ctgcacatac atatgcatgc atgcatgcat acatacatac atacatacat acatacatac 897900
 atacatacat gtgctgcaca tacaatcagt aagtctaaaa aacttgtaaa aagaaagggt 897960
 catttatatt tgacatcaat acttctggaa tcttatggaa ctataaagta tggctttgat 898020
 cattgctact tcattaagaa ttatataatg tttggaagge agatttagat ctggcttagg 898080

 gttgtaggag acctctcaag aatgcctgc tgttgccggg cgttgggtgc gcacacctt 898140
 aatcccagca ctggggaggc agaggcagggt ggatctctgt gagttcgaga ccagtctggt 898200
 ctacaagagc tagttctggg acagcctcca aagccacaga gaaaccctgt ctcgaaaaac 898260
 caaaaaaaaa aaaaaaaaaa gaaatgcctg ctgtcaggct gttcagccaa taaagtctc 898320
 actgtggaag cactggtacc tgattctgaa caccacttg ggaaagcaga gccagagaca 898380
 tgctcctaac ctcagtctg gggaaacacag atagaagacc ctggggactc agtggccact 898440

ccagccagta agtgagctct gggttcagtg agagacatg actggaggaa aaaaaataaa 898500

 aagctggaga atgatagagg aaaattccta acattggcct ctgacctcaa cacgtactca 898560
 aaaatgcatg cacacaccag tctacacagg tgtgcaacat gtgccatcac cactaccagc 898620
 caactaaaag cataagattg agggcccaaa ataaaaaag aaagtaagaa agaaaagaaa 898680
 taatgaggaa aaaagaaaga agaaaaaga ttgaggcca aagagttggc ttagcctata 898740
 aaggcgcctg ctgccaactc tgctgacctg tgtttgaacc ctcagtttca ggaaagaacc 898800
 accttctgaa agttgtcctc tgtcctccac atgcactggg gctctcttgt gcacacactc 898860
 agtgaataaa aatcttaaaa tagccgggtg ttggtggcgc acgcctttaa tcccagcact 898920

 tgggaggcag aggcagacgg atctctgagt ttgaggccag cctggtctcc agagcaagtg 898980
 ccaggatagg ctcaaagca atacagagaa accctgtgtc aaaaaacaaa aataaaaaac 899040
 aaaaaatctt aaaaataaat ggggctggag cgagagccta gcaatttaga atacttgttg 899100
 ctcttgcaaa ggaccttggg ttggcttca atgtccacat tgtgctcaca aacatctgag 899160
 cttccaattt cagggaatct gatgttctct tggacatcct tcttggacac tgtacacatg 899220
 tggtttgcat acatgaactc aggcaaagac acacataaaa tgttactttt tttcattttt 899280
 tttattttaa gggaaactgac aagatggctc agtgggcca ggcacttgcc aacaaggatg 899340

 aatccctagg actcacttgg tagaatgaga gaacaaactg tggaaattgt cctctgactt 899400
 tcatatgcat tggatctac ctgttcacac acagccacac aaaaacaagt aattagaaaa 899460
 ataaacaggg cccagcactc aggaggcaga ggcaggtgga tctctgtgag ttcgagacca 899520
 gcctgttcta caagagctag ttccaggaca gcctccaaag ccacagagaa accctgtctc 899580
 gaaaaaccaa taataataa taataataat aataataata aaaaataggg tctggggata 899640
 tggctcagtg gttagaaca acacttgggt ctgttctaga ggacctaatg ttggttcata 899700
 gaaccctgca gtgactcaaa cgttcagggt tatttaatgc cctgacctc cacaagcagc 899760

 tgtattcaca tgtgcctacc tacaggtaga cacacttgcc tatacatcat taatataaa 899820
 tggctcctaa aataataaa aacaagtcac tgatgctcaa aatctttaa tctttaagga 899880
 tatacaaatt caaacccgc tagataggag tttgtacaca ttaggaaata ggagaggcat 899940
 accctttagt gagcatgtgg aaaacgtgaa accttcattt ctgttaagag tgtaatgtac 900000
 tgaatggga gatagtgtgg cagctacca aaaagttaac tgtagccagg ctcggttaacc 900060
 atatccctgt aatatacctt gggaggcaag aagattgatc aggagttgaa gaccagcctc 900120
 agctatatga gacctgtct taaaaacaag aggccagcat ggtggcgcac acctttattc 900180

ccagtgtca ggaggcagag gcaggtagat ttctgagttc aaggccagcc tggtttacag 900240
 aatgagttcc aggacagcca gagctacaca aatcttgat tgaaccccc ctgcccctc 900300
 caattaaaac aaataaccaa aacatggaca gtttaaatat acagttaaca tacatgattt 900360
 accagtttta cticaaaaga attaaacctg aagaccaag cagatattgc tgcattgccag 900420
 tatttatagg agtgttgctc cagcttacct aaaggcaaaa ttaacctacc tgcattttaa 900480
 tggatgagca aacaagaaat gatgagtaca ttaatggaaa tcaactagcc cttaaagtga 900540
 ataaaacaaa aaaaatTTTT ttaaatgaat ataactgtg agtatatgaa ttttgaactg 900600

 ggcatggtat ctcatgcttg taattatagg tctaagccca gtggctctca accttctaa 900660
 ctctgtgacc cttaataca gttcttcatg ttgtgggtgac tctataaaat tattttcatt 900720
 gctacttcat aactaatTTT gctactgtta tgaattgtaa tataaatatt tttagagatg 900780
 aagggttGCC aagggttGT ggctcataga tttagagagcc attgtcttag aggctaaggc 900840
 agagggatta tgagttcaag agaagcctag gttacttagc aacgtgtctc agaagtagga 900900
 aaaacatgaa tttgtgctg gaagtatcac ttagttaaca tgctccagcc cccaaattcc 900960
 atcataagca ctgaggctgg gggaggggtg tttagaggat aatcagggtc cagatgcaga 901020

 gcacttcccc tgctacaca ggccctggct cagccccctg cactgagga aaaaagcaag 901080
 ttttagggc tggcttggg gcacacatct ctaatctcag tctcaggaa gttggaggac 901140
 cattgtaagt teaaggccag cctagtctac atgatgagcc ctgagctgtc atccttctac 901200
 ctccaccac ccaggtgcat aggcattgtg tggTTTTTaa ataattgaaa agttatatgc 901260
 aaaaagcaact tcttaggtg tagaaattga ttgaggcgga atatgggatt gaggtaacag 901320
 gctctgagag tttgttttag gatgatgaaa aaattctcaa gatagttaat agtatggatg 901380
 tacctaagtc tgctgtattg tacacttaga attagtaaca tggggagcta ggaatagggc 901440

 tgagtctata atgtgcttgt aatcaaagtg tgcattgaa tccacagcac actcggaag 901500
 ctggacacag cagcacacag cttagatgcca gagctgggag gcagagacgg gagcatccct 901560
 gaggtgtcct agccatctag tatagctgag aggacaagct gcagggtcca cgagagactg 901620
 tttcaaaaga cacagaagat agatggagag acattgagga agacatttag gattgacccc 901680
 cagcctccac acacaggcat ttgcatctga acatacatgt gcactcat gtgactatta 901740
 catttgccc acaaagtaac agggcagact ctgttagggg tatcttacct cactcttacg 901800
 tgtgtgtgtg tgtgtgtgtg tgtgtgtgtg tgtgtgtgtg tgtataaatg cacatattgt 901860

 gtacagagat ggcatggttt gcatatggat gcagagaaca actttaggc atcaggtctt 901920
 tcccttctat caagtggctt ctgaggattg aacttagca tcaggcttgg tgacaagcac 901980
 ctgtccact gagccatctc actggtcatt taacacgatt ttaaaaataa aacttaaat 902040

gtcctctata catgtaacac aatttgtggt aagaaacaca aagatgagac cagcctggct 902100
 tacaagagtt agttccagga cagcctccaa agccagagaa accctgtctc gaaaaaccaa 902160
 aaaaagaaaag aaaaagaaaag aaagaaagaa agaaagaaaag aaagaaagaa agaaagaaaag 902220
 aaagaaagag aaagaaagac agacacaaaag atgaagctgg gcatggtggc acacactttt 902280

 ttttttaaag attttattta tttattatgt atacaacatt ctgcttccat gtatatctgc 902340
 acaccagaag agggcaccag atctcataac agatggttat aagccacat gtggttgctg 902400
 ggaattaaac tcaggacctc tggaaagagca gtcagcgtc ttaacctctg agccatctct 902460
 ccaacccccg tggcacacac ctttaatect agcatttggg agtgagagc aggccgatct 902520
 ctgtgagttc aagggcagcc tggctacag agtgagtcc aggatagcca aggctacaca 902580
 aagagaaacc atatcctgag ttgtccccct catctccca aaaaagaaaag aaactcaaag 902640
 atgaactgaa ataattgaca accagattgg tggctcatgc ctataatcct agcacctagg 902700

 aggctaaaac aggatgattt tggagtgtaa ggatattctc aagtatatag caagcttgag 902760
 atcagtctgg actataggtt ggccctgaac gcacagaaat ccacctgcct ttgccttctt 902820
 agtgcctggga ttaaagggtt gtgccaccac agcctggctc ataagacccc cccccTTTT 902880
 ttttttttaa aaatgactaa ataattgaca gtaaataagg gaacatatgc attataaaaa 902940
 catgtgttgc tcagccaaaa taagctagag gatataaaca tttgctagaa accttatatt 903000
 tctggctgca tgtggctaca aataacctaa gatattgagg aaagtgggtg ttgcatttca 903060
 taagcttaat ttgatttgc cttgaacca agagatttat tcatactaga cttttgtgct 903120

 ctgagtaacc acaggaacgt gctataggac agtcaagtct aagggggaac aggaaaggct 903180
 gccctagaaa aacagagcca agagccttca gagatcctat cctgaggtct agtaaaggag 903240
 gctgctgagg ctttgatggg catggataaa tttattatct ggtgttctg acacccaag 903300
 ttcatttaag atttgaagt atcatttctc tttcttctc agtgagctgt atataccatg 903360
 acttaacatt tctccttgaa tgtaatgtta acagtttgtt aaagaaattg ataacgagaa 903420
 gaggatgaga cttctgcagt tcgttactgg aacctgccga ttgccagtgg gaggatttgc 903480
 tgacctcatg ggtgtgtata aaggctctt tctgtagaga aggctgttga ctttctgcc 903540

 tttggatgat tgtatgtgca acttaccagg agcaacaaac aggtccacag ttgacctgca 903600
 ttttgggac ttggagtga ctttagttct tacctcagtg ttttttttc ctgttttgta 903660
 agacagggtc tcacgtcccc tagtctggct tcaaaactcac tatgtagcca aggataacct 903720
 tgaattcctg gccctctgcc tccatatgta tttttgtaa agcgtatgg tagaagatat 903780
 atttgaataa acaataacct gttctgttt ttgggtgggg ggaggactac ctcttttct 903840
 ttaactttt attttattt tttttttt agtacattag tgtttgcct gtgtgaagat 903900

gtcagatccc ctgaaacagg agttacagac agttgtgagc tgcctgtgg gtactgggaa 903960

ttgaacctg gtcctttgga agaacagcca gtgctcttaa ccactgagcc atctcttcag 904020

ccccacttat gcctatTTTT acgaatataT ttgagtttaa gaaagtaaat tetctctaag 904080

cactggaaaa atcataaagc atataggaaa cagagacata gctgggcttg gtggcgcattg 904140

ccttttatct cagcactcgg gaagcagagg tgggcggatg tctgtgagtt caaggccagc 904200

ctggtctcca gagcaagtgc caggataggc ttcaaagcta cacagaaacc ctgtctcgaa 904260

aaacaaaaaa aaagaaaaac aaaacaaaca aaaaaagcca cttgaaattt attaggaggg 904320

aagaatctgt gagaatgact gcctctgcca gggTggaaaa agggcatccc caaactaac 904380

aggcacaggg cttatgtagt gtttcttagg ggtggagctt tccaaggtgg agattttcag 904440

agtgaggatt ggtagatctt tttgtgctga gggattggtt gaatttcagt ccctgagttg 904500

gttgggacag ggtgtgtttc cttggctctg gtctcagggc caggtgttct ttcagtggcc 904560

cttttacc taTcatgtg gcaggtggct tctgctgtat tTcaaatct tctctgttac 904620

atgttaattc acatcactga ctgcttatct ctgtagctca aatactttaa tgaaccttta 904680

gtcccagcgc tggggaggca gaggcaggtg ggtctcttcg agttccagga caaccagggc 904740

tacagaaaga ctgattaaaa agcaaaaaag gggggTgggt ggggggagca gtattctgaa 904800

atgaatagaa gggagcatgc aaagtgaata aatgtctctt tagtatagaa ctccaccccc 904860

catccccca cccccgccag ggtttctctc tgtattgttg tggagcctat cctggaactt 904920

cctctggaga ccaggctggc ctgcaactca cagagatcca cctgcctctg cctcccgaat 904980

gctgggatta aaggtgagca ccaccaacgc ccggcagtat agaacatttt taacagctct 905040

tgttcataac catctttgtt tcttTatcct cctggattct gtgtgtaact acttgtgagt 905100

gttcaaacac aaaagaacta cctgtctcgg ttgttctggg tctagtcatt aggatacagg 905160

agctctgtgc atggtgcacc atacactggg aacattcagt gttctgtcag ttctagttea 905220

caaggccaac aaacagcacc cactagcagt cttttgacc accagtgaat gcttcctagg 905280

gagcaggcgt gtccttttaa taaagccatg cttggtgctg attaacacca cagctgtgtc 905340

taacaggagg gaggaggcaa gcatcattga gggTgagtat gtgtctaagg tggctgtcc 905400

aggacctgtg agcaccggcc ttatgctgaa tttgctggct gctTacatgt gtagagtttc 905460

aaCaattagg tatctgtgtc tatgtgggct attattaatc atggcattgt gctattctag 905520

ctaaggaatg ataaatagag ctgcagggtt tcttcttggT atttgtcaac aaaatgattc 905580

tcaaatttca ccactgtca gaagcaccg gaagcttgtt aaaatgtca cctaagctcc 905640

tgcccctgga gttgtgatgc agtaggtttg ggacaggtct gtgcatctgg ggttctgaat 905700
 ggcaatgctg ctgctgaact cggatgcata atgaagaact ttaaatcagc aatttcttta 905760
 tgcttttact gtgcttttagg gagtaatgga ccacagaagt tctgcatcga gaaagtggg 905820
 aaagaaaatt ggttaccagc aagccatact tggtaagcaa aatcagaaat acagaaaata 905880
 aactttaaca acttagcctc tggctacttg ttagaaatga attaattttt ccatatctta 905940
 acagttttaa ctgaggcaga atttatgtct taaaaataa attcccttcc ctcttttaa 906000
 aagattgttt ttatttgtat atgttgctgc atgaatgtat gtgcgcatg tgaatttac 906060

 aggtgttgtg agctacctga ttcaggtgct gggaattgaa ccctgggtcc tctggaagaa 906120
 caataagagc tcataaccac taagccatct gatagctcat attcccccc cccccittta 906180
 ttgagacagg acatagccca agctaccctt gaacacctga tcttctgcc tctgcttccc 906240
 aatgctggg attacaaacc agaaaactga cccattttga tccatgatat agttttacag 906300
 gtttgaagtt gtttagagc ctgacctca actcaagatg atctctttg tgccattta 906360
 ccattcatgc accttctca cctctcaaag tgtaaacatg ggatttagaa tacttgtacc 906420
 ttacttagta atttactgaa cacaagtatt gctctttttg gtttctttt tgcaatacca 906480

 gcaattgagt tcagccaggc ctttcacat tcaaggcaga cctctataac agagctatat 906540
 cccagacct tattttctgg tttaaatgc agtttaacct cattttcaa aatgtcccaa 906600
 actaaaaage aaccagtgtt aacctcaaat acagttcatg ttagaattca gtttgtgta 906660
 atcacatttg gattttaacc ttttcaggf gtgtgtagtt cagtgttaag tgggttcata 906720
 tagttatgta ggcacccctg tcatctgttg gctgacatgt gtcactaac acacacctac 906780
 actctacagc tcttggtgac cagcattctt tttatctca ggacttttga ttaattcagg 906840
 tcctttctca gtatggaac tggcccttct ttgcctggct tgttttactt caaatgatgt 906900

 gttagagtac atatcacctt tttcttctt ttattttact gattgtgat tttgtgtggc 906960
 attaggaac aaaaccaaca ctttatattt ttgttagct aacattttgt tgttgaacca 907020
 cagccccage cttctatta cttttaattg acacaaaata attgtacata tttttatgtg 907080
 acttagtttt tgagacaagg tctcatgaag cctaggetag ctttgaatte ctattcatec 907140
 tgcttctaat gcccaaatac tgaaattata gacataaagt atcttgctta actatttatg 907200
 gacctatttg ctcttcgaga ggacctgggt tcgattccta gcaccacat gatggctcac 907260
 aacaactata aciccagatc caagagatct ggttcacttt tttggcttcc actggcacta 907320

 ggcacatatg caggtcatag atatacgggt aaacaaaaca cacaggtaaa aaaaataata 907380
 tatatttgac aataatgtaa atagttcctt gggtttttaa aaggtggaat tgtttatttt 907440
 atctcacacc tataagaaca caaacaaca aacaaaaga tactgcctaa aactcttaa 907500

gctgggctgg agaaattccg agctaagagt agaacagaga aatgtagagg gagcgaagta 907560
 ttagagggtc attttctgat atttctttgt gttgtttatg ttgagacaag gtctcactat 907620
 gcaaaccagg tggcctcaga ctcacagaga tctgcctgcc tctgcctcct gagtgtctggg 907680
 actaaaggca tgggccacca cacctggcct atcacttctt attctaacac gatacaccta 907740

 aaaccttgta tagcctgcaa agtctaaagt atttcttttt ggccatttac agtaagtgtg 907800
 ataaccactg atctagagtg gttgttaggg cagcatgagc agactgtcat ttcctgaatg 907860
 ctgaacattg gcactgagct gtgtgctggc ctgactatct accacagggg tgggtgttgc 907920
 tatccagttt accagagaag gcacttgagt gactcttggg aaggttgaaa gcagttcctc 907980
 aaaggcctg atccagttc acattgtcag aactttaag tgttctgca gagcaactgct 908040
 cacatctgtc tttgtatcct tccttttctt aagccaacaa tcttattttt cagttttaac 908100
 cgctggacc ttccacccta caagagctat gagcaactga aggaaaagct gttatttgcc 908160

 attgaagaaa cagaaggatt tggacaagag taactgttga gaccttaggc caccagagga 908220
 cagggactca tctacagtgc ctgccccttc cttctctgcc tgttgccat cttattgtaa 908280
 acttggactg tgactagaga gttatctgag tgaagttaga ttaacgttat cactgagatt 908340
 tatcttccag taattctgga tttctactca gcgtcttcag aaagcagatc tacaacagtt 908400
 agtcagaaac ttacttaaca tgagatttaa cacatgatga gatctcctt gtcttattct 908460
 actagattgt tccttaaca acagttttct gtgggtgcaa agtcccactt gggagtgggt 908520
 ctcttgggtg ctgttgtaaa gattctgcag acacaaggga catctccaaa gctgcaatac 908580

 acaaggtctt cctggtaaag cctctagcta ggaggcgtc gacaccagtg caagctcagc 908640
 cccgcgccgg cacttgagca attgccgtt gtgctctccc tctcatctca gcctggcctg 908700
 actgttgttt tcatccctgg agcatgaatc agtgcgtcag tgcgtcattc tgacgttatt 908760
 cctggcagtg acgcaggact cacatctttg tacaagtag ttttgtctat ttgaattcag 908820
 ggaaacttgg tccccgcca cacatgactt catacctctt tcattcagt ttataattat 908880
 tttattgcct tgcaatact aaactttaca agcagtatca gcactgtgggt tccttccat 908940
 tttagaagtt aacctaaaat taaaattatt ttttctgaat tcatctaaga tcattcttga 909000

 tttttaagtc ttacacataa attgaagctt tafggtttta tcataatcta atacccagt 909060
 tacatttcta aaccgttggg accatttcta atccaaataa aggtcagtgg tgcagctttt 909120
 gaagtcagga ccatatcaac aaaatgacag tgcccagcca cacctgtatg ctgtctttac 909180
 acttctgcca cacacaggag caggtgtccc atcttctcac atggctctga tctgcaatat 909240
 ttttctcacc cctaaaaaca ttagattttg ctttttttct tcatgacttg tttatttcag 909300
 actgctcctt tagtaactga tgaatgcaact ttgactttct ctgtactcag tttcccttgg 909360

ctttgcttag actgtcagga tggctgctgc catagatag acttcatgag cagtgaaatg 909420

aagcctcagc catgtgagtc cctattatag ccaaatcccc caaaagcctt ataacacaaa 909480

cagggacttt tggacacatg tcggtagcat agcacgaaca taaagcatga agccaagaac 909540

acacagagag tgacaaacct ctgttccata gaaagaaag tgtttctctg tccttagctg 909600

cttttctgt tctcacctg gaacattttg aattttgtca gctgtactct aacctgcca 909660

tcggtggtea ggggagactc tcgtgactga ggaagggttg cctcatctag agaccatcag 909720

tgaaggaag ctacgcttct cccagccctc ttttctctgt gtataccaca gaaatacat 909780

gtcatctcta gaagccctag ttatctccaa agtaggaact ctctgccttt ttgttggtag 909840

ggttaaaata tatatatata tatatatgct attgctttgt ctttcagagc gaatgtctgc 909900

caactacca ttactacat aggcctggac ttaatatat ggctataaat actaagcctt 909960

ctacaaagac ctcccattgg atcaaatctt tgtactaaaa tgtagtcac taccatatec 910020

actagagatt tatgaaatta aattaagaaa taatgtaaga aaataggctt tgttgattct 910080

gcataatgct tcatgattca tttaggacc tagagatatt atgtgaaatt gtataaatat 910140

cacccaaaag gctttctgcc ctatatTTTT aaaatacaga agttatattt gaagtagtec 910200

tggccctagt tctatagggc ttggctattt aatattttta tggaagaaat gtttagttct 910260

ggaaaaggta aatgcttcta tatatttttg cagccctggg gtctcccaac tccatttctt 910320

cctttaattt aattgatcac atgtatatgt cttccctgct gtgttaggaa aatggggctg 910380

gatatccaa gaatcagaga ttatataaaa taatgcaacc aaacagcaga cataaatatt 910440

taccaaagtc tctcacattt tggctcagag tgagtatttg gaaatagatt tactgtgttt 910500

aattagtgat tttccttaaa tccagactaa gttgctttta agaccttttt ctctgtaagc 910560

attgtaaatg ctaatcaatc ctgttaagtt ttttcttac tgcatgttac attgaaataa 910620

aaacagagta cagtgagcat ttgccttttc ttttgctctt tgggtgggtc cacagcagag 910680

tcaagaggga aggggcttgg gtatttgatc agatgaagtg atttaaagcc aactgagcag 910740

ttggtagcag ggacctctgg tgtagaagca tttaaattta gaagtatttt aaataactct 910800

ttaaaattca ggiacttttg tcaccaaagg atccgatcat ctgcctagaa gctctcactc 910860

taaatgactg cctcagtcaa gccctctgtc actctttact tacttgggtga aattacctga 910920

aatgtttttg gggtaactca tgtttgggtt ctaaatfact ttcactactt cagtggggta 910980

tcatgggtat ttccagccgc cacccttctt ggggtgactt tggactttca agtgtctgta 911040

tgtgcttcca tcaagtcaac cagggactgg cacccttccc tgtcccttcg atttcttaga 911100

ctgtgactta aaatgattag gtagctacac atcacagga ggagattgcc tcaacttggat 911160
 ttccctaaaa gatgtaagag tgtttataat aattaaagtt tttttgagtc cttcgtttta 911220
 cacacttccc tgttgttttt gttaggaaaa tggcatgtag gagagccttt tatgtgactt 911280
 ctttagagtt gcacgttgac agcctgcctg ctgtgaggta taggaaatgc agatctgctg 911340
 ctcacctgtg gctgggtgag gccatctgcg gggccacagg gcctcctgcc tcctactgca 911400
 gcagaagtgg tctgaaggag agagggctca gtcagtcaag ggcttgctgc aaagcatgat 911460
 ggacccttgg agcagcacta ggacagtga gacaggccaa tccctgaagc ctgtggccag 911520

 ctagacagcc tagctgatta gataaattcc aggttcattg agaccctgtc tcaaacaca 911580
 aaacacaccc actgctgagt acgggtggata gtgtcacact catgaccaca ctggttcaaa 911640
 ccattgggtc acaaagcaaa cacttaagac atgacagtgg gatggagagg gtgggatggg 911700
 tacgtgtgac cagaatgcat tgtatctgtg catgaaactg ctagtaagtt tttaaagtgg 911760
 agccaggctt ggigtgtcat gcctttaatt ccagcactgg agaggtagaa actagcaacc 911820
 tctgggagtt ccaggacaac tggattatat accttgtctt acaaacaaac aaaagtcaaa 911880
 cagctggaga gataagttca gtggtaaga gtgcttgcac cctagtgatg gtggcagtga 911940

 acgcctttaa tcccagcact caggtagaga caggtggatc tctgagtttg aggccagccg 912000
 ggactacaca gagaaaaacc ctgtcttggg aatcaaaaa agaaaaagaa aaggtactta 912060
 ctactctacc agaggatcaa aattcatatt ccatgcccat caagggcagc tcctgtcac 912120
 ctacgactct agtaccaaga gatctgaggc tgcttctgac ctccatgaga ccaggcgtgc 912180
 acatgatgca catacatgca gggtaaatat tcatttattg atttattcat ttttttcaa 912240
 gttaggattt ccctgtgtag cagctctgga actcgctctg tagaccaggc tggccttgaa 912300
 ctcacagaga tgcctgct ctgcctccct tatgctagca ttaacagcgt gtgccactac 912360

 tgcccacaag attaaacatt cataaatcaa tcttttttct tcttctaaaa aagactgacc 912420
 aaactccaca agtctgcctc ctcacccatt taagaatacc tcattagaaa tccaagcgtg 912480
 agcattgggtg agatgattgg aggtagagcc aagcaagcgg tggatctgag attaatcca 912540
 gggccactga gtacgaggag aaaattactc ccccaattg tcctctgtct gtcacagact 912600
 tgtcctgtgg cattcaggag cccacatcta tacagacaat gtttagaaaa acttgataa 912660
 gtttgcaaaa ttgctcattg ggtaaagata tttgccacac aacctgatt tcaaccctg 912720
 gagcacatgg aaaaggtaga aagatcgaac caatcccact ggttgtgctc aggcctccac 912780

 acataccctt aacatggata ccacacaact gtttagggaa ggagagagga tggttgtgct 912840
 tcctttaaaa cccgaaccgg cagagggaaa cttcaggaag tgggtagaaa ctacagacc 912900
 ctcttaggtt cttagaaggt ctgttgctcg ctctgtgagt ggttcctggt catccaagag 912960

tggctttatg caatagggtc tcctcagaac ttcagagaaa taactagaaa atttacagtc 913020
 atgtcttttag gtcactagac agctatgcta ttctttttcc tcatctctaa ctcagacctg 913080
 ctctatttga cttgcctggc atagtaaaaa ataccacacc caaagtgaca tcacttcaga 913140
 ctatcaatat ttactactat gtgctagtcg ctagtactg actatactac acttagagag 913200

 gaatgatcta aagaaaatag tccaaaatat taataacatc caaagaatta aatggagtgt 913260
 tcaaattaga atctaggatt ttttttttaa actccagaat ccttttatac tatattgcaa 913320
 ttacaagctg agacccttct ccactggcag ctccagacatc ctgtctaate agacttccaa 913380
 gtcttagcag ataatgtct ctgagtctc accacagctg ccccatcctg catccatctg 913440
 gttcgtgtgt aagatgagga tgatgatcca tgctgagcta attcctggga tttttaggga 913500
 tcctctggag gtgagttata cgcctaattg ttctagcatt caataacat ttgtttgtt 913560
 tacatTTTTT tttttgaaa cagtttctct gtgtagcct agctgtcctg gtacttacag 913620

 gctggcctcc agatcagaaa tcagcctgct tctgctgcc ttaagacgtg tgccaccata 913680
 cccggcacca ttttttttt tgatgtgttt tgccttctg tatgtatgta cccacgtgtg 913740
 tgcttggtac tctcagaggt cagaagaggt catcacatat cttggagtgg agctatagac 913800
 gactgtgagt tgcacgtgg gtgctggaaa ctgaaccag gtcctcagca agagtaccaa 913860
 gtgctcttac taggtgagtt cccctttag tgggggatcc tgcagagcac tgcacttagc 913920
 tagcttgaat tctggaatg taccacatag gttttttaa aaaaaacctt aaaaaaaaa 913980
 caaaaaaaaa caaaaaaaa aaaaacctt attcagtgct tttacatca tgcacttga 914040

 tcccactcac tccctgtcc cttgtccct tgcacttcc ctctaccct gcaaccactc 914100
 ccagtaaac acaatttaag aaaaagaaa gaacaaaatt aaaaatctc tctggaagc 914160
 cacagtatga catagtcaca cagtaaatcc ctttgcctc gcaacctgg caagtgtca 914220
 tttcagtc tggctgtgtt ccaggcctc ggttttact acattactct atcaatgtt 914280
 gccctactg agactctct tggatcctc gttgttccc tgtgtcatgg agatcctgca 914340
 gctttgggc tgaagatctg gtccttccac gtatccagta gatggcagat ggggtggatg 914400
 ttggagcagg ctaagtcta accctggtc tgggcctggg cagctgcagg gttggtctga 914460

 cctccagtc tccctggcc tcaccaccag gatgggctc ccagcattg tctggcta 914520
 ttacccttg aagcaatgag ctagggtgg ggcataatc cctgcttca tgcctcaact 914580
 tggaccatac aggccagctc ttctgtgtt cccaggccag gtgaagggc cactctcca 914640
 agtgctgaag ctggtgagg gcaggacag cctccact gttatgacc cggggatagc 914700
 tcctccact gcctcagct ttgatgtca ggggttgaca gggagggcaa gcataaagg 914760
 aacggctctc cttgcttga cagacacatc ggtgtcacct aggctttta ctggcgtttg 914820

tgaagctacc ttttgtgata gttaaccttt agtttgagac gtttgattct tatccgaatt 914880

cttcatgaag gggttagaac ctgactccag gctcactact tgccagtgtt ttaacctaag 914940

ttttctagaa accaatgttt tccgtaaact gtaagagttt caaaccttca agacaggact 915000

gtgggaaaat ggggccatt ttacaggcga gataatagta tggcagagat gtcaagaata 915060

ctctccaaag aaacacagga gtgcgggggt cagcaatata atcttacagg cgcagggcag 915120

tctgccccg ttgateccgg agcttgctcc tgagggtccc aacttcgggg ctgcccgtgt 915180

gctcagctca ttgggctct cgtctctgca tccatgcggg ccaaaggag tttccgcgac 915240

ggtcggcctc cgccccggga cccggtccca cctgaaagc agacgggag acccggcgcc 915300

tcttccgac tgccgctgcg gcctccgctg gctcgcgtca gcccgcctt acccactggc 915360

tctgatagg ctgccccgagc tgtccgtctc ggccaagagc tgtgcgagg ctgagaagg 915420

cggggaacte gctgagcgtc ggcgcctnnn nnnnnnnnnn nnnnnnnnnn nnnnnnnnnn 915480

nnnnnnnnn nnnnnnnnac cggaagctgg tgtgtgagg gacgccgagg agaccgccc 915540

tcccgtttgc ttgccttggc tctggggccg tgttggcgca ccctagccag gctggagcgc 915600

tgccccgggt ccctagacg ccgtccctc gcgtcttcac actcggagcc cggaggcagc 915660

cgtgtgggac tccaactcgg acccaccggc ttggcgccg cctgtgggct gtttgggtgg 915720

gaccggcggg cccaccctgg ggcatcctag agecttctc ccacctgacg agttgtgac 915780

aagttaaaag gccttttcca gcgttaaagc agacctcagt ctcagggctg gcatgatggt 915840

gcacgccga agtcccagct ctgggaaggc cgggatttgc acttcaggc cagccggagc 915900

tgtaaacacg aggccgtgct gcaaaacaaa aacttgaata gaaactgtt tagtttaatg 915960

tgtatgaata atgttttgc tgcatgtata tgtctctgca ccattagggt gcctggagct 916020

ggcagccctg aagagggggt cggatcttt ggacctggat ttacgatgc tgtgagccac 916080

cgaattgggt gctgggagtc aaattagggt cttttgggaa agcgttcagt gctttaaat 916140

actgagccat ctcttcagcc cctcgaaac tataggaagg aaactataca taagaaactg 916200

acaaggaaaa cagaaagcac tgtttctcaa cctatgggtt gagaccctt gaggtcgcac 916260

atcagataca gcaaaatgaa ttatgaagta gcaatgaaa taatttgggt gtgggtgtgt 916320

caccacaaca tgaggaagggt tgagaaccac tgacctagag gcaactactt aggcacattg 916380

tttttatttg ctgtagctac cattgactat tcaattgggg gttctatgtt tctcattaca 916440

ccacaaagaa tgictccaca ccatcaaac agtattgctt cacgtttgtg taacgtatc 916500

tttcaaga cttactgtg aaaacttaag ggactggaaa gatgggtca gccattatga 916560

gcatttgaag atgggttcag ttccttccca gcacccacgt gtctgcttac agaggctctgc 916620
aactccaatt ccagatctga tcatttcttc tggcttctgc agggctctac aggcacatgt 916680
cacatatgtg tacactctag cacacataca cacacacata aaatatataa tttaaacatt 916740
ttaatagcat atttacagct ttaagaaata gatttcagtg gaaaataatg tttctcatcc 916800
atccctaacc ccagcttcag tctccttcag gaacagccgg tttcttgat atttatacac 916860
gcatgtgat gccttgttt taatactgaa gtggtagctt tctatgatga gtactgtgct 916920
gctgtttgca ctcataaaat cattacatat ttagattaac aaatgaactc atgcagcact 916980

gtcatacata gtctttaaga agtgcatgtg ctcccttctt gacagtggg tatgcttctt 917040
tctggatttg tttgggtgtg agggactctt ttcctttgtt ccttttatag cccaagctac 917100
ttcaatttgc catttaacca aagatgatct ttgaactccc aatccttcat ctaccttctc 917160
agtgtcggga ttttggttat gtgccacat acccagcaac attattgat tgatagataa 917220
gctgcttatt gcacaagact agaacagttt atgcatgtt gccatacagt ttcctttatg 917280
ataaatataa acatgcttat tctggtctgg agccatggcg cagtgatcat gaggacatac 917340
tactcttcag aggatcggag ttaggttccc aaagctcaca actgcttgta actccagctc 917400

caggaaacca gcacctctt ctggcctcct gggtcactat acttatgtat ataaacctac 917460
acacataaag gtatgattac aaaataataa ttatatataa catgtataca tactcatatt 917520
ttcactcatt tattctctgt tcacttaaaa atatctacca ttgccaggca tggtagctca 917580
catctttact accagcactt gggaagcaga ggcaggcaca tctctgagtt cagtgctaga 917640
ccctgtctca attaaaaaaaa aaaaaaaaaag gcgtaatgg cgcacacctt taatcccagc 917700
actcagaagg cagaacagg tggatctttg tgagtttgag gatcagcctg ggctataaag 917760
ccagtttcta gacatctagg gctgttacac agaaaaactc tgtctcaaaa aaacaaaaac 917820

acaacaaca acaacaaca caacaaaaa cctatcatt acaagggct gtggatttga 917880
accctaggat cacactca cactcattc aaacacacac acacacactt tttctaaacc 917940
tacttcatt taaggctgca tagtagtgc ctatgcecat gtattcattt agtttacagt 918000
ctcttctcca gtgctaaagt aaactgcect tgtttcaaca ctgctgccag tgtttcaca 918060
ggatagtgtg tattgggtgg aactccttgi tagtacaatt acataaaatc atccatactt 918120
tgtgttcatt ttttctcca ctatgtaata gagaaaaaac aacttttaa actttttttg 918180
gttttttgag acagggtttc tctgtgtagc gttggagctt atcctggcac tcgctctgga 918240

gaccaggcct gcctctgcct cccaagtgtc gggattaaag gcattttaa agccaacggc 918300
cggctttttt aactattatg tagtaagtaa aagtaattta tcataaagat gatataatga 918360
cattatgctt tggacattaa ataaaaacca aatatgaaca tcttgaaaga tacaccagtg 918420

aaaaaagaac aggaaagggg gaaaacagtg ctgagttctg ggattaaata tgtgcaccac 918480
 catgcccaaa catgggtgta ctaaaatttg gcaaacatt tccctggggt acaagctaag 918540
 ttgtttccag ttcttaagtc aaagtcataa tgctatggtc tataatTTTT gcttgttttag 918600
 attatttctt tataatgata attttcaaaa tggaggcaaa aggaccagc ccttaagagt 918660

 ttttacagtg tattgtgttg cttccctggg aggttattca cctcaagagc tttgacttaa 918720
 tgagaccaac attaaaaaag tgctgcattg ctgaaacttt tcattcattt acaaggaata 918780
 atggctcttg tatataggtg tttgtaattt atcttagatt tgttttctac ctctcattgg 918840
 acacattatt ttccttaate attttatgta atatTTTTaa agttattttc ctgttaaact 918900
 ttgctatact aaagataaaa ctcaaggtca catgcctgct gggctatgtt ctgtcatcta 918960
 cctttatTTT gagacagcca ccttacgtcg tagctcaggc aggcctttaa tgcactgtg 919020
 tagctcagac tggcctgaac ctcatcagtt ttctaaatg ctaagatact gagataccgg 919080

 gtgtggtggc accagacccc acaaatcctg acctttattg gtgcacatac atctaactag 919140
 agaacacata acctgcctc ctcttcacct ctgtatagag tatatttatt tcacataate 919200
 ataagctaaa tcagtttaat caggggtgat agagatgggc tcagtagtta aaagtatttg 919260
 ctactcaacc atgagaacta atctttgaac acttatgttg ggcagttcac agataccttt 919320
 aacttcagac agctcaaggt cctgatgcca tctttggccc tctgcatgca cctgtgcaca 919380
 cagatgcata tattctcaaa caaatgaate aaagattaaa aacaggctac ataattaggc 919440
 cgggtctcca cagacaaaa aataagaaaa tatcaagagt ccagggcaga aggaaagcca 919500

 caagtggag gctgcctgg gccataaagt gaaagtcttg cctcaaaaca aaacacacac 919560
 acaaaccagt aacagactct tagttatTTT tctagtgtgt gaagaaacac catgaccgtg 919620
 ggaactcata aaagcaagca ttaactgggg gcttgcctgc tgcctcagtg ggttagtcta 919680
 tttctacat catgggagga agcagacagg catggcactg aagcagtagc tgggagcttt 919740
 acatcctgat ccacaggcag tgagcaagcc aagccagaca gacagacaga gggcctggca 919800
 tgggtctttg aagtctcaaa gcctatctgc agtgacacac cttcaagttc acaccaactt 919860
 ggaaacaaaa gattcagcta actacagaac ttatagaaga cagtgtttga tttgggcttg 919920

 tggtttcaga gggttagagt ccgtgatggc tftgcaaagg catggcagca ggaactactg 919980
 tgaacttga tcttcatctg caaatggag gcagagagac tgggaatggc ctgagtctct 920040
 tgaacctca taacattata cctccaaata ctccaaatat tcacacatag gaggcctacgg 920100
 ggccatttta attcaagtc ccacataaac atgttatcta tctttatta ttatgcagtg 920160
 ttctgtctgc gtgtatgact gcagggcaga agagggcacc agatcccacc atgtagtgc 920220
 tgggaattga attgaggacc tctggaagag cagccagtgc tctcaacctc tgagccattt 920280

taagaggttg agtatgggtc tgtgggaagg cagaggcagg tgaatctctg tgagttcaag 920340

 gtcagcctgg tctacagagg agttccagga cagccagggc tgtacaaaa caaaaaaca 920400
 aaaaaacctg ttgaaaaac aaatgatact gaatgtgtca agctccacag ccccatagt 920460
 agtgagctct cagggaatgg agcgaacatt tgtgtttccc tgtttatgtg tatgagcatc 920520
 acacgtgtgc ctggtgccca aggatgccag aaaagtatga tgaatacga acttgaatta 920580
 cagatagttg tgagctgcca tttgggtact gggaactgaa cctaggtcct ctctctgcaa 920640
 gagtagtaag tgctctaac tgctgagctt ttacttcca agtgctggga ttacagacct 920700
 atagcacaat tggctgacta gatatcttct ttttctgcc tctggcttcc aaatgctggg 920760

 gtttataggt ggaaccaaca atggccagca aaaatgactg tttgaaaaa aatacagtct 920820
 ataattccat gttctgtatg gctttgttt catctcaaga tttcttgttt ctaggaagtt 920880
 gtagccacat ggaaaact tttggtgtct tagttttgt ggaatgtcaa tcccagactt 920940
 ttgaggtggt tccatggcct agtctcttag ctaatgagaa gcacacttgc agtggatggt 921000
 tgggtttcc cgtggccctt tctgattac tgggcattc tctctgttt gctttttag 921060
 atgtcattgc agctggcatc ttgtagcatt cttttctct tggggttgt ttccatagga 921120
 tggattccca gtgggtgac taggacctac ctatagtgt tcccctaac acccagaaca 921180

 gcacctagca cgtactagga ggtcagtaag tctgaaatga ccaggatac agacatgtat 921240
 gccacactga ttgtactgtc ctccacagag ccagccctgc cctttacaca gtttctagat 921300
 cttagaggca tcaggctgct tgccactttg taggaggagc ctctgccat ccctgcagca 921360
 tctggcacta ttgttacagg aagtgggtgg tggtagctgg attgtcagcc tgtcttcca 921420
 gaaaaacaat ccattgtgct atctttagt gttcaggagc cccagccct agcccctttg 921480
 tcctaggaat tagggaacca tttttctgc aaatggtacc cctgtttcta aagaccatct 921540
 gctttggatg ttttgtgtt tttgtttgt tttgtttga gacatgtaga tcaggtacc 921600

 ctgaaactct cagagalaca catgccaggc tcaaactc tgcctttgag gagcttgact 921660
 agattttgaa cctctggagg ggttacctg agagaacgca tacttcaaga ccaggttccc 921720
 agccatgggg tgaggaggga ccattaggct tctgtttatg ggccctact gtgctgacca 921780
 ctgtggagac tgagtaatta gagacagtac ctgacacatg tctcaaaaa gcacagtcaa 921840
 gggcttgaag ggttggaggc acgatcattg attataggct tcatagaaga ggtgatgtct 921900
 tagttgtct ggaaggctat tgggtttcag agaagaagcc ttgtaattt ttgggggact 921960
 ggggagagcc aggtgtggtg gtgcacacct ttaataccag cactcaggag gcagaggaag 922020

gcaatccctt agtttgaggc tagcctgatic tacatagtga gttccaggaa agcgagggct 922080
atgtagagac cctgtctcaa aaactaaaaa tatagacaat agatgtgact gcagatggag 922140
tatagatgga aggtaaagtc ttgaagtggc aagttagaag agtctaaaca agttccatgt 922200
gctaggacat cccaccttga gcagtttctg gataatcaga attagtaagc cccttcctaa 922260
ggcacatttc ctgtgcctat atgtcaaatg ttactctgtc taagatgaca gattaagtca 922320
ccaggtttat tgtggagtta ttttctcct ttgaaatatt ttcatttgtg acatttgatt 922380
cacagaaaca aaatgcctct ttgctgttga gggttttttg tttttgtttt ttgttttttt 922440

tttggttgtt tttcaaatca aagtactgta ccatatgtgt gagtcatggg tgtctgtact 922500
ccagaaatag tgittatagt ctgttctcag atagccgatg ggccaggagg ggataactgc 922560
ctggtggtaa agagccagaa gcagtgtctc tcatggctgg ggctgaagct ctttctaggc 922620
cagtgggggc ctaaggagca ctctacctgg gcttggcccg gacagctttg ggggaagtgc 922680
aaatgtctgg gtgttactct cattcatctg ctgggctctg aagacctaata cttggctctc 922740
ttttctggc aggcagaggt ggaggaaaca ctcaagagac ttcagagcca gaaaggagtg 922800
caaggaatca tcgtggtgaa cacagaaggt aggtcctcaa tccacggcct gcactcagga 922860

gggcctccag aaaacagcca cacacatgtc gttgcccttc ctagtacctt cataaaccca 922920
gattcattct agttttgttt tgaacatttc caaagtctg atactattct tgggattttt 922980
cctcctcttt tegagaggtc ttgctgtgta acctgagttg tctggcact caggatcctt 923040
ctgcttcacc tctcacgtgc tagagttatg ggcatgcacc acttgtttta gaaatcttaa 923100
tttcagccag gtggtggcgg cggcgcacgc ctttcatccc agcacttagg aggccagagga 923160
aagatctcta tgagttcgag gccagcatgg tctacaaagc gagtccagg aaagactcca 923220
aagttacaga gagaacacct gtctcgaaaa accaaaccaaaa aaaagaaaaa gaaaaacaaa 923280

acaaaactta atttagtaaa taggaaaatt tttttctcg gtttcatttc actgacaggt 923340
cacagctgtc aatataatcc atgctgtttt cagcccttgt gaaaaatcta tttctcatgt 923400
gataatcagt tacttttgtt ttgaaataa agtctcactg tctcaattc acagagatcc 923460
ctttgcttcc tgagggtcgg gtttaaaagtg tgcacagtca gagccaggat agtagttgga 923520
tactgtatt ggaggccagc ctaggctaca tagttccgga acaactgtct cagaaaaagt 923580
agcaaaaaaa atcaagtgtt ttccatcaca cctgattgtt gttactcttt taaacatgtt 923640
taccttgagg tttgttttg caatttcttc aaaaactttt ttttttgca ctaagaattg 923700

accccaggct tcatacccat taagcaagta ctttaccact gaaatgctcc ttcagccctt 923760
tcaagcaaaa atttaaagtg tcagtacaat tttttgagac agtatctttt cttttagttt 923820
tgactagcc tgaactcatt gtgtagccca ggatggctag actttaagcc attccttga 923880

cccgagtctg tctgctcggg ttacaaactt gagtccacat gcccaattaa gtacggtgct 923940
 gattaatctg ttggtgctac tcttgggtgct cactagttag gtgtgtgca tccatctgtg 924000
 ataattctgc tgtttttgta ggtaattctc tggttgattt ctttgtgccc agagctcttt 924060
 gagggaatga gcttacttga atggctagta agatacggat agtgtgtgaa gggaactagg 924120

 aaacacccac attgtaccaa atcagaggac aggtgcttta ttccttcaag cagcctattg 924180
 gctctattga caaaacttga atttagaaat ttaatgactg cttctcattt caaagccaag 924240
 accttttcta agatttattt ttgttttctg aatgttttgc ctgcatataa gtatgtacta 924300
 tgtgtgtgca gtgcatgagg ccaaaaagaga atgttagatc ccctagaact gtagttagag 924360
 gaggttgtga cagtatatct gcaatgtctg tattcaagag gaggatcatg gcaaattcca 924420
 agctattctg gtccacatcg tgaattctag gtcagtcaag gttatataat gagaccctgg 924480
 ttcaaagagg tgggggtgag tgggtggtagg caattttttt tttttttaa ccataacca 924540

 ttttaccac aagaaagtg agatagagat caagtaggta cctggcatga tagcacaagc 924600
 ctgcaatccc agcctttggg agatagtagc ccaagagagt catcctcaat tgcattggtga 924660
 atttaaggac agcctaaatg acaccttggg ctccaaaaa acaagtgggg agcagtttgg 924720
 gccaggccaa ttaagtgatg tacctagtag gattgttcaa gttctgcatg gtcaacaaca 924780
 gagtacctgc tctcttttgc tcccaacaca actaggttag tacagaatgt gtgcttcata 924840
 gcagtatcta ttaagatttt ctttttccag tctgtggct caaactcatt gccttgtaca 924900
 tactaggtaa ataccagaa gccctattaa aggtcttggg caggtttttt gttgttgttg 924960

 ttgctctgag agcacctgac tgtaccatac ctagaattgt gcttccccg taactaaagc 925020
 tgcacagtat ttttgaagga aaaggactga actaggcatc cgtgaggagt atagacttaa 925080
 ttttgcctt gtttgaatt cttctgattt ttgtttcttg cccacctcc ctctgtctct 925140
 ctctctctc ctctctctc tttctctctg cctcagagtg agccactatt ggttaagttt 925200
 gctggctcct ttacatttgc ctactttata tataaccaa ctattgtta tctgaaccac 925260
 taaaagtaaa cccagaaac aactcaata ccaacatcag cagatgctta acatgttaac 925320
 cacagatgct aatgagagcg ggtctctcct cgagagaact tattgcctag tgggacgtgg 925380

 gtaaaatgct tactttccta atagtgtgtt gttgggatta taactactct aaaggaaaac 925440
 tgcattgtac tgggatgta tcaacttga ggtctctccc tctaggatca ttcgattttg 925500
 gatagattat agtaggtacc agttatagta ggtagcaggc acatagccac cctcagaaag 925560
 gtacagctat aaagaggcct catggggctc aggtgtgcac attgttgcca tctaggacce 925620
 aatagcagca cagcacttag ggccccatc agcaccttaa aggcaaatga ctactgtaac 925680
 ccgttcttat agcttccat ggctcacaaa agcctcttct gctcggctgc ttacatggt 925740

tctggtgccc taataaagta ggttgaatac ctatctttga cttatcttta ggctggtcac 925800

ttattggcca gattcacaga ttctgggcc catgtcttgc ttcttggatg tgaagagtca 925860

cttataccac attcttaagt gtcatagtca cctccagact taccttggat ggagccttct 925920

gacaggtcac agccaattcc aggaacctga tgaccaatg tggcatcag gttgagccac 925980

attcctcacc tccataacag taggacaccc agtaatgtcc atttaattgt tcagtcttca 926040

aaaagagact tgatacagaa tgatggtcac tggctgggta attataccag taaaatccta 926100

gcctgagcat ctatcaatag gggaaatgtg aatctagga ctgtcttact tcatggactc 926160

tttctatggt ttgttgtgtg gtgctgggta ttggaccgg gtctcagaca cacaaagtac 926220

tctggactat acctccaacc acctagtggg ctctttcaaa gacagcagtg ctcttatata 926280

aaaaccact ggagtgggga ggcatcttca ttatacatg gttacagctg agccctgagt 926340

cagccctgct aaaaataata ataaatgtct cgtatactg gtataagctg acctcttttt 926400

cttctctctt ttcagtctct tctttttgag acagggctctc actgtgtagc cctagctggc 926460

ctttaaccta gggatctgcc tgcctttgct tccccagtga tgactgagtt caagctttaa 926520

gtgttcaga agagtacctc tcttctatt gcttgaacce agtcaggcag agtgggttcc 926580

atgctcctag gaaaggagca tggagttaa tcaagtctac atttaaatcc ttatcctttg 926640

tgtacttata ggcaggtcac cccattatc agttctctg ttgcctggta gccaatgaag 926700

atggtgatcc taccacaga ggctccggct tacaaggtca gcactgtgcc tgcctataa 926760

caagccttca gtaaacagta gcattggtt gtaactgcca gccagcatt ctagaattag 926820

ggatgtgaga tgagacacta aacagaaagg aactccgta tattgcttgg ttccattta 926880

ttcttccac aggcatctcc atcaagagca ccatggacaa cccactact acacagtatg 926940

ccaacctcat gcacaacttc atcttgaagg cacggagcac tgtgcgtgaa attgaccccc 927000

aaaatgacct aaccttctt cgaattcgt ccaagaaaaa tgaaattatg gttgcaccag 927060

gtaagggttc ttgcacctcc atgtttagt tcaagaacca tagcaggttc cctgtggctt 927120

atctggaaag tgtggcatat tgttatcccc acagcttcaa ggtaggcca gagtggggtg 927180

gaaagagtca agttgcctca ctgcctagcc agtatctagg tggatccac cacctgatct 927240

tcagcaggcc tcacatggaa attgtagttt catgaggag aaagacacaa acatcaatac 927300

tgaatcattc tcatcttggg aagaattcct taagaatatg ggatatggcc tggcgttggg 927360

gacgcagcca ctggggagc agaggcagcc ggatctctgt gagttcaggg ccagcctggg 927420

ctacagagca ggtgccagga taggttccat agcaatacag agaaacctg tctcaaaaaa 927480

ccagaaaaga aagaaaggaa ggaaggaagg aaggaaggaa ggaaggaagg aaggaaggaa 927540
 gaatgaatga atgaatgaat gaatgaatga atgaatttgg gatgtggaag ggttgatcag 927600
 gtctgcctgg gcagtcaaca aagatttctc agaagcagga tgttagagct gaatcttaag 927660
 ggccagggaa atatgagtca gagaggtggg aaagctgttt ctatatgaaa aagaatttat 927720
 agtctctgtc ccaacccatg cagtcaactc cccaccagca ttggagcaga ttgctatfff 927780
 ggctcatcag tgaaaaactt gtctgggtag tacaagcatg cctgtgttta ggccttagga 927840
 tcattgtcag tgiaatgaga tgtttcacac ttggaggagc ccacaaggat gggaaactgca 927900

 gaggggaaggc atggggttgc ctctgctct gccttatcta actcaaacctc acagactaga 927960
 gtgactgacg ggttctacaa aactatffff ctgtggttac cactctctct gcttttcag 928020
 ccaagccatg gctgggacat gcatgagatc tcacatggtg gtgcctcagg ttgtagaaca 928080
 gcttgctgtg gaaggaaggt atgaaaagtg agacttgggt ccaacttaga aggggcctca 928140
 gactccaaac tcagctatgt ggatctgac ctgtgagcag aggtgctagg gcaggaagtg 928200
 atgatcatga gttgggtgct aggggtggtg cgctcatac ctttaattct agcacttggg 928260
 aggcagaggc aggcaaatct ctgagttgga ggccaacctg atctacagag tgagcttcag 928320

 gacagccagg gctacacaga gaaacctgt ctggaaaaac caaaaaggga aaaggggaaa 928380
 aaaaaaaaa aaaaaaatg aggagctgtt gtgaccctc gggacacatc aggaagagta 928440
 agtatgttaa gatcaggtta tcattaagcc ttgcaatcaa atttgaatag aaagtccacc 928500
 cccacccag ctactgctc catgtcccta aaactgatat tgggaatcat ctttcattt 928560
 agtagttatc agtgagata tgaggtatac ccagtggcac acctagaaac tcagtatcag 928620
 ggacaaatga tacagtgcca tggagacaaa cacttggtac acagtgtctc tccacctaaa 928680
 gctccagaga tgtctgaagt cctgatcatg caagtcttag ctcagttcag tagtacctcc 928740

 agtttgcct tggggacceca cagacattca gcgcccceca gggtagttgg tacttgagtt 928800
 ctcatgggc tcatgggct cagtgttcc aacagtctca tcagtggaga tgaatggcca 928860
 gactctcacc tgggcagcat acagagaggt gcaggaagtg cacatgctgg ccttgatctg 928920
 gctggtagtc ggtacgtctc acacactcac actcaagtta tgctaaaggt tgtgtgtgac 928980
 atgtagcca taaacagtgg tgtttatgga gctaccacac tgctgcatct cccttctgg 929040
 ggcttgtea cacacatcct cctgctagag catgctgtca ttccttatg cctgactaac 929100
 cagctactta gctacatttc cactgcttfc ttttccac agtaagttgt atgaaggcag 929160

 gaacttgtaa gcagtgttta acaatacat taaacaggtg gctttgttg ttgtttgag 929220
 ataaggttfc tgcacatagc cctggctgtt ctggaactag tgagtttctt tggctacta 929280
 gtgtagacca agtttgcaa gaattcagat gtccacctgc ctctgctcc caagtactgg 929340

gatcaaaggc atatgcccc atgcctgacc ccagtatggc tttaatcc tccctttgca 929400
gatatcccc tgttgggcat taggctggat tcagtagagg gtagagtaa ggatgtctgg 929460
gatgtggcat ttaaatatat gtgtgtgcat gcagcaatgg tggaggtcag agggcaccag 929520
aactggagca acattatgag ctgccatgtg gatgctagga actaagtgtg ggtcctctac 929580

aagagcatta agtactctta accagttgct aagctggaac cagccctgga atgaaatcag 929640
cagtacatac tacttagtgt acccagtttt atgtggtaaa tacagaaatt ctgggtttgg 929700
agccagaact cagtggagcag gaacctcaga ggcagtagag caaaatgtct gaggattgct 929760
tcagggcagc cccagtgtgg atcaggcctc actgagcttt ggaggggagg cttgtggttt 929820
cacatgcag tatgagcaga ctggagagaa ggaaggaaaa ggttcacata aatggacttc 929880
ttacagcttc ccaggccata tcttagataat ttgacatagt tggacttatt aacctcacta 929940
tttgatgcag tgtgaaaaac ctttactact atgtccctgg ctgtccagat ggctgagcca 930000

gtaaaggctc ttgccaccaa tctgaccac ctgagcttga gtcctggcat ccacatggtg 930060
taagatcaac cgcttttgaa agttctgca agaaccactc ttctgacttc tacctacaca 930120
ttacaacatg tgetcgaca cacaactaaag tttaaaatgt aaaacactgc ctcccacagg 930180
gtacttagtg tggatattga atatttagaa cttgatagcc tagttttgtt ggttgttttt 930240
gctgttaage ttgttaatta tgtatgcagt ttcttcttat ttgagacagc cagttgtcat 930300
gggtttatta gtaaatggt agaccacttg gcaccacgt agagtgttc tggggttaat 930360
ttaggtgtca ctgagaaaa cttatctatg acaaagctaa atactggcat acagacacag 930420

tcagatgccc agaaattaat ggcaacttct gtatacctgt aaaacctgca gtctttgtca 930480
tcaagatcag ggcttctggc ctggagaggt acctcagcag ttaagaatac tggctgctct 930540
tccaaaggte ctgaattcaa ttcccagca ccacatggtg ggatacaacc atatatagt 930600
gaatctgatg ccttctctg gcattggagt gtccatgccg atagagcatt catatacata 930660
aaataataa atcttaaaaa aaaaaaatc agaggctggg cattggttgt gcacgccttt 930720
attctcagca ctcaagagac agaggcaggc agatctttga gttcgatgcc agcctggtct 930780
acagagcgag ttcagaaca ggctccaaaa caatacagag aaacctgtc tcaaaaaacc 930840

aaaccaaca aaaatcagag ctttcatggc ctgagcccat aggttcaaac catgctgcat 930900
actgttcaac cctcatcaga tctgaggcac ctatgttaaa ctgagcaaac gttcattgaa 930960
cctttgtcta aagtccataa atgaatttgg gattgagggt atatctcagt gcacttgcct 931020
agcatttaac aagaccatgg cttagtctt tagtaccaca aaataaactg atggaaaaca 931080
tgatcaaaat ctgagttttg ccttgacaga cagcactttg cctgtttttt ttttttttt 931140
ttttgctaaa tgaagcctgt catctctatg ggattgtatc actggaaaat gctttaaaga 931200

agcaaataac tggccgagcg ttggtggtgc acgcctttaa tcccagcact tgggaggcag 931260

 gcacaggcgg atctctgtga gttcgagacc agcttggctc ccaagagcta gttccaggac 931320
 agcctccaaa gccacagaga aacctgtctc caaacaaca aacaacaaa caaaaacaag 931380
 caaataactt ccigtgacct atcaaatgt tctgttttc aggggctggg agcacatgtt 931440
 gtagaaggta gaaatcagcc acagccagg gttatcagga tgaagtaagg cagtgtttt 931500
 cagccttctt aatgctacga acctttaat acagtctctc atgttgaggt gacgccaacc 931560
 atgaaattat ttattgcta cttcataacc ctaattttgc tactgttatg aattgtaaat 931620
 atctgatatg caaactaaa atggatcact acccactgaa ctaaggcgcc cagcaatcac 931680

 gttgaaatct catttatact aatglatgig tgtgcacca cactcaagtg cagaagttag 931740
 agtacaacce ttaggagttg gttgtgtcta tcatgtgtgt cctgggattc aatcctcagg 931800
 ttatcaggct atcttgetta tatcttcata atacaaatga aagagcatgc tgtaaagtgt 931860
 ccaactttac agctggctct gcatgtggag actcattttc tagcagccac ttggcaggag 931920
 gcaataaata aactttagg ttaactcctg ttcccagctg tggaaaataa cctgctactg 931980
 atgctcttct gaaagtcttt ttctctctgc ctgtatgct gttgtcttct ttgtggttta 932040
 tgtttctcgt ggtttatggt tagtgatttg tttttctggt ttttctttt tcagataaag 932100

 actatttctt gattgtgatt cagaatcaa ccgaataagc cactatctca gcttctctgtg 932160
 tcattcctta atttaaggtc cccaagagt aatagtgtta atcatgtcag tgggcacatg 932220
 gtggttgccct aagagcccat gtagactatg ccattgatca agggatctc tgtccacccc 932280
 aacaaggagt gtctctggtg atccagtcag ttccataggaa agctcagttc ttatttccag 932340
 gctttggagt aagagcttat gataagccca ggctttggag taagagctta tgataagccc 932400
 acaccagct tccttcagac cttgagttca cttgttcacc cttggaaagc ctgtttttc 932460
 tttactaaa aataacttca aaacctgctg gctgtttggt gtgtctttac tagattggaa 932520

 aggtctgttc ctatgtcagc acatgatcag ctgaccaaac ccatggcctc tattccctgg 932580
 caggttttca tggctccttg gcttggctct cattgcacct gtggcatact tctgaataa 932640
 tgcacctgg taigtattgg ttggigccct ggttccctggg cctcattacc cttccttag 932700
 gtacctgttt gatcaaatcc tactctgct aatgattttc tgttgactg ccctgagcga 932760
 agaagaaagt gctgtctacc aagtaccac aatgcacctg gtgcatctta ggtgctcaca 932820
 tcattgtgtt aaaactgctt gagagctggg gaattaagag taatgaaagg aggaggaaac 932880
 aggtactttc cagggtctca tagctgggaa catgggtctg taggtagcct gttctttgct 932940

cagtcttctt cagaaactga ccccgctctt ccctggcaag ctcgttcttg gtagtcatcc 933000
 ttccacctgt accactatgt gcaaggtggt gggggtcctt accaggaggt ctaccccagg 933060
 ctcttagact accactctg ctgcgcctca ccaccctgaa aaccacctgt atttgccatt 933120
 acacttttgt tttcttttgc ttgttgcata gaaaaaaagt cctaggttca atccccagaa 933180
 ttccataaat ggcatgtatc tagttagagt tafgaaactc tgcctttaa aaaaaaaag 933240
 attcaggggc tggagagatg gctcagaggt taagagccct ggctgctttt cccgaggtcc 933300
 tgagttcaat tccaacaac cacatggtgg ctcaacaac tctatagtga gatctgttgc 933360

 gcttttctgg ttgcaggca gaacactgta tacataataa ataaatctt aaaaaaagat 933420
 tcagaattaa taaaagaga ctgaatttga aagcaagcaa ggagagttgt atgggagggt 933480
 ttggtaggag gaaaggtag ggaaaacaat gtaattataa cctcaaaaat ataaaaggct 933540
 tgggtagag agatggctca gttattcaga gaaccttgg ctcttctaga ggacctaaaa 933600
 aatttcagtt cccagcacc aaggagtaca gttcacaat cacacacaca cacacacaca 933660
 cacacacaca cacacacaca cacacacaca cacacacaca cactgctctt ctaggaggacc 933720
 taaaaaattt cagttcccag cacccaaggt gtacagttca caaatcaca atcacaatc 933780

 acaaatcaca cacacacaca cacacacaca cacacacaca cacacacaca cacacacacg 933840
 gagagaggag aaagcaaaag ttcaagagt tggagcctgg cccaggaggg tgagggatga 933900
 ggcaggtagc tcagttgta aaagcacttg ccacctgagt ttgagttctg gaaccgacat 933960
 gttggaagag aaaaccaat gcccgagcta accacctcat agctgctatg gcacacatac 934020
 cccacaata catttttatt ttgcatgta tacatgtgta gatccaaggg gtggggcctg 934080
 acccagttgt ctctgccta cctggctcaa gtctgctgac tgaaggaaca aacttaactg 934140
 tcctgactcc ctcataggg tatgatactg agggactcac aggatgctgc ataagtccat 934200

 ctgtgatta acaaaatcct gaaaatcctt caagacaacg atcatgcccc tgaaaagtag 934260
 tggttgttta caatcatctt gagaggaaca gaaaggataa gtaagtatgc ttagttaagg 934320
 tttctattgc tgtgaggaga taccatgatt atggcaactt taatgagatg gcttatattt 934380
 gcagaggttt agtccatttt gtcatggtgc aacatggtgg catgcaggca gacatggtgc 934440
 tggaaaagga gctgagaatt ctacatcttg acttgcaaca ggaagtagtc tgtctcacta 934500
 ggtgtagctt aagcatagag acttcaaac tcaccacac agtgacacac ttcttccaac 934560
 aaggccatac ctctaataa tgccactcaa tttaggggcc actttcttcc aatcacat 934620

 attgtactcc ctggtccca aaggcttgtg gccgtatcat aatgcaaaa cacattcagt 934680
 ccacttcaa aagtcccac agtctacaac agtcttagac ttgtttcaaa gtctcttctg 934740
 agatccatgg caatctctca actgtaatct cctgtaaaa tcaaatcaa aaagcagatc 934800

acatacttc agcatataat gatacaggat atatattact attccaaaac ctagggaata 934860
 ccagaccaa gcaagaccta aaaccatctg gacaaactcc aaactctgtg tctctgtctt 934920
 atgtcaaagc cctcttttga cataagacag ctttattgac tgaatacat ttctctcttg 934980
 ggctggttct ttccttggtt agcagctttc ttgccagct atcccattac tctggcatct 935040

 ccaatatttt ggcataatccc agacaaacca ggcttcaatg tcagtttcat gagatggccc 935100
 ctctgggect ceattcaggg acactcctga cacatgcctg gtctcagctg ctttcttaa 935160
 tcatggaggc aaattccctt tcttctatcc ttaactccag aaccacgtgg ccaaagctgc 935220
 caagtctgt ttgtcagggc tataccatct ttccccccc cccccagtt aaattacatc 935280
 ttcaccagtt ttccatggtt tcttcactg cctaagcttg gctgtcctag cacttgctct 935340
 gtacaccaga ctgccctcaa actcaagaga tccccagcc tctgcctcct gagtgagtgc 935400
 tgggattaaa ggcatgtatc tccctctctc ctccccccct cacacacaca cacacagaga 935460

 gagagagaca gaggttggcg ctacatagac aagcccaagc acatcaaatg cagttagatt 935520
 ttgtttccca ttgtctcacc gggatttccc tccacatggc aagagcctat ctgtgacctg 935580
 ctcatggaga cagacactgt gagctacc cttgtcaact gtgacacagc ccaaagtgtc 935640
 tggccttctt gccaccttc actttcccc aatgttgcta agaggctatt gagctgggag 935700
 aggcaagttc acccactctg ctgtgcggtc acttctagtt tgcctagcat ctatctgctc 935760
 ccctctctgt tgaccaaaac tgcagccaga tcacctctc ctgattacag gtctcacaga 935820
 ataaagcctc ctagaacctt cctgtcacac acacacagcc caggcaaaag tatgagacca 935880

 catggaccac ttggctgtgc tctgttccca gctacctgg tctccttga tgacccccag 935940
 gaactaggtg aagggtgaca gaagaccag gcgtcttctt ctggcctctg caggtagatg 936000
 tatgaatata gggacttctt gaggttccatt tctgaaatct aaggaaggag agaattgatt 936060
 ccataaaaact gtctctgac ccacacacac tgtggaatgc atcatacata caccacacaa 936120
 agatttttaa aaaataacctg aagaaggcct gataaaggca cttgctgcta agactcatga 936180
 cctgagttca atacaaggaa cccaaatggt ggaaaggaaa agaaccaact cccacatggt 936240
 gttctctgac ttgcacatat gccctatggc acgtgtacac acttacacac acacacacac 936300

 acacacacac acacacacac acacacacac agaatgaata aaattgaaa agctgggtag 936360
 cagtagcaac acctttattc ccagcactca ggaggcacag gcaggcagaa ctctgtaagt 936420
 tcaaggccag tctcaactac acagcaagtt cccaggggag ccagaaactc tgtctcaaag 936480
 aaaagaaaaa aaaaaccca cccccaaac aaacaaaaa caactagcca gccaaagcatc 936540
 atggcactgt cctttaacat tcaagcacag cctgatctgc atcgtttcat ggccctcagg 936600
 gctacatagg gagagctatc tccaacaac aaaaacacaa atgacaagaa atgctgcttt 936660

ggatgcaggg aaaacagact acttcttcac tgctagtgag aatgtaaagt ggtacacca 936720

 ccatagaaat cagtatgggg ctttctcaa aaaactagaa atagacctac tatatgatat 936780
 gatccagcta taccaccctt ggtatatacc caaaggactc aatattctac tatagagata 936840
 gctgctcact gatgtttatt tcttctctat tcacaacaaa cagccaagag aggaaaacaa 936900
 acaaattaga tgtccatcaa ctgatgaact gatgcaaata tggcatatth acacagcaga 936960
 gtatttagct attaagaaaa atgaaactat aaaattcaca ggtaaatgga gagagataga 937020
 aacaatcatt ctgcgtatgg taactcagaa ccaaatgtc aaatgcaca tgttttctc 937080
 tcatctgtgg atgttagctt cagatatgtg tgtttcattt aaaacactca caaatgttaa 937140

 gtattggact cccgattact gtgtatcctc ccatgatgca ataagccaaa acaaatccaa 937200
 tgaataagaa cagatthaat acacagagca aagcacagcg atgcaactcc caggtgactc 937260
 tgggaagcgg gagagagatc acatggcagg tctggtgacc aggtcttaaa caccctgtat 937320
 gtgtggtcct gagcagctcc agcggaggag ctgatccttg acaagctttc tgagggtgg 937380
 cgtctggaat gggaggatgg gggctatgtt ccaaagctga acatatgggc agggtttggga 937440
 atgggggaga gtgagctgg agtgaaggca gagcttcac cttgaagtc aggaagtac 937500
 taaggtgcca tgttccaggg agaggagata aactgcactg gtatgaagga atcatggaac 937560

 aggaagggtt aaactagggt gaggaagtgg agggcagagc agaggacaga gtagagcaag 937620
 ggataaataa tactgaaaac cttttgaaaa agacataaag ctctttctaa atctatccat 937680
 caccaccaca cacacacaca cacacacaca cacacagaca cacacacaca ctaaaatgga 937740
 gttactctgt aacagagcaa cagtgtcct actagacatc agaggctaac aaaaagtcca 937800
 gtgccaggta tgagttgcct gttggtgttg ttggtgggta cggccactgc tcttggttac 937860
 cctctccag gcagtcagaa ccttctgaa gacagcacaat gcttgagtca tagaacatgg 937920
 caaaaaccaa gctggttga acctggaagc ttatccta gtgaccagct agctttcata 937980

 atctgaaaag tcgctatgca agtttttggga gaggaaagt gttagtata ctgagctgtg 938040
 gacccttcaa gctaaaaaaa tgactgttaa tagtagcaca aacatcttgg gaagaaccaa 938100
 ccacctttg atgaaacta aatccctgtc tacaggatga aactcatacc tggcatcatt 938160
 atcaggctaa gagcctctgg ctaaaaagtc accagccatg ggaaaaacc attactgtta 938220
 tgctgctaaa tggagctatt attaaactga ctctaataga cttacattgt attcacagat 938280
 caatgtacat ctcatcctt atctgagaag cttctaattg caataaatag tgattaatac 938340
 agagactcac aactagtat ggtacagata agagactata gaatgttcag tcctaaaggg 938400

atcacatata atgcaccctc ctctctcaag gctaagggat cattgcagaa gaggtggagg 938460
 aaacagtgtg agacactgag acagtggatg actacaagaa aacatctttg gacacaacag 938520
 ggcagctgca cacataaact ctcaagtagt gcaacagcat gtataaaacc tgtgcaaatc 938580
 ctagcaagaa gagaggagct gggcacacaa ttatcattcc aggccacaaa actactggca 938640
 attgctagct actgggaaag ggataggcaa ttttctctaa gagtgcgccc cctggtaaag 938700
 gttatttaac cattcaactgt agaagatcac atatccaaga acatttgaca tcacaaaatt 938760
 ggtcttggag gtgaaaaaaaa attacacaaa ctgggtagg tagaaaggga gaaggtaga 938820

 aaaaaaaaa aagaaccca tgaaactctc atagagaggc tagagaaatg gcttaactga 938880
 tgttaagacg acttgaactt gaatagcagt gctcacatca gaggtttcac aacctctgt 938940
 aactctagtt ccaggggaat ccaactctgt ctctgggct ctgtggtcac tagacatgca 939000
 catggtgac atacatacat gcagccaaa tgtttttata aataaaatct cagagaacta 939060
 ataaaaatc ttaaaatatt gtatatgagt atgtgtgtgg gggggtatgt gcctctgggt 939120
 tagtcagttc ttcagttaac catgtaggcc ctggaactca gatcagctt gaaagcaagt 939180
 gcctttacct ccttgaact ttaaaatatt tcatgtcatt taccctagtc caaaggtca 939240

 caacagtaat cccatctact gagaccagag gatctgaagt tcaaggtttt ccaggtttc 939300
 agagtccag ggcagccagg gctacacaga gaaaacctgt ctcaataaa caaagtcaaa 939360
 tttgttactt atacaataa aagcttgatc tcttgctcct ccttgcttac accttcaag 939420
 tgataggatt atggacatga gccattagca tattaaattt aaaaatccta gccaaagcat 939480
 ggtggcacac aaaccttga tccagcactg gggaggcaga agcagatgga tctctgtgag 939540
 tacaaggtca gcctggtgtt actgagcaag ttccaagaca gcctccaaag ctacaaagaa 939600
 accctggtc tggaaaaaac aaaaaacaaa accaatTTa aatcttagcc aggcatttct 939660

 taagagagta aatgtccctg tcccacaact cagcaatttt gttcagcatt tgtccaagtg 939720
 aaataataaa acagccacac aacagttaga agaaatccac acaaaggaaa ttcattcagt 939780
 ctatgtgaag ctggggaaca aaccagagt ttctgcaat cgaggcaagc actctaacia 939840
 ttgaactaca tcccagcat gttgtatttc cataggtgat tgcaatgaat gtaaaatttc 939900
 tccagctctc acttgtgct atttactttt caacataatc tgcttctggc ttccatgttt 939960
 cattgtcctt cactaatccc acccctctt tctttctct gtatttgaaa ccatatttta 940020
 catttctata atcttggttt ttttttttt tttttttgg tttttcaaga cagggtttct 940080

 ctgtgtagct ttgaagccta tcttggcact cgctctggag accaggctgg cctcgaactc 940140
 gcctgcctct gcctcccaag tgctgggatt aaaggcaggc gccaccattt ttattatctt 940200
 aatgagccct ctgtttttaa ttttttttt ttacatttat ttacgatgtg tatgtggaag 940260

tcagagatag cttgtaggtg ctgggttct tctcccacca caaaggtcct gctttaaata 940320
 ttaaaaattc ttccaggat cagtaaagag atgccctgag acagacttac tattctgcct 940380
 actcaccaca gggaaaacag gaatgtgaaa tactttctgt aggaggaatg tctttagta 940440
 gtgaaggtac taaataggac ttaaggccat aattcaggaa acctactgtc ctaccctaat 940500

ttgtgggggc tacatactag cttagcattt gagggatata aggcctggct gatgtctgca 940560
 ggggcagcct cttgatcta accttgaat tgaactcagg tcctcgtgct tgagggcaaa 940620
 cactcttgtc tacagtcca tatagctgcc ttcttttac tgttgaaat atgtacctga 940680
 acaagcagac aataataac ttctttaaga ttttattat ttatcatgta tacaacattc 940740
 tgcttccatg tatatctgca caccagcaga gggcatcaga tctcataaca gatggttgtg 940800
 agccaccatg tggttgctgg gaattgaact caggacctct ggaagagcag tcggtgctct 940860
 taacctctga gccatctctc cagcccaata atatactttt aaacatatcc agcttctctag 940920

gacatacaaa aaaacaaaac aaaacaaagc cgggcagtgg tggcacaagc ctaattcca 940980
 ggagacagag gctgaggcag aggcagggga atctctgtgt ttgaggccag cctggtctac 941040
 aaagtatgtt caggacagct agggetgtta cacagagaga ccaattttga aagtcttta 941100
 ggagctgcct ctccgtgcc atgctccca ctcccataa agcctgggaa aatgaattta 941160
 agccttctc gaggtaggaa agtactgttc cctgcgtaac attcctagac tatacttctt 941220
 tctagcttct caaaggctc tacgtgtgaa ttctcagttc gtgtgttgc aatccgcat 941280
 gttctctatt gcctggtaag ctgcttctga tacatcctcc cattccgtga ttttctctc 941340

ctactttate tacategctt attaacceca catcgggaga ctatgctttt tacggetgat 941400
 gcagaaactt tttaaagccc ggcggggtgg gagggggag ctggagcgtt agttagctcc 941460
 acagttaaga gcactcgcta ctattacaga ggagctcggg tcggttcca gcaccgccag 941520
 taactcactc cagcctcggg aaatecgact ttgacctct cgggcaccgg cactcgcgtc 941580
 gtacacagac acgtaaaact tttaaaagcc ggggcgttcc actcctccc cgcccggtag 941640
 taaccgccc gtctccggtt actacctttg atctctaagt tcagtgaagg ggcagtgtca 941700
 agcgtggag gggacgacca accgctttc ccctcagttt gaggagccaa gagacaagcc 941760

agcnnnnnnn nnnnnnnnnn nnnnnnnnnn nnnnnnnnnn nnnnnnnnnn nnnnnnnnnn 941820
 nnnnnnnnnn nnnnnnnnnn nnnnnnnnnn nnnnnnnnnn nnnnnnnnnn nnnnnnnnnn 941880
 nnnnnnnnnn nnnnnnnnnn nnnnnnnnnn nnnnnnnnnn nnnnnnnnnn nnnnnnnnnn 941940
 nnnnnnnnnn nnnnnnnnnn nnnnnnnnnn nnnnnnnnnn nnnnnnnnnn nnnnnnnnnn 942000
 nnnnnnnnnn nnnnnnnnnn nnnnnnnnnn nnnnnnnnnn nnnnnnnnnn nnnnnnnnnn 942060
 nnnnnnnnnn nnnnnnnnnn nnnnnnnnnn nnnnnnnnnn nnnnnnnnnn nnnnnnnnnn 942120

nnnnnnnnnn nnnnnnnnnn nnnnnnnnnn nnnnnnnnnn nnnnnnnnnn nnnnnnnnnn 942180

 nnnnnnnnnn nnnnnnnnnn nnnnnnnnnn nnnnnnnnnn nnnnnnnnnn nnnnnnnnnn 942240
 nnnnnnnnnn nnnnnnnnnn nnnnnccgggc ctcacgccga gtgctgtccg cagctgaccg 942300
 ctgtaaggag gtgcagcaga tccgcgacca gcaccccagc aagatcccgg tgagtctcta 942360
 gcccccccg ccttggcctg tcttgcagg ccccgcccct ggctcacgag tccccgccc 942420
 actatgctcc caggtgatca tgcagccta caagggtgag aagcagctgc ctgtcctgga 942480
 taagaccaag tttctgttcc cagaccatgt taacatgagc gagtgtgtca agatcatccg 942540
 gtgcgtgggc agcctcctga agcccttggg tggggtcagg gccaggttcc actcgggaagg 942600

 ggtggagtgg ggcaaggga caggatatag ggcatccagc ccctgttcta ggaggctgga 942660
 caaggtcaag gtcggggttg gagtgaactt ctacaaaggt gagagcgtct agccccggct 942720
 gtgttggttc aaaagtggag attcgggagg gacaccagg ccccagcag gcgacctcct 942780
 cacctggcat gcctcctgc ctctgcaggc gccgcctgca gctcaacccc acgaggcct 942840
 tcttctgct ggtgaaccag cacagcatgg tgagcgtatc cacgccatc gctgacatct 942900
 acgaacagga gaaggatgaa gacggattcc tctacatggt ctatgcctcc caagaaacct 942960
 ttggcttctg agtcaggagg aggggtgggg gatggttggg gattctgttc aagctttctc 943020

 cagggaggtc ctggctccta agctgagcta tttcattccc gagtgggtta ggcagagatg 943080
 tgaactccct accctcccc tgggtgggga caccagccag cctaccatgc tctggttag 943140
 gtcttccag tcacgttagg gttgtcctc tgggtactgg ctcagttggg agtgggtggg 943200
 gaacagcacc cctgctgtgt ggtttgtctt ttttttttt ttttttttt cagcccttgc 943260
 ctgtctgcc acccttccct tatccacctg aggcatttgc ctctgccag gacctgcca 943320
 tctctgaaag gctgacccc ttgtctgac atggtgtatg gatctgtgtt catttctca 943380
 gcaaaataaa gattgcttag gcctgcctgg ccctttgcct ccagctgctt gtttgggagt 943440

 agggagggct gctaggtgac cgtctccaca tacttgtgcc agtcaggaca caggcttgtg 943500
 ttctatggac ttgggtttcc aaaaacctac ttcttagtac aggatactct gcagtattag 943560
 gggccagatt caccacctc caggaataga tggcatcaga acaacaatga aaaaaccac 943620
 acatttatta agtagccaca acctataaag cctgctcac ctgcaggttt ccccttctt 943680
 cctgtgcagt cacaaagtgg gaggtccaag tgggtgctc caaacttct cccctgggcc 943740
 agctatgagt ccctatggt accagagatt tgtaacctg gatttgaacc tcttctgcct 943800
 gaggactcgc ctgctggcaa ctctggataa gggacctggc gggctcctgg cccttcccc 943860

tcttgtccat gcagttctgt gccagccagg gctacttgag cacaagcata gcctctgtgc 943920
cgtccttggc agtcaaatag agaccatgtg tgaggtaata ctcccgtcgc aggaaggcat 943980
agaagtagtc agagatgagc aggatctggc agggaagaga aatgagaag ccatggggtta 944040
ccttagtgaa taagtccctt tgtgggggtta gacaggtact atgaaatagt tcttgcctgg 944100
catctctcat caaaccccaa tctataagcc tgcccaggga tctccttccc tcttggcaca 944160
aacctagccc tgaagagct cactggccat ctgacagctg cctgtatctt actttctgct 944220
tctactcct ggtttacacc tctatcctag ggaatccaga tcagtgttct accaaacagt 944280

gcatgcacct tgtctcttcc cacaggcatc ccccatccag cctcccttgt caaacatccc 944340
ctgtccaggg gttcaggaca cagacttgcc tagtatttct cccatacgtta catcccagaa 944400
atctactttg aaaatatata attccacca tcctgtaac aacccccacc aaagtcactg 944460
ttgtcattta aacattacca aaacagcttc ccagggatcc ctgctttgaa acctcctgtg 944520
ccagtacgcc agagggagct tttctttttt attttttatt tttttgtttt gttttgtttt 944580
gtttgggttt tggtttttcg agacagggat tctctgtgta gcgagagcct atcctggcac 944640
tcgctctgga gactaggttg cccttgagat ccgctgcct ctgcctcccg agtgctggga 944700

ttaaagggtg gcgccaccaa cgcagaggga gcttttcaga ccacaaatct gatcatgcta 944760
ctacttgact tgagttttcc caaaggcttc tcatgcttca gactcttggga gcttcgtggc 944820
cttgcacctg gtcctgcta catgttacct cacttccatg tgctacctct ctaaccacag 944880
gtctttgctg tttcctctgc ctggaacatt tgcatctgtc gatacctact tgctcttcaa 944940
ctcggttgca ggetgacttt ccctgggtt aggtcctaat cccttaacct ctctgctgac 945000
ataaagtctt tcaaactgca actttacatc caactacgtg aacttgatg gtaacgtgc 945060
ttctgctaag gatggacctt gagtgttctt gccacagtgg cacttatctg ccacagctca 945120

gtctgaccaa aaaaaccaa aggggccgag aattccagtt cattctcacc ctaaatggag 945180
cctgagagag ggacaggatt tgtctcactt gaacacttga ccccaaagtc tacaactcta 945240
gccaacatg cccaagactg gaataactgg aactgacatg gaagtgcacc acctcatcaa 945300
aggaaggcag gcacactatt agagacacca cagtttctcaa aagtttagag gttctcagta 945360
ccagcagcaa ttatctctta gctcaaatgg gagacaggcc tagaatgtgg caggcattca 945420
gtgagagtct tggggcagat cagaggtaa atccggggtc caagtctcca gagccctgtc 945480
ctgggcagat atacattttt ctgaaggtag aaaagcagct aagaagatct tggaggcca 945540

aaagcattga tattcaattg gacatacacc tgccattatc tcattggaag gctaatgatc 945600
tattttacca atagaaaaa tgaagcttga ggcattcaat tagttggacc aaggccataa 945660
ctggagatct ggactactgg gcatgcgtcc tcaagtatgt gatgtgcat gggccctgtc 945720

cataaaagaa cacagccctt ggccagcctg gtcgtatcag cagttattga gcttggagcc 945780
 caggggtttt cccaccagac ccttaaatgt tctgtctggg aaagggaaac ccagtccttg 945840
 tgccagagta ggtgagaggc aattgcaaat ccagaattca catgtcccca cagtgatgag 945900
 ctggctaggt caaggaagc cagatcaaac taagttatta ggttgagcca catctggaaa 945960

 taacatTTTT gtttgtttg caagtcagta atgttgcaa cacctgggtg gtggtggctc 946020
 acacattcaa tccagtgct cgggaggcag aagcagtcag atatTTTT aggccagcct 946080
 ggtctacaaa gcaagtcca gtacatccac cagggtaca ctgagaaacc ctgtctcagc 946140
 cagtaatata atgttgcaa ttttacagga tccaattaat gtatatggga agaaatatac 946200
 aaatattaaa cattattcag aagaacctga cctgaagaaa taactatagg actctaagag 946260
 gagctgtaca tttttgttg ttcagtctct gttggaata ggatctgcag agcccagggt 946320
 agctaaaact tggtagatgg cagaggatga ccttgaagc aatcctcttg ctctacctc 946380

 tcaagtgcct ggattacaga ggggcacctc ctaccacagg aggagctcaa gagctattcc 946440
 tataaacctt aattctgtgc accaaattca tgtattactt ggattaaaa taaaaattca 946500
 gggctggaga gatggctcag aggttaagag cagtagctgt tcttctgag gtcctgagtt 946560
 caattcccaa caaccacatg ggggctcaca accatccgtt atgagatctg gtgccctctt 946620
 ctggtgtgca gatatacatg gaagcacaat gttgtatata taatgaataa aatTTTTaaa 946680
 aaataaataa ataaaaattc aggccaggct ggtagtacat atttgtaac ccagcattgg 946740
 aaggggagc tggagaatta ggtttttgtt tttgttttt ttttctctcc gagacagggt 946800

 ttctctgtgg gtttagaga ctgtcctgga actctctttg aagaccagc tggcctcgaa 946860
 ctcacagaga ctacactgcc tctgaggctg gaggattaat aaaagTTTT ttgtttact 946920
 ttgttttca aaacagggtc tctgtgtagc ctgcctgac ctggaactct ctctttatg 946980
 tagtctagge tggcctcaaa ttcacaagag ataacctgc ctctgagtgg ggattaaagg 947040
 cattacacct ggctgactac tgcatgttcc aggtcagcgt gcgatagagt gagactgtgt 947100
 ttcaaaaca accccaaact aatgtgaca tacatttagc atcagcttga aatcacatgg 947160
 ctggcacatt ctgaccgat aatgaaaaca gggcttgtcc tagagattct ttctctttt 947220

 tatagTTTT aaaatTTTt ctttatgtt atttaccct acatTTTtgc ctgcatgcac 947280
 gtatgtgcac catatgtgtg tctattggga ttgttgaaga ttgtgagtca ctatgaagca 947340
 tactaggagt taagctcagg ttgtctacaa gagcagcaag tgttcttaac tgctgaacca 947400
 tctctccage cctggggat tctttaaaa caagaaaaa gaacaagtct cagtctaatg 947460
 acaagcatca gaccaacctt atttagggga cctgccaat atcccttaag cctgtcaagg 947520
 tcatgaaaaa taagacaag ggatacagag cagaggacac tagggagaca caaccaagtg 947580

gtccactagg ttggctctgg aagaaggcgt gactcccatt cagttaatgg taatgtccta 947640

gggagggttc ttactttaat agaggtcctg tgtaagatat tcacaacaca ggaaaacaat 947700

gaaaaataca ggacttctct ctactatctc tgcaaccttc tatggttcca agttaattcc 947760

acaataaaag gtttatctag agaaacaaa acaaacaaaa atgtgctttt tttttgttag 947820

ggttttgctt gtttaggggt tttgttgctt ttgtttgttt tgagacaggg tctctgtatg 947880

tagccctagt tgcctggaa ctctctatgt agactaggct ggccctcaat cacagagatc 947940

ttccagcctc tgcctcctga ctggigggtta ctaaagggtg gcatcattcc atctaacttg 948000

ttttgttttg agacaggatc tcttgaacc catgctggcc ttgaactatg tagcagagag 948060

tccccttgaa ttctgaate cacttctacg tcccatatgc tgaggtcaca agtatgtgcc 948120

actatatggt tttatgtggc aagagggatg gaatccaggg ctttttacct gctaagcaag 948180

aactctttaa gagctatctt cccaccagggt aggtaatggt ggtacacgcc ttttaattcca 948240

gcactggagg caaagggggg gggggggtct gtgagtttaa ggccagcctg ggttacagaa 948300

aaagtccaag acagccaaga ctgctacaca gagaaacct gtctcaaaaa aaaaaaaaaa 948360

aaaaggaaag aaagaaaaag aaaacaatca gataagaagc ggcagcagca atattctcag 948420

tctgtttgtt tctttgagat agggctctca tatctagccc aggctggttt ggaatttact 948480

atgtagccag ctagaagaag gtagaagcag gaagatggag ttcaaggtaa tccttggtat 948540

cttagtaaag ttiagaccag cctggctccac gtggattggt gtgagaacac aatgaacctc 948600

agaaacattg gtgggcaaga cacagtgaag aatactataa ttacagccct caggaggcag 948660

aagcagagge agagggatcc ttttaagttc aaggccagcc taggctagge taccagggga 948720

tacgtaacct tgatttcaaa ccaaaaatgg taaaaggtag ctttgacaaa tacacatgta 948780

agacccaaat tttcaactat gttacctttg tgcagtgaa gtggaataa actattcaat 948840

aatgtaaaag ctgacatctt tctttctttc tttcatttat ttttttgatt tttcgagata 948900

gggtttctct gtgtagcttt ggagcctatc ctggcactcg ctctggagac caggctggcc 948960

tcgaactcac agagatccgc ctgctctgce ctctgctccc cgagtgtctgg gattaaagge 949020

gtgagccacc aatgctgggc aaaagctgac atcttttagca gaaaatgtac tgatgtctgc 949080

atttcaactt gaaataaat taaaaataat ccagggcggg ctagtगतat ggctgaggag 949140

gttaagcacc cgtgccaag cctgatgact tgagtgacce ccagacccca cgtgatggaa 949200

ggagagaagt gactcctgaa agttgtcctc tgacaacatg caagctggga catatgcatg 949260

atccacatcc acaaacacaa aataatgtaa aataaaacaa acaaacaaaa caaccaggge 949320

ctgttgctga agcacctagg agatatccag gctgcatgag aactgatca aaaaaaaaaa 949380
 aaaaatagta agtaaaaagc cccaaataac agtaaaagaa aagatggctt acgggatgta 949440
 ttttgtaacc aagctagtac ttcggaatgt tactgatagg gttttttag taggtgaagt 949500
 gaaataaata tigtgcagta ttgcataac aaagtgtaga aaaggccat gctcatttgg 949560
 acacatagtg ttaaatgtcc tcacttatga gcaggtgcc tgaactacagg gaaaggatag 949620
 aaggctagct ggagcttggc ctttcagag gaaagcctgg gcctgggact ttccattaag 949680
 actgcaagaa gaagggattt cccagaggtc ccaggattca ccctgctcaa cagctgcaaa 949740

 cccacaggcc ctttgcctat tctgagcagg ggaaagtga gcaggaggta acaaaagcat 949800
 ggataaatta gtaactgact tcccattcct taaatttctt tttccttag tagaaatcca 949860
 gagccatcag ctccagtta ttatctgcc tagtgatctt cactagtga tacttaggt 949920
 tttggggccc aagaacgtgt ctgtctctgc cttcagagac ctgtggcctg tttttggaag 949980
 ctgccctgct tgetgtcgt aatctcccag ctctccctgg cttgtattc cacactccc 950040
 ttaggttcc tttatccc caacacagcc atttattgt tgttgggtt tttttgttg 950100
 gggacaaggt ctccctatgt ggctctggct tagaactcac taggtgacca gtttacctta 950160

 aattcacaaa gaaccacctg cttctgcctc caagtgctag gattatagga gaccaccacc 950220
 aactgggca cctccacagg aacttattag aggggtgcag ggctcaggga ggggtggct 950280
 cccttatcta acttcttggc cccagaagga tctcttttg ttgcttttc attttgagat 950340
 ggtctcactt tatttatagc acaggtgcc tggacctcaa ttatgtagac cagactggct 950400
 tgaactcagt gtgtctact gcttcaagca cctggatgcc cagactgcat gcagaagcct 950460
 ctgagctacg gtgcctgcac aactgacag aagcctcgt ctccctgcc cccataaaa 950520
 cccatgctc agttatatga tccaatggg atggcatctg ctccaactct ggagcctcag 950580

 acctggcaca gagctcattt tccgagtga tgtgttggc cttaggctct tggcactacc 950640
 cttcaggcat gacttgtgag acttactcc tttccttggc aatcataaag gcctcagggc 950700
 tgetcttctc tgetctgtg tagacactc ataagttaat cagggtcaca gtggacagaa 950760
 taaatcaaaa atgaaatgag acctaactg cttcagagcc aatgtgacag aagagagaca 950820
 aagaagaaca tcttctaagc acctggtcag gccttagga acttacaac tcccgggctg 950880
 gggccattt ataaaccagg atcacaccg tatgagaggc tataatca gctctacctg 950940
 ttacatcca aaaatcttc caccacctc acttcttagg cttggcactg gccaggcta 951000

 gttgatctc catgccctaa caagaccgc gggggggggg ggggggttgt gttcccaca 951060
 ttacagctct gccactccac cagattctcc ttggaaaagg caaagtaagt ttgagactc 951120
 agagccaact ggtcttgacc aatcagagcc tcttgactcc agcctccagg agacagatg 951180

ggtctccacc cctaggcctc ttccttctgt tagagacacc gacactctcg gggacttcaa 951240
 ctggttgcca tagttggcaa agtgcctgctt ccttggccac ctgcctggag tctaggcaag 951300
 tagaagccag aggaggctgg cagctgactg tggagctctg acctaccac tcaggccaaa 951360
 cagactctgc aaggaggagg acagtaaaca gtgcttcacc ttccaactct aaagattcaa 951420

 agcagcaggg aaagggaaag tgatgtcact aacagacctg caatccctgc acttgagagt 951480
 tggaaggagg atcagaaatt caagcattc tcaagcacta agtacattg aggccagcag 951540
 gagtaccag aaagagatgc tgtctcaaac aaacaacaa acaacaac acaaagaaaa 951600
 agtcaggaaa atcacaggac ttcaagacag tgcaccatg taggactgta gactggtgcc 951660
 agagtagcaa ttgtatttta cctggccctt tcaattgtca aaagcattct tgttcaacat 951720
 catactgaat ccatggccac cttccaagta aagaaacaa gactacagcc tctcaccaga 951780
 ttacagcagc caccttctcc acaccaggt tccagctcgc aacctttct ctctctggca 951840

 gcatacagtg cacagtctaa atccaatcac atttatcctt ggttgaanaac taatggttca 951900
 gcctgaacct cagcataatg aggtcccaa gggctgtgta gtctaaccac tgcaaccctg 951960
 gaatgttctc attcttctc aggaagcaca gtcagtacta cacaaccact aatagcacac 952020
 agaattacac tctttcttgg gtttccctt ctctcttct cttctcct cctagtacc 952080
 agctgaattc tgtatgttcc cccgactgt atctagaac cactttctcc aagaagcatt 952140
 cacagtctg gctcccagcc ccacagtgc cccatcacce tgettgccct gettgtttat 952200
 tttgcattct ctcccagact gtgggttccc tgaaaggaag gctatgtctc attcatctaa 952260

 agagctgtag agagcagtag ttatgtatgt ggagtatgat gagaactctc tttcaggatt 952320
 taacaaata ggaagctgcc tcatatataa gcaaaggaag attaccaaga tgttttctta 952380
 aaagaaagta gaagattctc tctctctc tctctctc tctctctc tctcttactt 952440
 gtaaacttgt acatgatgct tgtaaacaca tggagagtgc ctcaaaaagc caacctcaa 952500
 gcacacgatc cagattacag ggggtctcca atttgtaac cttccttaag cattagccac 952560
 atttatttat aattgtaagt aagattcct gtgttctctg ttcttacatt tatttagggt 952620
 gactgggata ctttctttt agaaaagaca gattcgtgaa gtgtgtgtgt gtgtgtgtgt 952680

 gtgtgtgtgt gtgtgtgtgt gtgtgtgtgt acataaatca ctgatagatt tgttacacct 952740
 ataatccag aatttgagag gtagaggcag gaagacaagg agttcaagc cagcttcagc 952800
 tacatagaaa gctagaggta tggctgggta catgagacc tgtccaaaaa tttatatagg 952860
 aaagaaaaaa agagactgtc tcttcttat aatttatgaa ctgaatactg ctccagaagt 952920
 ttgctgtgta tatcaacaga gctcactatt cacatttcac ctgccagcat gtgactgatg 952980
 gcaaaaaata gaccaggtt atatcaaatc ctttaaac cctatgaagt ggaaattatc 953040

accctgaaat ctgagactag aaacaggaac ctaaagaagt taaatcacct gctacaagtc 953100

actgtgagag agttggagga gacctcaagc aatcaaccag tagattcaa tcttatctct 953160

cacattcaat cacatacaca caaaaacaca catgcctcat tagatggttt actactgtta 953220

tttcctgtta ctgactctga ggcaatggta attaccaat gatgtgtact taccacatga 953280

tgaaaaatac ctaatggtcc ccaagagaga gaaccgagcc ttagtcactg gagtacatgc 953340

tgggataact aatagtctac acatattcat tctgtaatag gacgagatac ttttcaatat 953400

gaacagagca ggactttaac aaaactcagt aagtcaagtt gttctatgta gtctatatag 953460

ataaaactga ttttgacaat gaaggtctgg gttctggtca cccatctgga atttgtggcc 953520

at ttggcaca cagaaaagct cttatctgcc tgtaccaggg agagaaggag gaggctagag 953580

gaaaatacct ttcctgcta gaaaggtatt tataaaaaca ggctgtggaa tgagcatatg 953640

ttcccaatg cctgatatct taatagaaat gccagcacac aagaaggact aggcttggt 953700

gtgcaggaca tgaagagccc agatttggat ggaaggaaag gatggagaca gtgctaactg 953760

acctcagtca gatgtgtgac ttcacctca tctttgcttc cccccacc ttcacatcct 953820

cttctgttc tectcactc ttcctcctt gaggcgtatc ttaccactta aaatctactc 953880

taaaagcact gctatactca tatgaacat gtgaaaaaat aaaaaggac tctttcatta 953940

taagtaccaa attaaccaga agcacctca aatccaaca gcaaaggatt acctggtcaa 954000

acaaatcaca gtgcctccca cccaaggaac atgatggggc cactacaaac attcatctca 954060

agaggctgag gatggagccc agtgggcaga gtgcttgttt agtatgcatg aaacctcagt 954120

tcagtccca gcatgacata aaaatcggca catgcctgta attctgacat tcaagaggta 954180

gatcaagaag gtagtttaag gtcacttca agcacataga gagtttgaag ccagtcttgg 954240

ctacatgaaa gcctgttaga ttggttgtt tttaaagatt tattattta ttatgtatac 954300

tatgttctgt ctgcatgat gcctgcacac cagaagaggg caccacatcc cattacagat 954360

ggttgtgagc caccatgtgg ttgctgggaa ttgaactcac aacctctgga agaacagcca 954420

tccttgattg ttttgctttg ttcatttaa ttagaaacaa actccttta catgctaate 954480

tcagttccct ctctctccc tctctccctg cccaactga caccctatcc caactcattt 954540

cggctccca gggagggiga ggccttccat ggggatctt caaagtctgt catatcattt 954600

ggagcagggc ctagacctc cccagtgtat gtatctctct atgtggaatg ggctcccaaa 954660

gttcatttgc aactagggg taaatagtga tccaccacca gtgacccat agattgtcca 954720

gtcctccaaa ctgacctct tgttcagggg gctctggaaca gtcctatgct ggtttcccag 954780

ctatcagtct ggggtccatg agcaaccct tgttcaggtc agctgtttct gtgggtttct 954840
 ccagcctggt acttgattgg ttttttgtt ttgttttgtt ttgttttcg agatagggtt 954900
 tctctgaatt attttgagc ctgtcctgga actctgtaga ccaggctggc cttaactcac 954960
 agagatccgc ctgcctctgc ctcccagta ctgggattaa aggcatgtgc caccaacgcc 955020
 cagcccttga ttggttttt taagtactt ttattattt atgtgtatgg gcatctgggt 955080
 attttgcta tatgtatggt gtctgcataa gtcagacaag ggcatcatat cccctggaac 955140
 tggagttaga gacaattctg ggtgctggta atcaaacct agtcttttgt aagagcaacc 955200

 agtgctttta actgctgagc tgagccatct ccctatact ctgcttgttt ggattttgtt 955260
 ggttgtttgg ctttatttgt ttgtttgttt gagacagggt gtctctgtgc cctggctgga 955320
 ctagaactgg cttttagac catgttggcc tcaaaaatta gagatctgcc tgccctgtgc 955380
 tcccaagtgc atgctctacc accaccaagc aggattcttt tcttttttcc ttttttcttt 955440
 ctttctttt ttttttttt ttttttttt ttttttttt ttttggttgt tgttgccttt 955500
 tgagatagta tttctctatg tctgtatgta ataactttgg ctgtcctgga actggctttg 955560
 tagagtaggc taggctggct tcaaatctac agagatccac ctgcctctgc ctctgagtg 955620

 ctgggattaa aggcatcac taccacacc aagttttgtt gttgttgttt gttttgagac 955680
 agagtcttac tgttagctt tacctgtcct ggaacttata gaccaggcta gctttgaacg 955740
 cacagagatt tatctatctc cgctcgaaa gtgctgggat taaagggtga tgccaacaca 955800
 cctagtaaga ctgatttga aaaaaaaaa tgttttaatt ttatctcaag gtgagtatct 955860
 caaggtgaaa gcaccaagtc tgagagcagt ttgtagatta ggatgtttt gactcaaaaa 955920
 cacaaatgct cttatgtaca tgtctcata gccacctgtt aatgtatcag cctaaaagac 955980
 acaaaccaga ctaaacagag gaccaaata ccatgtctag tgctggagca caccagggg 956040

 tcttaagaat gctagataaa ctatctgtgg tggatgcatgt tgttaatccc agaatttgag 956100
 aggcagaggc tggaggatct ctttgagttt gaggccagct gttccaggac agccagagg 956160
 acacagagaa atctatctt gagatacca aaaaaagaaa ggaaggaagg aaggaaggaa 956220
 ggaaggaagg aaggaaatgc tagataaaga tgggtatggt ggcacgcacc tgtaatccta 956280
 gcatttggga ggctaaggca gaaggatctc caagagctgg aggctaccac aggctgtatt 956340
 atacagtaat gcaagccagc ctaagaagg gacacacact gtctcaaaa aagggtagag 956400
 gatagctcaa ttggtaaagt gcaagcataa gaacctgagt tcaatcccta gtaactatat 956460

 taaaaacca tgtggagcaa ctctaactac agtactggga gggcaaagac aggatcccta 956520
 gagcttgttg ggtagccctg ctggtgaac tggcaagtgc cagccaggtt cacggagaga 956580
 caatgtctca gaaaataaag tgaacgggaa ctgaagaaga caccagcat caatttctgg 956640

tctccccacc cacaagcata catatacaca ctctccctgc ataaaagcaa agattactag 956700
 gccaaacta tacactgagt acattctcag atcctactag agacttctat ttgttgtttg 956760
 ttcttgtttc tgtttgtttt gagatggctt taccaggcca ggaaagcctt gaactacaca 956820
 ggcaaggctg gcattgaatt cctgcttcca cctcctcagg gctgtaaatt aaagccgtgt 956880

 gctaccacac ccacctcag atctctcac tggggattta acctagggt tgaagcatgc 956940
 taattaagca tatgactgct aagctacagt cctaataattg gaactttact tttcattcaa 957000
 cattctttca ctctttttcc atgacaacaa taaattcatt tattgcttat gtgattaaaa 957060
 tgtattcaaa atgtttttaa agggtaagaa atgggagcta caaagatagc ctttcagtta 957120
 aaagcactgg ctactctttc aggactcagt ttcaattcag cactctcatg gtagattata 957180
 acatctataa ctccaattaa aagtctatac ccttttttca cctccataag taccaggaac 957240
 acacatagta tacacacata gtatacacac aggaaggcaa aacctcaaa cacataaaat 957300

 aaaaagaaaa aaataagaga tatgaaatga tggcgctggg gagatactc aaccaataaa 957360
 gtacttcaca tgcaagcatg aaaacataag ttgtatttcc agcatccaca taaaagcta 957420
 gacatggctg ggcagtgtgg cacatgcctt taatcccagc actcgggaag cagaggcagg 957480
 cggatctctg tgagtctgag accagcctgg tctacaagag ctagtccag gacagcctcc 957540
 aaaagccaca gagaaacct gtctgggaaa aaaaaaaaa aaaaaaaaa aaagcagcta 957600
 gacagagctg gagagacaga ggatccatgg gactggccag cttaggctaa attggcaagc 957660
 ccaagtgcta gtgagagacc tttctcaaaa cacaaggttg gtgggagggc tgcagaaatg 957720

 gctcaggagt taagagtgt ttgtactctt tcagagacca aagtttgggt cccaggagac 957780
 acacttgggt gctcactacc acctgtaact acagctccaa gaaatctgat gctctgttct 957840
 gacctctaa agcaagcatg cacacaaaca gtaataataa aagaatttaa aaagaaaaaa 957900
 acacaacaac attttgtttg tttttgtttt tggagacagg gtttctccgt aggtttggag 957960
 actgtcctgg aactctcttt gaagaccagg ctggcctcga actcacagat ctccacctgc 958020
 ctctacctcc tgagtgtctg gattaaagge gtgcaccacc tgcaccacca ccaccaccac 958080
 caccaccacc cagcaaaaaa caaaacaaaa acaaaaaaac aaaacaaaaa aaaaaacca 958140

 acttttaag gtaagaaatg atgccaagaa ctfggctatt ctctgtagtt caactaccaa 958200
 tatactggat cctactgect ttgatctgta gttcaacca gccctcttt tccaataatt 958260
 aagtttctct tgcttttgat ggcacctgat gatttgaca cagccccctg gattaagag 958320
 accttcttt catacaggca gcatcccaca gatgcctcat aaacattgcc aatttcatta 958380
 actgagcaaa attagagtca agacaacagg ctgagggcta tttctttgga gtttgccaac 958440
 ctccgtatag gccaaagtag gtccaagacc atcacatcca agtctggga tacatgcaaa 958500

agaaaaggac tctgaaaaca gaagtgccag gatggctggg atacatgcaa aagaaagggg 958560

 ctctggtaag cagaagtgcc aggatgacct ttggcttat tttagacct acagtgaatc 958620
 ctgtagattt ctgcccttgt aggacatact cattcaccgt cagaaactgc cactagggtc 958680
 gtttcatgct agaaacagcc ttttctgtt catatacaca aggtggatgg gttggatgaa 958740
 aatcctccag taacattcac acaagaaca ccagtccac cagttcacta gcaaaagctt 958800
 aaacttctcc ccaaacttct aacctggag acaagaagct cctgggccta ttctctgaca 958860
 ccattagtct tttcaaacag ctccacttct aagccatcca ctattcaggg aaatgcctgg 958920
 ctaccaaggg cattaaagtg accaacagta taaatgatct ttcaagacct caacaatgag 958980

 ggcagtctgc catgaaagaa catggcagat tgaacgagag aacttcagga aagatggatg 959040
 attccacaaa gggctttcca gaccttaag agagctagct aaaagtataa acctcaaact 959100
 ttgtttttca tgttgaacca agatctttag gaatgagcct tagaaatctg ttttaaggggg 959160
 gctggagaga tggctcagag gttaagagca ctggctgctc ttccagaggt cctgagtcca 959220
 attcccagca actacatggt ggctcacaac catctataat aaagtctggc accttttcta 959280
 gcatgaaagt gtacatgcaa gcagaatatt atatatatga taaataaata aaatatgtta 959340
 aaaaaaaaaag aaatccgttt aagaataaaa caataggggc ttggggctgg agagaaggct 959400

 cagtggcaaa gaacctggc tgctcttct ggacctggtt cagttccag tatctacatg 959460
 atggctcaca actgtctgtg actccagttc taggggatag tagaaactca ggaggttgg 959520
 cagaaggatc agaagatcaa ggtcattgtt ggctacatag taactttgaa gccagactgg 959580
 gctatgtaag acagctaccg ttacccaac agtccatcca tggcattccc aaactcctg 959640
 cctttgcttc tactgtctc aaaaccacc ttgaccac tcagcact tcatgtgata 959700
 gtgccaacaa ggtcaattt tacaagtaca ctgctttca agttggcct gactgaattt 959760
 gtttcttgac tccactgacc atgagtgaag agcctcagta aactattgt aactatgga 959820

 tagcacttct tctagatttg ttgtaaggat tcaatgaagc aacctcagc atggcactca 959880
 acacatgac agtgttggga ggtagaagca ggggcacag gggctcaaag ttatcaacaa 959940
 aagattcagt ttiacacaat tcactcccct atcccttct cccaagtgag ctcaatgaca 960000
 gatgagctct ccccgtgca taattcaaaa ctagaggatg ggaaccaggg tctcaaccga 960060
 cagcccaggg ctcaaatga acctgacc ctgtctacc ctcaactctc acctgccc 960120
 cgttgaaggt cagtgtgatg gcgtaaaaga aattggagtt ggcacttct gcataaatcc 960180
 agagatgcca caggacaggg aagagaagag agcagacgac gatgatgcag gtgagtacga 960240

aaacgttccg taggactgaa aaacagatgg tcagttagtc ccgcactctt cctctggccc 960300
 cctctttttg ctgtggtagc ctcacaggac agggagcagg tcatatggct caaaggcaga 960360
 gcactcctac aaatattgtg ttgggaggca aacctcagac cctggtaaat ggctcccat 960420
 gcccataact gcigggaaac tacatttga gactttctc atcacttcca cagccatgat 960480
 gtctcatgga tgagaatggg acctgaaccg gcatgatgag agttccacag tgggggtctg 960540
 catgatgcca tgcccacaca gggtaaaaat gcactgtctc acgtgcttgt attgctcttt 960600
 aaatgacctt cttactctt ccacagacaa cttacaatc tatctcctt tccatctcc 960660

 cagaccaaga tctctatag cacagcctgg cctcaacta agtaaagata actttgagcc 960720
 cctgatgccc ctgcttctac ctcccaaatg ttgggtgcag gccataacag gccatatttt 960780
 aaaattatat atacgatcat ttgtttgca tacaggtctg tgtacatgt gtgtgcctgg 960840
 tgcccaggaa agtcaacaga cagttaact ccttgaact ggggttatga acagtgtga 960900
 ttgccatgt ggggtctgta aactgaacaa gtgctctaa gcacagagtc atctctccag 960960
 cccacaacc cttttcaat gccctcttt cttacattac accttctcc agaaggaagg 961020
 ctgagacctt atagggggga gcactatacc agagcttga caggcaggca gaggtttagtt 961080

 tagattaggg cacagatgtt ggccacacaa agagttgact ttaagggaga gatgagtga 961140
 tatectactc tggcaagcaa agtgtgatgg cccatgccta taattccagt acacaggaag 961200
 ttggggacag gggaaagagg agttgtttga ggacagcttt ggttacaaac cctatgtcaa 961260
 aacaaaacaa aaaaacaaat caccaccaca aaaattcatc agtctttagg ttctgtaagt 961320
 cttagctacc tcatctctaa aatggggcta aaatgcctgt tatgtgaatc acatgagact 961380
 ttgtgcaaaa gtcagatttg ttgacaaata cctggctta cagcaccgga gggagaatgg 961440
 ctacataagt aagaaactta taacctctc aaaacacaaa tcaccaacag caaaagggt 961500

 tgaaaaaaaa acaaaactgg acattgtatt tattactatg tgagttttct attgctatag 961560
 ccaatttcca taacagcatt ttaaaaaata taattacca ctaccattt cttaggtcag 961620
 aagtcaaaa tgggtcttct gggccacact caaggtctgg gcagaactgt gttccttctg 961680
 gattctcttg gggagaatct acatgcttgc cttttccagc ttgttggggc ctggagtctt 961740
 tagctcataa tccccttaca gcttctggca ctgggagacc caatccatct tagaggttac 961800
 cattcttgc tcttccatgc cttggttctc cgtgttctg tttagaagac tttgttagat 961860
 ttgttagagc agttttaagt tcacagatag ctgagttgga gatacagttt tcatactctc 961920

 cggcctccac ctttcttctt tgagatatcc ttatacttat actgcacctg caatcattac 961980
 thtagagtcc cttttgctat aaaagggaac aaattcactg gttctgaaat tagtgatatg 962040
 gacattgttg ggagtgatga ggaagggaaat tattctgctg accacaggta ctcagtttgt 962100

tttcttttga tagtcatctc tgacagtaga agatgtcact gttaattctc tttctacttt 962160
 attgtatfff aatgtacata ttttaaatta agtaatttaa acaacataag atataatcat 962220
 ctgcactggg cctgggtccc agcaggaact cagtgaagtg ttgttcttac tacttctctg 962280
 atgcagactc acaggaaacc agttttcttt ctttttcttt ttttaggata aggtcttaca 962340

 ttgtagccct gaatagcctg tctctgactg ggattgaacc agagatcagc ctgcctctgc 962400
 ctttcaagtg ctgggattaa tgggtgtgtac catcatgccc agaaaattgg agatttaca 962460
 aatgaggcac tcacggtcac tctcagttct accatcactg gactgataca ctggaagggg 962520
 actggataac agataattct ctgttctagc tgcaaataac aggggagtcc cactagagtc 962580
 tagggtagac cctacacaga ggttttgtaa gtttctggg taactgaata tggactctga 962640
 cagtctgcca tagaatcacc actaatgtgt ggactaatag aacaaagtag tttgaggtta 962700
 tttttacata attttttaag gtttatttat ttattatgta tatagtgttc tgctgcatg 962760

 tattcctgca taccagaaga ggggtccaga tctcattaca gatggtttgtg agccaccatg 962820
 tggttgctgg gaattgaact caggaccttt cgaagagcaa acagtgtctt taacctctga 962880
 gccatctctt agccccactg aggttattat tggttttttt ttttttaatt tttcgagaca 962940
 ggatttcttt gtgtagccct agctgttctg gaactatctc ttgtagacca ggctggcctt 963000
 gaaatcacag agatccact gactctgcct ctgtagtgtt gggactaaag gtgtctgccg 963060
 cggctgccgc cgccaccgc actaccact ggctcactga ggttattttt aaagctgtgt 963120
 tggcaacata tagttcacta attttgtttg gctgattttg tttttgaag cagggactca 963180

 taaagttcag gctagcetta cttgatatgt agcctaggat agcatggcct taaaactcct 963240
 aatcctctg cctccacctt ccaaataca tgcccagcta cagttcattc tttgtaaaga 963300
 aggataagaa tccttctttt gttattatca tttaaaaagc cactttagcc ggggtgtggca 963360
 atgcaccctt ttagccccag cactcaggaa gcagaggcag gcagaactct gagagtttga 963420
 ggccagcctg gtctacacag tgagttccag gacagccaga gctacacaga agaaccagt 963480
 ctcaaaacaa cacaagtcat ttaaaatggg gacaatattg gtactgtttt catccaccac 963540
 caaaataaaa agctttaaaa aaatttcttt ctttttttaa aaaattttat ttatttatta 963600

 tgtatacaac ctctgcttc catgtgtatc tgcacactag aagagggcac cagctctcat 963660
 aacggattgt tgtgagccac catgtggttg ctgagaattg aactcaggac ctctggaaaa 963720
 gcagtcagtg ctcttaacct ctgagccatc tctccagccc aaaaaacatt tttcaaatgt 963780
 tagtggtgta gaaatccct taatttgac actagcctgg aggcctgaaa ggaatcagaa 963840
 aaggttgcct tttctgatct gatatttcca ttgtcctgga cggtaaacac tgaagggcca 963900
 aagtcctggt tcagctctcc tgagacctgc cagggagcct gggcctcttg ctctctca 963960

gggtagggag cccaggaaaa gctatgttta cactgttatac acattgttat catcaagcag 964020

 cattccaaac tgaagaaagg agaacagagc tgcttactcc cccactgtat ttcagttctc 964080
 agtggttctt tctcatcctc tataaataac ttggctgaaa agaacatgta ttattactag 964140
 aataaaactt tgcagggcct ggtagcccaa gtggctcctg gttctgtgac tcaggcagag 964200
 acagaggctc taaaggggta aaggaagag actgagtaca aatgaaaga ggctacgaat 964260
 gtagcctctg ggctgcaaag agacttcaat gtgcttggaa aaccttact agcatccagc 964320
 tggattcagg ccagtgggta cctttgcagg gacagggagc tgctactcac tcttgctggc 964380
 tggaggctg ggagattaaa gctctatgcc agagcagatg ggactgggga ggacctgagg 964440

 cacagacagg acagcttgtt ccaggcacca agagggtca gagatgacca aggcctacac 964500
 ctttcatcag acctgctagg tcagatggag tcaagttccc cagacattca ctggatggct 964560
 tatccaatct gtggcaccac actgaaaaac agaaacttct gactaggccc ttttcccttg 964620
 agcctcaggc gttcagaaaa aaaatatcac ttaaaatctc tggctctatc aggagggtca 964680
 cagagggaac taaggggctt caaagggtta agagatgttt cttttcttaa attaaatgct 964740
 agatacatga gaacttacag tatataatgc ttataattta tttgtatttt aatcaacatt 964800
 cttttacctt tacacaatag ttaatttaa aaacaaaaag aaatcacgca tatgttcaac 964860

 tccagtctcg tggtagctgg ctttgcattt ggggcattgc agctggcacc agctcggcca 964920
 gcaggctgtt cttaacacc acaagtatgc atctgcctga ctcatcctga cccaaggcta 964980
 cagaagccag tgactgacat ttattcattt atttgggtct gttgtttgtt gttttatca 965040
 aaacaagggt tctctgtgta gccctggcta tctggaact tgatctgcag actaggctgg 965100
 ccttgaactc agagatctac ctgaccctgc ctccaagtt ctggtgtgat tgagcattat 965160
 acccaaggaa gggcctattc ttttcttccc cactgatcaa tataagaaaa cagatgaggt 965220
 gggagcaggg agatcaatac tggcagcagg tgtttcaaaa tgggacatcc tataacatta 965280

 actatattca actaggagga aagacttctc aaaatctgag tagacagaaa tcagaggtcc 965340
 caaggcctag gactaaagac atttacaagt gattataata actcatagat gacaagtccc 965400
 aaacatgaga agtccctata cagtgcaaag tatggcagcc actactttcc gaagagcttt 965460
 agacaagcca tgccttggc cagtcagtca atagcagcct ctacttatag agtctctact 965520
 aatagagtct attagatcac ccagggttct ggaacecccc tcttcttct ctgtctcctc 965580
 atccctgtag gcataaaca atttatttta agttttaaaa aaacatatat ttatttcaat 965640
 gtctctggat gctaagctg aagctttaat ggtggaaata tgcaggtgat gaccctggtt 965700

aattattgat gacaagtgca gtactattca tatatttctt ttctcaaaat taaaaagata 965760
ttcatgaaag atacttttatt ttgaaagaga agtctcccta tgtggctctg gctaaactca 965820
aacttgctat cctcatgcct cagcctttta agtggtgggg ttaaggaccc acaccaggat 965880
actctcttca tctgggtgat ggaaaaggaa aagccagagg ctcaaaaagg ctaaagcagc 965940
cgcccagaaa gtcgggaggc aggcctgaagc tctagtcagt ctataaacag aatcagcaat 966000
gtgagattac tgcataatgc ccctgagaag ggacaacact ctgtgtagga cagacggcta 966060
aggaaaacaa cctgcctcag agagagcaag accagtgccct gaagcttttc cttcccacag 966120

accaaggcat gtccacatat tctgattgcc tcatgattca tcaactgggtg attcttgtct 966180
gtgaaacgag gatgtcacia gcagaagatg atgctacctc cctcagtcag ctcaagattg 966240
tcaccattcc accaggccca agcgtcacac ctggcctggg cttgtcctac ccacttagct 966300
gtttaccttt actctggggc ctacacttac agataggttt cctacttgca gctggctcagt 966360
ttcacttctt ggttgacacc cagacaaccc caaaactaac ttctctgaa gcttgtactt 966420
ggagttcatt tctgacacag ctcccttccc actggaagac agagaatcag gaggataact 966480
gggctctgct tcttcaaag ggagccttca aaagcccttc tacaggcatt cgctaatagt 966540

tttgtgtcag aatccatggt ggggtctgga aacactgagg caaaagatat cgccagaagg 966600
gagcctttag acacagaaca gaactacaa gagggatggg gggaatatga gcccaaattt 966660
gggaaacatt gggggcttaa gtaacacaga acatttctga gccatattat aagagatagg 966720
tagaattgag gggcttttat aggaagtctg gttttcaaaa cccaaggtta cagttgccac 966780
ttgtccaata gaaacttgg ccattgtcca ataggaagcc tggccatag tagcatccta 966840
catttgaatt taataaaaa catcagtttc tctggcacc atgactcact ctatattctc 966900
agtatttagg aagctaagac aggatgactg cttctaatt gagggcagcc tgggttacat 966960

agtgagcttc aggttagcca gggctacagc ctaggctgtg tgacaacaa atgacaacaa 967020
acaacaaaat ctgtcataa cagtacacct ctgtaatccc agatttgaga ggtacaggca 967080
ggaggaacgg gagttcaagg ccactctcag ttacatagta aacacaagcc caatttgggc 967140
tttatgagac cctatttcaa aaagctggga gtaggagaga aaaacaagaa aaaatttagt 967200
ctctatatta gtagccactg ggtatggtcc tcattagaga aatcaggctg gacagcactg 967260
ggcaaggctc taagagccag gcttcaatcc cagtgtttca cagcagtcac agggccttca 967320
acaagtagct ctcctttct gtgctgtttt tctcatctgt acctcaaggg atgatgcaaa 967380

gagcaaatga gctaatgact gacaatggtc tgtaaatggt agttaatgag ctaatgactg 967440
acaatgtcag gcgcagctctg taaatggtag ttatctgtgt ttccagcact getcacagcc 967500
caggaggcac acgggcatat gcatgtaggt tgctctctct ttctcagtc tgcagacaa 967560

caggtgccca gtaaatgctc attaactccc ttctcccagc tgtttcgccc aagagttaga 967620
 tggactggaa tctatthttgt gaagagagtc agactactca catctgtaga gatgattcca 967680
 cacaggggaag aaagccatgt agagggccac atctcccacc gttggatagg acttgaagat 967740
 agagatgatg gcaatctgga tgaacatgaa gaagatgggg tgctccctgg agcagggccg 967800

 ggaagacaaa catgcagaga gattagccag ggaccagtcc cactcttaga gactcctgac 967860
 ccaccaggcc ccagtagcac agcagcaaac tgcagagatc aagaaattcc cagaagtggc 967920
 aaggaagaac agacaaacac cagtataca gtttgcagga cactgcccac caatagccac 967980
 ttctgtcta ctagctctgg ccctggctcc cagaaaccaa atcaagaaag caaatatagt 968040
 cagctttcct tattagtagc ctaaatgact gcttgtcaga gaaatcaggc agcctctccc 968100
 agcaaaggcc ctigtcaaca ggtccaaaac aggaagtgcc tgctggctga tggcttgctc 968160
 actgaaaatg tggtcagagc aacatgtaga cccttactgt taagaccgag gactgaacgt 968220

 tacatgcagc attgctagct cctcaggggc caagaattct ctcttttggt ttttagagat 968280
 aggatctcat gtagcacagg ctggcctcca actcactata tagttgagac cagccctgga 968340
 cttatgattt tcttgcctct actttctagg tcttaggatt acaggcaact accatgtctg 968400
 tctcagagtg gaatthttgg gagcttaaac tagtaacagc tgaactgatt ttaaataat 968460
 aaactgccat ggctcccatc tctttcttt ctatactgag ttctgtgcag tttctcctgt 968520
 atcatctcag acgatectca cagcacctca gccagccctc caggcagaga ttctgttcc 968580
 ctgtccttcc caggtaagga aactgaaat cagagaaatg aagtcagtgg tatagctgta 968640

 tgtctacaga gctcctgata ccactatgtt cctctccttg gtgcttcaca tgtcttgag 968700
 caccagtaag gaggtggggg ggcatgcctc gtctaaagc ggccctctg agaacaccaa 968760
 gagctgaagg gaagtgaata ggaaaaagcc agttacggat ccctctcaat aaccctcagc 968820
 acaagcacag ggaagactct gcacagagct gatgcctgct tataaggcct ttggtcaggg 968880
 gctccgaagc cagggtaatg gagccacttc tgggactact gcaagtgctc tctcagaac 968940
 ttggcacagt ccaagtagat gagcagattc tggagtcaaa caaacctgtg cctgaacccc 969000
 agctccactg cttgctatct gtgtagctca agaagaactg ttcactcttc tgagcaacaa 969060

 tttatcaact ataaaactga atgatggaag tgaataatg ctggccttca agttgctgag 969120
 tttgctatca acccatctca cagcgtata taggtacctg ggaagaagca ggctccacaa 969180
 tgacagctct tacactgtag aagtgaacta cacagaaagc cccatttgag gaaaagtgat 969240
 caaagatcaa acagggctgt acatgccag tctccaaaat aaccaattg gaatcctttg 969300
 gataaatcat aattgagctg ttgatcaaga acatccaacc agaccactt tcccacaaaga 969360
 catcctcagt gtaacctttg ttcttgccga aatggtgagc agactaaaat gtggccccag 969420

gcacctccag gtgagaccag ggggaaacca gggctccgaa gcatcctccc tgcagcctgt 969480

acttggtgtg gaatctcaac tgctgaccct ggatactggc acatgacaaa aaagtcaaaa 969540

gcctgatggc aggtggfacc agtccaaagg atagctcagg caggccacag gagggagggt 969600

ggacaaataa acagcaggtc ctcaactta cttaatttg atggctaagg ggactgtgta 969660

gaagaagacg ttgatctgaa acacgcagac aaaaaagagg ctgaagtgtc caaacatctc 969720

tgcaaagaag taccagaaaa gcccgatgtt tggagtgaga tctggaacag aaagtctgga 969780

attaagaaaa cacaaggaga gaaaagagaa gagttacaaa tggtttgctt tgccttctt 969840

ttccaagat ttgaggtcac tactaggcaa ccaaggatgg cattatccat ctaaaggtea 969900

cagtagtata aagagctctc tatatactc catacagaca attiacaaaa tataggctg 969960

aagatgccc gaatagaagc tataatacat actagctcag gactggggat acagctgagt 970020

tggtagagtg ctgcttaga gtgcacaggc cgggcttct acccccagga ctgcattaag 970080

cccaaatgta aaaacaggag gatcaaaagt ttaaatcat tcttgattag atattgagct 970140

caaggctaga acaggtgaca tgagggaata aaaccaaac ccaaacaag caaacaagc 970200

aaaaaaaa gctaagctaa aagaatctga aatgaaaaag ggagtccag gacagccaag 970260

gctgcacaaa gaaaccctgt ctcaaaaaa caaacaaaa caacaataac aacaacaaaa 970320

accccaccaa aacaacaaca acaacaaaag aaatcaagag agcagccctg cttttctaca 970380

tcaggccagt ttacaatcag gagctactca gtattgctag aggaaggaga cttaataaa 970440

caaaatctat ttgggcatt ccaaagactt gccagagga acaagctccg agagcctgct 970500

cctcccagtt ctgctccac atccccacag caggagccag aagactgcat gcctgagcct 970560

gcaactgact ttccaaggc cttcaggagc catcagcagg ttgtgcaaat attcctagga 970620

ctacagaact catctgaaaa ttttgagttt atctaggaga cctctgtata gttaaatagc 970680

ataagaactg gctgcaatac tggctcttc aaaagctacc tatgtgtaca catactctct 970740

ctctctctct ctctctctct ctctctctct ctctcttggg ttgtctttg tttttcagag 970800

ctgggatgga actcaggact tccacaatgc tagaaaggca ctctaccact gggctacatc 970860

ctgagctgtg tigtgtttg tgtttgtgtg tctttcaaat gatgaagaca gcaaggggca 970920

ctaggccggc agtgacaaga gtattaactg ctgccctac catatTTTT atttgaaaa 970980

gagcaatgtt gaaattaatt tgtttataat tttattattt ttatgttatt gggttttttg 971040

tttatttgtt ttgtttttt gtctttttt agacagggtc tcaactatga cccttggtg 971100

gcctgaaact cactatgtag accaggctgt acttgaactc acagagatgc ctgcctgtgc 971160

ttcccacgtg ctacaattaa gggcatatgc caccatacct gtctccaatt cataatttaa 971220
 aaaggccaag taccttactc atttggcat cttacaagcc tcagaagtgt aatcaaaggt 971280
 gtaaaagagc agaggctca aactttgttc cctgttctac cctagtgcc ggaatactag 971340
 agagattaaa tttttgatct ctatctcata cctattgaat tagagcccct agggatgggc 971400
 cagcactctg gatttcagaa gctgaggagt cttaaaacct gaggaccct gctgtagact 971460
 gcctgcatag tcttctccct cttactccac taggagctgc aaaaaccaa ttagcagccg 971520
 ggctttgggt acgcaggcct ttaatcccag cacttgggag gcagaggcag gcggatctct 971580

 gtgagttga gaccatcctg gtctacaaga gctagttcca ggacagcctc caaagccaca 971640
 gagaagccct gtctcgaana acaaaaacaa acaaaaac aaacaaaacc aaacaaacaa 971700
 acaacaaaa aatagcttcc aggaatctct tatgaagttt gtactgtagg gagagatctg 971760
 accacgacca ctgggcgtg gtcacaagta tgtagaaggc atgtggaata aagagttgag 971820
 gagaagggga ctccctctct tttcggggtt ctggttggat ctgagaggac tgtggaaact 971880
 agagcacgga gcaccaatcg ggttatcagt attgcatgtg agagatttta ataaattgag 971940
 catctatata catatccat taacactgta cttacatgaa tccatagacc gcagggatga 972000

 aatccaaga gctgagaagg aagaaggaga ggcaaaactat caccacaagg cttcctatat 972060
 acatcatggc atactccaa gagaagatcc agaaggcttt gctcttact ttcacagga 972120
 tgtactgccg ctaggagaga ggccagaata ggacatttag ggacaccaag gacaaaaaac 972180
 acctctcagc ttatacata agatccctcc tataaaaatc aagccatggc acatagttt 972240
 acaatttgc tgtttcctc ctttcttct gtttttttg tttttcgag acagggttc 972300
 tctatacagc cctgactgic tggaaatagc tctgtaaatc aaggctggcc tctaactcac 972360
 agagatccgc ctgcttctgc ctcaaagtg ctgggactaa ggatgtatgt tgcccctgcc 972420

 accactcagc cctgatactt ttcttatatc agaaaaaaaa tacaatggt ttgaaaaaag 972480
 gtaataagaa tggatgagac ctctatcac tattccaggt gtgcatctg gagatgtgca 972540
 caaaatacca atgagaagat aatcactgaa ccaggaagaa agcatggact gtggagcaac 972600
 gggacaatgg catgctagca atgacatgta aactgcacct atgtatgtcc acatagctaa 972660
 gtctcaacat tcgagggtat agcacaact tgccaaataa tcgatagaaa ataataacat 972720
 tcatgctatc ttgaaattac acccaacaat attatgtatt atttatacat atgtaggact 972780
 ttaagcataa aaattttatg aagcatattia gaaggacata cattggccag caagatggct 972840

 tgggtggttaa gacacttgc accacacctg ctagcttgag tttaatcct gagatccaca 972900
 tggtggaana gagaaccaa tctacaaga gtccactga caatctcata tgcactgtgg 972960
 catacgtgtg ccatcaccac aaaaaataca ttaaggccag cctggtctac atatcaagtt 973020

ccaagccagc cagagataca caatgataac ttatccctgt tcttcccata aaaagcaagt 973080
atgaaataaa atggtaataa aaaatctttc tttcttttta cttcgagacc ctgtttaaaa 973140
ataactggtg ggaggggtta atatttctct gcctttcaca agaaagaaaa actaaaaatc 973200
aaacaacata tcaaaagggtg tgtattgagg ctcacacctg tgaactctca gtgttacaga 973260

gtctgggta aaaggattcc caagaattca agactagccc tggctacatt gttgtgtgat 973320
atthtgattg ttttctgaca aagtttgctt ggagtcagag ggcagagcta ccacgagctg 973380
accgtagagg cctggaggac tgtagatggg gagacataag tagggaagca ggcagagag 973440
aagatctcag cccctttgca tggaggaact gaagatatag gaaataactg gtggctgctc 973500
cttgttctct gatctttcag gttcttacc caatatttga cttttgattc tttattgata 973560
aagagtaaat tagattaatg cttcacctgg catccacaaa ttcacaagac agccactagc 973620
ccctggcttt gaaaccattg gcaaccaatg gagctgtaca cgcaggagcc tctgtgccac 973680

cagctggctt ttcctttctt tctccaagtc ctctaagcta gtctgggatt ttcctgttgc 973740
agcctcttta cagaaatctc cacaagcccc agactctaca ggcgctgca ctccaaatac 973800
cactgtgga gttagtctt cataaccagt cagctctgcc tteatgcagt tecctccaca 973860
agtgatcctt ctgcacaatc ccatgtgtgt ttttcagaca gccagctccc tttcgatgtg 973920
gactgcagge ttcccagga cctgtctctc aggtgtctgc aacctaggt agcagccttc 973980
acatcactca agcttctatt attgttgeaa ccgccacaca ctctcagtc acagetaaag 974040
gtgagcagct gcagctgctc tcagccaagc tgtgcaccac ctgttttgtc tgcccagatg 974100

tgctatgcag tgacagccag cctcactt cactgtcacc atcatcagag ctgggtgagac 974160
acctgggaat tattaaaggg gagaattagt ttaaaaggaa ggaagcaagg aaggaaggaa 974220
ggatggaagg aaggaaggaa ggaagggaga aagagagaaa gaggtgtttt ttttttttt 974280
accacattga aaaaaggaa acaactattac aaacagaggg agttaggtct ctgtatgatt 974340
ctgaaatgga cagtttaatt agccgggcgg tggttgcga cacctttaat cccagcactg 974400
tgggaggcag aggcaggtgg atctctgtga gttcgagacc agcctggtct acgagagcta 974460
gttccaggac agtctccaaa gccacagaga aacccgcct taaaaaaca aacaaacaac 974520

aacaacaaca acaataataa taataatagg aacaattaat gaggtttta ttaacttagc 974580
tgtgatttac ataatgttaa ttataacat tatgggtttg gtaattctta ttttatccct 974640
aaaaaagttg ctigatatga gtgccaagat acagacctta gaaaaggta ctaagaaaa 974700
taatgtaatt ttactgata aattacaagc cttagaaaaa cttataaaa cagatagaga 974760
tattcagaca aagaaaggaa tttaaaggt aactaacctc accatgacat tataaaatta 974820
gaggaacagc ctaaggttat aaaaaaaaa aaagccaacc ttaatttatc tagtaactat 974880

acaggaacaa ctgccaaatg acagatatcc ccaagactaa ggaagagctg actggattcc 974940

tatgtaaatg ttagatttga ggagatttaa ggacttgata gtctcatgtg ctacgcattc 975000

accttttgtg aggcagatgt gaaattcatg gtcaactagt aacagaatta tcccacacaa 975060

ttttcttaga aagacttggg tatagcagta tcagaacctg gtcttcaact gcagtggagg 975120

acctggagaa aagatgaggc taggaccttt gaacaacaaa gtagggctag aggtatggaa 975180

atitcccaag cccaacttcc tggagagggc aactatgctg acgtgtaaag acggtctata 975240

tctgatgacc atgccttggc tctatgctgt acagcagcct tgaatgcttg aggcagagtt 975300

gaagaagtaa gaaagagaac tgagtcattt actaaagtta cacagggccc aaaagaaacc 975360

ttcattgatt tttcacagag attgacttca gcagtaagta gaatgatacc aaactcagaa 975420

cctagacaaa taataattga atctttggct ttgaaaatg ctaattcaca atgtaaaagg 975480

gtaattagge ctttaaaggc aagatcagga cccacagagg aatggatcca agatacaatc 975540

aatatgfaat ctcataacca tgatgatgtt tggataggag aggtgatttc cgaggcttgg 975600

aaaaaaaaat caaaatgtca agtgttttgt ttttgtttt ttgttaattt ttgttggggg 975660

ggggagtttt gagacagggg ttctctgtgg ctttggaggc tgtcctggaa ctatctcttg 975720

tagaccaggc tggctctgaa ctacagatg cgcgtgcctc agcctcccga gtggtgggat 975780

taaaggcgtt cgttacctcc gcctggcatc aggtgtttta attgtggcaa acaaggtatt 975840

ctaaaaagag acigtaggca ggggtttcct aggaacaatg tttttctag gaataatcaa 975900

aacacaagac ccctaccttc tggagtatgc agaaaagtgt gcaaaggaca ttagaccaat 975960

gaatglagat caacaagga cagaaaagga aaccctttgc catcaggaaa acacctggag 976020

ggggggctac tctcatagge ctctatgtca aatttggttc aattgttgcc tgtcaattaa 976080

aggacctact gtaaaaaaaaa ccaactaca cggggtgata gaacagcttt aaaagataaa 976140

acaaaacttt tagaaccata aagcaaatc cataaacact agatttgaac aagagagacc 976200

tcttgattag aaaaggtgat agttcatcaa acaatatgac tactcaatct aaaataattt 976260

aaagatttgt atatttatta tgtatacaga gttctgctag catgtcagaa gaaggcacca 976320

aatcacttta cagatggttg tgagccacca tgtgattgct gggaaattgaa ctcaggacct 976380

atggaagagg aatcagtact cttaacctct aggtcatctc tccagccctc tatctaaat 976440

aacttaaga ctaacaaatg tttttaattt aatcagatat aacttgccaa gtgggaaact 976500

cccaaagtta gggttggagc agagttttgt ttttgtcttt ccaggagaaat aaaggcatcc 976560

aactaaggaa tctgaagacc tggaaaaata atacatctgg agaaaaagga caaatcatcc 976620

agagaaaata tccaaggaa aagagtaaac gggccatttc caacaggata aaatttcattg 976680
 tatcttccca aatgtttgtt tcttctgttc tctacagata tataatgcag atggtatfff 976740
 tgttgttgtt gttgttttga gacagggttt ccctgtggct ttggaggctg tcctggaact 976800
 agctcttcta gatcaggctg gtcttgaact cacagagatc cacctgcctc tgcctcccaa 976860
 gtgctgggat taaaggtgtg tcttaccacc cgcttgctg cagatgtag ttttatagtc 976920
 cctgtttaat taaaaattaa gcaagctttg gagttggaga tcatttctcc ttctctaac 976980
 ccaagcatgc ttgttaaagt aaaatccaaa atctctgttt catgtcagaa gagccacctg 977040

 atatgggaca gaagaaaaac caaaattaag gactattcta ttgccactaa acaatccttt 977100
 ggtattatff tgactcctta aaacttttct taggatataa atatctcaa tttataaaa 977160
 tttgtataca tatatgtttt taaatttctt gttatgatat taatggtcat acagagtact 977220
 aactaattat agaaaaaggc ttcatctagc ttccagtcca tgatfffggg tttgagtctc 977280
 tatcagataa ctaggaatta agcttttcta ctctggatgt acataataaa ttatggtact 977340
 ttaacctfff caagatctgc tgtatattat atttaaatg ttttaagfff ctgcagtcaa 977400
 tcatgacat gcttaacagc aacctttgaa gtctccaaaa ggagaatgag gcctacaat 977460

 gacaatccca ccaggactat gataacctca ctaactgac aaacatcacc taaagaatga 977520
 ctttggacta caaactgttc aggacaattt taaggtggct agctgagatg atccagcctc 977580
 acagactact atacctagga cttgagataa gtctgcattt ccccatffca cagagactga 977640
 gcaacaaatg atacacttag ctctcccagg acttgacaat tctcctaatt tttttcaggg 977700
 tcccctaaag atactgtcac cccagagag caggaagtaa ttttaagaac atgacaacca 977760
 cattcccaag aggtgggggtg ggcagttfff gggtggatta tggatatttg tcattattta 977820
 gcagtatgg ttacacattg ctattggtag tagtcaagaa aaaggagaca aagaagatat 977880

 ttataccta acaaaggaga ttagttagac tcagggatct tgttctgaaa agaaaaagca 977940
 gtgatataga aaggatagga taaaagagta gattatffta aaccaaaaa aaaaaacca 978000
 actactagtc ttaaatatff tatatggtat tttgtatat tgatacaaat ttgagggtat 978060
 ttttgttaga acctactgta cctgcatttc tactcttgtt taaggtatff taactatgta 978120
 actcacttaa tgaaaatfff agtccttgaa agttattaat acaactatt taggataata 978180
 aagaaatgag gttagtagtc acctattgca atcaaacttg tagtcatggt aggtatatff 978240
 tcaaatatca aatatcaaat atcaaataga gatatatfff agacaggtag tcttcaaaaa 978300

 cttcagaatc tacagaatat ggctfftaag atgtgttatt agccggacgt tgggtgagca 978360
 gcctfftaat cccagcactt gggaggcaga ggcaggtgga tctctgtgag ttcgaggcca 978420
 gcctggtctc cagagcaggt gccagatag gctccaaagc tcacagagaa acctgtctc 978480

gaaaaaccaa aaaaaaaaaa aaatgtgtta ttaacacaag gttatTTTT tgttatgaca 978540
 atgagacaca cctgcttctg gcagtGCCaA tctactttag agaagatgat gggcatcaaa 978600
 gaaactccat acagagtTta ctttctttgt ggcaaatgtt agccacttcg caagaaactg 978660
 ccattgcctt gactgctgac agtatgctgt ccaaattgga aaatcgggac acacgaaaat 978720

 atgactGCCa aatTTTgcca agacaaggca ggacagtCct tcaaaaatcc tgcttcatag 978780
 aaaagtttgt cagatatccg aggCctgtag GCCaaagatg gatgcctcaa tgttacagac 978840
 aaaccttGga tgactatcca ggcagccagc tgtttctgtg agttcttagt tctgaaagtt 978900
 gtttgCattg cacttctctg tttctcaagt aatagtatat ctttctcagg tctctgatgg 978960
 agttaagac tagatatagt tttccttGtt accaaattca gaaaagaaac tcacaaaaat 979020
 gtgtaaagtG tataaggttg agggacataa aagatagttc tgggttgGta atgcaagtta 979080
 tgatagaaaa taaattaggt acaagactct ggactcacca agataggata gatatgggat 979140

 attttctctg aatTTgtcaa atgcaaatga actaaatCtt gttAattatt gtctatatat 979200
 atttgtatat acttattGta cttattgtat gtagttttac tatgttagtt aaaacatttt 979260
 gtttttattt aaacaaaaaa gggggaaatg ttgtgtgata ttttgattgt gttctgacaa 979320
 ataaagcttt cagagggcag agctaggcac tagctaacca cagaggtttg gaagactgta 979380
 cagagaggag acatgaagta gcaaggtggg acagagagaa tctcagcccc ttttgatgg 979440
 aggaactgaa gaggtaggaa gcaactagca actaccCct gttctctgat ctttcaggtt 979500
 cttaccCcaa aatTTaactc ctgattctta attgataaaa attcattaga ttaacacttc 979560

 actacacCtt gagacCttgt atcaaaaaaa taagtaaaat gttagtggat gaaattctga 979620
 aaggaaacag acttgtttaa tctcaaatTa tctttctgaa agtactaatt acaagaaaaa 979680
 cccaggtgGg ccaagccGga cgacctgagt ttgacCCcca agaccatata gggagaagga 979740
 gagaactgct caaagttgtc ctttgacCtc ctcggtgTaca ctgtgtcatg tacacacata 979800
 gtaagtacac tagggaggct gaagtGagcc aagtacagta tactacgcct cacaacatgg 979860
 aacgtgttca aaagcactgc cggccagacc tcacaggtgg actacctgga agtctTTTT 979920
 ttttgagaca gggtttccct gtgGctttgg aggctgtCct ggaactagct cttgtagGcc 979980

 aggctggtct cgaactcaca gagatccacc tgCctctgcc tCctgagtgc tgggattaaa 980040
 ggcgtgtgcc accaacaccC agctctggaa gaagtcttac acaagaaaca tttttatttc 980100
 acccatca tattctggga tagaactgtg catggtgcct catacctatt tgtcctgata 980160
 attgaaggct gagacaggag gattgctgag agttcaaagc cagactgagc tagtgaatga 980220
 gtccaggtc agcctggGca acaatgtgag accctgtctc aaaaaaagat aaaagtaaaa 980280
 ctaaagttat agaacatgca aaattacaat ttttttgaa gtccagaata gttttcatta 980340

tggcattttt ctttttttac agatttattt attttatgtg tacgggcatt ttgtctgcat 980400

 gtatgtttgt gtgccaatgag catgcctggt actgagcaag gtgctggatc ccctggaact 980460
 ataattgtgg atgttttga gccatcatat ggggtgctgag aagcaaactt gcctctccac 980520
 gggctcgtga cacaggtgtg caccatcaca ctacaccttc attatggcgc tttcacgtgt 980580
 gtcactgtac tttgctttaa tttatatctc caatgccttc tttccacc ctgttcatct 980640
 ctggctagtt cttactgcac cctggaaaat tctcccttc acttacatat gacatgtatt 980700
 ctattatctg catacaagtt ccagactgtc aaaaaacaaa caaacgtaa aacagcaagg 980760
 gacctctgct gctctactct tcttatctca tctttccccc cttaaatgtg ctgacactaa 980820

 gccacctgtg aciattttaa ttaatgaaaa atataaatga aattcacttt agtctcacta 980880
 gcacttaggg gagggagttt ggagacaggg tttctctgtg tagccctggt tgcctagaa 980940
 ctcatatgt agagcaggct ggcctccaac tcagagatgt gcctgccact aacacttttt 981000
 gcaagtgttc aacagccaaa tgtggcatat gcctattgta ctttctgact gataaatttt 981060
 gtgattactg tatagtgtgt gacttctata ctttgtgtgc atatgactac tctattgact 981120
 aagtaagtga acatttccat catcataaaa agttctatcg ggagctaaag aggtagctca 981180
 ttgattaata gcactggctg tcttccaga gaaccagggt tcaatttcta gcacctatat 981240

 agcaattcac aactgtctgt aattccagtt ccaggggatc agacactcta gcacagacaa 981300
 acatgcaggc aaaataccaa tgcacataaa atgaaaaata aatcaattat ttttaaagc 981360
 cagaaatggg aatttttaac ataaattttg aaaaatacaa ctttgcattg gtgtggggga 981420
 tgtgtatatg tatgcttaca tataaggggt ggggtcacct atgtgcatgt gaaggcagag 981480
 gctgacactg gatgtctgct atcagcccga gctcatggct tggccagtct agttagccag 981540
 cttgtttcag ggactcctt actctatgtc tcaagtctg gattatacgt ggtctgctgt 981600
 gctcactctg aatttatgtg tgttctgggg tcccaaattt taagtcttc cacttacagg 981660

 tcaagtgtt taccactga accacttccc caatccact tacaacttat tgtctaagat 981720
 taaatgaaat gaaatgaaaa ttaaatacta agatgaacta aacctatctg tggccacata 981780
 tgggtcatgg atatataac accatcaaac tgaaaatttt aaacaatacc tacaatatcc 981840
 caaaagcata aatagagaca atacttctca agctgattat tatgggcttc tcatgacagg 981900
 aaaaccaaac cttattacag aaggagagg gtttttcag agctagacac tgacctaga 981960
 tcttgtaca tgggcaacta gtgtccaac agttgagaaa tgaatttccc tctcctaat 982020
 gctctaaaac atttcatag aaactatttt ctctcacaac atgaaaaggg aaaggctagt 982080

tatcagaatc aagtccttaa agggagctga aaccaaataa tggttttata tttaaactct 982140
 tgggatctta aaacaagagc ccataggtgg ctgatggctg taattccagc actcaggaca 982200
 tgcggacaag tgatacctgc aacaagctga ctagtagagt agacaaattg gggaaactatg 982260
 ggttcaaatg agatacctg tgccaattaa agtgggaaga gcccaaggaa atcatccaat 982320
 accatcctct ggcacctaca agcagacaca catgtgatca cgtgcatctg catacacacc 982380
 tacctcccac atatgtaaac aaaactacat gcacgtatac acatgaaaaa gattgcattt 982440
 taaacttgca tttcctccta tttgtttgia catatgtttg tctttgtgac tgtgcacaca 982500

tatgtgtgtg tgtgtgtgta cctgaatgca gaggaaaacc gtgaacagtg gtactgttcc 982560
 ttagggactg ctcaactttt ttttttttt ttttggtttt tgagtcagtg tttctctgtg 982620
 aaacagtcct ggctgtccca gaactcactc tgtaacaag gctggctttg aacttacaaa 982680
 ctgagagaga tctgcctgct tctgcctccc caagagctgg gtctaaggc atgagccact 982740
 actgcctgct ctttttgttt gtttgtttgt ttgtttgttt tgttttgctt tgtttttttg 982800
 agaaagggtc tctcactagc ctggaacaca acaagaaagc tagaatagct gactattgag 982860
 gcaaaaggat tagaagtata gtgattcata aatacatgaa caatctgact tatattttgc 982920

ctatttgtaa aaaggaaaa gcaaacagcc ctgctacctc agccctggag accttctgga 982980
 tgcagaacaa acagaaagct gttaggggaa cagagcaggg tgtaaaaatt ctaaataagc 983040
 gcctcctgaa gaaggcctgg gaagaatgca gctatcaaga aaaacctgat gggattgact 983100
 cccttgtgag gcatataaaa tgacctatcc caagacatag aaaaatatgg caatcacagg 983160
 cttaaactca attcaaagac aaaaggtcag attgtattaa agaaaaaga aaagtcaaaa 983220
 gaggcctgc aagctaattc cccagtgtct gttactgtca ttgaaaaaga ggacggtctc 983280
 aaacccaag gctttaggaa ttccaagaaa atgctctctc tggcagtgcc atatgctaaa 983340

attggaagaa tacagagact ggcatggccc ctgtgcaggg atgacacaca tatttgtcaa 983400
 gtgttcaata ttttaagatg ctttgaagt caataaagca tgtaggagac tttagccaga 983460
 gagagagaga gagagagaga gagagagaga gaatcccaaa caaaaaggaa gagggaaaag 983520
 aaacttctg gattgtgcta ggagttccct taaccccaaa actctagtct cctcaccag 983580
 catcacagtc tcaagatttt tttatttatt ttcttttccc attctgttcc tttgttattt 983640
 ttgtttgttt tgttttgttt ttttctatg tagcccatgc cggccccgga cctctttatg 983700
 taatcagact ggictcaaac tcttaacaat cccctgcct cagtaacctg agtgctaaag 983760

ttacaatac acatcaccac aaagggtaaa aagctcagct tgttttcac tgtggccccc 983820
 aatgctgtac aactagggc tctctgtttt attttgcgtg ctatcagatc ataactgt 983880
 aagcatctct ctaatttggg aagtaggctc caagccaagg tcaaaagaag agcagagttg 983940

ggggaaggca ccagatgggc tcaaaactatc attttcatca gtgactcacc agggagccag 984000
 atacagcatc ccttcttttg accccatatac tcctaagaga acagaaaaaa gtctttccct 984060
 ttggttctga tgacacacta gcttatccac tatctacatt ttggtctcta gaaacaacca 984120
 gaagaatgga ggcaggttta tgggtgcaaa agaagaaata caaactaatt ttacagttct 984180

 tttgattcta gaaaagaagt aatttccttt cccttcatca cccctcatat ttacaagccg 984240
 gtgactaagt cctttccatg accaaatcat tgccatttga ataccaaata actacatcta 984300
 ctgaactctc attagactgt attctagaca cacaacatgt attaaccitt tcaacatgta 984360
 ctattattct attttaattt tttattaata attattatta ttgtgtgat gcgcacattc 984420
 ctatatgcct atgtgtgca tacgtaagca tggcatgtcc atgccatgtt gtgagtgtag 984480
 aagtcagaaa accatgttgg aaataaggac tcttctcca ttgtaggttc aggggatcta 984540
 acttgggatg tcgggcttac gtggcaagtg agttacaggc tgatccatct tgggtggccca 984600

 ttatcctact ttataattga ggaaactgaa gaggaaagcc aagagtatcc aaactacatg 984660
 agtccacatg taccctattc ctttgtttct tattctgaaa attttcaagt atgcaaaaaa 984720
 ttgaaatga tacaattatc aaacatttat catctagcct atttctgttt tttcatttta 984780
 tctagttaa atgttaatac cttgtcatc tcaggctcag gttttctttt tatatttcca 984840
 gttacatttg tttattattt gtgtgtatgt atatgtgta cagtgtatgt gtggaagtac 984900
 acatacaact gtggaaatg gtttctctc ctgagttatg ttctggggat ataaccagg 984960
 ccatcagact tggaggtaaa caccctgaac cagatgaacc atcttctggg tccaggtcag 985020

 atttcctaaa ggataaagta tacatataaa agatgaaaga agctgtgcat ggtggggtgc 985080
 aaacctttaa tcccagcact ggggaggcag aggcaggagg agaaagcaag gaggaaagga 985140
 aggaaggaag gaaggaagga aggaaggaag gaaggaagac aggggaggaa atgcacaggc 985200
 tatggcgttg tctccgtggc taaaatgctc gctgcacaag cttgaggact tgagctcaga 985260
 tccccagcat ccctaaaaag tctagcatgg tgcctgaac ctgtaatccc agctctgagg 985320
 aggcagacaa ggggatcttg ggagcttctt ggccagccag tccagctgaa tcagtgagct 985380
 tcagattcag tgagaccctc tcagaaaata aagtgaagac accaggcatg gtggtgcatg 985440

 accttaatcc cagtctaggg agacagaggc aggcaactt ctgtgaattt gaggccagcc 985500
 tggctctacac agtgagtcc aggtcaccta aaaccacata ctaagtctct gtctcaaaaa 985560
 aaaaaaaaaa aaaaccccat ttggacctct ggccccaca tgtacacata taggcatgta 985620
 cacttacaca taatattctc ctctctctct ctctctctct ctctctctct ctctctctct 985680
 ctctctctct ctctctctct cacacacaca cacacacaca cacacacaca cacacagcaa 985740
 atacacacta attatgtggg aaaggcttga attcaacaag aacataaaag aaaatcaaaa 985800

caaagtaact tcacatata atgatttgc tattaaacta gcaaccacaa atctaatttg 985860

 aaaagtcagt gccagcagac aaagagacag ttcacgcctc tgtggatact gcaggtgaca 985920
 ccacaggctg gctcaagatt tctgatgaac actctggttt ttgcatataa taactaaaac 985980
 tttttgcagc ctttgatcca attagaaaat aacagagaaa aaaacttgtc attggctagg 986040
 gagagggatc agaaagtgag agcttacttt ctctgtgcta gcacaaagac ccaagtccaa 986100
 attcccacac tcacataaaa agccaggcat ggctgcaaac ccactgtaa ccctagcact 986160
 actcggggtg cagacaagac gattgatcca tggggccttt tgactaccag cctagctcca 986220
 ggttcagtgg aaaacctgtc tcaaggaat aaggagaaga atgctagaac aggttaccca 986280

 atgtcctctt ctagcccctg gatgttcaca cggacataca caccaacaca tgaccacaca 986340
 tacacatgta tatacaaaaa aaaaaagaag agtaaaaagg atggaaggaa ggtatataaa 986400
 ggaagaaaag aaggagtaaa aaaaggatga atgaatttca agctggcctg gtaataaaaag 986460
 tctgttatcc cagtactca gaagtcctcc ttacattgtg agtataaagc tagcttgggt 986520
 aatttagtag atggcatttc aatttttttt tgttttgttt tgttttgttt tgtttttcga 986580
 gacagggttt ctctgtgtaa cagecctagc tgcctggaa ctagtctgtg agatcaggct 986640
 gcctcaact cacagagatc cacctgcctc tgccttccaa atgctaggat taaaggtgtg 986700

 tgccaccacc cagcggattt tcaaattttt taaaaagaag aaaagggttg aggatctggc 986760
 ttagtggtag agcacttgac tgttgtgggt ccagccctac attcaattct cagtataaaa 986820
 aaaaaaaaaa gaaaacaaa tttctactac acacacatac tactaacaat aaacaggtat 986880
 ctcaagttct acgaacaaaa gaattaacct ttaccacta tattcatcaa tctgactcca 986940
 tattatcaag tacttaaaa tgataagcac agggcctggt ttaatgagtg gaggtgtgca 987000
 atctgcctg gctacaaacc actcttctgt atgtgaatcc cagtctgcc agtacacttt 987060
 gagcaaaact ctcttctaag aatgaacttg gattcctttg agtcctggt tttttttttt 987120

 tttttttttt aatggggtag ggtgagtagt caaggatcaa actcagagcc tttcatgaat 987180
 gatgactggt gtgctctact tccacactac atcccaagtt cgacgtgat atttataagc 987240
 tgaaaataag agacggttgg aaagcaaaact cctgagtcag actacctgaa ctcttagctc 987300
 agtgctgcat ctgatggttt agatgactga acctcctgac attctagttt taattcatgt 987360
 gtctaataaa aatatattta gttactctgt ggctgagaat agaactacc ccattaagtt 987420
 ctttaaagtt gatatacat gatgactgca gagggcttaa cataagtatt tcacatgtag 987480
 gttattctcc acaaatatca gcactttata ttcaattatt gtggtcggta gtgaccacta 987540

tgttcttgcc atggcaaagt ggcctagggt ccaaagtagt gcagaagtca gccaggtgta 987600
 atgatgtaag gctgggttgg gccttacacc aacaatacct accatcactt tcaccagtgt 987660
 gcagtcaact gcttattgaa aatagcagac actattttaa atttgccatt ttaggaaact 987720
 agagagggtg ctactggct gctttccag aggaccaga ttctattccc aacaccacat 987780
 gccagctcac agctgctgta actccagttc cagggaatct ggtgccctca cataaacata 987840
 tatacaggtg aaatgctaata gcacataaaa ataatcttt aattaaaaaa ttgccatfff 987900
 tghtaatcact attaagaacc ttacaagata agtghtaatta ttaagaaaaa aacaaaacaa 987960

 aacaaaacca tgagctcaaa gaggtatatg cacattaagt gaaacaaaaga aaatgtctgt 988020
 ccagtgttta gtggatgcca actctaagtt aactgtccct acacacttgc aatgacagac 988080
 acagttaaaa ctggccatt aagtctcctt tgtttcatgt tagtctgctt tttcaaac 988140
 aagtgggaag gcccaatccc agcaaacactt tgaaacgtct gctttgtttt gtttgtggca 988200
 tgagggactg aagcagggcc ccatgtatgt gaggcaaaca tcacatcaa cactgagct 988260
 acatccctag ctccaaatgc tgctgggtgac ccatgccatt cctcccccac cccccagaag 988320
 gggccaggca atgtactaaa tactacttgg gcaactggcac cagcaagcgc ttacctggag 988380

 gagatagaga agtcctgggg caaacaaggt gactgggtat agagtctggt atgttgctaa 988440
 ggcaagaaaa atagcactga ggaaaacact gcctgtgaaa agaaacaaag gtgtagaata 988500
 acccgcctc gtcaatcaag atttcactca gcaagtccac atcaaatga aactcctaac 988560
 tgctcaatta ctgccaagt gcttctgat atgcaaagta ctctgcaaac tcaacagaat 988620
 gaaagctctt ggcttagttc ccttgaaagg aaatcaagga agtcaaaatc acctgccttt 988680
 aacaaactgt gatgtcacag acatgtttct taagatffff ttcagatcca gaaagatfff 988740
 tataaaacct cagcccaggg ctggagagat ggctcagttg ttaagagcac tgactgctct 988800

 tccagaggac ctggggttca attcccagga cacacatgca gctccaatat ctgacactct 988860
 cacacagaca tacaagcagg cataacacca atgtacataa aataaaaaca aattggaggc 988920
 tggagatatg gctcagttgt taagagtact gactgctctt ccagaggacc tgggttcaat 988980
 ttccagcacc cacatgacag ctcaaacctg tctggaactg tcagttacag gggatctgac 989040
 attctcacac caatgcacat aaaataaaat taattttaa aaaataaaaa taataaata 989100
 agctgggcat tgggtggcaca tgctttaat cccaacactt gggaggcaga ggcaggcggg 989160
 tctctgtgag ttcaagatca gcctggtctc ctgagtgagt tccaggacag gctccaaagc 989220

 taggcagaga aaccctgttt cgaaaaacca aaataaataa ataaataaat aaacaaattg 989280
 caaaaaccaa aacacataat aaaactcagc ccaaagatff acaagtagac aacaactatt 989340
 aacatccatg tcaattgctc caagttatta aatctgcaat tactgttcat gaaattcaga 989400

gctgtgaaac ctagccctct ggatttcaca acagctcadc actctgtaat acctttatct 989460
tgaagccact ttttttttc taataaaaac attattgatg ctttattttt ggtttcactt 989520
tgtagcctaa actggcacca accttgcagt tatctaagtc ctccaagtac tggggtaaca 989580
aacataagcc accatatcca catctagctc agagtacatt ccttttatta atgagictac 989640

tccttacaca aaacagacta ctagggagtc attaagcatg caatgaaaga atctgtgatg 989700
atacgtatct aaaaagatac ggaaatacat tgtaagtag aacttagag atacatacag 989760
tttatgccat cagacccac tgttttcttt gaaaacttta aaatgaacat aggccaaggc 989820
tacaccgaga aactgtctca aaaaaacaaa acaaaacaaa acagaacata tccaggtggt 989880
ggtagtgcac atctttaatc ccaacattca ggaggcagag ggaggcagat atctgagttc 989940
aaggccatcc tgatctacag agtgagtcc aggacagcca gggctacaca gagaaacact 990000
agaaaccctg tctcaaaaa ccaagagtg tgctttgttt gtactatagg aaaggcatta 990060

atTTTTctat ttgaaaatac acaacaagc aaacaacagt tattcccttt cagatgtatt 990120
aagacaacta ggtactttca tagcaagggg agaggtgacc tagaaatcag ttgacatagt 990180
ggttcaaagt gcatgtctca tatgattatg gtttataaaa caatagtgtat atggctgtga 990240
ctgtcctgga actcactctg ttgagcaggt tggcctttaa ctcacagaga tccacctgcc 990300
tctgcctcct gagtgtctgg gtcaactctt ctcaatgatg tttcacaaga agaggaacce 990360
ctcagictac tcaatctgag gaagcttacc actttccaa cctagctcca gggagacata 990420
gagagaggtg atcaatatgc tcttttactc actaaagtag tctatttact tgatggcaat 990480

ctcaccacac cctctagtgg tctatagact tgaacatag aagaatcacc ttgggaaaag 990540
agacaggata tgggggagaa gaacgaatga gaataaagta taatgacaca cagatgaact 990600
gtctgtcaca atgaaatcat tattttgggt tttgtttgt tttttcttg acacagggt 990660
tctctgtgta gctttggagc ctgtectgaa attcactctg taagccagc ttgcctcaaa 990720
cttagagacc catccacctg cctctacctc ccaagtgtg ggactaaagt ctttgctgcc 990780
atcaccagec ttgtatgta atctttttt tttgtttctt tgtttttgtt tttcaaaca 990840
gggtttctgt cctggaacta gctctgttag accaggetgg tcttgaactc acagagatec 990900

acctgcctct gactccaag tgctgggatt aaaggcatgt gataacctta aaaacagatt 990960
taaaaaaaaa aaaaaaaaa gatgagaaag tagaaaagaa ggactctgta actataaaca 991020
agaatgatca tgggtggacag tacagtaagt aggaagaagg cagacaaagg aggaagtgg 991080
atgtaaaca caaagaacag aattcctgca tcaaggctgt cccactgtat ggggtgaagt 991140
caagatgttc gcaatttcag gtacttgcta aaacaactga gcagagatag ggacaggcct 991200
agccaagtcc tgataccaga agaggcctcc tcccactac tcagctacac agatctggaa 991260

ccagaaccag gtcaccctga gacagggatg tgccagccat aagaaaggtg ctttgctaca 991320

 ggctcaaagc aaagtaagct caggattctc tgacctggcc aaaaaaatgc ctaacaactt 991380
 gtagaaaatt ggctaagagt gtagaatgt tagagagaat tttttatttc acaagctttt 991440
 caacatattt ggtagttgga gagaggaaaa ccattaaat gttgtcagag tggggaggct 991500
 attgttccgc ttcattcatt catacaagg aggtaaaaac acaaaccttc accccactct 991560
 ctgccccagg agacaccaga gagtgaata aacacagtca cctcctgccc taattgccta 991620
 agatcaataa ctgcttgctt ggaacagctg tctgtaagac ccaagagagg aaaaaaggc 991680
 taatacagga acagaatgaa tttagaatg tcttagaaaa tgtgctctga ggaacaagaa 991740

 gtagcctacc ttcttttta ttattagtta attaattaat ttagagacag agtctctcta 991800
 tatagccctg gctatcctag aacttactat ctgaccagg ctcatagata tccacctgcc 991860
 tctgattcct gagtgttagg actaaatgca ttgcgccca cactcagccc tagggtgaca 991920
 tcttaatttt ttttttaat tagtactagg gattgcaacc caggaccttg ctgggcaagt 991980
 gctctaccac tgagctccat tcccagtgcc tagatagaaa tcttaggaag aataatctgt 992040
 tccacctgct ttctattaac aagtcagct ggacacctca tctccacatt cettcttaca 992100
 ccagttccca cgcccacagc cccacctctc aggtacgaca gacagttcat actctcatct 992160

 accatcagtg ctcagcagtc tctcttttct tggcccctcc ttcacagaag caccaaaaga 992220
 ctcttctgaa gcagacagtg acttatctaa gactaagcca ggtatggcag tgcacaccta 992280
 taatgtcagc actcctagat gcaagacagg agggctcagga gctcaaggac acctttggct 992340
 tagttgaaac cagcctgggc tgcatgagac cctatctcaa aaacaaaaaa agtcttttcc 992400
 caatactgcc atacatttcc caatacattg aggctcaagt gcattcaaga ttggacttca 992460
 cctataacce actgctcttt tctgtctatc cttcagtggc atgtgtaacc caagcagagt 992520
 taacaacagt agtgactgct ccgttactag gtgccatgta tatgcattgt gtaatgtcta 992580

 cctcaaaaat gtgccagact caaagaggcc ctggggggaa gcagcacagc agacttggga 992640
 aagaactgtt ctcagctcat tttcttgtga cacataaaat gtgataaaaa tcacataatc 992700
 tattcatttc actaatgaag aaaccaaggc acagaagcaa ggttaagtta aaaaacaaaa 992760
 aacaaaaaac aaacctaagg ctgccaact gccccaact cttgctaagc agcatcatct 992820
 gctgtcttct agcaatgccg tgggaatttc tcaaggcag taagtcttcc ttaattttga 992880
 gtctcttcta ctttccgaag cagacacaat gaatgaataa ctgactgact gaatgaacat 992940
 cattcagtaa tacacaggag atccttttaa aaagcacata gctgggtgtg gttgccaca 993000

cctttgattc cagcaggcag atctctgtga gtttgaagcc agcctggtct acaaggaag 993060
 ttccaggaca gccagggcca cacagagaaa tcttgggggg acagacagac aggaagaa 993120
 ggaaggaagg aaggaaggaa ggaaggaagg aaggaaggaa ggaaggaagg aaggaggaag 993180
 gcaggcaggc aaacacatta aagtaaacca acacccgtga ggaagacccc acaaagcttt 993240
 aaacagaaca ttatgtttaa tgttatgtaa cattaggaag acataacaca aacctgactt 993300
 taggatgaa caaatcttc agattagcaa ttgaggctc ctaatgccag gggcctgcca 993360
 tgggatgct ttctagaata atgatggctg aggccgaat tctggggcaa aagcacagtg 993420

 ctactgtagc cagtggcctg gtatctgatg acaagacagg catagatgtg gcatatgcat 993480
 agcctatgca aaggaagag ggcatatgga ggtacacaag atttgaagaa atctaaaag 993540
 ggcaagaaga atgaaaaagg cattgagttt gaatgaaacg tggttggcac aggggcagag 993600
 aagatgaaaa aaaagtaaaa ttaggttctc aaatatttta gacaaactgt gcaataagca 993660
 aacctgccc gagtttctc tgtgtcaaac ccagattgag aggtagaatg ttaccagcac 993720
 ccacaagaga cacctactc cttttttct ttttgataca gggcttatg cagctagaac 993780
 tggccttggg cttacaatgc agttgaggac gacctgaac ttctgatatt cctgtctcta 993840

 ctttccaaat gctatgacct caggcatagg ccaccactc tagtttatgc attgcaaagg 993900
 attatgtcag ctaggcaaac actctaccaa ctgggtaca tcccagccc agttttata 993960
 tttttcattt acacctagta tacttcaata aaagttacaa tctgccatct aaagtcaaa 994020
 caagcagaca gagatcacag cataaagggt ttagttcaa aaataattca aataactatg 994080
 ggtctacaac tgaataatg gctaaccagg aggagcagtg ccaagagga tatgagttt 994140
 acccctaac gatacaagg actagtgtt gctagtgcag cccatataag cattagttt 994200
 catgagcaa gctttacctt tggcctgatc acagaaacat taggataaac tagctgaatt 994260

 gatataagga ctggctgcca tatcaggga tgaacagcat tacccaaact ctgaatatgt 994320
 tttccaactc tctgatcag ggtggggcc aaaacaagcc tctgcaagaa ggtgcctctg 994380
 gggactacac cttcatgagg gcctgggtgg gtggcaccac agaagggcag agcaggaaag 994440
 agacacagga atgaaacaag gaaaagccag gggactgact cagtatacgg gttagcaagg 994500
 gatacacaga gtcagagact gggtcagaca gtgacctgtc ccaggcagac tggcagtggg 994560
 acagactgaa aactgacca aaagggtga ggtccctcag gactatcaga aaaggaatt 994620
 gcaccagcat ctgaggcaac aggagcagct aggaacagag tccactgcac ttacatccct 994680

 taacagggca gctgtctca agggagtcta accacaccag caatgaagaa acattgagaa 994740
 cctgtctgt tccagactcg actgtgagca cgccacatgc cgtcaaaagt ataccttca 994800
 ataacttacc atccctattt tatagatcag gatctaggat gacagaaagg ggatataagc 994860

ctggacaagc tcactccaga ccatctcaaa aagacaaatt aaataaagt aattatccta 994920
 tctttaactg tactatttat gcaatgcaaa tgtgaaatac agaaacagag ctggagaat 994980
 gtaaaactga tttagtttta ctgaataaat tattactagg cattaactaat atacttgaaa 995040
 agtcaacgtg gttcagagag atgtagctaa tagaggattg ttcaaatact ttaatagatt 995100

 aggaacacta tgacagtctc tctatagcat acaacaatgc aaaacaaatg tccagcaata 995160
 gggaagagca aggccttcaga gcaaatgtgt atgagaaatg gagatgaggg tagggttcag 995220
 aaagacttgc tttttgttta ctatgcttaa atttctttta ttcttaccat gtgcctgaat 995280
 tattcataat ttctaaaatt aaaattttaa gtataaagga aataacaaat ttgtgtttaa 995340
 tgtctgtatt acittagaaa gtttattaac caacacacac aatttatgaa gtactgggaa 995400
 ttgaaccag gacttcgtgc cttcgtgcat gctaggtgag tgctctatca agtgaactac 995460
 atccccaacc ctctgtatta ctttaggata ggttctcaaa agtagaaca ataaagccaga 995520

 tattatgaca cacccttta atcccgacac ttgggaggca gaggcaggta gatctctatg 995580
 agttcaagac cagtctgggtg tacagagtga gttccagaac aaccagagct tcacaaagac 995640
 tctatctcaa aaaaagaaa aaagaaagaa agaaagaaag aaagaaagaa agaaagaaag 995700
 aaagaaagaa agaaagaaa gaaaagaaa gaaaagtag aataaaaaat tgtatttttc 995760
 tttttttgag acaggttttc tctgtggctt tggaggctgt cctggaacta gctttttgta 995820
 gaccaggctg gtctcgaact cacagagatc tgccctgcctc tgccctctgc tcccagtgctc 995880
 tgggactaaa ggcattgtcc accaccgcc ggcccaaat acaaacattt taagaccact 995940

 gataagagtc ctcccagaag ggtcatacaa atgtgttaag tcaactggta atgttcataa 996000
 aatattaac aaaattatgt gtgtaacatt gaaaaaatgg ctatgaattc attcaacaga 996060
 aatccagaca tataataaaa aagcttcct gtgggaccaa aactgtaggt ctgagatttt 996120
 ctgggaacct ttcaactgaca gtttaaaaaa aataaaattg tgtatgtcca caaaggaat 996180
 atggaacca taggagaact tgtgagagt gggtctctcc ttacatcatg tgggtcctgg 996240
 gaatcaaatt caggttgta acttggtggc aggcacctta acatactgag gcaacttgg 996300
 agctcttct acggtttgtt tgtttggtaa acaggctctc atgtaactca ggctgcctc 996360

 aaacttcca cactaaagct gaggatgact ttgaaatcct gaccctcagg tgtttatctc 996420
 cccaagcctg accacactat gctaccatgg ctgacattac ttttaaaact tttgagacag 996480
 ggcttactgt aataggctgg cctctgatgt actatgtaag caaaggtaga ccttgaactt 996540
 gtgaccctac taccttagtc ttttgagtag ctctttaaaa gtgatatac aataataata 996600
 acaacaataa cagccataat aataataaac aaaagtgaca ttttagcac tggctatggt 996660
 gacacataac ccagctactt aggaagctga gcaagatggg tccctgtaac ctaaaagctg 996720

aaggctaacc tggacaatat cacaagacct ctaatcaggt aaaaaaaaaa aaaaaaaaaa 996780

aaaaaaaaa aaaaaaaaaat taaaaggga taataataat tagaaagggtg acatttccaa 996840
ataagagata tgcagcatat cttattctgg tggacagaat aagcctataa tatgctcagc 996900
ctatctgagc ttggcactct ggagacagac tgggcaaat ataaagtctc tattgttaag 996960
aagtgtctgt tgcaaaatga ccacaacctt cacaacaaga caattcaagt tatacagtggt 997020
tttttttctt ttttggtttt tttgagacag ggtttctcta catagctttg gagcctatec 997080
tggcactcgc tctggagacc aggctggcct cgtactcaca gagatctgtc tgcctctgcc 997140
tcctgaatgc tgagattaaa gacgtgcacc accaacacct ggctacagtg ttttttttca 997200

atactgaagt ttgaagctag gggctttatg ctacactcta ccaactgagct acatccccag 997260
tgtaatatga taaataacct aataaattta actaaaatgc ctgaagaaaa aacattataa 997320
gcaacctaga agaacaacac aatgtctcac gaggagctaa gtcattctta tgtgctacac 997380
tgagaaagggt caglaccttg tacataaatg gtctatgaca cataatatca ggtgacgact 997440
atctcttgat cttacaaatg attaacaat actgtttaga aataagaatt cttatgatat 997500
tatagggata tattataaga atagaaattt agcaacaat tttaaaaaat catgagcctg 997560
gtagcacaat gagaccattg taaaaaata actggtttgtg agagcaaaaa aatacacaac 997620

aggaaggat taggaggat ggcttattg gggcagctgt gtctctggga tctggcttta 997680
aggtttcaaa aaacttgtgc cattcccatg cactctctgc ttctgtctgt ggtctagat 997740
ctgagccctc agccgtggt ccagctccat gcctatcacc gtgctgctgt aaccctgcca 997800
cgatggaact gcaagcctca aataaacctt gtctctata agtcgccttc gtcgtggtgt 997860
tctgtcacag cgacagaaag taactaagat atataaagct acagacaaaa tgtttgttgg 997920
tataatggg accatgtac ttggtagctt cagatctcca tccctccctg tgtccaggct 997980
ttctgtcaac ttacagtgct ctttccatgt ggacaagaaa gatagtcac cctcccccg 998040

ttctgtaca agcattctac cactggacta cccccagg tgtaatatga taataatgc 998100
acgcaataca ttaatttgtt ttgtttttta attaggtctt cattgtcagt caaactggcc 998160
taggactctt tgttacagat aaggctgtcc ttaatttgt ggcaatcctc tgcctctgac 998220
tcctggatgc taaaatgaca ggcacataga accacaactg gccatgtat aatattttga 998280
gcaatgggat atttgttagt attcagcat ctgtactggc ctgtccttgg agttttgaca 998340
ggacatgcc tcagctgcag ccactaagcg caccaccgg gcacattcac tatgttccct 998400
tttaaatggg cctgcctac ctctctccc ctttctgtt ctctgtctct ctgtctctgt 998460

ctccccctt ctttctctt tgctactcct gtccccaaag gccggtctcc cttctcctt 998520
ccccctttt cctattcact ttcccccaa aaaagccctt cctccacca agctctattg 998580
catggtatct ttctcacaag tgctgctttt ttttgtttgt ttttttgcgc caccaatgcc 998640
cggcacaagt gctgcttttt aaaattacaa ctattaatat atatgattca acctgicatg 998700
cctggccaga gagtgcctt aatcccagaa ttccggggca gaggccagca gatgtcattt 998760
ttagggcagt atgggctaata tgaactccag acaaagccta ggctgcaaaa tgagatcctg 998820
tctctaagaa acaaaaatgt acatttgggg gctagagaga tggccaatcg atagtacac 998880

ttgcctacaa tccaatgct tggaaacgcaa aagtaagtga acttcagtga gatcaaggct 998940
atccttttgt acatagcaag ttacaggcca gccagggcta cacagagaga cagacctgt 999000
ctcaaaacaa acaagcaaga aagatagttc aatgggtaaa ggcacttgtg aaagtctgat 999060
gactcaaatt ctatcccaga atccagaaaa aggtagaagg agaggcaggt ggtacacacc 999120
ttaaaccaca gcacttgaga gccagaggca cgtagatctc tatgagttcg aggccagtct 999180
ggcttacaga atgagtctta gaatagccaa ggctatacag agaaactgtc tcaaaaacc 999240
aaaaccacaaa acaacaat aaacaacaaa aaaacatcag aaggagagaa ctgcagagtt 999300

atcctctgcc cccacacat gcacatagc atgaacatat gataataata aaattaaaa 999360
ctaaacaaaa ctaaaatga aacaaaaaca atctaggaaa aataggtgtg atataagaac 999420
atagaaaaaa ggaaaagtaa tactagaaag taaaaataat gatagttgct actctgtcta 999480
gtggtgaata atattcacag tatcacgaaa tgcaaaactg accacaagtt aattgatttt 999540
tttgggtgcta gaatttaaaa gaaagagcta gccatgcatg ctacgtacat actaccacca 999600
agccacatac ccaacacaac tactgattta atcaaaactg aaatataaga aaatcaacaa 999660
aagatgtagc agggacattg gtataaaga gctataagaa atcttctttt ctcataatgg 999720

aacacaatta aaaatgtcta aaatttgtca ttcataaggt agctatatag ttcagaaata 999780
tagaaataaa taatagtaaa gtattgctcc aaagaagctg aactagccag aagtgatggc 999840
acaagcctgt cttaccagca cttgggaggt ggaggcagga agattaagag tttagtcac 999900
ctctgccage ctgactcaaa acaacaacca aggctggcct tgacacctta catatcagga 999960
ctggttctct ttctttattt ctgtctgct tcacaaaag atttcatca gctaacaga 100020
gaagacaaca gctgaactag ggctacagaa gacagacatt ctcatcattg tctgggaact 100080
tttctcaaaa ccatatgca acagtgattc tttcagtgt agatttttca ggactaattt 1000140

tttctctctt ggtttaaact acattttcta taataatctt ttattatttg tgtgtaattt 1000200
ttttaaaata ttgtattttt attttttagt caaattcttg ctatatagca caggctgatc 1000260
ttgaattcca tatctgtctc ctgtctcccc ctcccagacg tggcgattat aggtatatgc 1000320

taccatgtat agcttgtgct gcttaaaagg aggaaaggaa aaggaaagaa aacaagctgg 1000380
 agcagaagt tactcttggg ggccttacct tttattgtgg tcaaatgaa gaaagcaatg 1000440
 aggtgtgtg tgatagcaca ggtagacttg gcaacacaag acaggatcgt ataaggattt 1000500
 aggaggtagc tggggaaaac acacatagtt gccattagta aacctgacca gtggaccaga 1000560

gagtcctggc caccacagcc atgaagttca acttatttac aaaaaggaag gaaactcctt 1000620
 agaaacaaat tatcccaaat acaagaggat aaagtgcaac tgggtgatat gaataaaggc 1000680
 actcatcatt atgctataag acatatgcaa aacagggtct catgtagccc aagctggtct 1000740
 tgaactctat atagctggga atgacactga aatcctgatc ctctagcttc tacctcctga 1000800
 gtactgggat cacaggaatg taccacctgg cccagtagca ttatctaact ttgcagatg 1000860
 aggaaactga gattcagtga ttaaataact tgcccaagtt cttacaagct actaaatata 1000920
 ttcaaaaac aggtcttctt ggttctaaag ccaacattct ttctactaag ccctttttat 1000980

agtcaagcag tatcccatga cccagactca tgaacagaca aagtttcctc taaattctac 1001040
 aaggagctg gcacagaact tcacagatct tgatctcca ttaggagagt gttaaactgg 1001100
 agtcccttcc cctaaagta ggaaagaatg gaatcagaaa atgaatccga agtgctttga 1001160
 gtaggaaagt ctacttggg caaatggatt ctttttattt atttctgtcc tgcttgtaca 1001220
 aaagatttgc accagctaaa atgacaacaa gtaacaaaag tagtaataaa gtaaacgag 1001280
 tcataatcaa gaccagagga aatacctaag aagaaaaggt aaaggcaaaa ccaggaaaac 1001340
 caaagaacca gagcagtaca ataaatacca gcctcagaca gactacagct gcacagtaat 1001400

tagcctcaga cagactacag atgtacagta ccagcctcag acagactaca gctgcacagt 1001460
 aattagcctc agacagacta cagatgtaca gtaccagcct cagacagact acagctgcac 1001520
 aataataacc agcctcagag aggtcaacag ctgaacagta accagccat ataggctaca 1001580
 gctttacaat aaccagcttc agacatgget gactttctg gcagacaaag ccagttacat 1001640
 aattctgatt gtcgaaagga agaaacacac cagcttctca gtaaaagatt ataataatta 1001700
 ttcacaata aagaccttaa atctaatecc acctcctagg aatgtaagat tagtagttct 1001760
 aaaaccaaag gcttagaac tctttcgggc ttggtgaggt ttttctatg ttttgtttt 1001820

cccagcaatc agatagactt gttacacaac ctttaaagaa atggctgctg ctatgatgaa 1001880
 actacectca ggggacacaa gagtccataa ggattcatta tgttgctaaa ctttggctc 1001940
 attaaagtat ttccatcaa atctctgaaa tatgtagttg agaagtgata aaccaatatt 1002000
 atctcacagg agaaaaaac agaaaacat ttctaataag tgggtgacat tgaagaagca 1002060
 gctgcctaga catctacctg gaacactgga gatttataca caggcacaag gctcctgaag 1002120
 acccccgcc caggacagac tctaaggtga cctaaactgg cttcaactc gccatgcagg 1002180

tgaagctgac ctigaacttt tgtttctcct gccaccctc cccaagtggg ggggttaagg 1002240

ataagtatca cccaccag tttcttgggt actggggacc aaaccaggg ccttgtatgt 1002300

gctatgcaag cactctgcca accaagcacc ctccacagcc ccttgtttcc tgatatgga 1002360

tacttctaca tagcacagat cagcttcaaa ctcatcaatc ctctgcttt aggcctcctg 1002420

aggctgggac accaagcttc taattctaaa aaattctatg gtcattgttt tccatgagaa 1002480

atattatggt ttgttcaata tgtgtacctt gaaactagca tgttattaaa atctgatgac 1002540

tactagttag ttaaataatt cacttcacct atctcagaaa cacaatggg aatgatctga 1002600

gaggatcaca ctactggca gtaccaatta ctctagaga attctttctt aaagcatcgg 1002660

ctggatcac tctccaagc tggtcacctt gccagatga gaattttact tcagttttct 1002720

aaattacaaa cagagaacta aatcatatga ggaatataga agctatatga aacaacagcc 1002780

acataaagac cagaatttta tacaggacat caggaatgaa gaactacat cttttagaaa 1002840

cagcaattaa agcaggttgg agcccagatc agcactgagt cagaaagcct ttgtaagggg 1002900

tttgattgtg catgtccctg tgtgagctt tgtctccaca gacacagaat ggctctgtgt 1002960

cttttctgg ccaaaactc agttgtgcaa gagaactaca gcaaatactt gatgactaag 1003020

accacaaatc tctaaaacta caacaacatg agaaagtctc atcagatttt ccttgcattt 1003080

gttgctctg agctctgatt tgtaaggga tacttacaac agggccactt tcagagggat 1003140

glatcgatt tccatagggg ttcggatgag ttcggccaca tctggagcat actggiccag 1003200

ttctaggagg agtttctgct ttttaacta gagatggggg aggttacaca gacacacaaa 1003260

acagatgatt tgccatggtt tttagaatga agacaaaaat ctttgcctg gccacacac 1003320

cactgtctgt gctcccctac ttctccaggg tactctcaaa attgctctc caccctacac 1003380

ccactgagat ccagcacatg aacagacaaa gctcctcatg ctcccagaac tctgcattta 1003440

accccgattc tcccctagtt aatgcccaaa cagccttgag agttcaccta agtctcct 1003500

ttcttgaaag gcacacagtc ctttagctgc cctactgcc attctttcac tagtgctcac 1003560

agctctaagt tttgcttct ttgtgaaatt aacacctggc tctccttag agagtaagtt 1003620

ccacaagggt gtgagttact ttacttgctc tctgtgatg cctaactt agcactgtgg 1003680

acaaaaatt agatgaacat atggtgaggc cacttcttag tcatccaag aggtacatc 1003740

actggtgccc ggacttcaaa gttctatcag caaagtatgt tgaacagtt tcaatgatct 1003800

ggatgatgt taictcaggt tcccctctc attcttctgt ttcaaaggtt tgtttgcttt 1003860

tctttatac ttccatagaa gaggtgtgaa atagttaaaa ataaaggaga ctggtgtgg 1003920

tggggagcta aagatttaag atgccgtcat accggggtgg aaagctcttt actttctctt 1003980
 atgcacccca acaaattcat gggcacgagt tctaaaaggg aaacatcatc acagcaaagg 1004040
 acagactagg ttaatgacac tttggccaag atcaactgac taccaacagt tagctttcac 1004100
 attccacagg ctaacagcag atagggtagg tgtgaagtcc cttcagcacc agttttccag 1004160
 gatgctgtgc agatggcagg gatagactct caagtctcc caagactaaa tgtttgcaga 1004220
 ctataaagca ggatccttgt aaaatggaga ctttttaaaa ataattttat gataacttga 1004280
 tcataatcat ctccattgc tctcttatct acttctcact cctgctgtac tcttggttcc 1004340

 aacaagtccc tctttatfff cttttatfff atgtttatgg gtgttttgct ggcattgtgc 1004400
 tgtgcacat gagtacctgg tgccaggaag gccagaagag ggctttggat cccttgaac 1004460
 tagagttttg aacagttgtg agctgtcagg tgggtgttgg gaatacaacc tgagtctct 1004520
 ggaagaccaa tcagtgtctt gagctctcta tgttcgaatg cgcacacgtg cttgcgcgcg 1004580
 tgcgtgcgtg cgtgcgtgtg tgtgtgtgtg tgtgtgtgtg tgtgtgtgta tgatagagac 1004640
 agacagacag agatggggga gggagacaga gacacagaga gaccagtgg gggggacagt 1004700
 taacagaaat agagagacaa agaccaactg agtttaatta ggtttgcttg catgagcatg 1004760

 ggaaggaggc ttatactgg agcatagaca acttaccagt ggtaacacta ctgaagaaaa 1004820
 tgactctccc tctttacaa agtaaagcct tttaggaata catgtgctga cattctatct 1004880
 aatcaatag tggataggtg tctaggtgtg gtggcataca cctgtaattc cagcacccaa 1004940
 ggcagaggaa agatcatgag ttaaccagga ctacataatc agttctagaa cagtctgaac 1005000
 tacatatggc gactcagtct caaaaaataa acagggtcag caaaaggact cataaagtaa 1005060
 aggatcttgc catcaaacca aatgacctga gttccatccc tgagatcaac atggtggaag 1005120
 aagaggatca actccggaat gttttactct acatgtgtag cagagcaagt gtagacgcac 1005180

 aataaataaa taaataaata aataaataaa taaataaata aataacgaaa tagcaaaggc 1005240
 ttggagtgtg cctcagtagt agactgcctc acatacataa ggctctggga tttatctggg 1005300
 ttttaaacac tagaaaaaga aaagaaaaaa agaacagtat atgacgtgat agtagcacta 1005360
 agagctgcta ctttcagcat tcatgtgggt gtgaaacaaa ccctaatcc agtactcaga 1005420
 agactgactc agtggccagg gtgggtgggg cgcacgcctt taatcccagc actcgggagg 1005480
 cagaggcaga cggatctctg tgagttcaag gccagcctgg tctccagagc aagtgccaga 1005540
 ataggttcca aagttacaaa gagaaaccct gtcctcaaaa accaaaaaaa aaaaattatt 1005600

 tattttatff gaggtgtgag tgtgagtggt tgtgtgtgtg tgtgtgtgtg tgtgtgtggt 1005660
 gcacatgtca gaggataact ttcaggaatc atttctcttc ttccaccatg ttggccctgg 1005720
 agacagaact cagatcatca ggcattgtct gcaagtgtct ttatcccatg agccatctca 1005780

ccagcccccac ctaactatTT aaaaatagtt ggatctTTaa gtacatgact tttgattcat 1005840
 ggccataata agcacattac caaatccac cagccttgTc ctaccacta tgacttacca 1005900
 caactTTatt gaagTcctga attgcaaaat acagggcaat agcagtgagg gcatctgtta 1005960
 tctgtcaaga gaaagagaag taacagaaaag agaagtaatg ggagTaaTaa aaagtacagt 1006020

 tagtacatgg tactggaata ctgccaggat ggaacagaat tgactTccca ccaccaaact 1006080
 cacagTcggT caagGcctac Tcagggaggt atgacagaaa aatctagatt atgatccatt 1006140
 caatcaggtg gccatatct ctagaccagc aagtTaaatg aaaataagcc agGcctTgtg 1006200
 gTaaacacct gTaaaccagg gacactggag aactcccatg agTtcaagat cagcctTgat 1006260
 cacatagtga gatctTgtca aagctaatgg gaataatct caccatctgt agGctTcagg 1006320
 tatgcaagca cctcacacat ggTaaGtct caacaattag ccattacaat taagaaagat 1006380
 ttcagggTtt ctTaaGatat ccagatTTTc aactctgtgg attatgTttc aagctgctct 1006440

 tctatcaaaa ctTgccctgt catctcaatc ttcaattctc gTcctTgaaa gCctctTcag 1006500
 ctccctcaga atccctTggc agaatGctta ggaaactcag gatGccctcc aaactggcat 1006560
 agTtagagcc aaccacagac TctcagggTt agaaaattga agactacata gTccaataaa 1006620
 ccaaaaaatg agaagaaga actggtTgca agaccccgca gTtTcctcat actccacaat 1006680
 accacgcaa agccagactc caagctaaag atactgtcct ggctTTTatt tTTtgagaag 1006740
 ttccagTtcc gTttTtct tTcctTtct tTcttataga cagggTctca aaatagccc 1006800
 ctggtTggcc Tggaatctgc tatgcagacc agGctagcct caaatTcaca aagatccatc 1006860

 cactGcctc Tgcctccag gCgctagaat aaaggtatga gTcaccag cTccttagtt 1006920
 tctTaaaaac aaactgTaaa attaaaagca tatacatata ttgattTTTc Tctggaaaga 1006980
 tacttaccat aaataccaat Tctgcataat cGattaggaa atgaaagagg tatattatta 1007040
 atggagTctg taggagaaaa acaaagatga aaaaaattaa gTtaaaccTt aatacaaat 1007100
 atccattTcc aagTtgggga cggggaaaac ttattcagct aaaaaatcca atcctTcctg 1007160
 caacagTtat cctgtactca ttgaacaagt tatcatccta gTtcacatgg tatcactgaa 1007220
 actatcagTt gaacacagta gaggaataa caaagcctga tattatctag attatctgcc 1007280

 TggcatgTtt gGctTgaggg ttcatccctg tagtagatac Tcaggaggtt gaggtgagaa 1007340
 aacagattga acctagaagt Tcaaggccat ttgaaaaaat aaacaaggGc agagggtgta 1007400
 actcagTtta taggatgTtt gcttaggatg catgaagccc cggggctTgt ctTcagcact 1007460
 ccaaaaaatc aggtgTatgc ttataatctc aggactTgaa gTgcagggga aagaaaggga 1007520
 atcataaact cagagTgatc ctgGctatac aagTtccatg ctagcctagg ctatgagaga 1007580
 tctTgtctca aaaataagta aataaataa aatgggaggG ggactccat agaggaaaca 1007640

gattgttga tgaacaaact aggatTTTT ccttcctcta tctctgata agtttgtaca 1007700

 agaatgtaa ttattcctca gagacctggg gagaaacca catggtgata cctgccgaaa 1007760
 tcccagcact taggctgaag atggaaagt caagatcaat ctgggttatt atactgtaga 1007820
 atcctgtctc gagggagaaa taaagtgtt gagaaaattc acttggata aaattaatat 1007880
 tggcctgagg ttttattat ttattcattt ggtttttggt ggtgttgag tggcagtgg 1007940
 agaagggtgg ctgtctgtt tttttcttg gtgctaagga tcaaactggg tctttgaaca 1008000
 tagtacatac atgctacatc attaagatac atcctcaatt tctctatcgc tgagatacat 1008060
 tcttttaaaa agaacataca attatttttc tatgctttgt ttttaattg gtttggttt 1008120

 ggaccttgt gatggagggt tatgtgcca aggcaggcct caaactcact atgtagtcaa 1008180
 gatgacctg aatttctgag catggtgcca ccatttctt agtgctagga ttacaagctc 1008240
 tggttttacc ttttctgctt tgttttgtt tcttgagaca ggatctcaga tatcacagge 1008300
 tgaccaagaa ctgggtatgt agccaaggat gacctctgaa cttctgacct tctcacctcc 1008360
 acctcctgag ttacaggcat gtagtaccac aacaggttta tgagatgctt gggattaagg 1008420
 ccaggatttc atgtaaaata agcaactgaa ccaacagagc taaatcacca gccttagtct 1008480
 cactattatt ttaagattta attttactat ttttattgtg tgtgtatgtg tgcctgcatg 1008540

 ctaatgccag aggagggcag gtgagggcat cagatccctg ggagctgggt ttacagcctg 1008600
 acagaacgat aatactcaaa cctgggtctc ctgtaagaat catagatgcc cttaccact 1008660
 aagccatctc tccagccct gagtctcact ctgcaaaactg tactcttggg ttctaattat 1008720
 tctggfactt cccaatgctt tcaaacacct tttgggattt actctacttt tctactgtc 1008780
 cttgccaaca tacctagccc actactgtaa gctaactcac cagtccatca gaatcagaaa 1008840
 ggaagtgcatt aattcggtt tgggtgtagt gctcacaagc atctgtcca ccatttcta 1008900
 actacatgta aaaaataggt tttataacac tataaaagga ctaaggatga gggcagtgg 1008960

 ggtgcacgcc ttagtccca gcgctcggga ggaagaggca ggtggatcac tgtgagtca 1009020
 agaccagcct ggtctacaag tgctagtcc aggacagcct ccaaagccct gtctcaata 1009080
 aaataaaata aaataaaata aaataaaata aaataatgta gttaaacttg tccacataca 1009140
 caaaaaccta agtggaaact ccattacaa cccctcaaa tatactctga gccaggaata 1009200
 gtgaatcaca tctatgatca cagcacttga gaaactgaga ccagtccatg ttacatagta 1009260
 agttctagga cagcctgagc tatgtaagag gtctgtttc aaacaacaa acaacaac 1009320
 aaacaaaaaa acaggaggag gacaaaactg taagatcac tgacaggctt ttagtaaat 1009380

aagaacaagt tacagtagaa agaaggaaaa cttagagttg ggatttggat ttaagtcctat 1009440
agtttttcta gcaagttgta actttgaggc cttcaggcaa gttgttttcc tctctgggca 1009500
ttagttttct ctaataataa ctgggggaca tgatctttgt cggaggctgt agagacagct 1009560
cagcagttaa agagcactgg ctactcttca gaagaccaag agtcaattcc caggactcat 1009620
acagacacaa atgcagacaa aacacctaca cacaaaactt aaaacttaaa taaatcatta 1009680
agacaatcta tctcacaggg ctctagggaa gattaaatgc agttatgtgt atgaagtaat 1009740
tactacaatg cctagcataa gctaaatctt agcatatggc ttcttgtgat caacttttgt 1009800

ttgtttgttt gttttttgag acaaggtttc tcagtagctt tggagcctgt cctggaattc 1009860
attctgtaga ccaggctggc ctggaactca cagagatcta cctgcctctg gtgatcaagt 1009920
ttttaattct ttttttaaaa aacaggcatc aattgtctct ttccaagttt taaaaggatt 1009980
actgtctact gatggatttt attatttgag tatctttgtt atcatatata tatatatata 1010040
tatatagaga gagagagaga gagagagaga tgcacacata tatctgatat ttatatttca 1010100
aataacctcc tttcaaaatt tcttgatgct tcagacagtt tagaaaggcc caaacaagga 1010160
aaacactgta acagttctca agaagcctat ggctagcctc tacagtgagc tagcatgtgt 1010220

gtggcagtggt ggttatactg gaataaagaa gcacatgttg aatataatct atcttcatgc 1010280
tgtctattga tttgagtgac cataaatttt ttctaagta ctactttagt gctatgttac 1010340
atatttgaca gctaacattt ttcaacttca tcaatttcaa aattacttcc taatttccct 1010400
tatgatttct tgattcctag gttatagtta ccaaagattt gggggatttt ccacatatct 1010460
tctgatgtta actctctatt tgatccttct gtagtcagca aaaatattta aatcgtaag 1010520
tgacttaaat atattgagcc ttgccagct acatagaggc tatgttctct tgggaattata 1010580
tgattgctga ggtaagagta acagctgcta acagacattt gcttataaat gctgctggat 1010640

tgacceaaac tatatatttt gaacatgctt ttgacttcaa aatttaagac taaggatagg 1010700
ttactttgga aaagaagttc tgtttttgtt tccacagaaa atgataagct gtggattcct 1010760
tctagactaa catggtttga tcaagcaaga cccctgaag cagtggccca ggtgatccaa 1010820
catccaaaac agctgagatg atgtagcctc agactactac agccaggatt tgaacaggtt 1010880
tctgggtttt ctcaggattc tcatggtatt gacagcgcct ccaaacagca ggaagcaatt 1010940
tggagagaac acacceaaat tcttaaatat tgtttataaa tgtttgtttt catttaaatg 1011000
gggttggtta caaatggta aagatcacia ccaatctctt tctaaagaaa gaaaaggga 1011060

tatgatatag aaatgaatac tttgtattgg aatggatttc agtttattga tataaattta 1011120
aggtcaattt tgttatatat gtatttctcc ccttgttttag gtattgtgtt tacacagacc 1011180
ttttaaacat gcaatatata attaaataca gactatagat agtcacctat aataatcaaa 1011240

acttatagtt atgttactta ggttttctag atatacatag atatatttca aatggataga 1011300
tattcttcaa accattcaaa gacctacaga atatggtatt taaaatggtt tagggttttt 1011360
cttgacagtg agacacagct gctcctggca acaccaatta cttcagaaag gaggatgtaa 1011420
tacagagttg ctttcaatat ggtaagatt agccatttgg gcaagaaact gctcttgcct 1011480

ggactgcttg acaatatgct gtataaactg gacatacagg acccacagga aagtgactac 1011540
tgaatttgcc aaaacaagat gagacagtcc tgcagggttc ctgtttcatg gaaaagtctg 1011600
ccagacattt tgcaggacac agagaaaaag gactgataga atgccaaaac aggacagacag 1011660
tttaaaactt cttgattcat tgagaagtct gccagacaca ctatggccta tgggctgaag 1011720
atggatgctc caatgttaca gagaaacttt ggatgacggt ccagacaaca agatttctct 1011780
gtcattacta gagtttatgt attatccttc tgttgccttt gatgaagtg aagacagata 1011840
gttatggtta tggttttcct tagttataat ataagttata tataaaacct tagactcaca 1011900

aagataagat agatgataga atattttctt taaattttac caaatgttaa tggactaaat 1011960
tttgtaact ataattctta cttgataact gttttgttat atataatfff accatgttaa 1012020
agttaaaace cttcttttta tttagacaga aaagaggaga tgatggggga tgttcttctg 1012080
tataatggtt tcttttattg gttgattaat aaaatgctgt ttggccaata gccaatagag 1012140
gcaggaagat aagcaggcca ggagacaaga attatgggaa aggtaggcag agaggacat 1012200
tctctggtaa cccaagacca catgggaata cacagactta tagaaatggt taataattaa 1012260
gacagagcta tgataagaag ccctagccat cagccaacag tttataatt aatatagtat 1012320

ccttgtgttc ctttggggac tgaggcagct gtgggtccag gctggaagaa actccagcaa 1012380
gaaattacat gccaaacttag catacaacta tttatggact gagagctgct taaagtttcc 1012440
attaaaaata atagtttctc ttcccccaat aatgagattg atgactacct tatatgcat 1012500
cctagaacct tcatccaggg actgatgtaa gcagaggcag acaccacag ctaaacactg 1012560
aactgaactc ctggaacca attgcaaaga atgaagagtg aagagcaaag aggccaagac 1012620
tgagctgctg aaaccacag aaacagctga cgtgaacaag ggggtctcat ggactccaga 1012680
ctgatggctg ggaggccagc atgagactga cccagagccc ctgaacatag gtgtcagtga 1012740

ggaggcctca gcaatctatg gggcctctgg tagtagatca gtatttatcc ctggcactact 1012800
aatggacttt gggagctcat tccactgga gggatgctct gtcagcctgg acacatgggg 1012860
gagggcctag gcctgctcc gatgatgtca gactttgggg aatccccat ggagggcctc 1012920
actctcccag gggagtggag ggggggatgg ggtaggagat tgggtgtggg caggggagga 1012980
ggagagggtg agggagctgg gattaacata tgaagcaggc ttatttctaa tttaaatgaa 1013040
aaatgtatat aaaataataa tatgtacata ttattattat tataatagc tctcatatat 1013100

tccaccaagc cagaaagatg gcatagcagg gaactgcact tgctgcataa gcctaacaag 1013160

ctgaattaga tcctagaat ccacagaaag ctggttgcac ctagaatctc agcactcctg 1013220

acaggagaca caccagccta ggcatgtccg gctaggeccag agtacagaga cctacctca 1013280

ataatgtgag aaaactgaca ctgaaaattg taattgtcg tgccccccc ttctccttc 1013340

taaaatccta acctggatca ttttcctgt aattgtgaaa catctttctt atgcaaagga 1013400

tgcttacaac agggctatc ctatcaaac aagctcaggc tttggtatcc atgactataa 1013460

actactctca atgccagaaa agaaaatata acacttactt catgaaatac tgctccagaa 1013520

tatggagaca ctcccaaatc caacagtgaaggccctcaa ccaactgaaaa ggaagaata 1013580

caagttcaca aagatgttag agacaatagc aaatggcat aaactaaaat gtcagatatt 1013640

cctaggacca aagaatgctt gagtttgtct aatccctta caatcggta accaagtgg 1013700

tgtaggtctt gatttgaac aatttcaagt ttgtacatat gcatgaaatt ctcaaagaac 1013760

tccccccc aacacacaca caattatcaa gaatggagaa ttcttcata caaagcagtt 1013820

ctttacatca tgagctatgt tcattatgag aaagttttat aataaactat aaccttctga 1013880

gattggagaa atggcttggc aattaagagt acataactact cttggttctc agttcaattc 1013940

ccgacacctg catcagctgc tcacaactgc cagtagctcc agttctgagg aacctcac 1014000

cctctctgg cctctacaat cagcatgcac atacagatct acacagatac acataactta 1014060

aaataaaact aagtataatt ttttttttt tttgggttt tcaagacagt ttctctgtgg 1014120

ctttggaagc tgcctggaa ctagctcttg tagaccaggc tggcctcaa cttacagaga 1014180

tccgctgcc tctgctccc gagtgcctgga attaaaggcg tgcgccacca ccgctggct 1014240

taagtacaat ttttaaaact ataaacttct aaacatcttt gtaacatccg tcagctctaa 1014300

agcatttgtt ttatgtgtgt tctatcctat ccaaagcaca attaacaac cagcagcagg 1014360

tttttaaaa tgctgtccag gttagtggaa caagcactct ctgtgcagtc tgtttcaggg 1014420

acatttgtgt ctttttcta cagaataaca tgtacctttt agctttgtgc ctttaatcct 1014480

aacctccag gagatttgag aggaagagg ggattgttt tttggatggc gggggagggg 1014540

ctggtaacgg ttgtttggcc aggtttgtgt tttgtggcaa agtatctaga cgtaaagggg 1014600

attgactcca agcttgcaac cccctgtct tagccccagc cccaagcgtt agaattatag 1014660

gaggcagcta tcaagcccag ccagggtgat atatttgtt tgtttttcag gatctgtagt 1014720

tcagctctggc ctcaaatctc ctgtgcagcc aagaagcacc ttaactctt caactctct 1014780

gcctccacct cctaagtctt aggattacag gcatacaca ccatgtccag ctgaaaatgt 1014840

ttgttttttg gtttgagggg gtttgggctt ggttggtttg gtactatggg ctgaacttgg 1014900
 gaacttgtgc atgataggca ataactccag ggctgagctc tatcacacac atgttttttt 1014960
 atacaaggtc tcaactatgta gctctagctg actcatgact cactacatac accaggctgg 1015020
 ccttgaactc agagatccac ttgcctctgc ctccccaatg ctggcattag gcacatacaa 1015080
 ccaagcctgg ccccaaatga taattctttc tttctttctt tctttctttt tttctttctt 1015140
 tctttctttt cctttctttt cccctctctc tctcttttgt ttttagagac agggtttctc 1015200
 tgtataacag ccctagtgtt cctggaacta aactataga ccagactggc cttgaactca 1015260

 gagatccacc tgcctctgcc tcccaaatga tgggattaaa ggagtgcacc accaccacct 1015320
 ggcttaccaa atggtaatc tttttttggt gttgttgttg ttgttttttt tttctttctt 1015380
 ctttttggtt tttttgagac agggtttctc tgtgtagctt tggagcctat tctggcactc 1015440
 gctctgaagc ccaggctgac ctggaactca cagagatcca cctgcctctg cctctctgagt 1015500
 gctgggatta aaggcatgca ccaccaacac ccgcctccca aatggttaatt cttaaagtag 1015560
 attattttag gaaataaatg atcaagtgc taatacaata tattcagtat agcactcaga 1015620
 gtaataatgt tttatcttct gtataggtgc tttgctgtgt gtgtctgtgc accatatatg 1015680

 tgcccaattc tgaggaggca tcagatctc tggaaactgag ttacagatag ttgtgagcca 1015740
 agaagcaggt gccgggaata gaacttgggt ctctctggaag agcaagtagt gctcttcacc 1015800
 gatgagccat ctctccagcc tcaactaata aaaacttcaa aatagccggg cattggtggc 1015860
 acacgccttt aatcccagca ctcaggaggc agaggcaagc ggatctctgt gaggttcagg 1015920
 ccaacctggt ctacagatgg agttccagga caggctccaa aacaatacag agaaaccctg 1015980
 tctcaaaaaa aaaatttttt tcaaaataat cccaacattg attaattggag atttatttaa 1016040
 ataatatatg tatctactag tatactaaaa tatacatata tataatatata tacattgata 1016100

 tattaagcat taaaattata ttgaatgctc agtgtcaagt gcaggaaggc tgggcatgcg 1016160
 gtgcagcagg gcaacatgca aagcatgcag gaggatctga gttcaacatc aggacgaaaa 1016220
 gggttaaaaa tgaagaatgg aagatggaac agaaagtcat ccgttgactg acccacagaa 1016280
 tggttctaaa ggcaaacgct gttagtggat gctaaagtta gtgggcaaag tatgaaagag 1016340
 aaagtatttg taaggggaaa aataataatt tcacgtagac cttacattcc ctgctttaat 1016400
 cgggagatac attaaaacat catcaatatg ttaattatat taattttcaa gtatctcatg 1016460
 attcactgat gtagggatag gaacatttct gtggtctca tgccaacaat gtggtataat 1016520

 aacaaaaaca aactaacaaa aaaactcata cctccacat aatcatggta aaacatcagg 1016580
 caatcaaaaa tgacaggcaa gcagggaaag cctttaatcc cagcactcgg gaggcagagg 1016640
 caggcagatc tctgtgagtt cgagaccagc ctagtctaca agagcaagtt ccaggacagc 1016700

ctccaaagcc acagagaaac cctgtctcca aaaaccaata gatagataga tagatagata 1016760
 gatagataga tagatagata gatagaatga caggcaata attgccagt actcttaaaa 1016820
 gattaaatca aaggaagtat cccagattgg cagtcactaa ggagacatag ccagtaaatg 1016880
 caacatgacg tcatggattg aacattagc cagaaactag ataacaaaag ggaagcagta 1016940

 caatccta at aaggtatata tactaacatc actgactgac tgaagccact atattacagt 1017000
 aatattgggt aaagtgtaaa tagaaactgt atttttgcac gtgcgagtgc gcacgcgtgt 1017060
 gtgcgttcat gtacacatgt gcttgggagt acccatggag accagaagag gttatcatat 1017120
 ccttcaage tacagttact ggtatttata aacaacctga catagatgct tggatccaaa 1017180
 ctcaaaaga ccagtaagtt ctctctctct ctctctctct ctctctctct ctctctctct 1017240
 ctctctctct ctctctctct cccccctc gtgtgtgtgt gtgtgtgtgt gtgtgtgtgt 1017300
 gtgtattttg ggtttttttt gttttttttt aatttttttg agatagggtt tctctgtgta 1017360

 ggcctctcct ggaactcact ctgtagacca ggtcggctt gaagtcacag agatctgcct 1017420
 gcctctgcct ctcaagtgtt tgtattaaag gtgtgcatgg tcaccaccac ctggcttact 1017480
 taataagtac ttttaactgc tgaaccatct ctccageccc tttgcaactc ttttgaaaat 1017540
 tgaatatgt cagggttggc aaaatggctc agttggctag gtgatgattg ccaagactga 1017600
 tgacctgagt ttgacctca gacctaaagt ggaagaacca tctctctcag ccagtggtg 1017660
 gtggcgacg cctttaatcc cagcactcag gaggcagagg caggctgac tctatgaggt 1017720
 cagggtagc ctggtctaca gagcaagttc taggacagcc aaagtagac agagaagccc 1017780

 tgtcttgaaa aacaaaaaa accaaaaacca aaaaaaacta tagatctaca tttatagacg 1017840
 gaaacctgtc cacaaaatgc caagagaaaa gcaggtagta atatgctttt aacatatttt 1017900
 aacacaattt taatttaatt tttaaagaaa ttttattaac atcaaatata caaaaagaat 1017960
 gggctttatt atgacatttt atacatgtga taccagcact cggagacaga agcaagaaaa 1018020
 tctcaagttt aaggctagcc tgggctacat tgtaagactt tctcaaata aataagaaag 1018080
 ggagggggga agagacaaaa aaaaagaaat gcctgaaaa ataaatattg aaagcctta 1018140
 aactatattc aacctaaaga aggaaactat agtggccagc attttttccc ccaagacagg 1018200

 atttctctgt gtagccctgg ctgtcctaga actcactcta tagaccagc tggcctataa 1018260
 ctcaaaatc caactgcctc tgccctctga gtgctgggat taaagatgtg tgccaccacc 1018320
 acacagcatc atttttttaa aggctgattg tgcaaaacaa ttttaaccag ggctagcaag 1018380
 acacctaat caggtaaagg ttcttgttgc caagctggat gattgagct caatcctagg 1018440
 aaccacatg gtataagaaa aagaccaact ccacaattt gtcttcttaa ctctacaagc 1018500
 atatgtatgt gcacgtacac atgtgcagac atacagagta aatacatata taaatattta 1018560

tagagacaac tgtaactggg accagaaaga aaatccctta agaagcagca tagaggtagc 1018620

tctgtaagac agctagctat taatctctca ctaacagctc tactggagac ccaaggaggg 1018680

gattcattag cccacttcac aagacttecc cggcctcag ccaaaggcat ctgagcacag 1018740

cagtaaaagc agcactttgg agatccaaca gtgcaaggct gccttgaaac atcaggcccc 1018800

acactccat ttaaccaca gagaggttct caggaagcag ctagagggca ggctccatgc 1018860

ctctctctca gagaaacttt tgctagacgc tgtgcatcag taaacttgtt tgagtattct 1018920

ctggctctgg tatctgggta tataatgacat ccagtataac agatttcatg atgtagagat 1018980

attcaatgga atacactgag ctttatgatt aactccttca ttattatatac ggtgcacatg 1019040

tatgaaaact ttcttagggc ctacagtgtg catttcccat ccaagacaaa agagtaccaa 1019100

aattctcttc agactctata gatgattcat tcaatgttta aaaactaatc aggctaaca 1019160

tggtggctta cgctgtaat cctagcactc aggaggatta ctacaagtta tagggtgtct 1019220

ggtctattta tgaagttcca gtccatcttg ggctacagtg agacactgaa tcaaaaataa 1019280

aatagcaaca aaggaatgat aacaccactc gggaatctga ggcaggagga tctctatgag 1019340

ttcaagttag cttggctctaa aaagttagtt ctaggacagc ctggctctaca cagtgaaacc 1019400

ccatctcaaa acaccaaacc cacaaaaaaa aaaaaaaaaa aaaaaaaaaa aaaaaacaaa 1019460

aagggggaaa gaacaaaaag gatgaaagt gaaatacttt cacatacatt atacacttgt 1019520

aatccttaca ctgaggagc agagacattg ggatcttgag ttcaaggcta gcctggaaaa 1019580

agaaatactt ttataaacat gcagttcca ctactccta cttttccaaa tgttttattt 1019640

actcgtgtgt gtgtgtgtgt gtgtgtgtgt gtgtgtgtgt gtgtgtgtgt taggtcagag 1019700

gacaatctga aggagttagt tctctcctcc cagcttgaac aaccccagc tgtcagactt 1019760

ggtccactga gacacctga gagcccctac ttattctttc aaaggagctt tctgtctct 1019820

tccctccac catcctgctg aggaaaagcc agatatgtca tggccacatg agccgtaggc 1019880

acagccacac agcatcggtg agtatggagg caatcagaat caactcgaca aacatcaacc 1019940

agatgacctg ggagggtctgg gatgcccac tggcacttaa agaaccagag ctctgcccc 1020000

actgtcaacc tcagtaactc tagacactgg ccagttagca gacatgggta aatgctgccc 1020060

aaattgagct gccatgggat gactgggctt ccacatatac tgacatggta tgactgggct 1020120

tccacaaagt tctagagaag ggctccttaa gcagcctgcc atcctgaagg ccaaatgctt 1020180

caaaggagcc acctgtgccc tgctggcttg acaccacaca aggagctagc tccattaggc 1020240

actaacaac ttaaaaagta aaagttaaga tgaacaagaa cattataaga ctaaaaaat 1020300

attaagtgtg gatgcctgtc cctgtttgaa acaaccacca aagaattaat caaactgccca 1020360
 gattctaaca catatgtata atgtgccaat actataaggc tagaaaatgt ttagttgttt 1020420
 tttttctttt agtgtctcat gtagcttcag ctggctaaaa gaagtttaac aaaagactga 1020480
 aaagaaaaag taaaaactca gaacaagggg tatagttcag tggtagaaca cttgtctaag 1020540
 atgagcaagt acctaggctc gaccacacac acacacacac acaaaaacc tacctatcca 1020600
 tataacacaa tactccacac ataaatagtt ttgaactata actctaaatc tttgttgta 1020660
 agcttggatt tgtttttttt ttaacattca ttggggggca tatatttggga ggtcagatga 1020720

 caactatgga gtcagttctt ctccctctac tctgtaagta ttggggctaa aactcagatt 1020780
 attagcatg acagcaagca accacacctg ctgagctatc atgtcagccc agttgtttct 1020840
 ttgctttatt tattttaatg tgtgtatcat atgaatgat gtgtaacagg accccagatc 1020900
 ttaatagga tccagacctt agcacaactg actctatgat ggcagtacca ttcagactat 1020960
 aaaactcagt acatagacag tattatttta ctacctgcca aaatgaaaac aaaggcctaa 1021020
 tccatcaaag tctatagttc tgggaaagtc tctaaatata ctaaccttgc tttttactt 1021080
 cttagtttca attctggtta actgttcttg ttaatccaga atgcggtttt taggcttaca 1021140

 agctcacct aaggaaggct agggctctac ctgggatcct taacaccag tatagtcacc 1021200
 agctaaacat atccaagca aactggccct caagattcca gagattctct gatctatgct 1021260
 tccatcacc cagtaagatt accagaattg tatatgetta cacaatgcat gttgtagaat 1021320
 attattttaa gacatgttac attcatttat gctgtggaac atttgtttaa tgatacttc 1021380
 ttttatgttg catttgttta actctatgaa gattgttact ttgcctgtct aaaacacctg 1021440
 attagtctaa taaagagctg aacagccaat agtgaggcag gagaaaggat aggcggggct 1021500
 ggaaggcaga aagaataaac agaaggaaaa aaagaaggat cggaagcaa gatgggttaa 1021560

 gaagtgagaa aagggggcca atcaccagc cagccacca gtaagattga aaataagatt 1021620
 acggaagtaa gaaaaggaaa aagcccagag gcaaatgta aatgggataa ttaagaaaa 1021680
 gctggcttta aacaagccaa gctaaggcca ggcattcatg agtaataagt tccatgtgt 1021740
 attaatttgg gagctgggtg gtggctccc aaaagagtca agcagtaaaa aacaaccaac 1021800
 tacactatgc atgcagcttt tacttgatt ataggatcag gtccttgctt gcatggcaag 1021860
 cacttgaact caccaagcca ttccctagc ctaggtttt tgttgttgtt tggttgtttt 1021920
 gttttggtt ggittttttg tggtagcagt gtagttttt tttttgttt ggattttgtt 1021980

 ttttagaca ggtttctct gtgggatggt cctggctgtc ctggaacttg atttgtagac 1022040
 caagctggcc tcccaggtac tgggattaaa ggtttgcacc accactgcct ggtttgttct 1022100
 tgtttttta agaaaggtct cattctgtag ctcaggctgg actacaactg gtggcctctt 1022160

gcctcagctt tcatgtgta gactgtagat ctgagacatc attatcatct acctatgaaa 1022220
 gaacaataa caccctaact taaaacccat cagttaggct gcaaaccagc ccaattggta 1022280
 gagggcttac ctagtatgca agaaatccag ggttcaatgt caagcaccac ataaaaccaa 1022340
 acctgtaatc ctagcacctg ggagatggtg gtaagcaggt cagaacctca aagtaatcct 1022400

caattacacg agttccaagc cagcctagaa cacatgagac tcactctcaa aacaacagct 1022460
 tttccttggt gtctctgctt tagtttctgc ctgagctcc tacctcagct ttcctgata 1022520
 atggattgta acctgtaaac caaataactc tttcccacc aagtcagctt tggtcagtat 1022580
 tttatcacac agcagaaagg agatcagtac atctttctc aaaaattagg tggaacacaa 1022640
 tcaaggaaga cactacagc aaatctggtc tacacacacc tgacataca ttgtgtacat 1022700
 acacagtgtc taaataata agccatatta cagtcaacca aagtctatga ggatactggg 1022760
 ccctttatcc aaagagctgg tgactcaaaa atctcaaat gtcagtataa accaaaatgg 1022820

ttcccacttt actttcattt tgtttctctg tgcgcctta gatgtcctaa aacttgcttt 1022880
 gtagaccagg gtgacctcaa actcaagaga tccacctgac tctgcctccc aagtgtggg 1022940
 aataagggca tgcaccacca catctggecc tatttcatga tttttaaag cataacattt 1023000
 agagtttaat ataatcgctt gcttgtttct ttggtttga gacaacatct tattctatag 1023060
 cccaagctgg tctggaactc actatatagc ccattctgcc ctggaactcc taatgaatcc 1023120
 cctacctcag tctctaaatg ctagaattac cacaatgaga caccatgcct ggcaacaatta 1023180
 cctgctttta aatccacccc acttgacttg taaatataag tgacagatac tatatcctct 1023240

ctttaaaatg aactagcaac tacccttgt taacacaatc caaatgcttt atcactactg 1023300
 tgaaagaaaa ctgacctcca aagagagtgg cactattagg tgtggccttg taggaggaaa 1023360
 tgcactactg tgggggtggg ctctgagggt tcctttgcac aagccactcc cagtaacaca 1023420
 gtctacttcc tgetgcctgc atatctcctt gtaccagctc cttctccagc atcgtgtctg 1023480
 cctgcacagc accattatag ttatggactg aaacctgaa actgtaagct gccacctcaa 1023540
 ttaaatgttt tccttggtaa gatctgctgt ggtcatggtg tctcttcaca gcaacagaaa 1023600
 ccctaactaa gacaactacc aaatctctct agtcttgata ctgacctaa getgtggaaa 1023660

tcaacctctg gatgtcacac tactaacatg tafgccacag acttattgcc ctatcatttc 1023720
 tgactcacat actcagtcaa ctgagtcagt gtaccacag ttctagtacc taaaccaag 1023780
 ttctcagaaa tgatgttttg gctttactga gctaagcttc aacatggatt atctcattta 1023840
 gigtctgtt tcacagacaa gaagtcacaa aggaagtaaa tggcagagaa aactcaaat 1023900
 ccttctacg attctagaaa tcatatacaa tgetgactca tctttaatt ctctacctt 1023960
 ttacctgta aatcacagag ctcatgcttt catttctcc ccatcattca acagtaacta 1024020

cacacctgtt ctatgccagg caccaaggaa ttaggcata aatcaaatag ttcttctaga 1024080

agctcataat actacaggaa gaccagatct aaacgaataa ttgttatata aggtgagaat 1024140
tttgtgtgat atattgttta tgatttaata aagccactgg aatcaaat acaaagctat 1024200
ccacagccat agagccaggc agtggtgata tacaccttta atcctaacag tcatactagc 1024260
tagccataga ggccaggcag tgatgataca cacctttaat cccaggactc aggagacaga 1024320
ggtagatgga tcttagtgag tccaagacca cctggacta taaaaagta tatcagtcta 1024380
aaagaataat aaagctcata cctttaatcc cgcactagg gaggtataaa aggaagaagc 1024440
aaagggtctc gtgtgggatt tagtttccag atggagagca ttcattgcac tctgaggatt 1024500

cctggagaca ggattgccat ttcagctggg tagaggtaaa agctactggc ttggctgctt 1024560
tgcttttctg gtctttagct tgaactcaa tatctgtctc tgggttttta ttaatcatgt 1024620
tataagaaat actgtttgcc gggcgttggg ggcgcacgcc tataatccca gcaactctgga 1024680
ggcagaggca ggtggatctc tgtgagttcg agaccagcgt ggtctacaag agctagtcc 1024740
aggacagcct ccaaagccac agagaaacc tgtctcga aa aaaaaaaaaaaa aaaatactgt 1024800
ttgatTTTTG ctttttagac acagtctcac tgtgtagctc tctgacctt gaattctata 1024860
aggagcttac attggtttca aacttgggat gtctctgtct cagactccta ggtgctggga 1024920

ttacagacac agccaccatg tccagttcat agaaatagtc ttaatacagg catgtatgag 1024980
gttctgagat tgiagaggaa gaataaatga aaaaaaagg ggggggttca tgacagcaag 1025040
tgaatcaag aacttggtat taaagtttga gaataaagtt agatgtggtg ggccacacct 1025100
atagtcccag caattaaagg cccaggagag atcctgtttc aaaaccaaac aataagagac 1025160
gtgtaaggct acaaaggact cttctaaggt gctggatatt ttgatctgga ttatccatgt 1025220
gtatgtggtt cataaaaatt cactaagctc tgtccacact tacatgtgct ttatatgtat 1025280
aatgtacttc agttcttgtt ttgtttaaag acctaaactt gatctggaaa gatggttcag 1025340

tgggtaaggg cacttgatat gcaagcaaga aaatctgaat tcaaatccc cacaccacg 1025400
tcaaacaaac aaaaaaagg tcatagtcac agatgcctat aactccagca ttgaaaggat 1025460
ggggacagga agaaaccgg agctcctggt catacagccc agtggaaaaa gcttcagaga 1025520
gacctgtct cagagaatta aggttagaat gatacagaaa gacatccaac atcctcctt 1025580
agcttctgaa catatgccac aagcacatac aaccctccc cccacacaca agtaataatg 1025640
ctaaatTTTT ttttttttaa ttaaactgia gcctgacat aaccacaga tcttctcaac 1025700
tctggatatt tcaaatctc aggtatttct tgatcctctt tgccttctgc aacctggaac 1025760

tcccccttt ccttatctt tccaaactct agtccttcgt tagtccattc tggaaaatga 1025820
 aataccgttt actcagggtc aggaaattat tacaaaaact tcttcgtctc ctctactggc 1025880
 ctgtgactcc ttcagcccaa tgtctgtgtc ttgttggagg gaataatatg caataagggt 1025940
 tgatgaaaaa cacatgcaca catatattaa caagtcagaa actaagaaaa acttcacgag 1026000
 agtctcagat tgggcagaaa tgacttcagt acagatacct ttcttgcaa ggggctggtt 1026060
 ccttggccc tccttacc ctcactatc ggtggaacac cgctgcaat cccgctgcca 1026120
 aaccctacga ctccacagga aagaatgcac acagcacctt cggatgtcca tccttcgcg 1026180

 gatcccgtc cccgagtcgg gatggtggga cacgccccct cggatacca cccctcgggt 1026240
 agcggggctc acgtccaca ctttcttac acccgtcct ccgcaccata gctccgacct 1026300
 cagctcggg aggacccag gcgcgggtcg gactcctcag aaccgcgac ttgtgcccgc 1026360
 tgctcagcc tccgattcaa ttcactgagg ctgggcggtg cagaccggcc tactccagcc 1026420
 ggcggcctca cctctctcc aagagctcag tggggacacc acctcaacc tctcgaaat 1026480
 gaactcagcc agactggagc gaaacaaggc cgccctcacg gtacggcca ccacaagcac 1026540
 aaggccaag ggagccgcca tgataactga ggcgggcaca caggcgggga gggcaaaagg 1026600

 caatgcgga gagcctcaag acctgcgcg cacactgtag tacctcgtc gagcgagtgc 1026660
 ggctactgct gccggagccc gccggccaga agactaccac tcccagaaag tcttgcgca 1026720
 gggcgacgga aagcgggata tgtcaactt gtagcaaagg tttggactac gcctccgctc 1026780
 acccaagaga agtgaataat attggactca ttttactga gaactgagc ttaacgttga 1026840
 agaaataatt tcaactctgt gcatatctt aatgttaaaa tgtttacctt tatatctttt 1026900
 aaagagtgcg acgtgtgtat ttattgaacg ccaactacc tccagctct atattgtgta 1026960
 ctgaggaaac acttggagt ggttaatat tagctttgcg acctcagca agttatntaa 1027020

 ccgagtgaag tcagagcagg aactcaagac aggtcatgaa gctaaaaccg tggagaacgc 1027080
 tgcttctgga ccttctctc tgctcatgcc tggcgcttt cttgtaccac acaagcacac 1027140
 ctgccaggg atgatgccca cctacagtga cctgggcctt cccacttgag tcaatttctc 1027200
 acagaccagt ctgatggagg caattgtttg actgaggttt cctccttcca gatgaccga 1027260
 ggttgtgtaa agttgacaaa aaacaacaa aacaactaac tactctagta aatcccatgc 1027320
 catgatgtgc ttctgctctt tctcaattc ggttggtagc gtgtagcgtg aatccctcc 1027380
 aggtgggagt gtttacctt ttgaaatcag caaacaccac aatcagggg tttggagagc 1027440

 ccttgataa gcattaacgg aatacctctt cattagttaa tgtattaaaa gtgctaaggc 1027500
 gagtgttaa agattagcta taatgattaa ttatacagga gattttagaa ccatgaagaa 1027560
 aatggaacag tgcatcaata gtataactat ggtaacaaa aattagtgca tatttcaaaa 1027620

tagtagcaga ggcttttgag tgttctaca caagtaaagt ctgaagtc atgccagtta 1027680
acctatatga ctattataca ttgtacacat gtattgggtt atcctactgt accccataaa 1027740
tatgtaaact gtttcagtta aagataaaaa aaaattgctg ggaggtggtg gcacatgcct 1027800
ttagtcccag cactctggag gcagaggcag gcagatctct gatctacaac agctagtcc 1027860

agcacagcct ccaagctac agagaacc tgtctcga ccccaaaaa aattttaag 1027920
aaaaagtga tgattgagat tccctctatg gctggaggaa tgggtgtaac ataacaagct 1027980
ggtcagggaa gactggacaa gctgacattt cagatgagta ctagaggaag agaaactaat 1028040
catagctaga acaggcaaca gactccggaa ccatgaggat caaaaaagag gtttgagag 1028100
ctggcccagc cactaaagtc taggatcaca acctagacta ggggagcagc aaagaaaca 1028160
gtccaagga ggagaacagc atttgtttg aaaggagaaa cacataatga ggcaagcagg 1028220
ggcctctgg ctgtagttaa caagctggaa gtattcaaa gtacaagcta tgtgccattg 1028280

gaaagtttt atttttttg tttttgttg gccattgaaa agttttattt ctttttattt 1028340
tcaattattt tggtttcag ggactggcac ttatgtagcc caggcaggcc ttgaattcac 1028400
tgtgtatcaa agatacaact gatcttctg tctttgactc ctgaatgctg aaattataga 1028460
attgtgtcac tgcttctgga cgttttttaa agtatttacc ttatttgc at tgggtttttg 1028520
cctgcatgta tgtctgtgta agggtgccaa gatcttggag ttacagacag ttgtgagctg 1028580
ccatgtggct gctggacctg aacttggatc ccttggatga tctcagtct ctcaaccact 1028640
gagccgtccc tccagccct cctgacctt tttgtattt tgtattttga gatgggtct 1028700

tgccagacct ggcaatctgt ataggatttt aagtggcctc aaatcaatgg caatcctgt 1028760
tttagagatt ttiattttat ttttgggtgc ataggggagg cgatgaagta catgtcaagg 1028820
tcagaggctt tccacctctg cctcccaagt gctgggccaa agcatgcct gctacacca 1028880
gcttccactg gagagtgta accagagtgg taccagatgc ttttattcgt ggactttttg 1028940
agggatgggg gcgtgtttcc tttgatgcta gggatgaaac ccaaggtcct ggtgcatgct 1029000
aaacacttg actgcaactc actttccagg tgtgtgtcta aaagatcact atgttcccaa 1029060
gcctatttcg gtgttagaga atatgatgtg atgacaaaa ttataccctc tacctttatg 1029120

ggactggaag agttggttga gactatatag atcttaagaa tgacataagt caggctggag 1029180
aggtggctca gtggttaaaa gcacatacca ctctccggg aagatctgag ttcaagtccc 1029240
aacgccaagt gactcacatt gtaactccag ctccagggga tctgatgtct cctgtgtatg 1029300
taccacaca gagattatta atgcagacca gtcattaaaa aataaaaca atcttgtttt 1029360
gatttgtttt ttttcaaga cgggatttct ctccgtagtc ctggttgtcc tggaaattagc 1029420
tctgtagacc aggctggctt caaattcaga gagctttccc taactctgcc tcctaagtgc 1029480

tggaaattaa gatgtgctcc accagttctg gcaaaacaaa tctttcaata attaataatta 1029540

 agtcataaac aatgattaga gggagatcag tatgtcagga aaatgtaaaa atcagctcca 1029600
 ggagtcataat ctaaggaacg ggggagaggg tggtagagtc acaaaggaac agaggaggac 1029660
 actcttcttt gagtccaagc cctgtgacat actctttgca tgagcttatt tagtttacct 1029720
 ttttcttctt aaaaatacag atgttgggtat atgcatattg cattatgaaa attggaagct 1029780
 gaagtagcat caactccata gtaagactga aaagactgta cacagtaaaa ggttttagcac 1029840
 atatatctag tgctgacac acaccagaca gctgctgtgt tagttacacc ctcttttttt 1029900
 aatgttttaa atttttatta ttttacgcat atgggtgttt tgtctgtgca tcttgtatat 1029960

 gcagtacctg cagagggcag aacatggtgt tggatccctt ggaaatagag ttatccacag 1030020
 ttatgagtga ccatgtgggt actgggaatt gaacctgggt cctctgggag agcagctagt 1030080
 gctcttaact gctgagcat ctctaagct cccagttaca tcattttaat agataattta 1030140
 aaagttcagc tgggcgatag tggcacacgc ctttaatccc agcactctgg aggcagaggc 1030200
 agatggatca ctgtgagttc gagactagcc ggtctacaag agctagtcc aggacagcct 1030260
 ccaaagccat ggagaaacce tgtctcgaaa aaacaaacaa acaaacaaac aaacaaaaaa 1030320
 ttcttgccgg gcattgggtga cacatgcctt taaccccagc actctttggg aggcagaggc 1030380

 agatggatct ctgtgacttt aaggccagcc tggcttagag ttccagaaca ggctccaaag 1030440
 caatacagag tagccctgtc tcgaaaaaca atcaaacagc aaaaaagta ggattgtctc 1030500
 tggggagaca atgacctga taaatggaag tgagatcaa accaataatt ctgaatcatg 1030560
 gttatctaata atactcttt gtaaaggctt gcaagaacta aaactcagaa gaaaacagac 1030620
 taaattttca caaacatag ttaacaatg gtttctttac tacctacta aatatgtggg 1030680
 caacaagaga agaataaatt tggctcttgc attaactttt cgtggggaga ggagaacaaa 1030740
 catgtagggt cccatgagag gcacctacaa cagaacaaag aaacagttgc atccaggtct 1030800

 agcttcatga accaatgagt ttaaagggtt tacttagaga tggataaaca aaaagtcct 1030860
 atactatatac aatagaacat aggtaggcaa taagaaataa tgaagttttg agatatgcca 1030920
 caacatgcaa gagccttgaa aatatgctaa gtgaaacaaa ccagatcaca aaacatatgt 1030980
 cttttaattc catttatatg aatgttcag aataggcaag tatacagaag aaaaacttaa 1031040
 gactttaggt agctaagaga ataagaaaag gtacaatttc ttctacttct ctctctctg 1031100
 tggattggg gattaaacce acagiatttc ctttctcatg ctgagcaagc actctaccac 1031160
 tgagatgtat gccagcatta ttttcttct tctctctcc ctctcttcc tccttctgt 1031220

tccccctcct ctctctctac ccctttctct tctccattc attcttcctt ctttttagct 1031280
 gctctggcct caaactcact ttttagccaa agatggcctt gcactttgaa tccttctgct 1031340
 aacacaacct aagtgtaggc agtacgtgtg tgagctaccg tgccccattg atgttgtgct 1031400
 gaggtcagac ccaggccttc agcatgctaa atgcagictg tcgactgac tacattccta 1031460
 gtcttgctt cttttccatg gcgtgtgtgt gtgtgtgtgt gtgtgtgtgt gtgtgtgtgt 1031520
 gtgtgtgtgt gtgtcttttc tctgttctca catctnnnnn nnnnnnnnnn nnnnnnnnnn 1031580
 nnnnnnnnnn nnnnnnnnnn nnnnnnnnnn nnnnnnnnnn nnnnnnnnnn nnnnnnnnnn 1031640

 nnnnnnnnnn nnnnnnnnnn nnnnnnnnnn nnnnnnnnnn nnnnnnnnnn nnnnnnnnnn 1031700
 nnnnnnnnnn nnnnnnnnnn nnnnnnnnnn nnnnnnnnnn nnnnnnnnnn nnnnnnnnnn 1031760
 nnnnnnnnnn nnnnnnnnnn nnnnnnnnnn nnnnnnnnnn nnnnnnnnnn nnnnnnnnnn 1031820
 nnnnnnnnnn nnnnnnnnnn nnnnnnnnnn nnnnnnnnnn nnnnnnnnnn nnnnnnnnnn 1031880
 nnnnnnnnnn nnnnnnnnnn nnnnnnnnnn nnnnnnnnnn nnnnnnnnnn nnnnnnnnnn 1031940
 nnnnnnnnnn nnnnnnnnnn nnnnnnnnnn nnnnnnnnnn nnnnnnnnnn nnnnnnnnnn 1032000
 nnnnnnnnnn nnnnnnnnnn nnnnnnnnnn nnnnnnnnnn nnnnnnnnnn nnnnnnnnnn 1032060

 nnnnnnnnnn nnnnnnnnnn nnnnnnnnnn nnnnnnnnnn nnnnnnnnnn nnnnnnnnnn 1032120
 nnnnnnnnnn nnnnnnnnnn nnnnnnnnnn nnnnnnnnnn nnnnnnnnnn nngtgtgtgt 1032180
 gtgtgtgtgt gtgtgtgtgt gtgtctctgt gtgtgtgtgt gtgtgtgtgt gtgtgtgtgt 1032240
 gtgtgtgtgt gttttagaag cagcctctc ctatgtggcc ctgacgactg ggtaccact 1032300
 atgtagtcca ggctagccta gaacttgcaa caatcctccc gcttcagcct cctgtgacat 1032360
 ctacttttat ttaagacaa attgcccagg ttggccttga actttaaatc ctctgtctg 1032420
 tcttcttccc agaagccggg attacagac tgtaccacca ggtaaagtat cgtaacacag 1032480

 ctcttttgca aagtagtcaa aatgttctaa atttacgttg tagtgatggt tetgctggtc 1032540
 tgtgagtgtg actgaaagat cactcagctg aatcaggtct ctccctctgc catgtgggag 1032600
 ccatctcagg tagtcaggca tggcatcagg ccacatacctt ttgagccatc tcaactggccc 1032660
 cagaatgtat tttttttttt aatgtaaact cctccagtct gccctaaaaa ctgtgattea 1032720
 ccatgctaaa ctgcatccct tattacttca ggaaattctg atgtcgctga ctcagactcc 1032780
 ataccttgaa aaatgtcatg ttgaaaagca tacatgcca gtagcctat caccaaaaga 1032840
 gtgaaaagag gaataagta gcaaatagtg cttacaaggg gccacggact ctaagtgttc 1032900

 catatgtata tacactgtta tagctgctgt tgtgtcccca tcaactatag aggaaactga 1032960
 ggtataaagg gacttagtaa tttgccc aaa gtcatatggc aggtggcata accaggatgt 1033020
 ttacgtaagc tctaaatatt atagctagtt gctctgcctg agaaaatgag aggaatttgg 1033080

tttgggttgg gttgaggtgg tttgggttgt tttgtagttg tagctgaaga agaagggtat 1033140
 ttaacaaaaa ggaagttata aatgatgatt ccttgtggat ggtttttttt ttgtcccacc 1033200
 agcctgctcc caaataatc acacagagac ttattattaa ttataaaaat tcaggcagct 1033260
 gggcgtttgg ggcgcacgcc ttaaatccca gcactcggga ggagaggca ggcaaatctc 1033320

 tgtgagttcg agactagcct ggtctacaag agctagtcc aggacagcct ccaaagccac 1033380
 agagaaacce tgtctcgaaa aacaaaacaa aacaaaacaa aacaaaaatt caggcaatag 1033440
 cttaggcttg ttactcacta tgagtatgca acaaggaggg tccatattgt tggagtatg 1033500
 gaagcaagag gaaaaactgg ggaagcaggt aagagtcaga tagcctttgg ggacatgat 1033560
 gttaggttga attcttatcc taaaaagaac aagaaatcca tgaaagaggg agagtttcca 1033620
 gttagaacat catcacaat tagatTTTTT gtgggggtgg acaggttctc ttgcagtctt 1033680
 ggggtgcctta aactcaatat gcggctgagg atggccttga acatttgatc ttgtctcaac 1033740

 cttctaagta ctaggattac agacataggt atcacatgcc ccatTTAAC agtgctgggg 1033800
 acctagctca gtgcttcttg cattatgagc aaacattcta cctatatctc cagccccga 1033860
 acttaggggtt ttttgtttgt ttgagatggg gtttctctct gtgtgtagct ttggctgtcc 1033920
 tggaaacttg tcigtatgac aggctggctt ggaactcaca gagatccatc aagctgcctc 1033980
 tgcttcttga gtgctgggat taatggcatg tgccatcacc actcagcctc aaatttagat 1034040
 tttttaaac cattctctg ctccttcac ctttttattt acttagaggc atggtgacac 1034100
 acacctttaa tcctaggctc aggaggcaga ggaggtaca tctctgtgag ttccaggcca 1034160

 actaagagta cccagtgaga ctctgtctta caaaacaaaa caaaacaaaa aaaacacaac 1034220
 aaaacaacaa acaaagccag gtggcgatgg cacacacatt taataccagc actcagaagc 1034280
 atcaggatga atctctgagt ttgaggctag catgttctat agagtaagtc tcaggacagc 1034340
 caggactaca cagagaaatc ctgtctcga agatcaaaaa taaacaaagc attaaattaa 1034400
 aattttaaag gcagaggtca gtttaagaaag aaacctggtt ttgaccttg cacttcacac 1034460
 aggtacaaac acgcaaacac aaacacacac acatacacia aaagtaagt cagagctaca 1034520
 atttcaaat gagtacattt aaaaaagtgt gtgtgtgtat gtgtgtgtgt gttgcctgca 1034580

 tgtatgtttg tgcaccaggg tgtgcctggt gccctggag gccagaagag tgtgtcagat 1034640
 atgctgggac tggagttaca gagatttgtg aactgatgct agggatcgag cctgggtcca 1034700
 ctggaataac agccagggtc cttaactgaa gagccatcac tccagcccct atataaaat 1034760
 tttaaacata actagaaact gctgtgcaac aatctttata caatgtaaat atgtattact 1034820
 ctcactgggtt aataaagagc tgactggccc atatctgggc aggaagagat tgggcaggag 1034880
 agccagagta ggagaatgct gggaagaaga agggggagtg agaagagcat ggagaagatg 1034940

cagagagaag caagatgtac acgctgtact gagagaaggt accaagccac atggcaaagc 1035000

 ggggataaaa agaggggttc actgttagct aggaacaagc ctgagatact ggctgagcat 1035060
 ttataataaa tattaagcct atgtgtggtt acttgggagc agcttgtgga actgttacia 1035120
 gaaacttctg acaacaagaa actatttttc cagctacctg ataaccagct accattatga 1035180
 acggcagaat aaccagctag gatgttcatg agattccaac tgacaatttt attaggaaaa 1035240
 taagaccaag atataaatga ggtctaaaat ccatatattt cacacaagta cccatagaaa 1035300
 tcaatagaag ctagccagaa gtttcataaa ggtaaatcaa aatttacaag aacacatcag 1035360
 atttgaagac cactttgcta atggcaaaaag aagctttgac attaacttga aaggtggcgc 1035420

 atgtctgtaa ttccagcatt tgggaggtag aggcagaagc atcatgaatt tagagccagc 1035480
 gigaactaca catatagacc ctgtctcaaa aacaacagaa agttaacaac tccttgaatt 1035540
 tacgcagaga aatcaaccca aacatagact ttccagatac acctgaatgg agaggaaaga 1035600
 gctcaaaaaa aaaaaaatc accaaaagaa aactaataa cgattactag aggctgtaga 1035660
 cagatttttc tttggggcca ccagctcaca aaaaaaaaaa aaaaaaaaaa aaaaaaaaaa 1035720
 aaaaaaaaaa acctaaaatg gatgettggt attaatatag catggtgctg gcagccagct 1035780
 ccagccagca ggcaacagct ggtagctgca cctctatctg ccaccagca ccagaccacc 1035840

 tgagagactg caggattagg aagctacatc tgactccttg ttcagtcaga actttcetta 1035900
 ccccccccc tciatttgaa cccccacaat ggacaccata tgtagatgga tttttttcac 1035960
 tgagccaaca gtcacaaaa caacaacaac acaaaaaaac agagacttat tctgaaagct 1036020
 cagcctatag cttaagcctt atcccactag ctcttataac ttaaattaac ccatttata 1036080
 cactctaagt tcigccccct ggctttttac ctctcttcca tctttcacct ctccatgttc 1036140
 tgacatctct ccttgcccta gattctctc ctgtctttct ccctgggcct gaagtctgc 1036200
 ccaacctctt cctgcctagc tattggccat tcagctcttt attaaaccaa tgagaaggea 1036260

 acttgcaaa gacacatctt catagattat tccacaagag gtcaggttgg gcaacatgag 1036320
 gtcaagtaca tcatggcaga agacaggctt gctatgaagg aagtcttggc ttgatctata 1036380
 gcgaccatgt tgttttacca ggaggaaatg aactctaata acttgaanaat gaacagtaca 1036440
 aacaatatca gagagggagg ggaactgttg gaagtaactg tgggggaaga caatccaagg 1036500
 gatctggag atttactaaa gaggaaggac cctaacctag tcctatgtat ggattggaaa 1036560
 actggagccc agagagaggc agtgccaggc gcaggaacac acagcaaatc agtgtggatt 1036620
 cagacccaaa caccagggtc tcaccatcag cctctataa tgtcagcctc cttttcctgg 1036680

gtcagggtct ctgcgaggct tactagaaca cacacaacta gttctctcct caatcctcca 1036740
 cccaaatggt gtaagcctc ctctctgtcc ccccccaaa aaaaaaaga agaatggagg 1036800
 atctggactt acaggcttat gtaattctc aggacagatt tcagagacc aatgtccaca 1036860
 gatctaccaa tttccttct acactgtacc cacaaatgcc acaattacaa aagtcatcct 1036920
 gttaggaaaa caacactaag atatgactat ggctaaaaac caaagctgtg gcttcattcc 1036980
 tttatcccc agcctcctgt attggaacct ctgtcctctt cctaagaggc tatgaacca 1037040
 ggctctgtgc cccaaatata cacaccttct ctgctctggg aaaggaggta catatccctt 1037100

 gtctttgttg ttctctgata tctatacccc caccctgtt ttctcttct agcaagacct 1037160
 tgaattcctc agcctcatt ccaggaatag gtcttaaatc atttaacta agaaatgcat 1037220
 gcttgctatg gaacaatggt tgtacactgt aaatatgtat tactctcatt ggttaataaa 1037280
 gagctgactg gcttatagct gggcaggaag agattgggca ggagaaccag actaggagga 1037340
 cactgggaag aagaaggct gagtctgagg ggtaatgagc cagatatgta gaaaaagacg 1037400
 taacaagtca tgagccatgt gatagaactt agataagaaa tatgggctag cttaattaaa 1037460
 ttgtaagagc tagttagtaa caagcctaata ctatcgctg gtcgtttata atatgaagtc 1037520

 tctgtgggtt tatttgggag ctgaccagt gtccagacaa aaaaaaact ctgcctatac 1037580
 atgctaaaa tcttaccata tcatggcatt atcatgacta gctgaaggat gaacgtgtga 1037640
 cccacatcag gctatttaga gccacaacaaa ctcaattctg agattttga tgagccattt 1037700
 gggaaaatag atttaccatt ttctttggg ttttaagtta gaatgcacct acacctaaga 1037760
 gcagctggca acttcttccc aatcttatcc atgctcagaa ggcaaggcca aagcctgaat 1037820
 ggttctacta agatatagtg aggtgaggca tcttccatgt aaacagtttg tgatctgcac 1037880
 agacagcaag cacatgcaa gcccttataa tctgtccta cacacctaaa aggttgacac 1037940

 tgacacacag aattaacaa ttgcectgtg agttaggagg tggatactct gtcactagga 1038000
 gccaatcca catggcagct aagttacaca ttctcagctg catcctgaac agaccgagag 1038060
 ggatgggggt ggggtggggg tggggagggc agaaccacc tctgcctgag gatggaaga 1038120
 tgactcagct gttgagtct tctgtctctt ccagaggacc tgactttggt teccagcact 1038180
 gtcaggcagc tcacaactgc aactcagact tcaggggatc taagacacac agacacagac 1038240
 acacagacac acagacacac acagacacac aggtgctgag aattgaacc aattgaacca 1038300
 atgttcttaa ctgctaagcc atctttcag tccttttta aattcaaat ctaagccagg 1038360

 cgggtgtggc acacgacatt aatcccagca ctcgggaggc agaggcaggt ghatctctgt 1038420
 gatttcaaga ccagcctggt ctacaagagc tagttccagg atagcctcca aagccacaga 1038480
 gaaacctgt ctgaaaaac caaaaaaaaa aaaaaaaaa aaaaaaaaa aggaaatct 1038540

aaaaaagat aatcctatgc ttcaacagat tctgggaagc cacagaatgg tctcctgtca 1038600
 gcctcccagg ggagaccagg ggcaggga gaaggat ttt cctgtctgac aagcctcctc 1038660
 atgctctggg gcagccacaa ggcat tctgc caagagccag atgaactatt cacgccttag 1038720
 gccttcaacc ttccagatt tatctgggggt tttagttcca actccaact tttcttaagt 1038780

 tcaaatgtct gttaaaagcc caagtgttt gtttaaggggt tagttgtgtg ttcaaaagaa 1038840
 tgctgtgttt ttgtttccag catttccgtg tgttatgtag caaggagttc cagatattgt 1038900
 cagcagagga agtctagctt gatgctgagt aaactctcca tcgtcactgt ctgtttactt 1038960
 ttttctctgt gagtatcaag ctctggggagg gcagggactc agctgactca tctctgggga 1039020
 caccagctca agacctgaga caaagtaaat attgattcta aacttccact tggatacctc 1039080
 tagtgatggg agctcatggg caatgaggga ctacctctc ctgagccatg tgcattttt 1039140
 cctgctcaag tgtccgtcct gattgtgcag aaggacagg agtcaagtaa tgactgagca 1039200

 ttggctgaga aggaagtgca caggccagggt ctgggtgtaa acctgaggca ctgactcatt 1039260
 gctggcagaa gtctaaagat ggcacggata tatagcaggg tgggtgggtg gcacagcttt 1039320
 aatccaaca ctgaggagg agaggcagggt ggatctctga gttcgaggat agcctggtct 1039380
 acagagggat tttcaggatg gtcagggtca cacaagaaa ccctgtcttg aaaaacaaaa 1039440
 caaaacaaaa atagttgaaa tgtgtatagc aatcaatctt atatatctga agtatctctg 1039500
 aatctat ttt tttaaaacag gttttctgt agctcatcat gaggttcaaac tagctttgca 1039560
 gctaaagatg ccttcagctc ctttgccatg actggtttca tgttgggatt aaagctggag 1039620

 gctgaacca ggatttagtg catgctagc aagtactcta ccaacagagc taccttttca 1039680
 gtccattct aaacagaaat acctattcta aaacagaact acctattctt tagtcctatt 1039740
 ataaacagag gtagttctta tagcattgtc tgtggaggca acagggaaaa cccaagtgtc 1039800
 caacaacagt gactaaagaa atggttttgt ttttatcttt tttttgggg gggggtcttc 1039860
 tttaatgagg tagagttga gtatcgacat ggtacaactt ccagacagta taaatcaata 1039920
 catcatgcaa ggtatgtact aatgtcttta atattgtat ttgggttttt atcttttttt 1039980
 ccatttattg tigtttcaga catgaacatc atagcactca tgtggaagtc agaggaaaac 1040040

 ttgggtgtt ggtgatctct ttctgtcatg aggatcctga ggattgaatt caggttgta 1040100
 ggtgtggcag cagctgacat ctctactgg ccctaatttt gattttttga ggcaaggctc 1040160
 catgtagcct gacttcaaag tttcaaagia gcaaagaata gccttgaact cctgatcctc 1040220
 ctgcctccac atctcaagtg ctgtcattac aggctgtgc catcacacct ggctaccctc 1040280
 aattttaaaa atggcaatta agccgggcgt tgggtggcga cgcttttaat cccagcactc 1040340
 tggaggcaga ggcaggcga tctctgtgag ttcaggcca gcctggtcta cacagtgagt 1040400

tccaggaccg cctccaaagc aatacagaga aaccctatat tgaaaaaaca aacaaaaaat 1040460

tgctcaact gtttagatct cattagaaaa taccttaaaa tatttaagct tggcatggca 1040520

acacatgaat ttaagcccag cacttgggag acagagacag gtagatctct ctgagtttga 1040580

gcctggcca cataatgaga cctgttttgg ttgggtttt ggttttttga gacagggttt 1040640

ctctgtgtaa cacccttggc tgtcctgagc tcactttgta gaccaggcta gtcttgaact 1040700

cacagagatc cacctgcctc tgcttcccaa gtactgggat taaaggtgtg cgccaccacc 1040760

acctggcaga attacagtgg ttttaataa actattgaga gcaaccttca tttcattga 1040820

aaactagcca cagtacattg atatgattgg atattacag tgtgaaataa aacaaagctt 1040880

ccttgcacac agttaatgaa cagtctcaag atacagtata agggctggag agatggctca 1040940

gaggttcaga gcaactgactg ctcttccaga ggtccagaat gcaattcca gcaaccacgt 1041000

ggtggctaac aaccatctat aatgtgatct ggtacctct tctagtgtgc aggcatacat 1041060

gcaggcagaa cacttataca taataaatat ttttttaaaa aaagatacag tataaacga 1041120

acaaaggggc ataaagcagt tttatttga tggataccac acacatgcat gaggacctag 1041180

ggatgtggct cagtgtctag agtgtatgcc tataaaatga gtgtgatc agaagcctct 1041240

aatcccagct ctcaagatgg ggaaacaaga acagaaatgt taggtcatcc ttgctacaca 1041300

gctcgagatc agggctggag agatgggtgtg ccgattatga gtattcattg ctcttgggt 1041360

tgccggtatc cacatctggc agctcacaac tgctgttgt caccagggat cgccagttcc 1041420

ccaggaatg acagagactc attatgaaag ctggccaat aggttaggct tatttctaac 1041480

tagttcttat acttaacta atgcatttct attaatctac atctggctgt gtgactcttg 1041540

gcagctgcct ctctctgc acgtctgct tcctctgcct ctggctgggt actctgtcat 1041600

cctcttcta gcattctctc tgcccccaa atctgccta gctattggcc gttcagcttt 1041660

ttatttattt attatttat ttttgtttt cgagacaggg tttctctgtg cagctttgga 1041720

gcctatcctg gcacttgctc tggagaccag gctggcctcg aactcacaga gatccgctg 1041780

cctctgcctt ccgctgctg ggattaaagg cgtgcgccac caactcccag ctctcagcat 1041840

taagttttt tttttgggt cagcttttta ttaaaccaat ctgagtgata catcttcaca 1041900

gigtacaaca gtattattcc acaacagcct gtaactgcag cgctagggga atccagcgc 1041960

ctctactggt gtctctgtgc accttcaactg atgtgcacag acacacacat aattattaaa 1042020

acacgttaa gtaaaaatct ttaaaaagca aaacagtggc cctgactata tcttggttga 1042080

attttacatt tatatttaa aatcatgtaa ttttataca gaatattaaa ttgttcatt 1042140

gttaaatc ttttaaac aataatagg acttcagg gcaacagagt gacgccaact 1042200
 ctcttcaca gaaaggattc atgtttcact tggttccacc agccttcca aggacactgg 1042260
 gcttagagat aggcaactgg gctataaac atcattcca gcagtttctc ctatcacctc 1042320
 tcacccattt ggcttctgt caccactggg ctgaggactg attatagggg ttgtatttc 1042380
 agaggtcca tcaatagaag gctgagaaga gccagtccag gaaaaatgcg acatttggt 1042440
 ttacttcttt gttcttcag ccacactttt actggctcca cctccaacgt atgtttctct 1042500
 ctgggtccat tcatcggagg catctgaaaa ctccattgga ctagatagaa agggagttag 1042560

 cattccattg tttcaactat tattgtaagc gatatctaaa aggagcaatg gtttactaag 1042620
 ggagatacaa caacactgaa ctatggtgia ttaagaagca aaaaagactt tacttttatt 1042680
 ctggagtccg attaataggc aacagtgaat aatgcttaag accaggccag atcggtagag 1042740
 tcatacccta cccagtctgt cactcagcag ctgcaaaaac ttagacaaac ctgtgcctc 1042800
 agtttcccag ttgtaagag ataaaagtag cttcatcata gggttattgt gaagctacat 1042860
 tggaatatca catcaaggtt ttgtgggtgt gtggatgat gcatatgagt ggctgcacct 1042920
 gtgtgtgggt acacatgtca taggtggaca tatgtattca tcctatgtgt ggtcctcacc 1042980

 tccctttgtg atcacacatc tatctacctt tgcacaactg aagacctact ttctgtcagt 1043040
 gtatataatt ttgtctatt ctagaatttc atataaatgc agttgtaca tgtctttttt 1043100
 gttttgtttt gtttttctt cttttttaa aaaagatttg tttatttatt acgtatacaa 1043160
 cattctgctt ccatgtatat ctgcacacca gcagaggcca ccagatctta taacggatgg 1043220
 ttgtgagcca ccatgtggtt gctgggaatt gaactcagga cctttggaag agcagtcagt 1043280
 gtcttaacc tctgaacct ctctccagtc ttgagttttt ttgtttgtt ttgtttgtt 1043340
 tttgttttt tctagacagg gtttctctgt ggctgtcctg gaactagctc ttgtagacca 1043400

 ggctagtctt gaactcacag agatecacct gcctctgcct cctgagtgtc gggattaaag 1043460
 gtatgcgcca ccaccgccc gctacaatat gtcattttta tgtctggctt ctactcagca 1043520
 tgttttttag attcgtctca atttgtggca agcattagaa ggctcttttt tattgctgag 1043580
 taggggtcta ttgcacaaat acatcacagt tctggcttga tattgagagt ataaaggttg 1043640
 atggagtttc aattctaggg agagatggtg gagagacaca aactgaatta aacccccgc 1043700
 ccattcttc ttcctctcc tttctgtac ataaggaacc agaagacttc taataactt 1043760
 tctcatgcat cctcagttt ttaagcttct ctctaaagg aaggtcaca ggatgggct 1043820

 ggagaggcgg ctgagcagtc aggagcactg ggtgctctta ggagtctcac attcagctc 1043880
 tagcatcccc atagtctca cageccttat gtaaattttg agaactccac aggcaccagg 1043940
 cacacatgtg gtgtgcagac attcaagcaa aacactcaga ctttctagc catttcatc 1044000

catattccct ccctttgtct gcagtcacct ttctatttga gcccagcttt ggccctttcac 1044060
 cacagcctgc tttctgagge tcttgaacc caccggcac cctcctccc gtctgatccc 1044120
 agctaagaat ctatcaccag agctttgggg agaaaatcca gggacacagg ttctgaatac 1044180
 tgtgcaaata ttgaccaatc caccctagac cttgcttatt gtcttccagc ttgtctggtt 1044240

 ttctgaattc tgcatttct tcccactaga ggaaccagct ctattctaaa ttcaaagagg 1044300
 ctgactttta cctatgagcc ttaataagtc tccaagtcac tatttgtgac ctgggtggtec 1044360
 aaacaagaaa atttgtccac agtgggacaa gactgtaatc ctagctactc aggaaactga 1044420
 ggcaagagge atgaaagttc aagactagcc taggcaactt aaaaaacgct gtcttctaaa 1044480
 aaaaaaaaa ttcaaggggc aggagagata gcccagcagc taagagccca ttctgttctt 1044540
 ccagaggacc tgagtccagt tctcatcatc cacataagat ggtgtacaac tgctataac 1044600
 tccagcccca agggatccaa caggcctcca tggacatcag gcatgcatgc ggcacacctt 1044660

 tacacacaca cacacacaca cacacacaca cacacacaca cacacacctt aaaaatacat 1044720
 ttcaaatgt atgtgtggta cactaccact tgtgtttaaa gtgaggtgat tctctctctc 1044780
 tctctctctc tctctctctc tctctctctc tctctctgat ccatgtgcag cectgaaacc 1044840
 atctcactcc ctggaagcag tgcacgtcac ctgggacaca ggggaagcat ggcaagcccc 1044900
 tctctctctc atgctggggg gtggcttttt gtttttgttt ttgcctctgc ctcccagtg 1044960
 ctggattaa aggtgtgcac cagcactca ccatattta cttgtgcatg tttgtatatg 1045020
 cagaggatat ttctgccccg tctcaccagg gactggtaag ggcagtttct tctgacaagt 1045080

 ggtggtggag ggaagtaaac ctatcccttt tgttctttga ccttttgaat cattggtagc 1045140
 ctattttgtt tatttagaat cagtgtctca tagagcccag gccaacctca aacacctat 1045200
 gtagctgagg atgacctaa attacacatc tttctgccag atccatctcc caaatgctgg 1045260
 aagtgcaggt gtgcgccacc acagcgggtc tcaaaaactg tttttattca aaccaagat 1045320
 tgagcatcct ctgagtgtag gatggtactc actgcctcac cccattgtct aatacttgat 1045380
 ttctgccacc tctaagcac tggccttttg ggtttgggag acgagttctt ggttatctca 1045440
 gaatgcaaac attctaccac tgtgcaggtt ggggaagttg tgggaagcaa gccaataagc 1045500

 aacactctc catggcctct gcatcagctc ctgcctccag gttctgctt gatttctat 1045560
 ccttactcac tttggtgatg aatagcaacg ctgaagtga agccgaataa acccttctct 1045620
 ccccagtttg ctttttggtc acgttttttg tcatgggtgt ttttgcacg gtggtttttag 1045680
 tcatgttga tcaatgaaa ttctaagaca gccctctct gaaaccctc cttctagaag 1045740
 ttgtcttggg tcatggtgtt ttatcaaaag gacaaaaagg tgcctttcac actcaggcct 1045800
 ggcaaccctg agttcaatct ctaaaatcca cttaaacttg gaaggacaga accaactctg 1045860

tcctctgacc tccacacatg tatcatggta cacatatccc ccataagtaa atacaaaaac 1045920

 actaatgttc tgagtctctc cctaaaggat aagtggttac tgctcaaagt cgatgtggat 1045980
 aagggttga gtggctggat ttaagaaaag atttccctccc tttcagtctt agtttcttga 1046040
 acagtaaaat agaacaacta tattatattgc caggctccatg cataggcttg taatatcagc 1046100
 atcttggcag gctgagacag agtgattgta cactgaaggc ctgcctgggt tagagagtga 1046160
 gtccaaggcc atcctgggaa gctttggaag ctgctgtctc aaaagaaaaa ggaaaagaga 1046220
 ggaggtgact gagtggtaaa gtggctgcag agtatgcatg aggcctgga ttctatcccc 1046280
 cacactgcca acaagataaa aaagaatcta ttatctatgc ttctctatc ttctcattc 1046340

 tctatcttag agcaaaggtt cggggagaaa gaggtgggga gtgaccagcc tgttgcacac 1046400
 acagactggc tcatactgc tgtgcacatt cagggtccca tgaggaacac acccagtctg 1046460
 acacatctca gcccttttaa gttgaggcct caagccagtt cagagtcctc agggcatggt 1046520
 aatgcaagc ccaaggccta gacacaaaca caagactggc ctcttgacct ccagtctaa 1046580
 tgcccataaa attaggcaga tgctcatgct tggaaatgag gggggaagag ttagattgga 1046640
 ttagatgggc agggaagctg tagtctcatg ggtgtgaact catatacact gtgtgtattt 1046700
 gtacacagat atcatgtaca tacatggata tccataggaa tggactttg gatgtaaac 1046760

 atcagggcat attcctagca ttatagtcac tacttttttt tttttgtttt ttttttttag 1046820
 agagaggttt tataagtata ggtgttttgt ctgcatgtat gtctgtatat cacatgcatg 1046880
 cctggtgcca cagtggctac aaggggacat catatacct ggatacagat gtttgtgagg 1046940
 cactgttttg gtgctggtag tcgaacctgg gtccctctgga aaagcaatag tgcttttaac 1047000
 cactgagcca tcctccagc tcctttttat ttacattgt ttattttggc agtaccgggt 1047060
 attgaagcta gggcatcaag catagggggc aactgctcta gcactaaacc acggttccag 1047120
 ccccttttg atagttgcca ggcccagct agagtccca gtagactgga atttgccta 1047180

 gcagtttgaa cattgggtac agccaatc ggaacagaa tccaggtcaa ttaggtacc 1047240
 agagtatatg ccaagagctg tattctctag acttggggaa ccagaatttt gtgctcctc 1047300
 caagatagag ggiccacggg gagactacta tgccagacac tgtctatggg cttcagctta 1047360
 caactactaa gcctttgatt agaacctta tacatcagat ctgacatata gcttgactgg 1047420
 gaaaatatgt ggacaagacc ctttcttgg gatgtcaaac attcacttgc taagatacat 1047480
 atacacaggc atcaatactt gcttgttatt ttttttaaat atatattttg ggtttttttt 1047540
 ttgaggcagg gtttctctgt ggctttggag gctgtcctgg aactagctct ttagaccag 1047600

gctggccgtg aactcagaga tctgactgtc tctgcctccc gagtgctggg attaaaggtg 1047660
tgtgccacca ctgccagat aatTTTTTTT taatatTTT aagattTTT tgtgtgtgga 1047720
gtTTTtacct acatgcatga ctgtaccaca tttacaatgc caagaaagct agaagagggt 1047780
gtttcatcct ctggagctgc agttaacaga cgctagttag ctgccatgta ggttctggaa 1047840
atcaaaactca tgcctctgg aagagcatct agtgcctca accactgagt tgtctctcca 1047900
gcccaacttg cttgtcattt aattaataga aaactagaga aatggttcag tgggaagag 1047960
agtttgcaga tcttttaaaa gtattttaaa tgagggtgat aaagtgtttt ttttaagtta 1048020

TTTTTtattt tgtgtgtatg ggtgttttgc ttgcatgccc agctgtatac cacatgcatg 1048080
cctggtgccc agggagggtca gaaaggatcat cagacccctt ggaactggag ttaagatagt 1048140
tgtgagctgc catgtgggtt ctggagtcaa atctgggtcc ccagtcagtg ctttttaact 1048200
gctgagccag atctccagcc atattaaaaa aaaaaaaaaa aaaaaaaact tcctatttaa 1048260
tgtacatggg tgctttgtct gcatgcctgt ctgcaaatca gaagagtgtg ttaaccaat 1048320
tacagacagt tgtgagccaa tatgtgggtg ttgggaattg aactcaggac ccctggaaga 1048380
gcagccagtg ctcttaatct ctgagccatc tctccagccc atccagccag atgttttttt 1048440

atTTTtaatt gggcttctct gagtatggtg acacatgtct ttaattctaa tacttgaggg 1048500
gcagaggcag gtggataggt ggatatctgt gagaccaggc cagactgac tacgtagcca 1048560
gttccaggcc agccagagtc tcaaaaaact gatacacaca cagacacaga cacagacaca 1048620
gacacagaca cacacacaga nnnnnnnnnn nnnnnnnnnn nnnnnnnnnn nnnnnnnnnn 1048680
nnnnnnnnnn nnnnnnnnag agagagagag agagagagag agagagagag agagagagag 1048740
agaatgtgca cactgactca cactgttgcc caggctgttc ctaggcactg agtagttaga 1048800
accacaggtg caagccacac actcagctac ttactattta ctgaacaac aatgagact 1048860

gtccatcaaa gtagtctcgg acacggacac atgagttagg caagagtgga ttccctgag 1048920
aagccatgga agaattttga agacaggaag taattttaga aaggcatgaa ggaggcaatc 1048980
aaggaagagg agagcattta acatggaggc gatggagttt tactagcaca ggttacacag 1049040
agaagaagga agacggagct ggagagaacc tgggttatga agagctatga atgctgttgg 1049100
attgttgagc tttgtgagaa tatgaggttt tagaacaac aagtgggtgtg acaggagga 1049160
catgttaggg attagtttgt cagcaaggag gtcaacagag ggtgtgggat tagtgggaag 1049220
tggtgtgct aggcagaggc tcaggtttgc acaaatgagg gcacgttga aactctagt 1049280

taaggaacac agtgcctatt gcctccctc aagcctctgg gtattattt ctggctctgt 1049340
cctctgcctg gcagtattca gtcctatctt agagcttttt ggctgtgctg aggcagggtt 1049400
cttgaatca ccagagcatg gagctctgaa ctgctcctg ctggccaaat gggcaactct 1049460

cagagcctca tciactagat ctgttctact tagagattca gaagctctag cctggaaatc 1049520
 cccaggaccg gtgtttgcaa tttctccca agtgtctcac aggccattgc aagaactggg 1049580
 gcctggagca tgaacatggt ggaattttgg ggatgaagag tctggaaaac tctcactcta 1049640
 ttggccctaa atttgaatat atatgtcagc aggaaagatc gactaaggcc cagagtggta 1049700

 aggacttact tggcaccaca cagtcgggac acaggactgg aagccagatc tctctggaga 1049760
 cacttcagaa tectggagtt cagaccctct ggtaaaggtt aaatcctgtg atttagactt 1049820
 ctgcttctgc cattgactat agcttaatta ccttggcgag ttacttacat tctcctggta 1049880
 tgtttcttca actgtaagaa gaggatacta tttacctttt ggggttattg tgaagattaa 1049940
 atagcagccg agtgcctggc atatggtaag tgttcaatgt cagctggcga tctggcagaa 1050000
 gcagtagtaa cccccctctc gcccccttt cctctctctg agacttaggc tgccttacct 1050060
 cttgaacctc tegtctacct accaagtgtc gggattacaa gtgtgtgcct gtattctgtt 1050120

 tttccatag caaatcaggg ccaacaatcc ctgtcttctc actcctctgt cctgttccgg 1050180
 tagcaactgt tactaaataa ggtgtgtaaa cctcctaggg ctgagctgtt tccaggtcaa 1050240
 tgtttgttca gcttagagca atttctttcc aaggcctact ctgaccaaat ttcccgtcag 1050300
 ccccaccaac tccccacac tgcaggtgc tcctttgtaa ctgcagaagg ggaaaggtcc 1050360
 gctccagccc agggaaaaaa ggagagctgg gaaaaatggaa aacgtgtagg gaagagatgg 1050420
 gacagaggag gaatagcagg taagaagggc agtgaggaag agcggcgaag gataaggagg 1050480
 ggggtgaaag ggacttacag atggagtgtg gtgggggtga gggggtcctc ctgagctaag 1050540

 atgcaggcta agggatgtgc ggagcactgg ggcaagtga agagcaaggt tatgtgcagg 1050600
 aagagcagcg aggtcgaatc cttgcggaag aacggggcgg agggggggtc gccatcagtg 1050660
 cgaggtctgt ggatgactgg gggcagggaa tttgggccgt cacctccact cggctcggagg 1050720
 ttcggagcgc agatcccggg ctgcagccac ccgcaggcga accgcgnnnn nnnnnnnnnn 1050780
 nnnnnnnnnn nnnnnnnnnn nnnnnnnnnn nnnnnnnnnn nnnnnnnnnn nnnnnnnnnn 1050840
 nnnnnnnnnn nnnnnnnnnn nnnnnnnnnn nnnnnnnnnn nnnnnnnnnn nnnnnnnnnn 1050900
 nnnnnnnnnn nnnnnnnnnn nnnnnnnnnn nnnnnnnnnn nnnnnnnnnn nnnnnnnnnn 1050960

 nnnnnnnnnn nnnnnnnnnn nnnnnnnnnn nnnnnnnnnn nnnnnnnnnn nnnnnnnnnn 1051020
 nnnnnnnnnn nnnnnnnnnn nnnnnnnnct ttgtctgttc tttgtctgtc tccgccggcg 1051080
 gccgctggag ctgcgttctc ggctctctat tggttgcccc aagccggtag gccatgacgt 1051140
 cgcttatttg catatgacat tgagacgtca ccaaggccag cccgccttc caggcttgtc 1051200
 tgggtgcttg tectctggtg acccggtggg cgtgtgtctg agcccgcccc agggttgaga 1051260
 gacattgaaa ggcaagcaat acccgagggg actcggcggt ttcccgggct catctagaga 1051320

ctggggtcgg gcctctcatc tgctttttcc ttgcaacctg aggaagggtc agaaggcaca 1051380

gctcaatcta agttgagagg gaggtcggtg gatcaaagag acttcagagt ccgggtccac 1051440

gagacagcac cagatggcag ctgatgcctt gtcttcaggc tccgcccccc ccaacataat 1051500

aacatcgtgc taatccctga catgtgtgca aagccttggg tgatgtcatt ttcagcctac 1051560

agatattgag ggtcttaaac cccatttcat ggaagggaaa actgagacc agagagacat 1051620

agcttactgg agaactcagc caattagagt cacactctat gagtgacagg ttccttagct 1051680

gggggcaaat gcttagtaca agctcagttc aattaaccag ctatatatcc atctactggg 1051740

gaccctatct tgggctcagc accaagccaa tttgatagaa tgtttcagtc tccccgattc 1051800

tggacatfff tccaggaggf ccgtaaagat tgagtcggtt tcaaggcgac cttctctgcc 1051860

ttctctctat cttagaacct aataaattgc tgtctcccag ctgttttgac cacagaacgg 1051920

tgagtcacta gttgcctgcc tccggtgtct cccgggcaga tgtttgtgag aatgagttgg 1051980

gagttccctt tattggcctc tcatcacctt gtcagatccc aagctgtcag ctaggaggaa 1052040

ccagaccttc cctagcacta gtgctgtctg gagagtcttc ttccagagga tcagaatggt 1052100

cttttcttcc caagtgagta gatatggagg ctggatctgg atcctcttcc caggctgggg 1052160

tttgttcagg aatggcctgg gctaggggtg gcttagggct caagtgctat tctgggcaca 1052220

gctgctgtag tattaaggga aggttcttcc tggagtggag ccaggaaact gagaaccagg 1052280

aagccagcag gctaggggag aaaaccagg aggctctcct tgtggtcaaa gggaggagtg 1052340

ggcagtcata gctggctggt tgttgtcatc tctcctggct gtcactgact cctgcatgat 1052400

ctccaccagg taccttctct gctgagcctc ttacctcact caacatgtca tcagttgagg 1052460

ttccttgtag ggictgatac agcaggaact ctgggaaata catgttagaa cttggatgatg 1052520

gctggatcaa ggcactagtc caatctcctt gtcttcggtg cacttttact ttcttgaata 1052580

ttatctttga ggcctttctg attatataatg ctctgcattt ccccaccact actaagctgt 1052640

agcttttttg atagattaac gttatcactt tgaggctctcc atcctagaac agggggcttc 1052700

ttttttgtct tggccagggt aaggactgtc tgaaggcttg ggtcttggtc caaccttgt 1052760

gtttatcctt aagggatgct tagatctgac tgcttcttcc ttccatcatc tgtcactgac 1052820

atgttgtttt actagggtaa ggcaacacaa tattctttgt cttggccaga gatgctgtcc 1052880

ttgaacaaga gtctggggga aggggttaga gtaaggagga cctgtgagca taggatctta 1052940

cacctcatct ggaatacaca tctgagggtc gtccaatccc atggtgagat ttagcaaga 1053000

accatgcggt ttctattagc acttttcaag ccacacaacg tcctatgagt attattgatc 1053060

tctggggtca aagattgctg ctcaaaaaac cttgctgaaa tccaagatct tttttttttt 1053120
 taacccttag aaaaacacac ctagacacag ccttagttac aaagctaaaa atgtctagtc 1053180
 tagacagata acccagaaaa gacaggagtg gactatagtg attatggagc cactggttat 1053240
 ctggattcaa atgctacctg tgtcttacta gctgtgagac tttgggctag ttgctttacc 1053300
 tctctgagcc ttgttttatt tctctcttta ccagaaaaaa aagtagatgt tctctctccc 1053360
 tttctcttcc ttttgacagg atctcataca gccacggact gttatTTTT taggtagggt 1053420
 cccatgtagc tcagactggc tttaaacaca ctatgtagct aaagcaggac ttgaactcct 1053480

gatcctcttg cctccacctt actaggatga tagatgtggc ttctcatgtc tgactttaa 1053540
 ctttttgatc ctcttgctc tgtctcccaa gtactaagat tacaggcttg taccttcata 1053600
 ccttgctctg atctctgtt attgtgagga ctacataggt aaaacagatg gaggttgctta 1053660
 ggatggtagc tgacacatga atattaattt tatgatgatg atgatagtaa gagcagtttc 1053720
 ttccctcaat ggaatttcc tatttacttt tcaaagctgt ttcttctcc agagacaaaag 1053780
 cctagtcata tatatcactt ctccgtatc cccaaagcaa cctgtagtaa cagcaaatat 1053840
 attagcttat tggacactta ctgtgtgctc aggcactgtt ctaaacacat tataagtgtt 1053900

tagctcattt aattctgatt aggatattgt ttgacaaata agaatacaaa gaccaacagt 1053960
 ttctgaatt cacacaggaa agcctgctga ctgcagaaaa gcacacacaa gagcctgccc 1054020
 atgctcaggg tectggagcc ctctgtcccc cagccaccac cattaggtag actttagcct 1054080
 taatgtcttt ctctgcttcc taggttttcg cactgccata gggcgccttc ttgaggttgc 1054140
 ttccccctg gaccatgtc cagccttta ccagcctttt cttcagcact ccttcgctc 1054200
 ctgaagactc caactgtctt ggggccttcg tctcagagga ggatgaagtg gatggctggc 1054260
 tcatcattgg cctgcagggt gaggcctgag tcagggggcc agcactagga aggcaccata 1054320

aggacagga ggccttatgc aatatggaag gggaatgtgg ctatttggga attggagtec 1054380
 ccataggcct cctgggcaaa atgaagtga ggacagtgcg ctagaggtga ggtaacacag 1054440
 accttctcc cgaagccct gtctgtctcc tgatttgttg ggggcataca cctggggccc 1054500
 cctagggcag cagggttaagg acctggctc tcaggtgctc tctgggcagc atggacaggg 1054560
 gctgtaggtc tgactaacga tgcctttct ctcccatcc cctgtttccg gtatgtgtgt 1054620
 gtgtgtccca cccctatccc ctgtgtctc ttctcttaag catggctccc cactcccaca 1054680
 ccctatagac agetacacag ctccccaaa cctggggct tctctgctc cggcaggccg 1054740

ccctccacc gcgccctct tgatggacga gagctggtt gttaccctc ccgctgttt 1054800
 tactgcagag gggcccctc ttggcccctc acgctccag agcaacccc tggaggacct 1054860
 cctcattgaa catcccagca tgtccgttta tgcaccggc agcaccatag tgctggagtc 1054920

tgggccgccc tcccctcacc ctgatgctgt cttgcctgag gaggatctca gtgatgggtg 1054980
 agtgggcacg ctcgggccta ggagcctagc aggggagtgt ccttgagaca aagggcgggc 1055040
 caggtgggta gttacagga taactgatcg tcttatggct aagatggggc ttgggagagt 1055100
 cttggctcag acgactggga tcatcttga ctgctaagcc agagcgaga gtgggcttg 1055160

 tattgtttgg ggggtggagc cctctccctc tctgtctag tttagctgcc tcagggtaga 1055220
 ctctaagaaa tatctctaat tgggattgag ggaagagttg gtaccctca gggcatcatg 1055280
 tgttctgccc caagagacag ggtgggagac tcaagcccc tgtccccctc tgacatttgt 1055340
 actctgtccc tgcagagagt tggcgctgc ccgccgggag cccagggtc tgcacatgc 1055400
 agcagctgct gcittgctg cgcgagcggc gctgctggag aaggctggcc aggtgcggag 1055460
 gctgcagagg gcccggcagc gggcagagcg ccacgccttg agtgctaaag tgctgcaacg 1055520
 gcagaatcg gcccgggaaa gtcgttcacg gaagcccaag caccaggga gcttcattta 1055580

 ccagccgtgc cagcggcagt tcaactactg agcgcctctg ctgcacctg agtcccgtgc 1055640
 agtctcctgg tcccgtctac ctctctgca gcagccagtg tgttgctcga ggagtgtcca 1055700
 gggtcgcctt gectccatct gggtagcaca acttccctcc ttctaaagt tetgaggtgg 1055760
 gatgatggcc ctctactccc ccgatttctc agtgtctgaa cttctaattc acccgctaac 1055820
 ttctttcacc cagggtcacc ctteccatct ccgtttctaa ttcttcacca tcacactccc 1055880
 cactctatt ttccaagct ccctttcag acccgattc ttgtcatctg gcttcttcac 1055940
 ttgcccctcc taaccagcg atttctaaga ccctctcca ccaagacctg gcacactctc 1056000

 caactttcag ctctacttt ccaagactta ctctttcca tgcggcattg ctctgctcc 1056060
 tgttcccctt ttcatctct ggcaattccc tccagtcct gaccaggtac agccggccac 1056120
 gcttgggcca ttgttctac cctgtagtca ggtgtcaggc tcagggtttt gattttagtt 1056180
 ttccccttt ctctgcctg ggggetgagc tcttggagc tgcttaggcc tggaaagttt 1056240
 aagtatgtgg aggacagtga gttgtaagtt agatgaggag aggggaacgg agggaaagcg 1056300
 ggcagcctat tgggaaatgc agacaggac aggtgggttg agacacagta gggagcaggg 1056360
 tattgtgaga gctggcactg tgcttgggtca gaggagctaa gccctggtct taggcttgag 1056420

 cctggagtct gcccattt cttttctg taactctgcc ttccagggtt tctgaaatc 1056480
 tgteccgtgt cccagcacc tctccccccc ccccccccc cccccccagc ctgcagcccc 1056540
 ccgcnnnnnn nnnnnnnnnn nnnnnnnnnn nnnnnnnnnn nnnnnnnnnn nnnnnnnnnn 1056600
 nnnnnnnnnn nnnnnnnnnn nnnnnnnnnn nnnnnnnnnn nnnnnnnnnn nnnnnnnnnn 1056660
 nnnnnntacc ttgtcacctt cccttgacat gccacccag gagtagaagc tgggtaagge 1056720
 cccgacatct ggccatcttt gttcatatgc ccaaggtgct agaattagct taggagacat 1056780

gcaggccaga gggcttctag gcagggaaaa gggtacacac cccaaggcag gaatgcagag 1056840

gaatgatgct aaggaggata tctttggggg taaagccgtc cccagactga cagctctgcc 1056900

tctgtcttgc ctctggcctt atatttcata ctccactcaa tatggctggt taataaacac 1056960

tcttgggtag gaggccagga gtctgttcca gttcccaaat ttttcttata aaagttcagg 1057020

gccttcaagg ggctttaatg ctctcccga gggctcttcc tgagttccct gtgggctttc 1057080

ctccctttct agtcaaatag ctggagtaag gaattcttgg gtagagcaca gggatgggg 1057140

agccagcttc tcccttcttg tgggtggggct cagacaccag caacagcctc ttgggatgcc 1057200

ccgagtgtt tcatattctt tctagctgtc cttttttaag tgtgtgctct ctttctcaa 1057260

aacttttaga tttcctgtta catattaaca caggctcttc ctttcacttc aactccaggt 1057320

ttccaggcct cagagccaag ccagggttgg agaaaactgc attcctctga gggtaaaagt 1057380

agccaccctc tccgatcctt tctcaccagg ctctctgtgg ggatgggaga ggggtgtccc 1057440

aggatgggga cagaggaagc cctgctaggg tcacctagcc caaggaaaag ccaaatgcaa 1057500

actatacgca gatcaaaacc ttacaccagc ttattagggc cctcgtagtt gataaccttg 1057560

ttctgtcct aagtctctg gtgacaacct agtatactta ctcttctgc tatctatcct 1057620

aaggtcactt ccaaagcaag cttaggatct tcagcacttc catgagctga aactccctcc 1057680

agcccttctt gtctattcct cactgccaga tggggcctag gctcagtcct gggcaagtgc 1057740

ccatgatcct gctgctgtgg gaagttgat agggcatatg gctcaaattt caaaaggcct 1057800

caccctgac ttttattct agaagctcct gtagttctag aacctccaa tctcttacct 1057860

gactggttgc aaggcttatt tttcttttgt actttctat agattctgta gcatttgagt 1057920

gtggcaatat ttaattgtg tatagatttc ttaagaacca aactactca gtctctgct 1057980

agtctgcctc ctgaagcatc agacctgtc atactgtatt gactgtgat gtgcctttca 1058040

ccttgagcat gcttcaggat tttttttct taaaccacag aacttgaata cacaaggga 1058100

ccagaattca caaagtccta tgcaacctag acaggaggag gttagagagt ctgtcttgat 1058160

tgatttcaga gaccctagag aaatttgtac cagtttgtat taatgtcaat actaccagca 1058220

ctttgccaaa actaaggatg tcagagggac ctgtttctag agtgagtccc aattacatca 1058280

aagggcaact tccagcttc tccaataagt ctgagtgggt ctcttgagct ggtgtcactt 1058340

tctaaccttt gccagctag cccagcagg gcactatgtg tgtgtgagtg ctgtttggtg 1058400

ctgttttggg gtatgcctgc tcccagcct ggaacctct gatcaacttg ctgtgaccta 1058460

taatgtctta ggtgcaacaa ggacctacc agagctcctg ggtggctttc aagatccatg 1058520

tagctttgtg tgaggggact gaatgcagac aaaccacagc ctactctaaa acctttcttac 1058580
cctaccacct agttccaat ggaaccaaca agttgagtgc agatctgttg ggtgtttgt 1058640
gttgagactg gctgaaatga aaaatctttg accgatcatg ttgtgatgtg tcgacagact 1058700
caaggacaca accacctcga cctggatcatg tggcatgcct gtgtatgtgt gtaacaggat 1058760
tctgaatgtt agattgtaat gctattcctg tafgggagaa aaaataatat aaacaaataa 1058820
aaatctatth aaagcacatt atgctttctg cctgagttga gctaaagtct gagaaacact 1058880
ataatctcaa gtagagtcaa gacagagggt gttattatta ggctggcttt ggctccagtt 1058940

tgtcatacaa gagaggaaga gggcaataa gttctctgga aagagacaat ataggattca 1059000
actcataaaa tatttttag aagatcctta taagacacat atatgaagta aaatacagga 1059060
atgaaaatag aggacacaaga gagacactgg ccattctttt agtccaagc actgggttat 1059120
aggacaaaga gctgcccatt taactgcaga actgcaccga caaccttgcct ggccagtctg 1059180
agagcacctg aatggagcag cacaggaatg aggtgggaa gtgccatctg tttgtctgac 1059240
agtccttgc ctctaaaaat cctgggtgcc ttgatatgg agggttggtt ttactttctg 1059300
agacaggtct tagcccaacc tggctcctaaa ttctccatgt agctgaagtt gaccttgaac 1059360

tcatgattct ttttggtttt tcaagacaga gtttctctgt gtaacatccc aggcctctct 1059420
ggaacttgcct ttatagacca ggcttgctc aaattcagat ctgcctgcct ccacctctg 1059480
agtgtctggga ttacagcat gcaactatact gcttggttaa cctgtggttc ttatgacttt 1059540
acttccaag cactgtgatt actagtgtgt gccactatac ttgattatth gcaacaaat 1059600
gaaattacac acacacaact tgctagtctt ggtttgttca aagccaaaaa tgagcaata 1059660
gatacattht ctcatcttg ctgggtgggc atttcaggtg gcaagtgtct gatttcaaaa 1059720
gaaggctgtg tctatgtatc tatgatcaca aaaaaaaaaa aaaaagaggc ttgcttacc 1059780

ctttccaata agatacttha aagtctatg acaagacat ttatttaaca cgttcaatat 1059840
ttcacattgt acaaacctt agattctctt tttcactgg tccttttcta caacaaatac 1059900
atccaaaaac actatataat aaaattatth acaacattc caaatgacaa gattgcttht 1059960
tgccccacta ctgctattca cacacagtac ttccacagca caatacatca ttagaagatc 1060020
tacaatgct cacctgtac tttaggctgc ttaagaaatg tgaactaat aacatttata 1060080
atggtattag ctctttcaa tacatggcaa catthtagaa gccttgaact tcattttgca 1060140
acacaaaag ggetgctccc ctttacactt tatgagacaa caggtttcag ggactaggaa 1060200

aaggattgag ttattaaat gactaactgt acagaaatag attaaaaagt cacagctgaa 1060260
aattgctctt tgtaaaatc acacacattt acaagtatca agtcatctc cagcttgctt 1060320
acttggatth tcttgccttg gattgcactg caccagttat atctgttga gaaaaggaag 1060380

gatatgttca acgcaggtag cagtgccact taggttgcc acaatgtcta gaattgacat 1060440
agtggagccc tattaggctc caaatcagtt tatgggacac atgattttaa aacagtcaca 1060500
ggctttacct gctgacttat gtggtaaaag aatggctctg tatattagga actgccaact 1060560
tggggaaatg tgatgaagac cagggatgat gctcagtgag taaaaaactt gacaccaaac 1060620

ccaaattcaa tccctgggtc ccacatggtg gaaagagcac taattgctg tgatatcaca 1060680
caatgtgata agggaagctg agatgtacct ggccagaaaa attggcagtg ttgggtagg 1060740
gaaaacctta tattctatca gtttgtgtgt atatgcctgg gcatgtggag gtcaggggac 1060800
aacttgggag tcagttcttt gctcctgctg gttcaagggt tctgtggcaa gcacccccac 1060860
ccctccattt ctctgtgtag ctttggagcc tttcctggaa ctgctccat agacatggct 1060920
ggcctcgaac tcacagagcc ccacctgcct ctgctctgc ctcccagtg ctgggattaa 1060980
aggtgtgcac caccatccag tgtggcaagc acttttacca gctttatctc taccceatcc 1061040

ccaccaacat gatcccttac aagctgtaca atcagcaatc tccctcactt attcccatca 1061100
ctcaattaag ttacagtcac actaacagtg cttttggcga gacaccagtg agtaagttaa 1061160
ctgccccaga aactagcctt tagctgtctt ttgtagecaa cccattatc tgcagtaagg 1061220
aacacttctt ggtatgctac agttaaagtc tctaaacttt gtgacatgga tcttcggtgg 1061280
cctacatata aggaggcttt ggagggtg gattacacaa ctctgcagag cacctgccaa 1061340
gcatgcatga ggcctgagc ataatctctt gaaccacccc accccacccc acagtgtaca 1061400
tatatttggga agcatttcag aacagggaac acaatcccag aacctgaagg ctacataagt 1061460

ggcaactgag tgacttatac acagtaacag tgacataaaa gggaaagact gctttgattc 1061520
ctttaacttc ccttacacat atcattgtct caagtcaagc tactcttacc tcagatttaa 1061580
atgtttatctt aaaacttctc cagtcttcta tggcagagtg cagtagtact ctgaagctct 1061640
acaaatgtaa atatttcttt agaactaac tattgactta ttttctaac aaaatatttt 1061700
atcttggtag tgggacagt accttgaat tacacctgtc aatctcagca cttggaaggt 1061760
acaggcaagg gagtcatttt tgatatatat aggtcttga ggatagccct ggggctatat 1061820
gacatgttac aaataacaaa agcaaacctc aaattcaaac aatgttttaa atacctctca 1061880

tcaaggtaaa acaattactt ctcatatatt cgttcaaaag ataaatcaga ttcaactatt 1061940
ttggatggga tgaattttct gatctatat taccaggttc agtattataa gcaaaaacgg 1062000
cttttataaa atcataatat tttgggctg gagagatggc tcagcgggta agagcactgc 1062060
ctgttcttcc aaaggtcctg agttcaattc ccagcaacca catggtggct cgaaaccatc 1062120
tgaaataaga tttggtgcc tttactggcc tgcaggcaac atgcagctg aacctgtac 1062180
acataataaa aataaataca tcttataaaa aatcataata ttttggagac cccagcacc 1062240

acataaaaag tcagggcagc agtgcgatgct tgtaatccca gtgcttggga agaaaaaacc 1062300
 aggcagctcc ctggagcttg ctggccagct agcctggaac aattagcaag gtcagtggga 1062360
 ggctctggag agatggctca gcagttaaaa acagctgctc ttctagagga cccatgttca 1062420
 attcccagca ccaacatggc agcttataac tgtccgttac tccagtttca ggggatccaa 1062480
 taccttcata cagacatata tgcagacaaa caaaaatgtg catgaaataa tttttaaaaa 1062540
 aataaagtgg agccaggcgt tgggtggcaca cacctttaat cccagcactt gggaggcaga 1062600
 ggcaggtgga tcctctgtgag ttaaaggcca gcctggctct cagagcgagt gccaggacgg 1062660
 gctccaaagc tacacagaga aacctgtct cgaactccc cccccaaaa aaaataaggt 1062720
 gtagactaat acicaatatt tatactggc ttccatgtgt atgcacatac atgtgtacia 1062780
 acctggaaga atatatafac atatatgaaa atgaaaagat taaaaagaag ctatgaatag 1062840
 gtgaggtggt gcacaccttt aatcccagca ctgaagaggc aaaggcagga tttctctgag 1062900
 tttgaggact atatggtctg agtagcgaat tccagaacag ccaggactac cagaaagacc 1062960
 ctgcctcaaa aataaaataa aataaaataa aaataaaaaa atcaaatggt gtatctgaga 1063020
 ctgtgtcaga tgtgactgga aatgaggtgg ggagagaagg acgagcaatg tcagattcca 1063080
 ccccccttc tttccaagtc aataaactgg aatactgcct ttgagtacia atcaacatat 1063140
 gaggccctca gtaaagggtg taatatattt ttataaaatg tcttttagcc cccccacia 1063200
 agacagaact ctggcagac cttacagcaa aattaataat accccttgaa gtcatttaag 1063260
 actatttact tttttgtttt tggaaacaga gtttctctgt gtaacagccc tagctgacct 1063320
 gaaacaagct ctgtagacca ggctggctc aaactcacag agaccatct gtctcttttg 1063380
 agtgctagga ttaaaggccc atgcatcac actcagcaa gaccatttat ttaactggt 1063440
 atcttactgt gtactcagc tgtttaactt ggccttaaga aaacaatgca attagccagt 1063500
 cagtggtgga gcaagccttt aattcagcac tcaagaggca gagactggtg gatatttag 1063560
 tttgaggcca gctggtctac agagcaagt ccaggacagg tagggctaca cagagaaaac 1063620
 ctgtcttgga aaacaaaag caacaaaaac caaaaaacia cgcgcacaca cacacacacc 1063680
 cacacacaca cgcacgcacg caggcccaca cacacaaaa acccccaaa aaacccaaac 1063740
 aaacaacia acaaaatggg aaaaaagga gaagaaaca atgtaacca ctttgctatg 1063800
 ccttgattt cccatgaaat tagcttttag aacctaaat aatgcatag cttaatcat 1063860
 aggttaggta ctctctgtg cccctggccc agaatgtgtg tgtgttttg gcgtggtaat 1063920
 catttctga aaacaacctt aaaaaciaa cccaccataa acactgcaa tgtgctcta 1063980

ggttgataat gtctgcatgc tgtgtggaga gagctatgta gtcaggtgtg atcaggaagt 1064040
 tatttcttcc ctggtgaaac cctgtgaaag atttctgtaa agaaccgttc attcctttcc 1064100
 catgccatgc ttctatact ggtcaacaaa tgcagagcaa agtcctttgt tagaaacaag 1064160
 ggcaactact ggggcacaga tgcagactca aacaacagac tgattacaga cacacccgag 1064220
 gctacagcca gacaaaagac acagggagag agagcggaga attcagaatt gggttactc 1064280
 ttggtcaaac taatccaatg ggcttcattt tcactcctta gttaagacac taagacactg 1064340
 agacaaaagac aaagagtgtt ctttgagggt acctttgatg tgcaagtgac aagtggcttg 1064400

 ggctgaaaac tgaaggctgg tagggatggt gaacagtgtc tctacactac catgagacat 1064460
 aaaatgtttg ttttctgaaa caggttgacc tggaatgttc cctataatcc agtcatgcct 1064520
 tgaatgatg aactttctac ctacagcagcc taaatgttgg gattaaaagc atgtacaaa 1064580
 atgcctggct gaaatTTTTG cttctctgta ttgtgacaca tgcctgtaat cctagcactt 1064640
 gggaggcaga aggaggtgag tggatctctg tgactttgtc tatcctggtc tatatagcaa 1064700
 gtttcaggcc agccagagat acatagtgag gtctcaaca acaaacaaaa aaacccaat 1064760
 ataaaataaa aattcctttt tctttcatca gatTTTgaag tctctatcac ttccctgga 1064820

 gggttgggga acaactactc tggaccatag agaaaagtca ttttcattt ctgtaaatgt 1064880
 gtctggtcat ttttatcttt tgtgattcaa tttgtatttg ttacagagct gtcacgtgga 1064940
 tgctgagaat tgaacctagg tcctctagaa gtcagtgatt ttttttttt ttttttttt 1065000
 ttttttttt ttttttttt ccttgtggct ttggaggctg tcttggact agctctggta 1065060
 gaccaggctg gtcttgaact cacaaagatc cgcctgctc tgcctcccga gtgctgggat 1065120
 taaaggcgtg caccaccaat gccccggcga agtcagtgat cttactgct gaactgtttc 1065180
 tccagctccc cattcaaac ttctaagaag cattgactct gcagtaagat atctctgtga 1065240

 ttcaggtacc aacattatat agcctccatg gaaagtgggt ttaacttttag ggcctctgtc 1065300
 ttatcttttag gtacctggca ggcccgtggc ttacttcaag gggctctttg tgaggcacc 1065360
 tgacattcct taccagcaac aggtgagtac tcatgtcagg gtctgatgtc agtgtacccc 1065420
 ctgccgttcc actgggatgg ttttgtatgt ttattgagaa agagagtctt gtagccagct 1065480
 ctggtctcaa gcttgctatg tagctttatt ggtcatcttg tccctgcctc ctaagagctg 1065540
 ggattataga catatgccat tatacctacc attcaagact gaaatgcaag gcctgcatct 1065600
 atgaaaacta aggatttgcc agagaggatg ccgaaaatga cttaaagatt ctggatcaca 1065660

 gaagtcaaga acaattaatt aaaaaaaaa aaaaaagaaa gaaagaaaag aaaagaaaga 1065720
 aaaaccaaac agtagagttg ggaatttca ttcagttggt ggagtacttg ccttgatcca 1065780
 ttaggcatg ggttcagtc ccaacacagg ggaagaaaa agagaagaaa gaaaaaaga 1065840

acagtagcta agacaggtgg ctcatgccca taatctcagg acttgggagg ctaaggtagg 1065900
 attgccacaa attcatggac aacctaggct acagagtggc attctgtctc aaaacaatct 1065960
 ccccttccca aactaaagac agctttcttt ctttctttct ttctttcttt ctttctttct 1066020
 ttctttcttt ctttctttat ttcatagaat tatttgttta ttatgtatag tgttctgcct 1066080

 gcatgtatgc ctgcataatca gctgagggca tcagatctag ttatagatgg ttatgagtca 1066140
 ccacctgggt gctgggaatt gaaccaggga cctttgtaag agcagccagt getcttaact 1066200
 tctgagccat gtctccagcc ctaaagacag tttcaacaa agaatactgg taatgtaaag 1066260
 ctgaggtcat aaaaagaatt attagaggca cagatggaag cactaggctt tgagtgaag 1066320
 aggggtcaca ctgtcatagc agcctactta gattaatctc ttggtagtgt aatggagag 1066380
 ttctattttt ttgtgaagat gtgagagccc ccaccaagac agagcagaga atgtgggta 1066440
 gaggtttaa gagcatggag aggtcaagtg taatagtggc tgcctctaac ccagcactca 1066500

 gaaggctgag gcacaggctt gagagttgag ggcaacaaag ggggataaag gagtagacag 1066560
 tatgtagaaa aaggacttg acttcagaaa agaagctggg ccatattcag gatttaaatg 1066620
 aggtgagatc atgagcttct tagtgtgtgg gtgtatgttt ttgacacagg acctcatgta 1066680
 actacctcaa actccctatg tagctaagga tccttaact cttaccttt aactcactag 1066740
 tgcactcac attacagatg tgtgtgcca cacttagtgc caagggtgaa tttaaaatga 1066800
 gaccaaccta aattctttat tcttcagca gtgtttatg ctcttgtgca cacaaacaga 1066860
 aaacacatat gctaatgaac tgacaatgaa caaagcacia aaccaagaga agaaagcaca 1066920

 ctgacctaac agaagagagg atggaggtaa agtccctctgt ggctgtgatg aggacacttt 1066980
 tattccacc ttattccac cccacccac cccacctca aagcatcaa ggcccactgc 1067040
 taacctttag tagagctgga ggctgaagca ggccgagagg atcgttttcg atgtccattt 1067100
 tccacgctct cagaagccac agttggctcc tcagttcgag agtttcttcg gettggggtt 1067160
 ttggacttct caactatctc ttttggctca ctgctgacag agggaaagtac caagtttcca 1067220
 agaaggttaa ggacatcaag acaaacaaaa agggactctt taagtacagt ttcatctcta 1067280
 aagtaaaaga taattagcag ctattcaggg ccaggaatac ggctcagtct atttagcatg 1067340

 taaaaatcct aggtttaatc cccagcactg aaaacaacaa aataaaacat atcagtcatt 1067400
 atagacagaa atgggacaat gctgtcaaga acttaaaagt gactctagtt ttttacatta 1067460
 gaaaaataaa ataggctgga tggtaggca catgccttta atctcagcac tcaggaggca 1067520
 gaggcaggag tatctttgtg aattcaaagg cagcctggtc tacagagcaa gttccagaac 1067580
 agctagggct gttacacaga gaaaccctgt ctgaaaaac aaaacaaaac aaacaacaa 1067640
 acgaaagcac aatgctggtg ggattgtgga aaagcaggtg atagaataa agaactgcaa 1067700

tagttcctct aaaaaccctc atttctttcc ctaaggcaat atatcccttc aaacattatt 1067760

ttgtaaaatt tcaggataaa aatgtattta atagatgttt aaaagtttct actagtccca 1067820

aataatatct aaaaatctagg tatggcagca cacaccttta attccaacat ttgaggggta 1067880

gaggcatgct gatctctgtg agtttgagcc taggctggcc tacatagtga gttctggttc 1067940

agccagagct acatagagag accctgtctc aaaagaaatt attatttggg ggggttacta 1068000

ggaaaatatg agcatatagt ggtattaggt aatggcatac atagtacatt ttctaagtaa 1068060

taggaataca ttcatcatcc actgcagata tgctgaatgt cccaactgca accctggctt 1068120

tttagcaggc aaatattaaa aattggtaat actgttatta aagacacagg ggcaaaaaca 1068180

ttttcatata tticttatgg agtataaatt gtataattca aagatttctca ataaggagca 1068240

actgtgatca gttagatgca ttcccagcct tggacacatt tttgattggt gcagtttggg 1068300

aagtgtgcca ttggtgtctt tgggtaaaaca ctctatggta caaagggaga cccttacaaa 1068360

taattatctg atccagaggt cagtaatgtt gaggtgggaa aacttgggtga catcctctac 1068420

ctcatttcta gtaactcctc tatttctagg tgcctaaaga aatcaatctt aaaacatgtg 1068480

tgtgtgtagg ggggtgggggg gcattggcaa gctggactca tactgcagtt tagacgggcc 1068540

tggaacttgg aatatgtagc caagtctggc tttaacacaa ggcaattctc tgcctttggt 1068600

tctgagtgct tgtgattata gttatgaatt tctacaactc agtgtaaaga aattctttta 1068660

catagctttg attataacca acaatgtaat aaattatcta agtagtggga ttatattcac 1068720

aatccactgc agatataatg aatgtctcaa ctccaacct ggagcttaag taggaaaata 1068780

tttaaatattg gtagtaaaga caatttaaag acacagggac aaaggggctg gagagatggc 1068840

ttagtagtta agagcattga ctattcttct agaggacttg agttcaattc ccagcaccat 1068900

atggtctgta actccagttc caggggatct ggcattcaca tacaagcaga caaacacca 1068960

atacacataa aataaaaata aagttaaaaa agacacagag acaagtttac agaagacata 1069020

aaaacaataa taataataat tagttactta attttggcac atctatatga agtcttaaaa 1069080

aatattttgt gaaaggttac tcagacaaat tattcatgct acatgagtga atgggtttga 1069140

cacacacaca cacacacaca catctggaac agcaccctc tgtatattct ttaaagaaga 1069200

ctacaagatg actgcaattt tctaagtgtt tctttctttt ctttcttaa cacaaggtct 1069260

catgtagtct agactatctt caaacttact acatagctga ggacgacctt gaactcttga 1069320

ttctctggcc tgcattctcc aagtcaggt gctggattta attctgctga aatctgaaaa 1069380

tttctgtaaa aaacttttta ctatatccat ggttcaaaaa tgcttattaa taccacttta 1069440

aaaatcttat taaatttcat tgcaagaata gaactgaaat gattacagaa ctgaaatata 1069500
 ttgcaacaga acaaaacaac tacaagtctg cttcttctgg aaagatctcc atgtccctct 1069560
 ctagctgtgg acttagcctt tccttctctt aggttcacag tgtatacaga tgacctccta 1069620
 aacctcttc tggggttcta ttatatggag ttttaaagaa tttgtttatt tatttattha 1069680
 tttatttga ggggtattht gcctgtatgt atgtctgtgc acatgtgtgt gcagtggttc 1069740
 tggaggccag gacaggatgt tacagacagt tatgagtcac catatggctg ctggcaattg 1069800
 aaccaggtc ctctgaaagg gcagtcaatg cccttagctg ctgagccatc tctccagctc 1069860

 tggatgatct atthtaatgt tttgtgcctt ccatgagact gtgagcccct tacaggtaca 1069920
 aatcacagtg tgataatcaa ctatcactac tccactgctc actcctgcca gaggactctt 1069980
 tgccagtaac actacagttg ggaactgagc cataactgtt cactcattac cttagcttha 1070040
 tataaaaaag ttacctat catatcaaaa actaagcaaa ttcagagagg ccacactgga 1070100
 gctagggagg aattacaagt aaacaggtht gtatctcctt ctagaggtht gaaggatgg 1070160
 tttctgttg agcccagaaa acagtccaat tttctgagga taatccctat gtggaacccc 1070220
 tttctctgt caaaacaaaa caaaatagcc aaagcaacac tacccttgtg tttgtgtggc 1070280

 caatgtatag gcagttctgc aaacagacac ctatgaacta tataactt tgatagacc 1070340
 tttttatgga caggaggcat gtatttgaaa aactcaaatg aattcaagta ttagttcatc 1070400
 tcaataaaaa acagatgggc agagtgggta ataggaaaat caaccaatth ggcatcaggg 1070460
 aggaactgtg catttatcag ttacaatatt taatgcctta tcctctagag tctagactth 1070520
 tatctacaaa tctccaactt gtctattgta atataggtca aatgtaaggc cctggagcc 1070580
 agaagagatg ggtttgtaca tcatatcacc atttgctata actgtgacct tgggcagtht 1070640
 agttaatgg 1070700

 gatattgtga aaaattgaga ggtaatacat ataactgct tgtagtccag agtatggcaa 1070760
 ggaataatat tcagataatg ttagttgata tgaagagctg acatgaagat tcaatgagaa 1070820
 aatggattht tacaagthaa atthctatac aaatgagaca tthtaaaaaa cgttactgcg 1070880
 ttccttcaact aaaaaaggga gtgattctth ctagagctaa tgaggttggg ccacagatgc 1070940
 acttcatctg tctgatggg ttatataggg tagcacagtt agcagacaaa agcacaggtt 1071000
 tggggttaca ctctacctc ctggcatcct cthtaataacc tctgagtatc aaacagccat 1071060
 gcttagaaga taattcaagg accaccagta aagaagctag tgtatatata tagaacactg 1071120

 atthcttca tttgtttg tgccgaatat gtaatcagtt ttgaaaacaa tggttagaca 1071180
 gaaacttagt catctagtht aattaagtga actgtcacc tggaggagtg agggctcaca 1071240
 gaaactctc cthttgagca gtagaacag gctgggtgcta gactacagga gaaagacaag 1071300

gtgaggagac ggttcaagac agaagaagct catgcatgg tcatgttaag tctgcagata 1071360
 tggatcatctt tcttaccttt gtccagagac tatgactgca ttgcctcaa gttctgtaaa 1071420
 aaataaaaag gagagaatga gacgtggaag cagtgtgtaat atgtccacag ggagtttcta 1071480
 gtagtctacc aaatgctgta tttagactaa caagtctcta cgtcctacag gagtctcacc 1071540

 cacctatgt ggtatgaaga caatgttggc actgatccaa cttggtttgt tgacaatgta 1071600
 agatactact tggctctatit ttatttctag ttcatactgt gaaataatcc tgttgggatc 1071660
 aacagaacta aattcacact gcctggttca tatttcatcc agataaaact agtttagtaa 1071720
 aagaagtctc ttcctttcat gttaaaatat caccaccttc ctgcattttc tttccaaagg 1071780
 caattatctt taaatataat agtgcctttt aaagattcat ttttccctg aacaacattc 1071840
 tcaactcaatt ttagagggga gagagctatg ctttgagata ctacccaaag actatattat 1071900
 atttgtttct gagacatttc acagacttca tcagctgcca agtgatgtca cagaaacagc 1071960

 cctctgtctg tgagggctgc atctgtgggc attctttggg aataccagac acttcttttc 1072020
 agcaccagca aaaaacaaa acaaaacaaa tctacttcta ttatgtgcct ctaggtagct 1072080
 ccatctctta caaagacct tccctagtat accaaacagc catgtctcct gccactggcc 1072140
 ttcccctggc tctgtgcctg ttttccatg tagagaagtc agtgcctcat gttcaatac 1072200
 taagctgcct gggggatctc tttgaaggca gagtacctag cttaaatttt tatctcagct 1072260
 cttttctttt ctctctctc cccttctcac tttgtagccc atgctgctct ggaattttct 1072320
 atgcagccca ggctggccta aaactcaagg caatcctcct gccttagcct aagtgtctggg 1072380

 attatagga atgagctgcc ataccgcca tatgtcattt tttattatcc atgtgtttat 1072440
 gtgcaaatta ttgacctct caggactcaa tgcctcatat ggaaagcaga gttgactacg 1072500
 ttatctgctt taatgttaag attaaattga aataaaacat atgaatttta gtatagtacc 1072560
 tgttacttag tagtgactca atattaacta ttattatttg gtcactttgt acttttctctg 1072620
 agaagaggca ggacttcaact gtcttcaatg caaaattttg gcagagggaa tccttgcttc 1072680
 ccgtcttctg cttagctccc agaatctctc ccataagatt gaagtaatgc ctcaagaaac 1072740
 atactaatat taactcttc tgggtctct atttccctgc tgggtaagct ggagtacaca 1072800

 aattcaccta atatatgtc aataataaaa atggttcaaa caaaaagatg tgctaacctt 1072860
 gaagagtgc caccccaac ttgcccagg catctattc tttagcacia gttgcttggga 1072920
 gctccatatt tagcccactt tggactcata ttcataatcc tctgtccca gcttctgag 1072980
 tgctgggatt ctctatagt gctacatctg gctagtctgc tctttaagtc ttagttttta 1073040
 actaattaat tctgtttgtt tttttgtgac agtctctcta tgtagccgtg gctgttctgg 1073100
 agcttactat ttgaggctca tagagatctg cctgccttgt gccaggataa aggtgtgtgt 1073160

gaccagccca gcttgtgtac tcttctgaaa gatgacaaag aagttgattt tgagaacttt 1073220

tacactaatt tattaagtg gaaggttctg aggtgtttat atttttatgt ttttgagata 1073280

gagtcccatg aggcccaggt ggcatcgatc ttattttgta gctaaggata acatttgaat 1073340

tcctaactct cctatctctg cctcttgagt gctaggatta gaagtgtatg ctaccatact 1073400

tggcttaaag agatcaatat atattaaact ttaaaaagga acaaagtccc ctageccatt 1073460

attctgataa aaaagaaaaa cagtaatagc ccattttctg gagtgaagag cctgggcagc 1073520

atcaacatta cagacatgga ttggggaggg actcatgagg ctccacctct atcagattat 1073580

ggctactgga aggtgtgtgag ggtcagttta gttcaatggt gtagtcactg gtaagctatt 1073640

catgctccaa taaatggcca cacacccatg ctcatagcaa gcaactcaa ttaaacctag 1073700

tgggtcatta aaagaaaggc acatgagagt aggaagaggg aagtgggagg agacaaggga 1073760

aggcaatggg aggttgtatg atcaaaatat attacaaaca tatatgaaac tgttaaagaa 1073820

tacattttaa aaacatttgg atcaggaaat ggaacacctc tcccatttct agtttgtctt 1073880

tttgttagga aaaaaaaaaa gagtattaat atagcacccc ttttctaac aatttctctg 1073940

ttcccaaatg tgcagtacaa tgttagttat catgtaggca gttagaagca agaggaaaat 1074000

gtgatggccg atgagtgttt tgtacatcca ttctttccac agtatgtagg aaagtaataa 1074060

aggatataga atcctgaagc aagttttaa atacaaatta tatcttattt ttattggctt 1074120

acattcacac aatcattttt tcttaaaaat ttggtcatgt gtatttctct ctctctctct 1074180

ggttttttga gacagggttt ctctgtgtag ctttgagacc tattctgcac tcgatctgta 1074240

gcccagggtg gectgaaact tgttatctc ctgcctctgc cttcttttagc aaatcctacc 1074300

ggtgttagcc accacaacca gctgtatact ttcaataaaa ggatttactt ttttttttt 1074360

ttttaatgtg tgcctgtgtg tgcatttgac acttgcaatg tgcatgaggg tgtccagaaa 1074420

ggaggccaaa aagaccctg atcccttga gctggagtta caggcattta tgaaccacca 1074480

gatgtggttc tcggaactga actctggtct tctgaaagag cattaagtgc tcttacctac 1074540

tgagccatta gcccaagttc acactgtcaa tgatattctg atttccttg ggaaccagct 1074600

cctttctttt ttgtattctt caacaacctt ctgtgaacca agaaccaagt aaaactaac 1074660

atgtccagca tactcacctg ctctgggtct aattggcaaa ggcagaagt gtccctactg 1074720

ccatcaaatt actcgtgtgt tcagagctga tccagcatct cacagcagct attagattac 1074780

acttgacttc tcctccaga aacaccacc ctagtcttaa atacgagggc tatttacaat 1074840

atcttggtta caggagcac cttaaaatca tccagagatg attgggatga ttcattgtaa 1074900

gcagaggggc tccaatacac ctctacatct gccaaagataa tctaactata ttttggtgca 1074960
 ttcattgcttg ctaccctagt aagcaacat ataacaattg gctggctgcc agccaagggt 1075020
 agcagggtca tggaacaggg gaaacaactc aaggtaggat gacagacaga caatgagcaa 1075080
 agagatgcct ttcttgagct ttctggctaa cacaacaaat gtgaaaatga acaagccagt 1075140
 tgggaaaagt actacgcaag ttctcccacc caactcaaac tggcttggaa acaaataggt 1075200
 aagacagtcc caggtaacta ctggcatgag aacatgtgac actgaggaca cactgattcc 1075260
 tacacatgta acccatctca ctcaaagaag atactctaga tagtgcctta cctggctctgg 1075320

caacaggccc ctgcagtct gtggctggag tctccttgg gactaaagtc tgtgaagggg 1075380
 ctgaggcaag aaacaaacaa ataagtcttt tacttttttt tctaactaaa ccagaaagca 1075440
 ttaaccaagt tactaagtcc ctgcagccac catgttctta aaaggcagta ccgtaacaaa 1075500
 gcaactgaac taacactcag caacaaggat tgccactcca gggtttgttc ctctttgtg 1075560
 cagatataaa gaaccaggaa ggggatggaa tggcaacaat agtaaccaca atttcaggtc 1075620
 aggaccccc ctttttttt ttgttttcag acagggtctt actgagtttc ctcagtttg 1075680
 tcttaaactt aaaaactgtt ttagtaagca acctagctat ttttagaatg aatataccaa 1075740

tcacctcaac attgaaaac ttctgactta ccctctaga gactacactc tccttgatta 1075800
 ataaaacaca caattctgta cttttctaca gcacttagca aaggtaatag acataaaaca 1075860
 gacaataaat ttatatctaa tgaataaatc aatacagtat tattacttt tctaaaaaat 1075920
 agtttaaaaa actttctagg ggcaagacac tgtgccaggc accctcagag attccatctt 1075980
 tttgcacacc agaaattcag cctagtattg aagttaagta catgtagtac actgcactct 1076040
 ttatgttata tggaaagaga cacataaaag tataaagtgc catggggatc caaagcaaaa 1076100
 gaatattcta ggctgaaaat gtaaaagaat gttaaagata gaaattagtc tttgaaagac 1076160

aggtatttaa gaactagaat acacaataca ttctagaata gaaccttctt ggatcactca 1076220
 glaaggattt aaggctcagg tttgccagat ctgtcaaagg tgtggcctct catcttaaca 1076280
 attcagccta ataaaactta tgacaaacta caagaataag ttacaccctt tgggtgaaac 1076340
 taaatttgt agatttctct ctgtttagta gtcaaaattt attttgcag cttctctgat 1076400
 gaggcttaaa gctgtacctt aacatctatt tagcttaaga ttggtttcgc acatttcaa 1076460
 gacaaaagca cagaagtccc ttggaaagga atagaaccaa ctattataaa caaagtaggt 1076520
 ggtcttaatt aaaactgaac cttttctaatt tgetagtca tctccctaaa ggttacatgt 1076580

ttattattat ttgigalcca aataaaaatt attttctagt tacttcatcg ttattctctt 1076640
 agtatcagag ggacaagttc cctgaatggt aacagaaatg gaaatattta gtagcagaga 1076700
 atacacttac accacactaa tttcttctgg tttagacaag gtcttgcata gcttagtttg 1076760

gcctcaaac ctgatatgag ctgaggatgg cctgtctctt gatagtccta ctcctcccc 1076820
 ccaagtgctg tgattatata catgcaccac catgccccagc tttctttaa atctttatca 1076880
 acaaaattca aactggaaac actgtccagc agagtccctt tctcctataa ggattctttg 1076940
 caggccttca ctcttcctg tatctatctc taacattgag gtaagcaggg gaaagaaggg 1077000

 aaggaaggct accagagctg tcagagccag catgctggca cttgatagtc aaattccact 1077060
 tgatagtcaa gtccccactg aatctacat atcctgggag gcagaattac aatttccact 1077120
 ttacaggtga agttcatgga actcactagg ttgtaactgg caaccaatgg tgttaaatt 1077180
 tgaactctga tcataacctc tatttctgtt cctcctccta attggcaggc actcaaagta 1077240
 ttttagctgc ataaataaaa gagatattat tagctggctt agatatgaca gaggcctccc 1077300
 agctatgggt accattaaga ctgacctgtc ttaagaatg tggaacttct gcatcattg 1077360
 agcctcaaag gagaagaag ctgtaaggac acttgtgctt ccagtattaa ctccctctgc 1077420

 agtacacagg aaataacctg aactagactt ccattaatgg aatttaciaa gagatcatgt 1077480
 ccaaaggaaa tgggaaataa catatgaact gtgttttagg tcctgtgcta agcacatcac 1077540
 atgcattacc tcaactgaaat cttgtaacta ttattgtctc cacattaciaa aggaggaaag 1077600
 tgaaacttgc cccagtcctt tgagctagca aatgctggta cagttaciaa ctcaagccta 1077660
 tctgactctt cacaacttag atcacgaaac ctggttttct ggtaagcttt tttggagcag 1077720
 cccaaacaga aaggtccttg aattagatg agaacaagge aaagagaaca agtaagtctt 1077780
 catgatgaga agtcgctgtg tacaccaag ggacctgcc aggcctggaga cttacagtat 1077840

 aggcctcaata aatagtaaac atttctgagc ttcaatcttt ttaccagag gaaggagtaa 1077900
 gtttacatca catgactggt ataagatgat gtgagatagt gtgatgaaa atgcttttac 1077960
 acacacacac acacacacac acacacacac acacacacac acacacacac acacacacga 1078020
 aatgaaca cgtcatcagt tcagaagcta ggaaggaacc atgttaatga atataaactg 1078080
 aatatgggat taaaagcat attttcaat gtactttcag taagtaaatc tacaactatg 1078140
 gccattttc ttctctaag cagaaaaggg ctcatgcttt ctctttgtg ggacaggtca 1078200
 acaaaacctt gacctgagga gctgatgcca agctcaagta catacctatg ctgggtagaa 1078260

 gctctggatg aggtcccacc ttctctcca ctaggccacc tgcaagtggc tcagatgcta 1078320
 cgccaccatg attgcctttt gtgggtggcg ctgtggagat gagctcagag ggtaccagtg 1078380
 tggttactat tgagcgtaca ctgggtggga gaccaccgcc aggttaagatg ggtcctgttg 1078440
 aggtggagct tgggccatg gggctagagg tcatttttag tagctgggt gctgagggtg 1078500
 ttggggtttt actgtccagc tctgtggagc actgctctgt tcccattagc ccaggagttg 1078560
 tggctcttag ccctgggctt tcagtctctc catctgcacc atactgttct tcccctttt 1078620

ccagagagcc tgtaactttc ttacaagcct tggtcagcaa aatctggcca attttgccta 1078680

cttttccttt gcccttagtg gatgagaccg ggcttcgccg attggcagag gaccctggac 1078740

tattggtcaa aaggggagaa actactgtgg tggactgtga agagagcaga gtgctctgat 1078800

ctgctgaggt gttcatctga ggactagcct catctggatt taattctttt acttgctgga 1078860

tagaagaatt aggagcgacg actggagagg atgtacaagg aggggaagc agctgaacag 1078920

gagtggcacg tgagctaagg accaacggcc ggctgtctg tatgtttgga gcaggactgc 1078980

tggaggaac attaggtgct acaggagctg aaaaaattt tatgttttga ggtatgtgta 1079040

aaggtccaac aactgcgacg gagggaggca tcaggccact gttggttgc aatggggttg 1079100

caggaattgt gcttggctgt gatcctttca taacctgaat aatgaagat gaattgataa 1079160

agacaggtgt aatgaactga ggccgggcat tagattgagc agcggactgt ccctcagaaa 1079220

ccataacttt gttaccacag ttgggcattg tgacaactgt tgacatcaag gcagaatgca 1079280

agtttttgg cagggctgct gatgtgttag atgaagtggg tatgggattg gaagtaacaa 1079340

atacagttaa ttggtttggg ggcaaaggag tagaaatgga ggaagagctg acaggccttg 1079400

acattactgg agggatgctt ggtgcaacat tagagctgac ctactcaat tetggatgcg 1079460

caagggttga acacggctca ttactgtgag gtaagtttaa ggaattagag ggctctttag 1079520

aagcgggac ctgcagtgtg ggaatgacag atgctttttt gaggtcttcc cctgaaacta 1079580

ctggaggtgc tacttcaga tctgtaagcc cagggggttt aatggtcaca ttaggagctc 1079640

cagagtgtgc aagaagtgg cttaatgatg ttggtgcttc tctcatggca ggagacatca 1079700

aatttttgtt ctctcaaca ctggggagt ttttagcacc caaaggttgc ccatcttttt 1079760

tggactgac ttcagggaca accattttag ctcttggat agggactact ttcagctcaa 1079820

catttacctg ctcttccca ccctgggaat tctggcaatc attgtcctga ggaacgttca 1079880

aactctcttt gttatectca agaacagccc cactgcagg cacaggcaca ggcacgctgg 1079940

gattctgagg attaagccca ctattgttag gaaagcttcc agataaagtg ggattagcaa 1080000

ttggagtggg ggagaccaat acatttctag gcagttccat gttctgcaac agggttgtgc 1080060

ttggttgaga agccagagta agttttgggg cttttgaatt ttgccttcca ggacttgggg 1080120

tagttttcct actggaccct ggactagacc tgcgactgtt acttggactt gcccgttttg 1080180

ttgttccagg attagactgt tttccagaat tcaccaccac agaactaat ttatgagctt 1080240

gtgggcgacg aaagttagga ggattattta tgtaagatt tgaaggtgct tgcccgatgg 1080300

ctttcagagt tgttggattt aaacctgtt gatcaaagcc cctatttaa tttggcctgg 1080360

gaggtaaagg aatattaatc tgtggaggga agagtctctgc tatggaggca ttgagtcctt 1080420
 ctggtgacag acttatttct gaagttctg tactgggagg gcggttgttg ggtgtctgag 1080480
 gataataggg tctggggctg gctctgtttg gagttttagg cctagatgtc tgggttgggtg 1080540
 cagcaacatt tggaaagtgg tggccatggg agctaggcaa agaatttaca ggaggttgct 1080600
 ggggagtgc accttgagtt gctgaaaggg gagatggtcc aggtttgggc cctgtcatca 1080660
 ttaactgatt ctgagaaact actaaatgtg acggcatggt atttgggcct cctgaaacag 1080720
 atggtacttc attgccacta gcttcaggaa gtgaggacaa ctctgctagt ggagagctag 1080780

 aagaattctg tgggttctcc tggatatacca ttttctcga attacttccc aatggagtat 1080840
 tcacagacat tgggattctt tgtttatcag gtgatggtgg cacagaggca ggtccttgca 1080900
 agctaaccat aacaggtaca ttgccactct gctgcacggg cattctctgg gagtctgggt 1080960
 tcagaggacc ccgtggaggg tggacatttt gggagactgg aagcctaag gatttagggt 1081020
 ctgtctgcat catgagcatc atcatcattt gttgctgctg ctgctgatgt tgctgagact 1081080
 gtggctgact aggtgggtgt ggtggctgtt gctgctgctg ctgaggcagt tgtggttgtg 1081140
 gctgctgctg tgggtggctgt ggtgggggtg ccacatgctg catgagttga ggaggcatct 1081200

 gttgcagtgg cctctgttca actggttgag taggataacc taaaacaagc ccccaaaat 1081260
 caggaagt agatttttca gcaagaaaac tttgctacct ttagagtgtg gctaagcagt 1081320
 actcataggt agcagactgc gcacaaacag ctgagcatg ctgttccat tgtctgacac 1081380
 aagcaagggt tcacactgct taaggaggca aaaagcaaag cattaagaac acgaagcccc 1081440
 ttggtgttta cgttgtgaat gaagcattac tgcattaaga ctgtattatg cactataaat 1081500
 gagaaaaacc ctatcaacag caaagggtct gttgccagct atttaggtct caggtagaaa 1081560
 taatcagtaa ttcactgtgt gtatgaaata acatatttag aatcgattt ttctcgtagc 1081620

 agaggacttg tttttctcaa aatttggttt tgatgaaaac agcctttttg ttcctttaat 1081680
 aaaagtaaaa gatataattc tagtattgag tccacgatct ccatatacta tgctgtatcc 1081740
 tttgggctcc atcctctggg ggaaactgaa tgtactgtat tgccccagg ttgcaacagt 1081800
 ttactaaaga gagcagtagg taggggctga ttattatggt gaaataaaat gaagcactaa 1081860
 agtttttatg catattcaac tctatttact ttcgtatata aaaatcttta tttggaaaag 1081920
 tatttttcat gaatccaca ttggagaata aataagtcag aagcatagac ctgaggatta 1081980
 aaaaataatt tggggacaag aactttgaga aacaatgcct tctagatttg cagaagacaa 1082040

 catctatatg attcttttgt gatggtttac ttgaaatttc tgaatgaaaa tcttatacaa 1082100
 tcagtataaa gagaaggaag attcaattaa accaagaata aaggtgggtc agtgtgggaa 1082160
 cgtgggcaca tgttgggat gtgattccat aattatattt attccattgt tgcagtaaaa 1082220

ataatttggg aggtttccag aaagtataag acatgaataa ctggctctgg cagctggtag 1082280
 aaattctggg ccaagatfff ctccagacta ccaaatgctt tggtcagact ctgatcaaca 1082340
 gagtcaactgt cttctagtca aagatttcca tggtagcaat gggcaggatc cagttctgaa 1082400
 gttgtttttt attttattta tttttttgic ttgttttttg gtgacagggt cccaagtatc 1082460

 ccaggatgac cttaactca ttatgtagct gagtatgac ttgaactgct aaccctcctg 1082520
 cctccaccct gcagaatata gacaggcgtg tgccaccaca cctggctcaa ttttgaagat 1082580
 tttctttaa acittttttt ttttttttg gttttgtat gttttaggcc cgagtaactt 1082640
 cttgacattt ataatctgg cattccaaca gatcaaacac aatgggttcc tatatagtct 1082700
 ggggttccca cattaagaaa attgtaattt ctgaagaagt tcgtttgtgt cagggtata 1082760
 acacagatgc ttctcatctt taaaatgagt ttatcagaca gcacagtaa taccaaagat 1082820
 agcaatagag atgacatggc agcctctcaa aagtcagagc taaaggctta aagggcccaa 1082880

 aagctagagg aaatagcccc agggagctta gtgatagtaa ggcagattgg ggttgagagg 1082940
 gaaagtcagg tacacacatg ccccataaca caatcaataa ctatattgt tagtcaaggc 1083000
 atacaaagcc ttgatgcctt taggggccag gcggcagtaa agacgagaag ttaggctgca 1083060
 taaaccagca gggctctatg gacactgccc aactgcagag caatcgctg tttctaact 1083120
 caaacgaagg ttatttgttt agacaccaat agcaattcaa attcattaaa ggccaaattc 1083180
 agcttgcagg ttccagttt gcagaaagga ggaataaat gtctgaagga attctggaat 1083240
 ccacacaaga gttcagatat gcctgatggg acgtacctt ctgttcacaa tgtcttctga 1083300

 acatactcac taaggactag agactaccta gcttcaacag tgctgctgtg gctcactagt 1083360
 gacaactgta gtatgctaaa caattttaa taagtaacat ctagtcttga catcatgata 1083420
 gatgtccttt gaaaaaatat gattaacgt agattaaagg ttagcctgaa aaatattatc 1083480
 acttttaata tgccaaaaag gagtgaaat tactcaggag aaagaacaa agcattaact 1083540
 cttttcccc ctttggtttt atgagacaag gtttctctgt gtatccctgg ttgttctgga 1083600
 actctttttt ttagttcag gcctgccaaa ttaactcttt acattcatag gagagagctt 1083660
 gtgaaacttt gttattctgg aataaactta tgcattgtt taggccaaga aaaaaacaag 1083720

 tatagagata ttgtggatc tggttttggt tccgtaatac ctgggttgag aagaatgaat 1083780
 tttaggtttt catcctttaa catttaaaag aaaacattct ataataaag aagaggcttc 1083840
 aataactg gcactattca tttatgagct gctattaagc tgacaatagt cacacgggca 1083900
 tgtattttgc tattttcat attctgctta tgttttaaag aatcacaata aaaatttat 1083960
 taaaaaagtc atcttgtttt aaactctggt aatagctctc tgctttgaga aagtcaaagg 1084020
 aagtaagaat tgcaggcaag caggatatag tgaaaagttg tctatgttat tatattttat 1084080

tctgatgcca actggaacta caatgctgat caaaaaagg cactttccat tcagtttgat 1084140

ttgaggattt ataatgaagc caattaagca ggtgtgcatt tacatgtgaa tttacatgtg 1084200

tgcccacaga agttatactc gaattactta cttaaatacc aatgcagagc ttaaagttea 1084260

gaagcagact agttagtagg caaagcactg ttgtttcctt gatgagaaag aagccttgta 1084320

aaggtatata tgcaatgcaa agcatgtgat tttagctaata attttattac ctggtggccg 1084380

gtttgaaaat tctggaagtt tagggcctgt gttgtccaaa ttgattcctt gttctccagg 1084440

taatgactgt tgatcagctt cctctagacc agccggacga ttatcttggg tgctaaaagt 1084500

agcacaatc aagtaagttg tataagtaat acatgaacct agctcaacct ctctctacct 1084560

acaactacaa taigtffaca tatcattctt atcataatct ttctagtctg gatactcaat 1084620

attgacctaa gagtaaaacta gccatttcat taacccttaa aatttactta ctcttagcat 1084680

tgtaactaaa cagtgtttcc ctctaattcc tgacacaatg tttcatataa tgacacactt 1084740

ttaggtgttt caatgactga tgaggagttt gagctaccaa tctctgaag tgctattcct 1084800

gcaaaaacaag tattcagttg ggccattaac ttaaaaccag gtgccaatga ctcaacagct 1084860

gtaaggtaga actggtaaaa acagatttca gaagaaaagg ggagaatacc acaacaaagt 1084920

tactaagctt tgctatagaa ggaagactta tcgacataac cactggaatt agaattcttt 1084980

ttgtaactta gaattttagc tggaaaggaa aaaaatgaaa atgtttttcc tgctaacatc 1085040

cactttatc atttattat ttatttattt atttattat ttatttattt atacagcgtt 1085100

tctctgtgta gccctggctg tcccgaact tctctgtag accagcagc tggctctgaa 1085160

ctcacagaga tctatctact tctgccttcc aagtgtctggg attaaagggt tgtgtcacca 1085220

ctgcctggct taagatccat atagtgttta cattcttttt taaaaaatat tttttaaaag 1085280

aattatttat ttattatgta tacagtgtgg tttctgggaa ttgaactcag gacctctaga 1085340

agaccagtta atgctcttaa cctctgagcc acttctecag cctgtgctta cattcttcat 1085400

ttggtttgtt tctattccc agttgtacct ttctttcctt ccttagtttc ctttgatctg 1085460

attacagtca tccactttta gatagtattt tglccatta cactctatat tgttttataa 1085520

accacacaat gcctttaaca gcagcagcag cagcagcagc agcagcaaca gggtggaag 1085580

gatggctcag aggtcatgag cactggccgt tcttccagag gatccaggtt caatttcag 1085640

cacaccata gtgtaattac accaccgtc actccagatc caggagacca gacatccttt 1085700

tctggcctct ggiggcacca gacactcatg cattggtgca cagacataca caaagccaaa 1085760

ctaccatac atataaaaa atagaagcag agggaaaagc cccaaaacta acagcatgtt 1085820

agcaggctcct aagcacaacc aaatcgctgt gccactcggg tcctatttca gagcacgaag 1085880
 aaggagtttg tggatattctt cacttaaaaa aagaaaaaac tataatctaaa acaaagaaag 1085940
 aaacaaaatc cacccaaatt cagttatctg ctccagfccc cctcttgta tggataagaa 1086000
 aacaaaagcc gtaagtgtat aaaacagggt tcacagtaag ctaacagcag gactggagggt 1086060
 aggttacctt cctattaatc ctactgtctc tctttcctag gaaccggat gctgtgcaag 1086120
 gtcttttaa aaggatgttg aataaacagt taagatctct taggagaaag ttgatgatga 1086180
 cagcaaatga ataaccgaaa ttaactccc agcctattag agggaataaa atatctacca 1086240

 ccataaaaa aaaagttaac tggacagggt ggtaacagca ggaatttaac tgaggatcag 1086300
 gtataagaaa aatgaggtag agtatattaag tctaattcat gaaaatata gttgtaaca 1086360
 caaatgact ggcttttaat atttaagact caagaagcag caagtacta taacaggtta 1086420
 aaaccaaaga atgctatagg cttggctaaa ggagctggct ttagtttgaa catttaagct 1086480
 tatttaaaaa aagcaccctt gtttgagttt tctctctgtc tgtctctggt ctttacattc 1086540
 ccagccttc ccccttctc gcaaggctc actatgctag cttcctcggg gttgagagaa 1086600
 caagtgtgag ttgccatact tgggtgtagca atttgtctaa gactgtttca tgctcattag 1086660

 tcaccgggcc ctgttggtaa tgtctctgaa ctccagttt atgactaaag gctgaaaatc 1086720
 cacctcaaac aatattcctt caggaaacat ttagtaaagt cagaacata actgagtatg 1086780
 tagttttagg atatgcaatg taattgtcaa ttagccttcc tattgtgtct tatgaaagag 1086840
 ctctctgag gaactgtgac tgaaggaa actgatttaa caggaccaat catgggttta 1086900
 agtttttagg gacaatgagg gacttttaga gaaaaggcac agatgcaaat gaataaatat 1086960
 tttttttca tttgtaagat ggcagggtgt ctccatgaat acatattgtc tcacaaattc 1087020
 cccaagagcc aagataacat tgaagtctga gcctgtgga atgacagtgg gtagccctgg 1087080

 tcacttttca ggttgataga tacaattccc attgagacta cagaattaaa aggcctatca 1087140
 gccactgta aggtactgat tttgtctgaa tccttaaca aataaactaa aaagaaaaa 1087200
 gaaatagaaa aatgtaaca ctattcgaa actattaagt agcaattttt ggggtgtggt 1087260
 ggcaacacc tttagttaca gcagttggga ggcacaggca gttgggctct gagtttgagg 1087320
 ccagcctggt ctacagatcg aattctggga tatccagggc tacaacagag aaaccctgtc 1087380
 tcaacaaaa aattttttc taggatgtt aatgttattt tgtggttata taagagaact 1087440
 atctttatca ttcagagtgg cactgatata tttaaaagc aaatttacct taaagtaaat 1087500

 aaaaagatca tagaaaagag tacagatgaa gataagataa actataagct gatagtgtt 1087560
 agacaatctc actgtaact cctaaattta gagaaagggt tcatgtagc caggttacag 1087620
 gactctacca ccatggctgg tttatgcca gattttgtgc atagtagaca gacactctac 1087680

tgagccacat tcccactc taattttaa tatgtttaa aatttctatc aacaaatgtc 1087740
 tagacagaaa taaatgagca atattcaagg ttaactgatt ataacctact ttagatcttg 1087800
 ctgacaattt ttcttctcc gaggcggttt cttcttcttc ggtttatttg cattcgtatt 1087860
 attttgttta ttgtttacac caaaatggcc tgcagaaatg tcactttgca gtaagttgac 1087920

 caacaatgga ctgttagtg ttacatcctt attgactggg aagcctggat ttgaccaca 1087980
 agacatctga ttccattgg gtgcaccact gaatggtgca ttgaaagaca tcccatggcc 1088040
 tgagaagtgg ttcccgaag cactgttcc ctgcatgctc tgcacatgtg gggggacat 1088100
 gttggtttgt tgcagtctaa catcaggcaa catctgagac aagttgacat cattatttgc 1088160
 ttagtagca ggatcacat gctgctgggc catgtgtggg ctgggtcctg ggggccgag 1088220
 aacctgccc tgaatccca taacctgaga tggactgctg ttacaggcc cttgctggga 1088280
 tagcatctgt cctgacatct gtctgtaaa ttgcaccatg ttctcttga tttcggagt 1088340

 tggccccctc attatctgtg ctggccccg catgacattg gattggttct gagtgttaa 1088400
 ttgctgctta ttcccctgca tctgattggt cattatttgc tctatcattg gtttctgtt 1088460
 gagcaaaact tgccccgag gccccatcat ctggttatgt ggtgccatca ttgtttggcc 1088520
 ctgctgggga agcatctct tgggtgggt catcctttgg ggtgaaggcc caagattttg 1088580
 gttctgaggg ttccatca tctggccctg tggcataagc tggcccttg aaaggatcat 1088640
 agggttctga gggttcaag ttcttgttg ctggaccatt tggccctgag agggtaaat 1088700
 ctgttgggtc atgccccca gctgagatgg tggccctgt tgaggctggc ctgcatgtt 1088760

 gcccagggtc acctgaggaa ccccagagct accagcctgc tggttgttta tgttgccatg 1088820
 aattcccatg aggtctgatt gcatcatatt tgggtggccc tgagacacct gcatctggtt 1088880
 ttgaggaggg ccagctcctt gaccacctta aacaaaaaca aagaatgaaa catcatc 1088940
 atattactaa gatactcaa ctaccttact cagaaagaca tccatcatcc atgtatctaa 1089000
 taatcaacac aaatgtactg tttagacat tttctgtgtg gtattttgac tctggaagt 1089060
 tgacatagga tgaagttaac tgcttatata ttcatgac atacagcagg agaaatgtat 1089120
 ctttactttt atatagtaac ttaaagataa cattagaaag taagtttagg agctggagaa 1089180

 atggctcaga ggataaaagc actcactgcc tgctctcca gaggtcctga gctcaattcc 1089240
 cagcaaccac atggtggtc acaaccatct gtaatgagat ctggtgccct ctctgatctg 1089300
 caggatata tgiagccaga acactgtata cataataat aaataaatct ttaagaaaa 1089360
 aaaaaggaaa gtaaagtta cttttaaatt aaatgaagca ttaccactgt tgtaactatt 1089420
 ttattcacia taatgtagt ataagcctta acaaaaacca tcatgggcta aaaatgagct 1089480
 ttattatgag taagtgagag aaacaagaa tgtaccagtg tcttcagaa aaaaactcag 1089540

gaatactgta aagacattta aaaaatgctt cttgggaaag taattatgct tttcaaaaac 1089600

 tatgtgtgtg aaatctagat gttgtacttt aaagaagata atatacaata tttcctaaca 1089660
 cgagggtttc tgcctgaaatg acaaaacttct gatctggtag ctgtggacag gagatgttaa 1089720
 aagtttagtg atcctactct gtggcagtcc cttgtggacc acaggggaca tgttctaagt 1089780
 tctctttaa ataggtcttg gcctattgca ttgtttgttt gttggatcct tgggattttc 1089840
 ttatagctac ctgctttatg cctacatctc actgggtggg atggagactg aaccagggc 1089900
 ctccaatgtg ttcaattaga gctatacccc caatctaatac taccacagag ttcacctgag 1089960
 taaaccttca gagcactata tagcagggtg cctgaaaca atgtgatcca agctgccttt 1090020

 aactattacg ttiggcttaa aatTTTTTca gctgggcaca gtggctccat gcttgiatc 1090080
 ctagcacctg agcggctgag gcaagagaac tgcataagt tcaaggctag cctgggctac 1090140
 atagtaaaat cctttatcaa aacacaaaa ataaaaaaa aggccactta catgctgggc 1090200
 aacaactcta ctattgagct atatatccac tgaactcatg ctcgtaacca ctgaactatc 1090260
 tctccagccc caagaattag gaactttata cttttttaa tctctataa cattaactca 1090320
 cataactcag aaatgcagtt ttacattggc agacaggaaa aatcaaatca tetgtctac 1090380
 tcttctctca tccttcaaga gacagtattt actttttatt tattaagtcc aatTTTTTc 1090440

 tcattctctt ttctttctg agacagggtc tctccatgta gtcttggctg tcttggaaact 1090500
 atgttggcta aggtggcctt gaactccgag atcctcccac ctttgcaccc cacgtgctaa 1090560
 gattaaggc atgtgccact gtgcctagcc tcattatTTT aaaaagaata aaaaaaatt 1090620
 aatgcatatg tatctgtgtg aatgcatgac acattcatgt ccatggagcc agaggagggt 1090680
 gtcagatttc ccgaagccag aaatacagga ggttgtgagc cactgacacg gacaatgaga 1090740
 attaagagag tagaaagcct ttttaaacac tgagtcatct ctctagtccc ttgttcttta 1090800
 tttcttagaa aattgaattt ttatttattt attattatta ctgtatgtga tgtgtgtgta 1090860

 ggcatatata tgccattgg caaggaaggc cagaaagaga actttaacct gctgagacat 1090920
 ctggaaggct ctataacttt tctcattctt taagtaattt acaatgaaag ttggaattca 1090980
 gaaaaattta agctaattta gttcaaaacta cttcaatgag aaaggcaaa aaattactta 1091040
 gttcctaaac aaccagaaga acccagaaac atgaaatttg ggcttaciaa actgcttcaa 1091100
 ggagtacttg ttagctaate cactgtatgt ttttctctgt ccaaactttc ttatatatac 1091160
 tatactattg gtactgactg aattggaaaa gtgccacatt gcataccaga atttagatac 1091220
 tcagcatgaa tgaagctgat atgtactatc cagagatTTT aaaagttgca gatgttcaaa 1091280

catgccataa acccatataa ctgtgaattt atggcttcct ttcccagaaa tgcctttttc 1091340
 ctgagcaagt tctaatactaa gggctcagca atcaggccta cgattggttt gaaaacaggc 1091400
 aaggatttgg aacctgttg tccctactaa gtagagtga ataactgcaa tacagactaa 1091460
 atgacctaa ctatttacta tttagccctt tatagaaaga agaggaagta tgtgtgtgtg 1091520
 agcgcgtgtt catgcatgtg tatgactcct gctcctaactg aagtttcatt tttttctcc 1091580
 taagggtgtt cctggttctt gaaaaaaaaact aaacaaaaca aaacttattt tctgttattt 1091640
 cccaaagatt atctacgtgt gaggaattta aaggatttgt tcatctgtat acctctattg 1091700

 tctatcaaag tatttaccac ataataatg ctcaataaat gtggctaatt aaatcaaat 1091760
 aaacaaacct ccatgctgga cattttgatt tgcttgcaat tgaagggtc ctgaattccc 1091820
 aggggtggtt gctgtggtgg aaggcacctg accttgcata aagttcggat tggcctgtcc 1091880
 tgctgagaag ccaggtggga ggcttttagg cattccttaa tagaaaacaa tgagtgaggc 1091940
 agttacctag caaatttata ctctgctga gatggaatga ataaggaagg atgagctgca 1092000
 tgaagttcc actggcttag ctctctctgt cacactggta ggatcttaa taataaggtt 1092060
 gggaaagatg gttaaaaaaaa tcaatacaat cccttacatg agcattgtca aaatgaaaaa 1092120

 gaaatactaa aaaatttcca ctcaagaacat gccaaggaaa agatggcaat ttgctcccta 1092180
 catgtgatct gaggccatac catagtaagg tttagaggct cacttttctc tgtaataaca 1092240
 atgactccca gtatttata attgcaacac aggcaccaa agattatgct aaattctctc 1092300
 atgttcaaac aaattggtat gaaatagtat aaagaaagag ttgggtccca attaaggata 1092360
 gatgggtgat gtattttccc ccttttagg aaaatgaatg acaatcgttg cagaaaaatc 1092420
 tccctcccc accagcgttg tgcttatctc ttggaagag acaagagttc acaggagctt 1092480
 caaagtgagg ctgcattaaa cttatgcctt tctctttaa gatttgctgt gattctgata 1092540

 gctatggtac caaaaatcat gctctaattg aatcctactc aagtttaca ctttttgaa 1092600
 ggcctaattt cagaaaacaa gtttgagta aagagaatct cagatccact catgtgcata 1092660
 ccgcaggtct tgatgtggtg agaccaccta ggctctataa aagcaacaat acctaaagct 1092720
 ctctcaaatt tttcatttag ggccagattt tcaataacct gaaaaactct ttgtagacaa 1092780
 atatgcattt gtcctttcat tacagcaaca agtccccatt tatatgcttt cgttgaatt 1092840
 aagtcagtaa tcatatctgc agaaggact acccagattc tactgatcta gggctagatg 1092900
 cccggaatag tgaagtttgg agcagaaaca ttcttacatt ttctaaaaat gctttagaat 1092960

 tgaaatatta gagcctgtat ttcaacaaaa tcaattataa gagagtgaaa ggactgatgg 1093020
 gcaacttaac tttaccagaa accatgggag catgcctttg ctatgttgca ttgaagatgc 1093080
 aagggttttt ttctgggtag gcaatgggtg tctttttggg gggatagtct tatcaggtga 1093140

gttttactga cactctctat gccttactga aaagctccaa gcacagtcac gtgcactagg 1093200
 tcaatgatta ataagaataa ataataaaca tggagatgga taagttttac tgtaatcgtt 1093260
 ttacctctca cacattaagc tccattgctt tttcttcata caagaggcac cttacaaaat 1093320
 aaataaataa atctccttta ggtataacta gtggaattcc ctctctaagg agcaggcatt 1093380

 ggcatataa aactataaaa gtaatgattt ttgaacttag tcccctttaa tactttaatc 1093440
 aaacttaaca aataccatgc ttagatttta gtaactagga ttatcaaaat tggtaaagtag 1093500
 aagggcattt tcccataaa accctgtact tatcttttca tttttgctca actgtataaa 1093560
 aatcttaate cttcaacaaa tgagaagttt aaattattaa taaaatacat gttttggtct 1093620
 ggacatttta atttactagt acatgattaa gcaaaaatag tttgaacaa aatgaacatc 1093680
 tctattttga attttacctg catgtttatc cagagagcta gcttatattt aaccagtaag 1093740
 atgttacata gtaatctaga taaaaataca ttaagttaac taagttttat atcaagtgtc 1093800

 atcacatat taaaaacca aacgattaca tccttatttc agtcccacca ttaacactaa 1093860
 aacctgacat tctattcaaa tctagcttca ctaaatttac caacacaagt aacttcagtg 1093920
 ttcctcacct cctaggcctg ggtgtaaaact ctgtggeccc tggtttgggtg getgctgctg 1093980
 catcacatg aagttagggt gcacatttcc ctgttgaacc ataggattcc gacctggaga 1094040
 gctgacagge tgctgaaatc cctggggaat tgggttattt tgaggtggcc ttggtcccat 1094100
 ctgctgttga gtttggttaa ccgttgggga ggatgcaggg gatccctgct ggaaggagga 1094160
 ggggtaggag gcaggagact tgttgggtgag gtggggttgt tgcagggggg ttgggacct 1094220

 ggagggtcct cctgcaagc tcttcatctg aggagctgtg aactggcctg ggttgetcat 1094280
 ttgaggaaag ttigtatggg cttgtgaggc ttgctggctg ccaaagggat aaggaggggg 1094340
 agggtgagaa ggtgtctgta ccgtggctaa ggaaggtctt gcctgaagt gttgttgcac 1094400
 tgggctagge aaaggagcct tcttccacc ttgatttga gtcattgtgc ccagagagcc 1094460
 ctgggctggt ggaggctgta gggctccaga aggcagctgg ttccagcctg gaggaacagg 1094520
 cacctgagtt ggagcagtaa actgtggacg aatcccctgt ggctgttctg gctgatgttg 1094580
 ctgtggaggt cttgtctgca actgttgttg ctgctgetgc tgctgctgct gttgctgctg 1094640

 ctgctgctgc tgcagctggg gaaaattagc tgggttcatt tgtctgttcc caggaacagg 1094700
 ctgcattggg tgatgtgctg gaggttaagga tcttgaggga tgactctgtt gttgaatatg 1094760
 gagtccagag agaaggggat ccatgtcatc tgtttaaaga tagtcaacag caattaacct 1094820
 ttgcaactca catcatagca cactggcttg gatctgctgg tagcactgat attaccatgt 1094880
 gcttgagtat ctctaaagaa caaacagaat accaacagat ataaagatgg atcctgcctt 1094940
 aaagacagct tatggttcat tgggatggtg aggcacatca aacataaaat gtagacaaca 1095000

ttttcaaat tgiattctgg gcaattactg ttaaaggaaa acaaaataaa atagtcaact 1095060

 atatttgtga aatgctagac ctaatgattt cagacaagtt tttctttcct tccttcctgt 1095120
 ctttatgtat gtatacagtg ttctgcctgc aagtaaacct acaggccaga agagggcaca 1095180
 agatctcata acggatggtt gggagccacc atgtggttcc tgggaattta actcaggtcc 1095240
 tctggaagag cagccactgc tcttaaccgc tgagcatctc tccagtcctt acaagtttcc 1095300
 tttttactgt aggaagctta gtgcttccaa catgttaatt tatgaacat ttaccaaat 1095360
 catatggctt caaagtcttg ttatgatgta tctcataaaa ctaagcatgc caaggatatg 1095420
 tggcagtctg aatgaatggc cccaaggct caaacagagg ggcacaatta ggaggtgtgg 1095480

 ccttgttggg ggaaggggtg cactaggggt gggctttgag gtttcaagt ctcaagccag 1095540
 gcctgtgtc actctctctt cctgctgcct gctgattcag atggagaact ctgagctact 1095600
 tctctagcac tatgtctacc tgccatgatg ataatggact aaaccctga acctgtaagc 1095660
 aagcccaat taaatgtctt cctttatagg agttgctgtg gtcatggtgt ctcttcagag 1095720
 caacagaaac cctaaaacag catacttctt gggaaatatt gggcatagct gataagaaag 1095780
 taagaaatc tgagaagaaa tgttgacatt tagctgtgaa aattcatagt agattttgta 1095840
 aagaaggtaa aaaatagaac taagcaatta gaaattcagc atcagtgatt aatcccaat 1095900

 gatatctgta agaagctcca gcctctctga ctgcagtgtg actacctgag tgagaagcag 1095960
 ggcgaggagt cctgggctgc agttctggac tggggcctgg ggccatcatg gaagatgaca 1096020
 tgttcccacc ctggggcacc ataacagtgg cagggtctgc catccttatt agtcctagaa 1096080
 gaaaaaaaa actagaataa catactgaag ttggcacatt tgtgtgtgtg tatgggtgg 1096140
 gcttgtttct gagatgagat cttaactctc atgaccagac tggtcggcac ctcatggtaa 1096200
 ttgcttctgg aagggtctgag attataggtg agtcaccaca ctgagcttac aatttttatt 1096260
 tttaatgata tatttttagaa attctaaaag atacaaaaat tcttttaaat aactttttag 1096320

 atttaaaaac tttatgtcta tgaatgtttt gcctgcatat acatatgtgt gcactacaca 1096380
 caagcctgtt gtttgtggag accagaagag gatttggatc tcttggaaact agagttacag 1096440
 atggttgaga tagggtctca ttatatagcc ttggctggcc caactgctac atacaccagg 1096500
 ttggcctcac actcatagag atccacctgc ttgccttctg agtgcctttt ttctcaatc 1096560
 ttaagfcaaa ttcttagctc attaattttg tattgatgtt caccactgat acccgagagc 1096620
 tttccttcca acttctataa tggacatatt tctcaaaatt tgattgatac ataatacct 1096680
 tactctaaat ttccaagcac ttttcaattt ccatctaatt accctttaa atcataagcc 1096740

atttagaat tatttctaaa ttttaaaga tatgggtgtt ttggttatgt gctatttatt 1096800
 ttgccaacca ctaagtaca ctatggctag atagggtact gttccatggt atttactaaa 1096860
 acttgctttt gaaaacatit ataatcatct catataaatc cacttatgct tgaagagatt 1096920
 aaaaactctg gaattagggt tacatatttt ctatacatat tcattcatat gaagtttttt 1096980
 ttggagataa tgttgccatg actgaatggc ctfgaattca cagagatcca gctgcttctt 1097040
 aagcactgaa attaaaggta tatgccacca ggccctggttc attatataaa atttttcatc 1097100
 atgtcattca agctttcttc atttttataa gtttgattca tcaattacta acagatgtta 1097160

 aaatctccaa gacttgacat ttcagtatta tttttatata ttcagaggct aggttattag 1097220
 gtgtgtaaaa atttagctat ttttgatgaa ttttttctg ttatatggtc tttttcattt 1097280
 atgattttta tcttttattg ttattatttg tggattagg gatagaaatg aagtctttgc 1097340
 atatgctaga taagcacttg agcaccaagc tacatgtgtg actttttaca ttctgggaca 1097400
 gaatataaat tactctaata ggccccaat ctggaatgta gtctcctcag gccttgaact 1097460
 taaagtcctc ctaagtaggt agaattacag gcaagtacta ctatgccaag attatattct 1097520
 ttactttttg agacagggtc tcaatatcca tcccttgctg tcttgggaact tgctttatag 1097580

 accaggctaa ctcaaacctc attgagactc attgcctgcc tcagcctccc cagtgtctacg 1097640
 attaaaggta tgtaccccat gcacgtgttt atccttttca tcttagcatc tgtcttgtct 1097700
 aattaaaaaa aatacttttt cctgetaata ttacctggc ttaatattat attgtattct 1097760
 catattttat gcatttctat attttctaca gttctccaaa cagtacagag ctaaatctga 1097820
 gactattatt ctaagtaatc acttccatat taatagtgtt ctcaatccat ttacctttac 1097880
 tgtcagttac tggatatatc tgatttatca ttcattctat gacttctatt tataatattt 1097940
 tctcctatg ctatactgtt ttattttccc tacattttat tggatttttt catcatacct 1098000

 ttctttttta ccattctatt acttgcttca agttgtacat tctattattt tactactatc 1098060
 tttaaagtat taatcagcaa acctgacctc gaatgtaaca actatatgct tgtcattact 1098120
 aagtcggcct tacgccggtc ctgggtggcgc aggccggaag gatttgctga aggagtca 1098180
 ggccggtgga tctggagttc gactaagttg gtcttacaac caactacctg tetttatcaa 1098240
 acatcagctc actattcctt cttagacctc cttcttctc gaagttcatc cttgagcagg 1098300
 tcaatagca aagatgtgtt aatggtaaat gttccttccc cccacccca aagaataaac 1098360
 tttatttggc ttatgagcca aacaaacttt ctctgcaca gttttggttc catgcagcca 1098420

 cccagtctag aaggcagcaa taagatccac ttgacacca gcaggggcac ctcttcagat 1098480
 agtggagggt ttgccaatgt gctggtagt acaccttca aaggaatgct ccaaaagact 1098540
 atggccatat cccatataca tgaccaccag ttctttgctt tttacttgtg gtatgcacag 1098600

tctgccttta agataggttt gtaacttggc cgggtggtgg tggcacaggc ctttagtccc 1098660
 agcacttggg aggcagaagc aggtggatct ctgagtttga ggccagcctg gtctacagag 1098720
 caacagagaa accctgtttc gagaagaaaa gaaagaaaga agaaaagaaag aaagaaagaa 1098780
 agaaagaaag aaagaaagaa agaaaggaaa gaaggaagag aaaggaagaa agaaagaaag 1098840

 ccatgccaac aacagctttg ttggtctgga aatgacctt cttggatcct gaaggcaaat 1098900
 tcacatgggt cttggtaact gggttgtggg aaatgaatgt tacatagtcc ccagaggcca 1098960
 gcactagctt gtccttgccc ccaggcttct tctccagaaa acatgtaata gtaccacag 1099020
 gcctggtgcc cactggtaaa acattgccaa tattgagctg gaccttcttg tcacagtaca 1099080
 cagatgtctg gtgtggatta cctctgcagc gaagcttctt aaatggatag gaatcacaaa 1099140
 ggacaacctt cacaagagga gtgccatgga caaggtcacc aatgacctt cagatgccct 1099200
 caatatagcc gtactgctca gcaaagtcca cagtatgcaa gtatgaggca caaagtttct 1099260

 tctgccctct atcagcccat ggcggcgggt ctgctagaag cacagctggt aatgctctta 1099320
 agtttctgaa aatttatatt gttctacttc tcttgatagt gcaactagat ttagagttct 1099380
 aggttcccaa tgatttctt agcatttga aatactattc taagactctg getttcaatg 1099440
 ttccagctga gaaatcagct gtgaatctga tagtcttcc tttgtaagca atggctcttc 1099500
 tggggtgtgt atgaggtgcc tttaacattc tgtttccac gttctgtatg tttacagtac 1099560
 agtttagatg tacatttacc tgtgatgctc ggtatttctg atattctgat atggaagaat 1099620
 tgtgtcattt tgaaaactat tctggaaaat tttcaggtat tctttaatgc ttgttctca 1099680

 gtttcttcat ctctggagc tcttttaaaa tttttcttg ttttaccctt caagtctcgt 1099740
 gactactttc atatttccac tatttctctt tctgtattc tgggtgattt cttcaaattc 1099800
 tccttcaagt acaactattt cttaattttc tgactaaatc attcatttgt tgccattaaa 1099860
 ttttttaca gttctgttcc ccttcaaac atatttgaga cagggtctct ctgtgtaaca 1099920
 gcctggctg tctgaaact tgctttgtag accaggctgg ccttgaactc acagagatct 1099980
 gcctgcctct gcctaccaag agctgagatt aaaggtgtgt gccatcacca cctggcctgt 1100040
 taatatattt ttcttatggt tttcataatt ttaaaccatgc tgtcactatt acctaaaatt 1100100

 ccaaaaactg gaagttaac cctaaaattc attaacttac ccaaaacttg tttgttacag 1100160
 tgagttttaa ctgaagtcca taatggccca gtggagaatg tgttctcca gagcatcagt 1100220
 ggcttcacca gtctagaacc acttaatggt aatgacaggt tagctgttca ggtcatttta 1100280
 ttaacatatg tccaacaggc aaatggttaa agaagatatt ccctgaacaa ccagcctcca 1100340
 agcagagcca atgtcaagaa aggcaaacac ccaggtatct gactgtgtca aaggtaacta 1100400
 acatttttag cctagaaaa ctggcttcat gaaggatttt gaattctaac ttcattcttc 1100460

atgtagcctt ccigccaccc aaatcacttg gctcttcaga ttctccgtga ttgtttttat 1100520

gttttgcccc ttctctctcc cccacttcaa agacatggtc ttaacatgaa ggtcagactg 1100580

gtcttgacat ggtcctgact gctgagatca caaagtetta tgcttcaca ccagctggtc 1100640

atcactatit aaatititcat ttttaacgga ttgttttctc tgcaaagttc ttttgcttgc 1100700

ttaaaatctc agctatgcat tacatattat atctttatgta gaacttttag gaatititcta 1100760

attagagaac acaaccagaa aaagagttac ctgttaaaat tagatctact tetgtagaat 1100820

cccccccat tttcaaagag gacaattagg aagaacactc tcaggaaaca ggtatggatga 1100880

tacacacttg aaacccaac aatcagaaga caaaggcaga aggatagctg caagtccaag 1100940

gctagcctga tctacatagt aagtccagg ttagtgaggg ctatcacagt acaatctgac 1101000

taaaaacaaa acaacaaca acaaaacaag aacactcttg tgatagaag acaaatctt 1101060

ctgggcccc aatgggggttc ttatttctgg aaatititcca gtatacactg actatatgct 1101120

cagcagtaac atgttgacat gcatttctgg tactatgtgg gaattgaac tagatctgtg 1101180

gtcttactg caggtaatat ccaggggatt ttgagttatc cagagatatac tttagttggc 1101240

acaatagaag gagatgcaca aggggtgctaa tagcatctgg tgggtaaaag cccaggatgg 1101300

tactaaatac actccaatgt ccaagacagc tattcacaac aaggaaatcat tcatcccaaa 1101360

taccaacaac caaaaatgaa agttttgact aaatgattac tacagtatac tcaagaatct 1101420

tgggattctc taagggcatg aaaaaaaaaa gggctacaaa tttatgttta gttgctttct 1101480

attgtcaatg ctaagagaag aaagtattac caagataaat tgataaatta agacattcta 1101540

gacacataat tctaaagtta cttaatatitg tttcagagta aaaaaaggaa tcttttaatt 1101600

ggtataaaga aatacctata ggttaaaatg tcatgggtgac tacagatcat cactaattaa 1101660

ttagtctctg actttgtgtt gtaaataatc acaatcagta tcttccaatt taacctgatt 1101720

tcattagctt caaggtcttc tatgtggtaa tgaacttaca gcaactgtacc actagccaga 1101780

tagatactag atgttggaat cattgtgctg gcctcagctt aacaagtatc ttgacaattc 1101840

aagacttgat gggatctcta acattgtttc caggatataa ttaaagatgt ttatgggtccc 1101900

ctaagaccag aaaaaagtgc ctgtggacag gagttgagat cagaactcag attccctgac 1101960

tttcttctgt tcaggtccac tcattgccta ctctagtac atacacagcg attgggctct 1102020

tcccaccctt cactcttcag gcagttggcaa tcgtaccacc tatgacttct ttaaaaattt 1102080

ttttcaagcc agggtttctc tgtgtagtig tcttggaaact tgctctgtag accaggctga 1102140

cttcaaacac agagtctctg ctgcttctgc ctctgagtg ctaggattaa aggtgtgtgc 1102200

cattggaggg gaagctgtag ccacgcctac ttaggggctg gccacagatg tgcctgacca 1102260
 tgcttgcgag ggcattggcca ggatgacgta cagcgagact taaaggggac tgtgtctctt 1102320
 tcggtttctc ttttgggctt gcgtacagac tgcctgccacg ccagctggct aggacgctct 1102380
 ataagtaagg cttttcccta ttaaataccc ttatatttcc acttggctcc atattggtaa 1102440
 tttcccacta tatgccaccg ccaccacccc accacctatg acttaaaatc aagtcgcttt 1102500
 aacacttgct cagagctgta caggggacca ggtctatata taagtcacca ggtagacat 1102560
 ttccattaat tatatgacac ttcacatcag tccaacagca cagattttga cagatgcaca 1102620

 aaacagcgag ggctggctca cagagtgagt tctaggacta cagagagacc tgtggccaga 1102680
 gctacagaga aaccgtgtct caagaacaaa aaaacagaaa gagagaaagg aaggagggga 1102740
 gggaggagg tcaagtccaa aactggtaa atgtcacaca caagtgagta ggaagcctca 1102800
 cctggaccac ttgccatggg aaatctgcc tccatcctaa cagaatttcc agatgccatg 1102860
 ggtccattca ttctcacatc ttggcttcgg ttctggccca aagccaggtt gatagcacct 1102920
 tccccgaaa attacagtag agttataaaa tggaaataaa agtaaaatc tgataataac 1102980
 cctaacccta accctaacc agcaccaccag aggtgcaggg aagatgggaa gctcaaggct 1103040

 gtgctcctac atagcatgct ggagcctatg gctagacaag atcctactta aaacaaaaca 1103100
 ccaaaacaaca aatgatattg tggtagagag gtcattgtaat gacaaataga gaaatctctt 1103160
 ctaactaacc tttgtgacat aaggtaagac tagcatgtga ataggtttat aatggacaat 1103220
 gctggggatt gaatccaggg ccttctgcat ggtaaccatg tgttgtatca atcattaaat 1103280
 ctctctgtagt atgtgtggtg tgtgtgtgtg tgtgtgtgtg tgttatgtgt gagtgaactg 1103340
 ggcggtggtg gtgtgcacct ttaatcccag ctcttgagag acaggggcag gcagatctct 1103400
 gagttagagg tcaggctaata ctacagagtg agttccagga tagctagggc tacatagaga 1103460

 aacctgttt caaaaaaca aaaaataaaa aataaaaatt tgtgagtctt ttgcctacat 1103520
 atatgtatgt gtatcacatt tatacagtac ccaaagaagt caaaagaggg tgttgatcc 1103580
 cctggtagtg gagttataga tggttttggg ccactatggt tggctcacat ggttgggtgc 1103640
 tgggaactga acctaggctt tctgcaagag cagcaagtgt tcttaactgc tgagttagct 1103700
 caatattcta tctcatttgc atttcacctg gtaggtaaca tcactaggat tgtttcaatt 1103760
 aaacagactc taaggaaact taaatcttaa ctaggcctaa tgaagacagc tgctgagaca 1103820
 actttcagag tgetccttgc acttaacceca cagtgcacaca gccaccttg tggggtgaag 1103880

 atacagctag ctgtcactg gggagttgaa agaccatatt tcccgtcct ttcataatcac 1103940
 agaactttgg tttccagctt gaagataaag caggaagcta ataaggagat actttcccct 1104000
 gtccctgtcac tgagctttct gtgtagagtt taatcagggg actgactgcc tggctcctagg 1104060

gaacaacatc ctccaataa aggaaccacc attagaggct atagcctata agaatcaaga 1104120
 gtgaaaaaat atatatatgg ggttttggaa gtctcaccaa tggaaaggaa ctattaatat 1104180
 attaaaccta ttaagacatt ttaagtagaa gcattttttt ttcttttttt gggttggagg 1104240
 ggtttttatt tatttaaaga gaagatctta cctgtagac tcgctgtct ttttttttt 1104300

 ttttttccc gagacagggt ttctctgtgt agctttggag tctatcctgg ctctggagac 1104360
 caggctggcc ttgaactcac agagatccgc ctgcctctgt ctcccagatg ctgggattat 1104420
 aggtgtaagc tacttacta agtaacctaa gcagaagagt tcttgaatg acatcaagta 1104480
 atatcactcc ttgtttttg gcagttctcc actgccagta gcttagttag taaagtatt 1104540
 gctcaggacc tgaattgagt tcccagcacc cattaaaaa aaaataaata aataaaaaag 1104600
 agcctggaca acacttataa tctcggcata ggggaggcag agacaggagc atcactgggg 1104660
 tttgatggcc agttagccca gcctaattgg taagtctgag tgaaagtatt aaaacacaag 1104720

 gtagggccaa tgagatggct caaagggtaa aggcatgtc tttcaagcct gatgacttga 1104780
 atttgattcc caggatccac atgggtggagc aagataactg gttcccatgg gtcgtctaca 1104840
 tgcacaaaca cacacacaca aaatatataa aaattattta taaaaagaag aaactcttgc 1104900
 atacttgccc acagttgatg ttacatcaa ctacagatat aattcacatc aatcatagag 1104960
 ttgtccttct taattaagat catgggctca ttgagttcc taacaatagt ataattatat 1105020
 accaggtgct aaaaacaagt aatgttatta tacccttct tgccttcatt caacatgttt 1105080
 attaaagaga ctaatgtata ccaggcaatt caaaaatagc acagtgaaca aaaccagaca 1105140

 agatcccttt cctactagag tttaaagtac acagaggaat aaacaataac cataaccaa 1105200
 ttctgtcct aaggaaagtg tgagataaat gatctgggag aaaggaactt ttgttagagc 1105260
 atagtaactg actccaagtc agccagagac ttaaggctgc aaaaactaac ttgaagaaca 1105320
 ggaatgagac agtactccat atacagaagg caacagtca aaagaactgt gacagaaggg 1105380
 agaactgtgt gttcaaaaa ccaaatgaaa actggagaga cagtaagca gagggcttct 1105440
 gggggtagag agtgtggaat taactagcat aagtttatat gaggaagaca gacattagac 1105500
 catgcaagcc ttgaggccat ggtagagatt ttggcctata ttctatgaac agcagcaagc 1105560

 aacagaaggg caagctggat atcatgtatg tattaggttg agcatatfff acattcaaga 1105620
 gggctactcc agtgataaca cttacaaaag aactgttcag gactcctaa tctgccacat 1105680
 aaacaaagga aattgtaaag ttattcagta aagggtagca attaaaatta gatattcttc 1105740
 aaaagacaaa tcagtttctt taagagtaca agtaaaacca aagcctgaga ctgaaggcaa 1105800
 aagagccaac ggaatgatgc ttcaggctgc agcaatacct caatgcttct ttatttcaag 1105860
 tgctgcaact tgaagcacag ggtgcacagc tgcttgagag tctcaacat aagagcagag 1105920

gaatagacaa agcagcatca gaaactatgc tggatatcac tgttactgta ttttggttca 1105980

 gaagggcaca tgacaaagta aaggaccttc aatctgaacg gagagaatcc ccagatcccg 1106040
 gagctgctgg ttgttgcctc gagccaggat ccgtaaccgc tccgctgctt cccgggggat 1106100
 gttgaaagt acgcgaacgc tgttccaggg ctccactttc tgtacctta gtttgctgga 1106160
 ttcttggta tgaaggaaag agaataacat tatcaatfff gtaggaacta gaggatgtgc 1106220
 aactaaaag caaaacaaaa actcctgctt taggtaaaag ttgagatccc actgaagcac 1106280
 aagaaaccga gggaggaaaa catacattca ataggtaagc ttcatggaga acagaaaaac 1106340
 atctggcatt ctgcaattct gaaaatgaca caaactttgg gacatattct taagaatata 1106400

 caaaagctaa ttictggaag aagcatgttt acacatgcta agtaaagagt gaagttaacc 1106460
 taatatcata tacaaaaatt aactgaaaat ggaacaaaca tttaaatata gacctaaaaa 1106520
 aaaatctttg aagaaaat at gtagcaaac ttaccacct tcaatttggc agtgatttct 1106580
 tggatacagc agcaaagagg caagcaacaa aagaaaaaaa tagaaatgct ggactttttt 1106640
 tataatcaa aaaccactac agagtggta gatatcatat cacataagga tggctattac 1106700
 aaaaataata tatagctctg ggcagggggt gggtaggcaca tgcctttagt cccagcattc 1106760
 aggtgacca gcagaggcag gtggatctct gatttctagg ccagcctggt ctacagagag 1106820

 aactgcaggt cagccaggac tacacagaga aacctgttt tggaaaaaaa aaaaaaaaaa 1106880
 aaaggataca gcaaatgttg acaatgatat gggaaacctg gggaccctg ttcactaatg 1106940
 gtgggagtac acaaatggta caatttgcata agagaactat atggtaagaa gttttctaaa 1107000
 aaaaaaatt atatgatata gcacttttaa ttttaggtat gatatagcat ttttaattct 1107060
 aggtatcaga atcgaaagca ggatatgcga gattatcc atgtttatgg cagcattatt 1107120
 cacaacagct aaaccataga agtaatcaa gtgtccagca acagataaac attagtaage 1107180
 aaaaatgggt acatccataa attctgtgga acattcagcc tgaaatggga agtaaatccc 1107240

 atcatgtgca catagagaaa cactgagaaa actatgttaa atgaaataaa gcagctgtaa 1107300
 agagacaagg actacctgac tctgattata tgacataggt aatagtcaa atcatggaaa 1107360
 gaagcctgga gagatggctc agtggcttag agaactggat gctcttcaga ggattgagat 1107420
 tcaattccca gaacatacac agcaactcac aactagctat agctctagtt ccagcagatc 1107480
 tgatgcctc ttctggactt tgtgggcaact gcatgcgtgt ggggcattta catacaggca 1107540
 aaatacccat gtgcataaat aaataaatct aatttttaa aattaaaaat atcatagaaa 1107600
 gtagaatggc gcttattaaa ggctagagta gagaaggaat ggggagttat atgataggtta 1107660

tagatattaa ttttatgtga gttatagaaa tggctgctaa tgattgttat aaaatattat 1107720
aattgtattt tagtaccatt gaaccatata taaaaacggt taagatagca aattcttcta 1107780
tatgtatttt aaaatcaaag attaaaatta actgaggcag taattttgtt tataattaca 1107840
ttttgcaggc agggaagcaa ataaaagctt tccagcagct caagactaaa taattttctt 1107900
tttgttatta actcagatca actaaatggt ttatatgctt tattcaatta catctttcag 1107960
tattaataaa atggccatc aggaataggc tttctcaaaa tccagacacc tatgaaaaag 1108020
ttttacatgt cacttaagcc tcttcagct cttaaacat taggtactaa atagtaacac 1108080

agaattcatt tgctctaag tacaacaaca acacaacaga tcaattgcta agggcaatta 1108140
gattaatata ctcaaaaat ttaaaaatgg ttagacaaca tttagccaac ggtctcttac 1108200
aggtaagga ctggggccca gagacaggct aagtgatcca gaaagctgca gctacctaata 1108260
gaacttacag aaagcattaa aaccagctc tagggtttaa aactattgac gttctgctga 1108320
aaaactttgg atcctggttc cacaggagag agacacgaag tttctttcca atctgatgat 1108380
cactggaaac ttaccatgt tctacatata catcatatac aaagcaaata ggtatgatgt 1108440
aataaagact ataactcag ccttcagcaa taagatcttc cttctttcta aaacacaaac 1108500

taaaaataa ataaaaatg atgggaaga gacatgcctt ccaatttact ttgcgtaaca 1108560
gtaacatga aaggggaac attcaaaaag agtaaccaga aggaacaaa aattaaagca 1108620
attaccatg tgtaacaagt tgggcacatt ctttaattt gcatccagtt tccatttgaa 1108680
gtctttatca tctatatttc ctttgaaggc taaaaaatt gtggaatcct caaaataact 1108740
atcacttttt gtgtcatcat cttctagtcc agagtcaaaa tccacctccg agtcttccat 1108800
tgttgatgaa cacaggaag tatagatgic ttcgaagttt ggaaggtcat ccaaaacat 1108860
ggtgctttat tccagaagta tatgcaaagt gaacaataag aaaaccttaa aaaaggggg 1108920

ggtgcagagt attatatatt caacatatta ttatttaaca taccacat acttatgtga 1108980
aaggtgtaat ttattcacta agtaaaattt ctttcatag tactatagc tacttttttt 1109040
tttttttgc aagactagga tactgacagg aatataaaa ggctacagg acataaaaga 1109100
agaggactgt gacagtgtat acctgtattt tcaggagaga gatcacaagt ttgagccac 1109160
cctaggctgc agagttaaga tcttgtctca aactaacaca acaacagtat ccagaaaatc 1109220
ctttgtaaaa catctatata tactttccag ctacatttca aaaattctaa tttaacacct 1109280
gggcaatgga ggtgcacatc ttttaattcca gtactcagga ggcagaggga gacagatttc 1109340

tgagtttgag gacagccttg tctacaaagc tacttccagg acagccagga ctacacagag 1109400
atactctgic ttgaaaacca aaatcaaac aaaattctaa taaactctgc aagtaaataa 1109460
ataaaactat taagatttt caggccttaa aatcttttgc ttaacttgag aaaagactga 1109520

gtcttgaaac tgctcaaaat ctgtaactat ttagcaggct tttcaagtag gaactgcaag 1109580
 aaaaataacc taatgatgta tgtcaaggc ttagtaaaac aagaacaagc caaaccaaaa 1109640
 ttagtagatg gaaagcaata acacaggcta gtgagaggcc taaacaaata aatactttgc 1109700
 ttctaagcct tggaacctca gactgtcaaa aaaaaaaaaa aaaaaaaaaa aaaaaaaaaa 1109760

 aaaaaaaaaac aagaaaaaaaa caaaaaaaaaa aaggtggtgg gctggtgagc tgacttagca 1109820
 gatacctgtg actgctgcca agtctaatagc tgagtttgat ctctgggac catgtggtag 1109880
 aagcaaagaa tcaaaactgca agtgtcctct aacctaaca cacacagaca cacacacaca 1109940
 cacacagaga cagagacaca cacacacaca gagacacata tgcgggcaca catacacaga 1110000
 gagacacata cacacacaga gagagagaga gagagagaga gagagagaga gagacacaca 1110060
 cacacacaca cacacacaca cacacagaga cagagacaca cacacacaca gagacacata 1110120
 tgcgggcaca catacacaga gagacacata cacacacaga gagagagaga gagagagaga 1110180

 gagagagaca cacacacaca cacacacaca cacacacaca cacacacaca cagacacata 1110240
 ttcgggcaca catacacaga cacacacaca cacacacaca cacacacaca cacacagaga 1110300
 gagagagaga gagagagaca gagacagaga gagagagaca gagacagaga cacacacata 1110360
 caacaaagcc atcgacacaa acaaacagta aataaagatg tttaaacatt tttttcataa 1110420
 aataaaagac aaaatgaatg ccaggacagg tgttaacata atggattaaa ataaaatata 1110480
 agataaatga aacaaagagt tagttctttg ataagataat cagactaacc aaaataagta 1110540
 gacatgaatg aagaaaatta agagtctgga gatgtaggtc agttgacaag tgcttgccca 1110600

 acatgcacaa agccctggat ttggtcctta gcatcatata aactgggtac agtgatacac 1110660
 ctatcagtac acggaagggtg gaaacagatc tggccacaca gggagttcaa ggtcagcctg 1110720
 tggctcaaaa ggcttccttt caaaaaggat aagtgtgtac acatgaatta cccaaattga 1110780
 accgagagga tataaactaa aaagatggct aaaacacagt taggtctggt gagatggctc 1110840
 agtgtgtaaa agcacttgca gccaaacct a agcttaatgc ccagaaacta catggaggaa 1110900
 ggagagaacg gcctcttctg gttgtttgct gacttctaca cctctggtg acacacacac 1110960
 acacacacac acacacacac acacacacac acacacacac acacacacgc acagaagtga 1111020

 gatgtagagt ctggagagac agctcagcat ttaagaggac acactgctct tacagaggcc 1111080
 ttgatggatt tcagcaacca tgtgggtgtt gggagttgaa tctgacttct ctccaagaac 1111140
 agcaaatact cttacccect aaactaacct tccagcctca ctcaaccacc cccactctta 1111200
 ttgaatatag tgcttgaatt ctctattatg tgtttgcttt tttttttttt tttttttttt 1111260
 tttgtttttt tttttttttt tttttttgag gcagggtctc tctatgtagc tetggetgtc 1111320
 ctggaactta ctatgtagat caggaaagcc tcaaaatata aaataaagtg tgtggtatca 1111380

ttcttagcta gtggttgaat tctttaccag gaggtaaata aaaagtatgg aaataagaaa 1111440

 ggtagaagtc aaattactcc tgtttacaga tatgattata tatttaaaga ccctaaggac 1111500
 ttcagcagaa agttcttaga gctggtaaat actttcaaca agatagtaga tacacaaaat 1111560
 taacatagaa aaatcagtag cagtactagt gagatggccc agcagttaag tgctcttgca 1111620
 gaggactgga gcttggttct tatgtcaggt ggttcacaac cttgcctata actccagttc 1111680
 tagggactct gatgtcgtct tctgggtacc cacaaacaca catgcaaata aaaataaatc 1111740
 agtaggttct ctatatactg ataataggtt gttaaagaaa tcaaagaggt ggttcaacag 1111800
 ttaagagcac tggctcaaat ccaggttcat ctctagaac ctacatagag gctcaatatic 1111860

 tgtaacttca gtttcagagt atctgtcttc ttcaggcctc catgggaact gcatgaatgt 1111920
 gatacacaga catacaggaa agcaacacac aaacaatata tatatatgta tatatatgta 1111980
 tgtatatgta tgtatatgta tatatatgta tatattatat atataatgaa atttaaata 1112040
 aaacaaaaa gatggactct aaaaaattct cttacataaa gcttcactta ccaaaatgtc 1112100
 ttaattttta tcaactttcc aggtcatcat ctaaatccaa acaaggtggc atctttgggg 1112160
 catgtatttc aaagtagcag ccaaatcaga attctttaga aaggaaagag aagaaaaaaa 1112220
 agaggggggg gcaagtaaaa ccacagtatt aaaaagaat tagggtaaaa atacaacaa 1112280

 gtaagttata aagtcaatat ggaaactcta gaaattagaa ttttcattag aaatcctaaa 1112340
 acagccgggc attgtagct cacgccttta atcccagcac tcaggaggca gaggcaggtg 1112400
 gatctctgtg agtttaggc cagcctggtc tcagagtga gtaccaggat aggctccaaa 1112460
 gctacacaag aaacctgtc tcaaaacaaa acaaaacaaa acaaaacaaa acaaaacaca 1112520
 acataacaaa ccaaccaacc tcaggaaggg aacaggccca gctgctcagg ctggtgatct 1112580
 cagcactagg gaggggagg ggcactcagc atgaggatta agagttcaag gcgagccttc 1112640
 agcaaagaca gcatgaggcc tgcatttcat aagattctaa ctcaataaaa caaaaataaa 1112700

 caggtaaatt aataattttt ttcaatgtg agtcaggtag ttactctgta gccaaactctg 1112760
 atattgaatt cttggcaatc ctctggctc accttgtgtg ctgtgattac aggcaggggc 1112820
 tatcatgccc agctcaaata tttttatttt gggagaatat tttttaaagt agttatataa 1112880
 ctagttaatt taagaaagta aagaaagaaa acaataagct gggtggtggt ggtggtgcag 1112940
 gaggatctct gtgagttga gccacagttg gtctatagat tgagttctag gacaaccagg 1113000
 actaccagag aaacctgtc ttgaaaacc acagcaaaaa tgaagcaac aaagaaatg 1113060
 aaaagcactg aagactattt tggtaagat tttgctcctc ataacatatt ttttttgag 1113120

acaggaaaaa tgttatttca cacttgctgc attaagtgtt atgtaacaaa atagcttcca 1113180
 gaaacaatct aaactaagat attcctgttg ggtcacagtg tcagtttctc tgtgtagccc 1113240
 tggctgtccc ggaactcact gtgcagacca ggtagtcttg aactcaagag atccacccat 1113300
 aaaggcatcc atgagcagct acaaaatcaa tactatactc ctcccaagtt gagagcgcag 1113360
 catgaaggcc cttgcaccca aagatctcca gggaaaccac gaatattaag cacataggat 1113420
 gtctttccaa taggaaaggt gtaaaacctt tttttccacc cagaaagctg gtcactggaa 1113480
 gtgcttagca gcctagggat ctgtgtcctg tgttgacca ggtcatatca agtcctaaa 1113540

 ccaggactgg agttggctaa tattctaaat gaacttcaca gccaggggct cctcaagttc 1113600
 ccacaaccag gaccagagct atccagtagt ctaaagagc cttatattat gtgtatggcc 1113660
 aggggctccc ccaagctccc acaaccagga ccaatgtggg ctaatagcct aaaagacctc 1113720
 catgctattht gaatgacgaa aaccaggcca gaccttagg tctttaagct agtatgggta 1113780
 acctattht tcaaagaaat gataaggctg agttgagtht cgatgtaatt atgcttctt 1113840
 gtgccacggg gattatatta cacccgaaa cttttccca aattatactg tgtttaaatt 1113900
 tgttgataa accacctgac atcagactcc ccaaagctg atccaggatga agtcaatctg 1113960

 aactaatht tcaattcac ctttcacag ttctthtcc ccaccatggc cattcactca 1114020
 tacagcacat acaaacgtaa tgaaaaacta acaatctt taaagagcac agaagtctaa 1114080
 tggccctgaa gttgcccag agcacacagt atacaggaaa accttcaag tctthttht 1114140
 aaathtctt tgiacgtatg tgggcatacc aatgccacag cactaacacg gaggtcaaga 1114200
 ggacagcttc agagagtcaa ttctctctt ccacttctt gtaggttcta gtgactggat 1114260
 gcatgcaggt aatcgggctt ttagcaaac acctttagg aataagtaat ctgtagacc 1114320
 cttcaattca cttatgaag taaatataa tactcaattt gtaggcagaa agctacagat 1114380

 caatcttht tacattgtht ggtcttacac caacgttht gattctgagt taaathttaa 1114440
 atagactctg gtagtacttht aaaagaataa taatgcatca tgaccaagtg aagthttht 1114500
 ttggaattca aagcaactt ggtatcagga tactggggga aatgthttag tggthtctc 1114560
 cactgatgta acttagccct gtctgcaaaa ctgggtactg aatctaggct thtatatatt 1114620
 cattthtact ttgccactta gctatthtcc tagtgccac cccctcttht ttgagagagg 1114680
 tacciaatct tagggtggca atthtactta ttagagacag ggtgtgacta ttagccccg 1114740
 gctgtcctgg aactcattat gtacaccaca gcctggtctc aatgaatag atccaactac 1114800

 ctctacctc taaatgctgg gattaaaggt gtgtgacacc atgccagcct gggctggact 1114860
 ggcaatggt aactcaggct agctthtact tctgactct gttgcgthttag cctccagtat 1114920
 atctggatta gaagcaaat gactthtacc ttactcttg atgacaatht thtthttht 1114980

caaaaaaac atacaaatag ccatgctttg gtggcacacg cctttaatcc cagcattagg 1115040
gaggcagaag caggtggatc tctgtgagct taaagccaga atgttctaca gatcaagttc 1115100
tagaagaatc agggctacac agagaaacc tgtctcaaaa aaaaaaaaa aaaaaataca 1115160
aaagtacaaa aaaacccaaa tgctttctta acatgacaac attgatttct tcagcacaaa 1115220

agtgaggact agtgtgtaac tgggggaatg gtggggggag gagtacttgc atatgtgaag 1115280
cacgacacac ggaaaacaac aagcacaagt cagcagcagc ttcacagagg agggcaggg 1115340
atatcaatga agtcaggagc acagaagtat aaaaatcagt aaaacgaaac aagaaacaaa 1115400
ggttaaaaaa taccacaagg gctggagaga tggctcagag gttaagagca ctgactgctc 1115460
ttccagatga cctgagtcca attcccagca accacatggt ggctcacaac catctgtaat 1115520
gagatctggt gccctcttct ggtgtgcaga tatacatcga agcagaatat tgtatacata 1115580
ataaataaat aaaatctttt aaaaaatcag aaagaatgta aaactaaca aaacgacaga 1115640

cttgaaagtc tgiattcttg aaagccaagc aaaggacaga taaccaatta agcaaagcgg 1115700
catggtacaa aatatacagg aaaaaaacc agcatttatt acctatgaat tcatcaacac 1115760
atgggtaag atctcatttt taatagtac aagaaagtta gattctttaa ctaaagagaa 1115820
aggtcaagat ataaaaagaa aacctaaaa tacttatgaa gggggttggg gagagagctc 1115880
attggtagag cacttgttgc tcttgcaggg ggatttgggt tcgattccaa gcatgcacat 1115940
ggtggcttgc agccatccat aactctagtt ccaggggagc tgaagcctgg atctttggga 1116000
accaggtaga tccatggtac acaccatac catacatac tgaagacaaa atgtatcat 1116060

caaaaaaatt ttaatgctt atgaataaca aaattttaa gacatggata aagtaatact 1116120
ctcatgtgca aagattcgca tgtgttagtt ttcctaatt tataatftaa ctagacaacc 1116180
tgactctaag gttttagga aaactctgaa taatcagatt agaaaatggt taaacctgat 1116240
cagattaaaa ctgttatta ggggctggag aaatggttca gtgggtgaca gtgggtgctg 1116300
tgcaagcatg agaattagaa cccaaatcc tagcaccac ataaaaagct gtgcatgggc 1116360
tggagagatg cctcagaggt taagagcacg gactgctctt ccaaaggtcc tgagtttgat 1116420
tcccagcaac cacatggtgg ctcaacaaca tccgttatga ggtctggtgc cctcttctgg 1116480

cctgcaggca gaacactgta tacatgatag atagatagat agatagatag atagatagat 1116540
agatagatag atagatagat agatagataa atcctftaaa aaaataaaaa gctgggcatg 1116600
gcaagtgtgc acctgtaact ctagcattgt ggggtggatg caagaggttc actggcttgc 1116660
tggtacctt atagctccag gttctgaaag aatftttctc aaaggaataa ggtggagagt 1116720
gacacatcag gacatecaaa gtcctctgac ttctaggcaa gctggttcta tgccccacct 1116780
cccatatgca ttaccacac acatacacac acacacacac tagcaagcat tgatgcatac 1116840

agtatattct caatagttag acctactatg gaaatttata gtgcatggga gattaactga 1116900

 attttggaaat ttaataatct cataaagggtg aagaaaaaat gaattcttgt ctttatataa 1116960
 tggacaagg tagtcatcta gaagattaat aaaattagat ctatttctcc tgctacacaa 1117020
 taactccaaa cagacaaaa acttcaaata ttacatctta gtattataga aacacagaac 1117080
 caacatttgt aatctttaag tggaaaggct tttctaata gaacaaatct aaagccctgt 1117140
 aagactgac aaacacaaac aaatagctgg tcatcgtggc agacaccttt aattccagca 1117200
 ctgaggaggc aaaacaagtc aacctctgtg agttcaaggc cagcctggtc tacatagcac 1117260
 gttccaggcc agccaagtct ccattaataa gatcctgtct caaaaataa taataaata 1117320

 gataaataa taaacaaaa aagggggggc accaacagaa aagcaaatct cagggtgag 1117380
 ggaattttct tacttagtta gcataagcaa ggtcttgct tcaaaccaca gcaccacaac 1117440
 aaaagaaaa gcaaatgaca ggggtagggt aagttcaatc tteccaaaac tcagatggta 1117500
 gaaggaaagt actaccttc ctccagcctc cgtatataac accacggcac tcacacatcc 1117560
 acatacatac acatatacata aatgttcaaa atttttaagt aaagtttatg gactcagga 1117620
 tagctcagag tcagatgta ggatagctca gtggtttagt gcttgctaa cacatatgag 1117680
 aactaggtt caattccagc actgccaaa aaatttaaaa gtatatttct aatttaatcc 1117740

 ttttagttga aactaagtct ttcaagatat tcaactttca tttgtattcc atagaattga 1117800
 cagacctgtt taagaactct ctgaacactt tcagagaagg tagtcaatag gaccctctc 1117860
 cattctccc aggacctaga caaaagggga aaagaacaaa gaagaggaga aatatacaga 1117920
 aagacaaat aaaccagta aacagattct aagccaaatt ccacctatta ttatttctgt 1117980
 taatttattc taagagttg taaaagaaat gacatatagt ctcttagcac agtggttttt 1118040
 agcaagtaaa ctattatcac caagaatgct caaggtattt tcaaacagct gtataacagt 1118100
 tacttacaca tgtcaattca tttttaaaat catgatgttt acagtttgtg ctttgtttg 1118160

 tttttgaga caaggtttct ctgtggagcc tgcctggaa ctagctctgc agaccaggct 1118220
 ggctttgaac tcacaaagat ttgctctgct ctgctctgga agtgcttggga ttacaggcat 1118280
 gcaccaccac tgctggcac atttttctta atgaatatta tatttcaatt gacatactta 1118340
 aaatacagac acatagccca ggaggaaagc ctgggctatg caatgtattc taggctagcc 1118400
 tgtgaaatgc tttgagactg tctcaaaaga ggaaaagagg aagagcatag gagaagagga 1118460
 agggggagaa agggaaagga gagagagaga aaggcaatat gtatttgccc aatgtagaaa 1118520
 ccctaagaga tttataatg gcattggagt ctcacaggct agctcattg tcccagcttg 1118580

accacacagt ccatataggt gttcttctgt tttaaactat aagtatgttg ataacatcat 1118640
 acattttaat ttagctttta ttttatattc tgaagaatt actttataaa tgacaactgt 1118700
 aaaaaacgaa caaagaaaca aataaataaa aacaaacaaa taaaataaca gatgtcacta 1118760
 accacaatt gtgccatagt acagttacta taccatccat tcatggaaat gaaataaagc 1118820
 ctagaacca tacaacatg tcttaaccta ctagtgttca ttttcaaat actaagatca 1118880
 gctggtatac atattcagaa taatatagct ttattcacta tttatattt tagacagaac 1118940
 tagctttgta gtccaggcta acctaaagct cctaactctc ccacctcagc cttccaagtg 1119000

 ctagggtcac aggtatgtgc caccatgtct gactctgatg agcaccaact acactaacac 1119060
 acaatgtgat atgggaagag agaggccgac catactaggg tggctttgcc ttgagttctc 1119120
 cttgtggcag tcagtaaagt tgtgaggcaa tacacaattt ttatgaatca acagttcttt 1119180
 aagttatata ataagatgcc agatcatgag ctacagctaa atagattttc aggtttcttt 1119240
 taggttttaa aacattcaag aactataaac aaaacattta ttcttctcca gtgtaagtgg 1119300
 gtagggaact atgataacct ttgtcaaaaa actcatctca cagtttaaaa taaaactgaa 1119360
 atttatcatt tggggattta cagaacaaaa aacctacat ttaaaaatat acacaaataa 1119420

 tatgtaagat tgttataat ggaaagactc agaaatatcc actgaagtac ataatacaaaa 1119480
 tatgcagttg ataaaaatta attagatata attttatgat ttagaaagaa atgtatgata 1119540
 tactcaaagg caaaaaaatt aaaaaataaa taaaataga agttgtaggc caggtggtgg 1119600
 tgcacacctt tagtcccagt actcaggata tagaggtag accagcctgg tctacagagc 1119660
 aagttccagg acatccaagg ctacagagag aaaccctgtg tcaaaaaaaaa aaaaaagaa 1119720
 aagaaagggt ttaactcaa gagctttatg ctttacagat ttgtctgctt aaaaaattat 1119780
 tttacttatt tattagtttg tttttacaga tacagagctg gagaaatggc tcagatgta 1119840

 ggtgcttgct atttttctag caggetggag tccagatccc agcaccctta tcaggcagct 1119900
 cataacctcc tglaaataac tccagtttca ggtatccagt gtcctcttct ggtatctgca 1119960
 gagagcaga catacagaaa cacacacaca cacacacaga ggggaaaaaa aaaagcaggc 1120020
 acaaaccate acaaaatcct acaaaagaaa tgcctccaat tataattatca ggtgtttgtg 1120080
 tgtaacctcc tcaccccagc tctgctttca gttatctcct aacctgaag tttatctgta 1120140
 ataacagttg atcaatttgg gttatactga atacaatttt atgtgcataa tataaataaa 1120200
 tataatgga atgtatcaaa tcaactgaa caaatggcca aatgagatga aaagtgctaa 1120260

 ttaatacaat atattttctc agatacacat ttctaagaaa tcacaaagaa aaaaaaatgc 1120320
 aactttataa tagagaccta gcaattacca ccttagtccc ctgatcactc acataatagc 1120380
 aatgtggcaa acaggaaggt acaggaaggt accatggaag tcaagcattg caggaccaag 1120440

tattcaatag tgtaacattt ttttaagac atggatgacg ggatagagag atgactcggc 1120500
aattaagagc acttgctgct cttgcaagta ttcaggttca gttcccagca cccatataat 1120560
ggctcagaga attccatccc ctctttggcc tccatgagta ttaggcacac atgtgataca 1120620
catacacaca tacatgtagg caaacactga tacacacaaa aataaaaatg aatacttttt 1120680

aaaaaatatg aagaacctga aagaagcaat gaaaagatta tgaaagaaca gggagaattc 1120740
tttttttctt tcagatgggg tctctatgta gccctgtatg gcctggaact caccatgtag 1120800
atcaggctag ttttgaactc acagatccag ctgcctctgc ctcccaaatg ccaagattaa 1120860
aagcatatcc cactatgact ggctgggaaa ttctgaaaag gtgaattaag ctcaactaat 1120920
tttacaaaag aagatttctc ttttaaggcaa ggagaaaact tagaatgatg tgtttcgagg 1120980
aggaccctaa gagagacata catggtcccc cagagaagag gaaagggaca agatctcctg 1121040
agctaattggg gaacatgggg ggaggggaga gggagctaga agaaagagag ggggaaaaga 1121100

ggaggggaag aggacaagag agaacaggaa gattgaatca ggggaagaat agaggagagc 1121160
aagaaaagag ataccataat agagggagcc attataggtt taaagagaaa tctggcacta 1121220
gggaaatgtc cagagatcta tgagtittgac cccaactaac aatctaagca atagtggaga 1121280
agccacctta aatgcccttc tctgataatg agattgatga ctaccttaat gccatccttg 1121340
agccttcate cagtagctga tggaaagcaga agcagacacc cacagctaaa cactgagctg 1121400
aactctggaa tcagtttga gagagggaga agtgatgagc aaaggggtca agaccaggct 1121460
ggagaaaccc acagaaacag ctgacctgaa caaggggttg ctcatggacc ccagactgat 1121520

agctgggaaa ccagcatagg actgatctag acccctgaa ggaggaagtc agtttgagg 1121580
tctgggcaat ctatggagcc tctgatggtg gatcggtatt tatccctagt acacgaatgg 1121640
acttcgggag cccactccac atagaggaat actcactctc tcagcctaga cacatggggg 1121700
agggtctagg ccttgcctca aatgatatga cagacttga agattcccc atggaaggec 1121760
tcaccctccc tggggagcag aaaggggtta ggatgggggg gaggggacag gggaggaaga 1121820
gaaggagagg gaactgggat tgacatgtaa aagaagcttg tttctaattt aaaattgttc 1121880
taattacaat tataaaaata ataaaaaaga atgttgtgtt gcttttttgt tgtagtatat 1121940

gaatctcaag atactgttct tgaacataga tgaacccat taaaacatg ctaacacatt 1122000
atggttgtec ttctccgtaa ggttttaaatg ttcaattatt ggtataagat ttctcagca 1122060
tattgcttct ttgtctgact aagttgcaaa atcccctttt agcctggcac attagataac 1122120
agtactgagt ccaggctttg tttctccca caaaattaag tactgtgagc ttctgttga 1122180
atataattct gtagctttac tttgtgctta gacctcattt gctacacttg ctgttattta 1122240
ttccccttgg atgcttttca agaaattccc ctagctgaat ataaaggata atgattttat 1122300

tatgattggt caggaattga aagatcagca acatgtatgt ccatgcttat ataatctgcc 1122360

aaaatctttt ctgigtgaat gctcatgttt ttgtccatta ctatttctag tgttacctc 1122420

actgtattag taagatccca agttatttag gcatttgact ctagaatgta atttacaacg 1122480

tatgcattaa aaaagattca cagctgggcg ttggtggcac acgcctttaa tcccagcact 1122540

tgggaggaag aggcaggcgg atctcttctg agttcgaggc cagcctggtc tccagagtga 1122600

gtgccaggat aggcctccaa gctacaaaga gaaacctgt ctcgaaaaa aaaaaaaaa 1122660

aaagattcac aaagcagatg tggtagtgtg cacctttaat ttcagcactt gggaggcaga 1122720

gataggtgga tcaactgtgag ctcaaggcca gcctgggtcta caaagtaagt tccaggatac 1122780

ttacaactat aaataatfff tctttttcga gacaaggttt ctctgtattg tttgagcctg 1122840

tccaggcttg cctcgaactc acagagatcc acctgcctct gcctcccaag tgctgggatt 1122900

aaaggcatgt gccaccaacg cctggcttgt aagtaattaa aaaatfffft tgttacatta 1122960

gtgggcatac actcatgcac acaactgaca catacagagg tcagaaaata actgttggga 1123020

ctaagcttfc tcttctatc atgtgggtcc tggggttcaa actcaggtca cgtaaagatg 1123080

gaaaatacac agtctgaate ctgcatatta ttgtgctgtc tttaaacttt ttgattgttg 1123140

atgaaagagc tgctaagaga cattgtatta tgaaagctgc tagattaaat caacctattt 1123200

attctaaaaa atatcttgac ttcaaatgg aagtcaaaag gtgtgttgc tgggtgata 1123260

ggtcatgctt ttatttctac aagaaatgag aggtgggggc tggagagatg gctcagaggt 1123320

taagaacact ggctgctatt ccagaggtcc tgagttcaat tcccagcaac cacatggtgg 1123380

ctcacaacca tctgttatga gatctgggtg cctctgctgg tgtgcagata tacatggaag 1123440

cagaatgttg tatacataat aaataaataa aatccttaa aaaatgacaa taatgtcaaa 1123500

aagttcactt aaaaaaaaa aagaaatgag aggttgtgga ttcatgccag gttgatatgg 1123560

atcaggtttg atcagagaag acctcctaaa aatcctggct acagacacac aaaataatec 1123620

taggaaaaat acaaaacaca ttaacatgta tttactaga aaacatttta acataagata 1123680

ataataatac agtctatact tgtattaatg cagatatgta tattacctt agaagtttat 1123740

gtattttcag agcaatggaa ccagagcaaa tggcccagg t aactcagcat ctcagaacac 1123800

ttctgttaca gtttcattag agttctatat ccaacaatt tccgggatgc tggctgagat 1123860

ggtccagcct cacagactac tccagccaag acttaacct tatcctaaat ttttcagggt 1123920

ctccctaaaa tgccagtgtt cccagatagt aggaagccat ctatggaaag caacatctac 1123980

atccccaaaa gatgaattat ggatgtttgt ctttgtttag ggggtttggt cacaaattat 1124040

tattggtcat ggtaaaaaaa aaaaaaaaaag caacaaccaa aaaactaaaa aacaaaaaca 1124100
 aacaaaaagg agttagattc aaagatctct tactgaagga aaaaaggggg atataatata 1124160
 gaaatgtga catgaaatga tagattattg aatctacttt aatcaacaaa ctattgatct 1124220
 caaaatattt tacattggca tggattttgg ttcattggta caaatttaca tttgttatac 1124280
 tgtatattat gtttctactg ttgtttaggg tattgcattt atggagctca tttaaaaatg 1124340
 taatgtataa ttaagaaata cagattgatt gtagtcaccc ataataatca agctttctat 1124400
 aacaaactta taattctgtt aggtatgttt tcaaggctcat acacagattt atttagatag 1124460

atggtcttca aacacttcaa aaaccaatat aatatggcat ttaatatggt taatacacca 1124520
 aaggcttttc atgacagtga gacatgtctg ctcttgacaa tctacttcaa aaaaaaggat 1124580
 gatgggcatc aaagaacctc cgtatggagt tggctttctt tatggcaaaa gctagccatt 1124640
 tgggcaaaaga aattgctctt gcctcaattg ctgacagtat actgtcctaa ctggaccagc 1124700
 agtatgcaaa aaagtgactg ctaaactttg ccaagacaag gtagatcagt tcttcaaaat 1124760
 tcctgcttc ttataaatgt ctgtcagata tacaaggcct gtaggcaaaa gatagatgtc 1124820
 acaaccttac agaagaactt tgggtaactg tccaggcagc cagatggcct tgccattagg 1124880

taatattaca actttctagg atctttgacg gagttaaaaa ctaataatt agacttaag 1124940
 ttttccttag ttatgacaaa aaggngaatt aggtacaaaa ctctagactc acaaagataa 1125000
 tattttaaga ttagcaaatc tctaattttg ctaaatataa atggattgga tattataatt 1125060
 ctacttgat aactgttttt gttgtatata attgcattat gttaaacct tcctttttta 1125120
 tttagacaaa agggggaaat gaggaatatg tcgctgtggt tgatttaata aagaagctaa 1125180
 ctggcctata ggtaggcaga ataaggttag gcgggagaac cagactaaga ggatgctggg 1125240
 aagaaggagg agaagacttg ggagtcttga gcagatgcag agagaagcaa gatgaacatg 1125300

ccatgttgaa agaaggfact gccatgtagc agagggtaga taaaaaatat gggtaattt 1125360
 aaaatgtaag tgcaagctag taacaagcca agcatttata attcatattc tctgtgtggt 1125420
 tatttgggaa ctggccggtg agacataaaa gtctacctac agtaattata tctgtatttg 1125480
 taagatatgc atgccacagt atggtatcaa gatgccttta tttgtttttg gttttcaaaa 1125540
 tagggtttct ctgtgtagct ttggtagtcc tagaactcac tctgtatacc aggctggcct 1125600
 caaactcaca gagatctgtt tgcttctgct ggaattaaag ccttgagcta ccaatgcca 1125660
 gcaagatgtc tttattttat atggtttaac ccattaagaa tataacaaca tgtaaacag 1125720

agatgacagg cactatgaca ggaggaagtt agtgtgtatg aaaacttgta tgataaagta 1125780
 ttttaagtat cacacagctc ccaataaac tgaatgtag cagggtgttg gtggcacata 1125840
 cctttaatcc cagcacttgg gaggcagagg cagggtgatc tctgtgagtt caaggccagc 1125900

ctggtctaca aagtgagggc taggataggc tccaaagcta tacagagaaa ctctgtctag 1125960
 gaaaacaaaa accaacaac aaacaacaa acaaaaaatg tgatgtattg caattgtgct 1126020
 acaagaaaat aatataataa atccagtta actagtagct agtagcaaca gaaactgggtg 1126080
 gtcattctaa agaatgatat gacaaaagtag ccaaaaaataa tacccttagt cctaatttta 1126140

 aatcacttta ggaatatag tctaagagaa aataggaaa ggcttaaaaa cagatgttac 1126200
 gggggctgga gagatggctc agaggttaag agcactgact gctctccag aggtcctgag 1126260
 ttcaattccc agcaaccaca tgggtactca caaccatcta taatgagatc tgggtgctctc 1126320
 ttctggcctg caggaatata tggaggcaga acataaataa aatctttcta atacttttta 1126380
 tttgtttttt gtttttcaag acagggtttc tctgtgactt tggaagcggg cctagaacta 1126440
 gctcttatag accaggctgg tctcaaac c acagagatcg cctgcctctg ctcccagtg 1126500
 gtaggattaa aggcattgac caccactgcc tggcctaata aataaaatct taaaaaacia 1126560

 aacaaaacia aacagatgtt acaaaggctac aattgagaat tgcaagacia aaaaaaac 1126620
 aaattgaaaa atacttaaac accaataat caagttttgt tttttgtgt ccaactaaaa 1126680
 tggcagatac atagacatga ctaaaagtgc atcaactctg ttaccataa aaaaaatat 1126740
 atgtatggta cagaaggctg tgtaggatg accttgttta tacttaata aataaagctt 1126800
 gcctgaggat cagagagcaa atcatagagg tatggaggctc tgtacagaca gacaggaaat 1126860
 aagaatgttg ggcagagaaa tataaacag gaggagacag gaaccagtc tcttttcagt 1126920
 ttgagtaatt cataggggta agagctctag aggctggctc ctccacttct cagatctttc 1126980

 agctttcacc ctgcaccgc cccatctctg actccaaact ttcattatta agacctatta 1127040
 gaattcatgt tgcatattgg cacccaacat ggggcttgaa accatgaccc tgagattaag 1127100
 agtctaactt tgaattttcc aatgctaat gagaaaggaa tgacagctgt ggagagacag 1127160
 aaaaactaca gaattaaatc agcctgtgta cttttaaaga tgtgctgacc tcagaatgga 1127220
 aaccaggatg tigtattat tggggaagg gttttgcttt tgtttccaca ggagaagaaa 1127280
 agctatggat accatcaaaa ttgataaaga ttagatttga ataggagaca cctcttgatt 1127340
 agaagagggtg ataattaatc aaacaacatg gctatccaat ctaaaactaac tgtaaaacia 1127400

 atgcttttca tttgattaga tataacttgc tataagggaa cctcccaaaa attagggtcg 1127460
 gggaaagtgt tttttttgt cttttcagga gaatgatggc attcagctaa ggaatctgaa 1127520
 gaccactgga caaatgagac atatgaagaa aaaggacaaa tcatccagaa aaaaatgttc 1127580
 caagaaaaag aataatttgg cctattactt taccacatct ccaacaagat acaatttcat 1127640
 aaattttcca aatgtttgt ttctgctttt ctctaaagac atacaatgca aatggctttt 1127700
 ttgtaatcct agttcaatta aataccaaag ctggctttgc agttggagga tggctctctc 1127760

cttctctaaa cccaagcatg cttattaaag caaaatccaa aatctctgtc ttatgtcaga 1127820

agagccacct gatatagaca gaagaaaaac aaaaattaaa ggactatfff attgccacta 1127880

atctcataat actttggttc tattttgagt ctttgaagct tttcttgata taaatattat 1127940

ctaaaaatft ataagattaa tatatacata tftaaaggft ttgtcacctg atactgacta 1128000

attctaggaa aaggcttcat ctgggttctt gtacatgatt ctggatttga atccctatca 1128060

aataactagg aattaagttt tcgtactctg gatgtacata acaaatattg atcccatatg 1128120

ctcttttgag atatgctgca tattacattt aacatgttta agttttctgc agtgaacat 1128180

gaccacacct aacagcaacc tttgaattat caatgaagga tggagcccca caacaacaat 1128240

tccaccaggc ctatggtagt aacaccacta agtccaaatg caccatctac agatgagctc 1128300

tggactacaa actgttcagg acaatttcga ggtagctagc tgagatgatg cagcctcaca 1128360

gactatgcta gccaggactt gagacaagcc ctgcaatttc ccattacaca gagactggac 1128420

aacaaatgat accactacct ctcccaggac ctgacaatta acccaaatft tctttttcag 1128480

aattccctga agatgtcatt gccccagac agcaggagta aatttaagaa tatgatgccc 1128540

acattcccaa gaggtggggt gttttgtttg gttattcaat gggttatgga tgtttgcat 1128600

tgcttggtta gaagttatta ctggtaatag tcagaaaaaa agttgaacaa agaagattag 1128660

attcagagtt cttgttttga acggaaaaag gggggatata catatgatag gctataaggg 1128720

tagattattg aatctactct gaaaagaaaa aaaggggata tagaacagg ataaaaaggt 1128780

agattattga atttactftt aaactaagaa agcaactact agttttaact attttatatt 1128840

ggcttggagt ttttgtgtat tgacacaaag ttgagattat ttttgttaga atatactata 1128900

tatatatata tatacataca tacatatatt tctaactctg ttcaagctat tgtacctatg 1128960

caactcattt aataaggtaa tgcaaattft tagcctftaa agttattatt atcaactact 1129020

taataaaaaa tgcaggttag tatgtagtca cttatcacia tcaaacttac agtcatatga 1129080

agtatatctt caaggtaaaa cacatfttag atagacaggg catcttcaaa cacttcagag 1129140

atctgaagaa tatgatattt aagatgtttt aatgacatat gttctctctc tctctctctc 1129200

tctctctctc tctctctctc tctctctgac aatagcat gtttgcctct ggcagiacca 1129260

atctacttca gagaaaatgg gcatcaaaga aactccacat ggagtttacc tcttttgg 1129320

caaaagttag ccaatgatca agaaagtgtt ctgacctaca ctgatgacag tatgctgtcc 1129380

aaattggaca agcaggacaa aagaaaggac tgccaaacct tgccaagaca ggatagcaca 1129440

gtccttcaga atatctgct tcacagaaaa gtctgtcaga tatgctaggt ctgtaggcca 1129500

aagatggatg cccaacccct gcagaggaac cttgggtgac tgtccagaaa gccagtgtt 1129560
tctgttattt ctcacatttt tttttttgga agtctcttgc ttgtacttcc tgcttactca 1129620
ggctctctgat ggagtgaag actttacagt tatagttttc ctcgttgcca gattcagaaa 1129680
agaaattcac taaagaaatg taaagtgtat aaagttgaga ggtagaaaaa gatagttttc 1129740
ataatgcaag ttaaaataga aagtgaatta ggtacaaact tttagacgca ccaagataga 1129800
atagatatgg agtacttttt ctgaatttgt caaatgttaa tggactagac actgttgatg 1129860
tatttattgc atatatatag tatatagtta atgtacttat tgtatatagt ttttcttata 1129920

ttagttataa ccttttttat ttttaacaa aaaagtagaa atgtggtgat atcttgtttg 1129980
tataacaaat aaagcttgcc taatgaccag agggcagatc tcgctctag ctaatcatag 1130040
aggtctggag gtctatacag atagattgtc agataaaagg gccagccaaa gacaccact 1130100
ttggccctaa taccagatcc aactctgccc ctaccaattg aaacatgaaa ccaaccaatc 1130160
cctgagccag agcctttact ctgaaccag agccagtga aaaaaaaaaa caaacactt 1130220
tatccctgaa cccagaacca aagaaaaaca tctgacttt gaaaccagtg ctgaagaaac 1130280
acactttgtc cttagaatca cagccagtga aagaaatag ccctggcctt aaaattagag 1130340

acaaaaggct aaaaaggacc agtgaagaa acacagctct gaaattagag ccatctctgc 1130400
ccagactcac taaactaacc aatccctgag caggaaaact aacctgtctc tgagtagaaa 1130460
aacctctctc cctgggaaaa acgtcttccc taataagtcc tatgtaagcc cctctgctg 1130520
ttcagttgct ggctgtcctt tcccacctg gcaaaggcag tcactctctc ggaatctcc 1130580
tccccaaata aatctctttc tcaagagtct tggatgaaga tcttcattcc ttggtgcaga 1130640
acagaagaac ttgctgggac gttcccttag gggtactgag caaggctgaa aagaacagaa 1130700
cagaagaac ttgccggaac ataccttag gggactgagc aaggctgcag cagaaaaagt 1130760

aacaattttt ctccagagcc ggaggagatt gctacatttc tgcagagget tccccttag 1130820
cagactgtag ccaaagagct aaagaagaag cagagcaggg ctcgctcggc tgtaaaggct 1130880
ttctcggaga ggagcaggat tgctgtatcc tgcggagaga ctaaccccca ttgcatccta 1130940
gcttcaggta gectggcttc ctaacaagtc acaacacctt tctctgcagg getgagatgg 1131000
ccaaggctc ccgcttcag agctgtctta ggtagcctgg cttcccagta agtcacaaca 1131060
cctttctctc cagggtgag atgttctatt gcatctccag cctccacagc tgtctattgt 1131120
ggctctgggt agctggctt cccaataagt cagggcaccc tttttggtt tttgtttgtt 1131180

tgttttacaa gacagggttt ctctgtggct ttagaagctg tactagaact agctcttgta 1131240
gaccaggctg gtctctagct cacagagatc cacctgctc ccaagtgtg ggattcaagg 1131300
cgtgtgctgc cccccccc cttgtagctc cagagctaca tttacacttg cttatatttt 1131360

ggtgcaaaat ccagcactcc cactcgctta cacagacagg aagtgagatg tttgggcaga 1131420
 gaggggaata taggtgggaa gagacaggaa cttggtttct ctcagtctga ggattttgta 1131480
 gaggtaaaga ctctagctct gcttctctga ccttttagct ttcattccct aacatctgac 1131540
 tctgggcttt tattattaaa acctattaga attcgtgtta cagaaggctc tgagttagat 1131600

 tcccaaaaac ttaaaaaaac aaaaaacaaa aaaaactaca aaagcctaca cgaattaagc 1131660
 ttataaagac tatataaact aataattata tttgcaataa acacaatttt taaaaatttc 1131720
 atggggatac ttgttcttaa acaccaaact aagaagcatt gccttgacac aactaaggaa 1131780
 aagcacctga agaccatcac tgatcataat ttgaatgagt atgcagtttg aacacagtct 1131840
 ttcttattgt ggacaaaacc aacaagctct cattagcgag acaaagaagc taatagatga 1131900
 ctcagtcagt aaagtgcttt ctgctccagt taaggattga attggaatct ctaggatcct 1131960
 gataaaaaaa gttgggcatg agggatggag agatagctta ttggttaaag agcacttgct 1132020

 cttgcagagg acccacaggg tgactcacia ctacctgtaa ctccagttcc aggtgatcta 1132080
 atgccttctg acttgactg gcaccagtgg tttgttggtc ctcagttggg agctgtttga 1132140
 ggaggatgag gaggtatggc tttgatgaag aagtatgtca ctgaggatag getctgaggt 1132200
 gtcaacagac ttataccgtt tagcgcttgc tcttttggc tctacttat ggttcaagat 1132260
 gctagctctc agtagcagca aaagaaaaca cccgatttga cctctagccc ccacacgggc 1132320
 acatacatgt geatatatta catatgcatt ctctctctct ctctctctct ctctctctct 1132380
 ctctctctct ctctatctat caagggggat ctatcattac cttgcataat acacaatctt 1132440

 ttgttgttgt tggtttttgt ttgtttggtt tttcgagaca ggttttctct gtgtagcttt 1132500
 ggagcctgtc ctggaactca ctctgtggac caggctggcc ttgaactcac agaaatccac 1132560
 ctgcctctgc ctcccagtg ctgggattaa aggtgtgtgc caccaacgcc cagctgtgaa 1132620
 tcttttttaa tgcatacgtt gctcacagcc cttttttttt tttttacatg getctattac 1132680
 tcagatatat tttcaaatt tatgtgtttg agtgttttgc ctacatgta tttatgtgca 1132740
 ggatgtgtgt gcccaatgcc catggaggca gaaaaggctg taagagtccc tgaaactgga 1132800
 gttatgaaca ttgtgagctg ccacatggga gctgggaacc gaatctaggt cctctgaaag 1132860

 agcagcaaga gagcccttaa atcaagccat cactccagcc cacacaacta agatccttta 1132920
 aagactatgg aaaaactgaa caggtttaga gaaaaaaca ggagttaaagg acagtaaaca 1132980
 gaagaatgaa gaaaagtctg taagaaaatg aaagcaatat gattatcaat gtctaacc 1133040
 acagacagge ttttgaatag agaccctgaa aagctatttc ccagtgccca cagatgactg 1133100
 accaagaaga gaagcttcat aaaatccaca agattactgg gctattgttc ttcataagaa 1133160
 gggctttttc ttgactatcc taatgatgaa ttattgagat gagcaataa atggcagatg 1133220

tgttaaatca ctgattctct gttttaactc aggggtgttta tttattcatg gtctactgac 1133280

 aactgtccct aaatcttgaa tcagttacc ccaacttgaa tcactgacca caatttaaaa 1133340
 attctacagt gatatectgc tcccacaacac tgtctagcca ccaaagccat caatatggaa 1133400
 atgtcctaga tctggcatcc atgccaccaa caaactgctc tggcttcac tctctacaa 1133460
 ctcaacacac cagcaaccag acatctcact atccaatgac ctaaataatgc ttcaaccatt 1133520
 ttatgtccac cattcccttg attcatttcc ccacttgta caatcttact ctttagtatt 1133580
 catttattha gtagatttct tgattgtgta tatgtgttta tgatgtgtgt gggacatatg 1133640
 tgccatggtg tgaatgtgga ggtcagagga caactttgtg gaaagcagga agcaccttta 1133700

 tctactgagc tgccttgctg gcctatthtag taaatthta tttactagct ctgtgccatc 1133760
 tcaaagcca cctattaaga gataaaatgt gtcctcagat cagthtaagt cthttattctc 1133820
 agaaaggaac thaatthgaa atagaaact agthcattaa gatgaggtgg tatcagacag 1133880
 aggaggctct thaatcaatg atthttatct thctaagaag gacatthgga catagagata 1133940
 ctgggatagc tccactccac aaaggaagag gcaaacaaaa agaathcaaaa atthaatgthaa 1134000
 gctgtacatg gcagcacaac tccctaaccc tggcattcag aggctacagc aaacaggcag 1134060
 aaggatthac tgaagcctga ggaacatga cattgttggc acccthaagth cacaatctag 1134120

 cctaggttht ggtctthcaaa actgthagaa thaaactthtag ththtaagtca ccgagthtgt 1134180
 gtctctgthaa ctgaagccca agaaatthaat acgccactt tcactthtthc cattthcccaa 1134240
 attcccacag cactgtgttg thttatathc agagactgtc thgtgatata gtctagctga 1134300
 actggaactc actatgtgac ctagaathagc thcaaaactth tggthactthcc thttctctgcc 1134360
 tcagthctatc aagagccgtg actctthtccc ctctthccat gthtcacagga cctthtctaga 1134420
 tgaactthtth tctggaaagc agaaactath gatggccctc tgtacthaag agthactgcat 1134480
 thaaaaaata gaaaththaca thttatactha thththtctth thththaaagth tghtaaacacc 1134540

 acaatathaat thaatthata gthattcathc tgtatthgggt atththaaata thctacacath 1134600
 aatththcaaga gthacaggagg athacacagag gththaaatgca aathagggcag thththtctath 1134660
 agggthactthg agcathctgtg ggtththtgth thcaagcagag thctgaaathga aacctccathg 1134720
 gacactgaa gcccacacath thcathactct gthgcatggct cththaacact ggcctgthatt 1134780
 caathathac thgaccaccag thcaththccc thaccaacac actthththtthc athctgaaathg 1134840
 thctgagthg atcathctca thathgctga caagththaac acggcacathaa aatththctac 1134900
 thgaaathct tagthththgt cthctthggth cthththcaaca gthcacacath cactctacc 1134960

actgagctac atatccagtc caaagatgct atttcttagg aaacattcct agattcatag 1135020
 ctacttatta tgcaataca caagattggt atgtacacat actgacttag ctaatgtcca 1135080
 caatggaaaa ggatgtttaa aaaatacctt attgcggaac cacttcattt gacttattct 1135140
 cttctcacta tctaggccag attgcgtaga aaatagaaac cctcctgcct caggctcctg 1135200
 agtgttggga ttatagacat gtaccatggc acctaggtct tgattctctc ttagtcttta 1135260
 ataaaacata gtttacttaa aatctttcca actttgctag catttgggtgg gtaatgatgg 1135320
 tacttttgaa tttttccaac tgtttaaat cttaagtct atattttata ggaagaccac 1135380

 agagtactt ccataaaaca ttaaataaat atagcaaaga agatggtgag gtgctcagca 1135440
 ggtaaaggca ctagttgcca agcccagcaa cttaaatca atcaatccct ggggctcaat 1135500
 ggtaggagaa aatagatttc tacaagttgt tctctgactt ccacatccat gcacacacac 1135560
 aacaaaaaca ataaacaat acaattaaga aataataata taagaaggga cttaacctaa 1135620
 tgaataattt cgcaaatagt aatctgattc acaaatcac cattatttct tctgagacc 1135680
 tctgtttgag ctttagaaaa tgtaaatggg cagtgtgaaa taaatctca acaggtttag 1135740
 tattaggtaa atgagatggc taatgagaac ttctgttgcc tttgtgtgca tactggggat 1135800

 gctgaagtta gacactgata tatacagaat ataaatacct atttatagag taagtacct 1135860
 tcaaatttga tggacattag tattgatata tatatatata tatatatatt attattatta 1135920
 tgcatagtgt tctggctaca ggccagaaga gaccaccaga tctcattaca gttggttgtg 1135980
 agccaccata tggttgctgg aaattgaact caggctcctc ggaagaacag ccaatgctct 1136040
 taaccactga accatctctc cagccctgat cattagtatt attaactggg acaagttaat 1136100
 attattagct gatcactatt ctaaatagata cagaatagga aatccctcac aattatgtat 1136160
 tctggtttgt atataaaata cagcataaca aactgtatgg ctgccattta ctcttccac 1136220

 cagtagggtt tattcccttt atgtacttat ccatacatag ctgtagacat ttattaaata 1136280
 ctttactagt tattatctgg ggggtgctca aagggtgtc agatctgaaa atggaattac 1136340
 aagtagttgt gagctgcctg ataagggcgc tagaaatcaa attcaggttc tttgcaagaa 1136400
 caatatacat tcttcttgc tgagecattg ctccaggctt agaaatttat taattaactt 1136460
 agcaaatatt tgttagctc ctaagcacc aacatatgta ttttttagaa taaactaaag 1136520
 tagaaaaaga tcaaatattt taaagtaa ataatatgcta gattacacag tagacaatgg 1136580
 caaggaaggg gagaatgtag gagcaaccct tggcccagcc cccaagaagc actcagtcta 1136640

 atgagcatca agggaataaa ccggtctat catttccctt tctctccatg ttgatcgagt 1136700
 gcttcacaaa agggcttctt ctctaacag tcagatttca ttaaaact aaaaactttt 1136760
 tttatatata attttcaag acaggtttc tctgtgcagc tttgtagacc agaaaagatg 1136820

gccttgaagt cacagagatc gcctgtctc tgcctcctga gtgctatgac tagaggtgtg 1136880
gccaccact gcctggccac tgaaaacttt tctgatggct tccactgttt agtcaatcaa 1136940
gtcaaaactct ccaaaatgaa acagaacatt caaaatcttc cacaaccag atgtgtggca 1137000
taaacctata attccacaac tctgaagaga aggcaggaga atctcaaatt caacactaac 1137060

ctgggctcca taacgagaag ctgtcttaaa acaaaacaac acaaaacaa ccaaaaaagc 1137120
cttccatgat ccattagcaa atgcacaaat tacgaagaca gtatttgcaa ctagactgtc 1137180
agaatgcaaa tttattatca actgttacct ctatcttttg cttagtctat aaaaaagggg 1137240
gttttaaaaa ccaggcttct tcaactaagt attatgagga tcaataaaaa tacaacttgt 1137300
gaaatgatca gcacctact agcaaacagt aaccatgcta aaatagagt cctaccactc 1137360
cttttaaaag ttttacctat cattgttgct gccattcaat cttcatttcg aaccttatct 1137420
ccaaaaacac tgtgtacaag cctgttttcc aggc aaatgg aactagaact ctttatttgt 1137480

tggagtgtga gtgtgagtg gtgtgtgtgt gtgtgtgtgt gtgtgtgtgt gtgtgtgtgt 1137540
gtaagt caga ggacaggttt ttaggtcag ttctctccta ctttaaggtg gggcaagtgc 1137600
ctttatctgg taagctgtct cacaagcccc aaactagact cttaccatac cetaacacaa 1137660
accactatac tcagggttca tcagtgcatc ttcatgtact aagattctca ccattcttga 1137720
ggctctatct cagctccaca atacattaca gacactcacc acacaaatc tgctagattt 1137780
atctttaga ctggcagtg tagagttcta gccagtttgt ggcatctac gtagctctta 1137840
ataaaatggt caaagaatga attcctgctt ccctctctt gtggaactgt tacgacaacc 1137900

gctccatate acaagtacaa agacttcttt tgcaatattt tgtaaagctg gctagcaagt 1137960
tctctatcac cagtgtggta atttctaata tagcacagta cccaaagcac agtagatgcc 1138020
taagtatcca gagagttaaa ctgaatttca cttcatctta taaattaaat tctcattttg 1138080
tttactgtgt tcaagtacag ctgagccctt taaatatatg ttattattta acctgtccat 1138140
aaacctatgt ctattttcag tcatttcgac cttatctcat ttgctatttc ttggtaaga 1138200
gagacaatat ccaaaattcc aaaaaagaaa aaattagaaa attaatgct tatagaacca 1138260
taaaacaage aagagagctt cagaacacaa agaactagaa aatacatctg cctacaagtt 1138320

ttgctgcgtt tttctatgaa agaatatgag cctggatttg acagatcttc caagttttca 1138380
agacaagtca gaaattcaga agtttgtata aaattttaaa gacattacca agagattcct 1138440
tccaataatc tccacctagt tctcaatcat ttttaactaa cctgagagcc aaatacatgt 1138500
ggcaatttat ttaactatga tgagtcctta ctcagtgcca ggtgctggaa aatgagacat 1138560
gaacagtage tataaatagc agctaacatt tattgaacat ttttaggtg ccaggcactg 1138620
ttctatgtgt tacaggaatt aatttaacc ttttaacaac tctactaagt aagtactact 1138680

atctttatatt taaagatgag gaagctaagg cacaaaagtt acataaatct gttccaagtc 1138740

 atgcaattag taaacagcaa agctgaaatt aggaccttag attacacca aaaacctacc 1138800
 atttgaaage aagcactatt caatatattag tactgagatc actgattaca catagataaa 1138860
 ataatgaaac tgcactctac ctcatccac acacaaagtg gatcagagat ctaaacatta 1138920
 aaggcaaac agttgagatt ctagaagata atgtacacag taacttaaaa atcctgggag 1138980
 aggatatgat tgataaaact gaaagtaaaa ttccaaactt tcagcaacct taaacagact 1139040
 tattttaatt tatttaata cttttatgtg tataattgct ttgcctaat gaatgtatgt 1139100
 gtaccacatg tatgcagtgc ccagggagac cagaagaggg caccggatcc cctgaaatta 1139160

 gacggttgta aaatgcaaag taggtgtggg aaactgaacc tggatcatgt gcaagagcac 1139220
 tgagtgtctt taaccacca gccatctctc cagcaccctc tcaccttttt tttctccca 1139280
 atactaagga tcaagccagc ggcaactgagt atgccaggca aattttgtca ttcagctatg 1139340
 tattctcaac tttcggagtt ttaaaatata tattacaaac tggaatatga catctgtaat 1139400
 acatatatac aaggtttaat aattagaata tgtaaagaaa cacttccaaa aataatacaa 1139460
 taggaaaata tatactctaa ctgaacaagc cctagctagg tataaattgt gcaaacctaa 1139520
 cactaccaga gttaacccat tcagcagact ctggaacagt caatttgcta tcaactgaaca 1139580

 ataataaata atcagggtctc tatgtcatgt tgcaggfact acagagtagg aggggaatcc 1139640
 agcgagaaga gcagaagcaa gatggcaatt ctccacagtt agagaaactg gatagcaagt 1139700
 agagggtgaa cagctaatgc atcaaaagta gatcaagtga tgaaaaactt ttttaaaaag 1139760
 gtattttcaa ctttgtgagc tgatataaat tctctgccac aactgctcaa ttcagtcact 1139820
 gggagcactt acagccatag atgctatgia aatgagtggt gttgtattcc aatgaaacat 1139880
 tacttcaaaa aacaggtggt tggcaagatt tgacctatga gctagtttgg tgaactttaa 1139940
 tataggaage tataattcct acactctagg aacactttct gcatcttatt ttacttttta 1140000

 tgtccgctga cacctaattt ttctaagcaa aaactatact acacttaaca gcttttgaat 1140060
 ggtaaaaagc aaaacaaca caacaaaaac ctctcttate tgtgacaatt ttccgatcat 1140120
 ttttatttca ctgaaaaaaa atgtttttga caatcatcca aactagtttt aaaatgcccc 1140180
 ttatcaatca cagtatcagt tatccatacc tagaatgtct aactccgctc aaaatccact 1140240
 ctgaacctta atttaggact ttattatttc tttctttct cttcagteta tcattcatat 1140300
 cttaaaagaa catccattgt gctgagaagc tagctcagtc cttaaagttc ttgttttcca 1140360
 ggcatgagga cctgagttcc atcccatgaa ccaattaaaa caaaatagac aacaacaaca 1140420

acaacaacaa aataggcaaa atgcctgcaa tctcagtgt gaagaggcag agacagacag 1140480
aatcctgggg tttgctgggc agctggccaa ccctacttgg caaattccag gccatcaaga 1140540
gaacctgtgg atagatgaat ggatggacag aaggaaggac ggacggacag caggcaagca 1140600
ggcaggcagg cagatacgga tgcatgcaaa gttaaatagt gcctgagaaa tgacaacaga 1140660
gattgaactc tgggttctac atatatgagc acacatacac acacacatac acacaaagag 1140720
cacccattca ccttttaaaa attaaacctt ataatafact cctcctgtct aaagtcttgt 1140780
ctcctcctca cctgaagagg gttcaagctt acctcctcag tcacaccttt aacagctttc 1140840

ctcatctcgt ctctcacat acttgacat aactgtgtct ccaccttatt caaggtacat 1140900
gtctttgaaa ttcaagttat ctatttcac actacatctt atttttttaa tgtgctggta 1140960
acaaagtaaa taaagggtc ggaagatggc tcagggtgta aagtgttgt cacacaaggg 1141020
cataaggacc tgaattcaaa accctagtcc ttacataaag gcagcatgct aacagtgcac 1141080
atctgtaacc cactgcttg agggtaaaga ctggcagatc cctggagctc cttggctagt 1141140
cagcctagct gaatcaataa gctccagggt tagtgagaga ccctgtctca aaaaataaaa 1141200
tggttgagac tgtaaaatgg ctgagcaggt aaaggcactc tatctgtcaa tcctgatgac 1141260

ctgagttctg gcatacccac ataagtggaa aaagagaagt gatccccaca agttgtcctc 1141320
agattccaca cacatggccc cacacacaaa taactacaga aaataaaatg tcaaggtaaa 1141380
aaaataataa ggtagagaaa caatcaagga agacacacaaa gtaacctct ggtctcccca 1141440
tgcatatgca caaactgat aagtactact cctccacctc ctccacacac acacacacac 1141500
acacacacac acacacacac aactctgca aggggggaat agttcagtat tgcaggctta 1141560
cctagattga gcaagacctt gagttcaatc cctaccacca cattcacaaa taggtgtaca 1141620
gatacttcag cataacaat ttttatactt agtaactatt tgaatgtaac tagtttcctt 1141680

tgtaatcaat gtcattfact ttatacaatt aaaaatatta ttttgagaga tccatgctac 1141740
agggaccatg gcacacataa gatcagatct ctgcattaga aagactcaga aaaattggta 1141800
ctgaatatac atgtggtttt gaaaatcctt ataaaattct tttgattaaa ctccatccct 1141860
tttgtgctgg gaataaaacc aaggecctta tgttgatgc taggcaaaca ctctaccatt 1141920
taactacaat gccaacacct gaaagtctat ttttttct ctggaggcag gcccttact 1141980
ctatagccca gactctctg cctcagctc ctatgtgtg agatatagat gtgaaccacc 1142040
gtgcctggct tcaagtttg ttttgtttt taattatgtg gagttttgta ttgtctgtca 1142100

ttccttggta tatccatggg caatggattc taggacctcc taggatatca aatcattat 1142160
ataaagtgat acaatatttg tgtatcctgt ctacctgtaa tagccaataa aatgtaaatg 1142220
tcatgtaaac agttgttaag ctgtctagtt tagggaataa taataacaag aaaaaaac 1142280

agtgacaagg aaaaaaccc t gatgtttag cacagtttca attttttgtt ttatgaatgt 1142340
 ttctaactcg tgattggttg aagctgtaga tgcaaaactc agggacatta aaagtcaact 1142400
 atatatcact ggctgattta tctcatagtc catttgaact ctcaattgcc tatttataac 1142460
 agaaattcaa ttaaagtgaa tatgatgggg accctaggtc tctatcatta tccttttttc 1142520

 cccttttaag ctttttgtgt tcttttctg tgcaataaac atccagacga gggggaacat 1142580
 ttttttaaac tctagaaaga ggttctttct tgatgctttt ttttttgtat caatggagat 1142640
 ctaggaaata tccaataatt gattatacat ttttgtatcc cactcaggct ttgtactgac 1142700
 aaacttgta aaacaaaaat taatgactct gataatttaa tggagtttga cttagcaact 1142760
 gaatgaggaa gccttagtcc atatccagga gcctctgtca ccgacacaaa ctatcttagg 1142820
 aatcaatta ccttggctaa aatcactact tgatttgaac ccatggcatg atctctgtaa 1142880
 agccaccgta gttattacat gtcttttct tcttcacgat tctgactagt ttcaacaaga 1142940

 cctttcagac gacctccca ggtgacctg ctctttaagc agcggctgtc cccttcagg 1143000
 aaacacactt tgggtcaccg ccccaaaaca gccgggtccc tccttttaa gacaactcct 1143060
 taagttgatg gaggttctct cctttcctac cagttccact ctgtacctt tgctgtccag 1143120
 ctctacatc cagccccctg ctggcaccct tcttttctc atcaagctct tccttttcc 1143180
 tgttctgccc tccaacggga ctggaggtc ctcagggtc acaggteccg agaccttgg 1143240
 gagtcataaa gactggccat tcatgtccag gacccttcca ggctgattcc cgcgtcggtg 1143300
 accactctg atccccgagt tgcacaacc cattcctaag caatctctc cagcgcacgc 1143360

 aaagaacaac tccagcctg acagccagga ctcggecccc aagetgcctc cctaccct 1143420
 ggctgctgct ctggggctcg gttnnnnnnn nnnnnnnnnn nnnnnnnnnn nnnnnnnnnn 1143480
 nnnnnnnnnn nnnnnnnnnn nnnnnnnnnn nnnnnnnnnn nnnnnnnnnn nnnnnnnnnn 1143540
 nnnnnnnnnn nnnnnnnnnn nnnnnnnnnn nnnnnnnnnn nnnnnnnnnn nnnnnnnnnn 1143600
 nnnnnnnnnn nnnnnnnnnn nnnnnnnnnn nnnnnnnnnn nnnnnnnnnn nnnnnnnnnn 1143660
 nnnnnnnnnn nnnnnnnnnn nnnnnnnnnn nnnnnnnnnn nnnnnnnnnn nnnnnnnnnn 1143720
 nnnnnnnnnn nnnnnnnnnn nnnnnnnnnn nnnnnnnnnn nnnnnnnnnn nnnnnnnnnn 1143780

 nnnnnnnnnn nnnnnnnnnn nnnnnnnnnn nnnnnnnnnn nnnnnnnnnn nnnnnnnnnn 1143840
 nnnnnnnnnn nnnnnnnnnn nnnnnnnnnn nnnnnnnnnn nnnnnnnnnn nnnnnnnnnn 1143900
 nnnnnnnnnn nnnnnnnnnn nnnnnnnnnn nnnnnnnnnn nnnnnnnnnn nnnnnnnnnn 1143960
 nnnnnnnnnn nnnnnnnnnn nnnnnnnnnn nnnnnnnnnn nnnnnnnnnn nnnnnnnnnn 1144020
 nnnnnnnnnn nnnnnnnnnn nnnnnnnnnn nnnnnnnnnn nnnnnnnnnn nnnnnnnnnn 1144080
 nnnnnnnnnn nnnnnnnnnn nnnnnnnnnn nnnnnnnnnn nagcgagcat gtgagccgag 1144140

gtgctgggtg cgatcttggc ctgctgcat gttcagcgt gtcccagcgg ctggctgtgt 1144200

 gtgctgcgta acgctccacg cctcagtgtg ctctccccag ctatggggat gatagtattt 1144260
 ccttgcgcag aggaaatgag ggaaaggctt ggaagcgtc taatgactga cgataaagat 1144320
 aacctttatt ctatctcccc cccccccact tctcccacc accctaaca acacggtagg 1144380
 tgctcacaaa atagaactgg tgagtgaaca ggtggaggcg ggcctctggc ttctctctt 1144440
 cccaaagcag ggaagtgttc ttagcactgg gctgagccca ggtcactta aatcagttec 1144500
 cacccttag ctcatgatt ttctttacct ctgtgtctca gcttcttct ctgtaaggac 1144560
 ggttggggca ggtgattct taacggctca gttatagtgt ctcatctaag agaggactct 1144620

 gaaacgcttt cttccacgg gtattattg agtgcacact gtgcacatag actggtatgg 1144680
 gtaccacct taccagcacc gccagcgtgc gccactattt ttcttgctag taatattcct 1144740
 ccgtcagaat tctgagcgtg ccactctctt actaaaaatg attcgacaga atctaggggt 1144800
 gtgtgtgtgt gtgtgtgtgt gtgtgtgtgt gtgtgtgata aaagctgcag agtgagaact 1144860
 atttgagggc agaagggatg ggagaggtaa tgcgaagtaa ctataagcgt gatacgatg 1144920
 tatgaaaate tcatgatgaa acctattaat aattatttta aagatctatt tatttttatg 1144980
 tgagtgtttt tgctgtgtg tgtgtgtgtg tgtgtgtatg tagcacatat gtacatatgt 1145040

 tctccacacg tgtatatatg tgcaccacac acttgtgcct gaggcctgtg gaggtcagaa 1145100
 gaggtgttgg gtcccttggg attggagtta cagagagttg tgagctgtca tctgggttct 1145160
 gggaatccct ggttcctctg gaagagtggc cagtgtctt aactactgag tcacctctcc 1145220
 agtcctaaa atcattttt ttaattaaaa aaaccaggc aggcaagatt ggttaataga 1145280
 taaatgact tgttatcaa ggctgacaag ctgagttccc tcagaagctc acacgacagg 1145340
 aggaaagaaa tgactcccac aagtgtctt ctggcccctt agcatgtata tgectacaca 1145400
 catgtgtaca ggcatacaca cacattaat ttttaaagat attttacttg gtatatgagt 1145460

 gttttgccag catgtgtgtg tgtgtatgtg tgtgtgtgtg tctgtgtgtg tgtgtgtgtc 1145520
 tgtgtgtgtg tgtgtgtctg tgcgtgcgtg cgcgcacgcg gcataccatg cacataccta 1145580
 gtacctgctt gtggaggcca aaagatggca ttggatctct tggaacagca gttatagatg 1145640
 tttgtaagcc tccatgtggg tgctgggaac taagccactg gactatctaa tgccatacag 1145700
 ccatttttta ttgtctata taatatattt tatgtatttc tttttattt atttttttt 1145760
 cattttactg accaaccaca gttcccctc cctcctcttc tcccactctt ccccacttc 1145820
 cctcttcca cctcctatcc actcttcaga ggggggtaag gcatcccttg ggaagtcaac 1145880

gaagtctggc ataccaaatt gaggcaggac caagcccctt cctgctgcat caagtctgag 1145940
 caaggtatcc taccataggg aatgggtcca aaaagccagt tcatgctcct gggataagtc 1146000
 ctggtcccac caccagaggc cccacaaaca gatcaagcca cacaactgtc acccatattc 1146060
 agagggccta gttcagtccc atgcaagttc cccagttgtc agtccagaga atgtgagctc 1146120
 ccactacctc aggtcagctg tctctgtggc tctcccatc atgctcttga ctccccctcc 1146180
 ttgctcatat gatccctcct ctctctcttc aactaagttc cagaagctca gcccagtgtc 1146240
 tgagtcatgc atccattttt aaaatgtaat taaaaaattt taaaccatt caacacctct 1146300

 ccatttctct taagctaaag gacaaacaaa tctctccctg gtgcagtcac tgcacacca 1146360
 gtcttatttt ggggtcctct ttccttcctc ctggctccct gtacatgctg atcccactgc 1146420
 ctgagattct ctctcacata gcgaaccttc atgtcccagg tcaaacatgg ctacctcacg 1146480
 gatatgatct ctcttgacac agattctctt ggcagcatgg acttatcaac tgactgcact 1146540
 agactgttta ttatctttgc cactaggctg gactcactat gttggctgct gtttctgctg 1146600
 taaatagcac gatgtctgtt agagagtagg tactgggtga gtatttatgt ggatcccatg 1146660
 tgtcattcta tgtactagge tcaagatctt aaaaagatgg agagcaacag gcaggccacc 1146720

 agggctctgc ttatgtagcc ccgtctggcc ttgaactcaa agattcatgt gcctctgcca 1146780
 catcaatgct gggattaaaa agcatgtaca accactccca agccttttct ttgttaaaaa 1146840
 taacttttta tcatggtatt ttaaccacac aacataatag gtttcattat gacatttca 1146900
 tatccatgta tgttatactt ggttctatc tactccatgt cattctctct tgaattctc 1146960
 ctctctttct ctggccccct tctcttccc aaatagctct ctttctactt gtcatttttt 1147020
 taaaaaaaa atctaaattc tacatatgag agaaaacttg caatattgtc ttttctgagt 1147080
 ctggcttatt ttacttaaca aatgatctc tagttgcaat cactttccat caaatgacat 1147140

 ggttttatte tttcattttt attttaatt cattttaact ttacatggat ttagctaggg 1147200
 agagggtgct tgcgcctctg tgtgtgtgtt gtggggaggg tgcccaaaga atctagaaga 1147260
 gggcttcaaa ttcctagag cagttgaatt cgggtcttct gaaagagaag ctagtgtctt 1147320
 taactgggtg gtcatgtctc catctcctat ttttattttt attttttaa acaggacatt 1147380
 tatatattcc tagctagcct agaacttatt ggacccaaac tcatggagat ctggctgctt 1147440
 ctgcctctca aggattggga ttaaaagtgc acttctatat tcagctgatt tcattctttt 1147500
 tatgactaaa taatacttaa ttatgtattg caagaacttg ggattctaga ctgattacat 1147560

 agtttgacca ttgigaataa taccacagtg aacacagtg tgtgggcatc tctgttgat 1147620
 attaactttg actctttctt aacttattaa tttttttta cattccaac ccagtttccc 1147680
 ctcactcttc tctctctgct cccccaactc tcccatctgc tctcaaaga gggaaggcc 1147740

tcccctagga agtctactaa gtttattcca tcatcatctt gagacaggat caagccatgg 1147800
 ctaggctgag caaggtatct ctccatagag aatgggctcc acaaagtcag tttgtgcatt 1147860
 agagttagat cttggaccca ctgtcgggtgg cctcatatat tgtcccagct gcaccactgt 1147920
 ctccatatt aagggagctc agtttggctc tatgcaggtt ccccatattat cagaccagag 1147980

 tcagtgatct ctactagct cggggcagtt gattctgtgg tcttgactcc ttttattatc 1148040
 actcctccct cactttgatt gtactccagg agctcagccc aaaggttagt tgtggattcc 1148100
 tgcactgct tccatctgtt tctggaagag ggttctaact tccctgggggt tgtgaattgt 1148160
 ataggctgtg tatcttttgc tttatgtctg gtatccactt atgagttagt aaatactata 1148220
 tttgtcttcc tgggtctgga ttatctcact taggattttt ttttagttc tgtccatttg 1148280
 cctgaaaatt tcaggggtca gtgtttctta ctccaagta gtacttcatt gtgtaaatgt 1148340
 atcacatttt ctttatccat tcttctgttg atggacatct aggttgtttc caaattctgg 1148400

 ctattacaaa taatgttct atgaacatag ttgaacagat gtccttgtgg tgtgaatgtg 1148460
 ccttctttgg gtatatgcc aaaagtggta ttgcaggatc ttgaggtagg ttgatcccta 1148520
 attttctgag aaatcgcat actgatttcc atagtaactg tacaatttg tattcctacc 1148580
 agcaatggag gagtgttccc cttactccat atcctttttg gcataaactg tcatcagtgt 1148640
 ttttgatctc aaccattctg atcagtataa gatggaatct cagagtgggt ttgatttgca 1148700
 tttccctagt gactaaggat gttgagcatt tccttaagtg tcttccacc atttgagatt 1148760
 gttctctgtt tagatctgta ccccatttt gaattgtatt atttgttagt ttgatgtcta 1148820

 gtttcttaag ctatttgat attttggaga tcattcttct gacagatatg gggttgaaga 1148880
 tcttttccca ttctgttggc agccattttg tcttgttgac tatgttcttt gctttacaga 1148940
 agcatctcag ttcaggagg taccatttat taattgctgc tctcagtgc tgtgctaact 1149000
 ggtgatctat ttaggaagtg gtctcttctg cctattcatt caagggtatt ttccactttc 1149060
 tcttctatga gggtcagtgt ggatggattt atattgagg ctttgatcca tttggacttg 1149120
 agttttgtgc atggccatag atatggatct atttgtattc ttctacacat tgacagccag 1149180
 ttatactage accatttgtt gaatatgttt tcttttttcc atttatatt tttagcttct 1149240

 ttgttaaact ttatgtgttc atagggtgtg gggttgatat cagggtcttc aattccattc 1149300
 cattgttcca ccttggtttt tatgccaata ccaagcagtt tttattacta tggctctata 1149360
 atagacttt gaagtcaggg atgggatcc ccccatatga tcctttattg tacagggtta 1149420
 ttttgctat cctggttttt tgtttttcca tafgaagtgt agtattgttc tttcaaggtc 1149480
 tgtgaagaat tgtctggga ttttgatggg gattgcattg aatctgtagt taaccttgat 1149540
 tcttttagtt aggtttacat aagagtgtga tagctgaatc atatagcaga ccttttatta 1149600

cctgtttgag gaacattcac actaatttcc atgatgactg gattaattta tgttttcatt 1149660

ttataaaaag ttgtaattta tatacagtaa aataaaaaaa accttacaca tgtacctaat 1149720

atTTTTgtgg tcttaggaat ttgaactcag caccttgcac ataactagata aatgctctec 1149780

cactaagcta tatccctggg gcacataata agtcttttac ttatgttctt gtggtaccac 1149840

cactccaate aagtgcaga tcagttaatg catcaagttc cttttgttt cttccagtg 1149900

aatgtccate ccattagaag taagagtta ccaaatttct agcatcataa acttattttg 1149960

ttaattttgg gggctgggca ttgggtgggc atgcctttaa tcccagcgct cgggaggcag 1150020

aggcaggcag atctctgtga gttcgaggct agcctggtct ccagagcgag tgccaggata 1150080

ggctccaaag ctacacagag aaacctgtc tcaaaaaacc aaaaccaaaa caacaaaca 1150140

aacaaacaaa agatttgaag tgatgagatt gttagtgcac atcaaacatg gagaagatga 1150200

actgggtgct taccagacac ttcaccctg ccgactagca tttatgggtg tggaggtcac 1150260

tctgcaggat acagagaaga atggtaatca ccaatccagc cataaaccta caatagtac 1150320

ctccctgaga gatatgctgg tatagcagcg gcacaaacaa tgtgggagta accaaacact 1150380

ctctgattgg atttaaggcc aatgccatga aatggaagcc atgcctgaca cttcaacaac 1150440

cggccacaga tctaaggaa aaccaactac tgttgtgtg ctgaaggaac atagcgaca 1150500

aatgactcct aatgtggggc tggagagatg gctcagtgg taagagccct ggttgcctt 1150560

tcttcagag gtctgagtt caattcttag caaccacatg gtggctcaca accatcaata 1150620

atgggttctg atctctctt ctctctgata cctctcttg ccatgcagc ttgcatgcaa 1150680

attacataaa ataataaata aataagtctt ttaaaatag actcctgctg ggtgttgggtg 1150740

gcacacacct ttaatccag cactcaggag gcagaggcag ttggatctct gtgagttcaa 1150800

agcaagcctg gtctacagag cgagttccag gacaggtcc aaagcaatac agagaaacce 1150860

tgtcttgaaa aaccaaaaag aaaaaagact cctaatgact ttcttctata tccatagatc 1150920

agtgccttac tcagtcatca ccagagaggc ttgcaataga tgggaactta cacagacca 1150980

caacttgaca atttacagc agtgagagat atattgcagc attcagtact aatggcatg 1151040

tcttcatcaa accctcctg tagggatgag agactgtgag aaggagggtg gaaagattat 1151100

aagagccaga ggggatggag gggtttaaag aaacagtgtc ttcctccag acacaatagg 1151160

accaatgcat atataaactc acagaaactg tggcagcaca aacagggcca gcacagattc 1151220

aagctagatg ggatctcagg atgacatggg gaagtggaca caggctccta ctctaacca 1151280

aggagctatc tgcaattgat accagcttgc aaaagaaaaa ttagtcttct aaaatgggat 1151340

ctcactggat atagtggctc atgccctttt aatcccagca cttaggaggc aaaggcaagt 1151400
 ggatctctgt gagtccaagg ccagccagag ctacatagtg agaccctgtc tcaaaacaaa 1151460
 gcaaacaca gacaaaaat atttgaattt agaatttaat tgggaactgg tgatgactgt 1151520
 cagcaataaa tctacatctt gtgtggaaaa aataacaaat aaggttggag caacaacatc 1151580
 tctactgtttt caggcccaaa tgacgttttag ttgggtgagt agtgcctat aggacattgt 1151640
 accgtgctag ttccttgata gttgaccagt aggtggcagt aaagtgcctt gatacacagt 1151700
 caaatgaagg agtgcctcct taagggaagc actattttat ataaaattta tactataaat 1151760

gcttaacatg ggggaaaatg gaagaaagga ttaaaatgga agaaattgat aactacatga 1151820
 ttgaaaaaaa actgaccacc gtcaagaagt gacctcctg aagataggta atcttagaat 1151880
 tcaaatatct gtttttaaaa atgatctgaa attttaaac taaaacaaaa agactttatt 1151940
 tttatttcac atatagagtg ttttcctgc atgtatgtat ttggatctca tacatgcagt 1152000
 gtctgtggag gccaaaagaa ggcatcagat tccttggaaat tggaaattaca gttatgagac 1152060
 tgagtgtggg tgctgggaac caaatccaga tcctctgcaa gagcagccag tgagtgacct 1152120
 aaacctctct gaaacagttc ttgagttccc tgaaaatttt aaacttcaa tagcaatgat 1152180

ataaaggcac acaagtgtac aatcataaa tcttatgagt cttcccaaag tacaacacac 1152240
 gtccagttag caccacatg aagaaataag aatgggctg cggagacagc acagctacca 1152300
 agcctggtag cctgagctcc agctctggca ccatatggta gaaggaagga accaatttgt 1152360
 gcatagcacg ggagcaggca cacatacaca cacacacaca cacagagaga gagagagaga 1152420
 gagagagaga gagagagaga gagagaagag gagaggatag ggagaaaagg ggagggcgaa 1152480
 gggagaagaa gaggtgtgag aacatgcatt atgagcacca taaatctact ttcaaggccg 1152540
 gacgttgggt ggcacgcct ttaattccag cactcaggag gcagaggcag gtggatctct 1152600

gtgagtttga ggcagcctc atctccagag cgagtgccag gataggctcc aaagctacac 1152660
 agagaaacc tgctcaaaa aacaaaaaa aaaaaaaaa gtactttcaa gttacattct 1152720
 agaaattact aggagtcccc ttagggtaaa cagaattcta acgtctcact ctacagatta 1152780
 ggcttgacag ttcagtttta catgetgtaa atgcactcac acagaaggta gtctctgaat 1152840
 ctggcttctt tggctcagta tttatattt tgagattcct ctatattgtt gcatatggtt 1152900
 gtaatttate ccatttcgtt gctgggtagc ctttactat gtgaatata tatggtttac 1152960
 cagttctgct gctgctgact gcttttgggt ttctacttt aaggacagt ttgtttttgt 1153020

ttaagacagt gtctcactat gtagtgctgg ctggcctcaa attcacagag acccacctgc 1153080
 ttctgcttcc taagggttgg gaggaatac tagcctgaca tttttgtgca tggaaatagcc 1153140
 taagaaatat gcttctttta aaaaaagttt tttgtggggc tggagagatg gctcagcgg 1153200

taagagaact ggctgctttt cttagaggacc tggtttcaat tcccagcacc cacatggcag 1153260
 ttcacaactg tctgtaacct caattcccgg agacctgaca ccttcataca gacatatatg 1153320
 caagcaaac accaatgcac atagagtaag agtaaataaa tcgttaaaat atttttttaa 1153380
 aaagtttttt gcttgttttg ttttgaaaag cctctctgtg tttccctggc tgtcctggaa 1153440

 tttgctatga agaccagact ggccctcagat ttacagaaat ccacctgcct cttcctcctg 1153500
 agtgattttt ttgttttgtt gttgttttgt tttgttttgt ttgagtctgt tcttatttta 1153560
 tatgttttgc ctatatttag tgtgccatgt gcatgcagta tctgtggagg ccagaagaga 1153620
 gccaaaactg gagttagaga aaggctggga acaaaatcca ggccctttgc tagagcagca 1153680
 aatgccctta atcattgagt catctctcca ctctgttctg ttaaagcttg ttaaagtgg 1153740
 tgttccagcc actgccgaca acacagaact gaagtacttg ctactgctga attgtccgtt 1153800
 tctcccttca tttctgaatg ttctgcttca tgtatttaag accttgcccc ttatgtctga 1153860

 cagttttgta agtgtatag gtgagtttta gtctccactc tattatccgt tctgatgcta 1153920
 catctttctc cccgacagcc ttcttcttcc ccacaaatcc cctcctactt gcatgtcttt 1153980
 tatgtgatg acccaatgag ttttaattagg gtgccttca tgagcatagg tggatggaag 1154040
 attgttcat gtttttgatt ttttattggc gtgtggatgg tgggtgtcat acatgcatgt 1154100
 gagtgtgtag gccgtgtgcc catgcacata tgcaaacaga gaccagggga agacatcggg 1154160
 tgtcttctc catggttctt cattgtatca ctctctcact gaatcaaaag ttggatgttt 1154220
 tggctagact gacgggctag taagcatcca ggatccactt ctctctacc cacaatgctg 1154280

 ggttcatagg catgtatagc catgcccaac tttttacatg ggttttgggg attcaaactc 1154340
 aggtcctcat gtctgcgcaa caagtgttct taccaccca gccatctccc cagacctatc 1154400
 cttcatagtt ttttaactgtt agtaggatat gtgtatatgt atatgtatat gtatatgtat 1154460
 atgtatatgt atatgtatat gtttgcctga tgggttgatt ctcttatctt tacaaaateca 1154520
 tcttgatctc taagtgactt tttgttttac agtctattgt gtctgaatcc aatactcca 1154580
 gttccctttt tttctctat ctctctcttt ttttttcttt cttgatagtt tttcattctg 1154640
 tagctcagga tggcctagaa atcactttgt agtgcaagct agcttcaaac tetgtgtgat 1154700

 ccccgctact atctctggag tgttgagata ataggcatgc accaccaaag ctggatcctg 1154760
 tgtacatggg tattttgggt gctcatgcac gtgtgtgtgt gtgtgtgtgt gtgtgtgtgt 1154820
 gtgtgtgatg ccagattcag gcagaagcaa agagcaagat cctggggaac tggggttaca 1154880
 ggtggttgca aactaccatg tgggtgctgg gaaccaaagt cttcctccgg aagagctggt 1154940
 agtgcagtta gccactgggg catctcgcca gcccttctt gtggcaatac cttgtttgta 1155000
 ctctaacaaa taaagcttac tagttaacta gtggagctag ccactagtta accacagagg 1155060

ccaggcagtg gaggcacaca cctttaatcc cagcgtttgg gatctcatgc ctttgatccc 1155120

agtacttggg aggaggaaac cagaagtcac gtgagagagg aacataaagt tggtagacac 1155180

aggagetage cccctttcag ttgcttgcct tgccttctctg atctttcagt ttttcacccc 1155240

taataacctga ctctggattt ttattattaa gaccaattag aactcgtgct actgttcctt 1155300

cttcctctcc ttccttcccc ttccttctct ccttccttcc ttctttcctt ttttccttcc 1155360

ttcttctctt ccttccttcc ttccttctct ccttccttcc tcttccttcc ccttccttcc 1155420

tcctcacctt ttttttttct tctgtttttg agacaaagcc tcactatgta gccttgctg 1155480

aactcactat gtagatcaat ctggcctcaa actcacagag atccacttgc ttctgcttcc 1155540

caagtgctgg gattaaaggt gtgcaccacc aactaggcc tctaaatttt ttatagtata 1155600

ttcacatgag atatttttcc tcattatttt agacctattt gtatttttga gtttgaagtg 1155660

tgtctattta tggacattga actgctggat cttatttttc tacccaaatg atgaggttcc 1155720

ttgaccagt tgttttatcc atccatattt aatgatacta ttttcagta caggggctca 1155780

aaccagaac ttcattgcata ccagacaact gtcttactac agaactacat ccccatgtat 1155840

ttattgactt gatgaatctt tgaatgatgt aactggceca gattatttcc ttctaattgt 1155900

ggaaatctct ctgaattaaa agaagaattt gtaagaatca ggcctataaa attgattagt 1155960

gcagtaatga tcatttagaa ctctccttaa tattaacaaa ggactagaga tcttcaata 1156020

gctcatctca gttgataaga gtgcttgcct agcatgtatg aaatcctaaa ttttgcctcc 1156080

agcattacat aaactagggt tgcattggc atatgactat aatctaagca cttgggaggc 1156140

agaggcagga ggacagaagt tcaagattgt cctcaactgc acagtaatt tgaggccagc 1156200

ctgggacact gcctcaaaaa aaatggtaag ggaataacca aaaatcaata agcaagtact 1156260

tttaacttta ttatttgagg cctcagagaa tattgcaaca ttcttcaaag ttccaagtct 1156320

cttatttcat ttcatagtta gccagttata gtcttaatat gagacaaact tttcaatgtt 1156380

ccttatgcca tcacaagaca gtacagtcta aataaaatga cagtgattag gaacagagga 1156440

tcttggtgtg caccaatctt gtctttgtca ctggtgtctc cagtgccttg ggccatgcat 1156500

gacagagtag acacataata aatttagtgg aataaaattt aatgttccac gcattcaata 1156560

taccagcaa taagggggct ttccttctc tctctctctc tctctctctc tctccttccc 1156620

tccnnnnnnn nnnnnnnnnn nnnnnnnnnn nnnnnnnnnn nnnnnnnnnn nnnnnnnnnn 1156680

nnnnnnnnnn nnnnnnnnnn nnnnnnnnnn nnnnnnnnnn nnnnnnnnnn nnnnagagac 1156740

acttgctgtg tagcccaggc tagcctttaa gttatgatcc ttctatctca gtctcccatg 1156800

tactaggaca gtattgaaac agacttccca agtcatcaga attttaacat tcaggaatct 1156860
tagctggatg cagtggctca tgcctataat ccaagttctt aggaggcaat ggcagaggac 1156920
tgctgtgagt tctagcaggc agagaagggg ggaaggtggc aattgtgaaa atacagtcc 1156980
atTTTTactt tttaaatata atctataaat gtgtagaaaa agagaataac atgtgctaag 1157040
ttactgacag tgctattctt ggaaagtgag ttcttttagga gggtagatga actaactata 1157100
ttatatattt ctgaaatata tgatatttga ataattgtta catctgtaat atatgaggca 1157160
tagtatagag cttattgtga tgatattgia ccttataggt atcattagtt ccttttgctt 1157220

gttttgtatt tgggtggtgt ggagattgaa ccaagagcct cgtgcctgct ggggaagcgc 1157280
tctctaccac taagccactt ctgctgccca gtgtctctca ccttactgtt tgtcttgttt 1157340
aggactgagg tctagggctg gagagatggc tcagccatta aagctaggct cacaataaaa 1157400
aatgtaagga ctgaagtcta ttgcctgaaa tagtggtttg aatgagaatg gccccatgg 1157460
gctcgtatgt ttgaatatgt agtctccagt tgggtggaact gtttgggaag gataaggtgt 1157520
ggtccttgtg agaagagttg acactgggaa ccagctttag ggtttcaaaa atatcccaac 1157580
aattcctagt gctgtttctt acctataaat caaaatgtgt gatctcagct gctgcttcag 1157640

tcacctgttg gcatgctatc cctctgacat cataaaatct aacctctgg aaccataagc 1157700
ccagttaaac tctTTTTTT tttaaagatt ttatgtattt attatgtata caacattctg 1157760
cttccatgta taictgcaca ccagaggagg gcaccctgcc tcattataga tgttgtgagc 1157820
caccatgtgg ttgctgggaa ttgaaactcag gacctctgga agagcagtgg gtgctcttaa 1157880
ccactgagcc atctctccag cccccagtt aaactcttta agttgtcttg aacatggtgt 1157940
ttttatcaca gcaatagaaa ataactaaga caggaagtac aaatggcatt atctatgaaa 1158000
gatactgtc tgttatgtga aatattgttc atagcaaca actcacctag tagttgtgaa 1158060

acaggttaag aaaacgagtt gtagagttag acatcctgag actgaacca accaagttct 1158120
tctgtttaat aggtaagaaa ctttggacaa gtcttttaca tgactgtttg cccatatccc 1158180
catcaataag gtgacaatag tatttgtacc taactcatga ggtttgtgac aaagattagg 1158240
taagattatt ctcataaagc acttagcatt aaatgcttga tagatatcta caatgaagtt 1158300
attatttttt attactagca caagttttgg aaacacaacc cctgaaagtt gatttcaggt 1158360
tgtccttgtt gtcacaggtt tctgagatgg ggtgagccaa ggtttctct ctcatccca 1158420
accccatatg ttgagcatt tggctcttag gtgggcatgc tttgacattt ttggaggtta 1158480

tagaacccct gaggaggacc tagctggagg aagagggtct ctagagaata aggcttgaga 1158540
tttaattact gacaccetta tctctatgtt atctctattt cctggtctcc cttaggtgta 1158600
agcaagtttc cctgtcatag cttggagctg ttctgttgc atggtgtctt tgcttgaggg 1158660

accagatcct ctcaaaactgc aagccaagt aaatcttttc tctctaaagt tgcatttgt 1158720
caggtgttct atcaaagcaa tgaaaaagca attacaacat catttagaca gagatcaagc 1158780
cagagtcatg gttaaagcaat attcttttct taattcccct ttgcaaatgg aagcccctga 1158840
gctgatacc acccccaccc ctaccgcact gcctggggac cttcaagtgc aagcccctg 1158900

ccttaacctg gtggacgggg aggattacct ctccctatga tggcctattt aaaaaatcc 1158960
tagtcactta agaatgggg ccaggtacag gaaaaggag ctggaagaca aggcctagat 1159020
cagaccagtc tgaaggtgtt ggggttgtga gacccttgag aagggtttac aagcacatcc 1159080
ctaagctcaa gggcagcatg gctgagatag gagaagagac agacagacaa tctgactcct 1159140
caaggtcctg cctgcctggt catggacact gacgtcacca ttaccaccaa aggccttcag 1159200
ttggagaatt ttccagttac tctgggatag ggtttgctaa gcatcccctc tggcccctga 1159260
tctgaggcat ccatggggtc cccctgagac caaacctggg agaaagaggg actctgggaa 1159320

catgcaaagg cggagaacag agatcccgc caccacaatg ctctacagga cggtggtcc 1159380
agctgcgtct ggactccgag ggtccttcac accgatgatg aagtgttgg ttctccgact 1159440
gccgtggacc caagataaga catctacctt ctccacatgg tgaccctgg cttccaggaa 1159500
ttcaatctct tcctcgggtga actcacctga aaatcatccc catggcaaca tgcacttaga 1159560
gtactgattt aggaacctca ccatcaggtt tcactttaac agcaggaatt ttgtgaattt 1159620
gcatcctcac ggacaaaatg gaggattgtg gacaacctac cacataaagt tgttgaggg 1159680
actaaaggaa ataatgcata aaaaggactg agcttgagat cttgcacaca tccagggatc 1159740

catgataage aatcgttctt ctgtttgttt gttttggggg ttttgtttt ttccagacag 1159800
ggtttctcta ttatgtagtt ctagctgtct gaaatttct atgtagagta ggttggcctc 1159860
aaactcacag agatccacct gcctctgcct tctgagtct gggactaaag gcgtgcgcca 1159920
ccactgccta gccttagcag tcattctttt attgtttgtt tgtttttcaa gacagggttt 1159980
ctctgtgtag ctttgtctgt cctggaactt gattttaga ccaggctggc ctcaaaactca 1160040
cagagatcct cctgtctctg cttcccagat gctgggacta aagggtgtgca tcgtcaccac 1160100
tgtctggctt cagcagtcatt tcttaataat ggcaaaaagac ctgaactcta tetccaagtg 1160160

ccaccactgc ttatgagggt tactgaacgg cggacttaat gttcattcgt tcgttcacce 1160220
agtcttgctt tctttacagc tacacacact agecaaaagt atccttctcc cactcaaaac 1160280
cctccaacag ctctgatagg tcttaaaata aaattcaatg tccacctcta gggcccactg 1160340
tcagctggaa cccagctccc tctttaaaat cttctctga gttccttcta ttctccact 1160400
tgcttaacte tgttccagc atactagcac ccttgctgtc tcttaagtac aaggcctttg 1160460
tacctgctac tgcttcatct tggaaatgctt accctggaga gtcacgaagc tggctccttt 1160520

acttcattcc tgccttggc caaaggcacc tcttcaagaa tttccctatt atctagaata 1160580

tcagtatctg ccaggtttat cctgcttcc ttccttccct ccttccttcc ttccttccct 1160640

ccttccttcc ttccttccct ccttccttcc tccctccctc cctccctccc tccctccttc 1160700

cttccttctt tccctccctc cgcctccct ccttccttcc tttccttttg aataggtgt 1160760

ctcatgtage cctggctgac ctcagactcc ctaggttcct actagttgag atgaccttga 1160820

acttctgate ctctgcctc tacttctgag tgcctgggatt cagggaagc accacaaggt 1160880

ccagtttaat atggctgctg actagaacct agagcctcac gtactttgag caagcacttt 1160940

accaatggtg ctacctcct agtcatatca tgctagttg ttttgtttga gacagtctca 1161000

cggtgtatcc ttgctggtt tagaagttgc tatatggacc aggctggcct tgaactcaca 1161060

gagagctgcc tgccttctat tctcatgtgc tggaaataaa ggtacacacc accgcaccta 1161120

gcactccctg cttttcccca aaagatttta ctactgttcc aactgattaa ctgtattttc 1161180

ttaatttcaa gtttaaaaa gcaggttggc ttgtttgtga ttgcttccca gtgcttagag 1161240

aaggtcagca cattgtaaaa attaagtcta ttttgcaag attgtagttg cttaacctct 1161300

gggttgagtt gaggttttca tcatctctg cctgagcca tatcccatgt ttgtatctag 1161360

acttatgttc tctcttcaat ccacctccc tacttaagc aatcaggcc atacgtctgt 1161420

ctccagctga gtgcttctta acatagacct caacgaaagc ctagtttatg tcacttccct 1161480

tactcctttg caaagatttg gtcttcttat gttctcaaac agaagattt taggtggttc 1161540

ttaagaaaag gcattatgt tttatttatt tgtttgttta tttttgaga cagagtctct 1161600

ctattatata gctctgctg tcttggaaact cactatgtaa atcaggctgg cctcaaactc 1161660

acagagaacc accaacttct gcttcttggg tgctagcatt aaaggcatgc accaccatgt 1161720

atggccacta aaaactccat tttactgagt atcattaagt taccatca gaaatctatt 1161780

tctttgtgg tttacttttc atccttttga ttatggcaag tatcaagttt caggctggta 1161840

tctaacattt tctgaactct tatacaatga gagtgatcct ccaggccttc ttagacaga 1161900

accacctaac aataacctca acatatttga cttttaagta actattcctc gctgtatgt 1161960

tgcaagtgat ataattttcc tgtttgtgat ttaggtttat gttcaaaacta tacttagttt 1162020

taaaatgagg ggttgcctga gagatgcttc agtggtaag agcactggcc actcttccca 1162080

aggaccagg ttcaatccca gcaccaacat ggcagctcac aactgtctat aattccaact 1162140

ccaggggatt tgacaccctc atacagacaa aacacaaatg cacagaaaat ataaataagt 1162200

aagtcattaa aaaataagtt catctgtgag attatgttca gggtgatgta gcattaaaaa 1162260

ataagttcat ctgtgagatt atgttcaggg tgatgtagca ttaaaaaata agttcatctg 1162320
 tgagattatg ttcagggtga tgtagcatta aaaaataagt tcatctgtga gattatgttc 1162380
 agggatgatgt agcatttgcg aagtagcaaa ggtactagct aggtaaactc agaagcctgg 1162440
 gaaacagctg gtcttactga tgttttccca cactgttctt tctgggtttt tcacagattg 1162500
 ttctctctgt ccaaaaagcc atttgtcact tctgcccac ttccactcc taatccagtc 1162560
 agttaccacc tctctgtga agcctcccag agctaccccc tggtagattt ctaactagtt 1162620
 tataaccagt tgittataac cagtttctaa ccagtctcta accagttatt tctaaccagt 1162680

 ttataccctc catgagcttc tctgtctgca aaaaagtgat ggtactgact aagcaagggc 1162740
 tgcctccatc acttctggat cttcttggaa caagcagatt gattgtaata actactcaaa 1162800
 aatgcaatgt tttcctatth ataaaactaa accgtaccca aaattaagct tttgttgta 1162860
 ggggcaactc tatctctta ccataaacg ctgaggttca tgatctggtc cctgcccctc 1162920
 tctttgatct tagcatatat cccattcac ctgggtctct tttatttctt aaaaaacacg 1162980
 aagcccaatt ttgctctgag ttctctgcac ttgttcttag tctacaaagc tctgccccag 1163040
 tttttggcat ggtagggact ttctcactct tcagatctca gcttagatgc caccaaagag 1163100

 aagccttcca cgatccctgt aggtccaatt atatcatct gctctgactc tgcgccaac 1163160
 ttttctcttg ctagctcaca tttctctgat tgttttctg tctgcctgta aatccctgaa 1163220
 gctgggatga tgcttggcac atacaaggtc ttcatacacc accactgaat ggaggtttgc 1163280
 ataaaacagc tattatctca ttttatgcag gagaaagtga agtctcaaga gttgaggcat 1163340
 ggatttcta atgtcacaaa gtcaggaaat gccaagatgg ttccaggctt cagatcttac 1163400
 attagcccta tagaatttgt caggggaccc cccccaaaa aaaataactt cacaaaaagg 1163460
 aagttagtgc tggcaaggc aggagaagct ttgggatagc ccttctccac caatccctgt 1163520

 gccatcctt aggaatttgc tctgcactta ctgtccacct gcaggaggtt ggactgcagg 1163580
 tctgggtgga ggcgtcctcg gcccaggctg tcacttaggt ttcggttcaa tgttaggaca 1163640
 ttcagtagaa cctgtgggaa aacagagcaa aaacatcagc ttctctgggg acaaaggttc 1163700
 aagacttcat agctctcatc ctcaagccaa actctttagt ctttaaaaag ctcaacttg 1163760
 atgtgtcatc taactctcc aacagccctg gaaacctatg ataactgtcc ccattttaca 1163820
 gaggaggaaa ttgagagcca tgcaactcct ttttagagtt gaaagaagag gtactactag 1163880
 cattagtctt ctataatcta gccaaaggct tccttttctc tggagaaggc agggttaaca 1163940

 gcgtgattta gtattcaata taggtagttt cagcttaatg gttaggggtt ggaaagattc 1164000
 tgaacttctt acccaatgct actagttaaa tgagcttgag ccaaattctt aaccagtctg 1164060
 agcttcagtt tccttacctg taaaatcaaa acagtcattc ctcccagagt tggatgaatt 1164120

ggtcaacaca tacattacag tgcctagcac ctagtaagga ctctatgatg ttagttgttg 1164180
 ttacctctac ttcacaggtg agggactaa ggttcagaag aggttacgtg attccccag 1164240
 catcacatag ctgaacattg gaagcatttg ggttggaact caggggaatc taattccaga 1164300
 gttatagtgc atcacctgtc aaaattatga gcctgggtgtg tgccagttgc tcaaggcact 1164360

 cttggaactg tcttgaggtg tcttggggag tagcaggacc ttcctttcaa aataagacc 1164420
 cacagagtgg tctattaaga taagagcagg ggatgatggg acttgaggct tacagaacac 1164480
 aggcagtcca gatgttaaat tacttctgaa ttctacttgc cctgcaattt ccccgaatc 1164540
 tcatggagac agaggtctcc agggcccat tttcactttg aagcccaatc ccagaacatt 1164600
 gtccccaaca caggcctggt acaatgtaat acagcttgtg attgctggga aaaagatgga 1164660
 aaacaacca gagataatgt ggggcacctg cagacctggc tcctgactac aaaatattc 1164720
 taacagagta aatctcacct gggtcaggcc actgaggcct cgggcagctc cgttggcccc 1164780

 cagtcaagg taggtccgc agagcccctc tgctggtcgg actacagtgg gcagcaggaa 1164840
 ggagaggggc cgtttccctg gctgtactga gttctcctgt tgccagaggg cagagatgaa 1164900
 aaggagatg tagcgtggag caacacaggg aaggaaccag ttcaccacca ttcattccca 1164960
 ctgcttttct catatatggt ccacaggttc agctcctggg agataggtcc cttcctagca 1165020
 acaatgtgct gtctgtgaaa gaggaagtgt tcctggaaga ctagagtgtg aagagcaaga 1165080
 gacttggaa cattgagcta tggggcgggt atggatggaa ggggaaagac ggagtgtaga 1165140
 aaaatggtaa tggggacagt aggattcca ttggaccacc tctgtgtctt tgcctatag 1165200

 gaagcttgcc agagtagaag tgctggtctc caagtggaca gatatgccta agttcttct 1165260
 cctggcccct ctttgggtgc cagtcacaga tttagacc attagcccag catatacctc 1165320
 tagtctaga aagagccca gcaactaatg gggatcaatg gtctcattgc ccagagagga 1165380
 ggcaagactt tctctagtca cactaagctc atgacagaac ggcacaagga ttccttagac 1165440
 ctaccagcct ccatgctcca catttagcag ggacaggat gaagtctta aaggaaatag 1165500
 gggggaagaa agacctatgg tgctacctag cctcaaggtc cctgggagag tagagaagag 1165560
 cctaccagge tgggtgcaga gtggttagca gtctgttgg gccaggagaa gtccaacatc 1165620

 tggctgttga gtaggatccc agaaggagtg atgaggccac taccaaaagg ccggttcagg 1165680
 gagctgggtg ggcagaagaa aggatgaatg ggcctgtgg ctgccttccc tgtcaccag 1165740
 cccacttcca tctgcttgg aatgatttat tgcatttgg tctaagcctg agctgacata 1165800
 cctgaccatg gccacaatga agtcatcagg acccatgatc agcacctggg cagctgtggg 1165860
 agccccatcc agctcataga caggaaggag tggggcaggg gctgcctgag agtcactgat 1165920
 gtggccccgg aagtggcgg cctccacctt gctgcaaagt gggtggtaga tgaatgagca 1165980

tacaacaact tttattacat cccacctgic tgtgatgttt gtgtgaatac ttagttaagt 1166040

ctgccttctt taccggaata ttaagtctac aatggtagat cacactgcta acacatagga 1166100

aactcccaga aaataactat gaaactgaac cgatttattt aggtgttatt cagagtctag 1166160

agccagcctt ttattttact tattttctaa tcaagagtcg cagtattttg gctctattcc 1166220

tttctatgaa aatgtctggg gtccagtgga tgctctgaga tatttgtttg gaataaacia 1166280

gcttgattga tttggctctaa tgtttgtagt ttggaactaa agttcattaa gagtttagtt 1166340

agatggggcc catgagatag ctccagtgggt aaaggtgctt tctgtacaag cctggcaacc 1166400

ccagtttaat ccccaggact cacactaagg tagatgggga gaactgactc cataaagttg 1166460

tcttctaacc tctccacaca cacaagggca aatatatggc ccacatgcat acacatacca 1166520

cacgtcatca tcatcattaa ataaataaaa taaagtttta aaaaatgttt agttaagcca 1166580

ggtaggtggtg atgcacacct ttaatcccag cacttaggag gcagacaggt agatctctgt 1166640

gagtttgagg ccagccttgt ctacaaagt agtttcagga cagccagggc tggtagacag 1166700

agaaactctg tctagaaaaa ccaaccaata gaaaaaccaa ccaatcaaac taacaagcaa 1166760

acgaaaaaac aaaacaaaaa aaaaacccaa ccctgttta gttagggggc tggagggatg 1166820

gctcagtagt taagagtaat tcccagcacc cacatggcag ctcataacta tttgtaactc 1166880

tagtttcagg ggatccgaca ccctcacata gatatacatg taggccaat accaatgcac 1166940

ataaaacttt taaaaaatta ataaagaaa ataaaaagtt tagttagaag ccagaagtgt 1167000

tgatgaatga ttgtaactt agggggtaga agtgaaagat ttttaagtgc taggtcagtt 1167060

ttaagtcatt ttaagaact agactgtgta gaattccagg ccaggcttgg ctatatagca 1167120

agattctgtc ccaagaggag gaggagagga tctttgtag taggttttct gttttcaagg 1167180

caaagaaaac acagtaagcc ctctctatt tactagcaga aatagttgta tatgtttcat 1167240

gtaaatgcag gcatgtttta gagctgaagt tttccatgct taaagcccaa ctgaggagtt 1167300

ctccattatt actgctaata acttgtgtgt tgggtgtttt gtagtgatta gggaatgta 1167360

agttagctag gactaccaa gacattcact cggttttcaa tccaaaatgc tgatgaccac 1167420

acagagtgag ctacagagct ttgggagggt gggagaggct tagttttcac actttgcct 1167480

ggatgctttg atgttcatta gctttcattg ctctatttt agccttgttt ggataaatga 1167540

tactaacttt tgtttctgtt ttttttttt ttttttttt ttttttttt aacacaggat 1167600

ctttctttct agccctggca gacctggtac tcactaggta gactaggtg gccttaaat 1167660

cagagatctg tctgcctctg tctccagaat actggagtta aaagtgtatg tcaccatacc 1167720

cagcacgata ttaacttttg ctatagtgtg tgcattgtgt tgtgtgaggg cacaaatctg 1167780
 ccatgatgca cacatgacat gatgaacatg tggagatcag aaaacaatca cggacatcca 1167840
 tctatccttg ctgttcactt tgagcgggct tttcccatta tgtataccag gctggctttt 1167900
 gggaattcta tccccacctc aagaggctac tagaattaca gacacccatg ctggcctaac 1167960
 agtaggccta atgtgtaggc ctaacagaag caggttttta tatgggttct ggggattcaa 1168020
 attcaggtec ccacatttgt gctgaaagt atttttccca ctgagctatc tcccctggct 1168080
 ccatagtttt aaactgacag gtacaattag atgtatttcc taaaaacag cttacatcgt 1168140

 agctcaggtc aacctatgac ctagctcagt aacttactgt gtagatccag cagtatttat 1168200
 ggcagttctc ctgcctcacc atccagaatg ctggaattat agacataagc caccagcatg 1168260
 atgttttggc cagatctcac tagttaacaa ctgtgagagt ccacagttat catttttttg 1168320
 tagtgaatat atcaaacact gtattcttca aaatacaata cttgtcatta actatagtca 1168380
 ccatgctatg caagcgacct ctgaaacctt ttctgctat ttgcaactat gcaccctttt 1168440
 ctctgaaacc tctggattcc catctttttg cttttttgtt tgtttttgtt tttggttttt 1168500
 tgagacagga tttctctgtg gctttggagg ttgtctgaa actctctctg tagaccaggc 1168560

 tggctcaaaa ctacagaga tccgctgcc tctgcctccc cagaggcagg gattcacgac 1168620
 atgtgccacc acctcctggc atctttttgc ttttaaatta taagttgctc acaatttaat 1168680
 acatagagtg gtatttgagt aacagtataa atttatatta accatatttt tagcttctga 1168740
 ttttctgga ccctgactgt aagtcaggta cagtagcagt caaacaacc attcttacct 1168800
 ctatggccaa ttaataataa taaattgcat ttattgcaca tttactgttc cagttaatgt 1168860
 gctaaatgct ttacatgcta ttcttttatt tatttacaag ttattgtcat gaaaacctcg 1168920
 cagagtggat acaatattgc caggctcctt gtggaaatag acttagtgag tttaaattac 1168980

 tctcccagag tgacagctag caaatgttaa tgtgtaggcc taacagaagc agatgttaat 1169040
 gtgtaggctt aacagagaca gtctgaccag agcctaactt caccactgtg ctgctggcaa 1169100
 aaatacaacc actcaaaagt cccatcaact ccagcatttg cacggagact attttgttgc 1169160
 tctcagactt tcttttcta cgcaaagtgg agaacagctg tgtccataca gattaggtac 1169220
 atgcagaggt ccaaaaggat tcatagacag ttgactaact cactgtgcag acagaggtga 1169280
 tgcagccaga ggcacctagt gtcacactga gttagggttc agctgaaagg gccttaagac 1169340
 tttgctagtt ttttacctga tcccttctcc catatctacc ccgatttctg cagcaeccag 1169400

 ggtcatgtcc cgggacaaac ctgagcatgt catccatgct ctgagtgatg gtagaatcgt 1169460
 aggcaggate tcccagtctg ctgaccaggg ccaatgcaat cttcaggctc tgaaaacata 1169520
 gcaggagggt ggaaaaggct gccaggcccc tcccagcacc cccacttggg agatcctcat 1169580

gtgcaagaaa acicaaaggt gttttagccc tagtccaagg aggtactcca ttttccatt 1169640
 ccttttgttc ccaaatccag gtaagtgga acagtggtgg ccttacctct gccaccagt 1169700
 gaagcgctg ctacaggac accaggctgg tcatgttga gccctctagg atgttgagag 1169760
 cactgatgag ggcaggcct gtgtgtgggg gtgggggact gagaaccagg tggcctgaaa 1169820

 ggataggaaa ggaccagatg gcaggagagg ggtcaagtca tcttcatata tcacatctta 1169880
 tgtgcacatc ccaccattac acacacagcg atagacctga tcaggcgagg aaaggaaact 1169940
 actaagtggc aaggggacct attgaagttc attcacatgc tggctagagg tggggctgag 1170000
 ctgaaatga ggtactgggc tttggcttcc tctgcatag caggaaacta aaacttaaga 1170060
 gctgtgtgt acicacgtg gcagcaaaca tactaaatct gtcttgtca gagtacatt 1170120
 acagctcact gacaaagcag ggacgggtga gcaatgtcta cagaatccta gtttgcatg 1170180
 aacttcctc aatccctccc acagctcagg aactgttcaa gggccctgat ggtttctctc 1170240

 aacctgaaac gtcttgggag cagcagcctt ccctccctac tctgttttc agtggttga 1170300
 cattaaga ataaccaca cactggcggc atggaacct gacagtaact acctgactca 1170360
 tggatcagg ggcagaaact gaggettaag aagcaactgg gccaggaata gagaccagt 1170420
 gaacctacag cactcaaggc cctggactgc tgagacaacc cagcctgggg aagaaaaaca 1170480
 gagaaccca tgttactca gcgtccactg tggtaaggc aacttctat agtatctcat 1170540
 caggtctca taggcacct gagatgcaga caccattatt gtctccattg taaggagga 1170600
 accaagactc agagtgggaa gttcagggca aatggtacag ctgatgcca tctaggcct 1170660

 cctgactcca cagctatatt ctttctctt catcatatac tactaactct gtttgaggaa 1170720
 taaggaagac aggagcctgg aaatgtgaac tcggaggaag cctcacctgg ggcttgggg 1170780
 aacctgtcct ttctagagag gagagaacct aagaactcta gagggacct gaacctaca 1170840
 tcttggggtc acaaatata aactgcattc atgacacagg cttgacttcc taaatttctg 1170900
 attggtttct tgagtcagg gggttgttcc attctctct taggcctcag ttgtctttc 1170960
 ctgtcaatga gggacaagtc tgttattatc ttaagggtt taatgtgcc ttagatggac 1171020
 tttggtctga caaattctta ggaaacacag gacaatgaga agcgagctag ggacagagt 1171080

 gaggaatac agaaccctaaa ccaagaaaac ctaagcatcc aggatgtaac tcagtaatgg 1171140
 ggaattgtc ctctgtgaaa ggcccaattc ccaactacta aaaaagcata taagtaaca 1171200
 atccccaca acaaaaagga aaagtcattg tcagaacccc aaacttccag gtcttagcca 1171260
 ttggctagat gccccacc gcctcctaat cacttagggt aactgacccc atagttattt 1171320
 cagaaggcgg ctggctctgg cttgtttcaa cagttggctg cctaggaggt tcaactgccc 1171380
 cgtttatccc ctgtgacacg gagaggagt tccaggccaa agagatgtgg ccatggactg 1171440

gaaagcttct cctgagtggg gacccttggg agctggggga gaggtcacct cggtagatgc 1171500

 cacacacagg ctctccatg agggcgctat agttgctaaa gtcctcttca gttatgacac 1171560
 cccctgcatg ctgagcctgg aggggagaaa atgtccgtcc atcactgtga gcatgtgggc 1171620
 atggcccatg atacatgtct cagtcacaga cagataaact gtttacaact tcagtcctt 1171680
 ccgtagccac cagcatgtct tttagggatc ccatcagccc aaggaaaaag gaggcagagg 1171740
 aaataacaag tgtgtcagaa ttatcaaac tgaatttgac gtttactgt aaccaattaa 1171800
 atatactcca gagttggggg tatagctcag tggtagagtg cttgtttagt atgttcaagg 1171860
 ccctaggttg agacttagca tggcccccc tctaacacgt aaggctgcta caaaacttcg 1171920

 aactttgaac gatcctggga ggactgacc tattgaacat aattgagcat tatttcctga 1171980
 caaatgcacc catctgtac aaatcaatgt tctcattcca ctctagcagc atgtgcattg 1172040
 tcaatctctt aaaaacaatt taaaattatt ttatgtgttt aactgttttg tctgcatggt 1172100
 tgtctgtgca ccacatgcat gcagtgccca tggaggccag aagagggcat cagattccgc 1172160
 ctggaatcgg agttacaggt ggttgcaagc tctgcggat gttgagaccg caaacctgga 1172220
 tctctagaag agcggccagt gttcttaacc actgagccat ttctccggcc ccacatcaat 1172280
 tttaaatag tattaccatt atcaatcttt tttcactttc tagtatgtaa aacttttgac 1172340

 ttatctgccc ttagtgaact actcactgta tttcttggct aatacatagt catgtttctg 1172400
 gcagattaat aaaacacagt gcctggtaca gagaatgtac tccatgactg agtgacacac 1172460
 ctatgttate cccacagtat ataacagagg cttagataag tgcccataa catagtacac 1172520
 tcaatccgcc tgtgcaccgt gttcttgaac ttttcttga caatgttctc agaatctatg 1172580
 attacctag actaagcctc tttggagtig ggggtatcct cctatgtcaa gttcctcaga 1172640
 cccatagttc ccagggaaaa aaatattacc atcagttctt ggaaaatccc agacagagca 1172700
 gggaagattt tgggcccagg gcaactgaga ctaaactgt gtttccatca ggcctgggaa 1172760

 gaaataggcc agactcctgt acagctgtca ccagccctga gaagcccagc ttccctctca 1172820
 agacagagca tctctgtccc atgtttttca taccacatag taggtgatgc tttttgcct 1172880
 taatgactga ccaactggtct catttctatc tccagaggtc aattttgttt atgagaaaca 1172940
 cacagccaga aactatgtag cagataaaag gggaaggaca gcatccctgc catagggcca 1173000
 cagggcatac tccactgtca cactcacctc ggcaccatc tccagtgtga ggttgccacc 1173060
 attgtagaag gcagcagggc cagagacgcc aagtatatcc agtacctcag ctagatcagg 1173120
 tcgtcgcagc agggcaccag gcaaaggtgg gtggcccgat ggcaggaaag tctccaggaa 1173180

gcgttcagac gcgttgggag gtagctgctc agccaaggca tgggctgggg ggaggttgag 1173240
aggctgggtg ggcaaggcca agactggact cgatggctga gatgtataat aggtggggtg 1173300
gatgagggct aagtgactgg ccctgagagc tctggctccc cagaagcctg tcatagtggg 1173360
gcagggatac acgtaggctc tccccagacc ctctcactgg aggctgtctc caggtgagat 1173420
ggaaagaagt ctgaggagca aactggaaaa aagaaccctt ttgtttgggg cccaagtctc 1173480
aaaggcctcc ccattaacct tataccttcc ccctacctc caggccccac tgacctagat 1173540
catgggtcac gttgaagcca tcttgggcca cagctgtca gaaggccagg acttgggacc 1173600

agggcagcct gagggggccg gagagcaggg ggtggaggag gtcttggggg aaggaggagg 1173660
ggtcctgggg ggaggggggt tcctgggaag gagaaccctg gcaagggaag gggatattag 1173720
gaaggggagt tgggaaggga agactccagg agaacaggag aaggccacc aaggagggat 1173780
gtaggcagag gcccttgctc ccagggggag ggtctttacc tgccatagag ctggtgagct 1173840
tcatgtagcc ctttaccat tccaggaacc cccaccaaga gcccaggctg ggcgaggcgg 1173900
gcaggcgagg gagagaggag accaggtcac tgaaggggg gggctgggct gaactccgca 1173960
gagccccaag ccaggaatgg ctggcacagg ggagagacat aggccaagta tcccaggaga 1174020

aggtaaact tccccagag gggacctctc cctcatcct aacttctat atgcaaatgt 1174080
agaatggtct ttgtctcca catttgagtg atttaataaa ttcagcaac cattttaaga 1174140
ggcaggacac aaacaatctg ggtaaaattc tgttcatgct gggtaatggg tacccttctc 1174200
tttttaaatg gtaacaaag gacctcagtt tagccaatcc atcgtcatgc caccgtcagt 1174260
catctgagtt gtgataactc aggggtgtgt ttgattttg tcatggcact aaacacctac 1174320
tttctcaagt tactctgctt cttcctttgc tctcaataat agtgaatttg cctctagcat 1174380
tttttctcc caatgtgaca cagcctggga aagtcatagt catcaggctt agagagagat 1174440

agacagaggg tttttgttt gtttgttct gttttgtttg ttttcatgtt tgtttgtttg 1174500
tttgtttgtt ttttagacag tttctctgtg tagccctggc tgtccttgaa ctcaactctc 1174560
aaaccagact ggctttgaac tcagatatct gccggcctct gcctccaag tgctgggacc 1174620
aaacgatgc caccaccacc aggctgagat aggtgagttt agggcaacaa ctgagtgaca 1174680
tttcagtatt caaaggtggc tttatactt cttccagaca ggtaaaactg ccagagaagt 1174740
aagatgttat tgcagtgcta tctgttatta atcatccaat tttcttatcc attttatttt 1174800
gatttttaaa ttatatttaa ttaattagt tgtgtgtgtg tgtaggtgca tataccatgg 1174860

tatgtgtgtg aagattctgg gacaatttgi aggaataggc cctctcttt tactttgtgg 1174920
gtcctggaga tcaaattag gttgtcaggc ttagtgacaa atgccattac caactgagcc 1174980
gtctcaattg gtccttgttc gttattttag atggggggag ggcaagcagc ctgtcgttat 1175040

atagcttaag agcattttgc ttgactcatt ttgccatagt aaatatgcag caaaccaatg 1175100
 ctccaggttag caaaagggcaa tgtaggaggat ccctcctgcc ccccnnnnnn nnnnnnnnnn 1175160
 nnnnnnnnnn nnnnnnnnnn nnnnnnnnnn nnnnnnnnnn nnnnnnnnnn nnnnnnnnnn 1175220
 nnnnnnnnnn nnnnnnnnnn nnnnnnnnnn nnnnnnnnnn nnnnnnnnnn nnnnnnnnnn 1175280

 nnnnnnnnnn nnnnnnnnnn nnnnnnnnnn nnnnnnnnnn nnnnnnnnng ggtgtccccc 1175340
 gccccccccc cctggggccc tctcctctca ccagggtcct caccttggtg tcccaggacc 1175400
 tctgcagggc ctcttcctg agagcccctg gtgcggactc ccggaatca atcaggtggc 1175460
 tctcatttgc tcggatatca tgtaccagca tcacaccccc gctgggaaag acacagaaag 1175520
 tggaaagcaa agagaacatg tcaaccttct gaaagattaa actaccactc cettaatccc 1175580
 ctgcggtgag gttgtgggct gtctgccaca ttgggtcaga tgttggagcc cctccccag 1175640
 caggaattca gacactcagc catcctacaa agggtaaaat caaggaggta ggggaccag 1175700

 gacactggag actttaatcc ctgattaaga aaaatgcaga gactggggga acaagctggt 1175760
 ctgtcccccac cctggaccag agctggacc cctccagttt cctgcacctg ccttcttgggt 1175820
 gtccctctcc ttttccctca gaactggatt atgtaaggat aaaccgttcg aagccaaaag 1175880
 gggaatgctg ttgtagagt cagaggattg gtctctacgaa gagaatgata tttgtcagct 1175940
 tgttcctttt ccttggcata tttacatccg agatgggggt ggcacagtta aatatgtgca 1176000
 gccaaagtaac aaaataagga cggcagggca gataagtggc tgcaacaaca gcaaaggagc 1176060
 cagcacctg acccaccatg ggaagctctc tctctgtca gctccacacg ggcttctctg 1176120

 acccaaatat cctgattggt ccggagaggt tagcaatctg aatttttatg aaaactattg 1176180
 atgttttaac aacagcaaac attaaaatga gcaaaccaaa ccaatctagg tgctgggtct 1176240
 ggcttttgag tgtccaattt gtagccttgg ttttaagaac tccaagcctg gggtgtattt 1176300
 tctgtggaca aagtccacag ctttcatcgg agtcacaggg atttgtgaac ctaaagctgg 1176360
 aacatcactg ctttaatcga tgtccccccc cccttgtctc tctgtacacc tcattttata 1176420
 catcacaata tttctctcct ggtggaaaac cgtgaaaact gaatacgcce ccatctcttc 1176480
 catatggtac tactattctg aattcateca gggagaaaaa gagttgaaac tgggtattga 1176540

 acaagaaaat tcgaggagta tgggctacc ttaagctcaa aaccaagaaa aacctgcagc 1176600
 caggcccatg gaccaggaga caagaagtag gcctgaggga cccaggcctc caccgggtcc 1176660
 ttaccagct ccttaccgc ccaggccaga actgtgtgga gccacgatcc ccaaacacaa 1176720
 ggctgtgcc acagctgcat ccacggaaga gccttgitta ctgagcacct ccatgcccag 1176780
 tgctgtgcaa cgggagcat ccgtcaccac agcacctgc tggaaagatct aggaggcaag 1176840
 agaagagtgg gctagtaggg ctgtccacca ccctccagta cctccattta cctacaacct 1176900

cggccttcat gtcttcttga ttctcgcggc catttccttt gggaaccttc ctctctcagc 1176960

 tcacctcttc ccttccatt tcttagcagg ctcccaccac ctaaccatcc aattcccatc 1177020
 acccccttct cccaagtcc cttctgceca cctgctecce tcacctgggg atccccgaag 1177080
 tagatctgca tgaccagcgc cacggtgaca cccgtggcaa aagtgaggca ggcggtgacg 1177140
 atgacctgta gcccgctctg gcggcaggag cactcggctg ctgcagctga gaatgggtcc 1177200
 ttgcgtgtct cccgtagtgg tgaccctcc tggctgceca tctcggatga ggacgaaggc 1177260
 agcccgctgta gccgggcgga cttcaggaag gaggccgggt ctgtgggttg tctgggtgtc 1177320
 agtctggcag cctcctacct ggccctgcag tcctcagggc ggggcattcc atatggcccc 1177380

 cctcggcccc cccattacac aaacccact gcctgcagt gctcagtttt cctccactcc 1177440
 aacacaccta accaccgcc cctcgcggga agccaatccc caggiggaa aagacctcaa 1177500
 aatggccagt tgaagggtg gatttctgct tctggcaaat agccatgaga ctggtaccgc 1177560
 gggataagaa tatccagaag tgtgagggtt ttcagcctcc cctggaaact ttatcctgtc 1177620
 ctagtctgat atcaaagcct ccaggacagg aaggcaacta accaagccaa ctacttagct 1177680
 tccagccttg ctccacgcac ccattcattt gatagataca agcacctact gtgtgtctgg 1177740
 ccctacacta gacagataa ttgcagacat tttcaagcca agaagaagaa aagaaaacaa 1177800

 gtaacaagt tgtgggggag attatataaa gcttgtgggg ctggggagt ggctcaaagt 1177860
 aagagcactg caagagagct cagtggtaag atctctgcaa gcgtgaggac ccgaattcaa 1177920
 gcctcagct cccacataaa aagcccctga taccattgtg gaacagagac aggctgatcc 1177980
 tgagccccag ctccacagtc aatctaccgc aaaaggccag cttccggttc agtgagggac 1178040
 tgtctcaagg cggtaaaggc aaggcagtaa gggataccat ccaaggttct actctggcct 1178100
 ctgcatatga tcccatgaat cagtgcgtga gtgtgcatgt tctcccacc cctttctct 1178160
 ctctctctct ctctctctct ctctctctct ctctctctgt gtgtgtgtgt gagatgctta 1178220

 ccagggaat caggaagtg ctgcctgagg aatgacttt tgaacagaga atgaagggat 1178280
 aagagaagct gccactagta gaagagaaca aggagtttgt ttgctataga atgttctagg 1178340
 aagagagagc agcaggttcc aaggccctaa ttaggagtg actttgcatt tgaagaaat 1178400
 aaccgaggtc tgggtgctct ggtgtggcag cagacagggg gagggggggt gccaatcagg 1178460
 gtggaggcta gtctgtata ctggccctat ggacactgag aacttgacc tgacctgtgg 1178520
 tgagaggcca ctagagagtt gtaagactgg taagtcacct ggggtggat gaatgagaat 1178580
 ggcccacagg ctcatatgtt tgaatgctta gtcacaggg aatggcccta tttgaaggga 1178640

ttagcagggtg tggccttatt ggaagggtgt cactgagggt gggttttgag gtttcaatga 1178700
 cccatgacaa gcccagaggc tctctcttcc tgctgcctgc agatccggac gtagcactct 1178760
 cagctacttc tccagcacca catctgcctg tgtgctgcca tgcttctgc caggatggta 1178820
 atggactaac ccctcaaac tgtgagcaag ccccgattaa atgctttctt ttataagagc 1178880
 tgccatgata caagcagatc tctgcaattt tgaaggccag tctggtctgc aaaatgagtt 1178940
 ccaggacagc cagagctggt acacagagaa accctggctc aggggaaaaa aaaaaaaaaa 1179000
 aaaaaaaaaa aaaaaaaaaa aaaaaaaaaa aaagagtgcc atggcatgg agtctcttca 1179060

 cagcaataga aactgacta cactgactaa gatgccatct gttttgtgtt ttcaaatgat 1179120
 ccctctggct gctgtgtgaa gaacagactg gagggaataa gaaaggaggt aagggaagt 1179180
 tgaaagccac ttatggacaa gtcacttcaa gtcatagacc ccaccttctt cattctagtg 1179240
 cagcacatcc ctaacagatg gcccaggcac aggagtccat gcagtgatat atgaagaaag 1179300
 tcatttctt tctacccat gtaaagtctt gggtagggtc aagcacacct gaaagtccag 1179360
 catcgtgaga cagagccagg aggtcacagc tagctcccca ggcaggctag ccggaaggc 1179420
 cagctgctgg ttcagtgcta aactgtctta agggataagg tagagagcga cagagaaagg 1179480

 gctggggtct tactctggcc tccacatgca cgtgcagtga tgcaaacacc tctcttatac 1179540
 ccatggtcct ctccactagg tgccattacc cttgaacca taccctaag tccagaaagt 1179600
 tctagacatt ttgaacaag gagagaggat gactttaaca ccttattgct gtactcacia 1179660
 taagtcttt gtaagttta atgtttgagt gatgacatta aaattgact gtcataattt 1179720
 tcatgtttac ttgataaaaa cccaaggctt ttgacttggg gtttaagaac ctatcatgact 1179780
 cacacctta tcttctatct aaataagaaa tcaatacat agataaaata atatgtgacg 1179840
 aattattaga atgcatttat gatgggcact ttcaggaaaa gacacttaca tcttatttta 1179900

 ctttgtgtgt gtgtgtgtgt gtgtgtgtgt gtgtgtttgt gtgtgtgtgt gtgtatgtgt 1179960
 gtgtgtgtgt gtttgtgaga caggcagccc tagctgactt ggaacttttt aagtagccta 1180020
 ggctggcttc caacttgagg caatttgctt gtccttgctt cctgagtact gtgagtacag 1180080
 gtgtgagcca ccatgtctga cttatattcc taaaaaaaaa aagtttatga ttttattgtt 1180140
 attgttatgg ttattgttag tgtgcatgaa agagagagtc acacagagag acagagaatt 1180200
 agaggcagac atagacagag gacagagagg agtgtgtata ccacagcagg tacgacggtc 1180260
 agagtacaac ttttctgggt ttacatctct cctttcacct tgctgaggca gaccctctct 1180320

 tcttgttact tctgcttttc acaccctaag ctagaaggca ggcaagcttc cagacaatc 1180380
 tctgtctct tctctctatc ttacagaagg agttttggga ctagatatgc aaaccaccac 1180440
 atctggctct tctgggtttg gtggatcaaa ttcaagtcac caggcttgca tggcaaatgc 1180500

ctctaaccac tgaaccacac caccagccct attccttttt atttttatct ttctgtgtgc 1180560
 atgcatatgt gtaagaglat gtgtgagaat gaacatgcat gcaagtgtgt ggggaagcca 1180620
 gaggacaatc tcagaaacat tcacatcacc aatgatgtct catttgttcta gagctttcca 1180680
 attaggcaag tctggctgtc tatcaaacct agggaccctt ctgtatctgc ctcttagcac 1180740

 tgggcttata catgcatgtc atcatgtctc gctttaaaca aaaaagattt tattattaca 1180800
 tttattttat tacatttagg aggcagtggt agcacatgcc ttttaagcact caggagacag 1180860
 aggtacacgg atcactgtga gttcaaggcc agtctagtct acagagttag ttccaggaca 1180920
 gtcagtgtca cacaaagaaa tctatcttg aaaaaacaaa caaaaatatt ttgttacatc 1180980
 ttttacttat ttatatagtc atttgaatg catgtgtgag agtgaagtg tgcacacatg 1181040
 cccacatgtg tagatcaact tgtaggagt ggttatcttc ttccaccaca tggatcctgg 1181100
 tattgaactc gtgatgtcaa gcttggcatc aagtcctttt acttactgag ctttctcatt 1181160

 gacaccatac cctgattttt tatgtgggtt ctgattgagc aatctcttca gcatttatac 1181220
 tcctttaaaa ttttaagcaca tataatttgt aataaaaagt aaaaatttca cagagataag 1181280
 aactgggagg taggccaggc agtggttagcg cacaccttta ateccagcac tttggagaca 1181340
 gaggcaggag gatctctgtg agctcgaggc cagcctggtc tacagaggga gttctgggac 1181400
 agccatggct gttatacaaa gaagccctgt ctcaaaaaat ccaagaaaga gagggggaat 1181460
 ggggaaggga gggaggagg gagggagaaa gagaacagga gggtagcggg tgtagtgtg 1181520
 cacaccttta gtcttagcac tcaggaagca gaggcaggtg atctgtgagt tggaggctaa 1181580

 cctggcttat aactgagtt ccaggacagc cagagcttct taatagaaag accctgtctc 1181640
 caaaaacaac aaaaggaatt ggagggtagg actagataac tggctctgta gctaagagtt 1181700
 tgtgctgttt ttgctaagaa ctggagtcca gttcccatca cctatgctag gtgattcata 1181760
 actgcctgta actccaatc caggggatca gacacctctg gcttctgtgg gcaactgtacc 1181820
 cacatacaga taccacaca tacacataat taaagataaa aataaaatca tttttttaa 1181880
 aagaataggc caggcttagt ggcacacacc ttaaccaca gcacttggga ggcagaggca 1181940
 ggtgaatctc tgtgagttg aggccagcct ggtttacaga gcaagttcta ggatagccag 1182000

 ggttacacag agaaacctg tattgaaaa aaaaaaaaa aggaatagag aaagggactc 1182060
 tttccccct cactatttta tttgttttt tttttacaat cagcaataa tttttaattt 1182120
 gattttaact cctttgcttt taaattattt tattgtaatt ttatgttttg tcttctgtg 1182180
 tatctgtgta ccatatgigt gcctgatgcc ctgtttttag cttatttttt ttttttttt 1182240
 aaaaaaaaa ctgtcaggct gaagaggtgg cccaatggtt aaaagcactg actgctcttc 1182300
 cagagggcct gggtttgatt cccagcacc acatggagac tcacaagagt ctgtgactcc 1182360

agttccagga gatccaatgc cctcttctgg cctcctcagg tacttcatgc atgtggtgca 1182420

 cagataggca gcaaacacc tctgtacata aaataataaa aacttataaa acaatttate 1182480
 ttcttggggg gtctccctga gttaatcatg cttgcatata aaccacacca ttatcaccag 1182540
 cagtctgtaa atcagattcc ataaccaaac agttgtttaa tatcttctgt ggatacaaaag 1182600
 cctcctage cccagagaaa tattagaagg gcaagaagg gctttgaact tttatttate 1182660
 tatcgtatga ggtgtgtgtg tgtgtgtgtg tgtgtgtgtg tgtgtgtgtg tgttgcattg 1182720
 gtatctgatg tgtgtgcaca tatatacatg ttcttctatg taacttcagg cacttgagtg 1182780
 tgtgtgtaag ttagagaaca gtcttggcca ttgttcctag tcttccatct tgcttaagac 1182840

 agagtctctt gtttgcagcc atgtacacag gctagctggc ccatgtgttt ccaggttctt 1182900
 gctccatctc ccatctcact gtagaagcac tggaaattacc aatgtgcctt gtcattctta 1182960
 gttttttaga tgggttctgg agatctgaac taaggctcac aacttgggc agcaagggtt 1183020
 ttaccactg agccaattct gatgatacac tactttttgg tttttttggg ggagggttgc 1183080
 atatatctc ttattaaagt atttttatga cttcacaagc taggctcac tatgctcact 1183140
 ttacagatga agaaaccaag gctaagtggg accacctgtc taaggccata actcaaataa 1183200
 gtaggagaat ggaattgta tcactggata gtctcctttc tattgctcta tgtggcactt 1183260

 gcagctattt tcaatacceca aaaccaacct aaggacttag gtgagtgtgg tggcacacat 1183320
 ctgtgatccc cacacttggg aagtagaggc agaaagatcc aggagatcaa aacttgcttg 1183380
 ggatacatct tatcccaagg tcttatcttt aaaaatgcaa ataagcaaaa atccaacctt 1183440
 ctccaaagag ataaaatgac ttaagatgaa gataaatatgg cttcaccaca actagaccta 1183500
 tttaaaatta tccaaccagc atatcaagtt actcatttat tcagtaaaat tatatactga 1183560
 ggaaaaatat caaaaatggg ggggggagtt tcttgagtac atgctacctg ccctgtgtac 1183620
 atgacagggc aataatcceca ctaataaaaag caagagtgtc atactgggaa aagattggtt 1183680

 tggggccaag agataaaagt ttattagaga caggcactgt ggttcaaact tgcaatacca 1183740
 gcacacagga ggctgcagca ctcagggttg ccacagtta gggctagtgt ggattacaat 1183800
 agtaactccc aggacagcct cagctacata gtgagttcca atccaacctg agctacagag 1183860
 taagaactca gactcaaagc aaacaataa aacccaagc aaacaaaacc aaacaaaac 1183920
 aaccaattaa acaaacacta acccagtatg ttctaggaga aaggtgagtt taattttgat 1183980
 taccctgaat ttgtgaggca caaggaattg ctgtctgaag gtactgtgtc aaaatattta 1184040
 atgttcttcc tctccatct taaaaaaaaa caggttataa tataacctag gttggacttg 1184100

aattccctag gtagcctagc ctggccctga actctcttaa gggaagattt ctgaacttgg 1184160
gagtgcacatg actggaagcg cagagtggcg agtgtatttg gggtagtgc atcagagtga 1184220
agaagagcta gggacttagg ggtcacacag gtacaacagg ttagtagctg gtctagagtg 1184280
gtgatgccag ggtggacctt cttaggaggg agggacatag aaaaccaggt cacattttga 1184340
aagtgagaag agaagagga aagattttaa agtggcttcc aggccctac tttggacact 1184400
tactgaaagg cagtgtcaca cactgagaat ggccttggac aaaaaggaag agtggagaag 1184460
acatgccgat ttggcatag aatgttggca ttagaggct gatgcctagg agaaggctaa 1184520

catggcttcc atttgaaga aaggaacga aggcattccc taacctgaa gaggtcacca 1184580
tccagttctc tgttctctgc gtcttcttgg ggaagtctgg cacttgattt tggagagtgc 1184640
caggcaacag gctagccagg cacatcaaag gtcttggcta agaagatggg acagtccac 1184700
taggtggcac tactaggttg agaatataga aggtcatatt agccaacaaa ctggtctagc 1184760
tggacaaaa gactcttggg acttggaaac aggcctaagt gacacggcat ctaaatgctt 1184820
atattgttgt gatggcaagg cactccaagg caaggtctg ggaacttgg tgtataacct 1184880
tgtgataagg tataagttcc caggagctca attaaccagg gtctacgctg aatttctagg 1184940

caagtgttct gccactgagt taaactcca gccctctcg gttgaattgc cttgcacatc 1185000
aggacacagc ctacactgaa ctccataaa gcatttttga ggtttgggaa ctccattccc 1185060
tgtgattatt teactctgaa atctctttca tctattcatt caaaaattat ttattgagta 1185120
cccaatgctt ggctgaatgc tggcaacagg atgaatttt aaaaaggcca tgattctgctc 1185180
ccttagagge ctcttaggta tgcagtaatc acatcacttc ccaaataaat aaccttaggt 1185240
ttttataaag caatgccttt aacaaggaat caggagacag attaaatggt ccaatctgtt 1185300
attagggca tatgggcatt cttttttgga agagaaaact aaggaacagt acaggtagg 1185360

cacacctact ttaatafaat gagtcaggac tgcactactc aatctctgaa tagaaaacct 1185420
gggttagca gatggctggt tccaccacca catattttcc cacattcttc cttctaccac 1185480
taaggctaat ccccaagaa aattagtttt gatgagcagc tgtgacattt gaggattcaa 1185540
agtctccata ccccatcata ggtaaagagt gatccagtca ggttggtagg acctgctagt 1185600
cagaaccata tgaccaaaaa gttagagaga actgccagtt gccagccag gtagtaaat 1185660
ggaagagtca gactggaag agctgggcca gagaagcagc ttccttcagt acagaaaggg 1185720
atctgctca agtgcaggca ccggaggaag acagagaggg aggcagaaag atgctctaat 1185780

gccaggaagt gacgttagg caaagaggtc agagggatgc aggataaaaa acggaggaga 1185840
gtatagcgt gggcccatg gataggagaa atagcctag ggaagggatg ttaagacttg 1185900
gccccagct ctctccaag tctgcttcc tcccccca ccccccatc tcttcagtt 1185960

tctgcagagg ttgagaacac agtaaaatgc ggagactgct tcctggggaa caaatcttgc 1186020
 cactgaccag aagctcctac caaccggca aacatccgtg ccagaccac atctctggaa 1186080
 agggtagagt aaccacaga acatcaaagg cactgagtcc ccaaggactt tgagaggcca 1186140
 tgcagacat cccttctct cccaataccc ggaattctca gatagaaggg aatcatattt 1186200

 tctttactca tctctggaca tgaagagata gattctcagc tcttctccgg actctctgct 1186260
 tcccataate cctgactgtg atgaagtctt ccttaagatc tagactatat ccctcctgct 1186320
 gcagcctctg acttggtttc ttctatccta tcctctgtaa ctaaagagaa gcctttccta 1186380
 ggtgatcaca gccgttctta aggtctctcc ttccagcatt ccttcttct caataggttc 1186440
 ttccgaatca taatccctcc tactgcagtc attgcatcct ttcccgctgc gcacccctacg 1186500
 cctctaaggc aaaaataccc ttccccccac cacacagtta tcagagctga gggagaaggg 1186560
 aagaggtcca agatgaaagg atgaatgaag gagatgggag actgtaagtg tatgatgccc 1186620

 agaacagatg aaggaggacc aggaccccc aaggcggggg agggatgggg acagagggcc 1186680
 tcaccggtat ccgggtctcc caggaaggcg tcctcgtcct tgcggcccct cagcggggcc 1186740
 gcagcgctg gctcgtctcc gggcagccgc gggaagctgg tgatgctcat gtagtccact 1186800
 ggcgagtagg cgcttagggc actctcctgg ctagcctcgt tctctgccgc catcctcgcc 1186860
 ctaaccccca gcagcgcagc gcctgccgga agtggcagtg gaggggggtg cgaggcgga 1186920
 gggcggggtc tgagctctg gacagccggg agggggcgcc cccacctca gcagtgtcct 1186980
 ggtctgactc gccccgcct gtttaagtc tactgttagc agcctgcaca ctggtgcagg 1187040

 agaatggaag cccggagggc agcggaaggt tgccagcaag aggacgctac tctgggctca 1187100
 tccttggctc ttgtccttc cagtctgaat cctgctcaga tcccatacac tcctaggacc 1187160
 agagactgac ttctgatcac aaactccact ttgactccag acctttttt tttttcctga 1187220
 gccactctct tctcgggccc aaatctctct gtgggcacca agattctct cctccgatct 1187280
 cagactacc ctcggaccca tctgagacta cttacccag acttacaact ctgacttcac 1187340
 ttccccag attcctttaa gtctccaacc ctacttcac cagactgttt ttttcatctg 1187400
 cagactctc ttgagcctcc ctteaatec acatccttt ctgcacceta aaactctct 1187460

 tttaaacccc agatccttct ggaatcgccc tgatgtgtca gcaagggaga gtaccctta 1187520
 ctgaagccca cccaacttt aggatcctca gaagcaaacc ctcagattcc actccaggga 1187580
 actaattcag taggccagaa cacgatcttt ggaacctta tattcgtctg catttttcag 1187640
 aattcttgat gtggctctgg aactaaggta aaagaagtca tgacgctgtg atagaaacag 1187700
 gagcagggtg ggatgggag gataaacgtg taagaacagg ggcttaagaa gtagcgcttt 1187760
 gatagaacgc ttgcctgtgt gaaggtttga cctccagcat cctgaggagg gggcggggg 1187820

cgaagaaagg aaatgtaaga atgagaacgc atccctgcac gctaggtgcc tgccaagccc 1187880

 atctctgga a ttgctaccct agctccaaga atgaagttt taagcccaa ctctctgtagt 1187940
 tcagcccaca ggcagagata cagggtcgtt gaagccgtgg atacacactg tetctcgctt 1188000
 tccaatccc tggctccagg ctcaatgtga cttgaactgt tttagcattt actctggaca 1188060
 caaggagctg cagtccaca cgtatacagc aggaggcagc agtagatagc gaacatttgc 1188120
 gggagaaagg cttaggaagg aagcgggtc agagctgtgc agtgaagggtg ggagtaaggg 1188180
 atgatgacgg tttcatacc tactggcaaa attgcatgtg ctttctccc cacggagagg 1188240
 ttttcatctt attagtgagg tctgtaggga ccatagtctt cgtgacctca taccctacc 1188300

 agtgagtttt gtcccacta aatgagatct gtgtcacctg agtgtgtcc actcctccag 1188360
 tgtatgcgaa tgcctcctcg tgggagtga gtctctcat cggggttagt aaagtctgca 1188420
 tctcatagag gaaatctat ttccctagtca gttaatgcca tctgtccta taagcagagg 1188480
 cagagctctt ccataggatc tgagacctcc agaaaattct gtacctccta atacagtca 1188540
 tgcaacttca gagagtgtgt atctactcag cggagtgtat gtctccttga cgaagtatct 1188600
 gctcctctc tgagatctat gtttattcta caaggtctgt atgtgcttag tgggctcaa 1188660
 gatcctcacc tcaggatcag ttaggctctg ggtcatatat ctgaacatga gaaattctt 1188720

 ttttcagctt acggtgtgct aagcttatgg tcagttggac aaagatcggg gcagctggtg 1188780
 ggtagatggg tccataagcc ccaagtaggg atcaaaaggc aagagagctg cctgcttcag 1188840
 acctcagact cactcttcta gttagatatt taagatcct ttttctatgg ccagtctgtg 1188900
 aattgttagg tgatccgct cttcttgggt gataactgtg ggcaggagat agagggtgtc 1188960
 ctactaggct tcctctggg ttaagaggat gggggggcag ggtgaggtaa actccatttg 1189020
 tggcagatgg agtatacata ggtgaattaa agagtcaaaa tgattgctct ttatatattt 1189080
 attattttgt tttgcacaga ctttggtaact ttacaagatc tagcttctgt ttgctcctta 1189140

 gctttgtgaa atttcatttt ctcccttccc ctttcttcc ttcctcttc cttccgtcct 1189200
 tccttcttc cttctcct ctctcttttt ttgtggtttt ttagataggg tttctctgtg 1189260
 tagcccaggc tgcctggaa ctactctgt agaccaggct ggcctcgaat tcagagatcc 1189320
 ctctgcctc tgcctcaggc gtgcaccacc atgcacagtt ctttctga atttacctt 1189380
 tgtcaaaaga gaacttgtc ttttggcaa aggtctggag gatcctcgcg gtcttcgctt 1189440
 agagtcttgt actttggatc aggggtggaga ttaatgcagg caaagaaat ggcaacatgc 1189500
 ccttagaggt gggaaatcaga aggccgcgag ttggcaggaa ggalcatatc ataccggga 1189560

gctgtgccct caaggtcgcg gaggaatttt ttcattgagac tggaagaggg gtgttgcttg 1189620
 gggggagact tagaggagt tcaccagaag gaactgtact ccacctggct atccaactcg 1189680
 gtggagtgac aggattgtgc aatcagacca cgggtgtgtgc acagcggatg acccaacgct 1189740
 tctcattagt cagccatttc agtctcgagc tgcgcggcgc catcacccaa ccccatctg 1189800
 tcactccaag accctaactt ggtcactcca cagccctgcc tctctctctg tcaactccaa 1189860
 cccggctaca ccccatcaact ccacgaccgc cctctctgccc tgtcacttct ggccccgccc 1189920
 ctgctctgtc attccaaagc tccacccttc tctgtcatt cttagacat tccttcgact 1189980

 ttcactctac ggctacaccc cttccggcaa gtcagctccg cccctacccc gacttcgctt 1190040
 cagcggtttc tgatgacccc gcccccctgc ccacggccct acccactatt ggggtgttaa 1190100
 agcacggcct ccagcctcag gctccgccct cgcggcggc cccgcctcta gggccgacct 1190160
 gttttccacg ccccgccacc cgcagcaacc gcaagagccg cacggtgctc agaacttgac 1190220
 gggatggggc ttcccaggga gcagcgcgaaa agcgcagcgc ggagccgggc tcgggaggag 1190280
 accggctccg agggccgggt gcgggggttg tccccgccgc cggaggtcag acgctcggca 1190340
 cacgtctctc cgtgcagcg ctaccgcgag ctgcaccggc attctgtgga ggagccaggg 1190400

 ggtgaggctg ggccccggag actcttgggg gcgccagaga gcagaagagc gggactccga 1190460
 ggggcattca ccgcctccc ttagggagga gatggaaaag ggattcgaag gagacgacgt 1190520
 tccatgagaa gaaggagggg tctgtgaagt gaaggttctt agaagttggg ggactctctg 1190580
 gcgatttggg agtttttga gatgtgtgct ttcacaagga gatgcgggtt ctgtgaggaa 1190640
 aagcggggtt cagtgaacag aagcggggtt cgggtgtcga agaacccttg gggagactgg 1190700
 aaaagggatt tccgcgaaga ctaagtgcga tatgagagag agagggagag agggagagag 1190760
 agagagagag agagagagag tctctgaggt aaaagaaaag ctccaaggag caagtgtgcg 1190820

 agacttgagg aaaggagaac ccagaagaga cagaaccttc tttgcctcca attcaacaat 1190880
 tgccctccct gctttgctca gcggcagttc caagcctggg tcccatcttg gggctctgca 1190940
 tctatttaat atagtagcaa tcccaatata cgattgaaca agttgttaat atgtcaagtt 1191000
 ttttgtttt tttttttaa tttggcccta agttgcagtg actcagattc taagagataa 1191060
 ttctatgctt ttaaaaactg gcccgggcag tttagggggc aaaaccatgt ccttgccagg 1191120
 cctggtgcca cacacctta attgcaatca ctggggagga agaggcaggt ctttghtaat 1191180
 tcaaggccgg ccttgtgtgc atgggtagtt ccagaacaac cagtgtctaca tggcaagacc 1191240

 ctgccaaaaa aagaaacaac cataaaacc cactaccata tcccggttgg gaggcagcat 1191300
 atttagtggg aggatacaca agccacgaac cacactcaga aaaatgcata aaaacctttt 1191360
 tttatagtct taggcagatt taaaacctta cctaaaatgt actcatctcc aagataggaa 1191420

taatagtact agcttcatag attatgaaga ctaaagtggg taataaagga tccattatca 1191480
 aaggtttgat gcccaagcag tcattaaata agtaacgatt tgtttagcaa caacaaatcc 1191540
 caagcagatc ccaagcaacg aaaaatagta ctgaatcaag tgtgaagttg ttccttgcta 1191600
 caagtagtgt ccaagtttga ttcctcgggt gtcttttctt tctctttctg tattttctcc 1191660

 catcaggagt tacatctggg gtaagtttgt accatagcaa ttcatttctt atgtatctgg 1191720
 cctcctacct tgtatttcac ttatatattg tccccaaatt tcataggact atagaccatt 1191780
 tgtatttcac atacctgaa caaaacaaga ctgtgagtga ggtttcccag ttttctctcc 1191840
 caaacttget tcttccata attatTTTT tctttcttct tcttttgccc caattttcta 1191900
 ttttctgctc gtgtcaatgg cactacccca actataaacc tcttccatca ttgtcttctc 1191960
 agatatcttt cctacacctt acaaatttat agatacttat tgtttactaa gcagtatttc 1192020
 agtttgattt gatctgagta ccaccacat tttatagagg aagaaacagg agcttagaga 1192080

 ctaactcact taacaaggt cataaagcaa atcattgacg gagttgggct taaaacaac 1192140
 atgatcttga ctagagaact tgtactctga atattatgct attcttctct aactctgcag 1192200
 tttgcttttc accaaattct gtcaaatact actttaaaat atctctcaga ctgacccttc 1192260
 ctttcatttc cacagacact taaagtcaga acaacaggaa gcagtttctt aatttgcctc 1192320
 ctctcccta gtcttaacac ctgcagttgc tccagcagac ttatctaac accattaggc 1192380
 tgatattctt ggaatatgct ttcatatgcc tttgttaaaa aaaaaatctt tctgtttctt 1192440
 ccgccccccc tctctgtga caggctcttg ttatatattc ttggctggcc tgcaactcac 1192500

 catgtggata tggacaaggc ttgctcaaaa cttgtgatcc tccagcttct gccttctgag 1192560
 tgctgcagtt atatgcaggt gctaaatgcc taccttttaa aaatgttccc cctaaattaa 1192620
 gattctgctt tcttccagga gcctttgggt aacctagctt cacctcttca atcttctctc 1192680
 tactattctc tattatattc ttcatcttag atagatctac ttcatatctt ggatacctaa 1192740
 aagtcctttt ccttgtttgg ttttgcccaa ccaaacctaa accccacctg agcctcagtt 1192800
 ttctcactta taacattagg aatatatgta tgtatatatt tcataagctt atgccataaa 1192860
 gattatatta agttagtcca gtccctaatta gtcccatctt tcatctttac agctttgtat 1192920

 atttactaaa tctcagtttc catttgattt ttgaaaaaaa tggccattca gtattttttt 1192980
 atattactag ttattaccag tttttaattg ttgggctttt gagtttgtgt gtgtgtgtgt 1193040
 gtgtgtgtgt gtgtactaga ggaaagcctt gggagtcaca gcaagtccca gaaatccagc 1193100
 tgtctctgcc cttaaagcac tagaatgaca aatgatgaca ctatgtcaga tctgtgctt 1193160
 gtgaggcaag cactttatga attgagctat tctccagcc ctggctttat gattttatgat 1193220
 ttttttaata gtcagggttt caagtagtcc agactggcct caaatttctt gttagctgag 1193280

gctggccttg aactcctgat tttctaccic tgccttccga gtgctaggat tacaggccca 1193340

cattgatgta cccctccttc cctagtttca cttttgtagt atttctataa aaactttttt 1193400
agtaatgctt tcttcccttc ttttggatta ttttcttga atatatcc aaattgagt 1193460
tagcaataa aggttctaaa aattttataa ctcttgccag atatttctta cagtgtctgt 1193520
attgtataaa agtatctgat tctctagata gatctcatgt agtgaagca tagaattaaa 1193580
ttaaattttt ttcgctagtt ttataggeat acagtagcac cttgggttga ttgcattttt 1193640
gttttcttta taaattgaaa ggtagtata caattatatt gttttgtccc aatagccaa 1193700
attatgaatt agttcctgct gatggtttct ttattttcag tctcaaatag tttctgtaaa 1193760

tgtaaaccct tggttttctt tcctatcata gtagtcactt tcttttggtt tgagagtaaa 1193820
atatattcct atcttttgaa aatcaacaaa catgtcttct taaggaaatt caaatcttga 1193880
cttagtaate tatgaaatct taggcaaat atttaatgct tccaagcctt gattttcaaa 1193940
tctatatgat aaacaaaata atgcatacct tttaggaatg tactaaagc taaattaaat 1194000
aatacatata aatagcttta agtaacacct gacacacatg agaacttgtg caagtagttg 1194060
taaagaaaat actcaataaa taattgctaa gagagaatga acaaactagg agatgattgt 1194120
ggaagactat atgggtaag aatttattta ctgattccct actggttact ggtcattgtg 1194180

ctaggatttg tgtgatactt ttgagtgtgc gtgcatatgt gcttctctct ctctctctct 1194240
ctctctctct ctctctctct ctgtctctct ctgtctctct ctctctctct ctctctctgt 1194300
gtgtgtgtgt gtgtgtgtgt gtactagaga caaggtctta atattgaagg ctggctttga 1194360
actcccttg taaaggetgg tcttgaactc ctgataattc tgcctccacc tcccaagtgc 1194420
ctggatcatt ataatgtgt gccactacac tcagatagac agctttgtgt acagaaggaa 1194480
caatctgaat taagattcag gaacagactg taggcagaag aataaccggt gatttagacta 1194540
gacaaatatt gagtctggg acaggtgat tgaacttgg tcccatacat atactagtaa 1194600

tccacctgat gtttgagata cttagtgata tctggccatc tctttttggt gcagagtttt 1194660
ggggaaacat tgccaaggaa ttttattgga aaacccatg cctggccca ttcctccagt 1194720
acaactttga tggactaaa gggaaaatat tcaactgaat gatgaaagga gcaactaaa 1194780
acatctgcta caatgtgctg gatcgaatg tccatgagaa aaaacttggc gataaagtgt 1194840
cttttactg gtaaaaatat ttatagtctg tgacagataa aaatctcgta tttatatgtt 1194900
tcataattca caatgtgctt tatttttaca ttgaaaata ttgaaattaa ttaatcaatt 1194960
aattaattgt gtgtgggtga gtgtgaaggt cagaggacaa cttcaggagt cagttctgtg 1195020

ggtcctagag acigaactca gatcatcagg cttggggaca aatgcctttt acctgcagat 1195080
 ctatcttgct acccccacaa ttcctacatc cagatTTTTT gagacagagt cttactgtga 1195140
 aatcctggtt gatctgggat ttgctatgta atgaaaactg gttttgaact tgttacaacc 1195200
 ctctgcctc agcctcctaa caggiggaat tacagttgta tgccattcac attagactgt 1195260
 aacaaagtac tttacattcc ataaatttac ttgatccttg caccaaccaa gatgagtaag 1195320
 caaagtattg ttgatttgat attttattaa gcaaaaatac atcaaggaag ttaaattaat 1195380
 tcttcagatt acataacttc tggtaacaaa gtcaatataa atcaagtgat cctcctcttc 1195440

 ttgatttatg ggtggagatg aaaataatgg gtatatagca gagaacagga ctaggttggt 1195500
 tgtttgtttt tcattcttgc tctggaacaa aaaaatgagt ttaggttttt caccagctct 1195560
 atcattgtta tcattaattt tattgagtta aaaaggttga gaactatggt taggagccta 1195620
 agaaatatct tatttgatgc tcacagtaac tacaaaagcc actatgcctt gaaatatttc 1195680
 tttcttctc ccttcttct tttcttttc ttcttttct tcttctctc cttcttctc 1195740
 tccttcttc ctttctttc ttttctttt tggtttttg aaagagtttc tctgtgact 1195800
 ctggatgtcc tggaaactcac tatgtagacc actctggctt caaactcaga gatctgcttg 1195860

 cttctgtttc ctgaatgagg aatcaaaggt gtgtgccact accacctagc aacctggcaa 1195920
 gctttctttt gaaatatata tgttttatta attctttgag ctttcttaa aatgtatttg 1195980
 atcttattaa attccaactc ctctctctc taattcatcc cagatctacc ctcaatgcc 1196040
 taccctca gacctgtctg ggttgatcc ccaatgtatg ttaagactct aagaaacagt 1196100
 gtttagtga actccaattt gggaagtact gctttaagta atctaccagg ttaattcaa 1196160
 tgctaaatc tigtgtaaga ctttattact tggcttttac atgagcacct gttcaataat 1196220
 aatttttaa gatactgagt accagggaga gatggctcag ggttaagaaa gcatactgct 1196280

 ctgfcagaag acccaagttc agtteccaga actcacattg ggcagcttaa accgcctata 1196340
 atttcagctt cagggatctt gatgcctct tctggattcc acaggcacct gaacacacac 1196400
 atacacacac acacacacac acacacacac acacacacac acacacacac cggaaagaga 1196460
 cacatacaca ataataaaaa attgtaaaaa gatattggat attcagcctt gtattaggtg 1196520
 ttataaatac aggggtagag aaataggaaa aagtatcaaa tggacaatta attttcatt 1196580
 cttttatgt ttatagtaaa gtaaacatg aatggactgc atttgctata ataaaataa 1196640
 atacaaatat actagacata tagctgcttt ctttgtttaa cccatattg taaatatact 1196700

 caaattgctt tccttcttt cttttcttt tcttactct cttctctat tgetgctgct 1196760
 gctgctgctt tttgtggtac tggggattaa acctaggact ttcacacatg ctaagcaact 1196820
 gttttatcac tgtgccacac tccagctcc cttttaattg tctttaaga agagattggc 1196880

ttctgttat catagatgag aatttaaac tgaaacacct ctaacttctc ctttactaa 1196940
 acattatfff taaattaact taaatcaca ttctttataa gcgagtgtag taagtgtgtt 1197000
 aaaaaggcta ttccctttcc tttttttgtt ttgttttgtt ttgttttaga gctatggttg 1197060
 cacatatctc aggctagcct caataacata gttgctgaga atgacccatgg aattctgatc 1197120

 ctttgcctct acctccgtct actgagtact gggattatag atctatacta ccatgcccag 1197180
 tttattctgg ggacttgtgc atggcaggaa agcattctac caatgaagct atateccagc 1197240
 ctttgcactc ctttcatgt acaatfffft tgttttctct ggaatcatca attacctact 1197300
 atctttttct tgtactatff gcctttatca tatactctga atttctaga ctttcttaca 1197360
 tgtattctaa gaccttcttt ctctccccac aagtcttctc tgttagggtc cacctttatg 1197420
 tttttttatt gatgctctaa aaataaagat tttagtata ttttctgggt agtgtttagga 1197480
 tttgtgctat atataatfff tttagcaaga gagtctttac tatatagccc aggctattgt 1197540

 ggaactcact atgtaacca gtttggctc aaattcatgg caatcctcct gcctcagccc 1197600
 aggtactgag attacaggca tgagtcatca tatctggcaa gctttctttt cttattgctt 1197660
 tcttctcage ttaaatagtg tcatttagat gaatgcaata ttagtagcat actacattta 1197720
 cagttcattt ctgtcttgg gacatcactg aagaaaacca caaggaaaat agcactctta 1197780
 agagcattct ctggtagct gaaacaaaac caccacaagg aagaatttgg cttttactt 1197840
 tggcttggaa cataataaat gtttatagaa ttatattatt tttagaactc tatgtgactg 1197900
 ttagagtcca cataggtcaa ctttctttat agattagcaa atctaagatt agctagagag 1197960

 ggaaagtgat ttgtatcagg gctatttccc tgtttgaaga taaaatggag actaatcacc 1198020
 agagagcttt actcctagtc aactattctt ttctttaata tgacactgcc ttgttcaagg 1198080
 agtctaaccg taggcttggc agataaaaaa tagaaatga ccatgttagt caaattaatt 1198140
 tgttttttca aattgaaatt taaaaccag ataaagtttg ttaagtccag tattatgggg 1198200
 tttacattct attttgggag accagatagg tatttaaaat tgctgtcacc aaaaagcaaa 1198260
 caaaaaaat caaacaacag caggtagagg cagaaagatc aggagctcaa ggccatacat 1198320
 ggctacatag agagctttaa ttcagcctgg gctgcatgag accctatccc ccaaaacca 1198380

 gagcaaaaa taaatafac ataaaaatag cttttatata gctgggtgtt ggtggcacac 1198440
 gcctttaate ccagcactct ggaggcagag gcaggcggat ctctgtgagt ttgaggccag 1198500
 cctggcttac agagcaagtg ccaggatagg ctccaaagct acacagagaa accctgtctc 1198560
 gaaaaacca aaaaaaaaaa aaaaaaaaaa caaaaaaaaa aacaaaaaa caaaaaaca 1198620
 aaaacaaaac catagctfff atattatgca gttgtcaact aaataaaatt aataggatc 1198680
 acaaacatcat ggttccaata tcttggcatg gtaaaagggc ttaatagata ttaactacta 1198740

ttactataat tttggatagt aaaaacatca agtctcacca agtggtcagc actgaaacca 1198800

 tatacatata agcaacataa aacagactta gcagattgta tttatgtatt tgttcacaca 1198860
 cataaaataa taatcatttt taaaaagaga ccatgaattt gagagggagt gaagagggaa 1198920
 tatgggaggt gtiggaggaa ggaatgacat aattatactt taatttttaa aaatagcaaa 1198980
 aactaaaaat tattttgata agaaacaaaa caaaacccat catacttttt tagaacaaaa 1199040
 gttttatgca aggaacaatt tattttattca gcaataactt tttgagaact tattgtatac 1199100
 caggcactgt tctgaacaaa acacaaaatt ctttttttta ttcagtataa agagatggac 1199160
 aataaacaaa caaaatgaaa cagatagggg ttgaggagat agctcagtta gtaaagggct 1199220

 ttcccttaca ggccttgagt ccaatactca gaacacacac acaaacatgc agacacataa 1199280
 acaaatataa cagacagtga taaatgttat ataaaaatgc agatcaccag gaaaaggagt 1199340
 gagactgcag agtgggagtg atgtgggaag atcctttgct agggtaacat cttttgggca 1199400
 gagattgaa agaaataatg cagtatgcca tgcagataat tggggcaggg aagagagatg 1199460
 ttccagatag atggaagagc aagtgtgtgc tgatgctttg tgtgcttgaa gatgggtaaa 1199520
 ttagtatage ttagaccctt taagacggga tcagggacaa tacggggttt ggcaggtctgc 1199580
 tagatcattt agatccatgg aaaccaatgt agattgttac tttttgtgca tggtgaaaag 1199640

 ggaatgcacg agacagtctt gagcaatgac atgacaataa cttgcattat acttaggacc 1199700
 tgtattttta atgaaaataa aaagtagaag ctgtgggacc aattacaagg tagaaataca 1199760
 tgtgagccat gatgatttag ataatagtgg caagttgtga aggtggttaa agtgctcaaa 1199820
 atccagacct attttgaatc aagagtccat ggcatttgcc atcatggaag gttctaatg 1199880
 atcttgacgt ctgctgacct caacacttct ttgatgcaga taaagtccag gaatgggaga 1199940
 tcactattct tgagataatc caaaagattc ttataaagaa gaatgatatt gccatagcta 1200000
 gatttaagaa gattaatctg gagttgggca aagtggcaca cacccttaca tttgagagc 1200060

 agaagaaaga gcatcaaaag ttcaaggcca gcctcagcta ccctatgagt ttgaggcaag 1200120
 cctagctatt tgaggacctg aattttgtga ccaattatta tattattgta atataattat 1200180
 acatatgaca ccatgcttgg cttcttgag atattatfff aatgtatfff tacatgtact 1200240
 catttattca gtgtgtatgt gtacatgtat gcatgccaca gcatatgtgt ggcataaaat 1200300
 attatattga tgatgtaaat cattaacatt cctacctact gtactgagac agcaatagtg 1200360
 acagagaggt tacaggcaaa gtcttatttt ggagaacaca tttaacctt tttaaaatga 1200420
 gtatgtgcct ttgaaaaatt ttagattaaa caagagaatt cttggttctt tcctcattct 1200480

tcctctactt ctattccatt catacttata tataatagtt tccttccatt ccaactccat 1200540
 tagccatctg ttctctccta ccatgtaggt tctggagatc aaactcaagt tgcaggctt 1200600
 ggtggcaagt gttcttatct aaagagccat cttgctggca caagatggcc cttttaaaaa 1200660
 gagctaatagc ttaatctagc catcctagtt tttatttga tttcttttac ttacacttga 1200720
 attacaaca tactcattac aacttcaaaa tttacatct agggtttttg aattctaatt 1200780
 tctttgaaca ttttacttta ggatcacttt tagagtccat agattttcct tacttctcaa 1200840
 attctaacac tgcacctaa cattaatgag ttcaaatcag atttattctt taagttatca 1200900

 tactcaagaa acatagagct ctgtaggata tactatatgg aaggtaaaaa gaaattatta 1200960
 gatctttcat acctttgta cctgccttgt agttccttct gacaaaccta gaaataatcc 1201020
 tgtaataaaa ttaaaaccac agagttacac tgtaagggtg ttccaatatt tggctactgg 1201080
 aggccatca gcagagacat caatgtatct tgcctcttta agtcttagtt ttccatttg 1201140
 tggaatggaa ataacagttt ctatcacagg ttgttgtag aagtcactgg gataatttt 1201200
 gtaggagcac agctaggagc ccaaagccac attacattgt tctttcca tgttctgtg 1201260
 gaggctgata tatgtcgtg ggaacttgc gagttcatgt gaaaccttg atctattgaa 1201320

 gggttcttgt tgtttatgg aggaggttat actgagtcct cattctctgg ttctcacat 1201380
 gatatagttc ctaaaataac cttttgtca ttagctagtc aactccagac atcctggttg 1201440
 tctaagatct ctatattcc agttatggc ttctcacac atcacactgt ttccatgctg 1201500
 tgacttttcg tgtctatgat gacatcagct acacaggcag ctgtgcttta accactcagc 1201560
 ttctcacagc tgtctatact acctaaagtt gactgataga ttgatttctt tctggtatct 1201620
 tttccttata aatagggtct ttgttgtag gtctgacagg aatcctcct gtatcatcca 1201680
 cctaagtgcc aagagtgcag gtatgtgcca ccaactcctag ctataaatct gtttactttt 1201740

 tataataata aactatact cccatttgc gcacttatgt atttttccc atatatata 1201800
 catgggatg gttcataaca ttgacagat aaggaatttg tggctcagac agtacaatg 1201860
 acttggccag ggtcttaag taattatgct tctactttca cagcctttgc tttttgata 1201920
 tttggccatt tgtctagca gtagtttatt aagagggtat aaggctgttt tgggaaatg 1201980
 caactactgt ttataaagct aaagatatta aagtgaagc ttaataaagt aatatctttt 1202040
 ccttaactga gatatgctca ctattaaat aatttccac tgaatatata catcataact 1202100
 tgagaacaag cttagggcaa tacatagggg atcatcagag aggcactttt gtagttcagg 1202160

 aaagagttga caatagtat aatgtagaa gtcagagaaa tggctcagatt ttatatata 1202220
 tgaaggcaaa ctcaatagac ttgcatagtg ggcttattat atgatctaaa aaagtatctc 1202280
 caaggagggc cagcaatatg actgtagtg gtgcttgcta ctaagtctga taacctgagt 1202340

ttgaccccca gaacctataa cttgtcttct gacttgcaca atataccgtg gcatgcatac 1202400
 acatacacat tgaataaaca ttaaaaaaga gtatctccaa ggagccaagc atggtgtcat 1202460
 atgtataata ccagcactca gtaggcttaa acaggagtat gaggctaggc tacatagagc 1202520
 aactatgttt caataaaaat aaacaaaaaa agatacaagt ttttccttac cttttttatc 1202580

 aactggaaaa atagaatttc cattattcta gatggataag atacttgaga gagaagtctt 1202640
 ggggaaaaga ccagaacttt ttgtttcatg caaaaacaca aagtgttagt tgtgacaagt 1202700
 gctagcaagt cattgaagag ttcaagtatg gatatgacat gccagattta tattttgaaa 1202760
 aaaaattctt ttggtcatta gtgcatttaa aaagataaga atcccaacct gatgacttat 1202820
 aggtagaggc ctaagctgct ttgggatttt aaacaaataa tgaaatcctt cctgaggttt 1202880
 agttttctca ctttcaaaa gggatagcaa atcttgtctg tcttaaaaga ttatgaagga 1202940
 gccaaagtctg gtggcacaga ctagcagtct aactacttaa gagacttagg cagtagaatt 1203000

 gagagtcaa ggctgcttg tgctgtgtaa ttaagttca gtccaatgtg ggtgatttaa 1203060
 tgagatacac tctcaaaaca aaaaaaaaaat aagtaagaag gttagggcta cagctcagtg 1203120
 gtaatgtggt tttacgtgga ccctagggtc agtctccagt accatcaacc aaaccaaacc 1203180
 aaacaaaag aactgccaca aggattagct gaagttttaa atgaataat atactacaac 1203240
 aattagaaaa ttatcaaatt tatagaaaag ttgcaaac aatacaata acctttccct 1203300
 gaacaatttg agggtaagat aaacaagaac ttttcctct ataaacttaa tatgactctc 1203360
 aaaacaagga aaacaatatt catatatccc ttgccatcta acccttgac tccattgctg 1203420

 ctttgtgaa atgttccag tagggatact attcagccc agatacatag aggaggcct 1203480
 aggctgtccc ccaaatgacg acagattttg atgattcccc cacagaaggc ctccacatcc 1203540
 ttggggagta ggtggtggg ggtgggttgt aggggattgg taaggggcat gggaggatgg 1203600
 gagggagagg gaatgggggt attgatatgt aaagtgattg tttctaaaga aaaaaagaa 1203660
 acaagttta gctaaaggctt agctttctta attaataata ataataaaga aattgttcca 1203720
 gtaatgtcct ttattgcaag agggctgagc taataaaat taacataaa cacataatat 1203780
 taatatatta tatatggctg ctgtgtcttt ttagtctcct tcagtctaga ctagtcttt 1203840

 agtcttgact ctcatgcttt taaaaggctt tcttctcagt cttaacagcc acaaaaatgt 1203900
 aacctagata ctaagctaaa ttgggtgcta tttattttat accagtgtat attaagttag 1203960
 aaaatcttaa atctgatatc tagatttagt gaacacacac acacacacac acacacacac 1204020
 acacacatat atatataat atatataat atatatctt tcttctagcc tctagcagca 1204080
 ggttttaaat tttttgatat ttataggtaa gtttcagata ctacagttaa gtatttaggt 1204140
 aataaacaag agaaatctgg tctttgtcct catggagctc acatgattgt cagctgcaat 1204200

cttctttagg aatgaattgt taggatcgat gtgaaataag gaaacaaaga aatgtaaaaa 1204260

aggaaattat ttcaaggag aatgtggagt tgtggaggc atgtctctag gagcaagtgg 1204320

ctatacatgt gttcccatga ctcttgacaa tgccaaggac tatttcactt ttatatattgt 1204380

ttacttattt gtttgggtgtg tgtgtgtgtg tgtgtgtgtg tgtgtgtgtg tgtaggccaa 1204440

aagacaattt gtcaaaggca tgtctttatt ttccaccatg tgggttctga gaattgaact 1204500

caggttggta ggcttggcag caagcaacct ttcccatgta gtcactcac catccaccaa 1204560

ggactattaa agttgacata tgagatcttc cttgtttgat tgaggttgtg ggtctttcag 1204620

gaaattgtca agtggtcgaa aagatgatgg taactgtggt cttggccaca gtttgaagtt 1204680

caaagtagat gggagtgtcc tgtacttccc acggtgcttc tagagttttc aggagagtga 1204740

tttttccatg ttcttttggg gcagtagagt aaatagtctg gaattcaaaa cctgacccta 1204800

gttacaggtt tacatttaat cccctgtgtg accttggcaa gcctcttctc ctggacttgt 1204860

aattttcaaa tgagaatagt aatcgtttgt ctaccactg ctagggtagt tgtgcggatc 1204920

aggtaaggg tgacctttag agtggttata tactatagtc atgtgaggaa taaactgcac 1204980

ctgtattgat ttactcaaca tgtgagcagg tatggcatta cttttctttg atatttatat 1205040

cagctaagtt ttccctctac cccatgtaag caagtattca atttctgtat aagttttata 1205100

ctctgaatct ttcatgaatg agtacactga tccactgtag aaactcaggt acatttctctg 1205160

acatatTTTT gtigaaactg atttagagaa ttgctccctt acctctggga aggagagaga 1205220

atcaacaat gtaagataga ctagagaata ttctgtctaa caccagcctt tcccctcttc 1205280

caactctctt ttcccatctt atattttaca gaggaaaaaa taatctgagt ttgtgtaaat 1205340

ccatatattg aattagggat aaatagtaaa tatagatcta gaaactccat attcagaact 1205400

aggggatcct gtatttttgc atgcaaaagt aagcacttga aaatgttgtt agaagtctag 1205460

gacccaccc cagcctttct gtttgttttt tattttatat gtatgggtgt tttgcctgca 1205520

tgtatctatg tgaacctcat gtgtgtagta gctgtggagg tcagaagagg gttcagatac 1205580

cctggaacta gacttataga tggttgtgag ctgccatgta aatgctggga atagaacctg 1205640

ggtcctcagg aagagcagag agtgcctctaa ctgctaggcc atctctccag ccctgccagc 1205700

ctatttaacc agaactccta gaaataaaac ctctgaatct attttataag ctctctcaat 1205760

agttgtctata taggaataga gtaccaccaga aaattctttc agcactgggg ttatatcagt 1205820

tgaaagcaca tacctaggat atgtgagggt tcaactacct ccataataat gtttaagata 1205880

ggaaactgac attttttaaa acataagaga aagggttaatt gtgaaagagt gggaaaagaa 1205940

aatcctctcc agatttccta atagatcagt gttaggaaaa gattacatac agaaattgaa 1206000
gaactggatt ttagtcttt taaaatttct tggttgggca ttggtggtgc accaaggagg 1206060
cagaagtagg caaatctctg tgagtttgaa ttccttcaac catacagtta tctgggcttt 1206120
aacacattga ttttcttctt taccctttcc ccttggattt ttgaaaaagg ccatgatatt 1206180
taggaggaaa atgtcttgaa tagacattta gaatatcaag tttcagggtc caagtgatg 1206240
attactaacc acatgtcatt ttatatitaa agtaagatta agagaaagca aactttattt 1206300
ttcactcaca ttttaagtg ttactagtta catatgggta ctggctacta tgttgacag 1206360

caccacttta gaataaagta atatgctagg gaacccaag gccatcactt actatttctg 1206420
tgcttagag caagtaagaa tggtagatct caaaagctct attcttcttt aaccttcag 1206480
gtgatttgatg attcaatttt ggaggtatgc cccccctcca ctttctttc agctttctgc 1206540
tacagcaaga gcagaagtc ccaaggggaa cattagtgc tagttgtca aattatgttg 1206600
tttccacttc ctactcctt ggtggaagga gaaaattacc tgagggtatg cttacatcag 1206660
agttccattt gtgcaacct ttatgggtca tagaactctt tcatattatt tcttcatttt 1206720
tatagtitta aagtttctg tttctgtttt gtttttctga gacagggttt ctctgtataa 1206780

cagccctggt tgcctggaa ctactttgt agaccagact ggcctcaaac tcagagagtg 1206840
gcctgcctct gtactgggat taaagtgta caccaccaca cctggatcaa agtattctta 1206900
ttctgccagg taigtaatgt tatgtctgta tccataaatt ccagaggttg aggccatctt 1206960
gggttagtga gatttggttt caaaagaccg aagtttggag atataactca gttctagagc 1207020
atitgcctaa catgtatgta caaggtctg agtttgatca ccaatactac caaaataaaa 1207080
taaaaaagaa attcagagtc cataatttta ataatttca tgaatataaa ttatatgggg 1207140
gaaatttgc aaatgagaag tccaagattg gtgtggtggc acacatctgt aatcccagca 1207200

ttcattggag gattaccaga agtttgaggc cagctgagct acatagcaag attctgactc 1207260
aaataccaaa acttaacaa aaaccaccaa tgccacattc tctggaggat catctagtac 1207320
aaataagtac tagagttttc ctggacaaac tgaatgatcc tattcttcaa ctctatagta 1207380
tatgacagag gatgtcttag tatctgcatt attagcatta tttgaacata ctttaagaaa 1207440
gactggtttt gcttggttct catggcagaa tttgattttt agtgtctctg caaatctcag 1207500
attctacttg ttacctcag agttagagtt cccaaaggag cacatctat ctttgaatac 1207560
ctctgccagt tagaaagact ttctgtatac ccagctctct aaagacacct aactactcca 1207620

cttatagtta cataatgcta acatgctca taccataat aatcattcag aagtattagt 1207680
tcagaaaaat ttattaagta cttactgtaa acaaggttct gtgaaaaaca ttggggagtc 1207740
agcaatgaac aagaacacct tggcctctgc tttcagggaa acagctaatt ttctttcatc 1207800

gatttgctgt tagttttggt gtgtgtgttt ctatggtgtg tacatatgta aatgttcata 1207860
agtgtgcagg tgcataaggg ggcaggaagt tgactttggg tgtctgtctc tgttgctatc 1207920
tgtttgagac aaggtcactc aacctggagc tcaccaattc agtaagacta gctggctctac 1207980
aggccacaga gatcttcatt tctttaattc accagtactg gcatttcagg cacatgctgc 1208040

cgtaccacaga catttagcgg gggctgggga tcccatctca gatcctcacc ctgtgcaat 1208100
aagcactcta ctgactgaac cagctcccta gccccaaac agccaatttt aaaagtaaat 1208160
cacataagaa tagcttgaga aaataaaaag aaaataagca gaatgtggtg atgaaaaaca 1208220
agaaggggtg gtgctattta gaattagaga aaatctcact aggtagtga catttaaact 1208280
gagatttgaa gcataagata gaacaattca aagaactaag gaaagatagt aatgaacat 1208340
ggggtgttct gttataaga aagggtat gtttgaacc ttagaaagca taataggaga 1208400
atggtacaag atgaagtaga ggaagatata agggacagaa gtttggtttt tcttccttat 1208460

gcaatggaat ccattggga gttttaggca agaggctatg tgcaggaagc tatgtggtct 1208520
gatttatgtt ttaattgag cattctggat gatgtgtata taaaaggggc cactatggtc 1208580
atccaagcaa taaatgaaaa ttgctgtaa ctagggtgaaa gcaacagaga tagagtatc 1208640
tgaaaatggc taaagcact ctcaatagct tcttttccc cagataaaca tctggtaat 1208700
gctcctctaa taacaggttt gacttcttat tgcagtgttt gttttgac agcctggccc 1208760
actagagtag aacttcccc aaaaagggtc tatgaataaa ccagttttcc catttctctt 1208820
ttattgggag gcagggtatt ggaggatctt catgcatgtc gggcaagtac ccagtctac 1208880

caacatctt tcttccagtc ctttggccca aatattcttt actttagt gtaaggaatt 1208940
aaaaatctcc aaactgatga ctctcttctc atagaaagag agggctctta gccttctctg 1209000
ttgttaatca ctaaacgctc tgatgacttg actatgacat tgagtacctt attcagctgg 1209060
ccttagctgg aaaaggcaaa gaaagaacat gaccctgtc ctctgggtgt aatagaaaaa 1209120
ataagacca tglaaatgca gtacaaggtt gtgtgtgttc aggtatcaca ggaaaatgaa 1209180
tgaaaaggg actgaaaagg tgaagaatt ttcagttttg ggggtaggtg gggacaattt 1209240
catggaggat gttcattttg aaggataggg gtgttcttcc aaggataga caagtatagc 1209300

ctcactgaaa aggcagccct tctgttaatt ccagcatttg ggaagctgag gcaggaggaa 1209360
tgctatgtgt ttgaggccat tccaggctac atagtgttc cacccagct tgagtgatgc 1209420
ccagcctcaa aataaataaa acaagccaac atttgagcag tgattcaaag ataaagagca 1209480
agccatgtgg tcatctgggg gaatagtgtt acaagtagag ggcaaggaat ctgggtcaa 1209540
gtgtgtttgt caagcaactaa ggcagccacg tgtatgaagc agagggaaca ggaaaggaaa 1209600
gcagaacaag aacatgtgag aatagaaga attaagaatt agtaagaatt aatagactat 1209660

tgtaggact tgggcttga ctcaaaactg tataagaacc aaccttagtg ttttgagcaa 1209720

 aagaataaca ctctgactta ttctgtaaat ggaataataa aagcccagag tcatatata 1209780
 agaggaaaat gctgaaagat cagagagaag gggcaagcca aagccacctt taccttatta 1209840
 gcttcccagt gaaaaagaga gtgagttcct gtttcttct gcttataatcc tctttctgtt 1209900
 cagccatttc acttctctgc tctgcccagc catctcactt cctgtctgtc tgtacagacc 1209960
 ttcagaccte tatgtttagc tagtggaaag ctccgtctctc tggctttcag acaagtttta 1210020
 tttgtacaag caagattcca ccacattacc cattgatgat tttgacaagg acaatagaag 1210080
 taattgtgaa aacacacata tgtacatata tttaaaattt tagtatttat gtgtttgtat 1210140

 gtgtagctgt gcatgtgcc aaagagggtca gagagggtct ggcttcctaa agctgaaggt 1210200
 tcaggcagtt gtgagccact tgatgtgggt gttgagaatc aaactccgtt cctttgcaag 1210260
 aacaatata actcttagcc actgagtcac tctcttagcc cctaagtata ttttcaacta 1210320
 ccagtggact agagtaaagt tggagggtat acagaagggc tactttgaaa agactctctg 1210380
 tagaagattc cccaaaagag gaacatgaga agggtttagtg atggtatata ctttgttate 1210440
 tcactaacca catggcttcc aagtgaaggg caagtaggct tatggcagaa gttctcaatc 1210500
 agtaatctat cagttaaatc tctcattaat agttctgttt ggtttatggt gtttttttc 1210560

 ttgagacagg gtttctctgt agctttggag cctatcctgg aactagctct ttagaccag 1210620
 gctggctctg aactcacaga gatccacctg cctctgcctc ccgagtgtctg ggattaaaga 1210680
 tgtgcaccac caatgccgg tggtttatgg tgttttaac ctttgaaaat tagttatccg 1210740
 tatttgaaaa ttgacagaa atatgttcca gacctttaa aatggcaaca ttgagccact 1210800
 gaacgaaatt taacaggagc taagttgggc actggatcct ttagccaaag catgtgttgt 1210860
 gttttctagt tgattcctct attgttgcc ctaaactgag gctgaatata gttctacata 1210920
 tattattact ctcatataga aaaattaaga ggaaggaaaa taatttctg tctctgtcaa 1210980

 attttagtta tigtatctac ttcactcatt tacctggaca cggtaatat ggttaatfff 1211040
 ttcacattgt gctgagaatt gagcccagga ccttgacat gcttgaaaa tactctgtca 1211100
 ctgagctcaa gccagtcctc tgtaatfff tgatcttgca attcccctg tgaagaaaag 1211160
 aagactggac tctgagctct tgtacctgtt cttctgtaa caattatfff ttccaacct 1211220
 ataactaaca gtctcttga atctcagagt taggcaaat taattgttct gttaaaagtt 1211280
 caaggatcct agtgggcttt ggatcttga aaggtaatt tttgttccct tccccctct 1211340
 agccagccag ggtcccaagc ctggtgtctg tgacagagaa agaagacact ggaatgagta 1211400

atgtacctat gtcaataatt tatagcttac gcacatagcc aaagagagga acacacactg 1211460
 tgtgtgtgtg tgagagagag agaggggggt tcaagtaagc tgtgcatata tgagctttgt 1211520
 acatctgttc tcattcatca accatcacatc aaactttatt ttcagtgcta gagatatagc 1211580
 agtgagcaag acaggttagg tctctgatat aatgtagctc atattcctat aaaggacatg 1211640
 aataataata agcaggtaaa ataaatgaaa ttatttcaaa taatggaaag ttttgtgaaa 1211700
 aaataaaagc agaatgatit gatgaaaagt ttctaaaaag gcaagctgta catgtaggtg 1211760
 ggtttgtaaa tgiactctca ggcagactia tgtttgaatt ctgggcacat atatttatgc 1211820

 ttatttgtgt ttgtgatgt agctcagcag cttttgtgag tataatgttt ctatattagt 1211880
 atatatggtc ttattcaaga gtatttacag aggtgagttg gtatgggta cacattgggg 1211940
 gtacatgcat gaggacatac atgtcagcat cagctgtagc tggagatggt ttgaagtffc 1212000
 tgtagcattt gacagtgggc agcttttctg ctctctggcat tcagggacat ttgccagctt 1212060
 cccctctcct tgitctgtcc ctttttagta agcttgctat gcttggcttc tctcagccaa 1212120
 ggagaagata gtaactgact catcaagcca gaagctggaa agaagcagat ctttctgtg 1212180
 taacttcgct cagtaagaag aggctggca tccttgccaa tccagtcct tatgctgtga 1212240

 ggaaatagtc ctgacttgaa atcagaagat ctgaggatct attcttgct ctgtcactta 1212300
 ttattgtgtg accttggtg gctacttctc tctaagtffc agtttctcc ttcataagta 1212360
 ttctggatag aaaagaagg gagggagcac agacagctcg ctgggtata ttatatagta 1212420
 ttgcatctgg aaaaggagg cagaagcaat gaatggcatg gtaaaaagtg tggagagtc 1212480
 tggcagatg gcaccaccaa gcctgatgac ctggaacca catggcggaa gtgtgaacc 1212540
 aactctcct ggttgtctc aaacctccac acatatgcca tagtatgcac tcttccaaac 1212600
 aaagaatata aaatggactt ttaaagtgg agataggcat gaacctgtg tataaggaag 1212660

 ccagaaagat gaataaaatt taaattacc accttaca ggttctact gatttaactg 1212720
 atgcctacct ctgttttca tctagtctct tgcttgctgt attccaacca cattgagttc 1212780
 cttttgtctc ttggaatagg cctcaattcc tttccgtctg atgctttctc tgcccagaat 1212840
 attcttccaa gaactgatat ggtcacctat ttcttattga ggttttagct gaaaaagaac 1212900
 ttccccaggc ctttctgac actctcacct taagtggta tctcctaata attatcaata 1212960
 tgtaaaatac acatatcttt ggccctaaat ttgtattttt ataattcat actatggata 1213020
 tatttgcaaa tagcatatga ataaggatga tcattgaatt attactgtt aaattaatta 1213080

 ttatatacaa ataataagata ttatatacaa atagtagata aagagaatgg aaccattttt 1213140
 gatagagaat ggtaccaagg catatattta atttttttt ttggtttttt gagacagggt 1213200
 ttctctgttt tttttgaa gctgtcctgg aactagctct gtagattagg ctggcctcga 1213260

actcacagag atccgcctgc ctctgcctcc caagtgcctgg gattaaaggt gtacaccacc 1213320
 aacgccggac ctatgtttaa attttttaa aagcaagctg attgagttat acatgtaaca 1213380
 tttgtccagt ttattgcttg tatatagtac ctaaggctaa aactgtacct tagtggcaga 1213440
 acacttgcct ggcatgcctg aggctctggt ttacatccct attatcacac aactacacaa 1213500

 ctgcttgggt atggtggtat atgcctatag aatgagccct cgggaagttc agacaggatt 1213560
 gtgatcttga ggtgacttgg gtcacatagc tatacttgggt ctcataaaga agcaataatt 1213620
 aaaatgccat catttgtgta taaaattaga atatgtaaga atacatgcac atagacaact 1213680
 ttgtctaaca agtgtattcc ctgagtacag caccttttcc taaatcttac tgtcccatgc 1213740
 tgggctagac tgaatgagc ttatcctttt aaaaaatgtc taatatttta agttcagttt 1213800
 ttaatttctg cctctattgg tatctgaagg atttttttt aattatgaag tgtttggcca 1213860
 tggctcaggc ttcttaatgg ctagctcttt ctctttttt aattttattt tattagtcca 1213920

 aattaagaac aagcttgctt cagatgtcaa tcccctctcc ctctcttccc ctcccccca 1213980
 acatcccacc tgcctttagc catccccct cactcccta ggcagggtaa ggcctcaaa 1214040
 atgaaggatt tattaattat gcagaaagta tagacttctt tccaagtcac tattttggtc 1214100
 atcacaaaag cctccatat tactaagagt ggccttgtct gcaaattggt tctagaaagc 1214160
 cactcaaaat atcagtagca gtggttgtca gcaggcaggg tgattggcag atatgattaa 1214220
 gaggtacact tatcaatata atctttttat gcagcatcgc ctatattact tattaaaact 1214280
 catgaaacag cagtagaagg gagtaagaaa aacatcctta tatgtaaatt tccatagca 1214340

 atcacagtaa ttcttttga tatgtttatt attggtgaaa caggatctca ctcttttaac 1214400
 ccaggctggt ctggaactca ctgtgtggc taggctgacc tcaactttt ggtaatcctc 1214460
 ttacctcaac ctctgagtt ctaggattac aggaatatgc caccacacc agctataatt 1214520
 gcataTTTTT aaaaggtatt tttccagtc actcagttt atatcgctgt attttattta 1214580
 tccatagtgc ttataactta caatttttt ggtttaattg ttgcttatat attacctaca 1214640
 atatcattag tatacaagct ctgtgatgtt ggttatcttg tacatcagcg tcttgttcta 1214700
 cacaagcata ttgcataagg tagctgttga ataagcaaag aaagaataac taaaagaaac 1214760

 caggccaaac tggcaagag atagaaatta tgctatagga agtgggtgat attttcattg 1214820
 ttgttgttat tgagttgaaa atatgtact gcctttaate ctagcacttg agaggcagag 1214880
 gcaggtggtat ctatgcgagt tcaatgccag cctggctctaa ggctacataa tgagaccctg 1214940
 tctcaaaaag aaaggaaaat tattttattc ataactttat ttatttactc ataggttaagg 1215000
 tctcatttag cccagctgt cctgaaacce accatatagg caaggatgat gatgatcttg 1215060
 gacttttgat gcttatgct ctacctctg aatactagaa ttataagcat atgccacat 1215120

gcctatntta tacagtgcta gagactgaac ccatggcttg atgcgtatta ggcaagcatg 1215180

ttaccaactg ataatacttc ctaggcccc caaatgtttt atntttaaag atgttacctc 1215240

tggaaatntaa aataagtata ttcatntttag aaagtgtttt atntttatag aaaagntaat 1215300

ttaaaaacct ttggctaggc tgggcgtttg tggtgcatgc ctttaatccc agcactcggg 1215360

aggcagaggc aggggatct ctgtgagttc gagaccagcc tgggctacaa gagctagttc 1215420

caggacagcc ttcaaagtca cagagaaacc ctgtctctgg gaaaaaaaa aaaacaaaaa 1215480

acaaaaaaa aaaacacttt ggctaaagt tnttttagcaa gatggcttat catctaaaag 1215540

tgctgtcac taagcttgat aacctgagct tgatcccaga acccatgg gntagagaga 1215600

gatctctgat taacactntt tgttcattca tcagaaaata aagntttata aaaatcaatc 1215660

atgttctgtg aaataaaaat gattgaaaat atntcatntt aggattgtcc tgtccaagaa 1215720

aaagaaaagt tgaacaaaa aaccagcatg tgagttaggt tggaggntt atacctgat 1215780

taccattact ttggagttag aggcagggag aattggacga ttgaagccag cctggtctgc 1215840

ttagttagac cctgcaccaa aagacaaatg aaggaagag ggaggaggagg gaggaggaaa 1215900

aaggaagag tcagttagat agataagtgg ctaaaagagt tagcagtgtc agcctgaaga 1215960

cccagnttca gtcctggtc tcataaaaag ccagatgtag tggacattgg caatcccaga 1216020

actccttcag tgagatagga ggcaagaca ggagaattac ctggaagctc ctgaaccagc 1216080

tagccttagag tacaaggcac agcagaaaaca gtatagctctg attcaacaag atgaaaggca 1216140

agaaccaact ttgacctcta cgtgggcacc atggcatgtg cacctacca cacacaagta 1216200

aatatgtaag gatntttaaa aagaaaagaa aaaacagtga tgaaaaacag gacaaaagct 1216260

ctntctgctt tcttggtgca tgttgaagcc tgctggaac aggatttctt ctntctntt 1216320

ctntcttctt ctccgagcc tctntctct cttnttctc gggaggaggg ggggtgctggg 1216380

gggaatcaag acagntttc tctgtacaac agccttagct gtctggaac ttgctctgta 1216440

gaccaggctc ttgaaactca gagatccatc tgctctgcc tgccgagtgt tgggattgaa 1216500

ggcatacacc accactgccc atattatgga aacaggactt ctaaaaagca gatatgtctg 1216560

gaaggctatt gggcaaggcc atntttgctc gctataatca aggtctctag aaccaaagag 1216620

tgcatatggc tcttctntaa atcaaagata tttatgcttg agaagaaact gaattctatc 1216680

taggtataaa gaaaaacaca atagcatgac tcttgagat aaactgaata aaaccagagt 1216740

aatctgtaga aatgtaactc tggcccatgg aaacaatggc atgntttgtg ccaaatctc 1216800

aagcaactgt cctataaagg ccactggaca cagaatctat gtgatgctgt accctcaca 1216860

gataaaata tttaaaaatg ggtttgtgct tttgttttta aaaaaggagc aaaataatca 1216920
aactgtattc ataaggactt acaggaacc caagattagt ctgaattta acatcgtgcc 1216980
tcatctgctg agtattggga caagaggat gtgccacat acctggttc atttgtgtc 1217040
tttttaaaa atgactatct ttgttcccca ctgtcccagg cctcatccc atattccag 1217100
atgcttggat agtcaggga ctctcatatg ccaggccagt gttgtaccac taagccatat 1217160
cctcaagtcc aaagatagtg atttttaa tttaaactta tgtcataatt acctaagt 1217220
tctctgtatc agctgtaata aagaagcaga tttatagtgc tatgcttcag tgggtaactt 1217280

catatccatg ctcatgcaga tgaccctagt taaactcagt gggtcacaaa acaaaataaa 1217340
atgacatgca agtgggaagg gaattgataa ggaagtaaga tgctgttagt atggggagga 1217400
gtgagtgtgg tcagaatata tttgtacctg taccaaattg tcaaagaaca tgtgtgtgtg 1217460
tgtgtgtgtg tgtgtgtgtg tgtgtgtgtg tgtgtgtgtg tgtgtgtgtg 1217520
tgtgtgtgtg tttaaagcag cgtctaagc tggtgacatg gctcagtgg taagagcaat 1217580
agctgctctt ccacagaacc agggttcaac tcttagcact cacatggcag ctcaaagtct 1217640
tctataacce attccaatg ccctcttctg accactgagg ccaccaggca ctcacataat 1217700

ttacatgcat agatgcaggc aaaacattca cacacataca tttcttaag ctggcaaat 1217760
gtctcaatag gtgaagggtc tttcttccag gccagatcta ctgagttcaa cccctctac 1217820
ccacatgggt aaagagaga ctcatatta caagttgtcc tctgacctcc acatatgtgc 1217880
catggtgtgt gtgtgtgtgt gtgtgtgtgt gtgtgtgtac atgcacaagc aaataagtta 1217940
ttcttagatt ttgactctg atgcaacaga gctgagtga agtccagaaa tctatattca 1218000
aacaattcc ttagtaact ggggcacgag caatgtgaag cccctattct aaataacaat 1218060
ataatttctt tcccgtgtc attttttct tacagtatcc caatctggca tcaagttgt 1218120

gatcctgctt taccctacgt agtgetggga ttacaggcat gcatcaccat acccaaatgc 1218180
atgtttcttc atgtatttt tgagaaaggt ctcatgtagc ctagactatc ctccaacatt 1218240
ctaagtaacc agagatgact ttgaatcctt gatcctctg cctttgcctc ccactgcta 1218300
agattgcaga tgactggatt ttttaaatg gttttgttg ctgtttgctt ttgttttgt 1218360
tttagataaa gactcactat agccatggct ggcttgaac ttactatgaa acccaggttg 1218420
gcctgaact tgacacagtt caacttgaga acttcttacc tteatctct gggtagtgat 1218480
attacaggag tgggtcacta cattaggctt taattcagtc ttacacttta taaaagtaat 1218540

gctggatctg gtgacacaaa accttaatc ccagtattct ggattcagag acaggcagtg 1218600
agttctagge taccttgatc tacatagtga gttccaggca tgagaccgc tetcaacaat 1218660
tgaacaact actatagggc accttgttg cgtcattct ccttaataca accctaagat 1218720

aaaagagaag ggcttatcac tctatTTTTgt caacataaaa aataagaatc agaggtagac 1218780
 agtacacttt ccaatctcat aaaacatgca tacaagtact ttgagaagcc aaagtatctg 1218840
 tctagtcagc taaagatgtg gtatcagggg actggagtga tggctcagca gttaggtgca 1218900
 ctggctactt ttctagagga tctgggttcg attccttacc tacatggtgg ctcatagcta 1218960

 tctgtaactc cagttttagg agattcaata ccttctctg gcctcttggt caataggctt 1219020
 gcaagtgata cacagacata cattaaggga aaatacacat ataaaaattt aaattagtta 1219080
 attaaaacat ttttagaaag atgtagcatg agattcactg acaggagagt gtcaacattg 1219140
 atatgaacag atggaatttt gtgactgctc ctatctcgtt tatgagagaa cagagctatg 1219200
 tcctaatta ctgattcttt ctgatgtatc tcagggaggg caatgaacca ggggagacca 1219260
 ccaagatcac atatcgtgaa cttctggtcc aagtgtgtca gttcagcaat gttctccgta 1219320
 aacagggtga gtatcagtgt ggaagaggaa ctgggggacc taaccctgag ctctctgagg 1219380

 aactgaaaa aaagaggaca agaaatgga ggaacctggt gacaggaaca gaaaagttag 1219440
 ctggacgggg gccatctgag tgggagggag caagggatag caagaaaggt ccatcatagt 1219500
 tcctgttctg tctctttttt tcctataggc attcagaagg gtgaccgagt ggccatctac 1219560
 atgcctatga tcttggaact tgtggtggct atgctggcat gtgctcgctt tggagctttg 1219620
 cactccattg tggtaggaac ttgggctggt gacaggaacc aagggtgagg gatagggttt 1219680
 tgagaaggaa attggacctg gatcatgaag taccataaat ataggtccaa atcagatgtt 1219740
 cagtatcttc tggaaacctg ttttgagat gctgaatttc atgagcacct cccttctttt 1219800

 atcaactcaat cactagccct cgcttccct tcaggTTTTt tttttcttc ttcttctct 1219860
 tcctagttc gcaggtttct ctgcagagtc tctctgtgaa aggatcttgg attccagttg 1219920
 cagccttctc atcaccacag gtgactaatt ctttaccctt tctccagatc ctctacacc 1219980
 tcaagtttgg tctctagctc gcttgttgat ttggggcaac ttggggcaga gggtaggggc 1220040
 tgcctgctg ccttctctc atcctacttc agctgactct gtcagcccaa atcatctgga 1220100
 agaaccagag tcaagaagct gattcaggaa gggccctgtg gacattagcc cactgggag 1220160
 catggtgtgt actaaggcct ggaatgttta ttgctcecca aagatgcctt ctacaggggg 1220220

 gaaaaacttg tgaacctgaa ggagctggct gatgagtcct tggagaagtg ccgagagaag 1220280
 taagtgtgct gacctaatgg ctactaactt gggttgacag gatctttctc cactgccagc 1220340
 ttccctttgt ccttgctata tactcctaga ggggcatggg tacatcttgt caacttcttt 1220400
 tagccaacca gaccagtact tcagcctttt cttttctcta ggggtttccc agtaaatgac 1220460
 tgcattgtgg tcaaacatgt ggggcgggca gagctgggca tgaatgactc tcccagccag 1220520
 tctccccag ttaagaggca gtgtccagat gtccaggtga gtctgacct actatgctct 1220580

cttttgggct ctaactcctt ctctcttctt acccaaagat ttcctatntt ttctccttgg 1220640

 ctcttctatc gtaatactga gatctgggaa caattccagg aaagcttctt ttaatagagc 1220700
 tggctggaaa gcaagaggtt ttgaccttga atataagtag agaaggaact tagcatgaga 1220760
 aactgtgaag gttaataggc agaggggacc cttagagttc aggcttgggt ttgggttggg 1220820
 aatgtactga ctgggtgac tatacatact catntttgatt agagtgagac ttgaatgagc 1220880
 gacatttgtg gctttggatc caatacttct gctgaaaagca gtaggaaagt gccattaaca 1220940
 gcctatagtt tggcggggca taggtatata aattctgggg tccaaaacaa tagaggatta 1221000
 cttagattct ttgatttga gtatctgag tagtgttggg actagagagg ataatatggg 1221060

 actagggagg ttgggaggcc aaacaatatt agaaattctg tacataatag ggtgaggaaa 1221120
 atagaggctg agggcactag tgagagggca ggctgggaag aaagaagaca tctaggggtt 1221180
 gagggaacac tcaccttcc ctctctctcc tctatctttg gacctgtct atcagccttt 1221240
 ccattccatg ggctctaac agggtaagct gaaagagaaa tccaagtgca tccgaccca 1221300
 ggatccact tcttactgc ccttgatcac tgcttccctg tgtgcttgtc tgtatgttca 1221360
 tctgtctct gtctgtttg tccagtgagg ttgctgacag agctaagtct gttccctttg 1221420
 ttctgggct ccgacatcca tattactcag aagggttaca aaatcaatg tctgtttctg 1221480

 cctctgtcca ctcatatata acaaggatat caaagtttgc aatgacatcc cagttcactc 1221540
 ctgctgcata gatcctttgt gtgagaggaa actgggaaac ctgtcagaaa gcatatgctg 1221600
 ctcathtagc tggcgagtag agccaggaaa gacaggaagc atatggagga ggcacgaact 1221660
 ctgatcttgt gatntttacca tcaagttagg aagttagacc tatattgtaa aagaaaaaaa 1221720
 tgtnttatat gggacaacag agaagaaatt cctaaatata tctttatgca acttggaaat 1221780
 tataaacag acataactga cataattaag tactaaattc aacaaaagtc aactgtagg 1221840
 tggtaactcaa tgetggttag tatggagcag gggcttggag tccgaggcca atatttagtt 1221900

 gcatgacttc aaataacca tgtctctct ctatacttca cttttaaaaa ttcaacaata 1221960
 aagacatgat atatgattaa acaaaaatgg ttccatccc taaagcaaaa tataaaggtc 1222020
 actgttccca tgggctttag tatcttcaca ggttactttg aatcttcatg gctgacctct 1222080
 tgtgctagta gtacataaa gtcctcactc tcatgagat gtggacacag acctgatttc 1222140
 tgggaaactg ttttacttat aaaatttagt cagcacccggg tatgggaatg cacacctttt 1222200
 atccctacac tgggaggtag agtcaaagat ccctgggagt tcaagactag cctgatctac 1222260
 acagtgattt ccaggccagc cagggtgta tagtgagacc ctgccccca cccaaaaaaa 1222320

ggaaggaaac aaaaactaaa ttaaacttct ttgaaagac aacaaacttg gtggtttggg 1222380
 atgtaggctc tggagccaga ctacttgggt tcaaatccta tctatcccat ctgcttaggt 1222440
 aacttagctt tcttgcttca gtttctgtct atatgaggta acgatagtaa ctgcacttag 1222500
 agtatattat ctatataat ggcatctggc atgtattaac tactcaaat atattaggtg 1222560
 ttgtcattgc ctttaaaaca tcagacagac tagcaatttc cagaaggaag actgggaaga 1222620
 ataaataaat aagtaataa ataaataaat aaataatgaa tgaatgaatg aatgaaatag 1222680
 catttcttgt aattcagcct caagcagcaa actcctgggt ttttgTTTT tggagatgaa 1222740

 agtaaagtga agtacaaaa aaaaaataaa aataaaaaaa ataaaaccaa aaacaagcaa 1222800
 gccagaagca aacacagaaa attaaattag tctcacaag ctcaggtttg tttgtgtgaa 1222860
 aactctagta aaagctgtag aagccatggc aggcctccag acccctgcct tactatgcag 1222920
 ttttcaaagc agggcctggt gctgttcgca ggtgtccttc tcaaccacac cacttaacat 1222980
 actccatatt cccttaataa cccagtaatc actaaggctg ttctggcca aggacaaggg 1223040
 ccaactctc agtttttatt ttagaagaca caatcctttt cttctttcaa ggccatgggc 1223100
 ctcatagaca cacatgaaat ccacaagcaa tgtttgcttc actaacagct cattctgctt 1223160

 cctggtgctc actatcagct ccacagtacc acacctactc tactcctccc tacacacatc 1223220
 acacatacaa aggaaacagt gttataagat tataaaaatg ctctcattgc caaacacag 1223280
 tttactgtg tcttaccata acaattcaac gtaccacaga ccagccat tttataaagaa 1223340
 tattgacata gtttactta aaagcattaa tgcctcagc tcaagtaata attgacagg 1223400
 aaaaaagtat ccatgtgaca atgtacacat aaaatcatgt agatcttcca ctaaaagata 1223460
 gggttcttca tgtttccttg ccaggacagc ttgtctgttt tcctccctct gaccctaag 1223520
 acagggttcc actttatagt cacaactgac ctggaactcg ctatgaagac caggctggca 1223580

 ttgaattcaa taggcctctg cctcctgagt gctgagatta aaggcatatg ccacctacc 1223640
 tagcctctta tttttaatga caccgcact tagatcattt tttataatgc tcatattctc 1223700
 ttaagttaaag ggcaggtaat acagaaaaac aagagtagtt agagagtcatt tttaatatat 1223760
 tagtatatgt ctatgtatta gagaaattta ttttaagagtg ctgtatttac caatcaacca 1223820
 gggccattga acatccaaga gcctaattgga agcagatgta atggcatata attgtcatat 1223880
 ggaagcttag actggagagt tgtagtttat ttaggcaagc ctaaataaaa cttgtctca 1223940
 aaaataagac aaaataattt actgactatg aaagggttt tagatagcca aagcaaacc 1224000

 caaacattcc tcaccatctt aacctttcc ccagggtca ttaaactcat ccctaacctt 1224060
 tctcctctct cctgaaaca aaggcctgat gttattagat aacatcttcc tetattgaca 1224120
 tttataaaat cctgtcagac ctttatggca aaaggaactt tctttgttta aaacctta 1224180

agggactaga gaaatggctt agcattaaga gcacttgccg ctcttgaggg gaacagaact 1224240
 cccatcactt acatcaagt gctcacaagt ggttccaggg gaacacaaac ccttctctgg 1224300
 cctccacagg cacctgcatt tacatggcac acaagcatac actcatalct acacacatac 1224360
 acataaaca gaaaaaaga aaaatgagtg acttcccgtg gtcatatggc aagaagatag 1224420

 aaccccagca taatTTTTga gacatctaga gaatccagct tcacctaaca gaatttagaa 1224480
 tggaaaaact agTTTTcaa gagtgacag caagaaaaag aaaacagttt caaaggagag 1224540
 gcgagagaaa cttcaggcta gcagaccctg aagacattat taaaggcaac caaacatagt 1224600
 aggacatccc ttcctgaga ggaattcacc ttggtgattc tctaccaact tgaacaagc 1224660
 ctctctgctg aatggaacct gtctctgaa gtaggggctg ctgtgagaaa ccttattggt 1224720
 tctacttcta taaagatacc agaaaggact tccagaatgg gatgggatcc aaacacgcag 1224780
 gaaaaaaaa aaaatccctg aacccaatc tgttgggttc tcttgctatt aactaacaga 1224840

 gttaagtgct cacctatagg cagtaactaa ttctgttttt ctgagtgtgt ggttgtctac 1224900
 atccctgctg atgtgccacc agtctatat tacttatgtg tgtattcagg ctgtgtttgc 1224960
 atagtagtca tttatecaac aaaaatgtat ttgaaatgc agatatatta ctaggtgcta 1225020
 aggctttatt ggagaaaata cgaatagcc aatgcctcct agaggtccct ttctagtgg 1225080
 ggatataata atcaagaaaa caaagtaact gggaatatgt gttgtattgg aaagaaacca 1225140
 ggcatgtgg tgaataatga taacaggtga gatggaagtc tgtcagacaa tggtcagggg 1225200
 aagtctttct aagaaagtgg tatttcagtt gactactgca agatgaagg agcaagtata 1225260

 gtagcattcc tcaaagtaat gccaggtaag gggagtctg gagtaaaggt agagcaagaa 1225320
 tgacagagta ataagcctgt tctctttgtt ccattgtgcc tttgaagggc ctcttcttt 1225380
 tcctgtacce ctatatgcag ggctcttgct ctccaggtg ccaggtaggg gtatttctg 1225440
 cctctatctt gaacttttta cagttcttcc ctteccattc ctgttttctt cttcagatct 1225500
 cctggaatga aggggtgac ctgtggtggc atgaactcat gcaagaagca ggggatgagt 1225560
 ttgagcctga atggtgtgat gctgaggacc cactcttcat cttgtatacc agtggctcca 1225620
 caggcaaac caagcaagt gtgtgcaactg tataagggtg aggagtgagt ttctgaggaa 1225680

 gcttgggatg atcaacagaa actattagat gcagtactag gaatgtgagt gatacatgtg 1225740
 actcagatth ctgagcatgt aagtggtcag tatatttatg ttacatcagg gtgtgataaa 1225800
 ggagatggaa gagagacaaa tgctacaaaa gtgcatcagc agggtagaa tctttaaaa 1225860
 ggttcttctt ccagctctgt gcagctcca tctgttggtc agtagagatg gacacaaaac 1225920
 cccaacctga ggacceattc tccccacagg gtgtgttaca cacaattgga ggctacatgc 1225980
 tctatgtggc tacaacttc aagtatgtgt ttgatttcca cccggaggat gtgttctggt 1226040

gtacagcaga cattggctgg atcactggtc attcctatgt cacctatggg cactggcca 1226100

atggtgccac cagtgTTTTg gtgagatggg acctgggaca tggacaagat ctttctgggt 1226160

gacctcttcc caacgcttct tagactgaag aaggagact tatacagga cctacttct 1226220

ggagaaagag caatcctgag gggttgtata tcctactaga aagtttcttg gcttgtgtaa 1226280

tcagagtta tcgtaaagac ataactggtc aaaaggggca aactactggtc ctgaggggat 1226340

ggtaggggga tggaggact actgggaagg gctaaaaata accagatttc attggggtca 1226400

gtttgagggg atccccacat acccagatga gagccgcttg tggagcattg tggacaata 1226460

caaggtgacc aagtctaca cggcaccaac agcaattcgg atgctcatga agtttggaga 1226520

tgagcctgtc accaagtgag accctcccc atctgctatc ccataggtat cttcagatc 1226580

tgagcagtcc tttgtgcaat ttctttctgt tgtctcaact ccctgacctg gaatagggga 1226640

gggggcaaag gaatgctgaa tgcatgtgta ttttggetcc tagtggact cagaactttc 1226700

ctctcttcca ctctcccgcc caaggcatag ccgggcatcc ttgcagggtc tgggcacagt 1226760

aggtgaacce atcaaccctg aagcctggct atggtaccac cgggtagtag gttcccagca 1226820

ttgccccatt gtagacacct tctggcaaac agaaacggtg agtaagtgat tcaggaggt 1226880

tagagacaat ataggaaat ggactcaaac cctgatctc tgacttccat aggggtggcca 1226940

tatgctgacc cctctccctg gtgccacacc catgaaacct ggttctgctg tgagtaaagt 1227000

gcttctgctg gtccataggct tggcaaggga tggagtttgg ggatttgggc ctattagaaa 1227060

gtaagggtct ggctgagag ctataggaa cttgggtctc tgggctcct tgaagctga 1227120

gtcacagtgt cctcattcct cttcttggat tgtgcctctc atttgccttt agtctttccc 1227180

attctttggt gtagcacctg caatcctgaa tgagtctggg gaagagctgg aaggtgaagc 1227240

tgaaggttat ctggtgagaa tctgggatct ttggggaagt aaagaggtct gtaacaata 1227300

ctttgtttta gattttacac cttatcgtca ctggtagctg ttagggacaa ataaagtga 1227360

gtttgtcctc tgggaaaga caccaatgga aatcctcca aactttgc ttgcatcctt 1227420

actctttggt acataggctt ttaaggcctt tctagatgat gttcccaggt ttgtgatgat 1227480

gctttggagt caggaaagct gagtccagct cttccttga taccatttc tagagaaagg 1227540

agtcttggta gcataaagaa caaccatgca ggttctgaag tcagcctgct gtattcagag 1227600

tccatctctg cctcttctgt gacctcagac aaattgttac ctgctgcctt tgaatgtaat 1227660

tttctcattt gcaaaattgg gttataatat gtataaataa tggtagcttg tctccatgt 1227720

tttattgaat tagataatcc atacacaagg attagctgga gctagctgag cagtcagtgc 1227780

tcacagatgt tagtgggtgc agttttttgtg gagtagctgt cagatcccat cccgtcccat 1227840
 ttcatttcat tttccaaga tcaaatgagg aatagagaca ggacttgaat ctaagctttc 1227900
 ttactcaatc tagaattctg ctgacacaga gtactactgg ttagaaatta cttattcact 1227960
 catataggct gcatttttat atgacttggt tgcctttaat aggacctggt ttcctgagga 1228020
 attacccaaa agaaacccca atttccaga tattttattac tcacagaaca ctgtactagg 1228080
 caattttcat atactatgaa cttaaccctt atagtaactt tagaatttat ttacttttat 1228140
 ttacagataa gggccctgaa gttcagagaa gcaacataga attgggattc caagccaaac 1228200

 tcactatcc ccaaacccta tgccttgac tacttctcag ggatggcatt tagggatttt 1228260
 tccttcaggt ttagcaatgt gatggttgc ttcctgtgag atagcctaga ggatgtgatc 1228320
 actgtacctt ctgaccctt cagggttca agcagccctg gccagggatc atgcgcacaa 1228380
 tttatgggaa ccacacagt tttgagacca cgtactttaa gaagttccct ggctactatg 1228440
 tgacaggaga tggtagect tggctatcct gccccattc ctctctcaa aacacatacc 1228500
 ttcatttcca tttcagaag agttgactag ggatgaagag tagagaaaga aatatgccct 1228560
 gatgtctgtc cctggatcc aggagagcta tagtaaggct gtaagagcag gaatgagggc 1228620

 tcaggacact tgttagtgg ttaggagtac tggctgctcc tctagaggac cttagtttg 1228680
 tttccagcac ccatgacagg tggcttacia ccacctgtaa ctccagctcc ataggatcca 1228740
 atgtctctc tgccttggg agacaccccc acacaagtgg acacactcaa acacacacat 1228800
 acataaataa tatatatata tatatgtaa taataaagaa taatttttta aaaagtgcaa 1228860
 gaatgagtgc tgcaggaaga gtctcagcat ggtgccatct gagatcagat tctggggatg 1228920
 acaggctctt attttttact ctagtgttga cagaggtggg gcatgtagaa atgggtatta 1228980
 ctatgatatg ttcggcctca tgtctggagc ctatttgtcc attgtctgtc taccagttca 1229040

 tccatccate agtattgagt gcctactatg accgggcact gatctaataga atacatggta 1229100
 tattactgtg aataacattg tcaaatctc ttatcttatg gggctcacat tttagtaagg 1229160
 aggggacaga caataaacca aatttattgg ttacaggtta gtcataagta gagataagtg 1229220
 ctatgaagaa aacaatgaga tagtgcctcc aagggtgggc agagaaggct tgtcctagtg 1229280
 atacttgaac agaggcctga gggttgaaag gggatatagc aggaagaaat ctacagtaag 1229340
 agtattgtaa agagtggatt caagcaggc attggtggca catgccttta atcccagcac 1229400
 tggggaggca gaggcaggtg gatctttgtg agttccaggt cagtctggtc tacagagcta 1229460

 taaaagaaa cctgtgtca aaaaaccaag agtggataca agcttgaat tcacaaggaa 1229520
 tggactgaag cctgtgaagc tggagtgaaa tacctagga agaagtctt attaagtgg 1229580
 aagacaggtt aggtaataga caactactgtc atgttgacag ggtaagcaac ctagatttga 1229640

ttcaaagtac agttgaagag ctgagatatg gctcagttgg tagagtactt gcctaagcat 1229700
 gcacagaatt ctggtttctg ttcccagcac cacattaaac tgggcacaat gcaatcttag 1229760
 cactttggag gcagaagcag aattaggatt cagggccaac tttgatacat agtgaatttg 1229820
 aggcctgcct ggggtgcata agaccctgcc tgaaggggga tgggagaatg gagatatagc 1229880

 tcagtatgcc tagcgtacct gaagtcttag gcttagtctt cagtaaaaca cacacacaca 1229940
 cacacacaca cacacacaca cacacacaca cacacacacc acacgattgg ggggggcagc 1230000
 taattagtat ctggaaaata agtttgaatg ttctaaaaat atatttgaga ttaggtagat 1230060
 tatttattgt catggaacaa attatgccca aagttagcag cttcaataa cacatttcac 1230120
 ctactttctt gaggatcagg atcagggagt gtcttggatg ggtggttctc agtcagggtg 1230180
 tctcaggggt tagaatcaag ctgttagtgg gggctgtagt cattgaaaag cttgactgag 1230240
 cctagagggt ctgtttacat gctggtttac atggatttag gcagtaatcc ttcggcaact 1230300

 glaagccact taacatgggt gctggaacaa tggttgcatg ggtccttagt tctcaggaaa 1230360
 aacagcaaat ttaggcagga tctctccata gggaaactca catggcatct ggatacacct 1230420
 acaaatgate taagagaata tgaccaagat ggaacctaaa atgtcttcag taagctaate 1230480
 tcagaagtga catctatcat ttctgcaaaa ttctgctgat cacgtagatt aatgaatggt 1230540
 atataatgag aaagaaggtt gtagggcttt aaatactagg agatggagat cagcagggcc 1230600
 atcttggagg ctggttgcca agccaaatga aagtggaagc aggaaaattt gttaaaagat 1230660
 taccataact ggtctaaaga gctagtcca ggacagcctc caaagccaca gagaaactct 1230720

 gcttcggggg aaaaaaaaaag attaccataa ctggtctaaa gagctagttc caggacagcc 1230780
 tccaaagcca cagagaaact ctgcttcggg ggaaaaaaaaa agattacat aagctactgt 1230840
 agtaggtgtg gcagttttta tatcatgtac cctgctgtag ggtctttact aggttgcata 1230900
 tttcttccca ggetgccgcg gggatcagga tggctattac tggatcactg gcaggattga 1230960
 tgacatgctc aatgtatctg gtgagagtcc tgtatccct cccatttcat tagttctttc 1231020
 ccccttgcaa atcctagcaa aaacttcaaa gggagagcaa ggactatcct actttgaaac 1231080
 tgtggtgttg agtatggcat tcagtcctgg gcctaggatt tggaggaaat gtataatgca 1231140

 cactaggatg ctccaagaga ggctctaaga tggcaagac atgcttgag gtgtgcatgt 1231200
 gaagaacgaa agccttccct atttgaccag attatgtcag cctgtgggt gcaatggagc 1231260
 aagaacaggg gcaaggaaga gctgagatcc ctctcatgca tttcccttct cttgacaagg 1231320
 acatcttctg agtacagcag aggtggaatc agcacttgta gaacatgagg ctgttcaga 1231380
 ggcagctgtg gtgggccacc ctcatcctgt gaaggcgcaa tgccttact getttgtcac 1231440
 tctgtgtgat ggccacacct tcagctccac cctcactgaa gaactcaaga agcagagtaa 1231500

ggagctttct ggggcaggaa ctgaagggcc tgcaagttac tggggagagg ctgcagcaaa 1231560

 ctacagactc caggggtcct gtggggtgac tgggtgtctc ccttagtctt tcttcactag 1231620
 tcttcacact gggataataa tagccaagag ctttagaaaa ctttctttgt gtcaccactg 1231680
 ggatcagtgc tttaaatgct ttatccatt taattcctat aattacctc acgaaataga 1231740
 tcctgttgtt actctagttc taaagatgaa gaaacttcag gtgcagagaa ctgcttgctc 1231800
 aaggctatgc tgccagaggf ctgatttaaa ctctagcagg ctgattctag agaaagagct 1231860
 ccatggacat gtattaaat aaaacaaagg agtaaagaga caccatgtta aaagagatta 1231920
 gggaacagta aacttcagaa tgactctagg cagaacttta atcagctggg gaaacaaagt 1231980

 catggcttta gaaagtctgg ctaaaggcac tgaagatatg ttgataatt tgttggttac 1232040
 agttagagaa aagattggtc ccattgccac accagactat atccagaatg cacctggctt 1232100
 gcctaaaaca cgctcagta agtgtggagt cctccaagga ttgggacggg ctaaagccca 1232160
 gtggtggcag gtgtgtgat gggagtcctt taaagaacgg gatcagtaag cactgttacc 1232220
 aagtaatcag aggtgtatgg gttaccaggc aaaatcatga ggcgagtact ccggaagatt 1232280
 gctcagaatg accatgacct gggggacacg tctacagtgg ctgacccatc cgtcatcaat 1232340
 catctcttca gtcaccgctg cctgaccacc cagtgatcac gattcttgtc caggatttcc 1232400

 ctgtgtgtgg ctctccaaac ttctgcccac ccaccctgca cgctgccccg gagtacaagg 1232460
 gccaatgctg gtttacactt tgtttgaaac tagggagaca gtttctaga ctgccaggta 1232520
 gaaggacagc ggcacaggtc aacctcagac tgatatgctc ctggactaca gagaggtctc 1232580
 caagcccaga acagatactt aacaccatgt cctcaaccac agttagctag tcagagtgtg 1232640
 aatgagggcc gagacagaag cagggcagta gctctaacc tttcagcttt ctaaagagca 1232700
 ccagttctta tcttggfcaa acccaagcct ttcgaaatga cagcttgtga gtctatgaat 1232760
 gattattttt taaaattctt tattgcttct gttctgagtc tgaattcttt gccagatggt 1232820

 agcacttgtc tgitcatttg ctagaactg tgtgggtggg ttcagtctcc agagggtttt 1232880
 catatcatct gtctcattga aagagtaaga tatgctctgt tcttagaacc aaggaggtta 1232940
 acgttcttag tctgcctta tgaacagaac cctgcccaca aggggcactc ttgagtgaaa 1233000
 ctttctttcc ttgtactttt tgtgctcaag actaactggt gtaggaataa agttcatgag 1233060
 ctcaagaaga gagtgggctt tctaaagtat ctgtgtgttc actagctgct ctgatgtgtg 1233120
 tagcagatgg gaagaggact gctattcccc agactgcccc agaaacctc atttgggcag 1233180
 aaccaggcaa agcttcgccc ttaagcaaga gcgatggaag ccagcacaac tatgacgtca 1233240

catcaggggt aciccttctt gggacacctat cttgacccta taatcctctg gaacattag 1233300
 caagtgacta agaattagga cttcagggtc tgaaacccat gagacccca gagcaatcaa 1233360
 gtacaccttc ttgcataatcc acctcccatg ggctgccctc ctccccttga tccatgaaac 1233420
 aatgaattgt tgiatcatca ttgttgcttt atttagggca gagctgggga aagtctatgc 1233480
 cctctaccc accttctct atcactcagt cctacccaa gtcaggcact agaacctgct 1233540
 ggaaaggctc acaagagggt aataagatct gcagggctta tggcctttac ctcaaagcag 1233600
 cttccttccc cacactcaa gatctgggga tctccagaac tcttctaag gaagcataac 1233660

 tcttctggtc ctcagatgga aggctgagag aaggtaccca ggattttccc ttcctgaag 1233720
 acctggagg tctatgaaa agacaagttc ccctaagggt gagacagggg tagccctcag 1233780
 gaattaggag aggaatgtca agtacagggg atagaaggtc tcttgagtga agtgcaggat 1233840
 gtgccctcat acagggtagg ggttgctccag gactgccact cctgcggcca cacctccatc 1233900
 tgcatttca gtggcttgg tccgaagcag atccccaca tgcttgttca tcacaagtgt 1233960
 tgttccctgt ctgtagaaat ggggtcagga gacgtacaac attaggaac taggccttc 1234020
 tctgggccca gctgactggc agattagaag tggctacatt aagaaatgct aggactttag 1234080

 aatcagattt ggagttgtat cctagcttgg aaattattag cccttaagct tcctaaaaat 1234140
 gtccctaatt taaaattgag aaatacctct tatattcaa gatgatcata tggattaaat 1234200
 aaagcaagaa aaaagcatat agcatgattc aggtgtacat ttatgtcctg ggctatacac 1234260
 ttccgataac tcaaggtgcc tgatgacaga aggaatagta gtaaggagag tagcagtcag 1234320
 aatgctgcaa gtggttagaa ggggcatttg ttgtaagggg aaggctgttg tggtagaagg 1234380
 catggtagca tttgtgatgt ctttaccttg cctgacctt tgcaggaagt tacattaggg 1234440
 ccttgttctt taccaattcc aaagtcctct tttcttctt cctcttttgt cttttcttta 1234500

 ttgaaatag ggtctcgtca tgtagccttg gtggttcagg aactcaatgg cctctaactc 1234560
 atagatatct gcatgtctct gcctcttaag ttctgagaca aaaggtgtat actatcatgc 1234620
 ctgctttctt cttgattctt agtattcaaa tccaaattca gaagccctc agtctttcaa 1234680
 agccactgaa taccctctc tctctcacct tcatgggaa tteccactgg ttttagagct 1234740
 ggacccaaac ttcatactc tctggagtct cctattcctt ctgtccaacc atcatttctc 1234800
 aatcctcttg gtggaatag gaatgtctt tacagttata aagcatgtct ctccaggat 1234860
 ttacttgta gcctgtgga atgggtaagt cttgggtcct tggccttact taacagacaa 1234920

 agagacagtt ataaaactag gaactagcag agctgaaact gcagtcagg actcatggct 1234980
 ctattcaaga ttcattctac actttcttgg ctggcactct tgtaggaag tagtagaagg 1235040
 agctgtcct gactagctta cctgacatag actccaaaa taccagttc tgagatacac 1235100

tggaccactc gggcagggct gccaggccgt agcaggcaat tcccaaaagg ctacagttca 1235160
 atcttctcca tgaggatata ggaggccctc tcctcgtgt ccttcagctg ctccagagct 1235220
 tgcaccattt cctctccata caggttatta cctgcaatta aaatggccat cacacagcac 1235280
 acatctggct tctgagaagg aaaggctatc ttaacaagaa agctcttaca cacgtgaaca 1235340

 cacctgtcac cacactgttc tgccctggtt gccccatcta tggttcctct taaatgtcgg 1235400
 tattctctgg gcctgggaag atggetcagt ctgtaaagtg tttattgtgc aagcacaag 1235460
 atctgagttc tgatccccag aacctatgta aagcaagcgt gggcacatgc atctgcacct 1235520
 ctcccctctg ctggggaagt gaaagtgaa aggtgaaagg taaagagagc tggactccca 1235580
 cagctgctgg ctactacta gtctaacgag ttggtgagtt ccaagttcag tgacagacta 1235640
 ctaaaaaaaaa aggtggggag caatagagga agatatcaac ccctgcatcc acatgtatgc 1235700
 acgtatgtga atatacatc acacatgtga atacacatat tcacacacaa agatgctaag 1235760

 gttctctagg aattctctac ccctgctctg ccctctatgt acttctgttc ctaaggtttc 1235820
 atctactctg catcactctc aaatctttaa ttcacactgt ttgttctaga aatcagaagc 1235880
 atgtaccata ggtctctact gcaaaactcag catatccaaa tgaaaatctc tttctgctag 1235940
 aacttgcttc tcctgaatct tctactcct aataaaatgg aaggcttccc tgagtctat 1236000
 ttaagttcac tctccctgtt acctatgta ctatctcaga aatgtctcca tctatgctct 1236060
 tgattgtcat agccctagct agcctgagcc tctccatggg cctctctgt gcctctcttc 1236120
 ttgacaatgg taccagcctt cttccatggt ctctgtcaca aatatttctc ctattccaa 1236180

 taaacttata aaggctgaag cactaagctt tacaagttt catcattgct aaacctactt 1236240
 ggatcctgga tagttcatgt gtccttccc acttgaact ttaatggctt cctatctcag 1236300
 ttatgataaa atacagttta tggcatatat ttgtgtctat ctgtgtactc acctatgcat 1236360
 atacatgtgg aggcagacac cgatattgag gcactctctt caattgatat aaacctact 1236420
 ttttgagaca ctaagcctgg agcccagttt cagctagact gcctagccag tgagcctcca 1236480
 ggatctgtct tcctttgccc tccacccca aagtcctaga gggagagatg cctgccatca 1236540
 tgcttgtctt taaggtggag gtagggatcc agtgcttgca tagtaaacac tttattgact 1236600

 gagctacttc cccaagccca aatttctga aatattgtca gtgctcttta taatcaggtc 1236660
 cccaacagtc attcccagcc catattctg ccatctccaa ctcaagcctc atcaacctct 1236720
 agtccaatcc atggtccact gcttttgcct aaatggctt cagtttgaa tgatcttacc 1236780
 ccttttttac ctggaaactc ctacctatcc cttaagacc aagtagaaaa tcaagtctgt 1236840
 acgataaaca tgatccctgc cctcaaggag tttcacagta cacaggaata cagccaggta 1236900
 ttcccttaga ccttccagta tgcacccatt ctgtttctct atgatcttac aaactaaggt 1236960

tgtccaaatt ctccagtgtt catctaattcc cctttactcc acagggttg cttccagggt 1237020

 gctgggagat atgctccatt ctgggatctg tgttgctttc ttttgaacc actaggcctg 1237080
 agactgtatc cacatcaagt gccataaagc actggcaata gagtctttca ctggacagct 1237140
 ctacaaagga gatttactta cctccaccct ctctctgggg cttcagcaca aagtggtag 1237200
 gagcagcaag ggcttcagca atggcctggg ccccttcttc accctaataag gaagcagaaa 1237260
 gtagtacta gaattcaagc taatgaggca gctgaggtcc tgctgatcat gcagagtggc 1237320
 atcagggaga gggacagcag ggaaaataat tgtaaatcc tttaggctag aactccaat 1237380
 ctggatgtga ccgttaactc cattgaagca ctaaacatag aacaggccct ttaagtcaat 1237440

 tccttgggtt tciatcgta tcacaatcat tgctgaggaa atggatttaa gctcccagat 1237500
 tctggcctca aggctcaagt gttgttcaga gcaccaggat gtgagtcata atgccaactg 1237560
 taatgccage tgcctgcat ccttccaac aactcaggt ccaggtctca gctatgtggc 1237620
 tatggtagga aatacact acataccatg tccaatgaat agaggccagc aaaggaggca 1237680
 cggagcggg ccacagcctc aggctgtcct gggagcagct cttcagcag gccaccctg 1237740
 ctcagttcct gctgcacctt cttggtccca gccagctgtg tggcaatgtc cggacacttg 1237800
 gcagcacatg atctctctag cagcagacgt gcttcccagt tctgcagagg taataagacc 1237860

 aaaggcctt tactgaacag gtgccaggca ctgtgccttt taatcttcaa gctgactatc 1237920
 attacaacac ccttgtgagg cagatagac ctggaagtct gcagaattct tgccttagc 1237980
 gaatttgta aagcaacta atccaagttc acaattaaat gggaattact aacaaggaaa 1238040
 tggctttggg gaggaggac aaggctcac agtgtagcct tgtctggcct gaaacttctt 1238100
 gctacataga acaggctggc ctgagattca cagagatcca cctgcctctg cctcctgagt 1238160
 cgtgagtgga ataaaggcg tgggccacca catccagcag aaaatgcatt ttataagaga 1238220
 ataggaaaat ttgtgacctt ttctcccac atccctctct ctttcccaca tectattttg 1238280

 tgagacagag tctcacttgg tagccaggct ggctgtaac tccttaggta gctgagcgg 1238340
 tccttctgcc tcagccttca gaatgctaga tttgtcactt ttttaacagg atctgattat 1238400
 ggaaccagg ctggcctggg actttctgag tgctgggatt ataacacgt gccaccacac 1238460
 ctggctggat aaggtttgaa gggcacggga cacttgatta taagcttagc ttcttattgt 1238520
 gctccaaata aatccaaca cttaaaaagc tggttaacca tataacctt agtggccttt 1238580
 tatccactaa agccattcc ttaccatgat ctacaagatc ctgtgagacc gatttcccac 1238640
 tggtttttca tctcatgctg ctgcttcag ctactccct aactactgac tccatattc 1238700

tagccaaaca agictgcaat tatcaaatTT cattccttct tcagggcctt ttatgtacc 1238760
ttttcttttg cccaaaattc tctgcttttt ggctttttcc atagatagtt acatccttct 1238820
catcctcaag cctcggttta gttacttttc cctgacat tataacttaat gtggggttcc 1238880
ccacaacct ctatcttttc atcctgttct ttaggtcaaa gccaattacc tctcaactag 1238940
ggatccccc caagctgggt atagtattac atatttgatt tgtaaggcta acagagtata 1239000
gtattacata gttgtaatgc taacactcag gtgattcagt agggcttga gcacatagca 1239060
gctcagttac aataatgagt tccagggcta tagaatatga gtctgtctca ataaacatag 1239120

caaaacaaa actcaaaaca tcatctgtct gttgcttttc tttccggtgc tcatctctct 1239180
gacccggctg tgiagtacc agaggaacca gacccgtgggt gtctacctg ttttctatta 1239240
tttccccga gcaaagcagt ttctgacact tcacagtact cagtgtctgt tattgttact 1239300
caatgaagt caatttgagt aattccctga caataggcag tctgacaggt gaaactcact 1239360
ggagagtggg tcctcgggca aacaggatca tgtaacaaa ggcctgcagc tggctaatca 1239420
caggttgaat agtcctgttg tattaggagc ttagaataca agatacaggg aaacatcaga 1239480
ggatcatgcc tcggagctct ggtecccatc ctcaggcact gggtagaaaa ttgcccttgt 1239540

caagattaca gacacctgc cagattacag atacctgtcc acagctggat caaggctgaa 1239600
gcctaaaatc ccaaccacc acccagggtc gtccatagga gtagctttac ctgatcctca 1239660
ccagtcatct aactcctggc ctgctgtttt ggtcagagtc atagaagccc ataacagaag 1239720
actagaaaa catctcacag aagcacagaa agcaaaaagt aaaccaagc atcatctaac 1239780
aagtcacaaa agcctttag ctctatgtcc atgttctaag ggtaacaaa cttttctaca 1239840
cataccact ctttccctt gttagcacac cctctcctct tctgectctg tectgaatct 1239900
tggatccatt tctcttctct agccagcaag ttttcagtac tctaaccact tctctggtca 1239960

aaaggacggt ctctaaatct gtccctttagc tgagctgtct cctgtagagc tcagtccgca 1240020
ggaactctaa gtgaactata aatctcattt tcaagtgtag cttgagatgt agctttgaga 1240080
agctgagagt cgggcggggg tgggaaagct actcatagcc atgactctca gatcacccat 1240140
agtatttcat agcttctgtt cagcatttta aaaagattta tttttacctt ataaacttta 1240200
gagtgttttc tglatacacg tatgtgtact gtgtgtgcct ggctcctgta gaggccaggt 1240260
gctgggtctc ctggaactgg agttacagat ggttataaac tgccataggt ttgagaacca 1240320
aacctgggtc ctctacaaaa gcagccaggt gctcctaact gctaaatctc tccccagccc 1240380

ttatttcttt ttttaaacc aggaaagcag ggatgttcag ctttctcc atgatataga 1240440
tgccaacagt gggagagaag aatagcatat tcagaatgta atggtctgaa tcagaaatcc 1240500
tggaaaatc ttgtgggatt ttagacaagc ctctgcatgg ctccaacct tagtttctc 1240560

atctgtgtaa tggggataat aacaagtctc ataggatggc tgtaagaatt aaataaaatg 1240620
 tatagaaagc caatTTTgaa gctacttggT agttagcaga tgaggtaata tcaaggttgt 1240680
 cactggctcc gtattggtaa tttcccactt tagccacgag catacctgag aacatgataa 1240740
 aacaaagaga ccacagaaaa acctttctga gggctggaga gatgactcag cagttaagag 1240800

 cactggctgc tttccagag aacctgtgtt caattcccag caccaacatg gcagctcaca 1240860
 actgtctgta actcaagttc cagaggaggt agcgccttca tacagattta catgcaggca 1240920
 aaacaccatc acacatgaaa taaataaaaa ctttaaaaat atacttttat tttattttat 1240980
 ttttaaaaag cttcctgttc agataaatga gaattaagga aaataaacat ggtcagggaa 1241040
 gctgggcatg acgacttaca cctgtactgt cagcatctgg tggctgataa aggagactgc 1241100
 cattcatttg aggctacaga gtttcaggtc agcctgggct acaaaggag agtttgctcc 1241160
 tcctaccgg aagaaaaagc cacagaaaag aacaaattaa ggtgggtggg tgggtggcct 1241220

 ggaactcagc tagtgagggc tgactgtacc catctctcc tagatctttg ctcagagttg 1241280
 ttaaattggg tagctcaaaa ttacactatg gaagtcagca gtttgtttgc caacttatct 1241340
 ccaaaaaatg tgtaaatggc taaaacacta cagatagatt cctgaagatt cagaccctaa 1241400
 agaccttgta gagtgaaaac taacacaaag cctgtaagaa gaaaggtgtt tccagcagca 1241460
 gatcccccc ccccaagaaa gaagtgagtc atagttgtga cgcctgagct gggtttctgt 1241520
 ggagctctgg taggtccctg gagggagaga atggtctaata agaaaaatac taacctgtga 1241580
 attatactga ctgggcatgt agccatctcg gaagtaaac acagcaactt cctgaccatc 1241640

 cctgaaacaa aggatgaaaa aaagcttcgg tatgaaatta ttactgatgt gctcaggggt 1241700
 tcagtctatt tcaggataca tcagagtaca tgtggcagcc cacaaggtaa gcctgggaaa 1241760
 ggaggggttt actagaatta gtgcaagcag aaacctagta cttctattaa aaaccggtgt 1241820
 gcagcacaca gtgctttaga atattctaga gggaaacaag aaggttagca taggtaaaat 1241880
 taaaaacaca catatccaaa attttgggac atgcagaaac ttttaataaa ataagttctt 1241940
 cccgttccc ttgatctatt ttatattatc tagtttatct aataagtaa ctagatactt 1242000
 tgttttgtta tgataacagc atattttgaa atatctaaag tgggattgtg aaagtccatg 1242060

 gaggctctta actttcttgt tgctttgttt tttgaggcag ggcctcttat atcccaggtt 1242120
 gaccttgagt tcaatttata cctgagaatg agccagagcc ccagatgttc ctacttccac 1242180
 ttctcaaatg ctagaattat aaatgtgtgt gtgctctcac gcctggctac attcttttgt 1242240
 ttttacaccg actctcacta tgtacttttc tatgtacttg gaactttcta tgtaaaccag 1242300
 gctggcctag aattcagaga tctgctgcc tcagtctcca gagtgttgaa actaaaggea 1242360
 tgtgccacca tgaccagccc tggctaggtc taactatgta aattgcagta ccacccaat 1242420

atgttgact aatgctacag tgtgttggcc catgggaaaa gtaggacctg gcttagaaga 1242480

caaatccagg ctacagacca gagagtggta accagatgga ttagaatgag tctgcagctc 1242540

taccaccca gcccaactgc tcaggcctgt cgaccagcca caaagagagg caagaagact 1242600

tttagaacct aaggttatct tgaaggatgc tgatgcactc atccaaaagg tcaacagttg 1242660

tgatataacc cattagaagc agagcatggc taggcattcc taaaatttcc tgtaaggatg 1242720

agataattca gaaattagga gaaaggaaaa caagctatca tatttcccag aagaaaggtt 1242780

cttagtgac aggaggtatc aagagaggtt ctaaccag ctgtctagt gctccttggg 1242840

gatgcttaca tgaacagcct tcggttttgg tctagagaac ccctttcaga gacatcttca 1242900

aattttcgcc ggattacatg gatgttccctg gaaaagagag gtgagaaatc agaggiatg 1242960

ggtgtggtgt ttgaaatggc cctccacttg gggccacacc tgaaggtctc ttctttact 1243020

tgctgtcca gtagctcatt ctctatggca cgctgggtcaa atatgttctt ttctttctct 1243080

tgagcgtaca gtagcaccac agcactagag aaagagcaca agtgagaagg ggctgctaca 1243140

gagcttatcc ttctgcccgc tcctttaaag tgaggtagga gcatggtttc tcagtagtcc 1243200

tgctgatgca ggctgcaacc ccagctcttg gggcggggtg ggggcaaaaa gatcgtgaat 1243260

ttgaggccag tctgggctac atagcaagac cctgtgtcaa aacagaaagg agggactgag 1243320

gaggtgactc agtcaggaaa atgcttgtca tgcaagcata aggacctgag ttgacctcc 1243380

agaaccctct taaaaaaaaa aaaaaaacia aaacaaaaac aaaaagatga agcatgtctg 1243440

tcatgccatc actggggaag ccgagacagg gggaaatctg gggcttgctg gcaacctagt 1243500

cttggcaaat tgatgagctg caagtttaat gagaaactct gtctcaaac caagatgaag 1243560

agagactgaa gaacacacta cacattgacc tggcctccac atgcatgtac acacaagaca 1243620

agcagataga cacagagaca gagacagaat atagcttctt tgcaagaaca gatgatgcct 1243680

caagttagga ttgccagggg caacaacaca ttcttttaaa acaggaaatt tggaggtgaa 1243740

aaaggagacc tctcttgtct gttctctatg gaagaaat atgtaatgat tcaaatatct 1243800

gtacaactta aaattgagat ttaaaacct ctaaccaacc gggcgttggg ggtgcacgcc 1243860

tttaatcccg gcaactggga ggtagaagca ggcggatctc tgtgaattcc agactacctt 1243920

ggtctacaag agctagtcc aggacagcct ccaaagccac agagaaacc tgccccgcc 1243980

cccccaaaaa accaacctca cccatTTTT cctagaaga catcttgagc catatatgat 1244040

ggcacactct tggatccca gcactcaggt agtgaagaca agagaattag gaggtttaaga 1244100

ctgacctggg ccagtggigg cacatggctt taatccaac acttgggagg caaagcagg 1244160

cagagttcaa ggcaggcaga gttcaagacc agcctgaact gcaaagtgag ttccaggaca 1244220
 actacgttac aacaacacag caaaaaaac taaacctat ttgaaaaca aaaacaaca 1244280
 aaacaagact ggcctgggct acacgaaacc gtatcttaaa acaacaaca gaaaccctag 1244340
 cacagtgata cagtaattca aaaatctgtc tgggagaata aacaccaaga atgttttgta 1244400
 aatcaactca gattcctaat actgcattat cagacagtaa aaggatctga tccaagaggg 1244460
 gagtcttag atgaaaaaac aaaagagcta aatggaactc tccagagcca actacaaca 1244520
 agccatcgtc tctggggacc actcagccag cctgtgatgt tcacagggcc acatctggtc 1244580

 tcacagtatt aacaggatca ctaaggctca ctaggccttc ctgctcctct ctgtttacc 1244640
 acaagttccc taaagaagca ggggcttgca ctttgctta ctattctaag tatatattct 1244700
 gacctccttc gttgattggc ctcttaatct acctgggctt tttttcaac cttagctgag 1244760
 cctcttagtc taaactgtgt tcacctgact tctttctact tggctaaagt ctctccagc 1244820
 ctgcctcaag tcaagaggac agacgggaca ttttagctga aaactgactt taagctggga 1244880
 cctgcaagac aaagtgaag tggttttca gaagccatct tgccttgaga ggccaaggg 1244940
 ctgctcttc atttgtacc ctgaaccact cggctcatgg gtgtttgggg tggttgggca 1245000

 ggatggcatc ccgccagga tggctcacct ccaagaagag gtgaaggagg aagcctgaag 1245060
 gctggagggtt aaaatggaat ttcagactct ggctaattaa gtcagctttt ccaactgcca 1245120
 aacctggga gccagactca gaaaacacat tctacctct actgccttca gctctgagaa 1245180
 atttggactt tgiagtgtc agttgaggaa ggtgaactgg aatagcatg ctggctggga 1245240
 gagaggacce aacactctta gtccgggctc tgccagtgac ttgtggtgtc cttagcagg 1245300
 tcagttagct tctttcctg agccttaact gtctcatcta tgaagtagat gtgttaatca 1245360
 gatcatatgt cccgatcttt taatatcaat aatcatcctt cttctactca ttcaactat 1245420

 aggcctgta tttfactgtt gttgtcttaa agacttagtt ttatttgtgc atgcatgact 1245480
 gtgttgtgt atgccacgta gagctagaga ttcagatggt tgtaatagac cctatgtggg 1245540
 tgctgggagt caaactcaag tctctggaa gatcaagaat cacttttagc cttagagcat 1245600
 ctctccagcc ctaggcccta tgtttgaaa atatttgtt aaatgaaac ataattttac 1245660
 agacggttgt gagccacca tatgggaata taagccaggt ccattgcaag cgcaataaat 1245720
 gctcttaact tctgaactaa ctctccagcc ccaactgaaat cataatttta taatcaggac 1245780
 tggtggcaca tggatgtagc ttcctacttg ggaggttaga gcagaaggat tgtcatgagt 1245840

 tcaagaccaa cgtaggctac ataacaagac ctgtctcaa aaagcaaaca agactgggga 1245900
 tgtagctgag tggtaggata ctctctggc acacacaagg ccctagattt gattctcaga 1245960
 atgacaaaa tagttttttt ttttaataa aacaaaattt taatcctcag atttttttc 1246020

taaaaacttt ttatTTTTTT tgaggcagag tcttgctata tattcctggg aagactga 1246080
 ctatataact tagactagct ttgaactaaa aggccagcct cctaactcag cttcctgagt 1246140
 actggattta caggtgggtt ttttgtttgt tttgtttttg tgaaggatc ttgatata 1246200
 gagttggctg gcctggaact tgctatgtag accaagctgg ccttgaactc atagagacc 1246260

 acctgccttt gccttctgag tgctaagatt aaaggcatct atcacatgg ctagctcaag 1246320
 aaaaaaaaa ttcagagac aaaaaagaag tgccaaggtc acacgcttgc tcagcagacg 1246380
 agcctcagcc actctcacac tgggtaaagc cagtacctgc tcaggagcca cagtgcctt 1246440
 acccaccagt gcctacctt ggacacatca gtgttttctc cccaaattac tcctaactg 1246500
 gcaagagact cctctgcag tgcttgtcat tggcagttc tcaagtgatg tcactttctt 1246560
 aaaacggaac ctggcagagg gttctactgg acatactgtt tgtccaactt agggacagaa 1246620
 cttgaggctt cttggaactt ggtgaggctt agcaagccta ggaaggcttg cttgaggca 1246680

 acagtctat tatacatgca ggttcagga gcttatcact gggttctact accatctcac 1246740
 catctgactt caagcaagtc actgcacctc tctgaacctc agtttctga tctgtaagac 1246800
 aggaaagagg aacagcacca cctcagagca ctattctga gagctcagtg agagcctgcc 1246860
 tggatgtgaa cacttagtac aggtggactg tgctcacact ggcagttgc tagcagtggc 1246920
 ctctcaacta tctggaagtc acttacctag catcttcaca catctggaac atggttgaga 1246980
 aataggaaga aagcaaagaa aacacttcta agcagttaaa atggacacca taaaattccc 1247040
 agatcaaac tgacatcaca aagagtcct catgcttttt acacatgatt agaacaacct 1247100

 ggatccctgt ttttcccaa gccacagcaa attggggaggc agagggagag cagcagagga 1247160
 ttctattgc aagcacactg acggcagtaa ctgtaaaagt ggatgttgaa gaagccaaca 1247220
 ttacagataa tgatgggaa ctgaaagcca gaggcacggg tgctttctga ccctcggtgg 1247280
 caccagtga ttgcaataag atgtgatec tttatcaca atgacctca cggcacaagg 1247340
 aaacagtaag ttacgattag cctctctcta gaaggaaacc cagaactcca ctaaaatatt 1247400
 tttggcactt aaatgtgtaa gtttctattc ctgaaacat cctttgtcc ctttctgatg 1247460
 tctagcaagg gagaagctgc cccacccatg aatgctaacc actgctacct ttccacattc 1247520

 ttacttagct gagccataga gctcccaggc tttggcgatt cccagggcca gtcccttget 1247580
 gggattattg gagaggatct tggcagcttc tttggtcttt ttcaggacgt tgagaacatg 1247640
 tctggtgga gaaagacagc ttctcagtaa ttggatggac cagggtacc tctgcatg 1247700
 acctcacaga cacatacaca aaggaatagc caagtctta aaggctcctt accaccgttc 1247760
 ctgaagcate caccatagct gggatgtaca tgcccagagg agtctgagc ccccatgtgg 1247820
 ccactccacc caactcagtt tctaaggag caggagccct tcagtgcta tatggaatcc 1247880

tgccgcagac catatggaat tgtaatgacc tgaagcatcc tgatggctag gaaaccacta 1247940

 ctgtggccca gctctcagac agaagcttct gaacgccctc tgctttgggt taagaactgc 1248000
 tcccaggcct cagatatgtc aggacccctc taccagagge ctctggaagg ctactctga 1248060
 gcctggagtg ttactttgca cagtgagggg caggaccaat atgctatgag gtctcttctt 1248120
 tctcggcata taaaagacct gatttcaagc agaaaactgc tatgaggaga agatgcaggt 1248180
 gtggagaaac caagactcag gaaggtacag tcacagaagg agatccttgg cttaatcagt 1248240
 gactataggt ccattgaaact cttcccttag gaaccaccg gtgcacagca ggagtccggg 1248300
 aggccaggcc cccaaagctg gcagagatag tgttgatttc aatctgttcc agggctttgg 1248360

 agccatctgc gctgcactgg aacatgtaat ctgagcgatt caggcccagg aacacagtct 1248420
 gtggagaaaa ctgaaggctg aggacactgg cccaggggct gactctggag gtctagccat 1248480
 actgcactct gcagagctaa ggagaaccac cgaatacccc caaccagaa ggaccattct 1248540
 gtcagcctcg aactgctctc tggatggagg cccagtagag actagtccag gcatagtaga 1248600
 ttctatgag aacagactga ggccacttct agtaaaaaca aaataccaca gataagagag 1248660
 acaaggtcca ggcaagaa gggctaggaa tggttacctg ggcaatgcc tctttcagga 1248720
 ctgcttgta gatatcaag agacgggcag tgtagtcgtc cttttgata gtgctagaga 1248780

 agaaagaaca ttttctagga taaaagagac ccttgaacc ccaggtccca tccctacca 1248840
 cccacttcta gatagcttcc taggtcttga ataccattc caatcaagca gattattagt 1248900
 atctaataat ctactctaga gccagatgac ctgggttcaa atccaagctc tactagctac 1248960
 tgtgtggtaa tctcaggaa tcccatcccc tctctggttc ttggtttgtt caactatgaa 1249020
 gagaagagga aaataactgc ttataaaata ggcttctgag gaaaagtaa tgatgcagta 1249080
 tagttttggg ttttgtttg ttttgtttg ttttgtttt tcgagacagg gtttctagac 1249140
 tgtcctggaa ctagctctgt agacctagtc tggctttgaa ctacagaga tetgactgcc 1249200

 tctgcctctg gagtgttggg attaaaggcg tgcgccacca ctgcctggct acagtatagt 1249260
 tttgaaaaat tcaaacatct tgaataactg aaggctggta agttttctga ctgacatcaa 1249320
 gttactctt ctccatagct tcccctgcat tctagtcact gccaggtaa gtctctctc 1249380
 ctccatgaca gtccccagg cagtttgcta tgtacctgca ggttttccag gcccaaggtt 1249440
 tactgcatca gttaatccat gtgtgatac atttcttgg agaagcctca ctatccaaac 1249500
 cagatccctt ttcttttctt tctttttat tatgtatgca gtgttctgtc tacatatatc 1249560
 ccagccggtc agaagagggc accagatctc attacagatg tttgtgagtc accatgtggg 1249620

tgctgggaat tgaactcagg acctctggaa gaggcagccag tgctcttaac ctctgagcca 1249680
 tctctccaat cccagatccc ttttctaggt gctcccacag cactgtgaac atctccttta 1249740
 cagagctgac tagagatgca attctacttt attatatggc aactaataatc atctctccca 1249800
 ctgggctaaa gacctcatga aagtggggct aggtctaagt ggactcatca gcttagccca 1249860
 gtgtgtgct gtggcgagt ctaggggctc atcctgtatg gatttctgga gccttaagaa 1249920
 gaccaagagc agtatacagt cactaacacc acattgttgc tcctaaagat ttagggcaac 1249980
 cttgtcctca gccaaagccag gctttaggc tgatctagtt atagaagttt gtggtggagc 1250040

 cattttagt aggaaggtag ctgtctttaa ggctgtctag aggatgactt ctttactgg 1250100
 agcctttctt agctcttggg gagaagagtc cccagctgg gcttagcca cctagagaag 1250160
 taggatacat tttctctct ctgaagagga gatgccttc aacccagc ttaggctgt 1250220
 tgtttccct taggggctag ctgtgatgt gtgtgtgtgt gtgtgtgtgt gttggtggca 1250280
 gggctccac ataatacat tgtcaagtgt aaatgcgcta aaccaggctg ctctagtga 1250340
 gcataaagca agccggtcca gagaagaag gtatgaacag ggttcacata tcatgacct 1250400
 actagattgt tggtccaag gcaatggtt tcagacttaa tatgattatt atcccttctc 1250460

 agccgggtgt tgggtgtgca cactttaat cccagcactc aggaggcaga ggcaggtgga 1250520
 tctctgtgag ttcgaggcca gcctggtctc cagagtgagt gccaggatag gctccaaagc 1250580
 tacacagaga aaccctgtct cgaaaaacaa aaaaaacaa caacaacaaa aaagagatta 1250640
 ttatcccttc tcacattcaa cctgtacca aagagcatat cggagaagga tttggtctct 1250700
 aacaaaagaa tctagtttc cattgaaaat ttaatcatag atacacaatt atacacataa 1250760
 agtacatata taaaacatta tatatattta attctaaaat aagcaattta tacttaatta 1250820
 caaaattaac caagaaattt cacttgcac aggacctgaa gtggaagaa aaagatctat 1250880

 cgggaagaga caaaggagt actacact tgcacttga gtatggtta gctgcattt 1250940
 tgcctacc aaagatatga aacttaggt gacaagaaa ggtcattaa aacattaac 1251000
 acatcctct aatggagga ttaaaaagaa gggccttgt ttagaagttg gacatctgac 1251060
 tttaaaaacc tcctggttt tctcccacaa cctggccatt ttcataatt ccaaatggag 1251120
 accttttaa ggcgttattt tttttatgt gtatgaatgc ttcacctgtg tgtatataac 1251180
 tatacttcat ctagtccca tggaggccag aagtgggtgt tagatcccc gaactaaact 1251240
 tatggaagac tggaccac caccatgtgg gtgctgggaa ctgaacccg atcatctgct 1251300

 gcagcaggac gtattcttaa ccaactgtcc atctccagcc ctctgcccc gatgactttt 1251360
 gtcattggaa gcaggggtca ccgatcacag aatcacagca accetaggct cagccaacc 1251420
 tcatgtgtc gactaagaaa ctgaggcttt gagaagaact ttccttttgc ttgtcataca 1251480

aagagcagtg gagccaggat tagaaggtag ctctctcac tccttttcta ctttttttc 1251540
ctctctgggg tacctgctcc ccactccacc aagtgagcta acacagcaac aactcgtagc 1251600
tccccaacct tcccatccaa agctttttage ttccttgacc ccagaggcct tagcacttag 1251660
tacctagaca gagtttgttc caggaaggcc gagttctggc tgacagcatc caccagcatg 1251720

ttgaaatcca tctgcacagc ataggcctgc tccagcagag cactaggac tggtagggg 1251780
aagagcgtga acggggcata ggtcaccacc tgatcaatga gaatgtggg cagagagaga 1251840
gagagagaga gagagagaga actgtgaatg ggctatcttc ttgcaaagtc aggcctatgc 1251900
ataactgagc acacaattgc agaacagcag ttatttcagg aagggaagag atgagggaaa 1251960
aaagcaagaa aggttataaa gacagtttcc aggttctgtt acaattctac aggattttct 1252020
ctaaatgaga ggcaaaaaca aaataaaaac ttccaaaaa actaagtact tactacatgc 1252080
aaatcattgt gctgaatgca tacaatgggt catcatataa ttctatgcag aaggtaacta 1252140

ctgttatcca tacttagcag acaaaggact tgagatagga attatgtaat aggtctaaaa 1252200
tatattcact gctggtgttt ggatttggac caggatggtt actaaaccac tctaacacac 1252260
tcatactgca tgetcatcca taceccactt tcccctecta tgetcctgac tgatatttaa 1252320
gccaagtcca tccccacatc aggagtac accccaggcc cctgacctc tggctggggt 1252380
agagggaaaa gcctgctggt agggctgctg aggtgaactg tggctccctg aatagaagcc 1252440
agtagtgaca tgccttgc ccagaaatga caactcaggt taacaggttg gcctttagtt 1252500
acactctggg ttctttggac tttacatggt catgaaatca aaataccatt taggacagtt 1252560

attcctaaaa gggagaaaac ccttctgaga ttcttaacaa caaatgaact ggaacttggg 1252620
agataattaa tagatcatag gaattgaatt atttaccctc tgagttaata tcaatttggc 1252680
attgtgtag aaagggttta tgggtgaaga agtttcatta atatacttac tttaaaaact 1252740
gccttgaact agataafaca aacaatcaca cacaatttaa aagagttcta aatagctggg 1252800
cagtgtggt acatgcctc aatcctagaa ctcaggaggc agaagcaggc agatcctgtg 1252860
agttcaagc cagcttggtc tacacagtt gatccaggac agtcagggat atgtagagag 1252920
accctgtctc aaacaaaca acaacaaat aataaaaagag ctaagggtac acagtgagaa 1252980

gigtatctta gtcccactgt ggcctgagtc atctagtctt cttccaaga cacaatgtat 1253040
acttgtgtea gatatcttta taactgatat atatgtttcc aaatacatca tcccctttt 1253100
acacatgcag aaagattctg cctcaaaaac acaggaacag ggttattgca ggtcatgtaa 1253160
aggtgacct aacccaaaa tgcattgtaag acaacaacag gtttaagac tcaggactcg 1253220
ggagattgce tctccaaaaa tttcccagag gttttctgcc aagccttctg tctgtcctga 1253280
ccccagaact cattgtacct tcttgaattt aggatgaaca gcacatagtt gttctctgct 1253340

gtccacaggc caaaggctga aacacacagt ctctcacttt ttagagaaaa aaaaaatagc 1253400

acacatatga caataacact ctgctttggt gccagggaaa caacaggaat ggtgagatgg 1253460

tgaggataag cagttgcatc ttageccaca gctggectc actagagctt agggtagact 1253520

taaacctctt ttaaaaatta tatgactatt ttttctgtg cgtgttttct atcgaatgcc 1253580

atgtgaagat cagaggacac tttctgggaa ttgattcttt cttctacca ctaggttatg 1253640

gaatcaaatt ctggctctaa agcttagtgg caaatgtctt taccactga gccatctagt 1253700

ggcccagtct tgaacttcta ttctcctga ttgcactcc ccaatgttgg gattacaggt 1253760

atgtgctacc acagcctgcc agtttgattt ggatagtta gcggtgtaac tttcattat 1253820

tattactaat tattattatg ttatttgcac gtgtgtgtgg tgtatatact tgtagcgtg 1253880

ggagagcaca tgtgtattca gagggtgta tcttttctt gactgatctc cacctttatt 1253940

tttgaagaca aggtctctca ctaaacctga aactctgatt tgccagaaca aacttcagag 1254000

atctgcctgt ctccagccc tggggtcca ggtatctact actgtctcag gtgtggattc 1254060

tggaatctga actcagtttc tcatgcttgc ttagcaggta tttcacataa caaccatct 1254120

ccccagccc tactggagag aagggttatg ttttaatgtt ggctctgact taaaaaaaaa 1254180

aaaaaaaaatgt cgctgcgggg ctggagaaac agctcagagg tccttcgaga ggacctcagt 1254240

tcaactccca ataccggcat ggcagctcac aaccatctga aacgacagtt ccaggggact 1254300

gaagcctctt ctgccctttg taggtagtgc acacacattc acctgggcac acacacatac 1254360

acataaaaca aaaaataata ttacaaaata aaaatgctgg taaattaaaa aaaaaaggaa 1254420

gacacaacce taacaaaaat ttgatgaagg ctgacctctg agggaaacag tggctggaga 1254480

agagaacctt tctctacatt gactgctttt gaacagtatg cctagctcat gtgtgacct 1254540

ttcaaatga actcactctg gtccccgaat ggagctggtc tgctatgctg atctatgctg 1254600

atctatgaag tgaaggtcac agtctctctt gcctagtatc aaaaagcctc ttggctttct 1254660

gactttgctt gacgtcacc actgacaagc cctgcctgga acattttggc ctctccctac 1254720

tttgaggcc ctgcatatt attactttcc cccatctgct ttttaagctcc aatttaactt 1254780

tcattctcca ttttgcctct aataaaaatg aactgctact tctaccagc atcctgagag 1254840

agacagtga ggtgggatat gcagagcatg gcctcagcag ccagacctg ccagtcttc 1254900

catgatttca gtgacccag tcaagttact taacttctct gagcttcgac ttcttctct 1254960

ctgttgcggt gcaggttaaa tgagtcagca atcccaaagt gttgagaata atgcctacca 1255020

cacagtgagt cgtcaataga tgacagtga tgctgtactg agcacgggcc acacctctc 1255080

ctccaatgac attccctaataa tttatttctct ggtacattct ccaactaaac cctgtgcttc 1255140
 aaaggttgag aacctctggc tgactcacct aatcttccat gtcaaggctg tctggcatag 1255200
 agcagggtac aggttagaac agaatttatt ttaaagtatt ttttttatt ttgtgtgcac 1255260
 tgggtgtttg ctggcatgta tgtctgtgag aggggtgccca atcccctgca actggagtgg 1255320
 gaagctgtag tgtgggtgct gggaactgaa cccagttgg tgatctaac tgctgagcta 1255380
 tctctccagc ctgctctttt tctcttgatt aggaatctca cttaggaggg ccagagagac 1255440
 agcttagtgg ataaaaacaa aaccaacaac aatacaactg gatttagtac tgcacatatg 1255500

 ttatcctagc actcctagga tgagatggca agcaaagaca ggtgaactat ttggaacccc 1255560
 caggcaagcc agcctggaat acacagtaca gcggcagaaa ggtggaaggt gagaaccgat 1255620
 tccaaaagtt gtctctgac ccacacatgc atactatggc acatgggtgc ctgcattcac 1255680
 acatatatac atacatacat acatacatac atacatacat acatacatac acacacacac 1255740
 aagctcttac gcacaataat agatttttaa ataaagagag ccgattcggg attccttctg 1255800
 tacatatggt tctcttatgg gttgatgaat aaaatgctga ctggccagta gccaggcagg 1255860
 aagtataggt ggggctacca gaccaggaga attctggcta gaggttggag agacaggttg 1255920

 tgagggagaa gccaaagtagc tgctgaagga gtatcatggt gaattacggg taagccacag 1255980
 cctcgtggca atacatagtt taatagaaat gggttaataa ttaagagaaa gctagccaac 1256040
 aaaaagcctg agccattggc caaacagttt ataattaata tgtttttgtg cgcttacttg 1256100
 ggctaactcag ctgtggggcc aggcagaaaa gaaactccgt cgacatctca ctgagagtca 1256160
 gggaagtnga tctaaaatct caggacttgg aggctgaggc aggagcattg ccataagttc 1256220
 caggctccat ttcaaaaacta tccccattc cccaaagaaa gaagcctcat tgaggactgt 1256280
 gccttttgta ggccccatta aacccagaa agattaataa ttaaactttt atacgatacc 1256340

 catttattaa tagaagaaat aaaaactcga acaagaatac attccatctt gattccaaca 1256400
 attcataaac ctaagttcct agaccataca atactatttc caaaaccaga gaccagcagg 1256460
 gtggtggtgg tacatgcctt tactcccagc actcagcagg cagaggaagg ctgttagttc 1256520
 aaggccagcc tggctctacag agcgagtcc aggacagcta gggctattat gcagagaaac 1256580
 tctgccttga aaaacaacaa caacaacaaa aaccaaacca gaggccaacc ttccacagta 1256640
 tcaggcgca gtcagtaat gccactctca agtatttgag cttcagcaag tatacctgag 1256700
 tcttgacaat ccaccagccc cacatctgag ccacacagag acaacaacaa cagcaaaagc 1256760

 atgtggctag gttaaagaca acaatgctgg cacctcttca gtaaccagtg tgggtggtgt 1256820
 taacgtaaat ggcagggaga gagacagaaa ggaagcaaga aaggaaggac ggaaaagaaa 1256880
 gaagcacaag acagaaaagc tgatctgtta catgccttta catacaaaga gggagagagg 1256940

gctgggtgtg gcggtatatg acagtaagca cagccactca gaggctgagg caggagaata 1257000
gagagtttga ggctggcata gactatacgt ctcaaaacaa acaaaaaatt ggagtaataa 1257060
caagtaataa cctagtattt tacttgttac tcatgaacta cctggaagga taagcaagac 1257120
actaagcaca gactgccttt aggacagggg agttgggtag acaggggatg tggaacagag 1257180

ggttagccaa ctcttagaac ttctgaatct tgacatagga aatgttctt gaatgttaa 1257240
ttaattagtt gcaaaataaa ctgatttctt tttgctttgt ttttaaat atttattta 1257300
ttttatgtgc attggtgttt ttgccacc gtgtatctgt aggagtgc attatagact 1257360
gtggtgagct gccatgtggg tgctgggaat tgaacctggg tectcaggaa gagcaactag 1257420
tggcttaac cgctgagcca tctctcaac cccagctttg tttgcttta aggatagtg 1257480
tttttggttt ggggtgtctat tgttttgaga taatatctca gtatgtgatc aaactgcttt 1257540
taagtgatcc tctgcctgt gacaaggccc agctaaagga ggagattttt aagtttggtt 1257600

acagcgggtt ctctatattt acaagccagt cctagagaaa cacatacaga gctgcccaag 1257660
caaacatgca tgattccttg ttgtgctatc tgcaaatata gagctcccta aatagccatt 1257720
ggtacagcaa agttaaactg tgattcatcc aactgaaac actacaacag aatgaaattg 1257780
tcctgagta gttatctca tacatataaa ctaaatgtg tcagtgtgca gcaagacctg 1257840
atgacaagca gtgaaagtg ggaacacgga tgggactgtg tagagttcta cctgaaagt 1257900
gtcagcagtt tatagttgta aggctaactg caagtgtcac agaaaagtg tatattcagg 1257960
acagacccaa accaacagat cagtgttca aaaattggga aagtgtggcg ttaacacgag 1258020

cacatttggc ttatacataa gtaagtgaac atgataattt gattgagttc ttttggccac 1258080
ataacatggt aataataaca ggaaatttgg ctatcttcat aattatgata agtataatac 1258140
caaatgataa tgatgggca atagtaggta tctctaaca agttatttct aaaaaatgat 1258200
acactaagct ggggtggtgt agtgcacacc tttaatccca gcaactcggaa gcagagatga 1258260
gtgaatctct gagtttcagg ccagctcct ctacagagca agttccagga cagtcagga 1258320
tacacagaaa aaccctatct caaacaca aaaaaacca accaaaacca aaacaacaac 1258380
aaaaacacce tgctaaattt cttttaaagt attttagtaa tgaaggctgt aaggtagag 1258440

ccaacctga atttaacaa aactttgcct ttgacttca ttcacagtt tatttaatag 1258500
actattttta attataaaa aaaatgatct agagccagcg gtggtggtgc acaccttag 1258560
tcccagtcag ggggcagagg caggagaatc tctgagtta aggccagcct ggtctacaga 1258620
gtgagttcca ggacagttag agctacactg agaaccctg tctcaaaaa gccaaaaaaa 1258680
caaacacca aattgctgcc tgacaaaatg acatatttaa tgtaccaatg agtgtttaat 1258740
ctttgacca cagaacagat acattcaaat aacattaagt gttactgcat atttataaat 1258800

gtgacataat tatggcatta ggggaaagta tgactaagag caaatagaat aagcagctaa 1258860

 gigagaacta aaatttgcc tttactttta aacatttaat ttcttataac tcttggaat 1258920
 aaaaataaac tgatattgtt tttatcaaaa acatgcagaa ggctggaga gatggctcag 1258980
 cggttgagag cgctgactgt tcttcagag gtctgaatt caattcccag caaccacatg 1259040
 gtggctcaca accacctga atgagatcca gtgccctctg ctggcatgca ggcagaagac 1259100
 agtatacata ataataaat aaataataa ataataaaa tattaaaaa tattaaaaa 1259160
 acatgcagaa gactaatttc ttagaaagag atttaagaca gactgctaaa caaaaattaa 1259220
 aaatacatca tagaataata catatggttc aacttggatt ttaaattaca catatatgta 1259280

 tattttatat ttiaaatgat acaaattaca tatatatata tgcaaagaag ctgaaggagt 1259340
 atataagag tatataaagc taggcatggt gctgcatact tagcaggac aagcgggagg 1259400
 gctgccatga gttcaaagcc ctctgctct acacagtgag ttttaggtca gttagggtc 1259460
 catgatgaga ttctgttca aaaacaaaac aaaaagagc aattgcagag aagacaagtg 1259520
 attgggggtg cttgatacat aatagttccc ctgacaaagt gcttctgga aattatctcc 1259580
 tgattatctt atgcatcaa ttatataata atattctgtt cacctattgg aggaaagtac 1259640
 aactcacaga aatgaagtag ctgcctaat tacacttcaa accccagatt ttgattattc 1259700

 cagcatgctt cttttactt tacatacttt tagaaatcaa ttttagctgt tgaataaata 1259760
 aaggagagat gtggtctttg gctcaaaggg gctgccccca ccctgggagg gcgggctcta 1259820
 agtggcattt tgaagcttgc ttgagaggag ctgggactct ccgcaggcct cagcaccacg 1259880
 ccctcagcca aggcccgtc tatggcctgc tgtgccaact cctcaagetg tttctcatct 1259940
 tgcaagatgc tccccagct ggtggccatc ccaacctgtg aagacaagag ggcttgggtga 1260000
 cagaaggcct agggctcagc agccattgaa aggtggctac atccatactg tgagacttga 1260060
 ccggttcccg tggaggggca attgtggcag ggaacatact gcttccactt cctccctgta 1260120

 cacaaaaca gttgacacag tatttccatg gctattcatc ctctcttga attctcagta 1260180
 acaatggcat tattctcaca gtgaggaagc aaaggctcag agaagagaaa tgacttgctc 1260240
 taggcaatgg caggtctagc tgggttttaa gtccaggtct ctggacttcc tgacaaaac 1260300
 tcctcaacgg agacagaggc gctaacgcca tafgtgactg gtaacgtgt atgtgacaag 1260360
 taactcccc tcccagaact acagattccc taagtgggaa gggataaatg agtggtttcc 1260420
 aaacctggct taacattctg ggttgagtgg gaaaaaata cttattactg ggccccacc 1260480
 cagagattat gattgaaggg gatcagtgag aggaaggggt ggaattgca ttttaaatg 1260540

ttttccttag atagaaacca ttgtggcaaa tcgttaatth cccttcttta aatctttcta 1260600
 ttaatttatt tattagtgtg tgtgtgtgtg tgtatgttg catggaacac ttggtaaagg 1260660
 tcagacaaca atctgcaagt cagttcttgc ttcccatcat gtgggtctct gggatcaaac 1260720
 tgaggtcac aaccttggg gcaaacacct ttacctaatg agtcatctct ctgggcgcta 1260780
 atttccttcc ttattctgac aacctgcatc agtagatctc aaactacata gtggataggg 1260840
 aggaaactgt ggagtatcat gaaatggagt caaagaagta tcaactgtgat tggcttaata 1260900
 aagagctgaa tgaccaatag ccagacagga attagcctag ctgggacttc tggggacaga 1260960

 gaggtcttgg agaagaagaa aggcagagtc gacagccagc tgtggaagaa ccaggatggg 1261020
 caggacagag taaaggtaac tgagacacgt aaaagaatgt agattttaa atagggtta 1261080
 atttaagtta taagagctag tggggcaagc ctaagctaag gccacatttt cacacacaaa 1261140
 aaataaatgt acagtttctc ctttatacga accaggagcc attttttctc ttttaatttt 1261200
 atttaaatga gaaacaatct tattttacat accaatccca gttccctctc gtcctcccat 1261260
 cccccacta atcaattccc atcccatccc cccatcttct ccttccccac caatccccca 1261320
 tcccatccca catccactcc tcagggaggg taaggtctcc caaggggaat aatcaaagtc 1261380

 tgtctcccc atgtatctag ggaaagagag tatcccttca cagggaatgg gctcccaaag 1261440
 cccattcgtg cactagggat aaatactggt tccaccgcca gaggcccat agactgcca 1261500
 ggccccgcaa ctgacaccca tgttcagagg gcctggttcg gtgacagctg ggtctgtgag 1261560
 ctcccaattg cccaggtcag ctgtttctgt gggtttcccc agcatcacca gatctcatta 1261620
 cagatggttt tgagccacca tgtggttgtt gggaaatgaa ctcaggacct ctggaagagc 1261680
 tcttaacctc tgagccatct ctccagccct taagccagga gccaatctac tagcacaaaa 1261740
 caattacatc tttctgtaga catttatcac catagtttaa aagggacaaa aatatTTTT 1261800

 aagaaatcac attattgta atcccagcac ttgggagaca gaggcaggtg ggtctctgtg 1261860
 agcccaaggc cagcttgttc tacagagtga gttccaggta agagctacac agagaaacc 1261920
 tgtcttgaaa aacaaaaaca aaacaaggaa ggaagggagg gaaaggggga gggagggaga 1261980
 gggggaagga gggagagggg gaggaaggga aagaaatcac attatcaggg tagaaatacc 1262040
 cgaaaccag ctgccagcc tagtgaagga gaagtactct ctctgccttg ctgccagagg 1262100
 tactcagaag tataccagct taccattca ttttcagca ggttttggg ttcagaggat 1262160
 ctggataaaa atctggaac atctggtcac ttttttgtt ctacctgct gtcatttaat 1262220

 tctaagaaac aaacatggct gctcaactca gtggttgtca ggaagagaat tagaaaatga 1262280
 tagataaact ccatctttt cagctctgt ctcttctcc tcatggtgac ctgtttatag 1262340
 aacatccatc taagtgggcc agcctcagca caatgctttg acagaatgat catgtgatct 1262400

caacacggtc caaacaattg gagacagctg tcagagtaaa gaacaagact tggagtccga 1262460
 cagacttggg tgtaagccta taacctgact tcccacataa gggcaccgtg gactaaatga 1262520
 gaaaaattaa tgatgtttta gcatgttcag cttttagtag ccagtcttct gtttgtatag 1262580
 ggaaagacct gaatctggat aactttataa agaggcttat tatttgagca tgctggtaca 1262640

 ttgtctatgg tctgtgaaa gcaggggcat ttctgaaagt tcaaagctag cctgagctac 1262700
 atactgagtg ccaggccagc caggatata tagcaaggta ctgtctcaa aaatacttat 1262760
 ttatttacac acagagattt gcctgccttt gcttcagag tgctgggatt aaaggtgtgg 1262820
 accaccactg ccaggcttaa aaaatattc aagtaagttt tattactttt ttttctggtc 1262880
 aggattttgc taigtattc aggtggcct ccaactcagc aatccttga tcaccaagc 1262940
 aatggcatca caagaatgag ccaccacacc cagctgaaga gttcactgac tataagttct 1263000
 atgtttttaa tgctgcaggg catggtgctg gctttggtga ggactcctg gccgacagcc 1263060

 tttccatagt tcgtaaatga gcaggaagga accaacaggg tgactcagga tcaactatta 1263120
 caactcactc ttctctcact cctcacaggg gcagctcctt aatgatctag ggacaaacca 1263180
 cctggtctca cctcttaagg gtcccaccac ctcccaaagt caccacactg ggaccaagc 1263240
 ccaacacatg aacctatgc agagtctat acacaggaat atgtctttgc tgtgttctact 1263300
 tcataagcag tgggagactt gttacaggtc atatagaac ctagtggcag agccagaata 1263360
 ggaactcatg gctccaact tacatcaact ggacctccat ttgagtctct acacactgag 1263420
 aaattccaaa gctgtctgtt gctgggcttt gcttatctga caacaatgct aatgcgaggc 1263480

 tcttgctag gtgctagga cattaacaat aattacttag gatgggatgg tggcacaggc 1263540
 ctgtaattcc agcactcaga aggtaggggc aggaggacca tgagtttggg gccagcctgg 1263600
 cctacacagc aagacctgt gtcagtaata ataataacag agctgagcaa cggctcagtt 1263660
 ggtaaagtgc tgccacca agaggacttg ctcccagca cccataaaag atggccacag 1263720
 tagtgtggtc ctcttctgaa atcccactgc caaggaggtt gtgacagctg gacctctgga 1263780
 ggttgccatc agtgagtgtg agtgaactcc aggttttagta agacctgtc tttagaaagt 1263840
 tcggcagagg gctggggagg tgactcagca ggtaaagagg ctttccatgc aagcatgagg 1263900

 accggagttc agatcccag aaccacaca aatgctgggc aggtgggggt gcctgtaat 1263960
 cccagaattt gaggggcaga gacagagata aagtggagag tgatccagc agacatatga 1264020
 tgttcgggtc ccacatgat gtatgtgcac atacaaatgc accctcacat gcaaactg 1264080
 agacacacat ctgtacacac acacacacac acacacacac acacacacac aactgaggga 1264140
 aaacaaagt ttgactttgg gcatccatgc atacacatgc acacaacac tacaatagta 1264200
 acaacaacta gaaaactgct aactgggtct cttgttttct tttctagaga tttaacctt 1264260

ctgtgacttg ttgacctgat gacactttgt gtttttgtat tttcaccgta agtacttctt 1264320

tgattttcaa acagagcatt tggctgctcc ctgggatgct tctcctctga cgaatctcac 1264380

cttggcacce aagccctccc cccaccccc gtgcactttt cteccacgtc ccatctcttc 1264440

cagtctctgt gattctgctg actaaacgca gcgctttgaa ttcctctctg ctgcctccac 1264500

tgatctagac gagcactggc caacctctc ctcttccctg ggcaactaat agattcagag 1264560

tagttacacc agcctctctc ccacttccag atcttggctg atgctggttt cctgtggct 1264620

gaaaggctgt cccttctgga ccagcccaa ctcccgatgt agttttgaa gccatcctg 1264680

gacctctctg tccagccagg ttcgatctta taccataaaa agagcatctg tcttgatact 1264740

tctcagctag tactagatca tagtagtcag tgaaggtaa ataagtagtg atgaatgaat 1264800

caccaagaac tttaaaacgc ccacacagaa atccggtcgg actttaatcc caggggcgag 1264860

gccagtgggg acgcagggcc tcgagctacg acagggtcgc cggccttggc ttgtcccat 1264920

gatggcccc gtctactccc caccctgaa caaagtttg tctgatctc tcccgttgt 1264980

tgatggtggc ttttaaaatt ttttctgga ctctggctct cgcctctttg accgcgtccg 1265040

ggctggaage aggcgagcta gaaatctagg ttcagcacgc gccagcccaa cccccgact 1265100

ggacacaagt ttccccggcg ccggccgccc cccaccac cgccccgcc cggccgcn 1265160

nnnnnnnnnn nnnnnnnnn ngcccgcgtc gccgagcccc gacctactcg ttcgttgtec 1265220

agctgctcgc caagctcaaa ctctctcgc cgttaccag gctcaggggg cggggccttg 1265280

gcaccacct gtgcctcgc gcagactgcc ccgctgggca taaagaggag ggtggggaag 1265340

gagcctcgcg tctgtgaagc cggacggcgg ccgggaaggg gcactccgtg agaagcgacc 1265400

tgggctttag ggatataacc atacctggg gtgtgacagg ctttgggaag tagggaaggg 1265460

gtgtgactca tggcggggg ggggcctgta ggcttagatc tcggagagtc agagcctct 1265520

gtgatttggg gacactcagt gtagaatagg gtgtcgggtc tctggcgac cgaaccgggt 1265580

cctctgcaa agcaacaagt acccttaact gcctctccc cggccccgtg gggtgtttt 1265640

taaatatgca gcttcatgac cctcttacc ctacacagac cctcatcct ctggcaatcc 1265700

gcagccattt aactttctta ttctagata atgagagggt tgttaaaatc tgaggcacct 1265760

gatttaaaaa atgtgtctga ccaaaccta gggaattaat tatgactaag ataccaaact 1265820

cctaactggt ttggtgtaaa taaaagatga gctctagagt gtggggcaga ctgttaagag 1265880

cctggggact ggagttttag catggaaaag agagttttct ttgttaggtt ccagcaggtg 1265940

ctggccagat ttcagggtgt agggccaggc aatgaggctg aggcaggcca tggttgtgga 1266000

gctagagaca ggggatgtta aattgaagag tcttaggagg gagatttgtt actgactgta 1266060
aatcagtggc ccaaccaga ggccagaatc cttccaactt cctagataaa gcacatacat 1266120
ctctccctag gacagacagc cttccagact tgtgtataaa ctcaagagaa ttggcagata 1266180
ggtggctctgg taattgccaa aagagtgttt gctgtctgaa ccgttttctt tgtcactatt 1266240
gtgcctgacc aggtaggaag cagcagcccc agtagccggt gaagtaacc atttctaaag 1266300
cataatgaaa ttacaataag cagggggtct tgggcttgag cctttaatcc cagctctcgg 1266360
gaggctgagg caggagaatc tcaatgagtt ctagctcaac ctagtttaca taataacagt 1266420

tccagaccag ccaaagttag ttggatgcc cttgtctcaa aacaaaaca aacaaaaat 1266480
gaattataat aaaaactaaa gcacatgac ccatggctca ctgtacaggt gcctctctaa 1266540
gatggaccag caatgatata cctattgatt acgggtgaaa tatgggcagg atcctagatc 1266600
ttaacagccc tttggctgag tctcctcaca ttgtggcttc atttcattt tgtagatggc 1266660
agctgagcct gagaagttac ctaactgttc aaagtgggtg atagtgagaa tgggaatgaa 1266720
gagccgaagg cttagccctt cctactctc tgcgatttac tgtcattcag atgtttgcc 1266780
ccttggatgc caccacctt tgtcactctg tctcagagca gctattagca cctgagatta 1266840

cttctctttg tttgttgtt ccatcctgtg ggtgtgaatt ccatcagcat ggccattatc 1266900
tgtcttgttc actaccctt ggaagggaaa aacaagcaac ttcaacagta aagcaggttt 1266960
agcctgagaa aatatcaaaa ccttcaaaag ggagatctct tacagcaatg attctaacct 1267020
gtgagtctga gacctttggg gatggaatga ccctttcaca ggggtcacct aagtccatcc 1267080
gaatatcaga tatttacatt atgattcata acagtagcaa aatgacagtt atgaagtaac 1267140
aacaacata attttatggt tggggtcagc acaacatgaa ctgtactaca gggttgaagc 1267200
attaggaagg ttgagaacca cttccctaga ccttggatg gtgcctgaaa tgatgatcta 1267260

acaggatggg agagaggag gtggatactg agattagtga aaactaagat acctcaggtg 1267320
cttctcaca gttccaaggt aaacattatc tccattaatt ggtttgttta ggtttgaggc 1267380
tgtagctcag ttggtagaat gtttctggt gtgcatgaag ccctgggttt gataaccagc 1267440
tccacataaa ccatgtgtgt ggtggacatc tgaatecta ccatttggaa agtgggggca 1267500
ggaagattgg aagttaaga gtatcatagg ctaccttct caaaaaaca caacaaccc 1267560
tattcatatt cactggacaa agatgtcagt gtatacatg tggagaaatg aaaagatcta 1267620
agatcatcaa atccagtatg gaggattggg atgtattgta gtatcgtggt gtcaggctca 1267680

gggtttgatc cctagcatcc cctcaaaaag gatttacaag gctcccactt agctccatca 1267740
tgaacatgtc tttaaaggct ggtcacagtg gtgtgtatct ataactccag caacttggga 1267800
ggctgaagca gtaggatcat gaggccgtcc tgggctgtac atagattgca tccccaaaca 1267860

gaaaccagg atgaggaggt tttcccagg tcttcctggc cccatgcctt tgctattgca 1267920
 tatagtaaac accagagaac ctagctgaag attctgcaga gggcgataag gatgcaatga 1267980
 gccttggat ctaagatctg agttcaaatc ccaactccac aacggagcac tgtgactaca 1268040
 gcaagccctg ggtttaataa cccaagccct gggctctctaa atcccacagc ctgacttcta 1268100

 aagtggagta attttccctt gtctaactgc tctttatgac agtggtcaca agtgctagga 1268160
 gcttggctag ttctttctca ccacaagggt aggagtccag tagtgttacg gtctccattt 1268220
 gtacagcagg gaagtggagg catgaagagg tgtcctgctt tgccagactt cacacagctc 1268280
 tgcacacgta gccactggcc ctcttcctat gctttgggat gaggtcaggc ttcccagaga 1268340
 tgactgttga atccgatgaa gtctatgttg aagggtctgt gggaacattt gagtatgaat 1268400
 taggcagaag actgccttta actttgtgct ctgcatttgc cctgtgaggg cctctccaag 1268460
 tctcagttgg ctttatggag agggagggtg agacaaggtc tcatgtacct tgttatggag 1268520

 ctgaagatct tgaactcctg atcctcctgc ctctacttcc caagtgttgg gattataggc 1268580
 ttgtgtcacc atcacaccac actgagcttt ggtctggcct ttgtattgag acacctcca 1268640
 ttgtcccagg gtctgcattg cacatggctg atgtctctct ttagccatga catcacccct 1268700
 tctggctcta cagtttatga ggctatctat ctctccacct ggctgggggc cactgcttca 1268760
 gctactcaga gtggaattcc tttgccttcc agcctctagc acggccttgg cccagacttg 1268820
 ctgctcagga aatgcctgtg gaatcaaatg gggactctta catgtgttga ggattcacta 1268880
 tgtgccaggc ctatcctgac actttatatg tgctgtctcg tttacttcc cgcagtaatc 1268940

 ctgggagggga gacattatg ttcttatttt actgagaaga aatagagaag ctggactctg 1269000
 ttgtaggcct acttgtcatt gttgttaggc ccaaaaccgg ttctaggcag tgcttctcaa 1269060
 cctgagggtc atgactcttt tgggggtcaa atgccacttt cacaggagcc accaagacca 1269120
 tcagaaaaca cagatattta cattaccatt tataacagta gcaaaatgac agttatgaag 1269180
 taacattgaa aatcatgtta cggttggggc tcagcacaat gtgaggagct gtgtaaggg 1269240
 gcacagtgtc aagagattga gaaccgtgc tcataaactg gggaggctgc cacttctatg 1269300
 ccccaggacc ctgagagaaa taccacaaat tctggctctg ctctaacttg atttacaagc 1269360

 aaataaaagt cccagaaaag tcagaagact aggctagtga gaaggctcct caggatgtgg 1269420
 cttttgtcac tgggtctgaa gatctgagtt caatccccag gactcacaag gtgcaaggaa 1269480
 gaactgaatc ccacaagttg tcctttcaat cccgtaagtg tgctgtgact catgggtgtg 1269540
 cacaacaca actaaatcca tgtaaaagaa taaccttata accattctga acatttcata 1269600
 tgaatggaat cctateccgt gtgacctttg tgactttccc ttggccagca tgatgtaatc 1269660
 tggatcagag ctttgcctct aggactggag agatgactca agggtaaga gcactggctg 1269720

ctcttgcaga agaccactgt tcagttccca gatctcataa ggcagctaac tccacttgca 1269780

gtgaacccca aaccctcttc tggctttatc aggcaccagg taagtatatg gtacacactc 1269840

atatgtgcag acaacaggaa aaagaaaaac tccatccctt tgagtnga atcaatttg 1269900

tgaatatacc attttgttca ttagcttaag gcatttgaga tgtttccct ttgtaaacat 1269960

ttttttttcc tcttaaaaga gtctcattat gtagccttgg ccagcctgga attcacaatg 1270020

tagactaage tggcctcaaa ttcacagaaa tcagcctgcc tctgcctctg cctctgcctc 1270080

tgaatataaa ggcgtgtgcc accctgccta gcctgttttc actttttgct attctaatg 1270140

ttgctaacaat ccacatacat gtctgtgtgt gaacattacc tcttagagtc cactggagac 1270200

gcccaggagt gaaattgctg agtcatgctc cctacaagtt aaatccttta aggaattgcc 1270260

aactgttttc caaatggca gtggatatag agttctggtt tttcatcttc tctactactt 1270320

gtctgtctga ttgtagtctc ctaaagtagg gtgaaagatc tcattgtggg tctcaggctg 1270380

gcctccaact cttacgttgt taaagctcct ctgtggcttc tgtttctgtt cctgcctagg 1270440

cttccttga tggtaggactg tgtgtctggct agtctcatgt caacttgaca caagctagga 1270500

tcatctgaaa ggagggaacc tcaattaaga aattgcttcc ataagatctg getgaaggca 1270560

aacctgtagg gcattttctt agctaataat tgatgaagga gggaccaact gttttgtgtg 1270620

gtgctgacc tgggatggtg tccataggtgc tataagaaac aggtgaacca caccatgaga 1270680

agcaagccat ggctctgca tcagtcctgc ctccaagttc ctgctctgag ttcctgcctc 1270740

aatggactgt cacctataag tcaaagttgc ttttagtcag tgtttacccc agtaacagag 1270800

aagcaaaacta gaacaccaag tctcagaatt gtccattgtt agttattatt atttcttctc 1270860

atctactgct tgagaagtga cagttcactg tggcttccca gattaataca ttttttcat 1270920

tatacctgtg tggtagatg ctgcttgag cctctgaagt aagaacactt tctgtggctg 1270980

gagcttcagg gctctgtgtc tagactctgt tggctgtgca gagggagact ggaatagga 1271040

atgtlaagga gggtaggac tatagggaga gggctgttgt caccttgagc cctgtggtgg 1271100

aaggaagcta aagttccatc tcttctacc ctgtgttatt aaaaaattaa accaaacaaa 1271160

ggagccaaag tcttaactctg aagacctaaa acaatgaac tcttaagaga aaaccagggt 1271220

gacactcatg gggatcataa gttcaccgat gctctcttag atacaatagt caagaggggt 1271280

atagaggcac atgccagtca ccacaacacc cagggtcgca caagaggatt gcaactgtga 1271340

ggtcagtctg ggccacataa caaaaactac cctcatacta ggcatggtga cacatgcctt 1271400

taatcccage actcaggagg cagaggcagg tagatctctg tgaccttgca cagagagaag 1271460

tggccacaga gaccacaaaa ccaagaagat gcctatggca cccacagttg ctggcatgac 1271520
 ctttttcttc tcatgacctc tgtgatggtg agttgtggac tttccttgct tgttctcctg 1271580
 aaatgagatg gtagtaataa gaaaagtaat tagtggatac ttattataag tggcgagttg 1271640
 gcgttgtgtt tgttcttttt aaaggtgtgt tatcttactc ctgaggggaac agctgctgtc 1271700
 tcagaggcag ggtaattggg gtttacacac agacagcccg actccagtgc tgtattgtta 1271760
 gcctggctca aaagaacaaa ggaagatgag caagcttggc aacaagtgtg ataaattaaa 1271820
 aatttgggtg catgccaggt gtggtaaatgc acacctttaa ttccagaatt tagaaacaag 1271880

 tttgagtcc aggccagcct aggattaata gtaagacctt aaataaaca aaggtcacta 1271940
 ggaaaacctt aataagttgg taatatctca tgtcaatatt gttacagggc aatccttcca 1272000
 tgtttttttt ttgggggggg ggttgttagg atctcacact gtagcccagg ctggcctgaa 1272060
 attcactatg ttgccatga tggcctcaaa ctcttgctc agtgtcctag gtgctaggat 1272120
 tacagacatg agcaaccaca attagaattc tgtatttttt tttctgagac agggtttctc 1272180
 tgtggctttg gaggctgtct ggaactagct cttgtagacc aggctggtct cgaactcaca 1272240
 gagatctgcc tgcctctgcc tcccagatgc tgggattaaa ggtatgtgcc accaccacc 1272300

 ggcttatatg taatataca aaattaaaat aaaaatcaat taaaaatata atctgttcag 1272360
 gggtaaatgg ctaccacca caaggccctg gttcagtcct cagcactaca acacttttta 1272420
 aaaaatagaa aaaaaattca agccataaaa attccaaggg cttgagacct cctgtccttg 1272480
 agttgatgaa gcccagcttc agaggtatgg ggctgtggta gggccactct ctgggtactc 1272540
 agggataggg ccgtggcgcc atcagtcagc tttcccagtt taatcttttg agagagtttc 1272600
 tgctctcagc tccaaaacct actgaccatg accacagagc aagtaagtgc acagccaagc 1272660
 cttttccatc tcttccactc cttcttggcc ttttactgag gatggttaagg tgttctttct 1272720

 ccattctcac tcaccagat ggagetaagt ctccattcct gggaagcccc aggtggttta 1272780
 ttaacctct atcttgggtg tgtctgatga cctgaggag tgagccaagt cccaggctgg 1272840
 aggtgtcagc cagtgactga tgtcttaaat taagtgggca gctgaccag tctggaccgg 1272900
 ttatcataat ccattacaa aaggcaaggc ctgggctttg gcacaggatt tggctctgctg 1272960
 ggacctata agatccaggg acttcagccc attccctatg gagggacact attgtagctc 1273020
 agatacagca aggagggcct aggcctccc ccaaacgatg tgacagactt tgaaggtccc 1273080
 tggtaggggc ctattatcc atggggagga gttggggcgt gggttggggg ggttgggtggg 1273140

 gaacatggga ggatgggatg gtgagggaaat ggggggcgat ggatatgtaa atatgagtgg 1273200
 taattaaaga atttaataa aaaaatacaa ctattaaaaa aaagatccag ggacttccct 1273260
 ctcacgtatt gggcccctta gaaccacttt tgaaaaatgt tgactgacca gggcatcatc 1273320

ttaaaattcc atccctagag tggcagactc aagatttccc tactacaaaa accccaattt 1273380
 atccacagct ggagccaagg tctcagccat tctgcccag gctctgact gtgtttggcc 1273440
 tgttctctca acaatttaca ttgggttctc tgtgtatatt tttttgcag agaaggaaca 1273500
 tgaggctcag aggtgaagca acttgcttgt aagtgcagg gcaaagattt gagggagggc 1273560

 taacttgttg tagagtaacc ctggcagaca ttcagattaa aaagaagtat tgggccgggc 1273620
 gtgggtggcg catgccttta atcccagcac tcaggaggca gaggcagagg atctctgtga 1273680
 gttaagacc agccttgtct acaagagcca gttccaggac agcctccaaa gccacagcgg 1273740
 aaacctgtc ttgaggaaaa aaaaaagtat tggcagccag gtggtggtag tgcacacctt 1273800
 taatcccagt gtcaggagg cagaggctga agcagatctc tgtgagttca aggacagcct 1273860
 ggtctgcagg gtgagttcca ggacagctaa ggctacacag agagaccctg tcttgaaaa 1273920
 acaaagcaaa acaaaaagca gcattgccat ctctgcagga gatgctgctg ctggttgggt 1273980

 actgtatact gtagaacaga cacaggctca ggcctttgca tagattaatt gaatacacat 1274040
 aacaactccg tgcatataaa gttataactt cttcataatg gaaattgggg ctctaagaga 1274100
 cctttgcaag gtcacatgga aagttagaaa atgactctct tctgccattt cttcccacaa 1274160
 cctcctatca ttggtttcct ccctctcct aactggctc cccagcccct ccctaatgct 1274220
 gtagctgagc tgctcttct tgatctcagg tctctggct gaccatgtc catagccctt 1274280
 cattcatatt cttaccatgt tttggagcct gatgttgggc taggctgtat ggattagtga 1274340
 accctggaga taattctacc tctgggcac cttatcactt tctgctgctg gacaagagga 1274400

 gtgatggagg agcacatcac tcaggccctc tgaatgtct gcatcttgt gagtagagca 1274460
 gtttagaggt aagagccagc aggatgtcca tacctggcat ggaggtcaga tgcacagagt 1274520
 ggggccagga ttggcctctc caggtctcgt ggttcccagg attggcctct caagctgaa 1274580
 gctgatatga gcagcagcaa ctgctggcat tatctggcct ctaagaatag cttgaggtaa 1274640
 agatcagagg ctgtggccag ggaaaaggac aggggcctct gtctccctgc ccaacgctgc 1274700
 tgcttggcat ggaggctgga gtccctcctc tgctcactg tttgtctggg gaggttttga 1274760
 atggacacac teatccatct gtggactecc agaactcaga cccaggttgt ggctagagac 1274820

 agtgaacaca cagtgcagg gctgtctctc acctagccat cctcccacat tctaaggcct 1274880
 ttattcactt agcaaacact ttaaaacagg cttacatat gattaaaaat gcaaagggta 1274940
 ttaaaaagga aataaatcag tttctctccc tgccccacc tactgcttcc atcagctcc 1275000
 tgaggaacta atctacccc agataaactc atggacacac aagcctacct gacacacaca 1275060
 gccctttcta aagtacatc tttttccag tactggggat ggaacctagg gectgtgcat 1275120
 gctaagcaga cgttctacca gcgagcatat cccagctcc tctcacactt ttctaagtc 1275180

tctgtcttag taacaaattg agtctccact agtaataagt gctagtctta gtgcttcaga 1275240

tgttccaatt ccacctttat gttcaggatc tatgtcgtag ctattctgct cactgttaca 1275300

ggcttaagtg acttctcaag atgttatggc tggtaattga cagagacagg attcttcctc 1275360

ttaagtttga gtcataatccc tatgatacaa gccttctctc ttcctaaagg ccaaggttaag 1275420

aatgtgtag tgaacattta ccaagcaciaa ggctaattgg gatacagtag agcataaaaa 1275480

agacaggctc ctgctctctt ggatctggca ccccagcact cacaagtgcc tgtcagcgaa 1275540

ggtggcagaa aggggaacct acatgtccta catcgtgttc aaggctgctg ttcagacata 1275600

tccttgttcc ttaccacag agtctccag ctccccagtc ttggagccaa gaaccttgg 1275660

agcttaagtg aaagttgaaa tagggaagat ggggtccaga cagaggtagc agcctatgag 1275720

gtcaccatgg agccctggtg agcctcatct cattctctg ggatccactt cagcaggcct 1275780

ggtgggggtg tctataatcc agggaccagc cattgtttga agttggggac aattgaaggg 1275840

cgagagagct atagatagat ccacagctgc tgcacctgt cccagcctgg gcctagggcc 1275900

caggcattgt ctacattgag ggcctctggg ggtgggtgat ggaacaggcc cagctgagcc 1275960

ttagagagac tgagtcaaa tccaggaggg agaaatgcta agtctcagag ggaaaaagac 1276020

caagtcctt gaaagattta aggattccta cccagtgtcc aaaacagcca gattggtgtt 1276080

ggggccagag agagaaaagca tgctatggag atactgcgga gctaaggcaa aggttgaact 1276140

tacatatgag cagatcagaa cccgagcaga gctagtgatg ggagctagag accctcagca 1276200

ccacacagat ctctgggac gcctgcacat gtactttttt atatcttttt ttacttgggc 1276260

gactacatcc cagagttgtt tatggaacaa ttgaaggat cttcatgaat gctctgagag 1276320

tccccaggtt ctttagaagc ttgaagatat gctgctgggt gatagcttca caaagacctg 1276380

tgtaccctt tgtgcctcag tttctatgac ttcaatgtgt tcatttgtac aaccattaaa 1276440

gggtccttca ttctctggtg ctggcaggac attatecctg tttcagatga ggccacagtc 1276500

cctgtactta gtcctttatg gggatggggg acagctggtt gccacttcc tccccagtc 1276560

aacctttcag acataaatcc atgctaagge atctctctct ggataaacag ctttgatgcc 1276620

ttttggctgc cctcatceta ttttctgctt ggagcatcag agctggggcc cactcaagcc 1276680

ctctgcacct gccagggcc ccatgaggag gacaaacctg ggacaagcag gggccaacca 1276740

ccccagagt gccaggatgg cgggcccctc ttggggcctc accaccttgc ctgtggacca 1276800

ttatggcagc ctctctga gtgagccttc ctgccaccgg tgggtctcgc cccttcaatc 1276860

cgctctccac accagctgcc acagggatct gatgaacaca taaatctggc tgcactgtca 1276920

gatctccttg ctcagggtc tttgatgaag aaataaataa aaacgccttt gatggtgccc 1276980
cagctcacac aggggaaagc tctaaatcct gctcttgctt ttgaagtctc tcacagccct 1277040
agcccaatga ccagggtccag ccttgccccg cgttatgccc tgaggcctag cctcagtcac 1277100
gcagttgctc aggagggatc ttatttctct tcctccagc actgtgggct caggacacct 1277160
gtctcatcgt ctcttcctg cctttagcac ctggcccat ctgcttctac ctgggtgacc 1277220
tcagcaaac caactgtcc ccgatgcagc tctaacctc cccagtctat tctcaatgtg 1277280
gcagccagaa tggccactct taaactttag gccatccttg ccctaaaagg ttcctattgt 1277340

tcttgcaatc aagtgtgtg cccaagtgtt ttgagattct gaacaatctt gcctattttc 1277400
taccacctgt taitcactag taaaactctt ctctaaaac atatactttt taaaaaccac 1277460
actcagtcct gtggggata ccgggggag agacaatttg gagctagggt ctaaaatcct 1277520
ggagtctagt ctctgaagc tggaccagac ttcagccatt gccactcca aagcattgaa 1277580
ccctctgtag ctactacagg cacactttct tccgaggctg gctcttcagt cacaggctga 1277640
ctctgagttt gtttgtttgc ttaatttta tgtgtattgg tgtttgcct ttatgtattt 1277700
ctatgtgaag atgccaggta tcttggaact ggagttacag accattgtga actgccatgt 1277760

gggtgctggg aattgaacca gcatctctg gaagagcagc cagtgtctt aaccactgaa 1277820
ccatctctcc agccctggct ctgagcttca gaaccacct gtgtatacaa ctttgcctcc 1277880
tgtcattgct ttgcccactg gtctacttcc cccatctctc tcccactccc agacttcca 1277940
gagaaatgtt ctacatgaa gtcattggct caatcactgc agattcgctt ttgaggctgc 1278000
ccaagtccca taaactcct ttgctcctga cagcatagac atatttgaaa ttatcacctc 1278060
aagccctgc aaattgcagg ctccctttaa tctctcagaa catgggttct ttgttgcttt 1278120
gctattctga cctggatact caaccttagc aggaagatgt gccccgagtg gtggaagtga 1278180

acctagcagg acatttctag gcctgtattc taggtttgtt tctaagcaat tgaatgtaca 1278240
ttgggcagta agtctagaat ttaccacaca ttgtatcttt gcatagacta caattatcgt 1278300
aaagtctga ttttttaaaa gttaattttg ttactcctgg gcaaaaagcc ctgcatgctg 1278360
agtaccttg agcagtgaaa agttgtatct actctctata ctgtgtgtgt atgtgagtgt 1278420
gtgagcaagt gtgtgagtgt gtgtgtatgt gtgtgagtgt atgagtgaga gtgtatgtat 1278480
gtgtgagtat atgtgagtgt atgtgtttgt gagagagtgt gtgagagtat gtgtgtttga 1278540
gtgtatgtgt gtgagaaagt gtgtgtgaga gagagtgtgt gtgtgtgtat gtgtgagagt 1278600

gtgaatgtgt gtgagtgtgt gtgtgtgtgt gtgtgtgggt gtgtgtgtgt gtgtgtgagt 1278660
gcaccaccc atccatgtgg gtgcaggaca tcaggctctc tgcctcatta ctgtgacct 1278720
tactcttttg aggcagggtc tctcactgaa cctgcagatg gccagcaagc cccagctatc 1278780

ttctgtttc ctccccacag tgccaggggtg acagatgtgc acttggccat gcccagtttt 1278840
 gtgcccata caaacccatc cctttacagg gatgctggga tctgaactca gatcctcaga 1278900
 ctggagcagc aagtgtcttt acccaactgaa ctatctgtct gttccctact ctccacactt 1278960
 ctacaagtgt ctccaactcg gctcccagct tctgacctg tgcagatatg aaaactctat 1279020

 cacctaaact atcagttta attcatttgc ctggtagcta tctactgaat tctgtactgg 1279080
 acaggcattc tgaagggtgc tgggaatgca gaccagactc ctgtccccag agtttttagt 1279140
 ggtgggaggc aaccaacctc cacaagagt gaaaatgacc ttattctcac acacatgtct 1279200
 agaggatgaa ggactagtga tataatagcc cagacataaa aattctgaaa ataggctgag 1279260
 tggtagcgca tgcctttaat cccggcactc aggaggcaga ggcagggtga tatctgagtt 1279320
 tgaggccagc ttggtctaca gggtagtitt caggacagca gagctacata gagaaacct 1279380
 gtcttggaaa accaaaataa accaaaagac aaaaatgctg aaaataggta aactaataa 1279440

 gtgatgttag agtcaagatt gtattacctc agaggagagt ttacactttt gtcagttatt 1279500
 accaaatgtg tcagtgaagt ttttatttta aggccttttac attttgtgta tatgtgtgtg 1279560
 taagagtata tttcagtgtg cgccagcgcg cgcgcacaca cacacacaca cacacacaca 1279620
 cgtgcgtgcg cgcatgcttg atttgattca caaaggagac acaactgtgc aactaccact 1279680
 tagctcagtg tctggagcac ttcttacatt ccagaagtct ctctgtgcc ctcaatcctc 1279740
 agaagaccag cctccacttc tgtecccata cttagtttta cctgctctga tagcataagt 1279800
 ggtgccagtg tataaaatta cttttgtata ttttgtttgg cacagctaca tatccggaat 1279860

 gggactgaag ggctgaaa gttctgaca tattctagag ttgtagcaga tggactgagt 1279920
 tghtaagcacc ccaactcctca tgagagtgag gtacaagaaa ctggctttct ctaagtcaca 1279980
 aatgtcagaa tatggaggca cttctaacta gtctaatttt ctctcctctt tttactgtgt 1280040
 ggtaccagct ctggttctgc ctgtcttctt cctcctctcc ctccctcctt cacatatccc 1280100
 cagccccctt tctacctaa tatttttag tttgagatgg ggttttgcta aattacctag 1280160
 actagctttg aacttggctt ctctctgtct cagcttctg agtgtcccgg tctcaaactc 1280220
 gggacaaatg gcaaacctgag gtgcctcctc ttagcaattt gtcttgagtt tctttgagac 1280280

 ctaacactaa gtaccaggag ctacaagtgt ctaccaggcc cacgtttggg tttcttcat 1280340
 gttggatttc cttttggaga cagaggccag gatggaggct aaggaggaag aggaggagga 1280400
 ggaggaggag gaggaggaag aggaggaggg tgagtgggtg cccggagctg tctctgttgc 1280460
 tgacctttga gaggtggtta gtgttttttt ctttctttct ccagacttcc tagtgcagga 1280520
 agagaactga aatagggtgt ttcagtgaac gctctatggc accttcccc gtttttttgt 1280580
 tttgttttgt tttgttttgt tttgtttttt aaactctgtt tctggaagtg caggcttttt 1280640

ttgcatgtat gagacttccct gtgactcagt ttccactcctt gaggcctta cagccttgtc 1280700

 cctgtccctg tcaactctctg aatcccagat tcttgactga gtggactgtc tctctctgcc 1280760
 tttgtgatcc cctgacaatg ggaggtaaaa atagcccagg ggctgagcta caggagataa 1280820
 aagggaaattt gccttttctg tctctgtggc aggctggggg gggctgtgac acgtggagat 1280880
 tgctgacata gttctccttt gctgaccttg acagtggcaa taaaaggggt agcacagctt 1280940
 cctgccctca cagtggtgcc aagggtgggtg atcagggctg ggggtaatc ggagctgggg 1281000
 gtgtgatcag ggctggggaa gtgatcaggg ctgggggagt gatcagggct agggcaggtg 1281060
 atcagagctg ggggtgggtga tcagagctgg ggatcgtgat ccagggctag gtttgggtgct 1281120

 ggaggggaagg caggagagag cccattgatg ggcccaggtc ctcactacct atagcaaagg 1281180
 atgctcttat gcttggaggt gtgcattttc atgctcacc ggggagacc actatcaaac 1281240
 ctgtgagatt agaggtcat actccagtat ggaacccggc cctgagttt cctgtcattg 1281300
 ctatcttcca gtgcctgctg cctagagcca ccttgaatcg ccgccagat tttcaggcct 1281360
 cctcctcctt ctctcctcc acctctcacc atcatgatgg atgtgagtga acttggagaa 1281420
 tcagccttct atctacgcca gggctaccag gaattgatga aggtgcacac tgtcccatgg 1281480
 gacggtaagt gagagcagag gggagcacag ccatggagaa gcccaatggt ctcagactag 1281540

 gaggggagag ggctgccatt ctgcttgta ctacaggggc actatggccc agcacctggg 1281600
 atgttccctc agtttctggg tgtgagagc taaaaatcac agaaacctg tgaatatgat 1281660
 tgtgtggctg caagcaaggc ttggtttgtc cctctgtaa atgggataat gtcactttgc 1281720
 tcttgatgtc tccatgaaga ctcaggctgg actggggcct ctgaaatgag actgatgtgt 1281780
 gcaggttggc tccatgttca caaacctgt gctggactta ttttagtgt tttccatgga 1281840
 gcccaagcct ctgtttatta gggacaggaa taagactac ttttatgac ttgattggct 1281900
 catagtacaa taataacata ggcagtgtgt gtctagggct tactgtgtgc caggcctgga 1281960

 gctgatgact ttctgtgcat cttctcaata atctggtagg tgggaaccaa agcagagcca 1282020
 gatcagtggt gtgcaacatc tggagctgta catagcacca tgttcaagag gctctggtgct 1282080
 tagctgggca tgggtggcata cactcagcac tcaggggcca gaggtaggca gatcttgggtg 1282140
 aattggaggc cagccagagc tgcatagtga gaatctgct caaaagagaa gtgtctcaag 1282200
 cttgatttga cattcttctc gtcactttaa ttgttttct ttgtttaaaa ttttagcatg 1282260
 cagagttgag gatttccttg aggtgtttaa actttttaaa tgcattttaa aaaacacaaa 1282320
 acaaacaaaac aaaaaaaaaa agggagactt gaatgaatag ttctgaccaa ggcacaaggt 1282380

taccaaccgg gagggcaggg accagaattt gctgtctgta tgagttcaca ttttttacca 1282440
tcataaaagt ctgggctctc agaagctcta gggtgagctg accagtcagg aaaaggaga 1282500
tccccaggtg ttcagtgaaa tggggaaggt acaagacacc tgagagctag gagcctgata 1282560
ttgatggggt cgiccacctg ggacatcagg aggcctcatg gcctttgtgt ttaaacaggc 1282620
ccagagagaa tgaggtttcc caggtggcag ggagctgaat ccagacatgc actgtagact 1282680
cctttcccaa tcagctcatt tgagaccttt agggaccttc ccagctctgt ccagggtttg 1282740
aatgagtcct cactggaact cccagcccct ggacagaagga ctagatggag aactgtgggg 1282800

agggcactgc tttatgcccc cagtatagga actcccctgg acacttagag cccctctcaa 1282860
agtctgatct ttctgcaacc caggcaagaa acgggtctgg gtgcctgatg aacaggacgc 1282920
ctacgttgag gccgaggtca agactgaggc tactggaggc aaagttaccg tggagaccaa 1282980
agaccagaag gttgagctcc ccttccttg agattggctc gccagggtgc atcccctgac 1283040
ccgctggatc ccgacagatg aatgaagctg gggtagggca tggtagcgtg tggtaggag 1283100
agagaagaaa agacagttgg cccacctta gcctcattt catgacacgt ctcttgaa 1283160
ggtgctgacg gtgcgcgaaa cagagatgca accatgaac ccacccgct tcgacttact 1283220

ggaggacatg gccatgatga cacacctca caggctgca gtactgcaca atctaccca 1283280
gcgatatgct cgctggatga tctatgtgag ttcaggcag cggtgggtgg ggccactaac 1283340
ggggctgacc taatatgggg cggggttaag ggaagaagcg gggctccgaa ggaatggggt 1283400
caggcaagct gggtagaac agagctgcag ggggactctg gggcggagg agcagaactg 1283460
tatagtggca gaagagaagg ctagaggag cagccgagg tgaatgagag gaccacctag 1283520
aacattgatt tggtagctc tagggtcttg gactcagagc aaggccacgg gtagggcct 1283580
gagatatggc tgcctacttg gcaccattga agattcagca gaggactgtg gggccgttg 1283640

ttacatggga ttcaagetga gacaggagga tggctgtgca tggtttctca ggagcttct 1283700
tgaagattgc aggtgggctt gggaatggga acttgacat ctacttccc tcccctaaa 1283760
attccatctg tgaactctt ctcttagac atactcggc ctctctgtg tcaccattaa 1283820
cccctacaaa tgctcccag tctacacagc cgctgtggtg gctgcctaca agggcagcg 1283880
gcgctctgag gccccgctc atatctatgc agtggcggac aatgcctaca acgacatgct 1283940
gcgcagtaag agctacctc ttegccacc ctacgctccg gggggcctct ggctaggact 1284000
cccctccct tccatctagc actgcctcc tgtggcacga ccctagctac tcgacctct 1284060

cagtctggaa gtccgcttg gtctttcca ctgggtcttt gccacaactg accagaaag 1284120
tccacctatg gttagtccct caccctggt gacgtgtgta ctctctccc tttcccctag 1284180
accgagagaa ccagtccatg ttgatcacgt gactgggct ctgggcatga agtggaaagg 1284240

gctggccatt tgctggtggt gatgaggcag caggaggagg gggggtggt gaatcaatgt 1284300
 tatttctcaa gattggattc aaagtctta gggcagggcc ttacctct ggagccagtg 1284360
 tcctccactt cccatttatg ggtggtgggc agaaagcagg taattaaaca caggagtggc 1284420
 cccaagctcc ttgctgtctt cccagagctg ggatctccca cctggattct ctggagggtc 1284480

 tatataggcc tcttccctgg tcttcaaagc atcttctcat ctctacctca gcctcatcc 1284540
 ttcctttgce ttcattggaa agagatccat ttctgatgta tccggttcat atccggtcag 1284600
 gccaatatc gtaatacac acacacacac acacacacac acacacacac acacacacac 1284660
 acacctttag cctggttatt acagtcactc tgaaccaga cagagctgga ttcaggcact 1284720
 cacacttga tttcttctg tgtgcctttg ggactctgag cctaccaat aagaacagca 1284780
 caacctaagc cgccacaaa aattaccaac agtcagtatg tttaatgtg aaccttgac 1284840
 agagcagggg caggccggga aatttctgag gtccacttcc ttattcataa aatgatcaca 1284900

 gctctgccta tggggtcttc tgatggaggt gggtagcat tggcaccagg aattaagctc 1284960
 gtggtgcatt ggcaccatca tctcagagtg tctgtacctg ggagtttga tctggggata 1285020
 ctgagttggg aacagagatg gggttgaggt ttgggggctg gaggaattag aacaatgggc 1285080
 attggtgact catgtttgtg ttgtccaagc ggagagtcgg gggccggtaa gacggtaac 1285140
 accaagcggg tcattcagta ctttccatc gtcgcagccc tgggagacgg gccgggcaag 1285200
 aaggcagtaa gacttgccca cttgggcacc aatccccact gcttctcact ggttttgctt 1285260
 tctttcttc ttttttctt ttttctttt taaaattgca actccccaga gtccccagcc 1285320

 ctgcctgagc ctctactt ggtaagagac tctggcctga gcaaggctt accagaaaac 1285380
 ctgtggccac ctccgtcact gtattaggcc tgagccaggc ctgctgcagc cgtatccgcc 1285440
 ctccaccga cagatgggag ccgcatcgt gctcccagat gttttgtgtg tgtgtgactt 1285500
 ttaccttga gtgactgtt tctcgggtcg tatgaatcaa agtcactgtt acctgctgca 1285560
 aaggagagga gcaggttat ccacagatgt cagttacca gagctggggc actgggagct 1285620
 cttgacaata gcacagcctg tggtttgggt aagatgttct gaaacttctt aaaacagtgg 1285680
 agacatgggg gttttgttg ttttaagtaa actagtctat ctctggcccc tgggccagct 1285740

 gctgagagct ctgtggcttc cgctgacccc catgccccta cactgaagt agctgtcttc 1285800
 tttctgggcc ccaggttcc tctgcacaac ccacactct ggtcctgtt agccttgctt 1285860
 tattctgggg cagttttctt tttctcttg ctgtgtttc tttctcttt tgtttttat 1285920
 cccaccccc ttaccctt tctctattt gattatctt gtttttgac tttgttttg 1285980
 tttttggtt cagccattt tttttttt tctgtccct accctttct ccccttct 1286040
 ctttgattg tcttggttt tggactttg tttggtttt ggttcagcc atgtgtttt 1286100

tgtttttgtt gttggctttt ttataactct tccttctctt tcccacatg ttttcccagc 1286160

 cctaaaaggt ttttgaggat actgcagaaa agtgagggtg accccgtaat aggaaagatg 1286220
 acagagacta aagctgaccg gaacacagct ggaaggctca gggccagggg cagctcagag 1286280
 aggtgcagag gccacccatg ggatttggig acttaaaacc tgtactaacc tctccccttg 1286340
 agtttagatt agctaagctg gctagaaaaga gttctgaaca gaaacagtgg tttgagctgg 1286400
 gcaggagat caggagtat ttctccata cttccagtag tgtgcctagc gcgtttttaa 1286460
 atcttgggct ctctggagat caataagtga atgagtgacc acaaagtccc tggcaacatg 1286520
 tatactgtcc ccagatctgt tcctctttgt cttctaaggc tcttggcgtt ggggtggggtg 1286580

 gaggtggaga ggcggagaac agtgaacat gaaaatggaa ggaagaatga agctaggagg 1286640
 ggaggaggga gtatagactc agaccctgtg tcctctgag tgagacacag aaggcatca 1286700
 caggaggcag gatgcttgag gtgaccctc ccccaggaca tgggctgac aattccttga 1286760
 tctgatggag ctaatcagtc acagctagca gggccacatc gaatatccgt ctacacaatg 1286820
 ctaacaacac agacagcaca gtacagaaaa tatgcagaag ggctgccagg gaggttagga 1286880
 taggaaggct cagggtccta ggatgtccct gttagctcag agatcaggga tgtcttctca 1286940
 gaggaggagg ggctttggca ggcctccaag ggagagaaga cactatccac atccctgtgt 1287000

 gaatgtggtc aatgaagaga ttctgagat ggagagacag gtttgacctt agtacacagg 1287060
 aggcctctgt gccacgggcc tcaaggctc aagcctatga ctgtgcttgc ttcccctct 1287120
 agcatctctc agctaagtc cacaggaaag ctagggttac agacagggga ggacagaaca 1287180
 ttacgtttaa cactactaaa tatttgggcg actaacaaca ctgtcccact gactactgtc 1287240
 ccaatgtccc acccttttcg gagagacctc acatcctctg acattttct tctccctcca 1287300
 gcaatctctg gcaacaaaga ctggggtaag tacagggccca gtgggtggta agataacatc 1287360
 tatggggtcc cagggtgccc acttettaca accaaagatt ccatgggctg cctgacccc 1287420

 tcattctctc tgccaccagg ggaccctcga ggatcaaatc atcagggcta accctgcat 1287480
 ggaggctttt ggcaatgcca agactctgag gaatgacaac tcatcccgt ttgtgagtgg 1287540
 gcacagtggg ggattttgtg gctggggtgg aaaagggtca ctaccagga gggccctgg 1287600
 ggtgggaacc aacaggactg aggggtggcat gatccgtctg ctgcaggca agttcattcg 1287660
 tatccacttt ggtccctcag ggaagctggc ctctgcggac attgacagct gtgagtctgg 1287720
 gaaagggcag ggcagggtg ggaggaggga cagaggctga actgaacaaa tcctttggct 1287780
 tcctctgct ctggccattt cttccacc caaccagttc ctacttgcac cttctcacc 1287840

catcatatcg gcctcctggt ctctactctc ctgccttgac tgctagtcag tctatggtcc 1287900
 aaagttagtc atgccctgtc cctgcttcaa aaccttctct agggagctag ggggaggact 1287960
 catgggtaaa atattgctgt gcaagtacaa gaaccagagt tcagatcca gcacccatgc 1288020
 aaatgctgag tgggtgtggt agcctacttg aaatcccagc ccttgggagg cagaggcaag 1288080
 aagtcttaga gcaagttgga tcataagggc ttcacagcg agctctgggt tcaattgaga 1288140
 gacttctgct tcaatgtctg aggttgaaag tgatggaacc ggacaccaga aactcactca 1288200
 gaggcagaca caagtccat acagtgactt cccagggtgt gctggcctgt gcacagactc 1288260

 aggcacctcc acacattgcc tgtccttcca ggctgctgcc tctcatcct gcagtgtctt 1288320
 tgctcagggg agggaaggag atagcaggcc ggcaactcct ctctgcagat ctctggaaa 1288380
 agtctcgagt gatcttccag ctgcccgttg agcgtggtta ccacgtctac taccagatcc 1288440
 tctcggggaa gaagccagag ctgcagggtg aggctcagaa tggagaataa aaccatcagg 1288500
 ccaggccctg ggtggctatt caccctctca gcagagatgt gggtaacctc cactcttctg 1288560
 ggggctcaca gcctgtctgt ctgtaccct cctactcct tctgctgct tcttattacc 1288620
 atggagccct ctttgtaaaa atgtttttgg tggtagttgt tgagggtag tggggtagt 1288680

 ggtagtgtgg ggtgggtga cgggtgcct gtggtaggaa acaggcctct taccgccatt 1288740
 gtctgccaa gattgcagct gctctgcca tctgagatt agaacccta cccagacca 1288800
 agggaacca gtgtagtct atgtacactc tcaccttgc aagcccttg aaggcaagt 1288860
 ctggtcctcc cttgtccca gtatccaact caggatctgg gctggagga tgactgtgag 1288920
 cagcgtcag aggatgagt agactcatgg actgaggtcc agtctccaga ggactgtaaa 1288980
 gagacacccg ccagacatgc acatgtgctt tagaaatgaa aacgggctga ggggtggcac 1289040
 acaactttaa tcccagcacc caggaagcag aggtagatgg atctctgtga gtttgaagct 1289100

 agcctcatct atatagtaag ttctagtcca gccagggata tatagagaaa aaccttatct 1289160
 caacaaaata aaataaatat ctaaataaat aaaataagaa ttttggtttt tttgtttgtt 1289220
 tgtttgtttt caagacaggg tttctctgtg tagctttttg ctttgaagcc tgtcctagaa 1289280
 ctgcctttgt agaccaggct ggcttccaac tcaactgagat ccacctgcct ctgcctcca 1289340
 agtgcttga ttaaagcagc agccagccat gcctgtattc ctctactcag aagctcttaa 1289400
 gttcagggcc agcttgggt acatagacc tgtctcaaaa gactaataa ataaacataa 1289460
 gtaaaataaa ttgaaagtca catatatgga taataggaa cagaaactca ggttatggag 1289520

 aagccctggg aaggaaacta gacttctga cagagatacc cccaggcct caagatggca 1289580
 aggagagga aggcagcctg tggactcagc ctgactcacc ctttgggca tcttctccac 1289640
 agacatgctg ctctgtcta tgaacccta tgactaccac tctctcagcc agggggtcac 1289700

caccgtggat aacatggatg acggggagga acttattgcc acagatgat gctcggggg 1289760
 ggagggggag tgggagtggg aggtggtgcc aagctgggtt cccatggtgt gcgtgtgtgt 1289820
 gcgcatgtgt gcctgtgtgt gtgaacatgc gcactgggtg tgtgtgtgtg tgcattgtgtg 1289880
 cctgtgtgtg tgaacatgcg cactgggtgt gcgtgtgtgt gcatgggtgc ctgtgtgtgt 1289940

 gaacacgtgc actgggtaga gaccaggaaa tatgactggt gtggcagtgc ctggctagac 1290000
 tctcaaggac ccgtccttct ctgcacctgc tttgttgccc cgctcagca tgcgatggac 1290060
 atcctgggct tcagtgtgga tgagaagggt gcctgctata agatcgtggg cgcctcctg 1290120
 cactttggca acatgaagt caaacagaag cagagggagg agcaggctga agcagacggc 1290180
 actgagagtg agggcctcta attccaggct gacctggcct cttccctgga taccttgtcc 1290240
 tgtacatggt cattaatcct tatccgtaac ctctgacctc tgaactctag accctcctga 1290300
 ggggtgacaat tttttatgca gtccttgact cctcccatcc ttctcttct aatcccactc 1290360

 tgtgacaaca gactcccccc ccccccccc ccccccccc cccaccccc cactctcccc 1290420
 cccccctaa cctctaaccc ctaccaagc tgtgctccct ccagggtctg acaaggctgc 1290480
 ctacctgatg ggggtcagca gtggagacct cctcaaagggt cttctgcacc cccgggttgc 1290540
 tgtgggaaac gagtatgtga ccaagggcca gagtgtggag cagggtgagat gcctgcagac 1290600
 taaagctcag ccaggacag ctgaggcagg gtcctttct tgccaggtcc caatcctgcc 1290660
 ttcttcate cacagggtgt attcgtgtg ggggccctgg ccaaggctac ctatgaccgg 1290720
 ctgttccggt ggctggtgtc tcggatcaat cagaccctgg acacaaagct gccccggcag 1290780

 ttcttcattg gggctctgga catcgtggtc tttgagatct ttgaggtgag aacagctctc 1290840
 aaccacaggc atgttctga ggcaggggtt gatgggtgga tatgggggac cacatcctg 1290900
 cttccccatg ggctgtgccc ccgtctacca ggaacctgct gactgtggca ctgccctgg 1290960
 tagttcaaca gctttgagca gctgtgcatt aacttcacca acgagaagct acaacagttc 1291020
 ttcaaccagc acatgtttgt gctggagcag gaggagtaca agcgggaggg cattgactgg 1291080
 gtcttcateg acttcggcct tgacctgcag ccttgtatcg acctcatcga gaaggtcaga 1291140
 cctagggggg gacattgtca gaagtgtca agtgtgtgtg tgcccagagg cctggtgctg 1291200

 gtcagctgtg tattgatgtg tggttgtggt gaagcatgtg tgtgtgtgtg tgaatgtggt 1291260
 tgcattgctg tgcacacagg tgtaaatggg aacgtgtggg tataggtgaa tagtgtcata 1291320
 agtgacgtaa gaatgctatg cagccattgt gggcagctct gccattcacc agggccggtg 1291380
 cagaactcat ctgagcagtc tcttatgttt actggattgg aacacattgc atatgcttcc 1291440
 ccaactgaca aagaagggaa aagtgaattg acatcgttgg aaataaaggg gggagggatt 1291500
 ccctttgagc ctcccacagc ctgtgcttgt gtgtgtgtgt gtgtgtttgt gtgtgtgtgt 1291560

ggggttttgt gtgtgtgagt ggggggggca gaggacagca ctgtgtgtgt gtgtgtgagt 1291620

 ggggggtca gaggacagct cagtgtgtat gtacttcatg gacacagtcc cagtgtgtag 1291680
 tatgtttatg gacacagtcc cagtgggtcg tatgttttcc ctctgaacac acattttccc 1291740
 tgctgtgaag aagccagaat aggccttgcg gcaggtgact ctgagtctct ggctgttggg 1291800
 catttaggtt ggcttttttt tttgtctatt aaattagat tgaagtgaaa tcattttccc 1291860
 atttgaggca attcatagct gcatgtaact tcagtcccaa gggatccaat tccttctggc 1291920
 ctccatggac acataaactc atgcaggcac acacacatat acacacatat acatacaaat 1291980
 aaataaacac ttatttttaa aaatatagac ttagtaaaat gcaggatccc taattttgtt 1292040

 gaatgtgggg accaaaatgc agttagttag ccttaagaaa caaaacccaa aaacctagag 1292100
 tgttcatgtg agccatggac attagtcaat agagcgcaga gatgccaggc tggctctcac 1292160
 gcacaggcaa agaaagagac tgaagtcaa gccacaaact cttctctcct agaaggtggg 1292220
 ctctggtta tagagctcgt ccctggccct cctgcagatg gctgggttat ggatttgaaa 1292280
 cagctcccag agggagttag tctggagagc gagagtctaa gaggccagtc agcatgttct 1292340
 agcccttcaa tcttgatccc tgtcccagc ctctgggcat tctgtccatc ctggaggagg 1292400
 agtgcattgt ccccaaagct tcagatgcaa gcttcagggc caagctctat gacaaccact 1292460

 ctgggaagtc acctaaactc cagcagcctc gtccagacaa gaaacgcaag taccaggctc 1292520
 acttcgaggt ggicccactat gcagcgtgg taggtgcccc cctggaactc tactctcaac 1292580
 cactgtcctc tccttctcg gggtcacat ctgggtcaa cacttgtctc ttaggtacc 1292640
 ttatagcacc gtgggctggc tagagaaaaa caaggacccc cttaatgaga ctgtgtccc 1292700
 catcttcaa aagtcacaga acaggctctt ggccaccctc tatgagaact atgcaggctc 1292760
 ttgtccagt gactactgag ggacaaggtg gtcatccca tggatccaga gtgacattcc 1292820
 ctggcatgat cagttctcat atctetacta gctgaacccc ccaagtctgg ggtgaaagag 1292880

 aagcgtgaga aggcagcatc gtttcagacg gtgtctcagc ttcacaaggt gaggtccaga 1292940
 cagggtccca gcagccctgg ccctctgcag cctgcaatgc cctccgcttt ctgccgcatc 1293000
 cctgtgtctt gggtaggagc ctgttaagac ttgcagtat gtttagctcc tctctatgtg 1293060
 aacatcacag caagtctgtg ctgtgcctg cccccgtgct gcctgcgag ggctcggggg 1293120
 agagggaagc cgtgggagtg agccctggga ggggggacgt gaagactttg gtggaggatg 1293180
 ggggtgcata gggagccaga gaaaaagac aggtgcaggc gcatttgggc ccctctgctc 1293240
 agtccccact ggtcccatcc actgcagtat ccaattccgg ttctctgccc ttcccgtgcc 1293300

ttctccactc ccaggagaac ctcaacaagc tgatgaccaa cctgcgggcc acacagcccc 1293360
 acttcgtccg ttgcattgtc cccaacgaga acaagactcc aggtgggtgc cctgggctgg 1293420
 tcaggattgg ggaactggaa atgctcttac cttgtagggt ctgctcattc ccaaagtaag 1293480
 gcctgggtag ggacctaaag gcatgtcctt ggatttctaa cctcctcctt tcaactccacc 1293540
 acaatctagg ggtcatggat tccttcttgg tgctacacca gctccgctgc aatgggggtcc 1293600
 tggagggcat ccggatctgt cgccaaggat tcccacacag gctgctgtat gctgacttca 1293660
 ggcagcgggt ggiactggct tcttcagcgc tgccatagcc tccttctcct gcttttagat 1293720

 taggtggagc ctgaggggtg gaagggacaa gttagagccc aagggacaaa gagaggttct 1293780
 agtcccggag gagaaggctc catcttggcg gggggggggg ggggggaggg taaggagagc 1293840
 cgtgaatacg ctgtggcaaa tgtggagagg gaggctgcag gcttgccaat tacgtggata 1293900
 cagagtaaga aaggatgagc tacggtgact cccgggttta gacctaaact gttgcagagt 1293960
 gtatctactg agcaatgtgg caggatgttt agattgggtg catacagggt ttgagcatgc 1294020
 ccagttagaa atatctccag cagatgtcct ggaagaggcg aggatgggat tgatttattc 1294080
 tggagctcaa gtgaggagcc aaagaggaca cagatttggg aactgaatat aggtttgtgt 1294140

 ggattggacc ccagctaagc cctcacaggt tgccagtggc ctgtcaatgt catcagctcc 1294200
 ctcccactt tccttggtag gttctgttta ttaagctaca agaagtgtcc tcagttgctt 1294260
 cctttctac aagtaacagg gatcatttac cctgcctgt ataaattaga tgtctataca 1294320
 aatactatac acacagtctg taagtttggc ttacatgtca ttatcagtct tggacatgga 1294380
 tcctatctc caaagactcc aacatgagtc tgtatcatca cccatttgtt gtttgaagc 1294440
 aggacattac tigttagtct gggctagcct caaacttca atactcctgg gcatggtgtc 1294500
 tcacacctat aatcccagca ataggcagct gggcaggagg atcaccaagg gttttaggcc 1294560

 agcctggctc acatagttag ttccaggaca gcctaggcta cagatgagac atttcaaca 1294620
 caaaattaaa accaactctt gggacttggc agatggctcg ctaaaaggct tgccttgaag 1294680
 catgaagacc tgagaacctg gaaccacat agaaaatgtt gggaggctgg tgcacactca 1294740
 ttatcccgtt gccaaggagg caggagtctt gagacccag gccaccagt atagtctaac 1294800
 agatgagatc caggcactga gaggcctgtc tcaaaggagg tggattgcat tcagggtagc 1294860
 cctgagcctg tggctctggc tccatgtgtc tgtgtacctg tgctgtgca cgtacattta 1294920
 aaaccagacc tigtctgaag agatgactca ggggttaaga gcatctgctg ctcttacaga 1294980

 ggacctgggt tcagttgtta gcagccacgt ggcgacttaa aaccatacaa ccagctgtgt 1295040
 gggactccag ctccaggggc tttggcgcct tcctctggta catacatgta ggcaaaacac 1295100
 tcacacacag acaattaaat aacaacctc aatccttctg cctcagcctc tgaatgctgc 1295160

cagtacaggc atgtgtcatc aaccggaata catcactatt gtttttctat tgcctgtaaa 1295220
 acatacagtg gtccaatgac caatgcatct tatttagtga gttcaccta gtgaaggggt 1295280
 ctggcctgtc tctgggaatt tcccttcaca gtgtgattat atgcccatct aagtggaaat 1295340
 gctaggaatc ctigtctcct ttgaatagaa ttctctctta aatttgtgat atgggttagc 1295400

 atctatgttt tttttgttt ttgcctttaa gaaattataa aagtgaaca tgcctttata 1295460
 aaaaccacgt ccctttacaa actcactaaa gtgcacttaa gccaccaagt ccgcttttga 1295520
 aacagggta ggtcaggtaa caggctggcc tcaaggatct tcctacctct gcctccaag 1295580
 tgctaggatt ctgggtgtac gctgtgcacc tggccctgtg ctgaagtctg ttagcatgt 1295640
 gctgcatccc tcagtatggc catacttccc tctgcatcc tgtttagcgt atgtccctta 1295700
 ggaacccac ctctgagagg tcaggcaaat acaattctct tgccacagct cctggcgtcc 1295760
 cattcattgt caatggcctg tgctctgtct tgtccatgcc agcttctccc tgatctccta 1295820

 ggtaccgat ccgaacccc agtgccatcc cagatgacac ctttgtggac agcaggaagg 1295880
 ccacagagaa gttgcttggc tcccttgaca tgcaccacac tcagtatcag ttggccaca 1295940
 ccaaggttag ggtgcactgg agtttaggct gaacctgggt gcctctgtc acactggaca 1296000
 ggggtcccac ttggctacac cctgcctta ggtgttcttc aaggctggac ttctaggcat 1296060
 cttggaagag ctccgggacc agcgcctggc taaggtgctg acactgctgc aggcgcggag 1296120
 tcgagggccc ctcatgcgcc tggaaacca gcgcatgcta ggaggaaggt agcatgggat 1296180
 ggggatggg caggaggat ggggacaggg tggcacaggg gggggcgggg taggtgtgat 1296240

 aaccgtcca aggtcacac tctcaccctg cctcactgcc taggttgtcc cccaggtgg 1296300
 attcggatga ggttctgtgt cacatcatcc caacctgttt ttatacctta aaaacaggat 1296360
 gagagccaga gagatggctc agtaggtaaa ggcacctact gccaaacctg ataacttaag 1296420
 ttcaattccc aggaccaca tgggtgaaag agagaactga cctctacatg tgctctgatc 1296480
 tccatgatg tgctgtggag catgtgtgca cacacatggc tttttgtgta ttcagaatgt 1296540
 ggctggagg gtaacggcat tcagtcttc ccagactttg aacctgtat cttatctatc 1296600
 ttatttatgg ttaaagtgag gtagecctct cgggtgggta ccaactcagca gagaagtcaa 1296660

 gcagtctgat cacagggcct ggcagcttag ctgtctttag acacctgcag aggccacctg 1296720
 ggcatcggga ggttatggac tttgccttgg aagtatatct gtgggttaga gagagagaga 1296780
 gagagagagg acatggcacc ttgaaggggc agaaccagct gcctcatagg agctgtcctt 1296840
 ccctagggat gctctgttta ccatccagtg gaacatccgg gccttcaatg ctgtcaagaa 1296900
 ctggtcctgg atgaagetct tcttcaagat gaagccactt ctgctcag cacaggcaga 1296960
 agaggagctg gcagcacttc gagcagagct gcggggctg cgaggggccc tggctgctgc 1297020

tgaggccaag cggcaggaac tggaggagac gcatgtcagt gtcactcagg agaagaacga 1297080

 cctggcctg cagctgcagg cagtgagtga gacaaggct ctgatgaaa tctctaacca 1297140
 gatgtggcca gggcagctct ggagggttct gactactttg atcttctgtg ttgtcttct 1297200
 actctggaag taccaggaga tgaggcctgg agactcagtg cccaccattc cctgtaggcc 1297260
 ttgactgtcc acatgtccta aggctaaagc cgcaggagag ccccagctcc accttcccca 1297320
 atgtccctga aatagacct tgttcccctt tctggttcag ggacacagga atctctgagg 1297380
 caggtaacag ggttctacct agagggcagg tgtcaaagtc tggaaactcc tcagcatagg 1297440
 ttttgagagt cacttgatg ccagccccag gctgatgctg gagatgctga tgctggggac 1297500

 ggcacagcca tgatggttat aaaactcccc ttctagtata ggaggctatg caacaggcag 1297560
 tgtagaagta tgaagaacct tgtctcctcc ttggatggcc tttggtgctg ctccgtggtg 1297620
 ggcgaggcct ggctgcacc cactcacact gcctcagag ggtggcagct ccgaacagtc 1297680
 gagtgcacag tagggcttct ctctgagagc tcttaggcc tctgggttgc ctgcattgtg 1297740
 gctaacatta attcttaaca gtgccattc tgtcccacgt ccaatgcct ggagaggccc 1297800
 ctgcaatcta cagagccct atagtttcca gggccgggca gagtgtgggt gettcaaatc 1297860
 ctcacctatc aaactgaatt gctaacattt gcctcaccgg agttgccttt gcaaggacaa 1297920

 atggccttcc tttctcaggg ctggigtccc tctttaatct ggctccccca ccccatctc 1297980
 ctgaggagca ggacaaccta gcagacgctg aggagcgtg ccatttgctg atcaagtcca 1298040
 aggtgcagct tgaggcgaag gtgaaggagc tgaatgagcg cctggaagat gaggaggaag 1298100
 tgaatgctga ccttgccc cgaaggcgca agctggagga tgaatgcaca gagctcaaga 1298160
 aagacattga tgacctggag ctgacactgg ccaaggctga gaaggagaaa caagccactg 1298220
 agaataaggt gtgggaaggg ccaagctggg ggccagtta ggtgttaggc agctgcaggg 1298280
 tcccctgggc cctgctgtg tagcctgaaa caggctactg cccctgtgg gectcagtgc 1298340

 tatcatcggc caagtcggg accagcactt tatctcacta gggatgatgag gatttgggtg 1298400
 gtaactagtc tttgctaagt atactaca gggccttgca tacagtaggt gcttagaaaa 1298460
 tgtcgcaatt atcatctgtc ctggactgag agctcgctgg agggggcaac ttgtccgaac 1298520
 tgcaaatccg tctatcatag agacctata gtccctatgg ttgccgatga tgtattgact 1298580
 ctgtcatacg ggagaggaaa gcaaggctgt tcaggttctc acaggggcta aagatacagc 1298640
 caggagtagt aaagagctca gtacctgtt atattgcaaa tggctgcat cactgtgtct 1298700
 ctactccgg gccagacaca gtgctcggct atgacccctt accagtgaat ccttctacat 1298760

agctcagga gcatgaaacc cttgggcagg aatggtggag gctcagtca gtggcctgcc 1298820
 tgcacctgc agctggtagg ggtggtctgt cagacagcct gtggggagga ctgtccctac 1298880
 tgtgactcaa ttgggctttg gcacaggtaa agaacctgac agaggaaatg gccacactgg 1298940
 atgaatccgt ggtccggcta accaaggaga agaaggcatt gcaggaggct caccagcagg 1299000
 ctctcgtga cctgcaggca gaggaggacc gcgtgagtgc actggccaag gccaagatcc 1299060
 ggctggagca gcaagtagaa gatgtgagct gcgggctaca tgggggccgt cagggtggcg 1299120
 aagtccccag cccgtgggaa gctgagcccc actctacccc acagctggag tgttccttgg 1299180

 agcaagagaa gaagctacga atggacacgg aacgtgcca gcgcaaacctc gaaggagacc 1299240
 tgaagctgac acaggagacg gtgactgaca ctaccagga caagcaccag ctggaggaaa 1299300
 agttgaagaa gtaggtgggg cttggtgggt ctctgagctc aatgggctct tcttccttc 1299360
 tgaattctcc cagccctgtt gtggggggagg gtaccagggc aggtgtcatg tcttgcctc 1299420
 tgaaccaggg ctgaggacag cagacgcatg cacaggattg aggctcctta ggcctcagg 1299480
 gacggaggcg gacggggggg actgcagttg ggaccagggc tggctcatcc caccatgtac 1299540
 tcccaggaag gattcagagc tgagtcagct gaacctgcgg gtggaggatg agcagctcct 1299600

 gggggtccag ctgcagaaga agatcaagga gctacaggtg tgcatggcag cagcggggaa 1299660
 tgcgctgggt agaccggcc cggggcagag gctcatggag ttggtacat ctaccaggc 1299720
 gcgggcagag gagctggagg aggagctgga ggctgagcga gcagcccggg cccgagtgga 1299780
 gaagcagcgg gcagaggcag cccgagagct ggaggagctc agtgagaggc tggaaaggc 1299840
 tgggtggacc tcagccgggc agcnnnnnnn nnnnnnnnnn nnnnnnnnnn nnnnnnnnnn 1299900
 nnnnnnnnnn nnnnnnnnnn nnnnnnnnnn nnnnnnnnnn nnnnnnnnnn nnnnnnnnnn 1299960
 nnnnnnnnnn nnnnnnnnnn nnnnnnnnnn nngcagcggg ggggcggcag ccgggggggt 1300020

 ggggcggcgc gggggggggg ggaggggggg tggggggccc ccggcggggc ggcgtgaggg 1300080
 ctgcccaag cgtgaggctg agctgggccc gctgaggagg gagctggagg aggcagtcct 1300140
 gagacacgag gccaccgtg ccgcgtcgc ccgaagcag gcagagggtg ctgaggagct 1300200
 gagtgagcag gtggacagcc tgacaggat ccggcagaaa ctggaaaagg aaaagagtga 1300260
 gctacgatg gaagtggacg atctgggggc cagcgtggag acgctggcac gtggcaaggt 1300320
 cagcctcctt cctgctcta aaccacttct gacccacag ctgaccagc cctgtctgat 1300380
 ggccacttga tgcaatact ccacagcagc accaaccctt gggccccagc tgcttactta 1300440

 acctggcacc taacccccag ctctgccag gctgacttc taacctgac tgctcaactt 1300500
 cagtcctcgc ctccaggtt ttctgattcg caccggaact tcagacctcc cacccaatag 1300560
 aagtgtgat cagctgtgac tcccagttc acacttaata gccgcctaa caccattctt 1300620

gtcctgaacc ccagcacga actcggacac cccctacct tgaacctaat ctaaacacca 1300680
 gttaccagtc acgcctatta gcagccgatg gcagatccag aacctaattc ccgactcact 1300740
 gcccttggga tgagtcaagt cccaccatag gaactcaaac ctggaacctg gaacgcaatc 1300800
 tcctttgat ccctggtctc acacctagtg ttccagatcc caatcccagg ttcccatctc 1300860

tgactggcag ccctgtcag tcaggactgg gtctgtcct tggatgcaca aacttgtctt 1300920
 atcttggatt ctgtgtcca ggccagtgc gaaaagctgt gccgtaccta tgaggatcaa 1300980
 ctaagtgaga ccaagatcaa agtgaagag ctgcagcgac agctggcgga tgccagcacc 1301040
 cagcgcggga ggttacagac ggagaatggt gaggcctggc tttagctggg ctatgccagg 1301100
 tagggtttaa gtggtgcccc tcaaccgact gactggcctg ctggccccta cacctgcagg 1301160
 ggagctgggc cgctgctag aggagaagga gtctatgac agccagctga gccgggggaa 1301220
 gacctcagca gctcagagtc tggaggaact tcggcggcag ttggaagagg agagcaaggt 1301280

ggattggcac tggcaactgc agggcagtcg ggtgggcct agggtcacta gcatggattg 1301340
 atgctgagge caccggtgtc cctgcaggcc aagggtgcac tggctcatgc agtgcaggct 1301400
 ctgcgccagc actgtgacct cctccgagag cagcatgagg aagagtca ga ggctcaggct 1301460
 gagctgcagc ggctgctgtc caaagccaat gctgaggtgg ccagtgagg gagcaagtat 1301520
 gaggcagatg ccatccagag aactgaggag ttggaggagg ccaagtgagt agctggtgtc 1301580
 tagaacataa ccgatgagag attcgggct gtgcctttat gtctgtatg tgggtgtcgg 1301640
 gattctgggg ttctttccc aggtcccta gtccatcctg cctgctgtgt ggtccaggaa 1301700

gaagctggcc ctgcgctgc agggagcaga agaaggggta gaggtgcta atgccaaatg 1301760
 ctctccctg gagaaggcca agctgcggct gcagaccgag tcagaggatg tgactttgga 1301820
 gctggagcgg gctacctcg cagctgctgc actcgacaag aagcagcggc acctggagcg 1301880
 ggctctggag gaacggagga ggcaggagga ggagatgcag agggaacttg aggccgaca 1301940
 aagggaggcc cgaggtctgg gcaactgagct ctccgnnnn nnnnnnnnnn nnnnnnnnnn 1302000
 nnnnnnnnnn nnnnnnnnnn nnnnnnnnnn nnnnnnnnnn nnnnnnnnnn nnnnnnnnnn 1302060
 nnnnnnnnnn nnnnnnnnnn nnnnnnnnnn nnnnnnnnnn nnnnnnnnnn nnnnnnnnnn 1302120

nnnnnnnnnn nnnnnnnnnn nnnnnnnnnn nnnnnnttc cgactgcggc acagccacga 1302180
 ggaggcgctc gaggccctgg agacactcaa gcgggagaac aagaatctgc agggtaggac 1302240
 ccaggtcca gagcacttta gggcacctt gaaattggga ataggaaagt cacctggagc 1302300
 agggcggatg tgagggtgag tctcctct gtgctctgtt caccctgtag aggagatcag 1302360
 tgacctcaca gatcaggta gcctcagtgg gaaaagcadc caggaactgg agaaagccaa 1302420
 gaaggcgtg gagggggaga agagtgagct gcaagctgca ctggaggagg ctgaggtcag 1302480

ggctggccac aggggtgggt ggactctggt ccacgcctcc ctggcctggt tggcttcacc 1302540

 caacctgcc tgatccacat ccctaggggg cactggagct ggaagagacg aagactctgc 1302600
 ggatccagct ggagctgtcc caggtcaagg cagaagtgga ccggaagtgg gcagagaagg 1302660
 atgaggagtg caccaacctg aggtctctgg agggcggctct tgatgtgcct acggtggcac 1302720
 attggtggga acagccagtc tccccctgcc acagggtcag ggagctccca ttccagatgt 1302780
 gatcctccac aagtctaagg atgtcaggg ccaaagtca gcccatgtcc cctggcctc 1302840
 tagtgaactt actgtttctg gcaagtcaca agtcacatgg ggctttaaaa cagagagaag 1302900
 caattcttgt ccccattg ggttttcac tccgtgcac cttgggcatg atgccacagg 1302960

 tggttcccgg cctgcttcat tctgcaggc taagtctgcc cttcatgcca cctcccagg 1303020
 cgcaaccacc agcgagcagt ggagtccta caggcctcct tggacgcgga gactcgggcc 1303080
 cgcaatgagg cactgcggct caagaagaag atggagggag atctcaacga cttggagcta 1303140
 cagctgggtc atgccagccg ccaggaatg gaggcacagg ccgctactcg gctgctgcag 1303200
 gcccactca aggaggaaca agcggggcgt gacgaggagc agcggctagc cgctgagctc 1303260
 cgtgagcagg gtcaggccct ggagcgcagg gctgcaactgc tggtgctga gctggaagag 1303320
 cttcgggctg ccctggaaca gggtagcgc agccggaggc tggctgagca ggagctgctg 1303380

 gaggccacag agcgcctcaa tctactgat tcacaggtgg ggatggcca agggtgtcct 1303440
 caaggattgg gagggggcag agccctgctg gccagctgag gctctgctcc cctcagaata 1303500
 caggcctcct gaatcagaag aagaagctgg aggtggattt ggcccagcta agtggggagg 1303560
 tggaggaggc agcgcaggag aggcgggaag ctgaggagaa ggccaaaaag gccatcactg 1303620
 atgtgaggct gggccagggt tcgggacgag tggtagagc ccaaagatg tctttcgccc 1303680
 cctggccacc atgctatttc ctccccacag gcagccatga tggctgagga gctgaaaaag 1303740
 gagcaggaca caagcgaca tctggagcgc atgaagaaga cactggaaca gactgtcggg 1303800

 gagctgcagg cgcgctcga ggaagccgag caggccccc tccagggggg aaagaagcaa 1303860
 gtgcagaagc tggaggccaa ggtaccttca gccccactt gcctgtagg gctgaggctg 1303920
 aggcctgctc ccctagcaga ctccctcct accctccgac tgtcccgcag gtgcgcgagc 1303980
 tggaggcaga gcttgatgag gagcagaaga agcacgctga ggccctcaa ggtgttcgca 1304040
 aacatgagcg ccgggtcaag gagcttgcat accaagtggg ttacggggtc catcccaggg 1304100
 agtggcactg gagctaacce agtccaggca aacctgaga cccctttgc ttgcgcagac 1304160
 agaggaggac aggaagaacc tggctcgcat gcaggacctg gtggacaagc tgcagagcaa 1304220

ggtcaagagc tataagcgcc agtttgagga ggccgtgagt aactggggg gccagcattc 1304280
 tgggattgtt catgatgcca gtggcgagct gatttcaact gcaggtcttg aagcccagga 1304340
 ggcatctgta gcaggctgca ttaaagggtg gcagccatgt ctgctcaacc cagggacttc 1304400
 tatggcatga tcaccttcag ctttagaagg gaccaaagtg aactgcttcc ttcttctgcc 1304460
 caggcctggg gatggcctgg tgggaaagtg acacataggc acctcttaa ggacagtctc 1304520
 cactttgggt ccagggtgtg ggaaggatgg tgacaggaag agtggaggag gaccaagaga 1304580
 agccagcttc ttctgggct gggagcaggt tggccatttg ttaccaaggg gaaccaaggc 1304640

 cctgcctatg cctctaggag cagcaggcca gcaccaacct ggcaaagtac cgcaaggccc 1304700
 agcatgagct ggatgatgct gaggagcgag cagacatggc agagaccag gctaacaagc 1304760
 tgcgggcaag gtccagggat gccctgggcc ccaaggtgag gaggcctctg tgttgggtgt 1304820
 gtttaagtgg ggcagacaca gtgtaactca gactgtctca tctctcagca caaggagtga 1304880
 caccaccaggc tctgaagagg gacaccact gcggtcctgc tgtctcttcc catcttcggc 1304940
 cagccacc tcctgaacc ctgaagaaa cacaggatg cacaccagc actgtcctga 1305000
 ttctggggt taggggagct gggaatagaa ttctatggac aaagtcaggt ccacatcagt 1305060

 ctttaaaata aagtcttta atagtctcca ttaattgggt ttatttgctg ttaattggca 1305120
 acacaggagg agccaagggt aagctctcag ccaggctcct gtgtctgggc tcaggcaggc 1305180
 acaggcactc cacacccaa gggatggaga gaaaaggccc ccccccac ttctggggaa 1305240
 ccttcgggat gaacacagtg gccaatgagc gaagaccag aggagctaaa ggaagacaag 1305300
 ggaggtgagg agggaggggg gaggagagat gggcagacct gggggaaggc agcatctcc 1305360
 gatacccacc cctgcctagg gctcaggagc ctctgtccag gcccagaggc cagggaggct 1305420
 tggctcacag ggtctgact ctctctctcc atcaggggac tgatgggaga agctcagaca 1305480

 gagatagttt cccatgttcc ctttctctgg caggccagag ctccaggatt gtgaggaag 1305540
 ggtgggcacg gtgccattgt ccttaccttg gggacagtga ggaaaacagg ctcccattg 1305600
 acccaggccc tctgaccag gagacaagag ctcttaggct gttcttcca ctgagcctat 1305660
 acctgaaaac tgggtagaca gagccgtggg gaggcagaga gggacgggga cgggcagagt 1305720
 gtgcggcgtg tgactcacg ctacaccaca cttgccagg cccagcagct tcccgaagcc 1305780
 tggctccage tcaactctca gtgaagtctc tgtctatgtc catgtagggc tctcaatgt 1305840
 agctgaccag ggcagagggc gactggcggg ctgggttcaa caggatggac actgtctctt 1305900

 tccagtatga gaagctgatg caggaactct ggttgagag agggggggtg cacagaggac 1305960
 ttgggccaag tctgctcaca caggagggac ttggcaggac aacagtgagc agcctgtcca 1306020
 cagaggggca acctgaatgc cctactgagt gaccctgggt tcacatgcca ctgtctccc 1306080

atcactcaag gctggggcac tcacattctc caggcaggtg ctgtccttgt ccttgtgcag 1306140
 gtaatgctgc tgccaaaagc gcagcaggtt gtggaagttg ttgagcagga agccagggta 1306200
 tttcttgcctg tgctccattc gctgtagaag acgcagatag aggggcagcc tctctttccg 1306260
 tcgggccagc atcaggatca ctaggctggt gttgaggcag ctgacattct cctgcaaggc 1306320

 caaaggcagc cggactgagt gcatgtcagc agcctcagga tgccagtga cctggacagc 1306380
 cactgggcag ggaggaggcc tacacagggg cctggcataa tccatgggca caccttcatg 1306440
 ttccctatgc ccaactacca ctatccacac tgatactact agatggctct tgtctacatc 1306500
 ttggttcagg tatgacttct tccaggagct tccatcccct gctggggctg ggtgcatggg 1306560
 ctggtgcact agaatgtgag ttttagaagc agagtctcag ttcaccttgc tcaccaagca 1306620
 ccctcgccc aaggcccagt ctctaacaat gtttggcagg cagcaacaaa aaaaccactg 1306680
 cacagggtcc tagtatgact ctcatcttag aaaagtgggt gtgaggctgg gagaagagag 1306740

 ggctgccagt tagtgaagga cttggggcaa tctcaggtcc agttccaccg cccactgtag 1306800
 cctgaaggta ggggtgtaggg tacatgggga agaacgttgg cttggagtca gaaggcggca 1306860
 gcgtcaatct tatctgtgct ccaactgact ctgtgacccc aggacacttg atatctggtc 1306920
 ttagttctcc tglaaatgg ggcactgggc gacaccctag gagaactaca tttctagaga 1306980
 gaagcggggg ttggggggca cagataagag agctgatctc cattctacce tcctttgact 1307040
 gctcattggc tgggacgtct cacctgggtt agtgtctgca catggatgat attgatgagg 1307100
 cggaagagga aggacatctg tgtgggcacc tgggatatgt aggcaagcag gcggcattcg 1307160

 gacaggacct cagccactac ggaggggaagc agaggtgtag aagcaggtgc atccagtgg 1307220
 gggccacca ctccatggtt aagccaactt tggtgaaga gatggcttaa cggttaagag 1307280
 catttgcctg tcttgcagag gacacacaac ggtggctcac actatctgta acctcagcac 1307340
 cacagcactc aatccccagt caccacceac tctgcactc acatgcagag cccatacac 1307400
 agacacacc acggacacac attgcagaag atctgtttgt acttcaagat gtgtctctgc 1307460
 ctaaagtgcc ttctgactgg ttttaataaag agctaaatgg ccaatagctg ggcaggagag 1307520
 agcaggcggg acttccgggc agagggagca aaactgggag gagtaatcta ggcacacgat 1307580

 ttttccagc agaactggaa caagctggat gtattgtagt aagcagaggt aaccgaggca 1307640
 catggcagaa tgccaattaa aaaatatggg ttgggggctg gagagatggc tcagaggtta 1307700
 agagcactga ctgctcttcc agaggtcctg agttcaattc ccagcaacca catggaggct 1307760
 cacaaccacc tgtaatgaga cctggtgcgc tcttctgggtg tgcagatata catggaagca 1307820
 gaatgttgta tacataataa ataaataaaa tattaaaaaa atatgggtta attaaactgt 1307880
 aagagctagc tgggaaaaaa aaaagagact aagcgaaggc caagatttca taatagtaat 1307940

tctctggctc attatttgg aggcggcagt ccaaagatag tctgacaaga aagcctgtta 1308000

catttggcgc ctaacacata gcatgtaaat ccacacaggg cctgagaaag cgaaaaaaaa 1308060

aaatgttccc agtaggetcc catgettgag gcctacagag gccctgctac caagcacttg 1308120

aataggtttg aataggttta tgagcggcag gtgggcgtgc tacttggagg tggtagcgcc 1308180

tagatagaag cgcctacagg cccaggtga ggcccaggct gagggccaga ggcatgacac 1308240

tccctctcac catgtgctaa gtggagccac acagtggagg gcctagccat agcttaacag 1308300

tttaaagttt ggctaccaca gtcagagaag gctgcagaca tgcaaaaaag tcaggtctag 1308360

attgagaata catctaaaca gatacaatat gcttaaaaat gtattagatg ctaaagaaag 1308420

aaaagaaaat gggatggac agtcatagaa aaaaagtga gcaggcttcc ttttggcca 1308480

ccaaccagct cccaaatcaa gacacggaga cttcttatta gttatgaatg ctcagcttta 1308540

tcttagctct tatttcttgc tagctctcat aactacttaa actatcctgt ttctcttcat 1308600

ttacatntta ccttgggtct ctctctctct ctctctctct ctctctctct ctccctctct 1308660

ctctctctct tcctctctc tctccctctc cccctggca tgcctctctc ttctctttg 1308720

cttagatctc ttctctgcc accagctctg cctaccectc tctacctag ctattggctc 1308780

ttcaactttt tattagctgg aatcaagtgc cttaggcagg caagtgaaa caaatgcaac 1308840

aaatctttac acaattaaac aatgcagca aaaacaaatg taacacacat ttacacagtt 1308900

actattctgc agcataaaca aatgtaaac atctttacat agttaaatat tccataaaca 1308960

aatagtntta aaaacaaagg ttcttaaaga gagttaatat aaaaggaaaa agatgggaaa 1309020

tatacagggt gtatggatnt tgatgggtgt tttgttgact ttaaattntt aaaatgctaa 1309080

tgaacaaaa aatagctgct gagagacact ggattatgga aactgctaaa ttaaccaac 1309140

aaatatatta tntaaagaat atcttaactt cagaatagaa gtcagaaaa acattgtgnt 1309200

gggggagagg tnttgcntt gnttccatgg gaaacaaaa gctatagatt tnttcaaat 1309260

gaataaacac cagatttgat cagaggagac ctcttgaaaa tnttggctac agacataaag 1309320

acaccaagaa agactatagg acaggtgata tgtattctga ccccttgaca tgggaacagc 1309380

tctgagactg gatgagacat gatgaatctt gctggctcca gaatcctcat ggctnttat 1309440

tacatgccag tctnttntgt gacatggata caggtntagt tatgcagtcc taacagactt 1309500

ttaagntaa cagatggctt ttatacctgc tcaaatatac aacaaaaaac tctctntat 1309560

aactgactta tgiacacctc acagtccatg cttgagntaa tntagatata taggtntacct 1309620

tntaaagntt gtgntntcgg gaaaaagaaa aacaaacaaa caaacaaaca aacactgaaa 1309680

acaagtagtc caggtggccc agcctctcag aatgcctctg ttgcagtttc ctcaaaattc 1309740
 tacatctaga acaacttcaa agctgctgag atgggtccagc ctctcggaaat actccaggca 1309800
 agacttcaga taagccctgc actttcccac cacacagaga ctaaacaata aataatacag 1309860
 tcaaactctg cccaagattc gatcattgtc ccaatttctt cagggtcctc tagagatgct 1309920
 gttgccccag acaacaggaa gcagtctaga gaacatgatg cccacattct caagaggtgg 1309980
 ggtagatgat ttttggttgt tcaatggatt atggatgctt atcatcattt aggggggtgg 1310040
 gctacaagtt gttgttgccc atggtcgggg agaaaagtga gcaaaggaga ttagattcag 1310100

agacctcgtt ctgaaaagga aaaagggaga tatggaaagg ataggataaa agggtagatt 1310160
 attgaatcta ctttaacta aaaagcaagt attaactca aatatcttac actggtatgg 1310220
 atttttata ttgatacaaa ttttaaggttt tttgtgagaa aataatata atatatgttt 1310280
 ctattcttaa gatatttttg tatattaata caaatttgag gttatttttg ttatactgta 1310340
 tatatgtttc tactcttgtt tacggtagta tacttatgta actctaaaa tgtaataac 1310400
 aattgggaaa tgcaggttaa tagtcaacta taataatcaa acttgtcatg taaggtatat 1310460
 tttcaaggtt aaacagatat acattttaaa tagataggtg atcttcaaac acttcaatat 1310520

ggcatttacg atgttttaaat aactgcaggc tttttataac agtgagacac atttgcttct 1310580
 ggcagcacca atttacttca taaaaggatg atgggcatcg aaaaacctcc acacagagtt 1310640
 tgctttcttt gtatcaaaaag ttagecgttt gaacaagaac ttgcccttac cttaactgct 1310700
 gactgtatgc tttccaaact ggacaagcag gacacaaaag aagacaactg ccacactttg 1310760
 tcaagacaag gtaagacagt ccttcaaaat tcctgcttca ccgaaaagtc tgtcagatat 1310820
 gctagacctg taggccaag atggatttcc taatgttgca gaggaacctt gggtagctgt 1310880
 ccagacagcc agcagctctt gtcatttcta tagttttgga agttgcttgt tctgcacttc 1310940

ctgtttactc agttaatata atatacttct cgggtctttg atgaggttga agcctagata 1311000
 gttatagtta cagttttctt tgttaccaa ttcagaaaag aactcacia aagagagaca 1311060
 taaaagtta agttgtttat ctaagatgtt taaagtctaa aaagacattt taggatgta 1311120
 atacaagtta gctgataaaa agtggattag gtataaaact ttggactaag ataggataga 1311180
 taatacagta ctttctccta atttgtcaa tgcaaatgtt ctggacattg tgaatgtaat 1311240
 tcttacctga taattgttct tattgtattt agttttacta tgttagagtt aaaacctttc 1311300
 ctttttaatt agacaaaaag ggggaaatgt tacggaatat ttgtttactg tgtaaagatg 1311360

tgtctcctgc taaacgtcca atagtaggca agagagacta ggtagactac caggcagaga 1311420
 gagagaaact gggaggagga atctaggcca ctcaatttca tcagcagact cagagcaagt 1311480
 tggatatgct gtattaagaa gaggttaactg ggggctggag agatgactca gaggttaaga 1311540

gcgctgactg ctcttcaga ggtcctgagt tcggtttcca gcaaccacat ggtggctcac 1311600
 aacctccat tatgagatct ggtgcctct tctggtgtgc agatatacac aggagtagaa 1311660
 tgctgtatac ataataaata aataaataaa taaatagata gatagataga taaataaata 1311720
 aataaataaa atctttaaaa aaaagtcaac tccattaaaa aaaaaaagaa gaggtaactg 1311780

agccatgtcg acaaacatag atttaaaaaa tatgggttaa ttaaattata agagctagtt 1311840
 ggggaaaagt ctaagctaag gccaaagcttt cataattaat aagtctccag gtcattattt 1311900
 gtgggatggc agtccaaaga cagtctgata agaaagcttg ctacacatat ataattaa 1311960
 gtaaatcaat gacaaaacct aactattaaa agctgcaaca acagtatcaa tctccaacta 1312020
 tttgtttatc aatctaaacc aaatctcaga gatccaattg gtgcttgaga acctcgtca 1312080
 gaaagtggcc ctctgcagc tctctcccag ctgagtgggc gccagctcc agctctcacc 1312140
 tataatcctt ctcaggaaga caggatgata atgaccatta agaaacagca agtctgggga 1312200

gatggccac tgggttaagt actgttacac aagcatgagg ttcagagctt agattctcag 1312260
 aacctatgta aaaagccagt gtggcagcgt acacctgaaa cccagagct gggggacaca 1312320
 gacagaggaa gaacctgaa gctcactggc tgaccagcct agccaaatc atgaactcta 1312380
 ggttcagtgg gagactctgt taaaaatta aaggatgtca aactctgacc tccacatgtg 1312440
 tatacacaca tgtgcacata cccacacata cataaatcac acacatacac acacacagag 1312500
 agagagagag agagagagag agagagtgtc agtcaaattc aaactacctc acagagctcc 1312560
 tactgtgact ggctggttta catgtctctg tccacttctg cagcctgtac gtaaagagcg 1312620

ctgagcaaat gacctctgt actattgtga agtgatcaa tacctgctta cactaaagtc 1312680
 tatgtgacca atctcctaaa acagaccctt cagagaagaa acaggaggta aatatctaac 1312740
 taacctgac caggatattt ttcactacca aagacaatga tgagggatac tgtccttttt 1312800
 tagaagtgtc cataaatttg tgagaaactg cttagtgaca cagacctccc agggaagaaa 1312860
 gcgcgtatgt ccaaatgat agctacacac aattctggat gacgtctgac accccacca 1312920
 ccataaccac aactacaca ggaaaacaga attgctagca gtcagtccag aggaaggtgg 1312980
 cttttccctt cactacaatg ttatacttgt tcactaaagg gagcacaatc agtggagaag 1313040

tcaacacagc tgagcaatgc agccaagccc acctcttgac cccagccaca catatctggg 1313100
 aagtaattca gcaattcctg gctggaggcc agtgtctgg cacgcataca gcaccattt 1313160
 gccttggtag ctiggctgcc tcaccttca tgtccactg gttttcaat cggccaatg 1313220
 acagagtaac acagcgcacc agcatgttg agtccaccag ggagctgttg atctgcttca 1313280
 ggaacacctg gaactgggtc agagatgatg ctactagca ggggctgcta gccggggacc 1313340
 actggctctac cccagctcca ctgctctgcc aacaagacac actaagtggc ctgctctcac 1313400

tgctgggctg ccaggatgct gtaaccagc caatgtctc atcccaaat tcttagggc 1313460

 tggctcaaag cctgacacag agtaggtgta gtgaacattt gctgactgcc ctttgaatcc 1313520
 cagactcttc caaatgtgtg accacacctg aagagttgca ggccaaggtt cacagacaac 1313580
 tgatgctgca gcaaccacca tggagctcct gggtagcct tacctttgca tcagtgttga 1313640
 tataattatt gaatctcttg aatgcatcga cattgaactt catcagctct cccaggaggt 1313700
 caaagtagct ctggagtaca tccctcgact tgcactcgct gtcacaatg cagtataaga 1313760
 tgtgctgggg tagcagggg acagggtag ggtgtggatg ggactgtccc tacctgtttg 1313820
 ccaactcagc ctggcctgga gcttagacca ctcaactgct tccagcaagc atccaggtag 1313880

 atggaagctg caactttgtc taggttctct gctgagggtta cttggagcca ggggagtaat 1313940
 gtcagcaggg ggctgggtgg gcaggggttc tctgctagag ctgaagctct gtctccagat 1314000
 ctaacaagca ctgctgtcca agcactaggg ccacttaagt aaatgaagga cagaatttaa 1314060
 gggcagcata cacattttga ccctaagagc tgtctttgtg tttatcaatg aaattgttaa 1314120
 taacatataa aaatcagtaa gtattatca agaatgaacc aatttaactc ctgtttccaa 1314180
 tatttccat tttgttttc tgattgggtg atccccctcc ttccttctct tectttcatt 1314240
 actgtttttt ttttttttg gagggggacg acaggatctg gccttgaact tgcaaaactc 1314300

 ctgcttctgc tctgaagtg ctgaggcttc caataagctc aactcctttt ccaaacttaa 1314360
 ctgatttggc ggtattttc ctttagaatt catgggccag ttagtaattt tttaaaaga 1314420
 cctagtgtaa ctggccatt tgctctctta tgaatttctt ttttctgaag gccattgatc 1314480
 aataagggaa tattaatttt tagtcaatac tatatcattc tcagggtcca gggatttgc 1314540
 gggtaactcc atagtctata ttcctacatg attattctctg agtcctcag tcacccatca 1314600
 gtacctatag ggaggggccc acagctggca atccaggga aacctggag caacatgac 1314660
 ttggaacaac tagacctgtc cctaacaaa gtactcaagg ctcaaggatga gacatcaagg 1314720

 caaggggctg gggaggatgg tcacctgaca cctggttctg cagccatacc tccagaaggc 1314780
 ctgcttcag caggaacatc tggctctcat aggaggtggc ccctcggagg aaactttcca 1314840
 cagcccgggc ctgcaaaaac ctgcaacca aatgttgacc cctggctatg gctgcctct 1314900
 cctggtttag gttcaattcc cccaggggtg gagctatttg cagccaagta tctgacattt 1314960
 actgaacatt ttccagttct gggcctcctc cttaggtctt gagaacagag cagtgaacaa 1315020
 gggaaacgct gtcttctat catggtcac aactcagcag ggaccagtct tccacatgac 1315080
 tgtaccagag aaggtttgta tggcagaggt agtagcatcc aggcttaaaa agtggccgct 1315140

agttaagtgc catgtgaaaa cactctcaga agactggaag gacatgggct tgggagccag 1315200
 ggaggtgtgt ggccagcagc agagcatgtg tggacaagcc actgagctag aaaagaggtg 1315260
 gcagacactg agtagcccag atggctcagc tgggatccat gagggaaggt ctgactgggc 1315320
 gaggatgagg tgacagggac cctgtaggca cagggctgct ggaatccctt gtctgcagcc 1315380
 ttcaaacctt tctgaggtg actaggaact ctgcagcctt ctcttggtg cctggtcacc 1315440
 tagcagatgg ctctggggc agcttctggc tttgttttc ccatgctgac tgaagcaggt 1315500
 gtctttcttc tcatgcttat ttctatgac tccaggaat gtcacacagg cagggccggg 1315560

 atcccatttt tgeccatct ctctagtgcc agcttgatga atgctcagtc ctctcctggc 1315620
 ataccatgtc gacgggggta cacacactta ccatctgagt catacggagc cagtggcaat 1315680
 gagggcaact tccccattg gtgaccactc ttaaggaatg ggtactagag actaaccaat 1315740
 tgggaaagcc ctggctccta ggccccgaag tgcacctgtc catagactca cctgaaggaa 1315800
 gactctgctg gctccttctt catgacctgc agcagccgag ttagtaagcc cctcttgcca 1315860
 tcacacacca aactcctgaa agcaaaggga cagagcactg gtgacagacc tgaatggctg 1315920
 acagggacca ctgagctagg ttctgtgct catgtagatg gatgacagag taggtgaagc 1315980

 aaggatgctc tcttctcca ccttggtcca ggacctcaga cactgcag ctgtcaatcc 1316040
 aacagcccag tgcatttcta ttgcatctta ggccagttt ccctcctcag actggctggg 1316100
 aagaggcaga ggcacatcca gggccagaca tggctcagaa cagccagagg aatggccatt 1316160
 tatatcacia gtgggtttaa tccagggcac agcagagtat gccagatgga acaaagtttg 1316220
 tgccaattgg gcagggccca aagtctctt tctgcccga gggtcagttc cagctgaact 1316280
 tgggcttcc aggccttagc ttctgtctg cgaggcaaag gcagtagta agaaaatgat 1316340
 taggcctgtc atggtgtcag gtgtctgggc ccttaattc tctcttaca cagcagcttc 1316400

 acttccacce cctgtagaca tcaggtggc gctgtgetca tctcatcagg atgctgggga 1316460
 gttatggctc tggttgctgg ataaggtcca cacttcataa gctcctgtga gcctggcatg 1316520
 tcaactgtct gttcccaaag atgaggcaga catagccagt acacgggact tgattcttgg 1316580
 cagggggcaa agatctgctt accctgcttg gcacagtgt cactggcagg ggatgaggat 1316640
 atcagcaaag gggccgtttg catgggaca ggtggaagga caggtacag ctgacctttg 1316700
 gcaggggcca cttgagacat gtctctaca tacagagagg aaggtgatga tggcacttcc 1316760
 ttctgagggc tgctgtgatg ttcaggtagg aatgcagat gtgagtatct agcacatgaa 1316820

 gccggcgggg catggtagct actcttgaga cagggcaggt atgcacacct gtgtgtgccc 1316880
 tcttgaage cctgtggeta cagctgtecc ccaccaggat cacctgtcag tgttgaggac 1316940
 agcttcacc tcagggatgt tggcttccag agagatggca ctgagttcat ttagctcctg 1317000

attgttgagc agcaggtact tgttctgaa acaaatgggt tcaaagggt aagggcagga 1317060
 cggggctgc tgaacagcac tgctgtggag gttctgcccc ttctgtggg gaagagaagc 1317120
 tgagaacca ccagcacttc cacacctggt tgcactcac tgccaatgcc ttcccttggc 1317180
 atctccagat ctccatgttg tgactgaac atttctatat gacttctcaa agtcactgc 1317240

 acttctgcat ggccaatccc atctgccatc ttattcctgg agtctagccc tgctgcacca 1317300
 ttctcagtgg ccagagcatc acataagcag aggcctgacc aactgtcaca gatctgtctt 1317360
 ctcatccag gctcgtcatg atgggtctgt gctgagacag catcttcagc tgtctccac 1317420
 aggaaggaa cctcacaca gctccttgag ggattttcag aacagggtt agacctgtc 1317480
 attattgaaa atgcttcccc tagtccccac cacttcagct gtgtaatgcc tagggagtga 1317540
 ccatgactca ggcctgtgc agccaggcta cctctgcagc cacactaaa accgagcagc 1317600
 ttacacccac cacaccatct ggccactctg gttttcatga gcaggccatg tccttctgc 1317660

 agtggcttct ccacatgtgg gccttctggc tagaacactc tctcacgctt cctttctac 1317720
 tcattcagge ctctgctcac aaattgcttc tgcagtaaag agtcactgag tgccagctgg 1317780
 ccagccagte aggaaacctg ccactgtect ttcacagaat tgtgctcttc tgtccccaaa 1317840
 tactaggccc atttgtcatc atgcattctt ttactggtga ccttttctaa tgttatactt 1317900
 cttcccaga tgtgcccttc acgatagcat gggccaaagt ttccattcct cactgtatec 1317960
 tctgagccag gcatatagaa atgctgattt gagagactga tgaaagctag gaacagacac 1318020
 agacacacac aaccacctaa aaaacccaaa gacaaaaga aaacaagtgt aattctgtaa 1318080

 cctatgggtg ccttcagcca tagacatcet cccaagagag aatcacaag agacagaggc 1318140
 ccctaggcca cactgttctc acaagagaga atcacaaga gacagaggcc cctaggccac 1318200
 actgttctca caagagagaa tcacaagag acagaggccc ctaggccaca ctgttctcac 1318260
 aagagagaat cacaagaga cagaggcccc taggccacac tgtcctaggg catgctctat 1318320
 tagcttgtag aatgctcaa cactttaaat caacatttaaat aatcaggtt aacccccagc 1318380
 actgtgagaa aatcaaaagg acaaaactcc cattgttaac tactctagge agttcacaga 1318440
 tgctttaatt tctttgggag actaaaaaag taaaaataaa accagaagcc atgtaccagt 1318500

 gfgccactt ccttgtgagc acacagtgtt ggtcaccgaa gtccttactg taaagctcag 1318560
 atcaagatcg tgggctttca ctcctcccc tgcactgttt tccttatagt ggacaacct 1318620
 tttcatgcac attctccatg aaaagcttaa acattaaaa tcaaagagga gaatatctta 1318680
 aaaagtgtgt gtgttgggg agtcaacaca tttcactgtg agggggcagc agttgtcctt 1318740
 ttaggggct gtggaggtgc aggaaaaacc cagtacagat gaaggcggga cagacactec 1318800
 aggacaccgg gcagttccca ccagcctcc tgagtccaag gtcagagagg agattccggg 1318860

acaggcctgt agacggcacc tccagggcac acatacttac tcatggtggt cactgaaact 1318920

 ctggagaagc ctcaaaaact ggatcttcaa gtaaatgtcc tataacaaaa attaaagcca 1318980
 caagagtcac ggcacttcca cataaaacaa gtgagctctg gagacatcta tcttctaca 1319040
 ctgcttcttt tgagtccctg tctcaagca cagtgggtgt ttttctttag ttgaaaagtc 1319100
 aggtgttcat agctgaccag tgtcaaggta aactaatgta gactttttaa ttagactttt 1319160
 ttctgctaac aacattcttg catattagat ttaaaaaaaaa aaaaatcact ccagtccttt 1319220
 tacatatgat gctgatttag aagctagaag aggaaaccag agagcccagg cagagatgct 1319280
 taggagctga gggagggtgtg tggatgagag aggagcctag ttacaacaag gctatggctt 1319340

 cagtgcctg cagtgaccag gcagaactaa cctgtgagct agagagctga gcaagaaacc 1319400
 tgctcttag gcgtggctgg taggagcttt ctaggagaaa tacctaactg aatgacgggg 1319460
 ccaagaaatt aaacattaaa agggagctcc tttgaaagaa ctactcaac aatgtccagg 1319520
 cagaggctgt acaggctccc aagatggctc cctcccaac accacacatg ccaccctgag 1319580
 ggtgtaaagg cccaaagaca agctaattgt accacaggaa catctccaag ggaacaaaga 1319640
 aaacaactga caaacatta gagataaatt gcaaaaggaa aaacagatgt agtgtgttta 1319700
 cctaacaat aaagaccaac tggctctga ataagtcaga tatgttatct agacatgtaa 1319760

 actatactcc ttttaaatta tttactcaa tggacggaat gaaaaacaat ctgacagggc 1319820
 caaagagaag gacacagcag gaggcaggca ggaggcaggc agggggcact gaggaagtgc 1319880
 aggttcagg acccaggca caggcttctg ctactttac agccttcagg ttggagcacc 1319940
 ttctgctaa tgggtgtgga aggcatatgg cctgtctgt cagagaaaac ggaagctcag 1320000
 agattctgtg acaaagctca gtggcaaagg acttccagtt ctactttaa cgctctatct 1320060
 gggattctg agaaacaag acctctgtt ctacttca agaacaagac cctcagggaa 1320120
 tcagcagcag caccctctt cttaaaggtt tttttattt attatgtata cagtattctt 1320180

 tctgtatgtt ggcttgaaca tcagaagagg gcatcagaac ccattacaga tggttgtgag 1320240
 ccatcatatg gttgctgaga attgaactca ggacctatgg aagagcatcc agtgcctta 1320300
 acctctgagc atctctccag ccccaaaaag cagtctttaa aacagccaac tcatagcagt 1320360
 taatatcctg aatgttccca ggctctctta cttaccgggc tacagtcaca gttctggtg 1320420
 tgaccatgga ggacaagggc agatgctgaa tgettctcc aatcagttt gcaacaaaa 1320480
 ttattgagtc ctggatcaa cttgaactca gcaatcatcc tgtggacctg tgtgggtgg 1320540
 gaagggagaa acaggagac caatgtatgc ccagatcag caaggcctct cctcagtaca 1320600

aatggccatc ctcaggatga agaaagcaat tgccagaacc gagtgctgcc atttaaagat 1320660
ggcattcaca cagcatctac cctgactgca cagaaaaacc gtccttaaaa atttctgtat 1320720
gtgagtatgt gcacatctgt gctggtgccc tcagaaccta gaaagggtat cggatcctct 1320780
gcagatgcag ttataggctg gcctgcaact aactatgagg agtgagtcac cctatttggc 1320840
ttagaaaaaa aaaaaagttt tgttttttgg tttttcaaga cagggtttct ctgtcctgga 1320900
acttgctttg taatccaggc tggccttgaa ctcacagatt cacctgcctc tgcctcccta 1320960
gtactgggct gacaggcatg cttcaccaca cccagcagcg tgagcagtct ttatggtctg 1321020

tttttctgtg gtactctggt cttttgagga cccattagaa tctcctgtta agctgtacac 1321080
atthttcttta ttaggtttct gtgtcactat gaaaggcagt ctgaaggagg aagatttgtt 1321140
tcagctccct gtgttttaca gatgtcttgt gtggagatga gtggtagaac agaacagtcc 1321200
ccgttgtgac aactaagagg cagagaaaaa gacaggaggg gcaccaggga caagaaacc 1321260
tgaatgatct accccccagt gatttactgc ctccaatagg tccttctctc ttgatttgag 1321320
aaactcctga agtgttgctg ccacctgtga actgatggct actgatcca aagtcagata 1321380
agactttgtc tcctttgccc atctgaaaaa gcaaaattgt ttgagatatg aatttctctc 1321440

catactgtga ggttgagctt ttcttgttgt gatttaagaa cattttcttg ggactggaaa 1321500
ctaagaaagg acaaccaga gtcaggacaa ccagggtac acagagaaac cctgtcttgg 1321560
aaaacaaaac caaaacaaca aacaagactg ttcattgaggt ttcagaggaa ataggattta 1321620
gaggtcatta ataatacagt ctggcaaata acttgcttat attctgccta taccctaaag 1321680
ctttgtggga ggctgagttt aaaggtgaca gacttaattt ggaaggagga aattttaata 1321740
tagcatagca cttgggctgt ggcatggtta ttgctggctg cttctagata attttacagt 1321800
gaaaactggg agcaaaaaac agaatttata aagcaaagta ggttagccag aaaaagaagg 1321860

aattgaaagt tgtggataaa gatgggaaag agattagggt cattaaaaag aagccaagca 1321920
ctttgcacag gaatagaaaa cagacaggga aagtcctat tagactccag gattagaggg 1321980
atcccactg ccccaggctt aggtataagg ccagaagctt attggaaca ctctctgag 1322040
agcagacagt ggtcagggtg ctttctctac acaaggccat ctatacaagc aactcccat 1322100
gtttggcttg ccagacactc aaagaccact gtagtgccc aaggaggcat agccattacc 1322160
tattttagta gcacatgtg gtatcactca caggatatta gttttttgct ttgtttttat 1322220
gacagtgttt tgctatatag cccagactgg ctctgaactt ctgatcctca tgccttctcc 1322280

tccccagtgc tgggattata gatttacaac actatgtcca gctcatgtga tgctggtttt 1322340
gcagactgtt aaatgcaag acttatggaa tcgagggtt ttcactgaga tttcaaagga 1322400
aggtctagag cggggagatg catgaacca agctgtgatg gagagcccag gatgtatgta 1322460

tagcaaccac agagggagct gcaagcaatg gtagagtctg tccgggagag atgtcaggaa 1322520
ggctacaatg acaaggtcac agggcaaggc tcccacgcca cttaagttca cctcaagaaa 1322580
ccacactcct tatttctaac acagggctac aggtttctct gatgagtttt ggtctcactt 1322640
tcatctagcc tttctttgcc agtcaccaga ggacctgagt ttggttctca gcatccaagt 1322700

caggtagctc acaactccag ctccaggggc ttggtgtct tttctggct tctatgggca 1322760
ccagcacaca tgtatgtgtg acacacacac acacacactc acacacacac tttattttac 1322820
aaggcttata atagtaaaag gcttgggtgtc cagtgttcag ctggagggtc tactttggag 1322880
agctttagga agtagaatct agtctgtctc cagcttttcc tcttggtttc tggtctcacc 1322940
aggaggaaaa ataaccctt ttcctttcc ctttatgata ctttctcagg tgtctggtca 1323000
tcagtcaaaa attctggcta attcagcacc actttgggtga cttggacacc agccatgctc 1323060
acaagtttct ggtgacaggg cacgctggta caactgcagg aggatgtttg ggcactactc 1323120

ctcaaattha caaatctgta tttccttggc caacaattcc cttttatca tcagctggac 1323180
ccttatacat gataaatgac attatgtact acatcagtgg tagagacatt ataataacca 1323240
atgcagatat aatttactc cagttaaaca aataatgata catccaaatg atgggataaa 1323300
cggaaaagaa agaatccaag ttttcacag atgctgagct gtgaacaatc aaagaaatac 1323360
aagtgtgtgt gctgtattca attgaatgta taaaaatcgt atttgtcct gtaagtataa 1323420
aatagctata gaaagaaata ctgacaatgg agaactcata tgtactccag gacgctgagg 1323480
cccaggaggg ggataggctc cattgattct actagtttgt attaactctg ggaattatgt 1323540

gcctactaat ttttttttt tacataacat gaaacaagac ccttctacc tcgttaggac 1323600
agactatccc tgctatatgc acagccagag agcgaatgag gctggaacca accctacgat 1323660
cagttactgt tattctatgg cgagtgaagc ccagcaagac tgtcctagac aaggtcagct 1323720
aaggacacgc taaaaactca ggcatcttgt cctgaggtct gcctctttct agctaaccac 1323780
tggaccgagg tggagaggt aggttacagg ggaatgtctt tggagggtat tatttaagtc 1323840
tcctgctgg tctgaagta agcaatttg ctctgcacac ttttcagtca tgatgtgtga 1323900
cctagttata ggccaggaata aactcagtca agaaagcacg gacctctgaa accatgagcc 1323960

acaataaacc attcctcct ataaactgtt tctaccagat gttaccatgg caatgagaag 1324020
caccagtttt caggtttcac agtgagcaca gtcttaggct ccgatcgcat acagagtgg 1324080
cagctgcttt actgcaccta cagggtgga ccttttttt ttttaagat aatgttttaa 1324140
tttttgaga ttaaattaca tcattcctct tttcccttt ctcctctaa gccttcccc 1324200
cattattcct tccccctggc tctttcaagt catggcctct tttgtttta gttgttatag 1324260
agtgtgtgtg tgtgtgtgtg tgtgtgtgtg tgtgtgtatg tgtgtgtgtg tgtgtgtgtg 1324320

tgtgtgtgta taaatacaac ctgcccagtc tatgttactt ctatgtatgt tttctgggct 1324380

 ggccatttag tattagataa ctaactgggtg tgctcttcat agagtcagtc tttttttttt 1324440
 ttttgagtca aggtttctct ggtgtagcct tcttggetgt cctggaaatc actatgtgca 1324500
 ccaggtacat atigtcaatc tttaatcttg cattactaaa ataaaagttt gttcttggct 1324560
 ttcaacaatca ctatctagaa atgtctgccta aagcccagag cagacactcc aggctctata 1324620
 atcagcttag tttccttacg aggaggcaaa taacgcacag aaagggcacc aagctgagaa 1324680
 gacctgggta agttacacct ggcacccac aggttatgtg gcatttgctc tcatctctga 1324740
 agtaagatcc tattggtttt atcaataaaa acacaaagtc agatgttttag gtaaatgctg 1324800

 agagatcaga gaagcaaaga agcagccagt cactttttac ctctctgcat cctcagaccg 1324860
 aaatagccga catcctgtca tacctggctt taccacttct gtctctgtcc catgtttgtca 1324920
 ctctctgtct cctctttgtc tagtctctca gacctctatg gttactagt ggatatctcc 1324980
 accctctgat tccaggcaaa ctttatttgi cacaacacaa ctctcccatt ctgaggttgg 1325040
 ggagcaccca cctggtttgc ttgacgccc atcagcagca cacacaggac gtagagcact 1325100
 tccagtttgi acatgatttc atgcataatc ttcatgtact ggggcagctg ggtcctggct 1325160
 gaggtatgcg gcagcgcatt gtcccctgaa gtgcctacag gaggggacac agtggaggct 1325220

 ggcgtagccc cagtaagatg ggtaaggat ggctccctga gaaaacctgc tctaccaca 1325280
 ggctctgtgt gaagggattg gatttagaga gccgtcagac aggactcaaa ccaccattag 1325340
 acattttaa agccaggaaa cctctcaca cctgcaaggc ctctgtagt tctgactct 1325400
 ccaacactaa gtaaggcatt ctgacacagc cagtgcagta agtagcctct cctgctgct 1325460
 tcctgtcacc aaccagtcag tcagtcagat gtctggcacc aaattgtgga gaccactctt 1325520
 caggtctcca gtgaccaagc atttgtgtct gtctacatat tgctggcagc aggagtcca 1325580
 gttttataag agttcccttt aaggaacctc tcttattcac tttattacc acttgtgaga 1325640

 gccagcact gggttcttag aagagatctg aaaacggaca gtgatgcacg aagatggtaa 1325700
 gaagctgcac ggtgcagtg ttaagagcac agacactggg ccaggctgca ggtctaacc 1325760
 caggcctggc tctgtgtgt tgggaagtt gaattacttc tttgtacttc ctagtcatcc 1325820
 tcatttgtga gacagtgggt atgtcagtag caagtacctg ctactgttaa aaggatagaa 1325880
 agaattaaac tacagaaggt gcttagtaca atgcccgaac aagtaagcaa catacaagga 1325940
 tgttaaataa acttaagaaa agaaaaagaa ttcttctgct aatgcttgcc tgctgaatt 1326000
 tagaaatttg aagttaacta atacataaaa acatactgta cttattaatg gggcatatta 1326060

gatgaagttt tgattagata gacatacaaa tacattgctt aatgaatggc ttaatcaagt 1326120
taaacattat cttttcaagc atccaaaatt ctctatgttt tttagatat ataataatat 1326180
agtatatact tgtctataat cccaggcaat aaccactgg aactttttgt ttttttttc 1326240
atttatttat ttggtttttc aagacagggt ttctctgtgt agccctggct ggccctggaac 1326300
tctctaagta gaccaggctg gacttaaac cacagagatt catctgcctc tgtctcatga 1326360
gtgctgagat taaagggtg tgccactact gttgggcttt ttttttttaa atttaattta 1326420
atttacttat ttattttagg gatggcttia cactgtagac ctggctagca cggaaactgc 1326480

tatgtggatc aaggcaggcg tgaactcaga catccacctg ccactgcctt ccatgtgatg 1326540
ggactgggtg gtgctgccac actctgcaga ctgggattcc tcattgtcat ctaactgtaa 1326600
gtcaggcact tigtctttct tttttgtcag tctgtgtgct cgtcctggta gcccaagtgg 1326660
cagcaggcaa agctgaagga aaaaatgtac cattaaaaaa aataaatcta agtgagaaaa 1326720
tggatttcat ttagtctatt tttcttaca caggagaaaa gccaggctca ctccatcccc 1326780
accaggatat cctcggcagc accgagaaca ccaggagagt ccagtggtct aaggagactg 1326840
ggcagcagca cacagactct tgcccttagc acacttgagt cttgaacact gttatttaac 1326900

tggctctata gagctctggg gaggcctgga ggaggacaca gctatgggaa ggaggaggtc 1326960
cagaatggta cacatacaat gctggcagta aagagtatct atgagggagg gctggggagg 1327020
gcaggctatg taagtgagca cagagagaag gcagctggag gggcaagggtg aggaggaggg 1327080
aaaggagaga atgtggagta tgaattgtta cctgatagtt ttaatttgta gttttttaa 1327140
tggcaaaagc tgttgggcag gttttcatat gtattcagcc ttttttttt ttttttttt 1327200
ttttcccttt ttggaaaaat gtctttttgg atgactccat tttccctatt tggaaaaatg 1327260
tctatttga tcctgccta tattttgga tgagctgtct ttttattatt cttttttgtt 1327320

tgtttttttg gtttttcgag tcagggtttc tctgtggttt tggaggctgt cctggaactt 1327380
gctctttag accaggctgg tctcgaactc acagcgatcc gcctgcctct gcctcccag 1327440
tgctgggatg acccccgcc agtgtcttta tttttctct acagtgttct tcacatgctt 1327500
tgttttttga ttcatattgca cgtttgtgtc tgtgtgagac cagaaaagag ctcaggatcc 1327560
ctgggaatca aatcatgtc ctctaaaaga gcaacaacag cgttcttaag aacgccctg 1327620
ggccatttct ttagcccat attactgggc actgaacaca gggctcact tgtgctagcc 1327680
aaattacacc cctagacctc tttatacatt ctgtattcaa gtccttatt acagacatgg 1327740

tttgcaaage cattctgctc ctccgggtcag tcttttact tctttgtga tattttgaag 1327800
acttttatga aatctaact gtgactactc tgetgctgtg cttcagatgc cacatctgtg 1327860
aaatctagtc aggaagacct tcccttctgt ttgctctgca cttcgtatgc ttcccagagg 1327920

caccctccat acctgtctgg aacctaacat ttagttcaga gacctgaaaa ctgtctccag 1327980
 ggtcccttag agcaatctgt atactccaa agaggccgct taattggctg cagaaatttc 1328040
 ttttttggag gtgaggggga tttttacatc tacatgtata agatgttagt ctgtaacttt 1328100
 cttgtgatct ctttggtttt ggtacaaggg tagaacttgt ctcaaagaat gagctgagaa 1328160

 gtgtttgctt tatggaagag cttaaagtgt ggtagaattc accatgaaac catgaggtag 1328220
 agggttctta ttttgagctg cttttgcac cctaattcaa tcaattaatt tatcatacaa 1328280
 attctgattt tttatttctt tttatgaagt aaagtggaac ttactaaagt ttaatacag 1328340
 tcctggtgta ggaccacctt aggggaaatt ctattgtaag caattcttaa ttctccacag 1328400
 aaagaccaac aatgtctcca aggggcctga aaagactcac cactcaagag gcccaaaaa 1328460
 agtaccttga ctgtgctcag actcctcact ggccactcgc atcaggcat ctaacaccag 1328520
 cgcgttgtct agccatgtat accactctc caattcctgc aggaagctgg ctgtgcctgt 1328580

 tgactctgac acitttctag tgcagcttt gcaaagccgt tccacaaagc cagggatgct 1328640
 gagaagagca gctagaagga aaaaaagaga aggcatttac agaacagctc tgcagtcctg 1328700
 aactgtgaca gggatgctc ctttgttctt tttgttgtct tcagttgaga aagcgtctct 1328760
 aaggcccagg ctggccttga attcctgac cctggcctc tacatccaa gtgctagggt 1328820
 tatagacatg tgctaccca tccagccagg aaagactcta ctgtgatagc agccaggggt 1328880
 acccttttaa aaacaattac caaggggctg gggagacgac tcagcaccac atagtagctc 1328940
 tcaaatgtct ctaactccag ttccaggggg tatgatggca tcttggca tccttgaca 1329000

 ccaggcacce atgtggtgta cagatatata cgcaagcaaa acaccatata acataaaata 1329060
 ataaaaaatt aggtagccag gcaagttggt gcacacctt aatctcagca ctcagcaggc 1329120
 agaggcagat ggatctctgt gagttcgaat ccagtttggc ctacaaagca agtttcagga 1329180
 cagccagggc tggatatacag agaaaccccg cctcaaaaaa taaataaata aatacataaa 1329240
 taaatatgta aatgaaatg tcaagccaaa ataaaatagc acaaaacttc agaacaagg 1329300
 tcagatttta gatgtgtagg gaaactggct ctaagtggga atataaatca aaataccttt 1329360
 atgattttag tgtgtgtatt tgagttaaat ttttgttaaa tttttttta getacaaaaa 1329420

 tatccagtca tataaacaaa aataaggat agagagacag ctcagttagt aagtgtttgc 1329480
 cacacaagca tgaggacctg agttccacce ctagaacct gtaagaagct ggcccttaga 1329540
 gccagcctag cctaatggc cagccatagg tctgtcttag ctgggatttc tatttctaag 1329600
 ataaaacacc acaacaaaa gcacttgggg gaagagggtt tatctcttct tattctcca 1329660
 tattaacagt ccatgactga taaagtcagg aaaggaactc caacaaggca ggaactgga 1329720
 ggctggaact gacgtagaag ccatgggaga gtgctgttta ctggctcgtc cagacctctt 1329780

tcttttattg ctcaagaac acatgcaggg gtggtaccac ccacagcatt ctgggcctt 1329840

cgctgtcaat tagcagtcaa gaaaatgcct tcctcccca ccctgcagac ttgcctatgg 1329900

gcaatccact ggaggtttct tcccatttga ccctagetgt gtgaagtta caaaaactaa 1329960

cagaacaagg tcccgtatga gatgatgtat ggcatctgaa cacatgcatg cacacaaaa 1330020

tctgtacaga gatattcaat gactttcttt tgtaatggta gaaatatggg gatcactaaa 1330080

tgtctatcat ttagcaaaac gaccacatac gacaactcca tatagaatat aacggacttt 1330140

aaaaatgatg acgtttttta tgtagtctt caaaactt ctttaaggaa aaaacacaa 1330200

attattaac aatattgatt taagcacatt ttttccca aaatttaag gacagaagca 1330260

ggactgggt gtagctgggt attgggcaca tctaggctgc atcaggctcat gtatttaac 1330320

cttagtaccg gagaaaaaga acagagcata tgctttgagg attcacagt gtgtctgctt 1330380

atgaacaaga caggatagaa acaacacttc agaaactggg tgtggtggg gttgtgataa 1330440

agaatgttg ttggccttc agagaacca agtcaattc ccagcacca cactgagggg 1330500

cctgtaactc cagtttcaag gaatctgat tcctctctg gcttctggg agacatacat 1330560

gggatacaca acacaatata cattttaaaa aaataacaaa aattgcatgt gtgacttatg 1330620

gaatatccct ttacactgtg tgaagatata tcattgtgac tggtttatta aaaagctaaa 1330680

tggccaatag ctaggcagga tttgggggca gagagaatgc tggaaagggt gagtcaccag 1330740

tcagatgcaa aggaagcagg acacgtgaga catgaggtaa caatccatga gccatgtggc 1330800

agcacagaaa ttaatagaaa tgggctaatt tacgtttttt ttaatataaa ggaattttat 1330860

ttatttttat ttctgtaca ttgggtttt gcccttggg tcaggtacc tagaactaga 1330920

gttacagaca gtgtgagct gccatatggg tgctgggaat tgaaccctgt ttgtctgcaa 1330980

gagcttgta gtctcttaa ccatcgagcc atctctcag cgcctaatt taagttttaa 1331040

gagctagtta gaaacaagcc taagccattg gctgaacttt cataattaat aagaagtctc 1331100

cttgtgttta ttgggagtt ggcaagtaga cagagacttg ctacaaatga catccaactg 1331160

gggggcatgt tatttcata taagacctga aaaagcttaa aaaaaaaaaa gtttccaaac 1331220

acacacaaaa aaaggaacca aacatggctt cctagtctg cagtctctca tggggccatg 1331280

gtacagagac acatctctg gctggctgct ggctgcgaaa atatgttatg tcagaaaga 1331340

ggttatgctt ttgtttccac agaaaaatga aggctatgga ttcatcaag gttgatagag 1331400

agcagatttg ataggggaag aatccctgaa aatcctggct acacataaag aaataaacc 1331460

agaaaaacta taagacaggt gacatattt acctgctcaa acataaaaca aaaaaattac 1331520

ctttgctgg attgggtaca acacacagtc cattcttggg ttaatgcaga tatgtatgct 1331580
 acctttgaca gtatgtgtgt tttcagagca ggagcagcag gcaccagtga aacaggtgg 1331640
 tccagcctct gttgcagttt ccccagagtt agttccacat tcataacagc ttcaaggcta 1331700
 ctggctgaga tggttcagcc tcatgaggac tccagtcggg acttcatata agccctgcac 1331760
 tttccatta cgtagagact ggataacaaa tgatacagct agctctaccg ggacttgacc 1331820
 attatcccga tgttctcagg gtgtcctaaa gattccagag ccccagaca acaggaaaca 1331880
 gactagagaa taigacactt aaattcccaa gaggtaggat aggtggtttt ggttattcga 1331940

 tgggttatgg atgcttgta ttgttttagc ggatacagaa atataatata ggataaaaag 1332000
 acagccacta acctcaaata ttttacattg gtatgggttt tggtaattga cacaaatgta 1332060
 aagttattha tgtatacta aatgtatctt tctactcttg ttgggttatt gtgcttatgc 1332120
 agctcattta aaatgtgttg tataattaa tgcaggttag tagttagtta tctataataa 1332180
 tcaaactgt agictattac gtatgctttt aaggttaaac agatatatta tagtttcaga 1332240
 ggttcagttc attattatca tgacagggag gatggcagtg tgtaggcaga catgcttgtg 1332300
 acggctacat cttgaccaga aggcagagga attcaactga ctgtcacact gagtgaagct 1332360

 tgagaaaaga gacctcaaag ttgctctcc acagtgacac cattctcca acaaggccac 1332420
 aattgtaaca gtgccactct ctttgggggc cttttcttt caaaccacca cagcagctct 1332480
 ttaaaaatc ctgcttcata agattctgcc agatattcta ggctatagg cagaagatgg 1332540
 atgcccacat gttgcagagg aaccttgagt gactgtccag gcagccagat gactttgatt 1332600
 tctataggtt tggaagtgtt ttgcaactgca attcctgttt actcagaaa tattatgtcc 1332660
 ttctggggtc ttgaagact aagtagttat tagtcattag ttgtggtttt actagtcag 1332720
 gtaaaaggta aattatgtac agagctttga actcaagaca gaataataa tggggtattt 1332780

 tctccaaata tacaaaatc aaatggacta gatgttttaa atgtaattct tagctgacaa 1332840
 ttgttattat tatttatggt tttcttacgt taaagttaa acctttctt tctatttaga 1332900
 caaaaatggg gaaatgttgt ggactattc tttacactgt gtgaagacat gtcactgtga 1332960
 ttggtttatt aaaaagctaa atggetaata gataggaagg atttgggggg aggggaagag 1333020
 agagaatgct gggagaaga aggtggaatc aacagccaga gtcagaggaa gcagggcaca 1333080
 aaggagatga ggcaacaagt catgagccac atggcagcac ataaatgaat acaaatacag 1333140
 aaatgggttc atttaagta taagagctag ttagaaacaa gcctaagcta ttggctgagc 1333200

 tttcaaatt aataagaagt ttctgtgtgg ctatttggga gctgcaggtg ggacagagaa 1333260
 agacttgcta catgagacct tattgtgaa gacaccatac acttcaggtg taggacttgg 1333320
 ggaacaaaag ctggaatgtg ggcttctcc ctgctttctg gagiaccaca agtaccagaa 1333380

ggtgttattg aagctgctgg gggagaactg tcatcaaaaa aaaaacttac tcagctgtgg 1333440
 atcctatag ctacactact gaccaaccag caaaagtgcc catgggtgta caagtggcaa 1333500
 gtccatagtg gggtaaccaa ctgctttcta attggagtgg aagcctgttc cataggagga 1333560
 actctatgtt tggfactgta agcctgggtca aaaaccagtg gtcaagtagg tcacagacca 1333620

 cagtggagaa gctactgctg ttgttttact aaatggacac aatgtgccta tcaaactgct 1333680
 gctctcagca ctggtcagag aggcctccctt ttacagctgg cagtggtaac tgcagagatt 1333740
 cattaactag tccaaatgct gagagcaaaa gatgcttgaa tactgtgcca taagctggca 1333800
 tccatattac cttcaagat tcaacaagg aggaaaagga ggcaggaaga atttaagaat 1333860
 gatagggaaa gaatgtatga gtggcaggga ggggtggagg gaaacaggct gttatctggg 1333920
 atgcccgca ctgctgcatg cttcacctca tagcaactct gcttaccaga acaagacctc 1333980
 cacacacca tctgccagca tcacaccagg ggatggggga agagcccata gggccccatt 1334040

 ctcctaatag acttaactata ggcagaaaca acatctaaaa aaggaggagc ccattagctc 1334100
 tcaccctat ttgagcatct ataggaatt aattgtcact ggggggaaag gaaagatatt 1334160
 tttagtgggt taaccactaa gtgtcacacc acttagtgtg taattggtaa gagaccaatg 1334220
 ctcttgcaaa taagccctct tctaggatcc tattataaaa aaaaaaaaaa aaccacacct 1334280
 aataaaatgc aatggtaaac ccacaagtgc ccagcacac acacacacac acacacacac 1334340
 accagtaagg gaatggctgg aatggttga gaacaagaga gtagtgagag ataactatga 1334400
 taaaagtaca ttataccctt aacacaaaat atccaggaaa tatgggatac tgtgaaaaga 1334460

 ccaaacctaa gaataacagg tatagaaaaa ggtgaagaaa tccaattcaa aggcacagaa 1334520
 aacatattca acaaaatcat agaagaaaac ttcccaacc taaagaaaga catgccaatg 1334580
 aaaatacaag aagcctacag aacaccaaat agactgaacc aaaaaaaaaa aaaaagtcac 1334640
 ctgcccacat aataatcaaa acaccaagca tacacaacaa agagaaaata ttaagagcag 1334700
 caaaggaaaa aggtcaagta acctataaag gcaactatc agaatcacga cttttccttg 1334760
 gaaactctga aagccagaag gtcctggatc gatattcnnn nnnnnnnnnn nnnnnnnnnn 1334820
 nnnnnnnnnn nnnnnnnnnn nnnnnnnnnn nnnnnnnnnn nnnnnnnnnn nnnnnnnnnn 1334880

 nnnnnnnnnn nnnnnnnnnn nnnnnnnnnn nnnnnnnnnn nnnnnnnnnn nnnnnnnnnn 1334940
 nnnnnnnnnn nnnnnnnnnn nnnnnnnnnn nnnnnnnnnn nnnnnnnnnn nnnnnnnnnn 1335000
 nnnnnnnnnn nnnnnnnnnn nnnnnnnnnn nnnnnnnnnn nnnnnnnnnn nnnnnnnnnn 1335060
 nnnnnnnnnn nnnnnnnnnn nnnnnnnnnn nnnnnnnnnn nnnnnnnnnn nnnnnnnnnn 1335120
 nnnnnnnnnn nnnnnnnnnn nnnnnnnnnn nnnnnnnnnn nnnnnnnnnn nnnnnnnnnn 1335180
 nnnnnnnnnn nnnnnnnnnn nnnnnnnnnn nnnnnnnnnn nnnnnnnnnn nnnnnnnnnn 1335240

nnnnnnnnnn nnnnnnnnnn nnnnnnnnnn nnnnnnnnnn nnnnnnnnnn nnnnnnnnnn 1335300

 nnnnnnnnnn nnnnnnnnnn nnnnnnnnnn nnnnnnnnnn nnnnnnnnnn nnnnnnnnnn 1335360
 nnnnnnnnnn nnnnnnnnnn nnnnnnnnnn nnnnnnnnnn nnnnnnnnnn nnnnnnnnnn 1335420
 nnnnnnnnnn nnnnnnnnnn nnnnnnnnnn nnnnnnnnnn nnnnnnnnnn nnnnnnnnnn 1335480
 nnnnnnnnnn nnnnnnnnnn nnnnnnnnnn nnnnnnnnnn nnnnnnnnnn nnnnnnnnnn 1335540
 nnnnnnnnnn nnnnnnnnnn nnnnnnnnnn nnnnnnnnnn nnnnnnnnnn nnnnnnnnnn 1335600
 nnnnnnnnnn nnnnnnnnnn nnnnnnnnnn nnnnnnnnnn nnnnnnnnnn nnnnnnnnnn 1335660
 nnnnnnnnnn nnnnnnnnnn nnnnnnnnnn nnnnnnnnnn nnnnnnnnnn nnnnnnnnnn 1335720

 nnnnnnnnnn nnnnnnnnnn nnnnnnnnnn nnnnnnnnnn nnnnnnnnnn nnnnnnnnnn 1335780
 nnnnnnnnnn nnnnnnnnnn nnnnnnnnnn nnnnnnnnnn nnnnnnnnnn nnnnnnnnnn 1335840
 nnnnnnnnnn nnnnnnnnnn nnnnnnnnnn nnnnnnnnnn nnnnnnnnnn nnnnnnnnnn 1335900
 nnnnnnnnnn nnnnnnnnnn nnnnnnnnnn nnnnnnnnnn nnnnnnnnnn nnnnnnnnnn 1335960
 nnnnnnnnnn nnnnnnnnnn nnnnnnnnnn nnnnnnnnnn nnnnnnnnnn nnnnnnnnnn 1336020
 nnnnnnnnnn nnnnnnnnna acagacactg aggaaatcca gagaatcatc aggtcatact 1336080
 tcgaaaacct atattcctca aaattcgaaa atctaaagga aatggacaat ttctggacag 1336140

 atttcgctta ccaaaattaa attaagaaca gataaggaac ttaaatagac ctataacccc 1336200
 taatgaaatt gaagcagtca tcagaagtct cccaaccaaa aaaagctcaa ggtcagatgg 1336260
 cttcagtgca gaattctccc agaaattcaa agtacagcta atatcaattc tcctcaaagt 1336320
 attccacaca atagaagcag aagggtcatt gccaaactct ttttatgagg cttcaataac 1336380
 cttgatacac aagccannnn nnnnnnnnnn nnnnnnnnnn nnnnnnnnnn nnnnnnnnnn 1336440
 nnnnnnnnnn nnnnnnnnnn nnnnnnnnnn nnnnnnnnnn nnnnnnnnnn nnnnnnnnnn 1336500
 nnnnnnnnnn nnnnnnnnnn nnnnnnnnnn nnnnnnnnnn nnnnnnnnnn nnnnnnnnnn 1336560

 nnnnnnnnnn nnnnnnnnnn nnnnnnnnnn nnnnnnnnnn nnnnnnnnnn nnnnnnnnnn 1336620
 nnnnnnnnnn nnnnnnnnnn nnnnnnnnnn nnnnnnnnnn nnnnnnnnnn nnnnnnnnnn 1336680
 nnnnnnnnnn nnnnnnnnnn nnnnnnnnnn nnnnnnnnnn nnnnnnnnnn nnnnnnnnnn 1336740
 nnnnnnnnnn nnnnnnnnnn nnnnnnnnnn nnnnnnnnnn nnnnnnnnnn nnnnnnnnnn 1336800
 nnnnnnnnnn nnnnnnnnnn nnnnnnnnnn nnnnnnnnnn nnnnnnnnnn nnnnnnnnnn 1336860
 nnnnnnnnnn nnnnnnnnnn nnnnnnnnnn nnnnnnnnnn nnnnnnnnnn nnnnnnnnnn 1336920
 nnnnnnnnnn nnnnnnnnnn nnnnnnnnnn nnnnnnnnnn nnnnnnnnnn nnnnnnnnnn 1336980

nnnnnnnnnn nnnnnnnnnn nnnnnnnnnn nnnnnnnnnn nnnnnnnnnn nnnnnnnnnn 1337040
 nnnnnnnnnn nnnnnnnnnn nnnnnnnnnn nnnnnnnnnn nnnnnnnnnn nnnnnnnnnn 1337100
 nnnnnnnnnn nnnnnnnnnn nnnnnnnnnn nnnnnnnnnn nnnnnnnnnn nnnnnnnnnn 1337160
 nnnnnnnnnn nnnnnnnnnn nnnnnnnnnn nnnnnnnnnn nnnnnnnnnn nnnnnnnnnn 1337220
 nnnnnnnnnn nnnnnnnnnn nnnnnnnnnn nnnnnnnnnn nnnnnnnnnn nnnnnnnnnn 1337280
 nnnnnnnnnn nnnnnnnnnn nnnnnnnnnn nnnnnnnnnn nnnnnnnnnn nnnnnnnnnn 1337340
 nnnnnnnnnn nnnnnnnnnn nnnnnnnnnn nnnnnnnnnn nnnnnnnnnn nnnnnnnnnn 1337400

 nnnnnnnnnn nnnnnnnnnn nnnnnnnnnn nnnnnnnnnn nnnnnnnnnn nnnnnnnnnn 1337460
 nnnnnnnnnn nnnnnnnnnn nnnnnnnnnn nnnnnnnnnn nnnnnnnnnn nnnnnnnnnn 1337520
 nnnnnnnnnn nnnnnnnnnn nnnnnnnnnn nnnnnnnnnn nnnnnnnnnn nnnnnnnnnn 1337580
 nnnnnnnnnn nnnnnnnnnn nnnnnnnnnn nnnnnnnnnn nnnnnnnnnn nnnnnnnnnn 1337640
 nnnnnnnnnn nnnnnnnnnn nnnnnnnnnn nnnnnnnnnn nnnnnnnnnn nnnnnnnnnn 1337700
 nnnnnnnnnn nnnnnnnnnn nnnnnnnnnn nnnnnnnnnn nnnnnnnnnn nnnnnaacc 1337760
 acatacctag gaacacctga tttttgacaa acaatccaaa tatatacgct ggaacaaaga 1337820

 gagcatcttc acaaaatggc gctggcataa ctggatgcaa acatgtagaa gactaccctt 1337880
 agactcaage ctttcgcctt gcacaaaact taagtcaaaa tggataaaag acctnnnnnn 1337940
 nnnnnnnnnn nnnnnnnnnn nnnnnnnnnn nnnnnnnnnn nnnnnnnnnn nnnnnnnnnn 1338000
 nnnnnnnnnn nnnnnnnnnn nnnnnnnnnn nnnnnnnnnn nnnnnnnnnn nnnnnnnnnn 1338060
 nnnnnnnnnn nnnnnnnnnn nnnnnnnnnn nnnnnnnnnn nnnnnnnnnn nnnnnnnnnn 1338120
 nnnnnnnnnn nnnnnnnnnn nnnnnnnnnn nnnnnnnnnn nnnnnnnnnn nnnnnnnnnn 1338180
 nnnnnnnnnn nnnnnnnnnn nnnnnnnnnn nnnnnnnnnn nnnnnnnnnn nnnnnnnnnn 1338240

 nnnnnnnnnn nnnnnnnnnn nnnnnnnnnn nnnnnnnnnn nnnnnnnnnn nnnnnnnnnn 1338300
 nnnnnnnnnn nnnnnnnnnn nnnnnnnnnn nnnnnnnnnn nnnnnnnnnn nnnnnnnnnn 1338360
 nnnnnnnnnn nnnnnnnnnn nnnnnnnnnn nnnnnnnnnn nnnnnnnnnn nnnnnnnnnn 1338420
 nnnnnnnnnn nnnnnnnnnn nnnnnnnnnn nnnnnnnnnn nnnnnnnnnn nnnnnnnnnn 1338480
 nnnnnnnnnn nnnnnnnnnn nnnnnnnnnn nnnnnnnnnn nnnnnnnnnn nnnnnnnnnn 1338540
 nnnnnnnnnn nnnnnnnnnn nnnnnnnnnn nnnnnnnnnn nnnnnnnnnn nnnnnnnnnn 1338600
 nnnnnnnnnn nnnnnnnnnn nnnnnnnnnn nnnnnnnnnn nnnnnnnnnn nnnnnnnnnn 1338660

 nnnnnnnnnn nnnnnnnnnn nnnnnnnnnn nnnnnnnnnn nnnnnnnnnn nnnnnnnnnn 1338720
 nnnnnnnnnn nnnnnnnnnn nnnnnnnnnn nnnnnnnnnn nnnnnnnnnn nnnnnnnnnn 1338780
 nnnnnnnnnn nnnnnnnnnn nnnnnnnnnn nnnnnnnnnn nnnnnnnnnn nnnnnnnnnn 1338840

nnnnnnnnnn nnnnnnnnnn nnnnnnnnnn nnnnnnnnnn nnnnnnnnnn aatggtgcca 1338900
 gatgccacaa gagtaacaga actgtgctgt ttttctggga ttttgTTTT tatatatata 1338960
 tatatatata tatatatata tatatatata cacattatac acacatatga aaatgtcagg 1339020
 tgcattctcc tgtaagttgg agggtagcct gatctacaat gagtgagttt cagccagagc 1339080

 tacaagaga ggctgtctca aatcaaatc aaaaccccca aaattacctt agttataatg 1339140
 aaattcatta ttacattaat taatacatat taatataact gaaaaaaca ctgagtgga 1339200
 cagtacagga gggctccaca ttcaaggatg gcctgggga cagagcaaaa aacttgctc 1339260
 aacacaaagg aaaacctact tgttttcagt ttctcaattt ttctgtgaca aatgcttact 1339320
 agtaggaaga aaaggatgag cattttcttc aaggtaaaga agaattggac taattactca 1339380
 acctatttc ccctggacca catttcatca gtaatgaata aaccaagttc tgatgagcac 1339440
 aaaagacat gatcaactct gacagcaagg agactgcgtt caaaatctgg ttctaccttt 1339500

 tgatctcctt taaatgaga caacagtata ttttgctta tataaatagc atcagatctc 1339560
 cctgggataa caagagatac caacagcaat agttgccata aaaacagcca aggaaacagt 1339620
 tgaatcaaac caaaccaagg gaaggggtct tcaatgaaca ctttctgaa tetgaatttt 1339680
 tctaagccat gtaacatata atcatcaaaa attaacaact aggtatttca tgctgtcaag 1339740
 gtatcactgt taattgtgtg tgtgtaacta tattaggtaa cgtctgtaa aagtcactat 1339800
 cagttggtag agtgcttgc tagcatgaag gaagccctgc ttttgattcc cagcactgca 1339860
 taaattggac atggtggtat atgcctgtga tctcagcact caggatgtga tggctggagg 1339920

 atcagctgtc caagatafac agacagtcca aggtcacat gggtacatg agacctgac 1339980
 caagaacaca cacacacatg catgcttgtg tattatatgc caagtgcagt aacacattgc 1340040
 attccattgg aggcgccggg gatcgaaca gggtttctct gtgtagcctt gtctgtcctg 1340100
 gaactcactc tggagaccag gctggcctcc aactcagaaa tccgcctgcc tetgcctcct 1340160
 aggtgctggc atcaaagtg tgtaccacca ctctctggca atgctagtat tcttgctact 1340220
 caggagaaca aggtagaaaa gatcaaatgg gcacaggctg gccagactg ggcagcacag 1340280
 catgactatc tcgaaataag aagtcactct gtagaacact ggaacatata ggatttctct 1340340

 caaagtaact caaagattt ggggtgtaac ttggttggga gcctatgta agcacatgtg 1340400
 aggtctgaa ttcaaccca tcattagcgc tccagcgttt ctctcaaga aacacaaaa 1340460
 aaaaacaaca acaataaaaa ccctgtgaa gcagggagtt aatggaacag aacagaacag 1340520
 aacaggccat tggttgagag tcaactgaagc tgtgtgtaaa gtaaacagag attataggtg 1340580
 tgttcgtctc acatttcaa atgtgaattt ccacaatta aagatttaac agtcaaattc 1340640
 aaaaaatatt attaaagaaa attgcttctt ttaaaaatga ttttttatg tgtatatgtg 1340700

tatgcgacc atcgtgcgta gggctcacag atgataaacg aaggcactgg atctcctgga 1340760

actgcatttc aggtggttgg gagccaccac gtgggaactg ggaactgaac ccaggtcctc 1340820

tgtgagagca gtaagtgtct ttaaccactg agccatctct ccaacctctt aaggaaactt 1340880

atttaaaat aaattatctt atgattgcta ctaataatga tagtaatgaa gatgcttttt 1340940

aaaaatatca taaathtagt gccattata gtttgccaaa taattttagt tcctttttca 1341000

tactccataa aagagtatit gatttagtat tactcagctg ttaaaaacaa tgacatcatc 1341060

atgaaatttg ctggcaaatg gatggtacta gaaaagacca tcctgaggaa tgcagaccca 1341120

gaaagacaaa cacggtatgt actcactcat aagtggatat tagtagtaag taaagtaag 1341180

gataatcagg ctacaattca tggaccacaga gaagctaaat aacaaggagg gctcaagggg 1341240

gaacacatga atgtcactgt gaaggggaat ggggagagag agtactggag agacaactgg 1341300

aatggggtgg acctctctgg gaagagctag aatctagtg taatggaaac tctcgggaac 1341360

ttatgaggtg gaccctaact aagacttttg tcaatgggaa aaacagggcc tgaaccagcc 1341420

atctcttgta accaggtgag atttctagtg gagggattgg gacccaccc cagccacaaa 1341480

acctttgacc tataatttgt cctgectaca agatatgctg gggtaaaggt agcacagaaa 1341540

ttgtggcgt ggccaaccaa tgactgctct agcttgaac cccaacat gagagggagc 1341600

tcacccctga cactggctgg agggccagga cctagagggt ggataacca aagacctagg 1341660

atagaaccaa acatgactgg ggggggggtc gtcaatgaaa tgactcctaa tgatattctg 1341720

ctacactcac agattggcac ctagcccagt ggtcatcaga gaggttcac ccagcaactg 1341780

atggaaacag atgcagagac ccacagccaa acaacaaaca gagctctggg aatcctgagg 1341840

aagaggggga ggaaggactg taggaggcag aggggtcaag gacaccacat ggaaccac 1341900

agaatcgact aacctggact cttagacact gaacaggcaa ccaaggaacc tgtatggatt 1341960

gacttaggcc ttctacatat atgtgacagt tgtatagctt ggtctggtgc ctagtctcac 1342020

tgcaacttga catggctggt tgatatgcat gggaggcctg ccttttctg aagagaaatg 1342080

gatgaggagg agtagattgt ggggcagggg ggatgggaga agaggaagg gaaactgtg 1342140

ttgtaatgta caaacaaaa ataaaataaa atgaaaaaaa aacagttaa agttgactga 1342200

gttctgaagg taaagtttag tggtagagt cttgcctatc atgcatgaag ctctggttc 1342260

agtcttcagt accataacac acacacacac acacacacac acacacacac acacacacag 1342320

agagagagag agagagagag agagagagag agagagagag agagagagag agaaagagag 1342380

agagagagag aggacctgca tacagctggc ccagcaattc cattttagg cacatactca 1342440

aagaactgac agtgagtact caaatacaca tgtgttcaca gcagcaccac tgacaacagt 1342500
ctaaacagcc cagatgttca ctgatggata aaaggggtgga tacattgtga tatatacata 1342560
tcatgaacat taccagcca tacaaggaa tgaataatg gcatgccaca atgtcagtga 1342620
cctcagaaaa catcatgtca agtaaaaaga aaccatgtac aaaaggtcac atattaaatg 1342680
atcctgttga tatttgtatt caagataaag ccacaggggc agaaaacagg ctaggaggctg 1342740
gcaggagtct acaggaaggg gaacaaggaa taattgctta ttgtatgtag catttcattc 1342800
tgggggaggt gggaatgtca tggaaactca tcaaaggatga agtgtgcagc ttataaatat 1342860

attaaatgcc aatgaattat tcaactcaaaa gtggttaatt ttatgccata tgagtgtgac 1342920
agttggtttt aatgccagct tgtcacaat gacaatcacc caagggacc tcacttgata 1342980
aattttcctg attgtcttaa ctgatatggg aagaccaacc ccaaacatgg tgtcactttc 1343040
tggcagcagc ctggatttaa gagcatggca gaggaagatc actgcttccc tctcaagaac 1343100
tagttaatat actaccctgt tgcctgctgct gattccttct aagacaatca gaaccattta 1343160
ctaccctgtt gctgctgctg gttccttcta agacaatcag aaccaggcat ccctcactaa 1343220
cagaggacca gaggcactct aagaatatac caggtttttg gcaactagatt aggactgaca 1343280

gcaactgggc tcagactttt atcttaatgt agaacaatta cagtgaggaa aaaaacaaaa 1343340
cacttttttt ttttaactt atcagcttgg ctaagtatca agcaattcaa gaacagcctg 1343400
cactggataa ggtgcaaaga cagcaagtgg caggactagc aattgtcctg caggtttaat 1343460
ccatcagagt ataaaattca aataccgagc ccattgcacc ctattattca agagttattt 1343520
gtagaacaa agacctgaaa taaaccaaat ttgtatcaac aggatattgg gataaattat 1343580
aatatgctta catatggaat attatctatt tgtaaagga actgtccaac ttttttgtt 1343640
gttgtttttt tgtttttgtt tttgttttc aagacagggt ttctctgtat tgttttggag 1343700

cctgtcctgg aactcgtct atagaccaag ctggtctcaa actcacagag atccacctgc 1343760
ctctgcttcc caagtgtggt gattaaaggc atgcccacc aacaccagc agaactgtcc 1343820
aattttatat gtataggaat ggaatgcttt gtaaagttaa ttcaaatag acaggcagaa 1343880
tagaatggtg cctactttat agacttccat ttgcacaaac taaagaattt attttttcc 1343940
ctcctgtcc ccgccccat gatgaggaat gtgtatgtta tctctggaag gagactggcg 1344000
acagattatc ttaacgaagg tggctcaact ggagggtagc ctagactcac agtgagtcca 1344060
aggctaccct gggcaaacct gaagagacct ttgctgtgaa ataatccttg tgtacactgt 1344120

gigaatatgt gtggctatga ctggttaat aaacaagctg actggccaat agctgaacag 1344180
ggtcaagttg ggggaaaacc aaactgtgaa tgatgggatg aggaagggtg gagtcagagg 1344240
agacgcctga caacagcaga ggaggcagga tacgtagaaa acgcgataac aagccatgag 1344300

ccatgtggca gagtgtaaat tagaaatgtg gattaattta agtgtagag ttagctagta 1344360
 ataagcctga gctatcagat gagcacttac aattaatata agcctctgag tggaatttg 1344420
 gaagcagctg ctgggatggg aaaactctgc ctacatatct tatctcaaaa tgggggctca 1344480
 cccatcatat gcttgcttag tatacacaag gactgaggt caacccata caccactaaa 1344540

 cagacagaca ttggagtaga ttagaatcct gtagggtttt atttttgttt acatacctca 1344600
 aatacagtgc tctaaatcaa acagcctgag aagcatacag taagaagttc cagcaatgct 1344660
 gccaaacact tctagtaggt aagtactgca cagttctttg tctcttcag tttttatgta 1344720
 tactgcatgt aaacaaatga ctgtgtagac ttattcatct tccctgtctt acagtaaagt 1344780
 atcccacctt ttctacccc actcctcacc tacctcaact gctaaggact gaaccaggg 1344840
 cctgtgataa gcaagcacc tctaccactg agctacagtc ctggaccac atttcccttt 1344900
 ttataatgaa ttttttttg tagattttcc agtctataga tgtattgcca ctcttttttt 1344960

 tttttttttt tttttttttt tttttttgga aatggagcct atcctggcac tcgctctgga 1345020
 gaccaggctg gcctcgaact cacagagatt cgctctcttc tgcctcccga gtgctgggat 1345080
 taaaggcatg cgccaccaac gccagctat caccactctt tttaaagcta teccattttt 1345140
 cattatacaa acattctgta atgaacatgt gggctgttct ggtcttctgt taccacaatg 1345200
 ctccatgaa aaaacattag gtatatacca tgtctataga aaggttgaag catgcactag 1345260
 taattttaat tagatagtggt gttttttgaa ctctggatc caaaaaaaaa aaaaaaaaaa 1345320
 aaaaaaaaaa aaaaaaaaaa aaacgactaa agctattgaa ctttgcctg taacataata 1345380

 aaaaaaaaaa gacacatata aaatttacet cctccaaatg gacccagag gccctaataa 1345440
 ctgatgacat atagctatta agagtcaggt gatttaaagg gggggctcaa ctacaatcta 1345500
 ggaatgctga gagctcttta ccttggttga tttcagctgc agaaggcccc aagctcaage 1345560
 tcttctctg ctgagcattt ttggcaagaa gtgtgtgttt gtcgtcattc cctgtgtcca 1345620
 tctctgaaat ggtgacagcc agaatccggc agaagttagc aagctgctgc tgatcgaat 1345680
 tggatactaa ggaactcaga ttaggaactt catctagccg aatcatttcc tatagaagac 1345740
 acaataaac aatcccctatg ctgagttcct caagaagctg tgtgtcctcc ttgtcctcct 1345800

 cctcctcagg actcagcagt gagggccacg tggctcctaaa ccccagcact gcagagctca 1345860
 gttgtgcaag ctgagttacg atctgggac tctttcttcc cctgctgtca cacagttata 1345920
 cggaggctac atttacctg tgagcacaac tctctccact gcctgcctta gttctggcag 1345980
 cacattttgt tcctttttta aaaactacc attcaaattt tataaatcac actgaaatct 1346040
 atatagacce tccaacaagt ggctctagtt aattcttttt ttttttttta agattttatt 1346100
 tattatgtac acgacattct gcttccatgt atatctgcac accagaagag ggcaccagat 1346160

ctcataacgg atggtttgga gtcaccatgt ggttgctggg aattgaactc aggacctctg 1346220

gaagagcagt cagtgctctt aacctctgag cctctctcc agcccccca ttttttttg 1346280

tttttcaag acagggtttc tctgtggctt tggaggetgt cctggaactg tctttgtggc 1346340

tgctttgtag accaggctgg tctcgaactc acagagatct gcctacctct gcctccaag 1346400

tgctgggatt aaaggcgtgt gccaccaccg cccggctcta gttaattctt tttttatcgc 1346460

tttactacat ggtgtttgct ctctctatg cacacttagg tgaactgtaa ctcttcatta 1346520

caactgaacg ctgcagtgag catctccaca ggtggctcct gcatacatat acacagcata 1346580

gagcttacct tcttggcttt atcagacaca ctccaagt tttaaaatta atgttcgctc 1346640

taatttttaa caggaacact ctatcacgia aaagaatfff ccttctattc ctagctgtat 1346700

gatttcagge tcaccacaca ttcatacata gagaactagg ctcatagga agtgctactg 1346760

gaaggaggag gaacctaaag agatccttag gaaattagga gtacctgct agaaggtggc 1346820

tccttctggg actcctttgt aaccaaggga gacaagtata aaaagccca gctctgtccc 1346880

atcccagtct ctttgtggct ctctcaaact ccatgctgct atctgcatg aggggatgca 1346940

gccactccag ttgtgctgtg tgaactttga agctccagaa ctgtaagcca aataaacttc 1347000

atcttctcc caaggagccc atgtcagggtg ttttaaaaa aaaaaaaaa tgcttctttc 1347060

tgggctggag agatggctca gtggttaaga gcactggctg ctctcccaga ggtcccagga 1347120

tcaattgcca gcaccacat ggcaattcac aattgtaggg agacaccgta accatgcctc 1347180

ctaagggtg gctacaggtg tgcttgacca cgcctgaca ggcatggtcg tgtgtcccta 1347240

cacacaactg tctgtaactc cagctccagg gaatctatca ccttctgacc cctgcaggea 1347300

ctgtatgcag ttggtgcaca tacatacata caggcaaagc actatacaca taaaataaat 1347360

gaacaaaatg ctgttttata atctcatgct tccccgtct taaaatcagt gtgtacacgc 1347420

catgagcttt teacatttta aaccatcaca cattctacag acagcacctg ctttctctca 1347480

ccccactcgt caacttctac tacgtggct attttctgt ctctgaatag aatgtttat 1347540

gtgtcctgta tctatttccc aaataatctg aacttaggcc ttgtcttttc tttagagccc 1347600

tattgcacag cacctgggtg caaagagctc agtaactacg cactaatcag gcaaatgatt 1347660

cctggacgtg gtgatgaaag acagtggttt gttagaagg aggcctttgg gaacagctgt 1347720

ctgtctctc cccagtccgg cacacggatg tcagctacta ctgttaccag caggctactc 1347780

ttcagtgcct ccagtcccc agcccatcta actcagtgtg tgactcttgg cttctccatc 1347840

cttctagccc tgtccaactc aggggtgtaac caggtttcac caccacac ccacttttta 1347900

ttgttgttg ttatgagatg gggatatctca ctgtaagttg ggcttgttta aaactcatgc 1347960
 tgtagcttag gctggactta gacttgcagt aatccccctg cctcggactc cctagaataa 1348020
 aggttacatt aactcagct tcaactaactt ttaatatattg acacgttata aagcataatg 1348080
 ggctttttca ctgtgtgagc cgctgtcagg tgagcactgc tattaattac tttgtcatta 1348140
 agaagtttta catttttagct ttctgaaaac ggcaagcagc ctacagtact ttgtagctgg 1348200
 cttgatccct cagtcacttc tctattcagc tgtgttttaa cccacagcac cagtcatgtc 1348260
 taacacttta tgatactcgg tctgtgagga gatatgggtc atgggcttac ttttagtctt 1348320

 ctactctcaa acagtgctac cctaagtact gttgcttgat gcccattggag aagttttcct 1348380
 agggcagtag ccaactgaaga attctgaaca atgacaaatg ttttccatca caagccaata 1348440
 aatgttggg gaaagaacat cttcaacaa tacccttga tgacacactt gaatgtgtcc 1348500
 catgtagctg acagacagac cttctgggtc tcctctagtg ttctcattc tttttgtgaa 1348560
 tgtatgtgca cacatgttca catgtgtgia caagtgtgta tgacacatgt ggtggccaga 1348620
 ggctgatgtc agggatctta ctagatttca gtctcttgtt tattgaaaca tgacacttgc 1348680
 ctatttgctt tgcctgagcta gccagcttgc ccagggtccc ttgcctatgc tttgtacaag 1348740

 tagggaccac ccgactgac cacttggttt ttatgtggga gtcggagatt caaactccag 1348800
 ttctcacact tgcacagcaa gtgttttacc cagcaagcca tttccctagt ccctagtatt 1348860
 tgcacttctt taaatgttt ttctaattac attttattaa ttgtgtgtgt gtgtgtaggt 1348920
 agatatgcat gtgtgtatat gaatgtgtgt gcatgagtat gtatttgcac atgtgtgtat 1348980
 atgtatatgg tatgtgtgta tatatttatg ggtaggggtg cgtgggcgcg cgcactgtag 1349040
 ttggattttt ctttgggcca ccagttcaca aataatgaca tggagtctta tgaaagttta 1349100
 gccttagttc aggcttgggt ggtggggctt tttttttttt ttttcttctt gagacagagt 1349160

 ttctctgtgt agctttgaag cctgtcctgg cactcctctt gtagaccagg ctgacctcaa 1349220
 acttacagag atccacctat ctctgcctcc cgagtactgg gattaaaggt gtgagccatc 1349280
 accacctggc ttaggcaag tttttaaacta gctcttataa cttaaattaa ccatttctat 1349340
 taatctactt tttgtcatgt attgectata ctgcttctg tgtctcttg ccccccccc 1349400
 ccacacacac acacaagact agattcttcc ttctacttcc tctctctgcc tggaaagtccc 1349460
 gcctatacct tctgctagt tattggcact tcagcttttt attacaccaa tcatagcaat 1349520
 gcaccttcaac acagtgtaca aatatccac aacagtgtgc atgtgtgtat gtgttatgtg 1349580

 tatgtatgtg tgggattaaa tgcattgtcc accaccgcc agctaacttt ttgtttgctg 1349640
 catgaattgc aggtaccttt tcgaagccag tggttcaagt ttccacttta gttttacaca 1349700
 ttacatcaag gcacccatac aatgtagtag acctatcac caatttagat agataacaca 1349760

aataggcaca agaaggcatg agggaccagg tgggcaaagc tgggaaggag caatcactgt 1349820
ctcctactct gagaaggcca aggagcaagc agctcctgca ttggcagcca ttctcacaca 1349880
ctggattgat cacacgattc ttggaaaata acaaaggcac tttgtcaaag agcacaagg 1349940
gactgtctgg ggctgtaca cactgagaat gtgttcaca gacaatgggc cacttgagat 1350000

tttctgtttg ggtaataaca ggcaaggtct gcagaaagca gaagtaaaag ctgggtgaca 1350060
gtgtgtgtag gtactctatt ttctgcaaca acaacctcaa ggagactata cagcaataaa 1350120
aagaaatcca ccaaccagca acagtgaggc gtggatagga ttgaggaggt aaactccagg 1350180
tcctaacaac cactatacca aaattccaac atagtgtata tgggtatatt tttggaagtt 1350240
tatgtgtttc tgatgagaaa actttaatgt tttcatcttt ttgttgctgt ttttagagac 1350300
aaagtctcac tatcatccag ataacctcaa acatgtgatg cactacacac aggataatag 1350360
ttcagttgta gaacacttgc cttaaatgtg caagacccta aatacccta aaaaaaaaa 1350420

aaagaagaag aagaagaagc caggtagtgg tggcgcacac ctttagtccc aacacttggg 1350480
aagcagaggc aggaggatct ctgtgagttt gagactacc tagtctacac agcaagttcc 1350540
aggacagcca aggtacaca cagagcaatc ctgtctcaaa accaaaacaa acaaacaaaa 1350600
aaccaaaaac cctcagcaaa atacaacta aaaaagaaag caaaaagaaa ggcagggttt 1350660
cagtgttat gttcaaggca attaaccaac tataacagaa gactgatagg aaaataaaaa 1350720
ggtagattaa aaaagcaag gccactaaga gaaacataca tggatctgcc taggaaggaa 1350780
aacagacaag atctcctgag taaattggga gcatgggggg caggggagag ggtggaagag 1350840

gaaaggggag ggaaggggag tagggggaaa tggacagctt aataagaaaa aaaaaagta 1350900
agaaattgaa ttgtaataaa gatTTTTaaa agtTaaaaa aaaaaggcaa ggcaaaggcc 1350960
aaacattgcc accagagaga acaaaactag tgaataaaag cttcacagat agctgctgtg 1351020
tgagcagtca ccagtgcaca caacagaaaa gctgctcaaa agaactcgt ccatgaaagc 1351080
gagaagcaat tttatcttag caaggaacac taaaattca ccaaatcaac gtgaaatTTT 1351140
gtgttttata ctgtttgact tcaatttata tatgtattta tgtttcacag ccataaagac 1351200
ccatgggcat aaggaataca acctaTTTT atatctgaat ctatctaaga ataaagaatt 1351260

taacattggg gtatggaaga gcttctTTTt aaggatctct gtccagtcgt taaccaagct 1351320
caacaatcca gtaccttga cacactcca cagcgggaga acacagctca cTTTTtaac 1351380
acccaaaata tcttcgatga gtgttgctgt ttgtaagaac gtcttcttac ttgtcatcag 1351440
tgtaaacagg aagatcaca aatcattttt ctctgcaaaa cgttttgTTa ctcttccgt 1351500
ctgtcatagg gagaaggcag aaaaggcaga attctttgta ccacaacaca aaacacaaat 1351560
agcaaagcac tattccagat gcagaaagca atccatcct gaaaaactag catgagccaa 1351620

caaatatagg aagttgcata taccgtgagg aaaacgtgaa aaaaaaagga ctctggcac 1351680

 tcagaccaca gaacaggag actactttgg agctaggaat gagaaaaaa gcagggaaaa 1351740
 aaaaaaaaa acgttcacct agctcatgaa gtctaagctc ataaggtcc atttgagag 1351800
 ccaacctgta tcatctggac aaaagcccat tgactaatgt gagccatccc acccagagca 1351860
 tccaagctac atgcttatga ctctgtaggc gatgacgctt cataagaggg tcaaaactaa 1351920
 attcgaatte tatctaggtg accctgagca aatcttttct cacctttgga tetccatttc 1351980
 ttcacctgta caggattctc tcaagagctt gggaggattc caacgagaga gcgcagtaaa 1352040
 cactctcatt taaccgttat cttgaagtca aagtgatctt ggtgcaacca acatgcttag 1352100

 tttcctttgc tatccattaa ctcacttttc tgactgacac tcaaaggtcg ttcaaacggg 1352160
 tgcacacaca gtatctgiga gggacaatca atccccaga ggcagcctca ctcagggcag 1352220
 cctgtcagca gcctcaetca gggcagcctg tcagcacttc tactaacctc ttcttccctt 1352280
 gaagcacaca ctaccacca agtccccatc tgcacaacc atttagaaca caggaacaag 1352340
 atgagtgtct gctggtagag aacatataaa tcaagtatgc tttgcctata ttatgggaca 1352400
 taccatcagg aaaataatgt agctattctt tttgcctttt gcagaataaa aaagcttgcc 1352460
 atgaaatgtg gcttctacaa atagcaacat acagaagtct gagattattt gtagaagatt 1352520

 gctggtagtt gtttaactcg cttaatggat ctcatgggat ttacactctg catctcatct 1352580
 atggttgtca ttttcttag tcaagaatat gctttggggc cagcaaaaca tcttgatggg 1352640
 taaaggcact tgccacaaa gttttctgac ttctacacat acatacacta acaaaagtat 1352700
 gtatatatat gcatatataa taaattacat atgctattat tcataaattg ttgtcaaaga 1352760
 tgggaacagg ccagcaatgt accaagtcct ccacaggatt ccctctctgt ggagtctccc 1352820
 ctaaccactc tacacacagg cacgttctt cctctgaagc ctcacctag tctacagcga 1352880
 tccacacctt ccaccgaagg ggacctceat ccatccctga gtgatgtcac agagggttcc 1352940

 tagcttcaca cctctgctct ctacagcaga cctagctcat gagacttaa gactagaata 1353000
 aaaaacaagg ggtaatgaag gaataaaaaa aggactagct ggcaataac ctcagaagtc 1353060
 atgttcaaga gtttgattt taaactggig agtgggtact ccaagctaag agaaactcat 1353120
 aatcggtgag gtaaaactga caagtgaact taatcttcaa aatgaagaga ctggtaaaaa 1353180
 tgcgccgagt ctctcaatgg cctagaattc agcaagtcct ctaggtgggc tggccagtga 1353240
 ggccataggaa cccacttgtc tgcctctcag cactatgatt acaggcattc gacaccacac 1353300
 tttttgtca tgtgggatca aattgagggc cttaagcttg tgtgcgaaac actttatcag 1353360

atgagccgag ccatctctgt aaccttaagt ttttaaagag caactgtttt attagaatgt 1353420
 ctccaattaa taattaggtt acaatctaaa aacacccttg tagtaaactt gacaattact 1353480
 gagtcaactct ctttcatgct gtcttttttt tttttaatat tattgaactt tagctgtaaa 1353540
 aagttgagca tttttgacaa tttagcctttt gtcttataga tcttcctgtg ctgttctgtg 1353600
 ctaccagctg taacaacatg agcacctgaa aagcagctaa tccaacacagg cacacacact 1353660
 ccatgtgaaa cacactggat cctgaaagct cgatacaaaa aaagtaaaat gtcttttaaaa 1353720
 actattggaa tgataatatt tttatgagat gtgttaaata aaatataatt atcaaaataa 1353780

 ttattctctt atttcaaaat agtggctcta agaaaatgta caataaccac acagcttgca 1353840
 ttataatcta tggcacgtgg ccatcacaga taccagtac agttcgtctt ctgtgctgct 1353900
 ggccactaag aagctggaac cacctatgag aactcacga ctatgaccgg cattttctgt 1353960
 ccgccagt tctgtgcatt atgtaccac cttttattat cctcccttt cgtatctact 1354020
 tctccatctg tggctcttagt agtattcccc tgcaatcttc cttagaataa gacaagaaac 1354080
 agttaaagt ttcttttct tccacaacag aggtttcact tctacagcat cacttagctt 1354140
 gtcttaccat gcaactgtgac aagtaagttt actgtaagtt cctaaagtca gcaacttgcc 1354200

 tttaaaacc aacatttaca cactgctttc aaagtatgtt cacactgtga tctcacttag 1354260
 ttctcacaaa cactctgtgg accaagctca gggagctgta ttaagccaac agccagggtta 1354320
 caaaaatcaa ctccaacag taagtgttta gctcttttct ttcttcaaaa ttgcttcctt 1354380
 ttttccat tcctcttgac acagtggctca accccacaga ctgtcgtatt caataaatgg 1354440
 gtaggaccac tggcttttgt tttccagtat aaatgaaaga aacaggcaaa atggagctaa 1354500
 aggttatctt aaaggacatg gacactctgc caatacttgt caccttcag caagtaatag 1354560
 cctcggcttg gatatccgag gagatggggg ctggctggct atggagtttg gaacctgttg 1354620

 aaatagcttt agctctaate aagtgtaca aaaattctct ctccattatt tetacctgct 1354680
 ggtcctgatt ctcaggcaca cagaacataa gggcaattcc cttacatc tgaagacagt 1354740
 tcttatgtct gccacccac acaaacattc tgcctcactc gtgaagataa aggcagaaat 1354800
 acacagacac taacagcaga aatactcaca cagacacagg tattgtacag gatgctcaag 1354860
 cagtctctcg acatctctgc actcactgaa agggaaggag gagtgttatt tctctctctc 1354920
 acaaaaaaaaa cacaatgcaa cgctagcaca cactggaaca taagacatgt tctagctggg 1354980
 cgtgctgcct gcctgcagtc ccagcactgg agaggcgagt gctgcgcagg cacttagact 1355040

 acgccacttt aagtgaacac acgagcacct caccacactg cagtgccacc agaaaaaaga 1355100
 ctcaaggat attttcagca tcagaacaac tacagtccag agtgtcagaa gcctgaccaa 1355160
 attttctcag tatattccca ttgaaaatct gctagcagaa aataaggca tcatttcttc 1355220

ctcagactta ccagctggat tttagggttt cttgttgta cagttattta tattaggaaa 1355280
 gtggcttcta atgtctgata tactgtcaat tccaataaag gaagaactca ctatttatct 1355340
 atgaccagaa caagacagta gcacaaaaag gaacttactt ttatgagccc caaacccaga 1355400
 gatgataaaa ctgagtatga gccatggtag agtgctttat ctgggtgttg acttattttt 1355460

aaaaaccaat ttccattcat ttctcacag ccataaactc taacatccac atctcccatg 1355520
 aggtcccaat gagtggccct ggaaggctag catggctgga cagatgggtc actaatctcc 1355580
 ttttgactat gtaggtatgt ggtgtgtctt attactatct ctctacctat ttgacagatt 1355640
 ttgacctg atattttatt aatgaattca gtagtagaacg aattaaata ttttagtagt 1355700
 tctcaacttt ccctttccaa agggagtttag attcatgcat tcattaggaa tttgttcact 1355760
 aattttaatg tgggtgtgca agcaaaagag gaagagaagt cccactcctc atggtaccta 1355820
 caaatctatt gggaggggga gaaaacaaaa gtgaccaaca agccattaaa tcagtgaatc 1355880

tcagccagtg ggtcacaacc ctgggatggg gggagtcgaa tgacccttc acaggggttg 1355940
 cacatcagat atttaaatta ctatccaatt cataacagca gcataattac agttatgaag 1356000
 taacaatgag ccgagcagtg gtggcgca cacttaatcc cagtgttgg gaggcagagg 1356060
 cagacagatc tctgtgagtt ggaggccagc ctggtctaca gagcaagttc tagggcagct 1356120
 agggccgtta cacagagaaa cctgtctca aaaaaaccta agtaagtaa taaattaaat 1356180
 aaaatgaagt agcaatgaaa taattttatg gttggcatca ccacaacatg aggaactgta 1356240
 ttaaagggtt gcagcgttag gaaagttgag agccactgta ttaaagatg ctactgcct 1356300

ccagagtaga aaagtgagac attcaaaagg agcaagagaa caggacatgg tgacacaagc 1356360
 ctgtaacatc ggiacttggga cagtggagct ccaagtacag tgggtcagga aattaaggtc 1356420
 attcccagcc agcctgcctc acccctgcc caacaaaaaa gaatatgaat tctctggcca 1356480
 ctactggagt ctcacacagt agtacatcat attgatgtag gtgcaaat taaaatgttc 1356540
 tatttattac acattcatgc atggattttt tttgtttttg tttgttttt tgtttttgtt 1356600
 tttttcgtga cagggttttt ctgtggcttt ggaggctgtc ctggaactag ctctttaga 1356660
 ccaggtggt ctgcaactca cagagatcag cttgtctctg cctcccaggt getaagatta 1356720

aaggcgtgtg ccgccaccgc ccggcttatg catggatgtt aactgtagtg atctcaggct 1356780
 tttaaaggca gagtgaagtg taccitaaag gtagaat ttaataattaa aactgaaac 1356840
 ctaaaaaaga atgcatgca cacatgtaag ttgcaaaaat aatacaaca ctaaacctat 1356900
 cacccaacct aaaaaattat gaattatata aacctgact ttttgccatg tatgactctg 1356960
 gcaatggctg aacttttttc ttattcattc attcattcac tcattcattc attcattat 1357020
 ttagaagcag gttctctctt tgtggccctc gctgtcctgg aacttactct gtagatcaca 1357080

ctggtatcaa attcagagat ctgcctgcct ctgcctcaga ggttgggatt agagggtttg 1357140

caccaccaca tccaacatga ctgaactttt tacaagagca taaatctcct ttataacaaa 1357200

aatctgatgg gttgatgggc tgttttaaca aaatgatctt accaggcaat gtattagttt 1357260

ctcagaaaac atgtaacaaa aaaatttcta aagaaaacaa aagctggatc aagtcactat 1357320

tagaaagtac aaagatacaa cttttttcaa accagtggtt ttcattgttct ttcttttaag 1357380

gtaccaagtc ttcatttcta acaaatatac aattgatgca gcatgttgct gagcttggga 1357440

tggatggagc aagctctagg gctgacaact ggatatgctc tcatgtctca aagaagagag 1357500

cagctcctgc cgatggccac cacacctgac acattgggac aaggaccaga acctaacaaa 1357560

catacttact ttttagtttc tgtccccgga tagagatcgt aggctcata agaatttcta 1357620

caagaagctg aaaacaaaaa aaattaaaga tcttcaaatt taattcaaag cacaactcaa 1357680

aaaacagttt ttattacaaa cacttgtggt ccaaggacct atcacaaacc ttcttgttca 1357740

aaagaagcac tttagctaga gctagacccc tcgagggcca ggagagggca ctggatcctc 1357800

tgacacaaaa ggtatagaag ctgtgatttg ccatttgagt gctgggcaca gaatctgagt 1357860

cctctgcaag agctaagaaa cactccacct ctgagtcate tctccagccc ctaaagaaca 1357920

tctcttattc ttataacaag ggctttcatt tgtgaagttg cttcctattt cagtatttct 1357980

gttatttctg agacacagtc tatctgagtg gcccacacta acctccagct catgatcctt 1358040

cagcttcagc ctttcaagta ctgggattac aagtgttcac ctccagccca ctttctactt 1358100

aaacatatta aaatatttta aaataatctc tgtgctaaca gaacagctaa gtctatgtat 1358160

ttaaagacat taaccataag taggtatttt gttgtttaag tcaaatcagg aatagttttg 1358220

aaacagaatc caaatgctct cttaaccctt tccagctaca agccactact ggacagcaca 1358280

gcagagacac ctcaagccaa ctgggggaaa aagatccac aacattttta aagtttctgt 1358340

ttcttctcat tgtttttaac accaacaggc agcctttaag attagcgatc agctgagga 1358400

tcatctcaga ccagcaacaa atcttaagaa atccaatcca tcctaacgac tttgggtgct 1358460

gagtgactcc cacgtgcaga actgagggca gaggctttgg catgagacag tagctgacaa 1358520

aatgaaaacc ctgacacct gtaccagact cacttctgga gactcacagg gcttggcttt 1358580

ctgcacaacc acattaaaag ctaactgcac tggtaggaga tgagaggact tgggcaaacc 1358640

acaaaaggcg ctctgaagcg agccttctgc tctgtgtggc agagtggtag gttgtgctta 1358700

cctactacta ccctgcctcc agccctcatg tcatacagtt taaagtttaa taatcagttg 1358760

tgtgtggggg gcggtgcaca ggtgcctgg catctctgga agtcagagga caacttgtgg 1358820

taattagttc tcttcttcac tctgcaggcc ctccatcagc ctacactttt cacaagagat 1358880
 cacaatccct gagctctcaa gatgtaagat gctcagatgc accaagtatt ttacctcaat 1358940
 aagctcagtg agaatacaag ctaggtcaat gagtaagagg ccctgaatgc caagcaggac 1359000
 cacatctgac cctcaggcat gcttcatttg acacataccc aggattccta atgctcctgc 1359060
 taagggcca gctttgatg gattctaggg actcaaacctc aggtcttcaa gctttctagg 1359120
 gcaaatgatt tttaccact gagccatctc cctagcctcc gacacacttt tctttgtttt 1359180
 tttttgttt ttgtttttgt tttttttgt tccaatgtgt atgagtattc tgcctgaatg 1359240

 tacctgcac ccatgcagta ctcatcgagg ccagaagagg tactggaatc cctggaacca 1359300
 gagttataga tggttatgag tgactatgia ggtttcagaa tcgatcttgg atcatctcga 1359360
 agagtaatca caacttctga actacttctt cagctcttcc tatatacatt tcttgataag 1359420
 caatttaaaa gtagaggta tgagtgtaaa agctaccgga tcacaataac tggctaacag 1359480
 ggaatgctga gcaacaatga agaacaagg gggactggga gtaggagtgt tgggtgtaga 1359540
 gctcttgctc agcatatgca agggctcggc tctatcagga tggagggaga aaggatggga 1359600
 atgggaaggc caggcacgat aaagacggga cactcactct ttagtttgca atggatgcca 1359660

 ttgtaaccag gcatggtggc acagggttag aaccatactt gggaagcagg aggattgaaa 1359720
 acccaaggcc tgcttaggtt acagagctag tgcaagacca atctgagtaa ctaaatgaga 1359780
 cactgtctca gggataaaca agaagaaaat ggcaactttt aaaggcaaaa ttttaagtta 1359840
 ggagagtcat acatacctat aaccagtact tagaagtag aggcaagaag atcagtgagt 1359900
 caaagccatc ctgagctata cagcaagttg gagactaact tgggcaatag gtgacctgtg 1359960
 cttaaaaatc caaaaatagc tgggcagtgg tggcacacac ctttaatccc agcacttgag 1360020
 aggcagaggc aggcggatct ctgtgagttc gagatcagac tggtcagagc gagtgtctggg 1360080

 aggcctccaa aaccacagag aaacctgtc tcaaaaaaac aaacaacaa acaaacaaaa 1360140
 atcaaaaat aaaggaacc aactcccc caccaaaaga cctaagttg attctaggca 1360200
 ctccatggc agctcattaa ctatctgtaa ctccattcc aaggaccag aaatactact 1360260
 atggcccca aaggtactgg acaccatga ggtgcgetta cacatgta ggcattcaca 1360320
 catacacata agtttaatg aagtaataag taatgaatg ggctgacaac caaactaaaa 1360380
 agacaaaaca gctattaaca gataattgat aagaaaagga attacttaca aacacatgaa 1360440
 catatccaat ctactcaca caaggataca ctttttatt actattaata ttattttgtt 1360500

 tttgttttt ttagacaggg tttctctatg tagcaacct gactgtctg aaattttctc 1360560
 ttagaccag gctggccttg aactcaagag atctgcctgc ttctgcctcc taagtgtgg 1360620
 gattaaaggt gtgagccacc atgcctggct tattattatt ataatactac tattattatt 1360680

ttggtttttt gatacagggt ttcgtaggt agccttggct gttctggaac tagctctgta 1360740
 gaccaggctg tctccaattc acggagacat ctgcttctg ctgcttccca agtgctggat 1360800
 taaaggctcg tgccaccacc attcagctaa aaaaaattta aaactatgga gaaaatacat 1360860
 aaagaacttt acatcttaat aataaaaaag agaaaaccca atttgaaaat gaaaacagga 1360920

 gatgacagtc cttgaaagac ttgtcaacat catcggccat cagcaaaatg gaaatccaag 1360980
 tcacagtga gcaatttact atcactagaa taggggtaat agaaatgaca gatgataaaa 1361040
 gtattggtaa aaacaaaaga gaaacctgaa ttttacacac agctgacagg agtatgaatt 1361100
 agtgcagcct ctttggaaaa cagtcaacca gttccctcaa ataattatac caagttacca 1361160
 tgtgaccag caatttact tctaagtgca tacccaagag aaaggaaagc acctatctac 1361220
 acagaaacat tcaagagtg tataagcagt actcttcatt acagtcaatt gtccatcaac 1361280
 aggcatagac acataaaatg tgctacacag ccatacagtg gaatatcatt atttggctac 1361340

 acaaaaagga gtatttatgc atgcttcaca tggatgaagc atgaaagcac tgtgctatgt 1361400
 ccaagaagcc aatcataaaa gaccattgga tacataattc cacttacagg aaataccag 1361460
 aacagcaact aactgtcaa aaggagacc aatggctgcc gtggcggcag ggaagtaact 1361520
 tctttggggc atgatgaaaa tattctaaaa ctgactgtaa cgatgcctct gaatacaatg 1361580
 aactgtacat actacactca accttagcca agaagtgaag aaataatcaa ctatatactt 1361640
 taaaagggtt atggcacctg agccatagct caataaacce agtttaaaaa aaaaaaaaaa 1361700
 aactgaaaag aaatgtattt ttttctttt ctttctctgt atctgcttag taaagacttg 1361760

 aaacacatag ggaaaagggc tcctaggtgc tggcatgggc tctttcttta ttgagcagc 1361820
 aggacaaaaga ggaacttatt ttgtggtaat taccagtgtg ctcttctgta tcaaggctag 1361880
 acttttgtaa tatgatgctc ttgcagagga cccaagtgg attctcagca tctatgggtg 1361940
 agctcacaac catccaactac tccagtctca gggtcttcca cctctttct getgctgcag 1362000
 gcaacacaca tggtgacagc aaactcatgc aggcacacac attaccacat aacacatata 1362060
 aataaaaaca aataaaacct caaaaaatac acagaaggga aaaatgatat aatttcaaaa 1362120
 taaaagaaat aattcctaaa aatacagata tatacagcat gtgtatgatg atatgggtaa 1362180

 aaagatactc ttacacttg ttctggaat ttaaactgat aaaagttagt gtaaaactgca 1362240
 gattaataaa taaaagacat acaagctttg gctccaaaag tccataaaaa aatcttctgc 1362300
 aatcttgttt gtaataaaaa aaaaaatgig gccaggcggt ggtggcacag gcctttaatc 1362360
 ccagaactcg ggaggcagag gcaggcaaat ctctgtgagt tgcaggccag catggtctcc 1362420
 agagcgagtg ccaggatagg ctccaaagct acacagagaa acctgtctc taaaaacaaa 1362480
 acaaacaaac aaaaaaatg gaaaaactaa atgttcaacc tgggcctcag caaatgaacc 1362540

atgatacaat ttataaccagg aaatattagt tggatatatta aaatgccaga tttaggtgta 1362600

 cagaaatgaa actgtaccca cttagtaagt tacatggaaa aaaacaaagc ataagagacc 1362660
 aaactggata tacgacctgg cagtgcattgg ggggagaaaa gaaactaagt tggagatagg 1362720
 tccttcagcc cttcagtccc aaataaacac acggaggcctt atattaatta aaagctgttt 1362780
 ggccatttac tcaggcttct tactaacaac aaactcttac aactcaaatt aaccacaat 1362840
 ccttatctac gtttagccaa atggettggt accttttctc agtatggtgg tetcatcttg 1362900
 cttcctctgc gtctggctgg tgactgtgcc tctgcctttc ctctttccag agttgtccta 1362960
 gtctgggtcac cccacctggc tactggccaa tcagtgtttt attaaacca tactagtgc 1363020

 agatctttac agigtacaag agcattagcc cacatcacgt ttgcacatgc atgtggacac 1363080
 aaacaagagc atctctggga cacgtgagaa actagtaatt acaatagcga gacacactat 1363140
 agtgattcaa caaaagaaaa tgccattcat ctcaaagtta aaatccagac cagagagaag 1363200
 gcacagcaga gtaaggcaca ggtgacaagc ctgatgacct tggtttaac cacaggaccc 1363260
 acatggtgga aaacacacac acacacacac acacactaaa tttgaaatgt ttgctataaa 1363320
 atctgaaatt ctttatgcct cccattttaa ttctcacatg attaaagtat taatagtatt 1363380
 aaacagctac ttacatcaac acctccaaac aagtcaaaaa tataatgtatt aggatacgt 1363440

 gcttcttgag taagtttctt atcttcagtt acaaatgcca tagcctccat ggagagaaga 1363500
 ggggaaatct cciggttcaa aaaagtacag attccgcttt agaatttaac acagactaga 1363560
 aacatccaaa tatctaaaat accactaaaa tatgcatttt agtgcacaac tgaaaccccc 1363620
 tgagcacaaa gctaggcctc aatgaagcat tagggacccc tagaatcctt ttcccatgga 1363680
 atctggctag tigtactgat gtcaacgaac agaattgaga gaagtgcac cgcacactta 1363740
 gacataagcc ttacaaagc caagcagagt tggctactgt agaacctcac tgtcatgttg 1363800
 tgagcagccc cctggggaag gccaggccat gcatgcatcc ttagctgact tccagcagea 1363860

 acacaccagg caccagtgag gccatcgtgg aattctgcac atcttaggc cctacagtaa 1363920
 atacacagga agcagaagaa cttctggcta agagaagatg gtgattacca ctggaagtta 1363980
 ctagatttca caagaaacag ctggttctac agccaaataa ccaaatctct gctggactgt 1364040
 gacctctga aggaagtctt cagtgacttc tccaagtcaa aggcattctg acagtcttcc 1364100
 acgaccacc aaaggaatct ctaagtcat tgtgacattt agcactttac tttgcaacta 1364160
 tttacaaacc tagggtttctc ttccttgaa gacaagctcc aacagattct tgtttgttcc 1364220
 ctctctaaag tctcaaggca gaggaggtgt tcagcatggt aggtactcaa aatttgggag 1364280

gggcccagca tcctttgttc ataaaacata cgtaacagac agaaaaacct cacagcatgc 1364340
 tgcccttacac agtgtttttc aagtatgtat ttacaggatg aagaaagtca agatcataca 1364400
 ccatgggtcac ctgagtacta atttccaag ccttcaattt tacctcaatt ctgtaattta 1364460
 gagatttggc aggaattaaa tgtaacaaat tttttggaaa ccacatttag tttttttgtc 1364520
 ttgtactgag agacaggatc tcactgtgta gccttgactg tcctggaatc atgtaataaa 1364580
 tgatggcctt gtacttatgg gggctctacc tgcctttggc ctcccaaatg ctgggagtga 1364640
 gtatgtaggc accacaccca acttggaaag cattttaagg cacatataga ggagctataa 1364700

 ttacttctat caaccagact gtgaaaagat gaagaatag taatatctct tcataaaggg 1364760
 aaaaactagg ctgatttaat aaggatgttt agaatacacc tggacagtca ttaacatfff 1364820
 acctctgaag agtactgcag tattcagttt tattatgacc acaggcttac acaggttgta 1364880
 actgtagctc cagctacttc tctaaattcc tgtttggaca cagcccccaa gtcagaaact 1364940
 ttgagtgtgg gtagcattga gacacactca agatggagaa caagtatcta caccaatgtc 1365000
 attgtactcg aaacctaacc agcaatccta acttcaatcc aacattagtg ataattacca 1365060
 acagccagaa agccccctcc aagagccttc agtgatatgg gtcatctaag gttagggatt 1365120

 ggggtagggg ttcagagtgt acaattctaa cctagcatgt gcaaggccct aggctcagtc 1365180
 cccagcacca caggatgtgg gagtgaggac acagtgcaga cttcccacac tgctttaaca 1365240
 gcttccacag accaacacac accttgattg gctctggaga tggataaact aacaaatatt 1365300
 ttgtttttca atgcttctgc tgaacttctc caatfffcta cagctcacia aaaaactggc 1365360
 tgtttttaaa aggccaacca tttgaggatg tggagacctg agcacaacct tctaaggcct 1365420
 ttctgagtta ccttgaggat gttttggcac tcaatgaagt cactgtggag gtggctggtg 1365480
 gcatgcagct taaggagcaa ctgaggaatt cactccatt tggacaatff gtcctctcc 1365540

 gtcaaaaagg tctcagtga ctgtgaatff aaaaaacaaa taaaaacaaa cattttactg 1365600
 gcaaggaagt agttttggca aaagagagca gctgattccc aaaggcccag gaagataatt 1365660
 ttttgtttgt ttgtttgttt gtttgtttgt ttgtttcaag acagggtttc tctgtgtaac 1365720
 agccagggag acaatffaaa agtggctctg aagaactctt acaagccgaa gcctaagccc 1365780
 tctgctccag atacagcacc attctgactc cacccttact caccagcttc atgcttttcc 1365840
 cagtgcacac tcaagcctcc aaattcagct gtgttctctg cccacaggct ctctcccagt 1365900
 ctttactgtc tgaatgctt gttttccttc aaatgcaaaa caatgagggc caggagatg 1365960

 acccagtggg taaggctgct cgctatacta gctgataact ttgattccta gaacctacat 1366020
 aaaggtggag gaagggatff atcaacacca tacactgtcc cctaaccccc aacatgcaca 1366080
 tcacagcaca ggggtgcaca cacatattta ataaaataat taaaaattaa gaaaactfff 1366140

atttaaatTT taagttacta tttatTTTat gtgtgcgggt gttgtgcctg gtacccatgc 1366200
 aggccagaag agggcatcag atcccttaga acaagtctac acagtgagtt ccaggtcagc 1366260
 ctggactgta gaaaccctgc ctcaaaacaa aacaatacat aacaataat tagatacaaa 1366320
 aagaaatcat gagctgggca ttggTggcgc acacctTtaa tcccagcact cgggaggcaa 1366380

 aggcaggcgg atctctgtga gttcagggcc agcctggtct ccagagcgag tgccaggata 1366440
 gactccaaag ctacacagag aaaccctgtc ttgaaaacce aaaaaaaaaa aaaaaaaaaa 1366500
 aaaagaaaag aaatcatggc aggagttgga tagaggTtaa gagcacttct tactcttaca 1366560
 gaagacccaa gttcagttcc cagcacacat gctcggcagt tcacagctgt ttataactcc 1366620
 agttccggcc tctgccggca tgcacacaca tTgggcatac attcacatac atacatacat 1366680
 acatacatac atacatgcat gcattTTtag tgcaggcaac agctagaaac cttcctTggt 1366740
 tggccctcct tctctcctt cctagggcag tggcccctaa ttaggggctt cacctattat 1366800

 atagtTtaac ctattgtaca tagttcccaa ttcattggag ccgttcttTc tctggatcac 1366860
 tacttcagag cagataccaa actgtgaaaa cactcactca ctcttacttt tattcaactt 1366920
 gcacagagta aggactcaat aaatgtctga aggctctggg gcagTggtgg cacacacctt 1366980
 taatcctagc actcctgagg cagaggcagg aggatctctg agttccaggc cagcctggTc 1367040
 tatagagcaa gttccataac aggcagggct acacagagaa accctgtctg aaaaacaaca 1367100
 acaacaaaag ttTgaaggca tcaacaaaag caacagcaca atgacagaac atgagtagat 1367160
 tatgaagatt tTcactaaca tgttactatt acaaggacca gacaggaaat tttTgtggtt 1367220

 caatcaaatt aaaagatctt gttatggttt gtgctgagca aacagacctt aaatgtttgg 1367280
 gTtaatatga acaggaatgc cctgtgagat ggacaagtct cataattctt tctacatttg 1367340
 tgtcttagag attatagcat gagggataac agaaaatgtt caaaagaata cttTgtctta 1367400
 gggTgaacaa cagaaaaata ctacttctta caacaaaaat atctgtatat tagcaatttt 1367460
 atagtctca agctcaaaat caatatgtgg tgatatattg tttatgatct aataaaggTt 1367520
 gcctgaagat cagaatgcaa agctagccac agtcatttag gccaaagcagT ggtggtacac 1367580
 accTTTaaat cctgcagcc atactagtca cagaggTtgg gcagTggtgg tgtatgcctt 1367640

 taactccagc actagagagg tatacaagac aggagctcag ggtctcattc tgtattcagT 1367700
 ctgatctga ggattTgTaa agccaggatc accctTtcag tctgaggTaa aggtaagagT 1367760
 ggctggctgc ttTgctttTc tgatcttcag gcaagcttca ttattTattg attgattgat 1367820
 tgattgattg attgattttt tgagacaggg tttctctgtg tagctttgta gaccaggcca 1367880
 gtctTgaact cacagagatt cacctgcctc tgcctcctga gtgctggggt taaaggcgtt 1367940
 caccaccacc gccaaagccag gcaagctTta ttagatcata aacaatatat caccatacaa 1368000

tacaagcttc tttaaaaaa gtttagaacc ccctttcttt tccttgagaa gcaaagcaag 1368060

cacctacagc ttcaagacct gcagaagcca tccttacagg atactatgtg agcactatga 1368120

cactagaggg ctttaacct gctgataacc caccatgaga aactagggaa ataaaacaaa 1368180

caaccccctc caagaaaaa caaaaactga acagagatgg gggaagtgct tctgtgatg 1368240

tgtttgtctt actggataat aaataaagta ctgtttggcc aatgaggcag caagttaggc 1368300

gggactaggg atcaaggagg attctgggaa atgtagtaaa gaagtgggta tccacgtggg 1368360

aagtacata gcaggagat tcctaaaaca agggcaagaa ggaagtggac ccccttctct 1368420

cttctcctg ggctctgctc tggagtcacc atgtgactgg caagagcgga aggcacctc 1368480

tataagataa gtcttataaa atatacagat ttatgataat taagagtgag ctaccagatg 1368540

agaaatccta gtcattggcc aagcagtatt tgtacctaat acaagtctct atgtattatt 1368600

tggggctccta acacggcggg cagatctcgg gcggctggca gaaagcacc acatggcgat 1368660

agggctccgg tggcttttgg gcagaaagat ttatcataac aaaacaggc agcagaagta 1368720

aagtaaatta aaagcaggaa actacacaaa catcaacaaa actaaaagtt tcaagatfff 1368780

ttgacaagac caattaatgc acaactttt aactgcagct actaatgcct ggctaaaatt 1368840

attgaattca ggaatgaatg agagaatatt actgccagcc ttaccagagc agaagagagt 1368900

atagtagagc actgtaaatg accatatgtc tacaatgac ctttctaa aggaaatgac 1368960

taggagaaca caactgtga aacaaagtat caagcagacc tacaacacc agcagagaag 1369020

tggcattaaa gatgagtcac acagcaatgg ccaacacctc cagaggagag tcctggccca 1369080

gatcaatgga ccaaacattg aaaggagcat taacacaaat actcagattc ccacaaaata 1369140

ggtgaggcca gaattctggt aacaagtcta gacaaataca gaagaaaact acaggtcaca 1369200

cttaccaata tagatgaaaa aacctagcaa cacatatggc aaaagcaaac aggattgatt 1369260

tatcctggga aggaaaatag ttcaacatat caactttaa aaaccaacag actacaggac 1369320

acgctcagga tatatcaaaa gacagatgaa aaatggcaa agccaaacac gttttcatga 1369380

ttaatactct gcacaaatta gaaacagaac ggaactttct caaccagcta aaggcattta 1369440

taaagagtct aaaattaaca tcaagcttat tagtaaagac taatgtttc ctactaagat 1369500

caagaagaaa agaagactca aagatgtctg cttttaccac ttccatttga ctatgtagta 1369560

gaaacacgaa tftgaacaat tagacaggaa aaacaaagag cattgaattg gaaatatgga 1369620

atactctatt cacagataca atgggatcct gattatcagt tacatttata gtagtatcaa 1369680

aaataagatg tftaagaata aatttaacaa aagcagttta agacttatac aaggaaacta 1369740

aacactatta agatagtaaa ggacacccag gacactgagg caggagaatg tcaagttcaa 1369800
ggacaggctg agttatacag tgagaacgaa aaaaaaaaaa aaaaaaaaaa aaaaaaaaaa 1369860
aaaaaaaaaa gacaaggaaa gataatctcat gtttaaggga tgggaattta ctgaagtggc 1369920
cataccttcc acactgctta ctgttactaa agcaacaata cccctgact gttgacttaa 1369980
tgtaattcct atcatggcct agttgtcttc attgtagtaa cataatttac tactaaatgt 1370040
cacacaggaa tgccagggac ccgtaacggt tgaaacagcc ttaagttgga agaaccataa 1370100
ttcctgaatt tctgatttgt aactttatca catgtctaca ttaatcaaga ttgtacaagc 1370160

taggtgatca tgtagacca ttggaatagc aatgagattc cctaatggtt aatcaatatt 1370220
tgttttgggg ttgatttgtt tgttttttt ggtaggttt gtgtagtcct gactggcctg 1370280
aaactcacta tgtaaaacag ttggcctca aattcacaga catctgccca tctctgcctt 1370340
ctgatggctg ggatttaag acgtgtgtgt caccatgtcc tgaggttaat tggtttttcg 1370400
acaagactat caaaaccaca gaacagtttt ctcaacaat gatactagta caagtgaata 1370460
tctctaagca aaaaaaaaaa aaaaaagact ccttgggact ggagagatgg ctcagtggtt 1370520
aagagcactg gtgtagggga agctggatac ctctctcaga tgactttagg gtttagttaa 1370580

catagatagt taggatgtga cataaacaga ttgttgtatc ttcttatatt ttacctgat 1370640
gattgtttat ttgggact ttaaaactgtt aagttttaat cctcttttag attaaaagg 1370700
gaattgtagg ggaagctgta gccacgccta cttaggggct ggctacaggt gtgcctgacc 1370760
acgcttgtga gggcgtggtc agagtacgt aggggactgc gtttgactt ttggtttctc 1370820
tttgcttctt gctgtacagg ctgctgccac gacagctggc taggtcgttc tgtaagtaag 1370880
gcttttccct attaaatacc cttatatttc tacctgactc cgtattggta atttcccact 1370940
atacactggc tgctcctcca gaggacaggg ttcaattccc agcaccaca tggcagctca 1371000

cagctgtctg taactccagg attcacttcc ctcacacaga cttacatgca agcaaaacac 1371060
cagtgcacac aaaataaac taaataattt ttaaaaaatg actcccgtgc ctggcgttgg 1371120
tggcacatgc cttaaatccc agcactcggg aggcagaggc aggcggattg ctgtgagttc 1371180
gaggccagcc tggctctcag agtgagtacc aggataggct ccaaagctac ccagagaaac 1371240
cctgtctcga aaaacaaaa agactccctt atagtatatt taaaattga caaatgagt 1371300
caaaggactt ggagagggca cttagctggt aatgcttac aagtatgagg gtgtgagttc 1371360
aatctcagaa cctatgttta aagggggggg gggtgtggta ggcacacttg taatcccagg 1371420

gctggggagt tggagacaaa gattccctga gacaagccta cccagagagg tccattcagt 1371480
gagagacctt gtctccaaa ccaaggaaaa gggcacccaa gacacaacac ctgaggttgt 1371540
cctctcatta actaatacac acatgtccac tgcacctgag catatataca caggcacatg 1371600

catgcatgtg taaacacaca cacacacaca cacacacaca cacacacaca agaagagaaa 1371660
 aattgttaca ttaggcatac tgtctgaaga catacagaaa aaacagaata aaatatataa 1371720
 aacatggatg gaaagggggg ttaaaaaaaaa atcacaccta ctggcaacac tggattcagt 1371780
 gaggttatcc ttgaaaagaa aaatatgaat cttctctgac aaaacttgat ctttcttacc 1371840

 agtaatatga gaggtagtta gctctttttg tttgtttttg tttgtttttt caagacaggg 1371900
 tttctctgta gttttgtagc tcttctctgga actagctttg tagaccaggc tggccttgaa 1371960
 ctcacagaga tccgcctgtc tctgcctccc gagtgctggg attaaagtgg tgccccacgg 1372020
 ccgccagct gagaggtagc tctttagtga caaggaaact gatgctagtg agaaactgtg 1372080
 ggtgtaacta agcatctatg tggctactgt ctcttctaata atgicattta tacactatat 1372140
 acaaagaggg ctgcttatga acaaatgaa cataagttaa cttttcaat ctaaatgaat 1372200
 agcaacaatt attaggtgat tacagcatct ggagaagtga actgaatggc agccatctta 1372260

 tgagggtatg agaaggaact gggatacttg ttccactcac aaacattggc tgactgcaat 1372320
 gaatgatcca aactctaggg taaccaataa aaataaccac tattgttggg tgggtgtagc 1372380
 aaacaacttt aatctcagca cacaaaaggc aggtacaggc agatctttat gaggttcaata 1372440
 ccagcctggt ctacagaaca agttccagga tagccagggc cacacagaga aaccctgtct 1372500
 tgaaatccca aaacaacaa acaacaacac aaaatcccca ctataacttc acacataacc 1372560
 tttttgaage ccaggttggc ttcaaactag cagcaatcct cttgcctcag cctctggaat 1372620
 actaggatta cagatataag ctaaacaccc agctaaaaat gattttaaaa gaataaaat 1372680

 tggggctagg aaaaatgctc acttagtaaa ttgcctgcca ctgccagcat gagggcccaa 1372740
 gttcaaatcc ccagcatcca ctaaaaagcc agatgcagca gcacacatct ataatacag 1372800
 cctggaacte agtgtctcca gcctagctga agagacgagc accagtgagt gagagcctct 1372860
 gtcggaagga agaaaaaaaa aaaaaaaaaa aaaaaagggg agaggagtga ctaaacaggc 1372920
 aatcaggcaa acctgagatc aactttggc tccacagggg aacacatcta caaacatata 1372980
 taaaacacac acacacacac acacacccgc acatactaca gaagatagta cactaagaga 1373040
 ggtgtcagtg ctgtctcata aatgttcaat caatccacag aagcagaaag ctcaggaagg 1373100

 taaagataac aaatgtaact cagctgcaca tfgggcagaa tctacctcc tatgccagtc 1373160
 tctgctcact gcacaagtct atgcatggcc agacacaccg atgactgcta cacactaggt 1373220
 ttagaaacta actagagaca gtatcaaaag cctatgaata atatatatat atatatatat 1373280
 atatatatat atatgccagt ggtataaaaa gaaacaaaag agcaactat atgttgtcta 1373340
 tgagaaacce actttagtga ctatagagag atggctcagg attgagtgcc tgtgccactc 1373400
 ttacagagga tccaagttca atcaacatga ggcagttcac aaccaccaat agctggagtc 1373460

tgagggaccc aatggctctt gcctcctcag gtacctgctt tatatgcaca tacccaaaca 1373520

 cagacttata cacatgctca taattagcta aaaatatatt ttttttaaaa agctcataat 1373580
 cacagtaata aaaatttatac tttttttaaa aaaatgettt aaacatgggtg ttatgtctca 1373640
 gttaaagta tagagactat gtgggtggcag acatttataa acccactatt tgggaggtgg 1373700
 aggcacaaag gtcaggagaa gttcaagacc agccttagtt atctagttag tatgcaccac 1373760
 tccagagcaa tacagagaag cccggtctca aaaaacaaaa acaaaaacaa aaaaacagga 1373820
 gtgcacaaaa taatcagata tcaaaatata ggaagcaaaa cctcaaagaa ctaccaagag 1373880
 aaactgatga gtgtttgaac ttcacgaatc ctcaatcagg caggaaaatc agtaaggatg 1373940

 gggctgacat gaggccatc acgatcaact agacccgaca tctgcagagt atttcatcca 1374000
 acaacagtag aacacacatt attctcaaag tcacatggaa cagtcaccag acagaccaca 1374060
 tccttggcca caaagcactc cttggtgagt ttcaaaagggt agcaaccata caaagagtgt 1374120
 tctcaacca ccatgtaatg tgtctagaac taaagagcag actggttggga aagttaagg 1374180
 tatctggaga tgaagcaatc tattttaaat aacttaagtc aaataagctt caagagaaaa 1374240
 caaatatatt ttgaactaaa tgaaaagata atttatcaaa attttagga aatggcaaaa 1374300
 tcaggattta agaaagaatt tagcacacta aaagcatgtg ttagcaaaaa aaaagagaaa 1374360

 tggtcttagt ctatagcata agcttctact ttaacaagct cgggagcgca tgacaaaaat 1374420
 aatttaattc aagctgtctt aggggttgtt ttggtttttt tttttttttt tttttggctt 1374480
 ttagacaggg ttttctgtgt agctttggag cctatcctgg cactcgtctt ggagaccagg 1374540
 ccggcctcga actcacagag atccgcctgc cctgcctcc cgagtgtctg gattaaaggc 1374600
 atgtgccacc aacactctac tctgtcttag ggttttatgg ctgcaacaaa acaccatgac 1374660
 caaaaagcaa gttatgaagg aaagggttta ataggcttac acttcaacat tgetgttcat 1374720
 cactgaagga agtcaggaca ggaactcaaa tagggcagga accttcaggc aggaactgat 1374780

 gcaaaaagct atggaggag ctgcttacag gcttgttccc catggcttgt tcaaccacc 1374840
 ttcttagaga acccaggacc agtagcccag ggaaggcacc acccaccatg cactgggccc 1374900
 tccccactg atcaccaat gagaaaatgc cttacagctg gatctcatgg aggcatttcc 1374960
 tcaactgagg ctcttttctc tcatgactct agcttgtgtc aagttgacac acaaaaccag 1375020
 ccagcacact gactgtagt gctcagacat gtaaacactca tgaggctgag gtaaaggata 1375080
 aacatgaatt caacactagc ctgaaggact gactgaataa aacctggtct caaaaggacc 1375140
 tccccctca cccccccaa aaaaaggaaa gattaaataa aaaaattaga tctataaaga 1375200

aaactagaat caataaactt taaccaggct aattaatgaa gaaaaaggat agtgccagaa 1375260
 aaacaagtag ggtcattatt gatgatccta tggacagtaa caataaagga atgtgtgagc 1375320
 aactctatgg tcacaatfff attagattaa atggaccatt ctctgaatgg aactaccaag 1375380
 atatacataa aaagaaaagg atatgctgac aaacccatct actatacaac atttttacia 1375440
 gtaaaagtgg gcaaacgctc taaacagaca tttttccaaa ggtgacagac ggccagtaaa 1375500
 tgcataaaaa atgatctgta tcagtagtca tcatcgaaag caattgaatc acatgagcta 1375560
 atgtcacacc aaccaggacc atatgatcac aaagtccaaa aataagaagt gtttgaggtc 1375620

 tggagaaatg gagctctcac tccaggcaga aatggaaaat ggcacagaaa aattcaacac 1375680
 agccaggaag aatggagtg gactctaatt ccagtacttg gaaagtagag acaggagggt 1375740
 cacaagatt taaagcctag aggagtact tagcaaggcc ttgggatgga ttcccagcac 1375800
 cacacacac acacacacac acacacacac acacacacac atacacacac acacacacac 1375860
 aactccctc ccttccttc aaaattatat gactcagcaa ttctcttctc aggcaatgct 1375920
 cacaaaagcc ttgtacacca agactcaca caacagtaat tttagtaagc aaaagtagaa 1375980
 cctcaagtgt ccatccactg gtgaacagac aaaatataga acattagtat gatggaaatc 1376040

 tttttggcc agaatacata cacataacac agataaatct tgaggatatac taccctaaat 1376100
 gaaagaaatc agaataaaag accatataat atttgatcct atttcatata aaaaatattc 1376160
 agaggggctg gagagatagc tcagaggtta agagcactag ctgctcttcc agaggctctg 1376220
 agttcaatc ccagcaacca catggtggct cacaaccatc tgtaatgaga tctgggtccc 1376280
 tctttgggtg tgcagatata catggaagca gaatgttga tacataataa ataaattctt 1376340
 aaaaaaata ttcagaacaa gccaatacat agagacagaa aacaagatta gctgctgcca 1376400
 caggccagag agaacaattg tgaagtaact gctatagta caaggtgat cagggttttg 1376460

 gtttgagact gaatctcaac taaccatcct tatcatagac tcaactatgta getgaggctg 1376520
 gccttgaact ttgatcttcc tgcttttacc ttccaagtac tgggattaaa ggaatgctat 1376580
 tgagtttact tgttgttta tttatttatt ttttagtct gtttgtttgt tttcctttct 1376640
 gaggaaatgt tctaaaatg gttatggtaa ctgtagetta gtacaacag ctactggctt 1376700
 gaatacgtaa atgggtgtgt gtgaataag tctatcaaca cttcaacaaa gctgttacga 1376760
 aaaaactaat aaataatgga cataagtga cttttaagt gacaggaatg ccctaaaact 1376820
 attttggca cagttgcatg atttataaa tgcattttc tagatttatt tgttatttt 1376880

 atgtgtgtgg ctgttttct gcattgatgt gcaccacaca tgtgcctgca gaggtctgca 1376940
 gagcacttca gatccctgga actgagttta ggtagagatg gctggaaact gccatgtggg 1377000
 tactgggaac tgaaccctg aaccagccta taattcatta aaaaaaaaaa aaattcctc 1377060

aaatggaact taaaactagt aaaaaaaatt ttttgagaca gtatataatg gagcccagac 1377120
 cagcctcaaa ttctgactt ccctactct ccacctcca agtactgggc ttacaagcat 1377180
 gggtaaatth gggtatttgc tttacgtctt gataaaattg tttttaaaa gacacattga 1377240
 ggactgggga gatggctcag cccgtaaaagt ttgcctctca agtgtgaaga tctgagttha 1377300

 gaaccagaa ctcacataaa aagccaggca tggagaagta cacagtaacc ccagcaatgg 1377360
 cagaggaag ctcaccagcc actaacttgg ctatgtgggtg aaggtcaagc caatgagagt 1377420
 ccatgctca aacaaaaag ggagacagca tctgaagaca gacacgcaag gctgtcctct 1377480
 gacttacaca tatacctcc tctgcatgta tgaactgca ctgacccca aaaacacagg 1377540
 catgtgatg tatacacaga catacacaca ataatatta aagagtcca aagggaacac 1377600
 agaactgata tgacatttgt agagcaagta ttggattaaa taaatacatt taaatctcca 1377660
 aagatcagtt atcatagtaa agatactaaa tattccattt aaaacaaagt ttattatgct 1377720

 gcctcccaga gaaacattta agaaaagctt gacataaaag acttggaaat aagccgggca 1377780
 gtggtggcac acacctttaa tcccagcact tgggaggcgg aggcagagc agaggcagac 1377840
 ggatctctgt ttgagccagc ctggctctaca gagctacaca gagaaacct gtctcaaaaa 1377900
 aaaaaaaaa aaaaaaaaa aaaaaacaa caacaacaaa aacctgggaa ataatacatg 1377960
 atgtaaaggc atacaccaca agaaacatgg tgcaatttat cggcaagaaa ctcaaagcaa 1378020
 agagcacttc cagacagcca ggctgatgac aagtgtctgt aatcccagca ctgaaaggc 1378080
 tgaagcaaga ggactgcat gaattcaagg ctgcatagg ctacatggca acacttgctt 1378140

 cacaagtaaa tgaagaacat gtccagagat aagtggitta tgaacacaaa tgtgccagtc 1378200
 tcagtgggat gcatagctaa atccaaagta aatccttacc acttcagaga cactcagagt 1378260
 cttcaagcct ttgagaacag gcagattctt aaacaggaaa aaccacataa gtaacagaaa 1378320
 gaactatatt aaaaccaagc atttatgttc accaggaaat gtgtctgtg tttttatgat 1378380
 aggtctcat tatgtagcac tggctggcct ggaactatat agaccaggct gccttgaac 1378440
 tcaaaggctt tgttgcctct gtctctcca tgcttgctc atcaaaaaat ctttacagat 1378500
 taaaaaggag tcacagaacg ggagaaaata tctataaac attgctataa aaggtacata 1378560

 tatccagtgg atgtagtgtt acatgccttt aatcccagca ctcgggagc agaggcaaac 1378620
 tctgagttha agggtaacct ggtttacaga tggaaatcca ggctagccag tgagacacta 1378680
 tttaaaaaa aagggggggg tgtatgtcaa agacttctgg ttaagttaa aagatgaaaa 1378740
 caggcctag agagatggct ctgtgattaa gagcactggt gaccttcag aggaccagg 1378800
 ttcaattgct accatecact tggtagtca caacctctg taatgtcagt tccaagggat 1378860
 ctgaggcctt gtctgtgtt cctcaggcac caggcataca catgacacat aaagatatac 1378920

gtacaagcaa aacaccctta cacataaaaa attttctaaa agaaaataac aaaaatttac 1378980

aaactattta acaggcaatt cacaaaagg gatttctgaa aagtgagtta atgaaaataa 1379040

acccatcata aactaaacac atagtgatta taccattaaa catggtgggg ggacctaaag 1379100

ttaagaagat tgacacaacc ctatagggtg gcaagaacat gaaactgaca gacactgctg 1379160

agaatggaaa ctggtataca cacctgagaa cctctggtga tggattatct tccaccctag 1379220

caattctcag catatagcct ccaggctata caaatgcaaa ccaaagacat gaacatatca 1379280

gcactattcc agcgcctaaa ctggaaggat ctcaaacatt tctcaaaatt aaaataaccg 1379340

aattgtgatt cactgatata ataacaagcc aaaacaaaga tggaccgacc atgacttcat 1379400

catcttcaag gacgagccta aaaacaaaat gtggctttaa agaatgaact tgatcaaaga 1379460

caatggaaca ttattactta aaacttagga gaaaataatg tgcaactcag aattaaacct 1379520

gatacgtgag tgccagagta aaagacattt tcaaatatgt aaacatgaaa aaaaaatacc 1379580

tcttacatac tttcctggga gtctaatac aaatgtgttc caggaaagac agatacagat 1379640

taagaataca aggtctaaaa cacaggaaag tcagcaaaaa acaagagtta aatgctctga 1379700

atgtgatgaa ggggtgttcta agaatccagc tgcaaagaca ccaatccaaa ctccagtgag 1379760

gaagaggagg atggaaaact taaaaagcca aagttttaga gtttggggtc aagttatgca 1379820

tataaagaga gtaaatgtaa aaaggatgca gttttatggt aggaaaagac tcagaaggtt 1379880

tcatgtagta tatgacatgt ctttatgaga tgtatcattt aaatataata tgtaccccca 1379940

caggctcatt tttgagcatt tggctcctgg ctagtgttac tcttgggaaga ttgtagcgcc 1380000

tttgggactg taacctaggt agcacaagtg gatactgggg acagctctta aaggtaacgc 1380060

ccaggttgtt ctagccagag cacactgcag cctgtctgca ccatggactc ctactcggat 1380120

gccatccct ccatggtgga ctacacttct gaagcctgag ccaaaataaa actatcctct 1380180

cttcagctgc ttccatcagg tgtcagtcac agtgatgaga gatgggacca gcatatgcag 1380240

tgtgactcca aaaggaaaa tctaggaagg gagatgaagg atcatggaaa agtctctctc 1380300

tacaaggaga cttcctagat tcaaaactgca gtggtcctca catgactaca cacgcccac 1380360

aaaccacctga gaaccacaca ctgaaaatgt ctcaaaggta tagcacacgc tcagcacatg 1380420

tgaggcctgg gctctagcac aaaaaagag agagcgaatt ttactatgta tgcatttata 1380480

tagcaataaa acaacatgaa aaggactatt ttgaatgcca aggaaaaata cattaagcca 1380540

gtaactttat gtatacatgg ctctgctata aacagtaatt acatcagcag cagaatgtaa 1380600

tttatacca caacaaaac tgtgatactg agagaatggt atagacacat gacatacaga 1380660

gtctaactgt ttacatgagg aagaaaatag atattatcaa attgaaaagt caagaaacag 1380720
 ctttataaac aagttagaaa tactggctct ctacttctt ggggccttct ctagtgaaag 1380780
 caatagctac actacggaca atggttgcct tgggagaatg gaagtcagag ggaagagtgg 1380840
 ggcaggcat tgctgttgc tgtaataagc ctcatgacac ccagagatcc agtcacagtc 1380900
 caaacacttc agaaggaatt ttactactta tacattggct taaaaaacac ttatttagaa 1380960
 taacatgtaa agccaggcat ggtagtttgt acctataatt aatcttagca ctttggacag 1381020
 agacaggagg catgccatga attaagagac catctgggac aatatagtaa gatccaggcc 1381080

 agcctgggct acagagagag atcctgtctc aaaatataat aaataaaaat aatcgtttcc 1381140
 actttgtttt ccttgcaagt agctgagccc tggaaaaag ccaccatcca gtcacttta 1381200
 cagctgagtt actggcagg gtcatacagg gttttcttt caagcacttg tggtttgaca 1381260
 gtttgaggc atgataatct ttacatcat gttccctaac ttgtcagcct gtttagtcaa 1381320
 tgtgacattt ccaggcattc acaattttca ttcattgtct ttactgcctt ccttttaaaa 1381380
 taattaaaag ctaatttcta tgaaaacaaa tgtatatctt ctttgtttaa tcctaagcat 1381440
 aacatagcta acatctcaaa atacctaagt acaggcaaac agacattaca aaggataatt 1381500

 aaatatcttg ctagggtagt ctgataacaa gcattaacca ctgaatactt gtatcctttg 1381560
 caatggtgtt tgtgtggttt caacacaatt aggagtgcac ctgagggttt gtgggtacaa 1381620
 atgctactga aattaatagt atttatacat tctgagact tacttatcca agaggttctt 1381680
 tctccctctc tcaccctccc ctccctctct ctcccctaac cagtgaggaa ggggtctagc 1381740
 ttttgagtca ggatctctct atgtaactct ggatggccta gaactggcct ggcttttag 1381800
 tgtgtaacag cctgcctgt ttcccaagt ctggagtac cagcttgcaa caccaccaca 1381860
 cctggtttcc caggctttct cagtatcaca ttgcccttac cagaaaagag aagtttttct 1381920

 taaattccta agtttcaacc ctaattagt tcaaccetaa agcaaacagt acatgggggt 1381980
 tgggggtggg catgaaaagg ggaggagggt gtggagggt gtttctagc ttgtaccagg 1382040
 cccaagtct gattcctagt aactcacaga aatgaaagta gggagcatct taaaaaacia 1382100
 aaaaaaaaa aagtgaaagt aagaacagg gaaatctaga gtgacacaa agacaaaaga 1382160
 acagcatttg gaaacagaa gggatccat aaccggact accaaacttc caggctacag 1382220
 aatacttgag gatggtgggt gaccatctgc acaggtacac tgttctagt cccagtttat 1382280
 ccagtctatc ttcccctca actctattgg cctgaagac ctgcgccctc attatacagg 1382340

 aaacagattt atttctactg caatgggaag cagctgggga gttcaagca gaggatttta 1382400
 agaccattt ttttttttt ttgaggatca aatgtgcaga tgaatatgaa ggcatcaata 1382460
 aactgcaaag tatcttgcca tatttattac cttgacagag gacagacaaa aggttgggaa 1382520

gaaaataagg caaatgaaaa ctcaaataga atcagcccat tctaactctt gtgacctaca 1382580
 gtctctccc aggctgctcc tgtgtcccac ttagcgaggg ggagactgag ggaggaaaag 1382640
 gtttgatgga agaggaacca agattctgat cttctacatg ttaaattttt atctacatgg 1382700
 acattcagag caggtggctg gaaataccta cccatgtgga gctaaagaaa aaaaaaagtc 1382760

 agaggtagaa atatagactt aagagccatc agaatataga gtatttgta aaaataataa 1382820
 aaactaacct atctgcacac tcatacttca gttactatit ttaatgcaaa aacttatitit 1382880
 cctcaccata atitaaagag gttagttagg tcctgggatg atitctatit tacatataaa 1382940
 gaaacataca ttgtcaggca gtgggtggcac atgctitaa tgtcagcact caggaggcag 1383000
 aggcagaggg agatggatct ctatgagtic gagtccagcc tggctacag agttccagga 1383060
 cagtcaaggc tacttagtga gagcctgtct cgaanaataa aaacanaag aaacagatat 1383120
 taagtatctt tctcaagac ataaagcaaa tatgtacct atccaggtit caaatcacag 1383180

 gtgtcctgac tctgtaattc itaaagcca tgggtcact ggagagtac tataggcaaa 1383240
 tacagactag ggatacaata ittcagtita aatagtitcc taagtcttc ctitcaagtg 1383300
 ctggcatgg ittcaggcac tgcagataca aagcaanaata agacacttc tcaanaagt 1383360
 ccagtctcat tactgtagc tgagagcaac tattatcaaa taaccagtat ctggcacact 1383420
 ggctaaactt tctggacct a itcacctga itctctaac aaccttatag gatagatgtc 1383480
 ctcaactaca cttcagaaat actgaaactg agatitgagg agatitctt agcctagga 1383540
 cacaggctaa anaaggtcgg aactaggat t gattcagat ccatcttacc tcaaatccag 1383600

 actitccag anaattcta ccatatggt a tactcagat aaacttcag caaganaag 1383660
 tagaaagtgg itacagaagc tgaggagggg catgaggagt tgcttagtgg atgcagtitc 1383720
 aggttcgcaa gctgaaagt tctagagat aggtgtgcat aggttgaaa atagtaanaa 1383780
 gtactgaact gtatagcttc aaacagtitgt aatgatcaga tgctgtattg tattititit 1383840
 ittatitaa aggtatitit tggcaggtg tgctatitg actgccaac ctgctgcccc 1383900
 itgtagtcta cttaatgaaa tctgtitct itccattcc accaccctc caaacgtit 1383960
 ittaanaacc tggcactit itactgtgcc atatcggt a ccaatatgt gtactgcact 1384020

 aaggaatat ggttgagcaa atgattat ctgcatagca ggaganaa tagggagagc 1384080
 atagcaagga ggaanaacta aaactctact aagagaggaa actatgaact gtaaggtit 1384140
 ccattatcac tactatitgg aggacaggaa itcctaattc aacctctgaa acaactcct 1384200
 cacctgtata aaactatca agaaatatgc aattacaggc taaganaagca atgtaaccaa 1384260
 acaactitg gggattaaca gagtaatct gaggaccaca atgcccagtc anaacaggt 1384320
 itaaganaa tccaacagc itccaacata gtitcctagt tcatagtitc aacctggaa 1384380

acaaattatt tcctaagtt gcctcatcca gcatgttaaa gatttctatg gctcactggt 1384440

 tttaggacac agattatctg aaggggtatt tagaatctca ttgcctaacc tttttgaact 1384500
 tcaatttccct catctgtatt aagagatgaa ttcagcacat ggctcaaaat actgaaaact 1384560
 gctggatgtg gtggaacata cctgtattcc cagcactacc tcaagttcag ggtagtcta 1384620
 atctatataa taaactcgaa gccagccaga tctatgtagg aagagcctgt ctcaaaagta 1384680
 aacttactta aaaaaaaca aaacaaaaca tgaacacctt gcacactgat tgatccaaag 1384740
 tatgtgatta ttaaaggta gtcccctctt tgcttgtctc tacatagtga gctcagtgac 1384800
 atatcctgac ttcaaggaca gaacaagtat tcctcagatc ttcttagggc agatgcagaa 1384860

 aaatgcaata aaggaaagat gctcatccac agtttctgta agaaaatatg gctacccaaa 1384920
 agtgctcctt catctgcaac cttttacaaa tacagactat ctcacccca cccttttagt 1384980
 cctttgagta atattcaaat ggctcaaaat taattttaaa tatgtaatgg tactttgaaa 1385040
 aaaatctcac acctattcca ttccctcacc cacacaccta attcccactc ctctccaatt 1385100
 caaacactcaa ctggtttctt gtgtgttctt gaaaatcata tgcaaaaacta tcttttactt 1385160
 aagctaatgt tctatctccc tcccacccc tctcgggttt gtttttcaaa acagggttct 1385220
 cctgtgtaac agccttggtt gtccctagaac tcaatttgta gccagggtt cctggaact 1385280

 cacagacaga gacccgcctg cctcctctgc tteccaactg ctggggatta aaggcaggca 1385340
 cccagctaaa cticcgttcc aaagcaaat tctgggacca cctgagagga tgaggaaaat 1385400
 gtgagaggag tcatccatcc tgcatattc aaagtagtgt cctgtgctgc cacctacgcg 1385460
 cgcgcacgca cgcatgcacg cacgcgcaca cagacacaca cacacacaca cacacacaca 1385520
 cacacacaca caaacacaca cacacacaca cagccacgc atgactgga ctgctgctatc 1385580
 aatcgggtgt atgataagct aggcattaaa tataacctta actgagcgt ctccggccct 1385640
 tatctgcacc tgaatgcac taacacttta cactactatc tctttgaaat ttagcaataa 1385700

 cctgaaacta agtcaactgaa agataacttg cacaagcaag acagaaaagta gggctttgaa 1385760
 ctgggcttg actaaagtcc ttctccaaa gcatgtcgcc ctacactggc aaaacagtct 1385820
 ctgcacccgt tggagctcag cctaagtgtg gagacaggcg tgaaaaggc acacaacaaa 1385880
 gaaatagca attacaggct aggaaaataa tgcaaccgaa aacgaactgg aggatttgac 1385940
 agaataacaa taggggccta ctttcgaaga gggggagcaa cgtaaggcc tctttgagaa 1386000
 gatgacatct acgataggct tgcgaaccgt ttggggggct gcaggaggga ggacccggtc 1386060
 ctgctcaaa ggggcaaacg ccaggccagt agaagatgaa gccaaactgc caaggccccc 1386120

cagacatgca gacgtggcgc agggaaatga ggatctagaa actcggccca gggctcatac 1386180

gcgccatccg caccctggca gcgcgacccc nnnnnnnnnn nnnnnnnnnn nnnnnnnnnn 1386240

nnnnnnnnnn nnnnnnnnnn nnnnnnnnnn nnnnnnnnnn nnnnnnnnnn nnnnnnnnnn 1386300

nnnnnnnnnn nnnnnnnnnn nnnnnnnnnn nnnnnnnnnn nnnnnnnnnn nnnnnnnnnn 1386360

nnnnnnnnnn nnnnnnnnnn nnnnnnnnnn nnnnnnnnnn nnnnnnnnnn nnnnnnnnnn 1386420

nnnnnnnnnn nnnnnnnnnn nnnnnnnnnn nnnnnnnnnn nnnnnnnnnn nnnnnnnnnn 1386480

nnnnnnnnnn nnnnnnnnnn nnnnnnnnnn nnnnnnnnnn nnnnnnnnnn nnnnnnnnnn 1386540

nnnnnnnnnn nnnnnnnnnn nnnnnnnnnn nnnnnnnnnn nnnnnnnnnn nnnnnnnnnn 1386600

nnnnnnnnnn nnnnnnnnnn nnnnnnnnnn nnnnnnnnnn nnnnnnnnnn nnnnnnnnnn 1386660

nnnnnnnnnn nnnnnnnnnn nnnnnnnnnn nnnnnnnnnn nnnnnnnnnn nnnnnnnnnn 1386720

nnnnnnnnnn nnnnnnnnnn nnnnnnnnnn nnnnnnnnnn nnnnnnnnnn nnnnnnnnnn 1386780

nnnnnnnnnn nnnnnnnnnn nnnnnnnnnn nnnnnnnnnn nnnnnnnnnn nnnnnnnnnn 1386840

nnnnnnnnnn nnnnnnnnnn nnnnnnnnnn nnnnnnnnnn nnnnnnnnnn nnnnnnnnnn 1386900

nnnnnnnnnn nnnnnnnnnn nnnnnnnnnn nnnnnnnnnn nnnnnnnnnn nnnnnnnnnn 1386960

nnnnnnnnnn nnnnnnnnnn nnnnnnnnnn nnnnnnnnnn nnnnnnnnnn nnnnnnnnnn 1387020

nnnnnnnnnn nnnnnnnnnn nnnnnnnnnn nnnnnnnnnn nnnnnnnnnn nnnnnnnnnn 1387080

nnnnnnnnnn nnnnnnnnnn nnnnnnnnnn nnnnnnnnnn nnnnnnnnnn nnnnnnnnnn 1387140

nnnnnnnnnn nnnnnnnnnn nnnnnnnnnn nnnnnnnnnn nnnnnnnnnn nnnnnnnnnn 1387200

nnnnnnnnnn nnnnnnnnnn nnnnnnnnnn nnnnnnnnnn nnnnnnnnnn nnnnnnnnnn 1387260

nnnnnnnnnn nnnnnnnnnn nnnnnnnnnn nnnnnnnnnn nnnnnnnnnn nnnnnnnnnn 1387320

nnnnnnnnnn nnnnnnnnnn nnnnnnnnnn nnnnnnnnnn nnnnnnnnnn nnnnnnnnnn 1387380

nnnnnnnnnn nnnnnnnnnn nnnnnnnnnn nnnnnnnnnn nnnnnnnnnn nnnnnnnnnn 1387440

nnnnnnnnnn nnnnnnnnnn nnnnnnnnnn nnnnnnnnnn nnnnnnnnnn nnnnnnnnnn 1387500

nnnnnnnnnn nnnnnnnnnn nnnnnnnnnn nnnnnnnnnn nnnnnnnnnn nnnnnnnnnn 1387560

nnnnnnnnnn nnnnnnnnnn nnnnnnnnnn nnnnnnnnnn nnnnnnnnnn nnnnnnnnnn 1387620

nnnnnnnnnn nnnnnnnnnn nnnnnnnnnn nnnnnnnnnn nnnnnnnnnn nnnnnnnnnn 1387680

nnnnnnnnnn nnnnnnnnnn nnnnnnnnnn nnnnnnnnnn nnnnnnnnnn nnnnnnnnnn 1387740

nnnnnnnnnn nnnnnnnnnn nnnnnnnnnn nnnnnnnnnn nnnnnnnnnn nnnnnnnnnn 1387800

nnnnnnnnnn nnnnnnnnnn nnnnnnnnnn nnnnnnnnnn nnnnnnnnnn nnnnnnnnnn 1387860

nnnnnnnnnn nnnnnnnnnn nnnnnnnnnn nnnnnnnnnn nnnnnnnnnn nnnnnnnnnn 1387920

nnnnnnnnnn nnnnnnnnnn nnnnnnnnnn nnnnnnnnnn nnnnnnnnnn nnnnnnnnnn 1387980

nnnnnnnnnn nnnnnnnnnn nnnnnnnnnn nnnnnnnnnn nnnnnnnnnn nnnnnnnnnn 1388040
 nnnnnnnnnn nnnnnnnnnn nnnnnnnnnn nnnnnnnnnn nnnnnnnnnn nnnnnnnnnn 1388100
 nnnnnnnnnn nnnnnnnnnn nnnnnnnnnn nnnnnnnnnn nnnnnnnnnn nnnnnnnnnn 1388160
 nnnnnnnnnn nnnnnnnnnn nnnnnnnnnn nnnnnnnnnn nnnnnnnnnn nnnnnnnnnn 1388220

 nnnnnnnnnn nnnnnnnnnn nnnnnnnnnn nnnnnnnnnn nnnnnnnnnn nnnnnnnnnn 1388280
 nnnnnnnnnn nnnnnnnnnn nnnnnnnnnn nnnnnnnnnn nnnnnnnnnn nnnnnnnnnn 1388340
 nnnnnnnnnn nnnnnnnnnn nnnnnnnnnn nnnnnnnnnn nnnnnnnnnn nnnnnnnnnn 1388400
 nnnnnnnnnn nnnnnnnnnn nnnnnnnnnn nnnnnnnnnn nnnnnnnnnn nnnnnnnnnn 1388460
 nnnnnnnnnn nnnnnnnnnn nnnnnnnnnn nnnnnnnnnn nnnnnnnnnn nnnnnnnnnn 1388520
 nnnnnnnnnn nnnnnnnnnn gccatgtctc ctctgctcgc aaacaggaag caagcggccc 1388580
 cagagccgcg tagatttcta cggggcggcg gaggactctc cacatgccc ccagtggaca 1388640

 gacgcggaga tgcaggccgc gtggcggggg ggtgggggga aatgtgcgcg cccggaggtc 1388700
 ttatgggaag ttagtcttt ctcccagggt cgggcagatg acagagatgc tggcctcctg 1388760
 gaccacctg tttcccaca tcccacctcc agcatttctg tgaggttget ccagatggaa 1388820
 gactgatcgc tgcgtggca tgctctcga tttcttctc gtttaggat gatgcagccc 1388880
 agtggctagt gaaagccct aggccagaat tgtggcttga ttctgagttc tgtcccctc 1388940
 tttttacgac tgcctccagc caagctacc ctgctctc agttagttca ttcaatatgg 1389000
 gctcagatga gtcaactaac atttgtatta taattaacaa atatatctta tgtaataat 1389060

 atataaaga ttcgaagaaa atggtagaaa acatttcatg aattacaaa ttgtgtgag 1389120
 attttacaga tgicaataa taatttctaa gggagccagc tgtactcctc aactgaaca 1389180
 atagaggacg tggagggtgc ggtgatgagc agaacagtgg agcaccctgt gaggggattg 1389240
 agactacagg gaccacagca agtccacaca caaagaaatg taactggcga gtttgtggtc 1389300
 aagttcagtg aaataatgca aggagtgggg ttgtaagtc gtagcctctg ccaaacagaa 1389360
 cactgcgctg atttccctgc gctagtgtgc tctctctc ttctgaaccg ctgtagcgcg 1389420
 gcggcagcgg taaccactct ttcctgttt tctctccagg gagagctgaa tgtgctgaat 1389480

 tgggatgtca tgaagttgc tgcttgtaac aaaggaggct ttaatttgtt acacaaacca 1389540
 aatcccctga aagtgtgaaa tgatgtaata aataataga ctaaaacaac agacatttat 1389600
 gggcactgcc aggacaaact agactgtggt tactatcttt ttgtttaat tttttgttct 1389660
 tttcgagaca gggtttctct gtgtagcttt ggagcctaac ctggcactca ctctggggac 1389720
 caggtggcc tcaaacctac agacatccgc ctgcctctgc cteccgagtg ctgggattaa 1389780
 aggtgtgcgc caccagcgc ctgctgtggt accatctaa aatgccact ttagaaagta 1389840

tgatttctgc tcacctccag cagatcacta ctgattgtc tggtttaaaa caaataaaat 1389900

 agggctcgag ggatgaatca gcaggtagag gcagtgggct gtcaagactg aggacctaaag 1389960
 ttgggttccc tggaccaata ttgggtggaag gaaagaaatg actcctccaa attgtcctct 1390020
 aatctctctc tctctctctc tctctctctc tctctctctc tctctgtctg tctctgtctc 1390080
 tctcatacac acacacaaat taaatgtaat ttttaaattt aaaatatata tatattgagg 1390140
 ggctggagag atgctcagag gttaagagca ccgactgctc ttccagaggt cctgagtcca 1390200
 attcccagca accacatggt ggctcacaac catctgtaat gagatctggt gcctcttct 1390260
 ggggtgcaga tatacatgga agcagaatgt tgtatacata ataaataaat ttatatatat 1390320

 atatatatat atatatatat acacatatat atatatgaa agagatcaag gaggttgcatt 1390380
 atggaagggt ttggaggag gaatgggaag aaaagtgatg taattacata ataattgtga 1390440
 ttgctggaga aaaaacagaa acaggaagt tctctgtag tgaaggagat tttcttcaaa 1390500
 ccaatggaaa aaaaaaaaa aacagccctt caactttaca ctaaaatcta aaattcatct 1390560
 taggaaaatc aaatctaac ataacaaaat cagagtgtat ttctaaaact gggttgcggt 1390620
 gacagtagtg cagctacata catttatata catacaaatc actggactgt attcaaaacg 1390680
 ggtaggtttt gaaatataaa ttatacttcc acaaagctgt taaaagcata tcatggtata 1390740

 tatacatatt catacacata cacaagctaa ttaaataaat acatgtaatt ttaaaataaa 1390800
 atggacaaaa agttttggat gactaataac agataatgca acatcttact tctctggcag 1390860
 ttttacctgt ctggaagaaa gtataaggct acctttgagt accccgagat atcactcagt 1390920
 tgttgcccta aaacttacct atctcagcct ggtgggtggtg gtgtcacacg acttaaacag 1390980
 cagcactcag gagtcaaagg cactggtttt ctgtgaattg aggtcagcct ggtctgcaga 1391040
 gcaagtttcc ggacagccag agctacacag aggtaaacc tgtcttataaa aagccaaaca 1391100
 cccaacaaaa aaaagttaaa agcataaaat gtcagcaatg aatggaagat aatcctctta 1391160

 tgatttgggg gaagaaaagt cttctcaagt ataaaatccg gaagcatgac tagaagacct 1391220
 caacatcagg ataacctctt gtacaagaca gcatgaacac ccatagaagg cacgtggcat 1391280
 tctgggaaag agttaaacta gtattatgaa gaacttctgt cgtgcttgcc ttgacctccg 1391340
 ctccaggtag ctgtctgagc tgctggcttt ctcatccct tcttctgat caaagactgc 1391400
 tttgtgac acagatccaa agcgcctct cttctgctct cagcctgct tcttccactt 1391460
 gacataaaat tcatcattct gtccacctct ccagttagag ctattcgtga tgcttagtac 1391520
 tttgccatgc tcaactccag taccagaac agtgcctgga acagtcagt atcatttttt 1391580

tttttatata atcaatagct cactgaacag ataaagctac tcctacaaaa ttgcaacaag 1391640
 ccaaatagca cagtagaaa agagggtatc gggaagctgg tgagatgacc tgtggtaaag 1391700
 gcatttgctg ccagctcaga agaccgaac tcaaaagtgg agagcagaga acccattcct 1391760
 gaaagttaac ctctgacctc cacacaagtg ccagaacatc cttgttatgc atgtgcacat 1391820
 gtgcgcgcg acacacacac acacacacac acacacacac acacggtgtg tgtaaataaa 1391880
 taataaatg tttttaaaaa ggaaatagat gagctgggtg gtggtggcac atgccttcaa 1391940
 tcccagcact cgggaggcag agacaggctg atctctggtc tatagagtga gttccaggac 1392000

 cgccaaggct acacaaagaa accctgtctc caaaaaataa aaaagaaaga aagaattaga 1392060
 tgggcaggaa taggcaagtc ttagaacaac gatggcaaat acatgtagag aaaacaaca 1392120
 aacaacaaa aatgtaagtc tcttagtttc cccaagtgga atgctgatgg tgagaaggtc 1392180
 tgttgctctt tttcaggaag caatttttta tcagtatcaa gtgagttaga agcatacttc 1392240
 ttttgactca ataactctcc ttcagcatta cactaaatag cattctagct agtataattc 1392300
 tagaaaacat agccaaaaca attagtcaag aaaaaaaaa aaaaagaagt ggccaagttg 1392360
 gaaaggaaga agcaaaatca tctctatttc ctaccatcca tctgtaggaa actaaagatt 1392420

 tccacacaca aacagaacca aagaacaacc tcagtgaagt ttgcacaata caaaaaccac 1392480
 aaataaaact gagcaaatgg ggttggagaa tgacagcttg gctattaaaa tttcctactg 1392540
 ttctctaaga ggatctgagt tcccttccca gcacctacac tgggagctca caccagctct 1392600
 aggggggact gatgccctcg gctagactac acaggtatct acactcacat gaacatacc 1392660
 caagaacaca caaatacgtt taaaataata aagataagtc ttttttaaaa cttcacctc 1392720
 aaatttggtt ctttaaggact ccatatgact aggaattaag gagaaaggtt cccaggtatc 1392780
 tgtgtgatgc taagtgcact tcatctcttt cctgccactt tctccatgg agacaagctg 1392840

 ctctcacca ccagcatcct tctaccaagg ggacctggat ttgggtcaac atggaaaaga 1392900
 aaattaaaca aaatggaac tcttagcttg actaattttt tttgcagtaa tcccatgaag 1392960
 tataactaca tatgacgctg taaattccca gaattaacta ccaagatcat ctcaattagg 1393020
 catacagatt tttctagagc aatttttttt taatcatggg gaagtcataa tcaaagagaa 1393080
 tcacattatt atactcaggc catagtaaga aatgtccatg taatcacgca gcatcttgag 1393140
 gtgtaatttt taacactatt ttcataattt gtttctaag tacttaagt ttgagggttt 1393200
 ttaaattatt ttttacagtg tgtgtgtgtg tgtgtgtgtg tgtgtgtgtg tgtgtgtgtg 1393260

 tgtgtgtgta tttatacatt tatttgatga gggagaagg gcatgtgcta cggcacacat 1393320
 aatgtccttt tctttccttt tacctgtggg tctgggttc atgtccatgt ttggtgacaa 1393380
 gagcctttac ccacagatcc atccactggc ccaatggttt gttgttttaa atagttactt 1393440

tatgggccgg gcacctgatt ggtctaataa agaactgaat ggccaatagc aaagcaggag 1393500
aaaggataaa tggggctgac aggcagagag aataaacaga aggagaaaaa gagagaagaa 1393560
agagcaagga gccagaaaag aaggagtcag ccaccagct acacagccag acatggaata 1393620
aaaaggaaag aaaagatata cagaaataga gaaaggtaaa aacctagagg caaaaggaag 1393680

acaggataat ttaagaaaag ctggcaagaa acaagccaag ctaaggctgg gcatttataa 1393740
gtaataataa taagactctg tgtgatattat ttgagagctg gatggtgggc ccccaaaaga 1393800
gcaaaggagt ataaacaac caactacact ccatgtcatt atttgggagg tggcagtatg 1393860
aagaaagacc cattacaaat ggtgtccagc gtaagtgcac atatttcac atagggcag 1393920
agaaagagac ctcttgagta gcctcagtg acagagctt tttaaagagg cctgctaca 1393980
aagtacttaa atggggttta tgagcatcag gcatcactct actcgggtggc aggggactag 1394040
gggactagga ctggggcaga tagactggct ccaggccaga cctctaggca tgaggctcca 1394100

ctctcacaa catgaagagg gcagagccag atgccaagcc atgtgcttac agaggagggc 1394160
ctagttgctg cttagcaatt taatgtttgg ctcacagcaa agaatgctgt acatgtgagg 1394220
ctgaagacac ctagtaaaat ctagaccaag aaaacctcta aatagagtaa gttttaaata 1394280
gtgctaagct gctaaagaaa agaaaatagg gatagatagt catatggttt tttaaaaga 1394340
ttatttattt actaagtata gtgttctgcc tgcatgtatg cctgcaggcc agaagagggc 1394400
accagatctc cttacaaata gttgtgagct accatgtggt tgctgggaat tgaactcaca 1394460
acctctggaa aagcagccag tgttctaac ctctgaggca tcttctctgc cccagaaaaa 1394520

aaaatagttt ataataata aatcaagtct ttaagaaaag agaaaaataa gctgggcggt 1394580
ggtggcacac accttaatc ccagactca ggaggcagag gcaggcaggt aatctctct 1394640
gagttggagg ccagcctggt ctacaaagt acacagagaa acctgtctt gaaaaacaaa 1394700
agaaaggaag aaaggaagaa aggaagaaaag aaagaaagaa agaaagaaag aaagaaagaa 1394760
agaaagaaag aaaggagaaa tgaaaaagaa agagaaaaat aatattttt aaaaacatgt 1394820
aaagatggga aatacacagg gcatctgtat cctgtatggt gctttgttga ctttgaattt 1394880
tttgaatgct aatgtacaga gaattacagc tgctgagaaa cagtggatta tgggagagac 1394940

tgctgaatta aactaccta tatactttag ggatatcttg gcttcagaat ggaagtggga 1395000
caatgtgttg tttgatctc tttatagttc aagatcagat ttgaccagag gagaccccat 1395060
gaaaatcctg gctacagaca taaagaaata aacctagaaa aactacaaga cagagcaaga 1395120
ggaccagtca ccaatgaaaa tgggtggccc aggtgatcca gcctcccaga gtgcctctgt 1395180
tgcaatttcc tcagagttct gtatccagag aagcttcaag tctgttggcc gagatggtgc 1395240
agcctcacag accattctag ttaggactac acataagcct tgcactttcc cattgcacca 1395300

agaatggaca acaaatgtta tggctagttt ccccagaact gggccattat ctcaatttc 1395360

 tcagggtccc ctaagatgc catcatccc agacaacagg aagcagtcta gagaacatga 1395420
 cacccacatt ctcaagaggt gggtagcttt tggttgtttg gtggatatgg atgttgtcat 1395480
 catttagggg ggttggttac aaattgctgg tcatagtcag ggagaaagct aaacaaagga 1395540
 aattagattc aagaatctct ttcaaaaagg aagaaggggg aatatagtat agaaatgatg 1395600
 gaataagagg gtggattgtt gagtctcctt ttgaataacc actattttac attggtatgg 1395660
 aattttgtat attgatacaa atatatgtt atattgtata tacaatttg agattatfff 1395720
 tatactatat atatgtttct attcttgttt aaggcattgt acctatgcaa ctcatfataa 1395780

 aatgtaaagt ttiagtcctt aaaagctatt taagaaaata aagaaatgca ggttagtagt 1395840
 catccataac aatcaatctt atagtcatgt taggtgtgtt ttcaaggtca tacaagata 1395900
 tattttagat aggtgatctt caaacacttc aaagacttac agaatatggc attfataaatg 1395960
 ttttaataac ataaggcttt tcataacagt gagacacagc tgctcctggc agcaccaatt 1396020
 tgcttcataa aaggatgatg ggccttgaag aacttcata tggagtttgc tttctttgtg 1396080
 tcaaaagcta gccatttgag caagaaattg ctgacagtat gctttcaaaa ttggacaagc 1396140
 aggacacaaa aaagacaact gccaaacttt gccaaaggcaa ggtaggacag ttcttcaaaa 1396200

 ttctctcttc atagaaaagt ctgtcagata tcttaggcct gtaggctgaa gatggatgcc 1396260
 ccaatattac aaaggaatct tgggatgact gtccaggtag tcagatgcct ctgtttttc 1396320
 ttagttttga aagttgtttg ctctgcattt caagtaatat tctatcttc ttggctctct 1396380
 gatggagtgg aagatgagat agttacagtt tttttgtta caaaattgag aaaaaattt 1396440
 acaaaagaga tgiaaaatgt ataaggfata gtgatataaa agcttaagtt gttgatctaa 1396500
 gaaaatgttt taaggtctaa aaagatagtt ttaagatgg aatataagtt atgatagaaa 1396560
 atggtttagg tataaacat tcatcaagat aaggtagata ataaagtatt ttctctgaat 1396620

 atgccaata caaatggact gaacattatg aatgcaattc gttaccaat aattgttctc 1396680
 attgtttata gttttattat gtaagaatta aaacctttcc tttttattta gataaaaggg 1396740
 gggaaatgtt gcagaatagt ccttiacact gtgtgaagat gtgtcactgt gattggttta 1396800
 ataaagagct gaatgatcaa tagctaggca ggaagaggtt aggtgggact tctggaaca 1396860
 gaaaggtctg ggggaagaag aaaggaggag tcaactagtag gatgcagggg aagcaagata 1396920
 ttcaggagac ataaaagcca agagctgggg ctggagagat ggctcagagg ttaagagcac 1396980
 cggctgctct tccagaggtc ctgagttcaa ttcccagcaa ccacatggtg gctcacaacc 1397040

atccgttatg agatctggtg ccctcttctg atggaagcag aatgttgat acataataaa 1397100
taaataaata aataaataaa taaataaata aataaataaa atcttaaaaa aaaaaaagcc 1397160
aagagccatg taacagcaca tagattatta gaaatgggct aatttaagtt ataagagcta 1397220
gttagagggg cciggagaga tggctcagag gttaagagca caaactgttc ttccagaggt 1397280
cctgagttca attcccagca accacatggt ggctccaac caccttgaat gagatctggt 1397340
gcataatgag atactaaatg cataaaacca tttaaaaaaa aaaagagtat aaaaaaaaaa 1397400
gagctagtta gaaacaaacc taagctaagg ccaaactttc ataattaaaa agaggctctc 1397460

atgttattgt ttgggagctg gtggtacaga gaaagacttg ttacatcatc ccctactct 1397520
ctagagaaaa ctcttcttcc caggaagtcc ctctctttgt gagtgacctg gtgaatttaa 1397580
ttagagtcgc ttacaagaat gtgcctggga ggttatttgc cagcacttgg gcaataaaac 1397640
ataaaaggcc ctttgtgtct ggcttctagc tagcatgaat tttcgagatt catctatatt 1397700
gtagcatttg gcagaactcc atttcatttt ggggttgaat tggcaattcc catcacattg 1397760
ttctgaggcc tctgccatct ctgccacaac ctgctgtctt cattacttat ttcttccat 1397820
ttctagtcca gcccaaaagca gacaagaaaa tctataatat gggaaagcta caagacaact 1397880

ccatcttttc aacaaattgt aatcatgtaa tttttttct atcaaaggta gttatcccaa 1397940
taagggtatg ttgtagaata ttaaagatgt gttacatttg tttatggggt ggaacatttg 1398000
tttaatgggt caaatatgtg ttgcatttgt ttaactctgt gaagctgtgt tactttgcct 1398060
gtctaaaaca ccgatttggc ctaataaaga actgaatggc caataacaag acaagagaaa 1398120
ggataggtgt gggctggcag gcagagagaa taaatagggg gagaatctg gtaagagaag 1398180
agatctagga gcaagaggag gaggaggact ccagggccag ccaccaact acacagcaag 1398240
ctacagagta agaagtaag aaaggtatat aggataaaga taaaagcca gaggcaaaag 1398300

gtagacggga caatttgaga aaatctgggt agaataaagc cacgctaagg acggacattt 1398360
atataagtaa gaataagtct ccgtgtgtat atttattcgg gagctggatg gcagaccccc 1398420
aaaagggaaa aaaaaaaaaac aaaacaaaaa acaaccaaca acaaggatac caaatgcctg 1398480
gacctctctt ttcccccttg ctctgattag cctactatgt cagattgtga agttgagttc 1398540
tcaccaatgg gatgagacac agtcactacc tatgtagag ataaaagaca gagaccatct 1398600
ggccagcatg ttccctgcc cagttttggt tcagggtgtac cctttttgca aaaagaatt 1398660
ggcaagttac tttgttttg tttatgtagt cctttgtggg aactgagat tattcttttc 1398720

ttacacaaca aaaataaaaa gtaagaggat gaggttaaag agatggctca ggggttgaga 1398780
aactgactg ttgttcagg ggacctaggt tcgattccca gagctcacat gttggctcac 1398840
aacctctgta actgattcta ggggatctga tgctcttttc ggacatctgt aagtaccagg 1398900

cacatatatg gtgcacacac atatatgcat gcaaaacatc catacacata aaataaagat 1398960
gagtggaaag agggaaagga gaagggagtg taacaaaggc agagaaggaa agaggattat 1399020
atatcagatg acattgcaga agcatgttgt ctaattacca aatacaggaa ttctgcttag 1399080
atcctgactc attaaaataa aaatttacac cacagtaaga atttgaaca tgaattagaa 1399140

attdaaaggt ctaaggaat agttgctcat ttggtaatg agctctgtat tattttatta 1399200
gacagagctc actatgtagg tccggctagc ctcaaaactca tgatatecct gccacagcct 1399260
cctgaatact ggaactatat gcctgtctgc catgctcacc ttccaagata ctttcacttt 1399320
gggttctaca taatattca tggaaataag taaggttgct tgtaagccta ccatcttttt 1399380
aactcttatt taiccatcca ttcatctcct cattttgtg gtgtctgtag aagccgagga 1399440
ggtttctcac caaatctgga acaagaaggc agtcagcaag cccagggaac ctctggtctc 1399500
cactctctgt tgctggtgtg tgtgtgtgtg tgtgtgtgtg tgtgtgtgtg tggccacaac 1399560

caggttttat gaggctggg atcagaacc aggccctcac acttctgcag caaagcattc 1399620
ctaccactg agccatctct ccagcccaa gtctactatc ttgaaggta aatttgttga 1399680
agttgaatga aaagcacag ggaccgceat ttgttctgg ttttttttt ttttttctg 1399740
atataaaat tctctctac caagagacc tccagacca ccctaccaa aggttgctta 1399800
gttttctccc cattactaat gtaacaacca ctctcttcc atctctccc ccccttct 1399860
atgtgcatg tgtttagat tgtgtattag ctccagaggt tgacatcaag tgcctcctt 1399920
aattgctctc cacttttga gacagtatct tgcaactaac ccaaatctca caattcagca 1399980

agactgacta ctgagcttag ggatccccct gcctcttccc tcacacactc cacctgctec 1400040
cccaactcc agcactgtga tgacagacac tgctggcct gtagtgggt gctggggatc 1400100
tgaactcata ctgtgcaaa tgaaccatct ccagcactca ctctgactct gtcttctact 1400160
aaacttacgc cactgtcact tcatacactc attagtgtat ttctctctac cggaatccag 1400220
ttccaacagg aataaatct gttttgtttg ttgctgtta ctctctggga ctatggctgg 1400280
caccaaagg tgtttaatag acctctactg cccggaagaa cgcattgata ggggggacag 1400340
ctaaaagggtg aaggcacatg ttagaaaatc acaaaagaaa tactggcaac atcaccttc 1400400

tcaaagatgc cagaaaagga agcgactttc aacttttagc cctgggggct gtggagctac 1400460
tttgggtgtt tgccatatat ccaattggct gcaaaaaata aactagattc atgattgtta 1400520
gcacaaacc ttttttgag tgaatctca tcaagagtcc atccagtatg taaaacctga 1400580
tagccaaaag caaatattt atttatagc ttactctcaa aaaaaagtaa aaattaaaaa 1400640
aattatccag tggttatgag gaatctagga aaacctggcc cagcaatgcc agtttggag 1400700
tgaagggtg gctagggcag ctgagaagtg gggttctctg cttggcagcc tgcttctccc 1400760

ttggctggtc ctgttttcca ggtgcggagg gtgagcctgg ccctgctggc ggctcccagg 1400820

 gcctgagct cgtcgtcttt ctctgagctc ttgacctgct ctgcttgagc gagtggagct 1400880
 ccctcatcaa gtccctctact tcccactgct cctccttcag cctccggcaa cagtgcaagg 1400940
 cagcagggtc aatgggatga gcctctgtgt tgaagatgta gccgccagct cccaggatgc 1401000
 attccccatg gggggtcadc acagagtcaa aggtggagcc gttgttgg atgaagtgt 1401060
 ttgggtgaaa cagaagatag aggtatttca cagtctcagc caggaagaat gactccatgc 1401120
 gattgtccag ctigtgtcc cggaggtcct tgatctgcca caggagagga agaagagagt 1401180
 cagaacgcac catggtttgg gagtaagggt caggcagccc agtttataaa ctgctctact 1401240

 aaatagctga gggcctttgg gtgaatcact tctcagagct tcaactcttc caagccacca 1401300
 tcacctctca cctgtgtaat gacaaaaact gggcttctgc gtctgccctt ccctatagta 1401360
 cacttagatt ggggtctta cctgacctt ctcataactc tctgggacat ctcatctcac 1401420
 acagactgaa aacctgagtc tggcggttcc ttcaggacct agacctgct tcctctctcc 1401480
 ctcatctctt cctacttggg tcttttctt gcagctccat ccacaaagca cactcatctg 1401540
 agtctttgtg agtattttta aacacagatc taagaagtga gggagccagc tatgaggctg 1401600
 ataggggaa caaaaaggaa gtgactcttc cctctgctct ctgccctct gcttctaata 1401660

 aggtcttttt gaactcttga actctgctgt ggtctcttta gccctttgta gctattccat 1401720
 cacctattca cattatata gaccacaga tggtcgatat agatagatct aactcctgca 1401780
 tgatgtacag tgtgtaacce aagaattaat attattatta aagattgga taaaagaaca 1401840
 tgtgtttgcc aatggatagc tatcaaggga aattgggact acttggaaag ctgcaaccaa 1401900
 cgacactgtg aaaagatadc aatgtgtcca tctgtttcca acacagtgt catgacaaac 1401960
 aatgacacat attcctgacc tgaccttcc ttatgagcat caggttttta ccattgtaaa 1402020
 taactaacta ggggttggct atagaaaatt tcaaaagttc acaagcagag atgtgaaaga 1402080

 cccccggagg ctcaggcccc caggatctct gcccaggacc acggcaacce caatcaccag 1402140
 gtggaggtga aagcttgatg caaacagcaa gaggctttat tgcagttgat taacgagcta 1402200
 accccatggt agctcaggcc tttcatccat ccaccatggc ggatggctag gaaagacact 1402260
 gcgaagccac ggcatagaga tattataggg cagcgttaagg ggagtgtta ggggtactca 1402320
 caggccccagg attggtgtgc ctccaagctt ggagggtttg ccctgtgttg attggttaac 1402380
 tggttgttat ggcccatagg ccctcccagg gtgattgcta tgctctgtgc atcattgctg 1402440
 tgcacttgtc cataaagcac acccagagcc ataaagcata gcaccaccag ctaactctg 1402500

attggttcc tgcacgagg caggcatctg acctcttagt gaccaaggca aggtcaggca 1402560
 agcactgcaa ggctgttatg gctgccgaaa tgggaagctg gtccttcag atgaatagga 1402620
 taatttacta caaatgctta ctttcagctt ctttagattca ccagtgcat taaacaaaat 1402680
 taattctcag tggacattta gcttatgcaa tactgtgatt caagtatgga ctcagtcaaa 1402740
 gaccaagtg gatcttctc ccagttgac aaagattgaa gggctgttc catcatgcat 1402800
 ctgggagac ctctggagg ccccttttc atggaaatgc ggttagctt cccagtgagc 1402860
 tcatcactgt gggtttcag agaactgagc aactgggag ccaaaacaaa cactgcttc 1402920

 actactgcat tcaactacgt cttctctatc aaaaaatgag tctagcagga agcagagctc 1402980
 agctgtagag ctctgcccga gaatacatcc agccctaggt tcaaatttag gaccatgaaa 1403040
 agaaaaatga cctatctata cttaaaaaaa taccaacaca ttaaaaattt ttgcaaaagt 1403100
 tttgtgttt tgttttgaat tccacacccc aagacaaact ctatagtctg tcaggaacaa 1403160
 gccagcttat ttacttagac atctgtttta tgtgtataca gggctgtct gtacctccc 1403220
 tgctgggtcc tataagggtg tcaacctctc tcaaggggga gctagtgtgt tatttctaaa 1403280
 gtacaaatca ggtcatggca ctgctctctg ttatggatcc taccccaaat tccactcct 1403340

 cctgtgccta caaaggcctt gcctgcgtca tctacctctg cctttctgg gacctcctt 1403400
 ccactcttc tctgtctac tctctctgt cttctttct gttcccaga cacagttgca 1403460
 ttatttttc aactaaatg taaactcatg agagcaaggg tctgggtctg cctgtctcta 1403520
 acctatggc tagaacaatg cctggcact gacagtcta cagtaatac cctgggaac 1403580
 agcagaactg tttattaagg agccatgtt tgaattatc gacttagat tatttattta 1403640
 ttattattta gaccaggtta ttgacttta gatttctct cttaaaaatc atttaaaaag 1403700
 ccctgggaca aaactttcta caaacactac tttgtaatc acatattctg acagataagg 1403760

 actgctggtg cagaggtaag ccaagagctt aggttctaac ccaccacgt aactaggcct 1403820
 gtgccattg taaaactcca ctatggttaa ttatgacaat tccagtaact acaataattt 1403880
 ggtttctgga agtggattaa cttgttctt tgaagtgtg accgcctgc cctgggggcc 1403940
 ccacgtagta gccaccagga aagatgttta tcacctaaca tttccaactg tetactcact 1404000
 gcttaccct agcaatgaca aaccacaaac caaatgaac ctttcaatc atcttcatg 1404060
 ctctctcct tgtgtctat taactacacc agcttctgag aagacaatgg gctctgattc 1404120
 ttacagatcc ctctctggac atcttcccc agaaaggcct gtgctgtctg actcactctt 1404180

 cccttacctg tcttctgcc ttgtaacct tcacacttc cactagacag tgacctcag 1404240
 caagcttctc tgttcatggt ttacaaccac tccttcagg agctaatget ccagcaccac 1404300
 caaatcacca ccatggcttc tgagcagcaa gaagctctta aacgcttacc gtggcaatc 1404360

cacattccac ctigtgatt ttctcaatgg actccacagc atctctcccg agttctaaga 1404420
gagtgggata ccctgtggca cggtagaggt acattgcgct ctcatgagc tctgaaaagc 1404480
caagcaaacc ttctcagtg ctgagcagtt atggcatggc gcccacacag cgaaggcaac 1404540
aaagcatgcc tcgctccat acctggctca ttgtgcccc ctggagagaa acatggcata 1404600

gcttttggga ctacttgca aactgcaacc aatgaaacca ctgtagctta tgaatttatt 1404660
atcaaataag ttctgatata attatggaaa gactgaaggt gtccatggtg ggttttcaga 1404720
gccaaagtgc acacatcctg aagctccgtt gagcccagca gactcccatt ccctggagag 1404780
acagaggcgg cctggctctg ggacagagaa ggtagaggag gttgtgacct gttccgcaat 1404840
gtctgtccc tgctgcccgt cagcagctca tgggctggc tgactagcaa ctactcccag 1404900
ctgagatgtg ataagaacag aacatggtgc catgaagaag cacttgttca acacatggaa 1404960
agctctggct atgatatcca gaaaaagaaa aaaaggttga ctaagaaaag tcagcttggc 1405020

atagtggcac aacttaaaa tcccagtcct tgagaaatga aggcaagaac atcagaagtt 1405080
ctaagtacc ctaccagta cagtgagttc agggctagcc tgggctacat gagactatgg 1405140
taaggggcte tagatatttt taagagtcct attctacacc acagctagat tatgatgttt 1405200
gaccaggggc ctttcctaa gctggatatt ggctaattggg aaggggcca ggtgagacta 1405260
tttaccatta aaaagaaaat acatttttc aaatacatga agaattttta tgggaaaaaa 1405320
aatgattttc tgctgtgac agccttgggt ggacagaagt agaactcatt gtgttttctt 1405380
ttttctttt gggggggcag ggccgggttc gagagctttg gaacctgtcc tagaactcgt 1405440

tctatagacc aggtgacct ccaactcaca gagateccat tgtctctgcc ttccgatgct 1405500
gggattaaag gcgtgcgcca ccacacctgg ctccattatg ttttctactt cggcactaac 1405560
tggttctcaa atcaatgaat ttctctctc ctccccaac atctctccat ctctttctt 1405620
ctttctggt tccttctga tggaaaggat cccacttatt caccateta ctcatctctg 1405680
cagtctggg agcagagaca gggctgtgca catgcgaggc acacccccac cactgagcag 1405740
tgtccagcct catctactct attttgaaga actagtctct gcctatctcc tcagatctct 1405800
ctcccctccc tctctgccc ccacagcct ctaaacaagt gctaatcaa ctgttcacat 1405860

cctagggtgc attccagggc agacaccaca cacagaaaag acagtctct cgtgggaggc 1405920
cttctctgc tgccagcagc tggctgggtc aaggccaact ttctctctt ctcaacatg 1405980
agcctagtgt gtgagtcagt gcttgcctgt atgctgtgtg gtcagtcca tgtgccttc 1406040
caccctaac tcaaggagct aaaggccctt acagtagagg acttcaggct aggttctgta 1406100
actgtcatca aagtcttata ccagggtacc aagcactagc cagcatagct acagaagagc 1406160
atcttctctc ccctattgt tgggggtgag gaagagtac tcaactatga aactcctagg 1406220

actcctggca gtgatgtgta tttccctctg gaaccttctt gccagccagt cctgcaaata 1406280

gagcaggtgc ctccataagc agcgagatgt ctctgggtgt gactagggca ggacttgaaa 1406340

actactgggt ccaataactg taggaggagt tcagtatgaa gggcctctct gaagccccag 1406400

tgctgaaact gcatctaaat atttgacaat gtagtcaaa actctgagtt ttattttatc 1406460

tcctggtaac aaaaaacatc actgatactt cccaggagtt ttcttaaaat aaataaaaaa 1406520

aaaaaagcca tgagaagctg ggcatgtgtg gtgcatgcct ttaatcccag aactcggag 1406580

gcagagacag gtggatctct gtgagttcca gactgacaag agctagtcc aggactgcct 1406640

ccaaagccac agagaaacc tcctcgaaa aacaaaaaaa aaaacaaaaa aaaaaaaca 1406700

aaacaaaaca aaaaaaagc catgagaaca aatgtcagag aaatcaag agcagcccta 1406760

gaagtcctg tatgtcattc ctgatccctc tactagtgtc attttactct tctctccctc 1406820

ccagggtgct aactcactg gggttagaag cagcagggaa tgggcagaga acacagaaca 1406880

gggaaaggca ctaggaaggc cagtcttgtg gctcaaaggg aattcagta gcaaggtggg 1406940

ggtgggcagg gtgaggggat gaaacttgat tgcccaaggt cccaggttcc accactccat 1407000

actgtggaag tttctttac acaaagcact cacagaagtg gcctacagtt tatgacgtcc 1407060

tgggtgcaga agcacccaag actcagcctc gctggcatct ctcttttgct catttctcca 1407120

agtttcaaag agcatagat ttagacagga aacctgggtt ctggtccccg ctctgcctt 1407180

ggctaagcca ctcaaccag ccagagctca gttcccatac ctagcaggaa aaccaccgag 1407240

agtgggtaga ggagagaaaa gctgcctggg gagcacctgt gaagggtgag ggtgtgaaga 1407300

agcagtgctt gcaggttggc cacggaccaa acacactgct tacctggtcg aagtggatag 1407360

ccttctcgct tctccactgt gtatccctga gcaatgttgt agaactctgg cagccccca 1407420

aactgcttcc atacagtga gtagtgaga aaggtcctca tggcattgtc aatatccca 1407480

ataaggctct gtggaaaagc agtggtcacc aaggtcagca gactcaggca ccgagtccat 1407540

gggtaaaaca tcaccatcaa cctcaaggga aagacaaagc aagccttgga agctaaaagt 1407600

gctattgacc agtcctaaag ttgatcactg actctatgca gccctgagcc acaaagtga 1407660

tgtcttgtaa gacataaac tcaacacctt ttcatacctt gctgaggacc cgagattaag 1407720

tctctggacc ttcttgacca gtgtctgcta ctttgggtgag ctgatccaaa tttctaagca 1407780

tagggtgaag ctgactgtgc taagactcat gaggtccca cacctccaac agacagcctt 1407840

gtccactaat ttctttaga atgtttcaa gtttctttat gcagacctaa gaaaatgagt 1407900

gigtgtttt cttacacagc cttcagtc tctctctgg tttctcca cacacaccga 1407960

gtaccacct tctgttcat gcagctgcac aggggtcagt caccagggc aaagtttacc 1408020
 ctgttctata actagacatt tggtttgggt ccagtccttt gctatttgcg aaaacaatta 1408080
 atgctgcaat gaatactgcc tatacatcac ttcaagcaca tgaaaatgta tctatctgta 1408140
 agacaaatct ccagaaacag gatttgggg tcagaggata tctgttacta gtaagictat 1408200
 ttaaagaate cttactttc tttctcttc tcttctcgc tccttttctt ttcttttcaa 1408260
 gacagggact taccacatga ctctgtctgt actggaactt gctatatagt gtaggttgat 1408320
 ctcaaaacta tagagatcca tttactttcg cctctcaagt gttggaatta aaggtatgtg 1408380

 ccacatggc caggtcactt acctatattt taaaattcta cttaagaact taaaaaatt 1408440
 aattattact cctactgggt tattatagtg caacagcaat cttgatttct ttgtgttcc 1408500
 ttgactcttt atatgtgcat gtgtgcatgt gtgtgtgttc ctgtgcctgt gtgtgtatat 1408560
 gtatgtggaa accaatagac agcctcaagt gttgatcctt agaagatgtc cccttgtttt 1408620
 ttgtggcagg tcctcactg gcctggagct cttaccaagt aggttaagtt tagtaagttc 1408680
 caggccagac aggactatat agtgaggctc tctcaataa caaaacaaaa caacaaccac 1408740
 aacagaaaca cagtacaaa actcaacttc ctcaacagtg ttgtgggata ttttatcata 1408800

 ctgtgtaaag atatgtcact gtgattgggt taataaaaag ctgaatggcc aatggctaag 1408860
 caggagaggt taggcaggac ttctgggcag agagaggaac tcggggatga atctaggcat 1408920
 gtaggagatg ccagcaagac acggaggaag tcagacgtac attatggagg acagataact 1408980
 agctacatgg caggatgtag attaacaaaa atggattaat ttaagttata agagttatcc 1409040
 agacaagtct aagctaagc taagcattca taattaataa gaagtttcca tgctattatt 1409100
 taggagctgg cagacaaaa taaagtccaa ctatataaca ctgtttcctg aacacaggct 1409160
 ttatgtttat aacacaaagg tagactgtct gttctcatag cctcttaagt gtctttctct 1409220

 caacacttgg gaggcagagg caggggaaat cagaagtca aggtcatccc ccattacata 1409280
 gtgaactcaa ggccagcctg gaagatatga ggtcctgtta taaaacaaag gcaaaactgaa 1409340
 ggcatggcat catttagatt acaaaactatt ttggtacatg aaatattgtg gtacaggcag 1409400
 ggaaggttag atgggctcca aggcccttt taattataac tctatcagag tggatcaggg 1409460
 aaaaaatca ggacagtggg cagagcagtc actgtgtcaa ggaggaaca tgaagaaat 1409520
 gcccagtgga aaaacagctc ttgccagtgg ctgttcttac ctggggcctg gagcaacact 1409580
 gcacattgct acagatggca ctacaccac agccactggg agctcagctc cttaatgctc 1409640

 cttgggaac catggaagg tagattcatg catctgtcta actcattta gttctttctt 1409700
 ccacacactg cccagagca ctcaaacac taaagttcct tatttgatac attagaataa 1409760
 gcttgcttac atcaccatc cacagaaaa tgatcacttg ctttgacaag tctactga 1409820

agaccaggcc agtaggcctc caaggactgg aagactggca tggatacggg gcccttgtag 1409880
 atctgcaccc agaggtacca gtcacgaag tgggtgtaat tccgaatggc tctgttgtag 1409940
 tctgcatcat gggagatcag aaaatggaca cagggtgattg aagagacaga caaaccttga 1410000
 caacagaagt gtgccattat actcttaaat gttgcatgat ggcctagctt tgaagcagac 1410060

 taggatacat tgaggaagc aactagaaa gaaacatggg ttcaaaactc catgctcaaa 1410120
 ttcttttcca cgtgctagct atgacctggg caaactctgc cctcttttagc ttcaggttta 1410180
 ttatatatta aattagggaa gtaatgtaat ataccttggg ggattattca gtcatttatt 1410240
 cattcatcaa gtaagtacct aactaggtat tcagttacca acaagacaaa gcctccccc 1410300
 catggagctg agttgaggtg acatttctcc cctaggatgt gcgtccaagg acttcagttt 1410360
 tgcgttctact gcagagtccc caacaccagc acagtgcaga ataatatgt gtaacaata 1410420
 ttatctggat gaacaaagaa ccaaatgcag acacaaattc ataagctatg gcaaaaaaaaa 1410480

 glaataagaa tgagacaaca catgctcaga gctgggccc 1410540
 acccaataac acatgctgaa taaatcaaaa gtggctgtaa taactattac tgtgagctcg 1410600
 acaagcttgc atggaaatta ttactagtgt tcagtggtct gaaaggtcaa tttttacca 1410660
 ccagataaat gtgacctact gcatatgaag gactaggaga aaccggataa tgagtaaggc 1410720
 agagagcaca tgcagaaaga ctcagcgtgc tctgaggagg agcacgtgc ttcctaggca 1410780
 ggacatgaaa ccaggcttta aaggaggaca gaaggtgaac acatgaagac aggaaataa 1410840
 ggagaagcaa agagcatgtg aagtggtaa gaggaagga atccagacca cagttagaga 1410900

 aagcagtgtc tcaggtggct cctacaggat gttgtatata ggcagctcct aggggttgtt 1410960
 gtgtagcagt ttactccaag attaaaacct tccacattgg agagaagccc attaagacac 1411020
 agaatgttag aaaaacaggtg aggcaacagg gacgttctaa ggggaggtga aacaatggag 1411080
 aaactcagaa ggetcaggaa gtgagcaacc caggcttcag gaagtcctg aactcaacca 1411140
 gatgactgg gccctccgt cagcaagaat atataagctg caagggtgc ttggagattt 1411200
 tctctgacaa gctgagttgc ctggaagagg ctgagagtgg tgccaagcca cctgggagaa 1411260
 gcagagcact gcctaataga agcgagggtca gtcaagccgc ctggagaggc ccagaccaca 1411320

 caagctgcct gcaagagact cttcgacctg ttgagctgct tgcaagttat gtggtatgct 1411380
 ccaggtttcc catactgttg cccatactgg ttcattcagt gatagactg tctctgagtc 1411440
 atttttgttc ctgtgagcac ctctcactga ctcatcattt ctgtaagtaa ccccagtaaa 1411500
 accctctggt tcacagaact ggatcttggg ggtgtccata ctttagtcac tggatcccta 1411560
 tctgggggtga aaaggtgttt attcatgtct cctcaggaac agtgtcacac aacaaaagta 1411620
 aaggtgggaa gataaagggt ttaaggttct ccttggctac agagaatttc agacaagcct 1411680

taggctacac atgagacacct gtttcaaac caaaataaat aacaaaaaca aacaaacaaa 1411740

aaaccctaaa acaaacacaaa ccataaaaca gaaaaagaaa gtttgaagag gtacagtgga 1411800

catcagcage ctccagtgac tctgaatgag gaatggacga attctatagg cacttggcag 1411860

taacgtgaca tacacaataa agcacaaatca acagcagagc catagaaaaa cccccttacc 1411920

ctgccctttt tacctagaaa catcgccatg agcttcttat cctgaagaag aatggctcct 1411980

tttaccaggt actcaaagta ggagtccaca cgggcccaca tgcttgcgtc ctgggccacc 1412040

catttgccag tgagcacgtc tatgtgattg ccaacctaaa agagaaacac aaggccaaag 1412100

aatgctctac cttagcctct gactgcccag tgagatgcca ggcgggcacc tcagtgtctc 1412160

ttaagacat gcaagtgtcc agtagataga aaagctggag gggagtgac acttcatcct 1412220

ttggacacta gcagatTTTT tcatcataac ttccaaccag ggaacaaaag cccccgatt 1412280

tgTTTTtGct gcttgagctt ggtgattagt ttgatcattc cttgtacctt aacagtgcca 1412340

TTTTgaaact ggaatgctta ttctatgcca ctatatattg tatatatgta actTTTTatt 1412400

ttatagcagc ttacagttaa gagacttcag aggtgttggg atcttcaaag actatgggga 1412460

atTTTTaaagt tagactatat tttagattgt gagcaaagta tggaaactta ggggaagtec 1412520

taagagtgat gtctgtgtgt caagttgaca aggattgaat tgtgatactg gatactgtac 1412580

aaccacatgg gaagggactt tcattgaagg atcgtctagg ctgcactagc ctgtgaggat 1412640

gtctgtgggg tGttctctag atcactgtta attgagacag aagacctgcc tcctgtaggt 1412700

aggacttctg tctaagaaga ggacctgtgt ctgtatgaga gaacagtaag caagctgagc 1412760

acagtaaaaca tgcaccattt aattcattgc tctctaccct tGtctgggga tacaatattt 1412820

aagtatttaa aaatatttca aagccattc caagttccta ctgcactaac ttccacacat 1412880

taaaccctag cctaggattt tGtGtctct tgcacatttt tGtcacagta ttttGttcca 1412940

gaaacagaaa gagatgctaa gacaatcatg gggcactatc ctcttatata ttgtgaggca 1413000

tggccatgag gctggaccac agctatccct tctgcacatc tctactgtgg agagacagct 1413060

cgtgtacctt tGaaaggact gacttagcat actagacaaa aaggaagaga gaatgatctg 1413120

aagtattcac gccgtgctta gcgtgagtgt agaggagaga tgagaacttg attctggaat 1413180

ctgtctcaga ctcaagacac cagtttGtga ctccagtgtc taaaaatcca acacagcgga 1413240

acatgaagca tagcagaagg gtatctgctt agcatttGca aggcctggg ttcaatccct 1413300

agtgtaaaaa agtcaaaagc acatcagctc acacacacac acacacacac acacaacaca 1413360

cacacacaca caacacacgc acacacgctc agttcccagc cacagtccac atctcactat 1413420

agctaacaga ttttttaaaa aatattttat ttatttatta tgtatacacc attctgcttc 1413480
 catgtatatic tgcaccccag aagaggccac cagatctcat aacagatagt tttaaagttg 1413540
 gattattatt attattatta ttatcattat tattattatt attattggtt tctcaagaca 1413600
 ggcttctct gtgtagctct gaagcctatc ctggcacttg ctctgtaacc caggctggcc 1413660
 tcgatctcac agaaagcctc taccacctaa gtgttgggat taaagtcatg caccatcaaa 1413720
 gcctggtgat ttttattatt ttttaaatg agtattacta ttttcattct atatatgtct 1413780
 gtctgtgtgc atgtgtgtca cacgtgaatg ttgacaggcc aggggtgcaca ggaatggtac 1413840

 aggagagagg ggtacagaca gggactaac caagtccacc acagttcaa ggctggagct 1413900
 aaatctgcct gcattggact aaagatgctc ccatgggcct ctaggatggc atctgaaggg 1413960
 attttctga atcctcagac aagcttcact ctctaagctg acttcacacc aaactttaca 1414020
 taaaatcact ttcaaaaaca caaggagctg tagtgtctca gcatagtgtg ccttgtttgt 1414080
 ggtttttgtg agtttctatg tgtaacagtc ctggctgtcc tggaacttgc tctgtatacc 1414140
 aagatggcct caaactcata gagatctgtt gtgggaattt gaccattcag tctaatgacc 1414200
 aatggcatgg agagagtgc cccctaggt ctctgagagt gacccctaa gaagcgtgag 1414260

 aggagggtt agtgggtctc ttggcgtgga aggcttctg acgctacagc tcagtacct 1414320
 ggtccagacc tttcccac ctttctagt ggacaaagag gcagcgggtg cacttcatec 1414380
 tgtattggtg agtgtgttat ttccatttca tccttaata aataagtctt catcctagac 1414440
 ttccagcagc atagctttta acacacttac atcactgctg ggatattctga gaactggagg 1414500
 ctgaacgac ttgaagcagg gccaggactt gcatctaggc tgaactgaac ccagagttac 1414560
 tgcctgact acictggatc aatgactatt agtgtcactg gcttatecct tgtgggatgt 1414620
 gaaattagat ttggggatta gctggtccag aatgttaaat atccatttgt taataggaac 1414680

 tgaagggaaa atgatgatct ggggtcaaat atgcttggga aatattaagc aaagctagag 1414740
 actcctttac cattgcattt aataactttt attctgtcca agttctttgt gactctaaag 1414800
 gaaagcaaaa acaaaaaacc tggtagcata tgcaagaatt ccctaattta actgttcaag 1414860
 aatTTTTTTT ttttcataga actcaacatc tctcagtct ggtgttctag aaaacacagt 1414920
 tttgcaatgc caatagtcat tggaggccag gtgaactggt aatccctggc cagtgagtca 1414980
 ggggtgtgaa gtatatgact cctgcctaga agaaagaaag gctcaaagta caacatagcc 1415040
 ctgttccaag gatgagcaat ctggetctct tcctcttgt gctagccagt tttatgtcaa 1415100

 cttgacacag ctagagtcatt tttggaagag aggacctcag tgagaaaatg ttcccactgt 1415160
 gggcatcttg acggaagatt gatgcagaag ggcccagctc actgtgggca acataacccc 1415220
 agggctggtg gtctgggtg ctctaagaaa gccagctgag caagccatgg ggagtaagtc 1415280

agtcagcagc actcctccat ggcccctcca tcagttcctg cctccaggtt cctgccttga 1415340
 attcctgccc tgacttccag ggatgatggg ctacaagatg taataaacgc tttcttcccc 1415400
 agctgcttct ggtcatggtg ttttatcact gcaacagaaa tcctaagaca tctctgtggc 1415460
 aaaatgtaaa tggctcagtc ttttttggg atcctggacc actcctacaa acacagttaa 1415520

 gattcctttg gctgacatct aactcattcc ttagacctct ggggtctcata aggggggtgg 1415580
 ggggcaacac agaagcctta gctgacacaa gaaaggcaac tgctgactta ccageccaat 1415640
 atctgaccgg ctctcccaga ggcgcatcag ggccaatctg gccacatctt caaacacagg 1415700
 gtccaccagt aggctgctca ggggtggcaaa ttccacaatg aagggtccaa tgctctgtgt 1415760
 acaggtaaca ggggtctctc ctgggttcac accatgaagc aggttcacag ttccataggg 1415820
 catgcccggt ggggtctgaa atgctaaacc atcagaaact tatgatttta ggtcaaagga 1415880
 gagtgagatg ggtgggttga tgatagacc aaagcttcag gcttcaatca gccttcttac 1415940

 ttttttecta agtaattgct tgtgtcagag tcagagaaag atgtgtctcg ctgtaggac 1416000
 cttaacccag atgcagacaa aactgtgct atgcaacctt tggctccac tgtgatgagg 1416060
 tgacctgcag agagctgagc tcccagctgc cacactccac accgcacaca actttttatt 1416120
 tattttacta ctttatctc acactatgcc ttccatagcc agttagataa tggagtgtga 1416180
 agtaggcaag gcttatgttt tatgcagtac tgaggcccca ctggtaatca ctctagact 1416240
 ctaccaaac aaaacagatc agtagagggg tcaattttag atccctgatt taaataaaaa 1416300
 gttcagggac aaaatattat tgttgttgtt gttgttgttg ttgttgttgt tgttgttgtt 1416360

 gttgttgttg ttgttgtgt tgttgttgtt gttgttgttg ttgttgttgt tgttgttgtt 1416420
 gttgttgttg ttgttgtgt tgttgttgtt gttgttgttg ttgttgttgt tgttgttgtt 1416480
 gttgttatta ttattattat tattattatt attattatta ttattattat tttgagtttt 1416540
 caagataggg tttctctgtg taacagtect ggtgtgctctg gaacttgatc ggttgagcag 1416600
 gctggcctct aactcactgg gatccacctg cctctacctc ccaagtagtg ggactaaagg 1416660
 tgtgcgccac caccgctga ctgacaaagt tttttttaa ataaaatcta aaaataggat 1416720
 acaaaccaaa ccaatgatac tatacaacc cctactttca ggtaggggaa aatcatgcct 1416780

 gtaacaagt actcagctaa aggtcacata ggagagtcac actgagggag ttggaatga 1416840
 ctgtcctgac cccaccttt caaatccagc ccagtgttt gcctatctta cccatgcct 1416900
 tctgagtcca gggaagaact caacaatgag cctaacatag aaatttctt tccagccaca 1416960
 aggcaagaga cagcagagca gtctgcacgt caccaaattg caaactaatc tgtcaaaact 1417020
 tctaagcgtt acaaggtcca gacactttgt ctgcaggagg aatgaaacct gctctctgac 1417080
 acacagcaag ccaggaggag tcataagcaa gaagggtcc ggagtathtt agggccaggc 1417140

aggaagttaa aggaagggtg tgagaatcct ctttcttgac ctacagagga gatacatcgc 1417200

 tgcaggctta ataattactc aatatgaact ttagaatgcg tgtattactc agtaaaaata 1417260
 atttttaaat gagaacaaaa cagaaggcgc aataaggcag ttttctccag ggatgaatca 1417320
 cacaggacat gatgtttgtg aggagacacg tggccgtgag ccatgggcta taagacctga 1417380
 gcccagctca ccctctttgc cgggcctcc ccagggttga cagacaaata agtgagatgg 1417440
 ccaaggagcc agtagaaggc acacaacagc agtcatgtgt ttgggtgtga agagccctag 1417500
 acttctacca cacccaatag ggaacacagt gtccagctga ttctgctgag cccaacttg 1417560
 atgacccccc tggatacaaa cacggaggct tggctcatag ttctgaacat ggcttaacca 1417620

 ccaaaaccaa ttctgccat ctgaagcttg ctaagcatct gctgtctaaa ctgagcttag 1417680
 ccttcaaaa gatacatcta gcaggctacga attacagttg acagagaaac tgaccacagg 1417740
 gaaggagagt gacatggcct agatgctggg tggcagagga aagcctagaa cctggagccc 1417800
 taatgctcag accatagcta gtccctgggg ccctcttatt ctggtagcat gtggcctggg 1417860
 gggggggcaa gcgggctcac tcaaaaataa tgcaagggcc atggaacctg tgagactcgc 1417920
 ttttggccta taccagcaaa cagtagtagc atcagcgtag ccatcctggg ccaacacccc 1417980
 cagcaagccc ttaaaatgct tagaactcct ctgactttaa tagtgagaac tctcctgatt 1418040

 tctatagtgg atggcttcta taggggcaga aatacagatt ggaggTTTT aaaaaatcaa 1418100
 aaatcagggg aaaaatctcaa cattgctatc cttatctcca gcaagcaaag taggattaga 1418160
 gcagaagtgt ggtacacacc tgttaactca gcacttggaa gcagaggcag gactataaaa 1418220
 agctcagggg tgagccttga ctaccagta agttacgggc cagcaagagc tacatactga 1418280
 taccctatct cgaaggaaga gaagaaaggg ggaggggcta aaagaaaact gtcactttcc 1418340
 agtgccccc cccattccat cccagctcc taccctcac ctctgcccc tctctgctg 1418400
 gctcttacct gggaggagt ttcgggctgc ttctcagcc atcctgagga ggggtccaga 1418460

 acagggccat ccagcttcta cttccacacc agccttcttt gacagcagat gagcagagag 1418520
 gagccctcct accactacag atggcacaaa acacaagggt ctcatacaag agatcctacc 1418580
 ttgaaaaaca acaattcta ttggtttcca tagtgccaaa aggtgatata caagccagag 1418640
 aaaatagatt taccagcag aggacctga atgctacgac tcttacctgt ccgccaagat 1418700
 aagtccacag gggtaatagc agcatgactg ctgtggagca accagccact ttgtgactgg 1418760
 atctgagggt tgctccaaag gaaggaattt atgtctggta ttgtacactt gatcaaaagc 1418820
 ccacggttgg gaaggtcaaa ggctcctagt gggaacctc atactgttgg gttgatgaat 1418880

gaatggacat gtcaaaactgc cttctaaata gttatttggg tacccataca ttagtgctgc 1418940
 aaaaaggagc ttctctgaaa gttatcagta tgataatggt ccacttattc tcaatgcaga 1419000
 gaatcataac tggccaaagt cctgagagta agtgactact gcgtgagtgc ccagccatca 1419060
 acagaatgtc tatattgaac tccctcaagg ccaggaatg tcagaaaagg gactggaatg 1419120
 aatgtaagag gcaaggatg gagagcagtg ctgtgaatat ggcatggtca ctgcactcgt 1419180
 gaactcacag cagctatggt tatctgtaca agatcaggct ggtaagcatc ccagcctgaa 1419240
 ggggacaggt gctcgtgagc ctccatccct agcggatgaa ccaactggtaa ctggtggctg 1419300

 cgagggttt ggccactggt aggttgccca tgctccagtg ggtgaccaca ctcatgtgca 1419360
 ggccagcattt actagatatg aaggctggaa gaggaagtac tgggggtggt tctggatcca 1419420
 gtgagaagag ggattccagt tgcataatgac caaggtacat tgtatacatc tatgaaatta 1419480
 tcaaagaatt cattttaaa gtgagttacg tacggtatgt gctgccaagt atgacaatgt 1419540
 gggttccatc cccaggacc agtagtgga agagaaaatt aattccccca agttgttctc 1419600
 tgatcacaca catgctacgt cattgtgcat tcacacacat ccatacaata aataaataaa 1419660
 taaatgtact acaactttaa aaaataaaat actctaaaac agtgattctt aaccttcta 1419720

 atgctgcaac cttatatag tcttcatga tgggtgacc ccaaccataa aattactttc 1419780
 gctgttactt tataactgaa attttgttac tgttatgagt tgtatttga atatctgata 1419840
 tgcagggtta ggggtgacacc cccagagggg ttgcaacca gagatcgaga accactgttc 1419900
 tagggctgga gagatggctc aaaggttaag agtgggggct cctcttcaa aggtcctgag 1419960
 atcaattccc agcaatcacg tgggtggtca caaccacctg taatgagatc tgggtgacctc 1420020
 atctggcctg cgggaacaca tgcaggcaaa atactgtata cataataaat aatctcttt 1420080
 tttaaaaga aagagatgag aacctgtt ctaaaacaaa caaagatcat tccttaatcc 1420140

 caccaatfff ttcccttggg ggggtataaa aacaatggcc actctttgaa gtccccagta 1420200
 cagacaaaaa ttcaggact acatcccccc tctgcagata caaatftaa ggttctgaga 1420260
 agcaagtggc ttgccctggg tcacctatgt gacaggtggt agacatctgt ctcaattcag 1420320
 tgtgtcactc ttctgtcacc tgttgcccgt caggggtga gaagacagct gtcattacc 1420380
 ctatgcgaca ggtgggggac atctgtctca ctgcagtgtg tcactcttct gtcacctgtt 1420440
 gcccgtcagg ggggtgagaag acagctatca ttaccctat gtgacaggtg gtaggacatc 1420500
 tgccctcactt cagtgtgtcg ctcttctgcc acctgttgc cgtcaggggg tgagaagaca 1420560

 gctgccatta catcacatga tattcaggat gtacaacaag acagagatcc tgtgactgga 1420620
 aataaggctg accagatacc aggaagtgag gaagtgtcct ctgacaaaaa ataacctgag 1420680
 acctgagct ttagttttcc ctttctctg gctaagaaga actgaggaaa aggcaggact 1420740

gggccaaaca agtcctctga taagaggtct ctgcatgaag cgggccctca aagaattata 1420800
 cattctatgt aagaatgaat taagaatgga ccttgcatat atccatgagt ggacattagg 1420860
 aaaattacag gcctcaaaca ctggaaccaa gtcaaagtaa gggggttatg tgagagccaa 1420920
 agttatgttt taagttttaa ttaagagatc cgtgcctaag agagccatga aacaaaaatg 1420980

 tcactgatct gcaagccctt tgccaagga cagctttact tcctgaaatg ctggaggttg 1421040
 ttattaatgg gagataataa gccacttctt tttgcacccc taaacaagtt catttgactc 1421100
 cactgcacca gatgcacgtg atcacacata ggtaggaggt acaaaggcag gaaatatgct 1421160
 agagtatatg cttgcccttg actggatata ggtgcatga gctggtggaa tcaaacttgg 1421220
 gtccctaaag aaitcatttt aaaagtgagt tacgtacggt atgtgctgcc aagtatgaca 1421280
 atgtgggttc catccccagg acccagtagt ggaaagagaa aattaattcc cccaagttgt 1421340
 tctctgatca cacacatgct acgtcattgt gcattcacac acatccatc aataaataaa 1421400

 taaataaatg tactacaact ttaaaaaata aaatactcta aaacagtgat tcttaacctt 1421460
 cctaagtctg caacccttcc tggatatagg tgggaggtaa acaggcagga agtacatcag 1421520
 gatatatgct tgcacctgat tgaacttcat ggaagtatgg tggtagcctt atgggtttgt 1421580
 ctttataaac cttagcaaaa tgtgactcaa gttgccattt tctgggactc ctggaccagt 1421640
 cctgaccaga gttcatcacc ctggccagta ttaattaaa gctcattca aatttcactc 1421700
 aaaaattgta caattggtct ttctcaattc tcaggtttaa gagttaggaa aaaaaatccc 1421760
 caaagaggta gtgattatcc acaaatTTta cagtctgaat tcacatgaac tcaatggtct 1421820

 agaaaacctc aaaagttagc ataagagttg gcactgtagg agcctggaaa gtttggggtt 1421880
 ttgttagtagc agagatcaaa cccccagcat aaagaggggc tttgtaggta gtacctcaag 1421940
 tcacatggca gaaatcaaca aatgtatct ggaaaaaaaa aaaaaaaaaa aaaaaaaaaa 1422000
 aaaaaaaaaa aaatTTtgaa aaaaaaaaaa aaaaaaaaaa aaaaaaaaaa aaagctcatt 1422060
 ccatccaggc ctctaagaag ccaattggtg aagtctagga aatgaccta tagtaataa 1422120
 tacaataaag acttttaaat cacaaaagca tgtggaaca aagctcatga ataacaacag 1422180
 agaagggtgc accaccactt cagatgctgg tgttttact cagagaatgg aaaatcctca 1422240

 tgagaaatat acttagagaa atgaaaaaaaa gtgggtatag aaagacgaag caaaaaaaaa 1422300
 aaaatagtaa aaaagattga ccagtcatat ttacaaaaat accatacaga acttctaaag 1422360
 ataaaaacac aataattata agtgaaaatc acatgattta ctagtacata aaccatacct 1422420
 gatgaaagac cttagcagact agcagacagc caaggttaaa gttatccaaa gtgcaatatg 1422480
 aagatacaaa atggttctta gatacaagag caatTTtaggg gacaaggatga gaatctagtt 1422540
 gaaacaaaa taggtaaaa agaccaaga atcccaagca agataaaaag aaaccacat 1422600

tgatatacat taataaacac attgttaatg tatatattgc aaaacgtcaa aaagagataa 1422660

 gatccttttt tctcactttg ttaccctaaa taaaacattt taaaagcagc tatagtctgg 1422720
 gtgacaatgg gtgatggctg ctggactagc ttctcagggt catgggtaaa attacttaaa 1422780
 attgtccaga ataaaaataa ttttaaaaag gacagataca gtaaaaataa aaaacaaaag 1422840
 catagttatt tatctacaaa gaaatgacca tgagattgat ggattatttc ttaacaaagt 1422900
 aaaagcagga aatagtggaa aatttctttg atagactaag caagagaaaa taatcattaa 1422960
 cagtggccat acatgcagaa aaaactctcc caaagaccga aaggaagcga gacaaagaca 1423020
 ttttcgtgta acaaaagcct gagaaagttt gccaaagaca tatccacaca cagggaatt 1423080

 ctaagttct ttagagaaaa gatggattgc acataataag gcctgagtca ctgaagctaa 1423140
 gactgtcaga aagggtgtaa cagggtctgg gagatgcaa agtttgtaa gattttgcc 1423200
 tgaagtatg aggatctgaa tcctatccta atactcatgt aaaaaagtga atgtgatggt 1423260
 acacacttgt aatcacacac ttgtaatccc agtgccgagg aagccgacag gagattgctg 1423320
 gggctaatag gcccgccagc ctagcatagt cagcaagccc caggctctaa tgagagaccg 1423380
 aacatggaat aataatacct gataaataat accaggatct gacctctggc tatacacgtg 1423440
 catgcacact tgcacaaaca cacacacaca cacacacaca cacagtgggt ggggtgggt 1423500

 gttaaatatg tgcaactaa aactataaag tactaaaata tggaacatgt ctatgtctat 1423560
 catttaggaa gagaatagag attttctact acttctaac tttgataagt tattttgtct 1423620
 atttgctgag aactagaag ataccatgca caatttcaac attaataaga gaaaaatgaa 1423680
 aactgggtgt ggtggctcat atctgtgttg tcagctagag aatggctttg actttaaggc 1423740
 cagtttgtag taigtatgga attgtaatac ggctttggca acgggtgag accatgtctc 1423800
 aaaacaaaac aaaacaaaac acaaaaacaaa acaacaacaa caaacaccc gaactatcat 1423860
 ggtgtagtgg tgcattgtct taaaccagc actaggagg cagaggcagg cggatactta 1423920

 agtttaaagt cagcctggc tatgcagcca gtttctggac agccagagt acatttgaa 1423980
 gctaaatctc aaaaagtaaa aaataatgaa agaaaataaa ccaaaccaaa aaaccatttc 1424040
 catccacaaa gataacacaa cctccacgga agcagttaca ctttcttgt tccaacacca 1424100
 aataaatgct atttactctg ggaagggggc agcgtgtct gtcactagtc tggaccagtg 1424160
 tcctgaaaag gtgactctg aagacctcat ttaccattct agttgtcaga gacaactcca 1424220
 atgtccttc atgcaagccc tagaaggtgg ccctcacctc ggatgttggt ttcgaacaca 1424280
 gaggcgttca cgtcgatac aaagtccag ttgtctgga gaacctcac cactctttgg 1424340

aattcagagg tattccccaa aatctggaat gaaagagtac cctgaccaca cagctcccct 1424400
aagcatggaa gcagttcaga tgctggtgtg gtcttcactt ttcagtcaga acctctctgt 1424460
cctgagttca gttacattat gccagcattc atacagaaac ccctagctga gcaatttctt 1424520
ggtccattta aatggatccc ataaaaataa agcagggatc agtagtagac accagctggt 1424580
tgtagctcac ttgtccttc cacttatgc aaaacagtat cagttgcttc ccaatcttct 1424640
ttaccccaaa gcctcctgcc acagagccca agcacccttg ggttccttta ctccaagagg 1424700
tcaccgtgtt accatactgt gatccttgta acatatacct ctgggaacaa atcttttctt 1424760

agtaacagac acggccagca cggtttttac ctggccctac ttttctgact tgaaagcaga 1424820
catgatttct gtagggtagc agctatgttt caccctgggg taaaaagcgt gagaataaaa 1424880
ccctaagcaga gagaggagga agctacaaag agcccaagtc tctggtgaca tagctgagta 1424940
gctggtctcat tactaggaaa aaaaaaaaaat acctcttggc ttcttttttc ctttctttct 1425000
ctttttgaaa actttatctt attttgggg tttgagtggt ttgtctccac acaagtgtgc 1425060
cacattcaca ctctgtgctt ttggaggcca gaagcgggga gttgggggct ggagagaggg 1425120
ctcagagggt aagagcacca actgctcttc cagaggctct gaggttcaatt cccagcaacc 1425180

acatggtggc tcacaacat ccgttatgag atctggtgcc ctcttctgat gtgcagatat 1425240
acatggaagc agaatgttgt gtacataaaa aaaaaaaaaa atctttaaaa aaaaaaaaaa 1425300
aaaaaaaaag aagaagtggg gaggttggatc tcttagcact ggagttgtga ggcacatgt 1425360
ggatgctggg acccaaaccc agggctctta accactgagc catctctcca gccccaaac 1425420
gttaggctta aaggaagggt cgcatcttca ttcagctttg tggttcttct ccatttgagg 1425480
ttggtgggga ttgaacctat ggcctcatgc atgaggcaag tattctatca actaagccat 1425540
atctctctct ttcttttacc caggaaaaga aatctctggt taaaccacca gccaaatgct 1425600

atagataagt gtgtctacat acacatatat ggtgtatata gatacataca cggaaggaga 1425660
gagcgtgtag ggaagagaga ggggggtgga gagagaggcg gcagggtggg ggggaagaga 1425720
acaagcttgt ttgaaatgtt ctcatacagt ccatgctagc ctctcataca gccaggcta 1425780
gcctcaaac cactacataa ggcaacaatg gccttgaact tctgatgttc ctggggttgt 1425840
gacacatga ctagcttgat atataatagt gatttttttt tctgctaata tcacctcaa 1425900
ttccccttga atactcttc tcccatagt atcccaataa ttcaggagag ggggatccca 1425960
tgtccccagc tgtggagtgg gtacttcagt gggaccagcc aaggtaccac atcccttccc 1426020

cagtgagact gtttggaaat acatatgtga tccaaatctg atcaatgaag acttactcct 1426080
tggatgaatg gaaagggtga ttctttgaac gtaactgttt cttaaactag gaagtaattg 1426140
gaaagacaat aggctgacct atggcttatg aagactgaga acacagcagc caagataaaa 1426200

gacagagata aaaggtgaaa ggagactcct actagcgtca ttgtctgtct ggatcaggtc 1426260
gaaggccagc cttcatctag acttttttagt tatctgactc actaagtttg tcttcttgcc 1426320
taagttagtt gaattgagcc tctgcaacce aaacaatttc tgactatttc aacactagag 1426380
ctcctctagg actgggaacc aacctacctt ctggcctctc tctctcactg ttcaccttca 1426440

tctgcagtaa aactgtgccc atttttctcc aattttctac tgttttctcc ataagaagtc 1426500
aagtactcat agtcttccat ttataaacc aactcatcac tggcgactgt cacctgctct 1426560
acaatgcctc ttttctttct ttttcctta agaaccctat gaactccatc catactactg 1426620
ttaggtctc tctttcttc tacattaaaa caaacaag agaccttga aatggcagag 1426680
gcctcattca tttttgtatt tcccctaaagt gcagacacag gaaaaaatta cttgacaaat 1426740
gtttgttga tgaggccaca aatctttctt cacattgcgt cagtgaaatg tcaaagcaga 1426800
aatgtcatca cttccttata cttaagaaat gccagtggct cttctatact ttcaaatgaa 1426860

agatcataca cactgaagaa gagcttacag tctccagatc ccacataacc cccagtgtca 1426920
cttgttccct cctctctccc catttccaat caatgcttca atctctgctg ccacaaagcc 1426980
tttgactag ctggcctgga acaacttctt ccagactttt cccagctacc accagcttct 1427040
tcaaattcca actccagttt catatcactg cttcagagaa cttctcccag cctcctcagt 1427100
ctaggtcaga tctttttttt ttgggggggg ggtttatttt gagacagcgt ttcttctgta 1427160
tagctctgac tgcctggaa ctcactccat aaactaggct agccttgaac tcagagatca 1427220
gcatgcctct gcctcttct tccaagtgtt gggactaacg ggtgcaccac tatgcctggc 1427280

cagatcattt ttgttaggg tctttccaat acaaagctct ggctgagtg tgtaattatc 1427340
atcttttatg gctatcattt gattctcagt gtgtttccgg tgctaacatc tcaagcagag 1427400
gtcatttctg tttaaactca tcatttgac tccaaagttt agcaccatgc ttggtgcata 1427460
gtttccctca ataactgttt gatgaatagt taagaacata caaattacca gtaaacaaaa 1427520
attataagac aaaccatatc tatgtagtgt tcagagtcac ataaatatta tagatgtata 1427580
aagatgagaa gtggccaggc atgggtgtaa atctcagcac gtgggaggct gagacaagag 1427640
gactgccaag tttaggtct gcctggctaa acaacaaacc tgtgtgtggt gcacagaaca 1427700

gaagacaatc aaggattgga gtcacacaaa attaagtta agtctgagtt ccacttttag 1427760
ctttctaagc atcacatttc ccagctatag gaaataataa gaccataaga attactggaa 1427820
ggattaaatg tgataatgca tgcatgtaa tttagtaag aattaattgt gacaaactgt 1427880
gtagaagcct aggttccag caggtagcac tttttgaga ggttatcgaa accttattaa 1427940
gtggacctag ctaaaggaag taaatgggaa aggggtccggg aggggggggg tgctttgtcc 1428000
ctgacctcc tctctctga tctctgttc ctatccacca tgagacaaag aagcatgtct 1428060

gctacattat tgcccaagca catggggctia agcagccatg tactgaaacc tctgaaaccg 1428120

tgagcctagg taaacccttc ctccctttgt tctcttgtgt ggccatagca atgttaaca 1428180

ccaactagta caacctttaa aggcccttagc acaagccata cacatgacac agtaactagt 1428240

gctgttatca tcattgcaca tggcggatgt caaagtcttt gtgtccctca ctgagctgtg 1428300

caagtctatc acaggtcctc tataaatatt tgctcaatga ctgaacctgt gtaagtgggt 1428360

tttctcttgg aacttggcat tctctcctat gcaattgggt aaccagagcc tgggtgctca 1428420

gaatcatgag ataaagacct aggggaggaa tttacttctt acccacagac aagctaccaa 1428480

aagaggaagg atgttgggtg ggcaatgata gagagggaaa gaaataggat aggatactta 1428540

ccagcaaggt gtccagggca tcaattagcg tcagagagaa gctgtaaaa gacaaagtcc 1428600

caactgcttc ataagaacat caaacaccag attcataact tcccagatca gattcaccca 1428660

aaactcaaag aggcccagtg atgtccctat ctatcccatg tatagttaca atagggaaac 1428720

cagggggaaa aatcagagcc ctttgactac ctgatggagc tcaactgtaa ttaacattta 1428780

cctatgttcc ctggcattct tctttacat ggaggggcag tacaagatcg taacatatta 1428840

aaagttagag aatgctcaag gctgtgttac ttaacatcaa aaagctagaa attactggct 1428900

gttcacaagt tgaagagtgc tgaacaaact atgatacaaa caaatacaaa tctatgacat 1428960

tattaagaca tggttaccgg aattctgcat actaatgaga agatcatgct gttcaatgaa 1429020

aaacaccata tattaagtaa gccacataat atgttttcat ctgcacttca aaaaaagaaa 1429080

agccacatta gtggctggag aggtggctca gtggttaaga gcatttatg ctcttgcaga 1429140

gaacctgcat ttgattccca cagcaacatg ggggctcaca actgctggca actgcagttc 1429200

cagggactct agtcaggagc cttcacaggc tctgtctcac atatggtgca cctaaattca 1429260

tgcaaaaaca acacacatac cattaataag atttaaaaga gtcctactga cagaaagcag 1429320

atgtgctgct gttagggcca gtattagtag agaataatt tataaggtgt gcttgggaat 1429380

tttttagggt aaagaagtat tctagggtg gagggaaagc tcagaggta agggcactgg 1429440

cagctcttcc agagaacctg ggttcaattc ccagcatcca acatggcagc tcacaactgt 1429500

ctgaaacccc acttacaggg atctggctct ctcacacaga cacatataca ggcaaatcac 1429560

caatgcacat taaaatttca aaaaaaaaaag tattctatat gctagtgtg gtagtggtta 1429620

ctatacatth aaaaagggtt attttttata tggagtatat aataagctac tttttttta 1429680

aaacaaagt aggctttaat aagtttaatt ttttacaag atagccaggt ctggtatatg 1429740

cctgcagtcc cagcactggt aatatggctg acacaggaca cagactgtgc tacatagcaa 1429800

gatcctgtct caataaacia ataatacatc tatgcacatg tgtctaacag tataaatgag 1429860
aatactcgag aatgccatac aggacaggtt gcggtgccag cgttctaagg aatgagagac 1429920
accaagcatg actctgtact acttcaatag ccatttgctt gtatttactt tttgttccaa 1429980
ctaaaaataa aaaatggcac aagticttag ctacttctg tagtccttgg catcagagag 1430040
catgctatca tttataaata tttgttaaac aagaataaca acccagaagt gatggtgaac 1430100
acctgtgatc tcagcaactg ggaggtggag gcagaagcac caggagtttg aggtcatcct 1430160
cagctatgca gttgagtttg aggtcggcct gggctacgtg ggacacacac acacacagac 1430220

acagacacag acagacacag acacagacac agacacagac acagacagac acacacacat 1430280
acacacacac acacccagc cctaattccc aggagtggta agagaattaa atggggcgac 1430340
tctgaaaaac atgtggcaca gtgttcagt tctgtgaatg caaggattct tcaactcagct 1430400
gggtttttat tctagtgaat atgaaaaatg tgacaataca agaattacta aaagaaacga 1430460
atcaggtgac ttgtttgcat ggtgtagga gctgaatctg gggaggtgat agagagatgg 1430520
tcacatgaaa cagtggtagc aagatggagg ggaatatatt ttcagtcata cggagaacac 1430580
caactacaaa ggaccttagc tttggggaga gtaacatccc ctctggacc tgggtgtcca 1430640

cctataaaat gaaggagtt gagttttctg actcttggga gatctttcaa aatattctgt 1430700
gactccagaa atgtccctaa gtcttcgtat gtggtgctg ttctgcaga ggtgagccc 1430760
agaggctag cctgccagat taatccaaga cttttttgta ctgtgaaaac tgtatagact 1430820
ctgacagtgc tggtttggat tgaggggaag gggttgcatc agcccaggcc gaaactttc 1430880
cagaatcagt gagacattga agccaccagc cctcctaggc cccagccaa ccccttggc 1430940
cctcaagctc gcctacactg cccaggtgt cgtgacctc acaggtgaga ggtctcagct 1431000
catcgtaggg aaaggcattt tccagtaac tgtcgtaggc gtggtagaac atggccttga 1431060

ctcgtccct ggtgagagg atgagaaata aggtaggggg ccagaacca aaagcagcg 1431120
ggagaaagga ccagacacag gacggagagt gggaaccacc atgtgatttc cgctgagtgc 1431180
ccagcagcg gaccgagca cgtcaggtg ggtcctggg gcggagggaa gggaagggc 1431240
ccggtggcg cttgccattc cccagccgtg gagagcagga gcctggcccc cttcacctgt 1431300
agtggcggg gtccggcggt gtgccctcg ggctggcg accatggtgc aggggcagga 1431360
acacgcacac gaggccgagc ggaatgagta gccggaagg catagagctc gtgtcctgct 1431420
agtgccgccc cagcagctgc agccaccgc acccgctcat cctccgagcc gctgctggtt 1431480

cttccgggga tacgaccac gacgcctgc cgtagggcaa taagccactc acttctgac 1431540
tacaagacc aggatgcaat ggaaccagc caaaagagca tctcgggata tetgctctac 1431600
agagaagagt tcaactgtc ttaaggacag tggctgctgt ggctgctggt ggtgatgttt 1431660

ttcttagtcc caatitccgt ttgttgagcc ctactgcgt agtaaagcgt caaggagcac 1431720
 ttacaggtg ctgtctagtt tatttttgtt tttttcccca aatacctttt taagaagggg 1431780
 ccagcaggaa ctcagaatta gagaagatgt ctatataaag atggatgaaa aatgatcagc 1431840
 ttaaccatt attaggcaca ggggtgccca aaccacttct ccgatcgtgt aaataaactc 1431900

 tagaattatt ctccaaagg catcactctt aaggtttgca gaaatccctt ttgttctagg 1431960
 aatttatgac atcatgggcc ctccagtcctc taaactgaag tctctaagca ttttgccagt 1432020
 cccagtacc cggaccatct cagtggctat agccctctgt cccgagtgaa aatgaaaacc 1432080
 ctggcactat tgctttgaga acattccttt ctttctaggt cctagaattt gtcagcacgt 1432140
 tagccacagc aacaccatc ttggcagtgt gggtgagcta tatagacaac cctatttgaa 1432200
 gttacatccg gctttattac tactgtaccg ttcacacaca acctatctac ataaccctaaa 1432260
 aggagtcttt cccctcctct gggcccagca accatgctta taaaaggaag gatttgatta 1432320

 aacagatctt tgagatgcct ttaatttaga cttttaatcc tagggttgcc cacctcttct 1432380
 ttgctgaaaa agtcagaggg aaatggctgt tcagtttatt gagtgcagtg caggcaggct 1432440
 tggcctcctt tggcccaca ttctttttaa gattattggt tttgacaatt tcatacatgt 1432500
 atacaatgtg ttctggtcac tggccctccc cattgcctc catcctctc tgctctggct 1432560
 gaatctctc tctcagcaa gccctccta ctctatatt ttttgtgtg ttgtttgtaa 1432620
 cacaataaag tttagttggg gctgctctg tgagcacagg tgaggagtt tgggtaagtt 1432680
 tagagttcag cataatttg tgactttatt aagtgtgga tatgagggtt ttgtccacat 1432740

 gcatgtctat gcatcaaatg catgccaggt ccctctgag gccagaaaag ggtgtgggat 1432800
 cctctgggac tggaaattaca gacattgtga gccttctgt gggiactggg aattaacct 1432860
 aggtcctcta gaagagcagc cactgttctt aaccattgat ccatctgcc agecccaatc 1432920
 cagcattctt gaaaatatcc ctcaagatg gtcccaaagt gccattagtt gataagcaaa 1432980
 ttaactctg tatctaact agagacactg aggttctctc tctctctc tctctctc 1433040
 tctctctc tctctctg tgtgtgtgtg tgtgtgtgtg tgtgtgtgtg tgtgtgtgtg 1433100
 tgtgtgtgtg taaataggaa aaatattaat acctgtttaa taggattggg ggggggttca 1433160

 gtaaaccatg taaaatgcct ataacaccgc tatagaaaac attgaataac taggagaata 1433220
 ttattggaaa gtgcatgga agggccagat agaagaaga ccacaggaaa ctgagacctg 1433280
 aaaaacaaga cagggacact gtatgtgttt cccaagatat ggtaacaaat tattatcaac 1433340
 ttgtagctt aaaacaaaag aaattattc tccatcttg tcttagttg ggcttttatt 1433400
 gctgtgaaga gacaacctc tgattggcag gcaataggac atcaactctc aactgaggg 1433460
 aagcttcaac aacctccca cctagatcac aatatcataa acgcagtgag ggtgaagcc 1433520

agaacagaag aattctaatt cttttcagga gtaaaaaaga atttttgtc tcatcagaga 1433580

 actgtgaaat cagtcacaga agaatcatga aaatgtaaaa attggtttgt tcattcagtg 1433640
 aatattgaaa agctatgat ttattaaaat aggaaaagaa aataagaacc tcaaccattt 1433700
 ctgttttgtt cggagacaca tatttccaaa tccaggcagc cttgtccac cctccctgca 1433760
 aatacttcat ctacactaga gttctgaata ggagacaaaa ggctaagcta cagggttgt 1433820
 aacatgggga aaggcacttg gctaagctga ctttcataat aaaggcctac gcctgaaaaa 1433880
 tactttgtgc aaatataaga taaaagtag ctttctaacc aataataatg agttaattta 1433940
 agttttttt ttttttaaaa gaagctagct agaacaaga ctaagctaaa gccaaagtata 1434000

 ttaatggtca gtctctgtgt catgatttag gggttggcag tccaagaaag cctgccacag 1434060
 tcatgtcttc ctgtgggaaa agagagttag gaaggcactt ggatcatacc agtagccaaa 1434120
 agcattgacc ttggacggtg tattgaatag agtaagcctc atattaataa ttagtaggtc 1434180
 ttggttctat ttctagtta gccattgtct ttgtgtgatt ctgggtgagt cactttccct 1434240
 tttagggact tagtttccat atgtggaatg caaacgaatg agactacctc tcaatatata 1434300
 tatattttaa aaagttagca aatacactca gagttattgc aagaaaaaaaa attcagaaat 1434360
 caacagtcac caacctcaga aatccctca gaaacactca tgaagcaaaa cacaactggg 1434420

 acaatattcc aaacagaatg aactgtttgc caaatggagg aagagaagta ggatgaggtt 1434480
 gagcaggagg agtcgggaga ggtaaaggag gaggaagaca tggctaaatg tgttgacaga 1434540
 gtctttatat agtgatttat gtcttcgaga tgtaccttc tcagtacttt gtatgacatc 1434600
 aatgccatta acctagccc agcagtatta tcaccacttt agagatttct ttaaatagaa 1434660
 gcacaacttt taaaagtttt atttcatgtg tgtgtgtgtg tgtgtgtgtg tgtgtgtgtg 1434720
 tgtgtgtgtg tgtgtgagt tgtgtgtgtg tgtacacatg taagtgcata tgcccacaga 1434780
 ggcaagaaga gggtatcata gccgtacag atggaattat aggcactcac aaaccaaacc 1434840

 caagtctct gcaagtacag aatgtctct taaccactaa gtcattgtct cagctcctca 1434900
 aagcacaaat tttaaaagtc aaagagagga ttaagtaaac agccttgtat cagacctaat 1434960
 aagctttaga gctaaagatt ggagccaggc agtccatatt ctaccattct gatgagaata 1435020
 acgaaaggcc agttcagaat ttaaaagtgt cagtctggtc aacttctaca gcatttgatg 1435080
 ttgttccagg gtcaacattc cctacacttt tgttggaaag ccagaaaaaa tgaagtgcag 1435140
 tcctaaggt tggaaagttag acgcctttgg ccatacact gaacttttc agttgagaac 1435200
 tagctggaaa tccttttcc gggatctaaa gttcagaagg ttcaagtgtt ttttctcagc 1435260

tctcagcaca gaatttgtcc actacatact ttccgactgc caagaattaa ctagtttgtt 1435320
cctgggaagc tctccatctg ttgtcttgta gaaattcttg catttccct gtgccagca 1435380
tgtccaaatg ttggaatggt gacttctgga ccagagtcct agacatgttt tcctaacaca 1435440
ctcatgtttc atgtgaactc agccttatta cagaatctat aactgagatg cagtcttaaa 1435500
aaaacagtta aaatgatata atctgttata cacatcttat cagctttttg gtactgggca 1435560
ttgaacctag ggtcttgaga atactaggca agcactctgc tttgagctgc ttcctttccc 1435620
acaatattaa agaaaaaaaa tttttaaagg ggtaaatgag tgtaaatga ctgaatagcc 1435680

gggtggtagt ggtggaacac accttaatt ccagtgtta agagacagag gcaggtggat 1435740
ctctgtgagt tctaaagccag cctggtctac aaagtgagtt tcaggacagc caagactgtt 1435800
acacagagaa acctgtcat gaaaacacac acacacacac aaagactgaa taaaattaca 1435860
ggacattcca tggcattact gccattgtag gaagattcaa tttctaaaaa caaacaaca 1435920
aaaaaaaaa acaaaaaaaaa ccctatcttt attgagcaga aagtgggat gccgagaaga 1435980
tattttggca atgtctgaag cagaggcttt ctcggttggg ttgacaaatg caccaagccc 1436040
catatcacat caagctgagg aggggaggta atacttttcc ctttagcct tctgttttgt 1436100

ggctccaaat tctgccactt ctctgttgg caagaacaga agaaatcttt gtagaggaaa 1436160
aaaaaaaaa ctctaataaa attctaattc tttcaacaaa agcttgagcc ttgtttttt 1436220
cttttttaat ggttctgccc ttttaagcta cagctatcct attcagtaac tgcaactgg 1436280
atgtaccag cagctgctgg gctgcaagag ctggagcctg aggaaattct gttccctcag 1436340
gcacccgact ctttcaaagc tactaaggaa atttatata atctctgtcc cactaaagga 1436400
ctcaagattc aaagcttaag gtagaatcct gattcccaga gagcctgaat agcaagcagc 1436460
tcacctcgcg tctccaaga agttctcatg ctttttttca ctctctcta taatccctc 1436520

tccacctgge tcttacagc ttctgtcag ctagttgctg acccagcctc ctgaccgag 1436580
gtgaatttta ttaatacaa cacatctttg cgtctttaa caaatgttcc agtacataaa 1436640
caaaattaac gtacctgaaa ttaatattct gcaagcctt gtaatcacag ctcttaggtg 1436700
tcttgtgagt taaaataagt agtgtaaaa agaacaatga taaaaactg ttcctaaggc 1436760
aagaacatga ttgtcagaca tttgcggggc ggggagatct gggcatagt gtatacacgt 1436820
ttacctttt ctttatttt atttatgcg tgtgggtgtt ttgtctgcat atatgtctgt 1436880
gtaccacatg tatagtgtc acggaggcag aaagagcaac cgatcccctg gaattagagt 1436940

tgtagatggt tgtgagctgc caggtgggtg ttggaatcta acctgggacc tctcgaagag 1437000
caaccagtgc tcttaacctc tgggcccgtc ctccageccc atgtgacatt gtgatgtcat 1437060
gataaatcat tgaacagcaa atctatgtaa gagtctctga aaccaggtat ggtaacatat 1437120

gctcaaaatc ccagcactca ggaggctgag gcaagagagc tgagagcata aggccagcct 1437180
 gggataccta ctgagaccct gttcaaaaac aacaacaaaa agaccaacaa gaggctggag 1437240
 aaatggctca gaggttaaga gcattgactg ctcttccaga ggacctgagt tcaattctca 1437300
 gcaaccacat ggaggctcac agccatctgt aatgagacct gatgccctct tctggigtat 1437360

 aggcaaaaca tggagacaga acattgtatg cagaataaat aaatctttaa aaaaaaaaaa 1437420
 aagtctaaca aaacaggtat ctatctctga aaagaatttc tttttttatc atcaaggaaa 1437480
 gcctagatag tggacaattc cagaaactga tagcacagaa gagaactcca aaggttgtgt 1437540
 tttattgtgc tgggggtcat ttaaccatct tgcattttac ttagcactct taagtcaata 1437600
 tttttctctt atattgatta tgaaaactcc gttttttaag ttctgtttta agttggattt 1437660
 gtcatcttcc tgitctcttc attgatgagt taaatgaact tgtgactcat gcttactttc 1437720
 tatttttata aaaaatgtcgt tgttcccaga gaacctaggt aacaaagagg accccaagag 1437780

 agacatacat ggatctgcct aggaaaggta agaagacaag atcttctgag taaattggga 1437840
 gcatgggggg cagggaggag atggaagaag aaaggggagg agagaaggaa aatgtatagc 1437900
 tctatataaa aataaaataa aacgtcgttg ttaacatgct gaagactatc cttggcacia 1437960
 agtaccagac cctgtgatga ataatgtaca gacctatgtt acccctttga gacagtttct 1438020
 attttatttt atttttatgt gtgtgggtgt tttgtctgca tgtttgtctg ggcatacaagt 1438080
 gtgtgcagca cctttggtgg ccagaagaag gcatacagatt ccctggggtc tagttacaaa 1438140
 tggttgtgag ctgccgagtg agggctggga gtagagcca ggttctctgg agaatcctca 1438200

 gtgctcttaa ccaccaagcc atctctccgg tctgagaga gtttctgttt aatcctcact 1438260
 ttccagataa gaagccagaa tctcagaaaa ataaaagtgt gcttttagta ccaagagggtt 1438320
 gactaatcac atttttctaa ttcttcccta gaaatcgtat ttgctcattg acttaggaag 1438380
 catctcttga gcactttacc atgaagctgg tactctgcca gtctggtgat acagacaagg 1438440
 ctgctgccct ctttggatg gaagacaaaa gcattcaaaa aaagaaaatg tcatgtagga 1438500
 gggttaagaa aaaaaaaggg ggggggtagg tttctgagaa ggaagcaact gattaacaga 1438560
 aatgacctgt gatcaggaag ggcttttcaa gcttcagtac gaactggtgc gtggcccat 1438620

 tgcagcagta agtghtaatcc acttacaagg aaagcatggt cacctagctg gaagagagtg 1438680
 ggcaatgctg taaagcaatg agaaacaatg gtggcaaggg tgggtgggca ctagatgaca 1438740
 caacccttg taaaaaacag caggaactt ggactttgtc ctaagtgtta tcaatggatt 1438800
 ttcaaggggc agaggagaaa acagaaaaaa acaaaacaaa acaaaacaaa aagccgggag 1438860
 gggtaggagg ctaggaagtc accaaggtgg tacaggctg taatccctgc aggtgaaaga 1438920
 tcaaggcagg agggtcagga gttccggtta aatgctcagt aaagtgttg tcttgagtt 1438980

cccagaatcc acagaaaaat actcgagggt agtgagcagg ctgagcagac aaaagtgcc 1439040

 gctgccaagc ccgacagctt ttcccagcct catgcggtgg taggagagaa ctggctcca 1439100
 aagttgtcct ccacacgtat tttgtgtgca tgtgtgtgca cacaccgtag atataaacgt 1439160
 tataatccaa ttcttttta agatgttggg tatggtggca agtgctgtgta attctagctc 1439220
 agaagtgaca gatgcagggg gacagatgca ggggaattcc tgggcctctc tggccaattg 1439280
 cctgtgccaa gctccaagcc aataagaaat cctgtgtagg cagagtctat cccacctgca 1439340
 gctcccaaat aaccacaccg aaacttcta ttaattatga aagctcatct gatagcttag 1439400
 gcttgttact aactagctct tacaacctaa cctattttta ttaacctatc tgttgactg 1439460

 agactcgttt acctcatcca tgtactgcc atcctgctcg ctctacatct cacgggtgtg 1439520
 ctgatttctt ctcccagca ttcccctgc ccaaaaatcc tgcctaccta ttggccattt 1439580
 agctttttat taaaccaatc tgagtaacac ttcttcacaa tgtacaaaaa agatcatttc 1439640
 acaacaacc tgccttcaa aaaaatgtag atggcattcc tgaagaacaa tgcctgaggt 1439700
 tgccttctgg cctccttcca tggactgggt atgaatacac acataaacat ggggaagggg 1439760
 agacagacag acagacagag acaggagaca cagagaaagg ggcagagata gctcactagg 1439820
 ctgggctaca tgaaggctcg tctttttgaa ggggagtgggt gtgggagata gctggcacac 1439880

 tcagggaatc ccagcactta gagaggcaga gacaggaggt aaagttcaag gccagcttga 1439940
 gctacacagt gagacagtct ttaaaaaaaaa aaaaaaaaaa gataactaga aagatgtctc 1440000
 agtagttaag agcatctact gttcttccag aggatgagag ttcagtttcc agcaccaca 1440060
 tcaggcaact cacagactca tataatttta gtttcagggt acctgaaacc ctctgagggc 1440120
 acctgcatac acgtggcata catacagaga gaaacaccta tacgtaata aatctttaa 1440180
 aaataacacg aaaaaacaaa taaaattaa gccaggcaga gtgacatgca ctggggagc 1440240
 tgaggcaaga gactccaag agtttagaggc cagcttggaa cccagtatca gaaggggagg 1440300

 gagttcaggg ggcaatgccc ttgccacaca agtgtgaaga cctgagttca gttccaaca 1440360
 cccaggtaaa agccagatgt ggagctgga atctcgccac tgggtgggg gagcagagac 1440420
 aagcagatcc aagggttgc tgcgtagtca ggccaacaga ttggtgaact ctgggtcag 1440480
 gaagagacc tgcctcaaaa accctgtctc aaaactaggg tagaaagtga cagaggggga 1440540
 aaaaagacc agtgttgatc tctgtcctcc acacatacca ccatggggga gtgcatctga 1440600
 gtaacagatt aatagtagc ataaaactta aaaaggagga aatccactat cgtcatctgt 1440660
 aggtgctgtg tctatccata aagtccataa atatcagtca agtgttagat taatacaag 1440720

ttcattgaag ttactagatg caaaattaac acaataaaat tgtcagcatc tctgtgagaa 1440780
 ataagcagtc agaatatgag attttctcaa atactccttt cagtaacact gattttctcac 1440840
 agggctgaca caggaggctc acttgagtcc aggagtttga gaccagcctg ggcaacatag 1440900
 caagactcta tacagaaaaa tacgtaaaatg acatgatctg gagagtggc tctgtggcta 1440960
 agagcactta gtctctggtg gaggacctat gttcagctcc cagccccac atggcagctc 1441020
 acaaccttct gtaactttag ttacacacac ataccctaac acagacagcc atacacataa 1441080
 attaaaaata ataaatataa ttccttttac tgttgatggt tttctgagac atggtttctc 1441140

 tgtgtagctt tgectgtcct ggaatttgat ctgtatacca ggctggcctt gaactcagag 1441200
 atctaccagc cactgactcc caagtgttg gattaaaggc attgcatgta gtatgtcaaa 1441260
 tggctttgga gagaacagat attttcacag tattcaatca tccaatcaca ggataaggctc 1441320
 tctctctctc tctctctctc tctctctctc tctctctctc tctctctcac actctctctt 1441380
 atatctnnnn nnnnnnnnnn nnnnnnnnnn nnnnnnnnnn nnnnnnnnnn nnnnnnnnnn 1441440
 nnnnnnnnnn nnnnnnnnnn nnnnnnnnnn nnnnnnnnnn nnnnnnnnnn nnnnnnnnnn 1441500
 nnnnnnnnnn nnnnggataa ggtctctctc tctctctctc tctctctctc tctctctctc 1441560

 tctctctctc tgttacaatt tctttgacat ctcttagagt tctataattt catttctaag 1441620
 caccttacc atgctttgtt agagttttc cttagatagc tcatatcttt attgtattta 1441680
 attatttatt gaacttatac ttatcttaaa agttaggtat gtatgtgtag ctgcatgact 1441740
 ctatgtgaaa tgagctagtc agggatataa agttaaggac ttccaagcta tctaaaata 1441800
 tgattaaaga gagtgaaagg atagcatgca tgcattctgt attcaggaaa ccagggggag 1441860
 tgagtttggc caacaggaat ccagggaaag ataagactgg agaggatggt gggagtcacc 1441920
 caacaccacc aggtacctgt caatcgctgg ggctggcaga gacagttacc ctgacctcct 1441980

 gcctctgttg acgcgcgacc catatgcccc gtgctgaagt gtgctgggaa ctgtgcctgc 1442040
 gcagaacatc ctaagacttc cagctttcta tttctccttc ttccttaag gaaatcacac 1442100
 tttattcaca tetaacttc actcttcca agccacagtt ccaactggctg tctataaage 1442160
 ctagctcctt tctcacacc cccaectact cagttccac agtgtgtgga cacgcatgat 1442220
 ccatacgatg ctaaggaaga aagcatgctg ggtgttacac agccccacct ctgacctct 1442280
 gggtatctta gcacggctgt gtcctcacct gtaaatggga gttccctggc tctgtgtgtg 1442340
 tgtgtgtgtg tgtgtgtgtg tgtgtgtgtg tgtgtgtgtg tgtgtgtata tgtgtgtgtt 1442400

 gagaaccaag cacaagggt cccctcactc aacagtctct ggacattgta aacttctgt 1442460
 tgggtgtgtt cctgtgtct gggggagtgg ggtgggcaca ctcttgttgt ggagttgagc 1442520
 caggtagggt caggtctgtc ttcaggacac agggaagggg gagggatcc tctgaagtgc 1442580

agctggggcac acagcccagc cttggcaggg gcactcctca cccaccgggg ctgcaccagc 1442640
 actggcccca gcctgtttcc tgtttccctt atctttcccc aacatgtgct ctccggggtc 1442700
 agaaacactg ccatttgctt ccttcacttc cgtttgctca ataagaccct tatttttcag 1442760
 attctagtca aatctggctg ctggcccaga gcccaactaca gtgtgtgatt tttcagcccc 1442820

 tcggctccaa cggcagcatt tctgggttta gatggaaaac ttctcaatcg gctcctctca 1442880
 gctcccagct tatttaccce tactettcta ctctctecct cctcagcccc atggcctcat 1442940
 cctcttttag ttccaattct gcttttagtt cccaagtagt gtgacctgtg tgttcctca 1443000
 cttgtcctgt ctgtaaagtg aggataatga cctcggcttc cccagaggaa gtgagcacag 1443060
 ggctacgtta gaaatgagca tacattaaac agtcaagaat gtcagagtca tgcactcaga 1443120
 aatgtatgtt gaggtctgtg tgtgtgtgtg tgtgtgtgtg tgtgagagag agagagagag 1443180
 agagagagag agagagagag agagagagag aaggagagac agaagcagag aaagagagac 1443240

 acagagagag ggagagatag agcgagagag acagaaaggg ggaagagaga gacctgggga 1443300
 agtgtttgcc tttcaagcat gagatactga gtccaatccc agcattcata taaaaacgtc 1443360
 atggcacagg agcagaagca ggagggttcc tccaagecaa tgagaggcct tgtctcaaag 1443420
 gaaggactga tgagcaagag gtggctcaac aggccaaagt atttgccagg caaagctgag 1443480
 ggctgaatt tgattacat atgctacagt ggagatacag aaccaacttt aaaagtgtc 1443540
 ctctgactag cacacgcatg tgcctacaca tgcatacaca ccacacacag acacacagac 1443600
 acacagacac acagacacag acccagacac acacacacca cagacacact aaaaataaat 1443660

 gatcttcaaa agaaaagata aaggaggtta tcttagggtt tctattgctg tgaagagaca 1443720
 tcatgatgac ttcaactctt ataaagaaa catttaatgg gggttttgac ttacagtttc 1443780
 agaagtttag tccattatg tcatggcagg tggcatgcaa atagacatcg tgctggagaa 1443840
 gaggtgagg gtctacatc ttgatccaaa ggcagcagaa gtagtctgtt ttccccactg 1443900
 ggcatagctt gtgcacagga gacctcagag cctgccctg cagtacaga cttcctcaa 1443960
 caaggttacc tccattcaaa caaagccaca cctcctagta gcgccactcc ttttggggac 1444020
 ctttttttc ccaaccacga cagaggtagg tagtattcct gaggatgacc cctgaggttg 1444080

 tccttttaca ttcatgcaca tatacacaca tfgtactca cacacataca cacaagtaca 1444140
 caaacacctg catacacaca catacagatg cattaaaaac ttttcatatt acagtatgaa 1444200
 gattaaatta ataaacttg gcatcgtaaa aaaaaaatc ccaatgacaa cttttgctgt 1444260
 gtaacctgag gtaagtcatt taacttctct gaaccagatt ctcttagtaa aatgctagtg 1444320
 ttgataaaac ccacatcata gaactgtcat ttgggataga attatttatg aaagactgga 1444380
 cactgcttcc agatgcttaa atcaaaggca cgggacacgg gaggggagag gaacccccca 1444440

tcctgtcact ggttaaagca tcttaccaac agcaaggaag agctgcagtg cagttaacag 1444500

 atgctcaagg cttttctccc ttcttagcta tcaacctgca attttctagg aatgtcacca 1444560
 gaaactccac ttacaggaag ggacatggac taaaccectt gtgcaaacct cttggetcct 1444620
 ggctttacct taccagagtc taatttgtca gaagacctcc aaagccagta taatctcacc 1444680
 tgggaggact ggagagatgg ctctgcagtt aggacctggg ttgattcca gaagccttac 1444740
 aacctttctt aacttcagtt ccaggggatt cagtgccttc ttttgcttc tgtgtatata 1444800
 accacacagt gtatatacat acacacaggc aatgttcat atgcataaaa taataaatag 1444860
 aatgtttaa agcaagagag agaaaaggag ggaagagcct tcagcaactt tatttattta 1444920

 tttgggtgt gtgtatctgt gtgtgtgtgt aaggaacaat agcagctgag cgcctcactt 1444980
 atcaaccttt tgagatgtaa ctggagagcc attaaaatgg tgtatataca gttaccacta 1445040
 aggtagtctg attgtgagtg tcttttgcgg agcccagagc cactctgtct attttcttt 1445100
 ctgctgctcc ctcttgaga agcccatgcc tgtctctga gctatgtctt cttttcttct 1445160
 tctcttttc ctaatctgc acttaagcct accttaagat tgcttgcgta aaatctcctt 1445220
 ttcatcacat gectgectgt cctgaaattc ttttcagtgc caaagccatg aagcccgtt 1445280
 tagccaagt caagatttct aaatatctag gaaaccag gctgccgagg gtgacagtgt 1445340

 ggatctgggc ctccacccc tcaacctga caccagcct ccatcccaga ttgcatgtga 1445400
 ataatggttg aagtgtgaga ttcgtttct tcaattccga aaccttttc caggacgcaa 1445460
 aggacgaaaa gtcaaacga agagacacag gagctcatta ggaatcagca aaagtcaagc 1445520
 caaatcaag tgccgtgta caccacccac ctggtgctac caaggctgg caaggatgtg 1445580
 aagctgggaa ctgcacactg ctgggaatgc aaattagcac acatcttgt aaaagatttt 1445640
 ggcaaatcta ccaaatga aaacctcta cctgtgact cagcaagtcc acgcccagga 1445700
 gtgcagctac acaactcat ctagacatga ggaatcacga acatgaatgc acatgtcagc 1445760

 actgctcata gcatgcaata aacaataaa catacatgac agcatgggga gatggctcag 1445820
 tcaaaaacct gcttgccttt caagcagggg gacctgagtt cgggtcttca gcacccatat 1445880
 aaaaagccca gcctggcatg gtgcacctgc aacccacca ttggagacac gaagacagga 1445940
 ggcatcatgg gcttctggt cagccagtca gtaagctcca ggttcagtga gagacctgt 1446000
 ctcaaaaaat gagatgaaag gctagggaaa tgactcagtg gttaaaatgc agaaccacag 1446060
 agctcaggca aatgaaggtg ggcatggtgg cccacctata attctgggct ctgaagacag 1446120
 agacaggact cccagagca agctggctag tgagactagc tttattcaag cttggggggg 1446180

gggagactaa ttaaattcaa tggagagaag cctcatgtat accagagtca gttctctcct 1446240
 tctacctctg ggttctgggg agcaaaactct gtcaagtgtg ttaacctgct gagccagctc 1446300
 actgacctca gtctctaggc gactgagtga caatggaagc atgaccaaag aagatcactg 1446360
 atgtcagcct tgggtttctg cacacatatg tacatacatg ctccttttca cattcatatg 1446420
 tccttacata catgtgaact gaatgtacac atgcacacat acaacacatg aaaagaagga 1446480
 aaaagaatga gatagagagc aattaaggaa gacacgcata tgtacttga catatacaca 1446540
 tacatacatg aacaaacaca aaaagtaatg tccaatatca gatggtgaat aaatagtgat 1446600

 atattctttt caggtttgtt tgactttatg tgtgtgaatg tttgcctgca tgtgtgtctt 1446660
 tgtatcttgt gcaggcctag taccttcaga ggtcagaaga ggggtttaa tttcctggag 1446720
 ttacagactg tgagcatagt taaatccgtg agctgctatg tgggtgctgg gaatcaacc 1446780
 tgggtcacct ggaagagcag acagtactct tacctgcaa gccagcttcc cagcccccaa 1446840
 tggcagtgcc cttaaaatgg aatgtgttaa agctgtgaca atgactgtac atataccaa 1446900
 gtgagagaag cagattgaag aggactaatg tatgctagtg ttatttcac aaagtagaag 1446960
 aagccacat atcatttaag gtgcatggat atacggcata agtatacaga aatgcaaaga 1447020

 aatgaaaaa tagtcaattt tcattttcat ttgatgtaat taattcaggg gccaatattg 1447080
 ggaagagagc tatgagtga tgccatttga gttatcggtg atgctgtatc tcttctcggt 1447140
 ggaggggaca gatgtattta gaatgcaatt ctatgaacac gaagcaataa tctttccaat 1447200
 gcaaggcagt tcacaatcat ttttgaattc aagacaatgt gattagtcatt gatttaaatc 1447260
 actcctcttt gaagcccacc cccctccggt ctccaatcca gagcaagatg atgagctata 1447320
 aaatctgcaa cgacagagag gtgagcatgg gaggcctaa agaaacagag aacgggagcc 1447380
 cacacataac catggcttgt cccagattcc actatgacag caagaaggat accaaataa 1447440

 aagttatagt tectctattg gcctttgttc tgcaggggca accttgagcc ctgtcaacct 1447500
 ccagacattc tctgtgcat tccaacagac agacagacag acagacagac agacagatgg 1447560
 ttaggaaca tgggtgggat tataaatcca tttcttgggc agcagtgcatt tttaaaataa 1447620
 gtacaacgtg ggaatgctg ctatctgtat ttggtccaca atccctatgg caccatcagt 1447680
 gtcacctgt ctgccgtcct tcccacacc acggattatc ttaacgtagg gatgtacctt 1447740
 aaactagtat tcaaatctct gtttttaatt aaacaagaaa tatatgatca tattctagac 1447800
 ataaaatcag ccatttaag caattatatt tataatggga aaaacccttt gcaaaatagt 1447860

 ggtaattttt ttacaagat tcccactcc tatctcagtc tctctgtgtc tttctctccc 1447920
 acctttctcc tccccttcc ttttccctc tectctctc cctcttctc tectctctc 1447980
 tctccctc gcctcccctc cctggaaata aactgctcta atacatatct ttccagattt 1448040

gtttgcttcc atacagaaac aggtgtgctt ggttattgtg tggctgacag atgaacaaat 1448100
 ggttctaata tgcataatgt ggtctataat ttactcctag aaatgtgtac aaatcatgac 1448160
 aagctcacc tgcattcgt ctactgatg gttatgtgtg acgtgcgtca ttggatcagc 1448220
 atggagcaag atggggcagc ctctattccc atgctgcttg ctttttgggtg gggatacaga 1448280

 caaatatata aataagtaat acaactttca gtgatcctaa gaaatatgaa aattaagtgg 1448340
 gggttttgaa gggaagtttt ttttttgtt tttgcttatg agtagtattt caccataggg 1448400
 actttcctaa ttgggggac tgactttaaa tgaatctact tgcttcccaa aataatctct 1448460
 gcatttcata ctgccatcca aacctatcat tgaacatat ccacacatca atcaacacat 1448520
 gaatgaataa aaactgtggc ttataagcaa aatagaattc tatttagcca aaggggaaat 1448580
 tacattgtaa tattacaag aaaacaaatg gaacttcagg tcatcttgtt aagtgaata 1448640
 acaagatttg gaaagacaag tactgtatgt tttctctcat atgtagagtg tgtgtgtgtg 1448700

 tgtgtgtgtg tgtgtgtgtg tgtgtgtgtg tgtgcgtgcg tgaaaatgcc ataataaac 1448760
 ccattgctgt gcatgctaac ttaaaaaatg cttaaaaggc caggcacaga ggttcatgtc 1448820
 tttaaatcct agttcccaag aggttagggc agctggatct ctgtgagttc aaaatcagcc 1448880
 tgatatagat agtgagattc tgttttgtt ttttaaaaa agaagaaat acacaaacc 1448940
 aaaacgccct tatataagt aacacatatt tcaggaaata ttgcttacta agaatgatgc 1449000
 accaaatttc ttattctgtt ctacttcata aaaaaattt aaaaaaccac gtttaactgtg 1449060
 atgtcattgt ccactaaatg actatgacct gcttgatgct gagatttatc tggattgttc 1449120

 gtcaatctct gttacaaata atgagctcct atatactcac tgggttctgt gactatttct 1449180
 gagagccaag ccctgattg tgtaattcct acacttaac ttctgataaa atatagacag 1449240
 ttattctgga aagctaaatt ccaatcctgg atctgccgtc atcacgacgt acaaactctg 1449300
 ggcaagtccc accatctctt cggacctcag ttcccctc agtaacctta tgatctctac 1449360
 attcttggag tcgcaacaac gaaagcagac gccccaccc ctgactcagc ggacttctca 1449420
 ccaagccctt ctccccctt tccgctcttc ctcaagcctc ggaagcaagc agcgggagaa 1449480
 gggaacagge aggtctagge aggagggecc aaggctggga ggggccgagg cgageccgccc 1449540

 ccctagtagg aaatgaggta gatagaagta aactttaaa agcttgactc cctcttctc 1449600
 caggcattec tggctctctc ccacctcgg ctactctcc ggccctccc gacagcttcc 1449660
 cttctcgttt ctaatctgca gcctgcagag cccgagcctg ccccgccca ggtgggaccc 1449720
 agaacttctg ctccaggatg ttgacgaagt tgctgtcgt gctgtgctg ctgctgctg 1449780
 gctgctcctt ttgtaaccaa gaagactcag atggtgagtt agggacgagg ctctgctg 1449840
 ggggtgttcc tggagacttg gtgtatttgg aaactttgac gcgattgtag ggcagctaag 1449900

cccgccgcat ggctgtctac agctgctagg gtcactctac ggtgcacgct gggctctggg 1449960

 catcagttta tgttccaaag acaaggcga gaagttcagg taactttcag gaggctggtg 1450020
 gaaggacct gtagagagag agagtgtgtg aggatgagga gaggagacag agcagagtgt 1450080
 cagtctggcg aagatagaag agaatcagcg aggagttag atggagagaa tgggaaaaca 1450140
 tcaggagaac ggagacaagt ttggggattg agatggagag gtagggaaag aggagaaagg 1450200
 ctggagggtg agctggtgag gtgggacctg ggcgggagaa gagcccaggg ccggaaggat 1450260
 tccgcggctg gaagctcttg aagctacca ccagcagtat tcagaatgct tactgtattt 1450320
 aatacacaca tcgactcgtt tatgttaccg cattgatctc acggaggaga aagctgggtc 1450380

 acagaacaga taaggaatga atgccgctaa ggttactcac accctaaaca cagaaagcaa 1450440
 cttctcaaat gcaccaccgg gtgggggttg ttacgatgt cacacatact catccagcga 1450500
 ttctctgat accaatacat accccaagg cacttttcgg ggtattgaag gcagggatga 1450560
 ccaaaccag ttaaacagct aggaggggtc cgtgtgtttt gggcactaac attaggaatc 1450620
 ccacgaaatc tgtttgatg caacacactt tgctcagacc cacttgaaaa ggagggggga 1450680
 aatggcagca tcgggaaaaa ggctccaagg agaaggccat ggagctgggt cttgaaacac 1450740
 agataaagat ctgccaggca gaacaagggc aggagagcaa ccctgatgag ctctgcacac 1450800

 agtggccaaa agtcagcatg aggaactcca agccattga tgaactgaa cgccgagact 1450860
 ggccagaaaa tgcagctgta gccagatcac ttgctgtgga tcccaactg ggacagactc 1450920
 cgagatctgt cccgtgatg ggtgctttat ggggaagcaa tctatgactc cagacaaaga 1450980
 ccggtaggct tctgctacca gtgttcaaat acttggettg cctcacatg ttagcctcag 1451040
 attccatac acatggggtt aataacagta gctactgctg taaggcatta ggaggaaggc 1451100
 atgcataagt taataatgtg tgcagagcag cgcccagggc gtgacaagcc cttaatggat 1451160
 attagetatt attatttggg aggggtaggg tatgtcactg gcgggcttta agggagtgg 1451220

 gtcaggtgga gatccaaaag ggtgaaattg agaacaagt ttctgtggca cccaagcca 1451280
 gatgacagtg tcccagaaga aagggaactg gggctggaat tgggatttta tcataggctg 1451340
 gagtggata ggctggacat gtgaggagg aggcaaagac acagagggat gcctttcca 1451400
 actgcaggcc ttagtttct cgtctgtaa gcgaagataa taatccccgt cctctcctgg 1451460
 cttggttgtt gtgagcatca aataggaggg caggtaggag agtgccttat aggattgaga 1451520
 aacggcggc aggcctctgg gtaaggggtt attatctctg gctgtcagcc acccctccc 1451580
 tggctggagg tctgacgct gcactgactc ttccccagg ctcccaaagc ctgcatatgc 1451640

tccagatctc ctacttccca gaccccgaac acgtgagaca tcaggccaat gcctcgatgg 1451700
 ggaaaatcct gacacatata ctggaaggcc ccgccaacaa tgtcacatc ctccagctgc 1451760
 aaccctggca ggatcccagag agctgggaga ccacagagaa gggcctgcag ctctacctgg 1451820
 cccaattcca cagcttgggtg cagctgggtgt atcgcgagcg caagaacagc gtagtctgtg 1451880
 agtggggatg ctgggtcggg gctggtggga gctctggaga ttgagagggt tggggggctt 1451940
 gtggcggagc tagggtgcta agtgcaaggg gaaggtgggc gtggtctctg ggtggggctt 1452000
 ccctgaagag ccctggctgg cccttggaga ttgttctgtg gggcctggag gtcctaagag 1452060

taagaaacct ctattagata gatagataga tagatagata gatagataga tagatagata 1452120
 gatagataga cagatgcatg catacatata tacatgagag agtctatcag gttctctcc 1452180
 agtgacctct cagagcagac cttcttgggg gaccctgtcc ctgatcctct ctgaccccca 1452240
 aagtttcagt gactactctg ccattctctt tccctcatac teggcctgt tctcatccat 1452300
 gtgatggtc ccaccacag ctccctcaca gccccgactc ctctcaagta ctccattgat 1452360
 ttcttctctg ggaagccacc cgctcccttc cacatcactt ctctgctcct ttctctcatg 1452420
 gtctctctct teatagctcc tgggtccttt ttagacaggc tccaacagtc tagctttcca 1452480

gtcagaacce ctctcttctt cctttcatgc cccccttgcc tccggtgaac atccccact 1452540
 cctggtacct tetcaagcaa gcacagaact gagcctcccc ccttcccccc cccccgcag 1452600
 ccctctcccc caaaccctct cccccctctg cgggcgcennn nnnnnnnnnn nnnnnnnnnn 1452660
 nnnnnnnnnn nnnnnnnnnn nnnnnnnnnn nnnnnnnnnn nnnnnnnnnn nnnnnnnnnn 1452720
 nnnnnnnnnn nnnnnnnnnn nnnnnnnnnn nnnnnnnnnn nnnnnnnnnn nnnnnnnnnn 1452780
 nnnnnnnnnn nnnnnnnnnn nnnnnnnnnn nnnnnnnnnn nnnnnnnnnn nnnnnnnnnn 1452840
 nnnnnnnnnn nnnnnnnnnn nnnnnnnnnn nnnnnnnnnn nnnnnnnnnn nnnnnnnnnn 1452900

nnnnnnnnnn nnnnnnnnnn nnnnnnnnnn nnnnnnnnnn nnnnnnnnnn nnnnnnnnnn 1452960
 nnnnnnnnnn nnnnnnnnnn nnnnnnnnnn nnnnnnnnnn nnnnnnnnnn nnnnnnnnnn 1453020
 nnnnnnnnnn nnnnnnnnnn nnnnnnnnnn nnnnnnnnnn nnnnnnnnnn nnnnnnnnnn 1453080
 nnnnnnnnnn nnnnnnnnnn nnnnnnnnnn nnnnnnnnnn nnnnnnnnnn nnnnnnnnnn 1453140
 nnnnnnnnnn nnnnnnnnnn nnnnnnnnnn nnnnnnnnnn nnnnnnnnnn nnnnnnnnnn 1453200
 nnnnnnnnnn nnnnnnnnnn nnnnnnnnnn nnnnnnnnnn nnnnnnnnnn nnnnnnnnct 1453260
 ggtaccttct caagcaagct cagaactgag cccccccct tcccccccc cccgtagttc 1453320

ctctcacaat cacttgcctc ctgggctgcg agctcccgtc caaggagcag actgagagca 1453380
 ccgaagcccg cgtcttcttc gatgtggctg tgaatgggag ctcttttcta agtttccagc 1453440
 caaagaccgc tctgtgggtg atgcgcacc aggagccctc cgaagctgct accttcacc 1453500

tgaagcagct taacgcctac aatcggactc ggtatgaact gcaggaattc cttcaggaca 1453560
cctgtgtgca gtatgtggag aaccacatca tcacacaaaa cacgaaaggt atgaggaggt 1453620
ttgggcctg cctgtgtgtg gggagagggg gcagcttcca ggcaagtgga cagacatgag 1453680
gtatcccttg tgtaacaaaa ggagggggtt ggagactgtg cgagggtata tgcattgactt 1453740

aagtctctgg gtgaagtaca gatgccttga ggtttgagcc aaacttggga ctcttggga 1453800
gtattctctt aaactcactc tctgcctgtt ctgcaggag ccaaacaggc cgctcttaca 1453860
cttcgcttgt cctgggcctc ctgggggca ctttcataat tgctggcgtg gccgtgggca 1453920
ttttctgtg cacgggtgga cggcgtgct aattactctc gactccctc ggaaaaagg 1453980
ctggactgaa gggggtgta agggaggtc acagctcata gaaagccaaa cagactccc 1454040
cagcgggcca ccgatctca ggagatttag agcaacaatt cacttttct cctgcagctg 1454100
ccaaccagtt tgaggaagg gtgtaagag ggtatgtaga caaagcactt gagagcaaca 1454160

ggcatgcttt gtttaactgg tctgagaagc ggtgcttct tatctgcgga aatcagacga 1454220
tagacttggg gtgtctgtga cctccctgca aaggcagatt cactggagc accccaacat 1454280
ctaactaaat aaaaatgagt gcctgtaacc aagataaaca acatttaatg ttatctaggt 1454340
gcgtacaact tgagaaggga tactggtctg aaagaaccag agaaatgtca caattgtaag 1454400
atcaagctat atgggagaac aagtaataat taattaaata ttaaatact tatttatgta 1454460
aaagggtgaa ttatttctc cattttatta aaacttctga aaaaaataa cctataacct 1454520
ttgttctatt tcttcatctg tegtgtctc ggaaccaggt ggtgtcctt ttctatgaag 1454580

tagtcaaaga tcgccataac ctctattgtc atcatacct ccaaaatgtg tgagtattg 1454640
actctgggag ctggaaactc tcttctgaga cactgtaatt cataaaacta ttctggaatt 1454700
cttctcaacc tcttgcctc cattcactt ggaagatgct gctttcttc tttttttcc 1454760
catgcaactg ctttaaatat ctatttctcg tggtttctgt ggagcaacaa gcatgtgtt 1454820
ggagctggat agatgactca gctctttcag aagacctgag ttgggttacc agcaccagg 1454880
atggcaggag gcgcactcac aactgcctgt aacttcaggg ccaggagtc tgggtgcttc 1454940
ttctggcctc ctgagcact agccacacac acacacacac acacacacac acacagaatt 1455000

tttttttaa ttttaagaa tttatttatt ttttattta tttatttatt tgggacagag 1455060
tttctctgtg tagccccagc tgtctggaa cactctgt agaccaggt gccctcaaac 1455120
ttgcagagat ccacctgct ctcccaccc acagagtgt aggattaaag gtgtgtgcca 1455180
ctcttacc tcaatgagaa gcctatggg agatggggg gtgtgaatgt agggggagaa 1455240
ggaggagggg aggggggaa tgggattgct atgttacaaa aagatcaata aaatttttt 1455300
taaaggtagt aaccatcacc actcggctt aagaacattc taaaatcaga tttcagctt 1455360

acatcttggg gtcaggcatt taacttctcc aaatctttct tccttaaagg gataataaaa 1455420

 tacacaaaag gatataacaa aatatctacc tcaaacacac attatgggta tcaggtaaac 1455480
 taatgcaagt aagataatac atacatcatg aatacagcaa tggttacctc tccaaatccc 1455540
 atatttgctc taatTTTTTC ccaaaggacc aactccaagg cttcacaag attaggcagg 1455600
 ctctgacag tgagcagcaa ttccaccctt aactgactt ctatgctttg ttttagacag 1455660
 ggtatcacta tgtaggccag gctggccttg aacctgtgat cctcctctct caaceccccc 1455720
 acccgttgtg gattataaat atgcctactg ctcggtttcc tttgaacatg atctctacct 1455780
 taatatcttg aggatattca aagtcaacat atgaggaatc aatgttatta ctttttcccc 1455840

 ttttctccct gttatttaat atgtgttaat aggtaaaaga aatacattca catagiatct 1455900
 gigttagagac ctcagtggtg agctctatTT acttactttt ctttatcccc acctataaag 1455960
 tgcaaaaatc ataggatcca ttctctctgt actgcccttc ctctttctct gtgagaggca 1456020
 cagaggtgtg ctgcccactt tcagggagta cagccagcag gggctctcag ccaactcagt 1456080
 tcccagtgac cacctcagct acagagaaca gtccagcaca agggcatgcc tgtcctgtga 1456140
 ctgccctccc ctgtgactgg gcacagcaga ggtgtggaca cccagctgtg cccattact 1456200
 ccagagtTcc ctgccgggtt ggctgggtct gtgtgggatc tacaagcag ttttaactttt 1456260

 cctcaacttg atcctgcttc ctcttccagt aaacatctg catctccacc tctctctcag 1456320
 catctgcttc cagaaaactc aaaactcgac aggcattgat gtgtgccctt ccctattct 1456380
 gigtctctc accacaccac ctgctctgcc caaactgaga aatgtccggc cttttttgac 1456440
 tagaccatgc aatagctaaa tgctctctct aagtgtctcc ttgtctgtaa ttgtttcttt 1456500
 gttcgaattc atcttataca tggcaataaa aaagggggca aattttgaaa agtctgtgtc 1456560
 atttctgctt ttttgttaat ttcccattct tcttgaatag gacacacaca cacactacac 1456620
 acacatgac atacacacac agatacacac acacacttac acacacatat acagacacgc 1456680

 acatactaca cacacataca cacacacatg cacatacaca cacactaccg cacatacaca 1456740
 catacacaca tacacacagt aaacacacac atacatatac acacactata cacagatata 1456800
 aacactacac acatacacac actacacaca cacacagaca ctacacacac agacacacac 1456860
 actcacacac atatacacag acacacacac actacacaca tacatacaca tacacataca 1456920
 catacacaca catgtgtaca cacacataca cacacactgc ccaagtgtct actactgtct 1456980
 accaggcatt ggtgaggatg gtccagttgt ggcatcctta actagaccgc tcttttgtgc 1457040
 tgtgctagta gtctcttggt ctgttttctg agcttgattc actatcatca ttatcagttt 1457100

atttattcat ccaataaatg tccatacaca gatttgatgc tatgtgcatt ggaagaaaca 1457160
 aagtgattaa ggcattgtcc ttctcaagga agaaatgaca taggattaag tcccacacaa 1457220
 ggcagatggt ctccaggaac gtaggttaga ggaagccacg tacaatgca aatgctattg 1457280
 ttatttacag ttttagctat cgcttataca ttgttcataa tttttatagt tctttaatat 1457340
 gatttgcac ttaaaattca gtgaagtctc ctaagatagc aattcttacc gtatcttagg 1457400
 taaagggctc aacaagtaaa gctgcttgtt aaaatccgtt ttgaaacca cttagtagga 1457460
 ggaaggagag aacctactct accaagttgt cctttggctt tctgcacatg ctccatggcc 1457520

 caccacact ctccacata cattttccat acacaataat aatgaatgtt ttaaaattca 1457580
 agaaaaatgc atagtatcct tcttaggaaa catgctacca acaataaata gaggggcaga 1457640
 acagggttta aaacctgtcc ctgtgttctt gacatttctg ctttctttca tctagaactg 1457700
 aggaaatcag agcaatttct aggggaagtgc atacatatcc acaacacaca cacacacaca 1457760
 cacacacaca cacacacaca cacacacaca catagacaga gagaatttaa aataaatcct 1457820
 taaaaagaag agtggacaaa gggctttgct ggaatgaac acgctcacct ttaaaaggta 1457880
 tatggccagg caacatagta agatcctgtc tcagaaaaaa acttattata taacttatta 1457940

 tataactcat caacttact ctttgtattt accccgaaga attgaaaaaa tgtgtctaca 1458000
 tgaataatta taaacaaata tcatagcagc attgttttat ctgtaagata aaaacaatgc 1458060
 agactactgc tgccttatct tgctatggga tgtgccaaga atcatagggt gtagatgtaa 1458120
 taggattatt ttgagtgtgt cttgattcat tttctgatgc tataacaaaa atctgaggct 1458180
 gggtaatctc gaaggaaagg aggtttactt agttcacagt tctgggggtt agaagtctca 1458240
 actccatgtg tgcattctca ggaaaggaag gcccttctga ctgtgtcatg tcatgataga 1458300
 tggcattaca tggcatgagt gtgtaccaa gagatctccc agagaaagag acagagagag 1458360

 atgggaaagg actcacttcc ataactgtg ctctcacagg aactaaacca ctctgtaca 1458420
 gtctaacca ctccatgaga ctggcatgaa tccttccca ttgacacat agctgggtca 1458480
 tctcccaca cagccccacc tattaaggc tctttgaata tcatggaggt agaaactaag 1458540
 tttaacatga gtatcttcaa atgatttcca aagggttctc agagcttttg tgtccacatc 1458600
 cagaaacagg aggtlaagga tcaggacct ggatgagtca ccttgggtccc tcaactctc 1458660
 aagagaaggg tgactggaaa ttcagctgac acccgagcag ctttcatggc tgtgtgtccc 1458720
 tgggtcagtc actactgtc tgtgggaagc agctgtgatt tcaaagatat aggccagttc 1458780

 tgacagttag gtttctagct cctaactcca ggcagctgac ctctgggcag attcttaagg 1458840
 gtctttagt ttctctcatc ttccagagaat gacctcagga tgtttgcctt aagtctgagc 1458900
 cttggcagcc aaactactga aagcccaata ggagtttaca tgagaataa acaaatctgg 1458960

aacatattta aacaagtgac tccaagagc attctaaaac cttcttctg ggtggcctgt 1459020
agtccccatt taacatcaaa cttgagtgtc ttcattgttt gcattctgcc aggtagccta 1459080
cctctaggca tctgtagccc cttctttttt tctttatact taaaaaaaa aaaaaaagac 1459140
atgctgctga tggatgatggc acacaccttt aatcccagca ctggggagac agaggcaggg 1459200

ggatctctgt gagttaaagg ccagcctggt ctacagagct agttccagga cagccagggc 1459260
tgttacacaa agaaacctg tcttgaaaaa aacaacaaca aaaaaagaca tgtgtcttag 1459320
ttagggtttc aattgctgtg aagagacacc atgaccacct caactcttat aaaagaaaa 1459380
catttaattg gggtagctta cagtttcaga ggtttagtcc attgtcacca tgctacaaca 1459440
tggtagcatg caggcagaca tggtagctga gaaggagccg agagtcctac atcttgattc 1459500
acaggcaaca ggaagtgtc tggggcactg ggtgtggctt gaacatatga gacctcaaag 1459560
cctgcctctt aggtggtata ctttctctaa caaagccaca cctactcaa caaagccaca 1459620

cttccaata gtgccattcc ctatgagctt atggaggcca attacattca aactgccaca 1459680
acagtgttc actatgtagt tctgactggc ctgtcacttg cttttagac tatgctgacc 1459740
tcaaactcag agatccattt gcctttggat cctgagtgtc gggattaaag gtgtgccacc 1459800
acaaccaaca atagcccatg tttccagttc attgcactat tggtaggac tattttatgc 1459860
taaacatcct ggtaactgct agtggggaga ggagaaatgg gtaagacgga gtctctgtgg 1459920
agccactcct aatctagagg gagaagtaca caaaacaaca acaaagatgc aaaatgagtt 1459980
tagctgcctt cccaggagaa agaatcccag gaaagcacac aggccaaagg cctcatcagg 1460040

gcttgaagaa aaacaatttc cacagggaaa gaaggggaag ccattgctct gctcttaggc 1460100
caagatctct gticactctt gtctagcaca agaaaggagt tcagaacaca tttgtcaatg 1460160
aatgaataat gagtagattc tgaactgata taacagcacc caggaagaga gtacaagagg 1460220
gttagggaaa tggctcggtg agtatacacc tgttatgcaa gtgtaagggc ctgagttcgt 1460280
atcctcagga cccacattaa agctaggcat aatagcatgc gtctggaatt ccagtcccc 1460340
tacagggaga tggggtgtgt gcagagaaag gagaatctaa agaaacatgt gggccagcta 1460400
gcctggtgta cacggcagca aaagtaacaa caacaaaaca aacaacaaa caaaaaccag 1460460

acagtgtctc acataggtg gaagacaaga ataccagga tagttctctg acatccactg 1460520
tggcagcaca gcacacacac caatattcac agatatacac acatcataca cataggaggt 1460580
gggggaggag gagggagagg aaggagggga ggagggggag gaggaaggat tgttctcgat 1460640
acagtggtaa ggtctagigt ggcttcattg actacagatt gtgcttcaga gtggagtggg 1460700
aagtaaatg agatttaaga atgctgtggg gctttaatcc cagcactcgg gaggcagagg 1460760
caggcggatc tctgtgagtt nnnnnnnnnn nnnnnnnnnn nnnnnnnnnn nnnnnnnnnn 1460820

nnnnnnngg gaaaaaaaaa aaaaaaaaaa aaaaaaaaaag aaagaatgct gtggggcttc 1460880

 actaaatccc acaggtgata gttaatgtta atgacttctt cctctagaca acaatatctt 1460940
 tattcatctt tgtagccata gtgcctggag acagccagag atttagacaa taaacgacag 1461000
 ataagcaaat gaggtgaaaa cttttgagaa agaaattatt cctctcgatc aatattattc 1461060
 ctcccttatt ttattttatt tgagagagca tctcactatg aatcccttgc tgtactgaaa 1461120
 attgctatgt agcccaggct ggcctcaaac tcatagagat ccacctgtct ctgcctcctg 1461180
 agtgctggga ttcagggtgt gcaccacat acccagctaa ttcctcactt gtatatataa 1461240
 ttttatagtc acagaaatc ttttctttca gtatctcatt taacatttta ttgatatacc 1461300

 caacaagttt gtgaggactg aaggacaggt cttatcctca tttcctgaag tcaactgcag 1461360
 gttctcatag ccagtgtaaa ggatcaaac tccgtttcct ttagtctctt cttgcatggc 1461420
 tggcacgctg ttgtgcatct ctgtgccgaa gccaggctc cctggagtag cttcactctc 1461480
 ctctccctc gcigtactca ggatttctac atgtcccca aatagatgaa atttatggat 1461540
 gggggccatt ttacctcag ggaaacctgg gaagagggtc ctcacatccc atggtgtggc 1461600
 acaaattctt agcaaatgtc taaacacttt tggattttgt tttgtttgt tttgacaagg 1461660
 tctcactttg taacctgggc tagcctggaa cttgatatgt agacctggct ggactcacac 1461720

 ttgaactcac aaagattcac ctgcctctgc ctcccagtg ctgggattaa aggcgtgcgc 1461780
 caccaacgcc cggccctgtc actgctttgc aacctttcc cagaaataca aagcccttc 1461840
 tttatttctt catctctcat gtttcaatat gtatgttctt ctctgaaaaa caaaagtctt 1461900
 acattttttt tgtttcttaa tttctaaaa tctgcctctt agtgtcttat tttatgcact 1461960
 tgcaagtgag tcagtttgag gatttcacac agcctgtagc actccacaga ccaggcagtg 1462020
 gggcttggga agaaaaaaaa taaaagttaa tctaattgca ttttctgaca gagcaattca 1462080
 gtaatgcage tgctgtctc acatgattaa atgtaggcaa acacttaag ttctgacctc 1462140

 tggaaatgca tccccacata ttcatagaga caatcatctg gcttacaat ctgctgcaga 1462200
 cttaacatct ttcagccctt caagggctct tcaactggctg tggcatttca gtaacctcca 1462260
 aaattcatcg ctttattatt agaaactatt tacggaagcc aagtaggtga tacacacctt 1462320
 taatcccagc actcacgaag aaggcaaagg cttgaagatt tctgtgagtt caagccagc 1462380
 ttggtttaca tagcaacttc cataccagca gggctafaca ataagacct gtctcaaaaa 1462440
 aaggaaaaaa aaggaaatat cttttcatt tcaagcatgt gataatttac ttggtatctt 1462500
 ttgattctga aggaaaaaaa gataagtgtg tctttttcaa aggcataatt ttctctatta 1462560

atcatcaata tttttttttt gagacagggt ttctctgtgt aagctttgga gccttgaac 1462620
ttactctgta gaacaggctg gccttgaact cacagagatc agcctgtccc tgctcctga 1462680
gtgctgggat taaatgggta taccaccacc cagctgttct tttaaagaac aaaaatgaaa 1462740
aatcaaggag ggaattaaaa aatccctaga gtcaaacgaa aatgaaagaa ccgcttagca 1462800
gaacctttgg gtgcagctaa ggtggctcta agaggagcat ccaaagctga gagttactgc 1462860
tcgcatcaaa ccaactgaaga gctctcaagg gaattatgtg atgatcctaa aggtctcgga 1462920
aaaatgagaa caagtcaaaa ccaagagcag tagatggcaa gcaataataa agattatggg 1462980

gaaattatta aataaaagaa caatcataga attaatcaag taaagaaaaa tgaatcagg 1463040
acatttgagc ggaatgcaa atcattatgt taagtgaac aaatcagatt caaaaataca 1463100
aacgcttctt ggttctccca tatgcagaac ctgatttgt gtgtacgagc atcagtgtgt 1463160
gcgtgtgtgt gtgtgtgtgt gtgtgtgtgt gtgtgtgtgt gtgtagaact aaaaagggga 1463220
caatgagcga atggggaggc tgaagaaatg gctcagtggg taagagcatg tgttctttct 1463280
ggcagacagc ctgggttggg tcccagcaca cacacctgt ctgacaactg tctagaggac 1463340
agttctaggg gatcacagcc ctcttctggc ctccactggc tctgcacaca cacactgtac 1463400

acaatgtaca ttcaggcaaa acacccatgc acataaaata aagaatcaa tgtttctaaa 1463460
agagggaggg gaatgagaag gtaatgggat acatgtgtct tggaaagcaga agggaaggac 1463520
aactaggagg aggaaggaga gcagcaagag ggacaagggg ggcaactggg aaggggagag 1463580
catcagaacc aagtataatg acacagagta tggaaaatgt catagttagg cccatcgctt 1463640
tgtgtgcaa ctttaaaagt tttttttttt tttttttttt tttttttttt tttttttttt 1463700
gggcccatta tgicaagtga aagaagccaa gtcccgaagt tccacattgc atcattccat 1463760
gacatgctgg gaaagtaga agctgggaag gccagggtgt ggccaaggca gagggaagct 1463820

tgggtcaaaa tgctagggga tgttttgag agtgattttt ttctacattt ttactgtggg 1463880
ggccacatgg tcctaacact tttgtcagta ttgcactgta atcccaaac agagacttcc 1463940
acgtaatata aattaacaag ctgtcccctc gaatcataag aaagcaacct ctcccgggtg 1464000
ctgcccgggtg agaattattt tttagtataa ttttaggact gccttcatca ctgtagctta 1464060
gttctgtcct cgctcccac aggacctgaa atctcatccg ttggcatttt tccgtctgct 1464120
ctggttacc cttctctctg gggacgttcc agctcttctc ccattgggaa tgatgggaaa 1464180
actcaggaag tcaggctaac tggtaatcgc aggggtgggg tgcgcagacc tctgaggggc 1464240

caagaccag cacaggggac gtgtgatggg aagaaagggg aaggcagacc tacagagtaa 1464300
agcacaggcc aggaaaggcc acgggaggtc gtcacagaag tgggcaatgt tcaacagggg 1464360
gggactgcga caaaaacaca ctggagtgc ctcacagctt ggctcctggc tggctctggg 1464420

ttagtagccac tctccttccg agcttcattt tccgatcttg ctcatctgtc cagtctctgt 1464480
 catagccctc tagctcacat cctctccgaa ctgacgctgc tgacaccgtc tccttctcac 1464540
 gcagctcggc atccacttta tagctgcgta actcgtctga tccaagggaa ggagaattat 1464600
 ccttcctttc cagaggagtg aagaggccca ggaagcttaa atgatttgtc taaagtcacc 1464660

 ctttgaanaac tgtggcccag acaccttcca ttgcttatgc tatgctgccc cctactggaa 1464720
 tgatcgcaga tacaccaaac tacaacaac acacttctac agtgggcttc tatttatctg 1464780
 cgtaccaagc attcattgat taacctacta tgtgctagaa acaattcaga agtgggctgc 1464840
 gccccatgaa aatatggacc cagtcatctg actgaccagt tacagttaga tgagctctgt 1464900
 gaaatacaaa gtataggca tagaataggg tgtgtagcct tacagtaaag aaattcaggg 1464960
 aatcgtggat gaagtagaat ccataggaat acattattgg ctggcaactg ggagagggga 1465020
 ctaaggagtt atcaagggtg cttcacaggg ctgaggatg aacaggaag gtgggatact 1465080

 gccactaagt tgagagtact taaaaggaga tgagacagct gggtagtggt ggcggcggcg 1465140
 gcggcggcgg cgcacgcctt taatcccagc ccttgggagg cagaggcagg cagatctctg 1465200
 tgagttaag gccagctgg tctgcagagc tagttccagg gcagccagg ccacacaaga 1465260
 aaccctgtct tgttggggga gggaggaaag gagatgatac ttacaaagaa cagtagtttg 1465320
 gttttgtggc agtttggaaa taccaatgag gaaaggaaag catagcagt aatgagaatc 1465380
 tgggctgagt gatcactgt gtgaactgag gtctacactc aaaccagtgg gaacaaaact 1465440
 tgggtgctgt tgggtgtgca gagagaatgc agatagtatt tgaactgtg gcagtggatg 1465500

 aacgcacaga ataggaagg ggcttctttt ttttctttt ttttattagt ccaaattagg 1465560
 aacaagcttg cttcacatgt caatcccttc tcctcttcc tcccctccc caaccctct 1465620
 ccaaccccc acctgctccc cccccagct catccaccgt ccaactccc ggcagggtag 1465680
 ggcccttgac ggtggtctcc caaagtccac cacatgatcc tggaccaggc ctaggcctc 1465740
 cccatgtgt ccaggccaag agtgcaccc ttcacgtggg atgggctctt aaagtctctt 1465800
 cttacaccag ggaanaaac taatccaata ccaggggccc cctggagtgt ggaggccacc 1465860
 taattgacat ceatgttcag gggctctggat cagtctctgt ctatcctccc agacagcagt 1465920

 ctggggtcca tgtgctctcc cttgttcagg ccagctgttt ctgtgggttt caccagcctg 1465980
 gtaccgacc ctttaactctt catttctccc actctgcac taggttccag agttcagttc 1466040
 agtgtgtatc tgtgggtgtc tgcctctgct tccatcagcc actggatgag ggctctagga 1466100
 tggcataaaa agtagtcac agtctcatta taggggaagg gcatttaggt taccctctcc 1466160
 atcattgcct ggattgtcag ttctgtctat ccttgtaaac aatctggaaa tcttgggaagg 1466220
 gggcttctaa agcaggccaa gaaacctctg catttacatt gaagagacag aaccagtgg 1466280

ggagagccaa gggagggtccc agagggataa ggtggagcat gggccaacag cttataaaaa 1466340

 cagttggggc tggcaggatg gctcaccagc tgaaggtgct tgctgcaaaa cctgaggacc 1466400
 tgaggttcaa ccacgtgggt gaaggagaga actgacttcc acgggtgtcc tetgatctcc 1466460
 aactcatgcc atggtatggt cccatgcatg attaaataat tagatgtttt gaagttaga 1466520
 agagccaact tgggtgaaga agttcgaggg cagcaagtca caatggagtt ctttcttcac 1466580
 aggcatatag tacgccctgt ggagaaagat gatgcttttg aagtggcact taagggtctg 1466640
 gccagcatca tgagcttggt ggccctgctc tcgctgggc cccctgctgt ttaaattggtc 1466700
 tgtttcgatc atcttgaat tcttagcatt tgaactcatt ttgcagccaa caatgaccac 1466760

 ccttttgacc ttctgcctc cccctcccag atgctgggac tacatcacag gggatgctt 1466820
 tgttttgctt tgctttttta gtttttagct ttttcaagac agggtttctc tgtgtaaccg 1466880
 ccatggctgt cctgaaactt gcattgtttg cttttagac caggtgccc tcaaactcac 1466940
 ggagatccac ctgcctctgc ctctgcctct caagtgtgg gattaaaggt gtgtgctgcc 1467000
 ttggtcaggg gtatgtttta acaagtggtc ctgagttctc cttttgcatt ggggctaata 1467060
 aatcatgaag taggccctga aaagaggcaa atgcaaggca gagaccagg catgatggca 1467120
 cttgtctgta atggagaatt gcaagtttga gattctgtct caaaaacaaa acatgttcta 1467180

 tttgtatfff tttcattaat tgagaatata tftctaagt agctagccaa tgactagcct 1467240
 gggataattg agaccctatt tcaaaaagaa ggaagggagg gaggaaggaa ttcattgaact 1467300
 aaacacacaa cgtttggcag tggagctgga gagacggctc agtggttaag agcactggca 1467360
 gcttttcag acgactagac ttcgagtecc agtacctacc tgggtgctca cagccatctt 1467420
 tcaccctact tccagaggat ttgatgcctt cttttggccc cctcaggac tgcacacgtg 1467480
 tgggtcatat tcafaaaatg gaggcacata aaataaaaac aatcgaggt tgacagttaa 1467540
 agttctccct gccaccctgt cctctggctg tatgggtccc tgactgaagc cattgcagtc 1467600

 acctttccat ccaggagcac ctttcgatgt tttctgtact gacaggcaca gagactactg 1467660
 tgtcttccca atggtgcaca ctgagggtgt ctacacctag gattctgcac ttgacttttc 1467720
 ttccactcag tattacactt caggagccat aagtagcagt tgtggctata ctgcctgcac 1467780
 ccaggaggcc gaggcaggag gacaaaacat tctagtccac cctgagcagc tgttagagtt 1467840
 tgctttctat tctgtgaca gaataccatg acttaaagca acttgggaag aaggaaagag 1467900
 tttatttggc ttacaattct gattaccatc aatcatgaag gggaggtcag ggcaggaact 1467960
 caaggcagga acctggaggc aggaactgat aaggaggtca cggagaggtg ctgctgactg 1468020

gctcgccct cacgcttgc tcagicttgc ttactgtac caccaggcc caccagccca 1468080
gaggtggtac tgccccagc cctcccactt cagtcatgaa aatgccctac aggccaatct 1468140
gatggagatg ttttctctca cccaggagt agccaggtcc tgtcttgctt agcttctaag 1468200
atcacacaac cgttcaaggt ggtacgattg tagactggag atgtttcctc aacttaggtt 1468260
tctatttccc agagaacttc agcttgtgtc cagttgacaa aaactgacca ataggctgca 1468320
tagtaagacc ttgcttaaaa aataactaatg ctacattaaa aaaataattt cctaattaac 1468380
aaagaacttt ctcaaaaaa aacaaaaaca aaacaaaaag caacaaaaa aaacaaaaa 1468440

acgggcgcac agtcccact gcatgtgcc tgccttgttt gtggttttca ggggaaaaca 1468500
tcagcaggaa ttacctcaa accagttggg gctagatctg caaacagagg tggcaggctg 1468560
aagtggggcg agggggctct tctagacccc cccatgcctt tgtcctccat ggtttgtcaa 1468620
ttaaatttc agtcattcat tgctcaaac ttttagacac atggtcatga ttgacgatgt 1468680
gtattacatg gcaatttgtt ttaagatat tatgtttgta catcctcctc tcaaaggcca 1468740
cctcctttg gcacgtttct ttgaaactcc tagatttct cagccagaat aacgtcagcg 1468800
gccccgatg ttctggagg cgatgtctg agttgtgatt attgtctctg tcttaagggt 1468860

gcttgttctc agcccttca tctgaagatg gtcccactcg ccctgcttcc ttccaatgag 1468920
caccagtga cctgccttag gggtcacagc ctgtgcccc tcaagctaga tttggctacc 1468980
tgtcctcaat aagccaattt aaaaagccaa attaatagtg gaaagcagaa aaaagtagca 1469040
ctggaacagt gttaacaca gttaccttgg gaagactcga gtggctgcaa gggctctatg 1469100
cccccttca cagtgaccac attcagtctc tctctctctc tctctctctc tctctctctc 1469160
tctctctctc tctctctccc cctcctctc cagaactaga ctagcgtccg actaacctct 1469220
gtttccttcc agattcctag taagaacttc tcttttggg ctgcagagac ggctcagcag 1469280

ttaggagcac tggtctctt ggcagaggat ccgggttcag ttcccagcac ccacatcagg 1469340
tggctcaca ccatctgcaa ctccagttcc agagacacta atgacctct ctggcctcca 1469400
tgggcattgg gaatgtacat ggtgcatata catacatgtg ggcaaacac tcatacatat 1469460
aaaataaaat caataaacct tttacaataa aatacctcaa ttatttctct tgccacttcc 1469520
cttcttcca cctcctccc tcgtcctct ctgttttctc attttggctg caccttctta 1469580
atatctttag ctggctctc tctgttttct taatttttaa taacagttgt tttagaactc 1469640
attactaga aactttcccc tctctgaatg tgettattcc ctaaacatt tcttctagcc 1469700

ccttggcttc aaatatttt attttgacg ctccaagtcc acactcact cgacttctcc 1469760
ctgaactgat acctgtgtag aaggetgttg ccacatccat tcgataatgt aatagctgtc 1469820
tcccttcca cacaccag acagggctct tgatatttcc attcaagctg ttcaagaaat 1469880

ctcttttga tcaataatg gcagctgcat tccagttgct tgggtcagtt ctctgtaatg 1469940
 tgactcttct ttctacttc ctatccaaag ctttgtcaac tccactttca aaatccttaa 1470000
 agaaccgggc tacatctcac tgtgtccaca aggatcctga tccaagacct tgacatcttg 1470060
 tgcttgcctt acagcgatag ccagctccct gccttctctgc ttctggcttc ccagctattc 1470120

 tctgcccagt aaaaccagtg gttctgttga gacctaagca gtaagttgtc tcttcagttc 1470180
 tcagaaactc ccaggagagc agtcttagga gccccacct tccaccccc tacctctggc 1470240
 ctctacattg tcccttaaac ttgcctggca gtttctcacc ttagaacatt tacacttact 1470300
 gtcccctctt ccagaatcat ttctccatgt ctcatccttt gttctttcag aactacacac 1470360
 acacacacac acacacacac acacacacac acacgcatgc acgtgcatat gcgcacacaa 1470420
 aaccttcatt gtttcttaca aaagtccctc tagacacct accacaattc cacaaaaggc 1470480
 acggcacaca cccctctaataa ttcaggtcct aacccccctgt ttttctcaac aattactgct 1470540

 atatacttac ttaaatgatt tttttgttgt tgtttgtcac ccatattcta agttctatga 1470600
 aaactgaagg tttttgttt gttttttatt ttattacat ctttaggggg agcttgcattg 1470660
 tgtcacaata tgtgtgtaaa aatcagagga caatttatag gactcagttc tctcctttca 1470720
 tcatgtaggt cccaggaatt gaactcgggc tcctcaggct tggcagcagg gacttgtgcc 1470780
 cactgagcct agttgcccc agagttttat ctgatttgtt tactgctgta aagcaagagc 1470840
 attcaatgca aagtggcat ttaaaaatta cttagtgaac taagaaaata tttttcaact 1470900
 tatgtcttct atttagaact ctttggatgat tcccaaagca gaggttctta accctttggt 1470960

 ctcaagaacc ctttatacta tcaaaaagca ttaaggacac taannnnnnn nnnngaatta 1471020
 aaagtgagaa atttaaaaat gaacatatcg atccatttag gatgataata tggggctctg 1471080
 gactagctca gcagtacaga acttacctag cctgtgaggc cctggaccta gtctccagca 1471140
 ccacaaaaat cagcaataaa ataggcaatc aaataccaca agtctgtaaa tacaataaaa 1471200
 ctctataata atttctaaa taaaacatag tgagaggact ggcatattt acatttttaa 1471260
 aaaatctgtt gaaaatttg gcttagtagg aattaactgt attacatgc ctactgctga 1471320
 attgaaccta tgacaataag cctggaagct tctagaaaag tacacagcac tttcatgaga 1471380

 gaggtagaat ctgaacattc acatacaact gcgcctttgc gccaccatt cctccactc 1471440
 cacatggcaa gttctgctg gtcactcag gctgactca cctcctgcca cctctagaca 1471500
 attcatttct tccttctct cccataatac attgttctct tctctctcaa gaatatattg 1471560
 tgttagcctc ttgttaccta gattagtgtc tgtttccaca gtttaactttc ttctccaga 1471620
 cagctagcta cataccaaa taatctttat ttttccagc ccctcttgca gtgtctggga 1471680
 gtcaaacact gtgtaataaa tgcgtgttga atggagagat gacacaggag agaggagaa 1471740

gggcggctctc tccttcctgt agtaacagaa aacagtatth ctgcataaga ttacagatth 1471800

 cagagtggca aatatgatgt gatcaagtat gttacagaca ggtgaacaca tagaaaaatc 1471860
 tcataataaa atcatattht gtacaacaat tacatactaa gttgtthtth ctaaaggth 1471920
 agttaggcat cggggcacac actthtaatc tcagacttg ggaggcagag gcaagcagat 1471980
 ctctgtgagt tcaagaccag cctgttctat ctacatagt agttccagtt tcaggtcagc 1472040
 cagaaataca tagagagacc agttctthaa aaaaaaaaaa ttatcagthc aggaataggt 1472100
 ctgagthagt aggacgcttg cctaaggagc acaaaacct gggttccatg ctggcactat 1472160
 ttaacctga tctggtggtg cacacctgta atcctagtac tccaacaaat gaagggcac 1472220

 ttaactgctc actgaaatg aggccagthc gggtgcatg tgacctggc tcaaagaaaa 1472280
 aattaacaat tcaaaagtht tctaactat thtttagtgg gcacattgth cacattgthc 1472340
 acaaagtga tctgaacct thtggtht thcatatth aagaataggt ggcaggtggc 1472400
 gtgggggaca gggaggatg tgacacacat gggacaccag thctatgth caaaggagga 1472460
 acacaaggct caggagatga agtgactthc thtaaggcac actgaaatca gcaacctggc 1472520
 ctgaaatca ggtgtcagac thgaaatga atacttht tagthtthc atacctct 1472580
 tggthtgag aggtgagaa gtcaagcag ccaatgaata caatgaagth thctaagaca 1472640

 cctctggct ctgtacagac thctacctg ctctgctc taagacctc thaggaactc 1472700
 atgatata tccattgct thtttccc caatthtaag actthtct thttaaata 1472760
 thtthttht ctatgtgta tgtgcacaag actacagga acctcggaag ccagaggctc 1472820
 cctcacccc accccacccc caagctgaaa thtataggcag thgtgagca cccaactgta 1472880
 atgctggaaa ccaaacctg thccccgta ggaacagcac aggtgcttht agccactgag 1472940
 tcaatthctc agctgtgct cctgtatthc gthtthttht thgtthttht thcgagacag 1473000
 ggtthctctg thtggctthg gagctatthc thgcactgc thtgagact aggtggct 1473060

 cgaactcaca gcatctgcc tgctctgcc gcatgcgca cggacgccc gcatcctgt 1473120
 atthtattg gctctctgc catgtaccac thactgcat ccactctcc caccgtcca 1473180
 thcatgtaga gcatthctg thggatcact agtagcagct gatggcggt thaccthaa 1473240
 caaaggaagt cacacctth cthccctgg thgtthttht thctctgca acacagccc 1473300
 thcaaacct ccaaatgta gcaatthct atthctctc agthtthct caatgctthg 1473360
 gthtctctg thccataact thataacct thctthtthc thctctct cctagatthg 1473420
 thagthgctc ggtgctatth gccagthc aacctctg thctctgaa actgacaact 1473480

cctcctctct tggaaacctt cctcctctc ccatcttggg gatcctgatg tttagctctt 1473540
 tgggagggca tgggtgtaca tgggtgtacg tgtgtgggga ggctgcactt gctcatacag 1473600
 gcaccttggc tgtcagaggt tggcatcaag atatctcctt caatcacatc tgtattttat 1473660
 ttatttactt attttgagac aggtccctca ccatttttagc gagacttgct ggccaatggg 1473720
 acctgctct ctaccttttc ctacaccccc acggtcccgg tgctgaggtt acagacacac 1473780
 actgacttta tataggggtg cgacggatcc agactcaggt ctcattgctt tatggcaaaa 1473840
 cgctttgtcc accaagcctt ctccttagcc ccagccctat ttgtttcagt ctttttatcg 1473900

ctctggactc ttcagtggga tcttctttgg gatggatcct gatagggcct tgggcctttg 1473960
 ctcttttctg ctcccccttt cagcttcggn nnnnnnnnnn nnnnnnnnnn nnnnnnnnnn 1474020
 nnnnnnnnnn nnnnnnnnnn nnnnnnnnnn nnnnnnnnnn nnnnnnnnnn nnnnnnnnnn 1474080
 nnnnnnnnnn nnnnnnnnnn nnnnnnnnnn nnnnnnnnnn nnnnnnnnnn nnnnnnnnnn 1474140
 nnnnnnnnnn nnnnnnnnnn nnnnnnnnnn nnnnnnnnnn nnnnnnnnnn nnnnnnnnnn 1474200
 nnnnnnnnnn nnnnnnnnnn nnnnnnnnnn nnnnnnnnnn nnnnnnnnnn nnnnnnnnnn 1474260
 nnnnnnnnnn nnnnnnnnnn nnnnnnnnnn nnnnnnnnnn nnnnnnnnnn nnnnnnnnnn 1474320

nnnnnnnnnn nnnnnnnnnn nnnnnnnnnn nnnnnnnnnn nnnnnnnnnn nnnnnnnnnn 1474380
 nnnnnnnnnn nnnnnnnnnn nnnnnnnnnn nnnnnnnnnn nnnnnnnnnn nnnnnnnnnn 1474440
 nnnnnnnnnn nnnnnnnnnn nnnnnnnnnn nnnnnnnnnn nnnnnnnnnn nnnnnnnnnn 1474500
 nnnnnnnnnn nnnnnnnnnn nnnnnnnnnn nnnnnnnnnn nnnnnnnnnn nnnnnnnnnn 1474560
 nnnnnnnnnn nnnnnnnnnn nnnnnnnnnn nnnnnnnnnn nnnnnnnnnn nnnnnnnnnn 1474620
 nnnnnnnnnn nnnnnnnnnn nnnnnnnnnn nnnnnnnnnn nnnnnnnnnn nnnnnnnnnn 1474680
 nnnnnnnnnn nnnnnnnnnn nnnnnnnnnn nnnnnnnnnn nnnnnnnnnn nnnnnnnnnn 1474740

nnnnnnnnnn nnnnnnnnnn nnnnnnnnnn nnnnnnnnnn nnnnnnnnnn nnnnnnnnnn 1474800
 nnnnnnnnnn nnnnnnnnnn nnnnnnnnnn nnnnnnnnnn nnnnnnnnnn nnnnnnnnnn 1474860
 nnnnnnnnnn nnnnnnnnnn nnnnnnnnnn nnnnnnnnnn nnnnnnnnnn nnnnnnnnnn 1474920
 nnnnnnnnnn nnnnnnnnnn nnnnnnnnnn nnnnnnnnnn nnnnnnnnnn nnnnnnnnnn 1474980
 nnnnnnnnnn nnnnnnnnnn nnnnnnnnnn nnnnnnnnnn nnnnnnnnnn nnnnnnnnnn 1475040
 nnnnnnnnnn nnnnnnnnnn nnnnnnnnnn nnnnnnnnnn nnnnnnnnnn nnnnnnnnnn 1475100
 nnnnnnnnnn nnnnnnnnnn nnnnnnnnnn nnnnnnnnnn nnnnnnnnnn nnnnnnnnnn 1475160

nnnnnnnnnn nnnnnnnnnn nnnnnnnnnn nnnnnnnnnn nnnnnnnnnn nnnnnnnnnn 1475220
 nnnnnnnnnn nnnnnnnnnn nnnnnnnnnn nnnnnnnnnn nnnnnnnnnn nnnnnnnnnn 1475280
 nnnnnnnnnn nnnnnnnnnn nnnnnnnnnn nnnnnnnnnn nnnnnnnnnn nnnnnnnnnn 1475340

nnnnnnnnnn nnnnnnnnnn nnnnnnnnnn nnnnnnnnnn nnnnnnnnnn nnnnnnnnnn 1475400
 nnnnnnnnnn nnnnnnnnnn nnnnnnnnnn nnnnnnnnnn nnnnnnnnnn nnnnnnnnnn 1475460
 nnnnnnnnnn nnnnnnnnnn nnnnctcatc ctctctctcc tctctctcct cctcttcttc 1475520
 ctctctcttg ggigcccttc gccatgccct acccctgccca tcctagcaaa caaaatgtgt 1475580

 ttgaggaca gattgctcca gcagcactct atgaatcatg tatgtttggc aaacgtattc 1475640
 agagcctcct ctttatctta aattggttta caataacaac ctgtttcaca gggcttgtct 1475700
 atgaggactg ggggagatat agttaagtga ggtgcttagc ccggtgcctg gtatgtagta 1475760
 ggcatcatt aaacagtaac tgtttgttg ctctgagtgt ccttttatgg ggactattga 1475820
 agtctctcc agatcttctt gtcatcttctt accttgggag gggactaaca tgaaacactt 1475880
 attataaatg ccaaggagca acagcagtta agtcatcatt ttataagtga gatgagccag 1475940
 tgcttgagca taggtcagac tctcaacact gctgctccat accgccaac caccaaacca 1476000

 ccataacttc cactatgct gctcaagaaa acccctagcc accatcttca tatgggaaga 1476060
 gccagactg acagtccaa aactcatgcc ttaccattt ctcttacttc ccagcagttc 1476120
 tctgtagaaa cttccaggg acccaggtac tctacagaaa ccacccaac cccattctgt 1476180
 acacccccca ctctccctt gtctaattcc tgcctttctt tcagggcctt gctcaaattc 1476240
 cacctctct cacacactt tctcgggctt ccttgagccc ggacctctgg aatctttctt 1476300
 gatatttggg aggtagtatc ctgtttttct cagcccttac attttcttac taggtgcaac 1476360
 cctctacagt gtacacatcg gttcatgggc ccctttttt gctttcgtag cccagtagc 1476420

 ccagggcgct gtgtgtagaa ggtgttccat caatgtggga caattggggg taaaggagcg 1476480
 agcttcccag ggctgtcccc caacccttt taagcactgc ccaggtctgt tcttcttgct 1476540
 tcttagaac cccccccag gcaagacct gagaccccc ttctctgatg ccaagcactt 1476600
 ctttagctca ttctctcca acccaattg tctccctage cccctcttct ccagtgtcac 1476660
 ccaccccacc ccagcctct ctctccagt gctagcctaa ggctgcagac cccaggccca 1476720
 acagggccac cccggggcca gcattattta tctggcctct tctgcctccc cgggggttgc 1476780
 cctctttgca cccggcgcn nnnnnnnnnn nnnnnnnnnn nnnnnnnnnn nnnnnnnnnn 1476840

 nnnnnnnnnn nnnnnnnnnn nnnnnnnnnn nnnnnnnnnn nnnnnnnnnn nnnnnnnnnn 1476900
 nnnnnnnnnn nnnnnnnnnn nnnnnnnnnn nnnnnnnnnn nnnnnnnnnn nnnnnnnnnn 1476960
 nnnnnnnnnn nnnnnnnnnn nnnnnnnnnn nnnnnnnnnn nnnnnnnnnn nnnnnnnnnn 1477020
 nnnnnnnnnn nnnnnnnnnn nnnnnnnnnn nnnnnnnnnn nnnnnnnnnn nnnnnnnnnn 1477080
 nnnnnnnnnn nnnnnnnnnn nnnnnnnnnn nnnnnnnnnn nnnnnnnnnn nnnnnnnnnn 1477140
 nnnnnnnnnn nnnnnnnnnn nnnnnnnnnn nnnnnnnnnn nnnnnnnnnn nnnnnnnnnn 1477200

nnnnnnnnnn nnnnnnnnnn nnnnnnnnnn nnnnnnnnnn nnnnnnnnnn nnnnnnnnnn 1477260

 nnnnnnnnnn nnnnnnnnnn nnnnnnnnnn nnnnnnnnnn nnnnnnnnnn nnnnnnnnnn 1477320
 nnnnnnnnnn nnnnnnnnng cggagggtcg ggatggccgc ggtggcgcg ggtagtgtgg 1477380
 cctgcaaggc tigtgtgag ggaaaccgta cgacgcctcg gagnaatag taagcgcagc 1477440
 cagtgtgttg tgggctggag aagaagccga ggatgttga gctggaaaag ggggaggag 1477500
 gagggcgagc accgaccgga tcgctgtctt ggtggctgaa gggccgtcgg gatagactcg 1477560
 atagatcggc atggtctcac cgggcagaac cgaggccagc cgacagtggg ggtgggggg 1477620
 tagcaagaag gcgcatttcg gcccaatgca ggaagtttgt aacaattgga ggtgctcagc 1477680

 cagcccagga ggcggtgagc tgctcatcac tggcatggga aatcggagct ccaagagggg 1477740
 attggatgga tgcatacata acgcctgtat ggatacaagc ataataatag tcgtgccta 1477800
 tgggccagge ttggcgtac atttgatagg aattagctca tttaatccca gtatgtgttt 1477860
 cgtgagctag ctggagcacc tgtcccat t tacagatga ggaaagagac cctgagagct 1477920
 taagtaattt gtccaagtc acagagctag tgagttgact ctagtctctt catgtttaaa 1477980
 ccaggacatt atatacacag gtgtcggagt cagttggact aatttctctg ctctctccca 1478040
 acctagaagc ccgaaattct aataataat gttgagatgg tgtaaatgtt gctggaggaa 1478100

 attagtatt gcttgaatta tctgagagg agtatgttg ttaagcatgc atctcttca 1478160
 gaagaatttg ccagaacagt agtttttaa ctgggcaaga gactcaaggg atcataaatt 1478220
 ctctgaatt ttttctaat ttgaatttac atgtgaaaat gtatggcttt caaggagaaa 1478280
 aatccctaga ttttttcca gactctcca agaagatag ttgaaaaaa attagaatgt 1478340
 gtgaaagaat ctttgtccc agccaatagt tggcctccta aggtttatc attgttacct 1478400
 gactttctgt gaaaacttc tctagttgt ttgtgggttt agctctatca cacatcaaag 1478460
 tgatgtgatt catgggtttt caccgtagca gaagtaggt tcttcagac tgcctgaatg 1478520

 tgtgcagggt gagtgggaag ggcctacc tggagatcaa ggtgtgtggg ctctcagctg 1478580
 accttggccc ctggaggctt gtgactttaa ttcactttt tccatggctc tcatcatctg 1478640
 agagatgaag ctgaatgaga tcaagttgga gacctttat gctggtctct ctgcaattaa 1478700
 gagacgacag tttgcttaga tatgtcaggg ttggaagaga aggttacgct tgctcagtgc 1478760
 ttattcttac cagccttaca ggcgtcaatt atccgctct caacgccctt ctccatttta 1478820
 aacttaagct ctccatcat gacggccac ctccatcac atgtttccta ggttattttt 1478880
 gttgttctct gtggatatct ggaggagttc atttcaacc tgaccactgt ctccagatgt 1478940

ggtgtccttt taaaaagaaa ggataatttc tcctttggct tgccggctct gtcccattac 1479000
 atccttttgt tagatgtcct gatctacgcc tatcagacca cagcctttgg gaaataccca 1479060
 caagagcacc ctgctccctt tcatgagcta aaactaattg cctggagcac aacaccttgc 1479120
 tgtggattgt tttatggga ctgactggca tggatctctc cacactgatg tccccacctg 1479180
 tccccacctc ccaccacttc cacccttggc acggcatttc cctgtctgga agggtttaac 1479240
 gtgtgctgca gtccctggaat tttctttgct ctacttttcc tggatcactt ataaaaaatt 1479300
 aagtcagaca ggiaccagtg tggctctctt ggccccttg tgctccttat cccttccat 1479360

 tcagaggagt gactggctgt ttccatctgg tctttcctat ccctaagttc attctcaggc 1479420
 cttaatgaag acatggcccc tccagcccat ttaaaatata tgccaaaact ttgagaaatt 1479480
 attgagataa ttgacaccta attactccgt cactgaatat tagtgggtga cagcactgaa 1479540
 actttataga aatatcattg cttttcagcc cacagataac attgtcactt cctctgtctg 1479600
 tcttaaggcc gctggagtc caccactccc tgctcccga ttagtaagcc acctttccca 1479660
 ctgttcatag ataatgcatc ctgactccag ataagctcac ccctcattta tcccaagaca 1479720
 ggctgctgg gttccctgga catggtcacg tgttatacct ccaccattt catcagatct 1479780

 ttccctaagg ttctggctca cacctgcctt tctaggaac cccttccttc ccccagaatc 1479840
 atttattcct ctgaggggaa catttagtgg catgccagc cagtgtgtca tctaattttt 1479900
 taaaaacact tgcacattgt ttgggaagga aaaggttgtg gatcttggtc aagtttcttc 1479960
 ccaagcaaaa cttaacacaa tcccacatct taataactta ccattaagca ttgtatcctt 1480020
 atgtccaagg gttacactca cctgaaatag gcacccatag acacataggt ttcaaggtec 1480080
 cttctaaaaa cttttttcag ggaataaaga gatgggttgc tgtgcaagca tgagaccgca 1480140
 gttcaatccc cagcacccat gtaaaaagcc tgaggagaa cttatttgtt gtccaattc 1480200

 tggagaggag gaaacagggt ccctgggggt caatagecat ccagcttatt ctaattggtg 1480260
 agcctcagg tccagtgaga gaccctgtct caaaggaaaa aaaaaagcaa acaaaaagaa 1480320
 aacaaagaca agatggatgg ctcatgagga acaacacgag attcatctat ggcttcaca 1480380
 tgcacaccta acacacacac acacagaggt accacacaca cgctcacgtg gacatctaac 1480440
 acaccacaca cacacacaca cacacacaca cacacacaca cacacacaca cacacatgca 1480500
 tacacacaaa taaagaactt cttagaggat gcattgcttg ggcttcttc cctggaactg 1480560
 cagtctactc ccctgttcta agcagtacca tcacaattca cctttgacat ctgtcttacc 1480620

 tccatagggt ggatgtcatc caataatggt gacctacagg gaagaaggac tgagaacggt 1480680
 ggtcatcact gtagcgatca ccaagtaaac aactgaagc tcttaacggt tattttctca 1480740
 attgtcttaa atcagggtgc caaggacaca aaccttgatt gccaatgatt cagaccagag 1480800

ctggccccg gcctcctggc ttctaattg aaagtgttt tctttactgc ctttgcttt 1480860
 tgatttcata tctctgtct ttcatocca agccctccc aaaaagaatt gattcagtct 1480920
 gtttttgctt ttgctttctc aagtgttct tttgtacttg tatgtgggt gaggagggc 1480980
 actaccaaag ctctaattga ctcttgcct ttggtttatt taaagcacc ctttctctg 1481040

 gtgctagcag gggagaatcc ccatcttgg tttgtcctt ccaagtataa ttggttttg 1481100
 aggaaaaatca gactagatag aatgagata agccagtgg cccaggccgc atgactctga 1481160
 gattcaggct ataattggagt cctgcccag agactggtt tgagtggcgg tgctctgagc 1481220
 agatggagag cactctctg tttgcacctg cagtccagga agtgaagaac cctggatgag 1481280
 tcggaggctg agatagcct attaggaagc actgacaaat tccaagtcc ctgatggatg 1481340
 ctttcagtac tttgtatgc tcccgtacat cccactctg tctgggaaa acaggccatt 1481400
 aaaagtctc tttgagacac aagttaaact cgtcctgcat cttcttatgt tactgtgggt 1481460

 tttcctggg tctaccacc ctccgggtg gtaaggagct tcgaacttc cagacctgt 1481520
 cacttatgtg tggctctagc aacagcctca tgaaggaacc aaggaaactg tgctcactc 1481580
 atggatgagt aaacagcggc tcagagagat gacagggtt cctgtcagct cctccagga 1481640
 cccaccaca gtaataaac aataaggtg agaccagagc tggattctct gccttctgc 1481700
 tcagcgattt cccctgcac aaaactgtcc tgatgtggat tactggggc gccatcttc 1481760
 actttcaagt atggcccag ccagctttg aaaggtgata gttgaaaat cagtaaatta 1481820
 tactgtgga agtgaacct aattgtatca agagagtgt gtttaggaatt gcttagcct 1481880

 gggataata tggaaattg tggacttcca atgaggagga agccattatc cctcagtgc 1481940
 ccaccagca ctgtctgaca cctactgtga gaaatgctt tactcctctt gtctgtgtcc 1482000
 cctaaccata ttctttggac agtcttggg acccaagtat tcagcagttc tcttgaagaa 1482060
 tacactggac tcaaatatat atatatatat atatatatat atatatatat atatatnnn 1482120
 nnnnnnnnnn nnnnnnnnnn nnnnnnnnnn nnnnnnnnnn nnnnnnnnnn nnnnnnnnnn 1482180
 nnnnnnnnnn nnnnnnnnnn nnnnnnnnnn nnggcctta ctgtggagcc caaactggc 1482240
 ttgaacttc agtgcagc ccacctcagc ctccccagt ctgggattac actcagctt 1482300

 gtccaagagg caaaaacatc agggtaggc aagtcctaag gagggaggc ctgagatgcc 1482360
 tcagctgagc ttggggcagt cagaggatgc ttcaggggga aatggcaact gagacaaatc 1482420
 tcagacagag gggaagagtg gagaatggtg ggtcagcaat ccaggcaggg aaaacagga 1482480
 accatggctt ccctgagtt cctggcatgt ttaggaaaca ctggataatt ggatatatct 1482540
 ggggcatcga gttactcgt tgtttccagt aagagtgtgg aagaagagtc tggaaagga 1482600
 agctgtgagc agtctgtaag attgctttg gccagagc taagggcct cgttaagc 1482660

atatgagtgg agaagtggcc tgtttggagg ttgtgaggag gctgaggagc caggattcac 1482720

 tccccctgc actgccctga gtgctgattg tagctccagg tgtttcagac ttaacaggac 1482780
 ttaggcctgg ctgcctgtgg tagcaaatgg tatatggata aagctatgaa ctctggccct 1482840
 gccccacc ttactgaaag gttttgcttt tttcatttgt ttattttgca atgctagagc 1482900
 ttgaacccaa ggcctcatgc ttgggtgtga ttatcgatgc tccctgagct acacctcagc 1482960
 cctgcagaga ggtttcagcg acaatcattt ggattttctg cactccagga ttcatttcac 1483020
 tcaagtctg ataagttttt ttttaatctc aaacattcca tttctttttt ttaacagttc 1483080
 caaagatfff atttatftta tttgaattac aaacaagatt gaattacatg acaatcacag 1483140

 ttcccttccc cctcccctcc tcccctacca ccccctgcaa ctaaaactct accaatcaca 1483200
 tacctttctt ctaatcttca cctgactcaa cctttctgct ccctcatgac ctctgcatcc 1483260
 ttctttttct tccccttcca ttctctgtagc tctctccccc ctcttcccat gttctcaatt 1483320
 tgctcagggg atggtgacc tttcccctc tccaggggtc aaagtttgtc tcctttaggg 1483380
 tcctcctttt ttactagctt ctctggcagt gtggattgta ggctggtaat cccttactct 1483440
 atgtctaaaa tccacatag agtgagtaca tatcatgttt gcctttttgt gattgggtta 1483500
 cctcgctcag aatggtttct tccattttcc tgcaaatttc aagattccat tgttttttct 1483560

 gctgagtagt actccattgt ataaatttac cacattttct ctatccattc ctgggttgag 1483620
 gggcatctag gcctgctcca ggttctggct attacaaata gtgctgctat gaacatcgtt 1483680
 gaacagatft cctgtttgta tgaatgtgct tcttttgggt atatgcctaa gagtggaaact 1483740
 gctggatctt gtggtagact gattcccatt ttcttgagga gtcaccatac tgatttccaa 1483800
 agtggctgta caagtttgca ctcccaccag cagtggagaa gtgttcccct ttctccacat 1483860
 cctctccage ataaactgtc attggtgttc tgataaattt tataacacaa atttgtttta 1483920
 caaatcaact ttgatctatg ctttaataat atgtacgaca ttagcaaagt cacatgtgta 1483980

 gtaaatatgt gtatgtgggg ggcggcttgg atatctgtgt acccaaagga tattgataga 1484040
 taacatftta tgaaggtta tgtatgtagg tctaaaaaag ttattcaaca tttactggca 1484100
 atgaatactt tacaattca atcctgcacc acaaacattt aggtgtcccc aaagtaagag 1484160
 tgttctttca cctttttctc tcccacctg cctcataaca gtagccaacc ccagtccggt 1484220
 gctgagcaca tcttcccggc atttacttct cgacacagct atcttaact aaactgctca 1484280
 tftaactfta aaatctcccc acctgagcag ctccgtgccc cctcctaate ctctatgaag 1484340
 aagtcagaag gatgattaca aaagcaaatc tagccggaca ttggiggagc atgactttat 1484400

tctcagcact caggaggcag aggcaggcag atctctgtga atttaaggcc agcctggtca 1484460
ataagagcta gtcttaggac aggcctccaaa gcaatacaga gaaacctgt ctcaaaaaa 1484520
acaaagaaa aaagaaagag agagagagaa aggaaaagga aaggaaagga atggaaaagg 1484580
aaaaggaaaa ggaaaggaaa ggaaaggaaa ggaacggaaa ggaaaggaaa ggaaaggaaa 1484640
ggaaaggaaa gaaaaaatct atatggctgt agctgtgtgg agcggcacac atctttaagc 1484700
caccaccacc cccattcggg aggcagaggc aggcagatct ctctgcatag caagttccag 1484760
gccaacaagg gtiacatatc gagaccattt ctcaaaaaca agcaaaaaa aatctatgag 1484820

atctgtgtat aaaccaatac aggggttggg gattgtgtca tagctggtgg agtggtttgtg 1484880
tggtgtatat gaagccctgg gtcctagccc cagcactgca aagactatat gtagtggtag 1484940
atacctgtaa ttctagaatt tgggaagcgg aggcaggaag atcaagaagc tctaggtcat 1485000
cttcatatag tttgaggcca gcctggacta tagggaccct gccctccaa agactggtga 1485060
gatggttcag tgggtaaagg cctgtgctgt ctgatgatgc acacttaatg acttgtgttt 1485120
gatcctcaga acttgaacaa aggttaaaag acagaatgcc acaaagtat cctgtaacct 1485180
ccacacctgg gccatggcat gtgtgctcac acaacacaca cacacacaca cacacacaca 1485240

cacacacaca cgcacgggtg gggtaggtt agggaggaga aataacaaaa ttactaata 1485300
caattttaat ataaaaatta aaataaaaa gtaaaaccaa tagagcaca aatatagctt 1485360
gtttcactct acctgtaag cgaggcttcg aacactgtc atcctgtta gcctegtccc 1485420
cataggctcg tagtgtgtg tgagcagata tagaaacagt aaacacttcc ttgcagagct 1485480
ggatgaggat tacctgatca gtctgttcta ttattttatg tctttctgaa tgcttaaaat 1485540
ctttagtaat aacaaaattt ttaatgact ccaatcacac catttcgttc ccaccctcct 1485600
cttgctcaaa ttacttctag gacaatggct aaccctac tactaaattg ctactaattt 1485660

ttaaaaagat ttatttatgt ctattttctg tgtatggttg ttttgcctga atgggtggat 1485720
gtctatatac cacaggcatg cagtgccttc gatagccaga agatggcact atattcctg 1485780
ggactggaat tacagacagt tgtgagcagt catgtggatg ctgggaattg aatctgggtt 1485840
ctctggaaga gtaagcagt ctcttaacca ctgagccatc tctccagccc caactgctac 1485900
tggtttttat taggggaaaa ttccaaccc acacaaaaat aggaagaata gtatgatgag 1485960
cccttgtgc ccagcctg cttctcgtgg cactgaggc cctacacgt ggcgtgttc 1486020
cactctcag cttcctcttt ttccatgact ctctttagt gttgctggac tccaagcacc 1486080

ctggcatact ttccactttt ttattctaca aactccttc ctttcagaaa ttgaacggaa 1486140
taatcttttc ctgaaatgtt cacttttttt agctttcacg ggtctcatcg gagatgttat 1486200
atataccttg ggaggtcacc cctgtttgct ttttttttt ttttttttt tttgagacag 1486260

ggtttctctg tggcttttag aggctgtcct ggaactagct cttgtagacc aggctggtct 1486320
 cgaactcaca gagatccact tgcctctgcc tcccagatgc tgggcctaaa ggcgtgcgcc 1486380
 accaccgccc ggctggaggt caccctgac atcgagcca gtgtctctga caagcacttt 1486440
 cacaacacct tgiiccagcc tttcattcca cttttatctc acaattctgt atctgtctcc 1486500

 caacgccagg ctgggagctt ccaagcaaga gttcagtggg gaccacagcc acgtaaagct 1486560
 gtatgagaca gactctgagg gaagtgatga tgccactgag agcacagacc aagtcacta 1486620
 accctgggac aggttgccct ctcgatgcaa ggcacgtttt gaaggatata taatagtcca 1486680
 tcaggaaaag gccagaatac aagcaaatgt ggtattctat tgtgaggacc agacttaatc 1486740
 tgcaggatgt gttcaggcaa cgtgtagat gaatcagacc taaagggtag gtctttgggg 1486800
 aaagtaaca aaaaggggct tgaagtttgt taagatctgg gttagacttt gcgactggca 1486860
 aggaggtaat agaagatgga ctccacactc aactcacctg aactcaata atggagactt 1486920

 acaaagtagc tggaggctac cttagctcagc cattcaattt tcccactgaa gaaacatcct 1486980
 caaccactgg tccttgtctc ctctctcctt gttcctaac tcatcaggca gcagagagaa 1487040
 ccaggagggc aatggaaaga gtaaggaagg ccaggccttg tccatcctca gagtgaatga 1487100
 gtgtggccac accctggcct tggctagagg ccttcccaga attagaaaac ggacatcca 1487160
 gtgctgatcc aaaaccccaa atgtgccacc tcctaagcc tggtgattgt ctggcttgtg 1487220
 gtggcctctt gggagtgggc caaggacatt gtgtagagct cccgggaatt cccaaatcc 1487280
 cgttagtgca ctaccacc actcaaaagc tgatggcagc caacaagcaa cactgtacca 1487340

 ttaagtggtt tgtcaagaag cttagctggg tgttgtgggc gattctgagg gcccttttta 1487400
 gactggctgc aacagaagaa gaagaagaag aagaagaaga agaagaagaa gaagaagaag 1487460
 aagaagaaga agaaggagag gaggagagga gaggagagag gagagagaga gagagagaga 1487520
 gagagagaga gagagagagc ttttgaagc aatgtagcac tagagttggg gtgtggcatg 1487580
 ccaaaaagac ccctccctgg gaggcaggac actaccctcc attctgcccc ccaacttgct 1487640
 ttgcattttt aaataagtga tttctctcc ctgcatttca ttttctctt tagcaaaaac 1487700
 attcccgtga aattacatga tcttetaagt ttctgagca gcgcatttcc tggctttttg 1487760

 tattcagtag gacttttttc tttttcctt ttttttttt aaatttacag taggacattt 1487820
 ttaaaaagta gttctaacat gggggaccag cagcaagggc cctcagttgc aaggctagag 1487880
 gagaaaggtt ttagtgggaa aggaattcaa gggaacagac ccagtgacca aggtgatcct 1487940
 gggaagccac cagagagact gggacagcag aagtccaag ggtgtagct gctgtaccgc 1488000
 agagtgtggg cacaagaaca cagtgacaac atgttcaaaa tcaaaagctt tatgttcatg 1488060
 aattagtttt ctactatgc tacaacaaat tgccaccaat tcagttcaat aaaataatct 1488120

agctattggc caggtattgt ggaacatgct tttaatccta gcacttggga ggcagagggc 1488180

 aggtggatct ctgtaagttt gatggccacc tggctctacag ggaaagttagc aagacagcca 1488240
 gagctatgta atgagacttt ctctccatac ctacagtaaa aattataaag ctgatcattg 1488300
 agttccattc ctagcaccac aaaagtaagt caggaaatca ggaactccaa ataggigtta 1488360
 tgggatcgaa gtcaaggagt aggcattggtt gcattcttct gcaggctcca ggggagagag 1488420
 actgtgcctt ttggcttctt gggctgcttc atttcttggc ttgggacctt ctgctgctct 1488480
 catcacacct ctgacctga ctcttctgcc tcctctctct aaggattctt gtgattccat 1488540
 ggtgctgtcc ttggtgcccc agggtaatct tcccattgga agatccttga tcccatcggg 1488600

 ccagtctctt ttgctatgtg acattcacag gctttgggaa tttggatgtg accatcttta 1488660
 aagaccatta ttacctaagc ctctcatgca ctgaggcctc ttaccaattc ttttattgtc 1488720
 ctctgttacc agatgaggaa cacgatgcag agagacgtga agtcatttgc ctgaaggcac 1488780
 tcagctaagt tagcaatatt caatatgcgg caggtatgta ggtccaagt gaaactacct 1488840
 tcagatagga ccctatccag ccacaggtgt aaaggggaatt tgtgtaagtc tctggaggat 1488900
 gcctcctaag gtctacagct tcatgatgc aagggccatg ctctgccact gggccattec 1488960
 cctagccctc ctgcacactc ctgagttagt atcgtgtggc ccactcctc acgtctttaa 1489020

 tgactcttat tcagatgtct gggaccttc cggaccacat tctataacat agcagtccca 1489080
 gaatcctctg tctcctcagc ctgcgttact ctctatcaca cttattacta ttgatcctcc 1489140
 aactagatga caactagaaa gtagctcaag tgttttgctc tgttacagcc ctctacgca 1489200
 gagctggtec atcgtaagtt gctcaataaa taccagtggg gctggactga tggctcagca 1489260
 attaagagca ctiactgatt ttgtggagaa cccaggttca attcccagta tccacatggt 1489320
 ggctcacctg taactccagt tccccagggt ctgacacctc tctgacctct gtggctcct 1489380
 gcacatacgg ggtgcacata catacacact ctggatcacg tagatatata cctatatatt 1489440

 tacattttta aaaataaaaa taaatattga atgaatgaat gaatgaatga atgaatgaat 1489500
 gaatgaatgg acaaaaaaca agttaatttg atgtttggga ggtaggacca atgtttttgg 1489560
 tttttggggg gtcttttggg ttttggagtg tttttttgta aaacaccgga tataagtagt 1489620
 aaggaagagc aaggaatcat gggtcataatg aggtctctgc gttggaaaac tgaggaagtg 1489680
 atggtgcaaa attctgggat aggaactgtc ttagttgggg tttctgttgt gtgataaaca 1489740
 ctgaccaaaa acaacttgag gaaagggttt ttttgttttt tgttttttgt tttttgtttt 1489800
 tttccttaca cactctgatc ataatccatt atgaaggga gtcagggatg gaacctggag 1489860

ttaggaaccg aaacagaggc catgggggaa gctgctgact gacttgcccc ccatagcttg 1489920
 ctcaactgc ctctttacc tactcatgac cactcaggc accacctcca gtgtgctggc 1489980
 cctcccacac caactatftaa tcaagaaaat acccgcccc agacttcct aaggcgaatg 1490040
 tgatgcaggg acttcctcga ttgaagtcc ctcttccat atgaccgtag ctctgtcaa 1490100
 gttacaacaaa actaacgca caggagccat ggcacaagcg tatgtgccg tgatctgagc 1490160
 acttcaggca tttgagaagc agaaagtccc aggaaggggg aaatcttctt gaccatgtgg 1490220
 atacctaaa tctgctgct tgctagtttt gtaactctgg gtaatcaatt aatctgtcta 1490280

 aacctctgtt ttctcatctg ccattcctcc ctcatgggct gctaccttct gagtgtctaa 1490340
 cacaatgcca agggcagagt tggcgcctag ataataacat ctatgatatt attgtaatta 1490400
 gatcatctcc gccaccacaaa aagtgtcttc tctggagtc aagctctgtg tctgcagtc 1490460
 tctattctg cactctgtgc ccgttgggca gctcccttc atgttatctc attctcttg 1490520
 aagccctctt cctccagct gaacatcgt cctgcatcct tgtaggaccg tctggtttg 1490580
 cttgctttcc tttggggagt tgcactttgt ctctctact ccgtagacaa acccctgagc 1490640
 ctggacctga aactctcttc atgctgaaat ctgtgctttg tcgccattgc tcacattggt 1490700

 tatggatttg attgccaga cagtatgtgt gtctgtgtat gtgtgtatgt gtgtgaatgt 1490760
 gtgtgtgtgc atatatgcac atagaggtcg gacctgggtg cttgccaact aggtgaggct 1490820
 ggttgggtcac agagccctgg aggcctgctt gggcttctct cccagtcct gggattagaa 1490880
 acacgtgtca ccctaccag catttgtact tgggttctag gattctaact cgggttcccc 1490940
 tgcttacact ttactgaggt agtgcctct ctccccggac ctgagattct ttgatcacag 1491000
 tctttgattc tctcttctc attccaatcc agagttccaa atcagacacc ggattgtctg 1491060
 gtccttcttg atagacttca ccagcagcct tctgacaat gccagcagc tcttactcc 1491120

 tgatcagacc cctgaccatc tttccaagtc tctcttcag ctggactacc ccagtaaatg 1491180
 gaatgctctc gaatgcctca gggaccatcc cagtagatgg gatgctctcg aatgccccag 1491240
 ggaccatctg ttgtaattga tccagcttct ctctctgcc caggccatga tggttttcta 1491300
 agtgtactcc ttagcctcag caatgatctt ctcttccac cccatcgat acttetaate 1491360
 tcaccaccgc ctctgctgtc tgccgctctc tttctctta gggccacatt ttttttctc 1491420
 tccttatget ctgttctct ttcctgtca ttcactatc agctctgact tctcaggaac 1491480
 tgaatcccc acctgtggc cagcggacca atcacactgt tctgtctatg atctccgtat 1491540

 cattggttca gccagctat tttggtcggc tftacctgca attcttctca ctttctctg 1491600
 agttttacac ctctctcggc acttagaagg tctcagacat cttggagtta gtttaactgct 1491660
 gtcaaggtta gacttctgac atggctgatg attgattaat gggtaaggt gtaaaaagat 1491720

gggaagccaa agcataactg ataaattcca gcaataactt ttttctacc ttactagct 1491780
 accaggattt atgctaaatg tcttcgtaca ttacttagta agccttctca agatggattc 1491840
 ctttccttgg tgctcagaca gtgcctccca ggccaactgt tcattcattt actcattcat 1491900
 gaacttgggt aciattgaat cagacactgt gctaaatact gtagcgggtt taaagaacat 1491960

 gacagtctct attccccagg aactcagtgt agtccgagaa aacagataca atgagtgaac 1492020
 aggtgtgatg cattgtagtg actacattta gcagagtaga caaattactt cagcaataaa 1492080
 gaaggccacc tacttctgcc aaggttttta aggaaagctg aatgaaagtg gggacatttg 1492140
 aagtaggcct tgaagtttgc taccatgtat caagagaatg gggtttgtgg ccaccaggaa 1492200
 gagcctggaa gtgttaaagg acaaagaatg tttggagtgt gtgtcttcgg tgtgatcagg 1492260
 ggcttcttcc tagagaaggc agtagaggct gtgagtggta gagatgaggt aagcagtga 1492320
 ttcagttcac tagtctgtgc tccatgctcc ttagcagaga gaatactgca cagggtctta 1492380

 gtgctttgat gacaggatct aacctgggag tcaatgttag agcagggtga tggctgagtg 1492440
 acttggccac ttccccaa tttgcaccta tcagtgtttg aattttatgg ctggctctag 1492500
 gtcaagggtc cagtcccaag tgattctttg tcatatgacc actttaataa tagatgaccg 1492560
 tataccagc ctcttcattt cctccttcc agcctcttca cctaccctca cccaaagtcc 1492620
 ccgtcatttt tacatatttc tcagactgta tcaccatac ctgctgggta gttccaattt 1492680
 catctccacc tggatgtctt ccatgacctc acctttctct ttatccctct ggttctctgt 1492740
 gacaagacag ctcactttct cccacagaat cctctccatg tctgttctat gaagctgtat 1492800

 cttcacaca ggttcaactg tcagtttgtg agctccttag tcatcactgt accccaaaac 1492860
 cctacacagt gcctagcgcg tagtaagtgt ttgctgtttg ttggatggac acaatgaaca 1492920
 actaaagcat gtccaactct gtcccaggca ctggataaat agagatggaa ggagccttcc 1492980
 cacaagagc ttagagtctg gtggatggtg atacggaatg gtcggggccc cataatatct 1493040
 gtaatagggg tttagtgagc acagaggaga gagaactcac tttgcctggg aagtcttcca 1493100
 gaggtagtaa tttatggatt gaacattaaa atatgaaagg tttttgcaa actaagaata 1493160
 ctcggcagag agaaacgtat gtgcagaggc ataaaagaga atcgggtgtg ggggactgtg 1493220

 agtattgaca ctgtgcagcg tcattctgaa ggcaaaacat gtttagaca ctgaatatga 1493280
 gaggggtaaa gctgtcgcctc ttttgcggat gttccaagac tattattctg gcaatttggc 1493340
 ttttaacag tttatcaca aggcagtga gatgttatag tcatctttgg tgaanaataa 1493400
 caagtaactt actttagatt tctagcagct accttctaaa aatggtttga tttgacttac 1493460
 agtaaggggc agagtcacaa taaagtgtt tgtatagaaa caaaacccaa aagctctcgg 1493520
 cctcagttgg tagagtgtt gtccagcagg caggaagctt tgggtttgac ccctagtgcc 1493580

caataaaact gggcatagta gcaaatgcct gcaatcctag cacactatcg gaggcagaag 1493640

gatgagaaag ttcaaagtca tcattgactg caacgtacaa gtccaaagcc cgcttggcat 1493700

atacaagaag ggaatagcac tatttcccaa ggtacctctc ctaatctcac tcatcagtac 1493760

tcagatggcc ttctgaagat ggacagaaaa ctgggttttg tggctgcaag cctggctttg 1493820

ggggtgtttc tgacacatta agaatgtaga agtttcactc attttccagt aatgacacag 1493880

ggaacctcgg tgetctcgtt tctttgggtt tccatccctc ctaatctttg ggggtgggca 1493940

aactccttta ccttgcctac ctgtggcttc tttgggtttc cctcccctct cacctttggc 1494000

gtggggcaag ctactttacc ttgctatcct tcagtctcac tgttcatgtg accttcactc 1494060

aaatctcttt tagtctcttg ccccttttac tctctctcgt tttttgttg ttgtttgtg 1494120

ttttttttt ttttttttt tgtagtgtt gagattgagc ccagtgctt tgtactcact 1494180

agttaagagc ccaaccacca agtcatatcc tcagccattt ttttccctt tttagaaaat 1494240

gactcctggg ttcaatcccc agcgtgtgta tgtgactcgc gacacacaca aacatacaca 1494300

tgatacaca cacacacaca cacacacaca cacacacaca cagttgacat 1494360

caactaagac ttttaggaag ttgacaggac taagaaccga caacctcca cctgactctc 1494420

caactgttag cattttactg catttacttg gtctagctat ctctttctct ctctcaaat 1494480

atatttatgc atttatttg gagccatta agcaccagt gcagatacca cacattctta 1494540

tgtaagcctt caatgtgtat ttctgaaagg caagaaattc tcttacataa tagattttcc 1494600

tatgcattta ttatttatat atatatgaa tatgttgctt tgcttattta taattgttta 1494660

taatggattg ctttgtgggg agatggttta gcaatgaaga atatatatat atatatatat 1494720

atatatatat atatatatat attgcagtgt gatgctatct atatcagatt gactttaggc 1494780

acaatatgtt ttaggagga agattccatg ggctattcta cctcagtga ttagctgttc 1494840

ctatgctctt acatgttagg cttgggtcag tggaaagcat caaatctatg aataaaagg 1494900

gcagagaaaa gctctgaatg ctgcgttaga gtcattctgt agccaggaga tatccaatga 1494960

gagattggca gtgggggagt gagtccatca gattccata ttctggagat taacggaacc 1495020

atgtctgcag ggtggagtgg aggagggggt aaaatgatcc ccgcttttaa aggcaaatct 1495080

ctgtcacatg gggcggagag gaacctctc cagcataacg catcattttc tttcacactg 1495140

ctttcagagc tggttaaaa cctatggcta tctgcttccg tatgagtcac gggcatctgc 1495200

gttgcatcca gggaaggcct tacagtcagc agtctccact atgcagcagt tttacgggat 1495260

cccagtcacc ggtgtgttgg atcagacaac aatcgagtaa gatttgcata gggcatcgtg 1495320

cctttgaacc tcttggactc tgtgttcaca tttgtgatgg tcatgctatg cccgtcctcc 1495380
 tgcctccttg gaagataata ccaaacagtg accttccatg gttcctgttc tggttcattc 1495440
 tccacatgcc atctccgtcc ccaccccaca cctcctaccc ccatctctct gatattaact 1495500
 ttatactgtg taactggaga caagtcgctt agcccttctg gtcctcagtt tcctcgtcag 1495560
 tacagtgagg gagtgggta tagaagatct ctctagtctc atcaggtccc aataactaag 1495620
 agctctctca gccatcctct ggggtgccct aagatgtgtg tgcatggttc gcttgacaca 1495680
 gagaagtgtg gagcaatcac aggcctggcag ttcttgtccc acttttcca tttaccaagc 1495740

 acctgctggg cgctgcatg tgccaggcac tgtgcttagc cccagcctcc tactcagctg 1495800
 ttttctgaaa aacacagtca tctggctatg ccgtcctagg gctcagaaac ataccaacc 1495860
 caggagatg ccaggaggc agtgacataa acccagccat gagaatactt ctccacctc 1495920
 agggacagca caaagaggtt agagagcaga ggctcacaaa gccagcctag aaggagtggc 1495980
 caggaggtg aagacctagg ggaagtgacg tcgaggcat ggccagctgg gttagtgtc 1496040
 gagtgtcca acagaaaggt ggctgaaagg cgttgttgtg ccttaggaat caggagttg 1496100
 tggataaact caggagatg gtggaacaa agtcagaggc actgagggga agagaccgga 1496160

 gctgagatgg caggagagga aaaagttttg agaagcctga gaacaaaagc aagagtaaga 1496220
 aatgggtggt aggcagaaaa agacacattt ttatttgtt ctcgtgggag aaagtgggc 1496280
 cagcaatcgc gtcactggg taaaggtgct tgttgacca gccatttgtt aggtcccccag 1496340
 aatccaagta aaggcagaag gagagaacca gctgcacaga gttgttccata atgttctata 1496400
 tgcatgtacg catgcatgca tacagacaca cacacacttg tagggcctg gagaaatggc 1496460
 tcagcattta agagcactta actactcttg cataagacc aggttcaatt cccagcacc 1496520
 acgtggcagc cacaacctcc tgtgaccca gttccaggt ctggtagtgt cttctgactt 1496580

 ccaaggtctc ctgcatgctc ctgctgcacc aacatacact cagacatata cacaccatg 1496640
 aaaaacaaaa cacatattta aaatagaaat aaatagaaaa tttaaaagac gaaagtagct 1496700
 tgataatatt tggtttggtt ttgctttgtt tgagacaaga tctcctaca tagcccagc 1496760
 tgtccctcaa ctcatgatg agaccagct gtccttgaac tcacagaaac tctcctgct 1496820
 cccaagtact aggattaaag atatctggct ccattatgcc tagccttttt ttttttttt 1496880
 taatagccat aggctgataa agtgggcca gcaggtaaaa gtgcttgcca cacaacctaa 1496940
 tgacctcagt tccatccta gateccacat taaaaggga aaaaaagtct cctagaagtt 1497000

 gctctctgac ctgtgtgtg gacacataca cactaataat agtagtaaat ataaataagt 1497060
 aaaaaaattg aactaaaaag aaaatctccg tgaagccac ttgaactgtt tcagaagaga 1497120
 catgcaggcc aggcaagcat agagagagca gaagtgaagt tctaaaggga gagatatagg 1497180

agcccacgtg aggggtggagg cagatggcag ggctggctga ggacacggga gaactggcag 1497240
 gaggcgaaat ggaaaatgca cacaactgtg gctcaaaaat cagttcatcc ctgagacaag 1497300
 ttactctggg ataggggact cagagtgtct ggtttgcgat caaatcctga gtccattatt 1497360
 ccaagctgca aaactcttac aacttgggtga tccgtaattc catccaagcg tttcctagtc 1497420

 cctccttctc ttgctgtgat attgtgaaat tcaggacag tccatccgaa ggctccctgg 1497480
 aggctgtcag caacatgttt gctcctgggc cttaccagtg agtggctctt agatcctagc 1497540
 atccttcta ggcccaggtt attttgaggc atttgtgcgg gcttcatggc agtgcacct 1497600
 gggccaggag cactgatgtc tctgtgagg caccacctgg ccttgggttt tactctgttc 1497660
 cagaaaagccc caggcctgct ggacagggtt caaacacag caggtggatg ggaaaagaga 1497720
 agacaaaggg aaggagctaa ggaaagaggt aacgttgctt gccacactt ctgcccgcac 1497780
 ttcttttggg aggatgggag cagtattctg gacacacaga aaggaaaagg ctgttcacac 1497840

 ggagtccaag cctggatcgg gatgggtgga attcagaggg ctccacccta gctctgtgac 1497900
 tttgggcaat agtggccttt cctgagccc atctcctgac attgggctct caggtctcgc 1497960
 tcagccttac agtagcaggg atggettttg cttctcttcc cagggtatat gagnaaggg 1498020
 aagcttgatt cacaatttca aatactattt ttgagtgttt acctgggaa atgccacaca 1498080
 tttattcctt cactcattcc tccagccaca tagctcctct aactctactc tgtgctaac 1498140
 tgcatttaaa gtctccaag tcaaggaagt tgcagccctg cctcactgac ttctgtgttc 1498200
 caaatgacct gattcatcca cgaaatcctg acgacctgag ttcgatccct gggatccatg 1498260

 tcaagggaga agagaacaga tcccatgaac catcctctgg gctccatgta taccatgaca 1498320
 tacagcactc ctcaacacat tgtgtacatg aaaaaataat aaacagctgg gcagtgggtgg 1498380
 tgtacgcctt taatcccagc actcgggagg cagaggcagg cggagctctg agttcgaggc 1498440
 cagactgttc taaagagcga gttctaggac aaccttcaaa gcaatacaga aataataata 1498500
 ataataataa taataataat aataataata ataataaatt tttaaaataa aaattctgct 1498560
 aggcagtggg ggcacatgcc tttattcca gcacttggga ggcagagaca ggtggatctc 1498620
 tgtgagttcg agaccagtct ggtctacaag agtgagttcc aggacaggtt ccaaaaagct 1498680

 acacagggaa gcctgtctc aaaaaacca aaataaaaa ataaaaaaa taatattct 1498740
 aaaagcagtc caggtgtaat tgtgtctgct tgtaatccta acacatagga gacagaggca 1498800
 gaaggatcat gagttagaag ctagcctcgg ctacctagca agatccatc tcaaatcaaa 1498860
 gaactctgag agcacacgaa tgcattgggag ctgcaaatgt ttactcgggt gtgtgctgtt 1498920
 gctgttggg cagtccatta ctgcccgtgag ttaggtcac tctctgagtg agtggagcac 1498980
 accaagatga gtaagaacta gttcattccc tctagaggct ttcataatgt gtaaacacgg 1499040

acagccttct tttttccatt gccaatgaca actgctttta acagctgtga gtgaggtcaa 1499100
 acactttccc ttccagtgat gccaggctat agttcagtgg gtcagctgtt agacagaaca 1499160
 taaaatgcag acagtctgac cctagtcagt tgtgggtttt taaatctcct getcaggccc 1499220
 ctcttaaatc cccagcgatg ttccaggctt gttccctggg gtgcctttac ctgataatga 1499280
 acaagtttat caagatttac tgagttccat gcactagact agctttggga cacaatgaca 1499340
 aatgtaacat ggttctcaa agaatctgcc actattagaa gcaacaaatc aatatctaaa 1499400
 atcacaatat aatgtaataa gtgctacaga aggttatatt ctacgtcctg tatctgctca 1499460
 gagatttctt ttgagtcagg atctggctgt gtagactagg ctggcctgga acacactgtg 1499520
 tagatagatc aggtctggct ggaactcact gtgtagacag atcaggctgg cctggaactt 1499580
 ttgatcctcc tgcttcagcc ttccaagttc tgtttttctt tttgtttgtt tgtttaatgt 1499640
 gtgttgatgt tttacctaca tgatatctgt gtgaaggtgt tgagttgcct ggaactggag 1499700
 ctacagacag ttgtgagctg ccatgtagat gctgggaact gaaccagat cctctggaag 1499760
 agcagtcagt gctcttaact gctgagccat ctctccagct ccttgagcca ctcttaaac 1499820
 acctgtagtg aaagacattt actgtccttc atgctcttct gttgtcgtgt tgaagagttc 1499880
 tgattcagtc atttattcag tcagtcctgc atcggttaag aatcattat tgaccctttt 1499940
 ctatgtgagg cactgtgcca gccctagga tacaggggac tcccctatc ttatccagct 1500000
 cagagtatgg tgagaaaaac aaagaaggca gatgtatacc tttcgggaag tgggaacctg 1500060
 gagaaggaa cattaaaca gttaaagccat gttattgttt tacatcagtt catcaggaa 1500120
 gctctctctg aagggcagag accggaatga agtaaggga caaactacat gaagacagac 1500180
 agacagacag aaaagcagac agcaaatgca aagactctgg agcagagatg gttactatag 1500240
 caaacagcga gacaccactg tggctggcta tctgacagga aaaggtaac acgtgctgg 1500300
 atacatgggc gggggctaga ccatgtggag cactgtagtc tgagctggga gttagacttt 1500360
 tattgcagtt atgatgctga cgaggaaact ggggttcatg ttgattcat ccttgctg 1500420
 gggctctcgc ttggtagaac tagaacttac agtgtctcct gaatccaggg tcttaagtgt 1500480
 ttattaaact taagtatttc tccttgggag agaatgaatt aatgaatcag tccatctgtt 1500540
 aattccttct gaggggtgic agagtгааag tcccagaatc taagctgagt atgtgactg 1500600
 ccatccagac tggagttgtg agctgcacaa tgccttecta ggatgttcag tgaccataat 1500660
 gcctatgtgt atgtgtgic gtgccttctc tctgccagg tggatgaaga aaccccgatg 1500720
 tgggtccct gaccatccc acttgagcag gaggcggaga aataagcgt atgcctgac 1500780

tggacagaag tggaggcaga aacacatcac ctacaggtgt tgcagcccct tgcttctcctcc 1500840
 ctggttttag ttcccatgct cactctcttt ttctgccta agtttctgaa gttcacatgg 1500900
 taggtatgtc ttcaggtggg ggagtcagga caaaggccag gcatgggaca tcaggaccag 1500960
 atgctgagag ccigtaacce tgtcttcttt gtgacctccg caggtgactc tggcttcagg 1501020
 tttcttggtt tgcttggtcc tttgggaatt agctgtgttc tatttagaca cctacagtta 1501080
 ctgaacacgg ggtataaagt gttttagga ttctgctgtg taaagacca aggcagagct 1501140
 cactgttcat gcttataaac tgccctgcct ctgctggatt cccaatttca gcctgacaga 1501200

 cttcacccaa catgctcaat gcagacagag tctcaactgt ttcttaagga gagtaaggga 1501260
 tggagacata gggtcacaac agcgtcactc tgtgagtgga gaagccaggg cagagcagat 1501320
 tctgtctcca agccccacaa tggctaacac gaggataatg aaagccagca cagcagggcc 1501380
 agacaccagg actcacagag gcttgggcag ggacctggct aggaaaggct ccaatgggct 1501440
 ctgcttgga ccctcagaa ctctgattcc acctcaggtc aattcccacg gtacagtcaa 1501500
 cgaaccaag acagagatca ctgggttaca gtaagagctt tccttacgac cagaagtaga 1501560
 tatcagaaca ggatTTTTT tTTTTctta aagagaagga aacttaagag gcgtctaggt 1501620

 tagaagactc ttgagtctcc caaagacgag gaatggatca agaggaagga aaaaaaaaaat 1501680
 gtttctagct ctgttctgat cttacctctc attactcaac ttctctagcc ctctgcttcc 1501740
 ttctatgga acgggtaaga tgatccatgt acccagcatt cttggggcag agaattcata 1501800
 agtagtagtg ttccattgtg gaaaaccgtg taccatagat acagttagtt accttaaga 1501860
 gctaagttag gcgttggatt aagtcatgtg ctgccctaca ccagctgctg atacaccagc 1501920
 aatagctagt tctttccac ttaaatgcct ctgtactatt tgagtatggt tgcgactttt 1501980
 acaaatgtat attatgtgtt cggagagaaa gagttagatt ttaaaggagt ctgcctatca 1502040

 attgctgcac attggatgga atcccttatg caacataagc cttgtcagga ataaaaaatc 1502100
 tgatgaaac aaagctattc tgtgggcagg ggtgggggtg atgctcttcc tgaagacat 1502160
 ttagcctggt cttcggcccc cagggcatct cagtagaatt cgggactcg aatgtgcag 1502220
 accactggac catgctggct ctgacagecc tttcagttc actggtctct gattctgcct 1502280
 ttctttctaa tgatccttct ctctttcacc agcattcaca actatacccc aaaggtgggt 1502340
 gagctggaca cacgaaagc tatccgtcag gcttttgatg tgtggcagaa ggtaaccct 1502400
 ctgacttttg aagaggtgcc ataccatgag atcaaaagt accggaagga ggcagacatc 1502460

 atgatcttct ttgcttctgg tttccatggt gacagctccc catttgatgg ggaaggggga 1502520
 tttcttgccc atgcctactt tcttgccca gggattggag gagacactca ttttgattca 1502580
 gatgagccct ggacactagg aaacccaac catgatggtg agtacctgaa aggatggggg 1502640

gcaggagggg atgtcagtc tgggatgttt aattgtcagg gaaagatgca ccaaggatgc 1502700
 acttgagac accattaatg agagacctgc ttcccagaac ttcttgttta aaaaccaagg 1502760
 actcaagaga gtgagagctg tgatctctgt taatattcaa cacttgatcc tgatccacca 1502820
 ggaccaggcc ataaaggcca ttgagaccac ctagaagtgg gtctaattgg gctgaggcag 1502880

gattgaacca tgaataagaa aatggtatgt cagaggctga agaaacagat taaaaggctt 1502940
 taacatagaa ctggagatct gatgagttct cgtctcaaag ctactctaag ccatggccca 1503000
 acctttctag catcctcaga taactttcct tgcaactactg tgattctgtg gatatgcaca 1503060
 gaacatcagt cagtatcggg cagtattgcc actcatcatt aaagaattca tccatatgaa 1503120
 ctaagacact cacttagcaa atgggaatgg aactatggt gtgtccattt aaatTTTTAT 1503180
 attacattca tttatttga tgtatgtatg ttgtattggg gtgcacacgc acagctctca 1503240
 tatggagatc agaagacaac ttggggaggt cagttttctc cttccattgt gcgggtgaat 1503300

ctcgggaatc agactcaggt gaccattcct ggtggcagaa cttctttaca tagagtcac 1503360
 tcaactggccc aataatctat ttattagact tatttggtta gttattattt gtgggatgag 1503420
 tgtatcacat agaaagtcca gagaacaact tgtgagagtc ctttctctac ttccaccagg 1503480
 taggtcctag ggcttgaact tgggttgtcc ggcttggttag caagcatctt tatccactga 1503540
 gctgtcatgc caactgttat gtccattttt aagatgaaga gttcaaggct caaatggat 1503600
 aactggtagg aggcggtgct ggaactcaaa ctcaattcaa catcacgta tgaaagggt 1503660
 aaggatgtag ttcaattggt agagtctttg cctagcattc ataaagccct gggttcaatc 1503720

cccagcataa tcaaagagtg gtggtatgtt cctgtaatcc gagtatacag gaagtggaga 1503780
 tgggtgacag attaaagtaat ctctaaggtc tcgtccaatg ctggtgtgac atggtataag 1503840
 tcctgcгааг accaaggggt atgtgaatat ttaattaagg agtaggcagc gtctgcctc 1503900
 tgaaaccag agtcaggtgt ctatataagt aaccaggcca taaggcagac tctactgaag 1503960
 gctgcagtac atgtccaag aaaatgcaac tagaatcagg gagattcagc cttcagatta 1504020
 tagtagatag taattaatgg atgttagggt tctaaggttc ataccaagta cctcccacac 1504080
 atcatgcat aagtaggtat tatcatcctt attttacaga taggcacaca aaagcataga 1504140

gaaacattat tctatctaag gccccatagt tagtcagtag ttaaacaagg ctttgaattt 1504200
 ggatatttga acctggagc ccataacctc agccaccact atgagtaata gtttttctgt 1504260
 atgccgtaa taggtttctc caccaacaca gtaagtcaga tcaagcctaa cagaaaaagt 1504320
 gtaacagcgg gtttatttga gcaaagcgac ttctggatgg gttctccagt tcccagagat 1504380
 caaggccaga gaaatcacac acccaacta aagcagggag attgtatagc ttgtaggcaa 1504440
 ggggtgatga catgtctgcc acaagctggg tttttgtcca agtatggtca aaagtgaag 1504500

gtttaagcag agacttgggc tgctggcaac tggggaggaa gctgcagcag tcaccaagaa 1504560

tgctgtcttg ggttgtgggt gccttttctt tgttggagat tctctgagaa ggcagggttt 1504620

ggagagaggg gtcgggagag aatggggctt tccagatcaa gcatgagtga ggtgaaggtt 1504680

ccaactaaac actgagtttc catggatctc aaaccacagg gaccatgaga ctaccagggt 1504740

tctatttaga aacatggatt cctgtccctg gagatcccca tccttaagct ggataaagtt 1504800

tggaaaaaa aggacacctg ttctacctt ggcacagctt atgggtacag gcaggtctt 1504860

ctcggtcctt ccctcataag ccatgtctgg ttaggtaga tgggcttctc cctttaggtc 1504920

actccagacc actgtgtgaa tcagggtttt gctcctctca gcatctctcc aacactggtc 1504980

cagtgccact gaccaggcag ttaagagact gttcagttc tttgtcctct tcctcttcg 1505040

gattttgtta tgtttctgt gaagctccat ttctctggc ttggcgtcat ctctctatg 1505100

tccttgataa ctttctgac cttttgtgta cctagtcttt attttactct tatttttga 1505160

gtggtgtcaa caaatgacta tgactactga taaggagtca ggggaaaaaa tttatcattt 1505220

tcaggcctgt tatgtccag gcaccattag ctgaaagggt tctagtttta gttctggtaa 1505280

acacaactga attttcttg ggccggggtg ttgagactgg gtttctctgt agccttggct 1505340

gtcctggcac tactctgta gaccaggctg gcctcaaact cacagagatc catctgcttc 1505400

tgctcccaa gttcagggat taaaagtata caccaccact gtctggttca caactgaatt 1505460

ttcaaagggt tattttccta tagagggtgct agaaagaagt gccctcctt ccctttctgc 1505520

caagccccag ggtctccaca gtcatgcca ctcttctgtt ttgaggagct tactaggtca 1505580

gcctgcagtc ctgagaactg gtgtgtgtgg cgtgtaggaa ggacctagag cctgtaaatg 1505640

gacaccattg caacaccctt ccctctgat tacctcacct ttaatgaaca acctccagct 1505700

gggataggaa cagggtctag gacattgtc tataaaaacca gaggigaact gggtagcact 1505760

tacaagtaga tccttgctg acgggagtga actgctgagc actacccaa gaagggttgc 1505820

agcagtagaa aggaaccaca atttattgag cacctggata atgtggcatt tgattttcac 1505880

atacattcag tgagggaggg agcaagtgtt atcttagctg gtgttatctt atccctcaa 1505940

gtccatcacc cttcagcccc aaataagcac acagatgcta tgttaattat aaaactattg 1506000

gccaatagct aggacttctt actgactagc tctctcttaa gtattaacc ataattacta 1506060

atctgtgtat ttctacatgg ccttatttta ccagagaatg cctggtgctt cctatcctcc 1506120

tggtctctat atggcatctc cttccatgic tacctttccc agaattctcc tcattctta 1506180

gccccgtctg tcttcttgcc tctattggcc aaacagtgtt ttattcatca accaataaga 1506240

gaaacataat gcagaagaac atccccatca ggcaggctct cctgggactt ggtctgatta 1506300
 ctgggttgc ttcattatgg aacattttca aactctctag aggaaggagc ctgaggagga 1506360
 tcctagatca ccatactctg ctccagtac caaacactgtt gttcctactt tgcccaacac 1506420
 ttccactttt attttatttt ccgctgagat ttgttttgt tttctttatt ttatgtatat 1506480
 gagtgttggg cctacatgag tgtacaaaa gcagtgtcct tggaggctgg aagagggtgt 1506540
 cagggtctta tggaactgga gttacagatg gttgtgggct gtcgtgtggg tgttgggaaa 1506600
 tgaacctgg tcctctacaa gagcaacaag tgctctaac cactgagcta gctctccagc 1506660

 cccatggctg atgtattcta aagcaagacc caggtataat atcattttat atatgactac 1506720
 tttagcatgt cactctaaca aagaccaaat ttaaatataa ccacaaaatc agtatcaaac 1506780
 tcaacaaggt taacaacttc ttaaaatcta atgccagag ctctggtaaa gtgttcaagc 1506840
 atggaaacc gagtttgact ccagaaactc atgcaataaa gccagatatg gtgtcatatg 1506900
 ctgcaagct cagcactgga gaggcagaga caggggtatg cctggggttt gctagctaca 1506960
 cagcctagcc tagtaaggaa gcttcaggtc caaggaaaga ccctgtcca aaatacaagg 1507020
 tgcaacaatg cccaaggttg acttctggcc tccacatata tccgcacata caaacacaca 1507080

 cacacacaca cacacacaca cacacacaca cacacacaaa cacacaccac ccagagtgc 1507140
 cactgaattg tgcataatgt tctcattccc tccccccaca aaggcgcaag ctageccatc 1507200
 ccacctaag ccattttcat taaactttgt cccattttct ttaaaatgag tcaaccagtg 1507260
 aagtcagcag atactcggct ctgccaggag ggaaccagc cctctgtgtt ccttcctaaa 1507320
 ggaaggtgac aagccaggaa gagccttcgt gaccataccc tgcttcacag aacagagcct 1507380
 ttccacttag ctactaaact catactccac agcggactta ggggaggtac tgaaaaagt 1507440
 acacagtgg aagacagcag agccagatgt gaaagtgaga tgccatatct ctgacagtcc 1507500

 ccccaagggt ctgcagcagg tggteccagg acagaacgtg gaacactaga gtagttttgg 1507560
 cattgtccc gcctggtgct gttgccttac tgtgtcaaac tcaggcagct gagccatttt 1507620
 tctggggcta ctgttccaa gaagctcagt cttggggcag aatacacacc cgtggctgta 1507680
 attaatgaag gttgaaaaat ggccagcacc taaagctgcc tgatattaag atgctgacag 1507740
 ggtggagaag gcacaggcca gctgggagag ccaggctggt ttctggggag atgagcactg 1507800
 ggggtgaactt taaaggaaga gaggaattt taggggacac cgctgataag cacacagagg 1507860
 tgaaaagaaa tgcttgggt ggggtctatt ggagtcatga agacaggaat ccacaacaag 1507920

 gaaagttcat ctgaaagag gccaggtcca cgggagaagc caagcagact gtcattctac 1507980
 agggcccagg acttctcca cacagacacc tgggacgctg gtcctctcac acagctcaac 1508040
 acacagtgat aatgagtaat gatccatctg caccaagccc tgggtggca ctttgtttac 1508100

cctgactcat taatccttgt tgctgttctt aggaggacgg cggccattat tctcttcgct 1508160
 gcagagaaaag ggctcttaaa atgccacacc gctaggacat ggagagctg cagaaaccac 1508220
 actctgatca ctcagctcct gcctccccct ttttggggag tgaagaccct aagagcctct 1508280
 tctccatagc tgacccccac ctgttccctc tgttctctca caagttcagt gtggctgctc 1508340

 tcccccccc tccccttccc tectctcccc tccctctgtg cagtaggatg ctgcttcccc 1508400
 gagtttctct tecttttggg cctgggaaga aaccacacagg cctctttgct ttaaggattt 1508460
 cactgtatac agaataggca caagccaagg acaatggctg agagtactca ggggctctct 1508520
 ggccccctgc tgaggtccct gtggatggtc ccaaggagag gcctggtcag gagagaggcc 1508580
 ctgaacagct tgtccaggta gagcagaagg ccaggagcag agccagggca ggctgcagga 1508640
 agctgagctg ccttctgccg gctccagcag ccaccttggg ttggagtga gctaaaagat 1508700
 gagctcactg cttccctgct gtgtgaaggg accaggccct gaggaaggag ctgggggcaa 1508760

 cctggctttc tctgtcagc ctgcctttct cagcagaagg ccggcccagg cttttggcca 1508820
 accttgcaat gatcttgccc agccccatt cctctccatt gctcaaaggt ggcatcatgg 1508880
 atgacatgga tgacgttgtt ggtgtcagtg gagagtcagt ctggcctgta gcattcttct 1508940
 catttccaa gaccttactc aaaaggccag acaactctca tctcatccg actctcccgg 1509000
 ggcttgatg ggctggggta aggcaagtct gccagggata ctagaccag agtgggcagt 1509060
 aaggttctg acccctggg gcctccctgg acttcaaggt ggagaaaagg aacggagcca 1509120
 tccttaggac tgggagataa gaggtaggtc tcatgggtga acaaatgcca gaggtgtaag 1509180

 caggagtctg taactgagca gagaggagcc agatgcaatg ccctgcccc a tccctaggcc 1509240
 aatttctttc ccaatactat aattacctaa tgtctacaaa ttcaggcctt gacctacca 1509300
 cgacttaaaa tggaaattga agggagctag ctttaagaaa atctggttgc tgaagccca 1509360
 ccaaccttcc ttgctaattgg gtttactctg gcccactca ggtctttcgt getgtagcaa 1509420
 cagagcaact acatcatgtg ttttacacct gttagtatt cagtccccac ccaaccaatg 1509480
 agttagtcca gcttctcctt cctacaaatg aaacgttgag ggtgaggtgt tgaccaagc 1509540
 ttgtaagtgt ggcaactgaa gtggcggtga cctgtcccat ctcagggtgc tcacaaccag 1509600

 cacacctcac cgtccctcag tttcatgttc aggatcccgt gtctgcctt cagtaccaga 1509660
 tttccaccgg tcttctctc tgcaccttga ttttggggg aattccagga atagggtcct 1509720
 gctgtcccc tacccccag agccctgttc acaccagcca cccaaggac tttttcttgt 1509780
 attgccatgg cttccttgac tctgtgacc cagcagcacc ccagcactg caccacctt 1509840
 tctgaactga cccactgat ctacctgect cggateccct ttgctctga tctctctec 1509900
 aatgtaaac agggtgactt catcatgccc cctcctctc ctgctacccc acaccctgct 1509960

atggccaaga aactgatcca aattcctttg tagggcatca cagagccctg cttgccagcc 1510020

tggctgacct catctctccc tggccctccc ttcgtgcttt gttctagagc caagtgaat 1510080

gaactgcttg tccttgacc tggtttatag cagcacctct gccaggaatg gcacactcca 1510140

ccctcttctt ccctaacct gaatcattc tgcagaccaa tgttttacct ttcaagactc 1510200

agcttaagtc tcacctatg ggcgtcttcc ctgaacacct tcctccaatc caaagggact 1510260

tagtagcaca gacatgtagt cccagctgag gcaggacggt ttcaagttca agaactcaaa 1510320

atcaaaaagt acaaagaggt cttgggatat tgctcagtgg tataatgcaag gcccaaaggt 1510380

accataaaaa aaaaaaaaaa aaaaaaaaaa aaaaaaaaaa aaaagggtgt gggggtgtgt 1510440

gcaaggggga aaaaaagagc caaaagaaa aaaaaaaaaa aaaaaaaaaa aaaaaaaaaa 1510500

aaaaaaaaag ctctcaatct ttacacatgt ctggatgcct ggatactgtg tagcctttgc 1510560

agttttctta tgtaccctc tgcaccaatc ggtacacagg caaagattgt gtttgatttc 1510620

tctatgtccc cagtgtcgaa cagaaggcca ggggcagaga caggggatat gctaagtgtt 1510680

tgatatgcta agtaacgtct gttactgact aataactaagt gggtatcctg gatacctcgt 1510740

tgtccctctc cacaggcaat gacctcttcc tgggtgctgt gcatgaactg ggccatgcat 1510800

tgggactgga gcactctaata gacccctgtg ccatcatggc acccttctac caatacatgg 1510860

agacgcacaa ctttaactg ccccaggatg acctccaggg tatccagaag atttacggtg 1510920

tgtatagtac gggggagggg ggtatcacta ttgttaatgt gaacattgct gttgcagggtg 1510980

tggggccact gttgttaatg tgagcatgcc ctgtggcagg tgtgggtca ggatctttgc 1511040

cattgtcaga attgctactg tgtctctgtg ctgacttaaa tgaggtcccc ctagecact 1511100

gggaaaccta agggagagaa tttgagctgt gactgggaaa ggtaaaatga ggtgaggccc 1511160

actattctc accctttccc acccactcc ctttaccaga gggggaccag gcacactctg 1511220

gggtgcctct aacctaggaa agtcacacat ctgcttgaat aatggtagta agtattatat 1511280

gtgaccttga gatgaaaagc tagcttgctg tcctcataag atatgaaagc ctaccatgta 1511340

caagtccac cggcatggag agtctaatca agttagtga aatgggagac cagttcattt 1511400

gagcaaatgt tggccaacac tgcactggag gtgggggtcc ctctggagga ggtgcgacaa 1511460

ccagggcccc catcacaacc cacggtgaag cagcaggggg caggtgggc agccagtact 1511520

agaagttatt tcaaaggtgg aatggtcagg atctgctgac agatcagatt gagggaaaga 1511580

aggaacaggt caatctaata ctgactttgc tgtgggtgtg gctcagctgg tggagtgtc 1511640

acctagcata catacatgaa gccctacatt tggcttccag caccacatga accagcatg 1511700

gcagcataca cctgtaatcc cagccttcta gaggtagagt caagaggatc agaagttcaa 1511760
 attcatcccc ttgctacat aaggtgtttg aggccagaca ggggtacatg agatcctgtc 1511820
 ttttaaaagg ggggggcaact ctggfatttg taactgtaga ttaccccaaa gatctgagtg 1511880
 agcccatctg ggaactcctt gaagatctgg agttgtagaa ctccctagg tgatccacaa 1511940
 gagctgtcca agttgagagg catgacaaaag ggaaggaaga aaagagacc ttaagggtac 1512000
 ccagtctttg gagcagggtg gactcctcta acaatgcagg ttaatagaga atccccccag 1512060
 gggcagacaa accaagagca caggccatg gaaaaggagg agcatggttc aaggcaaatg 1512120

tttcagaat cttgctgtcc aacttggtgg tctcaggcca gtgacatggg tttcacctga 1512180
 gacctgaag acatattgtc tctggctcca cccaggccc tctgagtcac aacctgcatt 1512240
 accaagatga ctactcgat caacaaagt gataactgtt ggtttccgaa acccagaggt 1512300
 cattggtgaa cttggcaaga ggtttgggta gaaaatggag ctgacgctct attgcagttg 1512360
 ccgaagaatg agcgtggta gagatcagag ttcagccagt gtgaaggagg gtagcaaagg 1512420
 agagtgtggg aactggccc tcaggaagga caagtttctt ctttaaaagg gaaagatgcc 1512480
 agccttgggg atgggaaagt gaaagtccct atctaagggc tgtttccatc tattttccca 1512540

aagactgaga gttaaatcag ggagagggga caggaagtct gaaatgataa acttaaccta 1512600
 gaactgccta tgtagtgatg gggcaatggc agatgacagt aagaagagc cacgtcctct 1512660
 ctaagacaca gccctctct ccaggacccc cagctgaacc cctggagccc acaaggcccc 1512720
 ttctacact cccggtccgc agaatccact caccatccga gaggaacat gagaggcagc 1512780
 ccaggcccc tcggccact ctgggggacc gaccatccac tccaggtgcc aagccaaca 1512840
 tctgtgatgg caacttcaac acggtggctc tcttccgggg cgagatgttt gtgtttaagg 1512900
 taaggttggg ggaccagggc caccagggg gtaccttccc ctacaatgga gctgggcagg 1512960

ctcctgctct atctgctctt ggctgctgta gggcctggac aggagctggt ctagtgtcca 1513020
 ggacctatag tcttctggag ctgacaggtc aatcaacttg gttctacaag gtgacagaga 1513080
 gattggtgag ctgacagctt ccaaggagcc aatcagtgt caagaacatg ctggagctgg 1513140
 catcgggtct atgacctga ataagtcacc ttcttctcc agacctcagc aataaacct 1513200
 ggggcagcca ttctctgac aaaggatgtg tgaagattaa tggctaggaa gatgcagagc 1513260
 agggcctggt cagggatggc agtctatagc tctgccagg gcatgagtga caggactgtg 1513320
 ccaggctatc tcgtgttctt tgtcatgtga gccaggact gcctgagcat ggtgcatggc 1513380

agggcaggtc cttggagaaa cagactctga gatagagtct ggaatgagag attctgctta 1513440
 aggaccttta ggataaacag atgtggtcag gaggggcaga aagccagtca ggacagtgga 1513500
 agaaggtgag gagacacaga cttggtgcca actcagcccc tcatgggaag ttctggagct 1513560

agaatggccc atcacagtca ttccatattg gatgcaaaaa tgaagctgaa gccattgcaa 1513620
 aagccctgaa agctgaatgc tgctgtctgg tacagtcctt caccaaatgg cagctggaca 1513680
 atggctctcc atgacactgg gtgccagagg aaggctaccc catttccttt cctaaggctc 1513740
 ccccaggaag ctccaagcac aaagtaaaat ccaggccatg taggctagcc cagttctgcc 1513800

 tctcactaag tgctgtctg taggcatggc ctctgtcctt cctgaagacc gtgtgtgtca 1513860
 gattgacttg acagagtgtg gcaagtcaga ataaaacatt ttccaaactg gacctgaaag 1513920
 tactttgtga aacatttgaa aaacgctgag tgatacctca gtggttaaga gcacttactg 1513980
 ctctgcgaga gcacctgtgt tccgttccca gcatccacat ggtggctcac aactgcctct 1514040
 agcttttagt tccagagaat ccaatgccct ctgttgatgc ctgcaggctc atgcacacaa 1514100
 gtacatgctt acactcaggc acacacccat acacatgagt acattttaa agatatccta 1514160
 tgtctgtact gtcttctgtg agtcatattc ctactgcac acttgatatt ccttgagcct 1514220

 cccaataaag tgttcacagg caagtgtgaa tttatcctc cccittacca cactgatccc 1514280
 aacggatate agtgactgtc tgctgccctc cgtggccac tccaggcctt ggcagtagtc 1514340
 gcctttctag ctttccaca cccatctgct gtgtgtetca tagtccttga acagcaggag 1514400
 gcttaagtga agaattacat cctgtcttct aagagtggga agcagcagat ggaccggctt 1514460
 gatgggaggt tgtgaggctg agccccaggc ttggtgttgg attgctgggc ctgaaccctg 1514520
 gggctgagat caccaaattc agagtaaga cctgccacct gcgtttctca tttccccat 1514580
 tcccctcagg atcgtctggt ctggcgctg cgcaataacc gggtgcagga gggtacccc 1514640

 atgcagatcg agcagttctg gaagggcctg cccgcccga tagatgcagc ctatgaaagg 1514700
 gccgatgaa gattcgtctt cttcaaaggt aacgtggggc atttctacgc cctttttgac 1514760
 gcttctttt tccatctaa atcagaagag gtgggggtggg aagcatggga agcagatgcc 1514820
 ctctgaaggg ccagatcccc ataggtagga cctaggtcat ctgggaaaac caagtcaaga 1514880
 aagtgtcaac attgacgggg taaaaaaaa aaaaaaaca tgcacatgaa gtacagggtg 1514940
 agacaagaa gaccaccag cacttgctgg aaggtcactc tcgaagttcg gtaagagtc 1515000
 agacagctgg ctaccagga catagatggg ggggggggtt aacatgcca gcctgggcta 1515060

 gccacttat gagctgtttc acattagtaa tcttgacttg gccctgctta agctgagtaa 1515120
 gatacagata gtgaaatgct aggcaagccc aagagaagtg aacaaggcag ctgaatgtag 1515180
 tgggtgttgg aagccatcc aagggtcag aagctaccc tacagcctct gaggcctac 1515240
 cttggagagc tagaagggtc ctatgagagc ctttctgaa gatttgggt tgccagccta 1515300
 gaattcagtc tggacctgc aggccaagc cggaaactca ctgcaggttt ctgagtagca 1515360
 cagaaacatg ggagaggtg catgcggtaa gatggggagg gtaattcaga ggacaatt 1515420

cccatgaggc cccagccaga gaggaacagc acagctaaag aacatgggac gctgtgagaa 1515480

 gacttggggc ctcatgagt gctgagtact gagaaggaag gaaagaggct cagaaatgat 1515540
 accggcactt ctaagggaca ctgggaggaa gaaaggtgat gaaaaggaag ccattctggt 1515600
 aggatgagga gctctgaaaa cccaatttgg agtagccagg gaccacgga ggcacagga 1515660
 tatgatgggg tggggcttag gtcaaatggg tatggggcta taccctcaga gttagggcac 1515720
 ataagcaga taggggagtg tgagactctg agagagtgtg cagagtggct gaagtctga 1515780
 gtggatgtgt attgtttgac atgagccagc catgtcaatg actaaggaac taggacccat 1515840
 gggaaactgg caaccttccc catgtgggtc agacttagaa ttgatttatt gtggtccagg 1515900

 tgggaatgtc tgigaacagt tagccaatgt gtcaaaaaac tagtacctgc agcttctca 1515960
 atcctgagac tgctgccta tggagacttc cgccggcact aatgccttat gccgaggttc 1516020
 cgagttgttg cagtagtagg tgctgctcca tcacaacaca cacatacct acctgaggcc 1516080
 ggccacagga agtagtagcg tgtgatatca caggtgtgat taccagaaat gaaagagggt 1516140
 caagacaagt aggtaggaaa gtgtgggtgc tacaccagc acttgggagg cagaggcact 1516200
 aggatcactg aaagttttag gccagcctga gctacataat taattccagg ctageccaggg 1516260
 attagaaaa aaaaaaaaaa aaaactttgt ctcaaaaagg aacacaaaa caaaacagt 1516320

 gggacagaga gcctgtgtag catggtgcac attgccaaa atctatgatt ggcttctcga 1516380
 gccccaaatc tgctgggcca ggggctaaga aaacacacat tcagacttta tgaagacagg 1516440
 caagtggacc acaacatctc ctggcactgg gtggctcctg aaggctgatt ctagactctt 1516500
 tccacaggtg acaagtactg ggtgttcaaa gaagtgcagc tggaaacctgg gtaccccat 1516560
 agcttgggag agttgggcag ctgcctgcc cgtgaaggaa tcgacacagc tctgcggtgg 1516620
 gaacctgtgg gcaaacgta ctttttcaaa ggtgaacggt actggccta cagtaggag 1516680
 cggcgagcca cagacctgg ctaccecaag cccatcaccg tgtggaagg catcccag 1516740

 gctccacaag gggccttcat cagcaaggaa ggatgtaagg gccaaagtga ggtgggaatg 1516800
 gggagttaat tttagtgtt ctcaggccc agacgtatgc ttctgggtat ccagatttca 1516860
 gtaatgtaac ttgtaatag acagctgcc taaatggacc atgttccat agtaaattaa 1516920
 cttgcagtga tggatagggg tggttcaaag gtgctttttc atagggtttg atgggtaggc 1516980
 tggcaattgc tcaccatgta ccatcaggca gttaccagcc tgtctcctg ccagattaga 1517040
 aacttctcaa aggaggctca ggctttacca gatgcaagca cccatgactg cctgttacac 1517100
 tgactcttga acaggtgtt tgggttcaca gacctgtcc accactccta agtttgggca 1517160

agccatcgag ctatccgtga agtgggaatg gtcacagcat ttacctgtgg actgtgtgat 1517220
 aaaagattga tagggtaaat tacagagagc atttgcgtaa taccaccac atggtctatg 1517280
 catgtaaaag ttgtagctgt cctcatcatc tcattagtgt ttcagtctgt gtaagatgac 1517340
 agaactgtca ttcgacgcat ggtaattacc gagagccagt ttgtgtggga ggggctcagg 1517400
 acagaagcag tgagacttgc atagtatca gtcactgac agaaaataac gtcacaacia 1517460
 agcgagcctc agagacagat gacatcaaag acgttgacca atgaaagtcc tggggagtca 1517520
 gccaatgagg agagtctgag tgagctgctt tgctgtctgt caactggctg ggttgctaag 1517580

 gctgttgctg ggagccttca gggagctgcc tggggagtaa ttggagttgc ctggcctgct 1517640
 gcctgcctcc ttgcttcca gccatcaaag ccactagaag agtcctaaga acttgtatct 1517700
 gtgttaciaa gtggtatag tcaagccctc cccacacccc ccaaataatc tgtaattgtg 1517760
 gagccatggt gtctgctgct aacatgaaat ttgctcaat tcccattggc ttggggcaag 1517820
 agttagactg aggcaactag agattgctct gcgcaagcct taaactgagg gcttgatctg 1517880
 acccttatag gaagcctggg ggcacagtgt aacagacctg tttccagact aagaatcatc 1517940
 cagactgggc agtataaatt aaagcacttg ccagctctat tcaaaaatcc cttagtggtt 1518000

 tcccagcacc ttigaaccaa caagtgagat tctccatgtc ctggagacct gtctctgctg 1518060
 ttagttactg tgcagccagt ggagcactgc aactcacca gccacctccg ttccagcagg 1518120
 ccactccctc catctaccat gcccttggga gcttctctct tgtacactgg caggeacatc 1518180
 accccaggtc cacattagtc cagagtaggt gctggggcgc gtctgggaat ggtggtagctg 1518240
 agtccttccc atttctgcag attacaccta ctctacaaa ggccgggact actggaagtt 1518300
 tgacaaccag aaactgagtg tggagccagg ctaccacgc aacatcctgc gtgactggat 1518360
 gggctgcaag cagaaggagg tagagcggcg gaaggagcgg aggcctgccc aggatgatgt 1518420

 ggacatcatg gtgacctcg atgatgtgcc gggctccgtg aatgccgtgg ctgtggttgt 1518480
 gccctgcacc ctgtccctct gcctcctggt gctgctctat actatcttcc agttcaagaa 1518540
 caaggcgggt cctcagcctg tcacctacta taagcgcca gtccaggagt gggtaggagc 1518600
 agcccagagc cctctctgtc taccagctct ggccagccag gcccttctc accagggtct 1518660
 gaggggcagc tctagccact gccaccggg gccagcagg ccctaggcca ggttcgtgtg 1518720
 tagctgaagt ggtgggtgca ttggtctagg ctgagtgtgg ggcaggagat gatggtggct 1518780
 gtgccccagg ttggtagct ggcaaccagt tgccagcctt ctggcctggg tacaccactc 1518840

 tcaagggaat agccaggcc ctgtcaggag gcaaggatca tgccaggagg tgcccctgag 1518900
 gtcactgcat cctatggtgt ctgcaaggta cgggagctcc aggcctggtt gggaccagc 1518960
 cctctgaggc aagccagcac tagctctcac cctccccct ttcggagatg ccaccaatcc 1519020

cagtcccctc tgccaacacc tgctggtcag atgtcccttc acccctaccc cactatcctc 1519080
 catggctgca gtgcccctgc tgccaacaca gtgggcaaaa gcctgggttt ccctgctag 1519140
 ccaatagcag attcctcagg aaacctgata cacttgtcag gtctcccctg agaccagga 1519200
 tttagggtca catgctgcag gcaaggctgt ggcccagctg ggtctcacia ggaccctgct 1519260

 gtcattgctg gaatatttaa atgtcctgtc actactgttt aaagtccat ttgcaaagg 1519320
 ctatttgagg ctttaggtca attagagggt actgtcttgg tgatgcgcc agtgtgatgg 1519380
 cccctccttc ccaggcatt aaggaccacg gtgctgcaaa gagccactct aggaccctga 1519440
 tactagaag ggtcctgttc aggaggctca acagctgggg caggagctga cctggttct 1519500
 ggaggcagat ccaagttgt gaccatcctc tactcccctt ccatgaatgt tgtcccacc 1519560
 ctgctccagc ctgtctttt ggcatgggg gtttagcctg actagttagt tggagcagag 1519620
 acggctctag agccaccatt gtcatagcct cagagtaaag gaccaggga gcctttaag 1519680

 taatccatcc acatcccag tgaccctgag gcaactcaat ttcttggcct ggagtgggtg 1519740
 tttgtgctcc ggtcttgacc ctggcagccc agctcactgg gcccatcttc ctgactgct 1519800
 cttagaaaag ggtactccta gctgtagca gcccgaagct cactccctac cccacctca 1519860
 cccactttt cttctttct ttctctttt ttaacctga ggcccttctt cacatctgac 1519920
 aggagtctc aggttttggc ttgacttgc ccagtctggc agccatgctt gtcattgggc 1519980
 aagaccaatg ggttcagtga tgtcactggc tctctgcaa agtccaaaag cagtgagagg 1520040
 caacttcag ggtgctagt ggttgccaac accaacctg ccctctgagc ctgcatgggc 1520100

 ctgcccctgc cctggggcct ctggatttgg gttagcttac cctgtagcac agacaggac 1520160
 tcctgccgcc ctgggagctg tggagtaaaa tctatctcc cagaagcatc tatatgggtc 1520220
 cactgtgctc cagcactcct atcctgtttt ttctcattc ggcaaagggc aggctcctg 1520280
 gggcagggtg ggaacaactg cagagattta gtgattcata ggtttgtaca gtgtttata 1520340
 ctttgcaaag cactttatta gctcacacct gttcactcac atgaaggccc tgagaggctg 1520400
 agggtaacac tcactttgcc cttagaagca caggaggctc ttatctgccc ctgcatcca 1520460
 gtggccctgg ctgggtctgt gttcccaact gtgggtcctt ctagggtctg agataaatgt 1520520

 cttttctatt ctctctctt gggcctcct ccccaactt cctggtcctg ctctcaggt 1520580
 tgggtctctc actctttgaa agctctagc cccgaggtt cctgttggc tctgtgact 1520640
 ccaagaccag ttgagaacaa gcaggagatg gaggcaggca gccaggctg cagatgtaag 1520700
 ggatgcaggc ccgggccag agggctcagc ctagggtctt ccaatcttgg attctctgc 1520760
 aggcagtcat ctgttttcc atcaccccag gccagagcag tcagaggggc aaagcaccgg 1520820
 gccccagag ctcagcttc cctcagcctg ggtgacatca cagcattca gtgtcggtca 1520880

cattttaaac tgatcagcct ttgtataatg ttttttaaat catttctaaa taaaacagaa 1520940

atacagtgtc ttttcctgg ggtgtgggaa caaagaccag ggccaagtg tgccttaag 1521000
aagcttcggg ggagaaaagg gtgcacgggg gtattctgca gttgtctcat gcatctatct 1521060
gctaaccagc aatcagatgt cctgccccca ggtccctcag gagtatggga gggtcactgt 1521120
ttgcatgctt ctctggagac agggcacaca gggccgtgac ctgggacacc tgaagcagct 1521180
cagttctage gagggggaaa ccagagttca acagcatcaa gggctctgcc aggaggcctg 1521240
aatctgggcc tgggtgttct ggttcaggta ggctgccccca ggacagagct ggaaaggggt 1521300
ccgggagtga tctggttag gggatggtaa ggatgggaac aagtctgagg ttctggtcag 1521360

tcccctgagg ttgccctgtg gacctctagt ttccaggagc tttttgaaat ctctaccag 1521420
agtgaggaag acaggaaatc atgggggtgag ggggacaaaa gctaggccag gcccaagagg 1521480
acacggagge cccggggaac ctgggtcagta ccaggatgtg caggcgatta gaaagcgac 1521540
atcatccagt agtccccatg gtccgggctc aggctgaggc tgctcggac cctctggcgc 1521600
tggaggctgg ggctgcgagg gctctgggcc ttcttgcca ccaactcagga gagcgccat 1521660
ggctctgtaac agaagcccat caggcaccag gccaggtagc accccacca ccaccaaac 1521720
ccttccccgc cctcacctca ggcagcgaag tgaaagcgga tctatcgga gcttgccccg 1521780

agaggagcgg cgttatgacg cagtcccga taacccttcg cacgccaggg gcgggcccac 1521840
ggagctcagg agaggttggg cgactggcca gcccccca ggccccccc cacagcatgg 1521900
ccgttgagc caacgacagg gggcggcctg gtctccaaag tcagacagg atgtaacaca 1521960
ctgaagctgt gtgcctgtgg cttcacagtg cgttcgcccg gcaggagaa tactagtgat 1522020
tctattctg aggccgggga aagcagaggc agaaagaaga tgggttaaaa tgtaatccgg 1522080
gagggatca ctacttccc ttgctcatct tttcttagat ggagttcac tacgcatacc 1522140
tggttgacce agaactccc aggcctctgg gattaaaagt gtgcccac ccaccctcag 1522200

gtctcctatc ttagtgaggg aaagcactgc atgtcaatcc caccgactt cccaagacc 1522260
ccaggaagt cgggggaaag gtgttgcaaa ccgaggatga acaaacagca cactgagcat 1522320
ggggggaggc agtactttaa tgggttggga cacaagacag cagaactctc atccaggagc 1522380
cacaactcaa agccagcatg acacggcaag ctttttata acaatagtct agagatggca 1522440
cggatgaaga agggttgggc gcgctcaacc attcagctct ggtaagctct ctgccacgc 1522500
ctgctgccag cgtttgttac atactagctc aggcattgta aatgagccaa agtccagagc 1522560
caggagccca cacagcagca tggaaggtga ctcatgtgag gctgcagaga gaaaatcgta 1522620

ttatcagtag ctgttttaca gggttacatgc tgccccaccc ttagacctgt tctagttcag 1522680
 tcattgaaaa gccatacttg tccccacaa ggttcagat ttaactaaat cctgtatatac 1522740
 aaggtctagc ctaaaattct gcatatttga aaagtaaaat caattctttc ctcatgggc 1522800
 cacctttttc caattttatc agttaatgat cataaccttg agctctgaac ataagagata 1522860
 gaagcaagga aggttggiga gaacaacatg tgcttagacc agtctctcag aggccaggct 1522920
 gaggccaaag ctttggctc tttccagaa ctccctatta cagctgatgc aaaggccaca 1522980
 aatactagac tggaaaacag atctgctcia caaggattaa gtgaaatctc tcttattgga 1523040

 ggtggcaatc attgtctgat aatgagactg gaatgcttat tgtgtatgca ggcatgtaca 1523100
 gaggttgatg tcatgtgct tctcagttg ctctccaat ttatgtttg agacagggtt 1523160
 tctactgaa cctggagctc atctctctg ctgactgac tggccagtga gccccagcat 1523220
 tgtagtaca gacatgtggc acacagccta gcttttatgt ggggtgctggg aatactgctt 1523280
 gcacagcaag gactttacc attcactata ataccttccc atgccaattt ggcatcttca 1523340
 ttgcgaagtc ttatgggcac ctaaaaacat gtccaaaac caaagaaaac ggactagtca 1523400
 agtttccctt cttttcaat acccttttct ttctattgct taacagcaca gacaaggact 1523460

 accagggaca caatgacaag tggctagcag ttctgcttaa ctttaataca gtttctataa 1523520
 ttgacaatat ttttctgata ggtatcaatt attagctat agaaacttct tttcaattgt 1523580
 tactaagaag ctttgtctt taatgattgt cactgtctcc ttacaaaagt ctacgttcca 1523640
 aacaaaagac agggcgtggt ctgatccat aaataccgctc tggcacgtaa aacgctgctg 1523700
 aacaacttct caggctgggt gtagctcaac agtacagcat ttgcctagtg tgcataaact 1523760
 ctcaattggt caccagctct gacagcaaag ttagtcagag tgaataaatg tcctcctcag 1523820
 aatttctcaa agtagcttat ttaaaaacac atgcacatag ccaggtgtgg tggcacacat 1523880

 ctctggccac agcacatcac cagcctgcat tgaaggacac tatctttaa agaactcaac 1523940
 agtgctggac tgiattccac ctacagtcag aacctctgag agatcacact aagaatccac 1524000
 ataaacaagc aaccaactt tcaactaagc tcaaaatctc aggcctttac tgatactgga 1524060
 atttaaagcc cttagectca ggaaaacatt tacccttcaac atatcagtat tttccatct 1524120
 ctctaactg tigtagggtc ttctcactc tcttctccat atttagcctc tcctcatcac 1524180
 ctgaaacaga ctaaatatca ctcatgaaac ttctataatc ccagaattt ccccaccagt 1524240
 ttcacaagct gcccatatgg ggacagttaa ggaactttgt ttctcctta atggctaaaa 1524300

 gttacacata gcaactctat ctccatgca cacagtgaac cctccggat atagaactac 1524360
 actctctgat tacccecatg cagcctcctc catgggcctc agtgcaagca aaggcaacag 1524420
 gataaagga aagtccttcc atggtaagta aaggatctat ttacttgtca cttttgggtt 1524480

tctatcttca tagagggtga cctggctttg gcaagcatta agaaaggtcc ctggcagact 1524540
gacagaaagg aggccaaact acccagcatt tgctcctgct gctcttcag agaaactca 1524600
agtctcagtc cagtctctca agtgatgaga gtgagcaaac atgcccagcc cagctggctg 1524660
tgtaatccac agaagtctag accagtgggt cccaacctcc ctaatgcat taccctctaa 1524720

taatctctat gtggtagtga ccccccaacc ataaaattat ttgttactat ttcagaaatg 1524780
taattttgct actgttatga atcataatgt aactacatga tatgcaagat atctgacaca 1524840
caatcctagg aaaggatcat tcaacctcca aagcgattga gaccacaag ttaagaacct 1524900
ctggctctggc ctggagagtt ggctcagagg ttaagagcac tggctgctct tccagaggac 1524960
ctgggttcaa gtgccagcaa ccacatgggt gctcacaacc atatataatg acagctaggt 1525020
ggatgatggg tgagccttta ataccaatac ttgggaggca gaggcaggtg aatctcagtg 1525080
agttcaaggc cagcctggtc tacagagaga gttctaggac agccaggact cttacacaga 1525140

gaagccctat ctcaaaaaac agcaacaaca acaaaaaacc caaacaaca aacaaacaaa 1525200
aaaaccaacc ccttcaaaa aaaaaaaaaa aaaaaaaac ccccccccc caaaaacatc 1525260
ttgtaatccc acaatttagc tgctttaaac catgatttca atacaaaata catctgcagc 1525320
ctacttttaa gagcacctt agcaatctga ggccgtctca gtgattaaga ggagccttct 1525380
cacctcccc agccaactga tcttttctat ctcatggctt agaccattag ctaaagacag 1525440
tggacacagg caacacaaac tgcaaaacac agccagtgat caagtgagat gggtcacagg 1525500
aaaggtctgc ctgaaagcc cagtctcaa ggaagactga gtgtgagcag atgacagagg 1525560

acatctgtgg ctctaagttg gtatgcactt tcaactctac atctggggaa aacaaacaca 1525620
acatggcttt cttaaggat acatcttctt actctcctct caaagacaaa gtgagccggg 1525680
catagtggca tatgccttta atcctagcac ttgggaggca ggggcagtggt ggacctctga 1525740
gttctctggc agcctgacct acagagcaag ttccaggaca gccagggtta cacagaaaaa 1525800
ccctatcttg aaaaacaaaa aacaagaag gcaaagtac ctgtcaatga gggaatccc 1525860
catgtgggtg gcaatagtc taggcttggc ctgcttttagc ttgaagacgc tctccaccac 1525920
tgacagctct gtgctggttg tgtccagacc acagaaagca caccaatcgt tcaactacat 1525980

tccagcagca atcacctgc tcctcgggt cacagtgcct gcctgcagag gtgtgagctc 1526040
aacataagtc acagaaccaa aagcaattc tctcacctca agtgaggact ctctcctga 1526100
agtctgttct atgtctcagg gccccagtcc caaattaagg aaggtaatga cccagattcc 1526160
caaggactga cataagggat tgcatctagt agacaggggt cagaagacag gaaagcttac 1526220
caccagggga acctgaagaa gggaggacag ctctctctgg tctctgatgg aagtcttagg 1526280
gtgcaccaga ccccttgat tactgaagac acagtagctt cctactaaca cctggtcagc 1526340

aactgtctgt ctgaagacct ccaccttgag cacgtcagcc aggatttctt ctgtttcctg 1526400

ttggacaaag gtactgtgcc caggatccag aacatgtagg gcaaataccc aggagtctc 1526460
tcagcaagcc agacctggtt ccctgagtcc ctttttacta aacatctgcg catggaagcc 1526520
tcactgagca agacatgggt atggctaaga gtctagactc agcctgaagc ccctaaaacc 1526580
taagcaagcc ctgaaaaaca tgactcttgg ctccatgtca cccttttcac taatacatac 1526640
cctattcaac tgcaaccaa ctatcatggc ccatggccca agactgaata ggccaatctc 1526700
cccaaccctg aaggattaat gccctacca gcttgatact gacacacaaa agccttagta 1526760
ttcctaggaa agtaagagtg ctgagataac taagaaaata cacaataaa acccttaatt 1526820

cctgccatgg gggaaataatg gctaactact agctaggcta gtcctgtaac ttccagacca 1526880
aactgccacc tcacctgtc caagtctggg tggactaagg ccacatagtc attgcaggtg 1526940
gtaacattgc caagggctga gagccgctcc tccaccgcc gtatctgca cgaatctgga 1527000
aggctgtttc ggatagtctg cagctcctgg tccgtggtgt tgttgggtac tagtagccca 1527060
tgctgttcc ctggaaagaa cacaattgta aggtgggata aagataaacc atgaacatag 1527120
gaaatgcttc ctgggatatc tcccattcta gcccaattag ctttctagg agagctcaaa 1527180
gctgaagccc caacctacag atccatatac gaacctggg tccctagaca gcctcagat 1527240

ggccaggaat ctattccaac aaacatcacc atcttatcat tattaactgg gggttggggg 1527300
gaggtcagga ctagcaagga aggcacttgg cactactttt tttttttttt aacattacac 1527360
acctactga acagctaaaa ttttcaaaga tcatcaagta atagcaatag tataaggaac 1527420
aactgaaact atgctctgac aggagcatac aatggctgtc tactccagat aattactgtc 1527480
atcatctacc aactaaatt cccacatacc ctcataggta ttatataatcc taaagaatat 1527540
ttgtacatat gttcatattt acagagtaac tattcctaaa acaccaaact aaaaattgtc 1527600
tacctgttat cattataaaa ctttctgtcc aggcttagga gccacagttt taaacttcaa 1527660

attactttca ttgaaagaga gcaaagacca ggctaagatc tcccttatca cgacagaatt 1527720
tgattcatat cctaagagca tggttaaagg tcaggatttt tttttctaaa gatcagagta 1527780
ctgaagtaaa tgactatgta gagtcacat tcatgtttaa cgcttaaaaa aagttttaag 1527840
gtaaatacat aaaggaggtc aggacaacc caacatgcag attcccccc cccaaaaaaa 1527900
agtgtcagca atgaaacatg atggcacaca catgctaate ccaaaacttg ggaagtggat 1527960
gcagaagtat caggagtcc aggccatttc tagctacagg gacagtgtgg ctgaggcgaa 1528020
catggaagga tcaaaaaaca aacaaaacta aaagttggag gctgttcaaa agtgcttaca 1528080

ggtcaaagtg caagggtgcc attcaagaga tgtatttaga gaatgtaaga tgtaaatgta 1528140
 gctgaagtat gacctgggaa ccttagttat tgcgatgagg cagaaattaa tgctcaaaaa 1528200
 catgaagcaa cttgtccata atcagaggca ggaaagagat gagattcact atctaggagt 1528260
 ggaacttggg gaggcacata gttctcaagt gtcagtttct tcaaacagtc aaaggagggc 1528320
 aaccctcct tccagcatcg ctgtggagga aaaacgcgac caagagtga ggcacttaat 1528380
 gctactactt tgctatgact attctcggga agtctgggct acagtgttct tgatctgcag 1528440
 tgagactgag tcccaccac ccctgagaga ttccagcgtc caccgagacc gcaagcctgg 1528500

 agatccccgg gtcactgggg taagctccag gagttaatga ttgagattca tagcgtccg 1528560
 aggcttcaact cgtccctcgg cgtcaacccc ccgcttacc cacacacatg cgcccgatga 1528620
 tccggcagcc ggcgatggat gcatgcacca cggggatggt ttcagagagc tcgccctcga 1528680
 acacactgga gaaacatggg gtcgctgggt actgctgggg tccctccctc tgccggacct 1528740
 gtcgctcccc gcateccttc cctcccctcc ccttcccgcc cccaggagcc ccggcctcac 1528800
 ctgtagaagt tctctgacc tccgatagcc accaggcagt aggtgttggg gagcttggca 1528860
 aagcagccga cctcgcagtt gttctcgaac gacgctctga ccgcatgga agcctggggg 1528920

 ctgcgcgacc gcagggctctg ggacgacaga ccctctcagg agccggtcaa cccacctcgc 1528980
 tccctcagac cccgccctct cggacctctc aggctcggg tcgccccac cgcatecctc 1529040
 caggctctcc tgccccaaa cctcccgcc cggggcccgg aaccgagcct cgccgccccg 1529100
 cgtcccacta actcacaaa cgactccaat cccacacgc tgcaacaact tctcccgtaa 1529160
 ctagctttcc gtttccgct cctcccagcg ggcttccggg agcacgcggg agcccagcca 1529220
 agcatcggcg ctctctaacc ccacccttc ggaggactct atggttgctc gtggtttggc 1529280
 ttggctccgc ccacccccg ctcccgatgg ttgtctggct ttcgtggtgt cttctctccc 1529340

 tattgggtct ttttaggagt aatcagccag atctgaggct gagcagacga gaacctcgag 1529400
 ggaaagaggg aaccggtgtc gtctggctga ggatggattg atgagggatg tgtttaccga 1529460
 gtgaggccgg agaaggggca ggtttgggaa aggagaggat cccaccctga ccgtgcggac 1529520
 ggaaatcagg atccgaagca gagcgcagag gcccgggctg aggattgggg ctaggctcac 1529580
 tcaggagagt ggccagtatg gagaacggg agcaggacag agtggttgga ggaggcacgc 1529640
 cgagagccat aagaacagg ctgaagaaga tattggagag aggaatgtg tgaagcttgg 1529700
 ggagactgga gaaaggtct aggggtgggca aagatgtgag ttctgacttg cttccttgat 1529760

 gigtcttac acacatacca cacacacaca cacacacaca cacacacaca cacacaagca 1529820
 gccaccatct gtcttgggga tagtgggtgt gccattttc ataagcagaa taaatttggc 1529880
 tgagggtgcc tcagaatgcc acagcaaaga aggaagaagc taagaacctc agatcttctt 1529940

tatgcctttc attcttctcc aaggaatcct attagtctga aaagggcctg aatgttgccc 1530000
 ttatccccc cccccatct tgtaatcca caatttagaa cacatcaggt tgctacttgc 1530060
 tctaaccata tctgccttta ttgatttgta ccatgccctg tctcgggcaa gcggtgagtt 1530120
 caagagaaag gccctgacc agctgcagcc tgcgcttcaa gagacactca gcaagtggct 1530180

tgtgtatgtg cgtctacgtg tccatccaca tgttctgctc atcttccccg tttcacccca 1530240
 gactcgtctg tttccatcta actctaccaa caattctaac tctcttcccc gctcgcctct 1530300
 gtcgacaacc ccatcctcca ggacctgctt gtaagtccgc ttctctctga tagactttcc 1530360
 tggtcacgcc accatctccg tgacctccg tccttagtac actttccatt tgatacagct 1530420
 ctgccttgtt ttctcgggtt tatgcatctc agcagctctg cagctccgtg gcatgttcag 1530480
 ggcagggctt tataagcaga gttgggatgg agttaatatg tgtacttaca gcttgtgaat 1530540
 ctcgaggggg ttctgcagtg tgtactaaat gcacgtatctt tctgtggcca ttcatttagg 1530600

cagacaagac taagtaccta caactaaagt tctgtttgag ttaatcacat agagctatgt 1530660
 gtactcactg tatgcatctc tgggtgtacc tagtactgt tctgtgtcta ctgtatgggc 1530720
 actggggcat cctttagtgg tctgtatggt atgtacatag tgactgcagg aactgcagat 1530780
 actgtgtttt gggcttttgc aaacaaaaca catgcttaaa gccaggggcc actgagctgg 1530840
 cagagttccc taccctgtca tttactcaga tctgcttcca aattaacat gcaaactctg 1530900
 gacttcagct cccgtactta tagaatggga agaatacctt ccagactctt tggcctctgt 1530960
 ggcagacaga acatgaggaa agaaacgtca tcctttggaa ggcatgataa taagatgcac 1531020

acactgtgcc atcactgtgg ctcttaggcc taccaccttc agaggtcgac ctgtgatgac 1531080
 tgtggcttca ttgccaaatg caagagaaag taaccagagt gccaaagaaa aaagatgaaa 1531140
 cactcctggg actaggtgga tgaggcacct aaaaattgtc tatttcagat tcagacatgg 1531200
 gttctggaaa aaaaaaaaaag aaaagaaaag aaaaacaaac ccaacaacat ggaaacccaa 1531260
 gagggcagct gttgcagcat ccagttattc ttgagatttc aatcagccat aaaataaatg 1531320
 ttctggttcc aaaaacaaaa caaaccaggg gtggaaactt aatatagcta catgccaaca 1531380
 agagatccat ctagaggata cagagaatga gaataaccgg tgtgcagtgc ccageccccag 1531440

tgacatacag aaaacactca gtaactctgg gttctgtttg tatgtatgcc tgtgcgtgtg 1531500
 tgtatgtata agtcttgagc ccagagagta tctgatctga gccactagat gcctcccttc 1531560
 cttatgcagc ccagctttat actctcatac tacagtcttg aacctgaata tgtcacctat 1531620
 ctgtggatgg aggaaggctc tgcccctgct aggagcagag ttaggactca aaacgacttc 1531680
 ggagctgctt gaatttgagc ttgttgtact tagtgatgag gtccagtttg ctgtgcccga 1531740
 aggtcagccg ttctcaggt gcaaataggt cattgctatt actattttga tggccactta 1531800

tgggagctcc cgggaggcct ggctcaggtc tctgcctggc accctgtagt tgatgatact 1531860

 tggatgatgag gtccagtttg ctgtggccca gagtcagccg cttctcatct gcagacccta 1531920
 ctccggccat gcgaactggg tttggttctg ggagaccatt ggggccaggc cectcactec 1531980
 ggaatgggcc aaatttggtg atgaggtcca gctgactgtg gcctagagtc tgccgtcgtt 1532040
 catctagact tggcttgtca ggcctggctg aagaattggc atcaggcagt attttagagg 1532100
 gctgggcctt ggggttttgt ggcaggagat ccaattggcc atggctgtgg ttttaaggga 1532160
 gcttctgtc ctctagacc agatcaccag gtcttaggga gcctgactca aggacacct 1532220
 gaccctggga caggagatcc agctggctgt agctgtggct cagggacaat ctctatcat 1532280

 ctaggcctg ctaccatgc tgaaggaac ctgaattggg ggtaactctg gaattggaac 1532340
 ctctgttc tctgttta gggaagggga caattcgatc cagggatca tgactctggc 1532400
 tcagagatac cttcttca tccactgtct ccagagctgt gccaggtacc cagcgacctc 1532460
 gtggaaggat gggctcttga ctgtctggga gccattctc tggaagccgg gacaatgctg 1532520
 ggactcccct agtgaagtgg agaagggggc gggaacatgg gagcagaggt gacccactg 1532580
 ccagggtcaa gggactggca ctacagtgt taagggcagg agaggactgg gaccatggag 1532640
 atgccccag ctgtctcagg ttggccctgt aggtccagg agttgagcta tggtaggat 1532700

 ctgaaagctg acggtacagg gatggtgggc taccagcttc atggtgggca ggacctgggg 1532760
 acaaggacc catcacatg tcactgcagc caccacccc tggcagagcg agataggagg 1532820
 aacggcccag aaaaggtgaa tgcttgatac tgccgaggct gttactggag ggtgaagagc 1532880
 ccgtagcact tggaaattca ggtccaaagg ccagggtcac aggaggagga cgaggtacc 1532940
 gggaagacag tgggtcctca ttgccacaga agccttcac aggtgtgac tcggcataca 1533000
 gacatcgaa ctcccgtca aagtcttca caatgtggcc cctcagctgc agcaccatgc 1533060
 tgggtgagc ctggctgcaa agccaggtga agctggggac agagagccag agtcagggtc 1533120

 aagggtgagg gtgtccaaag tcgtctatt tccatgtgc aggagtact ttctatgcca 1533180
 aggcagtaag tagaatgccc cccatctgcc ccttgccctg cctggtcct agcacacagc 1533240
 aggtgcctag gacatgttg aaggatgga tggaagaaat tcaaagcggg cagatatgag 1533300
 atgccttac taggtcatgg cgcagcccc caggcctccc tcttttaat catctacct 1533360
 gtaactgct gccaccact gctcacagtc aatgatgaca aacttctca gggcctgcc 1533420
 ggtgaatcgt ctaccgct tgctgcagta cgtgtctcc catgtgtcc gcacacgat 1533480
 attctggcc aagagcagaa gaagattgat ggaaggagga tgaccttaag gaggcagagc 1533540

tcaggctgga gagaccactc agtagttaag agcactctct gagaggactt gaggttctagt 1533600
 cccagctttt tctgtgaggt ggctcacggc tacctatgac tcctcaciaa gggcagctctg 1533660
 acaccctatg ttggtgcaact cacacacaca ctcataattt aaaataaaat aactgaaaa 1533720
 aaaaaaacia aaaagaaatg gcactcaggc tgtctctgac ctaaggggta tctggtccca 1533780
 cacagttaa aggaactatg tgttccactc cactgacca acctccatgc tactgaccg 1533840
 ccagctggcc ctcttactc cccgattccc ctcttccca tgggtggaagc tgtctgcca 1533900
 tactgaccac cagatgcccc ccattgaggt ccactttata acacatctcc aggaagtact 1533960

 tcaggtgctc ctgagccagg aggaggtaga caggacacc acggcggctg gaggcctcca 1534020
 tgaggtcaca cagaagctcc atgtcagtga atacgtccat caccacagcc accacctgaa 1534080
 ggagacaggg gaagttcagc cccagtcaa gtatggggtt gaaagccagg atgcaaaacc 1534140
 agaatacaat tctatattt attttggac agggctctcat tctgtaacc agtaatcaa 1534200
 gctggccttg agctcactct gatctgagcc ccatgatcac tgggattaga ggagtgtgtc 1534260
 accatgcctg ccttaacctg gaggctctag ctgggcact gggagaactg acagtctga 1534320
 accactgatt gtttaaaagc ctttgaggaa ttttctatg gacagcctaa cagattctca 1534380

 aagacatctc tagatcaact atgttagtct aaagctctgc tctttgaaa gctggagaag 1534440
 tcaggagtca gaagcagacc ccagcttcca ggctgattcc cattattggt accagctctg 1534500
 ctctggtcta gggacttccc cagtctctc tacaaggag aaagcttcaa tccagtctg 1534560
 ggaatttctg tigtttttg tttgtttt ccccaaac tcagttgctt tggaaactgc 1534620
 agagatctgg tgaataacc tatatttaca gcctcttta ctccgtctg tgctaagtgg 1534680
 atccaagctt cccgctcact tgaggggctg aggcgtgtgc ctccaacaca cagggcattc 1534740
 ctaagcccc cagcggcccc ttctcccgc tgtgtgtgtg tgtctactga gacaggagg 1534800

 gacagagtct actattgcaa ctggagcca aaaggaagtg ggttcaaac catattctc 1534860
 tacttcttag aagcagagtc ttgggctcat ctacgagcc tcagcttct tgtctgctaa 1534920
 atggagtga tctcgtagt acaaggata aatgtgaaa cgctggacta gacacacaa 1534980
 agaagctcaa tagccagcc tccccctt cctgctacct tcttagcaa tagagaacac 1535040
 tgggctatgg gaaaagaaa cacttctgag gtcactctgg gaatgagtgg cagctcagcc 1535100
 cagtagcctg actcttagc caagggcaga aaagtctaat tggaggtgag caggcgggt 1535160
 tcgggggatt ctccagtat caacacaggt ctggccagt tgggggagc aggcacgaaa 1535220

 gatcaaaggg ggacagtgat gacaacagca acaacctgc taattatccc attctggatg 1535280
 ccaatcaage tctgccctc tgtgctagg gcagaggcaa gcttgctagc aaggctttgg 1535340
 aggtgctggt gggatcctc ctgcagcagg agtctaccc tatctcaaac cctgccaggg 1535400

gtttcataac tattccctca tctgagaagg agccaaggct ccaccagtga agctatgctg 1535460
 ctttgagact aggggcttcc cagggtgtgac tgccccttcc taatgtctcc aagctcagtg 1535520
 gcttccactc ttcagtcctc ctagcaccaa actaagagct ttgcctatgc caaaacccat 1535580
 gtgcagtgcc cacagccttg cttcaacccc agctgttggg gcagcacagg ggattgatag 1535640

 gcagcggggg acgggggggg ggataaactg agccatgctg ggtagagc agagacctct 1535700
 ccctcccaga ccagacaac ctctctaggt aacttccttc tagcccctct ctgacctcaa 1535760
 cttctttcta agtcaaggtt gtagctcaga tgttccat ggttgagttc ttagtctggg 1535820
 gtgggggtgg ggggcataaa actttttgag ggtctgggaa acaggtcaga agttaagaac 1535880
 aagcactgtg ctctccaga ggaccaggt tctatccct gcacatttg tagctcacia 1535940
 cagtatggag ttctaattgc aggggattca aagccctct ctggccgtca atgactccag 1536000
 acatgttcat ggtgcacaca tgcagcatg caaaactctc atgaacatga aataaataca 1536060

 agtcttaaac caggcagtg tgggtcacac ctttaatccc agcactcaag aggcagaggc 1536120
 aggcagatct ctgtgagttc aaggcagcc tggctctacag atctagttcc aggcagcca 1536180
 gagctgttcc acagaaaaac tctgtctcta aaataaataa ataataata aacaaataa 1536240
 ttttaacaa aaaaattttt ttgagaatc tgatcaaggt tatagactcc ctccaaggt 1536300
 agataaggaa ccctccaat aatttccat gcacttccag ggggaagtt ccagagccct 1536360
 atgcctgtt ctttgcctaa ttaatgttcc tgagtgcaca cagaaaataa agtgeccacc 1536420
 catcctctga cagctgggga tctagcagag gtcaaagact ctagctccgg tgtccctgtt 1536480

 aagcttctgt gtggcacaaa ctggctccct tcccgtgagc cacgtctgtg aagtgaatga 1536540
 agaggtgagg cccttacgt gtggcctgg ctgaagagga atcgagcag gtccttgatg 1536600
 ctcttgcct tgtccctctg gaaatgaacc accgctggg tgggctgaa acctgtggcc 1536660
 tgtggcactt caggccagcc caggtccagg tctgggggat ctaagtcaga agccatgggg 1536720
 aagtaggtgc ctgaggtaac ttcagagagc atgctgaggc ggtcatgccc tacggtctct 1536780
 ggtccctggg cctcgttgag ctcggaacc ccacgacat ggccgacct gtagtcaca 1536840
 tccagggcac tcaggaagg caattcccgc tctcagaga tgacctgaag gtaggcagcc 1536900

 tcgcccctct ccaggagggc gtccgtagca agccttgcag cctcgtgtg ctggagcacc 1536960
 aggggggagc tctccctca ccaaggccgc tttagctcct ccaactcggt ccgaggggt 1537020
 cctgcatgc cctgggtccc tccagacgct aagctgctgg atgtgtgcat ccacctagt 1537080
 ccctaccac ctgaagctcc atggcttga cctgggttgg cgactgtagg aagaagatac 1537140
 tacctccage ttgccagccc ggtgtgtatg gcagggcccc caaagtgtg ccacctaa 1537200
 tctgaaccag gctccgccc attgccctg gccttgggaa cctgtcaggt cagccccacc 1537260

tgtctgtctg ctgttgggac tcgcctgctc agggaagtgg cagcggcagg cccttaaagc 1537320

 atgctactgg ctcttctcca gacactcctt acaggggtta cagccacaag cctgcaacce 1537380
 ctgaccctcg aaaccagcag aaattagcgc tcctcctc cctcctccc teccagccta 1537440
 cacacggtgg ggggtggggg ggtgttcagg gacacacaat tcacacaaac acacacacat 1537500
 acctggtaga tgaatgattc aagacacaca agcagatcct ctaacacaca gactactgac 1537560
 cagcatgcag atgtagacta taggttcata catgcatttg accaaataca tgtaaatgcc 1537620
 caacactaac atagagactg gccattactc caaacatacc accataggta ctgtgtatgt 1537680
 ctgtgtccac aaacatatta gacccccaat atgggttgaa cgaggataaa gaactctagg 1537740

 aacatcaaca ctgtctcccg ctgggcctct gccataacca cggctgctgc ataaccatgg 1537800
 tgctcacaac aacctcaacc caattctgag cccatcctcc aaggacctgc attaggagtc 1537860
 ctcaacttga ctcccaagaa gagttaaagt acccaccttc catgctccac ccatgctgaa 1537920
 tattccagaa gtctgaaac tctagcagag agtccagagc ttgccttttt tttctatttt 1537980
 attaacta ttttttaatt gtcacatagt cattgtacat agtactgggt tttgtaaga 1538040
 tgttttcatt taagtggag tgtgtctttt ttgttaagac agagtcttgg gectgatatg 1538100
 ttggctcaga ggttaaaac acttgcactc cttgcagaag gctagcgtc atttcccagc 1538160

 acccagtag tagctcacga ccatctgtaa ctccctgttt caggaggtct agcatcttct 1538220
 gatgacctct gtgggaaaca agcatgcaga tatgctggca aaacacatat aaaataaaaa 1538280
 gacagtctca tgtagccgag gctagtcttg aactcactgt gtagccaagg atgaccatgg 1538340
 acttacggtc cactggcctc cacctcccca gtgctgggat tacagcatgc atcatcatgc 1538400
 ccagtttatg cagtgtcag gttctaacc agggcttcat tagacaaaca ctataccac 1538460
 taaacctcat cagcaacct gcttggact tgccttttta gccagtgttt taatggcagt 1538520
 gcctatgcat caagagtggg gggctagccg ggcgttggg gcacacgcct ttaatcccag 1538580

 cactcgggag gcagaggcag aggcaggtgg atctctgtga gttcgaggcc agcctggtct 1538640
 ccagagcgag tgccaggata ggctccaaag ctacacagag aaacctgtc tcgaaacccc 1538700
 ccccccaaa aaaaaagagt ggtgagctgc caggcagtgg tagtgcacgc ctttaatccc 1538760
 agcactcagg aggcagaggc aggtggatct ctgtgagttg agacaagcct ggtctacaag 1538820
 agctacttcc aaagccacag agaaacctg tctgagtggt gggaaaaaca atggtgggct 1538880
 aaggtagacg gctgcatatc cacacactga gctccaggga tgcacgcagc ctggtgggaa 1538940
 ccaggtcca tcattgggg ctgagtttca gagaatgggc agacacacag caagatcaga 1539000

acggaacag agcaggttct gcctcgacga gagtcacagt tcatggttct ggaactggtg 1539060
 gggctgtcct cagaggacgg agaagcgggt ttgctctgaa gaagggtcat cagttggcaa 1539120
 ctgcacgtgg tggcagaatg tggggggggg cggatattta tcaccctcct gtagaggggt 1539180
 gagatctgat gatggtgtca ggaaatcagg gtccctaaag cttatcgtata taccacagt 1539240
 ccgatatgac tgaattgggt tcatctgttc taagggtcaga tctagagcac aggtcctctc 1539300
 gaaagagaac tcagggtgga gagggaggga tggaaagtct aggtagggtta tggggcagag 1539360
 gggtagcggg tccagggtgt agggagccat tgtctaggac ctgaaatgct tccatgtcat 1539420

 cccaggtgcc agcacagaaa ccagagagaa accaaagcgt ggggtcctct aagggggccc 1539480
 ttccctgggg gtttgatagg ctaccagagt gttagaagc tgagtaaca aagtcagagc 1539540
 atgggagggt gataagctgc gggggcagga agagtgtgag agccctcatt aggaccttat 1539600
 ctctagattg gtttgagggg agactgttc aggcctccca gaggcaggca ggttggtgag 1539660
 ctgctgagtt cactgtttat ctctggcaca tagttttagt gctgtatctt gtttaccact 1539720
 tttaaaatta tttgtgttg tttgtttatt gtgtgggtga gtgcacacca cagaacacag 1539780
 gtgaagtcca gaggacaact ttcaggagct ggttctcgcc ttctaccagc tggatcctgg 1539840

 gatgactgga ctcaggtcat caggctgga agcaaggcac cttcacctgc tgagccatct 1539900
 cactgactcc ctgttttcta cttttgtgtt aaaaatacac atagaattta ccctctccat 1539960
 cattgcacct cagtggcttt aaatacacc attgtacat ccacctcaga gctcaccatt 1540020
 ttgcaagcct aagagtctat ccacaagca cacttcctt tctcccctc cactgagccc 1540080
 ttgcagccgc cactctactt ttggtctcca tgaactgccc cagggaactc ttttaggaga 1540140
 atcaaggtgc atgtgtcttc cttcaaacag cttcttttca cttagcacag tgctttcgtt 1540200
 tcagccatga tgtagtgc aggttgaatg tgtatcatga gtgaacacac actcattcac 1540260

 tgctggataa tctggttgtt tatacctttg attttgagac aggtctcaag tagcccaggc 1540320
 tggcctcaaa actatgtatc ctcatgag acttcattc ctgaacctcc tgccctgct 1540380
 cccaagtgc tgggatcaca ggcatacatc accatgccta gctagattcc tttttgtaa 1540440
 gatttaaaaa aaattactga atgtggcca tttctatca tttaatgag aatataatca 1540500
 tatgcatgca gagatggacc tgtttatgac tgtatgtgtg cacactgtgg gcttgctgt 1540560
 ttgtctgaa atgcatgctg gtatgtgtac ctactgtgc atgtctctgt gaagattgt 1540620
 ttggttactg agtgtctggg taagtgggt agcccttgac aacaatttg tactatgtgg 1540680

 cttgttttca ttgttgtgt tgttgtgtg tgcagcttag tgcaaaggc agggtagag 1540740
 ggtgaggcga aaggaaaagg gtcccaagca ccctgacac tctgataata atatgtaca 1540800
 acaaacctat gtcccaagg cagtaagaca gctgctctc ctttctctc gtaggggtaa 1540860

agggcaacag gagggtagac gggtaggatac tggccttggg ctgggccttg aggtgctggc 1540920
 ctgggtgct ggaagccact gggcagactg aagctcagcc cgtggctgca atgtgtgtgt 1540980
 ggcacagacc ccttaatgac tgttattagg aggaacaaaa atatcttctt gtccagaggg 1541040
 agtgtccggc gccttcctgg caacgcttag ccttcccggg ggccatttag tcttgtctgt 1541100

 catctatctc aagctgagtg ggccttgggc aggtgcctgt cctatggggg tgggacagat 1541160
 gctagctata gtctttcaat ggcaggatgt tcagggtgta gcaactgccg acacagtctc 1541220
 tgttgactt ctgggtcagg ggagacagga ttctggagga ggggcagtca gactgcacct 1541280
 gatactttaa gccaaaggca agaagcttga agagctggag agcctaggag gacaatgcgg 1541340
 acgagtcctg gaggtcggct ggagctggat agtaaggatg aagaggattc tgtcagggtg 1541400
 agttagcat agcggcatac accttcaatc ccagcacttg ggaggcagag gcaggtgga 1541460
 ttctgggttt gaggccagcc tggctaatg ggcgagtcc aggatgctga gggctacaca 1541520

 gagaaatgct gtctcaaaaa agtcaataa taataataa aatgtaaca acaacaactg 1541580
 agtagtcaa gcaactcagga ggctaagtca agcaggctga aattgaggtc agctgacta 1541640
 cacagcaaca ccatgtctca aagagtcaaa caaacaaca aacaacaaa caaatcctgg 1541700
 agtgggtgtg cacgcttta ctctaccac ttgggaggcc gaggcagga gatctctgcg 1541760
 ttcaagtctg ctgggttac atagtgagtt ccatgtcagt tacaagctgg ccagggtac 1541820
 atagtgagac tctatctcaa aaacaacaa gcagacttag aatatacac ccagecaatg 1541880
 cagagtggca agcaggcat tccaggctgg aggaagaaga aggccaggat gtctggaag 1541940

 gaaggtagag tctgaggagc ctagcagggg actgcaggaa aggacacaga gacacaccgt 1542000
 gaagaccctt gggggcattt caggggaagt tgggaagatt caagagccaa gtcttaggat 1542060
 gcttaggaag taccagctg tgtaagagtg gccgaagca gccagttaa gtgtgacttg 1542120
 ttcaactgagt gccacatggg tctccagaag gtcaactgct tctctgtgt cccatcctga 1542180
 aacccccagg ggctgagacc cagggtagc ctaccatcag agccatagt tgtgccactg 1542240
 aagtgagtea gatccccctg ttgggacaat ggttctgct cttaatgggt gaggtcacct 1542300
 tctgagtcac agccaataaa tctgtaaaat gaggttagtg gcacatctt cattgagagg 1542360

 ttgtaggaa taaatcggtg acaactgcct gaccaagtgg tcatatctc tcagtacctg 1542420
 ctgaattcca gagcctctca ggctacggga gcaaggagtc atgttaggt atgacgagag 1542480
 atgaatagca gggccagaa gatcttctag tcagtctctt atagatcaa gactggccct 1542540
 gaagccaag atggctgcca gccatgtcag tggagtgtga ctgtaacc accagtctt 1542600
 ccaggatttg gctatcatag gaggaagat catcaagatc atccctctc tgcaacagtg 1542660
 tgtacatacg agtattcaca tacttctcca gcatgctgga cattttggct ttttttttt 1542720

ttttttcta aaatggann nnnnnnnnnn nnnnnnnnnn nnnnnnnnnn nnnnnnnnnn 1542780

 ccatccatcc atccatccat ccatccatcc atccatccat ccatccatcc atccatccat 1542840
 ccatccatcc atccatccat ccatccatcc atccatccat ccatccatcc atccatccat 1542900
 ccatccatcc atccatccat ccatccatcc atccatccat ccatccatcc atccatccat 1542960
 ccatccatcc gatccccgtag aacagtggga gacatgcctt cattcatgtt tccgtaagaa 1543020
 gaaggaggagg aattccactc cactctgtag aaggagacat ctgagagagc catcatccct 1543080
 cttcagcacc cttacagtgt cgtcctcttc ttccaaaaa gaggagtggg cttgtgtggc 1543140
 gatggcttgg ggaggagctg gcctcggctc tttttgattc cttctcatc tcttctctc 1543200

 tctccccctt cctgccttg gggggaatta gcatgttctg tataatctc ctcagtataa 1543260
 gcctctacta ggaggaagtc caccctgctc tggaagagca ggatgtctag ttctgtggca 1543320
 atgttaggaa gtctgttggg tgctctgtca gcagctttat ctgagatac agtaaagcca 1543380
 ccattttaat gttcatctgt ctgggtctt atttccatc cattctgaac ttgagagggg 1543440
 aagaaacatt atcttctggg cctttcaggc cctgttacg gttacctctt cctgcccacc 1543500
 cctttctctt tccctggggc cagtctccc aacatggatt tagtgtctac tttcagatac 1543560
 tagtgggtgg ggggttcccg aagatgagta agagcttgtg tctgctctgg taaagctcac 1543620

 tgttgggtga ggaagataga ctcataaata attataaact gcggattaaa ccaaggaata 1543680
 aaccaggtgc ttggggctta gcaccacgat cactctgga gctccagaga aagcaggctc 1543740
 tctgtggcat ctctccctat tttcccctc acattctgga aaggggcttt tgatctggac 1543800
 agattctggg tcttagctc accgacaatg gctcagagag gtgtccagaa agcctctgct 1543860
 ggggtggttag tacaagggca ggtgtgacta gggacaacca tggctatggt ttgaggtctg 1543920
 ctctccgc ctctaagagc aatgctgta tggcataggc aagcatgat gggcacagtg 1543980
 ggggtgggga ggctggtggt gggcaggac agggaggcag gggcaggagt gctactcca 1544040

 agggaagagc caaatcatt tgcagctgtc tcatttctc ccagtaaatc cattaactct 1544100
 cttctgact acttccaaat agtgacaaa ctaggtttcc tgggcatcac taacagccag 1544160
 tctctccta gcttctctc tcaggaatcc cttgtctccc ttctgtcctt gcaatctttg 1544220
 gtctcaagaa aggtgcaag ccggatgtgg tggatcatat aattgtccc agaatacaga 1544280
 aggcagaagc aggtgatct ctgtgagttc aagtcagcc tcatccatc agcaaatcca 1544340
 aggcacctg tgcgtggaa aattatttta aggtgtgta cattgtttg tgctgtagaa 1544400
 ctttttttt tttactgatg caaagatgtg ttactttgt ttatgtcga tttgtttaac 1544460

tctgtgaagc tigtatttt tgccttttcta aaacagttaa ataaattttc taagagatct 1544520
 gaatggccaa tatcgaggca ggagaaagga taggtggggc tggcaggcag agagaataaa 1544580
 taggaggaga aatctgagaa agaaacaaga aaaggaggga ggagcaagag atcaagaagt 1544640
 gagaacacaa ggggccagcc atccaaccag acatggaaga tggaaagata aggtagacag 1544700
 aaatagagaa aggaaaaagt ccagaggcaa aaggtagaca agataagtta agggaagctg 1544760
 gctagaactt agccaaacca aggctaggca tttttaagta aaaataagcc tgtgtgtgat 1544820
 ttatttgggt gctgggtgga agggccccaag agagtaagaa aaaggagtga aaaacatcaa 1544880

 ctgcagtctt ggactacaca gtgaaacctt gctgatagcc ggggtggggg gggctagaga 1544940
 ggccctactg attaggagca ctctgtctc tttcagagga ctctgattcc ttgtagtacc 1545000
 ttcgtgatgg ctacgaccg tctgtaactc cagttccagg agatcaaaca ccttctctg 1545060
 gcttcttcca ggactaggca cacatgtggt acacagacat acatacagcc aaaggccccg 1545120
 gccatgattc tcctatcac acctgtctca ggggacttta ctgaaccact gttggtgagc 1545180
 ccagcaccca gcatctgcca gaactcacct tgaactcata cacataaaaa caacaaaaa 1545240
 acattttttt aaagaaagga ttcttccac ctctacaggg ccaggtcttg ttttcgaagc 1545300

 cggacttcaa tttttgagag ggattaatga cagcaagtcc ctaacattcc agggaaatcc 1545360
 ttactattcc caccttcca aagactcaa accatgttcg tatgcactgc tgttacctct 1545420
 tgcaatctgc attctctcag cagtcageca tgttctaga acatctgaaa ccctaaacc 1545480
 tcccagctta ctctcagtc ccatgttga gcaggccacg tggggagtcc ttccagaagc 1545540
 tctccccctc ctctcgtct ctccagacc tgcctccagt gccattctt gctcttctca 1545600
 acacctctc tgagggtctg taccacctg cctgttctt cacctactt tacctgtggg 1545660
 aactcattca ctttcattac atgtctctc cataccaag atggactcag catctcata 1545720

 cacttttttg tgtgttttt ttgagacagg gtattattat gtagctttgg ctgtctgga 1545780
 actcactctg tagaccaggc tgagctcaa ctctagctg gaattaaagg tatgcaccac 1545840
 tactgcccg gtaatgcttt aacttttaa tatgtagggt tgtgtgtgtg tgtgtgtgtg 1545900
 tgtgtgtgtg tgtgtgtgtg tgtgtgtgta tgcgaccac gtgtgtacaa gtgttctcat 1545960
 aggtcagaag atggcaccaa gttctcggga gcaggattta gctgcccaat gtagatgctg 1546020
 ggagctaacc ttgggtctc tgaagagca gtcagtctc ttaactgtct ggccccctct 1546080
 gtgtgtctgt gtgtgttttt tgtttgagcc agggtttctc tatatagctc tggctgacct 1546140

 ggaattctct atgtagacca ggctagctc aaacttcaca gatgcatctg cctgtctgcc 1546200
 ttttgagtgc tgggacctaa agatgtgcac cgccacacct ggctcttcgg ttagctatag 1546260
 cacagatgca gcttcatcta caacttcca gaactaaagc agatggctgg agtgtcagtc 1546320

acatgagcct gtctcggga taaacctggg ccttttcaag cttccatttc cctcagctgt 1546380
 agcacgagct gacacctctc agggcttcgg atgagattta aatgaaataa taggtgaaaa 1546440
 gaggtgacag atgtgtctgt cacagggcag aatcaaatac cagtatttta aaaattttat 1546500
 cgtccacatc attgctcaat gtttctcatt cgaaaacctc tagggaaaaat gctgtcttct 1546560

 gatgcactca caagagacgt tttcctgtga cagaggggtg acagcttgag gcagtctctt 1546620
 tcctcacttt ggctaagttt tatactcaat tgcagatctc catgctgacc tgaggagggc 1546680
 agtgtggtct agggagaggg ttaggtgctg cagccccatg gtctgaggtg gagccatctt 1546740
 ggtaactct ctaggccacc tgagccttaa gcctcttcat tgtggtcagt aaaactactg 1546800
 aggatgatgt ctgtcatatg ggcctggtga gagtgcactt actttcataa ataaaaaac 1546860
 aaaacaaaca gaccacgtga gagtgggtga tgagcagtcc aggcattgga gtggcagggt 1546920
 cttgtgatac cacgaagact gcctgcccc a gcttgttata ctctgcctc aacctccaa 1546980

 atattccaaa catgatttca tgtttgtagt gtattttggg cgttctcaag cactactctc 1547040
 tctaccccc tctacttgc accaaacctt ctttctgaca agtatccct gccccctatt 1547100
 ttcatgactt ttgtttcttt gcgaccaggt gagttaggtt aggtttgcct gcatgagcct 1547160
 ggggtgaggag ttatttagtg gggcatggac aacttaccag cagctacact gctaaagaaa 1547220
 tgtttcctcc ccccaaacca taacttctca ggaaggggct gggcctgaaa agctcctcct 1547280
 ccatccacga tggggagttt ctgggcccc gcttgttcag gtaaccgcag atgctgagtc 1547340
 cagagtgcaa tggctaggcc atgtctagaa gacagcagtc ctccatcct ccagctcttc 1547400

 tggccctct tccgcatat tccctgagcc ttgaaaccga tgtccatta aatttttaa 1547460
 ttttactgac atggattttt ttctgccgac acggccgtct gtatattaca cacatgtctg 1547520
 gtatctgcaa agaccagga ggcatggat cctctgtaac tggattactg atggttgtga 1547580
 gctgccacaa gagtgtctgg aatccaacca agtcttccgg aagacagcc agtgccttta 1547640
 accactgagc catctttctt agatattccg tctaagactg aatactcaac agcaacttac 1547700
 cctgcatgac agttaggagc ctttgcata accgcttccc actgtaagta gttgctcctc 1547760
 tgaccaagge tgaagcaggt gctcatctgt ggggtgaagc taagtattca gaggacggtt 1547820

 tgacagcatg tccacttagc aatccacac aaggtttcac cataaggcct atgacctcct 1547880
 cagacatggg ctctgacca ccaggtttat agaaccagac atgaattcag tcttagggag 1547940
 tgggtctcaa atccaatcag gaagcagttg attaccttc taacagtcac gccactattg 1548000
 cacaaatggg cgcactctgc caacatggca gtttacaggg ttcacatctg gtaagaaca 1548060
 ttgacttctc tccccacag gtctgtctgc atcttccata ctctgaatgc tagccagtag 1548120
 ggggacactt ccagctcagc tctaatttta tttctctttg tctgcaact gaactatgtg 1548180

gtgtctcttt ggcaataggg ttttcctct agttctaag gacgaccaag agcaatagca 1548240

 atagcctgta ttgctgagg gcctctgggt aggagttcta tttatattat tttagttttt 1548300
 acgtcagtat gagggtgtca gatcccttgg agttaaagat agttgtgagc tgccatgtgg 1548360
 ctgctgggac ttgaaccag gtcctctgga agggaagaca gtgatcttaa ccaccggggc 1548420
 tatctctcca gtccgtgaaa gtcatgaatt tttatattta tttattctg agtaggatat 1548480
 tccttgata attattttcc cgctttcctt ccacttgcatt tttatatttc aaattttgct 1548540
 ttgctcagtt ttctttttat ttacttaatt ttactctgc gtgtgttcac ctatgccatg 1548600
 gagcatagaa gtcagaagac aacttgcagg actgagttct accatgtgga actccctatc 1548660

 atgtggagtc ccggcaatct aagtcagggt ttgtcccact gagccctcct accactacag 1548720
 atggcacaaa acacaagggt ctcatacaaa cactggggtc agcaacaagc cacctctacc 1548780
 ccctgcactg tcttgatggc ctttttattg atagggtctc attctgtaga ttaggctggc 1548840
 ctcaaggcaa tcaatcatgc ctacagcata ctacagctctt tgtaactgtc tcttaatttg 1548900
 ttctactctc ctctggaag tacatcaaaa gtgacaaaat aatcccaaaa gagcagctctt 1548960
 ctgggaacca gaaacaatgt tacttgtttt gtcttttttt aaaaaattta attagaaaag 1549020
 tgtttatatg gagcttttgg gtttggagct gcttgatatt ttagcatcac tgctaaaaca 1549080

 agatgaaccg aggatgggtc aataaaggct ttttgttggg ctgtatgttc gctctcactt 1549140
 atttactagg tgcacacaga tgttgcaaga cagtgcacag caagtgcctt cccaacacag 1549200
 cagccatctc gtgtggctgc agccaacatt gcagtatggg aggagggtgt gaacaaaaag 1549260
 tcacatctgt ttttagaggt gtgctaagtg agcacaggac gttataaggt gcacctgga 1549320
 aacctgcag gggctctgtg gagagagaag gggaagtgc aatcgggaag gttaaagtct 1549380
 ctttagtcag caccaggaag aatgaggtcc aggtagataa aacacagtgt ggtcccttca 1549440
 gataacttca agtgactcag tgtgtcagg gaagaatgga tgagagacct gttaaatcag 1549500

 gctggaatgg aggtggcagc aaactgaaga gcctgtggcc tataaagtac ctgagtgtta 1549560
 tcttgaagat gagagggtgt ggtgtggcaa ctggtgcata tggccacaaa taaggacccc 1549620
 gggaaccaca atacaactcc atgttgagtc actgtatctt aacctgaat gctatggata 1549680
 caatctccac aagcaagcac cttttctgc tactggattc agctagggtt tgcataaaca 1549740
 caggatctaa gggagggtgg caagggtacc aggatgggcc ctaatgacct ttaaagtgtc 1549800
 tagcaaagtt cctgacacta aagcaagccc agtagctaaa ctggtgctgt gggtgggat 1549860
 ctgtggctgg ggagctgccc tgggcagcaa atgggttaac actcaaatga cttttatata 1549920

tgaattaatg tgcagggtta ggagccaaaa tctgttccat taatTTTTcc atccattcca 1549980
 gagcagttta ggtacacaca gtaaagtTTA tttTggtgca tggcatactt cactccatta 1550040
 aaaaataaatt aatcagcaaa ttctgcttg gctcgcttct ggtttatgta aatagtgcc 1550100
 agatgtaatg agttacaagg tgttattatc tcgcactcac agaggacgct tcaactccaga 1550160
 gccccgcttg caaccaaagc atcgcaata aagcaagaga aggcggcttg atttgtaatg 1550220
 ttttcacaga agtggcgctc acctcacggt atagagtTtc tttatatgac tcattttata 1550280
 acaagttcaa tgaagaaagc tggatggggg agggagggca agactgttcc caccccttt 1550340

cctcaatttc agaaaaacct tccaagagat gacccaaact ctctgagagg aagaacaggc 1550400
 cccttaagag ctgagaccag gtgtccctta cagcttatgc ttcagaagct gaggacaggg 1550460
 tagaaattgg gctggggctg gaatggtact cacaggccag gaagactTtc tcatgtaaag 1550520
 gatgtcactg tgggtgacaa agggacttct atctccaga cctctttcta catgacttag 1550580
 gatgtgacaa gccccttggT cctcagagac ctctgggtc ccagagaatg tgcctggtgg 1550640
 actgcgattt gccagacag tggctcctc gtgaactgga gacaggagca gcaagtagca 1550700
 gggagcctct gacctctctc tgccctaac tgagctggag ttaattcttg agcctggatc 1550760

gtccaccgtc tcacctatgt ttctgttctt ttttagttg tttgtTTTT tgagacagga 1550820
 aggtttctct gtatagcctt ggctgtctcT gcacttgctc tgtagaccag gctggcctcg 1550880
 aactcagaga tccccttgcc tctgtctccc aagcgctggg attaaagacg tgccacaagg 1550940
 accggcttta ctaggtTtc taaaagacc tggaacaaag aagaacctg gcagaaatac 1551000
 atctTTTTt taatggctac ttcaaccca tggctcatag ctgggggaca gtatatggtt 1551060
 atccatcttg acacattaga aacttctcct aggcacaggg ggccctgggt gaggggcccc 1551120
 tttctaacct acctatcct tctcagcct ttgggaaaag ctctcagtca catgtgctgc 1551180

tggagggact tggaaagtgt gcttgggct tctcttgagg gaggaacat gtcgggagag 1551240
 cgagatgacc tcccgtagt accccactg gatcagactc ctgggatcac aagaagaaac 1551300
 tcaacacaaa ggaccgagt attcaacagg tctgttcaa aagtcagtTc aggccacctt 1551360
 cttcagagtc ctagataaac aggcacttct tccatggggg ttectcatag ccagccagcc 1551420
 agccaactga gcagtCagtc gggccagtct ctcaaagacc ctcatcattg taagtaggag 1551480
 tacgaggctt caagatgctc tgtggattct tttccaccag agggcgccat ctcacttctc 1551540
 ctgtcagaag cagatcctca ccattcatgg agtccaggta ttgcatctac aagtagagag 1551600

agcaggggga cagagctgta tgtgaggct gcaaagctTc cccaaggagt ggctggaagg 1551660
 gaacacgggt ggtggtgta acctgactgt ccagctctaa gattatggca ttaagggtat 1551720
 ttggagaaat aattacctag gtcagtggTt cttaacctgt ggggtgaaca gcctttcac 1551780

aggggtcgtata tacaatat cctgcatac agatatttta cattacaatt cttaacagta 1551840
 ggagaattag agttatgaag tagcaatgaa ataattttat ggggatctcc acaacacgag 1551900
 gaactgtact aaaggtggc agcattagag tgttaggaag gtttttttg ttttttttg 1551960
 ttgttgtttt ttigtttttg tttttcgaga cagggtctct ctgtagcttt ggaggtctgc 1552020

 ctggaacttg ctctgtaga ccaggtggt ctcaactca cagaggtctg cctgcctctg 1552080
 cctcctgagt gccgggacta aagcgtgca ccaccaacgc tcagtgcatt cggaggttg 1552140
 agaaccagt acctaggaaa ttgactgac gatgtttag ggaattccct atcacatc 1552200
 cccactccac ccattcaatc cctaggagg acatttacc tccgccacac actcataaca 1552260
 aagttcttac agccaagaa gttagaacag atgatttcca gaagtcaccc tgtctacatc 1552320
 ttgccttca tggccctt gtctgagag agccggaat gtgtatctta ccgggcacag 1552380
 gggagagtaa acagcacagt gcatgcaaaa cctggcaca ccaactgctt ttctaactg 1552440

 ttgactcca ctatcctca gtgggtcctg aactgcca gaggcctag ttgccccac 1552500
 ccgactgggc aggtcctta tggggagaag gaagactggg gcttcacctt aggccttga 1552560
 ttgtctctc ttccaagagc tcactgctcc tgtttcattt tcagactgcc tttgagctc 1552620
 aggccagcc tctgaccga gaggtcagc tttcctgggt ccacagtcca aatgaaccac 1552680
 agtccagcc ttttttagc tccccactc ctaccccgaa tgccaccatt ttgctacct 1552740
 cctgggttgt tgattttaa tgcagattga ttaccaaata gtaaccaata caatgttag 1552800
 taccagagac tgctcaaggc ccggcttctt gggctgcct gacacactgg gttagagcat 1552860

 gcctttctct ggttcccca gcacctctt gacctggac cacacacact agactggcca 1552920
 gttacccca gggctgcttg tgggctgca tggtccagg gcaggactga gtctcgaaga 1552980
 tcagcccagg gctggcactg caggtgctct aaggcatggc agaactgggt cccatcaaa 1553040
 gcttcttact ctcttaggc tccaccattg cccatttcta gtgggtcaa atgagacttc 1553100
 tcacaggggc atttgttaag gcaaacctt cttctgagc ccctggagag gtctggcta 1553160
 tgcttgtea tggcctctgg cacaagcca ccaggacaga tggaaaaatt ggggtggct 1553220
 ctaaaaaag ttttacttt gccaatttg actcctgtct aagggtgagg ctctctagcc 1553280

 acagtgcctt ctccctggct ctggcagatc cgaagagcag tcaaatggca atcgcttct 1553340
 ggggttccct acgtccagc taccatcagc ctcaacatgc cagctttaca tcaggcaact 1553400
 agctgtcct attagccctg tctgtccag agctgtgatc tggccttccc tttcctgctt 1553460
 gttggacgt agcaaggcca tggaggtgaa ctcatggcac gatgccctt cagccccagg 1553520
 ggccaagtcc atgaagcaaa ggtgtgactc acaacagctc atgtgtgtga gctgtctgca 1553580
 gctgtctgg tctccagtgg ttaatgatt caccagcct gggttttgag gccagtctg 1553640

cagggtgaac cactgggaga cccagaaaa gcctccatgt cctgcctcag gatgagtga 1553700

 tccattcatg cagacggaat gaatttcctg tccacgcagg atctagggca ggagatcagg 1553760
 agttaattct gcctggtgct caaacagtcc tccaaggag ctcacctcctgg aagctttagg 1553820
 gtcaggagcc ttcagagcca gaggggcaag gacctgatat tccaaccctg cttgacagca 1553880
 aagagcagcc agtggggaga atttgacgtg tctgtcaggg gctgcctgaa gcctggctct 1553940
 gctagcagta aggagcacag gaatcaatag ccacaaaatg ggcacaaaat gggcacagtg 1554000
 ggtgtcacta tgtctcattc caaatcttc agaactgagg gtgtagtaat tagcacagca 1554060
 cccagcacca gcaggtagtg aaacagcaa tgaataccac ggctttctga aagcacaagg 1554120

 ctctctcttt ccctcattc cccacccctg gcatcctcag cctcgttcac agctggacac 1554180
 gaaacgtgct cattcttcat tattgttttg ttgagacag ggtttctctg ttagccctg 1554240
 gctatcctag aactctctct gtagaccagg ttggccttga actcacagaa acctgtttgc 1554300
 ttttgctct gcttccaag ccctgggatt aaaggcatgc accactatgc ctggcceaag 1554360
 atgctcattc ttaaacatagg tctggtggct cacagatgaa ggcaggaaga tcagaaatcc 1554420
 aaggtcagtc tgggctacaa tgaaactgag agaagggggg ggagacagag agagagggag 1554480
 aggagggatg gaaagaggaa gaaggaagaa ggatgggaga agggagaaag aaggaagga 1554540

 gggagggagg gagggagga gggaggatgc tcagccttca tcatgggtgt gttgttgatg 1554600
 tggctgggtc agaatccctt aaactagctc ctggtcagtc agcctcttat gacctacaa 1554660
 gatgcttga ctagccat gcactcagga ggactcaact gccaccaggt gtgagcaggg 1554720
 agcgggtgct aacctgttc ctcacatact ccaccagcaa tteaagctgc cgagggtctt 1554780
 cacatttctg gtigaagaag gttctccaga gggcagcagc cagtcacga tcatcagaaa 1554840
 ggatcccta gaacacacaa caagacgtgt cttgcagagc catgatatta aactgggat 1554900
 atttgaacag gagatcaaag aatggattca gatggagaga gaggtaatg ggcgagctta 1554960

 agaacatctg acttttttt tttttttta ggggtgggtg ggtgtggtga cagggttca 1555020
 ctgtgtagcc ctggctggcc tgaaactcgg accaggctgg cctcacaag ctgcctctgc 1555080
 ctccagtgct tcttatttgt taaaagtaa atttatattt tattttatgt atatagggt 1555140
 ttggcctgca ttagtaccac ttgagtgcct gtttctctg gaggtctgaa aaggcatca 1555200
 gatcttctgg aactggagt acaaatgatt gtgagccatc atgtgggtgc tagaaattaa 1555260
 acccaggttc tctggaagag caccagctgc tcctaatcac caagcattt ctccatcccc 1555320
 tcaaccctc tttatacag aagccatgg gactctgaga gtcctggcac tggctgaggt 1555380

aatgcaaagc tggcactcat gcctgttgca ccctcccagg tatagtccat tctcctctac 1555440
ccattgtgcc tggccgaggc aatgaatgic tgcaaggccc acccagcaaa ggagtgtagt 1555500
agccatactt ctgctgctgt tcacaaatct gtgtttgcct gggcatgggg gtgggtgtga 1555560
actgctcata ctigtctggt ccaaggtcac acatctgcaa ggtagctggc tctttgggaa 1555620
agggaaactga gtacctgcc ttcactgtca cccgtctggc catgactggc ttggactctg 1555680
aagcaaggga caggctgttt agtaggtttt ccatgggcca cacggggctg cctagggcca 1555740
tgctcagagc ctgtctgtgt gtctgatatt gcctctctg gcaactgggaa ctcttgtttg 1555800

gaagcccgga tattatagag gccaaattaca gccatthtct agcccagacc tctagggcag 1555860
ggaggatgaa ggcaaatgaa gggaaaggcc ctaagaagtg catctgcctt ggtgccaaag 1555920
taggacatgg aactgaagtg ttgccttgaa ctcagacgac tggcacaatg gttatggcta 1555980
aacccaagtc tcagggctct aaaaagggtg ggggtgtgaa tgcctctcac cccagggctt 1556040
cagcggcaga ggtaaaagaa aatacttgct ctacctacag catccttgaa ttacaaagat 1556100
gaggtaatgt ggcctggggg tgtggctcag cgggtgagtg cttggttagt atcttcaaag 1556160
ccctggaatc aattcttagc accaccacac aaaaagttaa gtcttttaa gagaattaca 1556220

tgtattgatt ttgcatgat gtgggtatgg gtgtacacat gccagagtgc atgtgaaggt 1556280
cagaggaciaa cttgcaatgt ttggttctct gcttttacca tgtggatccc tgggatccag 1556340
cctggcccat aaggctttgt ggtaactgcc ttaactgaac gagctctctc cagaacagct 1556400
tttttatttt tatgacagag tctcatgtac caaaactgt cctcaaactc tctatgtagc 1556460
caaggagacc cttgaaactc cgacctctg cctatacttc ccaagcacta gaattacagg 1556520
catgtgcat tgtgccagtc tgcaaagcca ttttgaaaag tgaatatgt tggatgcaat 1556580
atacaaaagc attgctttca ctgggagtta gtatagtcga ggcaacagtg ggatatggga 1556640

gtcaaacacc ctaagttcag tgccagctcc gtcactttat ggtagtgtgg cettcgagaa 1556700
gacttagccc ctctggagcc tcagtttctc attcattagc agagcctgat taattctac 1556760
cccacagaga cgatgtccac aaaaggctcg ttacctagta agggttacaa agacacaggg 1556820
acatttagtc catgttatac agtggctctgt ggcatataag agggctgact acaggtcagc 1556880
tatcaaaaag gttcaaccta cccatggggg ggtaacagat aggtggaaaa gcacttcacc 1556940
tgctcgagat gccttctgt aaataacccc cacagtttca cagcgggaaga ctgtcctggt 1557000
gtgcatggc tgagctggga aatccgcttc ttctagcaga tggcaacaac aaccaaggac 1557060

aagctcagge acatcatcct cccgcaagct atttgctaac acaacagccc gcctgtgtgt 1557120
gaagtgccct gggcacagge gggccgctgt tggcaggaac ctacttatgt gatatgggaa 1557180
ggagtgggtg ggagtggcac aggagcttgg agaaagaata gagcccacia agagagaagc 1557240

cggggagtca tgacctgtgc agtcagggat ccctggagct ggggagacgg ctgagacagg 1557300
 gcgaatccac tcacaggggt cctgagaagt tagagggcaa agggggactc ggaggtgta 1557360
 gccttgctaa gaacctgttc cagattacca ggtctctttg ccagctagtg tctaattgact 1557420
 acctgcacca caccactcag cacaggtgtt attaccccca catgaaagat aagtaccgag 1557480

 gctcagaggt tagcgaggta attggtgttg agaggaacct gcctgtactg ctgaggtcag 1557540
 gggatggtag ctgcctagcg tcacacagcc ctggcataca gtaccagtgt gctgaaaatg 1557600
 gcagactcca acgccaacc cagcccgagt cttctttcca tcagactgct agtagctcag 1557660
 tgaacacaaa tgggagacta ttcaagtatg caaatgtgaa cgtcaagaaa cagaagagga 1557720
 gaaaggtacc aagcattagg gtgcagggcc aattcctcat aatctaggaa tcgtttgcct 1557780
 catggcataa aagaaggcgt tctttaggaa attagcgcgt ccaggtctag tgcggtagac 1557840
 aggaagctgt gtccaggtct agtgtggtag acaggaagct gtgtccaggt ctagtgtggt 1557900

 agacaggaag ctgtgtccag gtctagtgtg gtagacagga agctgtggca ctgtcccga 1557960
 gtggcagcta ccacctgcbc ttcgcacat tctaagatga acacagagtc acatcggtg 1558020
 agctcagctc tcagggggct tgcaatccag gacgcatgag gcaacatagc aaagtcttgg 1558080
 acagtgaaca aatgctaagg cccttgggtga gaccacaatc cactggtgcc tctgcctcct 1558140
 cattcttcag cctttacttt agaagcggtc cttggagagc tctcctggt ccacactgta 1558200
 tcttccactg ttattctcta ccggtgccct ctaagcattt ttctgcttat ttagtagcta 1558260
 cttgtgtgcc acctgtctca gtaacttcaa tgggagagag actgaaacta tgcagtttg 1558320

 agtcaccaac acaatcctca tctatcacac atgataaaca tgctaaaaac cattgttaaa 1558380
 tggatactga aatgcagagt aaaaacacaa gcgatctagt gaggtcagga aagaagtffc 1558440
 gaagaagtga cctagggaga tcagccaggc ggtggtggcg cacgccttta atcccagcac 1558500
 ttgagaggca gagacaggag gatctctgag ttctaggcca acctggtctc cagagtgagt 1558560
 ttcagaacat ccagggatac actgagaaac cttgtctcaa aaaacaaaca gaaaggaagg 1558620
 aaggaaggaa ggaaggaagg aaggaaggaa ggaaggaagg aaggaaggaa ggaaggaagg 1558680
 aagttaggaa ggaaggaagg aaggaaggaa agctgttttg gacttacaca tetaaacccac 1558740

 ctgggaactt tttttgttat tttttatttg attttgttc atgtgattg atgtttgtc 1558800
 tgtgtgaagg tctcgtttcc cctggaactg gaattacaga cagttgtgag ctgctatgtg 1558860
 ggtgctggga attgaacctg ggtcctctgg aagggcagtc agtactctta actgctgagc 1558920
 cgtctttcca gcccttgag atcttttgca gctatctact cacaacagtt aagtcagtac 1558980
 ctttgggtga taggttctcg acactgaaat ttctagaaag tatcccaggt aatcagtgta 1559040
 ttttccaggc tttcctgttc atgtcacctg ggtgcttctt gaagcaccga gtggctccta 1559100

ctggatcaaa gccttcaaag gggcataggg aacacattta acgtgtctcc tgggtgcaga 1559160

ctatgagagg ctcccatgca catacagaca gcaacaggta aactggtaaa ctgccagtgg 1559220

gtgggggggg ggggggagaa aagaaagggg agaggcaggt aagtttgaag gaaaaagtgg 1559280

tgggggggga attgtaggag agggaatggg ggtggattta atcaaacac atgatataca 1559340

tgcataaat tctcaaaca tgcaaaaggg gaataaaaaa gctagaaaca tagctcagtt 1559400

ggcagaggct tgctagaaa ggataaaacc ctgggttcaa tccctaactg gaataaattg 1559460

acgagataag aagccagatg agattacagg catgtgccac catgccgttt catcagtcca 1559520

gagaatcaaa cccagggtt catgaagtaa gtgacctacc aactgggctg cacccctgtg 1559580

ttactctgta cacttcttcc ccacatcact gcaggctccag cactgtgtta gacatcagaa 1559640

acaattgggc actgtcactt cccaaaagaa agccacacc agccaggatga cagacttaat 1559700

gctggttaag tgctgtaagc acctgggcag gtggaatgag ctaagcctgg gaaagtggg 1559760

gactcttcc caggagggtg tgcttgcata aagtcaggag ttaaccacat ttatcaagag 1559820

aaaaatgagg tatgatgaat ggttcgagta tgtatacagg tgttcattac accatctttt 1559880

taattttcta catgctttaa atttcataa taaagttgga gggtgggaa atgacacaga 1559940

tacaacatgg atgaacctag agacacgcta taagccagta acagatgagc aaacactgta 1560000

agagtctgct catagagaca gaaagtaaaa cagtggttgc cagggtctgg gaggaggagg 1560060

aagtggagaa ctggcattca atgggcagac ttccagttcg agactgtggc tgctcagcaa 1560120

gcatagcttt gtgcatgagg cactgcagac aagcctgcag gtgtaactca ttgcataga 1560180

gctgaggaa tgctatctat gtacttgtga cacctggagg gagacttgat gaactatgat 1560240

gacttctcct ttggggctgg agaagaacta ggtctttatt tgtatttcaa gcaggtaact 1560300

acagttttat gaatttttaa aatgagtata tgcagctagg tgtagtacg gcacatgctt 1560360

ttaatcccag cactctggag gcagaggcag gcagacctct gagtttgagg ccagcctgtg 1560420

gtctacagag agagttccag aacacccggg actacataga gaaacgttaa atacaaaaat 1560480

aaaaaaagag catgtcaggg gctggagaga tggcttagca gtttagagca tttgtttctc 1560540

taaacaaatg gcaaaggaac tggattcaat tcccagattt cacatgatgg ctcaaacca 1560600

acctaagtcc agttccacag gatccattgc cccttctga cctctatagg caccaggcac 1560660

tcatgggtca tcatacatgt tggcaaaaag ttcatacaca taaatgaata tgtgctgtct 1560720

taaaatgaaa actaacaca gtatacattt tgtcccat atcatgttgt tttatgtatg 1560780

agtatcaagc attccctggc aagagccagg gctgtggcag tctgatttga cttagtgcc 1560840

ccatccagca ctgagcaggc aggctctcaa tgctaattca ttgaatgttt aacaaaaaca 1560900
 tataatgctc tctttccctt gcactcgatg aaggtgaaga aataaatact aagaaaaaag 1560960
 gacaagtaga gggactggag agatggctca gtggttaaga gcactggttg ctcttcaga 1561020
 ggatccgggt tcaatcccca gcacccacat ggcagctcac aactgtctgt aactccagtt 1561080
 ccaggggacc tgacacccat ggcaaaacac caatgcatat aaaattgtaa aaattaatta 1561140
 atttaaaaaa tggcaaacag agaatatggt cctcaaagcc ttcacatatt ctctcaaag 1561200
 gctggagaga tggctcgacg gttatgagcg cctgctgctc ttacagaggt cacaagtgtg 1561260

 gtaccagca cacaagccag tgacttghaa ctgcctgtaa cttcagatcc aggactttct 1561320
 tctggcctct gcaggcacag gtgccccccc ccacacacac acacatgcat gcacacacac 1561380
 acactctgag ccttttctgg gactgggtgt ggttgatata cactttggtt cccagtaccc 1561440
 atgttgagt gttcacaact taaagccttt aactccaact ccaggggatt gatgcctttt 1561500
 tctggccac acaggcattg acatgctcct tcacacacat gtggcagaca cgcacacaaa 1561560
 ttaaaaaaaa aaaaaaaaaa ctttaaaaag gaaggaagag gagtgggaag gctggtgggc 1561620
 ctttgttggg gaggccactg tggcctaagg cttggcaaat gatcttacct catcatatcc 1561680

 caagattgac gcatagaaac tgtttgtcat gtaggcatg ttcttcttta ggatatagga 1561740
 attaacctac aaaaacaaaa gtatgatggt aaggaaaagc atgatgtctc ttagctgtca 1561800
 taggctgttg aaacaaagag aaaggaactc agtttaaact gccagtccat ttccaagccc 1561860
 cttggctgtc aggattttcc acaacaaaac tggcacttct ttcagathtt gattcaaac 1561920
 tacattcatt taatgactga accttcaact gaatgtcagt tttgtgttag tattgatcaa 1561980
 cacaaagtth cagaacatg gtctaattac aggaccacac agcctagcat aggaaaacag 1562040
 acatcaaca attactcaca ggtgtggtag ctactcctg caatccctag tgtgtgtgtg 1562100

 tgtgtgtgtg tgtgtaaagt taaagctcat acagcctggg ctacatgaga ccatgtctca 1562160
 caaacaaca aaggacact gagatggttt agcaggcaaa agtgcttgct atcaagtctg 1562220
 acaactggag ttcaatcccc aggaccaca tgatggagga gagaagtgac acctacaagt 1562280
 tgttctctga ctccacata cagacacaca cacacacaca cacacacaca cacacacaca 1562340
 cacacacaca cacgtaaatg caatttaaat gattatctta ctgtgtgtgt gtgtgtgtgt 1562400
 gtatgtgtgt gtgtgtgtaa tacctgaatg aagttacctc aaggaggaag gtttcatttt 1562460
 ggctctcagt tctgagagaa cacagtccat tgagcaatgg gaaatgtggc ttaggcaaaa 1562520

 tggcagggaa gtgaggctgc cagttcacat cttggtgaat caggaagcag aaagcttggg 1562580
 ccagaggtga ggccccacta tgttctctca agcctgtccc ctgcaatata ctctctccag 1562640
 gtagctgcca ctctctaagg gttccacacc tttctaaca gtccatcacc tagaaactaa 1562700

gtgccttgac acatgagcct gtaggggggc agtttacgtt caaatcgtaa catgataaat 1562760
 caaagactga gtgacttcta tctctgggatt cctaactgtc tctggaggtc ggaaaaggca 1562820
 aaagggtttg ggttttagact caagccctag ctgtggtata tttttgggt gtggtcttga 1562880
 gcaagccaac ctctctgagg ctattttgc ttttaaatgc cctgcacaca agaactgttt 1562940

tcaagagcac agaagttcgt ttgcattcat tcattaagtt aacaacatac cctggaagtc 1563000
 ttggtaaacg tcagtgaact cgacaacac aaggaactgt gagtaagacc tggtttgttt 1563060
 atacaaaact aaaactaaaa gcagttccag agctttacag ttgtggacaa tgttcaacag 1563120
 tgaagagaga actgtcaagg tctgaggctgg aaagtgtgag attggtggtg gctgggcctg 1563180
 taagccatgg cctttcctac ccagettcaa gccaggccac agtagccact gctcctttgt 1563240
 gctctcaggg ctctgtctgc atttctccc ctaggtagac aatatggttg cagttgctta 1563300
 tatacctgcc tttcccacca gtctgtgagc aactcaagct tggctcacag gaaacaggac 1563360

tgaatcattt tggcacccaa acacctgggc caggacaggg actaagaagg gcatcctgat 1563420
 aatgaatccc tgcaaggcca ccaccaggg ctttggatac actcagagct gagcacttcc 1563480
 ctagcatatg tgaggccctg ggttcagcac cccaaacgaa caaacaanaag cgagggtctac 1563540
 tcagagcatg ctctatccaa tgacacaatt atttgtctc ggttttctg aaaagatacc 1563600
 ttccatgttt ctgaaattcc agaaatata actactgtat ttctttctac tgettcatct 1563660
 aatgtgctgt ggtgagagtc agaataggca agagttaagg gttcctaccg tctctcaagg 1563720
 acaagaggtc agccagcctt ttaatacat cgggctcttc cttacttctg tactggttgt 1563780

tcccctaaac gtgcaagatg accagagcca aaaagcacgt caggcatcc aacacaaggc 1563840
 aaggcatcat tcttaggaaa acattacca agcccgtctg gtcagcagtt agcttacaca 1563900
 ctgcatcatg ccaactggct ttgaagtggc aaaggccttc agggatcacc tggcccactg 1563960
 accccaagga aatgaacggt gaagcgaggc tcaaacatgg aaagacacag atccaaagtc 1564020
 acatatcaag ttaccatcag agtatgagta gaggggatca aatgagtcca tttcaccatc 1564080
 tgacgggtat ttccaaagat cccccaaata ttattctgca aagcttggtt cctgctttcc 1564140
 agagaggccc aagtagggac aaatgcacct tctcctggag aagatggctg gttgectggg 1564200

gagagccagg tataggattg gagctcagtg ttagccaggt tctactccag tgtgccctg 1564260
 tcacttctac agagagaagc aagctgccac agctaggaat ggctttctca tatcactacc 1564320
 caggctagat tagatcatga aaaggtccct ttctggaaga cagtgaagc ttgatcactg 1564380
 caacacatga tctgcaggca gcagatgaag gaagtgcac caacctcact gggcccttga 1564440
 tgctggagtt tcctctctgt gaacccceat tctactccac tccttcaatt aagcatttgt 1564500
 ctgctggtgt gctgggtccc catctcccc gtgctggatc atctatagga agcgtgttgc 1564560

ttatgaatac tcagatcccc cagcagaaga tgggtgttggg ctgtttgctc attaaaatct 1564620

 tatcctgtcc ataatgcttt gctttttata aaaaccata catactgagc catcacatgg 1564680
 gaaaggctcc ctttataca gttactcata ttttccatt tatttaagct attaaaatc 1564740
 atgcagatat tttataagcc atcaggattc gatgactgct attactgaat gtttaataat 1564800
 aaactaaca gaagaaatca gagggttaaa tgatgactgc aattcctgta atgacttaat 1564860
 taaattttta ttgagtacat aaactatgat gtcacttcta gccaacatg getctgcttt 1564920
 cgcagcatgt cacaggggtg gagcactcaa taggaggcta ggctaaatga gcagcaggctc 1564980
 tctgctgaaa tgggggaggg agcaaggctc atgtaacaca ctcaataaat tatccgttca 1565040

 tttttaaaca aagtccatga gttataatat atttgccatg cactttttat gacataataa 1565100
 aaatgttacc ttaaggatta cttaacacat actacaaatg ttatagcaga ggcaggcaca 1565160
 aggggcaaag aaaaacaaca tgaacaggcc agggacgggt cctggagttt atgtcccggg 1565220
 ggaacagcac agtgtattaa aagggaatg caaaaaacag ggggtgcaag tgttcaggg 1565280
 tactaatcag cagattaatg aatgagacag ccaacagggg gcacaagcaa gaagggatct 1565340
 cacaaggcac atgtttaatt aatgggagta ttctcagggg gggattcaag ctttaaagag 1565400
 atgccagttc acttgaggct gccctgtct ctttctcact gctgcggccc ttagatgcct 1565460

 gtgcttaaca gagaactgga ctatgttata gagactgaag gagacctcg tttagcctac 1565520
 gagcactggc gaaggggctt caggattttc cctaggctcat ttctctgacc tcaactcctt 1565580
 ctgtccccc acgttctat taggccttgg tcagagtcaa ctctgccatt tccacagctg 1565640
 gactgtgctc tctgttctt agccacacta ataggagtcc ttgtctttac taacggaagg 1565700
 gatgctggc ccttctcacc ttcaaagatc cagcctcaa aatagttatt cccagcctac 1565760
 aggtatcatg aatggttcaa agccagaaac aggtcacata attggctatt gtccatgct 1565820
 agcagctttg tgcataattg ctctattagt ccttccaat gaactctgag aggggacat 1565880

 ttacctcca cttttaaat tccagttttg ctcatggaga tctctatatt taaaatctaa 1565940
 ccagtctaataaatgaa aagcaagata catggttggc agtgataccc acaaaaccag 1566000
 cagcctaac tctgaaatgg tcacataaca gacatttct tagggttttt aaaaagcaaa 1566060
 ccaggcagga aaagatgcca ggcatggcgg cacatgcctt gtaatcccag catttgggag 1566120
 gcagacatat cacaagtta aggtcagctt tagcctacaa aaggagtttg aggccagcct 1566180
 aagctatgtc tcaaaatcaa acaacaaat ctaaacagat gactgtcctt gcaaattacc 1566240
 atcacttate tagttgacag gcattcgaat acagttgtta taattgcttt ggaaagcagc 1566300

tgatgagcta cagtaagatc ttgagaagat caaatgtcag cttactattc ttaaggagac 1566360
 acacacacac acacacacac acacacacac acacacacac cataccccag gctggggccc 1566420
 agtacttaag gaaaagctga gtgcagctga gcacagcagc tgagcacata ctgatcccgt 1566480
 ctttctgggt tgcagatgca gactgctcat ctggctctgg atgccttacc tctctcacct 1566540
 tcttactga agtgcttctg ttgggtatta ccacagtaaa aaatgaggaa agcaaccaat 1566600
 acactcccaa acccagaaat gtggcaagat aaccataatt agacatattt aaaaaactac 1566660
 atacaaagtt aaaaatglat taatagaggt tagagagacg gctcagctgc taagagcact 1566720

 gttggttctt ttggaggacc tgggtttggg tcccagctca tagctgttaa caccaatccc 1566780
 aggggataca atgctctctt tttgtactcc ataggcacca ggagtgccca tatacacatg 1566840
 taggcaaaat acccaaacac acaaaataat attaaaataa taattataaa agaaaaaagt 1566900
 tttattacca ggtaaaaata cacttttatt gctttttttt tttaaactta ccatgcttga 1566960
 aaatgaattt catgggaaaa ccggagaaat atcagtgaag aacagataca gttacaaaca 1567020
 ctaaaactaa taattggcta ggacactcac tgttatatga ccaagagaat cattcagaag 1567080
 ttatttcata ggggtcttcc atcatcaaac tcaaaggact caaaggacca agagatttat 1567140

 ttattctgat cctatctgag atgatgttct ctccccctct acctccctt aggtcaagga 1567200
 tctactttgc tttcaaagta agttgaaata ctgcagatcc tggaaccctg gccctcttc 1567260
 agagatgggc acatagccca agctgattta tcaaatctt gtttctaaga acaaaaataa 1567320
 aactctgcta cagttcagtg accctaaagt tgtataagct cctgtagcta aggtcccttg 1567380
 gctacacaga gtctttcctt tccagggcct gttgtagaa cacccttcc actttggaag 1567440
 cctcagttat ctccaggga atttgtttaa atgtgccaag gttggcgctc tgttgetcac 1567500
 aatctgtacc atcattaatc aactcattaa aaccagatga ctgggctggg tggtagtaca 1567560

 cacctttaat cccagtactt gggaggcaga ggcaggggga tctatctctg tgagttcaag 1567620
 gccagcttgg tctacaaagg gagttttagg acaatctgga actcaaaagt gatacacaga 1567680
 gaaacgtgt ctcaaaaaac aaaacaaaa accgaaccaa accaaaccaa aacaagaaaa 1567740
 caaacaaaa acaaaaacaa gcaaaaatgc cccatgatg ggaacatctg ttgaacgttt 1567800
 actaagtacc agaggctgta ataaaaattt tcaatgagtt atctcttcaa tcattagaat 1567860
 aatcccaag tcatttagaa gaggcgtcac ctcttgttc cggggagctt ttcgagtctt 1567920
 ccacacttgc tgettttct tctctgggt ctttgettcc accaggaaca ctcaactgac 1567980

 tatttaatga tttgtttata ggccaagtcc aacacaccgc attagacagt atgtcccttg 1568040
 aaggcaaga tgtgctgcc agcacaagc agcttaacca gctagtgttt tgcctaaac 1568100
 atgtcttgaa gtagtggttt catgcacctt cccacattc aagaaagctc cctgagaaca 1568160

agagtacata cagctgctgc tgtccaagtg ggctgcaagc acagcgccat caagatgagg 1568220
 aaaccggct tctgtcctca tgtggcccat gaaatcccag cccccctcaa acagcatgtt 1568280
 ccctgaaaca agacaaaggg catctcctcc atcactagca cttgctggag ctgtaccagg 1568340
 aactctctac agaaacccaa tgtcacagag atacctgagg tcacagcaga gcttctggct 1568400

 gtggagaagg tctctcaaa ctgtcagcct ggaatcctgc aggtgtgtta tcagcctttc 1568460
 acctccacct gctcttcaat gaggagagct atgaaaacag tgcaaagctt cccaagtagt 1568520
 gcttgctcat cctccaagt ttaagagagt ttaacgctag caagtgttag tgcagacatg 1568580
 tcccaggcag tctttgctgt tctactgtga aatacgaat ttacaacgg aaaacagctt 1568640
 attggggatc accattcccc agtaatcatg gtagaatcaa taagcaacac aacgacctga 1568700
 agtacaagca acaggtagtt tatgactcc tataaggatg gctggaatta agtagggacc 1568760
 ctacaagag aatgtgaatt ggtgcaacca ttgtggagaa gcatttgaca gctcctctac 1568820

 aggttcgaca ttgagctaca gtgtgacccg gcaagcatat ctacagaagg agtgcaagca 1568880
 tggactggat aacttaaac taccatgtaa aatatggcaa tgggtgtggg cctgagggct 1568940
 ccggggaaga ggtgtcagcc atcatatcag agtgtgcaca ggttgtgttc agacagaaag 1569000
 ggtggcatgt gcaaagccat ggagaggaga acaaagtata gtattttcag agcaaagtag 1569060
 accaggttg cctcaaactc agtgatctc ctgtctgctt cttgagggct gggctttgta 1569120
 ttgtttgtt tttgttttt gagacagggt ttctctgtgt aactgtggct gtcttgagc 1569180
 tctctctgca gaccaggctg gcctcgaact cacagagatt cacctgcctc tgctcctga 1569240

 gtgctgggat taaaggtgtg tgtcaccacc gcccagtga ggctgggttt acaggcatgt 1569300
 accacatgca gcttcagagc aggtttgtaa caaacaaca actacagtgg gtgctgagat 1569360
 gtaaaggcac ttgccaccaa gtccaatgac ctgtgttcaa tccccatggt aaaaggagaa 1569420
 aaccaactct catgagetgg catctgactt tcacatgtgc cacaaggcat gtggtgtgtg 1569480
 tgtgtgtgtg tgtgtgtgtg tgtgtgtgtg tatgctcatg tgtgaaaacc aaaacctcat 1569540
 agtgggcaga agcagaaagg caaacagtct ttattgtctg taaatggccc caaatgccac 1569600
 acaaagacag gaagctgcat ggacacaagt aatttctagc agtgtggacc acagagtgg 1569660

 gcagaggacc agaggcagaa atcacagggg atgttgtgta ataaatagtc caggtgagag 1569720
 tgaataagga actcgtcaa tggaaagcact gaagggcagt gtacagctgg gtacataagc 1569780
 ctatagtctg agcacttggg aggcagagac aggagtatct gaaagtcaa gttagcttcc 1569840
 attaaacaat gatttcaagg ctacttggg ctacatgaga ccctgcctca aaggcgagg 1569900
 tagtgacga ccaatgggat caggttatcg atcaatgaag gagcaagggt gaggccataa 1569960
 cctgcacata atcagacctc gctgaagaaa aagcaaagag aaaagaaaga tggaaagcaa 1570020

ccaccaata cagccacaca ctggtagact tccaacctg gcagcactaa gtgtagaaa 1570080

 ccagtcttg agggttctag caatcactgt gcccttaatg tcttctgtgc tgtgtaatg 1570140
 gaaaacttta ctggataag atgtaatgtg agcaagatgt gtaacttagct tgagcccagc 1570200
 gggcgtctcc aggggagcag aggtacagca caggagggt ttaggagcct gtgcttcctt 1570260
 tccagtcatt tgttcactgc atgtccgtag aagtcattcc tctggctctc tgtattcaac 1570320
 ctgtgaccac gaaacctgat gactgtcagt gagaagatgc tgacacacat gggtttctag 1570380
 agacattcac agactcctaa ttgtacctg ggctcatga tgacattat gactacagaa 1570440
 agctatagge acaactttgc tttcttaatg atttctatt aaacatagac aggttacagt 1570500

 gaaaaactat aaagtgcttg ctccctatca caattagggg attcaaac acaatgtgg 1570560
 ctgataggta aaaacagata acaactcagt gaactcttaa ctaagacaaa caaggtaaag 1570620
 gatggtaggg ctgaaacaat gtacaggagc ctgaggacta tcccagttct tgtcccactc 1570680
 agcaatcctc aaatagatcc atgacactgc acagcaatgt ttgcttagga gccaccatcc 1570740
 agctccttgt catacact aagagggttc tagctacgac acccgacagc cctgacttcc 1570800
 tcttcaggta gtgaagtggg gatgtcccca gtgaacagag ttacacaatc taactggtga 1570860
 ctccactgg gcctagacta aagtctgcag actaacagt aaagcagaca tttcattgg 1570920

 ccacaggatg tttctctttt accactgtgt ccttattgca tactattggg agttaaatt 1570980
 ttccaagtga ccaaccaat ggtaactgta gaaagaggtc atttcccagt gcagaaatga 1571040
 ggaaacaaag gctcagacag ctgagtgac ttgtccaatt atcatagccc aacttgtttg 1571100
 tgagtgaaa ggtctcattg tattgttcaa gaactcctgg gctcagggga tgtttttgcc 1571160
 tgagcctctt ctattttggc acattgttct ttaaggctc agagagacct gccattcagt 1571220
 aatggctta tagaatccta tagaagtacc ctggaggagg ctgaactaag tgtgcaata 1571280
 agatcactcc cacccacagt gactgaggaa caactttgt ttggatgtcc ttaaaatgga 1571340

 gctgacacct ggtcttgga actctgagtg gctctgtctc taaagagtat tgtctcttt 1571400
 ttaaaattat atcttttatg tttattgtat gaatattttg cctgcatgta tgtctgttgg 1571460
 ccatgtgtgt acatagctcc tatggaggtc aaaagaaggc ctcatgccc ctgggacaga 1571520
 agttatagt actgtgagcc gctgtatggg tgctgggaat caaacccagg tcctctgcaa 1571580
 aggtagccaa tgccttgac ctgagacca tctctccagc actttttttt tttcttttc 1571640
 ctttttaata agcaaatgt tctttaaatg gtattttatc caaaggaaag agaatacctt 1571700
 ggaaagaatg ccatgtctg taaggacatc tctttgatgg tctgtattca agacaactat 1571760

taaattgcc tttatcaaa gcaaagtta agttccagta gccattcccc caccctgtca 1571820
 gtctggaaat aaaaatcact cccagactca gttttgcatc aaaaccatgc ctaactgcct 1571880
 tttctcatat taacctgtga ggggacatgt tcatcaataa ttaataaaat aattatctat 1571940
 ttcccagcgc tgcttcaagg tcctcatatg tgacagatac ctacaatac tatagtttgg 1572000
 gacaagaggc tgggtaccac tgtcatttct ttttataggt aggaaactga agcacagaga 1572060
 ctatgtacct tggccatag gctggggcag cctgtgaaca catcaagcct ggcttggcca 1572120
 cccactctt aaccactctg tgatatgctc acaaaggaag tttcaaactc acctaagggg 1572180

 gagagtgtgc atttctcadc ccacccttaa agcccccccc atcctatctc cattcactca 1572240
 ttctatctac actaggacag cttctctagg aagcgtgcca caaaacaaaa cagcaggtga 1572300
 gctcctatct ctcttgitta tctatttagt ttggaactga aaccaggaag acagccattt 1572360
 atcttccagg cactaaacta cttgtaagcc ctgtaaggtc acttttcctt gaaatactct 1572420
 tagccaatag tatttagagg ttagtgcatt gtaaggaaca aacaaggtg ttccttcaat 1572480
 aatgaatgaa acaatTTTTT ttgggggggg gtctttttga gcagggtctc atatagcaca 1572540
 ggctgttctg aaactcaaca gcagtggaga atgacttggg attactgatc atcttgctc 1572600

 cttttgcag gggatgggt tacaggcatt tgcatagta cccagctgta tgggagaaaa 1572660
 gctacacaag ttaataacta ttaggttgg gggtaggggt aacaacaagt aagagcactg 1572720
 actactatag aaggcaatgt caggtgtctt ccataactgc tctttacctt tttgtttt 1572780
 tgagacaagg tctcttactg gcttggccat actggctggc cagaaaacct cagggacct 1572840
 ggctcttctt tcttaggtc aggatgaag agacttcctt aggtgccag cttttatat 1572900
 ggatgcaggg atttaaactg gggctcttac aattcccagc ccgatcgaat tcttcatggt 1572960
 ggtgtagggc gtctggaaca gagaaggaag gagtgttaga agccaaggcc cccaaaagta 1573020

 ccacaggccc ctacatgat caagetagat gagacaggat aaggccagcc ctctttctc 1573080
 tagagagagg ctctctgg caagcaattc acttggggac taaagcactg cagacaataa 1573140
 acagctccag tttctaaaag agaaagctgt gcatatctac tctagatgcc aaagacaatg 1573200
 gcttatttga atcccaagaa ccttagcaaa gggcactgga ccgggttgaa aaagagagga 1573260
 gtgggggcat acagaaagcc actgaatacc cagggggaat catcttttat ccctgcccc 1573320
 agccactcac aagccatgg cctagaaaag gagcgacaga tagtttacac cttttattat 1573380
 tctgatagaa atgtctctcc cgggagcagg caggggtcaa aagtccaaca ccaaaactat 1573440

 atatctttat aagtcagag caaaaaagca ttacagcagt tattaaaaaa aaaaaagcc 1573500
 acagtgacca gccgagcagg aggtgttaga aaactcactc caaataattt attcaccgag 1573560
 aaccacaag ggctttccca agaacagcaa aacaccatt aatttccta ggaccctccc 1573620

tttcaaaggg ctccaaacac cacacatttc atattaaatt gtcctcaaag acttcaaaat 1573680
 aagggttact atttcctaa gtacagatgt agaaactaaa gcattcatgc ccaccacact 1573740
 ctgaccaggc catgctaaag agtgagcctg cttgtgtccg atccaggcct cctgatagag 1573800
 ggttacaag accaggagta ccacctccat cccccacaaa gaccaaaaaa aaaaaaaaaa 1573860

 aaaaaaaaaa aaaaaaaaaa aaaaaaaaaa aaagaaaaaa aaaggatctc taccctccag 1573920
 aacaccagag tccagtagta caaggcagat gcacacatat tccacttacg tttatgcgaa 1573980
 ctgctattgg aaaggcccat acacagcctg agagctgcca tttactgggg cctgatatgt 1574040
 tcctaggagt gagcattgtt taagtacccc aacagtatgt gactaataga aagaatgaag 1574100
 gcaaaaagag gtagagattt gccaaagggtc ctaaggccac ctgagccaga gacatgacta 1574160
 gaaccagat ccgtctatct ggttgtggaa ggtcctggag ctgcaagggtg actgcttggg 1574220
 aatgaaacc ggcctctggg cttttcagca ctgaatgcct acatggtaga gacagacagc 1574280

 aggcacacac acaacacaca gacagctgca ctgcatttga gaggagcctg ttgccaggc 1574340
 cagaattgca tatgcctaca ttaataggga ctttccatca ggggacagct cttgtgtctt 1574400
 tcaaagggga acaacaaagc gccttctggg caaagaagag ctgagaagtc ctgagccttt 1574460
 cttgttcttt tggggccct ggagatgtaa taaggccaag aaggcttca tctggtggc 1574520
 ctgctgtaa ggcaaccctg tagcctttgt tctgagccag actcctgctg ttgtcatccc 1574580
 tgaagaaggg cacagtgcag taacatcgag gcagaacttg tctaatagct gtaagctctg 1574640
 taaaagctct agtttgaag ccaagaaaga aatgccaga cttagggca agagagcagc 1574700

 aggccacagt ccccagcca gaaagactac tgaaaacat agccagtcat ggggactgcc 1574760
 tgagtctaa taacaggagg acagatgagg aaggagttt aaaatctta tttcaaccta 1574820
 acaaaatagg aaccagctca tacttaacac cagcagcttg ttatgtaatc ttagaatcag 1574880
 tccatgtggc catcaacata cactatgagt cactgtttgc tctattagta ttacttgtat 1574940
 tgtacctact ttgaaaagag ttcaacttaa cttaaaagta tatatgatgg ctaagaggcc 1575000
 agagactttg aaacagtcag atctggcctg tgactccagt ggccacagc acatgctttg 1575060
 ctcttcttc ttggttcaaa tcagetgtaa atcatggatg gattcaagc tatctaagct 1575120

 catttagtag ggataagcaa gacaacaatg actgcaaact acccagctag cagctgggct 1575180
 cctccatagc gtacatctaa ctcaaaaacc aaagaggtaa ggaatagagt gtgcaagaga 1575240
 gagggaccag tgacaggfcc tatcgaagca tctaaataag ggaagctttg tacttcctag 1575300
 gagtgccagc caaaggaag cgggattatt acctgttct catggttaat gaaggaagcc 1575360
 tgtaactca tcaggacaga ggaagtgtg aggtactgta ccctgtaccc tggagtaaat 1575420
 gcaaatgtgt gtgcatattt acacacacac acacacacac acacacacac acacacacac 1575480

acacacgatg ggggaagagg ttgaatggct ctccagagcc ttgctgcccc cctgacacca 1575540

 cacagctggt gcctccagtg aagtactgca agagttaaaa catttttgtg ccaatatttt 1575600
 aagagtgcag aaggttccaa attacatgta aaataaacia tgccagactg tgaaaactct 1575660
 tggctgcaac gtctctgat gttaacaaga gtttctttat tactgtaacc tttcagaagt 1575720
 gaataaaaat tatttctctg ccctagtttt gccctccagt aaaagtgaag agagcagtga 1575780
 ccatggaaag agctgtacaa taactcccc cccaaggct gggggctggg aagggggcag 1575840
 tcgaaaaaa agccttccat atatatttct tttccaaagt aaaaaaaaa aaaaatgctc 1575900
 ccccccccc ccccacggg cgggggggaga agagnnnnnn nnnnnnnnnn nnnnnnnnnn 1575960

 nnnnnnnnnn nnnnnnnnnn nnnnnnnnnn nnnnnnnnnn nnnnnnnnnn nnnnnnnnnn 1576020
 nnnnnnnnnn nnnnnnnnnn nnnnnnnnnn nnnnnnnnnn nnnnnnnnnn nnnnnnnnnn 1576080
 nnnnnnnnnn nnnnnnnnnn nnnnnnnnnn nnnnnnnnnn nnnnnnnnnn nnnnnnnnnn 1576140
 nnnnnnnnnn nnnnnnnnnn nnnnnnnnnn nnnnnnnnnn nnnnnnnnnn nnnnnnnnnn 1576200
 nnnnnnnnnn nnnnnnnnnn nnnnnnnnnn nnnnnnnnnn nnnnnnnnnn nnnnnnnnna 1576260
 gaaaaaaaa aaaaaaatcc ccccccccc ccccagagag tgtatctgca tatgtggagt 1576320
 cagaggacag ctgacaggag taggttctct ccttccatca tgtggatccc agggatagaa 1576380

 ctgagtcgt taagcctgat ggcaaatgcc ttaccaccaca gaaccatttc accaacacag 1576440
 actcccatat acatttagtt tgggctatgg gtcatattgt acaatgtcac attgctgaca 1576500
 tttgtatcac ttagaggcac aatagagcat ttgggaaagc ccaaaccaag ctgatactat 1576560
 gaagaaaatt aagatctaag caagaccct tactacttga gactgaagtg cacatcttta 1576620
 accccagcac tggagaggca gaggcagcag actgctctaa gtttgaggac agcctggtcc 1576680
 acacagatc taggtcagcc acagctacag aaaaggacc tttctcaaga caaacaacia 1576740
 aaacccaaac aaggaagagg gtttgtgtgt ggacaatact caggacaaaa tatagtattg 1576800

 tacagaccct tgagtcaatg aaacagtaaa tatcagacat gcagaaggat caaatagag 1576860
 ctagagaaag agaaccact ttaccacca caggaaaagg agtaaggcca gcaaatgaag 1576920
 tcaaactg cccctctct ctgtaacct cagtcaccta gaaagccatc ccaaatgtca 1576980
 tctaactga gctctctct ctggcattct cagtcattta atttgattt ctattatta 1577040
 taattatggt tacgtgtgtc ctctgctaga ctggaagtc ttagtcatcc ttgtatctct 1577100
 gatgctaac atagtagctg caagctagca ggccacaata aatcaacia gacaggtaaa 1577160
 atgttatgct tgatgaactg ccatttaaaa aaaaaaagc agaaccagaa cataagctct 1577220

ggaacataac atgaggcaag ctttttagtc ctctcagatg cagaaggttg agtctggaaa 1577280
 agaatgtgga gattacctaa cttacctctc agggactcaa ggggagtccc tcaaggactc 1577340
 aaggacttac tcaagagtga ctaggctggt tagaactcct tcctttaaac cacaccaca 1577400
 ccaccccttc attagcctga aatggtagta tacatgttca ttttctggta ggataagaaa 1577460
 tgtgattaaa aactgtatgg tgagaatgca atttcattat aaacaattg ggggtgtgtg 1577520
 ttgcagtaat ggcctcaaagg ttaagaggaa catgtgtgta ctgctcttga agagaacca 1577580
 agtttgattc ccagcaccca tgtcaagcag ctcaacaacca tctgtgactg cagttccagg 1577640

 agatctgaca ctttctctg gcttcttttg gcaactgcact caaatgcaca caatcacaga 1577700
 catataatta aaactaaaa ataatatgca aacaacaaaa ctatggatat catgttagga 1577760
 attagaatca ctgatgtaa caatattagg ttcccactaa agctatcagt taccactgga 1577820
 cccagtgaat cccaagaaaa tagaaacatg ttcagacaaa acctagctc aaatgttcaa 1577880
 tgtcaacaga ctatccataa agagaaaaag caaagtatgc tacaacacaa acagaccttg 1577940
 aaaagatact cagtaaagag agtcaaatgt caggctgggc gttggtggtg catgccttta 1578000
 atcccagcac tcgggaggca gaggcaggcg gatctttgtg agctcaatgc cagcctggtc 1578060

 tacagctgga gtgccaggat aggctccaaa gctacacaga gaaaccctgt cctgagaaac 1578120
 aaaagagtca catgtcaaag gctgcaaat atattacatt acattctgct gggatgaaaa 1578180
 gccagaagg ggtaaccaca aagagacggc aggaggggtg ggaaatggac agttatgagc 1578240
 acagggtttc tttctgaggt gttgggaatg tttctggaatt agacagtggc gcaggctcat 1578300
 aacctgtga aggtaggtaa aaccactact tattcattgt gcatgcgtgc aggcaagcat 1578360
 gtaccacagc tcccactgt gcccccccc ccccccccc cagctcccgc caggcccagc 1578420
 catttcatca gccaaaaaaa cacatttaa atgtggaatg ttggaagaat tatgtattca 1578480

 tttttttgt ttgtttgtt agtgaaaaaa atggaattcc tccttctagg agctaacaat 1578540
 agaatgagag gagccaggat cagtgaacca agatgtcttg tgacatgagt tttgaagcca 1578600
 ggggaagaag taaatgacag tggttatctt gatactgaca ctagagctgt tgctttctgg 1578660
 gcatgtcaga cagcacaacg cagtgatcag aaaaggacaa gctgcaggga gaggggggac 1578720
 ttagcactt gggaggccga gtgagccctt ggagactaag tatggttaagt tttggggttt 1578780
 ccatgcagac ttggttaaat tacctaagt ggtaacagcc ttccagaaga ccccatgac 1578840
 ctctttctg gaaccctgg ctgttacttt ctacagaaaa taaagaaaga aagctatagg 1578900

 cctgattaag accttaaga tgtagaaatc atttgaaga tctgaaggc cctaaatgca 1578960
 attccataca tccttaacag agaggctgag ggagatttga accagacaga agaggagacc 1579020
 agaggcagac cggagatgca gccacaagt c aaggatgct ggcagccatc agaggctaga 1579080

aggggaagac atacattctc ccccagaacc aacaaaggag catgggtcta gtgacatfff 1579140
 gatctcggcc cagagaaaat gacttttttc ttctatgtcc tagagtctag gaatatgaga 1579200
 gaataaattt ttgttgtttt aggtcaccaa gtttgtgata atcaatatcg tagctgctac 1579260
 cagaaacaaa tatactattc tccctgatct tctagtffff tcatcagtaa cgtgagggtg 1579320

 gagtgcctac ttgcagatag acagttttaa gacaataaaa gccaaacagt tcttctaagt 1579380
 cctgattctg tgtggctgca caccctcta agaactcaca agcagagagc ctggattccc 1579440
 cagtcagttt ctgatttaga ctctactctc tggctctcca ttaggtaaaa gacagggtca 1579500
 gaccaggat aatggttctg aaacagaagg gcttgtttta aaaatgaaaa accctgttgg 1579560
 gccctgtatt agctaattta ttactgtgat aaaacagtga ccaaggcaac ttatggaaga 1579620
 gtgtgagctt gtggcccag agggtagtc cacggaggca gggtaaagg cagcaggcat 1579680
 ggccgctgga gtaggcacaa agaggacaga cacagaggga gcaaacctaa aatggcaggt 1579740

 ggctttgaaa cctcaaagac tgcccatagt gacatacttc ctccagcaag gccacacctc 1579800
 ctaaacctac ccaaatagtg tcaccaaccg gggaacaagt attcagacat ctgagcctat 1579860
 agggggcagt ctgctcaca ccaactacagg ctctactcag agctgattct taacaaactc 1579920
 ccaagtgatg tggaggcttc aggtatagga acaaaaatct gagactcttt ggaccagtca 1579980
 gttcaagcaa gattcttttt cagggtggaag tctaagcttc ccagtatta tctgatgatg 1580040
 aagcactcag gcaataagcc actgctgcac gtgctggaac agccttggga cacacttacc 1580100
 ctggagagga agggtttgaa agagcgacca tgagggtgat ggtgtaggct agtttttaac 1580160

 ttttcaaga tgcagaacaa gtctgaaaca cagtgggaac aggaaggcac ggtctcctta 1580220
 tccagcaagc cggcccccatt ttaatttatc ttaatccac ctttctgctt ctccatcaga 1580280
 cccctcctg ccatgccctc ctctagaaac acatctaggt gtctctttaa ttcatttatt 1580340
 ggctttgcca ggagcagcat aatactgect ttgttagtct cctggcccag ccacctgtt 1580400
 ctgctcctct aaagaaaaa aaaaaaaaaa aaacataact aaggagtctc tgaaaaataa 1580460
 ttataagatc aactgaggca aattcacaag atgcagagac atccaactct aatgctggg 1580520
 aaagacagag tcatcacc actggcatca tccacactg tctttctcc ccttagtctc 1580580

 tattagtct gaataagaaa cctctgctgt actggattag aaattcaaa tgaaaaggga 1580640
 cctcaggctt gactctttct aagaagcagg tatttcaga ttcaaggaaa gctaccctct 1580700
 tggctcctgg taatgagacc aatgaggagg tggaaattgg gggctggtgt caggggatac 1580760
 tgggaatagg aatgcatag ctgtggtcct cacgcttccc tgtgctagct ggacaatctg 1580820
 gggcaagcca ctcaacactg ctgagcctca atttcttac caagaaatgg gaagggactg 1580880
 atccatacag caatataatg tcttctgga ttgaaaactc agagttaat aatctcccag 1580940

gtcctcactc gccagtttaa gagtgtgagg cccattttcc ctataaaagt agattcagac 1581000

 tacaaccaca gaactcagga ggcagggtgg gcagagaata atgaaccttt tgttggtgat 1581060
 gctggtggta gggagaagag ccacagaaaa caaatccagg tatgaccgga gacgattggt 1581120
 aaccagatga taatgctaca atggagcacc tatgctcacc caacaagaat gagcactgat 1581180
 aacaaaaggc aactgatgc acagaacacc aggggcatga gagtcttag cccacctact 1581240
 gtacgttact tgcacaaata aactatggca caccatacaa tgttccagct cacaaatttg 1581300
 tacagggggt gctagggaga tagcttagca ggttaagacc actgactact cttgctgagg 1581360
 acctaggttc aattcccaga aaccacatgg aagctcacia ccatctgcaa ctccaagtcc 1581420

 aagggatctg atggcctctt caggcatcag caaacacaag taaaaaata cataaaataa 1581480
 aaaatttaaa tctaattttt gtttttactt ttgttttttg attttttcga gacagggttt 1581540
 ctctgtgtag ctttggagcc tatcttggca ctgtctcgga agaccaggtc agcctcgaac 1581600
 tcacagagat ccgctgctct ctgcctcccg agtgcctggga ttaaaggcgt gcgccaccaa 1581660
 tgcccagcta aatttaattt ttttaagat ggctcagtta gtaaaatgct tgccactcaa 1581720
 aggacctgag tttagatccc cagcacctgc atttaccatt tgaggttttt gtttgtttgt 1581780
 taaatcattt gataagtggc agacatcaaa aactctagg gactctagga ggaggagagg 1581840

 gaaatgatgt aattgtatit taatttttaa aaattgcaaa tagccgggtg tgatgttgca 1581900
 cacctttagt accagcactc gggaggcaga ggcagggtgga tctctgtgag gtcgagacta 1581960
 gcctgttcta cagagctagt tccaggacag actccaaagc cacagagaaa ccctgtctcg 1582020
 aaacctcccc ccaaaaaaaaa attgcaacta gaacatttaa acattttaat attttaaaaa 1582080
 catataaaca gticaatggt ttatttaaga aaatacaaca cttaggaagc agaggcagga 1582140
 ggatctctgt gaggttgagg cttagctggt ctacataaca agttccagga cagccagggc 1582200
 tatatagtga gactgtctca aaacaacaaa caaaaaaaaa aaaaagagag agagagagag 1582260

 agagagagag aaagaaagaa aagaaaaaag ataaaagata aaagaacaca ttgcttata 1582320
 tacttataaa aggttctata caccacattg ccaagatggt taaatcttgt cccttatgtg 1582380
 atgagaacac tcagaggttt cttagcatgaa agggacacga tcagatacag ggcttaggaa 1582440
 gaaggcctct ggcagtcggt cggctggagg actgcctgaa atgaggacag ccgagaatc 1582500
 cttcagaagt gacttgcaat aaagcagaga tgaggctctga agtgaagcaa tggatcagtg 1582560
 agggtaagag ctacagatat ctaaatggcg accgacaagc catttagacg aagaggaggg 1582620
 ggcagaaatt gagaatgact aagaattcag cttaggaggc tcaactgaag gtggtgacat 1582680

cagatgtgag acaggaagga tgctttcatg gagctatattg tcctctgact cggagtgaga 1582740
 cttatttggga agaagcattg gcagctcctg aaaggtgagc tggaaaatga ctctggctgg 1582800
 ctgtatccat tgccagcacg tccaccatac actcacctct aaccacgtga tgactatgga 1582860
 actggggaca gcaaatgaaa ccaggcaaaa gaaacaagaa gggccagggg gagacctgtt 1582920
 cccttgaaag gagagctaag cgaggagcct gtatcatgag gagcactaaa ggagggatgc 1582980
 gtgtgtctat cacggcctcc atgtggaaga cagttttctc cttcgacctt gtgggtcaaa 1583040
 ctgtctggct tggcaccaag taccctcact tgctgagcca tcttctcact ggtccccaga 1583100

 aaggactttg aaaaaaaaaag gaataaagtc actgttcctt atataaatc taccaggtat 1583160
 gggaatccag ctaaataaat gtaattgaaa gaaaaggggg ggagggagac acacatgaca 1583220
 gacgacaact gtttcagtaa cttgagaaca acaaaggat ccaattcgtt atttttatcc 1583280
 acttggtgaa gacctatgtg ctgaaatgtc tttttttttt ctttctttca ttcattcttt 1583340
 tttgtttgtt ttgtttttca agataggggt tctctgtgta gtcctggcta tcctgaaatg 1583400
 cattatatag accaggctag cctcaaattc agagatccac ttgtctctgc ctcccaagtg 1583460
 ctgggattaa gggttgtgcc accgccacca cctggtttag agctccattt ttatgattta 1583520

 gaaatactaa gacctcagga acccacaatt taactgaatg taaaaatggc actagagatc 1583580
 aatgaccaag tgcacagctg caactcattt caaatacaga aaggtttagc aatcgtcttt 1583640
 caagaactcc tggttaaaaa gaagtgggtc caggcagagc ctagtatgta agctcccca 1583700
 gaggctgagg caggaggatc aaagtgcaag gtctacctgg atatagaagt tcaaggccaa 1583760
 cctgggcaac cttagcaagc cctgttctaa aaataataag caaaaaggaa ggctggggac 1583820
 ctagatacac ttagcatcct caaggcatta gattggatcc tcaacactga ggggtgggga 1583880
 aaggtgccaa actggttggc aaccgcctga gtatctctc gaatgctccc ctgctggctt 1583940

 ttagggactg gaggttgtac ctcacgggtg acagacagag tacctcgggg gtatatcctc 1584000
 tgtggactca gtcacaatg aaaaaactat ttgccttct aagaatttaa ctttggggct 1584060
 agagagaaga ctcagcagtt aaagtgcac tgctcttcca aaggacctga gttcagtacc 1584120
 cagcatcctg ttaggcagct cacaaccacc cgatactgca gctttgaggg atctgaagct 1584180
 gtggacagat ctggcctctg tgaacacccc cccaacaca cacacactca tacacataca 1584240
 catacccca catgcaagct tttaaaatct aaaaatttat cttctctaa tatctactct 1584300
 aatatctgag tatgcagctc caatagctca ggccatttaa agaccttcca ggagctcctg 1584360

 atgtctaaga aaaacacata ttcttatttt catggcctcc agtctaaagg gttcctcatt 1584420
 catactcaca tctcatgct ctatggttaa aaaatacctt tgacacactt cettcaaaac 1584480
 ctttcacact gagtthtaat cctgaccttg agatgtgaag cacagcacag gaaaatagaa 1584540

gttaaagatt tttttttttt tcattttaag agacagggat tacacttaag tccatgagtg 1584600
 tgctaggcaa gcattctacc actgagttac gtccttagcc ctctctggaa atctttatgg 1584660
 ggagacagag atgggggagg gactattaga gacttgggaag gttggaagga gattttcaga 1584720
 aaaatctaag ccttgtaaat atccaaatcc cacttttgaa acataaaatg ccctattata 1584780

 agctagggct taaaaaaaaa aagtcaatca attccagtgg aaaatagaaa agcattgaaa 1584840
 atagaaacat aaagactgac agtaggagac aggtaagacg gctcagcagt aagagcactt 1584900
 gctgccaagt ccaacagact gatcagttcc ccaggaccta catggtagga gggatgagct 1584960
 ctgcaagttg tctctgacc tccacacaca tacttcagtg tgtacacacc tgtacacata 1585020
 tgcattggtca ctcacgaaaa taaatgtaat ttaaaaaact acagtaaagg aaatcacttt 1585080
 ttctcccaa aactaacaca gctgacaaat atcctcagaa caacaacaac aacgaaaaag 1585140
 ggagctcca tttcccaata cctatcccag gctttcattc ttcagatatt tactattcgg 1585200

 ccaacaggca gaattataag cactctggag actacaaaga gggatataca catggtcctg 1585260
 acctcagaa attcttctag aagatggtca aaaggcatgg acaaccataa cataagagag 1585320
 aaagaataaa agcccaaaga aggctacata aattattatg atacttgcag caagggagaa 1585380
 gcggattggt cccactctgg taaaggcacc ggggatgaag tatgaggaca atgtaagtgt 1585440
 acacaccgaa gaagaaaaga cacaagacag gagcagcaag gcatttggct tggctggagg 1585500
 gaagggtgcg tgaagcaaga atggaatgtg actctcacta agtgctcagt aaatgccaag 1585560
 cacgtgtgct gaaggttcaa gaagcactgt aggaaatgag tttggagcag ttgacataga 1585620

 ctacaaagtg tgaccagaga ggactttgca atgcagaaca ctggttctga taagccaagc 1585680
 agtagttcac ctaagagacc agtttgcgcc agggctccct accagctctt ccctctgttc 1585740
 cctctgatca agcagctcgg aaacaaagag cagaggacag gagggtcagt ctactctgg 1585800
 agtcttattg aggtaacctg agtgtaggaa cactgatga gaataaatg taattcctta 1585860
 actacagcct atccccacc ctgcccacct tggcttggaa agcttaaac tgctcattgt 1585920
 aagccataag gtggagatgt ctggcagagc agaactgaca ggaagtcatt tcaccagcct 1585980
 aaggttacca ttaacactct gagccactgc cttgagctaa ttcttgttg ttttgaagt 1586040

 ttggttgaaa tgtcacaat ggaaaattta agtaaagcac ccagttagcc ccaagcctgg 1586100
 acacacctgg tgcaaatcca gcaaaaagaaa ctacttcat tagtaggaga ggcagagtga 1586160
 aatttacatc tgaagctgc ctgcagccgg agaaagtact gaggccaaag ggctgtctgt 1586220
 ttttacagct gtgtcaagtc ctggttctca ctctaccaa cactcaggag cgaggcaagg 1586280
 gccaggaaa aatggtctcc agctcttcag ctgcaaccg gctcacaag gtttttaaga 1586340
 cccagttaat gaataaaac aagaccagat gaggtgatat aatgaacttt atttccacag 1586400

ctaatttata tgtttaaatc ccaaatattg aaatattggt gggttttttt tcctttttaa 1586460

 aagtcagaac actaaattat cgatgtgatt ttgtaacct caaatttagc agttgctttt 1586520
 tgcactggct tcaccaatga cacatgagtc tgagccatgt gccaccacag ctgggcttct 1586580
 tagaagccga tgaaaagcaa agtttcccct cttatgagac cagaactcga ataccaaatg 1586640
 agttcttgat tggaaatcgg gtttcaaagg aattgttgat taaaatttct gactcgtcat 1586700
 cagtttgcaa gagggcgttt tgctcttgat ctctgccaca cgcatccact caaagtaatg 1586760
 gcttctaaga attctttggc atgagaaaaa cgcaccatt gactggcttt gtaagtttta 1586820
 ctttcttcta tgacttttct tacagaggta tacctggaac gccaaataac acagaaagat 1586880

 ttgcaaatta ccaccttcaa atctggagtt tttcaaagct gaaaagaaac tcggcagcca 1586940
 tgtagtcage accttgacc tgcttctgtg tcctctagag cacaggaagt caagacttgt 1587000
 ccactgtggg agaaccaggc cagactctat tcattccacc tactgatttc aaagtccat 1587060
 gtccccctgc tggggctgt acactaacac tgaaagcccc tctacctgca cactctagta 1587120
 tacatctgtc ttctataga aaaggtgcct gtttatacca tcaagttaga aagggggagt 1587180
 atcaaatata ataaagccaa gaacagtaat tacccaattc ttctaattt gtatttttaa 1587240
 aacaccgtct tccatttgta gttttgtca ctaagccaga gcttgggcat ttctcttcat 1587300

 gaagataatt tagaagccta ggggaaatca ctaacatctt gctattttaa agtatggttg 1587360
 tcacctccca cacccttatt aacacaggca aaacctggaa gcttctcaga agagtggaca 1587420
 ctctaaactg ggtgtgafgg tgaatacctg aaatcccagc ccttgggaca tgtgagcaaa 1587480
 aggacaacca gagatacaag gtcatcctta gctattcagt gagtccaagg ttcagggtgg 1587540
 gttacatgag atcctgtagc agagagacag aggagagaaa acagttctcag gactgaggat 1587600
 atggctcage tgggtcagtg ctgggttcac tcccagcaca gcataaaaagg ggatggaggt 1587660
 gccccctaca atctcagcat tggggagtgg aggcaagagg atcagaagt taaggtcatc 1587720

 ctgggttaca tagtgagttc aaggcctgcc tgggctactc tgttaaagag agacagagag 1587780
 aacaagacag agagaaaagga gagaagaaag aaaggggaagg gagggagagc agattccctg 1587840
 gcctttgtca gagacttact gaatcacatc tgtgccttac cagggtcacc gaatgaactg 1587900
 gaggtgcact aaaggcagga acactatgct gcctatagg atggcacact gtctaggaac 1587960
 aatccgaatg gacaaaagag gaaaaaaa ttaaaaagac ccctcagga ctgtacagaa 1588020
 aggaatgagt caagtacat taatctaatg ttaccttaa acagggtata ttagcatcat 1588080
 ggtgcacacc ttaaatccca ggacttggga ggcaacacag gtatatctct gtaaataaga 1588140

gaccagcctc gtctacatag taagttctag gccagccaga gctaactatt ctgtcgcaaa 1588200
caaacagaat acagcagaga ctgcagttta ctttgtgtcc tcctcattc aacctatcct 1588260
atgtgtccac tagacatcac catataagca aatagagtga gacagcctcc tgttcccaaa 1588320
agcgtaaagc gaaggaagga gagggagatc acacacaaag cgcatggaga agggcaaagt 1588380
ggcagctgct gggacatatg gaagagaaat tcagcgggag aggggtgaat taaaaatccc 1588440
cgtgggccac aagttagcaa tttctggatt attaagctat ttaggacagg acagctgtga 1588500
ctcacatggt cccagaggtc ccactgccag caaagttcag tcaacagaga taagccaaac 1588560

agtttcattt aatggaaggg acactaacac aacacctggc agtccacgaa ggctttggct 1588620
ggccagcggg tattactggc catcactaat aggggtgagtt gagatgcaa caccaccta 1588680
agtccaatgt gtgctgccac agaattgagt agtaaacact tgaggacgta gaaaatgcag 1588740
ctgtatgagt tgctagtctg ctgacctccc tctgaactga aagaatgcca gcaggcata 1588800
cagtgaggaga aatgaaacaa gaaccagagg acagttacaa aaagagctca gtacagggcc 1588860
agagaggtgg ctgaggttt atgagcacca cttgttcttg aagaggacct gggttcagtt 1588920
cccagcacct acatggtggc tagcagctgt ataagtaaag ggagtagagg gatctgacgc 1588980

catcttctga ccaccttggg ctctgcatc ttcattggcac acatacatac actcagggga 1589040
cacatacata cacattagag agctcattcg tgacttcaag gcaggtggtg atgataaaag 1589100
gtacaattga tgtttcattt tctcagaaca aacagaaatg ccaatggtat gctgtccca 1589160
cagaatgtaa tgtaaatgcc cataagata ctcaaaggca aacctatggt tacagtgctt 1589220
cctacactcc agttcattca gagacataag aaaacctca acccaggatc ccaagaggaa 1589280
accatgttcc acatgcatgg tataagtctc aaagattgca atttacaca agcaaaagta 1589340
cacggggtta acaggcagta caataggagt atgtgaaatg ggcaaagtaa caaaggtcag 1589400

ccatgactga acacceatgt agcatggaaa gacctcaaaa caatgctgag taaagagaga 1589460
gttgaggaa aglacataaa gaatgagatc atttgtaaca aaacatacac acatgcacat 1589520
atgtataaaa cttctacca cacatcttct atagctagca atcatttta cacatacaca 1589580
aatgtgcaca cacatgcaca aacatgaatg taaattatat atcctcttct ctcaggctaa 1589640
ttactgaatt tactaaggta tttatttatt tttatttta tttatttatt tatttattta 1589700
tgggacaggg tttctctgta gctttggaac ctatcctggc actcactctg gagaacagga 1589760
tgccctcgag ctacagaga tcagactctg cctcccagat gctgggatta aaggtgtgtg 1589820

ccaccaacac ctggactacg gtatttattt ttaatgggta gtttgcaaa atcttctagg 1589880
ttgctagtga ccaggtttt ctttagttcc taggactaca ggccccacac caggatcttc 1589940
ccataaggac taacttagag agtccaggta ctgcagtgca tgcctataat cttagcactt 1590000

aggaagtgga ggcaggagaa tcaggagttc aaagccaccc tcggctatat agcaagtccc 1590060
 atggccagca tacataagtc aatgtctcaa aaaaaaaaaa aaaaaaaaaa aatcaaac 1590120
 caatcaacca aaaaacttaa aaggggaatt aattcaaca ttgaataatg tcaaaggcag 1590180
 tgccttaga ctagattaga catttgggtc cccattccat cttccctaca accatttct 1590240

 atctacttct gtatacaaga tgtctcata cccacaaacc acaatcatgt gcacaaacc 1590300
 ataaagcate cctggtatgt caggetccca agaagcacia aaagggacta tagctgaaca 1590360
 gtctctttga cattagggaa catttcacag aaatcaaaa gcaaagccat cctaaagaag 1590420
 aaagaacctc agactcaggg cagacattct ttcaccacag ctgtccagac cggcatctgc 1590480
 aggcaagcac ttaccccat aactctgcct cgctgtcca cgtcttcca cataaatgg 1590540
 actatgatcc ggcacatgta tttccagac cggccttct gcttcattcg gactagacac 1590600
 atcctaagtg gaagcaaaaa gagtactga ataactgcat ttttttttc acacagtca 1590660

 cagaaaagag attttagcac agcatatgga atcaaaattc aggagtgacc ttgggtcttt 1590720
 aacacagtca cagtttaaaa aacaaatgtc catctgtgca gtgaaaaaaaa ctgctgctgg 1590780
 gcagtgggta tacaagagca cttggggaggc agaggcagga ggatctctgt gatttctagg 1590840
 acagcctggt ctacagagtg agtcccagga cagctagggc tacacagaga aaccctgtct 1590900
 caaaaaatta caaaagaaa gaagaaaaaa gaaaaaactt gcatattaca tatgataatg 1590960
 aaagccat tgaaccaggg atacctcaa agcctcttc ccacatggaa taaatctat 1591020
 gtggttatta gaaagacaat caagcagaat tctccactca actggggaaa atattgttc 1591080

 actactacag aattttctaa atgtgggtaa agaatttct gtctcgata gtagctacta 1591140
 gctacttgtg gctactgagc actttaagia tagctactcc aaggatttca aagatatagt 1591200
 aagaaaaaga atcacatgtt aatattgct gtcacattga atattattc atataagttt 1591260
 aaataaaatc tatcattgaa ttaatttcag gggctggaag atggctcagt gaagaatgga 1591320
 gttagaatcc cagcacccat aaaaagacac gtatggttgg gcatggctgt aactgtacca 1591380
 ctgggggttg gagacaggtg gctcccaaga gctccctggt caggcagctt agcccaaca 1591440
 gtgagcttca ggcccagagc aataggaacc caacacctc ctctggtctc ccatagtacc 1591500

 tgtacctgag cattcattg catgcacccc ctacagccac acctccaca tgcccacac 1591560
 attaaaaaac caccttctt ttcaaaacca ctctatttc ttttacttt aaaaatgtaa 1591620
 ctccatagt agaaaatgtt caattatatt tttggcttgc attctactt tcttgccaa 1591680
 tatttgttca gtatacagat cactgagaat attatgatca ctttttata attatcaaat 1591740
 ttttctcca ctatgataa attccattga aggcaaat caagtttgtt tttgttgtt 1591800
 gttgcttgt tttgagacag tgtctcagta ttagccctg gctgtcctgg aactcactct 1591860

gtagaccagg ctggcctcaa actcaagaga tccacctgcc tctgcctccc gagtgctgga 1591920

 ctataaaggt ggacatcadc acaccaggca agaattatgt aatitgttt tgctttgttt 1591980
 ttcaagatag ggtttttctt tattgctttg gaggctgtct tggaactcac tetgtagacc 1592040
 aggctgacct caaactctca aagcctctgc ctctgagtg ctggattaaa ggcattgtcc 1592100
 accaatgtcg ggctgtaatt tttatttaatt taaacatata tttaggggca ggagagatgg 1592160
 ctcaatggtt aagagcactg gctgctcttc caggagaccc aaattcggtt ctcaagcacc 1592220
 caatcaggtg gcccaggggt accccaggct tctggcctcc tcatatacca aactcact 1592280
 gcacaaacce acacatgcat gtatttaatt atacaaaaga atataatcaa ggttactaac 1592340

 ttttcaaagt agttcctaatt attcttatga ccataactaat ttctaattgc ttgaactagg 1592400
 tattaatga ctgcaacaga ctagtcagct gaaagacaat ccctgctata atttcagaat 1592460
 gctataaatt atctaaatg acaagtctat ctccatacaa aagetgcca ttaaaatcaa 1592520
 ctaaaagggg gctgaggaga tggctcagga gtttaagtca tgcctgtggg gatctgagga 1592580
 tgtactgagt ggataaattt tgacacagga atgtccacat ctccagaatg cccaaagcca 1592640
 cagaccatg agaccattgg taaagtgtt accagtatga acaggctcaa gagaaatggc 1592700
 agagctgttc ttgagagtca aagcatagat ggctatttgtt attgcacaaa gattagcaac 1592760

 tgcaacttct tctctctgaa caccgccaaa ctgctctact atagagacct cctactgaga 1592820
 ctagctaacc cttcccggg tgctgtacct gataaacaca ctgatgttct aggtttgtgga 1592880
 ggtagcagtt gcattagaga agcccgcctg atcccaactt cactgtacaa gtgtctgtct 1592940
 gttcttcatt cccttactgc cactagtagc atgcatgcac tgccattgca gagaacccaa 1593000
 agtcagctca tagctccaac agcaggggct cacagtggcc tgtaactgta gcaccaaggg 1593060
 atctcatacc ctcttctggc ctcttgaac acccacacac atttacataa gtaaaaataa 1593120
 atctttaaaa agaaaactag tcacaagcag tggcatctgc ctctagtccc agcagaggat 1593180

 ctctgtaaag gccagcctgg tccacatadc aagatcctgc ctaaaaaaaa aaaaaaaaaa 1593240
 aaaaaaaaaa gagagaaaaa gaagaagagg gagggaggag agagagagag agagagagag 1593300
 agagagagag agagagagag agagagagag agagagagcg agagagagtg caggttcatg 1593360
 cttagagcag gctatagggg gcacacataa acaaatcca gtacgcagga gacaagaaaa 1593420
 ttgcaaatte aaggccagcc tgaactacag agcaagacce tgtctcacta tgctgctctg 1593480
 taaaagaaaa atccacaagc aacaatggaa tgattccaat ctgacttgcc tcaacatctc 1593540
 tatgaatgac taaattggaa aaagaaaaca cacttatcaa atgggcagat gacaagctgg 1593600

gcaagagaac aaatatgcta catgacccaa ccatgaccca aaaatatctc cacaagtctg 1593660
tctcaatggg atgcacctta caagaatctg aatgggggtg gagaggtggg gaaggttctg 1593720
tacttgagtc tagtggctaa aactccagag gtccagaata catgaatgac acctaccaat 1593780
gtaaaaaagc ctttaaaaat gaagataata gaacacactc agtgcaagtc aaaagaataa 1593840
tgatgctgac cccaattaa tgttctagat acaattgaaa tatgccctca atggcaaagt 1593900
gagactccaa atctgcttgg aatagcatct actaattcta attttgaaca tcattatctg 1593960
aagaggtgag gtiacagttc tgttctactg cacagcaatg agactacaat aacaataatg 1594020

aaatatactt gagaatggcc agaagagagg attttaacta ttctcactcc acagaaataa 1594080
tatgagatga tggccctggt ttgattataa cacaatgtac acatgtgtca aaatattgta 1594140
taatttataa atatgtataa tgatgggcca attaaaatta agaagatgag gaagagaaaa 1594200
aagatgagtg agcaggctgg caaggtggaa aaggcaattg ccacctaac ctggtggcac 1594260
atccagcagc aagtatctaa agatttaagt aactggatgg acaacttcaa aatgcagaaa 1594320
actagctttt tcacataagg agaacagatg tttggtgtag atgaagcttt tcattatta 1594380
tttataggca gtgtgggcag cccaagttga gtgctgggaa ccaaattcag ctctacaaa 1594440

aaagcagtc ctccttaac cactgagcac ctccgtacc tgagcagttc ctcccgaag 1594500
caccgagcat ctctggagcc tgagcatgca gctttctaac taaagttca ctactaatct 1594560
caagtggatt tgttggatt ttcatctaa tttttagcct ctgaaccag ttcataccaa 1594620
aaatataaga ctttgagaca ataatgaaga ccgcatgata atatacaata gggagcatat 1594680
ttcaaagtag aaatgactg agttaagttc aacagcactt tctttataag acttttctaa 1594740
aagttagtca aattgttctt gtcagccttt cacctgaaaa tgtgcaatgt gttttgatgc 1594800
ttaagtgtca taggaggcca attcatcaac agcaatagtg aggtaatgga attcttcatt 1594860

tatttgaaaa ttctgttaat acacetgecc tctggggttt aaaaggcaca gattttttca 1594920
gaccataaac ttctacta tatcaacatg cggtaggtg ttgtttgggg tttcacagca 1594980
cagcttgctc tataggcatt ataagataat ggttagcaat gacattctat gctggagaga 1595040
atgtggagaa aaaggaacat tcctcattg ctggtggaag tgcaaactg tacgeccact 1595100
ttggaatca gtatggcagt ttctcaggaa aatcggaatc agtctacctc aatatccagc 1595160
aattactctc ttgggcatat acccaataa tgcattgtca tacaacaagg acatattgtc 1595220
aactttttc ctagaagtgt tgtttgtaat agccagaacc tggaagcaac ctagatgccc 1595280

ctcaactgaa gaatggatag agaaaatgtg gtacatttac acaatggagt actactcagt 1595340
ggaaaaaagc aatggaatct tgaaactcgc aggaaaatgg atggaactag aagagttacc 1595400
atcctgagtg aggtaatcta gtcacaaaa gacaaacatg gtatgtactc actcatatat 1595460

gaatthttaga catagagcaa aagattacta gcctacaatc cacatcacca aaggaattag 1595520
 aaaacaggag gacccaagag aagaatgcat ggctcccgg agaaggggaa ggggacagga 1595580
 tctcctgagc taattgggag catgggggta ggggagaggg agctgggaga gaggggagaa 1595640
 gaggcaggga gaagaggaaa tgggggagca ggaaggctga gtcgggggaa gaacagagga 1595700

 gagcaggatg agagatacca taatagaggg agccattata agttcaagga gagatatggc 1595760
 actagggaga ttccaaaga tctacaagga tgacaccaac tggcaatcta agcaatagtg 1595820
 gagaggctat cctaaatgcc cttcccctat aaagagactg atgactacct tatatgcat 1595880
 cctagaggct tcatccagtg gctgatggaa gcagaggcaa acaccacag ctaaacactg 1595940
 aactgagcgt tggaaaccag ttccagaggg ggaggagtga tgagtaaaga ggtcaagacc 1596000
 aggctggtga aacccaaaga aacagctgac ctgaacaagg gggagcatat ggatcccaga 1596060
 ctaatgtctg ggaggccagc atgggactga tccagacccc tgaacgtcga tgtcagtgag 1596120

 gaggcctcgg cactctatgg ggcctttggt agtagtaaat cagtattat gcctggccta 1596180
 tgaaaggact ttgggagccc atcccacata gagggatact ctctcagcct ggatacatgg 1596240
 gggagggcct atgccctgcc taggacgtta tgagagactt tggggatccc catggagagt 1596300
 ggccttacct tcctgggga gcaaaggggg gatggagtgg gggacaaatg gaggggtggg 1596360
 gaggagggga gggagagggg gcagggattg acctgtgaag cagacttgtt tctaatttga 1596420
 actaataaaa aaataatttc ttggggaaaa aaagattaat ggttagctca atagtcgtct 1596480
 gtgctaaaaa gataatacaa aatgaaggta ctctcacact gactgactac ccaatgaaca 1596540

 gatcctgagc tctactgca tgtaggtaat ggtagaatga ccaggtatta cagtgatggc 1596600
 aaagacatga gtccagcttt caagctgtgt gtctcctagg agaacaaaa caaggcacat 1596660
 acaaaaca gggaaaggtt taataagata gctcagtggg ttagggcaat tgctgccaag 1596720
 cctgactccc tcaaacccac atggcagaag gagagaactg attcctaaga getgtcctct 1596780
 gaactacaca ccatggcaca tatgccaca tgtgtgcata cacacaataa agaaataaat 1596840
 aaacaaatgt aaaaaagaa ggcagcatct caaacatgc aatggagttt gaaagaacac 1596900
 tttgggatga ataggatctg aagaagcttg acgggaaatg aaacattata cctgaggctt 1596960

 gaaaggatgg gctgaaatga agatgcaaca aacgtcaaga ggcctttcca aaagacaggc 1597020
 acggagaaca aagccagggc catggaagaa gtcagcacat gtcaaaggaa caatgaatac 1597080
 ctaaatttgt aacagggtag agtatgagaa ggaggaaagt gaagccagag gaatcctgag 1597140
 tgactctgta atgcatgca gagaaaagtc tgaacctctc tgggctaagc agtcaacca 1597200
 gagccactgg gagaaaaaaa tgtgaagaga ttaccacgtt ggcaactcaga gcagaagagt 1597260
 cactgagacg ttagctctta ttcccagcct tagcccacaa ttaaacacca acatcaccaa 1597320

ggttggaagc aacaaaaatgg aggaagtctt tctttgtgga actgaggtct ttgtccagtc 1597380

 tgaaaataca aggttgcctt gccttttgag agaaatgtaa acagcgacgt ttgttttaaa 1597440
 cctctatcta actttgggtg tcctaacagt ttaggaaata gtttagtatt gacagctatc 1597500
 aaccaaaaa gagaaagttc aaattactcc taaaacactg catcaaatta gttcagtgga 1597560
 tgtgtgacca atgcaaagca cttaacgata taaagctcaa cagcaaatat ctcttggaa 1597620
 gaccaagaat cagttttcct ctcagcgtat gtgctgaaag ttctgtgtt gtaaggaaaa 1597680
 tgtaagattc agaccacagg gccctccagc cactaacact aactaaaagt tcatcaatgt 1597740
 acaccctgag gtcatgaatc aaactctgta aggagctaag aacagaagaa aactcccatt 1597800

 gtaaagaact ttcgttctta ctctccagaa agaaagaaag aaagaagaa agaaagaaag 1597860
 aaagaagaa agaaagaaag aaagaagaa agaaagaaaa gcagagctgg agaccacacc 1597920
 tatgtggtaa aacaggcagc tgcctaggat gtccaatgag cagttcaagg ccagctcctt 1597980
 caagtagggg tgctacctg aagctcacac atattcaatt ctgcttcttc cctgcacag 1598040
 taactgcttt gaacagataa cacacggaag gaaaaggaag acaccttctt accccttccc 1598100
 aagcagtctt cagctacagc aactagctcc ccgggagtcc ttecatataa tettatcaca 1598160
 cacagttcca gtgtccaagt cttcctttct atacatggca gtagcttttc ctttcttcac 1598220

 cttgctaaca tctacacaca ttattctgac agtgagaagc aaagaggaga atccctggaa 1598280
 gcttactgcc cccaccccc agcctagccc atgcagtaca acatccagga gactccacct 1598340
 taacaagat ggaaggtgaa gaccaacacc caaggttacc ctctgacctc cacataggca 1598400
 agtgacgtgt gtacacaaac aaacatacca aacagttaga gtagtatctg ccacaggcgg 1598460
 aactcagctt atctggcaat ttttaatat ctacaaatga ctaagaagga aaaaattaaa 1598520
 tagcaaaaga gaaaaaatg ctataataa cagccaacac tgctccatac taagccccct 1598580
 ggctaagcgc tglaggtgca tttctttctt gttttcagag ttttgttate ctatatact 1598640

 caaactacca ccctgggcat gtagcttaca cctgtaatcc tagcactcag agagactgag 1598700
 gaggacctcc gttagttcaa gttcagagct agccggaacc aagttccaga acagtctggc 1598760
 agaagtatga gactttaaca cacacacaca cacacacaca cacacacaca cgggtgagac 1598820
 aaggaccctc ctgtctcagc ctctgcaact ctgatgctca cactgtctca attccactgt 1598880
 tgaaaaaac tcacctctgc atctgggggt ggagagacag cacaacagtt aaaagcactt 1598940
 gttctccaga ggacctgggt tggattccca gcactcact ggtaattcag aacctctat 1599000
 aactccagtc ccaggggatc agatgtctc ttctgacccc caggagtcc aggcattcac 1599060

acggtgcgca gacatacatg taggcaaaac atggatacac ttaaagtaag aatacttttt 1599120
 agcagaggcgg tgatggtgca tgcctttagt acaagcattt gggaagcaga ggcagatggg 1599180
 tctctgtgag ttcaagggca gcctgatcta caacgtgagt tacaggacag ccagagctac 1599240
 acagagaaac ccigtcttgg gggagggagg gacttaagtg acttttaaga aaggaagaaa 1599300
 aaaaaaaaa aactgtttag agcagtaatc cctccaacaa tacaatcta gtgagacctg 1599360
 cacctagaat tatactgagg catgtttgtt tgcctccttc actgaccaca acaagcctc 1599420
 cagaatctac caactcaatt ttccctttaa tctttacagg acacacttta agttttaaaa 1599480

 ctagcatcac attagaaaa gcatattggg gactggtgag atggctcagt ggttaagcac 1599540
 actggctgct ctigcagagg accagagttg agtctcagca cccacagggt ggctcagaat 1599600
 catatataac tctgttccg ggagaccaa tgcccagata caccagatat acatgtgatg 1599660
 gtacacacac aaacatatga acacaagcaa tacatttata cacataaaaa aaattttaaa 1599720
 aacatttttg taaagaaaa acatatgggg aagaggagag atggctcagt ggttacaagc 1599780
 ctactcttca atctgctctt ctagaggaca aaggttaagt tccaacaacc atgtcaggtg 1599840
 gctcacaacc tctctagct ccagttctag gggatacact atctctggcc tctgggcata 1599900

 catgcacatg tacacacacc ccacacacac tttataccta ttgaaaaata aaaatctaaa 1599960
 atccataatg gaaaaaaaa acactggaag ggaaagatgc ctaaactgat acaaacctac 1600020
 ctataagaac aaaagccact ctggaaagg aagaaactaa attgtactaa agataaatac 1600080
 ataccagggt atgacattgc aagcctgtaa ctccagcact ggagagaccg gatgaaaaaa 1600140
 gacactaaca ccctaaattt gagggcagcc taggatacac agggaaaaac ctgtctcaaa 1600200
 aagcaaaaag gtagatgaac cgacaccccc aaactcaaaa taaaccaatt aatggtaaac 1600260
 agaacagaat aaaactacca agtgagattc aaagacaaaa atacaagctg gaaggtaaag 1600320

 caaaattaat gaaacaaatt caaaatggtc catctaaaaa actagacgat tetagggcct 1600380
 actctaaaac aaagctaatt tgtcacatcc tatgagtcac tatgagctag tcaactcca 1600440
 gaatactaag ttacacaaa agaacctaac agctgaactc caaccttaat cgacactgtg 1600500
 aatgtattcc teacactaat gctcatcttt tttcttttct tttctttttt ttccccaga 1600560
 cagggttttt gtttggttgg tttggttttt ccagataggg ctcttctgtg tagtcctggc 1600620
 tgttctggaa ctactctgt agaccaggct ggcctttaac tcacagagat ctgctgctt 1600680
 ctgctccca agtgatggga ttaaaggtgt gtgccactgt cgccgctgtc acccgcttt 1600740

 ttagacaggg ttttatacag ctgaggctag tcttgagctt cttgattctc tgctttcgac 1600800
 ttccaaagta ctgggattac agccctgtac catcacacce agatcttatg ttaaattttg 1600860
 aaaagggtc ttttggggga aggaaagctt acagactaaa acaaaaatta tctcatgaa 1600920

tgcaaagaaa attcttaata ataaaaattc ttgcacttgc ttcacaagtc cttatgcgca 1600980
 cctacttgcg acacaggctg agctgcactg ctctacaggg attctacaca ctctcccac 1601040
 cgctactgat gttcttaaac ccacaattta ttattgaggt tttacgcctc agcactgtcc 1601100
 tgtctctcag tgattccagt ggctcataaa taatcctgat ctcttttaca tataaggaag 1601160

 gcaaacaacc cagctagcaa agtaaagaaa aaaagagtgc tcaagtcttc ctgacggctc 1601220
 ctcatctctg taaaaggcca acccaaagac ggccaaagag gaaaagctcg ctgagcatga 1601280
 gtctcagata aaggactaaa gacactgacc gcctcatgct attaagtcc gcaatagaag 1601340
 acttcatgcg tctgggcccc ccaccttct ctatttgac aattacacat ctggtacagc 1601400
 tctctgcatt tcacagaaaa ccaaggtgct taagtaacta aggtggcaca gtggagctga 1601460
 agcatagcta gagctttccc caagccagtg tctctaaatt agctcttcaa ttcagcgatg 1601520
 gcccagcacc agtggcctct tctgctagg acggcatccc tgtctgcaca gtcaaaagca 1601580

 acaagagcct ctctctctcc tctcgagccc cggagcaagg ccacagctct tctcaacatc 1601640
 tatccaaagg gtagggttct ttaggacttc tgccacattt gggcagcctg tgcactcag 1601700
 catgtttage atttgcctt gtttgaccac ataagctgct ttttaaggga tetgattcta 1601760
 aattcagtat cagtgggcag gtgagcaggt ctgtcacact ggctactatg aagaaatctc 1601820
 aagtggaact ttctagagc ttgtttgct tacttagcat cagctaagc cataaaagcc 1601880
 aggccagcat ggccatgat atgcccctta gattgctaat gaatggttta tttattggtg 1601940
 agctggcaca ctgacgctt cctggggcca tctctacct gtttctgaaa cttccccct 1602000

 gtgaagtcta agccttctag ggggagcaca ggagccacca gacttgtcag tagcaaaaga 1602060
 taagtggggg caaatgctt cctgaaacca tcttactaa acatataact tggttggctt 1602120
 ggcaagtacc agggcactaa aggtcatgtg tgctggtaaa aggcagccgc gtgggccttt 1602180
 ggtttgaaca aaagtgaaaa acaaccacct atacttgtgg gggggggagc aaagactctg 1602240
 gctgggggca ggagaaagaa gctgtgcaca tggccaggac atatcgagg tctcaagcta 1602300
 ttggaatcca gcagggccag gatgcctac agccacgtga aagctgctgg ggtgggttta 1602360
 aagaactcct cgaaaatgcg gccagtgtt gtcaggcagg cctctggcca cactgggatg 1602420

 gagaaagaat gcttccaaa ccctttcca ccagtttac ttctcttct ttacaagtct 1602480
 tctcatctgg ctctctaat gttcagctc catcttctt tggaaacttga atttttaaa 1602540
 gttacttctt ccctactca ctgctcaggc catcctctgg ctctcgacc cagaaggcca 1602600
 acaattgctg tccttaacca tctaccattt ccagggatta ccaggacaca gacagtcat 1602660
 accaagaag gcaatgetca ctttataget ggcaatcact aagtcatttc tattgetatt 1602720
 cacattcagg ggacaagacc cctatcccct agggacacta agggatgaac agctaacaca 1602780

gtcagctttg gctttgtctc agatcctcca ctgctgatgt ggaacatgaa gtgacctgtg 1602840

 acaaatatca taaatcacc aaaaccactt ctctttgtgt aagacaaggg aactgaacta 1602900
 gatacatggt ttttaaaact gccttctggg ttcccatgaa gctaccttca ggttcccttt 1602960
 ctacaggtat gttatacaga taagaagtga ccaggtcatt cccacatcct tcaatccaag 1603020
 tagtagtctt ctcatccact tacatagtat ggctaaggat gagatttctt gtgtgtgtgt 1603080
 gtgtgtgtgt gtgtgtgtgt gtgtgtgtgt gtgtgtgtgt gtgtgtgtgt gttgcgaaaa 1603140
 cacacacagg gcttggcatt taagagtgca tacggatctt gcagaagacc tgagttacag 1603200
 aatttcaaaa aatgtacaat gaaataacca acaacaagat ttataacttg aatttaattt 1603260

 aaacattaca aaatgatggg gggtagggag agtttgagac tagaaagatg gctcaatggt 1603320
 taacaccatg tacaacaca cacatatata aataataata ttggtttcac ttttgttgtt 1603380
 gtttacacag agtttctctg aatagccctg actgtcctag aacttgttct gtagaccagg 1603440
 ctgacttca actcaagaga ttcactgcc tctgccccgc aagtgtctggg attaaaggtg 1603500
 tgcaccatca ccaccagct cacttattgt cttagggttt ctactgctgt gaagagacac 1603560
 catgaccaca acaccttta taaaggaaaa catttaattg atgcggccac tttcagaggt 1603620
 ttagtctatt atcacggcgg cgtgcaggca aacgtggtgc tggaaaattc tgcatttga 1603680

 taggcagaca acaggaagtg gtctcaggta ctggatgtga cttgagcata tgagacttca 1603740
 aagccccacc tcacagtac accaactcca acaaggccac acctaccaa caaagtcaca 1603800
 cctccaata gtgccactca tctggggagc cattttcttc caaacatccg cattccactc 1603860
 cctggacccc aaagccttga agtaatatca tagtacaaaa atgcattcag tcaacaaaaa 1603920
 caaaacaac aaaaaaagtc aggcatgtct agcacatgcc ttttaattcca gcatttggga 1603980
 gacagaggca ggtggatctc agtgagtcca aggctagcct ggtctacaga gagattgcca 1604040
 ggatatccag agctattaca cagagaaacc ctgtgtcaaa aaacaaaaca aaaatgcatt 1604100

 cagtccaact tcaaaagctg ggcattggtg gtgtacacct ttagtcccag cagttgggaa 1604160
 gcagaggcag atggatccct gtgagtcaa ggccagcctg gtctacagag caagtgccta 1604220
 gataggctcc acagctaca agagaaatcc tgccttgaga aaaaaaaaaaaa aaaagtcctc 1604280
 ataatctata acagtctcaa actattcaaa agtctaaaat tcaaagtctc ttctgagact 1604340
 catgcaatct cttaactata atcccctgta aaatcaaaat caaaaagcag atccatgat 1604400
 tccaacatat aatggcacag gatacacatt accattctaa aacataggga agggagcata 1604460
 gigaagaatt actggaccaa accaggactg aaaaccagtt gggcaaacct caaattctgc 1604520

acctctacat ctgatgtcaa agcgcccttc agatctccaa cccctttcag ctttgttgac 1604580
 tgcaacacag ttcttctct tgggctgggtg tgcacatcccc ccccccccc caagcagctc 1604640
 tccttagcag gttccccaca gctttggcat ctccaacatc ttgggagtct ccaaggcaag 1604700
 ccaggtttca gcttcacaca atggcctctc taggtctctt ttcaggaaca cccctgacac 1604760
 aagcctggcc tcagcagctt tccttagtta gcctcagagg caaactccta gccctttct 1604820
 tctatcctta actctagaat catgtggctg aagctaccaa gttctgttgc ttactggggc 1604880
 tggacatgg cccctcatt caatcacatc atcaccaact tctgttttc aatggttacc 1604940

 ttcactacaa atgcttggct gttctggaac tttctctgta gaccaggctg gccagcctct 1605000
 gcctctggat tgctggaatt aaggggatgt accaccacac cctgctttaa gcttttctt 1605060
 aattcccttt ctcaagtgg aaatttagct gggtaggac ttgccctga agttaccact 1605120
 ccctttatct catttcttaa tctgtttatc tccttgaaca caggacttag cgccattcca 1605180
 ctgtctgggt ctcttttct cctcaaatat ttttctctg ctgagcttgt tccttttcat 1605240
 tataaatctt cattagagtt aacatcagta cccacacaac agagtctgta ttggggtgtt 1605300
 ttgagattcc ctctgccaat ggtattaatc caaaattttc acttagcct caggcagagt 1605360

 tttcagacaa gagcaaaaag cagccacatt cttcacaaa ataccacaag aatgatctct 1605420
 aggcaacgta ctaaaattct tctctgaaat tcttgagcca gcaccgccac agttcatctg 1605480
 atgacactca gcatcactgt ctccatgggt cccagtatgg cccattacga agcacttgaa 1605540
 gcattccact gctttcctaa cccaagctcc caaagtccat attaccctaa ataaaaacat 1605600
 ggccctccca tcacagcaat gcccactcc tagaaccaac ctctgattga gtaagggttt 1605660
 ctgttgctgt gaagagacac catgaccacg gcaactcttt ttttttttt ttttttttt 1605720
 ttttgagaca gggtttctct gtagtagctt ggaggctgtc ctggaactca ctctgtagat 1605780

 caagctggte ttgaactcac agagatccgc ctgccctct gcctcctgag tggctgggat 1605840
 taaagggtgt cgccaccaac gcccggcatt tgtttgtttg tttgttttt ggttgacat 1605900
 ggcaactctt ataaaggaaa acaattaatt gaggtaacag tttacagttt caaaggttta 1605960
 gtccattctc atcatggcag ggagtatgt ggttagaagt atagaggcac agacatagcc 1606020
 ctggagaatt ctacattgtg ataggcaggc aacaggaagt ggtctcagac actggacata 1606080
 gcttgagtat atgagacctt aaagccacc cccacaaaga cacgtttact ccaacaagac 1606140
 cgcacctatt ccaacaaagc catactctct aacagtgcc ctccttttg gggccgtttt 1606200

 ctttcaact accagttatt ataattat taagacaaag ggtgataaag caggatatcc 1606260
 aacctctcc tttggtctct gcacatataa gcacatgtag gaggacacaa acacaagtta 1606320
 tatagtgtac atatgtatgt attgaaatac tatacagcac tccattaata tgtataattt 1606380

ttatgtatca gttagatfff aaaatggaaa gaaacaccta agggccacag aactgccttc 1606440
 agaggaagg gaaagcttac gatgacaata gtggcttaat cagatactga ggaaagaaga 1606500
 tttgtccagc tgtgagaatg ataaatacct ccagaataaa gactccacag aacagtagca 1606560
 gacagcagta gtaaaagcat ctttactact ggctgaatct tacagaacat gaacaacaca 1606620

 ctaagaaact tgagagccaa ggtgggaatc caggtactgg tgggtgcacc ccaatgaaat 1606680
 aaactcagtg ggagaaacct tcaacttctg ctaaaattag ttccaataga ataggaagta 1606740
 tcagacattt cctgacattg caaaacacaa ggtttattta atgtttgcat ccaatactac 1606800
 aagcatgcat actgggtcac aaagtaaaat taatttactt ctgtgagctc agggtaaga 1606860
 gtttgagcta ggcaactaat gactgactga ccaggttaaa caaatgaagg acatatcaaa 1606920
 aaggaactcc cggtttctgg tacaggtatc tgaatgggct cacaatgaat ggctatatca 1606980
 aaaaggaact ccgggatctt ggtacaggta tctgaatggg ctcacaatga atggctggga 1607040

 taaggaaagt taggaggct gctttacca gccagtgtag ggatgctagg gatttccaac 1607100
 agcatctttt tcagcagcca cattcaataa tgatcgtgtt cagcaggac aaggacaca 1607160
 gtcagtgcca ctgcaagctc actgaatata caactaacag aggtcttcta ggaacacaag 1607220
 aggtatgtgg tcttaaatct caaccactg aaaaactatg gaaccagaaa gagtagacag 1607280
 acaggagaag tatagcatct tcagagagca tacaggatgg ctcggtatcc tgttctatcc 1607340
 caactacca taggatccac tacctagggg acccaggcaa acattctgga aagtctatca 1607400
 tcaggcactt tcatttctc aggagtctct ctggttttgt tttgtcttc tttaggactg 1607460

 tttcttctc tctctctca gtttccactc caaaaggtgt tatagttgt attctccag 1607520
 tggcacagct tacttcgac tctaattgg agtttgctg cccctcagtt tggactctta 1607580
 ggaaaggag tttccaatt ctgggaagat cactacacaa ctgtgtaggg gacagtaage 1607640
 cagcctgtt agagcctgt gcctgaccac acctgtcaag gcgtggtcaa ggtgaggtca 1607700
 ggatgatgca ggatgggctc ttaaggggct gcagagcaca tgggaacccc cttctcctg 1607760
 gcctcgtgc tcggctgcc tgggcacgct ctggcttgcg tttggctggt atttatctca 1607820
 ataaagatat ctgaccttac ggactacgga tcactatgtg tggtcacgca atacaactga 1607880

 gcccaaaact atttgtttgt ttgctttttg tttttattc ttagacaggg gtttctctgt 1607940
 gtagccttga ctgtcctgga actcactctg tagaccagge tggcctttaa ctggaagaga 1608000
 tattctgcc tctgcctccc aagaatgtgg ggattaaagg catgtgctgc cactgccacc 1608060
 accacctgce ttttttttt ttttttttt cctcaaaaac tactttctg gtcacccttt 1608120
 gactacatte ttccacgaac ctgtcaccac aaatgtcagc caactggctg cctcaaaata 1608180
 cctgcagggt cagcttttcc ctctcgtctc tcttcagaag cgcctctct tctaccaca 1608240

gtcattttac ttactcctca tgatctctat ccctcacaca ttagctctgc cctacactgt 1608300

 cctcactcct gccactgaat tcagacttag ttctacctgt gtgcttccac agcacctctt 1608360
 tgggctttgc gccaaacatt tcattagcat ctattataga caatagcact caaagccctt 1608420
 ttccaataca gtttcttgaa tgtgtgcact gtatcacagc ttctctccag caccccatgg 1608480
 tcccaaacac acagtaggtc cttgacaagg attttctgac tcaaacagac aagatgttct 1608540
 accaaaaact atttagatca tggcaattaa gagcaatgaa gagacgtggc aggcagtgg 1608600
 gcgcacgcct ttaatcccag ctctcgggag gcagaggcag gcaggtctct gagtgtgagg 1608660
 ccagcctgat ctacagcaac aaagagaatt ccaggacagc caaggctaca cagactctgt 1608720

 ctcagaaaac taaaaaggaa ggaaggaagg aaggaaggaa ggaaggaagg aaggaaggaa 1608780
 ggaaggaagg aaggaaggaa ggaaggaagg aaggaaggaa gggaggaaag aaagaaagat 1608840
 cccctcttct acttagctgg tgggtggtgca cccctcct cactcagctg tgtgtggtgg 1608900
 tgcacccac tccttactta gctgcgggtg gtacactcca ttctctgaa aagttaactt 1608960
 cagcaagaaa ggttgagtag acatittggc aagtttaagg aaatacaaat aatttcaagg 1609020
 ttctcccac tgetattagt caggtattga ccttgggatg tggttgcagg gattatatat 1609080
 tttactttgc catccacgcc ctctgccact ctgatactc tagctatatg ggcaataaag 1609140

 agtctttcat acaggctctg aatattatct ttgagctcct ctgggaacaa cttagccttc 1609200
 tctcaacct cccaccttc caatgagtaa ttctaccata cagtctcag ctctcaaaaa 1609260
 aagtagtttt ctctcaatg tatccagttt cctcctgt accctgcct taacctccac 1609320
 catggacacc aaagcagac tgtgccttct cagctgctg acaagaagcc acagtacata 1609380
 tctcagagaa gagaactagg aagggtctca aactgggag cgtcctattc aatcctataa 1609440
 gcaccattta catatatcca gaacctagca gcctgttta taactgggca tttatgtgtc 1609500
 ctagctcct cactaaaact gggcttcttg agaactagcc ctagtcca gcaagtgc 1609560

 caggacatag tgiacctct ataaactaat gcttcagagg gtttaaaaa aatccataa 1609620
 aataaattgc ccttcaggc tcctagcca aactcagtga cgatgtgaat ttggaagaag 1609680
 aaacgtttca gaggtgatta taactaaaac atctttatat agtagccagg cctgtgatgc 1609740
 aaagctcagc taaagacagt ctcaacaag ggtccttga tgggcagcca tccccacgt 1609800
 tccttggact gctcactatg gtgaatgtag taaaccagc tctccagagt ttactttccc 1609860
 aagatctggc aagtccccca gccccactt tagtgactcc tatacccc tttgacctt 1609920
 aatgctgtgt aacagtagat gaaaatcgat tttttttta aggctactc acatctgaag 1609980

aaaaaatata ctgtttaagg tgttaaataat tttcatatgc aacaaatcca gcttgactct 1610040
 aacctgcaca cacacttaga ggcacagaca taaatgtcag tggtaaaatt tgttataggt 1610100
 ttctgatgac cagagatgga aatgaccacg gattctcaca attcaaacca cttttacgta 1610160
 aatgtgaact ttctaaaac acccaagggg agaacttttc cactcgacct cagagagtct 1610220
 cttagagata ctgatagcat tattcgtggg gttaggtgtt ctttgaaaaa aaaaatatta 1610280
 caaatattgg tttcttttgg ggtttatgct ttgacctta acaaaaatgt gcttcaaggc 1610340
 accagttatg aaaaatgaaag gagcagggtt tcatgcttaa acaagtacca cttcatataa 1610400

 tcaagactca aagaaaacta tacccecgcc cccccccac atacacacac gtgcaattgg 1610460
 tgacctcatt caaatggct cacttaccag acatgaagca gagttataag aaacctgag 1610520
 ttgaatgtat cgggcatctg acaccctaga aaataacaat aaagtgtaaa tataagaagg 1610580
 tgcaaggag gcatactgac tctgtgttag cactgctgg gaatgtgcag tatggccatt 1610640
 ctgactatgc tattgcagaa aagatcagta aaaactcaat gtaagacct gggctagagg 1610700
 acggaatata gccagacaac cagccttcca gttccaacct tgttaccgcc ttgtggcctt 1610760
 gggcaaaactg catcttcctt ctgagtctca aacacctcat tttacagaat gtgacagaga 1610820

 tgatttctta tggctccttc caatgccatg agggcttaag ctagtctcc tttgtgggct 1610880
 tgaagtctaa agagttaagc atgtacacct gttccccttc agcatcagct actgtgatca 1610940
 tctgaacctt gctgaaaagg ttaagccttt ctggctcctt tttttgttt gtttttgag 1611000
 gtagggtttc tctatgtagc cctaactgtc ctggaactcg ctctagagac caggctggcc 1611060
 tggaaactcac agagatcctc ctgcctctgc ctctgagtg ctaggattaa aggtgtgcac 1611120
 gaccaccccc agctcttttc taatttttta aagataacc aatatggtat agccatgaat 1611180
 gtgctgaatg attgattcac ccaataaagc aggaggggaa agtgaaccc taggagccag 1611240

 ggctggattg ggaagtggac tgcacccgct gaaaggcagt cctcagctac agggacaaca 1611300
 ctggacaggg cctctcagct cagacacca cgcttctcca gtctcagatt tctaagaaat 1611360
 ccctctagct ggctgagggg tcccactac atgtactttc cttatcacac agcaaggaga 1611420
 aaagcttgac aaggagcagg aaggatgaag gggagaaatt tgtggggaat atggccctta 1611480
 tggtaaaacc atcttttga acaatgactc aaaaataaaa gtaaggcatg atagtacctg 1611540
 cctagaatc cacacacatc ctgtgatctt gtgaggcagc aggttgcaa aatccaagct 1611600
 agcctggact gtattatata tgtatccctt ccctcctc acaaaaaacc caaaagtatc 1611660

 ctctgcccc aacagcattca gtgaggtaac agttaacaac tgtcactagg agagaaaaca 1611720
 cactgcgacc ctaggagggg agactacaac ctgcactaat aaggaggtcc tagctcactg 1611780
 aggctgggct cataaatgc cagacatagt aagtgtctca cagacactag ctcaatgaat 1611840

ctgtctaaca acccgagtag gtgggtactg atatatcccc agtggaccgg tgagaaaact 1611900
 ggcagtagtg tcttgataac atttcatca agacaattgc tcaaggctcc tgaaccacaa 1611960
 acaacaagaa ctgagatata tgggattaaa ttcagacttc tttgattctg tgtacagtgt 1612020
 gtgactgcta cttaaagcaca tctaagtcta agatgcagac ccttccttga gaaagtgtct 1612080

 tactccacac ccaatctgct gctaatacctc ataatacagt atttctctta gtcctttcct 1612140
 taaccggga gaagcactgg agtcaaaaga gccaaagtaac tacgggcaag aacatgttaa 1612200
 gccagggacc aggctcgggt ttgaatccag gctctgcaca aaaggacacc aaaacactcg 1612260
 ggtgagctta ctgggtggta cccagcagct gtcaagtgga cttcctctct gaaccagca 1612320
 ggaggagct ggagactggc ctggccagcc atccagctat tgagagccat gccatctgag 1612380
 agccggccag ccgctctccg cctagaacaa gaatagccac gagaactct caagcccaga 1612440
 tctcaagttg ggtctttttt ttggatgtta gaacaaaaca ttaaaaagaa aagttttctt 1612500

 ggaagtctgt tttcaatct ggagaatgaa atctggctgc ttctacaaga cagtctgccc 1612560
 aactgctgcc tctacatcag agcttcccag cagcctccag gagcctgtcc agtttcctaa 1612620
 gaggtggaat cagtcttgg gctggaaagc acagacagac aaacaggtca gcagctggcc 1612680
 ctgggtcaca gttttccctt ctgggggtca gctcagggt gatgagaaaa gagttggcac 1612740
 atgagtaagt cactgtgccc atgtaggaca taacagaaac ccacagagta aacctcaaaa 1612800
 atatcaaac aacgactgaa tgttgactat gagcaacata aaaatagat tcttagctca 1612860
 acaagatatg ttacatact tcagggctaa acctgtgac actctgcat gctcactc 1612920

 ttgctcatgc aggatattct tttctaagc tagcctcttt cttgacacca gtttagtaa 1612980
 aattaaataa ttccattatt gtcaccagag agtgatatta tcatattta atataggctc 1613040
 agactgctta attgaattga ttttaattta gccgatttag gcgaagtttc tgggtctctt 1613100
 ggaggcccag tttcctctg tcaaaagtca gtgggcagaa caagggggcc tatctgagag 1613160
 cttctgtgat tataaccaat agattaaagg cctgtaaaat gcttagtaaa gccaggtgtg 1613220
 atggcgcag ccttgagctc cagcaccagc acttgggaag cagaagaagg tggatctctg 1613280
 taagttagaa gccatctac tctacataat gaggttctagg cccaccaata gtatataata 1613340

 aaactcttc aaaaaaaaaa aagcttaaca aatgattgc catttaaat aacgcctcaa 1613400
 tattcactat tgttgttcc actgaattaa ataataggc tcaaattatc tttgaaaagc 1613460
 ttcaccagtt aaaactgtgt cacaaagtag aacgaaacct caaccactgg ctcagaatct 1613520
 cttcattaag gagccccctc tctctaaggt agtcagtctc ttaggggcaa aaagccacaa 1613580
 acaagattgc agaattaagc acaagataac tgcggcctat gctcctcaca cccgtgagca 1613640
 aaccacataa cacagcaggc atgttcatta tgacaggcaa gggacattac cagagcatgc 1613700

cagagacagc agatgccaag gtgtctgacc actcagatgc atctagcgat ctagatctca 1613760

 gcggtaatga catgaggctc acactctggc agtgcaggga ggactgtcca agaagctgac 1613820
 gggcacagca tactgtgtaa cataacaact cgtcacaca gtcttcaaga aatgtcatca 1613880
 gcctcctttt gtigggaag aatgacattt gccacatgtt taaggctctg tcctcaggac 1613940
 tctttctgca aagatctaaa gtggcgtggc cactttaaag gtataatctt aggaagtgac 1614000
 atataaatte cctcatttta ttccaatecc cactaactcc ttagaatcca aaccacaaga 1614060
 aagtcagtct attttacaga tttttctaaa tctatcttac agatctttgc ctccaaatct 1614120
 gttctttggt cactagccac actttggaac tcctttggtt tgatctttaa atgtaaact 1614180

 agacaaaaaa aagggggggg ggcacagcag aacaacaag ccataggttt gcttgcttgt 1614240
 ttgtgagtag aacaggtttt ccttacgttt atggaaatct tcatgccctg tcttctaagt 1614300
 actggaatta caggcatgtg ccaccatgcc tacttacgct ataggtttat gtggtggttt 1614360
 ccgttcggaa gaggctctct ctatgtagtc ttagttggct gggagctcgc tatgtagaac 1614420
 aggctggcct gaactcagaa atctgcctgt ctctgactcc caagtgccac catgcccage 1614480
 ccatgccata ggttttaata ggcaaatgcc taataagtc ttagaaaatc tgaaggagg 1614540
 gtgtgatcat cagaaaactc actgccattt atcctaaagg acaaagcctg ggcaaacgc 1614600

 accaagatgc aactgttgt gtctgtgaac atgagtttcc aactagca caatatctcc 1614660
 caaagggaac tctctctcat caaataaaa caaacccaaa ttattaagtt gcattacaat 1614720
 ttccagtttg tggttacatt cattcacggg cagcatgcta cagtgggaaa atccctgagg 1614780
 ttttaagccag acaacacagg tgcaaggctt ggctaggcaa tcttgggcaa gtcactgagc 1614840
 ctctttaagc ctcaactgtt tctaacaca aaacaaaaat aaataataca agcacttact 1614900
 ataccacaag attgtgaac tcttaagga gacaaatg aaagcaaata aatgtgagct 1614960
 attaatacgc aattgtaact ttttgaact tttcttaagt tggtaatctg caagctatga 1615020

 ctgaaatag aaaattaact atgttataac agtccatttt gatactataa tattaataaa 1615080
 actcaagaac cttcactagg gaactagaga gatggctcag tggttaaaag cactggccgc 1615140
 tcttgagag gaccaggtt tgattcccaa caccacatg gcagctcaca actgtctgtt 1615200
 tgggaactgt agttccagtg tttccaatgc cctcttctgg cctctgtggg cactgactgc 1615260
 acgtggtcgg tacacataca caccaaatat tcatacatgt aatgaaaac tttaaaaaca 1615320
 gaggaacctt catcaatgag tgacgacaag cattcatcta aaataataat aataaatata 1615380
 aatcaagtat taaatactg atgataaact tttgtttttt ctttgggtg tgcattgata 1615440

tgtgtgtgtg tgtgtgtgtg tgtgtgtgtg tgtatgtgtg tgttgtgttt atgtgtattg 1615500
 tataggcaca tgagtgagca caccataca tgtgcatgcc tagtccagag gaaactatca 1615560
 agtgtcttcc tctgtctctc tacctggaag agctcacat tttggctgac cggcaagctc 1615620
 ccaggatcta caagctgtca tctcccctcc cccaatgctg aggttacagg cacatctgga 1615680
 tctgctcct tgcattggctc aaggacttg acctgaattc gggtattgaa ataataaaga 1615740
 aaagacaaat agatacatgg acacagacaa aaatgctgat tcagtggac tggggtctta 1615800
 gatagagaaa ccgtaacacc cctgaggctg tatgaagttt attacataga tttgaacaga 1615860

 cacagggtta tagcaaacac ctgaacaagg aggtggagtt taaggcatga gtggctaagt 1615920
 catggtagga atagtctctg tattggtgca gtcatacagc tgtcaatttc tgtggggaga 1615980
 acgatatagt ggacatttcc tacacacaag gtcaaacactt acacttggac ccctgaggag 1616040
 agctctacca ctctctgag cctctctatc ccgaaaggct ttgtcatctt cccatcagtc 1616100
 tgaggatctg aggtccttaa catggccacg cccacgtcaa caacacaaat tcaactgagga 1616160
 cgtcactcac tcccacatg gggccatgta cagcttcttc catggggtgc agatgcaaac 1616220
 tgggctctt atgcttgcac agcaagagat ctactcctc agccttgagg ataagtcttc 1616280

 tatgggaaaa gatacgatgg taggctggag accttagcat tgctctcagg ctctcgtgtg 1616340
 taagatcccc aaattgcaaa caaacgtaa caagcataag gtggatatgt tggttttgct 1616400
 tgtttgtttt teagattatt tactttttta ttttataggt atgggtgtct tgcctgcatg 1616460
 tatgtctgtg tatcacatac atgccacatt cacagagtcc agaagagggc atcagatcct 1616520
 ctggaattgg agtgacaaat gatcatgagc catcatgtgg gtgctgaaaa tcaaacttag 1616580
 gtcttctgga agaacagcaa gcgctcctaa tttctgagtc atttcatggg ctccagatat 1616640
 aattattcaa ttgtttgttt ggctttgggg gggttgtttt taatgttact ttctaaatta 1616700

 agtcatacta aaaaatcaag taaactaaag caaaataaaa aggtcaaggg aatgcacat 1616760
 ggaattaaga aaaaactcaa tattttctat atcatttgaa gaaagcatat tttctcattg 1616820
 tggattaatt gcttgataa taagaacag tttaggactg gcaaatggct cagtaggtaa 1616880
 ggatgtttgc caccaagcct gacaacctga ttatgattcc ctagaatccg aatggcagag 1616940
 agaaaccttt ataagttgtt ctctgactct acatgggcc catgatgtgt atatgctttc 1617000
 acacatgtgc atacatgcac acatacactc atacacacac taaatgtctt tttttaata 1617060
 aatgtctttt taattaataa aaaactcctt gtttacaag gagcaaggaa atgaccttc 1617120

 ctgatgaaca agaaaataga aagtaaaaa gtaaattaga attataactc aatatagtat 1617180
 tttaaatccc taatattaat ctgctgaaat agtgaagtag ccaaaacaac tgatatttga 1617240
 gttttaaca acccaaatag ttattaagca atcaaaactg catctagcct tgtaactat 1617300

gtacagacat ttgttgccag aggaaagcac cagctgtaca aacttgtag gtcctagct 1617360
ctttaagggg atggctgcta ctgtaagtgc acagagtaca ggttccttt taacgtctgt 1617420
ggacacagaa tggcttacat ttatittcca gtgacctac aaacacctat tttagttaac 1617480
cattttaata attatagttt acagtaacat ccttctggaa agcaatttat cgataggatg 1617540

ttagtattaa aattatataa gcctttgaga ccaataaacc gctaataaaa agaagaatca 1617600
ttgttgcaga acatttgtag actgtgtgaa gatgtgtag ttgctatgac tgggtgtaaaa 1617660
cagatgaatg gccaatagct aggcaggaga ggcagggtggg acttcccagc agagagagaa 1617720
gagataatca aggcagcatg ctgaatgaat cggacacaca aaatgggaga gaggtaaaat 1617780
ccacaaggta gaacatagat taataaaaat atggattaat ttaagttata agagctagtg 1617840
ggttaagcct aagttaatgg ccaagctttc ctaattagca ggtaagttgg cagcccaaag 1617900
gaaagtctaa ctacaaatca tgacatttat ttcaggatta actaaaacaa tcagaaacta 1617960

gacacaaaaa gagcaatgac tgacaaaaa agtccatgac aaatgctaag agaggcatg 1618020
gaggcacaag cctgtaaac cagccagcac ttgggagaca gacagtagga tcaggagtgc 1618080
aaggtcacce ccagctgac agcaagttca agggctggag aggtggctca gtctatgaaa 1618140
tgcttggcat gcaaacatga tgacctcagc ctgatcccta gcacccatgt aaaaatcacg 1618200
gtcatgtage aggcatagtg gcctgtgcct gtaaccccc tgatggggag acagagacag 1618260
gagggtcact ggagttcact agtcatcaag ttagcctaa ctgtgagtc caggccaatg 1618320
aaagaccctg tctcaaagga ggtagacagt gttttggagg aaaacaccac ggtgaacctc 1618380

tgagctatat acatgcatgg ataaacaggt ataacatata cacaaaaaac aaaggtttaa 1618440
aaaaacttaa aaccacagc cacaaaaata aacagtggac cgtttccttt cagaacaatt 1618500
gagagtcact tactctgaaa gaattcctca aagtcagttt tctccacaca gctcgtgtac 1618560
atgcgtaggg ctgcgatctt aatcttctag acaaaaagaa taaaacaaa ctcaagacat 1618620
gaccaagagg atgttctaga gtcattaggt atggactgca gagctcatgt ttcttcagct 1618680
agaaggagg gtgtaaacct atctttggcg atgtattttg ttttgctta gagaccggcc 1618740
cgcaagcagc ccttgttgac tgggatggg ctctgtagtt cagcttacca tetctacctt 1618800

taaaaataaa cataaatttt taaaatgtga acccgaat cctttaatct ttgctcagag 1618860
gctctactaa ttagtctgtg atttgggggg tgggtatgt cttttctaca gactcacaga 1618920
acatatgtgc ataaacaaaa ttctctaata aatatggaat acttctcact atgcctcaag 1618980
tactaaatat gaagaactta gtatgcagta ctacatctta agatcaaac taaaaattat 1619040
aatcaatc tgacagagtt gagttggctc gaagaacaaa ccagtaaaac aaaattgaaa 1619100
aactaaacca gtatataaac taaaaccagt atataacaa aagacttgta taagtttctt 1619160

tttctttctt aaaattacag agcaagctga acatagtggc ccatgcctat gatcccagca 1619220

 ctcaaagagt tcaagaccag tatagtctac agggcaggtt ccaggccagt ccagactata 1619280
 gtatagtata gatttttttg tctcaaaaac aaagcaaac aaacaacaa aaaaataaac 1619340
 taaagtccgg tgttgatggc gcacaccttt aatcccagca ctcaggaggc agaggcaggc 1619400
 agatctctgt gagttcgagg ccagcctgtt ctccagagcg agtgccagga cagcctccaa 1619460
 agctacacag agaaaccccc tctcgaaaaa ccaaaaataa ataaataaat aaataaataa 1619520
 ataaataaat aaactaaaaa caggggctgg atagatggct cagcaattaa gagcactggc 1619580
 tattcttgta gagaaccag gttcagttcc cagcaaccac atggtggctc aaaaccacct 1619640

 gtaactcaa ttccagggga tccaatgtct tcttctggcc tccacagaca ccaagcacac 1619700
 aagtgtgca cagatacaca agcatacata caggcagata aaatacttat atacataata 1619760
 aaaaataata actgaaacaa aagcaaacaa aaaagaaaca ttaaacaaaa ggtatgatgg 1619820
 ctcatgcctc aaagtccagc acttaggagg ctgagatgaa tcagaagctc aagcttcac 1619880
 tacaagatct atctccaaa taaataata aaaacaaata aatagagccc atcaagagtt 1619940
 aagatataat acatcacaat caaagagatt tatgcataaa tgcaaagttg aaccaaacac 1620000
 tggccaatca aagaagggat gagagaagga gctgcctgtc aaaattcatc aagaactgcg 1620060

 attcagctaa gcatgatggt gcatgccttt aatcccagca cttgggaggc agaagcagga 1620120
 agatctctgc gagttaagg ccagcctggt ctatagatca agaccagga cagttcgggg 1620180
 tatacacaca aacgctgctc gaaaaacta aaacaaacaa aaaacaagaa cacttaacca 1620240
 ggaaagtaca ggtttaggaa agcactgagc tacactatg ctggcctagt gacacctca 1620300
 tcctgacact ttggactcca gcagcccttc tgccttgag atgggaactt taggctcact 1620360
 caaactgca taccaaatgg agttctgcc acagatctaa atgctatggt gagggataaa 1620420
 caaatgac aagtatttct gccctggttg agtgtatggc ccaggttaac tataaacaaa 1620480

 tttataattt taactaaat tcttagttac ttaattcttg accctccta ccatgcttgt 1620540
 agtttcttc tggatcctc gcataaac ttcttaggtc acaactc actctgcct 1620600
 gggaaaggca gacttgctc caaggcccag ggtccaaat acatccatga aaaagtattc 1620660
 attacaaata gtaactactt gaccagactg gccagcattt ttatacagt ctcacactgt 1620720
 ggcaatcaga aacattttat agttcttcaa tttcttgaa ccaaagccaa acctttattc 1620780
 ttgggtgagc cattttctg gacaaatctc tgaagcaagt ccctgaggac tatcactcag 1620840
 ggactggaag taacagctgg aaagaatctc tttgagaacc atgagttaac gtgagtgaag 1620900

ggaaggaggc agactgaatt tccactcagt caacacaagc tgttccagtc ctgggatgac 1620960
 ttcattgttta ttcactctc actttgggag acttcacagg acacctaggc ctactctccc 1621020
 acctgcctgg acatgcgtac cctccaacaa gatgaggggt gaatggggtg agaggattgt 1621080
 agtaacggct gggtaaagaga gagctgcaca ggaatTTTT cTTTTTTTT tTTTTTTTgt 1621140
 cgtcatttga acttcttatt ctgtctgga atTTTTTTta caacattctt atttctgtgt 1621200
 taataatctg agccccatt ccaacaagaa caagctcgga agctcccgtc ctctggagg 1621260
 gctctcatca tccactactc tgagcacctc aggtgtcacg tcttcttca ttcactgttg 1621320

 atttgcctt caatactaag agaactcaca atgccttctc ttttctatac caagcatctc 1621380
 tatttcttcc aattattctt ttttctattt tgggggtggg attgggggga ggttttctgt 1621440
 gtcccccta actagcccaa aactgtttca cagagatctg cctgtctctg ccacccaaat 1621500
 gctaggatta aagccctatg gcaccattca tggTTTTctt caaccattct ttagttctta 1621560
 cacgatactg ctatttaaac agaagagggg gaagggtgac ttctgagtgg agcatggtgg 1621620
 tgcacatcaa taattatttt caacacttga gaatcagagg caggcagatc tttgtgaatt 1621680
 tgagttcagc ctggtctaca tagctagttc caggccagcc aaggctacac agagagacc 1621740

 tgtctcaaac aaaacaaaac aatcaataa acacagaaaa atgctatttt aggttgctca 1621800
 aataagtaag aaaaggctac acttaaaatc ttaaatatag gctagggaca ttgttttatg 1621860
 gtctatgatt gactagcatg agaaagtctt caagctagat ccgcagcaat aaagtctaaa 1621920
 tgtgaatcta taggaaccta tacatgaaaa catccaagaa aaatatagcc aaaaggtaa 1621980
 tcataagcat cagtagacaa gtaaacactt tgttctctaa gcaaattctt gtgaaaataa 1622040
 aaacaaggaa ttttgccagt gcaagccaat gcaagtatct ggccacagat ttctgagtta 1622100
 acagtgctaa aaaggattta cctataaacc tttaaaatgg aaagtcctca ctacattttc 1622160

 ccacccaaat cataccagaa tgtgtcatac tgtgatattt tgatgtgata gattttaaaa 1622220
 tgaaggctat aaaactgcc acatcataaa agattttttt taatgtaaat atttagttga 1622280
 ggtaacaaag ggaatcaaga aaactcagag gctaactcag ctataagaga gaattctccc 1622340
 actggtctca taatcttca aatggtggcc aatttgcct gaggaactt taaaaaaca 1622400
 aacaaaaaca taagactaga caaagcatal ggaagcaacc aagtgaacc caattactaa 1622460
 gacatgagta aaacagttaa ttttctctc tattctttct ttatttccat ttcactttc 1622520
 cTTTTTggg gggaggggag tgggcagggt agcacagcc tttattccca gtagttggca 1622580

 gagggagggtg gatctctgtg agtttcaggc cattcttctc tagaattcac aaagatccat 1622640
 ttaggattaa aggcattgtc accactcgta atTTTTaatt tctacttttt aaacagcaga 1622700
 catattttaa cTTTTatatt acaaatgtca taatcacaac tctTTTTttt tttgtttgtt 1622760

tgtttgtttt caagactggg tttctctgta gcttcggagt ctgtcagtag accagactgg 1622820
 cctcgaactc acagagacca cctgcctctg cctcctgagt gctgattaaa ggtgtgtgtc 1622880
 accaccacc ggcacagctt ctttttaaat acaggggaagg gccacaaga tggctcagag 1622940
 aataaaggct ttigccacca agcttgatga tataaattca acgcccagga tccacatggt 1623000

 ggaaggagag aacagagttc ccaaactgtc ttatgacctc catacattct ccaaggcaag 1623060
 catgtggcta catacatata cacatgctca cttgtgetct ctctctctct ctctctctct 1623120
 ctctctctct ctctcttgcg cgcgcgcaca cacacacaca cacacacaca cacacacaca 1623180
 cacacacaca ctaataaac ataacttaa aaattataaa tgggccggaa gtggtagtgc 1623240
 acaccttaa tcccagcact tgggaggcag aggcaggcag atctctgagt ttgagaccag 1623300
 cctggtctac agagctagtt ccaagacagc caggattaca cagagaaacc ctgtctagaa 1623360
 aaacaaaca ataaaaaca aaatatatgg aggaaaatct agtcatgata gtttacacct 1623420

 ataatcctaa cacttgggaa gctgaggcat aggactgcta caagtctag aacaggctgg 1623480
 gctatagtat gatgccatgt ttcaaaagaa aaaaaaaaaac taaaatttaa aacagggaga 1623540
 aaaggtctgg tcagtaatca aatatatcaa ttcattcacct gteaagaatt ttacaaacat 1623600
 aaatataaaa ctttaataaa aataactaat tccagtggta aggaaagcta aggttggat 1623660
 gtaaaatgaa acttaaaaaa tttatttaaa aaaaggaaag aaaataacta tttccttgaa 1623720
 gttttagcag agactgcagg gtctctaaga atatcactgt cacttagcat ttgtagcctc 1623780
 tccatatatt tgaaaacaaa gttgaaatca atgttgactt ttcagaattt gtatataaaa 1623840

 gcttgcagac agaaacctgt atttgctgtc atgaaaactg ttgggaaat gaactaacct 1623900
 aagaaagcaa gtagtctcag gcagtgtctc gtgcctataa ttccaatgtg ttggggaaca 1623960
 gatgcaggaa gatctctgtg agtttgaggc cagcctggtc tagcagagtg cgttctagga 1624020
 cagccagggc tacacagaga aatcttgtct ttaaaaaaaaa aaagattttg acccattgca 1624080
 atgtcccttt aaactcatct agatgctgtt ttcaggcaat aaaacaaggc cctgaaaact 1624140
 ttgcctagtt gccctgcaag caactgcaga cacttccaag gcattgggct gaaggagtac 1624200
 ttcgttctta tctatacata aatctgacta gtagtagagg gtgcattctg aagaaattct 1624260

 caaaagaatg tatgaatttc tcaaatcaga agtaaatcta tgatcaacag aaggcatag 1624320
 acccaaagga acataaaatc tttaccatt tactgtatth caaaggcca gtgaatccca 1624380
 tggcttctat taictctgtg aaggaccga ccttctctc aacaggcttt gggaaatctt 1624440
 ggatagtagg aagctactta accaaagaaa aagaaatcaa gttagttaca agaaatttc 1624500
 taacagagt gcttttattt ctctctctc agaacatttt tattgcttag attttttca 1624560
 ctttgatttc cttttttct acttcttgc tttgactgtt ctgttctgtt ttagtacagt 1624620

gctggagatc aaaccaggt tttcacaac actgggcaag tgctctctca tggagccaga 1624680

ctcagagccc tcaacttagt gtacaacac atctgaaatg gtatctaaca gacatcctcc 1624740

aaattacaaa gcaaagcata cccacctaag taacatgtg cctgtgatcc catgattagg 1624800

aaagaagaga ctagaggtag tagaataaag gtgacatgaa aaagagagag atggctcagt 1624860

ggctaacagt actggctgct cttccagagg acttaggttc aattcccagc aaccacattg 1624920

cagccaacaa ctgtctataa ccctagtctt aagggatctg atgccactt ctggcctctg 1624980

agggcaccaa gtgcaagcct ggtgcacaga catacaggca ggcaaacac ataaaaaat 1625040

agaggggaaa gggcaaggag tgggcagaag ggagtgaagg aaaaagagta agggggagaa 1625100

aaaggaggaa ggaagagagg aacggggggg gggggggggg gggggggggg ttgaaaaac 1625160

acagccctg cctagaaaaa annnnnnnnn nnnnnnnnnn nnnnnnnnnn nnnnnnnnnn 1625220

nnnnnnnnnn nnnnnnnnnn nnnnnnnnnn nnnnnnnnnn nnnnnnnnnn nnnnnnnnnn 1625280

nnnnnnnnnn nnnnnnnnnn nnnnnnnnnn nnnnnnnnnn nnnnnnnnnn nnnnnnnnnn 1625340

nnnnnnnnnn nnnnnnnnnn nnnnnnnnnn nnnnnnnnnn nnnnnnnnnn nnnnnnnnnn 1625400

nnnnnnnnnn nnnnnnnnnn nnnnnnnnnn nnnnnnnnnn nnnnnnnnnn nnnnnnnnnn 1625460

ttcttgaag atttatgact gtgttaaact tgtacaaact ccataataat tattttctc 1625520

taaaacaatt attaatttct agacaagag cctgcagtag aagaacaag ctcaaatgat 1625580

aggcttcaca tagtcaatga gtttgcact caccatctc tgtaacttg ggtaatccc 1625640

tccaactccc cgaacctcac cttctatatt cacgtaaggc atccacataa ggcagctctac 1625700

agtggacaca ctacacttac ttgtggtgtg gtatttecta ttctgctgtg tgtccatccc 1625760

aacactttgt tcaattcca cccatactcg agactggttc atctgtggcc tctggaggat 1625820

gaacagacag atatgagtga cactgagcat gacttatcaa agttagcca agaagagctc 1625880

tctggetggc tctacceaac cttgettgcc caacttctgg cgaaagacca tcatcgaaa 1625940

ggagccaaga tcagcagcca gagtgggtgc tggatcatgg cagggtctta acaagtatct 1626000

attatgtaat ggctcacact tgcaatctct ggaaggctga aacaggagga ttgctgtgag 1626060

ttcagtacca gtcagagca tagttgagag atggttccaa agaacaaaat gaagtccaaa 1626120

aattaatcg gtatagactg aagtcaactc agagaagtaa aattataata ggaaaatgaa 1626180

agagtactgc aatgagtttc tatgtaaatg ctgacaatgt ctgatgtgta agagaggggg 1626240

catcaatfff aagattaaaa cttgttactg ctggtaggca aatttctgta cgtttgaggc 1626300

tagcctggtc tgcagaacaa attccaggac agctagagct atgccaagaa actctgtctc 1626360

aaaaaaaaa aaacacattt ggggcagcca gtagtggtg gggcacacct ttaattccag 1626420
 cacttgggag gcagaggcag gcagatctct gtgagttcaa ggacagccag ggctacagag 1626480
 agaaacacctg tctcaaaaa caaaaacaaa aaatgacaac aaaaaaactt ggataatatic 1626540
 tctcaatgtc aatggtctta acttacccat aaaaatatat aggctaacag aattacagag 1626600
 agaaacacctg tctcaaaaa caaaaacaaa aaatgacaac aaaaaaactt ggggttaaag 1626660
 agatggctgc tcttccagag gatccagggt cagttctcag caccacatg gtaactcaca 1626720
 gctccagaaa atccaacagc ctcacacaga catacatgca gacaacacac caaaataaat 1626780

 taaaaataa aacaatataa aaatttttaa actgcttctg ccacctaaaa gctcaggggc 1626840
 cattgacaac ttgctgcacg tcagttacag tgaggcctga aggggaaaag catggaaaat 1626900
 gcatctcaca tgaaaaacac aattttttac ttttttatt ttaaaaacat aagtaaaatt 1626960
 acaaacaaaa ttatgaatgt gtgtgggtga atctaggaag caacacacag aatgaaagg 1627020
 gttatttggg taaattggaa ttgtaggtag caagttagga atgtaactca atagtagaac 1627080
 cctttgccta acatggacaa gacctgagc ctgagttcct gtaccacaag gagggaaaga 1627140
 aagaatgaat tatgggtaaa tttgggaact cagtgtccaa attcccagca atgttttaat 1627200

 tgccataaat taattaaag aggggtgtag tgggtgagag ctgggcatgg aggcacatgt 1627260
 ttttaattta atcccagcac tcaggagaca gacacagggg gacctatgag tttgaggcca 1627320
 gcctgttcta catagtgagt tctaccagc acagtctcaa aaaaataaaa taaattaa 1627380
 taaaataaaa taaaataaaa acaaatatgg gaggtgtag agggttaatc ctacaattct 1627440
 ggtttattcc aaaaagagga aggctaaatg gaattaacaa tgatttagtt gtttcatctt 1627500
 aataaaggaa aaatagtttc tcattgtgga ctagtactat ttgtatttct ttccaaacaa 1627560
 ggatattaaa agattagtca gaactcgtct gcaggcccag ggacacttat gctttaattc 1627620

 tcaagtacca agcaggettt gtgaaataca gactaaacac agaacacctc ccatgacatc 1627680
 acacacatca gtgtaatggc ccatctagaa cacaagcac ttcagctgcc tccaagaatg 1627740
 caaagtggag cctgaacaga gtgctgcctc ctctgtgtt ggtgttcgct gagacatctt 1627800
 tctctgtccc cacaggtcca cagtggteac agattccttc tactgtacac tgtgaagcac 1627860
 cagggcacca ccactttccc actctcctgc tcactataa acacacattt actttgggga 1627920
 ccacctcct tgcctttgcc tacttcaaaa ggggcctggg agcccctcaa ttttcatct 1627980
 ttttcaagct gaagagactg cccaaaataa ctcaaatatt acttttcaa agagaccttc 1628040

 tctctctct tttggttttt gttttctggt tggtttcctt ttgtttgag actgggtctc 1628100
 atgtcgtcta ggctagccct gaacttgcta tftagctgag gataatcctg actctccagc 1628160
 ttctactccc cgcttctgaa atgacaggca tgcctgcag tgtccaactt catgtggtgc 1628220

tggggaccaa acacgctaga ccagcaccaa ctgagctaca cccagccctc aaagaggccc 1628280
 tcctaacta cttataaag cacagttctt tacaacccat tatctccacc aaaacgtagc 1628340
 ctattcactt cctccatggt actagttaaa tgcataatta tacatcttact taagtatttg 1628400
 cttattagcc gggcgttggg ggcgcacgcc tttaatccca gcactcggga ggcagaggca 1628460

 ggccaatctc tgtgagttcg aggccagcct ggtgtccaga tcaagtacca ggataggctc 1628520
 caaagctaca cagggaaaaca ctgtctcggg aaaaaaaaaa aaaaaaaaaa gtatttgctt 1628580
 atttccagc accactgtca aatacataka tgatggtaag aacagcctct ctcacagaa 1628640
 tggactcaa tatggcacac aggagacacg taagcagttg ctgacaaaagc aaatcctcca 1628700
 ttccataat atttgattcc ccaccctac catctttgac cacatataka ccatagatac 1628760
 atgcttcatt tatccaagct ctactaaatg ctcaagatat gccagccctc atacaggctt 1628820
 gagggtagaa ataatctgt atcctctggg agctcatggt cttacaaaga aaagaaaaca 1628880

 aaagagaatt taacatagaa aaccagaact aagtgccaca ctggaaatgt cactcccaga 1628940
 agtaaacac tccagtgca ggaaggatgg agagcctcca gaacactgac aactgcttg 1629000
 tgtgcagaca aagtaaatgc gccacttggg aatgtatttg gtatgtctta gttaaatga 1629060
 atgccagca agtaaggctc gggaattcta cattcttacc tcaacagaag tgtatgcgtg 1629120
 cactgcagc agcagtgca tgtaaggctc cgagtagaca caacccaac aacctcagc 1629180
 aggagagctt gatgaatcaa ggcatagcca tataatgaaa tactgtggac tcaagccca 1629240
 ggacaaaaa agtcaact atggtgagaa ttagtcaacc accactaca agaacagatt 1629300

 tattaatct cccaacaag gctgaatgac agcaaacaca agagactgct tgacagatgt 1629360
 ttaaaggcaaatgaatcta cagaacatga ggtaaagatt tgctaacctt ggtgtggata 1629420
 gtagctaacg ggggatcgaa gagacttcgg caatcttttt gtttgttttg ttttgttttg 1629480
 ttttgttttt caagacaggg tttctctgtg taacagtcct agctagctgt cctagaattt 1629540
 gttttgtaga ccaggctggc ctggaactca cagaaatctg cttttttgcc tcccagtgct 1629600
 caggattaaa ggcagtgcc accactactc ggtgagactt ttgcgatctt agtaatgtgc 1629660
 tttgtttgtg tgtaagacag agtttcatgt agcccaggct ggcctcaaat getctacgta 1629720

 gctgaggata accttctgct cctcctactt ccactttcca cgtgctagga ctgccagcat 1629780
 ggacaccaca gctggtttat gtgccactgt gaattgaaca cagagttcca caaatgttag 1629840
 gcaagtcctc caccagatga ctacagcctc ttgttctact cttgacctgg atgctaggaa 1629900
 tgtttactct gtaataatc attgagttgt gatttgtgcc tttttctcca tttatcttat 1629960
 atcccaataa aaacacccca aaatttgggc tggggagatg gctcagagat taggagcact 1630020
 ggctgctctt ctagaggctc tgagttcaat tcccagcaac cacatagtgg ctcaacca 1630080

tctgtaacaa gatctgggtc cctctttcag tgtgtagaca tgcaggcaaa acactataca 1630140

taataaataa atgtttaaaa aaaaaaaccc aaaatcatta agatttggaa taggcaagat 1630200

aaacaacaga aaacaatgac ctggaatcac cagaaaatcc tcctagaaga ggacggagca 1630260

gagaagtgag agggcagctg agggacccga atgcagtga agaagacacg ggctgaacct 1630320

cctgctctct cacaagggtt ctgagaacca gaaacaaatt acatatgcaa aagagatgtg 1630380

caaaactgca tgagtaatat atgctataaa catataggtc tagccagggtg gtggcggcgc 1630440

acgccattaa ccccagcact caggaggcag aggcaggcgg atctctgtga gttggaggtc 1630500

agcctggctc acagggtgag ttccaggaca gcagtgtctac aaagtaaacc ttgtctcaaa 1630560

aaaaagtatg taigtatgta tgtatgatg tatgtatgta tgtatgtata agtgtatatg 1630620

cacatatgta cgcacatatg tgaataagta aataaaaaga gtaagatttc acacaacagg 1630680

aaagcaggaa ggctcagtg gcacaggccc ttacacacaa gccaaagtca aaatacggat 1630740

cctacaatgt ggcatgagta aacttctgag agatgtctc tgactttccc atgagtacca 1630800

tggcatatgt accctgaact cacacacaca taataaaata aatgaaatct gaaaaacaat 1630860

ttcacactta tttttgttt caaaaagttt gagggccgga gatgctggcc tccatctca 1630920

gccctagaca aagctgggtc agtgggtgtag gcctgtaatg ccggcactca gagaaggtgg 1630980

aggcaggcat agcagcagtt gaaggtcacc ctcacctaga tggttaactt aagaccagtc 1631040

tgggatatac gagtcaacaa ataataagga aatagttaa acaacaacca gcaaaaggtc 1631100

ttgaagtgta agaggctccc atgggtggga ggagtgggac agagacaggc tcaaacagtt 1631160

cttgaatgct gagagtgtgt gtatctcaca gtccaccagg gcacagccca cttaacactc 1631220

cttttattct ctgcaccagt gctcaacacc attctgggca tggaatcagt actcaataaa 1631280

cactagtag atttttgtc aaagagaagg acaacctgga ggaggtcaa aaaagaacca 1631340

cagcctgacc aaagggagga ataaaaggtc ctctggtgg aaaggttaa atgaactgaa 1631400

gtgttttagc ttggagaaaa ggcaactgaa gaattaagga gtaacttaga ataactgg 1631460

ggctggaaga cattgcagag gtctcccagt ccaatTTTT cacttcatag atgaggagac 1631520

taaaaccaag ggagaggttg caacttgggg aaggtagggt aggataatat tttttttat 1631580

ttgtgtttta tagtgaggac taaatttact caagcagat gagcttatat agtaataaaa 1631640

atagcagtta caaaactggg tgtggtgtca tatgcctcta atcccagcac aggaagaggc 1631700

aggtggagct ctgagttgaa ggttagcctg gtctataaag aaagtccta tctcaattaa 1631760

taaatcctca gtcaataaat gtaagactgg cagaaagagg aaatcaacag tagggaagat 1631820

gactgtaatg attattagtc aagaaccatc aagagaatta tgatatacatt cagcaatcca 1631880
aattggacat acatccaaga gtagggtctc agggagatct ttgcacacca atgttacta 1631940
taacattatt cattattcac aacaacaag atgaatccac ccaaacatcc aaagaatttc 1632000
atggattaaa aataaatata tacttgagtg gtggtggcgc acgcctttaa tcccagcact 1632060
cgggagacag aggcaggcgg atctctgtga gtttgagacc accctggtct ccagagcaag 1632120
tgccagttea gcttccaaag ctacacagag aaacctgcc tcaaccccc cccccaaaa 1632180
aatacagtat attatgcaac agaagattag ggtagccctc acaagaagaa atcttattac 1632240

atgccacata tgcatgaaca tagaagatct taagctaagt gaaaaaaagc gaggttgactg 1632300
cacttacatt caacaattag ggtgatcaac tccccgttaa aaataaggaa aaaggggctg 1632360
gagagatggc ttagaggta agagcactgg ctgctctttc agaagtcctg agttcaaatc 1632420
ccaggaaccg catggtgact cacaaccatc tgtaatgaaa tctggtgctc tcttctggcc 1632480
tgcaggcaga aactgtata cataataaat aaataaacct ttaagaaaa aataaggaaa 1632540
aagttcgctg ggtatgtga tgcaccctt gatcccagta ctgggaggca gaggcagagg 1632600
caggaggtgc tctgaattca aggtagcct ggtctacaga gctagatctg gacagccagg 1632660

actatataga gggaaaaaaa gacatactaa gaaaattaga ggtctggaga gatggctcag 1632720
aggttaagag cactgattgc tcttcagggt gtcttgagtt caatttctag caaccacatg 1632780
gtggctcaca agcatctaca attcaatctg gtgccctatt ctggcatgta agcatgcaga 1632840
aactctata tataataaat aaattaaaa aaaagaaat tagagcctat aatgccaaaa 1632900
aaggacataa tttacaatta ctatttcaat gcaataaag gctatctaa cattaatctc 1632960
gtctgttcta gtaagtgaag aaacaccaag atatataatt ctatatatat ttgatatttg 1633020
ttaaagtact taactatttg tttcagtgct ggagactgaa gccagatcct cacgcatgca 1633080

aggaactgag ctatacccca accctgtcag gatacttaag ggaaaaatta atatgcacaa 1633140
atctccataa agcctggaag agaaccagca gagatgaaa tattgacatt ttcagatttg 1633200
aagtcacaga tgattttatt tctttaata ctaaagtatt atatgactaa gcaggacaga 1633260
ggtggctcac gactttaatc ccaatacttg gaagtcagag gcaggtgat tctgtgaagt 1633320
tttaggtcag cctggttaca cagagccata tctcaaaaa caaacaaaa aaggtgttat 1633380
atgacttata aaaattaaga aatcaaac cattaaagag cccaaggttc aagacatcaa 1633440
aataaacat gtggtcaatg gtaactaag gccttcgata atcgtgtctt ggattttatg 1633500

ttcataaaga aaaggaaata ttttctacc caagaaaag tagcacaaa taatttttaa 1633560
aagaaaactg aaagttaact ctaagatgaa tatctggaaa aggtgcctaa cactaaaaat 1633620
tatcagacat ggtatccctg gctaagttcc acttagcagg ggtattaaga agcgacacc 1633680

tggacatgac accacagaga cccacagtga tctcatgggg ctttttcac acacgatgtg 1633740
 gtttgacat aaaaaaggtt tcatagcaac caaaagaaca aactttacct gggaagtgt 1633800
 ggagagagtc ctgtcccact gtctttgagt aggagacacc gataccagtt ggctgcatat 1633860
 tggaaaccac tgagagatgt tagtctgggt cctctagaaa agaaaaacaa tgtcaggaag 1633920

 ccatcagagt ccatatgtag agagtagagt gtacctgcaa tgttgtaaaa cagtaagaat 1633980
 tacagatttg gttgggggtg tggcacacac ctttgatccc tccatttggg agacagaagt 1634040
 ggaggacctt ttaaggtcag cctgagctac atagtgagac ctttttcaa agggggttgg 1634100
 gggagaagaa atacatattc agccttcaag tttggctcct ggcaagagtt cctaaacctt 1634160
 ctggcattca gacatgagt tttttcttt cataacaacc actttcaaac ttaagcgttt 1634220
 atgctaata ctgactcta caaacagagg acttggttgg gtaaaggaac taatcgccag 1634280
 agtgccactg agtgacctaa gtgttctgtt actaccctac tcatacaaag agtatgtgta 1634340

 tcaacaactt tccaacatca caaagttagt aaatggcagc tttaggatta atactggaac 1634400
 ccagatagct atctccagaa cctgtgcaca ttaagagat caagagaaca gtttaccttg 1634460
 aggtctcttc taattctaat actggaggta gagccattag cagagttttg aaccaattaa 1634520
 aacagcatat tggaggttag ggggaagggc tggagagaca actcaagtgg ttaagagcac 1634580
 tggctgtcaa acacatctgg gggttgattc ccagcaccca catggtagct caacagtctg 1634640
 taactccagt tcaggggat tcaatgcect cttctggcct ccgctggcac ttggactcac 1634700
 ccgtgtacat acacataata ttaatgtgt atttaaaaa atgaatctta aaaaaaaaa 1634760

 aacaccatat ttggagetgg cactatgact tgggtgcctg cctaccaagt ttgatgtcct 1634820
 ggaccatac agtggaaagca gaaccaactc ctgctggtat tctttggacc actacacat 1634880
 ggcacacatg agcatgtca caaacatgaa aataagtaaa taaataaata atgtaataag 1634940
 gtctagagtc atcttttaa aattaaatt aaaaaagaaa aaaaaaaagt caagcattga 1635000
 tggggcatgc ctttaaaacc aacctgggg aggtagagga aggcggatct cttgtgattt 1635060
 caaggccagc ctggtctaca gagcaagtac caggacagcc agggttacac agaacaacc 1635120
 ctatcttgaa aaacaatcaa atcaggggct agagagatgg ctacagagtt aagagaactg 1635180

 gctgctcttc cagaggtcct gaggttcagtt ccagaaacc acatgatggt acacaactgt 1635240
 ctataataag acctaaggcc ctcttcttgc ttgcaggtat acatggcagc cagaacactg 1635300
 tataataat aaaagtcttt taaaaagaaa gaagaacaat caataaata aacagaataa 1635360
 cagccgggca gtggtggcac acgcctttag tcccagcact ttggaggcag aggcaggtgg 1635420
 atctctgtga gttcgagacc agcctggtct acaagagcta cttccagggc agcctccaaa 1635480
 gccacagaga aaccctgtct caaatagttt attgtgggcc agcatgatag ttcaatgagt 1635540

ggacagatga ccagagtttg atcctcagat cccacaaggt gacaggagag aaccaattct 1635600

 caagacctaa cacatgaatg acaactgtagc acatgtctgc actcacacac acacatatac 1635660
 ccataacaaa tagcacatgt ggaatgaact gtgtacttgc ttcttcagag gtcctgagtt 1635720
 caattccag caaccacatg gtagctcaca accatctaca atgtgttcca gtgccctctt 1635780
 cttgcctgca gtgcaggcat aatgttaggc agaacactgt atatattata aataaatctt 1635840
 aaaagaaaa aaaagacaaa taagaaattc caggactgag aatggataaa gaaaatgtgg 1635900
 tatatttaca caatggagta ctactcagca gtaagaaca atgacatcct aagccgggtg 1635960
 ttggtggcgc acgcctttaa tcccagcact cgggaggcag aagcagactg atctctctga 1636020

 gttcgagacc agcctggtct acaagagctg gatccagggc agcctccaag agccacagac 1636080
 aaacctgtc tcgaaaaacc aaaaaaaaaag aaagaaagaa acaatgacat cctaattccc 1636140
 aggcaaatag acagaactag aaaaaaacat cctaagttag gtaacacaaa accagaaaga 1636200
 caaatatagt atgtactcac tcataagtgg ataccagaca taaagcaaaa ggtaccatt 1636260
 ctacaatcca taacccaat gggctaagct cctggagtac aatcaaagtg agggaggagc 1636320
 cataatatga acaaaggagt caagaccatg atggggaac ccacagaatc agctgacccg 1636380
 agctagttag agatcactga ctcagatctg acaaatgggg agcctacaga agaccgaaat 1636440

 aaactctctt aatgtaggag acagtgggtg gactgggaca gtatatgagg ccactagcag 1636500
 tgggccaag atctaactgt aatgcacaac tgacttaatg gagccattc tctatggaga 1636560
 gataccttgc ccagcctaga cacaggggtg tgggggtgga gaggtacctt ggtcctgcct 1636620
 caacaagatg atgggacaga cttagtgcac ttcgtaaggg aggccttacc ctctccgagg 1636680
 aacaatggg aggtggggaa gtggggggag ccggaagaga gggaggagg ggaactggg 1636740
 aatggaatgt gaaagataaa ttaataaaaa atgcaaaaa aaaaaagaaa ttctagggcg 1636800
 ggggtgtage tcagttggta gagtgtttg cctagtgtgt acaaagtatg aggggtcacg 1636860

 cctgtaatcc caacacttag gaagcagaag caggagaatc agaaattcac aatcatcctt 1636920
 gtctatatag tgggtttaga ccacctggg ctacatgaga ctgcctaaaa aataatttta 1636980
 aaaaaattta agctggaatt gaaatgtaca ataacaaaa tgaaaaatgg catgcctcaa 1637040
 tagcagattt gagcacaag aactgataac cctgaagata cctcagtgga gattatccag 1637100
 tctagggaac agaaagagac caatgggata ctatcaaac tgccaatat gtataacatc 1637160
 aggattctta aggaaaggaa ataaaggac aggaaaaaat ttaaaacaaa accatactaa 1637220
 ctaacagaag gcatcaggga agggctggaa gagatggctc agcagttctc aaggacctgg 1637280

gtttattccc agcatccaca tgatagttca caaccattca taactccagt tctaactctt 1637340
 ttctggcctc tagaggcact gcacacatat aatccatagc cacacatttc aggcaaacac 1637400
 tcagatacat aaagtaaaag tcaataaaat ctacacacac acaaacacag cagaagatat 1637460
 ccccaaattt gtictacaat ctaagaaatt caacaagctt caagtaggat aaacaaaaag 1637520
 atacatcata atcaaatgt caaaagagaa agaggaaaac ataaagaaaa aaaattgttg 1637580
 ataaactggg cagtagtggg gcacaccttt gatcccagca ctgggaaggt ctatagagtg 1637640
 agttccagga caggctccaa aagctacaca gagaaacct gcttcaaaaa accaaacaaa 1637700

 caaacaaaa accattatg acagcagcaa gagagaagca gctcatcaca cacaaggagc 1637760
 ccttagtaac actgaactaa tttatcctca aaaattgcag cagccaaaaa gctatgggaa 1637820
 gaattcctca aaatgttaaa tgaaaaaaaa tgttacagcc tgaccatatt gggacataac 1637880
 ctgtaatccc aatactcagg tgcctaagga agaaggacaa tggcaagtat gaggctagtc 1637940
 taagttacag tgggaccatt ccttaaaaaa gaaagagaat agaaccagta agtaaaattt 1638000
 ctatatccag caaaactatc attcaaaagc aaaatggaag gtaaagcaaa aaattcccag 1638060
 ataaacaaaa actgagaatt tgtagaccac caaatctcca aaaaatattc cttcagaatg 1638120

 aaacaaaagg atgctagatg ggctgacaat ttggctcaat ggttaattaa aagcacttgt 1638180
 tgctcttgca gagaacctgg gttcaattcc caacaccac atggcggctc atggctggct 1638240
 gtaatcttgg tctcaggaga cccaacatca tcttctgagc tcagtgggta caaagcatac 1638300
 atgtgtgtgc catatacagg tgggtcacat atacacatgc aggtaaatac ataaaataat 1638360
 aaaacgggga tgctaaacag tatttcaaat ctatatgagg aaataaaata cactggggta 1638420
 aagttaacta cttaaagtaa taaaaataga ttattatta ttattatttt taggtctctg 1638480
 ggagggtctt ttttttgagc gggatgaggc aggattctc tgtgtaagcc ctggctgtcc 1638540

 tggaaattgc tctgtagacc atgctggcct caaactcaga aatctgtctg cetctgcctt 1638600
 ccaagtgtcg ggactaaggt taaaggcatg cactgctgat gacctggttt tatgcctcaa 1638660
 ttttttaatt taaaagttaa tataaaagac aactataagc ctgttgatat acatatagga 1638720
 agctgtgate tgaatgacag tggaatcaaa aaacaggaaa tagaatagtt atatagaagc 1638780
 atagtctta tatcttgaa atcaagctgg taccaactca aactaaatca tcataaatta 1638840
 ggggtgctaat tgtatttcca atataatcac aaaaactttc ttctctccc taaaaaatgc 1638900
 cataaaacct tttaccatgg gctaggtctt atgagtggca gtgcatctgc ctagcttggc 1638960

 aaggcattta aagccagcct cagctacata aagtccaagg tcagaccgac ctgcttgaga 1639020
 ctgtctgaaa aaacaaacag atcaggtatc tgtttaatcc cagcaattcg aaggcagagg 1639080
 caggcagatc cctgtaactt tgaagtcaac ctgaacaaca tgagttccag gacaaccagg 1639140

gctataaaga gagaccccat ctcaaaaaaa aaaaaaaaaa aaaaaaaaaa aaaaaaaaaa 1639200
aaaaaaaaaa aaaaagacag aaggatcaat gcaagttcaa ggctacaaag tgagacctca 1639260
accacacacc aaaagatcaa atagcttggc cttttctcca aagatacaga aatgacgaat 1639320
atagaagttc aacatcacta gtcactagag acatgcagat ttttaaaaag cacatattgt 1639380

ctcatttcca ttagaataac taacatccaa aaacaaaaac taagctgtag agaagcttaa 1639440
tttttttttg catatagggtg gtacagatat aaaacagcac atcagctgtc cagttcccag 1639500
ctccacatc atgtagctca gaccacttgt aactccagtt ccagaggatc acacacacac 1639560
acactttttt tttttttttt tttttttccc ccgagacagg gtttctctgt ggcactagct 1639620
ctttagacc aggcctgtct cgaactcaca gagatccacc tccctctgcc tcccagtgct 1639680
tgggattaaa ggcgtgcgcc accaacgccc ggctacactt tttttttttt aaacagactt 1639740
aattcgattt atttttcttg tataaaaaatc ctatgtgggt gtggactttc acaagatggt 1639800

cagtgaattc ctgataagga gacttgggtga acacagtctc tttccagagg tctgaagtca 1639860
ggtagctgta ggtcttggag atggcatcaa aggtggcctt ggcaaagtgt cccagggtgg 1639920
cagtgcagcc cctggatga tgtgtagcgg tcatcaatac cggccatcat cagtagcttt 1639980
ggggcacagg agcagagacg atgtcagtgc ctctgggggc agggatgaga cgcaccaaca 1640040
cagagccaca tcggcctgtc actttgcatg gaacagatac acacactctt aaacattaaa 1640100
ttaaagaaaa aaaaacttaa tgctgggcct tggagcaaaa tgcctttaat accagcactg 1640160
gggaggcaga ggcaggagga tctctgtgag ttagaggcca gcctgatcta caaagtgagt 1640220

tccaggacag gtcctaaagc tacacagaga aacctgtct tgaaaaaac ccaaaaagaa 1640280
aaaagaaaga aagaaagaaa gaaagaaaga aagaaagaag cttaaataata ggggtgtaac 1640340
cctgttgata gagccttgc atgcacaaaa ccccaggttc tactcctacc accacataga 1640400
cttagtggag caggccagta atcccagcac tggagagatg gaggatcaca cccaagttea 1640460
agtccagcct aggtactta aaactgtc tcaaaagaga ggaggaagaa accatcacag 1640520
tttttattag ttgacctct gatcaaacct aacaacatca ctgattaaaa aaaaaaaaaa 1640580
tctgggtca gtgagatggc tcacggagaa aaggcaacca gatggtggcc tgatttcagc 1640640

cccaggacce acaaggtagg agaaaatacc cacaagtgt ctttgacct ccacattcaa 1640700
tgtacagcc caggcatgta catacccaca cacataaata tatcagatct ctgagttcaa 1640760
ggttaacctg gtctaaaggc acagtgcagg acagccaaag ctacacagag aaaccagcc 1640820
tcgaaacaca aaaaaagaca cagacagaca gaaagaagga ggaagggaga gagagagaga 1640880
gagagagaga gagagagaga gatttgaggg gctgagcaat ggttgtgcat gactttaatc 1640940
ccagcagcac tggagaggca gaggcagatg gatctctgag tttgaggcca gcctggtcta 1641000

cagagcgagt tccagggcag ccaaagctac acacacacac acacacacac acacacacac 1641060

 acacacacac acacacacac ggggagctct gaagctcaga gaagtcagtt ggttactcaa 1641120
 gactccacct acagcaggtg gtggagccac aatttcecca tgactgtcca gatcctagag 1641180
 aggttcacaa atigccctcc cggatttcta ctttgaacta gtcctgagag agttactata 1641240
 gctccatcaa gccctgttac aatgtataag aagatctcag ggaatctaca gggaaggaga 1641300
 ttttctttct ctaaccccag catttttttg taccaagaaa aataaacatg aaagaggaat 1641360
 agaccaact aagagaaggc aatgagagg tggattttac cgatgctttc agcaggagga 1641420
 aatgaacctg taataacccc tatgctcagg gacaatacat ttaagagagc tgggcacaaa 1641480

 tccccaaaggc aaatcaagtt tccatttcag gactccagcc caatacattt ttgttttcta 1641540
 ttccccaaa gtatctgtca aaactaatgt aggattcagc agtaaattcc ttatctagca 1641600
 tgcattgagge cctgggttta accctcaaca cacacacaca cacacacaca cacacacaca 1641660
 cacacacaca cactatttac aatagacagg ttgcaatttc cccagccatc ctcagatctt 1641720
 tttttttttt taagatttta tttatttatt atgtatacaa cattctgctt ccatgtatat 1641780
 ctgcacacca gaagagggca ccagatctca tcatgaatgg ttgtgagcca ccatgtggtt 1641840
 gctgggaatt gaactcagga cctctggaag agcagtcagt gctcttaacc attgagccat 1641900

 ctctccagcc ccatectcag atcttaattc aacttccact ttagcatcta taattacttc 1641960
 agcaaatgaa tccttctcta ggaaacagga agacacacct caaacaaaat ttcttgagca 1642020
 gcaactaaga gtctgcact ttgttagggt ggtaaagaat gtagtgactc acatataaaa 1642080
 ttattttaaa aacacataaa ataacaatcc aaaagataac caaaggcagg aatagtgtct 1642140
 gctacatcaa acagtgcctt tgaccaagt ttgcaaacac ctgactaaaa ttacaaactg 1642200
 tccccatgct tcgtgactag gaactccgct gtcattttct taacccttc cagaggtcag 1642260
 gagtgactct caagatgatt taaggccaaa tctcgggagg gagggacgtg gacagacctc 1642320

 cctccccata cggattagaa agagtctaca agtcttctt ttccttcatt cattcaacaa 1642380
 gtgttaggtt gtcccaata ctaggtggg cagtgaaagc cacagggcgg tttctcaagt 1642440
 ttgtcttga taacctatgc attcccctga actacacaag taagaattca ctttaagtctc 1642500
 taaaacaaac taaaagaacc tcagaatcca aaggactgc aaggagacgt gtgtcctcat 1642560
 ttttcacag gacctggaac ctccagttat ctactcaag gtcacactgt gacgggcgtg 1642620
 gactagacac ccctccac gttccccga ttacggtcag tgtcccccc accccttct 1642680
 cccagacagc gatgctcctc ccataaaggt ccgaggtcac tgccttctaa aacggcggag 1642740

aagccaaggc caaatggggg gtaaggagag gtgggaagct gccccagtg acccgtggaa 1642800
aggcggcagg caaccgagca acggcacggg ctccccact tctcccctgc tctcccgcc 1642860
cgccctctcc aacccccgagc tggagacgcg cgtgcgtctg tagaaaagta tccttgcaact 1642920
cacaaggact cgcaccagca acgccatggt cctccacgat catttccggg tgaagggtgg 1642980
gcttccggaa tcccgttgt caccaccac tcaggacgt gccctctggc taacgggact 1643040
caggctccgg caggcagcgc aggcgtagt gtcgcactgc gcaccccgcg gttgccacc 1643100
gtggatctga aggaggctcc ggggcgcgcg acccctcgcg ggtcttctgt ccccgtgtg 1643160

cgtcacaagg gctcgcgttc ttccccaca ccacctccg ggccccggc ctgtgacacc 1643220
ccgctcacc ttggggaacc cttgaccgc cattccttc ctgactccac ccccaggaga 1643280
cgacccggct gcaggagca ggacttcggt gtcccagtgg cttagaggag ctcggggagc 1643340
ctgagaacct aagagcacag tcttgaaag cagaccgac gcctggcaga ctcaggaacg 1643400
tgggcttgt ggttggctgg ttaacgggag catctttgag tattgacagg aaagagtaaa 1643460
tggggagaaa ggagcgtgga aagcgttgc tgtgggaatg agaggatggt cttgactgaa 1643520
gaactctgt atgccaagag aagtagaaaa gagaagatac tgctgctttg gggactgagg 1643580

ggaagccgaa gacctagccg ttgaagcgt tcctctccac ccagtcaata cagaccact 1643640
gggtattccg tatggactgg acaccgtcc aatgtctggt aacctgtgg agcttgtgag 1643700
ctcgttgagg aaagtacggg tagattgtc tagacaactc gtgagaaaaa taaaaactgg 1643760
tatgaaggaa ccataaatac ctaataaaga taatgatatg ggcaactacc tggccagctt 1643820
agccagataa aagcccatct gaggaagtga cgtgtaagg gggatgcagg gtatacttta 1643880
ttttttatct ttcaacaaa atttcttgia gccaggctg acctcagact ctttaagtata 1643940
tgaggctggc ctcccctgcc tcaagctccc atgtgtgtgt gggggggggg ggtttacagg 1644000

ttgtgacact aggcccagcc tcacaatit gttttggtgt tttgagcaga tetcaactatg 1644060
tagctgtgtc aggctggaa ctgagaacca actgcctctg cccccgact agcagccacc 1644120
acatcgggca aaattctgta tgtttatcaa gtttgtggt tttaaatatt tacatctaga 1644180
atggctaaat taagcttatg accggacaag acagtgcaga ggttcctcca tcttgtttg 1644240
ttttgtttt gaggctgtat aatagccctg taagacaaa ctggccttga acatacagag 1644300
atctgcctac ctctacctt acctcccaag tgttgggagg tggcatgcac caccactccc 1644360
ggcattccat ctgtattct tgctgagacc attcagggt taatttgatc ttcattggaca 1644420

atcccaggga aaattacca actctattca aggaaccca ggtcaagatg ccctatttaa 1644480
cctattttag ctctgttga actgctgtct tgtgcaaact tcccctctg getagetact 1644540
taccttagct tctgataaat tgcttgctta catgaagcac cctgcaactt ccgaaggaga 1644600

tgccaggca tggtttctgc cttcaaaaac cccatgctcg gaacactcgg cactaactta 1644660
 gatatggat acttgagat agtccagact agctggaata aagacttaa atgcctata 1644720
 aactgtgtc gagtggtcgt ctctgggtggg ctccctgtac aagtaattt gagccaggag 1644780
 tgatgacgca cacctttagg cagaggcagg cagatctctg tgacttagag gccaacctgg 1644840

 tctacagagt aagctccagg acaaccaagg ctacacagag aaattctgtt tcaaaaaact 1644900
 tgaaaaaaaa aaagtttttg taggggtctt ccatttggtc tctcgggtgg ctattctaat 1644960
 ttatatccc acttacagta ttgccagtgt tccttttct ccacttctca tcaacacggg 1645020
 tataatagct agcctcaag atgtgatatc ctatttgggt ttcaatttgc acttccctga 1645080
 tgattaataa tgaatatgtt tccccgtgtg cctatggcca attacatata ttctggggag 1645140
 aaatgactat tctcaaaaat cctttgttca ttgttgggga ctgatgttgt cttttggttg 1645200
 gctagtggg tgggtagttg gatgggtagc ttaagacaga gtctcactaa gtagccttgg 1645260

 ctggcctgga attttctatg taaatcagac tggctttgat ttcaaaaaga tctccactct 1645320
 gacggctgtg ttctggactc aaagcatgt accaccacac ttaataccac tgtcttggg 1645380
 tattagggat caaacccaga acatgataca tagcaggag ggggcaaaaa cctaccaat 1645440
 aagctacct ttgcctagtc ttaatacaga taattttgtt gccattgcac tgagtgaagt 1645500
 ctttatatat ttggatatt aacatcatgc cagatatatg attaacaat actttttcca 1645560
 ctccataggt gtctcttca cctgataatt gtttctttt ctagtgttaa gtagttaca 1645620
 ctgtcttgt tttgggtgtg ttgtttctat actttggaga tcattaaact aacaaacgaa 1645680

 aaactactgg gggttggcca tgatggtgca tgcctttaat ctacagactt gacaggcata 1645740
 tctctgttag aggccacct agtctacata gagagtcca gaatagccat gactatatag 1645800
 agattctctc taaaaaaaa taagactagt aataataaac tgttgttga gctggagaga 1645860
 tggcccagtg cttaaagata aatactgctt ttctggatca ccaagttcta ttctgacac 1645920
 caacataggt ggctcgaagt cacttgcaac tcagaagat ccaaggggat ttgatgcttc 1645980
 tggcttccat gggcacctac atgcgcacag catgcacaca cacacacaca cacacacaca 1646040
 cacacacaca cacacacaca cacacacaca caaatattgg agccatgtaa tcccagaact 1646100

 cagaaggcag aggttggigg atgatctctg tgagtttgag gtcagcctgg tctacagagc 1646160
 caaatctgt ctcaaaaacca caaaagaata ttgggtcagg gtgaaggctc agtgggtaac 1646220
 atgttcgctg cacaggccta ctgacctgag tttaatgatc cctggaatcc acataaaaag 1646280
 ctgatgggtg gcacacatct gtaatccaa cacttctact atgagatagg aggcggagac 1646340
 agaagaatca gggagaagct cctgtagcat catgggtttt attcttctga actctgggag 1646400
 tgcacatgg cacatgctta tccactca cacacacttg ttaagaaaa tgttgcccag 1646460

accaatgtca cggagctttt cacctacttt ttatgcagtg gttttaagtt tcaggictaa 1646520

 tgtctaagtc ctcaatgaac ttttgttttg aaacaatctt atactgtgtg gtttaaggctg 1646580
 ctttcaaact catagatcca cctgcctctg cctcctgaat gctgaggctc tcagtaaatt 1646640
 ttgagttgat ttttgtgtgt ggtagaagta agaactctagg acctagagac ctgacttaga 1646700
 ggттаagagc actggctgct cttccagagg tcctgagttc aattcccagc acccacattc 1646760
 agctcacaat tgtctataac tccattctag gggatctggc ccccttactt gggcatacct 1646820
 gtgcatacct gcaggcaaaa caccaatgaa cagaaaatga taataaataa ctatttttta 1646880
 aaaagaaagt aaggatctaa tctcattctt ttgtatattg gtatataatc atcctaacat 1646940

 gctcattttg tggggagaga gagaaagaga gagagagagg agagagagtg tgtgtaatgt 1647000
 ttatcagatt aaaaaaatat tgattccttt ttatctgtgt agtactgggt gtctctggaac 1647060
 tcacactgta gaccagctg agctcggacc acagagattc tcctgcctct gcctcctgag 1647120
 tgctgggatt aaaggagtg accactatgc ccagctaaga aatattcttt tttttcttgt 1647180
 ttttattgag ctatttcttc cccatttccc ttcctctctc ctctctcccc ctgaccctca 1647240
 cctcctcccc ccacactccc aatttactca ggagtctctg tcttttctct ctctcctaggt 1647300
 gggaaatatt aattcttgggt ttgctgagtt tgtagatgtg tgcctgtgta tgagtgtgca 1647360

 cgtgcacgcc catggaagcc ataggtggaa atcaaatggt ttctcaatc cctctccacc 1647420
 ttattttgca attttattat ttattattac catgtgtgta cctgtgtatg taggcgtgtg 1647480
 ccacagcata tgttggaag gcagaggaca ctgccagcc tcaccctcct tctttatgtg 1647540
 ggtttcaagg acagaattca ggttgctagg tctgacagta agtgccttct atgcactaaa 1647600
 ctgtcttact agcatcactg tatctgtctg ttagtttttt gagacagggt ctctctgtgt 1647660
 agccctggct gtcttaggat tgtctatatg gacagagatc ctctgcctg tgectcctg 1647720
 gtctctggat taaaggtgtg agccatcact gcctctctc caccgagttg tttggttttg 1647780

 ggttcttgtt tttagacagt tctctaactg aatctgaaga tggctaattt ggctagacag 1647840
 gctggctaaa atgctccagt ggagaaaaag aggtactctg agtgtgccga aggttgatga 1647900
 catggatgga ggctgaagga agtcaccagc caaggggcca cgtaaaaaa tgaacaatga 1647960
 cttacaaagt ggtcatttct ttcttgggtt tcacattgat gctgagtcca aactcaggtc 1648020
 tgtgctatct ccccagctc ctccccagge cttctccca ggtcttttgt atatagtttc 1648080
 ccccccttag aaaatgtatc agttttagtg atgtggtttg gtttggtttt tgcaggtttt 1648140
 tcagagtttg gcaaatgcta agcaagcact ataccagga tacacccat ctcttcata 1648200

gttctttttt ttttctgag atagggttgc tatgctggtc tcctggactc aagtgagcct 1648260
 ggtacctctg cctccagagt tgctgggcta caaatattca accaagccca gctttaagtt 1648320
 gaaaagtfta ggcataaaga atttgccttc accactttgt aagtcacatc tcacttgttc 1648380
 atgtggcacc ttggctggag tcttccgtca gcctccatcc atgtcatcaa ccttcggcat 1648440
 gccagccta cttccttttt ttatactgtc agtgtcttcc ccaaaagtig ctctaactcc 1648500
 agttccagat tccaagtag tatataagct cttcacaatc gcagagaatt ggtacttttt 1648560
 tgtttgtttg ttttggcttt tcaagacaga gtctctctgt gtagctctgg ctgtcctgga 1648620

actcactctt gtagaccagg ctggccttga actcacagag attcacctac ctttgccttc 1648680
 caagtgctgg gattaaaagc atgtgccacc accaccctgc gaggattggt actttacctc 1648740
 atctttagac ttcaaaatgc tttaaaccaa gagtaatgac tcatgcttat aatcccagcc 1648800
 ccaagaatgc tgatgtagga tgcttgctga gatcaaagcc agtctgaact accacagtgt 1648860
 gaaatcttgt ctcaaaaaca aataccaggg gaaagactaa tatgtcgaaa gtatattata 1648920
 tacttgatt aaaatgtctg tataagccca gtagtgggtg tgcacgcctt taattccagc 1648980
 acttgggagg cagaggcagg cagatctctg tgagtccgag accagcctgg tctataagag 1649040

ctagttccag gacagcctcc aaagccacag agaacaatg tctcggggga aaaaaaatg 1649100
 attgtataac acacagtatc atgtataatg aacatacacc acaaaaaatt tttcagaaat 1649160
 aattcataag ctttaaaaaa gaaaagcatt ccaagatctg cctagggagc gagctataca 1649220
 gtacagtaac tcacctatag gatgaagggt atagcagcta tgtcataggg tagtttgat 1649280
 aattaaggat gtagggattt agcaccatac ttggtcccat ccaaaggcga tgtctatgca 1649340
 tctcttagta cattgtctca gcctctcgaa ctacatgttc tgatggcacc tcttctacct 1649400
 acagaaacce ttcagctggg atgatgtttc cttacacggc tgctcttctc ctctccctc 1649460

atcctttagt ctctagtttc ttcagctaaa tctcttaaga ctttatttct agacctctca 1649520
 ctatcacaac ctctttgtt catcctgtaa tggcttagat caagaagtca gaaaacagct 1649580
 gggcatagtg ctgcatagct ttaatctcag cactcaggag gcagaagtgt agacagaata 1649640
 ttctgtcttc tgccagttaa ctctgtccat ccagccagct cccaataac cacttggaga 1649700
 tttcttatta attataaatg cttggctgat agcttaggct tgttactaac tagcttttac 1649760
 atcttaagtt aacctatatt tctaactac actctactat gtggagatat tttttcagc 1649820
 agggcatgtt caicttcttc tccatgcacc tctgggttag tccacccttc tttttctag 1649880

cattctctta gcctggctct tctgcctaac ctcttctgc ctagctattg accagttcac 1649940
 cttttattag aatcaattag agcagcacac attcacagtg tacaagagaa ttattccata 1650000
 gcatttcccc cttttgtct aattaaatag gaaggttgac tcactcactc agtagagcat 1650060

gagacttttt tttttttttt tttttttttt ttggtttttt gagacagggt ttctctgtag 1650120
gtttggaagc tgcctggaa ctctctttga agaccaggct ggccttgaac tcacagagat 1650180
ccgcctgcct ctgcctctca agtgcctggga ttaaaggcat gtgcatcaa cgcccagtga 1650240
gcatgagact cttaatccca ggatcctggg tttagcccc atgttaggca ccagatgttg 1650300

catttatcta ataattctct atcaataaaa aacaggagtc agatatcgag gtaagaacct 1650360
gaatgatcag agcagcatcg gtgaagtgac caatgacttc ctgtctcttc cattectcca 1650420
ttcaaaaaga ctgagatcct ctctatgccc cgcctacta cttcctgtct ctctatctgt 1650480
cctcagtcct ctaaacctc tatgattaat ttgggtccgc tagtagctag caaccccctt 1650540
tgattcaaag caaactttat tgtcagaatg tgatcaaaat atcacacaac atataagcaa 1650600
gcagatatct gtgagtttga gaccatcctg atcttcatag tgagctccag gtcacctgga 1650660
gatacacagt gagaccctgt cttaaaaaat aaatttcaga aaagtctcta aaactaaacc 1650720

agggtgggtg acatacttga ataagagca cttttatgtt ttctttgctt ctcatctcac 1650780
agggttaggg ttcagtccca gagtctaggc aagccagtat acctctgaac aggactgatt 1650840
gtctcagtc tgaactctt gtactacact tgttataatt atattcaggc agccatattg 1650900
cattccatta acttcatggg cttcacagcc acctaccaca tcatagtctt ccaatctgaa 1650960
gtttcacgtt ttttcatacc catacttact tatggagttg gtttcataga tttaaatgga 1651020
taggtttttt tttctctat tctagtteat ctactctcat ccagccttcc gtaecccaac 1651080
atgctttaag ttctttgtgt tcttttccat ttgttcatga accttaagaa tattgtaaat 1651140

atgaaaatc ccataaagtt caaagtacaa gaacctgaca catggtaac ctttagtaaa 1651200
catgtgcaat acttctatca tcatcctaac accaggtaaca gtgtctgtgc ctgactagac 1651260
cttcagtaac tattcattaa tcaatcaata aatgactaga taaaggttca ttcattgggtg 1651320
aatgaatga ataccatcat ataatgaatc tgaagattca tagtttttca agagtgtgtg 1651380
tgtgtgtgtg tgtgtgtgtg tgtgtgtgtg tgtgtgtgtg cgcgcgcatg cgcgcgcgcg 1651440
cgcggtgtgtg tttcaagata ggatttctcc gtgcaacaga attctagctg ttctggaact 1651500
cactttgtag accaggacag ccttgaactt tcagagatct gccttcatct tectectgag 1651560

tgctgggatt aaaggcatgc actaatcgct gcctgacaat ttatatattt ttatttcatg 1651620
tgtatgagtg gttccctgca tgtaagtatg cgcagcatat gtatgaatgg tgtccacaga 1651680
aaccagaaaa ggatactggc tcctttagac tggagttaca gatggttttg agctgctagg 1651740
taggtactag gatccaaaca taggacttct gcaagagcag cagtgttttt aacagctgag 1651800
ctatctctca ggtcccagaa ttataacttt tatattgtcc atttttacag acaaggaaac 1651860
tgagacttgg agaggttaac tgacttagcc tgggccactt acctggaaaa tgatagaacc 1651920

agggctggaa ctctccgac cccatcatgt gactagcctc gccctactct gcttcctcaa 1651980

 atgtatgttc aaatcaagag atcccataag gcttcccag atgtggtttc tcctgttgtg 1652040
 accctgggac acaggatgtg gaaagggccc agcgatgggg agtggagtgc tggagcctc 1652100
 cttctttcct ccctctggg cctctcatgt ttctgtcct aaactctgct ctgatatttt 1652160
 tcccaaggaa ctaacagcat ggtgtgtccc taaggagaga gttttggggc cagagagcca 1652220
 agccaggagag gtgactccat tgctagccaa gacaggggtc aacagactca ggggccaga 1652280
 agagtgggtg taagaatgag gagatctgca ggagacatgt ggttgccact ctgcagtcct 1652340
 ctaagtaaaa aacaacagaa gtcagtggtc ctcttaggag ctggacatgg ttgtgtcac 1652400

 ttttaatccc agaactaggg aggcagaggc aggtgaatct ctgtgagatc aaggtcagcc 1652460
 tggttaacat tgagagtcc aggacagcca gagctacact ttgaggaaca cacacacaca 1652520
 cacacacaca cacacacaca cacacacaca cacacacact cctcatattg cctattctta 1652580
 ggacaatttg aggcacaata gtgacaataa tgtttactga gtgtcatctt tgtgccactt 1652640
 actctattag gttgagtgc tttcaaaatc tcacagctag ttttatgaaa tagataataa 1652700
 atatgatgac taccctctt tctttcttat ttcctcttt ccttcattta ctccctctt 1652760
 ttctcaata aggaaccaag cccaaccaa tggtaacata ctacagtccc aaaagacaga 1652820

 ggaccagcct cggatacaca gtgaatcata aggcagcctg gccacatggc agcacctact 1652880
 tcttgttcaa agctgtaact ttttcttaag atttatttta ttaccaggca atggggcac 1652940
 acacattcaa taccagcact cgggaggcag aagcaggcag atctctgtga gttcgagacc 1653000
 agcctggctt acaagageta gttccaggac agcctccaaa ggcacagaga aaccctgtct 1653060
 tgaaaccctt cccccaaaa gatttattta ttattcatt catttattta tttggatttt 1653120
 ttgagacagg gtttctctgt agctttggag cctgtcctgg aactcactct gtagaccaga 1653180
 ctggtctcga actcacggag atctgtctgc ctctgcctct gcagtgtctg gattaaagc 1653240

 gtgcaccacc aacaaccgtt ttaacattat tttgtttat gaatatgtgt gtgcatgcac 1653300
 actcatgtat atgtattcac acatgtgtgc aggtaccac agaggccata agagggttc 1653360
 agatccctg gagctggaat cataggtgct tgttaccacc tgatttaggt actgggaact 1653420
 gaactcgggt cctcagcaag ggcaacaagc actctaaact gctgagccat ttctgcagcc 1653480
 cttaggcctt ataactgaca gaagacaaaa ctgaagtgtg aaactacaca agcttttgaa 1653540
 cccttcagag ctgaatgact atggagagtg tgaactatgg tgcagaataa aaaccctgtg 1653600
 ttgtttgtgt gtgtgtgtgg ggggggtacg tttgtgtgca catgagcatc caaatgtgtg 1653660

tgtgtgtgtg tgtgtgtgtg tacatgtgtg ttatgtgtat ttatgtagag gccacaggtt 1653720
 gatgtctggt gtcttccttg gtcactctcc accttatggt ttgagacaga gtctctctta 1653780
 ttgaacctgg atctcaaaga ttcagctagg ctggctggcc agcaagccct aaggagctgc 1653840
 tgctatcctt acctcccctg cacagggtct acagacaggt accactctac tctgattttc 1653900
 atgtgggtgc tggggaccaa aactcaggtc ctgaggctg gaggagagat ggctcagtag 1653960
 ttaagagcac tgtttgttct tccaaaggtc ctgagtttaa ttcccagcaa ccgcatggtg 1654020
 gctcacaacc atctgtaatg agatctgggtg ccctcctctg gcctgcaagc agcatgcaag 1654080

 cagaacactg tacacataat aaataaataa atcttaaaaa aataaaaact caggactca 1654140
 cacttatgtg gtaagtactt caccaatgaa ccatctccat tgcctcagaa agttctctat 1654200
 tctttaagca agaattcagt acatcagtat acagcttctt gtgattgtgg tcagatgtgg 1654260
 tgctggggag gagagtctc caaagaggct gttgccctga cctgatctga aggctggaat 1654320
 gaaaggactc ttgccattcc tgggtggtcag attggatccc cagatttgtt tttttgtttt 1654380
 tgtttttgtt tgtttgtttg tttagttttg ttcagggttt ctctgtgtag ctttggaacc 1654440
 tatcctagca ctactctgt agaccaggct ggectcgaaa tcatagagat ctgcctgcct 1654500

 ctgcctccca agtgcctgga ttaaaggcat gcgccaccaa cactggctgg atccctagat 1654560
 ttgtatgaag cggctgtaaa gtgtgggttg ttcccttgag aaaaagagct ccagggtggt 1654620
 ctgggggtgg aaaggaagct tcaggggtat ccagccagag ttaagactat tcaactcagt 1654680
 cctagccctt caacaggaag agctctgtga ctgaggtgat cctctgttgg ggctaaggca 1654740
 agaactttcc aagaacaag agataaaca cctaggaat aagtacttgg ggcagccagt 1654800
 gccacctgtg accccttccc gctgtctctc tgectgtggg tttctagcca cctcgcct 1654860
 aactgctct tctgtatcc atagctgtct ccttggcctt gccagaacct tcctctgggc 1654920

 tcattctctt ctcacacacc aggctctgt ctgctgtggc agctcttttg tttacttcca 1654980
 gagctcccag gcacactact agccaaacac aacgaagcca agccagagag aactctgttc 1655040
 cagactcagt cttgccctc tgggacaggt aatggcctcc aaaccaagga ggcagctcaa 1655100
 aagagggtg cccctacac tgggtctttg cttcaggtcc tgacaacca aagggaaagg 1655160
 acacaagacc tgccattgt tgggcaggga tcctactct tgagacagct ttggctggca 1655220
 gccctgggaa tcaaagacc agctggagag aggtggggaa aatttgagg ccctctgggt 1655280
 gggaaccaga gacttggact tttgtcttg tgtgtctct tagccaggtg gattctgacc 1655340

 ttgagccctc ctctctggga tccaggtgcc taatttccc caccagagga ctgtctctc 1655400
 caaaagtta tgtccatc ctcttcaaag attctagtga agaaaggga atgagcattt 1655460
 actgtgggcc aagttccaag caggaagcac tgtgaggata tgcctggcat tttctgtccg 1655520

tctgaggatca acagggagat gggtgattgg tatgtaatta tgtacttgta taatgtaaga 1655580
 tgtaaagga ggactcaact tctgactctg aacagtcaag tgcttcgac acacagagcc 1655640
 agagtgcagc agaggggtcc caggtcagat catgctggtc atgccagaac agtggccaat 1655700
 ggtagaaatg aggtaacacc atagggagga ggagacccat ggcagcccag attcttcaga 1655760

ggaaaaaagc agaggacccc ttcagtgaga cccagtcaag tctgtgatta gggacactgg 1655820
 gggaccagg attgggcaaa tgctggtaa cgaagtggag ataattgaa aggaaaccag 1655880
 ggccccctcc cactcttaa ggcttcattt tggagaccgt gaagttgatt aaggaatgta 1655940
 aaactctaac tctttgctag gcccgaatgg agcagaagga gctggggacc aatgggcctt 1656000
 tgaaggatc aggaatgggg ttagaggtga gcactggcca tgaccagctg tactctgggc 1656060
 ctcatctgc ttcagttccc aggagtgggg gtgggtcca agcctgggaa acagttcata 1656120
 cctgaggcaa cctacctca ctcatagggt tagcaattct gtaaggggtc tggggcccct 1656180

ggagtaaca agaatccgc tacaacttta ggcatgaaga ttcagctttt tatctcatca 1656240
 acgtacatt tagtctaaca gtctaataag ctcatactct acccaagtcc ttacccttc 1656300
 tccaccagcc caggcaaaga gcatetaatc tgcctacgg gtggaaagtc accaggcaca 1656360
 aagtaattc aaggaggggg tggcactgct gctgtccat gaagcgtta ggatatcacc 1656420
 agtcctctg gagaccgagg aggccggagc aggagggatg atggcccag tctcctctcc 1656480
 tgggtcccag tccactcag agtctgttct ctggcctgt cactgcctgt cagaggagca 1656540
 gaaggcagg aatctccaga tggggcacgg ttagccaga tcacaccag agagtacatc 1656600

cattgaaatc cctttctg caggetgtcg ggatactca caaccctct gtgattccag 1656660
 gagcatgtgg aggggttctc tctggatgt ccaccctgga agacagagg ccggtgctgc 1656720
 tactgcagc cacaagattc cagccatg tctcgtact gttatacac cacgttgttg 1656780
 gcagagtcaa tgaagaggat gctaagggga ctcagccgtg tgggcacaca gcaggtgggt 1656840
 ggtgtggatt cagggtccat agaattcatc aggtctgga tgactgcatg gtttgtggc 1656900
 tccaagtggg agcgaagg gaactcgeat agtctctgc aatggaagc ttcgtactca 1656960
 aggggtgcaa tgatccagtc gtcccagccc atgtcctga agttgacatg caaagctttg 1657020

cgactgcagc gagccttgag gttctgtctc ggtcgttgc cctggcgatt gccagtgagg 1657080
 gcccgcggtt tccgcgctg gctgaacagg tattcataca cagtcttgc atcctggcca 1657140
 gagcggcct taatctcatt aaagaacagg tcccgttct tagtacgacc aacaccagg 1657200
 aacagggcct tctcgtggac ttgtcggca gcgcgttcaa agcccaggcc gcggaggtcc 1657260
 acagcccgc cccgttccca ggctccagc tccaggcaca gctgtgctga gttcttaaaa 1657320
 tttcggaaga gttccagat gtcgaacacc tcccagccag atccatccag gcctggcacg 1657380

gagcgacat ccagcaaggc tgccggctgc cggccgctgg ggcagctgga cagcttcagc 1657440

tgggcaacce gcccgctact ggggaccgct ggcttggeca tgtccaaggc cttcttcctg 1657500

aggatccgca gttcagcccc caacagccca tcctttctcca gagcactgat gtcaaacacg 1657560

tacctctgct tcctgaccac agggcctcgg tcctctggag aaaacagccg gaagtcaatt 1657620

cttgtcactt caccaagata gtctagcctg ccacctcgga gcctccaggg aggacctaac 1657680

tctctccca ctaaaagaca ttctttaac ctcttcccca ctatggccaa agccaacacc 1657740

caaaccacca agagcccttt tccaaatgaa ggtaggtgtg ccactttgca cgatctcagt 1657800

gcctcgcca ttcgtgatct gtatgagagc catcaaacag tataccggtg tccgccccac 1657860

ccatgagcac attattatct cccatcgtg agacaggtga tatgtgcatt taaactacce 1657920

actcttcagc aggaggaacc tgccgctcag agtaagttag gggactcatt caatgtctc 1657980

tacctggggg aaagtagaaa tagaactgta gcctagaact tcaatactcc tttcgagctt 1658040

cctccacctg aaggacctta gcgtttttgt tctgggcaag gcacagagtt ggggagtaaa 1658100

ttgatgtagg taacacagca gattaataac aaagcccatc tgcaactcaa ctccctagt 1658160

ttccagtctg acaattttgt gtccatgagt gtggttcgtg tgtgtgtgtg tgtgtgtgtg 1658220

tgtgtgtgcg cgcgcgcgcg cgcgcgcatt cgcgtgtgca attgggttcc cgagtgagta 1658280

taaagtaata tatatgctat tggcacatgc aagtacagtt gggcttcaat gactacttga 1658340

aaaatgatga tatatgatg tatgatggtt tgtgattcgt ttaccatgtg tataaaatac 1658400

aaggctctgt gtgtgtgtgt gtgtgtgtgt gtgtgtgtgt gtgtgtgtgt gnnnnnnnnn 1658460

nnnnnnnnnn nnnnnnnnnn nnnnnnnnnn nnnnnnnnnn nnnnnnnnnn nnnnnnnnnn 1658520

nnnnnnnnnn nnnnnnnnnn nnnnnnnnnn nnnnnnnnnn nnnnnnnnnn nnnnnnnnnn 1658580

nnnnnnnnnn nnnnnnnnnn nnnnnnnnnn nnnnnnnnnn nnnnnnnnnn nnnnnnnnnn 1658640

nnnnnnnnnn nnnnnnnnnn nnnnnnnnnn nnnnnnnnnn nnnnnnnnnn nnnnnnnnnn 1658700

nnnnnnnnnn nnnnnnnnnn nnnnnnnnnn nnnnnnnnnn nnnnnnnnnn nnnnnnnnnn 1658760

nnnnnnnnnn nnnnnnnnnn nnnnnnnnnn nnnnnnnnnn nnnnnnnnnn nnnnnnnnnn 1658820

nnnnnnnnnn nnnnnnnnnn nnnnnnnnnn nnnnnnnnnn nnnnnnnnnn nnnnnnnnnn 1658880

nnnnnnnnnn nnnnnnnnnn nnnnnnnnnn nnnnnnnnnn nnnnnnnnnn nnnnnnnnnn 1658940

nnnnnnnnnn nnnnnnnnnn nnnnnnnnnn nnnnnnnnnn nnnnnnnnnn nnnnnnnnnn 1659000

nnnnnnnnnn nnnnnnnnnn nnnnnnnnnn nnnnnnnnnn nnnnnnnnnn nnnnnnnnnn 1659060

nnnnnnnnnn nnnnnnnnnn nnnnnnnnnn nnnnnnnnnn nnnnnnnnnn nnnnnnnnnn 1659120

nnnnnnnnnn nnnnnnnnnn nnnnnnnnnn nnnnnnnnnn nnnnnnnnnn nnnnnnnnnn 1659180
 nnnnnnnnnn nnnnnnnnnn nnnnnnnnnn nnnnnnnnnn nnnnnnnnnn nnnnnnnnnn 1659240
 nnnnnnnnnn nnnnnnnnnn nnnnnnnnnn nnnnnnnnnn nnnnnnnnnn nnnnnnnnnn 1659300
 nnnnnnnnnn nnnnnnnnnn nnnnnnnnnn nnnnnnnnnn nnnnnnnnnn nnnnnnnnnn 1659360
 nnnnnnnnnn nnnnnnnnnn nnnnnnnnnn nnnnnnnnnn nnnnnnnnnn nnnnnnnnnn 1659420
 nnnnnnnnnn nnnnnnnnnn nnnnnnnnnn nnnnnnnnnn nnnnnnnnnn nnnnnnnnnn 1659480
 nnnnnnnnnn nnnnnnnnnn nnnnnnnnnn nnnnnnnnnn nnnnnnnnnn nnnnnnnnnn 1659540

 nnnnnnnnnn nnnnnnnnnn nnnnnnnnnn nnnnnnnnnn nnnnnnnnnn nnnnnnnnnn 1659600
 nnnnnnnnnn nnnnnnnnnn nnnnnnnnnn nnnnnnnnnn nnnnnnnnnn nnnnnnnnnn 1659660
 nnnnnnnnnn nnnnnnnnnn nnnnnnnnnn nnnnnnnnnn nnnnnnnnnn nnnnnnnnnn 1659720
 nnnnnnnnnn nnnnnnnnnn nnnnnnnnnn nnnnnnnnnn nnnnnnnnnn nnnnnnnnnn 1659780
 nnnnnnnnnn nnnnnnnnnn nnnnnnnnnn nnnnnnnnnn nnnnnnnnnn nnnnnnnnnn 1659840
 nnnnnnnnnn nnnnnnnnnn nnnnnnnnnn nnnnnnnnnn nnnnnnnnnn nnnnnnnnnn 1659900
 nnnnnnnnnn nnnnnnnnnn nnnnnnnnnn nnnnnnnnnn nnnnnnnnnn nnnnnnnnnn 1659960

 nnnnnnnnnn nnnnnnnnnn nnnnnnnnnn nnnnnnnnnn nnnnnnnnnn nnnnnnnnnn 1660020
 nnnnnnnnnn nnnnnnnnnn nnnnnnnnnn nnnnnnnnnn nnnnnnnnnn nnnnnnnnnn 1660080
 nnnnnnnnnn nnnnnnnnnn nnnnnnnnnn nnnnnnnnnn nnnnnnnnnn nnnnnnnnnn 1660140
 nnnnnnnnnn nnnnnnnnnn nnnnnnnnnn nnnnnnnnnn nnnnnnnnnn nnnnnnnnnn 1660200
 nnnnnnnnnn nnnnnnnnnn nnnnnnnnnn nnnnnnnnnn nnnnnnnnnn nnnnnnnnnn 1660260
 nnnnnnnnnn nnnnnnnnnn nnnnnnnnnn nnnnnnnnnn nnnnnnnnnn nnnnnnnnnn 1660320
 nnnnnnnnnn nnnnnnnnnn nnnnnnnnnn nnnnnnnnnn nnnnnnnnnn nnnnnnnnnn 1660380

 nnnnnnnnnn nnnnnnnnnn nnnnnnttta ggtgaaaata attaccaca cacacacaca 1660440
 cacacacaca cacacacaca cacacacaca cacaacctg cagggtgctca gaaaaatctt 1660500
 ttacaaacct gaactcagga attggaacg gaattccaac ccaaaccaat ttaattactc 1660560
 tctgatgta tgetgtctaa attcatitaa gtgcgatata tttatgtgaa aaaaatcacc 1660620
 actgcccttt agaggccacg actcacgggg gctcttggct cagagcccca cagcgggact 1660680
 caggcttagg gggcctccca accccagaac agacttaggg gtcttcacct ccaccgctg 1660740
 gagcagccca cccaccatc ctgagcagag atgctgagga atgagttgca aagacctgca 1660800

 ggcactaggt atgcgagtta ggtttttcag tgaagtccga ggagigtcta taaaacagtt 1660860
 tcaatccctc tgtctagtct gggacctggt gtgtgctgct gtgtgtgtgt gtgtgtgtgt 1660920
 gtgtgtgtgt gtgtgtgtgt gtgtgtgtgt gtgtgtgggt gtgtgggggg ggccgcggag 1660980

gcggnnnnnn nnnnnnnnnn nnnnnnnnnn nnnnnnnnnn nnnntgttgt gtgtgttgt 1661040
 gtgtgttgt gtgtgttgt gtgtgttgt gtgtgttgt gtgtgttgt gtgttggggg 1661100
 ggagcacag atggcagcat ttaccacag tttctttat tttataaac ttgtgacca 1661160
 gaaacagaaa aaaaaaata gtgccatta taccacccc accaaatgcc attcgtaag 1661220

 cactgccatc ctgtagcccc cttggttga aacaggtcca gagtgagtgt acacaggcaa 1661280
 agaccgccag tttcttaga agaaattggc tggggccaga ggtagcagcc cctgcctaag 1661340
 gcagcagca ccctgcagg aagtgggaag agaaagtct catggactac ttgtgaata 1661400
 gctggtggag aaagctgaat tctgtctca ctcaagagtg ccctcgcct tccttttctt 1661460
 cttctcttt agacaaggtc tcatgtagcc caacctggcc tcaagttcac tatgtacca 1661520
 aggctagcct tgagctcctg atcctacacc taccagagcc tgagatgaca gatatgtggc 1661580
 accacctagc tacaagggtt tctaaatg cttgtctaaa gtatttaaac accctttctt 1661640

 tggagattcc gtgttataga gccctggga acttactcag ggtcaaggag aagggggagt 1661700
 gaaaccccag gcctcctca agtgtgatag gaaacacta ccgcagagct ccaccctag 1661760
 tccagagtct ctccctttt cttgagacag tctcctgtgg cgaaagctgg cettggactt 1661820
 gcaatattag ctgaggctgc cctggaagtc ctgatcctcc tacaccacc tccttggtta 1661880
 cagcgtggga ttatggaact gtaccactg cctagcctt cctttattaa tectcaaatc 1661940
 ttgcagctga ctaacagat ccattcacac gctaaagttg gttctagag actctctgct 1662000
 ggagtctagg catgtaactc agtagtctcg tgcatggtta gcatgcacag agccctcacc 1662060

 aagacaacce caaacaagt cctcactcag gatagctaag tggetgcaag tetatttct 1662120
 ttttaaata tttactttg tttatgtgia tgtgtggga gaggtgcca caggagacca 1662180
 gaaaagggtt ttaagtcct tgaagctgga gtggcaggca gctgtgtgcc accctgacat 1662240
 ggggtgccggg agcagaatc tgtcttccc caagcagaaa gtaactttt tcataatgtt 1662300
 gttcctggtt cacttactca gccactcaa gttcattga tagctccagg tctgaagcct 1662360
 ggacttcaa ggaccaagc accactgct ttcttcagcg agcttgagg atggcttga 1662420
 ctcatcag tcctcaagt caccagcc cagcactctt gtctttgctt ctgacttctc 1662480

 ttcttactgt cctctctggc atcttctcc tacagtctct gtcactatcc tgacccttct 1662540
 cacgtttta cctgccacat ttcccttaga actgacttct tggctccag gacctcttcg 1662600
 tcctaacce cccccacca caccacacac acacctaaag cctaccact gagcaagagc 1662660
 tgaccagct gctacttgac acaaagtcaa cgcttactcc ccaggaaagg catgaagctt 1662720
 ccaaacaaca ccacatact gctaggtttc tttctgctct tagagttcaa atccaccag 1662780
 ccacagccct tgctccatct gcaagtagt tcagttttc acagtctgtt tgttttttc 1662840

atagttttat tttaaactgaa ttccttatgc ctatcataat ttatgaacat atctgtctat 1662900

cccattagat tataactaca ctgtaccata tttgtctttc aattattccc aggccttggc 1662960
acagagccca gcacagagca gattctcagt gtgtgttgta tgaatgactc tcagactggc 1663020
ccttttaaag aaacactgtc attttctttt ttatcatttc tttttaaaaa ttagaataaa 1663080
taatgggttt cattgcgata ttttcatact tcatattatt acactttggt catattctct 1663140
cccctatctt ctcccacaac tcagactcct tcttcgacaa aagtaccctt tetactttcc 1663200
tgttctatct ccatatattt aaatatataa cttctgcata agaaagaaa taattggatg 1663260
ttcgtgtccc ttccccacc tccattagtt tactgttccc acatcttcca gtagccactg 1663320

gtccttcttc tgctttcaag tcatatataa aaatctagat gctaataata gagaaggcat 1663380
gtgttattta tctgcaaagc catcatttta aacattcccc gccttttcta ctgtacttga 1663440
gtccctaaaa gggagagacg ctattttgcct accaagaatt ttctaagctc tatectctgg 1663500
ataaacaag ctatgaacca gtccacgtag acatccaatg agtggttgat aaagatggag 1663560
gttctgcagg caggtctggg tttgattctt ggtggttctg ctatttatac actgtgtgat 1663620
gcccggagagc ctccaacca ctctgcagct ctgagcaggg gtaatgacag tactgtcata 1663680
caaagagctc ctgtgggtat ttgggggagt gaattattaa aaacctgaga agatagctgg 1663740

agacatggct cagtgggtta aagggtcctg ccaccaagcc cgacaacctg agcttgatcc 1663800
tcaggtccta caaagtagag gagcaaacag aaccaacttt cacaagctgc cccagtcctc 1663860
acctctctga acacatgcac acatacacac aaaataaata ctgtgtaatg ttttaaaaac 1663920
tctgataaat gttagtaaca gctacacctt gaggacatat tctccatcag atactggctt 1663980
gtgttctatt acttttaaaa ccttacttca caaccacacc cactctgaa caacttttgc 1664040
tgacgatcct tttagctccc ttcgttttac agacaaataa attaaaagt taaattactt 1664100
ttaaaaatta tttctttgtg tgtgtgtggt gtgtggtgtg tgtgtgtgtg tgtgtgtgtg 1664160

tgtgtgtgtg tgtatgtgtg tgtgtgtgtg tgtgtgaaca tgtgtgtttg gtacccttat 1664220
aggccagaag aaggcactga atcctctgga gttcaatttg taggcagttg gtgcaggttc 1664280
tgagaactga gttcaggctc tctccaaaag cagtcagtgc tcttaactac tgagacatct 1664340
gtccagccca gctcacaac ttatttatcg ttactatgaa tgtgcatgca tgggtgcatg 1664400
gtcccacca cacacacctg gaggtcagag agcaccittg caaagtctgt tttctccttc 1664460
tgcccttact tgggtcccag attgaattta ggccaagctt ttgtgacaag caccttcacc 1664520
cgaaagctgt ctactacc caagttactt ttgaagctca ctttctgctt ttccaagttt 1664580

tgttttgttt ttgttttaca agacagggtc tctctgtgta gccctggctg tcttggaaact 1664640
 cactttgtag accagctgcc cttgaactca gagatctacc tgcctctacc tccagagtgc 1664700
 tgagatcaaa gaagtgcgcc accaccacct ggcaaaacttg aactcgtgaa tctccttctt 1664760
 ctactctgtc tagtaggatt gcaggtgtgt attactacac ccatcccttt ccccatattt 1664820
 ttaaaaatga cattaaaatt ttttatttct ctttctttct ttctttcttt ctttctttct 1664880
 ttctttcttt cttcctttct ttcttgtttt tgagatcagg tctcactatg tacctctggc 1664940
 tgtcccggaa tccactctgt agaccaggct ggtctccaat tcacagagat ccacctgcct 1665000

 ctgcctcccg agtctgggg gatcaagatc tagcttaaca ttgtatttct gtttatatgt 1665060
 agtggcacac agaagtccagg gaataacctg ggggagttgg ttctctcctt ccaccacgtg 1665120
 ggtctccagg accaaactcg ggtcatcagg ttagagcgtc atctttatcc actgagccgt 1665180
 ctcaatgacc ctttaaagca cattatgcaa gaatctcgtc ctagaaagtg gtcataagtg 1665240
 ataaggtggt gtggtgggga cactagggaa ttaactttc agccacggac tcatccagcg 1665300
 gtctggaact tggaggacac agaggagtct cagacagggg ctattgtctg aagaccaggt 1665360
 tgggtaggag caaggaaaaa actccaatc tggatggaag gccctctcca gggaggagcc 1665420

 cagagtctct gcctggctct tactataaag gtgactaatc actttggtcc cctctggtaa 1665480
 ttgcaaccag atgctgtctc tggctatgct tcagtcccga catgtttaat tactgggaca 1665540
 cagagtctct gggctccctg tggctccctc cctccccat tctgtcagc aatattaatg 1665600
 tcaaacctaa ggtagaggat gggagccttg ggaagccact ggcatgaaa taatctttac 1665660
 aggccttcc actatgtaaa gcctttaatt tctttaaata tttccccatc cattatctca 1665720
 ttggcacctc acaaaacatc cttataaagc cagtaagcca aagtattact agacaaacag 1665780
 agagtgaact gaagaataat aatcccttgt tttattcaaa cattaggaag tttcaaagc 1665840

 atttcatatt ccttatgttc cctcaacctc ccaaggctc aagttagacc aacagggcac 1665900
 agtagctgag agatggactc aaggatgga tagcccagtt tatgtcccag ctctgccact 1665960
 ttccagttga ccggccttgg gtattcatcc gtttacttaa ttatgagcac taactatata 1666020
 atagtgatca agacatcaaa gtctgtgttc aaatttcggt gaaagagaca aataaatgca 1666080
 cagtttgaag gaactataag tgctgtgtgg gaaacaaaac agttgatata gtgtctgttc 1666140
 tagcaaggag tgtctcaccg aagggttgtg tgttggcaga gatggagaca tagggaggcc 1666200
 tctgaggtc tgcaagatga tcattccaga tggagggcc agcatatgcc aaggcccaca 1666260

 gttaggaatg tgctgggtac aagtgagaaa ccaaggaaag ctggtgttgc taaagcagaa 1666320
 agagccaggg ggttgaatca tatgggagat caagtcagac atgtcagaac catatcagtg 1666380
 tggctttgta agccatgaac agtgagttca gttgtatttg tagtgcactg gagagtcaag 1666440

caggggattt taggcagccg agatgtcaca taataactaa tacaagcta ccaaccttca 1666500
 aataaaccca gagcctggat tcacaaatta tfgatctca attaaatttt ttaaaccttc 1666560
 ataaacagat ttattttatt gattgattta ttcattatgt atacagtgtt ctgcgtgcat 1666620
 gccagaagag ggcaccagat cttattagag atggttgtga gccaccatgt ggttgctggg 1666680

 aattgaactt aggacctctg gaagagcagt cagtgccttt aaccgtgag ccgtctctct 1666740
 agccctcagt taaattattt gatctcactg taactcagtt tagtaacta tatgacaaaa 1666800
 gtaataataa aatcttttgg gggctggaga aatggcttag aggttaagaa tgagtactgc 1666860
 gtttccaaag gacctgagtt cacttcccag caactacatg ggggtggctca caactacctg 1666920
 taactccagc tccagaggat ctgacaccct cttctgactc ctgacacaca tgcatttaaa 1666980
 catggacaca tcacatagag acacacacat atgcacataa ttataaataa attaatgatt 1667040
 ttgaaagatg aagtatggct gaacatgtgg tgcaggcctt taatcccagc actcaggagg 1667100

 cagaggcagg tggatctctg tgagttcaag gcctgcttgg tctacagagt gatttccagg 1667160
 acggccagag ctgctacata gagaaccct gcctctgcca ctctagagca gttggttctc 1667220
 caaggtgccc actgcccccc cacatcttcc cgcctgectg catctggtct gttgatcaagc 1667280
 gttcagggtg gagagacaaa gagctgtatg cctctcagca acacaagcac agaagaaatg 1667340
 ggggggacag ggtgggaagg aggggaacct tctgagaaga aaagtggctg tgggttgggtg 1667400
 cctgtctgtg tacagggggt gattgtagc agagctgtca tgcatggtg tacaagtttt 1667460
 gcactaatta aggatgccca gttttagatg ggtggtggtg gtgcatgact ttaatcccag 1667520

 cactcagaag gcagtgccag gtagatttct gtgacttca ggccagcctg gtctacagag 1667580
 cgagtaccag gacagccagg actacacaga gaaaccctgt ctcaaaaaca aaataaagga 1667640
 aggaagatg gaaagaagtg tgggtgtgtg tgtggagggt cctgtctgca acattagcac 1667700
 ttatgttacc agtgggcaga atctgggtca ggcattttta gttcttgttt taggttcttg 1667760
 actctgtgtg tgtgtgtgtg tgtgtgtgtg tgtgtgtgtg tgtgtggtta gctctggctg 1667820
 tcctggagtt catagagatc tgcctgcctc tgcctcccaa gtgctgggat taaaggcatg 1667880
 tgccaacacc gcctggctct acagegceat cttatggaag cattttcttg aggttctgc 1667940

 ctctcagaaa actttagctt gtgtcaattt gatataaac tatccagcac aatccccatc 1668000
 accacataaa ttggtatggt ggcacttggg agctggaagc aagagaatca gggteatcct 1668060
 tagccttggc tggctctggag cttgctatgt agaccaggct ggcctcaaat ttctagtgat 1668120
 ctgtctgact atgcctcctg agtgcataat accatactcg gtggttcttg acctcttatt 1668180
 taagggattg agataaaggc tcacaccaac tgcaaaaagca acaaggaaat tctccaaagc 1668240
 agagcaatag aataggtcaa tacaatgtca acagtggtag cggggggccac tgagttggtt 1668300

ttgtgcctgg taaaagtact tgctgtgcaa gcctgatgac ttgagtttga tccccagaac 1668360

 ctgcataaag gtagaaggag agaactgact ccaacaaatt gttacctgtc ctccatattg 1668420
 gcagcataac actcgagccc ccactattat attctatcaa atgcaaaagt tattcaaagc 1668480
 cagtgcatag taagctatat aagaccttgt atcaaaaagg aaaggaagaa aaaagaaaag 1668540
 ggaaaaagaa agagaaaagaa gaggaccaag ggagatgcct aggtggttaa aaacatttag 1668600
 tgctcttcca gaggctaaga aactaactg ctcttcaga ggacctaagt tetgttcta 1668660
 gcaaggatat ccaggagctg tctaaactcc tgttaacttc ttctgaagg gatctggtgc 1668720
 ctcttctgg ctcttaaggg cactgcatgt aggcagtata ctacacacac acacacacac 1668780

 acacacacac acacacacac acacacactc atcagtaaga aacaaaaaaa atcaaattat 1668840
 ctgacatagt tgtgtgaggc aagaggatcc ccaagctgga ggtgagtcta tatagttgac 1668900
 acaatgtttt tttttttta atctactgcc cccccccaca aactcctacc tcacaggtaa 1668960
 cagttagga ccigaaaac tttcttgcca tttgtttgt ttgaggaagg atattgtgta 1669020
 tccccgggtgc aaagtccag ttggtcttga ccagttatc atgctgcct tactgctggg 1669080
 ttgcaggtcc atgctaaaa atttagcttc tcgacattg gggggggggg gaaggggaca 1669140
 acgacaggtt ttctctgtgt agctttggag cctgtcctgg aacaggcttt gtagaccagg 1669200

 ctggccttga actcacagag atctgcctac ctgtgcctcg ggaatgctgg gattacaggc 1669260
 gtgagccacc gcaactgctta ctcttgcca ttcttgagct cagaaacctc agattcttgc 1669320
 ttggtttccc ttctaccat cctcttcca ttctctctt cctccatctg acttctaaaa 1669380
 gtcttctgct ctgggataca aggagaacac tgaggcaggt tgtcctttgg gggtaaagaaa 1669440
 tctcatagaa gagtatcag caccatggac agatagttag cagtactgca ggggctctaa 1669500
 ggagagctca agcacacct gcagagttgg ggggggcgtc ccttctcata ggctcagag 1669560
 gtagggggtt ccttctcatg ggctcagag gaaaggaggt ctcatagcag gagctgtcag 1669620

 ctggggtgtc tgattcctag atggcatagg agagaaggga tgtgccacat tgaggagata 1669680
 gggaagttag gaggacatct agttgaggtg taccattat ataggtcagg gtatgtgtca 1669740
 ccactggttag tcttgaaac ccattctgta aacttccttg gggtggtgag aatggtacca 1669800
 gtcagactcc tggaatcacg gtacctggtg aatctgttta cagactcaca gacagctct 1669860
 ccagcagga tcacagagcc aaccacaagg atggagacag cgatggctat agataggcac 1669920
 aactagagca ctatatggtc tgggattctt ttttttaag atttattta tttattatgt 1669980
 atacaacatt ctgcttccgc aaatatctgc aactagaag agggcaccag atctcataac 1670040

ggatggctgt gagccacat gtggttgctg ggaatggaag agcagtcagt gcttttaacc 1670100
 tctgagtcac ctctccagcc ccatggtctg ggatttctaat gattcaaaaa aagaacccta 1670160
 gagtagtgtc aataaggtgg atcacaggta agggcacttg ctaaactgga caacatgagt 1670220
 tcaattcctt gaggccacat aaaaggagag aactaacacc aaataaataa ataaataaat 1670280
 gtaaaaccaa acataaagca aaacaaactc caaaccccaa gaacccagcag tgacatgtaa 1670340
 tcgataagaa gttaagaac tttattagct gggcaatggt ggcatactcc tttaatccca 1670400
 aactgggga ggcaaaggca ggtgacttcc taagagttag agcccagcctc tgtctataaa 1670460

 gtgagttcca ggacagtcgg ggctatatag agaaatcctg tctcaaaaa aacaaaaaca 1670520
 aaaacaaaac aaaactgaaa gaaatagcat agcacctcat cttgaaattt cacatacgta 1670580
 atttaaaaa aaaaaagag gaaactagaa caataagtaa gtttgataca gggtcacat 1670640
 tggacctgca cagaaggtga tttcccagac attcaattta ggatgtaaaa gatgtgcagt 1670700
 ttgcctgagg tgactggggt ccgttattcct ttaactcatc catttctctc tctcctctcc 1670760
 ttcctctcc caagactttt taattttctc cttataggcc tttgtcctc caaactatga 1670820
 acaccattt gttgtccaa atgtcccttg cactgtgcag gaagcccaa ggctcatgta 1670880

 tccactatgt gcccagacta tctctagggg acagtgtcac ccacttttcc acatcaggaa 1670940
 cccacttcc tgctttggcc caggtagttc ccagtgttac cacttaatat ttttatagaa 1671000
 ttttcaacag gttgttaaca cattgtgtta ttatctgata atagaacata actgctcaat 1671060
 aatgcttgc tgggtaaat gataaattaa taaggacagg aaagactccc catttacaaa 1671120
 gctcaatgat tactgtttga tattgatttc ctactttatt gaccccttt tattggtata 1671180
 ttttgtaat ctgaaaccta tatccactcc ctaaagtatg ctggcagttt gctgatggat 1671240
 tttctgtttt aatttttggg tttcgagtca gggctctcatg tagtacaggt tggctgtgaa 1671300

 actctttttg tagttgagaa tgactttgaa ctgctgatag cctggcctcc acctctcaaa 1671360
 tgctgggta acaggcctgt ccactatgcc aagtctatc agaccagag cttcacaat 1671420
 gctaggtaaa cccactaac tgagccacac tcccagcccc tgctgatgga tttttaaaaa 1671480
 agagttactt attaattatg tgtatagaat tctgcatcta tgatgccta caccagaaga 1671540
 gggcaccaga tctatttcta gatggctgtg agccacatg tggttgctag gacttgaact 1671600
 caggacatct ggaagagcag tcaatgctct tagcctctga gccagctctc catgccctg 1671660
 ctgatgcgtt tttatctcag taactttttt aaacctgagg acagcttgac ttatccagtt 1671720

 caatggatac ttactaaaca cgtgtcagac tacatgagaa acactctcat aacttcatga 1671780
 agcttcaatt tcatagggga aaagtatgaa aatggtaagt cagtaataa aaagtagaat 1671840
 gactataaaa gagacagaaa agcatgatgg gaaacatag ggcaagtctt actcttcaaa 1671900

aattatntta ttagggctgg tgtgtgtgtg ttcgaacaca catgcacagg tgtacatggc 1671960
cttggcatat atatgtacag gtcagaaggc aacttttggg agtcagttcc cctcttctac 1672020
tataggttcc tgggatctaa catgctgttc aggcttgcac ttttaccat ctcagccgct 1672080
tgagcttcac tgiagcaagc atgtgaggga accattagag acttagacga cctagtggcc 1672140

catgccttta gtcacagcac tggggaggca gaggaagggt gatctgtgtg agttcaaggc 1672200
cagcctggte tacagagcga gtgccaggat agccagggtt acatagtaaa atcctgttta 1672260
aataaataag taaataaaca aacaataaa taatgccagt taagccaaca gctgagagta 1672320
aggtaagaga gggggggtgt agtgtttatt taggtagagg gtaaaatag taaaaaggcc 1672380
tagaggcaga aaagatcagg tatgtctaac attaaggttg ttttttttt ttccaacac 1672440
agtaacagag tttgttttg tttgttttt gttgtttct tttttgaga caggaacatg 1672500
tcctggaact cagtctgtag accaggctgg tctccaactc acaagagatc cacctgcctc 1672560

tggctcctaa gtgctgggat taaaggcagg caacaccacc tgctagcaac agagaccatt 1672620
cttgcacagg acttgggggt tgttttctg gactgagcgc tctactacaga ttctttgcag 1672680
ctctttctcc agggctctga gatgtttctt ctctctgctc tagatagctt gtttttcgga 1672740
actacttgc tttcaatac tccaccacac cctcaaagt aaccattaaa gggccagcaa 1672800
gatagctcag caggtaaaag gcatttgcca cagagttcaa tgacccagc ttgctctctg 1672860
gaacccacag agtgaaggga gagaaccgac tctgcaatg tcttctctga cttcacatgt 1672920
gtgcattcac acatgtacac ataaaaaatt ttaaatttaa tgtaataaat tagggctgag 1672980

ctgggcagtg tgggaacact cctttaacce cagtatttag gagacagagg caggtggatc 1673040
ccagagtccg atgctagcct gcactacagg gtgaattcca ggatagccag ggatacacag 1673100
aaaaacctg tcttgaaaa acaaagtttc ttatataaag gatataaata gagggtcaa 1673160
agggtaaaga tgtttgctcc ccaagcgtgg accttagttc agatccaatc acataaaaag 1673220
ctgtgaggaa cttacaaagt gttcccttct cagattccct ttgtgtctta actcttctcc 1673280
ccaccctct ctcttcttt tccagacagg gtttctctgt gtagtctcgc tctgtagacc 1673340
aggttggctt agaacacaga gatecccttt cctctgctc tccagcgtg ggattaagca 1673400

tgtccaate caccaccag ccaactggtt ctcttgtgta cacacaactt gtacaactta 1673460
tacattggtt tactcaaac ttgtgggta tctgtttgt accagcctcc tctgtctca 1673520
aggagctcag tctttttag tggccacagg gcaaatcat gttgggtatt tgcaataatg 1673580
agattcctgg cttcatgctt ggtgtactga gtcttcaggg atggactcta agtggacact 1673640
taaaagtta tttctgcca ggcattggtg gtgcacgcct ttaatcctag cacttgggag 1673700
gcagaggcag gcagatctct gtgagttcga ggccagcctg gtctccagag ggagtgccag 1673760

gataggcttc aaagaaaccc tgtctcgaaa aaccaaaaaa aaaaaaaaaa aaaaaacccc 1673820

tcaagaaact agaaatcaaa ctaccaata atctaattaa aaagtctaataaaaaagtgg 1673880
ggtacagatc taaacagaga atttcaaca gaacaatctc aaatggcaga aagacactta 1673940
actaaatact caacattctt agacatcagg gaaatgcaaa tcaaaaccac tctgagattc 1674000
catcttgcag cgatcagaat ggctaacatc aaaaacacca atgacagctt atgctggaga 1674060
ggatgtggag aaaggagaac actcctccat tgctagtggg agtgccaact tgtacagccg 1674120
ctgtgaaaat caglatggtg atttctcaga aaattagga tcaacctatc tcaagacct 1674180
gcaaaaccac tgttgggcat atacccaaaa ggaggcacaat ccacaccaca aggacatttg 1674240

ttcaacatag caacattatc tgtaataacc agatcttggg aacagcctag aagcccctca 1674300
actgaagaat ggataaagaa aatatggtat atttacacaa tggagtgcta ctcagcagta 1674360
agaaacaatg acatcctaaa atccacaggc aaatggatag aactagaaaa aaacatccta 1674420
agtgaggtaa cccaaaacca gaaagacaaa tatagtatgt actcactcat aagtggatac 1674480
cagacataaa gcaaaagata cctattctac aatccataac cccagagacg ttagaacctt 1674540
cttcagaag gagatggaag caggtgcaga aatccacaac taaccattgg getgagctcc 1674600
tggagtacaa tcaaagtgag ggaggaacga taataaaagg agtcaagacc atgatagga 1674660

aaccacaga attagctgac ccaagttagt gagagatcac tgaccaggt ctgacaaatg 1674720
gggaacctgc ataagaccga aatagactct cttaatatag gagacagtgg tgtgactggg 1674780
acaatatatg aggccactgg tagtgggtcc aagatctaac agtaatgtac aaactgactc 1674840
agtggagccc attctatag gagagatacc atgcccagcc tagacacagg ggtgtgggag 1674900
gggagtgggg ggagcaggag gagaggaggg agggacaact gggactggaa tghtaatgtaa 1674960
aaaataaatt aatcccccc aaaaagaaac cctgtctcaa aaaaacaaaa atccatgtct 1675020
ttgttgtttt gttgtttgtc ctgtctttac taaaactaga gacaaccagg agtcaaaca 1675080

atgaaatttc aacgctaaga aattgcgtta ataatgtatg tgcaatatat tatgaaaata 1675140
actccccctt tacaatggaa agtagtctta tagaggtagt cataactgga caaactgtag 1675200
ccctctggt atttaagccc ttccagagaa gcaatactgt gtaagggtct gcggagtact 1675260
gagcagtcca aacgacacta agttgtttgc ggatgtttgt ttgcctgagg ctgcgtggag 1675320
gatccggaaa catggaaaaa tgagactatg aagcagtcgc tcgcccagat ttaatcgcaa 1675380
ctagaccttc tcggctctgt tggctcaaca gtgcgcagggt gcacctagcc cttggtttta 1675440
cgcgtgcgca ttatttaatt gtgaagctac aggcggaaga tggagagcga gtgtttcttc 1675500

tcccctcaga acgttcagtg ctagaattca gagactgtag ccgtgtctgt ttttgagaa 1675560
 cgatcgagtg tctcattata atcccccttt ccttttgggc ctctctgggg agctggctgc 1675620
 cagtaacctaa tatggcgaga gcccgtgcgt ccccgcgctg gttcccggcg ctcggtccg 1675680
 cggggcggcc ccacgaaagg gcgggagttt cggggggcgg ggcctggccg cccgtcagag 1675740
 cgccgccctt ggcttgccct gccgggactt gggtagcttc tgcggttgct gaggagcgt 1675800
 tcgggattcc cgggaaccga aggtggtgag gtgggtctgg ggcaggcggg aggtgccgag 1675860
 ggtaacggtc ttaggccagc acgggcgccc gcggggatct cggccgggca gcggcttccc 1675920

 tttccccgga ggagccccgg gcccgagag gagctgggac ggtcctaggg gtcccggctg 1675980
 gcctgcctga gcctcctgct gcaccaccgc agctccggag aacttcacgc caggccaac 1676040
 cggctaagac gctgcgctcc ccgcagatct cacttcgtgc tccccgagc tttgcagctc 1676100
 cccgttacc tgcctgccga gcgctttgca cgtgatctgc ccccttgaag gtctgttccc 1676160
 agcccctgc tccatcctca gatttagtca aagatcactt cttcaatc tttcctagag 1676220
 gcctgtcca ggctcagcta atttcgattc ttggttttg cgatctttgc ccaagtcagt 1676280
 gtcttcccc tcgctcgtgt tctgggcttg tttattagaa gccatgtctt ttttcaactg 1676340

 tatgtcccat gatgatgca gtaactaatg aagtttctga atagtcgaa gatgacagct 1676400
 ctgctaaatg cattatctgc aaagcccct ttagtccact ctgcgatcga tgatgtgggt 1676460
 tccatatgta aacattttat acatgaagaa ataagcacc ataatcaag tccacaatg 1676520
 agttagaatc tgcctatgca tatgattgat ggcttaacta gattgtcttt gaggttgctgt 1676580
 ttgtacatta gcctgtaaga tacagaggct actgttaaca attcacattt tactaaaagg 1676640
 gctttttttg agggggcggc cgggtaatag gaattgaacc cagagactta ttcatgccag 1676700
 ccagtgttat accactgaat taatcctgag ccgtcttttt gtttttaaat tacatctaca 1676760

 gtgttctgtc tgcgatgatg tttacacacc agaagagggc accagatctc attagagatg 1676820
 attgtgagcc acgatgtggt tgctgggatt gaactcagga cctctggaag aacagtcagt 1676880
 gctcttaacc tctgagccat ctccccagac cctgagccc tttttactta tttattttga 1676940
 gacaatgtct gaccaagta ccaaggctgg atttgaactt ggtgtcctct tgtcttgccc 1677000
 tcacaagaag ctgagatttc aggccttggt tatccaggcc aggcctaga aggtttatga 1677060
 aggagaatta atgttacc aaatcagataa ttcataacaa aaaaatctag gccagatcca 1677120
 ggttgctgctc ccagtacacc tacaccccgt gttcttcag gaccctcca cttattttg 1677180

 ttctttttac ctagaaaacc tcaggcctca gcattcccca ttaggaaatg ctccgaggtg 1677240
 ctgtgatatt atagttctg actttgacag ctaatgcttg agcatagaat ttggaatcat 1677300
 attagaattt ggtttctact ttgctgctaa ctagtgtga ctcttaaaaa aaaataagtg 1677360

cctgtggcag ggcaatggtg gggcacacct ttaatcccaa gcaactcggaa ggcagaggcc 1677420
atcagatctc tgggagtcca aggccagctt ggtctacaaa gctacacaga gaaacctat 1677480
ctgaaaaacc aaaacaaaaa ccaaacaaaa caaacgggg gggggggggg gggggggggt 1677540
gttaccatgg tgiacatatg gaggctagaa gacaactttg tggagtggc acttgccttc 1677600

cgcttcatg tgggtcacac tcagatcatc aggccacttc tttacttgct gagccatggt 1677660
cccatttccc ctttcattta aaaatttatt ttaattttg gggagggttg tgcataaatg 1677720
caggtgtctg aggccctaga cctggagtta gaggcagtcg tcagctgcc agagtgggtg 1677780
ataaggactg aatttggatc ctctgcaaga gcaatatagg ctcttaacca aagcaccact 1677840
tcctcacact tagatatttt gttttgttc tccatttgtt ttgtgtttg cccttgttgg 1677900
gttttgttt tgcttttga gacacagtct ctttaggtag tcctggctgt cctagctgtc 1677960
ctagaactta cactgtagac cagactggcc tcaaacctag ccatccacct gcttctgcct 1678020

ccaagcgtt gggatttaag acataggcca ggaccagct cacactaaca ttttttaaat 1678080
attagtttc catgttcttt ttttttctt ctttaggatt ttatttgtt tgattttata 1678140
tgtatgagtc ctttgcctac acatatatat gtgtgccatc tgtgtgcctg gtgceatcag 1678200
aagtcagaag aggaactgga gttgcagatg gttgtgagtc actatgtggg tgctgagaac 1678260
cgaaccacgc tcttctgaaa gaacaagtgt tcctaactt ggatccttga atcttagttc 1678320
tcttgattgt aaaatgatgg cactaatttt tgtttgttt tttagacaa ggtttctctg 1678380
tgttctggc tgcctggaa ctcatttgt agaccaggct ggcttcagac tcacagat 1678440

cctcctgctt ctctaagtg ctgggattga aggcatgagc caacactgcc caactgagac 1678500
agtaatccta ataccgctaa ggtttttgt gtttgtattt tttgataag gaaggttgca 1678560
actgattgtt gtaagagtc cacagccaca ccacctgaa tgtgcctgat ctcatctggt 1678620
cattgtaaga ttaaacactg tacacattgt gcatgggtt acttttgcct taggaatgac 1678680
tgtggaactc tgccaatatt ttgtaaagct attggtgac ataagggtca tgtaaggcag 1678740
gcactgaatt cagatgctct cggccagcct gagctactag agcaagacac cgtctcaaac 1678800
aaacaaaacc agtgcttttg tgctgggtgt atttacattt tggttaagttg ttacacatga 1678860

taattagagg cagatagaca tggtagtag aaatgccagt gcatatgtct aggagtgggtg 1678920
gtactttaca tggtaaacct tccccaaaag gtgacagttg atcagaaacc tggtagaac 1678980
aatcatgtg gataacaaat gagaacacag ctctgccgt gttctaagca cacgtgagga 1679040
tggctggcca tgtggctgga ggagtggcaa aggggagatg aaatagaatt gattcatttg 1679100
gctaagatgg gtcaattagg actctatgca cgattataaa gatttcttt aactgtagtt 1679160
ggctgttatc tagggtgtgg tggctttgtg ttttagaca ggttctctat atgtatctca 1679220

cgctgccctc aaacttaact gcatagtcca tggagacta actttagca gttcttctgc 1679280

 ctcagtctca caagtgtcag gattttaggc atgtcccact atgcctggct atttatggtg 1679340
 tgtgtgtgtg tgtgtgtgtg tgtgtgtgtg tgtgtgtgtg tgtgtgtgtg tgcctgcagt 1679400
 tctcaggtga aggttaaaag acaactttta tgagacagtt ctctcctcca ctctgggttc 1679460
 tgtggactga actcaggccg tcaggatggc agcagtagtact ttactcctc gagccacctc 1679520
 atcagccctg ttigtgtgtt taaaaggatc ctctaactgt ttagtcagg gaaaaaaca 1679580
 aaacagaatt tagtgggtgc accagcacct aggaagcttg gccagtgtc cagttttgtt 1679640
 gctgtgcaag gaatcctccc agggtagta ttaaacagca gttgtttgtt acctcagagt 1679700

 cactgtgggt cagaaattta gaactgattia gccgctgctt ctggcttaag aggctcaggc 1679760
 aaggttgaca gtgatctgaa gattccaca agggctggga gatctacttc catgatgcct 1679820
 caatcacaag gctgttgga gaagtcccaa tgtttctcc tgagcctcct cactagcact 1679880
 tgtgtgtcct caggacagag caggatattc tccagagagt aagtaagcaa caagccacag 1679940
 caccttctgt ggccttttct cagaaggcat ttctacttaa acattttctt atgatttatt 1680000
 ttattagtat agatgtgtg cctgcagtga tgtgtgtgtc attacatgta taacctcagg 1680060
 ggtcagaaaa ggggtgcaga gccctggaa ctgtcacaga tggttgtgag ccaccgtctg 1680120

 ggggctgaga actgaatgct ggtcctctaa gagcatcaag tgctcttagc tgcttagcca 1680180
 actgtctggc gtiagtca tctagtttat actacactca aagagaggaa atttggtttc 1680240
 acttttttat ttttagaaa gattcatgt aaccaggcta acctgaact cactgacttt 1680300
 aaacactgga tcttttgcc ttgatctttg aatgcccgga ctgtagatct gtgcctccac 1680360
 cagcaactta ggctctcttt aatttttggg ggggtgtgg tgggtgat gatagtagtg 1680420
 tgggtgggtt tttttttt tctggtttta tgtatatggt gtgtgtgtgc aagtgtgat 1680480
 ccatgtttac ttgggcaggg ccagagattg ggtgtctctc ttgatattt tccagttat 1680540

 atgttagtc agggttgagc acttgaacgc agaactcaac aattggcta gtggagatag 1680600
 tcgtctgtgt tacttaggaa atgagtgtat agagagattt aaggctgagc ctgggaccc 1680660
 tcagtcttca gatgctggag aggcagaaga ccttgagtca ctgccaatag cacaaattct 1680720
 aattgttctt agtaataaaa tctcctagtc agatattggg gggagaagca aagcagcctg 1680780
 gctctagctc ttacctctgc ctcagatcac atcctcagac tgcttcagac tgccactgct 1680840
 tggaaatctct ctctgtctc ctctgcctt atattcctct ctctgccag ccatactact 1680900
 cctgtctcca cctcctgtg gtgggattaa agacatgtga tcccagcact ttgtgtgagt 1680960

tctgtttctc ttttagaccg gatcattttc atgtagccca gggtagcctt gagctaacag 1681020
agatctgtct gcctctgtct cccaagtgct gggattaaaa gtgtgtacca cactgcctg 1681080
gcctctatag cgaacgagtg tggctgatct tcagacaagc tttatgtt agatcataaa 1681140
caaaatatca ccacaactgc cttgttggtt agtaggtagc ctggttattc aaaagagcca 1681200
gaaaggcata tttgtgatg tattcatgaa tgttggcatc tgtttttgaa ttcttaaaat 1681260
ttttatggta cagtgcacaga cacctgtaat tacaacactt gggaggtaga ggcaggagac 1681320
tcgggaatth tctttttttt tctttttttt ttttctgaga cagggtttct ctatagcttt 1681380

ggaggctgtc ctggaactca cttttagac caggctcgcc tcgaacacac agagatccac 1681440
ctgcctctgc ctctgactg ctgggattaa aggcatgtac caccatcgcc ctgcctgaga 1681500
ctcaggaatt ttagctacg tacaagtccc aggctagcct ggactgtatg aaacctctc 1681560
tgaaaaacag aaagaacctg tggcacacgc ctttatctca gcactcagga ggcacaggca 1681620
ggctgatctc tggagttca aggccagcct ggtctacaga atgagtgccca ggataggctc 1681680
caaagctaca caaagaaacc ctgtttcgaa aaacaaaaa agaaagaaag agagaaagga 1681740
aggaaggaag gaaggaagga aggaagaaag gaagtccaac ctgcaggcca ctaaatttat 1681800

aacctctgga ctaaggttga gatttgcag gtaggtgt gtattgtga caatttacta 1681860
atgactaaaa tgaattacac ggctcttgc ttgaggcaca cagtggtagc aaagacagac 1681920
agatctcat ggtaaaatgt aatgtggatg acagtacgat ggtggtgtac ctctttaatc 1681980
ccaacacttg ggaggcagag actggtggtg aaagaccctt ggaggctcag gccccagga 1682040
tctctgcca ggacctcagt gaccccaatc accaggcgga gtaaaaaact tgatgcaaac 1682100
agcaagaggt tttattcgag ttgtttaacc ccattttagc tcaggccttt catccattaa 1682160
ccatgatgga tggctaggaa agatcccgag aagccatgca gtagagatct tataggcag 1682220

cataagggga gtgtctaggg gtacatacaa gttcaggatt ggtgtgcctc caggcttgea 1682280
gggcttgccc ttgtgtgat tggtaactg gttgttatgg ccataggcc ctcccagggc 1682340
ggttgctatg ctctgtgat cattgtgtg cacttgtcta taaagcacac ccagagccat 1682400
aaagcatage accaccagct aacttctgat tggttccttg ccacaaggca ggcactctgac 1682460
caagtacca aggcaaggc aggcaacctg gtctaggct gttatggctg ccaaaatggg 1682520
cagctggtcc cttcagtgc tctcaaaagt tcaaggccac cctggtctac aaagtgagtt 1682580
ccaggaaagc caagactact cagagaaacc ctgtctccaa aaaaaaaaaa aaaaaaaaaa 1682640

aagataatgt agacattaga atacatgttt tctttaatat aggtgaatgt atatgtgagc 1682700
aagagactgc gagtgtgtgc atgtgcacac atatagccat aaaaatttga ctccaatgct 1682760
tcatctgggt gggcaggata ggagatagac taagccatgc tatagatgc atcttggcaa 1682820

atgaaaagga ttggagttc tagaaacttc cacattgtat ttaattgttg tgtcattgct 1682880
tctgccaaga tcagggcatc ttccagattc attccacagg ttgctgagtc acgagtcaga 1682940
cacaggggtg tggtagcata gcaggggttc ttagtttaat gctaagtgcc agacagagag 1683000
gtgcaacagc atagcaaggg ttccagtttt aatgcagagt cccaaaggca aacctagaag 1683060

caggggtcct gtgactacgc tcatcatagc tccttgaga ggtagagtc catcctagtc 1683120
ttttaaaagt tctgaagaga ttgattggag agatggetca ttggtttaga gcacttgctg 1683180
ttcttgcaaa ggatacaggc ctagtctcta gcaccacgt gtagctcac aactgtctat 1683240
aactccagtt cctgggtatt ccatgttctt ttggcctct tcaggcatca agcactcaca 1683300
tgatacatat acatgattc tggcaaaaca ctcataaca taaatatata ttttaaaaa 1683360
gaaagtctta gtcagtctgt ggtggcgcat gcctttaatc cctacactca ggaggaagc 1683420
aaaggtggc ggatctctgt gaggccaagg ccagcctggc ctacagagcg agttccagga 1683480

cagcctccaa atttacacag caaaacctg tctcaacaa acaacaaaa aagtctgag 1683540
gagtcctgta ataaaggaac ctatttactt cattcatcca gatccattc cgcttaaca 1683600
tttgcagagt aaatttgagg aacctggcct tctcaatctt gttatgtttt ggtccctagc 1683660
tcaagaggag gtctacgaca catagatcag tgatcagaca ccctgctgca agcagcctgt 1683720
agctgcacag gaactgtgga tttgttctt gatgctcca tggagacagg aagcctgga 1683780
ttgaacatga agcccaagtc gttacagcta gtgctggagg aacaggtcct ggcaactgag 1683840
caccagatgg cggagaacca ggctgcctct tggcagaagc tgaagaattc ccaagaggcc 1683900

cagaagagge aagcaacct tgtgaggaag ctgcaggcca aggtgaggca aatgccctc 1683960
tgggaaggga aaaaagaacc cctcaccag agttgagtg tagagtggga taaggactgg 1684020
atgagtgaga gaccatgtag gggagtgac caaacatcct ggtgaggatg gccagatag 1684080
ttcaactctc aaccatagcc tctctttga tggtcacaaa ctgctccaca aagtatggat 1684140
tatgttctt ccaaatatga cattcacaat agttaaatta gttgtctagg tttgttctt 1684200
tagtctagag tagtggttct caaccttct aatcctcga ccgttaata cagttgttca 1684260
tgttgggtg accccaactg taaaattatt ttcgatgcta cttcataact ataattttgc 1684320

tactgtatg aatcataatg taaatatgtg tgttttctga tggcttagg agacctctgt 1684380
gaaagagttg ttccactctg ccaaggggtc acgaccaca gaatgagaac tgctggttta 1684440
gaactaagcc caaaccaat acacaaagca tatattgtgt gtgtgaaagt gtgtgtgtgt 1684500
gtgtgtgtgt gtgtgtgtgt gtgtgtgtgt gtgtgtgtat tcaggtcac ataaactgtg 1684560
agagtgcata tggaaaccag aggtcaatat tgagtatctt ctatcactct ccatcctact 1684620
ttttaagttt atttgtata ttgtgtgcct atgtctatgt aagtatatgt tgtatgtcag 1684680

tgcctgaaa ggcagctgga gttataggca gttatgagcc gttctgggtg ctgggaactg 1684740

 attttgggta ctctgaaaga acagcaaact ttaagcacc gatctatgtc ttcagcctct 1684800
 accacactaa ttttgggaca gggctctca ctgaactgga aatcatagat tcagtaggct 1684860
 cgccagccag ggagctccag gatctgctgc cctgcctctg tagcactggg atggtggctt 1684920
 ttcacactgg gatctgaaat tgggtcttga tgcctgcaca gtaaacattt tactcttttt 1684980
 gtattttgtt tgtttgtttg tttttgtttt tgttttttca agacagggtt tctctgtgta 1685040
 gctttggagg ctgtcctgga actagctctt gtagaccagg ctggtctcaa actcacaag 1685100
 atctgcctgc ctctgcctct gctgggatta aaggcatgtg ccaccacca caggcacatt 1685160

 ttactgacca agccatcttt accagcccct tggaaatact gataaaaaa caaaacaaaa 1685220
 accttgtgta agtctgagag tacaagcaag cgtgcacctg acacatgttg aggtcagggg 1685280
 acaaccttag gtgagctagc caatgagttt agggttgctc ctgtctctgc ctccctctt 1685340
 gcctcaggag tgcgaacta tagacacaca ctaccacatc tggctgtact tgagctctgg 1685400
 ggatctgaac tcaggtcctc atgcttgcaac agcaagtgtt ttctctctga gccatctccc 1685460
 cagaaagtgt ttccaaacac ccggetagaa actcttaaga tgcctggtgcc ttaagaagat 1685520
 gactttgcca tcaccacctg cttcccatgt tcacagcaga ttcgccaag atccctaaa 1685580

 gcctttggct tgtgttgttt atatgggcta tagttgtgct cagggtctgc tctctttgct 1685640
 ttaggtttta cagtaccgga gctggtgcca agagctggag aagcggctag aagccactgg 1685700
 agtaagtgag attgagtccc ggacttctc tcagccctta aaatatactg gcttggcttt 1685760
 atatctgcc aaggaaggct ggggtatatac aggatgtttg gtaggagttc ctctgtctcc 1685820
 agctcaaag agctaccaat aaggcttctc agagaccctt ggcctgagag attccttccc 1685880
 atggtttccc atttataat gcagttctg gggacttagc atagtggaat gggcatatgg 1685940
 cattggaggg aaaattcatt tttcatccag cagggtctcag tgtttatgca tcaggaagat 1686000

 gtgcacctg catgcctgta agcatgcctg taagcatgcc tgcagtagaa ggatgatta 1686060
 attgcctggg tagggttggc tgtgaaagac cttttgtca ttctcaatt cctctcatt 1686120
 cccctaagga aagtctcag aagaaggaaa gaaccagaat gtattgagca cttctgtgc 1686180
 agaccgggc acccctaagc attggtactg ttatgtcagt caagtgcaa ctctgagaca 1686240
 aatgacaacc accttggttt gtggctctgt gatgatcgt gacttctga ggtcccaat 1686300
 tagtggata gggccctagt caaagatgca gcttgcaatc ctgagcggg gtgccatttc 1686360
 ccccaatgc catcttttag gggaggtgat tggttcactt ttgaagaaag gagtgtcctg 1686420

ggtttgcttt tatgacagtg actgagaaaa gaagcaaatt gctctcaaga ggaagaataa 1686480
 cagagaaagt aggctgctgt tgaagaaggc gtcagggatt gtcctgggtg atgtttttgt 1686540
 gtggatgat aaggcctgtc tgtctcataa gggactgata cctcagcgtt gggaaaggtg 1686600
 agaagaacca aacctggaac agctgctggt ccgattggag gaggagcagc agaggtgatg 1686660
 gacccaact ttctgatct gactgatgtt gcagagggtg gagaggctga gggaaaactt 1686720
 ctgttctgcg agtgggaaag tgctgggatg gtggttcatg tgggtagcat aaggcaggcg 1686780
 ggaagcaaaa aaagggggag ggatcttctt ggaaccttgt gtcctgaggg caacaagat 1686840

 tccagtcctc tcattctga tgatggaaag ttcgctcac tcttactccc aagaggtcca 1686900
 aggtgggacc agacctttat cctgccttg ttcttctga tgcccagtgc aggtgtgaga 1686960
 gtctagtga ggigaacacc gagcttcgcc tgcacatgga gaaagctgat gtggtgaata 1687020
 aagcccttcg ggaagatgtg gaaaaattga cagtggactg gactcgggcc cgggacgaat 1687080
 taatcaggaa ggagagccag tggcggctgg agcaggaggt aagaagaaca aggtggaat 1687140
 gtgactctg ctgctgtctg agcagtgtg gacctagtg gaaactgctc agtccttgtt 1687200
 ccagcctctg attagccctg cccaagatac agctgtgccc tgtttcagct ttcttctac 1687260

 ttctgcctcg tctaggcttt gctgacagg tgtgtcatgc tcaactcctg caaaagtac 1687320
 tatctcaggt ttcaaatgga tctgaaaatt tactgtttgc cttcttctga aggtctgcat 1687380
 agctagatgc taagaaggta gctgctggat taaatagaaa acatagtat aggcctggg 1687440
 aaatthttca gtcacaacta cagacagtaa atatttcttg aacctttgct ggggtgctggg 1687500
 tctggctgat ttgatgat tagatcacct aattctctg tctgccgtaa taactccat 1687560
 ttgccaggca gccactgctt gcttttctga tctagccaaa tgggaaggcta cttttcacc 1687620
 agggcccttt gacctctga acctactgc caactttta ttaagccct caatatgacc 1687680

 tgagtatagg cacccatcca taagetatct cctcaaagac cttcttctct teacctcac 1687740
 ccagtagcca tgaggcatcc aggactcttg tgttgctgca aggtcccctg cccttgggtg 1687800
 tgacttgggt ttctgaacac agttcttcaa gggctatttg aaagtgaaac atgacctct 1687860
 gctcaatctg tggcgtgagg tggtagacct ccgacgcat ttctgaaaa tgaagtcagc 1687920
 tactgacagg tcagtatggg gatgagacga gaggtttgtc ctgctgatct ggacttaaga 1687980
 ctgcaggctc tgggaagagg cactggggac agtgggcatg ggctaggagg gagatttact 1688040
 agatagagat tcctcagac ctgaaagcct atgcctgagc tctctacctt ggttctctgg 1688100

 agtcttcaat cttcttctt gtgctcagag atctgacaga gctaaaggct gagcacgcca 1688160
 agctttcagg gtcttctgtg acctgttctg tgcgcttgac cgtgagagca cagtctctgt 1688220
 aatccagtgg atctgggaga acagagaatg agcccccca gctgctgctg ctggtagcta 1688280

agaccagcgc gctggagaag gaagcccacg aaaagagcca ggaattaata cagctgaaga 1688340
 gtcaagggga tctggaaaag gctgagctgc aggaccgtg aggtgacata tggcccagg 1688400
 aggactgtag tgagggaaaag ctgactcccc tagagaattg tgggtgggca gaaaaagatg 1688460
 tcaggaacac cctcacctg ggaggggaag gggccactt aggaaccag tgtgtctgtt 1688520

 ggggcctgtt actgtccctc tggctacctt gcaactcagt ctctctctg atagtttgtg 1688580
 ttgctagctg ttctgtcaac agcagtctcc tctcagccat actctcccac acttctgtct 1688640
 aatgtatgc cagccatagc ctggagtgc tcctccttc cctctgcctt gcccttaag 1688700
 ggagagtca catgtcacct cttctgagac ttgtctcact ttaatatctt gtagtccat 1688760
 gagttttttg atctgcttat tacagcacta atctcactgt atctctttaa ttactttgtt 1688820
 tccttgatc cctccctct tttgggtgtg atgggtgggg tgggttagaa gtgtttttgc 1688880
 tgtgtctggg tttgaactca gggccttgca tatgctagtc aaacattcta tcattgagct 1688940

 ataccacc tggccttct taacttttgg attataataa aatgggattt taaaataat 1689000
 gagaggggaa gacatgagct gagtgccact gactaccaag gcaaacttgg agtctttgat 1689060
 ctgtgtgtca tggctagggt tcttcctac ctgttggtag tatacataaa ttggggactg 1689120
 tttcgtttc tttctgctt tagaaacatt aagaacaaat cttaccttag taggtttata 1689180
 tctttagtgt tcatgcctt atttctcata taatagataa ttattgtttg ttgaataata 1689240
 caatattca ataaaagaca atagtgatcc ccagaggtgg tttctaataa aattattgag 1689300
 gcttaaaatt ttcttttagc cagggtgtgt agtcatcact tttgtgttt tttttgttt 1689360

 caaggcaggg tttctctggg tagccttggc tgccttggaa ctcactctga gaccaggctg 1689420
 gccttgaact cacagatctg cctgtctttg tctcctgaat tctgggatta aaggcatgtg 1689480
 ccaccgtgg ctgtctgcta gttgtcactt ttaatcccag ctctttggag ttataagaag 1689540
 gcttgaacte tatgagtca aggtcagcct ggtctataca gcaaattcta ggtcagacag 1689600
 ggctatgtag tgagagcctg cttcaaaagt aaataataa atgagtaaat gaataataa 1689660
 ataaataaat tattctttgg taacattgat ttaagaaata cttgttggcc aagtgtcatg 1689720
 gctcatgccc atgatectat tactcaggag actgaggcag gaagatttct agttcaaggt 1689780

 catcttggac tacatagaga atttcaggca agactgggct atagtcag atgctgtcac 1689840
 caaaaaaaca aaagaagaaa gaaagccatg tgtgtaacac tagtcacaaa gccctgaggt 1689900
 gtgacagctg ttggtgattt tgcttgtcat ctagctgt attgtttccc aagtcatctg 1689960
 tcctttttcc ctatcagagt caaaaccttg ggctggaggg accttgggac tgtcccctgt 1690020
 ggtggcaatt ctgatgttct tattggcttc aggggtgctta acttcacaat caagcgagge 1690080
 ctggaagggc ctgggccagg gctttccttc agctctcagg cccacagccc gcgttccagt 1690140

cttgagatgt ggtaaatccc tgcattgtgc tgagtggcctt ttggctttcc ctaccagatc 1690200

 aagaatatag agtcacatgt tattcagga gtgcaaagga ctgggcatcc ccaaggatt 1690260
 ctgtgggctg cagtgggggt gtccgtgtgg gggctgaggt gtgctattgt gtggcggcgt 1690320
 caccatcctt gggctgtcca ggggacagtg atgtgctttc tttcttagag tgacagagct 1690380
 ctctgcgttg ctgaccagt ctcagaagca aatgaagat tatgaaaaga tggtaaagc 1690440
 tctaagagaa acaatggaga cgctggatg tgatcctctg tgttgcaaag gtgctcagag 1690500
 tgggttgaca agttccttgt tctttgggga caagtagtga atgatgctat ttaaattgtc 1690560
 cttgaggaaa tccttcaaag ctgaaaagta aactttggct gaatctgaaa atttctaac 1690620

 tcattcatct gttcagtaaa ataataactg tccactctcc tgactatatt cccagagaaa 1690680
 ttacaatgac atttatatat atatatatat atgtcattgt aattcatata tatatatgaa 1690740
 atgtgtcctt gtctgagaga gaagacttgt catagtgaat ttggggcctg tgtgagccac 1690800
 atgagacact aaggaaagct aaaggggtgg gaatgagcat ggtatcagag aagggttctg 1690860
 tggagggatt aaaaaccaat ttacatgggg gacaactgag gagcatggca gtgtttagcc 1690920
 tggagcagaa agaattgtgag gaagatagc ttgctgcctt tacatctctg acagtggagt 1690980
 tgatggggaa agccagttga ccagtttaat gttttccagg gtagagccat caccagcagt 1691040

 agaagctaca gataaagtag taggttttga cttgagctag agctgtcact tgaacagtgt 1691100
 gtgtcttacg aaagagtgtc ttatgaaaga gaaagattgt tctcaccatc ttaaacacct 1691160
 gtcaggggtg tcacagaagt gattttcaa gataggatgc caaaatcctt ggctgattcc 1691220
 atgtttcctt tcttctaac acatitttct ggtcatagac ttttggcagc tccagaacct 1691280
 tatccacatg ttctcctagt ctcatctgtg ttggagtcca ctaggaagca aacttgtttg 1691340
 tgccccttta attcctttct gtcaggaatt tgccaatgca gacatccaca gggctcaagt 1691400
 aaattaaaac gagtacatt gaattgcaa gaattctggt tttccagggc catcagtgtt 1691460

 cactgctgat agaacaaaga actttaatct aggcagtcat ttaggttttt aaccatttta 1691520
 ttcttagcct tttattccta tattacattg ttttcagact ccttgggaga gtatggttga 1691580
 cagaataaac agaatatgtc tttgaatgac ttggggacaa gagtttggct cttaggttct 1691640
 attctgtcct tttactagga gacaaacct gcagagtaa tggaacatga ggtgtctctc 1691700
 agtaggaatg ctcaagagga aatgttgtct ctacagcatg tgatcaagga tatagctcag 1691760
 gtgctggtaa gcctcttctc ctgtaactgg acagtgtccc ctcttcttca tacccttta 1691820
 gggccttga tttctagact gaggtttggg ctaagggtca tgtaaggata agttctctcg 1691880

gtgaacttaa agaggtgtag gttagcattc atgtcctagc actgtgtagt ggatgggtct 1691940
 atcctgttgc ttgttatggt tctcagcata ggctgaattc tgtctttgtc attacaaaag 1692000
 cttttcttc cctttcccc tcacttactg ccccagagag aattctagcc ttggtgctaa 1692060
 ctattcttag atgaccaaac atgaagaatt gaagggaccg gtcaattttt gctcttaggt 1692120
 ttccatcctt ggcctagcc cagagatagg acttgtaaaa ggaaccttgg ttctctgtt 1692180
 ctgtggtgca agtctctcca tgacactcgg ttgcatttca ggctcagtg gaagaagagg 1692240
 aactgtgac ccacagctca gaccatgaga gctcattaca gttggactgt agtggcttct 1692300

 cccatttga tcccagaac ccagacaagg ctcttactct ggtgcgttca gtgttgactc 1692360
 ggagacagca ggctgtgcag gtgagaagcc ccagagctgc ttagaggcgg actcctgcct 1692420
 accagttccc aaataaccga cttggaggct taatattata aatgcttggg caatacctca 1692480
 ggcttgttac tagctaattc tcacatttaa attaagccat gtttctatc tatctacgtc 1692540
 tgccacatgg ctggcacct tttctcagta gagcatgccc acctgcttc tctctgtctc 1692600
 tgctggccac tctgactct gccctgattc ccagcattct cagttttgct ctcccaccta 1692660
 acctttcttg ccagctatg ggccagtcag ctcttttatt aaaccaatca caacaacata 1692720

 ttcacacagt gtaaaggaac attccacagc tgctcctcag ccatagacac atatctctag 1692780
 tctggagtaa ccttttcagc tggctagtca taatgtatcc agttgcacat tagcttctct 1692840
 atttgccag tgggtctgtg gctcacaggt gtttatatc tccacaccaa ctgcatgtat 1692900
 gtgcaacact aagcagagtc ctgggagagt gtaaaagttc cccaactcca agtgacactt 1692960
 actgtccct atgccacat gtttgaaggt gttggattcc aggactccag ggccacagag 1693020
 ccagtgatc ctgattctt tgacgtctcc attggccaca tttctgttct tgccactgt 1693080
 tgttacact gtccccatcc ccttgcttg gactcatccc tttgtttgtg gctccttgtt 1693140

 ctteatctg ttctatggat ctctcccac aggacctcag gcagcagctt tcaggetgcc 1693200
 aggaggctat gagcttcttg cagcagcagc accgtcagtg ggaggaggag ggtgaagccc 1693260
 tgagagaaa gctacacaag ctactgggg agcgggatgc tctggcaggg cagactgtgg 1693320
 accttcaggg agaggtggac tctctcagca agtgagtga caggctgctt gtccctccct 1693380
 ttcatgcttg gttttgtt ttgttctgt tttaaaggaa agcaaagcct tcaaaacttt 1693440
 attttactcc atgtttgtt ttacttaatg gttttgcagc tacattctca gttctccagt 1693500
 gctgcttct agtctcatt tagccactta ccgtcactgt cctgttttg attggttctt 1693560

 cctgttgca ctggactcat ggatgcttaa ggctgcttg gttttctatt tcctgtggga 1693620
 aaacctttg gtctttagga tcaataata aatggttttc tgcttgaaaa aagttatgta 1693680
 tataatattg aaaagaaca agcttctctc atgttttgcc ctacaagtc ttttccact 1693740

agggctcttt gtccccaggt ctgtcccca gacctctgtc tgtatctcag ggagcgagag 1693800
 ctgctgcaga aggccagggg agagctgcag gacgagctgg aggtgctgga gcaggaagca 1693860
 tggcgactcc gaagagtga catggagctg cagctgcagg gggactctgc tcagggggag 1693920
 aagcaggagc agcaggagga gctgcacatg gccgtccgtg agaggagct tctgtaagtg 1693980

 tgaccaacct ctgtcaccag ggtccacacc ttccccacc cactcctctc tcttaggaag 1694040
 tggagtgtgt aaaacctgcg tgtgettcac actgcttact gcgtcttctt ttgcagaaag 1694100
 atgagttaga aagtcacatc agacattgtc gagtttctat agagatgtgg gactgtgagg 1694160
 gctacaaaaa actgatcatg atctcaagga gcttgaacc taataagtaa tgtgacaagc 1694220
 aaacagctgt gacgtgaagc ttgaagaaat acagcctcac tagagttcaa gcttgggtgt 1694280
 ttggaagcgt aggagcaata gttactattc agaaccaggg gcgactttat ggagatgggg 1694340
 ccttgacatg taggaaaagg gaccaaggga cagaatagca aagaaaagga attgggagtt 1694400

 tgtggcatgt tctgagttag ctgtctgaga aaagacaaaa ccactgggaa atgataggaa 1694460
 attcactggt caggaaggga aatccagggt cagtgccctc tgggaaatga taggaaattc 1694520
 actgatcaag aagggaatc cagggtcagt gccccagct aatctgtgag gtccactggt 1694580
 aatgctacag aaaggaactg tagagcagga cgaaggttg gtgcaggttt ttgctttgcc 1694640
 accagaatgg attagtctct tggcaaaagg gagatgacat ttgaagagtt attggcaaga 1694700
 tgtggcagta ctccataaaa tgctagcata gggctgtcaa gatggtgcaa tgtgagttca 1694760
 atccaccaac tcccatggat tgtcctctga tctccatgtg agtattgtag ttccctccc 1694820

 acatacaaat aaatgtaatt atttgtttgt ttgtttgaga cagggtctca ctctgtagtc 1694880
 ccagctcacc atgaaccac aatgccagca gagccctggt gacagctctt cacttggat 1694940
 agtcccctcc tctgtgctt attccttgca cctagtaaac agtagaagct taaggaatct 1695000
 gccaaaggt agggccatgc tgcattgect gactgaggg catagcagaa gatccacaca 1695060
 gatacatatg tgtttaaaat ttaatctatc tgactcaaca atatagttag ataagtcaaa 1695120
 agccaaagct gtttaaaaag ataccagggt atattgctc acatctgcaa tcccaatact 1695180
 tgggagacag aggcaagaag attgctgtga gttcaaagcc agcttagact gcagagcaag 1695240

 acctgtcac aataacaac agaaaacca tctatttaa aaggigcaca cagggaagtc 1695300
 tccctcatct tttctcgatc tgctctattt tcttccgtt ggtaaccatt tcagttaatt 1695360
 ttgtatttat tttccagtc cacttcattg aatattctg ctttctctca ctttttggca 1695420
 tgaaaggcag tacactaaca tgctgttatg ctctttcctt tttcacttg ctctgtctta 1695480
 gagagcttcc cttactagtt tttagaaatg aattccacat tttttttta aatagaaaaa 1695540
 aaattagatt ctgtctcct gttgggatgt ggtcactccc aaacacttcc cttagctccc 1695600

cctccttccc ttcttagtca ggagatgctg gtgagcctgg aagctaaaca gtcagaatca 1695660

 ctaagtgagc tgatgactct tcgagaagcc ctggagtcca gtcgcctgga aggggagcta 1695720
 ctgaggcaag agcaagtgga ggtgacggca gcctgggcca gggtatgtgg gccttctcac 1695780
 tcggaagct gtgttcccag gaaaggggct cgatggctca ctcttcaccc ttccgacttc 1695840
 aagcctttct cttaactcac tagtctgctt ctgggtcctt tccttccca catgcgctct 1695900
 acactgaaat tcagttcact ctctaaagta taaatctggc tgttagtctc tcaaagtgc 1695960
 cccatagagg tggctcagca gttaagagtg tgtactgctc ttgcagagc cccaggttca 1696020
 ctcccagca cccacatcag atggccaaca acagcctgta actctgggag aatctgacgt 1696080

 cctcttctga acttcatggg cacagcactc atattgtac atttattcga gaaaagagac 1696140
 gcagacacat atatacacag gatttaaaaa taaaagcctt tagaagaaaa ttcagtggct 1696200
 tctcaactct ggtaccat atcaacacct ttgccatctg cctcagacac tctctgggct 1696260
 ggccctccca ggcccaccac acgccaggtg tcctttgctc tcccacaaa ggtcagctgc 1696320
 gttctcaggt tctcttctt cttgactcta atacattgta tactctttc tttcaccttg 1696380
 actccaaga accatctccc tctcagtatt cattgttcca agcattttct cctctcccaa 1696440
 actaaactga tgcttcttt gagttttcag ttgtgtttac agtttctata ctgttggac 1696500

 aattgtagtt tgcacatctt tctgtgttc tattctgtga gcacatttct catgaatgaa 1696560
 tgaacgagtg agtgagttaa tgaatgaatg aatgaatgaa tgatagaaaa ccttagaatg 1696620
 gaagggaaga gatggaatga tattttataa ataaaagcag gttttgggag tgtttactga 1696680
 tccatgaaaa ctcaaagcag gaaacactaa cttttgttt taggcagaac agtccattgc 1696740
 agagttgtca gcttccgaga acagctttaa ggagaggta gccgatctta gagctgcagc 1696800
 tgtcaagctt ggggccttaa acgaggcttt ggcttttagat aaagtgggc tgaaccagca 1696860
 gcttctccag gtgagcaaaag atttgatttc caggaggggc tggaccttat ctgaggatta 1696920

 gcccttggca gacaaagctg atgccttaat ggggtgggga gtccttagag gattaggcaa 1696980
 aggcaggtga gctccagaat gtggctgaaa tgagcaagag ggacctctac agtgcagagg 1697040
 agaacaaagg attagactca agcactatag atagccctcc tctgtacctg ccgctgagcc 1697100
 tttgatagga caagggaagg gtccatgtcc ctggaagcaa gacttaagt tttaatccta 1697160
 ttgggtgtgg cagatctgct gactagccca cgtgccctca aatcacctg ttggttaaaa 1697220
 atttaacctg tcatttttag taggaaaaac ttcttgcttc ccgctttct gagaccaga 1697280
 aatgtcatta gtcggtgtgt cctgtttgtt ttttttttt ttttttttt gagacagtgt 1697340

ttcattgctac ctaggctgtc ctgatcctcc atcacttccc aagtgccttc accaccacta 1697400
 gtgttattct gagctctttg gaagcaagat ttgctctttt tatctctatc ccagcatcag 1697460
 gcccatctgg tgcccagaat ataaacacca gatcaaatgg acgggtctct tctcttcaaa 1697520
 gcaactgtttt gttcagctgt agggagggtt ccagtcacag cacttcagca gcatagggga 1697580
 actataccca ttacccttg atgcctgcat tccttcctt ttgtggccag tagttggagc 1697640
 aggagaacca gtctgtgtgc agcagagcgg aggcggccga gcatttgaga agtgctttgc 1697700
 aggtggacct ggcagaggca gagaggcaca gggaagcctt gtgggagaag aatactcagc 1697760

 tgcagactca gctgcagaag gcagaggagt caggagctga gctgcaggca gaactaaaga 1697820
 gcatccgaga agaaaaggaa gaacttaaag agaaactaag tgaggtgaga agagaatttg 1697880
 ctgtggtcac ttgcaagtga atgcatgctt acggaagca gaaaggactc agagagtgc 1697940
 tcagtgtgag tgaggtatct gcccaactgt ttaaggaatt tccccgactc cctattccta 1698000
 catgatttcc cctgaattct tagctagcac tgcataatta gttcaaacat ctacagtct 1698060
 ctcatgcat aattatttgt ttgatatcct tgaaggccag cctatgttgt ttacttattt 1698120
 attttggctt ttgagacag tgtctaacct tgcaccctg gctggcctgg aatttcttat 1698180

 gtagaccagg ctggcctcaa acttgcaagt tccacactgt tctgcctcct gagattatta 1698240
 gctaccatgt ccagctaagg ctgtgtatat ctgtctttct gtttgtttgt ttgagacagg 1698300
 gtgtatttgt ggatttttat tgttttgttt aactcacaac atgaggaggt atggccattt 1698360
 atagtgggaa aagcatggca gcagatgtct atgtggtagc caggatttgt ggcagctgct 1698420
 tgcttgctc ttagccacca gaagccagag aaaggggaat gaagtgttct gctgggcttt 1698480
 ctctgttgt ccttttaatt gaatctgaga ctccagcgca tgtgatagta ccattcatat 1698540
 tcaagtgggt tccctcctc cattaacatc ctcacagaca tatccagaag tgtgtctcct 1698600

 aagtgattct aaatcaccaa gctgacaata aagcttaatc ttggcaatct tgcttttccc 1698660
 taccaaacct ctattgctt taatacttga acataatcca ttcttagagt cccttctcaa 1698720
 gtgttagtca ctttctcatg tgtatatggg tctgtttgtc cctaggacag tatctcactc 1698780
 ataggagagc attctttctg gcctggggcc tctgattga tgaaggaaat aaataaatgc 1698840
 ctattatttc tgagtcattt cagtgtcat ggtgctgagt ctgactctc tgaagacccc 1698900
 ttggtctga cacgttgta gcagccctgg gcatctgct cactctgtat ctcatcagtt 1698960
 tcttttctc aggcacatca ccagcaagaa gcagccacag ctgagctaga gcagctgcat 1699020

 caggacactg agcgacagca agaaacactt gccagagcag tccaagagaa ggagacccta 1699080
 gtacgggaga gggcgaactc cgaggttcgc ctgcaggctg tggagcggga ccgacaggac 1699140
 ctcaactgaac aagtcttggg gctcaggtag ggtccacact taactctacc aagcaccag 1699200

agctttgcaa ggctaagctg agctccctgt cctgagtgca tgatctgtaa atgaattgta 1699260
 gacaagtaat taattgcttg atggattaga atacttctg attcccaaat ctgagtcag 1699320
 ccaaggaaca actggagagc aatctctttg agaccaaca gcaaaattct gtgatagagg 1699380
 tcactaaggg gcagctggag atccaggttc aaactattac tcaagccaag gaagtaattc 1699440

 aaggtgagag cccaccaggg tgggcacgct gcattccatg gcaatgttca cagccaagag 1699500
 ggcaatggga agctttctc atccagactt gggtcctctg agatggaagc tgctcatgag 1699560
 gggggtgggc cgggaaaata ttattaggta aaggagtggt cgtggagcag aggctcagag 1699620
 tggatcttgc ctgacatctt aggggaagtg aagtgcctga aactggaact ggatgctgag 1699680
 aggagccggg ctgagcagga gcgggatgca gtagccaggc agctagcca agctgaacaa 1699740
 gaggggcagg cagctctgga gcagcagaag gtggcccatg aggaggagt gaacaggctc 1699800
 caagagaaat gggtaggtag cggctgccca ttggggaata ggagaggcga cacggcatcc 1699860

 ctttagtgaa tctgccact gccctgtttg gtccagtat tactgcttag aaaaatgaaa 1699920
 tttgatcacc agggataaaa atccagttta ataatectca atcataggtg tggactttgg 1699980
 gagcccatc cacatagagg gatactcct gagccaagac acacggatgg gectaggccc 1700040
 tatctcaaag gatatgatg actctgatga caccctatga aaagcctcac tatccagggg 1700100
 gagcaaaaag gatatgtgat atgtagggtt ttagtgggg gggtagtagg ggaggacggg 1700160
 agggagaagg gaactgggat tgtcatttaa aacaatcttg tttctaattc aaataaaaaa 1700220
 aaaatctgca aaaaaaaaa taaccaaaaa ataataataa tcctcaatcc cagaatgcat 1700280

 gtctctgttt ctacttcagc ctctgttttc tgagatagga tacctccttg tggcctagtg 1700340
 ggccctcagag ttgaacagct tctagctatt aaataagtta ccatatgaaa aaatacaaaag 1700400
 actagtctt ggcatagtat gagctcttca ttgtaagct ctctctctct ctctctctct 1700460
 ctctctctct ctctctctgt gtgtgtgtgt gtgtgtgtgt gtgtttcttg tttgtttgct 1700520
 tggataaat aaagaattaa gtgtggttcc tgaagcagc catggcagag cacaactata 1700580
 atcccagcat ttagaaccag aaagcctgtg ggttcaaggc tacctgtttt acaaagggat 1700640
 ccacacaaag agatgtcaag aactgatggc gtacacctt aatcccagac tggggaggca 1700700

 gaggcaggca aatctctgtg agttcagtga caacctgctc tacttagtga gttccagtcc 1700760
 aggatfacct agtgagacc tctctaaaaa ttattttaa ttaaaaaaaa aaaaaagttt 1700820
 ggggctggag agatggctca gagattaaga gcactgactg ctctccaga ggtcctgagt 1700880
 tcaattccca gcaatcactg ggtggctcac aaccatccat tatgagatct ggtaccctct 1700940
 tctgatgtgc agatacacat ggaagcagat tgttgatac ataataata aataaaatct 1701000
 ttaaaaaaaa agttgtaaga gagcagtcta ccttttaac atcagggaga ttgtaagct 1701060

aggcaatcag aagatgggat tacctgagtg tgtggagagg aaaagagaag ggaccacat 1701120

gatccaggtg tggccatggc agtcactcct tccagggaaa ctgaagccat tagctcatca 1701180

atcagaaagt ttgaaatagt ttttactttg ggcttgcag tgggcattac cctgactct 1701240

tagagggatg cagccactgt catctcagca cataattcta aaagtgggca aacttttggc 1701300

tactatcttg ccaacaaacc caccttaaaa caataaataa tcaaggggct agagagatta 1701360

gtgcttaaga gagtacagct ctcaagaagg ccctggcggg ctctagcac ccacttcagg 1701420

tgattcacag ttgcctgtaa agccagcttt agaggtcctg aagtctttct ctgacctctg 1701480

tgccatata tacatacata catacataca tacatacata catacataca tacatacgtg 1701540

gcatacatat acataaataa aaataaataa ttaaaaacaa ccaataatca aaagccatac 1701600

atgatactta gtgtgtgctt ataatccaga acccaggagg cagggtctat tctttcagag 1701660

gaccatgct tggttccctg cacccatgtt aggtagtcca tgactgtagt acgataagta 1701720

aaagaccag agacagatat ggagttcaaa cttcaagctg aagaacagaa aactaaaaga 1701780

gccagccact agctctcact ccctcagact gaaaggtgat cctggctcca ccaaacctct 1701840

ggctagctgc ctctctcag cgtagctgga gaatcctgag acttaatgic ttcctatcct 1701900

caatgtggct ggagaatgaa tgccagctct gagaccctgg ccctgggtgtg tgataccagg 1701960

tgctgagatc acctttgtgt gagctatttc tctttaggac tggatcaatt tcgaggagct 1702020

cagtgtagcc ttgaaactaac agatctgtct acctctacct cccaagtggg gggattaaag 1702080

gtgtgtacca ccaccaccg atcactatgg ctgtgtgctg actgctgtct gaatcctcag 1702140

gcaagcttta ataatcata aataatatgt caccacactt ccccttttct atctgcaact 1702200

ccagctgcag ggigtctgt atgcccttct gaatcccacc agttcctgca agatgaagcc 1702260

agttaaaaat tccaaggagg aggaaggggc tctaaggcc caacttctag ttaaggaatt 1702320

attagcactt gatggctttt gaaaatcggg tctccttcca gtataggttc aggggatggg 1702380

actcaggtcc tcaagctgat gcagcaagtg aaccaagta ttctggttat agtctaacca 1702440

gaagtgatgg attattcctg ttttgacatc acagaattag ctctcttgtg gccatacatt 1702500

catatggagc aaacagctta atttgtttt aggtttcttt aaacaattgt caccattaat 1702560

ctttcacatg tgtttacagt tggctttttg aacctgaatg taaggtttgt catttacaat 1702620

gatctgtgg ttagcatctg tactactgtt cttgtttgt ttgtttgttt tatcgacagg 1702680

gtctctctgt gtaatagctc cgcctgtcct ggaactcgt ctgtagacca ggtttgcctc 1702740

taactcaaa aaatccatct tttctgcctc ccaagcactg ggattaaagg tgtgcgccac 1702800

cactgcctgg cctaaacatc atttttaaaa aaataaatct cacttgactc ttaagtttta 1702860
 atgagacaga taaggcaggg attgttgagc ctttcatcag aaatgattgc caggctgaga 1702920
 gcagtgccta aggcacagtg aggcagtgga gagattcgca ctccaacaa ctctctggtc 1702980
 tcctctgctc atgcactggg tctaacagta tggtttcctc cacatggtca ggagaaagag 1703040
 cgctccttgc ttcagcagga gctggagaag gcctggaga ccctggaaag ggagagaacg 1703100
 gagctggaag taaggctgag agagcaacag acagaaactg aagccctcgg tgcacagagg 1703160
 gaagaggagc gaacccatgc tgacagcacc ctgtaccaag taagtggacc cttgtgacct 1703220

 ttgattcccc ctggcttacc acttttcatt ctaacagcaa ggctcaagtg gggcttccag 1703280
 aagagtgtgt agctaccact ttgctgcttg cagggtggct aatacgagc tagctgcagc 1703340
 aggcagtatg tcatacttcc tgagggaggg ccaacattta ccacatcctg tcagcttgca 1703400
 aaccagtggc aatctttgca cttcctgggt ctaagttaat ggtcttagac gttcctttgc 1703460
 cctcagcctt catcctattt gttggaagaa cttggagcaa atgtgcttat ggcctcccgg 1703520
 gttagcatga taaccagag ccgtgaagcc cttgccttc ctgccttcc acagatgcaa 1703580
 ctagaaacag agaaggagag agtctccctc ctggaaacce tgctgcagac tcagaaggag 1703640

 ttggcagatg ctacacagca gttggaagg ctgaggaagg acatgaagat tcagaagtta 1703700
 caggaacagg tatgcaaggc gctcctgggc ctggtcctcc tgcctcctcc caaacccag 1703760
 agttacagc atggaccaca acaccagtt ttatgtattg ttaaccatca aacctcaagg 1703820
 cttcatgaat gctggcagga ggctgttctt aattacttta tttatgtgt ctgtgtgat 1703880
 atgtacatgc atgtgcacgt ggcatgaaac gcatatggaa ttcaactcgt gggagtgggt 1703940
 tctttccttc cactgtgtag gacctggaa ttgacagcaa gcaccttac cactgagga 1704000
 tagtttttga aggacaaata ggatttcact gtcatagggc cctgtagcag acagaatgag 1704060

 gcttgggaaa ttcaaggaca aaaagaggtg catggctctg gtgtgataaa cttgggggtg 1704120
 gtacaggaga gggggagagg atgggggtgg tacagagaga gaggagagga tggggtggtg 1704180
 caggagagag aggagaggat gggggggggc caggagaggg gggggagggg gggggggggg 1704240
 gagggggaga ggggggggga tggggtggtg cagagagagg ggagaggatg ggggggggca 1704300
 gggggggggg gggggggggg gggggggagg gggagggggg gggggggggg gt aggggggg 1704360
 gggggggggg gtgggggtg gtacaggaga gaggggagag gatgagggtg gtacagagag 1704420
 agaggagagg atgggggggg accggggggg ggggaggggg gggggggggg gggggggggg 1704480

 agggggaggg gggggggggg ggggt agggg gggggggggg ggggtgggg gtggtacagg 1704540
 agagagggga gaggatgagg gtggtacaga gagagaggag aggatggggg gggaccgggg 1704600
 gggggggagg gggggggggg gggggggggg gggaggggga gggggggggg ggggggt ag 1704660

gggggggggg ggggggggtgg ggggtggtac aggagagagg ggagaggatg aggggtgtac 1704720
 agagagagag gagaggatgg ggtggtacag gagagagggg agaggatggg gtgatacagg 1704780
 agagagggga gaggatgggg gtggtacagg agagagggga gaggatgggg ggggtacagg 1704840
 agagagaggg ggggtgtaca gagaggggag aggatggggg ggtacaggag agagaggaga 1704900

 ggatggggtg atacaggaga gagaggagag gatgggggtg gtactggaga gagaggagag 1704960
 gatgaaagga gaccttttta gctatagtag gagcttgggt tttgttttga ggccaatgaa 1705020
 aaatggtgaa tgatatttta agagtaggag aacatggggg gctggagaga tgcctcagta 1705080
 tttaaagca ctctctttc agaggacctg ggttcaattt ctggcaccca taaggcagct 1705140
 cacaattgtc tgtaattcca attccagggg acctgacacc atggcaaagc accaatgcat 1705200
 ataaaataa attaataaat taaaaaaga gtaggagaac acattathtt tttaaaaggc 1705260
 ttatttattt ttaataaata aatgttatgt gtgagttttt tgcctacttg tatgtatata 1705320

 taccatatgt gtgcctggta cttgcagagg ccagaagagg atgtcagatc tcctagaact 1705380
 gaagttaaca acatgtggat actgggaatt gaatctgggt attctgcaag agcaaagtgc 1705440
 tcttaaccac tgaccatgtc tctagccctt gtgatatac attttatgta tttaaatact 1705500
 tattctttta ttatcattat ctttttgtgg ttctggggct ccaacctgga accttgtaac 1705560
 attttaggca aatgttcagc tactaaatta taatgccagc ctagaatac tttttgaggc 1705620
 aggtctctg ttatgtggct tccacctgic ttgcctccc tagcactggc attaaaggca 1705680
 tgtgctgcca tgcctggcca ggatatcttt taatacagta cttgaccaag tgaaagtatg 1705740

 tacatttatg tatgcaatca agtgaanaa ggggtatggt ggggaggctg tgggcctgtc 1705800
 tagaagtttg actgagccca tgcaatcgtg tggaagaagg aatagggtat aaggatagag 1705860
 gggggaaca atatgcatc ttagtccctg cctcaggtct gtcaactcag tagaatcaaa 1705920
 cagcacttat acagcacagg ttccaggagc tagccctat ggaagctttt tgcactcact 1705980
 gatcctttct ccgtaggag accactgaca tgctgcagac ccagcttcag ggagcacagc 1706040
 aggagctgaa ggaggcaacc cagcagcaca gcgaggagca tgctgccttc cggaaggaca 1706100
 gagaagacct acagaagcag gtccatcttt cctacctgcc tcacagccct getcaccaca 1706160

 gccaaacctt cccactccct ttgtagaaa ggtcccagg tcctgctgct tgagcttggg 1706220
 aggacagggc tacagaaata agtgcagagt tgttgaaggg tgttcagagc tgatcatgtg 1706280
 cctcaacgag ttctgggatt gtattattag ccatcgttac ccagattcta ccaacagcca 1706340
 ctgaaaatac atactgtgaa tatacaggcc ttttcttatt ctctaaataa caaccgtttt 1706400
 acatagtgtt tactttgtat taggtactgt ttacattgta ttcaatatga gaaatgtata 1706460
 ggagaatgtg aataggttgt ggtcaaaagc tatataattt aatgccagca cttaaagattt 1706520

aagaggttga ggcaggccag gtgttgggtg caaacgcctt taatcccagt acttgaggc 1706580

agaggcaggt ggatctctga gtttgaggcc agcctgcctg gtctacagag caagtaccag 1706640
gacaggctcc aaagctacat agagaaactc taacccttgg agaaaaaaaa gagagagaca 1706700
gagattgagt ttgaagtcaa tcctagctgc atagtgggat tctgtcttta aaacaagaac 1706760
aggctagga ggtggctcag ttaataaagt acctgccata gtgcattaag gtctgagttc 1706820
agattcccag cccccatg gaaagctggg tgaggctgga gaggcagaga caggcgggtc 1706880
ctggagctca ccatcagctg gtcttctga aagtaagtag tatcaggttt aagaagacag 1706940
atcctgcttt aaaaaaaaa aaaaaagggtg gagaatgata gaggaagcca cacattaacc 1707000

tctgacctac acacacacac acacacacac acacacacac acacacacac acacgcacca 1707060
tgtgctggga ttaaaggcat gcactaccac caccacctt ctcaaccaag atttttattt 1707120
atggctgcac ttatgtagca tttctaagac ttggaaacg aacaagctta agagtttggg 1707180
ggaaggaat galaagaatg tggttgaagc caggtattgg tggcgcacac ctttgatcca 1707240
agcactcaga gtcatgcaaa tctctcagtc tgaggacagc cggctctaca gagcaagttc 1707300
caggacatcc agactataaa accctgtctg aaagaaagaa agaaagaaag aaagaaagaa 1707360
agaaagaaag aaagaaagaa ggaaggaagg agaaaggaag gaaggaagaa cacacacgca 1707420

tgttcattta gatagctcag aacaactaca aattgtctac tgacctccac aacatgtcat 1707480
ggatgtgat tgagtgtgta catacacaag taaatgtaaa aaagaaaaca aaatagtgtg 1707540
gggactagtg aaacctccag aactgtggag atgggccact gactaataatg gcttacctga 1707600
gcctaaacat ctgacttct tcttctgggc ttgtctatct cagcctcttg ctcttaacct 1707660
tccaggtaga ggacttgaag tctcagctgg taaccagga tgactcccac aggctggtga 1707720
aacaagat tcaagagaag atgaaggagg tcaggaata tagccgatt cagaaggaac 1707780
tcgagaaaga gaaagccagg taagctagac agccagaggg gtgcttggc ttatgtgtcg 1707840

tagtcacagt ggcactgact attctgtgca aggttatctc accatgtctc actctggagt 1707900
acacgtgtag tagccatctg gactggacat gatctcagct tcagatctta tatttagtaa 1707960
atatttagag aaaagacat ttatgcacca ttgtcttatg acaatgtagt ccctacctca 1708020
atagaattta tagtctgigg gattttttt tttttttt ttttactcc cagacagggt 1708080
ttctgtgtag ctttggagtc tgtctggaa ctactctgt agaccaggt tgccttgaac 1708140
tcagatct gcctgcctc gccaaagtct gggatcaaag gtttgcgca cactgcttg 1708200
ttgaaattt ttaatgaac aattttta acaaatggaa agagacaagg tgcagagaga 1708260

gagagagaga aagagaaaga gagagagaga gagagagaga gagaaactgc tttagaaagg 1708320
tataaggaat atctttccca ggaagttaca tttaaactga atgctaagcc agacatggac 1708380
cctcagtccc agcactcagg aggcagctct ctgagtctgg ccaggcttac aaagtgagtt 1708440
ccaggacagc cagggtcaca cagagaaatc ctatctttaa aaacaacaac aaaaagataa 1708500
aataaaaata aactgaatc tggagctgtc agatggttca gctggttaagg acgcttgctg 1708560
cgatgcctgc ccgacctgtg ttcaatcttc agaagcctca tgatggaagg agaggatcca 1708620
tgctgaagg ttgtccttg acctccactc gtccctctat acacacagta aataaataa 1708680

cagatggaat gttgaaagac aatggagcca cccttghtaat caaagagagt tctgttcagt 1708740
aagagaagaa gtcttgaggc aaatgagagc tttccctctt tggatgatcc agagtgtgga 1708800
aagctagtat tagctaaagt ccacagcagg agctttagg ttacattcaa caggaaactg 1708860
taaggatttc aagtaagga atcagcataa tcagatttct ggctgttag aaggatagtt 1708920
gatggcctga aacatggagt gacatgagcc cattcagaat gggagacagc atacgctcag 1708980
tgacctaggc acctgaaaag gaatggatct tttcaatagt gacaactgag tcctaaagac 1709040
aagtcaggag gctggaacag gtgtccaaat gagagttagc aagactgtgt gtgcatggt 1709100

aagtaggagg gaaggaaga agagaggaac ttaagataca ttacggctta agacaattat 1709160
atatagttaa agattggatg tggtaggat gaagggggaa ttaaatggt tgtggcttcc 1709220
atgctttgac actgtagatg aaagagccat tcacagagcc atgggacaga gtgagagatg 1709280
attgggtgga gaattgggga cacagggatg ggaagcttgg atataatgaa ttgaaatat 1709340
gtgcatatat atgtgggatt tatcagagaa gaataaattg gagtgaaatg agtcctcatg 1709400
tatgaagttc ctaggagccc ttaggtgttc aataaacagt agttcttact gaccctctgg 1709460
tcaccattat ggtttctgtt ttaacaagca gtgctatgat tagaacaatc cggtagaagta 1709520

cacttcacc cctgagaga atgacctctc tctccaacct ttgttttag cetggcactg 1709580
tcgctggtgg aaaaagaagg cagactctc atttacaag aagctgactc tttcgacag 1709640
caggagctga attcctgcg ccaggacata caggaggccc aggaaggaca gagagagctc 1709700
agtgtacagg tgetgacta tgctgagcc ctactttctg gagaggatgc tettagaggg 1709760
gctgggtgaa ttttttttt ttcctaagaa caagataggc tgggacctca gcatccctgc 1709820
cagttaggga aaagcagggc tgggcaccag gggtttagga acctgacaca cagatgagct 1709880
ctgtccatg tggggagcct gacatcctga acagagtgtt catgcataat cacttgacaga 1709940

tgtacttcat ctggttgca aatgcagca ggggaacttg gaggttaac accagcaaga 1710000
ggccttccgt actccatttg ttcatgact cggacctgag cctggaggag agacaaagtt 1710060
gaaaaggaga ggaaggggc tcacacctac ctactagttt tcatacagtc tgaccagctc 1710120

catgtcaagg ttcagggca gagttcta atcctcagcagg ctgacatatac tgtctgactg 1710180
 ggaacagggc caggtgtgtt agtgtagcct gggcccttgt gtgtggtgtt gatcaccccc 1710240
 agttgtcaga actactcatt tcagggccct tcctacctgc tgcagagctg agcccactgg 1710300
 acttctcccc atctggggtc ctgatggagc ttgctcagag agtctacttc ctccccgcag 1710360

 gtggaactac ttaggcagga ggtgaaggaa aaggagctg actttgtagc ccgggaagca 1710420
 cagctgctcg aggagctgga ggcctcacgg atcacagagc agcagctgcg agcttctttg 1710480
 tggaccagg aggccaagac aaccnaactg cagctgcagc tgcgcagcac tgagagccag 1710540
 ctggaggtac tggctgcaga acagcagcca gagaaccagg cccaggccca gctggctagc 1710600
 ctttactctg ttctgcagca ggccttgggg tctgcatgtg aaagccggcc tgagctgagg 1710660
 ggtgggggag actctgctcc ctccctgtgg ggcctgagc caggtgagga agccacatga 1710720
 gagctaagtc ttgtgggcca aagctgggga gagggaaagg aatggagttc ctgctgtaaa 1710780

 atagcatcca ggtaaggcc accgctgatt ccaggtagct tgaaccccag tctgtttggt 1710840
 agcaggcaaa gccacctaac ttctcggaac ttgatttttc ttgattataa aatgttaaaa 1710900
 gtctatctt agaatttgc taagaatata aaaagaggta ggccaatgg aggtgcctgc 1710960
 ctgtaacct agcactaagt tccaccagc tgagctacat agtcagttgt ttggggttga 1711020
 ggttgggata ggtggattaa gagtatagta aattccagc agcctggact acttaaatcc 1711080
 tgtcttaaaa aaaaaaaaaa aaaatgagc tgggcagagg caggtagtct ctgtgagttc 1711140
 gaggccagcc tcgtctacag agtgagttcc aggatagtca tggctattac acagagaaac 1711200

 ctgtctggga agggaaaaaa atacaatttt ttttatagct tgcacttttg agcatagctg 1711260
 ccaacagcca gcattttcta atgcagcagt tctcactgtg gggttgagat ccttttgggg 1711320
 gttgaatgac ctttcacag ggttcacata tcagatagcc tgcatacag atacatcaca 1711380
 attcataaca gttagctaat tacagttatg aagtagcaac aaaataattg tatgtttggg 1711440
 gtaccacag catgaggaac tgtgttatgg gttcgagca ttgagaaggg tgagaaccac 1711500
 tgcctaagt gaaagtatag gaataaacct tctagaaggg attctttgga gagagggggg 1711560
 gccagcggga gggccaaggc cctgtctggg gagggacagc taaagctgct gettattgtg 1711620

 gcagccaggt aagaagttc cttttcttc agatcagaat ggagctagga gacccttaa 1711680
 gagagggtec ctctgaccg cactgtcagc cgaggctgta gcattggctc tccagaagct 1711740
 tcatcaagac ctgtggaagg ctcagcaggc ccgggtatgt cctctgcct cctccttct 1711800
 tttctggagt tcccctgaga tctcaaca gacttgtaaa tggagggaga tgggtcaaag 1711860
 gttactcate ccgactctg cccctatcat cccacctgta tcagtgaact tectgcaaac 1711920
 ataactgagc ctttggattt cctgggcctt gctttcactt cctcagctgt cccactctac 1711980

tccaaacccc agttgctggg tggggcctag aggagccctg agaactgtaa acatgggttt 1712040

tctcttatat catttcttct catccaagaa tttcttcttg gtaccaaata ccctgagaaa 1712100

aggcaggtaa gctggggcgt attgaaattt gaggtcacca cttaacaaaa atattctaga 1712160

cttaagactg aacctacttc acctcactgt gcacttgcta gtcagtactg agagctgcca 1712220

gtgcacactg gcaccagcca ctcagactgt gtgatacaga aatataaaga cacagcctgc 1712280

cttcaagaag ctctgcatag tggagctgac agaaggacca gttcagacag acagctacct 1712340

gctgggactg gaagaaagtg tcaggggaac tgtgaaggag cctcttgggc gagaaggggt 1712400

gtggcctggg ataggatact gagcagttat ttcaaaagaa ataatccagg ttagcggca 1712460

catgcctgta gtcccagcac tcaggaggct gaggcaggag gattgagaac ttgagactag 1712520

cccgagtgat atattgagac cttgtctacc cccccaaaa aaataaaaat aaaagatttg 1712580

ggcagataag gtgtggggcc tcaaatgtct gtaatcccag cacttgagag gtagaggcag 1712640

gatgatagtc aggagttcaa gacaagccta gattttgtag tcactttaag agcaacctgg 1712700

gcttcatgag actgccagaa ataacaaca aaacctaat ccaaggggtg cccttaggt 1712760

tcacctccc ttctgataa gagtttaag cagtattct caacctgtgg gtcgcaagcc 1712820

ctttgggtgc tgagcgacc tttcacagg gttgaatacc cgatagcctg catatcaggt 1712880

ttttacatta cagtttataa cagtagcaaa attacaatag caacaaaaat aattttatgg 1712940

ttggggtcac cacacttcaa ggaacttatt taagggtcac atcgtagga aggtttgaga 1713000

actggcttag agagtgggt catgatggca gagactgcag agtatggata gtctctgagc 1713060

tctgaaagt gtgagctcag ccccgccctt cctctcccag gatgatctga gggaccagat 1713120

ccagaagctg aaacagcacc tgactgatac agaggcccag aagagccagg tccactcaga 1713180

cctgcaggac ctgcaaagc agctctcaca gagccaggaa ggtgagatgc tcaggggacc 1713240

aggctgaaag gaggcaagag caggtggtgg ctggaatggg gagactagct caggcacctg 1713300

ggaggggcga gcctcttcaa ctctgttcc actgtgcttg gctttgtgg gccaccctgg 1713360

aagaaggatt tagaaggaac ggacttggga aatcgataga cgctgcctcc tgggctgctg 1713420

atagtctctt cggggagttg tttttgttt ttcacttta aaattgact tattttgtgt 1713480

ggggggggg atgcatggc acacatggag gtcagaagca atttgtgaa atcagttctc 1713540

ttctaccaca taggttcccc aggatitaa tcaagtagtc aggtgtggtg gttggagctt 1713600

tttccttct gagccagctc accagcccat gcagggaaaa aaaaaattt tttttcaag 1713660

cacaaaatcc tggtagacct gggccagaac tatcagaaca taaaactgta tttctttgt 1713720

cgtttatccc tgttacttat ttttaccatt ttccactatc acctcaaaat tagcctttga 1713780
 ggacaaaagg gttgtaaca tactcttgag aaaggccaga aggggactca ggaagagcaa 1713840
 gcacactgcc atgtccctct gctgaggggt tggaggggtgg ggaccacttg gaaaggaaaa 1713900
 gaggtcaag acigtccct tctgaagttc tattgcagaa ggaaagaggt gacccittta 1713960
 ggcatgtgag acctgtgcta cccccaaaa aaaataaaaa taaaagattt gggcagataa 1714020
 agtgtggggc ctcaaatgtc tgtaatccca gcacttgaga ggtagaggca ggatgataat 1714080
 caggagtcca agacaagcct agattttgia gtcactttaa gagcaacctg ggctgaggtt 1714140

 ccgtcttcag accttgaggg cctctaggaa ccacctacaa actcatagaa ttggggctag 1714200
 aacgggccac tgcatacagct ggctctcatg tctggagagc gatctgagaa cccctgggtg 1714260
 atgggttctc agatgaagtg tagggtgatt agcaggctgt gctgtgccag gactctcagc 1714320
 agacacagat gcaaggctgg aagcagctgc tggcagaaaa gtgatggcac aggacactgg 1714380
 gtgtcatttt ctctccttg gccttgttcc cctttgattc tgatccctgt cctccatctg 1714440
 cttctgtacc ctgtgttccc ccacctgcag ccatgcacct gactccaaca tctctgttct 1714500
 tttcaaagag aaatccaagt gggaagggaa acagaactcc ctggagtctg agctgagggg 1714560

 ctgcatgag acigtggcat ccttacagag tgcctacgg caggcagagc tgcagaaaat 1714620
 ggaagctcag gtaaagtgt ggtctgggga agagtgcctt gggaattgtg tttagagttc 1714680
 aagcacctaa cccttatctt aaccetaacc ctaaaccttg accctttcct aaccctagcc 1714740
 ctgacccttt ccctaaccat aaccetaacc ctaaccctg actctgacct ttttcctaac 1714800
 cctaacceta acccgtgttc tgccctcag aaacacctg gcctgtctgt gctcatgcct 1714860
 ggcttccttc agcaagtctc aaagtccct gactcttccc accttccat tattaaggtc 1714920
 atagtgaacc tttatttaat tactttttct ggattaagat tagacagtta ttccctgatg 1714980

 tgcaagatca gggctctagaa tgctcttttg cattaggcta tctcccctgg acacagaaga 1715040
 gctctggaag gtggtagga cacttggata ggtcagctt aagtggggca cttcttcagt 1715100
 ccttgtaac gactggtcac tgatgttgc tcaaaataag aagccagtgt tagaatgata 1715160
 gtatcaagaa aataatcttg tccaggcagt agtggcacac acctttaac ccagcaggea 1715220
 ggctgacctg agttcaaggt cagcctggc tacagaattc caggacggcc atgactacac 1715280
 tgaaaaacce tgtcttgaaa gacaaaata aaaaggaata atcgtgtctt aaagcctttt 1715340
 gcctctgtt tccagaatga gcaagagttg cttcaggcat ccaaggagaa gctgacagcc 1715400

 caggttgaac gctcgaagc atttgttga gaagcccatg ctcaggcaag tgcggcttct 1715460
 gtctggaag aagatctgcg aacagctcgc tcagactga aactgaaaa cgaggaggt 1715520
 gagagcgagc gggagagagc ccaggctttg caagagcaga gtgagctaaa ggtagcccag 1715580

gggaaagctt tgcaggagaa tctagccctg ctggcccaga ccctgtctaa tagagagcgg 1715640
 gaggtggaga cgttgcagac tgagatccag gaactggaga agcagcggga aatgcagaag 1715700
 gcagctctgg agctgctctc cttggacctg aagcagcggga gccaaagagt agacctgcag 1715760
 caagaacaga ttcaggagct agagaagtgc aggtcggctt tagagcacct gcccatggcc 1715820

 gtccaggagc gggagcagca gctgagtgtg cagcaggacc agatccgaga actggagaaa 1715880
 gatcgggaga cccagaggag tgtcctggag catcagctcc tggaaactgga gaagaaggct 1715940
 caagtgattg agtcccagag gggacagatt caggatctga aaaaacagct ggtgacactg 1716000
 gaatgcctgg ccctggaact ggaggaaagc catcacaag tggagggcca gcagcaggtg 1716060
 attgcggagc tggagagcca gagggaaatg cagagggtgg ctctaactca ccttacattg 1716120
 gacctggaag aaaggagcca ggacctacag gcacaaagca gtacagctcca tgagctggaa 1716180
 agccacggca cccatctggc cagagagctg caggaaagag accaggaggt gaaggctcag 1716240

 cgccagcaga ttgaggagct gcagaagcag aaagagcagc tgactcagga cctggagagg 1716300
 aaaggccagg agctgatgct gcagaaggag aggattcagg ttctggaaga ccagaggacg 1716360
 ctacagacca agatcttaga ggaggacctg gaacagatca agcactcctt gagagaacgt 1716420
 ggccaggaga tggcttctca gcggcagctg atgctcgagc gggcagacaa tgggcagagc 1716480
 cctggtaaag cccagcgcgg aagcctggaa cacttgaagc tgatcctgagc tgagaaggag 1716540
 aaagggttag aatgccagca tgagcgcac caggagcttg aggagcacgt gggccaggtg 1716600
 gaacagcagc tccaaggcct gcacaggaag atgggtgaga ctagcctgct cctgaccac 1716660

 cgagaacagg aggtagcaac cctacagcgg cacctccagg aagccaagga ccaaggggag 1716720
 ctgaaagagc aggcacttca gggtcagctg gaggaggccc agagagctct ggcccagagg 1716780
 gaccaagaac tggaggccct tcagcaagaa cagcagcaga ccctggcca ggaggaaagc 1716840
 atgaagcaaa agacaggcgc tctgcaggcc gctctggagc aggcccaggt gaccctgaag 1716900
 gagcggcagg gggagctgga agagcaccgg gagcgggcac aaaggctcca ggaagagctg 1716960
 gtgctggagg gaagacaggt tccggccctg gaggaggtgt tggcagacct aaggtctgag 1717020
 attcgggaac acgagaaggc tgtgctggcc cttcaacagc agtgtgcaga acaggcacag 1717080

 gagcatgagg cagaagccag gaccctgcag gacagctggc tgcgggcca gccacactc 1717140
 tcagaacaag aacaagagct agcagctcta cgagcagaaa atcagtattc ccgcatcag 1717200
 gaggaggctg catggggcca agcagaggct ctgcaggagg ccctcagcaa agcccaggct 1717260
 gccctgcagg acaaagagca gagtctcctt gagcaggctg aattgagctg cactctggag 1717320
 gccagcacta ccgccttaca agcttccctg gacaactgcc agtcacgtgc caggcagcta 1717380
 gaagaggccc tgaagattcg agaagtgag atccaggccc aggggctcca acaccaggag 1717440

gttacgcagc agcttcagca ggccctttcc cagaaggaag aaaagttgag gcagcaggag 1717500

gagcagaggc agctgctgga aaagctctg acccaaagca gtcaagaaaa tgggatccaa 1717560

gagaaacaaa gtctggagca agagagaaaa gaggacacag gggcccttgt ggcgagccta 1717620

agggagctac aacggactct agcccaaaaa gaagaagaga ttttgatgct gagggaggcc 1717680

cagcaaaggc agagtctaga ggcctcttcc ccaagccaca gagccttccc agcagagaag 1717740

ccagctccac aattgtgcca ggagttgga cgactgcaga atgccctgag gcagacagag 1717800

gccagggaga tcgagtggag ggagaaggct caggacttgg cacggtcctt gcccagagc 1717860

aaggccagca ataacagtct gcaggagatc gctatgctcc tacaagcctc tgtcctagag 1717920

cggaatcgg aacaacaaag gctacaggig agtcactagg aaggcaggg gatagagttc 1717980

attaactgag ctcaaggct gcttgctgt ggtacctcag agagtgagaa agtggaggtg 1718040

gtgagcccc ccatacctca gagctagcgg aacagatgag caaccataaa cagtggggtc 1718100

cgtgtctgat aaaggaagt cagtgtgctc caagcacacg gggacaccaa agcttccaa 1718160

ggatggtacc aaatggcttc ctggtaaac tgggttttaa ggttaggttg gaagagacta 1718220

gtaggaatt aaccagacac catgcagggt ggactttctt gtggaaggc agaggaacaa 1718280

cgaggaagga acatatgggg gacctgtgaa agagggccaa gtcacgtgga acgtagagac 1718340

acgaggccag cagaagctat ggcatccagg gctcctaagg actaggtcac tcgtgggaag 1718400

tgggtagaaa atttaggaca atttcagaat aactgctcag gatgctgtg gatcgacagc 1718460

agacttgagg agacaaaagg ggactctgga agtccaggga aaggaggaga ctggggggg 1718520

gcgggcaaat gtgaataaag aaaggacaaa ggcagcacca ggaatctgcc cactgagatg 1718580

aagaaaagca gggtaggag gtgaacttgg tcggaagtgg aatgaggcac ctgggggaca 1718640

cacaggggac attcctgtag gggaaggagt gtggcgcttg aaagtcagt gttgattata 1718700

gacggttgtt ctcaacctgt ggatcaaacg acccccaga cgcacaactc ctggggcctc 1718760

ctcactttct gggaaactcac aaagctctgc cctggtaaaa aggtggtgtg tgaagaagga 1718820

atcacactca caaatttggg ggttgggttc ctgatttga aatagttct gtaatttact 1718880

ggctgtgtc tatttactt ttcaagactg cttttcttt ttttctttt ttttctttt 1718940

ttttttttt gttgttttt tgtttgttt tcaagacaag atatctctgt atagctctga 1719000

ctgtcctgga acttgctctg tagaccagge tgactggcct gcctctgct cctgagtgt 1719060

gggattagag gtgcaccaca cctgaatacg tgggaatgat ggtttcaatg aggctgtgtg 1719120

tagcaagtgc ttttaacat ttatctatt gagccacatg tntagaggtc agatgatagc 1719180

ttgcaagagt tggatctctc ctttcgctat gtgggtcccc aggattgaac taagatcatc 1719240
 aggctaagtg gcaagcatct tactggccat ggaacttata atcatatagc ctatcctgtg 1719300
 gcctagcaga agggggggcac atctctgggc atgaggatac ttcttaggct tgctctcagg 1719360
 ttactgagtg ttctttagat aacataacaa agatcagagg cagctctttg tgggtggtcat 1719420
 gcttttgttg tttttgggt tttttgttt gtttgtttgt tttttgagac agggtttctc 1719480
 tgtgtaacag tectggctgt cctggaactc actctgtgga ccaggctggc ctggaactca 1719540
 cagagatccg cctgccatct gtgtgtagag tgccatgca agccagaaga ggatgttga 1719600

 ttccctggag ctggacagt agaggcaact gtgagccatg ccatgtgggt gctgagaacc 1719660
 aaatttgggt ccctggaaa aacaacaagt tctctttacc acttagcatt ttacatattt 1719720
 tataatattt tgcatgccag gttccattgt tctcactttt tcaactacct caaagaagga 1719780
 actgatatta tgtccatttt gtagtgtaaa aatggcagtt tgagacttga gcttatccaa 1719840
 agtcagacat ctggttgaat tggttagctc tgacatctga gtagggctca ggattagacc 1719900
 atttggctct tcctttccct gtgagcctgt cacacgtgtg cgcgcgcgtg cacacacaca 1719960
 caccacaaca caccctcac accaaacatc acacactctc acatccggct ccattcttga 1720020

 gcacgattat gaagagtaga ggatgagata gttttggaca tgagtttggc gtagtgtgat 1720080
 ttttgcctc cgctctgtac cctaggagga gttggtgctt agcagacagg ctctggagga 1720140
 gcagcagtea catggtcac attcaaccag cagagcagac cgggggcca aagctggaca 1720200
 agatgtacat cctggaaagg tgagctgggc ctggtggcat aggaggagcc ctgccaacag 1720260
 tgtgttccct ccttggggaa tgggtctctg aacccaagct cacaatttg tccctttgcc 1720320
 ctctgtctct tcctcctgtc tgtctggatg cccatagag taccatgggt cttccctgca 1720380
 gtagtgtgt gctgagccca gtcctgggt ggaggagaag gagcagtga cacaaaggct 1720440

 tgaactctg cagcaagcag ttgcacagct ggaatttgac cggagcaagc tgcaacacca 1720500
 caatgcgcag ctgctgatta ccttagagct ggtcagtaac ttctgcagtc cccgtctgt 1720560
 gcctgtttct gaaacagttt attaaattac accatgcttt ctctgtggat gcctactcat 1720620
 catgctgggg agcatagtag ttgacatggc aggaacagct caggaacaac ccacaaagct 1720680
 atcctctgct ccagggcct gagagctggc ctgccttctc tgtaccagga gcaacttctc 1720740
 gtacctact gtatgcctc cccagcctc tacactcacc cctgcacacg tgctggctcc 1720800
 agatcaagac gtgatttctc acttgcataat tggcaggtag agcgagaacg gaggaagctg 1720860

 aagagggatt ccatgctgic ttcccagca ggtcactgg agatgaaaga agctatggct 1720920
 tgcctcccc cacagcaggt taccctgttt ttctcactg cctctttctt cctgccaacta 1720980
 tagaagctca accctctgta gtgactgtt gtatgtagag acagccactc tatttaactc 1721040

agagagcccc ttctgggttg attctgcccc ttgtctgtcc ttgccttagg aggaggtcca 1721100
 gcatcagtga gtaagcacag ccagggatag tgggttcaga tcactcccag gccagtgcct 1721160
 cacattgccc tctcatccag agcctctggc atccagggt atgtcgtgct taccagctct 1721220
 tgacacgccc aggagtttga gcacagcttt gtatctaaga gcccttagt tctgagtta 1721280

 caaagttagg gtctgatgt gtcctggcac agagccccat tctcaggaa aagtttgctc 1721340
 ttttaaaccg tcaccgccta aggtaaactg tgccatcag catggcagga ggaacttcta 1721400
 gtctgaaca tctccagctt caccacctt ctttaataga acgtttcca ggggcagata 1721460
 ctatctttt tccccttgg cccaatgctg ccacaaacca gatccctat gttaaataaa 1721520
 agagttcctc acagccgggc gttggtggtg ctttaatcc cagcactcgg gaggcagagg 1721580
 caggcggatc tctgtgaatt caaggccagt ctggtctcca gagtgagtgc cagaataggc 1721640
 tccaaagcta tacagagaaa cctgtctcg gaaaaaaca aaaacaagt cctcacagaa 1721700

 gatgctgctt gtggtgctgc tgtgaggccc tcttggcct tccctctgcc tggagccatg 1721760
 cccacagtg cttcagtctg agttcaggta ctctggccc tcatgatgag ctagaccct 1721820
 gcgaggggga taagaggtc agcaccgct tttccacaga tagacctct ggaggcctcg 1721880
 ccagcctagg agcacaggtg ggggtaggat gctgtgaaa ctccattcta acaggagcca 1721940
 tatctgtttt cctcaggatg ggagagcagc tcagaggggt tctcggata gcatgcgtgt 1722000
 ggttgaactt cagagagagg tatgttctgg aaggatccat ttcctattcc cttttctct 1722060
 cactgtactc aggcaacagg ttcagtgtct gcatgtccag caggagagg gaagcagctt 1722120

 tggcactcag agaactttga tctccatagg agacaaaacg gtgctccagt cccaactcca 1722180
 ccttcagtgt ggcaggaagt ctggggagag gagactcaga gggtctaggg cagaatgggg 1722240
 caagcagcac tggttgctt ggccctcct tgtaggcagg gctgtggaca agcacactag 1722300
 gcagaggcac tcagacatgg ccaggcaagc tgccatgctc aggaaactac tttaatgcct 1722360
 cctgcctcct gtgctaccta aagagtccag aagcctctt ttttctctc cttctgctc 1722420
 cctacacctg tcttctgct ccacctagga gtaatgagaa gtatagattt gacttctgaa 1722480
 cctctctcag aatcagtagt tattgttggc aggctgactc cagctggact tgagctatgc 1722540

 tttgtagtct gttaaattc tacgaagccc cctgacacag agtctgagc aagagaagcc 1722600
 ttgggacttt cgttttcccg tgctctagt tcaattgataa acaccagac aacagcaatg 1722660
 gacagaaaag gggttatttt agctcacaat tccaggacc agtccatcgt agcaggaag 1722720
 gcaaggctgc cagaacttaa agcagctagt cacagcacag tcagcagctg ggagagaatg 1722780
 catgcatgcc tggacttag cttactggag tccaggactc aaagccaagg aatggaacca 1722840
 ccggcacaaa caagctgggt cttccacat tgtttatgta gacaaagcag tcctcacag 1722900

acatgcacag gccaacctga tgtacctagt cccaggfact agattgtgtt gacagttaag 1722960

 cccgctgtct ttctgtgga gccagtgtt agaatcactg gatttggagt ccatgggacc 1723020
 ctatcccaa ctccagtgcc tgattctgag attcagatat gaagcagttg atcccagggt 1723080
 ggagccaaa gccacgagag cacagagcag aagggccagg acagcctcag agccttcagc 1723140
 tgctctcctt ctgggtttc ctgtccacca ggtagcgtg ctgcgagccc agttggcatt 1723200
 ggagcгааag cagaggcaag actacattgc acgatccgtg cagaccagcc gcgagctagc 1723260
 aggcctgcat cacagcctgt ctactccct cctcaccgtg gcccaggccc ccgaggccac 1723320
 tgttcttgag gctgagacc gaaagctgga tgaatccctg agtcagagtc tggcatcccc 1723380

 agagccagtt ctgtacatc ccagctgga cactgctcaa actacccca ggtagcagcc 1723440
 atagccaggg cagaacatag gccagtaagg tggtgacat tggacaattg cagaggggtc 1723500
 acagctccct cctgcaaca actacagtt tgcгааaggc aagatttaac tetgttacc 1723560
 aactaggagg cccgggtcag ctgatagtcc caggaгaaa atgggaaggc tcacatggga 1723620
 atgaggcaaa tcacattgc ttgctaacct cctgttacc aagaagtgc ttgccctgac 1723680
 tatggggcat ctgtgtctt tctgctgtt gaagcaagca cagtctacac tgagcctggg 1723740
 ccctgttggc accagcagca cagcacgtgg gtctctgtc ctggacagga gcatcctcag 1723800

 agcatgaagt gcagggaatg tccactgct tcttggcttc agtgtatccc tcccctccc 1723860
 cgtcaacaat aaatgccagg ccttcgcctt cgtcctcggc tgctgtctcc acttctgcag 1723920
 acaggcгaa gcaggacacc aagtgaatcg aggaagatgc tgcgtgggtg gctgtctaac 1723980
 tggggaggtt acagaggaaa atcctggctc agcttcaact gtgactggtg agagccatgt 1724040
 aacaagtctg acaagatgct tggcacttgc tgccaagcct gacaatatga gttctgtccc 1724100
 ccgtcccaca agatgгааa ataaatagcc ctctgacctc cacacatgtt cgatagaacc 1724160
 tgcccctaca tatacatatg catgtaaaca aaaaaгaac caagtaacac attaccgatt 1724220

 tagagacgtg tatgagcaga agtcctgtgg agattccaag gagcgaggca tcaccacctg 1724280
 acccctgagg gatggagtg ttgagagttc tgctaaacac gtggtgggaa cgagtctatc 1724340
 tgaggcaaag ggiggaccaa ggttagaggc tggattacag caggcctcta gctcctacc 1724400
 agacagtaag catccactgt gtttctttac ctaaaccaag ctctatgact tttggctaaa 1724460
 gccacgtct tgattggaga agtccatgtg gcttctttcc ccataacaca tggttgtctg 1724520
 aatatcctcc catgtccttt cctgggtgca tctcctggaa atgactctgg cctctaagtc 1724580
 ccacatgta tcaagcgagt cagcacгaa aggcctgggt ggatatagac tagagctcac 1724640

aggcctaagg ccattgttgg tgacttcctc aaagcctaaa aggagtagtg ccctgcatgc 1724700
 ttctctctc tccttctc ccgctgttcc ttccctctcc cctctctct cctccccta 1724760
 cccccccct tgaagtgtg gggatagaac tgaagacgtc agggttctgg gtatgagttc 1724820
 taccccaagc catgtcactg ccctacacca acttcttgtt cccagataga gaggcttgag 1724880
 cctgcagtgc atgtgccctc gtgctttgta tttttgacag ttaagtcatt cacatgtgtg 1724940
 tgctgtcca cacacacaca cacacacaca cacacacaca cacactgtat gtattggtat 1725000
 tccaatccaa tttcatcttt tagtatgtgc atatttttct agttccctat actgaagaat 1725060

 cagtccctc tgaaacagt gaaactaact tgagtttgat catgctactt agtgtaata 1725120
 cagttagcca atgcctttta ctggggttac ttatgggcaa ggagtattaa cagaagtaga 1725180
 aataacccaa agacagctgt gtcacaaaaa gcccccaca catgggtgac actcacaat 1725240
 gctgaacact ttagctcact gtataacttg caggcagctc cacgggctgg agactcttc 1725300
 tagcagtta atgatctct gcttcttcc aggcagctag gcttgtctgg gagtggctct 1725360
 cagtaggct cactgcttac atatacttat ggagtgaagg gtctagtga tctgctcagt 1725420
 ttttgggact tctgaagct tttgagttgg gaagcttccc tgcaggatgg aattttcgcc 1725480

 tctccttaga acccctgtg tcttctcca aagtgaagg ttttgtctg taggaaaatg 1725540
 ctacataaca ctgagcaagg cagtgcacac ttgtaatgcc agtcctcaga aggcatctcg 1725600
 agaacatcat gagtcaaga tcagcctggg ctacactgta aaattctgct caaggcaggt 1725660
 ggatctctga gttcagagcc agcctagtct atagaactag ttccaggata gccagaggcc 1725720
 agagctatag gggctgggga tggaggtgtc agaaagacag gcaggcatg cccctgggat 1725780
 ctgacccttc ctccccaggt attatgttta cagataagag aaccagacca agattttatt 1725840
 cagttccaga ctgatctcat accattttct tttgatcttc accatgaat gtcttcacag 1725900

 ttatgtggct gttatgatcc taaaactctg cagcattcat gcctcatctg cetgtcactt 1725960
 glaaatggca gccttgtctg gccatcccag ctgacaagcg tcttccgttt gtgcttctct 1726020
 agtccatgca gacaggtcct ggggctctg gtctgattat cgtaatggga ccatatactc 1726080
 tgctgttctg gtccaaatcc agaaaggtg gcctagcatg agagggatgt gcatgtcagc 1726140
 aggctggatc ctgtccttta gccctgttc cctcttccat catctagtga caggctgttt 1726200
 ctagaactgg gagagaataa tagagcttcc ctctctagg gtcgacagac tgaacacagt 1726260
 gcaataaaca ctctcataga cttacctga acctcaaaa gaccatcaac tagctaactc 1726320

 ctgttatgcc ccgggaaggg gattccagac agaagaaagg ccctgtgaaa aggcaaaagg 1726380
 caactagagc actagggaac tgcgcagggg ctggagaggt agcttggcta agagtactca 1726440
 ctgctcttgc agaggacctg ggtttggttc tcctcagcac ccacatggca gctcagaacc 1726500

atccagaact ccatttccaa ggaaccaaac tccttttct gacctctgag ggcaactaggc 1726560
atgaacatag tgcccacaca tacgtgcagt caaaatactc ctatacacia ataatttttt 1726620
aagaaattga agtgcagaat gggatacaag aaggcaagtg agtgtatgct cagagctttg 1726680
ccctccgcgc cgaagacgtc agggaatgtg gtgagtctgt gcgggccatg cagaccagac 1726740

tgtgaattcc agcattgaca ctgagcctgg ttatccagct ggttgcccgt gttatagttg 1726800
tatctgggct agcctgcatc tctcccaca gcagctcaga gatgcatgct cettacctca 1726860
tcttaactag ctctgcctc tagggaaatc agactgtctc caaaaatcta cagttgagaa 1726920
agaattggag atggtgaaat gctagaaaagc tcctgagacc taagaaaatc cctcagctgt 1726980
ccccagcgtt cctcccactt tcttaagggg aacccccaca cctccacct gagagtattt 1727040
gggacatctc cattaccttg tcaactcggg cgccatctcc acaagctcca ggagccactg 1727100
ctgcctcaa gagccctggt gactggcatt ctggggacag attaagggtc ctgtggtttg 1727160

gctcctcaaa actgcctcag atccgtgggt ggtgtcctga ctcatcctgg gaacaatggc 1727220
aaacattgac agaacctcgg gataagcctg gcccgggccc tgctacctc tacttagtac 1727280
caactgaaa gccatgtaga attggttgggt attgctgagg ccagagtcc ccagcatggc 1727340
acagggcaca cagggaagt caaaatggtg caggaggggc ctggggatca cttctgatag 1727400
ctcctccac gtttttcaa gcttcttac tgagttcatg ccctggtaac agcagaaaga 1727460
gaagtccggg ttctggcacc agccatcagt tcgggggtgg ggaccagga gaagcacaca 1727520
gcaaccaaga gaagagggtt aggataggag gtgagctggg catggagaag acagtgagtg 1727580

gctcagggcc cagtctgac cactgaccag ccaccagagg cctttgtcc tectcaata 1727640
ccccatggtc ttctcataat atgcttcaa ccagttccat tctccagctg tgtggtggca 1727700
agtggagcag ttcgggttcc ttgaaaggca gccacttcc ccagatctga agcacagcca 1727760
gttacagtgc tigtgtacca tgtatgteca ttctgctgg ggtgctgac cgtgtgtcca 1727820
atccaggtag ggagccatca gcaacaagac gagccccaa gagaccaac aggactccat 1727880
atctggcca tgcaccagt catgtggcag acagcagact ggggtctcta cctgaaagga 1727940
catggggctg aggctatgga cagtcccagc atccctcat gctggtctcc acagtcccc 1728000

ggctttcctt ccagcttcaa cttcccttc ctgtccattt tctaccccc agggagcgtt 1728060
ctcaactggac ctagagagaa cataaattt atcctcagtg ctcctgcag aaggaaatga 1728120
caggctgtca gggccactcc agttgtatca cagtgcacca cagagtccac attgtgacca 1728180
ctgcctgta gcctgcctgg gaaaagtctg cagcctctct aatgctcaa agtgagagcc 1728240
ctcgctctc ttccactaag atgctgaga tctctacca gaacaagcct gaggtgaac 1728300
ttgtggtttt ccctagaagc caagccttgc aagacagtaa atgaccacc atcccctgct 1728360

gctatggttt cagtgatcct ccaaaatgic ttagatttat gtaatgacac tctgtggcct 1728420

ctaatacata gatgcacata ctatggtatc aaaaacttcc cagccgggcg gtggtggcgc 1728480

acgcctttaa tcccagcact cgggaggcag aggcaggcgg atctctgagt tgcgagaccag 1728540

cctggtctac aagagctagt tccaggacag cctccaaagc cacagagaaa ccgtctcaaa 1728600

aaaaaaaaa aaaaaccctc ttcctaaca atggaagcaa cgggagcaag gttttttaa 1728660

ttgttttaca cttatttatt ttgggggggg gcattcattc cacggagcac gtgtgtggtg 1728720

atcacaggac aacctgcaag agtcgggtct cctccacct tgtgagtctt gggaattgtc 1728780

agaaattgtc agggttagtg acaagcacat taccactga gtcactcac tgccgcctg 1728840

cagaacattt tcatttgctc agaacagcca gtactattga tgtaaaagga aaaaagcaag 1728900

aaacccaac aactctgcat tgaaaatcaa tatgttaagc ttgatttcca ttagttatt 1728960

cttcacacta gaaattaaac aaggccata tgtgtaaata attataaac aaaacagtat 1729020

acttcatctt ctagacaaga atgccaat ctttctctt tgtgcaaac caattgtagc 1729080

ctagcatgtt agtgaactt tttttccc agcacttggg aagcagcagt aggaagatct 1729140

ctgtgagttt gagactagt ttgtctacat atggagtcc aggccagtga ggaccacacc 1729200

ctgtctcaaa aaaaattata attaaaagag ctgactcagc tgggcagtgg tggcgcctgc 1729260

ctttgatccc cacactcggg aggcagagac aggtggatct ctgagttcaa ggccagcctg 1729320

gtctacagag cgagttccag gataggttcc aaagccacag agaaacctg tctcaaaaa 1729380

ccaaaaata agaaaagaac tggctcagt ggtaaaagca cctgccacac aagcccagg 1729440

acctgagctt gatccttcag tgaggagacc agatttatct caaaccacgg tctacatcct 1729500

gctcacatcc acctccagga gtatctagca gctggtggat gtcattctag ttctgtggct 1729560

tgtggatcag ctgccaggcc ctgatagac tccttcaca atgtttatgt atgtgggtgt 1729620

gttgctgta tgtctgtctg tctgtctgtc tgtctgtctg tatgtatgta tgatgtacct 1729680

acaccatgtg catgcagtac tcatgagggc cagaagaggg tgttgattc cctggaactg 1729740

gaggtactga ccattgaggg ccaccaagtg gattctggga attgatcccc gggtcctctg 1729800

aaaaaagcaa ccatggtctt aactactggg tcaactctca agctcctata cccatctttt 1729860

taaatgcaag ttctaaggat caaactcggg tcaaatagtt ttgtttcct tttttctgc 1729920

agttagacct gagaatttac atttacagaa ctgattccta tataggtatt tagtttggt 1729980

ccagtgtttt gcctctaagc aacccacga actcatcctt atgcctttac tacctctgac 1730040

atcttttatt tgttttgaga tgagtctca cagcccaggc tgacctgaa ctgccttga 1730100

attatgattc tctgcctgt accttcttct aagtgcctggg attacaataa tcacatgac 1730160
 tggccttctt ttcagctttt tgtttttgtt ttgtttttaa aaacaaggtc tcccaggaac 1730220
 tggagagatg gctcagtggt taagagcact ggctgctctt ctagaggacc taggttcaat 1730280
 ccccagcacc aacatggcag ctacactgt ctaactctag ttccatggaa tctggcatcc 1730340
 tcacatataat gcaggcaaaa cataatgcac ataaattaga aataaataa tttaaagcaa 1730400
 acaaggtctc cctacatagc ccaggttgac ctacagcctt catccctctg actcaatcac 1730460
 tgcaaatggc ctgggaaact aaaatacaga acaaaccta tacctaggat agtttggatga 1730520

 tcagctttgc tcaaaggagg tgcagtgtgt agtgctcagg gggaacaaca gactcctaac 1730580
 tgaccaaagt accaagaata aatgactggt gaataaccag ccataaatga gacagccata 1730640
 ttacaccctc caaggctcag ggaacatttt ggaagatggg gttgagagaa tataagatct 1730700
 acaggaagaa gggagagcag tgtggaattg tgaattccag gcatgacaag gcatgacatg 1730760
 gtagttgtac ccttgatctc ataagagctc agattagggg ctggagagat ggctcagtg 1730820
 ttaagagcac tggctgctct tccagaggac cggggttcaa gtcccaggac ccacacagcc 1730880
 gctcataacc gctcgttaatt ctagtctcag gagaccaca acttcacata gacatacatg 1730940

 caggtaaaac atgaatgcac atgaaataa aataaatttt ttttaaaaag agctcagatt 1731000
 atctgcacaa aatctccata acattgggcc agtcaacacc agaggattta tatgcacaga 1731060
 atggttgggt agagaagcag agagattttt gtgagtgggt gaccacatga acacacaaag 1731120
 tcatgaaagt agaaggaag tgaagggat tatgggtaac tgtgtgtgtg tgtgtgtgtg 1731180
 tgtgtgtgtg tgtgtgttag aaatacattt tatatgtatg aagatgtcat aatgaaatcc 1731240
 attattgtgg gataatataat gctaataaaa aacattttaa aattaggtgt ggcagtacat 1731300
 gcctttaacc ccagcttctg ggagtcaaaa gcaaacagat ctctatgaat tcaaggccag 1731360

 ctagagccac atagtaagac cctgtctaaa ataaaataat acaaaaataa tgcttctggg 1731420
 tggtagtgca tgcttttaac cccagtactc tagaggcaga ggccggtgga tctcgtagtt 1731480
 tgaggccaac ctgggttaca gagtctagg acagcagggc tatacagaaa aacctgtctt 1731540
 gagaaagaaa aaggaaaact ttttaaaaat ccttagatgg aagggaaact attcaatact 1731600
 atgggtatgt aaccactcaa cagcataaaa tgggattcct aaagtgagat ttatgacctg 1731660
 aagcaggaat tctaataca aacctttaaag ctcaggctg gagaaagac tcagtgtggt 1731720
 ttctgctctt tcagaggecc ctggtttagt tcccagcaca cacatcaggt gactcacaac 1731780

 tgcccataag tctaattcta ggggatctaa tgccctctgc tatcatccag tacacataaa 1731840
 ctcatgcaga tacacatacc cataaaaaa aataaataa taaaccagc agtgggtggtg 1731900
 caagacgtta atcctagcac tagggaggca gaggcaggag gatctctgtg agttcaaggc 1731960

cagccttgtc taaaggtga gttccaggac agcctgaact gttacacaga aaatccctgt 1732020
 ctcaaaaaaa actgcataca tacatacata catacataca tacatacata catcttcaaa 1732080
 acaaaaacgt gagatgcat gaggetgagg caggcagtgt ccaggagtgc taggcctgtc 1732140
 tggacagcat agggagactc cgtctcaaaa gaaaactcag gagcattttg ttttagtcac 1732200

 cacagctgga ttaagccagg gctgctctc tacagccaat gggttacaag aggaagcaac 1732260
 tctccactct atagcctagg cctggagggg tggagcatgt ggatgaattt accgcattct 1732320
 gaacaatgat tttgtgttaa cccagaaagc actgggaagc tgtttaagaa ccgagggtag 1732380
 tttgaggtcc agtagaaca ggttccatta ctgatcagat tgtgcttgag aaaaatggat 1732440
 gctaacaatca ttttttttt tttctctccc gagacagggc tttctgtttt aacaaccttg 1732500
 gctatcttgg aactcattct gtagaccagg ctgggctcga actcacagag atctgtctgt 1732560
 ctctgctccc gagtgtctggg attaaaggcg tgagccacca gcaactggact ccactttctt 1732620

 ttaaaaagtc ttaaaaatta tatttactta tttgtgtgtg gccaccggcg tgccacggca 1732680
 ttcgtgtggg aggttaaagg acattttgca ggaatcggtt ctctccttcc gccacgtagg 1732740
 cctaggggac gaacttgggt gataaggatt ggcagcaagt gctttcagcc getgagccaa 1732800
 ctagcccgtc aataaccact cctcaaggca cacattctcc tgccttaacc gcattggaaa 1732860
 cacctcgatg ccaactctgg actttctgat gcggtcggcg ggaaccaatt atttgactt 1732920
 ggagccaatt ctaactcatg ctgctcgggg ggaacgtcgg aagcgtgtc ctaacaggtc 1732980
 ctaaggtccc aggagacgcg cttaccaccg gtgctgccac tcaagcggcg ccctctgttc 1733040

 ccggccccgc cacctcggga cgctgcccaa tctctgctg ggaacgtgac aacgcccaca 1733100
 ggtcagacag cctgtaagaa ggcaggtaa ggttgagcc cgcgtacga ctgctgcgcc 1733160
 tgtgcgcgac agcagagggc gtggcccaga ctccagccg gaagcgggag gctagagggg 1733220
 cgggcccgtc ggtgtccct tccggcggg tcccattgga ggcgtgggg aagctgaagc 1733280
 agttcgatgc ctatccaag actctggagg acttccgggt taagacctgc gggggcgcca 1733340
 ccggtaggtc tcggagcggg cggggttgtg gggagggagc tgtccccgcg tttggcccgg 1733400
 gctccaggac tctccctggc ctgctagagg ctgaggggtg ggacacaggc cattccaaag 1733460

 ctgctcccg tctgacgtg accatagtca gtggccttct catgctctg ctgttctgt 1733520
 ccgagttgca gtattatctc accaccagg taagggcgtt ggcctcgtc gtgggcgggg 1733580
 cttagcgttc taagggtagg accctgaaag ccgggatggg ggttaaggcca aatctgactg 1733640
 aggtggtgtc gcgccaggtg catctgagc tctacgtgga caagtctcg ggagataaac 1733700
 tgaagatcaa catcgatgtt attttcccgc acatgccttg tgcctgtgag taccgattg 1733760
 taggtggggg ggtgttcagg tgggcttcca gatacacgcc tctggcctta gatcccggaa 1733820

tggatgcat gtcatectca ttccctagc ccagttcttc cacgagatac atccttccta 1733880

 tcaaagctca gatctccagg ttcttgagc catagtcctg ctctgtttcc agatttaagc 1733940
 atcgaigcca tggatgtggc cggggaacag cagctggatg tggagcacia cctgttcaag 1734000
 aaacggcttg acaaggatgg catccccgtg agctcagagg ctgagcggca cggtaaccga 1734060
 tccgagagcc ggacatactc gcaactgcct gtgttagtgg gctgctgcag gctcagtac 1734120
 acattagaag tcagctggct tgcctagggt tctccagctg tgaagagcca agagtcggtt 1734180
 gaatccgtgc ttctcatatg agcacattga gtggaatacc ttaggagttg gagagatggc 1734240
 tcagcgtta agagcagaac acttttcttg gttaccatac tctcaagctt aagcaggggt 1734300

 ctcttttggg taaaagcttg ttgtgtgttt accttcccaa tgcattggct aaagtacttt 1734360
 ccccccttgc aatacaagtg gcctaagggt aagagtttca gttctcaagt agaactgcct 1734420
 tgcaatctct gagtagcaac tgtaaagtag tggtaaacag tagcacccca tacatgagat 1734480
 aaaggatcag aggcagacag atggttccca gctgaaggta tgagagcata cacattcaac 1734540
 ctttctgctc tctctttca gcagaggatt cagtaagtta ttcggagata actcagtact 1734600
 tcgttaggaa atagtttctc tgccagatgg ttttgcccag ctgtaagctg tgtatgtatt 1734660
 ctgagcgtgt ctaaggcagg ctagattaag ctatgttaga tgtactaagt gcattttttt 1734720

 caagtaagat agcttatcca catgtaacce catcataagt tggggatcaa caatgtgtat 1734780
 gaaagacctg gtatagtttt cactttcact tctgtttct aagccgctgt ctcttacct 1734840
 caggtccatt tcttcccc tctctctc tctctctc tctctctc tctctctc 1734900
 tctctctga caggttcttg ataggctc actatgtaag tcttctgga ttagaaactc 1734960
 tatgtagacc aggtcggcca caaattcaca gaaatccacc tgcctctgct tccccgtgc 1735020
 tgggattgaa ggcgtttggt gtttctatt ttctattaa tatgtagtgc atgtaaagt 1735080
 ctcttccaca cctgactcat ggaatatatt gtataaatac tagcttttca ttttttgg 1735140

 tcaaaggact cctgtgggaa ccagggttgt agatgtcact gcgtctgctt catgttgtgc 1735200
 ttttgctct gtctctct tagagcttgg gaaagtcgag gtggccgtgt ttgacccaaa 1735260
 ctccctggat cccaatcgt gtgagagctg ctacggtgca gaatcagatg atatcaagt 1735320
 agccaggccc tgggcatgga gtaggttctt atcagtcact gtgattagct agccgcagcc 1735380
 gtgttcagac cgtgggggt aggatgtgta ctccggcact gatccccatt catatgataa 1735440
 ggtaataag caggcctggc ctgacagctg cagatcagg cacacggcat aagaggatgg 1735500
 tcaactgctc tcagcctaga gaagcagttt aaaggttgtc tctgacttcg gttatccttg 1735560

tgttcagtcc gagccacctc acttctctat taataacaga ggctagcaac accttccttg 1735620
 caagagtcac ataaggatta agtgtgtgtt gtagttaaag ccctgaagta caaggccaaa 1735680
 gccacaagcc tctgatatgt gctaacggct gtgtggtttc ccagccctga ctctcgagag 1735740
 actgactcaa taggtttagg aagatctact tttttttttt tttttttttt tttttttaa 1735800
 gggaaaaaat tgggggaagt aaaggaaga aattggtgga agcaagattg ttaccattca 1735860
 gtgccaaaca ggcacaagcc cctggaatcc acaggaccac acacaataca ataataatag 1735920
 tggtagatat agcctaaagt ttgcatttia accattgtta tcatacaggt cattggcatt 1735980

 aaggacattc acaatgtagt gtgagcatca ctaccttttc tctcggagg gtcacagccc 1736040
 caagccacag aggaaggggt gtgtgctctg aatactgtgc ccaaactgag gagacagtga 1736100
 gaacttgggtg accagagagg aggctggcag agcctctgca gcagacaact gtctgggctt 1736160
 tcttgccag ggtgccagcc cttgtctgtc tctcacctc cacgtccaca cctcccgcta 1736220
 caggtgctgt aacagctgtg aagatgtgcg ggaggcatac cgccgtcgag gctgggcctt 1736280
 caagaacccg gacactatcg agcagtgtcg acgagagggc ttcagccaga agatgcagga 1736340
 gcagaagaat gaaggctgcc aggtgtatgg ctctttggaa gtcaacaagg taccaggagg 1736400

 gaaggaggca agacgggctg ggctgagcca ggctgggaga actccacagt tgaagtggag 1736460
 aatgagagga aatatcccct gcaggtggct ggaaacttcc actttgcccc tgggaagagc 1736520
 ttccaacagt cecatgtgca tggtagtga tccagagtgc gccaggggca tttagctctg 1736580
 ggttccttct tggcaggttg gcatgcccct cactgggcca gtgttctctt agctttgagc 1736640
 cacagtagga gacagttta gcacacttgt gaagagaatg ggggcagggt atggcttggc 1736700
 tggtagaggg ctgcccctg tgaagcccctg ggtctgatcc ccagcctgtg tggtagcagga 1736760
 gttaggactg tagcacagag cctgtgtaag tgtgctttg ttaagtgggt agccccccc 1736820

 catcaggtag ctgtgtgtga ggctttgggt cagcaaagct ggattggaac tcaggttttg 1736880
 tgctcttag ctgtattat gtagtcattc gttagatacc tagcgtgta gcttagatat 1736940
 agatacagca gtcagtaaag tgcctgcact cagaatattc aaacagacgt ttggacctgg 1737000
 tccacatacc tataatctca gcacttggga gtagagaca ggttgcctc atttgtataa 1737060
 catgtttcag gctagcctta gccacatgag acctgcctc aacacctct ctcacaaaa 1737120
 tatgaaaaaa aaaggacagg ttataaaaat atgtgatata ccctctactg ttaagtgtg 1737180
 agaccaggca gagcctggtc tacagagcaa gttctaggac agctagggt acatagagaa 1737240

 acctgtctt gaaaagagga aaaaaaaaaa aagagagcaa tggagaccaa gcctagcatg 1737300
 gtgttgcctc cctttaattc tagcaattgg ggggcagaga cagacagatc tctgagtttg 1737360
 agaccacctg gtctacatga ttagtgtag gttagccaaa actacatagt gagatctgat 1737420

ctctaataa acaacaata atgtggacca gaacaaggca gaatagagat ggttgaggga 1737480
 cagagcatct gctgtttagt tacagtgggt gaggaaagac tggggtttca cttgctcaaa 1737540
 gagctgagca cagtgaagca gccagcagtg ttgatgtcca cggcagcata acaagtagag 1737600
 agggcagtaa atatagatcc taaaggcctg agtgtgcttg gcaagtgcct gggacagtaa 1737660

 gaaaggatgg ctggaacaga gtgagcagat gagcatagtt gactacaggt gtgcggacag 1737720
 ctgcataggg cccgagggac caggettctg tgctgtgaga cgctaagaag ggctttcagg 1737780
 aggggtgat gtgactgcac ttaaaaaagt aaggtaagc atggccgggc agtagtagtg 1737840
 ctcaccttta atcccagcac tagagaggca gagatagtg gatctctgtg agttcaaggc 1737900
 caacctggtc ttctgagaga gttccaggac aggttccaaa gccacagaga aacctgtct 1737960
 caaaaaacc aaaaaataa ataaaaaat aaaaaagtc aagcatggtg gtgcagacct 1738020
 ttgatccaa cactcaaaag gtagaggcag ggggatctct gtgagttcca agccagcctg 1738080

 gtcagcataa gttgttcag gtcaacctgg cactacaagt gtattacagg gtctccatag 1738140
 tgagaaggct ggaggacgaa aggacagaca aggggcgtca gtgaggagtt ctgcagtac 1738200
 caggcctggc agagaacgtg gctcagagtg gtggaggtgg agaagcaact gggttctgga 1738260
 tacgttacag gtagagctga gaagagctga tagatgtgac agagaaggac aaaggagtcc 1738320
 aagatgcctt cagagtttat gcctaagtag tggaaaagatt ggaactacca tttaggagac 1738380
 tcaggaggac tgggggtggg gtggttattt gaaagtaagt acagagcaga tatctagact 1738440
 agtaggattc tcatttcta ggcctgcgg atgccaata agtgtttggc tggagttcaa 1738500

 ggacagagac tagccaagag acagacgttg aacctccca catatttaa gctatgggac 1738560
 tccatgcact ctccctgcag gtgaactttg ttggagaagg gaacctgagt actaccaggc 1738620
 ttcttgtgtt agaggccagc ggcatggggc tgtaaaggag actgtaagga tggctggtga 1738680
 ggtgggagct tcagccagga gtgtccatc ctaagagcca agggatgggt actcctggat 1738740
 accaagcaaa agatgaaggt tggttgttag tgtagtgtc gttggtggcc ctgacagaac 1738800
 atgactatga ctagaaatgc agaaaagtgt ttaagatttg cattagagca ccaggtgctc 1738860
 gaaactgaaa ctgcagatgg gcgccattac taccacgtca cggactagag caggggttcc 1738920

 caaccttctt aatgctagta ccatttaata cagttcctcg tgttgtcatg accccaacca 1738980
 taaagtattt ttgtttgcta cttcataact gtagttttgc cactgttatg aattataata 1739040
 taaatattctg tgttttccag tggcttagg cgaccctgt gaaagggttg ctgagcccgt 1739100
 gaggggtcac aaactgcagg ttgagaacgc tggtttagag gatggcaaca gaactggaga 1739160
 ctggggggcg gaggacaaga ctgaggagc gtgtccagga actggtgcgc aggctgtcag 1739220
 atggctcatg tacaggcctg tgacaagggc tgaagtgaca cagcgggtct ggagaagaca 1739280

gtctaggcct tgagcgtgtg gaaagagcaa actccagcca tggcagggga gcagaagcgc 1739340

 tcatgcagtg tctctcctgg cttcttctcg ggcagaggaa gcaaggtcat tagcgaaggc 1739400
 tgtggagaaa gggatggcat gctggaggca acagggggac gtctttggtt tcggggacag 1739460
 tgggtggaag tgagagcacc tgtgggattt tctggggttt agtgttgctc tgtgctgcac 1739520
 agacaagga gtaaaagagt atacaaagag gcaatcacag agctggacca tgggaggaaa 1739580
 gtgaggactc agggtttggg ggaggagtag acgccaatga ggaagcggag aagcaccaga 1739640
 ctgccgcagg cctttggtgt ggtggcaaag gatggttga tttggggcac tgcggggcca 1739700
 gggaaggaac aggaggaagt tagcaagctg gcagttggag catgaggtgc ttgtggttga 1739760

 cactagagaa ggiatagcta ctgctaatgt cagggttagg gaatggtcac catggtggtc 1739820
 tggagtggga gagaagagca gggaggcggg gctgtccagg aactgggatg acagggtgtt 1739880
 ggaaggctcg tgtacatgac tatgggactc accaaaagct gagattcggg tgccataaag 1739940
 gatgggcagg tagttactaa aactgtcctg ggggtgcctg gtggaatttc atgattaaca 1740000
 agtagggtgc cttgaactgc ctgggagcta aggactttga ctgtagatca ggggacagtg 1740060
 gtctgaaat ggcaggaagg agctagaagg acctctctct tgactacaga gtggataggt 1740120
 atgggagacc aaacagtagt tgagacgatg gaatggagct ggtgcctgga agagaaagtc 1740180

 aggctcggg ggaagcagaa gagtgaagg ccaaagtga ggctgaagat gctgctgcta 1740240
 cctggtgggg tgtgggtggg gtgagaatta ggatcatttg ggagatcgct accagccaag 1740300
 aggattccag aggacaagca ggacctggtg gttctgagct gctcccagt actaaggtgg 1740360
 gcgggcgtgg ggtcctgtag tctctcatgt agtctgtacc tgcagagggg gaaggcacia 1740420
 ggagaggtag gtggcctgga ggacctgaa gagctctgga acccccaccc acccctttac 1740480
 tctggaggag gccgagtaaa atagatttcc tgagaccata ggacgacatc ggtgtgtcac 1740540
 tgtgtgaage tgtggaactac aggcttcag aactcggga gggggctgct atcacaacag 1740600

 catttccgc tgcacctctg cttaggtcta ctttctgggt catggacccc gggcagctg 1740660
 actctgagt caaggatgct catacacata tggctacagt ggcccgtggc ccaagatctg 1740720
 ccattgagtc ctgagatgc ttttaacatc ctgttggttg cagggtgaac aacaccaggg 1740780
 ggtataaggt cttgtgaagt tgaccaagca tctgccctc ctagaccctc aggtcagccc 1740840
 ttggcagaca acaccggcca agtctctgce ccaggtcaca cagctggggg aggacttca 1740900
 ggctctaggt ctcatthgt tcttaggctg gctgttttta tgcttcagcc ctctttatg 1740960
 cctctttgt cctggaagag gccttttagc tagggctaga ccctcgtgcc aaagcaggag 1741020

tctccatcct ccccgctact gtgggtcttg ctccatagat cccactggag ctctgaatct 1741080
 ctgttctctt ctcccttccc catgctgcag ttcattgctgt ggagagtaag tggccctgcc 1741140
 cccaaggatg cctctctccc acttccaaag cagcctgccc tcttgaatg gggggaggtt 1741200
 tggatgggtc tgggatagag ccttctgacc ctgccgtgg gtgacttact cctgggatgg 1741260
 gctttgacat ggggttccca acagtgggca atfgggtta agatgggaag aaactgctgg 1741320
 ttcaaaaatc cctttgggga attttgaggg tagaatcaag ggagtccta ttgatgttg 1741380
 ggtacagtaa ttigtcagta actctggtta gtgagagacc tgtccgtggg tttgtttcc 1741440

 tgagataaaa gcctggccgg gaaatctgtg ttcttctcca cccactggg aggctgggaa 1741500
 ccctttacc aggtgcaggg caggtctctgg ccagctgtgc ttaagcaggg ccagctatc 1741560
 aggctgtggg tgaactgagg gtcagagcgt catatccac agggaggagt acggcctgaa 1741620
 aaaagactca ggaacctggt cctgctgcc tggtagctgt tttcttctc tctagtcca 1741680
 tgacttgag agcttcggcc ttgacaatgt acgtaccagg cggaaacct ggaggatggg 1741740
 tggcaagaga ctggactctg ctcatgtctg aaatggggag aaatcactct ccatgttctg 1741800
 ctggtgttca gaccagggc agagatcgtt ggacgggtgc acctcaaca gaaggaagct 1741860

 cagagcaaag ccaggacaga gtgtggcatt tctaggaagc tggcagagt ggcagggtcg 1741920
 aggccttggg actggagcca cactgaggag tctgcctttt gagaagagg gccactttg 1741980
 cctcacctta accaggggtg tgacatagtt agatttacat ttctaactgt cctcaagga 1742040
 agctgccagt tgggcttct ggcttagacc ttcacccctt gaggtgtgca gacaggacta 1742100
 gtgtcacat gtacaatgt gctgctttaa gctgtacctt aaacctaga gccagaaat 1742160
 ctgtggactg aggagagatc cctaagttaa aacaagtcc tggtagagac acttctccta 1742220
 ttaaagccat agcttctct gtacagggc gcttcttcc tccctctcc cacctgcct 1742280

 cacagcctt gggaaactc tgctactcta gctggtttt tgtgggtgt gtgctattg 1742340
 gcctcagaca gatgctgat ttgtgtgggt atgtgctatc gggcctcaga cagacgtgg 1742400
 tgttgtgtgg gtgtgtgctt tcgggcctca gacagacact ggtgttgtgt ggggtgtgtc 1742460
 tatcggcct cagacagacg ctggtgttgg gtgggggggt gcttctgggc ctgagacagc 1742520
 cactggtgtt gtgggggggt gtgctatcgg gcctcagatg ctgatgttgt gtgggtatgt 1742580
 gctatcgggc ctgagatgt gatgttgtgt gggatgtgtc tatcggcct cagatgctga 1742640
 tgttgtgtgg gtatgtgcta tcgggcctca gatgctgat ttgtgtgggt atgtgctatc 1742700

 gggcctcaga tgctgatgtt gtgtgggtgt gtgctatcgg gcctcagaca aacctggtg 1742760
 ttatgtgggt atgtgctatc gggcctcaga cagacactgg tgttgtgtgg ggggtgtgcta 1742820
 tcgggcctca gacagacgt ggtgttgtgt ggggtgtgtc tatcggcct cagatgctga 1742880

tgttgcttac agatcaacat gactcactac atcaagcacc tgtcatttgg ggaggactat 1742940
 ccaggcattg tgaaccacct ggaccacacc aatgtcactg cacccaagg taccatcctg 1743000
 ggaggtagcc cctctaccg ctaacgcctt tcctgggtgcc catgcctgt gcttgcttct 1743060
 cctcacagcc tccatgatgt ttcagtactt tgtgaagggtg gtccccactg tgtacatgaa 1743120

 agtggatggg gaggtgagtc gagtataggc gtccagtca gcttgttgtc aagctctcaa 1743180
 agtcctgtgt gtcattactt tggccccggg aatgaggtac tgctctcact cctgtgtgat 1743240
 ggatgcagag ctgaggctcc agggactga tgccctcgtg ggagacacac actagacact 1743300
 atttggtctt cctgcctccc acactgcctc cagacagtcc ttgggtgctt actgacccca 1743360
 ttgtctgtgc tgacctgggg gttggctagg ccaagcctcc ttgggcctgc tctgttctgt 1743420
 ggtctggaac agctgtcttt ggggtggtgt gacagggtg aagggaagg atgtgagtcc 1743480
 tagccttagg gtgctgcctg caagagtttc ttctcttccc tgtactacca gtgaaagtat 1743540

 ccatcagatg tagctaggac aggcaaaaac tgataagatg gtggactgga agggaacaa 1743600
 ggatggtccc caggccttgt gttgctagtt accaactggg agcttcattc tatctcttca 1743660
 tatatgcaca gctgacaag aagcggggct cagaacaacc ctgagccagg ttataaacct 1743720
 ctctctgctt ctggttccct tcttctgca ggtgctgagg acaaaccagt tctctgtgac 1743780
 cagacacgag aaggttgcca atgggtgct ggtgaccag gccctgccag gagtctttgt 1743840
 actctatgaa ctctcaccca tgatggtgaa gctaacagaa aaacacaggt aaggagtggg 1743900
 agtggcgaag gctctgagcc tgcgagagca ggtgacctac tgagccccc ttgtgcctg 1743960

 caggtccttc acccacttcc tgacagggtg gtgcgccatc attggaggca tgtttactgg 1744020
 taagtcccag agtccctgtt tggggagcag ggtgccagg cttcccgtgc tgtgtttggg 1744080
 caggtgttcc cccactgagt ggcacctca gcaatgcccc aggccttgggt tggggaagag 1744140
 gggaacctta agggccaagg acaatgctag cctggccagt tagatggcaa ggcagggtcc 1744200
 acatgagggg tccagtgcta gccctggtct ctcttcccag tggctggact catcgactcg 1744260
 ctcatctacc actctgctcg ggccatccag aagaaaattg atctaggaa gacaacgtag 1744320
 tcatcatcct tecttgtcat tcttcttctc ctctgttctt gtgatcactc ctcagccttc 1744380

 actaccccat attcctctc tccagagtca gcccagggcg ataaacattg tgatactatt 1744440
 gttgctctca gtgtgattct tgggatctgg ctgaaaccta ggaacagcgc cccctcacag 1744500
 ccacatgagg tccatcatga ctgacaggct ggggccacc ccttttggg gtcccacata 1744560
 tgcgtctcct gtttaafatg gcttcacagc catgtcctta gtcctcttc ttctgtgact 1744620
 gaatagaatg ttctaggta aatattttgg aagccacat agcttgtgga atagatggt 1744680
 ccagtccat tatcccagag ctctgagtcc aggctggatt gtgtcacttc tgcagtgatg 1744740

gacagctaaa gcagaggggg cttcccacag cctggactca gtcattggtt ccagctctct 1744800

gccaaagccc atagtgtctc ggcatgtgaga aaatagacct ttacagactc ctaaattgaa 1744860
gcaaaaactga aaaacagggg gagaggtggc actgccattt tggagcacag ccagcaccag 1744920
atccttgact caggacccaa ctggggcttc ttgttagagc ccttagctct gtgtagagaa 1744980
tcgtggccca gaggcctcac tgcctcacag cccagggagt caggacagcg gacagcagtc 1745040
agttcatcag ctcttctatt tccctaatg acagcaaac ctccggaggg tgcctgaggt 1745100
ccaggtgatt tgatcacctg agagttgtca atactactga ggaattgagg gagatggccc 1745160
tttggtcacc tggggaccgt ttcccttgtt aaaccgggca acctaccac catcagcctc 1745220

tgtggttcca gaggaaggtt ggtttacccc atgcccttag gaaggtcacc atctgagtag 1745280
gccagccacc agaccaaga taagccaggc ccctctgaag gagggagaga tggagctgca 1745340
cagtgtctct ccagttccgg ggcaggtctgt ctgcaactgt cctctggggg cagcaacagc 1745400
cagtgatacc atttaagccc tatgacaagc tacttgaagt cagccaacca aaacaataat 1745460
ttcccttttt gcttaagcca atttgggttg agatttcttt ttcttgacac tgaaagcttt 1745520
agcagacatc ctgtctctcg gggtttgtaa aaagttagtg gaacaaagtg cttaggtgtc 1745580
atggaaggta gagccatgag cagattgagg gcaaccagcc tctggttgga atagaaagca 1745640

tgctgcgggg gtggggggtt acaggttgac acagtgcact taatccttag ggcttgttct 1745700
tttctggggt tgcatgtgga cagtcttcga gacagacata ttgactataa gtttattata 1745760
agggccggta gaatggggag actaagaaga ggaacagggg taaatggctg accgccatgg 1745820
ccggtcgcca tagagagaca gagcgggaaa cagagagggg acagagagag agagagagac 1745880
agggggagag agagagagag agagagagag agagagagag agagagagcg ggaacagaca 1745940
gagagcgtaa aggtgcaggg gcctatcttt taaaggggtc ctctgcacct gcgtgcagac 1746000
ttctttccca tggaaccttg ggctgaccag ggtattgcct gagtggattc caccaggtaa 1746060

caggggcagg ccagcataat gcctgaacct ttaccaagt actgaatcct gacagctcac 1746120
gttgaagga aggacatcca gacaggggtt gaaaggttgg ctccctgagc tgtgtctctg 1746180
gtcccttggg ttagtgtttg tggatggggc tgaagatgac ctctctgac tgtccaggaa 1746240
tagttagaa gacgaggagc aggaagacag tgatgagcgc aagcagcagc agcagacca 1746300
ggatgcgcca gtaccggcgc cagatgaaga agacgaaagt cttcaggggg ttcaaaaacc 1746360
aattgaagga ggttttggga cggctgttgg ggaaggttgg agtcacatga ccaggaagcc 1746420
cctgacagcg gccccgcctc cctaagctcc gctacttact tgggcttctc cagagctct 1746480

ggctcttttc tccccttccc aaccggccgc ttctctgcct cctccacagt cagtagttca 1746540
 aactctgcct caaccttccc ctagaaggag atggtggggc catgagtgga cagagcccag 1746600
 ccctgagcca cgtcgtggtc attacactac gcaccgtgag gatgtagaca ttgccaccgg 1746660
 tgtctgtgaa ctccaggctc tccggccgic ctttctcct cctcctcctc ttgcgtttct 1746720
 tgccagcctg agcctctcgg gcctcccgtc ccacatcttc catttccctc gtcttacta 1746780
 caggccacca gccccgcagt cgacggcagc gaaacagatt gcatctcggc ccagecccat 1746840
 caagggctag tcgaacagaa cactgctcag ggacccgggc cccctcacc atgtctggta 1746900

 gctgcaactc gagggatcct gtgagagcaa aactcacgag gttagggtaa ggggtcaaag 1746960
 agacagcacc ccagagtgc aaagtgccaa aagggagaat gcagccaacg gtcagtccac 1747020
 agctatagac ttctaacca gtctagctac cagcaggtcc caactggagg tccaggacc 1747080
 tactgcaaaa gcaaggatca aaggccataa tgggaacca gagcgactgc agaagggtcc 1747140
 agggggagga ctgagacaga gccttgggia gaaaggttac tagccaggct gcggtggcgc 1747200
 acgccttaa tcccagcact tgggaggcag agacaggcga tctctggggg ttggaagtca 1747260
 gcctggtcta cagagtgagt ttaccacag gctccaaagc tacacagcca aatgctgtct 1747320

 tggaaaatca aataacaat aagtaataa ataaataag gaggttgctt tgcagcactc 1747380
 cctgaacacc gtgattagt agaaaactat gtttcacgt tgggtctaaa atcgaccaca 1747440
 gggctcaaag ttigcttaga gtaggaacca agggacagag aggaaagggt ggaggcaagg 1747500
 caaataagga caaatcaat gtaggcttga ggctagaaaa agccaagtac caagaaagtc 1747560
 gttggcggag attcggtaa agtcccaaac ctgcagcgc agcacagccg gctgccggaa 1747620
 ctcagcctcc tccaggcga aaggctcagg ctcccgccgg acgctcacct cccgctccgt 1747680
 aggcaggtag tcaaagcga acacaaagc ccaattgaag ttgcctctc cagttaggga 1747740

 attgaagtgg acgtctgtct cctgtttatc atgctccagc cctttacc aactgggtga 1747800
 ggaaggacac aaccaggtc aaggagggtg cagggtggg gccacacca gaactcagct 1747860
 ctctgcacag agggcctgaa cacagggtcc ccatttacag tttccttag acagccattt 1747920
 ggtgagccgg cctgcaagcc taccttttca catagatgtc acttgacatc tetccagtga 1747980
 gtgggttac atcatccaga accacatctt ccgtgttcca gatgacaact cggagctcat 1748040
 agctggggac acagtggttt ccgactgttg agaagggtcc tgggagtgtg ctggcctaac 1748100
 actacagtcc tggtttgatt ccccagcaac tcttaaactg ggggtgtggc acacaggatt 1748160

 gtaaatccag ctgctccaga ggtgacagaa ggagcaccta gagctcatcc ttgaggctat 1748220
 atgaaacct gtccccaac cacaacagcc acaaatcag ttcagttggt agagtgaact 1748280
 accatgatg cacaaggctc ctggggtcaa tctctagcgc acatcatgg caaggtag 1748340

tggtagatgc ctgtaatccc agcaatggag ggtagagggc aggaggatgg agagagttca 1748400
 aaagccatcc acagctgcat accttgttca gtgccagctg gttctacatg atacctgtc 1748460
 tctaaagaca aaggggggga cagctgtgca aacagaaagg aactaggtag gtgtcactga 1748520
 ccccttcctt actactacaa tggcaccaca aggcattggtc taaccaagc cagtacaatg 1748580

 aggtgtcaga agctgaaaac tttgagtggg tcaacatcca ccagctgcag ggtagagacc 1748640
 acagcaagcc acatgctgtg caacgcacag tgctggggta cagagaagtg tgaattgaaa 1748700
 agacaaccag agatagatgt ttctggttct tccccgttac ggccccgttg ctgtcatggg 1748760
 gttgcctgga tatctcttca tcccttcatt tattgattct ccctggtttt gtcttcttca 1748820
 gataaggtct catgtagccc aggccagcct tgacctctct atgaagcaga ggctggcctc 1748880
 tgaactcctg atcctcctgc ctttgccttc tgagtacagg gatataggca tacactacca 1748940
 tactgtttt ccctagaatt ctaccaacc aactatcaa tctatatggt tctgggtggga 1749000

 aggcattctac ccaactccag gtttgggaga accaccaga agtagccaat gtgaggtatc 1749060
 ccagccctgc ccatagtaac tgattcagag aagagcatct aaccctgcc agtcagtgga 1749120
 agtggtcttg ggcttttctg ttaataggat tgggtattta tttctgctca agagtctctg 1749180
 ctggtaaagag atgagtccgg cacccttaga agttaccttg ttctttgtgg actgcaaaag 1749240
 gctctctgaa tggctagagg gacaactcag tgattaagaa cacttgctgc caccaccacc 1749300
 taacttgttg cggggtggg tgggcgcaaca ctttaatcc catcactcag ggagcagagg 1749360
 caggtggacc accgtgagtt caaggacagc ctgctctaca tagtgagttc caagataggc 1749420

 tctaaagcta catagagaaa ccctgtcttg aatacceccg gcccacaaa agagcacttg 1749480
 ttgctcttcc aaaggactcc acagtgtggc tcacaacat ctgtgactct ggtttctgtg 1749540
 tctgtatgtt acatataatg ttggggcctg cagagatcag aagagggtg atgtggacca 1749600
 gtgtctgagt gtgacacct cacagagctg cacttgggct agctggggtg gaacagggtt 1749660
 tactgaaaga catttgact ctttacgata cccaacgctc acagattatg gggaagaaag 1749720
 tgaataaact cacctgccc taggcctgag tcagaagtct tggcctgact tagtgggagc 1749780
 tcagatttcc agagagtaga ggggcccacaa ttctctcacc tgattggctg acgaggctta 1749840

 atgtcaactg ggggcggggc aggcacatca ctggggaaga tgtcgatcca catatgaagg 1749900
 gatccctgag agcacaaaac cagctgcag ggtcatgctc gagaactctt ctctctacag 1749960
 ccttgcatct ggtggctgcc ctgtccccag tggggagaag ggacaggggc aggagtcatt 1750020
 gggtagattt gggggtattc aatgaaggt agtagagtct gaaatgaggg tcccacagtc 1750080
 aaggccaggt ttgggttcag gaagaggcgg ttccagagtg agaaaactga ggtcaagagt 1750140
 aggttgggtt cttagggccc agaccttagt gaatgagggt ggagctcaga tcaggagccc 1750200

caggtctcac gcttgttggc tcagggttgg ggatcctgta ggaccagggt gtgtgtgggg 1750260

 gggggctgga tagtaagtac agcctgtaac agaggttctc actgacacca gaagcagggt 1750320
 cagtggcggg gtagtgtgtg ggaagagggc ttggggaag ggtggtggtg gtggtggggt 1750380
 gtctcaatga gtcttgggag tctgaggctc cttcacctgc agcagccctg ggctccgggg 1750440
 gtggtacagg ggccgtgttt ccacatgttc aggtaccagc tggatcccaa atcctggcat 1750500
 ctctgccaa cgccgaagca caagcaatgc ttgggcctct tcagaagcct cttttgtccc 1750560
 cttgggatcc ctgccatctg aaacaagagg ggtgtggact tgggttcacc acagtccca 1750620
 gctctcctcc ctctcagca cctctagata aagctggttg tctatacatg gcgtggtggt 1750680

 ttacaccttt aatcccagca gagttccagg agtttgaggc aagcctggtc tacaaaatga 1750740
 gttctaggat agacaagact atgtagagac ctcttaaca actatgtccc tccccagac 1750800
 aaaaagtctg tggcctgcag cctgggagag caagtccacc attcacaaaa agcaaggggt 1750860
 gggagggtgg ggggtggggg ggagggtgct gctgctgtca ctactcctga ctgtgaagag 1750920
 ccagcagcac ctttgcctca gacctgtct agagacgagg ccaccagcca ttgaagtgt 1750980
 gagtcaatt ccacagccac agactgtgta gagctctgta tctgtgctc tgagggtct 1751040
 acctaagatc atgttctccc agcagccagg agctttgccc ttactcagac aaactcaaa 1751100

 acatcctgg gctactgcc atcagtgggc tctcctgggt aactagccc aacacctgct 1751160
 gtgtcctgtg ttcagctctg cctccctcat actcctctg gcctgccag cacaaagggt 1751220
 ctggtacctg aaggcagggc ctcggacggt gtcaggaaga ctctggtgcc cacctgaca 1751280
 gccccagctc tglattcagg agcagggagg ccacagcgt ggcacagccc cagcagaatc 1751340
 tgtgaaggcc ggaatgcatc gcgccaggca ttgtacccat ccctgcaggc agaagaggac 1751400
 catgcatcag ctagggcagt gtgtgggcac aatgggcaca gaggttcaa gaggtcaaat 1751460
 gacttactag taccaaaacc ccaatacct agctcaagtc ttgctactg agctaagatg 1751520

 tctttcaagg ggtgggagaa gttctcctgt aaaactataa tttgtataca agaatgggga 1751580
 tgtggcagct ggagggaggc aactgttcag tatgtagagg gcttgttgca taaacatgag 1751640
 gacctgagtt caaatcccag gagccacat gaaagttgac tcgtagggca agtgtctgta 1751700
 ataccagcac ttctatggga gatagaaagt tcaaggagac tttgaaagt catgagccag 1751760
 gtagcctggc tcacaacagt gaggagacce tgcctcacac aagatggaaa gagatgaaca 1751820
 acaccaagt ctgtcctcag accttccat gcatgttggt gaacatgtgt gccagattc 1751880
 tcacacatga atatactcac gcaaacacat tcaattata ataagattaa aaccatttaa 1751940

aatggaaatg tgagcttcaa tgtgtttcat gaatgggccc tgccagactc acacatcata 1752000
ctgtgaggct agcccacagt tggctctgtg gtggctataa aatctgttct ccaggtcaat 1752060
ccgtgtctcc ccaatgaggt catcagagcc caccaagtca tgatcgaata tggccacagt 1752120
cagctctggc tcggctggga gggaaact cagctccagg accctggcca ggaaggaaaa 1752180
gtagctaagg acagttccat gcactctgat gggacctgga gtggcagtgt ccagccccc 1752240
accatcagca agccaactgc ctaggccaga gcatttggag cccaggaacc cccaattccc 1752300
aagccagggc ccagcctcac tctccaaaga tggggtggag ttgcttgggg atgtagcgtt 1752360

ccttagtgtc ccgtgctcc ttgccagcgc tcaccaccac ataggggtct gccttgccat 1752420
tggggtctgc aggagccaag ttggtagcct aggggggtg gaattcaaat atagtggaat 1752480
catccttga gacctagccc ttgtggaacc tgattacagg atttatgag ctgctggagg 1752540
tcaaatccag gttttctcc atgctggtca agtactccat tgactgagcc acaccatagc 1752600
cctggctctt gttactactgt aagagataaa tcagtacagg ccatctgcag tatgaggtgt 1752660
gtttagaact cactggggaa gtcagagacg caggagcat tagggccta tcttcccag 1752720
ccagcagtgg ttgctatct ggtgtaaca gttcagccaa gggttgaaaa gttgaaaaa 1752780

tctcctatgt gactcagccc atagtatggg ccaataggat aaggtttggg gaggggacag 1752840
tactagacac tgggaagatt ataactgcct aaagaattca gccaaagaga accgcaggct 1752900
caggggatga ggggggcaat gtgctgggga tctgttagtc ttcattgcttg ccaagcaagc 1752960
actctaccta ccaagccatc tcccagcct attcactctt gagacagagt ctcaggtagc 1753020
ccaggcacgt catggctgac gataactttg aacttctgac cttctgcct tcacctctg 1753080
cgtgctggga ttacagcat gtgcacactt gctttgcatg attctgggga ttaaatccag 1753140
gtctttgtat attctgggaa tgcactctac aaactgagct atgtctccag tccttgctg 1753200

gtcttgaact tacagtctt ctatcttagc ctctaagca gctgggatta cagatctgtg 1753260
ctaccaggcc cagctcagat tgtttttgtg tgtgtgtttg tgaggacatt cgtatgtgtg 1753320
catgtatgtg gaggtcaaaa agtgacttca tagcctcaga tgttctcag agtcctttt 1753380
ttttttttt tttttttct gagacagcat ctctcaactgg actggaactt gccagtagg 1753440
ctagcttggc tggccagtga accccagcag cctctctcca cctctccagt actgggatta 1753500
cagacatgag tggccacacc agcttgtttg gccctttttg tttgcccct tgctttgggt 1753560
tgttgcttg tttggcttag tgaggagttt tgttttaatt ttattttatg tgtatgagtg 1753620

ttttgcctgc atgtgtgct atgtaccatg tgcattttc aggcaggggc caagagagag 1753680
cagatagatc tctagaact ggagttacag atgcttgtga gctgccacgt ggggtgctggg 1753740
aattcaatct aggaccttg gaagaacaac cagtgtctcat aactgctgat ctctctcag 1753800

gccctggctg gtattttgat cctcttgcct ccatttccca aatttgggga ttactgatgt 1753860
 gcactgcact cagttatggc ttggggtttg tttgggtttt ggggtttttt gttttgtttt 1753920
 gttttgtttg tcccactgta taggccaggc cgacctgaaa ctactatat gtagtccagg 1753980
 ctggcctaga attcacagta atcttcctgt ctgagcttcc tgctcagcct agtgctgggg 1754040

 atggacccca aggcctggag caacactttg gctccagtgt tctgagcttc tgggctgtca 1754100
 tggtgcacag cttaaatccc agcacttggg aggcagaggc aggcagatct ctgtgagttc 1754160
 gaagccagct tggctacag agcaagtttc agggcagcca gagctataca gagaaacct 1754220
 gtcttgaaaa ataataaaa aaaaaaagtg tctgagcta aagctgggct cccagaactg 1754280
 aggttttctg gattaacag ataatattaa tataaatccc agtcttaaat caatgtgggg 1754340
 ggcacactaa agacacattc cccaggaaga cactgtttcc ctgaaacagc ctccccttcc 1754400
 cagtggacaa gctgcctctc agactctctc tcaaggaggt cctgcttcat gcagggtctt 1754460

 gtctccagcc cctcccttg tcagactctc ggaaccaag gccaaagtgg ggacaaacta 1754520
 agctgagctc tggggcacat ggcccccttg gaattactgc tgccacctcc tcaactgggg 1754580
 aacaggaatg ctcccttcc ttcagagctt tgtgttcata aaaacagtct ttgtctgaca 1754640
 tgtctcaatg tattacaaag tttatctcag agcatcctgc ctgcatatt gctacaacac 1754700
 acaggcagga tgagtccac tcctagcag taccttagga ggactgtctc ttccagtgat 1754760
 gtctcagaat cctaggtca ggccgcagca tctgctccag ggacagaggg acagggatac 1754820
 agggacagag caacctgctt attcctgtt tctcccaag actcctttaa gaaaattcca 1754880

 ggacctgct agtctctgca tgacagccat agcaatggaa ggaactacag ggtatttgac 1754940
 aaaaggcatt caggatttgg ggatcctcca ctatagcctt cggctcccc tggccccaga 1755000
 ccaaaagtct gcataaggcc tgccacaggc aagctttgtg aggagaggaa gtctaatac 1755060
 acccaagatt tctacctaaa cccagaggag ccttcgagag cctttgtaga catcaggctg 1755120
 ttgcctctgc tgccatgggg atgagctagg gactaaggac actcacctc actacgtaca 1755180
 ctctaaccag aagcttgatg ggccggttct ggggatccc cctggagatc tggggttcag 1755240
 agaacgatgc tgctctgac tcaggataaa tgaggaagga gccctgaagt cggggagaca 1755300

 ggaaagcagg aaaggagtg gtaagaaagg tgtttgttc tgttttaaat tacattggat 1755360
 ttattttatg tgcgagtgtt ttgcttgtgt gtatgtctgt gtgagcttgg ttctgagaa 1755420
 ggtcagaagt gagtgtcaga ttccctgaaa ctggagttag ggatggttgt aaaccacgct 1755480
 gttgacttg gaatagaacc acgatcccct gcaagagcag ccagtgttaa ctgctgagcc 1755540
 acctctcage ctgtatgaaa gcttgtccct tgcagctc ccatcttcc cccaagtata 1755600
 ccttgaattt gccaccaag tgtccagaac ctctctgcc atctccagcc tggccgctt 1755660

gccctctgta cagggggaac acattcagcc agtcctcaaa gtggttaaac tcctcctcta 1755720

 gggagctggt gtagatctga aaggtagagg gtctcagtga caactctggt ccccaaatcc 1755780
 aaggggcacc ctctcctcca acacettgtc accttcaagg tggcgattgc tttcttctga 1755840
 ggtccagaca cttgatatac agttcttccc tgctcctgag cctccctgtc cccagaaatg 1755900
 agtgggtcc cgtctggaaa cagcagaaat ggtccaggta agaatgtggg gacagggatg 1755960
 ggtggagaga tggagcaaga acaaaagtca ggactctcac ctgggtcccc agcgtcctcc 1756020
 atctcatcct catcaaagcc ggactgaaat caaaagacag gtcggaggta gccctccca 1756080
 ctgccccct tggcccacc ctcttcttca gccacagtca ctcttttta aagtcacctc 1756140

 tattgtctaa acctatgctg ttgacttcag tcaccaccac ccaccacagg tcaactgagcc 1756200
 ctgaagtga ggtcagctg cactgtgagg tgggtgagt gggacacaca gcagacttac 1756260
 tgtgagaatg taaaatagca tattactaat ttttatgata atcaactggtt ggaacaatat 1756320
 tttgtataca ttaataaaac agtaccaaaa attattctca tttgttcct tcacttttt 1756380
 aaatgtggct attaacaaaa attaaaataa aaaaaattg agacagagtc tcatgttgg 1756440
 ataagctggc ttgaactcc tgacctttct gttaccacct cccaggtgct cactggagag 1756500
 gtgtgtgtca ccataccaa gtttaagagc taaaattcta cactcatggt tttgtttca 1756560

 gagacaggtc tcaactgctg ttatatagac caggctggcc tcgaactcac agggattgat 1756620
 ccagtgcagg gattaaggct gtgcaccacc atgctggcct catgttcttt ttttttttt 1756680
 ttaaggattt attgtttatt atgtatacaa tgttctgctt gcatgtatgc ctgcacacca 1756740
 gaagagagca ccagatctca ttatagatgg ctgtgaacca ctatgtggtt gctgggaatt 1756800
 gaactcagaa actctggaag aacagccagt gctcttaacc tctgagccat ctctccagcc 1756860
 cctcatgttc tttttatta gagcaacaga gtgttgggag gcagaagtac taatgtccaa 1756920
 ctactaaaat tgtggtatag aggagaaaag atgtccgcaa taaagagctc tgggacacac 1756980

 agtggctctg tttgatgaga ctccccact tcttgccttt cctccccag ttctgcctc 1757040
 aggttgtgct gtgcccact gccctggag ctccatccac ctgcccctgg agctccatcc 1757100
 acctgcccct ggagctccac ccacctgccc ctggagctcc tgcagtgagg catagiactt 1757160
 ggaccaccag tccatctctt ctgggtctgg gatgtcctcc tccagctcag gacctgacc 1757220
 caggagccct aaggtagctt tcttcagagg agcctgagge agagaggacc ttgttgctct 1757280
 cagtcagcac caccacaaac cctgacatcc ccctctccag cctcaggaac accccatcac 1757340
 cttcaggagc cggttgatt gtctgcttt agccacgaag gggccccag actgctctcc 1757400

tggaaagtagg gaagttattc catgagttta ggccagtaga aatcgaactg caggccccac 1757460
 tgggcgggtcc actagagtgt ctctaccagg gtccagaggt gcttctatct ggtggcccct 1757520
 atggagaaaag actcctaacc ttgaggtccc ttggagtcg ggtctcttgt atcctcctct 1757580
 atttctctct cctcaggggg atcctcatgg ccttgagtg tgaatcgag catatggggg 1757640
 acaatatggg aaccacaag gacagttcgg ccaaaggccc ggttttcaat caccaggatg 1757700
 ctgagtgggg gctgcaggtg ttgctgttct ggttaagtcct agggagggga aaacaggaag 1757760
 taactccaaa cctggggggg ggtacaaagt cagtgggaac aaggcattct gggctcagat 1757820

 ctgccacaca gtcagtcatt atggccttct gactctctgc cccagctgaa gaagggacac 1757880
 agcactggac tcaacagact gttctaagtt cggtgaaaca actgagacac ctacaaagtg 1757940
 caaccagaaa cacagttagc attgttctta cagggtaaat gctcagcctg cagagagagt 1758000
 gtcagaacca ttaaaatag tatggacctt ggacaagtga ttcctctgtct gtccttggtg 1758060
 ccccagaggg atgaagatag tgattcttat tatatacaa gaggagaagg aatagagcta 1758120
 caccagagaa aaacatctac ctttccttg aattattatt agtttttaat aagatgctat 1758180
 gtagccctgg atggcctgaa acttgctatg tagaccagac tagcttcaga gttgttatga 1758240

 ttttctgtct gctgcttct gaattctggg attacagaag tgtgccaccg tgcctaaat 1758300
 atgagaaata accatagctg tgtgtggtgg cacacactga ttcctgac tcaggaggca 1758360
 gagactgatg gatctctgga tctttgtgag ttgaggcca gcccgtcta cagagtgagt 1758420
 tccaggacaa ccagaactac atagtgagat cctgtctcaa aaaaaaaaaac agaaaatgag 1758480
 taataatctg aagtaagtcg tgaaaaatca gtactcatgt tgtgccaag tcacaaagac 1758540
 ccccagagac caccaggaag acagaccac caaactaca agcaaggttt tattgattgt 1758600
 tcatccaacc atgacaggca cccgctctgg ctagccaact cagcagcctc cagagggagc 1758660

 aagtttctg tctactgcta agttttaaag acaaaagtca gccgggcgtt ggtggtcac 1758720
 gcctttaatc ccagcacttg ggaggcagag gcagggggat ctctatgagt ttgagaacag 1758780
 cctggtctac aagaggtagt ttcaggaaag cctccaaagc cacagagaaa ccctgtctcc 1758840
 aaaaaaaaaa aaaaaagaca aaagtcacag gattacatca gtaggtatgg tttggttct 1758900
 gattggttga catttgggaa caatcaggag aatttctcaa agtcatattt tggcatgaaa 1758960
 tactgtgta ccaattatc tcattggtca gtctgagag ggaacattct gtggttctca 1759020
 tggctttgtc ttgttacttg caggtggcct gttgtacaca gatagcaata gttttcagaa 1759080

 ctgtatcctg gaaactacag gggaggtttt ggtctcccct ggagtttctt ttgtggccaa 1759140
 acagttccca ggaaccaagt atctaggagg ctggggaggg ggggtctgga gtttctttgt 1759200
 gttcagtttt agccctagc tctgggagc cagaggatct gggtttcccc ttgtgtcaga 1759260

ggcctacatg tcctttctgt agcctgtcat ggctgctgaa gcaggggctg agtgagggtc 1759320
 tgatcccttc attcctagaa gtgaagcctt tgagtttagt ttacaccttt caagtcacac 1759380
 ttgtgactgt ttctcaactg gatacaacct agactctcct aggaaaagcg tctcagtgag 1759440
 ggactatcta tataattacc agagacaatg agggccattc tacagtggta agttggaagc 1759500

 taaaacaact gtatacaaat acacacctaa caacagaatc caaaataaag taagaagtga 1759560
 cagatgagge tggggacagt ggccaagagg tactgagccc gtctagcagc tgcaattcac 1759620
 aaggtcta atctcagggt gaaaaaagaa gcaacagagc tggagaaaca cagaacaact 1759680
 tgagatttca atgcctaat attgataatg gacagaagag gtgtgggaaa cactgtgaag 1759740
 caacttgacc cgactgatgg atctacagc cactgagctc aacgggaggg tgcactcacc 1759800
 tcagatgcac agtgggaaaa gtggggccac cccatctgaa ccttggaaaca agggatgaaa 1759860
 gggaagccct tagtatagtc tcaatgtcta tgttcctata aacacatcac ttagagggag 1759920

 caaagggtga caglattaaa atagggtctt tgatgcccaa ggtgtggtgg cacacacctg 1759980
 tattcccagt atttggagtc atgggataca cgacaagttt gatgccagtt tgagctccat 1760040
 agtgggtcct tcctctaaa aaccagaaac aagattggtc gtttggttgt gtgtttaatt 1760100
 tttgcagttc cttatatttc ctagatatta accccatct taagtagata gtttgcaaaa 1760160
 attaaaaaaaa aaaaacaag aaaaagaaga aacaaatggc cacaacaaca aaaatgtggg 1760220
 ttgagctggg cagtgggtgt gctcacacac ccttaatccc agtgcttggg aggcagaggc 1760280
 aggcggatct atatgagttt gagaccagcc tcctcaaag ccacagagaa acctgtctc 1760340

 gaaaaaccaa aacaaaacca aaaaataaaa aataaaatgt gggttggtat tttgtctgtg 1760400
 cacatgagc atgcagtgtc aaaagaggcc ggaagaaggc gctggatacc ctagaagggg 1760460
 aatcatacac aattgtgagc agccatgtgg gtgctgggaa ttgaatccag gcctctgaa 1760520
 agagtagcca atgctcttaa ctgcttagcc gtctctgcag cctcacctta aagtgttcaa 1760580
 catccttagc cattaaggaa atgcaaatta aaactacttt gaaatttcca tgtctccca 1760640
 gtcagagtgg ctatcattaa gaaaacatta agagaagtag ttcagccat aaaagtgtt 1760700
 gctgccatgg cagatgaact aaatccagtc cctactgtcc catggtggaa ggaagaagcg 1760760

 actcccacag attgtcctca gactggcaca atgccacgt gggaacacaa acacaattta 1760820
 aaatgtaata aattaaaaaa aaaaagtaac aagaaatgct ggcaaggatg tgggcaaaga 1760880
 ggaaccctta ttiaatgctg gtaggagtgt aaatgggtac agcctccgtg gaagtcaaaa 1760940
 tggagattta tcaaaaagct aaaaagtgtt ggcaagacgg ctcagtgggt aaggccctcg 1761000
 ctgcacaagc ctgatgactg agaccagat gaaggtggaa agggagaact gactccacag 1761060
 agatgtcttc tgacctcac aggggaaagg aggagagggg agggaagggg agggaagaag 1761120

aggggagggg aggggaggaa aattctgctt tggacctaa catggcagcc cacagctgta 1761180

 atcccagcat tcaagaggt acaccaggaa gatctaaggt tccaggccat cgtgggctgc 1761240
 ataatgagac cctggctcca acaataaaaa gtaaaaagag gacagaatga cgaatctcaa 1761300
 ttaatacaaa tgatTTTTCT gaacatggta gcagacacat ttaatcccag cactcaggag 1761360
 gcagaagcag aagatcttca tgagtTcaag gccagcctgt ccacatagt agttccaggc 1761420
 cacaaaaact accacatctc aaaataaaac aaaatcaaga ggacagatga cttgatgaaa 1761480
 ccctaaattg cattggtaga atttgacccc caaacccatt caaccataac tgaactacc 1761540
 aagagtgagg aagcagctca gcggtttggt accagtctcc atgtgtaagg ctctggcctc 1761600

 ggtgctccag cactgccct caaaaatcat tagacctaat cattTTTTAC aatacagcgt 1761660
 atttcacatt ttaacatat atttatTTT acattgtgtg tgtgtgtgtg tgtgtgtgcg 1761720
 cgcgctcgca cacacacgtg cgtgctcgtg cgtacatgtg tcttttgggg ggtgtataca 1761780
 gagtacaggt acctgcagag gccagaagtc taagagacc ctggagctgg acctgatgtg 1761840
 gatctgaaga gctgtgctgg ctcttagtgg ttcagccatg tctgaaggcc ctgtactgtt 1761900
 ttttgaacat tcaggactct ggctaagacc ttccattcaa cagagctgag agaatgccac 1761960
 cagtctacag attaatccag gtcagggAAC tacagccatg attcatgtac ctcccactgc 1762020

 cagtttgtat aagctttatc agaacacagc catattcatt tctacaccgt ctattgctgt 1762080
 tttcatctac agtggcaaag ttgaagagtt gaagataaga ggccagaaca tttggagaat 1762140
 gctgctcctg aatccgfaat gtagccagct ggaattcact acatactgca tccttcact 1762200
 tcaactcctc gccccgcagc ctgtgtcctg gccccctct taccaccgtc acatgctgga 1762260
 caagctctgt gaagttaggg ctctcacggt agctggccag aacttcagac tccacacgtc 1762320
 tcccagccac ttccagaaca acctggggcc tttccacctc aaacaggtgt atacgacca 1762380
 ggctcgaag accccagaac agcacctaag tttgggaaag gagagagatt caaggctgg 1762440

 aagctgacac ggtgccacct ggttggggga agggaaaagg cttgttacct caatacggaa 1762500
 ctccctgagc acagggcgta cgttaggagg caggctcagg tgtccagtga tgggctgaac 1762560
 cagagatgcc agatcctggg gctccacatc actaggcact gtgggctaca agaagaaata 1762620
 aattagaatt catgccaca cacagaaagc ctaggcttgg agatggacca taggttctg 1762680
 tgggtggttg aaagacaatg gtcctaatg ggaggtgtgg ccttgttgaa gtaggtgtgg 1762740
 ccttattgga ggaagtgtgt cgctgtgggg gtggcattg aggtctccta tgctcaagct 1762800
 acaccagtg aaacagtTca cttcctgttg cctgtgagac aagatgtaag gactctcggc 1762860

accatgtag cctgcatgcc accatgtccc atcatggtga taatggacta aatctctgaa 1762920
 actctaaggc acccattaaa tgttttcatt tataagaaat gaaataatat tgtctcttca 1762980
 caacaataaa aagcctgact aagacagtct ctgtgaagta caaatgcagg ggagccagac 1763040
 aaggctgagt gtataggaag gattttccag aaagcagatg ggtgtgtaca gaaagccgtg 1763100
 ggggagcccc aggcattcgc aataggtaaa ctgagatga acagtagtct gggttctcta 1763160
 gggtagaatt ctggcaagat gaaccttaga tatatccatc tgtaatcctg ggtgtgcaat 1763220
 gaagtcaccc caagataacc ctgcagccag cattctcttg ggtaagtac tagacagtta 1763280

 tccttggggc accctgagtc tacacagcct gatgaataag aatggataca acttgctagt 1763340
 caggccagag aattctaacc tcgaggtggc ctctgtagtc cagctcaatg agttcaaagg 1763400
 tagcaatgac ttctccagca gcctgtgatc ccttcctcag ggggaagaac tgcagctctg 1763460
 ggcgctgata tgggtcttct atcagcttta ccttggggc tgcaagtgcc ctgccagga 1763520
 acacagcagg gcctgtagg aggcaagca gtgaggaaat aaagatgata taactggttg 1763580
 tgggtgctac atctttaatc ccagcattta ggaacagag atgataggtt ctatgatgag 1763640
 ttccaggcca gccaggacta cacagtaaga cctgtctca aagataaatg tgggaagata 1763700

 aaaatgctca gaagctaagg ggagcattca agggaagagg aggctggaga ggggatggag 1763760
 ggagggacac acttacaaac ttattgtggt caaagacgtt gatgaccact agcggaggct 1763820
 cctcctgcaa atgctcgcgc ctgccateca caatcagctg ctcaaacacc aagagttcat 1763880
 cccacagggg gctcagtgtc tgctccaaga ccttggggc catgcagaaa aaggggcaaa 1763940
 agcagatcag aagtggactc cctacacata ccagttagca gtcaaagaga ttctctgttt 1764000
 gtcacccaaa ggcaagggta tccagctctg gtgtctcctt atggccatct gccattctca 1764060
 tatcctcgtc ctaaagtcaa ccccaggaaa ctggttttct gttctccatc actgagtcag 1764120

 gccagggtgt tatctagtgg cctgtgctga aaacccaaag tgggaagaga aactcagggc 1764180
 ttgtacaaga gtgcccttg tcccctgctc cctctgccc atagccaagc ttggcctca 1764240
 cccgtgtggt ctggcactgg gtagagatga ggacatgtgc aaacgggtct gagaggccac 1764300
 tgtcatctgc tgccaacaca ccgcgggcct ggtacagatg agcccgcagc tggaaatagc 1764360
 tgaagtctga catgaatgga aggaaggagc catgcttgct caggagacca ctggagctct 1764420
 cctactcatg aacccccacc tagggcaaac agcaaggcgg ctgaccctt ggccctatac 1764480
 tcaccgtccc ggiataggct gtgaggcagt ccagccgagg gttcaggcag aagatctggg 1764540

 ggcagctcgg aggtgcaggc cttggcttgc ttggccagcc ccagccacag gaagagctcc 1764600
 agcttggcac agacctcccc gggggctgcc ccaggtgcct gtgtgggaag gaggcattgt 1764660
 ggccacccta aagcatgccc caaatctctc tgctaaatgg aaccaagct cccagtacag 1764720

gaggcgatgcc ctctgttccc acttctgcgt ctctctccat gccctccatc cgcceccaca 1764780
 cctcacatga cctgcttcc catccccaca gttttaactg cagattataa tctggactct 1764840
 cccttgtccc ttctagcctc aacacattta tactctatcc tttgtgcaa gggtcacagc 1764900
 ttctcactgt taaaaacctg ttttagtgic tttccagac acaattcacc tggaaaatct 1764960

 ctgtctgtaa tccaccagtt ctgcttgcca gaatggcac cctccttctt cattaccctg 1765020
 tctgtgtcaa agggccagcg ctggcccagg gcacacaagt ttgctgttca getgacctgg 1765080
 acaaagctat aacctccttt tggctttttg gatggttaaa aacagccaga gaggttctctg 1765140
 gttagaagcc acagaccatc acccctgatg tctgcctctg tgctatgaac cccactctca 1765200
 ccagcgctc caccacagc ccatctcact gtgagtagaa gactctggat cttcccacag 1765260
 tctcggcctc gttcctctc caccacagag aacagcacat cctgggcagg gacgcgggca 1765320
 taggccacc ggcgctggcc gctgatcacc cagaccagca catcaggga ggggtggctgc 1765380

 ggctgcaagt ggaggacagg tcacctgggg agtctggagc taatgctacc cgatcctaaa 1765440
 gctgaatggg taatttaaat gccccgactt ttctgaacct ctggctctgt ggccacctgc 1765500
 tccctgacct ctctctcat tgcaccatag ggcacctcag actcgaagac cacctagacc 1765560
 acctagtctc cacactgcat tctgccccaa tcactttttt ttttttcag acagggtttc 1765620
 tctgtgtage tctggagcct atcctggcac tcgctctgga gaccaggctg gcctcgaact 1765680
 cacagagate cacctgcctc tgccctccaa gtgatgggat gaaaggcgtg cgccaccaac 1765740
 gtccggagcc ctgtcactt ttaaatctac aattcaatgg tgttaagtgc attcacaggt 1765800

 gtactgacag ccatgcacc ccagaaatct tctcatttta caaacagaa actcaaaaaa 1765860
 caacaacaaa aaccagaaa ctcaacacc actgagcaca gctccgcatt tccagctgag 1765920
 ggcccagttc ccaataacca caaagaaagc aaagtaatac aaccttaaa aagaaagcta 1765980
 ggaatggagc cgggaggatc ccagggatct gacgcctct tcccacagac accaggcacg 1766040
 accgaggggc aaaaataac acacaggcca agaatttata cacataaact aaataaacct 1766100
 taaaaaaca aaacaaaaca aaaacgacaa cactagattg aatgagtatt tgtgctatga 1766160
 aatgtcattt gacaaaggaa gactttcatt acaatttta aagacaggat aggggtatga 1766220

 gtcagtggta aaacatgctt atcataggc aaagaagaaa gggagagagg gagggagagg 1766280
 gagggaggga gggggaggga agagaatgga aagaagatta atttactct aagattccac 1766340
 ttagtgaatt cctctctct tctccttcc agtgccattt tccaccagc ctcccagttc 1766400
 tgggcatttg caagtgtcgc tctctcaca caccaaactg caactatcaa atgtgcttga 1766460
 aattctgct gctgctaac cagctatgcc aagatagcta gactgtcagc ctccactgga 1766520
 tgctgttat ggcacagacc cctccccaa ggttgittga agaattacac tagaactcaa 1766580

gcagatgctt cgtgcagaaa gtgtccaag cacaagctct cctcatacac cccagccacc 1766640

cacggtacta aacagaggaa gccttgcca aggcaagcca gtcggctgtc ctttcagca 1766700

gctcttgagt catctctgga tccccgctga cccctcctt cctcactctt gacttcaca 1766760

tgaagcaggc ggcacaatgg cgccatccag aggacaactg ttgcagatgc cccaaggtct 1766820

ctagaatgat ccagaactta ggtgggggga aatattagc gtaagaaagc atggtgggca 1766880

aggcatcacc tccttagcca ggaaatgcag ctttgccagg agcttcttgg ccagtccac 1766940

cttcctttgc atgttgctct gcctcaggcc ccgtaaaagc tgcaatcctt gctttgcat 1767000

cagattcttg ggggcggggg agaggcaggg agaacataag tagaaggact cagctaggtg 1767060

cctcctcctc tcccagtcce cagcctgtac caggctgtgt gacagtagtt tcctcgaca 1767120

tcgatccagg gtgttgggtc gtgtcatcgt cctgcgctca gcaccaagc aaaactgtct 1767180

gcagagaaga gagaagccac ggtgagatca ggacctcaga aaccttccc tcagaagcc 1767240

tcctattcct gatcctgaca gcccttcttc agagagcctc atgccaaat gcaccaagca 1767300

caacctggtc tttgagcct gcagtcacca atatttaaca tctcctgccc tggctacttc 1767360

agttatggcc caacagcctg actaacctct gcattgctatt tagaaatgtc ctgcctgtcc 1767420

tgtcagcacc acccaagcc tacagacca ggcccttctg gtttactttc tgggagagtc 1767480

ctataccat actaaatcaa agaagaatgc ctgctttagt ctccaccagc ctaactaaaa 1767540

gatagctgga ctccaggtg aatggtaga tgacacctt aatcccagca cgcaggaggc 1767600

agaggcaggt ggatctctgt tagttctagg ccaacctggt ctattagagc gatttccagg 1767660

acagccaggg ctaaactgta gggtaaaaag ggccagtga agaaaacca ggccctaaga 1767720

cctaagccaa agaaacacac cctgcccctc accaatcaa taattgaaat ccaaccaatc 1767780

cctgaacct aaaccaaaa atccctgagt atgaaatcca accaatctct gatcttgttc 1767840

caaaactcagg aattaagatc ctaccaatcc ccacctgaa aatctctacc ttggaaagcc 1767900

ccacccttaa gaaatcctgt ataagctctg tactaactca gtttgggat gcctttttc 1767960

ttggcagagg cagcctctct cctggattct tcctcccaa taaatctctt gattgaggtt 1768020

tgttgtaaca acgttttctt tcctggagc aaagcagaga tgtaccgcc cttgaagcca 1768080

gagccgagca gaactgttac atttctgtag taaaatttc ttagcagagc agagctgtaa 1768140

caactttcat tggggcagag cagagctgta acaacttca ctggggcaga acagagcttt 1768200

aaactgtgg ctggggaac tttcccttgc tggaagaata attgttacac tctggggaag 1768260

ctgagcaggg ctgtaacatt tctctggagc agagtggaat agagctgtga caaccaact 1768320

ggggaaatcc tcctctgcta aagcagagtt gttatactga catgagggaa acatttcctg 1768380
 agacaaggat tgtaacattt ttctagggaa accgccctcc accgcaacag agctgtaggt 1768440
 attccttggc ttctgactgc caggatacct ttccttctg agcagtaacg cttacatcac 1768500
 agagaccttg tcttggggag ggagaggaat ccaatatcag gatggatata tgagtgagca 1768560
 acagagcaca cgcatagcat gtgtgatgct gagttaaag tccagcacca catgcatgta 1768620
 acatgtatgt actggcacc tgcactaac cacttctccc atcttctctt aggatcacc 1768680
 aggtgaaatg accatttgtt ctcacccagg atcactgcag tcacctctc actgcaactgt 1768740

 ttgctgttct aaccctcatg ccatagaaca ttctcaaaag caccagaat gctgtcaaca 1768800
 cgtttccatc tattttgttc tactcatctc aagctaaatc acaaaactct aaaaatggcc 1768860
 aaaaggttct gcacatctgg tccattatct ccactcctcat taaatatgcc ttgtcccatg 1768920
 aaggacaact atgtgtcaca ctggcttctt tgcctcctca taaattatgt agagagcacg 1768980
 aagtctttgt gcacacagat aagcaccaag gaatgttaga aaagctaaat gcatagctta 1769040
 actcttgagt ggaatgaggt gcttagctgt agtttacagc ctgatgacc tttgctgtct 1769100
 ggtgagccag gctttgttca catctcctag aatttgtttt acttatecca gacctcccc 1769160

 ctcaacaaca gcaacaaca caacatacct tgagcattgc ttctaagaca taaaaccacc 1769220
 ctcatgggtg atgtcacttg tatttttcaa cagcctaagt gacttctatg ccatcgtagg 1769280
 actagcccaa tectgacact cacagggatg tttatctagt cagtcacagc ctagatccta 1769340
 aatcttgggg cactatctct gagacaacag tacccatatt tatgaaagag gccagatgta 1769400
 ctttgtaaag agtctcaata caaacctctc tctctctctc tttctgtgtg tgtgtgtgtg 1769460
 tgtgtgtgtg tgtgtgtgtt caagacagtt tctctgtgta gccctggctg ccttggaaat 1769520
 agctctgaac agcagactaa ttttgaactt tcagagatct cctgtttcta cctcccaggt 1769580

 gctgggacta aaggcatata cataccacca ctgcccagct tcgtgtctta aatttgttat 1769640
 gcacttggga ctgaattaat tgttatcaga aaacctttc acccaaaatt atattgtgct 1769700
 taaatatgac tcaagtaaat gatctggtat cagcaccaat catggattgt ttcctgcct 1769760
 gctgtaagcc tacagggaca ctccataaaa ttataccata cccattacc ctcatagcta 1769820
 cacagtgata ccctatctta aaggaggagg gcagcaaaag gaggagcaa gccacacagt 1769880
 agaaaagctag ggatgttata gaagtcaaca acagtaagga atgagctcta ctgtgtctcc 1769940
 aaaagatatg ggtggagaag tgagcatcca caaccagggt cttacagctt ctggcgtgg 1770000

 gatattctca ttcttgttaa gtactctatc acttaaaatg ttattttta attaaaata 1770060
 tttttattta tttattaatt ttttccctg agacaaggac tcactatctc tgtctgtctc 1770120
 ggaactcatt atgtagattg gccttaata cacagagatc cacctgtctg tctctgcctt 1770180

caaatgtaga gattagtggc atgtgccacc gtgttcagca gcccctact tttaaaataa 1770240
 aaataatfff tagggctfff tgtgtfffff tttttfffff tgagacaggg tttctctgtg 1770300
 taacagctct ggctatcctg taacttgctt tgtaaaccag gctggcattg aactcagaga 1770360
 tctgcttggc tctgcctccc aagtgctggg attaaaggta tgcaccacca cttcccagct 1770420

 tagattgtat aaatffatct gggaagacc accagaactg tgggtggcac catctcaagg 1770480
 gctgaggttc tgggttgaat aaaatggaga gggtagctta agccccaagc actcctccct 1770540
 ccctgcttca tggctgcaga cacagtgtgg tcagctgtgt gtcctgctct tgctgcaaag 1770600
 ctttccctgc tacaatggac tgtaaccctt aaaactgtaa gccaacataa actcttccct 1770660
 aagtcattff ggagagtgat ctttcatagc aatgaggaaa gtaacagata ctgggtctga 1770720
 aatcttgaag ttcatctgtg actccacaca ttttctcct tttctacatt tagccatact 1770780
 gaggtgacat ctccaagtgt gaatccccag cccccccac ctttttttga gacacgatct 1770840

 ctgtatgtc aactggctc caagctgacg ctgacctga acttctgatc ccctgcctc 1770900
 tactcccaa gtgctggggc tataaatatg caccgccaca cctggtttct gcagtctag 1770960
 ggattgaacc agggctctgc aagcactcag tcttaggcaa gcactctgcc aagtcagttc 1771020
 atccacagct gtttaatccg tttacctctg ctccatcgcg tggttcagct ctctgtcccc 1771080
 taaactacta caaagccttc tttagtaacc ctgtcttctc tcacaccatc tctctgccac 1771140
 tcatccttfc taaagttata aagagaatff caagaccctc agtggctctc ccateacca 1771200
 gaaaagaaac catggctcatt gcaatgacat ggcaagtgtc acgagtgtff gctgaataga 1771260

 gagaaaaac ttgagaaagt gtcagaaagg gactcaagcg cttagagcatg ttatcaaatt 1771320
 catggcagtg aggtgaaaga cagaaaccac caggatgtgt tcctgtgatt agagcaacaa 1771380
 ctggttaactg ggaaggact agctaagggt gcagcagaga cagatgatgg cagagctagt 1771440
 tatgcaggag gtgacgggag attgaaatcag tatcccagac ctgcaaccgg ggaagtagct 1771500
 tcctccctgg atcaggaaga agggccaaca aatggatgta gaagctgacc aggtacaggc 1771560
 tctggggggg ggcagggtt gtccttctc aggaaatagg agagaagcct tataagcctc 1771620
 tagagccaaa caccctgta tctatagcaa gcaccattga tatggacact tccattctc 1771680

 tttctctgt agatgctgga caaataatgc agcttgaat caccctgat ttcaacagcc 1771740
 gccatgactc tcagctcacc tgcctccagc caccagctct tccagagtct gcttgagccg 1771800
 tgtgcaggca cccaaccctg acctgcctg aatcttctca acctctgca ggccctggct 1771860
 ctgtgtgggc tccagcagaa gtcagtcttg agggctctggg gctcacccta cccgcccc 1771920
 cccattcata cccctggctc tgcttctcta gccccctcc ggcttcactc cgtctatcat 1771980
 tgtaccatc cttcccaag ctcccacaac tttgttccc tcaggctgcc accatttct 1772040

tggccctaca ccaacaagac atgagctcca cccttagtg tctagtttgg agcaccttc 1772100

 caaagctgag tccttgtgt cctgtgtctg ggcccttccc ttcaggggtc accttgetct 1772160
 caccagcctc tcagccactt tgtacacact gttgtgcta tgcaggcgcc aagtataatc 1772220
 ctcccagcgg ctccacacat gcaggcaggg tttttggtgc agcagaggca agcagaggta 1772280
 tggcctgggc cagagagaag ggagggggct gggggcatcc cgagtgttg aagacctatc 1772340
 tatacctcc tacaagtac gcccgatcac ttaccattg ccatctacag getcgggcca 1772400
 ctgatccgtt gtccccagca actcttctc ttctgcctt gccctctgt cctcagatcc 1772460
 caggagagge cgagattgc tctctagtgt gctgccttcg gctccctcat cagcccttga 1772520

 cctttggccc aattgtcct ctggcgcc tgtgtgacct gccccagaa catcaaggat 1772580
 cagagcctca ggctgaggt cctatgcatc cctctgcagc ctctcccca gtaggagcag 1772640
 agcccaccac tctccctgaa ggtgaacctc cctccagtgc ctaaagctga aacaagaagg 1772700
 caaacctatg accttcagt cttatttagg ccacacacca atggaaatct ccaagctgat 1772760
 aggctgcttg gccagcgaag gatcaatcat ggtagcctca aagaccactg caaaaagcag 1772820
 gaaatcttcg cagggtgcca gggcattcta ggaaagagag caaggtcagc tggggtcagc 1772880
 tcccctctc cccaggagca gtttctcta tgcttggtca caatgccac agaaagatat 1772940

 cagctaaggt ccagggggct ctgtgagtgt cttacctccc tcttggcccc tggtagcttc 1773000
 cctatacatt ggiccagagg acagattctc tctggtccac gccctctata tatacattg 1773060
 ctgtgtacat cagaacactg gtgcacatac actgaattct caaccaagt ccccaaattg 1773120
 ataacagcat catgatttct aaagcttga aagggattha caagccctag agccgaggt 1773180
 caccaccacc agccccact ccggcagagg cagcaactcc tccactcca cctccattgc 1773240
 gctaggaate tcaggtgct ccccgtggc actggcatcc acaggcttcg gaacccagc 1773300
 cgtggtttga cgtgcttgg ttttctctt tttcttcca gtgagtcggg acaatctgga 1773360

 ccctgtgtg ctctggggg atgtaggttc aactctgct tccaacacct ccatggacac 1773420
 agctaccaga attcgcccc ggaaccaaat gccttctcca acacctcat tgagactttg 1773480
 aagaccatcc cggaacctgc cactggggag cgagccatag aggggcaccc aggctggacc 1773540
 aaaagtggg ttaaacccg ctatggggga caagaacagg gtttgaggga gacacaggg 1773600
 taatggaga ctgctctgga ctgtacacct ttgtatctc caggtgttg ggggagggaa 1773660
 agagaaggct gatttctgga agggaacagg tctgtgacaa acagtagcag acagaggacc 1773720
 tctctagact tcagagggga gctgagagt gggtagaagt actggtgtgg taattggcgg 1773780

agagggtgtg gatactgaaa ccactgactt cagagaggtc attttgcagc aaggcttgac 1773840
 tggaacagtg ggggtggggg gtgggggtgg gggtcatggt tggaaagacag agcctttag 1773900
 gggacagtgt aagccacgcc tgctagaagc tggtacagg tgtgcctgac catgcctgtc 1773960
 agggcgtggc caaggtgagg tcaggatgac acgtgatagg gttttaagt gctgcaaggc 1774020
 acatgggagc cccttctctc tggcctccct gccttgctgc ccctggcacg ctctgcttg 1774080
 cgtttggctg gtgtttctct aaataaagat atcttagcct tacagacacc agatcatctc 1774140
 aatagagcct ggcttagaac agttcgtttt gtgggggtgga tggctctccc ttgatcacct 1774200

 gtgttttaag gatgttttgt tcnnnnnnnn nnnnnnnnnn nnnnnnnnnn nnnnnnnnnn 1774260
 nnnnnnnnnn nttactca cctgtgcgac cggagtcca aatctgcctc aggtccagca 1774320
 catgtgtggc gagtgccaca tccaggagcg gtgcatcttc acgcagctgc aggcaaggc 1774380
 cacgtgttag cgggtgggaag agttccacaa agctcaactg ctctgtccac tgggctccg 1774440
 tctcctcttc acacacagaa gtctcaccct gaaggccaag tcaggaggag ggagttagtg 1774500
 tgggtcccaa aggatagttc tgcaggttat agtgcctgat atcaagtgcg atgacctgag 1774560
 ttgatcccc agatctata ctgctgtccc tctgcaggg tgcctctga cctccacaca 1774620

 tgtccatgg cactcagggc acccacacac atacacaaaa taaataataa aggctggagg 1774680
 gctggagaga tggctcagag gttaagagca ctgactgctc tccagaggt cctgagtca 1774740
 attcccagca accacatggt ggcttacaac catctgttat gagatctggt gccctctct 1774800
 ggtgtgcaga tatatatgga agcagaatgt tgtatacata ataaataat aaaaataaaa 1774860
 aaataataa ggctggagag agcgtctctgg gattaaagt agagcaagta ctctccagg 1774920
 gagtgagttt gcttcccagt ccacacaggg tgcatacac caccacctg actccagctg 1774980
 caggggtct gactccctc tcaggcctcc atgggcactt gtactcatgt gcacagaata 1775040

 ccacagatat tccacatata cacaattaag aataatagca gccaggcatt gtgacacatg 1775100
 cctaactcta ccaagggaat ctgagttcca ggcttgtag ggctacatag caaacctta 1775160
 tccaaaata agatatttt aataaataa taaaatttta aaagttcga gctgtggcat 1775220
 agggggataa gcgtgactta cctgetgecc caggaagctc accctcacat agggatccag 1775280
 gaggactgt tggatcatgca aggcacgggc cagactgcct agcagccccg tgcgactgt 1775340
 aggaagacc tctgcacgt acacacgtac acgcagcgt gccacggtc tctcagctg 1775400
 caccacagt ggcaggagta gattctagg aacatcctc actgaggagt aaagctagag 1775460

 cctgagcccc tctgttctc tgaccccc ccccagcca tgctctcc aatctccac 1775520
 tcccgtgta ctccgggtc actccagctc acttctcgat gtctgaactg gtcccaggga 1775580
 ttggagcggg cagtggaagg ggaagatccc cgcgtgcct cacagacaag gtgatcttga 1775640

caaagccctt ggtcccagat cgggtgtcac agggatcatg taggggagcc cacttttgg 1775700
 ggaaatgcc atctaaggat ggaaaggagt gagaggtgcc taaggaatac accgagtgt 1775760
 ttcaggacat tggacagtgg ctggggttct gggcaaagca ttctatctgg catagagaga 1775820
 agagcctaag cacaagaaag gtcagccatc acaagagatg accttctcag aagttagtgc 1775880

 actggggaca gcacaggtga gtgaccagag ctcagtttct ggagtctttg ttcagtataa 1775940
 tgagtttcaa tgagagaggg gggttcaata cctggctggg ccaaggccat gccagatcc 1776000
 atcctgaagg tgcctaccct ggtggccatg aatgggagag tctgagagt gaaaacctgg 1776060
 ggagagaagg gttagtctg gtgctttgg acctttctcc ctgccccctt gtaagtctct 1776120
 ctatagccct ggcagggtt tgaactcatg gcactcttgc tgcctcagcc acccaaagac 1776180
 tcagctgggc atgccccctt tctcaaaata atcctcttcc tctctcacag tgatctctat 1776240
 cagcaactct tggaggtgaa gccgagtctt gtgaaatcg aacaagaagt actgggttga 1776300

 gtgagatgag aaagggaaag agcgttaggt gtgaaagatg cattcagctt gccccgcaat 1776360
 ctcttcactc ataaaaccag aattgttga cccagcctg ccctctccag ggacagggtg 1776420
 tctctgatca cccccattct ctcaagccca cctattctct tgggtgtgct cacctcattg 1776480
 tagaaggggc aattggttcc acgctgtgtt gcagtcacac gacgtgatc cccacacga 1776540
 acagccacat agggattaat attgacgcc accagtttct gggcctcaag aatggtgacc 1776600
 cccacctagg taaggaatgc aaaagaggga ggaaagagag tgagacctgc ctggatgagg 1776660
 ggagaaacct gtgagattcc atgaggatta gagcatggcc caagatcat acctggaagt 1776720

 cctgggctct gcacacctgg aagggatecc tacggggcag gccaggggtg cggctgtaga 1776780
 gaagcatagg gtcaacttca cgtccccttc ctgagccgcc cacacataca gttgcctggc 1776840
 gctgggataa ggactccga ccatgaactt ttggagtta agtctttca gattgcattg 1776900
 ccctaccttc atctcagcc tacatccaga atttgactca ttcttgagc gccaaaacca 1776960
 tttgtttgct cagcaaaggt tgattgagac ctgctatgtg ccagcactgt tctaagagct 1777020
 gtaaacctga catgaacaat agacaaaacc tacctaatac aagtctcttt attaactagt 1777080
 gtgagccact acaactgagt ttgaacacga tgggtgtctgt gcctataagt gaatgactct 1777140

 tgatgccaga caatccacct ctcccctaca cctggtgtg gatgggtgtg gccttatgta 1777200
 tgaggaagac tgactcagtg acaggtgtg agagcaggtg tatgggaaca cgttaccttt 1777260
 tgaggggct gaacaccacc ccagaaatct ccacgtcagg ctctctcc agctccagct 1777320
 ccagctccag ctcttctct tcatcatct gtgtccctag gcttcgagct agcctgcggc 1777380
 ccagaccac tgcctgacgc tccagccggg cctccccagg cctaattgaa aagacctca 1777440
 gagatcatct gttgctgggc atcccttgtt ttgcttatt ttatgattga cctttgattt 1777500

cagattgac ccgctattct gggactaatt cttttttgt tttgtttgt tttgttttt 1777560

 aagtcaggta atagccctgg ctgtcctaga actcccttg aaggccagc tggccttgaa 1777620
 ctcacagatc tgctgcctt tgccttccaa gtgctgggaa taaaggcgtg tgccaccaca 1777680
 cctggctttg gactcttaat cctgagacca ttctaacttc agaaccttgt cctgctgcaa 1777740
 ggattgacct ctgacctat aattcattca tccattctc agactctggg actaactcca 1777800
 tgtactggt tctcaactc aaaactgacc cegtggetct caatcactcc ctcatactta 1777860
 ctccatctcc tggaaagcca cattggggat gatcagctct gagctgggag ggaaaataga 1777920
 gaggtaagac ccgctgagaa tgcactcaga gtcacagcac ccagcacacc cagtaaggag 1777980

 acgaatgctc cttttctctc tttgggctga gtttcatctg cggacaccag accttgctta 1778040
 ggattattac ctgtctcgaa tgggtgtccc aaagtctcc tctaccagg ttccagcagc 1778100
 tccctcaggg ggetgatact ttaagtcaag ctccacctgg atctgaaaca agatacgatg 1778160
 cccataggtc cctcaaaccg acatggggct aggagagtgt gacggggaat gttcttctgt 1778220
 gcagacgttt cttttattgg ttaatgaata aaacctgat ttgccaagc aggatgatag 1778280
 gtaggattgg gagacaagga ggattctggg aagtataggc agagaggagt tgttatgtga 1778340
 tcccgaagt gacatggctg ggcagaaact gcatcagc cgggacaaat aggaaatcgt 1778400

 tctcttctct gctgaaatgc tgaacagtcg agatgtaggt cgccagagga gtaagaggtc 1778460
 cctggacctt tctctggca aataagacca cgtggagata cttagatttt tagaaatggg 1778520
 ttaatgatta agaataagaa aacttagcca aaggccaaca gctttataac tatatagtgt 1778580
 ctgtgtgctt ttggggggac agagaagggc agtgggacca aatgggcaa gaatctgaca 1778640
 ttacaagagt atctggacaa tgcattacac ttctgtgca aatagagacc ctttgactg 1778700
 tgtatgtagt aacatgttcc tctctcatta tcaatgttag cactcacaat cctctgcatt 1778760
 tgctagctgc cagaagaggt aaagtcagct gtctttaatg acgtgacccc tggggggtaa 1778820

 actacactcc aaggcaggcc ccacttccaa gagcagtcag gcaacataaa ctgaactatt 1778880
 gtcaggggtt ggaaaagaaa aaagaaaact cacagtggg tgggaaggga ggtgagggtg 1778940
 gaaagaagac acatgggaag agttgggaat gaatatgac aaaatatatt ctattaagtt 1779000
 cttatggaat taacaaagaa tattattttt aaaatagtca cagccttctt gagaactaca 1779060
 ggcaatgac tggggagacg gcctagtagg ttaaagatgc ttgttgcaa tectgacaac 1779120
 ctgagtttga tgcccagaac ctacacagtg gaggaagaga accgactcct agaaggtgtc 1779180
 taacttctgg acatatgctt actcacacat aagaaaataa atgtttggct gggcaatggt 1779240

ggcgcacacc ttaaatccca gcactcagga ggcagaggca ggcggatctc tgagttcaga 1779300
 ggccagcctg gtctacagag tgagttctag gacagccagg gatgcacaga gaaacctgt 1779360
 cttagaaaaa caaataatg aactaaaata aatacatgtt taaggggcta gagagatgac 1779420
 tcatctgtta agagcactgg ctgctcttcc agaggacttg ggttcaatac ccagtaccca 1779480
 catagtgact cataagcatc tataatggga tctgattccc tcttctggca tgcaggtgta 1779540
 catgcagacg cccagcacta gggaggcaga ggcaggcaga tctctgtgag ttcgagacta 1779600
 gcctggtcta caggagctag ttccaggaca gcctccaaaa gccacaggga aacctgtct 1779660

 cgaaaaagaa aattatttat ttattatgta tacagtcttc tgccctgatg ccagcagagg 1779720
 gtaccagatc tcattcaagg tggttgtgag ccaccatgta gttgctggga attgaactca 1779780
 ggacctctgt aggaagagtc agtgctctta accgttgagc catctctcca gccttaaaa 1779840
 ttatttttga gacagggttt tagttagacc tggaaftcac taaaccaagc cagcctggaa 1779900
 cacagagaga tccacctgcc tctgccagga ttaaagggtg gtacccccgt gctccgctat 1779960
 aaataaaaag gaaatcaatg aaaagaactt aaggctggag atccagcca gttggtacag 1780020
 tgcttgtcta gcattcagaa aggcttgggt ttgggttcag cagtactgaa aacaaacaaa 1780080

 tctaagcttg gaaaacacaa aacaacagc acaaaaactc agcttcaatg tgcaagtgc 1780140
 ctcttgagct gattccttct ctggccctg acaacttctc cagctccatc tcattatagg 1780200
 tttctgtcct gctcagcacc ccaacaatgc tccatcagca cctgggatt tcaattatc 1780260
 aggatcctct atctcaacat tctccttct acctagctaa cacctataac cttcattct 1780320
 gagctcaagc accatttccc caggggaact cttctgactt cctcatctag gtcagactgg 1780380
 ttatccacgc tcatagactc ttaccagccc tgcagcattc accagcagca agactacctc 1780440
 tacctgtgtg gatgcttct tagtgttggg ccccttgggt tcagctagtg agcttcaata 1780500

 aagcaaatct ttatttgggt ttgcttatca ctgaatecct attgctcaat atcatccttg 1780560
 aacttaacca atgattgaat ggaaaaaaaa aaaaaaagt ctgattctcc attacgtaaa 1780620
 tggggaacaa gcttggagat gctgaactct actaggttct ccagggggaa cggagatttg 1780680
 aagccaggte cacctctttt aaaggtgtgc aaccttecag gaaaatccta ccaggttcat 1780740
 cattgtcacc tgtaagaaaa gaagtgagcc taccagat ccaaggagca atggtacact 1780800
 caccacccc ccttgtgact cagaaatagc ctgattctgg cctgtgtagg actcaggcag 1780860
 gggctgtaag aaaggagacc taagtgggg cgggtgctt gttgccactc ctgtctggct 1780920

 caacttttc cctcagttaa atggaacat ctgtttggag gaagtctcag acttctgac 1780980
 agttggctgg tggcacttac cggggacact cggagtttct catccactag ggcttcctc 1781040
 agcaccaagt gccagaact ctgtaactgc tgcagggaaa tcaccagggt cccagggac 1781100

ctagaagaaa ggcatagagc agaagagtgg ggcaggtagt tgacactaag ccacttcctg 1781160
 gtttcctcca gttctactca cctggggctg aacacacggc tacagttgac cacctgtaca 1781220
 gtcagactct ctccagccag tggagatcca tagtggggcc aacgaaacat ctgaggagac 1781280
 aggaagacgc tcgtaactgg atgctaggct gaccctcaca gagtctattc ccaactgttc 1781340

 aaatgtgagg ccacacctaa gagtaatctc ctaagcccag aacaaacccc tccaacatgg 1781400
 ggttgacttc agtctagggc tcatctggga ctctttgcca atcaagcact aatcccacta 1781460
 gttttgagac tggggcttta aaccagggct aacgtctcaa acctgagacg cacaccattt 1781520
 ctggagacca taccttccag gccaggaat gagcccttct gcccagcat ggaccccaaa 1781580
 aggaaaatac tgacttcttt tcagctggga accagctata ctgacctcac caacatctgc 1781640
 ttctcggcca caatgaattt tccttgtttt ctgggtaaag cctgctcaa aatgaagctt 1781700
 ttatcaggcc ctccacacac acaaatcatt tacctccca accatgacc cactgccgac 1781760

 ttccccactc aaacttaaag gtgggagata aggaaacaag tagaagccag ggagaagga 1781820
 gacgggttat agagctggca aggatttaag ttggaggga tgaagaatcc agaaaccccc 1781880
 agctctaaaa gtcccctcc atgcaaatct caccacggaa gcagagcttc acttgtcgg 1781940
 catggatgcc tggcagctct gttagcgctc tcacacacac ggtcagagcc atggcgagct 1782000
 gctgtggctc agtctgcctg cttgccttc tccccaccag tgttgcctat gactcactgg 1782060
 actcaccag caggttcagc aateccttc ctctagtcaa acacacaggg agcaggcctg 1782120
 gaggtcatgg gtgggaaggc ctgaggcctg agaggtgggg tcagcccaga gctcttcca 1782180

 taccgtcggc aggatggcaa gaaggcaag aagcttcagc ctgtatctca tctttgtggg 1782240
 atgggagctg ggatcgggta cagatagaga acatctcagg ctggctcttg ctagcccgtg 1782300
 aggcctcaag ccttcatgtt ctttctatcg ctgtggtaga acaccatgac caaaagcaag 1782360
 tcttgaaag ggcttatttc actcacgctt gcatacaaaa cagctggaac tcaagcatgc 1782420
 agaggctatg gagaagtcc gcttactggc ttgctcatca tggcttactc agtctgcctt 1782480
 ttagtttgtt tgctttctaa tagaatcgag gactgccagc ccagaatgt ccccatccac 1782540
 aataagctgg gcctccacc atcaataagt taagaaaatg cccaacaggc ttgcctaaag 1782600

 cccgctctga cagacatfff ctcaattgag gtttcttct ctcagatgac tttagcttgt 1782660
 gtcaagtga cataaaacta gccagaacaa ttgaccttt gtccacttga cacaccaata 1782720
 aaacactatt taacaataac ctttcattt ttgttcattc acaatctctc atattaataa 1782780
 ataaaacaat ataaaacata ctgagctggg cagtgggtgt gaatgcctgt aatcccagca 1782840
 ctggggaggt agaggcaggt ggctctctgt gagtgtgagg ccaacctggt ctacaaagct 1782900
 acacagagaa accctgcccc ccccaaaaaa aagaacattg gaaacttaga attctcacag 1782960

gtttttatatt attgggggca gggatTTTTg agacagggtt tctctgtgta gctctggttg 1783020

tcgtggaact cactctgtag accaacttgg cctcaaactg ggagatctgc ctgcctctgc 1783080

ctcccaaggg ctgggattaa aggctatgct accactgcct ggctaaaagc ctcaacaagct 1783140

cacagtcttt acaaaactcaa acactttaaa aatgcaggct tttagaatac aagattaact 1783200

caaaaaaatc agtagccctc ctatatacaa atgataaaca gagtgagaaa gaaatcagag 1783260

aaacatcacc ctttacaata gccacaaata acaaaatatt ttggggtaac tetagtcaaa 1783320

caagtgaaag acctatttga caagaacttc aagcctttaa agaaagaaat taaagaagat 1783380

atcagaaaat ggaaagatct tccatgctct tggataggta ggatcaacat agtcaaaaat 1783440

ggcaatcttg ccaaaagcaa tcaacagatt caatgcaatc cccatcaaaa tcccagcaca 1783500

atTTTTcaca gacctggaaa gaataaact taacttcata tggaaaaaca aaaaaaccag 1783560

gatagccaaa ataatectgt acaataaagg ataatectggg gacatcacca tccttgactt 1783620

caagctgtat tatagagcaa tggtaatgaa aatagcttgg tataggcata aaaacagaca 1783680

ggtggaccaa tgtccaaaga ccccgatatac aatccacaca cctataaaca cctaattttt 1783740

gacaaagacg ctaaaaatac aaaatggaaa aaagaaaaca tattttacaa atgatcctgg 1783800

tataactggc tgtcaacatg tagaagaatg caaatagatc cataatctatc actaggcaca 1783860

aaacaagtcc aatggacc cagacctcaa tataaatcca tccacactga acctcataga 1783920

agagaaaagt gtgacgtctg tggcaggaca aagtccgagt attgggggaa agactggaga 1783980

tttattttaa agccgaaatg tccgctgctc tgtgctatgt gcatctatcc aactttatc 1784040

atctctttaa ttccaggag agagcagcct tatatacact tacagcacag ttgaaatgcc 1784100

tcagatgtaa gagcacgtgg aggaagagct cgtgttttcc taggtgtagt ggggtgaggc 1784160

cggggctgta agccaggact agaacacagg atgcacctgt gattattggc tgacaagcaa 1784220

ctagagacc cgtgggggct gggacccaaa agaaagtggg aaatacactt gaaagcatag 1784280

gtacaggaga tcaacttcta aatagaacac cagtagcaca gacactgaga gcaacaatta 1784340

ataaatggaa cccctgaaa ctgagaagct tctgtaaagc aaagaacgca gtcaacaaga 1784400

caaaatggct cttacagaa tgggaagaga tcttaccacaa ccccatatct gacagaaggc 1784460

tgatctcaa aatatacaaa gaactcaaga aactagaaat tgaactacca aataatcaa 1784520

ttaaaaatgg ggtccgtgtt ggggtttgat ggtgcatgcc tttaatccca gcaactcagga 1784580

ggcagaggca gaaggatctc tgtttgaggc cagcctggac tatagagcga gtaccaggat 1784640

aggctctcca aagctacact gagaaacct gtcttgaaa gaaatggggt acagataaac 1784700

agaattctca acagaacaat ctcaaatggc agaaagacac ttaaggaatt gctcagcatc 1784760
 cttagtcatc agggaaatgc aaatcaacac cactctgaga ttccatctta cactgatcag 1784820
 aatggctaag atcaaaaaa caatgacagc ttaagctgga gaggatgtgg agaaaggaga 1784880
 acactcctcc attgctggtg ggagcgccaa cttgtacagc cactgtggaa atcagtatgg 1784940
 tgatttctca gaaaattagg gatcaactta cctcaaaacc ctgcaatacc actgttgggc 1785000
 atatacccaa gggaggcaca aggacatttg ctcaactatg ttcataaaca cattatttgt 1785060
 aatagcaaga tcttggaaac aacctagatg tccagcctag acacaggggt atgggggtgg 1785120

 agaggtgcct tgggtctgcc tcaatgagaa gatgggacag acttagtaga cttcctagtg 1785180
 gaggccgtac cctctccaag gaacagatgg gaggaagggg agaggggtga gcaggaggag 1785240
 aggaaggagg ggaaaatggg attggaatgt aaaaattaaa ttaataaaaa aattagtctt 1785300
 accaggccat gctggcacac acctttaaac ctaaaccttg ggaagcagaa gcaggtggat 1785360
 ctctgtgagt tcaaggccag cctggctgac agagtcagtt ccagggcagc caaggctaca 1785420
 cagagaaacc ctgactcaaa aaacaaaaac aaaacaaaac aaacaaaaag acagtctcta 1785480
 aaaaactagc ctctataaaa cttcaaaatc tctttaaag ttcacagtct ctcaactgtg 1785540

 ggctcctgta aaataaatta caaacttctt cattccaaga aggtagaacc agggcacagt 1785600
 cacaatctga aaaagcaaaa tcagacttct gggactcact cacaatgttc cgggtttctt 1785660
 ctaatggtct gccacagaac acatagcttg tctttaggc tcaggccagc tctactacat 1785720
 acataactgc tgctgtcctt ggtgactatc ctatggactg gcatctccag aatgctggag 1785780
 tttcttgctg caagtaggtt gcactttcac caatagcctc tcttaggcc tcttctggg 1785840
 accgagcaga atttctctc atgacccctt cagtcctggc cttcaactgt ccctttgtct 1785900
 gtaccttcac cgatgacctt tcttggcctc tcacagtgcc caagcctcag ctgctcgtc 1785960

 tccatggccc cttcaagcct tcaaaaacac tacctgagag attcttaca gtaaccaagt 1786020
 tcagctgcca gcataaagta taacctagc cctcctcaa acccttgac tgacctgaaa 1786080
 cactttccag aagatttccc ctctgagctg ggcttttctc actaatctct cagttccagc 1786140
 tgacctgcat caattgtcag aggaaagcaa tgttttcacc ttagaggctt tgggtgtctt 1786200
 ttaatcagtc aattcttcag taccagctga ccagacacca cagagtctta attcaaaata 1786260
 tgcaatggct ccaatagagt ctttaagtga ctctcaaac tccctctgga acttcataag 1786320
 ccacgtctcc atcatctgta tttctctcaa aatcttatct tccaagctcc tacagaactg 1786380

 ctcaccage tctgaacacc caatggcttt tctagccccg tgtgccaag ttattccaca 1786440
 ggctccaaa aaagcatatg atcaggtctg tcacagaaaa tcccagtc ctagtactga 1786500
 tttcttctt agttaggctt aactactgct gtaatgaac acctgacca aaagcaactt 1786560

gggaggaaag ggttatttg gctttcatat cccgagtcac acagtcatt gagggaaact 1786620
 aaggcaggaa ctcaagcaag gcaggaactt ggaggcagga gctgatgcag agacatgga 1786680
 gaagggtgc ttactgtctt gctcctcctg cctttttatt ttgttttatt ttaatagaat 1786740
 ctaagactac cagcccaggg gtgtcctcac ccacaatggg ctggccccg ctccatcagt 1786800

 cactaattaa gaagacactc tacaggtctg cctacagcca gatcttatgt aggcaattct 1786860
 cagttaaggt tatgagactg tgagaatatg acccttccaa atcaacctt aatcaagcag 1786920
 ataccacag gcttgcttac aggccaatct gattgggaca ttttctcaat tgaggttccc 1786980
 tcttctgaga tggcctaata ttgtgtcagg ttgacataaa tgaataaaaa atgtgtggcc 1787040
 tctgtgtaag cctggctgtc ctggaactca ctatgtagat caggctagcc ttgaactcag 1787100
 aactcctcct gttttaattt tcaaaatgcc atgaagagaa gccattccat gcaacaggac 1787160
 tcacatggca ggttatttag aagaggagag agaaggggca gaaaggggca gagagagggg 1787220

 cagagactgg tccttgggga caagagtgga gcgagagaaa gggagagagg gtgggagggc 1787280
 gagaaagatg ggggtgaggg gaagggagga gggaggggag ttagaggggg gggaggagtg 1787340
 agatgggcag gaccctttt aaaagagagc atagtgaatt gcacaggtgg tgctcttagt 1787400
 ggctgcagct gagggtgtat cctgtcagat acctgaatac tagcattcct cccttttatt 1787460
 ataaagaggt caggcattag gaagggtag caggtgagga aggaatgat atgatccat 1787520
 gtctcaaga ctacttccc ctgacctaaag gggcattgtt tatctttggg gtacctggga 1787580
 aactggggt gctgaccacg tgctggagca gctgccatt tcacttact gtccaggctc 1787640

 tgtggaacta ccaggeatgg cctggacctg gcagaatgct gttcaaggtg gatccaagta 1787700
 gactccctag ggctaagc acctgacct ttctccac aatgtcactg gacgtgtttg 1787760
 gtcacttgc accaccagcc ctgtggccaa tagtctgaa acaatagctg attaagaatg 1787820
 tccagtggca ggtgttggtg gcacatgect ttaatctcag cactcaggag gcagaggcag 1787880
 gcgatctct ttgagttcga gggcagcctg gtctccagag cgagtccag gatagatagg 1787940
 ctcaaagct tcacagagaa acctgtctc aaaaaacaaa aaaacaaaca acaaaaaatg 1788000
 aacccctct cccagtggt agtgetgcaa gcactacca cattgtttaa ttgatgagtg 1788060

 gttgaatgta tcctagact acatagagta gttggacttt gtgcctcta accagaagcc 1788120
 ataggctctt agcttaatgt actagaactt gagtgaagct gtaaatggag tctgggagtc 1788180
 tgcaaacctt agaatcagac taaaaattaa ctatgtgtgc atttgtatat aatgccta 1788240
 cttagtgtt aacatttact ttcactacta ttttttaaag atttattta tttatatgtt 1788300
 tacagtgttc tggcatgat acctacacac taggagaaga caccaaatct catgacagat 1788360
 ggttgtgagc taccatgtgg ttgctgggaa ttgaactcag gactctggaa gagcagccag 1788420

tgagcttaac ctctgagcca tccctccagc cctactttta ctattattga tgtgtacctg 1788480

 tgtgcatttg tgttcagatc cctgggagct ggagttgcag gcaattgtaa attgtctgat 1788540
 gtgaatcctg agaaccaaac tctggctctc tggatgagca gcaactcctcg ctctgagct 1788600
 atctctccag cctccgatta gttttgaatt tctaaattac atttgtttgc atattattta 1788660
 ttttgagggg tgtgtgtaca tgttacagca tgcttggga ggtcagacga caacttcag 1788720
 gagtgagttc tcttctcca ccctgtggat cctgggagtc aaatttaagc ctgcgttgg 1788780
 cagacttggc agcacatttt actagcttat ccatctcctt ggccaatta ttcctttttt 1788840
 tgtttgtgtt tttttataac tttttgtatt agaataaaaa ttattttaca tgtcaatccc 1788900

 aggtgtgttt tgttttttga gacagggttt ctctgtgtag tcctgcctgt ccttgiacta 1788960
 gctctgtaga ccaggctaac cttgaactca gagatctgcc tgccctctgc tcccagttc 1789020
 tgggattaga gatgtacacc accactgtct caactcccaa ttaactcttt tttttggggg 1789080
 ggggtcttcg agacagggtt tctctgtagc tttggagcct atctatcctg gcaactcactc 1789140
 tggagaccag gctggcctcg aactcacaga gatccccctg cttctgtctc ccgagtctg 1789200
 ggattaaagg cgtgcgccac caacccccgg ccaattact ctttttaaat ttacttcta 1789260
 tgtgcagaac ttttgcagtg ttctcaciaa tggagagata gagccaagca gtggtgaaac 1789320

 agatgtgttc tttatctctc agaagtttca tacgtgcaa taataacaca gcataaaaa 1789380
 gagtataccg cagtacttt cacagtagga aaaagtccagg aatggggatc tctgaggagg 1789440
 gagggcagag ggalctgtgt agtggcatct tgttctgcca atggacttgg ggtggcggcc 1789500
 acatcttaag gtgtgacttt actgtgtaca gacgtgacct ctctaaagga agaggagagg 1789560
 atggctcttt ctctgggtt gtggtgggag caccctgaag ggagaggct gcatcttcag 1789620
 gagcaggaag ggtcacgcag ttattacca tcattgtgtg agtgttcccc aaataaatac 1789680
 ctattatttc tttatctggg tatttggga ctcttcaaaa cagccttcag atctgaagat 1789740

 aaaaactggg accaaagacc agcattcagg cagtgggaag gaatagtgtg tccaagact 1789800
 agtaacttgt tcagcttggc tgaatacaa ggaatgcaca cagcaataac agataaggtt 1789860
 ggactatcag cagaactggg tcttgttata aaacttcaag ctaagtatct ggctcctccc 1789920
 tgtgtcagct tttccatctc aatagcagca tgaggagaa ctggagatat gctcagtttg 1789980
 tagaatacct gcttggcatg caggaggcca taggtttatt cccagcatag tgaataacta 1790040
 taaccccaga atttaggaga gggaggcagg aggatgagag gttcaaggtc atcattacac 1790100
 agtgagtttg agtcaaatgt gggcaaccgg aaagagatcc tcttctaaaa cctcaaagtc 1790160

acgcaaaaca aaataacaag aacaaaaactc cgtatttgac aagaaagggtt gctttttaag 1790220
 ttaatgtttt tgagaatttc atatgtggta tgattcccaa cacccttcct actccaaatc 1790280
 ctcccatgcc ccatcactcc ctctcaaact catgatctct tctataatta tcattgcatg 1790340
 tggacacaca cacacacaca cacacacaca cacacacaca cacctacag agcccgttta 1790400
 gtgttgcact tacacacatg tgctcagggc tgacccttg ggataacctg tcagtatgtt 1790460
 tgtctctaga gaaaactgat gctcctctc tcagcagcca cagtttgcca gtagctcatc 1790520
 aagaggtagg gcctcatgca agtccctca tcctgttgg cgtgccttgt gttattatgc 1790580

 agacctgtt catgaatgaa gcatctctgg ctttaacaat cttctgctc cttcttccaa 1790640
 tgtttcctaa gccttaggtg ttaagggttg cattgtagac gtttgggggt cctcccttg 1790700
 tattgttggc caaggtggtc caaggttgc ctctttttaa gatccagatt agctgtcaca 1790760
 gtacttagat gctaaggagg ggctttaccg cctctgtca gagaaactga aacccaaagg 1790820
 agtttcaaa ctgagtacag ggcagggtca gaatgggact gcctggctga gatcagattt 1790880
 ctattcctct ttctctgg gctctgtgga atctaaagtc acattaatgt cacctctcta 1790940
 gagcctggaa caagtacctc ctttgggcgg gaatacagct taccataaca gactgtctct 1791000

 gttcctcagc ctctctacga actgccactt ctgcaagctg gctaacattc taagtaagat 1791060
 gcgatgtgc caaaacaac aaaaacaac aaacaacaa acaaagcatt gggctgggggt 1791120
 gcatgcagga ttttgaatt gttttgggtg tgttttgtt ttgtttgtt tgttcttgag 1791180
 acggtatctc tgiatataga cctggctctc ctgagactcc ttatgtagac caggttgctt 1791240
 ttgaactcag aagtcagaga ttctctgct tctacctca tagtgctaag attaaaatcc 1791300
 tgttctacca ccatgctggg tcaggatttc cagatgcat gcaacatgat ctcaggaag 1791360
 taagcctctt tcctctctg cacctgttgg actccttga taaatcttgt gaggctgact 1791420

 ccattgcttt tctggtgtg gaccttaatt aggatagagc atatagttaa aatgtacatt 1791480
 ctaggacagg aagatggctc agtggcactt gctgccaagc ctgaaaactt gaatttgatt 1791540
 cctgattccc acatggtgga aagagaaaac taattccac cagttgtcct ctgatctaca 1791600
 catacacaga gagagagcag taagggggag aggaaataaa gaggagagag agagagagac 1791660
 agagagagag agacagagac agagacagag acagagacag agacagaggg ctggaagtgt 1791720
 agtcatgtag tcatgccttt accccagtgt tgggaggtag aggccggcag atctgagcac 1791780
 cagaccaact ttggctgcat agtgagactg tttcaaaaat aaagagggtg attgaaacaa 1791840

 agtaattttt ttaattggtt gaattgttcc ttcttaatat ttactaagta ttggtaata 1791900
 cctgggtact cattataggc tagacctatc taggtgctgg aggatacaga aatgaacaaa 1791960
 acaagcaaaa tccccattct tgccagccat tggtagcaca cgcttttaat cccagaactc 1792020

tggaggctga ggcagggtga accgtgagta ctagtctaca gatcaagttc aaggatggcc 1792080
 agtgttacac agagaaactt tgtctccaca cgccccacc cccgccaag cctcataagt 1792140
 taacattggg tatgacaggc ataatgaaac gtctgtaatt caatcacatg ggcgactcag 1792200
 tcagtattac tctgacttgg gatcatcttg ggctacatag ccagtaccg ggcagcaaga 1792260

 cttcatgtcc aaaatacata aaggacttgg aagatggcag tcaatgaaga cccaagtgga 1792320
 cccaagtgca gactccactc tagtgaaaag ctaggccagg ggctgtaat cccaactctg 1792380
 gggagggtga cacggcagaa tcccaggact tgctggtttg ctcagaaaac aaagtgaagg 1792440
 gctgacatag cccagtgaat aaactgcttg ctgccccgagc atgaggacct cagttgctag 1792500
 ccccagaatc gacatgaata aagggtgcaa tggcacatgc ctgtaatcaa aagctctggg 1792560
 ggagcagcca ggggggactg aagagatggc tcagaggtta agagcaccga ctgctcttcc 1792620
 agaggtcctg agttcaattc ccaaaaaaaaa aaaaaaaaaa aaaaaaaaaa accatggggt 1792680

 cttgcaggca ctagcttaca aacaacaaa aaacaaaac cggtagccc caggttcagt 1792740
 ctctcaaaag ctaaggtgga gagcgacgga agacagcaa catcaacctc tggacacaca 1792800
 ctttgacat acacgcacac acacgcgcac acgcacacac acgcgcgcac acgcacacag 1792860
 cgggtgtaaa taggtgtccg cttagctccc gtgacgtcag gcggttctgt gacacggctc 1792920
 ctctgtgacg ccaacagcgg gcaggtcga gacgccaggg ctgagtcggc cgcgccgcc 1792980
 ggggttcacg cagggtccga ccccggcg cgccgcagct gagggagggc cgagggttt 1793040
 ggctgtctgc gcgacttccg cttcccgggg tgggggcagc cccaggtcag gatgcggcgg 1793100

 agccaccgcc caggctcggc cgcatcctet cacaatcacg caccgactt ctacagcgag 1793160
 aacagcaata gtcccacag cgtgacttgc ggggacagca atgggcgccg gtcccctggg 1793220
 ccggagctcg agcagcccga gggcagaagg gcccggggct cgagctgtgg tgagcccgcc 1793280
 ttaagtccag gagtgccgg aggagacaca cgggcaggaa gctctcggn nnnnnnnnn 1793340
 nnnnnnnnn nnnnnnnnn nnnnnnnnn nnnnnnnnn nnnnnnnnn nnnnnnnnn 1793400
 nnnnnnnnn nnnnnnnnn nnnnnnnnn nnnnnnnnn nnnnnnnnn nnnnnnnnn 1793460
 nnnnnnnnn nnnnnnnnn nnnnnnnnn nnnnnnnnn nnnnnnnnn nnnnnnnnn 1793520

 nnnnnnnnn nnnnnnnnn nnnnnnnnn nnnnnnnnn nnnnnnnnn nnnnnnnnn 1793580
 nnnnnnnnn nnnnnnnnn nnnnnnnnn nnnnnnnnn nnnnnnnnn nnnnnnnnn 1793640
 nnnnnnnnn nnnnnnnnn nnnnnnnnn nnnnnnnnn nnnnnnnnn nnnnnnnnn 1793700
 nnnnnnnnn nnnnnnnnn nnnnnnnnn nnnnnnnnn nnnnnnnnn nnnnnnnnn 1793760
 nnnnnnnnn nnnnnnnnn nnnnnnnnn nnnnnnnnn nnnnnnnnn nnnnnnnngg 1793820
 ccgggcttg ttctccgcg gaccgaggct ctcccgcc gcatctggg gtgcgcagg 1793880

agcgcggcat aggcgcgchg cgggaccacg gcctgcccag cggtttagca ctaggctcag 1793940

 gagcctgcgc ccgggccccg ggggaaatgc gggccctggg tgcacagcac ctcaatggag 1794000
 ccctgggctc ccacagaacc gtgtggatct tccgcagtct tggaggagca getcaacctt 1794060
 atccccagcc tggatctgag gcaggagatg cctccgggtg ggggtgtcaa gagcttcctg 1794120
 agtacagacc agaccagccc cctcccctct gactggcact cggaaaccca gtcagttctc 1794180
 ctgcccgaga ctgggtccca gagtccagcc cgatcccctc tgacctggc actcgggaagc 1794240
 ccagtctctc ttccccggcc cgggtccgag tgtccggcct cagctcgttt tcccagccca 1794300
 ccctgcctc ctgagcccc ggacctcacc ccgcccctt cccgagcctc cctgaacctg 1794360

 caccaccctt ccctcatagc gcgtcctctc tgaacggctt ctctgtccc cgtcccagac 1794420
 ctctctttc aggtgctgag cgtattgtta tcgggtggcag gagacgcgct ggtcagtgtg 1794480
 tacaggtcag agcaaggagg agcagggatg gctcagggaa gggcagcagg gctgggcccc 1794540
 accaaggctt gagcttattc gtgtctggtt gagtcagtt cccgggaact gggcttagga 1794600
 tcctggggtc gaggcgaggg tgggttaggg cctcagagca tcagcttctg tcacggttcc 1794660
 tcagggaggt ctgctccatc cgcttctgt taactgctgt gacgctcctg agcgtctttc 1794720
 tggcaggtga ggagcttcca ttccctgggg tcccagctct gcaggtttgc agccaaatcc 1794780

 agctcgcagc tcctgtgcc cctcagctca ctctagtac cctgcttgg tctctcacag 1794840
 tccttgtgca gccccagcca ccatcccaac ccctttgctt tcctccgtgt ccctttatac 1794900
 cagagaatgc cccttctct tctccagcac tctgggtggg tctctgtat ctggtccccg 1794960
 cttagagaa tgtgagttgg ggagactatg tcccagggtg ggggtggaggt tgtgtgggtg 1795020
 ggtggggcat cactgggctg ctgggagtgg gcagtatagg aagctttggg tataaatatcc 1795080
 agaggccaac ggagaatgg agggaaatgg gtagtctct caagaggag gccgcgtgag 1795140
 tctagccagc ccttgcagac ttgggagaag ctgtcttatt tgtccctct tatttgtccc 1795200

 ttcaacagga acctaaggag atgctgactc taagtgaaa gggcagctgg ggtgggatgt 1795260
 gggcagctct gaaatctatc tatgggggccc agggacaggt agctaaccac atggtgccta 1795320
 ccgctcccc ccccagcct ttagccaat accaccagcg tgtgtactcc cagggccagc 1795380
 agctgcagca gctccagaca gaactgaata aactccaca ggaggtgtcc agcgttcgtg 1795440
 cagctcacag taggtgtgt ccctgcgttg gtttgggggg tgggtgtagg tattcgtct 1795500
 gcgttactc aaggctgcac tttggaacta ccacagcctg ggttctgaga cgaatcttcg 1795560
 ctccagatac ccacagtggg gactctttt ctaggccctt aaggctctat ctctgagtat 1795620

tgagtactg agaggcaggc ccaactgtaa ctgacctgca accctcctgt cccacacctt 1795680
 gagtctttag agagtggcca agctcgtgtt ccagaggctg aatgaggact ttgtgcggaa 1795740
 acccgactat gcaactgagct ctgtgggtaa gacacaaata tgtggaagga acttggactc 1795800
 caggtcatag acaactgtgt taatgcgaaa gtgacttctg cctgttctag gacacctcat 1795860
 cgacctggag aagacatcca gtgactatga ggataccaac actgtctatt tctggaaccg 1795920
 cctgagcttc tggaactatg cacgcccacc ctgagtcacc ctggagggtg gcctggaacc 1795980
 aggtgctgg ggatgggacc aaagggaag agccagggtg agagcaagaa tcaacttgg 1796040

 agaggcagga ctggagtga ggtcagttt gcatcaggag gtgccccact ggaggcaggg 1796100
 tctggcatgg tgtgggaagg ctccctccaa gccaaggatg aagttaaact gaagagaatt 1796160
 gtaactctg gggacttagc attgcctcac acgactaggc aagaaccaag ggaacaggca 1796220
 aagctctggg ctgagaagct ctagggaag gtcttctat ccagctcagg ctgctctcca 1796280
 attctcagta ctgtctggtc tccagttcgt tatatgttct gatggtctgc ccaaaccctt 1796340
 gcagccagat gtgttcctg gaaactgctg ggctttttaa ggtgatcaag gccaggtgg 1796400
 gatccgactg ccaggtcatg tgcagttaag cgagtcacc ctgcagcatc ctccaccac 1796460

 tgtggcacac actggaggag ccagcagtc accccgggac tttcagctt ttgtaagtgg 1796520
 ggccgaggcc aggaggtggg gaagttttag aaaccctag gtagtgggta gaagcattgc 1796580
 cggcatttgt cattgtttgt tcatctataa gctggacata ctacaggtt gctgcaggtt 1796640
 gtaagttag catccctgt actaggatgt cctggctgtt actggtttct tcaagcctac 1796700
 attccacaat gcaccaccta cattagaatg tgaacaggac ccatgtagct gttgaacatg 1796760
 tatgtagaag gcctgagcaa agcagtttcc cctcccttcc tgtgtctcac ggggctctc 1796820
 catatactct tcaccacca ggggctccag gctgatgatg agactgaagt gttcttggga 1796880

 aaattcatct ttgatgtgca gaaactgaa attcagactt tccatctaca ggtgtgttta 1796940
 tctctggggg tgctaacatg ggggcagtga aactgatgg ggaggacagt cttgagagca 1797000
 gttgttgga tgatccattt gtttcccag aatgaccctc catcagctt ccctaagggtg 1797060
 aaaattcaga ttctaagcaa ctggggccat ccacgtttca catgcttata tegagtccgt 1797120
 gccatggtg tgaggatctc agagtgggca gaggacaatg ccacaggggt cgctggggga 1797180
 cccattaaa aatgctgatg gttgaagcag aattgagatt tgtgctaaag aaaactgctt 1797240
 cagagtggg aggtcacctt ttggggaag ctctgcctat ggcaggtcag tatggcagaa 1797300

 tatgccctc aacacatcct ctttctctgg aaaagtccag agtcataatg tagcaaaagt 1797360
 tgatgtttcc agtgtctacc atatcaaga gacagtgttg tggacattct acaccgtaca 1797420
 agatgcagct tgatcctcaa tacaagaag gaaactgcta gtgcaacttg ctccactcac 1797480

gctagtgaag agttacacaa gaatggggcc ttctcaaga ggcatccttc cctcttcagc 1797540
 tggagaacta tcatgtcgtc aaagccacac gtcaactcaa atctctaccc caataacggg 1797600
 gaaactctcc tctggcaaac agtgaaaagc taagtctctga aaacttctag gaaatctttg 1797660
 agtcaaagct gacctaggct tggtagccct catgcagttg gtcattccta ggaccttagg 1797720

 tggatcatctg acgtccatct gatctaagtc ttcgctggaa tggtgaaaag aactaggggt 1797780
 ggaaagtaca aacaggcagc caagtaagtc gagttcctag ggtgggaaag ggcctcacat 1797840
 gagcaaagac aagcactatt tatcttggat gttgggatcc ttcctactga tatgtgaagc 1797900
 agatcactta ttattcacct atttaaatga gggatgatag attttgcctt ttgaaaaaag 1797960
 cacttacacc aagtattttc aaaacctaag atttcggggc tggagagatg gctcattggt 1798020
 aatactggct gcccttcagc aggacccgag tttgattccc agcaaccacc tataactcca 1798080
 gttctaggga atctaagcc ctcttcagc ctctcagc actaggcaca catgtggtat 1798140

 attcaagcag gcagaacacc caaacacatg aaaattcaac aaaaggtaag gtaggacag 1798200
 gtgggatgtc tcaacagga aagaccacca agcctaacaa ttggaattta atccctgggt 1798260
 cccatattgtt agaagaagac aaacaactcc agggatgtct gtcctctgcc cccacatgc 1798320
 tgtggcactt aacacacaaa aaaatatact aaaataactt aaggatcatt aagatgactc 1798380
 aagtgggcta aagtgggctt accaccacca agtctatgac ctgaattcag tctctgggac 1798440
 ccatacaata gatagccaag tctcacaggt tgcctttca actccatgtg cacatacaaa 1798500
 ataaatgtaa taggaacaaa ttaaaactaa ggttaaaaat agaactaagg gctggatag 1798560

 gcagcgccea gatgctttta attccagcac tcaggaggca aaagtaaggg gatttctatg 1798620
 agttttagtg ctacatagac cctgtctcaa aaaaaaaaaa aaaaaaaaaa aaaaaaaaaa 1798680
 aaaaagaaaa gaaatagaac taaagatcgg acatagtgtt gcacacctt actcccagca 1798740
 ctggggagge agagaccagg gcaggtggat tgatggagtg gatagagtat cagtttgcct 1798800
 agtctgcaag accccatggc cctggtttca gttctcagtg cacataaaca gaagccagag 1798860
 gaatcaaat ccttaagact tttcatacat tttcaccatc taaggctgge ctagaactca 1798920
 ctatgtagcc cagattagca taaggttcaa ggcattactc ctgcctcagg cactccagtg 1798980

 ctaggactgc agacatgaac cacctcagtc agtttctgtt catacttttt atagatgtct 1799040
 aagtgtgca accattgtta gtgcgggagg agttcagagg acagctttgt agagttaatt 1799100
 ttctcttcc gcctttactg ggatcctata agtaaaattc aggttggtta acttgiacag 1799160
 caagcactta atccagctag caatcacaca agaccctgta agttttttgt actctaactg 1799220
 tattggaaca tgccttgaa ctctacagcc cctacgtac actcaaagat aagataagtg 1799280
 gtagagcctg attcaaacat ggcttaggcc ctaggcacaa ttcccagtac caaacaaaac 1799340

aaaacaaatg cagccactga gggagtattt attatcattg atatatggat acatttttaa 1799400

 aagcagatta gcatttataa aaaataaaat ttccatattg catataaaaa catatgaaac 1799460
 agtaacagct aagggaaaaa taatttgaac atgttgaaaa gaacagcaga atgaagactc 1799520
 ttgacacata tagccatgaa caggctactg agaatgaagt cagtgtatga aatgattcct 1799580
 agccttacct atggaaataa attcaaactg aaaatgagat ctgggtgagg aaggtgacca 1799640
 agggttaaca aatggaatga gtgggactat gactttacag aaggtaacct gtaatatctg 1799700
 ctaaaatfff aaataccctc tgtgagctat catttccata tctagaagcc aattcctcaa 1799760
 aatgagtaa gcagaacaaa acaaacctag gggaaactact aaattctggt ataagagagt 1799820

 aacaggagac aaggcagttt ggataaggca tccaaaataa atgcaaacca gatataaata 1799880
 gctcatgtga tcccttagaa gatgttctgt ctgatctgaa actcagagaa gaatttaagt 1799940
 ccacatcaca atcacagcaa tcttcttgac ccagacttcc atgtgttggg attatagcca 1800000
 tgagctacca atctttatff cgattatctt tccccacc cccaccctt accccccca 1800060
 aacccttgg cagggttttc tctgtgtaac agtctggct gtcctggaac tcgattagaa 1800120
 gactaggttg gcctctgctt cccaagtgt gtgactaaac gtgtgacca cctgcccage 1800180
 ccattatcta tatttatatg atattgatat ttgaaacaat ttttctttg tttttgtttt 1800240

 gtttgtttgc ttgttttgag acagggtttc tctgtgtagc cctagctgtc ctggaactgg 1800300
 tctcaaacctc ggaaatcctc ctgcctctgc ctctgagtg ctaggattaa agatgtgtgc 1800360
 catcacactc agttttgaaa taatgtttta ggggttggag agatggctca gaggttaaag 1800420
 gcaccactg ctcttcaga ggtctgagt tcaattecca gcacctacat cacagctcac 1800480
 aaaattgtaa ctacaggatc tgacaccctc acacagacat atatgcaggc agaactaa 1800540
 tgcataataa acaaacctga ataattttag atctctatga attcgagcca gcctgatcta 1800600
 cagagtgagt gccagtacag gctccaaaac aatacagaga aagcccccc acaaaaaact 1800660

 ttaaaatate tctgcctcct gactactggg attcaagttg tgcacaacca tgacttactg 1800720
 gcagattgag tgaattttta cttctgcat taaaagtcc ctctccctg caagagaaaa 1800780
 tctgtttttc taaccaggc attaagtgca ccatagatcc atctactcca taagctgagg 1800840
 aaggagaagc tcttgagttc agagtctgaa gccagcctgc ataagtgtgt gaagatgggt 1800900
 cctcctaca aaatfffctt acaatataca tgtttaatct ctaatattaa aaaaaaaaa 1800960
 aaccattaag ctggacatac tggatcatgct tatgatttta gcacttggga ggtgagggtta 1801020
 ggaggactag gaattaaagt catccttgggt tacacatgta gctcaggac agcctgatga 1801080

aaaccaggca cagtagcaca agtctcta atccagcatcc atgaggttga ggcaggatgg 1801140
 taaattgcag gccagcttag actacacaag tgttcccaaa aaacagtgga acacagctag 1801200
 tcctagaggt ctaatagtcg tcaacttaca gtgaaatgtg tcattctctc aacttttcca 1801260
 cctcttatga ggcatagcac cttccatctt atccatgttc ccagctcagc tccactcgga 1801320
 ggatggacaa ccacacgctt actttatatt caaacttcgt gtttgcaaag tgagttgacc 1801380
 caatttgctt ggataggatt accagaccag gggtaacctt tcaactcaaca agcccaaggt 1801440
 caacaaagac ttaggtcaaa gtaaggctat cttacttaca ccggcctgta acctcgagaa 1801500

 agaggtcttt cctgaatggt gtcaggcaca ggtaggtagt caagagcagc aaaagcagaa 1801560
 gtaagtatca aagtatcaac tataaagtga gaagaatgtg caggtttggt ccatgcctgg 1801620
 aggatggtag cagctgaaat agatgggtca cagcctactc tcccagaaa cctatgcctg 1801680
 ggggggctgt gcagggacct tggctggagc tggaggtgcc ttcaatgggg cccaaccttg 1801740
 ggctttgaag taggaaacca gctgagtagg cacttctgca agtacagtct gtgccagtgt 1801800
 ctcccgtgga gcctgtcaga agaagaaagg caagttcaat gagggcctgt aggtctcca 1801860
 gggctctacat cttaccccaa attcaacctt gccagactga tgaaaaggct ttatctgctg 1801920

 gacctcaact ccatttctcat caccctgcaa actcttccca tactcacatt ctgaaatcgt 1801980
 cgatagggca caaactgtac tatgtcacgg gaagctgctt ctccatagcg agtacgaaga 1802040
 gggccaccat cagcatccag ctgctccatg acctcaaagt cagcaccacc cacgeccaca 1802100
 atgatcactg acatgggcag ctttgaggct tgcaccacag cctcacatgt gcctccacg 1802160
 tctgtcacag cgcctcagt caaaatcaac agtacgaagt attgctagag aaaagtcat 1802220
 atactgagga aaatttcttt tcccaacccc tcccaacaaa ccaggcacac attcccacta 1802280
 atgagatggc ccccatgata cagtctctgc cacctcagca ccacagctat ccgtagctct 1802340

 taccgaggca gtctctgct gtgcccctg gctgcaaat ctagccacat ggttgatgat 1802400
 gggtgcaaaag ttgtagggc catagagacg aacttggggc aatgcttggc gtaggcatc 1802460
 tacaatacce tggatgccta caaagaacaa cagaaaattc tgaagttgta gaccttagac 1802520
 ctcatgggat taagtaagac ctgaaatctg tccatctaga cccagaagat ttggaaacct 1802580
 gaaagtgttt taccttctc actcaggaca cagttctatc caacaaatga aattaaaagg 1802640
 cgccagacag tggtaggcga cgctttaat cccagccctt gggaggcaga ggcagaggca 1802700
 ggtggatctc tgtgagttg agaccagcct ggtctgcaag ggctagttat aggacagccc 1802760

 ccaaagccat ggagaaaccc tgtctcaaaa aatcaaaagg gcaaagacaa caggacttga 1802820
 tataaagaat atcttgtatt aaaactaata ttaaaagtta ttttctgaac cagtgggtgg 1802880
 ggtacacacc tctgaaacta gcccttggg aggcagaaac agaggcagag gcagaggcag 1802940

atggatctct gatttggggg ccagcctggt cttcaaagt agttcgagga cagctagggc 1803000
cacacagaga aactgtctca aaaaaaaaaa aaaaaaaagc atttttctga actgggagaa 1803060
tggtttagcc tggttatgtt agtactttgg aaactgagca agaggattgc tatgagtatc 1803120
aagagagcct ggcatacaca gtaagactct taaggaata agaccagcga gatggctcag 1803180

caggtaaaga gcttgggtga caatcccagt gacatgagtt ctatccacag aactacacag 1803240
agatagaggg agacaactga cccccaaaag caagatccac ctgccttgta ctcccaaaag 1803300
ctagggttaa aggagtgaac taccgtgcct agcctgggtc acaagttaga ggctagcctg 1803360
catacttcta ggccatccca gggtagagag agtctctgtc aagaaggga agaaaaagt 1803420
tgacagacta agaagacaat atagatttga acatatatat gtaatatatt ctagggttat 1803480
aaaagaaagg ggactatgag gtagaaggaa aaggtcttaa ggtacaagat aaggtaatgg 1803540
agccgggcag tggtggttca ctctgtaacg ataatcttt ccgccaagcc gcctgggccc 1803600

tgccgccaca tggttgccca aaataacaca cagagattaa tattaggtac aatgatgctg 1803660
ctcaatgact aggatttctt aactgtaaga ttagtcttaa ttatcaacca taactattaa 1803720
tctatatatt tacaagactt atctaataga ggacgcctgt cttccttget gccacatgga 1803780
tactctccct caactacatt tcccagaata atccttgatt cctactccta cttatcttgc 1803840
tttctattg gctaacagtg ctttattcat aaaccaataa gacaaacata tacagaagga 1803900
cctccccat catcactcct ttaatcccag cactcaggag gcagggacag gtggatccct 1803960
gggttcagg ccagcctggt ctacagagt agttccagga cagccagggt tacacagaga 1804020

atcccagtct caaaaaacac caaacaaaaa ggcaatggaa tatgtgacat gaagcaaatt 1804080
gggttactat ttggaaggga gggctagggg tgaataaga agatatacgt gatataatg 1804140
tgttgaata gcacagacct ataataca gttgggaggt ggaacagga gattcagttt 1804200
gagactattg tgaactataa caagaaccag actcaaatgc caaaaaaaaa aaaaaaaaaa 1804260
aaaaagcca aaaaaaaaaa aaaaaaaaaa aaaaggccat aataaaaca tcatatgctg 1804320
atgaaggttt aataaaagta atcagggctt gggatatagc tctgtggtaa agcaaattac 1804380
ctagtccctc agtaacatag aattatttaa atacaaaaga atggccttga ttttaggaaa 1804440

catacttaag tatttggggt gaagagctat gtgaacgaca ctgggcacaa agttgatgga 1804500
ggccaacgtg tctgtatag cattatcaaa tactccaggg aaagggactt ttaaagccaa 1804560
actcagagcc agtggagcct ctgggttaa ggcagttgtc accaagcctg actacctgag 1804620
ttccatccc agggaccaca tggtaaaaat aagaagactt ccagaaagt gtgcaatgat 1804680
gctcatgaac atacacatat acactgaata cacataattt aactttttaa aatgtaaac 1804740
tctgctgggc actgtggcgc acaccttaa tcccagaac tagggaggca gagacagatg 1804800

gatctctgtg agcttgaggc tggccaggtc tacaagaga gttataagac agctaggact 1804860

attgcacaga gaaacctgt cttaaagga ggagggaagg atatataacc cttctcttc 1804920
ctccctccct cctccctta cccctcacc aactaccctg tagctccaat gactccagaa 1804980
ttcctgtgac tgctgtaact tttctctaag gctgatgttt tgttttgagc catgcttatg 1805040
ttatttagtc ttctgtgact gctgttaact tttctctaag gctgatgttt tgttttgagc 1805100
catgcttatg ttatttagtc tagccttgac ctctaattc cccacttgca cttcaagtgc 1805160
ttaagattac actggcttcc aaatatggtt ttacatcaaa atacaaagtg agaagaaatt 1805220
tttagattga agccatagcc ttgtgtggtg ctcacacctg caatcttagc acctacatgg 1805280

ttgaggaag aaggatcacc tgggtctcaa ggctagcttt ggtagtgag ttctagaaca 1805340
gtccaggtga gggtagatc cggagctgga gcaaagcagc atgaactgct cttccagagg 1805400
acctgagctg gattcttagc actcaacca ggaggctcac aaccatgt aactccagct 1805460
acaagagatc tgttacctct ggtctctgtg ggcacctgta cttacatgta cacaccaaca 1805520
cacaataga cacccatata tacaagaaa aataaaaata agaagatcag atgagatcag 1805580
gtcaattttt ttttttttc actttaactt ggtgctcacg tggaaagtgt ggcaagacc 1805640
aaatcttggg tcttttgttt gtttgtttgt ttttgttttt ggagacaggg tttctctgtg 1805700

gctttggaat ctgtctgga actagctctt gtagaccaag ctggcctcga cctcacagag 1805760
acccccctgc ctctgcctct gcctctgcct cccaagggtt gggatcaaag gcgtgcacca 1805820
ccaatgcccc ggctttttgt tgttgtttgt atctcaacca agtttttatt gctctagcaa 1805880
ctgcaaaata tacaatttc tgaaagggtg gtctctgitta aaagcttgca aagcttcttc 1805940
ccaggccctt gagagagaca attacacaga acatgaagaa gtcatcaatc acacattgaa 1806000
aggcccaaaa ccaatggata gttaaacca atctatacag ctttctagtt ttaggcttcc 1806060
ttatacatat ttgataagta aatagctatc aaaataataa aaaaataatt ttcaaatatt 1806120

acaaatgaaa atatcattgg tgtgattcca acagtttttc ttctcataaa tgaagcaatg 1806180
cccagctttt taatacattt tttaaagact tttttgtat gagcattggt gtctgaactg 1806240
catgtatgtc tctgcaaggg tgtcagagct cctggaacct caaatcttgg gtctttacaa 1806300
agaagcttgg aaagtccca taaataacta cctaccctgg ctggggatgt gtctagtac 1806360
agattgtttt cccagtgtat agaaagctct ggactacacc cttagcacag caggcagtga 1806420
cagcccacct agcccttttc catgttttca tttgagaaca cgttgccag gcaggcttgg 1806480
aacttttgat tctcttggcc cagcccctct gccactagcc ccagataact ttagttttat 1806540

tttaaaacca aagcacaag aggtaagcaa ctgcccgaag gccatcagta ataagatgaa 1806600
 tttaaccca ctgggctagc tctgacctcc actcctctgt acaaagaagc aggctcctcc 1806660
 ctcttagtcc cctctgcccc ggaacactca ctcccagtgt gagactgtgt ctcaactggag 1806720
 aatggggaat tacctgcaca gtagggatta ctgggattga agttcaagc aaattcatgt 1806780
 gagacctgag ggcaagaatg aaaatgactc aaccaggtat gggttacctc cagtattagc 1806840
 tagcacacag gagactaaca cttgaagatt tcaaatttaa acctagcctg agttatatag 1806900
 tgagaccaat ttcaaaaagc aaaaaggaa aaacaaaacc ccaacaaaaa ccccaaaaag 1806960

 gctgggtata ggagtttatg cgtttaatcc cagcacagag ggacattagg atttcagtac 1807020
 ctttgggca gtctgaacaa aaaacaaaaa gccaaacaaa aaaaagagag agagagagag 1807080
 agaaaaatga caatctttct ttccaccttc cccttgttcc ccttttttgc ctctgagcc 1807140
 cctccctaac acacactcca aacagggctct atgtaaacca ggcttgtctt gaactcagag 1807200
 agatccactt gccactgect cccaaatgct gggttaaaag ttgtgagcca caacaccag 1807260
 caaagatttc atttatttc caacaggatt ttttcggtgt tgccttggct ggtcattaca 1807320
 tacaccagc tagcctcaaa ctccacagaga tccacctgcc tctgcctctt gagtgcctggg 1807380

 attaaagtg cgcgccacca tgtctggcaa tcagaagaat gcattgggtt ccctttgagg 1807440
 ccaagctcca ggtagctagc catcttaca gggtgctggg aactgaagtg ttcaacagcc 1807500
 atgccacctc tccaggtacc cccagccctt tctatgcca gacatgtcat tcttgggggg 1807560
 ctcaagtgca gtcagtagag tgcattgcta gcttgcttaa gacctgggt tcaagcctca 1807620
 gaactacaaa gtcaaagcaa gggcattctg atgtatgcc acgggtgcga gctatctggc 1807680
 cctgcacctg ctgtataccg cccactagaa cagatctctg tatctctct ttagctcaa 1807740
 tgccaagcaa taataaatt taccacagac tctggaatta ggatcttgat actaaaacct 1807800

 agaatagaga gaaggaagaa gagagcttac ctgccaatta ggggtacct gggcccaaaa 1807860
 tccaaatgct gggaacagct tgtctctgtg gagaagcagt gaggggatct tgagtctaga 1807920
 ggctgagatg tgaacagggc atgggagtgg ccagaacctg aaactcacga gtcattgtct 1807980
 tgaaccagc tccccacct ccacagtgt gtcagatact cgttgactcc tgaagggtc 1808040
 agatagtga gggaatcagg agaggatggg tctccattgg agccagtga gtcaacacc 1808100
 acctgggaag agaccaagaa tggaggtgag ggcggcctaa gccttaagc ctgatcacgt 1808160
 gccctagga cagcaactta cagtaaagtt gatttggcag cctccatca catagtccag 1808220

 gaaggaatac tctgtctcta cctgcagatg aaaccggggt taggcatgg ctactagcgg 1808280
 gctagcatca tacagtcaa agcttagaac tcagagcctg ggacacatgg getgcatct 1808340
 taccggcaa gtttctctc ggacagttcc agagttcttg tagcttttct ttttctgctg 1808400

cttctcgggg tggatacatt caaattcagc ctggtggaga gaaaaagtag ggcaggaaac 1808460
 caccacagca tcagctaagg acctaagctg cactggccag acgttcctat ggacagcagc 1808520
 catcacggcc caccggagca ctgtcaacag tcactaccta ccgggactgc ttgaagttgg 1808580
 gccaaaggtg tgtggaaggt accaatgaga tcatgtgacc cgtcactgtc atagtccgag 1808640

 cagcgcacct gagggagagt gtgtgtttgt ataacagaga tacaacacag ggccggcaag 1808700
 aagtcctccc ccagaatccg ttcccttcac ctttctattt acagttgact cctcacctgg 1808760
 atgggtgtgc ccaggtcccc accgcagaaa tctgaagag gaaccgagaa gcgcttccat 1808820
 gtagggttca ggttgttctt gattacctgg ggtggagggt agtgagctct gagctggccc 1808880
 atgaagatct cccacctct cctaccacc agtttttctc cctcagttcc caaacctgg 1808940
 agattctctc ccgtgccaac catcaacacc acgagtcaca cctcagatcg gtaagtcagg 1809000
 tgccacttcc catcaccttg gcggaagaac tccaagaacg gatcagattt tcctaggaag 1809060

 tcttccgat gccaaagaga ttcagttata agacttcaga agacagccag tgtcagccct 1809120
 ctgccccctt aattctcaga tccccatggc ctcccttcaa acacaccttc ttgtctaggt 1809180
 ttctagcttc tacctecatg gttactacc ggttgtctct taactcctga getgaaacct 1809240
 agaaagagag gactatatca tctcatgaat tactcattac ataaactgct tcctgcca 1809300
 gggtttattt cttacagtaa tggttccctg cccggcaggc ttccccgct tcaacatcaa 1809360
 gggtagatc aaagtctggc tggacacaat ctgggggaaa atgaggtgag agaggttca 1809420
 gcaccttaga cagggtgggg tctgtgtga ctggcacatc caagcttctt aatccctggc 1809480

 cctacacacc tgacctagg agcactctgc tccccctaag aagtcgtcat cccccagctc 1809540
 cgggtgtctt ttgtcaatgt catagattcc aaagcgcagc ttctggacag tctcaaagtg 1809600
 gtactcgacc tgcagagtct tggagaacgc agggcttgag cagttccgga ctgctcagt 1809660
 ccggcaaage tgtaggaaga ggccactaag catcagtaac aaactgcca cccccaaaca 1809720
 taacctccc ctccctcaat gaccttaacc ttcaaggttc atctcacctc agcccaggtg 1809780
 cccctccca catcctgtaa aaggacgcag agtgggtcag atttggagcc gatgtccttg 1809840
 tcaatgagat gatcacagga aatggacagc tgcaccaagg tcacacagtg ggccatctgg 1809900

 aggagacag cagggtcaag catcagggcc tctcctccat cttcactga ctatagtcc 1809960
 cagcctggga aagccacag cagcctttac acaggcagcc tggacacccc ggaaccttaa 1810020
 gtggactcaa tagcacagga cacatTTTTG ataacaaact ctggctccag atgaatcctt 1810080
 actctctaag tggcttctcat ctcaacaatg ctgtccagac ttggaacttg agccttaacc 1810140
 actgcagage ataateaatc tctatctggc ctcttagcac cttccccaaag gtcagaacga 1810200
 ggctatattt caattccaac agtttccagg ggggcatca tctagatact gctccctaac 1810260

tgctgataac cataacctct aattctggga cctgacatct tgcaaattgg gatccattcc 1810320

 atccattaac tcttcttacc tctaatacagc tgctcaggtc tactcatttc catgtatgtc 1810380
 atgatctagt ctaagctact gtttaggtta cctagaaatg gcaatagttt cttcagctgc 1810440
 tcacttaacc tcttgccaac cctacttcca ctteccatta ccaccagtg gactgttaac 1810500
 atagcaacca aacttatctc gtcagaacag tccatcacag cacacaggaa gcagaagcag 1810560
 gactgctgta agtgcaaggg tcaccttaga taacatacag agacttccat ggctacaaag 1810620
 tgaaccctg tctggggctg gagggatggc tcagaggata aaaacattgg ctgcttttcc 1810680
 acctgaacta ggtcctgagt tcaattccaa gcaaccacat ggtggctcac aaagtgaaac 1810740

 cctgtctcaa aaaccacaaa gtatggctca cactgtaata ctatctctgg gaggccaaac 1810800
 agaaggaata agagtacgag gccagcctga gttacaccgt gagtatgaag ccagtctagg 1810860
 ctatgtgaga tcagaccagt gtgcaacatg agtggctcac atctgcctac aactccagct 1810920
 ccaggggat ccaatgtctc tggcccaaac atttcgtcca cggacacata cacatttaa 1810980
 gataacaaca acaacaaca caaaatctc actgatata ctctaagctg cacactggtc 1811040
 tgatgtacca tctgaaagat ctaggtccct ctaatttaac ctgccagttc tctcgtcaa 1811100
 tcattctggc ctttgccatc cctcaagccc actggattcc tattccaaag ccccgcagtc 1811160

 acaggetgct ctttgttttt attaccaca tagtggttcc ctcttctgta aggttcttac 1811220
 catcgcatct taatgtaggt agtcttgcct gccactctaa ttccaacct accaccactg 1811280
 acatcagact ccatcacagc cttcacacca gtatccaact tactatacat attttagtta 1811340
 tacaatcagt ctctagcact aaaatgtaa ctgtacaaag gagaatttac ctgtttgtgc 1811400
 acctgctcta tcccagcaac taaatacact tgttgcatga aattcaagag gccatctcca 1811460
 ggaccagctc acagactgac ttgtctcaa atcaagcacc cccaaacctc tacagttcac 1811520
 ctatttctc catcacaatc atcaactacct tgcataaate aacacagtaa ctacaacgta 1811580

 gttggccta cagcccagga tgatccacag gcgacacaca ccatctacac aagtctcaa 1811640
 gattcctcac tggacttgtc tcaacagccc aacttctac cttagcagtc ttctggggag 1811700
 gtctccagcc tcttctgcc cccagcctgt atcatctcac gttggtctct aaagtctcct 1811760
 gtttgtctt gttttatgg attgggaatt gactagggcc ttgtgcatac caggcaacca 1811820
 tctgtcgtg aactataacc cagctctagc ctcccacca gaattcagta cacaacattg 1811880
 attattttta gactcacaca cagcacttgc tcaaatgagt gttaaaatcc actactcttg 1811940
 atccaaaagg ttgcaacaa actaaaccac atgtgtatat tctactccc acctggagg 1812000

cctccttctt cccaggtctc tatattccat gtggctgcaa gacaggtctt ggaagcagat 1812060
 gataacccca acaccacacg atggcaggtc ctgtgttcta aggctgctcc tccaagaggc 1812120
 ctgcagactt ccaatcttcc caatgactcc cctagaggct caacagacca cagcttatgc 1812180
 tgaattccac cattgtcagc tcatgtcttg acaaaggatc ccagaactca ggtagctcac 1812240
 aggtgtatca actaggtggg ctgtgctcac caccaaacac aaaggaatgc cgaatgcaga 1812300
 tcaaccagaa agaaccaagt gtatacatta cttgaaagat ctagactgca aagtctcagg 1812360
 taagtgtata ttcgatagat ctgaatactc tcacacagga atatacacag ggaacacgca 1812420

 tgtacacaca cccaccctt tgtattctgg cacagggttc catgtaatcc aggctggctt 1812480
 ccaatggact ttgcagatga gggtagctta aattctagat tctctcctt tccctgtga 1812540
 gtgctgggat tacaggcata catcacatg cctgagctat ttatgattta tacacttctt 1812600
 tccgtataga cttgtacatt gaaggccctc attagctccc tacttaacct caatacacag 1812660
 cctaagtatc aattattcta aacctatac ttttatccca cttcttacct tcccaagttt 1812720
 ctctccttg gtagctcctc acctagccaa cttccagtct caacaaaaaa cctgtataa 1812780
 ctgcccgatg actgtaaaca gcaaatgctc tagcaagcta tttgttcta ctctaaggg 1812840

 agaatttcta cagaaatgc taagtcttc ttagtcagcc actttcctta gctcttacca 1812900
 ataggagaca ggtgagaacc tacataacca acatcttgat acccacagct ctggtctgac 1812960
 gggactcccc ttatgaattc ttgccaggga agatttcatt gtctttggat aactgcagtg 1813020
 gtctccttac cagtctttct gcaacctcac agccatttct gtgtttacta gctaaatgaa 1813080
 aaccagatca tgtcacttcc ctgtttaaaa ctctgggaca gtttccaat acattcaaca 1813140
 taaaatcatt cgatgtaaaa ccctaacttt gaaagcagga gagatgtctc aggggttaga 1813200
 gcccttgtgt ttccagggga ccagagttca gttcctagca cccacatcag gcagcctaca 1813260

 cacaggtgcc tgtgacttca gctccaaaga atccaatgcc ctcttctggc acgcacagge 1813320
 actgcaatca caggcacaaa cccacacaga gacacaaacc taagtacact aaattaaaa 1813380
 caaaaccaac acacacacac acacacacac acacacaaaa gcattctgtg gctggcatga 1813440
 cagcttagtg ggtacagtgc ttgccattac ctgagtttga tccgtggaac ccatgtgtaa 1813500
 agagtcatct aaccaccaa gtgtgtccca caaggctgtc cttaacctc cgaagcgtca 1813560
 atcccattct ccatctctgg gtctttgtac tgtatggttc tatgtaagag caggaactct 1813620
 gtctactttg ccagtgtctc tggtagctac ttataacaga cactcggtaa atattcagta 1813680

 actgcattaa tgcigaaatt acaacagcag aatcgtatct ttctctccc gccatttaat 1813740
 tgtgggctcc tccaaactag ctctgagtat catctctata tgeccagtgc aacaagctgg 1813800
 tactcagcta tttgatgaac tcatgggaac tcacaacttc acgaactttt catttgaatt 1813860

aatgtacatc tgiaaccttc cctttcttgc ttttttgaca actgagttgt gaaattttaa 1813920
tgtggagggc taagatgtag tatagtggta agagtacaca tatccctggg ttcaaccccc 1813980
aacaccaaat aaaaataaac gaaaacgaaa accaaacctg taagacaaaa tttcaatgcc 1814040
agactcctac aattccattt taatgagaat caagttaaat aaataggcaa aagattcaaa 1814100

gattctttat aaaacataaa taagaataaa gcttgtgaaa tgatccacag cctaagtggc 1814160
ttgagaaatg caaaatgggg ctggacgggtg atggcgcacg cctttaatcc tggcactcgg 1814220
gaagcagagg caggcggatc tcagagttcg aggccagcct ggtttactga gtgagttcca 1814280
ggacagctag agaaacgctg tcttaaaaaa aaaaaaaaaa aaaaaagcca aaaccaaaaca 1814340
acaaaaaact acaatgagat agttagaaat ccatccatgc ccaacaaagc ccaatgttgg 1814400
caaaggattt aagattctta tagctggtca aagtattaaa tatgtcacct tggagacag 1814460
cccagcaagc ctgtcagaaa gccaaagttaa tacctagcta agtgcaattc cactggcaga 1814520

ttttaatcta aaagaaatga aaacatcatg tccaaaagct ttattaggac tgctcacagc 1814580
agatttagtc attatagcct aaaacttgaa acattcccag tgctcatcaa taggagaatg 1814640
aatcgetatg cttatagaaa gccaatggc agcagattaa tacctgaaat ctgaataaat 1814700
ctgaaggatg aaatgatgat tttattcatt agatttagaa tagacagaaa ctatctatgg 1814760
tgttggtgca cacctttaat cacaacactc aagaggcaga agcagatctc tgtaagtttg 1814820
aggccagcct ggictaacta cacagaagaa acctatttt gaaaaacaaa caaaagaata 1814880
tgcaaaacct aatctttgct gtccctcttt ctcccccaag ggagaagtgg ttgttaactg 1814940

cgggaagccc taggactcca ggaaaagatg ttcctttggg tcacagaggg tctcacttaa 1815000
ttccaacctt attactgtgg gtccactgtg tggaaagtag catatggggc ctaactctgt 1815060
gatgttacta agttggcctg gcttctattc tcaatgtcag ggcttctgt gcaaccaagg 1815120
tttcttattt ttgtttttt tttcttccca cagatctgcc cctttttctt tcttattgga 1815180
atattactgt gtgggaaaaa aagaaaaacc ttaataactt gcagctttca ctgggcagtg 1815240
agaatcacat ctacaatcct gtcacttggg gggtagagga tggaaagccag cttgggccat 1815300
gaaactgtct caggaatatg gatatgacac acgtgtactc ccttgagct attcaccag 1815360

ccccacccc tgaagtgact tgctggcctg aagtctcaat tctccttctg ctcaagcaca 1815420
gggatggaag gtgaaaacca caataactac ccatagctac ttttcttgtt gagctaagtt 1815480
tcctttaaata taccctgtaat ttatggcatt aatttttcaa ctctttctca taagcctatc 1815540
cctgcttggga aatctgtggc taaaaatcct ggtgcacttt tgaccactgt tgattactaa 1815600
ctacacacca cttgagacag catcttttca gatgggctag gctggtttca aattcactat 1815660
cctcctgcct ttggcttcag agtgcctggga ttacagcctt tgccactgtg ccttgccaac 1815720

tgccacatac tttaccaga ctcacttttc atatattata gtgccatttc aatcaacacg 1815780

 aggctttcat tccaaacccc ttgcatgtca cagtaagatg aatcagaaag taaaaataag 1815840
 aaaatttate atttaagaga tctggttatg cgtactagat ctttgtgtac agaattcctg 1815900
 ttcaatcaat tglagacgcc aaggaccttc tggaaactact taaaacttgt ttaatgctaa 1815960
 cccatcaaag gggaggcgag tttgctggca catctgacat agttagcttt ggtgtctcct 1816020
 ctttctgttg gaacttgtgc attagcgcag atgggaacac ctataaggta aagctccagc 1816080
 cttctctgcc ttgtttgtgg tcacttgggg tctcattcct ttcaaatctc ctttatttgt 1816140
 tgtttacctc tctcctact gccaacctca gagctttcta agccctgtac aattatata 1816200

 tctcccttaa agcaccatcc tcccagcagg gcacacctgc actcccagca taggcagggg 1816260
 atccaaggtc tgagtccaca atgcaatgtg cttacataga ggatctatct caaaaacaaa 1816320
 tgaaaccccc ctcatctcct cccatcataa ataaaatgga ttgactaccg agccacatt 1816380
 ctgtgacca ggcagaatth ggtaagtga aatgaggact agaacacaaa catttggact 1816440
 cctgagtcac ccttggaaact tcggtttttt tgagacagga tctcctgtgt ggtcctggct 1816500
 ggctgtaac ctgctatatt ggtcagactg acctcaaact tatgcctttg cctcctaaga 1816560
 aggtcggga ttaaaagtat gcactttcat ggctggccta gaactttctg tattataatt 1816620

 aaactccctt ctcttttggg ggaaaatgtt tttatattca ctgtcaacct gatgaagaca 1816680
 aaagtatgga ctcccaaca gtgagcaggc accaactact tccctcattt cttcctatcc 1816740
 atcagataat actgtaccag atggtgtcct gcataatag tttaggcaaa atgactaage 1816800
 ctcaggttcc tcagctgtaa agggittatg atcaacctct gaagattaat gtaaataatg 1816860
 tgtgcacaac tcatatacca ccttaagac ttgtgctgga attgtcatcg tgttactcag 1816920
 ccatcaccat ctccaagcc taactcagc atgctgactc tccaagctc cccacagcag 1816980
 cagcaatgt ctctggaggt cctgtatcta atctacaatg ggcaattgca ttctttccct 1817040

 gtgtgtctgc accttcttgc ttattgaaa acttttggca ccagggtctc atatagccca 1817100
 caatggcctc caaccacagg aaagccaaag atggtcagta tctttttgcc tatacctccc 1817160
 aaatgcttaa ttataggta caaattctgc cagtacatct tagctgggca ccatagacct 1817220
 atattcaatg gaaattcaaa acacttggga gaagctggca tcattgtact ggaccagact 1817280
 tgaagaate ccaagcattg tgtgagcagg tggccttggg aagttttaag gaaagactaa 1817340
 atgttgaag cctcccatat tgctccctgg gagatagggt atctgcatag cattgagata 1817400
 ggactctcat cggtaafaca aaaattatgt gcctttcatg ttttaaatga cattcattcc 1817460

cctgcattag caggctctaa ttgctatttg taaacccaaa aacagactgt gtcctcctgg 1817520
 gttcagttgc atctcagtac caaatggcct aaaattcact tatcagtcct ttaagctcaa 1817580
 gagttacatg agcctctcca ttcccaagag cftaaccagg caactgtgca atccctgtct 1817640
 ccctttgtct aacaaggaca tggcacagat gtggcagagg ctggccacaa gcaggtcagt 1817700
 ctgagtagca acagcatctc ttcagacaac tcacgtcatg ctcacacctg atgtcgcta 1817760
 ccttggcaag atggagcagc tcacagatgc tggatcgagt cttggaggcc aatcaggaaa 1817820
 tcctccagag gctccagaag cactccccac ccctcatccc caccctcgct gaacagccct 1817880

 tcccaagaa tcaaaagact gagcccacca acaccatfff cattcccgtc tcaattcctc 1817940
 aagggatatg gaggaggcag ctcttttctt acccctgaat ctctctctaa tttcagaatt 1818000
 ctccaaatft aatcagcag ctccaaaaac atttctcaca ggtcacgaat ttaatcaaat 1818060
 aatttctttt tgaggcagtc tttagagcaa gctggcttat tggcttagat tcctcttgcc 1818120
 tcagtctccc acgtgctgtt attaaagttg taccccatca tgaccctagtc aaagctctta 1818180
 ctatggagtg acattcttta ttcccccca cgtgactaag gtgactaagg actaacaag 1818240
 gagatttatt tagatgcacg aatttctaag aagcctatgt gccacacaga atctggcagt 1818300

 actacaaagc ttaaactgtg cacacacaca ggaacaccta gtggagaatt acagctgttt 1818360
 cccaccttgt actgggatgg ccaggaaagt ctgaaagcca ctcattcaac tctaacatcc 1818420
 ctgaagacta ccccaaagcc aaacaacatc tcacctatgc cggatcactc acagaaaaaa 1818480
 aatctatcc caaagagagt tggaaatgga gggaagctag gactgctcta gcatgctctc 1818540
 caccagaga ctcagaatac atcccatacc aaacttgaac tgcccacttc aaactcctgt 1818600
 ctgatcagca cctgaagata acaggtagta cttttgtgtc tccctgctta catggagtgg 1818660
 gaaaaccaa atcatggagc attgagagag gctcttcctt agaagactgg ggatgtatca 1818720

 cagggccact gctagtgact tcagcccca caacctcaa ggaaaaacag gtaaaccttg 1818780
 tgtctaagaa gtatgaagaa ttttactat gaagtgaata ttccattcat agctgggcag 1818840
 gttcctagct cacagctgta atcccaacat tgaggaagat tactgttttc aaggccagcc 1818900
 tgggccacaa agtgcattta aaaactctta tccaacacgt actagcaata gaacctcagg 1818960
 caagttagtt tccttttctt tatagattcc cctatctata aaatgagtgg tgatggcaac 1819020
 tctagaagtt aagctcacc ttaaaagtga ccaataataa ggatcccttg atagtgggat 1819080
 gectacagta cattaactct cccatttagc actcacaat gagtaaatgt gcctttgctc 1819140

 cttgtttgct catggaacac ttaggacagg ctatgagact gacaatgtag ggtttccgcc 1819200
 atgcagaaaa gagagggtc acaaaagtag caaatcaaaa gtgctgaagt tccatgcttt 1819260
 tagcttctgt tcagggccaa actcataatg attgtcaaaa gaaatggaat agctgggttc 1819320

acagaacat agatgcaaac cactggatag gataatccaa accttctttt atagaacaga 1819380
 ggccaaagga cacatttgcc atgggtcaca agaactcatg ggagcaaagg ggatttctct 1819440
 gttccattct gtcactagtt cacatcctgt agttcagtcc aatcttagac agttcactat 1819500
 tgtgtctcaa acacctcttc ttcatggcct atactaacca gccttataca aagatgtaaa 1819560

 ggaagtccac atccaccaca atctcattat tggaacagga atggagggtc tgctggactc 1819620
 catgtttata ggatttcata gggacaaatt ttaaacagca aacacaaata gtaaataaac 1819680
 atgtatagta aaattcatcg caggtagtca tttctggacc cgtcctacc ctgctgcaac 1819740
 ttacatattc aatgctgtt atatggagtg ctgtgaaacc accttctga gcatcatgag 1819800
 ggcaaggga tcgcaaaaa ccatcgcttc tacagtgtgc atgcaagttt aacagcacag 1819860
 caaacaaag cctgctgagt agctaactta agtttgttca caggcatgc ttcctacc 1819920
 gacactttaa caagtcactt ggttggaaata ttagaggat ctttaagactg ttctctaaaa 1819980

 cttctgtctg gaaaactaaa aatttcaaca gggaaactgt agaataaaca caaactagtt 1820040
 tcacatgtgt caagtgtcca gaaagccttt acacagttcg gtggtacagt cagatccaag 1820100
 cacaactaag cacttaagta tgtgaattta agaatctaat ctcttgagaa actgacatct 1820160
 ttctgttcac ctcccacca ttaagtcttg ttgtgtcaa cacacaacac tgcccccca 1820220
 aaatttagga caacatatag atatggctaa gctgtagtta caagaagacc aacagaagtg 1820280
 gagtctacc atgtaagaag caaagtggta tctactgtag caaataacca cctgagcaag 1820340
 tctgtaacct aggggcacag ctggtcccgt agatcacaag gctaaagga agagcagatg 1820400

 ctgtgtcage caactgtcca attgcagcct aacagtatag aacataaggg gagggaagcc 1820460
 gaactcagag tggagcaaga cataagaaa tcagtagccg catgttatat gttaagactg 1820520
 ttcaagcage tcaactcctt catcttttc tttccccct cgagacaagg tctcaacatg 1820580
 tagccctgcc tgcttggaa gtcaactatgt agagcaggtt gatccagagt getggaatta 1820640
 gaagcatgta caatgaatga ccagtcttc ttaagtgtga aaatttaaca gcttgtggag 1820700
 tgtatggcag cacattgtgg acactgtctg gtatgaatta tatttaacta tctttagcaa 1820760
 tcaaaagttc caagtaaagtc caggaggtc acattctgct gagactcacc acctggtacc 1820820

 cagatgactt gctatgtcag taggcaaac aaaaaactg aaacatcaag gggccggcag 1820880
 caactctgg gatgagttat gctgtgctt cccctctgta cttgtttttt ttttctcctt 1820940
 ccagattagt aagagactca aaactaattg ttccttaggc cagagtctag gtgtataatg 1821000
 ggggtgtgtg tggcacacat aatatcaatt ctgccattca ccttctcta caacttatgt 1821060
 cttaacctct cattggaggg acgttcccag ggttaagag aatcaaagg acataatgag 1821120
 attttctcc cctgctacac acagactcag tgtttttgaa gtgtgtcct atacctgggg 1821180

ctggactggt tacatcaggg ccgtgtctcc tggactcttc agtagcagag ccggtattta 1821240

gagtatgctc ttggctgiga catggtgac cagaaaaaa acgatgcttt tgagactctg 1821300

acagcacaaa acagcacaaa taagtccaga agagcacact gagaattacc atttaataga 1821360

ttaacttgct taigtgtta aacataaggc ttttttctc agaactgtgc ttaccaactg 1821420

actgtgctac caaagtactc ctcaaactat cttacagtaa accttcatga gcttaaagag 1821480

ataaaatctt agctggaagt agtagcacac gtgtttaatg ccagtacttg ggaggcagag 1821540

gcaggggat ctctgtgagt ttgaggccag cctggctctac aaagcatggt ccaggacagc 1821600

accagggatg ggggtggggg gcagagatct atatttagat cctatcatat ccctgaagtc 1821660

tattttgggg agagtagtga tgggataca taaccaatac actttcttct gaaaagctag 1821720

acaacagcaa acaatgtgtt acagaagtga tctgtcctga gtccactcct ctacataaa 1821780

gtcacactgt gtatgcgggg gttgtctgac tgatctgttt ttaagactca gaccaggtga 1821840

cctgtatcta ctgtccagtt actccgaaag ctgaggtaa agagtgttg aacctgccc 1821900

tgggcaatac agtgagacct agccctgtaa taataaaat cacttcattg ctacctgaa 1821960

ttatgtattg gtctaagctc gtctcaagca ggacatgtag ctcaagtga gactgactgc 1822020

tcagacattc tacaacacta ggaaattca acataagcta aactctgatg tgataaagac 1822080

aaaaattacg agcattttct gagaactttg gttgtaggga acagcccact aattctttca 1822140

actctaactc atccttttaa aatataaacc agcagtctac aacaacttcc ttactaatt 1822200

ttcctaagtt gaacaaatg gaaagggaca aaaccataa cagcgatgtc acaaagcacc 1822260

aattgctttg gtcctctttt ctccccacc ttaaaccat cgcatgaaa tacaaaaaca 1822320

aagtttagg taggtggaat taagaatcta ctccaagcat ttctttacc tttccactg 1822380

caaccagtat ttggaaaatg agagttcaca gacccttgg agactcctgt tgagaaggag 1822440

tatctggtec tcaagttctt tccaaateca cataacgaag ccattageta gcaaagcaca 1822500

cacaataaaa cgaatttctg aaaaacgagg ttcgcacatg tgacctagaa tcaagttcc 1822560

tcctgccgt cccaggcatc ttctttccac acttcagcat taggcgacaa aaagacacaa 1822620

acatttttac ctctaaaatc accaagtcca catttccaaa ggcaccaata ttgtcatgag 1822680

ttaaaaacaa aaaccacaa agtggatta gagctgaaag acgtactttt gtgcagttaa 1822740

agcattcaaa gcatcagcct ttatttgtg ataagttat tgaacagtat ccaagacttc 1822800

ttctttatca aaaaaactg ctaaatgatg ccagaggagg aggtgctggc aatgctgtgg 1822860

tcacactgtc aacagcctct tggctgtact gaggttctaa agtttggact acagaactgc 1822920

caataaaaca gctggaggaa aataatttac acatggcatt gtaagtggga aaggactcaa 1822980
 aatgatcacc tctagaaact ctccccaaa atggactaga agtcatttta catgttcttc 1823040
 actcattttt ccagtgcttt taaactgagt gcattttatt ttcacactta tacaatcaca 1823100
 gaatccagta aaatggagtt tgaatgagct tttgtgtttc cttatTTTTg tgcaaggtga 1823160
 tcatttcctc caaattgtg tatgcttgct tacttccaaa tatgtacata ttcttagatt 1823220
 ttcatcaagt aggtcaagac tgacctaac tacactgaat attactatct gtaagtttga 1823280
 catttcctag tgcaggaact gcatttcact taacactgtt gcattaaaac aaaaccaca 1823340

 acagccacta ataattgtac atccaaacta gtataatcac agaaaacacc tccaaattat 1823400
 gcttatgagc taaatctgtc actgaaaatt tacagatttg cttatttata aaatacattt 1823460
 gtaggtttca ctaatccttt aaaatcaaaa gaaaaataaa caccaattaa aaactcagga 1823520
 gaaaacaaat taaacctaat ggaaaagatt ctcttcatt aatgtcaaag tcaccaaaaa 1823580
 cagtaagatt tacacatgaa attaagaata ccttgacagt gtttacaac actctttgag 1823640
 caaagcttta caaagccttc atgccataca gatgagaaaa atcaagtaa ttcaatctat 1823700
 accaaaccta gttctggaga aaatttgtct gtcgagaggt atgaatagtt tcatggaaca 1823760

 cttttcatg gttatataaa caaaactgaa acttcaatgc ccagaacaag ataaaacaat 1823820
 atactcagca gttaggctctg ttaatagttt cagttataca aaaactgaag ttccagacgg 1823880
 cagagttatt tatatttagt cacatttcac aacaagcact gttgtgatcc aaggagtgca 1823940
 gaacacaatt ctctctgatt tctacacaa tactatgttc ttaatttatt taatgaacag 1824000
 tgagatccaa gcttttcttt ttagcattta tctaagatgt agaaataaca aaacagttgt 1824060
 aatgagtga acgaaatatt tggtcagtgt gtaggaatat acaacaaaa taacttga 1824120
 gaaaggataa aagattttca cttccaaca acccaatTTT tctaaatat agacagcttt 1824180

 ccaatgggaa aataacctgc agttgaaata cgatgcecaa gtagttctga agtttagtct 1824240
 ttgggatgag aaatgattac ttaacacaaa acatcacata taacatatt gctttttgag 1824300
 gcagtatcta tctgtcaagc aaattatct tgttgagttta ctaagtgatt aacaatgcag 1824360
 ccacttcttt ccaaagtctg cacaatcctt tcctaaca aaaactccac actatcaacc 1824420
 ctccaagact atactagtg ataggctttc caaactttat cacaagactg ttgccattca 1824480
 actctagagt tacacgacga aactgtattt cegtgttcca ctgccttaga acacaaaaa 1824540
 ggcaactgtgt atagacatac ataaatgtct gtgtatattt atgtgtatat gtatatatac 1824600

 atacatacac acgtattcat atataagtat ataagaaatg cctcttttaa aagtaaatac 1824660
 agacttgtaa ataatgttgg tgtgtttcaa accaaagcaa ggtcatatga aagataaaat 1824720
 tgatttccca tgattattca ttaatttcca attctgtgtt acgttaatgt gaaacagctt 1824780

tcaagcattt taaattaaga aaccaactct agacagagcc ttaagtgtca gtgaacaaga 1824840
 tgtgataaac caaatacttt tatggaaagg atacttagcc aaccaaagtc tatgtgacce 1824900
 cccccactt tgggtgccttg attgccaaca ggaaagaata tgaaaacgca atgagtgacc 1824960
 tcagttctct tgiiccgatag ctgtacttgt actttgcata aagaatatta gtgaacaggc 1825020

tcatgatcga acaactacac caaaaagcct ccaagttaac agaattaac acacatcaac 1825080
 ctatggtcca acttagggat cttacattct acaatactac tgctaacaaa actaccaatt 1825140
 tcaacttcag ttttaaacc ccaagataga atgctctttc ttatggactc ctttgttcca 1825200
 aatgtcacc taaattgggg caaaagccat ttgctaggtt agtccatcac agaaaggact 1825260
 tcaaatcaaa cacctaaca ctgattacca aagtggtttc tggttttcac tgccatccaa 1825320
 acaatatgaa caattttaa cgtactaac taataaaact tggcgggtcaa accaaaaag 1825380
 gccagtagag gactacatac tttattttta tggtaaaagt cattccacac aaccataagt 1825440

gtgacattag aaatcaaagt tcagggttat atagcacaaa ccaagtgtgg agtttttata 1825500
 ttagaaatta attaaaaaca aaatagttgt actcattaca agtgagtcaa ttaggcaaat 1825560
 aaagtggcaa catctgaagc aggactgtct atacagcaag aaccctcaag aagcaataaa 1825620
 ggtacataca atgaatccat atacagactt tattcaattt aaaaagaaaa ttaggtttt 1825680
 agacaaagct ttgacctat aacaaagcaa atatgtccaa ctttaaatcg aattgcaaaa 1825740
 gtagccaact tctaatgtc agcaactggc aagagcacce tctctgagct ctacttatgt 1825800
 ttctattttc ttcacccat gtggtataaa agaaagccaa tctagatttc cttgataagc 1825860

tttatatgat catagtttta gaaatggttt ccaactggtat gccaaaaatt atttttgtgt 1825920
 tctctccaga tagcttiacg aaacaaattg caatgtttaa ttctgtgagt tgtaaacagc 1825980
 caaccaatgc tctgtgttat agaaaccaat ctatctgcaa ttgaacaat ccacaggctc 1826040
 taacctggaa atactatgaa aacaatctgg atgcattaat cacagcaaca tgaagatata 1826100
 ccctataatg tgaaccacta tcttaaacg agctttacct ttctgaacc tataggtcta 1826160
 tcatttaagt caatgacagc agctgtggct tctcccag agtcaaagc caccatggct 1826220
 tcacctgtag gcataccttt ttcatgtat tttaaacaca ctgaacctgg gattacctga 1826280

taccataaa agaaatctaa aatttcatca atagatacag taaaggcat gttctgaacc 1826340
 ttaattattg taggtctggg ttttcagag ctagctccaa agccaggggg acccgcaata 1826400
 tgtattgggc caggcccagg cccagccca aaggctggag gccactcaa atgccaggg 1826460
 acacttcaa gactaggggg cccacttcca aaaccaggag gagcatttaa actaccaggg 1826520
 ccatttcaa aattctgagg aatgcccaca aatcctgacg gccacttaa attatttggg 1826580
 gctcctcaa aacctggaac ttccagtcct aggccaggca aacctgtt tccaactgaa 1826640

ggcataacag gcctaacatc accaaaagcc ccccctaatc ctggaggggg aagtgggtggc 1826700

 ccaaaggcat tcggcccgcc aaaattacca gggaaattaa atggcggccc attattggcc 1826760
 tccttcgate ctacagtcaa gaagacatgc tcctctctc ctgcagtggg gatgccagca 1826820
 ccaggcagtg caggaccagg tattgcggga ccaggtattg cggcaccagg tattgcaggg 1826880
 ccaggcattg caggaccagg cattgcggga ccaggtattg ctggaccagg cattgcggga 1826940
 ccaggtatte cagcaccggg tattecggca ccaggcattc cagcaccagg tattecggca 1827000
 ccaggcattc cagcgtggg catcccagca ccaggcattc cagcagcggg catccccgca 1827060
 ctaggcattc cagcacctgg catcccggca ccaggcatcc cagaaccggg aattccggca 1827120

 gcgggaattc cagcagcagg catccctgca ctaggcatca ctggtactgc aggattacct 1827180
 ggaacaggta tcittaagcc ctttttctt tgggctgggg gatTTTTtctc aatctctcgc 1827240
 atatcttcta gggtaaact atggacaaaa gcttctctcc cattcagctt ttacgggtgt 1827300
 aagtgttcag atttacgtgc atcatctca gttttaaact gaaccaatgc ctgcccaaga 1827360
 ccttgcccat tgttatcaac aagaacatgg acagcactct catccaccgg gattccttct 1827420
 aggaactgaa gaacgtccat cttggtaatg ctgaatggaa tgtttgttat atgggcacag 1827480
 actttggcag aactgacatc cccctctgga ttaacacca tttccctctg gtcatactgt 1827540

 aagttttgaa gtcgttttcg aatcatatct atcttttcta gcataccttt cttagtaatt 1827600
 ggatgaactt gaataaagcg attgccatg tattgtttat gacggcacag agcagcctta 1827660
 tagtcagcat cattcctgaa ttctacaaag ccttcaccag ttgctttccc attgggtcca 1827720
 taagctatat aaatactatc ttccacaata tccaacttct taaaaaatc aatgacgtgt 1827780
 ttgttttctg cticaaatgg tagccctttt aagtaaacac aataaccagc ctcatgtggt 1827840
 gatcttgacc gtgacctttt ctgcccactg ggcgattttg accttgaag tgtctgtgga 1827900
 ggggggtggg cttgtccaga aggcccctatg ctttgtttga aagtgatatg acctccagca 1827960

 gctaccact gtctctctgt ggcaggactg acttcacat agcgttgaat catcagcatt 1828020
 ctgttcggtt tcaaagcttc aaatgtatct tgaggggaga gaaacttaac caatccattc 1828080
 ccattatttc gacctacatg atcttttaac aaatgcaactg catcaacacg gagcccatgg 1828140
 aaaaactctc tgacatcatt ttccattgca gaaaagggca ttccgtgcac actcacatac 1828200
 agatcatcag ggttgacggg aagtgacttc acgtgcttt gagagtcat ctggataggg 1828260
 ttaacaggag ttaatggacc cagaacaca gggttcagat tattgttcag actcataggt 1828320
 gctccagagc cattcattcc agcaggtaga ggtgccacag gtgggtgatt caagggtggc 1828380

atgcctgaca tgggtggcaa tggggtcata ggaggcacat tagggactgg gggaaatggga 1828440
 gggacaggag gcacaggagg caatgttggf actggaggag gaactggtat tggggggatg 1828500
 gatggcagcg gtggcaaaga tggcattgct gggattggag gaatcggtgg tgggtgggact 1828560
 gtgttcattg gagaagctgt actcggaaatg gtcgagctga aggttggact cccaaacgaa 1828620
 gtccccatac ttggaggagc agatcctacg ctggctgtgg aaaatgtctg tatatTTTTG 1828680
 ttgctctcat gaacagaagt ggtagcagta actacacttg gcgaaggatt attaaagttg 1828740
 ggtactgttg ccggcaagtt taccctgttg ctcatccctg agctaggtgg tggtcctgat 1828800

 ctactagcat ttgctgggtg tatatctaag ttggcagttt caaaacgcct acgactcagt 1828860
 tcaatcatat tctgcatttc tgttttacta ctcaataata gtgttacttt tgacccttta 1828920
 attgtaccac ctgtgcgcat cataccaagc cttgcatctt catcagtggc aaaaacgatg 1828980
 aaagcctcac ccagttcacc ccctacaata tgcacgcccc catcagggat ggtcaatcca 1829040
 gagaagaagt ggcaaatgtc catggtcccc gccacaattg ggagacctg caaacggatg 1829100
 accacagcca tgctgcgctg aaaccacaca cacctgcaga tgagaaaagg caacggccat 1829160
 gtcagactcc tttttattac actgaatttt tagttgcaag aatgaccagc taccatatta 1829220

 tcccataaac attccctcaa gctatcacia tgtctttaat ttagatctga acaattaca 1829280
 cttccaaaga cttaattct agagtcagtt atagagaggt tcagtccaag actcaagaaa 1829340
 aactatgtaa caataaagtc atcataaaaa ctatgtaaca ataaagtcac cataaacatt 1829400
 cacagcacta aaacttcagt cagtgagatt taaaagaaat gcataaaaat ctatagaggg 1829460
 gaatcatgca aaggatgcat caaaattaat atttaaaact gatttagcat ctttctttta 1829520
 aactttaca ttttatagtt ttatcagagt gatacctat aaggtcaat ctcaaaagcc 1829580
 aaaagaaca gaaaactgga atgttcctgg attacaata cctattgata attaggttca 1829640

 tatctcaaat gaaagacata tctcaaatgt gaaagcattc acaagacca gttcaatacg 1829700
 tagcaccaga aatctcaat aacaaattcc atatttcata gtaaaacttt cgatttgttc 1829760
 tataaaaaca aagaactatc tggggctgtg aagatgattc agtgggtaag agcacattct 1829820
 gtatgtccaa ctgtaagaac atgagttcta tctgcatcc acatgggtgt ggctgcacac 1829880
 atacatctga aagtctagct ggaaccccc aactgtcagcc tagttccaag tatagagaaa 1829940
 gatactctca agagaataag gcacagaata atggaatgcc tgacaccccc ttccagcctt 1830000
 tgctgtata cacaggctta tatacgtatt tatgtatatg cacacacata catgcatgca 1830060

 tcactcataa acactcttc tgtatttatt ataagcaaag ttaatacata ttaagaatcc 1830120
 aaagaatact aaacagaaa gtcaaatct gaattaaccg taatatatca ccctaaaatg 1830180
 gaacctatca tacatccat tattccat ggctatttaa ccaaaactca ggtacagaga 1830240

ctgtatcaaa ctctgcatta catctttttt taaccacttt ttataaaaca aacaaaaaac 1830300
 cccagagcca gatactgtgg gattcccttt aaccccagta tgtgagaggt ggagtcttat 1830360
 gagtttgaag tcattctgac tacaagagc tccaggccag ggagagtttc acaatgagac 1830420
 tcagtttcaa agaaataaat atcagttggc agaatgtttg cctagcactc ataaagctct 1830480

 aggatcctcc cctaattcta tataagctca gtaggggtgt gaatgtcaat taccccagta 1830540
 cttagagaggt tgaggcagga ggatctagaa ttcaagagca acaccacaga ttacacacat 1830600
 taatgtataa ttactatctt gggcatctga cccaacttaa ctctgttga atctctgggt 1830660
 gctcactgat acccttatac agcaaaacct gtctcaaaaa ataaatgaaa ggaagacgag 1830720
 aagggggctc agtgagatgg ctgagctcac tgacaatact gaagacttga gttccatccc 1830780
 taggaccctt acagttaagg gagagactca actcccacat atataccac acgcacaagt 1830840
 aaataactgt aaaaatttaa tagggttcag ctggagaaat ggctcagcag ttaagagtgc 1830900

 tcactatcct tgcagagaaa ctgaggccca gcaccctcat agcagctcac aaccacctct 1830960
 aactgagctc caggagatct gatgctcgtg tctgtcctcc aggagtacca gacacatgtg 1831020
 gtacacatat gtacatagcg aaatactcat atacacaaaa taactcctta ataacagtaa 1831080
 cagggcagac ttgggagcca gaggcagaca aatttgctg tggtagaccta catgtttaat 1831140
 ctgagcatcc aaaagtccaga ggcaggaaga tatctgtaag cctgaggcca gcctggtcta 1831200
 cagtgagttt caggacagcc agagctgtat agtaacaaaa aacacaaagt agtaataata 1831260
 tgggctggaa atgtagctta gttggtagag tgtttgcatg gcatccatgt ggctttgggt 1831320

 tcaatcccat cagctcataa actgagtgtg aaggcatata cctgtaatcc tagcatggga 1831380
 gggttagtta caggagggtc agctcaaagt catacttggc tactaagtca atttaaggcc 1831440
 aacttgacat acatgaaatt gtttcaaaat aataaaggga ctggagaaat ggttcagtga 1831500
 ttaagatcac ttgcttttac aaaggatcca ggttaagtcc ccagcatcca cgtagcagct 1831560
 cacaaccacc cataaactcc agttccagga tcttcaaca cttcttcttg ccttgctagg 1831620
 tacatacaca tacatgaaat aaaaataaaa ttttagaata ggggcagaga gatagctcaa 1831680
 cagttaaaag cacaaactgt tgttctaggg aatcttagtt caattctaag tatcatgttg 1831740

 aaggcatata gctgctttca gccagtcca ggggtcaaat ggcttgaca agtacctgca 1831800
 ctacacata caaaaaacac agacatacaa atataaatct ttaaaaaatt gtattttaat 1831860
 atttttgagg aggggctgga gagatggctc agaggtttaag agcactggct gttcttccag 1831920
 aggtcctgag ttcaattccc agcaaccaca tggtagctca caaccatctg gaatgagatc 1831980
 tggtagcctc ttctgggtgtg caggcataca tgcagataga gcaactgcat acataaaata 1832040
 aataaatatt taatatattt tgaatctgga ttcaagattt tcaattattt attaatacat 1832100

tgttcctggt gccattgtgg tacctggttag cattaacact ttagttttgg gttttgttt 1832160

 ttttttttta attatttatt cttaggaaca tttgcctgc atgtatgtct gtgtgagggt 1832220
 gtcagatctt agagtatag acagttgtta gctgtctata gtttagcact ttagcacttt 1832280
 agttttaaag gcttctactt ttaatttttt tgtttttgtt ttttagaca ggctttctct 1832340
 gtagctttga agcttctctt ggcactctgt agaccaggct ggccttgaac tcacagagat 1832400
 cccacctgcc tctgcctccc aagtgtctggg attaaaggcc tgtgccacca ctgcccagca 1832460
 atggtttctc cttttatgaa atgttttggg atcaaatttt ggggactgga aaaatggtaa 1832520
 ttttgaaagt aatctgatca atcaagtttt aaatataaac ctattaactt ggttctgagt 1832580

 cctcagagaa atttcaatta tatgcgtgat ctagcttaat cacttctcaa gaacattaga 1832640
 aaggacaaga tttcctgcta taagctctaa gacttaatac aaatcaatgg agggaattct 1832700
 tcaatgtcaa atactafaca aactataatt taatgtaata aaatctaatt atatcacgat 1832760
 tttatgatta ctgtgtgcaa aatagaaata tggttttgat ggctggattt tttcctattt 1832820
 gtttacacag acacaccctt gttgtgtttt ttttcttttg agacacggtc ttactatgta 1832880
 gcctcagaaa gcttagaggt ctccctaagg agaccaggct gtcttccaaa tcacatagac 1832940
 tacctgcctc tgctctacc tctgagtgct tgggattaaa aggcatacca ccattctggg 1833000

 ctatatgttc ttttttaag ctttctgggc agccaaaaac aaaaaacaaa caacaacaaa 1833060
 aaagcccacc tcattgttta ctatactga agaaattca aaaatcaaac ataaccaaat 1833120
 ggtatattta aaatcacatt ctatttgtaa acagtttaatt taaaagctac tgacctttgc 1833180
 atcttaggac atacacagaa ccaacacaat gaaatgacaa attctgact gataacatgc 1833240
 ttactggttt ccttgcctc tctcttttga ctacgcaagt atgatttctt tttttgagac 1833300
 aatgtctcat gaagcctagc ctactcataa actggctttg taaccagagg accctgggtt 1833360
 ctcttgcctt tacctccctt agtgetggga tgtgctacct aataccagt tcatgtgta 1833420

 ccggggggtt gaaacaattt gtgcttgcta agcaaact ctactgactt acattctcta 1833480
 ccccttcata gctttctca cacaattaca cacaagata aaagcaatct tcaaatttaa 1833540
 tcaagaatga cggactagca cctagaacat attttataag gctatacaga gcactagaaa 1833600
 tggaggtaga atgggtgagt aaagatttca ggtatggact tcaagagtca acaaagagg 1833660
 ctggttaagat gatggctcag atagtaaaaa cctgagtttg acctctgcaa tctacatggt 1833720
 agaaaaagac aactgactcc cacaagctgc cctatgactt ccacaggtgt cactgtgagc 1833780
 gccagcactc tcagaaacac acacgcacaa ctacaaaaga gaaatagacc aatagactta 1833840

acaggcaaat gtaagtttaa tcagaacatt tccaagtaac tgaggcaaat tcacattcct 1833900
 tactgaatcg gaaacatggt taagtgaaaa ttgtggtggc actcttttca acttcaaaaa 1833960
 tatgttccat cactttctat agaggaaaca tcataggtaa accagatatg caatacctag 1834020
 ggaaaagata ctttcctttg taattgaaga ataagatgag aacttgaaat ggtccaata 1834080
 cacagacaga ttaaacacaa gcataaatga cattcacagt aagtttctaa accatattgt 1834140
 taagagattt accaaaagtc ggtacaaggc atccatgaaa acattccaat tattaataac 1834200
 ctgcctaaga ctgccagttg gaaaagggat ggagaactga accaagcaga gtacaagatt 1834260

 tgctcctaaa gctatctgac aacaaacact gaaagtatga agtgacagct gttactctgc 1834320
 tactaagtat ctaggtatct gagtgacagc aagtcttaac cagtcttgag tcaatgaaaa 1834380
 cattaatcc aattgctaag gtttaaaat cgcaactctac aaccttaaca tctacacctg 1834440
 ttttctagg gaatataacc atatcaagaa gcaactgaaat ccacaatcca tctgtaatgc 1834500
 tacaagggag ggcgcaggag cttactacct agcaataaga aatacatcca tataaataaa 1834560
 acactttcag aggaggaat tattcatccc acctatccc tcagataggc ttctaact 1834620
 aacacacaca cacacacaca cacactcaca ctctgctata tttatcttct ttttcttaa 1834680

 taaggtatct ctttttattt tgcataaaaa taaaccttct attcaaaatc tcttaccttg 1834740
 taaaacaaga gatgtatctt cttaagaagt agaggccaag tcaatcctgt gggcaaccaa 1834800
 ttaaaaccaa cttttagact gcaatagaga ataatggag gcaaaaaatc aatgcaggaa 1834860
 acaaaacaac acacacaggc cacactgcac tgtacattat gaaggagtct gaccaccagt 1834920
 gagtacttag taagaatgta tagttttgtt gttttttaag aaagagatac caaaatccca 1834980
 cacttgcttt caagtctgag aaccattcta tcaaaaatat gccatcaggt atttatataa 1835040
 atatgccatg tagccaaaac ataatataa aaacagtaca cgctcagctt cagatggtaa 1835100

 ttatcactca atgtttatac aatccagaaa tgccataaaa gtctattaac atgtccaacc 1835160
 tcaacttatt tcctaagttc tcacaaact tctgatgaaa agcaaattta cataataaca 1835220
 attctgaac tgtcatcagg tcagggatat tcacagaac cactataatt actctttcaa 1835280
 atataattacc tttgcatcaa actatcacag gtcaacaatac aactgaaatc aaatttcagt 1835340
 ctctaagcac taattccact atattcaaca gagatttctt tgaacgtaac aacaaaaaac 1835400
 ttatttataa agttatctaa agcatatctg taacctcagt cagcatcaag aagcaggagc 1835460
 tgaataacta cttaagtctg agactaacct gggctacatg ctgagttcta aggccaacct 1835520

 aagccaacag gaagtcctg tctcaaaaac aaaatatttc ttcagcaaat gtctaaggac 1835580
 ataataatac tttctaaatc acaaacgggg tagcagagta cttatcttct agagtaattt 1835640
 cttctgtact agtgaagtta ttaacaattc gcaagcaaca caaacaaca aataactgac 1835700

tatatttctt ttttttttaa atgtacctag tctgtacacc gtgagcatgg ccagtgccca 1835760
 gggaccagaa gagggttca gattccctga gactggagtt acacacagct gtaaactgta 1835820
 tgtgggtcct gggaatcaaa cccagatcct ctaaaaggat gccagtgtct ttaactgtct 1835880
 agccctctct tcaaccctct gatttgtttt aaaaggcat tttaaatgc atttttaatt 1835940

ttaactgttt tgggggcta agtgggtgca aacagtccca gactgaatct aagcctaaca 1836000
 tattttagge aagccctcta ccaactgaact ctatcctcag ctcaacatat ctaatttctc 1836060
 aatttatgtt acggacacat gcaaacatga atgtatgtta tgtgtatgct gatatatata 1836120
 tatatgccaa aaaaatgcatg tggaaactac acaactctga aagttgtggg tcccaggact 1836180
 ggaactcagt tcatctagct tggaaatcaag ttgaatcctc ttatcagccc tattatttta 1836240
 ctttttaaat caggctgggtg atgcttctgg ctcaaataca ctagtgttc atttttgttt 1836300
 tggggacaag tgtcaggtag tcaaacctag tctcaagttc aggaagtagc tgaggctgga 1836360

cttaagtact aatcctgtct ccatcccatg ctgacgcctt tagtcccagc actcaggagg 1836420
 cagaggcagg aggatctctg tgagttcgag gccagcctgg tctacagagc gagtgtcagg 1836480
 atagctcca aagctttaca gagaaactct gtctcgaaaa accaaaaaac aaacaaaaaa 1836540
 atctgtctga cgacggtggc acacaccttt aatctcagca cttggaaggc agaagcaggt 1836600
 agatctctc gtctgaagcc agcctgttct acagaacgag ttccaggaca cccagggtta 1836660
 acagagaaac ggggtgggggg gtggaaatct gtgttcttgg ggaagtcaag agagcatctt 1836720
 gggtttcagt ccttgccttt cacttgaga aagagcttct ttgtttgttt gttttttta 1836780

cagctgcaat atatcaggct agctggcctg tgaacttccc aaaactgttt ctaccacca 1836840
 tctcccata ggagcactgg gattacagat gtcatctct ctcttttctt tacatggact 1836900
 ctgagaatcc tcaacttcc acagctttat gaactaaaac accatcccag acaagcaacc 1836960
 atctttaact tcagagagta agaaaacct accactctct ggtactaaga ttaccaacaa 1837020
 aatcacttat ctgaatgatg atactcattg ttaaaactact gtgagaccaa gtaagccaca 1837080
 gtaataatth tttatcacca aaaagtaaaa caaggcaggc agtgtctgtg catgccttta 1837140
 atcccagcac taggaaggca gaggcaggca gatctctttg agttcaaggc cagccttgat 1837200

tacaaagcaa gttccaggac aggttccaaa gctacagaga aattctctct cgaaaaacaa 1837260
 atcatgttat tctaaacttg tctagaggaa aaagcaata tcttctaaca atttaaaata 1837320
 ttatacaatg cactttgcca aaaaggccaa gcttttaaaa gcctaaagtg catacattaa 1837380
 tctttagaat gtaaaaatct aactgaatat aaatctttgt caaatcactg tgtacatggt 1837440
 catgatacat gtgtgtgcac atgtgccata cagaactgtg tggatgtaag aaaacaactc 1837500
 catggagtgt aatctttcct tctaacttta ggtgagttct agggatgtgg caagacctt 1837560

ttaccttctg aacaatcttg acagctatgt tttcttaaac tcttcattta attagictta 1837620

tttcttctct ttattgatgt gtcagaaaaa ccacaacgta tgtgtgtgga cgtcagaaga 1837680

caacttttgg ccaggeatca gtgggtgcacg cctttaatcc tagcactcag gaggcagagg 1837740

caagtggatg gatctctgtg agtttgagac cagcctggtc tacaaggct agttccagga 1837800

cagcatccaa agccacggag aaacctgtc tcgaaaaaaaa acaaaaaaca gaggacaact 1837860

tttgggagtc aatcctctcc ttctatgtgg gtccatagaga ttaaaattag gtggtcaaga 1837920

tggataacaa gtacttttac tcactgagta atctcacaga ccctaattaa actcttcatt 1837980

ttaaaagttg tgggtgtgta tacctttgat cccaacattt gggagactga ggcagacaga 1838040

tctcctgagt ttgagaccaa cctgttttac aagtgagttg cagtaactt agggttacac 1838100

agagaacctg acttgaaaag taaaaacca aaaactgtac ctagggaaac agaaaacaga 1838160

aagtttgctt caaataaagc aaaaaaaaaa aaaaaaaaaa aaaaaattt ttttaaaaaa 1838220

aaaaaaaaa aaaaaaaaaa aaaaaaaaaa aattatggca atgcatatta tgtctaattg 1838280

cataaagaat cagccttaag agctatagaa ccagagtaat tttgtagatt ggttggttgg 1838340

ttggttecta aacatctgac acctactgga gatttaattc caaaggtctg gcacagcagg 1838400

gtgtggcagt gtatgcctat aaactcagt ctccaagagg caggaggaca ctcagttcaa 1838460

agtcagcaca gacaacatag agaattcaaa tccagccagg atatgagaat ctgtctcca 1838520

aaacaacaga gtaggaacaa aacagaaggc aaggcctgg gcatatccc aatattagg 1838580

aactgagttt cctaatgctt gtcttccctt tcagacacaa gacattcac atccatccag 1838640

aaggataaat ttaggtcagc cagttatgcc caaagggaac tccatatct acaaggttc 1838700

aagaaattaa taaggaaaat tcttattaca tcaagaaatg ttgaaagccc agctaactc 1838760

agtaaatgtg tacttcaaat tttgtgttca actttacagc acaaaaatca atccccacac 1838820

aagtaccatc tgaagcatcc agtccaagg agaattgtac acctcagggc taaataccac 1838880

aactgcagaa cttttctac cacagctctt cttcacaag tacaataatt gaaactgaa 1838940

aatttgtagc acttttgtt caactctca cttgttagag accagctttg tttatcagtt 1839000

caaaaattat ttgtgttatt cgccaccag tgggtgcaca cgactttaat ccagcactc 1839060

aggaggcaga ggcaggagga tctctgtgag ttccagacca gcctggtcta caagagctag 1839120

ttccaggaca gctccaag ccacagagaa agcctgtctc aaaaaacaa aaaaaaaaaa 1839180

aaaaaaaaat gtgtatttt atgtatatgg atattccgcc tatcacatgc acaaagtaca 1839240

agtagaggcc agaaggggga atcaggaatc atatccctg gaactggtgg cacagcacag 1839300

atggctctgg gctgccttgt aagtcttagg aattgaacaa ccctggatcat ctggaagaat 1839360
 gaatatatat atatattgat tgattgctga ggcattcttc cagccccaag aggtagtact 1839420
 gttttccaag aatctacttg ttcctatatg ttaaaatata tcagctagtg cctaactgaa 1839480
 cacaggattc caaactaaaa tctatcccac tcacctgata atgacctttg gaaggacgtg 1839540
 agtgaataaa tactatgcaa aatacaaca accgaaaaac agtattgagc catatgtgat 1839600
 ggcatgtgcc tttaatccca aagctcagag acaacagtca ggtggatctc tgggtttctg 1839660
 aggccagcct tgictacaaa ggagttcagg atagccaggg gcacacactt atctcaaaaa 1839720

 gataaataag aataggtatt gtaacgagac aatgtacaca tgcaatgcta gcagagtact 1839780
 taggaggcag aggaaggaag actgagagtt taagataagt tatcttataa acatacacat 1839840
 tttatctata tagagagaca ggcaaagaga aaattgacc tggtttgcca ctgatccatt 1839900
 gctctagttt aaaataccta aaacaagctt gtttagtgta tttttcattt catttccctaa 1839960
 catatgttgc ttcaatacaa taccagatac aaacacaaac taagtatttt cgtattatga 1840020
 caagataaac tttaccagcc attccaatta ttgaaactt caaggtaaaa tgtctatcaa 1840080
 caaacctttc catcatgaag aaaaggata aactaattct ccagcttttc cactcttcat 1840140

 ctggcaataa aactgagaa gtgaattttc actttgttca gtcacaatct ttacattaca 1840200
 aaggaaagaa aaccccagta accccttaa tgttacttt agaaaccagc aagttcctat 1840260
 tgaacagcgc acaatgttat cagcagggtg atcgcatcac agacatcatg aaaccacact 1840320
 tcattcccct tgggtttgtc cccatcacca aataaagcac acttcagatc ctgggaccac 1840380
 tctaataaat aactcttct gacactgata aaatgtgtaa tactgaattt tcacattaac 1840440
 ttcccattta gtactcatg gcagtaaatc aagacattcg aaataagaag tcctcctgt 1840500
 cgaaaagatt ataataattg tattattgat accaacaaaa atgtcctctt taattcattt 1840560

 gtacttcaaa acaaaaatat tgcttctagc ctaactaact acatatctac tttcactatg 1840620
 gctttaagct taaaactcta caaaccaaaa gctacatagg ttagaactac aactattaga 1840680
 actacaagtg aaattatttt tttctgtgta gtctaccctt aaacttttta caggcattca 1840740
 tttttgtgag ttttattaag aatatgtaga ctagggetgg tgaaactgat cagtggttaa 1840800
 gatctctggc tgctcttct gaggatccag gttcaattcc cagcaccac atggcagctc 1840860
 acaaccatct atatgtccag ttccagggga tctaaccacc tcttatggcc tctgaggtea 1840920
 ccaggcatga acatgaaaca tgtaggcaaa acaccatac aattaaaaaa agtagactag 1840980

 gcattagatt ttaactgga ctctacattt tagggaaagt aattctaac atatatacat 1841040
 tgtgcaacca attactaaca ttttcagaag aaatcactcg ttcaactaa atattcccag 1841100
 ccaactatta tccaatgac tccagaggct taatagtca atgctagcct aagctaccta 1841160

acaagatcct atctccaatg aggaacaaaac aaagactatc agtactggca ctgggttcta 1841220
 gatatctggcc cacagtacaa aagagaagta taaatgaaa ttttacacct aaaaatagta 1841280
 ccaagaagtc caaaactttc aatatgcagt cagtcaaaaac attcaatgtg tcagagaaaag 1841340
 agaaaaagaa gcctagagta gaccagaaca gtagccacca gtggtttcta aagtgtcaca 1841400

tattcacttg acagatctga acataaaatt taattattc attacaacc atcgaacaac 1841460
 atttaataca gcattaggtg atataaaaat gtagcacgtt ttgataaact acccaataaa 1841520
 ccctaagcac agccttgiga actcacctaa atacatttaa tttccctcaa aaattacatt 1841580
 aggaaagtta tgtgaacaga tcttcaattt ttaatatcct tagaaatgtc cagacacagt 1841640
 cactttccat taaacccaaa gtctcagtct caacaaaagt aacaaatttt caaaaacaag 1841700
 aacaccagtt tcgtatttct attaatttta gtaaaggttt ttgtagaatt tttttccaac 1841760
 tgcaaatgct cttaacactg taacagtata cactgctcaa caaggtcccg aacaatttgt 1841820

ttctcctaag actgaattca tcaaaattaa catttccaac tatccaagaa gcctgaagaa 1841880
 atagtccact cacagcctct cccftcaaat cctagttttt cccaccaggt tgtgtaggct 1841940
 ggtatcaact caatcttaaa gaacataaga tgattgttgc caactgcaca cattcagtct 1842000
 tctctgtcaa tctaggagtc aagaaggctt taggaccag aatacagcaa cacagcctgt 1842060
 aattctccac atacctatc taccagaatg aatgaatctt ttgactgaa ttaaccctaa 1842120
 gtagaccact cgggagtccc tcaaaacttt cactacatag cacacgcagc agtccactcg 1842180
 cttaccaacg ggcacccaaa cccgctacat tactccatac cccgtcacta acctgtagat 1842240

ccettaagga ctteccatct atttcacgcg gctgcaaact agcgcgccca accttcagcc 1842300
 agctacctaa ggcaccatc atccttctc cctgttgctc cccccgccca aaggtgccgt 1842360
 aaaggtgttg cagctagcag ccccttccct atctgggtac caaggacctg ccatccttgc 1842420
 tacagttgag acttcacccc ttctcctta gctacagggc ggctccagat tcctacact 1842480
 ccctagtaag acctcctta gtgctggcca tagacagcac ttggctgcaa cccgttgcac 1842540
 cttcaggtcc tgaaggcggc gggttcctgg cctccggggc gagcttctc ctcttaggtg 1842600
 tcctaagtgt ggtcccttt gctggtcata ggccactggg agctcttcac tttggggcag 1842660

gggtgggagt taaaacctcg gccccgtcgg aagcccaaga agcctcccc attctgcgtg 1842720
 caggcgtttt catcgcaacc cccacgccc ggcagttcgc aggccgcggg ggccaccag 1842780
 ggccggccga ttgccctctc aagaccaccg gggcgtcccc gctacggcct ggagccact 1842840
 gcggcacgcc ggtccacct ctgcgtcct cggaggccgc agagtgtgag cggcaccca 1842900
 ggacccccgc agcctcgccg cgaccctttg ttaggggtgc tcgcggccgc gggctccgag 1842960
 gcctgggaag gccccgccc gaggcaccga ggaggcggct cgagccccgc acagccccgc 1843020

ccgtttcggg gctgcgggag tcttaccggg gagagcttgc gcggcaccag aaccagacc 1843080

 cgagttacce cccgcgcgag tgcctcagcc ccgcggccga cagccccage ccggacggct 1843140
 tcccggagcc cactgcagcc agcacctccg atgccgectc acaaaatggc cgcccgcccg 1843200
 ctccggcggct ccgcgtccca ggagggggcg ggggggggggt gcgacgtcac ccggtgggag 1843260
 acgcaggcgc gctgaggttt gggggtagga aggggaagcc tcggaagtgc caggtgtttg 1843320
 cggcgaaggg ggtttcttaa ttccggtttg tggagtttgc tcccagcca ggcctgaagc 1843380
 tagtgccca ggttctttgc agggcctttg tgcaggctgc tttgaacctc tgtgaaagga 1843440
 gcgaacagtg cctaccttgc acaactgtct tgaggttaaa cggaccaaaa ttgtagcttt 1843500

 gattagactc tgccgagcaa aaaaagcgtg gtggtttttt gtttttgact attgaaaaca 1843560
 ttcggccttg gggctggaga gtaggctcag tggtaagag ttcgttcgta ctgctcttcc 1843620
 agaggtcttg aattcggcta gcaacatcgg gtggctcaca acctcctgta actccagccc 1843680
 caggagatct aacgccctac cctggccgcc gaggtttcct gcactcatgt gtacatacce 1843740
 tcattcacia acgttaataa aatgaaata aatctaagcc ggacgttggg ggcgcacgcc 1843800
 tttaatccca gcactcggga ggcagaggca ggcggatctc tgtgagttca agaccagcct 1843860
 ggtcaacaga gcgagttcca gaaaaggctc caaagctaca gagaaccct gtctcaaaaa 1843920

 accaaagata gatagacaga cagacagata gatcagcctg atctaaaag agttccagaa 1843980
 aagccagggc tgttacacag agaaaacccc cctgtctgga aaaacaacag caaaaaaat 1844040
 gttcaaccta ctgtggcaac ccacataatc ccctgtaggg agtctctgtc tgcaccagac 1844100
 cctgtctcaa aaatatagga ctaggtgtgg tgcctcatgc tcctaatccc agcatatctg 1844160
 aggcagaggc agtcagatct ctgtaaattc caggccacca gactctaaa agggagtgtc 1844220
 aggactagat agtaagattt tcctagggc tgggatgta gcaggcagta ccctgtgtga 1844280
 gtagcatgca tgagtttcta gatttgctc aggcacaaaa taagcaaatg tgggtgtact 1844340

 cacctgtaat tccattatat aggagtaag acaggggaat ttagagcccg ctataacggg 1844400
 tgagagactc ctgttgcaaa gtctgagccg gacagtagtg acacatgcct ttagtcccag 1844460
 cactcaggag gcagaggcaa gcagatcaaa cctatgtgag ttcgaggcca gcctggtcta 1844520
 ctgagcaagt tccaggacag gctccaaagc tacagagaaa ccctgtctca aaaaacaaaa 1844580
 gaaaaattaa taaataattt atttttataa gcattgattg gtattttgca tatatgtatt 1844640
 gttagatfff tgttgaattt agaaataaaa ggggagagca caagatgaga catgttggac 1844700
 atattaacta gtttattata ggtccggcag agtagggaga ctaatagaga agaggaacag 1844760

ggттаатggc tgaccgcat ggctggtcg gagaggagag cgagagagcg agagagagcg 1844820
 agagagcgag agagagacag agagagagag ggagagagag acagagagag agagagagag 1844880
 agcgcacaga ggagagaaga gcaaaggagg agagagaaga gcagagagta gagatcataa 1844940
 atgggcaggg gtctgtcttt taaaggggtc ctctgcacct gcgtgcagac ttggttccca 1845000
 tggaacctg gctgaccagg gtactgcctg tctaccagg taacagggtc aggccagcat 1845060
 aatgccccaa cctttcatgt ctgcttgtgt gaggatgtca aatccccctgg aacaggagtt 1845120
 acagacagtt gtaaactgcc acgtgagtgc tgggaattga acctgggtct tccaaaagag 1845180

 cactcagtgt татаaccac tgaacactct ctctggcccc cataaaatac atcttaatat 1845240
 tgtcttgтта cagaaaaaaaa aaaagaaaga aaacaacctt tctcagatta ctatggacct 1845300
 agtcttcate aatcctcate cctccacttc ctgctcccta actgtaccct gtatcttttt 1845360
 ctggggggg gggggtcaga ggttgcatг tcttgacaca ggatctcatg tagttcaggc 1845420
 tgacctgгaa ctatgcagtc caggatgtcc ttgaattct ggtcactttt cctcaacta 1845480
 ccaagtgtг gggttaaggc ctatcccatc acatccagcc tttgtatac tttgtatctc 1845540
 tttgttaaag acctgggatt gaacgcaagg ctgcaaaaa ctaaaccagt aagtactcta 1845600

 ccactgagct acacattctc agccctgcac ттаатgaaa gtctctctgt catggatcta 1845660
 gtcttctaaa tcagaaagtг aagcattaat ttaccaaca aatcgгagcc тaaactgagt 1845720
 agtgгctgca cactccttta atcccagcgc tcgggaggca gaggcaggгг gatctctgtг 1845780
 agttcgaggc cagcctggtc tacagagaga gttccaggac agcctccaaa gcaatacaga 1845840
 gaaagcctat ctgaaaaaaaa тaaatgcccc cacgggaggг ggggгtaact aacaaacaaa 1845900
 ctcatgacca catgtccctг caaccaccagg ccctgcct atcttgctta aatgtatctt 1845960
 гcttaatat atggттattг ctttacгttг tactттatgt aacaacctг agtaacctг 1846020

 gaaactгta atctгtgгc tctaagattt гtgгtcattг cctгtaaaaa ctttcctca 1846080
 ttгttггtag atacctttca ctctcaaaa catagaggтc cctгacггct тgaacaata 1846140
 agaaatcttc гctттгcat ctгagaatct гctcctггг гtgгtctatt тgagгттca 1846200
 agaacctггc атаacaattt ттаagacaa ггtctттccг тgaagттcac тgaaggagtt 1846260
 тaccagттг гctттттгг гctггtctгc aagatgaagg gatcctatta тttattcct 1846320
 тттcttacc cagcactггг гtgaaggcta агccгccaca ctггctттt тtactггггт 1846380
 тctггgaact aaactcagгt catcaagcct гtггgaaaag cccaagaaг агgactгtta 1846440

 caactггггг ggcaccttag тctacagagт gagacacata ccatttaaaa ccagaagaga 1846500
 гttгtггга тgtctcatcc таagcaagta aattctgaag caactactct caaaгтаа 1846560
 ccagттccct ctгtcttact аcaactatt агattacatt actgaagcaa гgccccagg 1846620

cccattccct tgtttggcca acccctcccc ctgaggctaa ctaccaaggt cccacaataa 1846680
 aagtgttgaa atccagcaat caaaagcccc ctttagggtt ggagagatgg ctgagaggtt 1846740
 aagagcactg actgctcttc cagaggtcct gagtcaattc ccagcaacca catggtgact 1846800
 cataaccatc tggaatgaga tctggtgccc tcttctgggtg tgcagatata catggaagca 1846860

 gaatgttgta tacataataa acatataata aaaaaaagaa cttaaaaaaa aagccccctt 1846920
 taaagccggg cattagtggc gaatgccttt aatcccagca ctgaggaggc agaggcaggc 1846980
 aggtctctgt gatttcgagg ccaacctagt ctccagagcg agtgccagga taggctccaa 1847040
 agctacacag agaaacctg tctcaaaaaa aaacaaacaa gcaaaaagcc cccttttagca 1847100
 gggcgggtgt ggcccacgcc ttttatctca aactctgtc ggcaaacaga tgcaggcaga 1847160
 tctctgtgac ttctagacta gcctggtcta caattgctag ttccaagaca gcctccaaag 1847220
 ccacagaaaa accctgtctc agaaaaaaaa aaaaagctcc ctttggccca actaat AAC 1847280

 atgtccaatt aaaattaat atctcatcct aacatggggt tccccttggt cttttataaa 1847340
 cctccat ttt cctatgagcc aatgagact gtttctctc tatccagagg cagtcctttg 1847400
 tctctggga caaatacccc tcccctttc cctgggtccc tccccttct ccttttct 1847460
 ctatctctg tctttgtct gtatccctgc ctctgtccct ctatggcaa taaatctct 1847520
 ttggtctgag aatttggct tgggagctc gagcccatac ttattggagt gtacacctt 1847580
 aattacagaa ataaataagt gaaccaggc cagtgacatg gttgagcagg taaaaaaaa 1847640
 ctgctatga agccttgacc tgagtccaa aagccttcat aaaagtagaa ctgactctc 1847700

 gaagctgtcc tcaacctcc acaagtgaac cataagtaaa tacacacaca cacagagatt 1847760
 tataaaaaa ttiaatgttt gttttggttt ttgaaacaga gactgtgagg ccctgactct 1847820
 ggaattcgat ttgtaaacca ggctgggttt gaacctactg agatcttct gcctctgcct 1847880
 cccaagaact ggtattaaca gtatgcacaa ccaatccagc tgtttgtgtt getgttttt 1847940
 tgaggcagtt atcaattatg tagttctggc tggtttagaa cttgcagtgt aaagatcagt 1848000
 ttggcattga aattagattg ccagcctttg cctgagataa cagacatata ctttcatgcc 1848060
 ccatttaaaa tcattaaaaa taaaagact ccctggccc tttttttga gactttttt 1848120

 tttcttttt ttgtctgctt acaggactgg gactgaact cagaaccaa aatgctctat 1848180
 gactgaggtat tctctaac cttataaagg cttaat ttt tttgtttgt tttagatagg 1848240
 tctcttttta ggcaacactc ttaaagaaat agaactaata gaatgaacat gtatatacta 1848300
 aaaggaatta attacagigg cttacagaca ggcccagtta gtccaacaat ggctgtttcc 1848360
 ctgaaagacc aagaatccat gagacagaat gtcttttttt ttttttttt tttttaagac 1848420
 aggttttctc tglagcttta gacccatcc ttgaaatcac tttgtagacc aggctggcct 1848480

agaactcaca gagattcacc tgtctctgcc tccaagtgc tgggactaaa ggcacgcgcc 1848540

accactgccc agccagaatg aatgtcttgg ttgagatcc aaagttacat ttaagtttta 1848600

ataattctgc ctaagagatc catgaacaaa aaatgcctct gatatgcaag ccccttgccc 1848660

aaggacagat agttcctaaa aggctggagg ctattgttta tgggccgtaa caagccaaaa 1848720

gtgtcactcc cctcaatgtt tatttgacct atctgcacca atgtgcttga tcacgtgcgt 1848780

gtaggagggt cacaggctgg aggaatgtca ggaagtatgc ttgtccctga ttggacctga 1848840

tggaaaatgc actgaattat gggtttttcc ttcttaagcc aatacaaaact gattctgggc 1848900

catttcccag gaacctgggt gtggacttga ccagaacca tctacctggc cagaatttaa 1848960

ttaaagtttg ctcaaattt ggctttaaat tgtgtagtg gtcttattct tgatcagtag 1849020

gattaacatt aacagtgtca ctctgggtct agagttgcaa tgaagtcctg gagaacttca 1849080

gtctaattgg aattcctaag aaagtccta ttgctttga tttagcatag tttctttatt 1849140

gattctttga taatttcaca ttatggacc cagtaatttc ccaatccttt catcccttgc 1849200

agcatctccc cacaaaagaa aattttagaa aaatttaaaa tcaaaacaaa ccaaacacaa 1849260

aagctctttg ctcttccatc tttcctaact ttccagcacc tcttcatttg gtgttagtgg 1849320

tattgggagc catggtgtta acacacagta tactcttttg tccaatcagc tttacctgca 1849380

aatgttcatt gcaataagtc actggtctgg ttggaagcct caggtttctg gcacaccatc 1849440

atcactggac cctcacaaa acacctcttg aatattctgc tattgccag agtcatggag 1849500

atcctgtggg taacattccc caggaccagc cccttcacga gcatcagcag atcatagatg 1849560

ggtagatgtt aggctgggcc aacttcaggc cctggatggg ggctgggtg ctagctgagc 1849620

tggtcctgcc tggccactgg ggctgtcccc cactttgggc aaagggcaaa cccagctctc 1849680

tctatgtaca agtcatggct agttctcca tgtccatgga gaagggtggg accattcttc 1849740

tgagtggagg ggagaggcag ctctctcatg aggggtagga acagctctct atgcagtgat 1849800

tagctagggg cagggaagt tttcctaggg ccagcaaagg gtagggtcag ctccagcatgg 1849860

ccctctaatt tcatcaggca tggttcctat gtcccctgat cccaacctt cctcccctg 1849920

ataacatgga ccacagacat caacacagac cccaactgca ccaggacat ggacacagac 1849980

gtggcactgg gcagcagctc agacacaatg acctgggtg acaataaagg ccagtcagat 1850040

cagcatggcc ctggtggcat cacagccctc agacaccaat aagaccacag gctttggcca 1850100

caggttcagt ccattgccat catgggtgga ggggagagcg tggcaatgtg tgggcagaca 1850160

tgacactgga gctgagagtg ctatatcttt caggcaacag gaagtcaact gagacactgg 1850220

gtgatatcct gagcatagaa aacctcaaag cccaccccaa cagtgcacaca ctcttccaa 1850280
 caaggccata acaactccac ccagcaaagc aacacttct aatagtgct ctccctatga 1850340
 gattaagggg gccaaattaca ttcaaactac cacaaaagtt ttttttttt aattatttac 1850400
 atttcaaatg acigagcagc taaagacact tgcgttctta ccagctacag aggatccaat 1850460
 gcctgtggcc tctgggagca cctgtgccca catgcacaga cacaacata ctacaaagaa 1850520
 catgaaaaat ggtaacagga tgaaatcaaa cacatatata actagcttcc tttcttcttc 1850580
 ttcttttttt tttttttttt gttttgtttt tcgagacagg gtttctctgt ggctttggag 1850640

 gctgtcctgg aactagctct tgtagaccag gctggtctca aactcactga gatccgctg 1850700
 ctctgcctc ccgagtgtg ggattaaagg cgtgtgccac caccgcccgg ctctaccact 1850760
 agctttctaa aatttaata tgtatggtaa attaaaagct ttttagtttt ggttttgtat 1850820
 tttggttttg tttaggccac taatatttgg caaaatttaa agaaacttct tccttggcag 1850880
 ttagtgctga gagtgtggag tgtatgctct gggcttggaa cacacattta ttatttttt 1850940
 ttttaactc aaaaaaaaaa tttaaagaaa atattctatc ccctaccta tctttgtgag 1851000
 tctaaagttt tatatgtaac ttatctttta tcataaacta aggaaaacca taaccataac 1851060

 tatctgtctt caactccatc aaagaccca gaaggatata atataaactc tataattgac 1851120
 agagacatct tgcctcctag acagtcacc aaagtctctc tgtaactttg gggcattcat 1851180
 tttcagccca taagctgaag tttctggcag acgttttaat gaagtaggaa atttgaagat 1851240
 ctctttgtc ttgtattggc aaagtgtctc tcttttgtga gccaggaacc ctgaagaacc 1851300
 attttgtctc ttggcaagtt cagcagtcac ttcctttgt aacctgcttg tccagtttgg 1851360
 acagctgct tactgtcagc aggtgaggca agggcaaaact ccataacgag tttcttctgc 1851420
 gtctatcttc ctctatgat taactggtgt tgcaggaaca gttgtgtctt attgtcatga 1851480

 aaaacccaa taagtcattt taagtcccgt attctgtagg tctttgaaag gttttcaaga 1851540
 atatgtatcc atatgaaaat atatctctgt atatctagaa aacctaaca acataagttt 1851600
 tgactattat aggcaggcgg atctctgtga gttcgagact agcctggtct acaagagcta 1851660
 gttccaggac aggtcctaaa gccaaagaga aacctgtct agaaaaaaaa aaattgtgtc 1851720
 aataaaaca aatccatata aaagcaaagt actcatttct atatcatatt ctttttttc 1851780
 tttacaaaga gattaactgc gatcattaac tacttataac caacctgtt taaatgaaaa 1851840
 caaacatcta taaacaatat ttgagaatgt gggcatagtt ctctccaaac tgcttcttgc 1851900

 tgtttaaggt gctgtcaatc ccaaggagat cctgagaaaa cccagaacca tggccaaatc 1851960
 ctggctgtgg tagtctgagg ctgctggctc tcagctatct tggatgttgg atcacctggg 1852020
 ccaactgttc aggggatctt gcttgatcaa atcatattag tctggaaaga atccacagct 1852080

ttctatcttc tgggaaaca aaagcagaac ctcttttcca aagtaacacg tcttttagact 1852140
 taaattttga agtcaaagca ttttcaaaat atataggttg gaatgtatac aacattctgc 1852200
 ttccatgtat atctgcacac cagaagaggg caccagatct cattacgcat ggctgtgagc 1852260
 caccatgtag ttgctgggat ttgaactcag gacctctgga agagcagtca gtgctcttaa 1852320

 ctctgagcc atctctccag cccaaccca aagtctttta gcagctgtta ttcctttctc 1852380
 tgcaatcaaa caattcaaag acaacataat aacatatagt atccaaaatc tgtgtatfff 1852440
 tcatctttat atggcttttt ttattacttt taaaatfff ttatfffatt tatttattta 1852500
 tttatfffga gacggggfff ttctgtgtaa ttttgctat ctttgaactc actgtgtaga 1852560
 ccaggctggc cttaaaatca tagagattca cctgcctctg cctctgaagt gctgggatta 1852620
 aaggtatacc acaccagct actctattcc ttttttaagg actttctcta tctttttct 1852680
 tttctatcct aagcctacct atatffftha taacaaatat ttatfftaaa gaaaagataa 1852740

 caggcaagat ttgactcaag gcatatagtt tgttgactac tgaactgaa aattaaattc 1852800
 taaatffaga aattatffaat tagaaatcac tgtaaactgt ttatcactag aacaaatffta 1852860
 gtgccaggga atatffctag tagaaatgt gcaagacaga tatgccacaa gttatattac 1852920
 tgtatccaat agtgacatgg gacacataat aattgaatffaa aaactgagg acttagatgg 1852980
 gaagttffaca tffaatgatt ccagttctct tcagtgcac taagttgaag aatffcaaac 1853040
 tgtatffthaa tagtaaaata tctaatgfff aacagataaa aaataaacac aggagagcaa 1853100
 atagtctcta ctatffctccc aatggagag agactgaacc tagaggcaga gtgtaaggtt 1853160

 gtttctfff tffcatffat tttctgfff tttggctcta aataactgaa atffctgctg 1853220
 aagtataagg aaactcaaac tcatactffia taagtataaa tffggagaca agttgaagtc 1853280
 atffttgatt taatffcac tffcaacc aatffctcagt tffctffactt aaggatggag 1853340
 tffcaattg gaatgattff tcatffcaga gaactffctgg caaggctffg ggatgffgct 1853400
 gattgfftaga gctgggtatt gagagagggc atggtgffca gcatagcttc tggctctgtg 1853460
 gagtgaacag aggccaggga taatatataa acatactata acacatgaga caatcctcag 1853520
 tagcaaaagag ctctctgct ccaagtgcga tgcgaacct gtcctatgat cactfftgag 1853580

 tagtatffat tcagaagtag tgcctffcag aggtaaaagg aactffctff cctacctata 1853640
 tffthaaatg cactgthaac cffthagaag tffthctffca tctgaatcag tctffatffg 1853700
 atatctctgt cffthctgca cagtgagctct ttatffctgct aaactgctg gctaggatffta 1853760
 aagctgcage tffggtagct ggctctgctc cattctffgg cffctggga atctatcttc 1853820
 atcgagaggg tctggcggga gtcattfftha tffccacaaac tffgcagagtt tctcctgctc 1853880
 atgccaccac caagaagcat gtcaccgct gctffgthaac accatfftagg tffthggtag 1853940

caaggcctca ttagccctgc agtttttgcg gctaagtctg agtcaggaag tctctcttga 1854000

agcagctaag cctctgctta tctctagcaa acagagccca ccagagaaaa tgctgctacc 1854060

gagaagccgt gtttgactct gttcttttgt ttttagaatt cttttttaag ctttgtcagg 1854120

ttttacgtgg gaattattgc caaatgtttg ggtgccacat aattccagca ctcgggaggc 1854180

ggaggcagga agatgggac tctgtgactt caaggccagc ctggtctaaa gagcaagttc 1854240

caggacaggt tccaaagcca cagagaacaa agctacagag aaaccccatc tcaaaaaaca 1854300

aaacaaaacc ccaaaaaaaa aaagatTTTT cactggaac tggatttaca gatggttatg 1854360

aactgccatg tgggtgctgg gactgaacct gggtcctcta caagaacagc caagtgctct 1854420

taactgctga gttatctctt cagccgctat tctaacatac atatatttca acacacacac 1854480

acacacacac acaaaaaaaaa acaaaaaaaaa caaaaaaaca aaaccacaca cagagtTTTT 1854540

gtttgtTTTT caagacacgg tctctctgtg taacagccct atctgtcctg gaactagctt 1854600

tgtataccag gatggtcttg aacttacaat gatttcctg cttttgcctc ccaagcactg 1854660

gaattaaagg tgtgtaagta acaccactgc cacttgcccc ctattctatc atattatatt 1854720

ccctcatTTT tttagggcta ataaacatct actcccaggt tcagacacac agagagatga 1854780

tctaccctag ttgcactggc attctttggg ttttctatTT caggctgttt ctgctccttc 1854840

ttacctagct aagccatcac tccctctcta ggggtgtttg cttaaataTG accttgtggT 1854900

gatttgaata ggaatggccc ccatagactc atgtgtttga ataattggcc acagggagta 1854960

gcactattag gaggcattggc cttgttggag tacgtatgtc tctaggggtg cactttaaga 1855020

tctcagaaac tcaagccaaa cccaatgcag acttcacttt gttttcagct gatagggatg 1855080

tagagctctc agctccttca ctagacccat gtctgtctac ccaccacat gctttctgcc 1855140

ataagaatgg actaaacatc tgaacagtaa tccagcccca gttaaatgtt tccttttcta 1855200

agacttgcgg tcatgtttct tcacagcaat agaateccca aagaacttcc ccagaacacc 1855260

tattgccaca attctccta ctagtctctc aaaatagttt attatttatt tatttaggtt 1855320

tttcaagaca gggtttctct gtgtaacagc tctagctctc ctggaacttg ctctgtagac 1855380

cacgaggttg gcctcaaaact cacagagatc ctctgcctc tactgcttcc taagtctgg 1855440

gattaaaggt gggtgacact aatgcctgcc aaaatactca ttttttaata aactgccac 1855500

atctattaca gtctttatc atttctgatt ttctatccct ctttttagtat gaaagctcac 1855560

agagggcagt gtgttttctg gtcctattaa ccagtgtgtc cctacacca gaataaaatg 1855620

tgtgtcctgg caatccttta aatgttggga tgaaaagata tgcaagtggg ttgagtcac 1855680

tgtgggaggc aggtgggagt tctcaagtgc agatcttggt cctcagcctc tcaagaactc 1855740
 acagaataag aagggaatg ggaatttatt tctccaatct tcaaattaac aaattttaag 1855800
 gaaataaaat gattagagta atggggggaa tcatatggat atttctactt ccattaaatc 1855860
 aaaagaaagg aaggaagatg agctggtcgg tggtaggcaca cacttttagt cccagcacct 1855920
 gggaggcaga ggcaggcaga aatctgtgag ttcgaggcca gactgttcac agagtcttag 1855980
 gacaccaggg ctatacagag aaactctgtg tcaaaaaaca aacaagaaaa taaaaaggaa 1856040
 ggagatgaga acacaaagga aataagcctt taataaaact tgctgttttg gctgcagttg 1856100

 atatatccag agacatcttt tgaagccaca aaaaaaggtt aaaataaggt ttgttgatgc 1856160
 tagttgctga tggtagccagt ccagctgagc agcgattggt gatccaaatg ttcacatgga 1856220
 gaaacagtct ttgaacctag agccgtcttc cagttcttcc acctcccaa gggtaggtaa 1856280
 gcctagtggc agagaggcag cagtgcctct aggcgcttag caaagaatgt ccacacacta 1856340
 aatagagaag agccccagag gaggaacagg gaacgtctcc ctacaaaggc tgaggctaag 1856400
 aaggatgctt ccttgaattt ctcaattaac agcgttcttt ggtgaaatca actgggctat 1856460
 gccagctctg gttgacctg gaccaccag caggtaacaa ggttctggc tgtacatggg 1856520

 tcagtgaggc aggaagggcc aggtcagcac aaagtcacag gccggctctt ctaatgttg 1856580
 gtccacttga tgccttgag gtcgatgcca tctgcacca tctcccagag gggactgcca 1856640
 aagagaagag gcaactgata gaaacagcag ccaacactgg tgcagggc ctgagccatg 1856700
 atttgctcc tgccttctg gctcctctgc ctttgacctg gtgaaccca atacaggaga 1856760
 tgcacaagcc tttccagcc tcagacctga gcactctctt atacaggaga tgctactgag 1856820
 aagacggacc ataccttaa accagactta cttccagggt gatggcaaca atgaccattt 1856880
 tgtttgtgtg cttgtgccac tgaagagtaa accctcttct gcactacagc cctatacca 1856940

 actattgaat tctgtgcctt ctgttccccg gttaatttc tteaacatta ctgaatcca 1857000
 gactttgttt ttgtttctga gaaaaggtct cattcacaat cttctgccc aagcctgagg 1857060
 gctgtgactt cagacatatg caagattcct ggttttggtt ttgttcttc ttggcaagca 1857120
 ctctgccact gagcttcca cccagcctt agcttgettt ttagggttca gtggacttta 1857180
 ttgattcaac aataaatggt taaggaaaac gcgttactta tcactctcga ggcgtcatct 1857240
 gcagatgta gaaccacct tcgaaagcct taccttgctt tttataggac taggatcaaa 1857300
 cccaggacct ttattgatg tagacaagca atctctatgc tatataaaa aaccaactt 1857360

 ttgggggctg gagaggtggc tcagaggtta agagctctgg ctgttcttc agaggtcctg 1857420
 agttcaatte ccagctacca catttggtt cacagccatc tgtaatgaga tctgggtccc 1857480
 tcttttggtg tgcagatata catggaagca gaatgttga tacataataa ataaataaaa 1857540

tcctaaaaga aaacattttt taaaaaatga acaacaacaa caacaacaaa aaaccctaa 1857600
 cttttaaagc attctaggct gggtagtagt gttgtacacc cttaatcca gcacttaca 1857660
 ggcagaggga gtcggatctc tatgagtttg agactagcct ggtctacaga gttccaggac 1857720
 agccagggtt acataaagaa actctatctc aaaaaaaaa caaaaaacaa aaaaaaaaa 1857780

 aaaaaaaaaac aaaacaaaga atctgaacaa taggaagcca aagaggtcca atttcttct 1857840
 ttgtggagcc tttagaaacc tgcaaacaca ggtttctgtg aatacagagc ccaaggacag 1857900
 gaaaggaggc agctgtgcag cttcttccac agcgtccccg gcagcagtgt atacctcatt 1857960
 tcccgagggc gcttcacgtg atggatgcat ttctccacag tgtagtccac ttctcttct 1858020
 gtagtgaagc ggccgatgcc aaacctgaga gaacacacaa gagctctaca ctaggcccag 1858080
 ggttggttg gttttcttt ttaggcagtg ctactgaga acctactaa caaaagacaa 1858140
 gaaagatggg ggtgggtgg ggagggttgc tctctcttt aatcccagca cttgggaggc 1858200

 agaggcaggn nnnnnnnnnn nnnagagaga gagagagaga gagagagaga gagagagaga 1858260
 gagagagaga gagatctggg ggtacagggg actcgggtca gggtagtagt gcctgcctga 1858320
 aatccagggt tcatctctga ctgcataaga aggcattggtg ccgcacacct gtgagtccag 1858380
 ctttaggag gtagaggcag agcaatcccg ggctacatgt gagtgggaag ccaactggga 1858440
 tacatgaaag ctattagctc aaaggaagag gaaaagagcg caggctgtct ttcttagtaa 1858500
 agcttcttag aacatagctg tggaccgaa tccactgaga agtctctac agctactctg 1858560
 aatatgacac tcagacatct tcatcttcc caagactcaa ggaggagacc gggacatagc 1858620

 tcagtaggag gtgtgcttgc ctatttcaaa aaatgcataa accaggcatg gtggtcatac 1858680
 acttataatc tcagtactct ggagctggag ataggaggac agacttcaag gccagcctgg 1858740
 gtacttgaca agaccttacc ttaacaacaa aggaacacac acacaccagg tgaactcaac 1858800
 tgacctgata gaagagtgtg ctaaatctc atcagtcca attgctctga ggacgtaaga 1858860
 gggctccagt gatgctgaag tgcaggcact aaggatggag acatgaacct ttagcccata 1858920
 ggacacacc agagccatta ctcccaggc cctggaatca taccatagg accaaagata 1858980
 catagcctgg aaatgtcatg gggcctggtg atgccctgta catcctggga cgtaaacca 1859040

 gtccctctgg tcctagagt agataatgtt ctfgaggaag gacctgtca aggtgtgaac 1859100
 cagcagttag atccatgac tttatctgac caaagagcca gagaacctc tgtatctggg 1859160
 gcagcaggca caatgtatga ccctgaagga cagataaacc ctaggcggct tacaacaaa 1859220
 ctaattgttt aactctgtaa aagacacata catcttcac caggcataat ggtgcacaag 1859280
 cttttaatcc cagcactcag gaggcagagg caggaggatc tatgtgaggt tgaggacagc 1859340
 ctggtctata cagagagtct taggatagcc agggctacat agtccaatc tgtctcaaa 1859400

taaaagacaa aagaagatag atatatcttc taggtcctaa agtcaccaat ttctgtcaaa 1859460

gacagagacc tgctagctat gtgacatca gcctatggcc gccagctaaa aagtgacctt 1859520

accagcatca agagcttctc cctaattccag ccaggaagct cagtgacctg taggttactg 1859580

aacaggaaag ctaactggtg ctatcacagt gcttgtctac ctggccaac tcaccttctt 1859640

gaggacaagg caacatcctt gagtgccatc agcagactct cccctccac atatgcaaag 1859700

gagaggttga tacacctga agaagagaaa acatgatgac agccctctgg gtctcagact 1859760

ctgccagaat ggagccgaga gctggagaca gagctaaggg gtagacaatt tgccatagcgt 1859820

gaaagaggca agtacagaca aacaacaaaa caaactttag ctaaaaaat atttaaaaa 1859880

caaaaacaga atggtggggc tgcagagggg gcaccaggat ggctcagcac gtaaagcaag 1859940

cacttgctac acaagcctga tgacctaatg tgtatctctc tggaaccac aaaagattgg 1860000

acgcagaaaa ctgactccac aaaattgtcc tetgacctcc acaagtgcac tgtggcaggc 1860060

atccccatgc ccacataata aatacaattt aaaaaagaac agaattcaga ttggaagggc 1860120

gcgtccatac cagggtagtg ctgtttgggg tccccgttca tcaccacatc tggaggctg 1860180

ttcattatct tetgtatcag ccgctctgct aacttgagaa tccgcttatg gtcatactaa 1860240

ggagcaggaa gggagagctc agtgcagtaa ccaccagaca gctcagcgac agagagtcc 1860300

agaagccctc tetaccagg agtgggtgtg tgecacacag gcccttctat tgtcttgcta 1860360

tgtgtggaga tcacaggggc tccagcactg tctggtgtgt aagaggtgct cagtagctga 1860420

acacacggtt ctaacaacc ggggaaaatg aactgggaac cacgaacagg acacgttttg 1860480

aatcatctcc tcagaacaa gggggcggca ggacctgac agagcaggtt tttatttagc 1860540

tgtgggcaca tgtgcacaca tttacttctg agggattgaa atcaaggcct tgcattgcc 1860600

aggcaagtac tttctactg acccagccct ttacttttta ttttagcca gggctctgct 1860660

atgtagtcca ggctagcctt gaactgaaaa ttcttctgtc tgggcccc aggcaactag 1860720

gataccagca ttgactgcca cacctggctc aaagacagga tttcttcca gcagagatga 1860780

gagtctgctg agctgttact aaatgggaga ccttgaaccg ctagtgggac ggacgttctg 1860840

aggggagctg cggtctctc cagtaccac ctccatctct tgctgtgcca cctcacaagc 1860900

tgctcccage cccaccacca aggggtgtgg caccgtcca gaccgcatc cccgctcctg 1860960

cccgcctccg ctctgtaggg cctccacacg gaccggggc ctacgcccga tatagatagc 1861020

accaaccct tgggaaaaa agttgttaga aaaaaaaat aagagagaga gagaaacacc 1861080

aatgaacaa actggggaac caacagagga ccaaccggg ccgctgaac gtgagtgtca 1861140

gctaggagca ctgggcagtc tatgaggcct ctggcagtgg caccaggatg tatccctagt 1861200
gcacgaacgg acttcagggg tccatttccc atggtgggac actctctttg cctagatata 1861260
cgggagaggg cccagggcct gccccaaatg acttgacaga ttttgatgac ccccgttca 1861320
tgaaggcct tacctcctt tgggagtaga tgggggatg gnnnnnnnnn nnnnnnnnnn 1861380
nnnnnnnnn nnnnnnnntg gggggggggg gggggcatgg gaggatgggt gggagagga 1861440
actgggattg atatgtaaaa taagagtgtt tctaatttac ataaaattta tttaaaaaag 1861500
aaattaaaat atttcaaatt ttatagttaa ccttttctaa ataaaaaaaa aattaaagga 1861560

aaagaagaaa tgtaaaagca taatTTTTtag caaaagtatt caatgtaaat tatgttacca 1861620
caggaataat taccaaaatt atttcaagca gctccctatc atacaacgta gacttctttt 1861680
taagattaat tttaaaaat tttatgagct ggggtgggtt ggtgcatgcc tttaatcca 1861740
gcatttggga agcagaggca ggtggatctc tgtgattaca aggccagcct gtaacatgaa 1861800
tagtgaataa taaaaacca gagacagata ttggatttca agctgaaaga tcagagaagc 1861860
aaagcagcca gccactagag agttcttacc tctaccactc caccaaggct ggagcagatcc 1861920
tgtcctcaga gtgactgcag actgcaatac tctctaccaa aacaaccca gactgcctag 1861980

actgcagact gaatacagaa tgagaccctg agctcctacc ttatattcct ctctagtgt 1862040
gggattaaat gtgagggtc tgtttctctt ttagacttag tcactctcat gtagcccagg 1862100
atgtcaagtt ccagaggacc tgacacccac ggcaaagcac caatgcatat aaaataaaaa 1862160
ttaatacatt aaaaaataa agttgaagga gaagaagatg atgatgataa caatgacaac 1862220
ccactagggg ctagagatgg atcaatggtg ttgctcttcc agaggagacc caggttcagt 1862280
ctctaaccac cacataacag ctcacacagt tataactcca gttccaggag agtcagtgcc 1862340
atctgtggt ctttatggac attgtgctca cacaacacac acatgaattc aagcaaaaca 1862400

ctcacacata taaaaataa tctttaaaaa atcaaataac ttaggtgata atcattggag 1862460
gaatttaaat aagtcagat atgttaatat aatgaaacac caagcagata gaaaagcctg 1862520
actttgtttg ttttcgaga cagggtttct ctgtagcttt ggaacctgtc ctggaactca 1862580
ctctgtagge tggcctcaac tcaagattga cattcttggg ctggagagat ggctcagagg 1862640
ttaagagcac cgactgctct tccagaggtc ctgagttcaa ttcccagcaa ccacatggtg 1862700
gctcacaacc atccgttatg agatctggtg ccctctctctg gtgtgcagat atacatggaa 1862760
gcagaatgtt gtgtacataa taataaata aaatcttaaa aaaaaaaaaa aagattgaca 1862820

ttcttgggct ggagagatgg ctgagcgggt aagagaattg actgttcttc cagaggtcct 1862880
gagttcaatt cccaccaatc acatggtggc tcacaaccaa cttgaatgag atctggtgct 1862940
ttctgctagc acacaggcag aagattgtat actaaacaaa taaaattctt ctaaaaactc 1863000

taaaatacat tgttagtaaa ctggtagagt caggcttgtg gcacatgccc ataatactag 1863060
 cactagggag gcagcatcaa ccttagataa agtaaaaccc ctgatgaaaa agaaaggaaa 1863120
 gaaaggaaga tctcaacaac tctgtactac ccccttcctt ttatttcagc ttcctttcta 1863180
 gactctcaag tactctaagg tgacctaaaa ctcaatatgt aatcaaaaat aaactttttc 1863240

 actggatggt ggtggctcac acttttagtt tcagcactca ggagccagag ttcaaggtag 1863300
 ttctaggatg gctaggggca ctacagagaaa ccccgctcctca aaaaaaaaaa aaaaaaaagg 1863360
 gtctaataat atagaactgc ctaccctgga actcactatg ttactatgg agcccagact 1863420
 ggccctgaac tcacagagat ctaattgtat acaggacttt ggaattaaag gaatatacta 1863480
 ccatgtctga ctttttattt tacttttaag atggtttgta ggtgaaaaag caaatgagaa 1863540
 cacacataat ttaggtaaaa aggggtggaa ggaaagtatg gctgtcctca taataaaaag 1863600
 gaactgtaaa aaggcgaca cagcagacat gtctatgacc ccatcactca ggagactgag 1863660

 gaaggaggat gcaaactcaa aggcaggtgg gactaaatca caagaccctg atgaggagtg 1863720
 aatagggtca agaagagatc ctactcaagt cacatttttag agtacaagtt ggcactctgca 1863780
 agaacagctc atagaactgt taattataac ctgtgggaac ctttggtagc cagcatggtg 1863840
 gggcagtttag tattatcagc ctatctcatg aaatctgttc tgtttttact tactgatacc 1863900
 tagtgaacc tgaattaaca gaaccctgtt tcctaagcc aaattaacat ccgtatcccc 1863960
 ttttaaggaca tgtggaggga tcaaagaaga atgcctgctg tgtacacggc acatatgaag 1864020
 aggcaagagt tttggctact gttgaacgaa acttgcatat tccaggccac tctgaaggta 1864080

 caaccttctt gaaagcaatg tgatgagcat ctgtcaaagg gtttgcctgag aagttcgaag 1864140
 aagaggcagg ggctggfacc tttaggacca tagagtttgt gaccgctgat gctcatcaga 1864200
 tcaattttca tatcattgac atcaagtggg attttcccaa cagcttgggc tgcactagta 1864260
 tggaaataga cttttctgga actgcaaatc tgccttgagg gatgacagag aagaagacc 1864320
 atagcacagt aaaagtaagc tgccagcagc cctgcaaggc accacggatg acataagcaa 1864380
 ctgatataata agtcctcccc tactctgggc ctteccacct tcatgtcccc tccccacc 1864440
 actcctccc aactcccagc ctctcagcta ttctctaaa gatcaagggc aaaacacaaa 1864500

 accacaaca cacatgatgt tttgatgcc aagattctgt ataccagctc atttaccttg 1864560
 gggctatagt atcacctttt aaattctttt ttatttaaaa gaagcaaaga ttaattggta 1864620
 tttttgctaa ttgcataca ggttacaagg tgaactctaa atggggataa agaacattct 1864680
 aaatggaaaa agaatagatg cccttatctt actgtgtgtg catttggggc aaaaaaaaaa 1864740
 aaaaaaaaaatg aaagaaaaaa aaagggcatt ccaccctcca ttctaaaaac tcaaatagta 1864800
 gccacaccac ctagaatgtg gtcagcaagg cacatagttc ttttcttgg acctcttggc 1864860

tactgtgtta aaactgtcag tacctgatcc cttatatgga ccccagggct ggtaagggtc 1864920

agggataacc taatatactc acctatctct gcaataggct gctttacacc aatctcattg 1864980

ttcacagtca taactgatac taggetgggtg tctggctgga tggcagcctc tagttcctaa 1865040

gaatgtagga gtaaggagta catgtgatgc caagagaact atataaataa gaatgtagac 1865100

aacctttage ctagaaaagt gacctttcac tataactcca tctgaacact tttttttttt 1865160

tttttttttt tggtttttca agacagggtt tctctgtggc tttggaggct gtcctggaac 1865220

tagctcttgt agaccaggct ggtctcaaac tcagagatcc acctgcctct gcctccaag 1865280

tgctgggatt aaaggcgtgc gccaccaatg tccggctatg aaccttaaa tcttaataac 1865340

agggggtttg ggatgtagct cagtggttac cttagcatgtt taatccctag taacaccaga 1865400

taaaaataca cagtaacaca caaggcactg gagacatggc tcagcaatta agagcaccac 1865460

ctgctgtacc agaggaccca tgctcaattc ctgacacacc atagaggaac agaactgact 1865520

ctaactccag ttccagggga ttggacacat tcttctggcc tctacaggca ccaggcacac 1865580

atgtgttaca cagacatgca tgcagagcaa acaccatac acaaaaaata gaagttaatc 1865640

aggcgttggg agtgcataca tttaatccca tctacttggg ggacagaggca ggtggatctc 1865700

tgtgagtttg aggccagctg gtctacagag caagttccag gacaggctcc aacacaatac 1865760

agagaaacc tgctcgaaa aacaaaacaa aacaaaacaa aaacaaaac aaaaagaaga 1865820

agttaaaaaa ggatgggctg aagaaatggc caggggggtt aatagcacgt gttgctgttg 1865880

tagatgacat aagttcaatt cttagcacc acacagtggc tctactaccg ctgtaacacc 1865940

caggcactca taaaacaaat ctaaaaaaag aaaagagaat ggctagttag gtaggtattg 1866000

taccctatga ctataatacc aactctcaat aggatgaggc aagaggatca ggagttcaaa 1866060

gtcattcatg gctacagagc cacttgagct agcctgagat tcacaagaca ctgtctcaaa 1866120

gacaaaaaaa aaagaaaaaa gaaagaaaga aaagaagaaa aagacttaaa gettacacaa 1866180

gagcctaact agaccaatta aacaaatcct gatttcaagc tgccacagag atacagaaat 1866240

aagagcagta tggatcatggc atgaggacag acgtgaacta ggacagaaat atatatcaa 1866300

gtcttttatt tgiagacagg atctcactct gcagtccagg ctactccac actctggtga 1866360

tcctcttgtc tgagcctcca gagggctgag ttttaagggtc tggctctatac ttgcgtgttt 1866420

gtttttacag ttctggggtt caagtctaca gccttctgca tgctatgcag gaattctact 1866480

gctgagacac acctccaacc acccggtcc ctttatagct cgtaagaaac attagtgcag 1866540

ggaaggatga ggcagagctc ttctgtggcg tggatatctg acatctaca ctcatgtcca 1866600

gcagctctcc tacaaccag gatcaccaa aaagctaaga ggcaagtctt ccacagagaa 1866660
 gatcagtga cacatagaga gcatcatctc cctctctgct caatgctcca ctctcaccat 1866720
 tagctcaacc tttaggctac acccacggct ggagagacag gatgaagcca ggccccgccc 1866780
 atttttgtca gtccagccta gcataggact cctacctta agtcaatgat cccactcttc 1866840
 tgcactggga ggtaagtac tcgaaagccc tcagcctcca gtgagcggca ggaatccagc 1866900
 acacatttgt gttcagtctg agtggtgacc acgtgctttt tccgtgactt gtagaacctg 1866960
 gccactcctt aaaaattgat gataatagga aaaaagtata acagaggtag caatgacatg 1867020

aatcctattht ataacagtt ttcttaagga ctgaatccag agcctcgagc atgctaaaga 1867080
 tattctatgt cactgaccaa gttccattc ttgtatgtga tactgtcaac atcagaagaa 1867140
 attataaaaa taggctagga aaaactgaaa taactagaat ctactatgt agctgtgaaa 1867200
 ttcacagaga tgtgcctgcc tctgtgttcc aagtgtctggg attaaggctc tgcaccatca 1867260
 caccagttt tgctgaacta tttataatag ctaagaaatg gaactcaaca gaaaatgccc 1867320
 ataaagagaa tgtggtacat atacaatagc atttaattta gatgtaataa aaaattaaat 1867380
 agtgacatct acagaaaaat gaatgaaatc acaaatcata tgttaagcaa tataagttag 1867440

acagaaacaa attctgagct gccaacaggt tcagcaggta agggcagttg ccacaaggct 1867500
 tactacctag agccccaatt gtggaacctc aacatgtgtg ttgtggcaca ggcattgaca 1867560
 aacataaatt gattaaatga tctaaaaaag acatgtatca ccgggcgttg gtggtgcaca 1867620
 cctttaatcc cagcactcgg gaggcagaag cagacggatc tctgtgagtt cgaggccagc 1867680
 ctggtctaca gaacgaattc caggacaacc tacaagcaa tacagagaag aaacctgtc 1867740
 tcaaaaaaaaa aaacaaaaaaaa acaaaaaaaaa aaaacaaaaa aaaacaaaca acccccccaa 1867800
 aaaaaccgaa acaaaaaaaaa gacaagtatt atatcctctc ttaagtggaa tatagatgtg 1867860

ttatagatgt gtgcatatgt gtaaatatag ccatatgtgt gtgtttctaa gtcataaagg 1867920
 tagaaaaggg accatgagaa aggaaagaga tctttgtatg tatgtatctg tctgtatgca 1867980
 tgatgtgtgt ctgtccatgg acatgaaggc aagaaaggat gtttggaggt cagaggacag 1868040
 acaacctcta gtatcagtc tcaccttcta ccttatttga ggcaaggcct cettgctgtt 1868100
 tgctgtgac ctgcaagcct gtgcagggtc tcttgtctct tctgcctagc agttacagac 1868160
 acacacactg ttatgcctga cttcacctgt gctccgagga tttgaactca ggtcctcaca 1868220
 cttgcacagc tggaaaggta gtcatgatgg agagggtaca gacacagtgg cgtgaaaggg 1868280

ggaggggacc tactgagga ggacaagggc cagcaaggat ggggcagggt aaaaacgaaa 1868340
 tgtgtgcatg aaaagccata ataaaaacca ttactttgta ttctgatttt aaaaattaat 1868400
 ttaaaaaatt taatcttgg ggctggggag attgctgtcc ttgcaaagga cccttgttca 1868460

gttccaaca ccttcatggc agctcacaac catctttaac tccagttcca ggagatccaa 1868520
 cactttccct tggcttccat aggtaccaag cacacatgct atgcatgcac actcgtatac 1868580
 atgaaaaata aaaatagggg ccagaagcct ttaatgccag cactcaagag gcagaggagg 1868640
 tggatctctt gaggttcaaag ccagcctggg ctacagagtg agatactaca gaggctacac 1868700

 aaagaaatcc aatctcaaaa aaaaaaaaaa aaaaaaaaaa ggcagaggca tgaggatctc 1868760
 tgtgagtttg aggccagcct ggtctccaga gtgagtgccca ggataggctc caaagctaca 1868820
 cagagatacc ctgtctccaa aaacaaaaaa cacaacaaca acaacaaca caacaaaacc 1868880
 caaaaaagca aaacaacaac ataaaaaact aaaccaaaaca aaaaaacaaa caacaaaaaa 1868940
 gggggttggg agttaggttg gagagatact taaaagttaa gagaattggc tcctcttcca 1869000
 gagaaccag gttcagttcc aaacaccac atggcagctc tgtaactcct gtccaaggg 1869060
 atctaacc ctcttttgac ctccacagc actacataca tgtggtacac agacatacat 1869120

 gcaggcataa acacccatag acataaaaca aaaatatatt taaaaggac aaataggggg 1869180
 ttagaatgga ggcctggtgg ctaaaagcac ttgttggctc tgcagagagt tcccagaatc 1869240
 cacatggcag ctacacagct tctgaaactc aaatcccaga gggccagaca cacttctgac 1869300
 cagctttaga cagcaagcat gcatgtaaga aaaatctgag ccggacgttg gtggcgcacg 1869360
 cctttaatcc cagcactcaa gaagcagagg caggcggatc tctgtgagtt caagaccagc 1869420
 ctggtctact gaggttcagg acagccteca aaagctacag tgaaacctg tcttgaacc 1869480
 ccctccaa aaaaaggaa aaataaaat gctgaaacac ataaaactaa caaaaatctt 1869540

 aatttccttt tatattttt aaataattta tttatttga tttatatac aatggtgttt 1869600
 tgcccacata ttggagttgt cagattcact ggaactagag ttacagacag ctgtgagctg 1869660
 ccatgtgggt gctgggaact gaaccagggt tctctggaag aacagccagt gcacttaacc 1869720
 actgagccat ctctccagct caatttctt ttttttatt ttttggttt ctttctttct 1869780
 tttttcttt tcccacaag acagggtttc tctgtggctt tggaggctgt cctggaacta 1869840
 gctctttag acaggctggg ctcaaacca cagatatccc cctgcctctg cctccaagt 1869900
 gctgggacta aaggcatgtg ccaccaccac ttggcagttt tctttgtct ttgagacata 1869960

 gtttctctgt gtagtctgg ctgtcctgga acagtctgg ctgtcctgga acatacacta 1870020
 tagaccaagc tggactcaaa ctacagatc cacctgctc tgctcctga gtgctggcat 1870080
 taaaggcgtg tgccactacc aacaggctcc acttttttt ttttctggt ttttcgagat 1870140
 agggtttctc tgttagctt tggagtctgt cctcgaactc acagagatct gcctgcctct 1870200
 ctccagagt ctggggttaa agacttgcac taccaccacc aggettaatt tttttttta 1870260
 aatgtcgtt ggtattctgc cttgggtgtc agatccctg aaactggagt tacagacagt 1870320

tgttagttgc catatgggtg ctgggaatta aacttggatc ctctgaaaga gcagtctctc 1870380

 cagtcccaac tccaatttt aagtagataa atccttaaaa agagataagt taatcttate 1870440
 aggtgcacaa atgatttttc aaaaaccaa aacttttaaa tgacaaaatg agggctggag 1870500
 agatggatca gtggtaaaag gagtatacag ctctttaga agaatcatga ccggtccaca 1870560
 gtataaacac tgaatggctc acaattatct ataattcact ccagagggat ttaatgcctc 1870620
 tggcttctga gaacactgca gtcacatgaa cataccecca cacagataca cacaaaacta 1870680
 aaataaagt ttttcatct taaaaagcc tggcgcagtg gggtatgtct ttaatcctag 1870740
 cattcagaag gaagaagcag gcagatcact aggagtctga ggccagcctg gccaaaagag 1870800

 taagtcttgg gccagccaga gctacacagt gagaccaggt ctcaaagag aaaaaaagg 1870860
 caggatatca gaatattaac ttatcagtgg tacagcacga ctttagtaag ctgaaagt 1870920
 gaaatgcccc tcacaaaaa ataaataaga aaaaaataga caaatagttg actagatcta 1870980
 agtaaaatgt gattgtgttg tatgaattat cagcatgact attaagagtg ggacacttgc 1871040
 acaaagtatc tgcttggccc aaatatagaa agactgatac agacctagac cgagtcaatg 1871100
 gcacaggggg taccaaagca acaattactg aaaaggcaga ggaactctgt aaacagatec 1871160
 aatcagaag caaagggaga gcccatagga aagtaagagt gaactgatcc ctgatgggga 1871220

 atgtactgtg tatgtttatc ttattgattg ttaaataaaa tactgtttag ccaatgagac 1871280
 accaagttag acgggactag gagtcaaaga ggattctggg aaatgtagta gagaagtgg 1871340
 gatccagcag gcagtgcacat agcaaggaga ctcatattta aagaaggaga aacaggaagg 1871400
 gtccctcttt tccccttgcc cctccagcag cacaaggtga tccaccggca aggagggatg 1871460
 ccaatcggc gtccgataag ataagtctta taaaatatat agatttatga tagttaagac 1871520
 tgagctaaca gatgaggaat cctagtcatt ggccaagcag catttgaacc taatacaagt 1871580
 ttctgtgtat tcatttgggc ctaactcggg cgggcggctg gtgtaaagct cacacgtggc 1871640

 agtggggctc aggcggcctt tggtagaaag atttatagta acagatcca gttagtttt 1871700
 tgtcaacacg aaacaagcta agatcatctg agaatggcta cctagctgga aaaaaatgcc 1871760
 tccatcagac tactgcctgt agtcaaccag taaagtiact gacctgatta ataattttt 1871820
 ttttctttt ttttagttt tgcaggcagg gtttctctgt gtagttttg agcctatcct 1871880
 ggcactgcct ctggagacca ggctggcctt gaactcacag agatctgcct gtctctgcct 1871940
 cccgagtgcc gggactaaag acgtgcgcca ccaacacctg gccctgatta aagattaatg 1872000
 tgcaggagct aatgcaatat ggggtggcact acccctgggc aggtggttct ggggtgtata 1872060

aggaaacatg ctgagcaagc cactgggagg aagcagccct tctccatgga atctacttcg 1872120
 gttccttccc taagctcttt ccctcacttc ccttcatcaa gagccagtgc tcttaacctc 1872180
 tgagccatct ctccagccac cacatatttt ttcttttaag gcataagaaa gaaatagga 1872240
 ggtgtgggaa tctgaggaaa aaaatatctg agtccaaatg ataaaggagc tctaatctct 1872300
 aaacccaaaa agcccagaga tagttctggc tccttctgt ttccttctgt ccctcatctt 1872360
 cccacatgct cctcactctc ctaaagaagt ggtccaccac acagtgtcct cacccattc 1872420
 tcttacctta attgctatgt tgttggattc agtagctcca ctggtgaaaa tgatttctcg 1872480

 aggatcagct ccaatcagag atgctacttg ctgtaagcca agagccaaag atacatagca 1872540
 tcagtccctt ggcaggagta gggctgcaga catagctagg ccagagtffc atggcaagag 1872600
 aaactccact gcattctacc cactgcctac caagacactc tgtgcatact aggtctggct 1872660
 tgagataaaa aaaggaactg attattaaag tttaaatggt ctattcttcc tccattctag 1872720
 gacagtctaa taagaatgct aaatgtggcc gggcgggtgt ggtgcacgcc tttaatccca 1872780
 gcactctgga ggcagaggca ggccgatctc tgtgagtgtg aggccagcct ggtctacaaa 1872840
 agccagtcc aggcagacct ccaaagccac agggaaaccc tatcttgaaa aaaaaaaaa 1872900

 atgtcaaatg gagctatggc tcagaggtta agagcactgg ctactcttcc agaggctctg 1872960
 agttcaactc ccaggaaaca aatgatggct cacaaccatc tgttacgaga tctggtgccc 1873020
 tctttgggct tgcaaggaca catgcagaca gaacactgta tacataataa ataaatcttt 1873080
 ttaaaaaagt aaaaatgca ttcagttgat agagtgtctg cctcatattt atgaagccct 1873140
 gcatttgatt cccagcactg cataaaccag gtatgggtgt gcaaacctca ggaagccaag 1873200
 gtaagacagc tgccatgagt tgcaggccag cctgggatac agtaagttcc aagttatctt 1873260
 aggctagaat gtgaaactgg tctcaacaa ctaacgtcgc gagccagtga gatggagcag 1873320

 tggcatagac actactaaca ggccaggttt cacttctga gatccacctg gtaaggtgaa 1873380
 agtctgctcc aagttgtcct ctgatctcca tactgcatag tttggtacat acatatatac 1873440
 atacatgcac tcaaaccaac cacacacata cacagatgtt cacgcacaca tatttgcaat 1873500
 ttaaaaaatt attctttgct gggcagtgtt ggcacacgcc tttaatccca gcaggcagga 1873560
 agcagagaca ggtgaatctc tgagttcgag gccagcctgg tctacagagt aagttctagg 1873620
 gcagccaggg ctgttacaca aagaaact gtcataaaaa aacaaatca acaaaaaaat 1873680
 tctaacaaaa tgcaagcaa gaaactggaa aaatggctca gtgttaggag cactggctct 1873740

 tcttctgag gaccagttt tagttctag caccgcatg gtggtgaca accatcctaa 1873800
 acttccagge acataatgg tacacacaca cacacacaca cacacacaca cacacacaca 1873860
 cacacacgca ctcaggcaaa cactcataca cacaaaagta aaaaaatttt aaaaaacatg 1873920

ggtatctaca tcicatcaat acatctatgc acaaatgcaa aaataaatat tcttaatgat 1873980
 aaatitgtt ttaaataat ttttaacat ttatitgttgg ttgggtaaca ttcattccac 1874040
 agcatgtgga tttttggggg attaaactta agttgtcagg ttagaaatgc atttttaaaa 1874100
 tatatttacc gaactctttc tatgcacttc ttgagcaatg tgtaagtgtt agcctttacc 1874160

 aaaccagcac tgtgtcattt aacttaccba atccccttat agagcatgaa ctatttcaact 1874220
 ttcaacttga taggtgagga ttttaaggct tagagaaatg agatgatttt cccaaggtag 1874280
 ttacctagt gaatatgga agtaattaa cacctgcagt ccaactcaa aactactctc 1874340
 tgaatctctt ctagaaatc caccatttcc taagaaagaa atgcctcccg caggccacca 1874400
 aacttgactt gcaacttcac agagttcttt gtgctaacct ggcgagcatg ttccatggct 1874460
 gcttcaactc cccagccata tgcattgagc cgagaatgag ggttcccata gtatttaca 1874520
 aggtatggga gcatggcatc cagaacctg ggatcctgta cacaagagaa cagatcagtc 1874580

 tctctgagtc tataatcaac tcagaacctg ctgcagccac tgcaactgcc caccttgctc 1874640
 agtgcccacc tcttcacata ctaatcaaag attgacctga tataccatac tcccacttgc 1874700
 aaaacatitit tttgggggga gaggggttga aacagggtt ctctgtggct ttggaggttg 1874760
 tcctggaact tgcctttgca gaccaggctg gcctcaaact cagagtcccg cctgctcca 1874820
 agtgctggta ttagtttatg ctagggttgg agagatggct cagcagttaa gaactactgac 1874880
 tgttcttcca gaggtcctgg gttcaattcc cagcaaacac atggtggctc acaaccatct 1874940
 ataatgagat ctggtgcctt cttctgacct gcagacatac tacgggcagg cagatcattg 1875000

 taataaacag acaaatcttt aaaagaaaaa aggaagtita tgctaccata ctggcaagtc 1875060
 acagctcttt gtaaggcatt tcttggaag aggactgcat tcttctctc ccctaggaaa 1875120
 aacaatggga acacctgag aaacagttgg aacaggcctg tgtgggatgg gaatctagat 1875180
 ggtagggcac tggcccagca tgtacaaagc ctttagttgg attaccagca cttcacaag 1875240
 ccaggcatgg tggatatacag ttctgatccc acacaactct aaagtattgg ggaggtggag 1875300
 tcagaaagat tgggatcaga agtttaagat cttcaactat agagtaaatt tgagggtatc 1875360
 tgaggttaga ggccttctt taaaaaaaaa tgtaaaaggg gttaggatgg agagatggtt 1875420

 cagtagttaa agacactggt tgctcttcca taggaccggg atttgattcc cagaacctat 1875480
 atcaggcaaa ttaaattgcc ctgtaactac agttccaggg aatctgacac cctcttatgg 1875540
 actccatgga ctcttggtga catgtagggc acatatacac atgaaagcag aacgcccaca 1875600
 cacacgtaat taataaaata actttttaa aaaggacaag attgtattgc tagaagaatg 1875660
 attaaaatgt caggctgttt tgttttgggtg gggccggtgg attttagaga caggggctct 1875720
 ttgtataact ggctggcctg gaaagcactt gcactgtagt caaggctggc cttcagagat 1875780

ctgtctgcct ctccctcctg agcaatggga ttaaaaacat gtaccaccac acccaggagg 1875840

actacaagtt tgaggtcaga ctgaactaca taagactcta tctttcaata aacaagtaaa 1875900

agaaaatfta aaccaggttg gccttcaaga gactctctct taaaacataa agtagcctgg 1875960

cagtggcca tccttttaat cccagcactc aggaggcaga gacagggtga actctgtctg 1876020

acctagtcta cagagcaagt tcccagcaat tcagagaaac cctgtctcga aaaacaaaa 1876080

agaacagtct taggttctag agagatagct gagtggttaa gagtaaaggt tgctctttca 1876140

gaggaccgag gttcaatttc tagcaaccac atggcagttt acaagggcct atagagtcc 1876200

cgtttgaggg gttccactct ctcatggcct ctacaggcac aacacgtatg tgctgcgtgc 1876260

agacaaacat ttaggtaaac acttacttgt aaggtaaaaa gaaataaaca gggctcttatt 1876320

tattcctagt tagtcaaaga tgaccttaag attccgatat tcctgcgtct acctctcaaa 1876380

agctggaatt acaggaatg agttttatgt ggtgctgggg attgaacca agactctgca 1876440

ttccagccaa gtactctacc aactgagcca catatccagc tcttagtaac tgtttttatt 1876500

tcatgcttac catgtgctgg actgctgtct tcatttcat ttaacacttg accaaatcct 1876560

cacacatfta ctatatgta gttaatccg gagctaattc cagagcctat gtatttctct 1876620

gttttcttta tttatftttt atfttttacac aggtttgaag ctccctatgt ggcccaggct 1876680

ggccttgagc tcaactcaaac tctccatgct acaatgtcca gctccaagc ctgagcattt 1876740

acaattaact acaataacctg ttcgaaagtg atttgaccaa gatcaatagc taaaaactag 1876800

taaagccttt tctagcaaac taaaatctaa gcctcctgat gcctgactcg cttttctagc 1876860

acatttaatg gttctgaatt ctccagaaat ctagccttct ggtaaaattt gttctaacc 1876920

tcaaagagcc tgggggaagg ttccctttag tccttaccag aggagtgtga gcctgcacat 1876980

ccatatagag aggtcgcagc actgtctctg agggaacagc cgagtgata gcatgatcta 1877040

cgactgacaa cagagtggag tggcaaagtg agaaatgacg caaccgtgga tgccagggtc 1877100

acaagacaac agattgccaa agccgcttcg aggtaaatfa aggaaggttg aggtcgagtg 1877160

tcaaaggaaa agaaaacaac gggcggtaaa agatattgag gaaaataata gacgcggggt 1877220

tctttgaagg gacgctggcg gcaaaaggga gcaatcttta aactatccag cagagtggat 1877280

ggctctaaaa agcaaaaacc tttataagaa cattgaaaag cacagggtcc ttcaaaggtt 1877340

catgactgga ggaacctcga atagcatctt taacagttgg tcaggagaga tctgaaggat 1877400

gagaccctgg ctcatatgtg gcaagatgia cgggccgtcc tgaggaaatg tgagagcgag 1877460

cggcgggaca cggaacgcgt cgggcaggct ccgcaacaat gcagtgcgta gcagcaacca 1877520

cccagcgggt tcgggcggct agggagactg ggcgctacaa agaagggggg cgtaccgcg 1877580
 aggcgcaatc cccgggtggg cgccgtgaac cggggccggg ccgccgcgcc gccgccagtt 1877640
 gccgcccccc tccaagtggc tcgcagcatg ctcccagcag tcgagcccac catccgcagc 1877700
 gcttgcaagt tctcagccca tgctcccggg agtagctccc agcgtccggg aagcgatacg 1877760
 acaggcgacg agcgcctccc gcctagcttt cgggtgtgaga cgtagagccg agcgaacgcg 1877820
 gcggcgaacg aggtgagggt gggccggggc cagccccggc tcgcgctgct ggggtccctg 1877880
 actgccagca gggtggtgga ggcgtgctcc gggtggcgt ccgccccggg gcctgcggaa 1877940

 gccttctggg cgccgctggc tgccggcgcg ccaggcctcc aggcctcact gtcgtagccc 1878000
 tctctcacc cagatgccgg tggcctggg tcctatggg cagtcccagc ccagctgctt 1878060
 cgaccgtgtg aagatgggct ttgtcatggg ttgcgccgtg ggcatggcgg ccggggcgct 1878120
 gttcggcacc ttctcctgct tcaggtgagc ctgcggggcg ggacttctg ggatccacgg 1878180
 acacttagtc gaggttgaa gccagtgct tagggatctg agctctggag tcaaaatggc 1878240
 tttgtgactc cttgtagtt tagtaacctt aggcaagtta gatgccgttt cctcagctgt 1878300
 ggtcgaggac agtacctta cctccacttt tctaagaacc gatcatacta gtatgctttc 1878360

 cataaactct agcatgtcgt aaatgcgcag taaaagctta ttgttgcag gcattttaac 1878420
 ttacaactga atgtgataaa atgagcttgt agagccattt tccgataaac ttaattctga 1878480
 gatacacggt tattctaaag gccatctcca ctatttatc agttcttgtt aaatgtgcta 1878540
 atgttagtg aatcagtttg taaagtttca cttacactt tgagcagctt ataaactggc 1878600
 caactttta atctgggtta aactccaaaa ataaacta aggcacatc tataagacaa 1878660
 aaaggctat taggtaacac acccatagaa gcagtcatga ctgcatttcc tgccattaca 1878720
 tgtcctctg ttctcttcc tgctacaaac agaagagaat tctgtacgta atgccctaga 1878780

 gcccttagat gtttacttg tcactgctaa tcctccttgg ggaaagagta acatcttaag 1878840
 aatgacaaag ataaaggat tatcaagctg ttaattcttg atatattca acaatgatta 1878900
 taaagggtga aggaaggtaa ttcaaaatct ttgctctatt ttatttcta aatgatcga 1878960
 tcttctcct caggatcggg atgcggggctc gggagctgat gggcggcatt ggtaaaacca 1879020
 tgatgcagag tggcgaacc tttggtacat tcatggccat cggaatgggc atacgatgct 1879080
 aatcaggga gtgattagct ggctacatct ttactttccc attcatttca accctgtac 1879140
 aataataaag tttttcttc tcagcttctg ctatttttac tccaaaaaaa catcccaaag 1879200

 ggctaagaa gttggtcagt ccctgtatcc ccatagttac attttctagc tcctgttct 1879260
 taggtcttc tggcctgtgc aggcacaga cacatacatg gtacacctta tattacatcc 1879320
 aaggatgcaa tacttaaatc tctagccagg cttaatgtgt tgacatacac atttaacct 1879380

ggtgcatgg aagtggaggc agccattgct agatagacct gtccaaaaac atttttttaa 1879440
 aaatatattga gctaataaaa atgagaagtc ccaacagatg atggtacacg cctttaattc 1879500
 cagcacttgg cacaggcagg tggatctctg cattatggtc tacagagccg agttccggga 1879560
 taggctccaa agttgagtac agagaaacac tgatcagaaa aaagtttttt ttttttcaca 1879620

 aatcctgttt ctgcatatca aatatagtaa acatttgctt cttggcaaaa gtagacaatt 1879680
 tggacatggt cacatacact acatgtcaca ttcacaatag aacattgcat gtcctgagat 1879740
 tgtcttcta actttagacg gaatgattta ttgaaaaggc cagtttctca aggactgtat 1879800
 ctttatcagg acattcctaa cagcctcaaa attggacatt agaatgtaat atccagacca 1879860
 aagatttttc tgatgtggat tacccttcaa ctaaattttg atcagaatgc taatgcaatg 1879920
 tccttaggac atcaaagccc ttttgaagcc ctagatgcca aagggcccca gccggctgag 1879980
 tggcaaaact agccatcttg ttttcattgt tcaccaagg attgcaaac tattagaaaa 1880040

 cacatgggca agagtggag gatctgcca ccaaaggata atgttcaaac caagagaaag 1880100
 gcctcagctc catctagggc tcccgaagat gcccgagccc catagaaaag gtttctgtca 1880160
 acatgaacac agatggactg gtgtaacaca caatttgcag atcatcagga cgatattgct 1880220
 gctttttaca aataaactag aggttaagatc tgtgtaaaag tgttttgagg gcataaaaag 1880280
 aaactcaaga tttagcatct acagatttct tatcaaagag ttgcaactgc aattaaatgg 1880340
 acttctacta gaatggactc ttcaaaatac tttctgtgca tcttatacaa gaacaagat 1880400
 aacaagaggc agcttgtttg acccagggaa catacctca ttgcaaacac tatgctgtat 1880460

 gtattgacac atatatacaa tttcaagatt gcagaggttg agagagtagc attttcaaat 1880520
 tgtgaaaaac ctaaactgta atgcttagac gctaatttga aagcaaaaga gaaaacaatc 1880580
 accgacagcc tatgctccag ttagtaacct caaaatttaa aaaaatgaaa attttcttgt 1880640
 ggcctttttc agagaatttt atttgagtgg ttcttataaaa gattgttgca atatgaaagt 1880700
 catttgtttg atagaaatat caagctgtct tgcacaacac actgaagtaa cccaaaaata 1880760
 tatttcagag ctcaacagac ttaaaaagag caaagattat atgcaaccag acaaaaccta 1880820
 tttctgcatt tectatact tgcccagact tctttgetca aactgttaca tcaaccatct 1880880

 tcaggaaatg cagggatcat tttgtttgga aactcaagac aactaaaaac acagtattta 1880940
 caaagaaact tttacacata cattaattga aaagttacca tcaagaaata taattttgaa 1881000
 ataccttctt gccaaatgat caaggtgaga tgctaaacag cctcttagct gcctagacta 1881060
 ttcatacact gtgtattcca gaaacctttg ctgaacctag agccaaatac atgaatgaat 1881120
 gtgaactgta actgctatgt aaaaagttag gcttctgaaa cattaaaata ttacctgtct 1881180
 gcctttatac agaaaggaca tttgttcccc tagagctatt ctatagatcc ttaatgtaat 1881240

ttctacatg gacatttaaa acggcagaac aagcgaacag ctttgcataa agtaggattt 1881300

 gctagttagg gagaatgagc aactgcatt cctgttaaca tctttatfff tcaagataac 1881360
 aggagtgtga tacaaatgac agtagaccct tgcctcttta tttttatcta aataaaaagat 1881420
 aactcaagat gaatttctaa gaaaaaaaaa aagctatata cataaggac tatatcttcc 1881480
 ttcatcgtct acttggaaac agtagttgtg ttgctgtcat agaatcagga aagaggttgt 1881540
 ggtaagttgg aagaggtaca tatgcagctg ttatcatfff acctgttgac aaaaagaaaa 1881600
 aaagttgagt gattactttc atgttatcac taggtgttca acataaagtc tttgtagcag 1881660
 tcactcacca gcaaacacc tgcctatgcaa tgcattgaca gcagcaatag ctgcagcaat 1881720

 agatgggcac ttcacatata cgttgccctg aaagcatatc aagaaaaaat cgtaattaga 1881780
 aacaactgta ttgaccacat attctcacia agaaaaaaaa gcaaaaacia aatgaaaaat 1881840
 acctgagctg aatfffftgc aacataaata tgaataactc ctccatgttt attacattct 1881900
 tcaataacat catctffaat ctctgtatcc catccaactt cttcttctct gtaagaaagc 1881960
 agaaagataa tagaattgta ttcaaatagg aaaggtgcac acattatctg tgtatgtatg 1882020
 gccatgtagg ttgaccctgc agagggagac cattctcctt gtcactatat gggtatcaag 1882080
 tgatccaaat ctagtctca cacagcaagc acctttgctc actgaaccac ctaatgtgcc 1882140

 ttacaccatg cagtaagtct cttcaagaag cataactatt cgatgggcaa aggtggtgca 1882200
 ctcatffaaa cccagcactc gggaggcaga ggcaggcaga tcttatgagt tagaggccag 1882260
 cctggtctac ccagccagtt ccagacaggg ctccaaagct acagagaaac tcttgtcaca 1882320
 aaaacaaaca acaaacaaaa caacaattca gctgggctag gaaacaaatg agctcactcc 1882380
 atgaacctgc ctatffatcc ccaactcaaa actgccattc atgcaaacat ggcaactaac 1882440
 aatacattct gagccatcta cctagaagct aagcatatat tcttaacatt taaggtatca 1882500
 aagggtatga agcataaaaa gatatacaag gtgttccatt tgagcttatt gttactacca 1882560

 ttgtaaattt ttgtggaact ggctcagtag ttgacagcac tggcaaatgt gtggcacata 1882620
 tacaaacatg cagaataact catatfcata aaataatfff aaacaaagca aaaagaatta 1882680
 caagtacaca aatacatggt atfftgggcc acacagaaat ttatcattaa cagagfftaa 1882740
 atffcagctt tgctatgtgc ccaataaaaa tataaactgc gtaaaaaagt gtcaactatt 1882800
 tatcataata cffcccaact atgaaatatt aaaaatggga aatfgcaat tgcaaacaca 1882860
 cttacgtffg agggffaaac atgttagaaa gffgaaaaca ttgtgffgca agffgffgaa 1882920
 cacagcagc tgcagctaaa gctgaggcta aaaaagaaga ggaaaaatta gattcctgga 1882980

atatgtgtga acatccttgg acaattacct aaaaagaaaa accaccctat cttaatgtgg 1883040
 aggagatatt ttccaatcac catcaacagt tgctcattat atcatgacag taatagtaac 1883100
 acaacagtta agctgtttaa ttaagcttat aagattaact aacttataat aggtaacaca 1883160
 atgtataaat acicaagtat tctttagaga tgagatgggg aaaacagtgc agacatacag 1883220
 acagaaattt ggtacagatg taaatataat tcctaaga tttcaggaac tgggtttgtg 1883280
 acttagttgt caatgtgctt gtctagcagg cacaaagctc tgggtttgat cctcaacact 1883340
 gaataaactg ggtgcatcta taatttcagc ctaaggaagg tagaggcagg aaaatgagac 1883400

 gttcacagtc acacagtcta tcataccaaa ttttaagtaa gactgcaaca tataaaatac 1883460
 tgtctctaag aaaatataca aaaacagtgt ttgaaatggg gaatagttgc acaggaggaa 1883520
 gcaggaggat ttgtttatag agttctaggt ccctgggct agaaagtaaa ttgtgggata 1883580
 tccaggacta cagaagagac cttttctcaa accaaacaaa acctaagaag agcttgagaa 1883640
 cagacatgta gtctaaatct attaaattac agcaaacaaa cctcgataca aatcattcca 1883700
 gaatgaacaa aggctaaaa gaagttgat cttattctga agtgatggga atgacaaaaa 1883760
 atggaattgt tggaaaaata ctaaatacaa cacccttcta cttctcttgg ttttaacagg 1883820

 aatatagttt tctttttaa agacacaggt ctgtatttta gatctataga catctcagat 1883880
 tcagtcatct caactacccc tcaagattta tttttacttt catctgtatg tatgtacctg 1883940
 atggcctcaa agggacacce tgatatgttc ttcatagtgc tgtgaactac catatggatt 1884000
 ctaggaacca aacctgggta cggaagtaag ggttcaagtg ctctaatca gggagcaatc 1884060
 tctctgttcc aactactttt tttcaatgca cgaaccttaa tattattaag gttttaaaag 1884120
 aaaaaagtat ccaaaggaaa aaaaatgcca ttgtaaacat tttacttgat ttttcttagg 1884180
 aaaacagaaa caaaaagaat ggtatagat gactattata atttggacat aatggacaat 1884240

 gcaacgctta aagtaacatt gtaacattaa agcatacata ggtgtagtta aacacttttt 1884300
 ccaaattagg tgttttcaa gtttggcatt ctttaggttt gggttttctg ttgttgagac 1884360
 agggacttgt ctctctccag ttttcacaga atcaccaaaa aattaattat agcaccagtt 1884420
 acagaactca cgtaatcat attatctgac catatcccat tccaatgcat aacaacaaac 1884480
 agctaaggat aaaataatgc attaagaaat cgagataact aaaataaatg atcacctaag 1884540
 taccagacaa attgactga aaaaaacttt acaaatatac atgaataaa taacaccact 1884600
 aaaaaattat tcttggtattt tgtgctttct ggtaaaaaa aaaaaaagtg cttttccttc 1884660

 attaatcctt tagataaaaa aggtaatttc ctttaacaac aaaacttttc tgtgtatttc 1884720
 tttctgagaa caaatattaa ctgcatagat ctaagagcta gtaattctca getagctact 1884780
 taggaatcta agggctgtta aagagaaacc ctgtctcaaa aaacaaaaca caaaacaga 1884840

aagaaaaat taaccattg tacatttaa tattccaggc tctaggaggc agagtcaagt 1884900
gatctgactt ataggacagt cttgttctac atacatagtt gcaacacagt cagagtgaca 1884960
acctgtctc cccaaaaata aataaaaaca caagtatgca taactaaat gttttaagaa 1885020
gactgaaggg aactactgaa tgattatgaa tagtacagat gaagcaaatt acaataggat 1885080

cattctggct taatctacgc agcatgcaga agaataaaga attctgactt tcaatcgata 1885140
aattattaaa aaagcagtaa ttacaaatgt tgcattingct taaagagaat taaaatata 1885200
ttaaactca tctaaaatat aacaagatgt ttttttttc acataggatc attatcaaaa 1885260
aacaataatc atgctactct aaaggtagta ctgaacaaga aactgaaga gaacctatg 1885320
aggtggattt catgaaatca ttgectactt gccatcattt caaatgcat gtaatatatt 1885380
tgaacagttt atgggcccat tcatggtttt tgatattaca ggctactaga aaccaatcag 1885440
tgtatcagta ttaaacatct agcccacatg actataaatc taagttaaact tatgttacat 1885500

atattccacg ttctaaatct ggtctgggaa aatactgagt ctactaagta aaccttacac 1885560
ctagagaaat acaagaaaga aatacaagac tgagttctgg ttcgtactgt ttaactgtc 1885620
aaggagagag tgctagcatg ctaggccagg gattaaacag ctacagctta aggctgaaaa 1885680
attcaagtaa tccaaaacag aaacaaccac agataatfff atcttctttg actcaaaatt 1885740
tagttgatta agtttaacta gttatattac actgaaaaaa ataaatcaa acaaccatta 1885800
aaacaaatc taictttgta catttaattg tatttcaaag acaaaaaaag tgaaaaataa 1885860
gtaactcacc ttcagtctgt tgggaaagtc gtgtttgcaa atctataaca aaagagaatt 1885920

ctacagctca gtgcaggaac aatgaagagc ctcaactaac agggtaaatg tcaggaaagt 1885980
attaataaaa gaggacttca acagcagggt ttattagaat aaacttatca aaacctggca 1886040
gcaaaaccte ctccccatt cctcattgag aaggctttgg ggccttttgt tgcctcatat 1886100
cgtggaagtt attcaccttt cctcetaacc ctaatacacc ctttctatc atatgtgtgc 1886160
tgcaactgtga taccacagcc aggaataatg ggaatgggg aaaggaagc acaccggcga 1886220
gaaaatagtg gaaacacct gattgagaat tcaattcaa gtacttagaa agtaagtttt 1886280
cttttgtttt ttcagtggtg ataagcacta agtatttcag aaggttatgt taaaatggtg 1886340

aaccttaact accacacaca taaggagct agagctagga ccatgttccc taatttcca 1886400
atitagcaat aactgagaaa gagacaattg caacaatgtg gaatttatct ttttatgaga 1886460
ttttcagaag ccgggcagtg gtgggacaca cctttaatcc ccagcactcc actgtcagag 1886520
gcaggtggat ctctgtcagt ttgagaccag gctggtaaac aaaagagcta gttctaaac 1886580
agccccaga accacagaga taccctgttt tgaactgcc acccctttcc tcccacaaat 1886640
tcaactgtgc aatggtttct agcacaggtt aacaatttga tgtaagtta ttctctcaca 1886700

tatgatgaaa attattgttt ctacactgga aagcattttc aacaaatctg tatgagctgc 1886760

aaaccaaat caagcagcta ataggtgtgg ccaatcagca acaacagagt aggagtcagg 1886820

caactctctg cttgaggcga gcttgatcta catagtgaat ttcagaacag ccagctaggg 1886880

gatcatcaca gtgagacctt gtctcaaata ccaaaacaaa ctctgcatt tctgcaaagc 1886940

tactacagct aataaaaaa ccataagaaa taaatatggc attattagt atgaaggaat 1887000

gtatttatac taaatgaatt aagatattaa tatagaacca gtgtcagaaa cttaaaatac 1887060

aatctctctt cttcacccca aataggtgat gctattaatt gccaatcccg attatgatgt 1887120

taaaaacaac tttggagcta ggtggtggta tcacacatct ttaaccccag cacttgagaa 1887180

gcagaggcag gcagatctct gtgaatttaa ggctccaaaa ctatagagaa accctgtctg 1887240

gaaaaacaaa ccaacaataa aacctttggc tacttttaac acattagtaa actaagcaca 1887300

aattgtgtat ttacacaag gaacattaga aaagttgtat tatctaaggg ttttgaaca 1887360

ctccgtaaat ccagtactc aggaaaggca gaattaagct caatgcctgg ctgtttaaag 1887420

caggaacaa ccacatgtgg accacaccac cttgaatgag atctggtgcc agtctgcagg 1887480

gcacatacag gcagaacact ggatacgtaa taaataaatc tttaacataa gttcaagcc 1887540

agcctcgggt atatacaca gtctctaaag cctgggatac ccaaaaaga gaatactttg 1887600

agggacaagg ctgaccagca gaataactga gttgtatgat acagagcaaa attgaagcaa 1887660

accagggata tccaataaca tctgtctca ataatgacaa tctggatata aacctaatc 1887720

ataaatgaga aagctgcaac tctgtccaca gttggatctc tgaatcacat gtacatggtg 1887780

gaaggataga gcaacacagc taaaatgcc tctgatctcc acacataagg aaagcaaatg 1887840

aaactacaca gagacacact agctccaaa gtgaatttct ctttaaatgt gtatgtttat 1887900

ttttgcctgg atgtatgtct gtgaaacatg ggtgtcagaa ggcatcattt cccctgcaag 1887960

aggagtata tatagttagc tgtgagtcac cagggtggta catagaatac acccagaatc 1888020

ctatgtaaga acagccaatg ctctgatgcc actatgaagc cttacacct aacaattca 1888080

ctaaagacaa cccggacaaa tcatcctgag ggttagtaaa agacatattt ttttttattt 1888140

tttaaaaaat ctctaaatc tatttattta ttatgtatac aacattctgc ttccatgtat 1888200

atctgcacac cagaagaggg caccagatcg cataacggat ggctgtgagc caccatgtgg 1888260

ttgttgggat ttgaactcag gacctctgga agagcagtca gtgctcttaa cctctgagcc 1888320

atctctccat cccaagaaat agacatctta ttcgggaaat agcatgatat atatactca 1888380

ggttgccctg ggactcattt caggacagtt tactcataga aacatagcca ctaaagttac 1888440

atggattaca ggagtgagca gaccttgcca aaccttgctc ctatgtcctc accttcatgt 1888500
 tgagaaatca cgttttcaca gagtaaccta agactatgag aaatgttatt taccacaaca 1888560
 tgaggaaatg taaaaaaggc cacggcaata aggttaaaaa ccaactgctct ttctaagagc 1888620
 accctttttt caaatgaaaa ttgaccttg aaagaaggga agtaacaata gaacagtttt 1888680
 caagttaaat cattattttt ggtggcagga tctcgctaca cagtccctgc tatccaagag 1888740
 ctcaacttga taaaacatag tgagctttga ccaccaaaagc actgagatta ggggccggag 1888800
 agagggtca gcagttaaga gcacttaaga gttcttccag aggtcctgag ttccaattac 1888860

 cgacaaccac atggtggctc acaaccacct tgaatgagat ctggtgcctt ctgctggtgt 1888920
 acaggcagaa gactgtatac ataataaatc aaacacacac acacacacac acaaagcacc 1888980
 gagattaaaa gtgaacattg ccagatttag cctatcatgt tttttgtat agctttggag 1889040
 cctgtcctgc agcccatctt gtagacctgg ctggagacaa ctaacatccg ctgacctta 1889100
 cttccaagg gtgggaattc aagaagcgtg ctagcatcat cctgctgat cgttttttaa 1889160
 agaattgttt tcatctttct gtgtagaggt caatgtgaat gcatatcaa agagttaaat 1889220
 tcatcttaac atcccatact caaggaaatt tctaaaataa attcctttca attacagaaa 1889280

 gctgcttga atgactatta attgactgca caacaaaca acctaacatt aaggttttaa 1889340
 aattcaaaag cagaaataca ggtaacagat acttgtggga gattacaaa tagtgcttac 1889400
 agaaaagcct caatgattac ttttacctcc tcataattaa ttacattggc attgtcttca 1889460
 gaaattgtaa gttgcataag attttaaagg acaccattg acaaaaagaa agtctttctt 1889520
 gcttttaaag tgtcaaaata tgaagacaag atcactaact tcacatttct taaattattt 1889580
 tgaagtattg catatggatg aatctgttgg caggatttgt gactggacag ggacttaag 1889640
 ctagtctgg gaatttagat actttaaaag agcagtacat gcttttaac tgaggaaaa 1889700

 tctgaagcct catcctcatt tgttttggtt ttgaagacaa ggttcttctg tgtaacagct 1889760
 ctggctgtcc tggaaatgtt tatagagcag gctggcttct aagttacaga gatccaacca 1889820
 cctgtctaca cctctcagtg ctggcattac aggcattgat caccaccacc aggcactggc 1889880
 ccctacttct tttttttat tgtgccttag gcatgaaaca gctttggcca ccaaaccagg 1889940
 catcaagcta ggatgaacaa agggctacta gctcctctgc ccctgactga tataagaaca 1890000
 acaccaccac caaggtgtct ctatgcccac tgccaggggt tcatcctac ttcttaatgg 1890060
 caaaataaaa ttacctgctt tagatagctt tgtatctaag cagatttaat aagaaagcac 1890120

 aagtttctta ttacattaac attactactt atctaaaact gcacatggtc ttactttcta 1890180
 gaaaacttag aacagaaatt actattagaa ttccagaaca cttgataaaa cagggtctgg 1890240
 acaactgccac ccaggctggc atggaaatca tggtaaagca gcctgacttt ttttttaac 1890300

caaagttggt atagcaaaag ttattattca tttctatcca agacatatat ataaagaaac 1890360
 aagtattacc ctaggtccta gatttaggac aatgtaaadc tcttttagg atttacttaa 1890420
 tttctatttg aatacaactt ttgcctccat gtatatatct gtaagacata tgacctgcaa 1890480
 atattagaag acatggatag atgtgacaat actggagatt actttagaaa tattattatt 1890540

 attattgcat aaagcaaaag ttaattttta ccaactctgg gcttttccta aacattaaca 1890600
 attcagtcta aaacttcaca tgtttccata gtctcatggg tcaactctggc taatactaaa 1890660
 gtatactaaa gctactcttc ttttgcaacc attaagggtc tagaagtact taatgaattg 1890720
 aattctcagt tagtctttg aaatgcaaaa aatttggcat gttttcgaat taggtgaaaa 1890780
 aacaaatgat ttcaaattag aaaagattca attcctacct gccacagcac caaatgccaa 1890840
 agagccactc atttgtaaag ctgtgtgtgc tgctgggtgga atctgcaaac ctgtacctgt 1890900
 aaaagagtaa gtcttaaagt tcttactatg ttaacggcaa aaaacccac aattttggga 1890960

 attatgttat caactcagtc atcggcaaaa tggttcacta caccaaggta aaataatcac 1891020
 aactaacttt ttttttggg ttttttttt tttctgtgta tctttggagc ctatcctggc 1891080
 actcacagag atctgcctgc ctctgcctcc cgagtgatgg aattaaaggc gtgcgcaacc 1891140
 aactcgaagc taatcacaac aaatttctta ctgagtctgg tgacacacaa aataaaactc 1891200
 attaaactca cagtagtaca caaaaacacc aaaataagga gtatataaaa cttaataaaa 1891260
 ggtaaagatt agaatgcact cctacaataa tataggaact ccaaaaacaat acacctgcct 1891320
 gcatatttcg tagtttgcag ggttaccttt ctttttcacc actataccta tacatcaata 1891380

 attgaaaact taccctctgc aagtctgcc attaactgga gacgaccagt tgttcccaag 1891440
 tcaattccag ttctttctag ttcatcactg tccaaaaatg aactagcact agaagcatca 1891500
 gttcgttcag taacatgacc aactttcatt ggccttccag ctagttcaaa tccattaage 1891560
 tgttccaaag cttttttggc acattctgag tcagaaaact agaatagaca ataggaatga 1891620
 tacaattgaa tactttgtat ttgtatcact acagacataa cattgccttc aagtgcattg 1891680
 gtgtcaattt gcttgaatgc acgttgtgag ggtgtcagac aagttgtgag ctgccacatg 1891740
 gctgcttggg gttgaacgca ggtctctttg atgagcagtc agtgccttta acaactgtgc 1891800

 catctatcca gccccaaaa tagcaacttt gtaagtctaa ttacacactc atgaaaaagt 1891860
 acaaaaagta tataaaaatt gtgtacatgt aaaattagac cataaatttt tgcaataaaa 1891920
 aatgcaagat agigtgaaaa tgattttttt taaagaccaa tttttacttt tttgacaagt 1891980
 tgtctttaca taagacatga cttttttatt tttattttta aattttttcg agacagggtt 1892040
 tctctgtggc ttgggaggct gtcccgaat tagctcttat aaaccagct ggtctggaac 1892100
 tcatggagat ccatctgcct ctgcctcct agtgcctggg ttaaaggcgt gcaccacaa 1892160

cgctgggcc cataagacaa aacttttga caagtattta ctatgtagat caagctggcc 1892220

 ttttaactcct cctccctga gactcataat ttgttccaaa atgccaagaa ccctatgtaa 1892280
 ttttttagtg aatctgacag agtggaaaag agtgacaggc acctaggatc ttaaacgtgt 1892340
 aacatgatta cccaaccaac caaatctacc aaaggtgttt tccttcacac ctctccttta 1892400
 gtctccagat cctttctcac tgtctttacc tctttctaaa caggggtaag aggatcctgc 1892460
 caggcagtggt tggttcacgc cttaatecc agcactcagg aggcagaggc aggcagatct 1892520
 ctgtgtgttc gagaccagcc tggctccag agcaagtgcc aggataggct ccaaagccac 1892580
 acagaaaaac cctgtctcaa aaaagcaaaa aacaaacaaa agagctgggt gttgggtgggt 1892640

 catgcctttt agtcccacac tggggaggca agctgatatc tgtgagttca gggccagcct 1892700
 gtctacagac agcctccaaa tccacagaga aaccaattta gtttgtgctt ttaacgccag 1892760
 gatatgggag gcagatcaag tcatttgtaa ttttgaggcc cgcttggcgt ctccagttg 1892820
 ctagggttac actgagaggc cagctctcaa aataaacaag gacataataa ataaataatc 1892880
 aaataaatgt gggctccaag ttagaggtag atctgatacc actatactct atgtgcacca 1892940
 gaatttaaat gcacaaagca aactacttga aaataactaat ctttcttcat tcccaacaca 1893000
 tacagttcac atattgtgtt acattaagag aactacttac tgtaatgaat ccatatccct 1893060

 tagaccggcc tgtttcacta tccatcatga gctgaatact ttcaatctaa aatttaatgg 1893120
 cataaattta ggcaaaatta ttctgtgagc tatagtitta aaaaatctga aatattctgt 1893180
 accttatac cccagccctc aagtaatgaa gacatcacia ccattcttta caaaaaaaaa 1893240
 ttttttttc atggcctaga atttttaaaa attttccac tttgacaggg aaatactgtc 1893300
 tggagtcagg gaactaaca aaaaactaaa acttaccctt ccaaaaggct caaatatccc 1893360
 ccgaagcata tcttcagtta tgttaaaatg taatgagccc acgtagagcc tcatgggtcc 1893420
 agcacttccc ttttgaatat tgtttgceat tgcagcagct ctgttttttt ctgcctgtaa 1893480

 gtaaaacca catcaaatac taataaaaag cagaaatgtg tcaatgacaa aggagcacta 1893540
 agattggaaa gccaaaaact atgagtataa aggaaaaaaa taaacctaata attgattgct 1893600
 aggaggcact gaaaatacac aaatctgtag aagacatttg ctaagaacta gtgtaaagag 1893660
 aaacatcatc agaaagaigt aggtgagata tataccatgc tgtgaatgtc attaatggca 1893720
 ctaaattgaa tgcaagagt gtgacacagc atattaaact caaatgtctg ctttctgtgc 1893780
 aagcactcta ctgagctaca ttccattacc ctaaactttt gcactcaata gcagatgtgc 1893840
 caacggtggt attatacaat ttttataacg tttaaagtat atgacaatta tatacaaac 1893900

tatatactca tgtttcatac ctatatgtaa tccactataa aacttaaacc aagtcaggtg 1893960
 gtgagggcac aagcctttat tcccagcctt ggtctacata acaatttgca ggatagccag 1894020
 ggcagttaca tggagaaacc atgtcttgaa agaaaacaaa taaattaagc caaaatatct 1894080
 tgttttgta taicacaacc agtgaaaaat acaataatc tgtttactga atatttgtaa 1894140
 acatataact cattattaga catacccaa gatgagttg agagttgaat gaatgtctta 1894200
 gcaaaccatg actaagtgtt tgaagaacca tafacatagt cacctaagta aagcatagct 1894260
 attttgtctc tattaagaca accctttttt ttttttttt ttttggtttt gacacagggt 1894320

tctctgtat tgtttgaggg tgtcctggca cttgctctgg aggcttttgg aggactttgg 1894380
 aggctgtcct ggaactagct cttatagacc agcctggtct cgaactcaca gagatctgcc 1894440
 tgtctctgcc tccaagtgc tgggatgaaa ggcgtgttcc actaccgcct ggctctatta 1894500
 agacctttta aaacttttta tatgctgtag gtgtttgtct gcttcagaat aggccagaaa 1894560
 gatatcaggt ccgatgaatc gacagccaca aacagctgt gcatgtggat gatcaaatg 1894620
 cagaaggtgg cctatagcca cagcaagtgc tctttaacta tggagccatc taaaaaccgt 1894680
 agctacatta atactttcta aattctcaat ctacattata aaacaaacta tctttctaat 1894740

aacaaactgc tagagagcac tcactcacgg accagtgctt cccacacaat gatgtaact 1894800
 accatctcat tgattccact tattaggtct gttaatgaat aattaataca tagcccaagc 1894860
 tgagtcaaat tgattccaat tctctgect aaccctaage cactgctgca tatgctgtga 1894920
 caccagctc aatgaccaat atctaatca agaagttacc tgtgatgcct gtactataat 1894980
 tggcactcct aaaaacggtt ggccagttaa tccaattgct agaggcactg aactaacatc 1895040
 aacaaattcc acataggcaa ttcctttgga acgtcttgaa tttctatcag aatcatcct 1895100
 cacatctcga acctaaaatg aaaagaaata taattattct atagtcaaac aatccacgta 1895160

agtatttcaa acatactatt tcttcagaaa cagtgtctca atcaatacat ggcaccaggg 1895220
 ttaaactgtt tigttagact tgattacct taattcaca taattctgta tacctctgtc 1895280
 ttcagaatgc caaaattaaa tttcagtagt caggcaaggt gttagtacat gtatttaaaa 1895340
 tagagcacta aggatatctc taaggtggat tcttgagttt caggtgagcc tgcactacac 1895400
 aatgaagact caataaagat aggggtgtcag agcctggcgt tgggtgtgca cgcctttaat 1895460
 cccagcactc gggaggaaga agcagatgga tctctgtgag atcgaggcca gcctgtctc 1895520
 cagagtgagt gccaggatag gctcattttt agagacagag aaacctgtc tcgagaaaaa 1895580

aaaaaaaaa aaaaaaaaaag atagggtgtc agtatttatg tccatcttat gaaaacttat 1895640
 atccttctac ctcaagtaata ggattacatt atccaagaac tgcttctaaa aataattgga 1895700
 gatgcctgtc atttgttgta cacaccttaa atcccagcaa ttgggaagca gagacaggcc 1895760

cagcctggtc tacagaatga gttctaggac atgacccaaa gctacagaga aaccagctct 1895820
 caataaaagg aaacaaacca gcttggctta taaaagctag ttctaggaca gcctacaaag 1895880
 ccacagagaa accctgcctt aaaaccacc caacacacag aatttggctct gcctgtgact 1895940
 ccaagtgatt aaaggcattt gccaatcacc ccttccgttt ttattgaatc tattgaaatt 1896000

 acctattgct gttatccttg agtacattcc aaaattttaa gctaagacc tattgttaat 1896060
 tatataagca caatgatgg aaataggact tggaggaatt tgctgaact gaactggagg 1896120
 actctctcat agtactggaa ggagctaata caagcttcca agggagaaag caatcaatag 1896180
 tcttacctg ctgtgacacc tccaaaacac aatgatgatc aacaggaaga ttcccaaaa 1896240
 gatacaatgt ggcactttgt tgtttttcca gacacggttt ctctgtattg cgctggagcc 1896300
 tgcctggaa cttcgcctgg attaaagttt tatgttaggg ctgggggat gcctcagcca 1896360
 atgtggcact ttcacttga ggattaccac aaactgtcta tttgaactca cagctgacta 1896420

 aacagaagag aattcataat ccattcctgc aatgtaact tacttaactg cgtttgatga 1896480
 ggccaaagag gcaagaaaat aagctaataa ggccatttca gaatgcaacc actaaatcat 1896540
 ggggtatcca ggctaaatg atacatttgt aacacatccc taacttaatt atgacagga 1896600
 agctgcacta aggaaatgta aacaataaag caggaaaaca agacatacca aggtagacat 1896660
 ggaggtcctt agtattggtt acccaatact aagtattatt tgaataaac tattaatcta 1896720
 caaagaccac taaatgtact cactagaaat acacacacac acacacacac acacacacac 1896780
 acacacacac acacacacac acacacacac acaataata gctattatta taattagagc 1896840

 tgggtatttg tggcatgtct ttaatcccag cactccggag gcagaggcag gtagatctct 1896900
 gtgagtttca gaccagcctg gtctacaaga gctagtcca ggatagcctc caaagccaga 1896960
 gaaaccgggt ctgaaaaca aaacaaact cacctttttt tttttgagat aggatttcac 1897020
 tctggcctg gctgtcctag aactcaatct atagacctac ctgagtgcct ggccttctga 1897080
 ctgccaccac tgctgtgtg cctcacttct accaacttaa cagtctcta taaatgggga 1897140
 gttaccttcc ctactgtaga gaaaaactct tccaaatccc ttggtcgaat tcttgctgcc 1897200
 agttgcatgc agaaaactgt ccttgcactc ctttctcag gagttagatt atcaataggt 1897260

 tcctaagag gagaagatta caaaattaat aactgcaaca ttttttagtg ggacacaaga 1897320
 ttattttgat cattggttagc ctcaaatcc agttcttctt tttactagac ataagatfff 1897380
 cttgccgggc ggigtgtgtg cacgccttca atcccagcac ttaggaagca gaggtaggcg 1897440
 ggtctctgtg agtttttagc cagcctggct ccagaacaa gtaccatgat aggcttcaaa 1897500
 actacacaga gaaatcgggt cttgaaaaac caacccccgc cccattaaag cetaagaagc 1897560
 tagagggttc agaaattaag gacatgtatt gctcttctca aggacttaat tttggtgcac 1897620

agcacatgt tgagtggcta taactctagt tccatggcct cttgggatag cagcattaac 1897680

 ataaatacat ttgtattaaa taaacatttt ttgttctctc tttactctat ttgaaacac 1897740
 taattcctga aaagtcttat taaagtttac caagatatca gtggataatt ttgtttgtaa 1897800
 agtttagat gaaatcatga tatccaagtg ctgtaccact ggtacactta caagtccac 1897860
 atgttaacgt caaaaggtat aaaactgaat tagattttac aagtaaacag attactaaga 1897920
 atatcacaat aagccgggca ttgggtggccc acacctttaa tcacagcact caggaggcag 1897980
 aggcaggcag atcactgtga gttttagttc taggactaaa gccagagaaa acctgtctct 1898040
 aaaaaccaa acaactatc agggctggag agatagctca agagttaag cgcactaact 1898100

 actcttctag gtctcagtt catgtgcaa cagccatcta taatgagatt tgatacctc 1898160
 cttcttctgg tatgcaggca tacatagaca gaatttctgc ttataataaa taagtcttta 1898220
 aaaataaata aatgaaagta attgtaaatc ttccccttaa ggtcaacaag gttagtgaag 1898280
 tatgtaccgt attacaaaat gtgccttgaa acaagatgat cattatagtc taaacttact 1898340
 gaggaagaaa ataagttgaa gaatattcaa tgatcattat gtaaaactcaa aatgttttg 1898400
 tgtttgttt gcagatgggg ggaaaaaaag gtcagcgggt acctcacagg gctcttgtct 1898460
 tttctgaatg gacttttctc tcgggaacgt cttctgctgt aagggtaaaa agtttcacaa 1898520

 gttacccaaa caagtaatgt ctcatagtt ccttgaaaa caatttaagc aattcagaag 1898580
 tgtgtttaaa aaccttaatt tgatgctatg aggcaacca atctttctc ggatggcact 1898640
 gttaaatfff ggtccggagc taaaaagaaa acacaaaatt aactagtta caggtttagg 1898700
 gtcttgcaa galcaagttc atgggctctc cagcaagact aacattgttt aggctgcttc 1898760
 ttttctacat caactataaa aaggaaacaa aagaacttag aaaaatttgt atctttatcc 1898820
 ctgacctgaa gcccttgtat ttatctatcc tggatgagtt agaggtgcca agaacaacg 1898880
 ttacagcttc aaaaatttct cactctaaaa atggattgca tctactttta gttttcaac 1898940

 catglaatta tgaacatgag ttgttaaaat ttagtagagt aaaaacaaat gattctgaac 1899000
 cctcatocca gcatcagttt actatacagt tctttcttgg aaaaaatag tacttatatg 1899060
 aactcactct gtagtaaga atgaccaaga actcctgttc ctgcattgct aatctctggg 1899120
 aggatftaaa aaaaaaaaaat gcatcaaacc atgaaaactg gtacgttcca tataatacat 1899180
 cctttctttt ttttaagaca gaacaacct catagtctg gaacttacta tattacatat 1899240
 caggccagcc tcacagagat tctacctgcc tctgcctcct gagattatta ttattttttt 1899300
 tttggtgttt ttcgagacag ggtttctctg tgcttttggg ggctgccctg aaactagctc 1899360

ttgtagacc ttggccccc agtgctgcga ctaaagcat ttgccaccag ggcacggact 1899420
 tttaaaattt tatgacaggt tctcactgtg tagtcctagt tggaggaaact caaaaaagcc 1899480
 tatctggagt gctggaatta aatgcatttg tcaccatact cagctcccat gtaataattc 1899540
 attttattac atttttaact atttttaaaa ttattttatg tgcattgggtg tttagcctac 1899600
 atgtgtatct gtttgagggt gtcagctctt ggaattacag acagttctga gctgccatgg 1899660
 gagtacctgg aactgaacct gggtcctttg gaagagtaga cagtgtctct acccaactgtt 1899720
 ggcactgcaa ctcaggacct ctgaagagca gttagtgctc ttaagctctg aggaagctct 1899780

 ccagccctga tttatgtttt taatgcagag tatatccctt tgtagccctc acccaacttg 1899840
 aacaggtaac aacatcatca gcagcaagaa caaggaagca aatcagaatt ctaaaaggtt 1899900
 attatcctaa ggagctaaag ggttcagcaa ttaaggatat gtattcctct tcccacgtaa 1899960
 ccagtgttat taaatgttga gccatttttc tagctccccc caccctcttt tttatcaata 1900020
 tggactagaa cttagctgtg atccctctct tccttactaa cccctaataa gataattact 1900080
 ggaattcatg taatcatata aacaattttt ataacttata ttttatgtgc actggtgttt 1900140
 tgcatacatt tacgtctgtg tgaagggtgc actgttacag acagttgtga gcagccatgt 1900200

 ggggtgcaggg aatlaaaaca ggatcttcag gaaatgtctg ctcttaacc cagaaccatc 1900260
 tgtctagcac cataaaaaag taaaatttaa caaggcattt tttatcctgt taaaaattaa 1900320
 tacagattgg tatttaggag tcagggtatc actatgcatc cctagctgac acatggtaaa 1900380
 glaagccaac taggtttctc ctttagttat aactgtggag tccagttata gacgccacag 1900440
 ttcattgaaa cccaacacca gtttaataa agtcagacta ggataagaag caggcacaga 1900500
 cagacataga caccacagac actcacatat cacccatcca tactctaaa atggtattct 1900560
 catgttttgg ggtttgtttg tttttgagac agagtttctc tgtgtagctt ttagagcag 1900620

 gctggcctgt aactcagaga tccccgcct ttgtctctg agtgctggga ctaaaggggt 1900680
 gcaaccatca acgctcagta ttctaatttt taaagaaact atatccattt agttcatcct 1900740
 ggtaagacaa ttaacaatcc taaaaaatgt agagtagcag ggcgttgggt gtcacgcct 1900800
 ttaatcccag cgctcaggag gcagaggcag gttgatctct gtgagttcga tgctagcctg 1900860
 gtctacagag tgagttccag gactagctcc aaagcaatac atagaaacc tccttaaga 1900920
 agcagagaat gtacagtaac tcttgaagaa gaaacaattt ctaataataa ttcagcatta 1900980
 aaataccatc atggctctag taatcatcat gtaaagctt atagtaaagt tacttatata 1901040

 agtaaagtta cttatagtaa ctataagtaa ctaaaaggac cctataacct ataaatagg 1901100
 gaagcatcca cagactcagg catgcatact aataaatgaa agccaatatt ctgagtattt 1901160
 ttagacaat cttcattact cattatgtcc aagtgaattc cttacaataa gtgaaggggt 1901220

tgattcagtt gagtgtcttt gaactcaatt ctaactact tcaacattta gaattaaaca 1901280
 gtaagggca atactgcttc cacagagttc ctgagttcag ttctcagcat ccacaaatca 1901340
 agaagctcac aaacgcctct taactccagc tctagaagta ctagaagtag agtgtagtcc 1901400
 aatgcttttg gcctacatgg acacttgcac tcaactggcaa cacacacaag catatgtaca 1901460

 tttaaaagtg atttacaatg gtgtgcattt taaattgaca attgacaaaa gattgttaat 1901520
 tgtcttacca ggatgaacta aatggatata gtttctttaa aaattaggtg aggaccttgc 1901580
 ttctttcaat cttttctcag aaatgcaatt tcttccaaa atacagatga atttatgtg 1901640
 cattggtgct ttgcctacat gtatgtctat gtgaggttgt cagggaagta ttagaactga 1901700
 ttttacagcc tgitgtgagc agccttgtgg gtactgggaa ttaaatctgt gtcctatgga 1901760
 agagcaatca gtgctgctca accccagcca tctttctagc cccagatgat tttttttca 1901820
 taagtgatgt catccttttt taagcacagg gtttctctgt ggctttggag actgtcctcg 1901880

 aactagctct tglagtccag gttggttggc aactcagata agtgatgtca tcttaaatat 1901940
 ccttaataa tgcattgcaa tttttgttgt ttttgagaca gcatttctct gtgcagcttt 1902000
 acagaccaga gatctcacat agatccgctt gcctctgtgt ctcaagtgtc gggactaaag 1902060
 gtgtgggcca ccaactccgg gctacaaagc actttcaatt taaaggttta aatacaata 1902120
 gttaaaataa tgagcctaaa agttgagaac acaaaatggt gacagatttc agctcaagac 1902180
 agccacaaat aagattttct atccaaaact atacagtta gacacatatt ttgtatgatg 1902240
 agtgttctaa tggctcacat actttagggt ttctctatca agtactcaa tgctttattt 1902300

 taatttggac tggcaagcaa tcaaagctgg tcaaaaaatg ttggtagttc tggtagtttc 1902360
 taagttttta tataatcaat ccacatactg tattttcacc ttactagggg tcaatgtcag 1902420
 tatctttcat tttaaatctg ttattggaaa acacaatctc ataatgcttt cagttaaact 1902480
 attatctaaa cacctgcaac aaaagtaatt gcagttacat actagggact tetgtagcgg 1902540
 cctcggaaac ttctatctcg acttctgtgag cggcttctgc tcctttcttt gcttctgctt 1902600
 cgtttccgtt cacggctttt gctcttttct ctttctctat ctctacttgc ctccgttcc 1902660
 ttacttttgc tccttttctg ctcatgacta cgacttctgc tcttgctttt ttttctctg 1902720

 ggggagggaa aagtaccatt atcatgctgg tgtaaatact aagtaataa tacttccttt 1902780
 tacggfcaaa atgtttatcc tttttaaata gtatttttta ccactgtaca atggtacaaa 1902840
 atcatacttt aggaaaaaat tcctaggcat gggacctaaa accccaacct ttgcttcatg 1902900
 ttaactgaat acaatcaaag aattgagaga caggtttaag aggaagaatt tgcaatcatc 1902960
 tcctgaggca gctacagctt gaaacaagag accgggactt gctggtaagt agaaaccaag 1903020
 cctcaacttc aaaaacaata taattgccat tcccctaata gaccaccaag caaacagtaa 1903080

taaaagttac agtatgttca catttaagaa atagtaattg tcatgtgaaa aatttccata 1903140

cagtaattta gttcaagtca attttgacac aatgtacatg tagtctgaac tttcaaaca 1903200

ccatatacat agcatttttg tttcatagga aaaattataa gaaatgataa aggacattaa 1903260

gaatgcagta aattcacttt aacaagccca gttttaatgt gaccatttat aaggtttcca 1903320

cttaaagcta ggataaaaaat ggaaaatgcc ctttttaagc tagtttatac aagcctatgg 1903380

gataaattaa aacaacttga ccttccttgg aaaagtaaaa aaaagcccat cacttatctt 1903440

cccatatatt tctgtgttcc tcacaatatt tcaccactg gtttaataat gaaaccttga 1903500

aatctgttcc tctgtcatca cccaaattag aggtgccttc agatatttca atgtaaatga 1903560

aagacatttc aaaataaatt tattccacca aaatgtccat ttttaagtgg tttgaagcct 1903620

gaacattttg acaactctac atcattagga aaattaatta gctatttaat ctgtatcaaa 1903680

gcaaagttag cacaagaacc actgaggcat gcctcagaga acctgtaagc aggtcatctt 1903740

agagtgcact gaaaatagaa aatggaaaca cccaccttct ggaatctcga aaccacact 1903800

ccaatcacia ggagatgtag agctttccaa ggaggcagaa actttgtcta aaatttcaag 1903860

ataatccacc tgactgtcag aaatatgcta ggtagcacat gacacaaaat taggctacac 1903920

tcatttatac agaagtcaaa gcaactcaa tgctcaaaag ggcaacaatt aacattcaa 1903980

ctttgatgtt tcaaacactg acaactattc ttaggactaa agaattctga attctgtaaa 1904040

tcctaccaaa ttaggggaca aggtaaaaat taatttcatt cccctggggg gaaaaaaga 1904100

cagcaagttt ttgctctgct caaaggcggc ccacagcaga gtcaatctta gtctgtcaaa 1904160

gaaacttaaa aaataactga gagagctaat ttttaactcaa tgtcttgcta gacgtttcat 1904220

aagcaaatcc ccaccacat ctgaaggcaa cccagatag gtaagtagac atactaagat 1904280

atcagaaaat tcaattttcc atataaaagc ccagacaaaa gataaatgtt gcaagaaca 1904340

aagatacttc tctagagtaa attccagcat taaagaacat tatcaactaa agaaatggtt 1904400

ataaaaatcc atcctaatag tcaaatcctg ttacaactta aatgggactt tccaagtct 1904460

ttagtggcag tggaatttgt actgaacatc attgaagtaa atggccact gggcctttgg 1904520

actttttggt tatatggcct ctgctgtaaa ggtgttttgc tataactgga tttgacctct 1904580

tccatgtaag aagatctaaa atttaaatgc aaagtattct ggaaaataag aaaaaaaaa 1904640

tagaagtcat ttattccaaa atttgataat ccacaccaca gtagccaata tattttaact 1904700

gtgccatttt actgttatcc ttttctaaat gattctttaa agactttaac aaaataaagt 1904760

ttgacttgag acttgcaaaa cttgtcacag caacatactt ccctgaggac gaacctaat 1904820

ccatagagag ttiactggag gccttgacaa acttccgtgt tacaactctt cagaaagtag 1904880
 gctaacagcg tgitatttca aacttcatcc ctactactg ggatagaca ctgtgtgta 1904940
 caagtcaagt acaatTTTTT tacacaagag ttatacaca tagctaactt tgtcagaatg 1905000
 tgaagtttct tctttctacc ttatcagcaa caattacctc caattcaata aggttttaac 1905060
 atgagccata caaaaatggt atctacctta ggtgaacaca aattatctta aatgagaaa 1905120
 atttatTTTT catccacatt aggttcaatt actttttgtg gcatgttctt tcaaataact 1905180
 agataaaaac ttigtgacta cattaggcaa tcacctaatt taaatcagct gtaattaag 1905240

 aagccttgaa cttttgaag atactactga ttaaagtatt tagggaagtc ttcctttaa 1905300
 acactatggt aaattgccca actgactctt tgcattagac aaaactacaa tgactaacc 1905360
 ccacccaaa aagcacaatc tctaataata tacatggtgc tcaaatgggt tataaaagcg 1905420
 tggatgtttt taatgaactt agacacagga ttcaaagaaa aactaaaga tattggtgga 1905480
 aagaagtgac attaaagaat gtcaaagatt tgcattcaag tttatctca tcctttcaa 1905540
 ccttaagatc aaaatcttta ctatgtcact ataaatatga catctgaaga aatTTTgtt 1905600
 ccaggatTTT atTTtgatta taaaattatg aagctgaaaa tttaggaaac tgttactctg 1905660

 gcaaaggTTa aaaatgcacg atatgaatcc tgcacactg ctctctgcat ccacttctga 1905720
 ccagtataga acctgattca acccaatcat gcataagaaa aaatttacac taatcagacc 1905780
 tgtgttttct cttaatatta attcattttt gtatttctta caggatctca ctatgaaacc 1905840
 caggctggca ttgaatttat tatgatcact atgcctctac ctaaggaggg agttataaac 1905900
 ctacatccat acccaaacc acatactaat agtaatccat tactacacca cattaaaatt 1905960
 ataaaccctt tgcttagcaa acctaaagtaa cccattgagc attttctcat ctattttatg 1906020
 aaattgtatc aacctaccta acaaagttgt tgtgaggatg actgaggtag ttactatgat 1906080

 gcactttgag ctcttaggag gaaaagagcc aaaaagagtc aagtaagtgg ctattttatc 1906140
 atcattttca ttatttatca cggggtcatg atatgacaaa cttttggtat ggcatacata 1906200
 acatgggcta gaacttaatg catatgacca tatcatgta agaactacta attttggagc 1906260
 taaatgctaa ttttacaaca gctgataagc tccaacctta taaattggat cctgtttaaa 1906320
 ctgttaacat aactttgtat attgtattct gtactaagtc tatagcatga agttcttatt 1906380
 tcagattact cacctaacc aaataaatta catattctta acggtctctt tagatacact 1906440
 aaagataaaa aggcccaaaa caatgaagga aaaaatttta caaagaatta ctgcaaaaag 1906500

 ggcttttaag ctgcaaggag cagaaataac tcatagccaa ttcctttagt gaatgaaggt 1906560
 aaacacagta ttttctgtgg ccttgatttg attttttttc caatgtaagt ctcttaattc 1906620
 aatgattatc acatctccaa aaaaattaag ccaaggttac caaatttaa acattataga 1906680

actcaagaga atcatgggat ccttgaaggg aaaagtgtcc agaaggtctc tgaaccata 1906740
 tgctgaagtc tacatcgcaa agtccatagt tttaaatcct gaaggacttt ctcatccaa 1906800
 agggatgac cagttttcta agaagcgaag aaaaccacag tttgatgctt taggcacaag 1906860
 aacataagat ttccaccaca agaagtttag agcccacct cccaggttcc ttgttcaaac 1906920

 ttactttttg ctacgttctt catggccgtt agcactgctc aacttgttct catcctaagc 1906980
 aaggttgata gaagaacatc atgaggacga agtggtaaca tttcaagttg tcaaagggtta 1907040
 aagggaatag gaataagaaa atacaagaca attttaaac taattactta tttagtctaa 1907100
 catggaagge tataaaaaaa attttagatgg tatatgttta accactttgt tgctaataat 1907160
 taagtcatca agaacaacaa aattaaatc tttccacatt aacatgttat attttacttt 1907220
 ctacattgt ttagataata aataagttaa ccagagttac aaaacgttga agtggttatt 1907280
 atttttatga aacatgaagt cactgagttt tattccatgt gctattgtcc cttttgtcgg 1907340

 taccatggct ctatttctgc ctaagcccca agtggccatg ctagcagcca gccactatcg 1907400
 atttctgtg accgatgcca ttctgagat ctctgcccac ttccgctgga gggttgggac 1907460
 tgtaagagct tgatgccacc tctgtcacac atctcgcct gaagcaaaca gggattcaca 1907520
 ctgctttagt aatgttgact cccaagaacc caagaaaagt taattaataa ttcaccagtc 1907580
 cagcctaac atttctact tccatactg ttacatgga attacatcca cgttaaacata 1907640
 agacaagaaa cattaaaaac agcaaacacg tctcaagag tctagcatta taaattatac 1907700
 tattttataa ctatcagaat tcatcaaaa ggaaccacat ggtcgtgcta cactcaaaa 1907760

 caaatgtatt attttaaatg gtttaagcgc aatgtttatt tcaaagttg aacacatcag 1907820
 ctacgtagta taictgctaa gttacagagg ctaaggtttg tgacaccagt gataatgcat 1907880
 gcatactgct attttaccac ccaagtgggg gaagaaggaa gagtgtttac ttttactctg 1907940
 aactgaaac gggatcatatt gtattactaa tcaaaataac tcctttgtag tttttagtgt 1908000
 gaaatacttc ggcagggcct aattaaaac aaaatactat ggagaacagt aaaacagtca 1908060
 tcaagtgact ctaatttgtg acattgcctc ttgcttttg ttttggtggt tttatattgt 1908120
 tttgttttgg tttctgctaa tgtctattca gggatccaag aatttcagta attattaact 1908180

 gaaaagcaga tcagcacctg cctgttttaa ggttactatc gccagccttg tatctattta 1908240
 tataaaataa attttaaac tcaaccattt ctcttttaa gactcgtaag atttacttgc 1908300
 cacagactgg ttatgattta ttcttgacc cctgctattt tcccaaacca ctacattcac 1908360
 ctttttgc ataccaaact ggagctggtt atcttagtt gagtcatttt acctagggga 1908420
 ccacgttaca gcgataagtc actcaattac taccttatga ttgacagttc aactggaat 1908480
 caaagtgaa ttcatgggag tagagtgag atatcgtag gcaagtctac aaagagat 1908540

agatgggcat ttattcatca cgctgaagtg aaactactgc acaatattat tacatcaata 1908600

 gcataatattt acttttgtaa gttacacgta atgcatctct gataagataa tcaagagggc 1908660
 tccgggaagg ttagtttaca tttcagcagt agtttcgtga ataatgctaa attaagaaac 1908720
 atattaaagc tcaactggcat gtttttctca ctttcttgta aggggcctca agcatcgctt 1908780
 caatatcaat atcgtctgcc attttctcta cacgcctagg gaagaacaag acagtctgtt 1908840
 taagtaaca acgactaatt cgtctaaaaa cactcgactc ctggcctaa aaaaaaaaaa 1908900
 ttcagatfff tgagaaaagt ccttagttta aaaaaaaaaa aaaaaagcc cgacaacgac 1908960
 taaaactgcg cgacgcacgt caacaaccag aggcttgacg tgggcgagca aacgcgaagg 1909020

 gctcctcctt ccagcaaacg cacgggccga gccccgctc tcatcgcgca gggcggcccc 1909080
 tgggcccccg aggccccacc gcagcggcgt acggagcgca cccggggctt ccttccgcac 1909140
 aaaaccgctg ctgccatctt agcggcgggg agcgcctcc gcggggaggg gttgtgtacc 1909200
 gaggcggcgt tcggcagcgg ccatgttggg gnnnnnnnnn nnnnnnnnnn nnnnnnnnnn 1909260
 nnnnnnnnnn nnnnnnnnnn nnnnnnnnnn nnnnnnnnnn nnnnnnnnnn nnnnnnnnnn 1909320
 nnnnnnnnnn nnnnnnnnnn nnnnnnnnnn nnnnnnnnnn nnnnnnnnnn nnnnnnnnnn 1909380
 nnnnnnnnnn nnnnnnnnnn nnnnnnnnnn nnnnnnnnnn nnnnnnnnnn nnnnnnnnnn 1909440

 nnnnnnnnnn nnnnnnnnnn nnnnnnnnnn nnnnnnnnnn nnnnnnnnnn nnnnnnnnnn 1909500
 nnnnnnnnnn nnnnnnnnnn nnnnnnnnnn nnnnnnnnnn nnnnnnnnnn nnnnnnnnnn 1909560
 nnnnnnnnnn nnnnnnnnnn nnnnnnnnnn nnnnnnnnnn nnnnnnnnnn nnnnnnnnnn 1909620
 nnnnnnnnnn nnnnnnnnnn nnnnnnnnnn nnnnnnnnnn nnnnnnnnnn nnnnnnnnnn 1909680
 nnnnnnnnnn nnnnnnnnnn nnnnnnnnnn nnnnnnnnnn nnnnnnnnnn nnnnnnnnnn 1909740
 nnnnnnnnnn nnnnnnnnnn nnnnnnnnnn nnnnnnnnnn nnnnnnnnnn nnnnnnnnnn 1909800
 nnnnnnnnnn nnnnnnnnnn nnnnnnnnnn nnnnnnnnnn nnnnnnnnnn nnnnnnnnnn 1909860

 nnnnnnnnnn nnnnnnnnnn nnnnnnnnnn nnnnnnnnnn nnnnnnnnnn nnnnnnnnnn 1909920
 nnnnnnnnnn nnnnnnnnnn nnnnnnnnnn nnnnnnnnnn nnnnnnnnnn nnnnnnnnnn 1909980
 nnnnnnnnnn nnnnnnnnnn nnnnnnnnnn nnnnnnnnnn nnnnnnnnnn tcaaggtcgc 1910040
 catgaggcgc ctatgacaga acgtagggcc gcggggtgag cgttcgtgag gacgcgcgca 1910100
 ggctgcgccc gagtgggaa taaagacttc cgtgtcctg tectctggtg tcgccgctga 1910160
 gaggcgaccg ccgtgctgaa gccacgaaa acaccgggac cctgacgagg gcgggcgggg 1910220
 aggaagaag tgcttctcc ctctctccg gttccctcac cgcgggcggc cttgtacacc 1910280

ctcagttcag tgggctgtgc gtcaggattg aggccttctt ggattttggc tgtccacgtg 1910340
 taaatttacc gcttttttaa tctgtttttt cctggagttt ttttttgcgg ggggggcgtt 1910400
 aatactgtcg cagaggaaaa gctgcgaggt cattgtaact tttgtttccc cttttcatag 1910460
 gaaagcaaac gtttaaaaat aaaatgtgaa accaattttg aacctgtca gcagcttgag 1910520
 ggtctaaaag agtcacagtg tgaacacctt gattggtgtg tagcttctgc aacgctgtgt 1910580
 gacctgggc gagtcaatta agctctcggg gcgtatattt cacttctcc tcataaagaa 1910640
 ggagggagaa tattgtaatt agtagcaagg gaaagcttga cactgaccac caaggctgca 1910700

aatgttgatg gaatgaattc caggtttagc agggaatgtc tatccaggtg aactccatga 1910760
 aacgaatgaa ggctcattag gagaaggggt gaggaataag cgacatgatg actgaaatgc 1910820
 tggaaaaata atattttcat cattgaaaac ttctagggt gacaatgcag ctctgttggc 1910880
 atattgctta cctagcatgc ctgagggagc atgtctgtaa ttccagcact cagaaaacag 1910940
 gcagggcct ctttgtgaac atgagatcag cctactgtgg ggagctccag gccagccaga 1911000
 actacaaca agacctagag gacatgtaac cataaagaga ctcaacactc aggagccaga 1911060
 gccagccaga cctctgtgag tctgagtcca gcctggfcta caaagcaagt accctgacag 1911120

ccagaactac aaagagaac ctgtctgga agaagaggag gggcaggtga ggggatggga 1911180
 ggttgggggg agacttgctt tctctctcag actttataga ctgcctaaga tccgggatag 1911240
 ctccaactga aaacctacac ttccaactt cccaccagt aaggggcctt agtcttctt 1911300
 gcaggcattt tgaccatggg gtggaggcag acagaggtgg cccttaccat gaatgaggat 1911360
 ggtcttgccc tctgttctt ttagagctgt ccttaacaat cctgtcctgg gatgacaaat 1911420
 caaggacaac ctgtgacacc tagtgaaagc ctatgaaaag gacaaaaggg gagctggaga 1911480
 gaaggtagtt aaggtcactg actgctcttg caggggactg ggttttgatt cccagacttc 1911540

atatacaaac tagagtttga gaggatctct agcccagtgg tggaggcga cacctttaat 1911600
 cccagcaata caccctatt cccgaggcag atctctgtaa gttcaaagcc agcctggtct 1911660
 acagagatag ttccaggaca gcctccaaag ccacagagaa atcctgtctc aaataaataa 1911720
 ataataagta tgetggatct gtatatgcta tggtttaate tacagtacac tttaaatact 1911780
 tttctacttt caactttcag gcagaagtat atttcttgt tttcatttgt ttttttttt 1911840
 tttttgtttt gttttttttt ggtttttcga gacaaggttt ctctgtggct tcagaggctg 1911900
 tcttggaaact agctcttcta gatcaagctg ggcttgaact cacagagatc tacctgctc 1911960

tgctcccga gtgctgggat taaaggcgtg cgccaccact gcccggcctg ttttgtttt 1912020
 caaaataggg tttctctgtg tagctttgga gcctttctg gaactcattc tgtagaccag 1912080
 gctgtccttg aatcacata gatccacctg cctcttctc ctagagctgg ctttaagga 1912140

atgcaccacc ctgctcatgg gccagatggt ttatgacctg gagggaatac ttgtgtttat 1912200
atggccttagc tgctagagta gcaattcttt agaatcaat ggacacaagg aaccttttaa 1912260
attgtctctt gtcattgggt aatacttctt gctagcttat aatcaagaat tccaccacag 1912320
ttagcaacat ttgaagggtg ctgacataga aacaatattc cttttacata caattttcaa 1912380

atgatgctaa aatagcaatg aaccatgctt aaggcctaag tatattggcc ttgaagtgtg 1912440
gctgtattac tttcccagat attttcagag aatcttacia actagattaa acatttgta 1912500
atagttaaca aaaataaaga aaaaaggagg aagaagcagc agaagtagta gtagtagtaa 1912560
tatatttggc caggcgggtg tggcacacac cttaatctc agctctcggg aggcagaggc 1912620
agaggcaggt ggatctctgt gagttcgaga ccagcctggt ctataagacc tagttccagg 1912680
acagcctcca aagccacaga gaaaacctgt ctcaaaaaac aaaacaaaca aacaaaatta 1912740
ttttatttgt ttacattggt tttttgagtc agggtttctc tgtgcagctc tgattgcccc 1912800

gggacttgct ttataaacia gaccaggata gcctagaaca gagattgtct gcctctgctt 1912860
ccccaagtgc gaggattaaa ggagtgtatc accatgccag tctccaaaaa agaaaaggctc 1912920
attttgcaac actttgagat ataacttcaa aagctacaaa aactatagc taccttaact 1912980
atcctaaaaa gctgctctct ctcaccattt ttttttttt aaagccagga tctctatgta 1913040
gcttagaagt cactctgtag accaggctgg cctccaactc agagatctac ctatctctgc 1913100
tgttattggt ttgtttaaa agaagaaaag agaaattgct gagacagaca tattgactat 1913160
aagtttatta taaggccctg cagaatgggg agactaagag gaggaacagg ggtaaatggc 1913220

tgaccgcat ggccggtcgc catagagaga cagagcgggg aaacagagac aggagagcac 1913280
gcagagagag agagagacag ggggagagag agagagagag agtaaagggg caggagctta 1913340
tcttttaaag gggctctctg cacctgcttg cagacttctt tccatggaa cctcgggctg 1913400
accagggtat tgctgagtg gattccacca ggtaacaggg gcaggccagc ataatgctg 1913460
aaccttcat ctgcctcca agttccagga ttaaagctgt ggaccaccac tgctgactca 1913520
ttcaaggtct tgtttgtag ctttttttt ttatgaacat gctgctgaga atttatcaat 1913580
tttaacactt atttatgca tatggatggt ttgattacat ctgtacacca tgtgtgtgcc 1913640

tggtaccate aagagacaa aagagagaac atccaatccc ttcagctgga gttacatctg 1913700
tgaggttcca tgcgggtgct ggaaggtatc cagatctct ggaagagggg ccagtgcct 1913760
gaactgctga accgtctctc cagaataccc ccaaagagac tttttcacg aggtcaacat 1913820
ccttagccct taaggaaatc cattctgggt ctcactttaa ccccagcaag taggcagatc 1913880
tctgtgtctg tgagtttcag gccaggggc tacatagtag aaaacctgtc tttaaataaa 1913940
atatttgta acaggaaaa taaaagacc agaaactgat attgggttc aaactccaag 1914000

ctgaaggaga gaaaagcaaa gcagctggca ctagctttca cctcaagttc aggctgaagg 1914060

ggctgggtcca catatgagct cttaccaag cctcaaactc tacctctccc cattgtggcc 1914120

agagaatcct gagacttcaa tgtcttccca tcctctttga tactgagcct tectgtcttc 1914180

agtgtgactg gagaatcaat gactgatacc gactagtga gaccctgctt atatctttta 1914240

taacctctca gccctgggtt taaagacata tgatctgtta ctcttttaga ctgattcaac 1914300

cttgtgtccc tgggtggct tgaactctga gagatccatc tacctctaata cctgacttgt 1914360

acaactaaag gtgtgtacca ccacctccta gcttctggct gttgggatta agtgtatgcc 1914420

tggtttctat ggcttgagc tgactttgct tcctgaatcc ttaggcaagc ttaataaat 1914480

cataaataat atatcatgac aatttattag tcaggtttct ctagagaata gaagtgatgg 1914540

aatgaatgta tatgtataga ttcatatatg taggtgggat ttattagtgtgttctgagt 1914600

agctcaacaa tgctgtctt cttacagaaa gataaaggac ctgctagtgtt ttcattccag 1914660

gagactggat gtctcagctg tcacaatttg ctgctaaggt caagaagtcc cagagagctg 1914720

ctgggttttag tcttcttgg aatcctgaag tagtagttct aataccactg aagaaatacc 1914780

ttaggaatgg aatagatggg aaaagtgaag gcttcttct tccaggtcct tttatgtgca 1914840

ctgctatcag gagatgtggc ccagattcag gatggatcct ctacctcaa taatccaacc 1914900

aagacaagat cctgacagat gtgcccagct acttgggttt tagttaattc cagatgtaga 1914960

taatggtgat gactagccat cagatgtgaa gagtgatcaa aggacacacc tgatgttggc 1915020

ccctagactc ccatgcatg tggacaatat ccatgtgcac acagccagaa atataccata 1915080

ccttctctca cacaaaccag tcagtaaata aataaataca aaataaagaa aaaggaaaaa 1915140

aattatttaa cctagctgga cctaaaagt caccattta acccagcact taggaagcag 1915200

agagaggcca atacctgta attcaaac agcttgatct acacagcaag ttctaacca 1915260

tccaggacta catagtgagt ccctctctca aaaaaacaaa agaaaacaaa aaaatgattt 1915320

aaccttaca gatgttctag tttatccct actggggatc taaccacag cctcaggaaa 1915380

cctatacaat aaacaaagca aagcttgtt tttttaagga cattgttccc taggggcagg 1915440

aaacatgctt tgagacagat tactaagaga caatacata aagcatcata ggaaaattaa 1915500

agctatagga atgtgaactc tgaaaaatc agagacttac ccttgtgcat gtgtaggag 1915560

ggcaaaaact cagataaagg agtgtttcca aatagccaag tgggctgtca ttcacctggc 1915620

tccgcttccc aagtactgga attacaggcg tgtatagtca cagaaggctt actttctctc 1915680

tctctctctc tctctctctc tctctctctc tctctctctc tctctctctc tctctctatt 1915740

gtttttcaag acagggtttc tctatgtagc tttggctgtc ttggaactca ctctgtaagc 1915800
 caggctgacc tcaaacctcac aaggatctgc ctgccgctgc ctccctgagtg ctgggattaa 1915860
 aaaaatagct ccaccacagg cctgcatctt ctttattttt tgaattatt ttactttttt 1915920
 aatcattgcg ctaaagagggc agacgttggt ggatctctat gaggttcaagg ctggctctata 1915980
 tagcaaacctc gaggctagcc aatgtgatac agtgaggccc agtttaagga gaaaaactat 1916040
 tctatttata tgaatatttt acctgcatgc atgtctgtgt actaagtgtg tgctgggtgc 1916100
 cctcagagggc ctggggagat cattagatcc ctgggaactg ggagttacaa atggtcataa 1916160

 gacatgtgag tgctaagagc ccgcaaatca tcaggcccat taccagtgtc cttaccact 1916220
 gagccaattg tgcaatccca ggtaaataca aaatagaatc ttttttgaa gtttttttaa 1916280
 aaaagatttt gtttattaat tatatataca gtcttctgtc tttgtactac cagagggtac 1916340
 catatctcat tcaaggtggt tgtgagccac catgtggttg ctgggaattg aactcagggc 1916400
 ctctggaaga gcagtcagtg ctcttaacca ctgagccatc tctctagtcc aacaatcttt 1916460
 aaaaaagaa aagttactgg aaggtggtgg ctgacacctt taatcccagc acttgggagg 1916520
 cagaagcagg tggatctctg tgagatcgag gccagcctgg tctacacagc aagttccagg 1916580

 acatgctcta gctacatgct cctgtcttgg aaaaaaaaa agaaaagaaa aaagaaaag 1916640
 aaaagttagc tgggcagtat tggcacagca ctgggaaggc agaggtagtt gtttctgtag 1916700
 gaagaggcca gectgatcta cagagctagt tccaagatag ccagggttac accaagcaac 1916760
 cctatcttga aaaaacaaag taaataagta aggaagaaaa atcaaaaaag aaagaaagaa 1916820
 aagttagaaa gctgggtgtg gtgacctatg ccattaatcc tatgcaatta gtaggcagag 1916880
 gcaggtatag tttgggacca gtctggtcta tatagtgagt ttcaagacaa ctagagctgt 1916940
 ataatagatc ctatctaaaa aaaaaaaaaa tgggggtggg gggtgaagag atatgtgcag 1917000

 gcaaacatc caaacacata aatatgaaaa gaaagaaact ttaagaatga ccatcatagc 1917060
 cagggtggtg tgggtggcaca gcctttaatc ccagcactca ggaggcagag gcaggtagt 1917120
 ctctgtgagt ttgaggccag cctggcctac agagggtgtt ctagaacagc caggggtgta 1917180
 cagagaaacc ctgtcccaaa aaaacaaaca actaaaaaga atgattatca ttagtggaat 1917240
 tgtttgttc agcattgtta aacatctgaa ataaagtaaa tggcccttct ttgcttcctt 1917300
 ttctttctgt atatttgttt gttctgagac ttggtctctt ttacatagcc ctggctatcc 1917360
 tgaaactcac catgtagacc aggttgcccc tgaactttca gagactcacc tgccctctgcc 1917420

 tctgccttct gagtctgag attaaagatg catgctacta cactcagctt taaacctttt 1917480
 ttaaaaaat tttttttaa aataatttat ttaactttat gtgtattggt gtcagatcct 1917540
 ctggaactgg agttataaaa tgcaatgtgg gtgttgggaa ttgaaccctg gcctctgga 1917600

agagcagcca gtactcttaa ccactgagcc atctctccag accctaatac ttacttttta 1917660
 aaaaataac ttaatttga tttatacat ttggtagtt ggtttgtta ttctattgtt 1917720
 tcatgtgtt tcttttatg tgtatggccg tttagcctgc atgtatgtct gtacatcaca 1917780
 gacatgcctg atatcttcat agggcaaac aggacattag atttccaggg gctggaatta 1917840

 ccgacagttt cgaatcttgc aaccaggtc ctctggaaga gcagccagtg ctttcaacct 1917900
 ctgaaccate tctctaggcc catggtttct tatatttta tttatttatt tatttatttt 1917960
 tgagacaatc aggcctggaa ctactatgt agaccagtct ggctttgaac agagctctac 1918020
 ttgcctgtcc ccctagtgtc gggattagag agacctgtaa caaaaacaga tggatctatg 1918080
 tgagtggag gccagcctgg tctacagaat gagtgccaga acagactcca aagctacaca 1918140
 gagaaatcct gtctgaaaa aacaaaaaca aaaaattgta tatagagaga gacctgtaac 1918200
 actgcactct gccttagggg gcatacatag tttgtgctct tgaagtagtc tgcgtagact 1918260

 tactctttt agtgactagg caaaaatgt tttttcttc cttgtgctcc cctacttaga 1918320
 atattgcaa atgctgaaa tataatgact gcacttagtt ttcctcatcc tcaactaggg 1918380
 attagttaag gctgaagaa ctcaaaaact atccatcaaa gtcagtctgg aaggacctca 1918440
 ggggtgggccc aaaactcagg ttgcctgggg ccaggccttg tggagttgag gctctgggag 1918500
 ctctagtctt tgtggttcta gcttctgag ttctcatgcg gtctgacagc agagctccct 1918560
 tctgggtatg ttgtgggtg ttgggctgat atgatgagta tgtatgatg tatgtatgta 1918620
 tgtatgatg taggtatgta tttgagacag ggtttctctg tattactttg gaggttgtcc 1918680

 tggaaactcac tttgtagatc aggcctggcct gactgccttc tgcgtgctag gaattaagta 1918740
 tgtgacttac cttttaga gttatcttag atatgctatc tcaaatcaa gtaggaaaac 1918800
 aaaagatcat ctgggctag agagagagat cgttttagtag ttaggaacat ttgttactct 1918860
 tccacagggt ctcagttcaa ttctgaggat ctacatggga ctaatagcca ctggtgacca 1918920
 cagctccagg caatgtgatg ccctcttctg gtctccactg gtacagcatg cacacggggc 1918980
 acaaataac atgtgggtga gacaccaata tattaaatca aaataaatat tttttacaat 1919040
 ttaagaaga atttgaatt tgttttctc ctattattag ttgggcaagg ataatgatta 1919100

 ttagtatatg aatgtgtgat tgctgggtgcc aggcctgta agcggagttt ctcccaata 1919160
 accattcaga gacttattat taattataaa tgcctcagtca atagctcaga ctggttacta 1919220
 gattgctttt acattttaa ttagccttct tttcttctt gtttcttct tcttttttt 1919280
 tggtttttag agatagaatt tctctgtgta actgtcctgg ctgctcttga acttgctttg 1919340
 tagacaagge tggcctcaa ctacagagtct ctgcctccca atgctgggat taaaggcgtg 1919400
 tgacaccact gccgggtccc taatatattt tttaaaaatg ccttggttta taactttctt 1919460

tgttctgttg ctatgaaaca ccatgaaact acttccatga agtagttaat ttaaatctgt 1919520

 gttttgccca gggcataatc actcacactt tggttccaaa aattctctct tacttccttt 1919580
 gacttgagag ctgtttttgt gtggacaatc tcagtactcc aggggcaaga tatgtgaatt 1919640
 actgtgagtt caaggttaac cttttctatg tactgagttc cagattagcc agggatacac 1919700
 actgagactg tttttaaaca aacatgaaag gaaaatagaa cgacacacag tgtgggtaga 1919760
 taagcaaagg cacaggacac agaagggtaa ttgataggtt cagtagcata gagaagtgat 1919820
 gtgattagac ttataattta tgaagcacia gtttgggccg ggagttgggt gcacacacct 1919880
 ttaatccag cactcgggag gcagaggcag gcggatcgct gtgagttcga ggccagcctg 1919940

 gtctccagag taagtgccag gacaggctcc aaagctacac agatcaacce tgtctcgaaa 1920000
 aatcaaaaaa taaataaata aataaataa taaaaataa aaaaataaat aaataaataa 1920060
 aaaaataaaa aataaaaaga agcacaagtt tggttgcttc cagtgtcaag tcatgactgc 1920120
 ccctggaaac agcaatttta acacttctgg ttggcacttg ctgagtcccc ctgtgaaaac 1920180
 ctctcttttg ttgtggctgc atctttgacc ttggtccta gagacaaaat acagccccc 1920240
 ccccccccc ccccccccc ccccccccc cacacacact ccttgggatg agagcaaaga 1920300
 cagagtaag aaggcgcagt cgaggacttg gaagaggcgg agcacagagg gcagactgga 1920360

 tgtgtgagaa tgagaaagcc tggtgacaat cgagcttga gacttagctc ttcttctgga 1920420
 gaggggaact aggcgtttga aaagccctcg cgcgtgaagg acggattgca agaggaaagt 1920480
 aacgagctgt aaagaccacg gtcttcgtgg agaccagtga cagaaggctg gaggaaagtg 1920540
 ggtgacttcc agaggcatta agttaggagg cgaattagga cggcagatgg gcagcatccc 1920600
 ggccccggtt tctagtacc tcagcgggtca cgggtgagtg cggactcggg gttcccgcgt 1920660
 cagggaggtg ggctggcct gctcgcgtg tctcccggg gaccggacgg ggcggggccc 1920720
 ggggcggggc cgccccggcg ctgcgtcact cgatggtggc gatggtgcgt gtgtgtaggg 1920780

 ggccggggat acgctgggcg cgtccccggg gtcacgtggt gcgcagcgcg cacagtcctt 1920840
 ctgtcggttg gtctggagc nnnnnnnnnn nnnnnnnnnn nnnnnnnnnn nnnnnnnnnn 1920900
 nnnnnnnnnn nnnnnnnnnn nnnnnnnnnn nnnnnnnnnn nnnnnnnnnn nggttgcccc 1920960
 cgggagtgac ggccaccgcg gccaatcagc gcggcccag ggggctgggc tgcgaggtgc 1921020
 gggccccggg cgcggaacag ggcaagtggg gtggggaggg gtgctggagc tgcacccctt 1921080
 gcttgccctg tgagattagg gcgcagccta cactgctgcc tctgtcgcgg gaacacgttt 1921140
 tctgtcagtg cttttcttat cctgctctgg gaagcacacc ctttctcaa gaccctgtat 1921200

atgggagtgt cctttctcta tagttttgaa aatctgggcg tcgctcccct tccttaaact 1921260
ctagtctcgg gattttctca gtttctagcc atccctaaga acggactgaa ggcattctcg 1921320
cttctctttg ctccctcaata ctgaggggaa actcccata tcaaactgaa ttaacagttc 1921380
tcctttttca gtttgggggt cagtctgctg ataggtcctt gagaagtcag gctctgaacc 1921440
aaagttttgc agtactttat tatacccac aactctgagg aaaggaatcc ttcttttcag 1921500
gccccaaatc tggcatgctt cagtagtgaa tttgagggcc agtttttgtt tttgtttgt 1921560
ttgtttgttt tgtttgttac tttggtctac ggtgagcatc tcttttcggg ttctagtcca 1921620

atcctgatgc ttatggctca tagtttccag tttcatctat aagaggattc gctgacttgt 1921680
ccttaagtct gtccctgggg ttgtattttt ttctttgttt cgccaagctt acttgtttct 1921740
gggggagact ggttttcccta tctgagagtg tgtttgcttt ctgggtctct ttagggtttg 1921800
agatgcacct cttttaggag gacacatacc accgtggggg gtgcagcagg gctgggcaca 1921860
cctttctctt gaatcctccc attcctagat ggggtagttc ttgagcacc ctcaccacc 1921920
ggttttccac ctgtcctgt tttctaattg aaaaaattat ttatttattt ggtgtgtgcc 1921980
ataacatgta tgtggcaata acaggacaac ttgaaggatg ttatctctct gcttccactt 1922040

cgtgggttct aggaatgaaa ctcaggtggt cacttgtggc tgcaagtgtt gagccatcca 1922100
gctagccagt cctcctgttt tgagaccagg tcttgtctgt tagctctcca ggaaatagtg 1922160
tgaagtccca gctggcttta aattcatgat cctcctgcct tggcaccgga gctgagatta 1922220
caggtgctct ttctatccc ctttctctt aagcttttct gccatgcaag atagtccac 1922280
tcttgggttt ctttcccct ttagaaccac attcccctc atgtgctctc ccaggtctg 1922340
tagtgtgtct ctttggctt ctttctctg ttgaatgtgt atctgcagaa cactttctgt 1922400
attgatgcc tctcccaca gggcagttct tttagtcacc ctgcccagc ctttcttct 1922460

tgacagaate ccttccaca cccatgagac tttcattgtt cattgtgagg cctgtctca 1922520
cgaagtgtt caggttatcc tggaaactac tgggttgtct aagtggctt tgaacctatg 1922580
atccccctgc ctgagctca caagtctgg ggattaccgg ccagaactcc ggtggcgtct 1922640
gagttgtgtg gtgcaactct ttagtcccaa tgcaagcagg agatctctga gttggagccc 1922700
agcctgatct gcagagctag ttccaggaca ttcagggcta cacgaaacc tgtcttgaaa 1922760
agcccccaa aagaactacc atgcttggct cacatttata tatatgtagt ttatcttct 1922820
gcaaatagga attctctttt ggttactgt ttgtccaggc attttctgg tttctggttc 1922880

ctgttgaca ctgttctgt tatctggtga tgataatgtt tctccttct cttcctctgt 1922940
gttggagatg gccgtaagac caggctgtct tgacctgtg ctacagtcaa aatataaaga 1923000
aatccccctg taattttga ttattcttag aactcttagt cctccgatgc ttacttct 1923060

gtaagtttct ggigaagctc ttaatagttt ttgtggatth gatcccagca atcatggctg 1923120
 gaggattgth gcaaatttga gggctgcctg gtccatatga tgagctccag gctagctagg 1923180
 gacttatagc aagagcctat ctgaaaccaa cagatctgat taggtaggct ctattccttt 1923240
 acttcccttt ccctcaagcc gtgcacacac acacgcacgc acgcacgcac gcacgcacgc 1923300

 acgcacgcac acacacactg tcttcttttt ccctcaagac agggtttctc tgtgtaggct 1923360
 tgtctatctt ggagctcact ctgtaggcta gtctgacctc aaactcatag agattgcctg 1923420
 aggcctggga tcaaaggtht gcaccaccac tgcccagcct cttttttaa cttccctgth 1923480
 ctgggttggg gcttcaagag atttttctac taatgtatgc cttctagccc ataaactacc 1923540
 ttccattagt tctctgatac aagcaaaaaa gtcatatggg ctcaagtgtg attatttggc 1923600
 tgccatgtgt ggagggtctt gatttgattc ttagcatgaa aaactgtggc agcttgattt 1923660
 ggtggcagac acctttaatc tcagtactta gggggcagag gcaggcagat ctctgtgagt 1923720

 ttgaagccag cctgctctac gtagtgagth ctagaacagc cagggttatt tagagactgc 1923780
 cttaaaaata aatgaatgaa aagaaagaaa gaaaaaaaaa ctgtatgtct ttctctcctt 1923840
 catcttgaat atctgaatat ctgtctgtct tttctcccaa cccccatttt taaaaaaaac 1923900
 ttcaaacacc tgggacatct tgtcttaata gatcctcact gctaataatt ctctttccct 1923960
 ctccagagth ttgcataggc cttttcagtc ttgaaccctt gattcatttc tccacagctg 1924020
 gagthtcaaa tgctgagggg ataatgactc ctctgacctt tcttcttttt gggaagtact 1924080
 tgaatgtgca gctgaaggag gcatgaggca gggggaaggg agthtggcta tgagaagcta 1924140

 taccagtagg acagggcagg aatatagcat ttcatgacct aagtactgaa tctcatttgg 1924200
 aaactggaca thtgccaggc acctgcttcc tagggatgct ggaggattta atggtacctt 1924260
 gggaacctgt aggaattaat ggggttttct gggaggtgcc ccaactcagt gtgagaacgt 1924320
 gaataaaatt gaccatcatt atgttttggg acagataagc tgcctcagat ttttttgttc 1924380
 actaaagtac tagaactaag ttgtgttatt tcaagaaggg aaataaatcc cttgttcagt 1924440
 accacattta thtatttatt tagatthttg gaggcagggt thctctgtgt aacagcccta 1924500
 gctgtcctgg aactagctct atagaccagg ctggcctcgg actcacctgc thctgcctec 1924560

 caggtgctgg gattaaaggc ttgggccacc actgcctagc acatactaca thtctttaa 1924620
 aaaaaaaaaa agaaaaggth ggggtgggtg ggtgggggag gtctgtttga thtagtacct 1924680
 ataaaatatg atctgctgaa gtgaacaggth agthttgtctc thtatttggc thttgctgct 1924740
 ctatctgtgt agtgctgtaa gcactccctt gaaggccctt acattcctgc thctcatcct 1924800
 gaatgtgact thaatgacc tgcttgtctt ggtctgtat atattccact ctagthttttg 1924860
 ggtggtgtaa agatagggaa ctacacattg agtagccaga thccatata cagctgaaga 1924920

gcgaatcctc agtgaaaaca aaactgattg ttaacaaatg ctggggattt gttctccatt 1924980

ttctctttgt ccagacacac aggtcaaagc ttgtacaatg taccggattt cttttttctt 1925040

tcttttttgg ttttcaagac aaggttttctc tgtgtagcat tgaccatcct ggaactcatt 1925100

ttgtagaacg ggctggcttt gaactcacag agatccatct gcctctctgc ttctggagtg 1925160

ctgggattaa gggagtgtgc caccactact ggcccaattt cttttttttt ttttccctcc 1925220

ctatttttag caaaaagaaa aaaaatcatt ttatgtgttt gcctgcatgt atatgtctgc 1925280

actatgtcgc tgcatgccta gtgccacag aggtcaaaag agggagtgtg atcccctgga 1925340

actggttata gtcagtttg agttgctttg tgactgccag aaattaactg gggtcctctg 1925400

aaagagcagc agiactcttc tttttttttt ttaaaggagg tcaagtgttt tatttatttt 1925460

ttagagattt atttattttt atttatttat ttattatgat ttattatgtg tacagtgttc 1925520

tgtctgtatg tcgctcgcag gccaggggag ggcaccagat ctattacag atggttgtga 1925580

gctaccacgg gttgctggga attgaactca ggacctttgg aagaacaagc agtgagtgtt 1925640

cttaaccact gagccatctc tccagcccgc agccagtact cttaacctgt gagccatcta 1925700

tccagtcag aaccctccc ccgaactttt gagatagttt gctgttttga getccagget 1925760

gtcttctctg tcgtcgtctt tttttttttt tttttttttt ggttttttgg ttttttgaga 1925820

cagggtttct ctgtggcttt ggagctgtc ctggaactaa ctcttgtaag ccaggetggt 1925880

ctcgaactcc cagagatcca cctgcctttg cctcccagat gctgggatta aaggcgtggg 1925940

ctaccaacgt ccggtcgttt tttattttgi ttttttttag atttttttaa taatgtatac 1926000

aacattctgc ttccatgat atctgcacac cagaagaggg caccagatct cataacagat 1926060

ggttgtgagc caccctgtgg ttgctgggaa ttgaactcag gacctctgga agagcagtca 1926120

gtgctcttaa ctctgagcc atctctccag cccaaggct gtcttcttac ctcatagtct 1926180

ggtactgtag atagttgcca ctgtttctag ctaaccttta gcttttttaa getgtctgta 1926240

aaatttactg gtttctctgt atattgccag atttaagtgc ttaaataat gttgctttaa 1926300

ggtgtgtttt gcctggtgtt ggtggtgcac gccttttate ccagcactta ggaggtagag 1926360

gcaggcagat ctctgagttc gagggcagcc tggctctacag agtgagtgcc tggataggct 1926420

cgaaaccctg tctctcgaat aatgaaaaaa gaaaaagaaa gaaaaaaagg gaaaaaaagg 1926480

tgaacttttt tttttttgcc ttgggtatgg gtttgaacca ggggtttgta catttaagac 1926540

aggtgtctct ctgctgagct cctgtacccc aaggctctgat gggtaatttt tgacatgaaa 1926600

taattctagt aagtattgag tagccagctt gtttctgact cctctcttgt tactgtgaga 1926660

agggaatcag gatacccac atcaagccac tggagtttct agagttagtt ctctttggtt 1926720
 ttctggctct tcagatggac atgagaaggt ccagattgca gctaggtgct tggccttga 1926780
 tggaagctgt cggacatctg taaatgctct agaagatagt cctggggagc tggtgccatt 1926840
 tttgatgagc ttttagtttg tgatactctc tccttgtgtt atagggggta tttctttcct 1926900
 ttatatTTTT taaagctagg ttctcttata tagcctagac tggctttgaa ctctctctgc 1926960
 tcaaacctcc aagtgttga attctaggca tctgctactt atgcccagct ctcaactgggc 1927020
 tttccactc tgaatctctt aaatcattca ttctgtttg cctgttagct ttcattggccc 1927080

 tttccaatg tgatctact ccaggtcttg atcatgagga acctgaatgt tttgtgtccc 1927140
 tgatcttccc ctaaaccctc cattctcac acaaatggca gattattgtc agtgacagat 1927200
 ttgatctgga tctggcactg gtcccagctc ttatgggcac atgtaacctc aggcaaatca 1927260
 ctttgtgctc ttatggctag gcctcattct ccccagctga atactgagca gttgactatt 1927320
 tcaaggtcca ccctcacag attctgcagg gaccttgttt agaaaccag ttgcctgcag 1927380
 gagcgctag tagctggctc gatttcttc acgtgcttca gctggcagac tgccaatggt 1927440
 tttcttgtcc caagtcactt ttgctggcac tgtctcttt ctagccaaac agccagcttg 1927500

 tcttcacgcc caatgtcaac attcttctgc ctctgtgttc tcttgtcagt tgtgggctgt 1927560
 atttcattca gaactacttc aggttctcaa agaagtctga cttgagtttt ccattcaata 1927620
 ttagctgctt gtctgcatca ctaagagagc agctgtttgt ttttaggct gtatttcaaa 1927680
 tataatcatt tacttgttaa tgcttttatt ttttaaatg atttattttg atttttagt 1927740
 gttttacctg catgtatata tgtatgaagt tgtttttgtt tttgtttttt gtttttcaag 1927800
 acagggtttc tctgtgtagc tttggagtct atcctggcac tcgctctgga gaccaggctg 1927860
 gcctcgaact cacagcaatc cgctgcctc tctctcccga gtgctgggat taaagtgca 1927920

 gcctgtatgt agttgtttaa tctctggaa ctggaattac agacagtgt tagctgctat 1927980
 gtagttgctg cgaattaac ctgggtctc tggagagca gccaatgtgt gtgtgtatgt 1928040
 gaaaagtatg tgtgtgtatg tgtgcatttt tggagccaa agttcttcaa tcaactagac 1928100
 attttatatt cattcattta tttagagaca agattttact atgtaaatca gacctcaaac 1928160
 tcacagagat ctiacttcat cttgcttggf acaccctca tgccactgcg gactccacc 1928220
 cccccccc cgcaaaaaa ttattcatt cattcattta tttatttatt tttggttttt 1928280
 agagacagtg tttctctgtg tagctttgga tctgtctctg gaagttgctc tgtagcctag 1928340

 actggcctca aactcagaga tccgacttcc tttgcctacc aagtctggg attaaaggcc 1928400
 tgtgccacca ctgcccctgt taaaaattt tttttgagac tgggtcttac cacatagatc 1928460
 tggctgtcct ggaattcaca gagatccacc tgcttctgcc tcccagtgct tgggattaaa 1928520

aacaattta tttacttag attttttct tttaccacc tcatttattt gttatttttc 1928580
aatcttaatt aaaagccttt ttttgtgtgt gtttttgctt taatgaatgt atacttcgtg 1928640
aatgcagtgt cctctgaggc cagaagaggg tgtgggattc ccttggaaact agagttacag 1928700
agagtggga gctgcctcgt ggggtgctggg gattgaaccc aggttctctg gaagagcagt 1928760

gctcctaate actgagccat tttccagcc ccatccctgt tggttcttga ctaacaatga 1928820
ggtaacctaa tagctttgtt ggattcttgc ctaggctctt ccagtggac cttggttatt 1928880
tggccaaatg gaactaatgg gctttcagaa atcttgcaaa aatttagaga gtctggtatt 1928940
agtcaccag tgtaaatagg atggttgtgg gaaagagagg tgggtctgga gtcagtggc 1929000
tttggaaaag gactcagagg tgttgtttgg ggaagggttt aaaatggggc ctttattcca 1929060
tgaaggaaca taatcctagg aattcaggcc aactcctagg tgtgtgtcct aggggagtgc 1929120
atgtgaatgt ttttttcta gtaggaacct gtgattttag aggtctctcc caaatgaaaa 1929180

agatctaate ttaattcca ttacacctt aatactagca ctgagaggca ggagcatctc 1929240
tgaatttgag gccagtctgg tctacacagg gagttccagg ccaggtgaga ctgcatagtg 1929300
agacctgcc tttttgtttt gttttgtttt gagacagtgt tctgtgtgg ctttggaggc 1929360
tgtcctggaa ttaggtcttg tagacaggc tggctttgaa ctcacagata tctgcctgct 1929420
tctgcctccc gagtctagg attaaaggcg ccagcacgcc tggcgacct gtcttaaaaa 1929480
gagagtgggt gtgggtgtct acagctgggt ggattgattt acctttctgg cttctgttgg 1929540
tgcacagatg attgaaatac caaggttgtg gaagtctgtc atagaaatgt gggacttaa 1929600

atcctgctgc ctctaccagg agcaagggtt gcaggatgct accatgcctg actcttcatt 1929660
ttcaaaaaag gaaacatagc agttccttat cgttagtata ctaaagatct ttttgtgtt 1929720
gtttgtttt tgagacagg tttctctgtg taacagcctg gctttcctgg aactcgatca 1929780
gtaaaccagg ctggcctaga actcatagag atccacctgc ctctgcctgg ctcatttat 1929840
tttttaaat aacacacaat tctatttga tgtatgtggg accatacact ataacatgag 1929900
cacacactca aagaaaagta actgtccctc ttccagtagc catcaattgc cacagctcct 1929960
cagctaagtg gaagactggc ttgatcttat gcagctctac ttaggtaac catagctgct 1930020

giggctttat gtgtgcaaca gctatgtcct atccaaagga cagcagttcc cagcagcct 1930080
ccccagctc tggctcttat tctttccacc cctcttcca agatgttctt tgggggatgg 1930140
ggattactat agattctcag cacgttgtca gttttgagtc cctgaattaa cactgctca 1930200
ctgtaaaaag aagcttgtct gtgcaggttg agaatagcac aaatctgtga gtataaacct 1930260
aaacatctag gaggtgcttg accatatac tgaccattta gcaaagcaat agtagctccc 1930320
ccaggcctt taagcacttg agccagggtt ttttgaccg gtttccaata tcaaaaggcc 1930380

tttttaaaga aagctatata gtggcatgaa gtccacttc tcagatttca gcttttctgc 1930440

 ttagccaggt gccatatggc ctttccctac cttgtaggtt gtgggtcatt gctgcctgtt 1930500
 tctctgcatt gttggaaatg ggatttttgt caaggatttg gtatgtggca aaaactgaac 1930560
 agatgttata taattcctgg aattaatagt taaggaaggc ctgggataaa agttaatatt 1930620
 taaagcgtaa gagaattagt tgtcactaat tgtggtggtg gtgcacacat taagtcccag 1930680
 gcagatgtag gcagatctgt gagtttgagc ccagcctggt ctacagagct agttccagga 1930740
 cagacaggaa tacacagaga aactctatct tgaaaaaaca aatagttgaa tattaataa 1930800
 tgtgttttta acattctata agcaacaaaa gggatgcttt tttcaaggaa aaacttagtt 1930860

 tagctgtgtt ttctatgac tttcagaaag aacacacatg taccaggta atggtggttc 1930920
 atgccatga tccaatact taggaggagg ctaaggcaga aggattactt caggagctaa 1930980
 cctggactac agagtaaatt tttatttcaa aaaaaggaaa tagggggaga aaagaaaaaa 1931040
 gaatctacac aaaactcact acaagcctgg ccaaaggcag gtagatttct gtgagttcaa 1931100
 aaccagcctg gtctatatag caagtccag gctagccagg gccacatagt gatccctgtc 1931160
 tagaaataaa ccaaaaagac aaaaaccaac caaccaacca aacaacaaa caaaaaacce 1931220
 tgaaaaatag aacagcaact ccccccccc aaaaaaac caaacaaaa cccaaaacca 1931280

 agcctcactt gagacctcta ctcttcagtc tctagacaat ggaggtactt acaggetgag 1931340
 gtccccaggg ccigtgaaaa gtagtataaa attttgcag acccttgag aaaaataatag 1931400
 cctgtcttca ggtgctattt tttccttagg ttttgccacc tccctgtgtt tccaaagagt 1931460
 actatTTTT tttttaaaga ttttattat ttattatgta tacaacatc tgcttctgtg 1931520
 tatatttga caccagaaga gggcaccaga tctcataacg gatggttgtg agccaccatg 1931580
 tggttgctgg gaattgaact caggacctt agacagcaga cagtctctt aacctctgag 1931640
 ccatctctcc agctcgagta ttattaataa ttaatagttc atatgtttt gtatgcagag 1931700

 catttttat tttgtttt ttattttatt ttttgcttt tcagggtttt agcacaatga 1931760
 tgtcctttaa tctgcatag gatggtactg acattcttcc acttctctag tgaggaagct 1931820
 gaggttacca ctaacaagt gtatgtcaca taaggctact gcctgttaga ctgggtgcc 1931880
 catcaagagc tccttagctt ctagaagagt tcagctgcaa cagtgtctca gtcaactgtc 1931940
 atgagaagag gatacagaac tgatgtctg ttgagaggta ctgatggctg tgcccaggcc 1932000
 taatggatga gggcgggct tttctgcaa gttcttcaa gcagtctgga ttggtagggc 1932060
 taaggctgc aagattagta gccttgacag tttattgtga gccaagctct tggacacct 1932120

gtgaaggtaa gcactagctg ctgatcctca atgttatagg ggaggagcct cagtctccgc 1932180
 acgaaatgac ttgttcaaca ttttgtgatc ccagcctagg ccaccctgat gcagagtctt 1932240
 ggcttagatt cctgcttcc ctcccttcca gctcccgtct ttagagaccc ccatttggct 1932300
 tggcagtaca gtgtttacct ggaatcagac cacctgtttt ccagatactg tccttgtgtg 1932360
 ctcaaagctg tcctcacaca gaatctcctg ctccccctc tcaggttctt aagtgaagg 1932420
 attataggtg tataccacca tgcctccct gcttgtgtgt ttgtggggca tgtatacatg 1932480
 tttgtgtgtg ggittatata taatcacttc cctcaggcgg tagaggcagc aggaaggtcc 1932540

aggtccaagg tcactctcag ctacatgaga tcccatctaa aaaagaaaaa gaaaaaatta 1932600
 ccaaaatagg ggtggatcct taattgggia ccctttggca aaggagaaac cttaagtag 1932660
 gcctgcaga atggtgacca accagaaatg aaataaact ggatgtgtaa tcttgccac 1932720
 ttgaaaagct gaggcaggag tttggctata gaataagacc atgtcgaaaa aaagaaagaa 1932780
 aaacacaaga agaaaggtgt tcagggcatt gcttgtgtca ggctggagc cttccttcca 1932840
 cagtggtgga cagggaggag gagtgattgt gagggtaaga tgttccttta gtgagctga 1932900
 ggaataggcc agaagtcata gagaaaaagt attccagga aaaacctggg cattaggctc 1932960

tcccactgac tgggaaagt tccactgatt cagccagctc attctcagta ataggaagga 1933020
 gtaaaactcaa cccatttagt tatggaagat aagcttgggg cctcagagaa tgcagtttg 1933080
 aatatggctt tgaaaacagt gtttactgt ataactcagg ttacctcaa cttggggcag 1933140
 ccctctttgt atcagagtgt ctcttattt tatttatctg tgtgtgtgtg tgtgtgtgtg 1933200
 tgtgtgtgtg tgtgtgtgtg tgtgtgtgtg tgcgtgtgtg tgtgggtgtg gggcggagga 1933260
 ggtgggttg tgggtggcg tgtgctgtgg cacctgtggc gatcaaagaa catctttttt 1933320
 tttctttgct tttttcaag atagggtttc tcttgaactc acagagatcc acctgcctct 1933380

gtttccaag ttctgggact aaaggcatgg gtcatcatct ggccagatga caactttat 1933440
 agtgtcagtt ttctcctcc atcttttatt ttattttta tttttgaga cagggtttct 1933500
 ctgtagcttt ggagactgtc ctggaactag ctcttgtaac caggctggtt tcaaactcac 1933560
 agaaaccctg ctgcctctgc ctctgagtgt ctgggacaaa aggcgtgtga caccaacgcc 1933620
 cgacaagaaa gatacttata taaaagaaag tcttttgttt taatttattt atttctatg 1933680
 tacaataatc tgcctccatg tatactgca caccagaaga gggcaccaga tctcataacg 1933740
 gatggttgtg aaccaccatg tggttgcnnn nnnnnnnnnn nnnnnnnnnn nnnnnnnnnn 1933800

nnnnnnnnnn nnnnnnnnnn nnnnnnnnnn nnnnnnnnnn nnnnnnnnnn nnnnnnnnnn 1933860
 nnnnnnnnnn nnnnnnnnnn nnnnnnnnnn nnnnnngaga gagagagaga gagagagaga 1933920
 gagagagaga gagagagaga gagatgggga gatgacttag atgaatgagc agttaagagc 1933980

actggccctt ctctcgagg acctggatta gattctgact tagatgactg agcagttaag 1934040
 agcactggcc ctctctctgg aggacctgga ttagattccc agcacccata tggaggttca 1934100
 caaccatctc taactgcagt tctctggggac ccaactcttc ttctgcaggc accagacacg 1934160
 catgtggtgc acagacaatc atgtaggcaa aatgtccata cacataaaac aaaaaacaac 1934220

 cttcataaaa ccaaaccaaa ctgtccctcc cctcctagtc ttcattcttc tatcctgtca 1934280
 gtctaataga ctgttagtgt gagctaggag aaggccctgc ttgaaacct tgatgttggg 1934340
 ataaactacg gatttattta tttgtagcac agatgtgcct cagatttact gggttgtgcg 1934400
 ggatgatctc agatatctgt gtccacctgt tgggcttgc tcatggagtc tggcatttat 1934460
 tttatctcgt taaggttctg ggaattgcac tcacagctcc tgcatgctaa agcacacatc 1934520
 ctgtgccgtg tccccagtc ctgtgataga cattttaag gaccttagag acttttctgg 1934580
 tctgatctc acagatccca agatagaggc caataggctg tatgatagat aacaggaaga 1934640

 aaggcctgag gagtagctg gtaaacagaa ctggagtgg aattaggggt ctgtggacag 1934700
 tggtgccac ttccagcact tgggaggcag aggtaagcag ttacaaaagt gatttccagg 1934760
 ccagccaggg ctgccaata agaccccacc taagaaaaa actaacaac tetgggatga 1934820
 gcctcttctg atagagtgtc ctagaatgtt ctgaattgc ctctctctgt tgtgggagct 1934880
 tcccaccact tgcctctgac tcccacatgg ctactgtggc acatgggccc acacatacac 1934940
 atgcacatga aataaatgaa agtgaataa aaattttaaa tggaaaaata ctctcttgtt 1935000
 cctaaatgtg agcattattt ctaaatttct ccagaactgg gttaggagg ctcttggttt 1935060

 ctgtcacag atgaatcttt tgtattctgg gttgtggtct tctggtgaa gtgtcagagt 1935120
 ctgggattcc aagcgtcttc acagcatgct ctgccctcta cctttaggtt taaaagatga 1935180
 ccgctgctag agtcccagct atgttccact tccccctca caggggccgc attagcttgg 1935240
 tctttctga aaacttaagt atttctgctt gttgtaaaag gtgtgtaat getagcacag 1935300
 cctttgaaag gcttcagtgg ctttatcttc cttattcaa aattgcctc tatctaaagg 1935360
 cgtgaataca aacaagcaca gccatgtctg cttcttttga taacagggat ttctcatgct 1935420
 tggatatttt gttgttacat tcatgttgat ttttatttct ggttatgtgt gtcccatgtg 1935480

 ttagatacc cacagaagcc agaaggcatt agatttctg aggcctggagg ctgttgtgag 1935540
 ctgtccggtg taggtgctgg gaactgaact cagatctct ggaggagtaa cgggtgccct 1935600
 tcttctgta gactcctctc catctctgcc ttgtatcttt ataaccttat gtaatctggg 1935660
 aatgcctgat gcttcagctt ttctgcaact atatctctc agtatcatgg gaacaagaaa 1935720
 tttagctta attgtattac ctggttttga aggtccagta acacagtata agtataatat 1935780
 tctttaaaat tttataatcc tatgtgaagg tcaggggaa agcttgtggg agctttctac 1935840

cgtatgagtt ttagggattg aactcaggtc ttcaggctta ctggcaagtt tacctagaga 1935900

 gacatgtttc cagtcacaa atgaattctt gcaattaaaa atttgtgcag caacaacaca 1935960
 aaacaaaaaa aatttttgta tgatataccta gtcacatgatgg ctcacatgcctg taatctcage 1936020
 acttgagaga ctgaggcaga aagattgctg tgagtttgag accagattgt ctatatagac 1936080
 atagtgagtt ccagaccagt ttgggctaca gggagaccct gtcctgaaa atataaaatt 1936140
 gttttgattt gcatttcctt taacttaggg tgcttatgtg gacatggacc tttgtgtctc 1936200
 cccttgctag tcagtataat ctgacagctc ttgcattttg cccatttttg gcatgccttt 1936260
 ttacctttgt ccttagttat agcactcctt gttaataaag gaagttgcct ctttgccta 1936320

 atgagctata gttatttgc cctttgaact gtgctccacc atgtgtatta aagctctcat 1936380
 tactgttgac tcagggcatt gacagagcac tgtgtctaag taaacacatt gggcttccgg 1936440
 tctcctttgg gccagtggat tctgttttag agtttgaatg ttaggagtat tttgaagttc 1936500
 tgccagctct gagagtagaa tctatagat ctcacaggc tttttatatt tttggttttt 1936560
 caagacaggg tttctgaata gctatggagc tagtcctgga actctctctg tagaccaggt 1936620
 ttgtcttgaa ctcacagatc tgtctgtctt tgcctctga gtgctgggat taaaggcaag 1936680
 tgccaccacc actgggcaga aattgtttac attaatcct ttttgtgtgt tttctgtgtt 1936740

 tgtgtatatt taagtgtgaa catcatagga cgactctctg gaatgtgttt tctgctgtcc 1936800
 atccgagtcc actgagccat ctcaccatct catgtgagac ttttgtaaag attaaaattt 1936860
 aatattgttt gagctgggac ggtactctgt agccctagct gacctggaac ttgatatgta 1936920
 gaccaggtgt gcctggaact cacagagatc ccttggetct gcctccccag tgctggaatt 1936980
 acaggtgttt accaccatac ctggccctta gcagttcaac accatggaga ctattttcag 1937040
 gagccacagg aaataatttg gtcacttca ctcacatggt cctgcttcat gcctatatta 1937100
 tttgtttatt ttttctctga gacagggttt cacaatgtag tcttggttgg cattaaactt 1937160

 tcagtgatcc tctgcctct gcctttcatg ctctttgatt ccacgatgt gttaccacat 1937220
 caggcttgat tgattgctta cactctgcag tgcgaattga atacaggacc ttgtgcttgc 1937280
 tgggcaaatt cttttctgcg gagccgactc cccagcacta tagagttcat ttagtcaagt 1937340
 ctggcctgga attggagctt gaaatgtagc cgaggataac cttgaactct tttattgtac 1937400
 ttactctttt tgaacagaa taagtcagtt tctgtgtaac tctggctagt ttgaaatttg 1937460
 cagatagcag atatcagcct gcctctgtct ctgcctctgg agtgcctggga ttgaagtca 1937520
 gttctactgg actcatgata gaccaggtg gcctcatatt ctttgtgttt cttctgtttt 1937580

agcttcttga gaactggaat tgtaggtgtg tgcataatg cttggccttc cttttgtttt 1937640
 taaaggatta atttttatgt gtgtatgtat gctgggtgcc atggaagccg ggcattggga 1937700
 tctcttggat ctggggatac aggtggttgt gatctgtttg atgttgggta ctgaactttt 1937760
 ggtactctgg aaaaaaagt aagaggcctt aatcaggcct ccttcctttt atagtatttt 1937820
 agtttttttt tttttttttt tttttttctt ttttttcttt ttttcttttt tcaaggcagg 1937880
 gtttctctgt gtaacagccc cacaaaactc actctgtaga ctaggccagc ttcaaacctc 1937940
 aagaggttgg ccigccctctg cttctcaagt gcctggccttt acttaagtgg tttttgagat 1938000

 agggttctct gtatagacct gtctgttcta gaactcacta tgtgattata agtgctcagc 1938060
 caatagatca ggcttgtttc tctctaactc ttacattttc aattaacctg tatttttaat 1938120
 ctatgctttg ccatgtggct tggtagcttt tctcagtaca gcatgtctct cttgtctttg 1938180
 catgtctgg caactccaga ctccaccttc ctctctccca gaattctcct agtctggctc 1938240
 ccctgcccaa tccttctctg gacagctatt ggacagtcatt tttctttatt aatgattca 1938300
 tagcaacatg tattcacaca gtgtaaagga atattcaaca gtatactacc atgctgagct 1938360
 ttatttattt acttattttg agactgcatt atttatattt atttgggtct cactgtgtag 1938420

 taatggctgg cciggaacac acagggagag acctgcctgc ctcttcttct ggagtgttgg 1938480
 attaaaggca cgcaccacc tgatttattc cccccctctt cctttttttt gtgtgtgctg 1938540
 gatgggactt agggccttgt atttgctagc caagcctct actacttgcct gggtagcat 1938600
 gcagctctag aactctgttt tttccttgtt ctttttatgg taaggtctca ttagctcag 1938660
 gctggctaca aactccctag gtaaaaggat gactatgtac tttttttttt tttaaagcag 1938720
 aaagaacaga tagagtgtat tttatgtgia ttgatgtttt gtctgaatgt atatctatgt 1938780
 aatattgtgt gtgcgctgca gaaccagaa cagggcgta ggttctctga aaccaagtt 1938840

 atagaaggtt gtgagctatc atgtgggtac tggaaatgaa cccaggtcct ctgaaagaac 1938900
 agctattggc cttaaccact gagccatctc tccagcctag gaacagattt ataaaaaaaa 1938960
 ataaataaat aaaaaataag gaaacctctt gatgtgaaat gttgacaagg gaggaatacc 1939020
 aggcctagaa ctctgatcc tttgectcta cttgcttaga ttataggag ggccaccatg 1939080
 cctggctttg ttcaatgctg gggatccttg tgcgcctag gcaagtactc taccaactca 1939140
 gcctacaac tttttgtcta cttttccaaa agtagggttg gaggacaaca gtgtgtcttt 1939200
 tgttgtgtt cttgtttttt gtttttcttg ctttgttgtt cagagttggc atcaactccc 1939260

 tggggctcag ggalcctctt tcagcttcta agtcttggct gcatctcagc tcatactac 1939320
 gtcctttcta gcaactcaact ttttatagca gttacagctt gaactgactc ctgtttattg 1939380
 gctacatatt aatatgaagg ctccctcagg gtaaggattg ttcactctt tgggtcttga 1939440

ctaagtcatt tcigaacaaa tatttgttga atgtgtcatc gaggttgagc tacatcatga 1939500
 gaggagagca gttatTTTT ggagctctga gggatgaact tcatagggga gcccttggtg 1939560
 agccttgctg agaggggcct ctgaaatttc agagatcaca ggcacagtag aggagtgctg 1939620
 ctggtgggga caccggatag gaggggaggc accagagagg gtgctgacag ggtcatggag 1939680

 ctggtgttt tgaataatgc ctgcttgttt tttatgtgt ggtggtgatg ctacacgctg 1939740
 ggcagacttt cccaagtTtc ataaatattt aattggcttt ttcaggagaa taaaagcagc 1939800
 cccgttgatg actgaaaatg acaaagcatc cacctaacag acgaggaatc agctttgaag 1939860
 tgggagccca gttggaagct cgggaccgtt taaagaactg gtacttttat atTTTTtct 1939920
 aattaaagca ctttagggag ggagctctac cagcacctat agagtggTgc tgctgtcctg 1939980
 tttccggct tcttgaaga tgaagggaaa caagtttaga atataggcct gtttttctc 1940040
 tttgggtcac atttgttct ctttttctg tttgatggag ttatgttaa ggggagcagg 1940100

 ggttacctg ggaaggaag cgttctcact cttggtgcc tgtttgaaag aagagcagaa 1940160
 gtgagataga gatgagtgga tggatagacg caacagcacc catgcatca caacctccc 1940220
 tgttttctg ggtgtggcgt aggacgctaa gaattgttga acaggataat tagattgaga 1940280
 agctgagggg ttgtttgac tgcatgtctg aattttgctt gttttatgtg aaaaggTtc 1940340
 tgtaactat ggccgacctt gaattgatag ctgagcctcc ttaatgctgg gattacgggt 1940400
 ctctgcaact atggctggct tgtgttaatt gctttttatc ctctggctgt cagatacttt 1940460
 gaatgttcat gtcatctata aatgtggTca ctggtaatgt tggcatctgg agaggatatt 1940520

 ctaagagtca catattgaat atctggagag caatcttcaa aactaaactt acctgggtgt 1940580
 ggtggtacac acctgtactt cagtagctgg gaggctaagg taggaaggTt actgagaact 1940640
 ggagcatagc ctggcataat gagtctctcc aggtcagcat aaactacaga gtgaaatcct 1940700
 gaccccaaaa atccaagcta gccaacggaa attcaggttc agttggtaga gtgtttgtct 1940760
 agcatgcaca aagccctggg tttgattccc agcactggat aaatcagagg tggagaggta 1940820
 gaggcagggg tgtcagaggt tcaagtttat cctacctgct gcatagttaa tttgaggcca 1940880
 gctatggtta tataagacc tgcctgaaaa caagaagaaa aagaaaaaca gaacaactac 1940940

 aaagatagct gtagttgagg gcatcctaga ttttggttat ttcgtggTgc tccaaaacag 1941000
 ttagaagTtt cagaaccaca aaccttttga gtttttctaa ggaatagcct aacctgtga 1941060
 tagttatctc agaatagatt gagtgatttc tgggatatag ggaaaggaaa ggggaatggc 1941120
 ttgggtagaa aactgtgcta ttaggattaa agaccctgga actagagagt gagtTtgata 1941180
 aaatactgt ctggtatagg tgaggccctg ggttcagtcc ctagcacctc agaaataaaa 1941240
 gaaaaatagg tttggttga tttatactgg ttgtgaacag aattactgat tctataatta 1941300

ttttaatggt ggtttcagct attttgtatt ttttgtgtgg ggggcagtac atgtctgtac 1941360

 atgttttcaa gtgcatttgc ctatttgcgc atgtatggta gtcattttcc tgtgtatgca 1941420
 tgtggaagga agcattaat ggactcttct atcactgccc atcttgtttt ttgagacagt 1941480
 cactcagaga acctgactgg gcagggaggc accatgatct gcctgtctct tcccttccc 1941540
 caagcaatgg gccctgtacc tagtgcttgg gattcaaact caggccctca tagttacata 1941600
 gcaagcactt taccctgaa ccattttcca gccttgcag tcaaggggaa gtggagattg 1941660
 aacctgtgac tttgtgata ttagacaatt gtttcttcta ttcccagcct gtatttctgg 1941720
 tttagtttgc tttccactcc tctgataaac accacaacca aaaacaactc aggaaggaaa 1941780

 ggctctcgtg tctggatcat agttcacccc tgaggggaagc caaggccgga acctggaatc 1941840
 aggaactgat tgaagcagag atcacagagg aatgctccta gaggcttgct cagtttgttc 1941900
 ccttatatac tctgggacca tctgccaagg gatggcatgg cctaagtggg tgggctcttc 1941960
 ccacatacat tgtaataca gaacatgccc ttacatactt gcttacagc cagtctgact 1942020
 gaaggagaca ttttctcagg tgggtttcct ctcccagat attgacaaaa aattgaccag 1942080
 cataattttg tttttttga gacagccagt aaatttttta aatttatttt ttctttttat 1942140
 tcctctgtgt gtgtgtgtgt gtgtgtgtgt gtgtgtgtat gtgtgtgtct ctgtctgtct 1942200

 gtctgtctaa gtttatgtct gtgcacatct gtgcattagt ggaggtcaga ggacaacttg 1942260
 tggagattc tcctttactg tagaatcaga gaaacgcagg tcacaaggga tgtagtaagt 1942320
 gcttttatgc attaaacct ctgtctgact gtggttttga catttttgtt catttgtttg 1942380
 tttgagacag ggttgccta gaactcagag atctatcttt ctctgtctcc ccagtactgg 1942440
 aattaaaggt gttcactacc atttctggct ttggtttga ttttttttt aaagtgtgca 1942500
 ttggtatttt tctgtcattt atggctgtgt gagggtgttg gatcctgga actggagtgtg 1942560
 tagacagtta tgagctgcca tgtgggtgct gggaactgaa ctcaggtcct ctggaagaac 1942620

 ggctagtctt ttcaccact ctctagcctg ggttttgaca tttattgaag gctgtctttt 1942680
 actgactagg atgggtgata cacctatatt tctagcactt agggtaagac aggagttaa 1942740
 agctaacctg caatcttacc tcaataaaca gatagcccca aataaaaatg ttactgttag 1942800
 tgttatagtc aaggaatcaa gggaatactt ttttttttg aaagggtcta actatacaga 1942860
 ccagacttgt tcttgaactc acagagatct gcctgcctct gcctcctgag tgctgggatt 1942920
 actaccccg caacattttt tgttttaaaa atgaaaaaat attaggatag agataaagct 1942980
 aattataaaa taatttacct gtcaatcaga atcagtaaat acatttttgt ttaatttgct 1943040

taaaacattt tagaataaag gtcttatacct cctgcttcat cagccttctg aattctggga 1943100
 tttgttactt taaaaaatat attaatttta aaaataagcc gggcgttggt ggtgcagggc 1943160
 ttctctgtag ctttggagcc tatcctggca ctactctgg agaccagact ggtttcgaac 1943220
 tcaaagagat ctgcttgect ctgcctcccg aatgttggga ttaaaggcgt gtgccaccaa 1943280
 cgcccggctt atttttgaaa ttttaaaaat atttgtatat gaattctttt ggctgcacgt 1943340
 ctgcacgtat gtgtctggtg cccaaggagg tcagaggggg gtgggatccc ttggaactgg 1943400
 atttacagag agttgtgagc caccatgtgg gtgctgggaa tccacgggtc ctctggaaga 1943460

 acagccaatg ctcttaactg ctgagccagc tcatttttat gtgtgtatgt gtatgtctaa 1943520
 gtgtattgtg tagcacatgt gtggaggagc ctttggagat cacaacaggt atgagaagtc 1943580
 tgggcagtgg tgggtaatcc cagcactggg gggggggggc agagaatgac agatctctat 1943640
 gaggctcagg acagctttgt ctacatagca agttggagga caaccagagg ttttacacag 1943700
 agaaacctg ttcaaaaaa cagagaaaact accaccaaca aacagaagag gcactgtgtc 1943760
 ccctagaaca gttgtgagct gctgtgtggt gctgggacat gaactgggt tttttcaaga 1943820
 gaagtaggtg ctcttaacca ctgagcaatc tctccagctc aggatttgtt taattttgag 1943880

 acatagtcca aciggtagct cttggtggcc tggaaactat atccttctgc ctcaagactc 1943940
 ccgagtccta tgattatatg tgtgtgtcag tatacctgcc tgaactctct actttgctcc 1944000
 tctttccctt attacattta tttatttatt tttgggtttt ttttgagaca gggtttctct 1944060
 gtattgtttt agaggctgtc gtggaactct ctgtagaaca ggctggcctt gaactcacag 1944120
 agatcctcct gcctctgcct cccaagtgtc gggattaaag tcttgtgcca ccaacacccg 1944180
 gcaaattttt actttttaac atctgtgcaa gatgcattct gacagtgtc actggctggg 1944240
 acatttcatt gtttgcctag atcattgctt ctgaacgcct tggatagat ggaggtagtt 1944300

 acgctgtgag tatcacagca gtgtttctgc caggttgagt gtgtatgtt taaataagtt 1944360
 ttagttgttt ctttccittc tcctctgct acccaggctg gcctaggcta gtcactctcg 1944420
 gactcatgtt tcccatgtgc tgggattaca ggtgtgaacc atacctaac aacttactaa 1944480
 ttttgacaca tagattcttc tttggtttt tttgaggcca ggtttctctg tagctttgaa 1944540
 gcctgtcctg gaacttgttc tgtagcccag gctggccttg aactcacaga gtgctgggac 1944600
 taaagatgtg ttccaccact gtctggctag acacatagat tcttggcagc acttttactc 1944660
 tttcttcccc caggaaaaat gtacatttaa caccagact actcacgaga ccgaggtgag 1944720

 aggttggag ttcaatgcca ccctaggcta cagaggaatc tcaaggcagc ctgggctgca 1944780
 tatgcatage aggatccctc tctcagaaac aaacaaacce agggaagcca gaagagggt 1944840
 gaatgggaga gatcatgctt tgaatgctt agctcttgggt ttaattcca gtacagaaat 1944900

aaagaaagaa agaaagcagg gatgtaattg gacaaaatth caggtttact ttaaactttt 1944960
ttgttttttg agataggaac tcattctgta gccttagcta gcctggctag gggcaatta 1945020
gtagccagaa gatgagaatt tgataagttc atagagagcc atccactagc ctctgcctca 1945080
agcgtctggga ttaaagggtg gcaccaccac gccttggttc atttcatgag ctagccaggg 1945140

agacaagaca gtagagcaat agctggttca aggcagtga cttcatctta agatctgttt 1945200
caggatcaag gcttgtagac cgtcattact atgccagttg aaactggctc gtgtgggaaa 1945260
tctgactgtt accattccaa tcttgatttc ttatagccag cttggcgatc tgggacttta 1945320
ttgtgagtga ttccattttg atgttgagtt caggcttagt ctaaaacaat ggctctctgt 1945380
aactttgttt tagcagacca tttttggcag agtagaaagg gaggttctca gacaaagtta 1945440
ccaccagcag agcctcctc tctaaaagtc ttgcttatta tcagccggca gccagggaga 1945500
gctgtgttgg ctgagagga cccatgggat tcgtgactag ggtcagttac tagccagaag 1945560

atgagaatth galaagtgtg ttttcaagtc ctctgaaggt aaactatctg cttattcac 1945620
tgatatctca gagctcaggg ccttgtacat ctaagcaca agccccacta ctgcgcctat 1945680
gcctttaggg cagagagaaa gcaaaaatth tcttcaatgc tggatggagg gtctcataca 1945740
tgctagaaaa tgcctatta ttgagccatc cccaattca tacttttctc aatattgcag 1945800
aattagatag cctatttata ataaatttcc tagcaagcta agggattgtt tgttgtttg 1945860
atthtattgt gtgtttgtg cacatgtgtg catattttaa ggtgtgcctc agtacacgtg 1945920
tggaggaag aagacaactc acagggttat ttctctctg ccatgtctgt cctggggacc 1945980

cagctcaggt ctgagcttc acaccaagtg ctcttagccc actgtgccac ctactagcc 1946040
cctagaaatg aggttaagggg gctggagaag tggcacagtg ggtactagta cttgctgctt 1946100
ttctgagga tctgagtttg gttcccaaac tgagtggctc acaactgctt gtaactcagt 1946160
tcaaggggac cctacccttt tctagcctct gtgcatcctc gcacctaagt gacataact 1946220
tgtacaaaca tatatgcata cacataaata aaaatagatc ttaaaaatga atgagggaat 1946280
aaacaagaat cacagagga aaaatttctt tcccatatta cagagtgaat gaaatggtag 1946340
agctgggact tgaactgtt agtcggactc taaaggcaaa ccatgcttcc aagtggattc 1946400

ctcttgcta ttttctggat atgctactat ttgcatagta aggaaaaaat gggaagcata 1946460
aaaaataaca agttaattat atttttcttt ttcttctgtg tcttggact cattctgtag 1946520
accaggctga tcttgaactc agagatttgc ctgtctctgc ttccaagtg ctgggattaa 1946580
aggtgcatgc caccacagcc caacttagtc atattttaat aaacaaagca ggagtgtaga 1946640
tgggtgtttt atgttattag tttttgctat gttgcttatg cagaggcctg ggtctcctc 1946700
atcttagaat gctgcttgtt agacaaacag caatgacaac taacatgctt gcaggtttgc 1946760

tttgacaagt atgaggcttg ttgtccccag tggtttttac ctggactgtc tcatttagct 1946820

 ctctatagaa atgctcatct gtgcatggga ggtatatagc ccagtggtag agcacatact 1946880
 tacaacatcc aggctctggt ttcaatttct agctctaaaa taaagacata aatagaataa 1946940
 aggtttatth ggaattgagg ttcagagata aaatgatttt tttgtattht ttatttaaat 1947000
 tctthtaatta ccaactatath ttacatathc atcccccat tctcttgctc tcccatcctc 1947060
 ccaagttctt caccaacctc cccaacctcc cccaactcct ccccaggac cttcaaagtc 1947120
 tgtcatatcg ttggaggag ggcctaggcc ctcttgctg tatctgggct acaatagtg 1947180
 ccctcataa ggaatgggct cgataaatg atthtaaga cacaaatc ttactctga 1947240

 gtcttagact cacttagtth tgttgacag tggtgctctg agggcctcat agatttattt 1947300
 gtaaatcacc caggagagath ttctthtcac aatthaaagt cctaaagaag taatactatt 1947360
 ggtatthtth ctctthtggg gtcaggagg gagctggcct cacatthgtt gagatcctth 1947420
 tgcctctgcc tccaaagtcc tgggattgaa ggagtgcath acaacatctg gcttgagatt 1947480
 tgtcaaaaa aagaaagcat gcccaaacag ctggtgggca gaggtgtagc ttagtgacag 1947540
 gacacttgcc tgtcatgca gaagccgggg ttcagaggcc tgcctgcaa agagaacaac 1947600
 acagatgth aagctgagtg ggtggttact cctgttacc ctgcattggg aggctgaggc 1947660

 aggaagattg tcaaaagtth aaggccagct tgggtgath agtaattthc aggccagcth 1947720
 acaagtcctt gtctcaaaaa acagaactth aaccaagggt attctaatth tggagctgch 1947780
 gctthtgggc aaatgtctct ctgtagagg taattctgth taccggctc actcccagac 1947840
 ttgtgcagaa aaactggcth aggtgatggg ctctgtthga thtctagth aagatgctgg 1947900
 gtggatgaaa tagaaaatg ttgctctgct tgatgctthc acctctthc tgtcagctgt 1947960
 cagccgtgca ccatctgthc cagcagcagg ctggcctthc ctgtctcac actgagcaca 1948020
 gtgaggtagc tctctgctg gtgcctctg gatcctctg ccacagtctc cctactgtht 1948080

 tctagthaa gtctcatagt ttgtthcatt taaaaaatct gattthgca 1948140
 tcactthatt thtggthct ttatttaggg tgtgtgtgtg tgtgtgtgtg tgtgtgtgtg 1948200
 tgtgggagag agagagagag agagagagag agagagagag agagagagg ggagaagaga 1948260
 gagtgtctth gaatacacag tgttagagca tgcathgga ggtcagath ctgatgacth 1948320
 tgagtgtct gthctctact ctccactgt tagaacagg actthctgt thccaacth 1948380
 ctgcathctc caggctagct ggccaagag ctthtgggaa gththtctc aactthccac 1948440
 ctccacag aatgctgga thgcagtht gtctgtctc ctacattgg cattthtata 1948500

taggctccag ggatcaaaact caaatgttta agttggttat ggcaagcact tatatccatt 1948560
gagctatcct gtctaccatt tggtttcttt ttcttctttc ctttatttta attttctaaa 1948620
attttatggt tatggctgct tttcccctac atgtgtatct gtgtctgcca cccacagagg 1948680
cctgaagaag gtgtcagatc ttttggaaact ggagttacag aaagttatga gctacatgtg 1948740
ggttctggaa atctggagga gctcctaag ccttaaccg ttgatctatc tctccaacc 1948800
ctgctttctc cttttattag gattctttcc actgatcata ttttgggtgtg tggtttatac 1948860
ctcctttttt aaaaaaaggt ttttttagtg ccgggctgtg gtggcgcacg cctttaatcc 1948920

cagcactcag gatgcagagg caggcagatc tctgtgagtt tgaggctaac ctgatctata 1948980
cagagtgagt tccaggacaa ccagagctac acagagagac cctgcattgt aaaacaaca 1949040
aacaacaaa caaacattgc agtcctttta atatccgaag gcttgctatt atggatgat 1949100
gctagcatgc ctgccttctc ttcattttta ttgtgtatgc ttttataaaa taattatgtg 1949160
aatatgtgtt catgttaagt gcaggtgtct gaggagaaac attggatccc ctggagctgg 1949220
agttgtatac agatggttat gagctgctaa acctggtgtt gggaaccaa ttctagcttt 1949280
ctgcaagagc agcatgtgtt ccttaccacc aagccatctt tccatcttcc cccaccttc 1949340

tttcttctc tcatttttta agatgcacta atatttttat ttatgttca ctgcttgc 1949400
ttgaagtctc tcagtacat cctccctttg attctatgcc acagtcctta accacacaga 1949460
gctgcaacca accccttcc gtttttgcac aagtttgcce attccttagt tccttcttgc 1949520
catcaacct aattaggtta tttggtgttc agaacaagg acctcctac acttacataa 1949580
agtaggccta tacagatggg tgaaagcaca caaagatgga ctgggtgctt gtccaaaggt 1949640
tagcagcttt gtgaatccac acatccagta gcaatgtccc ctctttagcc ctgggtgtag 1949700
gtaagggaga agctgaatct tgaaagcacc caagtctatg cttctgtatg acttgacat 1949760

ggcaggctta tcttcagttc ttttttttt ttaagataa tttattta ttaattttat 1949820
gtgcatcggg gtgaaggtat cacatcccct ggaattggag ttacagactg ttggaagcta 1949880
ccatgtgggt gctgggaatt gaaccagggt cctctggaag accagtcagt gctcttaacc 1949940
tgagccatct ctcagcccc ttctcttccag ttcttatagt gttttattta tttattattt 1950000
taaagtaacc ttcttttct aagaattttg tgtatttctg tttgcctgtg tgtgtgatg 1950060
agagcagaat gagcatagtt ttattgtgga aaagtgagga agatctctca agagtgggag 1950120
gggctccaag gaaggagtac cttcttttct gagttttcca caaacgtata tcagatggca 1950180

ctacactggg tgtgtggata gaagacaaaa tgcacagatc cctgatgaaa ttcagagatg 1950240
cttgaggatt tgggtttggc cttaatggca aagcattggt agtcatatgt tcttatgatt 1950300
cctgtctttg ccaattgctc acatttattc agtgatttac tctgtgcaa gcaaattcta 1950360

aaagctttac attcaacacc tcacagtatt ctgagttacc tacttttaag tatgccatt 1950420
 ttatatatgg gtaacaggca caaatcaggt gactaagttg tatgaagta taattagtaa 1950480
 gtggtaagtt tgggattttt tctttttgtg attttccttt ctttctttct ttctttcttt 1950540
 cttccttcc ttcttctctt ctttcttcc ttcttctctt ctttcttcc ttcttcttt 1950600

ctttctttct ttctttcttt cttttggaga tagggtttct ctgtgtaaca cccctggctg 1950660
 tcctggaact cgttttgat actatgctag cctcaaactc acagagatct getggcctct 1950720
 gcctccccgg tgctgggatt aaaaacatgt gccaccacta cccggtgatc tatttcttaa 1950780
 ttatttgat tgagggttca tgtaactcag ggtagtcttg aatttaacca tntagcaaag 1950840
 gatgcctcct gaccttctg ctttttccc aagtgtggg attgtaggta tgagttatca 1950900
 tgctctgctt gaatttggga ttgataca ggtggtctca gctggccaca atggtgcaca 1950960
 cttataattc tagtatttaa gaggctgagg cagggggatc tctgtgagtt tgaggccagc 1951020

ctggtttaca gagcgagtc caggataagc ccaaagcta tacagagaaa ccctatctaa 1951080
 aaaaacaaaa caaaaaacaa caaaagtgtt ttccaagaag ctgagtttga ctctgttttt 1951140
 gtgtgtttag aatccatttt taagctttgt caggtctcat gtggaaa 1951187

<210> 32

<211> 179771

<212> DNA

<213> *Cricetulus griseus*

<220><221> modified_base

<222> (23560)..(23633)

<223> a, c, t, g, unknown or other

<220><221> modified_base

<222> (23967)..(24012)

<223> a, c, t, g, unknown or other

<220><221> modified_base

<222> (25012)..(25225)

<223> a, c, t, g, unknown or other

<220><221> modified_base

<222> (27207)..(27269)

<223> a, c, t, g, unknown or other

<220><221> modified_base

<222> (27558)..(27642)

<223> a, c, t, g, unknown or other

<220><221> modified_base

<222> (28034)..(28294)

<223> a, c, t, g, unknown or other

<220><221> modified_base

<222> (36588)..(36936)

<223> a, c, t, g, unknown or other

<220><221> modified_base

<222> (40895)..(41191)

<223> a, c, t, g, unknown or other

<220><221> modified_base

<222

> (112869)..(112967)

<223> a, c, t, g, unknown or other

<220><221> modified_base

<222> (145691)..(151881)

<223> a, c, t, g, unknown or other

<220><221> modified_base

<222> (175480)..(175497)

<223> a, c, t, g, unknown or other

<400> 32

caaggtttct tctgatgcaa tgacagttag tcctcagga ggaggcttcc atgtcttttc	60
cagatgaatt tctttaagtc ttgtgtacta aagatatgat atcttcagta atgggatctt	120
atcttatctt tcttgaaggc acaaagggtg gctttataacc atttgttatt tcttaaactc	180
aacacacttc ctttaaaatt tagtagaggt gctgtgcata tagtaacttc ttccatgtgt	240
ggtgaatata tatattcacc tgggtagggt ggcaccattt tagaagaatt aggaggtgtg	300
gccttgtag aggaagtgtg tcactggggg tgggctttga ggtttcaaaa gcacatgcca	360
ggcccagtct ctctctctct ctctctctct ctctctctct cctccctgtt atgataaatc	420
tttctgcaa aagccaactga gcccactgc cacgtgtgca ctttacggcc agccgcccac	480
ccagtgaggg ccccaaatac tacacagaga ctctattat atacaatgct gcttgaccaa	540
tgactagat ttctcatctg cttagctcagc cttaattatc atatatctat atattttata	600
agacttatct tatcagacac ctccatggg cctctcctct tgctggtgga tcacatcatg	660
aatctggagg aagagaggag gggaaagga accacttctt gcttgcctt gcttaaatat	720

gagtctccct gciatgtcac ttccctgcctg gatcaccact tctctactac atttcccaga 780
 atcctctttg tctcctagtc ccatctaact tgctgcctca ttggccaac agtactttat 840
 tcaacaatca gtaagatgaa catacacaga agtacattcg ggctctctac agcctggaaa 900
 tccattgcct tccttaatac ctaaaggatg gccaatcata gttattgacc tgaagactg 960
 ctttttctact atatcattac atttagaaag tgatagaaat ttgcatttac tgtaccaact 1020
 cttataaact cacagccagt tcagagatat caatggaagg ttttacctca ggggatgcta 1080

 aattgtccta ctttatgtca acactttgta caacaacctt tgaataaatt cgtaaagaat 1140
 ttccacaate ctcattttat cattatatgg atgatattca tttatcatat tccaataagg 1200
 aaactttgga atgtgtgttt gacatggatg aggaagtctt gcctagatga gggttacaga 1260
 ttgccccaga aaagatacaa agaggagatt ctattaacta taggttgtaa gatagactta 1320
 cagagaatca ggccacagaa ggtgcaaac cttaatagtc ttcagaagct gctaggagaa 1380
 attttcaat cacagacgat tattggggta gaaggtcatg acttaaaaca tttaaaata 1440
 gctcttaaag gtgataagga cctaaacagt ctacgaatat tatctgccga ggcagaaaaa 1500

 gaactacaat gagtagaaaa cagaatattg gatgctcatg tgaagactt tagtttgctg 1560
 agagaaaaag ttttaaaaga ttttagttct cagagagaaa aagtttcca caggccttgg 1620
 cccattacaa ggaagttggc cccaacctg ggcacatcct atggtttaga caggggcaat 1680
 tgccaagaca actctctttg ggtcacacct ggctggccaa cagacaatca aggactttc 1740
 agggatggtt ctgtggtttt tctctgtag aaaagcaggt cacacctggg tgaccactt 1800
 aacatgagat catactttgt aatcaatcac tttgtgcccc ttgcctgtat gctgatctat 1860
 gattttttcc tatataaaga gcttgcaccc catgctgggg tgtgcagctt ccccgatatt 1920

 gctgacacce tactgggcat tcgttcaata aacctcttg cttttgcage tcttggtctg 1980
 gtttctgagt ctcagaggct ccttgggatc ctgaggecct taggggtctg gggggtcttt 2040
 cacatgtaga tcggataaac cttgatttag actgcattct ggttattttg ccatccagag 2100
 aatatcttc tgggattctg atgcagttgg aagacactat attagatgg atatttctgc 2160
 cacataaaca gaataaaaag ttaaagacat atatagaaaa aaaattctga tttgatttta 2220
 aagggcaaat taagacttcg tcaactgact ggaaaagatc cagcagaaac tatagtacct 2280
 ttaactaatg aggaatttc ctgcttatgg aaggataatg aataatggca aatagctctt 2340

 actgattttg ggaacaatta gcaacaacta tccccaacc gacagaatta gatccataaa 2400
 aaagacagtc tggattcttc cacgtattgt aagacaaact cccaattctg gagttcttac 2460
 tttctacact gatgctaaca aatcaggtaa ggctggttat aaagcaggtg aggtaagtaa 2520
 agtagtcaa agtcggtata catctgtata gaaggcagaa ttatatgcag ttctcatggt 2580

gcttatggat ttiacagaac ctcttaacat agttactgat tcccaatag cagagagagt 2640
cagtcgtctt atacatagag actgcagaat ttatccatga taatacagaa ttaacctcgt 2700
tgtttttaca attacaggaa acaatcagaa gcagaagcaa tcctctacac attatgcata 2760

tcagatccca taagtgtctg ccagaccac tagcccaagg caatgatgag attgatcatt 2820
tattaattgg tagtgtgcta gaagcctcag aatttaataa aaaaatcatg taaattgcaa 2880
aggtttaca aaggacttct ccatcacttg gcaacaagcc aaggagatag tgagaaactg 2940
tcctacttgt cctacttgtt ccttttataa ccaaactcca ctgccagcag gctataatcc 3000
taaaggcatt tggaggaatg agatctggca gatggatgtc ttttacttta caaaatttgg 3060
aaatttgaaa catgtgcatc atactattga catattctca gggttccaat gggctactgc 3120
tctcaactct gaaaaagctg attctgttat tagacacctg ctagaggtga tggcagtcac 3180

gggtatacct gcacaaataa aaactgacaa tgetccagca tatgtctcca caaaaatgga 3240
acagttcttc aaatattata acataaagca tgcaccggg atatacaca atcctacaca 3300
atcctaatag gatgcttaag gagatgctcc atagacaagc tggtaagtca aaacccccca 3360
aatatagggt gcataatgct ttattgacac tgaactttct taataccaat gacaaagaca 3420
aacagctgca gaaagacact ggactacgga aataactgct gaactgagtc aaccagtata 3480
cttcaaagat gtactgacct cagtatggaa gcctggacac gtgttacatt ggggtagggg 3540
ttttgcattt gttccacag gagaagaaag cctttggata ccaccaaagt tgatcaagat 3600

tcaagttgaa aaagaccaac ctctcgacaa ggatgagtga caggtagtaa ctgaggtata 3660
tctcataaac taaatagaaa cctcccaaag gaaaggaag tgtattgctt ctatcttcac 3720
aggaaaactc atttccagga atccaagaac actacatggg tagatgctta agaaaagaag 3780
gtaattacaa ccatcaaaa aaaggaatgt gacatacggg aaactttaca gctgtctctc 3840
gaataactat ttctccttat ttcttagacc ctatttaagt aaatcagtgc tggatttaga 3900
gttggatttg gcttttctcc cctaaaatcc aagcatgttg tttaactaaa ctttagagtt 3960
tctgtattaa atcaagaat aattcagcac tagagaggaa tttggggact gtctttgtct 4020

ttcttggctc tttccttcaa gatgiacact gtctcacaat cattattttc cactattgac 4080
tttttcagca taattacata tacaagcaaa catttctctg ctaacactta tgtttgagtc 4140
ccacacagcc aatgaagacc ctctcgacaa caatccctgg acgctctgga aaaggaattg 4200
ggccatacct cctagactgc actggatcca acttactcca tttcaactga cactccgact 4260
agagcttcca gaactgactt caatcaagt gaggatttca acctagatct tcaatcaaac 4320
aaattccatc taacatgggc tggatataat gttagagact tttactatac taacattttc 4380

ttcccacagg accccacaag gctaccatca tcccatttca gcaggtagta acttggagga 4440

 tgctacgcc ctgttccta ttattgtctg ttaggtagt gtaagtctag ttaggaatga 4500
 tcttcttatt gtttagggtt ggtattgga ggagatgttc aggtttggac acctctttca 4560
 gatgacttta gggtttagct gaaatagaca tagttaagat gtgcaataat agattattgc 4620
 atcttcttgt atttcacctt tatgattgtt agttttggat attttact attaagtttt 4680
 aatccttttt tagactaaaa ggggaattgt agggagacac ggtaacatg cettgtaagg 4740
 gctggctaca ggtgtgtctg aacaggcgtg gtcaaagtga ggtcagaatg acgcggcatg 4800
 gactcttaag tgaccatgag cacatggaat ctctcttccc tttctgctgc cccttctctc 4860

 tggcctcact gccttgctt gcatttggct ggtatttacc tgaataaagg tatcttgaat 4920
 ctacaagctt tttccttacc ctctctccc ctgctttctt ctcccatctc tccccctccc 4980
 tccccctc cctctccc acccaccctc tatcttacc tgtggatcag gatatagctc 5040
 tcagctactg ctccagggcc atgcatacca cctctccctg tcttcatcat aattgactaa 5100
 gcctatgaaa ctcttagcat gtccccagt aaaagctttc ctttctaaga gtttcttgg 5160
 tcattttgtc tcttcatgga aatagaacag tgactaagac aacatgtatc aacaaaatc 5220
 ctcaaagcta tcatttgtat ctgtctttac cctcagcag gccactatc aggaaaactt 5280

 tgtgaaagaa ttttctacat gtactctttt tattccttgt gatgagttca tgcttcaatt 5340
 tgccatctta tctaaaacac ccaaacaca tcaactacct taaaatacct caaagagctc 5400
 ttgctttcat cctgtgtatg accactcagc aacacgtggt gttcccaggt gctttctatc 5460
 tcaactaagg ctattgtatg ctgttgttt tcttttaag tattcccttc cagtctcctt 5520
 tgtctttact cttttctgc attctacaca ttgtgatccc tcagttttta ccacaagctt 5580
 ctctatttt gtgtctcctt tcatctaga attgttttat tgctagcttt aatttattat 5640
 cctageccaaa cccttcttt ggttacacat attagaatga ctatttgata tgactggaga 5700

 ccctaaaagc atttcactc caacaatcc aactgtact cgggattgtc ttagctttaa 5760
 acctcccctc tatttctgca tagcaatccc actgggtcat ctacattgc ttaagcaagt 5820
 aacaatctg gggatcagct tagatgtctt tcttcttac tatgatggtt tccatcaagt 5880
 tcatgtaaaa atgatacagc tcattttttt ccagttgaaa tggatcatgc ttgtatactt 5940
 gtgtcaccat tgtatggtg tcacctttta tttgtggagg attggtttaa aagacttctc 6000
 ataataca gaatcaatgg atgccattct catataaat cacaaagatt tgccataac 6060
 ttaggtagtc ttctgtgag ctttaagtca gctccagatc atttcaacat gtaaatcaaa 6120

ggtgatgcta tgtaaatcat tggtagactg cattgttttag agatattaaa ataaaattac 6180
 tttgagattt tatcttacc caatcagaat atctatgata aaaaaatgac aaagaatgct 6240
 ggtgtggatg tgttgaaaga ggaataatta tccactgctg gtgagagtac aaacttgtgc 6300
 aggcagtgtg cacatcaacg tggaaactttt caaaaaagct agaactagaa ctttcaaagg 6360
 agcgaactat accactcttg agaacatacc ccaaagactg ttgaggtatc ctactatcaa 6420
 gatataataat cattcatgct cattgtttgct ttgttcacaa cagggggaac atggaaacag 6480
 caaaagctta tcagctgatg aatatataat gaaaatatgg aatatcacia tgggatatta 6540

 tccagctggt aagaaaaatg aaataataaa atttacaatt aagtgcctgg aactagaaac 6600
 aatcattctg agtaaagtaa gccaggaatc agactctaga atgacaaaac atttgtgtgt 6660
 gtgtgtgtgt gtgtgtgtgt gtgtgtgtgt gtatctttga atcttcagat aaatatttc 6720
 catttggat tcatacagag atcaggaaat tggtaagggg caatggggag atttcaagag 6780
 acaggagata gaatatggtg gcataaaggc ttaaaagga gtaattctgt tggaatgatt 6840
 gaatgagaaa ggggatggca aagcagggtg gagggaggaa tactagacia atactaaga 6900
 cattttgaaa aggtcatgga aacctactgc tftagaagat ccctaaaata tatacataag 6960

 cacatctaaa aagagtttaa atggaattgc cctatgtaaa aataatgcc aactgaatac 7020
 tataggataa caaacagaaa gctcagtacc aggaaatggg ctacctctt tgaagtgtt 7080
 ggacaatgaa gtactataga cctccaaaca ttattggtta ttaccattg ttcttggta 7140
 cactccagaa ctggcagta tgatcctgtt gttaaagaca gaatatatgt gagtacagat 7200
 tctgggtgaa tctagctggt ttttatttgg aagcttcac catactggtt agctttcaga 7260
 gtcttagaat gtgctataca tggtagtaga ggagaagagt aatcttcagt catttccagc 7320
 tatgaacctt gagaactaca gtaatgagt gtaaacctgt caagacatga cactgtgta 7380

 atagtgtcac aaatatcatg agagtaacta atgaaattca gatttcagat tggatttagg 7440
 gtgtactcta caagatgaaa ccatatctga caccattatc aggatgggag cccatggcag 7500
 aaaagtcttc cactaggtct tagagaagaa ctgaatacta ttattctgtt gaatggacat 7560
 agcaataact gactccttat cattatacct gtatgcaat gcatactctt accttcatct 7620
 gagaatcatt tatttgcagt gatggtgagt aatatagga tccctgactg gtggatgggc 7680
 agagaataga agactctgga ttggattgtt cagtcctaaa tgggacactg catcacacta 7740
 ctctcttcca agctcaagga tgttgataga agagagcata taagaactat aagagctggg 7800

 tggctacaag aaagcagigt cttctagaca cagcagttgt tacagcatgc aaaagaccta 7860
 ccatggagag tggaaactaa catgaaattc cgtccccacc ccagccaagg agctgttgg 7920
 aactggtagt tgctcagaga ggaagagtca gtttctttga gtgtatttgc aagtgggtca 7980

tgttccagag gaaggaaggc cacacatctg agaacatgat aacaacaaaa ttagacctgt 8040
 gacctaagca aataaaaagg tatgaagtgg ggtgagggaa gtggaggat gtctgagagg 8100
 agttgtgtgt tgaagagtca ttatgattaa aaaatcttat atgaaattct caaagaatta 8160
 atacaaaatt aagatgctat cataaatcat acagagattt tgattggatt tcatttataa 8220

 attatgattt catgaatatac tgagcatctg aaaatatgac ctcctattc cagtctcacc 8280
 agaactttat attaccttt ggaaccccca tttttcagg aaagttaagt ttgtcaatat 8340
 attcacctc tttctacct aagtagacac tgttataggg actttcagaa ctgtgttgcg 8400
 aactgaagat ttttcaaga ggagtcattt gatcttcct ggtgtttaa tttcactgat 8460
 ggaaagtgt gatctttga agagaaatgt gttataaatc aagaagccta agatgtattg 8520
 ggctatttca gagccttga caagcttta tcgttgccct ctgcattta cgtagcattt 8580
 ttgtgtgacc agtagataaa accttaaaat ttgtgttatg cttgatgcac ttctagcctc 8640

 tattaatat taaagctagg aatgactgga gactcggatc attatggaag tttccctgcc 8700
 tagttgagca tcaactggtaa atttacaga agatttctac tcctttttaa atttcatcta 8760
 ctttaggact ctgtctactt taggactaag aaagatgttt tttctattca ttaatggagc 8820
 catgtctttg gagaacatga ctttgagagt tgtggtgtta acttgggat atatttcagg 8880
 gagaaaaaaa aatttatgtt gactcataat atgtcacct cttgtttcag gagttttgtc 8940
 tttacattga gagtgagatt gtgcacaaag ggtgaatcta acttaggttt ggtgttattc 9000
 tgtagtcaga gcttgatatg taatgaagtc accaatgaac tcctggatcc accttaagta 9060

 gatacttatt gagtagtagg taatccctca atttttctt ggcttcaaac ccatgttgtg 9120
 ctttattact ttttaataa aattgtttgt ggcaatacat cttaatattc ttttctattt 9180
 atagctatga tgtggtgttc ttgacttct taagatttct tttgtctgt ttgctctgt 9240
 tgatcaacag taaagtttgc cttgtccaga cacttcaaca agaataatgg tetctttctt 9300
 taagaccca aacttaattc taacaatttg ggtctcagtc taggatccta gttccccga 9360
 gggagaacct tagatctctt ccaggggaa aagtgtcca caagttttgg tttttgttg 9420
 tttgtttgtt ttttctggtc cttgggtgaa tgggtcttt ggtactatcc aggtcagcaa 9480

 aatgccccag gtttcaaagt actgaacagc acagggaggg gttgctcagg gaaattactg 9540
 tggatgataag gaatactctg tgcacaaacc gaagtcaaga aatgctcagg gaacagcaaa 9600
 gtattccttt agaggttggg tattctaggg gttgaggcaa gtgtttgatg tgaaatttgg 9660
 gtccaagaaa cctccataaa gggctctgga gcacaatatt cccatgatt gggaaaagaa 9720
 aaacctaagg caaaaagagc tctaaaagta aataaataaa aggaacaaat aaaagccaaa 9780
 gaaagaaaac atccccctac tccaggggaa atcaactcat ctggctggcc cagacattcc 9840

atcaaccctc cccaccctaa ggagagactg aacaatgtga ggtctccaca cttgttagtc 9900

tccccgtctt cctctctgt attctctctt ttatctctca ttgccagctc cttctgagaa 9960

cctagaaaaa cttggatctg gtctggagga agggacaaag agtctcttgg tgtggttact 10020

tctgattgcc ttagatgatg ccacctcata gctgcttttc taacatggta aagtgccaca 10080

cagataggac ccctatgga aggcctcacc ctccctgggg agcagaaaagg gtttgggata 10140

ggtagggtgt tagttgcagg ggggtggggg ggaggatgg gaaaagggga gggagaggaa 10200

cctgggattg aaatgtaaaa taattttctt tctaattaa atttaaaat gaacaaaca 10260

aacaacaaa aaagcggcac acagaaccac taagttttaa atcaggatgt actatttca 10320

cacgttggct tccaaagtc ttaaattcca gccaacatgg agagtcgcat gtccatttga 10380

tctctgcca caccatactt gagcggata aaatggagcc aagaacatc ttgtgttga 10440

gaactgagaa gagggtaaaa catggtccag ataacaatac taggcaccaa tagttacact 10500

ttgtgtgta aaatataatg actcaacttt catgaattaa gaccaaggaa ttccttcccc 10560

tgttcctttg ttattagggc cttccagcct agaacacaag taccatctcc ttctatatca 10620

atgctaacta agatgccatt ttttaagaa atgggtaaaa ttggtcatat ttttttgtt 10680

ctgttttga gacagggttt cactatgtag atcaggatgg cctccaactc acagagattt 10740

gccttctat gcctcatgag tgctgggatt agagggtgac atcaacatac ctgggtggaa 10800

ctatgcatat ttaatcttta ttatgttga atctcccagg aattgtggtc ttatggagga 10860

tagactcact ttaccatgga gtctgagctc acaaacagaa agaaaatgtg ttttggtga 10920

ggacagcata aaatggagat gaccatatga tctggccact atctttgtca atgacatcat 10980

aaagatgatg aataccaggt gactttggca ctatcttggg taatgtaatt acatggcatg 11040

aagcaaatg gtgacacca taaacttctt ggtgacactg aggcctcagg gacttacttc 11100

ttgtatattg tacttaggga gtaatgceat atctccatga tgtttatttg ttctgcttta 11160

ttttaacttc tgcacattgc tttgcatgat atattcacta gcttctagag gggacttaaa 11220

gatggatgta gatccaggac aaacaggtta aaataaacca gataaaatac aaatataatc 11280

cagtaagttc acagttaag agtcacatct taaagagtgg agaattcaag cagacagtct 11340

ttttatagtc cccagtgaag aaatggacaa aacagatatac caggcccttc tttgttatgc 11400

atactattha tatcagatac attatatttt taaaactttt tgttgattct ttgtagattt 11460

tgcatcatgt atccaatac ctttgtatct accctctgcc tttgcaatct tccaaaataa 11520

agtttaaaag aaaaacaaaa atcccaaacc aaataaaca aaacaaaaca aaacaacaaa 11580

atctgcttag ggcagctgaa gtgtgggcca gtgagtcaca caatataccc tttagtccat 11640
 gtaccttcac ttgtgtttat taaaatgagt cattggctcg gttcaaggtt ttggcttctt 11700
 atacactatc aacactgggc tcttactggg actcctctta gatatcctgt tgtcctgtgg 11760
 catggagatt attcaccttt ggatctgcag gtctggcccc ttcacatgcc ccagcagctt 11820
 atagaagagg tggatgttgg ggtggactag ttcattgccc tagttctggg cctgagaggt 11880
 agctgagttg gtcagcctgc caactttccc tcatcatcac caccaggggtg agctctccag 11940
 cactgtccca attagttcac caaatgtagc aggtagcaag gagcctagga aattctccat 12000

 ctctcatgcc ctcagggcag gctcatctgc attcactatt cttttgccta tacaaagggc 12060
 agggaccgct ctcccattg ctgcagttgg tgaggacag tgccagctct tctattctca 12120
 tgccctccca ctccctggcc aatgaggcca gctctcctgc ctgccacagt cagcaagagg 12180
 tggggcgtgt atttccctca cccatgccac catatggcat agaatggggg gcatcagctc 12240
 tgctctcacc ctctgtgcca gctcagctgt gcctctgcca gtaaggtcag ctctagtgtt 12300
 ttgtccaggt gaagtgcagg gtctgctctc ctgagtctg tggcccatga tgggtagggc 12360
 catctctect actcttgtga tcttggggcc agctctccca cctgctgcag gtggcaaggg 12420

 gcaaggggga gagggaacct atttcttacc catgccatca tatgtagag gaggagcagc 12480
 ggggtcagtt ttctgcaact caggctggct cacctgtacc cctgccaca cacagggtca 12540
 gctttactgt gatggccagg tgaggggctg agccctctct cctgagtctt gcagctggta 12600
 atgggaaggg ccagttctac ccaccacagg cagtaagggg taggagcagg ggtggggatc 12660
 actccttcac ccattctaac agatgagggg tgggtccaca tctcctaggc aacttgttg 12720
 taccctatt gacatggta gctttagca ggtccagtct tcccgggtct gcagcccttg 12780
 aggggcaggg tcagctctcc tactctctg acccaaactt tcccaccatc atgaccctag 12840

 ttgatgtccc agatgctggg catctgtgtg gcctttgatg gcaacatggg ccattgacat 12900
 caaccagac ccagtttatg gtacgaccac agaccagac atggtccttg tgcagcctgg 12960
 gccagatat catcatggcc ctactgtgta tcccagttta cctagattga catggctcca 13020
 gtggcagcat agccccagaa cactaacata tctgaggag acagcccaga cctgacat 13080
 ctgctctgtc ttctgatatc tgtagcaaga gtcacagata tcaacacaga tctggatgg 13140
 gataggacca tgcagatata ttatttaa ataatagtaaa gtgacttacc agataggtgt 13200
 atccatttgt catgttaact catgagaaaa ggaataaaag ctaggaaacta ggaactacag 13260

 tggatgttca ggagaaggaa acaaagatgt ggaatatctt ttaacaatgt ttcatttac 13320
 agaagggtag ttatcagta agactctcag tcaactgtatt gttaccatt gggatctctt 13380
 catccaggag ccttgcttga ggagggaatg tctaaggctt ttctgtacac agttctggcc 13440

tgaatataac ttaaaggata aagagtgcac tgatgattac aaagtggagt cagagatagg 13500
 ttgataactg gtagtttatt gggggaaaat actcactcaa gggaaccagt gaccaggttt 13560
 gcacctgagc aggatggacc cagaaatgct taccggfcag ctcagccaag tgagagagag 13620
 ccaagtgctg gccttcttaa acccttgttt aagtgggcat ggtcagcaat acctataatc 13680

agggtttctc cctacaagag tggcttttat agaaaaacaa atgcaaaca caaacaaca 13740
 gcagactgt attgccctac aacttgattt cttttagga ggggggtac ttactaagtt 13800
 tttcaggttg tctgcctctg tttgcagatg tacctaata gattgtgggt attggtcacc 13860
 ccaagtgtag ccagagagag ccttagtatg gatgcttggt aagacagata cttctgttgg 13920
 tttgatcctc cttgatcatg gatactgatt gccactcacc cttgatgaag atatcagaag 13980
 atgactctc atatttaaat gttctgtttg gtgaggttct catatattca atctgttaat 14040
 ccctgttccc tgtacacaac ccaaaagatg acgagtcag taaacaaatc tataaaggtt 14100

ataaagaaat aaggaagatt ggtgctttgg ggcccactag ttgtcactgg attcagcagc 14160
 aagtctctga atattgaatg tacacctcgg gatgcagctt tacaaggaa tctcatgaga 14220
 taagatatac ttagtaaaa acacttgata ggaagctcat ccatggagag actagagaag 14280
 atcctctatc taagatctg tctatagtaa cccagcatc agagttttct taatggattt 14340
 cttagtctag ttttactgga tgctgcaaac atcaatttga tgatgttctg ctatatattt 14400
 gctgctgctt tgtatcttct acatacacta attccaaaac aaatgcaagg gtaggttagc 14460
 aactctatgt acagcataaa aagtgtcttg tggttttttt tctttttaa taaggtttaa 14520

cttaacagta tgtcccaaga aatattaatt tattagatta ttttatgat tatcactgcc 14580
 taggaggaca gccccagta gcagcaagac tctaaagtaa gtcacagcat tggtgcatag 14640
 tagacttttc tatctgagag ggttacagaa aaaagacact cacattttct cttgatgttt 14700
 tccttcttta ttctctattt ttctacagtt tatatatcac aaaaagttt ttcaggcaat 14760
 ataagaatta caatgtggct aaattacaat gaatacaaaa caaatagtaa aaaaaacagc 14820
 atgtttttca tatcccttac atgattaaac attttgcag ttacaggtga aaaacaatt 14880
 atcctaagaa cccatgtaca ttcaccatac ccaaccagct tgttatagat taacctgta 14940

gacaagcaag gtattcttct caggagggtc ttttactagc aggttatatt ttgcagttgc 15000
 aaaggaaggg ccaattactt tttacttatt tttaaaaata atcttatagg gaatcttaa 15060
 gaaatcacia acctaaattt ttatataaga caagaatcag ttagctctac tttaacctt 15120
 cagggtgcat atcaatagtt tttttatc aggatagtg gggcaggaat ggttacaagg 15180
 agttaatcat cacctttgat catcaacaa tctatataag aaaatagtc agctaaaaac 15240
 acttgggctg ctttgtattt tgacctcagc tttgttctt tgtgaacttt agattgtttt 15300

cctgggatta tccatattaa aactattatt aaaacatctc atctaacctg aagttatfff 15360

aaggctttgt ttcagtcagt gatgcacacc aaaacctata actgcatctt tcagcattaa 15420

gattaaagga ttttgagcca gcttggctct tgggactcaa ttgttttgtt tgtctttctt 15480

tcatttatff tttgcttcat gtcagaaatt ttactttact attggaaaag agtatfftga 15540

tttttatffgt aaaaccccat ttaatttcaa gaattaatff taaattaatff taatttaatff 15600

ttaaatttac cactcagatg tgaattgaaa aactffttatt cttgtaactg tgaatattat 15660

atataatgt acatataat aatttcaatff tttatactc aagttactca attgtttact 15720

cattttatac accaaccata gttctcttfc ccttcttctac tctgtctcct cccacctccc 15780

cccaccctc atccactcct cagacagggf aaggccttcc catggggatt caactaagcc 15840

tggcatatca atffgagga ggacaagtcc cctcacacc cctgcatcaa gggatatgff 15900

gatatttate aagggataaa tcttggtecc aatgccagga gccccaccaa cagagcaagc 15960

cacacaactg tgattggfff ctcagaaaaat tgggaattta cctcaagacc tagcaatacc 16020

actcttgggc atatgcccaa agaatgctca atcatactac aaggatactt gcttgactat 16080

gttcataaca gcattattca ttaatageca gaacctggaa ataacctaga tgcctctcaa 16140

ctgaaaaatg gataatgaaa atgtggtaca tttatacatt ggagfattac tcagtggtaa 16200

aaaccaatga catcatgaaa tttgcatgca aacagttgga actaaaaaaaa aaaaagtcat 16260

cctgagtggt gtaacccaaa cctagaaaaga caaacatagt atgtactcac tcataaatgg 16320

atattagtgt aaagcaaagg ataaccagat tacaatccac agccctagag aagttgggta 16380

gcaaggagga ccctaagagg gacatgcatg gatcatccta ggaaggggaa gtagatgaga 16440

tgccctggga aaacggggag gaaatgagag atgagaacat gagggaatgg gatggttgag 16500

ttgggggagg gaaaagagag ggagaacaat gaaagagata tcttgataga gagagccatt 16560

atggagttag ggagaaacct ggtgatagaa gaattctcag gaatccacaa taatgacccc 16620

agctaagact cctagcaata gtggagaggg tgctcaact ggctttcttc tgtaatcaga 16680

ttggtgtcat agaaccttta tccagtaact gatgaaagca gatgcaaaga tccacagcca 16740

agcactgggc caagctctgg agtccatttg aagagaggaa ggaggagcaa gaggggatca 16800

agagcatgat gggaaaaccc acagagacag ctgacctgaa cttgtgggag cttatggact 16860

ctgaactgat agctggggtg tcttcatggg actgaggtag gccctctgaa tgtgggtcat 16920

agttgtffff cttaaataact aacttgagct acatctatgt ggctctttaa ataaaactca 16980

cgggccttag ctgigtgaaa tttccttgta tttactttta ttcatcaaaa ctctatataa 17040

gctaacatta ttgtgtcag ttagactaga cagtttaggg aggaatcatic tcatataat 17100
ccacaggtaa aaatgcccg tagaacagga tgtttccagg agataaacac actacattac 17160
aggcagaggg gatctcccca cacccattca caccatgcca gataccagag aaagatagta 17220
gcagcagtcc tgtaaaggca aggcagaagt taaagacatt tatggttctg tagtctcagg 17280
gccttgccca acagagattg actgacccat caggaggttt cctcctgggt ggctgacacc 17340
ttgaaattca aatgccacct gctgctctc tgacaaggca acaggcaatg tatgcagttt 17400
ctattcagtt ttttttttt ttaaagtgtt gctatgcagc actattctaa gacaaacaac 17460

tcctatcttc ataagaccag ctgtgcctgc acacaagaga tgatcacctc tgggtttgta 17520
gagggggtaa agtgggtcac tgaatcctca atctaacttc tcttctagcc acttgtatgc 17580
aattgacct taatcattgt ggcctagtgg tttggctaag aaagattagg gacaggaggt 17640
ccacttatgc agctatggga aagccactgt acacgttgtg tgggggcttc cagtctggct 17700
gctttggaga taccctgtg agtaactgtt cgcccacact cagtgagtga accccataca 17760
ctcattgttt ccccaggatg aattttgggt agactaaact ttggtttgtt gtcaggacct 17820
catgaggagg ggtggagggc tgtttagtcc ctctctatct gggagaaaaa tttcctaaca 17880

ataaatttgt taatgttatt atgtcttatg ttattaaaat aagtaaccag tatggagaag 17940
aaaatgttac aaggatgcaa atatgtaaat gttttaataa agaaggacat agatagatga 18000
agattaagat ggttggatatt tttccaataa gaaaagactg gaaaaatttt ataagttatg 18060
aaggtcagag aaaattatat aaggtacata aaggatgaaa cttagaaatg atgcatatga 18120
tattaaagt tgtaaggaca aagataccga atacaaggct tggctaaaat gtatgtctaa 18180
tcaaagttag atttagagat gtctggttat tgaataacta tttaacctga atggtgtgac 18240
taggtattta ataatcatic ttggaggcta ttcggatgtg ttcagagaga ttgaaagaga 18300

gaatattttc tcctagctc tccaaggtta atgagatccc acagactgtg getcatctct 18360
caaatcttc tctaattgtg gaaagatttc ctgagcactt ccaaggaaag ccacagtcag 18420
gctaagcaag gcctttgact cacctcaca ctgatggata accagtaaaa gaaaggccag 18480
aggagcctgg ggtttctctc aaggecaaga gacccccctg aggaccagat cttcaactgg 18540
cctggacagt acaaaaagaa aagttaatct tggccattgc agtcataaac attcaacagg 18600
aaagtataac caaagactag gagtgtctga gcctgatagc taatcaggct tcatactgg 18660
gaaggggagt gtgaattgaa gaaagaagca aacaagaaac aagagatagg gaggacattc 18720

agtaaacact gaatgtgctc aagtttaatg ttcaaagttt ttaaataccc caattaaaag 18780
agggggagaa ggcaaaagac ttcttttcta atgatacaag gaacaagcag agtaattact 18840
tctccaatac ccaaaatatic aagtaactac atcctgagtt aagtattttg ttgtttggca 18900

ggacatgaat cgaccacacc ttagccaag aatcctgttg tatttacatc ctaggccagt 18960
 catctttgat gtttcacctt ggaagaaca gggcaggtaa aaactctctg aacataaaaa 19020
 tggaatgggg tcaattccgt gggttctcac agaggattgg taacagtaca aagaactgaa 19080
 ctatccacac attagatgta agtctccatc agatgttatt tagacaacta tacctcacta 19140

 aaattttctt cctgataaaa agaagttgcc ccaatataag acttcagatc ttggctcact 19200
 gtagcacctc cctacagcca tgggagaaaag gaccactatt gttttaacct aaaaattaaa 19260
 tgatggataa tcacttcttt ccccatctag aagccaaatg agaaagacat tgtgttgact 19320
 tttagctgat gcagtagcta taaaaagca caaaagcaga ctgttggttc tgtgagagta 19380
 cagtgcatt accaactgga ccactccatg ggtagaaaga aagatttatt gggaagagca 19440
 gaagtgtctt taacatcaga gccacctctt cagctccaga tattatctc ttgattgtta 19500
 ctgggcactt taatatattt taaaatattt cattatgaga atttgtttt tcaaaagtca 19560

 ttgtaacaaa ttctaaagaa ataataataa tgtataatat ttacttttaa tgatgtgtta 19620
 aatgccattg tctctacatt aagtcttatg caacctaat agctaacttt taagtgtgac 19680
 cccaatttgt ggataaggaa gagcagacat aaaaactgag cagatagtcc aaactcatgc 19740
 agccactcac actaatgaga ttggaagca atcatcagac ctgtaccctt gatcaatagg 19800
 catttacaaa attcacttgc caattattgt aaaatattha ttgagttgta tgaactcgtt 19860
 agaattctat gaaatcaca ataggaaatt tgaagggcc aagtctctgc cttctctcaa 19920
 ggctgagtaa catttacct ggtttttctt tcaggcaaaa ggcagaagta atgagaaat 19980

 ttcttcagaa gattcttttt gctttgtctc caggcaacca tcacggcttg ccaaatagag 20040
 catgcaatac tctttaataa ttgcacaatc atatttatga acacatatca tcctttacct 20100
 ccagatgctt ccagattcag atacaagaca cataagtca tacctctgca aagtgcagag 20160
 gaagacagaa gctagaattg tctgtagtga tgcagttatg tacttatggt cacaagcatg 20220
 ttgccacatg cagcaagtag gattcagga ctggaggaaa gccctccacc tctttctcta 20280
 tgttctctgac tcatgtattc agtactgttg gcctttgtca ttccataaac agcagggggc 20340
 atgcttgctt ttctgatctt tctcccaca ctgatgtga gttttgtga atttctagt 20400

 gttcttgatc tgtttcttag gatatgttac atcttgtgtt ggaaatcatt caataattg 20460
 ggttcattaa gagttaaata taacctatg ttcacattct tcggtaagag atacgtttaa 20520
 aattcaata gaaaaattga agttagtgga ttgatcgtt aatttacaaa actcaagtta 20580
 agtattttaa gtaaaggac caaacgagta gactatgtca atttgaagtc aaaccagaac 20640
 actttctgtg tctggttgtg tacacactgt aatttaacat ggattgtttg catgtttcaa 20700
 tcgaaccatc cccagatta gatgtatta ttttctcatc ttagaggctt tgcaacttta 20760

gggtatgaaa gaaccaggac ttgtgatgic ttctttgtac catttgcct caccagatgt 20820

 agtcaacact taatttggga agactgttta gagagtataa aacatatttc cccatgaaac 20880
 aagtaataga tatctgggat catcctaact gaatatctga aaggtaatgt ttccttttaa 20940
 agttcatttt gcctgtgttt atttttgaaa taataatagc taattatttc ttcttataaa 21000
 gaaaatttcc tattttaaaa tgtttttctt ctttgcaaga aatagatact tctaattttt 21060
 aactttttaga ccaactccat gctttattta tgaacctgga agaagatgaa aagtaactta 21120
 taggcagcat ttattcactt aaagtacatt tatgaagact gcagattact gttgaaatag 21180
 tgccacaaag ccttccaaag atgactgagg actggaagtc tgtgctgtgg agcgtcttct 21240

 gcttgtgcca gcctccctg ctctcaaagg tctgtcctg gctgcagtgg agcatgacta 21300
 cctcctgttc ttctcgcaa gtgcctcca tggaaattct tgaaaaataa agcaacattt 21360
 caaccacac ttaaatgagt ggctggaat cctatccgt tagctatctc agaagtgact 21420
 catacaattg tctagcctgt gctttcctaa cttttccat ccaactgtaag ttatttttcc 21480
 atcttttact gctagagagc ttttcatgtt tgccagctga gaaactagaa ataaatgaaa 21540
 cctatagttt caaatttgaa tgggctgctg tttgagcttt ttaagtgcag tagtgcata 21600
 gtgtctggca gaagtacttt tgggaaaatg gacagttaga atgcaaatgt aagttactca 21660

 cctgaaattt acttaatgtg aagtcaaacc ctgtaacctg acctgctcat gctatctact 21720
 gttgtctttt gtagtcactc atttgtttgt taccgtttgt tactgtggaa gcaccttag 21780
 gccacccaaa gaatctaggt atttaatttc aaagcaaat caagtcctgc cccatcaatt 21840
 agggtagtgt ctgaaataca agacaagtgg gatattgtaa ttagggcttc aagtatgttc 21900
 tctggggtaa ctgggggtgg gggtaggaa tatgctagtt atgtgatttg tgaacgcca 21960
 agtgttcaga tctagctga tcaactcatt gcttctgga gattctcaca ttgcagtcca 22020
 caagagcagt atgtgtgaaa tgctatagca gaccgagaag ttacattttt aaagaacaac 22080

 ctatatggta aaaggcattt ccttgttgac tcataatttt caaatttctg cagccctaaa 22140
 ctttagcatt tgctttacca gtaagtcaga agccacgtct tgggtgacac tcttcatcag 22200
 aagcagagca gcigtggga gacatggagt agatgactca gggctttggt agttctgctg 22260
 tggtagttgt ggtatgtgac cttctgaaaa tcagtgattt catcttgact tcaagtgttt 22320
 ctaaagtatt tctactttg tctatctcat gagatttttg ttttgagcat caaatgaaag 22380
 gatacagaga gaagaaaatg gtagctaaga tgctaccatt tgtcacattg ttctatgcag 22440
 gcacaggctc aggaattata agctgagttg gctttttacg gactttgcta gacactctca 22500

attacagaca acagctggca gagggatggt ttctttttca aataagacct taggaagttt 22560
 gtgttaccca aacataactt cccttcttca ttagacttgt aagaactgac tgtgacttat 22620
 taacaaaaag agcggtcatt ggccaggaat actcaaatgt taaacaaata gaattaaaag 22680
 cttcaatggt cciataattg attacttact atgctttaaa aaaactatac atattaaatt 22740
 atattttaat aagatatttg aatagagaaa actagtagca cagaacatct ccttagatga 22800
 gaatactctg ttgtggggcc cctacagtgt gatcaggatc tgcccatctg tccctggtgc 22860
 atgagctggc tttttgggac ctatttcctt atgatgtgtg cctcaccag ccttaatagg 22920

 ggagggggct tggctttgcc tcaacttgat atgcatgct ttgttgactt ccctgatagg 22980
 ccttacctt tctgagagtg gatgggggag gctagaaaagg aggtggggga agggaactgg 23040
 aggagaggag ggaggggaaa ctgtagttcc tatgtaaaat aaacaaaaaa ttaacaaaa 23100
 atacatatta cagtattaca ataattttga taattttcat ctgaagtaga caatttctca 23160
 ctatttctta tacatgtact gagtattctt agagttattt tttattagtt caaattagga 23220
 acaagcttgt ttcacacgtc agtcccttct ccttccctc accctcacc ctctacccc 23280
 acccagacct accccctacc ccattcacc tccactctcc aggcagggtg gggccctcaa 23340

 tgggggctcc acaaagtcca ccacatcatc ctgggccggg cggaggcctt ccccatgtgt 23400
 ccagggcaag agtgcacccc ttcacgtggg atgggctctc aaattatctt cttacaccag 23460
 ggaaaaatac taatcacta ccagttggcct cttagagtgc agaggcctcc tcattgacat 23520
 ccattgctcag gggctctgat cagtctgta ctggcctccn nnnnnnnnnn nnnnnnnnnn 23580
 nnnnnnnnnn nnnnnnnnnn nnnnnnnnnn nnnnnnnnnn nnnnnnnnnn nnnccctctc 23640
 tgcaactaag ttctctgta tagctatggt tatctgctc tgctttcacc agccactgga 23700
 tgaggctctt aaaaaggcat aaaaagtagt cattcaatct catittaggg gaagtgcgtt 23760

 taggttatct tctccaccat tggctggagt gttagttcgt gteatccttg tagatctctg 23820
 gaagtctccc tattgccaga tctctccttg gacatataat ggctccctct aataggtat 23880
 ctctcatcct gctctctatt ctccccccc caactcaata tttctgctcc tcaatttctt 23940
 cctctcctct cctctcctct cctctcnnnn nnnnnnnnnn nnnnnnnnnn nnnnnnnnnn 24000
 nnnnnnnnnn nngcacctcc cccccctc tctcctctc atgctcccaa ttagctcagg 24060
 agttcctgcc ccttccatt cctggggctc atgcatttat ctctagagt acttcatggt 24120
 tcttaatttc tttggggaag agggctgtag gctttatttg ctctatgtct aaaattcata 24180

 tatgagtgag tacataccat gtttttctt ttgtgactgg gttacctcac tcaggatggt 24240
 ttcttctagt ttcatecatt tgcttccaaa ttcaatatt ccattgcttt tttctgctg 24300
 agtagtaac cattgtataa atgtaccaca ttgtctctat ccattcttca gttgaggggc 24360

atctaggttg cticcaggtt ctggctatta caaacaatgc tgctatgaac atggttgaac 24420
 atatgtcctt attgtatgaa catgcattat ttgggtatat gcccaagaga ggaattcact 24480
 ttttaatttc attcttttgg gttttgggtgg ctagcttatt gagttcattg tatattttgg 24540
 aaatcagccc tciccaaagt tgctgtacaa gtttgcactc ccatcaggag tcgaggagta 24600

 ttccctttct ccaagtcctc ttagcataac ctgtcattga ttttcttttg gtgactgtat 24660
 cctttgcctt ctcagtttta ggaggtccca ttattaatt attgatctca gtgcctgggt 24720
 tactgggtct atgttttaga agtggctctc tgtgcctatt cggcatggtt tatctccac 24780
 ctctctctct agaagattca gtgtggctgg atttatggtg agatctttga tccatttga 24840
 ctttaagtttt gtgcatgggt acaggtatgg atctatctgc aatcttgtgc ttgtctgaac 24900
 ccagttatgc cagcaccatt tgttggagat gctatctttc ttccattgta taaatttagc 24960
 aactttgtca aaaataaggt gttcgtaggt gtgtgggtta gtatcagggt tnnnnnnnnn 25020

 nnnnnnnnnn nnnnnnnnnn nnnnnnnnnn nnnnnnnnnn nnnnnnnnnn nnnnnnnnnn 25080
 nnnnnnnnnn nnnnnnnnnn nnnnnnnnnn nnnnnnnnnn nnnnnnnnnn nnnnnnnnnn 25140
 nnnnnnnnnn nnnnnnnnnn nnnnnnnnnn nnnnnnnnnn nnnnnnnnnn nnnnnnnnnn 25200
 nnnnnnnnnn nnnnnnnnnn nnnnnngtctg tgaagaactg tgttgggatt ttgatgggga 25260
 ttgcattgac gctgtagatt acttttgtca agactgccat ttttactatg ttgattctac 25320
 ctatccaaga geatgggaga tctttccatt tctggtatc ttctttaatt tctttcttta 25380
 aggactcaaa gttcttactg tagaggtctt tctactgttt ggtagtggtt accccaagat 25440

 attttatggt gcctgtggat atttgaagg gtgatgtttt tctgatttct ttctcattgt 25500
 atttatcctc tgiataaagt agggctactg attttttttg agttaatttt gtatcctgct 25560
 tctttgtgta aggtgtttat cagctgtagg agttccctgg tagagttttt tgggtcactt 25620
 atgtagacta tcatatcctc tgcaaatagt gaaagtttga cttcttcttt tccaatttgt 25680
 atccctttga tccttttttt gtctcattgc tctatctaga acttcaagaa caatattgaa 25740
 gagatatgga gagagtggac atccttgtct tgttctgat ttttagaggaa tcgctttgag 25800
 tttctctcca tttattttga tgttggctgt tggtttgggtg tatattgctt ttatcatggt 25860

 aagatatggt cctgttattc ctgttttctc caagatcttt atcatgaagg ggcgttggat 25920
 tttgtcaaag gctttttcag catctagtga gatgatcatg tggtttttct ttttcagttt 25980
 gttaatatgg tggattacat taacagattt tcgtatgttg aaacatcttt gcacccctgg 26040
 gatgaagcct acttgalcat ggtggataat ttttctgatg tgttcttggga ttgattcac 26100
 caatattttt ttgagtattt ttgcatttat gttcatgagg gatattggtc tgtggttctc 26160
 ttttttagtt gtatctttgt gtggcttggg tatcaaagtg attgtaactt tgtgaaaaga 26220

gtttggcaat atcctatctg cttctattgt gtggaacagt ttgaggagta ctggtattag 26280

 ctcttgtttt aatttctggt agaattctgc agtgaagcca tctggccctg ggcttatttt 26340
 ggtcgggaagg cttttgatga ctgcttctat ttcattcggg tttataggag gatttaaact 26400
 gcttatctgt tcttggttta attttagtaa atgatatcta tccaggaaac tgtccatttc 26460
 ctttagattt tcaaatttta tggagtacag gttttcaaag tatgacctga tgattctctg 26520
 gatttcctca gtgtctgttg ttatatcccc cttttcgttt ttgttttttt ttattaacat 26580
 gttctctatc tgccttttga ttagtttggc tagaggtttg tctatcttgt tgatcttctc 26640
 caggaacat ctctatgttt cattgattct ttgtaatgtt ttectagttt ctactttatt 26700

 gatttcagcc ctcagtttga ttattacctg gtgtctactc ctccgtggtg agtttgcttc 26760
 tttttactgt aaagctttca attgttctgt caattctctc atgtgactat tccccagttt 26820
 ctccatatga gcacctagtg ctatgaactt tectcttagc actgctttca aagtgtccca 26880
 taagtttggg tatgttgtgt ctacattctc attaaattct aggaagtctt taatttcttt 26940
 ttttatttct tctcaaccc aggaatgggtg taatcgggtg ttattcaatt tccatgagtt 27000
 thtaggtttt ctgcaatttg tattgctgtt gaattctagc tttaaagcat ggtgatctga 27060
 taagatacag gggattattt caattctttt gtatctgtgg aggtttgctt tgttgccaac 27120

 tatgttgtea attttagaga aggtgctttt acaaatatgg gtgccttcat atttggggca 27180
 tagatgttca agattgagac ttcatcnnnn nnnnnnnnnn nnnnnnnnnn nnnnnnnnnn 27240
 nnnnnnnnnn nnnnnnnnnn nnnnnnnnna ttttagttta aagcttaatt tgttagatat 27300
 taggattgct acaccagctt gtttcttggg cccatttgat tggaaaatct tttcccaacc 27360
 ctttactctg attaatgcc tgtctttgaa gttgaggtgt gtttcttgtt tatagcagaa 27420
 ggatggattc tgtctcatat ccattctgta gtatcttttt atgacattgg gggatattaa 27480
 tgtccattga ttgtttgttc ttgtttgctt tggatttatt gttggtggtg tcattatgtg 27540

 tggattttgc cctcctgnnn nnnnnnnnnn nnnnnnnnnn nnnnnnnnnn nnnnnnnnnn 27600
 nnnnnnnnnn nnnnnnnnnn nnnnnnnnnn nnnnnnnnnn nntgtagtgc tggatttgtg 27660
 gatatgtatt gtttaagtct ggttttgtca tggaaatatct tgttttctcc atttatagtg 27720
 attgaaagtt ttgcagggta ctgtagtctg ggttggcatc catgctccct tagtgtttga 27780
 aagatatcta tccaggacct tctggctttc aaagtttcca ttgaaaagtt ggggtgtgatt 27840
 ctgataggtc tgcctttata tgttacttgg actttttcct ttgctgctct taatattttt 27900
 ctttattctg aaggtttggg gttttgatta ttatgtgttg aggggatttc tttttatggc 27960

ccagtctggt ttggtgtctg taagcttctt gtactttcat aggcataatcc ttctgaaggt 28020
 tggggaagtt ttcnnnnnnn nnnnnnnnnn nnnnnnnnnn nnnnnnnnnn nnnnnnnnnn 28080
 nnnnnnnnnn nnnnnnnnnn nnnnnnnnnn nnnnnnnnnn nnnnnnnnnn nnnnnnnnnn 28140
 nnnnnnnnnn nnnnnnnnnn nnnnnnnnnn nnnnnnnnnn nnnnnnnnnn nnnnnnnnnn 28200
 nnnnnnnnnn nnnnnnnnnn nnnnnnnnnn nnnnnnnnnn nnnnnnnnnn nnnnnnnnnn 28260
 nnnnnnnnnn nnnnnnnnnn nnnnnnnnnn nnnncctttc tatttcagc atcacctcat 28320
 tctgtgtttt cttattctt tctatttcag ctttcatgcc ttgaactggt tcaagtgctt 28380

ccttcacttg tttagttggt atttcttggc tttctttaga ttctttgaga aatttgttta 28440
 ctcttgaat tctttggttt gtcttttcc ccatctcatg taattttttg ctgtttttt 28500
 ctccatttc ttaagggat tttctgttt actctttaa ggactctatc attttcttaa 28560
 gataattttg aggccatct cgtcttcatg ctctgtgttg ggcttttcag atcttgttgg 28620
 tgtggagtcc ctgattctg gggggtgcca cataggtttt tctgttattg agtgtgttct 28680
 tactttgtct tcttccatc ctttctcca gtgagtgcag gtggcttagc ttctgggtgt 28740
 agcaggatgg cagaggggtg tgggtggaca agggtgaggt gtgtccagac tcacagtgga 28800

ccttctgag gctcctgcac ccactgaggt tagggcaccg ctgcaggca gagggcaggg 28860
 tgaagacaag aatgaggtgt gtctggactc agggtgggcc tccgatctg ggctgttcta 28920
 ctcttgcg ggggttgggg tatttcagc agaagtgagc agaggttgat gggagaggtt 28980
 gggaaacagc agcacccaga ctcactgag gctagggcac cgctgaagga caaagggcag 29040
 ggtgtagtgt tttgttttag atattttatt aatagaacga ctgtttcaac aaggcatatt 29100
 aatttgaatt aataggtat atgaaaatca aggatgccag tcaactgttg ctagaatata 29160
 cttttcagat ctcaatagct tagcaattga aacattttat ttattgaaat aaaaagtatt 29220

gacagggatg ttgggggtgt atgcattaaa taccagtact caagaggcag aggcagaggc 29280
 aggcagatct ctgtgagttc cagaccagcc tgttctataa gaaccagttc caggacagct 29340
 ttttgaacce ccccaaaaga aataaagaat tcttgtctat ttttatttta attgtgtgta 29400
 tgtctgtgct tgtctgtgta tgcttgtctg tgtctgtgag tgtgcacgat cttcagaggc 29460
 tagaggcatc aaaatttctt ggagcaggag ttacaggcag ttgtgagcct tctgacatgg 29520
 gtcttgaaa ctgaacttgg gttctctgca aaagccatat gtgttcttaa tcaactgctct 29580
 acctctccag ttgggttttc ctctttttga gtgtgtgttt ggtgatgtgt tttacatctg 29640

agtgtacagg tctgcattta tgagtataca aacagaggct agagtagaat gttgggtggt 29700
 ctctattggt ctttgtgta ctacctgag acagatttc tcaactggaag tgaagcttgc 29760
 cattgcagct atagtgagct cttggaattc atttgcctcc acctccccac tgctgtgttt 29820

acagacatgc atagacataa cttagctttt acatgggtcc tggggatttg aactccagtc 29880
 tcatgctttc agtatgacta ttcttaacca ccaaatcgtc ttagctccta aaagacatta 29940
 tgccattgca gaccaacatc agggctctgc tctctgctgc tgctgctcag tgacactgac 30000
 agaggatcta gctgtctcct taaacttgcc tgtttcaagg caagagaggg tactatagtc 30060

 tccattgtc ttagaattaa cactcattgc ttagtttccc attttttaga cagaatgagt 30120
 cacatttcaa cctcctatc tccccccaa aagcatcaga aagtgaaatt taccacattc 30180
 ctaaaacaaa aaggagtaga agcagaagca ttgggtaaat agctctaag actaaagggtg 30240
 aaaactggag ttcatggaaa ttaactggag atcattatgt tatgtgaaat aagtcagccc 30300
 tacaaaaata agcatatgtg ttcccttttg tatgtagaag ctaagaaaaa cagcaacatg 30360
 aatgaaggt gaatagttag ggttgacaga agaggaaaag taaaaggggg ataaagaaga 30420
 gcaatagaag ggatggacat gatgaaagta aattatgtga atgtgtggaa atgtcatcat 30480

 gaaccctct gtataataca ttttagaaat taaatgagaa aattattgct aacattttcc 30540
 ttgagagcta tgtgttaagt cctgtgtgga atgagttcca catagtttct catgtaaatc 30600
 acacagtga accatgaagt gaatttaatt actacctta ttctaaaact ggaaaaacag 30660
 atgagatata ttaaatggga ctggagagat ggctcagcct ttaagacta ggctcacaac 30720
 caaaaatata agagatatat taaatgattc atccagtga atggatgcag tgagtgttag 30780
 attcagatct gtctgactct agaggtagca actatagact tccacctca aaactctaca 30840
 gtcacaaag ttcacattta atgaaaaggg tatgaacagg gattgctcca tattctgtg 30900

 ttaagcacta aatgatttcc ctcttatatt tatgacaaga ggagcccaat gaaggaagcc 30960
 agcctattag ctgagggagc aggagaggig ccatgcattc caagcatctt aattctgggt 31020
 ttaattactt agaccaagca gaattattct atgtaacatg caatttttgt atactttaa 31080
 aattaatggt gaatgtggtt cagatttgag agaaacttta cattcatgtg gtagttttag 31140
 aagtttttag agttaggcta ttttttcaa gtaaactgga atgactactg acagaaatct 31200
 tgtgaggata atttggagag tttctgtcta ctctacctca tttgtttgt gtttagcct 31260
 tatattagtg tctttgttac tgttatgttt ctgtgaagag acaccatgac cagggaatg 31320

 tataaaaatt aatgattatc atggccagta gcatggtggc tgataggcag gcatggtgct 31380
 agagcaatag ctgagagctt acttacatct gatccacaga aggaagcagg gtaaaactgg 31440
 attattaaga atattcctgc agcaactata gtacttgaat gaaggagagc tgagactcac 31500
 tcccagtcac acttccaagg ccacacctcc taatccatcc caaacacctg taattactct 31560
 tttctgcca tgacagccag ctccccaaata atgacaccaa gacttcttat taatgatgaa 31620
 agctcagcct ttgcttaggc ttgttccact agcgattata agttaaatg gtttgatttg 31680

attttaattt atatttattt taatctacat tctatcatat ggctcaatat ctcattgtctt 31740
 tgtactgccc aagttgcttc ctctgtgtct ggctgggaaa tctgccttct tcctagagtt 31800
 ctgtctctgt gtcaaagtc catctatacc tctgcctag ttaatgacca ttcagctttt 31860
 taattgtatc aaacacagca atacaccttt acacagtga taaatatacct acaacacagt 31920
 ccctcaactg ggaacctaaa attcaaatat acgagcctat gcatgccatt gtcattttaa 31980
 tgactacatt tagcatgaca catttgtcac aatgagtga ttaatataga ctactactg 32040
 ttgctctgct ttattcagat tctttagctt ttctcagta tttctttttg tttcattatc 32100
 tcatctgaga tacctcattg catgtagcta gcatgtttcc cctggttctt ctccattgtg 32160
 acacaattcc atatgcttcc ttatttttcc tacagttttg aagactaata aagtgtttta 32220
 tagaatgata cagctacttt ctataacatg aatctcatgt tcagactggg attcttagtt 32280
 ctgtattctc aagctttgga ggaagacat gaagatcaaa ttagcctcac gttttactct 32340
 tttttgctaa ttttccctcc aaattctctc tcccataac atattaagta aatttttaca 32400
 tttcataaat gtgcataatg ttttggttac tatctcccc actctcatct tccttcattt 32460
 cgggtgcaaa tcacctccct ccactacctg ttttttcccc agtttaaaga catttgattt 32520
 tgttatgtga tctgttttgc tcaatgagca acatctatgt gaccatcaga ttagcactat 32580
 ccattgaagc ttgatgggat caccagtga tatgcaactg aaggcaatgg cttttccttt 32640
 ccctgagtca gtccacagga aatagctcat cactaaaaa aggagtggag tggaggttcc 32700
 ctgaatatcc cctccatttt cttatggctg ttggtgggtc tattcctgtg cagctgtatg 32760
 ttgaggctga gaggttgaga tgacaataat tgtataatct ccagatggat ttcacagatc 32820
 ttctccgtgt gtcttagctc ttacaatctt tccacttctt tttttgtgga ctttggaat 32880
 aatggaatt tcccactgaa ggaactcagg actctcagga gtgacatcct gagccttccc 32940
 tttcaagca tagaatgcag tctggcacia attgtccct caggtgaata gtggaagag 33000
 gatgctctag atgagtttga gagactcact cagtttctg actcaaagcc gttggtggcc 33060
 aagatctcta gctatgtctg gactggaaac tcaacttggc caaaaatcca tttatatgat 33120
 accagtgatg agaagaaact tgatatcggg ctagaattag ttcgcaaagg atatacagta 33180
 gaagtctctg aagatgtgaa agaagacggg actgtcacag atatgttgaa ggacatggcc 33240
 actgaagcag atgcttctct tgccagcata ctcaatgaga ccaaagagag ccctgaagag 33300
 acagcacata ccctatctct cctcagctta tcagaaaaa ctatatagt ttttcttatg 33360
 tagcccagge ttcaaccgtg aagtgtttag aactaactt tcatcagtta tcatttccat 33420

taaataaaat gatTTTgagt aagaaaaaaa agaaaagaac tccttgatt tggTTTgtaa 33480
 Tgtattccat catcctgtaa gatgtgtcta cacttgctg aacctTgtg aaaatgcttt 33540
 Tgcaagcaac atTTTTatta gctctTTgaa aatTgtatgc aatgtatTTT gagcatatgc 33600
 actctactg tccccaacct ctcttcactc tcaccacct cctatcctat cgccacaaaa 33660
 cTTTgagatt TTTTctctt tTTTgaaatg tTTTTtaca tcgagTtcac TTTTgtTgt 33720
 acagTtagtc TTggaagtgg gacctccct ggcatTggT tatctatgag gggTtatatc 33780
 attaaaaaa gtagactTTT cctctccag tagctTTTaa atgctagagc tcatcatcta 33840

 gctgtTggat Tttatgctct cctgtccct ctatgctggg atTTTgtctg gctggagctt 33900
 gtgcagatat Tgtgcaact gtcaaaatTg TTgggagTtc atatgtgtaa catctctatt 33960
 gtctctagaa aacaccattt actTgatgt gatgtcatcc accacctTTT acattacagt 34020
 cTTTctgac cctctTTggc aaagatcccc aagatctctc tctctctctc tctctctctc 34080
 tctctctctc tctctctctg Tgtgtgtgtg Tgtgtgtgtg Tgtgtgtgtg Tgtgtgtgtg 34140
 Tgcatgtgtg TgtgtTcatg agTgtgtgct Tgtgtatatg Tgtgcaatat gtatgtccta 34200
 TTTaaggctg aacctccac aatctctTgt tctctgaatg TTgaccaatT gggagggggT 34260

 gccactgtat gtcatctatt gcaataagaa gctgctTTga TgagggtTta aagatgctct 34320
 gagctgtgcg catggtTcat tagatTTata Ttaataatgt gtcaatTtag caaataatag 34380
 TattggggTc tctgtagag ccaatgatcc atctagTcac aggtTTTTgg cctctgTaat 34440
 gatgccaggt atatagTtc catatcatgc agtagTctt agataccatc agaaagtggT 34500
 TggtTgctcc catatcattg atgccccctc cacaccagTg ggtgtatctt gTtcatatct 34560
 agatgagact gagaactaat TTTctctcc agaagcaagc ataacatctt ccagcaccat 34620
 gaaaatagTt agtatggatg cagctTTaag Tgagcatcag cTtgttatct tcaaggctc 34680

 aagTatgtgg TggtTTgggt aataaaatct taccatcaaa Ttctggaggg taaccaagag 34740
 cagtggcaat agactgTaat gTTTgagggt ctatatgatg ctatTgacca tcaatgcaaa 34800
 agagggcagt ccattTctga tagTggggct TTTgtTgct agtatgaggt atctagTtg 34860
 ggtagctTgg TgctaggtT ggctggTcag caagctTcag gggTTTgtTt gTctTcattt 34920
 cccagTgct aggattcaaa ctgaccacag ctctTTtatg TgggtTTTga agatcaaaact 34980
 cattcctcat gatTTctTga caagcactTg actgatgagg catctcccta gccctccct 35040
 TtcatctTTT ctctctctc atcgaatcag cattgtctctg atctatcaac agcctgatga 35100

 gagaaggatg TTTgctTTta gatgcaaac aatcacctgt ctcaaacct TTgtagTcat 35160
 cTTTggatat TctgctTata ggtTctcaat atcaatatgt tcaTTTTta cTTTctTTT 35220
 attattattg TtattgtTg Ttagagacag ggtTctctc aatatctgtc caccctgtaa 35280

cacactctgt agtccaggct ggcctggaac tcagagatat gcctggctct gccttccaag 35340
tactgggatt aaaggcatac accaccacc catctttcac tttctgtagg cctatgttca 35400
aatcacctcc ccagagagac cttttaggg agacaccgta accacacctc ctaagggatg 35460
gctacagggt tcctgataaa gcatgtcacc ggtataccac acaatcctac aggacaatca 35520

gtgtttgaga gatctaatag gacacttaag gagatgctcc atagataggc tgtaagtca 35580
actccccca aacatatgtt gcataatget ttattgacac taaactttct taatgccaat 35640
gaaaaaggac aaacagctac agaaaaacac tggactatgg aaaaaactgc ttaactgctt 35700
aaccagtata cttcaaagat gtactaacct cagtatggaa gcctgggcat gtgttacatt 35760
ggggtagggg ttttgattt gtttcacag gagaagaaaa actttggata ccatcaaagt 35820
tgatcaatat tcgagttgaa aaagaaaaac atctcgacaa ggatgagtga caggatatta 35880
ctgagggtata tctcataaac taaatagaaa cctcccaaaa gaaaggaag tgttttgctt 35940

ctatcttcac aggaaaactt atctcaaaa gcccaagaac actacatggg tagatgttta 36000
agaagagaag gtagctataa ccatcaaaca aaaggaactg gccttatggc aaaatttata 36060
gctgtctctc aaataactat ttctctttac ttctagtcc ctattcaagt aatcaatgc 36120
tggatttaga gtggatttt gtttctctc cctaaaatcc aagcatgttg ttaactaaa 36180
ctttagagg tcttattata tcaagaagcc aattgatagt actactcagc agaaaaacaa 36240
aaacaaaaac aaaaacaaaa acaaaaacaa aaacaaaaac aaaaacaaaa acaaaaacaa 36300
aaacaaaaac aaaaacaaaa acaaaaacaa aaacaaaaac aaaaacaaaa acaaaaacaa 36360

aaacaaaaac aaaaacaaaa acaaaaacaa aaacaaaaac aaaaacaaga tgttgetcag 36420
aatgttttcc ttccagatga tgactgagaa gctaattaaa aaaatggtat caggtagcac 36480
aagagtaaca gaactgtgct gtttctggg attttgttt ttacttttg tttttgttt 36540
ttttgtttt ttaaatggag tgtgetggat gtctctacaa tttgtttnn nnnnnnnnn 36600
nnnnnnnnnn nnnnnnnnnn nnnnnnnnnn nnnnnnnnnn nnnnnnnnnn nnnnnnnnn 36660
nnnnnnnnnn nnnnnnnnnn nnnnnnnnnn nnnnnnnnnn nnnnnnnnnn nnnnnnnnn 36720
nnnnnnnnnn nnnnnnnnnn nnnnnnnnnn nnnnnnnnnn nnnnnnnnnn nnnnnnnnn 36780

nnnnnnnnnn nnnnnnnnnn nnnnnnnnnn nnnnnnnnnn nnnnnnnnnn nnnnnnnnn 36840
nnnnnnnnnn nnnnnnnnnn nnnnnnnnnn nnnnnnnnnn nnnnnnnnnn nnnnnnnnn 36900
nnnnnnnnnn nnnnnnnnnn nnnnnnnnnn nnnnnnaaga gaagaattg aggactgtct 36960
ttgtctttct tggetcttc cttcaagggt tataccgtct cacaatcatt attttccac 37020
gattgctttt tccagatgt acacatatac aagcaaacat ttctcggeta acattatgt 37080
ttgagtcca cacagcaaat aaagagcagc ctaacagcaa tccctggatg ctccagagag 37140

gaattgggcc atacctcctc aactgcactg gatccaactt actccatttc aactgacact 37200

 ctgaccagag cttcgagtaa tgacttcaat caagttgaag atttcaacct agatcttcaa 37260
 tcaagcaatt cccatcfaat atggaatgga tataatctgt tagagacttt cactatacta 37320
 acattttttc cccacacagga cccacaagg ctactatcat cccatttcag caggaagtaa 37380
 cttggaggat gctacgtccc caacccccat tattgtctat tagggtggtg taagggttgg 37440
 gattggaagg aggtgttcag gtttggacac ctctttcaga tgactttagg gtttagctga 37500
 aatagacatg gttagaatgt gcaatagcag atttctggta tttcaccttt atgattgtta 37560
 attttgata ctttactg ttaagtttta atcctctttt agactaaaag gagaattgta 37620

 gggagacacc ataaccactc ctacaggctg gctaaagttg tgcctgacca tgcctgtcag 37680
 ggcgtggtea aggtgaggtc aggatgactc aggataggtt cttaaagcagc agcgagcaca 37740
 tgggaggccc ctctctctg gcctcactgc tccactgccc tgggcacact ctggcttgtg 37800
 tttggctggt gtttttctaa taaaagtata tccttatgt aagctccctt tgttccttga 37860
 tagaccttct atttttttc tccattttta atttaaatta gaaacaagat tttttacgta 37920
 tcaatccag ttcttctcc ctccccact ctctgcccc ccaactaacac cctacctac 37980
 ccataccatt tctgctcccc agggagggag aggccttcca tgggggctat cttcagagtc 38040

 tgtcatagcc tttgcaatag ggcttggccg cccccatgt gtctagactg agggagtatc 38100
 cctctatgtg aaatgggctc ccaaagtcca ttctatgct agtaataagt actgatctac 38160
 tacaagagac tccatacatt tcccaggcct cctcactcac acccagattc atggggtctg 38220
 gattagctcc atgctggttt cccagtcac agtctgggga ccaagagcac ccccttaatc 38280
 aggtcagctg tctctgtggg tttcaccagc ctggtcttga cccctttgct tatcacttgt 38340
 cctctgcaac tggattccag ttcatctcag tgtttaaactg tggttatctg ctctacttc 38400
 tatcagctac tggatgaggg ctttaggatg gcatataagt tagttgtcaa tctcattatc 38460

 agaggaggac ataaggtagc aggaaggttg ttaggggga agaataagg agagcaaaat 38520
 aagagatacc ataaaagagg gagacattat aggcataaag agaaatcagg cactagggaa 38580
 atgtccaaag atctacaagg atgacaccaa ctagccatct aagcaacagt ggggaggata 38640
 ccttaaatgc ctccccga gaccttctat cttaccctt tgccttcatt ctctctcct 38700
 ctcttctta attcaaaata tattcttctc tcaacaatac accctaacca gtttccccct 38760
 ctttacttc ttcagctcc cttatctcct ctttccccca gatccactct tcatgcaat 38820
 tacatcattt taacttttta ttattgatac ttaagagga aaggctctaa aagatcagag 38880

attttgttct gtacattgct atatgtcctt acaatactcc tgtatatagt acacacttag 38940
 tatttgttga gtgaatgaag tttgtagata gttgaacctg ctgttttcag tggtaatatt 39000
 actggtaacc attatgatca tagtgtataa cggttaatta agatttgatt cagtaccagg 39060
 tttattcctt gcctcatgaa gcagtcataa agacaaatta atgataaatg cctctttttg 39120
 ccttctttta gtcactttct cgagctcgac ttttagacac tgtctaaaaa atatttaata 39180
 aactaaaggg ttttccctca ccaataaga agctccattc attgaagttt tataccagac 39240
 agatcacaca gttgtcattc tttcctagtt attcataacc atggagcatt tttggtcagt 39300

 ggtttgatgc ataaattcta agctctttta actgctgctg tttacagtgt tcaatataat 39360
 ttctggctag acattttacc tccccttctt cctccccacc cctgccgttt cacccttctt 39420
 ggtcatgttg tagtgcata tcaatagctg tccttcaagt ttctctttgt gaataataa 39480
 taaaaataca gcctgatcgt ctcatatggt ttctataaat gttaaaagac aattattcaa 39540
 atgtattcta agcaatggga ctttattata aaacatgcaa atatgcattt ctttaaatc 39600
 actttcatgt gtttcagaag aaaaacagta ttttttcatt agctctagaa ttgggtggtta 39660
 cactagtttc ttttgtgcta gtgtggcaga aatacctggt agaaacaact taaggaggca 39720

 tttattttct ttcactcata atcttagagt atttgtctag tggggaagac atggcaaac 39780
 agcttgtggt ggtagcagga acatgaggca gtgactgttc atgtcctagt gggcaaggaa 39840
 gtagggaatg tgctggaacc agggetgect ataacctaca aaggcttgtc tacagtgacc 39900
 tcctttctct agaccgcacc tctaagtgt ttcaaagcct ccaaaaagag ctgacaattt 39960
 gatacacgat catatttggg gtacttcaga ctcccaccac aacagtggtt aatgataggt 40020
 tgcagtactg tgctttttaa gtgacggttt gcaggtggac tcagtcagtg tttgcttctt 40080
 cctggaaaac tgctgggatc ttactctgta tagaaaacta taagcctgtg agccttgggg 40140

 ctacttagct ttttcatttt gaaattactt cataattttg ctcagatgtt gaatacatat 40200
 actctgccct agaaaatata gaagtaattg aaccaacatt gtttggagat gctcatttgg 40260
 ggactatact gagtcatgaa aatcttctga agcaatcaaa ctgtgcacca ggccccgttc 40320
 tttggctctc tattttgttt ggatttgcag tgctggggat gcagcacagg acctttggat 40380
 actaggcaag tgttctatca aggagctgta caacagccta ccacagatct ttacaaagaa 40440
 accttgtat aatgtaccag ctacaaaaat aaatttttga catgtgaatt tcatttgtac 40500
 tagcttttta aaattagttt ttatattagt atagcagtgt ttgtggctaa cctggaattt 40560

 ttacaaaaaa tgccattatc attttacaat aaatatatag actatatgtt tgctggaaac 40620
 caacatttgt gtgtatatat aattcacttt tatatgaata acccaaatc aaatggttgt 40680
 tttcctatgc atgatatttg tttactttct aaaaagactg tcaataaatt tctaatcatt 40740

tctcttctgt ctttgagaaa tatgttttta aagtattgaa agaccctgc cccttagccc 40800
 tttctttctc aagtttgtct cctcttctc ctggcgcgcg cttcccgat ccccgcccc 40860
 ggtggccggt ggccttcccc ctccaccgc tgcannnnnn nnnnnnnnnn nnnnnnnnnn 40920
 nnnnnnnnnn nnnnnnnnnn nnnnnnnnnn nnnnnnnnnn nnnnnnnnnn nnnnnnnnnn 40980

 nnnnnnnnnn nnnnnnnnnn nnnnnnnnnn nnnnnnnnnn nnnnnnnnnn nnnnnnnnnn 41040
 nnnnnnnnnn nnnnnnnnnn nnnnnnnnnn nnnnnnnnnn nnnnnnnnnn nnnnnnnnnn 41100
 nnnnnnnnnn nnnnnnnnnn nnnnnnnnnn nnnnnnnnnn nnnnnnnnnn nnnnnnnnnn 41160
 nnnnnnnnnn nnnnnnnnnn nnnnnnnnnn ngacccttt cccttggctc ggggcgctta 41220
 gccacacaga agctaagtcg ccccggttac ccgagtctcc aataaagcct ctgtctttg 41280
 catccaagt cgtagcctcg ctgattctcg ggtgcgggtc tccttctacg aaagtacctc 41340
 ttcgggggtc tttcagtatt aatataaaaa acatgactct tttatcttga actcttctct 41400

 ttaaccatg ttcatgac aagatTTTT tttctgtat tctacttgg atgtctgttt 41460
 ttgttgtgt ttagtggtg gtggttactt ctttattcct taaaatcctt cactttttc 41520
 tttttgaact tggatgtttt agtatgaaat taaaatagac tttaatatta aagtaggac 41580
 tatggctga aagatatata tatatatac ataatacaaa gtgaaataat ccagacagaa 41640
 aaataacaat aactttatga tctcatgat ggaaatatcc ttctgtgtgt gtttatgtta 41700
 ttggttattg ttgttgaat aaagtactgt tggccaataa agaagcaagt tagccatgac 41760
 taggagtaa ggagaattct gggaaatgta gaaaagagaa gtctggtgat ccaggcagga 41820

 agtgacatag caggcagatt caaaattcaa gcaaggacaa gcaggaagtg gtctctctt 41880
 gctcttctc ctgctcaag ctatggagcc gccatgtgat ccaggaaga ggacgccagc 41940
 ggaagacatc ctggataaga taagcttat aaaatatata gatttatgat aattaagact 42000
 gagctagcat ataagaaatc ctagtcaatt ggccagcagc attgtaaact aatataatac 42060
 tctatgtgtt attttggccg tgcaagtggc aggtggcact cgggtggctt ggcttaaaga 42120
 tttattgtta caatctcaca ttccacaaga agaaaaatgt atgaaatcta aaaaaaaaaa 42180
 aaaagaaaga aaaagggtag agggtagaac agcatggcct tgggtgatta atggtaatg 42240

 gcaaatggga gatgtgac aatgattata taactatagt tagacaagag ggatatagaa 42300
 atatccataa taaaacatg cggagacaaa aagtagatac ataatcacat taggttggtc 42360
 tgaagaatgg agaggatgag agaatgatgc taatgatcat gaagtttgg tgagagagat 42420
 ttcatgagtg agcatgtgca catatgtgca agtacgtgtg caggcatgag ggcattctca 42480
 ggagtcatc cttatgaatt ttaccctgt gctatgcaag tgtctttctt tgggacctat 42540
 gactcactga ttaggttagg ctggctggtc actgagcccc aagggttctc ccatcctgc 42600

tttcccagaa ccggtactaa aggcattccac cactatatc ggctttattc ttttcatttt 42660
 gttggagggtt ccaggattg gactctcagg tgcttgcttg caaggccagc actttatggc 42720
 taagacattt ctcaaattca aagtgtcatt tttgagtgat gaaaatgttc tgaattgggt 42780
 caaggttgtt atctaaagta aacaaactaa aatcttttgt tttatgtatg aatggaagaa 42840
 gcagctgaga ccatgtgta tcaactgtca ggtatccctc agtgaaaatc acataagaga 42900
 ttctactgtc actgtgaaat gacctcatta attgcttttc cagaacttag ggaaaaaagg 42960
 gcttggctca agagattttc aaacttttcc taaatctagc tatcattatt acattgtttg 43020
 gaaagacgta gaatatctac ttcacctgcc acagaagagg agtacaagaa aaactgtcat 43080
 actgtggttt gaattgtgac agaaattatt tcctgaagca tttttttta tttaccagta 43140
 gaatcttctt tctggctcatt tactctagag cagtggttct caaccctga gtcattgacce 43200
 tttgtgggtt caaagactct tttacaggag tcacatatca gatatgctgc ataccagaca 43260
 tttgcatgtt gattcatggc agtagcaaaa ttagagtat gaaataacaa tgaggtaatt 43320
 ttatggctgg gtcacaatat gagtaactgc actaaagggt ggcagcatta cgaaggttga 43380
 gaatcactgc tccagagtaa ctccactccc tttaaacact tcagaccagg gctgatcaag 43440
 ctgtatcact tcttatgagt gagcagtata tattgtgtca agggatctt tgggtttcag 43500
 ctgatgcatc atggattctg ggacttaaat acattccttc ccaacattac atttttttt 43560
 tgatacaacc actaagaatg gcaatcattg ttctcattct ttcaggagat tctgctttag 43620
 cacattacca cagttaatta cccatcttt catatgagtc atttgcattg tgccatcatg 43680
 gatatgctgc ctgtctcca gagctactct gaccaatgtg gcttcacctt ccagctagcc 43740
 aaagcctgtc cattcttagt tgatggacaa agaaaaactc aattcacctt ttagcttcac 43800
 ttgtgcttaa cacccttggg acccattttt aggagtcat ccaagatgga aacacattgt 43860
 tgttttactg gctttcttac tcatatcccc cacaagggga ttatggtaac agctgtacat 43920
 attactcttc agggaccatg ctggctagt tttatgtcagc ttgacaaaac tggagtcac 43980
 tgagaggaag gaaccttaat gagaaaacac tgccaggaga cttagtccag gcaagcctat 44040
 aagcattttc ttaatcagtg attgatgtgg gaaggccag tccatggtgt gtggtgcat 44100
 ccctgggttc atggtcctgt gttctataag aaaacaggct gagcaagcca catggaacaa 44160
 gccagtaage agctctcccc ttggtttctg catcagcttc tgccctcagg ttctgcct 44220
 gttttgagtt ctigccttag attctctcag tggactgtga ttctggatc agtagccaaa 44280
 taacccttt tcaccaagtt gttttggcca tggttttcat tacagcaatg gtaaccctaa 44340

ctgagacaga aatctgatgg ccacttgtgc caaaatttta ctcttcactt gggctcattt 44400
 caggtgcctg gcaggatttc catcttcaga ttgtgcccg ccctttgggt tccagaattt 44460
 ctagatcaga ttctactcag ctctgcatgt agacatcttg attgtccact gaaagtatcc 44520
 agtgtgtttt ctcacactca gtctctgtgc tctttctgca gctttagcag ccggcatagc 44580
 aacaccacca gccttatcac taggcccaaga tgaaccacaa gcaagaatgt acaggatgct 44640
 taaaccattt gcaaaagaaa ttcagcaatt tccagaataa gctggctgct gattaatctt 44700
 ctaactacaa agtcaggata tttgcacaat agaaggaaaa taagtctcca aaaagaatgc 44760

 caaggcaact gtaaaattac caatcatacc agaccccagc aagtcagtga gaagttgcct 44820
 ctccatttgg ggagtctggt ctcaagaaca gtgctgtgtt cattgtgcc tatctcaagt 44880
 cttgttgaag gcatgcctgc atgttcttca tattctctc tagtgtgatt ctatggtttc 44940
 tgtgacacaa aagcccatat ccaaccacac tgettacacc acattgcatc tctaccatgt 45000
 ctatgattgt tctagttctt gtctgaactt ctctgaggtg tctactgctg gcctgatggg 45060
 agtgggcttt ttactttacc aaaggaagt ctgtagtgtt agtactaatg tttctgtaga 45120
 ggttcccatt ttggaaacct aaagagcttc aggtttttcc tgaaaggaaa agagttcctg 45180

 actgccaac ttccattcaa atagaatcac tctgacagac cactgttctg tcaaggctta 45240
 taggtgacct tgtggatggc aagggtcttg tttgtgaaac ccatcttct aagccattgc 45300
 ctaagaacct ctctctgt gactcttctt aggagtgatg gctaaatagg cctttgtaat 45360
 acctgggatg cttttatctt tagaaataag aggagagcta aggatattg aagttgacct 45420
 gaactcaaag gtaataatta acccaatcaa ttcttacatt tttaacctga ttctagtcca 45480
 cgaagctgtt ctctgtttt gctttgttga tttgtgctaa ttctatgatg tgcacatcaat 45540
 gatcacacac acacacacac acacacacac acacacacac acacacacac acgcgcgcg 45600

 gcacacacat atatatcata cgtatatata gtctttatat agtaaaagta tetatgatta 45660
 gtgggcttct tattttgttt tcttaattag gaaatattaa tactattaat aatagatagt 45720
 agttttgcac atcagttaat atataccaca cattgagtta tgtgtttcat atttgttatt 45780
 tgatctcact caccteggtt tattttttt aaaatcatcc tatcactagg aatattaat 45840
 actgttaata atagatagta gttttacaca tcagtttaata tataccacac attgagttat 45900
 gtgtttcata tttattatt gatctcactc accteggtt atttttttta aatcatcct 45960
 atcaaacaga aagaattaat gagttaattg gctttagga gttctacaac ttacactttc 46020

 atagaacatg gcaatgctga gattcaaatc aaagtctatt tacacaaaa ttaagttaat 46080
 taacactaga aacttaagaa aaacatcact aataaattaa gtatgtaact ttaggcataa 46140
 tttgttatat tataaagtg atttagatat attaataata aacacattca agtagtgaat 46200

tctattgaga agaaaaggta aaaagctctg ccaaccacta gaggatgaac aatgactaat 46260
 tttacatgat atatatacaa catatattta aaagattatt aagcttaaga ttttattctc 46320
 tcttctggaa acaatataga aataaatcag tttctacaca gatattcttt tagttttcta 46380
 aactggtagg tagagcttta agtaggtcac attttttgta atatgactca taagtgagca 46440

attcttaagg acatttttaa tgtggcaatt agacaacaac tgtatgcaat gtggcaaaaca 46500
 cacagttaa aattccagcc cacattttga agtcccttag aaatttgatg tcattctcta 46560
 agtcagaagg gaaaagcctc agatttctcc atttccgaaa ccacatagga ggcaatttac 46620
 tgtaagttag cagtggggct cagacaactc accagatag taacagttaa cagcacactg 46680
 tggtcagtcc acacgccaag tgacagcccc actgtagctg cccagcgctg gtctcacaat 46740
 accaactacc taatttgct aaaaagcatt taagagttaa tttgaactga cataaatatt 46800
 tgcacctaaa agcaggggca ggacatcagt ttttttttaa gcagctttct tgaattaagt 46860

aatgggaata aaaatatgtc aatatcttcc ttttgacaa agaaagaatt attagctgaa 46920
 tgaagcaaaa tttctaattt tgatttaaaa tgctcatcct aatacaggca aatgtcagct 46980
 actcaatcat attagctggt tataaataat caaaaaatgg tttctactta tttagaaca 47040
 atattgcttt ctgattttg tgatattttc agtaattcaa ttagttgctt gtgggtttat 47100
 ttatttactt aattttattt atttattttt tgttttttta ctttttatat atttgaatta 47160
 caaacaagat tgaattacat gaccagcct cccagggaca tcaaccaaac aggaaatgct 47220
 atgctactat aagaccaggc acacagcatc acatcaaggc tggatgaggc aaccagtag 47280

aagacaaagg gtcccgtaaa taggcaaaag agtcagagac cgcccctgcc accattgtca 47340
 ggagtccac aagaacacca agttactcag cataacaact atgcagagga cctaggtcag 47400
 atacctacag gtcccctcat ctctatgaac ccccttgaat ccttgtcagt tgattctgtg 47460
 ggttgtgttt tcatggtgtc cttgacccct ctggtgtgga tttatgtctt ccattctatt 47520
 ttattgacca atgtgtctgt ttttatgcca aaacctgtg gtattaaaa taataataat 47580
 aataataata ataataataa taataatagt aataactatc ctagctctgt agtagagctt 47640
 gaaatcatgg agggtagtgc ctccagaagt tttttatta tataggattg ttttaacat 47700

cctgggtgtt tttgttttc catatgaagt tgggtattgt tctttcaagg tctgtaaagc 47760
 attgtgttgg aatttagatg tgtattgtat tgaatcttca gattgctttt tcataaaatg 47820
 gccattttta ctatgttagt ccaagtgatt cataagcatg ggagatcttt ccattttctg 47880
 ataccttctt caatttcctt tttcaaaagg aaactaaaca acagaagggtg aggaaatcca 47940
 ggtaatatta tattatactt taaaagccta ttccctcacct gattggaaaa tctaaaacaa 48000
 atggataatt ttccaataa gtacctcttg ccaaagtaaa atcaagatca gataaacaat 48060

ttaaatggac ctaaaatgtc taaagaaata gaagcagtca ttaaaagtct cacaaccata 48120

 aaataccag aaccagatgt tttagtagac aattctacca gacatccaaa gaagatctat 48180
 tgccaatact cctcaaatta tttcacaaaa tagaaacaga aggaacattg tcaaattcat 48240
 tttatgccac cacagtcac ctagatctcg aaccacacaa agatacaaca aagaaagaga 48300
 attacagacc aatttcctc atgaacattg atgcaaaaat actccataaa atacttgcaa 48360
 accaggctgg gcggtggagg cacacacctt tagtcccagc actggggagg cagaggcagg 48420
 tggatctctc tgagttcaag accagcctgg tctataagag ctagttccag gacagtctct 48480
 aaagccgcag agaaatcctg tctcaaaaaa caaaaacaaa aacaaaacaa aagaaaaaga 48540

 ctgatcactg ggaatccagc atggaactaa tctagacccc atgaatgtgg gtgtcagtga 48600
 ggaggcctca gaaatatatg gggcctcttg tagtagatca gtacttattc ctagcatagg 48660
 aatggaattt gggagcccat ttcacacaga gggatactcc ctcagcttag acacatgggg 48720
 agggcctagg ccctattgca aaggatatga cagactctga agaccacccc ccatggaaga 48780
 ccttactttc cctggggagc agaaatggta tgggataggt aggatgttag tggggggcag 48840
 gagaggatgg gagggagagg gaactgggat tgacatataa aacaatctgg tttctaattt 48900
 aaataaaaga atggaggaaa aaaccttgca aaccaagtct aacaacacat caaaaagatt 48960

 gtccactatg atcaagtagg cttcttccca gagatgcaag aatggttcaa tatatgaaaa 49020
 tctgtcaaag aaatccatca taaaagcac atgattatgt cattagatcc tgaaaagcct 49080
 ttgacaaaac ccaacacccc ttcacattg agtcttagag aaatcagga tacaagggtc 49140
 atactgaaat ataatgaaag caatatacat caagtctaca gacaaatcaa attaaatgga 49200
 ggaaaactca aagcaattcc actaaaatca ggaggaaaaa aagacttcca ctctctccat 49260
 acctactcaa tatagtactt gaagtcttag ttagagcaat aagacaacca aaggagatca 49320
 aggggatata tgttagaaaa gggagaagtc aaacttttgc tatttgcaga agatttgcta 49380

 gtagcataa gtgaccccaa gaattctatc agagaactcc tacagccaat aaacaccttc 49440
 aacaaagtgg ctgggtacaa gattaactca aaaaaatcag tagtcctata tacaatgac 49500
 aaatgggccc agaaagaaac agggtaacag cactctttac aatagtcaca aataatataa 49560
 aatatcctgg gtaactttaa tcaaccaagt gaaagacttg tatgattaaa aacttcaagt 49620
 atttatttat ttatttatit atttatitit taatctatct atctatctat tctatitcaa 49680
 gacattcttt ttcaagacag gctttccttg tataacttac ttttagacc aggctggtct 49740
 tgaattcaga gatcctcctg cctctgcctt ccaagtgttg ggattaaagg cgtgtaccac 49800

cactgcccag ctiggtttat ttttattttt tgagattatg atataattcc aacattttcc 49860
 cttccttttg ttccctccaa atccctccat atagccctct ccccaaatcc ctttaaattc 49920
 atggcttctt ttttcactac ttgttattac atgcacacac acacatatca tatatatata 49980
 tatatatata tatatatata tatatatatg atccttttga tttttcgaga cagggtttgt 50040
 ctgtgtagct ttggagtctt tccctggagct cacatttttag accaggctgg cttcgaactc 50100
 acacagatcc atctgcctct gcctcctgag ttctgggatt aaaaacatgt gcctctacaa 50160
 tccgactttc tgcccacttt ggcatgtcca ttagtgtcat ccttgctcag gacgtgtgcc 50220

 tctactgtcc gactttctgc ccactttggc atgtccatta gtgtcatcct tgctcagctc 50280
 atgtttagac agicatgttg gtaagacttc atggctgtag ttctgatatt acaatctcac 50340
 agttaagtcc ctaatcctct ggctcctgca atctttctgc cctctctttc acaatgttcc 50400
 caagccatat atgtggaagt gttttttaga tgtgtagatt gagaccaggc tcccaacttt 50460
 gaattttgat cagtggttgt tttccatagt ggtctccacc tgttgcaaag tgaaaattct 50520
 tgacggagat gaagtttata tttattttctg ggtataagga caaatattta ctgattgttg 50580
 ggaggtatta tgctggttta aaactggtgt tgtggactct cctccaataa ctattacttc 50640

 acaaacacag agaaggttag ctaggtttcc aataccagggt gtgccttttc tcttgttgag 50700
 tgggtcttat gaacaaaaca atcccagact tacataataa taattgttga aaagagacac 50760
 catgaatttc aagttagtg gggaggagca tatggaagtg tttggatgga gcaaagggaa 50820
 aaaagaactg taatcataat ttcaaatta aaatagccca aaacgacaac acaaaaatgc 50880
 agcaccctgc atgtattgat atttcaacat ttcttccaac gaaattaact aatcccttac 50940
 ttctgagttt agctttatcc aaattttaaa gtctcaagct aatcaatcac aaattcagag 51000
 tcataagctt tctggtgcaa tttccagtac agtcgttccc atcataatcc tgtggagcaa 51060

 tctttaccac ctgcacttct tggaggattc tattattcag aacacatact ggagcaacce 51120
 ataacctctg ttigcaacat tcaaaggctg tagcctgcca caaccctaaa catatccaaa 51180
 tttctgceca aagcctaaga accacttgggt tcttatttat tggcaaattg aatctgcatt 51240
 tgctgtgtat tacatgattt taaaatttgt ttgtctaag gaacttttaa gtcaactat 51300
 ttaacatatg gattatttca tatacttctt tgaggtaaga atatttaaag tctattctgt 51360
 ggattataaa ggcaacaat gaactgttat taattgttgt cttatgtata ctataaatac 51420
 cctgcattta ttictattaa cagaatttta aatattttga tcaaactgtc ttatgtccta 51480

 cctttccgaa atatttatca ttccatttcc tatttttgtt aatttttaag ctcttatgtg 51540
 tatttaatat atatgataac aatatttata acctatcaa tcatctatta tcaaccattt 51600
 ctttatctat atttatctat attctctctc tattcatcta tttctcttcc tattgtttgt 51660

atacgctatc tgcacatctat atttctatat ctatcatctc tatgtatctt tcatctatct 51720
 cttatctatc atctttattt aagtatctat catctatcat ctgtctatca tgtttctatt 51780
 tatctgtact ccatctactg acttatctat ctatctatct atctatctat ctatctatct 51840
 atctatctat ctatcatggt tccatttacc tacattctat ccatctatca tctatctatc 51900

 atttatattt atgtataata tatctaacac ttatttattt atctgtaatg ataactcttt 51960
 ctgccagccg cctgatttcc gttgcatgt taggaccccc aaataacata cagagactta 52020
 tattaggtac aatgctgctg gccaaatgac taggatttct tattttctag ctctgtctta 52080
 agtatcaacc ataaccatta atctacatat ttataagaa cttatcgagg actccagaca 52140
 agtgtgtcct ctcttctgg tgatcatatg gagacttctt ctttactaca gttcccagaa 52200
 tcctcctcaa ctctagcct cacctatat gcttcctat tggccaacag tgctttattt 52260
 atcaaccaat aagacaaaca tacacagaag gacttcccc atcttctctt cttttctgtc 52320

 taaataaaag aagtgtttta acattaatat agtaaaatat ataacaaaac agttatcaag 52380
 taagaactat attcaaggta tttagttcat tcacatttag caagatttaa agaaaatatt 52440
 ctatcatcta tcttattctt gtgagtctaa agtcttatat gtagcttacc tttataact 52500
 aaagaaaact acaaccataa ttatctgtct tcaactccac caaagaccac agaagggtaa 52560
 tatataaact ctatctctga cagagacatc ttgctacctg gacagtcac caaaattctt 52620
 ctgtacattg gggcatatat ctccagccta taggccacag tgtgtctggc agacttctcc 52680
 atttcaggaa gaacccttca ggactgtctt gttttgccag ttcagcagtc actttctgt 52740

 gggctcttga tgtccagttt aaaccttcca gacaagagca gttccttgcc caaatggctt 52800
 atcttgccat gttgaaggca aacttcataat tgagtttctt ccatgcccac cctcctttct 52860
 gatataattg gtgtgtcagg agcagttgtg tctcatgaca tgaaaacccc tataaccattt 52920
 aaatgccata tactctgtag gtctttgaaa agtttgaaga atatctatcc atttcaata 52980
 catccctgta tacttaaaaa tctaactaa ctaactgta attttgact attatactg 53040
 attatataca atctgtattt aattattcat tacatttgaa aagatctgta taaagacaat 53100
 accaaacaag aagagatatt tacataaac aaaattaacc ttaaattgt atcaataaat 53160

 gaaaatccat accaatgcaa attattcact tctatctctt attcccctt tttccttca 53220
 aaagagattg gctgtgatca ttaccattta taaccaacce catttaaatg aaaacaaaca 53280
 tttataaaca atatttggga atttggcgt cgttcattct aaactgctc ctgctggttg 53340
 ggggtgatgt ccataccatg gggatcacga taaaacacag aaacatggcc aggtccttgt 53400
 tttttagtc tgtaagactg tatcatctca gctgttttag atgttgatc acctgggaca 53460
 ctgcttcagg gggcttctt tcatcaaac atattattct ggaaggaatc tatagcttta 53520

cattttctgt ggaaacacaa gcaaaaactc ttttccaag taacctgttc ttatattaa 53580

atttagaagt caaagcattt ttaaaatata taagttggat taatttagta gcacctttaa 53640
ttaaagtgtat tttagcagct gtagctcttt cctcggaat caaacaattt aaagacaaca 53700
atatagcata caglatccag actctctgtg ggttttccat ctttacctgg cttatttatt 53760
tattttattha tttatttatt tatttttata actctatctc ttttgctttt attttttctt 53820
tttatgagge agggtttctg ggtataactt tggctgcct tgaactcact ctgtacacca 53880
gactggcctt gaaatcacag aaatctgctt gcctctgcct cctgagtgct gggattaaag 53940
gcatgcacca ccacatcctg gttactctct ttttctttct ttcttttaat tattttatc 54000

tgtttctttt ctctcacaag cctttgtata ttttttaaac actttgtaa cctttagagg 54060
ttttactttt tcctctgaa tctgtctttt ctgtgtatct ttatctttt cttctagcca 54120
tgagtctttt atctctaaa cagcatcctt aaaactaaag ccatggctgt tttagtgtct 54180
gtcatttcaa gatggcgagg gtatgtttac cgccagcact gagagtgtg ctcactgcct 54240
tggctctatgc tgccatcaag gagtatgctg ccagcttga gttgtggtcg ctgccactgc 54300
cagttgtctc tacaacctat tcagttgtta gcagggectc ttaaaagagc cctgtgtccc 54360
caccctctat actgagtaag aaaactccc ttaagagagc ctctcgagtc tctgcttgtc 54420

tctagcaaaa aggagaccac ctgagaaaat gctgctacca agaagtcag cttgtctctg 54480
ttcttttctg tctaaaatcc tttttaaagc ttttgtgaag tatttatggt cgtaaaacca 54540
catgggtgcc atttgtaatg ataactcttt ctgccagcag cctgatttac acctccagct 54600
tagggccccc aaataacaca caaagactta ttaggtataa tgctgctggc caaatgacta 54660
ggattttctta ttttctagct ctctctaagt atcaaccata accattaatc tatatattt 54720
ataagaattt attgaggact ctggacaagt gtgtcctctc ttctgagga tcacgtggca 54780
actctctctt ttactacatt tcccagaatc ctctcaact cctagtecca cttatcttgc 54840

ttccctattg gccaacagtg ccttatttat caaccaataa gacaaacata aacagaagga 54900
cttccccat catttatctc tttctttctc tatgtctgtc tatctatcta tctatctatc 54960
tatctatcta tctatctatc tatgtattat ctttttattt atgtataaac tctctatcag 55020
ctatctacta tcttagctca agtgatactc aaattcttgt gccaggcata ttttacttag 55080
caaaacattt aaccacataa atgtcagaat ttcttcttt tgtgtatata tactatattt 55140
tctttattha gtcaccagct gatggacact tagattgttt ctttttttga gtttgctaaa 55200
gaatgctgca gtaatcatgg gactacagga atttcttcac actgatttct tttctatgaa 55260

ataattatct atgtatttac atccttgaaa aacatttggt attttccct ttgataata 55320
 taatttccta taaatgtgag gcaataactc tctgtttata atcacatttg ccaaaagtaa 55380
 tgaccaaaga aaftaagtaa taatgcatgg accaaaagca catacatttt caataatata 55440
 caaacataca ctgtttaata atatacattt tctaaatgct ctttgcttgc caccatcata 55500
 atacctttca tcacatcaat ttaattttct gtactggctt atgcataaaa gcataagata 55560
 aatctacact actattgtaa atgatctgaa aatgaccagt gttttgatcc atctaatttg 55620
 aaatctatct atacttagga tattataaag aagagctatt tgtgcctcct gttggtttgt 55680

 ggatagcaca gaagaagcac ccagtcattt acaatgatat tctgggcacg aagaaagtta 55740
 taatcatttc acaaattggt ggtcataata tacacagaac aaagatttct ttagttccca 55800
 aaaatagcta tcatatttgt ccatgtgctc aaactggtag agaacacca gcctctaca 55860
 catgcttcat ggattttgtc atctgtttct gagatctaga gtttaaaagt ctagaaaatt 55920
 tggagtagaa tcaactgcaa gctattacat ggtaaattgt ggaaagtga gattttaaaa 55980
 ggaaagcctg tgactatcca gtctgaagaa gaaaaagtga ggtgtgattt attaacttta 56040
 ctcaagtatg gaattaattt ttctgagaaa aagtatcgtc tgttttccaa ccacattata 56100

 ggaagaatta ttgaaagct ttcagattta agggagccaa aaataatttt tttttactgt 56160
 ggaaaatggt gggattataga gttgttagtc accccaatcc atggcacccc tcatcgaatt 56220
 ctttcaagat aaggttggag cttggcttca gagagagcat cataagctgt tagggagatt 56280
 tgtgcccatc atttgcctt accataaaga cttggagaat ttaaatgact gatgactagc 56340
 aagctggacc tagcacacat gtctgattga tatgaaagt ccctcttgac caaaagatgt 56400
 atgctttttc aatcttctct aatgtgttga tatgtttaag tggacaatta aattgattca 56460
 gcatagccaa tagtagtagt attttctccc ccaaatattg tgtgttacia agagataact 56520

 catttttggg caactggtaa agtgtctcgt gtcttatcag aggetcttct ggcatcatgg 56580
 ttttctctaa ggccaatgca gctaactttt atttcttta acaattcacg tataacaatc 56640
 tacacagacc aaacaaatca atttctgca catctctttg gggtagaata ttttgcctga 56700
 aaaatttatt tctaagtata ctgaataaaa tctgttcaga gcaactaatat aaaaatagca 56760
 caaagtctgg aatgattta aacttctgcc acaggatcag gaggccagaa atggaacagc 56820
 tgacaagttt taccxaaagg gaagagaatg tcttgtctta taagtgaac aattaccttt 56880
 tttgtagca ataataccat ttttagatt tctttgtttg gtgattataa ttctgttttc 56940

 ttcaaaaatt tatcttaaaa atgttgtgtc ccaaagagtg tgagaaaaat aacttgag 57000
 ctattgata ttgatttatg gataaatagt gaataacaca ttttgatgtc aattttgaat 57060
 atggagacac agaaaactca agtattagat agtcatttct gtccttagta gtaacaaaa 57120

accacagaga aagaacata ggcacagctg ttttttttaa aatgtatgga attgattaaa 57180
 gtcattgagt tacaaaacca acaaaactat acagaatgga gaatgttgtg gtgctgctcc 57240
 agatggccaa tttgacttga cagagtcaat ttcattggtgg accagatgac tttcagtaaa 57300
 atattcattt acacagaagc attttggcaa gtttcacaat atttacttta aatggacatg 57360

ccctgagtct gtgaatcagg tttctaggag cacaaaaaaaa atactaaaac cttccatcat 57420
 gctatttatt tagtgtcctg ggtcaccagc tttatagcat tcttattttg tttgggagct 57480
 tgagaaatgg ctcagagttt atgagcactg gctcacaaag tttcataatt tcaatttcag 57540
 gggacctaat gctctctttg gcctccaaga gcaactgtata cattcaagta ggcaaaacac 57600
 tcttgcatac aaaaatacta ataagcaaat cttttaaaag tttgttaaac tttatttgat 57660
 ataaggaaga ctatttttcc agctctcagc aggcactcct tagttgcttt tagttctttg 57720
 tctaggattc agaccttatg agttttcccc tagcctgttt gttggtgtca tcttggttca 57780

ggtttcattt gggcagtcatt gttattgagg tttcacgggt gtagcttctc tgacacttct 57840
 aggagacaaa atcccagcat atttctgtt tctatggatc tgatgctctt tctctccca 57900
 cttctgctat gatccttagg tgtagggtgtg caaatgtaga tggattggcc accacactgt 57960
 cacttgctct ctgaattttg atgtgttgtg gttttctgca ttgttctctc tgcatttctg 58020
 caaggagata tttctttgat gaggggtgta atagcaaatt gttagtctctg aaattatata 58080
 tacacaagta acattctata gtcggagcag gtgtatttat atatttaggg tgcattgagaa 58140
 gggctggaga gaggaagga gaggggaaaa catgtaattc cattttaatt taaaaatatt 58200

taaaaattca aaaagaaatt gtattttgtt ttagctattt tattacaaat tattattatt 58260
 attattatta ttattattat tattattatt gtgtgtgtgt gtgtgtaaca tggagtgtat 58320
 gttgagattc gaggacagtt tgtgggagtt gattctctcc tttactaag tggaaacctca 58380
 cactcaggte agcaagcttg gtgatggcac ctttatttac tgaggctcct gcattttcaa 58440
 ataaatgtgt tgaatcacag agtacctcca acttcagca ctacatgcta taataagcat 58500
 tttcagagat gctttcacgt gaccatcaa tagattatct acatagtact tacacaatgg 58560
 aagtcacatg tgaagcaata ttttagagca gctttattga gctataactc agggaccatt 58620

agttcatcct ttaaagtata tatcccagtg ctttgggaata ttcagaatcc aattatcact 58680
 gctacaaaat tgtagaacat tttcacacct ccagaagact tcttgacct gtattttacc 58740
 ttcaattgca tcaactgaag ctcttgccag ttattcatgc aaagaaaaaa aagcttgttt 58800
 gcaattcatt gactcttgaa ataacttcat tttacatata caaacaaaac ctgtgttcag 58860
 aatggtttct gaattactaa attttctgg aatgctgctg ccaagtatat ttaagcttat 58920
 tatatttagc cattatgctt agatgttcaa tacaagtcc ctgcaagaag caggtgtgtg 58980

tctgaacatt tacatTTTT ttactTTTT tcatgtgtat aagccatag catatgtgt 59040

cagggctgc agaggccaga agagggcatt ggatgctctg gagctgggt tagaatctca 59100

ggtgattgtt agcttccaa tgtggatgtt agcatctgtg ctctcatcct tagaaggagc 59160

aacaagtgtc cttaactcct gagccatctc tctagccttc agatgagtga tttggtcct 59220

gtgtttaate ttcatgagtt gattatgggt aggaacagga ttctattatt ccttagtata 59280

gtcatagtgt aggaatgaga gcctTTTTca tttttgtgt gtgttgcaat taggattact 59340

gatttgc aaagtggat gtgtatacat gatatttca aagtacaagt gttcaaatgt 59400

ttataaaaa ggcagcactg aatcagatca acccagagcc agttacttat ctaaaataga 59460

gaacaagtcc atgagccaca gatggcctgc tcttgatagt tttaaaagt cacccagctc 59520

cgggaaaaac ccagctgacc tgagcaagta ggagctcatg gaccacagtc tgacagctgg 59580

ggaaccagca gaggaccca ccagacccc tgaacgtgag tgtcagttgg gggccctggg 59640

tagtctagct tgggcctag ttttgaact gggTTTTtg gagccagttc cctatggagg 59700

gatactctct tagcctagat acacggggga gtgggagagg ttttatgtcc tgccgaaaat 59760

gatgtgacac tttggagcc tccccattg gaggcctcac cttccctgag gaatggatag 59820

ggagtaggat aggggttgg tgggggact gggagaatgt gaggaagagg gaactgggat 59880

tggtatgaaa aattagatca ttttaattt aaataaaaat taattaaaa agagaaaaaa 59940

agtcagccag ctccacaatg taatggacca gattggccat acttatattc tttgtatac 60000

agtaatttaa agagatcttt tttctagggt atggcatggt gtgtacacat gtgtgtttgt 60060

gtgtgtgac atgcatgcat gtgtgtgtgt gtgtgtgtgt gtgtgtgtgt gtgtgtgttt 60120

ataaacacg cagtgggat ctgacaggta gtgcctttt tgtctctgta aattacattt 60180

gatgtgtta aagcttctt ttccacctgg aagcccgtag gaaatgcct ttaagaatt 60240

aattagccta cactcttatt taaggagcta acatttgaag actgtacaag aaactacata 60300

agaattttta tttgaagtt aatctttgga tatgtacttc atgagaaatt catattaaat 60360

catttacaca ttcacaaaa gcaatattga caaaccta gtagaaaata gttatttata 60420

ctttatgaa gcttgtcatt aactaggatg cacataattt tggttctgtg tactgtggta 60480

tgctttggag atgtcttact gccatactc cctgagttg gaagcgtca cctcttctca 60540

ctctgcttt atgtctgtt agtctgttgc tatagcagaa tgtgcttct aacacttggc 60600

tggaagctca gacttgtgca gtgagtgata gacatgacaa ctttgcctca gccactggcc 60660

aaagtaaaga ccaatgtcag tgaatgggat gatcattata gtcttccca aatcctgtgt 60720

gagctacatg tttccaagc tgaataaaa aggaaatcta agctggatca taaagccaaa 60780
 tatgttactc ttagaaccaa gaactagcga gctgacatct gattcgagag cacgtatgat 60840
 ggaggagagg aacttttatg attcatattt ctcttgacta actgccaaagt cttttgtgac 60900
 tgactgacca aatgtcaaat atcctttgga ggatttcttg atgttttcag tcaatctgca 60960
 aatctcatta ctcttctaac aatctttcca gacttctttt gtatttgctt ttctatttcc 61020
 tatgtggttt ttgagaatgt tctttaccta agacaccatt tcaatgcatt tatgtagcca 61080
 ttagagacat tttctttgaa atataatttc aattaaacat ttataacttg atggtgactt 61140

 cttaatTTTT catccataat tgttattagt acatacttat ttgaattaat aagcattctt 61200
 agcatactga atgaattctg tgggattata ttgtttgtaa ctagatgaaa catgtgtttt 61260
 attctcagta cctttatgga gaaaagtgtt ggtgaagtgt taggcttttag gatctcagtg 61320
 gatttttaaa ataattacaa aactcattaa taataataaa agaaagtatt gtacaattta 61380
 tatatgcaat ataccaatat atgattatct catatatgtc tgtcctgaat gcttgttcc 61440
 tcaaccttat attctagttg ccacaggcac aaagatgtct gctgtatttt caaaggcttc 61500
 gtagaaggat aatagcaatg tctttttaag accagagctc atgcttttcc tcttatgtaa 61560

 ctgaaattcc tacttctgca atgtaatttc ccttttacia attctgaata gagaccatct 61620
 gctcaccatc ttactctctt tttatctttg ccaaatgtca ttggcagaac catctcctct 61680
 gccccttate tcicaagtct gaccttataa gagtccact ttatctttgt ctgttttagg 61740
 gcagagttaa cagcaatggc ttctttatct cagcctcatc gaacacatct tcttttggt 61800
 ctctacattt agctcccaat cctgggctcc acctattttc atgcatgat gtcaagctct 61860
 gagctacttt agagattcag aaagtggtaa tagacaaaagc caaccattct tgaggtagct 61920
 agcctctttg ttttagagat tggagcctgg agtcattaga ctatccacag gctcagtggc 61980

 cagtcagagt aagacatttc tgaccatttt cctcctagga taccttgacg ctattatctt 62040
 tacttgcttc aggtttttgag ttgatgtcia tgggcagcct gttgaggtat gattctcatg 62100
 aaggtaacca ctaaacagta tgtgtgtgca cttatttttag agacactata atttttaaga 62160
 gttacctaga gtaatgtcat gaagcaaagt ttaaaagtgt gcttatattt tgtacactag 62220
 tggcttact acatttatag caaaggtaaa ataaaatgaa agaaataaat acctttgttc 62280
 ttccatatat ttgtgtgtgc tttgttggct atgtttaata agcttttatg ctcttttctg 62340
 tctcttgtgt ggaattgccc atagcaacta ggacattaac taagtatctg agctctgtga 62400

 cccttctgta ttctgtccag gagacaattg gtcacttgtt aaaattgttt ggtgttttta 62460
 cttaatgaag ttcttaatat ctttttttag gaaatgctgt tagcagtaga gaaattttgg 62520
 tttctttgtt cattgtatct taaactctgt gtggtcacat tatttaattg gtaaatctta 62580

tgtagattt caactacttc tctcaccaaa caacttatga gatcatttgc caaatacaag 62640
 ggtgtgaaat atgagaatgt gggtttcttc tttatcttct cttttcatgt tgattttgtt 62700
 ttatgatcag gtaagaatga cacagacaag gaataatgaa aaatatagga aatactattt 62760
 cttaaacttt tgaaaaggat aaagtctgaa aattagtta aacttgtgaa aaattggttg 62820

 aggctgcttt ggaaaaaatg catggcatgt agttactgta atgaattaga atattcatat 62880
 tattagtgtc tggggttcaa aataattaag gagaattaga tcttgaatga atattaccac 62940
 aagactttgt aactcagagt tcttaggggtg aggtcactct tgcttgcttt ctactgcttc 63000
 ggtaaacacc atggccaaaa gcaacttggg ttgaaaactg gcttatttgt ttgatacatt 63060
 caggtaacaa tacatgatgg aagacagctg gggaaactc cagcggggca ggaacttgaa 63120
 gtagaaatca tggagaatg ctgcttaatg acttgttctc atctctttca gctgcttcat 63180
 ttatgcagct taggtttctc ttccaaggag tggcactgct tacagtggga aggtccatc 63240

 tacatcaagt agcaatcaag aaaaagtctt gaaaacatgt ccatagtcca agctaataaa 63300
 atcaatgcgt cagttgaggt ttcttctttc caggtgtgtc aaacgccaca cagtacacag 63360
 ccacatttgg aaaggaaagc aatacacatt tatttccctt tatttgtact cccccctca 63420
 atagtaactg catcaccatc aagggtattt ctgggccaca gaggaccagg gactcattat 63480
 agatagattg gctagtgtgt gtgaatataa aattgaattt agtcctattt tatccagatt 63540
 aagctcaagt ctttgattca ccaaactgtt tcattgggat gctagaaata aaaagtgtt 63600
 gatgagattg gtccttgaag gagtcttga gactgtctgt tttcagcaac aggaataggc 63660

 caacgtttgc ctagggttgg acccacatca cttagcaagc acagctgaga attggcactc 63720
 agctctttct ggaccctgct gcctgctctt cctgtctcac catgttgctc tctgacaatt 63780
 ggctattttc tggcacagctg caacttctt tcttccaggc aaaaaggaat aaaatctgca 63840
 ccactatcaa acaaccaaac tcccccaaaa atattacatt ataaaacttc ctgagtgtac 63900
 acagatacta gtacatacta tgttaccaca tgagcttcag tttaaagggc aatatttagt 63960
 tatgaacttc ataactaat gattttattt ctgagtgtc aaagaaccga aattattact 64020
 gtagcatat atacatagt atatatacat atgtatatat atatcccact ttttcagaat 64080

 tagttatctc ttatatttag ctaagatacc tgttttgaag agagtatctg ttgtaaataa 64140
 attattatac atacaaaatt agatattgtg gaataacttg aatactatgc caaatttgc 64200
 ttatagtcaa ggctagggtt acattgacta tttgaggcta ttattttta atttgtattg 64260
 aaataagatg atatctctat tggcaaaaca catatttgaa agagttgata tgcattgagg 64320
 ctatgtgaa ttttacaatt ttgaattaaa aactttcaaa tttgtttgtg tgtgtgtgtg 64380
 tatgtgtgtg catgtgtgtg tttacatgta agaataccca tataccata catgtaccag 64440

tgcacatgga gtctacaaaa agggcttcaa atcccctgga gctggaatta caggaagttt 64500
 cgagatgcct aatgtaggtg ctgagatcag aaccatagtc ccatggcaag ggcagcaagc 64560
 tctccccca tttattgaaa atagettttt ttttgtetca cataatacat cctggttaca 64620
 gttttccctc ccctactcc tgtcaacctc cctcccac tgtatctact ccctttctgt 64680
 ctctcattag aagacaaaca ggttttttaa ggataatagt aaaagaaaat gtaataataa 64740
 aagtaaaata aaaaggaata cattggaata gggcaaaaaca aagagaagtg aaagagccca 64800
 agaacaggca caagaaatag atatagaggc agagaccaac tcatttgcac actcagaaat 64860
 cccatagaaa cactaaacca gaagtcataa tgtacactct caagaatact ctttccattg 64920
 tctcttctca gggttccatg cacatgaatg agaggattca aagagacatc ccatttggag 64980
 ctgtgtgttc caagatctct tattctctgc ataatgtctg attgtgggtc acggtatttg 65040
 ttatcatctt cagcaagtgc tctaactac tgaaccacct ctcagatcc cttatatggt 65100
 tgtaatgttt cagaatctta tacattattt aaataaaca tcatcacatc atcataataa 65160
 gacagtaatg agactttcac cttgtattag aaaataaaag atgtctttaa aatggaggaa 65220
 tcatgggatg gagagacggc tcaacaagtc aagctgcacc atgtcatgca agtgtgaaga 65280
 cttgcaagtg tgaagacctg gcaaatgtga agacctgagg tgcttctcta gaatccacat 65340
 ggagccaaca gtgtacttct gtaattgcag aactccaatg aacaattcct gggggccata 65400
 tgggccagct agatttgttt gggcattaat gaacaagaga tcctatctca aacagaaacc 65460
 ctaaggaaag aaacccaag ttgtctctg acctccatat actcactcac tcaactatc 65520
 actcactgc tcaactacct gtgcttacac tcaatccat cacacacaca cacacacaca 65580
 cacacacaca cacacacaca cacacacaca cacacccac acacaaattt tcatatgcac 65640
 taaaatcaag aacacagaca gcccttcatt ctgggtgttc atcatttaga tatgtgtgag 65700
 atatgtgcat gtctttagct tcagtattgt ttataataga aaaactggtt tgaatcttaa 65760
 atttttccac ataatacact gtttaaac attttcatat tttccaaaga gaaacaatg 65820
 caaatattag agcattttgg gtgatgtaaa aatcacccca aattagcccg cctgcccagc 65880
 aggtcaggta tagtcagtcg cctggagaaa cagttaattc ttaaggtca gatgctcatc 65940
 taagagatct ggagacagca gagcagaatt ccccaggctt tctttttcc tttgaaattt 66000
 gccctttggt gactccttc tctgtctcag agagaaaaga aaggctttga gatttctga 66060
 tggctctacc acagagaacc caacacaggg gcagggaaaa tgcaagacag tgcacctttt 66120
 tgtttccttt tgttttgtg aactttttat tccacaaacc tgtttagtat gctgtgaaag 66180

agtagtctca ggacatggcc cattgctcaa tgcctttcta caaggctctt cagaagcctc 66240
 ttctggcttt agagataaga ttaaaaattt tagtttttct gtctggactt actagactgg 66300
 aagcaaggca aatctcagtt tgcatgtatt catcaccagt tcctgggtct gcgacattgc 66360
 aggcacgaaa gagtttatgc ttagtactaa catatggatg cattagattg aacgccact 66420
 gatggtatga ccattccctg aatgatagac acttttgc tctgttttct tgttgatggc 66480
 cattctgacc ttagtgagac aggatcgcat gcagttttca tttgcatttc cctgatggct 66540
 gaagatttta aatgtctatt ggatgtttct atttgtttta attgcctcc ttttgaagtt 66600

 tggggtgctt atgtttttga attctttgta catcctagat gttaatcctc cctcagatat 66660
 ataaataaca aggaaatttt ttccaatct gtaagctgtc tcatcactca tctgtatcct 66720
 ttgttgcga gaaacttttt aattcatac aattccattt gttaattctt gctattcttg 66780
 ctattatttc ctaggctgta ggaattctcg aagggttttg tatctcaaga gtttctttct 66840
 ttctttcttt ctttctttct ttctttcttt ctttctttct ttctttcttt ttttgaagc 66900
 tatctcagca ttttggcctg agcagtgagg tcttactct tctggtatta agttgagagg 66960
 ccccagatta tgtgtcttta tcatgaggtt actcaccttg caagggtgctt cagtgcacaaa 67020

 cacttaataa aataggctta gcacctttca cccaatgga aattttctcc cactttattt 67080
 ttgcaacatg tttttgattc actttaattg ttacatcatt ctgacctatg tgagagatat 67140
 tttcatatct gctttgccct tttgttaaag ctccacgcca gcttatttta attctatgta 67200
 gagtctagca ttggagccaa cataaggtaa gaattaatgc ctatgatcaa attgaatgga 67260
 tgatggaaat atttgatcat gagcaatcct tgtacaagag tatcagcatt tgaaaacagt 67320
 tgtttaagta acagtgggtc tgaatgaaac aaatgggtta tcaaagacac cttggctggt 67380
 aagactagag aagaaaagtt accatttgaa tggagaaaaa caaaagtaca gatgttaata 67440

 aatcacact atgaatttta ttctttggaa aatatgttaa atggctacac atactttact 67500
 gttttaatga ttaattgggg aatgcagtct tttatttttt attttcaga atttatatgt 67560
 gaaccagact ttaattttgc ttgggtctta actgtttttt ttaatttagc ttaatcatat 67620
 attgcattaa ttaacatttg taatttatgt ttggattctg agactctcat caaccaagag 67680
 tctctggctc agagatgttt ctgaagcctg gggaagagct ctgtagctgt tttctgattg 67740
 tttggtgaag atggacttgt acattatgct ggtcagccat gttcctcggc aaggatagc 67800
 tcaaaagga gcctctgatg gttttcatga gtccatggaa cagccggctg cgagcagcag 67860

 ggcgaggctc tgagagggct gtgcgtatgg tttcctcggg ataaaagggg tgtggactcc 67920
 gccttcaca ggacagaaac ttggttccca agttgaacaa gaatctgtga ggtggtttac 67980
 ttcccaaact ggccccagat tcagttttcc tggcatccct caaccatgga atcctgtctt 68040

ttggctcctg gtgacaggca gcctgtcacc tttggttctg gtgtcatgtc caaggaaatg 68100
 ctctgtgccca tagggcatgg aaagacacag ttagaacagg agaactgccca atggcagagg 68160
 ctccacacca ggatgagcgc aagggaaagt gccgtaggcc actgtggtca gcctgagcat 68220
 gcttcccttt cataaccag acttggatga ctataggtg cttatattg gctggctgtc 68280

 ctctggggac attttaaagt cctgccgag gtctttcatt ggcacagtga cgctggttta 68340
 gatccttggc caagctgcct ttgagttttt atactaaggt aagccagcca acatttaaac 68400
 cctgtttctg atgcctgccc ttatgattaa agtaatgcaa ctcatacagg ctactagtc 68460
 accatgccgt tacattataa cagagcttct gcttaaaact taaattcatt ctatgactca 68520
 gatgtgtagt gtcttcagca atggggcctt tccatcaagt tctagagagc agccaatggc 68580
 attggcagta gctgtaatat ttagggttct gtggcagttc actgacaaa cctcctcaaaa 68640
 gacttaacce actgttggca ctgggctatt tacttgttag tttgtggcat ctagcaggac 68700

 cattgccact ccattatcag gtaactcaaa ctttaaaaca aggaaaatg tccactgttt 68760
 gtgggtggtt cagaagaatt acttgcagtt tacctcaaca gtcttggcag cttcattcac 68820
 tatgaataat tgcagatgca taggacacca ctaagattat atgcaaatat tgctaaaaga 68880
 aggcgctcta gaaaacctcc aagggttagc gtctatacta cacaatctct tctccatfff 68940
 gatctctacc tctctgtctc cttacacaca tcccccttc ccttttcac ctgatcatat 69000
 tccctattga ttttaaaggg tatttctcta actttcattt ggcaatcacc ttaactcata 69060
 tttcacaact atttctagt tatttactgt tacaagatca gtttggagcc cttctcacct 69120

 cagatgcatg cagtggcca ggagcccaaa gtatcccca cttccatfff gccaggatt 69180
 gcaaagagct cacaccacta gcctagattg gttaggcttt tgacaatagc gtctgttgt 69240
 cttcagaaca caccaataga aagattcacg tcatgattcc ttttgggct ctgattaaaa 69300
 taagaaactg atttgacctt gttatttggc tccccctaaa gtaaaaatc catagttaa 69360
 ggaatgaagg aagatgagac gacaattaa agaggagcag gctgtcaaag aactcattgt 69420
 ctcaaaggaa gtagagatat acacacttgc acaagtgaag gctgagtttc tgttctgcct 69480
 ggtccgatg ctcttcagct ccaataaac aactgagge tatattaatt agaactctgt 69540

 tggccgaatg ctcagttttt ttactggcta tttgccctt aattattaac ccatttctat 69600
 taaactatgt attgccatga ggctgtggct tatctgtaat ccagcacctt actccttcag 69660
 gaacatggca tcccccttgc ctcttctctc tgctctctt tccagaatc tcttctctg 69720
 gtaaccctgc ctatacttcc tgctggcca ctggccaatc agcattttgt tcatcaaca 69780
 ataagagaaa catatataca aaacaacaaa acaacaacaa aaacaacaa aaaaacgcat 69840
 cccccatcag agaaggggaa ggcaaatctc tgcaaaggtg gcaggacaat tatgcacttt 69900

gcttgtggct gagggaggat aggatttgc tctgaagtgg cagctctagc tacccttaga 69960

gagttagaag tacactcccc agtgaagaaa aatgtagaga aaatggtaa gtccaatagc 70020
cattcaagca gaggaaggaa gaaggttgc gaaaaatgtt gttaagttat attattcatt 70080
atthtgaat ttccatgcaa ttgtaactcc aaattagtca agtaaaatct ggactaacgg 70140
ctaagcagtt cctgccacag atgaaaaaga acttggttaa acctcactgc ttggtgacaa 70200
gtaagggta tgaagtcaaa ttgtccgtat ttaaccgg ctgcttcatt taccaacccc 70260
tgatcttggc aagtaacttg acctcttgat actttagtct tcttcagtga atggatgta 70320
taggagaacg tcacaggact tgtagtacaa ataatgtat tttaaaaagt gttcacagaa 70380

agccttgtgc aagtgggggc tgctgttgc cgggggtcca ggtgcattgc atcttcaatg 70440
tttgaagtgt gctattcatg taattcagta tgaaggttcg ctagaagata tggcttaggt 70500
ctgctacagt ggtgaaatg gattttttct tatacatcca tgtccagcac acagaatgac 70560
acaaaataac tctgctggca ttccatgtg aaagtttata accgagtacc acttaatggt 70620
attgggacta tcttattttt tattatatga gcaagattgt tcaaccaagg gacatcagaa 70680
ataataaata gttttaaaac tttagattgg cccactgggg taaattgata aaacaattta 70740
ggatactcca gttaccctca agccctctaa tgagttctgg agcatttttg aaaaaataac 70800

ctttgatact gaattgccac aaaacaaagc caatgttacc ttgttataaa tatgtacata 70860
catttttccc acicttttat ttctttaaag ttgctctaa taaaatttaa ttttgaagct 70920
ttgccaaaga aaaaactaca gatgggctat tttgttaca aatgataaaa acaaatatgt 70980
tataatgta agtcaactca ctgttgttc taatacttt gaaatattac aataacctec 71040
ttaatgttat tataatcacc ttttaacat cttatcaaaa tagccttagg aactttttga 71100
aactgttctg ataaaaat agaaacagta ataaaatgaa aatacaacac gaaatagtaa 71160
tgcatttcag aaaaatgcga agaattattgt gtcaaaaatt gcttcatttt tttgaaatgt 71220

ggaatggttt aaaagctata attgacataa aaagtgggaa aaaggcaaag ccatcaggat 71280
tagttcagga agtcatagat tataatagcc agaatgaact caaaatattt tcagtgtatg 71340
attcagagtt ttgagactca gaatcatgat gaccccatgg tcacaagaag cctctgcca 71400
tgtcaacata tgtctatgta gtgcacattc aatgatttat tctttatctc atttttaatt 71460
atthcttca agaaagtaca tgtaaaatag aactgttgtt tccacagaac cattcttcca 71520
cgaacactcc cgiagttgct gccaaatatt tctgcaatag tttaaaatgt gtttcacat 71580
tcaccatctg cttttctct aatttttcaa aacatggaaa tagctgaaga taagggaaag 71640

ttctctgaaa tgccagactg tgctgtataa atataagtta taatatatac agctatgtct 71700
 tgggaatgca aactactaat ttgtaacatt gaaaagagta gttgctatft taatagtaat 71760
 tgtggtttct agtacattaa agccagtggf aagaacaaat gttttcaaaa attataactt 71820
 gagaaactca aaaaaatcat aacaacaaca tcaacaacaa aaaaccaaca aaaaccccca 71880
 aaaattcagt accgaaacaa tcaaacaaag ataactggat taaaaaatgc ctggcacact 71940
 attgattgtg tgaattagtg aagacattat agaaaatagt atggagggtc cgtgaaaatt 72000
 aacactagag ctaatgtttg agctattaac cctactatgg gtagatatcc aaggaagtga 72060

 aatcagtttg ttcaagaggt tctacactcc tgagcattaa aaataagttt gaggtcacac 72120
 tgaggcaaca aciccagctg aagagtctgg acaattcgag acttcactca agatggtgtg 72180
 tgtgctggaa agaggggaca cacggagaca aggacatgac tttattctaa ctgagggggc 72240
 aactgcttct ttctcacatt ggctggagtc cccatcaca gtcttactca attggtctct 72300
 tttaaaagaa ctggcacatg ggaagtgaag ggggaaggga tcagccactt taattggaga 72360
 atgtagtagg gcctttgtgt aaacaaaggg tgtactgggt ggagagatta aagcacttgc 72420
 ataaaagtct tacaagatga gggagataaa aagattttaa ttctcccta agcacaagtt 72480

 tcaaagtatt tgatagaagt ttcatattca atatttctta cacatgttca ctgaaatgtt 72540
 acttttaata gccaaagaaa cagaaaccaa aacctaata tcatcagtga tgaaaggata 72600
 agggaaaatg tagtacttat taacaacaga gccgtatatt cagccataaa atgacaaacg 72660
 ctttgttgta tgcagcattg tagattattg tactaatgaa agccaggac agaaagagca 72720
 atacaacatc tcatatgat ggaacctgaa aatgttgact ttcatataag aaagcagaat 72780
 agtagttccc agagcctgag gagaggaata ggagagggat gaggatggcc taatcaatgg 72840
 gtactgtgtc acagttaggt agtcagagga tgatttcagg aaccatttca caccatagtg 72900

 actgtaggta acagtaatgt acagtgcatt tcaataaact agaaatggag aatttaaga 72960
 aacagtgttt gaggacataa atatgccag tctcatttaa aacatgcaat atgtaaatg 73020
 catcaaacat catgtatgtg gagccaacca ggatgtatga gttttatgtt tccaccatt 73080
 agttaaaaaa acaagaaatg taataaaaat aaatgcaaag tgtagtttta ttaagagggt 73140
 aaaaatattc caaggtaaat ataatcgatt ttattcctat atagattaga acacacattt 73200
 ctatttcttt agaacctgcc actgtttagc atgctgaatc tcttgctata atgtgatggt 73260
 ttatacactt caaaactatt atagcaagtg attaagcatg ccttaggatt ctgtttaagc 73320

 acagtgttcc ttctgggaaa tgaggctgga gtacatggac ctacacagat attaatacat 73380
 acatgtctgt actggtttgt gagtatftaa gtaatgtgtt ggataaagag ctctagtctt 73440
 ccaaattata atttcttttt taggtaattt ccctttcatt gctctggaat ttctaaagg 73500

tggcttcatt tggcactaca ccttttgtaa cttgcctctg cttgccatga tgttcttctc 73560
 cggcattaga tcacggcctt gcttactctg aagacaacaa tactgccctt tcttagaact 73620
 ccctcccac cctttgttct tctccggcat tagatcaggg ccttgcttac tctgaagaca 73680
 acaatactgc cctttcttag aactccctgc ctgtctacct caaatctaag atggttcaag 73740

 gtgatttcat gtaaggtgat ctcttttacc tgacaggaac acattcttcc attactggtg 73800
 tgtgtgtgtg tgtgtgtgtg tgtgtgtgtg tgtgtgtgtg tgtgtgtgtg tgtatgtgtg 73860
 ctctttgttt gaaatcagag gggtagttat taatcttcag aaggcttgat ttaaagaaat 73920
 tcatcctatt tcgaagttac ctctttggg taggtacaat agggtaatat cagttttacc 73980
 tagagtcctt ttaaattcta gcttttattc cttactgaaa aatgtatcta ttagctcatc 74040
 agctactcat caagatgtcc tcacaaaggt cgtgctaaat gtctcatatg catgtttaa 74100
 tgtcaagaga agaggagaac cccagcataa taccatccac gacagggag ctaaagagaa 74160

 tatctttata ttttccagg agtaaatatt acttaagcaa tgtacacata ttgttagcca 74220
 aaagaaaaaa attgaagtca agaattctgt ctattcggca gccacagat tgggaaaaga 74280
 tcttcaccte atcagacaga tggctgattt caaaaatata caaagaactc aagaagctag 74340
 tcatgaaaac accaaataat tcaactaaaa agtgatgtgc agaactaac agagaattct 74400
 caaaagagga atctaaaatg gctgaaagac atttaagtgc tcaaattcct tagccatcaa 74460
 ggacatgcaa atcaaaaaca ctctgagata tcatcttaca cctgtcagaa tggctaaaat 74520
 caaaaacacc aatgacagtc tatgctggaa aggatgtgga gaaaggggaa tgcttctcca 74580

 ttgctggtgg gagtgcaaac ttgtacagcc actttggaaa tcagtatggt gttttctcag 74640
 gaaaatggga accagtctac ctcaagacc atcaattcca ctcttaggca tatacccaaa 74700
 aaaagcacat tcaactaca aggacatctg ttcaactatg tttatagcag cattatttgt 74760
 aatagcaagg acctcgaagc aggttagctg cccttcaact gaagaatata tatatctata 74820
 tctatatata tatagatata gatagaagat atagagatat agatagaaga atatagatag 74880
 gatagagaaa atgtgtgaca ttacacaaat ggagtactac caagcagga aaaaaacaac 74940
 ggaatcttga aatttgcagg caaatggacg gaactagaag aaacctcct aagtgaggt 75000

 actctgtcat agaaagacaa acatggtatg tactactca tatctggatt ctagacatag 75060
 tgaagagat taccagccta caatccacac ctccagagaa gctaggaaca aggaggacca 75120
 taagagagac atacacggtt cccagtgaa gcagaaaggg acaagaactc cagaacaaat 75180
 ggggagtatg gggtagggg gagggatgta ggagaaagag gaggggagaa aaggaggggg 75240
 ggaggagagc atgagggatc aggaagattg agcagtgag acaaatagag gagagcaaga 75300
 aaagagacac atcaatagag ggagccacta taggtttaaa gagaaatccg gcacttggga 75360

attatacaga gatccaaaag gatgacccca actaggaccc taagcaatat aggagaagct 75420

accttaata cctgtccct ataatgagaa tgatgactac ctaaatgcc atcatagagc 75480

cttcattcag tagctgatgg aagcagaaac aaagatccac agctaagcac tgagcccaac 75540

tcttgaatc cagtttcaga gagggaggag tgaccaacaa aggggtcaag accactctgg 75600

gaaaacccac agaacaact gacctgagca agtgggaact catggacccc agtctgacag 75660

ctctggaacc aacataggat caaaccaggc cccctgaaag tgggtatcat ttaggatcac 75720

tgggtagacg atggggcctc tggcagtgga accaggatgt atccctaatg caccaatgga 75780

tttcaggagc ccatttcccg tgcagggaca ctctcttagc ctagatacac agggagggcc 75840

tacgcctac cccaaatgac ttgacagatt ttaatgatcc ctcatgaaag acctcacct 75900

ccctggggag tggatggggg atgggatggg ggaatctttg ggggttatgg gaggatggga 75960

gggaagggga actgggatgg acatgtaaaa taagactgtt tctaatttaa ataaaattta 76020

cataaaaaga atgctgttta ttggtaaca gtgagagact atgtgggaga ctgatgtgtt 76080

tgtaaaactg atcagcatat aaaatgaaag ccttttatcc agaataaata aaatgcttgg 76140

aagtaaatgt gaacaaatg acaaaacagc agaaaaaata agccttagta gatggtagtc 76200

aatccattca taaatctatg aaaaagtctt ctaatatatt tagttgcccg ggaaattgta 76260

aattaaaacc caaatgaaat gccattccat accaatgat tggctaaagt gactgtgcca 76320

agtgttgggg aagaagtaga aagcctagc ccttctccg ttactgaaag aagttgtaaa 76380

ttgctaataga ctcccgaat tacttgttag gatttagtaa tactgacat atacatattc 76440

tctgacctaa taactgtgaa aattcatcat acattgcca gaggaagta caaaaatatt 76500

tctagcagtc ctatttatag taacattgt cagcagttgc caggaccacc ccagagtgg 76560

cgattcacag acatactctc aagatccaac atgattagtg ctatgttctc tggatggct 76620

tatcttagtg aaaatafaca caactgaagc agcacaagga aaatgacttc aggggcaaag 76680

tcaggagaca aatttcatat ccccagagtc cttttcaagt ggaaaagagc agaacatgta 76740

ccgccacat atgagagctg tctatcaggg aaatatggcg gagactcagt gtcaggtgta 76800

tttttccct ttiattgaaa atagattttc ccctcgaca atagatccta attgctgttt 76860

ccccttctc tacttcagct gctcttccc tcctcctat ccagatccac tccatttctg 76920

actctcatca gaaaacagc aggtttttta agagataata acaaagtaga gtatagcata 76980

ataaaacaat tagcacatct gaattggaca aaacaacaga aggaaatgag cccaaggagg 77040

tacataagaa acagagacac actcaggaat cccatcaaaa cactaaactg gaagccataa 77100

tatatacaca gaggacctgt gcaggccatt gggccaaaca ttcaatttga atgtcgtttt 77160
atgttttatac tcaatgaaaa gtttacttat gagcatgttt atcttataaa aaaaagtagg 77220
tagaaaggag aaacatatta cttaaaaatg gttagaatth ctaatagtth tatgctatta 77280
aatgaaata gtaaaattat gaacaattta gtgaatatta tgtcagaaag tttactgagt 77340
gtgccattac agagctttgt actgtctaca tggagacacc atatacaatt tctactcagg 77400
gcttgaatg tggccatttc aactgatgc atcctgtatg tctattccat ccgtagttgt 77460
catagctgtg tgttctaagc acaaaataca ggccagtctc aggatttca atatagacaa 77520

tcacatcttt tctcaacatt gtattgttgc aggcacaaca tgcactgctg agcacatttc 77580
aaatacattg tttaaagcag tctgtcttca ttttaataa actaccaat attaaaacta 77640
tatatgtggc tcatatggca tttcatttag tggtagttha aataaaaaaa atgaatagac 77700
atattttcta tttgattagt ttctaanaac caaactctta atcaagttgt tcttgctggt 77760
cctcaggcat ccaattccat aagccagtct agcatggcat ctttagaact cctttggctc 77820
tcaggtcctg ttgcctgttt aatgtttat atccactgac aaatagccat atgaatcaca 77880
agtgttaatg tcttattttc aattatctg acttatggca acatgtagac taaaaatatt 77940

atttaataga actatthaaa atattatcgt tcttgggtcc cagcctctaa ttaccgagaa 78000
cacagtgaag acagtgagag catgctaaaa gggaactaac tatacttgca ctgatataa 78060
tgagcacaag cacttctgct gccagggctg ttgtttctat gtgcttcccc tccactgaaa 78120
atgtcttgtt gggctttggg aaaagtttg aaacaaaatc caggatacta gaaatctgtt 78180
tattctgcta tgttattgat gaatcagtat ctgtagtcaa cctcaccagt taggtcaaac 78240
taagtctcag tgiaagtcac aggtagaaaag cacttctccc agtacttcat ttccctttac 78300
tccaggtggg actccgacaa tcaattggca caggtcagct cttttttagt ttatttctcc 78360

ttatcatggc agtgtttcca gactttcaaa caatgaacca ctctctcagg catgttcaact 78420
tcagattctg ctgcgggcac ccatggaaga agtttgcttc tggtttagtt ccatcgtgaa 78480
ctctgctctg agttgggatt caggggtgtac gtgggcgatt gctggcgtcc cacattgaga 78540
gctgggatac tcagtcaccc ttccatttc ctgtctgcca ccagctcagt ggttctatta 78600
cactgctgtt actgctggag ctgttggcat cagtgtctac atttccatg tctggagtg 78660
aactgacgc tatatgtata ccaacacagc ttggatcttt aaccataacc ctthcactgc 78720
aatattcatg ctaggggctc tgaggacatt ttggacagg cacaatgata cttagacctg 78780

ccctctcttc cagctgataa tcatatcctt taactacatt taagtcacct cacagttctc 78840
ctccattaca gaccagctcg tttttataaa gctcttgtha gcaccaccag acaaaacaga 78900
aattccagtt aaatthaac tttaaaaaca ccatcttagt caactctaac aaaaatatta 78960

tagatgagta gcttaaaaac catggaatt tccttcacag gctggggaga taatgaaatg 79020
cttgctatac aaccatggta acttgaggtc aatcccagga cccacataaa ggtcaggctt 79080
gccagtgaat gcttgttacc ccagatcttg ggagacaggc aaaggaagac acctgggact 79140
ttctcgacaa agagtttagc ctaaatagca gcctccaggc aagcaggaga tctttttcaa 79200

aaaaaaaaa aaaaggtgg atgtctcctg aggaatcaga gggacagatg acctctggtc 79260
tccacatgta tgcacactta ccagcacecca tacctgcaca aatacccata tgaatacccc 79320
cccaacacac acacaggaac aagcacacag aaacaccac aggaacaggc acctatgcat 79380
gtttacattt catagtctt tagagtaaga tttagtgtct agcaagggtt ctttctggt 79440
ttatatattt tcttagtggg gtgtgtgtgt gtgtgtgtgt gtgtgtgtgt cttaaatgat 79500
ataagataaa ggtaaatatt gtttctattg catacgatat tgagtttctc tatcgccatt 79560
tgttgaagat taggtttatc ctgtttccag taccttttc aaggaagaat caatcatata 79620

ttcagtttta ttiactgacg ccaatgatat accattgta tataacat ttgttatagt 79680
tttgaatth tttgtttgtt tgtttttcaa ggcagggttt ctctgtggct ttggaggctg 79740
tcctggaact aactcttgta gatcgggctg gcctcaaact cacagagatc cccctgctc 79800
tgctcccga gtgctggagc taaaggcatg caccaccacc gaccggctat ggtttttaa 79860
tttgtgcaat cagaaagtat gaagcttca actttgtct tcttgaatta attcagctgt 79920
ttgggtttct ttgtgcttc atataaatta taggattttt tttgtcattg agattttgat 79980
gagaatttaa actgtgactg attgaagctg tatgaacatt ttaacaattt tagtcctta 80040

aatccacaaa tagagatgtc ttccatata tttgtgctca ctttaatttc ttcactcata 80100
cctcacccat aatttttgga gttaaaaaaa ttcacttttg atgggcatgg tggcacacaa 80160
cttaaatccc agcacttggg aggcagagac aggaagatct ctgagtttga agccagcctg 80220
gaatacaaaag tgagttccag gacagccaag gacacacaga gaaagcctgt ctggaataac 80280
caaaaattaa aaccaagaaa aataacacac atccttgggt aagattattt ctaagacttt 80340
ctactcttc atgagaatga acatggaatt atttcccagc tttttagaat tctcccctgg 80400
cagtgataga aagacagttg atttttgtca agtcttatat cctgaaactt tactggttta 80460

aaaaattact tctatttcta gtttcattct ctgtttatac aaacagacac tatgatcttt 80520
taaaagctgc cgaggggagg taaggattta tttggcttat acttcaggt cagtcaatca 80580
ttaagggcag ctggggtggg aattcaagca gtaactttaa gtaaaaatca tggaggaact 80640
ctgctgtttg gcttgcttcc ttatggagcc tagagccacc tgctcaggaa atggtgtgac 80700
ccatacttga gctggtcccc cctacatgaa ataagggat taaaacaata ccccaaagac 80760
atgctcatag gccaatctga tctggacaat tcttattca agtctttcct tgcagaaaat 80820

tctagcctca aggtgacagc taaagttaag taggatggtg agctctttag aggatagaaa 80880

ttttctctct atataaggtc acatcatcgt taataacagt aaaagataac ttcaccttct 80940

tccattccaa ttggatgtc tctaattgtt ttccttgtct aattgctcca ctaaggactc 81000

tgggtctata ctgaatgaaa gtggcagcca tgtgtatttg tgtcttgctt ctgattggag 81060

ggaaaagctg tcagtttcac tacctagtaa gatgttgggt atcagttagg aggcatgggc 81120

aatctatggg gactctggta ctggatcagt atttaaccct agtatacca tggatttggg 81180

gagcccattc cacatagagg gatactttct cagcccagac aaacggggga gggcttagac 81240

cctgctccaa atgatatgat agactttgat gacccccat ggaaggcctc agtctccctg 81300

gggagcagaa atggaatggg ataggggggc agaggagggg agggagagag aactgggatt 81360

gacatgtaaa acaagcttgt ttctaattta aatttaaaaa gaagaaaaaa tgtgtgaacc 81420

attttaaaaa aggttttagc tatggggttt tggatatatgg ctttgcctat ggtgagataa 81480

gtttaagtgc ttttattatt taaatgtaat taattttatt aagcacctta tctgcatcta 81540

tttcaatgat tctgtgattt ttttcttttg ttctatttat tgggtgactt ggattgatta 81600

tttgcacgtt taactcttagt tgtcttcatt gttccctaaa caatttagtg taaacaattt 81660

tgttttatac agattctttt tataatccaca agaagaagag catttatttc ataagaaagc 81720

tcctcaccct accaccctct ctgctgcctt tctctggcat ttcttttctt tgttttatct 81780

cattcttact gcigatacat tttttccct cagaaggatc aaatatcata acagtcttaa 81840

aaatgatctt tttactgttg tgaattcac atataaagtg tttattgttt atgaacattc 81900

aaccacatgc atgaatgat gtgcacacac atgtgtgcaa acatgcatac acatttattt 81960

ctcttagttt ctcatgggct catattccca aggtaaatga acccacatca ttaggaccca 82020

ggaggtgaac caagactcgt aacaactcag gccctcttcc tgtactcacc ttcagtcage 82080

atcttttatt tectctttta tttctgtgt taagcatagg aaaattttaa accatagaag 82140

attaattatt cactttatat aatttgaat atatagtata aaacaaacta attttgtttt 82200

tttttgtca aactatatt tgaatgttt catcattgtg tcattataga ccatttatca 82260

ttgttctgt gtgattataa taaccacaca tttatccatt atgctgttgc cccatatttg 82320

agtagttgcc attttctct tttaggacta gttctggagt gaactctt atcatgact 82380

ttcatgagca aacagacaga ttaattacag tcaaatagg tttgtctaat tctctggctt 82440

attttggtc tttgttgac tagcttggc taatgtttat caagactcta tgaatgaaaa 82500

gaatgatatg cttttgaaat tgcaatgaat gatggacttg gcaagtgtct gtcagatata 82560

agtttcataa aatattgctc cagcacatga ttttgcgact aaatcttgta catgaggtaa 82620
 attgggagag gaaatatgtt tggaaattta aaaatgcctt ttaaataatg gttttactca 82680
 gtaattactt tagcagataa tttaaagaaa tttattgtga tgaatacaag acattaagat 82740
 attttgcctat aaagttgttt tagataggta tataatttta gctggtttgg ctttgataaa 82800
 aatagatatt tgaccttttt aattgaaact tagaatttac ttatttataa cacttggtta 82860
 ttacctatga aatattctgc aatacctcct ggggatacta taatgagtaa atgagaagtt 82920
 ttcaaccag cagtctaggc tggattcatg tgaatgtagc tcacaggagc aaagtgacct 82980

 attctggttc taagatctgt ttctcatgtg ctcatgtatg cctcttcatt ctgcctgtaa 83040
 cagaattcta cagctgggat tctgagaggc tgtctcctgg attcaagtga tttcctttcc 83100
 tcaactacga acagagatgc cccttctgag aaggaaagca aacaggtttg ccttgcccaa 83160
 agccccatgg cccagagtca agcccttaag tgccttttca agtgcctaga ctagtttctt 83220
 tgaggaccag tcaaggtagc ctaagaagga aattaccaa tcatttctgt tctggcatcc 83280
 attagtacac atctgtttct ttcagttctg taggagaatg gatctgaact gccacttcc 83340
 ccgatatga gatgaggata catctagtat gagatagaaa ataatttccc tatectacia 83400

 agagttggag acigtattat aaaaaatcat gcctaataac agtttatttg ttaaacttg 83460
 ctcatatatg ctgtatagta tttctaatga catttacaca agtagaaaagc ttgaaacttg 83520
 ggcatttgtt ctaggttttc tcaatatgtg gaccatgccc tggctctgta gaatctgagt 83580
 ctgttgaagg ggcctaacca ttgtcacttc tttcagttat tccagatgac tccagagtaa 83640
 actaacactc aatgtctata tggcctcctc cttagatcat gccttgctga actggctgtt 83700
 agcactcatt tgagaataaa agaaacatta gcaataaaaat gttaaagac tgggtgtaat 83760
 tcaaatataa atgctcttag cttcagagac aaagtaactg tggagttcag gcatcattag 83820

 tttctcaaat tttagtgtca ctctgataac tctaacacac acaattttgc accagattgg 83880
 cacagatttt ggtgtgataa gtatgcaaga gccaatgggc ttttcttagg tatgtagtaa 83940
 caatggaaat atttatctgc aagagtgaag aagaggcctt gtctgaacac cacgtgggtt 84000
 acatttcttg attctttact ttgtggtgag tatactgtaa ggcttggaca catggcttca 84060
 gtgttaatgt tagtgtgctt ggttttcccc tttatccttt gtttccagca gcctcacact 84120
 ttgtctgacc cctcaggtt taagtttcta tgtctcagca agtaacaaca tcttaatcat 84180
 attctgagta gcaccctccc cccagtttta tcaactatcc tagatactat tettaatgct 84240

 ttttcccact taaaaaatt agaatagtat tcctattttc ttcaacaaaa gcctgaata 84300
 taagaacatt tgatcattgc aaacagcgtt ttgcttacia agttgtcttt tetgcctttt 84360
 tttttgttt gtttgttttt tgttttttga gacaggattt ctctgtattg ctttggaggt 84420

tgtcctggaa ctgcttctgt aaaccaagct ggccctgaac tcacagagat ctgccgacct 84480
 ctacctccca agtgctggga ttaaagggtg tctactacca cccccggcct tttctgcat 84540
 ttttcaaata cagtttggat tgcacacat gatgagtatt gaagaatatc tgttttctct 84600
 tttttctttt gtttttggaa gattatttta tccaaccaga cagcctggac agtaatcaca 84660

 tacttgcttg ctgacatfff cttctctgat tttgtcctct ttctgggtgt aatfffgcaa 84720
 tttctgtatg ttcaccttca ctgttgaatg gcactctcagg atctgcaatg gtgatacact 84780
 tttgagcata ggcaatatat cgtttgcta tctcagtgat gcttaggggt tatagagtac 84840
 tgtatccctg atttcaagac cttgagacca aagaggtgag aagctttgct cagggttatg 84900
 ctacaaggaa gtggcaacat tcacagttag agtttaaat tgcttgactt aaaaacttgt 84960
 gatttcttag acttttaaaa attatatttt aaaatggttt ctcaatatat atgtacaatg 85020
 ttatggcttg gtgcttttta ctttttgttt tgttttcttg tttagtgttt gtgtttcagg 85080

 tttttctttt taaaaatfff agatcttcac aattctttaa gaagtctact atggggtcag 85140
 aggagaatgg gagatggttc agtgattaac agcactggcc actcctcaa aggaccagg 85200
 ttcaattcct agcaccaca tggcagctta caactgtcta taacttcagt tccagggtat 85260
 ctatcacata tatcagacaa acagataggc aaaccccaa tgtacataaa aataaattt 85320
 aatgataagt ctttatgcca aagctgcctg agttcagcct gtcattgttag ggcccaaat 85380
 aatacagaga cttatattag gtacaaatgc tgcctggcca actgactagg atttcttact 85440
 tgctagctca gtcttaata ttggatgcta gctgctggca tcatctcttg ccaggatcac 85500

 atggcagctc cagagtagag agcaggagaa agagaaaaag gaacgacttc cttcttgctt 85560
 gctatgtcac ttctgcctg tatcacaaga cttctttta ctacatttc cagaatctc 85620
 cttgacttct agtcccact atcttgctgc ctactggcc aacagttact ttattcatta 85680
 accaataaca taaatafaca cagaaggaca ttcccatca aataaatctt taaaaaaga 85740
 atttactat ctgctctacg ttgagggtac tactcagtaa gctcagttc cctaacgat 85800
 ctttactgt gatattaatc acattataat actttaatct acatactaga tatggccatt 85860
 acaaggcage aggaatctac ttttttttc agttttaaat tcttattttt ttttttgctc 85920

 ctgaaagggg ggggcatfga ataatgagt taagttagta taacagtagc cagtagaat 85980
 tagtagcttg acccaagct gtgaatccat tgcagataaa agtatftaga gaagggtgga 86040
 accctgggac atcattcaaa tcaaccaca tgactctgta cctagagtcc catttttcat 86100
 tttgcaagtg attatactaa agctgttaca attaatcac cttgctttgt ccatttacta 86160
 aaattgaggt cagagaatff cataattata aggctgtgcc ctttaaaaac agtttaataa 86220
 ttgctcttct aacaagccag ctcaataaat gagctacata agaaaagtga gcaaggatgg 86280

aaggaagaag actccagtc catacatggc acattagacc aacggtagag aagcgggtgc 86340

tgtttcagaa actgttccaa attgggccac atgagaattc tctaggaat ctttgtttga 86400
gacacttaat tgagtcagaa aacttcaggt tctggctca ggtctgctgt tgactgtgtg 86460
tcagtaagaa agaagtttgc ttgagcctca atttgcccac tattagagca aaggttaagaa 86520
aatgtaattc atgggaagtt cttgaagatt ttcataaaat cacataggaa aatagactca 86580
ggctgattct aaaagttgat gttaaaaagc atcagctaaa acaggtttca agcaggagac 86640
actgaaagaa gctctgtaaa ttatggctgt gataccaaga gtacatttct ccaaacacca 86700
aaccagctgg tatcccctta tgttcacttt ggaatctcac ctaggggggc ttggctacac 86760

agtgcaccca ctiagcttgc tctgcctgc ttcttttgc ttttaattgaa aaaggaagga 86820
taatttcaac ttttgttgtt aatttaatag gtaatctatg actgcattat aactacagga 86880
aaagagattt taatacattt taatgagtca tctataata tgacctctta gaaataaact 86940
ctaataagaa attttcaatt cttcctagac tattccctgt atttacta tattaatcta 87000
tattatgata tactatatct tatttaatat gacatgaata tttccacaa ttacttaaat 87060
atagccataa gtataggatg gctatctcaa ttcgttatat gcaggtttca tgatattttc 87120
cttcaagtca ctaatgtcaa acatctaaat ttctaccatt ttaacataaa atacaagtag 87180

tgaaaaacat atttatttgt atagtcattc tttcttgaag gacaaatgat aggggaagta 87240
tttctgtgta tgittatctt attgattggt taataaagtt ctgcttgcc aatgaaacgg 87300
caagttagc aggactagga gtgaaagagg attctgggaa atgtagtaga aaagtatga 87360
tccaggcagg aagtacata gcaaggagac tcatatttaa agcaggataa acaggaagca 87420
tacctcttt tcccctcctc tctgctcca gcgacacaat gtgatccacc ggcaaggagg 87480
gacgccaata aggtgtccaa taagataagt cttatagaat atatagatgt atgataattg 87540
agactgagct aacagatgag aatcctttaa caatggccaa gcagcattgt acctaatca 87600

agtttctgtg tattcatttg ggccaaactc gggcaggtgg ctggtgaaaa gctcacacat 87660
ggcgggtggg ctcaggtggc ttttggcaga aagatttatt gtaacagaca aattcccaca 87720
ggtactggaa aaaaataata tagacataaa taatatatgt ctatattata tacaatatt 87780
atgttagaa agaagccttt tgctatttta catattttat atcatcaaat aaaagagatg 87840
caaaataaat gtgttttct tttcatatct ctgtttacac tgtgtacaat tttccaaaac 87900
atttttattg taaaataaga gctggagaca agacaaatac acataaaaat acatgtgcat 87960
ctctgatgc actgtttatg taggcaattc ttctttcatt cggctttcaa ggtgatcagt 88020

tcagtgtagc accactagga aattacacat ttaagcatgt ttctgtgaaa gttaaaatga 88080
 tgcctctgat gtgtgaaaaa tgtttgactt taaaattagt ggtatttggc aatatattca 88140
 taagtggat ttcaagatca tctagcctca tacttcaccg tttttacctt gaggtctgaa 88200
 atcaggcagc tcctcgagaa ttactggatt ctttgaataa gaaataggag ctcagtgcta 88260
 cagcctgatt accacatctt atataatttg ttttatcttt tgtaaatgaa aacttgcatt 88320
 acaattttaa tttattttaa ctttgcattt tggacttagt tttgtgtttg gggagatatt 88380
 ctctctttg agttttacac acacacacac acacacacac acacacacac acacaatcta 88440

 tttatttatt tggggtattt gtaattattt ttaatataat aatattaaat tattgttgtt 88500
 agttttgcac atcattctat tagagttttt aattatgatt ttagtaatac ataggaacca 88560
 ttatttgttt aaatatgcaa attgaaattc tgggtctaca catgtaatat taatagtgt 88620
 aacatcgtgg aagagggggc agaaatattc taagagccag ggacagtaga ggatagccac 88680
 caaatagtat ttcagggta tgacagggac attgcacaca tgaactcaca gaagctgtgt 88740
 ctgtatgaac aagacctgca gaagatcaag ccagcgaaaa ttacagtgtg gcatggggag 88800
 ggtctcagga aggctcatct ctatctgtgg aactatggca attgatgact gctgaggaga 88860

 gataaattgt ttigttttgt tttttgttct ttctgatagg ctacccatgc tctactggat 88920
 gaccctatat tcaggctgac agcactgagt ggacttcagt gtagtaaaaa agagtccatg 88980
 aagttggcag tggaaaagtat ggggttggat atagaagagt tggagaggag ggagtggagg 89040
 tggagctgat caaaacacaa tatacttaca tgtggaataa acaataaatt caaataacaa 89100
 cagtataat ttcttttaac aatggaacat ctctactca tattaatttt taaggattta 89160
 aaggttttag tgaatgaggg gattggagag attgctcaga agttaagagt acataatatt 89220
 cttgcagagg tctgcagttc agtttccagc actggattgg gtcgcttaca agcacctgta 89280

 actctagctc tacaggatct gatgcctcc tttgatgcct ttgaggacac acacatatag 89340
 gtgcgcacac acacaaagac acacacacac acacacacac acacacacac acacacactg 89400
 tcgtggccca gcatgtctca gcttaaaccc atgacaacca tgaggttcta cctgagtggg 89460
 ggtgtgtaga cctgaaagct cctagcaacc aacagtcate ttgtcatctt cagagagctc 89520
 tcaggctcat gttgtagaac tagagtcatt tctttattag ccatcttttc tgggttttct 89580
 taaccatcct gccatgacca cgagggaaac atctctctct ttgttcctc tctctccgg 89640
 tcaactgacg ccctaactc ctaaccttct gtctcaciaa gttactcaca cacctctagc 89700

 acctctgtcc aggtgagggc ctattcagaa gcttaggcac atacagatgc aaattaggag 89760
 acatattacc ctgagtccat ggtaaacaaat agtagcccta ctggcattaa caatataata 89820
 gtgggccgga gctttctggt gttcctgctt agtgaaacca aaggctggat ctcaaaatat 89880

tccatagcgg aaagatTTTg gtccccaca acacaccaca tacatactac gccacagcac 89940
 acacacacac atatacatat accacacaca caccacatac actcatacac acaccataca 90000
 catatacata ccacacacac tacatataca caccacatac acacaccata tacacaccac 90060
 accacacaca cacacacaac acacacatca cgcatacacc atacacacac accacacaca 90120

 cacaccatac accaccacac cataaccaca caacatacac agcacacacc acacacaaca 90180
 cccacacacc atatcatata cgcaccatac acacaccata ccacacacac agtacacaca 90240
 gcacacacat acagcacaca tacaccacac tatacacata ccacaccaca caaacacaca 90300
 cgtacaccac agacacacca tactacacac atacagcata tacgcacaca catacacaca 90360
 catatacaca caccacattg cacacacaca catacaccat accacacaaa cacaaacaca 90420
 cacacacaaa cacacattaa aaagtggTca tttcaagaat gaattaatct tttttTgTtt 90480
 ttcatttatt gttgcagaat ttggtaggcc ttcTtgataa catttaatta atatctgtac 90540

 aaaataacaa gcagtgaat tttggagaca gcatgtcttc ttaactaaa ataagaagga 90600
 aatggTgctc tttcagttgg tagtctctgc tctgcctag gaagcacata caacagcttt 90660
 aagaagcctc acccctcaga ctttggagtc cacagtagaa aaggaactgc ccatggtcgc 90720
 caaatagggga ttccttttcc aaatgaagtT ccctaattag aaatctcca ttgctaaggg 90780
 atgctaaggt cagcattagc agcctTggTc ttccaactga tcatagacaa atctgctagt 90840
 ggatatttcc caagaaTgg agTgtttgca gattgctTgg catagattcc tataaaggag 90900
 aaagctcccg ccccatcctt ttatgcttcg tttcctgcct gccaggctcc aaggagacaa 90960

 atgtttagat acagttgaaa catcaacagc agtttatacc agtcttagta caatacatta 91020
 tggagaacag acaatgtTgc agtattgctc atttccctcc agttagcaag atctttaact 91080
 tcatccttga aaacagagga ctgcctatt tccagaccca tctTggTttt tcttttctc 91140
 tttcacactt tgaactgagc tagtacceac gctgctgcag gctTggccaa tcagaagctc 91200
 actgtatttg gatTTTcagT tttctacttc cattgggttc ctctgtcttt tacaatgta 91260
 aaatattcta atcaagtata aacagatgga aaaaacaaga ctattctgc tcagtCaggg 91320
 gattgggttg ctgatgtcat tctgtagtg gtggccaagc agttctaagg agaataatca 91380

 atctagcaga cctgctttt cagttagaaa cgaaaacatt tgtTgtaagc tctcttatct 91440
 cctccttttg ttttctcctt tgcccatagg aagggaagaa atagaggcga agagaaatct 91500
 ctgaaacagT tgiatgcttt cttTgtgtgT cacaccacag gcatttcttt ccatcctcct 91560
 gtctcatgcc actggTtaat acgaattTg ctTgcaagac tgttattctt tatggacaga 91620
 taagaatga cacagattTg tatttaacag tcccaaagct cttctcacac cagccttctc 91680
 cttaatctag gcattgctgt cctgtttcac ggctttgtct aggcctgtga ctctttatct 91740

tcacttaagc ctgttaaaag tatccgacgg agatccagct tccagccagc agcatgcctc 91800
 agatgtctta taaatttgaa tgcaaaatat gtgaagtga attggggatt catagcagac 91860
 acctgagcct catgtcttac tatttttata tgccactgtc ataaaaagct tcatcagcca 91920
 ccaagcatca aaactgagtt tctaaggtga tttttgactt ccttttcttg gcgattcttt 91980
 ctagtcaatt agtagtcaaa caccattgct ttgttctaga ttaaagggcc agcatcccag 92040
 aaagtacat gcctttgttg gttttgtggt gctaagggca gaatccaggg ccttgtggat 92100
 gccaggaag tgctttccta ctgaggtgtc accctggccc cagccttggt ttaatttaa 92160
 accagaaaac tcgagtttaa tccttggatt ccacttctg cctggagtga gtgagatctg 92220
 ctgctttaa tttccccggg tctcttga aatggaggta aacataatat agatctcaaa 92280
 agaattgtgg atttagaata gcatgttga agacttctat agatgttaac tgctgtctgt 92340
 ttttttttt ttaaccatt attgtcttca gtcacatggc ccttgacttt atttctgcct 92400
 atgatattga gttgtttagt ccgacttctg tctgcatctc tgctcattcc atttcaaac 92460
 ctgagcagag tttctgccag ttaaagacc aatcagagct gaataaagcc acattaggca 92520
 tttcaatata caaaatcaaa gatggaatga ccgtcattta ttagaacaca gaaaataacc 92580
 cagagaagga accagatgaa caacttatct ctgagcaga agcaataagg caggaggctg 92640
 tgggtctcac taactgaagt aatcctataa agcaggagtc aaacttatgt gatatggctg 92700
 ggatgccctt ggiacctccc caggaacaga agaagcctgg gataggaggg ccaggigaag 92760
 ttccaaaggt aaagtgtgtg tgacaaaatt tgtaacaaat ggaaaagaag gagctgtttt 92820
 tcaactcctt attgttgag ttttcagatt ccagatttca gagaaccaac tggtaaaaa 92880
 atgtgatttg cagcacacct ggtcataaag aagatgaact ggatgaaaca taagcagcac 92940
 agcatcatct aaaaacaga acctctctgt tgctgaaaa atcaactgcc tattcactgc 93000
 ttagatgata aagttcagat gcctcaaac tgggacaaa atctactttt ccagttcttt 93060
 ctctaatec tttatttct caccattatc cctaactggg agttccttga ctttgcattg 93120
 tttgattcat tctctgaaa cgtttacttc ctctagagtt ttactccatc gcctttttgt 93180
 tttctttatt tttttttat tttttgggt ttcgaaacag ggtttctctg tattgctttg 93240
 gaggtgccc tggagctcct cttatagaca agtctgttct cgaactcaca gagagctact 93300
 tgctctgcc tctgagtg tggtattaaa ggcattgtcc accaatgccc tgccatata 93360
 atgaaatcct cgtattcaa gattcatctc tactattctg ttgaaattcc aaggcaaat 93420
 taataacctg ctgtggtagt tacctttaa tttctcagac aacctctgt gaccaaagca 93480

gtttataaaa ggaagtgttt aactgggggc tcacagtcc agagggatag aactcatgac 93540
catcatgggt ggaagcaaga cagcaggcaa gcatgggtct ggaccagtag ctgaaagctt 93600
atatcttgag ataaagccat gaagcagagg agagagagag agagagagag agagagagag 93660
agagagagag agagagagag agaaccaact gggaataaat ggatggcacg ggcttttagaa 93720
acttcacagc ctgttccagc tgacacgcaa taagaccaca cctcctaaat ccttcctcag 93780
acaatttcac taacagggac aaactattca aatatgtgaa gccatggggg ggttcacatcct 93840
cattcaaaaa accacatctg ttcctctgia agtctacaac cattttttta ctcattcaaa 93900

taaagtatgt atcggctctt tattatgtaa gaaatgtgtg caaagtactg cacatacaac 93960
aatgagcaca gcattcttgg tcgctgttaa gttgaccacc ctatgggaca gaccctggaa 94020
ctggaatctg aggtaactag tggtaattag aaaggggaag atggattgga gagtagcaat 94080
aaatttggtc ttagacaagt taaccttgcgt gtattttttt aagatatcta agaagagaac 94140
ccagaaaact gtggtgcaaa tgagtttaga agtctaaagt aatgagtggg tagagagatg 94200
tatttggat ctggatttac atttacattc taactgaagt gctggagaga gagagagaga 94260
gagagagaga gagagagaga gagagcatct atatgtgttt cttgtgtttg ctgtctgctt 94320

ctgttggctt atatggctct ctctgtctct cactctgtgt gtctatttgt ctatcttgat 94380
tctttcccc tttctgtctg tctctctatg tgtattgttg tcacatgaca tagagtgcac 94440
ttgtacatag aaaagcttgc agtaactgat tttctcttcc ctgggttttg agcttacatc 94500
atcaggtgag actgctaagc cacttactct cagacattat aagacaaaat gattttaatc 94560
tacctgggtg tttaacagta ttgcatgttc ttatttaaga actgctcaca aggaagttag 94620
ctacactaac aaaaatatag gcaatagata atcccacatt atcaaaaagcc aaaaagggaa 94680
acacacacac acacacacac acacacacac acacacacac acacacacac acacacacca 94740

cccacaccaa aacaaaaatc caaaactagc aagaatcaac tgttcattaa tatcccttaa 94800
tatcaatggc cttaatttgc ctataaaaag acacaggcta acagaatgga tatgaagaca 94860
gaatccatcc tctgtctgca tacaagaaac acatctcaac tcaaaagaca gacgttacct 94920
tggggtaaat atgtaagtga ccccaaaaat tctactaggg aacttgtaca actgataaac 94980
accttaagtg gcaggataca agattatctc aaaaaagtta gtagccctcc tatatatatg 95040
tacaatcaat atagggaaag tggaactctt acccaaaaaca atctacagat tcagtgcaat 95100
ccccatcaa aatcccagta caattcttca cagaccttga aagaacaata ctcaacttta 95160

tatgaaaaaa ctaaagactc aggatagccc aaacaacct gtacaacaaa gaaactgctg 95220
gaggcatcac catccctgac ttcaagctct actatatagc tatattaatg aaaacagctt 95280
ggtaatggca caaaaacaga caggtagacc aatggatttg aattgaaaac cccgatatta 95340

atccacacac ctatgaacac ctgatttttg atgaagaagc taaaattata caatggaaaa 95400
 cagaaaacat cttaacaaa tgggtgctaac agctgcaaga ccatgtctgc ttgagctaat 95460
 ataaacgttg caaagcacag atcacagtgg ctgggtgtga ataaacacaa aatcattgct 95520
 ctttcattaa ttcagatatt tagcttttaa aaatgcattt tcttggttaa caaagcagag 95580

 atcagtaaag tcttctatc cctgtggaaa ggaatttgct gcactgtgaa agtgatcgga 95640
 cagaggcaat taaaatcctt gagtggaaga aaggagagat aagtaagaca acaatgccac 95700
 cattctcttt ccacttcaaa catatgaaca acagcagaac acagaattcc gaagaaggat 95760
 gtctagtgtt tttagcttg tattctatga tctaaaatgt tgagctacac cagtggaatc 95820
 ctggaggcag agtcacagat aaatctcaga taccctatcc ctttgcatac tagcattcta 95880
 tgcccacagc acatataatc catccaatgt actacagaca cattaaaaat aatctaaga 95940
 ttaaaactgg aaaacaaaat gagtttatgg agagatattt tgggtgcca aattaaattt 96000

 gaaaatgcga ttgattaac aatttgaana taattctggc aatgcaacta atactgaaac 96060
 acaagtaggc ctaacactga attagtcaag gagttagaca cacaaactca ttgagaatta 96120
 gttgtgcaa ccagtcctca gcccaaggca agtctgagaa gtctgagacc aggagtagca 96180
 aggcactcaa tigtctccta ttcatataac aaacacctta cctagagcct ggcttggaga 96240
 ataaagcact gctgctcttc cttttcacat gttaaagacc tgaattcctc caagaagcat 96300
 catatttgac taagttatg gaactctgtt ctttatttcc agtccccgaa ctgtattcta 96360
 acttttgcag catggcattt ctgagtcaaa taggagacat tccactttta ttgaacttcc 96420

 tctcacttg ttacceatca atcatgtttt agactgcagg gtcaccagct tttctctctg 96480
 tgacattgaa aatgtggaat gtttaaagca agaaaacaac tacatccttg taacaaagat 96540
 cgggccataa agcaaatat aatgggcaaa atcattagct gtttaatact gattgcttat 96600
 tctacataac ttataaaaag tgacaaatgg tgccttcttc tctcaacttg ctgatacact 96660
 gcaagttgga tattccttta tgtctagttc agcagtttca gaaacactga aacattctgc 96720
 atacagctgt gttcccactt gcacagacga aacatctgcc aaagcaaata ctggtctctc 96780
 cctgtaatte taccactcca ccagaatttc tctgtattt ataggatggg cgtgctgatt 96840

 ataagctgga gttctggigt ttggttctca actacattgt acttaagttc gttctatgtg 96900
 tttttggtta gaacttgaaa gcaatgccac ttttagattt gggagggtgc aaagaaatac 96960
 agccagacaa ttacattatg ttcatggat atcctcatta tgtgtctttg gaccacatat 97020
 atgtttgaag tgctcagat tctctcctt tccaaaatat aaatttaaaa actctatcac 97080
 agatttatat tttgtatgca acagtgtata gtacaaaaaa tgaatcttgt tcttaccatt 97140
 ttaatgtatt tgtgccatag aaaaacatac attgatgaaa aagggtttta aagacatcag 97200

tcatgatact aciccgggaa attggcttat taagttaaac tccttttaag aatgaagagt 97260

 tgctctgaat attttccagt ttaacagggga gtgaaatggt aatgatggaa acttgggtga 97320
 gagcagagta ccagattgat tttgtgcatc tgatctatac ttgtccatac atccacacag 97380
 tttgctcaat tgataattat atcagggatg accattatit ccaataattg cattttatac 97440
 ttttctacag ctctcaaaa gataacatgt atctatitaa gtttttacac ccctactcat 97500
 tttttaatg tagtaggaac tttcttcaat atttacacac acattaaaga gtcagatcag 97560
 gaatatatca gtggaactag atatatctt tgcaagtggca cactgcattc aacagtgggt 97620
 atgaaataag gctttttaaa ttttactttt aattacatca tttctcctt cattttttcc 97680

 ctcaaaccc tgiatataaa atatcttgat tttttcaaa ctcaagtcct ctttttaaat 97740
 taattgttgt tacatatgta tatgtacatg tatacataca caaactccga aatacataaa 97800
 gtgccacctg ctcatccatg gttgcttga tgatgtttgc agggatgacc atttgggtatt 97860
 agataaccaa ttaggatgat tttccctggg aagattatit ctcccactgt cttgcatgta 97920
 ggttttttt gtgtgtggtt gaggctttct ggtctttccc attcactttg gcattgtctat 97980
 tgttgttggc cttgttcagc tcatgtttag cagtacact gatgagattt taatgggtgt 98040
 agcttcttgt cttagttagg gttcctattg ctgtgaagag acaccatgac catagcaact 98100

 cttataaagg aaaacattta attgggatgg gttacattc cagaagtta atatattatc 98160
 atcatggtgc tatatggtgg catgcaggca gacatggtgc tggagaaaga actgagattc 98220
 ctacatcttg actcacaggc aacaagaagt tgtctgaac actgggcatg gattgagtat 98280
 ataccagagc taaaagccta cctccacagt gacttctcc aacaaggcca tacatactac 98340
 aataaagcca tatctcctaa tagtgccact ccaatgggc ttatgggggg caattacatt 98400
 caaactacca catatctgat actgggaaga aacacattct aacaccaaac tctcactcc 98460
 tctggetctt acagtatttc tgttccctct tcataatga tcttagcct taatacaggt 98520

 atcctattat atagatgat ccattgggac tttgctccac aactctgcat tctgatttgt 98580
 tgtgattttc tgcactgtt ttgaatagaa gtttcttga agaggatga aatgacact 98640
 tatctatggg tataagtcaa atatgttgg ttagtaaagt ggtggctgct gattctcggt 98700
 caagagctaa gtttccagca ccaggcatgg cttccctct tttgaggtaa tcttaagtct 98760
 aattagaa ctctttgta ccaccaagt aggcattgta ctactacacc cttaggacta 98820
 tcattctgta tggatcattg ctatggctca caggcaccat atttatgtag gattatcggt 98880
 tgtttctc atttggaagt tgacatggtg tttgcatgca aaaatgtata caaagcttct 98940

tgtaccacag gaggcaggttt tagggtttca gctcagggtc ctctgaaccc ttgtgtgaag 99000
 tacataatat ctttagcaaa tagggactca cattccacct ctgggtgggca accaagggca 99060
 atagcaatgg cctgtaatgt tttgtgagtc tcttggacaa ccacagacca acaactcaaa 99120
 agaggatttc tcatacctag ttttgggaat tttgttttgt ggcctttgac tcttggaggg 99180
 agcattgccca gccacagatgg gaaaattgcc tttgaaagat atatacactg acttatgtgt 99240
 attatgaaaa tggaaattcat tgtaaacatc taaaacactt actattaaaa caaacagctc 99300
 ttgatgactg atttctcaga catatcattia agggagggttt ctgataaacg gctttattca 99360

 atacatggct tccatttgtg aacaagtaat cctctcttga ttgtcccttg tccttctatc 99420
 aaaatttctt ccctacattc aaggaaagat cactggattt cttcaaaaag tggtttcttt 99480
 tgctttgtga ttcccttggg ctatttgtac tctatcaagg taaagatgaa cataaattca 99540
 ttttagcatac ctttttctaa ctcccacaca gtatgtagaa gtttctctag gtctctgtctt 99600
 ctagtaccca gacagttaac tcaatttctc cagaaactgt ttccacctcc tattatatta 99660
 ttgtaaactg agagttaatt aaagaatttg acaagaatgt ttgaattagt gttggattat 99720
 cagtagccac tgaagaaat gtacatttgc aaattaaata ctaatattaa aataataact 99780

 agaaaggggt aggatataaa gcaagataat atatgtcatt tagccatgca aacattcccc 99840
 ttccctgaag tccttgacat cttactaatt tagattgtca attcttcaca ttatgagatg 99900
 gaaaaatcct tggaaagggg ttgggtttat aaatattaga caattactat acagggttg 99960
 gtgttataaa tattagacaa ttactataca ggggttgcta atgaaatgac tttctttaat 100020
 attctgtgtt tttccttcta tgagtggat aaaaattgta agatactttt aaaaatttga 100080
 aaaaataata ctgtagtaaa aataaagtta agagatgaat attcttggat catgaaatag 100140
 atcagtattt gtcaagcagt atcaaaactt tggagtctt caaaatgttg taattattaa 100200

 ggatcctaaa taaatttggg ggatcatatc aattgatact aactatggtc tcaactctgag 100260
 ttttaagtta ttaattaatt taaaataata ataacataac aattacatat tgatataaat 100320
 gacattgttt tatgaaacta aaatttaatt agaagagaaa tattacattt ttaaagaaat 100380
 cagtttaata tttcatttaa tagaatacag cagaattttt atatttcat ctgatttcga 100440
 tctattgccca tatgtcgtta tggttaaagt atctgaaaaa ttctggcttc atacagacac 100500
 acagttaaaa aagagaaaaa tctctcccat gaaatctctc ccttcatggc tcaggggatc 100560
 ctagggaaga ggaggtaaaa ggagtgttag agtcagagga aatggaggac actaggagaa 100620

 cagggtcctc taaatcaaca aatcaatgga catatgaact tcagagaatg agggagtgtg 100680
 ggtaggacct acacaggtct gcaccacaag gggccctaga tctgaaagga gacatggaca 100740
 catggtccta cccttaaccc agaagcaatc tccaactgat tgccacttgt aatgaaaac 100800

ttagttttct ctaagaaatg ttactgggaa aacaaattac acctaaggtt agacaacagc 100860
 atctttggag gttccttgtc tcataatgtc ttgtcaaggg tttttcttct ttttaaaaag 100920
 tttattctta aaaatacttt atatatgtta taattttaca cacacacaca cacacacaca 100980
 cacacacaca cacacacaca cacgctaccc tagaggctct ctggtgagtg tttttatggg 101040

 atttctgaat gtgcaaatta gtgggtctat tgtgccttct cttgggctct ttttcttatg 101100
 tttattttat cttatttcaa tgttagcatt tgttttctct tatagtttat tgtgttacta 101160
 tcctttagat gcatctcctt ctaatgagag acagaaaagg agtagatctg gatcaggggg 101220
 agaggaggaa gacctgagag gatttagatgg agggaaaact gtaatcagaa tatattatgt 101280
 gaaaagagct attttcagta aaagtaataa aaataaaaaa aggaaaaatt tcacagactt 101340
 atactgtttc ctttctcat agaaaatttg ggagttccca agtgtattta ttctgtctgg 101400
 gatttagagg aagaacaga tgtcaggtct gggattaagt tctacatgac tcaactatat 101460

 atttttgcat gtgatttaat atctcttaat caaatgttaa ttatctgtaa aatgtgtctc 101520
 tacctcattg tgtggttgag aaaaatcaat gagatatgtg tgtaaaaatc gtctttgaca 101580
 tcaaaacaga ggggatgtaa caggcatttt taaactacaa attcagaaag ttctcttaat 101640
 aggaatgata tttcggatac ttatggtcat aaatggtaaa atatcaagag tttgattcta 101700
 tatatggtat ttaagaaact gtaaagtttg ttttatgtag cctctgtcac tttctctcaa 101760
 tcaatgtttt taagtcaatg ctcaaacgaa gtcaggaggt ttggagtaaa ctggcaaatc 101820
 aaccagcatt gcatcactta ctaccatcct cattttacct aggataaagt acattgtttg 101880

 gttaaaaata acttcagaat ctttattctt aagcaataat tgaacaggat ctttcttgaa 101940
 ctctttgtgt tacatattgg taaataataa taatatgtga ttttaatttt gcaatttaca 102000
 aagtttgttc atgaatgttt cttgtgggac tcttgggaaga acaagctgct ttttaaccatc 102060
 cggttttgca aagaaggcag tgggctctag ggaactctga gggttcceta tgtaaagtgg 102120
 ccagacctca catttcccat ggcccttatg ccagtgttaa tattctgaac aaaggtcctt 102180
 ttggagattt ctttaacaaa tgtggatttt cactccattt gttttcatat aaaattaaaa 102240
 tttggttata ctcaactctt taatgtttca cattaaaact gtatttgaag tagaaacttc 102300

 cagataaaat tagaaggggc ccacatagga gtgtttcact tctctctgat acattgactt 102360
 aagctgctga aaaagatatt agagagagcc tgggagatgg gatgatgtca ctatgtgaaa 102420
 aacagaattc tgatctacat acggttgcct attcaagcat agtttttctt gagccatgtc 102480
 ttgttttggga aggaatgctg tgggtgtgtt tctgcaacaa aaccaagcag agttgtaaaa 102540
 atgttatttt tttttctaca agaataaaga tgtggggata ttattcaagt atttttctgt 102600
 ctcccaatg gcctactata gagattccag ttcacaggc tgactaatga aataatttta 102660

gaagttccaa aacacaatga ttgtttaga agttctcttg gcatactgag tagaccatta 102720

 tgagataaag ctgatgtcaa ggctgggtt acagcagttg aatctctgag atatttctgg 102780
 taattcttct catcatatgg actcttaaat tgaagagtt ttgggtggga ttttggtttg 102840
 tccatttga tgagagacca gtgacttaac tctgcttggc tagtaataat tttttgtccc 102900
 acctgaattt tctttaatca ccatcaacc agtatttctt ggttttagtag actttcaaaa 102960
 gttcagtcta aattccacaa aatgagtat ccctccaag actttccctt acccttctg 103020
 tgttttgtg acttccatag gactcatccc tgtactactt atgatttaa tgcagtggt 103080
 tgatcttacc acctcatcca gtatagggac tagactctgc cctgtacata tttatttccc 103140

 taagggttcc tcttagcaat tgtgcattat attgaatgcc acacaacttt gaaattggaa 103200
 tctacttcat ccttaaatg ggtaaggaca ttaaggtaaa caaggcacat ttgagacaag 103260
 tgtgtggtec ctaatgetca tgtctcagga gtaacagtag catcttagtt ctcttctga 103320
 ctgttaattt ttatgttccc cataactgga atatttcagg agatttcaa aaactcttaa 103380
 aaatttagta gtgctcagaa tttgttagg aatgagata tgttatagct tcaggaattg 103440
 acaggtttg gggattgact acagaacatg aattcataaa attatctttt tgcagacaaa 103500
 tggatgtagg ttgaattaca gtagactaac aagaaatggc caggtattct atgaaccatt 103560

 ccattgtcta tgccttgtgt tttatataca gaatgagatt tcagacattc tagcaacact 103620
 tttcaagatt ccttttgttc ctgattgagg gaggcagtca caccactgca agggaagcca 103680
 gaggacattt ataaaatccc actcatcaa cagtacctta tgattgcatc catccagagc 103740
 tgacaagtca ctgtaaagta gcgcagtaga cacatatgct ctttcaaacc tcatgagagc 103800
 atgccactca cccccacaaa taaaacagt acttttctta ctggtgagtg aaacctgagt 103860
 tagaattcct atgagctagg aatagtacat gtcttttcat aggaagtgtt cacattgggg 103920
 tttgactttt agttttagct gccacagagg attcaggctt atgaggacac aataattgac 103980

 aatatacttc aatcaagtt cacaactgc ctttagcaa ctcttaaaga aaaggagtat 104040
 ttatttagta tatcatata tactgtatta attaaatagc aattatgtca gatatgcaga 104100
 atgcttctga tgcaaaatg gtataatcat tgagtaggca gccttgtggt gtttaaata 104160
 ttgaaaaat ctgctatata ggtaactatg tttcaattta taagtcaaaa ttaaccatg 104220
 atggttgaaa tttactttaa tatccattt tgaattcagg gattctgaag acatttaaat 104280
 agaaactgta gtgtaattat gtagtgatt ttaagtcact aatttgaca tatattttta 104340
 ttgattattt aagcctgtgg gcaggtaatg tgcataagg gttcagagca gaccttcta 104400

ctgttttgta cactcaagac tgagccctgc agttttttc ccatgtgaca tgctccacct 104460
 tggagagggga gaacagatgg tattttttta ttacttaaaa attgtctaaa aatatttttc 104520
 aaaagttagg catttcacac ttctgacagt gataaatggg ataattactt ttattcaaat 104580
 actaacaaaa ttataaccta taaagcagaa cacagcagaa gtggcttcaa gcaagttcat 104640
 gcatctgttt gtcttttcta atagctaggt tatagtagct tcctgcaccc cctgcaaaag 104700
 cagagaaccc ccaaacttca aaacaagtga ctacagagca caggaaatag ctccccaaac 104760
 ccaggaaata ttcaaattaa ccaatacca tagacttata aagcaggata aaataaaatg 104820

 gcttcctcac tctccactgc cctctctata tcaagaaaag actcattccc agaccccggg 104880
 ccaccacata atggttaact gaacaatgaa tgaaggctt cgatgggctg aatggtgact 104940
 tccagaaaaa ccatcttgaa acttctagta cttgaacttc cttaaagcag acatgcaggg 105000
 tggcatgctc atttggtaga aatggctttt ggtgtcagtg agctcctaga caatttctcc 105060
 tttgtagcct gtatgtagcc ctgccattta aaaagtttcc cccggggaag cctgactca 105120
 ttcattgactc ttatttttagc tacacagaat tgtctattcc agtacaaca atcatccatg 105180
 cctcaaactt attagactta aaagtaata atggattagt ggtttaaaaa tgaataaaac 105240

 tttaaaatat gaatacaaaa agttaaaaac aagctattga taggtcaaca tgggtgagtc 105300
 tgagaaccag acacagaaga ctaagaatag aatgaatcta tttatctaac aacttagaac 105360
 agcaaagcca tagaaaaaga aatcaggtaa ggctgccatg gcttagatga caggaaacat 105420
 tgactccaaa ttgaggattt tggggaggca aaaataatgc cctaggtatt gtgattatga 105480
 ttatgatctt acacatttgt cagaatctga agaactatac acctcaaat atgatgtctg 105540
 tttttagaaa ataacttcta ataaacacat ttctaaagag ggtagcaagt ggaacatata 105600
 ttgtgattaa attggctagt cactgtgttt tttattttta agtaaatttt attttaagta 105660

 aaagtctgac ggcaaaactt ttattatatac agcactaata ttactatgtt atgcaaataa 105720
 cttctaaatt ctttacaact ctaactcatt gcatttctcat aacaaccctg tgaggtagta 105780
 acctgggggt actattcca ttttgcagat gaagagattg aatcaaggag aagacatggg 105840
 ttttcttagg accaccatc tggtaaatgg ttggactatc atttgagttg tetgtttggc 105900
 tttagggcca catttataac tgctgcattt ccatgaaatg tttaaagcta tttcctaatt 105960
 agtaaaatat gggtaacttt taaattatca acgacaatgc aaggaatgct aagacttagg 106020
 aaagttatac ttgagaatga ttctttgcct tagaagaatt ctggaaagaa attaattaat 106080

 gttgttgaca tttcctaggg atataataag caaacatctg ttttcccag tcagtgttac 106140
 tgtagcagac caagaaaaa tccaccatt taacttagtg aaccaataaa tttactgaag 106200
 gcacataaga acctgtggtg actcaaaggc tgctacatca ttggaaaact caccagcatg 106260

ggtgatgact cacaaagcta atatgcagga agtgaagctc cttggagatc ccctctcccc 106320
 aatagtcctt actgcatgta taactttggg tagggacctt gtggatcttg taagtctcag 106380
 gcacttccca tgtttgtgag ttttgccctgc ttcaggaatt atcatttccc atcactacca 106440
 aggcctctct gtccatgaag gattgtttta attcagagaa aatagctaca tatcacttaa 106500

 ttgctctgaa tccaaatcac gtgaatataa aaagacattt caatatgggc atgtagacag 106560
 aagtaacata ttttgaagtt tggatatega taacacttaa aataaatcaa ttaacacatg 106620
 tgtttattta ctigaaaaga tcccgtagca cctgtgataa agtaaagatg catactgtta 106680
 agctatacat tttcagtttg atcctcaaga tttgtactgt gggagagaac tgacttttac 106740
 aagcttcttc ttgatgaaaa tgggataata ggaattcaa gagattatag aaaacgaagc 106800
 agcagttttt aatatgcatg aggtgcctta catggtatct aataatacca accatattat 106860
 tactgtgctt tagtggcttc caaagggact atgttaataa aataatgcat tttttttctg 106920

 ttcaaattcc catgttgctt ttttaacgag tttatatgta taggtgaacc taatgaatga 106980
 tgtgctctat ttctgctatt ttacctattc ctgtatagt atagttatct ctattatctt 107040
 cctagtcate tagagtagac atcttgcaag catctttatt tatgctcact aacacttctg 107100
 tctttgttat aaaccacctt tttgattttt tactaaatag tatgtgttca acaaataact 107160
 acttggaaaca aataccaac aaatacccat caaggagcct tcattgtggt agaagatacc 107220
 gataaataca gtgtggatc tctttaaaca tgcagctcg tatcacaaaa tagaagtgtg 107280
 gctggccaag gaggcaatgg ctaagttttg ctggcttcat tatctacata ggtggcagaa 107340

 gtgttgtccc ttatagaatc catgtttctg cgttttttag tggatgaaca gtcttttttt 107400
 ggccaggggg gaggcttcga gacagggttt cctctgtggct ttgaaggcta tcctggatta 107460
 gctctttag tccagctag tctaaaactc acagagacta actggaggaa gaagggtatt 107520
 gggattaagt ccttggacat aatttacata gacatatata taaacataca tacatacata 107580
 catacataca tacatacata catacacaca cacacacgcg cgcgcacgcg cacgcataca 107640
 cacacagaag gggagagagt tattagagtg gcttacactt acaggctgtg gtctgggtag 107700
 taccacacta gctgtcttat ggtacaaaagt ttttgttttag tccaagactc gttgctggat 107760

 gtctcagcag tccatttcta ggcctagaat tccgaattcc agagaattcc tggagagctg 107820
 ctagtcttca gtctatgtg gaatcccaaa taacttgttt ctaataccag caaagagatg 107880
 aagttgccag tggcagtgag ggccacagga agaaagcaaa aacctccttc catatccctt 107940
 tatgtgagtt gccaccagca tgtggagctg atgtttgagt ctccccacct ttatcctcac 108000
 aggcattgccc aagatgattg ggtttgactc tggatgctgt caagttgaca ttgaagatta 108060
 cccatcagat aaacaaagga gagaagggc gaactgtccc aagataagtt gaaggatga 108120

gaagaatgga gagggagaga taaactcaga aagagtgcta aagatgtatt tttttcttga 108180

gataggaaca tggigtgagg taggtctaga agagccaaga agcaatgga accctcatgt 108240

gacgttaacc atcacataag taggaacttt gatggactaa cggcagactt gatcaagtaa 108300

gcttctttaa agcatagctt tttttttata gagagtttga aaactaatag taaagtaagg 108360

ctttagaatt gttatgagaa ctgctagaga ttcacttaag tatttgcagt ggtgggttgc 108420

tggcatgcct catgagaact gggccttaat tctgacagcc ctgctccaac aataatgact 108480

agagctcatc ctctacttct caaaaggcta agaaatagtg gcgtttaatt ccccaggaat 108540

tcaattcaac tacatctgtt aaactggtat atttgctgac acctgtgtac attctagaat 108600

tttctgcatt gttgaggaag aaaagctcta gctgaaaact gttcactatt tatggcttca 108660

tggcaacaga tggcagaagc tcatggagaa ctacggtgca gacactgatt tgtctcagct 108720

ctcaggaaaa tgcctctcat gcatggtctt atcacagact tctagtgtga tgcaaagaga 108780

tggtagaat taiggaggtc tgagagatgg tttcattgtg tttctaattt ctctatgga 108840

agttgtgctc acaggtaaac ttaaaatact tatattgtca agcttataat aactgttgta 108900

acagcaaatg gaaactgata ggagcagata ctgaggatta gatttgcctca cttggtccg 108960

gcaatcttac cttatcatgt ttgaactttc agcctggaaa tagtttcaa gagctgtaga 109020

tcctctacaa acatctttta tctcagtatt tcagtgaaga ttgcaaatac ccaaaaagtt 109080

ggcccaggat actttttggg gccaggataa tgttgttacc taaaatggtc tcatagtaga 109140

agaaaactag taatctcagt gaaaactata ttttctctgt atttatttac tttttgttac 109200

tgcccttgat tatttaagaa gatacccttt ttattttgct ttttgagatt ataattacac 109260

catttctctc ttccctttcc tctttccagg ccctctcata cactcttctt ttttcaaatt 109320

catggcctat tttttcatta attgtagtta ggtgcataaa tgtaaacaca cacaaactta 109380

tctatttcta aatgcataac tgcaccctgc atcttctgta tcatgttact tgcttgcata 109440

ttttcagga tgaccatttg gtattggata accagttggg atgctcttca ctgaggaagg 109500

ctatttctct catgcttagc attccttagt tgectgtagt catctgtgtc aggttgagga 109560

ctcctggctt ttctctgtc tactttggca tgcttattgg tattgtcctt ggtcaactca 109620

tggttaggca gtcatggigg tgagacttta tggttgtagc ttctgatatt attagtagca 109680

gacaccgttt catagcaaac ttgctgatcc tttgactctt tgtatttctt ctctctcaat 109740

gttcctgag ccttaggttc aggagtgtt ttgtagatgg atccattaaa atttggccac 109800

tcaactctgc attttaattg gttgtggttt tctgaagtga tatccatctg ctacaaaagg 109860

gaattccttg atgaggatt aacaagcgta ttgacatcat ggattttctc agatattatt 109920
 caaagaatta gaagaaggtt gatttttgct cttcatttag cctattaagt gggagcaaga 109980
 cagcaatggg aacagcagta ttggtagagg agtcactata tagggctagg aagccattct 110040
 ttgaactttt ccagagtcta cctgtiacctc tcaaaactgaa gcctctggga tttcttttac 110100
 taagaaaatt aaatagtaaa tcaagcctat attcctattc taattataga ctttttttat 110160
 tttggagggt taattcattc cacacagtta tatatctggt ttgtaatttt tttttgtttt 110220
 atgtagtttt catcagttac atatgcttct taaagatgac agatgtggcc tttattttta 110280

 gtatgccatt gtcttaatta gggtttctat tgctgtgaag agacactgtg accatggcag 110340
 ttcttataaa gaaaaacatt taattgggtg gtttaaagtt cagagattta gtctgttattc 110400
 atcatggtgg gacgtggcag tgtgcagaca gacatggtgc tggagaagaa gttgagaatt 110460
 gtacatcttt gagtcatagg caacaggaag tgaactgaaa cactgattgt ggcttgagca 110520
 tataagagac ctcaaagccc acctccacag tgacacactt cctttaacaa agccataact 110580
 actccaacaa agccacacct ccaaatagtg aactcccta tgaacttaa ggagacaatt 110640
 acattcaaac tcccaaagcc cctcccttca gtgttcagtg aggetcaagg tacctaatca 110700

 gtaccaaata attatttaca gttgagtcac atattgtgtg gacagactgc tgatccttga 110760
 ggactcaagg tatcaaatat attagactgc tttaaatgca aggtcttgtc aagcctgagt 110820
 agggcataaa gttaatggct ttggetcata acaggaacgt tcagctggga ctacctgct 110880
 tcctggaag ccatttaggg ttaataacag taccatccac ttttatgtag gtagcgcttt 110940
 gcaatttggg atgtagttaa tggcacatta ctatttttag tgtcgccaaa ccatgcacac 111000
 tggtcagggg aaagcccttt ttccaacaag aaaattggag tgcacagaga taaggactat 111060
 gtagaacttc aaaaattgg tgagtggcag atctgatgct ggaaccacc ctttcttctg 111120

 ccaaaagcag tgtgttttcc tcagtctaca caactcttag cagattttcc tttgttttaa 111180
 catagtaaaa tgctctgtga caaggaaaat gtatagatat tactctttaa gagatgtaga 111240
 aatagcttag tgaaaagcat ctcaagtttg ttttgcagtt ttatctagtt tcttctctaa 111300
 gaatctctc agagcatgag aaaggaaaca gaatgaggat tggacaaga agtcttcac 111360
 ggcagtcaaa agaaagggtt aaaaattatg actttttaa ggcttaaagt ggcgaagata 111420
 gttcagaata cctaaacgca aaaaagaaag aaagaaagaa aagaaagaa gaaaaagaag 111480
 aaagaaaaaa aaitcactga aagggtgtcc atcctcctg aacctttttt agtacctctg 111540

 gaaaagtcag ggggtgtgtg tctgggggaa ggtagggag gggagggtta gacttcttct 111600
 attagctttt ctttaaaaa aaaagaaaga aagaaaagaa aagaaaaacc acacacacac 111660
 tcaacagaaa gaaataaaag tttgtctctc tttggctcca tctgcctta aagtctacaa 111720

gaagtagtga aaacccaagt cgcagaagcg cgcgctctga tttggttggt taccatcaat 111780
 cagacggttg ctggcagac actggatggt tatgagcctg aacaagctga aaggggcagg 111840
 aaaagaagtg gaggcagcat tcttcctatt taaagctgca tcgcttgaaa aaagttttcg 111900
 cagactgtgc cggagctggt gctgaaacag gctgaggcgg cctgggggct ggtgctgaaa 111960

 aagagccctc agcggaaattc atgggtgctac agtgacctca gtatctactc ttcgttccca 112020
 ggaccacat gtctcagatt tagacatgat ggcaaaactgg gtggtagcaa gacctctcct 112080
 cattctcact gttttattag ggcaactgtgt ctcaataaaa gcccaggaac aagagaatgg 112140
 tgagtttgcc ttttgctttg ctttatggtg tttatggctt ggtttgggac tagatggaat 112200
 gttaagctgc aggaagagtg tgaagaggag actattttaa gtttgagaag ggggctgtgg 112260
 gacttgggac ttgtacctgg gaaacagctt gactccggag cttctgtgct tgtcctggca 112320
 gagtgagctc tgccgtccag gaagagccag ggtagatcag ttttgTTTTT ttgtttttgt 112380

 ttttttttcg ccigaatgta agaataggac gtttaaaga aaacaagagt gcttaaaccg 112440
 gagccccgaa ggcactttta atcggagtca gttgtgtggg ctggcgcttt ccgagcaggg 112500
 aaagccgctg cagaagctgg gcaggggtgga gtcgttctctg cgcgaacttc agctgcttca 112560
 tgaagctctt tgtttagaga aatctctgcg gcaactctga tagctcggaa tttcctttgt 112620
 ctttctctt cattctctt tccccacagc ctcatcttc ccgccaacg ttttcatctg 112680
 tgatctttaa atcgtgtttg cttactgaga gagagtcaag tttatttctc catgacagag 112740
 gctgatggaa gccagatttc ttaactgcg gcattttcta accctactga cttggttatac 112800

 cggacagtgt ggttctctgg cgggggtggg gtggggtggg ggtggtgct gaaggcagga 112860
 aatcagcann nnnnnnnnnn nnnnnnnnnn nnnnnnnnnn nnnnnnnnnn nnnnnnnnnn 112920
 nnnnnnnnnn nnnnnnnnnn nnnnnnnnnn nnnnnnnnnn nnnnnnnnnc aaagcaaaca 112980
 acaagagcaa ggaaaactgg cttcaaatc atttaaaaa agtttaatcc ttaatttttg 113040
 agggttgaaa tgccaactac agacatgttc tcatttgcaa taggctggca tagatctgag 113100
 tcatcactag tactgcactg aagcttttaa cttagcacaat gtgttaatca tgtctgttac 113160
 tgtctttctc atgtatgtag caaccatct ctatacattt gcttcttcc tecctgtctt 113220

 tttctctaa aaatgtttag aaactaagt tagcagttag ccatgtgatc tagaaaacta 113280
 taaggagggg aaagaagatt ctggagatga atttcaagtc tgtcatagtc ccatagaggg 113340
 ggccctttct aaaatcttgg aacttttaag tcagtttcta tgtttcaaag agtgagggaa 113400
 tttagaaagg gtgaaactta tcatgtttct tcataatgcc atggaaacta tgtgttgctt 113460
 gtaaagtcaa ggacagagga gttaggaaaag agaacaaaca aagcattaag gtagcagta 113520
 aaaatgtcta ttaccagggg tctgtcact cccttcccc accaggggcc aatgttaaaa 113580

tgtctgtgca gacttcattc ccaacttaaa tttaaattat gtgcttaaat ttgcaaagta 113640

 tggtaacact tgaatatgtg tgttagtgaa agatataaga tgtttgaaag tcttagaggg 113700
 taggccatat gctaaaaaac acttetaagt cattccatgt attctgtagg tgttactgaa 113760
 aaccgagggg ttiaccttc tctactattc atttacataa attaagaata tgagattggt 113820
 tcaaaagcag ttctgcctct gaaccaacct cttttatacc agtgtgtgca aatagcaaag 113880
 aaactcaaac cccaaactgc agatttttac ggagaaagta aattctttca ttgacattga 113940
 ttgtaattca aaataaatgt gataaaatta attgcagaaa agtgtgtgtc taagtaagga 114000
 taatatattgc gactcaataa tctagtgtat tcaaagccat tcaaacttac actggactca 114060

 cttttcatgc aacttggat gtgactgat gctgtgtgga cacttggtat acttcatttc 114120
 tcctgttaga atctagtaat tccatgttat ttttttaaat ttgggaaaca gtacatgtgg 114180
 aatgttttta tattacagaa aagcctaagg ctgcatgtc aagaccatac aattttcaaa 114240
 ttgttattat aagtagcatg gatagtggta tttcctttgg gttcccttga atacgtgta 114300
 taaaaagctg gcattgtatg gacgtatata tatttaaaag cttaacctgt tcttttgta 114360
 gtataaagta tagctgttcc tttttatttc tttctttttt ccccctgtg gaccatgaaa 114420
 cacaaacaca gtcttagcct aattggaaca catatggaag ctaagatata gtaataaag 114480

 ttttagacat ttctggccaa aatagaacta cctctcactc aactttaaaa gattgattgg 114540
 attttaaaag ttttttagaa actaaaaaga aagagtttgg gggttgact aactttagta 114600
 gaaaagtata atgtagccaa gatgataaaa tcagcttttc aggatctccc ccaccccaa 114660
 acactccttc tgggtgtgat gatgtagggg gcttttggaa tgttccacat ttgttttttg 114720
 taagagaaaa atactaggtc attttatttc caaatcaaaa tgtaacatct agggaaagat 114780
 gcacattttt attattagca ccagcagatg gcctccctaa gactatttat tgacttgaat 114840
 cattttagtc aacactgcat gagtgatgga gagaaggctc agaagggagt acatattgtg 114900

 aacttcagtg attccagaag ctaagcatgt aacataaaca gtgatgcaat agttttgtgt 114960
 attagcaggg gtgatgggac ttgtggagaa ctgaagacac aaacattccc attttaagca 115020
 ttccaaatga acatttttca gaaagcattt catgagccac atttaatatg tctaagagcc 115080
 aaatgtggct catggactat aaattgtcaa taccatgct acaatctac actgaaactt 115140
 gattccaagc cagcttcaaa cgagcaagag aaaaagtga catagggttt tttttttta 115200
 atattggagt ctcttgcat ttttgtgat ttatatgtgt gatttatctt gtaagaatac 115260
 agacaggaag cattagacgt gtgagagtca gccattcttg gatgatgtca tttcaaagga 115320

ggcagaaaga aacaggatga atatatcact taatatattc acattcataa attgttttac 115380
 actcactact attgaaatga ttttatttta gaatgcttta tatgttagaa tagagtttca 115440
 atcaagaaaa atgtaacaga agccttttcc ttatgttaaa gaagatctca agtagagtaa 115500
 tgagctgtta gattgaaaag agctggagac tcaaagtttt tctctctgtt tcttttcac 115560
 cctagtgtat agtctttgac tttacagtcc ttggtgattg ctagagatcc agttattgca 115620
 tgtagctttc tagtcatctg gacagagaat gagaaagctg tgactctgta tttcttaaat 115680
 ggtatcttca aaacatttca acttattttat gcttggctgg aatttagtca tatagtcaca 115740

 caaagatgca agaatgggta gggaaatgtt tttttgtagg tggaccatgg ttctgtgatg 115800
 ctctactatt gaggaaacta gaaagaattt tgagtgatac actttgataa ctgctcattt 115860
 ctgagcagag tgaanaagcca agaacacaac agaaatgtgt gtgcatgtgt aataaatata 115920
 taattattat ctgaccaca gagtgaagtg tcaactctgaa tacttatctc tctcttcacg 115980
 ggaggttagg gaatccatta gattgaccag atattccccc atgatttcgt attgcataag 116040
 gggttgccctg cagatcttgg tattgatata gctttcaggt cttgtcctct ttaaacatag 116100
 gtggttaagct cggatgtgct ctgagaatca aacctttgta ggtgagcttt gctcacactg 116160

 gcgaagcact acattatgtt gttgaccagc ctgcttctga tactggtgca gagaatgcag 116220
 cttctatgta ccaagtagaa accctgggac ctttggtttc ctagtattc attttactca 116280
 tgagctgac tgaatttgt tggtaaacca ttacaaattt gacatcattt gaggaaaaga 116340
 taagccaaag ctaaacctcc acatggtgtt aggtaaataa ttctgctaca cagaggacat 116400
 tcataattcc aatataattc caggtaaagt tgagttctc tcacatgcct cctattccta 116460
 tttttcatac acicaacatc attacgtcaa gcctgggatt gattattgtg accatcccaa 116520
 acatgcattc agtgaagat gggagactaa aacaggaaga gcaggttttg tcttgaggag 116580

 actggaattg tgctaacctg acatggcagt atggaatcat tttaacata cagtttgctc 116640
 catgccaagg ataatcatg tgtctgtggc ctcatgggc acttgttagt gttggtttgg 116700
 gaacatttta acctaatgat ttttgattct gagatcaca cattgagaag tgtatgttta 116760
 catatgagag atatagtaat ggtaaaagga aaagattaga attgttagta agtaatgat 116820
 gatctaaatt tgggtaggtt gtacaaggtt atagaacca aatttatcct agaggtaact 116880
 aacattcttg tatgtattat tctcaatgat ttgttttga gacctggata tgacatgagc 116940
 tattatcaat ttactgaaat tttgagttct ttgaactttt ttccatgggt gtgtatagct 117000

 gtgtgtgtgt gtgtgtgtgt gtgtgtgtgt gtgtgtgtgt gtgtgtgttt gtggtgtgtg 117060
 tgtgtgtgtg tgtgcttggg tgtggataca catgtacgtg gaggtgtgaa attgacatta 117120
 ggtgtctttt ttgcttctca ttccactttt aaaatttact gttagtgtgt gcatgtgtgt 117180

ttgtttgtgt gtgtactttg tgaggtcagt tctttccttc catctttgtg tgggttctgg 117240
 ggatcaagtt aaggtagaca ggatgtacca gaagagtctt tggccttcaa ttttaatfff 117300
 ttaaagagta tccatttagc cgggcgttgg tggcgcacgc ctttaatccc agcactcggg 117360
 aggcagaggc aggtggatct ctgtgagttc gagaccagcc tggcttacia gagctagttc 117420

 caggacagtc tccaaagcca cagagaaacc ctgcctcaaa aaacaaaaca aaacaaaaca 117480
 aaacgaagag tatccattta tttttatfff gtgtttctga gtatfffgcg atcatgtatg 117540
 cgtatgtgtg tgggtgccttc agaagccagg gtgtcagatt tggaaagtga gttataggtg 117600
 gttttgagct gccacgggtg ctaagaaaca aacttgggtc ctctgaaaga gtgacaagag 117660
 ctttcatttg ctgagccagc tctctgttcc actcagtttt gttttgaga aaggatggtt 117720
 ggttcatgga tggctctaaag tggatggcat gtgagtttcc tgtctctgcc ttccttttgc 117780
 taggaagaca acctgacttt ttatgtgggt actgcttacc ctaactcagg ttctcatggt 117840

 tccatggtaa acactttacc aactgagcca tctccatagt acatgatcat tttataact 117900
 aaaaattcac tctaaaatta gaataatctg aaagacgcag acaatttctt tgcctttaga 117960
 tgccataaga ctgaagagct atgttttcca tgcctccatct acatggggag caatcctgac 118020
 aacagaagct ttgtctttaa ggtgcaactg tatgggacat ttttatcttg ttctaacttt 118080
 tataaataag ctgtgcttca aattaatatg aagccatctt ctactgaatt tattcaatag 118140
 gggaaaaate cagtgaagca atactttctt aactacacct tgccttctag ggagaaatca 118200
 ctcatgtcca tagcattaat aatgaacac aaatacattc atggaacttt attccttcaa 118260

 cattttggtg taatgtacia actgaaatgt ttacttttcc aaagcttaga tctaggaaga 118320
 agatagcatc atagttttcc tttttatggc ttgttttca atcagaactg tggcttcagt 118380
 ttttagatgg gaactatgtt gcccttgggt acttctcaag gagagtcagc cttgatccct 118440
 ccactgtgta tgagaactgt attcttggca ttgttgcagc tctgcaacct tccaagtctt 118500
 ttgcatcttc accaaaaatt gtaggaaata agacagcctt gcaaatggag tctgaagctt 118560
 taactgagge acaaaatag aatacttatt ccagtcgtga caggtataag ctccagcagt 118620
 gtaatctttt tecttttaaa tgcatcttag actcttttga agtattctat ggatttttcc 118680

 tgtagcttgc ttgttttcca tctttctgag gaactagcat caatcatgac ctcttcaact 118740
 acttgcctat ttgcctcgg cactttcttc ctagcctctt gagctaggaa gatggttgag 118800
 caagttcaac catctcccag aactcatgic tcttttctga gcacaagtgc ttctaagaa 118860
 gagtagttga gatttctgcc tctgtttccc ttcccttgaa tgcctcattt ttcccacttg 118920
 actctgactt tgacctctcc cccactgcca gcccccaat gcatgtaagc tgggtcagta 118980
 aggaatcaca tacatgctaa atggatggcc tctctctctt cagtttataa ggtctttctt 119040

ctggattaac accattgacc actctagaat ttcaaaaatg cagttctctg aaggttttcc 119100

ctccccctcc tgactttctt ttcttgttca ctcataggac tcctcttttt ctcacactag 119160

cttttttttt tttttcttcc ttaatggttc tgcaggata ttgccttttt agatcatcta 119220

ggaagcttcc acattgtcaa gggttttgct tgctgactag tgttaactca taactctccc 119280

accaatccca atctttcaca tgaattctag agtatatgtc tatccaccta gaaccatttt 119340

gagtttatgt atctaaatct gtctaccttc caaggttaac tatctaccct ccaagaatga 119400

gctactttct tacatattac ttatgtcagt taatggcaac atcattgtgt cattcagtca 119460

ataattttcc aacctgtcac gaattttccc gtttcattta ctaaataatt ctcatataaa 119520

aataactctt attcaccttt attacaaatt tctcagttca agccctcata gtccatccct 119580

ggggttagtg caatgccagc taaattcata ttcttgtctc tcttgggcc atttctatc 119640

agcacctaca tgcacccctg tttttaccag tgcaatccca aactaaatgc aagccattt 119700

ttactttata gttcatccat gggaaactcag ttggaagaga tagcaaggtt catgcttgtt 119760

agcttgcatt cattcttaat gtgacttgtc attctttacc tcacaataaa atgtctcttg 119820

taattctcac ccccaaagtg ctcatgctta ccttggacg tgeatgcacc cccctccaca 119880

cacacacata aagatatgca tgtacacacg aatgcacaca catttttct ttttccaaac 119940

ctctactctt cagagtgcac tgagtttta ttttctctta gttgaacca gtgttctcc 120000

attattatca cacagaagtt agctcacctt tccattccct gcatgagcca tatgtgaaga 120060

atttcttctt ttgtgtctat ttacaccttt cctataagat gcattttttg aaagatgta 120120

tgtttctca gaatcatcca gttgggcaat ttattcttac ttgaccactg tactatgctt 120180

aatatattcc atgttttgg aataacctgt ttcttttttt ttttttaact aaaaaatgct 120240

agaattatcc cactgacttt caagctact gatctcattt cctttatgta aacagctata 120300

attatgcttt attcttaata ctgtgtgcca tcctttctca ggtcatcct atgttttagt 120360

tgatttgtct gtaatgatta acctcttaca ttctctctat gtcttctgag tggcaagtg 120420

tactgaggct aattatttgt cttttgagaa atagagactg taccatgaat tcaatttatg 120480

tttttccctt ttagccaaaa aatgcaaaa ggctctttta agcctactgt gtgcatgtgt 120540

tcagataaat gggctcagat cttaaaatta cgtgttgttc ccacctttaa ttatctgtca 120600

tctctgtagt gtcaaaaca aagcaaggaa acaaaaggct gctcagttag ctgttccag 120660

gaggctgcat gtctcctgg tttgcactct gcttctcttg gattgtttca gaggcataga 120720

agccaaggat gctccacca tatacctgtg ccactctgtg tccatacca ctcagctctgc 120780

ttcagagttg attttctgaa aacatgtgaa tcataaaagt ctcacctgaa aattggaagc 120840
 caactttgta ccttgccttt ctctgggttt acctttgcag taagaggcat tgcttcatgg 120900
 caaagggatg tacaaggtag ctccagtact acctagatat agcagtgagt tgagcatctt 120960
 tccaaaactt tgcagtgagt ttctccgtta tccagaggct gctaattgtac ttcacttctt 121020
 ccaactccagg atattattgt gattgactcc agaaagtaaa cactgttgat ggttaggcac 121080
 tgttcggatt ctgcaagact tttcttgcct ctctgttcaa caaatgtaaa ggaaatcaca 121140
 acaacaacat caacaacaag atgatgggat taattcaaga ggagagacta agataaaatt 121200

 ttaccaata atttattaca atgaaattat tttattcagt ctgcaatacc caatatggtt 121260
 gtctctggc aatcagcatt aagttttctt attatgtaac tctgaagata tggggtggtc 121320
 tcatagcact gtactttact ttagagaatt aatatttttc ttgctttcat tacctgttac 121380
 atattttatt gcctcttcag taaaagaatc tatcaggtcc attcatgtta atttcaaggt 121440
 attcttaaaa ccctccatt cccaatttcc taggacttta tctggaataa gtgacaagct 121500
 ctacagttca atcttgagac tcatgtttct catgcaagta ctaaaagttt tagttggaat 121560
 tttatgatac aatagatggt ggacagtgag attaactgac tgtcatgaga aaagaaaatg 121620

 ctttcagatt tggctagaga aacaaaatct ctctgacatt tgcccagaaa acctatattt 121680
 tctttaaaac ttcagaatag aaatggctat ttcaaggcaa acgaaaatac tctgatataa 121740
 taattttatt ttgcaaaaa ttgtactgaa atgaaaacaa aatcagaaaa agaaaaggaa 121800
 aaaatatctg agcagcggaa aattctacca aggaacttac attgcagcct tatggtacct 121860
 gtctcagtta agtgtccact tacttactat tagagcaact gctatgggct ttctctgatgg 121920
 cttgctcage ttgattcttc atacaacca ggaccacaac actcacaggc taggctgtcc 121980
 cacattaatc aacaaaatgt actacacact tgcccacagg taatctgatg gaggcatttt 122040

 cttatttggg tccctcttt ctagatgtct ctaggtttgt ttccagttga caaaggtcaa 122100
 ccagcacagt gccatagtag gatgtgtttt tggatgcttc taaaaattt cttgggtgct 122160
 ttgtcttttc tttttcttt cttaatatga tactttgatc ttgccaatc tacacatgtg 122220
 tacattgcca ttatatccat cttcttcttt cttcaattca acacccata ttacccttc 122280
 agcttcatgc tctttcttc ttatttaaaa aaatatacag cccactgagt ccaatgagaa 122340
 tttcgtgtgt gtgtgtgtgt gtgtgtgtgt gtgtgtgtgt gtgtgtgtgt 122400
 atttcacat atgaaacct ctgctagagt attcagtatg gcagggacca tacctttaa 122460

 gaaacagacc ttccttcca cagcagccat cagctgccat aagctcctcg gatagtgtgg 122520
 gggattcata agccccctt ccatccaagc tagaatgggtg actagcttga tggtagctag 122580
 cttgatcttt ttttttctt ctttcttgct tgcttttttt tttttgtgt gagacagga 122640

ttttctgtga aaagttctag ctgtcctgga acttactctg tagaccaggc tggcctcaaa 122700
 ctcacagaga tccacttgac tctgcctccc tgggattaaa ggcatgcacc accacagcct 122760
 ggctgactgg cttgacctg agcagcagcc tcagctgctg tgagtcatg agtgcagcag 122820
 tctggcatg tccagagggc agttttcccc agttctctgc agcctatggc ttttacaatc 122880

 tcactactca ggaggatgct ttcttcatca cactcagaat ctgttaagtt tgttaaagg 122940
 ggaaatggtt ggaattatit caactcataa tatagaatca gggcaaatg caacagaatt 123000
 aatccaagat gaaccaacga agacattcca ggttccactg tgaatatgtg tgttcagata 123060
 aatggaggat gacaaaatgg acctaaagta gtacaatgta tgctatttcc atacaattgg 123120
 catgtaaaat gtgactcata catttggtaa atatgtacct tacatggact gcctcatatt 123180
 cctgccatct gttccttccg tggaaatgtc tagaactgtg gttctcacc ttctaatgc 123240
 tgttgacctt caacacagtt cctcatgatg tggtagcccc caagattatt ttctttgctc 123300

 ctgtttaat aaaagacca gagactgata ttggggttca agctttaagc tgaagatcag 123360
 aaagtcacta gctcttacct ctaactcagc ttagaccaa gggacaatcc tcaatctgct 123420
 tccgacttca ctgctctcag attcactcag actgctatgc tctctccat gtggctagag 123480
 actaattctc agactgaatg cctctacct ttatatctct caaatcctaa gattaaaggt 123540
 gtgagctccg atgactctc cagtagccta cagtggctt ggactcagag attcatctgc 123600
 ctttctgag tctgggtatt aaaggtgttc tgagtctgg tattaaaggt gtgtaccacc 123660
 actggctgat ttctataact tgaggctgaa ttgctttct gaatcatcag gtaagcttta 123720

 ataaataaca aataatafac tcacagctac ttctagaggg taattttgct actgttatga 123780
 attataatgt aaatatctgt gttttctgat ggtcttagaa gaccttgtg aaagcgtcat 123840
 tcaaacccta aaggggtcat gaccacagg ttgagaacca ctgtgctaga aggaagagca 123900
 ggtccaatc ttaataagaa aaaaattaat ttgatatac atgacatttt aatttagttt 123960
 cattttctt aaaaggggag catttttaa tttctctgaa gaaaaatgtt cagagttttg 124020
 ataccatatt tacttttctg tctccaagat cttatgttgc agctttgtat ggggtgccacc 124080
 ttctattttg tttatttttt tatttgggtt tttttgggg gggggaattt gagagagtct 124140

 ctctacatag ccttggttgt cccagaactc actatggaga acaggttggc ctggaactca 124200
 cagagatcca tctatctctg tctcccaagt gctggattaa gccatgtgcc acaaacactca 124260
 gctttgggta ccatcttatt aaccttctta aattttactt caaatttgag actccctcct 124320
 accttgacat cctttcagaa ttgcctgcta tegtgtttac ttacattctg ctctacaggg 124380
 aactaacatg ctttgcgtgc tctcatgtat agatccagta atagttttt ctgtaatgtg 124440
 agctccttaa atggcaattt gtattggaga catttcccc aatattcttt ggccaatagc 124500

atgtgctgat aaagtgtctc attgactctg gagctcatct ctggagcatg aatttcagtt 124560

tgtcataggt actctaccct tgtcaacaga ttacccatca gaacattgca atcacctcaa 124620

ttctattata acaggaactg aaaattttaa gttcttcaga atgtagcccc aaagttgcca 124680

tacaagacat gcctcaggtg aactggctca tggaaattgag atttacttcc caataaacia 124740

atccctgtaa taactttgaa actcgtgctt ctgagctcct cttctttacc cctctgctg 124800

cactgccttc cttctcctgc tatagggtgat taaacatfff ggtttgtctt ttctttctaa 124860

gaaatctcac cagcaggatt caagtcaacc ttgagcaaac tcttctggtc ctgttcagtc 124920

agcactgtgt gggcatcagg agtaaggggt tagagagcat aaagcccatg ggaagaaggg 124980

accctgagg ggctgcaagc aattctgatc agttgagtga gacagctgaa gtaaaagaca 125040

ataaaatttc aatfffftctg tgagcaaatt gtacttctct ctgagaaggt ggaatctact 125100

gtaatcatta tctctccctt attcaagtct catcagaaag cttgtctcaa agctatcagc 125160

tctgaggfcc tgtttgtagc atggcatctc tttttcagtg ggttgaaagt gacttggagc 125220

aagaagctga caaaaatccc cagcaatcag ctgagtgttt atacaaagcc tccatcttct 125280

ctcagacttg tttgccttct ggtgtatfff aagactctgc ttgtagaggg ggaagcatgc 125340

agttaccgag atgagagctt caactaaaca ggctgtaact tcttttcatg aatgaattgt 125400

tgaaataatt ttaatgaaaa gcttctaact taacgagatg agagcttcaa ctaaacaggc 125460

tgtaactttc atgaatgaat tgttgaaata attttaatga aaagcttcta acttaaaact 125520

ggaccgggac acagggattc tacgttctaa ttgcagctct gtcattgggt cacttggatg 125580

tttttgaggaa gtgactcaaa ttctctgggc ctcagaagct ttcttcaaac catgtggtat 125640

agtgtttgta agctctgaaa gcctacaacg acagaggatt tatgtaaatt ttctccacca 125700

aggtcagact aaatagtagt tataatacta cagagtatat gatgcacaca gttgaatcat 125760

tgggaccaca atacatattt tctgtgggtg atatgtttgt gtccttttaa attagggttt 125820

aaagttttga tccaggtttc tagttatttc ttggaggatg cagttatgac ttacagatgc 125880

taattttccc caacaacata atgttcttac taagctgaca gttcatccat aatgagatag 125940

cagtgatcgt atagaactaa caagaaaggg tagaaggtaa aaaggaaga gagggagaga 126000

aaaaggagga tttgagagat gaaaggaagc atcatgggaa ctggctgtgg acctgtctg 126060

aagagtaggc tatagaattg tctatfffct tctagttctt aatfffctat tttttgcaa 126120

taatgcta at tggaaagatg ccagctcaaa tatgtagctg tgattcactg tattggtatt 126180

tcctgagccc agaacacttt agaccttgc ttttgcctt ctttcatfff tgtgtttctc 126240

tccattttct tttcttcaca aacctgaat gaaatatgtg aacatTTTTg ttccagagtc 126300
 ctgatggaat ttactctga gacattcatt ctaagcagga aataagactg aatgacttac 126360
 tggcagacac acaatccctc tctattaaaa aaaatctcta cattgtatTT ggagttcaaa 126420
 tgcataaagt attaagatca aagtctgata gacaaattgt agaatcagtc ttgttgccata 126480
 agaaaagatg aatgcataaa gaaaatagag tafgtatgta caatggagtt ttatgaagta 126540
 tatggcttcc ctattcatgt ctcatcatal tttagcaata aagtataaaa ttatgtcatt 126600
 tgaagaact tagatggaac tggaaagTcaa caatgtTaaa tgaaatataa tgcataatcta 126660

 gaaataaaaa taccatgggt tttctcatal accttgaatt atatatatat atatatatat 126720
 atgtaattat catataacat atatacatat atatacatat atacatgtat gtatacatat 126780
 ataaatatag catgaaatgt aattatcata taacatatat acatatatac atatatacat 126840
 gtatgtatac atatatataa atagcatgaa atTattaggg ggactattgg agaagagggga 126900
 tgggtagtgg gaagagagag taaggcagga aaggatgatg gacagtgaat atgatccaag 126960
 ggcatgatac actttaggaa aactgacact caatccaaa tgcattcatg ctgaattaga 127020
 gactacaaaa agagcacagt gtcaccagct gaatggactc ttcagtaagt aagagatgta 127080

 ctTggccatc agaaagcagc taaatgtaat ttgctTTTTt agggaatata aagtcatttt 127140
 atcctTaaaa tctggctaag tgaagTTTTc tgatggcctt caataacata tccacaaaat 127200
 taaggaccaa attaaaaTTt ctaggcgTtc aggtatatTc aaatacatta acttctgaac 127260
 taacttcatg taatagccat ttacatcatt atatttgact gaaatccaac tcaagtaatt 127320
 tctTTtattt gcacactact ttctcaacat gagggcctct tggatattaa tgaaatgatg 127380
 agcatgatct attaggTTTT gcactgtatt agtataattt tatactaaga aatgcttata 127440
 gtgatattaa agTaaagcag aggactatgg tTtaattaag agTtcatgaa gTtctTggct 127500

 tggaaatgTt taatctatac acgatggTga tTTTTctac catcattagt gTaatataac 127560
 atcattttct acaaaataatt cactactata gtaccagtca cttctcttat ctacaggaaa 127620
 tgctctgatg agTctcagga ctgcatctaa tcattattga gcagttatTT ataataTTg 127680
 caattaaaaT tcagcaaata ttactggat atctactatg tttgattatt atgctagatt 127740
 atagaaatgc catagtgtat aagacatgaa cttgtTgccc atgaagagag aggTaaagac 127800
 atagaatacg aatgtTtaa aattaatgc cccctTaaaa tttctatTTt aagTaaaaaa 127860
 gaaattataa tGiatgacta tGtcatattt taaatagTtt atgatcatal tGattttatt 127920

 gatgctaaaa atgtTgTctt caaggcaggc catagcagaa ggaataggga atTTTgaaca 127980
 aaccctTggc taagattTac ttcaaaataag aataccacaa aatatttagT tccattgaaa 128040
 aattagcaca cattTTTact tTTTcatcca aagcacatta cattccagtc tctctTTTtac 128100

tggatgtat gacaagacat tttgaggtag acaataatct agatgagaat tccatttgg 128160
 agactctgtt cagtaagaat gcaaagccat ccatctatca tctcctcaa caggtagcag 128220
 ggtcatgttt gtgtgattat tattgaagat aaattatgt atgtattctt gtgcctttta 128280
 tatattttat ttaaagtgtc ttagaaagtc ctttagtgaa tgtttgaaaa tattctgtat 128340

 aactgtttgg tatttgcttt tgtttgcagt taaacttctc tatttctctc tctctttcac 128400
 tttctctctc tctatgcaca cacacacaca cacacacaca cacacacaat ctgtatatat 128460
 acgtgtgtgt gtgtgtgtgt gtgtgtgtgt gtgtgtgtgt gtgtacattg gtgttctgtc 128520
 tgcattgatg tctgtgtgag agtatcagat cagatcccct ggaactggaa ttatagacat 128580
 ttaggagatg cctgggaatt gaaccaggt cctttggacg agctcggaca gtgctcttaa 128640
 ccaactgagcc acctctccag cccatctata tatattttta aggattatit acttttgtgt 128700
 gtgtgtgtgt gtgtgtgaaa ggggggaggc attagatgtc tccctctatt actctattta 128760

 tttgaggcaa agtctctttg tgaatttagg ccttgctacc ctcaacctca aaattctttt 128820
 atcattgcag ctttccaaat cctatgatca cacaacctat ctctaaattc tccttttggg 128880
 attttttccc caagtgtatt aaaacatgca ccattaacaa atcatttgag ggctaaagaa 128940
 atggctcagt ggctaagagc atttggtgca cagtcatgaa gacaagagtt cagatgccag 129000
 cacccatgtg aaaaccacat gccctgtaca agcctggaac cccagctctg aagggaagg 129060
 aagcaaaaaa aatggctggg actttctagc ttttagactg aggtcagctg gggtactaat 129120
 aaaacacat ctcaaaaagc aactagccat ctcaaccacc ataggaacaa caacaagaa 129180

 gaaaaagaaa ataattcaat aaaataaata attttagtat ggattgtatt tggagtacca 129240
 tatattccag aaacaacatg taggaaaaat atatatgtat aaaatagttt atgatttctt 129300
 tagactatgc agaataattg gctatttctt tcaacataat atgcatgtca ttatcaaga 129360
 tggataaaat acagttagaa ctgtagtcat attactaatt gcttagactg aatttttttg 129420
 ttttctttcc atcattcagt cactatggca actcatctc aactgtaatt ccaactctc 129480
 attgaaaatt ttaagtgatg tattaactg tatgagaact aatactgcat gttctgctgg 129540
 ctgtttttaga tgttttataa gacaatataa ttttacattg tgaatttaga gtaatttata 129600

 gtagataagt attcataaaa atatatctga gagacaccaa aagacattca aaagagtttt 129660
 tttatacaaa ttaccaattt gagataatat tattgaatat aaatttgcatt tcttttgggtg 129720
 caacctctgt aacaaggtag ggtaaccttt taaaatgact ttataaggct aagacatgg 129780
 atatatatat cagaaaacca atatttaatg ttttgaagtt ttgaagtttc tataaaagga 129840
 taatatagaa aaataattta atttgtccct tgaagtgtaa tatgaattat tgttttgtat 129900
 tcttttctat ttaagtctt ctaattctca aaatacatag tcagaaactg tttctttaa 129960

aataaaacttt acagttaaaa agatgatggc tcaccagtgt taaaggtaga tctgtaattc 130020

cattactctg gaggcagagc tggccctg aggtaagctg gctagcaagt ccagcttgaa 130080
ctggatgagc tctaggetca gcatgaggcc ctgattcaat aaataagtgg agtgtgattg 130140
aggaggaaat gtgacgtcaa cttcaggcct ctgtgcacat atatgtgcac acacacctgg 130200
acacattcct gtgtctaata aggggaatat gtatacacac aacacacaca tacacatgca 130260
aggagagagag agacagacag acggggggag ggggagtgag ggagaaagag gaaaggaggg 130320
aggagagagga gaggaaatat tggaaatat ttggcccttt aaaaatgtta aatttggcag 130380
ggtggcgggtg gtggtggtgg tgggtggtgt ggtggtggtg gtggtggtga gttcaaggcc 130440

aacctggtct acaaagttaa ttccagtaca gtcagagggtg taacacagag aaacctgtct 130500
tgataaaacc gaaacaaaca aacagataga tgtttaaaaa acttttattg agacaggatg 130560
ttgtcctagt cccagttggc ttcttcccac tcccccaaga tttacttatt tttattttat 130620
atgtagtagc tttccctgaa tgtttgtttg tgtatttattc atatgtgagc ctgggtgcctt 130680
cagaggtcag aagagggcac caaaaatctg agaaatggga gttacaggct gtggtgagcc 130740
accatttggg tgttgggag gaaactaaac aagtgttttt aattgctgag tcattgctcc 130800
agctgctggg ctggtttcta ggccctggtc tgcttgtgtc caattcctga gtatttggat 130860

tacagtaag tacaacctg tctggatcaa aagggatitg aaagcgaatt tattcagtaa 130920
atattcatgt ctigtgtgtg cgtggcagac acaaacatgt ctcttaggat gcagtaatga 130980
ggaagtccct gactacacag aacctgaatt acacactgga gtgggtgtgg gtgaatcatt 131040
tccaccctct gatctctgtg acctgtgtgt agcagcctcc tgtagagtgg gacagtaatg 131100
cttactgacg aaatcatggc tgccaacaac tgacctccag atgagcctgg attaactggc 131160
gaggcgtcct gtgagcacat gactgaaatg aaaggaaggg ggtagaagag atgtagccca 131220
gaaggaaaat atcagagcca gagggagatt tgaaggtacc attcctctga ttctgacaag 131280

aggaagaggg gttagggtct cttttaagaa acaggaaaag gcaaagacgc agattaactt 131340
ttaggtctc cagaggccag gcctgtctac accttgatat tagcctgatg caaccattt 131400
tggacttata atgtcaaaaa ctaccagtaa tacatttata ggcttttcat accattcaat 131460
gagtagaaaa tggttacagc agtgatagga gatgaataca ataatatcaa atgaaagaga 131520
gacataggat ggcactgtga gctagaattg cctgatttgt aagtcttgac aatggggagg 131580
aatcattagt cagagaatat atttgaagct ctaggagctg gaaaaatgca agaaaacaag 131640
tggtttattc acccttcct gagtaatgca aactccttat tgtgcaagt acacctattt 131700

gggattctga ctccccaaac tccgctttgt tgtttaacct gttgtctgtg gcagactatt 131760
 attgcagcca ccagaggtat agagatacag ataataaatg aataaaatag ctatgtatgt 131820
 taatttaaaa ggatacttca acataacaaa cgcaagaaag tattagaaac agggtaggtg 131880
 tctagaatcg tgatttcaaa tataatctac tgacatgata atatttaaat ttaaattaat 131940
 catggtcgaa attataatgt aactagtggc tctgttagta cagaccttag aactatccat 132000
 catgacagaa atggctctgg ccagtgcat tctgaatgtt gtacaatttt acataggggtg 132060
 gatccagata agaggtgggt atgaggaagg aatcaggcat gagacagggt tctaaggtat 132120

 tccaggggga ggagcaaact gcagagttaa aaaatagata aaagacacat gtgacacagc 132180
 acatcttaaa ctcatcagaa tgttctagta acacagtatt attttactat taggtagtgg 132240
 caactactca ttcattcatt cattcattca ttcattcatt cattcattcc attccattcc 132300
 ccaagcattt actgacagca tatttttgtg ctgaattttt gcctggtaaa tatgtacaca 132360
 aaagtgagtg ttcacctgta agaatcaagt acaataatta ttctcttgta aaattcgtag 132420
 ttccttttga tggtttcaga ggtcattggt ttgataggca gagagctgag ctacaattct 132480
 gtattcttct tggttgaatg agggaagagg gaaactggaa acattctcct gtgttggggg 132540

 cttgacactt gtgtaacacc aaagatgtct ccttggtcat tttatgtccc cttttcaact 132600
 ctggcgacaa cacatagggc agcagcggag gcagcacgaa caagagtcac caacaatgtt 132660
 ccattaaatt gtaggctttt ccagtgagcc ttgaactgga gacttggctt tgaagtgta 132720
 ttgttcccat tacgctttca tttttatcaa attttgcagc taatgacaat aactttcatc 132780
 tgttagtaac agcaagcaca acaaatgca tctgaatgca gctttcttcc ttaaggaaga 132840
 ttgaagacct tgtgagagtg cacttctaca tttttgttt ccttagtttt ttcactgtaa 132900
 aatatgacct gattatacta aaacattaac atataaatg ttattattaa ttttatggag 132960

 agtgccaaag tgtgcagtca gtgaatacca actttccata gccagggaat attggaagc 133020
 tgttatcaa aggtactgcg gaatctcagg aggtctgcat gggaactacc ttttaaggca 133080
 aatgtatctt actggtgaaa gtgatggagg atgatttcca gatgtgaaa tgcttgtttt 133140
 ggcaactgct gcagaaaacc aaaacgcatt gccagaacaa ctgaaagtga tgtgaggcac 133200
 tgatctaaga ggggttgggc acacacaaag caagacgtgc tggattcaga gaggagatcc 133260
 aggggacata tctgggtgaa gggagctgta atcagagctg aggaagtgca tggagtgaaa 133320
 gtatgcgggc ctctatgta gaatacacc aagctcatct cattagtgtt atgttctcca 133380

 ctttctata ctgtcttatt atcttccca taacctcga cattatggta gtgaccatag 133440
 taactatacc tgactagtat ctgtcacag gttatgaggt tagtgaaata tacttggtag 133500
 tggaaaccacc aagtaacttg cctttaaac ctgcatccat tattttctac taaaatagac 133560

ttgattaagt ctattgctct ctacagttgt ttcttcattg tagaatgtta tcagaaatgg 133620
 caccaccgct acggaaggaa ggggtgttat aggaaaaatg aaatgaagtg aggtccttta 133680
 tctgaccctt ttcattccagc ctccagaatt aataataaaa aagatacatt tttcaaagca 133740
 acccagattt tattttcttt tagtcagatt gactttccat gagattttat aactgtctca 133800

 cagacaacaa agtactctgt tgggtgttgt tttaggcttg ttttctaaag gtaagaagtg 133860
 ctaaaacaag catcgatctt tgattaaata tttgtgttga ccacagtgtc tetttctacc 133920
 accattttaa atglacagct ggagtttcaa atggaggcaa gaaattgttg ttctgaagta 133980
 gtcagcctgt gttgacctgc tttaggtaaa tgagtattca tctaactaca ttttcgtgaa 134040
 cttttccctt ttatttctaa attgttttga ttacaccttt cccctgtaca atgctcttca 134100
 ctcaactct tccataaaca aaggcttctt ggcaatctct gttgtaacc ctggctctgg 134160
 gccagaaaag gccagccctt tccaaagcgt tagcctctgc aggagtggga gcctgagatc 134220

 ccaattcctg ttccaactat tttcacaagg agtggagcaa tagggccagg ataagaagca 134280
 gagacctcta tagggagcta acagttcagg actggagaag tgagtgggct ttactgcaca 134340
 ttttctcaga agcttttcca gtgttcgtgt tgaggaaagt ttcactgtat attgactttg 134400
 ctgtaacttg gtttaccata ttctctgtcc atactctttg acctactaat ttacctaaag 134460
 aaatatcaga cacatgagcc agaagatttt ggaatcttga tttgttgtct agaaatcaca 134520
 gactgttgac cttacctata ttgtgcttgg agttagctaa atgatcaatt ctttttattt 134580
 gaaagctctt gagtcaaaa aggagtcca tagcttcttg tgtggtgtta gctagcagac 134640

 tcttagacce agaaatgcaa tttacaatga tctctgtgtt tatgcaatgt ctctgtgaca 134700
 agcaaagagg ttttaaaagc aaaatgactt tcatagcatt actcacaag agagtttacc 134760
 aaagctattt agaactatga aacacgtgta attagtggaa gaatctcagc taaaatagaa 134820
 ttttaaataa ttatggagac taaaattaga ggccacacta gtgggtcttt gtagttaaga 134880
 tataaagaaa agaattgttg agtaatgtgt gtgggtttta ttcattttct tttttggcag 134940
 tttgaggatt gaaccaagag ccacacacat gccatgtaat cactgtgtca cttagataca 135000
 gctcctgtcc ctgttgttta gatgtaatg caagcacaat ttgataatc attttggag 135060

 gigactacct gaaacaggat cttacagaa gagataggta tatgccaggt agctatccag 135120
 tctgcacgtg acctttcatt tttcttaag cacttcatgt ctccagtcaa gaagagtaca 135180
 acagaaaaca cgcactcaa agcctaataa ttttactact agcttttttg gtgaaatctg 135240
 tattctagat catgtcttcc taacttcctt tggattatg taattattta atatttcat 135300
 aatattaatt acccagccat ttgtaacctc cctagactc tttgacaaaa getattttag 135360
 ttaaagaag atgcattttg gaagtacata cacaatcaag aatatggaaa atccattgta 135420

acagtattgg tgaggttatac atgtctaaat cacagaaaat aaaaataaat gggaagggtt 135480

attagtatat ctcaaaatgt ttgaaaaagc tctagctatg gaagtagagt tgaataaaat 135540

aagagaaaaa tggcatttat ttctctgaac ttcaataact tactagaacc atgtggttta 135600

gaaagcacag atagttcatt gcttccaatg acacattcaa agagtgatat acagaccatc 135660

tgctgtgggc tccatattta tacactctaa tatgccatgt ggcattctct atgaaagata 135720

atTTtaatac tttggcctaa caaaatggaa caggatccct ctgaggcaac atattcattt 135780

ttgaaagcag ccagtcaatg ggtctattac catggatact ttagaaggaa ttctaagaa 135840

attagactaa atagtgtttt gttcttttct gcagtttttt tttgtttga atttagtggc 135900

ccagtaacta ctgaaaaggf ccctaagctc attgtaggac aaaatcctgg gaagaatagg 135960

ggagcattta ttacaaacag aaaggaattt tttcaaagat catttgtaa aacaggagtg 136020

aagaaatcag aacttgattg aagtattctt ttaattaa aaaaataacc actgccaca 136080

gagacactgg tattttaagg taacctttca atctatgaaa cttaagaaa tgaacatttt 136140

tacatcttta aaatatttgt ctcaaaaagt tcattaataa acgtgagagg aggggaggcc 136200

gagggaatgg gggatggat atgtaaatat gagtaattaa aagaaattaa aaaaataaat 136260

taaacatgga aattctttcc aattcactat gtcccaaggf ttcataaaac tgagggtgc 136320

ttatgtacta atatgtgaca gttagcaaga gatccatttg cctcgtgtac ccagtcactt 136380

gtcacaagag cattttctga tataatttat tgcttgtaa gccatctcta cagtgcagtt 136440

gtaatgtagg gaaggaaaca atcactgatg tttagtggcc agactgttga ctgctttctt 136500

ttgacatgt ggactgtgag ttggattcct gaaggacata ttgttcagga atgtttacca 136560

gttaagaatg atggctaatt ttccatattg acctataca taattacata aattaaagca 136620

aaccataaca actgaggcta cacataaaat tttacagccc ctgccttgca ctaagcttga 136680

aattacatgc catacagcac atacgtcatt tttggaata tgtgtttaaa cccctctaa 136740

ggattgtaa taaaaggfct tcttttagaa tatgccacca tggagttttc ctcttgaaaa 136800

gtctggttac tgagatgact tattgggtaa aggtgtttgt tgacaaacct gatgaccgaa 136860

ttacattcct gggacctaca tggtaggata tggagacca cagcagatgt atgctaagta 136920

atgaatacat cattgaaaat gacctaccta tgtttcctgc taccgcacga gtagtaagtt 136980

gttggcattt aggaaactaa atgccagccc tgggacttaa atgtaaccaa catccacaaa 137040

ctactctctg accttcacat gtgtgcaatt gtaaatgtaa ccaacatcca caaactgctc 137100

tctgaccttc acatgtgtgc aattgtaaac acacatgat acgcaagtgt aacaataagt 137160

ctttccgcca tggccaccca agccctgctt ccatgtgggc actttctgcc aggccgcca 137220
 agttctgccc actgctacat taaggtctca agtaacacac agagacttat attaggttca 137280
 aatgctgctt ggctaattgac tagaatttct catctgctag ctgagttta attatcataa 137340
 atctatatat ttiataagac ttatagagga tgccttccgc tggcacctc tcttgctggc 137400
 agatcacatg gtaactacag agcagaaacc agtaggaaga gagaaggaa aaggcgact 137460
 tccttcttgc ccttgcttat atactgaatc tgcctgctat gtcacttct gcttgatct 137520
 ttttactgca ttiaccagaa tectccttga ctctaacc cacctatctt gcttctcat 137580

 tggccaaca gtaacttatt taacaataag gtaaacatac acagaaggac attccccatc 137640
 acacatgac atacatgccc gcacacactc acacatacaa atataaaatt ttattcttct 137700
 atttttaaa atttgtctac taagtaagag aaaaggagta tgtaaacca gggacatctt 137760
 ttttatctac ttactcatca atttgctttt cctagaacat aattacttga taaaaattc 137820
 taaagctggg attccaatct gctttagctc ctgcctgctg tgtcagaggg atgtaagacc 137880
 gagttaacac atttaactgt taaataataa aagactcttt gcttttgcac gaaaaaata 137940
 aaactacca ataattccagg cggtgggtggc acatgccttt aaacctagca ctgaggaggc 138000

 agaggcagac agatctctgt gagtttgagg ccagcttagt ctacagtata aattccatga 138060
 caaccaaagt tacacagaga aacctgtct aaaaaatgca tataaaaatt atataaaact 138120
 accaaacaat tttttttgg ttttttgaag cagggtttct ctgtgtagct ttggagccta 138180
 tcctggcaca ctctctggag accaggctgg ccttgaattc accagaggca gagttccacc 138240
 tgctctgcc tctgagtac tgggattaaa ggcgtgtgcc accaatgcct ggcccaaca 138300
 attttaaaa ctggaacaga aatggggagt ttttattgaa ccaatgaat agagaagtca 138360
 tcttttattg cattataat ttgtaattac aatttacctg gacaggtagc ccatgtaata 138420

 tgtgatttga ggggttgggtg atgtggcaag taattgcttt ttcttaatgt aatcataaga 138480
 tgtcacaagt aaagttagat tgtgtgcttc ttaagaatt acttgtgttc caactttagat 138540
 aaaatgtata cccacacta aatacatata ctaatatctt cttttagatt gtggagacat 138600
 ttagttatct ttcaaatatt aatgtttcaa gattattaat cagaaagtat tattacattc 138660
 attttacct taaaatgatt ttgtttaaag ttgacgtac ttatcttccc agctaggtgc 138720
 tggagcaaca tacaagatta atgaagaaa accctttatt gaagcctcac ctgtttttt 138780
 tttctttctc ttttgaact tctactcttt cccaatttca tacatgtac ctctatagtt 138840

 ccgtcactct ccatgtgcc ctctctatg tcttctac cccaacatc attccttct 138900
 cctcctaatg tcttccatt ctttactgac tttagttttg tttaggtcc cagagaattt 138960
 aattagggct gtcttgtag tctatgtta ggaactaacc attagagcct gactggctca 139020

aactgggta taaaactggg tactatgact ctctttcatc cagaatccat tatctaacia 139080
 tcagcaatgt gtgataaggc cttgaactcc ctttctccct ctataactgt taggaggaat 139140
 taacttttgt ggcccaaatg ctagtataga caccagtgag tttctcttgc catggctgtg 139200
 tcaggcttag aagatagtat tgctcagact ttcttctcat tctccagttc ttacatttct 139260

 accatcccct ctccatgat gttctctgag cctttaagag gtggtataaa tgtcttgttt 139320
 ggggctatcc tctcaacct cctttatttt tagcatctgt gcagccacag gtcttggcgt 139380
 ttacctctgt ttactgcaag gagtggcttc tagggttaag gctgagagta gcttctgcct 139440
 gactcaagtc agatccaac agcctgtttt ctttttttga taagaagaaa gttgacatgg 139500
 ctttggctgg ataaataaca ctctactttc caaaattttt attagcattg ttattggaga 139560
 cagtagcaga attaaaatga gctcagtgac ccctcttata gtttaggaat ttttactttg 139620
 gctaaggctg aagtctatgc aaattaatga tctcttatga tggatcatgt ttttgagatg 139680

 aaacatcttc gcagacaaat gaggtttcag aaaaaaagct atgattatag aatatatgac 139740
 attcctgggt gcattttgtc aacttgacaa cagcttagac atatatggaa agaagagaaa 139800
 ggattgagaa acaagattgg tctgtaggca agctgtgggg gcattttcct gattaatagt 139860
 taattcagga aagcccagcc caatgtatgt ggtgccagcc ctgagcagat ggtcttgtga 139920
 tgtataagga aaaagaacaa gttaagagga gcaagccagt aagcagcact ctcccatggc 139980
 ttctgatcta ctctctgcc ttcttgagtt cctgccctga ttctttccag tgatgggcta 140040
 ttaactgcaa gtgtaagatg aagtaaacc tttctcccc aagttgctct tcatcatggt 140100

 gtcttaccac aacagtaaac agtctaagac agaggctttc acacatactt ctgcccctat 140160
 ttatatctta taattgctaa ttaaatcttt ttgattgatg cagtacttag acaccattag 140220
 ggatttcatg cttttttct ttaccaactt gatagtattt tctttttaa ctttaatttt 140280
 catatttcaa gtctcatggc ttgttagatc acattcttgt tgatttcttt aacttcccag 140340
 gctcaaaatt gagactatth tatgtatgga ttaccaccaga gttcacttc ttttgtttt 140400
 gtttgacttt taatgacatc ttgtttatth ctatgtatat ttatttaaat ttagaaacct 140460
 aacatgaatg ctacttttct ctaagttcta gatattgcta tatgtgtgtt tatgcataat 140520

 atgtctgtgt gtatatgat agttttcaaa aatgtagta ttaaaactaa catcttgctt 140580
 aggtgtcttc aagaatgatt tcacaaatth ctgagattat ttctctgggt ctttttcatc 140640
 tttttatatt catgaatatt tactccaaga gaataaaaat aagttctctt atttttatth 140700
 ataattctct tgcattatct caatgcaaat aagttgtcca taaagaagtt cattaatccc 140760
 tcatatactt atcaaggatc atccttaagg atagtcactt gtaatttttt tattttccag 140820
 aggagtthta ggattatcca gtattatctg tgaagatttg ggtcccagtg ctgaagcact 140880

tcattaccgg ctcaccagat agatgttgca gatagtacca gacagagaga aatatgcttt 140940

catctcctcc atactccttt caacttttct ttctctctgt ccttttggtc ttaatcttgt 141000

tatcccaaaa ttgactgggg caccccagtg tactaaatgg attccaatat aaaaccecaa 141060

aatatcactc tgatactatg tatgataatt tgggtactgt tctatctaga gtagttatag 141120

catacaaaa cttgaaaagc tcaatatctg ggcttctttc tacctgaaga aacacttttt 141180

tggagataca tigtgcaaaag catctttgga atccagtggt aagtcaatat ttaagcagtc 141240

ttgttctgat ccatgttata tactctttaa aaatacagat aactacacc tatcagttct 141300

tgcaataaat gctttcttag cttgacaatt gtaacagatt atttaagcat tgttttcctt 141360

tccaggcctc tgattccctt tgtgggtct gttatagtaa gcatatacaa tgtatgtatc 141420

aagtcgatgt agtgaatccc accaaattgc atgtgtgtaa ttaaattta gattatcaga 141480

atattcaagg gattctgcta acaaatggag ttaagttga caattctttt ttttttaatt 141540

ttggctaatt tgtttcaag cagtcacatg attggctcat tgttcaatat ctaaccctta 141600

ccttctgtca taatacttga gaaactagt tctcaagtat ttctctgtat caaatttat 141660

gaataattgt tttcaacaat ttacttaata tttctgaaat gccattgaa actatacttt 141720

aagtattgaa attatcaaat aaataaatca aaagggacta aaaactaatg accattgaa 141780

tattctccaa acataccatt ttatttttaa gattccttca ggttgtctgg ttggattcct 141840

ttcttctatt tgacatttta aagaatcttc ttgttgctt tgaattcct tgaacatag 141900

cttcacaaat agttttctgg tctgcctaatt ttctactggt ctctgacctg tcacactttg 141960

gaagccttc ttttcttc atttgcaagc tttcttttc atgetatttc tctccatagt 142020

cagattttaa acaaaagagg caattctatt ctcagactgc ttcaaactcc ttagactgca 142080

ctgttctca tactgcaact ctctcagatt gccttttacc tagactgcac tgagttcctt 142140

tctctctctg ccttctatc ctctctccac ccagtggtat cactcaggtc tecacctctc 142200

tagggctggg attaaagggt tgggaccca aatgctgggg tcacctttgt gtgagctctg 142260

tttctttttt agacagattc attctcgagt agccctggac agccttgaac taacagagat 142320

ccctctgcct ttgtcttga actcctgcaa ttaaagggtat gtgccaccac tgtctggcct 142380

ctgtggctaa ctagtgtggc tagctttgca atctgatctt caggcaagca aatatcacc 142440

acaccaggcg tctaatggtt acttaaaata ggctccagaa cttctgtggc tcatcaata 142500

tattaatttt tacttgttta aaaataatgt aggattttca ttttttctt aaaattaaat 142560

tattttgtat ggcactccta ttttccaa aactagtcc tgattgtaa caggaaatac 142620

aagtgcacat ctgtgatatg gcaccaatcc ctgccctact ctgtctagat gttgagaata 142680
aaatttaaga aaacagtcac ttagagtctt cttgcattta aatatgttca actgactgat 142740
aagaggatga gcaataaaaag tccacatggc tactatttta ccaattatgt ttactttcct 142800
aattgttcta tactatttga ataattttaa cagctagctg taggtacagt gtaactttaa 142860
tgcttttaga caataatcca gactttaatc atgttatcct taatcaattc tgctttatta 142920
ttttttccaa ctttttaaat ttgaattaga aacaggattg ttttacctga caateccatt 142980
tcccttcccc caccagtctt cccctacccc cccaactaaa atcttatttg tcacatatct 143040

tttcttgtea cttatctgtg aagctatgga aggtgaggcc ttccataggg tgtcatcaga 143100
gtctttcata tcctttggga tagggcctag gccacacccc gtgagtcttg gctcaggagg 143160
tgttcctcta tatggaatgg gctcccaaag tccacactta tgctagggat aaatactggg 143220
cttctacagg aggtcccata gatttctgag gtttctcac tgaacccaa gtttctgggg 143280
tctggatcag tcccatgctg ataatccagc taccagactg aggagcaaga gttcccagat 143340
gttcaggtea gctgtttctg tgggtttcac cagcctggtc tggacctctg tgctttcac 143400
tggctcttct ctgcactcgg gttccagttc agatcagtga ttagttatgg gtgtcttctt 143460

ctacttccac cagctgctgg atgaaggcat ataagtcagt catcaatctc ataactcagg 143520
gagggcactt aaggtagcct ctctctgtt gctgagatag ttagctgggt tcatctttgt 143580
agatctccct tagctgttaa aggttaggct cacaacaaa aaaaaaaaaa aattcagctt 143640
tatttaacta tatgagtttt ggaaaatttt atactacaga tctttgtaa taatagttc 143700
tcttgagcct tgatgtatcc tgatagcttt ttgtaaagta tagtttcttc attgatcatc 143760
cattcaagta ttatctatat gtcctcactg agatcaaaac cttctctgta ggttattgta 143820
tagttgaagt acatttaaca tggctctaaat ttatggctct ttgcctaac tctactatgt 143880

cattcagggt atgtacaaat atgagagtca ctttttttt tcttacctga caaactccac 143940
tcattcaata tctttgtgga tttattaatt ttaactgggt atttaaggtc ctatgaaaag 144000
gcatgttat taaggactag gggctcaatt tctgccttat acttaccttc tctcatgtaa 144060
aaagaacctt ttttcatgtc agttactttc atagtctcac ctcatacttc atgtgttagt 144120
tttctttat gatctaagga actgtgcaag tgtttgcttt cttttaaagt attgtgttta 144180
tgcatagaa atcctatggg agaaactctt ctgctcacta gctaataata attgtttaat 144240
catgtctgct aacttaggca atataataaa cgtataaatc ataaatgaca gataaggctt 144300

taggatgttt gcattcatgg agtttctgaa tcagtctgtg atcaaaataa tgtataagtg 144360
tcaattattt gattttgaac cccagtaata ggtaataatg atgtggattt ttattgttca 144420
tccttccata gglagacaga atatacattt aaatgttttt agtgaagct tctattctta 144480

catataatca tgaattaatt taatttagtt gcttgtgatt tttctttacc agtttgaag 144540
 ccctcaaatg ctttcacttt gtgtgtttgg agttaaataat aacatttaca tgttgatat 144600
 tcaactgtgg cagacattta acagatattt ggggtctgtg tctataaata tattgtcgta 144660
 ttagtttcat cactacatgg aactctttta tactttttat tttgtttttt agagacaggg 144720

 tttctatgtg gctttggagg ctgtcctgga actagctctt gtagaccagg ctggtctcaa 144780
 actcacagag atccacctgt ctgcectcca agtgctggga ttaaaggcgg gtgccaccaa 144840
 cactcagtgg ttagtacttg ctttttaata gaaacaaaa gctatggtgg cccatacaaa 144900
 tgggaagtgt acaaaataag cacaattttg tttgtatgaa tgcattgtatt atcacagcat 144960
 gtcttatctc atttatccag agcctgagtt agtgaagttt atatatcgac atggaggcac 145020
 tcatcacgtc cacttttctt tatatatgga tatggaagta ctcaagtcca cttttcctta 145080
 tatatggaca tgtgcacaat catcatgtcc acttctcctt atctatagac atggaagaac 145140

 taatgtccac ttttctcat ctatggacat tcaggcaatt atcatgtcca cttttctaca 145200
 catgattgga ctgagatagt agcttgcaat ctttaaaggt gattctggtt gtagattagg 145260
 gaaacacage tttctatgat gttccaaact cagagaagtg ccagttcaga atggatcact 145320
 gtaatgatag agaattgtct gctaatgcac cccaggagct cttgaaatct cttatcttat 145380
 taatttggga ggactgaagt cctcttctgt agaatgtaat ttcccctcta aagaatctga 145440
 ggaatccttt cctgctcaga agcaaataga gaaggcttca tctgcattaa tcatgtctgt 145500
 tagtgccac agtgtgatta agtctccaga tacttttcta tataatataa actagttagt 145560

 tatctggtgt ttcagtgttt catggttttt tttttttta aattttattt tattttatta 145620
 gttctagtta gggaacaagc ttatttcaag tccttctcc ctctcctcc cctcaccccc 145680
 aaactttctc nnnnnnnnnn nnnnnnnnnn nnnnnnnnnn nnnnnnnnnn nnnnnnnnnn 145740
 nnnnnnnnnn nnnnnnnnnn nnnnnnnnnn nnnnnnnnnn nnnnnnnnnn nnnnnnnnnn 145800
 nnnnnnnnnn nnnnnnnnnn nnnnnnnnnn nnnnnnnnnn nnnnnnnnnn nnnnnnnnnn 145860
 nnnnnnnnnn nnnnnnnnnn nnnnnnnnnn nnnnnnnnnn nnnnnnnnnn nnnnnnnnnn 145920
 nnnnnnnnnn nnnnnnnnnn nnnnnnnnnn nnnnnnnnnn nnnnnnnnnn nnnnnnnnnn 145980

 nnnnnnnnnn nnnnnnnnnn nnnnnnnnnn nnnnnnnnnn nnnnnnnnnn nnnnnnnnnn 146040
 nnnnnnnnnn nnnnnnnnnn nnnnnnnnnn nnnnnnnnnn nnnnnnnnnn nnnnnnnnnn 146100
 nnnnnnnnnn nnnnnnnnnn nnnnnnnnnn nnnnnnnnnn nnnnnnnnnn nnnnnnnnnn 146160
 nnnnnnnnnn nnnnnnnnnn nnnnnnnnnn nnnnnnnnnn nnnnnnnnnn nnnnnnnnnn 146220
 nnnnnnnnnn nnnnnnnnnn nnnnnnnnnn nnnnnnnnnn nnnnnnnnnn nnnnnnnnnn 146280
 nnnnnnnnnn nnnnnnnnnn nnnnnnnnnn nnnnnnnnnn nnnnnnnnnn nnnnnnnnnn 146340

nnnnnnnnnn nnnnnnnnnn nnnnnnnnnn nnnnnnnnnn nnnnnnnnnn nnnnnnnnnn 151860

 nnnnnnnnnn nnnnnnnnnn nggtggggtg ttctggctcg gggtcgggag cgggcaggag 151920
 ctcactcacc tagttccagg tcagtctgcg gcgggggctg tttttttgtt ttgttgcaat 151980
 tgtaagtact atigtatttc caaatcatt agtattaaaa acaaactttc tgatgagggt 152040
 gtacatatgc atgtgtgtaa ctgtgtgaca tatagtggat tttgttgta ggttatttga 152100
 aaactccaaa gtattatata gcatatatat ctaaaaatat ccatgcatat tgtgtatgca 152160
 tataatattt tgtttgactt taatctgagt attattgcaa agattatatt gaagccacca 152220
 cttttcctta tgagggtaac ctataccgcc attaacaagc cccgttttgt aactcaaaat 152280

 ttagaataaa aagagcctca ttatttctct cttctttccc ttgaagaaaa tacagcattt 152340
 gatctcttaa ctctgtaaaa gtaatcagtt tcccatccat tctttcatga aatcacagtt 152400
 tttcgtaggg gcaaattgtt tcttcttttt atctgtgttt gggttttgaa ttactaggaa 152460
 aactctccag aacgttcttg cactctgttt cctgaggccc cagcttctc cacagcagca 152520
 gaggttctgc ttgggaggaa tgcttctgag tatccagcc catcttacca ccatctgctc 152580
 tgcagatgag ccacacagca ttgttttttg ctctttcttc aaggtctgaa aaacagattg 152640
 gaagcaaaat tctaacccag tgatgcttag caaattaatc ttcatacttg catgaagttg 152700

 ctcaggaatt tcatccatga gctccgtgtt tatttcaaga atgaacacat cacacctacg 152760
 agtaccatct gcaggacatt ttctgtctgt gtgacattgc cattcttttt ctgcagccta 152820
 gctagatctc acaccttttc taagtcaggg ttaagtctg ctcttctgtg aagtctctcc 152880
 tctgtcttat tccatagatc tctttcatta cccaaaactg ttttacacag cattggtgtt 152940
 tataattgct taaatgcctt gtctgtttta tcatactgta attagcctga tagcaggaat 153000
 ttttattttt ttaattttgt tttgcagtcc caaaacaagg aacataggcc attctgtaac 153060
 cagttgctga aatgatacta caccaatgcc tttgaagaaa cctgattata acagagtaaa 153120

 ttataggatt aagtctgtaa aaaaaatgc agtcagaaat ttaggaagtg gtataacttt 153180
 cttttattct agacaactgg gcatagagga aactgtgaa aacacacaca agaaacaacc 153240
 aaaccagaca gtagtcacaa ctccaagctc ggtctcattg tacaataaga tggggaagaa 153300
 actctggatc aaatgtcagc tcccagtggc tactgggagc ctctgagagt ttacaaaatt 153360
 ccccataatt cctcagtctc tccaagac aggtgaagca ggtgaagggc tcagtggatt 153420
 aggaggcaga taatattgca tactctgtgt ggtaggaagc tagaggccaa gtatctggga 153480
 atttatttgt cacattggga gaaaaatcta agtaattctt gctgatgtga atataggttt 153540

tgagttggca caggaaactg atcttaatga gaactgatct taatagtcca gagaatgcgg 153600
 aagtgacaac agtaggagag caacagacac ggctgtgaag gtgtgaatat caagatggag 153660
 ggcatgacat aattcacact gtgaggatga atttgttctc aggacagact gtgtttgggt 153720
 acaagaactg aggcttagag aaggigacat ggctgacatg ccatttaaga agacaatfff 153780
 aatggctaca ttgaaaatag atggcaggac agttacagaa aaatatctgt atgtctgtgg 153840
 tattaaacac tgaaaaaatg gagaaacaag taaggcaaaa tacacacaac ttatttggtt 153900
 gactctgtaa gcttgccatc tgggaaagag tacttaggaa attaaggggg tggaaataat 153960

 aatggtaact attatctfff caatggatat ctattaataa tacttatttt tataaggtta 154020
 ccatttgfta agattctcat gagcacagtg agttattagg cccaatacgg tacatcctta 154080
 taataaagc aaggactatt gtaatggcat tagcaatatt ttcttaacgt aagcttcaag 154140
 tattatftta atagaatcat ttgctttact ccatttacia actctatgtc atgcgctaac 154200
 ttcatactta accacatcct gaactcctgt ggttcacata tgtatttctt gaagtgtgac 154260
 tctagtcagc agtggcccat ggggaaattt taaagagcag atgttttaag tttccatatt 154320
 atgtttgccc gtatgctaga gaaaactata taaatgatca aatttgagat tatttcacat 154380

 tctgcattat atggaagcca ataagtgtat ctccatatt atgtttgccc gtatgctaga 154440
 gaaaactata taaatgatca aatttgagat tatttcacat tctgcattat atggaagcca 154500
 ataagtgggtg gcacatgctt ttaatcccag cactcataag gcagaggaag ggggatttct 154560
 gagttcaagg ccagcctggt ctacagctag gataactagg ggtacgcaga gaaatcctgt 154620
 attgaaaagc aatgaaaaa gtatatcttt aacaaaaaaa tacacaaaat aatggcacct 154680
 aatatataca gatgcacata aaattgtagt aatggtaaaa tagtgtgaaa catagaatta 154740
 atttgtgcag tgtgtgtttg ccataaaggc taagcattta ttataaaaat aagatgacta 154800

 agattttgtg agaggattat acacttttag acatgtctag tgtaaagagt agattttcaa 154860
 cagaaattat tttaacaag aatagctaac atgcaatfff atcttttctt tcaatataca 154920
 acccctctgt gactacatat tttagttagt gagagaacca gaaatactaa taactcatcc 154980
 cagtcaagtt ggtcctctac ttctatgat tcacacagcc cagctaaagt cccagaagaa 155040
 tggactcctt gtgtcacata gagaaaactc tgagaatggg ctccccctta actccttgtg 155100
 tcacagagaa acagctctga gaatgggctc tccattagct tggtaaaatc attttgctc 155160
 aagagctcta atctctttat ctgtaaagta ggaaactaat ttctgcttca gtttggtata 155220

 agcatggatc agataagata tgaaaaaaag cacatatgca tatgtgacc gatcagtatt 155280
 agtactgcag gctgagagcg tctgagagtg ccatttctt tttctcatat actgttcata 155340
 tgtttccaac tggactcca caccaaggaa tttggagtca tagttgacgt taccatctgc 155400

ccaactgggcc tcttatagtc tccactttgc caagctcaca gtaaatgtct cctaaaggaa 155460
 atgcatagag ctactttgta gttcatttta aataaaataa taatgattat cattaataa 155520
 ctttaaaagc aaggtatgct tttggtgcat ttaagaaga ttggtttgtt tttgagctgg 155580
 aaacttaccg tgtaacttaa ggtggtctcc aattcaaaaa tctgcttgtg tcatcctccc 155640

 aagttcaatg ccagccctga aatagaataa aggtgtgggc cagctaaca ggcgtgtgtg 155700
 tggagtactt aatggctgaa aatggatttt catgcagctc ctctcattgc ctttgacata 155760
 agaattgtta aatggacttt tctcatcgaa agaacagggc ctaagataga tggcttcttc 155820
 taggtttccc tgatggtaat tctagtata ttgaaaatta tgactgtatc ttccaatgat 155880
 ggaacccggt tcatatctta tacatcaaac ctttacaagg acaggtagca tttagtaaaa 155940
 aaaggagggg agagagtcaa gatagaaacc taaaggaaag taatgaagt taattctctg 156000
 gccatcgctt ggcagtcttt gactaattta aacccattc ttctcttcta tgctgtgtgc 156060

 acacctgaat gcacacctac aaagtctcag catcctttta ctagctcctg gaaccacag 156120
 tgtcactgct atgtccagct ctctgttcaa taaacacagt cattgtttgt tcaaagtgg 156180
 ctccgcctt acagtgtatt aatacataga acacttctt aatctaaatt ggaataaagg 156240
 aaacaaggaa acatacctgt caggagaagg tgctggagtg ggaatcataa ggcttagtt 156300
 cagccttggg gcctgtgtca caatttttat gccttaaagc accagagtat atgtttttt 156360
 ttctattcta tggcacttt atgggtatt tataagccaa agtgatattg ttttggtaat 156420
 aatttttta cttagaaatt tatctttatt tctatgtttg taaatacctg ggcagttttg 156480

 aatgctaact aattatactt taaatatget tcaatagctg gtcattaaaa aatgcacttc 156540
 ttgaaaacat atcctaaata aaatgtctta ggatgaagtc ttcaggctga atttttttgc 156600
 ttaaatattt ggattggctc acagtataaa tttccaagg gcactccaga cccaattctc 156660
 acccttccaa acatcatatt cagaagtaat gaactaatat tgatacttca ttgttaataa 156720
 acaaccttta tttatgtttc tttggctttt agctcatgac ctttctgtc tgaggagccc 156780
 aggcaatacc acatcgaatt tgatgagagt atttccttag gtgtcctttg gatgtgacag 156840
 tttaccaacc tttctttgtt ttcatgagtt ggaaaagctg gggagagcta atgaggactt 156900

 ttgtagaatg tcaactcagtt gggatttttt tttctttttt tttttttttt tgtcatgaat 156960
 agacaggtgt gtgagtattt gggaggaaac tttcacaggt aaagtacaat agttgactgc 157020
 cagcataatt tacaacaatg atgttagact tgaacacctc atttctgtaa tggttaccag 157080
 ttgttttccc ttaattttac tagttctctc catactgtgc tctaagaaag gactcagtgt 157140
 gaacagccca tattgaaaag agtagagtag ttgccctcaa tctccttaaa gttgtagtat 157200
 cacaaaaatt atttgaaatt ctttgtgagt tatttatcta tttgtttatt tgtcagtatg 157260

gattcttaga tacttattta tgttttagaa ctgttggatt ctatgtccct gtgactaaac 157320

cccatcctgt atgccactct tttgaattca gacataactc tatcatatgt aaccctttc 157380
aaattttccct tttttcaaat tttctttttt gacattecaa tatgatccat tttatgtatt 157440
tctcagccta gtccctaagat ctttcatttc ttcaatgtgg ccctgcatct tctattgagg 157500
gatgatatta aaagtcacaa tctatgatct aggtgtatct tgcttctgta tctacttagc 157560
tgtgagaatg aagatgtgtt tgtctatatt catagacaca taattatttc agtgagctat 157620
acagttatta aaatthagga aacagacaca gtaaaatgac ctagactttg gcatttcaca 157680
ggaaatcact aaaggaaata aaccaggcca tgttaatgga cagtaaaact aggtagaggt 157740

tagaaagaat atgaggagaa tgtaccataa gtcaaatgtt tctatctgga gtcttgggct 157800
ggatatgtct gcccaagcat tttgtttggc tcatggaaaa ctttgtaaac aatttgaatt 157860
gcatcactga gtaaaaatc agtgggatgt caaatgtaat gctccctttt agatgctctg 157920
agctttgtca ggctgagac tcccacacct gtgctgtcta tttgccaatt gtcttcact 157980
tattggcagt gccaacctta gtgaggacca cacaagcacc tctttccag aagatttact 158040
catcccctca tccaactcac catctcctgt gcactgggag ccaactcagg ccccaaatgc 158100
tcatgaacta ttgcttctat tccaatatga aagaaaggaa attatgtttt tgagcccatg 158160

gctaacaat ttggaaaatg agaaaaataa tttcatttgt ctaagtgaat gatatccata 158220
tttaagtaaa atigtgaact ctattgagat actacatgca attccagtac taaataaaca 158280
tttctcagta gattttaat tctgcccana tcttggttct caaatgataa tcatgagtct 158340
gccttcttag ccaactcttc aaaattgcat aagtaatatg aatcaacata aaagttggat 158400
ctggagggct ggagagacag attagagggt gtgtctcttg caaagaacct gatttcagtt 158460
cccagacca tgtcacgcag ttgataactc tgtgtaactc aagctccaga ggagccaata 158520
cctctggcct ccaagagcac ctgcaacatg tacatatacc tgtatagaga attaaaaaca 158580

cagaattaca tacctacca gaattgaaaa taatgaacct ttaaaattg aatttgtatt 158640
ggcctgataa atatgctgtc attataagag ctacatatta aatgctaga agatatttct 158700
tatgtgaaga tagaatttta ttttgacaa tttttttgt atatcttgaa gtatactgta 158760
ccctgtaaaa ggccagtat ctacctcaca cactttaat acatctaaag gctgagactt 158820
gtggctttgt agagagtttg gttagtttta aggctgacgg caggaagcag tggagtgtc 158880
atagtcatg aatagggccc tacattcatt cccaacact gcaagcaaa acagcaaagc 158940
aaacaacccc aagataggcc aatttacct tactgagaaa ggatatgaat taagaaaaag 159000

gtattaatta taacaaatgt ttctgacatg ctaaagatat aaactattgt acttgacatt 159060
 tgacttctgc cctagcaaat attatgaaac aataaaaaatc tgagccatca atagtcaaag 159120
 tgcaaatgaa atccagattg tgagaatctg ggagtgaagc aagctggcag ctccccaatt 159180
 gtactgact gatctaaatt aagcatatct tacaagacaa tgggctcaca atatgatgca 159240
 aaaaggtatt gtagttaagt gtagttaaaa aggggatgaa tttagttaa ttcaaagtat 159300
 taaaataaat gtagcataaa gtaaaaaagt cactttagt tagacaacat taaaatgat 159360
 gtcaagtatg gaaactcggc tttcttctt cctagcctcc atactagtgt ataattgtct 159420

aggattgtat ttcagaatgc tcatatctat ctctctgcat atatggatat acaaacataa 159480
 agtttcacca tgittgcata catatatagt tttatgtgct tataatattt ataaaaagaa 159540
 caaatctat agctgccaat gtataggtat tgctataaaa gacaatgtct atatacataa 159600
 tacatagata taaaaactat atacaatat acatttatct tttacctaga cacgtcgtac 159660
 acacacaaca ataattgctt caggagattt taattaactc tcttgaaact gtgtttgagg 159720
 gtaattaca tctaagatgt aaaacacaac tatggtagc atgtcgaag ttcttaataa 159780
 atggtagctt cctctcacca ctgccaattt aaacaagaca tttaaattca cacattttt 159840

tattttactg tcaattatga agttattgaa gagaccagta ttgagtgttc atttgctcat 159900
 tatttgacat taacctgaaa aattttacag gtttttggat tcggctttag tgtttgcaat 159960
 ctaagaacaa ctggaaagct aagattagtc tgtgcattct tcacaataaa aactaagtt 160020
 ttggttttta caccactgtt tgtaagcaac agtcatgaca ccaatgcatg gggttcatca 160080
 gaagtattg cactgcctct tttgtgagtg gaagtgttag ttctcttact gggggaggca 160140
 ttggccattg aatggaacac tcaaagtgtc tgggttactg ttacaaacc ccaactgcat 160200
 gtaagacaat aattgtccat aaaccattc agtcataatt tacaataac tcaaatatct 160260

aggcttggga agaagaagtt tcatattggg ttgagattat agcatatgac catctgtggt 160320
 aggttctatt tagttgtcta gcctaaatta aaatttaatt acttaaaatt aaattttaa 160380
 tcaacccttc tttcttacct tatttgaatg tacctatatt tgtaagttga aatagaaaat 160440
 ggaaatagge aagttaggaa aattcctata attgaagatt tattttatag aatataacat 160500
 cattctattt tatctgttgt gtctgtctgt ctgcctgcct gcctgcctgc ctgcctgctg 160560
 tctcctctc tctctttcat ctgtcttttc cagataacc agtgttgtgg cattggacta 160620
 tagcactgtc ttcagtggaa agattacttt ggaagctttg caactaatgc ttcttcaaat 160680

glatgaattt gcagcttcat gcaggagata gaggtaaaaa gagaagcttg gtagtagagt 160740
 aaagctttag gcagagtttc cctgattctc catccattct ttcattcaat gtttagggat 160800
 gtagcttagaa gtgtttttat aaaacaattc acttaatttt tctggaatct gtctgtggct 160860

gttgctttgt aatactttga ttccagaaaag gtgttttatg tataattcaa acacttcatg 160920
 cactgaatgc aaatcttactt tatgaagaat tattgaaaaa tataactat aatagagtcc 160980
 aggaagtgt caaccagttt tgtttacatt gtcagttacc atagaggaca tttcaggctg 161040
 aagctataaa ttactattgc ttctataaaa ctgtctgact ggaggaggga tgtagtgtta 161100

 ggtgtgggac acataactaat aactataact gggatgtaga aaatcccaa tacagccacc 161160
 tttgtggatt cagacaaaacc tggtcagtgc accgattagt ttagtcaatt tcacacaacc 161220
 ctgagtcagt tgggaaaagg gaacctcaac tgaggaatgg cctctactag actggctctg 161280
 cagcatgttt gttggtcatt ttcttgatta gtgttgatgt tggagggtat gggccactgt 161340
 ggggtgtgcc ccctgatgg ctgaggacc agggttatgt tagaaaacaa gctactaaat 161400
 agatcttgc atgatcttg gatcagttca tgtctctagg tttctgcctt gggttcccag 161460
 gatgatggac tgtcactggg aagttcaaaa tgaataaac ctttctctcc tcaagttgct 161520

 ttgtgttatt gttttgtgac atcaactgaa aagctaacta tggttgtcag catgtgattt 161580
 caatatattt ttcttgatat tttgggaagg ttgaggggct gtatcctcaa tagactgaca 161640
 ttagaggaca gagtccaagt gcatttcccc agtcccttgt tcagagagcc tagccccca 161700
 catctccacc ctggttgcac caaaaataaa gaaatagggc atgaactctt cagggcagag 161760
 caaggcagtg tgttttcttt ttctttctct ctctctctct ctttctttct ttcttcttc 161820
 ctctctctct tcttttcttt tgcagatttt tttattttaa ttagaaacaa ttttttttt 161880
 acatgtcaat ccagttccc tctcctctc ctctcctcc accacccat caactaaac 161940

 cctacctate acatatttt tctgttttcc ttggagggtg aggcttcca tatggggtct 162000
 tcagagtcta tcgtatcctt tgggataggg cctaggccc ccccccattgt gctttggctt 162060
 agggagtate cctctatgtg gaatgggctc ccaaagtcca cacctatgct agggataagt 162120
 actgaactac tacagaaggt cctgtagatt tctgaggttt cctcactgaa acccatgttc 162180
 ctggggtctg gatcagttcc atgctggtat ctcatctatc agtctgggga cagtgtgttt 162240
 tcttatacaa aatataattt cggaacttct gttttgacac tgacacttag gtggtgggtt 162300
 gcatgtcttt ctacttctg cccttctttc cctcttctg ttgataggac tgactgacce 162360

 ttcttagctc atagtaggct gcctttcaga tttgctgtgt agctccttaa ccaactttct 162420
 gataaacttc tgtgttcttt ttctagcacc cctggggatt caatcttgc acttgtcatt 162480
 tttctgctcc ctgaagtaaa ggcatccaag atatcacatc accaaaatga aatccagtcc 162540
 tgcagtatta gcttaaactc tatgtttgga ggcagccagg gctctctgac attttctctg 162600
 ctccgacca aagcaatctc taccacatg tcaaatgca ttccatctg gacatcttaa 162660
 tctctgagta attgcttctg tacttctga gttattatct ctgacactcc ttgacagtaa 162720

tacttgggca cagttgatat taatttattg ctttgacaat gaatcagctg aggagttagc 162780

attatataaa atgcatttta ttccatatac ttttgttatt ttactttcat tgttttttag 162840

tcctattatt ctttccaaag aatgtagtg gtatgtggtt aaaattaaat gcagttatac 162900

tgtagaaaa ctaagatggc ttaacttaa cactgaaatt cgtgggtaat gtgtttttca 162960

tctctaaaa tgtaacaaa tcattttctc tgattaacaa agtttttaaa gtgtacaact 163020

aagtttgtaa tctttccag aatgttttca taggtttatt tctttcttg atgttatgaa 163080

gtgtccgta caaaaatgac actgttattc aggaatgttg atgtggtagg aaacttctac 163140

ttatgtctct agaacttagg ccatgatgac atatcataaa aatagatgca aatgtggct 163200

gctcttgccct ctgggtgcc atgaggttgc ttaatcacac gtctgtacat gtcagcagtt 163260

aatttttca aaagtagatg ttagtatatg atgatcaaaa attaaaaaa atccaatgga 163320

gtgacataat accaataata taataaatta tttatcattc tcagaactaa cccctgttca 163380

acatttattt gtcattacat aaaattatta tttgaaatat tcaagtatta tttattgatt 163440

tacacataga atcctttcct ctagtgtgtt ttccaagta taagaggcaa atttaattca 163500

gaggaaaaa cctcttgaa tgacttcaat tttattaaaa cacatttgaa tattgatact 163560

tgtcaacaat gccttaatgc acatttcatt agatttgcta gagtttcatc tttttagaca 163620

aaagtaggta tgatcagggt gtctttttct gaaatcaatt tcacacacac agaattttgt 163680

gttttcccat ggtaaatgga tacagtgtc ccagatggct ttccaacccc caacagaaga 163740

gacagaaaag agagactgga aaaaccacat gtctattttc tggggggcag tttaaatacc 163800

ctgtgggagt ggtcttgagc atctctggag gaagggtcat catttgggtg ctttctgaga 163860

tgcggcaggg ttigcgggag ggggggcttg ggtggaactt ccaccataac attccagact 163920

ctttgggtat atggatgcca ggggctgggg tgaagcatcc accataatgt agacaacaca 163980

ggctgggcct agccctcagc cttccagagc tggcaattcc caccatcagt tttctataag 164040

gccttgtaaa gttcatttgt gtgacatgtt tttcttgagg tttctttta tgtgtgtca 164100

attctacct gtgataaac aactggggg accgtagaag catgcaggca ctctgggaga 164160

cctttgcaac ctacctcac accagaagct cactgacctg atagaaacca gatctttgca 164220

gagttgtctt tgaacttact gaactctt ggccagtaaa ggactttttg acttcagaat 164280

tttttacttt acagagtgtt caggatggtg gtactgtca ccagcaggct ttctatgga 164340

aaataccagt tagagtttat ctctgttgc acaaagagca gccaggaaaa gccctcaatg 164400

aaaatgatca tactggggca tgacaatcat ctgcttctc catttaatgg aaaggacatc 164460

attggaagaa gagcttgttg tgagggaaat ggtaaccatc tgcacccaaa ctatgaggaa 164520
 agcgtcaaat aacagaact ttccagactc aaagcaaaaa atagaatcag taggagcagg 164580
 agataggaat aagtattaaa aaaaaacccc aggaaacaac aacaaaaaat acccctctgt 164640
 gtttctgatt gagagctgag tttgagaagc agcaagttaa aattaaggct aaatttaaaa 164700
 tgaaattaaa aaccttcaat ttgagagata cactgtgttt aaaatcaaaa aacacatata 164760
 attctcatgg gactgaatit cagtgaaatg tttgaattaa ggaagtaaaa gattataaat 164820
 atatggtctt aaaaataacc tgaagtttta aatggctctg aaagacaacc tgtcttccta 164880

 tcccacaagc aggagcatcc actctttaa attataactg gcaaaatatg gtttatgttg 164940
 gcagaaatct cagaagactc ttcatcactc aagagcctct tgtcaagata ccttgaatt 165000
 agctccaaa gtctccatct gtgacgatgt taacacacagg tgaattgctc tgggcaagtt 165060
 gctcaggat tgtgatgta acggaatcaa ttaattgcta tagcggcttt gtagctttgt 165120
 tcagtatcac aactaactc agagacattc ttgccctgca gaaagcatgg tcttctctt 165180
 ccctaccctt gtcacttatg cacttgaaat atgaagttt aggtttgtga tattgtcag 165240
 cactgaacca atcccagtg gtctctgtgga atggcaggat tctccagcc agttatcaca 165300

 gtctatgtg aaggggtctc tgcccacaca ccgtaatgtg acccttattt tccttagtg 165360
 gacattatga taggccccct ctaaagaga gcggcctcgg gattctattt aaatttacet 165420
 aaaaatggtt gagtgagtga agaattttta taattatttt tgtaactatt caatttgcag 165480
 cacagttgga agagatgttg tactgggcaa aagtttaagc ataaactgag gacccaata 165540
 ttcatttaac aaaggctgca catcatgtaa ttttcatgg ccagagtgga aaaagtaaaa 165600
 gaacatgaaa aacttaggtt tcctaatta ttcggtgtct tcttctcat taatgttcc 165660
 cagtgcctat ttacctgcc aaaatataac tgaatctta gcagttagcc tgtgaatgtg 165720

 cctctctcca ttcttcttc tcttctctg gggtgacagt gtctactct ctctgaagat 165780
 gcaccaaacc aagcacacca gtaatctgtt tctaatactc cacaccagca ttccttcaa 165840
 cactgtctct tccaccacta ctacagcccc acctttctct gtaggatccg caggatctgg 165900
 cattaactca ggataacca agacctagt agcacagact tatttacct agagggactg 165960
 agggcagggg atgagagaca aagaaagggg atagagaact ggggagaggg gcaaaggaac 166020
 aagggaatgg gtcaggggta tttgtcctgg aaggaggcac aaaagcctgc ctccgatag 166080
 agaggagaga gagatggcac acaggcaaat ggcagtttat agaggtaaaa ggatgaggtg 166140

 gtaatttta attgaacatg ttaattcagt aagtcaaaag gggttttga agctgacttc 166200
 aataagtga tggttgatc ttgttagtca gtctcaggaa gagaaagtgg ccaaaaatga 166260
 aatagacctt agtagctagc tagctttagg aatgtaatat atctttttt ttttcaagg 166320

cagaggaaat gagcaaggct taccagagcc atgtttgcca tgctcagtct ggctagagtc 166380
 tgttcacttt ctttcttgag atagggtctc tctacatagc cctggctggt ctggaactca 166440
 ctctatggct ggccttgatc tcatagatag ctgcctgcct cagcctcctg agtgctagga 166500
 tcaaaggtgt gcccacttt tgtctctctt cttttgttgt gttttctttt ccctacttta 166560

 ctgttaatca tactgactta tgtattgttt cttttcagtt ctgagctgat gcagcaccgc 166620
 tacctaaaag attaaccmaa tctcccaca aagtgccata aacaagctga agtacactcc 166680
 ctgacaatcc acagtagtca gtatgatgca tcatgagggtg ggaccatcga tcccacggcg 166740
 ggggacaaac acagttacta taactgttgt gtcaagatcc ttgtcattat gcatttttagc 166800
 ttcttatttt gatgccttct tcattagact atctctgttt ggaattgtga tgatacattt 166860
 tctagagtat agttgaaaca tgcctcaac atttgctggg ttataaaagc catttatact 166920
 ctgtatgcac tgccttgga ttccttgcag aattcctcta tctaataattt tggaggacag 166980

 ttttgttctt gactctgcca aggcctttct aatacccta tacaacaaca aactgtgct 167040
 ggatatattt acttgaatgc agaaatttac atatgtatat atgttagaat ttatataatg 167100
 tacatttccc tctctattcc ctaccctct caattatgga agttttatag gtaccactaa 167160
 cttcttggat tggaaacctg tgccttctac ttcagtctct gtgatcccaa tgtgccttgg 167220
 ttagttgatt cagtgggtca tgttttcttg gtgcctgcca ttacttctga ctctataat 167280
 ctttcttctt cttattcttg ggattccctg agttctcagg gtggggacac aatggacacc 167340
 ttcaatttag actttctctc ccataaacag acaaggtctt tcaaggaacc tagagttcat 167400

 gagctcagct aaactgaatg gctaaactcc agggatccac atccaacccc tcagcactag 167460
 tgtaatagat gtgctctggt ccaatttttg tatggatgct gaggatatga actctagttc 167520
 atgattgtgc aactacattt caccactga accatccttc aggtcctata tgaatgaatt 167580
 ttaatgaggt aacttatcag tatttttagta ggagcatgaa tttgatatga aaactccca 167640
 ttacacacag tttatcatt gtgaaaatct atgtattctc acattgagat aacattcttt 167700
 ttgctgtctt tatcatcacc tttaatgttt ttttttcttg ttatggaata ttagtttaaa 167760
 atgtgttaca ttcatthaag ctgtggaata tttgtttaat gatgcaaaga tatgttgcat 167820

 tcatttaact gtgtaaagct gtgttacttt gtctgcctaa aatacctgac tgctcaata 167880
 aagagtcaaa tggccaatag ctgggtagga gagagaaata ggtggtgctg gcatgcagaa 167940
 ataataaata gaaggagata agaaagagga gtgagaaaag gagaaggaaa gaggatgcca 168000
 ggggcacctc taccagtca tgcagccagc catagaaaag aaggaaagaa aggaacatag 168060
 actagagaat ggtaaaagca cagaggtaaa aggtagatgg gataatttaa taaaagctgg 168120
 ctagaaataa gtcaagctaa ggtcagacat tcattcataa gtaagaataa ctctccttgt 168180

atttatttgg gatctaggaa atgtgcccc aaagagtaaa aaacaactcc ccccaaactg 168240

 tatttactag catttataac tctcttttat atttttaact tgaaatcttt aattactact 168300
 catatttaca tatccatccc gcaccattcc ctcaccetcc cagcctecca tgttcccac 168360
 caacctcccc tacccatccc ccaactcctt ccaggata gtgcggcctt tcaccagga 168420
 ccttcaaagt ctgtcatatt gtttggggga aggcctaggc cctccttgct gtagctgggc 168480
 tgcaatagta tcctccaca gggaatgggc tctcaaagtc catttgtgct gtagggttaa 168540
 agactggctc cttgttaca ggtcccatag actgtcttgg cctcctagct ggcacctaca 168600
 ttcagagggc ttggttccgt ccaatgctgt tccccagct ttatgactag ggtctccatg 168660

 ctttactag gtcaggtaaa ctgtttctgc agcaccatct tggctccttt gctcatccct 168720
 cctcctctc cataattgga ttctaggagt atggttcagt gcttagctgt tggcctgt 168780
 ttctgcttg aacagctact agacgaagc tctaggaatg gtaaccaagg tagacaccaa 168840
 tctcattata ggggaaggc aaaaatggca ttttctccac cactgcttgg attcttagtt 168900
 ggggtcatcc ctgtgatcc ctaacattt ccctgtgcc agacctctt ccatacctgt 168960
 actgtctacc tctatcaagg catctcttt cttgccctcc tctatctc cctgtctca 169020
 gtctcttgt tgccttccc ctccccacct ccttctctt aagtccaata atgttaatt 169080

 aaattaactt ccaataaatt ttacagttaa ttcctttaa agaattagct ttaatttta 169140
 tgactttttt ggaaacttta aatactagag tttatagttc atcatatgta ggcaggcata 169200
 aggttatggc ttgaaggta tattcaccac acatttcgta ttccttcaac tctgactaa 169260
 gataaagtgt tcaaggatca caaagcccag agctcatagg cacaacaag ctaattttat 169320
 tgtatagat gagtgagaac attgtgagca cagggaact gatactctga ggtagaataa 169380
 tgttgagcac atgggactg atactctgag gtagaacagt gtgagcacac ggtactgat 169440
 actctgaggt agaacaaggt tgagcaaatg ggcactgata ctctgaggt gaacaaggtt 169500

 gagcaatgg gactgatac tctgaggtag aatagtgtg aacacatggg tactgataca 169560
 ctgacagctt gatgtgaaa cagacaatga tttcttgag tctttaactc acagagaagt 169620
 ctaggaacac acagatgggt ttaacgatgc ctaccaatcc agaacctaca gacacctct 169680
 tctctatag ctgaacccta tactatcaga gatggagact gttgaaata ggcctctgt 169740
 tctctctca gtcaggcaca tcttatctca tttgataata cagtcatgcc aagaaggttt 169800
 gagatcatga aaatctcata gttgacaaag accttttagt catcgatgtt tcattaatgt 169860
 cacaagaaca tccaaattta cccaattacc ttctattatg caaatactca agtgattgca 169920

tttagatfff atagaggaca tgcttatagt attataaagg aacacctgca atcatatfff 169980
 tcctfffctt tcaaatfccc aactaatcca ttgcacacaa caaacacaat gaggacagtt 170040
 ggactttgtc tgtgtttgta gacaatgctt gctttcaaat tcctttacaa agccataaaa 170100
 acaaacagaa accagaaaca gaggttgggat atfffctfff ttaaaatfff tattatattf 170160
 atfffgttta tatattatf gttatataf tataaagtaf cttcccccgc ctctctctc 170220
 ccccagatca atfctgtfff ctcttaaaaa aaaaaagca gacctcccag ggatatccat 170280
 tgaacatggc ctaagaaatf acattaaagc tgggcacaaa ttccaatafc caggttggat 170340

 gtagcaacc agtaggagga aagaggttcc aagctcaggc aaaagagtca gagacacct 170400
 gactcccagt tactgggagt cccacaagaa caccaacta cacaatcatt aggatgagtt 170460
 cttaaaacta gttaagtfff aagacttta aaaaaagag agaaagaaag taaagagctt 170520
 tgtattatgt aatftaaaa tgtaggtagt tgatagctff aatfffact tttcaagttg 170580
 gatattfccc aaatfffga aaacaacatt atctggttag ttaaaagaaa acagagaaca 170640
 caatattatt gttgttatg aaagagagtc atcttatgc agtaaaagca gaatattctg 170700
 ggggaaatta atfctgtg ccctataaac taatctaaaa aggaaataa tagctggtat 170760

 gcagccatff gtaaccaca ttcatgcaaa tatctaaaga cttattcatg acatggactt 170820
 ggttfcccc tcaatatcct acaggatctc aggaaagctg ggggaatfff caccggatat 170880
 taggatgggg acatftggtg gctgcataga ccatgcctct ggagatgaaa tactggccat 170940
 taagggtcag gaactgaata gaaagcatgg agctcacatt cttccctaga ataacaaccg 171000
 tagttftaaa cattgatcgg tftaacttct cttfttaaaa tgtctaaagt tattatctff 171060
 tftftftaat gttaaaggcac actcgggctt cttccttca tgcaagctct attatccatt 171120
 atattacafc cagftaatca aattccatta gatfttgaat tftcaaatff tatttctgca 171180

 aaatftgatt ctctcaaaag tagaaatcca gttgtctaat gaaatgftag aatgatgagg 171240
 gcataggtag cttftgagtg tgctftagaa agftactatt tftaccaaaa tctctcagtt 171300
 cctctfttat gtcattggtc attggtatfc tcccttcttg tfttaccat atgftactff 171360
 gtctfttcta aatgattatt tcatgggafc cctctcacta tccaggcagt cttfttcact 171420
 gcaccgtata taatfcctff accftftcaa ggctgctta agaatctgtt cttccttaca 171480
 tftcaaaatf tattaaatff gttcttggac tattftgaac atftattcta tgcattctga 171540
 ccactftcat tcttaccat cfttatccat ggtctcttct ctacttaaat atfttccaca 171600

 tftagatata tftggttfff tftftftftg cgaccctftg acataaaca ggactgtctg 171660
 tatgaccatg cttftggacc tggftggactc agcagcaggt acacaactga agactcaat 171720
 acatcttctt ccagtatcta tcaagagccc ctgattcagc agtaagagt accagcctac 171780

tgagctgcct aacctctccc ttacttccitt ggctgggtggg agtgttggtc agtatgggtc 171840
 cagtgacgat aactagagtt gtgaattgat ggttgaatg gttacattga gtccaaagaa 171900
 tggatatttg cagcccttca ccttattgtc catctctttc atattttctg cccccattc 171960
 cacaataata taatgtttag gtcttagagg aggtgaaaag cccgtatgta tgtatgtatg 172020

 tatgtatgta tgtatgtatg tatgtatgta tgtatgtatg tatgtatgta tgtatgtatg 172080
 tatgtatgta tgtatgtatg tatgtatgta tgtatgtatg tatgtatgta tgtatgtatg 172140
 tatgtatgta tgtatgtatg tatgtatgta tgtatgtatg tatgtatgta tgtatctccc 172200
 ctgtttgtca ggtcagctat ttctgtgggt ttaccagcc tggctcggac ccctttgtc 172260
 atcactcacc cttttctgca actggattcc agttcagttc agtgattagt tgtgtctgct 172320
 tctacttcca ccagctgctg gatgaaggct atagcatggc atataagaca gtcatcaatc 172380
 tcattatcag gagagggcat ttaaggcagc ctctcctctg ttgcttagat tgttagttgg 172440

 tatcatcggt gtagatctcc agacctttca cttgtgcctg atttctctgt aaacgtaaaa 172500
 tgtctcccc aattatggta tctcctttct tgttttcttc tattcttcca aagtggattt 172560
 tctaagtcta aactaaaagt gaaatcctag tatgagtttt tgataactat cttaatgctc 172620
 agtgtttact aaattctaaa ttagcacctg tgaggagttt atgttttcaa actggtcatt 172680
 gcataatata cttttttaa aaatggaaaa tgttatgagg atataattca gaattcttaa 172740
 tctaaacttg aaaattggct atggaattgg acttggaaaa acacatttat agtgtatcct 172800
 acggttgcca gagttagta ttggcaaaa acatcccctc cctgttttac tgtgcacccc 172860

 tgtcctggct tctgaggaca ttctgcagaa tgttgagtca tagccttctc ccaagtcacc 172920
 tactgtggac atactaacag atttagaaac aagagtgaca ttgttcccc cttaggcaag 172980
 ggaaaaatgg aaagatggta aaggaatcac agtaggagca gtgggtttga ggaagtacca 173040
 tgtttcttca gatgtatgct ggacatctgg cagacaaaac atgtctgttg ccagttgcca 173100
 gcatgagcca ggaggaacac tattacacat cttggaaaat ggtttttgga atgaaccatt 173160
 ttggattttg actttcttcc ttaaagaaag aatgacctc agcacagtaa agaaaggaaa 173220
 taaggcatta cagaatcagc atcactggag gttttgatgc ccttctcca gectaggttg 173280

 agtggtatcc cctgagtgtt ccagcatccg ggtttgcccc aggtttatgt ttaaagaatg 173340
 atgtactatc agcctagttc ttttgctca ttgatttctt cttcagtctg taatggcagg 173400
 aaaaattgca tccactacct tagcttttat ttccagtgtc tggcataaca atagatgata 173460
 gatttttgtt gagtaaatta tcaacagggt ggcattatat tattttatgg tctctttcat 173520
 ggataaattt atttataat atgaaagcat ttttatgta aaaggtactg agcaactaaa 173580
 acatttaaga aagaatgaac ccacacaggg aatcttgact tactcactct gtgtgctaca 173640

ccagagggct ccgtttttga ttttcagtat tggatttctg ctctcttctt gccatgtacc 173700

 ccaatgatct aagtcctaagg ctcaaaatct gttccattac ttagtaagga ttgatgaata 173760
 tggcattttc cttaagata acttaatgcc acatgaaact tcttgtttct ttcactcctc 173820
 acttatttga tgctgtttt tacaaaggca tctcaactc atttccaaat gacagaaggt 173880
 tgctgttgtt ttacagtcta ggaatgtctc agattaatgt tttcaagatt tagttgtaat 173940
 taggaatata aacagaatta agcaaaactct tgccagaaga gaggaagatt ctagaatact 174000
 atttcaaaaa gctcctgaag agcacctaga gtgggaagat agaattgaat tcatgagtgt 174060
 ggttggtgtg ccctgaatga gacgagtcct ggaagctctt ttatttgaat gattggtcct 174120

 cagttgggag agtagtttgg ggaggaatag gaagtttggg ctgtcagag taggtgtgtc 174180
 tgtcactggg tggaggggtt ggtgaggttt caaaagccta tgcccaggtc tctctctctc 174240
 tctctctctc tctctctctc tctctctctc tctctgctt gtggatcaga tgtaagctct 174300
 gagctactgc ctigtgccgt cacctcctgt ctgctgctat gctccccca tgatggtcat 174360
 ggactctaac cctctgaatc tgagaggctt caaattaagt gctgtcttcc gtaagttgtc 174420
 atggtcatgg tgctttgtca cagcaattga agagtaactg agacagtcaa tgtacatgta 174480
 gaatttagaa tgcatataaa ggacacatgt gtgtaaacct tcacaaatat gtttctaaaa 174540

 agacaatttc ataactttcc atagctcttg tatattttgt tatttatggg taagaagctg 174600
 accctaaaat tctcttttgc tgggtccaag tttgttcttg tagtagataa tattcattaa 174660
 ggtttgatgg ataagtgaat attgagcaaa taagttaatt gctatttctt tttcagattg 174720
 gttaatcat tgggatacac tcacatttca eggcatattg atttataata cctttgaagt 174780
 atttcccctc caaattcaat gctcatttaa aaaaaatatt ttatatgttt atgagttagag 174840
 aaattcagca tacttttact ttattagttt agtggcaagt cattaacaag aaaaggtcct 174900
 accttatctt tcagtacaaa cttaatttta taatccacat tttacaacat atttatatat 174960

 tcttatatga ttttcacatt ggttaaatgc tttgttagca ccacataaat tttctttagc 175020
 taattggtta acaactaatt actgtaaaaa attgaaaatg ttaaatcttc tcatgggaat 175080
 ttgaaaaaaaa tgcaggggt gtactcttct tttatatatt cctcaaagtc ttggtgtttc 175140
 gatgaatttg caataatgat taaattaata atgaaaaata gctaaatggt ataaaattaa 175200
 tacttgagag cttaaaatt atagcaaagc ttatgcatat tcaccttccc tctgtgtaag 175260
 acttttgatt agttcttcta agtatggaac acacttgaaa tatacaaata aatgttatt 175320
 tctttgaaaa tcatgtaata gccaggatt aaaataaacc atgtttgcat ccagtatggt 175380

ctctatctta ctattggcac aacaattggc tttagaatga aagatatatt ctaaagatat 175440
 atatatatat atatatatat atatatatan nnnnnnnnnn nnnnnnnaaa 175500
 gaatcataag taaacaatat tcaccaaatt aattcaacaa aattcctggt acagttttag 175560
 gatatcagca taigttaagg agaaaaacca aataagttat ggagttgtaa ttgtatcgtg 175620
 aagagaccaa caatgcatac agcagtgaag gctatcacat aaagggaaaag ggaaagcagg 175680
 cataaagggg gagtgaagct agatggagtg gtgggtgacct ataactctag cacatgatgg 175740
 gctgattcgg gaggatcaag ggtttaagtc tatcccaggt ctaggctagc ctggggactt 175800

 agtgcaatcc tgtctcaaaa aactaccaca aattaaaca aaacagaata aataaaggag 175860
 agagtcccaa gcatcagtggt atttgagcat catggttttg tgtgtgtgaa gtagtcagga 175920
 aaagtagtgg gctttctgca gaaagtaacc ttcgactgag acctacaggt gaagaaggaa 175980
 atcaggtagg caaataatga gcacttgatc ttagctcaaa tgctgggcag ctgcagaaaa 176040
 tatgtgtgtg tigtgtgtg tigtgtgtg tigtgtgtg tigtgtgtg tttacaaagg 176100
 atagatattt attcatacag aaattactac ttagatctct atataaaatg tttatatatt 176160
 atataattca tattaaacac atataatgtt tacttgtata aagtatgtta gaaccaccta 176220

 aatactgtat gaagataggt gaataggatc acatcattct ctgtactgtt tttgcatcta 176280
 ttcagggact tgagctgtgt attacatctc tgtgtgtgag taaactaaca acaataacaa 176340
 ttccttaaca gtctgaaagt ccttcagac tgaattatag atgagcattg cacaaaggta 176400
 tgtgtagttt tagcttcata acttgccac aattgtttac atttccaaa ggcacatgga 176460
 aagaaaccta agtaatacct aataagcgag tctttgcttt tcatTTTTT ccattttaag 176520
 tcaagtaaaa ccagaagttt tgttagttaa cctgaaaagc ttttgtgtat gattaaaaaa 176580
 ccttcaatgg cagtattaag gaaattatct ctgtcataat ttaccaagcc tgtttatttg 176640

 taggatgccc tgcaattgtg tgggggtcat cttctttgta atttctcaga tttttcatgt 176700
 tgttttagat tataaaataa aatcattctt aatggaacag gaatttagct cagctcaata 176760
 acctttggat attatggtag gcaattcttt catccctgtg acagaaactc aggcaactta 176820
 agggatattt tgttaaaatt tccaaagttt aaatcagtgc tcaactggatg tttctgcttc 176880
 ttggcttgta tigtgtgaga cagtttcagg gtaggtatgt gtagagataa gtggcttacc 176940
 tctggcaaac tgggaaggaga gaaaaaact tacaggaagt ggccagagcc agtgatccac 177000
 ttctccagc cccactccat gtgataataa ccaattcagc tgtgaacaca gtgctttgat 177060

 ccattgatgg agctagaaca tgcatagacc agccatctct gaatagagca agctgggaac 177120
 caagacttgg gcactccta ttcaaacaca aatgcctact catgttcaact tagcccagtg 177180
 gcaaagagca cagaaaaatga taatttgac gaatatccta aaaatatatt tgcacttggg 177240

accctattac aatcaaagta gatttaacaa cagaaccctt ctttactcac ctacctgcct 177300
 acacgccagg agcttggggc tgaagtgaaa acttcagtta gaggcttcag atgcctctaa 177360
 cttttaaagg ccgagaaaca aaggcatggc atttactcct ggcatctact cattagaggc 177420
 taaagggaaa aatgagtgcc cttcttcttg tcttttccca tggtgattgg cgctctagag 177480

 tggaaggtac tttgatcaga agagtctctg gaagccaggc taagctgaag ttggccatcc 177540
 ttgctagaga cagtgtctgt gtccagagag atgggtggta ctgtttgctg ttgtttcctt 177600
 tgtgccacaa gaggacactg aggtcagtat gatagacaga gaagctttaa acaattgtat 177660
 gccagacctt cacaaccag tcaaggaatg agctgatctc catcaggaat ccaattgttc 177720
 ttcaagataa gctgttagga ccaacacttt cttcttecta tctgatctca cagaggtctt 177780
 gacaccagag acactctgtc aagagccacc ttgttaccca tttcctttca attcaaaaca 177840
 actatctgaa gaccatgtcc tctgggaatt taggtgggag gaaagatatg gaagtgctat 177900

 ttttcaataa atgttcacag gctagatatt tttctttgac caccatccat gctatgaaac 177960
 agataaagtc ataaggcatc agtcaaaatt cctgagatgg gcactatfff gggtcctaag 178020
 gaatttacag ctcaggagaa aaaaattgat cagaataaat atttgtctga gtaagcaagg 178080
 agaatttatt atagtgaag ggcaactacat aatttctaca ggaaagacct tcagtattta 178140
 aaagccctta ggctatttgc aattatagtt ttaaggcatg atagtaatat tcacatggat 178200
 ttaaactcatt ttcttcaggt tctatgaaga agaaactag ttgcatgatt taggaagcgt 178260
 gtatctctga ctcagaaagg tttcaaaaca catctttctt ttatttttca agaatttatt 178320

 tatttgtgtg tgtgtgtgtg tgtgtgtgtg tgtgtgtgtg tgtgtgtgtg tgtgtgtgtt 178380
 gtgtgtgtgc catgtgtgtg gggttacccc ttcatgcaa gaagaggtta ttgaattcct 178440
 cggagctgga gttacagggc attcagggca ttatgaactt tgggtactgg aaactgagga 178500
 gtagcaaatt agctcacaac ccctectaata gtctctecag cctgtccctt cettccccac 178560
 ctcttttttt tttttttttg agattagggtg tcatgacata ccctaactga ctttgaactt 178620
 gagatcttct atgaagttat cttttgcaca catactatat atgaagggat ggtaatgtgg 178680
 agcatgttag ctcatagatg gcaaatggca gctttaaaat ctagtittga attgtttatt 178740

 gttataagat gctgggattg ctctgccatc tagtgattaa gaactggatt tagacaattg 178800
 aattagaag cacacaagat ttgtaagaaa acagatctat gaaaactttt tataaatgca 178860
 ggaaaattga gttgatttca agtaaaatat gatcaaacaa aatacatttc tccatctaga 178920
 tacacatgcc agggctttgt ggggtacttc agaatggagt cagtctgctg gaatatttag 178980
 taaggggaaa acaattctgt agcttgggaag ttaaaacatg gtaaaaatat ggccagactt 179040
 caaccacttt taaattttag aggcattaat aaactataag tagcaaaaag ttaggttagc 179100

ataaaattac agattttagt ggtgtaagtg tgctgtatg tgtgcatg tctgtttct 179160

aggactcaaa tctagactct agatgtgagc ctggattatg ttctgaatta agtagcagag 179220

tcttgaggca ctattagagt tattcatact ctattttggtt attcatacaa tagttatgct 179280

gtgaccacat ctttgaatt ctttcaaca actggccacc atttgtttc ctattctact 179340

tttctctaa gtaaatggcc gtgtagaac acaaaggaca ttggccatat tatacactac 179400

tgccatgtag aaacacagag aagtgcaagc tctctatfff ctaaccactc tggctttaca 179460

cacatctttc attcagactt gcacagcgag atttactga gccctctgtg ataggaacag 179520

attctctgtg gggcgaagag aaggcatgcc tcagtagtga atgtgggttt tcatcttctt 179580

gccatttaa ggcattgcaa ttacatgtcc atatcatctt aaatttaatt ataaattctc 179640

aggggaaaga gaccagtgat gaatcagagt ataaaaccag tttttggtgt tgtaatttaa 179700

agaaagcaat gcagtgactc tttctccgcc ccttgaattg tgatctcatt gtcttaaact 179760

tccaggaaga a 179771

<210> 33

<211> 1947607

<212> DNA

<213> *Cricetulus griseus*

<220><221> modified_base

<222> (9131)..(9185)

<223> a, c, t, g, unknown or other

<220><221> modified_base

<222> (85917)..(85926)

<223> a, c, t, g, unknown or other

<220><221> modified_base

<222> (130258)..(130307)

<223> a, c, t, g, unknown or other

<220><221> modified_base

<222> (161268)..(161322)

<223> a, c, t, g, unknown or other

<220><221> modified_base

<222> (179391)..(179629)

<223> a, c, t, g, unknown or other

<220><221> modified_base

<222> (234242)..(234319)
<223> a, c, t, g, unknown or other
<220><221> modified_base
<222> (240083)..(240304)
<223> a, c, t, g, unknown or other
<220><221> modified_base

<222> (248487)..(248674)
<223> a, c, t, g, unknown or other
<220><221> modified_base
<222> (248916)..(249508)
<223> a, c, t, g, unknown or other
<220><221> modified_base
<222> (249800)..(252970)
<223> a, c, t, g, unknown or other
<220><221> modified_base
<222> (253181)..(254777)
<223> a, c, t, g, unknown or other
<220><221> modified_base
<222> (261192)..(261224)
<223> a, c, t, g, unknown or other
<220><221> modified_base
<222> (271171)..(271450)
<223> a, c, t, g, unknown or other

<220><221> modified_base
<222> (350331)..(351743)
<223> a, c, t, g, unknown or other
<220><221> modified_base
<222> (415672)..(415775)
<223> a, c, t, g, unknown or other
<220><221> modified_base
<222> (416570)..(416643)
<223> a, c, t, g, unknown or other
<220><221> modified_base

<222> (418904)..(419165)
<223> a, c, t, g, unknown or other
<220><221> modified_base
<222> (490061)..(491702)
<223> a, c, t, g, unknown or other
<220><221> modified_base
<222> (491876)..(491971)
<223
> a, c, t, g, unknown or other
<220><221> modified_base
<222> (492495)..(494343)
<223> a, c, t, g, unknown or other
<220><221> modified_base
<222> (494762)..(495476)
<223> a, c, t, g, unknown or other
<220><221> modified_base
<222> (495871)..(495972)
<223> a, c, t, g, unknown or other
<220><221> modified_base
<222> (541501)..(541667)
<223> a, c, t, g, unknown or other
<220><221> modified_base
<222> (572683)..(572867)
<223> a, c, t, g, unknown or other
<220><221> modified_base

<222> (659578)..(659773)
<223> a, c, t, g, unknown or other
<220><221> modified_base
<222> (685081)..(685182)
<223> a, c, t, g, unknown or other
<220><221> modified_base
<222> (700304)..(700570)
<223> a, c, t, g, unknown or other
<220><221> modified_base

<222> (765272)..(765398)
<223> a, c, t, g, unknown or other
<220><221> modified_base
<222> (765708)..(765827)
<223> a, c, t, g, unknown or other
<220><221> modified_base
<222> (779244)..(780414)
<223> a, c, t, g, unknown or other

<220><221> modified_base
<222> (845122)..(845545)
<223> a, c, t, g, unknown or other
<220><221> modified_base
<222> (845596)..(845965)
<223> a, c, t, g, unknown or other
<220><221> modified_base
<222> (846448)..(846905)
<223> a, c, t, g, unknown or other
<220><221> modified_base
<222> (857354)..(857888)
<223> a, c, t, g, unknown or other
<220><221> modified_base
<222> (858801)..(859269)
<223> a, c, t, g, unknown or other
<220><221> modified_base
<222> (859718)..(859885)
<223>
> a, c, t, g, unknown or other
<220><221> modified_base
<222> (862098)..(862386)
<223> a, c, t, g, unknown or other
<220><221> modified_base
<222> (862715)..(862796)
<223> a, c, t, g, unknown or other
<220><221> modified_base

<222> (863036)..(864561)
<223> a, c, t, g, unknown or other
<220><221> modified_base
<222> (866239)..(866369)
<223> a, c, t, g, unknown or other
<220><221> modified_base
<222> (902701)..(903997)
<223> a, c, t, g, unknown or other
<220><221> modified_base

<222> (922144)..(922563)
<223> a, c, t, g, unknown or other
<220><221> modified_base
<222> (941416)..(944119)
<223> a, c, t, g, unknown or other
<220><221> modified_base
<222> (1041513)..(1041688)
<223> a, c, t, g, unknown or other
<220><221> modified_base
<222> (1045833)..(1045842)
<223> a, c, t, g, unknown or other
<220><221> modified_base
<222> (1050701)..(1050711)
<223> a, c, t, g, unknown or other
<220><221> modified_base
<222> (1077729)..(1078115)
<223> a, c, t, g, unknown or other

<220><221> modified_base
<222> (1078582)..(1080364)
<223> a, c, t, g, unknown or other
<220><221> modified_base
<222> (1080556)..(1084088)
<223> a, c, t, g, unknown or other
<220><221> modified_base

<222> (1084827)..(1084945)

<223> a, c, t, g, unknown or other

<220><221> modified_base

<222> (1097720)..(1098028)

<223> a, c, t, g, unknown or other

<220><221> modified_base

<222> (1197367)..(1202559)

<223> a, c, t, g, unknown or other

<220><221> modified_base

<222> (1214087)..(1215732)

<223> a, c, t, g, unknown or other

<220><221> modified_base

<222> (1228684)..(1228693)

<223> a, c, t, g, unknown or other

<220><221> modified_base

<222> (1276187)..(1276346)

<223> a, c, t, g, unknown or other

<220><221> modified_base

<222> (1280263)..(1280632)

<223> a, c, t, g, unknown or other

<220><221> modified_base

<222> (1289545)..(1289589)

<223> a, c, t, g, unknown or other

<220><221> modified_base

<222> (1293820)..(1293908)

<223> a, c, t, g, unknown or other

<220><221> modified_base

<222> (1307008)..(1308419)

<223> a, c, t, g, unknown or other

<220><221> modified_base

<222> (1357503)..(1357852)

<223> a, c, t, g, unknown or other

<220><221> modified_base

<222> (1358256)..(1358351)
<223> a, c, t, g, unknown or other
<220><221> modified_base
<222> (1361968)..(1366005)
<223> a, c, t, g, unknown or other
<220><221> modified_base
<222> (1372210)..(1372404)
<223> a, c, t, g, unknown or other
<220><221> modified_base
<222> (1372746)..(1373278)
<223> a, c, t, g, unknown or other

<220><221> modified_base
<222> (1373864)..(1374217)
<223> a, c, t, g, unknown or other
<220><221> modified_base
<222> (1442158)..(1442268)
<223> a, c, t, g, unknown or other
<220><221> modified_base
<222> (1442716)..(1442725)
<223> a, c, t, g, unknown or other
<220><221> modified_base
<222> (1502335)..(1503771)
<223> a, c, t, g, unknown or other
<220><221> modified_base
<222> (1526460)..(1526881)
<223> a, c, t, g, unknown or other
<220><221> modified_base
<222> (1544592)..(1544884)

<223> a, c, t, g, unknown or other
<220><221> modified_base
<222> (1576491)..(1576586)
<223> a, c, t, g, unknown or other
<220><221> modified_base

<222> (1582073)..(1582325)

<223> a, c, t, g, unknown or other

<220><221> modified_base

<222> (1688500)..(1688644)

<223> a, c, t, g, unknown or other

<220><221> modified_base

<222> (1689703)..(1689841)

<223> a, c, t, g, unknown or other

<220><221> modified_base

<222> (1690915)..(1690935)

<223> a, c, t, g, unknown or other

<220><221> modified_base

<222> (1691371)..(1691590)

<223> a, c, t, g, unknown or other

<220><221> modified_base

<222> (1741208)..(1741217)

<223> a, c, t, g, unknown or other

<220><221> modified_base

<222> (1784568)..(1784585)

<223> a, c, t, g, unknown or other

<220><221> modified_base

<222> (1804117)..(1804126)

<223> a, c, t, g, unknown or other

<220><221> modified_base

<222> (1804433)..(1804483)

<223> a, c, t, g, unknown or other

<220><221> modified_base

<222> (1883118)..(1883150)

<223> a, c, t, g, unknown or other

<220><221> modified_base

<222> (1918208)..(1918469)

<223> a, c, t, g, unknown or other

<220><221> modified_base

<222> (1925852)..(1925883)

<223> a, c, t, g, unknown or other

<220><221> modified_base

<222> (1928475)..(1928518)

<223> a, c, t, g, unknown or other

<400> 33

taaaaccta cctatcacat atcctttctg ctcccaggg agggtagga cttacatagg	60
ggtcacaga gtctatcata tcctttggga tagggcatag gtccacccc atgtgtctt	120
gctcaggag tatccctctg tgtggaatgg gtccecaag tccacacctg tgctcgggat	180
aaatactgat ctattacagg aggccccaca gatttccaag gtctcctcat tgacaccac	240
attcttgggg tctggatcag tcccatgctg gtttcccagc tatcagtctg ggcaccaaga	300
gctcccagtt gttcatgca gctgtttctg tgtgattcac cagcctgac tggactcctt	360
tgctcatcac tctcctctc tgcaactgga ttccagtca gttcagtgat tagttgtgcg	420
ggctctcttc tacttccacc agctgctgga tgaagattat agggtagcat ataagtgagt	480
catcaatctc attatcacag tagggcattt aaggtagcct ctcatctgtt gctaagattg	540
ttaggacatg tcatctttgt agatctccag acatttgct agtgctgat ttctctttaa	600
acctaaaatg tctcctcta ctatggtatg tcctttctg tttcttcta ttcttcccc	660
aactcaacct ttctgtccc tcatgtctc ctccacctc ccttctccc cttctcattc	720
tcctaactcc cttccccac ctccatgct cccaattgc tcaggagac atgtccctt	780
ccccttctc ggaggacct atagtctct cttaggtcc tccttgttta ctaactctc	840
tggcagtgtg gatgtaggc tggtaatcct ttactttatg tctaaaagca acataggagt	900
gagtacatac catgtttgtc tttttgtga ctggattacc tctctcagaa tggtttctc	960
agttccatcc attttctgt aaatttcaag attccattgt ttttttctc gctgagtagt	1020
gctccattgt gtaaatgtac aacatttctc ctatccattc ttccattgag ggacatctag	1080
gatgattcca agttctggct acttcaaata gtgttgetat gaacatcgtt gagtagatgt	1140
tcttgttata tgcaagtact tcttctctt catatccga gtgtccctc ttctgttagt	1200
ctctcttac cttcatcaa catggagtgc ttgtcataat ttcacacctt tttattgtt	1260
aataaaactc cattgtgat atatacagca gtttgtttaa ctgttcattt gtcattttt	1320
ggtaaggctc ttttataaaa atatataata aatttaatgc tgctaatata aggaaataga	1380
attcatccat atgttaaatt agagttggaa atctgtctgt caaacattt tttgattccg	1440
accttcagga atggggacgc aaaaacctat gaacagggtg agaggatgaa caagtgaagc	1500

agagcctcct agtggttata attggaataa cagaaatgta aaaataaact actgactatg 1560
 aggacccttg catctactag gaagcagttt gcagagacac acacagggga atttggggac 1620
 atagggataa attcacaaca ctacctcctt caaggattag cagccagggga tcaaatttat 1680
 ctgcagtgtc ttttgaggat attctgtctc cagtacacag ctactcata tcccatgttc 1740
 ccttgaatg tgtcgtctta gatttgcttt aggtccaaca caatgcactt gaattcacct 1800
 tacttgacag agttcttgat ggttgtttat tttttattt ttttgaag ctaaactaaa 1860

 tttttaactg aaaattacca accaaaataa cactgatcat cctacagcaa aagataccaa 1920
 gaccaagaca tttttatta ttgtccatat tgagataatg atgccaattc ccccttatat 1980
 ctgttaatgt agcatattgc aatcataggt tttttttta attggaacat ggccctcact 2040
 tggatcatgaa caacattaga ttttagattt agcatttagt tttagtatag aactgtcaaa 2100
 gcttcagagt tttctaaaac ctcatctcta ttgaaagtaa ttatatttac tccagtacat 2160
 tttctttat atttttacaa tatacattcc tatcccctga cttgatgttg atgtaaatga 2220
 aaaacacatt ttgaagtcca atgaatgcaa ggttcctgt gatgtgtagc agggcacagt 2280

 caatatacag ggaccttgaa agtcagaaaag tgggtggtaa ggctgacaga gttfacatga 2340
 gtttctagaa ataccatagc aaaatgccac aaactgagtg gtttaaata acagaaagtc 2400
 aaggagtac caggtctaag gtatttctga gactctagat aaaatacttt ttaagatctt 2460
 ctagcatcta atgtttacaa caatccttaa agattttttg gaatatagag ataaacttcc 2520
 actgcatgat tatttttct ccaagtatgc tcttactgta ttctctctat gccccagtca 2580
 cctcttgtga aagagactct atatatgga ttaaagatgc ctagatattc ttcttatcat 2640
 tttgttcaac ctccaaagac attttcccaa ttactagaat agtaggatcg tatgatatct 2700

 tctgtggcac tgtatgtccc attctggtgg ttctataatg cccaatctta agattttgtt 2760
 tcacatcage aaaaacatga agtaagggaa acatgttctt agattatacc atatatcaaa 2820
 aatgttttta aattctactc acttttcaga gaaggtctgg tacccttgtc tctccatcac 2880
 agtagctacc cagaatccat catccgtata tgttgattat gacttataaa tgtgtgtgtg 2940
 tgtgtgtgtc tgtgtgtgtg tgtgtgtgtg ttgtgggcta tttgtacact gtgaagtgt 3000
 atttcagtga taggtataat aaaaagctga gtgaccaata cttagggatg agtggcacac 3060
 aggacttttg ggctgagaga gaatgcttgg aagaagaatc accagccaga cacagaggaa 3120

 gcaggatgaa cagtacagag taaaggtaac caaccagggt aaaagaatgt agatttgag 3180
 atatgggcta atttaagtta taagaactcc tgaagaacaa gcctatgcta aggctgggct 3240
 ttcataatga ataataaatc tccatgtcat tatttgcagt ctggggtccc tagaaaaaga 3300
 actactacat atggtatcca ctgtggggta tgtattttca cataggactc atgaaagcgt 3360

aaaaataaaa agttctaaac atacaaacac agagtcaaat atggcttcct agtccctagt 3420
 ttctcagga ggccactggt catagagatg cagctcctga ttgctgcttg ttggcttgag 3480
 ccagccaact acatgtgctg agataagaac tgtgtttaag gcttggctca tgtggtcaga 3540

 gaaagcaaaa ggtaggcagt aaagcagtcc agaccaagaa aacctttaa caaatacagt 3600
 aaaagatggg tatagacagt cacagaaaga aaacaaatag tttaaaaata atagtcttta 3660
 agagaaaata aagtaaaata aagaaaagcc ctataaagat ggtaaataca caggtcatct 3720
 ggatcctgta tggtgctttg ttgaatttga atgttttgaa tgctgatgac caaagagcag 3780
 ctgctgagag aaattgaatt atgaaaggga ttgatgattt aaaccacct atgtacttta 3840
 gacatgtctt ggtttcagaa tggatgtaat aaattatgat gcattagga agtggttatg 3900
 cctttgtttc cacaggaac aaaaagtta agttttcttc aaaattaatg aagatcaaat 3960

 ttgatatgag tgaggaagcc aggaaaaagt acaggacaaa tgacatatat gctgatcttt 4020
 tacatggaag aagtctaat actgagacag acatgatcaa tcttgttggc tacagaatcc 4080
 tcatgactta ctattatag ccatccttc aaatagcatg gatagagatt tatattagag 4140
 tctggttatg cagtctagac tgacttataa agttgacagg tgccattat ctgctcaaac 4200
 aaaaaacag aaaaatcatct ttagatgatt tatgcacaat gcacattcca tacttgtgtt 4260
 aatgcagata tatgtagcat taataataaa aaccagaga cagatattgg gttcaagct 4320
 gaagttcaga aaaggaaagc agccaaccac taaaggactc ttatttctac caaggggcaa 4380

 ttgtgtcctc aggatgactt cagactgaat aactgcact cctgtctcca cctgccttat 4440
 attcctctct agtcatggga ttaaaggagt gcatcaccac tgcccagctt ctacggaaaa 4500
 cgagtgtggc tattaggatt aaaggtgtct gccatcactg catggcctct atggctgact 4560
 agtgtggtta gctttgact ctgatttca cacaagcttt atttgagaga tcataaacia 4620
 aatatcacca cagatgcatg tgttaccttt agaattttgt gtattttgag aaaacaagga 4680
 ccacacaaca ataaagacaa gcagcccagg ttaccagcct cttaaatgc ctctgttaca 4740
 gtttctcaa aattctgcaa ccagaacaat gtcaaagatg ctaactgaga tggccagcc 4800

 tcacagacta tccagccaag atttcagata agctctatac tttccactca cacagaggct 4860
 aagcaaaaat aacacaacta gttctccat gacttgacca tcatcccagt tttctcatgg 4920
 tctctaaag aagccattat atcccacata tcaggacata tacagaacia gatgccaca 4980
 ttctgaagag ctgaggtgga tggtttttag tcattctgta gtttatggat atttgcatc 5040
 atttagggga attagttaca agttgttatt ggtaatggg aggaaaacag ctgaacagag 5100
 agattagatt cagggatctc tttcttaggg taaaagggt tatagtatag agatgatagg 5160

atgaaagggt ggattgtttc catctacttt tgaacaatct ctagtctcaa atattttata 5220

ttagtataga cttttgtata ttgatacaaa ttagagggtta tttttattat actgtttgtg 5280

tgtatctatt cttgtttaca gtattgtacc tatgaagctc atctaaaaat gtaatgtaaa 5340

ggtttagttc ttgaaaactg ttttaagataa taaagacagg ttagtagtta gtcacttata 5400

ataatcaaat atatacccat gttataaatg tttccaaggt caaacagaga tatgttttaa 5460

attgatagat gatcttcaaa cacttcagag atctaaagaa tatggcattt aaagtattta 5520

agtaacacaa ggcttttcat gacaatgaga cacatctgct cctgtcagca ccaatttact 5580

tcaaaagagg atgacagtca tcgaagtaca tccatattga gtttactttc atttgtggca 5640

aagttagcca ctgagcaaag aaattgccct ggatttgagt gctgacagaa tgctacccaa 5700

attagacaag caggacacaa aagaaggcaa ctgccaaact ttgccaaagc aagatagaat 5760

agtccittcaa aatccctgct tcacaaaaaa gtctgtcaga ctgagatgga tgtcccaatg 5820

ttgttgatga aacttggggg gactgtcctg gcatccagat agctctgttg tttcttagtt 5880

ttggaagttg attgctctgc acttctctgt taaatggata atattgcatc ctccctgggt 5940

atctgacagg gttaaaaatt atatatagtt acagttttct atagttttga taaaaagtga 6000

aacagataca aaacattgca ctactaaga tagaatagat aacagattat tttctctgaa 6060

tttaccaaat actaatggac tgaacattgc aaatgtattg cttacttgat aattgttctc 6120

attgtatata actttactct gtttagagttt aaaccttccc attttattta tacacaaaag 6180

gaaatcttgt gtgatagttg tacattgtga agatgtattt ctgtgatagg tataacaaaa 6240

tgctgaatgt ccattagtca ggagagatgg ggggacttct gggcagagag agaatgctga 6300

gaagaagaaa gcagagtcac cagcagacat tgaggaagca ggatgggcag catagagtga 6360

aggtaaccaa gccccataa agaatatagc ttgaaagatt tggattaata taagttatac 6420

aaacagttag caacaagctt acgctaaggc tgagctttga taattaataa taaatctctg 6480

tgtcattatt gttggtctgg cagtctgac aagaaagaac tacaactact attactgcta 6540

ctacacacac acacacacac acagagagag agagagagag agagagagag agagaaagag 6600

agagagaaag agagagagag gtagtctctt ttcttctctc atttatagac aaactcataa 6660

aaatatttta tgcataatagg aaaatgtaa ttaaaaagga aactttagaa gagagaaaga 6720

gttgatctct acaattaagt agcttcaact catgtgaata ttctcccaa cacaaagaaa 6780

tttgttcaga aaattcacac taatctaagg tataaatggt attttcatgc tactgtgaaa 6840

gcagagtgaa aggaattgat ctattttata gttacaaagc acatctggag gaaaaatcat 6900

tatatctgaa tattacagta taacctgcaa ccattttcct tctcaagtgc attgtctcaa 6960
atgtaaaatc cccattgtat tcttaactag ctacagagac ttggctgtga agaaactcag 7020
gtaaatgact cttgcttgac tctctacctc ttttaattgta ctgtagactt ctatcaaatg 7080
ctggtgagga catgtaccta attgattagt aatcttgctt aatcttgaac aaactttaaa 7140
atgaaaatat tctttcacat attatttacc aagcatatac cctactatta ataaagtatg 7200
gaagataatg tgcattcttt acagccctt tcaaaatctt ttattcctta ttttattgaa 7260
tataaatatt aacagaatag attcaactia agatacagtc atgttaagtt agtatgtcaa 7320

tatatttccc ttaaataata caactattgt aatattcttc tctgtttcag ataactatta 7380
atgttgatcc tttcttttcc ttttattgaa aatataatctt ctacatatata tatcctgatt 7440
acagtttccc ctctttctcc tcccaggctc tacctatctc cctccatcc atatctatac 7500
cttttctgtt tccaattaga aaacaagaag gcttctaggg gataatgata agataaaata 7560
aaatatagta agataaaaca aaaactaata tatctgaata gggacaaaag aaaagaaaat 7620
gagaccaaga aaaggccaag aaacagatga agatagacag aactaccagt tcccacattc 7680
aggaatccat gaaaatacta aactggaagc cataatatac actcaaagga ctgtagtaaa 7740

atggagagaa aaaaatttaa acaacaact ctgacgctgt aggaaaaact gtggccagcc 7800
taccaagca tcagtcaccc tgccagggtg cagccgaggg cagccctcat gagcatgcac 7860
agctggaact tectccctga gccaaagcctt ccctgtgccc cacagactga tgactaagaa 7920
acactgacc cagagacacc aatgagggaaa ggacaacaca gcagagtcag cttcctgacc 7980
caatgggacc ttgggagggg ggtataaagg aaggtgtaat ttccttaata aacaactatg 8040
cagcacgctc tgttactcac tgactccctg tgtctgagta ctgaggcatt ggtgctgcat 8100
cttctcacc actcccccaa ggggtgtctg agcaggatca ccggcaacac tgacacaaca 8160

taataagtca aggacctcc aaagtaata gtaagtttat tttctgttgt ctacctactg 8220
ctgggcatgt agtagtttgt ttccccagtg agattccatt ggcagaaact aaatttccat 8280
tttcatgtgt ttactaatta caggtagctt tgggttaggg attggggact gtgtctattt 8340
ctcctttcat ctctaggacc ccatgctgcc ttagaatctg taagttaata tgtgctgtat 8400
ttagaaggcc ttcttttctt ggtgtcttcc atcccctctg gctcctacac tctttcagaa 8460
ttcttttctt ttgtgttacc tgaaccaaga agggagagat ttgagggaga catcctgttt 8520
aaggttgagt atccctggat tttaaacttc tgcacaatgt ctggctgtgt gtcactatat 8580

ctgtttccac ctgctgtagg aggaaacttt gatgatgttg aacaaggcac tgacctatga 8640
ttacaggata atttcattag gcatcatggt attgctacat tcttttagta taacagtagt 8700
atTTTTTTT acctagttc tctgggttat ctagtttcac gtccttggtc aatcaaccg 8760

gggatggat tccatctcat ggagtgacc ttaaatcaaa tcagatcttg gctggctagt 8820
 cccacaagtt tgtgccacca ttacactagt atactcttga ggaaggaaac cattgtagac 8880
 caaagggtta gtgactgggt tgggttttcc atttctcctt tgatagtttc agagtacttg 8940
 ttttgaaag acactagcca gtaaggggta aagctctatg taagcaccag ctagatgtct 9000

 ccatatttaa tgagggatat atatatatat atatatatat atatatatat atatatatat 9060
 atatatgttt ttcttattgg ttaatgaata aaacactgat tggetgattg gccagagagg 9120
 aagtgaata nnnnnnnnnn nnnnnnnnnn nnnnnnnnnn nnnnnnnnnn nnnnnnnnnn 9180
 nnnnntttt cctcagcagc tcaacctctc tatatatata tatatatata tatatatata 9240
 tatatattat aagtctttaa taactttaaa tcagaattat ttggtagtac taatgtacca 9300
 tttctacata ttgagtgata agatgttaac aatctatcct taactataca gctaaatagt 9360
 caagactatt actctggcca aatatgattt aaaaacagag agagaatgat gagcaacaga 9420

 ataatcatgt taagtcaaaa tcaactgaaa ttgacataat ttctatcatg aatataagaa 9480
 aaatctgaat tattcattgg ttaaaaaacc atgtatttta tgaattctca actacaagga 9540
 actaaaacct ctgagactac aatagaaatt taacatgag agactggctt gtttctgtca 9600
 atagaatatt tgttgggaaa tgtttggttt caaataatag gagggttaata aatctgtaac 9660
 gtcagcggtc tgtgagggca ctgctattag aagccaaaag aggagtagac agttcatatg 9720
 aatacttaag aagagaagca gaagtaaagc cagaatttaa gaggaacta catttaagga 9780
 tcaaagggaa atgtttatgg gacattcaaa gttttaaacc agggagagag aaagcatcat 9840

 ataaaatggt aaccggagtg aaaggatgac aaggacactt agcaaatagg gaaatataaa 9900
 gaaatagaga tcaacttagca gcatacccct tattgtttat acaatatcat tattagcaaa 9960
 atggaatttc agtgaactgt aaaatgcat ggggtagcaa ttggtttata cctcctaagg 10020
 agaacaaaat acctggatag agcagaagtg gaacaataaa gaagcttcta gatcaaggga 10080
 gtctgacgca ttggtgagat ttaataagtg ccagttgaga aaaggttatt gaatttagg 10140
 aaggcagggt gtgatattaa cagaatgatt tcagtagcag ggggcgttca caagctggat 10200
 ttgcaaggga ttaaaatgga attgagtaga agctgtgtcc caggtatagg tcacatattt 10260

 cagggttaga taggcaataa gaagacacag gaaatacgat tgtcccaat acagaactta 10320
 aggagaaatc caaaaggcaa gagtggctct ggataacaaa ttgttgaca taacttgaaa 10380
 atgtgatctc gaatgacagc cacatattt attgagtgc tttggtctcc agaatttagt 10440
 ttctgcactc gagctgtgta aaatctattt agcgaagaaa gcaaatggtg acagttgtat 10500
 acaagcttag caaatcatgt ctggattagg gacaagtgat tggagcaaag acaacacaaa 10560
 ggagaggagc ctaactctgg caaaggtaac tgtccggttc cagctccagc atgctagagg 10620

tggagacctg cctgaatagc aggtagagat gagtatggtt tcgaagcaga gaggagagtt 10680

tttaaccagt atgtgggata gagaggcaaa tgaagggtt gtatgagttt tatatgtaac 10740

acaaggaaat gaaaccagaa gacaacagct ttgcattatt aagcaatttt getcaaggta 10800

tggtcctgtc catcatcatc tcaggcctgg tcttaciaag tgggtttata aattactaat 10860

aaattattaa tttgtaggtt gtgagttgtt atctacaaa gggactgatc aggtttccac 10920

aaaacagtat gctccagagt aaggcctctc tcgagctcaa ggatatac ctcagggtggg 10980

ctttctcaa ggiactcctg ttcttggaac ttgatgtaac tgcaggtaac ggataacagc 11040

atcttcttgc ttcattggat ggggtagata atgtgggcag atactccttg agtgtttcac 11100

atgaatcaga gacatcaggc ttccatcttg gttttagtta cttgtgtatt caaaggagga 11160

cccagctgca gagtgccctg cccaggggga tagaaggttg agtgctgaaa gttctcccag 11220

aggaggtttt caaaccaaa aagatggaag gtaaaaggcag aatgtaaca ataagtcttt 11280

actccatcta cccaagcct gccttggggg gtgggggat cccactcctg acaccagatt 11340

ttgagggaat taccaatagg atgctacacc tcctttctc cattgttata actaacgata 11400

atgtacatct agttaggat agcttcctat tgtttatggt tggattgaa ggaggtgttc 11460

aggcttggac acctctttca gatgacttta gggtttagtt aaaatagaaa tagataggtg 11520

gtgacatagc agaataattg atctccttgt attcacctt tatgattatt agttttggat 11580

atgttaagtt ttaatcctct ttaaaactaa aaggggaatt gtagaggaca ttgtaacaac 11640

acctgctcgg ggctggctgc aggtgtgcct gaccatgcct gctggaggaa gatctaagag 11700

tgagcggcag gcacatgaa gcccttctt ctctctttc atcatggct tgctctactt 11760

attccatgcc ctgccagctg gctaggttgc tctgtaagta aggcatttct ctaataaata 11820

ccctaatac tttacctgac tctgtgctgg taattccctc attatgaaa tgaggtgaaa 11880

aatagcatat gggagttatg tctccagtaa gaggagacta aagagaaatg cagtggatga 11940

ggtcagtgtg ggctccctg gtgattctt tgtagctgat gaactcaaa tacaggatat 12000

ttggtaatca ggttgcctgg acacaaatca aaaatttatg gaaattttta gctgatcaag 12060

aatttgttt ttatctcct tggcagaaaa aaaaattctc agattttcca caaaagtgg 12120

gaagagcttt tagacaatga atttatatt agtactatg tgtttcttga acttactgtg 12180

gtttaatccc actaatgaat taaaacaatg taaactgatg acagagctat cctcccaaag 12240

accccagagc agtgcctttt ctgcttttc tagtttccag acaccatcca cattctttct 12300

ccatggccct ctgtatagac aagttatgat ggagggaatt gtcagttcta attctgcat 12360

ggatTTTTct atgtTgTga TggTaaGtg cataaaatat attcagatct ggaagtGtaa 12420
 aatTTaatGg gaagccCctc agctTccatt ctgagtGcca atccaagcta tatagaagcc 12480
 cacaaaaTtc tacagactTT gggTctcatt cctTTTTgTg tgtgattTTT ttatttattt 12540
 gcaaataTTT ttaataagaa agTTTaaTac aatTTTTaaa aaagGtagaa agaatgaaag 12600
 aaaaaacaga agattgtgac acaatctctg gattaaccag tgagaagaat tcagcaaaag 12660
 ccaaatacag agatattgta gccattatct atgacaatga aagtgtTgaa aacactgaaa 12720
 ccgagccagt gcaaccagac atgacaacct gggTTTTatc aatagtatcc acattgtgga 12780

 aggagaggaa agactccac aagtTgtcat ctgggtTcca caagcatgaa cacgaacaca 12840
 cacacacagt gcattTTTaa atgtggccaa gtagccact attctgaaat ggaagtGcca 12900
 tcctagtggc atTTTAcaca tagTgTatt aatTccagTc atttaggaat caatgtTtga 12960
 aggcaaaaga cctgcattca tatgggatgt tatccattac ccactTctcc aaggGacatc 13020
 attatttctt gcataagTaa tacagaatac atacattcaa tatcagtGca ataattgata 13080
 atTTTaatgt aaaggagatt tacaactTT agagctTtgt acatgtTgat tGaatggct 13140
 ttgtattgct agactggggt tgtTtaggtt gtgatGfata aggagaaaga ctactacttt 13200

 tgtTctccaa tctgtgcctg aagtatgaca taaaggTTTT atagaagTaa gaggattaaa 13260
 tcagggacta tTTTgacatc tGtaatggaa atagaggaag gacaagatga agatgtagGc 13320
 ttggatgaag aactgTaaac tTcacaaaaa gcactgcaat gaaacctaac aaggaaaaat 13380
 agccctagga attaatggta tattTgttga aaataggaac agaaataaag gtgaacctaa 13440
 gacatgaaac agatattTg aagTaaGgtt atcacactgc aaaaataTaa ctgaaggGta 13500
 tgaagtatga gtatgaagat ttgaacatac acacgcatac atatctattt ctatagctat 13560
 ctatctatat atatattata tatatattat atatatagtt ctatgaacta tatatgagac 13620

 actgtTctat gaagtGaaat tgagaaagaa aatagatgat agattagata tagagtTgtg 13680
 taatagattt aaagtagata taggtagata acagatgata tattcaacaa gtagatgata 13740
 ggTaaagaat agatgatata atagggatag atagatagat agatagatag atagatagat 13800
 agatagatag atagatagat agatagatcc tTTTgtTtct ttgtTtcttt gtagccattg 13860
 ctataacctc tctgtggatt tTcatgtatc taaatTTTT tattaaaaca agTTTaaTg 13920
 gaagccctgt gtctgctTgc tctTgtTgt gaagaattat tTctgtcaag catcattTta 13980
 tgaacctTTt tcatatagta gaaactgaac aagcatacaa attaatcaat cagctacagt 14040

 acatattagG attTgtctta cagcaagcta tTTTgtaggg attaatTtct cctccataaa 14100
 gaagtaggaa ccattTctac tctTTTtcca tCactagtat tTtctataa tatgatgttt 14160
 aaactcctgg tccttattgt tTcctcagtt gtgtTaaGac cacatagTat caagaacacc 14220

ctttatctaa tcataagaaa gtgatgaaat ttttaacttc catagagggc tacatatatt 14280
 aataaaagt atataattaa atttgtatat caggttcacc tgaggaatgt tctgaaatct 14340
 tattatgtat aaggctgcta gcatgggaag aaggaaggaa ggaagaagga agaaaggaaa 14400
 gatTTTTata gaaatcattt ttttctctcc tatctataaa agcttttact gttgccacag 14460

 tataacagat aaaattgcct ttttaaaatt gtatTTTTac aattgcctgc cacaaattgt 14520
 cactgacact gaatacacia tctatatttt tgcttctccc agcactttac tgaatttata 14580
 ttgtaatatg agttgaaaat taggcagtgg cttggctaga taacttgata gacagttctt 14640
 ccctttgctt ctacgaggtt ggaataacct aagactaaca gtgggagaat tcacaagaga 14700
 tgcttctctt tacaacatga tacaacattt tctttctatt taccagttag aggcacctaa 14760
 tgaaaacaac agagtgcctg gcagaatcag agatactcct tcccatagga aataaaagaa 14820
 aaacgcgaga ttgcttgaat acattttcag aaacattagt cttttcattc catttcattg 14880

 gaaataaaca aggagagatc tttgtgagat gcagtgggtga agaatgaact ccagtagcaa 14940
 gaccaaatca ttagcaaatg gtccagtcag tgggaaagcc aaaactagac agtagtgaag 15000
 gcatggggag ataggggttt tcattatagc tgctggaata ggctggggat aggaatgtca 15060
 acaggaactc atgcagataa actggtgtgt tgctagacca caaatgaaag aactacataa 15120
 aaaattcttc actaggctag ttctccaggc agcttccactg tttgctctca agtctcaagt 15180
 tatgatcact tactcatctg agttctaagc ataccattgc agattcagt atctctttaa 15240
 ctatgacctg gccctctcca ggctctgcat tagattgagt ataaagtctg agctttattg 15300

 ttaaagaatg ccttgaagaa agggatcctg ctccacacag ttcataactt cttcagctcc 15360
 cttggcatct caggacaaca ggcaaaggac acaaagtcta ctagaggctt catttttctt 15420
 cgatgcctat taatctcaga agatctcatg gatcaatttt tttctggcc acttgtggtc 15480
 agagatgatt tgaaggcag ggtttttcca atttgattca aattgtcata atgtatccag 15540
 aaaattagt tclagactaa aatgatggtt attgttaagg tcttcaaagt agaagttttt 15600
 gaacttgagt tcattcatgt gtagttttct attgtttcat ttagaataat tttattgtac 15660
 aaatctaaaa catgtaaagg ttaacattac attttcaaaa cattaacttt ttaactttta 15720

 cattcctacc atcctttttc tataatgatt gtgtgtgtgt gtgtgtgtgt gtctgtgtgt 15780
 ctgtgtgtgt atgtgatatg tatgcgtggg gatatgcatg accatatgta tgtgaacgtg 15840
 tatatgtgtg catgtacata tagaagccat cttgccatca tagactgttt tccttagttg 15900
 cactctagtt attgaagcag ggtctcatgt ttagcttgtt tcctactca tcttacccea 15960
 gtggtttttc ctttctgctt ctcaagcact gtaattacag gtggacaact gtgcctctct 16020
 gcctttgtg tgggtattga aaccccaaac tccagtcctc acaattggag agcaaggatt 16080

ttatattctt gcctcagttt tgggtctta atgtggctct ttttaaatga gtgtctacaa 16140

 acctaagatc aatctcattt atgaatgtaa ggctttgatt ttcagagagc acacattatt 16200
 atatttgtgt gtcaaaaata ataacactca ttttacatac tttcattttc cactttaagt 16260
 gaaaccaaaa tgiattatag gctattgagc atcagagtgt cttgaaaaca aatatttcaa 16320
 aaagataaaa atcaagaat tggagcatatt tttctatata ctctggacag aatgagctgt 16380
 tgtgatttga atgtaaaatg tttctgtggg ctcatatgcc gagacacctg gacacagctg 16440
 ttggagctct ttgggatttt tgtggaacct ttaggaaatg cagcctcact aaaaaaaaaag 16500
 tgtgtgtgtg tgtgtgtatg tgtgtgtgtg tgtccatc ataaggccca tactgaacaa 16560

 aaaggtgagg caggatgagc atgagtgagg gtcacttcta ggaccaatta ctttctgtaa 16620
 tagagaagtg ttgaacttct gttgacctt gatgtgaagt aagagttgaa aatataaaca 16680
 actgtacaaa ataaaatcag ggtctattta ctacagagta gtctagtcc ttgaataatg 16740
 ctacctaaca ttaaatgctg cttttcctt actgtacttt ggctttataa ctacattggt 16800
 attagtccc aaagtaagt cccatcatcc ttaaacacgt gatgatgctg aagcaaatga 16860
 aaaagaccaa agttccactc tggcaatgat gtaagcaaaa aggggaatag accatttgtg 16920
 ctttcagtaa aagttatgac tttgaaatga acaaaaaatc ttagtagggg gtcttctcta 16980

 gatcattcat ctggtttata tccactttc atcatatata agctgtttaa gaactgtgag 17040
 ttacagaaaa cttataataa gcaaacatca aattttgtta tctctggtga aatgcaattg 17100
 attaattcca gtggctagat ggctgcatct tcctcagagc attagagcac atttgatggg 17160
 tatgaggaaa tagttcttta aagtcaactt tcagtaagta gtagcatctt aataaacct 17220
 ctttttttaa gttaaataca tttaaactta ttttactaag agttatactt ttgcttgaaa 17280
 taaacaatgc tctttaacaa aaacaaaact ctcagaagtg aagtttgagg gaaagattgg 17340
 aattcatctg cattcagaaa agaacaagaa aaaataactt tggtaatatc taagatacat 17400

 aagagaaaat ccacctttaa aaatataaaa gaaaacagag ttactgagag actgtgggtg 17460
 aagacacata atacacaagt tagggtctat aatgcatagc aatgttggg agagtctttc 17520
 atcctgttcg ctcttactgt ataacctttc tccaatatct aaacaatgtt ttattattcc 17580
 tcttttctgt agtagtattc accttgata gtctcaaaaa ctctagctca atgtagcagc 17640
 ataggtcagg gcttgcaaac tttttctaca aaggttcaca tcataaatat tttatgtttt 17700
 tcaggccata tggctctctgt cacaactatt cagcttcctt tttggagcac aaaagcagct 17760
 acagataata tataaataaa tgaacatggc tgtgtccat caaaatgcca tggacgtaga 17820

aagaggactt ggctcatgag gcatagtctg ccagtcttta atatagaact attaaactga 17880
tgactatgca gaagatitgt ctctataaatt atttattatg tattcatgag ggatcataga 17940
gaattctgtg cttgttatgg ctttaattat gaaatcataat tcatcccaaa aatgtaacaa 18000
agaattacca atagtcaatg taaaaatctt tgactcataa aaagtaatag ccacaaataa 18060
gtgactataa ttaagatata gggaaagaac agtgtttcat gatattttgt ggagacatga 18120
gcaagcatct gttcacttca aattaaggca ccaatgacat cgcaggaat gattttacca 18180
atgttttagct tagcaacca gaattcagag ttctttaaag ggttatttac agaatgatgg 18240

gccacatggg ctgctgtgtc actggaaggc ccacattagt gtgggtgata tgactcatgg 18300
aagccatatt acctgagttc catgccaat cttcaagcaa ctaaaccaaa gagtgttttc 18360
tcccccaaca gttgttactg atttatataa ccttgggtgag aagtcccagg agtctgtatg 18420
cttctcttg acccgcctat gcccaataag ttctcttctt tatgcaataa ggccatgctt 18480
tgatttagag gaagtagcta cataacactt gttttctttc tataggaaaa ccaaaactgc 18540
agtagacatg actattcttc caaagaatag aatagtagat ataattttaa ggctatgaag 18600
ctgagattta tgagtttggc ccacatcttg tcacagatct gaaggtagaa ttaaggacat 18660

atcttctcag atttatttct cattattttg taattatgtg taatgagga atctatgtgc 18720
acatgaatgt ggattcctga ggattaagga agaggattg gatcttttga agctgaagtt 18780
acaggtgatc cactaattaa atgaacactg gtgctgcaaa cagaacccaa atcctttgca 18840
aaagcagtat gtgctattaa gcactgagct gtctcttcag ttcccatatt tatcaagtgt 18900
ttgtgttaca tttttggat aatacttaaa acaatgctgt tttgttttat aatgactttc 18960
acatttttga aatcataata taattacatc atttccctcc acttttctcc ctcccactc 19020
tttcatgaaa tttcttaaaa tttgtgacct ttttttcttt aactgatata cccaataca 19080

taaatacaac ctgttcaatc tgtacaatat gatttatatg cacatattct tagggetgac 19140
aatttgaaaa tglaaagca attgaagctt agtttcctta tgtgttatat tttgttgtgt 19200
atcatttgaa ataagtttta gaatgaagtt taaaaatgaa catctttcat tttgcttatt 19260
gtcaaacatt ttccaaatta gctattcact tttgctttac ctactgagg aaaaagccac 19320
ttctaagtgt aggaacaat gacacctgcc tgccatgggg ccagggtcta tgaatggtt 19380
cctatgccta agtcttttag aattactgag gcatgaaaa gtatgaacac aagtactctt 19440
gtgagcacca aattgcacca cttgagtttg tgetctacag cattggaaaa cttgattaaa 19500

tttctccac ttttctactt aacatgcaca gctttttttt ttttaacca catgactttt 19560
tgtttgtgtt gttgttgttg ttgttgtgt agttttgaga cagggtttct ctgtggcttt 19620
ggagtctgtc ctggaactag ctctttaga ccaggctggc ctcgaactca cagagatctg 19680

cctgcctctg cctcccagtg ctgggattaa aggcattgcg taccaccgcc cggaaaccaca 19740
 tgacatTTTT attgattctc tgggagtttc acatcatgca cccagatcac aatcccttcc 19800
 cagtccttcc gtggttgccc cacccccatt ccttgtggca cctcctcccc cttgaccttc 19860
 ccctgaaaag atgtaaaaaa aaaaatcaaa atttaaaaaa gggggaaaat acaaaatcca 19920

 ctttgtgctg tctatatact cactgatgaa tegtcaaatt cttagtggcc tgtcccttca 19980
 acagaactga gtccttccca tcccacacct ctgtggagag ctctccatac ttaatagtta 20040
 atagtctctt ttagtggctt cctatctaag ctttcaattt tcttcagggg aaggtgataa 20100
 gggggtaagg gttgtcacag aagccttcca tgtctctctc cctctcaact gcattctgaag 20160
 tcatcgacat cacggcgaag gtgtctcttt acatacagca ggaacacaga ttcggagctt 20220
 ctacttgggt tctggagaca acacagacca cgaactcatc tgcctgcttc agcgggaccg 20280
 ctgatgttgg caagaccctc aaaggcagca ggggccacag acagaggtca gcattagcttc 20340

 aggtggcagc gcaagccact cacatcaata tcaatatggt tcccagaggc agcatgcccc 20400
 accggcatag aggtggcttt aggctgcagc agagacgagg gcattcagcat ggcccttgggt 20460
 ggaaactcag gaccacagac agcaagcata gctttaatga ctggaaagtc cctagtTTTT 20520
 aataatcata ttcttgaaga accttaagct catattatga aactcaaaat aaacaatacc 20580
 cttattgtta ttgcaaatgg gttaaataata cgagttaatt accagaggct atagaagctg 20640
 aactgtagtt tattatttcc gcttactagt aggacatatt tgttcctaatt gccagcttcc 20700
 cttttatgat ttggtaaat ccacaagggt ttcttcagag aagtcttgct tgcttctggt 20760

 aggtttattg ctagaaaatt ttatatTTTT attggTTTTT caaagggtac ttttttcatt 20820
 atagtctcta actgcctata cttaatatgc acacataaca gcttttgctt acttatttat 20880
 aagtggcttg tttttctat gaactcactg aaaataataa ctcaaggaca ctataattca 20940
 aggtttctaa tcttagcaag aatgtttcct gttgcacctt aatttccatt tcatttcaact 21000
 tcaaattaga atggaaagag taggccagaa attaaccact gctgttttac ctttgacaat 21060
 atctgcaggt catcccagc ttgtaaatg gcacttgcca ctaagcctgt tgttctgagt 21120
 ttcatccttg gtataccata tgctaaaaag agagaatcaa tteccacaag ttttctcca 21180

 atttcaaac atgcagatc ataacacaca tacatctgca acaaaactaa gcaaatgcaa 21240
 ttttggaaata tttgtcttct cttgagagat acacataaaa ggtcttatta taaattatag 21300
 tgccccagta actagaaaaa tacgttaagt gaatcgttac aaaacgtagc tgcataaatt 21360
 ctgtgtcctt agcatctata gacaactcca ttctaaacc ttgtatctat gaagtgaaga 21420
 cagtgttcaa aatacagtc gtggactcct aatagtgctt aagttattga tacaaaaata 21480
 cctttcataa aattattaaa gtgctattgt tcagtaactc ttctgacatt tgcccatggt 21540

ttctactat agtcaatcta ctgggtcttc agtttaaadc aaagctctga gatgaaatgg 21600
 catagtaggc aagtatccc tcatcagcat aaatttgcag attaaaagaa gagaaaaagt 21660
 aaaacaaaag gtccaccta aattttctct attgaatcat aaaatataag tattaatct 21720
 caatccacgg ctatattttt tgacattttt taccacaaca cttcattcag ttccttaggg 21780
 cacctgctct tgagagtggc ctgttggctg actgaagaga aagcactttt gtaacagtct 21840
 aactactggg ataaattaga caccttctcc ataggaatgt atttctttat caaaattgac 21900
 tcacaggctt atcgttactc agatttcaat atttagctga tgatttattg aaaatgaatt 21960
 cagagactct gattttaggg aaaacaactg gaaatatttg tttccaagca tacaactatg 22020
 tcaaccagac tgctacaaaa tgacttagtt caattaatct taatgttgta ctcttgatt 22080
 tcataccta gctatgaata gctacattac tttttatgaa ccatattcct ggtttgcatc 22140
 caaagtgtct tagagctgtt ttgtccaaag agagacaata agcctaactt aaataaacta 22200
 catgggttac acaaaatcag aatctgcttc caagttacat agacttctga tctgcaaagg 22260
 ggctgctctt agccaggcct gggggcacat gcctataatc cttgttaccg gggatgccga 22320
 gacaagagaa ttccgggtct aaagctgcc tgattatcga atcaattcaa gtctaaagtg 22380
 attgatctaa ttaggtcctg cctcgaata aaagtaagaa agagttgggg ctctgtatat 22440
 ttcagtagaa aagcacttaa gcagtgtgta ttaggatcat ttctcataa aacaaaacaa 22500
 acaatgaaaa ctcaagtgtt atattaatct ttctaaacct tagtatttta actttaaaat 22560
 gtgattaagc taccacaaaa tgacagcttt tcttagaaag aaaattcata caaatattaa 22620
 tttatggaat acatgatcac attagaaaca tactttagcc aagtgtctaa tacaagat 22680
 atatgaagac ttictgaaga aaccatgatt ataattaac catttttaat aatgttctgt 22740
 atgtttagc aagtaactca atctaagcac ttataataaa gaatttcttg gtacttcaaa 22800
 gtcatttagc tggaatgttg aaatggctat gcccaggaat gtgataaaat atttaccat 22860
 ttaccttctt aacctcagag gccattgtct aggtacattt ttttaaaagc ctcatcatac 22920
 actgtccaga gcttgagggtg aaatttctct ggatttctca tctaacgact caaagtcagg 22980
 ttcaatattg ctgttacttt tatgtttttt gtgtattaga cctttagcag accctggcac 23040
 cttccagtag acagtacata aatcctatca tctggcatga gtctaattta caggcagaga 23100
 aagggggaaa tgatgtagaa aactgttttt aaagaagaaa ttagttcttt gaaaatcatg 23160
 ttgaaatgaa cacaaacatt cagatatgia aatcagttca ctgagctggg taagacaaga 23220
 aaggtgtctc agaggatgtc catgagcaca gccccctacc aacgggatga gcctgcaaaa 23280

ggcagaagct gtgagttgac ctttgacagg tttccctata gtcacagcc tttgcagttt 23340
 ccagacacac tgctttggta cactgagctc aacagccatt cacatttaa acagaggatg 23400
 ggaagaatcc ttctgagaca ttttggcttc tagggaagag aagaacata atctcaaaa 23460
 ctggtgaagc ctctcggta gccacaagcg atcagcaggc tgtgttact gagataagaa 23520
 caatcatcag taacattact ggtgttctg cccagcagg aacctttgat gacaccagg 23580
 cacctttatg tgattactta attgttggtg ttcctcct gagacaggtc ctactgatg 23640
 acaccaagc accttaaga gatgacatat ttgcttga aatccactc aaattattc 23700

 tcattttaa ctgattatat tagctactat gtgttctct tagctttgt tgaatgtta 23760
 gtccacaaa cactattagg actagcctat aatacattga gccctgatat tttcatgaag 23820
 tcctctaat ggtgtatttt gttttatit cttttccta ctgcttatct gaatacatac 23880
 gagtctgagt aaccaagggt tctctaaaat gaacgatgtg cttctttgga tgaatgcctt 23940
 cagtgaagg atctctttt attggggata cattaagggt aattcacat ctctgacgt 24000
 caggcattta aaaaatagac atagagagag agagacattc tgaggaaag ttagacctc 24060
 aaatttatct tatgctgcag taggctttta tgcctatit taagaactag tgctggctct 24120

 ctagtttaat gagcagttta atttaaagct taaaattatt aagtattcca atagagtc 24180
 aaataatgca gtttataata ttcttatcaa gcacatgaag atacattgt ctccattaa 24240
 cgacatactt ttaaaagtag cctgacctc tcagatata aagagcatgc aattaggga 24300
 atttgcaca ggccttttac acgttaataa gatgtaatta attgtctgtt ttgttaatt 24360
 aacttttcag aactggcag ctctgttct tctgctgtag tgcaaggaag caagaagaac 24420
 ttatttcaa ttctaattt tgaccaagac ttctgacct aaactctaat ccacacacat 24480
 acatacacc aaaaagtag aatagaaggt gatggaaaa ttaactagg aaataccaca 24540

 ttatagttta acctaaaaag taggaaaat gctacattaa gcatgattca gattagaata 24600
 taaatgacat gagaaaagt agaaccatac ttaagacttt ccatataaaa tacattatcc 24660
 atacattctt tatgtaagca atctcattaa tttgttcccc tttgagagtc aactattcca 24720
 agacagtttg ttaggagtta gagtttcaga agagctatga taaagacctt gtccttggtg 24780
 agctgccatg acatcaatgg ttgaattaat tgagccctga agatttctgc actaaattca 24840
 taatctttt aagttttgaa atgaagatga gaaccagtat cattagcata tttgttcagt 24900
 atgtgctaat gtatttagtc attcacattg taaaattagg acattggta cacacattg 24960

 agaactttga gaaatattat gctgtacatt atttcttta ttagttctt gactcaaagt 25020
 gtcactagcc caaggagcct ccaaatcctt ttataggga ggtgggactg tatcttctga 25080
 ccatcctgcc tccacctcac aatgctgaga ttgcagattt aaaccaccac acacataaaa 25140

aattacttta tgcagtatTT tttagacattt ttcaaactca tgattttaat gaataaaaata 25200
aatctcatta ttaaccata atttatTTaa tattgactgt aaggcaaatc atccatggcc 25260
ctttaaaaag ttccagatag tatcaaatgc tgccacttgc atagagttaa agaaatTTTT 25320
cttcattgct ggtagagtca caaaattgia aagccacttt ggaagacagt tggcagtgac 25380

ttaattagat aaacttcata caaccacct gtcacttctt ggtataccaa aatgagtttg 25440
aagcatgttc atgcaaaaact ctacacataa aatagtacca aggcTgtaat tatagataga 25500
gcctctctat atgattgcaa tagactctca agtggaaaggT ggttttccat tatagcatat 25560
ttagctgatt acaaattaca ggtcaaatag tacaatattt ggcattcttc atagctaaga 25620
ttattttgtt tggttgggtg gcttttgttt atttgtgtct agtgttcacc ttagatttga 25680
gttcttgac aataggtgta ctatgtgcat gcatgatact tgtggaggcc agaagaaggg 25740
gtagatcctt tcaaacCGga gttacagaag gttgtaagct gccatgtagg tagtattgac 25800

ccctctgaaa gagtagccag tgtttttaat tgatgagcca tctttccagc cccaaatTTa 25860
aaaaaaaaat gttttttga gacaggattt ctctgtagct ttggaacag tcccaaaact 25920
ccctctgtag accaggetgg ccttgaactc acagagatcc acctgcctct gectctgag 25980
tgctgagatt aaagatgtgt gccaccactg cccaaatcaa attaaaaatt ttaaaactat 26040
atcatataca aaaatatcta gaaataggat ttctgcttat aaataccagt ctaggaagga 26100
ttgtttaatt actttaaaaa ttcacattta attaagaagg gtgtttgcat ggtggaattt 26160
taaagatgtc tatctaact atttaagaac catgaagaca aataatcaa gagaatcttt 26220

aaattacagt gactgtacga acatcccatg agacctctgc taacaagtcc taatctatac 26280
tttattttaa aactattaaa gtctctatc atgattgtag caaacatatt ctTcattctt 26340
ttttattttt actgtgataa aatgaatgcc ttagcagatg actctttgca gtctcattgt 26400
cacatcttc aagtctgat cctacctttg tcttcaccag tgtgtggcca agcaciaaact 26460
cctcaagcat gcaggcctca gtttctcat cagaaaagca tctgtctcac tgaggaaagca 26520
ggaggattag ctgtgtcaat aaatgcagaa cacttagaca gctctcttt ggtggtcaat 26580
gatccctaag gaagcatacc attaaactgg attaacactc tctcttcccc aatattcacc 26640

tgcatgcaa tcaatcgTTa gTccctttaa attcatgctg agtcttatac ttttatttca 26700
aggTTTTatt tataccagtc atctttttaa tttatatTgg agctacaatg acataaatga 26760
ataaacaaat gcacaaagta cctgtgtaaa tatgtacaac acaggctgtg taagaagtga 26820
cttaaatctt gtttcaattt gttatttagt cacattccta aattctgtat gaggttcaaa 26880
gattatttct tggTcatttg tggttatgat ggattactgg agcatggata atttataatg 26940
aatatagaat tatttggTca ctgtaccgga ggccaggga ttcagtatca aagagtggga 27000

acaagggtggg tcaaagccta ctggataatg tccccatctc accagtgatt gcagagcatc 27060

agtgtggca aatgaatgac ctctcaataa ctcttgaat tatgtactct ttatatggta 27120

tttttttaag tttaaattag aaacaagatt gttttacatg tcaattccag tcccctctgc 27180

ccccactgac ccctgtccca tcccctttct gctcccttgg gagggtgagg ccttcgattg 27240

gggatcttca aagtctgtca tatcatttgg agcagggcct aggccctccc ccatttgtct 27300

aggctaagag agagtattcc tctatgtgga tggctcicca aagtccattt gtatactagg 27360

gataaatacc ggtccaatac cagaggcccc atagattgcc caggcctcct aactgacacg 27420

cgtgttcaga ggatctggat cagtcctatg ctggtttccc agctatcagt ctggggcca 27480

tgagctcccc ctigtcaaa tcacctgtct ctgtgtgttt ctccagctta gtcttgacce 27540

ccttgctcct ctctctctgc aactggattc caggagtca gctcagtgtt tagctgtgag 27600

tgtctgcttc tgattctatc agctactgca tgaatattat tcaagttta ttcttcaaac 27660

atgtaattgg attccccata agtttccaat ctgatctttg tcattaatct atattttaa 27720

gctttaaaaa aagaaaaacc tattaattgt ttttttattt ttgtcttgat tctacttaga 27780

tttctgagt tcatctctcc tttattggag accatatctt tcagtaactt tttgtttctt 27840

tttctgttag agcatgtata ttcatgtgct gatctaaatt aaggaactag ttcttataac 27900

tgtaattatt tctggctttt ttctgaattt ttgcaaaaca cattgtgctt gtttaattgct 27960

tttgtttgtt tgttgtatgt ctatttgttt gtcaacttga tgcaaggcca agtcatttaa 28020

gaagagtga agtcaattga gaaaatgcct ccttcagatt ggcttctaga caagactgtg 28080

caggcattat ttgaaatgat gattgatgct gggaagaccc agcccactgt tagctctacc 28140

acctgtggcc aagtggctct tggtcataca gaaaggcggg ttggacaagc catgagttag 28200

caagccagta agcagtgttc ctccatgttt ctctctcagt tcctgcctct gggttctctgc 28260

tttgagtttc tgcctgacc tccctcaata atgaactcta ataaggaaaa gagaataaac 28320

cctttactcc tcaagttttc atggttaaca tcaaactagg aagcaggtaa tgtttttaa 28380

aattatttca aggactgggg aatctggatt tatgctcatt gtgaactttg cagaatcaa 28440

aatcacgttg gagaaaaatc tttggcatg tctgtggaat gtcttagaga ttagtttaac 28500

agaattgata agatgctcct cctccacca gtgtgggcag catcattttt aaggctgaag 28560

tcctagactg gataaaacag aaaatgtgga tagaaggaga aactaaatga gcatggacat 28620

tcatcactct gtgcttcttg attgtgaatg caatgtgaca agctggctcat ctattcctgc 28680

cactgtacct tctttgctg ccagcaaatc ttttctgcca cagtggaatc ctcttgaacc 28740

acaaaaagag taaatccttc attccttaaa ctgcttttgt caggtatattt attacaatag 28800
 aaataaaact aagagaaaca aattggtacc caaatgtggt gccctagctg tgataaaggt 28860
 ggctaagggt ttgggacttt tacaagtggg ttaagggggg attgtggaag agttctgact 28920
 cagactcagg aagtgtaca gcagagctta gtggacatg ctgctaggag ctgaaagaaa 28980
 tatgctcagt ggcacccatg cttttgggat ttcagaaggg aacagggact ctattcagaa 29040
 ttggagtaag ggtcatttat gcaatatttt cacaaagaca ctggcttcct taccctgtta 29100
 tctcaagaat ttggtgtatt agttactttc ttattgttgt gaaaaatatt tgactgacac 29160

 aatttaagga aggatgtgct tgttttagat tataattcaa attgaagtct gtcttggag 29220
 ggaaatcatg gcagcaggca ggaaaagaat agtgacagga gtgagaagtg gcaggagaga 29280
 ctagccatgc atgccacag tcaacaatca gaggcagaag aacctggtg gccagtgcaa 29340
 tttttctttc attcactcca gcagtttaga tgggtcttcc tagtgaatta tcctaaccta 29400
 aaagaacatg tattgagga catgtctcct tgttgattac atatccagta aagttgacga 29460
 ccagaattag ccatcacatt gactgaggct gaagacagaa gtagggaatg agtttgcttg 29520
 gtgaagaaca attgaagata gtgtatcatt ctgggtattg tttgctcttc tcatcgaagt 29580

 ctatggtgaa aagagcaatc agtctgtgtg tcttaccta aatctgggca gcattactct 29640
 ctgagccctg gtccctgatt gtgtaacaag aaaaaaaaa aaaaaaaaa acaaggatcc 29700
 atgagcttcc ttcactctct gcctctctgt tgtggatgca ctgtgacaag ctggcctctt 29760
 aatattgttg tcatattatc ccttacaca agaaaggatt ttttttttac tgtaaacgga 29820
 aataaacctc tctcccttaa atccttttgg tcaggtatct catcacaaca atagaaaaat 29880
 aactaatatt ttgtgtagct gagtggtaaa catcatgcac aaagacatag ttttaatact 29940
 tagcaccaca agatgatgat atattaaaat aataataata ataacctca gattttaata 30000

 ctgacaage agaagttttt tctgggtcta cttttttgcc tataagctgg atagagtaga 30060
 tgatttgctt tcagtatttc tcgctgcata aatggatggt agcaacatgc tgacgctatc 30120
 ccctacacag acctactgct ctggttcgga caggtgtttg acaaagaaaa atgtgttctt 30180
 ctccattg tactcctgat ggaacatgga agacttgaga attaagacce agtgggagaa 30240
 agaaggtcct ttatggggct ctggtatctg ttgccccatt tttggctgct ggccatcacc 30300
 tctgagttag cagcactctg tgtcactgga ttgtctctct gatgtgctaa tccattacat 30360
 gcatgagagg aatggagaga aatttccaaa gctgtaggct aaagcaaact ttgtatcttt 30420

 taaagttgat cacatgactc caaaatcacc tgcactcct ccttcaatgt tggcttcate 30480
 cactgtgatt gaaacttgtt tttagcatgtg tatagactct gtggtctcaa gaaacagctg 30540
 aaaattccat tattaaatc cacatcaaag catactggta taatcattat aaaagttttt 30600

gttttgtttt gtttttatta tcttttcaaa gtagacaaca catcaactcc ataagattcc 30660
 agtaatgcta ggctttgatg gctaaagcca gataatattg aactagagg gggcctcatc 30720
 atcatcgagg attgtctctg aattgtatat ttaacagaaa agttggccag ggaactgaaa 30780
 caatggatga tggttccaca ggggagactg gaatccaatg gaagttcaca tagaacagag 30840

 atttttctaa gatgtttctt ggactcctgc atcagcatag tgaacacaca aagcacaaaa 30900
 attcactgat ttagaagtta gttaccatca tacaagaata cacaattagt aactaagtta 30960
 gtgctcttac acacacacac acacacacac acacacacac acaagaacct tctgtgtcca 31020
 tgtaataatg ttttcaaac cttccaagtg aatgtcactg cttaggaagt gacaagatgc 31080
 caggctagcc acaggaagat gagcattcgg tgagcctgtt acaaaatctg gcactttaga 31140
 attagactct tgccatgaaat tcagtacaat actaaattga caaaggaaga aaaagatgag 31200
 tatttgttgt taggttcata cataaggcac atcacttaag gaggtactga agatcagctt 31260

 cttccagtag cataaaaaat ggagtatctt ctcatcatta attcaatgtg cataaaagga 31320
 gtttatcttt gtaaaacaca tgaaattcca tttgcaagtt ccaactcaaca ccttttcctt 31380
 tttttctaca ccttttagcca tatatggttc aaagtaccag atttcaaggg aatgcctgtt 31440
 cttttgtgac atattagcta gcttcaaaaa ggccttattt ctgtaataa aaaaaaatg 31500
 gtaattgact gttgttagag aaaactgtct atttggcagt agtgacacag ctgccacctg 31560
 gaggtctgtt atctaaatta cagaattggg tctgaaaata gaacagtttt taattttatt 31620
 tattaagttt ttagattcag tcatttaaag gaaaaaatc tgtcataaac atcaatataa 31680

 ttttaaagta aagtataata agcacgatac acagaaatga ttgaaaaatg gatccgaaat 31740
 gaaaaacatc ccaattttaa ggttcccaag aataagagat gaccacactt gtttcgcacc 31800
 tgttctgtaa caggcatggt caaaacctaa aaacacatgt tattagttag agtggtctcag 31860
 gcattactac tttcacacac tcagataagc atggcaggaa gactcagtaa cttttctgga 31920
 tttttttaca agctagtttg aatgttttat tctctgccta tagtttcca tgcggaacaa 31980
 ccagacagaa aagtgcaggg aaaagggtgc attctaagta gacactagat tcacagggtt 32040
 tgtgaaggct tgatcgttct aatcttatcc tgtgtgttca gacgtaatca tttacacct 32100

 tcagcagtcc tctagggaaa tgaatcactc catccaatgc catgtctaaa actgattcag 32160
 aagattcagg acccctaatt acagtgttga aagcaaacac ttctcaatga gtacacaaat 32220
 tagatttctc cccaggctt tcgtaaggac tccaaatta cgtaattgct cattgactat 32280
 ttcaataag tttgaaaaac tctgaataa aggtctgcaa tgtcctgcaa ttaataccaa 32340
 aatgtcaatt gacaagacag attgtctgat tagtacaaca gtttatgtgg ggactgtgca 32400
 acatgcatca ttataatctc acctttcccc agaatatata attaattctc tcatgtctta 32460

gctttctaaa cattgggata caccacccgt gggaagaccc tatctgaaaa gcataatcta 32520

ctggctctgg ggagatggct ctgtggttaa agatgagtac tgccttcga gaggatccat 32580

gtcaggcage tcacaaacag cagtaatgcc aacttcaggg aaccagaca cttttgggct 32640

ctgtgagtga gcaccttcat tcacttgtgc ctgcctacac agtatgtcag tactgaatat 32700

ttattcacia aattgaagtg aaaagtacct gtttagtgaa gtcatagttc ataaatgtct 32760

tgatgcgaaa gattatcatg aattaatact aaacatgac tctgaatgat ctggtcactt 32820

gccccacata gctacttctt tgaagaaatg aatttattct tacttcagtc tgtgaaataa 32880

ctttatgtac acattttttg atgggatga aaataaatag aaagacagac agacagactt 32940

ttaacaaaa gtatttatag aaaatgtaa gttccagag aaagacata taattttgag 33000

tacaggattt atgtttgctt gtatgaaatt ctgtagtga aaaactacta gggatgaagc 33060

tctgtctggt ttggaacag ctaaatgac ttatataaat cttcccgtgc tgtattgcat 33120

atagactgac agggacagaa taaaaccaa agcaaatatg agtataaat gattttttat 33180

tactttaggt atttctagat gtcagataaa aatgagaaca ttgctaaaaa ttttacagag 33240

tgacagctct gccttatgga taaaattcta cagtttgatg tatgaggcag aaaatgtgaa 33300

aaatattgag aagtgctgcc ctgacatgat gatggaaggg agctgggtga gtgtgagcac 33360

catagaagtg tagtggagca aagtcaaact agagaaggat atagtccttt ttgaatcctg 33420

ccgactacag aagcacaac tacaactgt tcacttttgt ttcacctttt taatgaactt 33480

ttagacatgc tcctttattg atttccttga agaatactt ctcagctctt tccattgcat 33540

atgtgtttc cagatacaaa ataaatctga aaagtcttt aacaatggag attcagctct 33600

ctgctgtttt gaaaagatga ctaatatttt atactcctgt tcttgctcca tttaggcatt 33660

tctaagtata ctcagccca catggaaca tacactgtat gatcatgtag tgaagttage 33720

cattgaggaa tgatataatt taagtacct gtctccttcc ctctaaggga acttacctgc 33780

agttcaaact attgaagtcc ttgctccaa gattttgctc ttgactgaa ttagatgagc 33840

agtggggcct gaggccttg gtttatactg tttagactcc tggacaagtc tggattcata 33900

aatctttcta tgictgaaaa aaatgacct cttggctccc tacaaaacat ctttccttta 33960

aataaattat gttcttctta acttatctaa aactatttct gaagtagaat acttaatggc 34020

tgagctgtgt catagagtaa aactggctca ggaagatggc aaggagagtg agtttaactt 34080

ctagaacccc atgaaaagcc aagaacatgt gagggctaac tgcatggtcc aaccagcaag 34140

cagagctagg gaattcctaa agcaagctgg ccagttagaa tagctatttg gtgagctctg 34200

tggccaactg agctcatgat gactgataac tcaggcatga gactccatga ctaaggcaac 34260
 aaacaaccaa ggaagacacc tggcatcaac cttgggactc cacatcacca tatgccca 34320
 taggagtatc catgcgtaca gatgaccatg acacatgcag atggcatgca cacatacaca 34380
 aacacatcat atagacgtat ggtaagcttc atgacatatg ggtatatttg gacatggcaa 34440
 gtaaatcctg aatcctctag taagataagt tctgttcttc cacacacaga gatgagatac 34500
 cacacgactc tcacagaaac acagtcatca ccacatcata tttctgtttt aaaaatcctt 34560
 cttggtagaa ttatttatat tcccacaaat acaatcagct gctaagtttt tcttttttaa 34620

 ctaaaaaat tcaatacac atacagttct tctaatacac ccctacttt tatttcttcc 34680
 tctcatcagt cctcctttgt tcctttttca cttcaacttt catgtcatat atacatacat 34740
 gtttttaagt atgtgcataa aatttagaat gacaaatggg ataaaacaca gcatttgtcc 34800
 ttccaagaca ggtttaattc gctgaatatg aaaacctcca gctacaactt ttttghtaag 34860
 caacataact tcacttttat gtttaagaaa aatttacata cacacacaca cacacacaca 34920
 aatgcgtgtg tgtgtgtgtg tgtgtgtgtg tgtgtgtgtg tgtaatacca tatttctgt 34980
 aaccattcta ccatttgttt tggataccta gtttacatct ataaattagc tattgagaat 35040

 attgctgtaa tagatgatat gcaagtgtcc ctggatgtg ttgatttcat taaaaatcag 35100
 attctctatg gactgatgaa aagacaaata aatgctattc aatcgtgtgt gtgtgtgtgt 35160
 gtgtgtgtgt gtgtgtgtgt gtgtgtgtct gtagcaatca accttgtgc attaatittg 35220
 aattaataa tacataatgt atctttctga cataatgtaa ttattaacac taacattatg 35280
 ccaaactttt ccatcagaat atagectata tatatatctc tgtcattaat ttaattatta 35340
 acattaacat tatttcaaac ttttcagca gaatatggtc taaaaacaa acttatattt 35400
 cacattagtt gtgggctaaa tgtatatttg tctaagatat tactaacaat tagtatggta 35460

 tgggagtgaa ctgggagtt caccatgcta agcacaagt ctaccactga gtgactgtcc 35520
 cagcctcact tgtgcatttt atcttgagac atggacaaag ttgaacttaa actttctctg 35580
 tggcccagat agaacacata atcacctgc ctctgtttcc atttatgtct tagcctggca 35640
 taatattgac aagcattctg ttaaaacaat tgatgcctat tcaactaagt tttatttaac 35700
 ttcattgtat cccacctcat ttaaatcca gaatctcca gtgaacataa gccaagtgt 35760
 aagtgggaag ctacattga aaaatattgt ctgtccttgt tggatttggg ggcataaacc 35820
 tgcagtatct gctacttgaa ctgtctctcc tgatgaggca ttaggattgc aacttcaaaa 35880

 agaattcaag gccatttgaa aagacatac cagtccatgg atccaagact taagaggtaa 35940
 aaagagtctt gagagcatta cacaatgggt gggcaccttc tagaatgcac aaagcccagg 36000
 attcatcctt aglacagata agggaaaaaa ataattcttt ggtatgttct ctgtgaacat 36060

tcttcccagc ctcttgaatt ctatacatcg aacataagga tttgtcagg aaaatggcag 36120
 ttttaaagta taaataggac acactttaca ggtaaatattg gctagaatta tgaagtctaa 36180
 ttgaatttct tcataagggtg tttgcatcag gaaattactg gaaatatttt taaatagcta 36240
 ctataaacia atgtgcatta caaagaatat ttacaatata gctgatgcaa tggctcagca 36300

 ggtaagatta tgagctgtac aagctatatg acctgagttc cattccggaa ttctacatag 36360
 taggagagaa ctgactacag aaagtgtta cctgacctgc acatagcaaa ggcagacaca 36420
 cgtacttgtg cacatgcaca tacatacaca cagggtactct ctcttacaca cacacacaca 36480
 cacacacaca cacacacaca cacgaataat ttagtthtaa aaattaactc tagtatacct 36540
 tatacatccc tgacattttc tcacagacta cagggtacta taagatttgc ttgaaataga 36600
 ttttgctta ttatthtaa aatacctatg gaaaatgcca tacatcgata atttgctagt 36660
 gtttaaggctg taaattgtta atggaagtag cttttgagtc tccttaacct tcagtacat 36720

 tttttgattt ttgttctca aatggttctc ctgcttaata tgtgtgaatg tttcctcaga 36780
 tcccctctga cagatctca gttcaacatt agctgatcac acattttctt cccactggat 36840
 gtaagatgaa taaggagtgc tgaatgcac aatgtgcaaa agacagtata ttttcatgga 36900
 aaataatcac aaacaacaaa cttagagtaa aattatgcat gaatgttctt tttattcaaa 36960
 tataattttt aagctcaatt gtcagtattt tctcaaacat gacacaacac tgcaatggga 37020
 caatctctaa gtttaagactt gtaaacctca actttataga agtactttta gaaaattctg 37080
 tgacgtggga tgcctttctg tatgttttga atatgtgttg ctctgattgg ttgatgaaaa 37140

 ataaagctgc gttggcctag gacaaggaag gatagagcca gacaggaaat ccaagcagag 37200
 atacaggagt tgaaggttag catctgggag acatcagcag tcatcaagga acaacatgca 37260
 agagcaccac ctgtaaaacc acagccatg cgacaatata cagattaata gaaatgggtt 37320
 aatttaata taggagctag ctagtattaa gcctgagcca ttggccaaat atttataatt 37380
 aatatataat tccttgagtg attatttagg aatgggtatg gggctgagca ggacaaaaaa 37440
 aagcctttgg ttacagttct gatgtattgc ttaccaaagt ttatgttatt atacctagaa 37500
 taattctate tgttgccaat ggtttagaac ataacctctg gcttctttg gcacatggca 37560

 gttaaaagag caatctttct gtatttata gacagaggag acacaatata ttatgcacaa 37620
 ataacagtgt gcaaaatata atccatccac acccatattc aaagggcggtt tcctaaaatt 37680
 cctgtcagtg ctgatttttt aatcacgctg tttatgcttt aaatgcattt ataccctc 37740
 ttgttgcaat tattccctt atcacatcct tcctctagt aaacaactac ctttgggatg 37800
 agatattttt gttaaaatgc tacttatact gaccttctg aaagtataa aggtttatgt 37860
 gggatagggtt gtattagatc cacttttctc cttgcttttg atcaataaaa ttaagaaagc 37920

tctccccaag aatTTTgata atcctTTTgta tctattggat ctagtattat tgccaataca 37980

atgtTTTTTT attTgTtaa accaggaata gTtgctggaa tacaagata gTtctcaaag 38040

tgccctgtat aattcataat atgactaata atatagcaaa aatattagca gacattaatc 38100

aaaagatggg taaattgaag atcacaattt tacaaaatag aactactata gTtgTtactc 38160

aaatataatc ttagTTTTca acaattTtct gggatatctt gctTTaatat gTaaagTTTT 38220

tcccatacta ctggtaggca aattaatgat ttgcatagag agacacacaa attctctcaa 38280

ggaactTTTg aatgggcatt atggctaaat tGtctTtctc cTtTcTtgg tctctgtta 38340

tctattataa ttctcttacg ctTgactatg ttaattagat tagccataaa gTcaaggaat 38400

tcatTCatgg cactattac agacactacc tcttcttaa aaaattagaa atggggagat 38460

gctgaaggat gTgaagtcca tGtGcttaca gaaagaatta gagaaccag aattattaaa 38520

caggctTTTT gcttcaatga aagaagTtga cacctgttta ccaggaagga tggagtggac 38580

actgtttatt attaacctgg taactTTTTg ctattctgtg gatccagccc tactctaat 38640

ccttcagact catgagcacc attactgact caatagaagc tatctatggt aaagaaacca 38700

cacatactct acaaaagaca tGtactTtTat aagggaCTta caatgtagtc atgcctTtgg 38760

ctttattgtg ataattatcc tgagaaaact tttcccaaag ttttattgtc tTaaaatgtg 38820

taaaataaat aaataagcca ctTggtgtca gaaccagaa gTtagagcca gctTgctaa 38880

gTaaaggctga accaagattc cTtctattt catgaggatg atttccctcc caaccatgat 38940

acctacaggg atcccacctc aaagattTat tctaaattt tctgttactt ctgctaacta 39000

taatatataa cacaataaa tttctTTTTg cagaaggatg ggtcagaagt taccaagcat 39060

tGagtTgTtc ttatacatc tggattTgaa ctcatgctgt ctgtattcta ggcaagTTTT 39120

ggattTgcaa tctctaac tcagctccc agagacctgg gattacatat gtgcatcacc 39180

aggcacagca caactattat gctatattga tGTTTTattc tGtaactTtG tTcaattTac 39240

caattataac aggttctTgt agTgtctTta agattagagg taaatgacca tGtagtctta 39300

gttacagtgt ctattgctgt gaagagacac catgatcatg gcaactctta taaaggaaaa 39360

cattTaatgg gctgtctTta gagtatagaa gTttagTccc tttTgttatg gcaggaatca 39420

tagcaatata caagtagata tagtactgga gaattagctg agagctctaa cccaggatca 39480

gcagacagca ggaagagaga gTgacactgg gctgactTg cccatctaaa acctaaaatc 39540

ccaccatac ttctccatc aaggatacat cactccaac aagtccacat ctcccaatgg 39600

tGtcaactct atgagcctat gTgggccatt tTctTtcaag ctaccactca tGccattTac 39660

agaaacaatc ttagttcact tctaattaat aaattgcttt tgctttttct aagatctgat 39720
 ctttacatat agcctagga tatctcaaac acactatggt tgaatgatc ttgaatttct 39780
 gagtctcctg ccttcatctc ctaaattctg gaattaaaga ctgatagctg gaaaccagc 39840
 acaggattga tccaaacccc aggaatgtgg atgtcagtga ggagacctcg gaaatccatg 39900
 ggacctcctt accagatcag tacttatccc tagcataggt gtggactttg ggagctcaca 39960
 ccataatagag ggatactccc tgagccaaga cacatggggg tgggcctagg ccctatccca 40020
 aaggatatga cagactctga agacgccctt tggaggcctt taccctcctt ggggagcaaa 40080

 aggttatgtg aaaggtagag atttagttgg ggggtggtag gggagaaggt caggagagg 40140
 gaactgggat tgacatgtaa aacaatcttg tttctaattc aaataaaaat ggaaaaaata 40200
 tgcaccatca caacccttac tctgttgaca gcagagatca ttgctgtgtg ataacacaca 40260
 tctggttagt acctgcttta tttaaaaatg atccattttg aaaggtagaa aatcagtaac 40320
 aagtgaaact atagaaataa cacaatgtat taaaatggtt gctcacagac catcagcata 40380
 tcattttata aagtaaaaca aatagatgga ctctaaaatg gaaacagtg atccctgcct 40440
 cctagcacc aggttccctt ctgtgtggaa taaatttatt caggctcttc taaaagaaat 40500

 aatacactga aaatagtagt acactattat tttattagac aacctgtga ctcttaggtg 40560
 tttgcattta ctcatcttgt atccttcacc tgaaaaaaac taagtaccta tttagaagc 40620
 aatactgtag gaagcaca aacaatggac agggaaactcc agaagattga acttgtaaat 40680
 gggacctgc tctcagttag aaccttcata atagaggcag caccagtcaa taaatgcttt 40740
 ggattgttg aagagaagaa gtctccagaa gccctgattc atcaagggga aatggactgg 40800
 acctcaagag caactgcaac tacagacact gagataaatt gcaagaacac cttgacttgc 40860
 tgagttgtag gataataact ttttaaacag ttgaacatta acaaacagta gaagaagatg 40920

 acgcatctct ggacgttata ggctatggtt ttgattctca aaagcatttc tecttcccac 40980
 aacacaagta tcctatagtg ccacagatta tttaatgac ctaactcaa atgacattta 41040
 aatccactag aacagtactc aaataggtag cctaagtcag aagcagcctt taaaagcaaa 41100
 tgtgaaaggg ttcaaaat atgaatggaaa ttcaatattt atttctttat tattggttta 41160
 ttttgaaat tagaatacag tttgaccagg tgatttgttt ccatgcaaac tactagaaac 41220
 accgatcagc tagttttctt aggtctaaac tatattatgg taatatatgc tgtggctatt 41280
 gcaaggattt gttatattat tccttttggt taatgcatgg atttttcttt tctttgaatt 41340

 tacatagtat atgttagaat ggattaatat gtccttggga ttgtaattat catagittaa 41400
 tagaaaatta gctgagctta atatagtggt atactttata ccaataatg ttatctgata 41460
 atgctatctg cagacaaaaa tgcaagccta atgtctctag gaaaggatag aattacaaat 41520

gctttaatgc attcagcctt cacttgcaca tcgacttcat tttgtctttt aattactctg 41580
tgtctcagcc agtttataag acatgtcaaa gtctttgtgt gattcccctt gaagatgcct 41640
ttaaggttat tctgctcact gttctgaatc caattctcca agacaggaaa attagaataa 41700
aagagatagt tcagttttat atgcatataa aatggagaga ttaaatctaa aaataagaca 41760

ctataggata gtgttgacaa cagaaactct tggacagagg gatcaaggga atcttgtcta 41820
gcttagaaca agaggaccag agggataaaa aaatttgtta cctcttccca aagtgtcatt 41880
tcacagtgtc ctiggctgaa attgtagagt ttggatccaa aagaaaaaaaa caagtttagga 41940
agtataatta aactttgttg ataaaaaggta gtgtcagagg aaaatgagct ggagtagaac 42000
ctactcaaac attccaactc tataagaata atatgattaa gagacaagat gaagagccac 42060
atggataact tcaatgttca ctgctggaaa tggggaagtg tcaccaagaa atctgtgaag 42120
gaatactgag aactgacaga cctggctact accccaatga cagaggaatt tggaaactac 42180

agaagtatag tctaccattg acaatttctg gctctcagat gaggttgcaa agagcaggca 42240
atagcatcca ggtgaggatg gaaaacagca tccaaccagg ggtgagaaac agcatccatc 42300
tagggatggg aaacaacatg catgcaagga tgggaaactg atgggagatt tccttctgta 42360
tatatgtctc tttataggtt gatgaataaa aacttgattg tccaatagcc aagaagaaag 42420
tacagacagg acttccagac taggagaatg ctggggagag gaagtagaga ggaaaccaca 42480
agagagatag catgtagcta ccaggatata agacactggg cattcccagg taagataagg 42540
ccatgtagaa atatataggt caataattat tagtcaatag ttaaagaga ggctgtgatc 42600

tccaccctct gcttgaggatg agttccaacc acaggceccac ttacagaaac aaccctccct 42660
ctccccacca tccataaaat ttttatgatg cccaaaccct ccttctatgg ttttctaaca 42720
tcctgcttaa actaacctt ggctcttggc ctcttctccc cctccccttt accccact 42780
actgactata tgagctagcc tggaaaaaat aaaattgtc acttgatcag aatcctgtct 42840
tgtggtcatt ctctctgcat ctcttatccc cattcatctc cctggatatac ttgccttagg 42900
ttgctgtctc acgggttggc acaactatat gtacctactt gaagaacaga tttgaagaca 42960
atagtataag aacacactca acaacagaca gaccaatata tgacaccacc agaactctatg 43020

gattccaaa cagcaagacc tgaacatccc aacgcagatg aaccagaaaa gaaagacttt 43080
aaaaacaact ttatgatgat attggagacc atcaaagtgg aaacaagaaa atcccttaaa 43140
gaaatggaag aaaaaacaaa caaaaataca gaaaatgtag gaaaagacaa atcaaaaaa 43200
ttcaagaaat aaacaaatcc cctaaagaat gcaaagaaag ccaagaaaa caaccaaca 43260
agtgaaggaa acaattcaaa cagttcaagg ctgaaaagct gaaataaaag caataaagaa 43320
aacacagaat taagggattc tggaaataaa aaagctggct aaacaatcaa gaactaccga 43380

t g t a a c c a t a a c c a a t a g a c t a c a a g a g a c a g a a g a g a g a a t c t c a g g t a t t g a a g a c t c 43440

 a c t a g a g g a a a t a c a g t c c t t g a c c a a a g a a a a t c t c a a g t c c c t a a a a c a a a a t t c c a g 43500
 g a a a t a t g g g a c a c c g t g a a a a g g g c a a c c t a a g a a t a a t a g a c a c a g g a g a t g a t g a a g 43560
 a a a t a c a g c t c a a a g t t a c a g a a a a c a t a t t c a a c a a a a t c a t a c a a g a a a a c t t c c c c a 43620
 a t a a a a a g a a g g a t a a g c c t a t g a a a g t a c a a g a a g c t t a c a g a a c a c c a a a t a g a c t g g 43680
 a c c a c a a a a a g a a g t c c c c t t g c c a t a g a a t a a t c a a a a c a c c a a a c t t a c a g a a t a a a g 43740
 a a a a g a a t a t t a a g a g t a g c a a a a g a a a a a a a a g g c a a g g g a c a t a t a a a g g a a g a a c t a 43800
 t c t g a a t t a c a a a c a a c t t t t c a a t g g a a a t t t t g a a a g c c a g a a g g c c c t g g a g a g a t g 43860

 t t c t a c a a a t g c t a a g g a a a c a t g g a t g c c a g t c t a g a c t a c a g c a c c c t g a a a a g t t t t 43920
 c a a t c c c t a t a g a t g g a g a a a a c a a g a t a t t t c a t a a c a a a a c c a g a t t t a a a c t a t a c a 43980
 t a t c c a c a a a t c t a g c c c t a c a g a a a g t a c t g g a a g a a a a a c t c a t a c c c a a g g a a g a t a 44040
 a t t a c a a t c a c a a a a c a t a g g c g a t a g a t a a t c c c a a t t t a c c a a a c a c a a a a a g a a a a 44100
 a g g g g g g a t a t c c a t g c a a a a t a c c a c c a c c a a c a c a a a a t c c a a a a c a a a c a a g a a t c a 44160
 a c a a t c a a t g g t c a t c a a t a t c t c t c a a t g t c a a t g g t a t t a a c t t g c c t a t a a a a a g a c 44220
 a c a g a c t a a a a g a a t g g a t a t a a a g a c a g a a t c c a a c c t t c t g c t g c a t a c a a g a a a t a c 44280

 a t c t c a a a t t c a a a g a c a g a c a t g a c c t t g g a g t a a a g g a c t g g g a a a a g a t t t t c c a a t 44340
 t a a a g g g a c c c a a g a a a c a a g c t g g t a t a g c a a t c c t a a t a t c t a a c a a a t t a g a c t t c a 44400
 a a t t a a a a a c a a t c a a a a g a g a t g a a g a t c a c t t g a t a t t c a t c a c a g g a a a a t t c t a t c 44460
 a t g a t g a a g t c a t a a t t c t g a a c a t c t a c g c c c c a a a t a c c a a g g c a c c c a t a t t t g t a a 44520
 a a g a a a c a t t a c t a a a g c t c a a a t c a c a c a t a a a g c c t c a c a c a c t t a t a g t g g g a g a c t 44580
 t c a a c a c c c c a c t c t c a c c a c t a g a c a g g a c c a c c a g a t a g a a a g t t a a c a a g g a a a c a a 44640
 a g c a a c t a a c a g a a a t t a t g a c a c a a t t g g g a t t c a c a g a a a t c c a t a g a a c a t t c c a t c 44700

 t a a a c a c a a a a a g a t a c c t t t g t c t c a g c a c c a c a g g g a a a t t c t c t a a a a t t t g a c c a c 44760
 a t a t t t g g c a a c g t a t c a a a c c t c a a c a g a t a a a a a a t t a g a a a a g g c c t c t g a a t c c t a 44820
 t c t a a t c a c a a t g g t t t a a a g t t a g a a t t c a a c a a c a c a a a t a g c a g a a a c c c t a c a a a c 44880
 t c a t g g a a a t t g a a c a a c g c a c a a c t g c a c c a t t c c t a a g t a a a g g a a g a a a a c a a a a g a 44940
 a c t t a a a g a c t t c t t a g a a t t c a a c a g g a a a g a a t g a a t g c a c a a c a t a c c c a a a c t t a t 45000
 a g a a c a c t t t g a a a g c a g t g c t a a g a g g a a a g t t c a t a g a a c t a a g t g c c c a c a t g a a g a 45060
 a a c t t g a g a a c a g t c a c a c t a g a g a a t t a a c a g c a c a a g t g a a a g g t c t a g a a c a a a a a g 45120

gagcaaaactt atcccagagg agtggatgcc aggaaataat catattgagg gctgaaatca 45180
ataaagtaga aacaaagaaa acaatacaaa gaatcaacaa aacaaaaagt tggttcttcg 45240
agaatatcaa caacatagac aagcctttat ccaaaactaat aagcagagtg agaacatgaa 45300
aatcaacaaa atcagaaatg aaaaggggaa cataacaaca gatactgagg aaatgcagag 45360
aatcatcagg tcatactttg aaaacctgta ctccacaaaa ttcaagattt aaagaaaatg 45420
ggcaattttc tggaaagata tcacttacca aaattaaatc aagaacatat aatcaattta 45480
aataaacata taaccataa cgaaatagaa gcaatcatca aaagtctccc taccaaaata 45540

aatcccaggg ccagatgggt tcagtgacaga attctaccag aaattcagag aagagttaat 45600
accagtactc ctcaaattga tccacacaat agaagcagaa ggaacattgt caaacctttt 45660
ctacaacgct acaattacct tggtagccaa gccacacaaa gacacaagaa agagaactac 45720
aaaccaatat cccatgaa cactgactca aaactactta tggaaatfff cggggatcca 45780
cagggagtg aatccaacta agattctagg cagtagtga gaggtgcct ttgatgtcct 45840
tccccataa tgagattgat gactacctg gttgccatac tagagccttc atccagtgc 45900
tgatcaaaga agaagcaggc acccacagct aagcactgag ccatactcct agaatccagt 45960

tgtagagaag gagaaggat gagcaaagga gacaagacca tgcttggtaa acccaaagaa 46020
acagttgacc tgacctagtg aggacacaga gatcctagat gtaaagctgg ggaaccagcc 46080
tgggaagtaa caaacctct taaaatgagt gccagctagg aggcttagga agtctatggg 46140
accttaaca gtggagccag tgttattact agtgcacaaa tggactttgg gagcccattc 46200
actatggagg ggtactatg cagccagata catgaaggag ggcttaggcc ctcccccaa 46260
atgatgtgtt atactttgat gatccccat ggaaggctc actatccttg gggagtggct 46320
taggggtggg ttgggggcat tggtagggag catgggagga tgagagggca agggaatgag 46380

aggattgatg tgtaatatga tattgtttct aaaataaaaa aaattcttaa tataaatttg 46440
tcacaggaga ggctcaaaag gcacagacag attaatttct acaaaacttg aaaggttgtg 46500
agtaaatgag aactaaaggg aaattgaggc aaaaaaggaa ctttaatat tatagatggg 46560
aagaatgaaa aaatgagaac tcacatcttc ctttttacag tcatgtgtac ttgtaaaata 46620
ggtattttct gactaaaagg aactttcaa ttgaaaatcc tctagtctgt aaagtacat 46680
gtaatattag actgtcagt aacatcctta tcataattgt ctgtggctga agaagaattc 46740
agaatgtgcg agaataaatt ttaaatatg tctgttagtg cactgtgaac tgcagtcact 46800

tgcaaagtca ggctccatag tgaaggtact gcagacctc tgacttctac tgataggag 46860
attgggtgtt gtaagtagag acaaaattat ctgtgtcat cttaatgtgc tgccattctc 46920
ctgttaggca aactcaaaag gtatagctaa taccagcaaa tatttagctt ctactggata 46980

tcagtcaaaa aggctgcaag ataagataca aagatttccc caccatgctg tgcccttctt 47040
 atgttatact cctgccaaca atacattctt tttgtttggg agggtaattc tgtttttctt 47100
 tcttgttttt tttttttttt ttgatttttc agagggatat gactgcactg tgctgattgg 47160
 aaatcactaa atttataata taaacaataa ccttgcaagt agtctgaaag atgattgtga 47220

 cttcctctta tgaagactc aaattgagct caaaactaaa aatacatggt ttcaggttta 47280
 agaaaaattt cagagatcac aagtagaaag gtagaaatga agtctgcact ctagctgatt 47340
 ttgattttca atgtgtgatg ctttttattt gcaaattctt tacaatggaa ataaattttc 47400
 aggacaaaca tcatcaciaa actgagagtt cagatcccca aggaaagcca aggagtaaca 47460
 aaaatggaaa aatggaaaat ttcagtgtac atgatgattt gcaagcatct ggcacaacag 47520
 taagtgaggg ataaaacata aaacaataag agtttgatat ttgcatatac tgtgtagagt 47580
 aaagggtcat ggggttttagc gtggctctatg gcagggtccca atgtgtcccc accagctcct 47640

 tcttgtttcc agatgtatca tttccagagt gttccaaaat aaatcaataa aaatataaat 47700
 aaataagctc aatggctact aagcctccag gcattttgga tcaaaacca agaagatatac 47760
 atcttgctca ttaggaaagg ccaaaaactat tggaaacaag tgttggtaaa ggtgtgaagg 47820
 agaggaaaac ctcatgtta gatgtagact aagctaatac agtcatcatg gcaaacagga 47880
 gaaatgtctc cgcaatttac cagacttata actgcaatat gataatatct gtgagtgtga 47940
 gtgtgtgtgc gtgtgctgt gcgtgtgctgt gtgtatgtgt gtgtgcttgt atgtagacgg 48000
 gttatctgta ttctcacatt tgttgcatca ctggtattga aagaatcaa gattcagatc 48060

 caatctactt gcctagtaaa gatagctgaa tagagggtg atgtttacaa acacagtgtt 48120
 gctatccata ctigaaaatg agaaagaatc tctgttttga cagcgcagat gacctaaagg 48180
 ccacacattt tgaagagtag gccagacaca gaaagagaac tactaccaa cctggtaaaa 48240
 tcttatcctt ctcaagaatt ctgatgcttt tgatgactgt tagtcttgcc agctcaaagc 48300
 aaaacagatt tcaggaacag gtgttttagg gtttatctat gtgaagatag gaaagtgtaa 48360
 agtatatgaa ggtctgggaa tgtagttaca aaggctctgag gatggaaagt cctaacacgg 48420
 tggataaatg caagttatga aggtctgaga atggaaggta taaaggctctg agaatggaag 48480

 gtcgaagatg gtaatgtaag gtacatgaat taaagttatg aaggctctgag gataaaaagg 48540
 cttaaagtgat gataaagtga gttgagacat taaaaagaat gaaatatgtt cctgatttct 48600
 ctattttcca tgctgctgtt aatagtcagt aaagttctac aataccacta tatgatcata 48660
 actactgggc caagattaag atgcttttca ttgtccaaaa aaaaaaatct gtcaatttta 48720
 aaatgttagt tctttcagcc aaggctcttc taacatgaat atgctgctaa tgtgtctaat 48780
 acttatgttt ccataaactc taaggattct tgtaagttcc aagaagctga attggatcca 48840

aacaacaga tcagattcac tccaataaa tattattcaa tctttccctg gtcccaggac 48900

tcccttccct catgttggga cccctttagg aaacctccc tcattcaca atcttccct 48960
caagtccag gacctaaaga attatTTTT tctaaetta acctgtctt ctgctctgcc 49020
aacatcttg caggtctaag aggctccta gggagtcca tacagcctgg actgtgatga 49080
aacaaccage taccacaga cgtggcagca cccaacctt ctcaggtccc ccaaagatgg 49140
tcaaagcccc cccacgacag cagaaagcag tcttgagaat ttgacatact tattectaa 49200
tctgccatgt ctaacaacc atcttttaa aaaaataata agtaaaggta ggattgaaag 49260
gttcaggcat tatgtggcc tgcctctgtt acctggcaga atccactcag ggggaatcct 49320

gggaggccca gggttccatg ggaaataagt ctgcacacag gtgcaaagga cccctttaa 49380
agacagacce ctgccattt atgtctctc tttttctct actcctctc ctacttctc 49440
ctctctact ctctctctc tttctctct tctggcgacc agccatggtg gtcagccatt 49500
aacctgttt ctctctctc ttactctctc tactctgcc ggcctataat aaactggtta 49560
atatgtctaa tagtctcatg tctcatctg cactgcctt tctttatct taatttaac 49620
aaaagtctaa caagatctc agttgatcaa cctaagcaaa ttatttcagt tcaataata 49680
gcaaaattca tagagtagat agattaacc acaggtattt cttcaact gtgtcataga 49740

tgaagtctc atatcagggt gccagcaagg gtgagttctg gtgagagccc tctccatgac 49800
ttcaagacag tcatcaaagt caagacagtc atcctttctt tgtgtgcaca tgtgttgag 49860
agaaagaact cctctgaagt cttctgacaa gtaagaagt cctggggacc cctaccctca 49920
tggcctcaca taatctcaag gatcactctc agttcacct tttaaaacat cactttgagg 49980
gttaggatt caacataaga ttttgtggg aaggaacata aatagtgtc agttaggta 50040
cacacacaca caatacatat atatataat agatagatag atagatagat agatagat 50100
atagatagat atagatagat agatagat atggatatag atagatagat agatagat 50160

gtatatatat gaatgtttg aataataata catatattt atgtatacat atatgagat 50220
catgtgttta tttggcttta taaagttcag cctaaacatt tataagtaca taaatgaaca 50280
aaactggatg gcagtaatag acacaagttg agagtcctg gaaattcaca agaaacaatc 50340
tggaggcttc agagtgtgt gggcatctc tcacctgcac aaagatgaag tgtaattgac 50400
acaacttctt gtaaggagtg aaagaatctc gaaaatgtg aataagctt acaaccaca 50460
gaatatgtga tagatgtaat ctgcttagct ggtatcactg tatctggtac aattgtgac 50520
atagttagaa tctgcagtca atttgacaca aacagtgagt cacttgggaa gagggaaact 50580

caagtgaaaa atcaccagct ttagactgat ttgtgagcat gtctgtgtag cattgctaaa 50640
tggtaatcgg ttgggtggg cccagcccat tgggggtgg accaaccct aagtagagag 50700
gcctgcataa taatgtagaa aatgcaagaa aatgcaacca tgttcattgc agcatttttt 50760
ttattttaat ttiagaagca ttcttattta catatcaatt cccccattcc ctgtcttcc 50820
catctccca tgccccccc caaaccccca cccacccca cacacactcc tcagggatag 50880
taaggcttc catgggagg gggacaatca aagtctgtca catcatttgg gggaagacc 50940
aggctctct cccatattt gggctgcaat agtaccctc cacaggaaat gggtcccaa 51000

agtctagga taaactggt ctccactgtt agaggtcaca tagactgtct tggactcctg 51060
aaccacatt cagaggcctt ggttcattcc aatgctggt ccccaggct tagactggtg 51120
tctctgtct ctactaggt caggtcaaca gtttctgtgg gttttccag caccctattg 51180
gttctttat tcatccctc tctctttcca caactggatt ccaggagtat ggctcagtgc 51240
ttatctgtgt gtgcctgitt ctgcttccat aagctaccaa atgaaggctc taggaatggc 51300
aaccaagga gtcatcaatc tcattatgga ggaaggcat cagtggcagc ctctccacca 51360
ctgcctagat tcattgttgg ggteatccct gtgggtcccc taacatttcc ctgtgcccag 51420

acttctctct aaagctatac tggctcttc tatcaaggca tttctttctt gctctctct 51480
atccctccc tgtctcagtc ctctgttct cctccacct cccctttcc ctctccct 51540
tcccacctc ctaccccca cccatgttc caatttgctc tggggttctt gctctctcc 51600
ccttctcag gggaccatgt gctcttctc tgggtctc ctgtttctc agtttctctg 51660
gtgggtgtaga ttgtaggcta gcagctttt gctctatgtc taatatccat atatgagtga 51720
gtacatact tgctgtctt tctgttattg ggttacctca ctcaggatgt tttttcttc 51780
cagtttctc catttgctg caaatttcaa gatttaattg ttttttcca ctgagtaata 51840

ctccatgctg ttcattacag ctttattcag aatagctaaa agctggaaac aatctagatg 51900
tccctcaatg gagactagat aaagaaaatg tagtacattt atgcaatgta gtactactca 51960
gctgttaaaa aattgacatc atgaaattg aaggcaaatg gataaaagta gaaaaataa 52020
ccccactga catcaccag acccagaaat acaaatatta tatgtactca ctataagta 52080
ggtattagct gttaaagtaa ggataatcat gctacaatcc acagaccag agaggctaag 52140
taacacaagg gctcaaggta ggacacatgg gtttcctgg gaaggggaaa tcaaatagat 52200
tttgtgggtg gactgagagt gggtagatat gggaacaaga gaggttaagc agtggttggg 52260

gagaaggag agaaaggact aggagagatg actggaactg ggggatattt ggagattatg 52320
ggactatgca gaaactcaat gcaagggaaa ttccttagaa tctaagagag tgacctaga 52380
gaagtctcct agtagtggg atacagagcc ctaacagttc atgttccatg taaggtagct 52440

ggactgggcc atcaaccag ccataaagcc ttcaacctac aatctgtcct gcctgcaata 52500
 tggagctagt gcaatggagg aacagaactt gtgggagtg ccaacccatg actggtccaa 52560
 cttgaggcca tgaattaga aagagcccat gcccaatact gcctctatgg ccaagaacca 52620
 gaagctggaa agcccagaga cccaggatag atagaaccaa acaggactgg gaaaacaaac 52680

 tcatagtga tagcctaatt gtcaccagag aatagcatc catcaactga tgggagcaga 52740
 tntagagacc cagagtca caagaagcag agccatggaa acctgacatg aattataaga 52800
 gccagagggg acaagagtac catgagaata tggcccatag aatcagctaa gcaggcttca 52860
 tagggtcaca gagactgaag caacaaacac agaccctgta tgggtctgag ctaggctctc 52920
 tgcattacc ttatggttgt gtagcttggg gttcttttgg gacaccaac catgggacac 52980
 ttttcatcct actgagttgc tacatccagc tgtgagttg tgcccagcct gcccccccc 53040
 ttttttctg tttttatfff tttgtaggga aatggaggaa agaggaagaa gtgatctggg 53100

 ggacagggga gatgaggaa caactgagag gagagaggaa gcagaaactg ttagccaaac 53160
 agaattgatg tgagaagaat aaaagttaa aaaagagaga aaagggggag aaagaaagag 53220
 agggagggga ggagtaaggg aggaaggaaa gaaggaagga aggaggaagg aaggaaggaa 53280
 ggaaggaagg aaggaagta tgccacatgg gggcaagcca taagccgtgc cactgcctgg 53340
 tttgtgtctt caggttctg ccttgagctc ctgccccagc tttgctggat gatgaactat 53400
 aagtagtaaa ttaaaattaa ccttttctc ccccaaatag ttttggta tagtgtttct 53460
 cccagcataa aaaaaaaaa aaaaggaaga aaaaaagaaa aaagtacact tgaacaacta 53520

 ctctggagct atcttctgtc tgctgctttt gatcacagtg aacttcagat getcacttta 53580
 gcaaccgtct aaggagccac ttgccttaaa ctccatgtgt acattacttt tcacagtatt 53640
 cagcagagac aggtatttct gagagtttca ctagaatgtt ttatttctga tacaaaatta 53700
 caaacattaa aacagcaatc aaattctagt ttctttacaa caatctggta gccaaattta 53760
 atttttccc atttttaaa atttgaatta gagccgggcg ttggtggtgc acgcctttaa 53820
 tcccagcact cgggagcat aggcaggcgg atctctgtga gttcgagacc agcctggtct 53880
 ccagagcgag tgcaggatag gctccaaagc tacacagaga aacctgtct tgaaaaacca 53940

 aaataataa ataataaat aaataataa ataaaattg aattagaac gattgtttta 54000
 tatgtcaate ccagttccct ctccctcccc tactccccta ccaccccaa ctaaaactct 54060
 acctacaca taacctttct gctccccagg gaggtgagg atttccatag ggggtcttca 54120
 gggctctgca tctctttgg gataggctt aggccaccc ctgtgtgttg tggctcaggg 54180
 agtatctctc tatgtggaat gggctcccaa agtgacaccc tatgcttggg ataagtactg 54240
 atctactaca ggaggcccca tggatttctg aggtctctc actgacacc acgttctctg 54300

ggtctgtctc caaatttaaa ttttaatgac tttttagtct ctctctctct ctctctctct 54360

 ctctctctct ctctctctct ctctctctct ctctgtgtgt gtgtgtgtgt gtgtgtgtgt 54420
 gtgtgtgtgt gtgcctatga gtgttttgta agtggagtgg gagtgagtgg gagttagtac 54480
 atatgtatgt atgtgagtgt gtgtaggagt atgtttgtgc aatggcctaa aaagggcatg 54540
 tggctttccg gagatgaaat cacagggcac tgaagccac cttacatggg aactgggacc 54600
 tggactgcag cccittggaa gagcaccaag tactctttagc tgtggatata tetctccaaa 54660
 tttggtttta attgtgctta catcttgctc ttccctgtac ataattatat ttacctgact 54720
 taacatttcc tccatttttg tcaaagtgtc ttttctatag agttccgagt gaatcctcat 54780

 gctctattag agacttgcgt tgtaacaca cacttgactc aagictgtcc cagatattgg 54840
 tcctgtacct ttgtcgttc aaatactggc ttccctctt tctctttaga attcagacat 54900
 tgtttgtgat gagatatgtg tgctctcgta cagcttcac agcaaaggtc cacattttaa 54960
 tatcatttaa gtttatgaaa ggaagagctc ctgaagccca ttcattgataa tttcttttta 55020
 cagtataaga atctgaattg gactttatat taatacagt tgttaaaaac tgcagatttg 55080
 tgaggcaaat gaaagccata agtttagcct ggagcagagc tgccaggcaa gccaggggaa 55140
 agtggctcct atggacattt gcctttaggc aaagtctttt gtttagagtc ctgaactagc 55200

 agctgaatag cccacaggct ctgagagcca ctgcaaaaga gaccaaggtt tgactgctta 55260
 acccatcttc tctacaactt ccctcttgaa ttgggtgagc taaaataaag ttatagcctt 55320
 gagaaagaaa aatgttcgca ttctaccact ttcaacttta gaaactcaa accagcacca 55380
 acttgttgca aaggttttca ttggaagtga agggggaaaa tcaatactct ggttctctgtg 55440
 atcctccatg attgtagtaa cattgcattc acttgcctca tgatgaataa aacctcatt 55500
 gcagcagggc aggccagaga tcttgtgaat caaattatga cataaatgca aaaaatgaat 55560
 tttaaccttg tttcacattt catttgcct agagaacata gaaaatctga aacatgttca 55620

 tgattcctgt ctcccagaa aagaacagaa tgtggcatca cactgctgag gagaatagta 55680
 agactggact aaatagtaag actggactga agctcataca aggacatcct gtgcttttag 55740
 cattgtattt gttatctaag gtgtgttttg gttgctctgc attccagttg tagaaaacac 55800
 tgctaaaaag ggatagaaac aataattaac agatataatt tacaataaaa tacaatacaa 55860
 ttctgatgca gtggctaaag ggaataaag aggccaatag tataaaacct gctgaatcca 55920
 tttactgttg cttatgtgta tatattcag agctgaccgc taggtattga ataaccaact 55980
 agggagatca tccccagga agactaattc tcctctctt agccttcata tagttgctg 56040

tagctcttta tctaggtgcg aatcccctatg aaatttcttc ttccacctta gtaggtctaa 56100
aggggctgtc attgttcagg tcttctttta ggcagccata ctattgaggt atcatggttg 56160
tagctttcct attgtttcta ggagacacaa tctcatgaaa gacttcatgg tcctctcatt 56220
cttacagtct tttcatcttc tctctattga tattccctga gccttagggg caaggattgt 56280
gttgcatatg tatttctgg agctgggtat agcaaaattg gttgatcccc gaattttgat 56340
gagttgcagt tttccgtgaa actctcagtg tgttgcaaaa atgaaaccac tttgatgagg 56400
ggtgaaagct acacttacct gtgtgtataa gggcaagtgc tagattacaa gttaaggaaa 56460

tatgctggct gagtaaagtg gtaatctaga ggtagatctc ctctaagata tgcaacatta 56520
ttagccttgt gtcttgact agatttctaa tactggacac aatttctttc ttgttgagct 56580
ggcctcaaat ccaattagac ggctatttat tcttgccaag ttatgaatac caccattgga 56640
cctttagaga tatctttcct tggccgtcat tgtttagat tctaggcaac aagactgggt 56700
aggactgttg atctcttct ctctcggcat cttgcatagc aatttctggt actataaaaa 56760
ctagacacca gggaggaagc ttccagatca gatccagcac acatttgagt catgtgtctg 56820
gtgatgtcat cagtagtact taccttcaac ttctgggaga caaccaagag caagagcaat 56880

agcctatgtt gctttcagtg tctcttgac atccagtcac tgaaaagggt tctcatgtct 56940
gatactagtt tttgttct catatgtaac ttcatatatg tagtccttct gcatectatt 57000
tctctgtage tcaagtcatg gtgtgtgtgt gtgtgtggtg tgcatgtgta attttacgta 57060
aaattaaata atattcctta aggcactctt gtcattgatt gtctcatcct ctccctctgt 57120
attgacctcc cttccccttt ccattttttc cattcttccc attcatatca cctgtatctt 57180
gttattctcc tttcttgccc ccctcatggt caaagaatga atttaattaa tgaagaataa 57240
gtataaggag gaccaagcag gcagagatgg agacacacac acctggccag agccatttgc 57300

cctgggcagg gaagagaaac cacagcacac ctgaggecac ctaggtagtc aagtgcatt 57360
atagtacca aatataattg ggggtatggg agagaaggga agaggcagaa tggttcattt 57420
cctatggaga gagacaaatc tgaagaggta aaggtggcga ggaatgggct catgtggaag 57480
gcctacttac cagggcctgt gttaatgtcc atggtcctt ttgccacaa aggtcacaca 57540
gatgcctaga tttctcagct gccacctata gccatattag gaaccaaggg acttgctgca 57600
gccaggacca tgaagatctg agtggcctgc actgccacct atggttattg ggtcaaccag 57660
gccaaccaa gctgctgcca agggccacat ctgggtccat ggcctcctg cagccagggc 57720

ctgtgtgat gccctggct ctggttaacta cctggggtct agaacaacac ctaaggctgt 57780
gttggctcct gagggctcatg ctgcaaccag cccatgtta acatctgccc aagctggggg 57840
gcagtgagcc cacagaaaa ctagcctacc gccccctga gagctcccac tttgagaaag 57900

ctggtccac ccctcacctg agtgagcaga ggtcccagca gcctattcag aacaatccag 57960
 ctactacca gacacacata cagggcactg ggtgggcact ccctaacatc gtcacattct 58020
 atgacctgtt ggagtgccta aagggactga tcctgtagaa acatagatgc aggatctcca 58080
 tgactacagg atatctgaga gtagtttcag tgagggtcca gtattgatgg tgtcccagaa 58140

 gccagagtcc ttgaacctga ccaacaacac attacacaat gaacatttgc aagcaaagct 58200
 gtgtgggcaa atataatgga tgatacacag cagctcctac tactgctaag acaaatgatg 58260
 aggtaataga gagacagaaa aggaggaggg aaacagtttg gtggagtctt tggtttttag 58320
 attatttgc ttttatttta tttattttta acttttatct taagtttatt ttttttccat 58380
 tttccttttg tgtaaggata ctacaagttt gaagggcaga tacagaggga ctgggaagta 58440
 attgggttag ggtgcatgat gtgaaattcc caaagaatca attaaaagat atgttaataa 58500
 taaaaataag tataagaaga aaataaaatt ctctagcaaa tatcaatttt agagtattca 58560

 agactacata accaatgcta accactttta agtactatct taatcattac acttgcaatt 58620
 gatgaatttt gaaatgagaa ttttacattc cattcaataa aattaaatct ttgtttctat 58680
 ataaatgagg gaagtngaatt attctgcac caaagtaaat gtctaccaat gcattgactt 58740
 gatgttttta cticagtgat tattggcaag tgttcagcac cctcagagaa aatagcacat 58800
 attatgacct gaggtaaaaa agagtaagca ttaggaaaag gaagaaatca aacgatatat 58860
 attttgtgat aaatccttc tattttgtgc atacaattaa aataaaaagt cagcatcctt 58920
 agaaacagat acagaggcct taactccttg aaacacaaca ttaagcctgc tctggctgga 58980

 ttccatagtt gctagctcca tgagcagget gccttcatag gattctgttg taaaaattca 59040
 ctctggtttt aatgctctgt tgtcatgttt cattttaaat ggttttttta cacctcactc 59100
 attttactg ggtaccacaa acctgaagg gaatcccatc tccaggatca gtatgtctg 59160
 tggagagcca gctagagggc atagaatctt ctaaaacctg cftaagtgtt ccatgaagca 59220
 tcaactgagta gccacaaaat cccacctagc ttaaggagag gggaattagt ctaagtttct 59280
 agagagtggg gatattttta tagtcattat ttgacacaca ttttggaaaat attcaaatat 59340
 atagtgcatt aattaccata actaagtcta ttctcaca ctaagcaat ggtaagaaat 59400

 actgcataca gcagaaagta ggaaaggtag aggctttgca gccagataac ttgatttgaa 59460
 tccagtgtt gctgagatca gtgctgtgat aattttcata gctgaattcc ttaactgtga 59520
 aacgatatta aatatagaaa ttacctgtca tgattattca tgaagaatt aacatttgt 59580
 gcatttaaga ctataacca ttagtatttt attatctgat taagttaaca aaatcttaga 59640
 gtgaagatat aatgaaaaaa attagacata tattattgct ttgcagtccc aatagcatga 59700
 acgccattct tggattcata atgataatta cattagcatt acagagaaga gtgtattagt 59760

ttgccagaac tgctacaaat tctatggcct acccagcaca catttatttt catgttctgg 59820

 aggcaaaagt ctgaattaca gtcagcaggg tgctccttc tgtgggctct gagggatgga 59880
 tctgttccac cctctctcct tggcttaciaa atggctgaat tttcccaggg gcattatatt 59940
 gtcttttttc taigtgcatt tgcgtccaga atttttcttt ttaaaaggaa gcagtctttt 60000
 agaaagaagg cacacctgaa tgacctcact ttaacttaat catctctaaa aaaaatccca 60060
 actgcagttc tctttttacc tcahtagatt tccatcaaac tacatgaggt ctctgctgcc 60120
 caccacaaa gcaagcctat attcctaac tgaggccca atgaggccaa actccaagga 60180
 ccctcctcca ggctagcagt atattctggg ggatgctgag caggtggggg tttggggagg 60240

 catggcccac ctigagaaat ggagctggcc accaccccca agtgctcatg ggaagiatca 60300
 accccaggct ggttgttgtt acaaatctct tcaaatgta tcttttgat gacaaaaatg 60360
 aaggagcttt gtaaattctt ttaattaag aatcatgttg attcagctc aggaatttct 60420
 tcagcctatg ggccttagc ctgacagagg tacctgagga gctacaggtt aggccaagaa 60480
 tatccagagg tgtactgagt acctggcaa atgcaacagt ggtagtggg atttctcagg 60540
 ctgggaaaga ctccctccac gatggcagtg gtgatggagg tgggacctc tagggaggtg 60600
 tgcaattatt tggaacagag atcatttgca gctgtctgtg aaagctactg gacctctaat 60660

 tgctacttct tcaggacat tcttctcta gtcatgcagg ctattccacc catgcacaac 60720
 ttcttgtgca gtgcccctgg ggtcagacac atctcaattt tgtctggctt gtgccttggg 60780
 acctcccca cagtttagc aggtcatctg ccagtactca acagttttt tccacagac 60840
 agtgtgagca gcttactata cacaacagct tccctttta tctcccctc ccagagttaa 60900
 tttttccat gcttttghta gaagagaaat ttagaagata caggcacaaa ttaaacagat 60960
 tttattttct gtctgatgtt aataggtctt gaggagaaaa attaagcaaa agtgatataa 61020
 ggtgaggaag acgctgagac aagatgatat ttgaggaag taaataacaa aggggtgagg 61080

 aagacgctga gacaagatga tatttgaggg aagtaataa caaaggggtg aggaagacgc 61140
 tgagacaaga tgatatttga gggaagtaaa taacaaaggg gtaagagaaa caatgagtat 61200
 gtcaatgaca acagcatgaa atctatgaga aatgtccatg gggagagctt gtggttatc 61260
 ctgaggtagg aaataattat taggtcaagg gcaacagcat agcatctgta agagaaatat 61320
 ccatgaagag tttgtaact atactgagat agcattatcg ttagtatcct agaggatgct 61380
 cttgtgcaag tggtaggtag ataagaatga aatgatgag aacataaagc caacagcaag 61440
 gaaataatgt gacttgtaaa ccacatgta tgatttctca tgtccctgtt gaaaacagaa 61500

cctcagaatt cagaacaag aaaggtgtaa ggagagaagt ggagaaggtt aggaaggtct 61560
 aacataaac tgagagtgtg gtaaaagtaa tggataagag gctataaaga taattttctg 61620
 agagtgcagt aacaataaca taggcagggt ggttaggtat ggagtgttag caatggctag 61680
 atcctcagac aaacaggatt tttcttaatt ttaaatttca atgttttgat aacttcaaat 61740
 ttgaatactc atttccagct ctgcctcttt gtctctaac tgattctgtg tcctccaact 61800
 ctttcttaag ctcatggctc cttctgtggt tcctttctc tacacacaca cacacacaca 61860
 cacacacaca cacacacaca cacacacaca cacacacaca cacacacaca cacacacaca 61920

 cacacacact gagcccatat agtgcctgac ttatgtacag gtgttttagga atgatcactt 61980
 acttgggttt gagttaatcta tcagtggctc cttccttttag aagactgctt tccttttct 62040
 cagtggccat tgattgactg tagctcttca tctaggaat ctctcctatc tgtaattttg 62100
 aacataatgt ttcataacat ctatccactt gactcattcg gtagagtttg ggcatccttt 62160
 ttatcaagtt tgcataatct atgactctgt cttgtaacaa acctttacag tattctgtaa 62220
 ttttggattg tgtgctttct ttcataagaat tttatgttaa gactcattca gccaaaactc 62280
 atgaaccttt ctattatctc acacttgcca ctgctcttta ggcaaatgtt tcttttcatt 62340

 tcttgctata ggaattagaa cattatttgg ttaaagcaaa ctgaatcaa atgaagcaga 62400
 aacaagcaaa ataacagta gatgctaata gacaaatata tcaggaagtt tctaatatgc 62460
 atcccatggt tctaatagat tcagttagct ttggaggcca acatcaggga acgatcaagt 62520
 tatcaatttc acattatcaa caccagtaa acattgcata tgttttgatc caaataaaga 62580
 aaattagtca tagtcacat taaggataca aaaaatatga attccaaact ttcatagttg 62640
 gaattcagca ttaatttgc aaatactggt aaataaatgt aaaattctcc aggcaaaaca 62700
 agacatgaaa aagaatgatg tatatgggta attgagaatc tgttctatcc atgaaaccag 62760

 atttctggag ctgagaactg acttttcatt atacttatg gacatcagat agatgacacg 62820
 gaaacaatat attctcaaca aagtagctgc agtaagtagc cttgcaagtt tcatgtccag 62880
 gtcacaggct tatctgtgcc ctggcattct caaagcagtt tgtgacacat taaactctat 62940
 gaaagttaga aactttcca gatttgatta agctgcagag aacacaaagc ttggaaaaat 63000
 ataatttgat ttgattttat caatcatttt tgaattgtat gcttgcttac attcagtttt 63060
 caacacaaat atcaagata atttcattcc aacaagaaaa aatttttgac tcactattaa 63120
 gaagaacctt ataatttatt tgcccattta ggaagccaag aatgtactat gtgagcaaca 63180

 ataaaaattg ttacatcaca tgcagcttca tttgagcttg gtttatgatt cagggaacaa 63240
 cataaagtag caaggcaagg atgtgatttg ctttatgctc aatggagtct atgtttgcca 63300
 catctgtggt atatttaata aaacagtata tatttagttc tatccaatag ctacaattct 63360

agtattttca gtgtgttcat tgtaactcaa attaacatac tggagaatat atatttgaaa 63420
 caagttttga ttctgcatga cactaactaa ttatttcact gtttgtaata cttggatttg 63480
 ttgagatcac aaccataatt aacaagatta tgccataaat acagtgtaga ggctaccaat 63540
 aaaagcatgc tgacagttaa acagagtacc actgagttag tttcagaaca gaaggataaa 63600

 ggaacattat ccatgacagc ccaagtaaat ttttaatttg ttatatttac taacattttc 63660
 atctccaatt gagaaaaat gtattgtttc ttagcttagt ttctaccaa tgttatagat 63720
 tcttatataa ttttcaactt gttcatctat ttttttgtc ctgtagcaa caacctcctt 63780
 ttcagtact cttctgtca atgttacaga tgatgctcta ggttacctga caagacagat 63840
 aaagactact gacttttcca aacatcatga aacatatctg gtttctaggc tatcaacgta 63900
 ttaatcatgc aatttttgtg aatggaaaag gaggaaatat acaaagtagt cttccatc 63960
 ttgtattttg catgtgtata atttttgaca cttgtagctt gtctataaag ctatgctcaa 64020

 atatttcgat aattcaaaat atcatcactt catatatatt ttaaaatttg agagtgaaaa 64080
 cattgctcaa gcaaaccta gtttataaat ctgagagtag tagctcacat ctataattac 64140
 agcactcagg aggtatgaga actatagcca taagtttgag acaagtatag gttagagtgg 64200
 attcctcttt aaactgggct agaataagat tctgcctcaa aagcaataa gtgaatatta 64260
 atgagcacca catttcaggg atgaagtttt tagtatTTTT gtgtggatat attcaatata 64320
 tagaaacatt aaattacatt ttcagattta attctaagaa ttaaatattc ttttcaatat 64380
 ttcttatagc ttaaaagaca aaaaggtaac ctaaaattag gttggaacta tattaataa 64440

 aatgctttaa tatcttggtg acaaagtaat ttcttagact tatagctaga ataagtcttt 64500
 tgtcactttt tccacacaat tcttaacaag attgcacatt ggccaagatg acctttggct 64560
 tcacctgct gatgtcagt gttatctgaa tcatttctat aatgaagaaa aattacaata 64620
 gttaaaattt tctttatta tacttcagtt tactttaatt aataacgatt tagctactaa 64680
 tttaaaacc agtcagctcc ataataatta agatgccat ggatgctgta taactatctt 64740
 gctatagcca atcttttgtt tcataatgat tcacttcaa attttttgtt ttctctcag 64800
 agaagccatc tcattgcag caataaattc taacctcaa aagcagtcatt teccaagaca 64860

 aactgtatt tcttccagca tgtaaatgtc acatgctata gcatctaggg tcaggcgttc 64920
 taaaaacaca gaaataccag ctatatatca ttttaatatg cttattgaaa attcaacatt 64980
 atatgaata gaaattactt ttatggaaat agaaagcttt gatgaagaat tgagctcaat 65040
 ttgaatgatg aaaagtagca ataacaagac tgaagctatg gcttagaagg acctgagttt 65100
 agaggccaat cacccatata aaagtgaagt aactgggat aggtttgtaa cccagcactg 65160
 tgtgaaaaga caagtgcac ctgggagctt gttggcaatc ctatcagcct gaaactgcaa 65220

gctccaggtc cagtaagaca ttctgtctca caaaacaaga tagagaacaa tagaggaaga 65280

 tactcttgtc tggcctttat attagacaca cacacacaca cacacacaca cacacacaca 65340
 cacacacaca cacacgaggt cacaaatatac aaaggataaa gaaagaaagg aaggaaggaa 65400
 taaaataata ccaatatcta atatgctaata atcttcaat acaagtcata agaatatgac 65460
 tctctaagtc tggaggatca tactctagac tgaatatgaag attttatgta caatctttaa 65520
 ggcttgacca aaagaaatta cacggattta actgacaggt tcatgaagaa agctgctatc 65580
 cctacaccag actgttttct tgaaggagat gtcttagcaa ggaactccag gccttggac 65640
 caagcatact catggctatt cctcatacta acctccaact ggaggctgat atcaggaat 65700

 accactgaaa tgcatttcta gagccccagc caaggctttt gcatatctaa gctacttttc 65760
 tcagtcttgg ttcattactt accactcttg ttctccctg tttccccct tcaacatcct 65820
 ggaatctgta aatgagcaaa gaggcaagta ctggggcccc tggccactaa gacagtcccc 65880
 tctgcctaaa catgtgtcct gtctgcagca ggactggtgt ttcagaggaa acaaaccaca 65940
 gtgaaccaat gcttatttcc atgccttgca acctgtaac agcaggtaaa taaagccctg 66000
 agtcacatga cctctaattg ggtgtcttaa ttaatcacia tgattatgag gacacaagat 66060
 tgttcacaat ttcactttcc acttagttgt tttcctgctg caataatgaa tctaagaca 66120

 agtcagtaga catttgtgta attggggaat ttctcatgg aataggaaat tattaacaca 66180
 gaggtttctt ttaaatataa ttaaaaacaa tctgattta cactctgac caagtccct 66240
 ctccccctc gatataaat atcttggagt aactctaacc aaacaagtga aagacctgta 66300
 tgacacatcg ttaagtctt aaagagagaa attaagaag atatcagaaa atggtaagat 66360
 ctcccatgct ctiggatagg taggatcaac atagtaaaaa tggcaatcct atcaaaagca 66420
 gtctacagat tcaatgcaac cccatcaaa ataccagcac aattcttcac agaccttgag 66480
 agaacaagac tcaactttat atggaaaaac aaaaaactca ggatagccaa aacaacctg 66540

 tacagtgaag gaacctctgg aagcatcacc atccctgact ttaagctcta ctatagagtt 66600
 atagtagtga aaaaagcttg gtaatggcac aaaaacagac aggtagacca atgaaatcta 66660
 actgaagacc ccgttattga tccacatact atgaagacct gatttttgac aaagaaacta 66720
 aaattatatg atgagaaaa taaagcatct tcaaccaatg gtgctggcat aactgtatgc 66780
 tgtcattaga agattgcaga tagatccata tctatctcca tgtacaaaac ttaagacaaa 66840
 atatagagtt tctatggaga tagagataga gatggatata tggatgaaaa ggtgatagat 66900
 tagatagatg atgatgatag agagagatag atacatagat agatggatga tagacatgat 66960

agaatatcat gacagataga tagatagatg gatagataga tagatagata gatagataga 67020
 tagatagata gatagatagg agagagtgtg tacatttctt ttttaatgtg tacattagta 67080
 tatttatatt ttcttttttt gaaattacaa acaagattga attacatgta gacacagaaa 67140
 tgatacctat caaattgtta tctttgaaaa ggaaggaaag aaaatgatca tttatggaaa 67200
 cagtctttgt gatgccacaa tgggtgcta atgcagtat ttttgtgttc aaatttatta 67260
 ggtttttcca ttattatata ttaaaataca tgatgctgca ttgcttattg tcctagttag 67320
 accctaaca ttaataataat gtaaatattg actcttcctt cttgacattt taaacatcca 67380

 attaatctct catgagcaag aaattgttat cacccaagct acattagtaa agaggccaat 67440
 atactgagca ggaaaacaaa gtttcgtagt ctaacagctg ctttaattagg gagtcgagca 67500
 cttggatcaa gtgaggcatg gaaatggatt acacagcatt tccatgggca acacattatt 67560
 tatcaataag ggcagtaatg ctactttgag ggaaaactca ccaaagctta tttgaacttg 67620
 gagctgttca ttcttctcat tctttttaag taatttacct ggacagatata gtaaccatta 67680
 tagcttctat taagttaaac aattcattat tccctagca gagcctaggg gaacaccact 67740
 cagtgacat aaaacttgat tctagtaaag tttcattttc agaagcatgc cattaattgc 67800

 atgttttaat gaagaatctg tgaatgctg gagaaagaag gcaagtttgc agggaccact 67860
 ggaatctaca gatgaggtga gttaaagaga tgggaatgag ggagatggaa catcccctaa 67920
 gcagcagctt tattcagtc atgccccac aaaaaataga agacatctac attctgttct 67980
 catctttata tcaaaataaa agagggaaaa ttccatatgg gtactgtaac taaatatatc 68040
 aatactactt tcaatttctg gaacaataaa actcttgccc tataataaca atcaaaataa 68100
 tcacatttca gatgtgtttg taagataaca tgatcaacaa aaaagccatt gttctacat 68160
 ttaagaaatg tgttgcatc tgctcctgt agttgcatcc agtctacaag ctctctgttc 68220

 ctagtctate agggagtgcc agattctctg taccacctat gattccaatt ttgttttatt 68280
 gtgtagtact gtataacat aaactgtttc aaaaataaca aagtggatgt aatgatgat 68340
 ccaacaaaa tgtaatgtga tgtgaaaagg aatgaataa aacatttttt gattcaaaaa 68400
 gaaaaaaagg aaatgttagg cgacatttat ctaactttat gtagagggtg gggattcacc 68460
 tgaacaatag aagcaatgag ataaaacatc tttcataggt ttagagacag tccagtttta 68520
 ccaattaaga ttttctgag gtaaaacaaa caaaataaat aacataaac attactcttc 68580
 aacctgaagt cctcacatat ggcacatata tacaacatgt cctttgttta tectctcatt 68640

 atgttaggcc tccactttat ttttacttt aacctattt tgaagacctt aattcattta 68700
 tttcttacac aaactcact cttttgaagt tctttcatg ggatattgtg tgtgtgtcat 68760
 ctgtaaatgt ctttactgtc aggagttaa agaaaaatat attgcctgtg agtataagat 68820

tatattctag cagtgtagcc aattcctggt aaagacataa actgaacccc ccagaaaaaa 68880
aatataatcc aggttaaaca tccaacaagg ttaattgact gctgagaact tcaatgagta 68940
tagaaaactt gaaggctaca ggtctagacc caaaaaacct tctgttgtct cagccctaaa 69000
tagccatgca ctgcacactt ctgggtgcga tttaacagtc tgtgactact taactcaaat 69060

cattttagga atgtacaac agaccataa cttcaccaa cccaaggct aagaatgcca 69120
tcagatagca tctgaggaac ttaccgtagt ttctggcat cctgggacct gettecctca 69180
tgaaaagttc cctgatttag gacattcttt gttctggtgt ggatacatac atgtatgat 69240
gtatgtatta tgtatgatg tatgtatctt acacctgtta gccacattgg agaataatat 69300
ttgaggtaac cagaatctgg gctatagaat atttatttat agaataaact ttcttactcc 69360
ctttgaggta agagcctttt ttttttttt tgtacaaca attaaaacta gcatttgctt 69420
ctcaaaatat cacttgcagg atgtctggtg aaccaccaag attttctctt agaattaagt 69480

gtccatggga acaataaaca gcagataatg aaatgtgaat aaatgtatt taagagtgca 69540
gaacagagtt taaaaggcat gcgatagcac ccatcattgc tatagtact aagacgctg 69600
gtcctaaag cttagaacca cttctctctc ttaccgtta ccttcggaac cctcaacca 69660
agctgtggat actgacttca cctgacctta ttctccctca cattggagca tcttcagca 69720
aaggacgtg acacctaaga aggtcccag agttacatct tccattttat aatggtgtag 69780
agggacagaa acgaaattag ggaaaggaca acttaattca tcccattgcc catttctga 69840
cggtttctctg ctgtctgac actgatggcc ttctagcaca gttagaaagc ctgggtctat 69900

ctttagagat tctctttgga agtcccaagg tgatgccag gaatagtagt tctgcttcta 69960
aggcagccgt agtagtactg tgtgaagcct atgccatfff tgccttgac aaagcttcag 70020
agtgtatct gggtttgta ctagaagccg ttttggaggt gaagtacatc aagtctctc 70080
gtccttaggg gtcagccctt gattccattt caaaatagtc tcaactgaaag tttgtcttat 70140
ttcataagga tttttctttt aaagtactct ggtatagacc agagtacttt attctagcag 70200
ttagccaat tcttggtaaa gacataaact gaccaacaga ctgctgtggc tctgaaaagg 70260
gcagtgggta aaagtgtgc agtgagaaac acagagccat gagtattaac agggaatttc 70320

aaggatccat ttaattttcc atgactgctt ataatcacct acagacattg aaaatgaagg 70380
agttatgta tttggatgtg tgtgtgtgtg tgtgtgtgtg tgtgtgtgtg tgtgtgtaaa 70440
tatgtgaatc tcaactgcaga gagacagaca agcaagaggg ggacagggtc atgggaaaag 70500
agggaaaaag taaaaagaaa ggtagataca cagaaagaaa aagcaagagt gaggcagaaa 70560
aacacacaca gacacacata cacatggggg tggggttgca ttatgtagca ttaaggagtc 70620
ataaaagtga tagaaccatt catggcaatg gctctcaacc tgtgagacat gaccctttg 70680

ataacctct atctccaaa atgtttacat tatgattcat aacagcagca atattacaat 70740

 tatgaagtag caacaaaaat agccttatga ttgggatca gcatgaaatg aggaaccata 70800
 ttaaagggat gcagtattag gaaagttgag aaccactgat caatgaactg gtgtccaata 70860
 aagatgcttt tagctgagta ttttcatttg gagaacttac cagagtctac ttcaaagttg 70920
 agtgctaggg taactctcac tgaatcataa tgtaaatga agacattgca agtcagtttt 70980
 tcagagattg ccaaatgctt caaagaaact gaaatgaaaa gtgatgggtt tcaagatgga 71040
 tagacttatt ttaataatac taaagtagga ataaaatacc tgttacagag acagttaatc 71100
 atctatctta atgaaaatac ttacggaaaa gttgaaaatg aatggaatgt ttaaattttg 71160

 atcaagtatg taigaaacat ttttcaaac tacaactgga tatttttact ttacataaaa 71220
 agcaactgca tgccttttat ttgttattat atcctgtcct gctgtgcaca agaaaaata 71280
 atctctgaat ttctgtctg ttcttctccc caaatttgct tcactataaa atctattctt 71340
 ggatagataa atacttacta atttacttca gccatgatct atagactt ttattccaaa 71400
 aatgaagata ttgtttaatt tgcaactcc cttagcttca cttcctcct tctagctcta 71460
 ataaagttat gtcattatc ataactccat tgtgagcagc tttactaaa ttatttgac 71520
 aatatagat agtataattg cagacttatt ttattctatc aattatgcag cctgtcatgg 71580

 caggcactgt tggcgggtta tattgcatca attttctca tttctgtta cagaaatcta 71640
 attgtatctt ctaaaaactg gggccttaat agcagacccc tgtgaagtta aaggttacia 71700
 gagttaaaat gtatataat cccaatagag tgcctgtata gaggaaatag ctgcttgtgt 71760
 tcgctaatac tgttggtagc tcaatttcta ttgaaattat tttggtctca gaggacgaga 71820
 ccaactccac aggcaaatg agagaatagc attccccttt gccaataatt agctggtgaa 71880
 taaaatgtta tgggatgctt gctttgaaag taggactgcc tctgggagta cacacagcct 71940
 tgtgaatgca cagccaactg cagtaaaatt caacttaaat aatgttata ataggaaaat 72000

 attccagata tagaaatac ttcacaggga ctgacagat ggctcaaggt taagagcact 72060
 tgctgctctt tcagaaggcc cgggtttggt tcttagtate cacatgacag ctcaacta 72120
 actgtaactc cagctccaga agatctgatg tcctctctt gtctcttata ctgacttggt 72180
 ttgtatcacc ttgacacaag ctgagtcac catcgaggaa ggaaccttag ctgagaaaat 72240
 gcttcaatgg gatccagctg taaggcattt tctaaattag tgatcaatag ggaaaagccc 72300
 agagcatggt ggggtgtgcc atccctgggc tgtaatcct aaattctata agaaagcaga 72360
 ctgaggggct ggagagatgg ctccatggtt aagaacta gctggttta cagagtcct 72420

gagttcaatt cccagcaacc acatgatgac tcacaacccat ctgaaatgag atctggtgtc 72480
 ctcttcttgc ctgcagggat atatgtgggc agaatactgt atacattata aataagtaaa 72540
 taaaatcttg ttttaaaaa agcatactga gcaagccagt aagcaacatc tctccaaggc 72600
 ctctgtatca tctcctgect ccaggattcc cgccttgcct gagttcttgt cctgactttc 72660
 tttggtgatg aacagcactg tggaaatata agccaaataa atcctttcct catcaacttg 72720
 ttttcttggc catggtgttt catcacagca gtggaaatgc taactaagat atctctgtag 72780
 gcacttccaa acatgtgaca tacaataca gacacatatt catacacatc catgaaaagt 72840

 aaaataaatc ttaataaca aaagaatat ttcagagtgt ggagcaagga aggaatcctt 72900
 aataaaaatc ataaaaaaa acataaaacc accaaggaaa catttgacac tttgacaact 72960
 gtcaaatcta attaacgcct tcccagtaac caaatcagtg tcaacagcag tcaatccttg 73020
 cacaagagaa gatggcaact tctgtaagtg gacacggaga tgccacatat aagaccctat 73080
 gagactgtaa acaagaaaca gataattaag caaacatat taaggaaaa taaagtacag 73140
 cattcaatg tactgacata ggaatggtca gatttatggt aaactagaga ctctttcttt 73200
 tttctatcaa caccaacctt ggtctctatc tacaagcagg cagcatccaa gtgaaatgcc 73260

 tcgcttgtgt tattcttctc tgttacagcc tagctgtagg gttaagcctt aggtcatata 73320
 tacacaatta actttggtgc ttcctacta tcaggtaagt tggattcatg ttgctcagat 73380
 gtgtttctca agtctaattt tgattgctaa ttcgtctaca gaactgattc cettctccag 73440
 tgaagagaaa tgggccactt agccagctct cctacttca caatgcaatt ggtgaagtcc 73500
 tctctcccac ttccttaga taggtgcatt ctgtttaat gtagtacttc aactctgttt 73560
 aaaatggctg cagacaatcc agaagcagga gctttctcat atattgcaa tatcacttct 73620
 atataaaga ttctgtcata tatactgag tctctgaaat aaaagtatac aaaataaatg 73680

 tgttgatgtt cttaaaatag agtgaatatg aacttgattt gattttttat tatataaaaa 73740
 ataattgctt ttccatgaag tcatttttct tccagttctt ctcttattgt aaacaaaaaa 73800
 ttatagggta aaataatatt aactgagtga ttaatagttt ttgtgaatta tcctctctc 73860
 ttatagaaat aggttaattct caattgcaa agtttagtagc aaagtagacc atattttcca 73920
 attctgagga aatcttaatc tccttcaaga gctcaaatat gatggccaca aaacagagac 73980
 atatggctca tctccactc gccaaaagat agtctcttgg atgtaaatct gtagcagatg 74040
 cactggaaaa tttttattag aaataataga ggaggaatgt tcagaaaaag ccaatcttat 74100

 tattaggtgc aaattaagcc acacagaaga gtgaaaaatc agatactggg tattttat 74160
 ctaggtacct ttgttatact taagttactc ttacatgcca tgccatctg atgaaaatgt 74220
 gccaaaaaga catcagacaa catcatgaag ttttcaatgt tctgctttg tattttatta 74280

gatccttatac ataaacacac actctttgga tatcatcctg ctaatgtatc tatcagtaat 74340
cacattgata aagctgagta aaccaaatat aaattataaa ccaaaaacca cctttgttca 74400
ttacttttgc ttcactatga taaaatacta agagagaaat aatttctttg ggctcatggt 74460
ttgaaagatt tcagttcaca tagttcttag gacctagatt ctggggcaaa ataatagtaac 74520

agcaaaggca tacagtgaag gaactgatct cacagcagac aaggaataga gaaaaagaaa 74580
gagacagggt aaagtcttca aggcagggtcc tagtctccta cttcctccag caggctctaa 74640
catctccaga acctcctaaa aaagggggac cacaaacaag ggagtaattg ttcagcagat 74700
aatactgggg tgggaaatat ttctagttaa atcataatac catttaagat ctcatctgct 74760
ctgtagctag tgttgaattt taactagggt tattgagact tgtgtatcta tcgactatta 74820
ctaaatctc attgagattt tattaactg tttcatcaaa agctgaaaaa tatcaacatt 74880
ccttccaata gagagtgaag taattcagaa acagaactga attcagatgc tgaacagtga 74940

catctaagct caactcagaa agccattggt atctagcttc tgagtaaadc taacaaaga 75000
aacgggcttc atttataagt aagaggttaa tttgatcaat tataaaattt tataaactag 75060
gagagttaga aattttgaag gttagaatat agtacttctc tggcataaat gaagttatag 75120
agcataacag tgctagtcta gaagagtatt gttttgctg catatgtatg agtgcagtac 75180
ttgtgtgctt ggtgtcccag agggcagaag gaagcactgg attctctgga actggagtta 75240
ttgggctgtg gacaccctag cagaacatgt cccaggctct ttgcaaacia gtactcttaa 75300
ccactatgcc attggccagc cctccctgca cattttgata aatagtttta ttgatttcca 75360

ttgtctgttg gttttgttaa tatctttcac aaagtgaaaa ttttcaaac cacttcccgg 75420
acacaataat ctaaaaaaaa aaaaaaaaaatc acttccttaa gatacggctc ctatagatat 75480
attgagttgg aggaagaata gaggagagag agcaggatga gagataccat atcagagggga 75540
gccaatatag gtccgagaag agatctggaa ctaggaagat ctccagagac ctacaaggat 75600
aacacgatct gacagtccgg gcagtggagg agaggatggc ctagaagccc ttcccctaga 75660
atgagattga tgactactct ctgtgctatc cttaggtcct catccagtgg ctgatggaag 75720
cagagacaga catccacaga aatacactga gctgaaatct ggaacctagt tgaagagagg 75780

gaggaatgaa gaatgaaggg gtctgtacca ggttgagaa acccacagaa acagttggcc 75840
tgaaaaaggg aaagcatatc gaccccagac gctctttggg aggctagtag gggactaatc 75900
cagccccctg atcatggatg ccaatgggga ggccccctgca ctcctgggag cctcctgagg 75960
tggactggcg ttttgcctg gtgtgtgtgg gggactttga gagcccatcc tacttgaagg 76020
gatgcgctct gtctctggac acatggggag gggcttaggc tcagcacagg aagatttgggt 76080
ggacttgggt gagcccaaaa aaaagatacg gctcctaact cctatgtcag tcagcatcct 76140

ttgataccca agagacttct gtgaatccag agtgaacatt ccagacacat gggcttggca 76200

 actaccactc caacaatcat tgttactcag tgggtgagca gcagtctcct cttgccaac 76260
 tcatttctat taaaggctt tattttcaac aacttataaa ctctccgttg ttcaaaagta 76320
 ctttgtgcat ttgaagtgcc acacttcaac attacaggaa aaagtccaag aaaggtagc 76380
 ttctttgttt ttgatacaat ttttaacttg ctcaaagaca gcaaggccta gaaagctcat 76440
 tagcaaaaga agaggaaaga tgagccgaag aaatgactct atgtgagaaa gaaacttta 76500
 aaaagaagat aaacttccat tgtgttttct cttttataaa atatgaattt agatatatct 76560
 tgtttcttat aagtttggga atccagggca ttcaatttag ctgggctttg aatcagtaca 76620

 aaatattgac aagccaatag ccacaacaca tcaggacata gatttttggga ttcaatttgt 76680
 gagtcctgaa gaagcatatg agaaataatg taacacgaaa aataaatgac ccagagacta 76740
 atattgaggt tcaaacctca tgctgaatac cagaaaagca aagcagcagg ccactagctt 76800
 cttacctcta cctcaggctg agagggctga tccataagat cttaccaag cccaaactgc 76860
 tgccctcctc cagtgtgctt agagaatgga tgcatctctg agaccttgct tctgtcttat 76920
 atactttcct aaagttcaga ttaaagggtg gagctataat tctcttttag actgatccac 76980
 tcttctgtag atatgggtga ccttgaactc agagagatcc atctatctct taacctgagt 77040

 cctacgattg aaagtatgta acacctctc ctagctttgg actgctggta ttaaagggtg 77100
 gtgcctggct tciaaggctt gtggctgaaa ttgcttttct gaatcctcag tcaagcttta 77160
 ataagtcata aataatatat cactacactt ccctttttg tcttatacaa aaagaaggct 77220
 ataactaaca taagaaaaac tatatacaat aagtatatac aatatatcta ggcaataagt 77280
 ttgtcaacaa tgictattct attttcattt gacaaattca gaaaaaatct agtccatttg 77340
 catttggcaa atctatccta aattggtgaa tccaaagtct tatacctaatt tactttcga 77400
 ttttaatttg cattaccaa tatcttttac tatcttcaa accatttata ctttacacat 77460

 atatagtgag tttctttact gagtctggta aacaatgaaa actacaacta tactttctag 77520
 tcttcaactc cctcagagac acgagaagaa aataatatta actgagtaaa caggaagtgt 77580
 gatcaagtaa ctccaacaaa atgtgaaaaa tgacaaaaac actgcgggcc tgaacagtca 77640
 cccaaggttc ctctgcaaca ttggggcatc catcttttgg gctataggcc tggcatctga 77700
 cagacttttc tgcgaaatag aattttctga agggctacce cactttgtct tggcaaggtt 77760
 ttgctgccac tccttttgt gtattgcttg tccaatttgg acagtatact gtcagcagtc 77820
 aagacaagag tattttcttg tccagtggct tactttttcc acaaagaagg caaactccat 77880

gtgtattttc tttgatgccc atcatcttct cctaagtaga ttggtgctgc caggagcaga 77940
 cacgtcttat tgcataaaa atacctatgt tattaaaaca ttttaaatgt catgttctgt 78000
 agaacactga agtgtttgaa gacaacctat ctttctaaaa tatgtctgtc tttgaaaaca 78060
 tacctaagt gattacaagt ttgattataa taggtgacta attactcacc aacatttctt 78120
 tattatctta tataattggt aataataaat ttcaagaact agaaatttgc attacattga 78180
 taaatgagct gtataggfat aataccttga actaaattag aaacacatgt tcagtatgtt 78240
 ttaacaaatt aatcttaaat ttgtaccaat ttacaatatt tgtatacagc atacaacagt 78300

 ccaatcaaat gtaaaatacc taaaactaat agttgctttt taaaagtaga atcaataatc 78360
 ttccctttat ctcatcatat ctatgttttt tagaagtgga ttcaataatc taccttttat 78420
 ctatcatat ctataccctc ccttttttct tttcaagaag agattcaata atctatcctt 78480
 ataccctatc atactgtat cctttattta aaaaaaaca acctgaatc taatcagtct 78540
 cctttgttca actttcttcc tgactttaat caacaagctt ttgtaaccaa tttccctaaa 78600
 caatgacaaa tatccataaa aatccattga atgacaatac ctcaaagccc cattctctgc 78660
 caccccccacc tccccaggg acacacttcc tccaacaagg ccatacctcc taatccttct 78720

 aaaaagtacc actcctttat gactgagcat taatatatg agtatatagg gtcattctta 78780
 ttcaaaccac ctcagtacat atgtgctata tattaccttt atcatagtcc tcatgtgtca 78840
 aaagaattct tatatcttat aatttaaga ttctcttaaa tcaacataca catgeatcac 78900
 atataatag tacaacatca ttactaaggt atttatatat tgctatacta tgtatatatt 78960
 atgtactatt tacagattta tttacatgaa gttcagttgc taatgcagtt atctagtaga 79020
 atatgtttct tacatgctaa atatcaaatg tgcctccctc taactatfff atgcaacata 79080
 ttatcatata ttcataatgc acattcatat ttctgtgtgt gtttgtgcac atttgagaga 79140

 ttttctataa ctaaggat atccctcaaag atgccctaa ttggtagctg tatgacctgg 79200
 gtaatgttt ctatgattct gtttcttggc aaaattaaga taacattggt atactttaat 79260
 attgtaagaa ataatgagt ctatacaggc aaaattcttc tgataaataa tgttgactgc 79320
 ctcagtgcat tgacatccaa ggacattctt agaatccttc cttcccaaac actatacatg 79380
 ttcccttagt gaataatatt gagtaagttt attatttata aagtatctta tcaattttat 79440
 tgaatfffgt atatactfff ctctagaaa tctacagcat gcttgattcc ctttgttttc 79500
 ccaagtttaa taatcact aaccacattt atccattggc tattgccttg catatagccc 79560

 tcatgcttat tttattctc tctatttcaa gtagtatcca ttctattttg ttctagtact 79620
 gataaaggtt tatttctgtg gatttatttt aactgtata tttcttagtt ttgctgtgtt 79680
 gttgcctgat aacctttctt aaaaaaaga aaagaggga gggaggagg gagagagaga 79740

gagagagaga gagagagaga gagaagaaag aaagaaagaa agaaagaaag aaagaaagaa 79800
 aggaatgaag gaaggaagaa aggaagaaaa gacagacaac acagagagaa agcagagaga 79860
 aaagtagtac tactgcatag gtgttttgtt ttttactctg gaggtccaca cccatctccc 79920
 aaataagtac atgaagattt atttttactt aggaatatct agccttagct tggcttgttt 79980

 ctagccagct tttctaactt aaattatctg atttctattt agctacattt tgectctggg 80040
 cttttcaact ttctttatc tatatgtctt tctttcttta ttactctgtg getaactgtg 80100
 tagatgggtg gctggttctt ggcacacctc tctctccta ctctcctc ctctctctc 80160
 tcttctctgg agccaagatt tctctccta ttattctct ctctatgcca tccctgcta 80220
 tctttctcc tgectagtta ttggcattc aactctaac tagatcaacc aggcatTTTA 80280
 ggcagggaaa ggaacacagc ttcacagaat taacaaatg ccacaaaaa tgcaacacat 80340
 ctttgtatca ttaacaaat attccacaac ataaatgaat ataatacatc ttaattaat 80400

 attccacaat gctactgtct tttataattt tttaaattaa tgtttaaatt ataaaacatt 80460
 ttctttgtgc ttaatatgat agattatgcc tgaataacta gcaattggga agctgaagca 80520
 gtaggaatat gacagctgtt ttgagacctt ccaggtcttc aaagcaagtt ctagagcagt 80580
 ctggctaga ctgaaatcat ctgagaaaa taaatgaatg aacatattaa ttaattaaat 80640
 gtttctttat ttaagagatg catttgcaa ttcttttgt aatcctgaaa taccatttt 80700
 ctgagcatg ttattcttgt gaatttttat tactatattt cctgctcttt ccttgagtc 80760
 tgtgcattcc aagtgtatag atgtttttgc ttctgagttt ctttgaata aagttacctg 80820

 tgtctagggt ggtttgctca gtagtaatga aagcagcagg ttgacatttg atccaggatt 80880
 gcaaagccag caaaaaaat gctgatccag taacattttg catttcttct ctgaaggcaa 80940
 gccgccatct agacaggagg tactgatttc cataaccttt agtatttggg ttgatacttc 81000
 agctctgctc aaccaattca gtccatgact ataaaatcaa aatcaactat gactcaattt 81060
 ctgttctcca ttatgatgtc caccatgatg cccttgatgt attgtaagta gaaactgaat 81120
 attctctcaa acatctgtaa tgtttcactg agtttcagag ggtaacaatg taacaaccta 81180
 atacttttat tttctcttc atttcacca ttgactatct cttctttttg taaattcaat 81240

 ctacatcact taattttaca tgatttcttc ctgggttggg gagatgatct gctttgattt 81300
 tgtagaggaa cacgtgcttt tgggttgtga actctctgtg aagaatttta agattgagtt 81360
 gtgttctagg cacaagattg gccctgaatt ttctcttta attttaagaa attctacttt 81420
 gccaatggaa aaaaaagaca tttgttgggg aagctgtagc cacgcctact taggggctgg 81480
 ctacagatgt gectgacct gcccttgcaa gcttgtgtgt gtgtgtgtgt atagtgtatg 81540
 tggtttactt acacatgtgt gtgcagagtc caggaaaggg tgttgggtga tctcttctat 81600

cactctctgc attatccctt tgaggaagag tctctctcca aacctagata tgggtgttta 81660

 gctaggatga aaaccaaagt tcccagcaat cctcctgact ttgacccta aaagtatgga 81720
 agtctacaac tgacttgcta aatggacggg gagatacata tgcctcata gttgtacact 81780
 aagcaatctt aactgctgaa ccatctctcc agtaccat agtactttaa attccttcaa 81840
 taccaaagt tctgtgagtc ttgtattgtt tcatatctac atggatgat gaatgaaact 81900
 gtgagagtat gtaaatgttt ccaagtact tttcttcatt ttgtcaatgg agaattgat 81960
 acacttataat aatgtatttc agtcaagctc accccatcga cttgtactct aatatcatac 82020
 attctatgtc aacaacagag aatgagaat actgatttaa aacatgaatg tcagacagtg 82080

 attggttcat tctcgcaaat actggcccca ttgagacatg ccaatgcttc tgatatttgt 82140
 tctcatggtg ccatctatgc tttcaccttc caagtttctt gcatcagtgc agaattctgt 82200
 agtaagtgtt cacaaagaga ggcctacaag ctaatggggc caaacaccgg atactatatg 82260
 gcccatgaga aaagaactgt ttgtgtattg acaaatggtt ggagaggaat caaagtaaaa 82320
 gcaactttcc ctgacatgaa agaactatat aaaatccaga tgtctatgac cataagttcc 82380
 tgtggaatac tgccatgcc acacatttct tatgctatc agcatagcag agtgtttgea 82440
 aaggaaaagc agaatagtat aatatttgc tacagattga atattgttc agacaggttt 82500

 aatggttttt gtcacggcta acgatgaact atccctgatg gtctgccctc ttttatattg 82560
 gtataagctt ctttgtcatt ccagtttctt ttcataatta aaccggcaca cagccctctc 82620
 tctagacca tctcataga tttcccaaac tccagaacca ggagccaaaa taaacttctt 82680
 tttttgtaa attgcctcat cttaagtatt ctgccagagc aatggaagac catgacagta 82740
 tatctttata cccagcacat gtaatttatt aattctcaat gattttctat attcagaaat 82800
 cacttaaat tgcttctta aatttctaac tgaatgaaaa ttctagttat ctgtttttaa 82860
 ttattgcttt aatattgtc atacatgata tgatagtffc aattcataga aatagacata 82920

 tatttcagtg agtgtacaat ctgtttttac agataactac tgaagaacat gctcttttct 82980
 gcttatagtg tacatacaac aattgttctt taatttacta ggaacattat agatttgggt 83040
 gatggacctg ttcaagaaaa acatgtcaaa atctattttg ctgtgcatct gagagttttg 83100
 ctttgtaatt ctgtcagttg attcttatgt taaaaagac tattgtttga aagacagtat 83160
 aaaagctttt tcttgatggt gaattgaaat cttttgcaa tatatgatta ttttcattat 83220
 attgtgctaa aatgttagtt ctctgtgttt atgaagcagt aaatttgttt tgggtagatt 83280
 ttgcatgatt tatgtttgcc aggcggttgt cagtgttaatt atgtcattca gatgagactg 83340

ggaatgtttg agtggttatg gccatatata tattcttatg gcagtgatgg ctatatttag 83400
 atttattata tcatgttctt tttggcttca catatagtat ctgaaattcc cagtggagag 83460
 cctttgtttt agcccttcat tcagcatgac tttacaatc acacagatgt aaggctcaaa 83520
 aatatccac cagactacct aaaactgttg acaatcagaa gaaaaaaaaag tggaaactgt 83580
 gagtgacctt gaaaggttct ctcttacaatg agggttgctt tgtgagctct aagaacttaa 83640
 ctgaaaaatg ttgggagaag gttgtggatt agcatgcaca catgattttg gggtagtgat 83700
 atcttggaca agttttcatg ggagacagag ttgactaat tgtatttatg tgcaggattt 83760

 gactcaggcc cactgtttgt gctgaaattt ccttgggtgac actggacagg gtgacactgc 83820
 ttcccagcca ttcttggact tgtggctgct acttggccca ggttttagagc tgttctgctc 83880
 tgtgctgta ccctgctttt ctccctttct tctgtgcaa aatcacagc tgttgctgtg 83940
 tgttgctgc tttcccaggt gttgttttat attcagtatg gcaacaggat ttaaaaagt 84000
 gtggcagttt gaatgtgat acccaagcca gaaaagcaaa gctggatgtg ttccagctat 84060
 tacactctcc tctgttttg actatgcaag ggggtaacat tgtattggtt aaccctgggg 84120
 atggtgtgat ttctagatgt ttacctccac tcacttttat ttctcaactt ggtctctttt 84180

 cattcacttc agaagcaaaa acttcaaaat tgattgatag actacaaatc tgaatttac 84240
 tatagctgga tactattaat aacttttttt tactttctct ttttttaatt ttaaagtcta 84300
 atctgttaa atgaccagca atccaaaatg tagcttgatg tatttctact gttttaaaac 84360
 acacatctgt gtgtactccc cacatagatc aagacaatgg ctctcatct cttcagaaga 84420
 ttgtccatgt ttctttctgc cttatacccc atcatgcctt aaacccact attctgacgt 84480
 ttataacagc taattagtgt gcttgtgtgt atatttcta taaatgtgca attattggag 84540
 gtggaatttc ttaagcatat aaaatcacag tcctcact aaagtatgga atgtgaagga 84600

 aaggggagaa ataataacac acagccctag gatccagctt tctaataagt gaataaaaca 84660
 aaatcttccc agaaagcatg aacttgaatt ctatacatga gagtgtctat agatatgcca 84720
 tgagatataa atgtaaggaa taactggaaa agaatctac gactgcaaaa atccctaac 84780
 ctaaatacta aaagaactga tgcaactgca aaagaaaagt cctgtgagta ttageccatt 84840
 attgaagaga aagtttaaaa gcagagggaa aagtaaaata ttggtatgca aatacattga 84900
 ttgtttgaac attatttatg ctaagtcaaa ctcatacctc actaaaaaga aatttaaaaa 84960
 atgagtaatg gaagctggta cttctaaatt tcttttctta aacatctaag gagccagctt 85020

 acctaaagaa ctcttataaa accttcagag cagttgcata aacctgacc cacttttcag 85080
 cctgcctggg atttcatgca ctggaaaatt cttatttggc taatttaact gcattgcatg 85140
 attcgtccat tattgattat tttagttct gaacacatac aggaagaaag gcatggtgat 85200

gcttctctc ttgtggcatt gggagtgtat tatcttctat tgtgcattgt aaggtttagc 85260
 caagtaaatt aaggcacata gatgtcatag acttgcaatt ttgtacaagc tcagcatcca 85320
 cctttcagtg gaaagatgtt cttttcagct ttctctttg ttatttttaa cacttcacct 85380
 gccatattaa aattaatctt gtttatcttt tcctatcctt aaaaaatatt ctgtgggata 85440

 gaaagatggc tctgctgta agagtgtttc ctgttcttca aactagatt tctgttccta 85500
 gcacttacat tggcagctcc tgagcacatg aaactccatg tccagtggat ttgatgccct 85560
 cttctggccc ctgaaggcct ccacacaaat ggcgtgtact cacatagata cagacacagg 85620
 agaaaaataa agagaatttc aacgaaaaat gcttgctttg ccctatatg ttaggtttta 85680
 tgtaggataa caactattta aactttgttt ttttattatt tatgtgtgtg tgagtgaag 85740
 tgtatgcaca tgtttgggaa cacatgggga ggccagaaaa gcaacaagt ctcttagcca 85800
 ctgagctcta tctgtaacc tggatactgc tacaattctt acacctagga tggatgatg 85860

 gctcaggagg taagggtgat ttctgcca gtcccagtac ctgagttga cgccannnn 85920
 nnnnnaagt ttgataaga gtcctctaaa atgtgtgtaa agatgctgaa gtgtagcttt 85980
 tcactgttga tggtttctgg tggaggaggt aggaagaact cagttatctt taagggactg 86040
 accactagga gtttgacaat aattgaatca atatatgggc acaaaaaatt gaacctgttg 86100
 tgttttttc tttgggagga gaagtcacaa gtctgggagg gtgaacttgg gaggaatggg 86160
 aagtgagttt gatcagggtg cataatatga aattccgaaa caatcaataa caatattatg 86220
 ctggggaaaa taataataaa acaagtcagg ggcacatgca gaataataaa aaataaatg 86280

 caatatcaaa atgaacaaca taaaggctt tcaaccttat ggaacactgt aatgatgatt 86340
 acagttagaa tattgatgca aaaaaagaca ctaagtacag atggtggttg gaggaaccag 86400
 tgcttctggc agatttataa ctgttaatag acattgcaa gtttgaggtt cttttcttat 86460
 agtacaggat tctgcatttt ctctcttgc aacattttat tctgcagtat atcttaaac 86520
 accataggca agatataatg tgcaggtgtg tgtgctgtg tgtgtgtgtg tgtgtgtgtg 86580
 tgtgtgtgtg tgtctgtctg tctgtctgtg tgtacatgca cacctgtatg caagtgacaa 86640
 tacacatctg tatctgatcc agtagaggca agaagtcaac attaggcatt ttcttcaatc 86700

 ataatcagcc ttgtttttg agacaagaga tcttactgaa ctgtggagct caccaattca 86760
 gctagactgg atgtccagca agcctcttgg atccacattt acatgaccag cactagggtt 86820
 actgatatga agcagcatat ctaccctatt cacatggatg ctgtgaatca aaacttactg 86880
 cctcgtgctt gcacagcaag cactttagt cctaagccaa ctgaagatcc caaactgtct 86940
 tttcattage agttatcttt tgatctgcta gccttgagat gactaaaagg aataaaaaata 87000
 tattttaaata tattgtttgg cttcacatga ctggtagtat gataaccata atggtttgct 87060

taattcataa aaatacacct tactaactta ctactttgtg cttttgtaat aagactcatt 87120

 tggctattaa tgaatgccca agagtagaga tacagttcag acctcattat tttgaccatt 87180
 aaccaaagtc ttatgctttc agtttctggt ttacaagctg ccaaaaatta agacaaacaa 87240
 atatctttca agcctgctca cagctgaata gctattctac agggcacttt ctctccactc 87300
 tgctggtacc attggaggat tcttgacca tgagcagccg aacctgaagc acctatggaa 87360
 gaatgctgtt ttaaagtcaa ttcttattct ggaatcccat ataccagtc tttgctttgc 87420
 atacattaag cagaggaat tttaagattt cttttcagac aacctttct agcaaaaatg 87480
 atgtcattta cctacaagac tactttgact tagcccatcc cataggcttc tgtaaagctt 87540

 caaacatcat gatattgcca aacaattctc taaggggaaa cactgcatga aattgagcta 87600
 gattgagtag tatattttgc agactgcac aaatgacttg gtcagatcac aaaattcaga 87660
 tactgataaa tataattact cgattcattt atttctctc aatactaaaa catatgcac 87720
 aacatcct tagtgccata gctacttagg tgattatggc tctcagttgc ctagtgcac 87780
 actagtatac agatattatc tttcggtttc agcatatata atctgacctt cagttgtgag 87840
 aaaacttctt tegtggtgaa aatgttactt gccacaaagc ttectcaacc tgacttcccc 87900
 agtggagtgg gagatgcctt aagaccata cttgtcagtg aattctgtgg agcagcccga 87960

 ggcatttgac aaaatatgta ctgtaccaca cattaaaaaa tgatgtgtag agtttgaag 88020
 tagtacaact aaaagtaaat acatacaaac aatgtgacaa tagatgggca cagtgtgag 88080
 gaaacaatat taaggtcaag gcttcaagac ccagaggcta tgattatcag tcaactattct 88140
 aaaaaagaaa tattctcacc cataacatct gaaggcagat acctattgct tctatgatct 88200
 tatgtattag ttacttttgt ggttctgtga caaaacaatg atgaagtaag ttaaaagaga 88260
 aaggcctctt ctgccttata gttcaaggtc catcatggta gtcaggccaa agcagcagaa 88320
 gcctgaatat cacaactaca gttgaaagat cacacagcac caacagtcag aaagcagagt 88380

 gaagaacaca tggatcatgct tcatttccta taattcagga ttcctgtct aagaaatgat 88440
 gccttcaca gttaaagat gtctttccac atcaactaac ctcatcaaca tgccaagatg 88500
 gtgcattttt ctigtatcc tggattctca aatttact aacctccacc acaagttgta 88560
 aacttattca tttagaaaga ttgtgcttag accagaagag tggggaggga gctaggagaa 88620
 taggaagggg agaagaggag ggatgcagag gacatgaggg agcagaaaagg ttgagtcagg 88680
 ggaagaatta acaagaatgg agataccata atagagagag acattatagg tttaaagaga 88740
 aatcaggcac taggcaatgt ctggacattt acaaatatga caccaggtaa caatctaagc 88800

aacagaggag aggctacctt aaatgccctc ccctgataat gagactgatg actgacttat 88860
atgccccca atagccctca tccagcagct tgtggaagta gaagcagaca ctcaacaacta 88920
atcaccgaat tgaactggaa tccagatgca gaggaggagt gaagagcaaa aggtccagac 88980
caggctggta aaaccacag aaacaactga cctgaacatc ggggacctct tgctccccag 89040
actggtagct gggataccia catgggactg atccagactc caggaacatg gatttcagtg 89100
aagaaacctc ggaatctac aggacctcct gtagttgttc agtacttatg cctagcacag 89160
gtggggactt tgagagccca ttccacatag aggaatactc cctgagccaa gacacatgga 89220

tgtgggccta ggcctatcc caaaggatat gatagactct gaagacaccc ccccatggaa 89280
ggcatcacca tccaggggaa gcagaaaggg tatgtgatag gtagggtttt agttgggggg 89340
atagtagggg aggatgggag ggacaaggga actgggattg tcatgtaaaa caattttcta 89400
attcaataa aaaaaataaa taaaataatt tagacaaaaa aagaaaaaat gtcacaatga 89460
aaaaaaaaa aagaaagaaa gatttgctt agaaatgcat tcaaggatcc atgctctcat 89520
catcataact cagatgtctt gaaccaggag atagctctgt tgatttgta tttgtcttgg 89580
cagaatgaga atggaagtgt acttccaaga acccatatta aacagccagg tgggtgtgtg 89640

tacttgcaat cacagtgcag gggcagtgc gacacgatgc cccatggtgc tcattggcaa 89700
tccagcatag ccagcttctc aaattctggg cctgtgacag acccttgctg aaaaaataaa 89760
ggtgtctgac atcctaaaga agaatactga gacaatctat ggctacacaa acacacacac 89820
acaaaagtgt acacacacac acaaaagtgt acacacacac acacacacac acacacacac 89880
acacacacat atgcaccata gacaatagat aaatagatgg tagatagata gatgacagat 89940
agttgataaa cagacagatg atagatggta gaaaaaaga tgatctagct acctgataag 90000
tggatatata aaatgactat aacacttact actttgaagg ctagttaaat gctaaaccaa 90060

atgctttcat gcaccaatcc tcagaggggc caatggttaa tccatatact gatcatgggc 90120
tacaatgcat tacaagaaag tctcttagct ctgagaccaa aagccttata actgaatctg 90180
ataaacacct caccgacata ttacaccaca tttctcactg ttgatgcaga aaataagaat 90240
ccttgaacaa tgetggctat taaaaatgc ttaatcaaca gtttgtgtgc taataatatt 90300
ttactgtgtg caaataaaat ttctctatga ataccggcct cttagtccag gcagctaaat 90360
atacttctga agagaagaaa aaaaaatgtg taaggtcaaa atgttttccc cagatttctt 90420
gctgatttaa caagaaaact taatagaaat tcctttgctt ctactttat gcacagcaga 90480

gataaattct tataaaggga aggaaatgct acaagtgaag aactaatga ttttaaggagc 90540
tattaacgat tgtaaaactg tttataggac agatgtccac agctgctaata agaaggcttg 90600
aaataggact tctcatgcca tcttggttgi taacccttt tagagtgtctc aacacactgt 90660

tttgtgatta atacctaatt ggaatatacc atagcagatt cattgcagtg acttctgaga 90720
 aggctttttg gttgactctt ttcaggccat acatttgaaa tttgtcttct gatggttaag 90780
 gataaactta aacccgagaa catattctta tcccattcct gcaatgagta tgtccacatc 90840
 tactggggtg cattttcttc acatgtactic atgcatccat gtttatccta gcaattgggg 90900

 aattgccaat aattgcaaaa ggtcaggata aagcagaaaa tttgtagatt gctgtgtctg 90960
 ccatttgtea tcaaatgtgc cctataaatt tcttcataat agagaggaat ttttttatta 91020
 caatatttac ctigccittg gcagagtta aacaagattt gaaaaattac tcatcgattt 91080
 tatcagccct taaattaata ctaaacatta caaacattc cggctctctaa ttgacctagt 91140
 gtgttcaatt catgttgaga tgtacccaaa taatgtgatt aggcattdca ctaatatggc 91200
 atggatatgg taagtagtct cttctcattc tgtgtgttgg gtttcatgtg ttgtggtatg 91260
 catgtatgta tgtgtacacc tgtgtagatc aaaggtagat gtctaagtgc ttcatacacc 91320

 actctttagt gtttgacaat ctcttttctt gaacctacac ctgcaagat tgactagact 91380
 cgctgtccag caaaccccaa gtatcttctt ctctgtcttt ccagttctgg ggttgtaagt 91440
 acattctgat ggtgtggtat tttgattagt ttagccaatg aattttggga cagcaagccc 91500
 taaggtgtgg tcttgtttgc ctatgtgaca ggttaaaagc tgaggaagag ggtctagcac 91560
 tctcactctc ttgggtggg ggagcagagc aggtggcttg ctgttgggtg tcttcaccct 91620
 tgggcaggat gcctggagga atgcagctgt atgagatcag cagcagcatg taattggttt 91680
 tgtatcagt agtgtttgtc cctatcattc acctacataa attcttgaga cccttaaca 91740

 cattctcttg acttctctct acattctgga ctttttaggt ggatgctgtg gactcgagtc 91800
 cttgtgcttg cacagcaagt aagcctttac tgactgcatg accattctct tctcattttt 91860
 ttcttataga tttatatgtt tttattttat gctgtgaag gctttacatg tgtgtgtgtg 91920
 tgtgtgtgtg tgtgtgtgtg tgtgtgtgtg tgtatgtgta tgtaattcct gtcttctaca 91980
 gaggccagaa aatggcattg gaacccttgg aagtgaagtt ccagatggtt ctaagccaac 92040
 atgtgggtgc tgagagccaa acatgcactc ctacaagaa cagcaactac tgctaactgt 92100
 tgagccatct caccacttcc tctcttctca acctttacac aactattat aattaaagta 92160

 ttttcaacct ccattctccc tatttctatg taagacagat gtaaaccgga ctgatgtcca 92220
 tgagtctgt ccagtatgac ttatttagca gtttccctta agactagttc taatcaataa 92280
 atatttacag tatttcattt gactaattca tatgtcaaac tcaagagca taatattttg 92340
 acacattatg ttcaatactg acttaaaata gattgagatt tatgtttatc ataaaacaat 92400
 attttgctg agccttgaat catatcatta gaaaattgaa agaacatttt tctctggaac 92460
 taaaatacac acttgtaaat caacatggga cacctaaaat tgtcagaac acaaggagta 92520

aggatatactg ttgtaaggta tactgctggt aactctatgc actaacttcc tgcctcagca 92580

ccggtcagaa taagttcaag tcagaaagta acaaagtcct agaaatcatc attgaacaga 92640

tagatctggc ttaggggtg tgtgtgtgtg tgtgtgtgtg tgtgtgtgtg tgtacctgaa 92700

aatataagaa agtacttaag aaaattacta aaagtttttc tctcatttca ccaaaaatat 92760

attcacaaaa acataacata aagaaatacc attgtctagt cccaggactg ctaaagaata 92820

cctttatata aagcaatcat attttgtttc tttgtattaa ccttgaacta ataaaaaat 92880

ggaatttgaa tatttatagt tgcaataaaa attttgcaa tgaagacaac taacttatat 92940

ttacaaaaaa aaaaaaagc acatggcacc tggccctatc ttgaggggat ctgtactcca 93000

gttcaatctg agttccttac agtagatcca taaatcccca aacagctaata cataaaaata 93060

ttaatgcaac aagcacatgg tttatttatc agacttggct tgctagcctc ttacaggatt 93120

gccaggaaaa gggaatatta aaataaacga tatatgtgtt cagctctggc aataaatcaa 93180

aggaggtaga gtccttgta gagtagattc cagcacagtg tgttgctttg tcactttaa 93240

ctgactagac attttcaata tttatagaat tactatagtt tgaataatt acctgggtag 93300

aattaaaaac ccaaaatata ttgaacattt taggatagta tatattttaa gttatacagt 93360

cagcccaaag taagatacat gttttagttt tccaaaatga tttgttagag aatttacaaa 93420

ctaagacacc ctttaataat ttattaaaac atgcagttag aaccatttac aggaaaaact 93480

aacatgattt gtggtagtgc cttatagcag ctgaatttgc actgtgttct gtttttgttt 93540

ggggggggag acactttctc actatgtcac ccaggttggc ttttaactcc taggctataa 93600

tgggtctcct gccttactat ctggggtagc tgagaggaaa aggcgtgcat tagcaaacac 93660

atctggacag atttacttcc ttagttcatc acttgctgaa tgcaaacatt tgacaaaagg 93720

aaaaaaaaa aacaacaaca acaatcgtat gctgacagaa ttcggaaata ccatccacac 93780

tggatacttg aacattttgc agcccgcaca accacatctg atcttaaca gagttactec 93840

cagggtctgt accatcccta tgtttggcat agtctgcttt ctttatttct tttttaaagt 93900

agtcattatt tttccattt tattaataat agatccttta ctcacacat atatcctaat 93960

tatagtttct ctttacta ttcccagttc ctctcacct cctctccat ctggatcaac 94020

tccctttctg tctatcattc aaaagaacag gcttctaaga ggcaacaaaa taacataaa 94080

aagataaacc aaaaactatc acattgaagt tggacaaagc aagccaacaa aggaaaagag 94140

cccaagaga atgaacaaaa atcagagacc cattgggtca catacacaga agtccataaa 94200

aatactaaac tggaagctat accatataatg cagagaaact gagggctggg gtttcatgga 94260

gatatcccat ttagagctgt ctctttctgt gtaatgtctg gctatggtga aaagagatgg 94320
ccagctggga ctctgtctcc ctcatgtctt agagacttca ttcagattgc ctcatatat 94380
ttaggaagt ttccatggca ttaggtatac atgtcacctt ccaaatgtcc ctcaaactca 94440
gcttttctcc ccaaattctg tccctcataa cacatctaca gtcttctttt tttctccatt 94500
tttttatttg aattagaaac aagattgttt tacatgtcaa tcccaggtcc ctctctctca 94560
cctctctccc tgccccaca caactaacac cctacatate ccataccctt tctgtctccc 94620
aggaagggtg aggccttcca taggggtttg tcagagtctt tcatatcatt tgggatagga 94680

cctaggtcca ccccttttg tctaggtcca gggactatcg ctgtatgtgg gatgggctcc 94740
caaagtccat tctatgcta gggataagta ctgatctact acaaggggcc ctatagatta 94800
cctaggtctc ctacatgaca cccacattca tggggtctgg atcagtccca tgctggtttc 94860
ccagctatca gtctggggac aaagagtctt cacttgttca ggtcagctgt tctgtgggt 94920
ttcatcagcc tggctctggac cctttgtctc atcactctc cttctcttca actggattcc 94980
agttcagttc agtgattagc tgtgggtgtc tgcttctact ttcaccagct gctggatgaa 95040
ggctatagga tggcatataa gttagtcatc aatctcattg tcaggggagg gcatttaagg 95100

tagcctctcc tglattgctt agattgttcg ttggtgtcat cttttagat ctccacacat 95160
ttgcctagtg cctgatttct ctttaaacct ataatgtctc cctctattat agtatctctt 95220
atcttgcttt ctctattct tcccccaatt caaccttctt ggtccctcat gtctctctcc 95280
cccctcttct ccccttctta ttctctagc tcctctccc tctctctata tgctcccaat 95340
ttccagagga gatcttgctc ctttcccctt ctccgagggga ccatgcatgc atgactctc 95400
tggcagtgtg gattgtaggc tggtgatcct ttgctctatg tctagaatcc atatatgaat 95460
gagtacatac catatttgc tttttgtgat tgggttactg agctcagaat ggtttcttct 95520

agttccatcc atttctctc gaatttcaag attccatttt ttttctctgc tgagtagtat 95580
tccattgtgt aaatgtagca cattttctcc atccattctt cagttgagga gcatctagat 95640
tgcttccagg ttctggctat tacaataat tctccaatga acatcgttga acagatgtcc 95700
ttgtcatcta cagtcttctt cccctctga tcttatactt tctgcctcc ccaggtcag 95760
ttcaccata aaatctattc tatttctccc ttctatgaag atttaattgt tctcttagt 95820
gtcttctct atacctacc tctctggatc ttcaggtgt agcatggtta tcatttgttt 95880
aacagcacat gtaagttaat acataccata tttattttcc ttagtctgtg ttacctcaat 95940

tagaaacttt ttttctttt ttctttttt ggtttttcga gacaggtttt ctctgtgtag 96000
ctttggagcc tgcctctggc ctggctctgg agatcaggct ggaatcgaac tcacagagat 96060
cagactgcct ctgcctctgc ctctgcctct gcctctgcct cctgagtgtc gggattaaag 96120

tgtgtgccac caacttccag ctagaacat ttttttttt tagttccatc catttgtctg 96180
 caaattttat gatgtcattt tttaaagaac tgagtaatat accattgtgt aatgtaaca 96240
 ctttttgtt atccattctt ttattgaggg gcatcatttc tggctattat gaatagagca 96300
 gcaataaata tgtttgagca agtgtttctg tggtagaatg aagtgtcttt tgggtatatg 96360

 cccaagaatg gtgtagttgg atcttaatgt agatctagtc cttttctgag aaaaagccac 96420
 attaatttcc atagcagctg tacaagtttg caccctatg tgtaatgaat gagtgttccc 96480
 cttgtgccac accctcacta gcacaagctg tcacttgtgt tattgatctt aaccattctg 96540
 gcagatgtaa gatagaatct caaagtagtt ttgatttgca tttccctggg gtttaaggat 96600
 gtgtaacatt tcaagtgttt ctacgtctgc agaagccagc cttggtgact ccccctgcct 96660
 agctagccac cagctagcct agcatccac cactcaggtt ctgggacctg gcctgagaag 96720
 caactaacac ctttcccat ttccttagtt gtgcttgaga taaacatagg agattccaaa 96780

 tacctggcct gagaagcaac taacacctat cccttcccc acttccttaa cacaggagat 96840
 tccggatacc tgctgagag caattagcat tcattctcc tcccactcc tttttctctg 96900
 ctccacctt tctctttaa aatecccttg gtttcaataa agttgacctt gacaaggaaa 96960
 tctgcttggc ctigtctttt ctttccgcc cattatttgc aggtgtgatc cactcacaaa 97020
 ttaccggage cctccggac ggggcactca gccattaaaa cttcctctgt tgagaattct 97080
 ctgcttacat ctgtaccca tattttcatt ggattttggg ttttgatac taggttcttg 97140
 agttctttat atattttgga tgtaatcct ctattggaaa caaaggtaaa aaaaaaaaa 97200

 tcatccatt ctgtagctg ctgctttatc catatgatga tgttctctac cttatagaag 97260
 cttttcagtt tcatgaggtc ccatccatt tattaattgt tgaagtaaat ccctacatta 97320
 aggttgttca gaagtattct cctgtaccag tgagttaaag attattccgc acattctctt 97380
 ctatcaaagt aaaatatata cagttttgtt ttgagctctt ttatccattt ggagatgagt 97440
 ttgtgcaagg tcatgagtaa agatctttt gcattcccgt atatgcagtc attcagttgg 97500
 attagacca tttgttgag atgctgtttt attttttccc caatgtgtat ttctgccttc 97560
 tttatcaaaa atcaggtgtt cataggcata tgggtttata tctgtgtttt cgatttgatt 97620

 gcactgatca acatctctat ttttatgcaa ctattatgct gttttgttg ctatagcttt 97680
 gtagttcagc ttaaaatcag aagggttttt tgttgtgtt gttgtgttg ctttttttat 97740
 tgttcaggat tatttttagt aatcatggg gtctttgttt ttccagatga aacttggat 97800
 tgttctttca tggatctctg aaacaattt catgagaatt gcaatgcac ttagattgc 97860
 tttcattatg acagccattt tattgttagc cctaccatt tatgagcatg agaaatcttt 97920
 ctatcacttg acatcttctt caatttcttt cttcaaagac ttgaagtttt ttttcaaaa 97980

gtctttctct tgcttggta gaggcatttt tgaagggtgt tttttcccta gtttctttct 98040

 ctgtcagtc tttgtatgta ggagggttac tcattttttt ttccttttag ttaattttgt 98100
 atccagctgt attgctgaat atgtgtatca gctgtaggag tttcacagtg gagtttttaa 98160
 ggtcactcct ataatactat catacatct gcaaagatat ttgatttctt ctatttgatt 98220
 tcttctatc caatctgtac tctcttgatc cctatgggtt agtaggggtg cctgtaggat 98280
 tttgtggctg gataaaggca acaagtgtgg gaagcaaagt taggagagga aagtctgtgg 98340
 gaattacagg agaagtagac aggggtgggga gaaggaagac tgaaggagc attctgttgc 98400
 agagctaggg atgagactgg gaattagatt tggaggaaaa gagggggggt gtgatgatgg 98460

 tcttcagtta attacctgt tttcctggc tgctaagcag gtatgttctt aggggatccc 98520
 tgctggaatt ggaagctagg ataatggatg ggttagcggga aggaaggttg cagaagatct 98580
 ttgtgatcta ctgggatgg gtcaaaggagg aaagggggat gttctattac agagctgtca 98640
 ggagattatg gggactggac ctggaggaac aaaaggagag ggggagattt gcatatttgc 98700
 atacagccta cctgtttccc tggtaggagt gccctttgga tttacatggg atgcctgctg 98760
 gagttgagg gtaggaaaag cacagagtca ggaagagga gttaggggtg gaagatctgc 98820
 tagaccaca agagatggga tcagagagac agggaaggta gcagccagtg tctgctgca 98880

 gatctggggg tgagactgaa ggcttggatc tgggaaaca gagagagcag tgaagacctg 98940
 cagtctgtct acctggttcc ctgacaggag tcatggttgc tttcataaac tttaaagaaa 99000
 tccttcagga attctcaggt ggtttgtcct ctcttttcag tcaatggttc gtgttttgtg 99060
 aaagtctcc tatcccaat tactttgcat tggctgctgt gcctccttgg agcccttttc 99120
 ccaccagaaa catttcaat ctctgtccct ctagcaatgt gcaacttga atagattaac 99180
 ctatctaate tctatttca cctgctgtt ttagacttgg ttaattcata catatggcag 99240
 cagccaaaat acaacaggaa gtatatttag aactgtgacc aaaacaatgg atggcctaag 99300

 acaggaatgt caagttcaat ctgccacgca tttaccatgt ctcaaaatg acccaaca 99360
 gagttgcaat ctcatcaaga atgaccagt aattaacctt cgtataatc aaagtcatc 99420
 actcattact gctagcaaag tcatcacaag ggtgggtgtc ttatccatcc agtacacaga 99480
 aactgcagcc attatgttcc agaattccag tccttagagc tcggtacaac tatgctttgc 99540
 ctcaactgac agatttccca aataatgaat ttgttttgtt gttttgtaga catcatttac 99600
 aacaatacca taacactcat tgcttcatac ccgtattata aatttattgg actaaaattc 99660
 cacactttag actcttgaat aactgagtt tgtgtagcta aaatttatta ctctttaca 99720

agttctgcca aatgacagtt agtacaaact gatgacttga aaacggctat tgattttgta 99780
 aagtttcctt ctggtttata atgtctcccg cttactgaca aatcttttca attcctttcc 99840
 tgcactccaa actcatttta acataaaactt acctttcttt tgtcctactg tgctactcca 99900
 taactgagtg catagcactc ccagcttctt aaccactgag gtgagaaata cagaggctaa 99960
 tctgtttctt tccccctctg tcagctttca ggagtaatta cacittgaga tatttccatc 100020
 ctgcatctac tccatctcca tgttctacac acacacacac acacacacac acacacacac 100080
 acacacacac acacacacac acacagaaat tcctttctc ttgtgtcaaa gcaaagacac 100140

 agctctcaat tcaaagagag acaggagaca gattattcta gagccaaact atgagtagat 100200
 cacaaaaaca tagatttaat gttccttggg cagctatgta gaacctgatt tccttgctac 100260
 ttaaaact caggacagag tacaatccct aaaatcatac ttaaatcaga gttcatgtca 100320
 ggttgtgtcc cacagttgaa tcagaagaga ggtgtcttgt tactaatgtt gaaatcttat 100380
 tgatttaaac ttttaataat taaaacatta gtttcttgat ttcatgtgat acaaattcaa 100440
 agtttttcaa agacttaatt atttttattt tatatgtatg catttttgcc tgcatttttc 100500
 taagtgtacc cttttgtgca gtatccccag aggccagagg ggggcatcaa atcctctgaa 100560

 gctggagtta cctatgactg tatgctagct ttgtggatgc tagaaactca accagagtcc 100620
 ttaacaaaag cagaaagttc ctgtagacac tgagcaatct ctacactggt tgaacatggt 100680
 taaaacttat tgtaattaaa atcatatgaa ctgggaaagc acattcatta taaatatcca 100740
 aaaggatcaa gttaagaaa ttaaacatt attctatgaa ctgactcaat ctcaaaaaaa 100800
 aaaaaaaaaa aaaaaaaaaac ctttcttaaa accctttcat tttcttttcc tatattgcaa 100860
 cactgaaata tttacatctt gtcacttttt ggttgcactc accaaaactg aaagttaaga 100920
 ttgaacatat ttgcatatc cttccttgta tagtctttta accatagact ggttttacac 100980

 tagctetaag aactaaatga ttggatttct tattatttct attccatcat aatctactgt 101040
 gattatgaaa tttcaatatc acatttctct ggcatcctca ttccaatttg tagcacttaa 101100
 gataatagga cagatcgtat agaaatcatt tcactgatga catcttgcta gcctaactga 101160
 agagtgtaac taacatcaac tcagtatcat tagcaagctt aacaggccac atatgatagc 101220
 aaaaagatat cattatattt agggcatttt cattttatta tgtgaggaaa ataacagta 101280
 tacaacatc aaaaatctat tgtaaatata ttgtcaaat ttatcaaagc atgtataaat 101340
 agtcaagaag ttaacaatat cagctgctct gccattgctc agggtttcag tggttcctgg 101400

 tacatgcaaa gaagtttcta ataatcccta aaacaggatg taaggggaga agttggttct 101460
 gataccttaa taccattttc cagaatgttc ttggctacag cattactgat gagacaaatt 101520
 cttcactcaa gggttaaaca catcagcatg actgtttctt atagtttctt gaagcagaaa 101580

aattatctct ctgcagtgc ttagaattgc atgatgtatt tacagcaact gaacaactct 101640
gaacactttt gatcttctgg aaaatatcca catttgcatt ttgaactcca tcaatagaac 101700
ccacagggct ttcttctac aatgtggatc tagctacaag gactgagatg gtgaattcaa 101760
gaccttagta tagacagaac aacaagagag aaaatctaaa cagaatgtaa tggcttgagg 101820

gcagtcagag aggaagctgg ccatctgaga ggctggggtt gcaaaattgt cttcctcctc 101880
ccagttgatt ccagcatagg tgtcagtagt aggactgcct ggctatggcc ttggatgatg 101940
gagttgaaga tgtttaagat ctgcaagccc ctgctgctgt attggtctgc acaatggcca 102000
ctggttgtag cagctgtcat gagctacact ttgggcactc ctgaaagtcc actcatagcc 102060
ccattctctt caaagaaaag tccttccact cctccatca gattcagtta tggttactat 102120
taggaccgtg gtgaacatta taatctggat atttgtgtac aacaccaaat gtccagagcc 102180
aacctagaac aacatctaga gatgttgaag agaatgggag agaaagtaca acatacctaa 102240

ttttttaac tgctgttttc aagtgc aaat ggtttctctg tgtggattta agcatttaat 102300
acacagtatc ttttaatttt aatttaattt aatgacctaa aaatcattca attttacaat 102360
accctgatag tatagccatg atacccttga aaactctgat acagggttta ttattcccag 102420
gttcttagtg ctttttgcta actagtgtcc tagcatgggt tatactctggc ttaccaaggc 102480
tctttctggg agtcattcaa gaagctgtgt gactttaaag caatgatgca ctgtatcgtc 102540
tcaccgtcca catgactgat tttgttccca gatggctata acaaaaatga aagttctaag 102600
tgatctttgg ctctttctg ccactttcac tccatgttta tctccaggcc tcaagctctc 102660

gggagtgtaa ggctgtgtc tgcactttaa cacattaac atcaactttc aaccttgcca 102720
ggatgagtag gtttgacttc tcttaaatgt caacagagtc aaagtaatcc tgggtctttt 102780
cttgcagtt agccaggaca ctcacagaat acagaccttc ttttctggct cctttgtaga 102840
aggaataaag catattgaag caggagacat ttcaaaatct gttgaaaata ttgaaaaaaa 102900
ttatggaaat tggcagggca gactcttgat gcatcaaatt attaacttc atccctaaaa 102960
atatgtgact aaaagcagtg atcctcctat aaactaaaat acttgcttca aaaactgat 103020
ttaatacatt taatactttt atattcattt tctttagaaa atattaatag ctccctgaaaa 103080

actatgtctt caaagctact tgaatgtgt gttgtttca caagaaaaa acaatacctt 103140
caaagaggat tattgcatgg aaagtttttt tttttttta agaaatctaa gtaaagaatg 103200
aaatatgcca aaaggaagag atgaaagaat gtggatggaa tagacataca ttagacttgc 103260
tactctccag gaagtatctc tgtttgcaga cacttgctg gagactgggc cactcaatgt 103320
catagctatt tctctaaata acagaaacca atatccagac aaaaaagtat cccttacttt 103380
taaatttctt ttgcttgcca cttacttttt ttccccctgt ttcagaaaag tatttaata 103440

actgcttaaa aacaaatact aagtttaatg gtactctttg tttcaaatta cgtcccatac 103500

ccctggcact ctcttctaag agagatgtct gatgagaagt catctgtgtt agcttttctt 103560

tggacgtttc cactttggtg aggtcataga cagaaaaata aaccacccc taaaactaca 103620

gttgtttgtg gcagcaaatg tttcatcggg tcaggaaact tggagattcg acgccagagc 103680

ctgaacaaaa gtagacaag aagacaaca agatatcccc tcacagcccc aagcacactg 103740

aggtgatggg aagtttgacg aaaacatgtg gacaacgaaa gaaaagtgtg cagatggctg 103800

cttcttgttt gggaaagacac tgttaggagt tttcaagag gaccagtaag gcaaaggatga 103860

gaaccagggg cctctattag tgaccecaagc cagcatctat ttcggcattt cacccttagg 103920

cctctctcat cgctgtgaga tgaagctttt tcattctcca agacttggtc tgtctttcca 103980

cgaccttcaa ttctttgcca gtgccaggga gcaaatcag aaatccccta gacaaacatc 104040

agcgtccta ttacaatgac gtatgtggtt cccccacca taatattatt aagtttttct 104100

aatgaatata atttttcaa agttttttaa aagccgccgg gtggaggagg cacacacctt 104160

taatcccagc attccggagg cagaggcagg cggatctctg tgagtttgag accagcctgg 104220

tctacaagca ctagtccag agtaggctcc aaagccacag agaaacctg tctgaaacc 104280

acccccactc aaaaaaaaa aaaaaagttt ttaaaaagcc atttttcaa agctacaac 104340

atttaaaat gaatgtttcc tttcaaaacc ctgtccacat ggctaggatt acttgatat 104400

ttatgtcatt agacaaggaa gggattttta caatgtcttt tatttaagac cctctttcat 104460

ttattggtga taggaatgtt actattatca ttttgtaata aatcacctta ataaaactgc 104520

atataacttc taatagcatt ttatggattt attctatttt tccatgtaa caattacatt 104580

atctgcaaag acatattacc acaccacttt aattactacc taaaatgcta acaatttatg 104640

atatagttta attctataga gcattgttcc aaaacaatgc tatttaacac tgcagtcac 104700

aattgccttt gtctcttttt ctageacttc tetgtccatt tcttctctet gtcactctcc 104760

aggacctcaa agatgtcaag atggcacca tcattgcta catattctcc accagccaat 104820

ttatgtctgc aagagtatac tcaatagtgc acagtctctc tggacatatac taatgtgcat 104880

taattgtaca aaataatggg ctcatataaa gatcatatac aggttccttg tcattcagt 104940

ggttcccatt ttgcacctgt gtgttcagca ccatcctctt gtctcagcgc tggagggttt 105000

cattcccact actgtcactt tacttcatgt tatcatcagt acctgagaag agacaagtga 105060

gagtctgttc tcattattga tgctagaatt caaaagacta ggggctttgc tcattttttc 105120

ccttttgggt atccttattg ctttctcttt ctttctttct tttttcttt cttcttctct 105180

tccttccttc ctctcttctc tccttccttc ctctcttctc tcttttctt tccttattct 105240
 ttacattcca atccaagttc tctctccctt ctcttctctc actccccac atccccact 105300
 ccacctccca tctgtctctc agagagggtta aggccctccc taggaattgt aagtctgtcc 105360
 catcatctca ttgaggcagg accaaagcac ccagtctctgt gtctaagcta ggcaaggat 105420
 ctctcaatat aaaatgggct cactaagtca gtttgtgcat tagagttaga tcttggaacc 105480
 actgtcagtc gcctcatata tcaccccage tgcaccattg tcacctatat tcagggagtt 105540
 ttgattacac agatgtcttt atcactccaa tgaacctgct ctctctactg aagagaaagc 105600

 atgtcatctg ccctctgctt tcagagaaca gggcacagat taagtgaaga aacacaaact 105660
 gtaatttctg aattcacaag atgagaatca aagagtaagt ctgctgcatc aatgccatg 105720
 ggagaggat atgtggtgaa tcttggtaat ctataaatat tcttgtacc attattctg 105780
 cagcttttgt ttaaactttt tattctgctt tcagcttctg cttgggttca agagttcatt 105840
 ttggaattca ttcttcgacc acatttcttt atcttcatcc ttatcactat aagcattcaa 105900
 cggctggaat atacagctag aaattaaagt tggtttttga aaagttttca ttgcccagta 105960
 aaagtgtgcc ccttgagatt aatatttctt actaatcaaa acccacaact gtgttcattg 106020

 ccataccaag gactgtcttc aaagataggc ccccgaggtt ttaaggagaa cagatctcag 106080
 ttaatccaag ctttgaanaat atgcaattta gaaaaatagt attcaaat 106140
 atattttatt aataggagg aaatacattt tcttctcatt cagtttctaa ttaaatggaa 106200
 gctcacatgt gaatacgaat aaacctgtt tggttcatgc tgcttaaatt cttgtaaaat 106260
 aatcctgctc caactttgca aagacacaaa ccagcactgg acattatttt ctcatttaat 106320
 tgtgtcaagg aaagacaagg ttgtaccatt tactcatttc agtattttaa ttcaaaact 106380
 caaagatgat tcccttataa tgtgaaagga aacatgggaa ctaaattgta attgcatcca 106440

 tcttttttca gttacaaaat gaaaaatgtc cttgaaatga cgacacttgc tctttagcaa 106500
 accaagtttc aactagaa aattcataga taataaagta gtgggatgcc attggttgaa 106560
 tttcattgcc ttcttcgctc catatatcaa agtcttggtc tctctgtcat atattgtaac 106620
 catactttga gaaagggtcc ttaggatg attaagttag aatgaagtgg tacaacatgc 106680
 cttaatattt gactggtatt ccaataagaa ggaaaaaaaa aacttatacc atgatagaga 106740
 gaggagat gatataaga cagaagatgc tatctacaaa tcaaggggcc aggcacagg 106800
 atgcagctaa ccctgttggc acctcagtct tagacctcta gcctctaag tagtgagaaa 106860

 aaaaattact gtataagaaa ccattacttg atagattgct cctaagctaa tgccattgac 106920
 catgccaca gagcagtgaa ctgcaattga aattgcaggt gtcagcccac cagaaggaaa 106980
 tcctctgatg ggcaaatctc atttaagcaa gagcacaaga ctgcagacc tgaatgtctt 107040

ttgattgtgc tggccttta catgtttgic acagttctct ttcctggta tntagcacga 107100
 tgtgaatgga catggggaca ttgccactgc ctttaataata gtgtacttat ctcttgaaa 107160
 catcgcattc tatggggcat ttttacctgc ggattgtcaa gaaggtgac actccctaag 107220
 cagtaccatc taatttgata ataatgatag tttatgcaga gttttaatga gtaaaaataa 107280

 atacaatgat agccagggtc tacaagtttc acccaaggag ctgcatggat ggtagctcaa 107340
 gttatgaatt taaaattgag tcccagtagc ccagctagtt taaattcttt taacctaat 107400
 gttgtgggaa tggttcaca ggtctcagag tatatcacia ctgaaacaaa gcattggaaa 107460
 taacaaagt aaataacttt gaggtgaaaa acccaagaag acaatctaaa gttttagaaa 107520
 ggcacataga tgaatgcaga actcttcaag ttcaggaat aagaacgaaa cagccaatt 107580
 attactggtt gatgtactct ccttgctggg ttggttgat gaccaaagt aatgattact 107640
 tccatatacc catttctgcc ctcaatttct tgatgttata aaaaaactat taataaatgg 107700

 attatgtaac ctaaagattt aaagtagagc tgactgattt tttcatatat aaaagcttaa 107760
 atttatgatt ccttagtat tgcttataag aaatatacacc tttcaatata agtaataaag 107820
 taattggcct gccagtaaaa gacctgacaa gaagaccttg cttgccaca tagttaatct 107880
 ataacaagt gcttagtag gaatgtatgt gagttcttga aataattgt ttttcaactg 107940
 taatacataa aatgtttaat catgtgaaag tgatgaaac tgtgtttat ctatagtcac 108000
 ctacttgaga aatggaatgt aataattttg actcttgac tgcctgaagg ttctgtggg 108060
 gtataaaagc ttgaaaaaa tgagaggatg gagagataat aaaggagag aaagaataaa 108120

 gaaacaagag aataaagaag gaaatcatca agagagttg tgagtgcctt tttctcaagc 108180
 cccctcaga tagagaagtc tagcctaacc aactccatgg attcctattg aagccttg 108240
 ctctggagg caggccctg agacagcaac aagctaata gtaagcgttg tgagaaacta 108300
 actcctagcc ataatacaaa taacctgct tttgctcaa catgagtctt tgagttcact 108360
 cttccaagt tttcatactc ttcataaat aacttcaat gaatatatt tatagagctg 108420
 gggagacagc ttagttagta agtcaaggac ttgagctaaa tcccttcaac ccaggaaca 108480
 aaataaataa gacctagta tgggtgtata tactgtaat ctcagtgctt aggaacaaa 108540

 gacacgtgga tcctgggat tcaactgacca gttgagattt aaaaagaaa ttttcgcc 108600
 tttgattat agtaaatg caaattatct caatgacttt gcaaatttct ttgtttgtt 108660
 ataggagatc ttgttcagaa ttgtattctt ggacccatgt tgcagaaga cccatcctca 108720
 taaaatgat ctctgggct gaagaacag ctgagtgggt aaattggta ccttgcaaca 108780
 atgaaaactg gaggtagtc ttcagaatct atataaaca caagcctgat gttgcaattg 108840
 taatccaac ctgactga ggagatggag atggaaggat ccctgggct tattggccag 108900

ccagcctagg cacatcagca agttcaaggg caatgattgg agaaagcctg agaaagatca 108960

 ccaaaggcca gtctctggcc ttacacata catacaaata tatgtctgcc tacacatgaa 109020
 cataaacaca cacacagcaa attaataaac tgcagtaaat tacactctct gaatggatga 109080
 gtactatfff atcgttaatt atataattta actatttggga cataatagaa tcttataagt 109140
 taccgagatt agaaaaaaaa ttatattaca tactcttctt gtcactactt taaggttaaa 109200
 tgaattatat cactatffta aatgctata acatgcaaca tggtaatfff tfftaatgfc 109260
 aggcagctga tctctatff aggttaatta ataaaaaaa ttatffaaat aatcctctat 109320
 cttgaccatg actccatgaa agacagaaac aaccagaaat aatgattga ctgactgaca 109380

 tagggfffct aaagttggaa ccaatcatgc ttcagattcc caatggggac agtctaaaaac 109440
 tcattgtcat cagagaccaa ttccttgtff agcttcttgg ccctaatfff ctcttgtac 109500
 cctffatffta tctctagag ctccacctca ataagtcaat gatgcaggaa gtccagtga 109560
 ccttaggcat tgacctcaa taagtaatat cagagagggg cagaggaagc caactctffa 109620
 gatatgagtc tcaagttct taactctca atcaaatgfc agtgagaacc cttcactggt 109680
 ggtgggagag gactgataat gtctaccatt ttatactatt gatacttgtc atgagccctg 109740
 tatatffctc atccattata caggatgagc taagacaggg cataggtaca aggaaatgga 109800

 caagttagtg caatgacagt tgaagttgt aagcactgtt gcaaagtgcc ctgfffgtc 109860
 gagagaatgt aagacactca gattgctfff tattaaaaa aaagtatffa cctffcatt 109920
 tgcatffcaa cctccattct cctccctcc ccttctattg caccctgcct cctctfftc 109980
 tacaccate cattcttcag aggaggtaaag gccttcttgg gaaagtcaat aaagtctggc 110040
 atatcaagtt gagggaggac caagctctc cccactgtat caaggctgag caaggtatcc 110100
 caccataggg aatgggctct aaaaagccac ttcattffcc tgcaatgggt cctggtgcca 110160
 ctgactgccc ctccaacccc cttcatcaga tcaaaccaca ttc aaagggc ctagttcctt 110220

 cccatgcagg ttcccagat gtcagtccat agcccgtgac ctgagfffct actagctcag 110280
 gtcagctgtc tffgtgfff tcccacag gctcctgacc cttcctfff catatgatcc 110340
 ctaatccctc tcttcaactg aactccacaa gctcagccca atgctgaata attgcacctg 110400
 cttccatcag ttactgtatg taggfffat gatagcaatt agggtagcca ttaatctaat 110460
 taaaggggaa ggccattca gacacctct cactattgc taggagtctt agctggggac 110520
 atccttgtgg atffctgagt atatccctac tctcggttc ctcctaacc ccataatggc 110580
 tccctctatc aagataaaaa tgctcgtatt taatcatgaa tcaaaaggaa tffttggtag 110640

cattcaaat atccagcat caattcctgc tgaaggaag ttttaagccat aaaagtttta 110700
accataaaag tgaagaaca tttgaagaaa gcttaaatct tgctctcgat ctcaataaca 110760
aaccagaata atttctctca taagcaaat atcaggattc ctgtgatttt ggatgggcat 110820
attccctga cctttgaatg aaacacagga aagtgtgcac ttttacctc acacagtcta 110880
gaaaattcca ggagttcaag cattccaggg cacccatctt cttttaagtg atcaatgtgg 110940
tcctgaatac acagataagc atgatggatg aaagaaaaga ataaactgat tcaagattga 111000
ctccaactat caccgactgg tatttcagtt ttaataattt gattggatca tcccatggta 111060

tatagctatt gatgagggca cttagcatgt atcctcagtg tttgtgcaat aggttcatga 111120
gcaaagcagc catatcatca acacaggcta ctcgatgctc cagcaatagg tattctcagt 111180
gaggttgatc tagataatgt catagataaa tgttcagcta atcaataata gagaatatgt 111240
taaatattca tttgagtact attccttatg attagccgtc cacaatgaaa gataatgata 111300
tcagacacct taatgcttag aactagcaat tctggaaggc acagatgtgc tggatagggt 111360
tatgcctttc ctgataacaa tgactgagga agcctcatca ttagagatgg gagacagtgt 111420
ggcctgcaaa gcatcaagcc aaacagcatt ctgccagatg aatccatttt aaccacagta 111480

gagctgtgat gatggccagg tgagcaatca tgcaacattg ctgcagcaca ctgcactgtc 111540
tgcaagttag catctgtctg acagagttaa gactcattgg aatgtagctt tgagaagata 111600
cacttagagc tagcttgaag gagaataaaa gtcatgtggt atgcatccta aaccaatggg 111660
tagaatatat ctttgaatca ccagtaggta aatattacgg agcaaaagat ctctggagca 111720
agggggacat aatagctgcc acttaaaactt ttttgagatt agaatttagt tacatttctc 111780
cccttttgc ccttcaaacc ctctcataaa tcctccaca ctccccctt ttcagtaata 111840
actgtaacag ccagaaatgt cctctatcta ttaacctct tctgatgtgt attctttaga 111900

aattatgagg agtcggaatc ctaaatagaa tggacatgaa aataatgtcc caaatgggag 111960
aagcaggagg atttgaattg cccaagcaaa gactgtagta gatactatgg tagcaggcac 112020
tattgctacc cccacctaga taagtctgtg gatttttgcc tgaagctgtc ccactatctg 112080
gagacctgtc cttgctcaaa agctccctct gcttgggaagt tactcaatca gaaacatcag 112140
ggaccagag gctacaatcg atgaacagct tggtaatggt atgtgatgtg taatcgcaaa 112200
tccatgtcc tgaagtcca ggatagataa agattccagc tgaacactgt agcctgggtg 112260
tctcccacca ccaactgtaag gtctctctgc cttgttccca cgctcccccc cccaacttc 112320

caaatgattc cccttttaa aactctaact tttacatctg cttgtgtgat tgtgtgaaac 112380
ccaacctatt ttcccagatt tcccagggat aaattctctt agagatgttt tctttagata 112440
ctgtttcagt gtacatata taattgtatt aatgaacaat atgcaacatt atttaatt 112500

tatgaaatth atatctttct ttgtgtctct ctctcaaaat ttatatgtgt gtgtatccct 112560
aatttattca tctcactctt atatgtcact tgatttatta tgttgagtha ttttcaaagt 112620
tttttgctgt ttctaacagc aaaaatggta tagctatgag catccttgta ggtgaaaaat 112680
gcttttgtaa gttttaaatg tctgactttt ctccaggcata agatgcttct tcaatctctt 112740

gctgaaatct caaagaagaa tgtgaaagtc attcatatth tcacaaggaa ctttgatgtg 112800
tccacaatgc ccatacttt cataagcatt agcactgtct ggtaatgttc cttaggactt 112860
taagggttta aagatatcac catggttccc agtttctgtct ttctaattac ttaagtgatt 112920
taaaaaatgt tgctgatata actcagtggg gagagacata tttgggatgt ttaaggccca 112980
gggttggata tctagtacca aacacacaca caaaaaaatt gtgtatgaat gagtatgttt 113040
ttaatttttg taaagagttt tttctctcac agattcatag gaattcttgt caattctaag 113100
tatcaatcac attaccttg aaagtaccaa aaattttaga tttagttaaa ttgaatttat 113160

caaccgattc ttaaagtttt aatttttaat gtatttagaa aatacattga agtcatgaag 113220
aattttcctt ctagtthtag aattctgttt tccagatgtt tacctttaag cccctgttc 113280
caacatcatt ttttgaattt cccctttatt cgccttaaga agtggtgcca gccctttcac 113340
atatgaactg tggggcctat acaattgtct tctacttcat ttcatthgtg gcatactaat 113400
ttatactgta ttccaaaact gtgttgcttc attctthtat tacagccaat actthttgaa 113460
agcataagge aacatthttt ttgtcagtgc tggcaatthaa agtgaactag cctcgcaggt 113520
atcagthaag ggtattacta cagagctgta tccccaggaa atgtthtaac tgtthatttt 113580

gthaactgaat cggactggg gtgtacagge tggcctthgaa cctgtgatca tcatgcttca 113640
gcctcctggg aggtagaatt aaaagcctac tctactgggc caagccttca gccacttgtt 113700
tcaaagttat attgtthttt ggtgagattc tctgcactct cttctcccat tcagtcttcc 113760
tttcctgga agcatctaat gttacagaat thttaatgac ctttcattaa tatttcatgc 113820
ctatattgga aagttcacc acttctthcc tatattagtc agggacatgg tcacaaagag 113880
tatgcatatg aatgtatth attthcttht aaacaagata aataaccaag cactaagaac 113940
tctthgttgc cctgcatcg acctcagcc atatgttccc atcatccact cgaggaaact 114000

gtggggthtt gctctthagc agtcccata agaaaatcca catgattht aatttgtctc 114060
accaaagccc atagtccac atattattgc thtctthgaa aagttcatth attthcttht 114120
ccctgcaaa catgtaagc thttctccag tgatatctcc tgtctthctt gthactgggt 114180
acatgctctg agcatgccc gatccctaat gtgattgtth catgaact gthcagctctg 114240
ggcatcactc agcagtggt gthcagctggc atggaagcag ggaatgctc cccagcctgt 114300
caggtcaccg gatgtaccg thtgaatctc catgttctcc actthatttc tgaagcagth 114360

atttcacatt tttcttcttt cctgttgctg ttatcttttt ggaggtaatg aatgagaatg 114420

 gigactatta gctcctcatt aatfttgctg ttttcttttt tctaagtaga tgtttatact 114480
 atttatcagg ttgcatctct ttgtactcag ttatcctgtg ccacagctgg ccaatattct 114540
 gtaaaattca aaattcctta agatgagata ttgggtatft tagtatttgt tcctatatca 114600
 aaggaataaa catagtattt attaataatt ggcacataaa actccaacat atctaagcca 114660
 tgcattctca aaattaacat acatttcatt ttaaataaaa atatctagtt ttaataaatg 114720
 ctgttgaca ttggttgaat tttcttattg gcttaataaa cagtatttaa aacattaatc 114780
 aattatatga caacattctc aggtggcaga tagaatggcc tagtaatagc agttgctgca 114840

 tttccagagg acccagtttg gttctcagca cccataagct tccagctccc tgacactcta 114900
 gttctgggat atctgacagc ctctcctaac ttctgagagc acatacatat gtgcatatgt 114960
 acacatgca acacacgca ataaacaaaa tcaagcataa tgaataaagg aatctcagac 115020
 ttcattgatga aacctccatt ttcacaatat gctttaatat gttgttaatt tcatttggcc 115080
 acttatgaat ttaagttttt gcaccaagtt cattgataaa agatagacaa ttgtgggtct 115140
 ttttaagtt tggaaaactc ttttcagaat aggtagtctt ttgcaagagg aaaacttgag 115200
 tgcctatttc agtttcttta ttgcttattg atccgttcca gttctttttt ctcatccca 115260

 gagagaaaag taacttacc aatfttctgt agccatttac tggcagagaa gaaagaaaat 115320
 ttagcttggg ttcatttggg tccattgctt ctgtgcttag ccactctgat aagtactgtg 115380
 tagtcatatc ttgtttttaga agatgccct ctaaatttta gtataggaat acaaggaaat 115440
 ggacaaaata gtgaaaatca tgcattttaga agacagcgt gttcttttagc ttttagattg 115500
 aaggcagaca tgatgaaaga agaaaagcat tacgttacc caggcataac ctgagttagta 115560
 ttgagtgtt tgttgggat tggaaagtaa agaaaagaga acaagagata gacaaaacaa 115620
 tagaatgtag agtttcaggg agtcaatata acaaaagccc ctgaaatctg tgatgctgag 115680

 attacatctg gtctttggca tacaacaaaa cacagcatga aaaaaaaaa acagaatgaa 115740
 aagaagaata gaggaagata gacatggcca cacatctgc agggtaagg gctcctcttc 115800
 ctcatccttg tgtttctggg cctatgggtg gaaggtcaaa tactcagtga gcatgccagt 115860
 ctcttatccc cctgtcatca ctccccagc actcatgcca gataaaggag tgaaggaggc 115920
 ttatggaaac attggcatgg acatctgctt cttctcttcc ttcttctt cttctcttcc 115980
 ttcttctt cttctcttcc ttcttctt cttctcttcc ttctgggata ttctgctctg 116040
 cctcacctat gagccccggg cttagatcaa atgtgtctc ctctcagtga aacctctgac 116100

cctcactgct ctgcgatgga gaggagggtt atatctagct tcctagacta cagttacat 116160
 gtgcgttatt tgaatattac ttcagaactc aagaaccaca aaagtcctat tttttactt 116220
 cctcaaatc tccaaaatac ataaacactc aaaagtcaaa aatgcatgaa cactatagat 116280
 ttaagatgaa tggttggta acccatttaa agcacagata agaatttctt gaagcagaca 116340
 cataaaagtg caggctaaaa ttctggaaac ccatcaagct tggagtcgga gctttgagaa 116400
 ctctttagat aggaagagag aaagcgagag agacagtatg cttcctggac ttcacaaacc 116460
 aatgagaaag cagtttcaaa gaagcaagag gctcttgta ttgcatgca ctcttagca 116520

 ttgtctgta aagaagcaag acgcaaacac tgccttcaa aagctgtgtt tctggctttg 116580
 cagagatgag agccagggtt gttttccag gatttcagtg ggacagatag agggctaaaa 116640
 tgcctgttt ttaatttct gtgaaattca ctgttctaac acagaacaca aatatactta 116700
 acacagctcc ctttcttaa tacaacttgc atctaaaaat aaacaaaaca tatggaaaag 116760
 aattatgacg cataggctga catgagttaa tgaggcacca gttattcaga aatcatcatt 116820
 caacgattg tctgaactg agcgggaatt tcagatttct gttctgtac ccctctaggc 116880
 ccaaacacaa ggaatacac agagctcagt ctttccct cttgactctt ttctgttcc 116940

 tgtgtgtctt ctgcttttc ccaccctca tcctcagttt gttttcctt tcagtttctg 117000
 ctttgtcaaa tactttcatt gtaattagt gaaaggcatg ctagcagtag gttatgttg 117060
 agaaccacaaa gtttctttg ctttgtttt tttttttcc ctcctgattt atcctcatct 117120
 ggaagtgtga agttgtaata aattaattct aacttaaaaa aatagagttc agtatcaatg 117180
 caggataaaa ttggttagta ttttcagtgt tgtctctact tgaagcagaa atccactg 117240
 ctattaacct atattcaatt ttgcagacat ggatcctcaa atgacacata aatgtactat 117300
 cattgtctg agacacttt cctctgaaga aacagaaaag gaatgctca catttcacac 117360

 attgtattac aaacatttag tgtcaggaag aaaataaact ggacagtcac caagtacttg 117420
 gataaaatct ctggcccacc tgctagtgtt agacccccga aaactcaagt atccggggtc 117480
 tcaggccagg ttcgcggtca cccaatcac caggcggatt cgagagcttg ctgcaactg 117540
 cacgaggctt tattgtaatt taacgaacta acccatgtt agctcgggtc tttcaccac 117600
 ccgcatggc ggacggctag aaaagacggc tcctaaggtc tccccaaaga tcttataggg 117660
 cagcgtaaag ggagtgtcta ggggtacgca caggctcagg attggtgtgc ttccaggctt 117720
 ggagggcttg ccctgtgtg attggtcaac tggttgttat ggctcatagg ccctccagg 117780

 ggggttgcta tgcctctac gtcattgtg tgccttgtc cgtaaagcac acccagagcc 117840
 ataaagcata gcgccaccg ctaacttctg attggttctt tgtcacgaga caggcatctg 117900
 actttctggt ttctaggaca aggtcataga agcacatgtt cgaccattat ggctgcaaaa 117960

agggaagctg gttccttcac tagcacacag cagtctaaac taaagtcctc cacccaaact 118020
 gttttttctt gatccttttc tgcagtgtag caggaagctg caccatgttg gctgacaatt 118080
 tcaagtatta aatagaaagt tgttcttaat gatgaccttg gcagaagcca gttctgaagt 118140
 ggacctgaaa agacattcac accttctgcc catccctgaa aatggtgatc tctaacctcc 118200

 ttcatttcaa taaaagtaca aacaaagact cctgcagcat tgctttcaga tccatgaata 118260
 aatgcttttt tectaacttt ttaaatgcaa agttctcaag ataagtacag cctttcctct 118320
 ttcccattta aatcacggtc tttggcttta acctacttaa aggttgtaca aatggcgaca 118380
 aaagccactt cagcggctga cactgcattg ataaatatag aggagaggaa ggaaaggaca 118440
 actcctgcag tactttccag ttaattaaa agagatttgt ttttcttgc ctctaagggt 118500
 catggttcaa gactaaacct aatcaatagt gtattctttc atttattcc ttcacagtg 118560
 tgttagaac tatgaataat cttgatttta cagaaggaaa atacaaagtg aaagtagctc 118620

 tgaactgcac tttcttttg caaaaggggg gtcaagacc aaacctggtt aaattgccac 118680
 ctaggtggga aaatcacatc attcttatcc tagcatatgt gatgactgtg ctttcttcca 118740
 ttggctggga tgtgactgag tattttccag atcaactcat ttaaaggaaa aaaacaaaac 118800
 aagcaaaaca aaaactatgc aaagaaaatt aaagaaagag agaaagggtc tagaaattct 118860
 ggccacaaa ttctagaaaa tggggaggga gagttgtata aataaacatc ttaccaggtg 118920
 agggaaatta aaattttga taaactgttt ataagggtga agagattaaa agttgagagg 118980
 atttttgaa ttgtggtctt tggcagggtg ggtacctttc ataaaataaa gcaaatactt 119040

 cttacatttg tgttctgaac tctaatecat atttgggaga gccaagtgc atggatattt 119100
 cattttgcta catgcctgaa tcaaaaacca tgtgagaact tggatcatac aggcctccat 119160
 agcctatcat cggacactca aggtttttct ttgtttgatt ctgtgttga gctccatcca 119220
 cttcacttcc tgggcgaaat gcctecceat ggtcacctt gagaacctgt ttttaagtga 119280
 atattttctc ctgtgtgcat taaaagatt tcaagtgtta tgccatata ttaggtattt 119340
 taggcttatt atacagctca gtatcattac ttgtttactc aaaatctttt caaaaagtgt 119400
 attcaggtta taacagcact gtatttgatt gcttctcatg ctgtattcat attgatacca 119460

 cttattcact taccttctt gataagagt attgtagact acttctaaga attctactcc 119520
 tacaataat gcgacattga agatatttaa tcttgacttc ggtttgtgat ctttcattgt 119580
 tgactccaaa gaggttgctaa gtcaacttg ctatctctta attaatacgt agccttaggc 119640
 actaatggtt tcttctctgt actcctgtcc tgcagtgaat gactttcgta catactgaga 119700
 gcatcactgt tatttcaacc agtccctcgg acttttccca gatcagctgg agtgaatga 119760
 tatcttgctc ttatgatttt cattttcaaa cacaagcaaa gttgaataaa taatttगत 119820

ttttataaac tatcctaag tccttctctg gagctgctta ctattctggg aaaagaaact 119880

 ccattttatt tttttcctat tgtttatgtg taaacctccc catcctccct tgctctcttg 119940
 tattttcttt cccggattca ttatcagttt caatagtgtg taccctcata catgtttaca 120000
 tatgccccctt tgitacaaa tagctacaga cttctctgtg ccgtttaatg ttacaaaagt 120060
 atctcttaac cagcaaatcc aacatgtgta aacactatgt caatactcca ataacttcag 120120
 aacctatgat ctggatgaaa gaacaagaga agatttcagg gttatgggtt ccatatgctg 120180
 agtgtagact ctaaagtgc agatactcct atgtgctgct ttagcaatct agtggagagg 120240
 agatgctatc gaggatattg aactctatag gaactttcat gctgtaggac tcaaataagg 120300

 cctctatgtc caggttctaa atatgtccct gttctcatat actacatgca gatgtttgag 120360
 agtaagtaag ttgttttaat tatgaactaa tctgcacttg atgaatatta ttcattttgt 120420
 tctaaatata ggagagtcaa aacccaatca ccaactgcagt cagcaaagat aatgactagt 120480
 taagcattaa tccaaaaaga actattttgc agaattcaac ataaagaaaa atagtagtag 120540
 gaattgatag ggatgccaga cagcagttag agatttagtt ttcattgcat gctaaactaa 120600
 tgagcatagt agtttgattt ttatataaag acaatataga aaaaaaagg aaattaaatg 120660
 acttgtctgc catcctacca agtggtaaac aagtggtaac cagagtctag atgcaaacat 120720

 tcaatgtcta gagactagta acagaagtta tttttcctac atatagtgat tcttcacatc 120780
 ataaatcttg tttttcagge tgaaattcat tgaaggagt taccatgaag tcaactgcat 120840
 cataagagcg tgggataaaa cccagacaa gtttaagtgt cttataacac atttcatcat 120900
 aactaacaaa gccaaacatg gacttaattg tttcccagac ccaactcttct acagtattta 120960
 gaccatactg tccaccagtg atggactcct gattttctct tttctctctt taatatttca 121020
 agaaagaaat atgaatcagt catgtttgtg ttaacaaa tcataaatct caagtatcta 121080
 atctttaga ctgatttctc ttgtaagtta caagctagtc aggtcagcaa taagggtgag 121140

 tggagggggt tttgtgtggt ataaatttg ctgctttcag tcttcaaaag acaagagcaa 121200
 gcaagagaag tagggcattc aatgcggtag tcaccagcat tctaaccct tccccatgta 121260
 caatgcatc catgtgtagc tgcaatcttt tactctgtct taaagagaca ttagctccag 121320
 ttgatcctac actaataacg caggccatg gtgtgagctg tttccaacac ctcagaatcc 121380
 cgtgtcctat aaatgttate ttgtatcctt tgagataatt acaaccttct gacaaaacat 121440
 caatatggaa ttatgtggaa agaagtcaat aatcataact caaatttta gaagaaaagt 121500
 agttgctaag aactggaatt tttactcaa tcttactag acagtagatt atttattcct 121560

ttattcctac tcatgatctg taagcctgia tttctttcaa gaatttcttt tgacccaaat 121620
 ctattagcca tgaatctaa tccataatga tttattctac aagatttatt tcacctcata 121680
 aaatagtggt gttgccaaac atattggggg ttatttagaa tctactgctt actctcatta 121740
 tgtgctggaa tgttgttgaa tatattgaaa atgagtcttt atttatccca caatacaata 121800
 tgtccacttt caaaaact ctttactca tftaaaataa aggactgtaa tttccaagat 121860
 tttacttcca atatactgga accattacaa cttgttacgg tagcaaaactt ccagatgata 121920
 agaactagca aagagcttaa gaaaaatctg aggtagtga taatatacat catggtggaa 121980

 agttcttaac agtgcataag aatgtgctgt gacttccctg ctttctttat ttttcccttg 122040
 cagaatcttt gtgactgctg atgtcttaaa gctcacctct gtcatttgtt ttctcacctg 122100
 taattcccag tcatttgtct gtctagagca catgcagagt aatgtctgct tgttttcttc 122160
 aaacagtgtt tattcagctt tcttactagg ttttttcagt ttggtgttac tctcaattct 122220
 atttttgttg gttttgctta aagcaatttt gcttttataat gtaaaattca tgcttgtgat 122280
 ttcaagattt ctgattataa ttttaacaat tactcaattc ttcataatgat gaaaaataa 122340
 aatagtgtca aaatcataaa cacagctgaa caggagagcc aacattttaa ttctctgtaa 122400

 ccaaagtatc aaatagcaac tatcttcaga tagtggagtc ttgacaaaaa tctcaaattt 122460
 ggcaatgaga gtgagtcatt gcactttttg tggccatata taaaaatcag tgccaacatg 122520
 gtaaaagcca gctccactaa accatatacat ctatcacat cttccacgag gctatggtgc 122580
 cacagagata actctccaga tgtcactgat tctaatagaca aacaaatgaa gaaggcccaa 122640
 atatttagtt ccccgtattc taagacactt ctggggaagc tcaactcttt ctaatcacgt 122700
 ggaaaaattg acaacctacc aaaaaataaa ctgaaaagtc aacctgagac tagatagaac 122760
 aaagtgtgga gacaaactga caaaatgcaa acaactggct ttagtgaaag atctttgggt 122820

 ctgccagcag tgacactgtg ttggacatcc aagtccacag cacatcccac ccaaagtga 122880
 catactgctt ggattgaatc ccaagaaagt caacttcaa tccactccac agcctgagga 122940
 aagccagaag accacacagt gaatccgaag aacagggaga tattaataat gccacacttg 123000
 ggagtttaag tagaaacctc tgctctctca aaaccacctc caggccctgc ccaagaagaa 123060
 gaaagaacc cacaggaac tacaacatca agcagacatt agttatgtca ccccttgaat 123120
 ttttaagcage tttcttgggc tcttcaaagc cactctctag aaaaagttgc atgaccacgt 123180
 ggtgagtaag gtcagtatat agacaacagt tccacatgc ttgggagata agcctatact 123240

 caccacagac tccaggttca ttcttacta ctggaggaaa ggattttaat ctgacattca 123300
 cactcaatct gtgaattatg gtctgtttta cctcttcaa ctaataatac aaacaatggt 123360
 acattttgac caagaaacat gtcattgtaa ttccattcc atataaaagc cactaataga 123420

aaaagaaaa aaagtacaga taactgcctc acctgaatgc acagcaagag tggtaataa 123480
 tccaatcadc cagagaacat aaaaatatct ctgcttctta aggacattgc tagctgaccc 123540
 agtcacaatc ataagctaga agaaactctt aaggtttact actacaaaa catacataca 123600
 aaagccagaa aaagtagttt tctctggaaa tgtaaagata tcaccttcaa gtcataaggat 123660

 agataacaaa tactcaaaaa attactaggc attcataaga ctctaacaaa gctctaataa 123720
 tggactcccc aaaaatgtat agcagatgag gaaaataatt caggataaca ttttaaagtc 123780
 catacacata tcaacaaaaa atatgaaaat tggaaaatag cacatgaaca aactgagaag 123840
 tctgtgagaa aacggaaatt gttttttaag aacaccaatc ctagagatgg acaatgtaag 123900
 gacctagaac aaaactgtca aggaaaattt caaaaattgt cccaagttga agaaaggtca 123960
 acttgtagac agaacacctg aatcactca actgtaagag gagaaaaggg aaaaaagta 124020
 acaaaataat tgtgtaaatt agcgaacata accagttgta gaatggttgc ctagcataag 124080

 caaagcctct gttttgatta caaaggcagg gggaggaaga ggaggaagag agagaaatta 124140
 gagaaggcaa agataaaggg ccaaaaactga tttttaacaa gacaatagat gaaaattcac 124200
 tagtctgaaa gggaagccaa catctaggtc taataagtac agtgatectcc catcaaatac 124260
 aaagcaatga gaaatttatt gcaacatacc aacctgtcaa aatgaaata cagagggaaa 124320
 acattaaagc agcaagagat aagaaaatac cacatagaaa ggagtcatac aataatttgc 124380
 agacttctca gcagaaatgt ggcagtccaa gagagaacat gtaaaactgg agttttcttt 124440
 tccaccctgg tctgcagcc cttcagcccc aaataaacac atagatatta tattaattat 124500

 aaaaatggtg gccaatggct agggcttctt attggctaac tctgtcttaa ttattaacce 124560
 atttctataa atctaaatat ttccatgtga tcttggctta ctgaagaatg cccggatcta 124620
 ttactccttt ggcagctaca tctctttaag gtctttctct gcctaccttt acccagcaaa 124680
 gatattcttc aggaatgaat gggctcttag gaggcttaag taggtcaaga caacctggt 124740
 gacctgagtt caatccctgc atgctacaaa agaaggacaa tcatgacctc taagttatcc 124800
 tctgacttcc atgtgcacac cagagcacat gtgtgggcac acacacacac acacacacac 124860
 acacacacac acacacagag agagagagag agagagagaa taataataag aataataaat 124920

 attttaatat taaagaaatg cttaaaactg aaagagaata atggaaattg taacaggccc 124980
 tccaaagttc taaagataat aaaatataca gacaaagtaa atattcagat aaatttgaaa 125040
 tgctatgata ctacgaaata gatcattaat attggaatt gaaaaatcaa aatatgcaaa 125100
 caaaaagtta aaggataagc agttttaaaa ttcaacatta tgatattaaa ttgaaatctt 125160
 ttagagaatg aagttaaatt gtaatagttt tcattttcta tataaatata tctctctcca 125220
 ctcaccttag gactacatgc ccactcagag atccatctgc cactgacccc tgagtgtctgg 125280

gattaaaagt gtgagcctgg ctacgcacat tcttaataac cttatcagga aagagagaaa 125340

accaacagca aacagactcc agtttccagt tagtttact gtgttttcaa agccttttcc 125400
aatagcttag aagaatgcac taggttttag cctgttccag cctgtgtgtc agtgaattc 125460
ctaagtatat ggccaaaggt gagccaaat atttattca tgtttttttt ttcttttttg 125520
agacaatctt accatgtagc cctgggtatc atagaattta ctatgtacac tatgctaagc 125580
tcaaactcac agaaatccac ctgectcttt tcccaaagge tgtttgtaaa gatgtgtgca 125640
accatgcctg gcttttttagt tgagtctttg tttcctaaaa atagtcaaac atttttcttt 125700
tcgggttttt ctttgagatc caaatccaat ttaatgaggt ctcttttgtt gtatttaatt 125760

acttattttg gtatagagtg tgtgtgtgtg tgtgtgtgtg tgtgtgtgtg tgtgtgtgtg 125820
tgggtgggtc tgttgtggac agaggttaag ctatcttct caatttgtct tcatgttagt 125880
ttttgacca ggatctctca ctaagtagga gccagccagc aaaaccaggt gatcctcctg 125940
cctgtgcctt cccagggata agattcatgc ttgggctgaa tgctgagaat ctgaactcag 126000
ggcctcctcc ttgaatgaca ggtgccttat tgactgggcc atctccctag cctacaggct 126060
cttctttgtc tgttttaaat aataacagcc gaatgtctgt aacacaaact caatatgctg 126120
gctagtttta tgtcaacatg acacaatcta gagtcataat ttcagaggag gcctcagaaa 126180

atacctctat gagattggtt tgcaggcaag cctcaggcat tttctcaact agtgatttgt 126240
ggaggaaaat atagccta atagcttagat gttctccctg tctgttctg tgctaccacc 126300
taaagtcata ttgatgtcca cgagctgtga catgaccaag ttggtgactg tggcctact 126360
gtggcctggg gcaatgttga tgtccatggc cagtgcagcc actgagggt agatggtgtc 126420
tgtggtctgt agtgcacta gaaaccatgc tgaagtccat agtccagact gccactggag 126480
gccatgtgga tgtccatgat acatgctgtt gccaaaaacc acttagaagt ccatgaccag 126540
tgctgctgct gactgtaaat gcaaggaatc ttcttttgca gtggtattga tgactgctga 126600

gttatagttg agaatgagag acacagaagg cttctgtaac aacttccta tctccccaa 126660
aaagaaatag tctagacagg aagtcattha agaacactct taaaaattga gacagggatg 126720
ctgaagtgtg gcctttcata gttgatgact tctggtggtg tgggggtggg gaaggagtca 126780
atcttcttca agaggctggg cactgcacta ggagtttgac catgtataat ggcaacacaa 126840
agtggctctt gtatgacttt tttctttttt ttttttcaa gaggaggtca caagctttgt 126900
ggggtggaac ttgaggact ggaaagtgag tgaatctgg tacattgtgt gaatttccca 126960
aataatcaat aaaaatatta tactggaaaa aaagaactca gtttgaaaga gctatggaca 127020

gcaagctagt aagcagcacc cctccatggc ctttgcataa agtactgcct ccaggtttct 127080
acctcacttg aatcctctgt gactctgatt ttgataataa actgtttcat agaactggtg 127140
agtgaataa acccttcctt tccaagtffc tattggtcat tgcattttat cacagcaata 127200
gtaaccctaa ggaagatagt aagtaatgia agacccccg agggaagatc ctcaactcaag 127260
cactcaagtc tcgggatgat gcaaccacct aagaactcac gagagatcgt ccttgctgca 127320
atcgcacgag gtttattgac aggaaccaga gcgctggggc agagactcat atccccacaca 127380
ggggtagagg agtttcgacc ctgaatggct gggaataggg gtttttaaag gaaaatttca 127440

caacccaaaa taccaaaaat accagtgagg aaagaaacc caacccaaaa taccaagaat 127500
atcagtgaca ggccccgagg gaaatcataa ggggaaactc cctgttcctt aaaattgttt 127560
gtaagattct aatctaactt tttatggcta gccttttctt ggaacagagt tgctgaacca 127620
gctagctacc ctatatccta ggcccttattt tgtctgctga gggggtcttc tttatcctgg 127680
cctttcagta acacattctt gtaattataa catttgcaaa tttcaacca catcatgtaa 127740
ggaccagctc cctacatttc agcagccata acagccgaac acgtatttgt ctgacctgt 127800
cttagtcact aaggtcagat gcctgccctt ttcggcagcc atgacagtaa cgagtgttt 127860

tctgaccttg ccttggtcac tagaggttag gtgcctgcct cgtggcaagg aaccaatcag 127920
aagttagctg gtggtgctat gctttacagc tctggtgtgc tttacggaca agtgcacagc 127980
agagcatagc aaccacctg atagggccta tggccataa caaccagttg accaatcaac 128040
acagggcaag cctccaaga ctggaggcac accaatcgtg agcctgtgcg taccctaga 128100
cactccctt acgtgcctt ataagatctc ttgggaggcc ctaggagctg tcttttgcta 128160
gccatccgcc atggcgggtg ggtgaaagac ccgagctaac atggggttag ctcatataat 128220
tacaataaag cctcgtgcag tttgcagca gctctcgaat cagcctggtg attggggtga 128280

atgcaactgt ggctgggac cccgatacc tgagttttcc ggggtctaa caaaaccaag 128340
gaagccatga ggttccacct gagtggggga acgtggactt ggaattcct agtaaccaa 128400
catcgataaa gaccagacat aggcactctg tcacttttag agagctctca gtgcatgct 128460
acaaaactgg agtctctctt ttattcagca tcttctggc tgtttctaa ctgtgcttc 128520
ttgacctga gactgcttct cttccatttt cctagacct atctggagat atctctcaac 128580
catctccctt cctgtagact gatagttcct aactatctgt cctcaccaga cttagactta 128640
gccctccgcc ctggtgcagg cctattcaaa tgcttagttc tatagagatt caaactaggg 128700

gacattctcc actgaggcta tgccatcaa tagcagatta gctaacatct gcaatacaat 128760
ttagaccag agctcctggt tactagaact agaggttttt tggacccag acactttcta 128820
atagaatcat tcttggctcc cgacagctgt gccgctttgc ttgaatataa taagtaagaa 128880

aatgctgtgt cttggctatt gagttcacct tgtccaccag agaacttctg aacactgtgg 128940
ccacgaggct tgatcacaac ccctggagca atatggtagc ctcctgactg taacaagctc 129000
tgaagtctt cagatcttct acagccttgc tacagccact gccctaaaac agaaggtttc 129060
ttatgccttg gaaagttgag cattgctgct tccaagtatg caaagctgga gactctagaa 129120

gctatagtgg tattgaaagg ccaggataaa gaagaccccc ctcagcagac aaaataaggc 129180
ctagaatata gggtagctag ctggctcagc aactctgttc caggaaaagg ttagccataa 129240
aaagttaaga ttagaatctt acaacaatc ttaaggaata gggagtctcc ctttgtttt 129300
tcctcgaga cccttactg gtattcttgg tattttgggt tgtggtttct tctttcttt 129360
aaaaaacctt attcccagcc attcggggtc aaaattctc taccctgtg tgggatatga 129420
gtctcggccc cagcgcgctg gttcctgtca ataacctcg tgcgattgca gcaaggacag 129480
tctctcgtga gtacttgggg ggtcgcgtca tcccagact tgagtgagga tcttcccttt 129540

cggggtagg ccttacagta tttgtctctc cttgaagcat tttgaattct gcaaaagata 129600
catgaaaact aatggtaaaa aaatttaaaa tactttaag aaaaaaaca aggacatcaa 129660
atctacactg tcaatttctg cagagatata tgtttggctg aggcagaatt ggactgtata 129720
tcccatgcag atgcttcagt agagacaaac tttggtctca aaaatgctgg ctatatgtat 129780
gtaggtgaag atgaggaag agttttgtgt ctgtaatact gggagacctg atggaggtgc 129840
tctccatcag tgagaatcaa tgccctttta ctgcattgag gtatgtatta cgattaaagt 129900
ctctttattc aagaagacac cagggcacaa cacaggccag aactaggtta tagaacccag 129960

caagcagcag cagaacaaaa agggccccggg tccccacgtg cagccccctta agaagctccc 130020
ttacgtcacc ccggctttcc ttcaccacgc ccttatgggc ggtcccggg tccacctggt 130080
acctgtccca ggactattgg gtggggctag ggtgtctccc tacaattccc cttttagtct 130140
aaaagaggat taaaacttaa tagtataaaa tatccaaaac taacaatcat aagggtgaaa 130200
tacaagaaga tacaataatc tgctatggtg catcctatgt ctatgtctaa cttgaacnnt 130260
nnnnnnnnnn nnnnnnnnnn nnnnnnnnnn nnnnnnnnnn nnnnnnnnatt cttactaga 130320
cttactactc cctaatacac aataatgggg aatggggacg tagcatcttt taggttattt 130380

cctgctgaaa tgggacgatg atagtcatgt gggggccctg tagaaaaaaa aatgccagta 130440
cagggaaagt ctctaatgag ttatgtctag tccatgttag atgagatttg tttgattgaa 130500
gatctacgtt gaaatcctca acttgattga agtcattaca atgagttgaa tccagtgcag 130560
tcggggaggt gtagtccaat tctttttctg gagcatgtag ggattgctgt caggctggtt 130620
cttgttggct gtatgggact caaacgtaag tgcattcaga gaaatgtttg cttgttgaaa 130680
ggcaaacctt gacaacaac gattatgaga ggggttgaaa gaaaaagcca agaaaagaca 130740

caaacactcg gacatagaag ttgaggctga ctctatatga aggaggaatg ggaacatfff 130800

 caaaacaaat gggaacacct gggagtctat taggttcaga caagaattat accagagcag 130860
 aaccgacagg tattaccttc ctccactatt cctcaagatc agaattcact gataaacaag 130920
 tggctacttg gattggcaaa gcagtttgag ttatgccccca cttgctgttc tcaacttagc 130980
 ttgacttagc tcaaagagtg ctgactcaaa ggtaatttga atttgtatc ccattgcacc 131040
 gaaccagtcc tatgaagtca ttaacagatt ctctggctca tcaaaattag gactacagaa 131100
 cttttgaaac taatttccac gagtgatgag atatactttg ctgattttaa tcaagacagg 131160
 ctaatagtag gcaggacatt taaagactca agttgaaaat attaaaaatg tattaactat 131220

 tagctaaaga ataaacaaat aagtatffta aagatcatat catatfftga tfftaattaa 131280
 tgttagtggt agagtcatca ctttcattaa ctttcttct tgggtatgga gagacagttc 131340
 tgcagcctgt aacctcagat ccaggggtgc aactccctct tctggcctca gtgggcatct 131400
 gtgaacacat gtgcataaaa taaaaatgaa gtaaatctff ttaaacctt tffttggcacc 131460
 cacgcaaagc agttgaggtc attaaaaaaa aaaatcagac tctacttgtc tgcaggtctc 131520
 ctgctgata tffgatgfta ggftatfftt aatccccaat gagagcaaaa actagactct 131580
 caaaggaaag attgaaagtt tftaacgtat ttacatttct gaaataagtt gctffctatg 131640

 gtaattgcca ggatttaaga catttcttgc acagctgctg acttcagact caagaaatgt 131700
 tccaacaggt aatcacagaga aagaaaggaa gaggaaacgt aatgaggcat gctfftagtaa 131760
 gacatctgta gtctffttct gtttgggctt ttcccttgtc agtttgatta atgggatgct 131820
 tffaaatgta tctcctfftg gatactftac atctcaacaa gtccatttca tgttcttggc 131880
 accaacattt ccagtagatt tcttctaaca tgcagaatg acagataagt ttcagtgftg 131940
 gcctcagaga gaaactatta ttgfttcaaa ccagtgcaaa taccagaag gtccctggc 132000
 cagggggcct gtggagagcc atgtcattcc cagaaacctt gtctagtaaa gatggtagtg 132060

 ggtffaaaaat aagggtgtac atcaccagtc aaggtaaggt gttggftffg tcagcatata 132120
 ataacctcct gagftaataa gaaatagaaa tgcaacttcc aaagtgcatt gtaaggtff 132180
 taaacctctt tftagacaga aggcctgccag tgatttctta ggatttgact agaaagtgta 132240
 aacttcagat aactactgaat atagcccaat aactffftta tftatggfta aatattfgaa 132300
 agaaacctcc atctffftaa gcataacttc agtgcagftg gatgftgtct cttffftccca 132360
 ggaaaaatff aataaaaata taaccacaca ttgaaagact taaaaattag caaagaaata 132420
 tagccagat aaagaaactc tccaaactga atgtagggca gcctaaccca gaaactaagg 132480

ccactactat gacatagggc ctggaattta ccagcttaca aggccataag ataactgggt 132540
 accaagaatt cccagatggc caccctcccc gaggagctca tggaggaaac agattgcccc 132600
 actggccaat gtgtcaataa ttaacaatta agggctcccta tgaacaaaag agatagctac 132660
 catttgctga agcaagataa gcatatcctg aggtctgcag gttttacaac tggtaggtca 132720
 ggaggccatc tgattcccag ccctctctc aagacaaagg agttctctc aggaactcat 132780
 gactctggtc acaccctcc ctaagcttgt ggttttgct ttaaaaacac ctgtgcctgg 132840
 gggacagggc tgctctctag cctgcctgct gagagagact gtttgtaca atgtccacct 132900

 ttcatataag cccttgctg tttgcatcaa gtttctgct cctcatgggt agtgggggtg 132960
 ctgcagctct gggaaaagat tctggaggcc tgagcttctg ggggtcttac aacatgtatt 133020
 attcctttct aaaattattt ttttgatca cccttgaatt gtttctttt gtttaacact 133080
 ttttttaaa atatgtgtgt atgataaaaa gaaaagtta acttttcagt agaaggatac 133140
 ggaaaacttg tatgtgaaaa aacttggtaa agtgtttga tgctgattac atggatattt 133200
 acatattgtt agtagctctc tcattaaaat ttgaaactaa tgatcaatat taattgataa 133260
 aagcactatt gaaagtgatg aattgataaa cagcctgccc taaccacttc agcaatgggg 133320

 ccaagagggg tgatttctact agctgcatta aacttaaaga tatcaataat aatttttatt 133380
 agttttgaat tctgagccct tagcattgag tcattctttc attgacttgg ctcccttctg 133440
 ttttctcag tacaatttaa acccaaaaaca atgctactag atcaattcaa atatagattt 133500
 tggtaggat cattttctca ggtaagagaa ttattcaagt cattgttaac ctacatacaa 133560
 aacaaacaaa gcattttgaa agatatttaa tgtgtctcag tgaattgaaa atcaactagc 133620
 agatagggag ctctctaaca caggttttat ctcttaaaa ttcctatttg ctttaagcatc 133680
 ttatcaaaaa gttcatttct cctcaagaag tttataaatt ctgttgtata aaaagatcct 133740

 gttccagata ttaagatgt aaaaatcctc tttatgttac actgtgttat tacaaaagcc 133800
 atgtcatgct acgaatgata tagatgtgtt atctaattca catgtccttt tttattcctt 133860
 tattatata agcatgtgaa aacaatcagg agaagttttc ctgagacaag ggagagggca 133920
 ctgtgtaaac ttagggcatg cccagtgecc atattaataa gccaggtgca aggacatgca 133980
 tttgtattcc cagcactgga aggcatgaca ggttgatctt tgaagcttgt tggccaggca 134040
 gactagccaa accattgaac taaagtctac tgggagacac tatcttaaaa aatgaggtag 134100
 agagaagctg aggaatagt gattgaagaa gacctctggt cgccacaggt atgtacgcac 134160

 tctttcatgc acacctattc acaagtattc ataacaagca tgtatacaca cacattatgt 134220
 acacacacac cctcttaaac acacaccaat attactatgg aggatccct tttaggagta 134280
 ttaagatatg attgaagatg ataacgaca atgttttaaa gtctgtcaat gaaaacaacc 134340

aaagattaga ttaagtctta ttctaataat taagagtga ttcagcattc ttaaatatgt 134400
 aatatattcat ttgagtgcga gaactatata caaaaggaac aattggccct cttgcgggca 134460
 aataccaaat gtgagcaggc agccttaggg cttaaggaca ccttgttatg tttccctata 134520
 aaaaaacaag tcaccatta ttgatgacat tggccattcc acagtgaagg ggttgctttg 134580

 atgaaataat aatgtatata aaccaatgga gaagagatta aatatttat tttattttaa 134640
 acttcagcat gttacttcag aaaaaaatac acacaaaaat gactgtgatt gtacctatgt 134700
 gtatgagtct cattattgta aaaagaggag ggagtgttga atcctgtgcc tgtgtcaaat 134760
 actgtactgt tctgaaaatg caacacatta atttagagtg aaaagaaata ctatggacct 134820
 atatttaaag ggggctgta ttttcatga gttgtagata atcatattta agtgtatatt 134880
 cactttttga aacaaagact tttatgtaca tgcatgtgtg taagcacaca cgtgtgtgtg 134940
 tgtgtgtgtg tgtgtgtggg tgtgtgtgtg tgtgtgtgtg tgtgtgtgtg cgcgtgcctg 135000

 tgtttatgct tglagaagcc agactagtca ctggattttc tactgcattt tctcaagctg 135060
 agtaactgac aattgtgagt tttcagatgt gggngaacca atacctaacc tctgaatcat 135120
 tgatccaaac cctgtgtaca gtcaacttttt aatgggtgttt caaggtaggt ttaaaggagt 135180
 ccacaagacc cagataaatg attaacaggt atttattagg gaagtactta cacaattaat 135240
 agtaaatage tgccacggtc ttctgtctcc tgaagatgca gtctttgtcc tcttggaact 135300
 acctttgaga gaggccaac ccctctcttt ccttataagg ggtcacatct gcacgcctga 135360
 agccatgccc ctaggatatg tccaccacca caaggccact ggtgaaacaa gttgccactg 135420

 gaggtgtttg ctgtgtaaat gtttacttca taatagtitt atctcatatt cattgaaatt 135480
 tcaaatagtt acttattggt ttcccaaata aatgtgcaga gaaattacat agttaggat 135540
 tcacaatgta acaaatcaga agacacttgt gtgtcatttt gaaagaaaat cattaagtta 135600
 atcaataata aatcatagta actcaatttc atctctctta gtagcagtca cgatgtctca 135660
 ataacttaa ataactataa aacaatgctt ataaatgaaa tattataatt ttaacatttt 135720
 aatatgtcaa agtgcagaaa tcatattatg tttttcatgt tttttcaaca attttaaaaa 135780
 ttgccacaca aagtaataga tttccgtatg ggattttcat acatatttct ttttggttgg 135840

 ttccacgctc ccatttcctt cctccactct actaatcacc cctagttttc cttctttcaa 135900
 tttagtctta ttgctttccc caaagccttc cttaaagcttt ctttttcagt tacatggact 135960
 cccatctagt ttcttggttt ttaccgtatc tacaaccacc tgcatgcata tagttaagtt 136020
 ggaggctaag acccacacat gagagagaac actgtctact tttcttctg aacctaggtc 136080
 acttccctga acagtttctt ttccaatacc atctgttttc caggcatttt cagaaattea 136140
 ctttttatat aactgaataa aatcctattg catacataag aaacattttt attatctact 136200

agtctgatgg tagacatcta ggctgatccc attcctttgt tattgtaaaa agggattat 136260

 tacatgaatg cgtgtataca cgccatttac atgcttttta aagagtgagt tcctgtttgt 136320
 taatacaacc tcatacaagc aataacceac tgaattatca ggaaccttcc acagttccta 136380
 ctattgggga atcatatag aattaataaa actaacatgt gcaagaatgt tatagtttga 136440
 ttaaatgaaa aagaagtatt ttctcacctg tggaaaattt gatgaaatct agaacacata 136500
 ttctatttt atgtcactca cacttatctg tataatgcca tttggctacc atttaacttc 136560
 ctaatttttg catgtatttt gagaaattta ttatatagta tgtgtgcata catactgacc 136620
 cacaaccata aaattatttt cattgctatt tcataactgt ttttactact gttatgaatc 136680

 ataatgtaaa taictgtgtt ttctgatggt cctacgtgac ccttatacaa aggttgttca 136740
 acccccaaag gtttcatgac ccacaggttt agaaacactg acttatactt tagtttttat 136800
 tttatacctc agctcaagtt catgagcaga agcagtgaaac tgcagatgat accagcagaa 136860
 aacaaatttg tagaatttgt atgagtatga agaggattca agggaggcta gacaacagac 136920
 ttcagaaatt ttccacaac cacctcttca tgttcgattt ctgcaccatc atcatgtctt 136980
 agcttacata tatgctttct tcaaatcaa agcctaagaa cagtgtatca cctgccttta 137040
 tgactacag aaaaaaaaaat tagttatctc agttccaata ttgtgggtga tggagccttg 137100

 acttccaaag ctgcttattt cacatggctt ttgtgtgcat gcttaaatga tccaagtaga 137160
 tgaactaaa ttictgagag gtatgtttgg tgtttttttt taaatttat attgtaaatg 137220
 taataaggtt ttggatctgt atgtttttct gcttaaaaat aatgttggtt agacatcacc 137280
 aaacctatgt tccactttct gatttctagt taatcagagt catttacagg ctataaacat 137340
 taagggaaaa tttcaaaaat agaattcaga aggagtgtt tcacaatata tattataaat 137400
 aaagaacttt atacttaaaa tttatacatt aaaaagcttt agaaatcatt ttaagacatt 137460
 tttgtctcaa ataatafaaa aaattttaag tcaactggaaa ttattttgat aaggtatttg 137520

 ttaaaatatt tcacctagcc agagtgaaaa ttacataaca attacctgaa aatattttta 137580
 taaaatctat attaaacttt tgctatacaa aacaaaaagt gcttagcaca cctaatttc 137640
 tatgtacttt gtagtccgga ttatgatggg ttttcacggt gttgtaactt gcagattttc 137700
 ctcttcaaat gtaattaata agaataacta atctcagctt ttcttaagtc atgggaaaaa 137760
 agaaaaatta taatataatg cagtacatat gtagcatgt atatgtatgt atataatcat 137820
 ctgtccaata tgiatagggt agagictatg atttttttaga aagtcactga aagtcttggc 137880
 acagatccct gtcaagagaa aaccacagt gttatttatt tgaagatggc taatgtgctt 137940

gtatagagaa ctaagtacag gacagctctc ttttaagact aaaatttcat gtttctgaag 138000
 ctcaattcaa ataattatc ttatgctccc tgggactact ataatcagag aattcagcac 138060
 atgtaacaaa atagcattaa tcacagggat caatcaacaa acagggtgag agtaaaattc 138120
 tctctcacag ctigagagaa tcctaaagaa gtgtgtgaca ccatccatga gccaaagaca 138180
 ttagtcctaa ttcagagtta aaagtttatt gtgagaaga actagaaaac aagtccaagg 138240
 cattcataag cagtacatat gatgtattgg ggactctctc atagacatta ggaaatacca 138300
 agtaacaaaa aagatgaatg tgtgcagtgc ttacttcaag atcacgagta tcaattgatt 138360

 tatacagccc aactcaagga cagatagcac tcccaaaata ggagtctgat gggaataata 138420
 attctgctaa tctgtgtggc ttatgcatag acaaacaccc cctaaaatat gttgttgaga 138480
 tacacatttt attatcagtg gtcaaggctg caaccgcagg tattagcttt tcatttttta 138540
 aattttagga agtagacctg attttatttg tctgaaaact acaatgagct agcattttga 138600
 aactggcata tttgttcat taattttgat atctgtgggc atctcccact gaaagatgct 138660
 gcttcatata atgcacagat atggcattct ttttgataaa tgcacttcta gcgaagacac 138720
 aggcaggagg gaaaaatttt ttactgaatg acaaatctt ttgtctttac atcattcatt 138780

 tgaaaaaat aaaaataaaa gctccttga gtaaaataca gtcttaaagg ggttattatt 138840
 tctctcaag tagctcttaa aattatcacg tcaagttgta atctcttga gaagttttat 138900
 gttttgatgc aatagtaaaa gagaagaaaa gaaaaagaga tgtttctca tttctttgag 138960
 gatcctggcc atattttct tcatggagtg agagctcaga caggcagaag ttactgtac 139020
 cccattgtct ccttgaaaat aatgtttgac tggaatgtat tgcattgtt ataaaatatt 139080
 cccagtgtat taagactaag acccattctg tgaatcaat ttcatggaa ctcagaacat 139140
 tcaatttga gtcagtatt agggtttaat gtcttctata tctcacaac tgaaatctag 139200

 gcttgacatg aatgttcaaa gataatctgg acattgtaat aaatgcctgc catcctagea 139260
 cggaagttag aagataacca ggacagcctt gtctgcaaga tcctgtatca aactaaagga 139320
 gcaggtggag gaggagaaaa gaatcagtgg atggatatta atcagtattt tctgcaagtc 139380
 taaaattata ctaaacatta tttgcaactt tttctttttt gggtttttga gacaaagttt 139440
 ctctctgtag ccttggctgt cctagaacta gatctgcaga ccaggatggc tgtgaaccct 139500
 cagagatttg cctgatctgc ctctcaagtg ctgggattaa aggcaatgtg tgcaccacca 139560
 ctgcctggcc attatttga tatgaatatt gaaaaacttt cataaacatt actgaaatct 139620

 atcttgtgtg ggtagaatag aaaataaact aaccttact taagataatc ctaaaaggct 139680
 taacaatgt gcccataaac aattacatgg ggcattctc agagaaatca tcagagtttg 139740
 cacaggagcc cagtgggtgt accatgtctc catggcaagg tatggggaat agggaaatga 139800

tacaagaaag aaatgtcatt ctagtgtga atgtcactcc aagggaatgc agctatctct 139860
ctatcccctt tccatctgct gtgaggtttg ggttttccat tgatcagacc atactagaga 139920
ccagtaatgt tactcattag ctcagccttg gagaggcaga gaaaaggatg caaagtagga 139980
aagagctgag atggaggctc aaatgataat ctagcttgta aacccccatg ttaagttctg 140040

ttctagattc ttaccctggt gtctggtaac aaatgtactt tttaaaaata ttatattata 140100
aagtaaagca ttcacattac aaagatgtt ggaatcttg aatttgacta aacagataac 140160
cagataagaa tagcagataa gaaaaaaaa agaatagcag ataagagatt aactatgagc 140220
caaagcatag gtgtgtgtgg tgtgtgtgtg tgtgtgtgtg tgtgtgtgtg tgtgtgtgtg 140280
tgtgtgtgtg tgtgtgagtt ctacatttta aagatcttta gtcagaatga ctagaataga 140340
aacatgacaa caaatgctag tgtggatgtg aggagaagg gacatttatt cacagttggt 140400
gggagtgaag actggtgcag gcacgatgaa aactactatg cagttcctcc aaatgctaaa 140460

aatagtttta ccacatgatc aagctatatac actgtactag ttacttttct attactgtga 140520
tcaaatgcca taaccaaggc acttataaaa gaaagtttc aattgggctt ccaatttcag 140580
gggattagga tccacaaaga cagagtgaag gcatggcagc cggaagagct gagagcttga 140640
aatctccaac cagaagcaag tggtaagag tgaactgaag gtgacctgag attcttaaac 140700
ctcaagcttt ctgccagtga taccatctc cctaaaagac cacacatcct aaccttttc 140760
caaactggaa ccaaggacca agtagtcaaa tgcccaagaa ttatgagcga catctcatec 140820
aatgagcac agccactctt gcttgataga ctccacgctg taaaaagta tactagctct 140880

ttcatgttga ttctacttt atgctcaaaa gccagaaaat ggaaccaacc taggtgtcta 140940
ataactcatg agtggatct gaaactgtta tacacataca caatggaacg ttgttcaact 141000
gcaaagaaaa atgaaactgt tagggagaaa aagggatgga gctggaaata actattctga 141060
atgaggcaac ctataccag aagtacaaac ctcatatgct cactcttact catggatgtc 141120
agatttgaat ctttagttat gcatgcttag actgttgaag ccagaaggca ggaaaatggc 141180
aaaggagga atccaggtga tataaagaga gaaaggaat cattgaagag gaatggtaaa 141240
tgggggagaa tgggggtgaa tggcagagga ggaggtgagt gaggggttac agattctaag 141300

ttagtaaac ttatatttct ttacttatca tcaacaaa actaatgtaa gtctctggtg 141360
tgttgacctt ctaggcctct tatactttgg taattctgtg tagataacag gcattaagga 141420
aagcaaattt ctataaaca agcaaggcca cttaaagact gatttgatgg aacttctttt 141480
tttctttctt tctgtttatt cttttgaagg gaccagcttc cttttggca gccataatgg 141540
ctgaacacgt gcttctatga ccttgccta gacactagaa agtcaaatgc ctgcctcgtg 141600
acaaggaacc aatcagaagt tagctggtgg cgatatgctt tacagacaag cgcacagcaa 141660

tgacacaaa agcatagcaa ccaccctggg agggcctatg ggccataaca accaattggc 141720

 caatcaacac agggcaagcc ctccaagcct ggaggcactc caatagttag cctgtgcgta 141780
 cccctagata ctcccccttac gctgccttat aagatctctt gggaggccct aggagctgtc 141840
 ttttgctagc catccgcat ggcgggtggg taaaagacc gagctaacat agggttagct 141900
 cgttaaatta caataaagcc tcgtgcagtt tgcagcaagc tctcgaatca gcctggtgat 141960
 tggggtgact gaagtcgtgg cctgggacc tggatactg agttttccgg gggcttaata 142020
 ctttgtgtct tatacatcat gtctcccgat cctaccata tccccagaat gaacaaaga 142080
 aaaatttaag agaaaaaaaa aaaaaaaaaagg agaaaggaaa aaaatctcat catggaagct 142140

 gcaatatgat acagagttag tcatgcagta aacctcttta ttccacacgc ttttacatgc 142200
 aggttctact gcaacaatc attggtctgg ttgagacc ctggtctctg atacacttct 142260
 gaggacattg ggccctcgtt gggactcttc ctggacattc cattgctgcc cagtatggtg 142320
 gagatcctac agccccgggt ctgtagaacc aaccttcccc acccttcca tctctgtgc 142380
 tcagcaaat cacagatgga ttgggcgaac atgtaacct ggctctgggc ctgaatagtt 142440
 gcagggttgg gcagctgcc agctctctg tgcatacacc accggggtga gatttctagc 142500
 agcattacc tggctagtct acctcttgca gccatgagca aggggtggat cagttctccc 142560

 actttcacat cctcaggttc ggttctcccc cacctgagcc tttaaacca gttctactgg 142620
 cattgccag tgagggtgta ggggccactc tctgagcgc tgcagctgat gaggagcaag 142680
 gccagttctc cttgtgact gcagggccag ctcttcacc tgcccctgga gatgatagg 142740
 gaggggagtg catatcttc ctgtccatgc tgccacatga cagatgagta atggggacag 142800
 ctctccatg ctacatcag ggctgcctca cccacacctt catcaacaga gtcagttcta 142860
 cattgctgcc ctgaaaggt acagggcca ctttctgag tgctacagat agtaagagg 142920
 aggttacttt gcctgtctg tcacaggtgg tgaaggcaa gggataagg agacatctct 142980

 cttctacc acaccacc atgacagatg agtagagtgt tatggatagt tctccaagt 143040
 taacaactc aaggctgtct cacccatacc ttaccaaca gtgttgctc tctcatgat 143100
 cccagtgag gtcagggcc ggttctccct aagtatgca gctggtggga ggcagggaca 143160
 gctctttcac tcttatgacc tcagtcagg ccagctctc caccttccc gggcattgat 143220
 ggggttgggg agggacttct ctteccacc cattcagcca tataacagat gagtgtcag 143280
 gctaggtctc ccatgctcac attctaggtt agctcatctg taccctcctc agcaggatca 143340
 gaggagattc agggccact ttcttgagtg ctgcaactgg gaaactcct cacaagctgg 143400

agttgggagg gacaagtggg aagggcatct tttccccat tcccaccact gtatgcaggc 143460
 aagggagggt taccagcctt gccctctca taccctcagg gctgtctcac ccacaccatc 143520
 catgtttgca cagtcaacct tactgtgctg gctaggcatg gttcagggtc cttttcccc 143580
 ttgctgcagc tggtagaggg ttgtgatgga actacttaag tgcaaggtca gttattcaaa 143640
 tcaattgcc a tttacagaga aataggccat ttctttccc tctctattta cagcagctgc 143700
 ctgtatctgt gttagaaaga aatcaccatt tcaaggaact gctatgttta tggctttatt 143760
 ttttttaag acaaacatgc tgaattattt ggacggcata acttcagaag gttggaagat 143820

 ccatcaaatt gcaaatctt caaggtcagg aatcatggt ctctattttg ctggaaactt 143880
 tatatgagcc tattaaaagc ttctaacag agcagttact ttgtgcatga agtttcagg 143940
 cccacattta ggtaaatatc ttatcttact gtcagggcta tggcaattga attgggctat 144000
 accttatatt ttctgcacat attaaaacac caagcttaca ttgccaaatg cttcatcctg 144060
 attatataatg cccatttaaa atggggttca atctttctct ttcttatagt gttcagctat 144120
 aataacatgg ccattaaatt ttagaaaaac atatttttag acactccaat gctatatatt 144180
 ttctctgcag aacagcttta agacaatatg gctgaattgt ctttatcccc aaggcttaat 144240

 ttattattgg attagaata gtgattaaat tgaacattct acacccatga gtggtctctg 144300
 agaacaaaag ctggagtaaa aaactccaa tgtatctcag aacaagttag ccactttag 144360
 acacatgatg tctaaagctca aatgcatctt gcttaaaagt atttcaaatc ctggaacaca 144420
 aaacccttaa aaactccaaa ccaactgatt acagagcttt gaaaggattc ctatttacta 144480
 tagaaaaaca tgatgatgat ttttatggca cactgacttt gtttcagtga tgtatggatt 144540
 taatatcaag actgtagact cggagtaaca aaatatctca tccctttgct ctagaactag 144600
 atgtattagg cagttgcctt tcagggtgtt ttgttttct ttgtttggtt tgttttcat 144660

 gttggtgctg cgtgttgaac attcacctca cagaagtgt cacagctgag ctatatccag 144720
 ctcatctctc ctgagaaatg aactgaagaa aagagtctc atggttcatg gagaacacag 144780
 agaaggggac aggggtccag aagccatctg tgacattctt ggaaaggaaa tgctcacta 144840
 aatcttctcc tgccacaacc agaaaaacag ttaagggaac acacagcatt ctggaagaaa 144900
 gaatgcagcc tttgtgatgc ctgtccactt tccacttgat taaagtctt tgtcaaatat 144960
 gattcaggtt taaatgctat agggatgtgc tccatgcacc ccaaacagaa gggatataat 145020
 tatacctaat taccataact catctagcca gaagttctcc atgacttget tgagtgtacg 145080

 caatgctatt tcagcaatga aaaagaacat tttttctaa gaaaaccaac ctataatcc 145140
 atgtatttaa taggctaaac tactttgaaa gaacattgat tcttgtttca tagtaaaaca 145200
 ggcctctcct cctcacagtc aatgtttaag gacacaagag agtttcatgt aacaagatgt 145260

gtatggtcac ctacaagtaa ctttagaatt ctctgcatc aagaaattct tttattttta 145320
 ttcaaggaat tacctcagaa atacttaaac agtagatgga aattccagaa ttttatttat 145380
 ggatctggct gtaatctcct tttgttgttt ggaactgtga agtttccctt acaatctgtg 145440
 atttacaanaa aaagaaaaaa agtagaaaaca tgacctacag acattttcct ttgtacttag 145500

 aaaatatcct atttaaaatg agtaaaattt taaagccaca agagacagaa atacacgtta 145560
 ccccagggga aacctgcatt gttcttacet tgtagtattt agaataaaaag aataaaatga 145620
 caataaaaga cagtcaaaca tggggaaata tattgtacct atggaaatga gctacatatt 145680
 aaaattaaaa caggtagaaa tttctacttt tgagtatatc atttaaaaat aaatagtact 145740
 ttgcattgca agacacaatg cagatagatg tggaaatgat gaaattaaaa tgaaaatttg 145800
 agtcgggcta gggagatagt tcagtcaata aagtgcctgc taggcaaaca tgaggacccg 145860
 agtttcaatg ctcagaacct atacaaaagc tgtgcacaga ggcaagctta tgcaattaca 145920

 gacattggga ggcagagacg ggtgaattca acatgtctcc ccactttcca tttatgtgtg 145980
 tacgtacata ttcatgtgtg tcagtgaggg tgcattgtgt tgtatgttgg gaggggtaca 146040
 tatgcatata tgagcatgta tgtagagatt ggggacaaca ttaaatgcta gtctttcagg 146100
 gcacagtatt ccagttacct ttctaataa agtacttttg tacagaatgt tacaagagtt 146160
 ctgtaactat gtttagaacc ctcttttaat ctgagtaatg ttatcaaaact gtgggggacc 146220
 gattatgtgg ggtcccaggt tctggctgtc agcagctgtg gtgccagaaa actctggccc 146280
 actattgtat tgtaattaa caccaggctg caactttacc tggcctgatg ggaatgtgcc 146340

 tcttattttg catctgtatg tgcctaagca tctgaatagg cccttacctg gaaggagggg 146400
 ctgggggtat gttgagttag gacagagagg aatgaagctg gagagggcca gagggagaga 146460
 ggaggacaaa gagagaaatg gttgctttgt agtgtttagca tgggtggttaa gggacaccag 146520
 aaaagatgat taataaagga atggetctag ttccacagca tggaaactgag agctctctga 146580
 agatgacaag atgcctgtgt ttggctgcta tcgccgttgg gttactagca gcttccaagt 146640
 ccacacacce ccaactcagg agaacctcat ggctgtcgtg ggttaaagct gagacaagcg 146700
 gggccacgac atcaaacatt tcttaatatc atttaagcat cactattctt tgacttataa 146760

 tactcatctc ttttataatt aaaagatttt ttatcttttt gggagaaaata aatttactgt 146820
 tgttggtatt tagagtgtt ctaattttta ttttaatac tttttcttga aattacttcc 146880
 tttgaagtaa aattacgttt atagcctaaa gtacattgta aagcacattg atttcgctgt 146940
 cctcaaatg cttatactat gtatctgtc attgtatfff attaatfff ttaaattatc 147000
 aactaattca agaatgaatc tttatcctaa aatagcatgc ttatgctaag agtgtatggt 147060
 gggtaaagga aaacatactt tgtaagcatc aaagtagtac aagacacaga agagtgagtg 147120

aaaaatgtta aatttctact aatatctaag ttaagaagca aatgtaaata aaattaagag 147180

 aaaatattca tatatgcaag gtatatggca ataagagtgc taaaatgaaa gaaccttaca 147240
 attcttaaag aaaatgaaga aagaacaagc tctggctgcc caagcatgaa cttctgagtt 147300
 ggatccacag aaccatgtaa aatgttggac acagtgcaca tgcttgttat cccagcactg 147360
 gagaggaaaa aaaaaaaaaa aaaaataggt ggttaggtgg gtctccattc agttttagac 147420
 tactttgaga gcctcaacct tcagtgatgt actctgtcac aaacaacaa gcaacaaaaa 147480
 aaagtcttaa tttgaggaa gctcgatttc atttataga tcttggtttt aatgtcacag 147540
 ctgagaaatg tttgtttagc tcaaagtagc tatcataact tttacaggaa tcctttgtag 147600

 ttgcagttct gaggttcatt cttagttaat tttacatat ggtttaagc atagatcact 147660
 agttgcttat tactatcgta ttattctatc atcattcatt gatgatgata gctttcttcc 147720
 caagaagttg gttttatagt ttttatgaaa atcaattggt agtatattag tgggtctatt 147780
 tctggatgct tcatctaat tcactgatct gtctctcttt aagaaaatat gcagggtctt 147840
 tgataactga aaaattcagt gtccttcaat tgaggagaat tagtcctcag gtttcatttt 147900
 gtatttttaa ttttcttgg ttaatgcata tagtgtacat gcttatgatt cttaaatfff 147960
 ctaattgtga aaagttcttg attttagttg tgattccttg gaatctagga attatgtgaa 148020

 ggaagattaa ggcattgcat attaattact tttgaggggt ttgaatcaac tcaatgcttc 148080
 cttagtgacc atactattta tggttggcat tgtttagaga acccaagata tcccagtaag 148140
 taaaaagcac aaaatcccat cttttgtggc cttagcactg tagctgggta agcagtgatg 148200
 gtagcttagt ttccatttct gttcctgtga taaaaacttc ctgatgaaag tgacttctga 148260
 aatatcggtt ttgttttaat tcatgtcaga gcagggaaat tggggcagca gaacatgaa 148320
 gctgatggtc acacacacag ccaagagtag acagagaagg aacacattca tgcttctgctc 148380
 tcagccatt cttctcttcc cattcagttc cgtaccaca cagtccgtga aatgctcctg 148440

 cccacatcca gggtagagttg tcttacctac cttgatgaac ccagctaagc aaaccctcc 148500
 ctggcatccc caacagccaa caaatccaca cggttaccat caagacttct tcccaggtga 148560
 ttaaaggatt tgctgagttg acagttagtc caaacatccc aaatgggaat cagttattga 148620
 cattataaat aatagttata taatatacta gaaggggtaa atttggtggt gaaaactaga 148680
 acgagagaag gagctatgat gtcagtcatg gatgcagatt aaaaaggggt cttggggaga 148740
 catgatgaag aaagtacat ttggacaaaa atttgatgaa agtagtatag ttgcatgga 148800
 aatatctgga agaaaaggtt tcaaggtaga aggggagatg tgcgctcagt gtgcacagta 148860

atatttgaag aggaatgta cccttctttt tatttagaca gaaaagagga gataatttgg 148920
gaggtccttc tgtgtatag tttgtcttat tggatgataa ataaagtact gttggccaat 148980
agggaaagaaa attagggcggg actaggagtc gaggaggatt ctgggaaata tagtaaagag 149040
aagtcttgtg atccaggcag gaagtaacat agcaggcgga ctcagaatat aatcaggaca 149100
aacaggaaat cacttgcctc ctctctctc ctctctctg gagtcatcat gtgatcccag 149160
caagagaaga cgctgccc tgggtgcctt gataagataa gtctttataa aatatataga 149220
ttaatagtta tggttgatac ttaagataga gctagcaatt aagaaatcct agtcattggc 149280

cagcagcatt gtacctaata taagtctctg tgtgttattt tgggtgtcca catggcattg 149340
gggcttgggc agcagacaga aagatttacc attacgataa aaggtttcaa cacagaaggg 149400
gagatgtgtg cacaggaata tttgaaaagg agaactctgt ggctatggag gtgaggtgag 149460
agagaataga cacccttcaa aacacatcca tcccttaaga actttggctt ttgatggcca 149520
atgaaggggt atacagtaat acagtagaaa gagaaatcca agaaacacat gtggaaccaa 149580
agatgaataa agaatgataa gggaacattt gctcccagct ctcacagctg gatgctaaca 149640
gcaacctctc tagaaagttt caaatgaaat gattacaata cagacaagtg atgtagatgt 149700

ccataacta agagagatgc cagcaaaaaa tatcttttta gatgcaccta tgttttaag 149760
agcaaaagta caggggctgg ctgcaagggt gctagtaggt aaagtgctta ctgcatatgc 149820
ataggacagg agcttggttt gtcagttctg tattggctgg gtgggtggcc tgcctgcaat 149880
cccagcactg gggagacaaa ggcaggggat ctctggagca agctggctat ccagatgatc 149940
tgtaacagca gctcaagggt cagctaggga gggacactgt ataagatgga gatcgaggaa 150000
gttaccatg tcctcttag gcctccacac acatgcacac acacctgcac actcaggtgt 150060
actcacatac atgcaaacac acaaacatac atgcaagca tccttttata catatgcaaa 150120

agaatatagg tccaaattca atgatgtata ttacattaat atggaataca ttatttaca 150180
attatagcca atttactag tgcctttcac atgctgttat cacattaat aggactgctc 150240
cacaacaga gaaaatggtt caggatagat gtttcctcag cacagtgtgc ctgctcattg 150300
aattcagact tgcaaggctg attgtgtgaa gggatcaatg aggaatgaga getccatccg 150360
atgaactgat ggaggcaaag gcatgtaaag atatgtcagt gacttactgg ggcaagacct 150420
ggagtgtgt attgtgctca ggcaatgaca acagtctcag ctgagagact gtggagttag 150480
gaagcaatca accatggagt taattcattt tagaaaaatc tgtgttttgc taacagaaaa 150540

aaaaaatga cattatgttc aaaagtagga catctaactg aaaatccaag actgtaatca 150600
tagaaaaata tctcttggca tagcattctg gaggtgacac tgggttaata attatagtta 150660
tgccattagt ccatctgcat gcataagcag aatgttttg taagaagaat ttaaattatg 150720

aaaagacctc aaattctaata gttacgcat tatagctagt tccccatact tctaataagc 150780
 atgttatcca ctaagcaact atgcaacatt ttcatttcaa gaacttcaag ggcaataaat 150840
 aaaaagggtgc agatgtgtgt tctggagctg ctcatgaaat attaaattgg gtggttttcc 150900
 atgtgaaatg taatcagtat gatttccaag cttttggca ttttacctt tgggtttcaa 150960

 atttacctt ggcatatcct gattaacatg aaaactttgt aatttcacag ttaaaaaaat 151020
 tcacggctat gtgtgagaag tctctgaacc aggtaatgta attctctgaa tctagtcaag 151080
 gttgttattt ttigtatacc atgtgtgtca ttagacacat tttaaaagta agctttctac 151140
 tcatgaagga aaaagaataa aattcaaac ttagatgtgg agagctgttt atggattggt 151200
 ttttattgct aatctatcca caaataaac aactgtgctc agaaaaagca tctaacagt 151260
 gattcctcct cccatttaat gtctctctaa ctcaaagccc aaataaccac aaaataaac 151320
 tataaattta atatgaccat aatgttaaaa gtctctaaag ctgagagttt ctcttctgcc 151380

 cagaatacca acaggcttag tatgttggta ttgttgata tatgtgtct aatgataatt 151440
 aaatgtgat tttctttct tgacatttta aattaggtca agtcttataa taaataaaaa 151500
 agcatatatt atggtcacac atcccataag atgagtggat cactttatat tttagctag 151560
 tagaaaaata ttggaacatt gacaaagctg agacagccta agataccaa aagaggagtg 151620
 ctaaaataac atatataaca cagaaatgtc agagaaatac ttctagtctt cttcagacat 151680
 gctattcagt gtataaatga gagaaagtgc tatctggtgg gtatcagagg taaactttcc 151740
 taacaaactt gttattgcac aggaaactaa acattatggt cacttagatt cttcagattc 151800

 ttigaaagtt caacttetat gcttttaagt caaatattc tgcctacct tgcactttt 151860
 gaaaaatgaa actggaatag tttagccttt ttgccttta gaggaatcaa aatcaatggt 151920
 atcatagtga agagtttgtt tattgtttg tegtattttt ttttttgag acagggttcc 151980
 tctgtgtaac agtgcctgct atcctggaat tacctctgta aaccaagctg gettcaaac 152040
 cacagagatc tgctgcctc tgctccca atctctggat taaaggcatg caccaacact 152100
 gcctgactac taaagaggtt ttaaagccat tttctacttt tcatttctgt tgtcgtgata 152160
 aaatactcag gaaaaaagca acttaaaaga gaaagggtt atttggcagg ttacaattca 152220

 tcactacagg aaaagtcata gtggcaggcg ctggaggcaa ctagtcatat tataaccgca 152280
 gtcaagaata gagaaaaata aatgcatgca tgettacatg tgcctcaaacc catctttct 152340
 tgcttaggga atggttcac ccacagtggg ttgtgtcttc ccacatcaat taactgtac 152400
 ttaagacaat ccccataga cttgccata ggccaaccta attgaacata taaaaaagt 152460
 attcatagcc tggagttaa gtttttgatt caatcaacta tagataagaa ctacatcaga 152520
 tttaaatcaa cccccccc acactcctca atgagtttct acaaatgtca gctggattga 152580

acattatgct ttatgctaaa gtaaaaattg gtttaatgta aggctagaga gatggctcag 152640

aagtaaatgc ccttgctcct ctatcagaga gtcaggattc agttcccaac atccacatgt 152700

ttgctcagaa ccatccataa gtccatttct agagatctat tgaacctttt gtctttgtag 152760

tcaccaagac acatacatgg cacacataat tccatgaagg caaacactga gacatataaa 152820

gtaaaaataa gtaagtttct ttttaagaaa tggttatcaa gtcttcagag ggttaatgta 152880

ttgaagatga tgttccttgt catggagtga catagaaact ggtctgagac agccattatt 152940

acacagtggg gctcagtaga aatcaaggag aaaggcatcc ttacaagtat aaggaattca 153000

aactgaatcc taatgtgtct gaaaagaagt tattggagtt ttaaaggtat gtaattttca 153060

tactaactta aacatacatt gagtaaactg ggggctttta aaaattatca tctgaccaa 153120

ggataaataat gttaaattta tttctagtaa tagacaagat tgaagaacta aaacaaaagt 153180

tcattatcag ataaaataga agtttaccac attatcaatg agacaggtaa cagagtagct 153240

gagactgaaa cttataatag ctatcaagaa caactttatg aatgaaaatc aactttatga 153300

atgggcatag gtcataatgg caaacagatt agataatgtg gctcaaagtc cctcattcaa 153360

ttaaaggtca tctaatttta aaatagtttc aaagattaaa ttgctagaaa tgacaagtga 153420

taaaagtctt aatatggctg ggcatgggtg ctaatgcctt taatcccagc attcaggagg 153480

cagaggcagg cagatctctg tgagtttggg ttacaaaagc tagttccagg acatcctcca 153540

aagccacaga ggaacccggg ctcgaaaaac aaaaaacaaa aaacaaaaaa aagttttaat 153600

atgaattttg ataataatc ttgccttatt aaaacaaaga aatagatc ctgagctgct 153660

tctaattggt ttattatctc ttgtttaatt ctctcaaca taccactggg agatggtttc 153720

tctataaggg gtactattaa aacaacgtgg tagaaagggt ggatcgtata aattaacaag 153780

caagaagata acagttgatc acatttaaaa ctttatatat tgataagcac aggagtact 153840

caaagtatc acatgggata tttaacaggg gggggttatt gcttataaaa gctctgttag 153900

ctacagttac agaacagtag ttgcaagcat actgctaaat tatctctaag aacagtttca 153960

attaaaactg tattgtttgg atatgccatt tgttttctct atgtattagt tacttttcta 154020

ttcctgtgat aaaatgccat gaccaagcaa accttcagaa gagagagtgt attttgatt 154080

aggttaggat tcacaacagc aatgacagca tgataacagg tggcagacat gacaagtgga 154140

gttgaagct aaggactcac atggtttttg ttgtttgtt gtttctctt ttgtttctt 154200

ctctcttga ggggtctttt ttgagatagg gtttctctat ttagccctgg atctcctgg 154260

actcttctg tataccaggt tggcctcaaa ctgagagtc cctcagtc tcctccta 154320

gctccctagg gctgggatta aagactaaag ttgtatgcct accacaccca gaattaagac 154380
 tcattttgaa aagccaagca ggaaaagtta actaacaagg ctgcaagcct ttaagttctc 154440
 aaaggtctgt ctcaatgtca tagttcttct agcaagacaa ctccttaact gcccaaacag 154500
 tgccaccaac tggggaccaa gtgttcaagt aactgagatt aaagaggaca tcttattcta 154560
 actatcatac cctgtatfff agttttatca tgtttattct gtatgtagaa catgttacat 154620
 atgagtaagg aatctgatgt gaacataata ggaatagtgg aggaatgacc acaaagagac 154680
 aaaagcagaa attccactag tacacaaaac tttccgtac cttaacctta ttggttaaat 154740

 gatgcatgtg ataattaca caacattata catgcataca cacaccacat acatacacc 154800
 acacatgcat aatacacaca tacacacaat caaacatat gtaatacaca acacaatata 154860
 gcacacatac acacatacaa tacacacagc atacacacaa ttgctgaaat agaaataaac 154920
 ttgcaacatg ttatatggcc agtttccaga ttgtactgtc atattataaa ttatgatcat 154980
 tggacaaaga ttgataagga gcacctgaat taattcctgt aattataatg aatctacat 155040
 ttcatgttga cagaagtffc tttcccacc agtctgcag ctatttagtc ccaaataaac 155100
 aaacagagac ttatattaat tataaactct ttggccatt gctcaggcta catccagcat 155160

 gtccattggc caagacagtt ttatccatca accaataaaa gaaacatata ttcacagcat 155220
 acaaaaggac atctccatt atctctctt ctctatttaa ataaaaagga aagttttaat 155280
 tttaacatag gaaaattata tataacaaaa cagttatcaa gcaagaacta tagttaaaaa 155340
 caatatttag tccactaaca tttggcaaaa ttaaagaaa atattctatc atctatcctt 155400
 tgtaatttta aagttttata tgtaacttat cttttatcat aactaaagaa aaaccataac 155460
 tatatgtctt caactctatc aaagacacca ggaagataat atagaatc taaagttgac 155520
 agagacatct gcctgcctgg acagtcacc aaagttctc tgtaacttgg ggcatacttc 155580

 tttagectat aggcccagaa tgtctagcaa actttttgat gaagcaggaa atttgaagat 155640
 ctatattggc aaagttcact agatgctttc ttctataagc aggaactctg aaagaccacc 155700
 ctgtctcttg gcaagttcag cagtacttta ctttgtaaac tgcctgtcca gtttgaacag 155760
 tgtgcttact gtcaacaatt gagacaagag cagttctttg cccaataagc cagttttgcc 155820
 acattgaagg caaacccat aatgagtttc tttgatgcc atcttctct ctgatgtaat 155880
 tggatttggc aggagcaatt gtgtctcatt gttatgaaca accctaataa accatfttaa 155940
 atgcatatt ctgtgagct ttgaaaggta ttaagacta cctattcatt tgaaatata 156000

 ctctgaatat ctagaaaac caaccaacat aactataagt tttgactatt ataggtgact 156060
 atctacaate tgtatftaat tatacattac attttcaaaa aagetgtaca aacacaatac 156120
 ctaaacaaga gtaggaatat acatataaca aaattgacct taaatttga taaataaacc 156180

caaatgcaaa gtattcattt ctgtatcgtt tccttttttg tttcagaagg gaatgactgt 156240
 gattattaac catttataac caacacagtt taaatgaaaa caaacattta caacaatat 156300
 ttggaaatgt gggcatagtt ctcttcaaaa tgcttccttc tgtttgaaga cactgtcaat 156360
 cttaaagggga tcctgagaaa actaagaacc ctccccaaat cctggctgta gtggtttgtg 156420

 agactgcatg gtctcagcca tttttggatg ctggattacc tgggccactg tttcagggga 156480
 tcttgcttga tgaactgta ttagtcctga aggaatccac agcttttcaa cttctgtgga 156540
 aagaaaagca gaacctcttt ttcaaagtaa catgctccta ggcttaaatt ttgaagtcaa 156600
 gtcattttca aaatacatag gttggattaa tccagcaaag cagttacaat tcagtgtgtt 156660
 ttagcagctg ttactccttc cttagcaatc aaaaaattta aagacacatg atagcataaa 156720
 gtatccagac tcctgtgta tttttcatct ttacatggct ttttaattat tttatttctt 156780
 ttagttttat ttgtttcatc tcttgataca gggttttctct gtatctttgg ctgtcctgga 156840

 actcattttg tacaccagga tggccttgaa atcatagcca tctgtttgct ctgcctccta 156900
 aatgctagga ttaaaggcct acaactaccac acccagctac tctatTTTTT aaaggacatt 156960
 ttctttcctt ttttcttttc tctcccagc ctacatatat ttttaaacac attgtatact 157020
 gtttagagtt tttttttcc cctatgaatc tgtgtttacc tgtatctcta tctttttctg 157080
 accacatgag tctttaatct tctaaacagg attgctgaga ttaaagtgga atttttggct 157140
 gctggcttca ttcagttagg ctttcagca tggcaggaat atgtttacaa tcagctctgg 157200
 gagctgtgtt caccacctca gctctggctt atgacacat caggcagctt gtagcacact 157260

 gctacttttt tgtctgtatg agtaaaaget aaatcttctt tgcagcatgc tgtatggctt 157320
 ggagacagcc tctgtatacc atagaaggaa tccacatgc tgtggtcaaa cccaactgcc 157380
 atagcatctc tacacatcg cctgcatgaa actgtgagac taggaaatcc cagtgcagct 157440
 ctgtttctgt gtgttcagaa ccctttttaa gctttttgca ggttttatgt ggaaattctt 157500
 gtcaaacctt tgggcaccac atatagatgg aaatTTTTTT cctgccaag tcccacagcc 157560
 atttagtccc aaataaacac acagagactt acattaatta taaactgttt ggctcaggaa 157620
 tattactaac aaactcttac aacttaagtt aacctatatt cttatctata tttagctaca 157680

 tgataccttt tctcagtagt aaggcatttt catcttgctt cctcttcatt tgaccggcag 157740
 ctgcgtatct ctagagactc actctctgca tctcttccc agctttctcc tatttaggta 157800
 gcctgccta tacttcctac ctggctacat ttgacctgct cattagccaa agcagcttta 157860
 tacatcaacc aataagagca acatatattc acaggataca aaaaaaaaaa aaaaaacat 157920
 catcttcaaa aataaagatc ttttaaaaaa ggacttttat gataaaagta atttggtcag 157980
 gtgagaaagg aactttcaga gacggtggga acaatcaagg caaagaggca ggtacatcaa 158040

gacaaaactgt attgagatat gcctactgtg ataatttttag caataatgtt ctgatccatt 158100

ataaacacaa tgttttaatt tcacagtcaa tcattcatta gtgtgtgtgt cccacttgta 158160
gctaggacac cttgaaacgc aacagcagtg tcagaatctg ctcttgagat gttggacagt 158220
gatgaaact aacctcttc tgaagaacct cttcaactca tacatgattt acagattgaa 158280
atattgtact catcatggat cagaatatta ttgttgaat tgtcccagta ggcactctacc 158340
tagaagactt gactcccaat gtagtttgc tgtttcaaca tacattttgt ctaacttctg 158400
tcttgctttt ttgactcttg attttttca acaatataat aaggaagaca cttaaagagc 158460
tattgagtaa ttaaagaaca gcttgtgtct agcagcaaga aagtatttgt taaaaataac 158520

ttcataaaca aaaaaattcc taaatgaaaa tgctatatga gtgaatcaaa gtgaattttt 158580
ttacattgaa aatatcagtt tactactaaa ataaaagtaa aaataggcat taaatthaat 158640
aatgaaca gttccaagaa atgtaagatt tacttgaact ttaacaaaaa agaaatatec 158700
aattcaaca tacagtaatt taggagagtg aaaagtaata attttagagt caatttghaa 158760
taatcagttt gtaattaat atatttgag gtttttaatg ttattcattt ggcaacaact 158820
tttctcacta tactatggct gcagtagtgt aatctecct tgatagttaa tattcaactt 158880
gaagtaacta tagtgacagc caatatatgg atgtttctca aataccacat ttacaaaata 158940

gttcagagaa aagaaaaata caaccatcac tcatgttgag agtaattttt aaaatataat 159000
tagcaattgg ttgtagtata aaatgttaag taataagaa agtaaaatat aaataacatg 159060
aaaaaatcaa ttatcttct cttgaacaat caatagtctt attgcataga tctggaatac 159120
aatccatta gttataatct gacttaaagg gagattcctt gaaacatata ggattthaat 159180
tatatctcc aaataaggat aatggccaaa ggggcttaag agcaaatag aggaccacga 159240
gtctttgatg taatgcaaaa aaccttcacg cactgaattg aaaatttatt tgaaatcctt 159300
ttacgttaag ttccatggt ccccaaatc tttcaaagta aaccgttgtt tcacagtaac 159360

aatcattcta acctaagctg cctctctgtt gtgattatac aagtagtcaa gcccacactt 159420
cacatatctg cttataaact gggctcataa cacaaatctt taattgggtc ttgggaccaa 159480
gtctgaaatc aagaaactct agctatthta aaatattaat tccaaccatt ttgtttatat 159540
taattggctt ggagtcagta gaaagcgtag aaataaatat aaaaatatga aaacaagtga 159600
gaatagtact agtaactata gtaagcttag caacacattg gcaaactcac ttttctttg 159660
ttttgcatg taacatttg gaaaacatga aaagaaaaac taatttagaa tcagggtctg 159720
agagatggct cttacagaac actcacgttg tgtccatggt gtatcacagga tgactcacia 159780

ctgtctgtaa ctccacctct agatctggag ctctctttg gaatccatga atacctgcac 159840
 acaattggca tacaattaca caaatataca tgcattcaca taataatfff ttaatcttaa 159900
 aaaataagca atacaattag gctatggatt tccttttaaa tatataggac aattagctca 159960
 ggttatcgaa gtatgcctca ttgaaatag aatctgaaat acaatgtcta aaatffffgt 160020
 ctaatttgag gcttaagaga gtactcata tttgttattc ttacaagaat ttacaaatff 160080
 tgttgtaatt taaatataga agatffffcc tactatctcc tctttctgta ggtcatgtgg 160140
 aacctacca attagaggca ttgtttcaag gggttataaa acatffaagg ggtggggcct 160200

 aacagaagaa agtggatcac aaagtaagg tgtgtagtct tgggctffat agtcatgccc 160260
 ctgtgagtcc cagctffctg cttctffgfc cactgaaatg taactaccac aaaccagac 160320
 ctgccatcac ccaattccta ccatatgtat tttctcatal tctgagctcc caagttggtc 160380
 ttgtffgtac tccctcagcc tagacacaca agggaggggcc taggcctat accaaagaat 160440
 atgatagact ctgaaaaacc ccccatfaaa ggcctfctc tccctgggaa gcagaaatga 160500
 tgtgggatag gttgggtgtt agtggggggc aggggaggag gagaggcaga ggcaactggg 160560
 attgacatgt aaaaataatct tgtffctaat tfaaataaaa atggagagga aaaaaagaa 160620

 tcttattcaa aatcattccc aaagaaaaa acttgcctgg gtcaacaag tcgacaggaa 160680
 gtactaacct caaaagtgtg gaaggcattg cfaaaagfff agctggaaga aaaggcatal 160740
 tacaactgta ttagattaat gttatcttca aataagfaat gagaaaacaa tgaagttgat 160800
 tttctatcta atgctgtffg ggaaccatg gcaatgttag gtatfcccag cagaagcaaa 160860
 ttcatctcaa tcaffcagct caaatctgfc cttataaagt agttgagaat tctfftcatt 160920
 caagcaagaa tffatfcat ttcagaatta taggggctat gtgtfaaaat aaaaataata 160980
 tcaacacatc agtaggtggc tgatatctat catagctccc tccagtgact tcaatagag 161040

 aacacactcg tcaactcaac tcttggggac tcaactca caatccat tcaaggattaa 161100
 taccttgcca gcctgaggcc atgaagcaag acaggattga tgccaatctc tcaaaagfff 161160
 tgggtcaata atctgtcata atcatffct cttctffgta ttaccacct cacactfga 161220
 ctgtatcaat cctcaggcag tctggtatgg aaagaaatct gcagaatfff nnnnnnnfff 161280
 nnnnnnnfff nnnnnnnfff nnnnnnnfff nnnnnnnfff nngactcaca aacactgaat 161340
 tffctfggaa aataatagtt gactfgaagt cccatgtgaa gatgaaatta aagtgattff 161400
 cagtaacata gtggaagfca tcaatctct gaaaaagaaa aattaataa ctggggtfcc 161460

 tgtaatattc aaagatcaag aaaagtatta ctaaaatfc thtagacatt cttgatctat 161520
 aaagtaata aaggtaatat ctccccctct ctgtgtgtat gtacagatga actgaatcat 161580
 gfcagggcat ttatgaaaag gtgatattc actatgattc tgtgttctaa tcaatgatgc 161640

cacattccaa ttttttacag cacagagcca tattcttggga ccgcatacaa ctaggcttta 161700
cagctagaaa aacttgatg tcattagtgt gcttgagtgc ttgagttcat atttcattgc 161760
cttcacattc taccatatag agcaattttg tgtggctaaa gatgaatttt atgggtgttt 161820
tctaaaactc ctaattataa ggtagtgtgc aatgactgct taaagttata gctccagcat 161880

ttgatttatt ttacaattct ttctcactg ttctttacta aatagacatt ctttgtgttt 161940
tattagagat ttctccatt gcatcatgct ctcagtggga tggetgctgg tgttttattt 162000
tacttctgcc attaattacc tgtggctcag tatcatgtct cttacagacc catttatcat 162060
aatagtcccc gccggtgtcc ctgcagtgag cagcctgtca gactttccat tggaaacccc 162120
acttctcaag ggcttttagcg tctgctgtaa aactgtgctt taatacatac atgttgaaag 162180
tgcattggaat gatctatggc tctctttact tttagccaca aaaagacata tttgggaaaa 162240
caattacttc aaaattgatg tgcattgaaca ttgtggtaga gaaccttgtg tgaaaacaat 162300

gtagcttaaa aatatttatt gttctgtgtt tttttttca tgaaaacatg cttctttgca 162360
gtagataggt aaccataaat agaaatacac atattttcat ggatgttctc tattttaatt 162420
tcacaaaaat gtgcacgatt gctacatttc ttgggaactt tgaataagag aaattgaagc 162480
atccagtccac aaatggcacg tcgttaacac attcctcacc ttaatgcttc agggatgtat 162540
gcagaagagg aggccaaaag actttaagaa ccaaatgtgg cataaggact ccagggaat 162600
agtgtcttcc agacaaaaca ggaatgatac acatatgaaa tcacatatgg aaaaacgaaa 162660
gatccaggat ggccaaaaca accctataca gtagagaaat gtctggagcc atcaccatcc 162720

ctgacttcaa gctctattat agagetgtag tactgaaaac agcctggtat tgacacaaaa 162780
atagacaggt agatcaatgg aatctaactg aaaaccctga tattaaccca cacacctatg 162840
aacaccagat ttttgacaaa gaagctaaaa ttatacattg gaaaaatgaa agcatcttca 162900
acaaatggtg ctggcataac tagatgctga tatgtagaag actgcagata gatccatctc 162960
tatcaccatg cacaaaactt aagtctaagt ggatcaaaga tttcaacata aattcaccca 163020
cactgaacct cttagaagag aaagtgagag gtacccttga aagaattgat ataggagacc 163080
gcttctgaa tataacacca gtagcacaga cactgagatt gacaattaat aaatgggacc 163140

tcctgaaact gagaagcttc tgtaagccaa aggacaccgt caacaagaca aaatggcagc 163200
ccacagaatg ggaaaagagc tttagcaacc ccacatcgga cagaggactg atctccaaaa 163260
tatacaaaga actcaagaag ctagtctcca aaacacaaa aaatcaaatt aaaaagaggg 163320
atactgacct aaatagagaa ttctcaatag aggaatataa aatggctgaa agacacttaa 163380
gaaagtgtc gacatcetta gccatcaggg aaaccacaac tcaaaaacaa ttctgagata 163440
ccatcttgtc cctgtcagaa tgactaaaat aaaaaatacc aatgacaatt tttgctggag 163500

aggatgtaga gaaaggggaa cactcctcca ctgctgatgg gaggcaaac ttgtacagcc 163560

tctttggaaa tcagtattgt gattactcag gaatatggga atcattctac ctcaaattcc 163620

agcaattcca ctcttaggca tataatccaaa ggatgcacat tcatacaaca aggacatctg 163680

ttcaactatg ttcatagcag cattatttgt aatagccaga acctggaagc aacttggatg 163740

ccctcagct aaagaatgga taaagaaaat gtggtatatt tatacaattg attactacta 163800

ctcagtagaa aaaaacaatgg aatcttgaaa ttgacaggaa aatggatgga aatagaagaa 163860

accatcctga gtgaggtaac cagtcacaaa aatacaacat ggtatgaagt tactcattat 163920

ggctattaga tatatagcaa acgattatca gaatacaatc cacactgctt cagtagctag 163980

gaaacaagga ggacccaag agagacattc aggttccct ggagaagggg aatggacaa 164040

gatctcctga gcaaatggg agcatggggg gaggggtgaa gcatttagga gaaagagaag 164100

gggagaaggg gagggaaaaa gaggcaatga gtgagaatga tgattgagtc aggagaatag 164160

gggagagaaa gaaaagagat actataatag ggggagccat tataggttta aagagaaatc 164220

tggcactagg gaaatatcca gagatctaca aggataacc caaccaagaa tctaagcaat 164280

agtggagagg ctacctgaaa tgcccttccc ctataatgag attgatatct accttatatg 164340

ccatcctagt gccttcatcc agtagctgtt ggaagcagaa gcagacacc acagtaagt 164400

actgagcgga actcctggaa tccagatgca gagaggaatg gtgagcaaag gggtaagac 164460

caggctggag aaaccacag aaacagctga ccttaacaaa ggggagttca tggatcccag 164520

actgctagct acctaccag acctcaagaa tatgggtgtc agttaggagg cctacgtaat 164580

ctatggggcc tctggtagt gatcagtaat tatccctagt atttgaatag actttgggag 164640

ccattccat atagagggat actctctcag cctagacaca tggggaagag cctaagtcct 164700

gctgcaaat atgtgagaaa ttgaaagatc cccatggaag gcctcacctt ccctggggag 164760

cagaaaaggg atgggatagg gggttggtgg ggagcagggg aagatagaag ggggagggaa 164820

ctgggattga catgtaaaag aagattgttt ctaatttaa taaataaaaa agtgaaaaaa 164880

taaacagaat aaagaatgtt cttcaacca atctacttat tgatgcttga ttagctagta 164940

ttaaaacaga gaaggaaggt atgacttcca taatgctcag ttcagagcga tgactttctc 165000

agcatgactt tgccagccat ggattttgtc tccaggcaaa gaaaggaaca gaaaacagtc 165060

aagagagatc ttcgttctact gaattccaga aagagatata cctctctcc aaaaaatcc 165120

ttgggctggg gaacattaca ggtctttcct gtttgctgaa aggtgttcac ataaggtttt 165180

gigatgctta acccataaat cttagggcac gaccaaggag aatgattgtc tgtttccatg 165240

actcagaaat ctgaacctat ggtactgatt tgggccaaat aatacttttc atcacctgtg 165300
 tcttggtttc attcatttga atgtgcagaa gattaaggtt atcattgtgg tcagtggat 165360
 tagtggaat aaagaaagga tagatgctgg acttgcagat tatagtгаа cactaaccta 165420
 gagttgggtg gattgtcttc attctctccc ttggtagtta cagcacagca cagctcaagt 165480
 ttatgtгаа gcaaagtca gcctatgagg catttgaca taaaagaatc aaggattagc 165540
 ttccatagt aaattttta tattatatct gtaaacaata gccattttc tctttattgt 165600
 tttattttc tctaggggc atctgcttc ttatttattc tcaactacaa aacaaagata 165660

 gcatcacaag aataacaatt cccattctg aaaaattaa tggcatgtca agaaattta 165720
 cacagtatca atactcaaaa tattagccag aacattctgc tctactaaaa ataagtcata 165780
 taacaaaaat attgttaaat tttaacacca tacaatgtc tagcagaata aaccttgctt 165840
 cagtacattt gttttctat agatgtaaaa ctaaatgtt ttaattatt ctcttttgt 165900
 aacttaatgt atacatttct tatgtgctct ttattgatat tgtaagacce tcagaaagct 165960
 gaggcttcca gaatcttagt ccaggacggc ggccaccca aacacagaat ggaggcgaaa 166020
 gcttgatgca aactgcatga ggctttattg tagtttaaca agctaacccc atgttagctc 166080

 gggctttca cccaccgct atggcggatg gctagaaaag acggcttgaa gctgctgcgc 166140
 atagatcttt atagggcagc gtaaggggag tgtctagggg tacgcactgg ctcacattg 166200
 gtgtgctcc aggcttggag ggcttgccct gtgttgattg gtaactggt tgttatggcc 166260
 catagccct cccagagtgg ttgctatgct ctctacgtca ttgctgtgcg ctagtccgta 166320
 aagcacacce aggttcgtaa agcatagcac caccagctaa cctctgattg gctccctgtc 166380
 acgaggcagg catctgactt tctagtgtct aggtcaaggt catagaagca catgttcggc 166440
 tgttatggct gccaaaaggg aagctggttc ctcaatata acatctatgc tatttgagaa 166500

 tttttatcct tcaatcaat tctgtagact gtttctaaaa atggctgcct ggcagtaact 166560
 gcttatcagc agttagcaac tatgtgcttg taaccaagaa caaaaccatc agatcatttc 166620
 atatggagaa tcattctgtt tttcttcaa tacccatctg ccagcaatta gttaacatga 166680
 gaaaacatat tatagcagat tacatctgtg tgctactta aatttgataa ggactaacta 166740
 catatctttt attatttgtt gaatctaac agaggtagca ccaatggtag gattgctcat 166800
 caattgtctc aaatgcaacc agttgaattc tgataagcaa aacttcatta aaccaatcag 166860
 tataattact ctttacattt gtaatcaaac tcagtaatat ttacaataca tatatttatt 166920

 tatgtcaate tttattaca aatctacaa gatttaaatg gtgcatgact taagaaaaca 166980
 aataccaatt ctttttttag gtgaaatagc acaaattta gcagaagttt cctgagggtc 167040
 tgaggactcc ctccctccc ttttcagtc tagctccatc acagtgagaa ccaactaac 167100

ccaccagga aatgctgigg ccttcttgaa tcaaaactgga gctccttttg ttatgcaaac 167160
 accatagcca taaatacctc atgcacatga cttgtttttt aattaggtaa accttacatc 167220
 aagactcctt tctctatgtg actataaaga cttctatctt acctataaat ttttaaccag 167280
 ttatatcttc ttaataatcc ccagtaacta gttaactgaa tcatttattt acattcactc 167340

 aacttgcaaa aataaagttt ttaacagttt taaaaactat actttgagaa cagattaagg 167400
 tggaagaaac aatgtttctg ttgtccacgc gacatttctg gtgatgaaga cgaaggtatg 167460
 tcttggctct atgtcttaat attttgaaat ttttttgag gttatgcttt atgtaagcat 167520
 ataaatgatg cccaggaatg agtgtgaagc aaacacagta tctgcaattc ttaggataaa 167580
 ttatctgatt tcattaagca agaaaattgt ctgtaagagc agattttcgt attctcttta 167640
 caaagagtcc tcaaatgaaa agtgttgata ggtcttgctg ttaggagagt caagctggtg 167700
 gaagccttct actggaaaca ttaaatattt aaatatctta tttattttgg agtgtatagt 167760

 gaaagatccc agtcatcatt cgaaatactt aaaaatttaa acaatttatt gttttgctcc 167820
 ttacaattta aatttgaaa agtcttaacc ttctcttat ttaatgaaa aggccatcca 167880
 ctggaagcaa gcttattatc tagaaaggaa caatacaaag aaaggagaaa tcagattcca 167940
 tttctaacac tgactgaaac tcatctcttc ctttgggcat gcagagaact gaaaagtaga 168000
 ataaactttg attttatgca tttctgagc aatacaaaga agaaaattag aggttcattt 168060
 tgatggcatt tttctgtgtt attttaagaa tttcgccaaa acctccggct gtcacctca 168120
 atgacaacta atggcattga aagaagtgc acattccaga agccatttga ctaatgatta 168180

 tctggtgaaa ctgaaacctt aaaaagagag cattccacag gaccactggc tttcttaatt 168240
 ctagaatgta gagataaagt ggccattatc tgtagtttat gtaaatcatg tgtgttttta 168300
 tcttctggtt gttttatagg aaagtgtct aaaaagtaaa ttttaaggct tcagagaaat 168360
 cgaagcatat ccaactgtct ggcatccttt atgcctgatt accttcagt catgtattaa 168420
 ctccccgagt atctgcacc ttaatccag tataataaat catgaaatga tttttctgtg 168480
 agagacaaa ggggaattac ttgaaatgct agcacactac tgaagtggag gggaaggctg 168540
 atgcaattat ctgatagtc tatttattcc ttctccattc ctctgtatat gaggaaggga 168600

 attattatc cacacagtta ctgtcagaac tgcatcagga gagagattag aaaactga 168660
 tttataacaa gaattacagg tagcttaagg aaatcatata aatgacttt aaggatttct 168720
 tatattttct ctatttttaa ctcatctcta gtcctttatg tctattgttt tgaatcatat 168780
 aacaattagt atcatattag gatttttact atttatctgt cccaagcat ataactttgc 168840
 attcagttgt tgtatcatct ttgaagcagg agaattctaa tatgtgggca tataaatcat 168900
 tgtgttgcat gataaatgtg ccatagaaca ttaggtctca tgtccagga gggaaatgaa 168960

tagctgtgct cttagagcac acagtgagag ctgggagtcc ttagctagt tttatctttt 169020

caatgtgagt aaacttcacc tacttcccct gaaacacatg aactcaatta ttaaacattt 169080

cattaatttc tttccgtaaa caagccaagt agaaactatt acagattgga atccatgcaa 169140

cagagtggca cacaaatctg ctgaaatgca catccctttt tattctcatc attgatgggt 169200

ccttttattt caggctatta gcttttaggt gcagaataat ttttagcag agcagtgcc 169260

tattgtcaat ctggccaatt tcgattgaaa aaagtatttt gtattgttct tcatgtaatc 169320

tacagaaaga gacaggcaga gtggaacagg tgcagggatt catacaataa acacatgcgt 169380

atcttctctg catactaatt accagccaaa ttgctagcaa gtaaaaacat agatgagcaa 169440

aggggtgata cacttgagga atattccaga gattacagtg tttaaagcca gtaggtaggc 169500

agaaagtagt agtcaaggt atttgctaca ctgaggcaaa gcagtaactt gtgagcagtt 169560

tggttccagg caaatcacat taacagatga ctatctctg atcctatttt ataaaaccac 169620

tggatttgag gcatagatct atagcccaaa ggagacaaac ttttctcag aaagctgagg 169680

gagacttaaa acatgctggt taaggtgtac ttagctagt caactcatac tattcataag 169740

tctgcaacta ggggtttgga gaaacacctc cgtctctgt gcaagcatgg tgtgagggtc 169800

tcagttcaga tccaatacc caagttaag aaacaaacaa aaaggctggt ttagtcaca 169860

tgttgggaaa aaaaaaaaaa aaacgggaac ttataggagt tgctgaccac caaattagct 169920

gcaagtgag ttagagactc actctgcaaa gaataaagaa gacagagaaa gacgaggaga 169980

gtaggccttc acatgtgtg gcacagcctc agatctacat gcagacacat agttacgcac 170040

tatacacata cacactcaca cacaggctta tgcacacaaa agaactacta cacatggaat 170100

aattacagtt aaataagaaa tagtgtatat ttcaatttta ctatataat gcaaatccca 170160

gagtttccaa ctttgaccag tagcagctac ataaaatctt tattaatgc tttattctaa 170220

aaataaacctt ggtaactcaa cataaaaaat aacagttccc tactaataaa agcatgataa 170280

aataaaagta taacagtagc caaaaatacc attcatcaat gttattttta tataattgat 170340

ttaggtttt aagttagata gaaaaagag tccagtgcct gtatctgaat tttactggca 170400

gacaccaaga agcattatat tttattttc tggatatatgt gaagaaggag atctcaagca 170460

tataagtgac tgaatttagg ataaatgaac tttagacatc attgagtcca atcctcttaa 170520

attgcaccaa atgtttaaat tggcaaaaac atagggcatt taaacatcta agtaatttta 170580

gcagcatcag cattgaaaac aaagaaaaga aatccttcca tttttaaaa caaaactgca 170640

tttggcaagt cattttggtc tgatagcaaa tgtgttgaac atatttctg ttgatcagta 170700

aagatgactt tgcagtacct ataatctgca tgacaggaat aatgaatcac ctcatTTGCA 170760
taggaacgaa gctatactta aagggtttgc aaacaagact gaatgttgcc aaaccttata 170820
gatgaggaca gaggaatgaa gaacaaaggg gtgctttgta accctaaaac agctgagcaa 170880
gtctctactc atggctctga cttgtatcaa aacttcctaa atcttTGTGT 170940
gcaccaggaa aggaaattca gagaatgctg aattaaata aggaacagaa atcatggaga 171000
ttaatgtagg agaaaaggag attaaaacag cttcagttct tcaaaaagta tctaagatgt 171060
agaaaactta ccaaccatta agtaccagtg gtaagaggca ctagaagggt gggttctaga 171120

attcctttag ctgtattcta ttgaggcagg cattgtaatc tggacatgtg agtttaattc 171180
ttttgaggac actiacacgtg aaatgcatgt ttatgatatg tagttgacct ttctattcca 171240
gtattcacag atctcccaag tagccatttc tgaagaacag aaatgttctg gtgccaggcc 171300
acatgggtcc agtgctgggt cttcagctct ctgactacac atccttgact gcagaaaagg 171360
ctgatggtaa ggiggcaagt taacatctca gcattcagca acctgcatga gtaagattac 171420
agccttcagc tgtaataat gtttctaate tttccagcag agggagtgat aatcctatga 171480
aaaccggatt cttcagggcc caactgttca ctgttgacaa gccacacaat agtggtagaa 171540

ttttgataat aactggctca aatTTTatat tctttagaac cacttgacag actacaaaaa 171600
ccaaggtgtt caagcagctc cccaatctc ttcaagtaaa gtgaggttaa actcatgttc 171660
ctgttcccta taggttttga aaatatgctt ttcatggtac caggatacac cacaaagtta 171720
gttttcactt attgcatTGA ggaacgatga cataactagga ctcatTGTG atctatctct 171780
ttttttcacc agtgaagtcc caagtatggt cagattggcc tcagcgagta gaaatgaaag 171840
catgacttct acccttgatc tcatggccac tTGTttaatg tgctcacagc caccaagcaa 171900
atcattctat ctccaattct ggggccattc tttggtgtga attcacctag gactccaata 171960

tctcctgatt catttaatac ctgaaaatat tagctgcagc ctataaattt ctataaatca 172020
atagtctttt ataaaaaat ctctcatttc aaaattaatg taaaactata cctatatctg 172080
actatgctta ctgagagatt tctttttgca agtttcccc aggacatgac agagtgaggc 172140
tgcagtactg tagccataac cacccatatt gaagaagtcc ctacattttc attcctcagg 172200
cagttgagta cactggctat cccatgagtc ccaggttga ggttgagaaa gagaagacat 172260
gtctgatgca gaagtgacaa atgtttgatc aatgttctta tctaactgat ttgtgccttc 172320
aggacatgtg ccaattgata tttagtactg gtgcttgggt ctcagtatgg tatgatgcta 172380

ccgtaaactg ttcttcaaaa tgttcaggtc acatgacctc atggcaggac atagtaaggt 172440
ggtttctact aagatctagt agcaagccaa aagctgttct ctaaagagga ttaaacctt 172500
ttacaaagga aggtgtaaag ccaggcatca tgatagaacc attaacctc aaaatttagg 172560

aaccataagc agggttatat ctgagttcca ggtcagcctg gtgtacattg caagttctag 172620
gccagccaga gatacactgt gggactttatc tcagaaacaa acaaaaagaa aatcttagag 172680
acagactttg ttctaataatc taaagtactg tgttattacc tttgggttct gtgaaggttt 172740
caaatagtta aataatttcc ctctatgtct ttaacatttc taccaccacc agatttcttc 172800

catcccatgg tcacagtjac aaatggcatc ataactggat attttgtgaa gtgtcctatt 172860
gttctcagge atcaattaag ctcttagcca taagcaatgg gtcagaaaag catactatga 172920
gatacacact gctttcaaag ttcaaagctg tcagagatat tgtttctttt tcttttggtt 172980
tgaatagatc ctattcaagt aacttgacct tcacctcaaa aggcataatcc cagaatagcc 173040
cataccactg gatagccata aatttgacta agtgagaaag ccacattatt ctgtggatt 173100
tatttctcat catctgtcat gttcctcacc aaagcatcta gtggatatgt cctatatagt 173160
gaagccaaac aagtttatac aatcaatgta atagaaaaga gagtgttctt gtagaataaa 173220

agcatggtca aaggctctaa gattagggct gggtgagtag ttcaatgatg gatcactttc 173280
ctagcataca tgaagagccc tgagttcagt cctgtgctg attagtttta tgtcaacaca 173340
agctagagtt atctgaaaa aggtaacttt aattgaaaaa tacttccgta agaaccagca 173400
ccacctccat aagagccagc accaccttgg gttagggatc ctgagttcta taagaaaaca 173460
ggttgagcaa gccataacca gatacctcc actgcctctg catcagttcc tgectacagt 173520
ttcaagccct gctgagttcc tgtcttgact tcctttggta atggactatg atatagacat 173580
gtaaccaa taatataata accaaataac caaataacca aatatgcaca cactcataca 173640

catatacaca cacacacaca ctgaactcct cctgccttg cttttggtca tagtgtttca 173700
ccacagcaat aggaacccta agtgagacag tccccaatg cacataaagt gggatatagct 173760
gtgcatagct gtaacctagc actgcatagc tgtaacctag cactaaaaat agaggcagga 173820
ggatcagaag ttcaaggcca tctttgtcta catgataagt ttcataccaa cctagggtac 173880
gtgtaagagt gtctcagaaa aaaaatattt atagagacca aaaagaaaat ggtgctgaag 173940
aatgactca gcccataaag taatatccca agaacaaaac ccaacatcca cataaaaact 174000
ggaggcatgt ctataatccc agaatagggg taggagaaac aagaggatcc ctgaggctat 174060

atggtcagtc agtatagcac aattagttag ctctgggttt agattaaaa ccttgtctga 174120
aaaaataaga tggagaaaa tagaggaaga caccagacat caatccttgg actcttcatg 174180
tgtatataag catgtccatg caaatatgca cacactcata catatatata tatacacaca 174240
cactgaactc tgtggttact acttgagagt aggagttgat agattcataa agtagatata 174300
aagcatatta tttgcttttt cagctaaaat tacactgctt cttgtggctt ttatgcaggt 174360
cagtagccat atcccagga gcacaaacat atttgatgag atgcatctc aaacttcagt 174420

ctccatctct ttcaatttat agtaattcac tgttattctc ctagaccact atttctcggc 174480

atatgccaaa ttagccaatc ctgcatagat gcggtgggaa gcaaatacct acatctaaga 174540

aacactgtta gattttacga gtgcattgcc tgcattgatg tttgtacatt acatgcatat 174600

agtgctgaca gaggtcagaa gatgtgtgat gccttgagc tgggtttgtg gatggttatg 174660

aggcacatgc caatgatgga aacccaacct gggatttgca ggagcatcaa gtgctcttag 174720

ccactaagtc atctccccg ccctecatct ttgaagttc accaatcagc aacctcaca 174780

gcaatataga acactcctgc tgcaacctc tcagcaatat agaccattcc cacttcatgg 174840

tcagtcatg agtaaaaaac cctctgggtc cactgtgtgg gaacctaac caacatctag 174900

agatcacatg atgtcacca ggccatctct aaacaaaaac cacagtgaca ttttgaatat 174960

ctaaaaagta gtgtgatctc agaccagtt gcctaaaac ccacaagtgt gggaaaagtt 175020

tgacttccgg gtactggctc cattcaggag agctgggcat gccatcttcc ctcaagaagc 175080

cgcagcctcc ccttcagtc ggggtataag gtagttcaag tgtgggaaac aatgacttca 175140

tttccatgtc tcaagttccc tgggtagaaa ttctactca gatgcaaca gaaccacat 175200

gtcagtcatt agcagtgagc tgattctccc cattcacagt agcctttctc cttgtgtggc 175260

ttctcataaa gccacatgag caccactta gcaataactg aacctgctct cccaggggca 175320

tctcaggctg gttccctgag ctgtgccat ggtactcttg tcaactgctc aactcacaaa 175380

cttctgggat ctacacattt ctcttataaa attccttctt taataaacat catttatact 175440

ttcatgataa atttactgcc caaggcattg ttctgcttg ctgaacagtg cttttctggc 175500

atatgtatct tctctgtaag gcacaccaca accacattgt gtccattccc agcacaggac 175560

attaatacca taattcgggg ctgctttgaa cactgaatcc agtcatgagc acaaaaggca 175620

gaaaatgtgt cactatgtaa agtgtgaaac ataagtatgc ttgtaataata acagctggga 175680

taaaaaggac tattacctg taagacagca gctgtaaata ttttcttita gtttgtttct 175740

tgctattctg tacaattgca tatccataaa aggtgtcaaa ggtaccgaac aatttcattt 175800

gggggttaaa agtaagtttt atgatatgta aattcttaaa tatggagcgt attactaaca 175860

agagttgatt gtattctagt tcatgaaaca gtgagtctaa ttatccagga caaaaagttc 175920

tatggtcaca atattgtgac aatagttttg gctctgctgt tctttacaat aagtgtagta 175980

agccatcata gcactccaa ggacatattt tccaggctg cgtgatgcct atcattggta 176040

gtctcaacac ttggggctgt aatgatacc tatatttaca gctgcagtct tataaggtaa 176100

tattctttct tattccagct ttattactga tgtgatgcta ttctgagctc catgctgaga 176160

ctgttaaatt catattttca gtcaacggtt ttctttgttt ctttttgttt ggtttggat 176220
 tggttggttg taccttttgg ttttcatagt gctgtgggta gaacacacag ccttgagcat 176280
 tgtaagcaaa catccaacca ttgggcagca ccccatcctc agcacaagtt ttgatgctag 176340
 caaatacttg gttaccaga gctgtgtatc tatgggtaaa tgactatgag tgtctacaga 176400
 tggtcattta tattaatgct tccactttat ctgacatggc ctcttcttct aatccaatac 176460
 tgaaaacagt attatttatg gcatttacet ttagtcaaac caaagacata atttcagaat 176520
 aaaaagcaga aataaaaagc aattattttag attctgttct tgagccattt ctgttaccaa 176580

 attgatacca aggttgtatt agagaagcag gtgccatgca cagcatgaag caaggcccca 176640
 gcagcactgg taactaccag atggccctgc tccaccccca atatctaaat caccagaaag 176700
 aaactctctt gacctcacc aacttgaac atacttggca gttttaagaa cattgtttat 176760
 ccctgtcaaa tttggatat tacatagcca tcacagtatc attaaaactc tgctctgaat 176820
 ggagcaatat tcagaccaga gtaagattgc tgggaatact gaaaatacat gagaatgagg 176880
 caagctggtt aaatttaaag gactaggcag gttttaaact agggctcctg aaacggtgag 176940
 agcccaaaga agatacttct gtctctaaact caaatagtct ccactccaac tccatctaat 177000

 ctgagaaagg agttatgtct attatcaaat gtgagtgtca attaaaatgg tctgattaaa 177060
 tacgaatatt ttctcatctg catctgccag ttctccctca gaaagccaca tttttctct 177120
 tagaatatca gtatgtctag acatcaata catttattat tcacctgagt tttgggttat 177180
 ttcgggtaaa gggatgacac tgtatgtttt tcaacctcca gaagtctgt aacacaatta 177240
 ggacacaaca tgctctcatc ttatggagag ggccactgca tttgtggcct ccaagacagg 177300
 ccattagcat gatgcaatgt tttccacact atcaggtaat cttatgtctca tagcagtgat 177360
 tttactaggg aaagattcct acagacagga aaaaatcaag ttaaagtact tagtccatag 177420

 agcccttaga tctgggtcat aagagatctg acaatagata aagaacaaaa ggccttgcca 177480
 aatagcattt ctgagcatag tgtcttgacc cattttccat ttttgctaat gtagtggcaa 177540
 gagaggccgt gggatcagca tggatactta agacattagg acgtaaatgg tattatctgc 177600
 aaagttacag aaccaaaaaac aatttagaca tactacttag aaagtcttct atctatggga 177660
 accaaaagag tacaacaaa atctggttta atatctgtaa ggagtgaaca ttactgaagg 177720
 aaagataaaa caaatttgac attccaagag agaactgtaa caaatgagaa ctactggac 177780
 atgtttttgt cagagcactt tatcaaacit aaccattgat agtgggcatg atattctgtc 177840

 ctatacagtt agtcagcatt gtagcacgaa ttctagtgg taacaagaaa aaccagaga 177900
 cagatattgg agttaaagct gaagatctga gaagcaaagc ggctatccac tatagagttc 177960
 tcacctctac caatactcag acagaaggct gatcttgtag tcagactgca tcaccaaagg 178020

tactacacct cagactgcaa tgttctccac caaagctcag actgccttct gctcttgtct 178080
 cctcctacct tatatttctc tctaagtctg ggattaaggg tgtgtcatcc ccttagctct 178140
 gttactcttt tagactgatt aacctcatg tagcccaggg tggccttgaa ctacagaaa 178200
 cccatctgcc tcigtctccc aagtgtggg atttaaagta tctccccac tgctgtcct 178260

ctatggctaa caaatggctt aggtgtgtgg ctaactagtg gcttagctct gcactctgat 178320
 cttcaggcaa agctttatta gatcataaac aaaatatcac caaacggctt catgcttaga 178380
 caccaaaaa caatgccagt ttgcagggt gcttttgag ctacttaag aatgagttat 178440
 aagcctcatg actactttcc attatgtatt tcacctgcag ttgagcagga aaaatttaa 178500
 aaaaataaaa ataaaaggta ccaccaagag aggaatggct ggatcttgag gtagactgat 178560
 taccatttt ccgagttata attatgttca tagcaggatt gttgtcata gccagaacct 178620
 ggaagcaacc tagatgcccc tcaactgaag aatggattga aaaaatgtgg tacatgtata 178680

caatggagta ctactcagca gaaaaagca atggaatctt gaaattcaca ggcaattga 178740
 tggaaactaga agaaccatc ctgagtgagg taaccagtc acaaaaagac aaacatgta 178800
 tatactcact catatatgaa ttttagacat agagtaaagg attaccagcc tataattctc 178860
 ttcaccaaag aaactagga acatgaagga ctctaaggga taaatggtcc ccaggaatgg 178920
 gaagtggaat gaactctga gctaattggg agcatgaggg taggggaaag ggagctgcca 178980
 caataagagc aagagaagag gagtagagga gaggaaatgg aggaatagaa atattgagtt 179040
 aggggaataa gagaggagag agagcaggat gagagatacc atacagagg gagccactat 179100

aggtccgaga agagatctgg aaccaggag atctccagag acctacaagg atgacacgat 179160
 ctgacaatcc aggcaatggt ggagaggata acctaaaagc cttccccta aaatgagatt 179220
 gatgatttct ctttatgcca tcttagagcc ctcatccagt ggcggatgga agcagagaca 179280
 gacatccaca gatatecatt gagctgaaat cgggaattta gttgaagaga gggaggaatg 179340
 aagagcaaag gggctgttac caggttgag aaaccacag gaacaattgg nnnnnnnnn 179400
 nnnnnnnnn nnnnnnnnn nnnnnnnnn nnnnnnnnn nnnnnnnnn nnnnnnnnn 179460
 nnnnnnnnn nnnnnnnnn nnnnnnnnn nnnnnnnnn nnnnnnnnn nnnnnnnnn 179520

nnnnnnnnnn nnnnnnnnn nnnnnnnnn nnnnnnnnn nnnnnnnnn nnnnnnnnn 179580
 nnnnnnnnn nnnnnnnnn nnnnnnnnn nnnnnnnnn nnnnnnnna ttgagggccc 179640
 tacctgcct ggggagtggt gggatgatgg ggtggaggag gtaggttggg ggttggggaa 179700
 gaaggatggg agtgagggga gggagaggaa gaaggactt acatgtgaaa caagcttgtt 179760
 ccctaacttg aactaataaa taaaacaaac aaacaaacaa aaaaccaaag ctaccaccaa 179820
 atttagagcc agtcattcca actatccaga tacatcacct tgatccatga ctacaaaata 179880

gtttttatgg ctttcatact catgaaagtg atttgagaag caaagatact ggtttggggc 179940

 tgcttgtaa tacccttctt caaactcatc aacaagattt aaaagagtcg ttcccatcca 180000
 agctggcctt ccctttcatc acattagagc acctagttaa acagcaagga cttgtaaggg 180060
 aacattcagc aatctgttcc acacacattt cttttgcagc caaattacac ctgtaagac 180120
 aaagcagaaa ctctttgggt tccaacacaga caagcgctga atgttttatg gtttatgcaa 180180
 tagctactgt gtgttgctgt ttttaatta gcatatataat ggatcccttt cttccatcac 180240
 atgtaattgt ggtgggtgta actcaaggaa agtaccctga gcatttacct tgtggggcat 180300
 tgtgatgatt tatgtcttgg gaatgggaca tactgtgctt tacatctgct cccaagtat 180360

 ccctgtactt cataatccca ttgcttttaa gaactagaaa cactgtgagt tttggagctt 180420
 ggcttttgtt gttgttatta gtgtttttac cacactagga atttctttct ttttaagtgt 180480
 ctgttcccca ctatgaaact caaatcaatt ctactgaatg gtagcaattt tctcctaaaa 180540
 tctgtcctta caataatgaa ttgtccactt aatccactcc tgcaaatcca ttgggtgttt 180600
 attgctgaaa acaacaaaca atatttctc tcatttggtc agtaactagg ctgactct 180660
 gcctcttaaa atgtctcatg aatagttaag ggtgacagtc tttattagag aactaaaca 180720
 cacatttgat gagtaacctg tataatttct ccatgctaca atattttggc aaaccacaag 180780

 gtccaactga acgaagtcac catgcagata atgtccttac cttctgaaga tgctctctgt 180840
 cttacttagg gtttctattg catccaagat tgagcaaagt aatataaaaa aagtaatacc 180900
 aagaattact caaggcagcc aggagtgtgt ggcacacgcc attaactcta gcacttgggc 180960
 ggcagaggca ggcagatctc tgtgagttca aggtcagcct ggtctacaga tcgagttcca 181020
 ggacaacctc caaagcaata cagagaaacc ctgtctgggg ggtgctgggga aataattact 181080
 cacagctgg agagatggct cagccattaa agcctaggct cataacaaa aaaataagaa 181140
 ttactcacat tcacaaaaat aatgttttaa atttatcaag actgttaaaa aagagttttg 181200

 tatgtgtgtg ttcagtcaat taccatctt cattttctta tctcatttaa actaatgggg 181260
 gaaatgatta ctgtcttttc acagatttgt aaattgggga attgtgggca ccctgtgagc 181320
 tgatctttga aaggggtgct gatgtaattgt gtgcattaat gctacaactt ctgaggcaga 181380
 agagagggga ggcttcagt tttacgtctc tgacctctc agaaagtgtt caaaagtgtt 181440
 cctctccagt gttactgctg ttgttactca caagtatatc cttgactcta tctctccagt 181500
 ctgcaatgaa aaccaaggag cagaggtagc aaacaaaaag ttactaggta atctggtgaa 181560
 cagttcaggg ccaactatgc tccatcctg tctttcatgt attaatgcat ccaaatgcat 181620

tgaacaggat aacttctctt tcttttcttc tgctctggtt gtgcctacaa gcaatgacag 181680
 agtccaaggt acagccagat ccacatgtcc acttctcttc ccagagaaaag ccatcatccc 181740
 atgtgcttgt gaaagtccat acccttggga cttgcttctt agtcacaaaa tgattaagaa 181800
 ttagaaaaga agtiacacagt ccaggtcatt tgctactaaa ctacaaaaggt taattagtta 181860
 ttttatacta attagatatt agtcatacta attagtaat tattatttcc accttcagta 181920
 gttgttagtg ttcatggcaa aaatctttta atatgaaatg aaaatctcag ttttaccaaa 181980
 atggtatgct gataatttag tatttaatac aatggttttt gtttgtatgt ttattgggac 182040

aggatgatac atttccaga ctggcctcaa atttactatg taaattgagg ttgatcttaa 182100
 acttctggtc cttttgctc caccacccaa ctgctaaggc atatgccaca ccctatgtta 182160
 agtacttttt tcagtaacat ttaaggataa tcaagttgag tcacataaat aacctcttc 182220
 aaaagacctt gggatttaca caaattttca gtaatgtcta aggaaaaaat gtacatgtaa 182280
 agaataatcc ccaagtgaac taattctgcc aatcttaaat gccaatata tgtgtgtgg 182340
 cagcatataa caaataaat gtcacaaaag agttaagttc ccccagagca ggtatttact 182400
 ggtcagtgac cacaatggct ataaatagaa gcatggfataa tgtttatgct cttttatgaa 182460

ggaggtggcc ttgtggacct gaaatataaa taaatctaca ttccattccc tcatttttct 182520
 ttacattacc tgatttgaag acacagtgtc ctaaaggcca ctgggtgatt catatgtaaa 182580
 cagggaatgg ttaagcctga acatctactt cctaagagat tcaactagtt acgatccagg 182640
 ctctgtaate attaagaaag tactggagtc ttgaattcat taaagtcttt taaaattcgg 182700
 ccagtgtage cctagctgtg caggetacat tgcttttccc ctgatgtgcc aggtctcctg 182760
 ggagctgaca tagagtggct gctccacact tagaaaggga agtaccacct gccaaatcca 182820
 aaaattgctg ctgggattag aagaaattcc caaactgcac cacagcagaa acaacaact 182880

agtctgctct gttaaaatag caagatgagc taaaagagct caaaactttt ttactccatg 182940
 gaatctgcca cagcaactgc tgggtaacat ggatgtgatt taaaattaac gaaatttagc 183000
 tgaaaattgc agctgggtgg aaagtttaaa ggatgaaaag taggacaacg cagatgagct 183060
 gcttggcaat tttctgaagt tttggaagcg ctttaattg gtaagtcact ctactgtac 183120
 ctgaaagtac acacggcctc gtggctgagc tgcatctgca gtgtttctgt tcaacagtgg 183180
 ctgccactca catgaagatt gccacttctc agtatgcctt gctcatcttt gtgtccctaa 183240
 agatcccaa gatgctctac ctatgagaca tacttaattg aatactaaaa gctgataaaa 183300

ataatttctg tcatcatctt aaatatacca gggctttgag tttaggtgac atagcaaate 183360
 agacagtggc cagatggata ttttggaaat tacaactca tatattattg ccatctgtg 183420
 gggaataatc agtcactgga tgtcactaca gatgacagga cttttccctg gcctctatct 183480

tccaatccac aatgctgtcc cttcccacac aaatgagaat cctgatttat cactggact 183540
 ccaggaaga aagaacata gtgcttttca gtaaccattt cattgccatc attagcctgt 183600
 attaaaaccg catggaccaa tttattaacc acttgtaaac atgttaatgg aacatttat 183660
 ggtgctttta caaggcagca cacttgagaa tttcctccca aatactcaga agtctgttga 183720

ttctattaag atccagccaa aggcctgggag ggtagtagtt gaggttggtg tgtttgcca 183780
 caaagcatga ggcttaagtt tgaaccttag aaacacacac acacacacac acacacacac 183840
 acacacacac acaccctgtc atgatggtgc acagttgtaa tctcagaact gtggaggtgg 183900
 agataggcag atctttaatc agcctttcta gcttacttga caagtcccaa gtcagccaga 183960
 aaaagaagtg aacacctgag aaacgaactc ttattttggc ctctagcctc cacatgcata 184020
 tgaagtccca ccccaaacc cactccacc ccacacaaat ttactcaaaa atttgcaagg 184080
 caaacagaaa agcacaatag tccctctatg aatactttga ggactgcat cacaatactt 184140

aaaagtcaag cccagtgtag aaaaattaaa gtccagttaa ggtccattaa ttataatgca 184200
 attcctcagc caaacaagag tttggcctta aatcaatagt caattacata cttcctgcag 184260
 ttctagtcat taattgctct gcagcttaga aaataacatt ctaactgctt gtagaaaggt 184320
 aatcaaaatc ggtgtctaat gcttaagctt gattctgttg tgatcatctt tcctcaaca 184380
 ggaaaattaa ctcttcggt gacttggggc caaacacttc caatgcactc ataactgtta 184440
 aaaactgagg acaatggcaa gtaacagatt ctgggtggtg gaataatatt taatgtatct 184500
 taagggacaa gcaagacaaa aatagcatcc ttggtcttca caaaagaaat gcctctgaga 184560

aatgccatca cttctctatc ggggttttag ctggagacac acagaaaatt tgctgtccag 184620
 gagatattgg atgggaaatg tttacaggat aacatctcct agctgctgct ggcaaggag 184680
 catttaatgg taaaaggac atgctatctg gctccgcaat gaggaatcac tttcgagctc 184740
 agttctcagc acagtgagac tccttccgtc aaaggtgatt tacaatgatc ccccttgtga 184800
 gcttcacca gcatatacat cgcccagtgg gagacttagg attaaggata tccacattaa 184860
 acatagagcc tcagaacctc gacaactctc agaaatcacc actgtagtga aggatgggga 184920
 gagaggagaa tataattgag agacacaata gaaatataaa tgccgtgcag ttgggggaat 184980

actttaatgc attactaata ctttaaatgc atttgaacta gggactagga atttacaag 185040
 cccatagtga gtatgaagct ctacctcagc cttccacagt caggggaagg atgctctgag 185100
 agtgagcaga ggagccacag ggcagagacc ctggaagaag accccattgc tttcattgca 185160
 cattcatgce ttactgtgca ttgcttagaa gcatgaaatg caagtgctc gaaatgattt 185220
 tatttgtacc gatttgaat gatcttttat gtgtgtgact ggcagggatg tgttcttcta 185280
 agtttccca ctatagatcc gctatctcct ctgagcctcc tttattttta tttattaatt 185340

tatatttatt tggctaaagc ttgcatccc aggactcatg caggctaaac ccaagttctc 185400

caactgaagtc ggcctccagt tccatcggac atacttttta ggagcatgga caggctttct 185460

ctatgtaatt cagtctcatg ggattggaaa gcttcctgga ggggtggata tetcatgaat 185520

caagatacag agctcaaata tttttccaac agtagcagtg aggcatagcc aatattattc 185580

tgtgcctgtt ctcatccttg tccctgtggt ccttgacaga gtgtttgaaa caaagcatca 185640

gctagcatag cagagggagt ggagggagcc ctgagggaat gtgcaaagtt gacgtggaaa 185700

cagtgatgaa gaggaccaag gcctcagacc attgaaaaca aaaactaaaa caaaaacaaa 185760

aacaaacaaa caaacaaaac aacaaaaaac tggcaactat aggcacctcg tggagacca 185820

gctaagtatg cctgctgtgc tgcaccaaag aacacacctg agtttccagt ttgcagccat 185880

ggaagtatgg ctactgtca gagcacacac cccccatg gccccagttt ttctcctgtg 185940

tctctgtgtg gctgtcattt ctccagtgcc cagctcctag tgaggtttcc ctageccaaga 186000

cttgtgagtc acggcagagt gggagagagg cagggtgttt cttatgagga ctgagcttcc 186060

gggttccagg gaaactgata tttcccagaa gtttctagtg acttttaagt agctggtcag 186120

aacttaacag aaagattttc tggctagatc ttttccatc attcagcagc ttataaaacc 186180

aaggataaga gcttcatgat tctaattact ggtcacaaga atgggtcctg agtcatatct 186240

ctggccctgg gaggagacat gatagacaat ccgaactgcc cagaggccat tagttgataa 186300

ctatctaata caggtttcag gagctttaa ccttttacia ctgctgtaga gcacgaagct 186360

tcctgataaa caacaggagc atgccattgc cctcctgta agactcgacc caaatgagtc 186420

tgtcaatcac ttagacatgg aagtgccct caggaaagct gtctgctctg gagacattac 186480

acatagtata agacctgctt ataaatgaag gctggcacia agatctttc tggatcatgtg 186540

agtgttttcc tcccagaagt ccttcagtc aagtcaatct ctcaaccct gagaggggtc 186600

catttgggtc tgaacaaac tctgtccatc ttctacatta acctctgtgt ctcatatgaa 186660

ttctttggct ggacatcaca attttagggg aatcaagaca agtccagagt gagaccatgg 186720

taacaaagac tatgtcagtc cttttgtct ggcaaaggta gttcttctt gcctctgcac 186780

tatgctagca gcctcgatga tgccaagagc ccattgcagg gccatgattt atgctggagt 186840

tctggcatga gaggagat tctaaagaga ggtacttgtt cccatcttgt cactatcaga 186900

gtatcaccaa tctttttcac ttacaatatt agtgtgttta gaggaatgct ggagttaagg 186960

agcagggggt ttattcgtaa agaaagggtt caacagatct ctcttcatcc ccagaaagaa 187020

ttgccttata tacctgccag gcctgggatg catgggatcc tacatttcac aaaacattct 187080

tttctccttc aactttaaga gcccttttc ggggagcaca ttagccccag actgctgtct 187140
 gggaggccaa catgggactg atccagacca ttgatcatgg atgtcaagga ggaggctttc 187200
 gtactctatg gggcccctgg tagtggatta gtatTTTTcc tgggtgaaga agggactttg 187260
 agagcccatc ccatgtgaag ggatgaactic tgggcctgga cacaggatga catggiggac 187320
 tttggggagc cccattaag gccctatcc tccatgggga gtggagagg gatggggtga 187380
 gggtcagggtt gagggtggg ggagagggtt ggggggagg gagggagagg gagaaggcat 187440
 tgacatatga agcaagcttg ttcctaattt gaactaataa tttttttta aagagccctt 187500

 tttcttgac tctcacttca acaaaacctata taccggaac agagaataga gacaacctgt 187560
 tgctcagggtt ctcctacct accccagtac ctcagagaga acaagttagt ctgtctcatg 187620
 gttaactga catgtgcatg cttcctggct tttgtttcat cttttctata aaactgtcag 187680
 atcactgtag gaaagcgagg gagaatccg gactccttct cctctgatag agcaaggtaa 187740
 acataaatct attttctta ctgatttctg taaaagtaca ccttggattt ctaaggctag 187800
 agatgtacct caattggcag agtgcctgtc tagcatgcct atagccctta gtttgatccc 187860
 caggattgca taaactgagc atgatggtag atgcctggaa ccccaggact agggagatag 187920

 aagccggcaa agcagaggtt caaagtcacc tttatctaca tggagagttt gaagccagca 187980
 gacactagag accatgctct caacgaataa aatggaacat aaaatcataa aataatatta 188040
 catagaaact aaactgtagt accactatgc tcttgatgtt tgacccttat cttagtggc 188100
 tgtggtttg caacattctt ttaggacgtc ccatggttta ttaagtcagg atataacttc 188160
 tctattgtcc tttgactaa ctgggtcctt cagaactctg ggatgcagtt gcaaggggat 188220
 tttgtgttg tttgtgctg aaaatacaaa tactttatac tctgtggac attccattca 188280
 ggagccatta tggaaatttg cctcccagag aacagcaact acactgtttc ttcctcaaat 188340

 cagcagctaa catggaaggc ctcctcacia gcctggaagc atgcatgtcc ctcactcaa 188400
 cactgctgc atcctgtctc catccatcc tcattacagg gacattgcct gcctcacc 188460
 atccttcta cgctacagta caggttatg ctcagtcttc taactttttt tattccagat 188520
 gattataact ttgaaaacta taatttaaaa agctgttctc aagtatgtgt tttgttcaat 188580
 caaaagcaca gacctgggtt tggggagatg actcacttg taaaagttt gccattcagg 188640
 cacaagact catgttcaga ttcctcagca cttaggagtt agactcctg gtaggcaggt 188700
 ggatggggag agtagccatg actaggaatg gaactttcaa gatggctagc ttccatcttc 188760

 tctctgattg gagcctggca gcttaaaaca aaggccttgc aggcctttgt ctccatcag 188820
 cagactgcct gttaacagac tggcttaaca agttcaaggc cagctcaaga cgtgttacac 188880
 aacagttgtg agccaatcaa ctatctgtg tttcttcaaa ctgactaatg ataaattagg 188940

agaggcaaac tcttcagggt cttaaaaaac ccacccctg agaagagacc agagtctctg 189000
 gcttcctgag gccccagccc cccaccctga ttcccaacc catccccatc cctgcatttt 189060
 gcagaggatc tttttctttg tctactgcat gcctgtgttt cttcacctt aataaataaa 189120
 tgtctgtctc aactgggat cctgtttgct gttgtctgtt gtgtttgagt tttctctgct 189180

 gttatctgtt gagtataaga attttctgc ctttttaatt gtcagagaca ataaatcca 189240
 tcaaggacce taaactgtgt catcttgtgc ctgtaatccc agagctggga agacaaaac 189300
 tgaaggatcc ctgggacaac tgattaacta ttctatctga atcagaatcc caaggttcgg 189360
 tgagaaagg aaccaatgtt aatgtctggc ctccatacat gaacacacac acatgtgtac 189420
 acagaggcgg agggagagg agagaggaga tccaggtttt aatagcatga tgtctacgat 189480
 gccctttcag aatccatttt aggacaatat atattatta ttgtttgtg ctctagtctt 189540
 gtttggagg agtctgttac tgcaatggac ctgagcatat gcatgcatta tccattgga 189600

 cttaccaaag gggataactaa gggtcaggaa gattaatgtc tacaaggctg cacagttaat 189660
 cacaggaaca gggagtggag gcagaaagca tccatgcaga gtccacactc agcttatcgg 189720
 gttatgatgc ctacagactc ctatactgat gggacataat aacatacaca aggaaatgag 189780
 caacactcc ttccaatgag ttatatgaat acgtatatta tcactttgta gtgcctgatt 189840
 taatgtgtag tagcctgcat agctctaate cactgggat tttcaaaaac cctcctcagg 189900
 atatcttaat gctaaagaac tctccaactt tctctcagtg tgtcacctgt ttcacctggg 189960
 ggaatgtttg aagaggcaga tcttctctcc tatactgcta tttgttttc acacatcatc 190020

 tctgtgtgta attatgtgga caacttctaa aaatgcctaa tggataatac tgcaaaactca 190080
 tgtaactcag tggagaaata agctctaaaa gttcaaatat aatcagagag cacaatgcct 190140
 gctaattgat tcaactgta gggtcacaca aattaagaag tttgacttga aaccattaa 190200
 gttagactag ggcagagagt ctagtctaaa agtataatta taatttttc tctagacata 190260
 ccaatattga attttcagca gaaaggagat taatcgtacg attctgattc taagtcacat 190320
 tgttactgat attcaactaa ctgtattcta gaaccaggc atgggtgcacc acaccattag 190380
 tcccagcact aaggacactg aaacaggagg attgccacta gctacagtct ggactctgta 190440

 gagagtgcc aagacagacc tgtcttaaac aaacaaatac aacaaaaatt aattccagga 190500
 agatagtata ttttaataa cccatgtaac aatatttatt taatatacca attaatgcaa 190560
 aatttctctc tcgatgtgat gatttgattt gagatatatt ttattttgta gttgttaaat 190620
 attttatgcc tgfactaaat cagtgatcat ttgttctgca tataatcatat tcaaattaag 190680
 tgatactcaa attaaatttg agtttgggta tgtttaattt gggctctgtaa gttttttatt 190740
 tgcttgaag tctttttaat aataaaattc acacaattag gagagatttt gagccaatat 190800

gcaaagaaag atgggggggg gcttatTTTT gtctacagca ctgcttttcc agcatgcatc 190860

 attcactgcc cagtcaggaa agcaaaaaaa gttcaactac tgctttgtat aggaaattta 190920
 atacaaagat ttaattacaa aagggtcccg aagggtgga gcagccagga ggaaaatgtt 190980
 gagttccatt gcactagtct ccacatgcc agtgctgagg tacagaaaag cctctctgc 191040
 cagcacactg cgtgccag acagagttcc tgaggccaca atgcttctat gacttggaat 191100
 cattgacaaa cgtgtttcac agacatccag ggtccatTTT cctgctgaac agagcagaaa 191160
 ccctgaggtg caggttatct gcagatgtca aaaacagcaa tggcatctgg ggcagagttc 191220
 aggcaggtct ggtgaagcac ctgtagtgct tagatgtgcc caatacaacc atggttgtec 191280

 tgcaaacaca ctgcctaac aggcagtaag tgctcagaca atggctgctg aagttagtgc 191340
 tacatgcaca cctatgtaca tgtacacata ccatacata cctgcatgtg cacacacaca 191400
 cacacacaca cacacacaca cacacacaca cacacacaca cacaccaggg 191460
 tgactggctc tttctttctt cttaaacctt caatcacttg ccagttgctc cctattgcaa 191520
 atgtctaata tagtgagtgg ttctcaactt tctgatgtt gctacccttt aacacagttc 191580
 ctgtgctac agtgaccac cacaagattg ttttaatgct acttaataag tccaattatc 191640
 ctatgttatg aactgtaatg taaatatctg atatgcagga tattgatac gagaccctg 191700

 tgaaagggtt attggacacc cctgaagggg tctcgattca caagttgaga aacactggtg 191760
 taaaggaaga catttgcat ggaaatttct ggagtatatc ccacaaggt gtaggcagca 191820
 tgcaggaate tatctacctc ccaagtccta actactTTTA cttcttgac aacagccttt 191880
 ggaaatctcc agactctatt ctctatctc tttcttctt gttagttttg aaatcagaac 191940
 atatgtatcc ctcttctag tagttatctg tacaattata acccattctt gcataactat 192000
 ttccacaca ttccaaaatt taatactct accctctta aagaggacaa aacatactct 192060
 gtcttcaate ttctgttcc atcttcccca ctattagtgt cctaaatttt agtgtcatag 192120

 tttaatatct tttaaaaat tcaccatttc aatctgtttt atglacaatt tggtagcatt 192180
 aattacattc acagtagtgt actgtcatca atgatatcaa tttctgacat atttttatat 192240
 ccctaagaag aaacctttag agctaccaag caatagcttt ccatttttcc ctacttctta 192300
 ctctcttaa acgctaatct agttttttta aataaatttt actattgtgt atatgtccta 192360
 caagtgacat tatgcaatat ttgtctgggt tttttactt agcgtgctgc agacctgtgc 192420
 aagtctgtg attactttag tctccatgag tccatatgag ctttgctcag ttaatttaga 192480
 gggccttgte ctccgggtgt tctccatccc ctctgactca cacattcctt ctgcttctc 192540

ttccatgagc atccctgaac tctgagggga gggaaattggt ggagacatcc cacttagtgc 192600
 tgacagtcc aatgtctccc tctctgtata atgtctggca gtgggtctct gcttctgttt 192660
 ccatctgcta caaaaggaag cctttcttat gatgtctgag caaggcactg atctgtgagt 192720
 gtagcagaac ataattaggg atcattttat tgttactttt ttttcttttt cagaagagta 192780
 gaatttggtt ttaccctagg tctctgggct atctagtgtc tggttcttgg tcaccaagc 192840
 agagtcatgt aactctagca cgagcaagtg atctcactag gaattttgaa aagctgtttc 192900
 acttacatat gcaaatagag gaggtccccc cttacgttca gagatgataa attcatatat 192960

 tttcatcaaa gattattcta attttctcta ttaatctgct gtctctattg atctcaattt 193020
 gatgtctatg ttaatctcac atacctaata gtttagtttt atttggtttt actggataaa 193080
 taagaatggt tctgtgtagc cagctgctct taacatttat tttaaatatg taatctttaa 193140
 agctccattt ttatatctgt gcctcctaatt ttatatatt gcctatttct tcattgttat 193200
 tttccaaaac attgtaattt agatgctata tgttatgtgc ctttctcaa tagaatatca 193260
 attttagtt tgcctctgtt ggtctattat tattattagt ttatcatgac tggattttgc 193320
 aataacaatt tattaaacta tttcaaatg gctggcttga tttctctatc gttttccaac 193380

 taaagatgat tgaataagac atataataac attttctatt atgatatttt cccagttggt 193440
 tggacagtgc tctatcatta cttttcaatt cacttcaatt cagtctcagc caaactaaag 193500
 cactgccaag tgatattata caaatgaaac ggcagataaa aataaactca ggtacatttt 193560
 attcacttaa atatatgga ctattagtgc taccctctac tatcatctat ttctaaataa 193620
 aaccacatt gttgattaaa atgttttaat tgtctattca ttccactata tatatgtata 193680
 tgagcagaat acatttttat ttccctaagta tataacttca ttaaatttac tccaaaaact 193740
 ctacccaaat ccacctacca ccagagaaca ttttttcttt cttatgagta gcacaatctg 193800

 gtagacaata tattttctta tattttaatg cttatgattt tttgcaggtc tttgcattct 193860
 cccatcaaaa tgcaataccc atgaagatat ttttgactga gtattctatg taagattgtc 193920
 cttggctctg atgaataatt caacatgtat tgactattgg ctacttctaa ggccatggaa 193980
 ttaggtggta aagaaaagag tttatcataa cttccaaaat gtagagattt taaaatgtat 194040
 gctataaact tagcctttta aatcctatta taataagatg tcaaattaat taaagatttg 194100
 caatatagct tacaccagga aaataacat tgtatctgtc tgatgagatc aaagttaaca 194160
 acaggactag gattatttca caataatcac cacactgatc ccctagacta tattccaaat 194220

 acatgtctga gaaataagtt gtatgtccaa gtgggatgat aaaattggcc ctttttcate 194280
 cagggggtaa gtccctggcac caaacaggag caggaactta gtcacatcta aagcattttt 194340
 aagtgcattg aggagaggag aggagaggag aggagaggag aggagaggag agggacagaa 194400

ttagaggaat tagagagagg gatagctcac atggcaatcc ctgaaagact gtgtgccatg 194460
 tataaagtta tgcacgtaga acccttaggt aggacaacat tatgaaatgc agaacttatt 194520
 acccatgtaa gtctccaag tccttgaaat gtcgctaaca cagtttaagc ctagaaagaa 194580
 atattaacaa tgaattttca agtaaatacc ccataccctt tctacataac tcagatttat 194640

 ccttggaagt ctaaaatagc ttgcagagac tgcaaaaacc aatgcaatta aataggctg 194700
 aactagaaca taatttctaa agcttgggtt aaaatttttg tctactattg gttacatctt 194760
 cgaatgtatt aagaataaat aaaagtacca aactgaact aaacaatttt aagacatgtg 194820
 atagttacag tatgcatgct gtgacatctg gtctaagtgt tctttagag tatgctggtt 194880
 tttatttaag cagcaaccta cagaaaaata aaaataagca agtcccagag agtcactaat 194940
 agtaacatta aacacaactt cattctagat gaggaaagag tggcatcaga aactaacatg 195000
 ttaaaaaaaaa aatcaagctg acaattcttc agcacatata taccaccaat gtgtcccttc 195060

 atctcctaag atatccagaa agacaatgtc atggaacaga agataaaaca aaaacatgaa 195120
 attggtttaa ctggaagtta taaaattgga gcacctcag aggcaagtga ggtaaaactcc 195180
 taagcaaac agtatgtcc ctctcttcac ccttctgag tagctgtgtg acaattcact 195240
 gccagtccac aaagccctgg gcctctcaag tcggcctaat cttcctgat cattgttcac 195300
 atcttcttta tattgagctc ccatttctca acctgaagct tccagcctgc tcccaatttt 195360
 tctccttagt cccttgaaa gtgcttcaaa taaatttaac ttatctcttg tgagaaagtg 195420
 ctcaaatgt gtctcatggt atgaatatcc tctctctta tccctccac atctcttaga 195480

 atcatctct ccaagttaa tatecatcat tctgtcaag cttctctgc tgagttgacc 195540
 acatgcatat ctaggatgca acaattgagt ttctgagctt caccctcaat ccaatcagaa 195600
 tccaaagctg tagattttaga tattttattt taaatgtact gaatttttc agacaatata 195660
 ttttcatcat atacatattg atgggtcaaa atttcattac tctacttcat accaacagtc 195720
 acaattggta ggagaattag caagctatca gctacatgga ccaaaacccc tgatggagtc 195780
 tgatctcttc agtctcttcc acaagcattc ctagtctaaa tccaaacccc cggagtatac 195840
 ttgcatgtaa agaattctag atcatcteca catccctaca acttcatatg ttctctctec 195900

 cttgctctct tccccctct ctcttcttc tctcctcaa aaaacaatta aaaaaaaaaac 195960
 taaaaaaaaat cctctcccaa ccccaccca tgccataaaa ccatgaagtt tattctgtgt 196020
 tagccaccta ctctgggtta tgaggccttc tctaggcat gattgatatg cccagtgaca 196080
 tcccattgga gaaaactagt attccctttt ccagcaggtg agagagttaa catggggtcc 196140
 cacatataat caataageta ttccagttag ttttattttc tggatctaag tggtaggttt 196200
 gcttatttct attcagttg ccgtgtttat tgtaagagat tctcctattt attttagagt 196260

ttccttttga atactgcctt tatcagatga ttaaatttag ctactaccct agtttttaca 196320

 attcgtagac tttattcaac tttcttctct atatttctaa gctgttgcta acaatgatga 196380
 atagataage caataaccaa gaatctaggt aaattatcat agtactagaa atttttcatt 196440
 agactgacaa ggttacatgc tcattccaag taagcagttt aaaacttgta agacaaaaat 196500
 ctagtatgca ttgacttcac gtatatTTTT atgtagtagt aactttaaaa aaaaaaaaaac 196560
 atgaaggcta aactgaattt taaaaagcat aagacattgt actatggaga aaccattcat 196620
 gttgtcatag gttagagaga aaaataaaat aaataaccgc aactctata atggtcataa 196680
 ctcccatc ctgataggct atctttcact cagtgtgtca aaggtttaag agaggagaat 196740

 gcttcccat ccicaacgta ttgttgtcta aaatctgata tgttccctga aatcaaate 196800
 tttatatatt tctcggatg gtgtgaatta gtctctgcta ctggaatcct gtagcttgaa 196860
 caggaccctc agtgaacata gattttaaat aaccaatgga aggaccacc aatgaatcac 196920
 actttagtaa atgttgattg aagaaggcag aattctagga tgactgttca tgatctaaa 196980
 ctatttgtgt taagctctag attatcactt tctttactga gtgtcttgct tctgaccact 197040
 tgactgtttc aggtctgata ggctacctat tctttggttt gctaccatta cacaacagaa 197100
 ttagtgggat gtcgcttga taatggcact atgtcatata aaatccctt tctccggatt 197160

 ggcatgaaag atttggtgct ggtcttaaaa aaggcaacaa taatgtggtg tgctacctg 197220
 ggtgacagct atgtaaggga gaattacaga taaaaacctc tagattctga aagtgaacctc 197280
 tagcaaaaag ccaggacct tgggcataca cctacatgga attaaatcct tctctaaacc 197340
 agaatgactt ctcttcaca tatttgactt attgcttttg ttttattctg ctcttgtttt 197400
 tcttacgtaa gcacactatt tatttccctg tcacaaaaa aaaaaaaccc tgaaaactag 197460
 actgacaaag taccaataga ttcaaagggtg ttaaatctca tgatcatctg cttataaacc 197520
 atcaagtctg agctgagcag aaccacaaa ttccatgaaa gtctagagag cagcaagctt 197580

 acttatgaag aggaagagaa gtcagagagc tacagagtag gacagaatag catctgataa 197640
 gaagacacag agagacctgt gaagtctat taacagtga ctctggcaac aaccattgt 197700
 gctggttacc actttgaacg tcagtacaga acccagcgtg tcttctctg gtgaagggtt 197760
 aaaaatggca cctgtaggaa tgtgcctgtt ctgaaggag cccagcattt cctcctagct 197820
 ttgcaatctt gttctatTT taatctgtat ccaataacag gtgagtcaaa gttcaacct 197880
 ggtgtctctc ttaggaaaag cgctctcttt gtgcccttct taggtctagt gaagtggaaa 197940
 attaagtttt tgcctctaa gtcctgaaa taggtcagaa cagatatcaa acattaactc 198000

tgaagcacat ttaacatgat ggcatthaaa tgtaaaataa aaaatactgg gttaaactct 198060
 ccctcgctct cccgactcta cttctaactc caatttatgc ccatctatat gctccagcat 198120
 agcacacaag agagagctat tcagagagca ccatatthta taatctthtc tattataata 198180
 gcaggatacc agttctacta gatttaagca aaggaaagga thtactatth aatgtaattg 198240
 aaaatthcag atgtggtagc agcttcagac atatgctgca aagtagggca gaggatgtgg 198300
 tcatgtthcgt thththctgtt ccggtgacca thgtgtggc thaatthcca gataggccct 198360
 thccacccca tggaaaagag gcaaattatc ctggtgttgg cgcacctcaa ccgtattaat 198420

tctaacagag accaggctca tggtaacatat cctagtcgat gtgactctgt tggthctagth 198480
 ggtgtthattc accgctggcc thgggaattta gaatcaacct thccaacta cgtgggctta 198540
 gaggaggcaa agaathgactc aataaaaaag caaaagthgtt thtcaatgaa thcacattca 198600
 gcaggthgaga aataatagat gacagaaata ataaaggctta ccatctccac atathaggag 198660
 gaaatathctt cccaaatgtg agcacaaaaa acaaaactca ataatthgth thathagthgt 198720
 thgtgtgtgtg thgtgtthgc atgtathgt thgaatgcat gthccatath actcctgtgg 198780
 gggcctgagg agcacagaath accctgctcc accaagctth ththththcc ththgggcacg 198840

ggtthctcac tgaathctata acaaccagct thcaacatath thctcacacc cccaccgct 198900
 cccagaacth gggthacagg thcctthcatg gacacaathg thctththatt thgtactga 198960
 agaththgaa thcaggctthc atgtctathc agcaagcact ththctthatt aagcctthcat 199020
 thcagthgcca ccctataathc atctththgaa atthaaagctc thataathgtt aathgtccaath 199080
 athctthcca thctagthgaa aactctagthc cagctccaca gathacathc thgtccaagg 199140
 caaacctgga ctthctathctt gthaththgag thctgaaaaa thcctthcatct gctgaaathg 199200
 athaagathath thaacaththcc aagththgath gactccaathc caacathaga ctctathaca 199260

acaagacaaa thththgthata ctthathgthath acaththgthc athathcagthaa agthcatcata 199320
 thgtthaaata thcataagathg aaaaathgact thaaaacact aaccaccaa athacaathath 199380
 agctthagthga cacaaagaaca cathgcatath caagthctthta accthggthgt thgtthggca 199440
 gctgctgcta ctctctggcc ctgcccagth thcthaaggag aathathathc cacathgccac 199500
 thcaththcaaga aagacccaaa thccaagathga aththctaatg aathacathathc accthctthg 199560
 thathaaathgt ctthacaata ththaaagthgt gggthcagthct gthathathaca gaththctgccc 199620
 thctagthaga thcthaagaath accaathathct cctagthcaath ggtcaaaathth cathathththg 199680

gathgcagggg thgathagthgt athaaagthgga thcaathctct cccathggathc accthgathth 199740
 ththththccath ggtcaththagg agaaaagthaa agcagactag gaththaaactgc ctthgactagc 199800
 agaaaaactg acccagathathc tggthcathth aathaaagact agctgagagg gaathagacca 199860

atagttaatt atcacaaatt tagtgagaaa aattaaatta tgaatgatga atacagtta 199920
 taagtctgtg attaaatgga gcttctgac agtatgtttt ataagtcttg cagtcagagg 199980
 ccagagaaat agaacttgtc gctttcttta agaaccctaaa ctatattccc agcaccacaca 200040
 tagagtagct catgaaatcc tcttctgggc tctaaggcca cccgtgaatg gcgtgtactt 200100

 acacagacac atcacacata tattttatftt atatacatat atgtaataa aaataaagaa 200160
 aaaatttgca atcacaccta aaagtcaaat tgggctttta aggcaagcaa taggagtgat 200220
 ttagccaaca gtttaccaca agggagtftt tgtttttctt agctaaagag ccaggaatgc 200280
 aatggctga ggatggftca cacagtccac aggcattggca tctgaacttg gcctctccat 200340
 acatctgtgg ccagtggatg gagaacaatt gcaaaacttg tttaatcccc ttaacatttt 200400
 tatcatcaac cacaaactt atattttcat tttaatcatg tagctgtgtt gccattgtc 200460
 ttccacaaac ctagagaagt cccagagcac cttgatctct tgacttttcc catgggaatg 200520

 acaaaacttg agctaaaaga gatccaattt gcaacagcac tgtttcccag atactctgcc 200580
 tcaatcatgc ctttcttcta atgtccacat ctgggatata tattgtttct ttgtattttt 200640
 ttatttcatt tctctagctg ctagagtcta gcaggaccca gtgttttgat caccgtagtc 200700
 aaggattaaa gaatggcata aaatgtaaat gccaatgata attttctcac tatgattatg 200760
 atgggttgac tatctaggag ctaatctcat gatgccaca taatggfcaa atttcattat 200820
 caacttgctt gggtttcgag tcaactgggg gacacagaat acatctatgg gtatttttat 200880
 ggggaaagt ccagaaagta taccaccct gaatataggc aacaccattg cataggttg 200940

 ggaccagac taattaaaa aggaaggaga cagaaacct aaagctcacc tctctccttg 201000
 ctttctgatt atatattcaa tgtgactgac cagcttctc aagtgctgt tgttatacct 201060
 tccccacat gatggactct gtcttcagge ctagaacaaa taaactttc cttccataag 201120
 ttgctcaca gggttctaat cccctctcc catagtcacc tatcaatacc tattttgatt 201180
 tgtatggcat atagcaaca ttaataaaca atcactcagt tattttatga cagaacattt 201240
 tcctctagat tttctatctc tatagggaac tcagagctct gggagctaac aaacctttg 201300
 gatatggfca ataagtgtga tggcctgac tcccaagaa ggaatccctg tecttagccc 201360

 actattccct ttgaagtgat tcctctgact ccagcttca ggctttagat tattttctgt 201420
 aacctgggt tattcttacc tactggaaaa caaaatfcaa cttcattata ctaaatactt 201480
 atcatttcc aaatgaatta tttgaaaaa agctgtatat gtttttttt attttctct 201540
 tatttctgt gttttatgg tcttaccaca aaagtcactg cctatattgc tattagcact 201600
 ttgaaaagat actgattcat gcttgccctg tgtttggatg cagtgtttca tttggaagcc 201660
 caagatggcc tcaaacfttt cccactgaa tactctgac tcaccatacc acatctgaat 201720

taagggcatt aactatcatg cttgcattct catgatcatg ctgataggaa gaatcaatat 201780

 ggatgccaat caatgaatga atgtatacgg aattgtggtt aaaaaaac agtggattat 201840
 tactcttcag caaagaaaga atgatgtcct ctcaattgta aaaaattcaa aggtaacagg 201900
 ttaagttaca tgagactcag aaactcaaat gtcaacatct gctctccatg cacatatttt 201960
 aaaaattaata gagattacaa ccagctattt ttataaaca tacatttga taaatatgag 202020
 tgtgatacat aaacatagat atataatagg taatgatcta atcagataat tacacttctg 202080
 tttccttatt ggittatatt aggagccttc agggctgttc tcttatagtt attcatcaaa 202140
 tagagaaaac acatactcca atgtatttgt aagtacttac actgtgtgct atagaacacc 202200

 aaactactgt ttctctctta ggaatagtgt ttgtggcct ccccatcct gctatacttc 202260
 tgttaattta atcttctaat aattggctat tgtgtgtgag agagagagag agagagagag 202320
 agagagagag agagggagt tggattttta aaaaaatca aacaatttcc cagggttaatt 202380
 tttctctac agaagtctcc attccattc tcttcaaat atagaatatt caataaatca 202440
 agttaaagg tcattagcat ttgaggagct agacaggcat cctctgcctt gatagagata 202500
 gatagatgaa taaaattaac gatgtagaaa atcaaattgg ggggaaagat caactttgta 202560
 tgggacaatg ggtcatatag gtgagcttat tttgtcata tttccctgt cacagctaaa 202620

 gagaagtact tgaatttga acctctagga aagtgacttt ataagcatca atattgccta 202680
 tggaaactgaa atccactaaa taagatatga ctgtgtaata atttcttac caggacacat 202740
 tgctagatgc agatctgta atttaagag caagctccgc aaagtctgcc aaatgtgcaa 202800
 acatggctgt tctccctaag ccatttaagt caaatctgct ggtgtcagtt gggcaatgta 202860
 agtcaactaa accaacgact aacagacctt gtgggatttc tcaagaaata gactcagctg 202920
 cctctgagg caaatcactt tctgtggacc tgaactagct acaatggaag gccaacacca 202980
 cacagatata ttttaaccgc taccagagag agtggatgag catggtgata ggggagactt 203040

 tgagggttca attatctct gttcatttca ttttaattga cagggttga tgagttgac 203100
 ttacaaatgc tataaactcc aaggaaagct ttgaaatta ttttgacat ttgcgtatgt 203160
 tggttataa atgtaagggc tgtgcatgag agctcattgg caatcagagg ccaacttgca 203220
 caagttgatt ctctctctt gtcttggga tcccaggat taaactcagc tcatcaggtt 203280
 tgggtgacct gatgcaatga cccaccacac ctccccaca aagaaagtct taatgggtgc 203340
 tcttttaaaa ctgtctctct ctgaagctct gcttagcatg gtgctattca tagtattccc 203400
 ttggccagct atggtaaca tgaactgtgc gcattctaat cagagagatg agtttcggag 203460

aattaaaagc atccatcata gcacagccct tggatcaagt agctcacttt ctctaatagga 203520
tgttctaata taaacttcta ttttgggcca ttccattcaa tgcittcttg cagatttact 203580
ttgacaaaga cattcctcag ttgggtgctgg agtcatgtcg gttcacatag cttactgctg 203640
gggccaggtt acattttccc acacttttct acattttctt gtataataac aaccattccc 203700
caggctcagt gactgttggt catttctga ggactgtgca gaatgctgcc taaatgagaa 203760
ccatcagtga ggaggatgta agcgatgcct ttaattgata ggataaacat ggaccattta 203820
gttttgcttt aactcagact tcaaagcacc aggccgtgca tttgcttcgt tttggcagac 203880

gcaggaagcc agaaactctt cagtaggtaa gaaagctatg aaaattagc atctgccc aa 203940
aatcaaggat gaaaaataaa cactgaaaac ccatgttagt gtctattctg aactgaaaag 204000
tgaaaagtct catgagagca ttggaagata ggaacacac aattttcaag accatggtct 204060
tgagtccatt ttacagtaga ggatgtggtc ttggggccag agaacgttga cccttcttca 204120
ttaaagcctc atagccctac tgagatgaaa cacagatctt tgagtcctct tctccttgc 204180
ccactgccac actttagccc acagtaggga cacttgctg ggcggattta tacatgcct 204240
ttggaacatc taacagagge ctctctttga gtagccattt aaaaggagaa taaactcaat 204300

taggccatat catttctga tgacaggctg ccttcaaaga ccactttaga gcacttttct 204360
acctcagtgg cctctgattg ctggtgaca gacacaggac accttcacac acaggaagac 204420
aggatggggc tatttttata ctactaatac cctgtatttt cagaatagct gcatgtgaca 204480
tgatgctgag cagcactaca gtgcttctcg gagcccaact gggcttgcaa caacttagaa 204540
gtgaaaccag agccctaaac ccagccttc caccagcct tgactgggg cctagagtct 204600
ccttgggctc tcttacctc tcaaagctta gtgtgtggtg actttttctc tgattttctt 204660
agtttatcca caataaattg agagctaatt tgcataatct gaaacaaggg aatggtttaa 204720

ttaatgatca tatgagtca atggactctt tggctaaatt acattttcat tgagaattct 204780
ataaaattg atcaaatcta cccctctcc ctctctcca atcctgcct catccatcc 204840
accattctgc cctcccagct tccatgctt tgttttcaat cacacttagt tcaactggtg 204900
ctgctcgat tgccttgggt gtaaggaact caactgtage atgaagaacc tctctgggat 204960
tgaattcctg aagaaaactg actctggttc tgccagacac cagcaattgc cacaagctct 205020
tcagctggga gtaggtgggc ttcacggacc cagccctc tccatgctg ggatttttgc 205080
tgactgactg tgccagtctt gagtgtggag tcaactgtctc tgtggctcca tgtgtaaaaa 205140

agactgtttg ctgtagatgc cctctacct tagccttggg tgggcccacc aataggtatg 205200
aaagggtgat agagatgtag catttagagc tgaccctct agtcccttgt tttctgcatg 205260
ttgactcgtt gctctgtgc aatcaccacc aatcactt tttcacaca cacacacaca 205320

cacacacaca cacacacaca cacacaaagc cttctcctat gtggattgat aggtgtatta 205380
actatgtgca taaatgtagg aacttaggat cagttcactg ccatgtccat ttaacaaaat 205440
aatagtagta gacagcccac acatgcataa ataatatgt ctgcaatatt gactaacaat 205500
ttcacttctt caaagaaaaa tcagtaatca ctgtgtgtga aaggaaacca gagccacca 205560

aatggtggg gttactagat tctgcaggaa ataattagat gaaagattg agatttgggc 205620
catttgtttt tattcatgga ctgtgagaaa ggaagaaat atgacagaga gaagcagaca 205680
ttaagaaga agaacaat aaaaggaaaa tgcagtatt tgctgccac agcctggaac 205740
taaagaccag ttctctcag agagacaaag aaacacacct gcttctccc acattcgttc 205800
tgtcagctgc tgggatgctc agaccatccc ggtttttat ctctcataa ttgtttagt 205860
gcttcagcca ggacgctgtg gcatttggcc aaggtttccc tgcatggtg cttttctac 205920
aaagttaaag aaggaataag ataaggttta aagtaacccc ttcatgttg gttgtagtg 205980

ccgcatgcct ttaatcccag cattcggatt tctgtgagtt tgagtgccgc cttgtctaca 206040
gaatgagttc caggacagtc agggatacat agataaacc tgtctagaaa acaactaaa 206100
aaaacaaaac aaaacaaaac aaaacagcaa cccttcttc atgtttgat attactgaat 206160
gtgtagggag tctgtgctcc tagaaacagc aggctgctca cttcccttag cctcccaggc 206220
ttcggcacta ggtggacaga gggaggcaag agaagatggt tgttagttga tttttccat 206280
ttttgtttc tcatgaaat gagagtgcc ttagtctag tttattcgtt tcattttca 206340
ttggcttgac tgtgcacagt cacctaaca aagaaacaac caaggctga aggattcaaa 206400

aataaagaaa gaaggggccc ccagctggc ctttctctt agctggaaac tgcttgaagt 206460
taattgctca cataagagga atcactgctg gtgctgtaat tgaattttta tggaaataa 206520
caggtggcag atttactata gctgtgggga tggtagggg gggtgagatg ctgtagccac 206580
attaacctgt ttaatttaat agcttcggtt tcatacagg gggaaaagca aggcagctca 206640
tggagtcagt tggatgcaa atgtaataa ctacaattac agagcatgcc catgtggttg 206700
agcaaaaaag ggcaccgggc cagcttgac ttagttctg agcttattaa ttaagccact 206760
agaagtcca caactctaa cctatgaagg aggccccca aaaagacca gagaaaagta 206820

catgacaaag gggaaatagg acagcagttg acaaaggatc tgctcacagg aatggcacia 206880
cccaagtct tgccttggg gaaccttcat tactgagagg gaagactgca cttagagga 206940
tgagtaaaa gctagcttg cactatgctg ccccaagtg gtctagttg ggtaatgcat 207000
atttttatc tgagaaaaa aaaaaaaaa aaaaaaggt cagttaggat acaaatgcca 207060
ttgggttatt ttctgctg gcattcactt ttaagccaac caataaaaag agtttgtgtt 207120
taaatTTTTG gtttttctt ttatcaciaa gcatgttaa ctctctgtac tctctatTTT 207180

tacttaaaga atgaaagtgt attttaaaga aaaatgcaac ttctcatgaa gcacttacc 207240

caggaatatag tagtaaattt aactaagaat cccttgcct gtttcttagg ctcttggtg 207300

agcagattcc caggtgaggc acttaaacga agccatttgt ccatactgaa gactatatac 207360

acaaatgtgg acatgaggct aaagcagaga ttgtcaaat gtcacttgaa aaaaaattc 207420

tacatgcttt tggagtacc tcatgaata cccgagatta taggatacag agagatccag 207480

tcaagcacia gtagatttgt gctctttgga gatttgggg atgttgtgt gtgtttgtt 207540

ttgttttgg tactgtagac caagctgtaa agaaatgaaa actccgaaag tgtgctctc 207600

tttctatcag tcttgtgatg tctttttat taacttctta agtaagtaat cttatccagc 207660

ctgatgactg ttccccctcc ctcttctcct cccagccctc caacccact ccccaact 207720

cacatccagt tctccccctt tctcttcaga aaaggcagg ccacccatgt acatcagcca 207780

gccatggcat atcaagtgc agtgagacta ggcacctcct gtcctattaa gactggatga 207840

ggcaaccag taggaaggaa gagttcctag agcaggtaac agagttagaa acaaccctg 207900

ctcccactgt taggagtcc acaagaagac caagccacac aactgtaaca taagcagagg 207960

gcctagtgca gttccatgca ggctccgtgg ttgttggttc agtctctgtg aggccttgac 208020

agcccagggt agttgatgct gcgcattttc ttgtggtatc tttagcctct ctggctcaca 208080

taattcttcc tccccctctt ccacaggatt caccaaggtc tgcctaatat ttggtgatgg 208140

gtcaatgcgt ttgtttccat cagtgtttgg atgaagcctc tctgatgaaa ataggctag 208200

gtaacaatat ataagtatag cagaatatca ttaggaatag ttctattgac tttttcttt 208260

tttccaatca tagttggttc tctcttaggt ctcttgcta tccagccctg ggtcctggtt 208320

ctcatggctg ggttagggct gggctacctc tcatagtatg ggtctcaaac tgggccagtg 208380

ataggggaag tcttctgta tatatgttct tcttttctt tgatgaataa aactctgatt 208440

ggctgattgg caagcagga agtatagaca gggcttggag atgagaattc tgggacacac 208500

aggcaccaag tacttcagag aggaagatgg gcattgaaaa aactagtat ggagttgctt 208560

tcaatgagge gagactagcc atttgggcaa gaaactgctc ttgcctgggc tgtttgactg 208620

tatgctctat aagctggaca tacaggacc tcaggagagt gactgctgaa ataagatggg 208680

acagtcatga aagactcctg cttcatagaa gactctgcca gacattctgc aagacacaga 208740

aaaaggactg acaaatgcc aatacagtg gacaggttaa aatttcatga ttcactgaga 208800

tgtctgccag atacactagg cctatgggtt gaacatggat gcccacact tacacagaag 208860

aacttccgtg gactgtccag gcggcaagat gtctctgtct gttctagagt ttatatatta 208920

tccttctgtg gtctttgatg aagtigaaga cagataatca cggctatggt tttccttagt 208980
 tatgataaag gataagttac atataaaacc ttagaccac aaagatagga tagataacag 209040
 aatatTTTTt ttaaattttt ccaaatgtta atttacttaa tattgttagc tatggttctt 209100
 acatgataac tgttctgtta tatataattt tactatgttc aagttaaaaa cgtttctttt 209160
 tatttagaca gaaaagagga gatgatgagg gaagtccttc tgtatatttg tttctcttat 209220
 tggttgttga ataaaacact gattgactga ttggacaggc aggaagtata ggcagggcta 209280
 ggagatgagg agaatactgg caaaaatagg cagatggagt caccatgtag ctgccaaagg 209340

agtaagaggt ccagaccctt ctctggttaag ataagacat gtggaatac ttagattaat 209400
 agaaatgggt taataattaa gacagagctt gcccataaga agccctagcc actggccaac 209460
 agttttataa ttaataaag tcttcgtgtg tttatttggg ctggagaggt gggacctagc 209520
 aggacaagaa aaattgccag caacagacca gtctttgatt ggccactccc ataacttctg 209580
 taccaccttt gtctcaatat gtattgtagg caggacaaat tgcaggtcag agattatatg 209640
 gctgggttgg tgtcccaatc actttagtgt aagctttgcc tggttacacc agaaggttgg 209700
 tcaaggctct gtatctcaa tttctaggaa tattacctag agttacceca tagatccctg 209760

aggatttcca ttgaccagg ttttcaatc attccagagc tgcccctggt tccagtttc 209820
 tttccagta ctgtcttct tcatcttct ccacctgac cctcctgttc ccatgcccac 209880
 ctcccatct caacctttc ctctatccac tttgtgaagt ctattctatt tgcccgtcac 209940
 aatgagattc ctgtgttccc cccaacaagc ctctctaat acttagcttc tcaatatatt 210000
 gaaatctttg atccactga attttggat tttgtgttgg tgggtggtgat agtgtgtgtg 210060
 catctgagtg tgtgtgtgtg tgtgtgtgtg tgtgtgtgtg tgtgtgtgtg tgtgtgtgtg 210120
 tgtgtgtctt tcttctttt ggggtttttg cgggtgatgt gaggtatatt attacctgtt 210180

ttttcaaggg tataattaat ctcttggct tggagtttt tctttatta cttctgtag 210240
 ggctagattt gtggatagac agtctttaa tttgacattg tcatgaaata tcttgtttc 210300
 tttatttatg gtaattgaaa gttttgtgga gtatgttagt ataggctgac atctgtggtc 210360
 tcttagagtc tgcaagacat ctctccagga cttctgact tttagagtct ccattgagaa 210420
 gtcaggtgta attctaata gctgccttt atatgttatt tggcctttt cctctgcaaa 210480
 ttttaataat ctttctttg tctgtatgtg tagtgtttg attattaagt tgtgtgggaa 210540
 cttttctgg ttaaatctt tgggtgttg gtaagcttct tgtacattta taggcatgtt 210600

cttcttagt ttaggaaaag tttctctat gatttagata aatatattt ctggccttt 210660
 gagccagat tcttctctt ctctatttc tagcattctt atattgac tttctatag 210720
 ttctggatg ctttgtgtta gatattatt tatattaac tttttttaa accaatgaac 210780

ctatttcttc tattgtatit tcaacacccg agactcttcc atctctcata ttatgttagt 210840
gatactttca tctatagttc ctgtttgttt acccagtttt cccattccca gaattctatt 210900
tgtttttggt ctatttgctt ctgtttctat ttctaggtct tgaatggtcc ttcacctata 210960
tgtttgcttt ttttcttgac tttcattgca ttctttaagg gatttattga tttcttccaa 211020

tttttttggt tgccttttcc tcaatttctc taaggaattg ttttcatttc ctctttaagg 211080
acctctatta tattcataaa tttggtttta agattgtttt attgtgcttc agatgcattg 211140
gattgttcag gtcttgcttt tgtaggatag ccaggttctg gtggtactgg attgaccttt 211200
ctgtggctaa ttgtgttctt acaatggcat ttagacatct gtgtttgggt tgattatagg 211260
tgtaggtgtt ggttctcaaa tttgtttttg ttggatgtgc attttgttcc ttggttttta 211320
tttctctct ggtcttcagg cctaagtagc caggggttct tgtgactagt gagtctccag 211380
gtccagtagg ctgcctccag tggggttttt gcatccagca agacctttgg catttggggt 211440

aacagcgttg tctctgcagt tecttgtatc tgtgtgcct ctggggttct ggatactgc 211500
ttggtctctg ggattcctag tacaacatgt cctccagtat agcaaagtct tctgctgatg 211560
ttgtgtgctt gaatatggaa ctctgggtgg gggtagatit gggagctgtt gttctagttt 211620
agagagtgtt cgctggctct gggcaatgtt ttccatggg tccctagaat tgacctggca 211680
tcagcagatg tcttctgctg gcattgtagg ctggaatatg gagcccagag gagggtgttg 211740
agtctaggtt tattggttgg gctttaaaaa gtgttagcat gtggcaggtc atgtcttacc 211800
tggggtccat aggaccagcc tggcttccag taaaggatct gaggtatgga gtatcttga 211860

atgtctttaa ggtcatcatg tcccatgaat acttgctaag tgcactttc ctgaaaaaca 211920
ttagcttata tgitatagca ggctcatttc ttacagtctt ttctctgtac cacaggattt 211980
atttttttgt acagatgcca gtaatttgit aatgtacctg gtgaacctat tgacagagca 212040
agagctccac attcatttca ttattaagca ttatgataga tatataatag gtagatagat 212100
agatagatag agatataatg ttatagatag gtagatagat tagatgaaaa gattacagat 212160
aatgataaa aggaccagtt atagataaat agatgataaa taggtaagca gatagatgat 212220
agatagatag atagatagat agatagatag atagatagat agatgatagg gatcatagat 212280

atatcttgct gtgcaagcca caaatacaca cacactactt cactttttct attacttctt 212340
gcctctatc aatcagttac taccagatca tctgtagtcc attcatacct actcctaggt 212400
atcccacagc cctccatggt cctgcatcca tacaataaac tcttacctgg attactgaca 212460
tacttggat cttatcttac cattcttagg gcacactcct aatgccacac tctactgca 212520
gccagtgaaa actttaagta tgtaaccatt gctccttgct taaaactgtg aacttaactc 212580
ctcatttttc tgaagatagg atagctgctg aagtttgaca actctttgct gttccattcc 212640

ttcctctcac atttttgttc ccacccttat catttcagta aggctgtttt attctaccca 212700

 gagactccct cctgatggtg atttggcttc ctctatctgc tttggtaaca cctgcctccc 212760
 cctgagaggt ttatctgcaa atgaaagget tttcgaaaaa gccctgttcc ttcctccaaa 212820
 actccagtgt atatataccc accaataaca acacagtaca gggatccttt cctggttttg 212880
 ttttgtggtt cttttgtttt gtccatctga ctcaagatag agttatctgt acaaagaatc 212940
 tcagttgaca aaatgccagc atcagattac tagcagtcaa ttctgtagag tettttcttt 213000
 attaataatt ggtgtggttg gtggcactcc cggccagggt gtcctgtatc atataaagaa 213060
 gaaggttgag caagccacaa acagcaagcc agtaagcagc acctgaccat ggcctctgct 213120

 gtagtccctg cctccagggt cctgttctgc ttgagttcct gccctggctt cctttgttga 213180
 tggactataa tttaaaaatg ttagccaaat aaacctgtc ctctgaaaga tgcttttgg 213240
 catgttctca tatcacagta attgaaatcc taagataggt tcctgtagc acaagctcat 213300
 agaattatct tgaacagcat ctattttga ccatcaaac atctgtacta ccaatgaaaa 213360
 tggcatgcca gaaatfttct tccttattga cctccatac acagcatgtg aatcttgact 213420
 ttgattgata ttgagtaaaa atttgttcaa ttcgaagggt ggtggttgca catgccttta 213480
 atcccagcac tcaggaggca gaggcaggca gttctctgtg agtgtgatac cagcctggta 213540

 tataagagct agttccagga cagcctccaa agccacagag aaacctgtc tcgaaaaaca 213600
 aaacaaaaca aaacaaaaat taaaaaggaa aatttgttca atggacacct gatatccact 213660
 ttataattgt tcagtatctc tacatcttta aaacttctac atattctttt aaaactgggt 213720
 gattgtttga ttgtgactgt ggtgcaggga gtggtgcagg tccaagattt ggcattgctt 213780
 aggcaagtcc tctacgctag agcttcactt acacactgaa tgcctgaaat agagatatga 213840
 gaagaactgg caactcagaa tctttcaagc tctaaacat agttttcagt tttgattcgc 213900
 ctataagaac gatttgcctt agattcagtc ttttagaaca tggagacagc aactcactec 213960

 atgtttcagg aaccagatg gcaactctac caattgctta agcgacccat ttgagtata 214020
 aagtcagaac aataatcaca caagactcaa ctacctagag gccaactgag atcgaaattc 214080
 aattaatat ccaagtacaa ttattattc tggtcagtat agacagtgaa attttcgggg 214140
 ctgttgaaat cagggtagct taaagtcata gtttaacaat gccccagatt gctggacttt 214200
 ggtggtgctc gctcaccttt aatcccagaa ctcaggaggg agaggcaggt ggagctctgc 214260
 gaatttgaaa ccagcctggt ctacagagag ttccaggaca ggctccaaaa caatacatag 214320
 gaacctgtc tcaaaaaaca acaaaacaaa aaaacaatag cctagatctc cggtcacctc 214380

tctctcgtag ttacacatggg gctgaaatgta ttttcacctt cttgagtctt acagttgtat 214440
 tgcagttttt ttagcatact gttgcattct gttcacacag agaatagccc gcctatgtag 214500
 ccagatctag gatataatgt aggtgctgta cctgaaaagt aagcagtcta ttttggtcac 214560
 aaagtcaaaa caataacatt tggctacttga acatgtttat gtgaatgttg acccctaaaa 214620
 gcacattacc cttagaatgt aatatctctg tgcattgatc ttaactggtc atcgttataa 214680
 aggagcactg gctattttaa atggtttctg caaaaggatg gcatgtcaca tccattgtgc 214740
 ataaatccag gacaaagaat agactgacta cattaagggc tatttatctg caatgctagt 214800

 aaataaccag agaaccctt tctaaggccc cgggggaaga ttgactgcac acacagtgt 214860
 attactgctg aatccaatat caaagagttc ttttttggga tgtaactcac atctgagaat 214920
 tggagtgaga gtgtttaacc ccctatcata gtggcctgag gaagacctat gcttcccagg 214980
 ggccggtagg gtggagtgtt ttctataatg agaatagaaa ggactatggc accatcactt 215040
 ctttcagtga aggttctaata gactacaaa gattttctca tatcagacct taaagaacaa 215100
 gggcttgccct gtggatcctt gtggtagca taggtagtgc cagtgggtgg ttgctacctt 215160
 ggaatggctt catcctccat gccatcaggg aagccacttg aacaaaagca tctatctacc 215220

 agtggggtaa gaagaacagg aattcaaatc ctatcaaaa ctgtgccctt ttcttgacca 215280
 atgcacttcc caagacctg gcaaaagaca tcttccagac ctcttgagat caaataaggg 215340
 gaaggtatgt tgaatgttat tcaccttaga ggacattctt gtcttctgaa ggactcctgg 215400
 gaactcgggt tcttatccaa agcctccatt aatctagcc tctagtcaag aactaagcca 215460
 taatcagact ccttcccacc actctggcta tcaattccat tgcagcatct cagaaagact 215520
 agcccctttg taaagtctga tactgagata tgcccaaagt caattgtgct tagaaatcac 215580
 catcattcat atacataact cccaattttgc tcaaaaagc aaagaatctc cagctagctt 215640

 ttacaatgct agtgactctt tgacacgttg ggatctgccc actagttaaa accctgaagg 215700
 taatgaggta gatgtagagc agtttcaaga tgagctgatt ttcctccca cagttggccc 215760
 atacattaat ttacttctct atcgtgtaa taaagcactc aattaagaaa taggggtgca 215820
 aagatttatt tctgccagaa taaaaggaga catagttcac ataaggtcag ctgtgccagc 215880
 aggtggctct gtacaagcca gcatgagagc ctgagaatta actctcaac tcttggtatt 215940
 acagcagaga gagacagcag gcagggagca gggacagagt gtagtctgta tcatgcagta 216000
 actcacctct tccaggtaga tgctacttcc taaagtttcc acagaaactc aaagcagcaa 216060

 aatcagctgc ttttgacca agtgcccaaa ccatttcaca tttaaccag aactccctaa 216120
 aagatggaaa cccatccaaa aagcagaatg cacattttga tgctcccaag aaaagatata 216180
 aacttcaaaa tgttttgtag tgagctctcc agcaaaaagag gacaagtgat ttttgatttg 216240

tagttctgac atctttcttt catgagaagt tgtctacatg atgacatcac caaacaagg 216300
tggaaagaaa taaatgcagt tgtcttctca gagccaggaa gcctggaata gcaacgggga 216360
gaagaggcat gcattcatag cattctcagt ttctggaatc actcatagga tctgattctg 216420
aagttcagca tccttcacat ttgtagtcat tgcactttt atgtgagaga accagcaggt 216480

tattaacagc aatgttgca atgacaacat taactctaat ctctgagaaa gacttttaac 216540
tatgtagaaa tctaaagtag tggagagaat ggaaactcct ggtactgtta gcattcctga 216600
agtttggttt ttgccacact gaagaacttt gagataaatt tatttaccat cttttcaact 216660
gttgattgtt ctcagaataa cctctgaaa ctatgtacat cttttatttg ttgatgaca 216720
acgactactt ggttttctag aatgccttgc cttaaatagg tatttaactc catgggagcc 216780
ttgtatttca gagcccacag agtctttaat tttccctttc cccacatat gcatggtttc 216840
tagggacaag tccacagaga aagatgaagt gtcactgagt cccttccctt cctggaaatc 216900

aatcctcga actcacatct cacaccattt ttctaaggc ttcaatactt agatgcacaa 216960
ccccactacc atcttttgca tcagaaatgt gtgtaaagca aaagaagtta aaccaaacat 217020
gatataatta agagaaaagg gcgaattgta gcagaggcgt tcgctcccac aactatgtag 217080
aagttggaaa gaggtagatg agaacaagg gaagtcagac agcaggaagc tctgtgttta 217140
gagcagcata aattctacac ctagtgccat caacctgctt ccagctcctg tggattctaa 217200
tgtgtttctc tggataattt cttttctatc cccagatgga accatctcac tgccaagcct 217260
agactatgtg cctgtgacct cactgtctaa gtggagaaaa gcagtgcatc ggatctgttt 217320

gtgcttatec atgacacct tcatcctgcc aagaccagaa taccagggt ggaaaaggag 217380
ttccagtgcc agatggttta acaccatcac aactgcagtc aatggacagg agcgggatgc 217440
tttcagagga aaatgttagt gtccaaggag aaagtgagac tcccataaag agaggattaa 217500
attaagggaa gaaaaatgac aggaaacaga ccaatctttg aaggaatttt gtattgatag 217560
aagggttagt agctttaag ataatgcagg tttagaata ttgctcattt ttccattata 217620
acaactaaat acatgtcaat gagagtattc atttaagaaa aaaaaagct ctgcagtcac 217680
taaggggata aactgatgaa tgactgcata tgggtaaaat taaaaacaat gcatatagat 217740

taaagagtta tttttccct tcacgtagga caaatggaaa gatgaataag gcaagaagaa 217800
gaggcaggta gccattgctc attaaaggaa gttgggacac ttggatcttt caaccttaat 217860
aggttataca ttgcagatca aagttcaaag aatgaagcag aatttaaaaa aaaaatgaaa 217920
ggaaggaagg aaaccttgat gactggaaaa cattaagaac cactactata aaaagtata 217980
atgaattagg catgaataaa agatctagtg gaatggagag ccacttccca tetgactgcc 218040
taaaagctgt gtaataatag tcactgacat tgggctgata gatttttcca ttaggaaaa 218100

cagtattctc tccactaaac tatccagact ctagtaatca ctttctttct tttgatgtga 218160

 ttatacacac aacagatgca ggagggactc tagacacaca ctcaaacacc cccccacaca 218220
 cacacacaca tatacacaca catgatgagg cacttttgac aggttataaa tgaggaacaa 218280
 atacagctac ctatggcagc cttgtatgtg gttttgtggg gtctttgatg cttattcaag 218340
 gaaccagaat ttaaccacct attaagagtg cagaacaggc ctgagattca cttttgtctt 218400
 ctgaggtttg tcccctttgc tgagatgatt ccagatgcat tttggtaatg aactgtatc 218460
 aggccttctaa gatcaatggc ctgagctcaa tctgctatag gaatcttccc agaagaaagg 218520
 gatgtttcat cacgcagagt cattcactct aggcctcact ctctgcttc tgatcttcca 218580

 ctgttaaaag cataacacac tggaggaaga ttgtgctata tttcatgagt gctctgtgcc 218640
 gccaccaagg gacacttcca tctgttattt gctctcagct ttgcctactg ataaaacagg 218700
 aaggacagct tgetgatggg ctctttgaag caaatggctc cactctttcc tgcaattaat 218760
 gtttgtaaat tatttctaca gtagtcagca ggtatggtac cacgatttca agattagttt 218820
 caataaatca agagcctgcc ttccttctga gagggcctcc attacaatga gactcatggt 218880
 tagtggcatg ctctagcctt gatgaatatt gctgtgtgta atctgatact ctcatthaatt 218940
 ctgtcaatta ccattccctc gtgggaagat atgaaggctg tatgttgggt tgttgaatt 219000

 tcacttaatg tgtagtatat gctgttcaca gaatctggta tttaggacac ttcaaaattc 219060
 cccagtaagt taatagccct ttggctgctg gagagggaga tggctcatca caacaaagct 219120
 gggttgtaat ggaagtaatt ttgggttttt tcccaggatt actctgttgt ttcagtcata 219180
 aatcattttt agagtagaga aataattata tattttccag ccgctgcaact attttaagag 219240
 gaattttctt agatctatag tatgaacctc tctttctaaa ttgaaaaaca ttcttttact 219300
 taaatttctt atttttagtt taatggttca aaaatatgtg attaaatag accctggttt 219360
 tgttattggt tgttttgttt ttttttaaaa ctgatcattt ccttattttc tetaatggtc 219420

 tattttcaag ggggaagatg gccacttaa ttacattcag attgccactt taaaagtta 219480
 gacaagggat ttgaacttga caagcaacat ctgttcttcc agagtagaag cacaagaaac 219540
 agaatgatag ttctaaaga caaccaggt agagagagat cactgagcaa aagagggggc 219600
 attgaacagc tattaaaagc ctatggtggc aattacctct tcacctgggt ctgagttcag 219660
 ttgagaactt gaactcttac caagagaaaa gatgaagggg aagatacca gacatctggt 219720
 ggcaaaaagt atcacagtgc ctacactaaa gacaccgagt gcgcattagt aatgggaaat 219780
 acaaagaatt acaggaatat gtggaagaa aattcagcat gaagctcca cattatatga 219840

acaggacctt ttcagaaaa agaatttttag gaagtacaag ccattcagaa ctgtgtgtgc 219900
actctgtggc cactagctgt gcttcacagt agcttatgaa agccatggcc ttgcctctg 219960
tgttcacaat actgagagta aactagaaaag catgccagac attaaagact aaactagttag 220020
tgtgagatat ggcacatgaa tattaaagag taatagagtt tattactttt taaaaatcaa 220080
ctgtctttta atgagaggtt agacaatcct ctctgagag aaaactatat aactactaag 220140
gagtgaaaag aataaaacat ccagagaagc ttctcttata atcaaatcag tctctttagg 220200
tttttaact tticaaglac ctcaactgtcc agtgtatgtg ggcattggga atagcactga 220260

gttaagtgga aaagaaactg taaactagca gaacaatcat gcagaggcaa ggtgaaagga 220320
gaaactgttt tggattctta agtctaaaat aaataattac aaacaaggca cacactgttg 220380
ttaaaaacag caagaccaac actgaactgc ctgtgaagaa taagagcaaa gaaaacattt 220440
tgctactgaa tgtcagcacc tttctgtgga caggtaaatg agaaagtatt ggaaatttgg 220500
aaaagcacta tggacatttt atttcaagt catggaagat ccagagaatg gtagagata 220560
taatattgag atacagggga aggggttgaa tatcaagcat ggagccaaag tcttcaacag 220620
gaaatgacca atctgttttc agaattccta agaacataca ttggggagat agctcagtag 220680

glaacatgct tgccaggaaa gtaggaggac tttcttttct actgtccaca cacatgtaa 220740
atgtctaggt gtgccagtgt aaagccataa tccattgct gtgaaagctg agacaggtgg 220800
acccccagaa tctttgacca gacagtaagg ccaaatcaga cagctctggg ctgagtgaga 220860
gacactgtct caaaaattaa ggtgacatat tgaagatgaa tacacgtgac atcagtcttg 220920
ctttttcaca tgtatgcata cacacatatg cacacgcacc ccacatgtac acaagcatat 220980
acacatgcat gatatatata tatatatata tatatatata ttggaatatt ggaatatttg 221040
tacacggtgt gaagatgtgt tactgtgatt ggtgtaataa aaagctgagc agccaagctg 221100

ggcaggagag ataggcagga ctctctgtgca gagagagaaa gaggagataa ttgaggcaca 221160
tgggaaataa caatggaaca aatcagacat atgagacaga agaaagttaa ttgagaaca 221220
tgatagaatg cagataaata gaaacaggtt aattaagtta taagagctaa ttcagaaaaa 221280
aaaaggcaaa gctaagccca agctttcata attaataact ttccatgta ttatttga 221340
gctgttggcc caaaggaaag ttcgactaca cacacataca cacacacaca cacacacaca 221400
cacacacaca cacacacga cacacacaca catgcacaca cgcacacaca cacacacata 221460
tatatataat atgaataaga gaatgaatga atgaatgaat gaatgaatga atgaataaga 221520

tggagaagca gttgagtaag gcaccaatg tagacatttg gttccacat acatgcatc 221580
taacgcatga acacgtgcaa aatgataata ttacactaaa gttagatcta agaaaataca 221640
cagaattgaa aagacactct ccattcttcc agtctttata aaagatgcac taccatcagc 221700

ttcatatact ttcatgccac tcttcttatg ggcctattca tgatgacctg tcttagcatg 221760
 cgccgtgtaa tacagtatag aaatagatgc atacactcat taaatgggcc aaatcacagc 221820
 atggctcttt tttcccagag ttgggtactt tgattactcc tacatttaat gagtcaactt 221880
 tagagagaaa aacatgttct tttttctctt gaagaaatta aatgcctggt tgtagagaac 221940

 taaaacaatc aaagcatgta ctgtgttatt ttcctatgaa agttgggtgtt tatgaggac 222000
 tgggaagaca taactactag ctactaatta cagagatfff tttttgtct tttgacaggg 222060
 aacttaaaag aatttctagc actttatctt agaattttca gttttctaat gaagacacag 222120
 gaaagtgggc agcacaggct ggtatgcagg aagaaaccaa gttcttcagt gaaagaaaca 222180
 gcatgatgtg taaatgacaa agaaatagaa ccggtatact ttaaaactac ctcaagccta 222240
 gaggtggtag cctacacctt aaatcccagc attaggtgga cagaggtagg tggatctctg 222300
 tgagtccag gacagcctgg tctatagatg agttctagga tagccagggc tactcagaga 222360

 atacttgtct tgagaaacaa acaaaaacat agaaaaagga ataaaacaaa caaaaacaaa 222420
 acaaaacaact acctctaatt tatatgggta gttttcttca tttaaccttc ccaagcaagt 222480
 aattactcca atgataactt tcttetaagt attttgaaaa tacaactttc agagtcaaca 222540
 tcgtatgcat ttccacattc acaaacgaga cacatgtaat ctgttatatg ataagataga 222600
 tctgtcttct tctttgtca cattacaatt agtatttttt actcaaaatt agtattcctt 222660
 actcaaaata ttgatgtct cctcatittca ttaatagcag cattcaatta agttgatata 222720
 tatatatgta tatatatata tatatgtata tatatatata tatatatttc tgtatttaga 222780

 accaccaatc taaacacaga cataagccag taagattgct cagagggtaa aactctttgg 222840
 cactcgtgtt cttatatgta cattcgaaga gagggggaga gaaagagaga aagagagagc 222900
 actcacaata gcagtaaaat taaaatttta aattaagtac aaacattgaa aaatttgcatt 222960
 catgatgttc tacagagaca actggaataa accaatgaac ccaccagtcc actcttgttt 223020
 tgctactgac tcagacacaa ggctgcctgt taccactaga taaacttta ggaaggaaag 223080
 tgctacaca gttcagatga aatatcacat cttagttaac acatttgggc tcataaatgc 223140
 cactctcacc agctcaatac tagtccaaac tctgcagtta tcttgggaact agttgttaatt 223200

 cacacttggc gtagttgttt gcaattcaaa gaatggtaat gcttctctgc ttaagaaggc 223260
 aagaacttga tgatcagaac tacacaactt gggtaacctc caaactcaaa attgagaatt 223320
 tcattttttt atcattatga ataaaattgt tgtactttta agaattcttt taaaatcgtt 223380
 aagaattttt aaagtccfgg ctactggaat ggcaatatgg ccaacaaaca gtgatgaaaa 223440
 gggacaaaat tctttcttg taaacattta gataggtaat ggtgatatgt agtaaaacaa 223500
 tccttgagta ggttatcaca gtattcccat aattattggt ttcaatattc cctcatgcct 223560

ttagaaagga tgttggcaaa catgagtaaa gctagcttgt aaaataactg tgtgcattac 223620

 acatctactg tatgctttat tgtgatggaa attattacta tgtttggaaa aggtgtcatg 223680
 atcttttaga ggttacatga tcttcagtta atgcatgtga gggagacatt gccaaacatg 223740
 tttcaagat tagtaactg aagttcagag agattaataa cttcttggtt aaggataaga 223800
 gccaaaattt acaaatctta ctcatgttga ctcttttttg ggggaaggtg ttatttgact 223860
 tccatgtact gatcacagac catcactgag gaacatcagg gaaggaattc aaggaggagc 223920
 agaggcagga actaggagga aagctgctta ctggcttgtt caaatccctt ttttacaaa 223980
 cccatgctca cctgcctagc gatggttagca cccacagtgg gctgagttct cttacatcaa 224040

 acagggatgg agaaaatgac ccaccaacat gccacatgc caatcttaga gaagctgttc 224100
 tttaatgaa gctccctctt cccaggtgac tctagtttgt gtcaatgtga aaaaaacaa 224160
 aacaaaactg atccacatag actgtaaatg ctctatgatg ttggttctca ctgtgtggca 224220
 cattctccta cattgctagg cccgacctt cagagtttca aactcagtag gtctagaagt 224280
 aggctaaaga attaggagtt cttaatttca agtgatgctg ctgatgctgg gacttatact 224340
 ttgggaacca ttgttctacg attttttttg agtctttttt agagtgtgtt tttgttttta 224400
 attttatgta taagagaatg cctgtgtagg ggaatgcaca tgtcaatgta gttcacataa 224460

 agtccggaac agggcatcag gtectctgga gatggagtta aaggcagtta ggagccacca 224520
 gacatggggg ctggcatcca aacttaggia ctctgcagga ggagtgtact cccttaactt 224580
 ctaagccate tctccagcca ctgtctcca ttgactatth ctgaaactag tgattttatt 224640
 tgttttagct attgaagttt tattaacaaa acttaatttg tgagagtga catgtataaa 224700
 ctgttaagta tcagtttaag aaacatgagg aaacaatggt taagtctgat attaaattct 224760
 tgaatcctac ttcttatttt aaaacatgat tgactattht tcccctgttc aattctcact 224820
 ggaatggcat atgatactg gagaatctgc agtctagtcc caaatggcta gaggacaaaa 224880

 gctgctttca tgcgtttct aagcagaagc tgaaaggcca aaaatcactg gagaaatttg 224940
 ctagggtgag atttttttca gttcaatttt attctccctc gaggttcaaa caaacttcag 225000
 ataatcatct tgaacttggg gacgaaccaa actcagattc agactgtggc ttctcagagg 225060
 gtcagccctt ccatttagaa taaggcacag cttaaagtga caagccaaat ggggtcaaat 225120
 gttcaatact tgggtgaaagg ctcagctgtc gtattgaaac aatgtgaca agatggcagg 225180
 ctttaaaata aatccctgtg gaggtatttg atatcattct tgccttcctt tctgtctcct 225240
 agccagctgc ttctttctac agtactgcca atcatgcca gtgcttgcta gaggcagcaa 225300

ggtttgtaca acatctcccc gtgctgggtc cagcaacaga agctagctat gggcattcat 225360
 agaaggtgac attcttgatt cctcagtaca agacaaagtg agctgatata catctacca 225420
 atcaagcagg tacagttacc atggfctta cttatcaaca gttaacctt ttgaatcaac 225480
 gtcattgaat aaagtgagat ttggfcatgg tgatttgttc aaactagtcc atgttaacag 225540
 ttgaaaata atgagtaatt tcagttaggg tacatTTTTc tggaagcaa gaggttatga 225600
 atcatgaaga gttgggctta gagagatggc tcagttcacc aactgcttgc ctggcaagca 225660
 tgaggacctg agctcaactc ctagtacctg tfgaaaagc tggcttgtgt ggtgcacact 225720

 tgtagtacca gagctggatt ggtagactgg aagTTTTctg aaacaacat agaaagtta 225780
 gaacaaatca gagtgcctca caatTTTTt attcaataac actgagtcag aagtgttaac 225840
 tgctggtgag tgatgccat agtgacaata gctgcctctg aatTTTTggc agatgtgaag 225900
 aaagtagact aattggcaag ttaaaattaa gataccagtt acaggtcact gagatgcatc 225960
 agatgggaaa gatgcctgat tccaagtcta aagatgtgaa ttcaattcct tgaaccaca 226020
 tgatagaaag aaaactgtcc tctgacttcc acacatgcac catggcatgc atgtccacat 226080
 acatacacat atatgaacac acaaaatact aataaaatgt aaaaataatg ttaaaagtgg 226140

 ccaatgaagg gacctgtgt tttcaaaaa aggtgcatgg cactcaagaa tcctaaggct 226200
 atcttctatg tgcgctcca tatgcacaca cacacacaca cacacacaca cggcaacaca 226260
 cagatgacaa gggttcagaa acatatatca actaatcctt agaagtgaca tcatcatcta 226320
 glaagcattt agctcagccc actaaagctt tgaacttcac atcactgaca gttaatgtca 226380
 cctgtcagct tagctgggtc aactgactcc cagaacctg ggtaaataaa tgccataata 226440
 tttaacgtat atgtgaacag gatttcaaaa gagatttga cttgatgagc taagtaagta 226500
 gctaaactga ttcaaagagg gtagcacat ccagaagttc cacagatgaa caaaaagatg 226560

 gaggaagggtt gagtcacctc tccactgac tgetgatctg agacatggat caactgcact 226620
 tgggtgctcct accaatgtgg cctagaatta aaactatcag ctgttgatct ctcatgcctt 226680
 tgaaccaca gtagctttcc tgggtcttca gtgtgcagac agcagatcat ggagctatc 226740
 agtgtgtata atcaagtgag tctattcctt ataaaaattt cattgtttgt aattgatata 226800
 tgtgtatgtt attgggtctg cttcctgggg gactccaact aatacaatga tcctcaacg 226860
 tatgcagcgc ataatacagtg acacattgag atgtatccat gcctgctgtg aggaaaatta 226920
 actttgggat aactgttcc tgtttcaaat tatgtctttt cctgtaaatg taatgtagga 226980

 gactaacaac atcataggta taaattgata ttgggattgt ttttgatgac ttggctcaca 227040
 ttgtgtttgc ttttgaaatc tgcatagctt ctggctctca atgaatagtt tctggcttga 227100
 gtcccaagga gaatactgag gtggattgta ctttggggta agagattaat ttaaaaagtt 227160

gttaatgcca tagatggcaa catgatggga aggtatgatg agagtcttgg tccacgaggc 227220
 agagagggat ccccttctca cagggtcat aggaaggagg attcatgcca tgaattgat 227280
 gagtaacata tcgctcaggt ctgccaggct gtccttgga tccagtaag tgtgctactc 227340
 tggggacaga actgagggaa atctaactga attgtagcca ttggaagcat gaggacacaa 227400

 caatgcaggc tctcttctga tgtccacaag tctggcaaac tgaggctat gatttccttg 227460
 ggatatgatt tggtttttt gtttcagca actgtaagaa agagtctatt gtagctcatg 227520
 ttgtttgtt ttgctctggg gcatactcca attacaaagg gtgtctctct aagagatcca 227580
 agcaaatgag gatgcccaat cttgacctg accttcagaa ccttgggcga gagtgaacat 227640
 ctccatttca tatgctatgt cagatatttt atgatggcta tttgaatcaa tctaataac 227700
 caggccctgt cataatccag agttggggaa ctactgtgta caaattttgt tcttttattt 227760
 ttgtttttt caaattttgt tctttaagaa ttgttaaaat attggttgtt ggagtggcat 227820

 gacaggcttt tcagaaggaa acatatagta cttatttgc tcttgcaaac atttatgaat 227880
 cccaatggta atatttggc atacagtta tcagaagcat gttattgcat tactggaatt 227940
 attattcaag aattattatt aaaaacctg agaaaagctt tctagaataa tctcatcttt 228000
 aggctagtca tctctgtacg actcttgaa tattaaagcc aattaaaaga ttagcacatg 228060
 aagggacct aatgcgattt gatacagttg ttcgtacac tgtggcactt tcttcagaga 228120
 ttacctcaaa ggatagcaga acagatgacc actcctgctc agcctccata actcgtgctc 228180
 cagctttatg tgtttgccct gtagccctgg cttctttcag agaacagcat tttgcttcta 228240

 gcaatgaagt aaaaacaatt tgtggctctt gtttacttat gggcaagtca gcaacttget 228300
 gggaggggtg acctgattcg gttgctactg cttatctagt ttcaggtcag agttgcagtc 228360
 ttctgctca gtgaggtcag aatgggtcac atgctttcag aagagtcaa ctctgctcct 228420
 tttgccagca tcacctatgt cctcttttct tgetaagttt cctgctcaca tttcccagct 228480
 taaatctatg gatccctttt ggaatccatg cctcattcat ccctatatac accaaattgt 228540
 aggatattca gagaagcatg catgaagaaa ctgaattcag taggagagac aagacataag 228600
 cactggttaa gcaactgatc taagttggga tcaccattat tattattatg agaacagtgt 228660

 cattgtctgc ctgtagacta tgctgtatta tctctgacaa cctgttgta gaatgtacat 228720
 gaactctctg aattccatcc tacaagtatc ttaatafact gactttgtga acatcaggaa 228780
 tgtgactgaa ctctgcactt taggtacaat tgttcctcag tatacacgat tccctcaca 228840
 gagtagattt aaaaatgtg aaatcccatc ctacgttatc tgafactttt gtattccct 228900
 tgtacctaac aaagagacat gtgtgtggca aacaactcga aaactcactg ctagtgaagc 228960
 tagaaataaa actaacacc ttaacctccg ggcccagagg caaagagtga agagcagaga 229020

gagggcatca acaccagata accacgggag agctgcagcc ttgcatgacc tccttctgt 229080

gcttaccgct aatgatcaga tcttcttct ggaactttct gttcccttg ttttatgtat 229140
catggetctt ttcttacctc tttgaacatt cctgctaagt ggcattttg ggttttgctg 229200
acccccaaa gattttcgtg tgtttcctac attttttca tggcatttct ttctttctc 229260
ctctctgctt gaaatactca tcttccaaga ctgagttta ataaaattc ctgtttaag 229320
gaatccaggt tggaattatt tgtttcttct ttgcttctt ttaaatagat atatttaatt 229380
tttcatgtga aaagtttctt ttgccctatt ttaaatgtaa cccagtttcc tttctcatca 229440
actaatttg tatgtgtact cccaaagata tttatacata aataagcaga gataagcata 229500

tttccctct gctttaatgt aattgatagg gtgtgacaaa gtatgttcta tacatttctg 229560
tttctactta attatatgtt taagaggggg ttgtttccat atcattcctt ggcaactatg 229620
tagttcccta ctgtagcata atagcatgtt gtatttaatc actttgttac caatgcaact 229680
cagatggttc ctaaatttta ctattataag cactcatgaa atgaacagca ttatgcatat 229740
gccaccttgc aaacataata taatatgcct ccattattaa atagaaattt ttctttgcca 229800
agtataacat ttaataaat tttcgatttt tcttcataca tgttgaacta attttctagc 229860
aatgttgta ctaaacctga gactttataa ggttccaaag ccaatactca gaaaaggaga 229920

acaaatagga aggaaatctg ttttactcat ggctaagcac ccaaagaaga caagccttct 229980
ccacaaaggc aaggttggga actcaggcat ctcaaaaagg caggctttca tgggaaaaga 230040
aaggaagtcc agaggactgc aaagaaact gtatgcagag cctaacaatgc aggccattgt 230100
tgggtctgcc ttctttctac ttttatgtgt ttcagttttg atttatttct attcatgtgt 230160
atgggtatgc ttgcttttct gtatctgtcc acatgtatgc aggtgcccaa aaaggccaga 230220
ggaaagagta ggatttctg gacctggagt aacaagtagt tgtgagcagc ctttaaggatg 230280
taggcactgg aaactgatct ctgatcctct gtatgaacac caagcacact ttcttaactg 230340

ctgagccaac tctccagtgt gtgtgtgtgt gtgtgcgtgt gcgtgtgcgt gtgtgtgtgt 230400
gtgtgtgtgt gtgtgtgtgt gtgtgtgtgt gtgcttgtgt gtgtgagcac atgtgtgtct 230460
gcgtgtgtta ttgtgttat ctgtttttc tgccagttaa acctcatagg aatgttgact 230520
ccttgtctg aatgatgcat aggactagaa taaggagtc attgcacact ctgatgcttt 230580
ccctgagtta tcagatctg agttttgtga cattagagag aaataaatta acagttagca 230640
gttgtctgtt tggttttgct ttccttgttt gtttctgcta tgggtttggg ttttgtttt 230700
gtgacaagat cactgctaag tagctgagge tgaccttaag gtctgtgtc tccactcgac 230760

aaatgatggg attagcaatt aacatcttgc ccattttagt gtagcttctc cagagttaag 230820
 agtgctagca aaagtcaatg gatactcac aaaggggtga acaatgctaa gacttgggag 230880
 agcttccttt cccacatit ttggtccat ggtatatgaa acagcaatcc atttagttta 230940
 agtagggaag agtttcaacg tcatataat tgcctttta tgattgaggt tgagtctttt 231000
 tcatatttta ggagttacac atatatcctt ttagtgaact atctgttttg ccatcacttt 231060
 tgttctgtga gataattagt tctgtgcatt taaaggagag ctttctgac ggtgagttag 231120
 attttctgc tgttgttggf ataaaacagc aagcttctta gtgtgagctt ttgggcttgg 231180

 gactcttcta attattcaca ttctgtagt gtgaaggggt aggggagtta gcttcctgtg 231240
 tcctttgtgt ttctaactcg aaactctgtg taacaaatga caaatgagta agagaaacaa 231300
 atcagttcag gtcaattagc tcatgtgttt tcttaagtac ataggagaat ccaggagta 231360
 tagactctag acttaacttc aaaggaacaa ttaaaactac agtcttaaat agcattgttc 231420
 tctgaaacaa agaaaggatt gagggaaagg ccaggaagga ttagatgaca ggggcattca 231480
 tgccttagac aaaggcaggc tcctttccac agatctaaga caacctcttc tccagttcac 231540
 catcctctgc aggggtttca gagaacagta acttcgtcaa aacaaaatc caaagtggga 231600

 gagatggctt attcagtaag tgctgtgctg aggtttgatc ccctacatct aaagccaaca 231660
 cagaggagcc agacacagaa gcggggatcc ttgaggtttg ctggtcagcc actccaactg 231720
 aattagggag ctccaggttc ggtgggagtc tctgtttgaa aataattatg atgatgatgt 231780
 tgttgatgat aatgtggaaa aagatcaaag aagacagctg acagcaacct ctggtctcca 231840
 cattcacaca tgtataagca cctgcactca aaggagcaca cacacaaaca catacagttg 231900
 agatacctc tctagatagc aatttctctt aaaaatagtt aactccaaat atgactctca 231960
 tattcaacat gctctagagg tatgttttag actagcatat tctgttgtgc tttgtgtgt 232020

 aatgtatcat gaattctagc atgacctacg aactattatt ttattacaga acgtatcata 232080
 gtattgaaag acccccgaag aggtactttt gtagaggag acccacacc aggaatcagc 232140
 gaggccacga actggatgta aaaacaagag gctttattgg agatgcgggt acccggggcg 232200
 acttagcttt tctgaggcca agcgcgcca gccaaggga aggggtcctt atataggga 232260
 aaaggcga gctaggagca gggattctat ttgatggttc aaatgaggca cagagccatt 232320
 ccagatcagc atattctcaa ggtctggtgt ctggtacaac agacttgatt cctccctccg 232380
 cgcccagggt gctgaccaga cagagaggca gcgggccttt cagtatgtca aaactgttag 232440

 tgaatttgc actctacctt gaaaaaaca agaaatggta tcatcttgtt cagctgttta 232500
 tgccttttgc acattaacat tatgtcaggt gttaaaaatg acagcactca attatctttg 232560
 aatgaatcat tgttttcta ttttctttg gattgtaaac tgggtctaca ttgcaattgt 232620

tctgggagat ttgaggtcgg agtttggacc ctggccaccc attctcaata ggccaattaa 232680
 aaagatgagt aatagctaag agcaggaaga tgattgattc aatgagatga ttgactcagt 232740
 gtagtcataa tgaggagaga aacaaaatac tgaatccagc gactactgag tttgtcttgg 232800
 gcagtagaat cgagagtcaa gcagctctgt ccatcatcat catctcagtg tagtctgaca 232860

agttgttga aatgtgcaaa ataactgtct ggaagacaag tttctctct aactggcacc 232920
 acagtcccaa ctgttttatt cctcagcata agactcctgg gaaatacca cttcatggac 232980
 tccattatit aaatgtctga cagccagagg aagaagtatc tctttgaa atcttcgttc 233040
 ctgccagaat ggttacaag caattccact ggtgctagca tatctcacct aatgacagc 233100
 catcttgta acatctcact ctccactgg aacttagaat tgttgtttag gtacttttt 233160
 ttttttttt atcttgagac aggaggtcaa gctcctgaat tcaggctctg acttcttacc 233220
 tctggcacct ctttcttccc caaactataa tgtggaactt tctttaaact taatgtccta 233280

tctgactaaa taccaggcgc attcctcat attctccaat aactgtcac catttccaga 233340
 aactctaaaa tcttccacc gatacagatt tggacactgt tcatgttcta aacatctggt 233400
 ttttcttcca gtcttatatt tgccagtctc ctgtgcatag gccatgata aatcatatg 233460
 acttctcctg ttagtctgtc taacatgttt ttaccagaga gttaggggga aaatttaact 233520
 tccttatage tccatttcat ctattttca gatattcaaa taatgaatac ttagatcag 233580
 aatatgattg ggagagcata aaatgctact cccaacatg tctttgcaat aagttatit 233640
 gagtgttaag caaagcttg aactctatct acctctgaag attactttt atcttaagt 233700

atctcccata aatacatgag gagtagacag taattaactt ctgtttgtcc ttcacttatt 233760
 aatctatatt taattatggg acatcttggc tgagaattct gaaaggatag agatcaaaat 233820
 aattttcacc ccataactaa caaacttttt tgacagactg gtttttatta cagtataact 233880
 tcttaaatit cttaagaaa aaggatatgg atgtatatag tgggtggggag tgtgtaagtg 233940
 aggatatata ggtgtgagga agataaaagt gtgtgggata tgtatgtgtg ggaatatagg 234000
 tgtatgggtg taggggaagt gtacatgaat atatacatc ttgtgtgtat ctttgtgtat 234060
 atgggctgga gttagaacag ctaagctaac ataaagcatt taaatgttgg tgtctttctt 234120

aatctataaa aaaaactaag tgcaaagcat accttctaa aagataatca agagttggtg 234180
 ccaacatcta tgcctgaaag acacacacac acacacacac acacacacac acacacacac 234240
 annnnnnnnn nnnnnnnnnn nnnnnnnnnn nnnnnnnnnn nnnnnnnnnn nnnnnnnnnn 234300
 nnnnnnnnnn nnnnnnnnnc acacccccc acacacacac acacacacac acacacacac 234360
 acacacacgc actaactttg aagtaagaaa ttgcctctca gtaaatccaa cagcagtcag 234420
 tataactttt gtgtactctt tagtttcttt tgtatatatt cactaaaaca tttgtagaat 234480

atcttttaaa aggaaaatgt aaacatcaag tatcttagaa cattagccaa ttatgctatt 234540

acttctaaag tgtttctgct ttaaaatgag aacaaagtgg tttctctcat agatacagtc 234600

ataggcagga ggattatgga aaccagttt acatgttcac ctataatfff cagttttctg 234660

tttgccctcag gtcttgca gaagccaaga cgggtgtcttg ctttgtttgg tcttgcaagtc 234720

tctgcctaca cacaaattag taaaagcaat gtgccatgac tcacctcctt ttttaagtta 234780

ctgatgattg cacaaaaagt aaacatffff cctacagtc tctatagcaa ccaaagtgc 234840

cagggcaagg accactttc aagtaaatga aataaaacat atgggaagaa actaagaact 234900

cttgtcaaaa ttattccact gtgaaattag ttacattcca caagaaaata taatcatgcc 234960

aggggttgct ttcttcagtg actctcgcat aaactgtagc tgggaagaat tcctagtgtt 235020

cagcttcata agctgtcagt gccattggct acctagactc attcatatff gattatfff 235080

agtccactgc catttctata cagccctggg ggatatttct ttggttcatt gaataaaaca 235140

ttcgcatcag tctgtgattg tgttctgtt gtccccgcta taattaacac agcaacagat 235200

tttttttaag tgctacttaa agtaactggg gtagagtca cttccaaata gaatacacat 235260

taaaaaaaa aaagaaatg tatccaccag agagcttcca aatgtactgc aaactggaag 235320

cgtttcagag tccttaaac acttggctag aagctagcta aaccacctct ctctgtcag 235380

caaagcatga agctttgaga tttgttttag ctccatcta gtctctgcca gttcaaagaa 235440

agacttccaa gggacaagtt cagagtccca gttttaatgg tgttgtctac tttctttgtc 235500

aaaagtatga catctcctc tgaagatgt ttgagtcctt ttaaacatg acagtctaaa 235560

ggacactctg agaagattc ccaactttca ttctcagttt tcttctcat gcagccctc 235620

tcacattcct agagctgtga tggcacatg agaagataaa acaatacccc ctatattfff 235680

cttataacaa tatgctatgg gaaacacct tatggacatg tgtatgtaca cagtagtaaa 235740

agaggagaac aggtgtgtgt ggggttgggg gtgaatgcag acagtaaac tetgtactga 235800

aaaaaaaaa aactctgtca aatattcatt tctaatcaaa tcaaatgtga ttttcgcagc 235860

ttgtcaaata cctatacaag atgaggctag actttcaaat ctatgtttta ccagtttct 235920

atatgtgtct catattccta gtaaacaaaa ttgctcagtg ttctgccac ccccagactc 235980

cccaaccctc cccgtgcctt cctgcctgt gctctcattc ccgggatttg cagagaattg 236040

agccctgcta gcccgatag gcaacaagag aaaagaaaca gataagtgtc cctctaactg 236100

aaccttatca atgggtggca gggtagaact gaggaagaa tctgcacacc tctttcatca 236160

ctgaagagaa aaattatgcc aagattctat gtggacagag cacttcagcg agtgtcttaa 236220

gaattccata atgcaacctg aggagacagt cgtgtattga ttagcaggat ctgagcacc 236280
 ctctgagagt gtgcagacag gagaagtgaa atgacttctg gtaggcaaga atgaaaccaa 236340
 agacaagaag ggaccagaag acaaccatgt gcttacaccc acaaaacatt gtctgcatgg 236400
 agtgccttca tcttccaggt ccaattctat tagttcctca agaaccctct agtaacaatt 236460
 cttcctagaa atctttacct atcacatcaa aagagtccag actttcctct tccacaagca 236520
 acccaacagt tctagaactt cttgatggct ttccttaata cattgtgggt tacagtcatt 236580
 tgtcccaggc cttcactgtg gcacttttaa tacatcttgt ggatgtgcta tcttaatatt 236640

 attgcaacta catattatgg catataactg ccaactcgaca aatatggcta ctatgatctt 236700
 gacatctggg aagagcaaat atttcatac tctgttgatc aggcaaaaaa ggtgccaaga 236760
 tccaaatata tcccttggat gctctcccag ttagccaata ttgttagaca ttctccaata 236820
 tgttccatag agataactcg atttgtttgg ctatattga atattcactt gcaattcacc 236880
 aatgacctgg tcaatgaata tgataattta tagtgacaaa attattcact accatctcaa 236940
 ggcataaaag gaatgttga tacacaatat cataaaacaa caacaacaaa attcacttcc 237000
 attttctctt caagtgttct tggcacaacc aggagaccat attattccaa aaaaaattat 237060

 tgactccaag gtaattgac tttctagtta gattaaaata tagcttattt ccatagtga 237120
 ttttagcaatc ttttcttct atcttagcca tgaattaaat gcaccatttt ggaagtatat 237180
 attagaatat gtaagcaatc taatttcatg gtggaataca caggaaaaat cttcaatatt 237240
 agaagtaaaa tatttcttca atgttctctt tgttaactac taagaaaact aaggtttaagt 237300
 tttcagccaa tctattagac actgtgaaat acatcttatg atttaaatatt aagtttgact 237360
 attttttctt ggtaatttc catttctcca atttcttaa gattggattt ctataagctt 237420
 atataaatac ctaaatggca tacatttaat gaatataaat ataaaactat aaaataacac 237480

 taataaacac aaaactcaag cgatctgttc ttattttatac ctcaatatcc taaagtcaaa 237540
 tagtttgcat tgaatataa tacaatcaa agaggaaata aatgactgct tttgcctctt 237600
 gaaagtaaaa tgatttcaaa actaaatgag gactcaagaa aactctgtat tggtagatcc 237660
 ctgtttttat tctttaacgt caaggcatgt catttacttt tactctcat tttgtttct 237720
 aaaagggtga gtaataaaa ctttcatctc accatccacc tcatttggca attctctaat 237780
 aaagtaaaaa ggtgaggaaa cctggttttc aaatacctgt taatatttac agagcgataa 237840
 gagtacaaga atccaaagag ctctgttca ttaaggatgc tactctcaa ggccaaagga 237900

 atgcatcaag gaaataaacc acaaatatga ttcacagtgg accactcaat gctcaacaga 237960
 ctctccttga aacccactt taaatgcat aattctttca ttaaaatag ttgaaaagtc 238020
 agagtttgaa gctccaaatt attgtaaaat cttaacctat tttctttttg tcagatgag 238080

atatattcat ataaattatt tagggttttt ttgcggggg tggggtgggc attgagacag 238140
 agtttctctg ttagccctg actatcctgg aactcacttt gtaggtcagg caggctctca 238200
 actcacagag actggacttc ctctgcttca caagtgctag cattaaaata gtgactatc 238260
 accacctggc taattattta gtatttattg gcatattttc atttctaatt agaatgtacc 238320

 aaaattagca ttgtactgca aatgagaagt aataatctta cactaataa gaagtctg 238380
 aacatgaagt cctcctctt tttaatgtgc agatctttcc atgaagctgt ttatgaaatg 238440
 aagttagcca gtgctactcc tgactcaaat gaagcatttg ctgtagggga agctgtagcc 238500
 acgcctactt aggggctggc tacaggtgtg cctgaccatg cttgcgaggg cgtggtcagg 238560
 gtgatgtaga atgactgcgt tttctcttc aggttcactt tggacttgc tggacagact 238620
 gctgctaate gttcccaatc tgtgggtgtc acctgttaa aggttgcca tgaatgaa 238680
 agctgtttta cgtatgggct atggagacca tatgagacaa ctgattaata ttcttaagat 238740

 ccttcagctg tataggttgc cattcataag ccatccatcc atgagtgtgt ttcttagaag 238800
 ctggcttttc taccatggta gctgggtaca ctaatggtgt acgagtaaca accttagaag 238860
 aatagtcaca atacctgggt ggagtaggtg cctgggattg gtgtgattct gcttctgagg 238920
 catccaatg atctttaagc ctagtaatga tacccttttg aaaagtttca atctccttaa 238980
 tcataaaaga ttccaagcat gttagtgaat ctgtaaattg ctctaactgc tcatttcat 239040
 gttttctag gtctttaata tgatcatect taggcagcat ctggatggca tggaaactgc 239100
 cttctatgta ttcgagtcta gattcgaggt catgatttgc tgattttgaa tcctcagcag 239160

 tcgaccgtat ggacctatgt aatctgtcag cctgtactg taaattatct tccaaacatt 239220
 caaatctaga ctcaaatgtg tgatctgctc ccttggatgc ttcaataatt gattgaaatg 239280
 cattgtccaa ttcttcaacc ctatctggg tattttgcac cgttgcactc agttgctggg 239340
 taacattgce tatctgagtt tctatctggc tacatatatt ctctagctcc tcgtggtctt 239400
 ctgacagcct agcctctaag gcctcagaca tggaggatct ctctgtgttt atcttatcat 239460
 caataactg catctcatct tgggtaacag acagctctgt ctttagcata ttagacacat 239520
 agccaagctt atcatecaat ttctgttcca cttgctecac agttatggtc tgacctaatc 239580

 tgttctcaa aacatcattg cgtaaagatg ttatttctg taagtagatt gtgaggttat 239640
 ccttatccct attcctgagt cctctggcta gtaatatat ttgtaccagc aagctaactg 239700
 ccattatggc atataggcca gtaattggca aattagcatc ctcccaaac attgaattca 239760
 cgtaataage aaaaatatta ccaattttag taaatgataa atattccacc ataattttac 239820
 ctgatttcta ttccagatgc agtaactatc tttgacgttc agttagtctg cggcgtttgg 239880
 cagcagtcgg tcagtgggtg agagaggtca caaaagcggc tgtgcttatc ttagagagta 239940

tacggccttg cggcagcaac cactgaaata gatgtggctt tactggagca gcagtggcca 240000

ggggaagcct ctgctgaaag ccgaggccta cccaactct aggcagctag aaactgtctc 240060

cgagctgggt ggatggttct gannnnnnnn nnnnnnnnnn nnnnnnnnnn nnnnnnnnnn 240120

nnnnnnnnnn nnnnnnnnnn nnnnnnnnnn nnnnnnnnnn nnnnnnnnnn nnnnnnnnnn 240180

nnnnnnnnnn nnnnnnnnnn nnnnnnnnnn nnnnnnnnnn nnnnnnnnnn nnnnnnnnnn 240240

nnnnnnnnnn nnnnnnnnnn nnnnnnnnnn nnnnnnnnnn nnnnnnnnnn nnnnnnnnnn 240300

nnnncggca tggcagcagt ctgtccagca agtaccaaag ggaaaccgaa agagaaaatg 240360

caggcactcc acatcacct gaccacgcc tcgcaagcat ggtcaggcac acctatagcc 240420

agcccctaag taggcgtggc tacagcttcc cctacaattt gctgtagaaa cagagggcat 240480

tggagtgatt ccagaagiga ggaaagtgtc tcatgtgaga ctcacctcat aagtatcac 240540

cattctgctc tgttgcctag ctggatcagg aagaggtgga cagtctacta acatagaaca 240600

tacagggcac agttatccac caagggcgtc atatcccttc atggctggat gcaatgactc 240660

ttggcataga aacttcttta ataaaccagt tactgatgct gagtccatca ctaaacttga 240720

acaaatattg caagtagtgc tttcagtcac ctggtggtaa ctatcacgag ccagtctctt 240780

acaacaataa ctgggcact gcagagtctg atttccgtaa agtagccttt ttacttcagc 240840

acaaaaagcc cattgccttc cttgcgtttt tatggagtct tttggcattt tectgctcaa 240900

ttagaattgt gaacaatgtg aaagcagaaa atggagatat cagtgaagag acacagtgtt 240960

gaaaacaaac ttcagagtca actttttact caatttctct ctctcttaat atttatttat 241020

ttccatttat gtgtatgagt attttgcat tatgtataca tgcacatcca tcatgtatgt 241080

gtcttttgcc cccagaggtg aaaagagaac atcagatccc ttggaaggag agtttcagat 241140

ggttgtgagc caccatgtgg atactaggaa cctaactctgg gtcctttgca agaggtatca 241200

ctccaacctt ctggttcttt tgttttgtct tttgtttgtt ggttttcaag agtttctctt 241260

agctttggag cctatcctgt cactcactat gtagacaaga acaactcata ttagacaag 241320

gcctcaaagt cacagagcgc tgctgcctc tgctctctgg gtgctgggat aaaaggcgtg 241380

taccgcaat gccagctca ttgtgtattt ttaattaaag gttataatgt catctgttct 241440

cacagtaagg acagaaaaga tatttccaaa tagcaagggt agaacttgtc acatggcggg 241500

aataattatg atggttgtaa aaaaatacat attgaagaaa ggaactcatc cattcctgtg 241560

ggtctatttc caactgcaa tgtattcttc aaactattg catcctagga gtttgaagag 241620

atgtgttttc gtttcagttc tatgataacc ctggttgtgc actggatttg aaaacacaat 241680

agatcacaca gtgagggtgg acagtgccga tgcctcaca ttctggtttt tgttttgttt 241740
 tttttgttt ttttgttttt tatttaagt ctccttgatt actaacatt aagcatagtt 241800
 atatacacca tgtcaatatt tggatcaatga cagacctcaa atgttatggt attcccatag 241860
 tattataatc cccaacattc aatggcattg tggacatggc agcagggtgtt gcaacacatt 241920
 ctttgagtcc ttagtgaigc agaagtaaac taccaccca ctggaatatg tatagaaca 241980
 cagtagtaca attacatata acaatgactc atgacaataa caaataattg cgcttatggg 242040
 ttttgatttt tctatatatt gtttatcatc atttcagagt gtactgtttc ttcaaaaag 242100

 ttaactataa aatagcctta gcttttgtgt attcatgaat acaacaagaa gtcattgtcag 242160
 aaaatagcaa ataaagctat ctatgtctct aatgacctc tttcagtctt ctaaaaaatg 242220
 tttattcagc cactagtagt acatgcagca ctgtggtaga ttttatcata aaaatatcaa 242280
 aagaatttga cacatgtgtt tgaggatctc aggggtttcc taaaaccaat agttaaatca 242340
 atatatcaga taaaaggctg taagiacatg agaagcgatg aatgtgtttg aggaagtgtg 242400
 tagtagaagg gccaccaagc aggagaaaca gaagacaatt tgtggaatag gacatcctgg 242460
 gaaaggaatc ttaaaatagt tgttgcattc ccatcttggg atatatccaa aggaatcaca 242520

 attcatacat acaaaatatc tacacccttg tgtgatttca ttcacaatag ctaagatatg 242580
 gaagtgttca aagtgaccac aggtagataa gcgacttag caatgtgctt agtgcgctca 242640
 gtggaacccg gtatactcta ttcaactata aaggagaaat ggaatcatat gtaaacacat 242700
 aaatacacct ggagaatfff gttcaagggt aaataagtaa agggagaagg cagataccag 242760
 gagatcccac ttaagcagaa atctataatt ttgattgcaa ggatatagag tagaaggtta 242820
 acagaggctg ggcattagag tgggtagag aaagtggaaa tttgacaaa cagcataaaa 242880
 tctaaccac tctctaagaa taagcattag tctctatag tacataattg acacaatgtg 242940

 gtatacattt cagagtgata gaagagtaga gcttttagcat tcaccaataa tttattaat 243000
 aaaaagtgat gggctgttca ggtggttaag tgtgttattt ggtctttatg cactttttta 243060
 aaataaaaca tacacataaa gcattttctt atagctcaga aacatatgca aatgctatft 243120
 attgacttaa aaacaaatft tcaaaactgt gattatgtga attaattgat aagtttatat 243180
 atgaattaac ctgtggaata cagtgaatac tgtctttct caccaagaga aggcacaata 243240
 gcatttaggg tccctatate ttcttgtac tctttactg gtttgcagge tttatttcac 243300
 aacctgtgag ttggttgatc agcatcctag tcatcatggg ttgatgttat cctgtccttc 243360

 tatttcttta taataaatgt cagaatctct gtaaattatc tttcttggg gttatatttc 243420
 catatcgttt tatcacacct gaatctgacc cagggtatft gtaagttcag tgaatggat 243480
 gctttcaaga ggacagaaga atcacatat gttcaaccaa cttggcttct tttattctcc 243540

atgacagctg gtagaaagga acatggaaaa aatctgtgta gcacagaccc agaaggaaga 243600
 cctcacgaag tcctcaaat caccaagatg gtggcctgct tctttgcat gaggggaagc 243660
 atggcattct tctgctttc tcttctgaa cttgtccttt caggaaagca gccaaaacct 243720
 tagcaccagc ctacactgaa gttataaacc tgaacttgtc aatcttctct ccctagacag 243780

 aacctaggaa cctgagtcac tgaatgaaat aaggatgtgt acaagcccag gtgcagtgca 243840
 tcctgaggte acttctgctg tgggattttt agcaatcgga ttcaggagat acctgggttt 243900
 caatgtggcc atttatgtgc agcccgcatt catcaccttc tccttctcag ctagtctct 243960
 cttcaataac tgcaacctac aaatcaatgc tatatgtaaa ccattgctta cattttcatt 244020
 tgcttaaaca caccttgttt ccaatccttc tctgtctaa gaaacagggt ggtaaaatgg 244080
 ccacctacct actagaccac aagctctgcc ttcttcagta gctcactaaa agtctggccg 244140
 taactcactc ccaatatctt ctttcaggaa caggaacatc ccaccacttt gaaagaagc 244200

 aattttctg taatttcaa tgtatgaaa gaaaaatfff tcttcagca ttggcagtaa 244260
 actgtacaaa caataaattg ttctgaagat tgattatgct cccaagtgtt cccatgacca 244320
 ttaatcaacg gcacagcag cttactacat acattacctg tcataagcaa gtaagaacaa 244380
 aacagaacc acaaacatg gctaaatttg cttgtaattc aggcagtctt aggaattccc 244440
 tgaaaatgga aagcaaagca ggcctatct gatagaacag aaacctgagc atttccatt 244500
 tttattaagg caccagcaga gtttgatttt aaattgtgaa ttttatatag actttggctc 244560
 ataatgtgat ccaattttaa aagttttgct atcattctcc actattgcta tgcactttg 244620

 agaaaaatta ctttatttct ctatttttct acaccatatt tctggttaca agaataaata 244680
 taagccgaat gtttaatatc atctctttag caagcatttc gatcattaca aagttgatgt 244740
 gagggtagct gaatacctaa gaaaacaaaa tatttcagtg aagtcaaata aagctgctgt 244800
 ctctctatga tcagagcctg tcactgctct ctgctgccag ccctcatggg ttctgggact 244860
 ttatagagag aagttcagta acaatgagta ttcttttatt ataaggatga agtgagggtg 244920
 attttgccat gttcctctca tagcatagtc tctggggagg ctagaagcta tccagtttct 244980
 agggaggatt ctgtgaaaac tggacttggt aaaataaatg tcaataagc tatttgaag 245040

 atcaaatgc tttaaagtg gaaacctgtt caatggctga agtaaaaaat gcctcttaag 245100
 aaggaatgaa gtacagcaaa agaaacattg gctaatctct ttttctagga aacctagttg 245160
 gttcaggttt tcttctgata aataaatgaa catgaaaagt agtttttaa attatccttt 245220
 agtcttaact tctacaatat agtagacaaa tacagcaagg ctgccaatct atacatccat 245280
 tcttcaccag aaaaaaatgc cacagtctca aacctgcct tctggggggc tgggtgggtg 245340
 agagatcttt atctgtcaa caagatagaa ttccaggaga aagaagata tttctgggca 245400

gttctacctc taagaccact cctaaaactg ttccagaaga aggtagagag aatggctagc 245460

aggtaactgc ccagggtcca ccagagattt tcaaatccag tctttgtctc ctaggaaaac 245520

ttaccttaaa acacagaaaag caacagaaaa ctgcaaagta agaatgagag gaagacttga 245580

ctacaataca agaatgcata tgaaatagtt aaggataaaa ataagctata ttttgaccac 245640

cmetaaagtt aataaacagtg aaaatgtgct tactactgca gcgagggaag atgtgaccag 245700

gaatccccct gaaagtcatg ctgtaaccac tgtcctgctt cctggttcac ttcaaatgg 245760

cattgccctt gcaaatgctc acatgcaaac acttatattc aaacaattgt caacaatcat 245820

ctgaactctt tttcattccc ccttaccttt gtaaatacaca tttatttcat aacgttagac 245880

tcaaaccaga tgaatcccc tgacaaaaga atcgaacaag tccaaattga tctcttaagt 245940

ggatcaatag aaacttaacc gaaatggatt ggggatttta tcaaacttga tgtagtagaa 246000

cactaataaa atcacttcca attcacacat atggagttaa attctcagca caaattgatc 246060

tgattaccaa ggatgaatgg tcacctttaa taatggatta aggtagtaaa gaattctttc 246120

tctgcacaca aacgtgttcc ccttttaaac tcatgaagac agctttcact tttctacttc 246180

cacaaaactt tattcatatc ttaagtgttc agatctgaat ttagaactgt ctcaatttgt 246240

aaaatttgac tctacttggg agtggtttca agagagaact ttggagacgc taaagaagcc 246300

atgagacttg tattgtctta ggaaacctg gtatccctag aagtacttg taagataata 246360

taaataataa gaaacatgtt aatatagcag aagccttctt gttggaaatg cttgctttgc 246420

ctattttata ttgactagt tgateattta tgtttatgct tttgaatata ttatatattc 246480

taacttacta atattcceta aaggaattta tgcattaaaa attcgtgacc atcatgacac 246540

tattttggag taaagattta atgtggtgat gaattaaggt tcaagatagc atttctccaa 246600

gaaagaaaac ctctatctgt ttctctcca tttgaaatat taaaagtctc catttcttca 246660

acattcaaca gcagtatcaa gtgttggctc tagaatatac aaggaagctt cacttctcca 246720

atggagggca aggttattac cacagaatgc tcagattctg aaatatcttg tcaaccctgg 246780

gccagtgaat gcacttgaat gcaaacatt aaccaccccc cccacacaca cacacatcat 246840

tctctgtgct atcattgctc tttggtcttt gacacactct ctaaatctta cttcagttag 246900

gaaaataggc cccaaagttg taagcttctc tgtccaagaa aacatatgaa ataaacagtc 246960

aaggttgagc atatgtctgt gtttcccaag aaaacaaggt cctctaaatc aacagggaat 247020

gatgcacata tgaactcaca gagactgagg caggacatgc aggcaggcaa gtatcttcaa 247080

caggtggggt tctagaactg aaaggagatg tgcacccatg cctccatcct gaacacaaaa 247140

gcaatctcta atggataact acttgcaaat ataagtttag gtttttccaa gggagtctca 247200
tggggaaga atctactctt aaggtaggc ttcattgcca gcaatagata actacagaaa 247260
atgaactcaa gaacaccttt ggcagttcct tgtttcataa tactgtgtca gggcttttaa 247320
aaaatcttat tttttatfff atttatatat attttctct tttttatact acaggicctt 247380
tttcatatgt attatggctt ccagattagt gattttcagt ccaaaaatat atgtagtgtt 247440
tccaaatagt cccattctt cagctgaaag taatttagga attcttact atagtgtgtt 247500
ctttagaac atctacagta cttctgttag tatttaggca ttttactgg cttgcctttg 247560

gagtgatcta tgtttcttct ctctgcagtg acaaagtcc agaggtaatg gccacatcac 247620
tctgaggaaa tactgtaggg actagccatg gagaatagcc agaactaatt actgagaaca 247680
ttcacaagag agaaactttt gttatcataa gtcaatatga ttttagggcc attcaccttt 247740
aatgtggcaa aacctattca ggcaaatcta ccttgccac agctttcacc aactgatgga 247800
ccatgtaaca tatgatgaca acaagaagtg cctgctagag ctgtaagatc cacactatga 247860
aagagagtta agagaagtag ttttctatgt gaggttgaaa agagaatc aggaagctat 247920
aagcaaacat tgggtctttt ttttttctt atctggttca tgttttaaac attttgtaaa 247980

ttgttatfff aataacttta tttttatfff attattgctt attattacac cattggcaat 248040
taatttatct ctatcaatga aactgtaaaa cttttcttca ctttgataac caggttttta 248100
atgtatcate ttagaagttt agttggttat aaattttata gtttttaaag caactttttg 248160
taccacctt tgaattagct tgaagcttga ttattttctg ttgctatcct tccatattta 248220
ctatggtaca ctgcacagag ctaacagtaa ttgtactagt caactgcaag tgtctcacac 248280
atataffff tctgactctt aaggaagtaa ttgacagata gaagatagaa taatttctga 248340
atgtcaattg cattaatgtt tacattctat ctgtaagaaa cctaagtcta gattcctcca 248400

ccgccgactg acctggaact aggtgagtga gttctctgct gctccccacc caggccagaa 248460
caccccgacc accccatccc cccaccnnnn nnnnnnnnnn nnnnnnnnnn nnnnnnnnnn 248520
nnnnnnnnnn nnnnnnnnnn nnnnnnnnnn nnnnnnnnnn nnnnnnnnnn nnnnnnnnnn 248580
nnnnnnnnnn nnnnnnnnnn nnnnnnnnnn nnnnnnnnnn nnnnnnnnnn nnnnnnnnnn 248640
nnnnnnnnnn nnnnnnnnnn nnnnnnnnnn nnnnccacc catccccca cccccgctg 248700
tgctcgagg cttgggccag acacgccag gcaggagga gctccctgcg ccccaaatct 248760
gtaaacacc cactcttcca ttccacagaa cgaccgagga actaggaact agtgaggaga 248820

ccaccaggag cgtctagatc atctagagtt gtggacattg aattcctagc cccacacac 248880
cactgggcca caagaggaga tagagagaac ccaccnnnnn nnnnnnnnnn nnnnnnnnnn 248940
nnnnnnnnnn nnnnnnnnnn nnnnnnnnnn nnnnnnnnnn nnnnnnnnnn nnnnnnnnnn 249000

nnnnnnnnnn nnnnnnnnnn nnnnnnnnnn nnnnnnnnnn nnnnnnnnnn nnnnnnnnnn	249060
nnnnnnnnnn nnnnnnnnnn nnnnnnnnnn nnnnnnnnnn nnnnnnnnnn nnnnnnnnnn	249120
nnnnnnnnnn nnnnnnnnnn nnnnnnnnnn nnnnnnnnnn nnnnnnnnnn nnnnnnnnnn	249180
nnnnnnnnnn nnnnnnnnnn nnnnnnnnnn nnnnnnnnnn nnnnnnnnnn nnnnnnnnnn	249240
nnnnnnnnnn nnnnnnnnnn nnnnnnnnnn nnnnnnnnnn nnnnnnnnnn nnnnnnnnnn	249300
nnnnnnnnnn nnnnnnnnnn nnnnnnnnnn nnnnnnnnnn nnnnnnnnnn nnnnnnnnnn	249360
nnnnnnnnnn nnnnnnnnnn nnnnnnnnnn nnnnnnnnnn nnnnnnnnnn nnnnnnnnnn	249420
nnnnnnnnnn nnnnnnnnnn nnnnnnnnnn nnnnnnnnnn nnnnnnnnnn nnnnnnnnnn	249480
nnnnnnnnnn nnnnnnnnnn nnnnnnnnca ccgtaaaaag gccaaacct a agaataatag	249540
gtgtagaaga aggtgaagat cccctttgac ctacaaggat gactcgatct gacagtccgg	249600
gcagtggagg agaggatggc ctagaagccc ctcccctaga atgagagtga tgactactct	249660
ctatgctata ctagagtcct catccagtgg ctgatggaag cagagacaga catacacaga	249720
aatacactga gctgaattct ggaacctagt tgaagagagg gagggatgaa gaatgtatag	249780
atatgtacce ccattttttt nnnnnnnnnn nnnnnnnnnn nnnnnnnnnn nnnnnnnnnn	249840
nnnnnnnnnn nnnnnnnnnn nnnnnnnnnn nnnnnnnnnn nnnnnnnnnn nnnnnnnnnn	249900
nnnnnnnnnn nnnnnnnnnn nnnnnnnnnn nnnnnnnnnn nnnnnnnnnn nnnnnnnnnn	249960
nnnnnnnnnn nnnnnnnnnn nnnnnnnnnn nnnnnnnnnn nnnnnnnnnn nnnnnnnnnn	250020
nnnnnnnnnn nnnnnnnnnn nnnnnnnnnn nnnnnnnnnn nnnnnnnnnn nnnnnnnnnn	250080
nnnnnnnnnn nnnnnnnnnn nnnnnnnnnn nnnnnnnnnn nnnnnnnnnn nnnnnnnnnn	250140
nnnnnnnnnn nnnnnnnnnn nnnnnnnnnn nnnnnnnnnn nnnnnnnnnn nnnnnnnnnn	250200
nnnnnnnnnn nnnnnnnnnn nnnnnnnnnn nnnnnnnnnn nnnnnnnnnn nnnnnnnnnn	250260
nnnnnnnnnn nnnnnnnnnn nnnnnnnnnn nnnnnnnnnn nnnnnnnnnn nnnnnnnnnn	250320
nnnnnnnnnn nnnnnnnnnn nnnnnnnnnn nnnnnnnnnn nnnnnnnnnn nnnnnnnnnn	250380
nnnnnnnnnn nnnnnnnnnn nnnnnnnnnn nnnnnnnnnn nnnnnnnnnn nnnnnnnnnn	250440
nnnnnnnnnn nnnnnnnnnn nnnnnnnnnn nnnnnnnnnn nnnnnnnnnn nnnnnnnnnn	250500
nnnnnnnnnn nnnnnnnnnn nnnnnnnnnn nnnnnnnnnn nnnnnnnnnn nnnnnnnnnn	250560
nnnnnnnnnn nnnnnnnnnn nnnnnnnnnn nnnnnnnnnn nnnnnnnnnn nnnnnnnnnn	250620
nnnnnnnnnn nnnnnnnnnn nnnnnnnnnn nnnnnnnnnn nnnnnnnnnn nnnnnnnnnn	250680
nnnnnnnnnn nnnnnnnnnn nnnnnnnnnn nnnnnnnnnn nnnnnnnnnn nnnnnnnnnn	250740
nnnnnnnnnn nnnnnnnnnn nnnnnnnnnn nnnnnnnnnn nnnnnnnnnn nnnnnnnnnn	250800
nnnnnnnnnn nnnnnnnnnn nnnnnnnnnn nnnnnnnnnn nnnnnnnnnn nnnnnnnnnn	250860

nnnnnnnnnn nnnnnnnnnn nnnnnnnnnn nnnnnnnnnn nnnnnnnnnn nnnnnnnnnn 252660
 nnnnnnnnnn nnnnnnnnnn nnnnnnnnnn nnnnnnnnnn nnnnnnnnnn nnnnnnnnnn 252720
 nnnnnnnnnn nnnnnnnnnn nnnnnnnnnn nnnnnnnnnn nnnnnnnnnn nnnnnnnnnn 252780
 nnnnnnnnnn nnnnnnnnnn nnnnnnnnnn nnnnnnnnnn nnnnnnnnnn nnnnnnnnnn 252840
 nnnnnnnnnn nnnnnnnnnn nnnnnnnnnn nnnnnnnnnn nnnnnnnnnn nnnnnnnnnn 252900
 nnnnnnnnnn nnnnnnnnnn nnnnnnnnnn nnnnnnnnnn nnnnnnnnnn nnnnnnnnnn 252960
 nnnnnnnnnn cacagttttt cacagacatt gaaagaacaa tactcaactt tatatggaaa 253020

 aacaaaaagc ccaggatagc caaaacaact ctttacaata aaggatcttc tggaggcatc 253080
 accatccctg aatcgaattg aaaaccctga cattgacca cgcacctatg gataccttat 253140
 ctttgacaaa ggtgctaaat ctatacaatg gaaaaaagat nnnnnnnnnn nnnnnnnnnn 253200
 nnnnnnnnnn nnnnnnnnnn nnnnnnnnnn nnnnnnnnnn nnnnnnnnnn nnnnnnnnnn 253260
 nnnnnnnnnn nnnnnnnnnn nnnnnnnnnn nnnnnnnnnn nnnnnnnnnn nnnnnnnnnn 253320
 nnnnnnnnnn nnnnnnnnnn nnnnnnnnnn nnnnnnnnnn nnnnnnnnnn nnnnnnnnnn 253380
 nnnnnnnnnn nnnnnnnnnn nnnnnnnnnn nnnnnnnnnn nnnnnnnnnn nnnnnnnnnn 253440

 nnnnnnnnnn nnnnnnnnnn nnnnnnnnnn nnnnnnnnnn nnnnnnnnnn nnnnnnnnnn 253500
 nnnnnnnnnn nnnnnnnnnn nnnnnnnnnn nnnnnnnnnn nnnnnnnnnn nnnnnnnnnn 253560
 nnnnnnnnnn nnnnnnnnnn nnnnnnnnnn nnnnnnnnnn nnnnnnnnnn nnnnnnnnnn 253620
 nnnnnnnnnn nnnnnnnnnn nnnnnnnnnn nnnnnnnnnn nnnnnnnnnn nnnnnnnnnn 253680
 nnnnnnnnnn nnnnnnnnnn nnnnnnnnnn nnnnnnnnnn nnnnnnnnnn nnnnnnnnnn 253740
 nnnnnnnnnn nnnnnnnnnn nnnnnnnnnn nnnnnnnnnn nnnnnnnnnn nnnnnnnnnn 253800
 nnnnnnnnnn nnnnnnnnnn nnnnnnnnnn nnnnnnnnnn nnnnnnnnnn nnnnnnnnnn 253860

 nnnnnnnnnn nnnnnnnnnn nnnnnnnnnn nnnnnnnnnn nnnnnnnnnn nnnnnnnnnn 253920
 nnnnnnnnnn nnnnnnnnnn nnnnnnnnnn nnnnnnnnnn nnnnnnnnnn nnnnnnnnnn 253980
 nnnnnnnnnn nnnnnnnnnn nnnnnnnnnn nnnnnnnnnn nnnnnnnnnn nnnnnnnnnn 254040
 nnnnnnnnnn nnnnnnnnnn nnnnnnnnnn nnnnnnnnnn nnnnnnnnnn nnnnnnnnnn 254100
 nnnnnnnnnn nnnnnnnnnn nnnnnnnnnn nnnnnnnnnn nnnnnnnnnn nnnnnnnnnn 254160
 nnnnnnnnnn nnnnnnnnnn nnnnnnnnnn nnnnnnnnnn nnnnnnnnnn nnnnnnnnnn 254220
 nnnnnnnnnn nnnnnnnnnn nnnnnnnnnn nnnnnnnnnn nnnnnnnnnn nnnnnnnnnn 254280

 nnnnnnnnnn nnnnnnnnnn nnnnnnnnnn nnnnnnnnnn nnnnnnnnnn nnnnnnnnnn 254340
 nnnnnnnnnn nnnnnnnnnn nnnnnnnnnn nnnnnnnnnn nnnnnnnnnn nnnnnnnnnn 254400
 nnnnnnnnnn nnnnnnnnnn nnnnnnnnnn nnnnnnnnnn nnnnnnnnnn nnnnnnnnnn 254460

nnnnnnnnnn nnnnnnnnnn nnnnnnnnnn nnnnnnnnnn nnnnnnnnnn nnnnnnnnnn 254520
 nnnnnnnnnn nnnnnnnnnn nnnnnnnnnn nnnnnnnnnn nnnnnnnnnn nnnnnnnnnn 254580
 nnnnnnnnnn nnnnnnnnnn nnnnnnnnnn nnnnnnnnnn nnnnnnnnnn nnnnnnnnnn 254640
 nnnnnnnnnn nnnnnnnnnn nnnnnnnnnn nnnnnnnnnn nnnnnnnnnn nnnnnnnnnn 254700

 nnnnnnnnnn nnnnnnnnnn nnnnnnnnnn nnnnnnnnnn nnnnnnnnnn nnnnnnnnnn 254760
 nnnnnnnnnn nnnnnnnntgg aaacagagac agacatccac agatatacaa tgagccgaaa 254820
 tcgggaattt agttgaagag agggaggaat gaagaatgaa ggggtctgtc aaggtggaga 254880
 aacccgcagg aatagttgac ctgaacaagg gagagcacat cgataaaaaa aaaaaagaaa 254940
 aaagaaacct aagtctaag tgtcaaat ttttgacat agaaggccag gcttttctca 255000
 gtgttcatta agagacaatg aaagaaaatg tcaagaacca atgtttta atcccaat 255060
 taattttttc cttccatc caagaaataa aactcctaag tgcaatgcaa ttttacaagt 255120

 caaaattatg acttattgtc ttagtcatta tcttattggt gggaagagaa aacttgatga 255180
 tggcaactat taaaagagaa tgtttttttt tttttttttg atttggggct tgcttacagt 255240
 ttcagaggct tagtcaatta ccattaaggc aggaagcacg gtggcaggca tggcaggcag 255300
 ggtattagag tagttgagaa ctacacactg atgggcaggc ttgaagagct ggagcctggc 255360
 atggactttt gaaatctcaa atcccaccac aaaatgat atttcctcca aggctatc 255420
 tcttccaaca aggccacacc tcctaatt tctagtetta tcaaagatat ccactctctg 255480
 gtgactaaca taggagtcta tggggactgt tctcaaagca ccactgac cttaattgtga 255540

 aaaatactag ggatcaaaga aaaacaaaac acccataatt catgtataga tgataaattt 255600
 tcatgcatat atctagatga ttgtgaaaat gggtaaaggg agaaatatta acatcactca 255660
 agtgatgcag tataactaaa ttccaaattt acaaacggtc atataaggat aaagtcatat 255720
 aaggataaag gagagtagtg gagcaaatag ccaaat tct ggcttgtgca atgagacaaa 255780
 tactagtatg agagaaagaa caagtagaga gacttgaatt taaaggccag agtctcatat 255840
 aaaggtggaa gtcagaagaa aaatcagatg tgggaattga tatgtatata tttgtttgtg 255900
 tgtctgtaag tgcagggata atgtcataca cttaccaagc cagttgggtgc ggtgctaata 255960

 ccatttatta acttgttcca ttctgtgatt taaattcca agggaagaga aaaccagagg 256020
 agaaatggaa atgttttacc gagacactga agtagtgaag atgaatgctt acacaataac 256080
 atgctttaac tcatttggag gaagtgtctg ccattaaata tagtcaaac agacactgtg 256140
 ctgtgaatta caagtcgta aacatccctt taactggtat ttgacttgtt agagtgtaat 256200
 ggtgggtgga gagaagtatc acaataaata ctagaagaca aattctaggc ctgtcagtga 256260
 ggatttctta tigtattttt tcacttaaac atggaaggaa atgacaaatc ctttaagtaga 256320

gtgaaagcca acttaatgaa gtccttatac aggccagaaa tactgaatct gaccattgt 256380

 ccagacagaa caaatthaag tcaaatctca gcccttgtgc ttctgggcta aaagtcttag 256440
 tcaaatatcc ttccagcatt gtatttgttg ggcatattag aatggtcaga atcttcctgt 256500
 cataagtgtt ttatattttt ctcaatgcca tggttgtctg caaagtcctg taaaatttat 256560
 tgggtttgct ccatgaagat gtgctgagga ttaatgctgg agttttgagt acagcaataa 256620
 atctaaagca aataaatact atgaacttct gaaggttaag aggcttcag acaggetgac 256680
 ccacctttca gcttctaag atgaagcaat gagaattggg gttgatcaa acttacctg 256740
 tcatcataaa atcaaaacat gtcaaatg gtccttctcat attcatttct aaaaagcaaa 256800

 tgtctgtgaa tgaacatgct ttaagaaatt ctgtaggtaa tacattttac catttaatta 256860
 catttctgtt ttatttcaga taccttatca taaactagta gcccaaaaat tcaagttcat 256920
 ctccctgta tatcttaggg aagtagctat atgacttgag ttgcaaatcc taaaaaacta 256980
 gaaaaaatgc caatgctatt ccaccattga tgaattcca aagacttact gtctctcagt 257040
 gtcacataa cttacagatc catccaaaaa gaaaattgtt tctttaatag gaaatgaaca 257100
 catctctgcc ctatctctat ttcagtaatg ctgttgaata tgtatataaa cataaatgta 257160
 atattttggc aggatgtcca gctttctccc attttttaca ttctctatct ctgtctattc 257220

 cacccttctc ctttccctca ttattccttc tctttcaaga ccaatcaaat tgctttctta 257280
 atttcaaatc tgacatgtct gctgtatttc actagaatgc tcaactgga aataaagtct 257340
 tctttctagt tgatagcacc aagtcaagc tctaactctt agggcaggag ttttcaatgg 257400
 gaccttctga gatgaacagt gatttatatt cctctcaaac acacaacaga cacaaggcat 257460
 ttgaaatgtg ggctagtgca agtgaagcac tgaatttga acaaatataa tttaatcat 257520
 tccatgtggt taatggccct tatttaagge atcccaagtg ttcagatgca aatatatgtg 257580
 catatgagca aactaaagg aagacagcta atttgtgtgt gtgtgtgtgt gtgtgtgtgt 257640

 gtgtgtgtgt gtgacaataa taattaaaga ataagaggct atgactatga gagggggcaa 257700
 cataggtgga gttggaggaa gaaagaaagg agaaatgatt taaatgtagt gctaatatct 257760
 aaaattctca aaacaaatag tcatgaatgt agaaggagg ctactagtgt gaagacaaag 257820
 aggattactg gcagtgggta agaaaggata atgggggtgaa tacgggtcaa atagaccatg 257880
 aacataaaaa acaaatcat gggccctgaa gataaagtgc cttccctctg ctaggtacta 257940
 catacttact taatagccag agcttatttg caatcaaca gttaaacata ctttcatagg 258000
 attcatttac ttcatatgaa ttatcaaagc acacatgagc acaccatttt agcagcacat 258060

gttcaaagta gttcataggc aaacttctgc cattgctaca tagagttacc ataaataaat 258120
aagtcaataa ttgaaagct tattttgatg agaagactca aaaaaactca catttttttc 258180
tcccctcgga ggcatttcat agacaaagaa agagaagtga attgaggacc tgatgcttac 258240
cttttttctt ctgactttag aaaccatgtc cactgggtgtt aggttaaagc aaccactgtt 258300
agactttaat ggggagaatg tgtttctgat tgcattcaa gataaagctc actgtttgat 258360
ctaagtccac catcaatcac aaaggagccc ttaataaaaa tcttaatat caatgcaaat 258420
tatctatggt ataaagtttt aatgttgcag agaccagatc cccaaaacag tccaaggcag 258480

aatgtaaaac aattatttct gtacagacta tatactgaca atgcttagga taagggtcta 258540
aggaggaaat atctggaata agcataatag cagaattttg caaaagcaca tgggacctct 258600
ttcataagaa tgggttctat ttactgagaa gcaatgtcga gaagtttta aatgtaaat 258660
ataattttgc tataaaactc agcaattaaa agtgttataa aatacatgct gataactaaa 258720
ataaaaaacag agcatcttcc cctttgttaa gagattattc ttattctctg ctgttaccaa 258780
atgtaggcat cccaaagaag gctttgggaa acatggttcc aatcactgc tctggcctta 258840
cctgcctaga ccttcaactt ttactgcccc cctatctcac agtcctcaac tgtaaatcat 258900

ttttctccac acattgtgat tatccgatgg actgccattt ttttctttt ttaagtagta 258960
gtctttttgc ttttttaaag atttatttat ttgctgtgga tacagtgttc tgtctgcatg 259020
aatgcctgca gtccagaaga gggcatcaga tcccactaga ggtggttatg agctactatg 259080
tgggtgctgg gaattgaact tggggacctc tgggagagca gccagtgtcc ttaacctctg 259140
agccatctct ccagccccac aaccattctt gaagtcaatg aatcaaata ccagcaagcg 259200
atttttgtta gttcatttgc atttacttcc catcttaatc agccaatacc tcatatgtaa 259260
attactaaac cctccaagat attttttcag ctcatgattt ttgatagata tcatattggt 259320

ccaccaaaagg tatttgcact ctcatcactt aatgctatta gtgtgttacc ttgaacagca 259380
aaaggctcta cagatgcaat tcattaagtt caagctgttg agatcaggaa tatttgaagt 259440
ccaggtgggt gagcacaact cagtattgag agaagaagaa tcagtcagag aaagaaatgt 259500
gatcacataa acaggccaga gtgatgtaag gatgaggtca taagccaagg aatggagaaa 259560
ctgggaaaac agccagcaaa cagaagaagc actaatccac tgaatcattg attctagtcc 259620
atggacttac ttcagacttc tgagccagaa attgcaagat aataagttag acctgcctca 259680
agccatttaa catatggtaa tttattatca agacaacaag aaaggaatat atcccctcat 259740

cttagtttct gtgtccacag ccctggttat agtctgtctt tccaaaaca cctgccagtc 259800
tttttactgc attccttctt tttaaaaatg atttgtttat ttattttatg tgtatgagta 259860
ttttctctga atgtatgtct atattccaca tgcattgctg gtaactgcag aggccagaag 259920

agaacatgga agttacatat ggctgtaaac tgcctgtgg atactaggaa ttgaacctag 259980
 aaccttgag aaagcaaatg atttgacag ctgagacagc tatctcttca gcctactag 260040
 accacttctt agcctactta acagtagttt ctctataatc agtagtctcc tcagcaaagg 260100
 actcctgaac actttctctt gtatcccacc ccaagcaatc ataaaatttc ctcatgatga 260160

 ccttccttta cctctctcaa caatctgtat cttccagtct tgcttgcaaa cacatacatg 260220
 tccctctttg actttccaag tggtgcaacc catagctagg attttcccaa aatgcaaccc 260280
 tccacacacc tttcacaga gagtctcaa ggcttgatg aataattatc cctccagagt 260340
 gccacctctt ggtttcttag atgtcatgag ctgtaactac tggatgtgtc catctatcca 260400
 tctttagacc cttcacatg tactttggac acatcgattc atgggtctgt ctgtcatcat 260460
 tttttaagat atgatgaaat gattactaag gggaggaagt gacaattatc tgtggttgca 260520
 tggcatacat cttgacacat aatagttaca tgttatatgt tgaaatgagc taaattattg 260580

 aattaaacta tglaggattg tgtatccctt caaagattag tttctaataa aggaagggag 260640
 attgtttaac acttaaatga aataaactg agaagctgtg atagacatat ctgtccctag 260700
 ggaaataagt tttcatgtgt gctataaaat gtcacaattc attctgtcat ttatatcctg 260760
 glaaacctct gcacaacaag gaatagtaga aaaggaatca ggattcagtg atggatttta 260820
 agttcaaaaa tacaataaa taggctgggg agatggctca gtgggtaaaa gactcaacag 260880
 gtataaggac ctgattcag atctcaccaa acatccttgt aaaagctgag tgtggtagtg 260940
 agaacctgtt tctcattccc tgggtgatgg cagaaaaaga ggatccatgg agcacacagg 261000

 ccagttagtc tagtcaaaat ggcaaggtcc atgttcata caaaacggcc atccctctgg 261060
 tctttgcaca tgiatgcaca tgcataact acatatcata cagacacaga cacacacaca 261120
 gacacacaca cagacacaca cacacacaca ctcacacaca cacacacaca gagagagcga 261180
 gagagagaga gnnnnnnnnn nnnnnnnnnn nnnnnnnnnn nnnnaaagag gaggagagag 261240
 gaagagggag agagagagag agagagagag agagagagag agagagagat tgtgtctatt 261300
 tgatgtggc aagatttagc aaatgaaggg gaaagatgta gcaggataat gcatagttta 261360
 aaatctgcat tcattattgg aattcactga aactctecat aatgatctcc cattgcaaaa 261420

 ttcatcgtat catatggcta aaaggttaat aggaccttct tgagacttat ttttgttct 261480
 tcatttactg gagagctaga aataaattgt gagagatata ttacttgaaa attactctac 261540
 ctgggtgctg cagattatta ggccatagat cctaccagaa aagctgggat atgagcagga 261600
 ctaagctata cacttgctt ttctctaaa ccagaaaac actagtaaat tcctgaaca 261660
 gggaggcagg gacttgctg attctacttg tgagatagaa tttttgctaa aacagcagac 261720
 taagcatctt agctcttttt ctttatttcc cccgctttct ttttcagacc tgaggttccc 261780

agacaactga agaggtacgg ttatttgcaa ggTTTTgaag ctgTTTccat tagcacacac 261840

 acatttctag ctgctcagtg atatcctctt tcctgttaa atgctctccc ttctgtcta 261900
 aaacctggca ttgatgcggt gcagttaatg catacagctc agttccttcc agtcaattgt 261960
 ctttaaagta ttaaaaatac taccagccg tcctcagcc catagccctt cctcttgatg 262020
 aacttattca gtctctctac tgtgtgtcg ccattgttct tttcccata accacacctc 262080
 cgtctctatg cttccaaaa tttctgtgc aaacagtct aactatagct taaacatgga 262140
 aggttgccat ttcttcatt gttatctatt tctaaatact taggtgttcg cttccccta 262200
 taactttct aacaattatt taaaaatgtg tagacctgca agaatttaag ccatcctttt 262260

 atactgcatt tataattctg ctatatttct gccacattct ccataatatac agatcattgg 262320
 cattctatat caaacctca gcacaattct tgtataagct tccggttag acagtaatat 262380
 acctgctaga ttctgcctt gatagttaac cagaattatac aacttaactt gatttagaat 262440
 cacacaagag atatgccttt tgagtgtgtt tatgaagatg tttccagaga ggttagggg 262500
 acaaggaagg acccattatg actgtgggtg gttccattct atgggctagg atcctgggct 262560
 gaaataaagg aaaacaataa taatttaagt gttaatctca gtctgttttc tgactatggc 262620
 taaaaagtga tcagtagcct tacacagcag tcacagtgtt tgttctgcat gatggacaca 262680

 tgatctcaaa ccaggagcca aaataatccc ttctttcat aagctatttg gtcaggtgtt 262740
 ttgtgatagc aagaagaaaa gcagicaaca cacctaggta gcccttaaaa aatattttt 262800
 ataactggcc tatggafact aaaattatgt ttaattgaat attaactata tatgccatgt 262860
 attggtacac ttaattaat atgtgtggac gcacagttaa acattttgca tttctgcgtt 262920
 ttgtcagttt gatctgaatc atttctgaga agtggttagaa tctcagttta aatgggtaa 262980
 tacattccaa cctccccatt attctacca cttcttctc ctacttacac ttactatcaa 263040
 agaaaatgag aaactgaaga cattagaatt gctcattaga aattaagtca attttgaag 263100

 ctatggtttc attgttgggg aatgaaaatg aaacctataa tttgatctcg acttctgat 263160
 gtgaaaaaaa cctctggat tacaattcca tctccatat ccccagatc tgcattgaggt 263220
 aacaccctgg taaactga catgctctgg gaccaattca tgtctacca gtcaggaggt 263280
 cactataaat cttatcattt attaacgctt cttctgctat tgcacactag caaaaacttc 263340
 caagatttat gaataaaatg aatattaagt gtatgtatgt aagagaacaa gatttaaact 263400
 cttcaaaacc atccacacag ctatttgat agcaacttta gttgttttac tttgggggtt 263460
 caaactaagt acttgaatt atgacagcag aatttgagtt tttgatctt tttcttgatt 263520

ggcatgtgt agagaaagta aaacatgtga aaatgaaaat ataatagaat cacacagaga 263580
 cataaagata agtagagaaa gagactgttg cctggttcct atttctagat ttggagccct 263640
 tccccaggcc agcctgcatt gcttatgggt cttgaagaca taactacatc ctgaagactt 263700
 ccctcttttc ctttaattcc ttgagttgat ttgcatttac actgtacatg taaatgcatg 263760
 tatatttcca tgttcacatg ttttactttc tctacacaat gccaatcaag aaaaagaccc 263820
 aagaactcaa attctgccat cataatccca agtacttagt ttgaaccccc aaagtaaac 263880
 atctaaagta tacagctatc atggcaaact tgttacaact gagaatgtg tcttgaccac 263940

 ttctgagatc agaagatgat cagtcacag ttctcacat gtcttttacg tttaacacat 264000
 acctgaacta caaagcctgg ataactacca tccatccaac ttgaacaaaa ttcgagaaaa 264060
 gacatcaatg gcagtttttc aagttgcagt aaattctgtc attattggga agagccattt 264120
 atcctagagc caaaggaact ctctaccctt tcccctttta gttcgtttgg gccattctat 264180
 ttctccctg gtgcattcga acttggatgat gaacgtgtgt tctttttaca ctctcagcaa 264240
 tggaaagcca tcagttcaca gtcaactacc aatttcattt actacagtaa acagaatcgc 264300
 ttctcaagtc attagtatct ccaggaacaa tgcctgaatt aagttggaat tacaataggt 264360

 agaataataca gtctgaagc taaatccact tctatacagg ggttctcata cacatgatga 264420
 ggtgagagga aaagatggtt ttgaatgtgg tatctacttc catgtagaac aggtgcatcc 264480
 cttgactttt ttctagaata acagcatctt aattgtgtta gtgactttgg aagacagtea 264540
 aacaaagtat ccaagtgggt cttgtcccca gaagcagtcc tggctctttg tttcactgag 264600
 ataggacatg gcataagggt cagtgggttg ggaatctatg ggaagaggcc tgattgcaag 264660
 cagcttctg tgacagaaaa agtctgaaat cttaatccta gaattcactc ttaggacact 264720
 ttcttgcccc aaacatcatc acattctccc gtcttgtgta tcagcaataa ggggtgctgtg 264780

 gtttttctcc tgctaccaa gcaatgttga catatgtctt aactgattta taatttgaat 264840
 aaggaagaga acattaatga aagttgactt aagtgtataa gcaatgcatt tctcaagccc 264900
 cccccccc cctcccacc caagaccttg cctgtcatc taataacaag tacttgtatc 264960
 acatgaacta atcaccacct caagttcagc acttcagaaa tagaagtatc caatctctgc 265020
 atgaaagaga aatggaagtt gacaccaggc atttctgggt tagccaaaac accttactta 265080
 tcaaagcttt caggattgga acccaagtca ctgatgatac tattacatct atctgtactt 265140
 gtaaagtaat gtaacattag ttcctattta gacgtctgca tgtcacacac acacccatct 265200

 cacaagctag atattttcag attccagatg ccaactttgac tacatcattc ctttccaaat 265260
 atctgttagt ggetgcacat tccaaatcaa atcctttttt cctgatataa aaacacttct 265320
 ggatattgaa ataaaccatg tttctctgta actgaagcat tcccttcagg gtgtggcctt 265380

ctaaagattc aagatggaag cttcttaaaa ttagaagtga atgagaccta gaaggcctgg 265440
 aaagtaaca aaaatcaccg gtctcaaaat gtcactgaag gttgaaaaat gtagaggctc 265500
 ttcccaaaat gtagacaagc aatgaccttt gatggggaga caagatactc caaactgtag 265560
 agcagcctgc aaaccagaca tggagctcca gagatacagc tttcatcagt cagctctcat 265620

 gctggggtgg gctttttggt catgcagttg cctttgagcc tctgaatta ctctggcct 265680
 gtttgctga caggaacct agtaagctca ccagtccagt cagataagct aaggtggaat 265740
 catttcttg gtcagttatc agtacctga ctggtgtgag aagatgttc ataggaaaag 265800
 tcacacagta tttatccatt ctgctgtatg tgttatcttc tgcactcaat cttagtcaaa 265860
 gacagggag caactaatcc tgtttacag aatgaactat ttatgaagca atgtttctac 265920
 tatatggctt tgctcaagtt gtaatctacc cacacatcat cactccaagc agcctctcca 265980
 ctctgcctaa ctctccaac tatttaaggg cagatgggaa gctcagcatc ccatccttga 266040

 atgctagttt tatagctgca atgcaggttt tcagttaatc atacactata tgaaattgag 266100
 tgttctgtg gtttattaga gcctcatcgt cgcctgtat gtagtattgt gaggttccat 266160
 agccgaagaa ccagggcctg catcccacat cataaaactc actgatgac acacagtggc 266220
 tgtaaaaaa tttaatgatt aattgactta taataaaaa caaagtaact gtcttcatct 266280
 aatgatagc ttggttcagg actatgaaat tcagagaaa tttaatcacc agaaattcta 266340
 ttctgacctc ttgacttcc tctattgctc caggcgggccc cttttagtga tttttgtatt 266400
 cattttctta atccaaaaat ggaagtaagg cttgtcatct gtcttactca cagagagtgg 266460

 tgaggagtat tctagtcgat gcaaggcaca cagctaatac aaagttaat aaaaatgata 266520
 aataatgtcc attataaaa tgaaccattg ttcaatttct actgcccttt cgggtgctttg 266580
 attcagttct cctcactga aatttgagaa ctttaactctg atgaaatgtt ttactaataa 266640
 ccatcggctt cctgcattaa ctttttctta tcattaggta cacctggatg gcatgaaatt 266700
 attcttttaa agaaatcaat acatcactgt aagtgcatag aaaacagctg ctaatgagct 266760
 tcagatgaga gaaatctgtt ttaacacgtg atatcagaaa ttctaagaac tttaatctgc 266820
 tgagctgatt ttgatggaat aacattttaa ccaatctcaa attgtatttt cettaattat 266880

 ttccataatt tcttaggca aaattcctgt tttctgtca gagaagttaa tttcttttt 266940
 ctgtgaattt ccaaaccaaa tattttttta ttttctaag ggaaaaaaa acaaaaagta 267000
 aattctatta aatgacttca ttacctcaa actgtttatt taaaagcact tgtcaagtaa 267060
 tgatctcttg tgataaatca aaagtcctaa gactgagtag attttgaag ttaggatgag 267120
 gcttaacaag gcatcagatg attatttcta gagagatagt tggtagtgc tcaataaagt 267180
 caattaaaat cacctgacct ggaaggaaga aggcaaatgt gccaacagag acagctgtaa 267240

acatctggaa agcagattac ccacagttgt gggttttgta attcttctgc ttaaaccac 267300

 tgtcaaatgc atatcttaaa gcctattaca gtttataaac atttttgaca gtgtgaacta 267360
 atcaacccaaa acgtaggagt gataaaaaat gaagtaagcc tcaaatcttt ttttttttaa 267420
 ataattctat ctaggagcat tgggaaagac aaagatatga agtttcttcc cttttattga 267480
 aatagattc ttttctcata taatatatcc tgattgtagt ttctgtcttc gccactcctc 267540
 gaggcctcc ccacctacct tccctctgg atccactccc tttctgtctc tcattataaa 267600
 ataacagact tccaagagac agcaacccaaa catgagaaaa agaaataaa taaatttcat 267660
 attgaagtcg gacacagcag cccaacagga gggaaagaat cccaaaagca ggcaaaagag 267720

 tcagagattc tctcatctc acagtcaaaa tctcatagaa atactgagct attagctaca 267780
 atatacactc aggggacatg atacagacc atggagtccc tgtgcttgct gcttcagtct 267840
 ctgtgagttc acctgagcct tgcttagttg atccagaggg cagtgttctc ctgggtctct 267900
 tcaactcttc tggctcttat aatctttcca cctgctcttc tgcaggattc cttgagctct 267960
 gaagagagga atttaatgga gacccccatt ttgaatccct tttcatgtaa tgtctggctg 268020
 tggatctttg cgtctgttct catctgatga tgactgaata aggcaccaat ctatgactcc 268080
 taactctctt ctcttctctc tctctcttc tctctctctc tctctctctc tctctctgtg 268140

 tgtgtgtgtg tgtgtgtgtg tgtgtgtgtg tgtgtgtgtg tgaatTTTT ggttttacc 268200
 taggtctctg ggctatctag tctctggttc ttggttacc aaacagtgtc aggtatgggt 268260
 tccttcttgt ggagtgagcc ttaagtcaaa tcagacattg gttggctatt cccacaagtt 268320
 ctatgccacc attaccttag cacatcttgc aagcaggaca gattgtaggt cacagatTTT 268380
 tgtggctgtg ttcatgtcca tgtttctctc ttggtagtat tttgagtatc tccccctcac 268440
 caaagagact agatgagigt tgtactcagc aatggggcct tgctgtcagt ttgttgagag 268500
 tgaccttttg tcttagcaat ggcctgggtt gtttgggaat ttccatgaga cccccctggc 268560

 caaccagtt ccaccactgg aagccttgac tggcaataag agatggccat ttgagactct 268620
 atccaccatt actaggagtc ctcattagga caacctcaa agattccaag aaagtttcca 268680
 ctccactagt ttccacccc tccaaggcc tccaattct agctgtctct ctcaacactc 268740
 tctcctcta cccacccca ccaactcact gatccccatc tctcatctcc acatgcccc 268800
 atctgectgt gaagtctga agaagttcag catctgtatt gcatgtgaat ttcatctctc 268860
 ctggcttctc gccttatgcc agatacaggc tcgggtctgg agcattttct cataagtcct 268920
 ttatgatage tctcttata ggcacatct atcccttctc ccagagctct agctgcactg 268980

gaattgcagt tatttcttgg tacaaaagat aacacagtct gacctatatt ggcctttaa 269040
 gttttatga ctttctaaat attgtctgtt gttgttcctt tgttttctat agtactgggg 269100
 ttcacacca gtcttgagca tgctaggcaa aggtggaaca caccgcccac cctctagctc 269160
 gtgaatctct ttaagcaatt tctctatttc tctggcatag ggtctctgcc acacactttg 269220
 ctggaagcat cccttcctta accttctact tgctatctga tgacaggcac ccatccttca 269280
 gtgtcaactc agctctggag attccaagac caagttatit tcacctagtt atactgactt 269340
 aaagcacctg agatttactc tgattaacag aatgctaat tagtgcatt aagaaacact 269400

 gtttcccaaa atatttatgt tcatgaagca gaaacaatac ctaaactggt aagcactgag 269460
 ctctggtacc aatcatgtgg actgcatgtc agggacttgg tgatttttgc taaatcaaaa 269520
 tgcaaacagc taatctttca ctataactca ttgaatagaa aactataaag ataactagc 269580
 agtgtgggaa taagaaatag ccataagcga gtttaaagca gaattcagaa catgatgaaa 269640
 atagaatggc ttiagatttc aggaaattaa aaacacacaa aatgatggt gtataagttc 269700
 tgtgctaatt agtatgataa aaataagggt aatattctta ttttaagaa aaattaagta 269760
 gggggaaata actagtatgc aacatgattc ttatacagga ttataatcac ttattaagtt 269820

 tttactgttg ctggaattta tttcaccttt tgtagtctt agcctatatac agaaaatcct 269880
 cattcaagtc tttctgaatt aataaaattt aaaggaactt gaatcctaata tattttttta 269940
 tttcagaatt ctttaaacat caaacatttc ttagaccata gtttagcca ctgtcagctg 270000
 gtgaccaggt gttttaaata taagaccata agaaccaata agagtgtgt gaaggttcaa 270060
 ctttcaaagt cagagttcca gcaagcctga aatgaaatg ttaagatgtg gaaacaaaag 270120
 taagggttca ttiacttacc caacacctgc ccgtacacaa tcggctcaag cccttattca 270180
 ttagatgaaa cctacaattc aagtccaaat catgaaatga agtccacttg cagaagactc 270240

 tggaagcctg aaacagcata tccaaaagac tgccaagatt ttttctgcta agtagtactc 270300
 cagtgtaaat gtaccacaat ttctctatcc attcttcgggt tgaggggcat ctaggctgct 270360
 tccagtttct ggctattgca aataatcctg ctatgaacat ggttgaacat atgtccttgt 270420
 tatatgtttg tgetttttt gggatatatgc ctaggagtgg aattgctgta tcttgtggta 270480
 gactcattcc caatttcttg aggagtccgc catactgatt tccacagtgg ctgtacaagt 270540
 tggcactccc accagcagtg gaggagtgtt cctctttctc tgcatcctct ccagcataaa 270600
 ctgtcattag tatttttgat tttagccatt ctgacaggag taagatggta tctcagagtt 270660

 gttttgattt gcatttcctt gatgactaag gatgttgagc actttctcat gtgtctttca 270720
 gccattttag attcctctat tgagaattgt ctatttagtt ctgtagccca cattttaatt 270780
 ggattgtttg gtgtttgggg gactagcttc ttgagttcat tgtatatttt ggagatcagc 270840

cctctgtcag atgtggggtt ggtgaataac ttttccaat atgtgggctg ccattttgtc 270900
 ttgctgactg tgcctttgc cttacagaag cttctcagtt tcaggaggtc ccatttatca 270960
 attgttgatc tcagtgtctg tgctactggg gtaatgttca ggaagcagtt tcctgtaccg 271020
 attaattcaa gggatattcc cactttgtgt tctaataagg ttagtgtagc tggatttatg 271080

 ttgagatcct tgatccattt gacttaagt tttgtgcaag gcataggtc tgggtctaac 271140
 tgcagcttc tacatgtctg caaccaatta nnnnnnnnnn nnnnnnnnnn nnnnnnnnnn 271200
 nnnnnnnnnn nnnnnnnnnn nnnnnnnnnn nnnnnnnnnn nnnnnnnnnn nnnnnnnnnn 271260
 nnnnnnnnnn nnnnnnnnnn nnnnnnnnnn nnnnnnnnnn nnnnnnnnnn nnnnnnnnnn 271320
 nnnnnnnnnn nnnnnnnnnn nnnnnnnnnn nnnnnnnnnn nnnnnnnnnn nnnnnnnnnn 271380
 nnnnnnnnnn nnnnnnnnnn nnnnnnnnnn nnnnnnnnnn nnnnnnnnnn nnnnnnnnnn 271440
 nnnnnnnnnn atatatgcta attgaaactc aaatatgtga tgaatccaag gtgtttcaga 271500

 gagtctcac ctgtgcatgc aaatttgatt tcacttttag taagtaata agttatagc 271560
 ttgcaaaaa aaattgacac actggaagac aaatgtcaca caatttcaat tttatgtgta 271620
 acctagaaat gatgaactta tgaaacagag agcagaactg tgactattag gettcaatgt 271680
 gggctcttta acaatgggga aacgattgct ttaaggatat aaaactgcag ttggacaaga 271740
 ggcatggact ctgtgaaggc ttgaggctca ctaagagcat gataaatatg gttgataaca 271800
 atacgtata ttttaaaagt tgtgagataa tatactttaa gtgttctcaa aacaaaaatg 271860
 atgaatatgt gtgatataac atgttaattg gtttaattta gccatgccat tgtgaacata 271920

 ctgtactgtg taccataatt gtgcatgact ttatttatga gctaaataaa taaatggaaa 271980
 aaaagatata tgactttaca ggccacatga ataggaaaa aaagactgcc aagagtcccc 272040
 aaacagaatg ctggctgtta tggatcttca ataatccac attcaataag aatccctggt 272100
 ttaaagtaag aacacactga tgctatagca tcaaggaatt acttaacatt aaatatgtat 272160
 aaaaacattg tacaacttca ttcattggtt catcatctta ttaattaaat ttgggttttt 272220
 ttgatgattt caaacatgaa cactataaac actctcatat taccaccacc acatgactaa 272280
 taccacatag ttgcattta ttttaaaaat gtaaaatttt gtaaatgttg aagtaacaa 272340

 aattattaga ttcttttagt aatgttttcc cttacaaaag cttcttatct tcagaatgaa 272400
 gctgcatcac ccacaattta ggctttcttc tgttctacac ttcagacatc aatgtttttc 272460
 aagttattat gattaaaata tatagtgttt tattatatac atggacagga taccacaaaa 272520
 taaccctac atttatatac acagaaaaaa ttcatagtat attcttgact gacagtatct 272580
 tcttatctac agaaagaaaa aaatagaaaa gagaaaaaga aaagtgaaat ggaactagaa 272640
 gaaagcaagg ggatagagag gggaaaggag gaggtggaag ggaaagccag aaaagagagt 272700

ggggggagga ggagggatgg aaaggaaaag tggcaaaggg aagaaagaaa ggggaggag 272760

 gggggattgg ggaagggga gaagaaagct caaacttctt agtagtccat tgtttttgtt 272820
 cttaataata gagatttcat acatattgtc accatagaaa cataacttta gagttgtaag 272880
 agtacatttc aaaaatccat tcatgctttg tttattaatt aggttgctct ttgacaattt 272940
 tatacatgta caaatacat agtgaccact ctcaaccccc atcctcttct ccctaccatg 273000
 cctgtgtacc tgccttcttc cctacaaata cctttcttct actcatgtct ctgattatgg 273060
 ctcagagtaa cctttgtcta cgttgataaa aagcatttat caactcttaa gagtctttgt 273120
 caggaaactt aagtggacag aatcataata tcatttcata tggataccat tacttctttt 273180

 cctatttatt ctttttattt ctgtctcttg tctacgtgct ataggcaata cttcaggcac 273240
 tttactgcac agaagaagaa ggtggacatt ctgtcttct tcctaaactt agtggaaatg 273300
 cttaagatt tttctccact taaccagtg ctggctatag gattattgca aacaactttg 273360
 gctaagctga aatatagct ctatacctag tatctccata tctccatgat tttttttatc 273420
 atgaagtgat gttgggtttt acaaaaggtc ttttctgcat ctactcacat gaacaaatga 273480
 tttgaaatta agtatctcaa tttttaaata tcacattatc agtttgttta tgttgaagca 273540
 ttcttaaatg gagcagctga caatgttttt atttttatat attaaataaa cacaattcag 273600

 tattgectat gctttccacc tcaatttctt aaactgtggt tgcaattcca tataaggaga 273660
 cataactaga tggatgggtt atagggaaat ttggtaaaag ttttctgatt acactataaa 273720
 agaaaagatt caaaatcaaa tgcacaatga atccattgca ttgtggtttg ggcagtatcc 273780
 ccatgctgta taacacaact tccctgcagc ctgggttatg aacacttatg cactttgcac 273840
 tgggcattcc atcatgatat gtaccagcag ccaactgctt ctgaaaacat tcagctcaga 273900
 atagccattg ctctatgcta tgaagtgcag tgcttttact atatacacia cacataatgg 273960
 cttcattatg gaaggttaaa cttttgtatt taaatgtttg atttttaaaa ttgtaggctt 274020

 gaatttttat ttttcaaaaa ttagtactat ctgcttggga ttaagctaga atttccaaag 274080
 tgactacctt gtagtcatat gtatttgtgt aaaatggcat tctcagcatt gatatttga 274140
 aaaaccaaac tgcagccaa ctctgaaaaa catgaaagat attctacatc ctgaaatatic 274200
 aaatacatag gcaatattaa attctttatg taaatataaa taagcatgtc tactttatta 274260
 gcatgcaagt ttacattcat ctttaataag ttgtaaaatc atacattttt tgaaaaaaat 274320
 tattaccagt aaaaatttca ttaacatacc tattttattg agctttatc ttaaaattgt 274380
 gtaagataat gtagtataaa tggaaatgtag tttccaatgg aaaaatga agccttcctt 274440

tattccatga aagacaaagt ggggaaatcc agccagagaa aaggtgtcca atcaatcaat 274500
 tacagtagct tagtgagctc taaagagaga cacacaaat gatgaagatc aggaaccagg 274560
 tcctaaacca acttctgag gacttctgga tgagaccatt tttttaacta agtgtgcaat 274620
 gtgaaataga ggattgcttt gtatgaaaaa gaatatgggt gtttgaatt aacatataat 274680
 tccttgaag agattgcatt aagtaacagt aatactgaag ttcatcttc attgaaaact 274740
 ctgaaaagat atttcatatg gtaacagaga ctgtgggagg tggagtaaaa acataatag 274800
 gaaagccta tacactatgg aaagtcctac acattacaga aaacctaca cactatggga 274860

aacccatac actatgaaag aaaaaaacg atgtattatg aaagtccta aacacaatgg 274920
 aaagcctac aactacaga aaatcatata cactatagaa aacctgtat tttgtgaaa 274980
 ggtatgtaca ttatgggaaa ccctatacac tatagaaatc tctacacact atggaaaact 275040
 ctatactcta tatgaaggag ttttaaggttt tttccagaaa caaacaagtg agaaattgtt 275100
 ttgaaaatgt gacctgattt cagttttacc aagactattc tagtgaaaca cgtgattttg 275160
 aattagatgg aaacaagaga caattctctt atgaagctaa caaatgaaaa gactttgtcc 275220
 cacatgagaa aacaagacat caggfcagag cataagccag accaacaatgg tccatgaaga 275280

tgttgaggg ataggatctg acaccactga gaattgtcgg ggccaataaa gatggctcca 275340
 ctcatcttg gctctaggtc atagagtcca aaactattct tactaagtca taagacctaa 275400
 aggtcgaagg gatggctaca gtaggatgtt taatcttggc catgtgtgtc ttatctaaat 275460
 aacaacagat ttggtatgag gtgtaatta atgtcaagag aagcttcaac atatgcat 275520
 aatcagtgag acaaattcaa tcataaaaaa cagaaacttc agtttaaatc agtatttatt 275580
 accgaaaagt aagtaaagca tcatgtttaa tatgtaaact atcaaatatt tatttaaatg 275640
 tccacttatt ttcaagtga aatagtata agacaaacat ataaagatat aagcagctag 275700

aagcataaca cgtgggcagc tccacaaata caactgaaat ataattcaat attgtgaatt 275760
 ggagtgacgt cataatgcac caaaatgcat tccatagaa aagacagaca agaagcattt 275820
 ccatcagaca gcataccttt ccccatgctt tcccacttat acaaatagcc tatgaacaca 275880
 ccattcagca atgagtttgc tatagcacag ctctccctag ggggaagtca tttagctgta 275940
 gaggaacca ctttatttca catatcgcat gttacaacac cagcaccaag gaattcaaag 276000
 acaccacatg atccacaat agttctctg cactgtctac aatttattat tcagcatttt 276060
 gtagcaaac taicgtacc tttatttget actcaatata aggcattttg tgaagttgt 276120

gcaaaactata gtcacacct tcaccaagat tcatcatcac aatgccagag taaagaactc 276180
 tgccagagat gaggagtgca aagaacacag gacaccattc tgtcttctca gcattctct 276240
 tatttggat taataccacc agaacaagc taccatgttc ctgcatgtg gacagtgtc 276300

caaggccatg agaaacacag tctagatcca acataggtct tagcgtgctt gtaaattaca 276360
 actggagcac agatcaaatt atagtgttta ccctgactac tgctagacta aagcgattcc 276420
 accagaacca cttgatgatg ttgacagaag aatggaaggg gtgttaaaca cttttgtcga 276480
 cagtgictaa tatcttaata tgaacaaacc aacacacata agaatttctc tactccctga 276540

 tgaaagaaga aaaagatagt atgaaaaaat atttagataa aatttataac cccatatttt 276600
 agcaaagtaa gtccagatat actaaaataa agaggcatgc agaacgacag tatactgaat 276660
 taataactaa aactttccct tcccagtgc tggctaccat gtaagtcca ctacgataaa 276720
 aactatgcac tatgaaattc aggggttgag ttttatcaga gagagaagac aaattaagtt 276780
 ctccaagcat ccagcacaag aggccagtca tagtgcattc tctggaatat gtttagtata 276840
 aaaccacagg caaccagcac agcactagag agacataact tcatTTTTc atcctgtttg 276900
 acacaggtag aaaatatatc tgaaaattcc cacatgttga aaaacacatg ttgactctca 276960

 ttactattgt actaaaacc atggacagaa acaggaattc cgggccaatg tctgcattca 277020
 aagtacacaa gcttctgaaa caagctattg ctactgattg taggaacttt ttttaagtgga 277080
 aaccctctga acatggataa tatcaagaag aacctagtta ataacttagt tgcagatttt 277140
 acagcagcag taatgaaatt ctacagagaca agggttggct agcaagtctc tccaagaaga 277200
 tgggtgagta actcagaatc ataagagaat tctgatggtt tgtcaataa tcactacat 277260
 atatctacat atatatagga aaatataggt ttaataatac aggatttttt ttgtcttca 277320
 gagtaataaa aagtgtgtt gactagtatc tgaataata agaatgcaa ggaagcgatt 277380

 tctcgttctc ataacattc atccatggca aacaatgtgg ttggttcttg ttttatttct 277440
 ataaagtact ttctacttg aagataatat ttgattatat tatttagtaa gtagaataaa 277500
 gattaatttg taaattcctt aaaacaagac cttcattcc ttggagctgg aaccataat 277560
 gccttgtctc ctggaatata tgactgttgt tctgagctcg tggttactaa gggtcattag 277620
 taaggacatg tgaggcttac cttcaaattg tgcttttag tcagaacaca caaatccac 277680
 ttagagctgt aacacagaaa gatctaactc attttccac aagatgctgt gcaaatacc 277740
 actacagatt aaaatacagt tgttctgca aagaggtaac tgagccttag tcttctccta 277800

 ccctggcct tcaacactgc ctttattggc tcatcaaga ggtaacaagg atgtagcaag 277860
 gcaggctttt caaacaaca ttaattcagt ttaaaaatca gtagcgtgta tgctaaagt 277920
 agctagtgtg ttiaatgctg agtggcagca gccatccacg tggctctcag acgcctaatg 277980
 agtcaccatt tctttagaag tattacctat aaaatgtgtg ggcagttatt gatactataa 278040
 acgtaccttt gatccaaaca gacttaata cacacacagc aggcagctgt ttggaggctg 278100
 aaaccacct ctacatttc agtcaagtgg aaataaggaa aagcaggggg taatccaag 278160

aaattaaata aaagtggcag atttttcact aagaaaatct tgggaagtga atatttctat 278220

 agttatcadc ttgaaggcat agtttcaaaa actgaaacac atggaactgt tactttatgt 278280
 aaatgaaaca gaaatagttt ttagaaaagg aaagaaaaag taacactaac agtattgaca 278340
 tgagttggta aagaagggca gtgtctcata aaacaaagaa atggatgaact ttctatatgg 278400
 tttgcactaa tacgtgacat aaatcagcat ttatTTTTtag atagaataa ttttaaatt 278460
 tgataaaaat aaaggattgc ttataaaaaa ttggctgtta actcacctat tataaagtac 278520
 agtattaaca atcggtggcc tacctagagg tcacactttc aactataaa tattttgaga 278580
 tagacttttg aaatactatt tatgggaaaa tttagctaaa ctacatatgc tggcagtaat 278640

 tcttttacc atatataatg taacagaag ctatgcagat gactcattat cttctctaat 278700
 ttatatcttc tatgagcttc ttgccattac acaatggcat gacttaattc ctggcttgat 278760
 tgattagga cataaaacac catctgcac tcaatcagca ccaacacaag gcttgttata 278820
 aagcaaatga tattcaata aaacaagttt ttttgagtca ttttcattgg aatctcaaat 278880
 ctatttcttt ccaaaataag aaaaagagct acaataaaaa cttcattcat ggtttttcta 278940
 ctattcacia caaaacacia tggaaacat tgtcttccat accacataga ccttatgaga 279000
 aagccactaa tattctttat gtgtacattt caactaatgt agcatttaa tattttaaaa 279060

 taggtttacc aatattctat gactatttta atgaaaaata ataggaatga tttttatata 279120
 aaatatttaa tttttaaac acaggctatt catgtcacat aaatagttct aattttaggt 279180
 tatctgctta tggccagcag aagcatcatg tfgacaaat aagaataatt tagatactgt 279240
 cacttaaagt ctgaaggctt aagactcacc atattaaaat ttcagagact tgaatactct 279300
 attttgctaa acttcaaac ctttcacttc ctctaagtgt ttaataattt gttagtattc 279360
 aatattcaaa taaaaggaaa atatttttct tacattaatt ttgttatacc aacaaaaata 279420
 ataccatcaa aaataaagtc gtcaactgaa aactcatttt ataggcatag agtgaaaatt 279480

 actttcttta aaatattctt actgtttcct gaatcatggt tttaaatgca ggttcacaaa 279540
 tcagataaag ggcatgaggt taaactggcc tttcagaact tttattccta tttagattc 279600
 caattaaaaa tgiacagaac agctaaaact ttccattttg cacattcaat ttcccagagt 279660
 ttctaagttt ataagtgatg agggagatgc tggttattta cctttggttc agaataattt 279720
 ctatcttatt cataaaaaaa tgtggatacc acagtgtata ttatatatgc aattttctg 279780
 gtctttaaaa tttttacata catttatttt attttaata tatgggtgtt ttgtctgcat 279840
 gtttatctgt acaccaagta cgcaaggaat agcagaagag ggtattggat gtcagaagag 279900

ggtattgaat cctctggaac tgcagtcacc catggtttgtg agtcaccata gatgggaatt 279960
 gaactcaggt cctctgcagg agcagtaaat gttcccagaa gccaagccca aattctccag 280020
 cccaaattct gggctttcct ttttaaaaat cacaatcttc ctaaagtagc actgggacct 280080
 tggagaagc ttgggtgtac tggagacacc aaagctcctg ctttaattagc ttctcagggt 280140
 actcatttac attcaacaga taagctttga tgtttctctg actttgttgt aggacagtga 280200
 accatggtta ctgctaata caggcacctt gaaatctcct cttatcctgt ccttgagttg 280260
 tcttttcaca cctcagttac aagacatcca caaaagtgag agatgcttgc tttctttgca 280320

 tcccattcac ctgtaaattg agagaaaaca gtaagtttgc caaaggctaa taccagcttg 280380
 tgaggacttc tgctacacaa ttgtcttcat gaaaaccatc tgtttgtt ccaatggcag 280440
 ttgaggaaac aatttaagca gacacataag gcaactgaa aaattaata atgtttctaa 280500
 atgcatactt tagtgttatt gagactgcag agcactggga tcaaaactct gtcaactggc 280560
 cggaccctgc acccacagag ctaggcgggg caggaagcc aaacacacat gcagattgtg 280620
 ggtatacacc tgtgatctta caagtgaag tggcgcagc catgtttgct aggacacatg 280680
 gccaatcgcc tgaagaaaga caaatggtgg tcttctgaa gctaagcaaa cccaccattt 280740

 ataagagcca ctgaagtca aaggggagaa ttgaatgctt caaaagagac aaaatagcac 280800
 tgttagaatg tcaatcagtg gaaatataat tatgtgagga gaataaaatt gcacctaaaa 280860
 tttagaaate aacatgcttt aaaaattcca tgttcaagc tttatatact aaacagagaa 280920
 tatttcaaaa tagagtactg tatacttaa gctgttcagg ctgcatccag ctttgggtta 280980
 tagtaatcaa atcataattt tatataaaca ttcaaataatg tacaccagca caaacactaa 281040
 cacactaaca ctaatgtgta tatacacaca ttatcctaaa atatgagaaa attttacttt 281100
 gtataaaaac tatatattac aagtgtgcag gagaatttct aaataaaaag tctgttttac 281160

 aagttctcaa taaaacaatt atgaacatga attccatgat taaagaaatg tgttctttta 281220
 gaatataact tcaaaataag acaaaatgca actccatgga cggatttta aagaaatact 281280
 gatttttttt atgcttgttt aaaatgtatt acaatggcat tataaattta atactacaaa 281340
 aagaatcttt gtaaagagag gagggatgat aaagtgtacc ctgactagct cacacaagga 281400
 aagacaaata gatattgcta tgagaccaac cagccaaga gcacattagt ctcaggaaga 281460
 accaagactc gcaggacctt ctccatggct ttactccatc tcatagctaa gaagactcct 281520
 ccatgttaaa tcttatgggt ctggtgtaaa aataacaata taaaatatg tacctccagc 281580

 aacatctgct agatatagat ggcaacaaag caatactatt ttggttctag aaaccataca 281640
 aaagttttg aaagcccatg ttaggaaaaa cagaaggaat tgttacaagt tcaacttagga 281700
 aaataaacac ttgtttagcc ttttgaaaaa aaaagtcaac tttgggtata tattaatgt 281760

cattggggct ttaaaaacct ggattgggga actgttctgg attaaatca tcattgttac 281820
tttgggcaat tgactatgaa ctcaatggtt ttgttaattt ggataatttt taaatgtctc 281880
atTTTTaagt ggtcagaatg taagggatga aacttactgt ggccatgctg agcatttaat 281940
ctttggatgt tagaaataag agtttaaaaa tcccatcatt acattaatcc ccattaaaaa 282000

ttgtccagtg ttctctaact ctgaccctgc atcatccagc tgaacacaca tactgaagac 282060
tccccittcta ataggtttgt tcgcaattac ctcttttgca agttgaattg taactaaagt 282120
gaagaaatga ttggaaaagc ctgattttat aagtagaaat gttttaagag atcagttgaa 282180
catcttacta agcagtgaca tttcttccat agtttttatg taaatctgtg cttttcctaa 282240
ttgatccaga tagttttatt cagagacata ttttagcaga actgtaaagg gaatgtacac 282300
attgtcagaa atcatcacca tgtaaaaata gccacaaagt aaaaggaaaa gtgattagaa 282360
ttactaacac tgtatatgaa tgtggttata gagataaaac tccatattta gagtttcctg 282420

ggcaatttct cccaggttca tattgtattg tagagattaa aatttccgaa gaggcagctc 282480
atcaatggat gtcatacaca aaagtacaca ttttccagaa ctaaggaacc aggatgaaaa 282540
caaagtgaca ttccaaacac caaacctccc aacaataagt gaaatcatat ttaacctaac 282600
aaatttctca tgatttttat tcaaaactcag ttcttaggat tgcctcataa ataatagcct 282660
caagacccta cctgcctgg ggagtgagg gtatagatggg tggggggtag gtcaggagtg 282720
ggggaggaga tgtgggatg atgggaggga gagggagaag ggattggcat gtgaaacaag 282780
cttgtccta atttgaacta atgaaaaca caacaaagaa aaaaaaaaaag aatgcttct 282840

ttaaagcaat caagaacatt aaggtttgag gatgtagctc aatgtagag tgcttgctg 282900
gcttttgcaa agccctgagt tcaatctcaa cctacacaca cacacacaca cacacacaca 282960
cacacacaca cacacacaca caactacccc atcttttgtt ctgatgctct gagtataact 283020
cattgaaaga taagtgacag ccatgttggc cactaaagga aaacaatcca aggtctatgt 283080
gagataaagt tatttctggc ccttttgcca caataatgac ttttttttt cagaaaagta 283140
gaaaactctt ttcacagtat agatgcccc gtaggtaaag ctatgtttac agatgccta 283200
tatacagaaa accctttggc ctccatttg aaggttctca gtcactataa gaaatgttgc 283260

agagaatcat atcccagttg ccaatgcctt ttgtctttt ctcttacctc aatgggtaag 283320
caccagactc aagaactgag cttgctcac tgtgtgattt gcatattagc tttctataaa 283380
tacactgagt taccagtaaa ctgctcagaa attagtttga atactactaga agatatgaat 283440
agaaataact ggttctctca gtccatcacc aaagctgtgt tttcttgaaa taaagatcca 283500
ttttgtatct cagtctggg cagatggcca agatctcgat tcatgaagtt cataattctt 283560
tagagtcttc tggtaaacct tctagtataa tctgtaatgt tctggttatt ctctctaaa 283620

agagataagg aaagattaaa atgcatgaaa atcaaacgg cataaaaaata gcaaaatgtg 283680

 aattatttgg ggatgaatac tgagagtgca cagccacctt cttttagtg cactttcaag 283740
 aattatttac ttcattacaa tcttatcagg ctcaattaat ttacttgtca cttctacaac 283800
 ttcccatgat gcttctcag taagaatata ttaatat ttt gtattcaaat aagaacactt 283860
 atttatgaac caggaggctg aaaatattt gagacaatgg gaccaagata caaatagatg 283920
 ttacaata tgcttcatgt tcagetcaaa atgggtttgt tctttttca cataggagat 283980
 gataaccaat ttctcaggac agtcaggaga agagtattat ttccagtgtc taattttag 284040
 tattgttgag caaattacca tgtttatcaa ggccttgttt atctcataaa tagattgaga 284100

 accttggatt aatctgggtc attaaggtct gatccttaga caagttacat taagcatcgt 284160
 ccacaattcc aaatttgctc caattttaat cattagtctc caatttagaa gctgaaggct 284220
 taaccagca agaggtcact gtaacagaca ctaaaatata aaaatacctg agttgtatta 284280
 catctaagga cactttttac ccactgccct agagtgccaa gctctgtggt gatgatttca 284340
 ggtacattct ttcttagtta ttgtcaccaa ccccataga acatcttcag aagccccca 284400
 atcttggaaa cccagctc tgctctctta aaggattcag aagcaaatca tctcttgcce 284460
 aggtattctt tctctttcc aatgactcat tattctaaca ggcctttcaa acaatattgt 284520

 aaaaagctgt tttcaccttt tgttctctga ttttttgggt ttcaatgcta aatgtcccc 284580
 agaggctcat gtatttgaac actagttccc atccattggg actgtttagg aaaactgtga 284640
 aaagttaag ggggtgcagct tcactgaaga atgtgagggc tgacatggag actctataac 284700
 ccagccttac ttctataggt tgttcatggt tttctgcccc ctcaactgcag acagtgtgat 284760
 cagccactca caaccattg cagtcttgcc tttctgcta tgatgggctg tagtcaactca 284820
 aactgtgagc cagagcaacc cctctctcct taagttgect cttctcaagt atgttgtcac 284880
 agcacaaga aaagtaaca atatagtcac agtcctaag gaagttttct gggcacatta 284940

 ttatttttta atcctgtgtt tattgtaaag ggtttatgta tagtattttc aaattaatta 285000
 aacctatata aattcttaaa taaattgtat tttttaacag tccactctgc catgagagca 285060
 acaatcaaac gccatattta cagaattatc ctattaaact aggcttatgg aaaaattatc 285120
 tgtcaacagt atgggaaag tgtcttttcc aggcagacaa ggagccaagc catatgatag 285180
 taggctacaa ggtaaaagaa aaacaagagt tgtaaagaaa atcaatggag ttaaagaaac 285240
 atggcctcaa gtactgttt caacacatcc ctgcttagct cccaagtta atctctacat 285300
 ccttgtcttc tcaactatcc ctggctctcc aaacctgaca gcaaagcttt tctagtacc 285360

ttccaataat gtgagtttcc aactgttgcc ttcttagatc tcttgctggt gtgggaactt 285420
 acaaccattc cagagccatg gaagcagctg ggatgccccat gtttgcattg gtccctctga 285480
 aagcgcagct tgtattcttc tttcagcagg gctaggcaga ggcccaaatc ataagttct 285540
 gcctcctcag ccctgctgac tatccccctt ggcatttcta aattctccct tttggattct 285600
 gggagtggca taatttgtat aatggttgag tgttcagtaa acagattggc attggcctca 285660
 ggtactcatt ggttcccaaa cttttccttc taggctgtct gtccctacaac actgggtctg 285720
 gcacaggggtg ttcagtggag gcaagggagc ttctaaaaac actgcagaac atttggcttt 285780

 ggagtgccat atattctatt cacactcacg ataagattag tggccctaca ataataatat 285840
 tactgcctct ctaaacaaag gtgagccaat gacctacagc tggagttttc cataattaca 285900
 acctacagga cttaaagcaa tgccatgggtg tggtttcagt tttatTTTTT catgttccct 285960
 tgctattcct gaaataaact ggaataaaaa ctgacttggc aaaatctcac tcaccccatc 286020
 acacctggta tccatagggg agtagcagcc aagattgagt gagcttggga agcagtgcca 286080
 agccactctg cccagcact tatattaaaa atcatagtat gttttcttaa gaagggtttt 286140
 taaaagcttt catatgcata atatttatta tgtggagaat cttctgagcc cctaagaaat 286200

 acaggcaaac ttaatgaatg aaaaaggtgc actctaactt tttgggaaaa tctgcaaagg 286260
 cattaaccag ctttcaatgg tctgtcccag ataaagctat cttgatacac tttgggcaac 286320
 acatgctttt aagctctgga gttgcaagcc tctgtccac aaagacagat ttaggcttt 286380
 cggctcatgt cagccacatt gggttttgtt gtttgcttgt tttacaatc aaagattttg 286440
 tttaaatata cctgcctccc tatctctacc tgagcaagag gggccaggtg ttaggcagcc 286500
 cactggctct cagctgtgat caggttgaat ggatagctag aggctaccaa gttcaatggc 286560
 tgtcattagc cctggcctgg gttaccaggg ctgtactagt acctctgtgt atctgtacac 286620

 atcggggtag aaactgcctc ctttttctt cactgggaag tttgccttcc ttagataaaa 286680
 taaatcatat aaacatcaa gcagtagaat taactgctgt cttccagaca gggagaaagc 286740
 tttctgcata tctgaccacc ccttaagag aatgcttcat tctagctctg gaaatgctat 286800
 aacctaaaaa gtggttcaat actggcatcc tgtggccaga ggtattcacc aaatctctag 286860
 aaatctcaca tccttgggct aagaagctag aaacattccc tggctatctg tgccaactag 286920
 ccttgtacca gtttctgaat gatgtctggt tgcaatttct ggagatagtc ctgaccaggt 286980
 gcattttgtt agactgtcac attttcccag ggttaatcca ttcacatgta atcagataaa 287040

 aaagcataac ataaaaacta gacaatttac caagcaaagc aacatgatat caaacactg 287100
 cacaaattgc ttcaagcaag gctctcctgc ctccaagctc acatgcagtt ttctctctaa 287160
 cagaaagtat gtcttttagag gaagggtcta gtactgctgc aagaggctct tgcttcgagt 287220

ctgtgtattt tgttttggcc aacggctaca aaaatacttg ccactacagc aataaatatt 287280
 ataaattttc tttattttac tacaagaacg ctgcctaaga ggaaatcaa acagaattac 287340
 agaggactgt tgttttttcc tacttccttt caaggtgtct ataaagataa agatttgcag 287400
 tgatgattac agtttaaagt agaacggctg tgttcctggc aaaaagtcag agcatccccg 287460

 agaaccgaac caccattgtg ggtctcctcc accgccgttc atttcacaaa tgactgacac 287520
 taacttcagt ggccttggag atgttcaaaa caatattaga ggcagaaaaa aaaatagcaa 287580
 gaactccaaa atgacaggag cagaatggca acaagaaaa atcatgtatg aaaatgatgc 287640
 atctaaactg accgagtggc tgctagcaca cctgcggtag agagaccagc tagaactggc 287700
 tgactgagca gggaaggaca gaaaaccttc taggtgggac aaaatggcga acttgcctt 287760
 tcttactcc atgttctctt cctctcaaag gctgctggct ctttcttcta ggggttggac 287820
 tttctttcgt gctcaaggtc tctttgtgta cttcagctc ccagctcaat cctcaactgt 287880

 agcaagaagc caagtgacac taatcctaaa tattttaaca gaacttgtct cccttcagat 287940
 ctatagtcca gtgtctcaa tagagaaaac ctaactaaat atgtcctaca gaaaaataaa 288000
 tacagctttg caggatacag aactatacaa gtactctggg aatcagcgta tttcccttag 288060
 ccttgaaatc ctaatttaca tagcagcatt tctttccaga atagtgttgc cagctagaaa 288120
 gttaaatcgg aatagaaaga gtggtagaaa atctgaagta gccaatgcc aattcagttg 288180
 gtaaggagtc atgacaatac tttaaatgg ctggtttctg aatgtattct tggaatatat 288240
 tagagagtag agaataaat gtttttcttg ttattttgta ccaacactcc cttgttgaaa 288300

 aatttcccat caatcactag acttctagt tgggttttta tatttttggg aacttcatat 288360
 atgagtattg tatttacatt atttctcct ctctaaccac caactcctac catgtcacia 288420
 ttctctttta aatttatgat ttatttaatt gttcttttta tatacacatg tatgttaaca 288480
 tgctgagtcc attgtgtatt gatggtttgt agatgtgtat agggtcggga tggccacctg 288540
 ggattggggc ttggcctggg agaagagcaa tcctccctct ctggtcagtc actgtttgcc 288600
 tgttgctctt catctgtgga tgggccttg tgagatttcc tctatcactt tggcatgtca 288660
 ccctgtgttg tcattctgca gttcttattc aggtgacat attgttggga tttcatagat 288720

 gtagagcttc aaattcctgt cctccctttg acttttaaga ttagccatgg taaactaagt 288780
 aaattaagac caaatagaaa acaaacaaaa aaggaatttg tattctaaac tcaccgaaca 288840
 tataaacaac agcatttctg gttttgaaaa tatatttaat gtgacttaac caatgicagt 288900
 atcacaaaac ttaaaacaac ttaaatgagg aaaattttat ttaccctaat gtgcctttcc 288960
 tgtgtcaagg gtcacgggga ttaatccatt gatgggtatt tagctgaatt tgtcacttga 289020
 aactgggttt gtttgaaca attatgatc ttaggactgc atttaaaaag gtatttttta 289080

accttagtct cttgttctat ggagtcctct gcatcccgcc tgtagcttca cctcatcagg 289140

 tgctccctgg cctctagaag caatagaacc atcaccatca gagcagaatg aagccagtcc 289200
 caggactgaa gtgtcccaga acggaaaagg gcaacaaacc atgaaggcac gtggactgaa 289260
 acttttgaag ccatgaaccc aactaagttt ttcttcctct aaatgttcc tgatcttata 289320
 ttttgcata gtgatgaaat tctaacacag tgggtattga tgtccagcaa atgagagtcc 289380
 aaattctggc tgtaaggctt aagattctgt attcttgttt ctaaattctc cctcttgctg 289440
 agccctggct tccttacctg gtggaacag aatcttggac atgggtcctt ggtgattgat 289500
 ctgagagcct gaagcagggg aagggatcac aagctccctt aaaccaagg ctcttccaaa 289560

 gcacccttct ggccagtga tcttgtgcat ttctcctcc acgtctaac tgactaccag 289620
 ttgagccage ttctcctct tagtgetttt aacttcctct tggctctgct aatgtcctca 289680
 tcactatcac tgaagaaacc acccatgtcc tgttctctgt cttcagctc aaccttctct 289740
 cctccatact cagtagcagg cattgcttca tcaaaggcaa ccgtctgagt ttgagccctt 289800
 gctcttttac ttacatccac atgacttgta agagtgacat gaattctctg gtgacataac 289860
 tcaatatcta cataataggg gcaatgactt cagatggttg ttaggactga cagtgttcac 289920
 acacatgcaa gcatgtagaa actaacaag aatgaaagc tgttattctc ttcattggttt 289980

 ttgctgttac cagtaccctc tgcagctccc ttctcctaac aaggtagtat tatagccatg 290040
 atgtttaaga catttgaagg taccatctc actcaccaag aaatctcaca tcattgagca 290100
 ctgacttca ctcaaccag gaaagcaatc attgatcac taggggattt aaaagaggag 290160
 ttgaggctgt ttacagtctt gaaaaaaaa aaacctctg cctaaagaag ttattctcta 290220
 aaatgtccat gattacaacc acccaaatta aataccaac aggattcaat aggggctgca 290280
 ctctgaatga cctgcctgtc ttctccttg gagcggcaat taaaacgtg taattcactt 290340
 taataacaat tglacctcat gtagctttaa actttaagag ttgcatatt ggatgtgtgc 290400

 acttttatgg gtttctata acatagtctc ttgatgggtc caagatgctt aaacatctta 290460
 cctgacaatt gtctgaacca cttgggtttc ttgtccata caatgaagag ataatatgca 290520
 gggactccag tcaatgtaat aaggaagccg acccgggtgc taaatgggtc tgaataaagg 290580
 gagaggacaa ccatgaagag gcaggtgaag gaaaacaatg ctgggatgaa cagaggcacc 290640
 tggaacacag ccaaaagaaa cagcttcaca taaagctcaa gagaccaggg atggagggca 290700
 ttagttacat taccagccag taggcccaca ctatttaag cagcaaaacc tctccaagca 290760
 gcacagagca tatattaggt gtggtttctt aactttaact tggtttagaa tgtttgaact 290820

aagtctcagg ctaggaaaag gtgtttgctc gtggatcatc tattcaaatt cttaaactag 290880
cagtgatcc ttataattta cagttgtcat cttaaaagat tgggtggttg ataattatga 290940
ttagaaccca ttttcacaag gagtcaagag caccagtggc catgctccat gttaacacct 291000
ccctgtgaat attgatttcc tgttgagact cacactctga cctgatggga ataaaacagg 291060
ccaactccta gtcaacagct aataaagatg ctgcaagcat gtggcgatga atgcaattag 291120
aaacagatcc tgataacatg gctggcagca ttatcagtgc tatgtcttaa aagcaagcac 291180
tgacccatgg acagctgggg ctaagaagat gacaagactg ctctcttgcc ctcccacagg 291240

aaaatggtgg ttacggtaaa tgggtgtcct gcttggcaac aagcaagctc ttcctttggt 291300
atitcatatt ttttagttca gtggttctca accttcccaa tgctgagacc cttttataca 291360
gttctcagc ttatggtgac ccaaaccata aggtttcttc gttgctactt cataactgta 291420
atitgtctac tgttatgact cgtaatgtaa ttatcagagt tttccgactg tcttaggaga 291480
cccatgtgaa aggtcagtcg gcctccaggt tccccagggt gagaaccatt gctttagagt 291540
atatggggga agctgctcta ctacaagggt aacaagttaa aaccttact aatctgtaaa 291600
gcagcacccc ttcccagtta caactaatga agtactttct ttcacagccc agctgtgtca 291660

acaactggtt ctgaagacag acaggagtat cccaccctct gaacacacaa tgccatgcat 291720
gaaaacccaa tgaaaaacct cttaacacta actgttctaa acacataaaa atctgtgatg 291780
agttcactat atcatacttc aaaatacata tactttccgt aagcaaagca tattagcaag 291840
tgcttctgc aagagttaaa tatgttacac tgaaggacca caccccacc caacctcccc 291900
atcaccaggt tctgacaaaa agaggtctag gtattaagag agagatttat gtaaaccat 291960
caagatggtt gaggttacct tgaaggacg atgcatatct ggacgtttgt atcgaagata 292020
aatcaacca gcaactgcca gcccataaa aagccactg gcaaaactga ggaaattcag 292080

aagactgtag agatctccgg agaagagcat tatcatctgc aaaggatgct ggcagtggag 292140
gagaggagac aaagtaagtg cccagaactg agaaggaggc ggcaattcca agcaacaaca 292200
ttataagtgt cttccaatg gttatttata acagaagtca ccatcctgat ggaaacctag 292260
attccacaaa ctcttttcc atattgtgtt ctgcaactaa gcctcagctg gaggggtgctg 292320
tcatcacccc agtttcagtt ggaactttat gtgaatctgc tgtttgtta ctttgcagt 292380
tcctttctt tcaactgaca ggagcaaaag tattttctgt tgctgtttag gttttgtgta 292440
catgtgtgtt caictatatg catgtacata aatgcaggta tgtttataaa tgcattgtgga 292500

ggccagagga caaacttggc tattgttctc agcctgtcat tcctcaagta actaccctgt 292560
gagatggggg tctctcattg gcctagaact ggccagatag gctagggtgg ctggcaggec 292620
agtgatctcc agggatctcc ctgtctctgc ctcccagca ctgggattat gaacacaagc 292680

cactatgcc a gcaatTTTaa aaatgtggTt ctggggggac taaactcagg ttctcaagct 292740
 gtcaaggcta gcacagtata caagctTcac ctTactctag acaatgtgtt tccaaagaat 292800
 aaaaagagaa aaaaagacat tcagTcattc aagatcaatg tagaatcaat tattagtaag 292860
 ttcccatcat aaatattaaa tgcggactcc actagaaaac ttaaaggatg ctctgaggtg 292920

 atttctgaga tgctctaggg atccatacac gggaaacaac tacgtggagg tgaatgtttt 292980
 ggttactgaa tgcaaaacat tgaccttttc ctgctccagg tcaactctcc cettgtgcta 293040
 actgcatgtg acctcaaga ccaggaaaga aggaagccta gagagtaggc cagtaatcct 293100
 ctgcatgtaa acagccaagg atggctcgac tgatagcaga ggcttcaatg aaagccctct 293160
 tcatggaata atacatctg ttgccacaag tgacgttagc ctctagattc ctccctgagt 293220
 gtgtgcacac tttaaaaga aatttcaggg agacattctg aaacaatta aatgcacaga 293280
 gaagaaaaaa gtgttcagtg cttcctaggg cactctcgac agcacattcc agttgagaaa 293340

 aaaaatgTta cTaaaataa aatgactata gcattgcca tgggtatttg agggctctta 293400
 caccttttac agtctttTgt atcccacatt tcacaaatat tgttcccggc atagagaatt 293460
 ccacagcttc aattTcatg tgggettttc ctttcttctc tgtaaggTtg actctcacag 293520
 gtctcagTta caatcagaga acctttcac tgcttagtgt tTcatctacg cttttattct 293580
 gttgtgtgtg tttcattatg acgggtccag gaggagacaa cgggtaatgc ctgcacagtc 293640
 tgcttttagc tgagctctgg tcagtaggtg agactgtgTc cttactgttt tccccTctt 293700
 tcctttctc tgccaaggaa agaagccaca tcctcactt cccattataa agcttgcaaa 293760

 tttttTcaa ggtgaaagag aagtgagatg aagcataccc agggcatccc atacacatca 293820
 gaaacacaga gtacagga gccaggGcaa aatctctggc ctTacaacaa tgataccacc 293880
 tgagttacac tgagcaccia ctgagTgtg aattaagatg cctgttccca tTccctcttt 293940
 tgctaaagge tttgtgaggc tcagTctaaa tatacgtgtt aatgtgcatt accaaaacaa 294000
 taacagctgg cagaggagtg tgctTgtgga catgaatcat ggagaggatt tctggaaggt 294060
 gccctTctcg ggaggcaaca tagaataacc tggTgggaga aaaacatggg aggtgttgac 294120
 tatatagaat caatcattca aagaggtaat atgctgaaac cccaatgca atatgtatgc 294180

 atctttctca cactcaacat gttggcattc ttagctggTc atttgagac aaaggGcaga 294240
 tttcatccta agTctcattt taagacgtac aatacctggg gcataccctt ttatgctttg 294300
 aggaaaagca tggcagcattc tcactgagTg gagcttttcc tacaacGaa gagctgtTgg 294360
 caaagtCagt tctagattgc tagtgtcaat ccaatctagc acacgtgttt tgcaacacaa 294420
 gtacatgca tgtggcattc atatctatct gatTtagatt gtaacataag gaacaaaag 294480
 agatTTctgt accatcaaac aaagcaaaag ggttacagat tgcggagTgg ttatttctgc 294540

tttctacttt aciccttttc gtggcacctt caggaaaaca aaagacttta tcgccagaaa 294600

 taaaagctgt tattagactc tgtagacaga ctctaaaaaa tgctcagagt gagctatgtg 294660
 tagacacgca ggcacctcta ctggacagaa tcaaacatgc ttcacttgta tetgccacaa 294720
 acttgcatat ccctttaaaa acaacagggt cggaaagcact attgcttttc tctttaaaag 294780
 ttatccttat cacatccaat ctctaaaaca gaaatgtgtt tctgaaaata catgaactcg 294840
 ctcacctgga gacagcgaac acgccaccgt tcatggagcc gaagcaggag agggcaacaa 294900
 agatcgggac tgctaagtag aaatttcca gcagccgctc ggagaaggtc tggggaaaga 294960
 aagaacgaag caaattaatg ctttccaga aagtggaata aatgaaaca atttaggcca 295020

 aacttgctct ttgactttct attagcctgg tgctacgtga atgtttata atcctgcttt 295080
 ttggttaggg tcaactgac tccacagaca atcatcagaa gcgggtacca tggcattgct 295140
 tgtctcgac ctgtggacia aggtctaac agtcgctcc tctctctct caaagcaacg 295200
 atccatttac tgaatcttta tcagctatga tgtataacgt ctctggctct gatcagagga 295260
 agaggctcaa ttcgggaatt ctacttttag agacagagat ggttctgcac aatacctgcc 295320
 ctttagccca gaaagcctcc tatttatgat cggggtatag attcgccctc acaagagtta 295380
 caggtatttg tttcacatac caacctggt gctagacggt aaaacaagac aatcgacaag 295440

 ctgatcattt atggcgtgcg aatgagcccg tctgcaccgt tctttcccc agtacagtca 295500
 taccagctga acctgtttaa ggagtggcc ctccccacc ctaggaagct gtcatttctt 295560
 tccagggttt ctgtaaaaa gctagaacac aattccaatc ctgacaagtg acaggaata 295620
 taaaaggtag aaaaagtctt gagatttctt gtgggctgtc acacatgcca cctgtacat 295680
 ttctatgaag gatacacttt atatttttt atgtatgatt ttttcatta tttctgatg 295740
 cagctggggc tatgcaatta acagaccca ttatgctctc caaaaattag tgctgcctt 295800
 tccttagaaa ggtgaggcaa ctgaccagac acccagaagc tttatacag tcaactgccc 295860

 atagtacgcc tggcagtgga caaagccctt tcatacagt gaaccatac attggttcac 295920
 acaaaatgag ataattatcc cctgtgggtg gtgttgatag gaagcgatcc tattttaaaa 295980
 ggaactgact gacattcatg aatgggaatg tcattggatg cttttatttt tttcacctt 296040
 tcctgctttt gagttaaiga gtgaattctt tcttacaagc taaaccgttc gagcaaaata 296100
 aaagtctgtg tgacataaca gcagctcat aacatgattt tcggaacaa gtatgatcct 296160
 gtggtcaaat aaattggggg gaattcttta gaattatag tatatattc ttatggagct 296220
 acaatgcaca ctggcatctt caagtattac agcaacatgt ctttaacatc taattgacta 296280

gttgttccca aatttatgag tacccaacg ccactattcc aaggttatgc tagaaataga 296340
tagccatggt ccacctgaaa tttcaagaat gataatttga agagagaatt caagtcaaca 296400
tctgaaaagt ttataccag aatgagaag agtgggtctc actttgaaa tcaaacctg 296460
catttattta cattcagtaa cagtccacct gtccttagag acatgctggg gaaataattc 296520
cttattctaa ggaagccttg gtggagtttt aggcagctat atgtggaat gttttctagg 296580
agattaaaat caaaacaaag aggatctatg gcagaggtta gctgtatcat aggatatacc 296640
ctaagtaagg tigtctcaaa attttcagaa tattatcatt caggtcaaga aaaaatcact 296700

gacttccaaa acccgttctc ctcaaggga tcaactacaaa gtcctatcaa ctcatnaacc 296760
taaatgtgaa ctggcatgat tttaatgtgg acttaccact gccacagcat tggatagcaa 296820
caactcctca gcaactgatag tcgtaaaata ggccacattt gttaacacat agccaactgt 296880
gatgatggcc atggaaatgc agatcgcaag ggggatgttt ctgtaataca cagacatcac 296940
tcatgagaca ttatgaattc tctgctacca aagaatataa aagactggtt ccagtgaagg 297000
atgtcatggc ctggccatg attgaaggct ctgttggcat atggaggac attttatcag 297060
aacaaaaat ctttgcaatt taatgagatt caatggaggc gggatattttg tataacttgt 297120

ctattgcctc atccccaaat atataggtct gtccctttct ttgttccatg aatgtgatca 297180
ccatgcttct actaacctca cagtcacctg gaaggcttgt taaagcacag gccactgagc 297240
ctatccccga gtttctgatt caatgggatc agtatactc ctatgttctg aggagacct 297300
gatgctgctc actggggacc acataccttt ctgatattaa tccactgtac tgacagctcc 297360
tttttttttg aattttctta tttgaattag aaacaagatt gtttcacatg tcaattccaa 297420
ttccaattcc ttctccctcc cctctctccac ggctctcccc tgccaactaa caccctacct 297480
atcctgtacc ctttctgctc cccaggaagg gtgaggcctt ccataagggg gtcttctgag 297540

tctgtcatat cttttgggat agggcctagg cccacccct tgtgcctagg ctgaggagt 297600
atccctctat gtgggatggg ctcccaaagt ccattcctat gctagggtta agtaataatc 297660
tacactacaa ggggccccat agatttctga ggtctctga cagcttttta aacagagtcc 297720
tccaatgcat ctttcatatt cagtgttttc cccttaggca gcttgtggtg ccaacaagtg 297780
aagactttcg gaagcaagag agtgagggtc atctatcttc atgacatgat ggcaatagga 297840
gttttgtatg taagagaagt gttcacaata atgactactc tgcatggccc tgctgtgagt 297900
tcagaggact ctcaagatca taagcatctc ataaagcagc cgtgcagata atcccatgaa 297960

attagaggtg acatgctgtg aagtatggac gactggacag tgttgacact gtgtggcctc 298020
gagaagtacc cagcacaat gcaatattat gtcttcatit aatgcagtgg gaaagccaga 298080
aagctactga ccctcataat ttgattccat gttaccgata cacattactt gcttaacata 298140

atgcctctt cagaccctt ccagttcaga caacttaaac cttcaactcc ctgcacaaaa 298200
 gctggtcatt tttttttct agccatcctg ctatcagccc tcatagatgc ttccccctgc 298260
 tgggtgccac taatgaagac ctcaatataa ttttttccaa gatgaaaatg ctgttctgaa 298320
 ctaggagggg aaaggcatag ccggccttac tggccaagct agatgtgttt aacacactga 298380

 gtcccagctc attatactga atggcaatat tccctgtcga gaacaggcaa aaggagctag 298440
 tcagcaactg ccattcatta tgctgcttgc agcctgacac ttgccctgat ccccaaagcc 298500
 ttcagccttg acctcctaat cctggcatct gaacatgaaa gtagcagatg ttctctatcc 298560
 ccagtgtgaa gaaggtcccg tggaaatttc tgtgagcacc atgacaggcc ttgctagctg 298620
 taattgatat gtgctaaatt taagtcgaaa taaaaaaaa atccacctgg ccaatgaaat 298680
 acaagggggt ggtgcaatta aagatgaatt ctgtttctct gaaagtctgg atgacattgc 298740
 aaaggggtaa gcaggaagag atgagttata tattcccctt ctgagtcatt cattgactta 298800

 tgtggaactt gggttatttc agctggtata atagcccccac ctggagacta catgctttgg 298860
 gtaaaggaag atggagatac aaagaagggg agatacagac cctccattcc ttccaagcac 298920
 atgactgatt aagatatgtt aagattctat taaaaaaaa actgagtgatata tgctcagtg 298980
 agtgggggta ctaactttca caagataagg aatatggtca tcgatgtgga ataactcttt 299040
 tgtcagtgta agatttgcca ctgagattgg ttaataaaaa agccaattgg caggtagcca 299100
 ggcaggaatg ataggaggga caaccaaaact aggagaatga agcgtgaagt cagaggagac 299160
 acaagccagc tgccaaggaa gcaggacatg tagaagatga ggtaaaaagc atagataaga 299220

 aatatgggtt aatttaagt aagatctgat tagtaacaag cctgagctat cgaccaagca 299280
 tttataatat atatgaagtc tcccagtcag ttatttagca agtggctgct gtttatttgg 299340
 gagcagccgg tcaggacagg aaaactgcct acaagtcata ccatataatg cagaaaaata 299400
 acagaaaaac acatctgaaa cttttgacta tggctcctcc agcaaaaact gagtttccta 299460
 gccctgtatc tcaaagctag acccctgcag ggtccatttc tcggtatgta tctcagtggg 299520
 gctttcatta ccattttgc agagggcagg cttagttaac ccagccttct aggttattgt 299580
 cttctttct caggttgcca ctaacaaacg taacagcagc agttatagct attgggctgt 299640

 tactggcccc aacattctat gaaatattct acatatctgc ctcatthtgt ccttggaat 299700
 tcctgtaagc tggaacatc agcactattt tattgatgaa gaatagcatc ttttgagttt 299760
 aaataactgt tcaaggatac ctgctggig agtgaaatcc agtgtgcatg acctaacctg 299820
 aaatcagggc attttaacc ctaaagtatg tactccctca cacaagtgtg gctcccttag 299880
 ctctattaag ttcatgaaa ttaagccata gaatattaag tgagttgggg aagtctcatc 299940
 aaaactacat ttcttgaga atacgtgtaa aggaagggga aacattcaat gatttttacc 300000

atgtttctgt acagcacaaa ttgtagtgtc agaaggggtgt cctcagatat gttatcattt 300060

tatggaactg attatttatt gctattatta ttgtggttgt tactattatt taaaagaaaa 300120

aatgttcact tgatgaattt ccccaaacat gtttgtatac aaaaggggaa agagtctaca 300180

tgcttgtcaa ataaattgta atgagttatt aacaaatgtg ctgtggagcc aaatatggta 300240

ggtagccctt gggaggggca accacaggca actgaaatat gaaatccgaa gagtgagatg 300300

gtatattgtg gagtacaata agccatgata ctctctaatt agataaaatg aagccatagg 300360

aattaagaga cactgtggct acagagccac tagcattgct gaccatctcc atgttccttt 300420

ccaatttgaa ggaaggggaa agtatggggc agattctgtg gttgccttgc tgtaaacagc 300480

atcaattttc taaagcaagt agctggcctg atcggggctc ggcgctatgt ggttaagttc 300540

tgtttacaag tatcaaagcc tatgaaacac tgtgtgagct gataaaagct atttgacat 300600

gccagagtga tctttctgga tgctttatat acagagggca gataagcact gttaggaacc 300660

caagaggaag gccagtggca caggaaatga aaggaattag aggaaggagc acagaggcca 300720

ggggtgtttc aaagctctca aattactgag aggcagacac ccatcctaaa tggtaacaaa 300780

agcattagct ttttgatgaa cacaaatgag acacctgtaa accctctct tctcaagtg 300840

tttgaatatg ttigtatga tgaacaaaac acaaattag tgagaagagg tcctcatcc 300900

tcaagagcct tccgtcatta cgtatgcctt tccgattaa caggtaatga gtgtgtgtat 300960

gatactttta ttagctgaaa attgtcttca aaaatgtctc agatagtctt cctacttctt 301020

aatttaaat ggcatctcca gccattctgg cacacaagga agaatgtttt attcttggaa 301080

actactaaac tgaagctctg aaatgtctgc tcaggagctc cttttccatt tctttttgtt 301140

atgggtgatg gcttgttttc caaaagtgat ggaagggat ttgtctttta agaactgcc 301200

tagccccac aaagacactt gatactgaag tagatgtct gcatttccga ccatttgtaa 301260

atgatacata aaatgattaa ataaaatgca caatcatatg ttttaagtagg aggtaactec 301320

catattttt taaacagaga agcccaggct gacaggggtt agtgaactgg atcaaagtcc 301380

cagaagcagt gagtagagag ctggaactca aagccaacct cccaggtgct ttgaactcct 301440

catcttgact gtttagtct gactttttc tcaagttcaa gatccatgag gtcctggtat 301500

gtcaacagat gcacatggtg tttatgttaa aaaaaaatc cattatcagg ccaattgttc 301560

tattccatat ctgatccat gcatgtgtga ctatgaatcc aacagccact caaagtggag 301620

aatctgctaa gtatgctagt attaactacc agaaagattt tttccagaat ttcagtttg 301680

gcagaaggag ctactgttgt aaaatcagaa tgagtaaacc cagcttgatg ctgtagtcct 301740

tcaaggaaac atcaaaatta atgggagttt tgcaactcag atgaccagag taaagcccta 301800
atcatttgaa ttaggatag tccaagattg ttataacat gaaaaaatg cctgaagact 301860
gttgtgacce aagcctttta atctcctgag tcaccatgat gacttagaaa tcattgcccc 301920
cattttatcc cctcagtcac catgatgacc tagaactcac tgcccccat attatctcct 301980
cagtcacat gatgatctag aactcatcat cccccgttat ctctcagtc acgatgagga 302040
cctagaactc actaaacct agggatgtgc tttatgtttg aaatgagata tgagcccaga 302100
catagtagta gacaattaag ctattaaaa acaaaacaaa caaataaaca cacatacaac 302160

ctgctcttat atactctgga accttctaag tggttcatgt ttcaactttc tatttagaat 302220
gcattattat ttcaatgat taatgggaaa gaaaggacaa aaaagtgtg atcaagaaga 302280
acaaaacca gcaacttct taatgtaaaa agcaaaaagt aagtaagtaa aggaaaacta 302340
gcatttttca aagattttta aaagtctgct gggaaacagg gggcttaggg attatgttcc 302400
tgaatgcag ccttgcttca ttgcagcata aagtatctat aattatatta agtaccttcc 302460
aattctaact atttatttta gagacataca tgtttcagat tttcttata atgacttga 302520
aaggtttate atttttttt cacaaattg accaggaat aatcaacat cattaactct 302580

ctcttttga ttcaacaact tcctttctt cattatcact gctattaatt ttttaattt 302640
tcagactatg gttgtgatg acagacaaa tattaataag cttatttcaa aaaaaggctt 302700
cacacatfff atgcacatga ctttatgtcc acacatgtta ttcagtctc ctgagccttg 302760
ctcatagcac tatcttcagc aatcccagag gttggactgt cccatgtggt catgtactca 302820
ctcactttta gcaatgggag ggaggttata actattagt acaattttct gtggttctgt 302880
tcatatgcaa ctctatttg ttttcaggga tttttgcctc agtgtcattt atggtagtgt 302940
tgccacatct ctagttttcc attaagagt ggaataagat attaaaacat acaaaagaaa 303000

cacatttgag gacatgcaga aagcaactga ggagaagggt tagtttgaca ataaaagaaa 303060
aaaaacata ttaagaggaa ggaaaaacca gatgaacctg tttaacgttc ttaaagttct 303120
taaaggatct gtgttggtgc ctaatgacca ttctggagca cagttgaaca tactgacaca 303180
agaagcatat tigtactgtg acgtaagtgc aaacaaagat agcactgagt tcaggetcca 303240
tccccactt ctacggagc acagcaagac tatgggtagc tgtgctgaca cattccaaat 303300
acagtacat tgtctcatct aaatctcacc attctctgtc tccacagata aagaggtcca 303360
gaaacagaaa gagaagacag acagacctgg gaggagatgt gagaaatgaa tagacacagc 303420

ttaagattgg aggccacaa gaggctcagg agaaaacaca catatatagg aatgcctaaa 303480
ggggagcaca gaaaaaaga caaagaaaaa ggtcaaataa aaaaaaagg atcaagtttc 303540
cccaaaacc tcacaggaca agtgaagaga aacataaatt tacaactcag aaacataggg 303600

taataagcaa gcgcaaacat aaatataagc attttatcct gcaaacactt ttttttcgt 303660
 cccactccct gaaataaact catgactaaa taaaattatg cagcaaaatg tagcatgagc 303720
 ataaattttc atttgtttcc actttataca gtctcaaaaa ctccgcatg tgtgcatctc 303780
 atttttctc attttctgaa gatttagtgt gtgtcctctg gatacattat tgttatctat 303840

 atttatcatg aacaaacaca agcatatfff aggcaagtta agacaaaact gctttaaatt 303900
 aaatgctage aattaatca taggatgaaa tatcttaata gtaataaatt aaattccaca 303960
 gtagtggta gtcttaatt ttgttatgac atgcatataa ttttctctt accatttcat 304020
 tttttctc attatctgac ccaaagtata ctgtggtctc agtgaaccac tttttacaac 304080
 agtgttccaa aaactcagat ttatgaataa ggcatgtaac tacacaccag tttgtgttcc 304140
 tctttcaaaa ctacattatt cctgagaggt tgccacctag ggaaaagccc agttaccaga 304200
 ctctctcata tgtaggaggg aatgtgactc atttttaaca atgggaactg agtagatgag 304260

 tgagttaaaa gctaaatgg ctactaccct gtctctactg ggagctggtt tttgttagtc 304320
 aatgctccat cactgtagtg aaacctccac cgcccccaa gagagtaaat atctgaataa 304380
 atgagtgtec tctcattggt ttgatgtcac ctgacctgt tgcttgaggc tgtgacaagg 304440
 ctgactaca cggctggagt gtgtaatagg aaaaaactt tcctctcatg ttatgtccaa 304500
 agagcaaac tgaggtaaaa gaagggaaca cggtcacata atctcttca aaggtaact 304560
 tccattgact caaagacctc ccaggaggtc tgtggagcag ttttctccta gataaagagc 304620
 tctgtctga agggaagctc cagtaagact cgggatgttc taaggagagg tggaaattcc 304680

 atccttcagg gaaatccctt aaaactcaga aagaaaacaa ctcaaggctt caggaagtec 304740
 ctccagtctt catctatac cagtaaggac tattgagaga catgctcaag catgtccagc 304800
 tacctctaag agacagagac cagctgagat gcctctacaa atgctgagct gcctgcaaat 304860
 tctgcagtgt acttgtgcca ggtteccagg ttttctgaaa acctgagct agaatgaggc 304920
 ttttggtgac aggctagtct ttgagtcatt ttgctcctgt aattaacctc ttacctatac 304980
 tcctaaaagt aacccaatg agtttattgg ttcatacagt tacactctgc tagaatccac 305040
 gttttagtct attgtcagtt ccctacattt tgccttecca ggaatagtg ctcaacaata 305100

 agccacacct cttaatgatt acatcacctc ctaatagtac cacacttggc ccacatcttt 305160
 atttctgtcc attgtggggg agaggaattt atcctgaaaa ctgaagcaag actatctct 305220
 gaaaaaacca aacctgaggg ggaatctga attgcagaat taacacagac aaaagcctac 305280
 caggagacca gacacacca aaataggaag ctctaaaatt taagaagtaa cttttcggtg 305340
 gttgaaagcc acaggcatta tgtggattga ctgttagttc aagaagcatt aaccaaata 305400
 atcaaagaat aaaggacttc ctttgtatgt atccatttct ttatattat agattttaat 305460

tagttagat aaggctgaaa acataacctc attaagtaat attgtataat atattatcga 305520

gtttaccaaa gatgagcaat tggcataaaa ttctttatga actaatgac aatgtcaaat 305580

caaagtggat atttatctaa acaaattaga gaaaatcaat cattattcaa ttttcccaga 305640

aatagcagac acctcttatg gtttgctatt ttttaagtaat acgagtctct tgaactcctg 305700

aaaatttcca ccaatctaac aaagagaaaa acacaattat ccacttttct ccccaaggat 305760

gcaaaattaa acaaaactcca atgatgaaag caaggtggca tgtactgtgt ctgcctactg 305820

ctgggtgata tagacaaatt ggtgtcaaaa atcttcaagc tgagttgggg ggtggtaggg 305880

gaggaagggg gggagaaggg aactgggatt ttctgtaat tcaatcttgt ttgtaattca 305940

aataaaaaaa tgataaaaaa aatcttcaac ctgtaatgta cagttttag gcactgacaa 306000

catgttgac acataaacta ggccaatcac atttctgaca gacaatgaga aatggtcag 306060

atagacacat ggccattcaa ttgacaaaac aaactattgc ttctgccacc aaagttgcct 306120

ccaatatctc tgaccaatga tgtcaggtca aattaatagc aatcttttta actttcacac 306180

ctggtagtca aattggatct ctaggcatca ggatataagg aagacagtga acaaaatgat 306240

ggagtactct taagttagtt caaccagtta aatctacttt tgtcacttaa ttagcagaac 306300

cctctttaa agaatgccgt gatcctgaat ttaaggtaa tttacaatt atggccctaa 306360

aaagtctttt tatgccttac ttaatatfff ggtttcaact atgactttct aaggaatc 306420

ttaaataaa aaattaggct taaaactgt ctgtatatag ataattacat aatttgtgta 306480

tatctgagcc tgtaaagttc aaaataatft taactata gtaattgagg aaaatfttag 306540

tagaaaaagc taatctgagc aagaaaaaaa gcattaagta gatgaaggag ccagtagcta 306600

tggctctggct ttagtcaagg tggcaaacc cctgttgag ggacatgac atagcagttt 306660

aggggaatgt gggaaagcga aaaactagag ttgatgggct aagcacctg ccagtttggg 306720

gagataatat gtcattgtca agaaagtgag gatggagact cctaggctag aagagttgac 306780

agctgcctga aaaggtcaca gaggcccaca gaatggccga gcctggcaca gcctccctt 306840

tcctcttctc aagctgtcca gctatcaaga ttaatgttcc cacaggaagt ggaatgctgt 306900

gatcttttct ctttcagcaa aaagtaaacc ttttgaaac tacactttca tgcattcatc 306960

ttatatttac taatatcttt tcttaggtca cagttgcaca agcaaacctc tctctgaagg 307020

gaaaatatta tcaaggcaaa catactgcct gatgactcgg tgacacacta cccaaaggaa 307080

acagaggggg gtgcacaaaa tcatgatcc ctcatgccct ttctcttcca taattccct 307140

catcttttct ctcatatccc cagaactaaa aatttccaaa tataaatct taatgtaaat 307200

agtttggagg atctttaa atgtcaccccaa ctcttacttt gatatttagt caacttgatt 307260
 tcatgggatg attaggaagt ctctacattc cagtctgaaa gttgggcctc agtcacaagt 307320
 ccatcactag cagaaacaca agaatattgg attgatggag tctagaacct acttctctaga 307380
 atgatcattc ctccacaatt ttgaaaaaaa gcatcctaga ggattcactg aggcagggaa 307440
 gtaattgctc ttaaccaga gtaccagaat gtagttttgc ctcttctttt ttgtctctc 307500
 agaggacaga agaggacca actttccaat ctctctctgc ctctaaagat gtgttgctgt 307560
 cctcagcagg cacacagcac atcagagcac ttccatcat caccatctaa aagtgccagc 307620

 ctgactgaaa gaaaaacgac catcacagaa gataatttag tggataagtg agttgtccac 307680
 cctctctgatt ctacacagac tctatgtgat caaatcacgg accatggatc acaccacat 307740
 aaacactcac agtgaggctt cataagtcac tggattttat aatgttgga ttatcaaaa 307800
 cttaatgtga tccattatta acacctgaat ttcaggagag tatacacaac aataactata 307860
 aggtaactgc caactgtatc tagcaagctc actgacacca agctcatgga cttgaccaac 307920
 tttccacat atcttctatt tgctaattat tataagtaga gtgattcaa tatcaaattt 307980
 acagaaattc tctcagtgtt ggaatctaaa attcaaatag gactgaggta ggagcctatc 308040

 ccccttaaaa gacagtttat cctggatttt cagattctgg ttcacaaag tatacccca 308100
 cacacacaca cctcagaga cctttcccc ctttttctag gtaggtctca gaacagtgtt 308160
 ttgaagtctt tctttatgtg ttagttagca ctagacaaat tccactaagg aaataagtgt 308220
 ttctgagta ttttaaagca cccaaggat ttctcttaag tctccaatga aaacatctt 308280
 gaagggcatt ttcaggacag ttgtccctc tcaagtataa ctgattttgt ctctctctc 308340
 tctctctatc tctctctc tctctctc tcatctctca tctctcatct cacacacaca 308400
 cggagagaga gagagagaga gagagagaga gagagagaga gagagagaga gagagagaga 308460

 gagaaattgc acatgtgcgt gctcgtacct gcaaagacca gaggacagcc ttgggtagtt 308520
 tgggtagttt cacaggtgcc ttccatcttt tatttgatat ggtgcctctc ttaggctgga 308580
 acttctccaa gtagccaacc aactgccagg ggtctgtctg tctcttacct ctacaagagt 308640
 atgtttcttt cctgttctgt ttctctttgg gggtttgggt ttgtttttta ttgtttgtt 308700
 tgtttgtttg ggcaatttga ccaacacaag cttagattat atgtgattga gaaccattt 308760
 ctattagatt acctgtaggt agacaagcct gtgtgctgtg gagcaatatt tgtatactat 308820
 aaagatgcat tgctctcatt gtaataaaa agctgactgg ccaatggctg tgcagaattt 308880

 tctgggcaga gagaatgctg ggaaaaagag tgaagccagg agtcaccagc cagcagccag 308940
 accaaaagga agcagcatat gcaggacagg taaaagccat gagcttgggg cagcacatag 309000
 atggatagaa atgggcta at taaagctata ggaagtagtt agtaataagc ctgggctatg 309060

aaccaaacat ttataattaa taataaatct ctgagtggtt gtttggaaag gtttgggtgga 309120
acacagctga ttgagattcc cccctaaaa aaaacctcc accaacacct gaaaaattga 309180
ttgaattatt gattgctgaa taatatggaa gggcctggat agttgtgggt gattctaccc 309240
ctaggcacat ggiactggac tgtattagaa agcaactaa gcaacacaca aaaagcaagc 309300

caataagcag cattccttta tagcctcagt ttccattatt gccttgaatt cctgcctga 309360
cttctctcag tgatggagtg tggcctgaga gctaaaaaat aaactaaacc ctttcttctc 309420
aaaaagtgc ttttggcat atgttcatca tagcaataga aacctaagaa tgacaaatcg 309480
ttatgaccag gtcacacacc atggagtcta ggaatgaagt ttagtttctc acatttgcaa 309540
accaagatga gctatttctc tagcccaaat ataacttact tttatgaaaa agactttgt 309600
attctatggt ttctcttaat ttttaaaaa tattctatgt atataggtgt tcttaactgc 309660
taagtaatct ctacaacct ggtatgtgtt aaattgtaaa cttttttgta ttttcttctc 309720

aggacatctc ctataagaaa aaaaatctta ttaaacagg aagagacagt tactccatca 309780
gaagctaaaa cttagacttt ttttaatcaa ttgaaataaa actaagtttt atagtagcca 309840
gaagacacaa aagagagcaa atttaagtca ctcaagaaa atgatgcat tcttttaatt 309900
catactcttt cttacatgac ttccacaacc atgtgataag tcagcaaaga tcccaaaaga 309960
agattccaga aaagtaaatg aaagcaacgg gggaattttc atcccaccaa agtgttgtgt 310020
ggatcccaag ttataaaatc tctcagaaca cctgatttat aaacagaata acaccactca 310080
attttaataa aaagcaggaa cctcctggat tcatgcagca gtcacacaca aacatttttc 310140

cttaaaacac agactgcctg gaaaccaatg ctggaccaag gatatgttac acctctgcaa 310200
ggctccctgt caaacagtg tgcgattgca tagacatcac aactgcattt gtttgtgttt 310260
aattttttc taatgtataa tttacatata ccaagtacc tggaaccacc acggggaaat 310320
acgctggtga taaaataagc caatatcacc actgtaagga ttcaggcatt atgctggcct 310380
gcccctgtca tctggcagta tgcactcagg cagtacctg gtcagcccag acttcaatgg 310440
ttgagtagta tgcacgtagg tgcaaaggac ccctttaaaa gaaagacacc ccccccttc 310500
tctcttttc cctctctatt tctagctgtt ccctggggca gacaggccat tttctttta 310560

ctgtctccct cttctcttcc gtctatctc tgtttctgtc tttgtctctg tctcagtgc 310620
tctttccctc ttttctttt tcttctccc atttccctt ctaataaaac ttctcactaa 310680
gctctgtctg tctggcatgc ttgtcccctg tctcagacac ccaggcttgc catggaatcc 310740
tccaaggtcc cccactcaca ttatcataac aaccacttg taagaaaagt agcaaacaca 310800
gaaaaatatg gtttccatgt ttctttgggt ggtgcattcc ttcaaaagaa aagaaatatg 310860
ccaagaagaa aagtatgtag tattctttt aatgtagaat agaactatg taattactta 310920

gaaaatacat ttattatfff tccaacatgg gacaaaatat tacttctcat gactatgaac 310980

 ccaaagagtt ttgaagtatt tatatataat aaacgtaact aatatttaac cctcagtggag 311040
 caatgttagt aattgtaaat atcataagca atatttcttt gtgttaccat tggtaacttct 311100
 gtaaatatff tagcatgffa gcttgffaaa agtattctga aaatagaaaa tcatgtfffa 311160
 aaagtctgt tttagtatt tcagagactt aagaaggcca aaaagaaaa aagattaatg 311220
 ccagtcacaa ctactffcat tcattaatff tctfffaatc agaaaggaca aaaagaagga 311280
 agcttaataa ttaagcatgg cacatggaga aagaacata tggagaaata tatctgccac 311340
 aaaattatag tgtgggggca ttattataag aaataatgcc ttcaagataa cttgaaaagt 311400

 catagcfff aaattccaaa gcattattca tattatffcc atatatagga aaagctgaac 311460
 agaaaatff atgcaaacat aagttatact caatatggat ttgtfftagag taattgagta 311520
 atattfftaag cagctffctc ctccaaaaa gaaagagatt ttgaaatff ttaataataa 311580
 aattgtatag taattggctg ttatatcaac agaatgataa atgaagtgga ataaatffac 311640
 tgaaaatatc ttagtatagg acataaaatf taatgtatat tatcatatca tgagaagtgc 311700
 cataatffgt cagctfcata aaattagggg tattatffact ttacatatat atatgtgtgt 311760
 gtttgtgtgt gcctgtgtct gtatgtgtgt gtttgtgtat aaatatgtgt atacatgtat 311820

 gtatgtgtgc tatagatffa ctccaaaaat aatgtgtgta tgaaagagag atffaaatgc 311880
 tctatacaaa aggctatgac cacaaaagca atatacataa atgaaaatgc ttattgtatt 311940
 tacatacaac tgcaaaagt ctgcaagctg acaactcaaa caaacaaaac aagagtgaca 312000
 tgggggaaaa atgacaaaat aactatacca ctaggctgtg agtccaggcc ctagaactgc 312060
 agaggaagaa cagtggaacc aataacagaa agtagtgacc cctggtgctg gtaacaggga 312120
 agcagtgact ctctffaaa aggcatfftg caacacagtg acctfftaagt gctcattgca 312180
 tactaaaagt agacatgacc cagtagtcaa tcttaatff atgtacagac acataggaaa 312240

 tctatatcta gcattatff atcacagaaa aattgaaatg tfftcacat ccaaaaagaa 312300
 aaagagaaaa cagaggtata ccatccacca ttaaaatggt gccactaag aagtgaagga 312360
 tacagaaatc aaatggaata gtgtgagatt aaaaaaaaa aaaaaaactg gggcagatcg 312420
 gtagccacat gagtagaaaa agcagagtgt gggacatagg aggtctctga ggtgagactg 312480
 ggaatgggac atffaatggag gtaaacaca cctgggggaa agagacaata aatacacaaa 312540
 aataacagaa tgccaagtt tcaaagacaa atfftatatgt atctfftatcc aagtgaacaa 312600
 atccagtaca tgtgatacac acacacacag ggatgggaaa acggaggacc aaaatffatcc 312660

aagtgagtac tattttgatt cagtgtgatt cacagactac tcgtggctct acatttctct 312720
ttcataatth gttggaatth tcaaatthgg ccatctgtta ttattaaaga gaaagagtgc 312780
atattacat cttggaaatc caatgaaaat catthttcact gctattgaaa atgttactth 312840
cactcttcta gcagagtata aaatatatga aaaattgatc atcatctcac taagtggatt 312900
attggattcc aactgcttht tttgagtccc agctacttht aaatgagata aataacatgt 312960
tctcattagg agaattcaga aacaagataa tcagggtgat ctgggtatth aagtgtctct 313020
attcagaagg gtagagtgga caggcagggt ttagagttht ggaatthcca cacatthgtc 313080

tctgtagaaa tggctthcatt tgacaccacc tttagagaac agggagtccg ctactctgct 313140
tagtcatgga tttgtatcat caacttgaag gthtaaaaac cacctagata cccagagtgg 313200
agctthctac catgctgact tacagcacag cttgtgatta atatatatag aaaaccccca 313260
tgactcaaag cattgcatct ctgagthttag tgcatacttg cthttctaca gcccaatcac 313320
ttggtcatct ctccgtgaca agaggatact gtatcagagg gthcaagtaa ataaaaactt 313380
gcataatgatc aagaaaggaa atgtthtaacc thttcttacct aaaggcctac acagctactg 313440
aatagcacct cagatcttag acctctactc actgthtcage tcacttactg cthttgtcat 313500

thtcagacag acaacaaaag thaacctgtt cthctgtatc aatthtatctg thttctctcc 313560
cagtacaaaa tacagaaagt ggaagthttga ctgthttgaca gtatcaataa cagagaaatt 313620
aaatatagcc actcagagat accaagaatc taagagctag ggtacatgtg aagatactag 313680
agacaataaa agcagctatt cthttacaat atcctgaaac thcgccatct tctcttcata 313740
atathttctth thtaactthc taatctcata atctthtcta aatgactthg aatagatthg 313800
thactthctac tagtctagaa accacatgca thatccactt gcagactaat thtagaaagc 313860
tgcatgacaa agctgctgat thtactgtht taagagcagt tctatthaat gctgcacagg 313920

acatgtctaa tgggtgatatt tctcaccacaa ctaatatcaa gacaaaagtc thgccatagc 313980
catattatag acctgtgtga cthattthtct caagtcaaat thattgtgggt tgaactacag 314040
caaggggata thtaataaac taaggcatgc aggacatgcc aatggaaaat aatgtaaaga 314100
catgtaaaga aagataagta agaatagaac thtagtaca tggtgataat atgaaaaaat 314160
tgagacattg ctathththt thcagagaga atagggaaag thtcacacca aatcagaag 314220
gagaaatggc atcatgaaaa aatcaataga actgatactt tggaaaggca gaacctggct 314280
gcttatagaa gcccagtgat gtatagacaa ctcaagccta cthcactthac agcatcatgc 314340

atthtaacct gctatctthc thttgtgcat gaagagtaca tcagthcagt thcagctgth 314400
cacatathaa tgcatctthg aatgthgtgc thtaaaatha aactcaaac caatthccca 314460
cctctacaaa atacgaaggt gthtaattht agcattcaca actaatgtat accaaggctg 314520

agagctgggtg ggccctttctt gtaggtagaa ctatctactt tacctctata aagaaaaaag 314580
 aaagaacata aatgaaagaa agaaaataca gcacagaagc aatggccagc aaattcaaag 314640
 aaccataaac ctatttcctt agaaaaccaa gcacaaaaat aagctacgat tttgtaaaat 314700
 agcctccatg tcaaagatta caaatgctta actcaaatg agataaatc tgcttcagag 314760

 agagtgggtg ttcaacaag ggtagcattt acctgaagat aatgagcaa ttgaacacta 314820
 agttaaggca aaggagaaga aagaaagaaa gaaagaaaga aagaaagaaa gaaagaaaga 314880
 aagaaagaaa ggaaggaagg aaggaaggaa ggaaggaagg aaggaaggaa ggaagaaaga 314940
 aagaaagggc tcatcatgtg tacaaccaca gacctggtaa tcctgagag ttgtaaatag 315000
 ctaacagaat catgttga agaaaagtaa aaatcaagtc tgggtgatg atgcacatct 315060
 ttaatcctgg catttgaag gcagaggcag gtgaatctct gtgagtatag gacagcctgg 315120
 tttacagatt gaattctagg gcaggcaggg ctgcatacaa gggagacctt gtctcaaag 315180

 cacccccacc aaaaaagaag taaaaggaa gagagaaaga aagaaagaaa gaaagaaaga 315240
 aagaaagaaa aaaaatcaga tagtgtatca agaagtaagt gtctacatta agaatgacac 315300
 tgtcagacag aactagaaaa aaatcactct gagtgaggta acccaaaacc agaaagacaa 315360
 atatagtatg tactcactca taagtggata ccagacataa agcaaaagat acacagccta 315420
 caatccataa cccagagaa tctagaacc tctccagaa acagatggaa gcagatacag 315480
 aaatccaca ctaaccattg aaccaagctc ctggagtaca atcaaagtaa agaaggagca 315540
 aaaaatgaa caaaggagtc aagaacatga tagggaacc cacagaatca gtgggcctaa 315600

 gctagtgaga gatcactgtc tcaggtctga caaatgagga ggctgcataa gaccaaacta 315660
 gactcccttt atatagggga caatggtata tacagggaca atatatgagg cactggcag 315720
 tgggtccaaa atccaacact aatgcacaaa ttgacttagt agagccatt ctatttagag 315780
 agatagggtg tgtgggtag agagtttct tggacctacc tcaaggagat gatgggatgg 315840
 gacagactta atagacttcc taatggagc cttaccctct ctgaggaaca gatgggagat 315900
 ggggaggagt ggggggagtg agagaagagg agggaggggg aactgggatt ggaatgcaaa 315960
 aaaaaattha aaaagaatgg cactgtcaaa catactgata tattatcctt agttccgata 316020

 acaactgtat ttggtgagag tcagagcata caattagcag gttagtactt ttaaaagtca 316080
 agattgtaaa tacttatgaa aattaagacg aagggtctc ttcttctatt atgccacctg 316140
 atgcaataa ataataagat tccaactggg ttattgaaaa catcttcagt aactcaggag 316200
 acttcttcaa agatctttac ctgcttataa ttatgctttg aagaaatcca aaaaagcaca 316260
 tagaaaaata ctaacgaaaa gccttctgga ccaccaaggt ttaccaggaa ctgtttgact 316320
 cctatgagaa tatatgataa agtaaatata accagggatt cctcatcaca cagcattatc 316380

aatttctca caagtggttc ctactggcac actcatagat catgagcct gctttgaggt 316440

atcctcactg agttagattc caggatgtgg tcctctgttt taagttctaa tagattagtt 316500
cattttctcc attcaactgt cttctgaaac taaactgtga tcaactgtgt aaggtttctt 316560
ctatctcacc tcttgggtga gctcccatga tgacctacc ttctactcac acttggcatc 316620
atgtgccatc tacacagggt atgctaggat ttaaaggaca ggcacagtca gctaccaagc 316680
atccttcctt aataagcaag atggtgagaa aggataagga acatagatag tgctaagcca 316740
caaagctaaa tatccccaga atcggaatag tgttttggat ggtatggcag cccagagtct 316800
ataatcacag tgctgggagg ctgaagcagc tacactgtaa gttcaagacc atcctgggtt 316860

acatgctgag accctatccc agaaaaaagg aaaaaaaaaa ggcagaaaaa tctagaacct 316920
tggccatctg atccatgigg atctatgaac acagcatgac tgtgaaggtc actgtcatgc 316980
agtcccagag ccttctaagg gaagcttatg ctatttgcag cccaacaccc aactatgtc 317040
ctacgcagag tgiattacac attattctct gaaatccatc attctccac aaccttgtgc 317100
ctgcctagtc actgtctcac acaccttcac ttctctcttc tgcctttcac ttctctttt 317160
tcagcaaaat ttcatcetta tttaggacaa ggatcacttc tgtcttttgt ccccaaaaga 317220
ttagcagtgt gttagaaaga ctctgagctc tggtgctaga aaaatgtgga ttaccatcct 317280

aatcttctca ctggtcaact gcaagacctt agaatgaatt ccatcacacc tttagacttc 317340
atctttcttc tctgcaccag acacatatta agctatgaaa aagtcactctg agctactaag 317400
tcctgagacc cacctatgag ccagattaaa atgctgttta cacatttaat aaagaactat 317460
ttttcaagca ggtatggtag cacacaccta ttattcctaa acttgggaaga ctaagcaga 317520
agtattgcc tgaatacaag gccaacctgg gctaccaagg gaatgcaagg ccagcctaga 317580
tgatataatg agacctgtct caaaataaac ctatatatga gggctggaga gatagctcaa 317640
tgtttaagag cactggetgt tcttcagag gtctgagtt caattcccag caatcacatg 317700

gtggctcaca accatctata atgaaatctg gtgccactt ctggcctgta gtcatacatg 317760
caggtagaat actatataca tgataaataa ataataaat aaaactatat atacaaaaca 317820
agattttaga tctttaaatt atataaaaac tcataagact ttagcttaca ttctcatgca 317880
ttgtactatc ttctttactg gaaaaagtca taataaaatg tttaaaatac atggtgaaag 317940
ccactctgac aaagacctta ttccacagat ttcttaaaac ttttcttga taagatagtc 318000
aatctcaaaa taggtaactc tagttaaata ataaagcagtc taccattct atctgcatta 318060
tcaatcaaat gtgigacaat ggccgtccag atgaaatcat actaacattt atcaciaaag 318120

gaaaaaaat gtctccaag aaattccttc tgactcatct gggtagcct ggtgttcct 318180
tcccctcagc ctcttaactg ctaataagta ggtgatttgc tggtagtgca ggcaacattc 318240
caagctgatt attgggtcac atgagcagaa aaggcacccc ctgttcatga aacaattatg 318300
ttaatccttt aatttttca gagcttatgc ttataaaata ttctaactct ccaagaatat 318360
aggtttgggt tgcagctggt gtttgcata tacttgttga gctcactaac attttcaaat 318420
cttacaatatt cattcccaca accccaagaa gagcaaaata gaggattatt acttccatat 318480
taaagaggca aacaaaagct aatcaagcaa tgtgaggtat atatgaggtc aaacagccgg 318540

ttaagccag ataggccttg aattttgatt ttctgaacca gcactatttg caatgactct 318600
aagcaaacac agttcctaac attaaaggaa ttctcttct tccctggata gctttaactt 318660
cctttggttt ctttcaaatt taacctaaga ttagatctca gttgtgcctg tacaacaca 318720
agggttgta attttctaa gtagaatgat aaacggagtc agtgtttgaa tgactggaaa 318780
aatgatcaa aacattttga ggcatgatgt gtgtggacat aaagactttc ttatgcatg 318840
acctagagac atgataacat atcttgcac taccataaaa gaatcacatg aaagtgtgtt 318900
ctactcaagt gagaatctta agcagaagtg ggtcagtggt attgcctaag cagcaacaga 318960

ccatagactg gagcttacag ttccaatgag tttttcattg actacaaacc agactgtaaa 319020
acttacttct acgtcatatt ttggcacagt tatttgaatt tcaagtgcag acagagcaaa 319080
gagtaagggt tgattatctg cataaatgaa aatattgatg aggggtgttg tgaacatgtg 319140
acctcaaaat tgggagacaa actaatagct gactctgtac ttctaatat gcaaggaata 319200
tccatgtaga tgagtcgatg ggaaccagag cagatgcttg aatgttatta tagtatgagt 319260
gtctgtggaa gtgtgagata ttttctcct cacttgggta atatctactg tgatcagaca 319320
tcaacaacca cctgcttat cccattcaca caataattta tccaactag aatggttgt 319380

aatgacaaa gttgctactc agcatgcaca tgtaaaacaa aaaggcatag atgtgatggc 319440
ccaggccttc ttcccagaac tctggaaaca gggatagatg gatctctgtg agttcatggc 319500
catctgggtg tgcataatga gttccacact accagagcta cattgtgaga ccccaactc 319560
tgataataat aatattatt aaggtagact gttttaaaga cacaatagtc agttgctcat 319620
tctgtcgtt acagcttctg gctgtctcag atagaataga ttcatgctta ggtttctaag 319680
ctaagtcaga aactctccac cttccccat gatccaaga ccttccatcc tgtcactcta 319740
tccactctac cagtcgtggt ctcttatttc tttctctaaa agaacagaa actgggtgaa 319800

gataaattaa cactgttat tgatctcaaa acatgacttc ttttattcta gatgtcaaat 319860
ataaacttca atgagattaa aaatagaact cagaaatgac tgaactgaaa ggaagtaaga 319920
acattcaaaa gcattcccct tcaaaactct gccttttgat gtggttagaa taaaaaaaa 319980

aaagtactgt accttcaca aagcacttga atacccatg acaaaaatata tataatataa 320040
tcctataatt ttaatttctt catcacttat tagatacttc agccttatat gaacaatggg 320100
tcttgagacc aatgtaatt tttatgcata tgtgaagctg agaaatgcaa gaattctgat 320160
cccaagttat tgggagaaag tttcagactg agcaacagca aggaagagca accttttgac 320220

caaaggtaca accttctctt cttgcctgt ggtcacatgc tggcctctga ctgcctcagc 320280
ggccccaact atgtcattat atttctattg tgaaacacag tggaccagc tacaaaactt 320340
tgtgcttatt cccaggaaag cgcaacacgg gaacatttta atttagatgt tagttatttc 320400
aaaactgaag agcagcagtg tcttgattta agataaatct aatgatata gttgatattg 320460
aaacagaata aagtttcatt ttgccaagg gaagaccttt gtagacttgg atgtaaattc 320520
agttttgcaa tttgtattac ttttcaagct cattacaatt taaattttta aagtatttct 320580
tacttatgag aactgtaata ttgggataat tgccatccat ttaaaagtag taacaaaga 320640

ttcaaatgt ctcatcatgg ggtggagtcc ttaaactcct ctattaagaa acttcatatt 320700
ttaagagaat tacttggcaa atatgtttgt aagttaaatt ggtttaataa tataggattt 320760
ttctataaat ttatttagag taagttaatt ttctatgaaa aaaacagttt atataaccaa 320820
aaaccatcaa acatgagat atataataa aatttgaata tattctagga ttataaatt 320880
agagtaattt ttagtaata gtttcacaaa cattaccata acacacacac acacacacac 320940
acacacacac acaaatgct gttattttct aatgagttga aatcttctaa ttgaacacat 321000
aaagaggaag atttagctca tgggaaggctg aatctaaaag tgccaaaatg aaagataaaa 321060

ctaattcaa gccagcttc agtctttgct catgcaattt cattattaaa cattaaggca 321120
agattttttt ttttgcttgc ttgttttgt ttgctatctt taatcagatt gatggtttta 321180
tataaccttg tacttacagg ccatatataa aagtgttaata agaaataaaa cagttggtga 321240
gaaattaaat gcctatctta aaaatttaag agtgtaacat ctgaacaaa tttaaacatc 321300
aagattgttt ggagggccac tgtgagccag ttagagggat tgtactgcct cagtgatctc 321360
agagtacttt ccccaaagca agttcctctt ctaagttatc agtgatacaa ggagtgatga 321420
ctttgagatg ccaattaata taaattggga gcagaagaga tattaattaa acgtgacact 321480

ctgattattt aaaccttcta ttaagttga tcattcagag cacggtgatg gcttgttctt 321540
caaaaatgat ggatggcatc aagctttagt gactccctct atatctgtgg tttccaacac 321600
ttcagaacag aaggaacaaa tgatgtgaga agaacatgag aacaagtcta atagacagac 321660
tgactaatct cagaccccca aggtcaaacc aaagcaatct gtttcttagc tttcatcaac 321720
acaagacatg atttatcaat cgatgaacag tgtttcaaac attatacatc taaatgatat 321780
gttctttgta ctgtgtaact ttttgaacaa agatagattg tgtgatata tccctacaaa 321840

agtaatgtca tgagcaaaac tcattatatt tcccaaaaca cattaaaaaa aaaccctgaa 321900

 tatgtcatct gtcattatta ctccacatgc ctttgggga gattatattt ccaaactaga 321960
 ttccctggaa ttctgtgcc ttcatagtac aaatattaca cactaacatc cetgaaaata 322020
 gtccctctat tctaatacat ttatttgtga agttggttga tgatttaaat ttatatttaa 322080
 atctatagat aattattaaa gacaatgtta aaaaaaagta tttcttgtgt tgttataaaa 322140
 tttagtggag ttgatagat ggctcagttg gtaaagtgcc tgccacacaa gcctgaggag 322200
 ctgagttcag atccccagca tctgtataaa attcttgtgt ggtggtgttt gtaattgcaa 322260
 tgctgacaag gtagagagct cactagccag gaagtctagc caattggtga gctcccaggt 322320

 tcagtgagag acctgtctca aggatgagat ggactaggga aggttgagag ggattaggga 322380
 agacattcaa cagggatctc tggctctcct atgcatgcat acacacaggt gcatacacac 322440
 cagcactaat atttatagag gaggaagtat ggttaaagaa aaaaggtcat gagaaaattt 322500
 cttactata acataatgta aatgcaagca tagatattat tgtcaggctg ttctctcctt 322560
 tgttacagca cctaagaact atttatgag gcatgcctat gatagttcag aaatgagttc 322620
 atagtgtcat gttaggtaat ctaggagatg cctcaaaatg agattacatg agaagagtag 322680
 ttggttgatg tcatgaaatt tcactcttca ttccacctcc gtaaaatcgc atggctattt 322740

 tcactggctt aaattaatta ccaccttctt tccattagtt tgggaaagat ctgattgctc 322800
 atatgaagga ggcagtaaaa gggttatacc cttggctgat gattcatcgc accagctgcc 322860
 agcagttgc atgtctcggc acacctggat acatgcacca gtgactgatt aggaaacaca 322920
 tttatcttgg tgcatacaaa aggagacaca actgtaatta ctctcccctg taatgaaacg 322980
 cattctggaa ccigtgtcca cctacaaaat aatagaaagt acgcttttgg acccgatcca 323040
 tgtaattgtg ccatctgttc ttgatactta gctctaaata tttcccaaat cactcttgtg 323100
 ttctaaaaat aaaaatgcagt ttgaaaagac ctacgttaac tgttaaaatg gtcagaagat 323160

 atcaatttaa aacctaacac taatgaaaat gatcaaaact cagagtttct ttggttgata 323220
 aatacagaac atgacattaa ccttactgtg gtacttagga aattctgtgg atttatcatg 323280
 ttttaatttg gagaaaatga atatattggc taagtttttc agagccctct aaatgagaac 323340
 tgacttaagt gtcccatgtg aaagaagaaa aaggaatcaa agcttttgtt cttcaacttg 323400
 tctcattata atgacctcaa aattctggag actcttaacc tatactgaga aatcccatat 323460
 attaagacct taaagtagga tgttgattta ggggactaga gagatttcat agcagttaat 323520
 agcatgttgg gttacatcta attgagttgt tgaccaaagg ggtcctatgg gaatcccaa 323580

gcaaaccagg ttgttgccaa gatatagggt gctctccaca ctgacagcaa gcccattgct 323640
gaagataaca cctacacaat taatcgaaca tgaagaggtt aagccagtgc ctacacagag 323700
ccttcacccc tacattacag catccttaag acaggaaggt actctacaca ctgtcaaaag 323760
agaaacaaaa acatcaacct actcacaac cctttatcta cagtgggtga ttgactgcag 323820
gatacatgag ggcaatggtc acacaaagct tftgggagga aacatcta ttaacctaag 323880
gcccactcca caagatggaa cccacacca actactttgg tgaccaagaa cctgagggta 323940
gatagtcag gaactagag taaaacaaa taaaatcaa aatgtactga taaaatgact 324000

tctattgata ttctgtatc ctcataaatc agtgtgcctt gctcagtcat catcagtga 324060
gcttcgcct gcaacagaaa cagagacca gagccagaca tttcatataa agtgagagac 324120
cttggaacac tcagccctag atgggatgtc ttcataaat tcctccattc agagctcagg 324180
gaacacaatg gaagaggagt tagaatgagt gtatcagcca gagggaatgg aagacactaa 324240
gaaaacaagg cctctaaat caactgtatc aaagctgata tggactcaca gagactcagg 324300
cagcatgcac agggcctgca caggtctgca caaagtcctt tacgtatata ttatggcttc 324360
cagtttagca tttgatgag attcctgact gtgtgaacaa agtgggtctg actctgggta 324420

cttctatfff ctgtctattg gtttctcttg tccaatfff atgtgatagt ttttattfff 324480
atcttattta ctttattctg ttatatgtaa aagtgaatga atgaatgaat gaatgaatga 324540
atgaatgaat gaaaaacaag ccactagggt aaaggttaac aactgaactg gtgatgatac 324600
ctgctgggag agcgcaaatc agttttctca aatagagtga tagtaagtat atcaagcact 324660
ccaggatagg tctgatgttc aggagtagct gatcgaatgc cattgttttg tgtgtgtgtg 324720
tgcttttatt ttgttacagt tggggggggg gggtcgtcag ggggaactgg ctttattttg 324780
ttttcttggg ttgaggggt tttgtgtta tattggggtt ttgtttctt tctttttgt 324840

ttctttttgt cttatttatt tatttattta ttgcttttat tttgagacag gttttctctg 324900
tattgctttt gagcctgccc tggaaactgc tctgtagacc aggctggcct caaacttga 324960
gagatccgcc tgcctctacc tccaagtgc tgggattaaa ggtgtatgcc accaacgccc 325020
agcggttttg tttcttttta aggaagaact taaatttcgg tgggtaggga ggaagaaagg 325080
atatgaaggg actttgagga gagaaaaat atgatcaaaa tatgtttaa ttttaaagt 325140
cttctaata acaaaaaat taatttaaag aaagcatgtt tttccaaagg atccaattc 325200
caatactagc acccaagtca ggaggctctc aactacctat aactcaagg gatctaacc 325260

attggcctct gcagacacct gcaactcatg acacacatac acacacacac acacacacac 325320
acacacacac acacacacac acacacacac acgcacacac acacggacac acacacacac 325380
aaagttttaa acaataaaat aaaaatctca aaaattagat attgaattag gtgttctata 325440

taagtttagt gaagaatgta tcaaaatcaa cacttccaga aattgaaagt attcgatcca 325500
 atattttaaa attctagat tacttaggat cctgtgagct tcatgattga aactatagac 325560
 attcatgtcc ctcaaaactc taatttttat tgaataacat atgcaataat gtaataatat 325620
 tctaagactg ttcataaatt gcttttaaag atttattttt tctatgtgta tgtgtctatg 325680

 tgtgttcgtg cataccactg gtgtgtaggt gctgaaagaa actaagggtg cttggagtta 325740
 caggtaggtg tgagctgtct ggtgtgggtg ttgggaaact cactcacatc ctctggaaga 325800
 gcaacaagta accttaactg ttgagccatc tctccagaac caagtgagtt tttatttatt 325860
 ataaaagttg tattttgttt ttttcatta taagtagcct tactccctat caatataaaa 325920
 cctcaatgaa ttctctgcac acaataaga ctaatcatga aacaaatatt caactccagc 325980
 cctgaaaatt gcaggagctg gattcaatat gatgtggtga ttttcatac tcatttcaa 326040
 aatgactgag aaaacaaact tgcttgggat gctgaaacct agaaaaacac tcttaaatga 326100

 glaacggttt accttgctct aaagtaagga tacaacaata atggtagcaa caatcaatta 326160
 tgtggagatt aaaaaataat catcactaat ctaaataat gtgctaactc cttagcacac 326220
 caataaggca tatactatta ttattttcac ttttcagatt tatctttgaa gactatgtgt 326280
 gtgtttgcat ctctgtgtgg tggatgtgt acatgggtac aggtgcctat gaaagccaaa 326340
 agcacaggat cccttggatt tggagtcaga gacagttgta agcaagtgat gtgggtgctg 326400
 ggaattgaac tccagtctc tgcaacteca ttttcattc ttttctttt tagttaagaa 326460
 aaaaaatctc tttctgggtg gtggtggcac acgcctttca tcacagcact gcagaggcag 326520

 aggtaaagge aggaggatat ctgtgaattg gaggccagcc tggcttacag agttccagga 326580
 caggctcaa agctacacag agaaacctg tctgaaaaa agaaaattct tttcagtga 326640
 aaaattcact gaatcaacat atcacagtca ctgttcctta gtgtttataa aactgaage 326700
 atggccttag tctgtgtctg aaactaagag atgaaatacc attaaggaac agacttctc 326760
 aaccaagac cattccaggg ccatgtgtca gaaacatgta acagcggat gaaactta 326820
 aagacagaca cacatacata tgcacacat agcagcatgt atctagcaa cacatctgtc 326880
 taaactgtta aacaactcca cctagaacag tgcttctaca gcaactgat tgtgatctag 326940

 aacatgtcca taaaccatta cttactattt tcataataa atattctttt acattgcatt 327000
 tagcaatcag tgcctttaaa atatttcage tttaaatgcg ataactagcc ttagtcactc 327060
 atttccaaa atcagaattc aatcaatggt taacataaca tatagtataa aatgcctttt 327120
 ctctgggtca ccgaccaca ctaaggagtc taaaaacta aatcacagt tccacctatt 327180
 tatttctatt atcagtgtgg ttacagccac taggtagttt gcttatcatt tccaagaaat 327240
 glaagaattg cticcttgta aacattccct ttctctttaa tttcaatgac aatatgaaa 327300

acattcttat aaattgacca tatttcttaa taaattggtc ttcttcatgt tgaattaca 327360

cattgattta cagaacagtt taatcagata ctatgaggca ccacgttaac tccattggt 327420

gactcttatg ttctaaactc tgatatctct gatatttggc caaatgcaat cagctaacca 327480

tctccaaaga caccggggc cataatttga tagttcatct tactttcaac agtcagccct 327540

taggcacact ctctgattcc aacctgttcc acaatgatgt actttctcac ttcaatactt 327600

ctgcttttcc ccacaggtaa agttctctct ctctctctct ctctctctct ctctctctct 327660

ctctctctct ctttctcttt ttctccgctt cctgcactct tgatgagcaa catgtcctag 327720

gataaagtta agaacatccc attttctctt tggtagataa cactctgctg tgggtcagtt 327780

cacactatta agcttttgtt tccatacttc cattcagggg aaacacaata aaatggttgc 327840

agataagact cattcatcct gaaagagggt cttacacaat agttagaaga tagcctatgc 327900

tgaataaagg caaatgagt taaatatcat tatattttat atttcttaa ttttctctct 327960

ttaattgata tttatttttt ctatgtaaag tcaaaatttt attcaaaaat catgaaaata 328020

attaattttg cagcctattt tgaccatttg ttaactaac atcaaatctc ctatcaatat 328080

tttaatgaag aaaaattaa aaaaattaac tgagctecca aatttacaag tttctataac 328140

atctttcatt tacttcacca agtttccatt cattatacta ttctctctaa ttgcatagtt 328200

tttttaaggt acatgtggaa ataattaact tttttagtcc aaactacact tataaagagt 328260

ctgtgttagg ttatatgtat atatgtaaaa taggttatat aaaacatata attattcttt 328320

cctatgttga gactgtaagg caatttagga ttaaatatag cacatgatta tatataatat 328380

atctaataa tattagtata taatatatat ttgtgggggg tcatttatag tgaaaattta 328440

ggtgggttta tctaacagaa caatgatagc aacaacagtg aaattaactg gcacacactg 328500

ggtttctct tcaagcctat tattcaatta gaaagtcaa atttatttt aacgaaaatc 328560

tcacaggaaa tgaggttact tacttttcag gattttctac ttcttcagta ataaagtga 328620

ggtaaaacct gtaattttaa ttaaaaaaa ataactatta gtatgtttta ccaccacatg 328680

ttaaacattt taaaatcaaa ctaagaatcg tgaatttac ataaaagtgc atgcaggag 328740

atgtaaatag gaaaccagta agaacttcaa tagcacattt tctactaaat cgtagtgggg 328800

gcattaaaat gtgtcagaca caatggcgag gagagtggaa accgcataat ctgtatgcca 328860

agctcacagt ttacaggaca gctcagaaca acagatgca atgccagcaa agggcacaga 328920

agctagaaga gtagaggcag ccccaacta aggtggggga agcatttcca gaggaagttc 328980

ccccaacct ggaccttcaa gaacgcacag catttccat attgagctgc cattccagc 329040

tgaggttggt ccagagcaca gaggtgtgaa acaatggtta tatacagga aagaaggaat 329100
 gctatagtat tctgccagt ggaaagaaag tatggaagga gaaattaagt tgaaggtggc 329160
 ctgagtttcc tgtaactcta aatftagagt tagaaacagg aaaatccaaa ttatatgaga 329220
 tcaaccttgt agggaactgc tatcgatttc ctacacagaa cactctgcat aaacagggac 329280
 caaaacttgt aggaatgata atttattata tatctcaaat tttcaagaag ataaagtttc 329340
 aaatgttttg ccacaaaaat aaaaactata ctttgttatg gaatgttaat tacttttggtt 329400
 taattatttc atgttgcat cataaatcat aacctcatat ttttacctca gaaatgtata 329460

 cgatttgcca atttataatt tcaactaaa ataaaagtat taaaccttcc attcacactt 329520
 cttcttcaaa ttcactgcca gtgtttacc tttataacct gattcacaag cctacagga 329580
 aggaggtctc gggatgttc aggtagttaa ctgtaagcac attgttactt actacactgt 329640
 ccatcaagaa caaaaaagca gggaattttg aaccttctc aagtcataa tacttttctg 329700
 gaaatcatac gtgaaaagaa gcattttagg cagaaagtat ttcactttca atgccaacgg 329760
 gatctcatat tcttaccta atgtcagggc ctgagaaatt cttattgctt tcttcacagt 329820
 gagctactac caagccata cagacatggc taatgccttt catcctggac ttcattttcc 329880

 aactaaaagg ggcctgctgga ggcctttta gcccatgaa gttcttctta agtatcctca 329940
 aagaaaggtt gaagaaaatt aagatttctc atgagaacaa ctgaacatag taacaagaac 330000
 tacctatate ttcattccat aaactcaggg aactctccca gagtgaaacc ctaaccctaa 330060
 ccctaaccct aaccctaacc ctaaccctaa ccctaaccct aaccctaacc cctaaccct 330120
 aaaccctaac cctaaccct aaccttaacc ctaacccttc tacagttatc ttattgttcc 330180
 ttagacgcta aaataaccta aaatggcaca tggaaatcata ggtctgaaag tcaaattgtc 330240
 ttctctctaa atacaaat atcagaatatt agcccatcgc ctgccacatg cttcaatcat 330300

 ctcacaccct agaagaaagg agaggaagct ggtcctaact gaattcacta gtcagttgat 330360
 gttcaagaag aagatggcta cagctttaat aactaagtta taaatcaata ttagaaattc 330420
 attgactgaa aatatggtag caataagggt gatataaaaa gtgtacacac atacatataa 330480
 aactggtgat acattttaac aaccaaaaag ttaaatttct aaaaacagca gttgttgttg 330540
 ccctagaaag gtgcacatat agcagactgc atataatggt gttattatag gaaaagcaac 330600
 agtcattgtg acccttgcta tgtgcacacc ccatctttca ccatataatg caagctggaa 330660
 gaattgaaag tgggactat aatgagctia ctattcttgc attaatgta ccagagacag 330720

 tgctgtgga tgctgtatt gagacagatt tgacatgttc gttataagcc tgaggcaaca 330780
 ggaagtatgg ggaacaaata aaaataagta agcaaatata ttaataacac ccaaaactga 330840
 ataaatcacg tgaattaagg aatagtgtt ggttttgcac gtcagagata gccagttgct 330900

ttttaatagt tgatgaactg gtcttttctca acaaccttaa ggcaaggaga ggactatttc 330960
 tgaaaaagaa tgcaacttca aatatttttt tcttagagaa tagagaaaaa gaaagtgctt 331020
 ggggacaatt ttggggggga gaggacagca gatcatttca aagccaaagt ccatgcactg 331080
 tgggaaataa actgggacag ttgtctggtc tcagtatgga atgaaggcca cagtgggcc 331140

 tttccctgg tttacttctg aagcccctg gagaacactc acaagtgta ttgtccaga 331200
 ttttctatga ctgtgcagaa aatgetatgg ttggccctgc attgtagcac ccaaccttgt 331260
 acatgacttt tgaaggaagc agattcttta ggtgagattt gacacaaagg catacaataa 331320
 tctttgctgg tgcttcaggg agactaaatc cattgaggat ccgattaaag agggcgacaa 331380
 aagacactga aaaccaattt tctatcacac agtgaaaaaa gagaaaaaaa aaaaaagtct 331440
 caccacactg tgcttagctc tggacctaga tacaggattg aaatgggtg acttcccaa 331500
 ggccaccaga ggactggcag atgtatttct ctgaatacgg acattggcaa taatatgaaa 331560

 gtgtttctga ccgactccg tgacctgact gagttaatga tttctttccc cctaatcatg 331620
 tttcagtgaa ggagttttca tcattctgga taggttctgt gctcctcgga gccaaaactt 331680
 tactccattc aggateccca ggggttctg gtatcttctt cctattcagc ctaacagctg 331740
 gaggtgactg ctcttagagt aaggtatcca ggacaacaga gggctagcat gttcccatc 331800
 caaacaggta gcagcctggc ttgcaattcc tgaccataac tgctttgttt ctgtctcatt 331860
 acaatgtctc cacattgggt ttatttcttc cttttcttc cccacttaa taaacattat 331920
 tctacagcaa tgcagggaat ggtagccatt tacagtcca attacaagt gtgcaagcca 331980

 gttttgact cacaaggtaa aagatggagg attcagatag caaaggtttt tcttacaatg 332040
 ctcccatctt tgagacccat ttcagactcc accttgatac attiacatgg aaatatctac 332100
 atctatggag tactgagccc aaagattctt tctgtactt gtgctttttt ttctaagacc 332160
 gagggccata gattcataac cagatcattc ctctctttc caaagcagca ttaagccagc 332220
 ataataacc atgaagcaaa atagttccct atcattcccc agctaagcca cttggatcag 332280
 ataacatctc atttacaatc ctgacttac tttccaatag tgtgactgaa ccctcaaca 332340
 cacatacaca cacacacaca cacacaaaaa aaaaaaaaaa tgaaattatg gttcctggct 332400

 cttcaagcta ggttaagac acaaggatta ctgggggggg gcagaggcg gggagtatat 332460
 atcaagtttt cggtaaacct cctttagagg tgaaaacagt ggcacttcgg actcagcatc 332520
 agtaaaatac aatattaata agataagtca agatgaagag agtcttttc cacaaaaat 332580
 tccagactc ctcaaaacc tcagaagtgg agaaaattgg ctgtacatga agcaggtgac 332640
 ctgaatattc agtgccgggt ggtggtggag agagggtaga aatgctttaa tattccgtgg 332700
 gaacagatgc atggtgctcc caggcaaaag aaactccatt caacagaatt aatcaaatct 332760

gccttgtgaa gatcaccaca ttccacattc ttgacagagt acaacaggct cccagcacc 332820

agctggagct gaaagctctt gttccctccc ctgatttgc ctggggctcc cagggacct 332880

cactgtggct tgctgtgc cccagggcat ggcgccetga ttcaggctca aaagacatag 332940

aggagtgat tctgctccta acactgtgat cacactcagt tctttctct gcttagcacc 333000

acattgtgct ttgaacaaaa gtgaaaagac ttcaaaacca ttgagattca aactaaagc 333060

gtgcacacaa tgctgcaag aaaatcttct tcgggtatac aaatattta cactgatctt 333120

cttatgctat aaccaacag ccttcaaca cttttgctt caaagctatg ctaaaccat 333180

gtagctacac tctgctgatt ctcttcta gccatattt cacaattgt gagattaata 333240

gggtacatat tciattgatt ttggaatgca tttgtatatt ccctaaaaga taagatcaa 333300

aaacataaac aaaaaagaag gaataaagaa gagaaaatt gtattcatgt tatatacata 333360

ttcacattca cataattgtt gagatactga agtttctaga tagtattttt aggagtattg 333420

tcacagcttt aactattggt tttataaata tggaaaaaga actattacca ttatttactc 333480

caaaacaatg aaaattaatc gtcctgcaat gatttttagtg tttcaacaat atcgtttcac 333540

ctagtgggct ctctgaaat agtcatittca acttagaagg tcaatacaat ttagttacag 333600

gaagttctc tcaaatattt gattactgtg actcatgctc ctcaacaaaa cagtgtgctg 333660

ccagggcagg gaggaatcac aggcagacaa gcatgaagga aataaacgca tccatggcat 333720

cgtggtgcca atcacatttg ctgcctgttt gtgttttcag ctactggaag catttagatg 333780

aaatatgtaa aggccctgta atatgctgta tactatttga tttttattac tttgatttct 333840

cctatcctgt ctttatcata cgaaccattt tgatctctg agaccatctc atttctacat 333900

ctaaattggt tcttctcat aacagggtag acaaaaagtc attaaccact atttataaat 333960

atccatggta ctctagcaca aaggcctttt gacagggagg gtactaatcc aagtatcca 334020

tggcactatt tcatcctaac tgatgaataa ttagaagtaa tgtatactga ctgttgaaaa 334080

ccagcatctg ttgtttgtt ttttttatg cactgagct gaatctaata acaacctga 334140

ctcatcaggg actcctaact gtataagttt gaagctttgc cacactgcag gaaactggaa 334200

ggacctctga agaaggatca gtttcaagta tctcccacc ttccttcat gcttctctt 334260

ctcccagggt aagctgcaga agataatcag tcttacctaa gtgttccag aaactagaac 334320

ctatctccca caaaggcaac tgtaaaacct agaaatatgt ctcacactc ctctgcctt 334380

tctgtgaaa gcagctgcac tgttctatgc tccactttgt ctcataatac atcgtaagag 334440

ccttggttga gagagttct attctctccc agggggaaga aatgttacac aaaaaagtca 334500

agaagaatct gaaccaacac gtcacttagt ttccctccag tctattacca ttgcactata 334560
 tcttttggcc atgaaaatta cttttcctgg ctttataggt cttcatttct gagaattcca 334620
 tgttacttga aactttgact aaataatcac tgtgtacctg acataatgaa aatctagttg 334680
 gggaagaaat gtgtgatgtg cttcctcatc cgttactagg gtcaaagctg acactcctat 334740
 gataaaagac agattaacaa gagaaaaggc aaatgaagca atttaatgaa gtatctggag 334800
 atatccactt accaaccagc atatgcatac atcccataat aaaaagccaa gggcaacccc 334860
 attagatttg catctcttcc tgaaaatgca tcttcaaagt gctgtgtatg acctgcaatt 334920

 aggatgcaag gatTTTTaga gctttgcaaa gaattttcta ttatttgttc caaccctgac 334980
 atggttggga ggtgagctgc cctgttctga ctctctgttc acagccaact ctattgatac 335040
 tgcaaccacg ctagggcagg agtctcaaat gcacacttgt tgtcacctag accattttaa 335100
 agttcttttg tagatgacga gcaggatgaa agtggcactt aaaatagtg atatactttc 335160
 cattgtttga gtgcctcta ttttaaccag gatagtagac taaagcttct cctattaatt 335220
 gaagttttaa gtttgtcaaa attcttagaa gataatgaat ggcatagtag ggatgaaaag 335280
 aaatctcaga gtctgccttg actgaggagg catcaagaaa tgcttgcctt gcctcccaca 335340

 tcacatcact taacaccctg ctgtttatcc ctggagtaca ttggacacct gcctcctaaa 335400
 gcagggaagg ctgcagacaa aactcactgt caaaacccaa aaggcttgtt catataaagg 335460
 ttcatatcaa ggttcccatg cccactcttt gtagaggtaa cttattgaca ctgtattggc 335520
 ccatcccacc attttcttct aaaaatatga ataagaaatt gtaccaaacc tcaaaccaag 335580
 ttttaccac gttggcatca acatgcagac tgaacacttt tgtccatcac acccctccc 335640
 cctctatgtt gtggagagcg ggtatctttt cctttgaatc ttttgggtag attacaaaac 335700
 cagatttgtg ttagtaagca cagattcaaa actaaccaaa aaattatctg tgtcatccac 335760

 cacccecaag gaaaacagca aatgagatta ctcaaatagg aaaggaacat gttttaaaac 335820
 tgacctttag ttcaataaaa gggggccaag aagagaaaag gaagaggatg tataataaac 335880
 actctctttt aagtcaata tcagctattg cccacatcat gagaccaagt attcatagt 335940
 atagaatatg aggatgggag ccaagatgga catggttgtg ttacataaag aacaatattt 336000
 ttttctcaaa gcaatcaact tctaataata gttttatgaa aacttgacaa ggtgaatcaa 336060
 aaatgccat tttcctgaaa catttctatg ccttaataga aggaaattat gcacactgag 336120
 atctgttggg acttgagagg atgctctgca cctaaaaaca gaggatctga gttcagctcc 336180

 cagcatccat acaaaccatg tgttgetcca gcttcagggt atctgatgcc ctcttcttgc 336240
 ctttgaage acctgtgett atgtgcacat catcatttgc aggcatacaa atgtgtgtgc 336300
 gcgcacacac acacacacac acacacacac acacacacac aaacatgtac acacacaaac 336360

acacatctaa aaataaaaata ttgtttaaaa gaaaaaaaaac acctatcgag tgttcttcta 336420
 tgatctgtgg tctccttagc ctaaaaagaa aatatccttt agagtgtagc aattagtaat 336480
 taataagaga aaatatctaa actgtaaaga ctgggctaca gttcttcaaa tgagccactt 336540
 tgagagtgtt gcaaagaggc acattgtttc tgaacttcag gaacattttg gatgcataac 336600

 agaggcctta ggaagatgaa agtaacattc aaagggaagt tccaagcctc ataagtaaat 336660
 gcacaatatac cagctacaat taggatctga ttagagtaga attaacaca tcacacttat 336720
 tggatgaagtc ttttcttcc tggggctca gagaaatgtg gaaaaattaa atggttgat 336780
 tacaattta aaatctcaat ttataaaaat ttcataagtaa taaagaaaat atgactggtc 336840
 tccaaagtac taaaaaatgc tccaaatgca gtaatatcct cagggaattt ctctgttgtg 336900
 tgagaagcaa gaattgggtt ggggttatgt tctggatacc ataagcaata attaaaatag 336960
 cactgtattg taactgacaa gaaagattca ggagtctcac catggtctct gttctcaagt 337020

 aatttgtgat gcaatagcaa ctgctaacca tgctcatta catgctaacc atacatagat 337080
 gaggggtcag aaccagctac agactataac tacatatcat agccggcatt ataccaacag 337140
 gaaaagccag aaaacagcca agtctagaag ggttagggat tcacccttcc gttacttcc 337200
 agaatctcaa aggctctcta cagaagacta gaaagtgcgc tcaggagatg aaagctctga 337260
 gagtgtgaac aattttgcct ctttcagag tggaaatgtga gcaggccagc tctgtggata 337320
 ccatggtgaa ttgggacagc aagcccacat ctctcatac accagctcta ctgttcaaat 337380
 ggcacattgt gttattcag agactgaagt tttgggattt ggtgaaagca ttttactggc 337440

 aggactctaa gattgcccac taggetgatt aaatggacaa gaacagttcc ctcteccaga 337500
 tagagtaacc aagtctcag tgtttgggtc ctctaccaat ggcaagggtt ttctgaact 337560
 tcgtcacttc ctgtgtatt ggaattctcc tctgtggag tcattaaatt tctctataaa 337620
 ttcttttct tggaaactgac gatgtcaatg taacaatat atatttacca tgcccacatg 337680
 atatatcagt ttttaattga tttgctctaa tcatttctcg ttatttctg ttgcaaattc 337740
 agtaaaccct tggactctct gtctcttcca gccatttcca ccaaatctaa gccaacacac 337800
 attaccagge caaccctaac tctgtggtag catccctcac attcttatct tattaatag 337860

 gaagctccat gactgataaa tccagaagct tccccattca gaaatacaaa ttttacagag 337920
 aaaaatagtg taacaattag agctaagttt tttcaactct tttattgtca cataaggatc 337980
 ctgttttttg gaatgttatt cttaaacccc actgctcttc tgtggggtaa ttgtctcaga 338040
 ataaggaaat gcaaatgaga aaataaagac ttgttagtca ttttcatta ttttcaagaa 338100
 ctattttate atatttgttg ctattattga aaagttctgc agtgcaaaca aaggatatat 338160
 tgatctgtac ttaaagctat atagcaaat cattgtgtgt gtgtgtgtgt gtgtgtgtgt 338220

gtgtgtgtgt gtgtgtgtgt gtgtgtgttt gtgtgtgtgt ggagtgggta ggtgtttttt 338280

tctttttcac tttgggtttt gactcctagt aattttaatt tataacaaaa gaattcttag 338340

ataccttatt tttgttgctt ggtctcctct taattctctt gctgccattc gactataaat 338400

actaacttac cctcagtga gccittcaaa tcaattagat gacagtacag agtttaagtt 338460

ccacaagcaa agactaatta aggattctgc tagacaagcg aaagtcagtg ttagaagaga 338520

ccagaagcag atacgcagtt taaagcgcat ttacttttca gtccatacct ttaattagct 338580

gtataactcc agggactata attatcagga ttgctgtgag cttgcagaag gttaggaaaa 338640

tctggatccg ggcactccag ctgacactca tgctattcag gaccatcacc acagctgtaa 338700

acaaacagac aaagttacaa aaggcaaacc cccatgagca caatgatgtc ttaggtcctt 338760

gtcagtcgaa atgigtacta taatcctgca gtgctggcat gaactaccag gaccaaagca 338820

gtgcagaate ccaggtcttt cccagatct agtctctccc ccattaagac tgctctttga 338880

tataattca agcctgaaaa gcttacataa agctcctgca cagtcagaga gcctgttttg 338940

ttctttgcac attggaaga aatgaacata cattgctgtg caataacaat aaagtaaaat 339000

atcttcactc tgaagtcac taatgggtca tgatagtgtt ggattaatcc tgaagtcac 339060

tagtggatca tgatggtgct gcatttgact caggaaaggg taagaagtgc tgattctgag 339120

gtcttgttct tctccatcag gaccagcct actcagtgt cttcttgac ttctccctg 339180

ctttccaaat agatgatgaa gggtaggttt taactacat gcaagtgtca gcttccaatg 339240

tgtgtttggc tatttgatca aataaaaatc ttggactttt caactcagta tgcatagtgg 339300

gtctgaagcc aggagacttc cctcttctta ctgatactgt tgacagtttc ccaagcagcc 339360

acatcaagga cagaacaatg gctgttcatt tgggcattgc agttatcacc tctattcctg 339420

gctagggaga taactaacat atttctgttg tgtgagtaaa tgaatgggtg aagtaggttc 339480

ttaaaaatgc taaggaacag ttttaatggt gataatgtag gctttcattt tcttatatgg 339540

ttattctaca cagtgaattt caactttata ttcttgacaa aaacatagcc acagtgtagc 339600

taaaagcagg tagcagctat tacacaccta tggttttcat caataatctt tctttttgta 339660

aagatgtgtt ctccctaagc aaagatttta aaaatgtatc tcagaaaatt aaaaaaaaaa 339720

accactagca aaattcttac cattcaaatt ggaattgtgc aatcaggagt tgcaccatg 339780

tttccttgt ataataaat cactacttca gttccctaat taggaattgc tgaagtataa 339840

tcaatataca ataactaatg ggaaaaatta aaacaatcta tatccaaaca gagcctaact 339900

aatgtacagt cttttaatgg ttttggacag ccatctaaaa tcaatatata atcaataatg 339960

tattacatga aaaggtgttt atggcatgct actgaccac acagtaggtt aaacagtcac 340020
 taatgtgtgc atgaggagat gataaactca gagatagagg aaaacaggat gcctgaagaa 340080
 atatttataa aataatatcc agtatctaaa aagacagAAC atcaaaatTT ttcaaatttg 340140
 aaatttaggt tacagcaaca ttccaccaca ttttgtggaa gattagaatt ttaatgacag 340200
 cagtcagtga atgaaccatg cacataaatg tgcttacaac ccaactaaa gaggtattgg 340260
 ggtgaggTga cagcaacagg agcaaaacttt cactaggaAA cagttcacat ggcataggca 340320
 gattgtcacc acattacaca tactaaaata atgcaatTTT attggcaaaa tatatctcag 340380

taaacgtaga cattttaata agtaataaaa gcagcaggta aagtcttgct gagaaaaga 340440
 caaagatgag ggatcagaag agtccactaa aagcgtaatg gagcagtaac gaagtatgtc 340500
 acagaataa tgatacaaat ggtcagaaag gcccgagggg gggggacaca tcataattca 340560
 gctatctttg aagctgacta catgaggaaa taacacagtc ttctgtcagt gctcaaagac 340620
 attgtttcat caggaattat gaaaaataaa gtaattttct gtctccaata catagagaag 340680
 ttacgtatca gaaataatca gacacaacc tgcttctctc cattttatca aatgaatag 340740
 catttctcta tgcaaatTcc tatataatta atggatcacc acatgatgat gataatTTTT 340800

ttaactaaag aggcccaact ttgacaggaa agtggagaaa aaaaaaaaa aaaaaaaaa 340860
 aattggcctt gtgtcatcag cagcaaggga gcaactgtgt tgcctatct caggtggtac 340920
 aaagtagaag agaggccctg ggagaaagag ggaataaag agacagacac actgggaaag 340980
 aagaaatagt ctctttgaa gaacacctga ccaactgcata tttgagaaga gagagtccgc 341040
 tgcttctaa atgctcgatg cccctggaa catggaaac aatgaggatc ggaatattat 341100
 tcctttttgt aaacttttct gagacaatg gaagacacaa atcaatcaaa caaacatcag 341160
 gaattgatcc ttcaccttg ctttcttct cttagctgag gaagaatgct tagtgagact 341220

gcattccctc tcaaactctt ctccaaagtc agctttatct gagcatctaa tatccctca 341280
 ttggtagaag ctacaccaca ttccagggtg gcctcagtga ccctggaata cagtctagtg 341340
 actaacgagg ctgcctatgg ggcagccaga agatgttctc aggcctgctaa agctgctgct 341400
 tcatcctgtg tctacacaga aggatttaag gctgcaaaagt gtgctactta cccaacagta 341460
 ttgaatagcg atttgggatt cagtaaacac aggcgtgttc tgagtttctg acataaacc 341520
 tagctgtctt ttaaatgtgt accatctacg catacaaaag agtctgagcc agcactctgg 341580
 tatgaggttt aaccctttg agtaacagtt aatttcacac atgaggaaac tggggggggg 341640

cttcaacttt ttagcaaaat gaaaattcag caacacatgg acttttattt acttatttat 341700
 tgcaatttcc tagaaaccaa tatgtagcag gaaaagctat atccataaat cctacagata 341760
 agaaacccat ttttgaagg agttgtattt aaaaggatg tttagggaAA tctttaggac 341820

tgatgctatc taigattcaa ggactagcaa gtatttcttt ctgcacactc catcatttac 341880
 ctctgtcttt cattttgaaa aaaagttaca gattattgga ttgtctctca gagtcatatt 341940
 ccttcaggct tctgccttta gagcactttg tgctaaaccc gtaaaacata cagatgctat 342000
 atatgaatgc tatatgatga gataaagtgg gtgcctccac tgtttcctgc agcagctgct 342060

 gagtttcttt atctcttagc atccatttcc gagatgcact gatctcagaa agtaccttta 342120
 gaaggcagat ggccaactct gtatctatga tctcactggt gggaataaac agagccagga 342180
 ccgcaaaaat gtaaacattt atcttataatc agacatagtg cagagacttc catggataac 342240
 acttgtaaat ctgcacattt ctatgacatg gctgctatta tcagtcagtg atttcatata 342300
 agcgggtaaa aciccaggct ctgtttaatt tgctgggtgt catatacagg cagtgcgtgg 342360
 taagataaga ttagaaggta ggaaggcaaa ctctgagct caagccttca ccaccagctc 342420
 acaggtgcag caacgaggaa atagctcaaa agaaatgtgt gaactcactg atacaaccag 342480

 tttttgaca aacttgtgac atctcttttt cttagtctc tgggaggggt cgtgtctgtc 342540
 ttaggatctc agggcacttg aattccacat tttatgtatc atccttctga aggatatggc 342600
 tgctgttctt tggatatagt atatcttctg gcacataact acggaagagt caactttatt 342660
 gtgctgtagt ttagctactg gagaaaagga gtaaggatac ctaggcttca gatttaaaga 342720
 gatccacaaa cacacactgt gattgaaatg ccaacacagg ctactcatat attttcaata 342780
 taagtgaag gtgccagaaa cacagaaatg acagtactgt atttgtagca ctggctgggt 342840
 tgatttgtc tttctctgta tgtacatgtt ttctgtgtt tgcgtgagtg tgggcaggtg 342900

 tgcatgtgtg tatacacatt aagaggccag ggacagatga tgaccatctt tctcagttgc 342960
 tgtcctcttt atttctgagt gggatttctc attgaacca aagatcactg atttatccct 343020
 ggaggtcgtc cagttcctaa ttcttcagtc ctagaattac aggcctggggc tgaactcag 343080
 gtcttcatgc ccgtcagca gactctttac ctactggatc atcttctcag ctgctagcta 343140
 tgcttcacaa tcatgtagaa atactgtttt ctttgcgtc cccagttact tccacaaggt 343200
 tcaagtgtac aacatggctc tctctatata aaagtaaacc atcaaaggtt ctgagactga 343260
 gagagatgtg ttaggggtga tgtgagtaca acccacaaca taaggagaaa gcactgttat 343320

 gataatattc cacctgagaa catgcttctt tagggtgcag ctttaaggac cagagccatc 343380
 ggcttgatat tttgtatact gaacacatat cctagtctt tgaactgta agagaagtgg 343440
 aacttgtgat ctttcataag tgatcatgic agaattgaac ttagggacat aagctgaagt 343500
 gaacttaaaa gattttccat tacacttcac tgtgcctaac atttttgcta aatggacag 343560
 gattttggat aaacacaagt gtctcatctt tattatttgc cagaagtggg gtactttgaa 343620
 aactgtgggt atattagat ttaataaatc cctcccctgc tctgctatta tttttcaaat 343680

ggttggttaa tatttcacaa aagttgaaat gcttttgaag tttgacctt ttctctactt 343740

 aactagagat ttagattcct catttctctc taggaacttg ggagtaatt catgcaatta 343800
 aactgcactt tctacatttc cacaaccttc ccctgtaac aggcagaaca tcacctatat 343860
 tcactttgaa aaataatttg agagatttgc ccccaggtaa attactcttt atctttgtct 343920
 tcacctctgt tgttccatta aagctaaatt ccttttaaag gcactttgac ttttccaatt 343980
 aagcctttga cttaaattac gtcccactga ttcattgagca tattctagtt ttctttcagt 344040
 acctccgagg ttaggaactt ggttctctgat cagcatctgt agtttatgtc agaatttaca 344100
 aactaatact gtagctacta tcaaaaataa gatgaaatat cgaggttcca tcaatccttc 344160

 aggctctaac cattcctcca ccaaactcaa ctacaaatct gtgagccac acacagccgc 344220
 ccgatccttt ctgaaattg ttttaaattt ggggggagat ctgaaatttt gaattctcta 344280
 aaatataaat gtctgcattt aaaaagttaa aaattgggat taataagagt cattcaagcc 344340
 gggcagtggt ggcacatgcc tttaatgcca gcactcagga gacagaaaca ggcgatcac 344400
 tgtgagttcg agactagcct ggtctacaag agctagtcc aggacagcct ccaaagccac 344460
 agggaaacce tgtttcgaaa aaccaaaaaa aaaaaaaaaa gtttgggtt ctggcaagat 344520
 ggctccagtg gaaataaaaa tacaacatc atcatttatt taatttcata gtcaaagcaa 344580

 gctgtgaatt ttaactatc tatacataag gatttgcttt aagatcttgg ctatgcttt 344640
 ttagttaata acatgtgatt ttgtctcatt cagggaaaaa ggatgacg gatgtaaaaa 344700
 tgtctgctag tctaacctt cagtgaaca tcagagcat caagaacttt ccatgctaga 344760
 ggaactcttc aaagtctta atatcttaca ttctatagc cattcaacac acattgttat 344820
 atcaaaggca tttatcaac caacaacag aagcataaat aagtttaac caagatcaaa 344880
 taacaagaaa ccaggacact ttgtccaac tccagcttgt tggctcttag taattataac 344940
 cattgtataa gatgattcac ctcaaaaag ctcatggtgc cagaacatct tgctagcaga 345000

 cggttgctct ccactaatct cttgcttcc tgagaactga agcttctaa aacttaagtt 345060
 taacaggtta caaactacaa gtatttctgc taggttttaa aagaaaactt ccttagactt 345120
 tttctcataa agicaatcag taacagacag ctctgagca tgaacaagca acctaagagc 345180
 tgctgggtgt ctgggatga agccttgtgc aggccccctg gtcccagagg aattccagtg 345240
 gcatttctcc acagaagfat aaatattcat cacttgcct gcattcgtaa taagttgcac 345300
 gcatcatcac aaatactcta cacacattga gtctcatag cccccacaac actggcataa 345360
 ttatctcatg acaatactga ggtgcagtga tgtaagtca attgctccta ggtttcctgt 345420

ctgtagtgtc tataaatgaa gaacttcata ggcagctaca tcttaattcc cagaactcca 345480
 aaatgtctac ttttgagta ttttctttgt ctttcagag acgtcacaaa acaactgtgt 345540
 gtttaggatt aagctgttta gttaagaaat ccatgtatgt cgtaccagag atggttttac 345600
 atagaatcac tcacactctg tcacagaaaa gtccttaggg catctgctgt caaaagtgca 345660
 ttgagtttta tgttattcta ttaagccact gtggagcaac cctctaagca gtcttctg 345720
 agtatacaat tcagttatc ctgtgtacca ttctctgggt tgtttaactt agtcaactat 345780
 ctatgatcgt aaggattcag caaaacatga tttaaatagc aattattatc catttccatg 345840

 atattctaga atgttataca aaatgaccac cggatttggc ttgtttaga atattat 345900
 aaggtgtgtt acatttgctt atgtgtggaa catttgttt gatgatacaa agatgtgtt 345960
 tattcttttg tgctgcattt gtttaactat gtgaagctgt gattctttgc ctgtcaaaaa 346020
 cacctaacgg tctaataaag agccgaacgg ccaatagcaa ggcaggagaa aggataagca 346080
 gggctggcag gcagagaaaa taaataggag gagatggaga aaaaaatgga ggaaggaaca 346140
 agagaacaag ggaggagaat ggcaggggcc agaccccagc caggcccca gccagtctc 346200
 tagccagcca cagagtaaga gtgaaagtaa gataaacaga agtgtcagt agctcccact 346260

 tgctcaggtc agctgtctct gtgggtttcc ccatcatgat cttgaccctt tgctcatata 346320
 atccctttc cctctcatca gctggactct aggaggttgg cccagtgtt agctgtggat 346380
 ctctgcatct acttccatca gtttctagac gaaggtgcta tgatgacagt tagtgtgtc 346440
 atcagtttga tcacaagaga aggtcagttc aggcaccctc tcaactattg ctaggagtct 346500
 tagctgggggt cctccttggt gattcctggg agtttctcta gcaacagAAC tctcctaac 346560
 tccataatgg ctccctctat ggggatttct atttcttgc tcttctatc tctcctcaa 346620
 ctcaaccatc tcattcctc atgttttcac acccctccc atttactca gaagatctta 346680

 tctatttccc ctcccaggg gcatecctgc atgtctctct taggtcctg gggaatctgt 346740
 ataggactga actaggcctt ctgaatatgg atgacagttc tgtgacttgg gctgtctgtg 346800
 gagccactgg tggtaggacc aggtattatc cctaaagtat gaactgactt ttggagcca 346860
 ttccctaggg agggatacct tgcacagcct ccatgcagga gggaggggct tgatcctgtc 346920
 taaacttgat atgccatact ttgttgactt cccatgggag gcctcacct tactaaggag 346980
 tgagtggggg gttgattgag gggaaaggtt gcatgggcag gaggagggga gggaggggaa 347040
 ctgtggttgg tatgaaaaat gaaaaaaaaaaa aaaacaaatg taaaagaaaa aaagatacac 347100

 agaagtaaga aaaggaaaaa ggctggtgtt agactgggat agtttaagtt aagaaaagtt 347160
 gcctagaaac aagccaaggt aaggtttgta tgatttatgt agaaactggg tgttgggccc 347220
 cccaaagaga aaagagtaaa aaacaacaa caattgctta tggaatcttg tatatgttcc 347280

tcttttcatt ttatctgttt cttcaatttc caaatgtcta tgccaattaa taaaaaata 347340
 aacaacttcc taatttatag cccataaaca aatattccag ctgagaaaagg ctactggta 347400
 tcaaactttg agagaaaatt cttatcatga ccaaaaatag gcagagaaaa atgataacag 347460
 tgagggtgac agtcaatata actataaaca atacaaacac aatatgcaca cccaacatat 347520

 aaacatagcc caaggactac tggtagtaaa taatttcaca tactactggc atagggttat 347580
 ttctagttta aaaagcaatt cctcagaatt cgtcatctgt gagactgtct tttgatccac 347640
 catccattca atattttacc caggaaggag tctttgtcta ctttaaaagc tcaggcccca 347700
 cacttgtaga cctgtatag agttagcaca cactgtaata gaagaggcca cttcaaatct 347760
 tctgttcttg cctctagttt cccacacaga tttgaaacca taagcacaga gaagacaatt 347820
 tgggaaatac tatgtcccc ccccaaaaa atgctaaaga aaatttgctt ctaatcacat 347880
 tgttacatta catttctctt ttctgttata gctacaatac tcaactgatgc ccacagctgt 347940

 tacgagcttg attgcaagtt caggaatttc acattgaata aaaaatggtt ccagaatgta 348000
 tcgtccaaat gccagggata tcacagcggg agctccaggg ctaagaaata atgtattaag 348060
 gttacttca ggtaacacta agtaacagtt tcaactaaac tttttatctt taggtcttac 348120
 tacctgacag gtggaaccta actaacaagg aagtcttaga acttcatatt tcattaagtt 348180
 gccatacatt ccaaatgaaa tattgtctat ataagtaatg gctatTTTTT aaaaaaaat 348240
 ctctgtgaaa attagtacta ctaagagttc attgccaaaa tgtgtctaaa tatttaagt 348300
 tgactcttaa ttgctagta aaaagaaatc tctaagccac atgaatattc ttaatttctt 348360

 aagaatattt atataagag aaccactaaa taagaagaca aaaaatccca gcctgaggag 348420
 aagaaaacc agacaataag tcatccact ttagttcttc aaaggaaaa aagagtgttt 348480
 catttcatct tcaatatgag tgcatattgt tgccacacac aaggaaacc acagaattgc 348540
 ttaacatctc atgagtctct ttcagcttct ctctctctt gtggttacct aacaccagg 348600
 cctcatcctt ggattaccag aaaccaacca ccatcactg tctccagcct ggttctccta 348660
 ccttcagtea ccaccacaaa cattgtaact ttcttctctt cctaagaac ctttctctt 348720
 ttctccaaag aggatattct tgccattttc tatcatttgg tttgtaaaat gaagtctgg 348780

 cgtgtggttt cggtagcctt aaaccatgct ttgactctcc ggtccaagct tctcctaatt 348840
 cttttgcctt tctctcagga tcaagatctc aatcacttct gccagagct ttttcaata 348900
 gctgcttttg ctctgcat gaatggcaca ttagaggcaa catcaaatag ttacttttta 348960
 taccttgcac ctgggttcag tcttggcca gagaagtgc ttcaaccctt tgctgagtc 349020
 gtccaagtgt ttttctaca cagcaccaca tttgtccctt ccacactgct tatcacagea 349080
 gtttttttat tcttcttaag gtgattccca gattgaaact ctctacttcc acttgacttt 349140

gaagtctatg agaacaagac tgtgtctatc actaatcaga attttatccc agtgactgg 349200

ctagcacagt atctgtcata cagtagaaat tcaatagtta ttgaacatat tatgaatgag 349260

tgaacttaac tttgaagccc ccatcatggt ctgttgggtg actgtgtttg aattcatttt 349320

gaaggttatt tctggcaata cagacttatt ttgaaagtac accttaacc ttagagactg 349380

catctattac tatttagatg tcatgagtag tactaataga aaagaacat ttatgtactt 349440

aggggatcat gtcctttttc atgtcatatg ttattttgtg tgtttgaaag actactcaa 349500

cagtgtgagt ccagtatgac aaaaaggaat acaaatgtat ttacaagttt ctggaattta 349560

tttaggtaat ttggctacac acatacactc acacacacac acacacacac acacacacac 349620

acactaaaat agttcttctt aaattaaggc aacatctgat tatcagctgt ttaggagcag 349680

gaattgtggt tcattccaat ttagatctct ttatcttgca tttgccattt gcaacaattt 349740

gtggaagaa taagttaatg aatgggcacc atatctgtcc actgcaaag gaatgatcac 349800

actcatagaa aacttggtaa ttagataaag ttacacaacc aatgaatgga tgaagatgga 349860

gtgaagtcga aagacatcag tctgggtagc tcaacagcct gacaggccag cattcaaagt 349920

gttctattt caatgctgag tttgttacct tcaaaataag aattcatatc caggatatac 349980

aggtgctga tctaaatagt atgaaagtta taaaaggtg ttaagacttg ttttcatata 350040

cttgaatgg gaaaaataca acacaggtag ctaaagtatt aaataaaga catggttaata 350100

agttcaatgt caaatgggat gtagaggcta cttttgtttt cccaaagaat taagacatga 350160

aagaaagctg ggcagtggtg gcacacacct ttaatcccag cactgggagg cagaggcagg 350220

tagatctctg taagtttgag gtgagcctgg tctacaaagc tacacagaga aagcctgtct 350280

tgaaaagcca gagagagaga gagagagaga gagagagaga gagagagaga nnnnnnnnnn 350340

nnnnnnnnnn nnnnnnnnnn nnnnnnnnnn nnnnnnnnnn nnnnnnnnnn nnnnnnnnnn 350400

nnnnnnnnnn nnnnnnnnnn nnnnnnnnnn nnnnnnnnnn nnnnnnnnnn nnnnnnnnnn 350460

nnnnnnnnnn nnnnnnnnnn nnnnnnnnnn nnnnnnnnnn nnnnnnnnnn nnnnnnnnnn 350520

nnnnnnnnnn nnnnnnnnnn nnnnnnnnnn nnnnnnnnnn nnnnnnnnnn nnnnnnnnnn 350580

nnnnnnnnnn nnnnnnnnnn nnnnnnnnnn nnnnnnnnnn nnnnnnnnnn nnnnnnnnnn 350640

nnnnnnnnnn nnnnnnnnnn nnnnnnnnnn nnnnnnnnnn nnnnnnnnnn nnnnnnnnnn 350700

nnnnnnnnnn nnnnnnnnnn nnnnnnnnnn nnnnnnnnnn nnnnnnnnnn nnnnnnnnnn 350760

nnnnnnnnnn nnnnnnnnnn nnnnnnnnnn nnnnnnnnnn nnnnnnnnnn nnnnnnnnnn 350820

nnnnnnnnnn nnnnnnnnnn nnnnnnnnnn nnnnnnnnnn nnnnnnnnnn nnnnnnnnnn 350880

nnnnnnnnnn nnnnnnnnnn nnnnnnnnnn nnnnnnnnnn nnnnnnnnnn nnnnnnnnnn 350940
 nnnnnnnnnn nnnnnnnnnn nnnnnnnnnn nnnnnnnnnn nnnnnnnnnn nnnnnnnnnn 351000
 nnnnnnnnnn nnnnnnnnnn nnnnnnnnnn nnnnnnnnnn nnnnnnnnnn nnnnnnnnnn 351060
 nnnnnnnnnn nnnnnnnnnn nnnnnnnnnn nnnnnnnnnn nnnnnnnnnn nnnnnnnnnn 351120
 nnnnnnnnnn nnnnnnnnnn nnnnnnnnnn nnnnnnnnnn nnnnnnnnnn nnnnnnnnnn 351180
 nnnnnnnnnn nnnnnnnnnn nnnnnnnnnn nnnnnnnnnn nnnnnnnnnn nnnnnnnnnn 351240
 nnnnnnnnnn nnnnnnnnnn nnnnnnnnnn nnnnnnnnnn nnnnnnnnnn nnnnnnnnnn 351300

 nnnnnnnnnn nnnnnnnnnn nnnnnnnnnn nnnnnnnnnn nnnnnnnnnn nnnnnnnnnn 351360
 nnnnnnnnnn nnnnnnnnnn nnnnnnnnnn nnnnnnnnnn nnnnnnnnnn nnnnnnnnnn 351420
 nnnnnnnnnn nnnnnnnnnn nnnnnnnnnn nnnnnnnnnn nnnnnnnnnn nnnnnnnnnn 351480
 nnnnnnnnnn nnnnnnnnnn nnnnnnnnnn nnnnnnnnnn nnnnnnnnnn nnnnnnnnnn 351540
 nnnnnnnnnn nnnnnnnnnn nnnnnnnnnn nnnnnnnnnn nnnnnnnnnn nnnnnnnnnn 351600
 nnnnnnnnnn nnnnnnnnnn nnnnnnnnnn nnnnnnnnnn nnnnnnnnnn nnnnnnnnnn 351660
 nnnnnnnnnn nnnnnnnnnn nnnnnnnnnn nnnnnnnnnn nnnnnnnnnn nnnnnnnnnn 351720

 nnnnnnnnnn nnnnnnnnnn nnaaatggcc ttccttcttc atgacaacag tcatttcata 351780
 actgagattt accaagtcc tcttttaact tccttacct tgagacctgc ctaataagaa 351840
 agaaaaaatg aagaagaaa ggaagaaaga aagaagaaa gaaagaaaga aagaaggaa 351900
 ggaaggaagg aaggaaggaa gaagaagaa agaagaaaa atacaagcca aggactggaa 351960
 agatgactca gcagttaaga gcactggctg ctctccagaa gacccaaact cgattctcag 352020
 ctccatgtg gtgactcaca accatctgta tctctggttc caggtgatcc agtgcctcc 352080
 tctggcctcc tcgagcacca ggcattgca ttgtgcatag acatgcgcac acaggaaaag 352140

 taccatata cataagaacc aaataaaatg aaatgaaaat aaatgtaagg aaagaaattt 352200
 tgtttggaat ggtatctaca aacatacttg agaatctgtg gtcagaaacc agagggcaga 352260
 ggaaaaagac aaggcagcag atatcaaagg tctgacctg gcctttgaat aacaatacca 352320
 tttcatgcta agacaagtta tacgetcaaa cttacctcac tteggcattt tagtacattt 352380
 taataaatat tgtttctgtg gcatatcaaa atatgggta tctgtcttgg ggaagaatgg 352440
 attacacatc ttgtgagacg ttagttaact ggtagaatat gttttgtcag caaatgaat 352500
 cgcgattcag ttgttctgtg gctagaaatt gttattatgg atgttttcaa aatgtacatt 352560

 aaggaagttg aaagaagagc tgttttacia tgagattcca tgtgtaccgt catgtatgta 352620
 atgtaaaatc agttataaac taagttgtgt ttagaagtaa tattaagatg ggattgggga 352680
 agctatttaa actcccaaaa tggactttt caccatctt gaagtgaag aatgaactt 352740

tcatctcgta aaagacttgc atataaaag gtataaaga gtaggactga ttctgacact 352800
 gtaaacacca catgacatga atatactcac ctactagtgc atagttaatc atgatggaca 352860
 taaaaaata catttttacc aaaaaagcc tctgacattg ctcagtgtcc aaagtaaca 352920
 aagtttctgt ccaaacacca cctgaggagg ctccaagtgt ggaatgtaat tactgatcag 352980

 taatgtctcc tgaagtctga gtacacttct ctgattccca aatccaggat tatctcagag 353040
 tcacttggag aatatttttt taagagtga caaaggagga aagactctgg gaacacaccc 353100
 tctactctgt cagagtccag acttcacccc aaagaacaat ccaagcagct ctgatgctat 353160
 ttaatgttaa acgagcttgc aggtagctag ctgcaaaaga agtttggagt atttcattaa 353220
 tgtagaacta aaggtaacta gttatagtga acttcttttg aaaaagtaat caccatgttg 353280
 gtaggttacc cagaaaagca acaatatgac ctagttatta aaaagagtct taagtaactt 353340
 gcaatttact gtccgggaat caatacccag ccagaccctt gtacactttg ccccaggttt 353400

 aaattgagtt ctgagagaat ggaattttca tttaaaggtc tcaagctcca taactatgta 353460
 cccagatgaa aagaagtcca aagctggcta taaaagtcca tatgttgacc ttagaattca 353520
 aaaagttaca aatcaaatc aggtgtctct ctccctacag actgtgactt tgctctcttc 353580
 ccccccccc aaaaaaaaa cattcaaac actagtcagt gagaatttca ctgaccatac 353640
 atagcctagg gactgtctct cacatttggc ttgagttaga caaaagcacc ctacaaaaag 353700
 ttcattttac aagtgttaa atagtcaag taatttactg aatacaaat tcttatcacc 353760
 cagcactgga aggttaaac atcatgtgcc aaaccactt aaattgggga ctctgttgg 353820

 ccacattctt gacttacatt ccctgagttc tagagcttca agtaacagaa gaatcttctc 353880
 cttgtatctt gcttgcttcc tatttgtgaa gactctgtgt ccagaaagt cccagtaatt 353940
 taggtggaaa tattatgagg gcacatgtct gaagttaaca gctcaagcat ccaactgtggc 354000
 tcacatcaca cccctcagt tgctctctgt aatttctga gtttccacca aagatggcag 354060
 acttacatac aaacatattt cctccataca agccagtgtg tctttaacta gctcaaccaa 354120
 gtaatttatt ttagagcacc tgaataacca ttgattgtgt gtgaaatca aatcataccg 354180
 tgggagctgc ctgtatttaa gtatttgaag tccaagaaac tgggtgtagt ttttctgatt 354240

 agatattgat ttattctaaa tatatcaagt attgtaagac atttaaac tgggagtacg 354300
 ctgtcactta agatcaaca ttgagcttct ctttgcctat cagtacctgc atatgccaga 354360
 accactttaa tattaacaat ggtaagatt ctactggaac tttcaataac tgcattactc 354420
 caaacaatga agagaactgg aaaggggtaa cacacagctg tcaccaaaca tttcataaag 354480
 cataatctag tcacataaat gatgtcacca agttttccag attcaagtaa tttctccatg 354540
 gatctttcta taataagtgt gctttcaaaa ttacttgaat tgtctccatc ctaaaaacag 354600

atatttaagt tcictgggta ggtaactcct cccaaatagt gatttcaa atcacaagac 354660

ttaaacagaa agaatgagtg gagcaagagt tagagcactt ggaccagag tagcttggtc 354720
tcaggtaaat gaagtaactt taaagtgtgg tctactttgg gatcaaagga taaatccaat 354780
ttaaaaaaa atggatcatt caccagtttt tgcactcttt acaatggaca tgaagagttt 354840
tatattgatt tgcctcctg atcaaggatc aattatttcc tcttcagtat taatcctcaa 354900
accaatcaga gaaacataaa ttctgaagag aaaaaataat aaccatagta aataccagtt 354960
ctggtcagag gaacttcagt gaaaaatgat ctgtttcccc agagaccagc taaatcacag 355020
atgatgaaaa cagatccagg catggagaga agactgacac ccaagtgaag cctggaaact 355080

catactgaga aacgttctca aagggtttac aaaacagaat aataagggga gaaagtcaa 355140
gtcattgcct ttgtgccact cacagagccc gagtcacatc aaacttctgt ctctccaagg 355200
acttatgaaa gcatactatt aggaacagag aagcctatga attaaaaata ttaaaaaagg 355260
cagagagtgc caccatttg ttaagctaat aaaatgtcag cgatactgct ctgaacatcc 355320
ggttctgcat gtaaataggc catgcaggct gcacctcaca ggtgtttcat ccagcgcgcc 355380
agctgccagc atgctctagg catgcctcgc aaaacccaaa cctcagcag agaaggttg 355440
tctggctttt gggggtcatc aaagttagtt ttgtctcttc tcacaccaga gaaaagtcag 355500

agaagagtcc ccggcaggaa aggagagtat agcctcaagg aaagactctg agagcattcg 355560
gtctgatgcc aacagtggac cgtgtgtttg ggtgtgtcac atacctgaac aacagcaaca 355620
aaacttcaaa acatttctgt tagtatttgt cattcatcta ctctcagaa ataacccttt 355680
gctttcccag agagccacac agccacacc cagagaaga agtgactca ccaaaaagtg 355740
acagtactcc acaggcagac cagaacacca gggacatgcc cacgtgcct gtgttctgga 355800
gtatgccctt gggggagatg aagatgccg atccgatgac ggtgccgatg atgatggaga 355860
ccccctcag caaagtgatc ttctttttca gaaccacttt ctctgcca ggtgcctctt 355920

ggtccccc at ggagggcagc ctcccgtca cattgcctg caggtaacct cttttcgaga 355980
tggtggtcac aactggcttt ctgaccatgg tagtgtcca ccaagcgagg ggagtgaaaa 356040
agaaaacagg gaaaaaaca acaacaact ttcaactttg gtttctctag acgtgactga 356100
tcaactgtca gactcggctt tctctttgct ttcaactgact ggctctgac tattttgtcc 356160
acaggtgaaa actctgggtg gtgtcttagc cttagcagct atctaactac tctcttctgt 356220
cctccggagc acctgtgtgc caccggctcc aggcgcagtc agtttgcagc agccgcagct 356280
gtgcctctat cattacacac cagctcagct tctctgtggg ctctgtattt tgctaccgcc 356340

tgtcacacca acttactggg ctacaatgat gatgcaaatt ctccaggttt gcatcagcca 356400
 catgagaaag ctccaccttg ggaaagcgcc aacattactc agcttttttt ttttttttt 356460
 tttttttttt tttttttttt tttttacagt agtgggctgt ttgctcaact gacccaaagc 356520
 atttccctga acaaagcgtg caattaaaga ggggcttaac caatccaaaa gaagtaaaac 356580
 aggaacagat attgtcgtcg tgggtactgt aagcaactca gctctcagag agaaagaaaa 356640
 tggaaaatga aacaggaaac gattatttca ttttaaggag ttgcttctta actttaacat 356700
 gtgcataaaa tgttgtatgc acaactgttt tgagaataga aaagtgcctt agggctgcat 356760

 tgttttcaac agcaaagttt agactttata atttgtattc tacttacttc cccgggtggt 356820
 tcctagcaac actgtcaaat ctaatattta caaagctaga aagtttctgc aactagagc 356880
 cgaggctact gcacagctcc acatgaacgg gagtaattgt ttcttaagac ctgtaatatg 356940
 ctgtgtttaa gatgccatc tgcgtttgag aagtccaag atcccagtga ctggagaaaa 357000
 tagtctttt ctgattcttg tcagctcgga gtggtttctt gaactaagta gaggactcct 357060
 tcatttgcac gttgtccat caaataaaa agactctact tggaatctta ggcaatactt 357120
 ataatggcat gaaggtacac atagagcaaa agcttgagaa ggaattcaca atgtaatagt 357180

 tggagaaagg aaggggaatg tgggtcatat ttttggatct ataatctatt atgattataa 357240
 tttaaaatgt attaaaatca acaattcta agttttagtt agctcaaagc cataagtttt 357300
 cagtgtactg aacagaagta cagtgtccat ttcataaaag tcacaggatt ttttttttt 357360
 tgacattagg aaataatgaa attttgagga gatgaaggga tttaatctga ttttgtgctc 357420
 tacagtgtgc acatgtactg aaacctaaac ccctattata tacacagctt tcctttttgg 357480
 tctgtcagtt aaaaagaaat ttaaacatat aaaagtatat taagattgca aaccagggtt 357540
 aaaattttta cattaaaaag atcaaaagta aacacttaa cctgaaagt tctgcttcta 357600

 accaagtgtc ttataaaagc caaataaata ccaagagaaa aggaatctca actatatcat 357660
 ctttggctct gggtcctgt ggtttgaatt taatgagaag aatcccatgc catcattatc 357720
 ctgaagctac attcagacc atgatcaaat atgctttaga atctcagaat aaaaacaaac 357780
 agaaaatctc tigtggaagga aagttggctg caggggagtg agagaaaggg agaggggtgg 357840
 ggggtaaca gaggcaggaa ataacctggc tagaggggag gggagggagg agcaagagag 357900
 agaggttggg cgggtgacag aaacaggaaa taacattgg aaaggaatc tggaaagtgc 357960
 cagaaccctc tgttggctct tacctgagaa aatgtttatg acatgatggc cttatcacac 358020

 aaataactga ggccacatga tttccctttt acatgaccta cccaagtctt gtataatttg 358080
 ctttggatat cccaattggc atttttataa agccgacatt aataccttta ctcagctgaa 358140
 atactattat gtatttcaa acataataaa tgggaaatgg ttctcattaa atcttgtaca 358200

aatccctcag aaaggaaagg ctctctctccc ctctgctcca cttctctgt tcttgcctg 358260
atctccactc ccataactct cctgattaat gaacagaaac agggagggga gtctattgtc 358320
tcctcaaagg gaaacattaa ttctaagaa ataagagttt aaaataaagc acaaagcccc 358380
ggggcaactg tgttctgtcc ctgccaaggc accacacttt ggtgactaaa ttataaatga 358440

ttggactagt aaaactaggg tactattcag acaggatgtt ggaagtatit taaaggaaga 358500
aaaagtatit ttcaaaitit aaataacatt ctgctcetta gcaaititaa taggtatitca 358560
tggagaaaa atitctgaagt tatcctaata gccagaaga gggtactctc ccacatggga 358620
ctaagactga agtititctc aaaactgcac acagttata aaaacctcag tatatctctt 358680
tgaaccactc acaaititac aaaaaactac aggtitcaaa gaaagtggg aaitacitit 358740
aaitatcaga gttaacitit taatccaaga atitggitgg tittcaagta tgtgtacatc 358800
ataaaaaata atitcaaaga aataggtitit ttgtctitct cctgctititg gtgtaititct 358860

gagcaititit gagactgtc attaacactt acttaatgtt tactctgctc aaggatggcc 358920
ctagtcctta aaitctitct atgtaitatg gtactaaca ggttacta aagatgtcag 358980
ccccatgtgt aataaitatg ctgtaaaaac ctaggcatag ccaaacacat aaitaititit 359040
ccagtitgccg tgitattaga ttcaaitctga gctaccatit ttctaaaitag aaitagaait 359100
accaititctt atitgtitggc agtitgaitg acaaggacat caaitggcag acatgtctct 359160
ggctgtititg aaaaagcccc catggatata tittacgtcc cagtitacag gtactatgtc 359220
titcatgacca agaagaccag atitgtgctg gacctgaaga tctccaitg atcctaitag 359280

ctactggggt gcctaitag gaitgctaac tggtaictca caagaaitc agtcacacat 359340
ggatggtggg aaitgaaitg aaagctctc attaaait ctagaaitg gtitgccctt 359400
gitatagcca ttagcccaat gtitgtacca gtitctgaaa tgtgtitaa tctaatgctc 359460
tataaaaitga ctitcataag aaagaititit tatagtitgt gaaaititgg acagtctitca 359520
atataagata gaitgacat ataititgtt tgitaitgtt ggaacaaaa accaitctg 359580
aaititcaaa gactaaaaaa atgaitgtc tgagcagaga gaaaitctca aitaaitcac 359640
atacictaa cctaitgaca gaaitaait atititctc gtaacagaca aitaaitaait 359700

aitittagct taitgctcac tctitgtctc tatatgtgc tctcacata tgitatgatg 359760
taitgtitgca caggtitait aaitititaa aaagtaag ctcaaititit gctitctait 359820
agtititcagc atctaitgt taitaaitg aaacgataca aagcaitit aaitggctitg 359880
agtaagait titgtagaca aaitititc aaitaacacc atagccaitc aitaaitctait 359940
tittaagct tititaitgt ctcaacagct ggccaititg aaitagaitg agtggacccc 360000
aaaitggaaa tgggaitgt ctaitaaitgg aaaggaaait gttggaitct gggacagggt 360060

ggggaagtga aagagctaag ttataactgg ccgtgctaaa aggttgatat gtaatacaca 360120

 gaaatgaaaa ctataaatat agaagaatat ttttagaga tttggagata aacatcagga 360180
 ggggtaatat caaccagga agaaaaactt ttgtccctga ggaacaagaa ggagcactcc 360240
 tggggaatga taaaagcaa ggacatctgt tcatttctta atcctattag aataccatgt 360300
 tctaactgat tgacaacaaa taacacaaaa acagagtgtg ctggaaagta agacaaaata 360360
 acataaaact aaaaagtgtt catggtggtt tctaaggccc ttttatttgg agaaatgaga 360420
 ggtgaggtta tttatctgca ttaacaattg aagataaatc actaatgga aagaaaaagg 360480
 gagagaggag agaggacag aagatgccgc ggaaaggaag ggaaagagga gggcagggga 360540

 ggaggaaagg tgi aaggcgg aaggagcaat aaggaatgag aggaaaagaa tgacagaaaa 360600
 gggaggagg gaggaagga gggagggaca gaaagaagag cccaagaaat gagaggggga 360660
 gagaaggcag atgaaagaaa aagaaaaagc agtggaaagga ggaaaagggg gggagatggg 360720
 gaggaaga aaaagagaag gaggaggga gaaagaagaa aaaagtaac caaagaatt 360780
 catgactcct aagccataaa aaagaaaaaa taatactaaa aacctcaata attctaattt 360840
 ataactcagga atgttaataa aagaggttag aaaaaagcaa agcaagattt aaaattactc 360900
 aaaccagtag ccaaatatat aatcatata ctagtatagt taaatgagtt acattcacc 360960

 agtataagga ataaactaca tgttttttt tttccattat ccacctaggt tctagttaa 361020
 aaaaaaaaa aaccatgaag ttaacaagg taatctctgc aaaaattgtc agggaggaaa 361080
 agagtcagaa aaaaatcttt acgcattaag gaacaaacat gacagaatta caagtgttc 361140
 atgattaca ctacagcact cttacattg cctcacatt cattaaaaca atgagaaaa 361200
 cagttatgga ttgcagcaa gttctgtct gcaccacatc tcttctcacc cagccccacc 361260
 ctttctctt tattctctaa tttatggtct gctttgcccc tgccatagt tagatctct 361320
 ctgaggacca acttgactg ttggagccat tattcctatg gaagtagaat ttcaaatag 361380

 ctaggaaaac actagccaat gatttctga cctgaggttg ggaaatcta atactctga 361440
 atggagataa aatttaagac aaccttact atgtgagttc atcttgaga atctcactga 361500
 tgtaattaga ctttttttg tctctttta ccctctccat tctctctct gcctctctg 361560
 gttctccac tcctaactgg caatctgga agatttctt aagcaaatct tttttattt 361620
 gattctcat cttattgtct tttcatagag aactgttc aaggtagttg ctattgggat 361680
 tgttgaat gcactgcta aggttaaggg cacaggtta ctacattct ggtcacttgg 361740
 caatcatgcc cgactcaaa aggatgttg ccagctctg ataggctgtg gtgttactat 361800

ttcaaagact ttcacctaga aagaatgaga acagaattga cttacacagg atgtatgcct 361860
 gtgtgaagtc cctttatttg ggagtactaa aggcaatgcc tttaatatca gcagtaagac 361920
 aaatccacgg tcaatattgt ccttaaacat agtatatgtg ttcactgact agccatttaa 361980
 attaaacaat agaactaaag catgaaaatg taatgatgtg gagaaacatg gatgagcttt 362040
 gatgtaaaaa taaaattgaa tcaatgcaca tafacaatag acataaaaatc atggtatatac 362100
 aatttaaaaa tgaatcataa aaacatgggtg gtgtcctctt agaatatata gtgcagattt 362160
 atctaacca caaactctca gaaaaagtaa gtttgccatg ttttattcta aatccatata 362220

 acaaaaacaag taagatataa aacaggaatg atacacttag aaacacagtc aaaagtttct 362280
 agtctcttta agtcacacaa agtgttctca ttccattctg ctgittatggc aaataccatg 362340
 gcaaaaagta ggtgagggga aggaaacatc ttatttttaa atcttatttt gcttacaaga 362400
 tatagttaa cattgagaca agaaagtcaa ggcaggagct tgaagcagaa accatgggga 362460
 attgctgctt gctggcttgc ttatagcttc atgcttagac agttttctta tacagtcctg 362520
 tatcacccat ccagagagtg atgctgccca cagtgagatg gacatactct atcagttaag 362580
 aaccagact gtccctcaca aagggtgcat attctgacct aaaccagaca attcctcaaa 362640

 tgagttaacc ttctcagatg actctaggct gtgtcaagtt gacagttata atacagacac 362700
 aaggcaataa gtaaacgaca aacaacacaa tagaaaatta gcacttatac ctatgaaaac 362760
 atactcaacc ttattcatag gagagaaaca aaatggcaat gacacacgtc ctcagtcacc 362820
 catgaatgtg cccatagagc tgtcttcttg aaactgtgtc tattctgtca aacatgaaaa 362880
 agaaagtgac tgaatgaat tcttacatgt tatatgtttt taatgaggaa taaagtttac 362940
 ttaggtgatc gaggaaggag agaaggcaag ttcttccaag gacgcaagtt catattcttt 363000
 aactggatga gataaacat gtatggtggc tcaccacata cgccaaggac tctagcgact 363060

 gatacagaag gtcttcacca aattcaagat cggctgaggt tatatagtaa agttgttctg 363120
 ggtgacagaa tgagaaaaca acaaaaagag ggaaaggatt ggaaaattta tgacttttta 363180
 tattaatgca atcattgatt caggcaaaag taagtataa tgaacaacac aaaccactgg 363240
 ataaaacttt gctgaaaaag aatattcatc taattataaa tattgtgca gagattatec 363300
 atacattttc aaaagggaaa acttaacttt acaacagaga gatctactta ccctttcttg 363360
 ggtaaccaa gtaattgatt gacactgata gttgacataa aatattaat aaccaataa 363420
 catctatgta caattcttg caaaaatggt gagcctgaat caaggagagc aaataaaga 363480

 agaaattcag aacatcagga aaatttgctc aacagactgt ctagtgtttt caaaatattc 363540
 aatataatga aaaaatgaaga aaaagaataa tctagactta aaaaaagctt gagaaaatat 363600
 ggataagaat tataaacca aataattcat ggaataacta tgagttttct tacatgctca 363660

taaaggagag cactgttcca gatgtacaga catacatata aaatatgtac aacatatata 363720
 atttactaac aagtggtcta cttaatccaa tgtgtaagta gagaagtac aaatgccata 363780
 cgctattata gttttaacaa aggtttgtaa atagttctaa tcataatcca aaatcaaaag 363840
 acatatgtgc aaaatacaat aaagttctaa agagtttatt taaaaaactt aaaagatctc 363900

 ctacttatta atagaagtaa acttgtgaaa cataatgtgc actaatagta aactaatgaa 363960
 agaagggtaa aaacatgact gtgtatgac tctgcataga tgggataata ttagctatt 364020
 tcctgtaaat tcaaacattg tcttttgggg taagaaggaa actcgtaga cttaggaagc 364080
 taatttaca gactcagaag ttacaaggtt tacaaggtct tcccccaagt cagggaagca 364140
 gtaaaacatt gctgagaaga ggcaatgttt cagtggggct ctctcccagt cctgcagaga 364200
 tctccaggga tgaagcttcc acaatttctc acccttgctg gagaggcttt tcctggatt 364260
 gagctgcttt tgagccatca agctcctgta tgcagccttt taccatgtta taagtagccc 364320

 caacaaattc atgggctcac taaaagtcag acctgaggtt aagcatctct ttgatctatc 364380
 tatcatcagc tatatcttgg gtgaatagat gcttgctcac ttgctcacat ctcccagaaa 364440
 aaagtcacat gacatgggaa taagaagac aaacttttaa cttcataaaa tatttgttct 364500
 ttcggatatt taaccatct taaatggtta aattaataat tatttttgac aacaacaatt 364560
 aagtttaaag agagcaatga aaaagtgaaa agaattgagga gaaaatggga tggggttaa 364620
 acaaaacca gtataaacac aatgatgaga aatgaggagc aacaattact tttctgaaag 364680
 ctagcaaatt aactatgtct tggtcagcat agataaaagt aaaaggagac aagacatagc 364740

 aaattttaa agaaaaatgc acatgacaac taacaacaaa gtatagattt gaaagtataa 364800
 ttgctatgaa tgcaacaaaa cttcttagaa aacaaattta aaataacttt taaacatata 364860
 attattaata tcaaccagaa taaatagaaa atttgagtga aattcttatt ggttagaatt 364920
 aatgaatagt ttcaaatcat atttcacagt aaattacgat tgggaaattt tacaggggtt 364980
 tctacaaata cttcagagtt atataattct taatttatgt aaactgctcc tccaagtaat 365040
 acaccatata gactcccttt cataaaggca tgtttagtta gatatcaaaa gctagaaaaa 365100
 ctattaaaaa caaggtcaat gagaatcaaa ttttaacaa atgcaaatgt gtgctatact 365160

 gtaataaat aaattatttg caaatgagac aaagtcataa agtctgtgac atataaggat 365220
 atatgtgtga atatgttga aaagtgactc aagtgaaaac aagtaatgga ttattcacag 365280
 attggtaca gagaaaacat ataaaaacta cctttagata taaacgacta gtccacattt 365340
 atcaataata aatattgctt gaaagaacag tgttgcttgt gaaaatccag cagggtggac 365400
 ctacctgaag tacagagaag ggaacaagta caaagcagag ttaagatgca cttcagctat 365460
 gtcagccaca gcattcagca gggatggttg gtcgttctcc tgtcacagac tctaaccat 365520

gatgagacga gtaaggctcg tgggatttct tttgtacac catgctcttt ccagatctag 365580

cctgacaaaa agaatgctga agcgatcggc atacaagctt cgtctgggca ttgcccagcc 365640
agcaactgcc catctacaag cttatctcat caaccccaga ctcttgatta caagttatag 365700
tactctagcc ctagacacta acaaaacatc tcactcttc tctcagccc tctcctggcc 365760
aacatactcc tactgaagac ataacagaga aaaatggagg ggagaaaaac caactcagac 365820
atatttagca tatgtaacac acaaggccat atagtgttac ctaaaacaaa tcaatcataa 365880
aatatttcag ggaagaaata tatagatagt gttttctgat tacacctctg ccagaaaact 365940
gaaagataga aaattaaagt cccattcaa atctctggtc aaaaatacat ggtaattaat 366000

tgatttaata attcttagag ataaagaaa agtaacaaca ttacatctaa atttgtgaga 366060
attcattatg gccacattag ataacaagaa aaactaagaa ataaagagta agtcttcaat 366120
gtaacaataa actcaatgat tgcagttagt taagaaagtg aaataaaaaa tgaaaacaaa 366180
atacagaagc tcaatgaact ctaactcttt gaaaagtaac aaaataaaag taaacctata 366240
acaatattag tattactaaa aatagtatga ataatagaag aaacatcatg ctaatgtgat 366300
taaattaggg gggctgggta gatgactcag catacaaagg tgcttgacc aagcctgatg 366360
acctgagatc cctgaaaata cacagtggaa gtccagatcc aactccaaa tagtcctctg 366420

tcttctacat gtggagcatg gaggatgcaa acttgccctg caaggttctc cctctctct 366480
ttctttctgt ctctctttct ttctgtctct ctctttcttt ctctcttctc tccccctct 366540
ctctctctct cctctctct ctctctctct ctctctctct ctctctcaca cacacacaca 366600
cacacacaca cacaaattaa aaataaatga aatctatta aagtatttaa aaataccaag 366660
gaaataatgt tcaactcagc cttactggat tgaatccta gaagagacaa atggaccaac 366720
tgctcaaact tcatcaaaaa aaactgactt gtgaaggtat taaatcctag gattaaccag 366780
ctcttcgttt tcttaacat atgtaaaatt aacacaagac caaaaatgct tcatagcaga 366840

ctcctataat tgittttaaa gatcagtata atgaaaattt gcatatttta aacccttagt 366900
tgtaacttta aaaaaagaat gtcttacagg aagtaacctg acaggaatga tcaaaaatct 366960
acacatcaca aacaacccaa atcccttcta actggaagac gttaattgat tgtgctctat 367020
ttacaaaaca agagtgtgaa aacatactct acagtgtacc attatgttga gtgaagtctg 367080
accaccattc aatatggaac tctcttcac cagcaagcaa aatcaaggca cacacagaaa 367140
cacatgaata attcctacag ggaaagtaaa atcacaggac atagggcaca aaaaagagga 367200
catgaaacct atggacatgg gtacctatga cattatttga gaataggaaa attatggctt 367260

tccatcttgg gctaatcttt ctgttgcaac aaacttagag atagaattct ctgtgtcaga 367320
 gatcctagaa aaaaatataa catgactgca ttgtgttgg tttagatact tttctcattg 367380
 ctctgacaaa gttcctcaca aagccaactt agtaggaaag agtttatttt ggctcagttt 367440
 aaggcaatgc cgigtatac agtggggaag gcatgggtgt agaatgggag gccaagggtc 367500
 aggtcacact gcattcatac tcatctgggt ctcactcac ttcctctatt ctttctactt 367560
 ctttttcta gcacccaat ccatggagt gtgcttctta cattaaagt gagactttcc 367620
 tcctaggttc aatctctcaa taaacaatat gactgacatg cccaatcca atcaagttga 367680

 caaaaaagat aatcatgat gtgtgtctta gggttccata attactgatt ctttttcagt 367740
 gtgagacaga gaacctaggg ctttatgcat gctaggcaaa tgctctacca ctgagccacc 367800
 accccaaagt ctaataacaa gtttaagtca gccagctatt ttacagaagg aaaagaaaaa 367860
 aaagctaac cttttcttc cacaagttgg caaaggttta aatggataa tgtccatgta 367920
 tttgtaagaa tatggaggaa aagaaacttg aatattgact caagagtata aatttataca 367980
 aagactttag gaagccatct agaaatacat agaaaaacta aagtgtata ggtactataa 368040
 attggaatg tcaccagaaa acaccattta aaaattctat gtaggacaca aatcctttc 368100

 ttagcagcaa acaccatcag aggtccaatg taatgtgtgc tttgcccta ctactgaagc 368160
 ctatgaacta aatttgcata tgttaatac cccaaagcat catgttaaat agaaaaagca 368220
 agttacactc agcatggccc catctctgtt aaagctaaaa gcaactcaatt ttgcatgttt 368280
 ttttatggat ccatactaga atatcaagga tttccatgag gattcaccag caaccaaag 368340
 atgctacctt ttgggtggg tgagataaga aggtgacagg aaaaggtttt gatgtgatct 368400
 atgtattcat ttcttaaaag tgaaaagtac accttcagtt caaggaaatg agcacaatgc 368460
 tgtcagttaa acccacatcc tgtgttggct ttattgtctg taaatgtttt tgtctatggt 368520

 atttgattat atcatecata aacctgaatt gaatgggatt gtgtgacaat ctagtgtgac 368580
 acctgcaact ctgctaagt ccctgtaagc atctccctc ccagaaggat tctgcacaca 368640
 ccaacaaagc aagcactgga atccatgga ttgctcatgt gtccagtctt gcctgaaatt 368700
 acctacactc acctaaacct aaattccaac tcataaagag gaaaggaact tggaggaaaa 368760
 tgcttaggct ccgggggaat gaaagaatgg gctctttttt ttgcagtgga ttattaggat 368820
 tatattaage aaagccaat catccataaa caagcatttc agaaccctt tagcacatga 368880
 gagtgcttcc ttaacatctt gaagtgggag tgctatcatt ttaaaagggtg tgtatactcc 368940

 acaaaaatat gtagaagtaa tgaaaaacta taagagtaca agtgagagcc atatgaacac 369000
 cataactcat ctgggtgttc tgtctcacag cttcagactc ctaagaaatc gtgggtcttg 369060
 gtttccatca aattgtgagt catcccactg taatcacaag caagtctcaa cctggaccta 369120

caatccttgt tctcgagcag caggaaatct tacaatctct ggaaagggcc cgcccttcat 369180
 tactatgagc agcagataga cacagtgact aatgggtca tttgtcaggg cctggtgctg 369240
 catacttcat cctggcaaaa tgcttttcca aggagttaac cggaggaaat ggctacaaat 369300
 aagagcatta ccagaaggag aaggattgca gattgcagtc tctagcataa atagactcat 369360

 gcctattatc cattgaaaga cacaaaggta ctcatattca ttgtgagcta catgtataca 369420
 aaaaaaaaaa tcacaccatg aaattcagga ccaaattcac taatattgct tagtaaaatg 369480
 attcactgtg gcaggtgttt caaagaatta caaataaatt ctgaaattta caaaaaaac 369540
 tatgtagtgg tttttctaac cttggtttat tttaatctgc ttatattaat aattaatgta 369600
 tgaattaatt taactaagga aattttcata cagcttgaac attctttgaa tggatataaa 369660
 agtcctaaat gtccttagag ggagcactca atgtgcaaga acagagtga gtcagtctat 369720
 gttcctctc tgagcatctg cccatctatt tcctcctttg gcaaacatct gataactatt 369780

 ccctgtgtag ggggaattat aacaggaatg aataaacagt ggtgcttcac aataagcatg 369840
 tttcatatac ctaactctat ataagaactt cacaggtcct accttcatga gctttgtatt 369900
 tagtaggaaa gacgaaagtg ataaattgat tataattgta aaagaaaacc tacaggattt 369960
 gtaacagcag gcigaatagc agcaccactg ctgttataaa gaccaggaac acagtttcta 370020
 cagatcttcc ttattttacc caatactgca tttctctaaa acccaagcta tcttctgac 370080
 agccttgctc agtcttctgt cttctcteca catgctaact ggcttttctg taaggaattt 370140
 ggactcatgt ttgggtaaat gaaggtcatc ccatgcctat gcagagatgc acatgaacac 370200

 ttgcacacaa ttcttccta cagggcacca agacacccaa agaataagct ggcattgcag 370260
 agggaaagtc atctcttcc agtgtgctca catccagaca atcacagtct agcttctgaa 370320
 cagaaaatgt aagcaggagg caagaaatgg gtaatgaagg aagagagaca gaagctaagg 370380
 aaaacaagag aatatgaagg aaaggaaaaa cagagagcgt acctgcagaa ctgtgatgca 370440
 tcttttctcc ctctttttc acactttcct ccttagctat agactctcac gaatgaacac 370500
 tttaaaactg atatctcag agtccttcc acttgtggat cacattgaga agcaatggca 370560
 ggccctggg tgetgaggac actaaggatca ttttaagtaa atctaaggaa getacagatt 370620

 tgatttggga agagaatggt gctttcatgt cttctgatca caagtgctg gaaggcaggg 370680
 gtgatttgtt tgtgcattgg ttgaacagca gtatggaacc actgcttctt gcttatgctc 370740
 tgcccttctt accttttctt cctttacttg caacagcttc agccattaca cacacacaca 370800
 cacacacaca cacacacaca cacacacaca cagtcaaaat tgtatccagc acattcttga 370860
 gatttattta tttattttaa aagtgggttt cactgggagg tggatgatca cgcttttagt 370920
 cccaacactc gggaggcagg gcagagatgg gtggatccct gtgagttcga ggccagcctg 370980

gtctacagag cgagttccag gacagactcc aaagctacat cctgtctcga aaaaccaaaa 371040

 gaaaaaaaaa ttagtaaatg agtttcatac ttgatcaaac acacagagaa caactcaaac 371100
 tgaaaatcag atgtgtctgc taaattatgt gttgatataa caaaatacct gggctgggta 371160
 acttctacac tagaaacaag ttatttggct cataattctg gtatatgaag gatccaaaca 371220
 cattgtaaca gaatcctgga aaggcatccc tcacaggaca gtagagaact agccagcagc 371280
 cagcagaagg agaatgtgca agcaggggggt tgggggtggg gcgagggaag agttagagag 371340
 tgggaggagt tagagagtgg gaggagttag agagtgggag gagt gagaga gtgggaggag 371400
 tgagagagtg ggaggagtga gtgaggggag ttagagagtg ggaggagtgc ggattccct 371460

 gcaaactgc tggggaatct cctgtcctca acagaccagc attaattctt tctgagcaca 371520
 agcttcccat gatctactca tctcttctc ggttccatct cttaaacctc tgccacaggg 371580
 gaacaagctc ccagaatagc accttggcag cacaaacccc agctaagcca cagaacctgt 371640
 cttctcagtc tcccagccac tctgacagc aaatacgtca acatagaatg ccgaccttc 371700
 ctgggcccctc tgtcttctct cattcacatt cacttgctct aatgctgtgt tttccagtca 371760
 aaacagtcag tttccctctg cctcatgect agcccaactt gttcctccac tgagagccat 371820
 cttcctgccca accaaattac ccatcatggt gttcgtctca agaaacacat ttgttgacc 371880

 taagaggcat tctttccctg ttctcaaatt aacaggcagt tttccccctc tttattacaa 371940
 tttaggaaac ataattgcaa aatgaaaatg caaaagtaaa cagaacaaag tctacaagga 372000
 atatatgaa aggtaaagta tgctataata cagagtttaa aagtccaac cggtaacgtg 372060
 ttcaaagctc tattgaacc attgtaaagc tttttgtaat ggtttctctg catccaccag 372120
 ttcttaaaat agcaataaaa atctagcaaa tcaaaaaggt tttgtaaagc aatataggga 372180
 caggggaaaa gactgttaag acgtaggcta acaggcaaac agtaaatagc atgctagaac 372240
 tcgggcatag tggtcacgac tcctaaaagc ctagttgatg gtgtttgtct atgagtctgt 372300

 gctggcgaga aggggaggac caccctgaaa aggtatccac agtgaacctg attggtaaag 372360
 ctgggactct ttaggtcagg gacagtggca tttgtgaagt agaagctgca ggattggagt 372420
 tcaagattgt tcttagacta gtgagtttga agccagcctg ggctacattc tctcagaaac 372480
 agacaaaaca caaatgacaa caaaaaacac agggtagggg agatagctca gtgagtattt 372540
 actgtaaaag caagagaaag ctgaattaag ttctagagtc catattaaaa gaaaaaaaaag 372600
 aaagaagaag aaaggaaaga agggatagag agaaaaggaag gaaggaagga aggaaggaag 372660
 gaaggaagga aggaaggaag gaaacagct gttctggagt tccaataca atggaagtag 372720

gtggatattt agctgaacat atgccatagg atgaatgaat cattataaaa ttataactg 372780
 gaaaatctga tcaactgatga ttcagtgttg gggggaggat tttggagggc aaatctctca 372840
 ggaatgcatg tctaattagt tttcttatca ccaggataaa atatctgtaa gaagcaactc 372900
 aagtgaggaa agaggacata ttttggctcg tgatttgaga agaatttggc caggagacaa 372960
 agtggccata ctgatagctg tgtctgtaag aatttgctca catgtgggta gatcaggaag 373020
 caggaagcta gctggaaggc aggaccaagg aagggccagg gtataccctc agggattgat 373080
 tgttccttga tgatccattt cctccaatga agcccatcc ctaaagggtg gacaaactct 373140

 caaaaccctt gaaccatcga gggaccgaat gttcaaacac atagcccatg gggcatatta 373200
 aaaccatagc tggacctta gaagagaggc ctcaaagaac acatagggga agggaccatc 373260
 tatgaaccaa gaaatagaac ctcaccagac tagttctctg atgatgctca tttcccatga 373320
 gaagtctgtt ttatcacgtg ttaattactc gggctctggg gtttctttac agcatcctaa 373380
 gcatccaatt acagtaactc atatttctat gacacacttt tacataccea agaaagacat 373440
 gggagccagc ctttttatg gatttgactg aattaaata ttttttctg tttcaaaca 373500
 taaactatgg gcatctgtgc cacgaaaagt tgcctcaaaga agaaaatttc agtcatatag 373560

 ctccaaaaat gccaaattag gaaagattta ttgctgacat gattctgcca tgctcctccc 373620
 cacttgctag ctgagtcatt ttgctctggt ttctactatt cggtttctc ataggaatcc 373680
 acaaaggacc tectataac aaatagccaa ttctcaaag agaacacatt taactttact 373740
 taggaaaatc aaaagagtga ttgtatcaga gaaaagcaag gggaatgctg aaggctttct 373800
 aagccttaat ctcaaaggag tattttctgc taaaaatcaa ttgtggaaca tgaaggcagg 373860
 cttttgtttt atttgctttg gcttgtttgt ctttgcatgg agtgttgaa gcacacagtg 373920
 cttgctgaga tggagtagcc tttcatccga agtgccttca gaagaatgac aactctggc 373980

 gaactttcta gtgagtttcc aaaccttget gagacacaga tactgctcac cccgtttgta 374040
 acgcagcacc atctccacc ttcagaaatt tcttctcct tctgtatct actagcatca 374100
 gaggattcac tctcacaag accctctgta ggtatcacag gggacaggta gtgaattacc 374160
 agcccatac aatcaaacct tgacttatta ccactgctg aatagcaaga atctgagct 374220
 acccttctca ctctgatgcc caccttatga tcatgattt ctacctgct cacagtggcc 374280
 cagtgcattg gaagatgcta ctgcatgggt ttatccat atctctctg ttttgactgt 374340
 tgcttcatcc agagaagcat gaatctctta ttcctttctg gtctccctg ctccactt 374400

 acaagtgcct cttgatgac accaggccta ccaggtaac caaaagtaat cctgtcattt 374460
 gaagaacct aaccacact gtaaaaacag agtgccttga atttatgata gttccatttg 374520
 ccatatttg actccataat tgtgtgaaag tcatatgcat tccatagaaa ctacacttca 374580

aatttccatc cgttctcaag gtttgatgt gacataaaat atactctcct ggtgtggcaa 374640
tggacagtag cagtgagcca tagctccagg tggccagaa aaatcacaag gggaaaaatg 374700
acagcctaaa gtgcattgct aagcttcgac cttcacaggg aaggtgtgct taatccattt 374760
tcaatgggga tcatttcaat ttactatgca tttgtcaaga cattacccta tctatacaag 374820

ctagcatagc tactagtffc aggaattaaa tgggcatctg tgaatagata tttattctgc 374880
ttaccactga gagcaagtga aaaatgaacc tctttaaag aaatggatac aattttaaaa 374940
atctaactctg atgtcaaaag gagaagaca cattagaagc taactctaaa gtcagatttc 375000
ttcagtgaga ctcttagctc tggggtcttc cacaaattgt ttaacttgta taaactcatt 375060
ttccctatgc aaaatagga taatacatgg aacagctctt atattagttg taaggaataa 375120
atgagattat acagtaccaa atctgaatag ggattattaa acctctcaat aaacatgta 375180
ctgtatgaat gtatgtttaa aaggtaaagc tttggaagtc agctcgggca ggagatcata 375240

aagtctccat tgccataaat tgataaatac ccaatataga aggtcttcag gctgcaattt 375300
ccatctttca ctctatttta catatgtatt catTTTTctt ccaccttcac ggaatgatgt 375360
ggttataagt gctttaccag attcaggtct agacctgtag acagcaaagc catgtaagtg 375420
gactgcctga ggcttgaga accaggttca cacctccatg tgaccagaaa aaagaaacag 375480
ggatttaagt aggattgttg tggaaattaa gatttaatat tgtttctcct gttgagtttt 375540
aggctTTTTg gaaaccagtt actgctcttt tctgcctat ttcttcttt tggagagga 375600
atgtcccacg tctgtcttac attggatttt agaagggata acttgctttg ttctcaagct 375660

catagctaga gagaatttgt cttagcatga attatgtctt tgaatttact cctaagttag 375720
acaagaatgc agagtggaac taggtgttat tacaaggata ttgtggagtt ttaggataaa 375780
attaatgcat gaggcattct gcattccaga agggaatgca ttttatttgg ggaggaagag 375840
agggggcatg catagaatca gactatgaag ttagagcatg cacctgccc caagttagtg 375900
ttgggaattt aatcaacacc ataatgtttg gaggtggaac ctgatgagaa aggtttacat 375960
taaccacac tcagtgtgg gttttgacaa tcttgaagga cttgaagcta taattttgta 376020
tcttcatgat atatatgatg tcttccat atatgcctc tactgtgggt tgactaccag 376080

gaaggcctct acctcataat ctttgcctt tctagccttt agaactgtaa taggcatgct 376140
tttgcctttt acacaggact cagtcgtgtg tgttctgtca caggagagca aagtggatca 376200
gagacactta gcgttactg taaacatttt aaatcatctc ccatttcata ttacagatc 376260
actagacctc acagcacaga agccagagtg agttttgctt tgtaacattc agttctgtta 376320
gctttctcct ctgcttggaa gtgccttggg aggtcctgca gttctcttct aacagtgttt 376380
gctcctcgaa tgcctcagcg tatgacccat actgacttct gcaactgttct tgggaaatgt 376440

ttctcttga cctgcttcac cacaccact tctttactct tatctagaac acattagctg 376500

 cagaaatcta ctggctgcct atctctgcct tgtttccagt gctagggagt gaaccaatga 376560
 tcccataggt cctctcaagt tgtgagcaat aaagccagtt cctgcccact ctgaataaat 376620
 tagcacttta ctccatagat aatccccaat gactctgttt acattttctc caaagcactt 376680
 tcttacctcc tgcataacta tgaaacacct acttactgca tcttttacct gacttcccca 376740
 cccagacata cattctaaga aatcagacca ttttgteccct tttattcatt gccatatccc 376800
 ttttgcttag aacagtgtca cagagacact agctcccttg tttaaattga tgctttcact 376860
 tgatttctac taaaagagat cctaccata gcccatcact cactgcaaat ctctctcca 376920

 atccttcaag aagcatatcc tccattgtca gaagcaagta gtttatgaaa ccatcctcct 376980
 aatatttttt taacacattc ctggatcaca tacttaagct cataattttc acaggggaag 377040
 gccaaatgat gctgggaaat ataccataaa agtaacagcc aggaaatttg ataaaattct 377100
 ccctgcata gtaagtcttc ttccactact gctgttttac tttgataacc agatatcatc 377160
 tcattcaagg tttatgagac tccaatggga tgcacactac aatcccatgt tacagatgaa 377220
 agaacagtct taggaaattt aggaacacca tagatgectg taatcatcat gaagaataac 377280
 gtgaacattg agttgctcaa cccccggagt ctacatggtt ttgcccttc tttctctcta 377340

 ggaagaattg gcatccatgt aaaaattcgt gaaaacaaa aaccacactc aattttctgt 377400
 tgatccctag agaaacatta gttagctaaag tatatatgaa aatatttcta ctgtgtttat 377460
 actccaatca ggaaaaatgc tttctttaa tgcttcctat gtgtaaacctc caaatataac 377520
 tctacagcaa aacctcctct gtgtccctgt agcaagcagc catcacttct tetgaggaaa 377580
 caatggctta gcaatcatcc acatagccat ttaagatctt agtcagacc cagaagacac 377640
 atattcgtaa agttgactaa ataatggaaa caagcattcc ccaaataata taacataaaa 377700
 taaggaaagg aaagggatga gacaacaaaa acatttgagt taatctaggt tetctctgtt 377760

 aagaaagaaa ttaaaataaa aacagagaaa acattcggaa cttggctttt aaaaagttaa 377820
 gccttctgaa tgaatagtgc cagatgtcac attatgctct ccatgctgga gttgagctgc 377880
 catcactagg tcgtagaggg gcccatgtac ttgatacagt gtacatactg cagcttccta 377940
 agcaacgaat gttcatgcag aaggagcatc actcagagcc cagtgaagga ttacagttta 378000
 gaagaacaga gcccatgtct ctgtctcgca ttttcttgag atcagtattg agcttcacaa 378060
 tgtgtttcca aaatctatcc ccacctttt tcccctatca gaaaaatgic agcaactaaa 378120
 agtaccagtt tgactccttt atttttcaat acattttatt aacatataac atacctttac 378180

acttatatat ggagaattgg aaactaataa aagaaaaatg tcatcttggt gagctgactc 378240
 tgcaggatgc atcacttttg gtatcatcct tcttttccaa aagcataaat cggctctcttt 378300
 cacattgccc cgaaaacact tgatctcgtc gaagacaagc aactaaagtg gatccctgca 378360
 ggttgtctag tgtaagccc gtggagaaca gtgatcatgt gcccaccag ctgatcagtg 378420
 tgttatgcac tgcattctgc tctgttgact aacaactctt ttatttgact aactgcaat 378480
 atgaaaccaa aatacttgaa aacaacattt aatgatttta aggtattaga tgaatcataa 378540
 cccataaaat ataattctgc ttcttattgc ccagggtaga tattcacaag aactgatct 378600

 tgtctttcct ctatttctaa ctgactcagt tcccatttta ggcccctctt actaagcctg 378660
 aatagtgtca tgcttagact aggatacctg aggtggattt ctgcctccc tctcctcct 378720
 ttcttacttt ctctctttct cctaatttcc ttctttctc ttctctctt ctctcttga 378780
 ctctgtctga ctctcccctc ctctcctctc ctctctctc ttcttctt ctcttcccta 378840
 tcttctctt ctctcctctc tccctcctc ctctcctcc ttcttctt ctctcctcc 378900
 ttcttctt ctctcctgca gtctcactat atagcctagc taggaccaa gctcataata 378960
 ttttttctt agcctgacc tgatggggga agtacttctg tgtatgttta tcttattgat 379020

 tgtaaataa aatactgttt ggccaatgag acagcaagtt agacgggatt aggagtcaaa 379080
 gaggattctg ggaatgtag tagagaagtg gtgatccagg caggaagtga catagcaagg 379140
 agactcattt aaagaaggag aatcaggaag tctcctcct tttccttgg ctctcctcag 379200
 cggcggaatg tgatccaccg acaaggaggg acaccaataa ggtgtccgat aagataagtc 379260
 ttataaaata tataggttta tgataggtaa gactgagcta acagatgaga atcctagtca 379320
 ttggccaagc agcattgtac ctaatacaag tttctgtgta ttcatgtggg acctaacca 379380
 ggaggacggc tggcgtaaag ctcacacatg gtggtggggc tcaggcagct tttggtagaa 379440

 agatttattg taacatgacc caagtgttg gattgtagac atgcaccatt atgcctagct 379500
 gacattcaca gtaaatatac cagcaaaact ccattaaaag ttggggggga ttctggttac 379560
 attttggcag agtaaaacat ttaaaattt aaataaaatt taaaataaaa agtatggaca 379620
 gaattagaaa ttcttacaaa gtctactgag ttgaacaata atctgaaatt ttagtgcaat 379680
 caatgtatat tcttatatgg catttattt aaacaaaacc aagtggccaa tgaaaatgtg 379740
 ttcatagaa acccattctc aacacctact gtgttaataa gctttgaata actgtcacia 379800
 ataccaggaa gaaattgtct aacaagagg aaaggcttat ttgactcaa agatcgatca 379860

 gagatgcaa ttcatgatcg agtacctc agtctggggc ctctggtgtt cagagtacat 379920
 caggggacaa gtcccattaa tagcacagtg aggatgaaga aaagagaaga gtaggggtcc 379980
 tacagteccc ttttattgca cagcctgagt gacctctc tacattccat gtctcagtgt 380040

gctttaggag acattccaga tccaaattgt atcatatact acctaagcat ggtaagagac 380100
aacagctcc atttaagaag caaatcagta atagctggtt ttcaaagcta agtcttcata 380160
ataactatag catgatttaa ttttctgata ttcagatact aaaatgagct ctgcattcac 380220
ggacaattct aatggctact gttcacttgt tctcaacatt gatgacctca ccacaaacca 380280

acatgcagct gggctcctgtt ttaacttatg gtcactttaa tttgaaatca tatcattgag 380340
atgattccaa ttgtttgcta tgttaactag cattgtcagt tcccttggtc ctcaacaaga 380400
cattagaagt taactcagta acatccaatg aattttatat attttattca tttaaagtgc 380460
ttgattcctg tcaataagaa tgccaaatga gtatcaagta cctgttcac acagacagca 380520
ctttgagtta cagatggccc atattcattc tttgcttagc tgatatgaca ttggaaatag 380580
taaacgtaag agaaagggtg ttccttaata cttagtctt ttcccatgaa tttctctcc 380640
ctgacctcat ttttgggtt ctcttctcca aattgaaaca ttcactctt gaacaggaat 380700

gctcctaaga ctcggaagc taactaagac cctagaagtt gccgagttac aagatttga 380760
aggcttcacc aagatcataa aagcagtaaa gctgtgtgca agttgtgtgt tattcagga 380820
gcaccaggaa tatacttctg gtaaattgtc atctgtgcta aggtaggctt ttccaaaatg 380880
caactgtgct ggctcactga cacttctgta aataacttca ataaactgga tggcttgcca 380940
agtcagactt gggtagaacc atttatcag tctgcatag gtgacttacc tgggatgaat 381000
agccatttgt teacatctct gcagaaaaag tcacaaaaca ctttactcac aaacctctac 381060
ttcatgccct ctgggtgtg ttccttagct tgagagtac cattgaaatc tcagtacaag 381120

atctgtccta ctattgaaac aatttcaact ggaatatatt gactctgata tgaaactgtc 381180
tgcttcaaga tctacctatt tttgagtctt tcttcagttt gttccatctc ttttaagtct 381240
ctgacatacc tataaaatcc ctgacatctt aatattctac ttgtttgtct tttatattga 381300
catttatgct ctttatttga ttctgggaa acagcaagct aaggggaagt ctgggttct 381360
gccctgtaca gtgtcccaat ttattataac ttgtaactt tagagatggt tgcacaaagg 381420
agattgccag catgcatgaa agaagatga tcttactc caaaagtatg ttaaaaaatt 381480
gattacctga gtcaaatct taagtaggct aaggactata taatggtgaa atatatctcc 381540

aagattcaga gttcttaigt aatagggtg aagtccaaga ataaaaacac atactctac 381600
ctgcttaata aaattcatgt tttgttcagg agaatgtaca attacacaag gggcccatga 381660
tatccaaata atcagtcacc ttggatttga gaaagcattg tactataatt ccaaacttta 381720
tttgaatcat aaggagtttt aatcatgcta ttcagaaag actatgaaat tttacatggg 381780
ctaacattac aaagctatat aaatttaata tataaatcag aatttcccaa tgctagattt 381840
ttattggaaa aatgatagca tagtcttat ttctagaaag atcgttacag gaaagtacaa 381900

atacaacaat ccaaaaatac ttaagtctag ctctccctat ccattgaata ccacttgta 381960

 aagggacttt atataaatta tttattgtgt ctaggtcgca atttatcat ctgaaaatga 382020
 atgatttgc tcaatcfaag gttaatitga aatitatta atititctaa tattccaggt 382080
 aattaaagac aaggaaatac actacatatg aaagattagt tgagtcacca catcctatat 382140
 ttaatacga tgcattcag actitataac tgaagttaa tgccactata tacactattg 382200
 ttaaaatcaa tttataagct aggtactct gagcagtttt ataacttat acaattaaga 382260
 aggtttctgt aataaacatt ccctcatct gtaagtaaaa ccattctcta ttatgcaaag 382320
 tttaaaagga aatataaca tgcagaaatt ttgaggttg tgactitaa aaattagtaa 382380

 tgtaaagcaa ttataaaaag taatacata ttctgagtgg catgatagt tcatgttagg 382440
 gttgtttgtt ccattattag gatataattg ttactgcaa actctccct ctgggccct 382500
 gttctgttct taacttagaa atgctggatg aactcagaga aaaacccaaa agcaatacca 382560
 atgcatcatt ttggcaaat acagcagttc cccaagcatg ggtgctgta cacattcat 382620
 gagcagtat ctcttttggt attatctctg cccatatcac ctctgctatt caatggttg 382680
 gggaaaatgt atctggacta gagaaacatc aacaccgagg accaagatgc caggacgaa 382740
 tgatgactta ttglaaataa cttattcag gtaataccag agatttattc agctagatgg 382800

 ttggtctctg atgcctgaca gctgtgtgag ggttcagaaa tggtagctgc ttcttcagaa 382860
 attgtcacia ataagagatt ttgatcattt tttccctt caaatggccc ttgtcctgg 382920
 gaaggaaaat atcagggaga gtggaatca aattgtttt gctctccct gctagccact 382980
 tataaacaga tglagagtt gtctgctaa ggaatttct agtaactaca aataactacg 383040
 tttcaaagg aaaaatgaat tggtaaatgt ccataaat gtgtcagcta cttctgggt 383100
 ttgtcctggt ttgtctcagc gctcgcatc ttgtctaac acaaggttga taatgctgt 383160
 gagcatgtat taaaggaac attgtttgaa agagaaagtc aaaagaaagg tccaagacat 383220

 aaagattgtg aggaaacct ccatgtggcc ccattctcc ctacttgggt cgctggactt 383280
 tgttgtttat aagcagattc ttactactag attggaatg acacaattct ccagctgagc 383340
 tctctacatg tacaatgcaa aggaatitit gttccatgg atgaagtga agtgctacia 383400
 taatacaata gctctatta aaggtitcta gatactgtct ctggtattac tatttattct 383460
 tggataaac ttttgggga agtgaattt tgaattgtg tagcaactgg gctcttatt 383520
 tttaaaatat attacaagc aatactacc aatitgaaat cccagcctt aaggacacat 383580
 gtacagttt ttatccagtg acccgaggac aggtcacact tcatcagact ggacgtatta 383640

tgtgctgacc agatccaggc ctgctgaatc aattagaaga ggcataaact gaaatctagg 383700
 ctgtgactga ctggaatgaa aactcagaca ttggacctgt tatttagttt agtgcacacc 383760
 cttgatcttc agctgtcaga gcaacttggg gcattgtgca tttttatga ttttaacaaat 383820
 attagcaggt ctgaagacaa aattctttta agcaaaggga atatttcttc aaaattcaaa 383880
 tgacctcatg aactaaatgc ctgactcta atcttattat tatccctggg atatttcacc 383940
 ataaaaatag caaaatggaa atctagtatt tcatggfcat atgttaaata taacatacac 384000
 ggctttaatg tgcatgacaa gtctacaatc atctaaagca catgtatgta taacaattcc 384060

 aagccacaca actagacatt actgtacagt ttagaatfff accttttttt tccggagtat 384120
 gtattgagca caaatftaac aactcatgga gtcacaaacc acaaccttgt acatacaata 384180
 acaagagcta gagatctgtt tcccttctgt ttctgggatt aattccttgg aatttggaac 384240
 atcaaagcaa ataaagtfta gagagaaaag agaacacata agtgtctacca tctgtgacct 384300
 atgtcactat cacagcactt gggtagctac agtgaggaaa gaaagcatga attcacagtg 384360
 cactcaagca ggtcttctgt ttacattgat ccctgtgtg tagttaaggc tacaaggaat 384420
 gcatcccat ttgcctctgt gttttttcct cagtaataat aataacaaac tcctcaaaaca 384480

 ttatttgcca agatatacat tcatccaaag aaaatgattt tagaaaatgg tgttctattc 384540
 aatgagtata attagaagca caaagcacc aagcctftta caaatccctc tccaatattg 384600
 ttgaaatgtc aaaaataggaa ctgctgacat tcatggatta ttgggtcact gtgtctaagt 384660
 ggaaaagata gaattggaaa aggcaatgta attatgtttg tccacagcat tttatattct 384720
 caggagtgtt ttaacgtatt tcaactgtatt tagctatggc aacaactcca tatcataatt 384780
 tatttatcat cacacacaca aagacttctc tgcatagcag tttcttcccc tgtactcaac 384840
 ctgccttgtt tttctgcttt tccacataca gcaatgggaa agcactcaag tatgacctgt 384900

 caggccactc acaaggaatc cacttctgtg catccgaatt ccagaccaag ggtgaaatgt 384960
 cagcaatfta aattgatccc tactgtgatt atctgaacat cccatgtcca gtcacagagg 385020
 tagaatacce attacaggt gagaccata ctgtgtctgt taaaatatac ccctgaataa 385080
 ttcttcacat gcaaaactcac atacataaca catatacatt tgttgttaca tgtgatcatt 385140
 attaattattg caaaactcaa agcaccaaat aagcagcatc agggtcacta tgacacaaaa 385200
 ttttttttt atcccctgtt ggaaaagagg tcttttgaac tgggtgtttt accatttgtt 385260
 aaaaaaactt aaacaagaat tftaatgtga gccaggtgtt ggtggctcgc gcccttaatc 385320

 ccagcactct ggaggcagag gcaggtggat ctctgtgagt ttgagaccag cctggctctac 385380
 aagagttagt tccaggacag cctccaaagc cacagagaaa cctgtctca aaaaaaaaaa 385440
 aacaaaaaa aaagaacaaa caaacaaaca aacaaagaat tftaatctga agtttctcta 385500

agtgctggct tcacctaaaa ctacaagcat tagtagctag cccattcaaa ggccttgaca 385560
 aatttccaga agttcaaaag taatttcaat atttaattct tcatctaaat gaataagcat 385620
 gaaatgaata tcaaacaccc acagctttat gaataatttc acccgaaagg ttttcaactg 385680
 ggcagagact gccccaggca tcctggttcc aggcatttaa aactttctct tgagtcatca 385740

 tgcattgggc tttcctggag tgcaagtatg tgtcacatat aggtacattc acacctaaaa 385800
 acctagatgt acatgttgat ttacataggg cttgaggtat cctctggagg aaaaattaat 385860
 aaaacttagg gatgtatttc taagtacttc ctgagccctc taggtctggg aaagagccag 385920
 atgtccctgc agtttcagaa gcaaagacag ctgggctaac agaaagactt tcgtgtcaaa 385980
 aaaacactcc ccaccaagtc cacaggcagc cctgggtgtc cttcagaata taagaggtgg 386040
 gagggaggag ttaagagcaa ctgaggaagg attgcattgt cacaagattc tgaagtta 386100
 gcaatttaat gatgtcatct ctctaacac taaagactgc tcattcttc caaccaaaaca 386160

 agtgctctgc tgttgaagaa gtgagttgat caacctagag agccagttaa gatgaagttc 386220
 aaggaagaca tgcttatact gagtttcata atgtttctat agttttcaat cattctctg 386280
 tgcaattgca ttgtgtgag ctgtggcaga actttaagaa cattctactc aatgagtaag 386340
 ccccttgca tgacactaaa ggtagatctc ctggtccact cacaatgcga acaagttta 386400
 tagcacctgg atccagaaac acagagggtg aaaaaaacg gaaaacatga agtttgcaga 386460
 ggcaaaaagt agattgtgga aaagttacc aatcaccaga caaatgtata aattgggggt 386520
 ctctagagga acagaacaga cagaatcatt atatgtatgg ggtttattag ggtgacttac 386580

 aggtcgtgga cctgctagtt caacaatgac tgccactcaa agaaagttca agaatccgta 386640
 gttgttcagt ccatgaggct ggggtgtctca gctgatcttc agtacctgat ggaaacctga 386700
 agaagtgggc ttagtgacag tgagaatgag ggcaagcaga caaaaagcaa aggcttcttt 386760
 ctctctggte ctttatgagg ctgccacaaa aagatgtgac ccacatttag ggtaggtctt 386820
 ctgccctcat ctgatctaga ttttaaggtaa gtcttccaac ctcaaaagat ccagataaag 386880
 gtggatctcc tgacctctg tgatattagt ttaaggtgtg tcttcttacc tccaatgatc 386940
 aaattaacta agaatctccc acaggtatga tatctctga gtttttagtt agttccagat 387000

 gtagtcaatt tgactaccaa gaatagccac tacttagctc ctgcccgggtg gcctcttccc 387060
 atagctgtgc ctggctccaa aagccagttc tttctctggg gcttcaggct tgggtggcaa 387120
 tggcagtgtt ctggaccgtc ctatgctcac cttatagtct tctcatgcag gtttaactct 387180
 tttctaataca acatttgaaa tcctctcca tcttgacctt cttgaggtca aataaatagg 387240
 ttgagaatth tcacccaac tgtggcacc gtcaaaacca tatggggttg gatagaccag 387300
 gaaatgtcta talacaaa ctacataaaa aaatgaagaa atttctaca accaaaagga 387360

aaaggggga tcicaaatgc tcaaatgtac ttggatttct gcttaatcta caaatTTTct 387420

 caattcacc cctfacagt agctctcctg ccagctgaaa gctgaggca agtcccacat 387480
 tcctggaaca aggacttgag ctctggaaag ccctgacaa tctcatctct ctaccattc 387540
 tctctatttg tgctctgcta caaatgcca ctatgagaaa gactacaatt taggggcttg 387600
 aacttatgtg agcaaggctg aacaatgaag caactgggtg gggcttgctt atgtccttct 387660
 gttcagttac acaaaatcgt tcatctcttt cctttcacat tttccagtt ccaacttct 387720
 gtgattatgc aaataagatt aaaagataaa atatatagg cttacatttt accttcaaat 387780
 aaacaacaa acaaaaaaga gtatgtcaca tgctagactg gaagtatact aagggtttca 387840

 ttacttgtct gaaattcaaa gttagctggg cactttttat ttatatgttt ttatcatgtc 387900
 tgtttttatc atggagataa attttaggat tagagatcta ctaattcatc atcccacatg 387960
 taattcagaa gtgaccagtg aggagaggag aaagtcttg atatgaaata aaactgaaat 388020
 tctgaagtag cctgcagcaa actgcaatta tctccaagaa agagtgactg taaatctaag 388080
 tgtgccacaa atctcattaa aggggtgacac agagagaaag aaaagaaagt tcatgctttt 388140
 gagtcttcc agttttaggt gttctcaaaa tacagcaaat tgtggacacc atgataacca 388200
 aatgcaagca cagattgtca ttaattcaat aacagataca tcacctctct tgtgcatcaa 388260

 taactataaa cctatgagca gatgcaatga aatttgaaa aacagccatg acattctttg 388320
 aggacagatg caaaatTTTt gatatgaatt cagatacaca cccaagaacc aagatagttt 388380
 cggaaataag gcctctcacc ctctttttca aggctgcctt ctggacacag acctatgact 388440
 aaatgttcaa gtgggatct tgtgtctact gccttcatgg actgtgctga agatgctgat 388500
 gttgctgtag tctctaaggt gcttttgtga aacatggatg tgtatggagt gatatttaa 388560
 taccagtTct gtcaccattg tgtttttaa ctaaatatca ttttaataa tgaagaaaa 388620
 gatggaggag aagacatagt gtataacttg gaagctttct ctgaagaatt tggtaacagc 388680

 atcaaaacaa aaataaaaac aaaacaaata acaaaaaaca ggctcattgc ctataacagc 388740
 tataacagga gatgtctaag ccttttgtga caaaaaaag tatgtaaaa atcctggatc 388800
 tgcccaaga gataaaattt ttggttcttg attagaatga gtcactgaga ggactaaaga 388860
 ttggatcta aagtaagaga aatactcttt tcctctatgc ctgagggaat gtcattgact 388920
 aaagatgctt ataataaaat tccatattga agatcaagag atgtccatatt cataacttt 388980
 tttaaaaaac aaaagtcaat gcaagaaat tccccacagg attctcatgt tttgatgact 389040
 tgatctaaaa aatTTTtTga aatcattcaa aggtttgtaa attaagccaa tggacaaaag 389100

tcactactgt agtcagagtt gatatttctg aaggcaaaca caaggtgcat gaataataga 389160
 cactgacagt tatggattga atgcttatag gatggtttca atatgtccac caaaaactat 389220
 atgctgggca gtatttccca aagtatccac attgggagtt ttatatttac accaaaaact 389280
 atatgctggg cagtatttcc caaagtatcc acattgggat atgggacctg ttgagaagtg 389340
 actagcctat aacgattctg tcaccacaac ttgattaacg tcctattagt gaaagtgggg 389400
 tcacatgaaa tagcatgat ggcaatgcac ctctcccttt cttctctgtg atagtcttaa 389460
 cttctgccag gaccataact tagtacactt cagtgaattg caaattatcc agccaatagt 389520

 attttgttac aacatcacag aatggataaa ggcaatttgt tttttacctc ccccaaaatt 389580
 tcttcttcaa ctgtatcccc taatgtgatg gcatcaggaa acagacctt gtaaggaggt 389640
 gaattgtgga tgaggctatg agagtgggc ctatgagaat aatgtgctca cagagtgtca 389700
 ccagagtttc ctatcttcac agcatgattc agcaagtcac agcaggggaag atgccactta 389760
 ccagccatga catagttctt tatcaagacc ttaatctacc agtactttaa tcttagactt 389820
 tccagacccc caactatgag aaattaatat ctgatgttaa ggcatctagc acttctacta 389880
 gaagcccaag gtgtcccta ttctgggggtt aattaagtta atttgggaaa atgaaaagaa 389940

 agtcaaagtc actgaagaaa gacaaaaggg ttgaaacatt tacaatcatg gaaatttctg 390000
 ttcaagattt tgtaaaacat ggctgctctt tggaacagtg ttcatttgat aatgtcaagg 390060
 tgtcttagtt agggtttact attgctatga agagacgtca tgaccatggc aattcttata 390120
 aaggaaacat ctaactgtgg tggttcactt acagttcaga ggttcagtcc atcatggtgt 390180
 catacaggca ggaatagcac tggagaaaaa gctaactttc ctacattttg cagacaacag 390240
 gaagtcaact gtgacatgaa ataaagctta agaaaaagac ctcaaagccc atcctcacag 390300
 taacacacag aaggtatggc ccaaatataa agtgtgcctt ccagcctcaa ggtctggtta 390360

 aaggcaagtg tcatccagct tctccaaca atgccacacc tctaatagt gccactcctt 390420
 aagagtttgt ggaggccaaa tacattcaaa ctaccactca aaccctaaa gcaagcaaat 390480
 ttagtcatgc tacactgtct cctgctgag tagtgcttga aatctgattg tactttgta 390540
 ggtgttgagc tcttgacca gtaggattct accagaaata aggtgtaatg tggaaagtat 390600
 aacttgaag aacatagaga aaactgtttt cataagtaat caagaaaatg ttatccaaga 390660
 atgaaataag ttagtcacca gcagattaga aaaacaatgc aggtttatag aacagcgcgt 390720
 aaaggaattc aagtcagaaa gaaatcggca agtttgacct atcaagtaga gatgttcagc 390780

 tagaacatgt tgagaaagca agttgtggaa aagaagttaa agtggggacc agtgaaatgg 390840
 cttagcaact aaaggatctg agtaggaacc acatagtggtg aaagagaatt gacacctgag 390900
 aattgtcctc tgacttccac acgtatgctg tatgctgtgg tgggcatggc acatgctaca 390960

tacactcaga aaagaataaa agtaaaaacc tattcttgag aaagaattg agtctttgtt 391020
attaagagga aaacagatca gtgaatgaaa gtgatttggtt taaagaatga atgattgcat 391080
tccacatgtc aggtaatttg agggagaaaag gttgcttttag gtacagagaa cagtgggtact 391140
gttacaaaagg aaaggaaata aaataaatcc tcagaacctc cccaaaagaa aaaaacaagt 391200

aacacattaa gtctttaga aaacagtgtg gttgtggaca caaacatagg attgttaggt 391260
ttaaagctc atgaggctac acgtgaagaa agagacacac ttctactgtc agaagaaacc 391320
cagtccccac atttgaatg taacaggaca aaataaagca tctttgttct cagctttgaa 391380
agtccaaat catccctgaa gaccagggct gtggaatc ctgtgctgct tcaatctttt 391440
agtggctcta ccttcttgtt cctaagaaga gtatactagt tagggtttta tagtggttgt 391500
ggctcaacta gtccaacaat ggctatgtac caataaaaag tccaaaagta taattattgt 391560
tgaatccaag agactgtatg tctcatctgg tcttcagtgt agaataaat cccaaagaag 391620

tagactctaa tgccagttaa gtattggact tgctagcaag gcatgagcaa gtttccttct 391680
tctacgtcct ttccataggc tgccaacaga aggtgtgggtt cagattaaag gtgtatcttc 391740
cacctcaaag acctggacta gaagetggcc ttctcaetta aaattattta ataataaaaa 391800
aaatccttca aagtgtacc tggacatttt gggttttaac taattccata tgtaatcaag 391860
tagacaacct agaatagcca tcacaagtcc acctctgtc aacttgacac acaatcatat 391920
ctccttctgt aatgcttaat ttccaatga aaacaataac caggtcataa ttaggcctaa 391980
cataataaaa ctatcacatg tacaactgca aatgcattat aaatttagaa gaggttacia 392040

tgtcccttga ggcacattct tttgatatct caaccttaaa tatggtaacc accaatattc 392100
tcttaattga tgtttacta catgaaccaa acatgactga ccaaaataaa taaataaaca 392160
aagtcaatga aatgattcct aatgaattga ttttgctgta ctcacagatc agtgcctgagt 392220
ccaatcatca tcagagacac ttcatcacc aactgatggg agcagatgct gagaccaca 392280
gccaaacata ataggcccca agtcttcatt gggctcctcc tcttagagct caggaaacct 392340
tgaggagaa ggaaggagg aactgtgggg gctcacagag actggagcag caaccacagc 392400
acctgcatgg gtctatgcta ggtcctctcc atatgtgtta tggtattgg cttgggtgtg 392460

ttagatgact cctgaagggtg gaagtcagag tgcactttt gcctgctctt gggacccttt 392520
tctcttatt agattgcctt gtccagccct catatgagga tttgtgctg gtattattat 392580
atcttgatgt gcctgttca gacaactgia ctggcctgtc cctggggttc tgacagcata 392640
tgcccagctg cagccactaa gatcaccacc tggcctgccc acctccatt tctctctctc 392700
tctctctctc tctctctctc tctctctctc tctctgecta tctctttgtc tctctttct 392760
ccccctct caagtcctc ttctctctg ctgctctgt cccagagac tggctctcct 392820

tatccctcc cccactttct catttacttt ccctaatta aaacacacac acacacacac 392880

acacacacac acacacacac acaccactca agctctgttg aatggcatct ttttctcata 392940

tgccgatttt ttacattaca acaatgtecc ttggagacct gctctttttg tgggggaggg 393000

aagaaactga ggatagatgt ggggtgtggc aagaggagag gtattgggac tggaggagt 393060

ggaggaggga gaagtacagt caggatatat cgtatgagac aagaacaaat aaaaatcttt 393120

ttttcaaaaa gaaatcaatc aaggaaagag aacacaaata tcggtacaaa cgcatttttt 393180

aacgaaatgc ccagaaata ctcatgttgg ttgtataatc tttgtttctg taactgctca 393240

cattacctca gctggatatt atagctagct ttcttacta tccattctgt atttctcca 393300

ccttctgcaa gtacctcagc aggtcttgac tctttctgg ttagtgacc catacctca 393360

ttctggaagg gtccatgccc ttgtcatcc tgctgttga gtttctcaat gactttaatc 393420

acaggacatg gtaactccaa gggatgcctt aaaggatctc ttgtactcca ttcataatct 393480

ttcttacttc cattgtgaag aagcaatcca atttccctt tgtaatctgg atcaatcact 393540

cttctaatac tgcattcct ttcttagtgt gttggcttaa gggcatcaga agcccaaagt 393600

agcctgaggg aagtcttagc ttccagttca atagattatt tgtttagct cctggcagga 393660

gctcactcca ctctggaacc aaaacttcta ggccaacaga acttaaggtc acaggaacag 393720

gaagcaaaaa ttttctagt gagtactag ggtcatatg agtgaatta ttttctctt 393780

ttccaccgct tgcttctgg attattaaaa atgaacattg aacataatta ataaactggc 393840

tcacaagga actaattata tcttatagg agaagattat cagctttat atcacattac 393900

acaatccttc actaattgga aactctattt ttaaaagtat atttactgct agtgtgtgag 393960

agtgcattgt gtatgtatgc acacatgtgc cacatgcatg tgtggaggcc agaggacggt 394020

ttttagaat cagttctctc gcattttaca tgcactgtag gaatcagtc ttagtccta 394080

tgtggcaage acttttacc accaagccat gtcaccagcc tctcatgaaa agtttttgtt 394140

ttcaattttg ttgtatttag tatggtatgc tttcaaattt caaaagaaat acctgctgat 394200

tttgacatag aaaataaata ttgtaaaaaa aaaacaatg cttacattct catcgcttc 394260

ttcaagttta aataactaat atttgtaact gtaaaaatc agttattcaa gtatgttaa 394320

ttttgattgc tggagcatca gaggaaggca cacttcacc aggaggagca ttaccagaa 394380

gctctgctct ccttgtgect gaaggagcca tcaatggagc cacagcccc aactatacca 394440

atcggagaaa gagagaacc ctgaaccaca agttccact ataacaatta gaggaagaga 394500

tgtatagaca acaaggtaag aacatactca acaatataaa gagcaatatg acaccaatag 394560

aaactaggtg ctacaacagc aagacctgat aaaaagcaga agaaaacagc ctaaaaaatg 394620
 actttatgag gatgactgag ttccttaaag aggaaatgaa aatgccctt aaagaaatag 394680
 aggaaaaaaa caaacaaaaa attggaaaat gtcaacaaat ctcttaaaga aaaccaagaa 394740
 aaagtaatca aagaggtgaa ggaaattatt caagacatgg aatctgaaat agaggcaata 394800
 aagaaaacac atactgaggg aattctagaa atggaaaatc tgggtaaatg accaggaacc 394860
 acaaatgtaa gtacaaacaa cagaatacaa gagatggaag agagaatttc aggcaactcaa 394920
 gatacgatag aggaaataga ctcatgttgc aaagaaaaat ttaaatccaa caattcccta 394980

 acataaaaca ttcaggaat tgacaaaaac ctaaccaag aataatacag ttggaaggag 395040
 gagaaatcca actcaaaaac agaaaatata ttcaacaaaa tcatagaaga aaactttccc 395100
 aacctaaaga agaacatgcc tatgaaaata caagtggttg ctgggcattg gcggtgcaca 395160
 cctttaatct catcactcag gaggcagagg caggcagatc tttgtaagtt catagccagc 395220
 ctggtctaca gagcaagttc caggacaggc tccaaagcaa tacagggaaa tctgtcttg 395280
 aaaacaaaac aaaaaagaaa atacaagagg cttacagaac accaaataga ctggacaaa 395340
 aaaaaaaagt ccctcacca agaaataatc aaaataataa acatacagaa taagaaaga 395400

 atattaaaag ctgtaaagga gaaagacaaa ataacatata aagacagacc tatcagaatt 395460
 atacctgact tctcagtgga aacaatgaga gccagaaggt cctggttagt tgttatgcaa 395520
 aactaaaggg accatggttg tcagcgcaga ctactttact caggaaagt ttcaatagcc 395580
 ttagatggag aaaacatgat attcatgaaa acaaaaaaca aaaacaaatt taacaatac 395640
 ttatccaaa acccaatcct acagaaagta ctagaaggaa aatgccaatc caaggaaatc 395700
 acttatgttc acaagaacac aggaaataga tgaatttaca gcagcaaata acaagacag 395760
 gaattgaaca caaatgcca ctaccaaaa taaaactaa gatagcagaa attagcagtc 395820

 actggtcgtt aatatecatt aatataaatg gtcttgattc acatataaaa aaggacaggc 395880
 taacagattg gatatgaaaa cagaatcaat ccttctgatg catacaagaa acacacatca 395940
 aattcacaga aatatecacc ttacaaaaag ccacacacaa aaaaaatc ttgggctaac 396000
 gctaacaaa caagtgaag atctatatga caagaacttt aagtcttgaa aggaagaaat 396060
 taaagaagat accagaaat tgaaagatct cccatgctct tggatcacta ggatcacat 396120
 agtctaaaca gcaatcttac caaaagcaat ctacagattc aatgcaatc ccatcaaat 396180
 ccagcaciaa tttttcacag accttgaaag aataatactc agcttcatat gggaaaaaca 396240

 aaaaactcag gataaccaca acaatcatgt acaataaagg aatatctggg agcatcacca 396300
 tcccttactt caatctctac tatagagcta tagtaatgaa aacagcttgg tattggcata 396360
 aaaacagaga ggigtaccaa tggaatcaaa tcaaagacc cattatcaac ccacacactt 396420

atgaacacct aatTTTTtga caaataagct gaaaatataa aatagaaaaa agaaaacata 396480
ttaacaaat ggtgctggtg taactaactg gctatcaaca tgtaaaagaa tgcaaataga 396540
tccatatcta tccccatgca gagaactcaa gtccaaatgg atataataca tcctcactaa 396600
acctcacaga agagaaagtg tatagtacat ttgaatacat aggcacagaa gaccttcgta 396660

aataaaacac cagtaacaaa gacactgaaa gcaacaatta ataatggga cctcctgaaa 396720
ctgagaagct tctgtaaaga aaagaatata gtcaacaaga caaaatggct ccctatagaa 396780
tgggaaaaga tcttcaccaa ccccatct gacagaggac tgatctcaa aatatacaaa 396840
gaactcaaga aactgaacat caaactacca aataacccaa tttaaaaatg ggggaacaga 396900
tctaaacaga attctcaaca gaacaatctc aaatggtaga aagacactta gtcacaggg 396960
aaatacaaat caaaaccact ctgagattcc atcttacacc aatcagaata gctaataatca 397020
aaaacaccaa tggcagctta tgctggagag gatgtggaga aaaggaaca tccttcatt 397080

gctggtgagg gtacaaactt gtacagccac tgggaaatc agtatggcac ttgctcagaa 397140
aattagggat cacctacct caagacctg taataccact gttggcata tacccaaagg 397200
acacacatte acaccacaag gacatttget caactgtctt catagcatat tatttgaat 397260
agtcacatct tgaaaacaac ttagatgtcc ctcaactgaa gaatggataa agaatatatg 397320
gcatatttac acaatggagt actactcatt ggtaagacat cctaaaagtc gcaggaaaat 397380
ggacagaatt agaaaaaaaa acatctgag tgggtaacc caaaaccaga aagaaaaata 397440
tagtgtgtac tactcataa gtggatacca gacagaaagc aaaagatacc taccataca 397500

tcctcaaac cagagaagct agaatcctct tccagaaaca gattgaaaca gatgcagaaa 397560
tccacaacta accaatggtt caagctctg gactacaatc aaagtgaggg aggagcaaaa 397620
atatgaacaa agtagtcaat accatgatgg ggaaccac agctgacaca agctagttag 397680
agatcactga ctcaggtcta acaaatgggg aaccagcata agaccaaacc agactccctt 397740
aatataggtg acaatggtgt gactgggaaa acatatgagg cactggcag tgggtccaat 397800
gcacaaacta atgcacaac tgacttaatg gagccattc tatatggaga gataccttgc 397860
ccagcctaga cagaggagtg tgggggtgga gaggttctt cgacctgcct caaggagatg 397920

agggggaaca cctagtagac ttcttaggag aggcctaacc ttctcttaag gacagatgg 397980
gaggtagggg gagcagtagg agaggaggga gtgggaactg gaattggaat gtaaaaagta 398040
attattaaaa aatTTTgatt gctagcatag actcactatt gtacaataat ctttTgatg 398100
atatctgtga ctTtaagTta cattTtaatg agactTggag aaaacatatg aaataatag 398160
gtTgaaataa tTtagTgtt tTaatgaaga aacatcacag tgtcaaacat aagcaaatgt 398220
gtgaaattat cTTTTattt tTaatgtga atgtTgaaat tcaggggtca tctacatggt 398280

taagcaactc cagaagttgg aaaacctaaa cctttataac tgaaactgta aataaccatt 398340

 atgaattact cagagatatg ctgagaaatg cctaaaagac atctctttaa tctagtctag 398400
 gaaaagagta actctcatca caataaaaca aaatgaatgc tgaaaacgtc atttatatat 398460
 ctttgaattc ttaaaaaaat ttggtgtggt tttatgacta ataaatagca ataaattaac 398520
 ccaaataata gtatacatca ctataagtgt ttgttattta gtttgaatt tgtataatag 398580
 ggttgtgaat gagcaagtgt tcgggattgc taagttgact aagttgacct ttggtgatat 398640
 gatttatctg aaatggttac actaaaacac taagcttctt tgttttcta ctacacaaat 398700
 tactctacag gtaggagcca tagcttatct tagtctcaga acctgatacc tcagcatgct 398760

 caacaccact ttcagagtga acctggactg ttcaaagaag ttctgggctt ggggatggct 398820
 cagtgggtaa atcctcctat catattaat gacctgac ccatctgcat aagtcatgaa 398880
 gcagaaaaat aacacattat cttataaata aaatgcactg ctgatataca ctaccattaa 398940
 gttgatgctc caaaaatc gaatgttgc catccattct ttagttgagg gacatctagg 399000
 ttgcttcag tttctggcta ttacaacaa tgctgctatg aacatggtg aacagatgtt 399060
 ctigtatgaa tgggcatctt ttgggcatat gccaaagagt ggaattgcag gatcatgtgg 399120
 tagattaatt accattttcc tgaggaacca ccatagggtt gctcatggac cccagactga 399180

 tagctgggaa accacatagg actgttccag acccctgaa ggaggaagtc agtttgagg 399240
 tctggacaat ctatggggcc actggtagt gatcagtatt taccctagt acacaaatga 399300
 actttgggag cctctccac atagagggat actctctcag cctagacaca ctggggaggg 399360
 tctaagccct gctccaaatg atatcataga ctttgaagat tccccatgg aaggcctcac 399420
 cctccctggg gaagcagaaa ggggtcagga tagggggtcg gtgggggca ggggaggaga 399480
 agaggagag gaaactgaga ttgatgtgta aaagaagctt gtttctaatt taataaaaa 399540
 agaaaaaatc gaatgttgc ttcgtataca gtgtgtgaca acacctgaa attctgtcac 399600

 ctccacccta ccacataaa tccatcactc tgctatataa acagctatgc ttctctctct 399660
 cataaaaca cataagtgtg ccaggaatga tatcaataat tcttaacaga acattcctaa 399720
 accatggaca tgatttactt tgcagggggc ggggcctggg aaaaagcatg tgctaggagt 399780
 ttctggctt atttctgccc ctaaaccatt tcttctctac cggatccacc cttgtgtgac 399840
 tcactgttaa agagcttcc tagtctctcc aagtatcgat gtcttgctt accacctgaa 399900
 actgaactca cataagactt cctgtttaag gatgcatctg gagtgcacgc accaatccta 399960
 gccagatcct catgtctggg aagactctag ttctgcctgt tctgcttctt acaatgctgt 400020

taaagcttca ttaagtgttg gctgaacaac tgatgcctaa gaagtacatg gagtccaaaa 400080
 acaccattaa caagtgagac taggccttcc cattctccac atggctaaca tcttttgta 400140
 aggtgttttt ttttttttc cttctaatcc accaatccac ctgcctactg atgtgcatac 400200
 ataagattct gtttactgta cttcccccc ttattttaaa ggcaatatga agtacaaggt 400260
 aagttattgc tttgtgtga tttttgctac aggcattgtca ttgttctttt actctctgaa 400320
 taataaagtc accacttatt ttttgttacc agattttaat aaaaacaaat gtacaaaaca 400380
 cttgagttct cttacatgct gactgatggg atgctttctg ggtttttact ctttaagaaa 400440

 tgacttcttg taagtttaga aagtgtttt tcagaccatt taactataca ccaaaattga 400500
 gcttttaatt tccaaaagta tcctcatagt aataggaagc ttgtgttaaa caaatgtaag 400560
 caaaatttat ctaatatcta ataaaactta attaaacatt gttattgaat gacttttgta 400620
 tgaacaaaa taccaggcat cgtggggcaa agaaaaatac atgggataat ctgtctagtt 400680
 tcagaagttc agagattaca aagggttcaa gacagctact agaaaggata agattagtta 400740
 tgatagtttc acacaatagc caaagacctc ctctgttaag aaaaagctat aaacatgcaa 400800
 attattaaga aaagaaaagc aactgaatgt gaaaacattg agtcaaaata atgcaattag 400860

 tcaaaaagta cctcaaatgc atattttcct ttcaaatgtc aaaaattat ttaattatc 400920
 acacctaagg ttatatgacg attatgctat agtaatatag taagtttttt aaaacatttt 400980
 tataggtatt ttttatgagt gttttgcccc aatacatatc tatgtaccac agacatgcct 401040
 ggtgttcatg gaggccagaa gaaggcattg gataacctag ggctatagtt acaaatggtt 401100
 gtgagtcact atgcaggggc tgggaatcta acccaggtcc tccaaaagat cacccagtgt 401160
 tcttaaccac tgagccatct ctctagtcct ccttaactta acaagttaag ctttgctgtt 401220
 aaattaggac tggaaatata aatataaaat cctgcaaata aaatagagag taattactaa 401280

 ttcaaatgca ttagcaactgg gtgagtggtc aattaaataa ctaattatct tgaaaaatta 401340
 actgactgct taagtggatt gccacaccc acctatcttt tctcaggccc cacaagtgtc 401400
 ccagagctcc catacttctc aactgactca gtggtcttat ttaatagctt aaacactctc 401460
 tctctctctc tctctctctc tctctctctc acacacacac acacacacac aatcttaact 401520
 attcagttga ttatcttttt attctataag cacagaacaa atgttaattt tgggccaggg 401580
 actatgttag catttataaa aataaaaaac aaagataatt actcatcagc caattaatct 401640
 tcctttctctc tctgcttgcc cccaaatctc acatattgct tggctatgga agtgcttggg 401700

 tgaacctatt ccttctactt aaacatagtc ctaggatggc acattaaagg aaaaaatgga 401760
 attctcttga gatttgtcaa ctgtgggttg cacctgataa tttggaatgt tagccctaaa 401820
 gtttgagaaa tacactagaa ggtgaatttt agctactgtg atggtaaac tttataatat 401880

attgagaata aatgtgttgt gagtcatttc tatatcattt ccacttctag aaatgcctga 401940
 cctaaaagag gaattccaga acagctttca gtatttagat atagtctata cacagcaatg 402000
 aaaattaatt ttctcttaaa acttccctta ttcaacagaa cagctttata gtaattggtc 402060
 ttttagtaaa tagaaaagtg tctgcatcaa gaagtgggga tgaggaggca ggagtgacag 402120

 taggtgacct aaaatagaat ttagagtgaag agacacaggc agtgaccac tacttgtgat 402180
 catcactgtc aggaataatc agaaatgtca aggtgtatag ggtagtcttg aaatgtttat 402240
 ttatttatct ccttaaaatt taaatagaa acaagcttgt tttacatgtc aatcccagtt 402300
 ccctctccct cccctctcc cctgeccctc accaacctt tatcccatcc ttttctgct 402360
 ccccaggag ggtaggctt tcatagggg atcttcagag tctgtcatac ctttggagc 402420
 agggcccaga ccctaccag tgtgtctagg ctgagagagt atctctctat gtggagtggg 402480
 ctcccaaagt ccagtctgt actagggata gatactgatt aattcgatt tcctgatgg 402540

 ctaaggatgt tgaacactct catcaaaaca ccaataatc caatagggt acagaataga 402600
 gaattctcaa cagaggaatc taaaatggcc aaaggacaca caagaactgt ttgacatga 402660
 gaagacttc agagactga caacttcag ctgtttattg tgaccctgat cttttatgca 402720
 catcattctt atgtagctca cagtgacctc tttcagtgga atgtgaccgc atacatgttc 402780
 atctttatat tctttctgaa ctgagctcag catgttctag agtaggagaa tcaggagggg 402840
 atgattttga ctgctcatga gaaacaatag aatataagcc aaagctaaat aatgacttg 402900
 tttattatgt gagtgtctct gactgtatgt aattgatttc cgtttgtgaa cctgcaatct 402960

 acaaaattga ctgttttaac aagatgtgct gactgggat atgctacagt agcataagtg 403020
 ttatggaagt aactaacat tttctgattg gatagaaagt ctgctccatg tgatgggacc 403080
 catacctggc acaggtaaag gtgccgaaaa catgtagcta gaacatgtag cgttctaage 403140
 aacaactcca tactaatatt ttgctaaact gacatcagta ttaaaatgac tectaattaa 403200
 tgactcgatg atatacttat agttcagagc atctcccaga ccttattaga gaaggttctc 403260
 cttgaattcg atggcaatta ataccaatat tttgtgttca actagtcagt gtgcagagaa 403320
 caacaaactg tgaatgctg agacttaata ggatatacat atatcacact cctccaactc 403380

 aagacccaag actcccatcc tgggaagact ctaagagcca gaaatgataa gtaacatcaa 403440
 agaaacattt ttgagcagga ttgtggtagt gcacgccttt aatcccagca ctatgaggc 403500
 agagataggc ggatctctgt gagttcaagg ccagcctgat ctacgggaaa agttccagga 403560
 cagtttcaa agctacagag aagccctgtc tcaaaaaaca aacaagaaaa gaaacatttt 403620
 ttttccagac acaaccagaa agctgaacag gagccagtgg ttatgacaac atgtacaaga 403680
 cctgaataaa cttaacagac aaaatcctag tgtaacatgg aaaaaaggt gtgcacaaaa 403740

tcccaccact agccaaagag ctatttgtat tttaaagcta gtaggagaaa gtgagtgttc 403800

ttaatgata caactctgta ggttggccac actctagggc aggcctcatt cccaagtcta 403860

cttgggcaac acaagtggac tcaaggggaag aaaaaacaaa aagaagaaaa atcaaagttg 403920

ggaatgaata tgttaaaatt acattttatg aaattctcaa cagattaatc aaaccattgt 403980

tttagaaaat catccaatta cagagtctct ctatatacaca ccctcttcct ctatcataat 404040

gtctatcatt tctccatgat agacattatc ttcttcttgc tgtctattca ttgacatgaa 404100

ttgagggca ttaactatct tattgactcc ttattataag tacctgaaga aatggtgagt 404160

caatcaatct taatatcaga aagtctctctg ctatctctctg atagtttctc attcattcaa 404220

gagcaaacca taatcagaat tagtaccaaa aatgtttgtg gtgtttgaat atagcaacat 404280

gattctctaa acctgttat tgaactcttg ccatttatga ttataatgta taaggtaaaa 404340

tgattttact ctatagagta aaaaataatg gctgtttata tttctgcacc ctctcaaatg 404400

caaactatag agccaaaac tgtgggcaaa aacctgacac aggtgaagaa attaaatagg 404460

gaaaggaaca gaacctcatg ttcatataaa tggttttttt gttagcaaac tgtaattatt 404520

ctaaaagagg aaattattca tcagtctgta acttgatcct gcataattca aaaatatatt 404580

atatattaaa atttaaaata acatatatgt tatgtgtcat atgtataagg ctggaatag 404640

catacttatg aaagcatatg tataatatgt aattaatatg tatatgggtg agttatatat 404700

gtaccacatc aaaaactgaa aattcaaac aaacaatacc tagaagaggg aaataattat 404760

agttcacaga gcaactctgt ctctgagctg tgcctgtatt atccacaatt gtgtaacaat 404820

tctgtacagt agatcttctt ttcttattat ttgaaaagca aaagcaacag agatattaac 404880

ttgttccatt aagctgaagt ttccagagga catttgggct ccttctgaac ttatggttgt 404940

tattaatcca ttaagatta atgaatttaa ttgaactatc actacattca ggtatggcat 405000

aggagttag caggcaataa aagagactat gaacctgaca gaaataaatg attggatcaa 405060

taaataagtg gaaaaagagg caagtcactc ataaattaat tctgaatagc ttatataagt 405120

attccgtatt ttgaggactg gagaatattt tcttagccct agattgtagg ctaagtttat 405180

tggttagca gttttctagc aagaaataga gtttataaag ggaagagagg aggcacaata 405240

actttacaga agggaaacca accctcacta cctcaacagg tgagcattga taatgttagc 405300

catgtagaca gcatgtgac ctagacggcc ataaggagaa tggcatctca tctcttcatt 405360

cccttctca aaataaatag gcaagtctga tcatgaaaa gtacatctaa catccaacgt 405420

gtactctca aaaccataac ggtcatcaaa gtcaggaaca tccacataga aagacgaaaa 405480

actgtgagaa catctgtaat gttatgccct ggatgagatc ctggggaaaa tataagacat 405540
taggcagtaa ttagtgaatt ctgtctaaga gtggagtga gttgataatg taagagtgtt 405600
ggtttcttgg ttgtgacaaa tacgccatag taatgtgaaa tgttaccatt gaggaaaatg 405660
gggaaagga tagatagaaa ttctatcttg caagtttcta tctagcgatt ctaaaaccaa 405720
aaattaata catacatgca cacacataata ttcagtatct tggacaagaa tataaacag 405780
ctatatttcc attcctggcc aagtaccttt attgactgcc tctccaagtg ttataaaatg 405840
tacatcctct cccaacacaa acacacaaaa tattcagact tgaagcatga agatagtgtt 405900

taaacttga agagtcagag tgagtctact ggctaagctg aagagattgg agatcataat 405960
tatgcggatg aaggatggtg gctctcctaa tttcaggcct ggatgagagc ttctgaatgt 406020
tccttctct gtaaaagaaa aggttcatta agaactctgtt acttgaggtg aaactcagaa 406080
gaaattacgc agaagacact gggagtagac taaactaggg aagccatggg agtggtaaaa 406140
cacaggaaag cagttacaaa agatcccttg gggctcaggg aaggaaaagt tactctgctc 406200
agtggaatgt gatggaatga ccctgggagc aaatccctac tgaggccaca caggcactga 406260
tggcactgtc gtctctcagg taccatatgg gcatggtaga gcagatttat gagggttttc 406320

tgggtgtaat taaatctct cctacagcct gtgtaacaa catttgcttg ttaggatgtg 406380
tatttctccc ctctgagaca aactgggtgt tggttttgtt aatcctttca tagtgcaaac 406440
ttgtactcta tgctctgaa gtcttgaatg taagcatgca ggtataattc tggatttgag 406500
tgaagcccaa acaaggaat ggggacttcg ggaagcagca ccatgaggca tacacttgat 406560
ttttaccttt cttatTTTT gtgtcttgcc atatctgcac tgaactaaag aactgattta 406620
gaaaaataag gtggTTTTT tttttgttt tcaaaataag atgtctttt tttttttaa 406680
gaaccaagag acacattttt tttctttaag aaccaagaga cacatacttt tgaggcaaaa 406740

taaaaaata atactttct cctgggctct gatcatttac agctcttact tatgattgct 406800
ttccccaggt gtaataattt attgcctatt agttcagtat atcaaaggct cgctttctct 406860
ctttgactgc atgggtgact ccattagtgg taatgaactg tttcatgggt aatcacacct 406920
tcaagaccca tcacctaaa ccctaaagcc tgaaacctca gctgtttgtc ctgcagagag 406980
aaaaagagca atgacctgca aaaagagatc tgagaacctc tggagatatt aagtttaagc 407040
ttaatagtaa gtcattaata aataagatgc agcacaatta tcaatatgaa gcacatttaa 407100
taattaatac ctigcaacaa aaagagaaat gaaatactag gtggaattag gcagaggtta 407160

tattcagttc cccttgaaga gctgctttg aaaggaaatt cacaaactgt ttaaaactat 407220
gaaagaacca tttccgcaaa gctccagtgg agagccactt tgcaattgct attctgaaca 407280
ctagcttacc tctgggctca cacatattct ctgtgctcca ttctaaaggt acaacttctc 407340

ccttttagtc acaactttct ctctttcaag gaagtaccaa aagttcaggt ggatgtgtgt 407400
 gatcaataaa ataaataaat aaataaagtc cttaatatgg ctgtaattct tactatcttg 407460
 gatttttagg gtagtgtttg ttgaccataa gatgaagcaa ccaacattta ttatttacca 407520
 aggtagtttg actacatag tgggtatgic atggaattct ctaataaac ctgtatggcc 407580

 actttcatta agtgcgtgtc atagactaga ggtttcaggt tgagataatc taaggcactt 407640
 gcctaagatt aacagtgtgg atagtgagtt ctgagaaatt catttctggt cttcggaggc 407700
 ctaagaatat catccttggga ctccaagtg actatatcta aagtaataca ttattttaag 407760
 tattatTTTT taatcaatg cccacaacat ctggcagcta tgctatcagt tgtctggaga 407820
 ctaaaaaacag taagacttcc caagtcatga ttcagaaagg cttagctact ctctggcatt 407880
 gctagccaat caagtcttcc agcgttgctc atgagcctgg cttttcgcc agcctgtggc 407940
 tttttgcagg agccactcaa ctctattgaa aggttgactg acagtgtctt cccaatgctg 408000

 ccaccaagca ggagctgttc taacctgcag catagtatgt gttggcctta gactggaata 408060
 aaaaaaagtg atacctcagg atatatgttg agtttctcag ctctaattg ttagtgaatg 408120
 cttaatttcc ttggtcttct agatgaccaa ccatttacta ggccaagatc tecttagaat 408180
 gaactgttca gtaattctg agccaccttt accatccatg attccaggag taaattgaac 408240
 tttttctttt ctaccaaaac tgttctggct cactgtgaat acaataggaa gttcactcat 408300
 tccacattaa atgcattgac ttatgtttga atttcatggt ctattcaca cactcatcaa 408360
 ttccatttac attgcctaaa gtttatagcc aaatcctact aaaaccactc tgtaagataa 408420

 cattaataaa aaggaaatct gttgaaaact attttgcaat aataaaagca ttcaaacttc 408480
 aaggtttgag actctttaga gtgagtcctt attataaaca ctcaataagt actagagact 408540
 agaaatagtg aagtttgagt catgtaggat tcttaaaatc tagattatag gtttatttaa 408600
 tacagttata tcaatgggat gtttttctat tcttctctct tctatttatt ctctgacaat 408660
 gtcagcatg caaataatga atcagttata ttcataccat aatctccctc ctacttccca 408720
 cacacaacac atcattgagt ccaattgggtg ctgcttctg gaatgctgat aaatcttggc 408780
 ctcatcttgt gctggttaacc atagatgcag agtccacaaa tgtggtggtc atgceatgct 408840

 acagcatacc ttccagtcct cctgatgtta cattcatttt ttaaacaggg tttctatgtg 408900
 tagccttggc tgcctacac ctcaactcaga gatccactg cttttgcctc caagagctgg 408960
 tattaaggagg tgcctgccgg cagtgtctca ctgctgtttt gatctttgtg ttccctcttc 409020
 aattatattc ctgaaactt tggaaggagt tggatagggc aactaattta tagctgagca 409080
 cccaatagta acttattttc agtactgtca ccagttataa gtctctgaat tacttctgac 409140
 tactatagag agaagtttct ctggccaagt ttgagggcag cactaattga ttagataaaa 409200

cataaatact cgagacagtt taatatcatg tctathtagc aaaacacccc aagctacaaa 409260

cttttaagag cccttaaatc tgaatcaaaa gcagttggtt actccataac attgcacca 409320

ctattgcate atctttcctg gcaggtccag catcatagca ctcagggttc actgctactg 409380

gtaccactga tggttttttc ccttcagcag cctgccacgg cacitttctga cactacgaaa 409440

actgaccage aaaggggaat ttttcaagcc cagcttgatt gctttatgtg ctgtaaccaa 409500

aatgtcttca gattattatg ttggcatcta gttatgtgag caaacaagag caatggctag 409560

taatggcata tttattgaca atcaaacata actttcaact gaagataaat aggggagtat 409620

tgctgtaggt tttatcagcc taatacattt caatgcttaa gtataaatat gtagacacaa 409680

tgttttatca cgaatgattt ctctctaaat aaagttggac aatacaagga agtcttagag 409740

cttagaatg ccctttcaaa ggccagacaa ttggtgccat ctactataat aaaaaagaag 409800

acaaacagag tcatctctgg tggatgaac tcagtgtaga gagtctcctg ctcaaaaaca 409860

aagtaagctt ggatccccta tatttgtacc cttttatcag aacagccaca aacaccata 409920

ttcagcctct tccaggaat tccggtggcat ctgtgttagc tctagtattc tctcagggtt 409980

cagttcttca aatttcttc ctaaagcaat tgatggtaaa tctataaagt gtacagatat 410040

accctaaca atgatatgtc catatcagta cttatatcca cagataagtg aagtctctac 410100

ctctcatcat gaaattgct ctttgaaca gaaggaaacc actacagaaa acctcagtga 410160

atcaaattgt ggagttgtgg aactcagtcc cagttgatat atctataaaa cattcacact 410220

cctaaggctt tgggaacatg cagaagatag ggcagaaaagg ttgtaagagg caggagatca 410280

ggaagtttgc tgtgaaactg tttcctagta atatcagaag ctacacccat gacgtctcac 410340

caacatgact gccaaaatgc gagctgaaca aggaagatc ccacagacat gccaaaaagg 410400

atgagagaaa accttcaagg tctcaactct atacaaagaa ctatcagcta ctgaagaage 410460

tgggagctgg aaaggtgggt tttctcaggg aagagcactc caattggttg tctagtatgg 410520

tcatccctga aaatataaat acatgtaaca aaacaagggc tgaacaggtt atatttagga 410580

acatatatgt atatacatat attcatgtaa taacaattaa taaaagaggc catgaatttg 410640

aaggagagtg gaaaggatc aaaggaagat ttggaggag aaaagagaaa gaaaaaatgt 410700

tgtaattata ctaatctaaa aaaaaataga attagcatct aaaaatgtat gcctgtattg 410760

taaaagtaga cctatgacac aagcatgcat cttacagttt aaggtactgc aataagtcca 410820

tatcacattc ctttcttta cacataactg tgctttgtga atgcagacgt gtctctccc 410880

cacataactc tttctgtaaca aggactagaa acatactgct ctccataaag gcctgtgggc 410940

tgactactag gacaaaacta attaattcic tggttttgag tgtgtgttct gcttctacag 411000
 tgttgcatga ccattccatt agatgtatit tftagcctta caactcaact gtgggggttt 411060
 ctctggctct ggtaggcaaa tattctccat ttccatgga tccaaaatgc tacatttctgt 411120
 taaaacctgt ccicaattac ccccttgtcc aggaagtccc actaaagctc ttgtctctcc 411180
 atacctgtca tttcagtgat gagtatatgt cttaaaatta atgcctcaca gtgttctctc 411240
 gtgttctatg gcagacatct tatctctgca aaatgttaag ctcccttgag ggaaggggag 411300
 gcaacaaaca gctcctgtct ggattatcat gagctttata gccaccctca actacttttt 411360

 taaaatttat ttaaacacac agagagtctg taactagact ttcttagtat gtgccagtct 411420
 tttctctttt taaaagact aatttttatg cttaggaatg tttgtctgtg tgcataatata 411480
 tgcaccacat gcatgcctgg ggttgtgaag tccagaagag ggtgtcagat gccttggat 411540
 tgggtggctc tgggaactga acccaactgc tttctttgta ggagcagtat gtacccttaa 411600
 ccaactgagct gtctctccag ttccattctt cccaacttta aaataaaatg ttttaagagg 411660
 ctctcaatgc ctgaggactt ccaagaattt tttaaaattt ctcttcttag gttttcctaa 411720
 ttcatattta gctgagttc tcttttctaa aaatctaagg agtcagacag tatgctacgt 411780

 ctgcctgtct ttttccatag tggcaaactt atttagatta acttcatcct tctgagagaa 411840
 caacagtaaa agtctccaca ttgactctct gctaaatgct cctgctccat agacatatgc 411900
 actaatgtat ggggtgatat attatttatg atttattaaa gcttgcctga ggattcagaa 411960
 agcaaagtca accacaagat ataaggttca gtggtggaac acacctttaa tcccaggact 412020
 caggagagaa aggcagctgg atctctctga gttcaaggcc acactgggct acatgatatt 412080
 gaatcagtct aaaagagtaa cagaactcat gcctttaatc ccaggactca taaaaggtat 412140
 ttaagacaag aacagggtct cagagctggc tttcattacc cagccacatt gaggatagga 412200

 aggtattaat ttctccagcc atgctgagge ttggtggagt cagtatctct atttcattct 412260
 gaggtagagt aagagctagt agccattac tttgcttttc tgatcttcag cttgaaactt 412320
 gaacccaat atcaatctct gggcttttat ttttcatgct acagatgtat gcaactgatt 412380
 acatgtggac atatgtgtga cgtatgcatg taagcagatt ctgtaagtcc tacacagaag 412440
 gagctgtctc ttgagacctt agagcgacag aacatggagg taacttttac acctagagat 412500
 tattctaaca actgtatfff ctgtttttta atttgcagtg tagagaaaat cataaacaat 412560
 tttgctcttc caaaaacgat taaaattgaa atctaactaa ggagtgtttt ttgcttgttt 412620

 tatcttaaag atattataag attgcaaaca catttaatat aaagaaaagg aagaaaattt 412680
 gagtgttcag ggatggfact gggcataagc tttttttttt ccttttttaa attaaaatag 412740
 aaacaagttt attttacatg tcaatctcag ttccctctcc ctccctctct cctttgcctt 412800

ccaccaagtc cciatcccaa ccctttctgg tcctcaagga ggctgaggcc ttccatgggg 412860
 gaatctttaa actctgtcaa ctcatTTgga gcagggccta ggcccggccc catgtgtata 412920
 ggctgagaga gtatccctct atgtggagtg gactcccaaa gtccatttgt atactaagga 412980
 taaactga tccactacca gtggcccat agattgtcca gacctcaaa ctgatctct 413040

 ccttcagggg gtctagaaca gtcctatgct ggtttcccag ctgccaatct gagcttcag 413100
 agcaaccctt gtTcaggtc agctgtttct gtaggtttct ccagcctggt ctTgaccct 413160
 ttgctcatca ctctccctc tctgcaaatg gattccagag ttcagctcag tgtttagctg 413220
 tgggtctctg ctTctgtTtc catcagctac tggatgaagg cattaggatg gcatataagg 413280
 tagtcatcaa ttcattatt ggagaagcat atttaaggta gcctctcaac tattgcatag 413340
 attgttagtt ggtgtcaacc ttgtagatat ctgggcataa gcttttaaaa gcagcattag 413400
 agcttattaa gggagggTtt ttcaggctgg ggagatggtt cagtcaacat catagtaaag 413460

 gaggacctac atttgattcc cagaaccaa gTtaagcagt cctgtgataa catgtgcttg 413520
 taatcccaga gTtgggaagg cagagatgaa tagattcaca agcctTactg gtcaatctgg 413580
 ccagccccag ttagtaagtt ccagccct gagagacct atctagcaca cagccctat 413640
 agtaaggcac tcaagactga cctctgacct ccacattac ttgctctctc tctctctctc 413700
 tctctctctc tctctctctc tctctctctc tctctctctc tctctctctc tctctctctc 413760
 tctctctctc tctctctctc tctctcaac acacacacac acacacacac acacacacac 413820
 acacaaactc atatgagcac ctccaccacc acccatatgc acatacatc atatagagac 413880

 aggaagaaaa tgetgcagta aaaacttaag tatagacatt agTggagaga gatgcaagca 413940
 tcagcttttc aaaggcagat gTtgtgtaca aattttattg tggTtttata ctgttacaac 414000
 catctaahta tgacatafca ctattTggat atgtgtgcat gTgtgatggt caaatTttta 414060
 atctagacaa cTaaactTtt attttattat gtgaatacct gaagacaagt aagccctgta 414120
 caattTacc tgtTtactg gTttattTgt caacaactgt atttatcaa cactaatatt 414180
 aacagTttcc ctgtTgcaag cctTttgTgTg gcaatagcac ttactTcaa gTtaaactaa 414240
 tgcctTtctt gaagtaattg ttagctTtca atgagaaaa aagtgaagtt gctTttcaaa 414300

 gcacagagaa aataaataga aattTgaaga ctagaatgca ttgatgaaaa gaataaatat 414360
 tggaaacagt attctTtttt cagattTtta aattTgaatt agaaacaaga ttgtTttaca 414420
 tgacaatccc agTtccctc tccctcccgt cctccgctac caccctaa aacactacct 414480
 atcacatage ctTttTgctc cccctggatg gtgaggcctt ccattgggtg tcatcagagt 414540
 ctatcatate ctTtgggata gggcctaggc ccaccctgt gtgtctTggc tcagggagta 414600
 ttcatctatg tggaaTgggc tcccaaagtc cacaactatg ctaggaataa aaactgaact 414660

actaaaggag gtctctgtaga ttccccagat ttctcaatg aaatccatgt tcctggggtc 414720

tggatcagtc ccattctggt atcccagcta tcagtctggg gagcaagagt tcctgatgt 414780

tcaggtcagt tgttctgtg gggttcacca gcttggctg gaccctttg ctcttctc 414840

atccttctct gaatctggat tccagttcag ttcagccata agttgtgggt gtctgcttct 414900

acttctacca gctgctggat gagggctatc cggtggcata taagtcagtc atcaatctca 414960

ttatcagggg agaacattta aggtagcctc ttctctgtgg cttagattgt tagctagtag 415020

ctactagtag ctagtagcta gtagctttgt ggctctccag acatttgctt attgcctgat 415080

ttctctgtaa acctaaaatg cctcctctca ttatggtttc tccatttttg ttatcatcta 415140

ttcttccct gactcaaaact ttctgctcgc tcatgtctc tgcacccctc ctcttcttcc 415200

cttctcattc tctagctcc ctgccccctc ttcccgtgct ctcaaccagc tcagaggatc 415260

ttgacccttt accttctct aggggaccac gtagtctct tttagggtcc tcttgttta 415320

ctagcttctc tggcagtggt gattgtaggc tggtaatcct ttactctatg tctaaaattc 415380

gcatatgatt gactacatat catgtttgtc tttttgtgat tgggttacct tgctcagaat 415440

gatttcttct agttccatcc atttgcctgc aagattccat tgatcttttc cactgagtgg 415500

tactccattg tglaaatgta ccacattttc tctatccatt cttttgttga ggggcatcta 415560

gactgcttcc agtttctggc tattacaaat agcgtgcta tgaacatcgt taaacagatg 415620

tcctttttgt atgaatgtgc ttcttttgag tatatgccta agagtggaat tnnnnnnnnn 415680

nnnnnnnnnn nnnnnnnnnn nnnnnnnnnn nnnnnnnnnn nnnnnnnnnn nnnnnnnnnn 415740

nnnnnnnnnn nnnnnnnnnn nnnnnnnnnn nnnntcttt tcccagtctg tgggctgtcg 415800

ttttgtctta ctgtgttctt tgccttacag aagcttctca gtttcaggag gtccattta 415860

ttaattgttg atctcagigt ctgtctact ggtgaaatat tcaggaagca gtctctgta 415920

ctttgtcttc taatatggtt agtgtggccg ggtatatttt gaggtctttg atccattttg 415980

acttaagttt tggcatggt gataggcttg ggtctatctg tagtcttcta caagtctgca 416040

tccagttatg ccagccatc ttgttgaaaa tgttctcttt gttccatcgt ataaatttgg 416100

attgtttgtc aaaaatcagg tttcatagg tgtgtgggtt aatatcaggg ttttcaattc 416160

tattcccttg gtctacctgt ctatttttgt gccaatacca aactgttttc aggactatag 416220

ctctgtaata gagcttgaag tcagggatgg tgatgcctcc agaagttcct ttattgtaca 416280

ggtttttttg ttgttttgtt tgtttttgtt ttgttttttg gctatcctgg gtcttttgtt 416340

tcttcatata aagttgagta ttgttcttc aaggtctgtg aagaattgtg ttgggatttt 416400

gatggggatt acattgaata tgtagattgc ttttgacaag attgccattt tcctatgtt 416460
aatcctacct atccaagagc atgggagttc tttccatttt ctggaatcct ctttaatttt 416520
tttctttaga gagtcaaaat tcttatggta caggctcttc acttttttgn nnnnnnnnnn 416580
nnnnnnnnnn nnnnnnnnnn nnnnnnnnnn nnnnnnnnnn nnnnnnnnnn 416640
nnntactgtt ctttcaaggt ctgtgaagaa ttgtgttggg atttgatgg gcattgcatt 416700
taagatgtag attgcttttg acaagattgc cattttctct atgttaatcc tacctatcca 416760
agagcatggg agatatttcc attttctagt atcttcttta atttcttttt gtaaagactc 416820

aaagtcttg atatataggt ctttacttcc tttggttagt gttacaccaa gatatttttt 416880
gtgtttgtg actattgtaa aggggatgtt tctctgatt tcttttttcg cctcatcagt 416940
atatagtagg gctacagatt ttttgagttt atcttgtatc ctgccattt gctgaaagtg 417000
tttatcagct gtagaagttc cctggttagcg ttttttgggt cactcatgta gactatcata 417060
tcatctgcaa atagtgagag ttcaacttct tcctttccaa tttgtattcc ctgatctcc 417120
ttttgtgtc ttagtgctct agatagaact tcaaggacaa tattgaagag gtatggagag 417180
agtggaaagc cttgtcttgt ccctgatttt agaggaattg cattgagttt ctctccattt 417240

aatttgatgt tggctgtcag cttactgtat attgttttta ttatgttgag gtatgttctt 417300
gttatccctg atttctccaa gaccttaggg ctgttggatg ttgtcaaagg cttttatggc 417360
atctagttag atgtgggctt ttttctctca gtctgtttat atgggtgatt acattgatgg 417420
attttcatgt gttgaacct ccttgaatct ctgggatgaa gcctacttga tcatggtgga 417480
tgatttctct gatgtgttct tggatttgat ttgccagtat tttattgaga atttttgcat 417540
taatattcat gagggacatt ggtctgtagt tctctttact agttgtgcct ttgtatggct 417600
tgggtatcaa ggttattgaa gcctaataaa aagagtttgg caatgactct tctgcttcta 417660

ttgtgtagag gagaattggf attagctctc tatttgagga gaattggat tagctgtacc 417720
ttgaatttct gglagaattc tgcagtgaag ccactctggca ctggagtttt tttggcggtt 417780
ataggtctat ttatgttget tatctgttct tgatttaatt ttggtaaagt aatctgtcc 417840
agaaaattgt ccatttcctt tagattttca acttttgagg aatataggtt tttgaagtat 417900
gactgatgat tccttgatt tcctctatgt cttttgttat gtcccccttt tcattctga 417960
ttttattgat ttgtatgtc actttttgct gtttggcaag tttggataaa ggtttgtcta 418020
tcttgttgat tttctcctag aaccaactct tcattatatt gtttctttgt attgttctcc 418080

tagtttccat tttattgatt tcagccctca atttgattat ttcttagcgt ctgctcctcc 418140
cgggtgtatt ggcttctttg ttttctaaag ctttcagtig tgtcgttaat tctctagtga 418200
agaattctaa atttacagta tgggtctctg ataagataca gggggttatt tcaaattttt 418260

ttgtacctgt tgagttttac tatgttgcca agtatgtggt agattttaga gaaggttcca 418320
 tgggtgctg ggaagaaggt gaattgtttt gtttttgat ggaatgttct atggatacct 418380
 gtttaagtcca tttgtgcat aacttccatt atttcccttg tttctttgtt aagtttctgt 418440
 ctggcgttcc tgtccagttg tgagagtggg ttgttgacgt ctcccactat aattgtgtgc 418500

 agttttatgt gtgatttcag ttttagtaat gtttctttta caaatgtgga tgcctttgta 418560
 tttggggcat aaatgttcag aattgagact tcattctgat agatgtctcc tgtaatgagt 418620
 agaaagtgac ctcttcac ccttttgatt ttttttaatt taaagtccaa tttgttgat 418680
 attagtattg ttacctcat ttgtttcttt ggtccatttg attggaaaag ctttccctaa 418740
 cctttaattc ttaggtactg tctgtctttg aagttgaggt atgtttcttg tatgcagcag 418800
 agggatgtgt tctgtctct tctctattct gctaactctgt gcccttttat aggcgagtta 418860
 agaccattaa tgttgatgga tattaatgac tattgattgt tcannnnnnn nnnnnnnnnn 418920

 nnnnnnnnnn nnnnnnnnnn nnnnnnnnnn nnnnnnnnnn nnnnnnnnnn nnnnnnnnnn 418980
 nnnnnnnnnn nnnnnnnnnn nnnnnnnnnn nnnnnnnnnn nnnnnnnnnn nnnnnnnnnn 419040
 nnnnnnnnnn nnnnnnnnnn nnnnnnnnnn nnnnnnnnnn nnnnnnnnnn nnnnnnnnnn 419100
 nnnnnnnnnn nnnnnnnnnn nnnnnnnnnn nnnnnnnnnn nnnnnnnnnn nnnnnnnnnn 419160
 nnnnngtacc ttctggcttt cagagtttcc atggaaaagt caggtgtaat tctgataggt 419220
 ttgcctttat aagtacttg acttttccct ttgctgctct taatatttc tctttattct 419280
 gtatgtttgg tgttttgatt attatgtggg gaggagacct ttttttggtt cagtctattt 419340

 atgttctgt ggcttcttg tattttcatt ggcatgtctt tctttaggtt gggaaagttt 419400
 tcttctatga tttgttgaa tatgtttct gtgccttga gttggacttc ttcacctct 419460
 tctataccta ttattcttag gtttggtctt ttcattgat cccatatac ctggatattt 419520
 tgtgttaggg atttgttga cttaagattt tctttggttg atgaatctat ttctgctagt 419580
 gtgtctcaa ctctgagat tctctctcc atcgcttga tctgttggg tatgcttacc 419640
 tccgtagttc ctgacattt acccagcttt tctatatcca gcatttctc agattgtgct 419700
 ttctttattg tctatattc agtttttagg tcttgaactg tttccttgag agatttgttg 419760

 atatcttga tttttgggt ggttttctt tcatttctt aaaggattt ctcattctt 419820
 ctttaggtc ctctatcatt ttcatgaaga tgttttagg gtcattctt ttggttcac 419880
 tgcatttga tttcaggtc ttgctggtg atggttcaa gtctccgtg ttgtcatatt 419940
 gggtttctg ttgttgaata tgctttaca ttgctctt ctcactctt cttctggtg 420000
 gtgtagcagg agtctctcc tttctggtg ggtatgggac caaagttccc ttctggtaaa 420060
 tgcaaacaga tccaatactc tgatatctg cctcttctg tggatgggga ggaactgta 420120

ccctgctcat ggcagtgicc agggttgttt ggatctggtg agcagatccc tggcatcaga 420180

 tgtctctgag cagggcagcc gaactgtgga aacagtatta tttcatatga actatatgac 420240
 atgtttcaaa ggcctgtgac atacacatac atgtatgcat gtgtcttttc tggatgaaac 420300
 ctcttaccag cacagcatca ggaattcaat acagtcaaca accttggctt caggcctttc 420360
 tttttaggaa tcttgccctg atccccattt atagtataag acatgtctca agccctttgt 420420
 gcaattctag taccttttgg ttttaccata tcagattata accctatcta agccacctct 420480
 gaagtcaacc ttatagtcac acttcttcaa ataagagaga ggggggaaag tgtcttacca 420540
 gttatttgat atgggagcca cctaaacaat gacttaacaa tgatcttcca tttagaagcc 420600

 cagtctactt agatatgtct ttttcttcc ctggatatct ctcttctacc tttcaaaaag 420660
 ttcataccaa aaagctcttt ttaggagtgt ggtttcaaga gagggtttct ctttgggttt 420720
 tgagactgtc ctggaactag ctcttgtaga ccaggctggg ctccaactca cagagatcca 420780
 cctgcctctg cctcccaggt gctgggatta aaggcatggg ccaccacctc caggcccaaa 420840
 aggcctcttt aataaaccca gactctgctg agctcacacc ctgctctcaa gtgtgcattg 420900
 tcatttcccc ccaaatcttt ctttaaatit taataaacctc caaatctgct tcttactttc 420960
 tcacctaata acicctttct ccatcaaagc taggggaact gaggggagcc ctctgaaaac 421020

 atctggggct gcttccagtg acagtatgga gcatgtctct tcccttctctg ctactgacca 421080
 ggtcatcttg taigtctgtg gtctgcctct gtgttctctgg aactgatctt tcttgggtgc 421140
 tcatgactac tctacaatgt cggtttattc atctgtcttt aaacagttct ggcactcaac 421200
 catgcctcga actaggtatc ctggcacctt cattgttgca ttagatacat tcagtttgag 421260
 ggaagggctg cattcagaac cagcttcttt ctccccagca aacagcctgg acttgccagc 421320
 tgctcccaga tttgccctt acttctctagt ctctcttcc atcacatttc tcaggtgtct 421380
 gctcactcag tgggtccagtc atgcaggact tctcttttct cacgtagctt gtaattttcc 421440

 accttgggtc ttcgagggtc attccaatta aaatacattc catttgggat gcagtgaaaa 421500
 tcaaggtcag gcttaaatgc tgctacctct gtgctccctg agctcttga tcataaact 421560
 aatatagcac gaatcacatt gtgtttagc cagtgatctg tctttccac cacactgaac 421620
 cctctaataga gcaggagccc tctggtttgt ctttgtacct tcagagaggt taagtgattg 421680
 gcttaagatc aaaaactgg caaaaaaaaa agaaaagaaa agaaaaagaa aaaaaaaaaa 421740
 cagaccaacc cticcattct gcctccaagt ccagtatgct aaaaatattt cttctaaact 421800
 tccttctgct tttataaagc tcaagaacat tttactaaca ttaacaatgg tagcagatat 421860

atacatgtat ttttattgta tcttttcaaa taaaatgtct gcttcaaaaa cgcagggga 421920
 aaaacaatgt ataggtaggt ggtaaagtgt gaggttcttt tcaggaataa ccctcagtgg 421980
 aaacctgcct acaaactcct aaaatatcat ctctctggc catgtagctt catttgctga 422040
 cgttttctac tcccaaatag attctggagc acaagacgaa ggctcgtgac agttgactaa 422100
 gttgcctaga tatccctcta tgtaaagtaa acatctttga aatatagtta tatgagacce 422160
 tattctagag gagaaactgc ctgttaaaca gtgaagaaag ccagcagcaa ccagtcatg 422220
 cctggctctac tttctgggct gcacctttag acctcctgca catttgctga cagcagttca 422280

 agtgctcacc agagggctcg gagggcggga ggggagagaa gcttacttta aggaggccaa 422340
 gcggcttgga atacatgcag tggcctgagc acaggtccag gagtcttagg ctttcggaac 422400
 tgtaatccta gctcagacac tgatccctcc tgctcccagg gataaattac tcaacctttc 422460
 tgccttgctt tccagatctt tctaataagg ggttaataatc ttgacctcag aaggttggtg 422520
 tatgaattaa acatccgta ggcctcatct taaaatccag cagaactaag cagactcagt 422580
 aactcttttg atgtgggtta acaagaacta tttctttctt tctttttggt tttttgaaaa 422640
 tttttttca tttttttat tttacttaga aagaagatta ttttacctgt taatcacaag 422700

 aactatttct gttcaagagg tgaagatac ctgattctag cagcctccga aaggaaggca 422760
 aattcatgaa ctatttctgt tcaagaggtg aaagatatcc aattctagca gcctccgaga 422820
 agaaggcaaa ctcataaatg aaagaagcag aaagctagga acaaaaacaa gcaagccatc 422880
 aaaaactttt acttcacccc aaacctcac gcctgactgg ttcatctcc cactataatg 422940
 agcaccgagt ttggccctta acaagctttg ggagaatggc tgcctttcag gacactgggc 423000
 tacagactga gcctcagcat attttcaggg tcttgtaata gttactggac acatttagtt 423060
 ggagaaagat tcaattgta tcaactaata gagagaaaac ttttaatat ctggaagttt 423120

 tgttgaaggt accatttata actatacggg aaaagattat tatcttagca atacaattta 423180
 acacataaaa ccaaatggct ttcagagtaa gtgagggatg tatgctagat gattacatgt 423240
 aattccagat ccacactagt gaagcttgac tttcccatgg agagaacat aatacattct 423300
 gggaatggtt ggetccaaag ccagcatgac atcttggttt taggttcgtt tgcttcctaa 423360
 gcattacctc tctcatttgg atctctccc ttcaactaac agcagagcat aacacacagt 423420
 gcatttgtcc ttcattgtaga gttaaggatc gtggggcctc aggcgtgcta gtctagtact 423480
 ccactactga gatatgttac tgtgtgtttg tccttgaacg agttateccac tgttatccca 423540

 taacttaacc tcaaaatgta aagacaacat taggtttggt attcacaat ttctcttgggt 423600
 ctggaatcag gggtgaagcat aactgggttc cctgaattat ggccactcaa aatcatgatg 423660
 tggccaagag gagtgttagt aattgccaag cttagcgagg aaggggctgc ttcacagatg 423720

acttggaaaca cagttggcaa caggttatcc acagtttcca agaggagatt acatcagaat 423780
 agcaaaagat ggggatgact gaagccacct gaaggtaccg tgatacagat ttctgcatac 423840
 tataactgt atctaacttc ctttcagcag tattcatatt ctggaggatt ttattattag 423900
 cataagagtt acttgtaaaa cactgggaaa ccagcatggg actgatccaa accccatgaa 423960

 tgtgggtgtc agtgaggaag cctcagaaat ctatggggcc tctggtagta gatcagtact 424020
 tcttctage ataagaatag actttgggat cccatttcac atagagggat actccctgag 424080
 cctagacaca cgggggaggg cctagggcct atcccaaagg atgtgacct ctgaagacct 424140
 cctatggaaa gcctcacct tcttggggag cagaaaaggt atgggatagg tagggtgtta 424200
 gtggggagag gcaggggagg aggggaggaa cagagaactg agactgacgt gtaaaacaat 424260
 cttgtttcta atttaaattt aaaaaatgga gaaaaaaaag aatgtaaaat cacctctatt 424320
 agtatcatag tgaatgttta aatgacagca aaggagttag taagaccact caaggaaaca 424380

 tggaaagtgt accaactgca gcttgaagc agaaaacaag gaaggcagtg gggatgtgtg 424440
 aaggctcaga gagccttata tatgacaata gtatcaactc gtctcacaac tcattcagat 424500
 ggaatttcaa aataataca ctctcaaatc aagaggtggg ggcaggaag tttcacagac 424560
 tgggaacata gctccctggt ggagaattta tccagaatgc atgataccct gggatctatc 424620
 cccagaatca gtctctcaag tttggatctt atgctgtgtg aatatgtttg tttctgaaaa 424680
 caagacctgc attccatgtg tgtgtacatg ggaagattaa gcaaataatt ttgaatggat 424740
 actgtagtca aaatgagata tctatcagg tttcaaaagc atttcaagcc tgattttgaa 424800

 aaggaaaagt tattgctgaa atattttcct actcagtacc agtaatatat tcatttgttt 424860
 aggggtgtgta tttgtgattg tgtgaagcct gtggagagct tgggtcaat gaaatatctt 424920
 agcatcttta tggaaatggc tcaagctata cagcctgcaa agtgacaata atgttgctta 424980
 cagacccct cattgcagta atcatttaac tttttaaaga taatcctgac atgagaaggc 425040
 catgcagttt tcctcagat gttgttaaat gtgtattcat taaaagtaca cacacacaca 425100
 cacacacaca tattgtatga gtgtgtgcct gtgtgcatat gtatgagtgt gtgcatgtat 425160
 gtgtgtgtgt gtgtgtgtgt gtgtgtgtgt gtgtgtgtgg tgtgtgcct tgcacaccta 425220

 cagaggccag aagaggatgt caggtgtctg cctcagtcat tctcattta ataatttgag 425280
 atagggtctt tcaactgaacc ttttaactcac taatttgcta ggctcagga agacacatca 425340
 ataactacagc tgcattgaca tatggctttt acatggctgc tatgtgtctg aactcaggtc 425400
 cccatgctta agcagcaaga gctctttccg tctctgact aagtgtaatg tttatcaaag 425460
 gagtctcatt acagcagaag cttttctcac gtgaagccac ttctgacatg cagccttctt 425520
 tgtcccaca tgctctatga ttgctgtttc caaacatggc tatttgagca cctccaggtt 425580

agcaatctgt gacaagatga attacaaaag acatatttct acttctgtgt catcagagag 425640

 aagatgaaga aaaataggaa gtctgttttt ttctttccaa actttgtgga ttgatgaag 425700
 tagctgctga catagttgag aaaaatcccc ttccacaagg gtttcaaagc atcatttctg 425760
 catctgaaaa gcagaaagtc attctgagtc aatagttaaa tctcaatgca gcatgactg 425820
 agttaattgg ggacacacac acacacacac acacacacac acacacacac acacgtacat 425880
 ctggaggagg aggaggagaa agagagagag agagagagag agagagaaca ctaacaacta 425940
 accttttctt ctcttcattt tcagtcttgg gatcaaattg caagtgatca agccccgtgc 426000
 ctgtgttcat catccactgg gctaacagtg ttgtaagaga gagatgaaga acttgtgagt 426060

 gcagatttgg ttigtcgagc tgccacaagt gccacctcat cccagggatt taagcaatag 426120
 ggatttattg tctctcagtc ctggagtgtg gatgtttgaa gtctttccta gacccctggag 426180
 ggtacatcta ttccaggcct cttttcttaag attgtattgg attatattt cccagtattt 426240
 tcacactgcc tctctgtgca aacttttgtc taaattgtcc ttctcataag gatatcacca 426300
 caccagaata agttccacc ttatgaacta ctttaactca actacctctg aacccaaatg 426360
 catgttcacc aaataaggtt gcattctaaa aaacaagcgg ttaagatttc catacatgaa 426420
 ctgggaaga atactgttca aactacagaa gatttttctt attgttgtca ttttaattgt 426480

 tttatttatt gaggtaggtt cttatgtaa cccaattgct ctcaaacttg atttttagt 426540
 taaggatgag tigtgagctt tgatctcct gcctttgtat cctatgtatt tataggcata 426600
 tgccaccatt gattttagca ttgcagctgg aaccttgggc tctgtacatg ctagacaagt 426660
 gctccaccaa ctgagttcca tgccaagccc ccatattatt tctgtcatct acaacaaaac 426720
 aacgcggatg ggataactta taacaaggc tgggaagagc tgagtcaatg tgctgttaga 426780
 ctcagttatc tgggttttcc tccagagatg gttgtcatal caccaggtcc tgaaatgaca 426840
 aaaagtacaa gagataacct aagtcattt tggcaaggaa attagtctca tccatttaag 426900

 aaagcattac aatagctata ataattactt tcaagtttct aaaggactag gatagaaaa 426960
 agaacgtgat ttttcaggga tattctaaca tacaaaacaa aatgagcac atgaaatcag 427020
 ggaaatgaaa aatttgcat aaataaagga aatgcattct ttgaaactct gtatagcatc 427080
 ctataagaca gactttggct tttgtagaag tgcaaataat aatatcaat cttatgatta 427140
 gtagtaactg cttgatggac cttgaacttt tcttcagtct atctctctcc ttgactatta 427200
 tcctgcagtg caagaggtct ctagcaacta ttccattgc ttctgtagga atgaaatgag 427260
 atgatgggca gcactgtgct cagggatact agttattaat attgttacta ttgatttttg 427320

cagtttccca attactgtaa gatgttgaga tcattcctgc aattaaaaca gtggctagct 427380
 ggccatacac agaagaagca ggaggtaggt tgagtggctg gagtttatgt attcctactt 427440
 cagcaaaact ggagttgcta ttgcttgatt gtatcactcc tcagatactt aatttcataa 427500
 gctacagtgg tattttccct tgtcatgtgt ttgactaatg ttgaaaaata cctgtgcaaa 427560
 catcaacatc aattttaatg taatcttcag tgtcaaatat taccacaaaa aagcagcagt 427620
 gaattatata ctgaggcagc tactaagcat tgaatgtctt taaattttta ttacatttca 427680
 ttactcagt gtgtgtgtgt gtgtgtgtgt gtgtgtgtgt gtgtgtgtgt acatgcgtgc 427740

 acgcagcat aatatggcat acccatagag ttcagaggac aatttgaatt ggtagtgtcc 427800
 ttccataatg tggccctgag gagcatagcc aagttatcaa ccttgccagc agaagctttc 427860
 acccactgag acatctcatc caactttaat gcatttcttt aaatgcaaat cctctgtgag 427920
 cttattggaa gaacatgaa ttagctcttc cttatatgaa gaaatataga caatacttc 427980
 tgcattcact cattaatttc taaatcatcc aaacaccccc ccccagaga accctgctaa 428040
 ataatcagag agcagtttcc cataagaatg caaaattaac aagcttgta gccttccatc 428100
 actcacttgc tggtttccta ctaaatgcac cagtacttat tttctaaagt atacaaacta 428160

 tgagaaatga gctcaggta ctgaagaaat gggcagacgg gctcctaacc acattttcaa 428220
 tacaaggtt gagctgagga agggtttcta agcttataac tgaagggcag tagacattta 428280
 caggtggaaa gaaagctgta gaagagataa aaacgaatat gtgatgttca gagaaagaaa 428340
 ggccatgtat caaaggaaga ccttaagaat tccttggat ttagaagaaa tgaagtctgt 428400
 tgtaatatct catgagtcag tagaatgcta attgatgctc caagtctat acatgaatac 428460
 agaatggcct gtgtaacatt ataaatggtt gccagtgtca gaggagtcca cacactattt 428520
 aagatctctt actcagacaa ataaatgtaa gacatcataa catacattat actgagatga 428580

 aaattcaagt ttttctatgt tgtgettcta aaagccgaat tctttatttc cttttctttg 428640
 cagcaaccac actgcccagc tctgtggaaa tgtggagcca tggatcacca acactcttct 428700
 ctctttaaa aaaaatgaagg atgtgctatt caacagggag tgggtttttc caatggaaac 428760
 atgaatagga atggacttgc tttattaagg agaaaaatga actctctgtg gttctctgga 428820
 gaacatccca gacagaagcg tgggaatcag atagagacac tcaaattttg ttgacagatc 428880
 caagtccgaa cccagtttgc tgcctctgcc ctgtgtttcc aacttttttc tttaccgccg 428940
 tgaacatagt ccaaatgcat cagttcattt cacgccagtg tgcctttgtt atcaaccctc 429000

 cctctatctc aaatgtcctt gcccttgaca tccagtgcc tgtttccag gtaactgcc 429060
 acacatactt caagactcat ctctttaaaa tttctccat gcccttagtt cacacttggc 429120
 cactcatttc tccatgttct tatgttaacc cttacctgct gtaaaactgc tactcgtttc 429180

tgcacatttg agaacacatt tctttctctc cttacagcct ttgatatgat cagtttccga 429240
 tgaatgaatg aacgaatata agaatgaatg aaagctagtc cagagcatta aagcatagat 429300
 gcaaaagtta gacttgccctg tttcaaaccc tttcttgact cctaccagac atgtgaaatt 429360
 ttggaagtaa tcttacgatt caatctcagt ttttcaatta taaaatggaa atcataataa 429420

 taatatatga aaaatcaaaa tgaaagtgca atgcataactt aatacatgaa ctggcagccc 429480
 tggctttcca aaatcgtgtg ttcgtgtgtg tgtgtgtgtg tgtgtgtgtg tgtgtgtgtg 429540
 tgtgtgtata tatatgaaaa tttcatttaa ttttttttta ttaaacatta tccatatgta 429600
 aaattcagtt aacatgattt cattaaacat catcagctctt tagtcaaatt tcaataactg 429660
 cagtacacc acigtaactc acctatgtaa aaaaaatgta aaaaaacatc aaaattgttt 429720
 gcagaccagg tgggtgaag gccagttgtg gtggtgcacc tcctacccc ttttacagat 429780
 tttaaaaaaa aaaactcac cttgaaaaaa ataatgcaa agaactttac atgaaaagg 429840

 ttaaattgct catgtggagg atagagaagg gtcccagcct taggggtcag agtggagcaa 429900
 agcctgactc cctcctgaa gacatagtca cagggctgcc tgcttctga tcccagagtt 429960
 cccagcacat tgggtattcc tccagctgag tcttagetat aactatgcac catactattc 430020
 tctccccga aacctaacag cttagtgtc ctttctcaa aactccaag ccccaattc 430080
 ctgttgact cagcctcaag atgaggggtt caactgttc cagccttatt tatattgta 430140
 atggggtcag gaaaagacc taggggceat agagaccatc ttgccccacc ttgatcccc 430200
 ctccctattt ctgacttctc tctctgttcc tttccagtg tctctgcca cgtctatct 430260

 tagcatagge tgctagagct cctaaggaag ctctgccagg agggacctcc agggggttaa 430320
 tttgctgtca tctaaatagc atttgctgta cctcagagtt tcttgacca gaggaagcag 430380
 caggagtggg tgagatgaaa cagagctttg atgaagcccc tgttcagctc ctccctggtc 430440
 tggcagaacc cctccaggcc tcaggtctca ctgtgcaggg ggcaggcagg gttggggtgg 430500
 gtgtgagatc agtgtgattt tgcagttcct ggtcttgggg gatatgagtc aatgaaacac 430560
 tgtgtgatg gcagttgctg atgagggata ggcacgatt ctggtcctag tcccctagtt 430620
 cctctgggct ttgatatgag gacatccctg ctggcagcag tgtggcctca tatagccaac 430680

 cttcagatac ccagtccagt ccctatccag ctgctcagat attcatgggc ctgtttggga 430740
 gttcagttct gggccctgac ttgggcactg tatggtgtta acgataaatc tttctgcca 430800
 aagcggccca agccctacca acatgtgtgc gctttacgcc agccaccgc ctgagttagg 430860
 gcccgaatta atgcagagag agacttgtat taggtacatt gctgcttggc taatgactag 430920
 gattcttcat ctgttagctc agtcttaatt atcataaatc tataatttt ataagactta 430980
 tcttatcgga cgccttattg gtgtccttcc ttgccggtgg atcacattgg gccctggag 431040

gaagaacaga ggggtaaagg ggccacttac tgtttctcct tgctaaatat gagtctcctt 431100

gctatgtcac tctggcctg gatcaccacg tctctactac atttcccaga atcctctttg 431160

actcctagtc ctgtctaact tgctgtttca ttggccaaac agaactttat ttaacaatca 431220

ataagataaa catcacaga agtactttcc tcatcagttt ggagatagga tggagcttga 431280

tctcttagaa gaaagcacc ctaactggccc agtcctacag gtcactgact agtgtggtgg 431340

cattctctat ttcaaagaag ggctctgggg acaggcacct gctaccactc tcatctcagg 431400

gatgttggaa gaaggatgag gccaggaagg tctcactgaa gtccgagctg tcaacagcct 431460

gttcactgg agatctacag atagcagggc agctgatgtg ttagccatgg acagtaaggt 431520

ccatgtctca gcaaggggca tagccctagg gcctctggtg aactcagcta ctcagccaga 431580

gtgccaacct ggaagatggc ctgccagtca aagtggctt tgaagtattc tagctcacc 431640

tgattattcc taggtcaatg ggaacttggc taccctctta ggagctggct gctgacattt 431700

atactccagc ctgcccacc ctgtgtcca acccaacaac tcatctgtgg cctcctgaca 431760

ctcctgtaac aggtgctggg tctccatttc atagtcaaag gccacctag ggagcagtgc 431820

tggagtcctg tgagcttgg caggcaaaag caggaggat gtgaactagc agcagcctct 431880

aaggcccagc taagctaagc agaggctcta catactgagg gtcaatgcaa cagaagctct 431940

ccctccagg ttcactctc tctcaaggca ctttgatgta gcacttgtac agggacaggt 432000

tgtggcagat ggaattctgc caggtaggat ctgcatggct caaagagcag aagtagttgt 432060

tcatgattga ctgtacatg gctaacagag tgatcatggt ggttttgcta gttttctgc 432120

agttagatga gaatggtgaa cgaataagc agcttgggca catgtatgcc tttaatcca 432180

ggaagcagag gcaagtggat ctctgtgtga aggccagctg gactacacag agacttcag 432240

gacagccaga actacataat gagaccctgt ctcaaaaag aaaaaacat ctgagtcata 432300

cctgattgct atcacacaac taacaatgta aacaagatct tatcgtcatg gaagatggtc 432360

attaacctct ctaagtacca gtaagtgaat gttttattgt ttgacttgaa ctatttcag 432420

gagattttag tgtgaggttt cttagccagg gctacttctt ccaggatata ttcaactct 432480

tttcatctat gtcaacttcc ctttcagtga ctctctggg actcatattt agtaaccctc 432540

aatgacaac aatgctcatc tttcagctat ctgccatct cccaatcag tatcatggct 432600

ttgtacttct ttacaactct tgcactact gcacaattcc cgctttccat tttgttaaac 432660

atcacacatt tttgtcacag aaagacacac aggcaacaca cttgcacggt ttgctttcta 432720

tgagtccagt aacagatatg cactgaagca attgtttga caatgattc tggactgaaa 432780

gttcatcctc ctaatctcaa attgttgtgt tcccataaca ccaaacaatt aagggagaag 432840
 caggtcactc caataccatc cagagaagca tcttaccctg tcttcccttt ccttctcatt 432900
 tccctcatcc ctctccttct gccatattct ctctttgtca cctcctctcc ctgggttata 432960
 tgtatttate ctccacacag tcccagttat ggaatctcaa tttgactgag gccactggga 433020
 ttatcttttc tgacaaccat ctgctctgaa gtggtggtaa agggttccta gtgaaggtcc 433080
 ccactcttct atgatttcca gctcttgaaa gtagaatatc tacaagaaaa aaacctcct 433140
 gttggtagca ttaattctct cttatagtgt aactggatat gcaatatttt catgttttcc 433200

tcttattatg agaacaagga agaaaacaga tgttaaacta tcataacttt tggataatga 433260
 taatgaatca ttctaggaat taccaaaaat aaatgattgg gattttatga aaaatacttt 433320
 gttttccag acactttctc acaccaaga ctttccagta aattatgtct agagaccatg 433380
 ggacacagat aatctgggct tgtgtcccat ggtgggtttc tggggtgatt ctttgggaagc 433440
 agattcctgg gccccatttt gaattaatca taccacaacc aagtgtgggg atgcacagat 433500
 gcaaaatggc attgaaagtt gcattttagt gagttatctg gatgttgcta atgaggtctg 433560
 accatcttcc agctctgaga aggaatattt acagtgcggc cacttcatgt ctctgtctat 433620

gctctttctt tctgctccag gctcaaacca gtcttttctt agagtctgaa ctagaaaaaa 433680
 aataaataaa aggtagactg ttgcaaagcc cctgaaaact tggcactatg tttttaagat 433740
 aagataacat aaatattctg aatataagga gataaaataa cctgaatact tttctttctt 433800
 atagctaaaa caatggtagg tatggccaaa taaacgcaaa aggtgacttt tgtaatatca 433860
 aaggtagtag agtgaacaca ccagectata ccaaaggaga gcaataactc atgtttaggc 433920
 caatctccct gccacagccc cactccacat tactcgagga taactgctct gtcttcagat 433980
 caattcaagg aagattattt gccctgttct ctaagcattt caaagcacac cttcaaatct 434040

atcttatctt ttccaaggct ctttctagtg acttttcaca aatcacaat cttctgatct 434100
 tccatgacaa cagaacaaaa caatgtgctg tcaatattca agagctgttt cactaggcaa 434160
 catagtctg ttcagtaata agaaagaagt cctattcaaa atttaaaaat cagattctct 434220
 ttaaagtgtc ctttctgcta tatttcccat aaatattgcc cccaaaacat gttactagaa 434280
 aacttaattc actgtgaaaa gtgttgtgtg tagtggtagg cactggtagg gacaaggcca 434340
 caagtacttt gccctcttaa gtggatttaa tgttgattat gataatgttt gagaaagtga 434400
 gtttaatttc tgaatctttt catctccctg ttctctttta ccatggataa tcatataaga 434460

aggcctccat cagatgtcag ttcttgcac ttggtcttcc taacctccac aatggtgagc 434520
 caataaacta tgttcaatat aaatgacaga acacaatgtt ctgttaaagt cattgttgca 434580
 tagcaatttc ttctgaattg aaatttttct tccaggaaag taggggagag aaggggaaag 434640

cagctcatga gactgaggaa ctgaacaaac ttcgatttc tgggaaagct aaaatctaaa 434700
 agattcacag ggccttctc caaagtata gaaacagtaa acaattactg agcagctgag 434760
 ctgcctagag gagactcttg ggcatgttca tctgtttaaa gtcatgcaga gagctcagag 434820
 ttgcaatttc tgagtcatta cctatgtcag gatgggcttt ttgatgatat aactgctttt 434880

 gagtcctccc tctcctgta agtagcctct taccagcct cttgctagta ttcccagtaa 434940
 gctcttttagt teacattgct ataattgta tgttggtagt tgggtatttc catatctggc 435000
 atgagtgcac gcatgcattg tgtctcccag gcaaaggctc atataatggt aacatattaa 435060
 gattaagtat taattaacat attaaagcagc aggttaagac acatccaggt gtgaattgca 435120
 gacaatctac ccaatgcctt tgccagatcc ctgatttcat cttctctgat gcagtggtta 435180
 aaaatacaag tcagaatata actaaaatcc atggctaac catctccatc tactcttgat 435240
 gtaccataaa tcagcaaaat aggcaagact ctgaaatagt aacataagta gtatcgtgaa 435300

 tgctacttgg agctaagata tttacatgaa ctagaatagt gaatgctact tgggctgtga 435360
 gacttataca tggaaagaaa tgaccagata ctacctgact tagctgcagt catctgaaca 435420
 agtaagcaca tatgcaaatt aaaaatacat caataagatg ctgtacccaa atgcaactat 435480
 gtttcaaagg taigtataat tccactctgt atctgtgtaa catgtaagtc ataatgcaa 435540
 tgaagtatgc catttacgt ttttgattag tccatcatcc ccatgttgta tgaaaacaaa 435600
 cacatctgtt tgataataat aataataata ataataataa taataataca gcaagcatac 435660
 catttttaag tatcatgtgc caatgagata gctccaatta tgtttagaga gctaccttta 435720

 aaggatagag gctaccttg aagccaagc gttactgaat gcagtttcca attgtggttg 435780
 aaggagctaa cataaatcag ttcaatcatt gccatttta atglagagaa aggagcttc 435840
 cataaggact agggctattt acaaggcaga attagccacc aaagaaaacc acatattcct 435900
 ttgcattatg gctcaagtca accaaggcag agagatcaca acagccctc acagtactgt 435960
 acctaaaaa aaaaatgctg cccaccatt tatatgggac cactccagga tctctccatc 436020
 ccctaagt ttttgaata aggattagt aacccctgc ccacagaact acctgttg 436080
 gaatagttt ccagcacaga caataactaa gacactgtta agggaggatt ctttgcctc 436140

 tctccctaa actgtaagag tgaagacatt ctgaaaatg taggtgcggc tcatttggtt 436200
 tcaaatttc cagaacacca aaagatacca cactacttg taaccccagg gctatccag 436260
 atctcactac tgttccctct ttcgtgcccc cacaacacat actgactatg ggttgattg 436320
 tgcagccatt acttagactt atatctgtat aaatactaga gattcatatt gtcgacatta 436380
 tcagccttaa ttcatcaatt gacagtcatg accagaagca acaagtttag catcactcca 436440
 tgagggcaca gatgtcctcc atttcccagg gattttctta cttgtagtat accgtcttct 436500

atcaatttct tccccatca cattttcaaa atatatgacc ataataagaa tgccatctag 436560

gctggttaag gcatttggtc attaaaaagc caactcgcag ctaaataag agccaaagat 436620
cattagaggt gacagagcat ggaatgtctg aaatgagtgc ctcccacaag gcctcaaata 436680
tcacctggc catttatggc tctatggctc tcttgggtgc tattttatac accatttatt 436740
taaaacagct ttgagagaag gtcattcagg tatttggatg tgggttaaca tctaaaatga 436800
accatggttt attattcttc ttattgtcca ttactaagg atagtatagt gaatggtga 436860
agtctatggc ctcattingat aaagtgcaaa aacagcattt ttgcccagtc atattagaat 436920
ggatatcttg atatttaag ccctagccct gtaggaaaga gtgctgattt ttctgcatat 436980

aaatacatct gcgccacatc tttctaactc tagagcataa tattctaact caggcagagg 437040
agagccacag caaaaggaca ttagtgtctg cagcaatggt ctctttaaat gaattggatc 437100
tttaagacaa tcttatcagg cttgctttta tgaagtggc agctttatgt ggaagcacia 437160
gagcaggtag tgaagggtat catgctgcat cataaacctg caggaatfff acaagccaag 437220
gtagatgtca agataatgag aacagattca cttgtcaggt gctccgatgc caaaaccgga 437280
gttttccagg attttcaaaa ggaatcctcc acagtgtttt ctttttcata cattgacagc 437340
acgacagcgc ccaacagcat ttgatgatgc ccagaaaggt ggataaatta atattaaat 437400

gacacacctg cctctgctga tcatgaatgc ctctgggtaa tctgagagtc actttaaatg 437460
cagatfffft ttacattac tatttgcaaa caatctcagc ttcattccct tcatactgaa 437520
actaatcaga ggggcatact cagactaaaa agtaattgat gcaagattct gagtaatgtt 437580
tttgtctctg ttcaaatgc tttgtttgt tttgtttaat tttgtgcagg cagggactca 437640
agtcatctag aatggctgca actctttatg taggcaaaga tgactgtaga ctctgacta 437700
taacctcctg ctcttctc tcaagtctg ggatcccagg aacatgctta gttacacct 437760
tgctctgaga aatatctctc taaatttctg aacaagtgag aactcaggaa atgtagtaac 437820

caaaggtcaa aatataaggc cgagtcattt aattacctct acaatgaact aagaagaatt 437880
aaatgggtcac agctcagaat ataaagaaat tgatagtggg acacaccag agcacaattt 437940
aaaactgtta atgtttaatg aatttattaa cctagaaaga gaatggcttg caattgcaaa 438000
tgtgtacaca tgttgcagaa gtctaagaga attcagcaat gaaaggatca taagggtttg 438060
gcagtggtta tctgaattct tctcaagatg cttcttaggt gatggaaaaa tgctttcgca 438120
ctggaacctt ggctaaagtt tctatccaga gaaagtactt aggattctga aggtgtgtgg 438180
aaggtggaaa ccaggaaatg ctcaaatcga gactataact agagaaagaa aagattcagt 438240

gatttcttaa tcactgatag catggtcatt ggaatggtg aaaataatct atccagcaca 438300
tgtttagaat taaagaaact aatctgggaa gttctaactg acttaciaag tcaaaactga 438360
agatgaaata cttttttta aatcacatta tatgaacagt ggtagaggag gcatatagtg 438420
aataccattt atattttagt ttgataagca aactgggcat ggttttgttt aggaatataa 438480
agggttttaa ccattttatc ctattatttc cccaagacc cagtacccc agctgctcca 438540
aatggtgcag gaaaatgaaa ttagctgatt cctggaaag tctgtagcat tcagctttgg 438600
ggcgttgta atctccttc tctgggggtt ccaaggagg catgcctgag ggcagagcaa 438660

ggaggaaggg agaaaagagg aattaacaag ctttctaact tattgctacc cttacatctt 438720
ccaagggaat tgcttaattt cactttgtac ctccattcag atcagctcaa gtttgaagaa 438780
aagagccaat taaatagatg gagaaggag acaaaggcaa ttgggtgggt agggaaggat 438840
agctagaatt taaacaagta accacaatct gagacattcc cccacaatac ttaagcataa 438900
gtatttcttt tttcttttc tttctttctt tctttttttt tttttttttt tgaaaatcta 438960
gccaggacag gactttttat gttttgttaa ctcttacttt tctttaaata atggatggaa 439020
ccctgactt ctattttttt aatgtagccg attcacaggg ctggcagttg cctgatccat 439080

acaatactca ttcatttct tcacaactcc acctgttctt aacaagtgtt ctaaagtga 439140
aattgagaaa tatgtacctg gaggaagcaa tgctttgggt gacaaaataa ggaaggcat 439200
gaatgggaaa gataaaaagag tgataggtag aagtggacag cagggatgac actatgaaaa 439260
tagtaagtac acaattaagt gcacaaaagt tacccaagga caatggccag catgctgtta 439320
aagatgacag gaatgagcac tgacatacac atttgttcaa gtcactagat tgtacgaaaa 439380
tctcattat gaccccagct caggaaacct cactgaaaca aatgtttaag tgctctatgg 439440
agtatcgga tctttaaatt acctgagaat gtctcttctt gcttttatat gatacaactt 439500

agaacattgc tgetcataat cacttttcac aaatttgact ccattcaacc ataaaaacat 439560
gagtatgcac agagtattgt tgatagctat cacaatagct taagcttaag ctttaataag 439620
cttaagaagt acaactttgg ttcaggactg taaacaaaat ctaaacttat ggctgtccaa 439680
gaggattccc catgtagcct taggaaaatt acttgactaa gatagaaact aaaattaat 439740
ggcaactttc ttigagaaaa aggggtagt aagaactact gtgcaaaatt gtcaggttca 439800
aaggtgcage tgtttcataa agtgactgac acaatacaca tccacattat ttctgtgctc 439860
aacctcgtc aaacttagag atatgtcttt attactatta ttagtagtaa tagtggtatt 439920

tgatgttcta atactgtatc ctttaataat tctctattt tttcctaac tctgtcttcc 439980
tggaagataa catgaaaaca catttcacg actttccata gactccttac tatgttgttt 440040
gtaaacaatag acctgaataa agttcccaga tagacaatct tccatataag tacataaaag 440100

gagtattaaa cctagacata actgtgagtt attaagcaag aaagactagc aagcaacaga 440160
 ttaccttcc tgtctgaagg agctggaaat aggttgata aaccaagatt ctgaagacat 440220
 gggcaacaaa gggcagtgaa ctctgcaggc taagggatga gataatgctg gtaaagctgc 440280
 ctctcgctcc ccaaggagct tccgggctat tgtggagtga ggagaccttg actgctaaag 440340

 aggggtcaga ccatcagagg atcttctctg gctacagtgg aattaactta gaaatcaaca 440400
 acagttgagg ccctgaaaa agtcccaaaa tatttgaaa ggaaataatc ctttcttaa 440460
 taaatggtaa gtcagtgaag actctgagaa agaaaccaag tgttttgagc tgctttggca 440520
 taggtcctga gtgtcctcca aagttcatgt gctgaagatt aggttccca ttcagcagta 440580
 ggacatttct ggtgggaaa tgaggaggac tgtgacctca aaagtggatt aataattcta 440640
 tagactcaga tcataacagt ttgggagaaa ttattttat aaaaggctc tctctctc 440700
 tctctctc tctctctc tctctctc tctctcctc caagttaaag gaattttgag 440760

 gaaaaggaaa agtctctgaa aagagggcta gaggcattgg tgcaatact gctgcctaaa 440820
 ccaacactgt gttgtcaact agtgaggcgg tttccataa gggaaggtgg tataaaggta 440880
 cctaattgccc agaatgacaa catctagaat tcaaggagca aggaagtccc ctttcttcc 440940
 tagtcactat gaggtgagca gtgtggctcc accatacct tccacatgc tatgctgctt 441000
 caccacagct cggaggacaa ggccaagagg ctatggattg aaatctctga aactatgaaa 441060
 tgaaggtaat ctttcttcc tcatttctta tgagcctage atcttctt tttaaagaca 441120
 tgtttctcag tttcttagat gtggctgata atcagcttc ggacatcca ggaatgaagc 441180

 aaatacttcc atgcagtgc cctcatctc ctgtgagccc ctccttgaa tctgaggtct 441240
 aaggaaagca cctctcttc actcaactgt gggttttaga cacagataga gttgcatcc 441300
 attttatcag gacttccgtg aaaacagtag ctgaaataac catctgtcag tctgtcaatc 441360
 atgtctttac ttcaggttgg agcagcagtg ctgtgaaagc aaatacatac cagccatatc 441420
 ttaaccaga aaatgtgtcc tcaagagatt aaagtgtcca gtgtcaaaag aaacccatgc 441480
 cttttgctc tcttatcagt acgagcaagc cagatgatct ctaatacaaa aaccatagc 441540
 cacatactta tcaatgaatc taaaagtcta atagccaaag tcatagttat acagaagact 441600

 gtaattagcc tgtgacctaa gtgtgatttt tgttaataa ataacaaaat caattaattt 441660
 ataaaatcat ttgatttaat gtcttttgcc taattggttt atatgtgaaa ttcagatgag 441720
 aataaaaagg ccaaaaacag ataagagaaa aatagagtga aatagtcttt aaaataggag 441780
 tcatttaaat atctaafata tgttttaaga aatattgggt acatctaaaa tttttaaga 441840
 tgcaaaaggag aaggctatc attagcatga tttatgcaaa aggatctaca tattgttgca 441900
 ccaattttta ttagaaaatg attagctaca cacacaaaa ataaaatgct gtattttatt 441960

aattaaatgg ctgtatctgc agtccctcaa agcatggact tctcataatc acaaatgtac 442020

aacaggcact actgcccc tgagtaactt gtggtactac tgatataatt ctcatittgtg 442080
tgttgctaag agatgaacga actctacttg agagagagaa ataagaagac ctccittgtc 442140
ttttcaaatc ttgccagata acatcttcca tttttcttgg caacataaaa ctctattaga 442200
gcttgtagta gaattgcata gtccaaaaca gaacattgag tctaaagctg ttttcacaaa 442260
taataaaaag agagagagaa aaaataaagt cacagtatit tgaatccaca aagaacattg 442320
tttaaatata tgacatggtt taatttgaag aaatatttat ttaagatctg ccaggaataa 442380
ctagcagtac acacatttac attcaacaga aatcatagat gtccacttca aaggctttaa 442440

aacctaagaa gttttttcaa acctcttttg ggaaggtaac agtgtttatg aagagigtga 442500
agaaaatttc tccaggctta aagtgtccac aacctgatc ttaaacttac tctctctcca 442560
aatctctcac ttgtctact cccaaagtac atatcacact cttgcaatag tgaaaagata 442620
caatctcaag gtcagcaagg agctattaaa tacagccaaa tagaataatg attaaaatag 442680
tgatgacata actttttttg ttaaaagggtt acattaaaat atttgttatt tttctttgag 442740
aatttcatgc aatgtatitit ggaaggcagc tatgctcacc actatattac caatgctcca 442800
cattatattt tgaacatatt catatccctg tcaattcttc atttctacc taccattaaa 442860

atgatcttgg tctcaccacc ccttctcatt caacttttaa tttcttattc tttctccctc 442920
tctccctccc cactccatt ctttctcttc ctccacctcc tcatttttct tcccctgttg 442980
agtctggtct gtgttgccca gttagtgtca ggagtgggcc ctgacctggt atgcagtcaa 443040
ccttccagag gtcacgtcaa taaagaaaac tgagtctccc tcttcaaag ccagtagctc 443100
ttcagatggt ggiagaaagg tttctgttcc acctttccct gctttgtgct gggcttttgt 443160
ctgggtggag ttgttcagg tcttgtatct gttgtgtga gttcataagt tcatatgccc 443220
tggtgttctt agaaccactg ttccatttat gtaattgagc atgctggtct cttacattct 443280

tctgccctct tcatgaagat ccttgagact tggtagagag aggggtgaca ttagtattcc 443340
atitagggcc gggcactata ctgtttattc tcttactgtt gtctaacatg tattgttcca 443400
cctcacgcac cgittgcata ctcttgatgc ccaaaggaag cattatttag actcttaacc 443460
ctcattcttt gcttagtatt tatatgcaaa tcagaccaac ctgagacttc ctgtgacatg 443520
cacatggtta aaattagtgt tcttgggaaa actcagcatg acagtctct acacctcag 443580
ttcaccact ctatccatcg cctctttgaa cctctctgtt ctgttacaga atcctttatc 443640
agcaggttct gcttattttt tttttataga taaaagtcat caaaccttga ttttacttcc 443700

aactccattg ttccaaactc tgtgactttt aatggacctt gagaacacaa tcaggattta 443760
aggaaagaat acactaagca aattggagt cagtgcacata gaatgaaaat attaagacat 443820
ttgggaagta tatgtacttt tcattacat ctgttttagac ctcctttta tgaatataat 443880
tttctcttc ttcttgtcca cccctccttg ccagcaaatg gtcctgtctc tagttctcta 443940
agactgactg aaggtcagta tgaaattgaa atttgagaac tggaagcagc ttagttacat 444000
attcctttgc attgaatttc aaatttattc atttgcttgt tcaactaaat ggttttgtgt 444060
gttgccatgt aatgctaggt attgaatcca gggctttgtg gatgctaac agattctcta 444120

ccacaggact actctccac tctctccaa aaatattttt tgaagtcatt atagacttac 444180
ttggacttta acttcttcta gtttatccca gcttgttctg cacctatatt acttgagcat 444240
ttgtctgttt ccctctctgt ggccacacct tcatgaaga aaacttgtgt tattgtacgc 444300
aatactgaag catatgcaca ggactcagtt taatagtta ggaatgtaga acgttccagc 444360
ttcttgttct acaattcaag gaaaacaaca ctctggaatg taagggactt ttccaatctc 444420
atataattga tcattggaaa ataccaaag aatcattaac ctttagttct ttctgtagga 444480
tgagtctagt tgaatttgaa tctttaacag atattggaag atgattgatc gacatgttaa 444540

ggtgtggttt tgttttgttt ttggcattca gcaacccatg ctgattcagg agggttttta 444600
taataaaggg cagtgaggtg gggcagggtg ggaggcagga acatcctcct tgtgttctct 444660
caatcccagt acaagactca gcttagggga gaggcagaac tctgcaatgg cacaggaaag 444720
ctgaagcatt aggaggtttg aggtactgaa tgaggaggtt ctcaggatcc tcaagcattg 444780
tcctcagatc tctgaataga gaaaatgaat aaatcatttg tttgcatctt ctgactcaaa 444840
aacaacaca aaaaagaatc aagaggtaat caactacat cgtgtttaat tgtatttcac 444900
tccaaaccag ttacaaactc aggcagcttt ttttctttc tgtactaaa ggcacctgac 444960

atccaggaca ggetttctgt gcctgttcag gcttaagaac agtactgtcc tattgtttct 445020
aaaggcctat ccaagaacta cagacactga attaatcct gtttgaact gtgccccat 445080
gcctggactg gaaacctgag catcgtggat gatctcactc ttctctttc taattcagcc 445140
tcttctgctc attttcagg ctctagctcc agcctcagag agaagggtca tagtggaat 445200
ggctcagctt ttggagctag gtgatattc ctcccactg ttttgcaga ctctttgag 445260
tgtttgtcta agtattcacc aagtgtgggt caattgagc aagatcactt ctctagtgat 445320
geccatgact aactgagtt actgetgaat tctccttgcc tctttgagca gaccttctgg 445380

ttgctgccct ttaggagctg gacttctgcc agtttccttt actgggattt atttcctag 445440
aatggtgagg tgtgtgattg ctgatcccag ggcagggac atctcattca tcagagacac 445500
gacctcact actaagaaga gagacaactc cagtggaaaa actctggcgc acaccttaa 445560

tcccagcact cgggaggcag aggcaggttg atcgctgtga gttcgaggcc agcctggtct 445620
ccagagcaag tgccaggata ggttccaaag ctacacagaa aacaaaacaa aacaaaacaa 445680
aacctcaaat tacatcttca gacatcaaga tcatgactaa cacatgttca agattttattc 445740
cttaatacat ttgttttaat tgctatctaa agtcattaaa actacatgct ttgatgggta 445800

ctacctgttg ttccaagata tgtatatac atgtgatatt taaattgtgt taaatatctt 445860
tatacctca aatatctaca attcccttat ggtaacattc tttctagctg tttgaaatac 445920
atggtatatt ctigatactc ccctgtaa atcacacca aatattta atctttataatt 445980
atgattactc aaaaatcaac ttttctttat actgtcttct cccagctcca cagtcttcaa 446040
gctctgaaaa ccacaaatat actctcaatc cctacaagac tgactgttgt agattctaca 446100
tatgcatgag agcaagtagt cactgttttt cctcgcctga cttgcttcac tagtgaatg 446160
atcaccactt ctgttcatg tatgacttta tgcaattttg gggactatct cccagtctct 446220

agaagaatgt catcagcatt ttgacaagga ttgcccttaa tctgtatatac aatttgaata 446280
atatggatat ttaaaacata catgtctggg gccagtgaga tgatttgatg ggtaaagatt 446340
cttgccacta atcttgactt gggtttgatt caagaaatcc acatggtaga aggagagaat 446400
agactctcat aagtcttct ctgacatccc tatgcaagcc atggtatag catgtctgca 446460
cacaacacta atacaaacaa taaataatc taattataaa ttttcaaaa catattcaaa 446520
cttccaatcc atgaacatgg gatgtctttt ttcttccat tatcttagtg tectcttcca 446580
tatcccat ccatggttat cattgtagag atcttttctg tctttggcta aacttattcc 446640

tagataatat ttccatact gttgtacata tggttgcttt cttggtttca atttcagata 446700
atgttgatt tgcatataga aatgctgagt ttgcatgtt ggttttatat ctttgaatat 446760
gccaaactta ttgttctaa ttgctttttg ctagtcttca gaattatgtt tgccatagtt 446820
tgaatgctgc ccattgtccc caaatattca tataataaag gttttctcac cagggtgta 446880
ctattgaagc agtaaatct ttaggaagta gaggcctaatg ggagtatat aggtgacctg 446940
ggacaagccc ttgcagggca cagttgaggt tgagtcttta tctttctggg ttttgcctcc 447000
ccccccate ctgcaccct gtgatgtact agtgcagacc caaagcaact ggattgaaac 447060

aatcatgaac taaaactcca aaactgagcc aacacaagcc ttacctctc ccagtgtgtg 447120
ttataacaat aggatgctga ctatcacagt gttcacttga tctttcttg atccctctca 447180
cttaaagaag gctggtaatt acaggctcct cccaacca taggcgtgcc tcctgaagc 447240
catggagcat ataataactg gtatgagcaa acccattta agaccacca ctttgcaagc 447300
ctaaacccta atttataatg ttccattatt caaatgtgga tctctggaga cagatcaaca 447360
gaagttccat tgaacatatt atagttcaa tgttcttcac acttgatca gcttagaaaa 447420

tgcaatggtt aacctctaaa cttcaggttt aaggacaggc tagatcccac ttgatgcata 447480

 atccctcagt gccagcaacc tgtttcggca aacaggatcc tgagagtga ttgggatggc 447540
 aactagcage ctttaattga aaaaatacta ctacatctat actactatac tctgtggttg 447600
 gaaataggat taaatggaag ataagaagca tgagagctgg ggtagagcct aaatcaggga 447660
 ttgagggatc cagcactgac cttgacaaca ggcatcagcc atatgttaat agaagggcca 447720
 cagattcttg gtagagataa gaatatctcc ctttttagca agcaagaact ttcctcaagc 447780
 ccccaggaaa tggaggccct tatccaaaca ttgaccttg gaaaagtatt tcttctggg 447840
 agcagacact atactacaat ttcttagtct tattatacgg tctgttacc ctcataatgc 447900

 tcactaaagg gaaagtctg atgtcttact cttttcccat tatacgacac tattctagtt 447960
 tctctacatt tattgactga actcttgccct ttaattgtct caggttctgg atctgaggtt 448020
 ctggatctga ttatagcat tttattctca aggtcaggtg tgtccagtaa atctctaaca 448080
 tttctggtct tgggtgaatt gggaaggcac gatggaattc ctggttctct gagggggtga 448140
 aggggggggg ttccaaagaa gtatttgtt tagagaggct accattttac acatttatat 448200
 cctttacca agccacaca aaatttccca aatggaaagg cattaatatt gggagtcatt 448260
 aaaaatgaaa gtaaaaaggt cctagagaaa tgtgctctac ataatgttga attgctggaa 448320

 ctttgccaag cagcaatagt caccatgtgg tccatgccac ctaaagacct tttagttttt 448380
 aaaagttaat agctcacagg ttccctatgt atttgatgac cacaacaaa aaaaggagaa 448440
 tatgatgcaa ttcagtaaat atctccacgt tacttagata ttctttatct catcgcttcc 448500
 cttttgtttg aactggtcca tcatgacaac acaaagcttg ctatttcaca gataacaaaa 448560
 cccaactggg ataaaagaaa tatttgaat tcaataaac caactatgca ggtaccacaa 448620
 agcttagaaa acataacaat aatagcactg gaaaggtaa gaaatagga aatagcattg 448680
 ctttctttaa gataattact agtgatgata ataaatgtta ttaacaaaat ttcatagtct 448740

 tcttccttc ctttagactc ttccattcaa ctgtacttgt atgtcttctt tcttgggcca 448800
 gatattataa aatataatta gggctcatgtg ttctcctgga aatttgttgt agtttgaaag 448860
 tttcctcagt tactctacat ttatigactg aactcttgc ttttaattgic tcaggttctg 448920
 caggttctgg atctgaatta taggcattct atttccatat atatataat atatataat 448980
 atatataat atatatactg gattctagat tagtcttcc taaatctgat ctgagtaaaa 449040
 ttgggctcag agctcattgc ttctcttagt gagcctgaat atacacatac agccacccat 449100
 agcataagtg agcaatttag atatcctcat atgaggaaga tggatgatct agttaacatt 449160

ttacaaggca cattgaacaa aatcaacaga tattctggcc tctcaactaa cctgcaactg 449220
 gagggttttc ttttctggc ttttgggtgt gtctctgctc tcttgggtgtg ctccctttga 449280
 cagcagctcc tacattatg agaatatggt ttaaacaatgt ctgagtatta gaccatccct 449340
 attaaggctt gcattgctca tctttttttt ttgtttgttg tttgtttttg ttgttttttt 449400
 tgagacaggg tttctccgcg gctttttgag gctgtgctgg aactaactct ttgtagatca 449460
 gactggcttc aaactcatag agatctgcct gcctctgcct cctgagtgtc gggattaaag 449520
 gcatgtgcc aactgcctg gctctgccct gttcatctta agctctatca ctttagtctt 449580

 ctatatgaga tgttctcctt tctcaatat ataatcctgt gaagtaacag aaataacttt 449640
 tctctctgat tatttctctg tctatattat tagtattgaa tgtatattcc ttattagcca 449700
 taacagttgc actcattcag gtgacccaaa tacagggcac agcactggta gggaaatggaa 449760
 tggatagtgt catcacttgc ctgtggaagt ttgtgagtca acagggcctg aggacttggc 449820
 cagaagacag gctttgcttt ccagggccca catgtttccc agctctgaga agcacattcc 449880
 acaactct atatttctaa tcagacggct acaaactgt tgagtagaa gtgatcacag 449940
 tgatccagat aattatatct tgaatttata ggacactttt ctgaggagct cagaatttgt 450000

 ccatggctct aagactcccc actactccc ttcctgagt cccatcttct aacagaagt 450060
 gattataact ataagtaaga cattctgtga gtttatgagg gctttgttag atggagtct 450120
 tggaaactc tcctgtaac tctgggaatg atgaataaga agctggcagt gagctctggc 450180
 tctctgatg gttgtaatgt agtttctct ctgcctgagt aaagtgtta gacatgcgtc 450240
 aggtattgtt agagatggtg ttcagcaact gtcagcccc aaataattac agaccacagg 450300
 catctcagat gtgtccaca ggggctgaaa ccgcttcca cactgtttt gttggcactg 450360
 tagagcaaga atgtaaagga tggctctagg ctcacctgag gctactaatt atactgtggc 450420

 tcttctctac catgtacaca tcaaatgttc tgtattgtag actggaaatt ttagaggaaa 450480
 agaaagaagt caatgcagat taaggtcacc atcgacttc tcaatggctc gtgtgtgtgt 450540
 gtgtgtgtgt gtgtgtgtgg ggggggggga gagagagaga gagagagaga gagagagaga 450600
 cagagacaga gacacagaga cagagacaca gagagacaga gggatcaaca tettaacatc 450660
 ttgcaacacc ttaagtcaa tgtagaaaag gaaaagtgtg ataacaatga ttccagtcaa 450720
 aatgatctct tcaaatgtt gctaacaat ggaaggatgt ccttgatggt gtcacaatga 450780
 ctcccactgg ggtattttgc atcctgtagg tcacacatat ctttgtagg ctgatttcaa 450840

 ggcatgtttt acaaaataac cacacagaaa agtatacaca tcaagagact tcagacttca 450900
 ttgacattcc ttaataatg ccttcattca ggaaggctg gtcttcatgt gcctgagaga 450960
 ccatcatttt aggccagcaa agctccttct tacgcagaga aaatgaaagc ctttgaaga 451020

ttgatgcac atctgtgggt cttcattcat ttgcaaggg cacaaccacg ctgtttcctg 451080
 ctctgaagca atttaaggag agcgagtatc agcctcgctt gagagaaatg aatcatgatt 451140
 cagaactctc tagacttccc atatttgccc agcctccaga tcattatgcc caaactctgc 451200
 tcctccagag accactggga gttaatactg agtcttgaag caaatatgaa aatatatgaa 451260

 gaggtcagac cttttgccc agccatcagt gtgttttggg tagcatgtaa gaacattttg 451320
 aatggcatt tggagtccct tggaaactt ctttagacaa gtatagcaca cacaacatta 451380
 tatttccta aagtgcattt ttaacatggc tcaggctcat ttacaggaaa acaaagctgt 451440
 cttttgtag ctttctggcc caggecccta atgagacttt gctttgctaa tctccaactc 451500
 ctgtaagtgg ctctttttt ttttttttt ttttttttt tttttttcc 451560
 ttgcatttgg gcttacagct gtgtggcttt ggcaactgaga ttccttcttt aagctttgtt 451620
 taaagccaat ccatttgatc aaagagttct accctctgac ttcattttt atcattcccc 451680

 agtcagacct gggctatggg tagaatcctg ccgttatattt attaacata aaaaatgatt 451740
 tcattttcct gccagaagca ggtcttactg atcatttcgc ttgccaccta gcagcctgga 451800
 gaatcatage tttfacataa cttgcagtag tgggaaatgg cagatcatcc taattaagaa 451860
 aaaaaaaaa aacacggaca gggagaaaga ctacaacata gaacaggaag aatagcaact 451920
 ctggtgaagt cattattccc atagtcctag agactgagaa attgtcaagg ccgcaggaag 451980
 tgcttcaag ggcagactct atgcagctca gtgcatttgg tcttccacct ctctttctc 452040
 acttcaagtg aggatttcaa ttaatccag tgccacaata ccagcagctc agaagaaaac 452100

 attgtgaatt cagaacagaa aatcatcta actattgcag tcaccacatt tgggttcagg 452160
 aggtctgaat atatttccc ctaggcattc tttcttctt tttccaact tcaaaccgtc 452220
 agtcagtatc ttctattga aaactcaaga gttgatagaa gagagggcaa tgctgtgta 452280
 ccatggctgc tttagatgat acctcactg ttaacttggg tteccaactg ttaccaatt 452340
 gttggaatgc ctigattata gccccgagcc atggaaataa gcatcataca ggtactgtg 452400
 gcatgagtgc taactcagaa tgtagacatc tagaaaatac aagattagca gcaaactgta 452460
 gccggtttta tatatgtgct gcctataatt gatatcatgt gttctatgaa caggctttga 452520

 caaaaggaac cactaagcaa gtctctggaa ccatagacac aactttggca tcagatgaac 452580
 atacactgtt aaacacatta agaaatagca ctggcaggtg ggtatttcat gatactcaca 452640
 agctcagtgg ctccaattg tagtgagcag atgaacagcc cacatctaaa agcaactgtg 452700
 gacaaacttc tggccaaaga atatcaagaa tctccatcc tgaaatgta cagaaatatt 452760
 ctttagcatg aaactactc tgtagtattg ttatggcatt taaaggattt acctgaaagg 452820
 aaggaaggaa ggatactact gttcttcaa ccaacaaag ggaagatag actttctgtt 452880

ttggctagaa agaaactaga aaaataattt caatgtagta ggtgttgctt atcaaccccc 452940

 ccccccccc cggtgtgtgtg tgtgtgtgtg tgtgtgtgtg tgtgtgtgtc acatttattg 453000
 tcactagagt aaagatatta taacctttta gaattagata cgaagaaaat gatgaaacac 453060
 attcatactc atggttttttt attcctattc tatttgccat ttccttacta agtactttaa 453120
 atgtttaaac tcatataaaa ctgcccagaa aaggtgacta ttttgccta attttagaaa 453180
 tcaagaaatt ggaatgtgca atgctggaat ttttttcca agtcaacaca gcaaaactag 453240
 aaggacaaga ttaatacga atcccttcta caagctctaa taaccaagtg gctcagctat 453300
 gataagcttt actggctaga aatcttagca gttgtaactt gcaggtcatg tgaaataggg 453360

 tgagccaatg aatcaccact agctattgca atacccccaa gctgacagta ttcaccaggg 453420
 aaataaccac atttacagaa tgaaatctag tatcaggtgt ttggagtctc gtctgtgtgt 453480
 actggaggaa gtgctatgtt cattcatgcc tatattatac aatacataag aggtttgacc 453540
 atgcaacttt ccigaactta taatcaagaa actttataga aatgtgaaca ctgcttttca 453600
 tatgaataaa taaattctta gatcgttttc ctttgaatt gagctcctgt ttaattaaaa 453660
 gtatacctag ctatcatttt tgtcaaaatt gtttccaatt tagaaagaga gatccctgaa 453720
 gttattgtca accaagatca catggtttta ggttttgata gtgattgacc tagaaaaatc 453780

 ataaggtatc ttaataataa tcacagacaa aagatatatt gtataaaaaga ggaggcttgc 453840
 atctccatta ataaggatag aagaggctgt ggagcataaa atatgaataa acatgcagca 453900
 ttgccacata ttttgtgca cataaccact ggtatttcat ttaaaaaaaaa atgaaactaa 453960
 aaggtggaca aaagatcctg tgaaaaagt ttgaaaacat tctcatattg tccccaaaag 454020
 ccctttccaa gtaacttaat taacatatt tttttattgt acaatttaa gcctatggca 454080
 cttctttact gggatataga ggggtccggc tcttgagga catcccaat atcagtgtgt 454140
 acccttgtat ttcccagtgt cctctacagt atcagacat tttgctataa ccagatataa 454200

 acctctttct tgccaagctc ctatcttagt cattttccaa gccagactc cccagcctgt 454260
 gcatctggaa gtgcaagtct ctgaaatagt aaagtcaacc aataggagag cttctgctcc 454320
 atcagtgcct gctgagagca caagtgagg ctgtggttgt tgtgtgaaag gatacatgta 454380
 taaacactag ctaatggtc catctgggga gcttgtggga tatttagtga ggaggccta 454440
 gttggaggaa gtggatcact gtggctggg tcatgagctt tagactccac cctcctcatc 454500
 acctgggttt tctctgactt ttgggggatg acagatggaa agagcagtggt cctccagctt 454560
 ctgtcatcat tgatacaact ccccactgcc aagtttctct gtcctgaaag actatagctt 454620

gaactgtcag ccaaaataaa ttgtctctcc ctgaagttgc atttztatgg aaagtatttg 454680
 gtcacagtga tgacaaaagt agctaataca gcctcttgac tatgacactc tgtaatttct 454740
 gatggatgag aatgaacctg ggttaaccaa aaagaattgt tccaaaggct gtcagcctta 454800
 ttttatgact ttigatttac taagiatffa taaagttcct gtaaagatgg ataacataat 454860
 gaacaaagga cacactcaat accctcttta catgaatttg acctggagcc tatgaagtac 454920
 tctgtttacc tgitagcaca agaagatagt caaacaagtg tttcacaata tgcctatggt 454980
 gttatatac cattattata ctacatatgc actcatatgt atatatttat catatatctc 455040

 atgtaaacac actcttattg gggtccttac attagcctac tgaatatata gagtatggat 455100
 tttataatga ctacttcta ggtaccgtat atggaaaaag tccaatcaga gaaacacaaa 455160
 tcaaaactcc ctigagattc cacctcacc aagtcttaat ggtagtcatt gagaaaataa 455220
 ataacaaaaa ggatgacagg gagtggataa aggtgagccc ttacacagtg ctaatgagaa 455280
 tgaaacagg ttaaacact ttggaaatca gcacgcagct ttctcataaa actaaaaata 455340
 gatctatgag gtgacaaagc tgcaaaagtc ttgggtattt acccaaaaga cttcaagtca 455400
 atatatcaca ctagtgcaat aaaattatgt agccagccat tgtatctaac aacagaggaa 455460

 aggataaaga aaatgtagtg cacaacagag tgttttccac ttgttaccaa tgtaactta 455520
 catcacgtgc aggaatgca cgcaactagt aacaagcata ctaagtgaat taagccagtc 455580
 tcagaaaaga aaatatcgtt tgtgttttct caaagcaaat attgcatgtg tggttcctag 455640
 atgtttaatc aatacataaa gtaagatctg tatatgtgat atgaaaatag aagagaacct 455700
 atctagagga ccaaaaaagt ctaatgggaa taagaagaga agtgggggta tgagaaagat 455760
 atgcttgtgt gtagtatata cctgcatgaa agtgtcctca tgtagcacag gatcaagtag 455820
 catgaaatg cacaataaaa ttgtcaaat aaaagtcaag aaaaagaatg ctgtgagaca 455880

 cgaaacttga gttaatcatt tgggtttcac agcagattcc tagcgggtgt tcttctcctt 455940
 gggggaacag aacagaagat tcagtcatgt agaatcatgg gctgacagcc ctacagagtt 456000
 agcttaattt agccttttat attgaaagca tagacctata gaattccagt ttgacacca 456060
 acatgatggc ctctgcatat tattattaag caagcatgag attttccaa gatagaaagc 456120
 tattatactg atttattgat cttccagaag ccctccata ctcaactgaa ttagatagcc 456180
 aaagaaatcc tccaacaat ggtgggtttc gaatcaaatc ccaggacgtg agggtcacaa 456240
 caatgatgg catgagaagt tagatgaaat actacatgac aaacatagtt gaaatcagct 456300

 atatacctat agaaagaaga gaattgaacc agttatagtg gtgtgccctt gtcacctag 456360
 gtttcaggag agtgggatgt cagggtcaag gccagcctgg gatacataga aggcccaatc 456420
 aaacaacaac acaaaagcaa aaaaagaca gagagaaagg gaggaggaga gaatgaagaa 456480

gaggagaggc aaagaagatt agaaggaggg agagagaaag ggagaggaga taggaagcaa 456540
gcaaacaaaa ggaatagcat tccaaggctg gcatattaat gttcaacctg gtacatatct 456600
agtaagattg atacaaaaga ggattatgaa ttcagaggca aggtctagcc tagcactgag 456660
ctgatccagg attccaggtc tgggtaacat ttaaattca catgccacgt ttggtttacc 456720

tttcagatac aaatatcttc ctgaaaacc acccccaggg ccatacctcc tctgcaaag 456780
cctaacctcc tccaacaagg acacacctcc caatecttcc ctgacagctc ttcaactgga 456840
gactaagcat gcaagtatat gaacctgggg gccagtctca ctgagaccac tgcacagatt 456900
aaggcccttt ctctgtgaga gaagacagaa agttggagct ctcatgataa ttgcaagata 456960
ctatcctaac agatcccaaa gttgcatct attaagaaac agcaagatct aaagaagagg 457020
gtagcaccag gtatttccca agctcaagtg tgaagctgtg tagccgactg acaatttctg 457080
ccaagtatga tcaccttcat tcagctggat ttgcccttgg cctcctgcag gggcaagacc 457140

tctccccca tcacatgta gtatttgtct attcagtcga tgaatggat tagtccatgg 457200
ttggaatctg ctcttggta aaatattcca gcaaaagagt tgttttactg cactttcccc 457260
tcccaacca gtccagagaa tgcaacceag ctctctagac tccagcctgc tgccccgagt 457320
cctttaccac ccaatgcttg gttgctatca ggcagactgt tctgtggcgc acagctgggg 457380
tccactttct atctgctaag accatttaag cgtgttctgc tccattgctc agcattaaaa 457440
gagtctgtag gcaaatcatt tttgacaaa atgtacaacc tagctcaggt tgagacattc 457500
ttgagcagct tgagctctgg acacatacag gcacctgaac aagttaagtg actttatcac 457560

aaggtagtt accacatfff cactgttgc tagacttttt ataaatagat aattatagat 457620
agatagatag atagatagat agatagatag atagatagat acacaatfff tcttgttgc 457680
attatctgct cacatgtggc ttagatacta atgacggtgt tgaacatata atcatatcaa 457740
acataacate acctacaat gaattccaaa cagagagtct tgcttctttt tctttttttt 457800
tccgtatffc agtttagtt tcttgaaatt attctagctc caaagattgt gtcctatgc 457860
aaactaagga acaggctgat gtttaagtggc ctgtgctgcc atctgagccc atggtgatcc 457920
atgatgcccc caagggtaat ttctgagget gttggcatgc tgtagtcagg atctgtgctg 457980

gigtccgtag cctgtgttc cagcaaaggc catgtggatg tccatggtct aggctccaaa 458040
gcatgttga tgtgagtggc ctgtgctgcc tccatctga ggccaagtg atgtccatga 458100
ttcaggctgc ctcccagggc ctgctctgca tctgtggccc tactgcagca gagggtttg 458160
ttcatggtct gtggtatcac cacaattctt gtggaagccc atggtctgtg ctctgctga 458220
ctctactga ctgctgcaa aaataacaag gaggctactt ttgcagtgat accaacgatt 458280
gaagatgcac agttgagaaa gagggacatg gaaggcttct atgacaaccc ctaacccac 458340

ctcacccac cccactctaa aaaacaaca acctaaagaa atccatcaaa aagaactctt 458400

aaaaaatgtg ctaaggatgc tgaatttggc tctccacaat tgatggcttc tggccaggat 458460

gcgactcagt cctatttaag gggcagggcc gctttgaatt tgaccatgct ccattgagta 458520

tatagtaac acaaattgga cttatTTTT gttttgtttt cttctttatt tatttggttt 458580

taatttggag agggcaggaa gtcacaaggg tggggacata catggaagga ctgggaaatg 458640

agtgtgagta cctggtatga aattcccaaa gattcaataa aaatattctt taagaagcat 458700

actcacatgt agagatatct tcccatatat acagcacaga aacacttcaa actattccag 458760

cattcttaga gtcagtgaat agcagctgta ttgaagaaaa tgctgggaga agcccaagcc 458820

aggaccgaga gtictaaga cacccatagt tcattattc aagaaagggg aacatttgat 458880

ttcagtcaag taataaaaac aggaaatcaa gcattggtta aactagccaa agaacatagc 458940

ctacatatcc ctctctcatt acatttaaaa tatttagaaa ccagagacct caatttgaag 459000

catgaagaga tggtttacca ttgaaatgtt ggttatctac atgttgctgt ttgcatcacc 459060

cctccagtgg accttagcta tgaaaaaggg ataactttaa tttgaaagaa cttagaattt 459120

tacctgcaac agaactagat aaatccacc agagtctaag atccagtggt ataacttttg 459180

atgctcgtgt tctacatatg gatgagggga agatagtca gattgacgtg cgcaagtcc 459240

tggtttgggt aattctctct ggctttattt aattatctg tgacatttat ttaaaattag 459300

ttagaaaggt caatgggagc tgagagctca gttagtaaaa tgtttgctat acaagactga 459360

ggatttgagt tcaatctcca gcacctca taaaagctga gcatggttat gtggatatgg 459420

aaatccagca ctggagagtg caggaaggag gattcctggg gctcactggc cagttaaaca 459480

tctggtttgg caagattaag gtcccatggg agacctggtc tcacaaaaca agctggatgg 459540

ctctgaaga atgaatgta cctgtggttg acctctggtc tcctcatgta caagaacaaa 459600

gaacacacac acacacacac acacacacac acacacacaa gtaaataaat aaacagtgga 459660

aaatcagtg gactgttggg atttcttct atttttcacc tagttccaca gtacagtgtt 459720

aaaacattat gggaggacaa acagttcccc cacatgccag agctttgtgt cttagaaaca 459780

aacacaatga ctttcaaatg ctgaatgaga ggcaggaatg tggtccttg agcagcagaa 459840

tctcatcaac ttggggaagt aagtgaacat ttgtaaggtt caacagcaaa caaaacaaaa 459900

taaaaacaaa caacaaaaaa actgatactg gttgttctga ctaagatcac aattctgtc 459960

atgaaggcca ggcagccatt gacctgaga atgaaaacag gaatctctcc tggattttca 460020

gtgggcaaca gagagggact aactgccaag actttcaaca tgagcaactg ctgggatgta 460080

atgcagtgtg cacaatgaag gatgatagga acctgagcta agacatggca aaggatgcca 460140
aaaaaggatg ctcaggagat ttgtaatgta ttaacagagc ttggtgacaa attggatgct 460200
tacacctgtc gagtaagagc tttatcctgc aacctgtagt aggcagactg aaagtcctc 460260
aaagactgca ttctaacttt agaaactaaa cggaaaggta caccagaaat ggcgtacat 460320
aaagtaatag agaaatagag taccttggct tafgcagatg agtttggatgg gatcacaagg 460380
gctcttcaga tgtgaaaggt agattcagaa gagccagggt tttgagagcc ttgatagaca 460440
ctgctgcttt gaaagtgaag agagctggga acatgagaga gttgggcagc actggaagcc 460500

agagaggcta tgaaaattct ttttggaaag aaaggcagcc cctgctggga acatgttgat 460560
ctgggtggcc tigtctgcca cctgaggcta gagagacatc tggacccttg gacacagcct 460620
agggtcttgt ctgggtccat ggctttgcag tggcagggtt ctggggtgat acctatgact 460680
cctgttacca ccgagggtc tactgatgcc cagggtctag tcagccacct gagagcctgc 460740
tggtatctga gggccatggt cccctagga ccatactgac ctgagtggcc tgtgctcca 460800
caggggccat ggtgatgicc atacctgagc tgctactgag ggttacgttt ggtccgtgg 460860
ccctgctgca gatgggtgt gtgatgatgt ctgtgggtcca tgttagcagg gtgtcattgg 460920

aacatgctg tgctgagcca gccccacct tcaactggcac tggaatagct ggccctgccc 460980
ctcaactggat actgcagcat gagaactgga cctccccctt aggtccacct tccccacc 461040
ctgcaactca gagggatggc tcaactcacc ctcaactaca ggaatgcacc tcacctgggc 461100
agcacactag agctgacct gttgtcagg gcacagatga gccagccctg agggcataag 461160
agcaggagag ttaaccctag cccacttgt atgtccctta cagcaatagg aagagagggc 461220
cctgcatctc acctgagtaa aacagtgtg tgagtgtggg taaatgggct atgaggacct 461280
gagagcaggg gaatggcct gatccttgc acagcctgca ctgggtgagc tagccaagcc 461340

agtgttgagc agttcacttt cttagtgcag atgagggaaa gctggcagcc tgagcaactc 461400
agctaccata caggcccaga acaagggtta tgagttgtcc cacctcaaca tcacctcatc 461460
tatgaactgt tagagcacac gaagtggatg aacctataga tcaaaaactg caggatctcc 461520
acaagacagg ataccecaaca ggagcccccag taagagccca tgatcatcgt gtagcagaat 461580
ccagatgcct gagccagacc aatgaccca atggcaatga acaactgcaa ataaagatga 461640
atggactcaa cagaccgcac tggagcctcc atgatgagat tcttcttttt gttgtgtcgt 461700
tattggtttt tgttttatg ttttcattag tttgttttgc ttgtttgtta tgtttggctt 461760

ttggcttttc ttttaaattt tgttttgttt tgggtgggga ggttgcaagg gaagaggag 461820
gatgtgaggg ggtlaaggaa tgagtgggat cagaacggat gatgtcaaat ccacaaagaa 461880
tcaataaaaa tttcaagaag aaaaatgaaa agagaagaaa ggtagctctg cacgtatctt 461940

tgtgttacc cacaagacac atgtccacaa ttgtaggatg ttatctgaag ccaggaactt 462000
 tgtggaattt tgatccagaa tttcatggct taaaaggaat acatttacca tttgtgcttt 462060
 ggtaacagaa ccatggcttc tcagattagt ttacattgtt atcactttta tctttcatat 462120
 gctttatata cttctttgca tgctttatag ctcaagtgtt atagtttatt tagaatccaa 462180

 cttttagata gtaagcacia gctggctaga ccatacctac tactgtgtta ctctagtact 462240
 ctaaactatt aggtgtatit cctgtgaaca gggtagccca tcaaattact tccatagaaa 462300
 ctagaaggca aagagcattt tgtgatgcag tctccttctc ctttgcttat ctactcatca 462360
 gtcaactaac gtagtttgca agcaataaat aatitagtaa caaaatttag gcagctttct 462420
 gtcacaagat atattttatt tgctgttgaa ttaattaatg tttgggaaat gccatgtaaa 462480
 tgttagctct taccctttcc ttatttatag taagtaaata actttcaatt taattcccta 462540
 cactaagaaa tgctgtgaag tgtaagttct aaagtcttaa tgatggaaga aatattgctt 462600

 gccctcgtgg ctttctctgt aacctacata taatattcag aacttgaat gatggagata 462660
 atatcttcag acctagcttg gcccaacagt catgaaacat agatgtgaag gattttggct 462720
 cagagcctta aaaaatgaat gagcttttca cagtgtctat atagctttcc aatgagggaa 462780
 tggatagaga tgagaaggta agacattgtt ctcatgttac cctgagggca attaaaagtt 462840
 gtatgtgttt acttaaggac ccaaattgca ttgaaaata gattttaaaa agagactatt 462900
 ttaattctgc ttaaggctc caaggagtct aacgcagtgt tcatagaagg gctcttctt 462960
 gaatgatgga taacaactgg aagaatgttt tatgttcagt accaggtgtt ttaaaaggtc 463020

 aacagaagac agtggcctgc caaaagataa ggatcctatc gtcccttgca ggcatagaag 463080
 tgctgggaat attattttct tacctaaagt ggcaggcagc caaccaggtg agtcagcaaa 463140
 gaatccgate tctaggttag tcttaggtat tatgctacta tccaaaggac aaaagacctt 463200
 caagtggate aataacaggt gcatgagtct tgtgtgtgga attgaagctg atttccaggc 463260
 acaaaatcag caggagacac ccttcttag aatccagggc tgtctagtct atgcgattaa 463320
 gctacagaga acaaaaagcc aatataaaaa tgacactgag tgctgtcatt tggttaatgt 463380
 tgaggtacca tagtttcaaa ttacagacaa aataataacc attcaaaata ttcaaaaact 463440

 gtctggattt ctgtgagtta ggctatatac cataaatctc aaagtcagg gtaattgcat 463500
 cactgtggca agtctgtttg cagtgaacc ctgtatttga gcttctctgg agggcgaagg 463560
 tgtaatctgc cacagctgtg taattgagaa ggctctgatg cacagagcca tacaagtaat 463620
 ttgcaactag cagggtcag ggtattttct ctcagaatgc aagggtaggg ttctgggtta 463680
 tagttgtatt tctccctcac aaatgcttac aaaagcttct tgtggtgaca gaagcagttc 463740
 taaaataggc agtgaagta tatttcacct caactatgta atttcaaac aacttttaaa 463800

tgccataaga aaaatcccac ctgagcccag gtacacgggtg tatctttccc aggaatgttg 463860

 actgtaaatg agttttgagt aagtaaatat cctgaaatcc ttcaataca tgtccctatt 463920
 aacttcctcc tactaaatac tgaaccaag taactcatgg tatgttcaag ggaagtttat 463980
 gcctgtatat acatagatgt ttccacttat catccaagct cagttgtaac agcagattca 464040
 cagcaacttc cactgccttt gttctatgaa ggactttcta tttcattaat ccgagagtag 464100
 ctgtgctgtt tctaagcctt tctgcatgaa tttctacat gcattgtcaa gatggtttga 464160
 tttctgcctt ctctcttaga gttacattta caaagagcaa gctgtaggcc atacatagac 464220
 ataacctaata cacaatatca ttcaatagtt atgtcccaaa tccttctttc atctgtgaga 464280

 acctggctga aaaaagggcc acggggcttc cagtaactac taatgagctc ctgcctccct 464340
 atgggcccct tcaaagcccc acatcatctg tgtaagtgg acaaggaaga ctctcgattc 464400
 acacaaatgt acctgggctt gttcttggag tcaactagctg agagtgaagc tcatttcaaa 464460
 aactgactca aactcaggac ttacctggaag agacagcttt tcccagaaca tggtttgcag 464520
 aggacagtca agtcaagagg acataaaaagg agagaactgg caagccgact tcacctcagc 464580
 tgggatcagt cagcaaggag gagtgtcaca gagggcagca tgctaccagt tctcctttgt 464640
 ctctactaa ataaatttac ccttattgtt ccacagcata tggataatt attagtagcc 464700

 ctgtcatgaa tatattagaa ttaactctta cagatccagt ttgtgcattt tctgacaga 464760
 gatgaactct gaaggagggc cataatcatt ttgacctgac tgaattagta gtccagcaca 464820
 ctgacctctg ggcatgacat gacaattgcc tcttgaactc tcagtaactg tgagtagccc 464880
 ccaggagacc tglataggac tgaggcctgg cccaccaatg tgtctgtccc agaaaggaaac 464940
 aggatctcac actgtcccac ccctctttga ggatatgtag acaattacta ggttgctaag 465000
 agagagaaca acttgtcctc agtgatgcag ccaactgtaa attgacctg ttctgtcaa 465060
 taacccctca tcctgtggc tatgaatgag ctcaactgagc agttcactaa gttagacgtg 465120

 agtggagtca tttctttggt ctgtgcttgc tgctctgac tggggatgaat agatggctag 465180
 ttcatgcttt cagaacaaaa tgtgcatgca acacatagta cttcacagac agtgaatgct 465240
 aaagaagaat tgattaattt gtcttttcaa aaactgtccc acagatatct agtgtctact 465300
 aaaaggagg tcaaggccct ggaattggta caggacatac tcagatacca aattcttgac 465360
 cacaaggaga tttattacc cagagggaca aatgaggtgg ggagaggctg caaaggttgc 465420
 agcagcagca agcacaagaa gcaagaacag caagagatgc aggagtggac ttttatggat 465480
 aaaaaaggg gagtttggc taggggagtc tgtgctaggg gagtcttgct agaggagtt 465540

ggtaaatcct gatgggacat attagccaaa taatgaattt tgattgtagg accttggtgt 465600
 tttgtatgag gaatgagtca ctggccagat aagggaatag accttggggg ctggctttag 465660
 gaatgtaatg ttttttagca agggagagga aaaggggtaa aagggcaaaa cctgtctgca 465720
 atgcttgcca tgctcaggcc tgttagagcc ctttcatcta taccttcctt agaaggagta 465780
 ttttccaaat ttcatgaaat tgaatgaaga aacatgaaat aaatacttaa ggtaataatg 465840
 ataccacagat agagtgtcac aagactgatt gaagcatgaa ttaatccttc tttgtttacc 465900
 aatgactcat taaatagatg agagtgagcg taaagacacc tgtttgact taggggtatt 465960

 taagaacgtg aaagtcccca ctagectgag acaatttact gcagattgtg ggcaatgtga 466020
 aataagggaa aacattatca atctcactca agagttcatt gcagatattc aataaatgtt 466080
 aagtgactga ctagttaatg gagattgggg aactcactga aaataaagc tgaattaaca 466140
 atgaaaaata attctgacta acccagggaa tgtaccctg ctattaaatt ctgtgcaaac 466200
 acagagggtc ccagatgita attatTTTT gtttTTTTT ttttTTTTT tttttgcttt 466260
 cacagattgc ttctatttca gtgggcagat ccagaagcag ggcagaagtg cagagtgtgc 466320
 catgtgggac tcagaattct tggcattttt cttcagattc ataaaacaga agaaccggaa 466380

 agatggaaga gcttggttt caccatcaa ttcccaacc tctgcatggt ttctcttctc 466440
 ttggaacaca caggcagctt atgatctctt ctctccctg accagctgta ctagggtgag 466500
 gacatctgtg agacgatatt gatgagaaga cagacctggc atcttcagc tcaactcagac 466560
 aacactcttc cctgactcag gggttcagag tgaaacatgc ttggtcagaa gcatgaaat 466620
 cccactcac aggcttccta ccatgggcag ataaggtgtt ctctgagcat ctgcctggc 466680
 cactgggctg ctgtctctgt ccttgaggtc tggaggcaat actccatcat gacaatgta 466740
 cttccatgc ttcagtcag aaccagaaag atagggacta caaatatggc tcatttagca 466800

 aatggetgac atttaaccac agggacttga gtttggattc ctagcacca catttcaaaa 466860
 gctaggcatg gcaaaatgca agtgtcacac taatgcacgg tggagggaga caggaggaac 466920
 tttggaagtc actggtcagc cagtctaaca gatgagtgtg caccagtga gtgagagacc 466980
 ttgcttgaga aatgatgtg aagagcaata gaagaagaag agagcagacg ttgccatttg 467040
 gcctcaacat gtctgcacaa aatcaggggc atacacacaa cacacaaata catagaacac 467100
 acacacacac acacacacac acacacacac acacgcacac acacacacac acacacacc 467160
 tggaaagact aaaacaaaat gacaagcttc ttgatgtgtc tcttccctg tgtcttgttc 467220

 agacaaggtg gttacagcca aaggcaaggg agaattgtgg agcccagatc aagcatgcca 467280
 ctgatgtgta atgtgtggct attctcatca atgttgggtc ttggcttgtg cagattcccg 467340
 tgtcagacta tgatgtagag ctcaagggat catcataccc tctacatgct ctccatgta 467400

tctacctaca tgtgagagcc taccaaatga ccaaaacagc tgccaatcag caacaaaact 467460
 cttacgaaga aaagccccat gaaggtttc atatcttatt ggagaaacct gtgagtgcag 467520
 caaccaatgt ccttgaggtc tctgtagttt ttatgacagt gctaggccct gtaggtcagg 467580
 gctctggaga aactgctggc cttggactct gtagtcagca ttcaacgttc atgtggcttc 467640

 tgtgaaaatt acttaacttc tcagtgcctc cacagcttta tctataaagg gagacgatgc 467700
 taatgcgtct acctcacaaa tatacttga aaaagtgtca tgcttgagag aaccacaga 467760
 agcaaatgct ccctaagcgt tgccctgagtc aaccttgca tctgagtaga ctgtaagaag 467820
 taaaggtggg gaaaaacagt gagtaggatc tgtggtctta tgaaaaaagg aaacatttc 467880
 atttagaat gatttcaaaa ctgaaggaca gaaaaatcct tgggcacata aatgggaaag 467940
 agaccaagg ctgtttggtg tcaattattt gcaagaagaa aggtctctgc actaggcaat 468000
 gaagttaaat gtgttttgaa tgaacattta taaactctg tgattgaatc agccaacat 468060

 taaatttta atlaagccaa gccctataga aaagataggc agctatctaa gcaacaaaaa 468120
 tagagattag aaacctgct aatttgattt tcacatagtc ccttttatga tttatataaa 468180
 tatctgcaaa gtagatgact taacaaaaat ttcataataa aatgggctta tattagtatt 468240
 tccaagtaaa tcaagcaagt ttccctata aaatatattt tagatttcat atatgagaat 468300
 ataaatattt agctatttca aaaaatagca tgtatagata tttcaaaaga aagagtaaga 468360
 aaacaaggaa gaaacaaaca tacctcaagc aactaataat gttgttagcc ccaattggaa 468420
 tgtatttata taatgatggc atgaatgaaa taaagaggtc aaattcctca tcaccgtgtt 468480

 aagattatgt aaagaatgat tgaattttag agacatttta aataattgat catcacctct 468540
 aacttccaag ttttaaaatt gaggcctaca gaagacagac aacttttcca aatcataat 468600
 taaaatgatt tctggtgtg tctcacagaa agatagcttt tctctgtga cgagaacaac 468660
 atgaggttgc atgatggaat tcgtttccta aggctgecat aacaattaa cataaactgg 468720
 atggcttcat acctaataaa ggtataggca ttgctgtctt ccctctgtga gctccagagg 468780
 ggcatgtgtc tccatgctt ccagtgctt ctggcttccg gtaacagctg gtattccttg 468840
 atgttacct catatttctc aaccacactt tccatecat caataactcc taatttcate 468900

 acttcaaca cctatgggac aataaact cagaataggt ttctcttag atccttact 468960
 gatcacattt gtcacataag gcattactca tcccttact ctgtaaagca atagtcacag 469020
 aactggaggc caggatgtgg aaatatctga aagtagaagg tagagaggta ggaagaaca 469080
 cgctgagccc atcatagctt tcagttagtag caagcctatg ggtgtttctg aaatagagat 469140
 ggctttaggg taaaacctta gagaaggatt accttttcc acttgcccaa taactcattc 469200
 tttagggtgtt tglattggcc tgcctttgga gttctgagag aatacaatct aggctgttgc 469260

cactaagagc accacctctg cctatttatt atgttccctt taaaaagggc cctgcctcc 469320

 tctcattggt ctctctcttt tttccctctc tctgtttgtc tgttcggttc tctctctctc 469380
 ccatcctacc ccccctctct ccccttctct ctcccttctc ccactgtacc taccctagga 469440
 ggctgctctc ccigtcccc tttccctttt ctacgatcct tttcccttaa taaaaaact 469500
 catccacttg aactcttgtc tcatggtgtc tttctctcat gcactgctta aaaaaaatt 469560
 aaacagtgac cacagacctc agatcaccaat ttttacctag gtctcagggc cctactcaat 469620
 tttggcattt gacgtcaagt taaagaaggc aaaagggaca catccaatta tgtctgcata 469680
 ttcttaaatc tctctaaaa agacagctaa ggaacaaaac atgttcaaaa aatccatgca 469740

 ctatgaaaga aggtacaaaa ggaaagaaat acatgaatca aattctgaga aatgtgaagc 469800
 tgatggacaa gaggcaactg acttaacaca gcaaaaacca ccagtcagag cttaaaaagg 469860
 gagaagttag tgaatgaag acagatgggg ctggaaaagt gactgggcag atgagagtgc 469920
 tcactggtgc tgctctctag aggacagggt tttagttccc aacatgactc aggttccaga 469980
 gaatcagata cctctgctca catgggcaag tgtgtgtgtt tgtgcacacg gacaaataaa 470040
 taataagtaa atatttaaaa cctgtgaatt cattcatacc aaatacatc aagaaaagct 470100
 aagaaataga tgiattatta ttttcaaagg cccaagttag acatagaaaa ttaactatcc 470160

 ttttctaac acctccaat gcaaaatttc tgacaagtaa aattgtttca gaaaatttta 470220
 ctagtttacc ctaacttatt tgtaggata caaatacaaa tcaaaataca atctaaagta 470280
 tgtaaggcta attataatct ttattaatcc ttgcttagta agaatttca tgttccatgg 470340
 aaggaaaaaa galcaatgtg ttttaattac gcaactactg caggtcccat taggtgatgt 470400
 atcaattaca tatcttatta ttttctaaaa tctaaaaatt aatctgaatt ctcaaatatg 470460
 tctagccttg aggagtctc acaagacacc atgggactat ataatgagcc ttttctagcc 470520
 ccaaatectt ccttgccat tctccatctc aacaagaagg ggtctgctct ctgggaaacg 470580

 gaattcta atcttgggg tcttatacc caggctcaca catggcacca tcttgaaaaa 470640
 cgagacagga gagcccagtt ccttacttag gcttcacaga taggaacaac aggcatgtat 470700
 ttgaattagt gaactttgct catggtgaca aactagagtt cagtgttcag tgttctcttc 470760
 tatcactccc aacctggttg tttgcttgtt tgtgtttct attgttgaga tagtctctca 470820
 ctaagtcag agcttattgt ttcagctagg ctggttggcc aattaacttc aggaatcctg 470880
 tccgaccttg cctatctcat gcctcaccct tgccagtgg gattatagat gtacctcttg 470940
 caatacctcg ctttttacct gggcactgga gatccaaact tgggttctca ttcttgtgta 471000

gcttgctgt ccctcctaa gccatccctc cagctcctag ttccttgctt tcagatttgg 471060
gttgggtgt ggttggaga tgagaccttg tgcacctca tatataatac tcctcctgag 471120
tgctagggtt agaggatat aacactactc ctgagtaaag attcattctt tgcctcttg 471180
tactgttgc tcigagcctc tatagtcaca gtacaccatg ccagagtgc aggaaaagaa 471240
aacagggtcc tcaagtctca atatccctt caaaaatccc cagtcaacag cctgacttcc 471300
ccaccagcct gacctctcaa aattctatca cttccaataa tactacagga tgggaaccaa 471360
ggaagggact ttcaggacat ttaagattca aaagtgtagc agaattctta gcagaatgac 471420

acaggttga agattttccc ctgagttaat aaaaaatcaa agatctatac atttgacact 471480
tagggcttcc cagaaagact gtggaaactc catctgctca ccttcacag tatctcacc 471540
aagtgtacag aactcttaaa ttgattgaa tgagagtcaa gagtattag acatctgaga 471600
acatgaaaga ataagtaaaa ccatgggaa aatgaactct tggtaagagc ataccaaaa 471660
ctgtatttaa taatcacaga aagataaaag attatatcct tgagatgaga ccaggaatag 471720
ttttacctt aaaaatcttc agaaaataaa caacatgatc tgatcatggg tataaaat 471780
ttatatgaa cacaaacatt agaaactaaa attgggcaaa acaatggcca gaaataaagc 471840

aaaaaacca atgcatgata aatgataaa aatcaatgca cacaatagta aagcttaaga 471900
ctataatgga cttttttaa atcctaaagt tcccagata aaacaaatgt gccacaaca 471960
tatacataat ttgtgattat aataatcata atacaaactg ttgcatcatt gagaagtagg 472020
agatatttaa ccagtctcca aaattctatg agaaattaat ctctactaca ttgttaatta 472080
tgtatlaatt taagcaataa tataacatat atgtatatta ttgcttaaat aatatatata 472140
aatagatggt acatacttaa agaaagccac ataacaagga gaaaaaaaa acatgaaatg 472200
aaaaaaaaa aaaaacagga gactggattc aagcaaacag aagtggcat tcaagaaa 472260

atacaactcc tatgtaacag tgttattctg agcacagggt taccgagcac ctgttctgag 472320
atggagaaca atagagtgtc taaccacact gaaaaggcta caagaacaag caaacaaga 472380
gggtagtatt cacagccagc acaaagaaag tagctgaagg aaagaatgt ggtggtccta 472440
gtcaccagg tggtcagcc atgcatcata cttacacatc actcatagga atatcaatc 472500
aaaaatggct aacacgactg cactagagca atagagaagt atggggtgaa tggagaggct 472560
gatcgtlaat ataggcaat aaaatgctca tttccagat taggggcaaa agatactacc 472620
taaatttaaa acicaagaat gagctattta tgettgtac ttagaaataa ggaaggagac 472680

ctgggaagaa actgtgggtc ttgactcaga gatacagcag ctgctggatc agagcagagg 472740
ttttattttt agttgaccaa atcaatcttt atagtatagc tcaaattagg tcttctcttt 472800
aagagcaaca gtaagtgacc aaactccctc attgggcatt tacattcttc ccagattatt 472860

tcccagcaact ttctctctta cttttagaaa aactgtggag cagtagcttc tgggtttggt 472920
 ggaagcacag tttatcttc tctccggg ttcaaatatt ggtcattcac agatctttta 472980
 ttggggctct ggttccttg atatectct tatcgttttt gaccttttga gtttttattt 473040
 ccgttttgtt ttggctttgt ctgagcactt ctttagtttc caccactaca atatggctca 473100

caactttgaa catcatgggg tgtagcagc tcaatggcat gactgggact cttcacaact 473160
 gcacatggt tacagtgcct ccctctatc acgtgtgggc tgcacagctt cctaccacag 473220
 aataaccttg gatttccaa acaggaagac tgatgaagta aaggagattt cttcttcaa 473280
 gctgctgttt tatagggatg tttaacattg ccttgctaaa ttgggtcaca tgatgagcca 473340
 ggccccctc ctatacccc aaatctccat gaactaattt tgactaggac agaatacagt 473400
 gcttctctct gtctctgtct ctgtctctgt ctctgtctct gtctctgtct ctgtctctgt 473460
 ctctgtctct gtctctctct ttctctgtgt gtctgtatgt gtgtctgtgt gtctgtctgt 473520

ctctgtctct ctcttacaca cacacataca cacacacaca cacacacaca cacacacaca 473580
 cacacacatg gaaatgaaag cagatgaagt cgagtgaatg tgtactgttt ccattagcat 473640
 gaccatgta aggataccaa tgcacagac tcatgggaat ggcaaacctt tccctgggtg 473700
 tgactcaggg ggatggcaag agcctcccct aggaacacag atgttgatgg acagttgact 473760
 gccatgtaaa aacagtacat gcaaaaagta ccaaccacag ttctctatcc tggatgaaca 473820
 ttttcgagag actgccacac tacagagatc cctgaaaag atcagtgaag ctgctgcctc 473880
 ctccactgta tataataaat gagcttagtg tctagactgc tggatcatct ccatacaagc 473940

ctgtggcctg ccagatccca gctttacctt cctatgtct gtctctctta atctccatc 474000
 attcccagtc cagattaggg ccagcctgcc agccatggca aactggaatt cattttttat 474060
 ttgttttag ttgcatctt tgatttgtct gagccattct ttttctggcc tatagtaagg 474120
 ttcttaatag aatttgtaca caagagaaat gaaaacagtt ctctctgcag gcacaaatgc 474180
 tgcatatgac tagcgggcaa tcttttcct ttttcttggg ttttaaatgt aaaatcagtt 474240
 tgacagggcc ttggataaat tgatttatca tgacatttga gagtgaattc cttagtttgt 474300
 gacatgtaag tggcagaaaa cacaaaagca aactgtacac ctgaaacac taaaggtatg 474360

ctttaagcta aaagcttcaa gaggagagcc atgtgtttca agggtttgct atactcattc 474420
 taataaagat tccacaaact gaaattcacc aggccaaatg ttcatctttg ctttgttttt 474480
 ggtgtgttga attaggctaa gttggactaa aatccatagt tactgagcca gacagcattc 474540
 caggcattgc tttgaaggca ttctgtatg taatggaagc cctcacctg ttgagcttca 474600
 attaggcaga ttgcctctca tcatctcagt aggcctgatc tgagaggcag gaagacatta 474660
 agagcaaggc tgagtttcag gcagatcata gaaattttcc ctgtgggtag cttccactca 474720

gaagaatata ctcgagtta cctctcctaa caccatccat ggactttctt aaccagctct 474780

 cacagtgtga aaggtaagtc tttgtgatat ctcttctca gtctcatctt cttaataca 474840
 acctttccct tttcatcccc ccatcaaget ttagctacc tttcattgat ccaactcact 474900
 aactacctat ctacctaat acttattatc catctgccta gcatctacca tctatctata 474960
 tctattatct ccctatatac tatctgtcta tcagtcatgt agcatctcac tcatcttact 475020
 tctctggttg aatgctgatt tatgtactta aactgcttca aacaggacca tcttcttgtt 475080
 taatattatt ccttcttcac cttaatattt cttttcaatt ctttatttct tacttttctt 475140
 cattcatttt gtgttgaagt tgggggtacc aagtgcccaa tcacggtgtg tgtgtgtgtg 475200

 tgtgtgtgtg tgtgtgtgtg tgtgacaggt cagaaggaca acttgaaggg atcaggtctc 475260
 tccttccact gtgtgagctt tgggatcagc ctgggtcct cgggattgat aacaagcacc 475320
 attatctatt gaccacctt gctgacttta cactaatgtg tctataatc gttttctctt 475380
 aaaattattc ttiagaatat aaataaagaa taaatggttc tgtgctccag tatccacaaa 475440
 tcacaggaca caaattctct agacggaaag ttctcacaag tctggctaata acagtagaga 475500
 attgagaaat ggttgtgta gggagaaact aggacagagt ttgaaggtga ggctatgcat 475560
 tcacaagatg aaaaataatt catgttgacg ttttgacaaa ataatatat ttcaaacatc 475620

 cactggtcct ggggtttttg ggtcctacat gaagttgttg acacagtggg agaagtaagc 475680
 aagagtccaa ggctgattca gttcagctct tgcctttcaa caggggtcaa ataatagtgt 475740
 ttgtatttgt ctgaaaacta aagtttaact gccttagaag tgacaagatt ccaggccatt 475800
 ttctatgaca tttcttctact ctttattgca catttgaaag agaacataat aaacctcaga 475860
 agttattgtt tctgtggat ccatctcagg cagtaatttt tggaccaaaa tcaaagtagc 475920
 tgggggtttt aggtaggata tctggaactg aaagcaacaa gaatccccc tatctctctc 475980
 ctctgttttt tcactttctt tcactgaata ccatttgta acctcatttt ctaccttgt 476040

 tactagcata taagttgtag gccagagact ctatatgaac ttcagtgtat tccagaagtt 476100
 agtataatgt ctggcacaca gtaaatgctg ttgaacagta catgcattgt tctgtgtct 476160
 ataatacagg cataatgata gtgcccaacc tctagctta taattatagg gaatagacag 476220
 ttttttttt ttttaggaat agacattttg tafgatattc tttaaattcc tagtcaacat 476280
 gaactctagc tttccatgtg ggcacataa tttgcttcat tacagattgt atatgatata 476340
 gagaaatatg gaacagaaat aaaatatcaa tcagttctgg ttttctgaag actttactat 476400
 actgttttca atttattgaa ttcatatca gggtttttgt cttgggttgt gagctattga 476460

aggactgttt gtttcaaaca agtcccatat caaataagaa ttgatgtaga gccttttgct 476520
 ggttatcatt tagtcaaac agacagctgg tcaacaatg ggatgattgt tgccttccat 476580
 gatgctggag atggtgaaat attaaaaata gatatgacat tttctagtaa ttaatatcaa 476640
 caagtatfff ggattttag cctgagcact cttcattgta tttggcagtc tgccttcttc 476700
 tttgttgggt ggaactgaag agaaaaata tacatfffct gtaatcaaac actgaatgga 476760
 gctttcacia caaactcatt tgagtattca ccttgacccc tcagatcaag gagcaaaaat 476820
 ttgccaggcc acatfffca atactctgcc atggaaatga atgatccaaa gttaaataaa 476880

aagtgatcgt gtataaagtc cacagagtca accacaggaa tctcagcgt agctgtatct 476940
 gagtaacagg tttatctgat atggttgttg acatcccctt gttttctgca gtgatcatgc 477000
 attattcatg ctctgataat aaaaagaata aaaaggattt tgtttcttag aggtaataga 477060
 aatfffacia ctgcctgcag agtcttattt cattaactag agagaatggg ggggtggtaa 477120
 aaagcaaaga ggagfffga acatgaaagt aggtaaacat gggatcatgca agaaatatat 477180
 agtcaagagt ccagtaaaca aactccttgg cagcagagtt aacttaaacg atffataagc 477240
 aacttctctt agcccttctg atatfffct gtaaatggca ggatatcatt gttttcagag 477300

gttgccaagc tgttggcagg ggacaaaaca caaagtgtat ttttactcgt taatatttta 477360
 ctttaaaaca ccattgatct taagctacct cccaattgc aaattggtgg cttttcagat 477420
 aatffatagg aaaacactat gaagfffatc tttgaaatga aatgaaataa tacctgcact 477480
 tcctactttg gggaaatfff atgttaaac acccggacag gcagagatga caaacattg 477540
 agacatattt agagatttca tttctcttcc tgataacgac aaggttgatt ttgtgctctc 477600
 agaggggaaa tcatatctga tttaccatca gctgcctcca tgccaccagc cacatttcac 477660
 attctffaaa cagccacagc tcggtgatgc cgactacct ttactgtggg gttgatcaac 477720

tgccaaatgc ctgacgaatc acggaacact ttcactetca gctacctgtt tetffatcgt 477780
 gataaagcag gatgtgcagc aagaggcaaa ctgtcataat tttattggcg aacgaagtct 477840
 gatttacacc accttcttc tcggtgcaag aactaaaagc atccgtgaaa ggggcagtct 477900
 atagcaagct tccacttccc ttctcttgc tcttctgatt agcctfffcc aagcagaaga 477960
 atagctcact ccctccaag gcaccatctg aggaatgfff aggtcagata tffaaggaag 478020
 cccaagacag cataaggaaa gtaacctga ctgcccttat tcaataacc cacaaattcc 478080
 tattctgac atgaatctca agcagacctia cagtgtgaac tgagggaag ccatagcggg 478140

acaggctgtg tatgtaaatg tccagcagaa aggaattgaa atattcaacc atffttacaaa 478200
 gctcacaggt ggaacaagat gtcgaggtgg aattactgtt tagaggaaag catgtgtfff 478260
 ttcgggtffc atctccagct gaactagaa gttatgatat atgccttaa aataaattta 478320

aaaaatagg t atacctctc t tcaactctc cccactgctg tgcatgccca agtcaacatt 478380
 tcatctcadc tgagttttac gctgtggaaa tttcaggaaa caaatgagga cggcaaatga 478440
 tgacctacta t gttagtcaa gacatatcag ataaaggttg tggctacca ctgggttttc 478500
 tttgttggat agatgaaggc aggacataga aaagtgttg cagaaccaga atggacacgc 478560

 aggaaaattc tgaacttgtc gcttaaaagg aaaatggaaa atcagaatgg tagatgctcg 478620
 tttggatcca agtgatagtt aattgcctat ttcctgaac tgtttgaaag agctatacca 478680
 aattttcttt gccttgtcat ttaaaacact taattctctt tgcacttccc aaccaacttg 478740
 gcacttctgc catctattga agacctagct aatctcctag tcatctgttg atcaatttag 478800
 tgggttact agacaacctc tgagittcaa acattaaaat ctgactatct ctccttacct 478860
 ttgaagcaag gtaagcagag cgaagttaat ctgttcagat ggccatcacc tgctctgcaa 478920
 aagaaaaaaaa aaggaagctg taaaaaattg tgttggcatg tctagacaaa gcaaatattc 478980

 actgggaaga ttgctgcaag gtcaggggccc tgccaattta ccgttggtaa gcattagaaa 479040
 tggatactgt aaagaaaagt tgaagcgttc tcatcttaaa atatgcaaag gacccctcaa 479100
 tggacttgac agattggcca ttggattctt cttaaagcct tgatatttgg ttcattgatt 479160
 ttcaagtatt ctgacatttt tctttcatta ctataccaca gcctagtgcc tttccctcct 479220
 accttgagtt tttcaatttc tgaaccccaa tctttatagc ttgtgttacc atgaatatgc 479280
 cacaaacatg attatctaca ggaaaaatgt tgcctattat ttatagtctc cctctacttt 479340
 cctcccccc cctcatcctg gggctggtag tttcttcac ttgctgcaca gtgtcactgt 479400

 gaatgacagg aaataaagga cggctgaact tactcacaaa aataaagaat cctttgtgga 479460
 agatgaggta ggggacagca gcaaggggta agataaaggt tatggaaaga aatgaaagag 479520
 aagaggtagc t gttgtgaga aggaatcttg gggaaagtac tgaaatattg aaaagcagtt 479580
 aagaagtttg gctgtgggct gtgtcttacc tggcttgtgt ttacaagacc ttgttgaatt 479640
 ccatattcac caatgtttct gaagctgggt ttgtatctga gcagtttgag tggcttttgt 479700
 ttgtgttcat ctctctatga ctttcaaaga caagatattt tgatctcttt cctctgtaga 479760
 aaaaagaata aaactatcac agtatcacia cttctgtgtc atgtaagacc caagtcctcg 479820

 gctttctgct agtatgcttc cttcccatgc caacctcagg catctgaaac tcaacctgcc 479880
 tacacctaaa ctcaaaattt tcatcttgt cteccaattc cctctcaaaa ataacagtac 479940
 catccaccta ctgctatag tcatgaatat tgaaggagag cccttgtatt tctcattgtg 480000
 tctcaggcag tcaccatgct ctactcttt actacctca ggatctcttt actccacttt 480060
 ctcttctta agcaccataa tccccaggaa ctattgctaa atcttctaga ctttaccctc 480120
 tttcaatcag agtaactctt aaatgtgaca gactcattag agcaactcct accatttctt 480180

gttttggctg acaaaggatt taggcttggt ttccacccat tttcactatc ctctcttctt 480240

 tcttctcttg ttgttcatg attgatccct gtttcattcc tccaagagc taagtatccc 480300
 cctgtacatg ctgttctaag taaaagccca gcccacaactc aaccccagtt tatcttacct 480360
 atcgtttctc ccaccactc ttctgttcta gactttcagt tggtaagtca ttctcttcag 480420
 ataagtgtac atccctaaca ctctgtccc acccctcgcc cctcccagc tgttatttct 480480
 cctcattage atctctgctt gtatagtcaa catTTTTTtC ctacagaatt tattgcattt 480540
 ataattagat aacTTTTtC ctaattattt aatgtctgct ttcattggcag actctcagtt 480600
 atatgattta taatgttaat gccagtatta tactgggtgaa ttgctaatta tttagtgttg 480660

 tatagaccct catttctgag atggctattt ctgtcataga atctTTtaag gctaagacat 480720
 taaaacttaa aagttctcta tgaacagttt acctgaacaa ggggttgctc atggactcca 480780
 gactgatagt tgggaaacca gcataggact gtttcagacc cctgaagga ggaggtcagt 480840
 ttgaagatct gggcaatcta tggggccacc ggtagtggat cagtatttac tcctagtaca 480900
 caaatggact ttggagccc tctccatag gagggatact ctctcagcct agacacaagg 480960
 gggagggtct aagccctgct ccaaatgata tgacacactt tgaagatccc ccatgaaagg 481020
 cctcacctc cctgaggc agaaagggt tgggataggg cgtcgtggg ggacaaggtg 481080

 ggaggagag ggaactgaga ttgacatgta aaacaagctt gtttctaatt taaataaaaa 481140
 ataaataagt aaataaataa taaaagtatc atacttataat ttactatttc tatttctctg 481200
 ctactctag gagaagact ctaagacatc taatgaaact agaaactaag attaagatgt 481260
 gtatgagact aaaaataaaa ttctggagcc atcaaaggaa tagtactttc cttaaagag 481320
 catgtcagtc acttacaagg acaagattc acatctcaa gctcggcact tgcacctgta 481380
 gtgaggaata tacctatcc atttcaattc agactatcat cctcattgcc gagcaggctc 481440
 acaaatggag ttcattagt ccacgtggga tggcagggtt ctggttccat catcatattt 481500

 gctaataaat gagctgataa gtaaaattcc ctaaaatctc tcttcatcta gaatatattg 481560
 taaaatatca aagttgaggt gatgatgtac ttcacagtat ttcagatgta ataaagctta 481620
 aatctctcac tgcaaatgg aaagiatgtg cagtgagcta tctTTtaac acaaaatatt 481680
 tggggggcta ataaccatg gcacactgct catcaacatg gaccaagaaa aaagacatct 481740
 ttaaagtcaa cgtgactcta ttatcaccag tacattctgt ctttgctcc aagagaatcc 481800
 agacctgcag atatctcac agatactcc tgtgtctttt actggaaaac tactttctc 481860
 ctttgataga cattatgggc attgtctaatt ctttctttg atacaattt aatgtatgtt 481920

caataaatgt ttatggcata tgttgcttca gactgttgaa aactgaaata gaaggtgaat 481980
cgtcacagct ttaaaactat atagcatggt tggatgaat aacttccatg cacccatata 482040
cacaaaaacta gcagacaact aatfttaaaa gtatgtgctt ctgatctggg tgggtggtggc 482100
acacgccttt aagcccagca ctctggaggc aaaggcaggc tgatcattgt gaggttcaagg 482160
ccagcctggt ctacagagct agttccagga catactccaa agctacagag aaacactgct 482220
tggataaaca aaagcaaaaa cattggggaa aaaaatacat gcttctgata cagatcttca 482280
ggtggatatt aagtgaatft cctaacaaaa ttaaagtcaa aacttcatta aagatgacaa 482340

attacctata cttacaccta tagataactt aaaaggttgg gcggagggga gtaaaaggta 482400
acaaatggct ggtgtttggg ggcagtaaga gaaaatattg gaaaaatagg gacacgttaa 482460
gaaatatttc accttaaatg cccatcccct ataatgagaa tgatgactat cttaaatgcc 482520
atcctagagc cttaaccaa tagctgatgg aagtagaagc agagctccac agccaagcac 482580
tgaactaaac tcttggaaac cagtttcaga gagggaggag tgaccaacaa agaccacgct 482640
gggaaaacc gcagaaacac ctgacctgag caactgggaa ctcatggacc cctgactgac 482700
agctggggaa ccaaacatag gaccaaacca ggcctcctga tcgtgggtgt tgttagtcag 482760

gagcactgtg cagtctacgg ggcctctggc agtggaaacca ggatgtgtcc ccagtgcacg 482820
agaggacttc ctagcccat ttcccatgga gggatactct cttagcctag atacacaggg 482880
gagggtcttag gtctgcccc aaatgacttg acagatttta gtgatccctc ctggaaagcc 482940
tcaccctcct tggggagtgg atgggggatg aaaggagag ggaactggga ttgatatgta 483000
aaataagatt gtttctgact taaattgact tacatttgag agagagagag agagagagag 483060
agagagagag agagagagaa gagagagaga gagagagaga gattgagaga gagagaatga 483120
gagagagagg agagggaggg agagagataa agagacagcg agagagggca agagagaaat 483180

atftcacata ccaaaatgag aacatgtgag caagatcagc agggatgaag catggctaga 483240
gatttagaca tatggttgat tcaattggtt agtgactgct ctggcatgca taaggccttg 483300
gctttgggtt tcatcccagc atgatataaa ctgcgcatgg tggcacacat ctgcaatccc 483360
agcactaggg aggtagatgc aggaagaaca gaagttcaag gatacctca getacagaat 483420
gagtctgaag acagcctggg ttacatgaga gtctgtctca aaaaaaaaaat aatagtgggg 483480
aatgctatac tfttaagcag tgtcataaaa ggtaccacaa agattcgtcg attaaggaaat 483540
agacttgcca atgcaagaaa aaatttgtga tftctaaaat gatcaaaaca ttgattgact 483600

tatatacact gagaataaat atcacaaaa tagatagaaa agaatactaa aaaataagaa 483660
tcagtttcca tgacaaatgt actgtgatct taggggatag agatcataaa gattaaaatt 483720
acttcaatat aaccatattt aaaattggaa ataattgcaa tftaatacta cacaaaaagt 483780

ggaggaggta gaaggctcaa tgattaagag tgcttactgc tcttatagag aaccaggtt 483840
 tgcttcctc agagaggfca caactcctgt aactcctgcc gcatgggctc caacaggctc 483900
 ttctggcctc catagggccc tgcataatg aggtgagcct aaatacactt aggcacacat 483960
 ctacacacat tgaataaata aacaaataaa taaatgtttc taaaaactga aggaacctgt 484020

 ccaactgcca aatgtttgag gtgagatgtc tccagtaatc catgcactcc aaatcctctg 484080
 taaggttcag gaggcatttc tattttattt ctaccagaag tgagaacact tcctatgatg 484140
 ctagtaatcc ctctcctgtg tgacttgata ttacccttc ttagcttag acgtagctga 484200
 catctaaaag gtccatgttt tcttttctga aaacacattg gacaaaaatc tgttcagaac 484260
 cctttcatgt gatgattgtt caaaaactct gagagtcatt gcatcattgt attgtagatt 484320
 ttaaataatc tactatttac agcatacaaa actcattaac ataattaata aatgcctgtg 484380
 ttattaatga taatttctaa ggcatcacia atatctgcca acagatttac tgatgctatt 484440

 tcagtttaca gttagattta tggcttctc ttgtttttaa aaaatacaga caactttctt 484500
 tccttgagag ctaagaatat gaaaactcta ttctaaatca aaatgtcctg agtttaatga 484560
 aaaccaggaa cagaaagtct aaggcctgt ggtcgggctc ctaacttgaa agaataaatt 484620
 aaaaagcatc aaattcaatt ttcccaaaga ttgtgatttt ctatttgat gtgctacaaa 484680
 tttggcagge tatacagatt tggaaaaatt attattattt ttccaatact tccaaaaatg 484740
 tatttgcttc taaaccttag ggtgcattca ggtaaaagaa aaaaatctat ttacgtatec 484800
 attatctctg ggtagaggct gaggttgatg aacgctccat acaactaaca aatgtttgcc 484860

 tgcccagatg gcttttctc tagcgttatg cctcagaaaa taaattatta ttattattta 484920
 tgctcatcat aaaccatgtc tgcataacaa gtttctcaca ggagttgaaa ctagtttttg 484980
 ctgattctac aacacatctc atttgtaaat gtcagaaaac tgtaccttg ttgttctgag 485040
 tgttagatgc atggaagcaa aagtgagtgt tcagtgtgtc catgcgtaga gacactcatg 485100
 aatcaacact ctgaaatag aaaagccatc cagtgtcagc tgtgcttata aaataaaact 485160
 attagaaact ttaaaactac caagtactgt atgtacctgc tgcaagacca agatttcttg 485220
 atgtggaagg aagagtctat ccccaaagat aagatttcaa aataagaaac aactttgaac 485280

 tcttatagta gacaatafaa tggcttgttt aggaaaagca gttgctaat tatagtagaa 485340
 gaataaaga gaggttctgt ttatcccca ctctgaatcc aacccaaagc tagttattta 485400
 tcccactgt aaagtgaat aaaactgcac actacaatac tgtcccagaa ggataggtgg 485460
 ggattaatct cctggaagtg tctggagttt cacaaatgtt gtggigatat acaaattgtg 485520
 gtaccttcat ttgctttta taacacattc atgggcctaa cacactggag ggtaccttaa 485580
 ctgccaggc agttcatcaa cacacactca gcaccctct tcagcatctc ctgaggatta 485640

gctgaaaacc aagctaaaaat tactgttttag tgactgcaca ttaaatcaca caaggttgag 485700

atatccaagg tctcaattta cttttgtaat acaaaattaa ccttgtaggt gcaaaattac 485760

agtattatit tataattata gctgtgggtcc ctatatttat gagatattac aaaacacctg 485820

accttcccaa tacaggctag ctaattatit tgtatccaac tagaacaagt tcattaaact 485880

tgaatctcag tgaactgtg gctaacgctt catcttaaca ggttcattg tcattgttcc 485940

tggagtatta attaaattta gtattcaagc atgaatttaa aatctaaagg acctagccaa 486000

gtacaccagt gactatttgt tgtttatggc atcagatata caatgtaaaa ggactataaa 486060

taacttgata tttatctgcg tgttgtcatt tttatctcct ttactagaac aaaagctact 486120

tcaaggaggc aaaattcagg gcttatttgt aatatatgtg tttctaaata tagctccaaa 486180

gaaaaacctt tgtaaatggg aaacaaaata tttgttgact tgaacaatag taggttgaaa 486240

tgaaagatgc agatititcca gtcagttgta ttagtgagta aaggtgttca gacatcagtc 486300

atattcttat aatatgcatt tcaaccaatt ataagcctaa gacctaaagt tctgtacaat 486360

gaaactatta ctgcccitit agcttcacag tcacttctga aggagtatac catagtgttc 486420

aagcatgtga tgttgtacaa tcaaaaatcc aatctcatta gaatgcatag aggtgaggtg 486480

tagaaatcct tcttaattac agaaggttga ggataatata gaaatcatcc tttcttactc 486540

ttgaatttca aatatgcata atgataagaa acacttcaat gttcacatgt aaaaaattaa 486600

ctaaattaa acigtattgtt gaaatttatt ttgtaagtat aaagctaaga aaactattct 486660

tgaccttgtt aatgccctit ttgtgattit tttcaacctg aaacttcata taatctactt 486720

ctitititac tatataaaaa tgcaagaacc atttgcitgc cagtctitct gtgagtagaa 486780

ctcatagcaa gtctgtgtta ttaatatgaa agtitttaatt taagaattit aatatacatc 486840

acagaaatcc ttttgataaa ataggaaaat tcaaggctca cttattaaga catggctatg 486900

aaattaactt cacttattct gaaagaattt ccatcttaac catatatatt ccatattctt 486960

tcataagggt gatgcaggac caatttgata ttactcaagt gtgcttcaat gcaagtttaa 487020

tttccactaa gaatagtaga atggfatgtt tcatttctgc taagaatgga aaaatatgag 487080

acagtggtag aaatgcaaat gaaatataaa agttgaactc gaagagctta aaagtaact 487140

tacagaaact gtactcagac tcacgacatg attaagaatt attaacaata acaagtcaac 487200

acatacatac tatagaacac agactattca tggattgtgc aagtcttca gatcaaaagc 487260

cctaatagct aatgctggag actgtttcat ggcatcagt gcccacacat aggcttagtg 487320

ggtcacagtc gattaagacc agcttcattt catgttctct gtaaagacaa tgatataggc 487380

ataatatcta cattgaaata gtggatgggt aaggacaaga agatgaccaa agatcaggtt 487440
 gtaagagtgg tcccatgtca catcaccatt gatcctctga taactcatat attgaacctt 487500
 tgtattgagg agctttatat catgatgaca aaataaacaagaagaagaaag aataattttg 487560
 gttcactgtc tgagtttcca gttcagtttc acttagcact gttgctttgg gcctgtagga 487620
 ggctcactgt atgtaggaac atgtgatata ggaggtttgt tccctcaggg cagatagtta 487680
 gcccaataga ggcgaaggtc ccaaagtctt aatctcagt tccagaacac tccaccagta 487740
 gtctaacttc tactgacttt taggctctga ctcttaaagt tctcagtccc tatcagtgc 487800

 accattagaa gaataaacct acaatacact ggcttgttgt gcatttattc aaaccatggt 487860
 gcccccttt gttaacatt attcagttta cctcagagta ataaaagcat attaaatc 487920
 aacaggaaaa tcagtaacta taagaactct ttacttgaaa gatcaaatgg taggacaact 487980
 gattttctag tctctcttc gcctcaaga caaaaacaca tcttctatc attttattca 488040
 cagtaatac caaagtgatc ttgagttatt attgtgatca gataattta acaacaata 488100
 aaaaaacag gcaacagact tgttctctt gtgaaagttc aactgcttgg gaagaattgg 488160
 ttgtgctttt ctctctgect tccaattctg atgctcagta taaatttatt gacttcactt 488220

 tgcgacaact tggctctgga tgaagcacct ttcaagagtg gaaaacaaca acaaatcaa 488280
 agactgaaac cagtgtctaaa tataaaaacc aaggaaagtc aaaagtgaga aaagggtacc 488340
 aagcagacaa gatccaacca ttattagaac catctgaaac acagaatttc ttctagaag 488400
 aacttaaagt gaaaactctt tttttcaat tatcaaatca ttccatttct ctgatagtgt 488460
 ttgtgtctata tctgtttatt ttcatagtt aagatttcat tgccatgata acatacctga 488520
 caagaagccc tctaatggag gaaaggctta ttttgactct cagatagtaa atagcccatc 488580
 atgccagaaa aggcattgca gcgagatcat gacataggta gccacacat ttccacagct 488640

 gagaggcaaa aagagagaag aagtgaagt ggctggaag cttcaaggcc ctccagacc 488700
 agtgaccac tttctcaac aaggctccac ctctgctgt ttccacagcc ttcacaaacc 488760
 accagcatct gggagtcaaa tgtcaaaaa catgagctcc tgggggacat ctacattca 488820
 aaccacaaca ctactgaaac aatattgcaa aggacctaa gtgttattgt ctaattgact 488880
 ccagtaataa atggaggcaa gctcagggca tggatcccc acactttact tatgttttg 488940
 ttttaggtcc ttcaagact tgataagcct actcttgag gagcccact cacaggtacg 489000
 ttttagctct tagggaaagc tgcctatgia cttttcaac attgtttat attattttat 489060

 gigtatgagt gtttgctgc atgtatgtac acatacact tatgtgcctt gtgcctttag 489120
 aggccagaag agatcttgg atgcccatag aactggatta cagatggttg taagacatca 489180
 tgcaagtgtt cagaacaaa ccagggttct ctaccagat accaatggct ctcaaccaca 489240

gagtcaactc tccagctctg agatttttgt ttataaataa tgcaaagttg gtatctatta 489300

ttcatcctta ataaatttaa taaatgctgg gctgaggaa gtagacaaag gagattgtta 489360

atgacttaaa tatcttaagt cagatgtaac tataccttta gtatctttaa gcccttggga 489420

agcagaggca ggigaatctc tgaggtgcta ttttgtttat gatctaataa agcttacctg 489480

gagatcacag tacaagcta gccacagtca tagaggccag gcagtgttg cacacacctt 489540

taattccage actcaggaga cagaggcaga tggaactcta tgagttaag gccactctgg 489600

gctacatgag agtgtatcag tctaaaagag taacagagtt cataccttta ataccagcac 489660

ttgggatgac atgcccttaa tcttagaact agggaggtga agacatttcc tggattgtca 489720

gatcgcgtca tctttagg tctctggaga tctccctagt tccagatctc tctctagacc 489780

tatagtggct ccctctgata tggatctct catctctctc tctctctct attcttcccc 489840

caactcaata tttctgctcc tccatttct ctcctctact cctcttctct tgccttgtg 489900

gcagctccct ctcccctacc ctcatgctac cgattagctc aggagtcat gccacttccc 489960

attctgggg accatttacc ccttagagtc ctcatgttt cctagtctt tgggaagag 490020

gagtatagac tggtaatcct ttgctctatg tctaaaatic nnnnnnnnnn nnnnnnnnnn 490080

nnnnnnnnnn nnnnnnnnnn nnnnnnnnnn nnnnnnnnnn nnnnnnnnnn nnnnnnnnnn 490140

nnnnnnnnnn nnnnnnnnnn nnnnnnnnnn nnnnnnnnnn nnnnnnnnnn nnnnnnnnnn 490200

nnnnnnnnnn nnnnnnnnnn nnnnnnnnnn nnnnnnnnnn nnnnnnnnnn nnnnnnnnnn 490260

nnnnnnnnnn nnnnnnnnnn nnnnnnnnnn nnnnnnnnnn nnnnnnnnnn nnnnnnnnnn 490320

nnnnnnnnnn nnnnnnnnnn nnnnnnnnnn nnnnnnnnnn nnnnnnnnnn nnnnnnnnnn 490380

nnnnnnnnnn nnnnnnnnnn nnnnnnnnnn nnnnnnnnnn nnnnnnnnnn nnnnnnnnnn 490440

nnnnnnnnnn nnnnnnnnnn nnnnnnnnnn nnnnnnnnnn nnnnnnnnnn nnnnnnnnnn 490500

nnnnnnnnnn nnnnnnnnnn nnnnnnnnnn nnnnnnnnnn nnnnnnnnnn nnnnnnnnnn 490560

nnnnnnnnnn nnnnnnnnnn nnnnnnnnnn nnnnnnnnnn nnnnnnnnnn nnnnnnnnnn 490620

nnnnnnnnnn nnnnnnnnnn nnnnnnnnnn nnnnnnnnnn nnnnnnnnnn nnnnnnnnnn 490680

nnnnnnnnnn nnnnnnnnnn nnnnnnnnnn nnnnnnnnnn nnnnnnnnnn nnnnnnnnnn 490740

nnnnnnnnnn nnnnnnnnnn nnnnnnnnnn nnnnnnnnnn nnnnnnnnnn nnnnnnnnnn 490800

nnnnnnnnnn nnnnnnnnnn nnnnnnnnnn nnnnnnnnnn nnnnnnnnnn nnnnnnnnnn 490860

nnnnnnnnnn nnnnnnnnnn nnnnnnnnnn nnnnnnnnnn nnnnnnnnnn nnnnnnnnnn 490920

nnnnnnnnnn nnnnnnnnnn nnnnnnnnnn nnnnnnnnnn nnnnnnnnnn nnnnnnnnnn 490980

nnnnnnnnnn nnnnnnnnnn nnnnnnnnnn nnnnnnnnnn nnnnnnnnnn nnnnnnnnnn 491040

nnnnnnnnnn nnnnnnnnnn nnnnnnnnnn nnnnnnnnnn nnnnnnnnnn nnnnnnnnnn 491100

nnnnnnnnnn nnnnnnnnnn nnnnnnnnnn nnnnnnnnnn nnnnnnnnnn nnnnnnnnnn 491160

 nnnnnnnnnn nnnnnnnnnn nnnnnnnnnn nnnnnnnnnn nnnnnnnnnn nnnnnnnnnn 491220
 nnnnnnnnnn nnnnnnnnnn nnnnnnnnnn nnnnnnnnnn nnnnnnnnnn nnnnnnnnnn 491280
 nnnnnnnnnn nnnnnnnnnn nnnnnnnnnn nnnnnnnnnn nnnnnnnnnn nnnnnnnnnn 491340
 nnnnnnnnnn nnnnnnnnnn nnnnnnnnnn nnnnnnnnnn nnnnnnnnnn nnnnnnnnnn 491400
 nnnnnnnnnn nnnnnnnnnn nnnnnnnnnn nnnnnnnnnn nnnnnnnnnn nnnnnnnnnn 491460
 nnnnnnnnnn nnnnnnnnnn nnnnnnnnnn nnnnnnnnnn nnnnnnnnnn nnnnnnnnnn 491520
 nnnnnnnnnn nnnnnnnnnn nnnnnnnnnn nnnnnnnnnn nnnnnnnnnn nnnnnnnnnn 491580

 nnnnnnnnnn nnnnnnnnnn nnnnnnnnnn nnnnnnnnnn nnnnnnnnnn nnnnnnnnnn 491640
 nnnnnnnnnn nnnnnnnnnn nnnnnnnnnn nnnnnnnnnn nnnnnnnnnn nnnnnnnnnn 491700
 nnacactcca gaacctttat catgaagggg tgttgaattt tgtcaaaggt tttctcagca 491760
 tctagtgaga tgatcatgtg gtttttcttt ctcagtttat ttatatgatg gattccagtg 491820
 atggatattc atatgttgaa ccatccttgc atccctggga tgaagcctac ttgatnnnnn 491880
 nnnnnnnnnn nnnnnnnnnn nnnnnnnnnn nnnnnnnnnn nnnnnnnnnn nnnnnnnnnn 491940
 nnnnnnnnnn nnnnnnnnnn nnnnnnnnnn nagtcatatc tttgtgtggc ttgggtatca 492000

 aagtgattgt agcctcgtag aaagagtttg gcaatatccc atctgcttct attgtgagga 492060
 acagtttgag gagtgcctgga attagttggt gtttgaattt ctggtagaat tctgcaatga 492120
 agccatttgg ccctgggctt ttttggttgg gaggcttttg atgactgctt ctatttcatt 492180
 aagggttata gattgattta aactgtttat ctgttcttga ttttaattttg gtaagtgata 492240
 tttatccaga aagatttctt ttacaaatgt gtccatttcc tttagatttt ccaattttgt 492300
 ggagtacagg ttttcaaagt atgacttgaa gattctctgg atttctcag tgtccgttgt 492360
 tatatccccc ttttcatttc tgattttggt aattagcatg ctctctctgt cttttagtta 492420

 gttttgctag aggtttgtct aacttgttta tcttctcaaa gaaccaactc tttgtttcat 492480
 tgcttctttg tactnnnnnn nnnnnnnnnn nnnnnnnnnn nnnnnnnnnn nnnnnnnnnn 492540
 nnnnnnnnnn nnnnnnnnnn nnnnnnnnnn nnnnnnnnnn nnnnnnnnnn nnnnnnnnnn 492600
 nnnnnnnnnn nnnnnnnnnn nnnnnnnnnn nnnnnnnnnn nnnnnnnnnn nnnnnnnnnn 492660
 nnnnnnnnnn nnnnnnnnnn nnnnnnnnnn nnnnnnnnnn nnnnnnnnnn nnnnnnnnnn 492720
 nnnnnnnnnn nnnnnnnnnn nnnnnnnnnn nnnnnnnnnn nnnnnnnnnn nnnnnnnnnn 492780
 nnnnnnnnnn nnnnnnnnnn nnnnnnnnnn nnnnnnnnnn nnnnnnnnnn nnnnnnnnnn 492840

nnnnnnnnnn nnnnnnnnnn nnnnnnnnnn nnnnnnnnnn nnnnnnnnnn nnnnnnnnnn 492900
 nnnnnnnnnn nnnnnnnnnn nnnnnnnnnn nnnnnnnnnn nnnnnnnnnn nnnnnnnnnn 492960
 nnnnnnnnnn nnnnnnnnnn nnnnnnnnnn nnnnnnnnnn nnnnnnnnnn nnnnnnnnnn 493020
 nnnnnnnnnn nnnnnnnnnn nnnnnnnnnn nnnnnnnnnn nnnnnnnnnn nnnnnnnnnn 493080
 nnnnnnnnnn nnnnnnnnnn nnnnnnnnnn nnnnnnnnnn nnnnnnnnnn nnnnnnnnnn 493140
 nnnnnnnnnn nnnnnnnnnn nnnnnnnnnn nnnnnnnnnn nnnnnnnnnn nnnnnnnnnn 493200
 nnnnnnnnnn nnnnnnnnnn nnnnnnnnnn nnnnnnnnnn nnnnnnnnnn nnnnnnnnnn 493260

 nnnnnnnnnn nnnnnnnnnn nnnnnnnnnn nnnnnnnnnn nnnnnnnnnn nnnnnnnnnn 493320
 nnnnnnnnnn nnnnnnnnnn nnnnnnnnnn nnnnnnnnnn nnnnnnnnnn nnnnnnnnnn 493380
 nnnnnnnnnn nnnnnnnnnn nnnnnnnnnn nnnnnnnnnn nnnnnnnnnn nnnnnnnnnn 493440
 nnnnnnnnnn nnnnnnnnnn nnnnnnnnnn nnnnnnnnnn nnnnnnnnnn nnnnnnnnnn 493500
 nnnnnnnnnn nnnnnnnnnn nnnnnnnnnn nnnnnnnnnn nnnnnnnnnn nnnnnnnnnn 493560
 nnnnnnnnnn nnnnnnnnnn nnnnnnnnnn nnnnnnnnnn nnnnnnnnnn nnnnnnnnnn 493620
 nnnnnnnnnn nnnnnnnnnn nnnnnnnnnn nnnnnnnnnn nnnnnnnnnn nnnnnnnnnn 493680

 nnnnnnnnnn nnnnnnnnnn nnnnnnnnnn nnnnnnnnnn nnnnnnnnnn nnnnnnnnnn 493740
 nnnnnnnnnn nnnnnnnnnn nnnnnnnnnn nnnnnnnnnn nnnnnnnnnn nnnnnnnnnn 493800
 nnnnnnnnnn nnnnnnnnnn nnnnnnnnnn nnnnnnnnnn nnnnnnnnnn nnnnnnnnnn 493860
 nnnnnnnnnn nnnnnnnnnn nnnnnnnnnn nnnnnnnnnn nnnnnnnnnn nnnnnnnnnn 493920
 nnnnnnnnnn nnnnnnnnnn nnnnnnnnnn nnnnnnnnnn nnnnnnnnnn nnnnnnnnnn 493980
 nnnnnnnnnn nnnnnnnnnn nnnnnnnnnn nnnnnnnnnn nnnnnnnnnn nnnnnnnnnn 494040
 nnnnnnnnnn nnnnnnnnnn nnnnnnnnnn nnnnnnnnnn nnnnnnnnnn nnnnnnnnnn 494100

 nnnnnnnnnn nnnnnnnnnn nnnnnnnnnn nnnnnnnnnn nnnnnnnnnn nnnnnnnnnn 494160
 nnnnnnnnnn nnnnnnnnnn nnnnnnnnnn nnnnnnnnnn nnnnnnnnnn nnnnnnnnnn 494220
 nnnnnnnnnn nnnnnnnnnn nnnnnnnnnn nnnnnnnnnn nnnnnnnnnn nnnnnnnnnn 494280
 nnnnnnnnnn nnnnnnnnnn nnnnnnnnnn nnnnnnnnnn nnnnnnnnnn nnnnnnnnnn 494340
 nnnctagctt taatgcatgg tggctctgata agatacaggg ggttatttca atacttttgt 494400
 acctgtggag gtttgctttg ctgccaaacta tgtggatcaat ttttgagaag gttccatgtg 494460
 gcgctgagaa gaaggtatat tcttttgtgt ttggatggaa tgttctatag atatctgtta 494520

 aatacagttg ggtcataact tctgtcagat cctttgtttc ttccgtctca gtgggtgaag 494580
 cggggtgttg aagtctccta ctctaagtg ggtgggtttt atgtgtggtt tgagcttcag 494640
 ttatgtttct tttacaaatg ggggtgcctt catatttggg acaaagatgt tcaggattga 494700

gacttcataa agatagactt ttcctgtgat gagtatgaaa tgcctttctt catctcttct 494760
gnnnnnnnnn nnnnnnnnnn nnnnnnnnnn nnnnnnnnnn nnnnnnnnnn nnnnnnnnnn 494820
nnnnnnnnnn nnnnnnnnnn nnnnnnnnnn nnnnnnnnnn nnnnnnnnnn nnnnnnnnnn 494880
nnnnnnnnnn nnnnnnnnnn nnnnnnnnnn nnnnnnnnnn nnnnnnnnnn nnnnnnnnnn 494940

nnnnnnnnnn nnnnnnnnnn nnnnnnnnnn nnnnnnnnnn nnnnnnnnnn nnnnnnnnnn 495000
nnnnnnnnnn nnnnnnnnnn nnnnnnnnnn nnnnnnnnnn nnnnnnnnnn nnnnnnnnnn 495060
nnnnnnnnnn nnnnnnnnnn nnnnnnnnnn nnnnnnnnnn nnnnnnnnnn nnnnnnnnnn 495120
nnnnnnnnnn nnnnnnnnnn nnnnnnnnnn nnnnnnnnnn nnnnnnnnnn nnnnnnnnnn 495180
nnnnnnnnnn nnnnnnnnnn nnnnnnnnnn nnnnnnnnnn nnnnnnnnnn nnnnnnnnnn 495240
nnnnnnnnnn nnnnnnnnnn nnnnnnnnnn nnnnnnnnnn nnnnnnnnnn nnnnnnnnnn 495300
nnnnnnnnnn nnnnnnnnnn nnnnnnnnnn nnnnnnnnnn nnnnnnnnnn nnnnnnnnnn 495360

nnnnnnnnnn nnnnnnnnnn nnnnnnnnnn nnnnnnnnnn nnnnnnnnnn nnnnnnnnnn 495420
nnnnnnnnnn nnnnnnnnnn nnnnnnnnnn nnnnnnnnnn nnnnnnnnnn nnnnnnaagt 495480
ttcttctat gattttgttg aatagtttt ctgtacctt gagcagtgtt tetttacctt 495540
ctccaacaca tattattctt aggtttggtc ttgcaggtg tcccatatt cctggatatt 495600
ttgtgttagg gatttgttgg acttgaggtt ttctttggtt gatgaatgta taccctctag 495660
cgagtcttca ttcaatagct gacattctct ctccatctc ttgaattctg ttggttatac 495720
tcacatctgt agttcctgat catttagcca gcttttctat ttctagcatt ccctcagatt 495780

gtgctttctt tattgtctct atttcagttt ttaagctctg aactgtttcc ttgagagatt 495840
tgttgatata ttgtattttt tgtttttttt nnnnnnnnnn nnnnnnnnnn nnnnnnnnnn 495900
nnnnnnnnnn nnnnnnnnnn nnnnnnnnnn nnnnnnnnnn nnnnnnnnnn nnnnnnnnnn 495960
nnnnnnnnnn nnggatttcc ttgtttcttc ttaaaaggtc tctatcatct tgctgagata 496020
atthttgagg tccatctcat ctccatgctc tgtgttgggc ttttcagatc ttgctggagt 496080
ggagtcctca gattctggtg gtgtcatatt ggtctttctg ttgttgagtg aactcttatt 496140
ctgtcttctt ccataatctt cttttagtagg gtgcaggtgg ggtctctcta tctctcttg 496200

tgaccagta gtgtgtggga gccaggaatt caatgtccac aactgtggat ggtcttgctt 496260
ctctctgtag tctctcact cgttttgat cggttggggg aaagaagtgg gagagggggg 496320
tgtttccaga ttcaggagc tctccttgt ctgtgcgtgt ctacccaag caggtgggct 496380
caggccccgg gtggtcaggg tgagtgatgg ttgggtagg ggttgggtaa gggcagaggc 496440
tcaactcacct cattctctggg tcagtcgttg gactaaaatg atthtttttg ctttgtttt 496500
ttaagacag ggtttctcca tgtagcctta gttgtcccgg aacttactgt gtagaccaca 496560

ctggccacag actcacagcg atccacctgt ctctgcctcc taggtgtaaa ggtgtgtgag 496620

ctaccacttc ccattttttt tttaaagaaa agaactgaaa tatgttaaca tttactatc 496680

ttagaatcta gctatacaag aagtecatcc caggactgta actgttgta gataattata 496740

agtagtaata cttttcaat ccttctaaaa ttatctaata agttcttggc atatgtaatg 496800

tctaaaagta attccatgta ccaaagaacc aatgttatta gcataaagaa tgaaaggta 496860

aagaggaagg gcaatcctgg gaaatggttt tcacatagc cccaccacac actgctcctt 496920

cactcacctt gggcatcttt aatggagtgt gtatatgtat ctatataca ggaattctgg 496980

gccaacctat taggaatgca gcctgataag gacaagacaa caagtggggg ttcatacacc 497040

atgtgataa ataagtaaaa gttagaacc cagcaaaaac gatttaacac aatgtattgt 497100

atccatttac atggggaaaa atactttcat cacaagtgg caggcttgg tctaatttga 497160

aatatgttca tccaagttt tctgtgtaat atctgaggta ccacaagtca ggccctgtct 497220

ctaataat tccccttctt tcaaccatag ctttaactta tactacaagc tgtttggagg 497280

atgtgtctgc atgacacaca cacacacaca cacacacaca cacacacaca 497340

cacaaaagtc atctggagat ctttgggact tactgtgtgg gccctggcat cctggcatat 497400

ctggcacaaa agggagatcc caaggagatg cttgctcatg atacataaaa caggctagta 497460

gtggctacag actatgggat ttcttatact agatatctag atgaggaagt gtacattaga 497520

ggaaaagtac ccttaacaac tacaggcttc ccatctcata gggggatgat aacgacggga 497580

gcgtaaatat gtgactacta aaaatgtgta ggatgacaga cttctactga ggaagtgtca 497640

tgattaatct tatttgtcaa cttgacagta tctagagcca tctaggagac aaatttctgg 497700

gaatgtctgt gaaggaaggt ctgtgggtta attgatgtgg gaagaacat ttggtgtggg 497760

tactattcaa taaaaaagg gaaagggagc tgaacatagc attctctctc cctgcttctt 497820

gactgtcgat acaatgtgac caacaatctc egggtcctgt tgccatacac tcctcttca 497880

aactgtaagc caaacaagc tctttctcc tcattgtgcc ttgttcagt attttctgc 497940

agcactggaa aggtaatgaa caaataagt aaatactata ttctcaaca gtaacctgct 498000

tctttcttct tgcatgggtg ccatagatat ctcaaataat ttaagattta ttgcaagcag 498060

ctggccagtg ctggctcaca ctttaatcc cagcacttg gagggcagag gcagaggcag 498120

aggcagagc agagaggcag aggcagagc agaggcagag gcaggcagat ctccgtgagt 498180

ttgaagccag ctttgtctat agagatagtt ctaggatagc tagggctgtt acacagagaa 498240

actctgtctc gaaaaacaaa caaacaaaa caagataaa gatttattgc aaacaactga 498300

taggagaata cttttatctt tcctcctaaa gtacaatfff acttgtatta aaacttcaat 498360
 tagaaccagg cagtggaggc atatgcctat aatcctagca cttgggagga tgtggcagtc 498420
 agatctcttt gaggttgagtc tagctacaaa gcaaatttca ggacagccag agctgttaca 498480
 caaaaaaatc ctatctaaaa caaccaaaaac aaacaaaaac ttcaattaga attgttctga 498540
 tggcataatg aaagagtaca aatgagtcaa tagagatggg cactactcac tgtgtattta 498600
 aaattcctaa ggcaacctta ctacagcatat ttaaagaaca taggaatcag gaagcttaaa 498660
 ttctagtttc atgtttcata tactaaatff tactgtttta cataaagact ctttgagtaa 498720

 aatcacaact ctagcactca attttttatt ttcaaacca caaaattaga ctgaatcaga 498780
 attttgaana gggctctttg tctatagaca ttacttgaaa gccggtgaca atgaaggagg 498840
 caatggaagt aatttgatta gtctccatag ttaaacaagt taaactcaca ttgagtcaag 498900
 cttggtgaca tttatttgag taggcatata tcatacagtg ctctctaaag ttatttttaa 498960
 aagaaaaatt ccaattagtg attctcaggc cacaagttag aaatgtgggc cttaaagatca 499020
 ttggcttctt ctctctgtgt aaaaaattca ccctaattgt gattactata ggtcaggaat 499080
 tccaaaaggg ttacgattgg gaattctagt acagttcaag tttcaatgtc agccatgatg 499140

 gagccatgta aagccttgcc tggaaactgcc aatgtgttca accacatgac cagctactgg 499200
 caggttcccc ttacaggaac ctctctaagg atgcctgaga gtctcctttc atatagcact 499260
 tagttttctg ctctctgaga aatcaagatg acagccacaa tggtttcaat gaccaattct 499320
 cagaagtcat ttactcacag atccactgta ttctactgtc cccatggttc tgtttaggaa 499380
 gagacagtgc aagggtcag aaccagagg tgaggacctc tggaaacat tgtgaatgtt 499440
 gactactaca cacagcctcc atggacccgt ctgtttctaa tattgtataa ttgtaggaaa 499500
 tttacaatta ctactaatag cattgaaata catccattg aaaatgtacc taatcttaca 499560

 gatatgtaaa acacattgcc ttcaaaaaca ggatattgac tcttcaagge atccatctec 499620
 tgatccttgg aatccaggat tacattacct gataagggaa aagagacttt gtagatatga 499680
 ataataaag acattgaaat aaaaagaaaa ttctggattc tctgggttgg cccaatatgc 499740
 tagagctaaa ttaacaata tttctggctg tgggtcaaagt gtctctttta ttaaaggagg 499800
 ggagtaataa agacagcaag aggatttgac cctctgtgcc actagtgttg aagacggatg 499860
 aatgggcca aaggaatgtca gtgtgttcta gaaattggga gagagaagaa ttctccccta 499920
 aagcttcaga aaagaactca gatttcaagg tgctttgagt ttagctagct caacgetaga 499980

 ctcatcctgg acttctgacc cacaaaacta agaatccata aaatgtgtgt ctttggaatc 500040
 taccagtctt cccatgggta cttagttttt taatattttt attatattaa attttgaatt 500100
 atttcattat ttaatggaac tgtgcattat ctaataggac ttccaatcca tgaatcatgg 500160

gcattgtatt ttatttcttt atattaatat tcaagttttg ccttgggac aaactgacaa 500220
 aatcaaaat ccctcaagcc agaggatata ttgtagttaa attattttga agaacatgct 500280
 tcaccttta aggagactac ggtgactttc atttttaata actctttgca agtggtaaag 500340
 gtgttgata ttataaagt gtaaggataa gctttgaggg tgatgaagat ggaaagtgtt 500400

catataatgg tgaatttata taaaacttga ttgtatttat ttcaaatgat ttgctatcag 500460
 tgttgggctt aatttgcagt agaaaataat accatctttt ttctgtataa tacgtatgta 500520
 ataattttga tcattactaa tgctttttgt ttgcctaata agctatatac aacactgagt 500580
 agacttcaag aaagttaaag atttaacac taacctcaga gcctgcatat ccatataaga 500640
 atatgaaatg atatattaaa gattaaattg cagttgaaat gagcaggaag agaattgaaa 500700
 atatagcaag tgactacttt ccacacaagt tattcagaaa agtaagttat gtaggtcttc 500760
 aatgaaaag aatcatcac atgagatgag ggaaaacacc atatggtaga tgttatttaa 500820

tctgggtttt gaaaattaca ggaaattagc ataggaatc ctgactaact agattaaatg 500880
 tatgaaaatg ttctattat aataaagttc acccaataat ttggttattg atttattatt 500940
 tatgaatttc ttaaagacaa atgaatgtct tatacatgtg ctctgggatt aattagaatc 501000
 tatagcaaca agcatgaact caatatttaa tcatatatat tgaagctgta tgccatgttt 501060
 tctaccacce aaataattaa tattgcatat tatgatatag aacagaaata gtttcttcta 501120
 agaccatgct gtctttagca aatttgaat agcaatttat agcaatatga aaacatgtta 501180
 aattagcaaa ctttgggttc aatgatttc tcttacacac cagtagataa agcctgctgc 501240

ctcctctcat gctgacattt ttttgtcaac acgttctgct aattattcag gataacattt 501300
 ttcataattg gcaaggccat gccccctgca tggcttttct cagtaaatgt tgaaaattga 501360
 taaatacaat ttgtgtgatt tatttttgtt aaatgacctt attagtgtct ctctgcttg 501420
 aactgtgttt gtgggtggat gtgggtatga aaatgcagtc ttgacttttt caagaaagaa 501480
 gttatgcaac ttacacatc ataaatttaa caacaaaat gttatctgta ataagtgttt 501540
 cgagaaagcg ttatttacca ctgactgggt tgatggaagt tgattagata atgttttttt 501600
 tcatgtgtgt gttgtcattg atattggecc cattccagtt ggctgctaag gtgtctaaac 501660

actcaaaaac aaaaattacc cgtaaagctt gtgacagcat cctctgggtt catggatata 501720
 gatcactgca catctggatg ggttgttctg actgagtta taatgtcata tcccttgtaa 501780
 acacaataca ccgtctctc agtttaacag acaggttttg aagctaaagc atttgttttt 501840
 cctgagaaat gagicacaac acattattta caaatattaa acccaggagt cacaaaaaca 501900
 ttttagtatt tcatatttg tatctttaga cagagtaacc atttgataga agaaaaata 501960
 tctaccttat gttggcattt tgggaaatct aaaagtgaga taatgaaaac atcaataat 502020

tgatgaattc ctttgacttt tagagcataa aagcaaggat ttgtaactat tttcattctc 502080

 cacatcttga aatttacttc tgccttccat gttacaaagg atgaacaac aaatthtgg 502140
 gtgcttccag taagtacaag gaggttcaca ccagacttac aacattacag agtatttctc 502200
 tgacattaca ctattctgga ggagcttgca acccactgca aaggatagaa tggctacaca 502260
 tgagaagata ccacactccc caatgagtag atgtcagtta tatgccaggt gcaaagaagg 502320
 caggtaaaaa ctgataggtt ccaggtttgg aaacaagaat gaaggatgcc ctttgatttg 502380
 aagtctgat ctgctgcctt ccaaagagct actctgccc tcatttaaaa atcattgact 502440
 ctaaatgagc cactttatta ggtttccaga ttcatttccc accacactaa gggtgtata 502500

 tcagatthtc aciccccatc ccttgttca gatgctgaga ctcaaatatg agtattattg 502560
 ccaagtgca cacaggtcca cctcttcat tatgcttttg ttaacatcag ccaagacagt 502620
 tacagggaaa gaaactcaca aggatthtcc agtgatcgaa cactgttaac acatttggag 502680
 gtgggggctg aataacctac agaataaac cctggaggt cttaggctca taggtgtagt 502740
 gactgcactt aagtcattta gcaaagcagt gtgaatgatg agcaactcat aaagaagaaa 502800
 acactctctg ggatthtctt ggtgatgaca ggacttcacc ctcatgattc aacattaatg 502860
 catttaaat gaacataga tcttctcata atctgcttgt ttccattctg tacacctta 502920

 caaagcacct gctctctgct gggttctctg gtggatgctg ggtattacag gcgtaaaaa 502980
 attggtgtct gtaccaaggt aatctacatg ttgatgaaga agaacaggg aaacaaacta 503040
 tggggaagta tagctgtgac tgattataca agaccacaga tcaaggaaag aaagagagcc 503100
 aagaacacac aataaagaac aaactggaa tgaatgaaac cagtggatcat cgcattaggt 503160
 gaactaagtt ggatactaa ggaactaaga attgagaaca ttatagtga aacagtgaac 503220
 agaataaatt caagaggaaa ggaagaaaat ggaagaaat gaggggcaga caacttaag 503280
 tgtgacaata agcatgtata gaaatgtcac catgaatcta ttaatattta taactgtata 503340

 aattaataat tatcatgaag ggcaaagaga aggcaggaaa agaggccaac acatgtcata 503400
 agtccacaga ggctcaagaa atagtattcc ctcccacaa acaagaacct agtgaggaat 503460
 agccaagata agagcagagg agatctagtg tgtaccaac attgtatcc ctgagattca 503520
 tgctgagctc ctgctgcctg gactgatgat atcaggaagg accttggaa gtagtctagt 503580
 accaagtatg gactgcatg aatgcatgtt ctattaaag tgttcttaa acttctctat 503640
 agtctcttgt tgiagtgtga tgactaaaac gtcagccatc ttcatcccag aagagaatac 503700
 ttcctaaaa ctcatgacat catacctcaa tctcagactt ccagctthta taaactctg 503760

ttataaacc atccagactg ttccacacac tgaagacagg ggattagaaa cactctatTT 503820
 tatgaatgca ttaatgccca ccccatTTTC aattctatga gccatcact tataactaaT 503880
 ctaataattg ttccaatatt ttgaagtctg tgactcattt tgatgatgtc aatctctgag 503940
 gaatataaaa caacaaattc tgtgcctaga atcagcaact atgccctctt agtatctcca 504000
 agacctaaca ttgctctaaa agTTTTtgTg tataagacaa ttaaggaaat attggctctg 504060
 tgtctttgaa tagaagaact gtaggaattt aaagttattt acttttgact aaattattga 504120
 tcttgcaaag aaaattctgc caatctattt tctctccgtg gcctacaata ttgagatttt 504180

 gttttagtca acataaaca ttctgaaat gacaacatga ctttaaata attgtttcta 504240
 attcactcca ttattcagat cagtTctcta gaaaattctt tcatcccctt cataaaagat 504300
 agactggaac accttaacta gaagtgggga agtgattgtg gtggagcaca tatattcaca 504360
 aatgtgatgt gtatgtgaag acacaaaaga gactgagata ctttgattg ttccagaaga 504420
 gcaactatgt gtgtaaacat tggagaggaa acagcaagtg agaaataaaa gcacccttgc 504480
 tgtggtgttc tgtgttctt ccacctacta aacagcattt gcatcagtct gcctactctg 504540
 ggagtgttca agcgccctga accaaacagc aaaacaaatg tgcctatatt tgcaagtgtc 504600

 acctcacctt aagaaaacc ctcctggat tctctgcact ctgcttgct cctgaagccc 504660
 tctgattccc actgctgaag ctctgtttg ctctcagaac tgtttgatca ctcaagggca 504720
 caacagaaca gcatgtagct cttgcctttt tggcaggggc ttgaagtcca gcagtaggtg 504780
 gtttctcacc agtttgctc tagctttagg acaatgagtg acaagatgtt agttcacaca 504840
 gcacgactta tgtaacttac aaaagaaaa agatcaggct ggaggtttat tcagcaaatc 504900
 agcaagattt ccaaacaaga ataaaagtct tttccctgtg tccaagaca aagagggctt 504960
 ggccaaacta ctaaaggag acttatctg aaaatgagt aatgtggaca atgccctttt 505020

 gaggttaatg ccaactcaaaa cagccagact gggtccctg aagaagatgt cttttgtgag 505080
 gagagaagtt acaaaaaaa tattatttac caaggtgttg attcactgaa acagttctca 505140
 tatgactata agcaatttaa atcttaaac atctacceca gtacacaaa tgctacatag 505200
 aataattgtg ttgaaacca ataaaactca tataaatgtt tacctcttgc ttagaggaat 505260
 ttttagctcc acagaaaaat cattgccaga aagccaaaca tctcttaaca tgagagccca 505320
 tggttgttct ttgaattgtg ttttgaggt tctcctgtg ctttaatgac aaagattgag 505380
 ggaagtgtca tgattgttgc tgaagggtt agatggctca agaagctatg acaatttatt 505440

 cacattggac tcttctctt tcttgcttgg agagaggaat cacaatgcag ataaaattc 505500
 cagaattggc caatgtttgt gctttttatt tttttctgag taggaggaag aagaagaaaa 505560
 gggaaagaag aggtggagga agaagaggag gaggcagcca caacaggatt tatgcaagac 505620

tgcaacgcta atctcaatat ttattcctaa ttatgtttga gtcagtttct ttcactttta 505680
 aggagtctg ccaggcaact tgttatgttt ccctttact cacctgctac catcacctgc 505740
 gagcacaact atgaacacat gagattcttc tgcctctatc tctataaata ttaagagcat 505800
 ctatgattat atataaatat ataaatatta agagcattat ctttgataat aaggaagaaa 505860

 tcaagtttat aatctcattt catagaaaaa tggccagaag attgaaaatc aactgatctt 505920
 tattcaagaa aacttaaagc tagtgtacac gctacatatt gcaaagttct aggctttgaa 505980
 ttggtttccc ttggtttttg agatgggtat tcattatata gccctgactc aactggtact 506040
 tactatatag accaagcttc aaacttaaga caacccttca gttctgcttc ccaagatctg 506100
 ggatcaaagg aagtggcac tatgcctagc taagtttctt tatttttcta taaatgaaaa 506160
 attctggaaa ggtcaactat agtcaccaa gcacagaagt ggggctttaa ttggtgatgt 506220
 agaccattat gcttacacct aaagaagtgg gctacctcca acttgagcat ctgagattct 506280

 ggattacgac atctgcttta ttcactact ccatggagca gttgtaaagt tcagctcaca 506340
 ccgtgaacat aaaggtgtgt tcagaaaggt tagatgttag gtacaaatgt aaagtgtgat 506400
 gattttgtca gaatgatgca aacgcagctt gcctcattca tctacccta ctttcaatct 506460
 ttgtaaagaa tgcttttcaa aacttaagtc atgatctgct ctagatttgt cacttctctc 506520
 ctgcatccgt cttatgtcac attgctttat cctttcagat atatgaagga tgttccttaa 506580
 ccaactaaca gtcactagtg ataatttttg gacacaaaga aactaaaata caggtacatg 506640
 ataacagggc caacattgtt gcccaaaagt ctccattgca agcccaagaa aattgtaggt 506700

 aaagacagtg agtgtctgtc cttagtctcc tgtcttttgc tttggccaat aatgccttgt 506760
 agggtgatta gcacaggaat catgaaatgg gtatctgaat gcccaagaat tcagggagga 506820
 ccctagctat gagagttaac aataatgac agatctggcc acctgtatta tttgtgtttg 506880
 aaaagtgtcc atgttgactg aacaaacact ctcgggcacc acacatctgt getctgcaga 506940
 gtcgctttca tcacactaag cctgttcttc gagagcaacg ggcttcatgc tgaactcagc 507000
 atgaagacaa cagggcagga caccaattag tggaggcatt tgcaccaacc tgacaagacc 507060
 actgtgctggg gaagttcact gaagcctata caagagtga agcatgtcct teggcagtaa 507120

 ataattaaac tgaaggaaa aagtgttatg ctttatagac ggagatttga tttatgttca 507180
 ggaaaatttg aagccttcag aaatctgac agttaccaga cccacatgat ctgacaaaag 507240
 ctgttaggaa ctgcactgtt gcctggfact atacttctt tgtcatctaa actcagtttt 507300
 tgaccttcag cggggtggac atgaaaacac aggtcaggct gtgagtcagc agagcacgga 507360
 gtagatagaa gttgccagga cccaactct actgcttgaa aacaaacacc aggcacatg 507420
 atttgtcatc ctigccagtt agtacttcag tttttagct tataagtttc acctactat 507480

aatgaataag tattctatTT tctagagaga gTtaagagc taaaaataaa aagaaggtaa 507540

ctagccaagt actgaacgta gTtttctgta gcaaataaat tttgcattta atcccagtat 507600
agatctaact cccacttggT ctatttccat tcaagttgat attctggaaa atacaaagaa 507660
aagatcacia ggcaaatctc ctgtgtgata acattctcag aaactttaa cagctttaag 507720
agatttggcc tcaaaccaa acattaacat gatcgctcaa ttttaatgag gtcaagcaag 507780
cttctgggca tctggctggT gctcaaggTc ctgccctgag tggatagggc caccttgTtc 507840
ttaccaagaa tgtaagaggT agtgacaggT gataatgtaa tgcagaaagc ttttgcctt 507900
ggTcacttca tctttgaacc ccagcagatt cccagaggct atggcatagg ccctagccag 507960

atgtaagcag ctTcctcttt atctagggag ctgaaaaaga cTttttgcaa aggaaagatt 508020
gtttaaaaa tgtaagtga cccctagtat gtgtgggttt accagcctga ggaaggaagg 508080
gagataaaac atctgtagaa attcttagca aagagatgaa ggtgatgcta caataaatat 508140
ctacattaca cagggtaaac acaaccatct gctcattgct taactattta ctgtgataac 508200
attctggctc ctTctaact ggtgaaatgc acagtacatt accgttatct acagcaccat 508260
tatctattgt gtgtgcaagc acacactaga actctgtgtt cctctccacc tgtgaatcag 508320
cttttgcttt gaaattcagc cactaatcaa tgTttaccag aactcaagc ccctaagaaa 508380

aggatcacia gTttgaaagc tactttctg gTtaatagt agagcataaa taggataaca 508440
ggttcttcag tactccagga caagTcctct taactccctg caatgttgaa aacactcgat 508500
aactacag ccagggcaat ggccattagc ttacatcag caccaagtat gggaggcatg 508560
gatactctga ctgaagaatt tgaactaatt taagTttaaa tttcccatg aagctaataa 508620
gatggttgtt aaagtgcaca gagcagagct ggagaaatga ctcagcattt aagagtacct 508680
cctgagtttg cagtgaatct gaattctgta cccggtacc acctctgctg gctcacaact 508740
gcctttaccg ccagttccga gggcgtctaa cacatagga ttctacagac aactacattg 508800

atgcacatac aaagctcgtg ggctgaggct cagtcaata ggctacgagc atgtagccat 508860
ttttcttcta ttggcaactt tgTttgagTc ctTtaactTc atctgctgaa gaaattaaaa 508920
accagactag aaaatctcac ccttcaaag ggtccacac caggctggTg aaaccacag 508980
aaactgctga cctgaacaaa ggagagctgt tgTccccag actgatatgt gggaaaacag 509040
aatgggactg atccagacc cctgaatgtg ggtgtcagTg aggagacatt gataatctat 509100
gggacctctt gtagtggatc agtacttatc cctagcatag gaatggactt taggagccca 509160
tcccacatgg agggatactc cctgagtcta gacacaaagg ggttggcccc tatccaaag 509220

aataagacag aactgaaga cccctatgg aaggcctcac cctcccttga gagcatgggt 509280
atgggatagg tagggtgta gttgtgggt caggggagga tgagcgggaa agggaactga 509340
gattgacatg taaataaatt ttctttctaa ttaaaaggaa aaaaaagaaa atctcacccc 509400
ttacatgaga ttgtctttaa catacctggg aataaatgga ctacctgact atccatacac 509460
catggtgtaa aaagtacatc acacaatata ctatgcaacc ttcattcttt ctaaggcaaa 509520
ctagtctacc agcaaataca atcagttatt taagttaatg aaagtctaaa acctaagaac 509580
ccttaggtca atggaagggt aatttaagaa tcatctatct ttcattgtaa ggcagagtat 509640

ctcaaaagaa ataggctaag gacacactaa aaacatatgg atcagaatca aagagcctcc 509700
ttcccacttc aatattaagg atgggatggc ttttcaaagg gtgactacag agtccctgac 509760
acaacatagg gcaactatcaa acatgccatc tggtttaact tactggtgtc atccactgtg 509820
ttatttctag aattgtgggc ttcatttcag ttgatttgt ttgactgagt agcctacata 509880
aaggtctgtg tgiagctctt ccagactttc aactcccaca tgcataagga ttcccttaaa 509940
agtatatgtt caggataaag gctcataaga gtttagtgat gtataatcag aaaactgtgc 510000
caatgtggtg ggcaccacac caaggtacaa aagatgcagt ttttaaccta agcatcttat 510060

ccaaaattca gtccatgaag gataaagaaa tggatgatgct ttgattatct agaatttgat 510120
tggtagacaa tttctggggg tgggctggtc ttagaagcat tattgaacca tatggaatat 510180
taaattcaac ctttaaaact tagagaaaat gacaaaggca tgaagaaaaa gcaatttggc 510240
atatgggcaa gaatttatag taataagttt gttatatatt cattagtaag agacaatgag 510300
tttattaact gttgtagaaa ataaattgct gcaatgggct atatttgcta agtgcagttt 510360
tgacaagcag taattttttt tagcagagtg gtcccttcag agctggttgt tattttctaa 510420
gttttggttg tgtgtaggtt tgttagagag ttgcttgtgt gtgtgtgtgt ttagacatg 510480

atctctcact gaagctggga ctattatat ctgctgaact ggctagctag taaaccctta 510540
gaagctgtct gtctatggca ccttctcaag cagtattgtt acaggtacc accactgtgc 510600
ctaacttttt acatgcatgt aggggatcca aactcaagtc ctcatgttta cacagcaaac 510660
actttaccac tgagccatct ctcaaggecc tgggttatta ttttgaagct tttgcatc 510720
accattcccc aaaattatta ctataataca acattacagg cacaagtctc caggtggtct 510780
tgatgtacat ttctgtcat ctgtaagcac tcgctatgt tctgaagaac cagagagtct 510840
tgtccacctc tactctagtc cacaagcaaa agagaaggta agagatgtga tgatgtaaga 510900

agctcagaaa gatcattctg gggcttcaa gatagctcag tcagttaaagc agtcaattag 510960
ggcagagttc aatccctacc atgcacatga aaagacctgg catggtggca aacgcttata 511020
atccctgccc ctgagatatg gactcaggta gatcgctgga gttcactagc aagcctgttt 511080

agtctaataca tgatacactc tgtctcaaca aaacaaggtg actagctcct gaagcatgat 511140
 acttttagag aaagttgact tttgcctcca tatgcacaca cacatacaaa acaaacagag 511200
 agggagagag agggggcagg ggagagagca cttcaggtag tgtacaaaagg tcatgcagat 511260
 ctgagagatg gcaggtgaca aagaattaaa tataggagat ctagaaagag caaagaaggt 511320

 caagacttca gaagccctac tggcatgttt ctttccttg atctggctgc agaagtgaaa 511380
 tcaatgcgtg cgtgacacag ggcttgtgac agacctctct cttgtggtat tttctataag 511440
 cctccttcta ccagcatgac aaagaccaca cagaggtctg agctgaaaat tagctcatca 511500
 gcctccagct gatatgactg ccaacaccag gtttgcccaa gacagctgga tattgtttta 511560
 atgactggta tcaccaagtg actccttggc cagtaccaag gagtacacacc actgaccagc 511620
 tgtgtgatcc caaacaggtt aataagactc tccaggactc agttacccaa actgtgactg 511680
 aggactcagg aacactaatg cagcagcctc tgagaatgag ggacactaag atcagagtct 511740

 acagaacaga ggctgatfff gttccaaaca ctgagcaaac ataatcact gttacgtatt 511800
 ttagactttc cactgtgtt aaaatagtgt aactatattt tctataacaa gcaaaattac 511860
 taatgtttaa cttaacagat agacatggtg gctttagtgg ctattgaatc taattaaaca 511920
 agttcctaata agccaactag tatttaagag gcataattaat ggtcttattg tctttaactt 511980
 aaatcttcat ttcaaccttt taatatatac ttataactta cacttccatc cttttaaaat 512040
 aagcacataa agcttctctt aaagcaagta ccagcgtctg ttgtttctac ttcttccttg 512100
 tttaatcttc gaaactgggc aaagacactg gatcctttta atccttctgg ttcagatgat 512160

 gctatgtcat tttttcacc taaccactaa tgaagcaaac tgggaccacc tectctttta 512220
 tatttggca gtctgacaga tggcctccta atggccaaca catactcctt ttgcttttag 512280
 acacatagct tcttcttta tattatffff cactcctggt ttgccttttc ctaccgtaaa 512340
 taactttaat ctcatgttt ctgattctgt ctacttgcaa tctcaatatt attttgtgt 512400
 tattttcatg ttctttatc cacccaatgt ttgttaatgg tgaactggt tctcagaat 512460
 gtttgaccaa catgacatga aggtctgttt cttgtctcc tattggtgaa atttattgca 512520
 tgccacagag aagtaagaga gtatctgct aatgcaagat acatttacca accacacagc 512580

 aaagagtcac tgacctctgc tcatgtgctt acaggggaagg gtgaaaaagt cacagaagcc 512640
 cctagaaaag tcagccatca acatttgtca tcttctcagc tgtgaacaac tagcatcatg 512700
 ctgacagacc actcccagag cagcaatgca ctgtcttatg aagcctctct catccctttt 512760
 ccctgttgcc ccaactatag atgatccaga acattcagtt ggccagagga atggaaggtt 512820
 tgatgacaag ttcatgetca ctcagggacc cacagtgtca gatagaagga aacctcaact 512880
 ttaaacacaa gttggcaaca tgagctactg atagttaaat ttctaaatgg aggtcgtttt 512940

cattgacttg aacttaacta cctagaagtg atcacagaag ccaactaagct tcctgtctt 513000

 tgcacctaga catgagaaag accaatctta gtctgtatth aaaaagacag aaggagacaa 513060
 gagtgaaact atthgtgac thtghtthgc agatctthccc aatcaaatga aatcagctac 513120
 thcattgagg agaaatggcc atgtcagggg gaaaaggtag ththcccagg agtaaatgag 513180
 ctattgccag acaaatcag tgacagtccc caaaactaag gaaattaccg tagttggaa 513240
 ggtgacttht cacctctgga thattactga tcaactgctc ththctctc cgtatagaga 513300
 cacatagaaa ggcataatt gcacctthct ccatctthgc ccaagatgct thgaagagat 513360
 caccttaaaa tgcctctcc cgtcgtggtg actcttatga agcattgtta tagtcaaaag 513420

 tgatgacgca gathththaat cccagcacta gggaggcaga ggcagaggga acatgagthh 513480
 gaggccagct thgactatgt accagaacct tgacaaagaa agaaaggaag ggagggaaga 513540
 tgggaggggg aggaaatgga aagaaagcat gtataththt tatgattat ththththaat 513600
 agtggthcat gtathaatga atgaaatca aaagaaggag gtaatgthcat thcaggaaaa 513660
 gatgtaaaaa thtatgccct ggaaagthth gaactaatat caaaactthca thactgtatg 513720
 thaatctcta caaatagac thagtagata caaccacaac ththtaacaaa athaatatc 513780
 thcaththatt atcatathth tacacaagct thtagatgth ctgtctgct ththththaaa 513840

 tgaacctca cthgtthgca ththgctthct gtgcctthgg gaatcacacc ccaaacacag 513900
 thgtatataa aaaggagaac ththccaggg gcaatgthcc tgactatgth aatagcact 513960
 atgaththgc agatgggct thgccacagct thctgtctth aaaaacatga aatgathcta 514020
 atctagthga athcacaagt thctththgg actcagcaag gcagcgaaca thgaaatgth 514080
 gaagatgaag thaththaaa thacagthth ththththggct ththcaagat ththaatgagg 514140
 aaathccacc cagthaaagth aagthgggaat aaththgaagg gthaaaaggga ggggagaaca 514200
 agagggaggg agaatthaaa ggagaaggga atggaaagth cagagacaga gggaggagg 514260

 gagagaagga aggaggaata gagggagggg aggagggaaa gagggtcag thagatggg 514320
 gtctgathat thaaacataac aacaaatagc aagthaaaga agaaagcagc aatgthagth 514380
 thaatcccaa agcctthcagg caaaggaatc actaaththca catgccacgg gthcactcac 514440
 thgathctca cthggagcaa gthactthcta aaththctth cththgathct gccaaaggag 514500
 thgththaaag ththactgth aataactthth aththcaaaa ththactthcc agctctthth 514560
 ththththctc thththaaatg thgactthth ththctctcat ththaatccca catcaatag 514620
 aagccagaat athcccatcc thcccatctg ththtaggagth thctgtctth gcatthgggg 514680

tgggagtgat ttttcatct acaacttgat aattcctaac ttctgaaaca gtaatttgca 514740
 ttttggaaagt cccaacaggg aaacaaaatt gtttctacaa ctgttttctt aattttatct 514800
 tccagatttt gaaaacaata gggacatatt gtagagtata ttagaaagta taaagtttta 514860
 aaaggcaggg ggaaaaatcc cccaactgca caaaatcaac aatagctaaa acattatggt 514920
 actttttcat ttttccattt tttactttgg aacggaagtc ttgctatgta gcccggttg 514980
 ttcttgaact catggtcctc ctgcttctct atcacgagag gtgggaatgc aggtgtacta 515040
 gcacacacag ttcttcttgc tgtttagcaa aagctagctt accttttcag ttaatatcac 515100

 atcatgggca tttttcttca tccatagtta tttgttcaat agtatttgtt tgatagtata 515160
 ttttaattgt cattttgatg taatgttcaa attcagaatg ctttttgta gttcctagag 515220
 aacattggtt tattgctatg tgtttgaatc tacttatagt ctgtttgctt cttaacagc 515280
 aggaactgtt ttaaattgaa gcaaatgttt tcatagacc aatccagttt ttctcattta 515340
 cctgttaatt attgttacc ttcatTTTTT tgcTTTTTgt ttcatgcaa attgaggaaa 515400
 aatgtgttgt tttcagaat gaaaaactgt gtttagagat acattgctga tagcacacat 515460
 gctctttggt atttagagct ttcacaacag aaaaggctct aaagattatt tttataagca 515520

 taaaggaaac tggctgttga gtataaata gaaatttccc catggactgt cctagtgaat 515580
 gcttgggtcca caaccagtgc tgtcattttt tgagatgtca gaaatattaa aagatagtgt 515640
 ctagttcaga aagtaaacaa tgagaggctg ggggtgcttt tgagggcagt acatgtgcc 515700
 tggttccttc ttctccatca gtttccatc cacaggagga gggtaggctc tgaacagtc 515760
 tccttcata atcacactct atcttaccat ggaccataa ttaacaaagc cagaaacctg 515820
 aaaattcgga aactgtgaga caaaattgic ttcttctta ttttgcttct gttagcatt 515880
 ttgtcagtaa caaaaaaac ccaatttcaa tacttgcaaa tctgttttca ctctatcatt 515940

 tctctaccta ataatgtata tagtgatgcc ccaacagggg aattagtagt gtcaagacag 516000
 tacaacactg tgtttcttc attaccaatc attgtctagg aaataatttg gtaactgtta 516060
 aaaggtgacc aactatacta ctgctatag gtagaaaatg tgggacattt gtacacaaaa 516120
 ccaagacagt ctcaacaat tttcccagg aaattcctt tgtgcagttt actcaaccaa 516180
 aatacttaa cgttacagca agccaacagc caacatcaa ataatggag agaaactcaa 516240
 agtgattcca ataatcag gaacaagaca agctgtccc atatctccat atctattcaa 516300
 tattgtactt gaagttctag ctacagcaat aagacaacaa aaggagatca aaggataca 516360

 aattgaaaag gaagaagtca aactttcagt atttgcatg gatagatag tttccataag 516420
 tggcccaaaa aattctacca gagaactaca gctgataaac accttcatta atgtgacagg 516480
 atacaagatt aacaacaaca acaacaacaa caacaaaaa cagtatcct cctgtatata 516540

gatgataaag aggttgagaa agaaatcaga gaaacaccac ccttcacaat agccacaaaac 516600
aacataaaat atcttgggat aactctaacc aaacaagtaa aacctgtatg acaagaactt 516660
taagtcttca aagaaagaaa ttaaagaaga catcagaaaa tgggaaaatc tccaatgttc 516720
ttggataggt aggatcaaca tagtaaaaat ggcaatctta ccaaaagcaa tctacagatt 516780

caatgcaatc acaatcaaaa tctcagcaca atttcacaga cctcaaaaga aaaatactca 516840
actttatatg gaaaaacaaa agcctgata gccaaaacaa tctgtataa caaaggaact 516900
tccagaggcg tcaccatccc tgacttcaag ttctattata gagctatagt aatgaaaaca 516960
gcttggatatt gttataaaaa cagacaggtg aaccaatgga atcaaatcaa agaccggat 517020
gttaatcctc atacatataa acacctgatt ttaacaaag aagctaaaat ttacaatgg 517080
aaaaagaaa gcattttcaa caatttgtgc tgggtgaact ggatactggc atatgaaagg 517140
atgaaaatag atccatatct atcccaatta ggtccaatg gatcaaagag ctcaatataa 517200

atccagccac actgaacctc ttagaagaaa aagtagagag tatgctttac acaatggcac 517260
aggaaaccac tttgtgggac aaacaatgaa atcaacaatt aataaatgga gtcacctgaa 517320
actgagaagc ttctgtaaaag caaagaatgc agtcaacaag ataaaacagc agcctacaga 517380
atgggaaaag atattcacca accacacatt tgacagaggg ctgatcccca agatatataa 517440
agaactcaag aagctagcca ccaaaacaac aaataattca attaaaaatg gggtagaac 517500
ccacagaaat agctgtcctg aacaaggggt tgctcatgga ccccagaatg atagctagga 517560
aaccagcata ggactgttcc agaaccctg aatgaggatg tcagtttga gttctggaca 517620

atctatggga cctctggtag tggatcagta ttatcccta gtacacgaat ggacttggg 517680
agcccactcc acatagaggg atactctctg agcctagaca catgggggag ggctaggcc 517740
ctgctccaaa tgatgatgact aatgtttag atccccatg gaaggcctca ccttcctgg 517800
ggagcagaaa gggtttggga tagggttcgg tggggggcag gggaggagag gagggagaag 517860
gaactgggat tgacatgtaa aagaagcttg cttctaattt aaaactggtc taattacaat 517920
tataaaaatt aaaaagtat acaaaaaaaaa agaaaaaatg gggtacagat ctaaatagag 517980
aattctctac aaaggaatct caaatggcca aaaggcactt aaggaattgg tcaacatcct 518040

tagtcatcgg gaaatgaaa gtcaaagcaa ttctgataaa ccatcttaca tctatcagat 518100
tgcttaaat caaaaccact gatgacagct tattctggaa aggatgtgga gaaaggggga 518160
cactcctcca ttgttgggg gagtgcaaat ttgtacaacc tctttggaaa tcagtatggt 518220
ggttctcaga aagtgggaa tcaatctacc tcaagacca gcaatgccac tctttgtcat 518280
ataccaaaag gatataaag gacatctgtt caactatggt catagcagca ttatctgtaa 518340
tagccagaac ctggaagcaa cctagatgcc cctcaacca agactagata aagaaaattt 518400

gatacattta cacaatggag tactactcag cagttaaaaa aaatttaaat cttgagattt 518460

gcaggtaaat ggatggacct agaagaaacc atcctgagtg aagtaacca gacacagaaa 518520
gactcactca taagtggata ttagacataa agcaaaggat aaccagctta cagtcacaaa 518580
accagagaa gccaggaac aaagaggacc ctaagagaga catacatgga tccccagaa 518640
ggggaatag acaagatttc ctgagtaatt tggggcatg gggagaagga gggagagtgg 518700
taggagattg gggaggaaga aagggaagga ataggagaaa atgagggatc tggaggttg 518760
aattgggaaa aaaacagaga aggagaaca gagatacctt gatagagga gccattgtag 518820
ggttaccaag aaacctggca ctagggaaat tcctaggaac acacaggatg accccaatta 518880

agaatctaag cattagtga gatggaacct gaatcaacct tcccataa ccagtttgat 518940
gactacctta attgtcataa tagaaccttc atccagtgt tgatggaagc agatgcagag 519000
atccatagct aagcactagg cggaatacct ggagtctagt agtagagagg ctggagtgat 519060
aatatgagca aaggaatcaa gaccatgtac agaaaccac agaacagct gaactgagca 519120
agtgggagct cactgactcc agactgacag ctggggaacc tgcataagac cgaactagge 519180
ccctgaata ccggtgatag ttggtggaga ggggtttgga cagtttatgg ggccactggt 519240
ggtggaacca gtatttatcc ctatgcatg aactggcctt ttggagtcca ttaccttagg 519300

aggataacct tgctcagct atatacagtg gggagagcct tagtcatgcc ccaaatgatg 519360
tgatagactt tgatgattcc ctatgggtta gggttagggt tagggttagg gttagggtta 519420
gggttagggt ttagggttag ggttagggtt agggttagtg ttagggttag tcttagggtt 519480
agggttagag ttagagttag aattagggtt agtcttaggg ttagggttag agttagagtt 519540
agaattaggg ttagggttag gcctcacctt ctctgaggag tagatatggg gtggggtggg 519600
aagagcatag gggaagtggg gggaagaagg gagggagaag gagcaggat cggtatgtaa 519660
ataagattgt tttaaaaaca aaaataaata tttaaaaaag ccaactaagt aaataatctc 519720

ctgtggaaga gggcatatc tgtaaccctc aacagaatcc actgaatgat cctggtaatc 519780
ttgaataatg tacattgggc ttcttcatct tatctatgat gttcatgaa cctttttcc 519840
aaggatctat ttatgaacta cagcacacca tggcagatga gctgcttccc atgtctctct 519900
tctctgctc tcttcccc ttacttcttg gtcactatc tccagttgct ctggttctt 519960
tctgatctc aaacatgct atttaccatt cttctacct ctgtactagc tgttctgca 520020
aatgctcata catccttctt cattccattc atggcacaga tcttaccat cagaaatgcc 520080
tcctggaca accatttca gaataacatc tgatcctacc atttcacaga agtgtccata 520140

tctacagttt tgctttttgt ggtatcaagg ttcagaggtc aaaaattcta aatattaggt 520200
aagaagtctt ataataaagc cattcataag acttgaattt tgtggcattg tatgctgtga 520260
taaaaagtcc catgctgtag atgctgtgtc tttttcagag tgtgaatcat taatctgtcc 520320
agggtatcca agctgagtac acaaccttaa tgatggatct cttagaaggt tgccagttca 520380
actgttatgc agtcatgctt ctgctccatg gacccttatt ttacttaata aggacctatc 520440
ctgatacttt gttagtaatt atattttatt acatgttggt gttagtatca taccatacat 520500
aaggaactta tacacacaca cacacacaca cacacacaca cacacacaca cacacatgt 520560

acatattacc tactatttca tcaccaccg gaggtcttcg catatatcct ctgcaaataa 520620
ggaagactgt gattctcttt gtcacagttc caatcttagc atatgcttat gtatttgttt 520680
accaccacat ctgcttttac cccaataaac tacaaggctc agaagcaagg aaaagtgtt 520740
taatcactgt ttattaagag aatatatgac ccaaatggga tagcagtga cacttgagac 520800
tntagagcaa aatgcttcta cttaatcttg catgacagaa ttctgtggtc ttgagcaggc 520860
tacctaggtg ggcttctgtg ggcataagt tctaggtaat atggatgta gcaattatta 520920
ttgaaggttg ctctgggaac aaagaaagac actttagcca ggtgaagtgt tcaactgagtt 520980

gcaagtactc aatgagtttg cctgigtatgc tactgtttta ctattaatg aaataattca 521040
accattgcat cccaaagagg ttgcaaacct ggagtcatat gaatatgaga ataattgaga 521100
tctcaaatg acaggtgcta tctgctgctg tttaaactgtt caaatgttgt attatgtttg 521160
agagggcata ctctctcaa gggtagaatt tccatcccat aatcttgatt ctggttttaa 521220
gcagaatgtt accgaatgca tctgagagga gtgtaactg agtgttttat aaggcttttc 521280
aagtttcttg ggaatgggtg gtgctgggtt ttactgagaa cattggaact gtgaacaaca 521340
tttgaattgg gaattgttcc tttaatctt aaggcattta caaaactggt ttccctgact 521400

acgatcattt tctgggcat aaaacacact aaatttggtt tactaggagg catcagtga 521460
aacctttgtc atgggtttca gtaacagggc tttctacaa acatgccatc taaatttttc 521520
tgaaatttta gagagtggaa cagatggttt agcgtctga gactggccat aatggcctca 521580
caaagctttt tatatcattt gtgaattttt aatctttaa caatgaatca tagaggtagg 521640
gaggacacac actgaatgtt gcttctaaga gttattcaga tcacctaca tgccacatg 521700
cagttacata cagatactta ttcaaaagct tatgatctat tggcctcaag atttgggggt 521760
gagaaggaag aagcttgaag atccaaaact gaaatgatga attctataat ttactagagg 521820

ttgcaatata aaatgaaact accagccaga agtcaggcat ctcccacaac tgagtcttcc 521880
tacatcaatt gcatggetct ctttgatatg agggcaaggc taaccccacc cegtctaaaa 521940
actgctttgt ggtccacagg ggggaaaggg ccttgtgaca tccgaatggt cggggaactt 522000

actaagttaa caaacttcaa actgttttat gaaaaaaga ctaataacat ctattgaaga 522060
 gaggccactg tactgtttga agattagtaa aggagtcacg atctttgttc aaggaagtaa 522120
 aatatlaaga aaagttttgt tggtagagtt ctgaactgaa tgtgtgctgt gaagatcttc 522180
 tgatcacaga agctgcttcc catccaaaaa taaaataaaa cactctgata tgcaaatgat 522240

 aagaatatcc ttggcatca aataatatct aaaagcaaac tctgcaaat gtcccagaat 522300
 ttgtttattht aagaacattc tgttccaact tcaaggtgga ctctacagc aatattht 522360
 acagattatt ttaaggact tttgtaagtt tctattgtcc agctttattht cattgatgtc 522420
 tatcaattag acttgthtta taatgatagt gtacccttac cataagaaaa tattattatt 522480
 gggtcagaaa tgttataata gtaataacaa taataaatag aatccaaat cgtagagcca 522540
 ttaagtctct acaaccaact gtgcatgacc aagtagcccc tgttaccat cagthtaaca 522600
 ggagtggcat acctaactga gcaaagagca acagctctg cctggcctta cagagagagg 522660

 ccattgggaa actthtca actattcaag gaggacatca gagthtctta ttgattthga 522720
 ctacatccta actaccactt thtctgat thctgtgtg thcactact thtctgacc 522780
 thtactgtg aaaaacacag actggtatca gctatcactt ccttcataa gcagthcct 522840
 ttgctgagcc caactattht tgagggcata gttgtagctg thctcttht agccctgagt 522900
 thttaaagtt gaactctatt attgggcaac agcacatgt ggccatggg ctagthtct 522960
 ttggtgctg ctthtthtga tcacactthc taaacagcat cctctgctg ggattctgag 523020
 acaagcctta ggagactggg ccagaaggtg gatgattaat aaagcttaca thaaactact 523080

 aataatcctt catgatcatg gtgacattcc gcattgcat ctctgtgaga gggagccct 523140
 aatcaaaag aatthtga aaactggcac agthtctgca ttgcaaatga gacagaagat 523200
 ggcaatgtht aaactagac tagthtctc thtthgagaag acagtagccc caggcagagc 523260
 ccattgtcag ccatcatcca cthtaactc thaaaggag gctggcacac attccctaa 523320
 ttctttgtgt ggthaaagg ccagactthg aaaaacaaaa tgtctaaagc aactaaagg 523380
 gcagaagaat atthtcttht tgacacttht aatgctagaa gcattthgag taggcctthg 523440
 attthacata gthcactthg aactthgat thattthcct thaaacttht ththtaaaaa 523500

 aaaaatccta aactthctat gatagthttht thtthcctc aactthaggg gattthcaat 523560
 caccatggaa aactthcctt actthtctct ctgagagtht thcagaaaa gtgthactga 523620
 agagagatga gccaccccaa ttgtgagccc caggctgagt aaaaaggaga aagaggaggg 523680
 gggaccagga thgtthgatc thtthtctc gactgcaaag gcagcataag cagthtctc 523740
 thactgctg caggthcctg cctthcagg ttgatttht cctctgac thaaagccaa 523800
 acaaaagctt thtthcttht agthtcttht thcaggtatt thgtcatag aatgagaaa 523860

atgaattgat atatTTTTatg atgatcaaat gtgttcaatt tcttcaatga taacattgcg 523920

tcttcacaaa ctTggatTTT taaaaccact cctcccgcac catgtTTTtc ttactcttct 523980

cagacaccac atactacatt ttaacagaga cacgaaatta aagaacatgc tcatcagagc 524040

tgactgtTgt tgtgtcatag tccactagtG taatcctTtc tgtcaacca ttcatTtcat 524100

ttgggtatgg taacagaagg caggactagt aggaacattg gaatttaaca ggtgcagagt 524160

acaagctgta gggacaatct atctgaaagc atgtggatat tgacataaaa acattcatcc 524220

ttgctaacca ggagattaaa ttttctggaa cactggTgat aacaattgta caaggagtaa 524280

aaaaaaaaatg agtctcagc ttcataacag tacttgcaat tttcattTgc aagccattca 524340

ccatgacctc aagtcctac aggttaatgt cactaatacc atttaccatt tctgcagaga 524400

atactacgga agtctgaaac acacctcatt atttaaactc taaaatctag ggatattTtg 524460

aaacttaaca tatacctcta gtaataatga ggagagtTct cactaataag ctgtggcaag 524520

tttgacatc tccaagacag atTTTccaag gacttctagt atagtTatga catgaaacca 524580

accatacatt acaagtaaag tccaaggtcc atcctatgtg aaacctaaat aatattTatc 524640

atgctTtccc ccaagagtc agaaaaacatt aagaactaag aggttctgcc attaataaag 524700

tgcatgactt tgggaaagtc acttaatgtc tccaagcttc aatatccac tcagaggatt 524760

tctctactca gggTcatggc cattTacagc aaagTtttat tctagactcc atgggaagcc 524820

agaatataaa actTtTgTaa tTtaagcatt tTtctattat aagcatagtT ttTgaaagaa 524880

aatagTccca aatgtTttca gactaattct tcttagcaac tTtgccacag tcatcaaatt 524940

tattcaaatt aagtagcaaa tggagacatc ctagagcaga tatacgtTaa gTtttaggtT 525000

ggTacctTta tattTtcat atcattgaaT tctcaaacia tacaattagc aatagtGcaa 525060

aatgTaaTgt gatTgaaTct aaatctgTaa gctgcaggga tgaagTtttt aatcactgga 525120

tgtTttgtac cataactaaa tcacgatgtT tatgataatt ttattacttc agccctcttt 525180

gtagcagagt tattatattt ccctgtgatg tatggcatca cactTaaaa accctTtCag 525240

taatcagagc cccacaaaac tggctTctaa ggctcattaa tgtgaaaaac gatcataaaa 525300

gttaggtaag tgiagtCatt tcatTctTgg attagaactc ccaactatgg aaggtatgtT 525360

ctgctTctct gatggTattc ttgactagac attaaactagt caaaaaagat agagagattc 525420

acaaaggaca tgtattcaag actgaaactac ccagcctaga ggaactgtgt ttcttatttt 525480

agtctcttct cagTttgcta ctggaattcc aaactccatg acttattttt gctgaccatt 525540

tttctTtttc cTttctTttt ccttaagatc aggcctcccc acacagcgca tgatagcctt 525600

aaaattctta attattcccc tgaagaagcc tccactctgc tcatctaagc ttctctttc 525660
 ttctgtctcc caacagtttt gaaaatgctc ctgaaacaga agttgctgta tgatctctct 525720
 ttaagtactg tataacgggtg gtacacgtat tatccatfff acagaagaga aagcctttaa 525780
 ttttaccaaa ggaccatata tagtaaataa tgaagtgaga cgaaggagtc aggttattgg 525840
 aagatagcag accactgtca cccaccaata gctattacct ccaggagagac tgcttaggtg 525900
 ggaaaaatgc caaaggcagc tgcagaggga gtgagctgag gttaaagaaa gtgtaaggtg 525960
 tcaagaatcc atgtgccttg attttaatta ctgaaagaac aaaacaaatg aaagaagcaa 526020

 ggaaggaagg agagaccaa ataaaaacc cagaaattaa tatttatccc agtgagactc 526080
 agaacagtgg tatagagaaa gtggctcttg ggttttctact tcatgttacc actgaaaaag 526140
 ttctagaaaa ccattctgtt agggatcaaa agggacttat ccagaaatta cactgtagt 526200
 caggtgctag accagtgagt acagtcccaa aacctggtca aactttgaga aacctgaaa 526260
 ttccatgtag aaccatagtc aggagtagaa gtaacttttt taatacaatt ttaatttaa 526320
 attagaaca tcttgcttta catgtcaatc ccaattccct ctccatcccc tctccctg 526380
 cccccacaac cctgatctca tccactttct gtccccagg gaggtgagg cttccatgg 526440

 ggaaaacttc aaagtctgtc atatcatttg gagactttcc ccagtatgtc taggctgtga 526500
 gagtatccct ctttgtggaa tgggctccca aagtacattc atattttata ttagggacga 526560
 atactgatec actaccagaa gccccataga ttgcctaage ctctaatg aaaccatca 526620
 tcagttgggg tcatcctgt acatcactgg acatttcct aatgcatat ttctctttaa 526680
 acctataatg gctccctcta ttatggtatc tcttttcttg ctctccteta ttctctctc 526740
 tactcgatct tccagctccc tcatgtcccc ctttcccctc ttctctctcc cttctcttc 526800
 tcccaatccc tctcccctct cccatgctcc caatttgctc aggagatctc atcccttcc 526860

 ccttatccag gggatttatg ttcttgggtg tcaactgaa acagtagaaa aaagaaacct 526920
 cagttgagga actgcccca ttgggttggc ctataggcac atatgtaggg catattcttg 526980
 atttctgctt atatagaagg cccagctccc tgtgggtggt acaattccta ggcagttggg 527040
 cctgggctgt ataagaaagg cagatgagca agtcagagga agtaagcaat gagcagcatc 527100
 ccttactgt ctctacttc gttcctgcct ccaggctcct gcttgagctc ctattctggt 527160
 ttgcctaata gatggacttt cctctcccgc ttgtttctg tagtggtatg ttatcacaat 527220
 aacagaaagt ttctagtac agcagctcag gtgactttat ccaaaatata ttacatttta 527280

 tagtattaac cactccccct ctctcttga gacagggttt atctgtgtag cctggccat 527340
 cctggatctc actctgtaga ctggtttcaa attcaaagag atttgcctgc ctctgcctec 527400
 caagtcttc gattaaagtc atgtccacc actaccagc ttaagtcata tcttaatgca 527460

agagaattga aatggcttct tatattttca gattataaca aacaaaatta gatgttcctt 527520
 acaagataaa ttgcataaac tatgcttaca catggagatg aatgttgtaa aataataagt 527580
 tggccaacaa ggtttcactc acataggcag ttttttaaaa agcaataaa gatgtgaaag 527640
 taagaagtga tactattaga aagagaaagg gaactcctaa gagagggttt taagtgtggg 527700

 taattgaggt ttgaccatga tcaaaatagt ttacacacgt ctatgaagag gccatgatta 527760
 aactctttct ttatgcaaat ttatacacta accaaattct tgagcattaa aaggacacag 527820
 atattcatgt gccaggctct gtacaatgtc catttcaatt attcttgact ttcacacaaa 527880
 actgtaatgt tatactgtcc aaggagacag atagcaatga ggagagaaga gaggagctt 527940
 atactgcata cagttgagac ccactaccta cctgcattca gcccatgaga attctatcag 528000
 ggcatttggc aaaacctcca gtggcttca gaaattctat ttcctaaag acagatcatt 528060
 tgaataaaca attaaaattc tttagttttc agccacatca attttaaaag tcccagccag 528120

 aaagggtgtc tagactgttt ttttttttc ctctgttact tttctctgat ttctggctc 528180
 ctcttccta attaaaattt cccaacactc ccacattctc ttctctctgg gctccacatc 528240
 caggaaagaa aataaaaacc cttccatgcc tgggagcata ttttaatgta cataattaaa 528300
 actaaaagtg aaaagaaaaa gttcatataa caaagactta cagagtatca tgacttcgaa 528360
 attcatcaac acagtcatgt gcacatgatc aatctgtgcc ttttaactcag tccaaagttc 528420
 ctctgcaaga gttcattcac ttgcatgaat aaatcaaata tgtgctccaa cagccaattt 528480
 ctatttcctt atgtataaga gcagtctaca acaagtgtaa agccaactgt gtttgaaca 528540

 ccaagtgtgt cttttactta atatggggaa aaatgtgtat ggaaagggtt tcttgcagat 528600
 tgactcaaac ttagtggtta aaacagttac aaaaataaat atgtcagcac aactacagca 528660
 gaaagaggta agaatttctc tgcagctgtg acaccaaggc tatgtataca agttccaaat 528720
 tggaaagaag gcaaaatgct tattgttcta gtttcatcca tttgcctgca aatttcaaga 528780
 tgtcactatt tttatTTTT attttttaat cactgagtag tattccattg tgtatatgta 528840
 ccacatttctc attatccatt cttcagtttt agagacattt ggttacttct aggttctggc 528900
 tattacaagt aatgctgcta caaacatagt tgaacaaatg tccttgtggt atgagtgtat 528960

 atcctttgga tatatgccta agagtggcat tgctgggtct tgagtagat cgattcccaa 529020
 ttttctgaga aacagccctg agtgaggttaa cccagacaca gaaagacaag catggtatgt 529080
 actcactcat aagtggatag tagacataaa gcaaagatca ctagcctgca gtctacaacc 529140
 ccagagaaac taggaaacaa tgaggccctc aagagagata tacatcccc ccaacagaag 529200
 aggaaacaga taagatctcc tggaaccttc atccagtaac tgatggaagc agaagcagaa 529260
 gcagagatac acagctaagt actgggccaa actcctagag caacggtgag agacatatt 529320

ggggaaaccc acagaaacag ctgacctgag caagtgggag ctactgaat ccaggctgac 529380

 agtcaggga cctgaataag accgaactag gtcccctgaa tgtgggtgac agttggggag 529440
 ctggggccat ctatggggcc actggcagta gaataagtat ttatccctag tgcataaatt 529500
 ggctttttgg agcccatcc tatggagaga taccttgctc agcctagatg gggggcggga 529560
 gtctttggcc ctgccccaa tgaatgata gactttgatg atcctccatg ggaggcctca 529620
 cagtcctga ggagtgcag ggggtgggat ggggagacgg tggggaagtg gaaggcagg 529680
 agggaaaaa ttttaaaat gcttattgt tactcaagct atttactgt acatgcaagc 529740
 cagagagagc actgaagaca gggaggttc tggagtgggc atggtggtc ttttctctt 529800

 ctccccact aagggcaaat gtgtatacac acacatgcac attcacatgg gcaggcacac 529860
 atgacatctc cacatcacac atatcagata ataaacatac ccaccactag caggtccaca 529920
 tattaacata gtcaaaaact ctctggactg taacaaagga atggactgag actcgaatac 529980
 aagtacctgt gtgtggtaga aacataacat ctccatcgt ttggattcac aagtctaat 530040
 caaaaatgca tcatgatatg ttctctcatt tactaccaac cctacctgcc cttttttage 530100
 ctccaaaac acccaggccc tactaggtta ttgacttca agccttggaa ctaaaattt 530160
 tcaaccaga ttaataacc caagagctga tggtgctatc agaaagaggt agagattgca 530220

 aataacattt aaaagcactg cttacttctc tatctggaag taactctcag ggattactaa 530280
 gtatatgaag tggttttgaa ctgagagtga cttgactata gaactcacca cagttttttc 530340
 agccaattaa gatcgtctt tttcggtgtt acaactagaa aagaaggcat gagacaagag 530400
 atttgttcag ttatgatcga gattacttag aattcacctc cgagttacca gggagtacaa 530460
 ttccccactt gggcaaagag ggaccctca cctagaaggc acatgtactc tcctcctc 530520
 caatcctata ttctgcctt tccatgcaga ataaaattct atcatttga gatgatgtcc 530580
 tcttttagta ctgaagatga gcaaaataga tttttattt ttagggattt aaagcctggt 530640

 gatagaatta tagtctttat accttttgac aatgacctg atggttcata aacccaatc 530700
 gtgaatgaaa actaattaca gctctttcag gctaaacagc agccactgaa taccactaat 530760
 tatgcaatga agctcacagt cactactaaa acattggcaa taaatgaatt cacaggaag 530820
 acaaaaaag aaaaaaggag aagaaaaat gcagtatc agccattgtg aagaaaatgg 530880
 caaatgctaa aatctttct tattacacca tggatatattt aatgcttta attactgtac 530940
 aatgattgct tccagctcga cacaaggca gttctcaagg ctgacaaatc cccccaaat 531000
 ccccaatgc atctttcata cactactgat attgtgagct taatattggt ggagatttgc 531060

ctaggttcag atggcattca gtcagcgtcc acattcaagt catcagattc taatgtataa 531120
 gaccagaatt ctccaaatac ttgggaccag gacttgtttg gatttgggtg aagtaactgt 531180
 gaattaactc tgftaacttg gccaaagattt tcttgcagac ttccagttaa atcagatgct 531240
 gtggaaaatc ctgaggattc agtgggaccc aaacgtcaag tttatccttt atgtgctctg 531300
 atgccaagag acttagtctc aagaggttat ttatcattta aatataaaac tttggtaatc 531360
 ccatgagcat cttcccaact cttctaaggc agatgtgccc cagggggaac atgatatgag 531420
 aagcatgaac ccgctatcct cgtgtcctag gttcagttct tctgtgcctt gcacatgtg 531480

 agcatttcgt gccttccaga ctatttgaag gtttctacag gataatttct ttttcaaac 531540
 attgtatgtg cttgtgtgt atgtgcatat gctaatgtgt aagggaagtg aagattgcca 531600
 ttatcagtgg tgctcttggg tttggaggtc agtggtcac acagtgtctt cctcttttgc 531660
 taaagacctt attttattt tagaacagtc acttactaaa ccttgatctc atagatcagg 531720
 ctaagatggc tagccaataa acctcatagg cccatcattc tttacttccc caatactgaa 531780
 atggacatgt tcttcttcc ccagtattt gatgtgagtt gtggagatca aattaaagcc 531840
 aacatgttta caaaagacaa ctccagggtc aggaagatac cctacctcaa aagaataata 531900

 cagagtaaag gggacttact gatgcccttg tccagactct gcacacaaac atacacacac 531960
 acacacacac acacacacac acacacacac acaccactct acttaaaaca tagctcttcc 532020
 cctaaacctg ttactgctgt gggcatgatt atttttaata taacactatc atttctttga 532080
 atgctctatt tctatctgca tatcttctta tctcccaaaa aggtgaattt aaagataaca 532140
 agagtcatta aatcaacaga aaaaatccaa agttcagctc aaatggaatg tttgctccct 532200
 atcaattatt ttcaatagc attttataag taatggtata taataatcat gcaaatcatg 532260
 gagttaaatt acagcatgct cattcaagta taagatgcag ttggcttgca tccaccccc 532320

 tccattacte tttcatctct tccctgcctt tctgtcttc ttttctttt tetcttccac 532380
 atggctggta aagcctgccc tcttagttt cctatgaatt ttaagttctc acatgtgat 532440
 cttgaatatt atttgatgcc cattggcaga tctgcaccac cttaccactc aaagtgtcct 532500
 tgattcatca cttcaaaga atcctgaaat ttgcacacat gataaaaaaa ctctatcca 532560
 caggatggac tgtaaaaaga aggaagggg caaaatact tcaaggtctg aggagtggct 532620
 ggtcagtggg aggaagagac aggcaccaga accatcaggg actggctcag aggggatttt 532680
 gaccctgggt ttctgggacc tggatgtggg tgaagtttgc taaaagtcaa gggattcaa 532740

 ggaaagtgac ttcaaagtag atggagtctt tcaaagcagt actgtacgta gagaaaagaa 532800
 acaagctcca gcttgtacca gaatcatttg gaagaacatt ctggactcct gccttctgag 532860
 gacaagatc acagggatct gagcagcctc caaggcctca gggaacctc tacacagatc 532920

atcatgctag ctatgattc ctgtacatgc ctgcgaacca aataactaca ccctactcat 532980
tctaaaccaa tcataacct gactcagctt ctctgagct aaattcaaaa ctaccctccc 533040
acctctcgtg cctctcaaat gccttgcaaa aggaagaaaa gtttcatgat ggaggtagaa 533100
tgaaaagtca atgggttctt aaccaactgc tggcaagcag acttactgtt ccaaaatgtt 533160

tccaaataaa tcatcataca ggccatcccc catgcctgct gtgggttctt ctatgcagct 533220
gatgtaagtg caaagcactg gagtcggaag gtcctcagct ctgcaataca gcctcctgct 533280
aaagaccccc agacttcaga gagctgccac tgtgcttctg agatctttgt gtgcctgact 533340
cctctcctga tgcacaatat aacatccaac tcagtgatgg acatttccaa ttgagtcctc 533400
tctccttctg atttcattat cctaaactag aggaattagc catcagatga gtgttgagag 533460
tggccacacc taactcttat tacagaagta taaaggctaa ctagccttca gcctcctgct 533520
tctgtctcta atcttctcca gagagtgatg tgactacaga tgctgtgta gtgcttctag 533580

cttttgggtg aattctgttt caactcaggt cctcatgctt gcatggcaag cacttttaca 533640
catggagcca tttccacaac catgggtagt agtctacac accaaaacca aatatgatcc 533700
ctatgttaat tattctttgt gtttgtttgt tttcaagac atatttctat gtgtagccct 533760
ggctgtcctg gaactcactc tgtagaccag gtggactttg aactcaccga gatccatctg 533820
cctctgcctc cagagtgctg ggattaaagg tgtgtgccgc caccaccaca agtttatgtt 533880
aagcattttt agagaaccaa gaatcattct taataaggtt tttcattatt aattacacat 533940
ttatgtgtaa ttaagatatt atgtgtctga gatgtactta gtgtttatat acctcaaat 534000

tcactttgac agetaatcca ccaccagaca aaggcatgat gaagtaaagc ctttgtgatg 534060
tgagtaagtc atagggcaga aacattataa aagagtcacc aggcacattt ctggctcctt 534120
ttgcatgctg agattatagg aagaaaatga ccatgaagaa gctagccctc accaaacacc 534180
taatcttcca ccactttgat cttgaaatta ccaatatcca aaatggcaat aaaataattt 534240
ctgctatctg tcattccatc tacgatattt tcttataact gccactatga actgagacaa 534300
tgtacaate tcaagttaaa tggaaagcaa tggggctgga gagatagttc aaaggttaag 534360
agaacataca tctcttctg agaatagtgg tccagtttcc ataccceaaa tttgggaagc 534420

tcacagccac ctataaatcc agctccagat gaccaatac cctcctctga tctccacaca 534480
cacacacaca cacacacaca cacacacaca cacacaccac atacatgaaa aacttttca 534540
agtagtaaaa tatttcagtg ttttaagaat ttcattgataa cctgtaacaa tatgtaattt 534600
ttctactcct tgtattcaaa tcttgggtta gtcattgatg ttttccttac tttctgttta 534660
aacattcagt ctgaccttc ttcctcatag tttttctccc atgttcaeta tatatttacc 534720
ctgtcataat gccgaaggaa gcactggctt tcaatgatga atttccataa ttgctgttcc 534780

ttggccttga cgctcttctt ttcacagttc atgccacata ggattaaaca atgagaagaa 534840

 gaaggaactt gaagttcctg agtgcattac aaaccagctc cttaacctaa tcatctcagt 534900
 tcattaaaaat ctgcaatcag tgtgcccggt tcattttetca aatgcttcaa tataaaacac 534960
 cagcatttgc tggaggagtc taatcactgc ctaattagca taacttaacg actcccagct 535020
 cctctttctc aattgactct cttgcttctc agaatgtcct catgctgttc tgacagtaaa 535080
 agctgcagct catctgcaag tgaagcctca cttggcccaa gccatttcta actttcaaat 535140
 gacagaaaaa ttgtaaagga aaattatgct gattttaatg tcccacatca agatgatata 535200
 gataggacca ggtgatattt gttgctttgc aaggcactgg gacaccatcc ctgcatctac 535260

 tggcactcct aataatctcc ccggttcggt ctatTTTTTT ctatTTTTat ttatttctat 535320
 tttatttatt ttatttctat tttttctaag tttcctctgc aaattggagc atccttacta 535380
 atttttaacc tacttttcaa atctgcccta taactcttaa cctaaaattt ttctgtcttt 535440
 ccctgaaatt cctactagaa cattctttta tcatagacct ctttgactct tctgctacce 535500
 cgagtacca taatttctg tgagaatgaa aagtgaggcc atgaatactc atcactgcat 535560
 gaatcatttt tttcttcacc tttaaatggt ctgcatcaag gctgggagat tgctcagget 535620
 tcaagactgc tttgtgctga tctgaagaa gatgactttg gttccaagca cttatacaag 535680

 gtccaagtgg ctcataactg cctgtaactc caattccagg ggggtcttat cccctcttct 535740
 ggctcttctt agtacctgtg cacaaatggt ctatataaac tcacacaggc atacacacat 535800
 acacataaat aaaaaataaa tctaaaagat gctctacatc catagaggaa ttttgtttgt 535860
 ttgttttgtt ttttcaagac agggtttctc tgtgtagccc tagctatctt ggaactcatt 535920
 ctgtggacca ggctggcctc aaactcagag acatgcctgt ctttgtctcc tgagtctctg 535980
 gattaaaggt atgtgccatc tacaagga ttttgagaac tgtcttctct gtaagaattt 536040
 ctctgataat ccagcatag tggcgcattc atttaattct ttaattagag gaagaggcag 536100

 gaggatctct gtgagtttga ggccagcctg gtctacacaa tgagttccag gacaaccaga 536160
 actacatagt gaaactctgt cctgaaagaa gcaagcacia ttccttaagc ctgcactgg 536220
 ctttactaat gaaagtgttc ggataaacta tagtattctt ataaaagggtg caaagtatgc 536280
 tcacagctag aggaattatc acaaagcaaa taagtcttg aatgcagcag tttggtccag 536340
 atagacaact cgtaagtgtg caattaatc aaagcttcca tatgcccttg taggtacaat 536400
 gaggttcatg ctctgtgtac ttctgcaga cagaatctgt cagcaggtac ctctgtgtc 536460
 ttttgcacag cattgtttgt gagagtccat ttttttttt tactttagg gtttgcttat 536520

gctcactcct gaaccatcag tgataaagag attgcaaatg catgtcctct gtactgttga 536580
ggagcacagg agttcctccc tgagtttggc atctgtaaat agggctgcaa tgaatattcc 536640
tgtccatgcc taagtgtata atttcaaagg agtacgatgg tggaattgtt gatccagaga 536700
agaaacacat gttcagattt tgtagagttt gagaatgctt ttctgaagta atttactga 536760
tgcagctctt acagttttaa attagaggcc taacatgca catctctcta atactcagta 536820
ataccagtct tttcatctta cccatccagg taagagtcac aacctgattt tgtgaatatt 536880
tagcaaagca ttttttaaaa tacacaggat actttaaagg taatggttac acatattcaa 536940

actgaataga ttgtagtttt attatacata tacatgtaac atacatacat acatacatac 537000
atacatacat acatacataa caacaattta ataaaaagaa gtcaagaatt gaaagagatc 537060
agggggagat ggtacatggg agagtattga gggagaaaaa aagaaaggag aatgatgca 537120
attatattat ataaaaaatt aaaaataatt aaaattgaag gttaccaaca gttaagactt 537180
tgctttaaga tgaatgtatt ctatgaggaa aactaaagat ttactatata aatatcatgt 537240
tctatagaag ataatgaat acatgaatga tagattatac atgatagaaa gataagtaga 537300
tagacacata tatacatata tagaagatag atataaatag atgataaata aatggatgat 537360

acatagaggt agttatagat ataaagagat ggaatatata tatatatata tataatagat 537420
atatagatag atgatagata gatagatgat tgacaaatac atagactgta gatagacaga 537480
cagacagaca gacagacaga cagaccgata gatagatact ggtggaaaca cagtcattat 537540
agtcattaaa agaacagata attttaacag tcaaaaatgt ggcttgcaat acaataatc 537600
tgatttaact cttagaactc ccaactgacaa attgagtgat cttggtatata aagtttgctt 537660
ttgtttcccc atgtgtaaaa ttgtaataac aacattattg taccceatag tttcttggtg 537720
aaaaaataac ctaatataca taaaacagta attcagtaaa caatgcaata aacagtagac 537780

aaatatcaga tgttcttgcct attataccta agcctgtgtg agatcattta catatatcca 537840
caggttacca agctattacc taaacttgta agaatcaggt gtcgttacc tctttcttct 537900
tccttgctcc attacttgtc taagaaaaac atcctatgtt aaaaaaaaaat gaggacaaga 537960
tagtaacate taaagctggg tgttggtggt acacaacttt aatcccagca ctcgaggagc 538020
agaggcagtt ggatctctgt gaggttcaatg ccagcatggt ctacagagca agttccagga 538080
caggctccaa agcattacag agaaactctg tattgaaaaa aacccaaaaa aatgatagat 538140
aacatctaaa atatgcaaag aactctaaaa ctatgtagta agaagtcaac ccaatcaata 538200

aatgagcaat tagataaatg gacagttctt gtccaggtaa ctcatgaaaa gcatcttcag 538260
cacctccage catccaagaa attaaaatga cattgcaatt tcatcttact ttaatcagaa 538320
tggcaatcat tcggaaaaca aagaaaagca tgtagtgac tatgtgaaga gaagggaatg 538380

gttacacact gcagctggca acataaatca gccagtcac gagggttctt agaaaaactg 538440
 aaagcagatc tatttacaac acagttgtac ctctccaag tatttacctt aaagattcca 538500
 aatcaaccta ccagaaagac atctatgttt actgcatagt aactaagtta aggaaacagt 538560
 ctagatcccc aaacagagga atggataaag aaaatgtgct atgtatgcac aatgaaattt 538620

ttcagtcatg atgaaaaatc aacctgtttg tgggaaggtg gatgtaataa gattatcata 538680
 ttcagtgcat tcaatcatat ttagaagagc aaatatcaca cttttatct cttttgtagt 538740
 tcctagattt cttataacta catgacatgg aagtagagct gaagatgtcc ataggaaagg 538800
 aaagtgaga gaaagtgcac agaaaggcaa ggaagagaat atagtccaag tacattataa 538860
 aatccacat cgatgcagt gagtatactc cagcgtttac taacactaac aaaattgtgc 538920
 ttataggtaa gcacaattgt tccaatattc cattagattt gttaggttcg taacaatgtt 538980
 ataaaaaaca taaacacatt agagtcaatt ttcccaaact cctgaacttc aaataaagaa 539040

aatgagattt ggatacatta aaatgcctgg tgtgagatta tntagataat tagcaatgca 539100
 tataaagtcc agggaccccc cagcaaggag ttcagttata tgtgcaataa tcttctcgt 539160
 ccatagcatg aattagaggg ccccaaaagt caaggtcctt aggtcagagt cagaagaatg 539220
 agtctcaaaa ctttttagaa agggaagaga taatattcat taaaatgtaa ataaattaa 539280
 ttaccaaaact gcaatcttac atatctcaag atgtcagata aattatttat ttttttgtg 539340
 tacattaaag tgagttatgg ggctgaagag atgacttaat ggtaagaaa acttgctgct 539400
 cttacagagg acccaggttt ggctcccaa acccacatct atcaagtgac tcacaactac 539460

ctatactcta gtgctagggg acccagtgtc ctctctggc ctctgagggt tccttaattc 539520
 acacgttaca catgcagagg aacaggcaca cacatacata gacataaatt gaaaacttaa 539580
 agtcacaaaa gtaagtttat aacatcttat ccaattagta agatgttggt ttgatcatat 539640
 agcttactac aaaaacactt tcagaaatgc aagctccata ttttctaaag aataaacaca 539700
 attctgtaaa atactactac aatcttctat actttttta ctatactta ttttactct 539760
 tagtgggacc tccagtgaac cctcttagta ggacttcaag tgtaacagac taaaagtaaa 539820
 gatcattgat ttttattcct tcaatgatga tagaagattc ttgtattttg aattgccttt 539880

ctagaatgca tctgttttat agaatgaaa taaattgaca aatatgaaag ttaaatacag 539940
 caaaggaatc tgcatagtta gaattctttt ggtatcagct agactgtgaa ccaattaata 540000
 agaacaggtt ttgttggaac actttgtcta tattgaagta tgagccataa ttaagtacag 540060
 cagcaccacc cttagcaaca cagatctttg tattgagatg tagaaattc agggtttggt 540120
 cccagtatgt atatacaagt aagatactct ccattttttt ctctgagct ctcaactctct 540180
 tgttcaatcc acccaacct gaaacttatt gcaagcgagc agcctcttcc catcccagcc 540240

agaagtaagg attgtggttt ctcaaaaaca cgcattgagac aagagacagg gtgcagtaca 540300

ggagaagcat ttgactagct gaacaataaa gttgccacac cacttatcta gtcttatttt 540360

cccttagcat gttttcaact ttttttaatt tgaattagag acaggattgg tttacatgac 540420

aatcccagtt cccttctccc acctgcctta ccaccaaccc cccaactaaa atcctatcta 540480

tcacatatcc tttctgctcc cctggatggt gatgccttcc atagggtgtc atcagagtct 540540

attttatcct ttgggatagg gccttaggecc acccctgtgt gtcttggctc agggagtatt 540600

tctctatgtg gaatgggctc ccaaaatcca caactgtgct aggggtaagt actgaacttc 540660

caacaggagg tctgtagat tctgaggtt tctcactga aacctatgtt cctggggtct 540720

ggatcagtcc cattctggta tcccagctat cagtctgggc agcaagagtt ccccgatgtt 540780

ctggtcagct gtttctgigg gtttcaccag cctggctctgg acccctgagc tcttcaactca 540840

cccttctctg aatctgggtt ccagttaagt tcagtgatta tttgtgagtg tetgctttta 540900

cttccaccag ttgtggatg aaggctatag gatggcatat aagttagtca tcaatctcat 540960

tatcagggga gggcatttaa ggtagcctct cctctgttgc ttcgattgtt agctggtgtc 541020

atctttgtag agctccagac atttccttag tgcttgattt ctctgtatac caaaaatgcc 541080

tccctctatt atgatatttc cattcttgtt atcatctatt ctccctga ctcaaccttt 541140

ctgctccctc atgtctctg catecctct catctccact tetcattctc ctatagcctt 541200

ccccctct tctgagcaa atttgtccc aatttgctca gcagatcttg accctttccc 541260

cttcttagg ggaccatgta tgtctccctt agggactctc ttgtttatta gcttctttgg 541320

cagtgtggat tglaggetga taatccttta ctctatgtct aaaatctgca tatgagtgag 541380

tatatatcat gtttgtcttt ttgtgattga gttactttgc tcagaatggt tccttctagt 541440

tcgatccatt ttctgcaa tttcaagatt ccattgtttt tttccgatga gtagtactcc 541500

nnnnnnnnnn nnnnnnnnnn nnnnnnnnnn nnnnnnnnnn nnnnnnnnnn nnnnnnnnnn 541560

nnnnnnnnnn nnnnnnnnnn nnnnnnnnnn nnnnnnnnnn nnnnnnnnnn nnnnnnnnnn 541620

nnnnnnnnnn nnnnnnnnnn nnnnnnnnnn nnnnnnnnnn nnnnnnnatt gctggatctt 541680

gtggtagact gattcccatt ttcttgagga gtcgccatac taatttcaa agtgtctgta 541740

ctagtggca ctcccaccag cagtggagaa gtgttccct tcccacatg ctggcataac 541800

tggttgaga ctgtagaaga ctgaagttag acccaagcct atgccttgc acaaaaactta 541860

agtcaaatg gatcaaagac ctcaacataa atccagctac actgaaccta ttagaagaca 541920

aagtgggaaa taccttgaa ttaattagta caggagacca cttctgaac attacaccag 541980

tagcacagac actgaggcca acaattgata aatgggacct cctgaaactg agaagcttct 542040
gtaaggcaaa ggacacagtc agcaagacaa aacagcagcc cacagactgg gaaatgatat 542100
tcaccaaccc cacatctgat agaaggatga tctccaaaat atacaaagaa ctcaagaagc 542160
tagtctccaa aacaccaaac aatccaatga aaaatgtaca gaactaaata gacaattctc 542220
aatagaggaa tctaaaatgg ctgaaagaca cataagaaag tgttcaacat ccttagccat 542280
cagggaaatg caaatcaaaa caactctgag ataccatctt actcctgtca gaattgccaa 542340
aatcaaaaac accaatgaca gttcctttaa catttttatt acaccacttt tcacacctct 542400

ttaaaagcta atggaattat atatacctga gctcttacta actaaattct gaggttgcttt 542460
tacatattct gagaattgct gtatcatata actatccact tatgcacca ttaattgatt 542520
ttatittgtg tgggggtgaa cacatggaca tgggggtgtg tatgttcaga tgcagagga 542580
cagtacctg tgttgttctt tgagaactgt tcaccttatt ttctgagaca gggctctcca 542640
ctggctctgga aattgcccc aggctaggct ggctggctcat caagtaccta tacatatgtg 542700
tgtacctgtg tgaaggccag aagttgacac tgggcatctt cctcaattgc tctccacatt 542760
atTTTTTTga gacaagagac tttcttgttg aacctagagc ccaactgactt agcaaggcaa 542820

ctgtctagtg agccccagca attctctggc ctctgcttac ccagtgtgg gattatagcc 542880
acatcctcct ctcatctagc cttttatgtg ggttctgggc attcaaactc agatcttgag 542940
gggtggcacag caagcacttt accaaatgag tcatctccca agcccctggg tctccagtta 543000
caaatgcatg gtctgtacct cgtgagaaat ctttggaat gcacataact gtacagccca 543060
aaccacaatc tatcatccca gcatgcctac tctgtctgct tctcagtgtc taaccattat 543120
ccacaaaagg agccaccatt ccaacatttt catcacaaat taattagcca agcacagaat 543180
ttcatgagtg gatcctgtta ctacagatgc tgccttatat atgaggcgca ttctctgtca 543240

tcgctgaaaa gtattccact ggagttttgt aattctgttt gctgatcatt tattttttat 543300
tatatttaat tttataatt tcaagtcctt ttagcataga agttcttttc cattttatta 543360
aacatgcatt cttttgtcat acaatatata ctgattacgg tttctcccc ccccccccc 543420
ccccctccct tcttcegett ccccccccc cccccctccc ctctactcct cccagttcat 543480
ccccactcc tctctcatct cgattcactc cttttctgtt tctcattaga aaagaacagg 543540
tttcaaagag atagtaacat aaaacaaaa accatcatat ccaaattgga caagacaagt 543600
cagcagaaag agccccaagg gaaggcacia aatcattca cttttaggag tcccataaaa 543660

gtactatact gcaggctata gtatatacac agggggccta gtatagacc atgtaggccc 543720
tgctgttca gtctctgagt tcatatggtc ttgctaagtt gttttaaaag gccttgttct 543780
tctgggtgcc tccattctg tctgctcct ctccatgga cttccctgag ctctgagggg 543840

aaggatttga tggagacata ttgttttagaa ctgtgtgttc caaggtgtct ctctgtgtgt 543900
agtgtctgag taaggcactg acctgtgagt acaacagatt atcattagga gtcattttat 543960
tgttactctt ttaaagaaca atagcacttg gttttatact aggtctctgg tctatctagg 544020
ttctgggtct tcattgacaa agcattgtca ggtatgggtt ccatcacatg gagtgggcct 544080

taagtcaaat cagacaccag ttgggtgcc acaaggttg tcctagctta ttggtattta 544140
catttctctt ttggatcct tcaagagtac ctttgccata gatgtagaac atggggaagg 544200
ttctatgtag gtaccagctt gacctttctg tggtaaatga gttgtgtgta tgctgttttt 544260
agcaatggga cgcacctac gtgcagtttg atcattttga tgacaacctg ggttgcttga 544320
ggatttccat gggacccttt tggccaataa ctcaattgga tgaattcag tcctgtact 544380
ggaagttca ttgatgaag agagacagcc agtaggcct aatctcctt attttagac 544440
ttcattagga tcacctcat atattatagg aagtttccat tgcactaggt ttccatacca 544500

ccctcaaat accttcagt tctaactgcc ttccctcat tccctcctc aattctattt 544560
cctctacccc ttcccactg atcctcctgt tctatctcc acctggcccc ageccacca 544620
taaaatctat tctattttcc atteccaggg agatccatgt gtectaccta gtcatttctt 544680
gcctctttgg gtctgtggac tgtagatggi tatcattat ttaacagcta atatccagat 544740
atgagcaaat acatgccata tttatgtttc taggtttggg taacctcact caggaagatt 544800
tgttttatac ttctatccat ttgctgcaa atctcatgat gtcattttta gcagecgagt 544860
aatactctgt tigttaaatg tactaattct ctttatccat tcttcagttg gttgacatct 544920

aggttgtttc caggttctag ctactatgaa tagagaagca atgagtgagt gaaaacagca 544980
ctaagctagc ctttccat tctcatgtta gtcttttgag gacggcaaag atttaatttc 545040
ttatgaatat atgtttgtta actttccttt atgaaaaaga aatctagaca gtcccagaaa 545100
actttccaag ggetgagacc attttgact gttacctaca aatgtggttt gctagatgg 545160
cccatgtctt taccactcg gtgttaacat gttctttttt ttttaattt aactagata 545220
atagcttctt ttaaaaacac tgtatcacat ttctagaaa gcatcaagag gcagctaage 545280
tgaagtaaat tttaggtaaa gtaggtaaat taagatagtg atgtaagcac acgcatggg 545340

ttggtaagca gtaaaatggc tgctcctggg tcacctagac atgaactact gaataatga 545400
aaagccacat tatagttct ctectacatg cagtttctta aagattgatt tctctgatt 545460
ctctatatct accatgttgt tgaattgatt tcagaaacta ttccatgttg cagacactaa 545520
gtttcatgac tgaagcagt ctgtgtaatc ttatctccag tgccctggcat ggtgcctggg 545580
ggccaggaag caatggataa gcgcattatc ttacatatg attatctgc aggtcatgtc 545640
caccattct tcctagacc tttcttttg gggaaaaatg gtgaatgttc atcggttgc 545700

ttggaagcat aataaataca tgtcaagtat ttacaggat tttaaataaa tagcacatgt 545760

 caccaagaat acttaatgac ttttctaca tacaagcatc attgtaagac ttgttttaac 545820
 ttctgtgtct tctctccctt tttttactta cagaatctga tgcaatcttg tggcttcagt 545880
 tcttgccccg gtctggaata tectatgagt tctatattcc ccaaggatta ctacacattc 545940
 acatttaate ataaaactca ccatgtcttc aaatttgga tgtctgaaat caaatgctcc 546000
 tatttcatte ctactggaac ttccacatac ccaagcagtt tgtgtaacat atttctgttt 546060
 tactttcctt cactcttctg ttccaaatcc agtcttctca ttctgatcac tacttaccta 546120
 aaggaagtgt cctcgggata gcattccaat gagatgcttt ggctcttact ctctccctat 546180

 gtttatttca tacatttgtc ctaatctcac taaagcattt tcccagacct tcagaatctt 546240
 cccatgactt ttcatgtctt gttgtaaatt cagaacagct aatctaatat tgaaaatacc 546300
 ctaccaagag tctgtctcaa ggcgtgcaat ctcatctctg tgaccttttt atatttactc 546360
 acttgaggaa agcttcagca gctattgcca acagatgacc tatgactttg gaactgctta 546420
 caccagccct taggtaggag tgcatcattt ttcatgtgaa gtccaaatc tgtctcatct 546480
 aagttcaaga taaaagccac aaatcateca ttaactgacc aacgtcattt ttcacttacc 546540
 tgagcattgc tigtgtttata tgcaaatcat cacacttctc agttcataca ttgtatacta 546600

 gattttatgc aatttattaa gtgggtgagtt tagccagtgc agtgaacctg tatgtttcag 546660
 aattagacag aagtcttggg ttagctcaac tatttcaaaa taattaatct taaggaaagg 546720
 cgtaacccc aggcaaatta tctgcaaaaag ctgggataaa actaatcaca tttattattt 546780
 taaagattaa ttatgataaa aagtctctca ctacacagct gacaggtatt tttcagcctt 546840
 tatatgtgcc tgcaaatfff gcatgctaata ctcatctagc gctcatcaga atttttcaaa 546900
 atagatttaa tgccatttag catctgaaga agcagaggct caagtcaatc tgcagttttt 546960
 gagcgaccac agacctgtca ctcatgttta cattcctagt tgctccatga catgtacata 547020

 gagttgccta atgaactaaa gcactcaaaa ttactgaatt tgaagcaaat ctagattaag 547080
 aaagtatcta catgagcaag tcaatcttaa ttaatgtttt atgttatatt ttgtgatggg 547140
 aataaaagcc acagatgcat actaaaagtg attgcaataa tggacatggt ctggaataag 547200
 tgagaaagga aatgaaaaaa tggatcctt ctggacaaa gaaaaatcaa tatatcttag 547260
 gtaaaataat cccaaactac cagaaggcag taatgacaca aaagacctgg agaaaagagc 547320
 agatgacaga tgatctatgg gcttgcaacta tgatacagaa ataggaggat gaaagcaaaa 547380
 actaatgtaa ttttctgta agctcaaagg gatcatgatc ctgggcaaaa ttttacctcc 547440

aaagcactgg tcagttctgg atatcatcgt gtgtaataga tataaaacac tggaggcagt 547500
 tccaaggaat gcaataaaag tgagtccaag aatagttgga tgtgggctga atctgtacat 547560
 tgctctgtg tgcaaatgga ctgtaaaatt cagtctcaac catttatttc cattaacaca 547620
 gcagcagaga acagatcggc ttgaagaatc aaaccatfff gcaaacgtcc acatttgtgc 547680
 acacagactt actacagttc tgaaaaatc agtgtatcgt ttcitttcag agtttaaaag 547740
 ctaaagatat gagccatfff ccagttttgt ctagatatga gacaagaaga ccagtataag 547800
 ttttagttct aatgaaaaat ttacctgctc tgagggtgat caaaaattga tacaagaaga 547860

 tggaggtatg ttctaaaga agtagtggg taatgtagta ttttcagaga cagaattctc 547920
 tggccatttg cctgcatttg tctacctctg atatgcatat agctttgtgg cccttgaca 547980
 aattattcac tagattccag cataggcaaa caggattaat aaacacactt atcaccagg 548040
 gatggcaata atcactgaac aaactaatag aatgaacttg aggatcga ggacaaaatt 548100
 agtatttacc ctagatagta ttttcaaaat aggcttaaaa tcaaatgta aagatgtga 548160
 ctattagagg aatacatgta aactttatat gtaaaatgta tactcattct gggttcactt 548220
 tggagttgca cggttacttg atatgtgac tatgagataa cccctgacac agtttgacta 548280

 tgaaatgttc ctccagagcc tcaagtatac acaaagtggg cccaacat tggatcatgg 548340
 gaactgtgac ttgatgaatg aaataatcct ttgatggact tgccatggtg aaaaatggga 548400
 agtgagatat agtcagagga ggggaagtggg tggggtccac cctgaaaaga tgtacctgt 548460
 tctagctccc tccttttcta tctctctcc tagaaaactg cactctgtca taccttcag 548520
 gcatgctatt ctgtagtacc atggcccaga agcaacagaa gcatccatag actgaaagct 548580
 ctgagtttgt gagccaaaaa ttctctatcc tcaactaaga ctatttccat ctagtgttt 548640
 tcacatgtat ggggaagtctg actaatatgc ttttgcttc tataccttat gtgacaatat 548700

 ttctcttctt ctgtcagaca atttttgata atcaagttaa taggcaagaa aatatgttta 548760
 ttttactggt gtgtcacag acacacacca gaaccccag tgcttccat atattcagtt 548820
 aatgttaata ttatattaat ttaatttaa aagacatfff caagtaatca ttcaaggtaa 548880
 ttagtagtaa catagaggaa aggacaatcc acacatctaa cacaaagcag ttctgtggtt 548940
 ctgatttatt ggctggtttt gttttgattt tcagataat agcctccat tttcactttt 549000
 gcacagatgt aattaagtac ttgtatatag atcaaagcaa agggatttgt ctattaaga 549060
 aaagaaacac attatgtaaa gttattaat gtaaattata cccagtgcac tatatatcat 549120

 gctatcagcc atcaagtttc agttatttaa aaagtgggac caatagattc cacccaaatg 549180
 caaattcacc tcattctcca atggaccag ttttttct atggtattaa gcataggagg 549240
 tcattaatta ccaatagcaa aaacagcatt gaaagcattg gttgagtga agcaatgtgt 549300

cagacaaaca tggtaacctt ctcacagtta catgacattt ttatattaac tcgtgtattt 549360
aacctttgaa acaagtcctt aaagtaaaat gaatgtcatt atttccattc taaacttgaa 549420
gaatctccac agacaatgct gctcttagta ctcaatctga aacagccttc tcattaaggt 549480
caagaatgag agaagaatgt ctcctttgtt cattcttgg tagcaatctt ctgaaatctc 549540

cagctaatga aggatacatg ctacaaaggg gaaggcaaaa attattgtat ttgcatagag 549600
tgtttattgt tcaatataga aaattcaata aaattatctt taaaaccaa tgaggaaaaa 549660
aaaaaacag gcagtgtggc tgtagattt gagtcaggct tccaaaatt aagccatctt 549720
agcaaacagc cacttctgtg taaagtgaag tgacaaaggc acatggcaat tctccaaaaa 549780
tcatcaggaa gagccctctc ctggccatct atcttgccat gtgtagagaa tatcttcatg 549840
gcccagtggg gcttctgcac cttagcaatct tatgaatacc tgtgcagaag ggctatgaca 549900
tttcaagtca ttggttacia tatatatctc cacagtgaat agttaaaaaa aaaaaagctg 549960

aaaaatatct ctgctcagga agaggatgac cataggtaaa actcaagaaa tcttttgagg 550020
atgagaagat gccccctaca gttttctag ttttatttct gttgtgataa aaaaaaaaaat 550080
acctgatgg caaggaactc aagcaagaaa ggatttaatt tggttcacag tttcaagtta 550140
tagctcatca ctatggagag agtcacagta gaagccagac tctggtccca ttgtatccac 550200
agtcaagagc ggagatgaat ggatccatac atgcttaata ctctgcttcc tcatctccta 550260
tgcaaaccag ggcccaaact ctggaaatgg tacttcccat tttcagtctg agtcttccca 550320
catcaattag gacaacaaag acaactcctt cccacagac acagacatgc cactcgaca 550380

aactgatcta gacagtcctt cacggagact ccttccag gtgagtgtag atcttgttaa 550440
gctgacaaaa ctaccatcac aagagtgcag aatggcacct cttctcccaa ctagagtgga 550500
tgctgccct gaatttgcta attccccctt cccatgtaa catgggaaat ttgcctcctt 550560
ttctacttt ctccatgtg aaattctact taaatctata ctttctgatt tatatcctaa 550620
ttaattgatg tctcccttc tacatcattt gctgtttttt ttttaaatt aactcagcc 550680
tctaatttac cacatccca ggtatttact ctcttagat agcttcaact actccgtgca 550740
ttttatactt tttgtgcta actgactact ctgaaaactt gtcttcaact gaaactctt 550800

cccttaaate aacgtgctta catataactt cttaatat atttttactt agatgtgtc 550860
ctatttcatt tctgttacta tggttaaaaa aatctgaca aatcaattt ataggaaaag 550920
tggtttactt cagcttaggt tacaatccat cactgtggga aattcaagc agaaacttca 550980
gatgcacagt cagcagcaga gggaatgaga acacacatgt tcacttgttt gaatgtgtc 551040
agctcaatat ctctactctt ctacagttca aggcctctg tctaggaaac agtgcgtccc 551100
acagtgggct ggctcttctt cccacatcca cagactgcc acaggccaac ccacagtaaa 551160

cactcctgac tgagactctt ctgaggagat tttagagctgt gtcattgtga tagtaaaaag 551220

 ttaacaatct agggatccc agagtagctt cagaggcaat aaatctcaa catagcctt 551280
 aatttgcaat tccatgaaaa taaactatac aaaatgtatg gggccaacaa aattagtacc 551340
 tagaaggata tcigaagcct aattaagaca ttataaagc atagacaagt gaaaacttaa 551400
 taacttaaat atctaaattt aaaaaagag atgagcattg aaaaactatt aatctgtgta 551460
 gataatctaa aacaattaga aaaatagggc ttggcatgta gttcaagagt agagcagttt 551520
 tctatcatgc ataaagcctt tagtccgata cctagtacca taaaaaatat taggaaaaag 551580
 aagaccatga aattaaaagg aaggatattt aaaataaggg tataattgat tgataatttt 551640

 tgattctgaa agtaaagtag agaaggatcc caaagggggc aaaatctaca gcctcctgac 551700
 tagagtaacc aaggatacag gtgtcagaaa gaattggaaa aataaaatga atctgaagaa 551760
 atggcaggtc caagtcceaa ggtagtcaag ggccaacca aggetatgta tgcaataaag 551820
 cttaaagttg aaatcagggt tttatttatt tttctaagct cccctgtaac acatcttcag 551880
 aaaatcacct ccatcactgt gctggatgga ggagagagaa aaccagtgag cactcagtgt 551940
 ttctcattct ccatgtgtgt tttacccatc tctagataat gatgaaatca cacaacacaa 552000
 agatactttg cttttgaaa tcaatgcttt cagggttaga cttggaaact gaaagaaaag 552060

 agaatcctga atatcaacat catctatat cccttgacca tcatctgtgc cacatcactg 552120
 tgacagcagc aagtatgctg cagacagtca ctgaggaatc cacctgtgtc ccctagcaca 552180
 gatccttcaa gtcttgaat ctgttatac ttccataat cagtggtaga cgtttacaca 552240
 tcaggagatg cccttctaca ctgatagtga tgttgctaga cactcttgag ctcatgagg 552300
 tatgcaaact accacactgc agtcaactct gccgctgatt cattttgcca ggagcaagaa 552360
 ctgagactct caagcatcta atgagattaa gtcacatatg gcagcacaca cctgttatat 552420
 gagcactttg gagatagaga caggaggatc tggagtcca tgaaacactg ataaatattg 552480

 actagggcac atcacactct gctgcactag cccttgactt ggatttggtc atgtgactaa 552540
 cactaagtgg aatgctcaca aatgtgcatg ctgctaatec ctggggttct tgtttgcatc 552600
 cctgtagtcc tggatagaaa atacatgaag atgttagttc tcaaaggaa gaggctataa 552660
 aaacaaacta taactcacac tcagcctgac tccaagtca actgaccta gccaaagatc 552720
 agttgcttgt cagctgacct cataagcaaa gactacatac tatgtttagc tcaactgaagg 552780
 gtatgtatat gttcatgtgt tggagattgg gagggtgagt gtcattgtga ggtggccaca 552840
 gatacatgca catgtttgta catgtgaata tgaagccaa aggacaaact tggttgttgg 552900

gcattgttcc tcgggagtca ctgtcaactt ccttggtttt gtttgtttgt tttttgtttg 552960
 tatgttcatt tgittggttg gttttgaaa caggatctcc ttactgagac attcccatga 553020
 ctgttaatth catagaatta ctctagcagc attttatgac catattacct atcaggtgtg 553080
 cgtcctatga catccataac catgccatta ttatgacagc cacaataaac ttcacattaa 553140
 agaagtcac actaagtgat agaacacttg cctagcacac tcaaagttcc tgggttcatt 553200
 tccagtagaa gggagagagg ggtgaggag ggagggagag agggagaggg gagggagggg 553260
 aaagaaaaaa ggaagagaag agagagaatg gaaggagtga gggacaaagg aagagaagaa 553320

agaaaggagg gaagaagtca tgtttcataa tcagagaata ctaacaagaa tggagctgaa 553380
 catacataat gtagatatta gaggaaaaac atagggtta acaacactga ttttgttaca 553440
 aataaatgaa gtccttttca gtatatagta ttgttatatc tgctttggag atcataaatc 553500
 aggcacagca attaaccagg aagtggcaaa aatgggattt ctgctgagat ttggttctaa 553560
 atacctgtg ccaccagtaa gtaagggtg tctcaaatat tctaagagc agatgcacaa 553620
 agttgtctc acagtttatg ggatgtcaga tatcattcag aaattagagg gcttttagcaa 553680
 gagcctgtgg gtcacttcaa gatactatgc cactcactta ggtagcceta ctcccccctt 553740

gaaacatct aaaagtaggt tgaagaatc ctaataatat tttctgatga aagttctaga 553800
 gcctggatac agtggagat cttcactaag aagagctcaa aacactcacc ctcaagacat 553860
 gaactaataa cagtccttgc caaatggcaa ctagagtttt tccatggaca ttgccttgtg 553920
 aaaattgtct atatttaaaa cacatgatct gcagctgatt caggcatggg tgataacctg 553980
 atcattggat gcttggcctt atgtaaaact tattgtcccc aagtcaatag agcattgtag 554040
 agttgtttca cttaggattt ttacagagaa tacaattgc atgggttacc tattctctag 554100
 ttcaaacatt tggaagtgat aacatccctt gtagagattc tcctgttttc catccatgta 554160

acatccttac tcatcagaga gttggagggt ttctaagttt ggccccatct gggatttgaa 554220
 aggaagaata ttgaaagcat tctgggcaag agtatcgag ttttgactgc caaatgaagc 554280
 tttcagtatg caaatgata cctttttccc ttctgttcc attatgggac aatccatgca 554340
 cagagaaata aacttagtat ccatccttga ggccaaaaag ataaagctta atctaagtga 554400
 caccaattht aagctgctct caagatagca gttcaaagt gtgttttaaa agcagggtga 554460
 ctgaagatth caggttggga aataaatcat tgagaagtac ttaggcaaga acatagtgtt 554520
 ggagggtttg gttagggttg agccattcca caagacatat gtgtgggata actttcagct 554580

gaatgatttg aaattctcaa atcagaagtt tcactgtta caaattatgt acaaaccatt 554640
 tatagatcct acagcttctt attgaattat gctaattttc acaaatat tatataactg 554700
 tatcagtaga tgcaattaac atgatgtagt atagaaacaa ctcaaacatg ccatcatctc 554760

accccgcctg aatatcctaac aaaactggaa ttcaggaag agtttcagag aaattaaaat 554820
 atacatgaga agaactctac caccagagtt cttaggttca ttggttcaag ttcaaatcac 554880
 cagcacccat tcaaatggca gatagatata aagatctgct tgtaatcca gcactcctaa 554940
 aacagaaaca ggggggttct gaaccaagat ggttagccag agtagcagaa acagcaaact 555000

 ctgggttcaa caagaaggaa gacaactgat atgtgacctc tacatgcata ctttcatgct 555060
 tgacatgtac ccacaccag caggacacac atacaaaca gcacaaacac catacataca 555120
 actctacccc tcaaaaatta ctctctacc tctctcaga tcccatttat tcttgtgttt 555180
 aaatatatgt aaataattct gagttttata gtctttgtaa tgagtattga tacttacaat 555240
 ttttagactc caatttgaga tgtcttatgt ttttacaat ataaatttta aaagttgggtg 555300
 gtgtattctc ctgggtttg taatgctgga ggaattaatg caagaagtat gttctctct 555360
 tcaaaagact ggacatttct atttcaagaa tagcagatgc acaaaacaac taaagaacaa 555420

 aatacagttg ctctgtttga tcacatggag caaaggaatg gttttggcca gtctagcatg 555480
 atgaaggccg tgacaacatg cttcagccca tattcccctt gtttgaatat tagtgctaat 555540
 gacaaggaat caatctggaa agaacatttt acttttacta caaaccttta ccatcttct 555600
 accactttcc atgggaatga catcattggg gaaattata tgtaataatc atttctttat 555660
 tgtagacaga agtttctgct ctgctcaggt cctgcagttg tttagtcca aataaacaca 555720
 cagaggctta tcttaataat aaactgtttg gtcaatggct cagacttctt attggetagc 555780
 tctctctctt aattattaac ccatttctat taatatatgt atctccacgt agtcttgact 555840

 tgctggtgtt gtctcttct tctcagtag ctacatgggtg tctccttgac tetgectact 555900
 acctttcttt atccttgttt ggatttccca catgggtaaa tcttgcctgt cactggctg 555960
 aaacagtttt attcatcaac cagtaagaga aacatatatt tacaccatc actttaagcc 556020
 ttcacagtat atgtaaagtc aacctgaaa gccagtgtt tgccttcaa gtatttgaa 556080
 aatatacagg cttttcaggt cacgtgatca atgtgacttt ataaggcatc tgaataaaa 556140
 gccagtccag gatggcttct gcttgacact ggaatctgct cctgtgcaga aactaagca 556200
 gtctgtgaaa agtctttctt ccctgcttct cgttttctca ctacttctc cctccccga 556260

 ggtcctggat ttactctgca gcttctgat acatttccac ccaattgat ataggagtcc 556320
 ctcttcagaa tgcactaaa gactcctctg atccaaaact cagacaggaa gaattaata 556380
 atcaaagga gagataacca catgctaatt tttcacctca aattaggatg tctgagaagc 556440
 atgttgatcc ttctagaacc ttcttttggc tacacagtga tgtaagctg tactataatt 556500
 tggacttgaa atgactcctg aaaagtccct gtggaaagcc tttatctcca gtccagtgat 556560
 atgggaatgg gtgaacctct aagatattca gcctattggg acatggtgag ttgttgaaga 556620

actggctctc taaagagata atgagacttc cacctccatc ccttctacc tttgactccc 556680

tgagcaccaa agtggcagtt ctctcattct ttcatactct ctgccatgtg ttgccacagg 556740

ccctaagtat tagcaaatac ctgaagcctc ttctctttgt aggttgctca ttaatttcat 556800

ttgttacatc aagctttgta cacaaaggca ggactcttcc cattctactg ctgctttctt 556860

ttgggagagc aagccatgac ctcatgacta cactatctaa cagttagcaa aatcagacac 556920

tttgctcttg ggattgctat gtttccaggt gcagagtctt ccatatttgc agaacaacat 556980

acatcatgat ctctatgac accatccagt gtctgtctaa agctgttttt ttgacgttta 557040

gatttctagt cttaaaacac acctaaaatt aaattttga aaagtttga atctctgaa 557100

aatttcccat ataacaaaag cagagttcac aaaaaacagt tgactttgga gtagatccct 557160

atnttaagat ttcattctat tcaaaaacat caaactgaaa aaagaattat gactgagggc 557220

tgaaatttaa attaccctat actttcaaaa acaacttctg gtgtgaggtg ggagataaga 557280

tataactta tcaagagatt ccatttttac attggctctat gctattggga gctaaagggc 557340

ttcttttaaa ttggaacaa gtaagataaa atagttgta ttcttatttt tgaagtcctt 557400

gaagggcaga tcaaatgaag cttatccatg gtaataatga ttgatgagtt tcatctaata 557460

atnttaaat agatgcaaac agcagtgaag ctccagttcg gggaaggca tttggaagag 557520

gcacaaatag tgtcaattag cagcatttca gacgaggat cttactcta gcattgtata 557580

aaggaagggg gttaatgttt taattttcaa ctctctcgtg ttcatctcag ctgtatcaat 557640

tagaaatcgt ggatactcta aaatttagtt agtttataag aaattcaaat ctactgcat 557700

aaaatgggta ctgtctaat tccttctttt cactcttgat tttaaattct atgaggttag 557760

agacctcgtc tciggttctt ttttgttgia aacgtgttca gcataatgct tggctctcgc 557820

taaatgaaga ctggctatga ctgaaagaat gaagccattt agcattcagt ggattgatgt 557880

gaaaatctcc agtgggtgcag gtgttgttct tgttgtacag gggcaatggt gggaagacag 557940

gaaaaatacc ctctctttgt ggagtttata ttctttctga tgaggaaaa atttcaaac 558000

aaataataaa atgatacaaa aacaaaatct tagttggaga ggaggatgga gtattagttg 558060

ttgggtgac agaaagggtg gagtattagt tgttgggtg acagggagga tggagtgtta 558120

cttgctgggg tgaaggag gatagattat taattgttg ggtgacaggg aggatgaaat 558180

attagttgat ggagtgcacat tgaggatgga gtattagttg ttgggatgaa aagaagtatt 558240

tttgttgaa tttcagaaa aggtgacttt ggtaagaaga taactttcaa ggggatct 558300

ggagaaaggg gcctgctccc caaagtacag tcatagaaga aatcctctac acagcaagtg 558360

cagaaaatgc caagactctg aagaggaggg aacttgaaga acatagtata gtggccaatg 558420
 tgacaaactg caaacaatca gaaggaagga aggaaggaag gaaggaagga gggagggagg 558480
 gagggaggaa ggaaggaagg aaggaaggaa agaaggaagg aaggaaggga agatgacatc 558540
 agagaggag ataggaggga ggggtcatcc aagacctgtt acttaaaaca gagactctta 558600
 ctttcattct gagatgcaga aaggttctga gaaaaaatg acatcacgtg acttatttct 558660
 gaacagggtc actctgtgct gttataacac taggtgagca agggcagaat caaaatatag 558720
 atggctcata tigtacaagc acagacctgg tactgaatca ccttagtgac taaaggggag 558780

 ctattaagag tctcagagga aatggttga cctgccaac agacataaat ggaggacctg 558840
 ggttgacacc tccttcatgg agcccagagt caggcagcag aatgaagtga gcaacagtta 558900
 atgaaaagaa gagaaatccc ttctctgag gacttactca agctaactcc agaagctacc 558960
 ctatttaaca ttctgcctt gtgccaccag ctgtcacaca cttaatggca aggcattaaa 559020
 tggttgtaag gaagctggga attcagattt taccgagatg gctgtattga aatttcacag 559080
 cacggctatc aaagagcagc tatttacacc aacatcttc aacaaaatac acagtgctct 559140
 ttatacaaac cctggatctg ttttcttgag gaaaagctaa aagcttcata aatgtgaca 559200

 aaactcatga ctttgattaa atttctctc aaaacacaat aattagacat caactgagac 559260
 tctgtcccag agaagtaact gattccactt ttacttctgg gataaaaca ataaacaac 559320
 acaaaacctg gacagtggga tagaatgtgt ttccagtggc ctccacttgg caaacaagca 559380
 gctgagcagt cagtaacctc ccttctctt cctccactc acatgttggga agtattccat 559440
 tcttgggact gcccttgctt gtttctgct ctgagaagcg ttgcaggatt catccccagc 559500
 agttacctga gcatctgttt tgtctattg tcagtggtaa ttaccagga gaagtcaaat 559560
 acacattgat ttcttcggcg cttactttcg agtacttggt gagtttaaga gaggaagacg 559620

 agaagccaaa gaagagtgc ccatcttctt aaactgectc tatcagtgat ctccagtgag 559680
 ggaaaatgga caacaactg gaatctattc cccactaca gtatgtgaat tgttgtctct 559740
 tatgtagtac taagcaaagg gaagatggga gaccaacggc ttgttctgga gtttttggg 559800
 gcttatactg gaaatttga cattgtaaat aaaatagaag ccaagactat caaggttttc 559860
 tcatttttaa agtatcttct aacacctttt aagttttgtt attatttttg tccccacagt 559920
 gacttcagtt tttccagtgt ctccattgtt tggggcaact acttttgaga caatgctcat 559980
 gacagttggc tcgctggaac aatgagagc tattcctggt tgggggagaa ggttttctg 560040

 gttctgtttt gttacctct cttcttctag acaaggaata gaggtcagag ttaatactag 560100
 agtcagaaac agcactacc tctatagagt tcttaaatga atgacctct gtcataggag 560160
 aggctctgtg tcttcattgc ctcaactac tctgttactt acaggccaaa gtagtagtac 560220

aggtacagca tggagctgtc atgattctgg gcaaatgcaa agtttacttg cagtccagat 560280
 tctaacaga aagaattct tccagtcaca agatcttttg aatctattcc atctgttaaa 560340
 agccatgaga agagttaagt tgcacagcc cagaattctc accaaggcag aaaacataaa 560400
 cacacaactc agcttagagg ctcatgctcc ataccctat attatgggat gaccttgtgt 560460

 actaggcaga atttaaatga gtatgaaaat aaatattgta ttttagaaca aaagtttaaa 560520
 acataatgtc agaagaccgc ttatctctag gacaaaacaa tgaaggacat aaagcaataa 560580
 tccagattga ttagacatgt tcctaacac tttcaacct atcccctaga aacagaagag 560640
 actggtaaca gaaactgctt tgtatattgt atgttctttt ctaccataag atgtatgctg 560700
 catatgtata ctttcttaaa gattttccca tcatattcag caggaatta agccacaaat 560760
 gaattctaaa tgggttctc tgtatctcta ctgataaatt aagattccct ccacagtata 560820
 caaaaagcca tctttagaaa gatggctgcc ttagtggttc ctattcttgg aagtgtacac 560880

 ctctagaaag gcctttgaca tgctgctatg aattcaatta ttttttctc cctgtggttg 560940
 tttgaaagaa ggtggcacc aaagggagtg gcactattag gaggttgtagc ctgttggag 561000
 taggtgtgct ctgttggag gacttgagtc actgtggagg tgggatttga ggtctcatat 561060
 atgctcaagc ctcaaccagt gaaagttcac tttctgtgt ctgcatgata cagaactctc 561120
 agatccttct ccagtacat atctgctgc atgcagctat ggttcccacc atgatgataa 561180
 tgtactgaac ctctgaacta taagetacca ccatgaaatg ttttcttta aaatagtgc 561240
 catggtcata ggttctcttc acggcaatag aaacccaac taagacattc cccttgatat 561300

 gggctgtcct tgttgcattg cttatcaagc caatggcatg aagaagtgtg acttgagaaa 561360
 tttccttcta gaatgcctgg atcttcttct cttatcctgt tgctgccctg acaagtaagg 561420
 aagtctggcc tcctggggt tgcacacga ggaaagagac tttatgggat aggcccaatg 561480
 atctctattg aggccctcaga tgtgttcag agactacatt caaacagtgc attttcagcc 561540
 aactcaccaa cttacaggag ccctatcaca gacactatgc agtcgtatag aaatacagcc 561600
 tatgcaagaa acctacctta aagcagcctt gatccacata ccccttctt actttagta 561660
 tgttcaacat ataatacat gattcagaaa agactccatg tactctgaag gaaggagcca 561720

 ccctagaagg accatagctt ctcttagta gaggacagtt ggttgtatcc catacctgtt 561780
 cccctcctc tgaagagagc atctggcaaa gagctgggtt gcttgggaagc aggtgctttg 561840
 gggccaggcc ttgcctctaa ttaattttct gcttctaggt ccaccaagat tgaacaaac 561900
 cataaaataa tctccccag catgggtgaa gccgctgcag cttgcatgcc ttccccacca 561960
 tgatggactg tgcctcgaa actgtcactc aaaataaatc ctttctcccc tgagttgttt 562020
 ctgtcagtgt ttgccacag tgataaagaa agtcactaat gcacatacaa atccagtttg 562080

caaagcctaa gccagttata taaaagggaa cgtttgaggg ctagagaggt ggggtcggca 562140

 gctcttagag aggtcctgcc ttgagttccc tgcacctata ttgagtgacc cacaacttcc 562200
 tgtaactcca ggtccaagaa atccaccccc tcttctggcc tttgtgaaca cetccacaca 562260
 tgtggaattc acacacacgt acacacttta caaaaacaaa tcattaacaa actgaactca 562320
 ggaacaagca gtgagcaaac agctttcttt ttccacatgg ttcatcacc caacctttct 562380
 ctacggctct gtagagcact gggttcaaat tctgtggatt ctagatcata ctcagacatt 562440
 ttaattttta attccatgct ctgagttcat tcatgacttc actcctatth taagtctctg 562500
 gtctatgtgt tctagaatcc atgctaaaat ttcaccccag ccgttgttgt ggacaactgc 562560

 cctgtgcadc aaaggcagct tagcagcgtg tctctgttta ttgagttgat cccagiatga 562620
 ctttccccag ttgagcaac caaatataca tatgttatca aaatttctct tgggatacaa 562680
 aatgtcccc acttaagatt tattgtctca gaaacagcat tcttaatagg ggtgatattg 562740
 ccctcgaag gacaaagggc tggtaggaat gcaaacattt ctacagctgc ccagtgatgt 562800
 gttgccctc aaaaggccaa agcatatagc atacaatgaa tccatagcac ataatagaaga 562860
 gcaaagagga gaaagcagtt aggggtaaag gtacagacagg tcttgtggag aacagaaatg 562920
 ataatgcag gacaaacgtt gcttttaggg caacggtagg atgcaaggct tgcttcttct 562980

 tctgtctccc tctttactc agcagtaagg caagaaatgg aaggcaaagt ctgtttcca 563040
 ctcttgttat atagtcccg tttactggta aagtcctct gctatgacta ctgtctgaag 563100
 gcatgtctca ctgaaatggt aacctgggtg gcacttcaca ggtcctcact ctatactact 563160
 ctgaagctga taatataacc tctaagtaact ctcataggt taaccaaac acaactctct 563220
 tctacaagcc catggctctt aaagatthtt cttaaatgtg gttatthaaa gatggctttg 563280
 atgtgactac tcatthcaa tccaggaact aagaagtagt ccaagagatg atthcactct 563340
 acccagctgt ctacacaata tctgtgcctt gaaacttcac aaggagcct gagthtaag 563400

 gtgattgatc aatcagctctg gtagaaaaat thtaaaaaga accagagtca aactacagtg 563460
 tggthactaa gatctctgt tagccaggtt tatatgagac cagaaagact tgacagtht 563520
 gcagthtgg tcatagaagcc agtgcaaatg tgccggtaga gaaggaaaag aatthgaaga 563580
 gacaththtt aacctggggc tggagagaca gctcagcagc caagagthgt tagthtctt 563640
 gcagaagact aaagthcagt tcttagcacc cacagthgt gactcacaac tgctctaac 563700
 tccagctcca ggacctctgc aagcaccagt agacatgtgc acatcccc cacacctatg 563760
 catacacaca tacagthaat gaaaaataa gaaatgaaaa thtaaaaaa aaaagaaagc 563820

caggcacagt agtgcattgca tttaatccca gaattttctc aggagtcaca ggcaggtaga 563880
 tctctgtgag ttgaaactg gccttattta catagcacag tgtttcttaa ccttcctaat 563940
 gctgaattct ttaatacaga tctctctttt gtggtgacct ccaaccatta aagtgttagt 564000
 tgctactggt atgaattttc caaatagtca taggcaactt ttgtgaaaga gtcctttggc 564060
 cagcttgcca aagggtcat ggcccataag ttgaaaacca ctgatataga gagtttcata 564120
 cctatcagga ctatgttgta agaccctgtc tcaaatgatg ataataataa ctgaaagaaa 564180
 aaaaggagct atgtatacca caggaaagat accttgagta aacctgagga attatttga 564240

 gtccaaattt tgccatatca agtacatgga agagtaaact cattagaaag gcttttcctt 564300
 gagaagagag aacctgttgg gtattctgca taaacacagc ttcttaggaa cttccctagg 564360
 actcacttta caaggttcag ctgcttgggc tctcagaagc tgccacagct gtggtttatg 564420
 gaggctcagc tactactcaa gcctgtcata gacttcagca ttgaaagtat aaagccagtt 564480
 ttatggatgt atatggaatg taacagaagc ttctaccagg atttgaaacc caagcaagag 564540
 aggccaggca gtatgtggca gggttagaat tataatggct actctctaac actgtgatgt 564600
 acaaagctgt gagaataaag acaaagtcac aggggagact ccattgtatt gaagattttt 564660

 ggaaacctag gcgtctacc aagaagctct ttgggcagtc aacagaaatg gcccaagaga 564720
 gaggccatat ggactgcaaa tggcaacaat gcaggagcaa ggctgccag gcacactaaa 564780
 gctcacatca tgacaacaaa tgcatgaaca caaacatgg agctacagga tttatgtgcc 564840
 ctttctgtt tccagtctc tgttgactca atccttctt ttaatctcat attcttcctt 564900
 tttggaatag gaatgcctaa tctgaagtat ctacttctg gggttatgta acttgttttc 564960
 tcagttttac agatgatcac agttaaact gaaccttgac tttataataa ctagagctgg 565020
 tgaactatt aagcactctt ggagatgatt aaatgtattt ctatcttgag atggatatga 565080

 gtcttttggg ggcagaggt ggtctattat ggttaaagga tgaagtgtct cactaaagaa 565140
 cttgaattaa aagctctggg ccctacctag tggtgctata tttggacatt agagaagtct 565200
 ctagaagata aaatcttgat ggagatgca gaacctggg tggttcttg tgggcatctt 565260
 gttcctaate ccttcttacc cctctgattc ttagctgcca tgaggagaac ggatcttacc 565320
 atgtgttctt gccaccacgg tgcctgcct cacataacc cagaaacaca gagacatgtg 565380
 gccatcacca aaacttcaga aactgtgaac taaaacagtg tctcttatt tagtttgttt 565440
 tgtgagtatt ttggttgcaa caatgaataa ttacatggaa taggaaaaca aagttgacag 565500

 ttaagccata tttattaag cattgttaga atctatctac aacctctctg aacaaccctt 565560
 tgacttaatt tgagaacaaa attaaaattt tctgaaaagc aaaaaaaaaa ggacaatagt 565620
 catcaaatgc ctatttttat agccaatttg tcagtcttgg gtccatatgg aaagaagaga 565680

attttagcca atgttttcca gttgggaaga aaactgggag ttattatgag tctgctacct 565740
 cactaataca ctttcattca ttcgtgaaca ttaataagc acctgcgagc acaggtgctc 565800
 acagctctag acaacaagaa aggcaaagcc tgaaacatg gagaatagtc taacaagaag 565860
 catcaccaac aaataattaa ttccacattg taaaaagtgt tactgaaaca ctcaattaag 565920

 agtggctggg gtgagtaagt gtgggtttgt attgagtgg catagagggg atcttcatgg 565980
 aggaatcadc tcaggcagac ttgagaagac ctcgaggagga aagagtgcaa tgaaaggttg 566040
 aacaaatctg acaaccaagg tatagagatg ggctggctgg gttctggaga gaatgaagtc 566100
 tttgtgcttg ttcttggat gtggagaatg ctgtgagtct ggagagacag aaaagcaaag 566160
 gagaagatgt tccccagtag ttcttgggaa tagcataaag ttctgtttcc agtgtgatag 566220
 tcaactccagt catagagggc tccactgctc ccatgtgctc actgccattg ttcaaatgca 566280
 tgaaaatttc gaaaatgacg tagacattca ttgaacaaat tactagctat ctagccactc 566340

 tccattatga ggatggtgac atctgttgat aacaaaagcc cttatgtctg aaaatatcag 566400
 acaccagagc ctgcttgact ccccttgggt gtgttgctat tctatcttgt tataaggaga 566460
 cataaaaaatt tgcaaaaggaa aaatttatgt agggattcct tacatgtcct ttctgaaagg 566520
 aatgaattct gtttatagtg ggcagagttg agtgtacttg atggtgcaag cagagaaacc 566580
 agattccagc cccaggcaag tggctcttgc agtgtggaag gctcagaagc acggggtctg 566640
 atctctcctg agatgctgca tatttacatt tcaaatcact ctaagtggaa caagatttgt 566700
 accttatcac ctcccgaagc atagattttt ttccaatcg aggtataaa tacagttact 566760

 cctaatgatg taaattgaaa gcaggctgtt tttactggct gctgccaaaa tcatcatgaa 566820
 gctaccttta acttactatc agaggcttat ttaccataat tgactttctc actgttttat 566880
 ctgtctttg acctggagc cccaagcatg atgctcctga atttaaagga gaaagtgatt 566940
 aatgtgggga gagcagagac agccacattg gggacccag tggggacaaa gaagaagcct 567000
 gataaaatac taacagacc accatctcct cccatgttct ctttttttct gtgtctttca 567060
 gggagccctt taatgagaag tcaactgatt taaagccaaa tatatttatg ccagggtcag 567120
 agggaaatat ttacatctaa aaatgctgaa acatgaaaca ctagccacag gaaaggttac 567180

 tcagatgaaa aaagaataga agtttgatc aacataattt acataacttt tttttccttc 567240
 ccccaaaaca aattcttggc ttgagagact aatccaggta gcccttttgc tccagtctct 567300
 taatgagaca aatccaaaat tgaaagcttc tggggctctg tgtaaaatcc tctaactatg 567360
 aggaaaaaat aacaaagtaa atcagttctg agaagataga tgactggaga agagtggctg 567420
 tgagaagtta aagaacaagc ttggacttca aattccttct gtgtaggaca ttctgaatta 567480
 gaaatggaat atccggtttc taatttcttt ctcatcaaga gataatgagt actacaattc 567540

actttggttt tcaaagatca tttatatcct cctcccactt cttacctatt atctttccat 567600

tctattgccc ctgggtctg tttggaagca tattagtta ctagaatgg tgctcactcc 567660

ttctgttgag tagtaaaatt acccaaggca tggatagaga gttagtggaa gcaactgaata 567720

tattaataga aaaatggtct cagtgggtg aggagaaaag atccaggaag aaggaagaac 567780

aagacagaag catctctggc ccttgggtga ctggattaga gggaaacatg tctgtcagaa 567840

tcaccttta ttcaaagcag tcagcattat cccattttag agatgagttg gtggtaattt 567900

atcttccatc tgcacttaca aatttggatt tctactagga gccttagaat aacttgggaa 567960

aggtcttggg tttaaaacat ggctctgccg tgtagtagca aatcatgtga acccattggt 568020

tcaggttctt cacgtgtaac atgaaactgt ggcatacca tagttggaag gcaggagcct 568080

tggcccttcg aaactgcaca gaactttcca ggggctgtgc ctcatctgag cggtaaatgt 568140

ctgcccaatt ttgagccaaa caatagcaat ccacagactt gctgcatgcc cttatctgta 568200

aggagttcac aacgaactag gaatttgacc aagagaagct cgtaaggaat cttcacaatt 568260

tattaacatt ctcccatcag tgtctttata taataactaa gacttgtaa atcacaaaac 568320

caacttcaag gcaaaggata ctttctcaga attactcagg cttgggtcta ggaagatggc 568380

tcagtgttta agagcacatc aggatgttca agaagacctg aatttggttc ccagagtcca 568440

tggcaggcat cacacaactt tgtatgatgc catctccagg gggatgatgt actgccattt 568500

ttgggcaata cactcacata cacaaagcca ttagacactc acatatacac aaactaatta 568560

aacataaaaa actttttaa gacacatgta catatttata cccctgtaat acataaataa 568620

cgtgtgtgtg tgtgtgtgtg tgttctgtg tgtgtgtgtg tgtgtgtgtg ggggtgtgtg 568680

gtgtgtggtt gtgtgtgtgt gtgtgtgtgt gtgttactat gaaataacca ttataaggaa 568740

acactaagta cagaacaag gaatttcatg ttcaaatcac aatttttatt agcatattca 568800

ctaacatccc ttgggtaggg aacatgctcc ctttgatttt ttcttacaaa ataaaccaat 568860

ttgggtgcta agacaacctc atatctgggt gtatactaac cacagtgaga aacaaggaat 568920

cttcagattt atgatagttc taccctgttt gacatatagt taactagttc actatgcatt 568980

ctgaaccatc tcttttagat actatgctag tacttattgt caaataaac aaatttccag 569040

ttttaagtga aatgtctgta ctgtgtttaa tafggaaggt taatgaagaa aaaattcatt 569100

tctaaactat ttttatgcat gtgtcaaaat atctcacaca ttttactgtg tagcatatac 569160

ataggctgta ggaatcccta tagccagtgt tttgaatgga aaaacaaata ctgaccagat 569220

cattgtgagt cactggagct gagacagga gattgttctt aagaaactag actagaataa 569280

gaaacttcat tgacatgaaa ctcaatgttc cagaactaag actgaaacac agactagtct 569340
 ccaacagga agacttggat taaagacact gagtctttct cccaggcacc aaaagaactg 569400
 gtgggttcag tcaatgccac ggtggagaaa gccaatcgtc tcagtctatt gatctgaagc 569460
 taagttaagt cagtcaaagc aatcaatcct gttagtccac atgctaagtg agaacggggc 569520
 agagtcaatc actcaggaa tcacattggg gaaaaaagg cttttgtctg taatggatat 569580
 ttggcatgca agtgtctctg gcctgatcta ccctacaaca tgcattaatt caccacttaa 569640
 actaggaaga gaaggtaaaa ttaaagccac ttacttctga gggaactcac tggtttggtc 569700

 ttccgtctct atgacatata tgcacgtca catacagaca tgtccacaca ttaatcatct 569760
 gtgtcagctt gaggaaaaat tcatcattag aatggaaaat tcagcttgac atgtttttat 569820
 ttatatcttc catcagggac cttcattctc cttggggaag ttatggtcta gtttcagaac 569880
 ttggtaaaac tgacagatac acacactagc atgtatata ttaacattct caaatgggga 569940
 aaaaatgttg ctataacagt tacacatgct ttgtagattc tctgagccat taaagtagag 570000
 ctgagagcct ctgctttgta tacttatggt ggagttagtt ataaaggtcc tgaagtaatc 570060
 aagataggac cacacaggca agggcataaa acaaaatggt acagtttggg agaggtgagt 570120

 gttggatcat ccgaaacat acactgggat gggaagtaag aggacactaa gcaggagcca 570180
 tggagtggaa gaccacacag atcacactgc aaagttagtc aagatgcagc tgggccagca 570240
 ttacttatca tgagtctatg tgctgatac gagaaaatct gtgcatgttg acaaatctct 570300
 gaatgatatt aagcatttag aatgaagtca gaattaaatc atatgaaggt caacttagta 570360
 ccaagcactt agagtattg ccttatctga cataaaacag accaaagtcc tatgctgaga 570420
 aacaactgac atgagaaatt aaaaaccaag cctgtagact gcagtgagca cgcaaaactca 570480
 aacacacctg gggatgggta ttataaagt tataataaaa gtcaacattt gggctgggga 570540

 aatggetcac agggtaaagc acttgttgtg ctgaatgac cccatcattc agataaaagc 570600
 taggtatgag ttgtgtggtg gtgcctgcac tcaggaggca gaggcaagtg cagctctgag 570660
 ttcaaggcca cctgatcta cagagcaggt tccagaacag ccagggtac acagaaactc 570720
 tgtcttaaga aaacaaaca aaagetaggt ttaacagatt gtacatggaa ccccaagct 570780
 gggagccaga gacaaaagga ttctgaggg ttgctgttta gacactgcag gcagttggtg 570840
 aaagacctgt cccccaaat aaggtagaga gcaattgaag atgttacgct ctacactcca 570900
 tactacactc atacacatga gtctacacac acatacctat atatataac agagagagag 570960

 agagagttga tatttccat aagagaggga aatcaactat tcaataagaa ttattattaa 571020
 atagtttaat ttgtactatt aaataattc catgtgatat atagatata tetatattat 571080
 atataataac ttatactatt aagtaatagt ataaatgagg ccattcaata ataatgcaac 571140

aaaatcaatt agiatgaaga aaatattaat ttagattgca gccccacaac tggagctaga 571200
 aaatttcata ctatatttat aaactacaga tagttttggt gtacatatgt gagaagaaga 571260
 aaagtgagat gttttataa cttttagtg taaaagacct ccctgagaaa gacagaaaat 571320
 ggaaatgtct acaagataac agttaccttt gaggtcataa aatttgagca tgttgttaca 571380

 atggaaagac catacaaaca aagtatacaa caaggctttg aaaggacaaa gccccaggc 571440
 aagccagggg ctgtttgcag ttccggttct gtggccctgc tcagggatat ctaatgccag 571500
 ggtatctgct gaccgatct gaaattggca gcaggatcca acacatccag aactgccaa 571560
 ggccctggta acattctgc ctccatccac tggcccaggt aggccaaggg ctgtttctag 571620
 ttccaattct tcagtctgc tcagggacat ctgacgccag ggatctgctc actagatccg 571680
 aactcggcgg caagatgcaa cacaccaga cactgctaag gccctgtaa cagtcccagc 571740
 tccatccaca agaagaggac agacatcaga atattggaac tgtttgcatc taccagaagg 571800

 gaagcttggc cccagacca ccaggagaga aagagactcc tgctacacgc accagaagaa 571860
 aggatgagaa gaggacaatg taaaagcaca ttcaacaaca gaaaaccaa tatgacaaca 571920
 aaggagacta ggaaccatac accagcaaga cctgaacatc acaatgcaga tgtttttata 571980
 attttatggt agaaaagcag aaagaatgac cgtaaaaaca tcttcatgaa aatgatagag 572040
 gacctcaaag aggacatgag aaaatccctt aaagaaatgg aagaaaaatc aaacaaaaa 572100
 gtacaagata tcaacaatc tctgaaggaa acagttcaag acctaaaaac tgaatatag 572160
 acaataaaga aagcacaatc tgaggaatg atcaggtaaa gctgggtaaa tgatcaggaa 572220

 ctacagaggt aagcataacc aacagaataa aagagatgga agagagaatc tcaggagatg 572280
 aagacacact agaagaaata gaatcatcaa caaaagaaaa tcttaagtcc aacaaatccc 572340
 taacacaaaa tatccaggaa atatgggata ccaagaaatg cccaaaccta agaataatag 572400
 atatagaaga agtgaagaa atccaactca aaggcacaga aaacatatc aacaaaatca 572460
 tagaagaaaa cttcccaac ctaaagaaaa acatgccaat gaaaatacaa gaagcctaca 572520
 gaacacaaa tagactgaac caaaaaaga tctccttgcc acataataat caaacatga 572580
 aacacacaga ataaagagaa aatattaaga gcagcaaagg aaaaagtcaa gtgacttata 572640

 aaggcaaatc tadcagaatt acacctgact ttccatgga aannnnnnnn nnnnnnnnnn 572700
 nnnnnnnnnn nnnnnnnnnn nnnnnnnnnn nnnnnnnnnn nnnnnnnnnn nnnnnnnnnn 572760
 nnnnnnnnnn nnnnnnnnnn nnnnnnnnnn nnnnnnnnnn nnnnnnnnnn nnnnnnnnnn 572820
 nnnnnnnnnn nnnnnnnnnn nnnnnnnnnn nnnnnnnnnn nnnnnnngaa ggaaaactgc 572880
 aaccgaagga agttaactac aaccataaaa agataggcaa tggataatcc cattttacca 572940
 acagccaaaa ggaaaaagga atagaatccc acacataatt tcaccagcac caccaaatcc 573000

aaaacaagaa tgaacaatca atggcatta atattcctca acattgatag tcttaacttg 573060

 cctattaaaa gacacagatt agcaaatgg ataagaagac agaatccatc tttctgatga 573120
 atacaaaaac gcacctcaac ttcaaagaca gatggtacct aagaattaaa ggttgggaaa 573180
 agatttacca atcaaatgga cccaagaaac aagcagggtt agcaatccta atatccaaca 573240
 aattgtactt taaactaag taaatcaaaa gagatgaagg aggtcacttt ctactcatca 573300
 caggagaaat ccatcaggat gaagtctcaa tttctgaacat ttatgcccga aatacaaagg 573360
 caacatggt tglaaaagaa acattgctaa aactcaaatc acacacaaaa gtgcacacac 573420
 ttgtagtggg agacttcata accccactct cacctctaga caggaacaac agacagaaaa 573480

 ttcacaaaga aacaaaggaa ctaatagaag ttatggagca actgggatta ataggiatct 573540
 atagaacatt tcatcfaat acaaaacaat ataccttctt ctcaagtcca cactgaacct 573600
 tctctaaat agaccacata cttggcaaca ggagaataat cacactatag aattaacagc 573660
 attactgaaa gctatagaac acacagaagc cagtacacc cagaggagca gacaccagta 573720
 aataatcaaa ttgagggtg aatcaataa aatggaacct aggagaaca tacaagaat 573780
 caatataatg aagagtgtgt ttttcaagaa aatcaacaag atagacaaac cettatccaa 573840
 acttaccaaa caacaaagag tgaacacaaa aatcaataaa atcaggaatg aaaagggaga 573900

 cataacaaca gacacagagg aatccagag aatcatcagg tcatacttg aaaacctata 573960
 ttctcaaaa ttgaaaatc taaaaataa actaaaataa aaaaataaaa aaattcgaaa 574020
 atataagga aatggacaat tttctagaca gaattcactt atcaaaatta aatcaagaac 574080
 agataagcaa cttaaataga cctatcactc ctaatgaaat agagcagtca tcagaagtct 574140
 cccatccaaa aaaagcccag ggccagatgg cttcagtga gaattctacc agacattcaa 574200
 ggaacagcta ataccaatc tctcaaaat attccacaca atagaagcag aagggttatt 574260
 gtcaaaactt ttttacaagg cttcaataac cttgatacce aagccatag aagacacaag 574320

 tgagaaagag aactacagac caataacct catgaacatt gatgcaaaaa ttctcaataa 574380
 aatactgcca aattgaatcc aagaacacat cagagaaatc atccaccatg atgaagtaga 574440
 cttcatccca gggatgcaaa gatggttcaa catatgaaaa tccatcagtg taatccatat 574500
 aaacagactg aggaaaaaaaa cacatgtcat ctactagat gctgaaaaag cctttgacaa 574560
 aatccaacag ccttcatga taaaggtctt tgagaaatca aggataacaa gaacatacct 574620
 caacataata aaagcaatat acagcaagcc aacagccaac atcaaatgaa atggagagaa 574680
 actcaatgca attcctctaa aattggggag aagacaaggc tgtccactct ccacatacct 574740

cttaaattt atcgttgaag gtctagctag agcaataaga gaacaaaagg agatcaaggg 574800
 aatacaaatc agaaaggaag aagtcagact ttactatatt gcagatgatg tgatagtcta 574860
 cataagtgac ctgaaaagcc ctaccaagga acacctacaa ctgataaaca ccttcagcaa 574920
 agtggcagga tacaaaatta actcaaagaa atctgtagtc ctactatgta ccgatgacac 574980
 attggtggag aataaaaatc gagaacatc actatttata attgccataa acaacataaa 575040
 ataccttggg gcaagactaa ccaaaaaagt gaaagacctg tactgtaaga attttgagtc 575100
 tctaaagaaa gaagatacct gaaaatggaa agatctccca tgctcttggg taggtaggat 575160

 ccacatagca aaaatggcaa tcttgccaaa agcaatctac agattcaatg caatccccat 575220
 caaaatacca acacaattct tcacagacct tgaaggaca atttcaact ttatacgagag 575280
 aaacaaagga cccaggatag ccaaaacaac cctgtacaat aaaggaactt ctggaggcaa 575340
 cacctccct gacatcaagc tctattacag agctatagtc ctgaaaacag cttggtattg 575400
 gcacaaaaat agactggtag accaatggaa tagagttgaa aacctgata ataatccaca 575460
 cacctacaaa cacctgattt ttgacaaaca atctaaattt atacaatgga ataaagaaaa 575520
 cacctcaac aaatggtgct ggcataaacta gatgctggca tgcagaagac tgcagataga 575580

 tccaagtcta tcactatgca caaaatttaa gacaaaatgg atcaaagacc tcaacataaa 575640
 tcagacatt ctgccctat tagaagacaa agtgggaaat acctccaat taattggtac 575700
 aggagaccaa ttctgaaca ttacaacact agcacagaca ctgagatcaa caattgataa 575760
 gtcagacctc ctgaaactga gaagcctcta taaggcaaag gacacagtca gcaatacaaa 575820
 atggcagccc acagactggg aaaagatatt caccaacccc acatctgaca gagggctaat 575880
 ctctaaaata tacaaaaact aaagaagaac taaatagaca atttcaata gaggaaacta 575940
 aaatggctga aaaacacata agaaagtgtt caacatcctt agccatcagg gaaatgcaaa 576000

 tcaaaacaac tctgagatac catcttactc ctgtcaaaat ggccacatc aaaaacacca 576060
 atgacagtgt atgctggaga ggatgtagag aaaggagaac acttctccac tgctggtggg 576120
 agtgccaact tgtacagaca ctttggaaat tagtatggtg actcctcagg aaaatgggaa 576180
 tcagtctacc acaagatcca gcaattccac tcttagacat atacccaaaa gaagcacaat 576240
 catacaaaa ggacatctgt tcaatgatgt tcatagcagc actatttgta acagccagaa 576300
 actggaagca gcctagatgc cctcaaccg aagaatggat agagaaaatg tggtagattt 576360
 acaaaatgga gtactcagca gaaaaaaaaa tggaaatctta aaatttgag gaaaatgggt 576420

 ggaactagaa gaaactattc tgagcgaggt aacccaatca caaaaagaga aacatgatat 576480
 gtactcactc atatgtggat tttagactta gtagtaagaa ttaccagcct acaatccaca 576540
 ctgccagaga agctaataaa caaggagtac ccttcgagaa acatatgtgg tcccctggag 576600

aaatggaaag ggicaagatt tccttagcaa attgggagca tgggaagatg ggggagggag 576660
 ataggagaat gagaaggaag gaggaggagg gatgcagagg acatgagga gcagaaaagt 576720
 tgagttaggg gaagaataga agataacaag aatggagata ccataataga gggagactaa 576780
 aatgtttaca gagaaatcag gcactaggga aatatctaga gatctataaa catgacacca 576840

 actaacaatc taagcaacag aggagaggct accttaaatg ccctcccctg ataatgagat 576900
 tgatgactga cttatatgta tagccctcat ccagcagctg gtggaagtag aagcagacac 576960
 ccataactaa tcaactgaact gaactggaat ccagttgcag agaaggacga gtgaagagca 577020
 aaggggttca gaccaggctg gtgaaacca ccgaaacagc tgacctgaac atcgtggagc 577080
 tcttggccc cagactgata gctgggaaac cagcatggga ctgattcaga cccaagaac 577140
 atgggtttca gtgaggaac ctcgaaatc tatgggacct cctgtagtag ttcagtactt 577200
 atccctagca taggtgtggg ctctgggaga ccattcatag gtgtgggctc tgggagacca 577260

 ttccacatag aggaatactc cctgagccaa gacacatggg gatgggccta ggcctatcc 577320
 caaaggatac aatagactct cctgacacc cctggaaggc ctcaccgtcc agggggagca 577380
 gaaaggatat gtgatatgta gggttttagt tgaggggggt ggtagggggg gagggtaggg 577440
 agaggaact gggattgca tgtaaaaca tcttgtttct aattcaaatt ttaaaaatct 577500
 ccaaaaaaaaa taaaagaagg acaaagccat ccacagtact ttcaatgaag gcataatatt 577560
 tgtactagat aaaaatctat tttggcacac ccattgatta aggaaactca aacaaccaga 577620
 taggagaggg gaaaaggcat atgatcaaga gagtcccaa gttaaacga ttgtaactt 577680

 atgaaactaa gccatcttcc tggttgtcag aggactacaa agcttttcag tagagtatta 577740
 ggcatctcta atigtgtac gaatacctca ctcaagacc acagacttg aatggatgca 577800
 gtgaggcatt gtgaatcaca ggcttgatgc tgtttttag atctctgtga ttgctcatca 577860
 cacatacctg aaacttcatg accatagagc agcaactagt tatttattgt ttttattact 577920
 cagatggcct acagttcaca aagacacata taaactacaa gcaggaagc aagatacaga 577980
 cttctgtac acattccaaa tgagcacaaa ggagcctcag gctttgtcct tttttcttct 578040
 gttgtaataa aacacctga caaaagtgat ttaggggaga aagggttct tetgactccc 578100

 agttccaggt cacaatctgt caccatgaga agtcacagta acaggatcat cagacacctg 578160
 gtcacatggc atcagaagac agcaaggacc gcatacatgc tggagctcag cttaactct 578220
 ccactttgta ccatcaaagg atcacttgc ttgggaatag cccactcac ttgggactac 578280
 ctccactcgt tcaagataat atcacttact ttgggaatag cccactcac ttgggactac 578340
 ctccactcgt tcaagataat cctccatagg cataccecca gacacttctc tcacgagatc 578400
 ctagatgctg tcaaggtaac agttaacatt aactaccaa gaaggccatc tgaggaggaa 578460

atcatagtgt ccttagggag catgggttct tttagacaga tgtccacat aactagcttg 578520

tgaggtctgt cagtagaagt tctccagtac acaccagtg aatgtcaacc tcagttttaa 578580
gaatctatgg caaattgatg cttgtcaaag tgcagaaatg tgtgcataca ttggtgttca 578640
tttataattg ttttggaat ctaaagaaag aaaaaactg aagtcaatct cacttatcac 578700
cataaaggaa ggtaagtaa atgatggcat attcatgcca tggattatta gtcagtgttt 578760
aaaaaatgaa cagagtgaac ctaaagagaa aaatatagaa aattgtagac tataaagttt 578820
ggtttttttg gtggtttttt ttttcttttt gcaagttgca aatcacagaa ccaactgtgt 578880
atthaattta gtatttaata tagtatgcat attgtggtat cttattccat atgttaacct 578940

gactgtatca tggaatgtgc agacaaagat aaagatggtt tctgggtgtt atgctgaggg 579000
agtttctgaa gagatgaact ttgagattac agatggagag aagaggattg tccttctct 579060
catgatagct caggcatgta tacctgagat caaccctgag aaccagcaa gatagcatgc 579120
tgcaaatgtg agttcttggg gctcactggc tatccagctt aatctgctg atgagttcaa 579180
ggccagtgag agaccctggc ttaaaaacca agggtcacag acagatgaca aagtgtcag 579240
gatattttga agctaccctc tgtctcttac gccacccac atgtatgcat gtacacacgg 579300
gtgactaca tggcatctgc atatatccc aacacacata cacatgcaca tgcccgcaca 579360

cccgcacaca gagagacaga gacagaaata gacagagaca gcaggtctct ttgttcagta 579420
tggatgaggc taacaagatt gctatagatt gaataggaaa aaactgtaa agatccacc 579480
tctctctgcc caactgctta aactgagcca tcctgtct cctcccacc taagtgtca 579540
tggttctcag gcaggeatct gctcattggc tctctagctc ctacccgat gcacgacagc 579600
actggccttc tcaagtctc agattgcaga cttctctgcc tccaaaatca cacaagacia 579660
ccccataaaa ccattttgta gatgtcttca ttccacagc tctatctctg cagagaacct 579720
acacatgtgt acttggatgt gtaagcaagc atacaattca gtgtatgaga atattctgat 579780

tcatacaaaa gcgggtacct agatgatgg ccaaggggca gttgcttct ctagggaaag 579840
ctgtcagagg caaaggcaga aggagggaga gtggcttagt ggcttgcttt ttctgttctc 579900
tgaacagttt gactcagcta caatgagaat gcatcttaca actgtaagta ttatactcat 579960
atatgtaaga ccatcaaat actacacaca ttaccttta gaactcaagt cagtgtcacc 580020
tctgagcata tcatctgaaa gacccaagtg tgaggaatca gccttatctc aggaacagca 580080
ttttatgtgg aatttgaatt gacttttaa attacctaatt ttttcagttt gaaacatttg 580140
acctctgggt ttcagccagc gtccttgca tctctttagt cgaaattgt gctttgcttt 580200

aagtaggact cttagaagca catggggaat gcaggttagc tcacttgta aacatagaat 580260
ggcctgagcc aaaagccatg agcataatcc tctctatatt tttcaagcca gctcatcatt 580320
tgcaatccac attcccttac atagttacgg tgttttcttt cacatcctgc aacactgatt 580380
ctgaaagggtg aagggtgagg cgaggcattta aggtgcaaga tgactgagcc tatctctata 580440
aagggtatatt tatttgccat aaaaagctgc cataaacatg aactgtggtta cttagcatat 580500
gataaagaat ttaaagataa cttagaaatg taacaaaaac ctttgtactg ccaaataattt 580560
ccccatagtt aacagaacaa cagctcagag gaaaactttt ggtagcttaa ttaagagaat 580620

tccatctaga tgggtgcatg ccttgagaag gctgcatctg caaataggta cactctctgc 580680
cttgggaggt gtiaccacag aaagaacacc aactctccag cacaaatcta tctgatctaa 580740
ttcccactaa gtttctgac acatttcca gtagtctcaa tataatatt gagacatggt 580800
ttctttgtat aactttgtaa accaggctta cctcaaactc acatagatct gcctgcctct 580860
gcctcccagag tgctgagatt aaagggtgtt ggccccagca cccagcttaa atagatataa 580920
ttttcaacat tatgcactca ccaaattaac accttagaa tattttcacc caggagtaaa 580980
agcaaatgga agctccatct ccattcattc ctattcttac atagggtgtc tggagaacgg 581040

aatggtgctt tgcaaaagtg gtgtgtatatt ttctgagata actgggcatg ctttcgttta 581100
cctgcctgac atagctctt cctggcctcc tagaagacaa tgaaccattg tttttcaggt 581160
gacaagaata tactcactga atttggggga acctaataaa gcaataaaag tctcactga 581220
tggcagtcaa aactctgca ctctgggtgg agttggagtc aattggtatt ttaccttag 581280
ttccaattat taatttgact tttgggtgga cattcagtgt gagattacag ttcagacaaa 581340
gagtttcata ggtaattag agtccctcat atcctttaga ggagacttcc ccaccacat 581400
tagctgtagg cagagtctg tacttccctt tcccatgtg acaaagatcc cagaaaatgc 581460

aaataactgg acatattttt aggatttatg tatttattat gaacacagtg ttctacctgc 581520
atgacagaag agggaagcag atctcattac agatgattgt gagccacat gtggttgctg 581580
ggaattgaac tcagaacttc tgaagagca gtcattgctc tttacctctg agctatctct 581640
ccaggcctca tgaccttca ttttttaag atctattcta attctgtagc ctaagetggc 581700
ctcaaaactg tagccatcct cctgcctcag cctcccaaaa ctaagattac aggtgtgagc 581760
caccatagca ggctgacatt ttaaattttt taatatatta ctgggtatatt ctacataaat 581820
actattgaca gcacagcata aatttttaat tcattttctg ttctatctta atctttggct 581880

gaccttgtct ggtatagctt aaccacatcc aaactcttca gaacaaaatg tactgttact 581940
gaatgttaca aagaggccct ttgtttcccc tgcaatctga aacaccacgt tccagagatc 582000
aagactgcag agcaaagtga atattcacac attctcagtt gtttcaggct atttcctcca 582060

aaaggccaag acitaaata ctcccaggca aaaatgagat ggctatctgg gtggccaac 582120
 agggaaagat ggggtgtacag aaagcaacc atgtactgcc tacctaatta ttccaaagag 582180
 aaatttaaaa atggtaagtt cacaccacta tactgtttaa tcaaggattg gtaccgtttc 582240
 atatccaggg ccagtctgaa tcgccaggag cctgtattgt gtcagggtgc caggcaacaa 582300

 acctggctgg tgtcttgaaa agtcaaggga aatgacgaca tactgtttaa cccacattct 582360
 tgacacagat gggaaaaatct ggcagagctg aggttatccg tcagccctgg ggagagcagg 582420
 tccccattt tgctttcacc tggctctctc aacatatgct tctgatgcgg catcaaagcc 582480
 agaaaagcac atctgaaaa gaaaggtcta tcacattcca cacttctttt gaaacatcaa 582540
 aaagccacac aaagaagcaa tcggactaga aaacctgacg aggagcggca tagtgtgggt 582600
 gagaatgtag cagtactgag aggtgaacca acgggtggct catgaaaagg caagagaaaa 582660
 ccagaaatgc gtgctgatga gatgaaaccg cccacagctg tgtcatgcta atcaaaagtt 582720

 aatttcagct ctacacact ggtcatggtt cctcacagtt gaacggcca gagctcactc 582780
 actgtgcagc atcacctgcc aaggctggat ctatttaca gctcccagaa tccagagaga 582840
 agcgcaggga aagacgtat gcctggaaga tctcacagg ttaagaatat gtgtggtcct 582900
 gttggacagt gaccgcagaa tccttgcaaa ctccagcttt ggacttcgag taaaccctaa 582960
 aactattcag atcttcctc aggtcctcta caaaggcagc acactcctc aactactgag 583020
 ccatctatct atcagctcc tgtaaaactt tttttttttt aattgagtca gagctggaaa 583080
 ggtagctcag caggtaaagat tatctgctgg gcagtcatga agacctgagt tcatactta 583140

 acactcattt caaaagctgc acatggccat ctacacctgt aactctagtt ctgtgtaagt 583200
 gctgtgagga ggggtgagac aggaagtggg tggagacagg aggacaaggg gagactggag 583260
 gccagttag acaggaagta actggagaca ggtgagttaga gacaggaggg ggtgaagaca 583320
 ggagggggct ggagacagga ggggctatag acaggaaggg ggtggagaca ggaggggtgg 583380
 aaacaggagg gggctggaga caggagggtt ggagacagaa aggggtggag acaagagggg 583440
 gtggagacag ggggctggta gagacaggag gtgggttagag acaggagggg ggtggagaca 583500
 ggagggagggt ggagatagga agggcgagg aaaagtgggg tggagacagg aggggagtgg 583560

 agacaggagg gggctggaga caggaagtga ctagagacag gagatgagt gagacaggag 583620
 gtgggtggag acaggagggg gtggagacaa gattggtgga gatagaaggg gctggagaca 583680
 ggaggtgggt ggagacagga agcactctgg gacaggagg ctgcctgtca agctccaggt 583740
 tcagtgaag aactgaatg aaaggaatga gacagagtt tagagcagga cacccaatat 583800
 cctcctcggg ctcacacaca cacattcaca cacatacata cacacacat gtatattcca 583860
 cattcacaag catgtgtaca tcacattcac acaaacatgc acactgtac atacatacat 583920

acacatgtac gcatatcatc cttataacaac ttcacactca cattcatgga cacacacgtg 583980

 ctcatgtgca catacgccat atacatacac acatattcac acgcacacat atcatgcgta 584040
 gtccacatte acacaccatg tgcacaccac attcacataa acatatacat acatgtgtac 584100
 aggcatatac acaatataca catatcatcc gtgtataact tcacatacac atacatggac 584160
 atacatgtgc tcatgtgcac atacaccata tacatacaca catattcaca tacacataac 584220
 ataccagaag tactccacat ttatgcacca tgtgtgcacc acattcacag aaacatatgc 584280
 acacacatac acatacatat acacacatcc atgcatatca tccatataca acttcacaca 584340
 catgcatcca cacacatgtg ctcatgtgca catacacaaa acacacacac acacacacac 584400

 cacattcatt cacacacaca gaaagagaga gagaataaag tcatgacact tagttttcaa 584460
 ctgttatttc ctaaaacat aaatccaaac tgcgtgttac atagaagggt cctggaggaa 584520
 tcttgtacag tgggttttaa gaaatacaag ctgaaaacaa aaatccaatc attttccaca 584580
 agtgtctatt attggccctc ttgtaccctg gcctcattaa aagccatagg ggccatttca 584640
 gccacaatgt aatagggccca caaagacat gggatttga ggatctagta aaacctagct 584700
 atgacctca gctttgccac aaatgaattc attgtaagca agacacttac aggccattat 584760
 ctctgctgg ctacagtga agctgccttg cctgtccga cttaccttac agaggatcac 584820

 aagcagatga ggaaaacttt gcacatttta caggaagata ttattagaca cggcaatgcc 584880
 tacctatatic caacaatgaa gccgttcagt aactggctg attccatgaa aaatttattt 584940
 ataatgcaaa gtgacgaaac tttgtgatat gattttattt caactaatat attctatgat 585000
 ttgtatcact gtatcacagt gtccitaaaa ttgcatgacc tgtgcttcac attatcagtg 585060
 gtccctgtg acaacttctg ttgctcactg tgctcttgtt cctggacttc tggccttcca 585120
 ttgtgtttgg agtctcattc ttacagaggt atttgtctca gctgtctggt gggctctctgc 585180
 tgctgagca cctacctcta tctgetgcag cctgccaac atcatggggg cggacagaca 585240

 tggcgaggct tggcctga gggacatggt ggcacattct cttcagtaga gccacctggt 585300
 ctttgtagct acaggaaaca ctgctctgca gactcatcac acacaatgat gtccagtggc 585360
 acaccattca gatgaactta ttctcacaag caactggttc agaggctgtg atgcggagtg 585420
 catgctggtc ctaccatgcc cctgccagct gatctctct tctccatgt gggggaacta 585480
 ttgaagagct ctacttacc aaagccttcc ccttagggag tatccaggtg attcaatctg 585540
 cttccttttt ttcaaaaaga cttcatttct ctaagaaaaa tttactcctg gctttgattt 585600
 ggtaagggag atggtaagtt cagtccagcc agaaaacgaa caaccaaaaa caacaatcta 585660

agagttatta ctatgcaatc agtttagtca gtcataattc acttgctggt tataaacaca 585720
 tggtttttat tgtgcttttg gcatggtatt aggaatggaa cttgggcctt ctgcatgcta 585780
 ggtaagcact ctaccactga gctaaatctt cagccatgag agcaaatgat tttgatcaga 585840
 aattcaaata cagcaaaatg tatccaaaga taagtagaga atcctcccta ccccttcag 585900
 ccctactcct tgaagattac acagtcaaca gttttccttg tgcccagaag ttgacatgc 585960
 accagtatgc ccatggacat tcttatttca acttagcaat atgacttgaa aatcctaac 586020
 aacacatgta ggiatgctaa attattttct atagctatat aataacttac atgattacat 586080

 cgtaacccat ataattggtc tctgttgag tgacacacag attattcadc acatggatta 586140
 tttttctctt aciatctgaa ataatgtaac agtgaactat tttattcata ccactatgtg 586200
 tagatgtgca aataaaaccg aggacaaatc accaaaatta ggacttgcaa gatatgcata 586260
 tttcaatttg catagtatta gccaatgata ccaacttctt gcatacagc atgtgtgaat 586320
 gectgtgtct tcacaccctt atccattctg tcaatttga cttttctat catcagtctg 586380
 gtcagtgaga aaccggtctg caattgggat ttgcatttct tgaattatga atgagatcaa 586440
 gtattcttgt atgcataaaa tagagatttt ccctctgaa ctgatttttc aaagcctttg 586500

 ctcattttgc taggccactt gtatattttt gtcagtctag aacaatcttt aatataacc 586560
 tgaccataca atgcacacat agtatacatg tgtaaaactt ggttcaatct cttttaaata 586620
 tacttgagaga cagacatttg cattcatgga tcactttttt gcttttgctt ttaattgctg 586680
 tatttttttc ctggaggagg tttaaggttt aaagcagatt tacatggctc ttttgttgtt 586740
 aatacctatt caggtggttt cttgcttgaa aaaagatcaa gatctttttt ctgatcccc 586800
 ctccaaaaaa aaaaaaaaaa ttcccatgat atcttatgaa aattttacag tttttcattt 586860
 tatttttaaa gctttagtat atccaaaatg catttttagtg tgaggagaga gatagagatc 586920

 caattttttt cctaaatggc tgaaaacgtt gactcagtgc catcttctaa acaatccatc 586980
 tttctttact gatttaaaat accactttta tcataacta gattccctga agtatttga 587040
 cctacttaag attctgttct gttccattga tctgtctgcc tatgcagata ttttagaagc 587100
 aaatacattt atggagctgt aatttagcat atgtgggttt atttccaggc ttcagttatt 587160
 tgtattctac agaatgtttg tttgtcattg tgtacctgg gcttgacttc ttcaagggca 587220
 aggatattgg atcctatgcc ttctgtaact ccctgaaatg ctagtctctg ccaagtttga 587280
 tattttggaa actgaaattg agccatgtct ttctacaaag ccagggatag tctgagtgg 587340

 ttcagcagat tggacctctc tcaaggtatt cagccccag atacaatact accacaatta 587400
 actcttttca tcaagatgc tctcctaata agatatgaat atgatgcatt ctctcaaaaa 587460
 tgcattcatt attatttctg cttggcataa gttttggtgg aaatgtgagc tggcttttag 587520

agagctgggc aaictggcac caagacacat tccatctctt ttagtaccac aacacagcct 587580
 ccaaaatcgt gcctattagt ctacttttc agaggagaaa aggctcaggc aagtaagtta 587640
 ggatggcagg ttggaaagag gcagagcctg tattcaaata gaagtttacc tggctcaaa 587700
 taccctctc ctcttgctct cctatgctgg gggtagagac aaagatcctc aagccagaac 587760

 aggaaatcat ttcccctcc ggtgccagcc ctgcagtac tgccccgaca gctagatgaa 587820
 gaataatttc tcccacacc agttgctcag tgggaagaag ggccatgata aatgttccat 587880
 ttctgccaca gaagtcaggc caacagtagc tgttctcttc ttaatagta agcagatcca 587940
 aaaagatctt accagcttca cagctgtgtt cagtagttgt ccaaaatc aataagtaaa 588000
 attcatctct caagccctaa aaagccagaa tttaaaaata aattttgaaa aatatagtaa 588060
 gtaaaagagg gtagtatgta ttattccca agttcactac aactgctggc ttggcatgct 588120
 gcatgttcaa cactacttgc cacaactgtg tcctggctct gctagtttga agaaggctgt 588180

 ctcaaactag ttttcttga cacagaaga agaaaaggaa tactaggctg gaccacttgt 588240
 ggtatgtatt aaaccttct tgcttaccac cctaaattag aactagaggt caaattatgt 588300
 aacaaagact tgagtcaaat tctgcacaca tctgtcaatt ccaagaatcc aacccccagt 588360
 gtataggatg atcagtaact ccaggagcag cctctggctt ttctaagga gcaagtaag 588420
 gtaggcattc agcttctct tctctctc tcctcagaa atctacagat ctaattaagt 588480
 attcggagct acccccagt gtcatgtcac tcgggaacca tcagcctcac tctgcttct 588540
 gacagcccag acaaaaagcc atgctctctg tcagaaaaa aaaatgtcac cagtgggaca 588600

 gtaggcagag gttgtccag gcatagatca agttcttct tgtccctctg gaacagcaca 588660
 aaaatctttt atttttatgt ctactttgcc acgagaccaa gaaccacagc cataaccct 588720
 tccagccttt agagcagttg ttctcaacct ctgggtttg acccctttgg ggacgaatga 588780
 cctttcaca ggggctttct aagaccataa gaaaacacat atatttacc taagtttcat 588840
 aatactataa aaatcatggt tatgaagtag caatgaaat aattttgtgg ttgacagtca 588900
 cccaacatg agaaactgta ttaaaggttc tcagcattaa gaagttgag aaccactgca 588960
 ctagaggagg agccaaaaga aatccactc tggggaagtg acccaggaca cagctatgat 589020

 gaccacatgg ttctaaacta gagctgtcaa gtcaacaaat gatgtttca ctatacact 589080
 ttaccagagt ctctgagaag atcagtcttt ggacattttg ctatgtctcc tagaagccat 589140
 ttgactacta aaagggcatt gtaggaatta agaacatagt tctaatcctg gccagacac 589200
 tcagtctctg tgtgacttct ccatgcctta gatgtttcat gtgtgaactg gaagaaattg 589260
 tcacatgcca gctgttcaga atgcctagaa ctgaagctgg tatagaattc ctactgttat 589320
 tgcattaaat tgtctcagca cctagctccc aactgtccct ctttcaacag tgttcagta 589380

gcacggttct tgcacttatt tggaccatca cctataattc caactctgaa tctaactctc 589440

aatcattcc aaaccagct gaccttttc acatctggct attgttatca gattttcctg 589500

tgtaacaate ttagagataa tacagccaac acacatgtgt agcctaaaga aatccaagcc 589560

cattgcttga agagtctta tgattttaat ctggttacct tggtagaaa ctacttaaat 589620

gtctctcctt gctggcttaa tgaataaaga aatgaaaag taattttac tccttttgg 589680

tttgtttctt cataggaat caccttctg taggaatcat cccttcgat cttgcccag 589740

ctgtttaatt catttggcat aacatTTTT ttgtctttac tatgagctgg tagacagaat 589800

ttcaaaagga acctgatgag ggacgatttc aaatatcttc tttcactttt cttttctct 589860

agcaaatgaa gttgcagagt ccttgtgcca tttaatgtgg cagtgggtg catggaacaa 589920

ctcttttaag atcacatacc tatggctctt ttccacagcc ctgcttcagt ttgtctgcca 589980

cttgtcatgc agcctcactg ggaactgtgc catgttccac tatcattttc tgctttatat 590040

aaaaagaaga agaagtgaga gatcaggatt gttagattct ataaacactt gaatgcctgg 590100

gaaatgcaga gccatgagcc aggctgctgg tgacaaggag cagagtgggg agaaaggaaa 590160

ttacatccta aactccaacg catactattc ttacatgatg tctaagaga caggaactca 590220

agttgagcat ttgaatgta aaacaaaata gacaaagcaa tgctcgcca gcaaatagc 590280

tgtcagatat gtgttctct gaatggaaag ggaaagaaaa aaaaggagaa acagagataa 590340

aaggcaacat gggggaagaa ggagacagat tgtctaggga gggtatagtt aagactccta 590400

gagttttgca tgaatgtaa ttttgtcca taaaggatt taaaatgagg gagagaggaa 590460

agagtgggc tcaacttcc aagctgtgat tcctgacat aatatttctt catctgattc 590520

caacagtcc aggtagccaa ttcagtctg tgcaattctg aaaatcacc attaggccga 590580

aatctaactc caggagcacc caaactcca ggtccaaagc tgggaacatt gttgccattt 590640

ttatttttcc tttacctgct ccacagtcc aagacaaatt aacagaatga gattttattg 590700

tgtgggctgc attgttctt tctcctgtgg tacgagtaac ctttccccac ctgcatggag 590760

acgcagaggt ctgtccata tgctttttgt tattttctg cttgttgca aatgaattg 590820

ctgcagagaa atcagggtct tagagacttg agagcagggt actgagtctg gcttctctg 590880

tgctgttctg tcactttgtg ctaccaaagc cccactag tgcaggtcac agactttaca 590940

ctgtgaccac aagccctgg acaggaagaa aactgattgt gagacatag ggattttagg 591000

ggaacctcaa aagccaactg atgttctctg aaccacgga gaaaaccct agttggagtc 591060

atcagattta acaattctt gaggaagatt cagaagcaaa atcagggcaa aattgtattt 591120

cttaaaatth cttttgcctc tttcatgcac gctaacacag gaaggtaaat tgcacgtct 591180
 gttaaggtg tctgcaacat tattgattat atcatagcca acaacaact cgtgcatttt 591240
 taaaacctgt gggttttcag tctccctaac tgagctctaa acacaaagga gaaattaagc 591300
 aaaattatta ttaaatgaa ggacaatgaa ttttaaaaa taagctggcc tgggtatata 591360
 gctcagtata tttcaatgc caccagaagg gaaggcgagg gaagattca tacagaggct 591420
 caaataacca agaggcgggtg gacagcatca attcttcatg agtttcatgc tatcaccaag 591480
 cacctcttca gaaccagtgg ctgctctatg tggcttatga atcttttcat tccctcagga 591540

 ctgtctctct tgtgaggtag aattacttaa gtagatcggg caaggtggct cagtgggtaa 591600
 ttctgatgac aaacatttgg ttcccagagc ccaggtgttg gaagtagaac aagaactgag 591660
 tcctcctgca agctgtcctc tgacttccat acatacacta tggcccatat gtgcccacac 591720
 aataaataaa cgtaataatt tttaaaagaa attcttaaaa gtaaacttat ttatgaaact 591780
 atatcctgta tctacaaatg accaagataa gacatgtttc ataccagctg cagtaagga 591840
 ggggtatgaa gacaggtgtg agtgagtcac gacattttca catgactgct ttcagagcag 591900
 tggggctcta ttcatgaaat gggctttgtt actttttaa gtccgtttac aaaatccatc 591960

 tgcattagtt actttagaat cactgcagaa aatacctggc agggacaact taagggagga 592020
 gagatctact ttggctcata gcatcagggg atttcctgc attgaggcaa ggaaggtgga 592080
 aagtgtgtgg tgggagtatg tgggtggaggg ccttcatatc acagaacatc aggtagcagg 592140
 aaccaagggc tttcaagaac ctttcaaaga ccagctcaga atgatgtatt tctgccagct 592200
 agtccccacc tccagatgat ccacggcttt ccaaataga gacagtaca tagtgaagga 592260
 acagcctccc caacatgagc ctgtgggaag gaacatttcg catttctatc ttcgtgccat 592320
 tttcaacta agaatttact tgaaccatta atagaggttt tctatttttg gtagattaag 592380

 agattttttt cttaatcttc attttcttgt tcttgtaag tactgtcagg tttcagtctt 592440
 cagatgattt ttgtaataa tgaaataaac tgcaatctaa taatcaactc attgaagaac 592500
 aacttttcaa aaagacaata cagcttaaaa taaattgtca ccttccacac agctccatgg 592560
 ggcaacagat ggetctcttt tcagataata aacagaagt ccgaatttaa taatggaaaa 592620
 ccaattaaga aagtgaaat gtaaagaaat aaaagtgggt ggggatgagg ttgagttaa 592680
 agaaatcttc atacagtgtg catgctgggc tgctgccata ctggatgcta tagccttctg 592740
 ttgggacctt ttattgctct ctccgaaaga caggggtctg agcttctgag agaggccac 592800

 aggggacact gacaacatct accttagata gtttactca aaggtaaga atgataagat 592860
 gtactcatct gtcagagcca agtggcaggg aacttgaaga ccagaagatt ggtcttttct 592920
 ctctcatgcc catgattgat ccaaggaaat tacatggatg gagactagta aagtgaagta 592980

ggtggtacac ttiagagggtg gctcacagaa gccaccctgc caccgtagat catggtaccc 593040
 ttccaacctc tcttcatgcc tgtgaagttc gctttcctta cctctcaagc atgacaggat 593100
 ggatgcatga aagtgatctt atgcaaagaa aatactcttg aggagagaca ccgaaagcac 593160
 cccatgtggg ctctgaagc tactgaataa acaagcttgt gtcattccta gcaagtgaca 593220

 aaacgccgta tcttgggtgag agtaaaatta atccaacat cagtgtatcg tttgcttacc 593280
 acccgggagc acaagcaaga ataatattaa gttaacatta aaatttatga gcaaattact 593340
 ctaaacaca gcaaagtagg cgttatctgt gaatatagaa atttaagata tcctttgaga 593400
 cacagaattht aatthttgat aaactctggg ttcatthttc atatctttgg tttggthttg 593460
 aaagcatatt aatthtctat tatcttgtat atthttctaa tcaaatttat tttagtagaa 593520
 atactagtha tgaatctatg atthttgtct tcatatcat ttgatcagct atgagthaac 593580
 thaaagtatt tgaagataa atthtactacc caagaagtha taccttgttt tctaaatcc 593640

 thaatthttt cacagthgta tctccatag ctatgggtgc accttctga cthttcacagg 593700
 cttatathgag gcatthttctg tctthagtggg ctggggagtt caaaatgcag ccatccttgc 593760
 atthtcatgta cgtcaccttc tctcaacacc ataacaata tgcaaagatc aataataatt 593820
 tcatatctgc tactagcttg gtgccatgtt atagcaaaga gthgatthgt atggatccta 593880
 atthttctct gthttctcag aaaatthgcc agthaatthtt acagthtttt gtccttagat 593940
 gaaatthtca tcaagthtct tgatgaatag ataggatthg ggatathcaa acacatthta 594000
 ctccagthca thtcaataat gtcatacttg accagggaca gthaatthgt thaagthcat 594060

 atthaactht caaaatata actgathact thaatagthg catthgttat thaactactaa 594120
 cagthtagtht thgactaatg thaacatagth cagaggaaag ccagthgggg ctgtgaatgc 594180
 thataatggc actgctgggg aagaagagat ggaccagcca thtcaacca thtthgtgagth 594240
 tctagatthg thgaaaacca agththtaaaa acaaaaacaa ggtacacagc athcaaaagaa 594300
 thaactgagth thtcttctat catathactg catgacacaa atthgtgact cacaccata 594360
 thatacagth cacctacacaa cacacataca cacacacacaa cacacacacaa 594420
 ggaaatagth agaagthtca aatctactg thgtactata caatagccat ctccagaacaa 594480

 thgagctgthg ctctcagagth thctgactca gcactatgth aagccatthg agthttgthg 594540
 thggtgggggc aagthtactg gcaaaaccaa accgthttccc ctgtgggthg thaacataag 594600
 atthtcatca gcttctagagc atthtgaccat cacaaacctg ccagaatthc catathcatt 594660
 catgctcagaa atcatcactg aagcatggaa agaagagctg athaaaccaag thttgaaggc 594720
 cctthgaagaa gtcagacctg thgattgthccc thgctagccc cacatgcttc atthagccaag 594780
 gcaagatgca thgcatthgat gagthttgth thcaaaagaa agthaccatha thcctatgthg 594840

tgaatgctag aaggcactgg tggtagcatg gctcccactc acatagccct tgaggaatga 594900

agtaagaagg cagaggtttg aaaagctcac tcaaaaaata cccaataact tttcaaagaa 594960

attaattcta ttcttttga tctcaggcta tcatcagtga ggggacaaag tcacagctct 595020

ccactgccac cctcagcatc ttgaggggtt cctttaatca tttagggatc ttgatctaaa 595080

caaaactgaga ttcatgtctc tgggtgcagaa aagaatttca agactaatca gctgagttgg 595140

ggttttatta aaaataaaaa ggaaactgct tgcaaaaaga gtaaagaaac atgacagcat 595200

aagcatgggc ttcttaagag agagcccagt gtagtaatca acacatgac cagaaagcaa 595260

gctggggagg aaagggtta tttggcttat acttccatat tgccgttctc atcaaaggaa 595320

gtcaggggca ggaactcaaa cagcaaaaac ctggaggcaa gagctgatgc agaggggtgc 595380

ttcttctct ggcttgctca atacaagctt gctcaggacc cccagcccag ggatagcatc 595440

accacaatg ggetgagccc tccccatca atcaccaatt aagaaaatgc cttagagcca 595500

gatcttatgc agacatcccc tgtgcatcca tcctttcata taacattagc ttgtgtcagg 595560

ttgacataag actgagccag cacaattgct aaggcagact ttaagagca gagggctcac 595620

agaaaagaaa agatcaaagc atacccaaaa tctggacttc tcaggggata acagcaatta 595680

agtatcttag catccatcat ttgggtgtct agggttacaa atttcattgt tccctcttt 595740

ttgatatgtg agattataaa gtgccccaga gatacctgg aaggattata atctggttaag 595800

gtaaaacca ggaaccactg gtgttgcaca agggatttag tgcatgcctt ctgctgtggt 595860

tgaggattct ggtgaggttc cttgttgggg gtcttttagct ggggaaggag aaaggcctta 595920

agtagttggt aattgtgctt aaatgcttgc ttctcagctg ctggaaggct tagctagact 595980

tctaggtaa tgttccttg tcttcccaca ttgccataaa ttttctgtc tttctattct 596040

gcctcaggac caaaagaaag aggtatgcat caacagaggt ctacctctct tcttcgcatc 596100

actcagttt cacgtgtaaa tgcaagtatc caatggagaa cacccttct tectctagea 596160

ttttcacatt atgaattgca gcatctacca gtaaaattaa ggagatgtta gcttagattt 596220

aagatcgta gactgaaata catggtggct ctcatctact tgggttctgg gtagattctg 596280

attcttcatg gcctatagaa atcatcacac aatcttcata gtaactatgt gaagcatgga 596340

tactgagacc caaggactga atgaggaaag ggaagaagag taaagaattg attagtgaaa 596400

gaagatggat tccggctact ccctaggcct gctccctgag ctgcagcccc tcagagatga 596460

ctgtgtctcc cacatacgt gatcttggca agtcggccaa ggatgttttc accaggggct 596520

acagctttgg cataataaaa cttgatttga aaacaaagtc tgagaatgga taggaattta 596580

ccagctcagg ctccaccaat acagagacca ccaaagtga cggcagcctg gaaaccaagt 596640
 tcagatggac cgaatatggg ctgacattta cagtgaagtg aaacacagac aacaccctta 596700
 gataccgaga ttaccgtgga agaccagctc ccctgtgtac tgaagctgac ctttgactca 596760
 tccttctcgt ctaacattgg gggaaaatgc tacaatcaag acaggggtaca agaggggagca 596820
 tatcaacctg ggctgtgatg tggactttga cattgtctgg ccctcaatcc ggggtgctct 596880
 gatgcttagc catgaaggct gctggctagc taccagatga attttgagac ctggaagtct 596940
 caagtgacct agagcaactt tgcagttggg tacaagatgg gtgagttcca gcttcatact 597000

 aatgtgaacg atgggacaga gtttggtgcc tccatttacc aggagctgaa caacaagttg 597060
 gagactgctg tcaatcttgc ctggacagca ggaaacagtg acattcgctt tggaatagca 597120
 gccaaagtacc aggtcgacct tgttgctgct ttttcggcca aagtcaaca ctctagcctg 597180
 atcggtttag ggtccactca gacctaaag ccaggtatca aactgacgct gtcagctctg 597240
 ctggatggca agaattggca tgcgggtggc cacaagcttg gtctaggact ggaatttcaa 597300
 ccataaatga atattgtacc aacgttaatt ttaaactatt tcacagtata actaccttca 597360
 gaatttagtg taccttttaa tgttacatgt tggagatgca aaaatgata aataccacat 597420

 tagatgtcca ggctaaggat gactcggctt taagggtgtt accatttttag aggtgcagca 597480
 gaaatcccat tcctaaaagg gtccttttag ctgtagatgt gggttgggga agtgccactc 597540
 cagagacgct aggtcgcaag cagaagctgg gaatgtgtgg gccctttgta aatctgtgtc 597600
 aagtcacag atgaaattgt gacttctga gcattaaatc ttgggtgtccc aataataact 597660
 gctgagaagc atgtacacac ctgtgtgaaa gggacttttt aagacagacc accatgtcct 597720
 gtcccacac tagcccatca gtttctgtt ttacacaaa agtactatta gctatctctt 597780
 ttgtgccatt ttaggtgga gaggttgggc atgatggagc cagtcattca ggacttaatt 597840

 tttccttgtg gtatggtttt cttttccttc tatacttctt gccttctctc ctttctctct 597900
 ttcttcttcc aattctctct ctctctttct ctctctctca ctctctttct ctctcccttc 597960
 ctttttttcc tttgccatta caccagagta tgaacagct tccaggatct ccagctttaa 598020
 gctgggcagg tigtttatag gcctcaccac tctatttttt tagcagttta atgggtacat 598080
 tatagagtct ttcatctcgt gtagaattag ctactcctct tcaaatgctg taattaatat 598140
 cacttaaaat aaaacttga ataaaatatt gaaacctcaa aagaaggggg aggaggagga 598200
 ggaatccaac tccgacctgc aaagcattcc tctgaggag cataccacaa tgaacaacac 598260

 tgatgaata tcttaccag cgatgtcatt tattgtgctt ctgagtacca gttcatagct 598320
 gtgatcccaa caaagagtt ctaaacagtg ttctggcaca gccttctccc catctcccc 598380
 cccccaaaaa ggiggctttt agttgtgcca cattcctgcc acacaacaaa taggatttat 598440

aaggaccatt tccggggccg ctttacaac tttgcatggc tttagactaa ttacagattt 598500
aaaatattag cacaaatgaa taagactgga agattttgag tcttacacag ggaatattaa 598560
tagtactcag agctgctact tcataacttt ggagtgacat tcttggaggt caaggaaatg 598620
ccaccacctg gagtgtgca ctacacaata tgtgtgacca tatgctgggg ccctgaattt 598680

cttatgggca gtctgccttc acctgcactc ctatcttgag atgcttcac ttgacaggtt 598740
tctgttttgg tcttcattct tcaaataacc ttcaaataat taatacctta aattcttctt 598800
tggcagttag tagaggattt tgccatactg gacatgctta gtattgtgaa accaacctta 598860
aaggaggatg ctccatccat gtctctgttt gcaaagagtc tcatggcctg catctacata 598920
tgcaaataat aataactgat cagagggcct aaaaaatagc tgagtttatt ggagtgtaaa 598980
acaatgacta attgatataa ctacttaaaa ttttcttagc aatacattct gcatcttga 599040
gcataggatt cacgtgttta ctgatatttc aagaatgaaa caaagaaaca ccacttcaat 599100

cagcagctgc aacagcttcc tccccgcac tccagtaaac tgctgagtct ttcctccctt 599160
cccacagggc cctaggggac cctctccac tagtgccatt gtctcttggg tttatittaa 599220
tcataitttc agtcccccaa cccattccaa tgcagcaaaa gactgttgat cttcacaagt 599280
ccttgctgtg aatcccctg agccacttgg gcagataact gctctctttg aaggcctgcc 599340
ccaatggctc ctgtgctggc tgtctcactg aagaaataaa gcagcatgcc ttagggaaga 599400
ttcttcagtg tecttctag ccatgtttgt gcagtttagt catcctagcc actcagtgga 599460
cctatgaggc ttgcagctct gtgagagctg tggtagacac taagaatatt ccacaatcct 599520

tttcattctt ctgaaccaag ccctcaaaag aatgacttg tggacaaata tggattcctt 599580
tttcttccc aaagataaac tattatgtat gaaaggacag ctaaacatga aattgcaagg 599640
tttccactgt caaataagga caggcggtag agaaggaaga ccacattct ctacctcagg 599700
acacaaggtg gagggaacaa atcaggaatg caacacctca gaccttcca gtcagtcttc 599760
cctaagcaac taatgctaata ataaaccggg tgatttggga atagctttc tggctgcaga 599820
gagtgcagca tttactattg taagatgtct gctattggca ggagctatca gagggttttc 599880
cttcatttcc aactgtataa taattatgtg tttgaggtat agaatgaatg taacacttcc 599940

atagaaaaaa tgcacattat gaaatgatca aatcgggata ataaacatat ctgtcacttc 600000
aatgtttct cgtcttttg ataatgatcat tttaaatact attcttagac tatttgaagt 600060
atataatgta ttgtggattc cagattcatg cctggggtcc ttgttacaat gaggctgact 600120
ccttggctca ggaaggcata cttttgcttt gcgggatggg gggggcctgc tgtttgttcc 600180
ttcatttttc ttgagatagg gcctcattgt atagtccaaa ctggctagaa ttcccgttcc 600240
ttcctatgac gcccatctga ggaaatgaag aggtattcat ccaccaggac agcttgtgga 600300

tgatttagct taataatgta tagctaaaga gcttctagtc taatgggttt aattctgcac 600360

 cttagagacc acagctcaag ggacaaacat gcaggacact tattacttgt gacaaatggt 600420
 ggcatcttca aacagcattt ccaaaaacctc tcatctgcat tgccctgcctc gaaaaataag 600480
 gaagggttaa gaagcccatc ccatgcccag tgacttcatt cgatcaagag gaaattccac 600540
 ccctcgaga cagggatgga agccggcact ggaaccagt attccacagg ctgagctgtc 600600
 tcagtggctc tgtgctggg ttctgggttt ggtttttaca ttaccagcct cagtgaggtg 600660
 gaacagagga ttacaaaagg ataagctaaa tggcaattgc tagtgattg ttgtgtcac 600720
 cagcaccttt tccaacagta ttttctattt cttcaaagct atatggagca gctaattctat 600780

 ttatgtgctt tcttaagaga aaaaaatgga taatacctaa ggggcaagtg tagtacaagt 600840
 taagaataac attttctttt atcccaaga ctccagaatg ctacagatc ttactattat 600900
 cataaagata aatgacaggg ggatttagtc cagtgagaaa tcaccagctc attggccata 600960
 tacagcaatt taaataaaa cacaccaatc tctagcctcc agccccttgc agtctttagc 601020
 actgacataa aagtccaata tgaagtggg tgttggttca tgattcaaag agatgcttat 601080
 tttaatgggtg atcgtgacca aagacttagg aaaaggggga attctaatct ggggcataaa 601140
 acaatagatt tatgctcaga tgtttgttc ctttgagaa tgtttcaata accttataga 601200

 aattcatcca agtgagctct ctgctctgcc catgagtagg tgtcatcaga aaaggttaa 601260
 gaaagaagag agtgaggaa ggaggaggg agggaggag ctctctgatg tttaatccat 601320
 tctcaagtgt tcagtcctaa acatgtacat tagaagaaca ttagaaggac acaaaataga 601380
 ctgagtaggg tgtgtgtgtg tgtgtgtgtg tgtgtgtctg tgtctgtgtc tgtgtgtgtc 601440
 tgtgtatgtc tgtgtgtgtg tgcgtgtgtg tgtgtctttg tgtatgtctg tgtgtctatg 601500
 tgctgagta aaaaagaatg aaaaagaagag gttataaatt ggaggggata acaggaacac 601560
 ggagagagct ggaggggaga tcttctgcc tctgcctcac tagcattgga ttagaggcat 601620

 gtgccaccac atggtgacat ccagatattt ttgatgtgac tccaatgatc ctgagaatgc 601680
 ttgttcaaac caagtctgtg tcaacacatg tggaaagagt acctgtgtaa agcagaggca 601740
 aactgaaata aatattgctt tgcaacctg attttccagt ggtgtactgg attgagatgg 601800
 tgatcccctg ttttccagct tctgaagtgt gcctgtgct ccagcaacta aaggagctgt 601860
 ttcttgccat ttggaatgc aaacctcaca gacgtgtgt cagaccgacc ttttctgcc 601920
 ttctgttctt gatcctgttg catacttatg tgttcttcca aaagaaaaga aaggttaaag 601980
 actgaaatca ctgagccag ataaagtaaa aagagaaata aaattaattt gtcccttaag 602040

taactaattg caaccgctt aagatttcag aatcataact ttacatatta gtatcccatg 602100
 agctaggcca ttcttagtg cagaggacaa aaggcaagca agataaagtc tccagctcca 602160
 tggaaacttac tctgtaagga agacagtaat gaaacaaaac aagcatgaga ctataataca 602220
 gtcttatatg ctaataaatg ttataaggaa gaataagcct gtacagggga tggagggaaa 602280
 agtcaagagc acagccatag taggtctatc tgagagaagg ttacagAAC gcatactcac 602340
 atgaaggagg acaataaac tCACagatat gaagaggccg agtccccaa gcagtgagaa 602400
 caaatgcat acagggagct caagcttgat gtttatgaag aacatgaata atctatgtga 602460

 cagaaccaat gacaagagaa atagacactg agactctata gacaggaaga ggtaagagca 602520
 tgtgaggccg gtggcgggg tgggagggca tagtaagacg ctatgttgc attctagttc 602580
 agccattgga ggataaaca gagtaacaag tcatttcatt cacatcttaa actgcagagc 602640
 tcttgacatg ggaagaggca agatcaaaag cagagtgacg ggctagaagt ctgagggagg 602700
 tcttgaacca gtcgagtaac aataattaag gtgaagtga tcagtctgt ccatgtttat 602760
 gaactggaaa tgatgaggtt ctgatataat gtcaagaggt ttgtgaattg gagggcccca 602820
 aggggtcaca cccagcttc agtgggaatc ctgtgatcaa tagtactgtt tgcagaaatg 602880

 gtaggaagaa aaatctaggg aagaggaacc aagaacttg tgttcaccct gccaaattca 602940
 gaagtgttct ttacgttct catagagatg ttggggggg ggtgttcaat gtatatgcct 603000
 ggagccgata aaagagaaga gatagaattg tctagaatta tccagaaaca cacaagagg 603060
 aaaaaccag agtgcctaac aaaatcacct gtgaaagag tgaaaaaaaa gaaagaaac 603120
 catgaaactt taccttacag taaccaccaac tctctaagtc agaattaaga gtgccatca 603180
 gagaagaagg ggaaggccaa ccagtcttg ggaagaaaa gaagcacgac agagttacat 603240
 ttgccaagt gaaaatgagc ttccgggagg tggaaggagt ggccagctat ttgttcctaa 603300

 catacctgc aagatcaata ctaatgttct ctagatgtgg caagatgta gccattagaa 603360
 agcttgacaa agatttctgt agcagagaga cttaaagta gtggggccag gaatgcagat 603420
 gagacacccc tctcccaaga gggacagaag gtaacaaaa atagcaagta aattctgttc 603480
 caggggagct ttaacatac tttcaaatc tcccagcagt agtaattca tggaggaaat 603540
 aacgatgctt gagaaaggat gcctaactgc aggggtgaag tctttgagga gtagagaagt 603600
 ggtggcatct atcacaggtg agcagagctg ggtgactaaa gaaacaggac tccccatcca 603660
 ctgaaacaaa gacaagacca agggctctgga ttactgtgga tggatttgc atgaactgtt 603720

 ctttttggtt tatctgtaat tttagtaca tttagacaa gaccatctgc atggacagaa 603780
 aggtatttag atgctggagg aacaggacaa gtttaggtct ctaagagcag agctgcgagc 603840
 tgtccagga actctgagtg ctgtctggca gtgcagacag cttgcttgga gatctgtgaa 603900

caaagtcgga tgactctcat tctccaattg cttcaccagt gttgaaaagg atctaataatt 603960
 tacaggaaga agatTTTTgc ctatacggaa tcttcagaga atgaaactaa atagagtgga 604020
 agtgatattg taaaagacaa atatatgtga atagaaggat aataaaaaac ataattgtcc 604080
 ttattcttat ttctatcct taaaattag ccctattaaa tttagaggat gatggaggat 604140

 tccttcagta taagggggtc attctctgcc attagaaaat tgtacattct taaccagtta 604200
 tttagaagtg ctgtaacaga gatgcagget atcacccac tattattaac aagcaccatt 604260
 gactcttacc ttgtagaatt aagactccat tcccaaatt cttttccagc tagctgtggc 604320
 cacagaacaa atcacatgtc aaatgagttg gaaggaaaag taaattaaca caatttctgg 604380
 aaatttctct taaggatgtc gactccttac cttccctagg aggtaaacc cttaccagaa 604440
 gatgggttga attctagcca ccatcatgaa ccctctaag aaaggcagtt tgaattccta 604500
 gaaaggttat agaacctcca caatctaaaa agcaaaaatc tgggctcacg agagtgaacc 604560

 acaatggtgc ccatcaaacc acctggagac tgatgtcctt taacagtctt aactttgttc 604620
 tttatactaa agctattggc aaattttcag ttcaagtaca caatccttat ttacattgtc 604680
 tctaattctc agttcattgc agtagttacg ggaactaagt ccacaacttc ttactctaat 604740
 tgtgatcgag tactgtctag tgttcccaca agaccaataa ccaggattct gactctactc 604800
 atcacttaca tttccaacat gatatctgat ctgcagggt agcaacacaa gtcaaggat 604860
 aggcctggcc tgicaagaca aggattatca cagagcactt tctctgaacc actggacatt 604920
 gacttccaa ataccaccaa tgttcatagt ctgctttgct gtggaatgtt agtttaagat 604980

 gtgttatatt tgtttatgct gtggaatatt tatttaacaa tgcatagatg tgttgattc 605040
 ttttatgttg catttgttta actctgtgaa gctttctatg atactttgcc tgtctaaaac 605100
 acctgactgg tctaataaag aactgaatgg ccaataatag ctaggcagga gacagggata 605160
 ggtggagtgg ccaggcagag agaataaata gaagaatgga agaggaaaga gcaagaaaat 605220
 gaggagaaga agacaccagc ggtcagccac acagtcagcc agccactaag taagaaggaa 605280
 agaaagatat acagaatagc gagaggtaaa aagcccagag gcaaaacata gttagagaga 605340
 aacaggataa taaagctaag ttagaaaagc tgctagaaa caagccaacc taaaaccaag 605400

 catccataag taaaaataag tctctgtgta tttatttggg agctgcatgg tgggcctcca 605460
 aaagagttaa aaaaagaaaa gaaaaagaaa caaccaacaa cactcctctc caaggggaaa 605520
 aaaaccagat ttgaagatgg aggtttctct ggaatatatac ttaccaaagg gtgtgctttg 605580
 gggggaggca tttttcaata atgaaattgt gtctacacac agattcattc attaaactaga 605640
 agtccatcca ttttagattc taaaatgcca ccacaatata ggacacaggc aacatgccag 605700
 acaaaaacaa ttatatgcaa caagttatgt aatctatgac ctttaggaaa taaaatattg 605760

aacttatatt gtttgataat ttataagtaa cttttatact tttacacatt ttattactat 605820

taaaccacaaa tagaatgttc tcccttatgt tatcatttat taaaaatctc tctggatttc 605880
caggcagttt aacaaaatgt acttcgtagg gagctcaaaa aacttacata atattttagc 605940
agattttctt ttaaacacaaa accaaaaaca gttgtgtttt ctagagtcta taccaatagc 606000
attaagccaa gagaaacttt tggagaagcc agtaatgtct ctgcattttc atttgatctc 606060
tctctggatt taataacctc atgaacctcg aatggaatat atgcatgtca cagcatggca 606120
gagggataat acattttccc ctgcttcact gagcatgagt tgtgtatctt gccatcttga 606180
gagtcactg tgcggcacat ttatcccat tagaaaagca tggttggata atatatggat 606240

gctgcagcca ttcatgacaa atacgtaaaa ccatacctta tgcatccagg gatccgtgta 606300
tataactga agctattaac tatgcatcaa caggattttg taaaaacag gttttcaact 606360
ccaaagacta aaagacacaa tgtattgatt acttttgac atttattcag cttcaaaggt 606420
agcaatatta attccaagaa agaaaagaag agggcttgcc acattggcca tgtgacttaa 606480
tgttctcac cttaataaaa atgctactta ctgagggta tgcatctata agtacatctt 606540
gaataatfta tgaatatata tagctccttc tttttatftt attgtgtgtg tgtgtgtgtg 606600
tgtgtgtgtg tgtgtgtgtg tgtgtgtgtg tgtgtgtgtg tatgtatgca cagggtgtta 606660

aagagacacc agaagagaat gctggacctg gagttacagg tagctgtgag ctgtcatctg 606720
atgtgggtgc ttaaccactg agccacctct ccagcccctg ttccttctac ctttacttca 606780
gagacatate acaatggaat agcacattta taaaagtaat tcccaataa gcaaatgcat 606840
attcttcaaa cccaacatt tactggttgt atattcttta gcaaaattat ttatccaaag 606900
cttcagtttt ctgtaaaatg aaagtaataa tacttgtctt gtaggatttt ctacagaata 606960
ctctagatcc tgggggtgga ggagcatata atatgtagca ctcaggatat cattggcact 607020
caacaaatat tggcagtttt caccaacctt catgaaaacc ctgcccacca tgccaatggg 607080

acagagggag tatatataat acataggatt tcattaacca tatactccag ccacttaggt 607140
cagttctcaa ggtgaaatct ggtgtgttcc ctatatacaa tgagaaagga ttcacatgac 607200
acagagaagc aaacaaagac ctgaaaagcc taacagaagt ctttctata gccagaatta 607260
taaatgccca aattcacatc tgtgtctgtg cctattgtgt acatagaaaa caactatgca 607320
caatgtcaca acaaaagaaa taatggccag agtcaagaaa catcatggtt agttctctct 607380
ctctctctct ctctctctct ctctctctct ctctctctct ctctctctct cctttgtaac 607440
cagaaatttc agaattcaaa tctttccaaa ctcaagtga aggttttttt agaaaaaaaa 607500

atagtaaaa aaaatttgcc attcttagag ttgctgagct cattcctcaa attctttggc 607560
 ttttagagtta agtgcctcca cattgaaaaa taacggttta ctttttccat aaaattaaga 607620
 attcaaatac attactgggtg ttaaactctc atagatatgc ttaatatact tgcttctcca 607680
 attaaaaaca cacggtcatt aatatactgt attatgttat gaaatcataa ttgcagccaa 607740
 gcagaaaata attacatct atcagccttc atggtttaca aaagcaaat tatttttctt 607800
 ttgttttaga agtttcaca gacaaatact agttttatag tggcaaccct ctacttaat 607860
 attacccact gtcatgtgta tctgtaaact gtctctgtc cttctgggcc caacttacet 607920

 tgagatgatt taattttaaa atctaatecc agggcaaatc cttctgattc tattgtgaac 607980
 acctggtatg gaaaaacact gggcttcttt caaatgtatc tccatgtgaa aacaagtgat 608040
 ttcacacatc tcccagacca gagctaaaac actactgctt gcaattactt tatatcaata 608100
 aacctataat aaacacacac tgtagctggc ttgtttgggc aatgtgtcct caaggcctta 608160
 ccctcaagct gcatatagat ggctggacaa cactatgagg aaagggcaca aatgaatac 608220
 aacacaatgg tagagtgaaa agggaatgaa agaaagataa gtatctcaat gaagcttagg 608280
 gacaaaacag ctcaagaata gcgaaatgga tatattggca tcattgcaag gatgctatat 608340

 atactgggag aatttcattt aacagacaca gggctatgtg ctttggaaac agtatgtgat 608400
 atctgagaat aaacaaggca tccagcttgc ttgagtcata tacggactgt tgtttctgct 608460
 acccagaate cacttaccce actgetaaaa ccagcctcgt tttcttcaga gacatatcc 608520
 tgtggcccat agcgtctaag tatactgtt cttgtctcaa gagacctcaa agtgtatact 608580
 taactgcagt gacagttggg agtggataga cagcccactc taaccacca ggatcttcag 608640
 ggcagctcaa gaaggcaact gttactttct cctgttaatg aaccaggaag tttgggactc 608700
 ttgggtctac taataagcag tttatgaggg caaagggact aagataaagc aaattcttca 608760

 attttagate tgcagaaga caaactcacc ttcttatcc ctcatttccc cccaaaataa 608820
 atcttttctt tcatgtcctt ggaattctac atggtgctac tatctaccta gttcttcaga 608880
 ttagaaagta tagtgcagc catatttccc catgctttgt aaattcagtt agtctagatc 608940
 atcccagcaa tgactatctt ctteccacta tctctacacc actgactctg gtttcacctg 609000
 tgggttttgg agtctgaaga tcaagaattg aagtcttcta ggctgactag ccaggattcc 609060
 cattccctac ttaaacattt attaatccca ggaacttcaa caaattatgt aatataccta 609120
 accattttc caictgcaaa atgagggtgg ttgtttatac ttcacatg ttgggatctc 609180

 atgagtagag agtttagcaa agtgcaggcc acatgctaag caacaaagaa atcctatgac 609240
 tcctaaagca aacatctgct taccatctc ctctactctc aactgcccac cttttttca 609300
 tttctcagag atttctaacc catgtcagtt agctgtgtaa tttgcatggc tatttgttcc 609360

tggtttattt ctccaagatg aactatggaa tgaattggtc tttccagta tcttttattt 609420
 aaagagaaga gttggtttca aagtagagca actgtaattg agtcgggcag tatgatggat 609480
 gagtgaacgt gggtagagag tgtctcctga tgcattaata cggacagtat gtcttattgt 609540
 atctttgtaa acaagttgag agccatcagc ctctgggaaa agcccaccct ctcacacatt 609600

 tgcagccagc tgacctcttg agcctttttc caagtcagtc attccacagc aaatctgtgg 609660
 cctacttata tcttctaaaa attggcgttc cacatctcct tgttttattt ttgttttact 609720
 tttaaagtaa aacaaacttt tcttgaggta agtaaatattt ataataaaat agtctcgttt 609780
 taacataca gtttgataat tctggtaaat gtgtgcactc acacaactat ttccacaact 609840
 gaactatgaa ctattcccat catccccaaa tgectacttg cactcacttc taggcagtcc 609900
 ctgccataa atccactttc tattgctttg tccattctga gatctaattg aatgaactc 609960
 acctagtgtg cactcctgtg tctggctcca ttcccacatt acatgattca tccacactgt 610020

 tgggtgtatc actaacttgt ttctttttta ttctgagga gaattagatt atacagtga 610080
 gggaatgaat attcttatgt cacacaaaga aacacacaac cagaataaag ttatccacaa 610140
 aaaggatcca gtgtccagaa ccccaaccaa gctagcaaac aggcatgccc aaaatggtct 610200
 ctatctttta tcctaactat aggtgggtgac tgtgtctcat cctattgatg gaaccacagc 610260
 ctcaaatct gacactactg gctaactcagg accaagagga aggggtggga ccctatcag 610320
 tctaactaca ctagatagga taaaatagca ctctcacac atagctatac aagaactgtt 610380
 ttttccactt ccatattgag ggacatttga ttgattttct actttggact tttatgaata 610440

 aagttgctag gagaatgtcc acacacatct ttatgtgggt gcatgttttc atttctgttg 610500
 ggtacatgtc taaagataga tactgagcat tcaggaaagg gcatgtttta tcccataata 610560
 cactagacca aaccattttc caaaatggct gtgctagtct gcatttgag aagcaatgta 610620
 caagggcacc agaaacttta gttcatgggc atcaggtact caatatttaa ggctctttaa 610680
 tatcagtcat tcagttggat gttcagagga ataactcacg tcttaactctg tgttttcac 610740
 atgtttgtca tgtcttcggg atccttagac attctttctt tcttttacag aatatctgtt 610800
 caaatcatta gcatgtttag tagatcactt acctttaaataa aaataacagt ttgactcttc 610860

 ctggtcattt ttacatgaat ccctatgcac tggccaatct ctctgtctct gtctgatgca 610920
 tatttttcaa atttactttt catttatgta tatgtgtgta tgccctgata agtttatgta 610980
 taccacatgc atacaggagc ccacagaggc cagaagaagg catcaaattc cctggaacaa 611040
 gagtgacaga cagctgtaag tccataggt gctgggaact gagcctgggg cctgtgtgag 611100
 atacataagg acacttaact gttgacctt ctctccatcc gcctgataca ttcactaaaa 611160
 gcatagctca tggggacctc ttttctatga aaccttgcca tacctccca atcactcctt 611220

tctctatgat cacactactg ctcccccttt ccttcaatag tggcaattat tcaagggtgt 611280

cataacttat atgtctctat gtcagtattg tatacatctc tatactctct agtatatgat 611340

ctccttgaga acataggaag ttttcttttt ctttaaattt gcccatggat taacatagta 611400

ctcaacacat gtaagagaag agacataata agtggcatat aaagactgaa gctattggag 611460

agagagtgtg ggatcaggat actgagatga atatccctgt ctttatccac tcttttcaca 611520

gatgttcgct gatctccttt tgtgacgagg cacctcagat accatcatac agacacataa 611580

aaaagctaag tcaacgggta aaccacaga aacagctgac ctgaacatcg gggagctctt 611640

ggtccccaga ttgatagctg ggataccagc atgggactga tccagacact atgaactggg 611700

gtttcaacga ggagacctca gaaatctatg gaacctccta tagtagttca gtacttatcc 611760

ctagcatagg tgtggacttt gggcgcccat tccacataga ggagtactac ctgagccaag 611820

acacatgggg gtggccatag gccctatecc aaagtatatg atagactctg atggccccct 611880

atggaaggcc tcacctcctt ggggagcaga aaggatatgt gataggtagg gttttagttg 611940

gggggtggga ggaggagggg agggagatag aactgggatt gacatgtaa acaatcttgt 612000

ttctaattca aataaaaatg cagagaaaaa taatcttata gttcaccatt aaaatattat 612060

taaaatgaaa aaaaaaaaaa gctaagctga atctctgtcc ctgtagaatc cagactatgg 612120

taatggagac atatatacca gctaaaagt gaaatacact atagtgagtc cagcatccca 612180

ggagactggg gaagactgga gaaagtctc taactcaagc ttagaatca gtctttctga 612240

agaacagggg tctgaaatca cactgaagcg ggcattgcag gttggccaag tcaggagctg 612300

ccgatatcag ttcaggcaaa gggcagaggt aggaaagaat cagggttatc cagggaacca 612360

caggagtgga cagagctaga gagaggattg caaaggcaaa tgctgctgac agctccatta 612420

aatggccaa tggatccaaa gggaagagtt tttatgaact ttaaatttcc ctgtagaaga 612480

gattttggte acctccatca taaagccacc tctagcccct gctttgagta gtcttagcaa 612540

ggaggaatga cctacacttg atcccttatt tctatcatga gaagaatgtc aaaacatagg 612600

tgtgagtaat aagctaagtc aagtcagatt ttgtactcac tgaacgtgtt actcttgaca 612660

gcaccagtta acctgtgctc tgcaacaacc tcccagacag acagaacaca ttactcagca 612720

gcagcaaccg actgtgagcc cactaggtgt gtgtcacttc tgcactgtgg cagtaagggtg 612780

ctactttccc atgagccccc tcttttttct gcttttagtgc tttgaagtct ttgaagtctt 612840

ggtgggtgag ccattccctc tgagcaggaa caatacttcc cagaaggaag agacaaagtt 612900

gtaagataca ggaagatcac acaatttaca ggactcagga tgctcaaac attttgaaat 612960

tcaactgagcc cctccctgag atataaagca acaattacta aaggtgaagg agtctcttca 613020
 gtacttgggt ggacttttgg tgaaggatca gtatttatgt catccaggct ctcataagaa 613080
 acccttcacc catgttcctt cttgaagtaa ctttaatgaa ctcatgtgtt caccaagata 613140
 gagttagagg aaatccttaa gtttgcctgt ggtgcctgt gtgcagtctg tgcacatctc 613200
 cctggagcaa gtcacaaggc catgcaatga cttcactgga ggaaaacctg ggtccctcga 613260
 tgacttcatg tagcagaatc ccgtggtaac ttccacatgc ttcatttacc tcattgtcat 613320
 gagttgtgca ttgcagtgta gtaagacact gaagattaga agccattttt acagtgggtga 613380

 tgctattctg ttctattaaa atattttacc cactggtaac acaatcatta ctcactgat 613440
 ataagctaaa aagattgtaa tttttattgg tcttcattac atgagacagc atgagcacta 613500
 gttcagcctc agacactgaa attaaacaaa acttgagtct cactcccacc tctacactta 613560
 ccaacctgtt tttccctgcc aaatgactca atcccctgtg ccttacttca cccactggta 613620
 agatgtagat aaaaatttac ctgtctcggg tcaactggaa cttacttgt gtatatgttt 613680
 tgttgcatg gcatacagta agtgcttaat aaatggaagt gactaacacc atgatctttg 613740
 gcttggaatc tgattgagaa tttgttgta tatgattttt ggggggggaa ctccacagca 613800

 ataagcatca cctccctgtt atttaacaac tcagaaagga aattgatcat gtctgcctct 613860
 ctctgcccc ggacatatgc aacgtggact gatcaccttg gcaacctgaa aactttactt 613920
 catgcattea cccaagaat gcttctctca atgcatatcc ataacattgt caggccagta 613980
 attactctga ctgaaataat agtgtgttaa cagatcaagc ctccagggt catcagtaat 614040
 tccttccctc tttcctcggg gaagatttca gggccagggt gatttgagct gttattggcc 614100
 tcagaggttt tccaatgggt ggttctctta ctcataatgc ctctggcatg ctccattttc 614160
 ccagcaccac aagttgcaat caacacatgc tggcagtga catcttttaa tatttgttgc 614220

 tctctttctg cctagcactt gtggetccat cttgacatga agctgttctt gttattgcca 614280
 ttactagcta aatagccctt ggactctagc tgggaaacag tatcataaat tgcttagagt 614340
 tatcctattt cctgcaaaaa aaaaccagg cagcttcagg cccattttta ctttattatt 614400
 catacagcca ggccatttat tgcaggatat cgcctctccc tgggttgag taggccaatt 614460
 attccatttc ctatcataaa tgtgcaactc ctgattcagc agccccaaca ggaggcatac 614520
 ttgggatgaa agtgttgaa catttgttgt tgagagtaga aattcattat ctatcccttt 614580
 ctcttatttg gcactaaaca gagagtgggg ctgaagaggt gaattctccc atctaggtag 614640

 ccaatgggtt gggtcattgt tatggagaga gagataaaag agctagcttg gacagatgag 614700
 tgatttctaa cggtttgttg gttctatttg gtggagtcct gtttaattaca taacatgtgc 614760
 ctgtgtctgt gtctttttaa taacatttct aaccacctgg agaattgtga aaaagcagag 614820

ggagatatat aaagaatggg taccattacc ataaaggctg gagaaaggtt tgaagggaga 614880
 gaagaaatat gctcttgcat cagttatggg atttttaata gaaaggcaat ctgcttaatt 614940
 atgggagggtt ttgatttga aattactgta caagtaacat catggctgag ggaggtgagt 615000
 tcctcagga agggatcgga tgtttataaa agtagaagga aggctgggag tttttctcac 615060

 taaatgaaaa gaaacttctt aatattttta ttttttagta aacaaaccta ttggacagag 615120
 tgcttgctta ttttgatgt tagcaacaca gcagcactga atggaatggc acacacctgt 615180
 aatccaata ctctatagcc agatgctcca gtgagctaca cagagagttc taggctaacc 615240
 tggaatatat taaacctggt ctcaataaaa caaaaacaaa aacgcactct ctatttgc 615300
 ctacattct cctgtttatt ctctataaat tccatttccg tgaatgtgg gaatgaagga 615360
 cgtcttgtgt tttcaagctt acctggatc gtgtgcacc tggcagaacc cacacctctc 615420
 ctgttggctg ggattgtgca ttgctgagga agagaagcac cttgttcct ggggagagaa 615480

 gctgcccagg tgagagtcgg actccttcac catatcccag cattctttgc taggagtact 615540
 gtctcccag tctacaaaga gccagtagct gttcagagca tctcatcttg agaaagagaa 615600
 gatggacatc tggaaactta tgaaaacatt taagtttgtg tttatttgaa agaaggaat 615660
 caatttcaac tgatccctcc tttttgttt gagaattgtt ggattgtcct ttgctaagaa 615720
 agaaagcatc atgttagaac gtccctgct tggagaacag tctcaggtga cagaaataag 615780
 cagcttaggg cctggctcct tctgctgtg gccacctga gaggtgtagc gttattgagg 615840
 atcaggcttc tccaccagt acagagaaac tggatatcac tgtggcaaag acagactctt 615900

 gtcacagcat caggaagggt gaaccactgg cctagagtct tctgactta ggggtagaaa 615960
 ctcaattatg gtgttaagtt ctaggaagaa atggttatgc catttaaggc tctgtcaaca 616020
 tcaacttaga aacagcaaca gacaatattc aatatttcag tacaagggca tgagactcag 616080
 attcaggcta ggactggatc ttatttaaag gatcatacat gaagatttcc agaatgtctc 616140
 ttttagccca ttctgcaatg actttgatga agcctgctct gttaccagat aaaaactact 616200
 tagcatactt cataatataa acactatcaa tctctaacag aactgatgac ttcattatct 616260
 ctgctcacca aacacagtgt cttttcactg acaactcaaa ttatgtaaaa taagtagaat 616320

 ggggtggaat tctttgaaga gagggtgaaag ttgtcaatgc aatataatgt ccctatgtg 616380
 acctgtcat ggatgaatga cacactttta aatatgctg cactccctac atgatgaagg 616440
 aatgatcaaa tgaccttccc ttttaagatgt aactttcaa agacagggtc atcttcttat 616500
 ataagaccaa gtggaacca cagctaaacc ataaaacacc actgatgaag caaatgtaac 616560
 tcacgggcac aaaaagaaat gcaactggaca gtttgaatgt atccctgaaa aggttacttg 616620
 ttggaatgt atctctgaaa ttcatatgta atagagacgg gacctttgga aagaagctag 616680

gatcagatga tgccacgagg gagaaggcac cacgatagtg ttaatgaatt tacaatagga 616740

agaaagactt agctgtaatg tttcttctgt ctccatgg gatacttttt gccatgctat 616800
tgtggcaaaa ggacctacaa taatatgcta eggggactgt gacctgcac tetagacctt 616860
tccatcctcc aaaacctga accaatgaac cctctattca tttctattcc ttttcatttt 616920
tttctttttg cttttgttct aatttgtttg taacagccag agcctcaatt tcaggtggc 616980
cttgaaactt taactcatca tgaacttctt gcttcatacc ctcaagtgt ggtgattaca 617040
ggtgtgtgca agtgtgacgg tttgacatct atttttata taaattaatc ctgtagcatc 617100
cattgaagta atagaaaata aacttagaag acggggattt tatttaaagc aataggtgac 617160

tatggtttag atgtttgca ctaggactca ttactgataa gacagtgtac atggtttgcc 617220
tgccaatfff tgacacaaaa ttggagatcc ctctcagtct cccattgccc tggccattga 617280
ttagagaagt gtatttccaa ctggcaaatg agcaaggaaa agacaaagca ggtgttcaaa 617340
tgtaaatfaa gatgcagaaa aatgcttaca agagacaaga taaaactaag aaaactaagg 617400
aatcccaaaa aaatacctcc caaatatccc ataaggcatt tgtcattcgc tgcatttta 617460
taagttaaga aatgcaaagt tagccaaca gtagctgaaa cattgtcctc aggaagagct 617520
ttgtttgctt ttgtgacatg gaagatatca aaataataat aaatctagac agtacacaat 617580

agtaagcact taccatagac aggaatgacc tagagggatg caagttgcct caaggccaac 617640
aagatgtaca tctcaagcat gatcaactct agcagagtaa ggcaaaatat ctccataaag 617700
gaccagctag caaatgttcc acttgggggt tacataaaca gctctttggt aactagccc 617760
caaagtaacc atgcacaata tacaacaaa agggcatcag tgtgttcagt aaaactggac 617820
ttataaaaa acacagtcaa ttagtaagat atgtttcact ggctgtaact taacaacact 617880
tactcagaag aatataatgg gagctgagca agtagtctca gcttcaaact gcaacacaca 617940
catgtgtctg ctctcaaca agacaactct atttttattt tatttgaaaa ctcaaacttt 618000

aaaaactagt tctttactta taaaactata ctactataa aaaaatctat tatttaatga 618060
aaatfffatc cagaagatff gtgcttgaag agaagtccca gagctaatat ttatttgatt 618120
acacaattta tgggtttgaa agcaaacctt tctgggatac ctgataacag ggatagatgg 618180
atagacagag agataaataa tatttaccat ccttgaagaa gcttcctctc tatttctagg 618240
gaaagtffca ataagacctt gtctccaaca ttatttatta atactatgca aaatffagtt 618300
aaatagtttt aatcagggat gtttatgaaa aacaggatcc actgataaac tttcagaatg 618360
tctgaggcta gaccccagcc agtgtctttc aggaatgagt ggcgaatcac actatgagaa 618420

tgctactgtg aagcaaactt aggacccaaa ccaattatth acaaagtcaa gctctgttat 618480
 agaagcagag gataggacaa cggcatttgt tttagacaag tgttctttct attgtgggtg 618540
 tttcagggac atctgtttgc cctggttgtc tgaagaatag tttactctct gctgttctct 618600
 tcaactcatgc tcctttgtgt ctgctcttaa aggaaatgtg tttaaacagc acagaaacac 618660
 aacctgcaca gtgtaagatc tataatthaa ctctggcttg gtttcagacc tttctcaggt 618720
 gctttggggg gattgagttc atattctgtt ccaagagtat cagtgtctca tagacaagag 618780
 tgttgagtgg agttgaaatc actggtcaaa gatgtattht tttttcttt gcaagtccag 618840

 acctcattca gaatctaaaa aaaaaaaaaa accttcactc tgccttcata aacaatagct 618900
 gctgtaactt ctaagacaaa aataaaatag aaccatagta acaagaaata ttgatctctg 618960
 actaacaatg tacacaaaaa aggaacacac gaggaagtgc aaaatgtgtt ctgtatcca 619020
 aatgtgagca tgatgacaat ctgcaaacat atagaagcta tcagaaaccc ttccttggga 619080
 ggaagagcca cccattact gagatcaggg tacaagaaga gatgggtcct gatctctctg 619140
 tagctthttg tcaaaccxaa agthttctgac taccttgact acctagtthc agccagthtt 619200
 gaaaaaaaaa tgtgtthttg cacacaggtg aagcccttht ctaaccaaga actgtggatg 619260

 tggatacaga gagagthttat ttacaactaa gccaactatt cccagaggth agactcactt 619320
 thaaaaaatc thgtggaaac thagccctgg gaaaactcta tctccactcc cccaagggtg 619380
 tcaacttggg aatathaat tcaatcataa atctatact tthctgcta cthtctactg 619440
 tccaacagt acaggtccta cactthcta tcaagaatcc ctatgaatca aatgcccag 619500
 ggaagcaxaa aaggttgctg acttggaxaa thaactcaxa atccagagca aaatgctat 619560
 thtccactc gcagtgccag gctacacacc atathctacag taatgthtca gtgccaggga 619620
 aatgttgctt gcctthtga thgactthc thtaccaga aagaccaact caxaaagatc 619680

 agccctagat catgcctctt cthctthttt aaagthtcat cthtctacce tgtcatgata 619740
 thaththtcc thgcaththt ctathgtac tagthactth tctathgcta tgataaata 619800
 ccatgatctc agtcaacctt taggagaxag agthththt ggcttatggt tccagagtgt 619860
 gagtccatca tggggagggg agggcgggag gcaagacagc agaathctgg aacaggatgc 619920
 tagctgctag catcttcatc caxaacagta aacagtgaxa acaacagga agtgggttht 619980
 gaccataac gtccaxagcc tgcctacce athaaagtac thctctatc aaggatctac 620040
 cthctaxagg thcataacct ccctacctac tgaggactca gtgtthaac agatgagtct 620100

 athtgggca atthctattc aaaccaxat actatgtht gctthataat axaaggaatt 620160
 gaththaxat actacatgat gcaccaggaa thctgagatt ggactctcta gtgtthaac 620220
 atctatcagg atcatctaga agcaatath atctcaxaa tgaathcaa acagatagag 620280

ctggagtctt catccttaaa gatccctaaa tggctagcac acaccataaa cctgaggaac 620340
 caaagtctt actgggcaag gaccataaag agccctcacc tactcctggg atcctgattt 620400
 ttgcatgac agaaaatcta tactgtgcag attgggcaga aagtaatgct tgagatattt 620460
 ctctgtgtt ttctttagtc aaaaggatga tagccaggca tcatggtgcc ctctatgat 620520

 ctgagacat gggaggctta gtcaggagat ctagaatcca agccaagtct gggcttcatt 620580
 ctgagatctt gcttcaaaac aacaacaata aacaacaaga atagtaggga atcatttate 620640
 aatgtcactt tgtccaaggg aagtgtata gacaagaata ttccaaagag tatcagttct 620700
 tctcattata ccaccagtga aaaagagcag tgtggagctt gcaatgggtg ttcactaata 620760
 agctgccagt ggaatccttt atttcattgc tgacttatgt aaggatctca aaaacttagc 620820
 agtgtgatga gcatgagatt gcctttctca cggtttcatt gccacttatt ctgtcaaac 620880
 gattgtcttg tgagactcag agtcagttgt caatctcaaa tccaacaac aacactgcag 620940

 atgaggctgc agacttcagg atattcattg acttcataat ccatgcatcc caaacttccg 621000
 agggcttggt caaacctaac tacatggcac acaactgggtg ggcaactaac aaacactgct 621060
 gacagactgc aaagatccat catcgctggc ctgagtttct gtgacttggg ccagcctcag 621120
 agggaaagca ttacaggtt tctccatcca tgttgagtct ggacagactt tcaccaacac 621180
 agagagctaa ttgcttcctt gtcttgagat tgcatattgc ttagtgctgg catgatgttc 621240
 caaaacccaa gaagcacaag tagtgatccc ccaaagctgc tttaaccttt tcaaactcta 621300
 acaactttat tgtctacctc attatactcc ccagactttc tctggatgac agtctgatgt 621360

 agaggactca gccagtgtcc tttattagca ctttcttctc tgttggccca catagcaagt 621420
 gtcttgagaa ttcagaagaa aaacttaaac agccttctct caggatttta gtcttcatg 621480
 tccccagcag cttttcaac taataagtct aatgtatgtg ttcaaagcca tggactgatg 621540
 gcaagaggct ttcccacccc agcttgatgc aggacaagca cctcatcaga taatttctec 621600
 ctgggtggat ttcccaccac aggagaagaa cactagtggg aaacttgggt actcacaaaa 621660
 taaaattaaa gtgtgcaaaa aaaggaaaat aactgggcaa agcctgggaa ggtgccctat 621720
 aaaattatag ttatattgtg tcacagttca tcttgggtact caacttaatt ggatctggag 621780

 tcaatgacga gacatgcctc tgagggaatc tacagagtat gtccagaaaa gattcactgg 621840
 ggaaagaaga ccttgtctcc caccgttcc agactctcac agaagcttag atacagagct 621900
 ctgaaggaaa gtactcatgc tttgtccac catcaccaat acagagcatt tttgcctct 621960
 tcccactga tctgatgcc catcctttgt gctgactgaa gaaccagac tccttagcct 622020
 tgaagaaaag ctactctttg ggggatcttc cagtcgttcc atgctggtt aggaccactg 622080
 aggcaccag ctgatggag tgagcagctc ccaagtctc gttttctgc agtgtgaagt 622140

cagctgttgt tatccaggca tactgtgtaa gccaatctaa taaatgcct ttgtaacaac 622200

 cattctatca gctctgttcc tccagagaac actagcactc taccatatit gatagcagcc 622260
 atggaacccc tgtaaatctt atctgagtca gcttgcaaat tcactcatcc ctttttttcc 622320
 atttaccgtt ctccactcc agcccattca tctatctata aatgggcaaa gctcatcaca 622380
 tgcactataa ccctactgtt tttctaaaac tgctacattg atagtgtatg agaatgtgtg 622440
 caaacaaatg ctactttgat agtttatatga gaacatgtgc agacaaactc aagtgtgaca 622500
 ctcttagttt ctattcaata taaaaatgta gtaaaactca aggacaaaaa gaaataaaat 622560
 tagggcttag agaaacacct caaagatgag aagtttatcc ttagcaagaa caattcttgg 622620

 gactagggga gtgactcagt tgcttiacct acatattgga agcccaggac tccatcctca 622680
 gtgcctcta aacctggcac agagacatac acctgaaatc tcagcattga aaggtagaag 622740
 caggaggatc agaaaattca aggttatcct cagctgcatg agttcaaggt tggcctgagc 622800
 aaagatggac tctgtccaaa aataaataaa acattcaagc ctttttattt ctttttttgt 622860
 tgttgttttt gtttttcgag acacggtttc tctgtatagc tttggagcct atcctggcac 622920
 tccctctgga gaccagctg gcctcgaact cacagagatc tgaactgcctc tgcctcccga 622980
 gtgctgggat taaaggtgtg caccaccaac acccagcaa gccattttct tagcagtttc 623040

 catttccagt atcttctgta agaaaacat gtacaatit atccatgagc ttcttctat 623100
 agtcacagtg tigtgcagga atatttttag tcttaaaaca ctcaaagaat atactctgca 623160
 aagtaggcat taaaaaaaa acagggaaat tcaccctta tttatctgtt tgtttgtttt 623220
 ttaaaattaa acagacacaa tattgtcaaa taaaaggccc tttcttttca gagaaaaaaaa 623280
 tctgtttcca gcacctcta ctcagtgtga agagacaagc caaacacagg atgctgaatc 623340
 tgtgggacce tctgtccat ttattatgcc taagaaatit gttctgatcc agggatctta 623400
 tgtgtgaacc ttcttgacag tggactttgc ctctgatgt tcacacacac acacacacac 623460

 acacacacac acacacacac acacacatcc ttcaaacacc aggctgtcag gaatctcaga 623520
 aaggagtgga atcaagcaca cagactcccc atgtgacaca ttcagattag ttactttgcc 623580
 taaaacaagt agcagacaaa aacagctatt tcattcattt gaagacaata gctttcaatt 623640
 taacacttcc aaaatccag catgtctgac aatggccatc agagtaaact gaagttagat 623700
 tctgccagag aggggttct ggtctctatg tctagagaat gtccactcc tcatgagccc 623760
 agtgccatga agaagccatg tgagtttctt tcttcgccct cttggatggc agagtctttt 623820
 tcacttatct gcatcttaag gctgtagata actgtttttg tctcacctgg ataaagggtt 623880

ttgcattcag tggctttttc tcttggcctt gcatagagtg gaaagtcact gcagatgtga 623940
 ggaactacct cagagggggg acacgagggg tgcataagat aatttgtgta aagagcccct 624000
 agcagtgcac gccacttaat gaacacataa tgacagctgt tattacttct gccttgccat 624060
 caatatccaa ttgtcactaa acagagaaat gtgataatta cttacttctc ttcactatg 624120
 aaaaaaatg caagcctaga agtgaagttt gaaagccatt tggagagtc taaagaaagc 624180
 ttgcccctat gaaatgtgag gggactcctg gcccttagct agtgatggcc tcggtgaagc 624240
 aggcctgggt tctgaggctg atttccagaa atggccctgc caaatgtttc agatccctc 624300

 taatggctga gaatgtctta agagaaagt tttccctttc tgtgaataga aagtggataa 624360
 ttccaaggag ttctttctcc atgcactcaa agttggctcc ctggggctct gcagatgctg 624420
 catcagcagg gtgggtggct ggcaggcaaa gacacatcct cttgcatccc agaaactcat 624480
 tggaggtca tgctacattg atagttcagt aaaacataac cacatagcaa aagccagttc 624540
 cttttgttc ctttacaaa aagctcttgc aatttaaatt actccaatgt cagggaactc 624600
 atacatgtgt tcaggagctg agtgtctatc ttctgaatgg gctctgaact gagacttcag 624660
 actgtagaac aagcctgtca atgcaggaaa cctaccgccc aaagcagttg ttacacactt 624720

 tgattatting ataataatag gacttagaaa aaacacgcct taagaacaaa tgagcacagc 624780
 aaggcctgaa tatcccaaca cagatgaagc agaagagaat gaccataaaa acagctacat 624840
 gaagatgata gagaccctaa aagaagaaat aagaaaatcc ttttaattgga agaaaaaac 624900
 aaaaaattaa agaatggag gaaaagacaa accgaaaatt gcaagaaaca attcagacat 624960
 gcaaagtctg aaaactgaaa tagaaacaat ttaaaaaaac aatctgaggg aatgctggaa 625020
 ttagaaacta tgggtaaatg gtcagaaact acagatgtaa acataaccac cccgaataca 625080
 agagatggaa gacagaatct caggcattga agatacacta ggagaaacag attcatcgac 625140

 caaagaacat cataagtcca acaaatccct aaacacaaaa tatgcaggaa atatgagaca 625200
 ccatgaaaag accaaaccta agaataatag gtacagaaga aggtgaagaa acccaactca 625260
 aaggtacaga aacatattta acaaaatcat agaagagaac ttttcagcc taaagaaaga 625320
 aatccaatg aaagtacaag aagcttataa aataccaat agagtggacc acaaaaaagt 625380
 cctccccac ataataatca aaacacaaa catacagaat aaagaaagaa cattaagagc 625440
 agcaaaggaa aaaggccagg tacaatataa aggcaaacct atcagaaata cacgtgaatt 625500
 ctccatggaa acictgaaag ccagctacaa aactaagag accacagatg ccagccaaga 625560

 ctactacacc cagaaaagct ttcaaacact atttatggag aaaacaagat attccatgac 625620
 aaaaccagat ttaacaaaa catatccacc aatccagccc tacagagagt actggaagga 625680
 aaactaaaac ttaaggaat taactacact caaaaaaca taggcaatag ataatccaac 625740

ttaccaaca gacaaaagaa aagggggcat aaaaacacac acaaaaccaa caacaacaac 625800
 aatccaaaa caaataagaa ttcacattaa atggtcttaa tttccctcaa cattaacagt 625860
 cttaatcac ctataaaaag acacaggcta acagaatgga tagaaggaca gaaccattc 625920
 ttctgctgca tacaagaaac acacctcaag ttcacaaaaa aacattacct cagagcaaag 625980

 gcttgggata agaatttcca atcaaaagga cccaagaaac agctggtata gctatcctaa 626040
 tatctaaca attagacttc aaactaaaat caatcaaaag agatgaagaa gggcattgca 626100
 tattcatcac aggaaaaatc cattgagatg aagtgtcaat tctgaacatc tatgcccga 626160
 atacaaaagc agccacgttc ataaaagaaa cattaactaaa actcaaatca cacataaaac 626220
 cacacacact tagagtggga gacttcaaca cccactctc accactaggc aggaccacca 626280
 gagagaaatt taacaaagaa acaaaggaata taatagaagt tatgacacaa taggttttaa 626340
 cagacatcta tagaacattt catccaata gaaaagaata taccttcttt tcagtaccac 626400

 aaagaacctt ctctaaaact gaccacatac ttggcaacat agcaaacctc aacagataga 626460
 aaaaaaatg gaataacccc ctgtatctta tcagaccatc atgctttaa gttagaagtc 626520
 aacaacaaca taaattgcag aaaactteca aactcatgaa aattgaacaa tgtgcaattg 626580
 caccatttct gggccaagga agaaattaa gacttcctag aattcaaaga aatgaagac 626640
 acaatatatc caaacttaag ggacactttg aaagcagtat taagaggaaa gttcatagca 626700
 ctaagtgtcc acataaaaaa agaagaagaa aaagaatagt cacacaagag aattaacagc 626760
 acaactgaaa gctctagaca aaaagaagca aacttacctc agaggagtag atgccaggaa 626820

 ataaccaaat tgagggetga aatcaataaa gtagaaacaa agaaaacaat gcaaagaatc 626880
 aatgtagcaa agagttaggt ctttcagaaa atcaacaaga tacacaaacc tttatccaaa 626940
 ctaacaaaaa ggtggaaaga gaacatgaaa ttaacaaaat cagaaatgaa aagggaaca 627000
 taacaacaga cactgaggaa atccagagaa tcttcaggtc atactttgaa aaactgtact 627060
 ccacaaaatt cgaaaattta aaggaaatgg acagtttctt ggatatatat cacttaccaa 627120
 aattaattca agaagagata agcaatttaa acagccctat aaccctaaa gaaatagaag 627180
 cagtcatcaa aattttcca accaaaaaaa gccagggcc agatggttc agtgcagaat 627240

 tctaccagaa atccaaagaa gagcaatac caatactct caaattgtc cacacaatag 627300
 aagcagaag ttcaatgcca aactctttat gaggctagaa ttaccttgg acccaagtca 627360
 cacaaagaca caactaagaa agagaactac agatcagtaa tcctcatgaa cattgatgca 627420
 aaaatattca ataaaatctg gcaaatgat tccaagaata catcagagaa atcatccacc 627480
 atgatcaagt aggcattcat gaaggatgac aaggatggtt caacatatga aatctatca 627540
 atgtaatcca ccatataaac aaaatgcaaa agaaaaacta catgatcatc tcaattgatg 627600

ctgaaaaggc ttgacaaaa tccagcacc tttcatgata agggctcttg agagatcagg 627660

 gataaaagga catacctaac cataatgaaa gcaatatata ctaaatacaac agtcaacatc 627720
 aaactaatg gagagaaact caacaggatt cctctaaaat caggaacaag acaaggctgt 627780
 ccagtcatac ctcttcaata ttgtatttga agttctagct agagcaataa gactacaaaa 627840
 ggagatcaag tggatacaaa ttagaaagga aaaagtcaaa ctttctactac ttgcagatga 627900
 catgatagtt tccatgagtg acccgaaaaa ctctactagt gaactcctcc agctgataaa 627960
 caccttcagg aaagtagcag gatacaagat taactcaaaa aatcagtag ccctattata 628020
 tacagatgat aaatgggctg agaaagaaat tagagaaaca tcacccttta caatagacac 628080

 aaacaacata aaaatatctt ggggtaaacac taaccaataa agtgaaagac ctgtacagca 628140
 agaactatga gtctgagctt ttaaagaaag aaattaaaga agatacaaga aatggatat 628200
 atctcccatg atcttggata ggtaggatca acatagtaaa aatggcaatc ctgccaaaag 628260
 caatctccag attcaatgca ataccatca aatcccagc acaattcttc acagactttg 628320
 aaagaacaat acttaacttt atacagaaaa acaaaaaggat agccaaaaca accctgtaca 628380
 acaaaggaac ttccggaggc atcacatecc tgaattcaag ctctattata gagctatagt 628440
 cctgaaaaca gctgggtatt ggcacaaaaa tagacagaca gaccaatgga atcaattga 628500

 agatccagat attaacccac acacctacga acacatgatt ttgacaaaag aagctgaaat 628560
 tatacattgt aaaaaagaaa gcatctccaa caaatggtgc tggcataact agatgctagc 628620
 atgtggaaga ctgcacacag atccaaatct attgtcatgc agaaaattta catccaatg 628680
 aattaaagac ctcaacataa atccagccac attgaacctc ttagaagaga aagcaggagg 628740
 cactcttga ggaattgggtg cagggtactg cttcctgaac ataacaccag tagctcagac 628800
 agtgagattg acaattaata aaggggacct cctgaaactg agaagcttct gtaaaggcaa 628860
 aggacacagt caacaagaca aaatggcagc ccacagaatg ggaaaagata tccatcaacc 628920

 ccacatctaa cagagggctg atttcaaaa catacaaga actcaagaag ctagtacca 628980
 aaacaccaaa taatccaatg caaaagtgtg gtacagaact gcacagagaa ttctcaatag 629040
 agaattcatt tttccttttg gaacattctt agactgcaga gttttctttg aaacaaaaac 629100
 tttaaaagta aaaactcaaa gaaatcaaaa taaggttcta aggggaattt acaactcaa 629160
 ggctcctgat acacactgca aatttcaaaa ccaaacgtga gagtgccacc tgaagattt 629220
 tcattttctc agggatttgg atgcatcctg accactgact aacatcggca agccattggc 629280
 ctgtccctct cctcatgcc acaaatatag aaaccaaggt cccaagagg tcaggaaca 629340

ggaggacatg tigtgaagta gtgacagagg aaaagaaaag cagattccac ctctcactt 629400
 ccaattcagg ctgctttgac ccaagtccca aatgttgctt ctgagtgga cttctgtttg 629460
 ttttgtttta tttaatcttt gtcttcaaag ctttctcagt ttaacatgct gctatgctgg 629520
 accccagcac ttctgaggag cttggcagtg accatctatc agagtgaatt tggagatccg 629580
 gacatagcaa acacaggcat ctactataa tcatcccttt caagttgaaa agtctcttat 629640
 gtttgcctca gtctagtttc atctctgaag aaaataaagc agttggaggg aagtattgaa 629700
 gccagcaggt aaagagccat tgtggatgga ggttaattca ggtggagacc catcttgctt 629760

 gactgtagat tgtcctgccc tcatctagaa ttcagaaagg aatttggga aagaaggag 629820
 ccatgagagt ttatgctgaa cagtgaatgt gctgcacatt ttctgaggtg catctcccct 629880
 taaaggaaaa agggaagggt gggttatcag tgtattctgt tgattcccct tgctgagctg 629940
 gctcctgctg caatgagggg aagtctgata atcagatttg tgcaaggatt tctgtccagg 630000
 cttgctgagc ttigtcagca agaaaaaaaa agtgctaaca tacagtgctt ttttttccc 630060
 agtaaatctc tatggtttca tttaatcttg cttttctcca actatagatc aaatatttc 630120
 attcccagag aaaagaaaaa tgtactcacc ttggtactca tcttttcccc tcacaaaacc 630180

 tgaagatta caaaaatgcg gtgatataag ggtaaaataa ctgaagccaa ttcttgaac 630240
 tctacgata aatatggaat tgacatccgt gtcttccagg ccagcctgga tgtgttcaag 630300
 ataaaccact gtgatggtta atatagatgg tcaagttcaa acgctctaca gtcacctagg 630360
 agacaaacct ctgggcatat gctctagtta tctttcagtt actgtgataa aactctgaca 630420
 aaatcatctt ggggaggaaa ctatttggct tctgcttcta ggtcacaatc catctctgag 630480
 agaagtcagg gcaagaactc aaggaggaac agaagcataa accctgaaga atgttgctta 630540
 ctagcctacc ctctggctct tgcctaaccc tcttatacat cccatgccac tttctaagca 630600

 tagtaccate aacctgatac tgggccttcc cacatcaatc ataaatcaag acaatctttc 630660
 atgaagattc attagacttg gccacagttc ataagtgggt gccttgcaat gagactgtgg 630720
 tttgtttatt tattttttt attcccacat actcacaag ctttctcctt ttagaatgat 630780
 gttatgtggg tctccagcac ttccaagga gtttggatg gaccactgat caatctgatt 630840
 gagataattc ttgactgag tgagattctc tttccaggtg actctaggtt gtgtgagttg 630900
 acagtaaat ctcatatgc tgtgagaaag tctctatatt aattgaggat ggaatactct 630960
 gtatgtagca tcttgacta aattaaag agaaaacaag tggagcaatg acttctggc 631020

 ttaggcata tatgacctat gcttttgcta catgattcc ctgccatgat agacttgtgc 631080
 ctctgaactg tgagccaagc taacctttca ttagttacct ttttctagtt attttgacac 631140
 agtaacaaga aaagtaacag agccactgaa gaagatgact aagcattacc tatgaccag 631200

aagtggacca cgaggccacg ccacaggtct gagtttttcc aggcaccacc ataagtttta 631260
atatttcaga gaagagaatg gagcaataaa tgcaacccaa tgtcccccta ttcaccagg 631320
gcagaagcct ggggtcccat ctcccttctc cctgtctctt cagtaatcaa tctctgtgct 631380
ccttttctt tttatcctt cctttgtttt gtgggtttgt ttgttggtt gtttgctgag 631440

gcagggttcc ttgtgtagct ttgtagacca gagctctgcc tgcctctgcc tcttagtgct 631500
gggattaaag gcatgcatca ccaccacca gctcttttcc tcttttcaa tctctcttcc 631560
cccttctgtt tctccaatt tgatcagccc tgcaactgta tttccttga acattttcaa 631620
tccattctaa tttattcatg tcatgggttt tctgttttcc ttttcgttcc ttatgttgct 631680
actgagtaag tttccttaaa aaacaaaatt ggttatgtga tatgcctctc caaagtcctc 631740
tgtggctccc tggacttac agaataatga caccatctct ttttgtgtct tttctagctc 631800
tgttctactt tctggatgc atagtcctcc tctataccca tttgttagca tgctccatca 631860

acactctggg atctattaat ttaattatgt ttcaagactt gaactcagat catttggact 631920
ccaacacctg caaggttaac ctctccatga tgtagttaaa ccttattatg gtccaacagt 631980
ggactctate tagattatgt tttccactca ctgcaggact catgggcaac agtttcagca 632040
tgtctggata tcaattcatt tccatgctca catatattac aattttaata tatatgatac 632100
aagtaaactc tctcccaca atgtatacat taaaattctc attgagaca aaccagtgca 632160
aaaattcaga cacatactc taggaaagaa gagtaaaatc cagattatgg aaataagatt 632220
caatggtaaa acaagaatct tagcagaaaa tgaagtctag ttccatagga tttagcatca 632280

ggtaagggat atagaaggtt aggactgagc ttctaacatc aagtcagtag gaaaatatgt 632340
agtcattggc ctaagataaa ggaaactgca tctaaaacac ggaataagtc taacagtgac 632400
tacaatctgg ccatctgtg aaaatgagac tacaaaaata ttgaccataa ccacagggaa 632460
agctaatact gttaggaagc tgtcattgaa ctgactctgt tgggggttgg aagattacag 632520
aattctaaac ctcatgcca ttccagaatg gcagacctga cttttcattg tttgtacaaa 632580
tttaacaaca tccaataaaa attggcctaa gctattacag ccacaaaact tgaacaataa 632640
caagtaagga tctattagtt aaggaccagc agtagttcta tgcttatgga cattccaga 632700

aaatacaaca cacatggigt ccttatagta aattattatg tgtaacaagg aaaagcaatt 632760
aaccataagt cagagaaatt atgacaggag atggtttagg taacccaaac aaggatcagt 632820
agagtcagct gagtagagtc agaaagtatg ctaacttcag tagagtcaga aagtatgtta 632880
acctcaacag gacccagaa ctatccttga aaacaaaatg ctacttgta tggctttaac 632940
ttatgtgttt gcatcagg tcaacaaggg gacaaaggt gagctagcaa tagttcatct 633000
tccttctcag ctgactggg tctagaatta cctaggagat gtgccctgt gcttctctat 633060

ggggacatgt tcagagaggt taactgagat aagaagaact gcctggccag gtgttgggtg 633120

 catacacctt tagtcccagt acacaggagg cagagacagg cagatctcta tgggttcaag 633180
 accagcctag tctacagaac catttccagg acaggctcca aagcaataca gaaaaacct 633240
 gtctggaaaa atgaagaagg atggggaaga gaaagaagaa gaagaagaag aagaagaaga 633300
 agaagaagaa gaagaagaag aagaagaaga agaagaagaa gaagggcagc accatcccat 633360
 gagcagggtg ctgaagtgat taaagtggaa aagagatcca acagaacatc agcactcatc 633420
 tctctctgct tctgactat gggcacttct atcttcatgt cttcccagca atgatgggct 633480
 gtattccac catgatggct accatgatgg actgatcccc accatgatat actgtgtccc 633540

 catcatgatg gactgtatcc ccacatgat tactatatcc cacatgatg gactgatgcc 633600
 cacaatgatg gactgcatcc cctcaacca tgattcaaaa taagtccttc ttttacctcg 633660
 ctattatttg ggtatttagt ttatcacact aagaaaagta actaatagat taccaaaact 633720
 acaaaggcaa tttcctcctc ccccccaaca aatttcctt tccagtgttc atttgagtcc 633780
 taatgtggct tctacatat atatttttaa ttctctgctc tgtgattacc tttgtctatt 633840
 tactcagaaa agataactcc ttgtttcctt atggatecat ttttccatgt atcacataga 633900
 agctatagta ggtaaatgct taaaaaattt ggttctgtaa ttaattcat gagtttatcc 633960

 tgattctgcc acttagtaat taaataactt tgaccttaaa tttgaacctt aaactctttt 634020
 tcaatgcaaa atgagaataa taacatgact tataaaaaga tctatgagat ggtaccataa 634080
 actctcgacc tagggcctgg ctcagaaaag tatttggtaaa tgttattcat tattattcat 634140
 gctaattacc tggaacacat gctcataatc cttacaaca ccttgtaaaa taacactatt 634200
 acctctgtgt tacataatgg ccaacagttc gaagaggtta ttaagtaatt tgccaaagga 634260
 aaacttctc ccaagaggga gagctacagc ataaactctg aaactacta ggtcaacctc 634320
 tccacaacac tcagggtcac acagaageca ccccccttca aaattataca ttatctacta 634380

 actaccaat gatgggcaac aatgaaaatt cctttcatat ttaggtttat tgcacttcaa 634440
 atagatgtct gaaattacaa gaagcacagg gaagacttcc acatgctctg tggatgaagtg 634500
 acaaacagat ctiaccacc aaggttacta caagaacaca taagctagga aagtgcattt 634560
 aagctgagac ttaaagctt atgaggcgca catagaatac cttatgaaga tgctgtctac 634620
 tggaattacc tggatattgg aaggatgaag ctgcaccaga gtggttgggg aaggaaaagc 634680
 agatgaggga agtgaacagc agaaagcaag aaccagtggg gttaattaat ggtcattagg 634740
 tggagttcag accacatcaa gtgtcaggga agccacagaa accttttaag ggtgtgatct 634800

gatgatgttt tgaggcttta ctttccaagt ctaacagaag ggacttcaca gccagcatgc 634860
aacctatgaa gaaaccaagc agaaaatcat ggcaatgtgt tggtaaggat aggaaggcaa 634920
cagagggaga tgagaggagc tgaaaacaaa ccattgagag aaaatgatga gttacagagt 634980
tgctgagggt tacagagatt ctgatagaaa tggctcgcctc attcaaaatc actcactcta 635040
tatttaatac tgctccacca atggattggc tgtttctggg ttctgtgttt actcctaacc 635100
aatgatccat tagcagagat aagaggagga gaaaaacaag ggataatgct ggagccagta 635160
aggatgaaaa ggtcccacag aaactgtcag ctgcctcccc acaatgacag agttccttca 635220

tagtacggag atttatctta cctaataatta attaatattg ccccaatatt actgccccea 635280
tattaattaa taatgtctat tatgtactac tgcattatat gtaacttaca aatataatatt 635340
caaatcaatt aaattathta agataaaacc aatgtcatct ttaactgaaa atctgactct 635400
ttgttcccat tttatctcca tattcccctg tcttccacat aactagaata ttttttttta 635460
cttgctgaaa gactttaaca tttagtaatg gccaaaacaa aaggaaaaag tggtagagag 635520
agaaaatcag cagttctgtt caataatcgc caattgtttc cctgacagcg tccagacaaa 635580
tcgtctaagt cacaaatgca tttgtgacce tcattttgga agggcttctc taatctcagg 635640

gattggaatt gaacttcaaa aatgggtatc aaggcttttg ggggcccctc aatttgctgt 635700
tctaacacce tagtggctga atggccacca tcctttttca ttcgcttaat aaaaaataac 635760
atgaaaaact ataatagcca aatttcttct ctcaaagcc aatgtagaga gcagtcttc 635820
ccaaactcca aggcagtaaa aaaggcaact ttgaacaatg ctttattttt gcttcattta 635880
tttctcaatt tttatctcca gattagatat atacctatag gaaggagac aatgctggaa 635940
actgcagagt ggittgatgt caccaagcag attaagcaaa gaattatcta taatcaccac 636000
tgagtccca tgcctcatgt tcatctcatg tcttttgca ggagactcaa aggtagcctg 636060

gatttaaaat gaaaagaaaa attaccctgt gactgaagag agagtcttag agtcaatgta 636120
tcctccttc tgccccatt ttcttaggaa atagcagatg aaatagctct cattggataa 636180
aataagatgg gggtagaaaat agctatggag gctgaaatgc attcatta attttatact 636240
gtgattgttt ttgagttttt atgagtcgat ttcttaacac tccacttgca tgcaagcatc 636300
catgaagtat gaatccaaga tgcagatgtt ttttagaaat attaatata ggtatatgga 636360
aaaaagtatc ctaggggaac atttagactt gagtttcagg gcctgtacaa ataaacaacc 636420
aagtatttct aatacaaatg tgcattgcctc ctctgaatta tgaagtattt tattggacat 636480

accctttggt taatgaaggt ttgaataaat cctatgtgtt ttgaagagaa ctctgacaga 636540
ctcataacat ggcttaaat ttattccaat ttattgtgta cattcgaaaa ttaaatgtaa 636600
ataaaatggg gggtagattat gagccttctg tccatacata atacgaaac acatgcattt 636660

caaatgacta ataatgtcat gtagcaactg agctgcactg ttaggtttaa caacaatgat 636720
 gcatattagg cccagttgct caggaaaaga aaattcatgg gtgtgtttgg gttttacagc 636780
 aaaaccaaat ttctaataa cagcagtgagg aacaagggtg aggtctacac actatattca 636840
 gaccaactca taatataatt atgagttata tgaaccaac taattaattt ctatgggata 636900

 gaatcgttca agggttgaag acccacactg aaatgttcta cattacaaac acttgtctgc 636960
 cactcctcag tgtttgaatg actgcagaaa actcactatg tatatacaat gcgtcatata 637020
 catacacaat gtgtgaaaaa actaaacatc aaagtgaat gcagttcatt cagtgttcgt 637080
 tgcattgcat agggataat ccaagtgaat catacattta aaatctctca tataacctcc 637140
 cccaaggact cacacaagga gacacacact agataaacac tgggtttttc ctttctgttt 637200
 ctgtttgat gtttgtttt agaaccctaa tgactaagat ttgcttagcc ctgaacacat 637260
 aaacagcatt ctttaaggag tatttgtgac tttttataac tctactcatt tgttctccat 637320

 taggctgatg agttcgcttg gtagaaaaag tgcttgagg gaaagtccag gaatccaagt 637380
 cctaaggcca taacctatat ggtggaagga gagaatagac cctgcaattt gtctctgtc 637440
 ctccacatgc ttgctatggc acacaagcat ccatgcctac acatacacat acacacaaac 637500
 actcactcac acaacatac acacacacat tcacttgcac atacacacta aaaatattaa 637560
 aattcaaatt atataaattc atagggaaag acaaaatag acttcatcta cttccaaagt 637620
 aaaagatfff ttaataaaa tatttcagtt ctaattaa accatttcca atagatatta 637680
 aaatactgga aatgcaattg atctcaatgt agtccaata aaagtaagca acaaaaagtt 637740

 agaactagag aaaagagaaa taagataata ttcatgaga tgtaaacfff actttagaat 637800
 cttgtattta aacaccagaa aagtgtaat taacaataaa atatgtattc cattatctca 637860
 aaattatcca tgccttaga aactatattc agctatgctc acaattcaat tcatctctag 637920
 tatgaattcc caatatgttt ttacacctac acttattttt ttaatctgta catatgccag 637980
 tatatcactc agcactcagc attcagaaa taacaagcag atgtcatgtg aaatacacc 638040
 aatcgaatcc ttatttctct cattaaaca cttccctact taatttaggg gattagaatc 638100
 agtgtggggg tgggctgtag ctggccatg ctcacccgta agaatggfff cctataatta 638160

 gattccatta agatgaatcc acaaaagacc tgagagaagc caggtaggag ctgaataggt 638220
 tagatcaaac cctggctcag cagctacca accttgtgac tcgaacctgc ctgccagtct 638280
 attgtctaca cctccatcta ctcctcata aaataagtgc catgatactt aatcacacgg 638340
 cctaagatc ttataaata taaatgatat aacataatat aaataacctc agacactgcc 638400
 tgccacatag tgcctagtaa atattatttt ttcataaaaa tgttcacatt tagataaact 638460
 cccagtgtag taaactagta tctgtttaat tatctaggaa aacctctagg acaggttttc 638520

aacttgtcga ttgtgacccc ttgggggggc ggtctaacta ccctttcaca gggatcacia 638580

attagatata ctgcataatca tataattaca ttgtgattcg taacaatagc aaaattacag 638640
ttataaagta gtcattggaat aattttatgg ttgggggtcac acaacatgag aaactgtatt 638700
aatgatcac atcattagga aggttgagag tcaactgatat agaacaagat ttctttccta 638760
agaggctgca gagatgggtc agtccatcaa atactaagga agcatgagga cccaagtcca 638820
agtgccccaa actcgcataa caatgggcat ggtgttggaa attaggtgct cctgcagcct 638880
tctctcaaca gctcagtggg ccagcagcta tctacatcat cacaagtcgc caacccttta 638940
aaaggtctct gtcacagact attctcttat gtttctctc tctctctctc tctctctctc 639000

tctctctctc tctctttgtg tgtgtgtgtg tgtgtctact tatctctatc tcccagtctc 639060
tacctgtctc tgccctgcctc tcacatgtcc ccaactaag atgacttttg ctctcccta 639120
tcccataaaa cctctctgtg aagatctgtt gttgtgtgtg atttctatg cagcctacct 639180
tggcccagac ccgccaaggt actctgctac taaaccctaa ctttggttcc attgctaatt 639240
ccttataaac aatagcacac atctggaatc tcagtgcacc tatagtgaat tggtaggcat 639300
tgacaaaaac atccccagga gctgtcaaga aggttagcct ggtataagca gcaaaaaagg 639360
agacccttc tgaacaata tgattgccct atgaatccac tcatactgtc acatgtacc 639420

acaccacac atagggatga atgaatttat gaatacacgt gtgtgaccac aaaagattgt 639480
tttctcaaa tgaagaagtc agcaatatga ttacatgttc cttctgtgta tataaaatgt 639540
atcctcattt tttcttaaaa ataagaatat ttggttaata ttactattag cgtaacaaaa 639600
ttttgcatg tcaaacctct gcttaaaagt ttttaaac aatatcgcat tctatgaaag 639660
tactgagtaa gggctagtag ttgctgcttt taagtataat tataaaataa ttctgtgtaa 639720
cattttaacc taaggtgcag tagttgacca agtgttaatg ctgtcactgt tgctcttatt 639780
tttctgagc cccgttaatc agatagtgca tgaagtgatt aaactacatt ctgtttttta 639840

atgtgtaaaa agcttaagtc atttaattaa gtatatcaat gatcattttg ttgtctaaaa 639900
attattactg aagttaata taagtgaag aggcagatct gtcagttatt tcaagcacct 639960
cccttaaac cactcaggag atggatcact ttccccagaa tgtcacacat agactcttag 640020
taaaataact catcagtgtg attccaaaat gcatgcggtt ttcctcttgt ctgtaacctt 640080
ccacacatca gattagcagc accctatcat gggagatgac ttcagaaata tgatggcatt 640140
caatagccca gaggtttagcg tctgttaaca aacttacca agtccccact taccaggctc 640200
tagctgagtg tcaagagaca tgagtgatgt cactttgct tagacttcag agcatttate 640260

tgagagagct gtcaagaagt tgaaagggat ataaggctgc cagtgtttaa acacagcctg 640320
 atgttagata tgattagcat tgttactaac tgtaggataa tggaactata atattctaaa 640380
 ggaatcctca ataattaggt gaaagcagtt gtaggagacc tgacctcttg aaagtccctt 640440
 aaagccttca gtgacatctc aaacattttat ttgcagccta aataccatag catatgctct 640500
 ctgtagtgag ggcaagtcca tgtccaagaa atctacactc agaaccagga aaaaaaaaaa 640560
 aaaaacacaa gctaaaaggg taggatctga cacacatcaa gcttccttca accttcatga 640620
 gtagtaatta tccaacccat gttgtcccaa gacctctagg gaattgtcaa tcaaggccta 640680

 ctggcaggag attccaaagg ccacggggaa catctacaca gcttctcact gtaaaatcct 640740
 ccaagtcctt taaaactcca gatgagaaat tcaactgaa aagatctatt cttttccaag 640800
 acattgtgtg aaatgccaga gtactaacac tgagaatcta tgctgataat tatatccggg 640860
 gtgggaaatt cctgccctc agtgcttgtt aggaatgtgg ataaaaaagg tggggtggaa 640920
 ggtgttctat ctaggggcca ttttggttcc tttggctctc atagttttat aagtttcaa 640980
 ttatagtctg aaaacagaag catcttattt tggcagattc attaatatcc gatttaggtc 641040
 cagcttctca tacctgaggt agccatacag agtgttttaa ttctggcttg taaaaataag 641100

 tgtttttaa gatgcattct tcatgcttgg atcatctata attacagtcc acagatttat 641160
 gtttgacat caggtacaga agattctctt aatcacacca ttaggttgag agcacattat 641220
 tagctctggt ctgtgcaccg cccctttctt tactccactc ttctaattct ctaaccact 641280
 cacattcctt tctcatgctt tggccaagta ttttaacata ttttatgtct acctttctgt 641340
 tccatgagc actcacaata tgaatgtgtt tctccttctt agcatgcatt tttttgtgaa 641400
 acagtaaata ttctttttg gttatttttg tttttatcat tgtgttttta aggttaacct 641460
 tctttaagaa cacctaattc tttgatctgg gatgcagcaa gaactaacct cgagtgtatg 641520

 ctcactgtat atgctctcac ttctctgcag aggaatgcct ccgctgggtg tgattgttaa 641580
 tatttaactg aacgccaacc tgtcatggga gtcacttggga agatattcct tcaggcacat 641640
 ctgcaaggac atttcagag aagtttggct gaggatggaa gaccactga gtatcacagc 641700
 accatcacat gggtgaaga ttggattaaa aacaagagag cacatgagga atgcagcact 641760
 ggttgctctc ctgctttctg attgtagatg cgatgtgacc agccacatca tgctcccatc 641820
 actatgcctt ccaatcaca taaagtgtcc cctcaaacca tgactcaaaa taaacacttc 641880
 cttctttaag ttgctactgt cagttaattt gtcaccattt gaaaaaagta actgatgcac 641940

 aaggtatata tggiccagtc caagatgctt ctacaagaag atggiggcac tattgtatag 642000
 gtcacacagt tacctgatga aggacctttg ggattctcca caacaatca tgtctttctt 642060
 atctagtgtc ccaccagaaa ccaggattag ccaacatgcc catcagtcta cagcctccac 642120

tcccaatcat ttcattgta atgtttagct gcagacagtt taagtctttc ttttcttatt 642180
 tataaaaatt tctcttaaat atatatcaaa gaaaattggc tgaattatat aagcatcatt 642240
 aaacacattg agaaatgaag aagctctcag atatagccag atgctaaagg cattctgcaa 642300
 accatgtatt catttctttg cacagtcaag attgaattgg tagattctta gatataaact 642360

 tgcccaaat cttttcttaa ctaaaacata attgacaata tatacatttg gaggttatga 642420
 tgattattgg tctagaatcc ataacttata cctacaaact gcaaaatcat ctcttcattg 642480
 gcccatccta aaagtatgga aaaaatgcta tctgtgacaa ctattgttat ttatttaatt 642540
 ttagctttat tcattttatt tattcatttt taactttaac cattggattg aaaagcatag 642600
 gcgagtatag aaaaaaatgc agtcagaata ctgccccacc cgttccacct ccaacctact 642660
 tttatggatt cctcaataaa gactgttctc attgtttggt gcataaaaatt gaaccgtatt 642720
 attgatgatt actaagaaac aatacttgat gacattttta catacaaata tacctcaaag 642780

 ataataataa acaaatgct tcaataaagt gtatatcaga ataaaacaag aaacatggat 642840
 tttttggctc ctaaatatat atatgaaagt tatatttata ttatattgta ttctattaac 642900
 tgagaaatgc tatcatgtcg caaatacaca tacttctttt aaaactgtgt tectaggtgt 642960
 taaaggatcat gctgacctc agcaaatgtt accttttatg ctagtggagg atgttgacct 643020
 gatgttgggt agcaccaaca gaccaggggt gtggttgctg aaggctagag tggctaaggc 643080
 aacttcttaa aataagacat cagtgtagtt tgccacatca gttgactctt ctttctttc 643140
 atgaaagatt tgcggatagt gtgtgatggt gcttgctacc atgtaccac agtagaactt 643200

 ctttcgtaat atgtggcat cctctccaat cctgtttttg atttagcaac cgagtttatt 643260
 taatattctg tatcctttgt tgtcatttca ataatgtgtg atcatctcgg aaaacaattt 643320
 tatttgctta tctgaaagaa ttagttattt atctaatacca gctttatcaa gaaattacaa 643380
 cacatcattc acatgttcag gctccatttc taagtctatt tccacatata cagttattag 643440
 ttctacctga gtctagatg cctcaaagat ctccaaaagg gttgaggtca acttcttcca 643500
 aattcctggt ccttattggc attctgatct tctcccatga ctcacaagtg tttttgggtg 643560
 cacctagaat gtgagcactt tccagatttt caatgggtat tactcagatc catcagaaga 643620

 atgacagccc ttaccttata aaatatattt attaattaac aagaggtgga atttaaatg 643680
 attccttggt ccattgaatg taaaatgggt gctatggtgg cagacataaa aacagcatga 643740
 gttctcttat acatctatca gtgctcttgg gtgactaggt acatcatcaa taaaaataa 643800
 cattttgaaa cgagtccttt gtctttcttc taaaaagaga caagtatgga atactcagta 643860
 atccatgta taaacagatg tactgttgtc agccatctat tgtgacatgt ataagccata 643920
 gaataaattt aggataattc ttagagatac taggattttc agcatggcat gttgttggtg 643980

cattcttggg acgcagtccc aagaatggag tcattcttgt gaggggaatt ctgagtgtt 644040

gtgagaaaac tccaagcaaa caagacaaaag tcttgtgacc acagtttctt caaaagcaca 644100

aaattgttct tggaaagtgt agcagatagc agggagttac ttcagctgtt cttatttga 644160

tgccctctac gaaaaacatt tttgtcacat gtggtttgtc tttgtggtg aatgccttac 644220

tcattgacatt cttctcaatc ctcggagtat aaattgtctg atgctctgaa taaagttgac 644280

tattgcatga gacttaagtt tatacatttg taggcctac tccctcaggt tgacaccacc 644340

aattagagca gtaaacagta tgtgatcata agagtaatgt tgttccccta aaattcataa 644400

tttaaaatcc tgcctcccca tgtgtctgca tttaaaaata acatctttaa ggaggcaatg 644460

aaggcaaggc agaggaaca gcaccctgaa aaaccaaac tctgaagca ttgactttgg 644520

accgcctgtc tccagaatga agaaaaata atctgttctt gatgtatatg cctctcagtc 644580

tccaatattt tgttatctg tactgagcca aaaaaaaaaa aaaaagaaat gggaggaaaa 644640

taaaatcaga cttacaagct gcattctacc aattttattt attcttgctt actctgaggc 644700

ttctaaattt acctcatttg ggtgatgcat acagaaattc accattatga ttatgtgttt 644760

gtcagggttt gctagtattt ctaacagttt cgttgaattt atttaatac tetgacgttc 644820

agtgcacaca ggtttataat tcactcataa atcttgctc ccataattgc ataataattc 644880

tatttattct gttaatgtgt ttatttcatt tagtgttttt gcttccagtc ccattaatta 644940

tggataata ttaatactgt aactactgct tttcgcatgt gtttctctt agccaacttg 645000

tatatgttga ctttttacc cttattttta agtggttctt gaatattat gcacattaaa 645060

gcataattag actggctttt tacctcatac aaatatttc agcattttaa taaagaattc 645120

agccttttta tacattgttt aataagtttt cttttttcca taacattaca cttttgtgtt 645180

atagttttat taccacat atcccatgtt ctgctttggg gtacatttaa tgagatttgt 645240

gtttatacat tctctatttt ttaaatcatt ttaaatgtgc attaatgtaa ggggtgcaga 645300

tcccctggaa ccggatttaa agagaattct gagctgccag gtgggtgctg ggaaccgaac 645360

ctagatctct ggaaaaacag tcaatgctca taaccactaa gccatctctc taatcctagt 645420

cttttcttt ttatttggac atttttttt ctgaccctac tctttattta gaccatgaca 645480

actttcctc ctgaaatag ccattcatca tctccaatgg aatgctattt attccagttt 645540

cttccatcc taagacaatt agattagata cttcttttgg cttctgtctt ttccaactag 645600

atgaagtatt tagatttatt ttagttaatt cttattgcat tagtgttttt tttttctttt 645660

tcagtgacaa gatgcctgaa agggcaactt attgaaaagg gatttgtttt agctcctggt 645720

catattgtct attgtggtag ggtagcatgt tggcagctga ccacactgta tccagtcagg 645780
 cagtacaaag atgagtgcat ctggttctca aatggcttct tctttcttca gtctgggacc 645840
 tcaacctatg ggatcacacc atccacattc aggggtgggtc tttctacctc aattatatat 645900
 ctccataaat gcccttgatg acatgcccag agctgcatct ccaaatgatt ccaaatgcag 645960
 tcacattaac agtcaacacc aactacttca tctatcaata gactctacga aaaaaatctt 646020
 gaagctttgg ttgataagt tagtgttaga attccagaca gctacgggtc ccaactgaaac 646080
 ataattcctc atttaagttt tgttttatac tgctgtggtc cctttttttg gtatcctacc 646140

 atattaatta agctacagat attgttggtc tcattggcta caacttgtct ctttaattctc 646200
 tgcaattaaa attgcttttt ctcatgattt gtcacttggg agttttcttc ttcctctaat 646260
 ccagtgttc tcaacattct taatgctgtg accttttact actgtcctca tgtgtggtaa 646320
 ctacaaccag aagattagtt tgttgctact tcctaactgt aattttgcta ctgttacgaa 646380
 tcataatgta aacatctgat atgcaggata tctggtatgt gacacccaaa ggagtcatga 646440
 cacacaagtt atagaccact gccgtagtcc ttttctaata ggaaaagtag agaccacact 646500
 tcttaccct accccaacat gtaaagatag atttctttca tgtttttagt gaatgccagt 646560

 ccttgagtat cagccccct cctcatcag tctcctgggt ttagcatcca ctgtactaat 646620
 gcaaagtttt ctacaaagag ccagctgtta acctaggact ctgtactata atagcagggt 646680
 ggatagtggg gtatgtaggc aaaatggtag tcttctcat tctttcttat tctataacta 646740
 gcttgttctt tcttctgaa tgattggaaa atacttttct ctttaaaaag aattctgatt 646800
 gacacatacc acctgttgat atttatgagg tacaatataa taagtgaatt cacatattcc 646860
 ttggtaatga tcaaatcggg ataattatca tatctatcac cttaaaattt tatttctta 646920
 agatgaatgc attaaattcc tctcttctat ttctagatat gcaatacatt actgtcgatt 646980

 gtattcacce cactgtagca tataatacca gaacacatta ttctattaa acaataatat 647040
 gatacctgct gagttcagga atattctcag ggcttggagt aacagtctca tatttacttt 647100
 tttgagcttc ttgcagaatc tgtagtcaat cttttgtcag atcagggaaa ttttaattctt 647160
 ttgtttgtct ctctgttatt ttttattttc ccaactgetgc tctataattt gettgttata 647220
 aaacagaaat gtatgaagca aatctgttgi atttctgggtg gtggttcctg ttctttgtgg 647280
 ctttgttttg ctattaagat ttttctatct accttagcct tctggctca gatttgccaa 647340
 ttttctttc aaagtatttc ccacatctga ggctgggaaa caatgacctc ttttctttcc 647400

 ttggagaaaa tgtgtgtttt cattagatca atttttattg ttaagttaa ttcacaggg 647460
 ctagaggaat ggctcagcag taagagcatg tgetgcctct gcagagaacc aaaacctggt 647520
 tcccagcacc cacatcaaat agctcactac tgcccataat tccagatcca gaggactgaa 647580

cacttctgac ctacacaggc accatactca catggacatt cccacacata cagaaataca 647640
 atgtacacat aattaaaaat aataaaaatt aagacattgt ttaatgttta aatcaagtta 647700
 aatgcatcca actctccaaa cattttcatt tctttataag gaaagcattc aaaaattatt 647760
 ctcttagctt tataaaaatat acagcacata attgttatta atggttttaa aggactcagt 647820

 gagaagctac acagtctaata catactttaa gaaggccgaa attaatagaag acaatagctg 647880
 gaagtgaage ttcttgggta gagctagcaa aagacactat gactgggtgaa ttccccacct 647940
 gtccaagag cagcaaagtg ggaaagtgtg agatggataa ccatggggaa cagagccttc 648000
 tactaatgaa gtctttgaca ttgcctaagt gaaatgcaga gctgctgcag agatctgagt 648060
 gatgagtcac atcctattaa gtataaaaata atcactacta tgtcgaaaat caatggaaga 648120
 gtggaaggat tagactattc aaactttaca gaataatcca gatgagaaat gagaactggg 648180
 tagagttcta tcgcagggtt catgcttagc aagcacaagg aattgacttc aatcctcagg 648240

 agagaagaca taatagatca gctgacacca gagaaggtac agagagtggc cagatcttaa 648300
 acatatgccc caagtagaag agatgattaa gggtagaaca gaagaacgat gcagatgcca 648360
 aagaatgaag ctgataagag gctcatagaa ggaagaattg atgcaactaa tccttggaat 648420
 agttgagaaa ggatataatc aattccaca aatgagaaat aattaatta aagaagagca 648480
 taactattcg gctaggatta tgtggacaga ggaaggctg agtctagtca tggatactaa 648540
 attaatacaa tgtttgctgt gtttgtctga tgagaagcca atgggtagac aaagggt aag 648600
 tctgaaaag aaggtcagat cctgattttt acatgagttt gaggcatcaa acatccaagc 648660

 tagtgtggca tagagcttca tctggacatt agagtagaag tctgtttggg agaactgttt 648720
 actagattat agatggcatc gagtgttctg aaacagtata gaatgatcaa ggagctagag 648780
 ttgatagggg gaaacacatc aaaataccaa gtaatagga tccaacatta aaggattgtg 648840
 aagaagatca tcaccccgag agatgaaaat acagcaagga gtggattcat atctttgaag 648900
 gaaaagaatt ggatacatcg aaaccattc aagaagtatc ccccaaaaaa tggagaagaa 648960
 aaaggggaca gaagggaggc agaggcaggt ggatctctat gaggtcgaga ccagcctggg 649020
 tctacaaaag ctggttccag gatagcctcc aaagccgag agaaacactg tcttggggga 649080

 aaaaagggag gcagaaacta acaaggaaac aagagcagga atgtgaaggg aaaagacatt 649140
 agaaataaca tgtgaagatt gattaaaata atcagtagaa gatgagaaat tgatgatgta 649200
 agaagtagga aacatthtgg gaaccagact ttaggatggc tgaaaaagta tataatctat 649260
 tccacaaatg aaattagaga ggaatataat gattcagttg gtattgtgta gacaggggag 649320
 agtatgggcc cagtcactga aactaaatta atacagtttt gcagtatttg tattaaaaat 649380
 acaataatcc ctgtctcagc ttaatccatg aggttctgcc tgtgttgggg tgtgtggacc 649440

tggagctct tagcaacca gtggigataa agaccaaaca caggcatctt gtcacttca 649500

 gagagctctc agttccatgt tgtagaacta gagtcatctt tttattagcc atcttttctg 649560
 tcccttctta atcacctgc caataccaca agggaacat tctctcttt gttctctct 649620
 ctcttcttaa tcatcctgcc aataccaca ggaaccatt tctctctttg ttctctctc 649680
 tcctctgga gtcacccct aaccttcaa accatctgtc ctcacaagt actcacacac 649740
 ctctcacctt tgcccagggt agggcctatt cagatgetta ggcctcaga gaagcaata 649800
 ggaggcattt tacctgagg ccatggtaa caatagtagc cctactggca attaacaata 649860
 caatagttag ctggagcttt ctgggtgcc atgtatacag gagctggagg ctgggcccc 649920

 aaatattcca taacagaatt atttggccc ccacaaatcc ccagagactg ttgttttaa 649980
 atacttggtc cttcccagt ggcatcttt taggaggtt tggggacttt aagctggagg 650040
 acctgccat tggagcaga ttgctggagg ttgcagggc agccatgctt cccacttacc 650100
 tgtttctga ttgccaagt acaaaaagt ttagccacat gctcttggga ttgtgcatct 650160
 ccaccatgcc ttccccatca acatggacta tttttctca aactgtaage cactataact 650220
 tcacctgtgc gtcagaacct gctgacctgt cgaacagcac ttgaaatgag ggtatgagga 650280
 ttaaagagac aagacaaaga gttactca ggaggactgt cagtgaatac ttccatctgg 650340

 agttcattct cctctgtgct tatatacagt tcagaaatag gcaacattgt tatagactca 650400
 ggttcaagga acagttaagc cacttcaaaa catcctgttt tcaaggaggt aacatgcatg 650460
 ctgttttact tgcataaata tctcgtttgt cctgttcggt aaaactagag caaaacaagg 650520
 aggcaccttt gaccatcag accaagatgg agtcaactaaa gctccccca cttcttctg 650580
 agttttgtca gatattccat cacagaaatg agagacattg ctactaagga atccatgagt 650640
 gggttctctt aaactcttag agttctctta taaagttaga ggcaaagcaa taaatcagca 650700
 ggtttctga gagtctgggt gtgggaccca caggaaaaga gaggttaagt tactggcaag 650760

 aataatataa cacattgtgc tactatcaac aacaggtatc ctgactcact catatgagcc 650820
 aatttttaa tgccaaaaga tactcagaca ccgttgtaa acataactgt taagtcatat 650880
 gaaatccaaa caaataatgc atttcaaaa caaaagtaat aaatgttcac tactgattag 650940
 ttaattacat ttgacaggt tgttcttga atcttcaca caagctgcat ctgcatctgc 651000
 atatctagaa tgggtcccc ctatgactct ctctcaatt gtacattcag tgaatgata 651060
 caatgagttt gaaattaatc atgataaggg tgttcacacc acagaaatg gaaagtaaa 651120
 aaatcaatgc ttcatctctt gtttcttgc ttgcttagac tgaagcaata gagaaaatgt 651180

taggagtgtg gggaaaatgt aaatgtgtgt ggcagtggtt gttacattgc acaaacacaa 651240
agttaagcaa ctatttgccc catattcaaa accatccttg ggttcagcaa agacacttct 651300
gtgacactga catctggcta aagttcctat gtaaactctcc attgttttac tttgacctta 651360
attgttaagg tacataaaag tagcaactga cattgatgct ggaacaatat cagttcatta 651420
gctcaaccac aggtagatga cacatgagaa ctttgtcaag aatgactaaa gctactatct 651480
ctcagtgcaa agtatagtaa tgtaagtga tgtttgttg ttttgcttg cattgttttt 651540
cggaagcca gcagttaaga actcagcagc ttatcatctt ctttcaaaa ataggaaaca 651600

tgggcaggag agtcagtcaa caggagactt tcacctgtaa tacatgcttt ttctctttgt 651660
ctatagtttc agaattccta aatatattat cactgtcatt tgtctactca ccattccctt 651720
tgaaaatagc aatattcaaa agagtggcaa cagaaaagac aaaaggacat cagtcagtcc 651780
cttcttaatt ccttttgta caatacaata ttgtacaatt tcaatcccc agaggtcac 651840
tgaatacca aagtgaagaa aaactccca gaaaagactc caagtattag agttggaatg 651900
tgaaatgcc ccacaggctc atgtgcatgg atacttctg gtctgtgtag ggaaaagga 651960
ccagccaaag aaacacacc tgtgcagagc caaagaaaca gactttgtcc ctggaatcag 652020

agccggtgaa agaatacac ccaggcccta aaactagagc caaaaggcta gaagggatca 652080
gtgaaagaaa cactcctgaa accaggcca aatctaacc taaaccttg cagaaaacta 652140
accaatcctt gagcaggaga tctagccatc ctaagctcaa gggattgaaa tctgaccaat 652200
ccccacctg aaaaaactct acctcctaag aatccctata taaacctgt gtctgttcag 652260
cttgtggctg ttacactccg ctctccactg tcctggggag cagagctgaa cagtaacaac 652320
ttttcagggg aaactctccc ttactggaac agagttgata cactggagaa gcctttctct 652380
gaagcagggc tgtaagctgc tgtgcttct gtgacttatg gtattcgttg gctccaagt 652440

gccagaatac ctttccatcc aagctgtaag accaagtatt ctgtgattcc tgggtgccag 652500
aataccttc catctgagct ttaacattca gtattctttg gctccaagt gccataatc 652560
atccccatcc atcccatccg atctgtcca aatgcttac agtctgtcca caatgtaaga 652620
agattcaaca tgatgcctg aagtgagtgc accattecct gatggaccac cattcctcta 652680
aatcatgagc caaatcaatc cttcttcct taagttgctt ctcttgagta cttttcaca 652740
aaaattagaa ttcaatacag aaaattggta ttaggagtgg agtcattgaa ataaatctga 652800
ccaggtatcc cataggtttt ttgaactgitt ttgtgggagg aatgtggaag agctcagagg 652860

tgctttagaa tgccataagc aaaacttaat aggtagtctt ggtgggagtc tggaacacta 652920
aatggatttg atattatgag aaagacatga gcatgttgag atcagatgca gactgttatg 652980
gctcaaatat gaaatatcta ctattggcat atgcacttg gcttttggtc cctatatggc 653040

ggcacagctt cataaagtgg tggaaatata caccaaagca aagatggttt gtaggaaaac 653100
 ttgatggcca tctctaagtc tgttcagaga gttagctttc agtattgttg gactttctgt 653160
 aaggagggta gatttattga gcttttggac tcatccactc gtagtactca tttataagac 653220
 tatgtgagca gtgaaagtat tgttagactt aaaagtcaca gacttctatt ctgggtcccc 653280

 catagatatt aaggaatata aagcattaag gaatttggat caaatgaact ttaagtcctt 653340
 tataagtcta aatttcttcc caaatttact catggtgagc aaggagcacc atgaaacagc 653400
 aagtaactat tactaccaa gagctatgaa caatgttcta aggctgaatt ttgtctctaa 653460
 aaccaagaa tacagtctac tacctcaatc aggctcaatt tataaggaaa atatccacta 653520
 gtggttcaaa ggaaatgttt gacaacaaat gaaacagaca gcagagcatt taagtttctt 653580
 agtgtaacat gtattagttc aagagtactc aagacaaggc aatttcatca tcacctcact 653640
 gtccctactg agatgtatca agattttttt tgtgacaaag acaattatgg ctcacaaaaa 653700

 aaaaaaaaa cacttgcctt ttttcatttc ccagatgctc ttgaaattgt attgccatgt 653760
 gacaggttta gtactgataa catgctagta gagattagga aagctaattc taaatctgtc 653820
 cccttgggag cccacacgga gctacctcta cagtggtaag ttcattgagag ataataaatg 653880
 tgcctactac aaactcttta tttccacat taatacaat acctactaac tcttgaattt 653940
 gtcaagcaat atcaaggaat ggctaatacg cacaatgaac tcagctgcca ctgctttccc 654000
 ctctcttcca aaggacaaac actgaaaatg aagtattact tcatgtgaca atgcatgtac 654060
 catgagaata gaatgcatcg ctatggtcaa ttctgtttga tcaaataaa ccataagtaa 654120

 tctcacatca taacttaaga gatgtaaagt gaaaaataat gtttatgaat ttttgacaaa 654180
 taatagtatg aagaattgtg tatttagtat attctacaaa gggctagaga atgatacttc 654240
 aggttattca ttactggtta cttatttttt aactttttgt tcagaataag tctagattaa 654300
 tggaaagtca tataaaaaga gatagtaaac agatatagta ctgagagttt cttgaaacct 654360
 ttaaccaagg atgacaattt catgtaacct agtacctgaa caaaccagg aaatttatat 654420
 cagaacaatg ctgacataga ctttactggg aaaacacttc tctctctctc tctctctctc 654480
 tctctctctc tctctctctg tgtgtgtgtg tgtgtgtgtg tgtgtgtgtg tgtctgtgtg 654540

 tgtgtctgtg tgtctgtgtg tctgtgtgtc tgtgtgtgtc tgtgtgcctg tgtatctgtg 654600
 tgtgtttgtg tagggttaca aagttttatg tactctgttc cttttagat ttcattgtaac 654660
 taccataaaa catacttaga ctctttttta tttttacca aaccctccc catctcctag 654720
 caatgactat tctctatctc tatagattta gcatttctgt aatgcatat agacacaatc 654780
 ataaagtgtg taaccttttt tatattttcc ttctcacta accataatgc tattcacccc 654840
 tctccacggt attgcttgtc ttaattgttt gggtttttgt tttatcttct ttttcttttt 654900

attgatcaat agaattccat tatcttgatg taccagaagt ttgtctgact tcacctattg 654960

aaggacattt ggattctgtc catggaaaag ttgtagctaa ctatgaataa cactgttgag 655020

aacattaatg tttgggattt acataagcat gggattttat ttctctgaga aaaaagccaa 655080

gatacaatta ctagagaata agactaatgc atattttatt ttcaaatgaa ttgccaggtg 655140

acattttctca atgttaatac cacatgccac ctgcaatgac aatggaacta tgtcctcctg 655200

gtcatctata ccatctggtc ttgacctact ttaattttg ccatcgagta ggtatatggc 655260

aagtctcttt gtggctctcat gtgcacattc atgactaatg aacagctttt cgtgcatgtg 655320

cccattttct tttcttatat tctctttaag gaaatgcacc gtcatgattg ttaccattt 655380

tctgattaga ttgtttcttt attcttgtaa aggttcatta cattttcttg atacatgctg 655440

tttgtttcat atgcttaaca aacattttta cccactactc ttattgttaa ttcttaaaat 655500

gtgatttaaa tctaagattt ctcaacaatt caaatgaatt tggatgaaga cgctgaaaat 655560

tagaatataa taagggacta tatataacag ccattttctga aacaatgaga aattatcatt 655620

gcattttagg taggagatgc atgaaggtaa ttgagaccca gtgggaaagt gttacatttc 655680

agtcaagtga cctgcaactg attgattaac tttcaacatc ctaaattgaa gacaggggaa 655740

aacacattga agtgatttac ttagaagttc atcaagcatg tgccaatata ataatttttt 655800

aatccaacaa gaaaataggt gtcaataaat aagtcattaa taagctaaag agtcttattt 655860

cctgtgcatt gaagcttatt taaagattaa gaacggcatc aagggatgca tttctcaaag 655920

actaaagggt aatgttaatg tgctataatg tgctaagtgt ttactttcaa tgacagaaag 655980

gtctaataca acaaaaacta gtgaaagaaa agcattttat cagcaaacag acaaccagac 656040

cttgataat ctactaacta aatatcaaga actattatca ctgttactaa attaaaaact 656100

gataagaaaa agcaattac tttacaagag tggtaaatgg atatttgctt attacctgaa 656160

aaaaaaaaaa aataaccctc tagagtgggt tcaagaataa aatactttag taattaaaac 656220

aaaattatat ttaatggatc agatttgta tatatgcaga taaagcaaga atataatgaa 656280

gcataatgat gaaaatggaa tagagtgtta ttggtgagac ctcatctcat attatcaaac 656340

tctagacaaa cactactaat aaagataatg actataacag atgttctcac cttgcattaa 656400

tgagaaagtt aagatcattt taaaattgtt ctgaggtcac atgttaactt ctctacatgt 656460

cttgagaact atgtatttct taaaaaact attcaaatgt taatgtgctt ttccctgct 656520

gggaatggac cacagaatag cctgcttgct aggtaagtac cccactctgc cttcatccct 656580

gtctcaacaa gaatctctcc gagtcttaca aaaaaagatg cctcttgat caaagtaaac 656640

ctaatttaca aaagtgaagg gatgcctggt ctccatagcc taaaaccaa agctattcta 656700
 ttatnttcca aatnttctga ataccaagta cctcatgctt actgctcaat ttagaaacaa 656760
 actggacatc cacccatgtc tacacaagga gttgaaatta aaagcaacac gaagctgtca 656820
 atcaatcaag tttttagaat gccatccaaa accatccttc agaattctta gaactccata 656880
 cctatcaata acatactatc caatcattta cccatatttc aaagacacga gtttcagtgg 656940
 tcataatcaat taacccatgt tctgccagga ttacatagaa gggttcattt taccactaaa 657000
 gctgggtaaa caagagtgg tgttttaatt agcaggatcc aaggagaaaa catatatcat 657060

 tttaaaggtc ccagtatacc ctcatatatt tttttctgg ctctccaga tctttttaa 657120
 aagctttatg agaggtaact acagaacac actatgaaac aaattatttt taagatgaaa 657180
 taaacaaaat aggtctctta attgcacaaa cagaaaagat tcattgatct tgagggaac 657240
 ttcaaagtca ccatacggcc atgtgtgttt ccaaaaatgt aattcagaca catgtattgt 657300
 ggtgcagaaa tacaagccat ccctgagtag agaggaaagg aaagaagaag ggggtgtcag 657360
 agagagagag gtatctgttc aggttctgca ggggggatgc tgtccactct tctttgggg 657420
 gaaatttcag gttgttggc taatttgcct tcgttttatt tttttatctt ttgatgatat 657480

 ttctggtcat tgaagtttg acttaaaaa aatcttcag ttcgttttg aaaagaacct 657540
 ggactagatt tctaattgtt cctatagtct ggtttccaaa ggtgattaag ccagagtaca 657600
 cagatgtggg cctgcaaggt tgtatccac aaaacctgt gtggttcct caagaaagaa 657660
 gcagtcaat gttgacatct tgggcctttc ataaaacagg cccaggactc cctgctctct 657720
 ctgagtgatg tggtaactga gctcaggctc cacagcaact tgcccacaga cctaattgggg 657780
 gtgtcaggct ggagcgggtc caggccagag gccaaatcag aactgtgaaa ttagagcag 657840
 tcaagtctca tagttcattg ttaattaatt cccacggtgt ttccttcat ctctgtgaac 657900

 ttatggtata gcctaataa aacctatget tgatctcaac tctgtgtgaa agctctgacc 657960
 taaataaaga acaaggacat aaaaggcaag gcagcccca tttggactag aacatcaggt 658020
 cctagaagac agaagtcttc taaggatgat gggacctga tgtagaagca ccagtcagta 658080
 tacaagcctc ccacaagga aatggctaaa gagaggacta tataagggcc cagtatccta 658140
 aagtatctca ggaaccaaac atctacaaac tcatggtcag tggataattt tatttaciaa 658200
 gaactgcagg ctgacatgta tatatttatg ggcattttta ttgtcactgg gtcttttgc 658260
 ttgctttcaa ttaatttttt tcagttggca tactaagtaa tggatttcat tatggcatag 658320

 tgtgtgtgtg catgtgtgta tgtatgtca agctgtgtgt ggtggggaca cgtgtgtgaa 658380
 tgcctttgta ctgtgggca gataagtcct cacacttaca caccagtcat tacccatgga 658440
 gtcactctcc agtactttgc tttgtttcat attatggcac ttgtatacac atgtcagtat 658500

actttgttca ctgtcacect tccctactgc cctccacgt tcttgctgat cccttctcc 658560
 ctcaacattc tgtatattcc atggccctct ctttccctga cccctgaag gtttctcct 658620
 cccctctcat gagcttcttt ctacttccat cacatgtaga tgcacacaga cacagacaca 658680
 cacacataca cacacacaat tcattttgca tacaaaagtt gtggtattta ttacatatg 658740

ctttctttgt cttaatataa tggctcttac ttccattcat tttctacaa gtacaatgat 658800
 ttcatTTTTT ctttataact gtatcatact cgatgtgtat aggggggtggc atgggctgag 658860
 atcccagaaa tgiagtttca ctgtcataga gttgaagttg gctgggctgt gttccctcca 658920
 gacactgaca gggattctgt gccctgcctc ttccagatcc tgggtggctgc cagaactcct 658980
 tggcttggtc ccicatccct tcaatgcctt ctttctttta aacaggattt tatgtgaagt 659040
 ctacctatgc ttttccata aagtatgcat gtgattacat taagatctac ccagatgagc 659100
 caggacaatc tcccactcc aagacacttt aattaatccc agtatggaga tcctttttcc 659160

tctgttttcc atataaagga acattgaaag gcttggggct tgaggcagga tattagaggg 659220
 agaccacttt ttagtagaac agacagaaga ctgcagtga ggcagactat gaggcattggg 659280
 caaacattca gaagcatgag aggactttgg agacagcaga gttcaatgtg getgggctgc 659340
 tgtctacaag atgggacttg gaaaagaaa ggtcagaagg gaaggatgct ctttctatat 659400
 aaaagagatt tggcatggtg cttctctctg tgcactgagt cctgggttca atcccagca 659460
 ccataataca caggcatggc taagtgtgcc cataactcta gccaagccta gettacaaga 659520
 gaccatgttt caagatatat atatatatat atatatatat atatatatnn 659580

nnnnnnnnnn nnnnnnnnnn nnnnnnnnnn nnnnnnnnnn nnnnnnnnnn nnnnnnnnnn 659640
 nnnnnnnnnn nnnnnnnnnn nnnnnnnnnn nnnnnnnnnn nnnnnnnnnn nnnnnnnnnn 659700
 nnnnnnnnnn nnnnnnnnnn nnnnnnnnnn nnnnnnnnnn nnnnnnnnnn nnnnnnnnnn 659760
 nnnnnnnnnn nntcgaaaa tatctaaagg tgacttttgt gcttcgaatg aactgggaca 659820
 cataggcatc ctgtggagct ctgtactcac aaatgagcag attgcagaga agcaccggtc 659880
 ccaactcatc acagcaatca cacacacaca cacacacaca cacacacaca cacacacaca 659940
 cacacacaac acacacacac acacacacac acacacaaac acacacacgc acacgcacgt 660000

gcacacgcat gcacacgcac acataaagag cagcagctga agggctctaa tatcaacatt 660060
 gtttttccct taatgtcttg gatttctttg ggtaagaaag taagaggata ataggctcaa 660120
 aagtggcag aggagaatga gaggcatgag agatgcagag agagtatgg gagtaagttc 660180
 atccactcag tgagtacttg ccaagcacct accacacatg tgccaggaac catccacatt 660240
 gtgcacaaaa cagcaaagag caagatatga gaaacttatg ttcttgaagc ttggcggttga 660300
 ctttttgtg tcgtaataa ggctctgctc catgctaggc tcttactttt attctcttta 660360

ggcctcacag aaggggccag gaaatatgga ttgtatgccc tcatgaacaa ggcagaagca 660420

 gaaatgtagt tgatccatct gaaacgttcc tggatgtcca ttcccatag aagtctgttc 660480
 tctacagcta ttcgtttcag acttcagtgt gcagtcagat gttctcccaa aactctaacc 660540
 aaggaaagca gaagagtccc aaggataaaa cagaggggcg ttcctgagtg tgaccagcac 660600
 tgttgccat gttaagctac gtggacttgg ctggatactc atggttattt atagagcaag 660660
 taagctctaa aataagctgc aactgcagat ggctgggcca gatgatcttt catggtcctt 660720
 tccaactcca tttattttgt gattttttat ttttattttt aatttttgtc ccagtgtata 660780
 tcacaaggac taacaagtgg actgttatta agaataagaa aacaggacaa aagatttctt 660840

 gtcataacat caattgcatg ataagaaggt acaaatgtat ctttaaagga ggaagtaatt 660900
 gcattcctga tttgagaact cctaattatc caagaacgtc ttcagtgagt tgtactgaag 660960
 gtgatttcta caacccaaaa aaccacaaag gacccggaga catgagaata acccccttgt 661020
 tttatagaaa aagaaactgt gtcctaaaga ggcaatatgg aatgtgatgt ttcctgttcg 661080
 tccaatggcc acttataaaa aaaaagtatt caaatcattt taatacagat tttagtttcc 661140
 actaaacaac tcatagaaaa ttctagacc agtaaaatgt taaaatagat gcatgtgatg 661200
 tactaaatgc atatgatttg tgatcatggt ggaattttta tataaattca cataaaaatt 661260

 aatgattatc tattgagaca agtttctcta actcattaga tagaccagg agctagttaa 661320
 ctcttttaca acaagaatac aatactgaag taaattatag tctccatggt atattatatt 661380
 acatcttact taataattt ccaaggaaac gtacattaaa tctggagctt ggcccatatt 661440
 tgaatttccc ttgggattca aggaatcatc tggcaaagaa atgtcccagc tagaaatttc 661500
 atccatctgc ataatacaa ggaaaatgic ttatttgagg tataaaagga ttaagtattt 661560
 ttgggggatg gggctctagg cactgttgct tttagaagga acatgagaat tttcagttaa 661620
 gaaatatctt catcaatttg aagaataagc atccactcag ttgctgcttt acttatgtcc 661680

 agagtggaaa taaagcatcg agtacaccag actccaacac tcagtgacca tggaagacaa 661740
 aaggcatctc tctccataa acatcattga actattctga agaccacatg gttttaaaga 661800
 gtcacaatgt atggcctcct tagaaaacca agagaaggaa tacagagttc tcacaagtac 661860
 actgattctg tgaggtagca atactatact tagttggaca tagccatttc acaatgtatt 661920
 tcatacttca gaatatcatg ttgtatacaa taaatgcaca taattgtgta tgccatataa 661980
 aataagctaa tagagataat gggatggctc aacagataga ggtgtttata gaggcctgat 662040
 gacttgagtt tgattcctga gttccacaag gtgacagaag aaactcccaa aagttgttgt 662100

ttgctgcctg ctcgctctct ctctctctct ctctctctct ctctctctct ctctctctct 662160
 ctctctctct ctctctctct ctctctctct ctctctctct gacacacaca cacatattaa 662220
 taataaata aaataagcaa gtatctttgt aaaggaagt cagtctctct tctccctact 662280
 aaacaaaaca atatgccaaa cattccataa atcatatcaa acatcttaca aacataacta 662340
 gaaagattat atttttccat cactccagca gcctcttgct caataacctt tatttagcta 662400
 tggctctctct tcactccaat gcaaaaagta gaagggacag ccaggcatca gccttcgaga 662460
 aaatctatta ttacctcccc aggaagcatc agtctttatt tatgaagaaa atcaatgtcc 662520

 acaaaagcct cttagcaaaa gccttaggag agaaagatac attattactg tgataaata 662580
 actttgggtt gaagagaaca gtaaagaaat taacatttat cgagtcttta taattagctg 662640
 atacttgaca tactcattta atcctcacta aaatacctct gtgtgccac ttgggggtgg 662700
 cggcgggagg ggggacttta caatagtcca caccataaat aataaaagcc caggtttctc 662760
 ttccaccatg tttgtgtccc catatcacca cctagagatt tttctcatca aataatgcaa 662820
 acggggtgat gaaacaagct ttcagaatat gaacagccac cttctctctt cactgggaca 662880
 aaatatgtgc atgaagaaat gtgaaattct tftagttgtg attacaagtt agtttcagaa 662940

 ttatttacct gtgggtttca agaattctgt ggcatgaat ttccagccat cagtaaggaa 663000
 agtcccagat ggctccttcc acctccatt ctgtgacct tgccatatca aacctttgt 663060
 ttgtcttatg aggagactaa tatttctggt aagttcccct gagggcgtta gagttaagca 663120
 gggatgtaca tgctctctga atgaatttcc ctgagcatta atagaacacc taacaagaca 663180
 acaaagactt gtgacttaag agagcttcta gctgttaggg agtctattga cctctacca 663240
 ggccctcggg tagatgaaat tatacagtct ctgtcacaag tttaaagcat gtgctttaca 663300
 catttgttcc aagaaagatt ttcacaaaat ggaatgcaca caagaaagat cttttgggaa 663360

 tgctttcaac aattatattt ggtataatgt ttattgttac tactgaaaga gtaacaaagt 663420
 cagaaattat aglatgtgta aacaaactta tggaactgct tcagatgttg tgtgatagag 663480
 cacaccaagc caatagtgtg aggggtgtgt gctcacacaa gtgtaagtgg ggggggggtg 663540
 attgcgtttc catacattgt tattctgcca gagagtaaat gccaatgact aatcatggaa 663600
 actgcttctc aaagtatttt ctctgtgctt ccagatcaca gccagctgaa atgaaggcat 663660
 ttgtgggcac gtttgattg cagaagtaa aatagaatat ggtcagattt ggtcatggag 663720
 aggcacaggt gcicaacatg ccttctgttt cctctgttgg acttctatgt ctcttctctg 663780

 gctgctgata ctgtatttga ccttacagtg cccagcctc acaacatag aaaatgaacc 663840
 agaggcaata actgctccag gcttgcctt cagctctgac cactactgta aggactgggc 663900
 atggaagccc tggttgaaca acccccaggg cttcatggtg acttgggagt cttccctgat 663960

gctggacttt catttcccaa ccttcatttc tccagattct ttcatagttg gtaaggacca 664020
 actcctatTT tctgtattct ttttaaatTg ctgccatcaa tcaagccctg gaccatatac 664080
 atactagatg gtactctacc actgagtttc aatcccaaca ccttttattt tcttacttta 664140
 tatacgttgc tcttttccaa gtggatttgg ctgacatggt tatcaaataa ttataattca 664200

 ttatcactta aaagattaaa caataaatTT gatcagaatt tagtTTTTgg aagtgagtgt 664260
 ctgggccate ttctacatcc ttaataccta gcactgtctc agacacaaaa atgcatgctt 664320
 aatattggTc aagtggaaaa ggaataacct ttagataact taaaattttg ctccacccaa 664380
 cagatttaat actctataat tcagggaaat gaccctaaat atcaaaggct ctttttattg 664440
 gccatttagg taacaagaac tgaactctt gtcaatgaca acaacaggct cctcttTgta 664500
 ggaagacaga cactgcttct gctgatctct ccaggtatca gcttactacc acacaactcc 664560
 acacatccct gatgcctatt ccaaacttct tggTgcctga gttctctgtc cacgatgaga 664620

 aagtgaatta aacagatatg ctCagcaagt tccatatcca cctgtcttTc cccagcttca 664680
 gcctgtcccc acaggatgat gggaagacgg gaaactTcat gcttattttt ctctaccctc 664740
 aactttgcaa agactcagc cacaacctcc aaaagcagcc ttatgtctta gtcacttcca 664800
 taacagtTga acttttatct tcattactta ccagcactta aaagTaaaga ggttttacet 664860
 taaaattgag acgaccagtg Tgccttaaaa tagcttataT accaaaatag aagTaaatag 664920
 cccaagtgag gagctggctt gatccaagct ttacctgcca cttagcgtca Tgcttaccct 664980
 Tgatttacc Tgactatggg gTaaagagat TgTaaactatt tcctagactt Ttagctgacc 665040

 ctgtacttag tattctccta cctgTaaatg taatacccat ctggTcattg tagTcgtgca 665100
 tattatgatg atgacctaaG tccaatcaat atgtacacag gctgtctaaa ggcggggaag 665160
 gattgtgtct cccatgtagg tTaaagagac catcctgagg aaggggcaga Tgaggtcaat 665220
 ggTTTTcaaa gagaacctg gaaagagtat tagcagTcga TgtTgctgga acattcactg 665280
 aacagtatt ctggagaagc aatggaagc Tggccttcta caaggtgtcg catggagcta 665340
 ggagtgaagg tcaaatggTg tctTgtcaag attgtggaag ttgttttcta ttatgTaaaa 665400
 gaatgaacce ccaaaattca ctaatattgc aatttcattc ataatgagtg atattTgatc 665460

 atgcctctga gTaaaaagag tttgtaccag acatctgaaa tttgtcccga cagagccaca 665520
 ctctccgTc ctttattctg accctTgtTg actagtagat aacagcagTg gctacctgag 665580
 tcctaccttc cagccaggtt caatcacaag ggagctgggt gctgctgtga ataaaggaaa 665640
 gggttccttt gctgcaaggt catctcaagt tcattgcctc tccccatcca aaactgatca 665700
 cagttcccaa agagactaaa gcttcagagc tcagtgtctg ccctatgttc Tgcagcctaa 665760
 gggtgcttat ggctttgctt ctgacagacc caaatcctaa cagcattccc tatggTgtt 665820

tcatagcata ccttttaaaa tagatccttt aaattaataa agaattcctt gccgacttaa 665880

 cctatttcaa gtataccatc tgcttcctat ggggactctg actgaatcag ccccaataga 665940
 gtaaaacagt tcacactgtt accctaagaa aagcagcact atgatgacaa gtgaccatgg 666000
 agcttcaaac ccaggggttc acttgcttag agtggagggtt gtaagtcaga caggaattga 666060
 actggtaaag atttgaaaca tgggaattcta ttcaacaaga agatttaaag agtaattttc 666120
 tactaagaga gaaaaaaagt aagggaacaa gaaaaggga attgagatgg gggggctcta 666180
 gaactacaca gaaagttaca gagaagtaca ttgggtcttt taataggttg ggacaaggca 666240
 tgctctggct ctggcccata aaaggcttcc acacagcagt tgtacactca cagtgtaaaca 666300

 tgggcttcaa gacattgtct actggtacat agaccattac acacagccct ttagatcctg 666360
 catccttgag agtccttgag ggatgcatac tgtttgtgga gtacatggca tgatccagtg 666420
 ggattcatat gagtctggaa aagggaacaa aagaagagct agttacatag ttcaagctga 666480
 ccttgatcct tcigccctcat gatccttctg cctcagcttt tggactgata ggattacacg 666540
 catatgceca ggcaccaggc ttggagtcta tttttctta taccacatta atactctgat 666600
 actaaagcta agctagtcc tgggttcttc tcaaagataa caagccatga acatgggaca 666660
 tctctacca tacgtcaacc ctagaaggca tcacttctg gttttgtcc tattctatcc 666720

 atctccagag tagatgatga cctacatctg ctggagagge cgatttccta gtcaaatgtt 666780
 tattcatgca aaaacacctt cagacacatt caataacagt gcttaatctg ggccactcac 666840
 cacttttctc cttcattcat gaagtcaata aaatctgtag cacgtaatga ttttatgttg 666900
 tatgagaagt atgattctgc ctcttaacga ctaacatgta acaggatgag aattcattac 666960
 agtggcttgt acaagggaga aggttaaggtc agtgtgtgcc caagtggctg tgcaggggga 667020
 aagttatatt tcagatatgg acactaatca cccgggaaca tcctgactcc aggccagttt 667080
 ttgcagtttc ttaaatagat cgtatatcc agtgtaaagt tcttctctg getgttttgg 667140

 gcttgctatt gttataaagg tgccctgga gacagaactc aggctctgtg tatgctatgc 667200
 aagcactcca ccaataattt ggacccttta cagtttgggt tccaatgtc ctctgaagtt 667260
 tgtatgagaa aggcttggac actaaccctg aataccattg taaatgatgc agccttccag 667320
 aagtgagacc tagtgaagg aagtgaagcc atfgaaagca tgtcctttaa gggcttatta 667380
 ggaccecaag accacagacc ataccctccc tctcttctt ggatgccata aacactttct 667440
 ctaccacaca ctctctcacc atgatagact gcctgtcgt agcaccaagg tcaagcaacc 667500
 atcaacagaa acctctgaac ctgtgagctc aaataaatgc ttctcttct aagttgattg 667560

gcccagatat tttgtcacta tgcttgatac ccagctaagc catatgccct aatccacaaa 667620
taccttgttt tataaatctt ttagaaaatc accaaaaggt atgtaacaaa gtatcttctt 667680
ggataatcat tttcaactgg atagecggtag cgttagccat tgttatcaag atttttaatg 667740
tactattcta catttttaaa gtgtatacaa ggaacaaga atatagattc tactcacca 667800
tgtttttaca caaaagagct cacagagaga catgacgtac acactgtggt ctgcctttta 667860
tttttcacct cacaataaat ctccaagctc tcttcttate agcgcacgag gctcctccat 667920
tctttattac agagccattg tatttcgtta aatggatgag ccacacttta ttaaccgac 667980

ctgctccatt gacgggcact tgggttgttt ctaatctttg gcttcatagc actatattga 668040
gctcttagat aataacaaga aaaaggaaag gaagagacag gagaaagaga tggaaatcaga 668100
aatgagaaag tgctgtcagt ggcacaaaagg ccagcgagct catgtggggt aggaaaggct 668160
ggatgaagtg aaggatagtg acaacaaga tcagctgtcc tctccacca ccctaacttt 668220
ttcctttgaa gggttcatgt tgcaataaga gtagactggt aaacattgtg ttttctctga 668280
aaagtggat catcagcatg aattagccat tagaggggtt tctataaaca tgattaaat 668340
actggggtct ccgtcacttc ttctaaaaac aaaaattcat tccaatcagc cagtgcctta 668400

ttccagaaa taaatacta accttctcca aattcaacac tccctctaaa gccatgggct 668460
gtagtgggc agttgcagct gtgaggcca caaggggctg actcccagg ccacagcca 668520
gaaaatgcca agcctgattt gtaatctcc cttcgttccc atcctccag ggctaaaatg 668580
cccagctgcc tcttttaac aaaaattat tttatcaag gaagcaccat attcgctcag 668640
ctctagagaa agcaggctctg agctgcagag accaaatgat tgttctcatt tgcacaactg 668700
cttcgagaga aaatgagatt accagcatca aggggaaatt taaaaattt ccccaggcaa 668760
gaagaattga cgtcctctgt tccaagatga aggtaggggg gaattactgc tccacctagc 668820

tggagcctaa taaagccggg caactggcat gctcatgtgc ccatgaacce agaaattctc 668880
tgtgctgtga tttatgcaa cgtgttaatt cataattta aagtaattgg gatcatctta 668940
atggcctttt cttcctgtta gctgcctca gtggaagacc cctgtcacat caattgtgga 669000
cgtaataca tcaateccaa tgattttatt gtcttaaaaa taacttagct getatagcag 669060
ctgcatggg gagcctggtc tccaaggagg aaggtttcta accgtcagtc cagtctcatc 669120
ccccagttac tgacatgac aaaaagaaac attcactttt aataatagg ctctctttca 669180
tgcaagaaaa gtagaggatt tctaaaaata aataattcat gctcctccaa gctcccagag 669240

aataaattg ttcttttct gttttgttt tcttcaagat atgacatctt aggaagaagg 669300
ggctgagggg gagacagcac tttctgcttc tgtggataga aacatgcaga gtgtttcatt 669360
ccctggtgca acaaagcctc aagatcaaca gacaagagct gaaaacctt tcccaccaga 669420

cagacagcgc catctaaatg ttctctccaa agacagcgct gcacagacgg gcgcacagag 669480
 gcatgtcagt tttcccttta tgtgcacaca caaccctttt caaaagaaaa gagaagagaa 669540
 aagaaaaaca acgccatacc caaatcctgc acacaattaa ttacactgtg ctgaccacat 669600
 gaccagtagt tcigtgttta cagtttcagg ttttttatgt gttttgattc atttgcatt 669660

 aaaagaacat gagtttctaa tataccatcc cctgatattt ctcaaacac agtccatctg 669720
 caaataacaa aaaaaaatta actaatacaa atttctgacc attactttcc caaattctta 669780
 ttggctttgt ctggtatagg tccaggtaat gctggctctac ttaactggt tgggaggcac 669840
 tcatataatg ttgatgaaat atggcttgac gataaataca tataacaatt tcctccctga 669900
 tacaataaca ttggtcattc ctgaaaattg actttttgtc cctctgtgcc cttcaatgga 669960
 ttgttctttt gaaggcaatt gtatatttgg gcctggggaa tgggtctggt ggcttataat 670020
 tgctgatcaa actgaagcag aagtatagaa atatcataaa atctaagctc ctgagatatt 670080

 gattcaaac ttigagaagg aaggccaagc aacaggttca tcaaaagctg gtggaagctc 670140
 tgtactcttt tccagccaaa agaagggggg tagaggagag gaaaggcaac aagggaagga 670200
 agcacttcaa cacaaatfff atacaattct gagggtcact gagctcagag cagaagccag 670260
 tgccatcata gtcttctgtg ttcttaggtc acagagtcaa ggagagcttt gtattagtgc 670320
 tcagcaatga gaaagaagta tgctctgtga cactatgggg aatacaacta aatgattcac 670380
 aaatcgggaa ttagatattc caaacacaag aaacaaaact tgttagcaag catgtaaggg 670440
 ccaagatgtc tagtgcaaaa tcaagcctaa cagctaatca tttcacataa gccatggcaa 670500

 cagatacttt taaattctaa agtgtlaagca tttggggcta gagagatggc tcagaagtta 670560
 agagtgcag ctgccccttg taaaggacca aagtgtggtt cccatcaacc atactgtgca 670620
 cttcacaaac acccatagct ccaagtccaa gggatctgat tccttcttct ggcctccagg 670680
 ggcaccacac tcacaggcag aacctacaca cacacacaca cacacacaca cacacacacc 670740
 acattattaa aaatagtaca aacaaagaag gaacatagta ggactagcat agggaagggga 670800
 tgaagatttg taatttgagt ttcaaaagaa tcttccaaa ataaagctca agcccttgga 670860
 ttgcccattc ctttaattctg cattctgtta tgcctttgtg acaattcccc aggtgagtea 670920

 ctggcatcac acaaagcaat tctccacaaa gtagaacaag gtcagggcag agccagaatt 670980
 tctatgcaga tattaaggtt gctcactcta ttttatctat ctgattgcac aattagagga 671040
 atggtgagat catgtctaca aggcaacctg agcctgcaaa gaaaggtatt ataataatgt 671100
 gtagcattgc ttcacagct tcagatggcc taccactgct atctgtttat ttaagagtgc 671160
 taggagaaac caataaatgc cttcttcaaa aagacattgt ctatataatg cacacataga 671220
 ttgagtgtcc cttaccaga atgcatggga ccagaagtgc ttgggggatt tttcataatt 671280

tggaaatgctt atatatacac aatgagatgt attagaggta gacccaagt ctaaacaatga 671340
 aattcactta tggttcacat acaactttta tgcatagcct gaagatgatt tcatccaaca 671400
 ttttgaactt acttgtatit taacaccagc ttagcatgtg aggtcaggta tggaaatgta 671460
 caattgcagc aaccaggcag cactcaagag aattggactt tgcagcattt ctggctctaa 671520
 gtttgcagat taggaatgcc caagctatgt aacatataga aataactaat aacaaatgaa 671580
 gtcaatatat accaaataca aaactcaagg acttttgaag ggcccagaaa aagaaaacta 671640
 aagaagccag aaatgccaat tagatggaaa gacaggggct aggaatgtac ctcagtctac 671700
 agaatgtttt atctatacaa gtacacatag gccctggatt cgatcccat agccatataa 671760
 actatatttg ctggtttgfc tggtttgaag gagcatggct cccatgggct tatagactga 671820
 atacttggtc accagggagt ggtgctgttt gaaaggatga agaggtgcag ccttcttgta 671880
 ggaagtatat cactgggggt gggctttgag atctcaaaaa gccattteta agccttgagt 671940
 ctcttctac agcctgaaga tccagatgta gaactattct cagctactgt tccagcact 672000
 gtgtgctgcc atgcttctta ccaatgttaa taatgacta caccctgaa actgtaagcc 672060
 agtccaatg aaatgcttct tctataaga gttgcatgg tcattgttct tecttgcagc 672120
 aatagaacac tttagtctg tctattgagg gggcatgac tataatacca gcaattcgga 672180
 ggtggagaca caaaggtcag aagttcatgg ttacacttgg ctatgtaagg ggttcaaggc 672240
 cagcctgcgc ttcattgagac ctggtatcaa aaacacaaaa agaggggctg gaaaaatggc 672300
 tgagtggta agaacaatgca gtgctcttgc agaggacatg agttcagttc ccagcaccta 672360
 ctccagccag ctgcaacca cctgtaactc cacttccagg acatctgata cctctggctt 672420
 cagcagatgc tcacaccctt gtcacacaga tacagacaga cacacataca cgcacacaca 672480
 cacacacaca cacacacaca cacacacaag agagagagag agagagagag agaaatacaa 672540
 acaaagcaaa tcttataaac aattatttca aaagttaaag gaaggcaggg tagaggaagg 672600
 acaattaacc tgiactttat tcagttgcct cctgctaagg aaaaagacga aacacaaagt 672660
 ttatgtacat gaggtgggta tttgtttgtg ggttagtaat aagggtcatt ttgtgtggct 672720
 ttacctggct tcactcctat gtctgggact gaaaatggag aacgttgaat atctgggaca 672780
 actcaagttt tagggtctct ctccacttgt ctctcatct tcaacaggca gggctctgaa 672840
 ggatcaaagc aaaagcctca aagcttcgta tagccttggg tgagacctca tggcttctat 672900
 tgacacttca ttgtgtcaat caaaagaagc cacaggccag cctagaggca gacaccagca 672960
 aatacacact tgtcacaaga gggattgcaa attatttgtg gtcgctttaa tcaacaaaaa 673020

aatactatcc atgaacctgt acaccatgca acgctagctt cttttaaatt aggaaagact 673080
gtttcattac gactatcgcc ctgaatgcaa aaaaaaaaaa aaattcatgt caagtaagac 673140
attgatccca cagcatttat taaaaatgga gaggccaggc acacaccttt aatcccagca 673200
cttgggaggc agaggcaggc agatttctgt gagtttgagg ccaacctggt ctccagagtg 673260
agtgtcagga taggctccaa agctacacag aaaaacctg tctcaaaaa aaaaaaaaaa 673320
aaaaggagag tattttttaa aaaaatgttt tccagtgaga taataaaatg tctttttgaa 673380
atcttttctt tctgtctcta ctggaagag aaagaagagg acagaagcaa gaatgcttgc 673440

agtccagcag actcagagat atgtgtatga actctacat gccaggagct tgcttcatga 673500
tgctctgaat gatacagccc attataacag agggtaaagg acagtgtgcc agttcacctg 673560
tgcacttttt ctgggcttaa caccgcaggc acaccatgca cacaagagca cagataaaaa 673620
cacacatag taaatgtaca ttcaggagga gggaaaaaat actcagaaac ctatataact 673680
gttgggaaaa ctgtaactca ttaaagaatt tactagtagc tgtattctat ggtttttatt 673740
tccaaaacta attattcaag taaactttt taacactaaa tcttttcttt cattattgtg 673800
gaaccttta atagcccact tatggtgatc acaaaaggca cccttccaaa gaggtttctt 673860

acaagaacac ttaaagcag taattccaaa ttgattgtc ccaccatgag taggccataa 673920
aaacaaaatt atagaattct caaaatgcaa ggagctaagt ctagtgggt ttttatatgt 673980
actattgtgt ctigtgttta tgaaaatctg ttttcaaaga ttgttaagtc attgcctggt 674040
gatgtttatt tgtatttagt atctacttat gaaaactgaa agctaaactt atcacggaat 674100
ttttgcttcc caaagctgag tcataaattg atggtagact cactgctatg ttcttattga 674160
tagatgatag attaacagat gggagctcag ataatgggga aacttgatca aaatgcttct 674220
tccaaaagca agaaaaactt ctccacttaa agaaatacac tgtggaggct ggaatgcttt 674280

aatcaaac cagaaagcag atatatcttc tcacagtat gataaggtgt tagagagcta 674340
atttactctc ttatttgaaa caatggggtg aaatagaaaa caggaaaatg catgaaaaaa 674400
taaaacaaca ttaggcaatg catgaatttg gggataagga aaataaagga agaaagccct 674460
tgatactcta cctaacaac taaagagaga atccaggctg ggcatagaga acaccccagg 674520
aagaagtctg cattgtggaa tatactcaa aatccaagta aagatgaagt ggtagagttc 674580
atggaccagt acaccagaga acagaccact agctgtataa accaacaaca gataccagca 674640
gagttcatcg ctigaatttc ccaaatagaa ctggccacc atgtgacaga aaactatctg 674700

aggctaagga aaaacagaaa atccttaagg tacccaagaa aatgtccttt ggaattcaca 674760
ccagataaac actaatgtct tccaacagc cagcagaatg tcaactaaaa catgaactgt 674820
accatggagg atctagaacc actgcctagg tattgaagaa agtttaaca cagcttttgg 674880

gctgtctaac aaggcttggc cacaatctga aaagacaaaa ctttgcctaa gtgatctaac 674940
 tgcattctaa aatagataca gactacgtat ggcatTTTTca aatttatcca gaacaacaa 675000
 gaaaaatgcc tccattttc aaaaatggcc aagcatgatg ctcagtattg tacacagtct 675060
 cttgctggta tttgttggcc tcagaggcct tgaggatagc tttttccaaa gtgtctcagg 675120

 ccttctgtta ctccagcct acgtcctca caatcatgca ggttgcttt ggaaagcccc 675180
 agggcactag tgtccagagt tcacactatc caagtcatca tgttcatctg tacctagcta 675240
 taggacaagg agaataatgat taggcatcga cagaaggcca agcccaagat ctagaataat 675300
 acctctaaa gtcatgggtt ttacctagat taatacaaat aaattgaaa gcatgggtct 675360
 gaaaagtggc ccaaatcagc tgactgtggc tttttacaca tatatttctt tggacacagg 675420
 caggacctt gttgatgagt gactcccagt gctcagcctg ccccttagtc atccccattt 675480
 gtacaaaatg agaaaatgta caaggtattg aaagacaaag tcatggttga gatactttga 675540

 atgagaatgg cccccacagg ttcgtatatt gaatgttggg ggcccagttt gctggactat 675600
 ttaggaaaga ttaggaggtg tggccttatt ggaggaggta tagtcttatt ggaggaggtg 675660
 tggccttgtt ggaggagctg tgacctgggg atgggctttg aggtttcaaa agcccatgcc 675720
 aggctgtgtc tactctcat tatttctcct gcctttggac caggatgaaa gctttcaact 675780
 actgctctac caccgtgtct gcctgctcac cgctatgatg atcatggact cagctgctga 675840
 aactgtaage aagatcccaa ttaaatgctt tcttttataa gttgccttgg tcatggtgtc 675900
 tcttcacagc aatataacag taactaagaa aatgatttac gaagaagaag agaaaaatta 675960

 gaaaaaaata ctgacctaga aataatagtt tttaggttag ctgacaggta tattaaaatt 676020
 attactgtga gtctatccca tacttcagag agctagagaa acatctacat attaaaaaca 676080
 aaataaaacc accagagata aaaaataaaa tgactaagat aaagaataca tcaaatgaga 676140
 ggagaaaaga aatagaaaaa atttagataa ttgttgaatt ttctacactt getaaaaaca 676200
 taatatatg gatctgagcc ctgagcctta aaacatagat acacaaaggt gcagcatgct 676260
 aaattgctta aagccagcta tgaagaaaat agttaaaaat accagaata taaagaattt 676320
 tatagagtga ggaaaaataa gaatgtaagg gtcttcccct tgttaaggga cttgccttgg 676380

 aaaacatgca gtcagaaaat aacagagtac tataatgaaa catgaaaaga taaatagaag 676440
 tcaatctaca attccatgct caaaatatga aggtaaaata aagaattttc agggggctgg 676500
 agagatggct cagggcctga ggagatggct gggtagctac agaaatggtt ctagagtgg 676560
 gaggatggct tggaggctac agagatagct tagcagttaa aatgtgtgct gttccttcac 676620
 agcactaaca gtctgattcc caaaatctgc cttgtgcagc tcacaacctc ctgtaactac 676680
 agctccaggg gaatccaagg ttctcttttg gcctctgtgg gcaccacaa gtacatgcac 676740

ataacacaa ggtacatgt gtatgcatac atgtgtgccc acacacaaat tagttaagta 676800

 gttaattaat taacttattg aaaatittga aagaaataat attgagactg gaatgaactc 676860
 atcattggaa gaccttctct acaagaaata ttaaagaatg atgtctaggc tgagggaaaa 676920
 gaacagccaa tggaaaccca gatctacaca aaggaaggat gagtcttaga aatcagatgt 676980
 atatacagaa ggatgaagat tctcatctta gttctgaagt ggtcttcaa tctgactaaa 677040
 gtgaaaatgg taacaatgct ttgcagtttg tgacactgca gaaccttacc tacacaggtt 677100
 agaaatggaa gcatattgct ggaagtctct ttacataca taaagtaacg tggttatcag 677160
 ttggtgagaa acaaggttgg tgtatattat gaaccatgca tcaaactg aaaattcaga 677220

 caaacaatga gatctggcaa tccaaccaag gagacaaagt gaaattatgt cactaaaaac 677280
 aatgtgaaag aaagtgagag acagaacaaa gatctcatgg cactaagaga aaacagatgc 677340
 agtgaggagg tagatcttaa gacaactata tcaatgatca tatcagctgg aaatggctca 677400
 aatgtcccaa caaagatga aagtggttca actcgatatt aaaaaatgta aaagccatta 677460
 ttataaaaa gccattgtta ttcatactca atcatattc cataatataa ttattatttc 677520
 cataagaagc ccaatttaag aatcagaata gaaatagggt aaaaagaatg gaggataacc 677580
 attaataata gcagttaaat catatgaaca acctgacaag gttttatcta agaagatctt 677640

 gcagctgtc aataggaact gggggtaaaa ttacctgcca ccaagcctga cagcctgagt 677700
 tcaatccctg agaccacat ggtagaaaaa gaaccagctc ccacaagttg tcctctggcc 677760
 tccacacacg tggaatgggt tacatgcatt cacataccca aaccttccc tacatataca 677820
 catgacaaat aaattaatit aattctttaa agtagaagta cttgctactt tcatgtttaa 677880
 aattaatatic ttagatgctt tttctctttg attttagaac tacctgtaaa gttgatgatt 677940
 acacagtcac accttttggg tgatagggga atgaaagctg aaataggag atgaaaatgt 678000
 ctttttgtat ttatttcttt tctttgggct ttttattttc tgttgactga acagcaaaag 678060

 aaagcagcaa cataatcttg aggtcttttt gctcagtaca ccaaccacat catcgatcca 678120
 ctatcacgga gtatataaag caatgtttgc ttcagtggct ttaagcttcc ctccaaataa 678180
 acagaaatag gattgaaaac agacgcctac aatggtaaat ttaagggaaa atgcacttta 678240
 agttggttct atttccccac tctgtatctc ttacaaataa tgcagctgga ttgaaatggt 678300
 ttcttatgca agaatgctga atattgttgg tgaattcaaa gttttctgta gagttattgt 678360
 ttaaggacat tcggtccctg tgcaaagata gggtgacgtt taaaaatagc taaaagcata 678420
 aatacccaac aacatggcct gtgcttcatt taactatggt ctattttctt gtgacctaaag 678480

aggctcatca gtccttctaa aattggtaag catgcagtga ggccagggtt gcaggatgtg 678540
aagcagtgca aggaaccaga tgtagttcag ctggaagcag aactgaaata aaaatacagt 678600
gtccccacat gtctgaatat gtctgaagag atactgaaac tgaacaaggg aagggatccc 678660
agcagctgga cctcagatac aagaaagaag aaatggtgaa gagaacatga tgtgtccatg 678720
gggtgaatcc atgttgccc tggcattgac tagacaaaa gacaaaagaa gacatttct 678780
ttcaggggac agttcacctg aagtagggaa gttgaagaaa agtacagtga ggtacagctt 678840
ctaaatggcc ctcaagcaca cccaagcac aacccttca gcatccaatg gagaatgaaa 678900

ggcttccatt cctttaagaa ctgatcagtt tggaggtgaa ctgttacca tcttcagccc 678960
tagactaaga atactgcatg tctagtgagt atccagatga gcaaagagaa agaataccaa 679020
cagcaaagac tigtgagagga acagtgggtca aggggaactt ttaaaaatct gattctcagc 679080
ctgcatcaac ctacaagtta atatactaat atgcatctta tacctaagaa acaaggtgct 679140
ggtcatttaa atatagacca aagtcaaatc cttgggacca gtaatgtata aacaagagat 679200
ggtctaacac caaagcccaa gctggcttca ttaaccaca gagtacggat ccttgaaggc 679260
tcccatagag tatttatgga aattagatgg acaatgggca gttgcccgct gtatttggag 679320

atgattcgtc ttctgtgata aaagaaatga agttagaacc cctccccagg tgcaaagggc 679380
atgaaggcat aagtagaatc acaggcaggc tacaagaaag acaaaagcac agagaatata 679440
gtttactggt acatggccac acctgagtct tgggtacata aaatcttatt gtcagcctaa 679500
tgtgaacaaa aaaaagctc ctgcctaaat aatccctat gataacaaca gctgttaagt 679560
gtttactatg ctttatact ctaataagca cagtaaatgt atcattatgg tcttcacagc 679620
cacaagtaga tccagtctca acctatttaa agataagggt ctttaaccga ggtccaagt 679680
taaacccttt gcaaccaact ctagctctgc cttctgtcta attccagatg ctaactacag 679740

acctgtgcta ctctcttga aactagccct aaaataatit tgggggcata gtcaattcaa 679800
gaagacaaa ttaaagaact acatcattca atttcaggaa actgctagaa gaaatatttt 679860
ccctatgaac cagcaaaaagg gaggagagga gaaacacaaa taaaaggag gaaaagggaa 679920
cagtgggggt taattttaa tgtcaacctg ccacaacttg agcatcatct ttgacgagaa 679980
tctcaatcaa ttgtctgtca acttggctta tagtcatgtc tgtaagtgat attcttgatt 680040
atcagttgat gtaggagact cgccccattg tgagtggtag aatccccacc ctttagatga 680100
caaagataac ttgaaggagg tggcatttat ttaggtgcat ggtttcataa ggtttggacc 680160

ataatgacag tgaggttgtc agaccagaga gttagcagag atcagaaagc aaagggtccc 680220
gtacagttt teacgcattc ccctttatit ccctttact ccagatatac ctctgccaga 680280
ccatgggagg acaagatggg ccctccttgc agttcaacct ctggaaatgc gctcttagga 680340

acacctgga gtgcaccga gtctcctggg tgatntttaa accagtcaag ctgacaatga 680400
 agactaaaac atagcataaa gatacatcat tacatttggc aaatgcttgg ctgagccatg 680460
 catgcttaag atggagaaac aagtaaagga agagaagaaa ataaggaaga ggggagaaaa 680520
 gggggaaca tcacagtagc ctaaggaaga aagataggaa aagaaatagt gacactgcca 680580

 aaaagctggg ctggcacaga tntagacat ggacgtgggg aagaaagcaa aaggagctga 680640
 cttacagaga cctcaggacg actgtgactg tgacctttcc agaatgttga tatcgaatca 680700
 ttaatccctc taaaatctgc ctccatcttc ctagctcacc gacatcatct gagatcaggc 680760
 cctcacagca ttttatcaga acaatggtct atcccacca ttcctccatt ccttgactca 680820
 ccaaaccxaa tcggtcattc aaacctatgt caaatgaggg atcaacctgc tctgtgtta 680880
 aaattccttc ctcggtcttc tgtatctca tgatgaagtc aagtccttgg tttttctgat 680940
 actgtccca gtccacttac agcttcagct tgtgctgtgc ccttgataa cctacgttcc 681000

 attaatagct aaaatatntt ctgttcgagg tgatccagga tcttttatac cactgtgttt 681060
 tcccacaagc atgaaaatca acccccccc cccgtctcta tctggttcat tactactatc 681120
 catggaggat gtaccxaaag ttaactcttt cccatcccat tgtccctcc tgctgcacct 681180
 atgcatatca ttgtcagctt acccctgtct cccttactgg cctcttgctg gactctagca 681240
 cacacaagag acacaaggca ttattaattt atatctagga tagtaattga cacatctaag 681300
 cagggtctgt gtgattcttg agataaggca ctgcaagca caccatttca gagatagtga 681360
 gcagactctt gctctccctt gctttagacc catggctgtt tgtglagttc ccatgtgaca 681420

 tgggtgtgtt aagaactaaa cacaacatta tgaagatagt gatatttgc t gaccctgtgt 681480
 ggggtcaatat ttagaagctg cagcaxaaag ctgactttca cttgacttaa tgtcaaxaa 681540
 aatgtcatat tttctttgct tagttttggg aggtgtttca gtttatttgt tttgggagtt 681600
 tggggaaggg ggaaxatgaa attatttata gccagttttt cactctgctc ttcatttggc 681660
 ttttttttt cagttaaggc tcaatatgat atttttatct cattagtaaa ccttattgat 681720
 ttagatccat aattctgtca ataacaacat tctgcattct aaagctatca ttcagaaggt 681780
 tattgagaca tatttgata ttaggcaagc atacatttta gctttaxaaa tatatacata 681840

 taaaaacaca ttatatact catagtcatt ggtagaxaaa ggacatttgc cacagaxaa 681900
 tgaagtaac cactccctaa ctctcttag ctcaactact gcactgtacc ttatccctcc 681960
 attgaxaattc ttcaacttag acttaccagc cattctagca tcttctatga agatctggag 682020
 ggaxaaaaat ctacaacctg atttgcaagt gttatttaac tcacgtaatc tacaaxatatt 682080
 aataagtct actcaagatt agttaagctg gcttgtgctt gatgaatgca acaccttcc 682140
 acatctccat caxccagtc catctccaaa actactgaac aagcatcttg attagcctt 682200

ggcttcccat ttctaaaaa atggtatatt tcaagcacct ccctttctag atttcaagat 682260

 gtatattata atcactttaa gaaatatctt agttatcagg ggctatggtt cctcaaagcc 682320
 aagagcccta gatggcattt aacacaggca gaggtttact ctctcttcag tgctcactac 682380
 catggcattg ctgacttctg tgttcagaac aaactccctt gatggaaagg agaggagagg 682440
 aagtagaact ttgcaggagc gcattctttt gggtcacag gtcttctga cacctcttgc 682500
 tccaggcatt tcaactgacc caaccttggt gtccttgctc caggcaaaca gaaccagctg 682560
 actgttagtg tatgagtctg gctaaactga atatcttgag tcatgctact acagctctct 682620
 aatttgggcc tattctatag acttgggtta aaatgctcta aacctttctg aacttatgct 682680

 tttcaatac tacattggca gtttattaac actcttagcc tcatccatca gaaagagccc 682740
 ctcttctggt gaaattctga tgcctgggtt ctagaatatt tgctcatttt tttttttgc 682800
 taacctaaa atgcttactt atcaagcatg tattgaacac cttcatctac ctatcttcc 682860
 aactgtcaca aatgccactt cctgcagctc tgagggttaag ctgtctctca caagctatac 682920
 tggatttctc acgctgtcgg acaggtcctt gacctgagac tctggagaaa accgtgttct 682980
 aaacataatt cccggtcact cccctccttg acctcacatc cacactatat cccctgagct 683040
 tctgaatcg tatctgcttc aaagtattat gtgcatctga ccttcaggct tcaaagtaca 683100

 actgatatcc acagtattgc aaaagttttc ttaactcccc aaaggaagct aaggctccac 683160
 ctgtgtccta gatgtcactc atggccaccc agaccacag ccaaggataa aattggagaa 683220
 actaaattca agccttactt gcttcaccag aaaaaaaaaa tgccgttgag ctctgagga 683280
 cagctgtgca ttttcagga ggtatgcatt tcacagcagc tctggtacct ataaattgac 683340
 ttcccaatct gcagcacaca taacttttct taatgttcac tgaaaacaaa caaacaaaaa 683400
 tattcccaa aggtattcat gtgaggaatc tgcaacttc ttgactccag acctatgatg 683460
 aagtcacctg agacaacaga aaaaaatgat ctggagcctg aagcactgtc cctggaacct 683520

 gccctgcctc tggacactac aaagtacag attgtgtctg ctcatccagc ttctttctgc 683580
 aatgactata atggatgctc tccagctcct ttcagacctt gctatgagcc cctccctatg 683640
 tgttatccca ggctgtgtaa agatgagctc agtttgctgc taggcttaac ctgccaacaa 683700
 acacatatct cctagaatga acagaattgg aacatgaggc caatcaccag atgccattt 683760
 aggaactcta tgttcaactg ctcccatatg tgactagtca tattctttat ctatttaatt 683820
 ggttgttatt gttgttaaag gttgtcccc caccaccatt accaccacca ccaattcgtt 683880
 ctctctcagt gtaacaaata cctaagataa atcaacttat aaatataatag gtttcttttg 683940

gctagcagtg taaaggtttc catccatgac tggttggcct cattactgtg gagttgtgt 684000
gaggcagtaa gggaaggcca gaccaggttt tctttctaata catggatatg gcattcatag 684060
gtgtatatta cagcaggagt gcacggcaga gcaagacgga aataagagaa ggaggaaggg 684120
atgaaatctt gcctcccctc caaggacaat accctaactt tctactacta agctgcatct 684180
taaacattcc atcatctccc agtaggacca ctagttgggg accaaccctt tgctatataa 684240
acctttgggg cgtttctag atacaaacta tagcttactt ctcaaagact aacttttaac 684300
ttcagtagtc tcgaagacac cacagagtta cctccattta ccaccacaa ggggctgaac 684360

taagtgttcc ttacggtctt ttctagcagt aaaatttatg atcccatata agaagcagtt 684420
tcactatctg cctgagatta cacataaatg cttttctttt atctgaattt atgtcaggtg 684480
ggacatccac taaatctaaa agcaaagcca ttttacttag gatcctttta gaacaaacag 684540
aatagaacaa aacaaggagc ctgcatgtaa gttgtctttt gctaaaagaa cacatacatt 684600
ttcttgaata tatagtttat actgttgtaa aaaatattag atgataattc ttccatgaaa 684660
aaaataggac ctcataatga ttcagagtta cacaaaagat gattgacata agtgaataa 684720
gggcttggag agatggatta ggggttaaaa gcacttgctg tataagcatg aggtcctgag 684780

ttcagatatg aatgcctata tgacaagctg gccatagact cacgttcac tghtaatcca 684840
gcactgtggt gggtagagac aggatgatca ccaggcttgt gggctccagc ctagacaaaa 684900
acacatcctc cagctccagg agggacccta ccttaaaaga gtaaatcaa gagtaataga 684960
ggaggatacc caatgctctc caagtgccac tgggtgctca cacaaatgtg gatgcacata 685020
tacacacata tgtaaaggct ctctctctct ctctctctct ctctctctct ctctctctct 685080
nnnnnnnnnn nnnnnnnnnn nnnnnnnnnn nnnnnnnnnn nnnnnnnnnn nnnnnnnnnn 685140
nnnnnnnnnn nnnnnnnnnn nnnnnnnnnn nnnnnnnnnn ncccacacac acacacacac 685200

acacacacac acacacacac acacacacac aattagaaaa cgggtttcca aaagacagtg 685260
aaatagggaa atcttgagtg ggtgagacct tgctaaactc atctcattcc gaaacctcga 685320
atctctcatt gggccaaatc ccatgggtaa aatgcatcaa taatgcaaga cctggccctg 685380
aaaggaaggg agttggaat gttccttgtt ctacattctg aaatatcttg cagctgccga 685440
agacagcagt aagctgtgtg ttcttttaag tatatgacta ttttttagt taaagaagaa 685500
gaaacccccc ggatcatatg tgtctctctc ttgtttctaa ctgtcacaga ggcagaggct 685560
gctggaccag tgagactgat gcagcatgac aggggcagca cactgctctc aagatatgat 685620

gatacaatc caagagagag agagaacctc tgccactctc attatctgct gctgtgctct 685680
ctggatgccg cctctgctcc ctccacaatg aggggggatt attaaatata attctgttaa 685740
ttatggcttg gtgcaaaagt tggatgggtc ctgaatcagt gcccacaagg aagaacaaca 685800

tgaggtaaag attggagggc ttttatggtg gtgctcaaag ataattatag gtatggaaac 685860
 caatttcaga gtgagaaaaa aaaagccaac caagcccaga ctgttttcat aatgcagcat 685920
 agctcccttt taatgtgata cattaactga ttttccctga gggaggataa ttcttgccat 685980
 gtcagtcctc tggacagaaa gtctctggct tagggcaagc agtcagcagg aacctaggag 686040

 cttcaagtga atattgccat ttcccagcct ctactgaag cagtcaggag gctgcatagc 686100
 ttatttttcc acaggtactc cagcaagaac aataaactga aaaaaatat atatacatc 686160
 agatgtacag atagccttca gcacagatta tgcaaagatg taaatgggtc cactatatgg 686220
 cacagcatca aaagtctgta tttgaataa tgataataac tcactctcag ttgtgccttc 686280
 tgttaatatc caaaatatta gcctttctct ttaaaatatt atgggccagg ataacgatcc 686340
 taatacacag actgaaggag agtcacttta attccaggct aaggattgca agcatcttag 686400
 atgggcttcc taatggagta gaagtgggca ataaaatctc tgagaaggca tctactgtca 686460

 cttgacaatg atggactctc agttttttat actgctagct aagatttctc taatatcttc 686520
 ttggtgctct ggtgaaatgt gccttctgat aaagttcgga aacatctgtt ccatctacaa 686580
 caacgcaate cagtgttctc cacattatgg gacacaaatt cgtgataacc tgtcttagtc 686640
 agggattcta ttctgtgat gaaacatcat gacaaaaaca tcttgaaca gaaagggttt 686700
 atttgcttaa gcttcttcc atacatttcc tcataaagg aagt caggat gggaacacaa 686760
 acagggcagc aacctggaag caagaactga tgcagaggcc atggaggagt gttggttgc 686820
 tcctggcttg ctctcatag cttgctcagc ttgctttctt gtagaaccca aggccatcag 686880

 cccacaatgg gtggggcct cccacatcaa tcaactaatta agaaaatgcc ctataagttt 686940
 gcctacagct ggatccttta agagcatttt ctcaattgag gttccctcac caatgacct 687000
 agcttttgtt aagctaatat aaaactagcc agactgcctt ccctggggca agaaatagta 687060
 ttgagtttga agagaatatg agataggaac ttaagtacaa ggactcactg catgctcttt 687120
 caatctatca aactataact gaacaactgt ctcagttggg atttctcaat ctaaaaaatt 687180
 ttgtgaaagg cagcagagga gatgtagcta taataaaaag aatgatggtg gtagaggaat 687240
 gttggtctag aaatttagac tgggttgtgc tatgtcagca cctctgacct ggagggaaca 687300

 ggtgtttctg tttctgggtt gaagctgtcc tgfactctgt taacagtcac agtatccttg 687360
 ggacctgccc actggatgca gaaagttacc tttccccaag actgtgacac caaaaggtgt 687420
 cttcagacat ttcccagtggt cccctgtgia aggaaggagc cactctgagt taaagctaac 687480
 ttagggcaaa gtgatgtctg cacacttgtt tafgggcaaa gattgtagag aacagtgttg 687540
 gacttcacag atatgccaat atgaagaatt tcagggatta tagccatcaa ccaaaggaag 687600
 atgacaaatg gactcaagga atgctatttg gataaatctc aataaatctc ctttgagggt 687660

ttccctgtg cactagttca ttcaaatata ttaagatcag ccatcttcta attacagatt 687720

 ccagctgtga accctcaagg caaggtgctg agggctcttg cctttgcagt ttgtctgtct 687780
 gtccaaccag actgtagaat ggtctcatga attttcataa agaaaaacac atgatcaaac 687840
 ctgccgatct ggtatgcctc agtgggctaa actggctcgg cttttgatg aggtgcttgg 687900
 cagcctgaat atttaatfff gttcttttat cttatggttg aggatgcata tgcccagagg 687960
 cctttggaca cttgcctctt ttttaataaa gctaataaat gccctagga aatttacctg 688020
 tatctaaact gacataacca agctgataca tcagacgggt caggcatgag agattccagc 688080
 aatttatata aacggaggaa gctggcatgg gcttggactg cctggagtta ttactcaggc 688140

 cttggcagcc ttccaggctg ctcataatff taaataaatt ctgatcttgg tgatgiatac 688200
 ttattgatca agttttcaga aagtcatcac catgtactct ttcactacat attgatctga 688260
 aatctccaca gttcctgaga gaagctggc attacattag ctattatctg caccacaatt 688320
 tatccttcta tctgaatcaa gcttgcggat aagttagctt tcttctcca cttactatgg 688380
 aaagagacct ggcaagctgt aagaaaatga gactcttggg tcccagagtgt ctcaatctgt 688440
 cactaatfff cattggttat tttatttctc aaactctcaa ttectcctt gtattacaaa 688500
 aagtaaacag cgttatcagt aggtaagcaa ttctagcatc ttttctctcc cttcaaatgg 688560

 ttgttctgaa aatgctctgt tgcagacagg tcgccacat tccactagggt gctagtgggt 688620
 gtcacaagac aatcttgctc aatttccttt gtaaatgatg gcctgtgttt ctacacagct 688680
 gacctgagtc ataggcgagc tgggccacca gagagctttc atgagtacaa gctctggctaa 688740
 aagagaggca tctggacgtt agttcctcag aaaattctcg ggtatgtgct tctctgttga 688800
 tcttgtactg agatcaacca tagataatga aatgcctcta ctcccaata cctcaagtat 688860
 gaagattctc cactagacac atgtgacaaa tgattatcat attacacaat ttgggagaga 688920
 ccactccac agctgccttc tgatgagctg caactgagta caaaccaeta tagcattatg 688980

 cttacatgat attatgtctt ccctttgtct tcctgcaag gaacaggagt caccatggca 689040
 gtttgtgtc acaatttggg aaaggaatat ggtcacagag cctcaccagg tgcttctacc 689100
 ctgcaaccaa gaaacagtac cccacacctg gctagtcaga taaaaataac ctatgagaac 689160
 aagtgccttg gctttgtgct ttcagggttc atattcttac gtgatccaga gacccccaac 689220
 atgcatgtc accagaacct cccccaccc ctttttaaaa cttccctgtt tgagacttgt 689280
 aactgtaag ggacagacaa taaatgatgc tgaatgccca gccataaaag gaattgtgta 689340
 catcacccct gaaggaaaat catggaaggg ggggcaggga gcaaaagagg actgcaaaga 689400

tgcacagagg atggctatca ggtgctgctc ttacaaagga cctgggttcc gttcccagca 689460
 cccacatgat ggctcacaac taccctaaaac ttgaatttca aagaacccaa tgcctgtgg 689520
 catccaaaga cacctccaca cgcatacata cactcaggca cacatgtata cacataaaat 689580
 aaaataaata aacctttgca aagaaggctg caatctggac tatgaggagg tgtgctgtca 689640
 atcactgtct tctggatttg gcatggcgcc tgcattcatt ccctcattac agctgtgata 689700
 acctgaatca tatcctgtgg atgatatcct gatggagtgg gtatggactc acaaggactt 689760
 aaaatttcta tgcaactaat ggtaggaat gggagtcttc ctgagagta tgccaatgga 689820

 aatgttctca tgcttttgca aagaaactcc cacctgaact ccataaaca actttaagga 689880
 aagtagaac aaaagaagt aatgtgggga aatgaacacg atcaataaaa cgcaatatgt 689940
 acacctatga aactatcaaa atgaggcata ttattgtgta cagttaattt atactaataa 690000
 acatttttaa aggggcaagg tcttgtttag agaataaac atgaatttat aagtaaatta 690060
 aaaatgaaga acttgggttc ttaggccaca gatctgcttg tgctctcctc caacctgtgg 690120
 agtatattct aggccttttag caacactctg aaataaactt gtgctttcat tacaaaatta 690180
 caaacctcct ctactctaca gatgatcaca ttctctctgg attagtgtgt cagtgggctc 690240

 ctaggtgaag ccaccagtgt gaaatagtgc ctaacacatg gagagtgttc aatggctaca 690300
 tattgaatta atgacaggct tctttgctac actaaggagg caagtggag acagtacct 690360
 ctgtcactct caggaatgaa tctaatagata tctattgaca gatatgtgtt ggaatacagg 690420
 agggcagtga atagaaaatg ccctgggaag ctcttgcac caataccttc cattctgctt 690480
 gtttgcaata cccactgtca actctcaagt gtgctgaggg ctggaaagat gcacagactt 690540
 atgagcactt gttgctcctc cagacacctt gaattctgcc ctgagcacc atgttggctg 690600
 ggtactgact ggaattccac atccaggaag gagaccaaca ctctctctg gcctctacag 690660

 gcaaccagac atacttacac acacacatac acacacacac acacacacac acacacacac 690720
 ctaaaattaa ttaaatctat aaaattcaaa gtttctagag taccactgat cagtctgtgc 690780
 aaattctact gacaatttca aaagaaggca gaattgcaat ttgacaata cacaaagggg 690840
 gtttctgacc tggtagtgg tagctgtaac ctttgttct tccttactat gatcaacgag 690900
 agagagagag agagagagag agagagagag agagagagag agagagagag agagagagag 690960
 ggctgggagc tgagagctga aagaacagaa ttgacaaaaa taagactgat acataggaaa 691020
 ggtcttatct tgagtaggta aatatgatgt ccaggccagc ttcctcccaa atgcctaaga 691080

 acttcatgag ggaccactcc aatccccaga aaatgctggc ttcccagcac gcattcctac 691140
 aggatttgag ttagttaaca acgtctccac taaggatgct tgctgcttg ttgcattgga 691200
 tggactgagc tgiattacct ggaaccctgt tcaactgca cacactcaca tgccactgct 691260

ttctaattct ctctgccatt aaagatgact ataaccaatc ctccacagac cacagctctt 691320
 gatatttagc atagcaatta tggatgata gccattgctt ccagaacatg tccacacagt 691380
 ttctcagaac ctactgtca tattatagga taacattcaa atgaagtcac tgtcagctga 691440
 ccctaaaacc aaagcttacc ctgactgact aggtgaaacc aatgtaaca caaatcactt 691500

 aaaaaggat gaaagcagaa gtgttcctaa cacaatggtg caatgtgaga aagacccaaa 691560
 tggttatcgc cagctatgta catggaaggt ggccagtggc caaaggagca gacaaattct 691620
 gcacactgtc aatgtgcaga aataaatgca gtctgacaa taccactga actcagagac 691680
 aacgtgggct tatcttcaat ggacagaaca ttataacaat caatttatgt tgtttcaacc 691740
 cacaaagttt gtgataattt gccattggta attgacggat gcaactacag gaaagtaata 691800
 cagtaacaag ccacgggggc agggcagggg gagaattgga gctggggaga gagctatgtg 691860
 gtaacttaac tagatgccta aggactaaca ctcaattctc agcactacaa agaaaaagag 691920

 ctaattaatc acaggtatgt gaggagtgat ttgggctaac tctctgttc tgggtatcta 691980
 caggttcaga aaggatgggt aataaagtca gccacaactg gttctccagg acatgaagtc 692040
 tcctatgccc tagaatggtt ccaccagta aattaatttc aattcttget cagttttctc 692100
 ttaagatat tttatttta tttcatgtgg atgagtgttt tgcatacata catgtttagg 692160
 caccaaatgt agacagtca cacagaggac agaacagacc atcagatccc ctggaactgg 692220
 cgttacagag ggttgaagt caccacactg gtactatact aggtggtgtt tccttttact 692280
 gaaaacagat ttttccctc acatagcata tcctgatgtg gtttccctc ctatctactc 692340

 ttcccagtec cctccataca cctcccttc catccacagc tattcccttt ctatctctca 692400
 ttaggaaaca aacaagcttc taagggattt ttttaaattt atttattagt tctagttagg 692460
 gaacaagctt gtttcttct gtgctgatcc tgggcccttc accatgtgtc cagggccaga 692520
 gtgtaacctt tccatggga tggctctca aagtcccttc ttgcaccagg gaaaaatact 692580
 aatccaccac cagaggctcc ctggagtca gaggcctctt tattgacatc catgttcagg 692640
 ggtctggatc agtctgtac tggcctcct gacagcatct ggggtcgatg tactctcct 692700
 tgttcaggcc aattgttct gtgggtttct ccaacttggg acagaccctc tcgctcttaa 692760

 taaaatataa taagatgaaa ctaaaacca atatcaggat tagaaaaaa ccaagaaca 692820
 gaaaaaaca gccccaagat aaggcacaag aaactgaa gaatccatg aaagcactaa 692880
 cctggaagtc atgataaata cgcagaggac ctggtgcaga cccatacaag ccctgtgcat 692940
 ggctgcctcg gtctctgga gttcatatga gctttgatcg ccttgattg gaggacctg 693000
 ttgggttctc tccatctct ttggttctta cactctttct gtctctctt ccttgggggtt 693060
 ccctgagccc caaggggaag gatttctgg agacttccca tttagggtg agtattccaa 693120

ggtctagctg tgggtctctg tgtttattcc catctactgc tgcaggagga agcttcttga 693180

 tgatgctgag tatagaagaa tattattagg agtcatttta ttgctaagtt agtattttgt 693240
 ttgtttgttt gttgtttgct tgtttttaga ccaatattac ttgtttttac cetaagtctt 693300
 tggcctatct agtctaaagt tcttgatcac ccaaatagtg ccaggfatag tttccatctc 693360
 acagagtggg ccttaagtca aatcagatct agcatggttt cttctacaag ctgtgccac 693420
 cattgcacta gcatatgttg caggcaggac accattgtag atgaaagggt ttgtggctgg 693480
 gttggtgttt acatttctcc aagggttgat ttccaattct cacagagcag ctcaaacctt 693540
 tctgtaactc caggggatcc aatgcctct ctgacctct gaacaatgtg gtgcacatat 693600

 atacactcag tcacacacac taataataac aataaacaaa taaataattt ttttaattct 693660
 gagcattaag actgtgtgtc ttgcctgcag cacagtttca tgtgctttca ttcaaggctt 693720
 attttcccat ttttaacat aacattctaa atggttcatt tagctttcaa actgaatgac 693780
 agataattag aaaatagcac attataagac agaaagactg ctaaggatac acagcctgtt 693840
 agcaaaagta tatggtgtga ttgtggcagc aaaaaaaaa aaaaaaatca aagacaaggt 693900
 ggaaccaatt gtctacagg caagtagcca gagactgtta cattgcctg tactcacaat 693960
 gatcctgagt ctcttctaa aacctgttca aattatgtcc tgcatactct attgtgtcag 694020

 caaggaagta tatactactt tggcagagat ttcattagaa actgttgaca taatttaaat 694080
 gttgatgttc cccggaggac catattcact cttcagtttg ctgagtgtg tgtaccgcaa 694140
 gagagctgaa gagcatgccc agtgggtccc agcaaatggg aaaagaagac tcgtgcttct 694200
 gctcaaacct actaaatag tagagagcca cagaggcaca gtgacatggc tatcccaaat 694260
 atcagtcctt gctattagta aaatcacagt tcagaggag agattgaagc aatcattcca 694320
 ggccggacac acatttgcaa atgtcacatc ggaagtataa ctttattatg ggaaagcaat 694380
 ttaagttcat cactaatgcc tgacatttca ggatggtttt tgecccgttt ttactaatca 694440

 cactcaggtg agctctgtct ttcacagctc ctttatgat tagactgctg aactttacag 694500
 aaagagtgc tgggtgaagc tccagaattt gattttccag ctgatcttta ccaactcaag 694560
 tagcttcagt ctgtctccag cttttttcc tttatataaa cgtatgtcat aattccaaga 694620
 taccttttat gagaaataaa tgacgtcatc aacaacatca acaaattctg gaaagtagg 694680
 ttgccaagga aacctatggt aggaaatcca cccctctgtg gttcattgaa ttgtttgggg 694740
 gttgcctcat agttaactcc tttacaaaat ggttcaggat ccttgattg attttatggt 694800
 tatctgttgg taagacattc ttctttttt tttattttga ggttttttag tcattgtagg 694860

aagccggttc ctgcattatc cattacaata ataggtgcct catagggtaa cacgtcccag 694920
gcggctggcc agcctttata agggatggtt ttcttggttc aatgtctccg ctctggaag 694980
cttatgctct ccctcaca gatgcattaa agcttgtctg cagaaggatc cgagtgtcct 695040
gcgtatgatt tcttgccggc gagaaataca gagcgcgagg gacaagtcac gaaatctggg 695100
gctaaggttt tacagtagct tgccaggcta tgcagacaga gacctcagtc tgctcagct 695160
ccaacactca tgtctatatt gtaccaaca tctccctcta aaaatatgta taaagcaaag 695220
atggtatcaa catatacaa agagagtcac aaatagtat aatgggactt gtctggaaga 695280

tatacattgt ataacatcta tattattgta taacctacca cttgtcaaaa cccagctact 695340
tggtaaaata atacattaac aatttattat agcttataat acaaaaataa ccgtaagcta 695400
ctattctgga gttatatata tttctccact ttgatgtgg aagcctttca ctaatttaga 695460
aaggatcttc atggtctcct tagtcttctc tactctcta agttccaggt agacccatt 695520
attccttata ggatacaagg cgtttataat tcttctctct cagtaccct cctaaagaaa 695580
cactgtgttg cagatatggt cagactagca aaaatacac tgtcaacttt aatctagatg 695640
gctcacttct gagcaaagaa actttcttag ggtgatgcca gtgtccagg tgtttacatc 695700

ctaaaagac tctcaaaggt ttgctttgct aatccaaatt gttatTTTTg tctcctgaa 695760
atattaagct gttgagctcc acctgaattt tcaatctgat gaaatcagtt tggatgatga 695820
ttcgcatcca teatattata cttgtttcta ggttctgtca tccacaaatt agataagcaa 695880
acctatgtgt ctttatgtaa ctcaaaattt taagaacatg tatgagacaa attttaaca 695940
gagtcttgtt agaaaatttc taaataatga tttctaagt aatgaatgag tactcagac 696000
aaaattcttt gagaatgaat atgagctagc tatctatttc cctgctgtat ccataacat 696060
ccacatactt gacacacaat cctgtatagt taatcaagac atcgTTTTca tctatctggt 696120

ctcttgggat gttttcattt ctccatgatt taaaataat tgtccaaac attcactagc 696180
acgcaactca gcctaagaca acacagtaa aaacacagaa tggctttatg tttcctcag 696240
ttctcaacag cctgctaaat tttccagat taataactgc tctccttga agagaaagtc 696300
gaatcaaac agtgtgagca gcctcagttc tctcctctct gtgtttgtag tgcaccatct 696360
gaagcaagca gtgctgcagg aaaattgttc tactgctat ctgctgtacc aatcaagtta 696420
aaccttggat caaagagcag agtcagtgat tggctgactg gaattagcca tagatttgtt 696480
ggaggactga ggaatcaga tagagaagga caggaagaga taagaaggc ttggagagat 696540

ttcgtggggt tttgtttgt ttgtttgatc taagaactgt ggagagtagg gtcagtgat 696600
tgttctctg ttgtttttg gatttatcag gttttatct caatttctga ctctgagtt 696660
tttattaaca ttagaacaat taaggtaa tctttaagc aggagatttt tcaactactc 696720

atttgattat ggtaaacactg actgaatgaa tatctgagct tcatgtttct cacagccgtc 696780
 aggggttctg tgatttggtg tcaccctttc ttttctcttc cctccatcct gggaggcctg 696840
 ttaggagacc ccttaagaca cagaaagtac acaactcaga agtctcagta agtcctgaa 696900
 acttaggaag atagcattca caaagctccc tcctcagtaa tagctgctat ggacaggaga 696960

 gtctctgacc catccaactg cttacaagtc atgtagagtt ccaggtttca tgactcatga 697020
 cccatgctgg aatgggcttt cagtgatgga gcagcgittg agtcatccat getcctgaaa 697080
 gtaaccatac tcctttaagt attctcccta aactcactga ttgaccatac tggacttcag 697140
 tggactgtc catctattat aagcttecta tctgcagtga gtagacgttt gttcacatct 697200
 ccccaggaat agtgcgcc aacacctatt tgaattggt ctttaacatc tatgctcaca 697260
 gaactgcat tataccatca tcatttctat cactaagcat accaattcca ttcccacatc 697320
 cctcttgagt tctttattgt tgaaattcac ctttcttttg tcacagaatt gcctggttgg 697380

 taacatactt gaggattttg ccttggttaag tgatatcact ggaaggttca gacgtttttt 697440
 aaataggaac ggcataaaag taatctctaa tattatttca ggttattatt tactacaatc 697500
 tacatgcatg taaatcgata caattaagaa gcaaaagtaaa agaagcatgt atctgaacac 697560
 agtaatgtac aaatcagaac tcactcaaga aaattgtggt atccaaataa acagtccaga 697620
 attcatggag aagccataaa aataaatcac attcaagatg aaatgtaact atatgtcttt 697680
 tagtatagtg taccttggtg ggcaatggca aatgagacaa gaaatgcctc ttgcctctag 697740
 gagcttccat tatggcagga aagactgtat aataataagg aaattaataa aagaattaaa 697800

 atgctagatg ggaagatgtg gggaaagagtg ttcttttagg taagttggtc agagaaaact 697860
 ctctgagaaa gtggaatgag ttcaaaactg atggataaca agtaccagc tatgcaaaca 697920
 ttgaaaagag aaatccagga agagggcaat atcccaaaga tcaaaatgag agaaacctat 697980
 caatcacagg aaacctgcat agagaaaaaa gtaacagcac agggatccta agtatcatga 698040
 atatctatac taagcctaag gaagcaccaa agaactttct agaagacaaa aacataattt 698100
 tacaaggtc agagaataat gccatatcaa agaagtacac agacaatttt tctactttaa 698160
 attcatctca aagtggctgg agagatgcca cagcagttaa gaacaccaac tgctcttcca 698220

 aaggaccagg gttcaattcc caccgtacac atgacagctt gcagtcactc gtaactccag 698280
 tcctgggtga tatgaacccc tcttctggcc tccaagggca ctacatgcac atggtgcaca 698340
 ggcaaacaga taggcaaaat acacataaca ataaaagtga ccatccctga cctacttaa 698400
 tattccatct acaataaagc tcatgcatga ttccgtatgc tctaactgt ctctaacaac 698460
 tgtatgttta gttttaagat gccacttttc acttttcaact tttcacagct actgagaatt 698520
 gccatagttc aaaaatgta aacccaagi gacagcagcc tcttttgggg ccttcccttc 698580

tcagaaccct cccttctcca tggaaataac ctttccttg tccaatctgg tgctcagaac 698640

ctcagtgttt cttggggttc tgcaggcaat gctcagagaa gtgaactgga aaacatgcac 698700

aaagacaaaa tgacataaaa taggccacag aattatcatt ttaaggtaaa aactcaggtc 698760

acatcactgg agagatgact gaacagttag gaatgcttgc tgttcttgca caggaccaga 698820

acttgggttc cagcaccag gtggctcaca agtgcctgta acttcaggtc caggtgatcc 698880

aacaccctct tctgttctct gtgggtacct gcatgaatgt atataccac agaaacacag 698940

atatacacat atataaaaat aaagcctttt taaaaagaac tcaaggtggg catggaggct 699000

ctcaactgta attctagcaa ttgagaaaat gaggtaggaa gattgataca agtttgaggc 699060

catcttgggc tacatagtga aaccctgcat aagaaaaaaaa gaaacaatga taaaagtaag 699120

tcctcctctt agtggttcaa ggaggcagag gaaagatga cagaaccagg gcagagcaag 699180

gtgaggcaga gttctattga acaggaagtg gtgatgcagg cagcggcaac cacagtactg 699240

tcatcaaagg ggaagagcag aattcatttt aaggaaatgt gtaattata ggaaagtaag 699300

ttttttgttc tgtggcatat gctataattc cttcctctca cttccttaag gcctcttcaa 699360

cataaacctg aattactttc caaggtctcg tgggatggag ttgagaataa tggcttgctt 699420

ttgttaggat tttataggcg aatggacagt ctgtaaatcc ttactttata ggctcagttg 699480

aacccttacc atctgttctg tgaaaacaca tcaactgattc tcctttctat ccaaaagaat 699540

ggattattcc agattttcct tatcacatcc cttgcctcc tggttcctag ccaggctctt 699600

gctcactaac tactaaaaa aataaccaa gtcactcgtat ttctacctc ttctcttcca 699660

cttgctccca tttcatcacc tgcttgcttc cttctgttag actgggggaa aacatgctcc 699720

tgctcctttg ccagctaagc ctattgccct ccttggtta ctaaggtgaa tgtatcatca 699780

gtcatcatta atacctcagg tggaaatgtct tctgtatgc tgtgaatatg ttttattacc 699840

attggttaat aaagaagcta atttggccaa tagccaggca gaatagagtc aggcaggaaa 699900

tccaagcaca gtttcgggga aaagaaggca gaatctggga aatgccagca gccactggag 699960

aagcaagatg tgaggtaaca accacaagcc acatggfataa atatagaata aactcctcc 700020

actgctcgtg ggagtgccaa cttgtacagc cactgtgaaa atcagtgtgt tgactcctca 700080

agaaaatggg aatgagfcta ccacaagatc cagcaattcc actcctagc atataccaa 700140

aagaagcaca ttcatataac aaggacatat gttcaacct gttcatagca gcattatttg 700200

taatagccag aaactggaag cagcctagat gccctcaac caaagaatgg atagagaaat 700260

tgtggtacat ttacacaatg gactactact cagcagaaaa aaannnnnnn nnnnnnnnn 700320

nnnnnnnnnn nnnnnnnnnn nnnnnnnnnn nnnnnnnnnn nnnnnnnnnn nnnnnnnnnn 700380
 nnnnnnnnnn nnnnnnnnnn nnnnnnnnnn nnnnnnnnnn nnnnnnnnnn nnnnnnnnnn 700440
 nnnnnnnnnn nnnnnnnnnn nnnnnnnnnn nnnnnnnnnn nnnnnnnnnn nnnnnnnnnn 700500
 nnnnnnnnnn nnnnnnnnnn nnnnnnnnnn nnnnnnnnnn nnnnnnnnnn nnnnnnnnnn 700560
 nnnnnnnnnn gggattttgt ttttacttt ttgttggtg ttgtttgttt tttgttttt 700620
 gtttttttt gtcttggttt ttgtttcttt taaatggagt gtgatggatg tctctacaat 700680
 ttgtttcaaa tgactgcaga acctggaaaa gctgttgctg ctattgatgc ataacatatt 700740

 gccattattg gtctttaaat ataaatataa atataaatat atgctaattg aaactcaaat 700800
 atgtgatgaa tcttaggtgt ttcagttagt gctcacctgt gcatgcaaat ttgatttcat 700860
 ctttagtaag tagtaaagtt atatgcttgc caaaaacaaa agtgacacac tggagacaaa 700920
 atgtcacaca atttcaattt tatgtgtaac ctagaaatga tgaacttatg ggaacagaga 700980
 gcagaattgt ggctattagg ctccaatgtg ggccttttaa caatgggaa atgattggtt 701040
 taaggatata aaactgcagt tggacaagag gtatggactc tgtgatgtct tgaggcttac 701100
 tgagagcatg ataaatatgg ttgataacaa tatgctatat tttaaaggtt gtgagatcgt 701160

 atactttaag tgttctcaaa acaaaaatga tgaatatgtg tgatataaca tgttaattgg 701220
 ttttaatttag ccatgccatt gtgaatatac tgtattatgt accataattg tgcattgactt 701280
 tatttatgag ctaaataaat gaatggaaaa aatacaaac taaaaaaaaa aaacaaaaat 701340
 atgaacaaa ataaaaatag gttaatttaa gttgtaggag ctagttaata ataagcctga 701400
 gctaatagac caaacagttt gtaattaata ttaagcctct gagtagttat tttataagca 701460
 gctgtggtag ctggtaggag gcataaaaagt ctccagctac aaatatectt aatattattt 701520
 tctgtattct caatagtttg tgtggttaaag gtcccctaaa gactcatgtg ttcaagtctt 701580

 ggaccagtg tgatcctatg tgatgataat gaaactttaa agggtagagt ctcatgggag 701640
 gaagtgggc tattgaagca tgacctcaga gagcgttcta gaattcagcc tctcttctac 701700
 ctctttgctt ttggcgtcca tgcgacaagc agcttctctt aacctattgg tctgtacta 701760
 cctcatcaca ggtccaagta gcaggatgaa ctagccatgc attaacacaa tgagccaaaa 701820
 aagcagtctc ctcttgtaa gttacctcag gtgtttctc acagtggagg aaaattaacc 701880
 acacaccctt ctacttctgc tatagcctct tcttctctt gctctcatgt ctcaacctct 701940
 cagttctact ctigaaaaca ccataaacia agattcacat tcttattaca gtatctcata 702000

 gcagacctcc aacaatatat aagttcacia tccaaacact gtttctcag tttctagtct 702060
 caaagacata ggagatgtcc ccaaaaatac tatgatacat tatatttgat agtgtctcat 702120
 tcttatgtaa ggtttttttg aatgctaaca attttccacc cttttccaat tactcacaa 702180

gtgctttgga tctacttct gaaatgatct tcaaacctta cttttcccta aggtgatcca 702240
 cactccaatc catcttcagt gcatctctgg atagtaacag attcatagca ggatccttat 702300
 tgaacttctt gactctatit cagcactttt accattctat tttctcagag ctattgcttc 702360
 taaaactcta atiggatcat gtcattgtca agctcaaaca cctccagtga ctttttagca 702420

 cctaaaaact aaagtacaaa tctcttacc agcatgtaaa aacctcaagg atgtgacacc 702480
 aatgtccttt tccataatit tcatctccac ccatcacaca cacacacaca cacacacaca 702540
 cacacacaca cacacctcta tacacaaaca agaaatgcta cacatcagca tatattaatt 702600
 atacaacata atacatggtt ttcaattgtt atgtgttcat acatgtataa aatgaacata 702660
 taataaatca taitccecta cacatgcatt tttccttaac accttttttc tcttctatt 702720
 ggctccttt ctctctgaa atgctcctgc ttctacttta atgtcttttt tccagtctag 702780
 agtctttaag ttcaaggaaa ggggtgccat tggttttttt aagtctggac tatttgttta 702840

 acataatgac ttctgtctac atgcatgttc atgcaaatta cataattgca ttttctttat 702900
 gactgaatga taccattgt gtttctgcac cacagtttct ttgccattg ataattgatg 702960
 ggctcctaag ttgttttcca tacctttgtc attgtgaata agataacgat aaacatagat 703020
 atgaaagtat ctgtgtgttg tgctaactta gatctcatgg gtatatatgg aagagtggct 703080
 taattggatt ataatgtaat tctatttga aattctattc gttttctttt gaaaactcaa 703140
 catcaattgt tagagtaaca aggctaattt gcattgccac taacaagtgt ctctgttctc 703200
 acacacttga cagttttcac ttgttttctc agtgacagcc attgtgacta ctgtgggatg 703260

 gactcttgtt ataattttta tttgcatttt ctggatggct aagctgtga acactttcac 703320
 gtttttactg accacttga cctgaccttc ctttgagcag gagtttagtc cctccagcct 703380
 ttgtttgttc ttcatagaca aagaaatgga attaccttc atctatgact caaccagatc 703440
 ctactcacat gaaccacacc aactgccttg tgaagcttga ctcaaggacac tcatggaatt 703500
 gggatattgt tttcactcca gtaactgcat ctgtccccag cactgaagac catcctgtgt 703560
 gacacaggta ctcttatagt tctaccttc tccagattgt gaatatttgg aaaatagga 703620
 ctttttctac tcacaattga tttctttcta aatgtataat atgtagtaca taccttttat 703680

 tgaataagta tttgttctct ggagtaata taatagattt gtccatgaga tggttaatat 703740
 tgccaacttg acaagaccta gcattcgtca tgggctccaa ctctgatttt catatgtcac 703800
 agtgtttttc agttctatgc atagcagtaa aactgataga ctaagtataa ctcatagtgt 703860
 attgcaatgc ccatttggga ttgcagtctt ctttgagatg cagctctggca gtcaaatctc 703920
 tgggcatgtc tgctaagggg tttctagatt agatcgattg aggtgaggag acgcattcta 703980
 agtaggagat gcattccaca ggcaatgata ctggactgaa ttaaaggag aaagtgggct 704040

gagaagcagc attcatttct ctctctgcat cctgactgtg gaagataatg cgaccagctc 704100

 cctcaagctc ctaccactat ggctgtccca ccatgctgga cagtacctt gaactatgag 704160
 ccaaaaactaa atccttctcg ccctaagttg cttgtgtcaa gcaatgaaat gtcaagtttg 704220
 acacagcaat gaaaaagtaa tagtatttgi atccacatag cagttaccag taccacactc 704280
 tgttgattgc tttcactgca tatgggagaa ttacaattac aatgcttaag tatatTTTTG 704340
 agttttgttt taaatgtaag aacaaatgga atgaagatgg atttattca taaacacctc 704400
 tttggaacca cctgtttaat actaatcata gcaacagcca ttgattggat gtcttctata 704460
 ttcagacact taattacagt tttgtattca ttgtatcact tactcttcta agaaaatctg 704520

 tgcagcaaat accagcttaa gcctatttca cattaagtga aactgagtct cagagaaatg 704580
 gtcagtctg agccacacag aaaagtagaa ctgccaggca tcaaaaggaa atttgtgtgg 704640
 tgttgagac actgtattct gccaaagtctg tttcacccggc tttcttctgct gcctgctgtg 704700
 gagaactaca aaaaccaagc aactgcctca caagaccgaa tcaggaagag actacaggct 704760
 gtgtcagaat gcaccgagag aatgccgat gttactgga aattgcgaga aaagcacaga 704820
 aggaattaca gaactgggtt tatagagcca ggagtgcagc agtacagaag agtctttgta 704880
 aatgacaagt ccatggtttg aaatactcag catgccaaaa cctagtccaa ctatgaggt 704940

 atcattcgcc tgtgccaac cccccatcc ctattaaga tatactaaa aggttgcct 705000
 taaaatgaca ctagaactta tgttcatttt agtttcatct tcatataaaa ataattcttt 705060
 aagttagga cagatgaatc tcttgaagta atgaccacat ttctaatttt gttttcacct 705120
 ttgtttgaaa gtgtttctgt tctccacaga agatatttcc ccagaataac tcttgagatc 705180
 acaaacagag aaagaaaaaa tgtctaggga cgagtgttta tacacagaca cagtggcctt 705240
 acgttaacca agcatgaatt cccacttcta gctggaccgg ttcattggtgt gaaaactgaa 705300
 aagagtcat tttgtttctc gtagectagg agccctttct ccaagctgat ggcaattaat 705360

 ttctcccttt cctttaagtt ttctcttcaa acctttacct ccttcttcta aatgtcttc 705420
 accataacte agtgtgagtg tgtggggagg ggtggtcaag aaaaaatag atctctgaac 705480
 atttagctag atgtcaaata tgtctacccc aagggaacaa ccaagtttct ccatcttcat 705540
 tttctcttt atggtcttat gtgtctcgtt agatcgtaag tctcagga gaattcatgc 705600
 ttttagtate tattcagcaa gcagcatatt gcaacgaccg aaaagatgct tatctttaga 705660
 aaaatgcaat gacgtaaagc tatagtcatc actgaggaga actgacctat ttctttgtta 705720
 aattatctgc agttttcatg tcagagataa aagtgtttta ttcaaaatat taacctctag 705780

aaaatctcct aggaatgagc cttggctgag aattggaaat ggaattcgac ctaattcttt 705840
 tcctcacag agtctatgca actgatccag cttcttcacc tctttgtatc tgttttcttg 705900
 ttcatgaaac acatattcta gccccgttca gtctccctca taagaatctc tggggctgga 705960
 gagatgactc cticattaaa atcatcttct actcttgcaa ttaggttccc agcaccagg 706020
 ttaggcaact cccaagaaga cacctaagag acaagacca cccgtgaact caaggctgta 706080
 gaaatattca gggaatggca gaggaacagc taagaactgt gtaagtaaaa actcagcagg 706140
 caaagaaaat catagaatac taacaaagia ctaaagtata ttattttgaa tgttttaaat 706200

 ttacttttca aagaatcat tatatactaa tggaagtga tctggctcct acttttgatt 706260
 tttctctact agatcatagt aaattcaata aagggtgaaa aatacagtga aaaatcatcc 706320
 taaaatggcc catgcaactt agaattgtct caggcaaagt cagcccagtc agggcagaaa 706380
 cacatgtcca caacagtgtt tgccctgatgg gtcttactc acgagaagt gaaaggatgg 706440
 gccatggggg tccttgatat atctgagggc acaaagctac ctcaggtggg gttgggatca 706500
 gccacctgaa ctgccttttg tgaacaggat caacaataaa atcacctact ggcatttctc 706560
 ccttattata cccaattct gtttccaaat gtcagtctga tggctatcta tcttccataa 706620

 acctctcatt gtctcacact cacaatcag aataaggctt ggtcactgcc atccaccag 706680
 catggttctt gaatgtccat gtccctgtgc ccaccaaca gagaactctt caccttccc 706740
 ccaatactca gatacttca tctctggaat gctgtccaac tttccctggc cccatccttc 706800
 tccaagggtt taiggacagt tcatgttga caagacagtg aaagacattt ttttcaatgg 706860
 ttcagtctgg catcctcaa tagatcctca cccatcttac cctaagtaac cgtaattaag 706920
 ccattggttc acaaagctgg agaccagtgg agtcatttct ttgtcctgtc tttggtgccc 706980
 tgtctggatg aacgtttgtt catcttcta gaacaattc acacaatagg actataaaag 707040

 tcacacaacc aaacacaggc ctccatgctt acaagtctc tcagacagca agctttagta 707100
 gctagagtgt gagcctatac acacagcaa ctgtgtgga acatccttgc acagcctgac 707160
 ctggagacag cagtggatgc ctggagaatc cacacctat gaaattagct gatcacaggg 707220
 tgcagacatc tcagactgca tctcaaagca gaccatactc ccaaatgggc attgtcatat 707280
 gccgtgagct acaatttgc tatcagttt attgctatct agagaactga aaaactgt 707340
 gagagaatga aaaacagagg gagagacat gtcaaagct attggtcctg ctactgcaac 707400
 tttctggggt aagctaccac tgtttcttct aattctttgg ttttgtctt tgagatagac 707460

 tctcagtga caccagatc tgcaacttt ctgtgcagct tccaaggct ggcattgaaa 707520
 gtacaacacc actcctggct tttcaagctt cctgaggaca ggaactcaga tatctgtgtc 707580
 atcactaacc tgaatatct cataccgcg ttgaactaaa ctcaattgaa cagatttggg 707640

gttttttgct ttgttttgtt ttgtttgttc tgttgctttg tgaggttatt gtttgittat 707700
 ttgtttgtta cttatttttg tttgtttctg aaaagtaaga atctattttg gctcacagtt 707760
 caaggacaca gcccatcaag gcaggggaagt catagtgagc ttcattttggc tgatcacata 707820
 ttatagcatc agtcaggaag cagagagcaa tgagcagtct gcttcctttc tactttttat 707880

 ggagtctggg accccagttc aagggatgct gccacatcca tttacacagc atctcaatta 707940
 aacttaccta gaaaatccat taaagacaca ccagaagctt gttacctggg agtcgctaga 708000
 tcctgccaag atggtaatat gagcaatcat atctagcaat gctatcccca cctgctgat 708060
 tgccattcca ttggcttcac agtgagacag acaggtggca gtgcagttac ttttgacact 708120
 ggatacgaac tcitttatta attaattaat taattaattt tccagcccaa tcacagtttt 708180
 ctctctctcc ctctctctct cctagttcct cccacaacc tcccctctct cctaacccea 708240
 tccacttctc ctccattctc ttcagaaaag gacaggectc tcacgtatat cagtcagcct 708300

 ggcatataaa gttgcagtaa gactagatac ctctctctct attaaggctg gacaaggcaa 708360
 cccaatagga gggaagggtta ccaagataag gtaataaata gtcagacaca gcaactgcttc 708420
 ctcggttagg aatcccacaa aaagaccaag ccacacaact ttgctgcttt acaaacataa 708480
 acagcctggt taaatacatg aaatatttta tacttaacat atttaatatg ttaaacaatgt 708540
 ttcaaaatgt taaataactc attttcatca gtgaagtctg tggtagagag tggatcagaa 708600
 cacagacttc caggtgaata tttctaccac tatactgtac taactctat ccatttcaga 708660
 aaaagaaaat taaattgag tacttttttt ctctacccat tattacatct ctactattac 708720

 gcctaaatte ctctctgctc cagcttgctc gggcagcatt taatgatgtt tattgaagcc 708780
 cacttagccc atgttcaaca aaaacattaa atgcacagtt tttaaaagga gaaaaacata 708840
 gcattgagta ttgccttact ttcagaagat aattttgtat gcatgtagaa ctactatgg 708900
 acttgggaat aattccactt tatgaccctc atattcagtt gctaattact ttttcgttgt 708960
 cttcaatata tttctattgc atcaatggga aactatagca gtcctctagt gacaaaaatt 709020
 atccatatca attgtttgtga atattaatta aaagctttgt gtcttcatgg aaaaccatct 709080
 acatctact tcaaagacat ttcattgcag cactataaaa aatattacat cagttaaaat 709140

 tttcagtaca ttccgatcaa taagattata ggttcctttg ttgttcttca atttctgaaa 709200
 agacaaaacat tttttaaatg aagtcattga tctaccacac tttgcttga aaagaaccta 709260
 tttcaaaaga aaataaatgt gtcatatctg actgagggaa aacaatatca gagaaagaaa 709320
 gccagttagt tgttgaggct tcttaacgag agtgcagttg agagaatcaa tcagccatgt 709380
 ttgctgtgtg ccaagcctca cagaagtgga acacagaggg aagagtaatg ggactgggtt 709440
 ctcaaggtag agagactggt gtcttcacat gtgttcaggc atgtcacgtg tacacttagg 709500

tacgactatg ttcaggaaag cactaagata tgtgatgaga taaactcctg cctgtactga 709560

 tattgttctc tctcatctcc ttgttttttg agagagcact tcaagaatac gaagtgagct 709620
 gtaccgaagg caacttgtaac caagatattg tgtagaacac tctgtcttaa ttaatcttgg 709680
 ttatgtctacc tccaaggatc aatgcagttc tctaaaatat tataatctaaa acatcaaaat 709740
 gtggccaaga ttactagag caaaaattaa gtcattttat gttgcttttt aagatttgtt 709800
 ttctttttga tctatgtat gtagagttag attttgtact catgagtata ggtgcctacc 709860
 gaggcaaaaa gaaaaaagaa aaagcatcag ttccccagga ggtggagtta caggaggttg 709920
 tgagctacce actctacacc gatgctagga acttaactcc catcctctgc aagagctgca 709980

 ggtactccta gccactgaac catctctctc gccacaaaga atcttatttt ataagcgtga 710040
 taccatttat ctttacctga aagaaggctc ttgcttcaaa cacaattaac agtgcggtta 710100
 atttttacaa acaaatgtgt tctgggccta ggccctatcc caaaggatac aatagactct 710160
 gatgacaccc aatgcatggc ctcaccatcc aggggaagca gaaaagatat gtgatagata 710220
 gggttttagt tgggagggta ggagaggatg ggagggagag gggactggga ttgtcaagta 710280
 aaacaatcct gtttctaatt caaataaaaa aagttggaaa aaattttaca aatagataat 710340
 gaggtcttga gtttcaaaaa gtcaagagga ataagtcgac aatgactggt gcacagcaat 710400

 gtttctctg cataaattgc aactcattg actatcacag agcccatgcc agtatcttcc 710460
 ctagtccat cattcacctg caattctaata ctcaaagtga ctgatgctaa ttgagcatt 710520
 gtccaagtct catttgtaaa ccctgctctc tcagcacag gatcaggcca ctatagagat 710580
 gagatctgcc ttttctgag ctgattgcat cccatcttgg ggcttgagga tgaatgcttc 710640
 ccaaaggctc ttgtttccag tgcctggtgc ccagacaggg ctatctggga agcttgggag 710700
 atgctaccag ttggagtaag tgggtgtctg gtggtggatc attgattggg gacatcttgt 710760
 ccctgcttcc atcatctcat tctctctctc tctctctctc tctctctctc tctctctctc 710820

 tatctcccc ttctctctc ttctctctc ttttctctc cctctccaa aaaagtgaag 710880
 aacagcctct cagcctctct accactccca tatctccatg actcaagtat gtgagacaga 710940
 gcaactgtgg gatggtctct tgaacctgtg caagccaaat agtgttttct cctccctcta 711000
 acttatcctt tcaggtattt tcatcataga tataagaaaa gtaacaaacg gattccattt 711060
 atcagataga agactctact gaaaattaga gcagtcaaaa gaaataatgt cacaagcagg 711120
 aaaaaaattc aaaaattatt attttgcctt ttgattgtta acacacttct tacccaaaaa 711180
 tagaaatgtt gcctagattg tggagaagtt aggacattta tcagtcaagg ttagattata 711240

aaattcacag taaaaccagt atgaaaaaca gctttgtagc tcaagatgtg aaatacagag 711300
 ttacatataa cctggcaatt ccattcctag gaaaataccc aagggaataa aaagcatatg 711360
 tcctgctatg gaaaaaaaaa tattttgaca gttgttaaaa tagcaaggca gactttattc 711420
 aggaccattg tgaagggtgt caagattgca ataggcaaga gaggagtgtc tcagctcaaa 711480
 gcaaggatgc tggagtatgg acaacaagca aagtggggag cagacaagga ctcaaacaca 711540
 tcaaaagagg attctccta caaaacttaa cagggtcctt attagaggta cattcgaggt 711600
 ctcacatatac aaaattcaat aatgagggac acaatgagca ttcagagtag aaacatgctt 711660

 tctaagccaa tttgacaggg atttttctca cactcacgtc tccagtctg gtgagaatgc 711720
 tgctatggta aaggcttcac tgagaggact tggagaatt ttactaaatt tggatcaatga 711780
 aagaattagt cagtctcac aaaatcctgt acatgtaggt gtctagcaaa attccccata 711840
 accaccaaaa gagagaagaa gtaagtaaat gcctatccac gggagaataa gcagaatata 711900
 tataatatata ggaatattct tcaaccctac aaaggatgaa gaactgatgc atgctgagaa 711960
 ggcaaacctt taaaacatga tgctaagtga aagaagcctg tcatgaatga tcacaggatg 712020
 tgtatgctcg gcttctttga gatgtgaaga tgggcaagt ccttggagac agaaactaaa 712080

 ttggtggttg ccagaggaca gggaagaaag tagggactgg gcggttatgg tatacagttt 712140
 cttttgagac tagtgaaaat gcagtagaat tggatagtga taatgattgc ccaacaatat 712200
 aaatactaca aacactggat agagtgtttt aaagggccag ttttcacagt tttcaaatc 712260
 cccagatatt ttacaggtg aggttctagg cacacactac ttttctcaat cctttttaa 712320
 ttcttcctta gtggtgggtg gtgtggggga gggatgattgc tctcatctag ttatgcagag 712380
 aaaatgcact ttacctgctt cctgctcaag ctcaactcca ggcaggectc tcctccctt 712440
 atacaccaac acacacacac acacacacac acacacacac acacacaaat aaataaatta 712500

 attaattaaa ttttatatta aaaaatagct gggattggga tgtagctcag aatttagggt 712560
 gtttgcttag ctigcacaac cctctgggtt taacctctg ggtttgccac acaaactgaa 712620
 cgtagtggtc acgcccacca ttatcccagc cctgagaaga tggaggcagg agaatcagaa 712680
 gttcaagccc atcctctgct acttagtgag ttaattcca acctgtgat gttacatgag 712740
 actctgttta aaacaaaata atcttagcta gctgtatgta gtcacaatgt gatttccatg 712800
 aagtcaaat gattccatga atcgattga atgacctca tgccatccat tgtgctcatc 712860
 tactcacagc ccaccctgg agcctcaaa ctctctctgg tatcatgaag atttcagata 712920

 gggcatgact atacagcaaa agtcacaaaag aactagcat gaaaagacat ggcactgagg 712980
 atgctgcaga tataacagta gggaaaagtc acatggagaa gctgccagtc aatcctttcc 713040
 tggctttact gaacaaagaa caatgacaca ataagtcaaa cgacctggga acatagctaa 713100

ttcaaggctc aggattacag tcttccacag tttaacacaa aaccatatca tgatgactta 713160
 gactagatgc caggagtgcc cagaccaaag gcaaatatga aacctcaatg acttcactgg 713220
 gggagaagct ctctgtgtt cccactccac tgtcctagaa tgtagatttt tgttctcctg 713280
 ttcgttgccct catgtctgca agataactac aaacccttgc cacccccccc ccccacatac 713340

 atctaagttc cctaaggacc agaccagaaa atataaagga ttggatgaag aaaaaattat 713400
 gaacatttcc ttaaagtctc cttgatcaaa accctacccc ttgatgtaaa ctaatataga 713460
 atgtaaaatt tgaaaacaac aacaagataa taataataat aaggcttca aggtaataag 713520
 attagaatgc ataggggtag gcaattagag ttagggttca tgaatacttc ctcaatggct 713580
 tacagatttt ctctacagtc tgtatgtgca cacgtaggtg ggaaacagat acatgtatgc 713640
 acatgatatg gaagccaaag gaaaatgtct agtgtcattc ctcaggcact gcacacctgt 713700
 tgtttttgtt ttcttttctt tttttgacaa gatctgtcac taacttggag gagtccaaga 713760

 agggcagaca ggctagcctt gaacccccig tgttctcct ctgtctgcct cctcaagact 713820
 gggattacaa atgtgaacca tcttacttgg ccttttccat gaggttctcag cattaactg 713880
 gagcccttta ctgactcaac tatttcctaa gcctttaaaa aaaaaaacct ttaattttta 713940
 attttcacac agagtatagc ttacagataa aattcaaata tagagctaga tgcccatctc 714000
 ctcatcaggt gagtcaaat caatttgcca ttttcattgc cgtaactaa atctctattt 714060
 gtgacaaact gatgccaag accattatit taattgtcac agactaatga gaaaaggaga 714120
 taaaagctag aaaggggtga cagtgcataa aggatgggct gggacaaagt gaaaaccaa 714180

 ctacactgca cactattggg aaaagcagat atacttacta atctgtgaat tcatcagaca 714240
 aggctatgcc tciggctgtc tcccggagca cttgcttcca gacagggagc gagaagccct 714300
 tctgatagtt ttcttctttt cctagtgtac agggctcaaag tagttcatag agccctgtgt 714360
 tcagagaagt gttagccctc tgatttaaat tcaattgttt ttctttgttg acaacaagat 714420
 ccaagtcttg gatttgactt caatttctga tctcctgcc tccacttccc ctgcaccgcc 714480
 atgccagtt tatgtgtgtc cgggatgga gccaaaggct ccacgatgt aaggcaatca 714540
 ttctaccgac ttatcaactt agctacagtc caagccetta aggcagataa tttaggtatt 714600

 ttgttaacca aattgcatgt agctacttgc gacacaatga aaaaccacag cagctgtaaa 714660
 ataagaagaa aacctgaaga atgtgcatta ttatgactag gtagcttctg cagattcctg 714720
 ctatagtcta gtggttgttg aaaaacaacc ctccctgaaa ctatcaacca gagtaattaa 714780
 aaaaaaaatc accaatgtta aagtcactgt ggaaccagct gagaatttg atgagcttcc 714840
 atctcccagt ccaagaagag tggcattgtg tagcctgctg agctcttgcc cagtttcaaa 714900
 gcatctttcc actcgatgat aaacagactg gcacaagggg ctgtgccaag tgttcatcgt 714960

tgtgaccaag atacccatgg aatcgagctc accctattat cctgcctgga ctactaaaca 715020

 atcatgcaac aatggatggt tatagggctc caaaaagaat aatgtgtcta acttaaaacc 715080
 tccagaacag cttcctttat tctcttactc tgaagaaagc aatcctttga atgctctgtg 715140
 gcttcctgga gcagcctcag tggatttgag cactctgctt ttctatttaa agctcctaag 715200
 aatgaaagat gccattatag agagaactag ccaccagcag tgggagcatg acgagtcctg 715260
 ggcttcaaaa tgaacttgta atggcagagt ttccaacca aggaccatct acttaatgat 715320
 cctcaaccg tgttcaaaat ctcccaagc cagcaagact cttctttcta ttcgaatcat 715380
 ttcttattct ttccttggac aaatattctg gagttgtggc tcacaagtcc ttcacgctgt 715440

 acagtgctat ctacccttc cttaccact tcccagctt ctgccgggta agataagcaa 715500
 tggcccttaa gctctctct ttcaacaaag tcttccacta acagigtgga tgaagattt 715560
 cagccatcac acagcttctt ctatcattcc tgaattctgg gcctctagta ttcagatgag 715620
 agtttgattt cattttctta agattgtgtg tgtgtgtgtg tgtgtgtgtg tgtgtgtgtg 715680
 tgtgtagaca ggaaggttc ttcacaaag tattatcctg ggctgggaac tgagaagctg 715740
 gctcagaact ccaatgttcc acaagagcaa gcagactaa gggtgcaacc acggtgccat 715800
 ctcccagcc agagagtctg ctttctaaca gctcagaaaa cacagggatg cagcttagaa 715860

 ctgggagcaa gtgctctctt taatctcatt ttctttatcc tctcattccc caggttttcc 715920
 atatgaaaag ttgccaatt cttcttctta atcttcccca ccatcaattt cttaccecaa 715980
 ttctcccaga ggccccctt ttctcacatg ttcttctgc actctctctt ttctgattga 716040
 ccaatcttg aaaatgcaaa cactatcacc tacctatcta tcatctatta atctatcctc 716100
 tatcaatcat ctatccatgt gtcatttacc tctatcatct gtctatctag ctatcattta 716160
 ttgacctctg tctatcttta tgtctatctc tatctctata cctaacatct acctatctac 716220
 ctgcctatca tctatctgtg atgttagttt taactgtcaa cagagcctgg aatcacctgg 716280

 gaagagtctg gatgaggaaa tgtccagatg gggtttgct atggacctgt ctatgagga 716340
 ttgtcttgaa tgcctgtgta ggaagatcca gctcactgtg tgcagacaaa ttccttaggc 716400
 tacaccctga actgtttaag agtgaacaaa gtaagcaaag atccctctgt ttattaagtt 716460
 cctgcattaa cttcaccaca agaagagact gtaatctgaa attgtaagcc aaataaactc 716520
 tctcttccca agttgtttat tgttgggtta ttttatcaca gcaacagaaa tgacactaga 716580
 acactatctc ctctctctct ctctctctct ctctctctct ctctctctct ctctctctct 716640
 cttctctct ctctctgtgc gtgcgtgtat gtgtgtgtat agctatttat atacatatac 716700

ttgtaacaag aggcaaggta taatacaaga cagctatctc caagctttac ctcattgatat 716760
 tggggagcaa aacatttcta tacaacttc ttttaagtctt tgttcacata aggcttgata 716820
 ggaccatctg gcattcaagt gatccaaata catcttttac atatggagac tgcttcctt 716880
 tcctccccag ccagagtggg gggggaaaagg agcataatgc ttgcttctaa tttagtctt 716940
 ggtgtcttca gacacaaaa gcaccaattg aacagtgagt tagccattga gaagacaact 717000
 caggtattgt taggttctgt agatatcaag cttggaaatt ctttcaggta actcacaag 717060
 ctccaagaac aagtgacaaa ccctgcttta gcccaaacat gtaagtgtct ggtggaactg 717120

 gagtgagtca acctagaagg gtgattcacc actgctgaca taccacctct aacacactca 717180
 aatctgaagt cacttcttc ttattgact ctggggacaa atcttgagaa tgaatgacct 717240
 tcttagctgg aacagctaga gtgagattg aaaaaaagc cctccctgag ccagaggagt 717300
 ttgatggtgg atttctccaa ggcaacgagc aaggagaagc tgacttact ctaagctgct 717360
 accataaatg gttgaccagt tggcatctct gcagaactca ctatggccac tggtagagac 717420
 ccaccaggg ccatgggggc agcctgcat tctgtaactg ctctccccac ctgtcctaga 717480
 gcaggggttc acagactgaa gatgtggttg ttcagctact cttttatgat ctgaagaggg 717540

 ggtagtctg ggcttgctta gttacgaatg ccttgctcat gctcactgtc tcttcacata 717600
 tctaccagta tctactga gcccttccac ttgtggtcta gaaggccctc acacacacac 717660
 cccacagaaa cctactccag ctgaagcatg tctttctgct tccatgaca tgtttgtggt 717720
 taactggtg ccttctccac agctaaattc caaacctcat gtaatatcct tgaagtcaga 717780
 gacattatc tctctctcc tccctctctc cctccctctc ataactgctg agagctgttt 717840
 agaattgttt gacactatg cagaagacag aacaaaggaa tgggacaagg ggtggctgtt 717900
 cagagtgatg gaacaaaaag gagaaaacag ggctgggtc ctgacctta tgcgggaca 717960

 gacagatgca cagtactct gggggcaatg tggaaacctc cacattatcc tgcattatca 718020
 tctccacatc aaccacaaat ttcataagag gaaatagcca agattctaaa atgcagccca 718080
 aatgacttt gtttttttt ttgttgtgtt gttttattgg taggttgggt ggttgggttg 718140
 ttggttgggt ggttgtgtt atgttttttt gttctgtttt tgttggca caaccaagct 718200
 ctgtcattca taatatgcaa ggaaatgtat ctctttctg ctattatca gagccagcgt 718260
 cccatttctg gtatagagag gctactgctg cttttgtgga gcttttcata ctagctgatg 718320
 atggcacttt tgcaggctgt ctttctctg gtgaagaaac attcctggaa caccaggtac 718380

 agtattctgg acaagttgca agtctttcct gcctccagaa agcctcacag tgggagtctt 718440
 gtctgtgtt gtgagaggtc atagaaatgt tctgaattaa ttatggatga ggactctcag 718500
 caaggggtga gccaatagcc agacacagag aactgtccc agaccctgtc cctccagga 718560

gcagagaccc tgagggagac acttaagact gtctcaatt tctacacagt cacacacccc 718620
 acaggggatg tgactaaggg aagagaaaga tcaaagagca aaaagtaaag ccaaaggagg 718680
 aggagagaa aggtggagaa agggataaaa gagagaggag ggcaaggagg agtaaggaaa 718740
 ctgagaagca ggggtaggc aggagaggac agagacagag ataggaccg taatgaggtg 718800

gctgggcttc tgtttcattt tctctccttg ttatttaaac gcctccctta ctggagtggg 718860
 tgggatgggtg ctgaggttga gctggctgct gctgtgccag tgcctccggg gctgtgggtt 718920
 ctggtctcca tggaccctca ccgtgccctg cactaactcc tctgaagtgt gggaacttga 718980
 aagcatccac tctagacagc tcaactattt caacaaaatc catttccatc aaattatcac 719040
 tagtggcagt gatagaaaaa ttaatgattt cttgaaggga ctattgtatt taaatatttc 719100
 aagcccgttg gtgtgatgtg tgtcagcatg tgagaaacat attgactggg agccacagcc 719160
 aatgccggct tttataaata tctgtcaga taataatgg ctctcaatgg atccagtatg 719220

atgtacagtt ctaaagcaag cagggttttg ccaggaggct caaaggaaat gccatcacia 719280
 tagcacaggc tgaataatgg gagttttcgt ttatcttctg taccagagaa agaagctaga 719340
 gaggtttgct cagcgggac caaggagagc tgagattgag tcttcagatt ctgcaaaggg 719400
 tccagccttc tgaggctact actgagagcc tccagaatac caaacagcaa gcaccatttg 719460
 catttgaatc tctatccagc aggetggcca agttgaggca gccaggctg gctgtgctgc 719520
 cagggaacag ctctcttgg ctcagaatct caggatcaag ggagaaaacc aagtcacaa 719580
 agtgccaatc aggatcaact gctgtcccag caatgcagac atgcaatcat ccacctcata 719640

tccatcaact tcctccctc ctteccctaa ccccttggct cattcacgtc acatgaaaac 719700
 agaaacctga ttaggaaaag tgaatactct tcatcttctg tcctacgaag aacaaccaac 719760
 attaagttaa ggaagggatg agagaggggt tagaattgct gagtggatac tgtggattcc 719820
 ccataccac acacagctgc tctgtcagag gaacactggc atggccacgg tttgtcttca 719880
 aaatccattt gaggtgaga agttgcagag catcagaatt acaacaacc caattgaaaa 719940
 ggagacagtc agttaacttg gactcttcca acctactctg tgtttaacac tgccttctct 720000
 taaagcagtc aagactatct gttctctagc aaataaaca agttgaaaat taattcaaac 720060

atagagcaga aaatagctg ccataagtca taagaggatg aggtaagggg aaaaacaac 720120
 taggtaaatc atcagtaatt caaaagacct catcttagct gaaatcaatt tgttaataac 720180
 ttaagataga atataactct caaaaatata agtccagggt caccacgta gttcaatgg 720240
 agagccactg tcagatacat agagaactgg gttctatgcc caacaataca aaaacaata 720300
 taaacttga taaccaatc actaactatc ctggacaca tgaggacat acatgttctc 720360
 cctagaaatc catctaggtt aaaattgtaa agaagagaaa tcacacttca tccccattgt 720420

gcctagtggg ttgtttgaat gagaatggag atataatfff cccacctcca caaatttcat 720480

ggccacttct ttacagagt aaattaggct ttgtcatata actataagca gacattgatt 720540

aatgataagg catgttctga ggaacaatgc atcatcatcc agtgatgttg ttgtgaggca 720600

agcatcacia agggatatta cacaaactac atgcaccag atggtagaac ctgcaacaca 720660

ttgagctata tgggataac cagtctgtca ttgaccagac atcattatgg agtttacta 720720

tgtttatatt tacatcacca tctataagtc ggttctctta agaatcaagg cttttgcaag 720780

ccctccacag acacagaaag ccacaccata tcttgtacca agtatagtca cactggggac 720840

ctaaagagat gactctccca tcacatacaa gtgatacaag ataaaccttg gctctccatc 720900

acatggaaac aatgacagct tcggaagaaa aacgtgattg atgcgtaacc tgcctgggtc 720960

tctcatatff gtaaaggaaa tggccttaca tgacaccaga ccaaatgttc catgcttctc 721020

agttgctcag ctcttggac atactgttc aagaaaaaga gaaagatgaa aaagtcaaaa 721080

aaccagattc ctatfffag agtctctgat cacttgtctg gtttgagctc aagttggatt 721140

gcctttcaac tttcagcttt tcacatggg gactgatcat gcaggcagcc aaaatgtccc 721200

cccatcttcc atgaagetat tctttcaaat tctcactctt catcttactg acatgagacc 721260

gtcatatgct agagggaaat gtcagcttcc tacaacctcc tacaattagg gggagagctt 721320

gaactaaaga gcataaggga cctggttctt ctatgagtcc atcagtagcc attcctgact 721380

cctcccccaa tcaaacacaa cacacacaca cacacacaca catacacaca cacacacaca 721440

cacacacaca cacacacaca cacacacaca gtgaccatgt ctgcagtgtg taatgggccc 721500

aaagcccaca ctgttctctc tcttgatggg gtttagataag caaacataaa aaatfffcac 721560

ttggaagctg tgaggcattg ggcaatgtgc catgttctct caaatgtgcc ccaaagatgg 721620

aaccaaatgat agaatgcctc atcctgggtgc cagagaccat ttctctctgg atacctgagg 721680

tgctctctcg tccaaaatta catgttcatt gttcttctc ctctggcctc cctgtaaata 721740

tgcaatttct ggaacattgc attgggtgcc aagtaaaagg atattctttg cattgagaat 721800

tgatagttaa gacattatff ttacataact aaaccactct ttatggggta gcttccctga 721860

accagccata gcacfffat tataccfff aaattcagca gtgaacattg ttggggctc 721920

tgctgtcatg catctcatg gcttgtttga aggaggacaa gaaagaaatt gagaacagaa 721980

aaagaagcca aaataagtaa aatactcaca ctgttgacaa gtacattaag tgctattctg 722040

ccacagccca ctgagctcag gactttagag aggttgcagc agcaacacac acacacacac 722100

acacacacac acacacacac acacacacac acacacacag agacacgcgc cccccacaca 722160

cacacacaca cacacacaca cacagagcca agttcctggg tcccacaatg gttgctccac 722220
acagcaacac acacacatag caaagctcct ggttacagat cccacaatgg ctactccact 722280
gttcaaacag tgactttctg taggttctta cttaataggt aaaagaatgt ccatcctata 722340
atcacacagt ccagtcaagt gtcacactg caattgaagt gacttctcta tctgaaattc 722400
caaaatgtgg ggttaatgtc ctatcttaat tcctatccta tttttgttca cccagtgtaa 722460
ggagagatgc caagagagca ggcagattaa aaatgcatga cttctccac tgccatgatt 722520
ccttttgcaa tttttctagc agactttgag aatatggagt ttttgaaggg gggttttctt 722580

tgttccttta ttttctatga ctttatagct ttcaaggctt tttatctttt ctttcaaat 722640
gtttgaaggc tttgctatca gcctetaaca acctaaacct ttgtttacct tgaaagccat 722700
ttcctgtagt ctcccagaga ctctcaggt tatgacatta cttccaact tggtttagct 722760
gccagcactt cttttccct gagctcctaa cccacaaaga atgccaggt gtccttagac 722820
ctggtcacaa gttatgtttg cttctttgtt cttctccacg accctgctgt cattggcagc 722880
caaccagaa agtggctgtt tctacagact ctccattcca catcctgttt tgtttttctc 722940
cagatgtcta taggttttcc aacccaaagt gagcaatagc ttctctggaa gccatttcca 723000

caccagcagg caagccttga gactctaag gaaattgtg gaaagagggt aagtattcac 723060
ccaaagtttg cagcaggaaa tggcagctct ccaaactcca gcagagctgt cactagacaa 723120
aggtagcaag gagaattgtt tcagtgccat tccccagtgc caggtgaaag gcattttagc 723180
tgtgaacaca gactacatct tgattttcag atgaagcatg agtttttaaat aactcacacc 723240
agagtttttt aaaacatatg gaatcaggct gggaagatgt ctcagtcaat aaagtgtttg 723300
ttaccaagca tgagaacctg agttcgatcc ccagaattca tgtaaaaatg ccaagtgtaa 723360
tggtagctgt tcacagtct agagatagga ggatttctgg ggcttgttgt ccaatcacac 723420

tagcctactt ggtgagctcc acaacagtga gagatgctgc ctctaataac tacacataca 723480
cccagagata accaaaagaa gatgggaatt accattatat atcaggccca ctggtaaca 723540
aagcataaac acagagagat ctagtacca aatcacaaga gaaacttcat ttctctctcc 723600
accaatgacc tgagtcacca catattatca ttatactta tcagccaata attatctctt 723660
gcctgctact gctccagacc ctagataaaa atggggtaat gaaggcttgg aactcacttt 723720
caatgagttt ataataaca actatgtgta agacagaatg tcagaactat aagtagagt 723780
ttggatcagc aaagagaaga gagccagatc cttagacaga agtgggaatg atccatgggg 723840

aaagcagcag ttgaagtcac cttgggtgag ggatgatgag gatggagagc attctaagc 723900
agaggagcca aggtagactt tgctatcttc tcagcaatct tctacagctc cttttgtct 723960
gcatcaaatc cccaccaaac ctcaaaagca gcaccccca gaccaacctg tactgtccaa 724020

cctctgggca ccgtttcatg ttctgtctag tgaatatgg ttgactgtga attcagtaat 724080
ggggaggctc cagtatttat gatcctggta gtctcacaca cgaagtaggc aacatttaaa 724140
tgtctcttaa gtgacagact gtgagggaaa tgaagtatat gtgttaggaa gtgatgatgg 724200
cacacttggc acacaataat gattctatac atacttggca ttcttgaaga agataaagat 724260

gatgatggtg tggaaaagca gaaaaactaa atgagagcat atcattgatg tgctttcaga 724320
tgaccacact gtggcactca tgacctctct ggggctgtgg tatatacaag acctgcacaa 724380
gaccaagcca acaacatcag tcaatattgc agcatgccac actaatgaa ctcatggaat 724440
tacaaggggg tgggtgtttac aacttactta agagctctcc tagaaagagg tgggtgtctat 724500
atcttccctt tacactaatg ggctctgtaa ctgctttggt cagtgaata agctgtatgt 724560
gacagacact gtgccagttt acaagccagg atcttgacaa actggcagct tccactatct 724620
gtcattttaga acactcattc ccaaaaacta ttgcccagac agtagtagct ccagccacc 724680

aaggagagac tacttgaana caaaccaagg ctcaaatcca gcactatata cccagtcgac 724740
agccagcaca aacctgttca tggggagtaa gtcatcttag gaagtgaatc ctccaggctg 724800
agggcaccac ctgacctca gaggactgga agagagacaa acaacgctcc aaccaaattg 724860
aaagtcatga gtaatgaaat tagtgatgtc attgcaggct cttaattata aagatgtttg 724920
ctgggatage ttaaatgggt ctagagaaat cagttactca gtagtagagc tctaccttg 724980
caagtccaag ttctaggttc aatctcagc accaaaagaa agggactaa ataatgggcc 725040
acctaagtcc aattcaaaa atctaagtt ttcttaact tctctatatt tgtaactttt 725100

cagtgtggcc aattaatgaa cagtctactt gccacagttt gaaccttaaa atattcctca 725160
aagcccattt gctcaagctt agtctttgct tatctcagag tataaacttg agggcacagg 725220
gcctaattag gaagaagtca ggtcatggaa gatatgacct tgaagagat ttaggaccg 725280
ctgtccctct gtcttctttt tgctttgctt cgaagctccc atgagttcaa cagattccta 725340
taccacttgt tctactgag atagtatgct atcttaactg cagcacaag acaataggat 725400
gaagccccc aaactgtgag ccaaaaataa tctttacctt ttaagataa ttgacttgca 725460
ctatttgta taggagcaga aactgacta acacacctt catccaagt gaactttaa 725520

ctgtggtatc atgttcaat tagatcctac cgaatctga gtgggatag ggctaagcag 725580
gaattgagcc ttggcctgt gtgtttcaat caaaggctc cctctgcat ctgttttgac 725640
attctgagtt gtcctagga atccatttga aaaggatttt ggagctgcaa aatgcttgaa 725700
agatgtttcc ctgcactatt aaaccagaa aaccaaaggc tgtgttttct gagaggaagt 725760
ctgattacat tcacgaacca gtggaacaac tacttcaatt gttttcagat ttcaggcata 725820
acgttttcta ccatctctca tatgtctggc atttttgctt ctgcctggga tgccctgtac 725880

agcaaattta acicctgaag ctttcggaag ctccctctct aagcgacaaa gcagtgacac 725940

 ctgcttggaa aaattcctcc caggagtcac gcatgacatt tctgggaagg atcccagaat 726000
 ggcacattgg aaattaataa gcgtaccaag caaatggctc ctgtggaagc tgtaccctct 726060
 tgttcattca gcaaaattgt attgtcagtg taatgaccta cctgtctccc tgggccacta 726120
 ccaactgactt ctggagccat ttaacattat ttcttatagg tcgacgcttg ctttagacac 726180
 tagcatccca tatatectca gtcaggggtg atttacagat atataggtca gaaatacaag 726240
 cgtttgggct tgccaatgac cttggttagt ccggtcttcc ttatgactag acaagactct 726300
 cctccagtga caggtgcctg tatgcctctc agttgtgagc acgtggctgc agccttgctc 726360

 cctacctcca taaacagcct tatecttggc ttcttcaagc ccatcaccat ggaatcttcc 726420
 tcattatgca gccctgtagg ccctgcctt cctgagtcag agcatcttgt tgtgtccag 726480
 atctctcccc accacacctg tctgcctgca cctccctgta aagcaccacc tgtcaactct 726540
 tgatggccca tcttgatgct aggaattctc caacctgtct tcactttcca gatgtcacac 726600
 aatccagagt ggacaatccc tatccattcc agcagagtca ggctctctct gggcctgccc 726660
 caggacagca agtgttattc taagatactg ttccatttct gtttagagt tecttgaaca 726720
 aaataccaca ggctgaatgc ctgcaacaac agaagctatt gtctcatggt tctcaggcta 726780

 ggaacttga gcttaaaatc aagatgtcaa cagtgtccat tcttccaag agccgtaagt 726840
 tccaatatgc tctccttgac tctcaggatt cactccgtca tctccttggg taggcatgct 726900
 gtcgacctc tatgtgcatg tctctgtcac tcttattcta aggcctcatt gaattagtgc 726960
 ccacctaat gactttgttt taactatctc tgagaagatc gtgtctctaa atgcagttat 727020
 attatgaggt gtacaggta ggacttgagc atatgaacca gaaagaacac attcacctct 727080
 tcacagatgt tgtgtatccc tccggtccat cgtcgggect caggcataag tgtgtgccc 727140
 aagctcctgg cacaagatc cccttctacc tgagaaactg ggggaactct gggagaaaac 727200

 caatttaaaa agaaacctga cgaagcagtc tggacatcac ttgcatgtct gcacattctc 727260
 atttcttagg gggaggaaaa tggagcctca gctgaaacta aaagaattct ttttcttac 727320
 attttatgaa gatgggtgtt ttgtctgcat gtttgtacgc ctgtccatca tgtgtatgcc 727380
 tgggtgctgt ggtgaccaga agagggagcc agatccctg gggctggaat tacagatggt 727440
 tgtgagccac catgtgggtg ctgggaatca agcctaggtg cactgcaaga gcaaccagta 727500
 cccttactg gctgagacat ctctccagcc cctctttctt gtttgtttaa tttgcagttt 727560
 agacacacga atcagtgtc cctcaggctc ataaagaaaa aatgtatcct tatcccttac 727620

ctaaagtagt tagctaggta caatgacaat tcaggaagca caggggtggc agggggcact 727680
 tggacaatcc aggggtctgg taatcagcta cctgtgacat aagtcacac atagcagatg 727740
 actcctctag ttcataagca ttcattgagaa ggtcattgag atgctcaaaa ttaatggtga 727800
 aggtgtaagg tacagacatat ttatatctgc taaacacaat agctagcaaa tgtgtgttgc 727860
 ctttaatac atacagattt gtgcctaact ggataagtag ttagggctat gagtgtcaaa 727920
 attaaaaaga ggatttccac aattctaaca ttttaaaaag gaatgttatt tggctttgcc 727980
 aagtcataaa ggiatacttt gtgggaaagg gttgcactaa aatatgtgcc tatcatataa 728040

 gtgataagcc agaggccagt ctccaatgtc attccttagg cgctgtccat cttatatttt 728100
 gagacagaat ctctcattgg cctggagatt actgacttga ctaggctagc tattcatgga 728160
 gccacagggt tctgtctgtc tctacctccc cagcactgag attacaagca cacaccacca 728220
 tgcttggctt tttcacctgg gttctggaga tcaaaactat tcttcatgct tgtatggcaa 728280
 gagtttact gacagagcca acttcccagc ccagagaggt cataatttaa ttagctcctg 728340
 tcggtacatt ttctcacta acaccatgta aggggaggca ggcttcagcc tctttgaaca 728400
 attgtaggtt gtcgttttca tttaggcaaa ggaattgagt gtttgcagag ccacaaagaa 728460

 gaacactatt tctctacct gagctattat gacttcatcg aggaagcatg atcaaagcca 728520
 gagcctcttt ggttagcttt gtctgggcaa acgaaattcc cagaagagga ggtacatgag 728580
 catcaagaga cagccagaga accaagcagc tgccaggcta actgcatcaa atcctagcgt 728640
 tccattgagt cccattgact cctaattgtg ctccatagta aaaggctggg ctgcctgcaa 728700
 tgaatccatc aaccaaagtg aaaggttttt gataatctta tttttctttt tgggaagaat 728760
 atgagaaaaa ccaaggagag aagggaaca aagggcagaa atccagagc taaattaca 728820
 gtttatgaac cctggaaaca gtattagcct actcacattc caaccgagtg tctacattct 728880

 attggatttc tctccagctt agatagggcg ggcgccatgc tctatgctcg actgccttct 728940
 agagtgttgt tatttaatag ttgacatatt ccgccagctg tggcagccat tcccacagag 729000
 gtttcacatt agcttaattt tcaaagcttt gcaaaaaatt ctctagttta acagaagtga 729060
 tacacagagg tagggagitt aatcaaggtt gttcttaata gagatgac tcacaagtga 729120
 tgcccagtgt ggacatcctg acctggcacc tcgacaggat agatactcag caggaagtac 729180
 cgctttcacc atccacagtg cccacaagtg ttgccttata ctcaagtcat gcacatattt 729240
 tcaaatatat ccctaactat atctgagaat atgcatcttc agaaccaagt tcaagtctgt 729300

 aaggagacca acccttctgc catgctactt tftgaataaa cacacagctg aatcctcact 729360
 ctgagctcag tggctattct ggtggttggc caggagttac atgggactca gaaaatcagc 729420
 acctggactg gtgagatgag ccagaaggca aaggtccctg ctgtcaagcc tgatgacttg 729480

agttcaatcc ccaggacca catggtggaa ggagagaacc aactctcaca agttgtcctc 729540
 tctacaatgt gtatatacat gccacatcc attaataaat gtaatTTTTT aatgtctaaa 729600
 gaacggttgc agtgtgtttt atttgcttga ctgtgttgtt ttgttttTgT tttggctctg 729660
 agacaggatc tcactttgta gccctgaatg aactTTTTTT tttgttttgt tttgttttgt 729720

 tttgctttga gacagggttt ctctatgtaa cagacctggc tgcctgaaa ctcaactctgg 729780
 agaccaggct ggcctccaac tcagagatct gcctgcctct gcctcctgag tgctgggatt 729840
 aaaggtgtgc accaccattg cctggatgat aataataatt ttaagacgaa agaaattctg 729900
 cagaggctgc tgtacagatc aggaggtaga atcaaatgct cttttccagg cggttccacc 729960
 acagcacatc catgcctcca tcttgtcatt tgtgacactc cgctgtcttg taggatgttc 730020
 ggagagtgca cagggccctg tcatcttaat tatgaagcag actgcgcctt taaaagctgc 730080
 ctgtggctat ttctgcttcc taggttgtgc aacagaatTT atcttcaggg gagaattgtt 730140

 tctctgtctt ttttttttta atttgggaaa aactgaagt atacttttta atctgcagag 730200
 aaaatgccca aagcctaata tgaaaagaag gatggaacaa tgtgaaacca gtgttaacac 730260
 caagccgttg ggtggcctta agcaccccta ggaagacagc cttgccatct tacttaaaaa 730320
 gtctctttg tcatcccca gggaggaagg tgcctgaggc tctggaagaa accacaggtg 730380
 aaagtaaga atgaaagaaa gtggaccca acataagatg gtcaccagcc aggaccggga 730440
 catgtacttg tgaatatca atagccgtg ttcatTTagg cccatcgttc tcacacagta 730500
 gcctctaaac tgctactgtg gtctgtctgt tcaccaccgc ctcaaacag cacagccact 730560

 gaaggaagaa ggtgtatttg gggaaaactg gtgcacaagg aggcagagca actgtgcaaa 730620
 tacagagaaa aggtgaagag ggagtgcatt ccagagcagt ggccaggaaa agtgacagca 730680
 ctggagcata gaggcatgca ccactatatt tgatcaagaa aatacttacc ccggaagact 730740
 ggacactgtg tctatttcag tggctctggg gaatcaaact caaaccttga actcgatagg 730800
 caagtgtctt atccctaaag ctacactaca gtctgaaag actTTTTgtt ctctttgggt 730860
 tatatttatt agtttagcaa tcagtagcct tctaggcaca ttgaagatgc actgaaaata 730920
 ttgggtaagt ggttgattga atggaatgga atggagtgga ataaagaaat gggttttgtt 730980

 tcaatgtggt ctcaagtcta tactcttctt ggcaagtgc atcatgtcac attgtatttc 731040
 tttcttatac ttactttgct tttacaatgt cttcaggaga tagagaagac tctaaataca 731100
 aagaaaacac acctcccaa ccttagtcc caaatgcaaa gtgctgatct tggtaaaca 731160
 gggaggaata ttggctaate agcctaagat gtcataagacc tcatattggg tcctatgcat 731220
 gctcctcagg gcagcctccc atcacaccga tggcctaaaa ggacattatg ctgggaaggc 731280
 ttggtccaag agctcctggt tttactcca gagagtctta aggtgacaag caactcagca 731340

gggagtggtc aggggacttc tcctaccaca gggagcctct gggagtcctt ggaagtcagg 731400

 aagaaagcaa taggcctgta caagcttccg ggccagaggc cttcaggagc ccaaggtcag 731460
 caaccttcca tttcagaatg ctcatccagc atgaagecac tgtccctcag acactactct 731520
 ctcaaaaaga aatttgaana cttttgcat gcttgctgtg acccctgcac gcttcctcct 731580
 tctttggctt acttctattc ttcagaagtc attggatfff gtcctatgaa gcacaaaagt 731640
 gtgcaccttc tctgcggtgg ctgaaaagt aaggtcacag gaaatcccaa catgcacaga 731700
 gaagcccagg tgtgaccac actaaaaaca gagagtacag acttactgc agtgtgccag 731760
 gggcctgcat gctgacgcgt gcctgagttg ccagttagta ggcctgcagg catgtggaag 731820

 gaggcgggca acagggcacc actgggaatt ctcggctctc ctgtttacta ttttaagtgc 731880
 ctctgcaaag aatatgagag gcagaaaggt cctggctgtg agctgccac aactgctcct 731940
 agcacaaga ctgacaaga ggtagggaaa ttacagaatt aatgatgaaa caggaggag 732000
 atcaaaagag ggatggaaca agctgagact gggaatgaat gtgtcatac tctccatcct 732060
 aagggtgaa gaagacagg ggacacagg acaggagaga caccaaggtg cacacatcag 732120
 agtgttttaa tcatggggga caaaaccaac aaagcacagg tgagcattgt caggaagaga 732180
 ttcgctgttg gtaagaat tataatcaga ctttgtgta ttcaaatgag cactcctgct 732240

 tctaggtaca caaaagaaa aattgactt tctaataat ttgaaactac tagtctggtt 732300
 tccaagatag aaacatgaaa gtatcaagtc ctgggttggg gatgtagttc agagtctgaa 732360
 atgtgtgaat ctatgggatc aaatcctaat actgcataga ccaggtgtga tagcacacat 732420
 ctatagtctt agcacttggg ggatagagac aggagaacca gaggttcaag gccatcctga 732480
 gctgtatagt aaatcccaca tcagacaaac aagaacaata accatgcaag cttgatgatc 732540
 cagatcactg gaaccacat aaaggtggaa agaaatagca gattctgca agttgcctt 732600
 ggaccttca aagcactcat ggcgagcatg cactcacaca ccaccaccac caccaccac 732660

 atcatcatat gtacacagca ataatacta atatttctgg gtgttcttgg cacacgcctt 732720
 caatccaagc actcaggagg cagaggcagg tggatctctc tgagttcaag gtcagcctgg 732780
 tctccaaaat gcgtgccagg ataggtcca aagctacaca gagaaccct gctcaaaaa 732840
 accaaaataa taataataa aataataa cctagtacct agtatttctt aagtaacttt 732900
 gaattcacat tttctaac ctctattta aatatttgg ggagtgagcc tgatgcttgt 732960
 gttaagata ttattatcg tcacaaccag aacacagttc aaatgcagta tctgggcct 733020
 attacaatac tctgcatg gcctagagca caaaagccac agttaaagaa ctactgtgct 733080

atgctgaagc aatgagcctc ttgcttttgt gtatgaatta ctattaagaa aagctaaagg 733140
 tgggctgtga atgtagctga gttggtagag agcttaccta gcacgtgcaa agcccttggg 733200
 ttccatctcc aaaactaat acaccaggtg tgggtggcagc cacacctgtt attccagaat 733260
 gcgggagtta ttccagagta aaggatcaga agttcaagct catggtcagc tatgcagctt 733320
 gttcaaggca atcctgggat acatggaact gtttcgaata caggaactag agagatggca 733380
 cagtggtcaa gagcaacctt agttcaaatc aacatacaca cccccattta aaagccagga 733440
 gtggccacat gcatctgcaa ccccagcact gtggtaagat agacacaaag ggagcacttg 733500

 ggacttgctg gccaatcaac ctagctccag tttcagtgag agaccctatt ccaaaggact 733560
 aaagaaagtg atggacaggg ccatctaagc tctgcctcca gcttggcaca tgccttgggtg 733620
 ggcacacaca cacacacgag catataccac atacacaaaa tgcatacact acatgtcaca 733680
 catatgtgga tgtgtggatg tggggttgtt aaagatgaaa atgaataaga atgtgatgca 733740
 tttagaagaa atactataaa ataggaaaac agaactccta aatgctatta gtaaatttac 733800
 ctgcagtggt actaatcaac taaatactat ttacttataa agccaatatt tagatttatt 733860
 ctctttttaa ggaaagaaca aataagacag tgctctaaag cacaggaaaa aacaaagtgg 733920

 gtttttttcc aaggaattgt tgctactgtt gcataacctt aaaaagcaac actgcctaata 733980
 ttctcttctg aataataact gccaaacaga gactcagtac tgttggctaa agtgtaagtg 734040
 tgccaagaca agcagcaact cacaaccagc ctgaggaaaa gtcttgaaaa tcatgctctg 734100
 attgaaggga aatttccatg ccttcagaag tatgttcagt gtggagagac gggtcagcca 734160
 gtaaggcact tttcacaat gcttgaagat gtgagtgtga ctccccagga gccatgtaaa 734220
 tagctggatg caggccagtg agatgctcag caggtaagg cacttgattc caaaaccaat 734280
 gacttgggtt caataccttg gaccacatg tggaaagaga gaaccaagtc cttcaagttc 734340

 tcagacctcc acatatacac cattgcataa gtaagtacac acacagcact gcataagtga 734400
 gtggccacat acacacacca tggcatggat tgagcgaatg tttacataca tgcattgaca 734460
 cataccatgg catgaatgag tgctcacata cacacacaca cacacacaca cacacacaca 734520
 cagagagaga gagagagaga gagagagaga gagagagagt tacagctaga tatactactt 734580
 aatgtaagtc acttgttcat aggcagatat gaaatatgaa ggcagaatgt tagtttcagc 734640
 atgatgtact aaaaatctca caggaaacca atctctgagta cagatccatt tcccatgcct 734700
 aaatctcctg aaaaatagaaa tagaaattca atccccagca atagctttct ctaaccacaa 734760

 gaccttactc taaatctgag acaaagtaaa tgttatcttt atgagattac ccccaacta 734820
 ccaggttcat ggttctgata caaatctggg gtgatgccac aggetaaga cagtgcaagt 734880
 gccacctgt tctgtggaga ccctgtgagc atctgctttc catgattggt tatgtgtgcc 734940

aagggatgca gccatgagga agacagtaag atttctcacc agggacttgt ttacatttgt 735000
actgtcagtt ctaataggtt tttattgaat taaattcttc ttcctcatt agagtctga 735060
ttgcttgtcc ttgagtgtga tgtgtttgaa ttcccacagg gtgttagacc cttctccatc 735120
ttatatactg cccagcaggg atcaagaaca aggctcagtt agaatttggg cataatcctg 735180

gactgatgct acatggcttg taccaaactt ttcctttttg gccaccaacc agctccaaaa 735240
tcatgacatg gagacttaac attagcttgg cccagcttag ctctcattc tagctagctc 735300
ttataactta ttctgtttgt cttcatctac atttacctca gggctttttt ccctttcttt 735360
ctgtatgtcc tactttcctg cttctcgtgt ctggctggct ggtggctgcc tggcttctga 735420
ccccaagcct gtgcctctct ttctcattg ttctcttctc tcttctctg ttctacgcaa 735480
gcctagattt ccctattta ttatctctac ctgccagtcc cacctatccc tctctctacc 735540
tagctactga ccattcatct ctttattaga ccaatcaggt gccttgggca ggcaaggtga 735600

aacaaatgta actcatcttt tcattattag caaaggcagc ataacaaat gtaacacact 735660
ttcacacagt taatgtaata ttccacagca taagcaaatg tgacacatct ttacatagtt 735720
gaatattcca caacaatggc ttaaataatga gatgcccccc ttaggcccac gtgtctaaac 735780
acccggtccc tagcaagcta cactatttga aaaggctcct gaacctttac aaagtagagt 735840
cttgctgggg gtgaaccttg aggttttata gcctgcacct ccttgctgtg caccctccac 735900
tttgtaacta ctgacacgtg acaagctggc ctcatgtgc caccttcaca cettctgac 735960
catgacagag tctatcactc tgaactcta aatcaaaaga aatgctttct ccctgggtt 736020

gctttccttg gggatttcta tccctgcaat agaagaaaa gtagaccaa tacctttcaa 736080
aaaaaaaat aacttaccat tcttctgcca ttggctcatt ctgtgccact ggcacaactg 736140
tgatgacca cagccatcca gcatcagcat ggaatatgg cacagctggc cctctacaa 736200
actgcacca caacaacatg cacaagcaa atggccagag cccaaaacce tcgagaacaa 736260
tatcacctga gtcatggttt ttgaggtgag aattactcct acaaacatag tggaggcag 736320
agaaaacacg tggacaccga ggagggcaga tagttctctg ctccatgcga aaagagatct 736380
ttcagattga tggtcacatg ccccgagcac tcgtctacta agcacaactt acaccttgtt 736440

catttaatga ttacaactca aagaggagta atgcctgcac ccacttcca tgtgccctg 736500
tggagaagaac tggggtttgg aaagtaattc ttcctatgtc acattcaagg catgaccag 736560
accttggctc ggigtgttag gcttttagtt cctccctcta attcctacc tggccctggg 736620
caggagatcc tafactcact gaaatgacag gccaggagca ttggagacac agaaatggtc 736680
cagctccgga gaaagatgag aactcacaag tagattccaa cacagagacc tcagagttea 736740
aatgcacttc ccaatcaggc atattcata tttagaattt gctgtttctt cagtaattat 736800

gtgaagagct attagagttt gctacctaata aatttatggc aagacacaaa cactctctca 736860

ctcatttacc tctagtttcc agccaagaaa gcaaaaggta gtccataaaa ctatgattgg 736920

aggatatatt taactaccag atctctgcat ctctataacct caacatttta acatttttat 736980

aactctcctg atttctcaca gtttcatggc ctgggtttct tactgccctc ccttaagaat 737040

ccaaatcagt attctggacc ctgggactgt gttctgacat aagtctaca ggccatcaaa 737100

atgagaatct ctgtgatggt taacctggt tgcacctag agcttgcctg tgagaatggt 737160

tcctgagaag attaactgaa ggaggcaaac ctgctctcag tatgggcacc tcccagcagg 737220

cagccaagga tgccaacagc ccttgttgaa ctaccaaat cttacagcat aagccaatct 737280

aataaatcta ctttaataac atacctacat tcttttagtt ctgttcttct acagtccctg 737340

acatgaataa caagctttgc aattagatat caatcagtca tgatctgtct gtctgaagag 737400

aaaatccaaa gagatggcct tgggatggaa ggccaggaga gaggccagga tacaaagaga 737460

gaaccacctt ctcagtgcta ttttaatttt ctccaagaaa cctglagtca gttgtactgg 737520

tgaatctgaa aatttctcc tgttataggc aaacagttag tctagggaga gtagcgtgta 737580

agttcagcat ttgtttgta atgtatttta ttcataataat tgaagctcaa gtagcttggc 737640

ttaagacctg ctattgaaac tgggcattgg cagcacatgc ctttaatccc agcactccag 737700

aggcagagge aggtggatct ctgtgagttc tagaccagcc tggctctaaa gaggtaattc 737760

caagacagcc cccaaagcca cagagaaatc ctgtctcaaa aaaaaaaaaa aaaaaaaaaa 737820

aaaaaaaaact gctattgtct agtcttctgc ttcaatgact gttttcaacc atgcccttt 737880

caggaagcca aacagggtat tttctcttgc tcttttcttt cttgttccca gtctctctct 737940

tcactctgag catcccagcc ttctgagaa acccatccat acattgtgtc taggatgcat 738000

ccttctgttt ttttctctg ccttgcactc caggatgect tctattctaa tatcattcct 738060

ttccccacca ctcacaggtc cacagtttgg tacccaagct gctttctgtt cattggcacc 738120

tagccttgaa ttccattctg ccacaggagt tagctctaag tcaggcagta aatgagctct 738180

ttacaaacct cgcttaattt aaagaacct cctgtgagc tgcatttctg cagacatttc 738240

tcaaggcatt agcaaccagg ctatatgcac ttgcttgtac aacagcagat tggctgctgt 738300

tcctgtcact ctgagcactc aatggtctgc ctcaaattaa ctagcaaggt aaaccacagg 738360

agccagagag agattgtaga gacttggggc ttttatgtt gttattgtt ttttctct 738420

cttgtttgtg aaactttagc acctaggata tgctgaagtg gtgtgggatg gtggtagcag 738480

aatagtgagt ttgttgagtt gagggagagt tgaatgttg aagaatgaagg ctcttagtt 738540

gtgattctat cactctgctt aaattgggag aattgtggta actcagtctt tcatttttat 738600
 tcctgtggta cttcatctcc tatgccttca gtgtgtgtat acacatgtgc agctgtgcat 738660
 gctggaatgc atgttcgtgt atgtgagaga gagagagaga gagagagaga gagagagaga 738720
 gagagtgtgt gtgtgtgtgt gtgtgtgtgt gtgtgtgtgt gcgtgcaagt gtgtaatctg 738780
 ccagtttgtt ttttacttga gttctgggga tcaatatctt tttctctgtg tatagttag 738840
 agcataatth gctttacaag gctagttttt cacaagcttg ttatcaaaga caaactgtca 738900
 cctggttctg tctgtgiacc aagtctccaa tcaacttggg aacattatgc caaagagggc 738960

 cagaaaatgc aggactcagt ggcaacatca cagaagatgg cccagtacca ggaagtgcag 739020
 cacatgggga caacatcaca gtatatgatt cagtaacagg cagggtagca ctcagtggca 739080
 ccatcacagc cgattggcct gacattcatt tggggagagt atgcttttca ctgtgattaa 739140
 agtcatttgc caaggatata aggactccta acagtaaaag gaaaattcca ttctctggtc 739200
 ctttctcata actgagctgt atcttcgatg ttaggggggt gatagtgaaa aactagagga 739260
 catggtagaa aaaaaatgg agctctaaca gtagtgaggg tgggggagtc ctttgtgtgc 739320
 tagcacaaca atcaagccac acacagagac cagcatctcc gctggacatt atgggtaagg 739380

 cccaatcttt cactgcccac tagagtatcc actggccata gataactgtt gaactttaca 739440
 ttaattcaaa ttaaaaattc agtcccttaa ttgcaactggc cacggttcag gtgctaattg 739500
 ccacatttgg tcaactgccta ccgtgttggc cacaacagac aataacatct aaagtcatca 739560
 catgaggatc tccagacttc caacctctaa taaattccag actaatgaag cttcctgacc 739620
 ttagacttca atggggagcc attctcaagg caaaggggaa agccttaca ggctattaga 739680
 gaaagagaat ccacatggcc cttagagaagc agccaggagg cccaaccaca gctttctaac 739740
 aggaacattg agaacactct tgcaggaact ggagagatgc cagagattgg agcatcttct 739800

 tccaaaattg tgggcttccc ccctcccaca gctgagggc tcaccagga gttacaagga 739860
 ggagagttag ttctcctat aaattaaaat tcagtagagg tcagtcctag cactcggggc 739920
 ctgggaagtc aagagtgcca acatgattac ataattgaac tgtctcacct cgcccagtca 739980
 agctagatc caaggagggt aattaatctt cctgatgcct gttagtcct gecctgttca 740040
 tgtttctgcc cctgctcaaa gtcaagtctt ccaacctgga agggaaagaaa tgggggtggg 740100
 ggaggacaac ctccatgagc agggggaact ttaatctggt tttgtgaaat ccatgcacaa 740160
 aactaggatt aaggctgtaa ttgaatgtaa atgtgtatgc aaatcaga gaagcaaaag 740220

 tatcttatct ttcaaaaaa ctctcagtca ttgtactct gcaagcccag agagaaaaca 740280
 aacaacactt gaggcacagc caagtggacg ggccatcctt gtgtggccca cattagtac 740340
 tagtcaagag caagccgag aaaggagaca ggcatgctta tggctgcagt gttgaataa 740400

gctcattcac tctacaaata ttcatcaagc agttggcagc aggtactcac tgtgctgagc 740460
 ctgggatcta cccctgagca aggaaagtgg tggagtttca gtttctagtg tcaaaggatg 740520
 gatttgttct tagtgtgaca taggggtcca tttcaaagat gcaaaacatt cacatatttt 740580
 cattctgtat cacctcctgc agagccacag ttttactcct cagaaagtat atccacgagg 740640

 atgcctcacc agaactataa tcttagggaa gggccaggac cctgtgttgt aagtctttgt 740700
 ggggcttcag tcagatccag ctgacttgcc aggttcgtgc ctgagagggg gaatatggat 740760
 tgagaaacag caggtaaaga tgctaaggaa aagacagaga cacagaagag tcaggaaggc 740820
 aatccagtga atactggaca cccaagtgtt attcttcaac atccttaaat accccaacca 740880
 aaaaggcaaa aacttctttt tcaagataca aggaagaaac agactttctt cettaattct 740940
 ccaaacattt ggtaacccat cttaagacta aatttctctt gtctgtcctt gaagttaag 741000
 agtaaccaca cctcaagcaa gtctcttatt atttagataa gacatccacc accaagatca 741060

 aacattctac agtagccata tcttagacct ttaggtctta taactttaac cttggaagat 741120
 taaagatagt ttggaactct ctgaccttaa gccaagatga agcgaagcca tttttgtggg 741180
 ccccgacaac catgaaaatc aggaacccag tttggcacca agggtaactt tccagccaag 741240
 ctcacctcac ttccactgaa cttcacaac tgaccaggca caccaagggg caaccacag 741300
 aaggctctgc tttaccttga aggagagcag gtccttggca gtaatgcaag aacaatgagc 741360
 tgagaaagge aaatcgaaga aaaaacagaa agtataaaat gtaatctcac tacgtatcca 741420
 ccaccacccc taagcatgta tttatgaact gacgtgatat ggcccagaga gtcttaatac 741480

 tacaatatta aattccaaac acagaagaca caaaggcggc acattataac aaagagagct 741540
 tgggttctgt gtgtttggtt ttctgggtgct tgctaagtgt ctggttttta gctttgctca 741600
 catagatggt atgttctttt aaagggctgc cttcctggga gactgttttc caaccaaagt 741660
 gcaatgctgc ccctggtgt ctgaatgcca tgagcgcgca cgcagaaacc tagcttcccc 741720
 aaagccgact ccggttctac ccagatttca ttttgccatt tttccatctt ccaaagtgca 741780
 actatttcat ctttaaagat tcaactgctg ggggtatfff ctggcttaca cgctaatcaa 741840
 cacgtatfff tctcctataa caggaaccgt gctctggtta cttaacgagg gggagtgtg 741900

 ggtatgtggc agctttctcc cttttttgct ttataaatta agtgatctcc ccagagaagc 741960
 tcagaaatca ggcctattcc atgtaacctt tagaatcttc actgcatctc tcgctgggga 742020
 gacgttctcc gagagctcaa gctccaggag atcaatgcct gggctgaca gacatcccac 742080
 tcttagccaa atgtatttga tttcagttca tccttcagtt cttgtaccgg ggaataaact 742140
 gaaacaaaaa gctctgaaaa tagcaatgca ggtgaaacac agagctgggg aaagactcct 742200
 tcttgggttg caaaaaagca aaactcccca cttagagaaa agcagcgtgc atgaaaatac 742260

caagaaggac tagtggaagg ttcaggggca gctggcttca ccatccctct ggatccagcc 742320

accaacgtgc cctccagcc aacaacatgc cctgtgtta ataacctgag aatctgtgga 742380

aatgcatggt gaagagggcc atacagagct actgaatact gaactctggg cataggacta 742440

agaagcctgc cctaccaag gttctccatg acttactgca taaaaactt tgtaagccac 742500

tgagcaatat ttaataagat tttaaatctc cattaagaag ttattgttgt tagggattgt 742560

cgaatactgc aaagatacaa acaacacaca cacacacaca cacacacaca cacacacaca 742620

cgcttccac tgccttctt tgatttttct atcaaattaa aaagatatta cctggcaacc 742680

cgaggacaca aacctgata atcaccaacc aaagtcatga tgcacatttg gtaattgctg 742740

atgataatth ctaatggaat ttgcaaaacc aatgataatc cttttaaag tccatcagtg 742800

aaaaacaaac taattcgttc tggggaaaca gtcaccggat ctgaggatca ggaagcctgg 742860

agatatttgc agagcatttt tgccttgaag gaaagggacc taaccaaaaa tcagcaaggg 742920

aagagaaaga ggaatgagga ggagggaagg tggtaaatgg ggaaggggga gagagaagga 742980

gtgaaaggag ggaggggaaa tttcgaactg actgatagtc accttttga gctctctgaa 743040

caactgccca gtcttagtac tgcctcttgc tcacctcct ctcaggcagc cattgtctgc 743100

ctcttgctca cctccctctc aggcggccat tgtttgctc tatcattctt ctataaccac 743160

ttgtcaccgg gtctgtctcc aggccatggt gaaaacagag tatcttgcca agcccagctg 743220

caatgccagc acagccggct gcccgtaca caggctagca tggtaagcg gtgccaggcc 743280

caacaggttg tatttcaact tccccctta agtctgact gagccacagg aggtgggaac 743340

acggaatgga aaaggttgtg ttttgctga aggacattgc atgatgttaa cagagggtct 743400

gttactcttc tactgtctg acctgccaac agtcactagg gggatgtgca aaaggaaaa 743460

ggaaggggca gattgaaaa ctttcacact gtcagagag gtggcaccgc gcttctcgg 743520

ggctgggatt cccggagaaa ctaacattca gaagaagcct cctctgagt ctcccaccgg 743580

agaaaatgct acagtggaaa tcaaaacctg cccaactatc aagaaacaca aagaacagtg 743640

actgcgtggg ggggggggag gtctggaagc atgatgacac tagcagaagg gctttttgtt 743700

ttagtttggg gacaggtaca ggagccatgt caagtgcatt tgttctggaa gagaaatgga 743760

atattaccct aatcctaaga acctatgact aagtccccca cacagcagag gagatgtttg 743820

cagatgtggt tagttaaag actggtgtgg ggagggtatc ctggaggaac aaagaggtcc 743880

gttaatccca gggctcttct aaagcaacag caggagagtc tgaacaggag atgtttcagg 743940

aagacatggg ctggggtgag gcaatcgcca gatttctga cgggaggaga atgcccaccc 744000

aagggatgtg ggccctcttct aaagactggg aagacaacag agttgaccaa cccttagagt 744060
gctcatagtc ctctagagtg tctatctgta aggtggacct atgacaggat aaaaccact 744120
ttaggtttct ttaaggtttt attttacct caaatatata tatatatata tatatataga 744180
agagtcttga tttcctggag ctggaatcac agactgttgt gaactgacat gtgggtgcta 744240
ggaactgaac ttgggtcttc tgcaaaagca gtacatgctc tttactgctg aaccatttct 744300
ctagccctct gggaccatt ttggacctca gactcccaga aacacaaaat actaaatctg 744360
tgttcttcta aaccactaaa ttgggtgtag gggtagactc taacagtcaa taggaaagta 744420

acagtctcca tgccttttct gaagagaact gttgagtga gttctgaaga gagagtgtt 744480
atthgtatt ttcaagaac tgacaatctc caagacactc aaagtcagtg aaattctggg 744540
glatgactaa aatcagacac agtttatagc actgagcatt gagcactaga acaaatgact 744600
ttgaatata cctcctagag gaagtattat taagaattca tcacaaagtg ttccagaatg 744660
aatgaactat actgtggaa gaagcctggc agtgatttta attgtttcta atgtctttgc 744720
atctcatgat ttaacaaatc atggacaact gacatagaaa caatgaatat gagagatcat 744780
tccattaaaa tggactttgt gaccttcata tctaccagat ggaccaagat attttgtatg 744840

gtgtgtgtgt gtgtgtgtgt gtgtgtgtgt gtgtgtgtgt gtgtgtgtgt gtgtgtacat 744900
atgtacatat acatatggga acatgtcaca tccaatcac agaagtcacat ggaaaatag 744960
agggtataga aaagccttca gagagcatga ctccctccc ccaagagagt aagccaagca 745020
gactgtgact tgaacaggaa atcgtaccct tgaactaacc tctgagggtc gtctcttct 745080
gcctacctca gcaagaggc tggagtggaa tagccctcaa cagaaggac atggaagacc 745140
tttctctttt ataaccaaga caactggata ctccgctcat gtttcagtcc ttattcagat 745200
atthataagt ggaagtaag ctgggtgtgg tagctccggc agttggtccc agcatttgag 745260

agacagagge aggtggatct ctgagttcaa ggccagctg gtctgcagaa tgagttccag 745320
cacagccact ttctagcatt agtcacttgc aacacagttt ctcgatgagt ctgggatagg 745380
gtggcagcca gcaagctcct ggggaatcct cttgtctctg ccagcccca gcattagctt 745440
ccaagaatac ttcatctttt atatggtgca ggggatttga actcagttcc tcatgcttgc 745500
tcagtaagct ttcttactca tgaggtatct cactccagta agtgtttctt aaaaaataat 745560
ctgattttgt tcaaacccca tggaaacaac caaagtccca gaggttttc tttcagtgtt 745620
taaggtgtcc ttcccagaag agttgaagtc ttgcctttcc cttccatttt gttttcttgt 745680

gttttagatt aactgtgtct tgggagctgg ccagggataa taagagtgtg tggaaaggag 745740
aaaagtaga aaatgaagag acagggaaag aatcacccag gcaatcagaa aaacaaatca 745800
tccatctctc tagctaaggt tgaggataaa caaggagccc acacaacaca gggcaggctg 745860

gtgcagcagg aaccatggct ctaagctgca gaaactgatg gacctctaac ttctccatag 745920
cagtaagtac caaagatgag gctgtgtgcc tctcctacaa ataatagga aaaattgctc 745980
gcaatcatct ctaatgggtt gtcagtttca tgacagtggg cttgacaatt agtttgtcaa 746040
tttctaacta aatgtaaaaa taatgataat ctctcagga gcctttgctt ggccctggcag 746100

cctttcacct gaggccagga agtgaactcc actggcttgt gcatatttct catgcccgtc 746160
attagccta aaattaatcc actgcactca ggctctgagg aagattccac aggacagctt 746220
ggctatcccc tccttccttt cctggacccc ctaatcgaaa ccaaaagaga cctttcactc 746280
cacccttac atatgccta agtccaagat gagtcttita aaacacttga cttctggcct 746340
gctgataggg aaitaatttc tagaagtaga tgctgtgtct gccaaaaaca cgtttgcatt 746400
tcccttccca gtcttctaac aggcacagcc cacagcctgc tctgaggagg ttacacaagc 746460
ccccatgagg ggaagttagt gagagaaaaa tgacaaggag aggatccaaa catcccctga 746520

agtacaaggc ctggtgcctc agacctgagc aggagatgag ttttctggc tggccctggc 746580
ccagatactt ccagcaaatg ccatcaatgc ttgtgttct tcttccattc ttgagagaaa 746640
atcatgccaa acctattac tgctgtgect cagagcactt cagagaaaat actctgtgaa 746700
ttcaaaccca ggcacatgt tattaagatt ttactcaat ggctgcattc tttctttcta 746760
aggtttgagg tattctgcca gccctagcc acctgctcac aatgatggac agaagcaagg 746820
aggatagaca ggggtgctcc cccaaggaca catggtgaac cagcaaaact caaagcaaat 746880
tcctctctct gattctttaa tgtgaactcc ctgcattaaa aagattggag gcctatggct 746940

ttctactcac agcctaactca gtggtcctta ggcaaagtgc ccctggaatg agaaaaacca 747000
gaagagcttg cticactctg ggaccagagc tatcacaata ccataggtac gcaattctcc 747060
gggacccttc tctggcaatt cagtgaaaac catagacct ccttattcag attgcagcct 747120
tcatgccttg tgacacataa actccattgt cattgcaagg gaacaagtct atttcatccc 747180
agcatcaacc acagagctca acctacatt ccatccaact aattgcctaa ttaattaact 747240
gcaattgcca tgatgacaat ggtagtcagt gcagtgattc cattttacag atgagaaacc 747300
taggcctccc tgagaggggt aatggttttc ccaggtgacg cagctatgta getaggagtt 747360

caaacctctt ggactctaact acctgaagt acccccgtt ccacttcac cgatgaagtt 747420
gtctaccctc tccttgagg tgcctgcat ttctttgcc accactgccc ttttctgtgg 747480
gcctcgggt tgacttatac aatagctcat attcatagaa gccatttgtt tccttataca 747540
gaaagaaaaat gaagctgaaa agaagaaagg agataggag agaaggaac atggggagga 747600
atltgtgaac agcacatct caagagagaa aaagcaact aacggaatca aaccagcaag 747660
gtccagagag agcatgcatt tagcctctgc agaagaggga gctggatgag ctgcagagcc 747720

cagactcagc ctgcttggtc ctgccacttg ccaatgttgc tgcagaccac cctatagga 747780

 ttctgctgtg gatgctgagc agaagctgga agaaatgcct gactccagga gagctgcttc 747840
 cctgtgctgc accaagcctg ggggaagcag accagtacat tcccacctgt tetatttga 747900
 gcatcccaaa ccttcagtat ttcccaccta caaggagcta gagaaaggca gtgctgcaaa 747960
 gataaaaact ttccagtta gaggtaaagca gtgtgagcga gcgcatgtgt gtgtggtgtg 748020
 tgtgtgtgtg tgtgtgtgtg tgtgtgtgtg tgtgtgtgag agagagagag agagagagag 748080
 agagagagag agagagagga agaggagag agagagactg tgtgtgactc tgtatgtgtg 748140
 actctgtatg tacgtgtgtg tgtgactctc tgtgtgtgac tctgtgtgta actctgtgtg 748200

 cgtaggctctg tctgtgtgat actgtgtatc tgactatatg tgtgactgtg tgtgtgactg 748260
 tacgtctgac tgtgcttctg actctgagta tgtttgactc tgtatgtgtg tgtgaatctg 748320
 tgtgtgtgtg tgtgtgtgtg tgtgtgtgtg tgtataccca cacatgtgct tgtgcacatg 748380
 gagaacagag aacagccttg ggtttcaaga gccttcacc aatcttaggt tggctctgct 748440
 ggctggagc aactgatta agctaggctg gctgaccag gactccaag gatgaatctg 748500
 tctctgtctt cctggcactg aagttgagat tacaccacac ccagctttta tttttaatta 748560
 atttttattt ttacatagg ttctgggat tgtacttggg tccaatgta catatactat 748620

 actactgtg gatagacttt accaactgag ccatcttacc atccatcca tagcatgctt 748680
 gaaatgtaa gtgaaaagtt ttactctata gtctgctata tgttttcccg taaggcctg 748740
 gtgaatgctt gatcatcagc acttaagcag ggagcatctc acagggtcag acacagagaa 748800
 aatcagttct ccatctctc gggctcctgt gtctccacag aacacaatta cctcctcgaa 748860
 gatctttact acaccagcc tggggtgccc cagctagctc aagagaaaat aggacctttt 748920
 agaggcaaag agctctctgt ctatccagac tgtcactaca gcaaggaag aatttgaag 748980
 tatgtatata caccactgaa gcaaatcaag aatggcttct gtgctgcag tecttgtccc 749040

 tgctttaaca aaagtaggcc cctcctttgg cccacattat gcagggggga aaaaagagg 749100
 tttatataaa ggatcaccta ttgcccactt ctttattcta ttacaggcag gagcagaggc 749160
 tgacaccac aaggaccctt tccagtgagg gattatata catgcatag aaatacataa 749220
 aagacaaatt atcctgagat catcatgctt ccattgacct gctcaaggtt taaagccagc 749280
 tgcaattaga tgccatggtc gcagatctgc aggcggctta aaacccagt cacgtgcttt 749340
 aatcctacag aaacagacc ggggtgattt tatgggtacc taagtttga tctgtgggt 749400
 ctgatcctga ttcttaggag gttagtaac tgcttttgtt aacaggtcc tctcaactt 749460

ctgagatatt tataatatga tatctaattc aggcttaaaa cactcatgaa aattaactgc 749520
 attgcttttt aaaaacacaa ccaggagag agatggcaag ggaaagcagc atgatgtgct 749580
 aaaaatcttat cactctccca cattcaccag agagttctcc cagctgctgt ggctgacaaa 749640
 tctcacagaa gctaattgtc cattccttaa gtcagacctg ctttctgac atgggggcta 749700
 ccgactattg taacaggaga aattgaaaat ctagccacat gggagcatat agatttcatt 749760
 tattttaaca cttaaaaagc atgtaagaca cctgttgtaa agatcttagg gcatggtaga 749820
 aatggctacc aagttagtga ttgccacacc cttttgtctt caattataac cattccctta 749880

 ttaggtgtgt cctatgtacc tagcatggtt gtgagcactt tacatagtaa ttcacaacta 749940
 actgatgagc tggtaggaga agaaaggac cccaagctat acagctaaca ctggttaact 750000
 cacagatfff gaaccctca cccattatcc atctgatatg ctacttgctt cacactgata 750060
 cttctaagag agacagagac ccattagatc atgacaacca tgttcctaa acattaacta 750120
 tgctttaaat atcttaattt atgagtttaa taaaaagcc agctaggtgc attccgggac 750180
 tatgatgtaa aagatggatc tgtccaaaca ttcgagaaat atggctgcag agttctaaaa 750240
 tgaaagaatt gcctgttcag agcacaagga tgaagtgtg ttctccacc aagacaggtc 750300

 agcatcctgt ctcaaaaga caccagtcct ttgggcaaaa gatctaattt cttcacagtt 750360
 tcagagtgaa cccaactcca tctcagagac aggagagaaa caaacagcag tggacaaacc 750420
 cacaatccca tggcattcct ctcccatgaa aattaggtct gccaaatggt ccatagcaga 750480
 aactgtccg cctcagtatc tccaaggct gattttctct gaggtcagca tggtaacctga 750540
 agggcaatgt tgaacgtgaa atcagaatgt gagatgtggg ttaatgctcc tgggggcagc 750600
 tcatccaaa atctacttc acaagaatgt ctgtgactc agacctgact gaatccaatt 750660
 gtctggggct tctctcctt taaactatgt tctgaaaggg caggtttctg agaccctca 750720

 ttgtctatgc cttgtctga gccacacttg ttttttttt cttttatcct ttattttatt 750780
 aggaatfff caacaaaaa tggcaagtig accaagtga cacctagtaa atatttctgc 750840
 tgcagtaat ttctatagg tgtctgcgca cgccttfaat cccagcactc gggaggcaga 750900
 cgcaggcaga tctctgtgag ttcgagacca gcctggtcta caagagctag ttccaggaca 750960
 gcctcaaaa ccacagagaa accctgtctc gaaaaacaaa aaacaaaaa caaaaaacaa 751020
 aaaaaaac aaaaggcttg caagttaatt gtagcatctc tgtctttaa taccttttgt 751080
 aggcaataa ctattcccc tctagtttcc aaacgatta tttcaccaa caaatttga 751140

 tcaggaattg ttgiggcaca gctagtttga gtaccaggta tcaacatgaa acttaagtac 751200
 agtcattctt ggtgcatttg gctggttccc agccattcag ttctagtaca tagaggcaca 751260
 cattatfff tttctcccac atctgcagag atccttttag aatcaatgag aattacaggc 751320

tgtttagcaca gtggagaagt ctcgtaagac ttatttgtgt cctttgattt ttttttggg 751380
 ggggggat atacaaagag tgttctagaa ctgactgcaa taacttttca cagttgtaaa 751440
 ggacttcagt cacctagctg aacactcctc actccaatt tacacacaga ggcttcaaga 751500
 ctctacatta ttagaataag aatagttaat gtagagtgg tggaaagata gtttagataa 751560

 cacagtacaa gcaataagc ccgagttaa tctccagaac ttgtgacaaa agctggatag 751620
 gatggtgaat gcttttaatc ccagttctgg gaaggcagag atggtgagcc acacttcttc 751680
 tcattgaaaa atccttgtct tgccttcttg gatatacccg tgttgttatt gattgatagc 751740
 tctctgggct ttggtgaaag gggggctaaa ctttaagaca cccccagtgg ggttccaatg 751800
 gaagcaaact ttgagataga tatctattaa ggaatgagtt tatgactgcc aacaaagaca 751860
 gggggaaagg aataggggaa gcaaggcagt accaaccaag cccaagccag cccaccaagg 751920
 attcaggaac tggatgttat gctgtccagt gttgtcccga gatggtgtga agtattgggt 751980

 ctttgtgcat atccaatgag gagtcattgg atggtctccc tgaaaagtgg gcaaggctgc 752040
 ttgctcttca ggtgacgcaa ttcagaagt cctctggtag ccagagaagt ccttcctcc 752100
 cgaagggtaa gtggacaatc ttccaaagcc tctacaacaa agaatagccc tgtcctcttg 752160
 aagcaaact tacctaacc catccacatt gcaaaccaga gaaagactga gcatggggag 752220
 agtgaggcag gctaaatctg ctctctaca gccaaggata caccaggact acaagccatt 752280
 tccaaagcta ggctcctaat acacccaaaa ctttctgac cttccccat cactgaaaaa 752340
 ctttccaac cctgatgttc cttcctctgc cataaacaat ccaccatcct ctctccaga 752400

 cctaagctca gatggatctg ccaagggatc tactgctct ctgcccttct ccatggttct 752460
 cccagagatc agcactgaga ctgaggaatg gctggtatth ggtaaacaaa cagataaata 752520
 agtaacagat gaattcttgt acctcaggc aacacaaaa caatgagaag aggctcaggc 752580
 agacctccag ttctgagatg gctccaagaa tgatccatcc actacagata aactatgtcc 752640
 agctggttta ggtacccag caagatgtcc ctccaacatg tgcccctagc acagcactaa 752700
 gttaatagcc ttatatatac ctattggttt gcttttgttt ttttgtttgt attttcaat 752760
 tatacttaat tacatgtgac atcagaagcc atttctgtct gattcattgt tttatctccc 752820

 agcacctggc ccaggctgg cacatagtat tcaagaaat atgtgctcaa taataaaac 752880
 agaaagtaca gcatttagtt agaaagtct gtgaactgct ttcaaattta cactggcata 752940
 aatgaacaa tatgagaggt ttaatagcct ccaacagagc tgcaaacaaa agggcgggaa 753000
 tcggaatate tgagaggagt ataggagccc tagagataat gctttagtga cagaagagtc 753060
 atctcttcca ttaaagagt taggaggtga ttgacacatt gcaggatagc catcattgat 753120
 tatagtcata gctactacac taaaccaagg acataccaag tccaacagg gctaagcatg 753180

ttaaataac aatatcatta aaccttcata gatgactgga atgtaggaat tcttatgccc 753240

 acttttcaga taatgacatc aaggctcaac gaaattcaga tacctattcc agcttaaaac 753300
 ttactagtta gacacagaac aaaagtctaa acccaacttt gtctgactac aacacctgtg 753360
 ctcaaaactaa actccgtggg gaacatcctc tcaccaaca atcgggatcc tagtcacaga 753420
 gtattcagt caatatgtgg gcacaaattg tgaagttgat attatgatag ccaggctttt 753480
 aaatagctta ccaattacc agcttgacaca catcacacce acagaaaaag agagtggagt 753540
 taattataag atctcactgg ttgaaggaag cattcatttg caaatctcaa ctgcatgtt 753600
 tttagaattg gcaccctat gtctctgttg ttgtgaaaaa cattgactaa agccaacctg 753660

 aggaggaagg gacttatctg gcttacactt ccacatcaca gcccacaaac agggaagtca 753720
 gggcaggaac tcaaacagg aacctgttgg caggatctga aacagagacc atgaaggaat 753780
 gtgtcttact ggcttgttca tgacttctc agcctgcttt cttattcaac ccagaactac 753840
 ctgccaagg gtagtgagac tcatggggg ctgtgccttc ccatagcaat catcaatcaa 753900
 gaaaatgccc cacagactta cccacaggca aatctgacaa agacaagtcc tcagtcacag 753960
 ctttctcttc ccaatgact ctagtgttg tcaagttaat aaaaactaac cctcacacce 754020
 tacaagattc ggatattgga atttgccatt tggggcaata gtagtacaag gtgggccttt 754080

 gggaggtgac tagttcgtga atgagaatag accccttgtg aaaacatccc aaaagaactt 754140
 ccttgcctt ttgccacat gagaatacaa agaaggatca accataagga aagtcctttt 754200
 gcagacacca aatatgcaa ctctcgacc ttgggtctca gagctccaga gccataaaag 754260
 gcaaattcct cttgattata aattacatgg tctaaggcac tcagtgatag ttacaaaat 754320
 aagctaacac actgactata gtctggtcac taaagccaca ggaaatggac cctcctttca 754380
 catctgtcta gtcaagacc atcagccata tgctgtgctt tgcaaagcct acagagggcc 754440
 tgcaggttcc ccaacgcac cgggggcaat ctattcacat ggaaagcaca aatttaagt 754500

 gtacagctag aactgagcta gacagagcat ttgcctagca tgcagaagac cctgggttct 754560
 gtctccagac cctgaagaga aattaacat aaaatgcata tccactcaat ctacaaaaca 754620
 gaaagagaaa aaagaatgtt cggcaatgcc tctggtgatg gtgctggttc aaacgaccac 754680
 cagggtcaag gctacttctc attctggttt gtcacacctg aaaggaaaag gcaggtaggg 754740
 tgaggagatc taaagaatta atgtattaaa acatttttctc ttatttaatt cctgtgttcc 754800
 catggtaact gagccatcaa ccaacaaatg tgcccgtctc tccagcaat taaaaaaaa 754860
 aaaaatgttt cttcaaagga gaaaatgtta gggacacatt tatctacctt gatgagtaat 754920

atgtctgggg agcttccaaa aacaagaagc catacctttt caatcctccc atcttctca 754980
 ttcttcaacg acacatacag gaattaagta ctacataagg acagaaaagc tacagtatac 755040
 ctaggagatg gctttggggc agccctttta ctgaacccaa agaaattcta aagttgggat 755100
 ttgttttttt ctctctgaac ttcccagtac atggcttcca aattttctta attatatcta 755160
 ctgggtcaat ttataatcc tattactcct gtttggcctc taccaatac tgtaaatagc 755220
 catgacccaa acctcacccc attctccttg ctacagccct atccatcacg tgtttgtgtt 755280
 tccttgagga aatggagctt ctagggagtg gggggcttct ggagtacct cttgctcatc 755340

 tgagctcagc atcctaacag tttatgtagc attatattha gtcactggtt ccctgtcctg 755400
 ctttctcctt gcaactcatt tcttagccct gaattccaca aaactgagtg cagccagctt 755460
 gcttgatcac atgtcatggc taccctggac tgtgcctaac tggtagacgt cctaaggaaa 755520
 gttacaacac cttcagaata acagtaattg ggattctcct tcaaaataat attctacata 755580
 cactctgtct ttiagtttgt tacttcccat ttaaaagga aaaggtaaac aggtagacag 755640
 aaggaaggaa ccacgcacag cagacacagc catggtaaaa aataaactca gccttgaagc 755700
 tgccagtggc aacagagacc aggctcttg aatgcaactc ctcttggggg atgttctgga 755760

 gttgcttcca ttgaagtc cctcactagt tcatccaagc tgccttgha caaaaatggg 755820
 tttctgaagg agatgggaca ataggacaga ttcccacat aactgcaagg cccatctgtg 755880
 cataagacag ttgggtacc agtaattaca accaccttcc aggaaccttg tttcctaatg 755940
 tcattgtcac ctctgggacc taaggaaaa aatatccaaa gcatggccct cagtgggcca 756000
 caggatatag taagtgtggg gtggactgtg tggctgtgcc tgtgactttt ttgagagttc 756060
 caccagtatt tctgctgggc aagcagatct gagactccca acctctggca gtctagtaat 756120
 tccaagagca catgggaggt gccagtcctc attcatctg tacttcagct agtccaagcc 756180

 catgagtggc acgagcaaca gcagtgagct aactcattct tgtaccattt ttctcttct 756240
 gctgtacaaa ctgcatgaa ctgaacagct aaaagacagc tccagttcat gaccttgtgt 756300
 ttatgggggt cagaagcctg aaatcctttt tgagagctaa aaccaagatg gtggcagggc 756360
 tgtgtccctt ttcaggggac taaaaggatc accataatcc atgcccttgt ctttctagct 756420
 tcggtttcta gaagccaaca tggctgaag taccagccag caatgacatc atcattgatc 756480
 ctgattctc agatctctgg ctctctgcc tcctcttcc attcattaga ttcattgtaa 756540
 ttacactgtg ttgggctcac caggataatc ggagataatc tctccatct gaagatcttg 756600

 aatgtaatcg catctgcaaa gccccttttg ccacacagga ttatatattc accagctctc 756660
 tagattagat gtggatatat cggggaatgg ggtacattat tttgctcacc tgactcatct 756720
 tctaggaatg ttggaggatc cagtccagaga atacttgtct gccaaaggac tttctcatta 756780

ctggggcctc aaacacatct ttggcttcag ttgccttgct ctttctgctt gcttcttatt 756840
 tccactctgt gtttctggc taatggtctg ctccatttc atctctcctt gtcttcacag 756900
 aaacacagtt ctggatgaga ctcaagtgtc acttctgaag gagatgagtc tctctgtgct 756960
 tggcaagcac aaaagaaaaa taattccaga gcatgagttt acaaactttt tgtgaaacaa 757020

 gcttgggaaa ctctgccacc aaatattgtc aatcagcatt cctggcacgt ctgctcatta 757080
 gatgctatgc aagtcaagcc ggtctttatt gttgttgaaa cagcaaatct gcacgttctg 757140
 tgtggttcca aatatttga atagtctgc tactaaatat ataagtgtgg cgtcggcctc 757200
 agattgcaat cctctcta atgtgacaggg ggaatcaaac ccagccatat ctctctaggg 757260
 agttttgctc atgataatag agagctctag agggtaggtg ggaggaacaa ttgtgcaact 757320
 gaggggatag gatgaaggaa aaacagctgg aaatacactg tggatgttgc agaaaataag 757380
 aaagtttctt ggaatttaa ttcaaggaag atgaaatga aagcatgaag agataaaaat 757440

 gctcaccgat ttgaaaaag catgcttaag aaaaggtaaa atgtgtggca cattcttctt 757500
 ctgatgctc ttcgtcgtc ctgttcagtg ttggccaggt cgtctttgtt tttctaacgc 757560
 agcattgate ttttctattg gtttgtacat ctttgtgtat tagggctgtt aatttgcccc 757620
 ctccaaaaaa aataaaaaat aaaatacatg ttacaaggag atttctcatt tcttaacctt 757680
 actgcagata aacttatfff tttccgagta gaagatttaa atttgagttt aatcatccct 757740
 atcaactfff tctttatgtt ttgtgaattt attcttaaga tctgccagg ataattaa 757800
 ttccaccac tagtaattaa aatgcaaat aaaagggaga ttaattttg cacctatcag 757860

 atccactcag tcatttctc aacaaacatt catcaaatgc cctttacatg gcaagcatgg 757920
 gaagaaaagg cagaaaaata caacaaaagc tctgctgggg ggcaggggggt acatttctgc 757980
 ttatcgggctc aagagaagca caaacacgat gaataagtaa agtgaataat atattaaata 758040
 ataagcacta cagaataaaa gaaagctggg aagggggaca gcgagtgtgg taggggacag 758100
 ctggccactt aaactgcatg acaggggaac agtactgcag ggaactatgt tggcacctgg 758160
 gtaaaaaaga gagcacttag catgtcccat gtggctagtt acaaaggaa gagcacaat 758220
 aggggagagc agcaggcagg gaagcttggg gcctgtcacc aggggccttg tggctctgctg 758280

 taagaataca ggctttttct ctaagtaaaa taacacctac atgttaaagg cttaggtccc 758340
 aaggtagtgg aacctttaag agctgggacc tagcaggagg tgtttaggta atctctctgt 758400
 cattctctct gtctctctgt ctctgtctct ttgtctctgt ctctctctc tccccctgac 758460
 ctctttctcc cctctccaa cctctatcg gtcttctctt ccatctcctt tgetctctgt 758520
 ccttctctct tcaccagtct ttctctgecc ctttctctct tcttggaaat gaggacaaga 758580
 gttttgttct tcccacatag tctgtgccct gctgcctcac tacaagctcc atggcaacag 758640

agccaactga ccatgcactg gaacctccaa cactagtgtg accttttatt ttttaaggttg 758700

atgtcttgg gtagatcttg ttatgtaaca ggaagctgac tggcacagat agtttgggag 758760

ggtattttgg catagaatga tgttatittha caaactacta ttttctgttt tcctgttga 758820

aatgggcatc aaaacatagg acagacagcc tgttgtgtga gagatggtgg cttgagccat 758880

gaagtggcta agcgttgggt gtgacagccg agggagttaa gccgaggag ttaagcttga 758940

agtcaagtgtt gaggccttca ccataggcac acagaaggat gaagcagcca ttaactgtga 759000

agagcaacct acaagtggat caggggggtg agagaaagga agactgagga ctttagtgta 759060

aggcatgtta gctttagaat gttccctaaa gatccaagcc aagggtgcag gtagacaggt 759120

agacctgcag agccaagtcc cccagctgic tttcatctat gagctggagg catacttctg 759180

ggagagagca caagggttta tggaggtcat gaaactgggt ggggttgctt agagacaagg 759240

attaagaaca ctggcaatgc caaatattag caggagtaca tggaaatcca tgtgttcaca 759300

tgcttctatc taaatcagga taataaacct tatggtatca agtataaaga tataagcctc 759360

tgagccaatg attccatttc taggaatttg ttttaataaa gggactcaat agttcagtaa 759420

gaatagctga tcattgtagt gaaaagctac atgtgaactg aatatagacc agaataataca 759480

atgacaggta tagagttatt ttttcatggt ccattaatatt tgcagtataa agatttttat 759540

tcacatgaac tgtggaatct ataatctacc caacagtca gtaaatacag cataatattt 759600

tgttgctgtc cttaagttta ggctgtgccc taggagggga caattgtact aatgatgagc 759660

ccactccctg ggggtgctag ctgactctt attacaaagg ctgtactcca gaggcgatta 759720

ctaaaagccg ttctgtaatt cacatctcta atcaacaaga aaggttctcc taattagcat 759780

actgaatttc agaaatgggt tttcataggg gaaactaatg ggggtgctaat gagcataatg 759840

gatattcaaa atgggcaatt gtttagtgaag tttatggatt ttgagaacag agaagccact 759900

aaaatgtttt agggacactt gctcctcccg aatgatccca gcagaaagca tttagagaga 759960

gccaaggcct gtgatgtgag gtttattcca agaacctcca tcctacca caagactga 760020

atccagttat ctgtttcttg ttgtaaaagt aagggaatac tttttgagct ataggatttg 760080

cctacagagc aaggactgaa actcatctag gagaaaacat aacatgactt tgctcaacat 760140

ataaacgggt aaaacagagt gtttactag tgagtgttca tctactgagg gtgtgcacag 760200

gtgggagaac agctcgggga tccattctca ttgtacctga gatcaagata attccacact 760260

ttggctaaca ttcaaatctc tctctgctgc cacaatgtta aatctcaatt gtcaactggt 760320

aaggtagacc tctgtgatg ctgggtggga ttaacttgct aagattcact ggagtggaaa 760380

gacctatgta ccataggtgg caccatgacc ctgactgta gggaaagggg aaagtgagct 760440
gagcaccagc attcacgct ctcttctcc tgactaggca tgcaatgtga accatctgct 760500
acagtctctc cactgtaatg gactgaactg tgagccaagt gagccccttc tcccttaggt 760560
ggtttgtgtc aggggtgttt atggaaactt caggaaaagt gactaaaaca catggctata 760620
ctttaactc cagaaaaacc ccaagtattg taggattcag gcaaaactg cacagggaca 760680
tatcagaagt agaagtgaga caagccatc tcccccaagt atgctgggga tgagggcacc 760740
acaatggggg aagaaatagc tgataattgg gtatgttctt ataatgagaa aaagaaaaca 760800

taaagcttaa aaaaaactgt ccttataaaa ttaaaagtaa atctaggcag tggtagtgca 760860
tgcctttaat cccagcactt gagagggtga ggcaggcaga tctccatgag ttcaaggcca 760920
acaagttcta ggacagccag agctgttaca caaagaaagc ttgtctcaa aaaaaaaca 760980
aaaaaaaaa caaaaaaaaa aacaaataaa taataaata aaagtgcaa taggaagtag 761040
aggaacaaa aatgtggaga gacggtgtgt tgaggaagga aatacctaca gatttctact 761100
accagacaa tcaaaatctg atattccatc tccattctg tttctactct tttatttga 761160
cgttttattt tcaatcaga ttgagactt aaatacctag aacattactt tctttccacc 761220

ctctgaggat caggcatcgt atccctgaaa ctgaacatgt gcacacacac aaacttggaa 761280
atatctacat tatgttgttc tcttcttcc ccccaggca gacagcacta tcaaatttat 761340
ttcccatctt tgttttgagt gcttagatgt tattttggat tgttcaagt tttatgatc 761400
ccggaatctg cctttccctt cgctttttgt cccttccctg catgaataaa gcaggctctg 761460
actgatttcc ctgacacct ccttcggttc ctatctgatg ttcttgctg cttttccag 761520
ctctccctct ctcttctat cccttttctc tggcaatcta ggctctgaga gaatcataga 761580
atgtaaagga acagcctaaa gagaagataa atgtccaag aaaatttcat gcctaatta 761640

gtacaccccg aaattaaaa cacagcaagt tttataagc ccacattcac cetcaatgag 761700
gactgaaaga aaataaat taaaacaagg cttccagaa gcaccatccc cctggcttta 761760
aatgggctaa ataaggcagg aagactaaaa cccaaatgca gggatgcacc agacccaag 761820
atgagaatgt aaccaaatgc cacttctca cacagctcat acaaaaagac ttgatttca 761880
gtcaccaat tctgtttgg aagagtgtgt attgccacac agattattcc atttcaaaa 761940
atctccactg ccctacaaa cagcagaagg gaaattgctg gcaggggtg ggctgtaaga 762000
ccccagatgc ctgaccctt tagctgcttt aagtggcttg cctgttctct tctgcatct 762060

tcttgccct cccactgtg tgactgtgt ctctgcttg caaggacatg tcactttaa 762120
taccacttg ctccccctt cttaattggc ctgcagtaaa aatacaaatt gcaccactgt 762180
actttatta ttagccatt gatggccaa aaaatgctc ctaactactg ctagagggt 762240

attaatcaga cctgctgact cctaagcacc cactttatac cttgactccg agatgaggcc 762300
 agtagtagt aatcatggcc ccttccaag ggatcattta gctggctact gcctctccat 762360
 caagaaaggc acagcctaaa ggtgtggtgg ctgacctgca tgatctaagt acacagcccc 762420
 aactcctccg ttgccatta gctttaatgc cagttgttct ttatggacat ggaaagtctg 762480

 cctccttctc taggtactag ggcaccgagt gaatgtcttg catcttaaag caccagctaa 762540
 gcttcataat ctctctgcc agctcacggc ttggcaagta cagcctcctt cettgaagca 762600
 aacccccctg gggaaactgg cagcagagaa gaggggtgggg gaatgaggtt gactgagtta 762660
 gggcagaggc ctcaggggta ctgtctgccc tgctgtttcc aacccctgaa tcccactgta 762720
 catttcagcc ctcaactcaga tcctatactg aagctctgct ggtgttgaaa aggtgatggg 762780
 ggaagtggaa gatttctgct tcacaaagct tgattcctct tattaaactc accacaaact 762840
 gtctgcggtc agctatctca cgaatccaca tcatcgccat gtgtgttctg aaactgga 762900

 atggaggaca caggcacaaa ctgtttcaat ggaataagaa gcaatgaaat attcaataa 762960
 agtcacaaag tcaccatggt ccaatctctg ccttcattac tcattcagta agttctttat 763020
 acacagtggc catcctggat accagacact gcctcatttc tcgctgacct tactagggea 763080
 tgccacagat aggcttggaat tataccacag aactttcggt ttcgtactca attaccaagt 763140
 cagagcaact cctatgattc tgtctcaagg tctgttctct cctcagatat tcttacctct 763200
 agtttctggt tatatatgtt catgatttct gacccttagg agaccacacc aagttttaa 763260
 agggcatttc agctccaaag agagacttca gctatcatat atgcaatgag taatcatcca 763320

 cttagaagaa ctccagaat gatctttggt ttcagggtgtt acagtgggtt tcattgccat 763380
 caacgaagag tagaaatccc tgagcaatgc ctgtttctcc tacattccag gtccttgag 763440
 atcagtccac atatgttcaa cacactggag attacatgct atgttcctaa ggcgggtggtt 763500
 cttaacctat gggttgtgac ccctttgggt gggtcacata gcagctatcc tgtatatcag 763560
 atattgacat tatgattcat aacataatga aatagtagca aaataccagt taggaggtag 763620
 caactaata attttacggt tgggtcagca caacatgagg gattgtatta aagggtcgca 763680
 gtatcagaaa ggttgagaac cactgctcta aagaaaatta catctcaata agcccataga 763740

 acagaggccc taacaaaacg catgaaacag cgatgaaaat taaaaagga atgaggaaca 763800
 gtgagcaaga aagaacaaag ctgcttctta acaatagcat aaagaaaatg acatcagctg 763860
 ctgcctagca tgtgggaggt cctgggtttt gtcacggggg aggggggaga aaatttgaga 763920
 ggaagagaaa tgaagaagg gaagaagtgg ggggaggaga aaccagagaa gtaaaagcaa 763980
 gagtccagaa gcattccat gggaaagaag agaggaaaaa aaaaaataa ggaatagact 764040
 ctactaaat gtggtggttt gaatgagaat ggcctcata ggctcaaaga tttgaatact 764100

tggagggaga gggactatTT gattaggagg tgtggccttc ttggacaaaa tgtgtcactg 764160

 aggggttggg ctttgaagtt ttaaaaagcc cattccaagc tgagagcctc tttctgectg 764220
 ctgcctgcag atctggatgt agacctctca gctactgctc cagcaccaca tcggcctgca 764280
 tgccaccatg ctccccacca caatcataat ggactaagcc agtcctaaat aaatgcatta 764340
 ctttTtaaaa gttgctgtgg tcatggtgtc tcttcacagc aataaaacag tgactaagac 764400
 caaaagcaag ggagatccca ctggaccag gtaagttagt gactaacagc atgtattaga 764460
 cagtttacca cttacaaaac cactctagag taggcacagt aggcatctgt tccttataa 764520
 ttacctaca tctcacacag acctggatag atggacagtt agctaggtgg ctaggtaaaa 764580

 taactaagga ctttggggT acactctctc ggacatcctc atactcatag ggatggcatc 764640
 aagggaag aagctctacc aggaaatcag taaagacaaa agacagaatg agagcaggac 764700
 gtggaccttc ctggatgcta tcttgggagg tctccctgt gacttcagtg aaggccaccg 764760
 ctctctcac aggggcaaac cccgtggaat gattccttct tacaatctag gtaacaaaat 764820
 gcagcttgta cactacgctc ttccagtcct gtggtggtgg tgactggaaa ttgcaaccgc 764880
 aagctctga gtcatgactc ctgctgtcc tgtcccacac cttcacactg agtctctcta 764940
 gacttccctt acatcatccc cactgagtgt tccattagtt tctctgagg atcctgactt 765000

 acacagacaa gcgttgggg tttgtgaaga gaagcgaata tttggattca tgaaattgtt 765060
 tgttctacca tttcaattc atgtttgcaa acctttagca caggaagaaa acagaagcag 765120
 cctattgcat tcattcccca acatctaggg cagaaataga tccataaaga ttgtgttcta 765180
 ctatttgtaa tagccagaaa ctagaagcag cctagatgcc cctccactga aaaatagata 765240
 gagaaaatgt ggiacattta cacaatggag tnnnnnnnnn nnnnnnnnnn nnnnnnnnnn 765300
 nnnnnnnnnn nnnnnnnnnn nnnnnnnnnn nnnnnnnnnn nnnnnnnnnn nnnnnnnnnn 765360
 nnnnnnnnnn nnnnnnnnnn nnnnnnnnnn nnnnnnnnag taaaggatta ccagcctaca 765420

 atccgacta ccagagaagc taataaaca ggaggacct aagagagaca tacatggtcc 765480
 cctggagaag gggaaaggtt caagattccc tgagcaaatt gggagctcgg gaagaggggg 765540
 gagggagcta ggagaatgag aaggggagaa gacggtgtgc aggacacaag ggagcagaaa 765600
 ggttagtca ggagaagaat ggaagatac aagaatggag aaaccataat agagggatac 765660
 attttagatt tacagagaaa tcaggcacta gggaaatgtc tggagatnnn nnnnnnnnnn 765720
 nnnnnnnnnn nnnnnnnnnn nnnnnnnnnn nnnnnnnnnn nnnnnnnnnn nnnnnnnnnn 765780
 nnnnnnnnnn nnnnnnnnnn nnnnnnnnnn nnnnnnnnaga agcagacacc 765840

cacaactaat cactgaacta aactggaatc cagatgcaga gaaggatgag tgaagagcaa 765900
aggggtccag accaggctgg tgaaacccac agaaacagct gacctgaaca gtggtaaact 765960
cttgctcccc agactgatag ctggtatacc tatagcatgg gactgatcca gacccaaga 766020
acatgggttt cagtgagga acctcgaaa tctacgggac ctctgtagt agttcagtac 766080
ttatccctag cataggtgtg gactttggga gctcattcca tatagaggaa tactccctga 766140
gccaaagacac atgggggtgg gcctaggccc tatcccaaag gatatgatag actctgatga 766200
caccttatgg aaggcctcac catccagagt gaggcagaaag gatatgtgat aggtagagtt 766260

ttagttgttg ggggtggggg tggtagggga ggacaggggg gagaaggga ctgggattgt 766320
catgtaaac aatcttgttt ctaattcaaa taaaaaatc tgaaaaaac aaataaata 766380
ataaataaaa acaaaaaata aaaaagatt atgttctaga aacttcatt taaaacaata 766440
aaacaggcag gggttcaaaa aaaagttag ctagcagatc taacagctcc tcatccatgc 766500
taagcaagca atcgactat attcacagct tgcttacta ttttaaggct gaagacccat 766560
cttggctcat aacctgttg tgtacaaca caagtgtcct tggcctcct acaactgtga 766620
tcttcagcta gtccaaatgt aggtcagagt ccaatttctg gattaacaac acatccaaag 766680

tcgaacatga attcagaaca aattatcaa gtaaatgct tctcccaaa gtccactgt 766740
attaattact ttgtcttca gggactggaa gagaggccag ttagggaat gaacggttta 766800
tttgattca cegtccag ggattcagt ccattatgtg gggaaggctt gtggtggaag 766860
caactctgcc catgggtgtg ggagtgtgat ctgcattgt tcatgtgcct caccaggagc 766920
accgtaactg tcaaaggcct gtccctggta acctgcctc accagccagg cccccatc 766980
ctaaggctcc aacccccaaa ctggcatcac aagctgggga atggatattc aagtcatggg 767040
ccttcaagtg catttcagat tcaagcgtg accccttgt caacctcct ttaatacagt 767100

tcctcaagtt gtggtgatcc ccaaccataa aactaacttt gatggtattt cttaactgta 767160
gttttgctac tgtatgaat cataaggtaa atatttttg agacagatgt ttgtcaaagg 767220
tgtcatgac caggttgaaa gccactgcc tagacaaata agacactgtt tgctccacc 767280
atttcgaatg atcaatgtt ttcagacctc agaggagaga tgtcaacttt ctattcacia 767340
gaagtttctc ttataaggca agtatcccag cgtgggcatt cccacacat gtcacctgac 767400
ctctgtgaac tccaaacaa agaatggtca gacccaatca taaaaggaat tcagccagcc 767460
agattcagcc atctctgtaa cccaccccaa ctcttagagg tgtaactttg gaggaagttc 767520

acaccagcta ctgacatgt cttttatata tctctgttac agaaatttt tttctgacc 767580
tgattttgta atcactttgc tttagcaagca ccatatttgg aagtcttggg ctttctatc 767640
cacggaagct ctgaaaata gagatattct tcttagtcac atacagcaa tgtctcgttt 767700

ctacctctaa atagtctagg ttaattgcct cacttaataa ctgcagcag tgaatctac 767760
 agcctaattt aatatcactc taggaaaaaa ggaatccctt tctgtaaaat tgggcttcca 767820
 ggtagacca gaggagaaa gcaatcgtg ttaacatttg cctattcccc agatagatgt 767880
 ggtcttggct aatggtctcc acagt gaaaag aagggcacat ctactctcc cattcaggaa 767940

accaactcaa catgtgtgtg tcaccgggag gaagtcagct ctgtaaggcg aagtgagaga 768000
 agcttgatc tctgtatata aatcacgtct ctttgcaagt acaagtcgtg tccaggcaaa 768060
 gcttattaca aatcagttt gaaatctcaa gaaggaatag gagagaaata acaacagctt 768120
 tatggagcca tctcaggaa atgacttgaa ctcatcccaa ttttaagtt ccctctatac 768180
 aacaagcagc taaaacccca ttttggggg gaactgcccg tacaggaag gtgtggcgaa 768240
 gccatctgct gctttaaact gatagtttcc agccttgttt tcctggcca gctatgaaat 768300
 tgcactaacc acagagacag gctgcttggc caggaagctg tgtgtgccag atacaagtga 768360

atthaagccc gcatgtattg aagctgcaag cttactttgc aatttatgtg caagtggttt 768420
 ttggatttat tgatctggac cgagt gcaag tcctataggg gaagtatgac agatttcac 768480
 tgtctgacag ccaagtctaa ttgtgttttc agtctgaaat gaccaaagac aaaagtgcac 768540
 atgtctcagg tcttcaact ggtgccatat ggagtattag atacaggct gtggctactg 768600
 taagtgttcg ttttaataac tagacacaca ctgaaatctg agcagggcac gcaggagagg 768660
 tgagttttta atgcaaagt gaattaatag gccatctgat cctgcctgaa tgtgggtggg 768720
 ccattttaa gagtgtcttt ttatagacat gattggggga atttaaaaga tgtgtcatat 768780

attactgatt catctgcacc gtgaaacatc caagccaaaa gtcaagtact tcccacaatg 768840
 gctgtcacta aaattatata caatacttct gggaaagcta gcatgataaa aaaaaatcaa 768900
 agagcatctt ctagaatctt actacatag tttgaagatt aacagtgcc aagagaatat 768960
 gagctataat ttctccctgc agceatctct ctctgtctct gggtatctat gtctccctct 769020
 gtctccatct cactcatct catgcacaca cataacgcat gtgtgcacat aacatgagta 769080
 aactcacaa cacacacact gttttataga ggccattatc tgactataga cagtggacat 769140
 taatgcatat gttgggagaa tgtcatctca tgtcaacatg agctgggttc tccagagggt 769200

caggcaagac tgagtgtgga tttaccagtc tttccagat gatttcagac tctttccctt 769260
 ccttttagtg acaccacaac accccacaag cctctctcc tctctacccc ctctctggc 769320
 ttcttcccc taagtgtgca cgtgatgtaa aggagtgtga acacctaga taacttctct 769380
 aatctatat ttgcatctt ttaaaatggt actatcatag tagacagaaa atatggaggt 769440
 ttgctaagaa aattcaaact attaatatta aaaacaaagt gtgctctgat gectgtcacc 769500
 tgccTTTTT agactacgtc aacaatctt acctgttcat tgttacggca tctcccagag 769560

tcacatctgt gatgccaact ccttttctac tgttcattct attaaccag ttatcacctg 769620

ccaatctatt attgttccat attcttccaa gtcccaggac ctggatttgc tagttatgct 769680

ccaagttcag cttattgggt acttttctat tcttgcaata aaacaccaca gccagaagct 769740

acttacaaaa ggaagatfff atttgagggt acagttccag aaaataagag tccatcatgg 769800

tgagcaggca gggcagcaaa cgtcaagcat gacaacggca ggagcggaaa ttgagccctc 769860

atgtctcaac cacaagcact aaacaaggaa agagaattga aagtagctaa ggcttttaat 769920

catcaaagcc ctgctgtgat gtacttctc cttcgaggct acaccacctc acctccaca 769980

aacagcatcc ccaactggca agcaagtatc caaatgctca aggctatggg acatctctta 770040

ctcaaacctc aacattcagt accaatataa cacttctactg taccagcctg tccactctgc 770100

caggcagcct ctctctatct ttctcttcta ctgagctgcg tcaccacat cactacagcc 770160

agttaggtgg gacagccaca tacttgcaact actttccttt atcatccca aggacacttt 770220

aagttgatct tigtcttctg tctatagga caaatcacca caaatttagt atcttcatat 770280

aaccggaatg ccttgtctta ttgtgttga ggtcagaagc tggaaatgag ttccacagag 770340

ctcatttgaa ggagttggca aggttatatc ttctagagga gttttgttct cttggtttct 770400

agtcgcagcc tctgggtct actgcattct ccacctatgg cctcctttct ctatcctcag 770460

agccccgaga gccctccagc tacctccagc ttctctccca cttagtagca ttctgtaat 770520

aatatgcacc cagcagatgc tacagaaaat ctctctgtct agactcttag ccttaatcac 770580

tctgttctca aaggagtcta tggaaatagga tattaaaatc tggggagaag taggaatgaa 770640

aacattatft tactttctac atcttctctg ccaacctttt tttttataat actgcccctt 770700

atftttctat gcataccagc cccactaatg cctacataaa tcttcaaata aaccagttat 770760

ttttgtcata caacctttgt taccctggtc cttcttcagt tcatgcactc ctaactatca 770820

tcaaggcagg ccaagagctc cagtcaaaca tgaatactca tagcatcata tttttgctgt 770880

aagcccatgt catggtttct tattatattt gcatgattat ttggttagtg tctgcctatt 770940

caccagact gagaaaacat agaaagaaca ttctgattt ttcccaactt cattctagac 771000

cataaagcac aaagttaaca ttgatgatt attttctcag tgatgaaatc agtcctgttg 771060

acctgaact atggggggta aacatggtaa catgtatagt tactctacac aacacacaca 771120

cacacacaca cacacacaca cacacacaca cacaatttat tagaatttac aatgagccat 771180

aagttgtctt acttcatctg atcctattca catattctat agagtaggaa ttcaatggcc 771240

aactagtaat agaaagcaca aagctagtca ggaccttctt tgggtcacca gaacatggac 771300

aaggaaaggc taaaggaaaa actcagaaga aaaaaactta atgcagagtg gagacattgc 771360
cagattccat cacttaata aaaatgtagc acctgggttt attcatcccc caccagccct 771420
tcaacaaatt taagtgaagc taaccatcca atcaggttaa tgccaacact tggaaagtgag 771480
gaagtcaatt ctcttataa ggctgtggta caatcagaac aaaaccaaaa agcagcagca 771540
gcagcagctg gagagctgcc agtccccca gaaaagccaa gagacttggc tgagttcagc 771600
atatgcagca atagaagtcg gaggccaaga gaacacgac aagtctccac agagatgacc 771660
cagcttcac tagaagaatc ttctgagaaa gcaaatagtg aagggataga agaaccaccag 771720

aagtatgta aactgcagtg gaagaacac aggacaaatc cagaagtcct tgcagtttca 771780
ggaggactta ggtgagaat gtctgtgcat acccaatccc cagccagaaa aggaaattaa 771840
ttccactcat cctgcagta cccatattgg gatccctgga ggttgtgggt tctatccaag 771900
aaagaattca atggtagac ggagaaattt tggtagaac aagcttattg gaccaaagtt 771960
ttaaagtata ctctgaagc acaaagagaa catgaactag aggaaaaaca aaaacaaca 772020
aacaanaat cctgctttt tggcagagtg aggtgtatta ggattggac tgtgtacat 772080
aagtctttc cattctggag gcaggggagt cttttgatg ctggatagtc aaaccagccc 772140

tgtcttggg tgggataat gaagactttg ctcagcttg atgctaacca cctgttaatc 772200
agcccaaagg tgttaacca tcaactatggg tgaatccta ctgctgggac tttcattct 772260
gtgagggta taigccaaca ggatgcagct gtaagccatt agtgtctctg tggacacttg 772320
tatgactgga ccaggatgtg gtgtagcaac agaatccaag tgattgtttt ccctcagttg 772380
tttctaaca cccacattaa tacaagacat caccacgatg caggtcaacc cagctacca 772440
atcacgtctt aacaacagc gaagccctac acaagcacta gagaatttgt ctagcatgtg 772500
agaattccca gattcatctc tgaatagggt aatctctgt agagaaaagt gtggtacttt 772560

tttaagggg cctaaacatt tactecagga atttgtctac tttagagaaa caaccatgga 772620
agagatcaa taaagattga aatttgaagg atgtatataa tgtgtgtttg gtctttcctc 772680
tttaagcctt tgaatacact gagttttggg agtgcctttg aatcgtgagc ctgtttatgc 772740
taatgaacag acaggatagg tagagagcct agagggattc aggggtggggg ttgaagacca 772800
gaagtatcta atattccttt caccattagc cccaccacat acctccagag atgagaaaga 772860
agttggatat ttaattatga aaactctca ataacacagc ccttgccttc ctctgtctc 772920
tgaaatggg gaaatgtgtg caactcacc ctaatctgt ggggtgggagt taacttcagg 772980

gttagaaca attcaattat ttgatccca ttggtgtcag agatctggag aattgcttag 773040
tgtcagaaaa gacattgtat atttggtgtc agagagaatc agacagatga ggataaaatc 773100
ggagatggaa ggcaattgca tttttgatg gggagaacta gggtcattca agaaaccgga 773160

aatgctactt tcacacaggg aaccctgcag gtgaaactgg ccagataggt cccaattgtc 773220
agcctgggat ttggatactt ctttatactt tgagttttaa ttaagatggt gccagctttt 773280
ttcaacatth gagcttctct tatcacaag gaaacttcta gcaaagacag caatagcaaa 773340
tttataaaat gtatgtacat atcaagaaag aaagcaatta tcttttgttt gcttcagatt 773400

ttcatttgtt ttatthtctg gagttgtttt agacttgaga caggatctca caacacagtc 773460
caggagtttt gatcctccag cctcagcctc ccaagtgtag aatcagcatt ctactaccac 773520
acagctgtaa ctttttgttg ttcataaaca cacatatgaa cattggtaat tagcatggat 773580
gtatacaata cttatgacat ttacatacaa cttcattggc ttttcaccac atagccaatg 773640
tttgtcttta gagctttcat gctaaagatc ttaatcgtga cctcaataat tttaaactaa 773700
agtgttaact ccaggacact ttcatgagca ccttatgtta gcttttctta gcggagctgt 773760
tggctgctat atgccgtgac attaataact ttctcttctt tctttctgtg tctgttgaga 773820

cagggtctca atatgtagtc cttgatggcc tggaaactgc tatgaacttg tagcaatcct 773880
cctgtctcag ccacaacatt aacaattht gaaagaaatga attgagatta ggatccttcc 773940
tacetgaaaa attactgtca actcaactga aacaaattct aagttcagcc cttaatgctt 774000
atthtcatgg gcttaaaagg tgcattht gacagtagga cagctgatca ttgtgtgtc 774060
aggaatagat aagcacttta ttgatcaaga tggaaatcca ccaaaactgt ataccatcaa 774120
catcgcgctc ccacacagtg gttgacctgg taaaacaggg ccaattactt acagecttat 774180
taaacagggc tgagtacaaa gtgagtacac atatagtctt ataaactgag tcatgctttg 774240

gggaggggag gcagtaaggg gatggatgat aaaacacgag cctgagacc agcctgcctg 774300
agcaggagtg ccagctgaga ggttcaggat ctcatgtgtg acaaggaag tctctccaca 774360
aacatcctct tgtgtctaa gccatacagga gcacttggca ctgtgtaaat tcaaaatgaa 774420
tttgtthtat catttctct tgcctcagtg ccacaaacag ctgattttct tttgcagtct 774480
ctaaaagaag caggggaggg ggttgtccc atgaacatcc aatgattcat cctcgttcaa 774540
gtgtaacca tgggagatgc tgccaataac atgctttctt tcttatcttc agttctcagc 774600
agacaacatt ttgtctatat thtttcaaaa gactcataaa thtttcagtt agtgtacaaa 774660

taataacact gtgtaatttc catttggctt ctgtccttgg ggttttggga gaggagaagg 774720
aaaacagggg tgccttagtt gacgttggca gtgggggggt gtgatttctg cagcctactg 774780
gggagtgcag ggagaggttg ggggaggaa catgtgtgta gttgtaaat cttagatgca 774840
ctgtcaaagc agcaggcttc aggtagccag aggactccac tgattgtccc cgtgacaagg 774900
ccagagtgc aaggccagag caggggacta ggatggctcag cctcctgcaa tcaactaacg 774960
tgctctgatg gacaatgctt ggaaacatga atccctgact ctttctctgc cccaactctt 775020

gtcaaattat ttcacaaaa ctgaggaaaa aataattttc aggattactg tatgatttgg 775080

ttactacttc aagaaaattg cctaatacgg catggtaggt acacaaagtg ttatctctca 775140

acattctagt gactgtcctt gggtatgaga ctgactatct acagcaatcc tgcaggactg 775200

tcatgcaagt gacaatcaca ggtaataagc tctcagccca aatctgctta aacataactt 775260

aattccaatt atggccatcc caacagttca caaaaagaca tgtttgagct acaactggta 775320

tttgggagaa caagtgcaaa tctctccatg tgtccagaat gaaattgggt cctattactt 775380

ggtgacaata gtagggccag ccattgccaa ttagtgagat tctggccgga gctctgcaca 775440

gcccttcttt aatttgaagg aaatagttgg aggatgcaaa tcaacattgt tttctacaac 775500

tccaccagtc ccagatatag gaactcaagt cccaacatg ggccccttcc ctaaccaca 775560

gcctgacccc tggiggcttt ttatctaaga gaccaacatt cactatgcca cacaaggaca 775620

atattcccta tatttctctc cattccaagg ctgggagtag cttctcttct ttgctttgct 775680

cacctcccta cccaccagtc aagagcccct ttcccagggt ctattccagt cattttccct 775740

tctcggatga agaaaagcat tcaactctgag gcactctttg aagcaataaa cagcttactt 775800

cttttgaggaa aaataggcaa ttttcgagta acctttggaa gcactctaaat aaccacaca 775860

tatttatggc tgagtgactc ttcggattga agaaactttc agcctgcggt tgcaaagatt 775920

tccattaacg tttttgagc agcctctcat ctcatttta aacaaatggc tagctagcag 775980

aagagaaatt tggtttgttt gtttcaggct ttctctctct ctctctctc cttcagcttg 776040

ccagtgattt gatgcatgca tgaagcagca gcagaagttc aaatggtaac tctttgcca 776100

aagagctcca ggtcagaggc tcatgggtgc ataggtcagc cttctctctc cattttaaaa 776160

gaacctccac ttactttgt ccacttggtc cttcttgag ggataattcc tcaaggaagt 776220

gagggggctc cgggctttct cccacccca caatgcctca ggaagtactt tttaaaaggt 776280

tctctctcag gagaaaatgt tagatgctat atttatctcc aactaatcca tttctcctc 776340

tactcctaga ttaaggaatt aatggctgct acagctgctg tccttagcaa ttactgtaaa 776400

ttggttacag cctcaaaaa tatccactca tcaacaacag tgagaatcca ggttctatgc 776460

agagcatcag gtacacagcc taagtaataa atcagtgtct catagagtac aagatctaca 776520

cagcctgagc cctggggttt caacctgga ggccagagga gataggtgat aagggtggac 776580

atacatcata tgcacatata acttctctca aggccacag tgaatcaaat attaaggaaa 776640

ttccccctc attgatcaga gtttcacca cagcaagccc ttttaaggtca tttctcagt 776700

tgctggctgt tctaacgtct gctttacct ttgcagatag gacacagtaa actctcagag 776760

ttagcacgac ttgtcctacc aggttccctt gcctcctgta ctctggagat gacacattcc 776820
 atcccttagc tcacacacat cctgtctcaa aatcttgcca caggccattt atatcacatc 776880
 tgccatgat ggtaggtat tttcaaaaga ccagaaccag aagaccatgt tataggtagc 776940
 atggataata taccatggat tatcatttgt gataggaggc taagtagaat ggccatgaac 777000
 atactacaga aactgagaac tcagcttcta ctccgtccaa gaaactagaa catggggtac 777060
 caacatgca gccccattt gatgctaaaa gcttaaattc ttccagaaga ctagcagcaa 777120
 aagcatggaa agcctgagta ttctggagtc tgatacccat ggtcaatggc ttagcagta 777180

 gattcgtagg aagagtggag ttgcataca ttggatggat ttctctgctt tcacataatt 777240
 ccatcacaga cccaacctt ttggatgata ctgtccacat tcaggtgagt atgtctgctt 777300
 cagtcactat gtcacctatc aattccctct agaaagactc tcacaaacac agtgggagcc 777360
 aaaaattatt aatgctggac acctatcact ccaatcctat ctataatcaa aactatctat 777420
 cacactgtcc aattctttac ttggtacagt atggacctaa aatgtatctc agagtcacac 777480
 actgatgggg gatgtccttc tatatgctat gaatatacac ctgttgtact gtgtcatcgt 777540
 gggtagctaa gattttcagt gtgacaatct ctttacctgt cacgtcaggg tacatagtaa 777600

 acaaaggctg aacatagatg agacttctcc aggtagaagc ctgtttggaa atttactttc 777660
 agttagacca ggctgggaag caacagagaa ataaagccct gttgctccct gaggagaatc 777720
 taccgtaac cegttttctt tctctgtagt tcacttagag tcaaacctac cacttagctg 777780
 atgataacag ctcttatag ctttagccaa aatagcaata atctttctgg ttccagtttg 777840
 ctgtttgac ctcacctaa aataattgct gagttaggatt ttaaaggctc agaagaaaat 777900
 cagataaaaa gcatcaacag ggctaatgca atatctcaac atcactataa cagtaaccac 777960
 ctccctatct tgaagttca cctctagact ccaaagacgc cagggtgcag aggtcacagc 778020

 atcctataca tggttctaa cgtaaggcag acaaccaag ctctgtctac agtcagcttg 778080
 agcaaccag gttttcactt cctattacac cctgagatgt ttctcttctt tctctctac 778140
 cttccattac ttgctttta atgtcaata ctaattatgg atttattta taaaaccgtt 778200
 ttgcaacat cctggggatg cagaggggaa gggaggacaa gaagctgaat getgagaaag 778260
 cctctaagga tglatccatt cattctttt aaaaagcgtg tttagaagtc tgtgagcatg 778320
 caaggaactc aggtgtggtg atagtggagg tgggtgggtg ggtgggtggt gtgggtgtgtg 778380
 tccacaggcc tglgaaggcc agaggctaaa attggttgtt gttcctcagc ttccttccac 778440

 ctgttttat tgltagtggg gggtttgtt gatttttggg tttgtttcat tttgtttga 778500
 gacaggtctc cacatcagcc aggagctcac aaagtaatct aggacagctg accaataaga 778560
 tttagcatcc tcctctctcc actacttagc tctggacaca agcatccagc tttttaacat 778620

ggattctaag ggicaaactt aggttctcgg gcttaggagg aagttcactg actaagctta 778680
 ttgccccac tcagaacaca gactttaaag gcacaaatta agagatgctc cagtgttgac 778740
 cagttgctct ccatgagaga tgctctgggtg ttggacagtg cactctccat gagagatggt 778800
 ccagtattgg ccagtcgctc tccagcctcg atcccttgtg ctttatgggtg ccaatactga 778860

 acagagcaga ggaacgggtca cttcacaagc ctgcctagca gaagcatcac cccaaaagct 778920
 tgctgaatgt gtattccagg agcaaccaca ctgattaagt tagagttgtc cgcagagtca 778980
 acatgagagg aatttttaac atgatcctca acaactgact agttggaagc agcatttgac 779040
 agtacctctg ctggctcttt ccaagcacat cattgtagag gtccccacct tggtgcaca 779100
 gggaagtgc ctggggagct tcatacacac cacaatattc catccaatct ggctaattca 779160
 ggcagaagct acaggggtggg gagcaagtgt gtgcatgtgt gtcagcgtgt gtgtgtgtgt 779220
 gtgtgtgtgt gtgtgtgtgt gtgnnnnnnnn nnnnnnnnnn nnnnnnnnnn nnnnnnnnnn 779280

 nnnnnnnnnn nnnnnnnnnn nnnnnnnnnn nnnnnnnnnn nnnnnnnnnn nnnnnnnnnn 779340
 nnnnnnnnnn nnnnnnnnnn nnnnnnnnnn nnnnnnnnnn nnnnnnnnnn nnnnnnnnnn 779400
 nnnnnnnnnn nnnnnnnnnn nnnnnnnnnn nnnnnnnnnn nnnnnnnnnn nnnnnnnnnn 779460
 nnnnnnnnnn nnnnnnnnnn nnnnnnnnnn nnnnnnnnnn nnnnnnnnnn nnnnnnnnnn 779520
 nnnnnnnnnn nnnnnnnnnn nnnnnnnnnn nnnnnnnnnn nnnnnnnnnn nnnnnnnnnn 779580
 nnnnnnnnnn nnnnnnnnnn nnnnnnnnnn nnnnnnnnnn nnnnnnnnnn nnnnnnnnnn 779640
 nnnnnnnnnn nnnnnnnnnn nnnnnnnnnn nnnnnnnnnn nnnnnnnnnn nnnnnnnnnn 779700

 nnnnnnnnnn nnnnnnnnnn nnnnnnnnnn nnnnnnnnnn nnnnnnnnnn nnnnnnnnnn 779760
 nnnnnnnnnn nnnnnnnnnn nnnnnnnnnn nnnnnnnnnn nnnnnnnnnn nnnnnnnnnn 779820
 nnnnnnnnnn nnnnnnnnnn nnnnnnnnnn nnnnnnnnnn nnnnnnnnnn nnnnnnnnnn 779880
 nnnnnnnnnn nnnnnnnnnn nnnnnnnnnn nnnnnnnnnn nnnnnnnnnn nnnnnnnnnn 779940
 nnnnnnnnnn nnnnnnnnnn nnnnnnnnnn nnnnnnnnnn nnnnnnnnnn nnnnnnnnnn 780000
 nnnnnnnnnn nnnnnnnnnn nnnnnnnnnn nnnnnnnnnn nnnnnnnnnn nnnnnnnnnn 780060
 nnnnnnnnnn nnnnnnnnnn nnnnnnnnnn nnnnnnnnnn nnnnnnnnnn nnnnnnnnnn 780120

 nnnnnnnnnn nnnnnnnnnn nnnnnnnnnn nnnnnnnnnn nnnnnnnnnn nnnnnnnnnn 780180
 nnnnnnnnnn nnnnnnnnnn nnnnnnnnnn nnnnnnnnnn nnnnnnnnnn nnnnnnnnnn 780240
 nnnnnnnnnn nnnnnnnnnn nnnnnnnnnn nnnnnnnnnn nnnnnnnnnn nnnnnnnnnn 780300
 nnnnnnnnnn nnnnnnnnnn nnnnnnnnnn nnnnnnnnnn nnnnnnnnnn nnnnnnnnnn 780360
 nnnnnnnnnn nnnnnnnnnn nnnnnnnnnn nnnnnnnnnn nnnnnnnnnn nnnnttttac 780420
 accccatccc catatccatc cctatttaca tctacagcca tgaacaggaa ctgcaggaaa 780480

gacacatct ttacatgata ggccaggcac aagccacagt tctttttttt ttttatattt 780540

tttttttttg atttgttaga tttttaataa gaacatggaa atccaatca gcccttcaat 780600
aaaattaaag tacagaaagt gaaattaaaa gtattctaca gtaaatgact tttattaaaa 780660
aaaaaaaaa ggctttgtga acactcagag gccagagaag gatgcatgt gttgactgt 780720
cactctccac cttattccca tgaggccagg gtctctcact gaacctggaa ctaaggggct 780780
agtcagcaag ccctaccct cctgtcteca acctccacag tgctgggtga gtcatacccg 780840
ggttttcatg tgagtgtga catgcaaact caggctctca tgtttgtgca gcaagcactc 780900
tttcccatgg agccatcttc ccageccccag tctgggaatt ttcactccca tccacactac 780960

catcctatt tacatctaca gccatgaaca ggaactgcag gaaagacacc atcttiacat 781020
gataggccag gcacaagcca cagttctttt ttttttttat attttttttt tttgatttgt 781080
tagattttta ataagaacat ggaaatccca atcagccctt caataaaatt aaagtacaga 781140
aagtgaatt aaaagtattc tacagtaaat gacttttatt aaaaaaaaa aaaaaaggta 781200
actgtgaaca tataaacaag gctgcagggc agtacacctg gaaagagata catttcccaa 781260
tgtacctatg ggccagttaa ttccatcatt tccaagtaaa ttcttaataa aaacgccact 781320
gagtaggaaa gttttgtga aaatattttc agacaaaact ccaaaaaaca aaaccttta 781380

tattgaaac caaacttccc accccatttg gagaggcagg cggagtcca agggaacgct 781440
ggtggtttgc aaacggctcc tggagtgcag agtgtgcacg aaggggtagc tccacagctc 781500
agacatgaca cggtgctttc ttggacaact gctccctcaa gataaaactg agagggagtg 781560
ggagagacta aaagaattct aataaaatgc caattctttt aaattacgct ttggctgatt 781620
ttgtgtata aggacagct gatttctaaa aatcatatct tttcagagtt tcattggaag 781680
gaagactaga gcaacttgcc tttctcata gtccaggaaa acaactgtta tttcaaaagt 781740
tctaaaaata tctactttca tgaaatagta actatttcac tacaaceta tttttcacta 781800

aatacacacg tttcctaate ctggagtctc ctgggaaaag ctgtgggctt ttctgggctc 781860
ccaaagactc cagtgttccac agagagtatg gggaatggct gcatccccac ctctgggat 781920
gggccaggtc agaagtcatg tgcggaaaca cggccaggct tccccaggc acatgaaatc 781980
atctttttac cagttatgat ttctccgcc tccaaacaca accccaatca gctaggcaca 782040
agaggaacag agaatgaagg tgtgccaca ctctggttt ccatggtctc aaaccaggag 782100
aatgtcagg aaagcccagc gatggtcaag caacctggat tcccaaaagg ccaactgaatg 782160
ggaatgtaag ccacagtctt taaatagatt aaatgtcaag gtgctgattt acaagtcttt 782220

gctagggttt taataagaaa tgttccccta tgtatttgag catttggttc ctacctagtg 782280
gttctttgga gagatttga aacccttaag acacaggac tagctagcca aagtaggctc 782340
ctgaaggcca gccttgaagg tagtgaactc tgggcagaat tcaactgtcgc cagttccagc 782400
cagagctttc cgctttctgc ctgccacat gacgtgccca catccaactg ttgctaccac 782460
agttggagcc tctccacat gccatctcca cagtgggtga ccattacctc tgaagcatga 782520
gccaaagaaa gccattcctc ccttaaatg ctctgtcaag catttatcac aagcaaatta 782580
tctaattgag acatcttctg gattcccaat caaaactgcc ataccaaagc ttctagaaga 782640

cctagaacaa ataatccaga ttaattttgt ttattaactt taaatttgta taagcctatt 782700
taaaatctgt gtccacatt agttgcctgt gaagagaact tgcctagtgt gcatgcttgc 782760
ttggtagatg gaaggttgtt ctggatgta ctagcctgtg tggcaggaat gcacaaaaga 782820
atggcctgct ttgttctggg aacgaagaac agcctagatg tcacactgca gttggtagca 782880
actcctgaat tatgatgctg cttccatttg gctcttcaact tccgttcccta ttgctatatt 782940
attgttgctt cattcctttg tcttgtttgt gtgtgtgcat tgactctcca gacttgcagg 783000
ttctcccctg aggaacctga ctgagacaaa actcttactg cttcttctac ttccaccctc 783060

agttactgcc tcatagaaga accacgcaca tgtaccgtga tgctcctcca ggcttcatcc 783120
aggctgcatt cccgcttgtt gttttgtttt gctttttaga gacaagcttt ctttccctgt 783180
gcagtcctcaag ctgcataaaa ttcacaatcc ttgcctact cccagtttcc aatatgactt 783240
tcagggcctc aactccaagc aagaaatgaa tggtaaaaca ggaaagtgga agccatgcat 783300
gccctagagt tgatccatgg ttgattctcc actgcaggaa aattatactg gaaggttgta 783360
cacacttctt agactggcca atttctgaa gaggtaagcc attaaaacac ttgaggagaa 783420
caaagtggaa aataatggac tcttgggggg ggcaggggct attacatgtg gcatgtgaat 783480

ctgactgctg cctggaacag gatctctcca tagcagcctc cctcacattt cccactgggt 783540
gagtatttat tgtggggctc tcaggcacta caggaagtta tcagcacccc tcccctgtgt 783600
ctactaaaca ccaagaaaga agctcccca ctgccaccta gctgtgcagc cagaaatgct 783660
tctcaccat gctgcatgct ccttggagag gaaaagaaaa ttataccagg tgaagagctc 783720
ttgctctgga acaaagtctt acataaaaga caatataaat tggtaagaga aatgaaaaa 783780
aattaataca caacctttct tcaagttaat ttagtcatat aacaaaataa ggataattaa 783840
gcacaaaata tttttgaagc aagaacttaa gctttttatt tcctattaa aataaacatg 783900

ttccatgctg ggcatagiga tataacctg taatcacaga gctggaaagg cacagatggg 783960
aggatctcaa tttgggtgct atcctgggct acacaaagag accctcatat ctgggttttt 784020
ctttttggac tgccaaccag ctcccaata aagacacaga gacttattat taattacgaa 784080

tactcggcct tagcttaggc ttgtcagcia gctcttttaa attattttaa cctgtttcta 784140
 ttcactaca ttttgcccag ggacttttac ctttctttta ttctgtatgt tctactttcc 784200
 tgcttcctct gtgtctggct ggctggctcc tggcatctcc ctggtgtctt tttttctttc 784260
 ttcctcaagc ctaaattcct cctcctatit acttgccttg cctagaagtc tgtaggagac 784320

accataacca cacctgcttg gggctggcta cagggtgtgcc tgaccaagcc tgccaggag 784380
 tggtcagggt ggcataggga aggtttaaga gtgaggagca tgccgtttct tccttttcat 784440
 cctctgtttg ctgtacttac tgctgccctg ccggctggca aggttgctct gtaagtaagg 784500
 cttttccta ataaatacc ttgtatitit acctgactcc gtattggtaa ttcagctttt 784560
 tattagatca attagggtcc ttaggcaggc aagataaaac agcaacacat ctttacataa 784620
 ttaaacaat gcaacacatc tttgcatagt taacaataa tccacaaca ttcctatct 784680
 taacaaaaa aatgttgatt atcatititaa aatgttaaca ttaaaaaaa aaccttttag 784740

aaagtcttca gctaccaga agaggaaaga cagcaggacg taggcaggaa aataaatgtg 784800
 caagctcaat ctatititit taattgccat ttatgttaaa ttatgattit gctatatgaa 784860
 agtttaaac tcaaaaatgt aaatgaaaa caaaaagtga aaattaaat atatcataag 784920
 aattaacatt caacatatga agagtttatc aataattcta taaaaatgtc aaactgag 784980
 actgtgactc ataagtagcc agaaatacac agaaaactca caaaagagga catccaggaa 785040
 aagagttaga atgagcaact aaaatctcca gcctcctag aaaattaatg ttttaattaa 785100
 acagtittac ccaaaaatt attgtgattt gaataagaaa agattctgca ctgatgtgga 785160

taagaaggaa aaggcattca agtattgcag acatititit aattaacaca atgataagac 785220
 ttaaataat tcactttgca taatctgtcc taaaaaatga tactaattit tttcaagagc 785280
 tcaaagatgt gcattatagc attaagtaaa ataatgaaaa atcaagtatc acctaaatac 785340
 ccaataagta agctgtgttg cagaagttac atggtagtga tgcaatgtag tgtcatgagg 785400
 ccatttaaaa atigtitaaa ataacaagta caggatcata ttaaagcat tactgcaacc 785460
 acacacatag atataaatag tatacataga tgatagatag attatagatt tatgattaat 785520
 gggtagcata tatatagatg atgtagatag acagatagat agatagatag atagatagat 785580

agatagatag atagatagat agatagatac atcttttaaa ggcaactaat aagtacaaa 785640
 tgctgacagc agcctgggtg agcaaaactt ttcactcctt atatttcata atttcaaat 785700
 acttatagta cacatgtatt actttcacca tggaaaacat aacctcctcc aaaaatgatt 785760
 gttttccaaa agcacactct gtgtactgag gcattaaaat cagtgcacc actccagtca 785820
 tgtttcttc aaatgagct actttcacia aacattcaga tcaaaaaatg ttgattgcag 785880
 ccaaggaaag ctaatctgct ctaatctaag ggcatcacc ctcttgcca cacgaacacc 785940

tggggaagat agttctggaa cacccagaag aagcttaaag ttaaagagag gatttttttc 786000

 tttattcttt agccacattt ttttttact gcacacatca aacaggctct tctccacatg 786060
 tcaacagaaa atcccaaaga gagaaaataa catcaagtca gttcatgtcc taaggtaacc 786120
 cttttttaa agagaaaaga gaattgaata atgaatgact acctaataa cctttggtat 786180
 agattaatct gatcaataa atttattatt actctattcc ctttatcata ttcacccata 786240
 agacatagga gaaaagcaaa atatatgaca gggacttaag tctgagttgg aaattaggaa 786300
 gaagaaaaag gtagatgaat taaagaatca ctgtttatca acaattcaag tgaatttgg 786360
 gctttacatg tatctatctt agatttgttt tgtataggct tttgtgttaa aatacagaaa 786420

 gccatagaag gtcattacag agatatgtca aagggccaca aaggtgagaa gattcttaga 786480
 atcccagtcc cagattaag taaattacac aattaaaca gtaggagagg tcttcagcca 786540
 tcaaaaagag gattgttctc cacccagaag cagtctctg gttcttaagg agaatacttt 786600
 ttggactatc atatatgact tcatctatcc ctgtattata ttccaagtca cagatttcac 786660
 ctagaacact ctgtgtctc tctcaccatt ctattccatc agtcttgta tagatagata 786720
 ggggaaacat cagtactatt ccaggcagaa aatgctctag agaggagat agacacagaa 786780
 ctatgtaacg agaactcttt ccaccagctg cctgagttct gctgcatgt ttgggcccc 786840

 aaataacaca cagagattta tattagttac aatgctgctg gccaatgact agatttccta 786900
 tctgctagct tggctttaat tatcaaccaa ataacaacct atctatata tttataaag 786960
 aattatctga tcaaggactc tggcagcatg tgcctctct tgccaggatc acatggtgac 787020
 tcatttacta gatttccag aatctctctt ctctctagt cccgcctaac ttgcttccct 787080
 attgaccaac agcactttat ttatcaacca ataagacaaa catatataca gaaggacttc 787140
 ctccatcaga actaagtgtt aaaacacaca tggaggttac caaaaagaga ggcaagactt 787200
 gacacctagt tcaatataat atggtacceca ggttttctga atcaaaaaga aaaagagaaa 787260

 tgggatgcat ggtccaacaa tcataaagga acttctgagt taaatggggc agaatatttt 787320
 ctgtctgggc taactcagaa aagaaatcca tagaggtttg tgttattttt atttttcat 787380
 tgagtgtgac tgggagttat agagiagagg tcaggatgaa agaggagga gagccaggta 787440
 gaaaggaag aaagacagcc cctctaagct ttgagtacta ggttattttc tttctctatt 787500
 caagcatgtt ctcttggact ggaaaaatct ttgttaaact gatctgaggt cgtttccatc 787560
 ctcatgagaa atctgatgca gtatttcac ctaaacatta taaagcttgg cattaaaagc 787620
 ttcccaaagt ctattttccc ctggagtcag gtaccgttg tcatttgctc acacattcct 787680

tctggcagac ggctttatga tgattcccat gggcagctgt gggctggaga gcatccttca 787740
 cacatgactt cccacagagt ccagaggcca atgggcacaa agagaaagcc agtccttgg 787800
 attgatgatg gctcccatTT agagcatgtg tatggtatcg tctcttcata ctgcttacct 787860
 gagttttatca cgtactatca aaactcagaa actcatagcc tcagactcaa aaacaagttt 787920
 gtatttaaaa taccactcc tcctgtgag tccaggtact atTTTTTTTT ttttgagtgc 787980
 ttactgcagc caatggtctt caaaaaact acctcttcac tgctgtctct gcatggaagc 788040
 agaaaggttg tgagcaatga ttgtgagcag aatatcacc aaaatatggc catcatgtgg 788100

 tttaaatata tgtcccccatt aggctaatct gctggaatac ttgccccca gctgagagta 788160
 ctcttttagga aaattgtgga tcgtatgaga gacagagctt tgttgaaga agtgagtcac 788220
 tgtgaacatt gagatttcat agccaggctc agctgactgt tcactctcag tttcctcagt 788280
 gtagatgtct cctgctctag ttgccatgtc ttccatgcca tggtaagaa tgcactacc 788340
 tctctggaac tagaagccaa aactggtcct ttctccctta tgttgcttct gttagagtta 788400
 ttttatcatg caacaggaaa agaaactaag ataggtcatt atgtttctg aaacaaaaac 788460
 tgatatTTat gggctgaagt atgcattgca ttcaatacaa tggagatgag gaaagagccg 788520

 tccttaaaat cagaatagaa aatccatgac attggtcact ggagcagcac aatcacacgg 788580
 ggaaaatcat gcttgaactt tgatttccaa ataattttta atgtttgtag gggaaaccgt 788640
 agccacgctt ttttaggggc tggctacagg tgtgcctgac caggcttgtg agggcgtgg 788700
 cagagtgacg tagtgggact gtgtttttgg tttcccactt ctgacaccag atattgtggg 788760
 aaattacca tacagagtca ggtagaaata taagggtatt taatagggaa aagccttct 788820
 tacagagcaa cctagccatc aggcattgta gaggtctgta cagcaagaag caaagagaaa 788880
 ccgaaaccga aaacgcagtc ccaactactt gaccacacc tcacaagcct ggtcaggcac 788940

 acctgtagcc agccccaaag aaggcgtggc tacggctttc cccgttatta aatttgaag 789000
 acataaagac aaggggtgaa tgctagaatt acatatctta gctaattaag ttggcaagcc 789060
 acctgtgtgc tttgtaaag tagtgtgtgg tgtagaagag ggatgtgctt gctctgccgc 789120
 aaaattcccc aacacacttt caacctgaaa cataaaacaa atattgagta caaaccttc 789180
 tgggagtTgt gggaaagtgaa aagaacatac atTTTTTct cactttgtga caaggaagaa 789240
 tagtgggtgg tgagtataga gagacctgaa gactgaaata gcagctttct agtctgtggt 789300
 cgaggctgtg gtcagaatgt gtgctgcaga ggcagaagga actggaggct gggaaacaca 789360

 gagaaagcaa cctctaaaca caactttcca gctgggtgtct gaatcggaga tgaagtttct 789420
 gttattatct attaatgcta ttgattaaac caaatgcttt tatgcatcca ggatatagtt 789480
 tgcgtttaac atatttcttt taaataaaga tttttctaga ccttacagct tcccgtatt 789540

gaatgcaat tttttttct gttcaaaggg caacctgat gtagaaaggg ctccaatct 789600
 gggcagcaaa tagggattcc tgggccactg gaaaaggcct ctgtgaacat gaaaaccaca 789660
 gctgcgcaac ctctagtgcc ttttctctc ctgtgaatgg cccaggagca gactctcaca 789720
 gtccacagct ccaacagttt ttggaacccc atagtattg tttgggaatt atctctagcc 789780

 attccaagta ctatacaaa atacctgcta ctgagccatt gatgggtaca gaaatatact 789840
 tccaatggtt ccagagattg aaaatccaga tcaagacctc agcatcttg aggtgggttt 789900
 ctctctatct atgtccatgt tagggcctcc ctgatgtgta atcatagaac agaagggtat 789960
 aatccagtac aggcaggacc aatatttga cattgtggca caataatgtc atctacaatg 790020
 ttcatgctcc aggaaagcac aacagataac aaaataacac aacaaacttc ataattttgt 790080
 gtcaggctac atgcaaagct atcctgagcc acagattgga cacacctaga tagtgcccc 790140
 aactgcatt ataaggcat agatcccact gatgagggtg gaaactttat ggcctaatca 790200

 cctcctaaaa ggcttcttgg cactatcata ctgagtttga atatgaatct ggggacacat 790260
 acatgtaagc cagagcaag catgaaatct gggacacctt cataggcaca gtattcttag 790320
 atgaggagaa actctgtgcc ttggggcagt ggggggtgggg taagaaaaca cttctggata 790380
 aatcaaccc cttccaagg agagacattt cctgaccac caaaaacaag ctccagaaga 790440
 aagctgggaa tgaacctca tgctaggcaa gattgtgagg gaagagacta gcattgctcc 790500
 acaccgaca catcagggtt atcttcacac acaggtagat tttcttcatg ttgagttcaa 790560
 acagtggccc acagagaaaa ttctagacac tatgccctgg gactacttgt ctttaaagtc 790620

 ataaatacag ccagacagat ggctcagcaa taaaagtgcc tgccacacag cetaacaatg 790680
 gaagtttaat tctgcacct acatgatgga aggagaaaac tgactttgac aagttgtcct 790740
 ctgaccctg aacatacaca cacacacaca cacacacaca cacacacaca cacacacaca 790800
 caaataaatg taatgaagta aaaaacacag agatcaatgg gtataatctt cctcaaggac 790860
 aagtggtgg ttcttttcaa aagcctttgt aatacatatg tattattaga tcaagcaagt 790920
 tcccaactag gaatgtgtgc taaaagaaaa ataaaaaat atataagggt gcacctagaa 790980
 agatgttcaa gaaaataaaa aatgaaagat gtccaaccta catttcttcc caatactaaa 791040

 aaggtagaaa caaccgaaaa aatccagtat tgggggtgga ataaataat gaatcttagt 791100
 atattggtat gttatcatt taaaactagt gtaacagaaa aacatttaat agaatggtat 791160
 gttactaca aggaaatagt acaaaatcat atgaaaactt gatttcatat ggggactcta 791220
 agaaatatac aagtaaggaa aattaagaaa atcaagtctt ttacttcttt tttaatatc 791280
 tggagccatt ttaaaaatct gtgtgaagat gtatagtctg aaatttttaa aaaagtttta 791340
 caactactac ttttaagttt ctaacaatga aaacttcttc aatattaatt atcagcatag 791400

atgtgggat aacaaagaat gaacatggtt gttcctacat atttttaaat ttttattgtg 791460

ttgaaattta ggcttaactc aactcaaaaa ctgtcccttt aggttgatat cgaagctaat 791520
tagaattgca ttttctagtg agaaaagaag gagatgcttg gctccttctc tgcattctct 791580
tccacattga aactctgatt aagattatit cttctgttta ctagactgga tagattctgt 791640
agctctaact ttctcctgaa gtaaagggtg taatttgcac taactctgat taccattctg 791700
aagactgtgc cggttgcatc tgctatgtac tgtgcagtga acgtttgatt atctgaggag 791760
acaaagacag cacaggtaat aaaaatccat ggagactacc taaacttcat gttagccaga 791820
agtgtcagat gtttgccaac gttgttagca aggaacaaag cggatttgag ttttaagctca 791880

caactccctt ccatatgctc aagattatgc taagaagaga gatgaccagc cacaggggca 791940
gccttaggta attcctagtc gggaaaattg gtttctgatt aatcaagatt tggcagaatt 792000
ggaccgcaga cacgcaactg tctcactgta aacaccaaac caaacaataa cagcagcagc 792060
aacaaaaacc tactattcac tgggccaggg agatggctca gtgggtagtg cctaccgtga 792120
aagtatgagg ctatgagttc aacctacac ccatataaaa aagccaggtg tcatagggca 792180
cacctctaat cccagagagg aagagacagg agggatatct ggggcttgct acccagccag 792240
tctagctgag tcatttagct tcacattgag tgagagacct gcctcagaga aacaaaggca 792300

agagcaattg aggaacacac ctgatgttga cctctgacct ttatacagtc atccacacat 792360
gtgcacacac accttcgtag acacaaaaaa gtttccctct gttgtgtaac atgccaggg 792420
gagctcattt tactcatgtg tcacagtaac atgaacccca gtaccctac acacagagaa 792480
tagacagtga actcatttcc tgtcatatta tcccccaaaa tcatctaata aaaatgtcta 792540
gctatgtata atttatagtc attgcaattc tgtataccag attgatttag attgaaaaat 792600
tgcaatgagc ctcaaacctc atgtctatg attacaacgt tttggaaatg catattcttc 792660
tatgaccttt cttgagctg tgcaagccac agaggttctt tactatactc ccatggactc 792720

acatacaaac agaccctaac ggtgcccatg attggattta acagatattt ctgatacccc 792780
tatacccaca cttattgttt taaaattgaa attaagaaag ctacgtcggg cttttcagac 792840
cttatgaaaa taccatgtct ctaaaactgc cttttcttta aggaatgcca taaattgact 792900
gataggcatg tcctacatt cactttttaa gattctttca actccataag ataacagtag 792960
atttaagttt gtaggtttgt gtgtgttttt ttctccac aacaaatatg aaaaagataa 793020
gttgtaccaa aattcttagg cgttttaatt gactaacagc cagtagtaag gtaagaaagc 793080
tccttgagca gatctaacat cagaggcatg gcattggctgt aagctgcctc tagtgcactg 793140

gagcgaagat tggtaggctc ttctaggctt ctcaactgga aatTTTTtagt cctTTTTgca 793200
 aagtataag actttcttta cctagtcat agacaatgaa tgtttctctc ccagaaaaa 793260
 aatcccacct ccatcaaaa ggaagaaatt aggaagaaca gcagtcaatt tactcgttgc 793320
 tggctctcag caatattaag ttattgccac caaattaa gtcaaactg agcagccatc 793380
 ctcagttact ttctgtttc caggctgagg agctagcctg gtgggttaa aagtgctaga 793440
 cacacaagca caagtgatcc ccatcaccg cctcaaaata cagaggtggt agtactctgc 793500
 agagacataa agagaatgat ccagccctca tgggccagcc agtctagctg agtcaggag 793560

 ctcaggggtc agtaagagag agagactctc tctctctcaa aaggagataa aggatgacac 793620
 ccaatatcca cctctggcct ccacacacac acatgcatgc acatagaaca cacacaaagg 793680
 aagaggagga gtaaggggag gaggaggagc tactcagaag gaaaagaagt tgctgatgta 793740
 ggtttcttgg gctaaggatt tgctttccag tgcggcttt cttgctttaa taataggact 793800
 tttctcctag agtggtaagg aactatgact ttctctctg agttagctta tttccatcaa 793860
 gcctgatact tgctttcttt gtatcacatc agatgcaatg aagaagagcc aatacaccac 793920
 gatattgttc ggagatttct ggcattaatt tgcaagtttt ccagtaattt ctctccaggt 793980

 ttttttttaa gacaaacata tgccctaac ctgaaacga cccagacaga cttagtaagc 794040
 cttccaggt ctataaaat taagcttcaa tactgactga cccatcaggg ctccaaaata 794100
 cccctgctat tccccccca aaaaaaagc ttccaagaag taggattgga gaataaataa 794160
 ataaataacc aaataaataa atagtacct acctaaacat gaaggaagga gccatatata 794220
 gacccatac acttcaggct ttcaataatt gctaatttta aaggaagcac atcctagtgg 794280
 tgatgataga gaaaactgtg ctttctgtga ttaaaaaacta tgatgctaata tcatgactca 794340
 aagctttcct gaattggcaa tgttttttt ctcagctttt atttttaaca cttccatac 794400

 accgttacct catttcaact tgttgaata gactcagaca tggcgagttt cagctccaaa 794460
 ggaaactgac acatgtctca gagccagtct gaactcacgg tccagttaaa ggctgcttgt 794520
 cacatacatg caagtccta catgtagaag cctcttcaac cttgttcaa aaattgactt 794580
 ccatttatec tcctcccca tccatgaca agggcgagg gatggatagc tgtgtgtgct 794640
 cttagggcaa acagcatctg taaagtcctt ttagtgaggg ctctgaaaat gggacacagt 794700
 ttagtacaag agcacaatc aaatgaatt cggcacttct tgaatctcac aggaattga 794760
 aaattatcac ttttttaaaa acttagtgat tgaacatgt ttagaaggaa aaagaattgc 794820

 agattcagct gttacttag attaaatgtt cacaggacct gtcctgtta tagatctcta 794880
 catgtcacat gtattttaaa ccaacatag agaccaaact gggcctttta tcttctatt 794940
 tttaaaaaa ttcagaaaat gtccagaata aaggaaaagt atttcatat attctctaca 795000

gtaagattcc agaaatgacc cttaaattcc ctttatgtag ttgcattagc tacaagaaac 795060
 aagtgttgtt gtttaggttg ggtttggttt tgggaacaag gtctcactgg gcccaggct 795120
 ggcttggaac tcaactctata gctcaggcta ggggctcagg ctggcctcaa gatcaccaca 795180
 tagctcaagc tagctcctaa ctcccagacc tgaactcac attgagtgtg ctgacttagc 795240

 ttcccatgca cctgcgttac agacaagagc ccaactcctgg cttggttttt ctttacttgc 795300
 agacataate tatccagata gcaacttttc actttacctc aagcctagac tgacacactc 795360
 taactgggac tcttcccatt ccaccggtaa acttctctaa agacaagtcc taactattta 795420
 ctttgcctgc ctcccgtcc aagaatggga aaacctggct ctacccccac cttcagccaa 795480
 tctcattaat gtccccgtg aatggtggtc actcacctc aagactgcac caagatgacc 795540
 tgccccttga ggctgtcaa gtcctgaca cagctgatga ccttggactc ccatccctgg 795600
 tgctatacaa agacattttt gtgttttctg agagcagtta gcacaatgcc atgtactatt 795660

 gctttttctc cccaccaatt aaaagaatgc agagtgttc agtcctatit atctttatac 795720
 ccataccacc tgcccagcct ctagaatcac ctatccaatg aggcatttca atgggggaag 795780
 tgaagcagac agcccaggct gctagtttca tggcaatcaa cacaggtaga tttagcctaa 795840
 tttttgtttt caaatcacag ttctgaacac atttgtccat acattcttca tcttgggcta 795900
 aatgaattct atctcagacc actgtataat ccaacaaact caaactcct ttgtacctga 795960
 aggggagcct gagcagagat tgggtgtgtg tggcagaatg caggacatt tcggggacat 796020
 atctattatc ctgcctctt ccctcttctc catgcatttt catctcttcc ccaagcactg 796080

 gcacctccta gccatctaat caagacaaat ctttcatgcg gcaattaaca tacagctcat 796140
 cttcaagggg aagagaaaaa caaaggctga gacaattagc tgactgtgcc aaacagcatg 796200
 gttcaccccc tccagccctt gcccgccga tcctccctc cccagcttcc tccaaatgcc 796260
 tgcttttaag tattttcaca ggaaggggaa acttcattcc tgctgaaagg taagagaaaa 796320
 gacagcctgg aaaatggttt aattgaattt cgtatgaaa atgcttagga ctatttaaga 796380
 caaacgttgg gcttcttctc cactggaatt gcattagtgg agaaagagga caagagacac 796440
 tgactaatct gtagctgtca ggttagggca gaatatagca ttagcaggac acagacctgc 796500

 agtacaagga gagacaaggc ttcccaaagt gggcactgca gagcagagag gcacactgta 796560
 cttgtaatga ctcagaaggt ggagaaggaa ctcaggactc tcaaggctat gtgtgccttg 796620
 attacattag cacagcccat agcattatgc agaacacgca ctttgattgt attagtctg 796680
 aattgtctgt aaaggccact gttttatttg gctccccaca acacctgcct ttctacaac 796740
 atcccctacc agcatactca agcattagtg gttgggtttt ctaaactctt ttagccattg 796800
 atggctgcca gcagtcaaat taaattcaaa gggtttagta tagctctggg ttttagctat 796860

ataatttact aagaatgcc aaagcacttg caatctaatt ttcagttcag caatgaatac 796920

 catttcctaa caaaatctgc ctgaaatttc cttttgaggc tctgggaagg aaaaataaaa 796980
 ctgtgacacc tgtgtgtctt ccttctggca ctgactcaaa aaaaaaaaaa aatgggggaa 797040
 aaaggaatcc aaacctagga aaaaagatat acctcatgtg aatgtggtac aggaaaagaa 797100
 atcaaagaat ggcctggttt ggatggccaa ggcatctggc taacgaagac atctgcattc 797160
 ccttttttag acttagtttt ttccccact ttctaaatcc aatactctat ctgttacatc 797220
 cccactatta accagcatag gcctatcaa agctgtggtt ctctaaaatt aagcaaaacc 797280
 ttgggaaaaa aacaacaaa caaacaaacc tgatttgacc attcctacat ttttaatgat 797340

 aaacttagtc tgctttccgt gggaaagaag actgtaacc cctaactcgt gtgtaaat 797400
 catttctgac attcagtcct caaaaatacc atgacttacg atttctcat gaggtaactt 797460
 cacactcctt gaaaggaat aagagagtaa caaaagcatg cagtacttt gcaaggtggc 797520
 aatcctcgta cccaggaatc gaaagcagac agatgatgag tttgaggcca aggcaggcca 797580
 tataatgaga ctctgttctt aaaaggcaac ttaagtcta tagtttaacc tgcggcattg 797640
 actgctttct tccatgaaaa agatagcctt ctgaatgggg cgccaatatt atcaccttea 797700
 aggcttttgg aatgggggga ggagaagaac gtgagagaca aaggatgggg aagagtgcta 797760

 tgaaaagctg tcttctgcac atgacaagge tgeccactc acactctcgc agtgagtgtc 797820
 attatccaca aaagatgggg ctccccaac atcccacat aaaccggaga agggcaaatg 797880
 aggtccact ctccctgggg agctatgggg agctaacagt tcctggggaa gacttctgtg 797940
 atttgaccac cattatagtt gccctgttcc agaaaataac cccagcccat gctcatgaga 798000
 acaaccctaa ttaactcag tgtatcagaa agaaaaagaa aggcataaaa acaggagggg 798060
 gctttctggg atgctcaaat aataattaag aaaaaattga agatggactc ttaacatgag 798120
 atttgcgaag gcacaagga tagttagaaa atgtttagag tcaccagtag ggtctaaaaa 798180

 tatccaactc cattaaagct tacttttggga tttcccctc tctcactg gcacacagga 798240
 gttctgaatt ctggccatag ggacaaagta gctgagggca atgcagctga cagttgccag 798300
 gtgaaagaaa tgcatgtgcc ctctccctgt cacagaaaca ggatgagcca ctgaaggagg 798360
 ctgtagcaat caaatcatca agctgaatta atttaattaa taaacagcat aattaggaa 798420
 gccattagag aagtcagaga tgttggctat ctaccagag cagtggtaat cactccat 798480
 caagccagct aatgtaactc tagaagtcag agcgtcaaag gataaactga aaagagccaa 798540
 attcctaag gctgtaafga tctaattctg tttgttgatc tcacgctat gattttccac 798600

tcaacaagcc cttttatc ttacaataaa ctgtatagtt tagctggaag cttttttgta 798660
 ggtttttaaa gccaccaat gtatcagccc tgccatgga aaccaaggcc aggcacagaa 798720
 acctctttct ctcaggtcac catcccacct cactccctct ctgcctcatc cactccttaa 798780
 gcagtctgtg accagtgtc cgaagggtg acagaaaaac atgacaatgg catcaaagtc 798840
 aaagctaacc aatttttag agtgtaaatg actctactct ccaagtgcc actgaacca 798900
 tctctacca cttgagttcc taacagaaa gcacatttgt ttgtagagca gccgacagaa 798960
 aattaatgta gtcagccttt cactttccaa ttaatttagt gaagctgtag ttaagtaatc 799020

caactctatc aagtccagat acgaaaagat cagctgcaga gagacctagt agatgtgggg 799080
 gaaggtaggc ggcattttta ttttgttttt aattacatta attagggatg ctgcatgcca 799140
 tgggtcttgt gtggagggtca aacaccatct tgaagcagtt ggttgactca tcccaccaga 799200
 gaggttccag ggatcaaact cagaccatca gacttaacag aaagcacatt cactcagtga 799260
 gccatctac caaccctagc ctgtatttgt aaatgatttc tgtgccaggt acttttagtag 799320
 gcccttacc gttgtgtatt tcaatttcat ctctgtggga accccacaag gaagaaatga 799380
 tatgtctatt ttacataagc tctctttaca taggaagttt aagtaacttc taaagaacca 799440

cagaataaga atgtgtcaat gctgggacag tatccaacgt ctgactcctt aaattaaaa 799500
 tgaagatgaa tgaataataa aaattacggt gcatggttat tcatgggatg catgtatttg 799560
 cctgatgggg ttaattatct tttctttgtg tgtgttgtgt gtgttgaaga ggtgggttgg 799620
 aacatgcatg ctccatgca catacagagg tttccttgt atgtgttaca gggacaggtg 799680
 ggtacatgca tgcctctgca cacacatgaa gatgacagct ttcaggggtt gtttctctcc 799740
 ttccaccctg tttctgagc acagctctc tttctttct gggctgcata ttcttgcta 799800
 gctggtcctt aagcttccaa tcagttttcc agagtccact ttccagctca ctacaggat 799860

gatggcactg cagatgcatg ccatccagc cagctttgtg gctgtctaca tgggcagga 799920
 tatcaaactc agatcatccg gtttcatgga aaagtacctg aagatggttt cccagacat 799980
 gcctgatggtc tctgacaatc cagtataagt tttgactttg ttgttatttt atgaccatct 800040
 tcaatgtcac cattgaactc aacctgtatc cattcttttt gttaccttaa cattttcttt 800100
 ctttctttct tttctttttt cttttttttt tttttttttt tttggcactt gctctggaga 800160
 ccaggctggtc ctcaaaactc cagcagatccg cctgcctctg cctcctgagt gctgagctac 800220
 acattttctt ttctacatc aaagatttag gcaggaaga taataaagat aaggacaact 800280

tgaaaaataa tgatttgcaa ttaattttaa actaactctg aataatggttt gttccatctt 800340
 acagacacac atcacatgca tttttgatgg gaataacatt acaaaggatt aatgtccaat 800400
 aaaatccaca cgatggatat atgtgcatca gacatctaaa aattctccag aaagcaatta 800460

cactgagtgc catctaataa taaatccaca aggacagcca tgatccaggc tgcattgcct 800520
 aacagctctg cccccaccta actccacact gcaatctttg ctagacgctc tatgtatgag 800580
 agaacagatg ttctgctttg ggttgagaaa tcaacggtta ccattcatat gttccaaaaa 800640
 ttcaagggcc tagtgctgct gttttgagga tgctaattaa ttccagcctc tatgctccaa 800700

 tgtttccaca gtttcaatca attgcaatct caaaggacct cagtccccac tatctccttt 800760
 gaaagcccat ggaagaaaaa ctaggaaatg tatatttcac tgacatagca gggagaaggg 800820
 aatcatccga tatgctctga gtctgtatat ttcccatgt tggcatcatt gccatccttt 800880
 ctgttgtatc aacttgaaca tgtaggcaaa gtctaggtga caaatacaat tgaacaatg 800940
 cctagagatg cctttgggcc attttcttgt gtctatttac cactcaaaca gactaatttt 801000
 ggaatcatga gtttgtttgt ttgttttaac ctctgaatgc atttatttag atgtttgata 801060
 tctgagcatt tttccctctg aaaatgataa agagctgagt cctgcccacc ccatggcctg 801120

 ccagtccagc ctgcagaggg cgactccact gcctcggaaa ttccgaaata aatagaatca 801180
 agtgttagcg ctcaatggca gggtagggccc agccacctcc agagcagcat tatggggaca 801240
 gtctcaaggt gtcttctgat ggatgggcac tgtgcagtgt gtggctgtgc aaaactgcct 801300
 acagtttgc caggaagttg cccagtgtca ggatgcctc cttaaacct ttgcgcttgc 801360
 gggctcagc caccacttag ctgggacggc tgcgtttgtc gaacgggtcc cgggcagaa 801420
 tctgccagtg gtccaacaca cactggggga aagcttggcc accagtgtg gacgtaggt 801480
 cagctgtgaa accaaaggac tcgttgaccg gaaggtaggc cttgactaca aacatggggt 801540

 gccagccacc tgggactctt caaacacgtg accacgcttc ctgttcagga caccatagat 801600
 gccacccacg acttgttcag gacactgaat ctccaccagg tagataggct ccatgaggcg 801660
 gggctgtgcg tcaacacact ggcatacaga cagcgataag ctgtggggat gatctggcca 801720
 cctcctcggt ggattgcatc agcatgtagg gtccatcat ggacatcaag cgcacaccac 801780
 gcatgttctc gcagagagcg ccctccttag tggccactg gaagccagcc accacactgt 801840
 ccttgatttc attcaggtac tgcacacct tggatgatgc ggtaagaatg ttggggccag 801900
 tgccatcagg cccaaagcgc cagatcttgc gggcttcagc aacatcccac tagtactttt 801960

 catctaggta gcgtgcgct gccttgagct cctgtcgagc agacacttca ctcttgcga 802020
 tgctctcgcc caagccatca gggaagggccc aggcccttca tatgcaatcg gttgtgcttg 802080
 ttggcgatt tggacaggca cagcacattt gactcctcgc tcaccgtctc cgggatgag 802140
 acaacaggtg cagatttctt gatggggatg cacgtgtggt cctcctccag gtcttggagg 802200
 cagatttcca ggtgcagctc acctgctcca gcaatgatgt gctcccaga ctctcaatg 802260
 atgcaactgca ccatagggtc agatttagcc aatcacttca gccctccac cagtttgggc 802320

aagtcagctg ggttcttggc ctccacagcc actctgacga cgggctgacg ctgaccttca 802380

tcacacgcat gttatgtgag tgttcaaagg tggatgatagt ccctgtcttc accaggaact 802440
ggtctacacc aaccagcccc acaatgttcc cacagggcac atcctcaatt ggctccacat 802500
gccggcccat catcgggatg gttctttgga tggccttcag gtgcaggtcc tccttcttcc 802560
cagcgtata gttggggccc atgatcgga ccttgagtcc tgtcgacact accccggaga 802620
acacactatc aaagcatag aagcggcctt tgttggaggt tggcaccatc ttagaaatct 802680
acatcataag gggaccctta ggatcgacg ttttaatgcc catggccgcc tcatcatcag 802740
gtggcccctc gtagagcagc tcacagcggg atttctgggc cgtgacagga gaaggagct 802800

ggatggttac catctgcagc agggcatccc ctgcgggcag ccagcggagc atttaactga 802860
ccttctgca aatcatgagt ttttaaagc tattgctgaa tcaatagctt cttctattgt 802920
ttgtttgatt ttgaatctaa tgatgcttgg gcataatacc aagcatgtca agaaaacagt 802980
tgatgggttc gaggcccaaa gaacagggct ggtaacatgg ctccatgagt taaaaaaaaa 803040
aaaatgtcaa aacagccagg caatgggaag cattccagta ttcccacat tggtagttg 803100
gagatggtgg aatccctagg gcttgcagac cgacctgtct gggttcagct aaagaccctg 803160
tctcaataa catggatggg ctggagagat ggctgggtga gtaagagcac ttgctgcttg 803220

cattgcagag gaccagatt tggctaccag caccacgac ggatagctca cagctaattg 803280
tgttgtgtga cactattcct ggagagactt gaacacacat ttactcacc ctaaatagga 803340
aactagcaac aggtcaaagt aaggatacca ccaaagtcca acttggta ccaattagtt 803400
ttattggggt tgettacagg aataagggt aagagtaatt tacaggagt ggtaaagagg 803460
tgacccaaag acccaaagag gtgttacct aacaaaggct gccacagcag aggtgacagc 803520
tcaggaaagc tggagatcac tgcagaactt gcaggcagct ccacagatca gagagtatat 803580
tttccatgca gctcagttgg tctgagtgtc ctctcatcca tccttactgc atagtatgag 803640

tgtgggtaga cagaagcctg gtgaatctgg tcagtttcag gaactccctg aagcttcaa 803700
gttgttact tcccagttt taacaagttt gcctcctgaa tgaaatgctt tgctcttag 803760
tagagcatcc tgaattttaa tgagcttccc tccaaatgga aagtgctaag aaaaattgct 803820
atacaacagg ctgcaactac cgcttcatgg gatctgaac cctcttctgg actccgtggg 803880
gaccacatg caagtgcaaa taaagaggga cacatacata cacagaaata aaaataaatt 803940
taaaaatata tgatggagga tagctgaaga caccaaagtc agcgcgagca cacacacaca 804000
cacacacaca cacacacaca gagagagaga agagagagag agagagagag agagagagag 804060

agagagatgg gctgctgctg aatagcacca gggcaggtgt gcccagagag agcctcagct 804120
 gagtagtcag ccagatctga ctggaatcca gggttttctg ctgagaatgg cctagcttgg 804180
 aaaaatttctt aacctgggca catttcttaa tctgaggcaa taatatacacc tttcaaatg 804240
 gtcagaatca agtataatgt aatcaaaatg catggcataa agtaaaagta tagaaattga 804300
 accccaagtg tattgtcccc ttgactgagt gagtaaac agaggaggac tgttttgctt 804360
 tttgttgggg gaacatgagg ggcatcatt ttttatctta taagaatggg gcgaggtaga 804420
 tgacttggtc agtaaaatgc ttaccttgca gctaggagaa cctgagtffc agatcccaaa 804480

 actcacacta aagcctgagc atagcacatt tgcaatccca gccctgagaa gacagagata 804540
 ggaagaaacc tggggctccc ctagecctact ttgagagttt caggcaaatg agaggaaccc 804600
 tgccccatc tcacaaagaa aatgaaaggg ggacagtgtt cctgaggaat gacaatggag 804660
 attttctctt ggctctgtt catgtgcata catgtgcatt catgccagtg acacacataa 804720
 gcaagcacac atacatacac aaacattcaa aaaagaaaaa tctagaaagg atctataaag 804780
 ggcttaagta agagacgggt gacatgaata acagacatta caaacttagc attatgtctc 804840
 cctaaatccc tcaactgacat tctaaccctt aatgtgatag tatcaggagt tggaaaccacc 804900

 ggggaaaact atttatgag gatggggccc ttgtgaatga ggttatgctc tgagaagcag 804960
 agaccagaca gagaaagtgt gggcactcac tctttcttc tgctgtttcc tgaagaggca 805020
 ggtcactate tcctgtctc tctatctctg tctctgtctc ctatctttcc ttccttact 805080
 ccctacctt cccaataaa ctttccatgt aaaaagaaag tgtgggctct cttttacca 805140
 tgtgagaata cagaaagtca gctacatgca ttctagagaa agccccacca gaactttata 805200
 ctggacttct acctccaga agtgtgggat ataaatgtta attcttcaag ccaccagtc 805260
 tgtgatacag tgttatggca gccctacca aggtccactg gtactcatcc ctcccctacc 805320

 actgtcatca tgctgtgcca aggaagggaa cagttagggc tagagtggga agatccagtg 805380
 tgttaaagag agtctgagaa cttatgccc gtccggtgatg ttttagggcc caaggttagg 805440
 gcccaggaaa taatgaaag cagaagagaa gggggagagt aagaaagaca gggaaaggga 805500
 aagagggata gagagagggg cagggggagg gagaggcaga aaaggagggg gagatggagg 805560
 agaatcattt tctatttctc tgtggttact tagggacaca aagatgaaaa atgtttgggt 805620
 gtaagaatca ctggctagc ttttaatccc tttaatccca gctcttggga ggctgaagca 805680
 ggctgatctc tgtgagtcca aggccaggat ccaaaactac acagagaaac cctgtctcaa 805740

 aaaaccaaac aaacaaaca aaaataaata aaaatcactg gctagccagt agaatttgct 805800
 gaaagaggca gaggcagcct gggctgcaca tttgaaaaa acttaccgat ctcccaggaa 805860
 ccgctattaa aatgtcaat gaagagatct catcaatggg tatgagggct aagaattaag 805920

acatcactat acagagtaag ggatatagtc taataaagct tgatttccac agataaaatc 805980
 cagttgccat gagacacaca tactcagatg tggaaagtct ttgcaggaaa agtttgaggc 806040
 cctgttggag cattaagagc caggagctgt ggggttaata tcaacacacc tttttgtgca 806100
 tccgcagatg gaagagtagt cacaggaatg attttcatta taaatgctta ttattgatcc 806160

 cagaaggaaa ccagccaagc aagagcagag aacagtaagt gcttttcctt caccagaact 806220
 aaatgtcaaa atctaggctc aaatagtggc aacgatcctt tctgtgtggg cttagttgcc 806280
 actaacctca agcaaactat ttatatatat atatgatatg tgacaattga aatagcatag 806340
 atgatatatg gagagcatac aaaaaaagt gggaaattta gagtttagtc tataactgat 806400
 ggtcaaatag tgcagccagc tgtgaattat actgttttct gatgggtggc agcaagaata 806460
 cagaatcctt agtggctctt ccaagaacaa gctgagtgac cttgagcaag tcctctaacc 806520
 ttgttgaacc tcaactctct agtctgtaag gggaaagaggc ccatgaggtc tgtttcacc 806580

 tgagagtctt aggtagaagg tgtccagtct cctgaagaac tactgaaaac acattcccac 806640
 caacatgcca agggagtctc atctccaggc cttacaagaa tccaatggt gcctgagacc 806700
 ttctgtgate aagaagctct gaaaagcctg gtcaggcatt ctgtagtcac ttgctgatgc 806760
 agatttggat gcatctatct taagcacgcc cagatgtctg taccactcgg ttgtgtggtt 806820
 aaaagttagt attagacctc aggaaatgca agaaggacc tttctagtgc tagaaccaca 806880
 atgaagaatg gccaatagc cagcttcacg gagaatgtga cacactgtgg ctageatctt 806940
 gctgatggca cttcacattg agtttaatac cccatgtttg tgcatgctct catcaactgg 807000

 ctgagcatgt gcgagcgcgc gcgtacatgc acgcgcatac acacacacac acacacacac 807060
 acacacacac acacacacac accacactta tatgttacta atgaggaatc tacttggaaa 807120
 acacaagtac acaagcaatt ccaaaataac tttccacggt ttcacacagt ttaaggcagt 807180
 aatgacacg tatttagtag attgaaatgt attcattatc ttccttcagc aaagtgaacc 807240
 atcaattcta catgattagt gctctgtggc ttctccagtg aaaggagaac atgatggatg 807300
 aatagaaagg aagcgtgac tggaggatgc tcacaccagg aagggaatt catacaaca 807360
 aaggcactga ggtgggaaac ctgagagcaa ccaggataaa agcagctgaa tcttgcaatt 807420

 tttctcacag ggtcaacca cctacagtc cctaatcact ccatctctag ctccctacag 807480
 ttaatcta atctcacac caattactat aaatacctcc ttggcccaaa gtatatgttt 807540
 ctttcaccag gaatactcag aagtcatttc atgacaggac tagctgctag acatcagttt 807600
 ggaggtctta aggaccaacc tgttactga catgggggaa gaaatgacct tcccatttct 807660
 gttcacatgc aaaaagaata gagagtctca atcctctca ctatccactt accctgagat 807720
 gaattctctt cctttggctt atccaatcat ttccatcaa acaaaagcaa ggaatgtgt 807780

caagagcaca agaagcaaaa ggtcaaagca ttggaaatcc cagtgggaga cggatgaacag 807840

aaatacagac acatttgtat ggagccgtat atcactcctc tgctggccat attattaata 807900

ttattagcct tagtcataca tggatccatg tccccataat gaactttctt tgaaaatcat 807960

caggactaaa agggtaaata gcttcagcct cgggtcatga tgagaaataa actcaggacc 808020

aaggccaacc agagacagat tttaaaagcc aatgcactca tgagtatgat aaggacattt 808080

taatcagaga tgcacagtga ccccaagaaga ccatagattt taaagtccta atgcccagtg 808140

atgctacagt actgaaaatt agctcacacc tcacattttc agtgatgctg gtgtagccaa 808200

acttgcatg ctgcagtcac atagtaggac agcatgcaaa tattcacagt acgatacact 808260

tgatattgac aataaciatg ttacaggcctt gtgaatttgc tatattaagc ctttatggtt 808320

gttttagagt gtaatcaata attctgttgt attttaaaag ttactatga aactctaagc 808380

tgaggtaacc ctcttgtctc ttcatgggat caagaggcca agttgaataa ttggccttgg 808440

acatctaggc ttgggtgctg gtgctctgtg atgttcaagc aacctaaac tcatgggatg 808500

gcatgttagc ccacagtatc tctgccgtga agctgtgcac aaaacaaaag agaaaatggt 808560

ttctaacaca ctacgaatg acctgatca caaccaagtt agcctaaac attatttcat 808620

accatttcca ggggtcagag tactttaaaa ccttgttcta aaagatcttt ttataataa 808680

attactttcc tttttccttt caaggtttct gcttcaatta gcttcggaaa cactgtgggt 808740

ctattgtttg caagtttgaa gttgggccct tcaccttcca cattccacc ttcgacaagc 808800

tcctctcaac tggcagtttc tatttatatt tcaacatatt agtattaca atttaataa 808860

aattctccac ttgtatcatt aattagcatt tggcaatggg cctgattaaa tgcccttggc 808920

aacaaaatga tttaaatatc gaaaagggtt tttttatcat gtattaaaa tgtctgttag 808980

gcaaccaact taccctctc tgctcagggg cactgtggt tcttaatact cctctccagg 809040

ttgtattggg taactgccag tcaatatgac cagctctgcc aaagactgag gaaagcttct 809100

tacaatgagg gcagttcatt ttttagagg cactcatatt tacatatcta tccacccta 809160

ttccctcacc ctcccatctt cccagctccc ctaccaagct ccccaacc atccccaac 809220

tcctctcag ggatagttag gccctccacg gggcaccttc aaagtcctc atatcatttg 809280

ggggagggcc taggctctcc ttgctgtatc tggactgcaa tagtatcct ccataggaa 809340

tgggtccca aagtcattt gtgcaatagg gataaacact ggctcactg ttagaggtec 809400

catagactgt ctggccccc tagctggcac ccacattggt tgggtccaat gctgtttcct 809460

catctttata tctagggtct ccatgctctc agtaggtcag gtcaacagtt tctgcaggtt 809520

tctccagcat catcttggtt cctttactca tcctactaa tgagggcagt ttagatgatt 809580
 ctcttcttcc tcttcttctt cctcttcttc atcatcatca tcatcatcat catcatcatc 809640
 atcatcttcg tctttatctc cttttagttt aaataaataa aataatcctc tactaatcca 809700
 agctaagcta tcacaaaata agattttcat tcagttattg atattttaca gaactataaa 809760
 caaatatcta tttagccaga tttcatgggg ctctctgtg aaagggagg gctgaatctg 809820
 aactgtgcca gatgtagaaa atccctgctg tgfaattctg aactttcatt cataggactt 809880
 ttgggtacac acctggcttt cttagcaagt gcctagtgcc tagaaactgt aaagacttgc 809940

 caagcatggg ttgaagaagg gggatgatgaa tacccatcca ctctatactg aagagagggc 810000
 cagcatacaa taaggagacc agacaagggc ctctgattgg agagcttgat gctcttcaga 810060
 tgacctgagt tcagttccag acacccatgc tgggctgctt acaaccacct atatctgcaa 810120
 ctctagggct cgctcagttg ttccgacctc tatggcacc acacatacat ggcttacatt 810180
 cacacagaca catacacata aataaaatta aatcttaaaa aactaagcaa gaaagatggc 810240
 aatccttgtt tgcaattcta attgaatatg tagttatgtt atcaaaaata aataatatgg 810300
 aggggaataa ttgggagaaa acagtgcaaa aacatttaga aatcatatt tttctcattt 810360

 atgaggtgtt ctgggtaaat gaaatatagg aaaggagtag aggttgaaga aaaaagaaaa 810420
 taaaagaaat gtgttcataa ttaacataag gaaatattat acttaataa ttcttaccac 810480
 tgagtcatct atcagatgtt taagagcatt attgcatgaa attaataaaa aaaatctatt 810540
 tactgtgatt ttgccagact tagtgttttg tgttttctg acacatcagg ggagttagaa 810600
 aattgtccca tgatgactaa tggtttggtc attagaataa agatttcaat gttaaaaatg 810660
 gaaagtttta ttaataaag atttttgaat gtcttcttga catagaagta aatatttgtg 810720
 gagcaaagaa attcaagcta aagaaaaata gggagttgga tgttcatgtg tctgggaaac 810780

 cctcaaaaaa gagaagetgg gcctagtgga ggcaccttt aatccatta ctcaggaggc 810840
 agaagtaggc agatctctgt gagtttgagg ctggcctggt ctacagagcc agtttcagga 810900
 catccagggt tacacagaga aacctgtct caaaaaattg agaaaaagga agggaggaaa 810960
 agagggaggg aggcaggaag ggaaactgga aacctctcag acaagatgag aaactacaca 811020
 ggtgatgcat gagcctctag ctctagagag agggtaatta gaaagcacc accatctttg 811080
 atcataataa gcattttacc caatttttg gcaaaaaaga gaaaaccac gtcttgaaag 811140
 aatcagagc agacctaaaa tatactgttt ataaaaacat ccattagtca aacactaaca 811200

 aacagaagat ggctagtttt caaatacaac tcaccagtga aaaaggtcgg ctttaggaca 811260
 agttacatag gattgaaatt gtctctgaa catcaatgtt agctttccta tgctccccgg 811320
 aacattccgt tgccatcatt ttagagaata cacattgctt tgactgggta cagagtctta 811380

attttttct ttcttttct tgggtctact aaaaagcaaa cagccaaggt aaggattgcc 811440
 accctttgcc ccggtgggtt aaggcacaac atcagtcagg actaggtgac tcagtcaatg 811500
 aagtttgtgc tgagcaagca cgaggacctg agtttgtatc cccaagaccc acaggaaggg 811560
 ctaactgggg caggcagagg gaagaggaac tcagtggcca acccgtctag ccaattagtg 811620

 agctttgggt tactaagag aacctgcctc caaacagcaa ggtgaaagta ataggggaag 811680
 acacctctgg ctccacacat atacacatac aactcaetca cacatacaac acacacacac 811740
 acacacacac acacacacac acaataaaat aaagtccttt ttaagaaaag aaaagcatgg 811800
 agagatggct cagccattaa aagttcttgc aactcttcca gggaacagga gtttagttcc 811860
 cagcaccag cccaaatggc ttataaaagc ctgtatctct agctccaggg tatccaacat 811920
 cctcttctag cctctgcagg caccctaac acttgatatac tcatacacag atacacacat 811980
 ttgcataagt aacaaaataa tacaattaa ttaaagtgac aagcaagtgg atggatttga 812040

 atacacttac actgtaggag aagggaatgt gtggattaag aaaaaacca atcttcatgg 812100
 ggtcccctgt gtggcagatg ttgtactaag gatattacat gtattatctc tcttaatcca 812160
 tacatccctg aaaattggta tatttataag aatattatgt ctatttcaga gataaaagaa 812220
 ttgaaaatca agaggattta ccagttttca caaatctgtc aattagtgca agtaggagct 812280
 gaacataggt cagttggagc aaaagcagct atgatcctcc tcctagccca tgcaatatec 812340
 gtgatgagag gggattccag taccagacat gtactcattg tgggcttcaa atataatcc 812400
 atgtttatgt gacctttcta taagcactac caacctgtac cctggtaata actgtcacac 812460

 ctgagggtca tgaccttgt gggtaacttt caactaactc ttgtgaagtg aatattgcct 812520
 ctattatgag tactggcttt aagtcagtct tatgatcttt actaccacaa ccaccatcag 812580
 gaccaaatg tatctttttc ttctctgcag gttctactgc aatgccttgc agataactga 812640
 actgaaaagt aatgacctga actgaattgt caggagtac aaaactaggt agctgagtec 812700
 tcattgtctt tcacacaaat agttactgag cctcaagttt gtgcttgggtg gtattatgat 812760
 tacatcctag tgacattatt gtgttatttc atgtttttcc aatatcttcc tatttttagga 812820
 ctgggtgag gttgtttttg tttttgttat tattgacaag acagagtcac actcagtagc 812880

 acaggctggc ctgcagctca tcatgtaact caggctggct ttgaactcag tattcctcct 812940
 gctttgcctt cccaagtgtt gagattatag tggtagccac tataactgga tcagtatctt 813000
 ttaaatagaa aataaaatcc tatttcttgt tacatcatag tagataccta taacataga 813060
 cacaatagaa tttataacct tgaacattg ctatttggag agaaaagtag taaccacaaa 813120
 cataggtagt ccttcttct agtggtgact tctcattag ggaggtggaa aaagagcatt 813180
 ttatcccaga atcctttcaa tcatgaaggt tcgattctcg aagtggggag gccttgctag 813240

tggggagaag agattgggga tctgaaactt caagtcatct tgtgatttca ctccctttcc 813300

 tgctcaggac tctctctgct ttaggtaaag gttctgagaa ccactgcccc gagtcattta 813360
 atctacagat tectgatcct gtcccttcttc tccatgcagc tattgccaag tggccattct 813420
 ggtagttaag atatgcagat ccttggggat ataattaagg agccactgag atgcttccat 813480
 caaagcacag ctcatcctcg gcagccaact gctgtttgtg cgggttaaat gcttaacagt 813540
 cctttcatgt cccagagtca atctgtgttt aaaggatgga ggtgagtggg caggacgggg 813600
 cagtttatgg tctctgcctc ctctgttatt atcacactga tgtttcacgg gcactacctc 813660
 aactgatgga aaccaagggc cacatatac cccagttatt gggatgaagg gtaaaataca 813720

 ttctttgttc actttttata aaagiattta aaataatcat ggcaataaat ctgattttaa 813780
 aaaaatacc caaaatagaa ttggcttctt caagagcaaa attactatgg gtttgctcc 813840
 ccagagcagt tgtgggcatt tttccaatgt acagttttcc tatgtacaaa tattcctttt 813900
 tagacatttc atcagtctat gaatattctt agttctgagg tcagcttata gaaccgtgtc 813960
 agtctgcaaa ctctgcctgc agcctgcata cctgctcttg atttcacatg gggaatagtg 814020
 ggttatcacc agggtagtct cagctctgtt ctgctcctcg acataaggcc ataaccctct 814080
 aaaatacttc agcataaaga tggcccagga aaataccatt cattcaaatc atgctttctc 814140

 tctgtccac ctgaacttca acacaattaa aatgtatgat gtgctcattg tgttctata 814200
 gggtcagtgt aagtagtcat aaaaagtatg gcttaaaggc agactgggta ggatggttca 814260
 gaggcagaac ctgtgcttag catgcacaag gccttgatt tacctctcag caccaagaaa 814320
 caaaaggaaa cacacacaca cacacacaca cacacacaca cacacacaca cacacacact 814380
 atatagtgac agaggcaggt aaacactcag gcagatggag tagcaaaact gcaagtttca 814440
 aagaaacct gaagaatatt ttaaatacca gaaatcaggc cgcaagcatc acacaaggac 814500
 aaaaacagca agtagctttt ttctttaaaa aaaaaaaaaa atccatcgag aagacatgac 814560

 aagttttgac attgagtaaa aatgacata aatgtgacaa cctcagacc ttaccacaga 814620
 aaacttgaag cagaacctg tgccagagag acagatggaa tgcatcattc caccccagca 814680
 tcctaaaata catggggctt ttgcacacca tcctctgaa ccatgagagt aacatcattt 814740
 aacacagcca ttaaatgcaa gagccataac atgcataaca accatgtgta ggtgatagca 814800
 gcctgccaga aaaacaccca ggacatctca gactctgctg gcagactgaa caaagacaga 814860
 gctgtacaag cctcccacac agagctgaaa aactgagtga tccacctaaa gcaattgagg 814920
 aaagatgaca agcgccaact taacatcgtt cagtaagctc acggtcagga ataactcagc 814980

tgagaatggc aatctctgtg cccacagatt gagcataggc aaaaagtaca gatggagggg 815040
 tacagaagac aatgggggag gcctaagtga tcggtttcag aacaagacat gcctcttcta 815100
 ggggtctcca aaatagagca tttttgctga aatgaaatgt tatctgtgaa caagccatcc 815160
 cagcccaaga cagcatgaac taacaaagcc tgaaggccag tgaggccacc tcctcacctt 815220
 gctttattat ctgtggccac tgttgctatg acaacttttc tgaggcttta ttggggaccc 815280
 agaaaatccc cacaggcagc ggTTTTgtct ataggacatg aaggagctgg tcagtttggt 815340
 ggaggttaaa tggtcaggtc atctcacaag cttactttgg aatcctccat ccctagtttt 815400

 aaaaaattgt ctgaaatatt cacttaaat gtcccaaaag tacacagaca cttctttatt 815460
 aaccttaata taataattcc acagaacccc aaagactgac ctttctgatt cctagtctcg 815520
 aatgtaaact ttctcctgtc ttaacatgga catcccaagt ggaaagagga tttggTTTT 815580
 tgggttttgt ttgtTTTT ggttattgtg gatgtttcaa ctacttggtt ttcaacctta 815640
 tgagaagggg gcctttggag cagaaaacca aataaaacac agagatcaga aagtcctgtt 815700
 ggcatatca cttcatggtc aaagacaaac agtcaaagta gaacaggag tgaagaattt 815760
 ctcttgttg cccattctg tcaagagccg tgcgactcc ccttagtgat tattttttt 815820

 ccactttccc tacgtggttc tcataataat tactaacttt gtgagatgtc agaacatggc 815880
 cacttaagca aagcaaagtg ctttcaaca tttatgaagt gctgattctc tataaataca 815940
 ggagagcgct aatcaccgga gtaccggtt gcacggcaga tcaatactga agatgaacac 816000
 tcctcttca ttgaaatca gaaggcaaaa aatccatcc atttgttate tttctgataa 816060
 actagcattt ctgtgacttg ccgaataaaa ttaagatca gagctatctc agagactcga 816120
 aaatatctaa gaaaagaatc gtgggtcaac ctggtctatg tcctctcctt gtatagctct 816180
 atatatagat atatgtgac gaacacctt ggagagagat agtggtagca aactgtcac 816240

 tcacctgtg atcgcttata aaataaaatc atccattgtg agtagcctgt agcattaat 816300
 agctgcgatg cgcatcaca aatgcctgga agcgagata agcttcaatg gtgatctggt 816360
 gaatattaag tgtaaatgt gtttctgctt taggggggac acttccttc cgggaagcca 816420
 gcggcactta taggagacca caattcaggg gggatgetta gtctggatcc aaagcttcta 816480
 gaaggaccga agatggatgg tgaagctcat ttgtccattc aaatcttgc aagcttgctt 816540
 ataccctag caaaggccag atatctgcaa gccacaaact aaggccacg ccagtggagg 816600
 ttctgctgt ctttcaaca gattgaacac cagttccatt ttagcttctc acagctccaa 816660

 agtggctcac tggccctct ctcacagat ttggatatct taatggatca aggctctaac 816720
 tactgtccag aaggctctga ttatactgt gtgatgtagg tctctataat ataccatgtg 816780
 atggctactt ctaatggcca ataccacaca atctagaacc tgctgggaat agtctcctg 816840

aggaattgtc tggattaggg aggccctgtc ccacgcctgt cagaggtttt ctcaaatggg 816900
 ttcatggagg tgggaagacc tatcctgaaa taggactga ttcatgggct gggcccaggg 816960
 ctgaaagaaa aggggacctc atgctgaaca ctggaatgca cacataaatt cattgctctc 817020
 cattcttatt gtggatgtaa tgtgcatagc ttcttcaagt taccactacc ttcacttctc 817080

 aatggtgagg ggctgtggcc tgaccatatg ggaaaaagaa acacttttcc ctcaaatgtt 817140
 ttgtgtcaga gtattttacc atagtaaccg aaacaaagcc tgggtaaact agatgggggg 817200
 gggcacactg attcaaacctg tccatcctgg agtcctctgt acctcaattt gcttgactgt 817260
 aaaatggagg tcagtgtact ggctttatgc atagcctggg aggatgaagt aaactgacag 817320
 ctctgagcac ctgagcaaca cctaaaatga acagaccttg ataacagctc aggttgaacc 817380
 aaacacctgc taatgtccaa tacttcagga gtttaggggc ctctgatttt acatgactta 817440
 catagtctgt tcaaaaggac attcactctt ccatattccc ctcttaaga aaagtccaac 817500

 ctgccataca ataagctatt aattgcataa gtctttccaa gatacttacc ataattaatt 817560
 tcttaatcca tctggacaaa tatttttttag agattgttaa ctccaacttg aaaaggaaat 817620
 gctggagtct ggaggcgcag atcagttgga aagtagcata tacaatgccc tgagctcaac 817680
 tctcagcagc acatcaagct agacctagt ggtggcacat gcctctaagc actcaggagg 817740
 tggaggctgt aggattagaa gttcaaggcc atctctagct acatactgag ttgaaacta 817800
 gactcagata catggtgccc tgtctgaaag aaaaagaaat ggagaggaaa gacaaaagagg 817860
 gagagagggga gagagccaga aagaaaagat gaaacaccaa cttccaatg tataacctaa 817920

 ttagaaataa taacaatagt aaatatgac cttttatgga gtattcactg cctgctagge 817980
 atgttgtaa gcacctgaaa tcgctatttc atttaattct tagaaacatc acaaaaaaag 818040
 tggttgctag cctttccagc tcatagacaa gagagggaag gactgactca cctaagatca 818100
 tgcacgtaga catgtaggag aataaacactt gcagctgtga caaacacacc ctgaatctta 818160
 acggctcgac aacagctttg ctgcttgtgt gtcagcctgc tgcaggagtg ggacgatgac 818220
 gaggctatgc tacataatac atgagagggc caaagttcct tcagtcttct tagacttctt 818280
 ccaagtcttc ctccaactcc tctccttca tctgactggg gggttcggggg tgggggagca 818340

 aggatctcac atgtgtttct attccaggcg ccatggtagt taagactgtt tctgggttca 818400
 ttccaagggc cctatcatgt catgtaccac tgacatctca aggatgggat ggaatggagc 818460
 catccttgac actctcagcg tcaagattca cggccaggaa acagcagagc cgggacctga 818520
 acaccagge tcacgagacc ttctctctc ctactacact attcctatct tgcattagcc 818580
 ttgcagattt ccccgaagca ccctgccagc tgccttctca acagcttgtt aagactctct 818640
 cactccagct aaagttgtac ttgtgaattt ttttgaag tttttatata tacctagtgt 818700

tatttaacta tcttgacatg gtttgctgat ctccccaaga aaagttaaaa gcaactgtatg 818760

actcacactg agctacctcc atcttcatct gctttccagc ccataaatat ggatcatgtc 818820

taccaagat gatgtctctt caaagtctat atcagaaaca gtaactgctct atttaattta 818880

aatttgtgac taccaagatt gacttatgct taatcatttt tatgtatcta ttaattgcat 818940

tcttattttt caactaagga aataagagga gaggtggatg gctcatgtca tctgtaatgt 819000

gataaacatg agaaaaatgt taaaaatgat attcaaagta atgtgggtgcc atagtcataa 819060

ataattgata aaagagatat gcaaaattat tctaaatcta tgaaggctca tggaatgatt 819120

aagcattaaa acagtcttgg tcataaataa agacacacat agaagctagg caaacactca 819180

aggatgatgt aagtcttgaa tctgactggt taattctgaa tcttgggcaa cacactgcca 819240

aaaatccatt cagtaaagcc atcatcaatt cctaaccata aaggcttcac gctcagtgat 819300

aaagatgaaa agcttattgg catcattatt cccaatttcc aaatatttcc agctttctac 819360

ttgcctaaca aaggtgagtt cagttccctc ccttccttga aattagaata gtcacatgat 819420

acttgcctggg gcttatggaa catgagagaa tgtaactatt gttatgctca ggcagattta 819480

agagcaagca tatgatatgc tccaatctca ttttctttg ataatggatt ttaaaaaatg 819540

gctataaatt ctctgaggct tctcccatca agaactagaa ggtgttcct cccttttct 819600

gagctagccc acaggaagct ttgacacctg actcacttgg aacaatgttg gcatgtactc 819660

caggccaggt tagattccat taaagatgaa acagcagatg ttgggggaga gcctgctctc 819720

ccaggagccc ctcatcacat gagtgaggca aactagcgcc aaacaattag ctgccaacce 819780

atcaagtca tgaatatatg tgagtgtca gacacagcag ttgcccagct aaatgcaagc 819840

caagctacaa aaatagttaa taaatgaatg gttattttca ttgctattag aatagaaact 819900

tgtttgttac acaacaacag ttaactgaga tgtcagccta gtcaactaac tatatataga 819960

gtgtatgtgg catccggtag cctgggtctc ctgcccagatg ataactgtag taagagcatg 820020

gagaaataac ccattgttaa ttaagacact gagagttatt tttcatttct tctctctgtc 820080

tctctgcctc tgtctcttcc tctgtgtgtg tgtacagaca ctgccagaaa tcaaccttgc 820140

tttttgaga cagagactct ctctggcccc aaacttccca ggctactcag gctggcactg 820200

agccccaaga atctcccagt ctcttcttcc tgagtacaga caaacattg cgctgttgt 820260

tttcatggg tcttgggact tgaactcagc tctcatgct tacatgatag gcagtttact 820320

gtctgagata acttctttt actacataac cttgtccttc ctgacaaatt cagaacttgg 820380

caccaagaag aatgctactg taacaacaga aaactgaatt gaaggttaca taatggatag 820440

acaggaatt gctttcagaa acttcaatgt tggcaacatt tatttacta ctacacagta 820500
 ttggcaaaa tgttcgctg tgctatatac ttgatgaga atgtcccca atgctcatgt 820560
 gttggaatcc tggccctgt tggggtgtgc tgctggaag gtggaatcct tagtgggcaa 820620
 ggcattgtgg aaggcttta gctcattagg gagtggcctt gaatgtttct ttgcaccttt 820680
 tggcatacca taccagcagt ggggtgattg gttttattct gctgcacatt ctccaccatg 820740
 gtgtggccca aataataggg ccagctgttt gcagaccaa acccctaaaa ctaagagtca 820800
 tttctacact gtttatctct aatatcatat gactgaaagt tgactcatgg tctgtgaaaa 820860

 ctcagaaggc agaaaacatg aaatagtgtg ctattctaag gaaatgttgg gaagatgaca 820920
 aggaagtcc ttagccacc tacaaggac aatcagcatg attgaaacat agaaacagtg 820980
 cttatgacat ggctggctat taccaaaagc atattaccac acagcctatg agccattcct 821040
 agcactaaag tgggagagg cgccacacca ctgctgtgcc atggcctgtg gaggatgtac 821100
 accgcaatg tgagcatagg aaatgctgga ataagagaag gcaactggct ttggaacggt 821160
 aggaaatggg accagatgcc aacattcag acttctgcc aatgaaggag atgctggtcg 821220
 ccttggctct ccagaaaagg agcttctac tggaaagccta agaagagcag gtttgagatt 821280

 tccttctct ctcataatc tttcttttt aaggttttgc aatcttcaa acctttgtg 821340
 aaaatttgc aaaaccattg tgaattccc tctgcggttc ctactctgg ctcttgtttt 821400
 gtttaattag caaagcaatg atcttcatcc atacttggac ttgaatggc ccccttctt 821460
 atcttgcct gtattctgc acgtgcacca tgccacccc agtgttcct tttgactat 821520
 cataacacat atattctctt attcttccac attccacac tctccttaa gaccatattt 821580
 tcttttttc tttttttat ttaaattaaa aacaagcttg ttttacctg taatccagtt 821640
 ccctctcct cccctctcc cctgcccctc actagcccc tatgtcattt cctttctgct 821700

 ccccaggag gatgaagcct tccatggggg gactcttcaa agtctgtcac atcatttga 821760
 gcaggccta ggcctcccc atggtctcat ggtctcctt ctgatcat taactatata 821820
 cacactcatt ccaggggat aaatgcacat atatggaat tataagctaa gaccctcata 821880
 tgaggaaaa taigccacat ttgtctctct gagcttgggt tacctcctt aatattttat 821940
 ttatcagttc cacacattt cctgaaattt tcataacatc attttcttt atggctgaat 822000
 aaagtccct catgtctatg ttccacattt ttatcatcca atcatctgt tatagacatc 822060
 taggatgatt ggatttcctt cttctttaca atagagcagt aataaccaca gatgtgtatc 822120

 tctgtgtag gatgaagtc ttcggtccat gccaggagt gacatagctg ggtcatatgg 822180
 ttacagcttt tgtttgtga gaaatttcca ctgatttcca tagtgactgc tgttgtttgt 822240
 atgccccgg cagtgaagtg ttctctctcc ccacatcagc tgggaagtct gtgtgtgtgt 822300

gtgtgtgtgt gtgtgtgtgt gtgtgtgtgt gtgtgtgtgt gtgtttcata caggcctctc 822360
 gaggttataa tccaatattc tttatataag ctaaaggatc taattatctt cctaccatca 822420
 aaatgggctc tgaattcaac ttcaaagaca aataagggtg agctgtgaac tctggccagt 822480
 ttttctgaa attgtgtctt aggttctgtt tcttgcccag ggtaaagtac actgatgacc 822540

 atttcatctc tgtgaagtag ttgttggcca tgaactatat ggcccacagt tagctcctga 822600
 gctgttctctg atggtgacca gagacaaaaa ggctccactc tgaatcttcc tattccatgt 822660
 cagtggcaac tcttcaggaa acacagctca gaaagaaaaa gagtcttgct acaattctct 822720
 ttatcaatat gcaagatggg tgcaatcaag cacacgctta ggggattatg taactttgac 822780
 ttttagcatt acittttattg ggatttgagt acattttggg gggaacatg atttttgcaa 822840
 gacagcagga cagagaaaaa ctagttttaa aatgtttttt atactgattc ttcaagcttt 822900
 cccgatgttt ttatagacct gacctccact caacctttct tectcctgta actgcatcca 822960

 ccatacttaa agltgtgcaa agaaggctta gatatcagca ggcaactgcag gtgggggact 823020
 gagatttgag tgcgattgat aacaggcgtc agataaatct caaccaaggg aatgagtctg 823080
 ccccttcaca agctgcaggc tcatacatgc ccacatctgg gattgataga tgtaagctgc 823140
 tgcttcatac acaccaaggt gaccttttc actcagcctg ccatggcagt gattcctgaa 823200
 taaatgttcc cagcagagaa agaagtgcaa gaagtgattc tagcaagcca gactcattgt 823260
 cgagccagca tctctgagct cgggtgactg caccagagcc caggacttca tcagttacac 823320
 ttcaaacagc ccaggacttc atcagtggaa tttcatacaa gcacggattt cccacagaa 823380

 gctctgctga ttctctgga aaccagcatc ccaatactaa agtcaggcag gcaactaata 823440
 aagtaactac tcctaacccc aaaaggcatt aatcttggct caagaaaggg aaggggtcaa 823500
 gagtaaaaca acagggatgg ggatatagct cattaagtaa agtacctgct acagcatgaa 823560
 taactgattg ccttccccag taccatgta aaatgccagg tgtagtgatg cagtacactg 823620
 taatcccagt gcctgggagg cataaatagg tgcatctctg gaggttcacta cctctttgct 823680
 taccctaate tgcagatccc agggaaagac cctatctcaa aaaaaaaaaa aagtaaaata 823740
 atgatgatga ggetatcgca cgcatacaca cacacacaca cacacacaca cacacacaca 823800

 cacacacaca cagggtataa agcagagatg cccaagagag gacaagagta aactccaga 823860
 agaagtaaga gcagaatggg caatgctaaa ctatcgatca ttttaactgga gcagagttaa 823920
 attagtghaa atttgtgtgtg tttagaattg aaaagcttct gggtttttcc cccaacaaaa 823980
 acagacactc acagagaatc ctaataatat gctttcttac agagtgtgtc ctttgggttg 824040
 aatcattctt tttagtaaga tctgtcagct gagagatgtg gggttttctg atgctgcata 824100
 attatcaacc tgtgaatata tgattctgtt atttatcata gcctttagaa atgtaagct 824160

gaaataattt ttggcactt tgattcattc cataggtatc cttgaaatgt aaatatacag 824220

 cccaatctat gccaccacct ccaaactcaa taatatagta attccaagcc atccaccttt 824280
 ggagactcta tgaacaaaag atattcccat tatgactcct aaaacaaaac tgtagetgac 824340
 agtcaaaagg cctggaaggc cataaaaggg ggagatgggg tgctttagtt cctaactgat 824400
 gcagctactg gcagttgaca gagcttttaa gaggtgggtc ttgatagaag aagttaagcc 824460
 actggggata catcattgaa gaagtactgg gaccccagcc tccagagtac acagcaattc 824520
 cagtcccat tttcttaagg actgagcagg cagtttgaat ctcatcctt tgagttcttc 824580
 aagcactggt acttgcagca agctaaccct agatctaaac agtatcgatg atttgagatg 824640

 caggcaaggg tgttactaca ccaggaagct caagtcagtc tgtctcagca ggttttcaag 824700
 gatgcctgat gacgtggagt tctattaaga gcctagccct gggagcaaat ctctatgtg 824760
 tatatcgctg aggaatgttt atcaaaacca aaatagattt caacctatcc ttatgagaaa 824820
 ggtaatcact atttgccttc tggatccaga gaagggggtg gagnaagcta gtcacctccc 824880
 ctgaaaactc aggagctggc agagggctgg aaaatgggag gagggaagcc agtaagataa 824940
 ttagaaaate aacacaaaaa tatactggtt tgttagetga ggggctgtcc ttagcatcta 825000
 gatgttttaa ggagattcca aattggcagc ttctcatatg agagtgtgc aggaaagatg 825060

 agaaactact aggcccttta tttgcttaca gtagaaacaa ttgaagagag gctaaggagg 825120
 gattcaataa agttcttctt gcacaagaac aaggacatga gttcaaatcc ccatcaccta 825180
 cataaaaagc tggattagcc tgacaaagaa ggctccatag tgtttgctgg ccagccagcc 825240
 taacctaatc aagcaagccc aggtcccagt aaaatacctt gcctcaaac agaggttggg 825300
 gaaacattta ctcttgctt ccacattcgt gtgcatacac acacacacac acacacacac 825360
 acacacacac acacgcagc atgcatgcgt gcgtgtgtgt gtgtgtgcgc gtgcacgat 825420
 gcatgcgtgc acgcgcacac acacacacac agagagagag agagagagag agagacagag 825480

 agacagagag agaaagaggg agagagagat cctaagggtg aaaaaacatt cagtgtctct 825540
 ctctttcttt ctctttctt ttctttcttt ctctctctct ctctctctct tctctctctc 825600
 tctctctctc actgtgtgtg tgtgtgtgtg cgtgcatgca tgcatgcgtg catgtgtgtg 825660
 tgtgtgtgtg tgtgtgtgtg tgtgtgtgtg tgtgtgtgta agagaagtca cacctgataa 825720
 tactgaatag attgagtaa aaataaagaa aatctctggg catggtaatg catgtcttta 825780
 atccaagtat tcaggatgca gaggcaggta gatctctacg agttcaaagt cagtctggtc 825840
 tacattgtca attccaggct agtcagagct acaaagtata aaaacaaaca aagaagacaa 825900

ctccagataa acagtctatc ttgcatttca taaagcatat gccttttacc gctggagggg 825960
 tttaggtca aggttatatg aaagtgtgaa ctatccctgc ctctcctcag gatcacagct 826020
 agaacataga aggcttagca gagggacagc agaggggaatg cttacagtat tgctgtatta 826080
 tactacagca tgaattcttc actaccatct aagagggagg ccttgatctg agtgcttaga 826140
 ctccctaag gtttcaaagg gcaaaaggaa attatttatt ttatgatatt ccagctgtcc 826200
 tataattgac tacaacaata catcagtttg gacctgatta taattctacc tatcacatct 826260
 gtatctagtt gcataggaag gccaggtaca caatggaaga gacctaaagac cctaagtcac 826320

cacacacagg gctattgtac gctaagcccc tgaagtcttg cacataatth ttgtataggt 826380
 ttgtggaatt atcctggaag gaattacttg gcctcttacc caaagctcta aaaaccactg 826440
 ctggcactaa aactgtggca ctggacattt gtttggtaa tcagctcttc aaatgcaaat 826500
 tctccttggg aagttaggtt attttcacac ctttctcaga gtctcagtga gcctgctcag 826560
 tgctgctga gagggaaagg cttccactgg cagcctcact ctactttat ttccatggcc 826620
 ctgggacagg taaaaagac actcacctt gtcagcagat gctggcaggg gtcgtctgtg 826680
 gccatctca gcagtgtgag acttctctct cacagcagcc tttctcaggt ttctttcag 826740

ccctgagaag agagggtgcc ggaaaagcca gggacagatc atgagctgga gcaccaact 826800
 gctgagttca actagaacat tccaaataga gcttgaagag gaagtttgtt ttcatcaaat 826860
 tcctccctat gaaatgtgat gtttgacagt gactatagaa aaaaaattaa ctctecatca 826920
 ttttagatga ttttgacctt ttgatgtaga ttgttcaatt gacaacttta tctgtggatt 826980
 tataacgca tattgaatac tgcaatttta ctgaatcaa tccattaaaa cgtgtctctt 827040
 ttttcaaata tacattagca taaatttgca aatagtctc tattgggtta aactatttt 827100
 tactgtgagg ttgtatatct acatccaat ttataggaat ttttatttca taaaattatg 827160

acccttataa gctaaataaa aaaaatctga caattcaaat ttttcaacat tttcattatt 827220
 cataaaaatc ccaaagccta gagctaatac aataatatga attaacttat cagcttaatt 827280
 tccacttata ggagttttta aaggggctgc aaagatggct aagtgggtaa gaacactcac 827340
 tgcacaagca taaggagctg atttcacatc cccaacacce atataaaagt ctgggtgtgc 827400
 ttgcacacac acacacacac acacacacac acacacacac acatgaaacc ctaactgt 827460
 aggaggtgg tgagaaaaga atcactggga ctgctggct gccagctag ctccaggctc 827520
 agcaagtgac cctgtctaga gggaataagg caaaaggcaa taacacatga cacgtgatgt 827580

cctcatctga tctctacaca cacatagatg gtgttagttg ttatgcccc attactaat 827640
 taagaaaga catgggcaat aagaaaggat aggtgccaga gctatcctga gtctggaaca 827700
 ctgtgggaac gttgctgtct tagtctgttt tctgctgctg aaactgaaa agctatcac 827760

agctaaagtt atttttcata gttctagagg ctgtgagttt aagataaaga caccagtctc 827820
 tgggtggggt ctctgctgca tccctgcatg gcagaaggta gaaagatgaa agttatcaaa 827880
 atcattccag aaagtccttt ccatgacagc tttagtccat acaggagccc ttctgaccca 827940
 agccccatc aagctctcat tcccatcact gtggcagtga ggtattaagg tcccaacaca 828000

 ggaatttagg gtgacatatt aaatctgagt ctcatgaggc agctctctgg gtaaagagcc 828060
 tggtcaccaa acctgatgac ctgagaccca catggggaga aggagagaac tgactcccac 828120
 aagttgtcct ctgacttcca catgtgcact gtggcacaga catgcttgcc atagacacat 828180
 acatgctgc acatgaataa ataaataaat aacattttta attaaaaatg aagaggttca 828240
 cataattaga acattcttgc agagcaatga aagatgtaga gatgtgggta ccaacagaag 828300
 atgggaggtc ccccaaacac attctgattc ttctttcagg gttactaatg acctgtcctg 828360
 cctgccagta tctgcctgtg aaaataactg tacaagagtg ttaaaaactc ccgttgcaaa 828420

 aacttggctg gttttatgta aaattaacag ttgtttattg tcttaaatgt ttgtttatac 828480
 agaatttttc aagttttttg actttattta taggaattct gccactctga aaacacttta 828540
 ttatctgcaa ataaagagat aactgtctta aaatacgcacat cccagtttgt ctattaaaca 828600
 aatcctagag aaaccactag gctcacccctc acagttaatg gaggcccagt gttctggcca 828660
 catggcgtag aagttcccac tgtatgcctt cctgcgtgca ttccaaatac tgcacaaact 828720
 gtccctctac tecttcagca aatattaatt tagaatgagc taggtcttcc aattctatct 828780
 cattcaactg gctgatacac acatcagtca aagagtatgt tggattgtta aatatcaagg 828840

 ccatatttat gttaaatggg aaatgtgtct ttaaatttct gaaaacgggg cagaaagatg 828900
 actcagcagt taatagcact tattgttctt gcaaagtaca taaatgttca gttcctagca 828960
 tccacactgg gtcattcatt caaccgcttg taaactccgg ctacaggtgc accaacatgc 829020
 acttttggcc tctaagggca cctgcactca cgtgcacatg cccacacata gactcaaaaa 829080
 taagcacata attaaaaata atataaatct ttaaatttct ggaagtctctg aagcactttg 829140
 gctctctctc tctctctctc tctctctctc tctctctctc tctaattttt ggatatgggt 829200
 ctctgcactt tttctaacca tctgaactgt gccatcagt ttgaaaagtg accagtcacc 829260

 ctgaagtga aatctctctg gaccactcat tgcccttggc ttaaacaaca gaaagcctca 829320
 ttctgtaact atgtaaatg atttttctaa taaaaacaaa acacctatct atgtcaaagg 829380
 aatattggaa ggatgactag ataatgcctt ccaagttgct tttaaacggt gctgtggaaa 829440
 tagaagacac tgcacaact gtcattttgt tacttttttt tttaatcgtg gagaagctag 829500
 tattacattt aaaaaaatca gaaaagtcga ttttcttaaa gcaaccattt ggaggcctaa 829560
 aaaatatctg tgctagatga gcccttttgt tctaggttcc tatccctgtg tttcccacca 829620

agttcaagcc catgactcct gaatthttctg tagccaagga caatgagaag aaccaagata 829680

 tgcaacggaa ataataaacc agaaggcatc agaggaccaa ggtgcagaag cctatcacia 829740
 gagatatttg acagctcata attcaacctc tttgctcttc tagcagaaga ttcggettaa 829800
 agaattgaag cagccttcca aacattacac aggcagttag aaaacaagtg ccatcatata 829860
 accaaatgag tgggaaaggc atgaaaaaag tcaccaacac tgttcataa tcagcctcat 829920
 cagttccata acatgcctca cgttcaagtt catgaagaag ggggcctagg tectgggtcc 829980
 ccacagcaga ggatgacagt gactggatgc cttctggcat gagtccaact ctgtcccaat 830040
 ccatttctgt tactgcaata aaaataccct gacaaaaagc agattggggg aggaagggtt 830100

 ctgttttagc tcacaattca ttgctacggg gaattcacag catcatagac tctgtcacag 830160
 catcatgtga cagctggica cattacagcc acagctaatg acagagagag tatgttctct 830220
 gagctgtgaa agatgtgagc aggacctatt cactgtagag ttattgagag gatggaagga 830280
 gactatacag tgtttagcag aatggaatga taatcattgc ttttaatgic cctagataag 830340
 aaaatfaaac aagaaagtac aaataaagca tttgtcaaat ggcctggcat cataataaga 830400
 gctcaacaaa tattgggaaa tattattaca gcacactctc acacaagcat tcatgtaata 830460
 agtatttggt aaatttatga aactcttacc agttgcagga actatgttct ctggggcaag 830520

 gctgtattca tggaactcca cttgttcatg gtcaaataga ggatgaagac atgcatcaa 830580
 atcaatgtcc taigccaaag gtgggcaggt ggagcctaca tgccaactcc attggtattt 830640
 ttatgactgg cttttatagt tttcaatgtt taaaagaaaa aataaaatga gaaagaatat 830700
 ttcattgccgt acacagtgtat tatgaaacce aaatthttaga gtccataatt aatgttatt 830760
 ggagcccagc caggcttctt catttgcata ttgctgtga ctgtttcacc ccatgacagc 830820
 caagtggaat ggttgtagca aagaacatat ggacagcaaa atctgaagtg tttacgatct 830880
 ggtthttttac ataatagtct gcaaccctgt tctgtttctt ggtaaacatt ataatacagc 830940

 tgtgtcctgc aggctactat agaagttcca ggttaagggtt aggagatagg taactgtgcc 831000
 ttggaatata ggggagacac tgccaaggag ctaagttata aagaatgagg agagctttat 831060
 ctgatggaaa aggagaccca gaatctttac agagcaaagc agggtcagga aatagaaga 831120
 tgttcattgc tttttcaag taaccctggc ctaacaggct agcaagatca tcacatatat 831180
 tctgatctt caactgtcta ctaatctctg aggcctttatc ttttaatgcca gaacaattat 831240
 cttctcccag aaaaaaaaaa tcacatagaa cttttgatcc ctctgaggtt ttttaagttt 831300
 ctgatggaaa tgagacataa tggccttggt tgaatatgtt ctttctgtg tctgtgtcca 831360

gtctcattag catgtgtcac agaactaatc tgtaagtgtg actggttctc actgcaggtc 831420
 ctaaaagcat gcgtggctac caaggttaag gggcactgag gcatgcactc catcaataaa 831480
 aaaccagctg aggaaagagt aaacaagaca aggacaggac ttagcagagg ctcaaaatga 831540
 cactaggaag catgagcaga tagtgaaaag aggcaacaca gatcattaga aggcacactt 831600
 gaacatgceg ggaagcaaa aggcagatgc ctcagtgccca tcagtgatgg aacccttag 831660
 cacagccttg gattcacttg ttggtagaag gccatgctca tagagttagc aggctgtaat 831720
 aaacttaaga tcaactgaca aaactaaaa acaccaaat cagtgtggg tcacagagac 831780

 atacatgcaa cacatactca catgcatgct gatgtcttct tctctctaac taggaaggat 831840
 cagctcgggg tcaggtgact tcccaggaca gctcaatcct ttagctgccca caacaacaca 831900
 gcaatttacc ccagttctgc caagtcccc caaacagcat tattcattct cccaggaaag 831960
 gggccttctc catgaggagg tactatggtg atactcatga cgcttagcta agttagggtt 832020
 tctattgctg tgaagagaca ccatggatac agagtccttt ataaaggaaa acatttaatt 832080
 agagctggct tacaggttca gaggtttggt tcattgtcgt catgtggaaa gcaaagcagc 832140
 atgaaggcag acatggtgct ggagaaggag atgggcaggt agtaggaaaa taagtatac 832200

 tggccctggg ttgagcatct gaaacctcaa agcccacca cagtaaccta ctccagcttc 832260
 ctggatacce tctaggecatg tctacaatgg acaggggaagt aaatggacga ttctcttga 832320
 tagttctat ggittgtgct atttctattt tggggtagt acagttaac aaatecgact 832380
 ttagcttcta accatgagtt cagaaagact gcatatggga ggaaaatgca agtcacaaac 832440
 agcccataat actcagagta ttctacggg ctctgactc agtcctttc atgcttgct 832500
 atgctttgct gaagatgaat gccatcatag agttctctc agtgactctg cagtagatgt 832560
 tagtggacat cctaaccag gtcttcagag aggccagac ttgcctccc agcagcagga 832620

 gacaccagag tacttccctg ggaggctgca ttgccagga ggacatgcat ctccagcacc 832680
 tagcttgtgc ttcatagcc gtgctgggca tgctgaact gcatctgaa gcaagccaac 832740
 atcccagcaa cagccatatt cgaatcac ctactgagtg acctagaat aaaagaatt 832800
 gtatggttg gatggctggg atcaaaattg aatctgtact gcatattat agtcctcca 832860
 ccaatatcca caccataat caaactctag ctctttgttg aaatgcttc aggtagcaag 832920
 taccttcaag ttatgctcgt caccceaaa cagtgtattt tcttacatt caagccagga 832980
 gcagcaaacc atcaactaa ataaggaac actcataatg caacaatgt tctccaggt 833040

 gcctaactcc tataaaagct gaatgaaaat acatctctt gccctcaata gaaagaacga 833100
 gcagaggctt tgtttttctt ttttaagac agaggggccc acttataacc tctctcaaa 833160
 tcacaatcga aaaatgacct gctctttgta aagaataacc acatgagctg ggtgtagct 833220

cggtgtaga gcaagcactc accatgcagg aggcaccagc tcccatctcc agcaccaaaa 833280
 agagaagtca aatgaacaaa aactacaaag gaagccctt caatcaaat aggacattgt 833340
 tattttcata tttatgctg tgtcaacagt attcagaagc ttacacaata aataacatcg 833400
 cctgcctaa ggacctttac catcaaaagt attgataaaa caaggaggaa gcctgcagct 833460

 gcagctgtga agaatggga gccagagggt ggaagcctca ggcagttgtg agctgccaca 833520
 ggtttgagga ctctgaaaaa aaagetgttg tgatgagcag gataaagaca gtggtgtaga 833580
 agagaaaaga acagcaagca tttgttgcca gtgtccctt ccaacaacct tgagctgagg 833640
 ctgctgcaag ccagtcaggt ggtaagtggg tgtggtccca taggtgacac tgagaggtaga 833700
 ctgtgtgtgg ttggagcca agtccttaat cacttatata atcgccaggt tcctaggcta 833760
 taacatgggt taacaatagc tataccact cacctagact ccctcacctc caaactgatt 833820
 aaatagaaaa atgaagacag tacagtctg agataactct ctctctctct ctctctctct 833880

 ctctctctct ctctctctgc cattgtgtgt gtgttctctg tgtgtctctg tatgtagggt 833940
 gtttgtgtga gttcatattt gtatgaaggt acgtgcgtat atgctttgta cacacacatg 834000
 tggaaagctaa aggtcaacct gtggtatcat tcatcaagaa ctacctctct tcctgtaca 834060
 ataaaaaac ttctagaggc atcaccatcc ctgacttcac gctctactat agagccatag 834120
 tcctgaaaac agctgggtat tggcacaaaa acagacaggt agaccaatgg aatagaattg 834180
 aaaacctga tattaacca cacacccatg aacacctgat tttgacaaa gaagctaaaa 834240
 ttatacagtg gaaaaaagaa agcatcttca acaaatggtg ctggcgtaac tggatgctgt 834300

 catgtagaag attgcagata gatccatgtc tatcccatg cacaaaactc aaaacttaag 834360
 tccaaatgga tcaaagacct caacataaat ccagccacac taaatctctt agaaaaaaaa 834420
 agttggaagt acccttgaac aatttggtgc aggagactgt ttctgaaca taacaccagt 834480
 agcacagata ctgagattga caattaataa atgggacctc ctgaaactga gaagcttctg 834540
 taaggcaaag gacacggtca acaagacaaa aacggcagcc cacagactgg gaaaagatat 834600
 tcaccaacce cacatctgac agaggcctga ttccaaaag aaaagaactc aagaagatag 834660
 tcacaaaaac accaaataat ccaattaaaa agtggggtac agacctaat agagaactct 834720

 caatagagga gtctaaaatg gctgaaagac acttaaggaa gtgttcaaca tccttagcca 834780
 tcagggaaat gcaaatcaaa acaactctga gataccatct tactctgtc agaatggcta 834840
 aatcaaaaa caccaatggc agtttatgct ggagaagata tggagaaatg ggatcactcc 834900
 actgctgttg tacagccact ttggaatca gtatggagat tcctcaggaa aatgggaatc 834960
 agtctaccte aagatccagc aattctactc ttaggtatat acccaaaaga agcacattea 835020
 tacaacaagg acatctattc aaccatgttc atagcaacat tatttgaat agccagaacc 835080

tggaaaccac ctagatgcc ccaactgaa gaatggatgg agaaaatgtg gtacatttac 835140

 acaatagagt accactcagc agacaaaaaa caatggaatc ttgaaattct cgggcaaatg 835200
 gagggaaacta gaaaaaaca tcctgagtga ggtaacceca tcacaaaatg acaaacatga 835260
 tatgtactca ctcatatag gattttatac atgaagcaaa ggattaccag cctacaatcc 835320
 acaccaccag aaaagctagg aaacaagaag gaccctaaga gagacataca tggtcacctc 835380
 gagaagagaa aagggaacaag ctctcctgag caaattggga tcatgggggg aggggaaagg 835440
 gaactaggag aatgataatg ggagatgagg agggatgagg aagacatgat gggacaggga 835500
 ggttgagttg ggggaagaac ggaagagagc aagataaaac cccctataat agaggtagac 835560

 attataggtt taaagaaaa tcaggcacta gggaaatc cagagatcga caaggatgat 835620
 accaactaac aatctaagta atagtggaga ggctaactta aatgcccttc tccaagaagc 835680
 tgatggaac agaagcagac acccacagct aaacactgaa ctgaactctg gaatccagtt 835740
 acagagagag agaagtgatg agcaaaggga tcaagaccag gcaggagaaa cccacagaaa 835800
 cagctgacct gaaaaaggg gagctcatgg accccagcct gataactggg aaaccagcat 835860
 aggactgatt cagaccctt gaacatgggt gtcagtgagg aggcctctga aatctatggg 835920
 gcctctggta gtagatcagt gtttatccct accttacgaa tggactttgg aagccattc 835980

 cacaagagg gatattctct cagcctagc acatggaaga gggcttagc cctcctcaa 836040
 atgatgacag acictgaagt tcccccttg gaagcctca ccctccctgg agagcagaaa 836100
 gtgtatggga tagggagtta gtgaggggca ggggaggagg ggaggagag ggaactggga 836160
 ttgacatgta aaacaatctc atttctaatt taaattaa aatttaaaa gaaccactca 836220
 cttcttttg ttggggggg ttgtttgttt gttttggttt ttgtttgttt gtttgtttgt 836280
 ttgttttga aacaggcat cattagccta gcacttactg agcagacaaa gctggccgac 836340
 aagcagggcc caggagtctg cctgttgtct ccaggteccc agaactgaga tgataagtac 836400

 atgccacacc tagcatttca acatggttc cgggactgg atatatgtct tagcacatca 836460
 ttgactgggt tatctcccaa tcctctatct ttcaaagttc tgaataaatc taatctaaa 836520
 tctcttaaat aaatattcct tcctttatct tcaccaaag aagtggtaga atgtacggtg 836580
 agtaagcctc ataacacca agtgtcttga ggtcagcaca gcaaaagtta tctgctaact 836640
 ctgggatcag tttgtttgtt gttttttca ttcaaaaca aaatgttggc ctaaactatc 836700
 ttgggctaaa tataaagatc tgacacatcc ttaaataatt ctctggctct gagtttaaag 836760
 ccataggttg ttaaataaat cacatttgtt gccaaaaat agactagtac catatgggcc 836820

ttcttgctgt ctgtaacctg gattcgggtg tgccataaat catgttatgt ctctgagat 836880
 acagctgaca tcagattgga gtgggtgtgt ttgtctcatt ctctatggtt gctacaagaa 836940
 ggggccagtg tctttcttac agttcagcac caatcccaac aactctggat gctctttatt 837000
 ctgtatgtca catgactgac acttttattg ggtaaggatg ggtgtcatcc acaatcatct 837060
 atctttagag aaatacttca aggcctagac ttatgaaatg atactccaaa gtttttctaa 837120
 gttggtgcct ccaaaaataa agatgcaatg cttgcctgaa caataaaaat gccattagaa 837180
 ttccatgagt cagcacagta aaaaatatat atatatatat atatatatat atatatatat 837240

 ttcatatata tatatatgaa aaagtgttta tcgaagaaaa tatctagctt tgggtggtec 837300
 taaaatctga ggttgtagct ctgagggata cgggtgtggtc tcaactgcat cggggccaca 837360
 cttatgctca ttagctaagt gctagataac atctcaccac cctagtgttt gccagcattt 837420
 tgaaatctga caacacaggg tgatatggaa caggtatatg agatttacct aaaccccact 837480
 tgtgttaagc aaicaageta ttcacagaag tctcatttgt agatcacacg gataactta 837540
 ggcagcaata tacagaatcc gcaataagtg attgctactg actgcttgag ctgcaggttt 837600
 aaagatggcc tcatctcctt ttctttgac aaccagagcc ccattgatct tagctcattt 837660

 ctacagaatt ctaggcctt tggttgaatg tgctcctcct ctcacctgtg aattaaatta 837720
 aatgttctga cagctaaagt cagtgtccca tccaagagaa gacaaacct tctgcccaca 837780
 ttgtgcttct aactactgagt tttgctcagt tttagtggtt gaagagtgtt tcagtttttt 837840
 atatgcaaca cataaaataa aaaagtctca tactaagctt aatcattgta ccaagccagc 837900
 gagaaagcat gacaccatga aagagtcggt gtgtaagtta ggaaatacgg gactccatcc 837960
 tgctccgata ctgactaaga ccgagatgac tcgccagtga agcaaaagat gggaaattca 838020
 cctgtaggac cattgtgagt attaaatgaa gtaatcgaga ccatgcaaat aagagacatg 838080

 attctgttat ctacceata tcacatgaga tactttttgg gggaaggag atgactgaat 838140
 gcatatagat agatagatag atattattgc taataaaaag tcctaatata catacaggtt 838200
 atattttatc attataaagt aaacattagg gctaggaaga tggttgagta agagcacttg 838260
 ctgtgaaatgc aagaggactt gagttcaaat ttccagcacc cacataaaag ctagacattg 838320
 ccatacacac ctgtatcctc aactgtagg gttagagaca agaagatccc aggagctggc 838380
 tgccggtcag tctaagagaa atgtgtagct ccagttcag agaggtccag agaaatagag 838440
 gaagaccccc tgatgaceta ttctggcctc tigtgtgtgca cacaggcata cacaatatga 838500

 catgaataat caaatgttag aattcagggg gtctctgggg aaaaaataa aatggtagtt 838560
 accaggggct ggtggaaatg ggaaattagg agttactgtt tagtaataaa ttttactttt 838620
 atgaggtaaa acatggataa tgggatagc tgagaaattt taaaatgca tcgagacaac 838680

tgaactgtca taactaagct gggaattagt tgttttctga ttgttatgac aatatttgac 838740
 agaagcgact gaagaaagga agggttgctt ttgactcacg ggttatgggt acagtcctt 838800
 gtggtgacag aagcaaggtg gtaagaggca actgatcaca ttgcatctgc agggaggagg 838860
 cagaggcaga tggatgctgg tgctcagctc ctagtctcct ttttatcaag tctgggaccc 838920

caggccatgg aatagtgagg tccacattta tgggtggcct ttgcacctca gccaacccaa 838980
 tctagaacte actcacagag ataccaagaa gattttgtctc ctgagtagtt ctagatcttg 839040
 cctagttgtc aatcaatatt aaatcacaca ataactctta cttttatgc atcttggcac 839100
 aatgaagaaa attgggacta aaagactgca cagttgtgtg ttctgtgcc tgttttagcc 839160
 aagtagatga aaaggagatc tacccatatt ccactctaaa gagtcacacg ctggcacagc 839220
 actgtgccta gaagcagga tacctgtttc tcatttgcac aaagtatfff tatggaccag 839280
 ctgtgaacat gatcacaat atcccatcaa gatctcagag aattcctaaa ggtattatct 839340

tcccttttcc tccaaattag gaaacagaga cttaaaaaaa gaaaaaact aatatgaatt 839400
 gtctaaggaa ttgaggccta aaacaggtct taaaacaaat tggccaacga aatgtctaac 839460
 tcacagtage aatgtaaggg caaaggaatt ctcaaggaag tgttgagcag agaaacactg 839520
 gatgacaaga caagatttc acttagtact gttcatttct agcacagttc ctgttaaagg 839580
 ggtgatgtta taccaaggat ctactgcagg gttgggagta tagctgaacc cctgggttcc 839640
 aatcctaaca ceatgaagac caggtgtggt gccacaatcc tgtaattcca gcaacttgaa 839700
 ggtggagaca agatgatgag aaggccagtg tcactctctgg ctacacagtg agtctgagcc 839760

aacctaggct acatgggatg ctatctcaaa agaaaagaaa aagaacttta gaaaaggagg 839820
 cctaactata gatacgacat aataacttct aatctatcca tcataaact ctgaatataa 839880
 gaggtgaagc agacatafag ctaaataagc ccagtgaagg attaagagga atgaggatag 839940
 aatggaaaa caaacatggt tttctaactc atatctggaa gctgatggag gattcagata 840000
 aatgctctca aaagaatttc caggaagctt agagaccagc tagcctggca tgaggagcag 840060
 aaaacaacac aatgccctt ccaaaaataag gtggaaaaca aggacaaaca cccaaagctg 840120
 tcctcttact tctacactca caacacacac acacacacac acacacacac acacacacac 840180

acacacacaa cacatgcaca ggcacaacac accgcaatca tactcaaafg ttaaaaagaa 840240
 aaaggacttc tggtaaatct ctctggcctg ggacaggatg gagcagacaa ctatagcatc 840300
 tacatcttgc agaagagact caaggaatca tagcagataa aaccctaaaa accaaataaa 840360
 tgaatacccc atgaccact gatgaaagaa aatgatcaag catttgggaa agatgagaca 840420
 agggacaaca agtagtcaga agggacttga gcaacaaca aaaaagcaaa atatgtgggc 840480
 tctgttaata cactctaact acagatgtgt tggttttatt taaaagggtta aggtcagatg 840540

gaatgggaga atctgagcct gggttccaga agtcgttgag tgaaccaaca aagcatctgt 840600

 acaaatgaat atccactttc aactaggat gtggtccagg agtgggtctc taggaccaca 840660
 gcttgagca tgcagetca aggctttcta ccacctatcc ttgtcacatc cetcccatct 840720
 gtcaatctat caacaaggc gatcaagtcc aaggcctgcc agaactcaag ggaagagaaa 840780
 aacagatccc acatccgtga cagagtggcc atgttttaga aaattatgtg gtttagaaaa 840840
 tacaaccctt gccgtttatc attgtttgtg gtttatataa cttagcaaat attcttgcat 840900
 tttggcatg ttgtgtcaaa tttccttttt gtttaaaat cagagtctcg atattgtaga 840960
 tctatctgcc ctcaaaactca caaagatcca cctgtcctct gcctccaag tactgggatt 841020

 aaaaaccagt gccaccacac ccagttcaaa tttcattctt tttaaagctg aataatattc 841080
 catgatgtgg atgtaacaca tatatacatt tgtctgtcag tgagtatttg agttagtccc 841140
 atcatctggc tatggtaagg aaagctaaaa tgaatatagg gaacaaatgt cttttctgag 841200
 tcctgtttt caattcttcc agaaacacac tcagtagaag ttgcttttta tcgtattcaa 841260
 caaatgaggg aatggctaaa taaagtataa gcaccctggt agtgtcttct gtagaggact 841320
 caagagcgc catgctgcta cgaaccttcc ctattgetgg catcccacca getcttgct 841380
 ctgccatagc tcatgttccc ccctgatgtc ttcccctgt ttcctagact agagctctgt 841440

 caggagacag attgtgtctt cageccctagt tcctcaatac ctggcatgca atatgagctt 841500
 agtaagtgtt gactgagtaa aaaatagatg agctaggaat agaacagccg taaaccacct 841560
 ggtactaaac ttgattcaga tgttattggc tgcctatcaa gaatatggac ctacactatc 841620
 atttaaggaa cacaaaagga aaaatcttaa aatggctaga aaaatcttag aagacatacg 841680
 ggtacagcta gcacaagagg acaccacagt gggctgtgtt cttttcatat ttaatagcca 841740
 tggatgtggt gtgtaagctt ctggagaagc ctagactctt ggcgggggca gggcaggtga 841800
 gttctcaagt atcccatagg cagattgttc tgtttctact caatgactgt gactacaaat 841860

 acacaggtgt gataataatc gtaactaca ggtgtgatag taaataaaca tctaacattc 841920
 aaaaaccctg gacctaccag cagttaataa tatgtagcca aaatatacct aatctacttt 841980
 taagtgtcaa aaaaatgaac ttgaatgtca ggaaaatcta aatctagttt ggtctagatc 842040
 gtccctcttc tacttaatc tctcatccac ttcaaaggcg ggacagatgt cactgtcact 842100
 tctacaaga agctttctac aggactgggg agatggctct tctaaagaac caggcctgc 842160
 accccagcag ccacaacagg aagctcaciaa tttcctgtaa ctgagctcca ggagatccga 842220
 tgcctagtc tcatccacag gacctgtgc tccctgaat ataccccccac acacagtcag 842280

aactttaaga taaaatcgta tattttaaaa gaagcttcca ttcctacca gcctgtgaga 842340
 cacaccagc ctctctctct ctctgatggc tcctatagatg cctttttcaa ttttgtgca 842400
 ctcttttgag gatgtaactc tttgagggca aatgttataat gcaacaaata ccacctagca 842460
 tatctccatt gaatagcaat gcaataaata tttgccaaat gtctctacaa ataaagctaa 842520
 atttaaaac ttgaaacatt atgtgcacat gattagcaca tgatgctaata cctagcactt 842580
 gaagggatgg agaattttgt gggtgaggac agcctggaca attctcctc tcaaaataag 842640
 ttaactaagt tacatacaca tcttgaaaaa ttgtgtatgt aaatatataa gcatgtacat 842700

 gtatatgtaa atacacacac acacacacac acacacacac acacacacac tcaccactgc 842760
 tgtttgaagg gttgccctc cagatttccc gtgttgacag tcaccaatgt ggcaggactg 842820
 agaaggaagc cttataggag ctgacaaagt tgtgagacca gagcccttgt gggtatgatc 842880
 agagccctta tgaagggtc tgtctcttc tgtcttga tgacagggtc tgttctctt 842940
 gttctctac ctgtaccac gtgaataggg aagcccttac aagacacaag cccagcatc 843000
 ttgatagaga attccaagc ttctagaaca gtgaggaaat aaggtttat actttttct 843060
 atatcattac acatattcat tttatgtgtg gtgtatgtac acatgtgggc atgaccacga 843120

 catgatgcat gtgtggaggc cagaggataa tctaccaaag ttggttctct cttccatca 843180
 tatgggtgcc aaggatggaa tccaagtcct cagacatggt ggcaagcacc tttcccact 843240
 tactctctt ccaacccea tttctgatt cataaattac ccagtcataat gaattttata 843300
 caagacaaac tgccttggc cagatgtgtg ctggtcaagg aagcctcact gtgactttga 843360
 cagcatctgt tactgaccat ctacttctc tgcccaacga cctgtcatal ctaccatt 843420
 aactcagttg aactcactgt gggtttccat gtcatalatag ttacttctgc atttcacatc 843480
 ctgtttctga acctcagcaa cattatatt taagtcatgt tttacagata tcaaaagcca 843540

 tcattatgtt tttattttaa agataatecc tcaagactta agagtacttt gttttcgtgg 843600
 ttgtctgtgc tagaattaca aagagcaatt tctaaagtca ggagggtcaa tagctgtatt 843660
 aagaaagtgc ctctttttt aaattatgct tttaaaatgt aatgcatta gaaattagaa 843720
 caaagtccca gtcacaaatc aaattgcatt cacctcagat atagtctatg tgggcattgt 843780
 aagatgcca tgctatgct agaacagact tctccaagga aagagctgag cccgtggaac 843840
 acttctaage cctgagctaa aagtgaacag gaagcaaaag aacatggcat gtgattgtca 843900
 ctccgctct cctgtagctc acaccaccagc aaattgtgac atgaagagcc tcaatgtttc 843960

 ttccaatgaa ccctcacag ggcctttaga ctgcaaaata tcagcagcct tggtagactg 844020
 gtgaccatgt ggtgagagac acaccttctg gaacactgcc actgagcatg gcaatgattt 844080
 cagtacctt gglatcaagg gcacaggctt cagtgccttc cagtcatcac atgaagaccc 844140

acagacacta gaccaatgcc tcttggctag gcccagggat gtaacataat cttacatctt 844200
 cagtggctag agactgctgt ggacatttaa tagaggagat attattgaag tttacatagt 844260
 gcagatgttt cttagagctg ttgagactat tttgctgaat ttgaggtgac tggacttgtt 844320
 tgagaacaat gaaaagggtg tacagaaata ctgttccatt cgtgttgta cactgacaca 844380

 tttcaaggca aactggcct ataaaatgtt gccaaaaaac ctaaagtffc aattgaataa 844440
 aatcatttca cttacaaaaa atgattcctt ctcaaaaaac agaagatcaa gcaatcatca 844500
 ttattcctgt ttaaataaag ctatctggac cttccggtgg ctgctcagag cctggggact 844560
 gagcctgctg aggctgggg actgtgcaca gaagaactgt cccagcagat cagccctcac 844620
 aaagacagcc agcatcctag tcctgcctcc acccacggga agaggaaagc catcagagta 844680
 ttgaacctgc ttgaaccac cagaagagac ccttggacc cgtaccagc agcagagggg 844740
 gagacactac cagcaccac tggagaaagg gatgggaaaa caacagtata agaacagagc 844800

 cagcttggta ttggcacaag aatagacaga tagaccaatg gaatcgaatt gaagacctag 844860
 atattaacce acgcacctac gaacacctta tttttgacaa aggtgctaaa tccatacaat 844920
 ggaaaaaaga tagcatcttc aacaaatggt gctggcacia ttggattcag acatgcagaa 844980
 aattgcagat agatccatac ctgtcacat gcacgaaact taagtcaaa tggatcaaag 845040
 atctctccat aaactcagcc aactgaatc ttctagaaga gaaagtggga acaacccttg 845100
 aacaatgg cacaggagaa cccccccccn nccccccccn nccccccccn nccccccccn 845160
 nccccccccn nccccccccn nccccccccn nccccccccn nccccccccn nccccccccn 845220

 nccccccccn nccccccccn nccccccccn nccccccccn nccccccccn nccccccccn 845280
 nccccccccn nccccccccn nccccccccn nccccccccn nccccccccn nccccccccn 845340
 nccccccccn nccccccccn nccccccccn nccccccccn nccccccccn nccccccccn 845400
 nccccccccn nccccccccn nccccccccn nccccccccn nccccccccn nccccccccn 845460
 nccccccccn nccccccccn nccccccccn nccccccccn nccccccccn nccccccccn 845520
 nccccccccn nccccccccn nccccccccn caaggacata tgttcaacca tgttcatagc 845580
 agcattgttt gtaatnnnnn nccccccccn nccccccccn nccccccccn nccccccccn 845640

 nccccccccn nccccccccn nccccccccn nccccccccn nccccccccn nccccccccn 845700
 nccccccccn nccccccccn nccccccccn nccccccccn nccccccccn nccccccccn 845760
 nccccccccn nccccccccn nccccccccn nccccccccn nccccccccn nccccccccn 845820
 nccccccccn nccccccccn nccccccccn nccccccccn nccccccccn nccccccccn 845880
 nccccccccn nccccccccn nccccccccn nccccccccn nccccccccn nccccccccn 845940
 nccccccccn nccccccccn nccccccccn ctacgagaat gagaaggaa gaaaaggaag 846000

gatgcagagg tcatgaggga gcagcaaggt tgaggcaggt gtagattaga agacaggcta 846060

tgtgataggt agggctttta gttgcaaaga gtgggagggg gggaaggag ggagaaggga 846120
actgggattg tcatgtgatt caatcttgtt tgtaatcca ataaaaata aaagagagag 846180
ggagccatta taggttcaat gagagatctg aactaggca gattttcaga gatctataag 846240
gatgacacct actgacaatc taggctgacg actactttat atgccatcct agagccctca 846300
tccagtagtt gatggaagca gacacagaca cccacagcta tacactgaac tgaactctgg 846360
aaacaagtgg cagacaagga ggattgatga atagttgcag ggggtggtag aggaggaagg 846420
gagggagaag ggaactggga ttgtcatnnn nnnnnnnnnn nnnnnnnnnn nnnnnnnnnn 846480

nnnnnnnnnn nnnnnnnnnn nnnnnnnnnn nnnnnnnnnn nnnnnnnnnn nnnnnnnnnn 846540
nnnnnnnnnn nnnnnnnnnn nnnnnnnnnn nnnnnnnnnn nnnnnnnnnn nnnnnnnnnn 846600
nnnnnnnnnn nnnnnnnnnn nnnnnnnnnn nnnnnnnnnn nnnnnnnnnn nnnnnnnnnn 846660
nnnnnnnnnn nnnnnnnnnn nnnnnnnnnn nnnnnnnnnn nnnnnnnnnn nnnnnnnnnn 846720
nnnnnnnnnn nnnnnnnnnn nnnnnnnnnn nnnnnnnnnn nnnnnnnnnn nnnnnnnnnn 846780
nnnnnnnnnn nnnnnnnnnn nnnnnnnnnn nnnnnnnnnn nnnnnnnnnn nnnnnnnnnn 846840
nnnnnnnnnn nnnnnnnnnn nnnnnnnnnn nnnnnnnnnn nnnnnnnnnn nnnnnnnnnn 846900

nnnnnggat gcaatgttgt ttctaattgc aactaaaaa acttcataca cataaaataa 846960
gtaattaaaa ataaaaata acagagccaa cagcaaaaag atccacatga aggcaccaga 847020
gtggactcta caccagcaag acctgaacat cctatcacag atgaagcaga agagaatgac 847080
cattaaaaca actttatgaa gataatagag acctcaaca agataatgag aaaatccctt 847140
aaagaagtgg aagaaaaaca aaaaaattc aggaaatgga ggaaaataca aaacaaaaat 847200
tgcaagaaat aaacaaatct cttaagaaa gcaatgaaag tcaagaaaa aacaacaaa 847260
caaatgaagg aaacaatgca aacagtgcaa ggcttgaaag ctgaaataga aaaaataaaa 847320

aagacacagt ctgagggaat agaaaagatt aggaactatg gatgcaagaa taacctacag 847380
aataaaagag atggaagtga gaatctcagg cattaaagat aactgggag aatagattc 847440
attgacaaa aaaaagtctt aagtctaaca aatccctaac acaaaatc taggaaatat 847500
gggacacagt gaaaaggiga aaaaacacac ctcaaaggcg cagaaaacat attcaacaaa 847560
gcatagaag aaaactttcc caacctaaag aaagacatgc caatgaaagt acaagaagct 847620
tacagaatac caaatagagt ggaccaccaa aaataagtcc cttcacaaca taataatcaa 847680
agcaccaaac atacagaata aagaaagaat attaagagca gcaaaggaaa aaggccaagt 847740

aacatataaa ggcagaccta tcagaattac acctgatttc tacatggaaa ctctgaaagc 847800
cagaaggccc tagatagata ttctacaaac actaagagac cacaatgcc agcccaaact 847860
actataccca gcaaagcttt caatcactat agagcaagaa aacaagatat cccatgacaa 847920
aaccagattt aaacaatata tatccattaa tccagcccta tcgaaagtac tagaaggaaa 847980
actctgacct gaggaagtta actacactca caaaaacata ggcaatagat aatccccttt 848040
accaaaagcc aaaagaaaaa gcaggataat ccacacacaa taccaacaac aacaacaat 848100
ccaacaagc aattaacaat caatggtccc taatctccct caataataac ggttttaact 848160

cacctataaa aagacacaag ttaacagaat ggttacaaag atagaattca tccttctgat 848220
gcacaaaaga aacacacctc aaattcaaag acaggtcacc tcagagtaaa caggaaaaga 848280
ttttccaatc aaatggacc cagaacaaa ctggtataga tctcctaaaa gtaacaaat 848340
tagacttcaa actaaaaatc atcaaaagag atgaagaagg tcagttcata ttcacacag 848400
gaaaaatcta tcaagatgaa gtctcaattg tgaatatcta tgcccaaat acaaaggcac 848460
ccatgctggt aaaagaaaca ttactaaaac taaagtcaca cataaaatct cacacagtta 848520
tagtgggaga cttaacaccc ccactctcat caccagacag gaccactaga cagaaactta 848580

acaacgaaat aaaagaacta acagaagtta tgaccaatt aggtttaaca gacatatata 848640
tgacattcaa tccaaacaca aaagaatata tcagcaccac ctggaacctt ctctaatac 848700
aaccacatac tcagcaacat agcaaacctc aacagataca aaaaaatgg aataaaactc 848760
tgtatcttat caggccatca tgctttaaag ttggaattca acaacacaaa tcacagaaac 848820
cctacaaacc aataaaaatc gaacaatgtg caattgcacc attcctgggt caaggaagaa 848880
ataaacaag aaattaaaga ctctcttgaa ttcaatgaga atgaagacac aacaacccaa 848940
cttatgggac actttgaaag cagtactaag aggaaagttc atattacaaa gtgccacat 849000

gaagaatctg gacaataatc acattagaga attaacagca caactgaaag ctctagaaca 849060
aaaagaagca aactcacccc agaggggtag atgtcaggaa ataatcaaat tgagggtga 849120
aatcaataaa gtagaataaa ggaaacaata caaagaatca atgtaatgaa gagttggttc 849180
ttcaagaaaa tcagcaagat agacacacct ttatctaac taacaaaag gcagagagag 849240
aacatgcaaa ttaacaaat cagaagtcaa aagggggaca taccaacaga cactgaggaa 849300
atccagaaa ttttcaggcc atactttgaa aacctgtact ccacaaaatt ccaaaattta 849360
aaggaaatgg acaattttct ggatagatat cacttaccaa aattagatcg agaacagata 849420

agcaatttaa acagacctat aaccctaata gaaatagaag cagtcacaa aagtcttccg 849480
accacaaaa gccagggcc agatggcttc ggtgcagaat tcttcagca attcaaagaa 849540
gaactaatag caaaactcct caaattgttc cacacaatag aaacagaagg ttcattgcca 849600

aactcttttt atgagcctgt aattaccttg gtaccaagc caaacgaaaa cacattaaga 849660
 cagagaacta caaaccaata tcctcatga acattgatgc aaaaatactc aataaaatac 849720
 tggcaaatca aatccaagaa cacatcacia aaatcatcca ccacaatcaa gtaggcttca 849780
 tctccggcat gcaaagtggg ttcaccatat gaaaatctat caatgtaatc caccatataa 849840

 aaaaactgaa aaagaaaaac cacatgatca tctcactaga tgctgaaaaa gcattggaca 849900
 aaatccaaca cccttcatg ataaaggctcg tggggaaatc agggataaca ggaacatacc 849960
 tgaacataat aaaaaacaat atacagtaa ccaacagtca acatcaaatt aaatggagag 850020
 agactcatca caattcgtct acaatcatga acaaggcaag gctgtccagt ctctgcatat 850080
 ctcttcaata tggtaactga agttctagct agagaaataa gacaataaaa ggagatcaag 850140
 gggatacaaa ttggaaagga aaaagtcaac ctttactgt ttgcagatga tatgatagtt 850200
 tatataagtg acccgaaata ctctaccagg gaactcctac agctcataaa aacctttagc 850260

 aaagtggcag gatacaagat taactcaaaa aaatcagtag ctttactata tacagatgat 850320
 aaacgggctg agaagaaat tgaagaaaca tcacccttta caataacat aaacaacata 850380
 taatatcttg gggtaacact aacaaaatag gtgaaagacc tgtataacaa agactttgag 850440
 tctgagcttt taagaaaaa tattaataaa gataccagaa aatggaatta tcttccatgc 850500
 tcttgtatag gtaggatcaa catagttaa atggcaatcc tgccaaaagc aatatacaga 850560
 ttcaatgcaa tcccatcaa aatccagca caatttttca cagacctga aagaacaata 850620
 ctcaacttta tatgaaaaa caaagaact aggatagcca aaacaaccct gtacaataaa 850680

 ggaatgttca gaaacaccac atccctgaat tcaagctcta taatagagct attgtcctga 850740
 aaacagcttg gtattggcac aaaaatagac aggtagacca atggaataga attgaaaacc 850800
 ctgatattaa cccatactcc tatgaacacc tgatTTTTga taaagaagct aaaattatac 850860
 atgtataaa agaagcatc ttcaacaaat ggtgctggca taaatggatg ctggcatgta 850920
 gaagactaca gttagatcca tatcaattc catgtacaaa acttaagtcc aatgaacca 850980
 aagacctcaa cataaatcca gccacactga acctcttaga agagaaagta ggaggtacc 851040
 ttgaacaaat tegtgcagga gaccaattc tgaacataac atcagtagta cagacactga 851100

 gattgacaat taataaatgg gacctcctga aactgagaag cttctgtaag gcaaagggca 851160
 cagtcaacaa gacagaatgg cagccacag atgagaaaag atagtcacaa atcctacacc 851220
 taacagaggg ttgatttcca aaatatacaa agaattcaag aagctagtca ccaaacacc 851280
 aaataataca attaaaaagt gggatacaga cctaaataga gaagcctcaa tagaggaatc 851340
 taaaatggct aaaagatcct taagtgtca acatcctgag ccatcaggga aatgcaaatc 851400
 aaacaattc tgagatgcca tcttgtttct gtcagaatag ctaaaataaa aaaccaat 851460

aacaatttat gctggagagg atgtggagaa aagggaaacac tccccactg ctggtgggag 851520

tgcaaaactca tacagtcact ttggaatca gtatggctat ttgtcaggaa aatgggattc 851580
agttctacctc aagaccaccgc aatttcactc ttaggcataat acccaaagga tacacactca 851640
tacaacaagg atatctgatt aactatgctc atagcagcat tatttgaat agccagaacc 851700
ttgaagcagc ctagatgcc ctcaactgaa gaatggatag agaaaatgtg gtacatttgc 851760
acaatggagg actactcaga agaaaaaaaa acaatggaat tttgaaattc gcaggcaaat 851820
ggatggaacc agaagaaacc atcctgagtg acgtaaccaa gtcacaaaaa gacaacatg 851880
gtatgtactc acacatacac agattttaaa catgaagcaa agaattacca gcctacaatc 851940

cacactatca gagaagctag gaaacaagaa ggaccctaag agagacatac atggtccctt 852000
agagaagggg aaaggaacaa gatctcctga gcaaatggg agaatggagt aaggggagag 852060
ggagttaaaa gaaagaaaaa ggggtaagag gaggggagag gaggacatga gggaagagga 852120
agcctgtgtc aggggaaaaa tagaggagag caagaaaaga gataccatct tagagggagc 852180
cattataggt ttaaagagaa ttctggcact agggaaatgt ccagagattt acaagttga 852240
aaccaactaa caatctaagc aatagtggag agactacctt aaatgccctt ctccaataat 852300
gagatttatg actacctat atgccatcct agagctttca ttcagtagct gattgaagca 852360

gaagcagtc cccacagctaa aactgagcc gaactcctgg aatccagttg cagagagaga 852420
ggagtgatga gcaaagggat caagagcagg ctggagaaac cacagaaaca tctgaagtga 852480
acaaggagga gttcatggac cccagactga taggtgggaa actagcatag gactgacca 852540
gaccccctaa acatgggtgt cagaaggact gagcattcta ttagaggacc cggcctctgt 852600
tagtggatca gtatttatcc ctagtataca aatggacttt gggagcccac tccacacaat 852660
agggatactc tctcagccta gacacactgg ggagggccta ggccctgctc caaagttat 852720
gacagactct gaaggtcccc catggaaggc ctaccctcc ctatggagca gaaaggggat 852780

gggaccgagg gatggtgggg gagcagggga ggaggggagg gagaaggagc tagaattgac 852840
atgtaaaaca agattgcttt taattttaat taagaaaaga aaaaataaat caggctatct 852900
gatttcttta aatgtagagt tttaaattha aaagttaaat gcataggaga tagttcagtt 852960
caaaagtgca tgccttacat gcacaagtcc taagtgcctg cccagcatcc agctaaaagc 853020
tgaggagcct ataccacac ttctcatgca gacttcttc tgagcatctt tttctcctaa 853080
agctaagct taaacctata ttaaaatc ttaataaaa tcttaaacac tgtttcatta 853140
aaaaaaag ctaggtgtgg gtgtgtacct atataatctc aagtgggaa ggcagagaca 853200

ggaagatccc taggaattac tggccaacag tctagccagg ttagtgagat gaggattcag 853260
 tgagaaccct tatatcaaaa agggataata ataataataa taataataat aataataata 853320
 ataataataa taatgttaaa aacaattaag aaaaatactc aacatcaacc tcagacatcc 853380
 ataagcatac aatacaagaa aataatgaaa aaaaatgagt acaagtgttt ataaattccc 853440
 attaccacct ccaagatgaa ctagaggaag tggaaagatt gtaagagtca gagaagatgg 853500
 gggacacagg agaacaaggc cctctgaatc aactaggcaa ggtgcagatg agctcacaga 853560
 gactggagca gcaagcacia ggctacatgg gtccgtacca ggtcctctga atatgtagct 853620

 aacagctata tatggaaatc ctgaatatga gaaggagtgg gtctctgact ctgtgacctg 853680
 ctcttggAAC tcttttctc ctgctggggt gccgtgtcca actttgagat catagttttt 853740
 gcttcatctt attatattta gttttatcat gtttggttac tatctcttaa aagcctgttt 853800
 ttttctaatg aaagaaaggg ggtggattaa ggggagggga agaggagagg aactgggaag 853860
 attagagggg gaagaaagta taatcatgat atattgtatg agaaaataat ctattttctt 853920
 tttttaagat ttattttttt attatgtata cagagtctg tctgcatgta tgctgctgg 853980
 ccaaaagagg tcaccagatt tcattacaga cggttgtgag ccaccatgtg attgctggga 854040

 attgaactca ggaccctgg aagagtcagt gctcttaacc tctgagccat ctctccagcc 854100
 ccggagaaaa taattttttt tcaacaaaaa cattttgtca taaatacttt caatcagtgg 854160
 gcaatggtag tgcacacctt taatcccagc acacaggagg cagaggcagg tggatctctg 854220
 tgagtttaag gccagcctgg attacaaaga gagctctagg acagtcagag ctgttacaca 854280
 gagaaacctt gtctggaaaa aaaaacaaaa caaaacaaaa agatacttcc aaacctttc 854340
 ttttgaata taatgcagaa gagtaaagat cctgcttctt aatacccctc ctccattcca 854400
 tccccatgcc tcaccatc ccacgtcga tgtgtacaat tttcaatac accacacatg 854460

 tgtacataat taactacaaa gcaagaatat aaagacaagg gatggacctt ttccaaggga 854520
 caattttaa atagaaatg aaaagagact gttctagtct tcttataaat gctataagct 854580
 gtaacaaacc agtttaattc ctcttaatg caagggaat taatcaagag taaccaatca 854640
 aatgctttca gtatagaaga atattagecca gctgtatctc actcctctat ttggttaagt 854700
 gtgagaaaat gataggagac ggctgagagc tggaaaccac agataagata gcatttcgtc 854760
 ctccagcga gccttcttc agaaactggg agaggacct atgagagact cagattgat 854820
 ctctgagcag taagtagctg gaagagccat aatcctggcc aagcctcaag gacaaggcac 854880

 atctctgaac atggctttcg attccaagct aagaaatgcg agataggcta caggaaaagt 854940
 attctaattg gggcccacag gtgtttgggt acaataaata gatccacca aaaagtgagt 855000
 gggaaagcta cgctgttctt ccttcatttc cccggaagtt tcttcggatt ttaaggatga 855060

ctatggagct cggttttata atcgttaaag atattttaa ataggctctca attgaaaagc 855120
aataatgtac agatggcgga ttatgcattc gggactagat ttctaattaa acaaggagat 855180
taaatctatt cctttatctc cgcacttccc tgaatttaa gcactattaa tattaaagga 855240
ataaagacac acattagctc cccagccctc agagcctgca tgaggcccag caatttacc 855300
tagacttggg aagaggaaag gaaatctctc agacagcaaa tcagggggtg cagagaacag 855360
ggaaagaggg actatcaagg tctcaggatg ggaggcagta ggaacttgtg gtaactgaga 855420
ggcaaacaga ggaactggaa accaccagag tgggggatat gagaaggcag tagaactgag 855480
cccttctgt cagtaattc cagaaaatga aagatttggg agtgatggga tacagaccag 855540
tcccggcacc ctctttgtc ctcaacaaag cacaaccag ttaagatata aatatgaaac 855600
ccagagccag gggagcacc ttaatgtggc ttggatcctg gaccagcatg tagacaaact 855660
aatgaaatcc aaatttacct ctgaggattg gctagtgtt gctgctgtt tttttgtgt 855720
gtgtgtggg ggggggggt ttggttgggt ggttgggtgg aactcacaga gatctacctg 855780
cctctgctc ccaactgctg ggattaaaag catgagccac caccaccagg atagtcttaa 855840
tatattcaga acatcttatt ttcagctgtg gtgtgtagtc agtaaaatgc caccactagg 855900
gaaagtggg taaaggctac aaacataggg cctgagtac aatttttga acttttccat 855960
gaatccaaaa ttactgaaaa ctaaaact tattaaagca aatgtttc tctttttaa 856020
tagacaatgg atactttat tatttactca gtttaggtc atggagactc gattccttt 856080
agtgtccaac tgtgtatatt ataactcaa ctctaatga agctgatttt tcatgctta 856140
aacctgtttt cttttactt tagaaatgat gccagctcat attttgaatg cctgtacctt 856200
tcctcactga caagtggag agtgaggga gaagttacag tcaatggga tagaccctat 856260
aagactatc ttttttcc attcatttgt ttagctcata aataaagtca tgcacaatta 856320
tgatacagaa tacagtatgt tcacaatggc atggcaaaat taaaccaatt aacatgttat 856380
atcacacata tcatcattt ttgtttgag tacactaaaa gtatcagtc tcacaacttt 856440
taaaatata catattgta tcaaccatat ttatcatgct ctcagtagac cttagacat 856500
cacagagtc atgcctctg tccaactgca gttttatc cttaaacaa tcatttccc 856560
attgttaaaa gaccacatt gaagcctaat agccacaact ctgctctctg ttcccataag 856620
tcatcattt ctaggttaca cataaaactg aaattgtgtg atattgtct tccagtgtgt 856680
cactttttt tggcaagcat ataactttac taggcacact ccatttaaaa aaaaacaac 856740
aaacaacaa caacaacaa aaagtaaaaa acaaaatccc agaaaacagc acagtctgt 856800
tactctgtg atacttggca ccatttattt ttttaatta gcttctcaat catcatctgg 856860
gaggaacca ttctgagca catcattaa aacagctctg ataaagcatg gtcaccacta 856920

tgtatcatag agcagggtcca catatgcgtg agtacatatac atgtttgtct ttttgtgatt 856980

 gggttacctt gctcagaatg gtttcttca gttccatcca ttttctgca aatttcaaga 857040
 ttccattggt ttttctgct gagtaatact ccattgtgta aatgtaccac aatttctcta 857100
 tccattcttc agttgagga catccaggct gcttccagtt tctggctatt acaaataaat 857160
 gctgctatga atatggtga acatatgtcc ttgttatatg aatgtgcttc tttagggtat 857220
 atgcctagga gtggaattgc tggaaactgt ggtagactca tteccatttt ctgaggagt 857280
 cgtcattata atttccacag tggctgtaca agttggcact cctaccagca gtggaggagt 857340
 gttcctcttt ctccccnnnnn nnnnnnnnnn nnnnnnnnnn nnnnnnnnnn nnnnnnnnnn 857400

 nnnnnnnnnn nnnnnnnnnn nnnnnnnnnn nnnnnnnnnn nnnnnnnnnn nnnnnnnnnn 857460
 nnnnnnnnnn nnnnnnnnnn nnnnnnnnnn nnnnnnnnnn nnnnnnnnnn nnnnnnnnnn 857520
 nnnnnnnnnn nnnnnnnnnn nnnnnnnnnn nnnnnnnnnn nnnnnnnnnn nnnnnnnnnn 857580
 nnnnnnnnnn nnnnnnnnnn nnnnnnnnnn nnnnnnnnnn nnnnnnnnnn nnnnnnnnnn 857640
 nnnnnnnnnn nnnnnnnnnn nnnnnnnnnn nnnnnnnnnn nnnnnnnnnn nnnnnnnnnn 857700
 nnnnnnnnnn nnnnnnnnnn nnnnnnnnnn nnnnnnnnnn nnnnnnnnnn nnnnnnnnnn 857760
 nnnnnnnnnn nnnnnnnnnn nnnnnnnnnn nnnnnnnnnn nnnnnnnnnn nnnnnnnnnn 857820

 nnnnnnnnnn nnnnnnnnnn nnnnnnnnnn nnnnnnnnnn nnnnnnnnnn nnnnnnnnnn 857880
 nnnnnnnntc ttaagtttta tgcaaggatga aaggcttggg tctatctgta gcttctaca 857940
 tgtttgcatc cagttatgcc agcaccattt gttgaagatg ttctctttgt tccagcataa 858000
 atatttggac tgtttggcaa aaatcagggtg tttatgggtg tgtgggttaa tatcagggtt 858060
 ttcaactcta ttccattggt ctaccagtct atttttgtgc cagtaccaag ctgttttcag 858120
 gactatagct ctgtaataga gcttaaagtt agggatgggtg atgcctccag aagttcctct 858180
 attgtacagg gttgttttgg ctatcctggg tcttttgttt ctcaatataa agttgagaat 858240

 tgttttttca aggtctgtga agaattgtgt tgggatattg ataggattg cattgaatct 858300
 gtagaatgct tttgtaaga ttgccatttt tactatgttg atcctgccta tccacagca 858360
 tgggagatct ttccatttcc tggatcttc ttaatttct ttcttttagag actcaaaatt 858420
 ctaacactaa ccaacttttt ggttagtggt actccaaggt attttatggt gtttctggca 858480
 attgtaaagg gtgatgttcc tctgatttct tctccacca atgtgtcacc tatatatagt 858540
 agggctacag tttttttga ttaactctt taccctgcca ctttctgaa ggtgtttatc 858600
 agctgtagga gttcccttgt tgagttttc gggtcactta tgtagactat catatcatct 858660

gcaaatagtg agagtttgag ttcttccttt ccgatttgta ttcacctaaa ctccctttgt 858720
tgtcttagcg ctctagctag aacttcaagg acaatatga agaggtatgg agagaatgga 858780
cagccttgcc ttgttctga nnnnnnnnnn nnnnnnnnnn nnnnnnnnnn nnnnnnnnnn 858840
nnnnnnnnnn nnnnnnnnnn nnnnnnnnnn nnnnnnnnnn nnnnnnnnnn nnnnnnnnnn 858900
nnnnnnnnnn nnnnnnnnnn nnnnnnnnnn nnnnnnnnnn nnnnnnnnnn nnnnnnnnnn 858960
nnnnnnnnnn nnnnnnnnnn nnnnnnnnnn nnnnnnnnnn nnnnnnnnnn nnnnnnnnnn 859020
nnnnnnnnnn nnnnnnnnnn nnnnnnnnnn nnnnnnnnnn nnnnnnnnnn nnnnnnnnnn 859080

nnnnnnnnnn nnnnnnnnnn nnnnnnnnnn nnnnnnnnnn nnnnnnnnnn nnnnnnnnnn 859140
nnnnnnnnnn nnnnnnnnnn nnnnnnnnnn nnnnnnnnnn nnnnnnnnnn nnnnnnnnnn 859200
nnnnnnnnnn nnnnnnnnnn nnnnnnnnnn nnnnnnnnnn nnnnnnnnnn nnnnnnnnnn 859260
nnnnnnnnnt ggtaatgacc cttctgcttc tattgtgtgg aatgcttga ggagaattgg 859320
tattagctgt accttgaatt tctgtagaa ttgtgactg aagctatctg gcctgggct 859380
tttttggtg ggagacttaa tttccatgag ttgtaggtt ttctgtagt catgttgtg 859440
ttgaattcta atttaaagc atgggtgtct gataagacac agggggttat ttcaagttt 859500

ttgtacctg ttgaggttg ctatgttgc aagtatgtg tcgatttag agaaggttc 859560
atgtgtgct gagagaaggt aaattgttt gtatttgggt ggaatattct atagaaatct 859620
gttaagtcca attgcccat aacttctatt agatctttg tttctttgt aagtttctgt 859680
ctggtgttc tgtccagtg tgagagtgg ttgtgannt nnnnnnnnnn nnnnnnnnnn 859740
nnnnnnnnnn nnnnnnnnnn nnnnnnnnnn nnnnnnnnnn nnnnnnnnnn nnnnnnnnnn 859800
nnnnnnnnnn nnnnnnnnnn nnnnnnnnnn nnnnnnnnnn nnnnnnnnnn nnnnnnnnnn 859860
nnnnnnnnnn nnnnnnnnnn nnnnnngatg tggtagatt atgtgtgga ttctgtccct 859920

tttctcttt ggctgttgg aagtgggat tatctattgc ctatggttt ctggtttag 859980
ttacctccc taggttgaa tttctctcc aatacttct gtagggctgg attggttag 860040
atgtattgt tgaatctgt ttgtcatgg aatatttgt tttctcaag tataatgatt 860100
gaaagcttg ctgggatag tagtctggc tggcatccat ggtctcttag tgtatgtata 860160
atatctatcc aggatctct ggcttccaga gttccaagg aaaagtcagg tgtgattctg 860220
ataggttgc ctttatatgt ttcttgacct ctttctttg ctgctctaa tattttctct 860280
ttgttgtgta tgttgggt ttaattggt atgtggcaag gtaaccttt tttggtcag 860340

tctatttgg gtctctagg cttctgtat ttctattgt atgtcttct ttagtttgg 860400
aaagtttct tctatgatt tgttgaacat gtttctgcg ctttgagtt ggatttctc 860460
accttctct atacctatta ttcttaggt tggctcttc acagtatccc atagttcctg 860520

gatattttgt gatagggatt tgttggactt aagactttct ttggttggtg agtctatttc 860580
tgctactgtg ttttcaagcc ctgagattct ctcttccatc tcttgtattc tgttggttat 860640
gcttacattt gtagttcctg atcatgtacc cagcttttct atttccagca ttcctcaga 860700
ttgtgctttc ttcattgtct ctatttcagt tttagtcctt aagagattga tattgattga 860760

cttgaagatt gatattttgt aatttttggg tagttttttc ttacatttct ttaagggatt 860820
ttctcacgtc ctctttgagc attgtgatgt tcaggctetta ctggtgaaga gtgaacagcc 860880
cccagccaat agtgctaagg ttttctttat tgagatacac caatcaagct agaggagggga 860940
gcttgaacca gcgccagtag ccggggggagc agaagagaga aggccggggg ctccacgtgc 861000
agcccttaag aaccttcctt tatgtcaccc aggacttccc ttcacccgcc ctcatgggcg 861060
tgtcccggta catctgacac ctgtctgggt tgcttggggc ggggctaggg tgtctccta 861120
caattcccct tttagtctaa aagaggatta aaacttaata gtgtaaaaca tccaaaatta 861180

acaatcataa aggtgaaata caagaagata caataatctg ctattgcaca ttctaactat 861240
gtctattccg gctaagccct aaagtcatgt agaaagggtg tctaacttga acacctcctt 861300
ccagtcacca ctctaaaca taagaaggtc attcttaact aggettacac taccctaata 861360
aacaataatg ggtttcaggg gcgtagcatc ttctaagtta ctctctactg aatgggacg 861420
atggtagcca tgtgggggtcc tgtgggggga aaaatgctag tacagggaaa gtctctaatg 861480
agttatgtct agtccatgtt agatgagatt tgcttgattg aagatctagg ttgaaatcct 861540
caacttgatt gaagtcatta ctcgagggtc tggttggagt gtcagtcgaa acggagtgag 861600

ttgaatccag tgcagtcggg gagggtgagt ccaattcttt ttccagagca tgcagggatt 861660
gttgtcaggc tggttcccat tgactgtatg ggactcaaac ataagtgtca tcagagaaat 861720
gttcgcttgt acatgtatgt gtaactgggaa aggcaatcct tgaaaaaca caattatgag 861780
agagttagg ccttgaaga aagagccaag aaaagacaaa gatagtcctc ttattcttta 861840
tttattctgt attacagcaa ttggcttctt gatataacac agaaacttta aaattttgtt 861900
aaataacatg cttggatttt aggataggaa agccaaatcc aagtctaat ccaacatcga 861960
tttaattgaa tagggactag aaaatgaaga gaaatagagt tatttgagac tacagctgta 862020

tattttaccg tatggcacgt tccttttatt tgatggttat agctacgttc tttccttaag 862080
tatctacaca tgtagtgnnn nnnnnnnnnn nnnnnnnnnn nnnnnnnnnn nnnnnnnnnn 862140
nnnnnnnnnn nnnnnnnnnn nnnnnnnnnn nnnnnnnnnn nnnnnnnnnn nnnnnnnnnn 862200
nnnnnnnnnn nnnnnnnnnn nnnnnnnnnn nnnnnnnnnn nnnnnnnnnn nnnnnnnnnn 862260
nnnnnnnnnn nnnnnnnnnn nnnnnnnnnn nnnnnnnnnn nnnnnnnnnn nnnnnnnnnn 862320
nnnnnnnnnn nnnnnnnnnn nnnnnnnnnn nnnnnnnnnn nnnnnnnnnn nnnnnnnnnn 862380

nnnnnntttt ttccgtagtc cagtgtcttt ccgcagctgt ttgtccattg tctttggcat 862440

 taagaaagt ttagcgttaat aaagcattat gcaatctatg tttgggggtt tcgccttacc 862500
 agcttgccta tggagcatct ccttgagtgt cctgttggac cttacaacaa ctgcttgtec 862560
 ttaggggttg tgggtatac ctgtgacatg cttaatgtta taatatttga agaactgttc 862620
 catttttgtg gagacatatg ctggagcatt gtcagttttt atctgcaccg gtatacccat 862680
 aactgccate acctccagta ggtgtgtaat aatgnnnnnn nnnnnnnnnn nnnnnnnnnn 862740
 nnnnnnnnnn nnnnnnnnnn nnnnnnnnnn nnnnnnnnnn nnnnnnnnnn nnnnnncctc 862800
 cgaaggcctt taggattaca gcctgctggc agcagagttt gggtataaaa ggaacaata 862860

 ggacagtttc tcaactatctc cttggcttgt tgccaagtga tggaggagaa gtcctttaa 862920
 tccttgctat ttacatgatg ctttttatga aattctgagg cttctagcac ggtgtcaatc 862980
 aatagacgat caatctcgtc attgccttgt gccagcgggc ctggcagacc cggatnnnnn 863040
 nnnnnnnnnn nnnnnnnnnn nnnnnnnnnn nnnnnnnnnn nnnnnnnnnn nnnnnnnnnn 863100
 nnnnnnnnnn nnnnnnnnnn nnnnnnnnnn nnnnnnnnnn nnnnnnnnnn nnnnnnnnnn 863160
 nnnnnnnnnn nnnnnnnnnn nnnnnnnnnn nnnnnnnnnn nnnnnnnnnn nnnnnnnnnn 863220
 nnnnnnnnnn nnnnnnnnnn nnnnnnnnnn nnnnnnnnnn nnnnnnnnnn nnnnnnnnnn 863280

 nnnnnnnnnn nnnnnnnnnn nnnnnnnnnn nnnnnnnnnn nnnnnnnnnn nnnnnnnnnn 863340
 nnnnnnnnnn nnnnnnnnnn nnnnnnnnnn nnnnnnnnnn nnnnnnnnnn nnnnnnnnnn 863400
 nnnnnnnnnn nnnnnnnnnn nnnnnnnnnn nnnnnnnnnn nnnnnnnnnn nnnnnnnnnn 863460
 nnnnnnnnnn nnnnnnnnnn nnnnnnnnnn nnnnnnnnnn nnnnnnnnnn nnnnnnnnnn 863520
 nnnnnnnnnn nnnnnnnnnn nnnnnnnnnn nnnnnnnnnn nnnnnnnnnn nnnnnnnnnn 863580
 nnnnnnnnnn nnnnnnnnnn nnnnnnnnnn nnnnnnnnnn nnnnnnnnnn nnnnnnnnnn 863640
 nnnnnnnnnn nnnnnnnnnn nnnnnnnnnn nnnnnnnnnn nnnnnnnnnn nnnnnnnnnn 863700

 nnnnnnnnnn nnnnnnnnnn nnnnnnnnnn nnnnnnnnnn nnnnnnnnnn nnnnnnnnnn 863760
 nnnnnnnnnn nnnnnnnnnn nnnnnnnnnn nnnnnnnnnn nnnnnnnnnn nnnnnnnnnn 863820
 nnnnnnnnnn nnnnnnnnnn nnnnnnnnnn nnnnnnnnnn nnnnnnnnnn nnnnnnnnnn 863880
 nnnnnnnnnn nnnnnnnnnn nnnnnnnnnn nnnnnnnnnn nnnnnnnnnn nnnnnnnnnn 863940
 nnnnnnnnnn nnnnnnnnnn nnnnnnnnnn nnnnnnnnnn nnnnnnnnnn nnnnnnnnnn 864000
 nnnnnnnnnn nnnnnnnnnn nnnnnnnnnn nnnnnnnnnn nnnnnnnnnn nnnnnnnnnn 864060
 nnnnnnnnnn nnnnnnnnnn nnnnnnnnnn nnnnnnnnnn nnnnnnnnnn nnnnnnnnnn 864120

nnnnnnnnnn nnnnnnnnnn nnnnnnnnnn nnnnnnnnnn nnnnnnnnnn nnnnnnnnnn 864180
 nnnnnnnnnn nnnnnnnnnn nnnnnnnnnn nnnnnnnnnn nnnnnnnnnn nnnnnnnnnn 864240
 nnnnnnnnnn nnnnnnnnnn nnnnnnnnnn nnnnnnnnnn nnnnnnnnnn nnnnnnnnnn 864300
 nnnnnnnnnn nnnnnnnnnn nnnnnnnnnn nnnnnnnnnn nnnnnnnnnn nnnnnnnnnn 864360
 nnnnnnnnnn nnnnnnnnnn nnnnnnnnnn nnnnnnnnnn nnnnnnnnnn nnnnnnnnnn 864420
 nnnnnnnnnn nnnnnnnnnn nnnnnnnnnn nnnnnnnnnn nnnnnnnnnn nnnnnnnnnn 864480
 nnnnnnnnnn nnnnnnnnnn nnnnnnnnnn nnnnnnnnnn nnnnnnnnnn nnnnnnnnnn 864540

 nnnnnnnnnn nnnnnnnnnn ngctcttttt ctctctcagc agataatatt tgtggactgt 864600
 ttaagtcctt atcacctttt agtgcatttt ttaagtgcct taagtcattt ccttccacac 864660
 caataatcgt ctgtaattaa gaaattttct ctagtagcct ttgaagactg ttaagagttt 864720
 gataacggct ccttctaatt tgtacctttt gaggtctgat tctttgtaag tctatcttat 864780
 atcctaaata gttaatagaa tctctctttt gtatcttttc tggggcaatt tgtaaatccc 864840
 catctaggca gaacctcctt caacatttta aacatacgtt ccaaagtttc cttattagaa 864900
 tccgataaaa gaatatccat ccatataatg ataacaaga gattgtggat attttttacc 864960

 aattatttcc aaaggatggt gcacaaagtg ttgacacaaa gtgggactat ttagcatccc 865020
 ctgaggtaaa accttccatt ggtatctccg aactggctgt gatttattaa gatttggcac 865080
 tgtaaatgca aatttctctc tatecttttc ttgtaatgac atagtgaaaa agcagctctt 865140
 caggccaatt actatgttca gccatccttt aggtattaag gaaggcaatg gcattccagg 865200
 ctgtagagag cccataagct gaattacctt atttatggct ctcaggtctg tcagcattct 865260
 ccagttacct gaattcttct tgataacaaa tacaggagaa ttccaagggc tggtagattg 865320
 ctctatgtga ccagcctcta gctgttctg tactaacttt tctagagtct ctacttttc 865380

 agaggtaaaa ggtcattgcc ctatecagac cagttcatct gtaagccatt tcaatggcag 865440
 ggccitttgg tctctgaag tctctgaag gtctatcatt tgtatttagt gtctgtacag 865500
 cctggatagt tggtaacatt tttttatggt atcttaccg atcttttcta ctatccagcg 865560
 attttttaga attcgtatct gacctggag ggatgttaat ttgagtattc cattgttgta 865620
 ataatcatg accccataaa tttatacaa tatctgtac gtaaggattt agtcttctt 865680
 tttgtcttc cagtccaata tagaccaccg agttaacact ccatcgaact ctagatagag 865740
 ttccaatttg cccttttagg gggccatttc ttaggccagg atttctgggt gataatagtt 865800

 acatcagctc cagtgctac aagacctta atagctctgc cattaatttt ttttctaac 865860
 tgaggccttt tatcattaat agaaacttgc caaataatgc gtttctcatt ttcaccagtc 865920
 acatgtgatt cttatcact attcaaatc cttctagag cagtatcatt ttccataata 865980

agcaaggaac taictattcg tcctgtgaga gattgtcttc cattgtcaca gggaacaatc 866040
 aaactgttct cgaggcgggg gcctgctgga ggtccccttt ggagtttccc aacgttaata 866100
 ggttcccttg catgtcccta gtcgatctgc attcgttagt ccagtgtttg cccttaccat 866160
 atcacctaca taaccagag ggcaaatgac ctgtcacgtg gggaatcggt agaatttctc 866220

 tgtctacaat ttctcctnn nnnnnnnnnn nnnnnnnnnn nnnnnnnnnn nnnnnnnnnn 866280
 nnnnnnnnnn nnnnnnnnnn nnnnnnnnnn nnnnnnnnnn nnnnnnnnnn nnnnnnnnnn 866340
 nnnnnnnnnn nnnnnnnnnn nnnnnnnncc cctgtaagg tgctcttct tccaagtcc 866400
 ttctgttct atcttttcta atctctgat gtcgttgaa acctctaggg acagcttctt 866460
 ctgccagat tccagcatct tgtatgttac agtcaacttg ggagtagt agaacccatt 866520
 ctctagtgg agctgatctg atcttcagag gcaaaagtat tctttgcac attgggtttg 866580
 cattgtcata agctaagcta taaacaattg gatgttggat cgttggatct gctacctgta 866640

 tgtctactgg tcigtcaat cggctcaaga aatcctaaa tagttctgtt tgcctctgtt 866700
 ctattgtcgc ataagcttct agtcattctc ctgattcaca aaccttatcc catgcattta 866760
 gtgttctgg cctgcatagg tactgcatat gtcgtcata ttcagcctga atttgtggt 866820
 cagcataaat accttctctc aggatTTTTT ggagggatgc atcaattccg tcctgggtgg 866880
 ttctaggagt ctgctctctt ccctaataaa ctgggtggg gggccgggt ggggtccacg 866940
 tgaagagtga acagcctgca gccaatagtg ctaaggTTTT ctttattgag atacaccaat 867000
 caagtgagag ggaggagct ggaaccagca ccagtagctg ggggagcaga agagagaagg 867060

 ccgggtctc cacgtgcagc ccttaaggac ctcccttat atacccecg acttccctc 867120
 atcccacct catgggcta tcccagtaca cctggtacct gtctaggttg cctggggcgg 867180
 ggctagggtg tctccctaca tactgtgat ggttctggt ctccagtggt atcatattgg 867240
 gttttctgtt gttggatag tttttacct gtctcttct catctttct tetgggtggg 867300
 gtagcaagag tttctgttc tctggtggg tgtgggacca aggttctct ctggtagatg 867360
 caaacagatc caatactctg atgtcggctc tcttctctg aatggaggt ccccggtgt 867420
 tggcagtgtt ggggtgtgca gggctctggg ccggtggatg gaggtggct gcctctgggt 867480

 gttcgggtgt tggaaacct cccgaactg gtccagcatg caggtcact gcgtcagggt 867540
 cccaaaatgt ctcttgatt actaagaaag ctcatattag aaaacagctt atctgaatt 867600
 tgaaaaatgt atccatttta tctccctca catagaccaa tttgctagt catgactgta 867660
 ggcaatgaag agcaactcac atcttaccat gaaatggagc cagtaggctc tcagctgccc 867720
 caaccaaagg cagatgatgg tgcatgctta tttatttatt tttatttatt tttatttatt 867780
 tttttttt gagacggaat ctcatgtgtt caggctggct ctgaactcat taggtagcca 867840

tggatgacct tgaacttctg ccccccgcc ttatttcag ggtgatggaa ttactgctat 867900

 gcctaccac tcctaatcag gggccaacct aagatgcat tcctaaaaat gaagtgctct 867960
 gtcagctgag caatatgctt tcttacagac aacataatct ccaccattag cgtctttggg 868020
 tctcccaaat gaaaggtgag ggacagaagg gctgagctat actactcaa attagtaaag 868080
 accccatggt ggtggtatca tgttactatt tctgtagcga aatgcctgat acaatcaatg 868140
 atacaattac aggaaatacc ttgccccaca ttactgcaag tttcagtcca taggcagttg 868200
 gctgcattat ttgggactca cacaagcaga atattgtagc tgcaggtaca tggaggagca 868260
 aaacttgata gtggccagag atagaggcaa agagagagag gagtcaaggt cccaatatcc 868320

 cttcaagag cacacccca gtgacctaaa ttctccac cagacctac ccctaagtg 868380
 acaccaggag accaagcctt gagtacatgt gcctttgagg gacacataag gcccaaaaa 868440
 taacaaaaa taattaacca taaagcatac ctttattatc tatgtattaa tttacttcaa 868500
 cagaattaat agttacagta cagattaaca taacatattt tgtgaaaaat aattatttc 868560
 caaagggaaa atacatgaaa aaaaagaaat ggccttgatg tacaattttt tcaagtctct 868620
 tctttaacag aagccagcta gagtctcatc tgtgcttctg cattcaatct gtcaggatag 868680
 cacaggtcat gttgccttgg gaaacttctc tagtatgctc ataggaaaat aaaaatgaag 868740

 tggataaata atggcttagt attactataa aaacatttt acccatcaga caccagagat 868800
 tccaggacca catcttaaaa tctgccattc taacaaatgc ccctctacat gcagaaactg 868860
 caaggtcaat gtcgccctaa gaggagccag caaggcccta taataaaagc tagaagaaag 868920
 gtgaatctga gatggaaagc ctttgtctaa atatctatag agcagccaaa cccctgcccc 868980
 aggacctctg gttcagctga cacagttgag tgacaatttc tttctccatg ttagcaattt 869040
 actaagagge tgagtcttac agtctctaga cacaggaata ctaagcagaa ctgaagaaca 869100
 ttctctaaag cagaaaggct tctagtgggc ttctagaatc cagatagcct gatttgttaa 869160

 caatccctta atacacagc atgcatacac acacacacac acacacacac acacacacac 869220
 acacacacac acacacacac acacggcaaa atattaggta acttttcct gaagaaacta 869280
 aacaattcaa gaaaaaaaaac actgcattga tatccatcaa tgaatagctc aatcaatta 869340
 ctgtaaatta ttgttccaat cttgacaagc cttgtgccta cacacacagc tttagctaca 869400
 gcttatgtg ctaatagttc agaataactc aactagacac tctcaggaag aaaatgaaag 869460
 gacaaaatgt gtgagaaaac aaagagaaag gaacattcat taaatgccat agtaagttaa 869520
 gaatagaaaa acagatatct aaaattgaga gatagctttg agtaaggctt tcagaaaata 869580

gatcagagaa aaatagattg aaagaatatt acttagaaaa tcaggaatth aatataaac 869640
atgaagaaaa tataatccca gaaagaggaa acttacagat ttgagaaatt tttcaattht 869700
aatgaataca taagaaaagc ttcatagaat aaagagttha ggcttcaagg ttgagagatt 869760
ttatatthta ccaagaaaaat acacaaatat aggaaagggt agaacataca tataaaactc 869820
cagaatgcaa gaaaaaaaaa aaaagatcct aaaagttcca aaaatacaaa agtagacaca 869880
tgacaaagag attcaaacctg gcatcaatct gactaacaac tctggaaacc atggcaatga 869940
agcacagcct ggacaatcct cggggaaaaat gaatccacgc agaggtcatc actcagtatt 870000

gagaagagag tacagacaca tacagaaatg taggctctaa aaaagattgc atcgcacata 870060
acctthccca aactgcaaca gaagaacaa gcctggctga ggacgaagct cagttggtag 870120
gtagaataca tgatgagcac aggcaacact ctaggctcca ccccagcata actgaaaacc 870180
agatgaggtg gtgcacacc ataatcccag gacaagaaga tgaaggaagg agtgggatga 870240
atgagaggga tgatgtaata gggaaacttag aagccaagct tcagatgact tcaactgctgg 870300
aagaaacctg aagcagagcc atacaggtga gctgtccctg cattccctag tcacaaaaac 870360
tgtaagagaa aaacaacaat tgatacttht gtgctgctaa atgctaaggt gattthgttac 870420

aattaagcaa ccaactcaca ggtaatcgag aacataagaa acccaagata aagaaaccta 870480
gagcatagcc gtgcagtcct ctcagagtac ataacctagc tatgagtgtg aagcctcccc 870540
caaaagcaca actgatatgt cttacctatt thtatagtag gccaaagttg cgttatthta 870600
cttcaaatg gatatgtgtt tcattgtatt cacaaaatac aatthtacac taaagtgcta 870660
aaaaattata caaagttaag caaaaggaga agtagtcatt attaaatcta agaggaaaat 870720
gtgttctaga aagtagatag catatgtgca gatcaagtgt gaaaaatact ttatatcatc 870780
ttaggaacaa aaatagtga cactgatttg cctcaaat tctgtttht ctgctggaaa 870840

tgccagagat aaagatgtat ggtagaaagg gtagaaagtt tgcaatthaa gaaggctgaa 870900
ggatatctth tctthtatat thttccttc cthtthtctt cacgtgtgtg tgtgtgtgtg 870960
tgtgtgtgtg tgtgtgtgtg tgtgttattt gthtatgtgc agatgcactc atccatttht 871020
gggggtgtgg aggccagaag actatgtcag gatgtcttcc ttcattcttc tcagccttht 871080
thttgagaca gggctctcact gaacctgcag ctgactagc tgtccacaga gccccgagaa 871140
tacacgtctc caccctcaa gctctaaaaa ggcatacact atcacagcca ggaaggactc 871200
thttcacaca cthtthtctc agctthtctc cagaaaaaa tccgattaaa ataaaactth 871260

aactthaa ca agatthtct accacagggt aaaacagggt aaaataaata tgcaaaggct 871320
tcaatgaata aatcactcaa cagaaactth actthctctaa gtcaggagcc aggagatgat 871380
atgaaaacta gaaactgtha aatgaagthc cctctgagag ataggactga gatcagtht 871440

ctaatagccc ttctacaat ttcaatcatic tgccatgact aatctccatt gtcaaggtga 871500
 tgggagtcac cacatgcata caccttcaga agtatctatg aaggatattc cacaaaggtt 871560
 tagctgagca gagaaaaatgc accctgaatg tgggtggcat tgtcccacca gtggggatgc 871620
 aggactggat gaaaaggaga aaacacgcag agcacttggt ctgcttcctg actgtgatgc 871680

 tctgggactg actgccttat ggtcctgccca ccacacctcc ccagcagaga gactcccccc 871740
 tcaagctgta agacaagaga agttcttctt cctttaagtt gcttcttggt ggatctttgg 871800
 tcacagtcag gagaaaagta gctaacatac ctgggaaatg ctatcccaa acttttagat 871860
 gacatttcaa agtcaatgca ggggttggga aaaggtgttt ggctctgctc cacctggaaa 871920
 cacacaggag gacttggctc ttctgggaag tctgtggtct gcagatcatg aattctggct 871980
 ccttgtaact tgctctgcc tccagtgccca tctaaattcc taaagtaact ttattacca 872040
 tgctgacttg caaacatact gtcagacact agaaacagca gaaaatcatg accattagag 872100

 actaaagggc acagagcata gacacacccc tcacgtccag gggctctctc tctcattgag 872160
 gctgcagtcc aaagagtggc aagagacaga aaatgtggtt atgaagtgcc tcaccaccc 872220
 agaggcatct ttcagctctc agtgcctttt tggagccagc acagatggga gactagatat 872280
 ctcaggacag taactgagat gagtgacat ttctacaga gatccaacat gttttcaaag 872340
 ccaaagaacc acagctatcc aaaccttaca cagaatatct cgacaagact tgagtttcat 872400
 gcttcaacag ccaatgctc aacagccaag caggtagccc caaggctgcc tgtcagaata 872460
 cagatagcta acaaaaagac aagcaactct ggatcaaagg gtaagacat gtcacttct 872520

 catctctttg aaatgtccc aagacccaag acagatgttt gactccttca catctaaagc 872580
 caattaacca aattgagttg gctgagtttg aaagttggca gacaggtgac atttttaaga 872640
 attctgccct agagctcccc attgcattga caccagctag tgaacaacaa cacaacctg 872700
 ggggttgaca ggcctttctg actgagagaa agaaagccca ttttaagca atttcacatc 872760
 ctgtgggttg tgatgacttt gagaacggat ttcttttctt ttctctctct cttttctttg 872820
 acagggatct tacattgctg tcttcatta tctaagttc tactatggca atagtaaac 872880
 ccataaacte cctagaatg agtttaacgt ctctatgtcc aacgtgaatg atcatcagtt 872940

 atacctgggg aaatgaagca agaaggaaag cagtgaatgg ggtacactgg tcctcagcct 873000
 tgccacacc aaagaatttt ctggttcaat ggcatcatct ctgttgaaga tgtttatgta 873060
 tacgaggaag atcaaagtca aaccaaattt aagacaacac aaatggttaa agctcatctt 873120
 gtttgatgat ctctgggaa aaggctctctg agatggttaa tctcagttgt caacttgatg 873180
 gggctctagaa tcaccacaga aaggcaacca aggtatatgc ttgagtgact atctacatgg 873240
 gtcaattgag gcaggaagac ccaccaaaag ttaggttagc acttttccat gggactgggt 873300

cctaacttga atacaaagaa gagcaagctg agcaccaaca accatcattc tcctctgatt 873360

 ccttattgca gatgcaatgt gacaagccat ctaccattc ctgccactgt gacttcctcg 873420
 ccatgaaaga ctgtgtcatc ttgaactata aatcaaaata aactctcctc tectcaagtt 873480
 gatttgatat cagagcaatg agaaaagtga ctaacgtagc ccaggctggc ctggcactca 873540
 ctgtgaagcc aagccaagga ttactttcaa ctctgatcc tcttgtctcc acctccacag 873600
 agcttacaag aatgcaccac tatagctgaa aagtcatatc ataagttcag cagtctactg 873660
 ctgtatgtgt gtatttagaa acaccaaggg aacagttacc atgaagtgtt cacatatata 873720
 aagaactgtg taatgcacaa ataatctatc tacataagtt aagcaaatth tgctattcac 873780

 ttgggaaaaa tggaaagaat tgtccatcaa gaaaagctgc atgtttttac ctgcagagca 873840
 gagcagcatt tgttcacagc aatgtttact gaagaagtgt gttctgagca ctatcctagg 873900
 ctttagggaa catagcagtc ctctgagtag ctactgatac taaatgaaaa tctgaaaaat 873960
 taatggctca caaataaca atcaagggct agcgatgtag ctagagtata gagttaagta 874020
 ttgggtgttg ttcttaacac tgggaggtgg tatactgtag gggggaaggg tccagctaaa 874080
 gaaacacacc ctgagcagag ccaaagaaac acactttggc cctgcaacca gagccaaaga 874140
 aatgcaccgt gacccaaaaa gaaaagaaa aattcaatct ttcattgacaa gttagcaaaa 874200

 aatgtgaggg tttttatcc tcatccctat gtttggagca tggggaagct gacaataaac 874260
 aatcaagag agaaagaaag agagatacag gaactacaca gtgataatgg catctatgaa 874320
 gtagaccatg ggaatggaag agatgtagag gaaatcatga atacaatctt ttgtatgcag 874380
 tggctgtaga agacttctct gattaggggc catttgagca gagtttgtgg aggcacccaaa 874440
 caaatgagcc ctggagataa ttaggagaca gatcactgca gaacagcagg gacacaggtc 874500
 atgaggacag agagcactgc atgtggtcag ggaatgacc aggaagccaa tgtgtggtgc 874560
 agaaacaaaa gttcatttaa gaaaaagcca aagatgttaa gggccaatcc tgcaagactt 874620

 caggccatga agccaagaca aggacagaaa gtttacagga actgagattg gaagccactg 874680
 gaaggattht tagtaggtca acagcaaat taacttgtgt ttttaataaca cagggccagc 874740
 taaacttcca ggtgagatgg aaggctagag gctatttctg tatgacccgg taaaaaacag 874800
 tcaaatgccg tcaaatgagg gagttcagtt ccctagcctt tcccaaaggt aaggcagatg 874860
 atagataaac agtcccaat cctcaggata tgeccattct caggacatgc ccacagtct 874920
 cataaatccc aaatacagtt tggaaacatt gtcattacac tgacagccaa ctcaaaggca 874980
 aagagaaatc ccatcttgtc aagctatatg actggagggg gcagtcacca gcctactgtt 875040

aaaagccgag ctgtcccagg gcctggaatc aaggaacaac cctgggaaag agaacctcag 875100
 ttggcctgc cacagccctt tggtagagga agcccagaga gtcaagtgtg gagaacagtg 875160
 ggactaatgc tgaggagcag aaagatgtag aaatggtaga aggcagaagg gtgtagagat 875220
 ggcaggagca gaagacatag agatgatagg agcctgggct caggctggga actgcataag 875280
 aagtgtgagt ctgtggtatg ttgacttaaa agttcttcag tgtatttccc agagtggaac 875340
 agctggccgt tatagtaact ctattttcag ctttgcaagg agcatccaca tgattttata 875400
 gtagctgcac aggatcacac cccatcaggg gtaaataagg gtttaccttc cccacatcct 875460

 ccaaattaag acatatacaa aaagcaaaaa tcgatgtcca aattacacta gtttagaaaa 875520
 attgagagca tttcctctaa aagatagaat gagataaggg tgcccactct ctccattctt 875580
 attcagtgtg gtgtttaaag tctttgttag agcaataaaa ccaaaaaaaaa ctttaaaaag 875640
 gaaaggggat agaagtaaga aaggatggaa gtagattatc tgatccagag agatgactct 875700
 cataggtaaa ggggttttac acacaagcct ggtgacttga gttcaatcct ggcatttgac 875760
 cgacatagac acaataataa taataataat aataataata ataataataa taataataat 875820
 aataatctaa atattaagaa agaattcttt ttaaaagaga gaacaattg tttattccag 875880

 ttgfcagatg tcataacctt atacttaaaa gaccttgaag actccaccaa aaactcttac 875940
 atcttttaaa cactttcaga attcacaata caataaagt caacacataa aatccatact 876000
 ttgttttatg ccaataatga attcatagag aaggaaatca gggggaatcc ctccacgggt 876060
 aaccttaag aactaaaata acaaggaata gccttaattc aggaggtaga atactctgca 876120
 atggaatgtg tgagacacta gagaacaaag ctgaagaaaa caatcaaaga tggaaagatc 876180
 tcctgtgctc acagaatagc aaaattaata ttataaaaat gactctgtta ccaaaagcaa 876240
 cccatagatt caatgcaatc aaaatcccag tggcattcct cacagagcta gaaaaaaaaat 876300

 actaaacttc ttatggatgc acaaaagaca atgccctccc ccacctacc tcaccecaat 876360
 ccacccact gcaaatagcc aaagcaacc tgaacaaaa aaaaaagagc aatatggggg 876420
 cttcacacta gtcagtctca aattgtatca cagagccaca gtggcagaaa ccatggtcct 876480
 gaataaaagc agacaagcag agcagaagag gctctcaagc ccagactaaa cccatacagt 876540
 tacaactacc taagttctgc caacaccgtc aacaacatgc ttcaaagaga agagagcctc 876600
 tttacaacat ggcactgtga gaacggggct tgcaagtgtg aatggatgga actagatcta 876660
 taagtctcac tccacacaaa gatcagctca aaacgcataa gaggccttac tgtagcactg 876720

 gaaactttga aacttttggg gacaaatgca aagcaaacac ctcaagagaa aacgtttctg 876780
 aatggactc ttgtgcacag ggaatagtcc caagaattga caaatggctt agatgaagtt 876840
 aaaagtttc tgcaggctgg gcctggaggc acacacctta aataaattac agcactcaga 876900

agggagagag tggatgatct ccacaagttc aagtctagat tggctacat agtgagctcc 876960
 aggacagcca agtctacata gagattctgt tcaaaaacaa acaaacaaaa ttttctgctc 877020
 caaagaggaa gcaatcacca gtgtaaagat gggagacaaa cctctctggg catgtgtgtg 877080
 aggtgtttcc agaaaagttt agctgaagtg ggaccatcca tccagacat gggcggcacc 877140

 attccatgtg ctgaggtcca aagttgaata aatagataaa gcaaatgcca tgtccaatc 877200
 tctcggtttc ttgtctagga tgcaatgtga cagcagcctc aactgctgc cactgcaccc 877260
 tccccaacat gaagcactgt gctctcagac cagaggcaga cacccttctt ccaggcattt 877320
 gatttcacca ggtgttttgt cacagaaatg gggaaaagtga ctaacacaca taccgcatg 877380
 gattacctct gaaatgcttc tgaacacttc ttaacaactt cagtacttcc cctttctatg 877440
 acctaactct gtccacattc caaagtgaa atatgcagtc aaggcaatta gtatgtcggc 877500
 gggtaggggg tgggtaccat ttgatccaat gacatctata atgggggatg tcctctgtat 877560

 gctgtgaatt tatctttctc ttattggttg tttcagcaa tggacaggca ggatgtagcc 877620
 aaacaggaag tataggcagg agttccagac taggagaatt ccaggaaggg gaacgcagac 877680
 agtgagtca caggcagatg ccaggtagct gccgatgaag aaagaggcct gggcatcacc 877740
 agtaagccaa aaccacgtag agatacatag attaatagaa atgggtcaat aattaagaga 877800
 gagctatcca acaagaagcc tgagccatca gccaaacagt ttataattaa tataaatctc 877860
 tgtgtgttta ttgggtcta aacagctgca ggaccacgca gacaggaaca tccatttaca 877920
 taactaggca atgatgagtg gatttccact tcctgtaca gtcacatata acagaagtag 877980

 ctggactgaa actcatgggt cagaagtaca ccaccctgt gaggtaaaca gcttctttga 878040
 ggacaagtga atcaatctct cctcaggttg gtactgagtt cctaaaggag ctcagtcctc 878100
 ctccatgca gattgcttta tttccttcag gttttacaca tgcttgcccc cgactgtaca 878160
 gtcagtacag gcagctcttc acagaatgtg agttctttcc atgtagtgtt tgctaagtgg 878220
 tggcacatat aatcattttt atcatgtaga gaaattccat gaggtctcc ctggactggc 878280
 caaatccaaa aacacaagtc tctgtctat ttctttatgc catgactgaa agtgagatga 878340
 gccaatataa gaatacataa taagccaatt agttgttctt tacttttctt aatgagtga 878400

 aaatgtgtgt ctgctcaat tacagctcat ctgacaagat tctttgctcc gtgactacta 878460
 cgatttggca ttgtttcatt tttttaatat caatggcacc agtcacagga gctgagcttc 878520
 tcctataagc ttgtgcaaga aatgcactca tttttaaaaa taatcactca cccttgagc 878580
 ccaggtcctg gctgtctttg cctctcttct gttgctgtga taacacactc ttacaacagc 878640
 aaattaaggg gactcttact tcacatctcc aggtacagta catcatggca cagacatcaa 878700
 ggcagcagga gcttgaagca gccagtcagt tgcattcaca atcaggaagc agacaggaat 878760

gagaacatgc tccgttcact ttctccactt tatatagttc agggtcctt gccagggaa 878820

tagtctaacc cacagtttag atgggtcttc ctgaatcagt taaaggatc aattaaatcc 878880
tccagccaca tgcccagagt ttgcettaat ctacataatc cctcacaggt aactcagag 878940
gccagctct caggagatcc tagattctgt caagctgaca gtgcactcat agccatcaca 879000
aagagtgtct acctgaatgc tgcagcagca tgcctccaca caacacagct gagtccagca 879060
catcctgaag atacgactct gctcggatga gtcaactgtc acctcagatg gaagagcttt 879120
gcaaaactca gtcccaagt ttataacatt attttggtgc catggtagat taattcatat 879180
attgtcattg ggctttgtct acaaaagtca agtgaagca atgagtacca catggtaaag 879240

gagcacaatt atagccatgg ataatggggg aaggggaacc cttgagttac tgtaagacag 879300
ccagctgtgt atccaaaagg aacaacaaga aagaaaaaaa gaatagagtc agaaaat ttt 879360
gtaactttgt caacatttat ttccacaaa caactcatta aatcactata aaagtcaacg 879420
catatggttg gatatgacag ttaaatcc agaaagagtt ataagtcaag ttaactcat 879480
aatacataat atagtcaggg tgtctcatcc atgaattata acat ttttat tacgtcccaa 879540
ctgcaaatca ccaactgtct ccctgtcctg ccaatctctt gattaatgg gggaactgtt 879600
aggcactgtg aaaatatatt atggtaaaag atgactccat ctttttctc agttatttct 879660

aagtccttat ttaaagcttt gtcactagag cagctgttcc aaactgaact gtggatttaa 879720
caaatgata gcagaatgga tgaagtaaga agaaaaaat gggtccaaa ggacctgtgt 879780
ttattgtaac ctctccaat atttgtgtat cctcgatact tttggtatct gtttcaatct 879840
ctttatttct gtctctttaa agttattctt actttgcagg tcttattccc atgagcctac 879900
cttaagggta tttattttg tgtcttacac tgataatggg acaataactt atacctca 879960
agtttccca taaacagtt taatgtcttg aaacagtcc aatacgtcag ctaaagagag 880020
tgaatcaaat agacattatt ccacatttac cagageccac actgtatcag gtccttcaag 880080

aacttactaa atcaccagtg tccttagga acttgaattc taaagttaat acatccatta 880140
atattcaaa acatagacta catatatata tagattaat tcaataattt acctttgtt 880200
tatattttgt ttcaatgtgg tgtacttact ttattctaga gcaacaaat acttaatcat 880260
tacaggaaaa caat tttaaa taacaagacc ctagccaggt gtagtgaca cacacctta 880320
attccaacac tcaggaggca gaggcaggca gatctctgtg agtttgaggc cagactggtc 880380
tacaagagaa gtccaggac agcctccaaa gccagagaga aaaacaaac aacaagaaga 880440
ccctaaaaga aagctataat cacctccaat aaaacataaa catacagaat gtaaacatta 880500

tttctagttt tcatgagtaa ttatgatttg ctactcctat tcttggcaaa tgagataaag 880560
 ttactgtatt agtagcagaa atgccatctt tatccaggaa cacaactgaa tggatatgtc 880620
 tgattataaa ttataacca ggtacaatca aagacagaac tagagatcta tgaatcagaa 880680
 agtcatagga accatcatct aggtatggca ttcatgaaag atgtgtaaac acaaacagca 880740
 gaagtctagt gtttaaatag aagggaggac cagtaacatg taaggcagat atgtctgaca 880800
 tgtagacagg aatgtctaata aggcttttaa taaaagcaat gaacagaaac cctctggatc 880860
 tccaggccat cccactacta accctcaaac ctttgtttaa tcattgtgca gctcacgatg 880920

 tcataaatta gtgggactta gagaaggac attggatagt cacagattca gcaggaatc 880980
 atcattcagc aggtgcatcc aaaggccta agtgcagact ggaaatcaa gcagagcctc 881040
 actaggaact cagccaacac cgagtacaa agcatgtcac ttccttgat atccagaaat 881100
 gatggggggg gggatgctga ccttcacatt ggaatgaaca ctgacactaa attttgctta 881160
 catacaaag acaaatgacc ctaagaaagc tggaaatttc atagctggaa tacaggctgc 881220
 atgtctaaa agcacatata cacagagaaa gagagaggag gggagggaga caggagaga 881280
 ggagagtga ggctatgtga aggaagattc taaagactgt atggtcactc agctgaatga 881340

 aactctgcta ttttgctaag ctctccaag gacagattat gtactttca tgaagtgcta 881400
 gggactgaat ttgaagtcaa ctgcttcaa gtttctatc tgatccatt taccagcttc 881460
 tgggacattc cacctectcg attccttcc ccccatcttt ggagaatctg tggaaactgt 881520
 aacacataac tgaggaaga gtttgaagt ccaggagaga atgtaactga cttgggataa 881580
 tttcattcac attattacca agcagtgcc taacctacag ccaaagcga cctcaacaac 881640
 acagcccca attcacaagt gaaatcacag cagtgcacac aactgcaatc tatagaccaa 881700
 gtgaggagag accatcagga atccaagag ctgagaacac taggtaacct cagctggacc 881760

 caaggcagga ggaggaaaa gaaaaagaaa gaaaggagg aaggaaggct ggggttgggg 881820
 aagggggaag aaaccaatc aaacagagt tctgggttcc agatagtac ctaaagaaga 881880
 ctcagggtac agaatgaac tggattgag atttcgttg ctaggaaaca gtgtggtgtc 881940
 ttgatgagg gctacatgg gaagaccgac attatcacag acagaccagc ttttctctag 882000
 ctgggagatg gaatgtgtt agcattttta acacagagaa cacagagaag gttgccactg 882060
 taatccaagt tcaaggtgtt gagggatata aatgagtggg cccagcatat cttccacgtg 882120
 aaattgactg taittactag gcacctgaga gcaatgacac aaaggaaggg gaacttgagt 882180

 aagtgcctgt tcctatttta ttgtctaaaa ttccaggat taacaagatt aataaatctc 882240
 ttagtggagg ttagggggag acaggaata catagagagc taagtgagac aaacagctta 882300
 actagaaaac aagtaacca aggattggct tcctgttctg tggaaaaact tgttacattc 882360

tcagcatctt gaaacagcac aattgttacc ctatgcttct gcaagtcaga gtctgagatg 882420
 agtttctcct gatgaagtg cggtgtgttc tttctggaag ctcagggaca accatcggt 882480
 tttccaccta taaccagtaa agagcacaag actatagaga tcagttagga ctgaactggg 882540
 ttgatcctaa cagaaacttg aaaaataatg atttcaacat gaaggaattt ttttctactc 882600

 ataccttttc caagggagga aggtgaaggt ctgcctcagt gcctcagttg gtaccagcc 882660
 ttttgagtc caccatcctc ggcacataag catctttctt cacatctagt cccgtgatca 882720
 ctaccagatg gatgctgctt ctctagcacc atccccacct ccacatccta ggaagaaaga 882780
 agaggactgg gaaaaatgcc aaaggggtct ggggatgtgg cttcgttcta gagtgcattg 882840
 ctgacttgca caaatctttg gattcagtct ccagcacat ataaaaccag tcttagtttc 882900
 acatgcctat gatcctagca ttcagaagga agcaaaagat cagaagttca aggtcatcct 882960
 tggcaacata gcaagtttca ggctttgagg ccatcatacc tcacataaga ctacatcaa 883020

 agaaaaagaa agaaagaaag aaagaaagaa agaaagaaag aaagaaagaa agaaaggaag 883080
 gaaggaagga aggaaggaag gaaggaagga aggaaggaag gaagaaagaa atcccacatc 883140
 cttatgtgcc aaggatgggt ggctccaaaa ggctgggtac ccagctgagg cactgaggca 883200
 gacctgcacc ttctccctt ggaaaacgta tgagtagaaa aaaatccctt catgtagaaa 883260
 ggaagaaaga aagaaagaaa gaaacccatc ataaattata taaggctcta tccaaagaca 883320
 gacagacaga cagagacaga ggccagaggc ctcatctgtc cttttttggc aagctcttac 883380
 aaagcctgac tctacctt ttgtttacat ccagggcctg caacctgac ctgtggtgat 883440

 gctgagctgt ggggtgaaggt acttgggtct gagatggatc agccagctga cagagtctgt 883500
 cagatctata aaaggatttc ctccatggca agagagagct ttcaagtgga agtcaatcac 883560
 tgcttcaaat caagcattga gaaagaaaaa aaggaggaga gagagatttc ccagtggaaa 883620
 acacttttgt gatattagat attacttatg ggataccagg aactatttcc tagtgacatg 883680
 ggcatctatt ttatcctgga gacttacagg tgttttcatt gcaatcaaat ggattgggat 883740
 gccatgtgac ttatagcaag aataggtca ggacacctt ttagaatatt gggtttctaa 883800
 ctcttttggg gggggttcaa gacagagttt ctttgtgtag ctttggagcc tatcctggca 883860

 ctgcctctgg agactaggct ggcctcgaac tcacagagat cccctgcct ctgcctcca 883920
 agtgctggga ttaaagcat gcaccacaa caccacact ctaacttctt ataaccactt 883980
 tggagagcgt tcttgaata atctagaggt tccagtataa gaatgagaaa agatagtcag 884040
 ttatgaaaaa atcataaaaa gccagaggta gtggccatg ctttaatcc cagcactcgg 884100
 gaggcagagg caggcagatc tctgtgagtt tgaggtcagc ctgactaaa agtgagtcc 884160
 aggacaggct ccaaagctac acagagaaat cctgtctccg aaaataaata aataaataa 884220

taaataaata aagatactga aatattccca gaactgtgtt aaccactgag aattgtttac 884280

 gaatgccatc tctcactcaa atgctaagct taagccagtg ttattcatgg tgagtcaaat 884340
 tccagacatg acttccaaat ggtaaatcca aaacaagggt agaagaaatc taaggatctt 884400
 cgagagtctt cccatatgag gaaaagttaa catcccaaat attcaggaaa tagtgaaaga 884460
 gaggttatgc aggtatgtg atgcgtggga gacatgaagc tggacagata taggagacct 884520
 gggaaagggg aacagtataa agaaatggac attatttatg aataaaactc ttaaaacact 884580
 gcattctacc tigttagaaa ttattgaaaa cagcattttt tgggctgact gagcaagaat 884640
 ttattcagca aatctctga ctcatgaaaa cccaatcgtc aaattattta acttgcttat 884700

 aactttacag agcaaaagtt ctctcggac ttaaggtggc acatcctggc ttatgaatgt 884760
 cccgccctgc tctgcctgca gctacttctc cctccccctt catccagcca ccttctctct 884820
 cccagcttac ccccaaatcc caactcggcc atttgtttgt ccaggaacct gcattatgac 884880
 cctgcagagc tcatgggtac ttgccagaa tgaatatatt caagtggtc cctccaatac 884940
 tcctctgtc aagagacacg taatttatga aaaggaattt ttcagagctt tagatatagt 885000
 ctgtgccgta ttcaatttaa ttcagtaaat atttattgag tgtccaccta gaattgtgct 885060
 atgtcctatg tggaaaataa aagaatata taacacaggc tctggccaaa gggtcggcaa 885120

 tgttcttggg aataaaagct gaatgctgat atgattacag gatgcaaac agcacagagc 885180
 aaagcaatag aattatgtaa ccagaaccaa aatagagggg agagtcaaca ttacatttgg 885240
 caagaccaag aaggatagag ccacagggaa taatttatgg gggagatgga acttgagact 885300
 atccctgaga gatatgtggg ttgggccgga tctgcagcc aacaagggca cttctggccg 885360
 tggaaagaat gtgagtgaaa tcagagagcg ggcaaagtaa tcgtgatatg ttatgaagaa 885420
 atgtgagaag cactctgga tggagagaat acataatgac cacagaaaga ctggaagctg 885480
 taatctccc atactctgc ttggtgttct atcattgtcg gagaattcaa tcaactgggag 885540

 ccagcatgag atgtggagaa catgggctct ctctcagttg ctttctcac agctttgaca 885600
 aaaccccagc acttgaaga agagatgatt tctctccact cctagttgaa ggtgcagtcc 885660
 tccatgacag ggaaggaaca gcaagcagtg ctggaggtgg ctggtcccgt catatgcagt 885720
 cggaatcag acagcatgca tgttggccct cagcacaact ttctcctctg tattaggtct 885780
 ggtactccaa cctatggaat gagtccacac aaatggfgag tcttctcggc tcagttaacc 885840
 ctttctgga gcactcacat agacttacca gatggtgtgt acctatggtg attctaagtc 885900
 ccatcaagat cataacagac ttgaagtgtg ttgctggagg ttctctgtc ccaccaggtc 885960

ccgccaccga ttcagctcca aataagcaca caaaacttct attaattatt aaactgttga 886020
 ccagtagcta gggcttctaa ttggctagct ctgtcttaat tattaacca tttctattat 886080
 taaccatct ctatactgga gaagggtctg gagctgttac tcctttttgg tctacatcga 886140
 gtctctctct gcctccatit cccagaatit ctctcgtctc ctagtcctgc ctatcttctt 886200
 gcctctatgg ccaaacagtg ttttattcat caaccaataa gagaagcata tatgcataag 886260
 gatacacccc atcagaagtg agaaagcacg attcttctct ctgtcctacc tcagcagaac 886320
 cttgttgctt aggcattctc ttcacagatg ttcaaaaaaa aggagggaga accgatgttg 886380

 acaatitagg actgctatga aaatcagagt tctaacacagg atgtgctttg tgcctacaaa 886440
 taggtagaat cctttgccag tcttgttcat tttttgtga atcttacta tgggttaaaa 886500
 aacaacagca acggggttca gcactaagaa aatgaaacca aaaatatgca gtgtttcctc 886560
 caaagacatc agcaggtata tcttaaaaca agcaacaagt cagtgcacatg gctcagcagg 886620
 tcaagtggtt taccatccag cctgatgttc tgagattgat ctctgggacc cactaaaagt 886680
 tgaaggaaag aaaggactac tgcaagttgt cctctgatgt ccacacaaat ggtggggcac 886740
 tcaaacacta attaattaat ttcaaatitaa aaaaaagca atgttttggga gttacaata 886800

 cttaaaactg aagcttgctc ccaccaatta caagttgcat cactttgggg gaacaagtaa 886860
 ttctgtatct cagtttctc aattgtgtca ctggtttggc aacattgacc tttagtctag 886920
 tttgaagatt caataccact ctatcaagaa accaacatgg tacctgacac ctggaagctt 886980
 tcaataagtg ttgtttgaat tatagtgggc agtggacaga aaacatagtc tgataagaaa 887040
 gagcaaatca ctgggagtca gaggaatttg tgcactgagg caaacatgga ctagaatit 887100
 ttgaagtagg cacaaattgg aatattctga gaagagggaa caatgtgaaa aggtacagaa 887160
 atatgaaaga aatggatgct tctatagcat gcaggtaatt tggatattgct ggactataaa 887220

 gttcaaggca gagagcccag gagatgaaag tgaccaaatt atgaagactt gcaaagccaa 887280
 aggaaggtgt tggaaaacac ccatcaggca atgggtatc actgataaac attgagtgg 887340
 ggagtaagtg aggcagctgt ggagattgaa aattccccta tggtaaggag acaggaagca 887400
 tttagggaaa cactgaaaac actccatggc cacagggaga cagagaaggt ggaatgatcc 887460
 ctggagacct ttaaaagtg attgcaacag aattcggttt tgactgatgc cagaaaaggt 887520
 tgactgtttt taaagaatgc ctcttctctc cttgcagtgc acttgctgag actgagaaca 887580
 cagatgtaaa acaagtttgg agtaaggatg atgcctctg cttaggatat gatgaattaa 887640

 ctagaggtgt ctgtggccta tcgaaatgga gaacaaactg ggttcagcaa cacacttgg 887700
 gaactgggaa gtctgaagag gtggacttgg gaggcattgg cctatatgga tgaagactgg 887760
 tcataagaat ggatccatcc aggataaagg agaagatgag acaactctca agtcatgtca 887820

ttccttactg gcccaagaat attaaactca aactctttaa ataaaaacac aaatctcaga 887880
 ttcagagaat gtttaaatat gcccaaggtc aaagaaacac attttctggc gagtcttttc 887940
 tctccatggt agaagctgga tgtgtgtgaa agaaatgaga gggaccacat agagagcaga 888000
 tcttggatac tgaggggcta cacagaggat gacaattata aacacactgt ctctaggaaa 888060

 acagttcatt tacaagtag atttgacagc tcaagttgct tcttggcgga gcagtcttgc 888120
 ctgccccca cgcgacctgg tgagettgga ttatagcctc gatgctggtg caaccgcaga 888180
 gacccccata aaggggagtg atgaatgagg tctgtcagg cttcattccc tgggtggcct 888240
 tgaatctctg ctgttatctg ttacctgcc agtctgaca gtgatgaaca caaggcaggc 888300
 agctaacgac accccgattc attaccaga aagaagagag agcagaaaata aagagttagt 888360
 gaccaccatg caaaagcttc ccacatcagt gctgtcttcc tcctgcagct ttgaatggag 888420
 aagaagtgat ggagcccctt tgtctcatgc aaggactcca atgatactca gaatagagtt 888480

 ctcaatgaag ccaactggga aggccaaaata ccagcctcag ctgggtaaag ttcttcacaa 888540
 gacttatgaa tacaagagat atttagcaac attttaaact cactattatt gtagcaaac 888600
 caaaaatgaa aggcacataa aaatcatcaa cctgtacagc cttcccaacc taaattgtta 888660
 tttattttag gggagtgcac tgtctctccc taagactgta ttagatttat ggcaccacac 888720
 tagcaaatgg ttaaatagtc ttagecattg cttccaatta taggcatttt gtgtttaaag 888780
 tggatattgg ttcttccta aaaagatcaa gatttttgtt tcaacacatt ttttttctaa 888840
 ctagtaaaga atgaaggctt ctacttcatt gtctcttttt tcttattaat gggacttctc 888900

 atgatgccta aagacatgaa acatgtccaa caaatgcac ttgaatttaa tgccccaaaa 888960
 agacaagttt gtctgcctaa tccaatccat cttaacccag aatgtcaatc agagaactgg 889020
 ttcttcaagg catcaagaat ttatcactct ctgtctctct gtctctctct gtgtctctct 889080
 ctctgtctct ctctctgtct ctctctgtct ctctctctct gtctctctct ctctctctct 889140
 ctctctctct ctctctctct ctctctctcc tgtctgtctc tatttgtatg tgtctgagta 889200
 cactgtctt tgtctacatc tgtgtctata catgaaggca ggactttgtg gtgtatatag 889260
 ctaagcaagg gcttctcca ggaacatgtt ttaacagaa agaaagtcc acagtcaaat 889320

 ggatttgaag aaacctgigt taatcaagtc tagcaggtac ctttcacacc atattttctg 889380
 ggaatcttta acataactat gtacattttg atgttcttaa agcaaatata atccatgata 889440
 ttttaaatct gttttctgt tacacacaat acctttgtgc aatatgtatt tatcctgctg 889500
 ttacaaaaaa cccacaatt tgggaacagg tagtctggat gaatcccaca ttctcattcg 889560
 ctatattgag caataaaatc aggtgatcac caagatatgg tctaagtatg tggcagacca 889620
 agacagtctg aggttacaat gagtgtctaa gaaaacaggg gtggagtggg gctgaagatg 889680

tgcctcagtg agtattgtgc ttgcctatta ttaggaaga cctgagttca atcctcagta 889740

 ccacataaaa ccagaggiga tatgtgtgcc tgcacttta ccacttgggc ggtagaagaa 889800
 aaaggaaaat aagctcaggg gtcacctcca ctacatagct ggttcaagga caacctcagc 889860
 tacctaaaca ggggtgtggga aacaagaaag agtaacataa gagagccaag agagtaaaag 889920
 tgcttgcttg caaaacttgc cctccaacct ccaaacctgc tctgcctat gcacaagttt 889980
 gaacacacac actctcgaac atacatatac acacaccata cataaatata tacatacaca 890040
 caaataataa taataaaca ttttaaaagg ggagaacaga gggaggaaga ggaagcagga 890100
 ttatatacta tgaacaagat acattattta tacacatgtg ttaaaatgtc caagaattaa 890160

 ttccittaaa attaataaaa acatgggtgtt agctccaaa gaatgcaaaa agagagccta 890220
 cagacatcct ttcatacatt ctgacttctg ccgctatttg cagtgttctt tgttgaaaag 890280
 aaagcagcgg gagttaaaga cgatactgaa ggaagaaagg tagttttctt agatttggga 890340
 aaagggcagc ggaggtagta aatacatgga tttttatcct tgcttcttgc tgaaggccaa 890400
 attgctgttc taagaacagt agcacaagac atcactatct ctttgagaga gtgttctgaa 890460
 ttttcttttt acatacgtat gaatggaagt tggtcagacg ttcagaacac ttaaaaacta 890520
 ctgagtaatt ttcttaagtg cctaatagca gagtgagcac aaaaggataa ttcgctccag 890580

 tgcctaaga catgcaagca ccgtacgttt cctgttatgt aagaggaggg cacatcagtg 890640
 gccttttctg ttcagctat ttggcatttc ctattaaaac aagtcactag ctacattcaa 890700
 aatagctgaa gaaaggtgat ccaaaaacct agacttgagc tgaacaagaa gagatgagaa 890760
 ccatctacct ttctctatca gcattaattg cttaaagctgc aaagcaagag aaaacgttgg 890820
 acaaattaaa accatacaca aattccaaca ctttaagtag ggtgtttaag tcaaaagcag 890880
 tgtggaactg caaaaaaaaa aaaaatggta atgtagatgt gaactttctg cctcttctc 890940
 gtcaacaagc aaatgggtgtt caggtgggaa gaactgacca tctaagaact aacctaatat 891000

 ctgaacgaga tacaaccatc gtcataaatt aggaaaggac attaataattg tctgctgtc 891060
 ttctcaatag gaagtcagcc ctggaagaa aaatctcacc agtatcttct ttctgtgtgc 891120
 tccaagaaat caaagtcagt cgtgggtgctt ccaaatgaag tgcaaagaaa cctgcatcca 891180
 tttttccctc tcattgcca tggcaggtta ttcagctctg gcggcgtcaa agaatttagc 891240
 agaggaggga gaaatataat tctgtggctt ctggcagaat gaagtttatc ctccacaga 891300
 ttctgtaata agttcttctt ttctacttc ccacgaccaa attgtgtctc ctacttttc 891360
 tgcaaaggcg ctcatctctg actaacaat acgaatgatt ccattgcttg gccatctatt 891420

ggtgacaaat acactccttc atttctcagg cccttgagag ctcgaggatt gatgggcatg 891480
 agggaagagc tgggaccaag aattcaagga agagattcgt gttattggtc ttttattcaa 891540
 gttaatcaca ggggaatagt attttaagac ttcattggaca tgcccaaaat ttctccagag 891600
 acacagatca atagatcaga ataatacaaga aaagccaaca agtcttctaa acactacttg 891660
 agtgttttac ttgagtaagc aaaaggcaaa tgggaattatc ccaacctcgt gaagtaaggg 891720
 agaaatcaga tctctgggga agtgcctcca gtttggagct gaaaataaaa cagaaggtga 891780
 cattttaatt ccagtctccg gcctggacac agggatgtgg gcggcacttg tttgtaacat 891840

 gatttagtta atgaactgct tccccaaata ccaccgaatt ccctgtccgt tcacgataat 891900
 acactctatg tgagggtaca gggctctgatg cttttgcaga tagcctctct cttcactttc 891960
 cactcaact cagtgaaaat gaaggcagcc tgattgtctt gagggcatgt tgggccccag 892020
 tgatgcttaa gtattagcct gggaactctg agccttcttc tcatcagcaa actagagata 892080
 gatactgcc acggtgtcct gaatgagaat aaaatttcaa aatcgttcat gtgaagccta 892140
 cgtcaatttc agtaaatgaa tcacacgagg taggatatga gtaatgaatg aactttgagt 892200
 gcccagcaac gttttccaaa atggctcttt tgcgatgtta atgataaggc agaacgctgg 892260

 ggctcctgtt tgggatgcac cgccccttca acagtcttgt ctgccctgac agctcctttg 892320
 gagctcgcgt tctttcacag aactgtcttc ggcttcatgt gctcctctag cttttcacc 892380
 ctcttctec gctatecact catctcttcc tgcattcttc tttgttctc tcaaccgccc 892440
 tccagccctt tttcttctct gataaggcag ccacttatgc atccccgat acttctagga 892500
 tagggagccc ctgaagctgc ccaagaaaaa caaacaagc ccccacccc gctccagaaa 892560
 gtgtacaaat ccgagctgga acaaagtgat tctttaactc acattcaaaa gaattttcct 892620
 cagcccagc tcggtgtgct gtattgttaa cttgtatcaa aggggttcat atctcaggaa 892680

 tcacaggaaa ctttcaaaat tgattgatgg ctagtcaaaa gaacatcctt ggcgcgataa 892740
 gccgcggaga gggaatgtgc tgagccggtt caggatcggc ctggctgtgc ctttcaaatt 892800
 ctttcatcg caatggcgac cataagctct gcagggtgag aacaagccgg gactttttgt 892860
 ggaattttcc taaccgctga tatgtaatcc atacagccag aggtagcagc gagaggataa 892920
 aagatttaaa gaaaatggag acacatggac tgattttatt ttttttaag caacttggaa 892980
 agaaaaaagg gggggtgaga acagcaaggt ttatgttaac ccattgggag tgcattggaa 893040
 tttctttgat gaaggattga gattgcttta aagcacttta ttgaagcaaa atgtaagtat 893100

 agtgaccaga actcagggtg actgggtcac tcacttgett ctccctcacc caaattctgc 893160
 aggctaccaa attgttaaaa tgctgcaacta gattttcctt ttgaatagga agctgtataa 893220
 ttagtagaaa ctctccctct tectcttctt ccctctctct ctctctctct ctctctctct 893280

ctctctctcc tcttctctc tcttctctct ctttctctcc ttttctccct cttctccgtg 893340
 tgtgtgtgtg tgtgtgtgtg tgtgtgtgtg tgtgtgtgtg tgtgtgtagt caagctaccg 893400
 atgtgaagat acagagtatc ttaaggatac agaacttaa agagacagtt cttacttccc 893460
 attgtgtaga ctctgaata gagcttgggt catcaggttg ggtggcaaac acccttacc 893520

tctgactgat ccattgacc aagaggaagg gggcatgtgc acatatatgc ccaatgaaac 893580
 atgaaaatgg ttgctaaaa atcaataacc tattaacac atccttcctt gccatgaatc 893640
 agatttaaag tggcatttca aaagctggaa caaagcagat gacatctatg aaaagacaaa 893700
 gcaatgtttg ttagtttcca ctgcaaagag actcaaatat gtcttaggaa gcaagaagac 893760
 agtcttagct ggggaggaga gaacaaaaa tttgcctgga attgagagtc taaagcttcc 893820
 cttacacagt tcaggtatca tgaagagct tgaacaaaa ataaagtta ataaaatgga 893880
 ggccagaaag acagctcaat ggttaagaga actggctgct catccagagg acccagaatc 893940

gattcccagc atccacaggg tggctcacia ccatctgtaa ctccagtccc agggaatctg 894000
 atgccctcct ctggcctctg aggaaacttc acacactggg tgcactata cacatacatg 894060
 tgggcaaac atccaaacia ataaataaat aatgtagca gttggtgcc cacatcctga 894120
 ttatgctttc atgttctacc tcccctttat tgcacacaaa gttaacaggt atatgtcac 894180
 aaacaaaagt aaatacacia aattttagaa ttagatcaga gaacctacc atcatctgtc 894240
 actgcccgg caattaggtt gtgcttataa ttatgctttt ccatccatgt tggctgtgac 894300
 cataaagtaa taacgatgat ttaaaaaa atactgctca tttatttaa cagtgtggt 894360

tttcaaagat agtcatgcag ctgctcttag attttgatgt ctttgaggt tgtgtttgc 894420
 atctgaaagc agtaccagg gaagaccccc ccctccca agtggttcaa acaatcacac 894480
 agcagtgtt taggcatca cagaagttag cttttacctc ccaggaaca ttttgaagg 894540
 atgatgttaa ttggggagtg tggagtcaa gagcagtaat tcagaaatca atcatccttc 894600
 cccccagtga agctgggaca ctgatggagc agcagagctg gccctgctg tgaactgaaa 894660
 cactctctcc agagggatgg aagaggttct agaacctcac agggacagga aaaactgaaa 894720
 cccacagatt ctcaagacct ctccaaggc cttaaaagca aaaaacagta aacaactgtc 894780

aacaagagag gactctcaa gggagactgt cctgcaggag actgcatca gtcaagtgc 894840
 ctacacatca tggccgggct aactctagga attcaacttt ggtgagttat cacccatgct 894900
 gccatgctgg tgiaggcttc ccagtgagtt agctgctggt ctaagacgtc aaaccaggt 894960
 tgtcagactc ggtgacaagc ctttctacat gccaaggcat ctctctggcc ctgaagctgc 895020
 cttttaggaa gtaattcttc tgcccatact cctccaaata accccagtga getcactggt 895080
 tccacaaact gaacttgggt agaattctga gcttgatgtg ttcctttggt ttgttcaaat 895140

ctaggcagag aaagttcaca gaacaatccc tcaactgcct caggagcaca tgctaagaaa 895200

tgtatcagtc tggigcaact cactaatgga gaattctcag taagaatac aaaggcaagt 895260

gcagtggaca ttccagacca ccaacactcc tgaacaacaac tagttaagtc attgtattaa 895320

catttgcct gataaagaaa tataaataa gtatatgctt gatgttagca aacagacacc 895380

taccttaaca catcacagac tttatgctaa cagcctaggt ggtttcttca gggaaatcaa 895440

taatgctaaa cttggcaatg atgacacceca ctgtctccac agaacagaga ctagttaaag 895500

aggacacaaa gaaacttcag taccctaaat gaataactgt ctttccaaag acgactcttt 895560

ctttgcttct gtaaggaagc tggctggggc agaaccataa acaggcatca aagcagccag 895620

caacatcagt gtcacaatga ggaattccag cttgtcctat agcatatggg ccagttccct 895680

atgttttatt acaagccttt accatttgcct ggaatcctc agagatggct gctcccgtga 895740

ctttttttaa aatggcattt tttattgttt ctgtgggaaa acaaatatag tttcccata 895800

aacctagagg aagggttgtt ttttttccct acttgccagc ttctagaaaa tcagtcaatt 895860

accttaacct ttttcaaaaa cagaaaggaa cttagcataa aatgttgaac ttctgctctc 895920

agagaaaacc cataatccaa agtaagtaga cagttcgtga atgagatgag ctacagcatg 895980

atccaaggtc caagtggggg acgtccttga ggccatcaca ggatagactc ggaaatatca 896040

catgtgcctt cagagcagtg ggtgagtcac cagatcctgg aaaaggcatg ggatcagcac 896100

cagggatagg ctgattctct gtcagagctg gccaaactct cggataaact aacatggtgc 896160

ttgcacttcg gcctcaactg gtgtgctaat gccttgagaa gggaaaaggg gtgggtgaa 896220

ctgacatttg ttgagcttct atcctgtgct aaagacttcc tgtcacaatg gtccactgtg 896280

agaagaatcg ttgcctcctt ttctatgcat gaatcaactg gagactcaga tgttaagtca 896340

tttatccata gccagagaac gtgcaagtgc ccacacaaga ttcagaccct gacctttta 896400

gtgtctacag ctagatggtg tgtgtgtgtg tgtgtgtgtg tgtgttcatg tttgggcagg 896460

ggtgtgtgtg tgtgtgtgtg tgtgtgtgtg tgtgtgtgtg tgccttggcc acctctgct 896520

gccattactc atgtgccata cactttgtcc tctgagacag tctctggctg gcctagaacc 896580

cactaagtag gtttggccgg ctagccagca agccctggga atcctccctc ttctctgcct 896640

cccagcactg agatttcagg tgctgcca ccaactcgtt tttctaacac gggtaaaact 896700

gcaatcttca tgettataag gcaagctcct taccactga gctatcatcc caggtcctga 896760

aagctaaatg cttttaacac ccctaagctg agtatgagag acagacggct tccaaggtgg 896820

tctgtctgtg cctcgcactc gcttaatgta cgctatgaaa attcaattgt cataatcaga 896880

atgagactca agagatgcac tgctattggg ttccctttgtg tgaagttca ttgaaatgta 896940
ttgaaacacg gaaagaacct atcacgtgat ataccttgtg ttgatacaag catggaatca 897000
tcaaaactgt tcttcccat ctgtctctc gacaccctgc cccaccaag accacttact 897060
aacaacccca caacaatgat caagiattta ctctataaga acaagtgtg gtcctcagat 897120
gggatgtggc atttaaacag gtgaaaacta tctaagagtg tgaacccggt aacgataggg 897180
cagtgtccat ctctgactt ccagctcccc tctctgtgt ttgactcact ttccacagcc 897240
ttccactaga aagctatata gcagccattt ttcagtgtca ggcaactcatt aaataaaaca 897300

taaactctat actccatgtg gctccgaaga aaacacagtg tgcaaacagc actcagaggc 897360
ccttgttctc aattctgttt ctcccatcag cagcctgggt cagaacceca taactcgtcc 897420
ctcccacgag tgacatggct gcagagtgtg ttttttagag aaatagataa caacatccct 897480
tgaaagaaac aaggagggca tttcagcaaa cagggtccat agtactgtgg ctgtcagacc 897540
cacacgccac ctctcaggac ttgtcttct ctggcgttgc tccaactatg ctgcttgagg 897600
tctgtgatag acaacggttc tccagcactt ctcaggtaga cgatgccag gatcttctct 897660
gcacttgatt catgaagaac tggaaagggtg gcagtactaa aggactttcc cctcgggttaa 897720

taaaagaatt tgagattgca tggaaaagct cagctgattg cagaggctct gggtgtaat 897780
gagacttgtg aggtttctct gccttttagc caggcctttc ctaaacaacc tggctgagac 897840
tataacctat ttaagggtc tcttaggaaa agtttttaac tcttttctcc tgcacaggaa 897900
tagagagagg tatggagggc aatccattc catctccat caggatgtgt gtgatacagc 897960
atagctggtc aacaaaacta cattccacgg caatagctaa actagtctct tagaccattc 898020
gtaatgaaag tgcttttctg taaatcacct atttatgaga cctgaactaa gcaaatccag 898080
ccaatcattt ccttcatcag gatcatacca tggctccttt atatcataag ccatctcacg 898140

taggaagatg ggagaaagaa acccaaactt aatatagtct gtggctcatt cctcacttc 898200
ctccaggact gtatagaaat gtcattccct catgaaacct tccattataa cccaatcaa 898260
aatgacagca cacacaagca cgcacgcag cacatgcaca tgcacactta tacacacatg 898320
cacacataca cactcataca cacacacttg tacatacttg ctcacacaca aggtcataca 898380
aacacacact cacacataca tgctcataca cacacatgca catgcatgca catacaaca 898440
cactcataca tgctcacaca cacacaagct ctctctctct ctctctctct ctctctctct 898500
ctctctgtct ctctctttct ctctctctag ggttttgtag tatagcttgg gtaggtgatg 898560

ccatcagaag ctctcccag gctgaacttc ttaattttt cttttctctg agtacttacc 898620
attgtaaaat ggttttgttg tctattttcc caacaaactg taacctccat gaaagaaaat 898680
gctttgggtcc tctttttttt ttattttgta ttccatctta ttaaacata acctgatata 898740

catcaggtagc ttatacatga ctgttgggag gaccaaatga acacacagct tcgtgcaagg 898800
 tatggagcct catgttagct aataaatgat tgctattccc cggcaggatg tacactgatg 898860
 aatatgcaac aggtattccc atttagagta tcagttctcc atctctttaa aagtctggag 898920
 tgtccagcac tcaggaaaca gaggcaggig gatccctgtg agttcaagac cagccttgac 898980

 taaaaagga agtccagaac agctagagct attacataga gaaatcctgt ctcaaaaaa 899040
 aaaaaaaaa aaaaaaaaa gagggagagtc tggaatgtaa tccttggagt ctgggtgcta 899100
 gactgagatg caccttctct caaccccaa gtgaggcaa aagacagggc gtctggcttc 899160
 ctgcttggg cttcagccaa accatccctt tccttctctc tcttatgcat tcaggttact 899220
 aagaaagaaa ttgtttcact gataaaagca tagatactcc agccagacct tgaggttgaa 899280
 aacagtgaaa gaaaataggg tgaagtgtaa gtgaacacgg gtcattca ttccataagt 899340
 acttataggc cattcattgt gtgtctgctc atgccagtca ctgggaaggc ataggaagc 899400

 acacatggc caaacccaa atcaccaact tcccagtaat aattataata accttgggaa 899460
 atgtatgaaa tctgagcaa ctgaagaaga gtgtgtcctt ccagaagcgc cactgagtct 899520
 tgaggactat gggttagatg aagcctcggg agactaacct tcaactgatg gtttaaaata 899580
 ataccgtggc ttcttgggac tctgcctca ataataaaat atgacacttg aaagtcaact 899640
 gatttgtgaa gtcctccca aatgccacac tgaatccaga ttcaattgact taacctgcac 899700
 tgtggtttgt catctaccac tccaaaattc atgctgaact ttaattgcct tgttaaaggg 899760
 atcagttaga tggggcttta agagttgatg aaagtctgt ggtctctgcc tttatgtgtg 899820

 gaatgaagac tgitatccag aaacaaactc agcttctctc tctctctctc tctctctctc 899880
 tctctctctc tctctcccc acgcttcttc attgccagca agtgttctctc ctctcagggtg 899940
 ccagcatcat ccaaggtact atcagaaggt ggagcctttg cctttacaaa aactaaatc 900000
 taccactgcc tgccttgatc ttgaacttcc ctteccagcc tccagagcca ttagaaatca 900060
 gtatctgtcc acaaattatc ctgcctcgtg catctgttac aggagtacaa aatagacaaa 900120
 gacctcttac agacaggatg aaccagcagt ttcaagtaat gaattgctga ataaggatgc 900180
 tcggtccatt catctgaccg ttaacgtttg atatggcaca gtgatcgtca gtaggctcta 900240

 aggaaaagtc atttgaattg attggtgttc tcttccacat atgagagatt tttgttgcac 900300
 tgtccaaatt caacttcaag agttccatta tagctatggt tgatatcaga agcaaggtaa 900360
 tcttgaata agttgtggat ttcaagcttt attgctcacc attgcatca tgtttgcttt 900420
 gcattgaaaa caaatctcca catttaacat attgaagaag aaaacaggat gcttagttct 900480
 ggcaaatttg gaaccaggac agatttcaag acattttct cctccatgct ttcaaatcat 900540
 aactaacatg tcagccagaa atttgttcgc tgtcatcagc tactgaagca tcagaagtta 900600

acagttagc acaatgacag tgaggggat cctgaaggct tgcagaactc ctgtgtggag 900660

cttttaagtt atatgtaatt ttcattgtac tcaaggtgcc taagaattta gtttctgccc 900720

agagaggtta aaggaaatga catcgggggg ctacagagat ggatcagaga tcaaaagcac 900780

tttctcttgt tgaggaagaa ggttcagttc acagaacca cctgactact cggttctgta 900840

actccagctc caggggatct gatgcctct tctggcctcc atgagcattg caagcattgg 900900

tacacaacaa gcatatacac acatacaatt tttcaattt aaagaaaatg actttacata 900960

aaaaaagaat caagttatag aaatacttct gaaactggtt actgaaaggt ccttcatttt 901020

aagaggaaac aaggaggaaa gcataaatag atatgcttca agtatgtcat gtgctctggt 901080

ttgggttttt gtcattctgt gggatagatt ctctgggctt ttggatagat ggcagaagtg 901140

cttagattta ttaagtgatg gcagcaatac ctagaggaat ggagacagga taggtcttag 901200

gatctggtea gtgagccatc aaaatgaggc agagccacac gacttattat ctagcattag 901260

gaaaaagtaa actactaatt catgctataa tatggtgaaa aacatatacct tagcaaaaga 901320

tgccagtcac aaaaggccag acatcaatca gttacatfff attaaaggcc cagtaaaagc 901380

aagtctatag agatagatgg tgtattcagc attatccagg gcagagagaa gctaatgaat 901440

atgagagggtg agatgacgaa aatgtaaaag taggtattgg ttgtagtaat ggttttttgt 901500

gaccatgaat gaaccagaat ccacttgcta agtaccaaac gtttgtgcct caaagtttga 901560

atattgaagt cctaacctca gtgggatgct actcagaggt aggaatttca agagactgta 901620

gatgaagacg aggttcccac aagacgatga ctgtcctttt aagtaaagga agcagatgagg 901680

actcccatcc cgtgtgagg gcatactgca agaaggetgc cacccaaaag cctgaattgt 901740

gccctcacta agatcccagg ctcatctggg cctactggtg caggactgta atctcagcta 901800

ccaagaaact gaggcaggag gacccaagt caagcctgt ctgggctatg aagtaagggtg 901860

aaagctagcc tgggcaactc agtgacacc tatcttgaat taaaaatgta aaaagcactg 901920

tgatctaaaa agcttgatgg tagagcactt agggaatagg ctaacagctc tggcttctac 901980

agccaatgat gaaaaagaca aaagaggggg gaaaggaaag aaagaaggga gagagggagg 902040

aaggaggga ggaaggaga aagggaataa gggagggaca gagagggga aagagggagg 902100

aaggaggaa gggaggagg gaggaaggaa ggaaggagg aaggaaggaa ggaaggagg 902160

aaggaagata caaagaacca tatctgtcag caccatgacc tttgaaaaat aaatatctac 902220

aacttctagt cctgagtcta cggacttaa ctatgacaat ctaacctgac ccaaatacca 902280

ccgagctgga catttttaa tagatgaaat atatggtatg tgatttatat cctgagaaag 902340

ctataattat agtactaaaa aatactgctg ctactaccta tcagatttgt tgtaaagata 902400
 acactggaga agggggattt ggcttatctt tgcacatgc tcttacagca ctgttgccct 902460
 gttaatccca aggctctgta tcatagcagt ttcattttca aggaagtaga caaaataatg 902520
 ttgaaggaaa aaaaacacat aatgcttatg aaagtccca tttaaaaaaa aatcctatat 902580
 gatatcagcc atgtaattat gtttaagttc tcctcaaaca aggcattttc tttctttttt 902640
 ttttttagga attttaataa tttttttatt aaattattaa tattttcaca tgtactttcc 902700
 nnnnnnnnnn nnnnnnnnnn nnnnnnnnnn nnnnnnnnnn nnnnnnnnnn nnnnnnnnnn 902760

 nnnnnnnnnn nnnnnnnnnn nnnnnnnnnn nnnnnnnnnn nnnnnnnnnn nnnnnnnnnn 902820
 nnnnnnnnnn nnnnnnnnnn nnnnnnnnnn nnnnnnnnnn nnnnnnnnnn nnnnnnnnnn 902880
 nnnnnnnnnn nnnnnnnnnn nnnnnnnnnn nnnnnnnnnn nnnnnnnnnn nnnnnnnnnn 902940
 nnnnnnnnnn nnnnnnnnnn nnnnnnnnnn nnnnnnnnnn nnnnnnnnnn nnnnnnnnnn 903000
 nnnnnnnnnn nnnnnnnnnn nnnnnnnnnn nnnnnnnnnn nnnnnnnnnn nnnnnnnnnn 903060
 nnnnnnnnnn nnnnnnnnnn nnnnnnnnnn nnnnnnnnnn nnnnnnnnnn nnnnnnnnnn 903120
 nnnnnnnnnn nnnnnnnnnn nnnnnnnnnn nnnnnnnnnn nnnnnnnnnn nnnnnnnnnn 903180

 nnnnnnnnnn nnnnnnnnnn nnnnnnnnnn nnnnnnnnnn nnnnnnnnnn nnnnnnnnnn 903240
 nnnnnnnnnn nnnnnnnnnn nnnnnnnnnn nnnnnnnnnn nnnnnnnnnn nnnnnnnnnn 903300
 nnnnnnnnnn nnnnnnnnnn nnnnnnnnnn nnnnnnnnnn nnnnnnnnnn nnnnnnnnnn 903360
 nnnnnnnnnn nnnnnnnnnn nnnnnnnnnn nnnnnnnnnn nnnnnnnnnn nnnnnnnnnn 903420
 nnnnnnnnnn nnnnnnnnnn nnnnnnnnnn nnnnnnnnnn nnnnnnnnnn nnnnnnnnnn 903480
 nnnnnnnnnn nnnnnnnnnn nnnnnnnnnn nnnnnnnnnn nnnnnnnnnn nnnnnnnnnn 903540
 nnnnnnnnnn nnnnnnnnnn nnnnnnnnnn nnnnnnnnnn nnnnnnnnnn nnnnnnnnnn 903600

 nnnnnnnnnn nnnnnnnnnn nnnnnnnnnn nnnnnnnnnn nnnnnnnnnn nnnnnnnnnn 903660
 nnnnnnnnnn nnnnnnnnnn nnnnnnnnnn nnnnnnnnnn nnnnnnnnnn nnnnnnnnnn 903720
 nnnnnnnnnn nnnnnnnnnn nnnnnnnnnn nnnnnnnnnn nnnnnnnnnn nnnnnnnnnn 903780
 nnnnnnnnnn nnnnnnnnnn nnnnnnnnnn nnnnnnnnnn nnnnnnnnnn nnnnnnnnnn 903840
 nnnnnnnnnn nnnnnnnnnn nnnnnnnnnn nnnnnnnnnn nnnnnnnnnn nnnnnnnnnn 903900
 nnnnnnnnnn nnnnnnnnnn nnnnnnnnnn nnnnnnnnnn nnnnnnnnnn nnnnnnnnnn 903960
 nnnnnnnnnn nnnnnnnnnn nnnnnnnnnn nnnnnnnnttc caggttctgg ctattacaaa 904020

 caatgctgct atgaacatgg ttgaacatat gtccttgttg tatggacaag cagtatttgg 904080
 gtatatacce aagagaggaa tggctggatc ttgaggtaga ttgattccca tttttctgag 904140
 caaccgcat actgctttcc aaagtggctc tacatgttca cactcccacc agcaatggag 904200

gagtgttctt tcttctccgc atcctctcca gcataggttg tcattgggat ttttgatttt 904260
 agccattctg acaggtgtga ggtggtatct cagagttgtt ttgagttgca tttctctgat 904320
 ggccaaggat tttgagcact ttcttaagtg tctttcagcc atttcagatt cctctgttga 904380
 aaaatctctg tttagttctg cacccactt ttaattca ttgatggtg ttttggggc 904440

 tagcttcttg agctccttgt atattttgga aatcagctcg tcagatgtgg ggctggtgaa 904500
 gatTTTTTcc cattctgtgg gtggtcgttt tgccttactg actgtgtcct ttgccttaca 904560
 gaagcttctc agtttcagga ggtccattt attgattgca gacctcagtg tctgtgcttc 904620
 tggcatgatg ttcaggaatc gttctcctgt gccaatgtt tcaaggttg tcaaaacaag 904680
 gcattttcaa tgccacctta taaatccaaa aagatccaag accttaagaa agtcgtcaaa 904740
 acaagagttt gtcatcacgc aatggctcgt ttcagttgtc ctgtgtgaca aatataagat 904800
 gtccacggg ggaccgtgca cctcagggct cccagtctcc ctagaactcc tctccatct 904860

 ccatggcagg agtcacttga gccagacctc taactaactc ccagtttgat acgttggctt 904920
 aaaaacattc tactaaagca agcatttccc aagatttgtt ttggaaatag gagataacag 904980
 tgtaaggagt catgcccagg catacatgag gagggaaagt cccggacaac aatgtaatg 905040
 ttgatcccat tctgaggctc ttgtttccct ggccactgggg catactcag tgaacatgct 905100
 gtcttgtgtt tcacctaaca actgctgtta gaatgttagt gacagatgag aaagccattc 905160
 aatcaagact gtcaaatgct taactagatg gaggttgaaa acaaaggaag ggaacggaac 905220
 tgctaataat aacgcattca gacatcaaat cattgcacct tctttgttaa agtggaatgc 905280

 gcagataaag ggttctctgt gattctccac tgataactcc atcaggacce ctctattgact 905340
 gctggttttc aactctatgt agagctgatg aagctgacat ccagcatctg caccagctca 905400
 ctgcagaccg aaggaaggac tctggctttc taaaattaaa aaaggaaca tcatttgatt 905460
 tcttgaanaa ttttaaaagg ctcttctgca aaaaacagct agataaatct gaagtctaaa 905520
 aagcaaaactg ggaagctgaa cagggtgcctt tggctccatc agtcagttgc aaaggtagat 905580
 agatctctga gttcaagcac aaccactct ggtctactga gtgagtgca ggccaggcta 905640
 tgtggtgaaa ctctgtcaag aaaaaagag cagagggcaa aagagtaaaa tgtttgcacc 905700

 aagaaaatat tttaaaagtc ttttaacta atatgaaaag atgatccaac aagaaaataa 905760
 gctaagggtt gagcatgggt gctcatacct gtgattccgg cactcaagaa ggtttaagtt 905820
 caaggccagc ctgggatacc taatgagttc caggatagaa ttacatagta agactttatc 905880
 tcaaaaaaca aaaaataaag ataaaacaat tttataattc attgaaaaat gaatacaaat 905940
 agccaaaaaa gactgacagt aagattacce atagtaataa tcagagaaat acaataaaaa 906000
 tcactagtta tgtttttcac cagacaagaa gttgacattt gaaaatgcca tgcaccaagg 906060

tttttgagag tcatcagtga tggctgagag cattacaaca ttcactcctc accacctggt 906120

 caaacaaca ctgttctatc tgaccagcgt ttctatgact ctaaaccct actcatttag 906180
 aaaagetaca gcatacaaa gtgtttgttg caatattata taaaacgggg attattaaat 906240
 acaacactag ctattcaaga ggtgagatat tatatagtaa ataaaaggaa tgaatgctca 906300
 ttgtatattg catgattttg ttcaaattta caacattaag tgcaacataa gacttcatgt 906360
 tagaaaaaa tagcatacat ttataaaaat gaatgtatat atgtatgcta gcacaaagaa 906420
 atcaatcatt tgggataata taaaccaaac ttagagtgtg aataccgttg aaaactaggt 906480
 cagcgaaga gcaagattta gataaaatac cagatatgat gattcacacc tacaatccca 906540

 gfacttcgga gactgagaca gaaggataac cagttcaagg ccagttgggg aacttgggtg 906600
 agactctgtc tcaaaatcta aaagagattt agatggagtt gaaggggatt tgcaatcttc 906660
 ctgaaatata aaatatttca gtttttggaa aaaacataga gctttcatta catttaatgt 906720
 aaagataatg aciatagcta aggactatat tatattctta aagaatgaga gtagatgtta 906780
 aatgtcctca ccaacaaagc cgggtggctat atgacatgat agacacaacc cctccacaaa 906840
 tcatacatgc ttcaaaatgc catgttcttc aagataaatg catacatgta actgtacaag 906900
 tccattttta aaatagaaaa atacctaaat gttttaaaca gagtatgtgt tcaacagaat 906960

 tgccctccca aatgttcgag tggactgggt gcatagtcca gtggtagagg acttgcttat 907020
 catgcacaca gtcttaggtt caactcccag caccagaggg ggtaatgaat gctgggtcat 907080
 gtgtatattt ggttattttt gtataaacat atttgtggat ataagtgtgt ttccaaatc 907140
 ctgcaaaagt gactgttaca gcttgttatt aacagtcatg ggagagacaa gcccaacctt 907200
 aaggatgtct gatttcagag aggtaaatgt actccagaca taaaagcatt ttctgtcctt 907260
 agaggccag cccactaact aatacactgt tagatgaac atcaggctaa aaatctttat 907320
 taagctgtag gctcaccttg gaaatcagag agagtggacc tttgaagaaa tgagtacagc 907380

 caggagattt ttgtgattaa acattaccac ataatttgc ttaacacttt tcctttttaa 907440
 aatgtcaaga taatttatg ttaaataata tcttaataag ccctagaaat tcaggtttta 907500
 attatgcaaa ctiaggaaat gtaagctctt agcctcacac ctcttgctc tggcccatg 907560
 gaattgtggg ggctatacca aatccttcat tacctggta caggctagtg gacagcgtga 907620
 cttttgctt ggaatgata taggataata taagggaata taactgtgcc ttttccattg 907680
 tgcttttctt ggaaggccat aaataagtaa aattgtgctc cccttgattt atgtttataa 907740
 ctgtgattat gatgattat ttcgggttga gtgctgacag tgtgccgagt gctacaccag 907800

gctcataaga agaaatggtt atgccccaga ggctaacata ccaagacaaa cacttcggcc 907860
ataaaacaca cactaagag atgcttactc tcagcagagc gaggcttctc tgagcttata 907920
tgtaggtgga gaaatthtcc tccatctcgg ggaaggagct taatgcactc tgaaagtctt 907980
cgaggctgat tcctataaag atttcagaca aggatagaga aacataaaac agtgttctgg 908040
gagcacggtg aaggtggigg gcaatggagg atccccggca agcaagcagt caggtagctg 908100
gttacatgct gcaattctag gattgccttt caaggtaaac atctgaatcc aaggtagata 908160
aaacgtgctg ctttctgtat gacaaccctt ttaagggtta aaccctttta agaataatgt 908220

aggatgagaa catttaacaa tgtaaaccag ttttcaaaa cacatatttt ccagagaact 908280
tgcttgggag ggtattatta gtttgacaaa aacaaaaata catttggtgga caattgagtt 908340
tgaaaagtat tgtaaaagg gtctcgatag ggaacttagt attgataatt aactaaattg 908400
acgccatcaa attgccttcc aaatagctat gtttgtagac agacaagcgc tgcctcagc 908460
cttactcaga gaagcagctg tttaaaatga atgggtgtaa attaagagat tcagggctgc 908520
ccaagatgct cagaataagt gacagttgtg ggttagcca aagacgagac attcacacca 908580
ctccctctaa ggctcgggga acgctgcaaa aggcgaggga agcttgtaag agctgaaaga 908640

tggggtgaag ggctacaaat gtcacctct gaagtgtac agtcattaac aatcatcagc 908700
tcacagcaac tgtgggccca tacaaggcca accctatcaa caatcagtca tggaaaggga 908760
aagggtctac aaggtcctat gctgtagtgt ccagttatta gatattggca gattctagga 908820
gagaagtcac tgcctttagc tgtgtgctca tttgctgatc acaacaggct ccaacaata 908880
gttccattt tcacaaggac agctctgaat aaaccagta ggtcacagcc tcagttactt 908940
ctctgttct gtgaagagac accacacat gtaaccaat ttaagaaggt gtttaattga 909000
agacttgctt accctttcaa aggggtgagtc catgaccatc atgatgagga tcacggcagg 909060

aggcaggcag gtgagacact ggagcagcag cagaagagtt tatactgat ccacaaattg 909120
gaaatcgaga gtgagaggct gggcctggca tgaacacttg gaatttcaa gccagtgaca 909180
cactcctcc acaaaagcca tacctcctga tccatcctaa agcagttcca ccaaataggg 909240
ggccaagcat ttaaacccat gagcctatgg aggtcattcc catttaaatc accacaatga 909300
caaaacaaac tcaatagaca aggacatgag ctagaacttt gtggggaggg aaggatggaa 909360
aagggtgga agaagatgga agagcatgga ggtaggatg agagcagcca acacatgtaa 909420
aatgtgtgaa attatctaata aacaatagat aataataaaa aaaaacagaa ggagttccaa 909480

tgcagggatt gtgagacca ttaagtgggc cataaaattt gccatcctct aagtthtaact 909540
aaagagcagt tctagtaggc acttcacagg acttttctag gatactcaca ctggaaatca 909600
ccaagttgat tgacaagagg atgaacagaa cttccatggt ggtttgaaga gttgtttccc 909660

caatgtaacc ctcgcatcaa aaggctggat ggaccctgcc gtttccacca gctgagcacc 909720
 gcacccctc accttctaag catggttaga aggaacagga aagcaacta acgtcaata 909780
 aatgagtcta cacaaatgca gtgcccagtt tcctagaaag tccccagtga cccctgttgc 909840
 ttggtttttc tgcctgggg cattttcctc ccacaataaa tacaactaaa gtgtgggcct 909900

 cacagagtgt gctgcaaggc taggtcacga accacattac agcttgtacc ttgctgtgtt 909960
 ggatggcttg ttctggggaa agccagctgc catgttgtga gactcacaga gggatgcgtg 910020
 ccgtaatgaa tgcggtacct acagatgctc cagcgagtct tcctggaagc attgagtcca 910080
 gtcttcagat gactacagct cagccaacat cgtgactgca accccagaca ctgagccagg 910140
 gccaccata aatgctcaa aattcctgac tcacaaaaac aaagtaagat ggttttaagc 910200
 catgttagaa gacattgtcc agactttgaa gatccccatg gacggcctca cactccctgg 910260
 ggaacagaaa gtggatggca tagagagttg gtggggcag gagaggagg aagggcgagg 910320

 gaactgggat tgacatgtaa aacaagattg tttctaattt aaattaataa aggaagaaga 910380
 atttgttcat aggtctcatg agagcagcat gattcaaaga gactatgaaa taagtgacaa 910440
 ggtagacata tgtgagtaac tgagcatagg agagagagaa actgagcttt gaacttgggg 910500
 aggtgggcag aagagacggg agagaaaaga tagtaatatg tgaattatt tttgcctgga 910560
 gaacaattgt gttggttgg ttcccatcac tctaacaaaa tacctgagat aattaatttg 910620
 taatgaaaaa aggggctcac ggttttggag gccctgtcc atggtggatt ggccttgtca 910680
 ctttaagcct atagtgagc agaaattaca ccatggtgg agtatgtggc tgagtaaaat 910740

 cactccatgg taagagagga aagagaggat gactgaaatt acagtcttac agtcccctca 910800
 aaggcacacc accctatgac ctcaagtcct ccctctgggt tacatcttc aaaggttcca 910860
 ccctcttct gtagcaccac cctgaggatc aaaccttaa cacattggtc tttaggggac 910920
 tatccagact gaagcacaag tcccattaag accatttggg aaactgcat gaatacaact 910980
 gaatatgaat gtctggatgg acatgtaaac cataagaaaa taaattaagt cctttgggac 911040
 cgtagatctg accccaaagc agaggtgcat aaatgtgctc caatctactt ttgtaattt 911100
 ttcatttgtg ttgacaatct ttaaagaatt ctatacaagg aagtggaat tattttctct 911160

 cattaacca aatccagaaa tagctcatga ccaatgatcc attacagctg ccaatagaaa 911220
 taaatgtaact cgaactttg caacaggctc aatatgcaca cagtcttacc cagggaaatg 911280
 cacgtagcag taatcagtat tcctctccag gctcggacct ggtggataat tacaattaag 911340
 ctccaatgga ttagctgcca gaaggacagt acagagtga aggtatgta cagcactact 911400
 ttttctttt caacaaattt gggcatgcag gttgttcttg gttttgttt tgttcttccc 911460
 ctctccaca aaaaaaaaa aaaaaggtat ttccaattaa tttagaagca catcaaatg 911520

actgcccgtt gtgctgggtg gcaggatgaa tgaggttccc agtgactctc tccactatgt 911580

tagcaataca agggtcactc acattacttc cagagcctct agtttacatt tctcaattag 911640

gagataatca gtgtgtcatt atgagtaaaa attgttggaa tgaccttttg actgtctatt 911700

ttaaccagca aatctgcagg gagggtttga tggaaatgcat gacaggagaa caaggcaagt 911760

tatactgggtg ataataaagg acaattatca cacttattat ctgataaata atttattgtg 911820

atgtgccatt aatccatctc acactgcctc ctggatgaaa acacaccccg aagagtgact 911880

tcttcagcgt ttctgtgac atgtcagaaa ctcttgtctg caaagcacia aggaggcatt 911940

tacctggaat agaaagagct gtcatgtcac acttgatcat tttaatcaat gcagataaat 912000

tatgcccctc ataaatggta gatcagtact tctcactgac tttaaaaggg aagtcttcaa 912060

gaagccagct gaaggacaag ccatagccca aacttagga gtctgctctg tttcagatcc 912120

tgatcaat tcttgcataa agccatcagt ctacacattt tagtcaacat ctgaagctta 912180

atcctaagta cagacaatat atcatcttac aataagataa ttaaattctt tacagaactc 912240

cagagattca gctggtaggg actggttggg tttgtaaaac tgattgtgaa ttttagagca 912300

ccatgatgaa tgetgcttct ttttaactctg gatcgctctc ataggcatgt gtgaagcatg 912360

ttcagctctg cgctggatga gtgaagtaga caggcccttt ggacacgcta gtcatacttc 912420

cgatttcaac tgetgatttc ttgaatgata tcagcaatac tgttttctct tttgtacact 912480

caagaagaga caccatctct cttttttata acctttgttc tctttcaaca gtagagtta 912540

aggaaaatag tttgacttcc tactgtgtgt tatgctaaag agatacttct tactctattt 912600

tgttgtctgg ctgtttttc tcttccatc tgtggctact gttttgcttt tctgtactca 912660

ggtgagctac caataagcct gctctcattt catgggctcc caggaacact ttgaggcag 912720

aaatccgtgt attgctatca gaaaacacia gctgaaatg cctgttggg tcttccctgc 912780

aagtgaaaa cacttctaaa gcactgttga ggatgtgatt atacaacagt gcaagcaatg 912840

tgacttctc agagctaggg aactcttctt tacaacttc caaatctc cgctacaaca 912900

gaaacccctt taaagttgct tttaggatgt ggaggtcaac ttgtctcctt tattccaca 912960

gacaggataa ttttagtgag ggaaaggtag tcagtgctc ccaccaccag tacttctca 913020

gaaacatgga gtcaggaat ggcttgttga ccagtgtcc cactcagttt gcctgtcggc 913080

tcttgcact gtgattaata cctagccaaa gcaacttca gaaaggattt ttttaagctca 913140

tgttttcaga ggiatattag ggctctctag aagaactgaa ccaatgggat ggatgaaaga 913200

tggtttccat ctatttatat tcaaatatca gcacttctt cacacctgag aggctgagaa 913260

ccctttatgt gtttgaatgg gtactcatca gtcagagtag ccctacaggt ggctggctca 913320
 cactgggaa gtcaaccaac atcctagttag cttctcagtc ccacaaggtt gggtactcag 913380
 cagtcccaat ctggagctga aaagccagca gaggttgctgg ctcttagtcc acagtggaag 913440
 cctggagaca ctggctctga catgagcaaa ggaagcaagc agcagcagca gcagcagcac 913500
 cagtaactgg gtaaccaac caggctgcag gaggaaaggc caagcaagca aaaagcaagg 913560
 aagagccttc cttctgtac acttttttgt ctgggctgct agcagaaggt gcctcccaca 913620
 atcaggatgg gtcttccac atcaataagg caaccaagac agtccttcca tggagacctg 913680

 ctactcaggt gatactaatt tgtggcaagt agacattaaa accaaccata gctagggatt 913740
 tcaatcactt agttcttggg tcaactgtaag ccagtggtaa agcaaagtg aatagcagag 913800
 aatgggtaac agaacacaga tactcacctc acagtggcca ggaaatggag atggacagaa 913860
 gggactctct tccaactagg cccacctcc taacaacca ttcagctatg aattcatcaa 913920
 tgaattagtt cactgagtgg ttgcagcctt tgtgagccaa tcaccacaca acgacggaac 913980
 caccagatga gggcccagtt ttcaacacat aagccttttg gaggccgttt caaatgcaa 914040
 acacactact cacagtctga aagtccttta tccactgtca ggtggtgagc caggatcagt 914100

 atcatagccc acagccagca catcactggg agaccccagc tccacacatc ttatggagca 914160
 cagctacagc atggaaagtg tcctctgtgg caatgtaatt ttaaagtatg gggagggtcc 914220
 taaaataagt tegattttcc tacaacacat ctctaataca tcatatgtaa ggacatctta 914280
 gtgaagaatc agaggaactg gtccaagaaa gctcataaaa tcagggcac caggaaagtctg 914340
 tgacaatgta ccattgaata ttttaatgtc atcatcatga gaattcagaa agagaaaaaa 914400
 tacctcttct gactttctcc tgtgtccttc cataccacat gtatctgtga ctatggtttg 914460
 gtcagaacac acaaatatcg tcctaaaatg agaaagaagc aaactttcac atgcatttct 914520

 tacagatatg ctctctttt tcaaagataa ttccttttga atctcattat ccagcctctg 914580
 ccttcagaa gctccatggg attcagttaa ggagtcctgg attaacaagg tttcactgaa 914640
 tgcaaaagga caagccttcg ccttgaagca aatccaggat ggccttctg ccaagatagg 914700
 accctccagt acaccccagc aagaatgagc ttacaactca tagaattcca gatacctgc 914760
 tgtggggct gggggctcac cacttagcac ctgtggtttg gatctaagca aacagaaaac 914820
 tagaagagag gacaatcac cagtaattt cttaggcgtc gatccacaaa tacgaggagc 914880
 caagggaat aaccaggaag gccttgaagt gatgctcca gaaaggaat tatgagctgg 914940

 ttggcatcag ggaagctgtt gggataaatc aagtgagtga aacgtcaata ctgaggaatg 915000
 caatctgtga agagaggaca aaggggtggg aaaggagggc ttgcgccata gatcaagaag 915060
 agcgggactc gcaaggaat acagatggat gataaaggaa gtggcagcat tgacgttta 915120

tgagctaagg tagaagaaat atatgaaata aaggggaatt agcaccaggt gtcctccatg 915180
 caccactaaa tcaggatgaa ctactgata aattaccata cggggaaaaa acagatacca 915240
 tgtccccata aataaataaa atgtatcatg cagtataaat ctcaatgccc atgttgctcc 915300
 cctgctgct ccctctgaaa tggcctgagg ttcttgaggt tcctctccat cttttctcc 915360

 ttctgactct caaataagtg tgggtggctaa gaccctgtt taactacttg ctgttgagtg 915420
 aatgactgat agtcttggtt tgggtccctc ggggcccaaa ggcagactct aacctctctg 915480
 gggtttaaat ataataaat aaacaacaa acaagccaaa catagctaaa tgctaagtga 915540
 caggatcaca aaactctgct acttgagatt tcaattactg ggacattgtt taagggataa 915600
 taaaaagaag caaactgcag gtcatccggg gatTTTTAGA gcagtgtcgc tcttagtgcc 915660
 ctgtttcata aagtggaaag ggcagctaga ggtgaggtaa tttggcctg ctcaaacctc 915720
 ataaggaaaa accaatcagg aatcttgagg tgaagggcac ttgggagcat gacctgattc 915780

 catttgctat gcctgacttg tgcaacttct catagataca caaaatagga aaagggtgaa 915840
 gccgtaagag ggaattctac cctgaaagtT aaaactcacg agggacaaat cagtggcaca 915900
 aaattacact gtgaaatgtc attctccaaa gggcttaaac aagaagtgtg ataaatgTta 915960
 ttactctgca gtgccataag ggtgttgagg actcaatcac tgctccgatt ttgcccaaca 916020
 agtgcaagaa ggcagttata ggaaaacaga cctgctcca aagagctTtc aaggccaaag 916080
 gctgtcgagg agaagcaaaa tgggaaagcc actaatatgg ccatcaaTg cacatataac 916140
 ttgggttctt cacagcctgg tggcctctgg gtttaaagt accataaggt cagggtgagc 916200

 aaagaacaaa taaagtTgaa ggtcagaaaag gtctgagga atgcagacca ggaccaaagg 916260
 aaaagcagcc cacggcaatc cttaagactg gcttcgtTaa agaggctcag cctacacttg 916320
 caagaacccg gtaaagtctt ccaagatccg gcaagtatgt ctaagcctgg agaacagctg 916380
 cactgctaat ctgggataca gatcaaagac tatccaaata gctagaaaac aacaccaggg 916440
 gtggggggaa ctgtgattat agaaactTta caaagactgt gtgtgcctgt gtgtgcctgt 916500
 gtgtgtgtgt gtgtgtgtgt gtgtgtgtgt ttgtgcactg gcactcatgt aagtgtccag 916560
 tactgtcaag agacagactt tagtgagtgg aagtgttatt tcagcatttt ttttcatatc 916620

 tatgttttca acctgggagt gggttagtgt cagggtatac gaccaagta tgatcaaggt 916680
 ttccaagTt agctaccgc agggagTttt ccaagaatgg gcataaacta agggaaagct 916740
 ctctgtatac cattaaggag aaggaagaaa gactcaaac tccagaaagg ctttgcatcc 916800
 cgaactctcc ttgTacttg atcacctagc tatgaacaag gctcttcca aggctctcaa 916860
 tgaatcagag ctatcaccaa gggTgaggca gaagagctgg actcagactg ggagtctca 916920
 acagggatgc aaaagtccac tctcacgtgg ctgtataaca cactagtTta tttttaaaaa 916980

gaaagatatg ggataatatt tatagtatgg cctcattttc attttaaaaa gcatacgtg 917040

 taaattcata tattttatga gcatagaaaa tatttgaac aatatagcaa aatcctgaac 917100
 tctttattca aatgagagct aggactagga ggaggacttt tatttttget tgattcactt 917160
 ctgtgttttt tataataact gtgttgtttt tataactttc ttaataactc cttatttta 917220
 tgactttcgt attctcagaa ttcaaccttg ggactccctc acagcctttt acagttgctt 917280
 gttaaaaataa catttgtctg ttcagcctcc gtgaaatctc ttaaggtcaa aaatctacce 917340
 tctttgtgaa acagagaatg actgggttga tgattggggg taaggaagca aaaaaaaaa 917400
 aatgagaaaag aaaaagaaac aggacatcta tatataacgc ctgagccttg cctggatctt 917460

 gaaccaacga aaactatggt ttattgtggc ttaggacat tattaagata attgacagat 917520
 tttgggtgca atagatttaa taatatcatt aatttaattt gctgattttg ataattgcac 917580
 tatggctatg taagaaaata acataatggt tataaactt agagtgtttg ggcataaagg 917640
 gatatgtatg tttcttaatc aggtcagaaa ataacattta aatatagatg cacaaacaag 917700
 aagaaagagg atgcaaatag gattaaattt agtgtggaat ttatgccaga attgtttggt 917760
 ctgttcttgc aatttgtctg ttttaagtctg acattatccc aagataaagt tctgggaaat 917820
 cagagaaaca agaaggcagg aaagtacca ggctacctcc tcattcacca ctgtctctaa 917880

 aggaagcaat ccgtctctat tttgtttgtt tagctggttt catttatttg caaagtttta 917940
 tcttgttaat aaaacctgat atatatcaa aaagttgagt tctgaacaat attttgtgta 918000
 tggatatatg atcataggg tgtgtgtgta tatgtatgtg tgaatgtgtg tgtatgtgtg 918060
 tgtgtatgtg tgtgtgaatg tgtgtgtgtg ttggggtgca tgtgtgtcta tgtacatgtg 918120
 gaagctagcg gttaacatcg ggttttgttc ctcaatcttt cttcacaatt tttattgaga 918180
 caaggtctct cactaggacc tggactcgcc aattcaacta gactggctgg ccagccagca 918240
 agccccagga atgcacgtgt gtccaccttc ccggcactgg gacctgggt getcacctca 918300

 ctgctgcaac cagctgtttt gagtgggtgc agaggatcca aacctcatgg tgtggcaatc 918360
 acttttgtgt gtgtgggggg ggggttgttt gtttgttttt cttttctgag acagggtttt 918420
 tgtgtgtagc ccggctgtc ctggatatct ctctctctct ctctctctct ctctctctct 918480
 ctctctctct ctctctgtgt gtgtgtgtgt gtgtgtgtag accaggctga cctcaactg 918540
 aaagatccac ctgtctctgt ttctcgagta ctgggattaa aggcgtgtat caccatgccc 918600
 agccaagtca catcctcagc cccactcaaa attaagacta actaataaat atactcaaag 918660
 atatttcatt cacaactaaa ccttaagagc cagtataatt accctaacct cttagtgggtg 918720

agaaggttta ggaattgtag atggtaaadc tatgatcaga atagaagctg agtttactag 918780
 ttgctcattc agtatgattt ttttaagtcag aattttgtga tgcagttggt ctcttcagt 918840
 ggaaaattgc ccctgggaaa ctacaagagt tcatcaaagg cagagggtca gagtcttctg 918900
 tcggctatgg tgagacactg gtcatattgc tatgcacccc ataatcaca agtaataata 918960
 tcctgaggca ttctcttctg tattaanaaga taagaactct gttttgttt ccagaacat 919020
 tgctctcttc cctgcttcac acggctcatg taattcagaa gatagacttc attcaaagaa 919080
 tgaaaaatag gtgagtctga gtccccgtgc ttccctccat caattcagca agctgcagaa 919140

 cgttatctgc cttgtaagta gcccagctcc tccaacaaga tgaacctctt tcctccaaca 919200
 gccttcttcc tggggtctca ccaccaacc tgtaacacc accaggagaa aagtttgtgt 919260
 tgctacagga agcccaaata tgaactttat gtaggacagg caggactcat tttgaagaa 919320
 caaaacacat agcatatgtg aataatgggc ctggcagta aaataaggaa atatgctttg 919380
 tgcagcctgg caaatgaggg acctgctcaa gtcatcctt aacaggaaat atgagtcag 919440
 agtctttgtg tgcagatcct ccagatttc cactccctgg gtggggcgg gggataaagt 919500
 gcacgatatc tcaggccttc ccacagatac attgatccat ccacatccac attttagcag 919560

 gattcagagt attatcatgt acattagtgg agtctggcaa aactggcta caggaaatga 919620
 tgcaatggtc agcccaggtt gtgcctaaga aaagtgggaa gaaaggatgc atacatgcaa 919680
 acgctatcga gggcgagtaa aaccacaaag acagacgggc atctccagca actcatcct 919740
 ccatcgaagc tcatctctgc ttccctgagt tttggatcca taactggcat tcacccaac 919800
 tgaagagcag tggcttagca gcctaaaggc tgcattgtca aaaggcattg aggagaaatt 919860
 aaaactaaag cticagtgtg atgcagcagc cccactctt ggttatacag ccagagggaa 919920
 taaagtgagt gtgtcacgga gatcctgcac ccacacctc aagcagcatc gatcacgaca 919980

 gccggtttat aagattaat gaagtatttg tcaatggatg aaacaacaaa aaaaaagaa 920040
 aacatggagt attcacacaa caaatatta ttcagccatc acatgaaaa gaacctgtta 920100
 actgagatag tgtggatgaa cccagagatg caggaagaca agcaggacat ggggtgtgcta 920160
 gcggagagca ggatgggttt gaagagatgg tcaagagtac aaattttcag ttacaccagt 920220
 agaatccatt tagagggtct gttgtactac atagtgaact gtagttagcc agaatggatt 920280
 gcattttgaa aagattttat ttttaactat gtgtatatgt gcctgtgagt agaggggcca 920340
 gcagaagggg gcactctgac tcctggagtt gtaattacaa gtggttgtga gtgctgaaaa 920400

 cctgagtcct ctgcaaaggc agtacacagt ctgagctgtc tctccagccc catcccagtc 920460
 tttttaaaca tggttttat tgacatgtag tgattgtgca ttttccgca gtgcggtatc 920520
 actttcaata catgaaaata atggggagtg atcagatcaa ggtaactggc ttatccatta 920580

ctttggctat ttaccatttc cttgtgtag aatatgtaa agcctcccta ttccattaat 920640
 tgctgtacc aatagtgcc tactgatcca gaatgtaaga aacctccc cataccagc 920700
 tgtacctctg tgcccactca ccacctttc cccatctctt cttcccttga tccttcccag 920760
 gatccagcaa caactattcc attccctggt tctctgagat cagcttttta gctcccttgt 920820

 atgagagcat acagtgtctt catcagccta acttatctca ctttgccata tatcttcaag 920880
 ttccattcat gttgccacac ataacagaat ttcactcttt tgtggatgaa aaaaatacca 920940
 ttgggtatta taacacaaat tctttatcca ttcactcagt gatgggcatc taggtccgtt 921000
 ccatttatgg gttactatga acggtaatgc aatgcacttg agagtgtagg tttctctttg 921060
 catacttact tcagttccta gtggatataca gtaggaagct tgttaaatca cctagacatt 921120
 ctgtttttag tattttcaga aactaccact cttttttcta taacagctaa ctattaata 921180
 ttcccagtgt ataggagctc cctggaccct ggaccctgga ccccagcca gactgattat 921240

 tttcgtcttt ttgtcataa ccattctaac tagcatgaga tatctcattg agttttttta 921300
 tttgcttttc tctgatgagt agggaaagcta aacatttttc catggaattg ttcatttggt 921360
 tattttttga gaaatgtctg tttaggttat tttccattt tctagtccta ttatttggtt 921420
 ctgttattct tgttatgctt ttgatcaggf tccttaaagg atctggaaat cagtcttatg 921480
 ccaaataat ggcccgtggg tgtctcctc tgttccatag gctatccctt ccctctgtag 921540
 agtacttctt tttagcaca gacttccagt ttgatggaat cctatttgtt agttttcttt 921600
 ggttgctat gatttgggga tcagagtctg aaaatgcttt tcctaaacca atattcagaa 921660

 gtgttttcta gtaattacat agtttggggg tctcacattt aagtctttat cattttccta 921720
 tgtaagatga gactcgtgtc tgatgtagtt tcttttttct tcatgtatgg gtgtccaact 921780
 acctcagcac cacttactga caagctgtc cttccccca agacatattc ctgctggcac 921840
 tgccaaagat tggttggaga gaaatgaatg ttaggetta ttctgggtt ctctggtcta 921900
 tccatcagc ctgtgtatca gggtttttgt cagaaccttg ctgtttcact cataatgact 921960
 tcacagtatg ttttaatat caacattaaa ttataatgct tccagcctta ttctttttgt 922020
 gtgggatitc tttgctgtt ggagagactt ttgtggtttg tgtatacatt ctccaaaatt 922080

 gctaagattg tgtatTTTTT ttcttttta aatttaaatt agaaacaagc ttgttttaca 922140
 tgnnnnnnnn nnnnnnnnnn nnnnnnnnnn nnnnnnnnnn nnnnnnnnnn nnnnnnnnnn 922200
 nnnnnnnnnn nnnnnnnnnn nnnnnnnnnn nnnnnnnnnn nnnnnnnnnn nnnnnnnnnn 922260
 nnnnnnnnnn nnnnnnnnnn nnnnnnnnnn nnnnnnnnnn nnnnnnnnnn nnnnnnnnnn 922320
 nnnnnnnnnn nnnnnnnnnn nnnnnnnnnn nnnnnnnnnn nnnnnnnnnn nnnnnnnnnn 922380
 nnnnnnnnnn nnnnnnnnnn nnnnnnnnnn nnnnnnnnnn nnnnnnnnnn nnnnnnnnnn 922440

nnnnnnnnnn nnnnnnnnnn nnnnnnnnnn nnnnnnnnnn nnnnnnnnnn nnnnnnnnnn 922500

 nnnnnnnnnn nnnnnnnnnn nnnnnnnnnn nnnnnnnnnn nnnnnnnnnn nnnnnnnnnn 922560
 nnntatatat atatataat atatatattt caaaacaaca tatatacatg ataagtgtat 922620
 tcaaattttc caaactaaag caagaataag aaagtgttca agtgtgaaat cattctttgc 922680
 aagcttctgg gctacacttc aagcctcaca taactgcata tctatggtat acagaacccc 922740
 agtctccaca tctaactgga ctatagaatg agggggggat tctgctttgc tttaccact 922800
 ttgcttctgt tcaacaaggt taccattca tgaagagctt tccaaagtgc agaccatgat 922860
 gcattttgac cacatcacac caggctacca ttgtgttccc ttgctctgaa ataccatagg 922920

 acgccccaga aatcagttaa gtgaatgctt aaacttccac caagtgaagt ccctcctggt 922980
 gtttcagca gaagctgccc acatcacctt gggacactac atcactgaga agttgtcatt 923040
 tccattgact ggaacctgt ctgtcaaagt gctgccacat cccagtgggc cctaggcacc 923100
 accgggagcg ccaactggagg cccacagctg agctgagctt ctccatataa aggtataaaa 923160
 ctgagcagac gaagctggta actataggta taaaaactgc aatgatggag ctgggaacta 923220
 actataggta taaaaactgc atagacagag ctgggaacta taggtataaa aactgcaatg 923280
 atggagctga gaactaacta taggtataaa aactgcatag acagagctgg gagctatagg 923340

 tataaaaact gcaatgatgg agctgggaac tatacagctc tgtgagtaag agtgcttgct 923400
 gtacaagcat gtgtgatgag ttgaaaccc cagcatccac atgaaagtca gacgtggcca 923460
 cgtatgcttg taacacaagc acttgggaag ggaggagaga cgggcaggag ttcatggcc 923520
 cgccagcatg gctggctgaa acaacaagct tcaggtatag tgagagattc agcctcaaga 923580
 gaaggatgag caagttacag gaagacactg acatcctcct ctgctgctgc acaaacaggt 923640
 gcatacact acacataatg atagaacac agcacacgc gcacacacac acacacacac 923700
 acacacacac acacacacac acacacacac acacctttt agcctgagga aaactgcata 923760

 gattctgcca taacacctca ctgaactgtg gtgaccctag tacttcagtt tcattccca 923820
 gttcgcttc agcctgagac ctgaaaagag accacaggca ggggtggcatg ccaccagga 923880
 caagaacccg aaagttgaaa ggccaggctt gccatttacc tcatttttct accagagtga 923940
 gatcttctcc tgggattttc tggatccttt gtgcaaataa accttctaga agttctcttc 924000
 cctttccact cctctagttc ggtgcttcag atagatggga agggatatgg tttagactcc 924060
 cgatgggaga tcttcagcta cctttacaat tgagttcaag gctgtgtggt attctgtcca 924120
 tggagaatca cagattatcc ctgcaaggtg gaccactggg catagtgacc atgtttaaag 924180

gttacgtttc caattctggt ccagaaagct cctccttcat ctctttccca actgaaaccc 924240
acaagcagac attttatgtc taactggact tggaaaccaa tgcaaagggt tctcacgttt 924300
atggtccaat cttgtacttg aaaaagaaga aaggacacag agaccatgga gcaggtcatg 924360
tcaaaacaga ggcagagatg ggagtcacag ggccacaact aagaaccaca gacaagagca 924420
gaaattgctc gctggccatg aactaacttg atctctgatc tcttccatat aactactat 924480
ttctggcacc ttttccatcc tggatggtcc tccatacaca cactaatcag acattggtct 924540
atcataaagg aggaggccac aacaggtctc agattcaact gtgtggcggg ggtatcctca 924600

tctcctcta tctagattgc agccccagct gctcatattc aaactcctct aaaatgtcat 924660
ccatcttccc aggggtagtt ctgcagctaa caacaggagc acattaactc cccaaagcct 924720
ttggccagcc cactcaccca cctgcctcgg aaggctccca ttttgaagtg gcaatgtgat 924780
ccatcatggt ctacagccca cacagcacag ggggaaatta atgacactga ctgtcattaa 924840
tttcagaatg tcagaagcga ctcaactaga cagcagcctt cacaacaatg ttctggaaag 924900
gaacacccca tttttagtct tcagtcttca gtaagaaaag ggaaagagga aataggagag 924960
agagagagag agagagagag agagagagag agagagcaga gagataatat acatacatat 925020

acacatatag ataatgaagt gcaaaactgt ttgcctacca accacagcag gaactatgct 925080
ctaccagtcc atgtaaaaac tagagctgcc ctttccactc gttgcttaag cacttcccag 925140
acaccaaagg caatgaacag agatgtgctt gatttagaat ctcaaccag ccctgtggt 925200
ttgcagatgg ggacttccaa agccaacca atatgaaccg atagaacgca aggacagagg 925260
aaggccctct ggccatccat caccactcc cagaggctct gcttcatttc ctgccacca 925320
gacctcaaga atgaagactg gtgtgctcgt tctcacattg tcttctctc tctctctctc 925380
tctctctctc tctctctctc tctctctctc cactccttt tctctctctc cctgcctgct 925440

caccactct teattcttgt ttcaagatga gcccaggagt ccatgtctcc attacaaaac 925500
agctaatacc cacacaggaa aagcggtag gttaaagcca gccagatctg cttagctgtg 925560
tgcaactgctt gaggccatgc ctatttctct cactgttccc atgaggaaaa gacttctcta 925620
tatttatctc tccgctcctt ggtccaactc agatttacac acccttaaac aatctacttc 925680
ctaaatccaa tttccttaca tgaccattta caaggaacaa tgtaatgatt ttgaaacttg 925740
gaccttgggg agctgacatt agggtttcca agtcataccc agaagaggag acaaagaaag 925800
gtgacaagat ggacttcccc ttctcgatgt ctcactttca catatgggaa ttctttgtag 925860

gatgtctgtg cacatgaacg cacttgaca tgggtgcaaa tggaggtcag aagtcaacct 925920
caaatgtcat ccatctctcc ctccaccact ctctgtccct ccacacatac ccttttctc 925980
tctctcaggg tctttgactg atctggaatg ctccaagtaa gctaggctaa ctgaccagtg 926040

aatcacaggg atttgcctgc tcgacctcct cagcactagg aatacgtgtg cttgcaaccc 926100
tgccttactt tttaggattc tgggatgga actagggtcc ccatgcttgc acaccaagca 926160
ctcttatcaa tcaaaccatt tctcaaatgc agattcttct taataagact agttttcatt 926220
ttaagaacaa acacaaaaca ggcatcattt tattataata ggaaggcaaa cattcctcat 926280

ttgccaactt atgactattc tgtctgtctt tctgtcttcc tatctctctc tctctctctc 926340
tctctctctc acacacacac acacacacac acagagagag agagagagag agagagagag 926400
agagagagag agggtgccat ttctgcttgc catgaaacaa aaaggactaa caaaggcctt 926460
tgtgttcagt agtaaaaagc cacagacagg tagaatgttg actgcttccct ttctccctgt 926520
tcttagaacc acaaactgcc agagaacatg agtctctgag gtccagccct ggtaacttgg 926580
gtcgtgagga aggaactcag aaaggctaag ggcttccctt attattagag aggcaaagtt 926640
tctaccagtt tctcagaggt tgcgggacct tgggatcgaa agaataaatg ttacaggag 926700

tcctttgttc acctatctgc tcagttcact ccaggaaaga gttcagatag tttttctagg 926760
agacagcaaa caagcaatgg tgctaaagaa aggtgaagaa agaatgcaag ggtggaacca 926820
gcacattcag gtcttaaac tgcactccac aagtttgctc cttactgcct tgcagactca 926880
agactaagac tcttagaatt tacattccct gtgcttttct ggtctgttct aaattctgag 926940
tgatgaacaa ttttctactt agaactttaa ataactaccg aggaggcaat gaggacttgc 927000
aggctatggg tttcttgta gatgatggct tgtacttatg tgaatctgcc ttgattttat 927060
taaaacctat ttactcttct ctcaagacca gcacctccc atttaccact gactgaaaga 927120

aaccagaact gggttaaaac aaacagtggg ccaaggagag ggctacaag aagcactggg 927180
tagccagtat cgtgcatgga tggccttgtg gatatacaca aatacctcag aaaagagtac 927240
ttctccatct ctaagatctg ctcaacaacc agcagcaacc acctggctgg gaggttgtcc 927300
aaacaatgga ttcgtgggtg tgtccagacc ccataaatga agataggctt cttagcatga 927360
cctctcattg atctttgtcc atattaacac gtgatacata aactcactga ttagatatt 927420
taaaatgcag aagtagaata attaaataat tcttgggcca ttcagttccc atcattgtga 927480
aggtatttgc gttggctggg tgtgttttga ctggggttga aactggcttg gcatttgtt 927540

gtctgtttat attttagagg tgtctgttgc catcttact gatctgcagt gagaaacatc 927600
aatgagagt taaatgaaga aaaggtgatt ttggagccaa tttgtttagt catccttggc 927660
acacactgac agagatattc acccccaggg gcataattg ttcttgagaa gtgactttgt 927720
ttagagaaa acttttgctt ccagaggcac gagctacaca gcacggcgca gaatagaaat 927780
atggcgatta tccagttcat ttacctgctt tccacagcac acaaaccaat cctggtaaca 927840
cagccataaa aatacaacc aaggtacctg aatcctccag gttactgct aatgtggctc 927900

agataaaactg gatttcagcc agcctccac atcacacttt gaagacttaa acatagaaca 927960

 aaggggtgcg cgtgcgcaact tgcgtgcgcg aacacataca cacacacaca cacacacaca 928020
 cacacacaca cacacacagg tgtgagcagg gaggcaagta acccctgtgt aatgacagca 928080
 ttgtgaccaa ggatgacatc aggcttaggc aaagcctcac cacccattt taaagtgggt 928140
 atcacatgga aggcagagtg gcctgcaaaa atacagacac agagatgggt tgaattccat 928200
 gtggggagca gagacaggaa tgtcagcaga aactccacc tggctgggta gcaacacacg 928260
 caggactgca ggggagagtc caacaagaaa gggaagggtt ttggcagggg gttgtttttg 928320
 gttttgtttt ttgcccacat ttgttcaaac aaggtatggc aggccagctg gaagatatgt 928380

 cagtcaagga gaaggctctc tgctcagagg tgtttctgtc gcttggacat gacagctcct 928440
 caaaactaaa tataaaggga aattacagct agatttctctg gaggcattga gtctgctctg 928500
 attgcaattt agaaagccag cagattacat agtatttgtt cagtccctcc taagcaacaa 928560
 gggcctttct ggiacattcc atctactgct tattggaagg gtgtaggggg tggcttattg 928620
 gaagggtgta gggggtggca gtgccttctc gagcccctgt ttagactcta gggagctcag 928680
 acattctga cattgactgc gaatgtttgt acatattgac tttttttttt aatttattec 928740
 ttgtgtcttt cacaccatgc ctccaatcc caccccaat aaaaacaaaa tcaaatttaa 928800

 cgggggaaaag aaaaggaaga agggaacatc tcattatgga agctgcagta tgacacagtg 928860
 agtcacatgg gaaacccttt tatccacgtt ttgacaggca tttaccgaaa agaactgttg 928920
 gtctgtttca agacctctgg tctctgctgc accgtcgact ttggatctc aatgggactc 928980
 ttctctggaca tccatttctt gccctgtgtc atggaaatcc tgcagctcca taggactggc 929040
 cctccccat gctccagcag atcacagatg gaggatgtt tggggtgggc caactcatag 929100
 ccctgtttct gagcctgggt agttgtgggg ttggtcaacc tgccagctct cccctgtctt 929160
 cgtaacagg gtgagctatc cagcattgcc ctggctagt cactccttgt agccatgagc 929220

 aaggaacagc accagttctc ctgctttcat gtctcaggg agaactatct caaaaaaaaa 929280
 aaaaaaaaaat tgggggagag atggctctgtt ggtaagagc accatctgct ctttcagaga 929340
 acccgagttc aattcccagc actcccatga cagctcaca ctgtctatga aactccggt 929400
 ctggagatcc aatacctct tctggccttc acagacacta agatacacac gtgatgaaca 929460
 gacatgcatg caggcaaac actcataagc atagataaaa ataaattaaa ttaagcagag 929520
 tctaggaacc cagataagta gtaaagtgtc tcacaaggcc ctggcttcac tcctcagcac 929580
 acaaaaaata acaaacaaa tgatccaatt ggctgaaatg gctgtgaagg gtaaacccct 929640

ttctgccaag ctctcatttg gtggctttat tcaattctcc taaaaccctg tggctagaat 929700
 caactcaaaa ccacaaaggg aatatggaag tttattctga aaccaagtat gagtgaccac 929760
 ggctatagaa cacagattca ggttacccaa agatctatgt tccaacctag taataggttt 929820
 gttttgtttc tgttttgttt tgcttttcat gtttttagta caaagaaaga aaggaataaa 929880
 ccaagggtta ttttttaatt caatagtgga aatcaccaggc aggtggttat agcaaaggag 929940
 agaaatctct gttataggtc tcaaatgtg catgatggcg ttcttagcct ttggtttgg 930000
 ggaagctaag ggictgtttg cacattccaa aaagggtttt actgatagtc atgaggatgt 930060

 caggtcactc acagaggga acaatggatg acgattaaag gaacaaaaaa atagaccgg 930120
 taattggctc caaatcagca acatttctga tctccacagt catagatgic ctagtattg 930180
 gaccaatcct gaaaaatctt taatacaagt atggcttttt tttctaaca cttcagtcgg 930240
 tacttagtca cttggatatt tctttttctt ttggtagaaa ataaattgta aaatttataa 930300
 aagaagacac taaggagagt cagtgtgaga atcagcatga ctctcagctg gcctctgaag 930360
 aacaaagctg agcccagaca ttaggacgga aggaaggcca ttctagctag atgcaatagg 930420
 caggaagaaa cagaacagtg ggaaggaata taatgctaac agagggcacc cctcctccta 930480

 ttgactgagg taaaaatcat gagacttaag tgcattcaag gattaaactt ccagcccatt 930540
 tagtcttaaa tttcctgtca cccaatcccg ctgcaaccaa agaataacct cgctatcag 930600
 agacctgac acaaagccca agagccactt aatgccaata tcatccaag tgagtgcac 930660
 tgtttactcc taatgcatag caagcaggga acgtgggttt actgtaggtc aggaggaagc 930720
 caagggttta cggaaaggct tggagtccag acaaccacgt gcagcttctc tagaaggaaa 930780
 aggcatcag ttaagtatgt agggctaat gtattggtag tcccccaaga ctggacctac 930840
 ctcaacataa ataataattg gagactagaa tattccatgc acgtgcaat acgttttagt 930900

 caggctttta gacacacatg gacattcggg acatccttct gctttctgaa gcagaaaagg 930960
 aactcaacag agggaatata agcagagaat cctatgtaat tgaattgtgg tttttaagtc 931020
 ctgtgactaa caaaaagcaa agtctctccc tatgtactgg gggcctcttc tcctcagcct 931080
 cggaaaaacc ccagacacc atgtgggcca tcaactgicag ccacgatcc ttcggtgta 931140
 ttatTTTTtag tggcatactc tttttttaa ggatattggt attagtgaga caagaactcc 931200
 aaggatttgg ctcataatg aatcttattc ctcagtaagc cagtctaact cagcatccct 931260
 ggatgggaat cactgtgatg ttttcatttc ccacaaacag agggtaataa aatagttaa 931320

 aagtaaaggg gtatggcatt gacctgttg aggtagatca gaagttcctg gagggcaggg 931380
 ataggattgg tgattggtg atctaagt tattaagtcc gaaccattt cttggaccct 931440
 acaagtaaat gtatcaatg gcttcatcac aagaagaagg aaaaaggac atgttgctct 931500

tttagaaaag aaatatgttg cattcccttt gatgccttct ttccttcagc tgattaacga 931560
 cttgaaagag ttgttgctgg ctttaagaaac agagagtaga aagtgctgtc tgtgttccat 931620
 atcacaagag caaaaaatct ctctctttcc atccctccct cattccctcc ctctctttct 931680
 ctgaaataac aaggtggtaa gcaatggaag agatgggggtg ggaaggaagt gtgggactca 931740

 ctactctcga aaacattcga agcacacaat gtcaaaaatt gtgcatagtg atgagatttc 931800
 atacttagta tttctcaagc cacagtcccg actgcaatgg atgtgctgtc taaggaaacc 931860
 taaaaataat ttttaaaaaa aaaatacatg aggagaggcg aatttctaac agttactgtc 931920
 aaggccagca aagcatgctc ctaaataaac ttctgtcttg tgcccaccag taagttgctc 931980
 gaaaggagta tcagacaaca aacctgaagg aaaggggcag ttatcctctg gggaccggct 932040
 gcaggagggtg gaagtgcccc ccataggctc cagcagctcc acagtgccca attggcagcc 932100
 tctcttccat tatgcaaagg ctatgtttta taaacacatc taatttggtt taaacttttt 932160

 aatccataaa gtcattactg aaggaataca ggctggtaac ctgatgaact gacaggcacc 932220
 taaagcagaa ggaaaagctc aggtaagggtg agagtttgct gcaactggctc cccctctct 932280
 tccccacccc ctactctctg caggeccttt tgactgetct ctcctctgtg gtttcttcac 932340
 caagggacct actctttctt ttcagcctgt tctcccctc gtgccaaaga attctctctc 932400
 tctctctctc tctctctctc tctctctctc tctctetaag acactttctc tctgtgtage 932460
 cctgtctgtc ctgcactct ctctgagaca gagagagaca gagacagaga gagacagagt 932520
 ccattgcctc tgtctagctc tacatcccaa ttactgcctc ctgtaccatt aagttgaata 932580

 tacttctata cataaacatc gctgtgttg ttttttaatg aggcagggcc tcatgtagec 932640
 caggcttgtc acaaattcac tatgtagtca aggataacct tgaactccta ctagccactc 932700
 ctagctcaga gagctggatt agcatatcct acagtgtcta cttcatacaa tgctggggat 932760
 caaaccagg gcccaagcat gcttggcaag tattttgcca agtaagcttc atcacaagca 932820
 cccaagcagg cctgtgctgt ttttgttttg ttttgttttg ttttgttttg ttttgttttg 932880
 tttgagagtc tctgccattc aatccctgat gatgatgtag cctagggaaa cctcaagttc 932940
 atggcaattt tgcctcagtc tttcaagtgt tagaattaca actatgagcc tcagatatec 933000

 cagaattcac tatgctgctt tgtactcctg acaatccctc ctttgagttc gatttctggc 933060
 aggtaactag gcataacatg agaggatttt tttccctca gagaacaaag gagattctga 933120
 aaccatacca cgaactgtat ttaggaagcc tctaccacat gtgcttttaa gggatttaca 933180
 aacctgactt gcttactcct cactacagtc ctaggaaaag ggtttcatct gcctatttcc 933240
 cagaagacaa agcacagcga aggcagacta cttgcccaaa gccgcacaac tggaaagcag 933300
 ctgtcagaat gtccatacac ctagtctggt tccaaagtct gttcttaatt tttttttca 933360

atttatttat tgggggtggg cgaacatggg tttcacagca cacatgcaga agtcacagcc 933420

 agccagatgg tatgctggct gatgacctga gttcgatccc tgggacccta tggtagaaag 933480
 agagaactaa agtccattct ttttaactgct gttctctgct gcttagggac tgtttgtggc 933540
 taaaggtttg ggagatgctt tcatcccttg tgtatagatt ctgaccactc taccagggga 933600
 aactagataa cttatgagtc aatcgattat cacctatctt ctccttttgg actgggtggt 933660
 ggtgctgcat acctttaatc ccagtactca ggagacagag gcaggcagat ctctgtgagt 933720
 tcgaggccag ctgggtctac aaagctacac agagaaacc tgtctcaaaa aaacaaaata 933780
 aataaataat aatatttctc ctattggatg tttaccctac tgtgcaaac aagtatgctc 933840

 aagactcaag attaccgctt tgcctttgac atgtctacta actagaagta ctccagacca 933900
 gcctttccca tctctccag ctcatctctt tgccagtcca catatataac catcacattc 933960
 cctttccaaa aagcaatatt ttgtccctag cgttaggaat ccagtcttgt gctgggccag 934020
 cactctccca cttagacata ggtccagctc cccagagtag cttgggtgcta gtcattggtg 934080
 tcatggtggt ggtttgcttt gtcttgata gtttgaagca aagcctcact acataatcta 934140
 cagtagcctc aggtcacta agtaggctgg actatctca ttcctgcac actaggatta 934200
 caggtgggag ctatcacacc cagcaaactg gagagagagg tggggggag aaaggaaggt 934260

 gggcggggct cttaaagaac tattctcaag ggctttgccc tacttctcag caaggtaaa 934320
 tatagcatcc gaggcagctg ccgcacccag acaaccctgg aacaccaat acataagcca 934380
 gcaggctgac acagaggta atgcacacta ctctcagtcc cccctctcct gtgacagttg 934440
 gcagggcttc ccagatgaaa gtgggcaaac gtgagagaga ggtggtgggg agaaaggag 934500
 gtgggcgggg ctcttaaga actattctca agggcgactc cactcttcgc tgcttgagat 934560
 cagaacattt tcttacttc ggactggtat tttttagtga agtttcttc aaagtatgct 934620
 gtgcttttgg attttaaac ccagaggcct cgggagtttt ttcctcctt caaaaatgga 934680

 tggttctgct tttcgtttaa ggtgcagttt agaaagaagc agcctgtgaa accaattaac 934740
 taattgaaa tcaactaatg actgtggcag cgttttgggt ttctggcgtt ggttcacagc 934800
 agtcaagaga aattgctttc caatattatg ataaggtaag ccgtggaggt ctctcggggg 934860
 cggctgacgg ctgctgagag aaacaatcaa ctctaataatg cccacaaaa taatagagac 934920
 attataactc ggagctcagt gattgtaaag taaagcaaaa cataaaaatc caaagatagg 934980
 ctgggatctg ctgagaacaa atgtgcagcc atagtccttc gtgatgattt ctgagaactt 935040
 gcagtcctcc acacacatta ccccgaggaa actgctctca ctgagccagc caggcatgtg 935100

tggaaagga agtgacatgc aaagggaaaa gaaatagagt aaatgccac cccggaacaa 935160
 ttgtccaatt aattgtttga gtatgaatac agtcattgtt cacattaggg aaataatcta 935220
 gctaattgct caagagttag cagagccaga gaaaataaat tagcctagac acagtgtttc 935280
 ccctatttgc catttgtttg tttcaaggta gcaaatctct tttgcatttt tccaaagagt 935340
 ttatttcatt agagctaaat catcactgga aaacaacatc agtaaccct aaggcttctc 935400
 attccttttg actttattta aaagggagat agtgggacct gcacagccaa aaggatttaa 935460
 aattgctgag atggccatta cccagggctt cggacctatt ctgagcatgg aagttctctt 935520

 agtccccctt ggtcttagtt taccagctg taaaatggac tgctggaaga aatgcttact 935580
 cggatgatgg ccagattttg tgaccaggaa ggtactacag actctccagc aatgatgaac 935640
 ttttgctttc tctccccctt tgccacagta atcatgggca acagagattc tctggaaag 935700
 tgtaactact gctttccaac aagagaaatt ccagagttag agagatggct ctgctagctc 935760
 tttcggggga ctggctttag atcccccaac atctgtatca aatatctcaa aactgcccaa 935820
 aaatgccagc accgggagat ctagtgcct cttgtgtct ctacaggtat ccacacgagt 935880
 gtgtgtatac gtagagtgga gaggggagaa tctttctcta aaaaggaaat tcaatacaca 935940

 cccttgtcac accaccct gtatatgggg cttacattac cccagccgtg ttgatgcatc 936000
 tccactgggc acattcttag atggctgcta ttatggttca aatgtgaagt gtccccaaaa 936060
 aactcatgct atgaacagtt ggtctccagc ttgtgacact attttgaatg ctatggagcc 936120
 ttttaagagt ggctctggct ctcagaagag ggtcactggg atggacctt gaagatgata 936180
 cccacccctt ggttccagtc cctgtgtct cacttcagat tcacacacac acacacacac 936240
 acacacacac acacacacac actcttacca caattgctcc tgcaatgcct tcccacagtg 936300
 tggactgaaa catctctgta accatgaggc aaaatcaacc ttttctcact taagtgtta 936360

 gtgttggata ttttgtcat agggacatga aagtaactaa tatatttgtg ctgtgcttgg 936420
 ttattacca aaagctgaaa ggatgaaaga tgtccctgt gtgacagtac cataaacaaa 936480
 gatgagtgct atttctatga atcactatgc caagcaatag attacctagt actttctctt 936540
 ctctgccte attcagagaa aactacccta gaagccttta acaagtgaaa acacttaggg 936600
 taaaaggaca aatttaaac tataataaag agatagtct cctttacaa atattcacc 936660
 ctgtgttggg gaaaatgta tgattattc ttttctgag tcttgattc caacttgcac 936720
 tccagaaagt agcatgtttt attaatatca agattgtatc aaggcatcaa tactgatggt 936780

 atgattttta attagtaatt ttaaaaaatg tgcataggg actgggaaaa tgactccatg 936840
 ggtaggagca ctgtctgcc aagtctgac cccagcacc ttgtaaaaag atgggcctg 936900
 gcacacctac caccctagtg ttgtggggaa tgcagagaca agagaatcag tgaatttgc 936960

cagctggaag cctagctcca gattcactga gactgtttca agggcacct gacatccttc 937020
 tctagtctgt gcacacacat gtaagggcct gactacatac agcattcata ttcacactca 937080
 tatacacaca caaaaatcac caagtaaaac agagcaacaa accaacattg aggggtgaaac 937140
 ttccctaaca ttaagcaggg tgtggcggca cacacctgta atcccatcac cctagaggtg 937200

 gaagcaagag gatcaggagt tctagatcat cctccactac atagcaagtt caagtccagc 937260
 ctaggctaaa ggtgaactgt ctcaaaataa tcatcatcat aataataata ataataattt 937320
 cccagatgta aaataaaagg aaaatatttc agccctctta gtgaaagcaa acctccagca 937380
 tttcagagaa gaaaatcttg aaaattaacc tcaagtagtt cagaacattt tccaagatga 937440
 cacggcctaa gaaaaacatg cagttcaacg gacaacattc caagactgtc ccacttacac 937500
 atgctgcaca ctgaccgaaa agtgaggcta ttctatgaa gacaggctaa atgccagcac 937560
 acagcctcgt ctgcaaagct ctgcactgga gcttaaatgt ccctgattaa caaatggtga 937620

 gccatttagc ccatctcaca gagacaagac caaggccgag gtctaacaat agctctcctc 937680
 tctcagagtc cttgaattag tgaatgttat tacaaaaaga aaatatgctt ttatctaggt 937740
 tgttactttt cctgtgctc atctgcgget ttgcctataa gctcacagtg cacagttaaa 937800
 ttggacaatt accaagcgag aagtacataa ttaatgaaca gtcactatat atgtttggga 937860
 aactgtgacc caatcacaga acagatagca ccaccactaa aataaatgac ttgttccact 937920
 cattacctga teagcatttg tttagaagtt ccttgggtgc ctatcaaaat tctaatcagt 937980
 tctatttaaa ttacattttt ttccacagca ttgttaaaaa tgctaattta tgcttagaac 938040

 cgaacggctt tatttcttac ctctgaaga aacggatgaa taaaaacaca ctctgcagg 938100
 gcacagagga ttatcaaggg ttcaatgact attggatttt gcaacttgcca aaacacatcc 938160
 tgcaactcag agctgaagct tttgggaaca acaaggacgt ccatctccat gaggggacac 938220
 agcctgttac cgcagcatct gctaccacc ctgagactct tcttttaagg atgggaccag 938280
 ctctaggagt atggaaagaa agacaagctc aactgctgat gcaaagcatc ttgaggacaa 938340
 tgatggttgc ttcaatctct aggcaacctt ctagcatgca gaagaacctc tctgggcca 938400
 gtatccctct tgtttatgat gatgtgcca gcagaggcta aatggtaact ccacatctct 938460

 ttatcactgt cagtctggga tccaaattta ggaccaaagt ggcaactctaa gcaaggagag 938520
 tgacctcaca caagtcatga ctcaaaaact gctttcactt cttctgacat acaagtgtta 938580
 gaggaagaa aatccaactc ctggcacga gaatagcatc tctggcttga atggagacct 938640
 aacctccag ttggagcagg ttgtacactt ggccaaggtc ctaccttagg aaggcaggct 938700
 acctcaaat gatgctaaag agataggtgg gatacttagt cctgtgatga ggtattatac 938760
 tttccctct gtcctagta cagtaacttg cagagccaca gggctacagc agggaagttt 938820

gcctgctaaa gtgtcatttc tccctttgic cttttccctt tctaagcatg ctttccttaa 938880

cacattgggc tcttttatcc aatattttga acttcttcac cctgtctctc aagcctccct 938940

ccctgtctta tgtctcacca ccattaaaaa gtcacggggt tttgtttgtt ttttgttttg 939000

ttttgttttg ttttttcctt ctctcttgta tctcctctt ccaggcaact actgaagttt 939060

acagtttatt tgccccgggg tttttcttct aaacagaaca atttcttctt ttagcttcca 939120

tgtgagtcca ttcataaatt cttattaatg aaactgagga ctccaagaga gggcccagat 939180

ttccccagta ccatcaggtc agcctcttgt cacctatagg tggcccagac acacccttat 939240

gtcatttagg atccagaaga cttcagaata gggagaagat ttccaataat gttctggaac 939300

ttgctagaaa tctgctaata agatcttata ggcatagct tcttagctga ggacttagca 939360

gagaacttgc ctacgctgcc tgaagccctg ggtttaatcc ctggcactgt ataaaccatg 939420

aatagtgggt aatgcttcta accccggtgc taagtgggta gaggcaggag gatcagaggt 939480

ctacagtcac ctttcgcaag ctacataatg cttcaaggc cagcctgggc taaatgaaac 939540

tgtgtctaca aaaaaaaga aaagaaaaat caaaaaatgc cttatacaat attgtgcacc 939600

ctaccaggc taggctcagt gtctgtggaa gtcagtgagt ctgccattat cccgcttggg 939660

gtgggcggca tcaaatcag aattcattgc agaagttttt ttataagctg aggaattacc 939720

ttgagaggat tgaatttcca agtftaagcc agcagctgcc tggatgcca ggccacctca 939780

atcatccac accagctggt ctctgatgga gagggggcaa agtaaggctg gatcagcctg 939840

gcttagggcc gcatggccag aggggtagaa aacataggtt cacacaggca tttaaccttg 939900

attaagcagt gtgctatggc aggggcttaa aacaaggctg gggcattttc ccgcttatta 939960

tcacctgat aacctgttct tgtagctggg aaggagtgtc acaagggggt ggggggccga 940020

ggggagccac cagaaggag ggggggacac aacctgagc cagaagagaa gagtggctgt 940080

tttcagagtg tagttgggaa gaaaggaaag atgttgetct gcatagttct ctttttaaat 940140

agaaactgtt tttccaggct gcatggctaa tagcttcatg ggaaaggaag aaaagaatgg 940200

ctttcactca ttttctttga agcctattca gcacagttt aaagcagaat ttcctatga 940260

aatacctaca gcagtgtgga gttttcacia gatctgagga taaggctgga gagggagcag 940320

aggcgaagcc taggaacaac catgttcaag tctttgtggg agacggggga ccacctctgt 940380

ccatgcacag aaagtgtctg taaggccacc agcagcaata gtctcaagg agaaaactac 940440

accagcctcc ccctctccat tccctcctaa agagaagcta acgaggcagg aacgaacca 940500

accctggatg gactgggttt ggttttgggt ttggttttgg ttttgatttt ttggttttgt 940560

ttgttttaa tgggtatttg tgcattgtg tatagtgtag atgtgtgcac tgctgtgtgt 940620
 gtgtgtgtgt gtgtgtgtgt gtgtgtgtgt gtgttccaca gattaatatt aggtgttttc 940680
 accaacactc tccaccttac cctttgaaac agaattggctc attggacctg agcagcaagc 940740
 tctgggaacc ctccgacacc caaggttaca cctcatgcaa caaagtttgg cttttctgta 940800
 agtgtggggg gtctgacat ttgtatacag aaactgcacc cactgagcat ctccccagct 940860
 ttgacaaatg aagtctaca gttctcattc tcatctacac catagtgggt gatcctgacc 940920
 ttcttaaca gtgactagaa ggatagtcca gtcagcaaag tgactgttgc acaattatga 940980

 ggccctgtat tgagatctcc agcatctgca taaaaaccag tgtgggttac atgttcttaa 941040
 tcccagcaga gacaggcaga tcctagagc tcattggcta gccagcctag ctgaactttc 941100
 caactccagg ttcagtgaga gagcctttct ccaaaaaaca aggtggaaag taattaatgt 941160
 aaacagccaa catttacctc tggcctccac atgtgtacac acacacacac acacacacac 941220
 acacacacac acacacacac acacacacac accacccttc tataactgta ataaattcaa 941280
 atttgttaa agaccggaac tccaaaatat aatatttgat tattcccaa tccttttact 941340
 acttaacatt ggagttacag aagaataaca ttttggcgcc caactggaa aggcctctgcc 941400

 ctatacctt ctgcgnnnnn nnnnnnnnnn nnnnnnnnnn nnnnnnnnnn nnnnnnnnnn 941460
 nnnnnnnnnn nnnnnnnnnn nnnnnnnnnn nnnnnnnnnn nnnnnnnnnn nnnnnnnnnn 941520
 nnnnnnnnnn nnnnnnnnnn nnnnnnnnnn nnnnnnnnnn nnnnnnnnnn nnnnnnnnnn 941580
 nnnnnnnnnn nnnnnnnnnn nnnnnnnnnn nnnnnnnnnn nnnnnnnnnn nnnnnnnnnn 941640
 nnnnnnnnnn nnnnnnnnnn nnnnnnnnnn nnnnnnnnnn nnnnnnnnnn nnnnnnnnnn 941700
 nnnnnnnnnn nnnnnnnnnn nnnnnnnnnn nnnnnnnnnn nnnnnnnnnn nnnnnnnnnn 941760
 nnnnnnnnnn nnnnnnnnnn nnnnnnnnnn nnnnnnnnnn nnnnnnnnnn nnnnnnnnnn 941820

 nnnnnnnnnn nnnnnnnnnn nnnnnnnnnn nnnnnnnnnn nnnnnnnnnn nnnnnnnnnn 941880
 nnnnnnnnnn nnnnnnnnnn nnnnnnnnnn nnnnnnnnnn nnnnnnnnnn nnnnnnnnnn 941940
 nnnnnnnnnn nnnnnnnnnn nnnnnnnnnn nnnnnnnnnn nnnnnnnnnn nnnnnnnnnn 942000
 nnnnnnnnnn nnnnnnnnnn nnnnnnnnnn nnnnnnnnnn nnnnnnnnnn nnnnnnnnnn 942060
 nnnnnnnnnn nnnnnnnnnn nnnnnnnnnn nnnnnnnnnn nnnnnnnnnn nnnnnnnnnn 942120
 nnnnnnnnnn nnnnnnnnnn nnnnnnnnnn nnnnnnnnnn nnnnnnnnnn nnnnnnnnnn 942180
 nnnnnnnnnn nnnnnnnnnn nnnnnnnnnn nnnnnnnnnn nnnnnnnnnn nnnnnnnnnn 942240

 nnnnnnnnnn nnnnnnnnnn nnnnnnnnnn nnnnnnnnnn nnnnnnnnnn nnnnnnnnnn 942300
 nnnnnnnnnn nnnnnnnnnn nnnnnnnnnn nnnnnnnnnn nnnnnnnnnn nnnnnnnnnn 942360
 nnnnnnnnnn nnnnnnnnnn nnnnnnnnnn nnnnnnnnnn nnnnnnnnnn nnnnnnnnnn 942420

nnnnnnnnnn nnnnnnnnnn nnnnnnnnnn nnnnnnnnnn nnnnnnnnnn nnnnnnnnnn 942480
 nnnnnnnnnn nnnnnnnnnn nnnnnnnnnn nnnnnnnnnn nnnnnnnnnn nnnnnnnnnn 942540
 nnnnnnnnnn nnnnnnnnnn nnnnnnnnnn nnnnnnnnnn nnnnnnnnnn nnnnnnnnnn 942600
 nnnnnnnnnn nnnnnnnnnn nnnnnnnnnn nnnnnnnnnn nnnnnnnnnn nnnnnnnnnn 942660

 nnnnnnnnnn nnnnnnnnnn nnnnnnnnnn nnnnnnnnnn nnnnnnnnnn nnnnnnnnnn 942720
 nnnnnnnnnn nnnnnnnnnn nnnnnnnnnn nnnnnnnnnn nnnnnnnnnn nnnnnnnnnn 942780
 nnnnnnnnnn nnnnnnnnnn nnnnnnnnnn nnnnnnnnnn nnnnnnnnnn nnnnnnnnnn 942840
 nnnnnnnnnn nnnnnnnnnn nnnnnnnnnn nnnnnnnnnn nnnnnnnnnn nnnnnnnnnn 942900
 nnnnnnnnnn nnnnnnnnnn nnnnnnnnnn nnnnnnnnnn nnnnnnnnnn nnnnnnnnnn 942960
 nnnnnnnnnn nnnnnnnnnn nnnnnnnnnn nnnnnnnnnn nnnnnnnnnn nnnnnnnnnn 943020
 nnnnnnnnnn nnnnnnnnnn nnnnnnnnnn nnnnnnnnnn nnnnnnnnnn nnnnnnnnnn 943080

 nnnnnnnnnn nnnnnnnnnn nnnnnnnnnn nnnnnnnnnn nnnnnnnnnn nnnnnnnnnn 943140
 nnnnnnnnnn nnnnnnnnnn nnnnnnnnnn nnnnnnnnnn nnnnnnnnnn nnnnnnnnnn 943200
 nnnnnnnnnn nnnnnnnnnn nnnnnnnnnn nnnnnnnnnn nnnnnnnnnn nnnnnnnnnn 943260
 nnnnnnnnnn nnnnnnnnnn nnnnnnnnnn nnnnnnnnnn nnnnnnnnnn nnnnnnnnnn 943320
 nnnnnnnnnn nnnnnnnnnn nnnnnnnnnn nnnnnnnnnn nnnnnnnnnn nnnnnnnnnn 943380
 nnnnnnnnnn nnnnnnnnnn nnnnnnnnnn nnnnnnnnnn nnnnnnnnnn nnnnnnnnnn 943440
 nnnnnnnnnn nnnnnnnnnn nnnnnnnnnn nnnnnnnnnn nnnnnnnnnn nnnnnnnnnn 943500

 nnnnnnnnnn nnnnnnnnnn nnnnnnnnnn nnnnnnnnnn nnnnnnnnnn nnnnnnnnnn 943560
 nnnnnnnnnn nnnnnnnnnn nnnnnnnnnn nnnnnnnnnn nnnnnnnnnn nnnnnnnnnn 943620
 nnnnnnnnnn nnnnnnnnnn nnnnnnnnnn nnnnnnnnnn nnnnnnnnnn nnnnnnnnnn 943680
 nnnnnnnnnn nnnnnnnnnn nnnnnnnnnn nnnnnnnnnn nnnnnnnnnn nnnnnnnnnn 943740
 nnnnnnnnnn nnnnnnnnnn nnnnnnnnnn nnnnnnnnnn nnnnnnnnnn nnnnnnnnnn 943800
 nnnnnnnnnn nnnnnnnnnn nnnnnnnnnn nnnnnnnnnn nnnnnnnnnn nnnnnnnnnn 943860
 nnnnnnnnnn nnnnnnnnnn nnnnnnnnnn nnnnnnnnnn nnnnnnnnnn nnnnnnnnnn 943920

 nnnnnnnnnn nnnnnnnnnn nnnnnnnnnn nnnnnnnnnn nnnnnnnnnn nnnnnnnnnn 943980
 nnnnnnnnnn nnnnnnnnnn nnnnnnnnnn nnnnnnnnnn nnnnnnnnnn nnnnnnnnnn 944040
 nnnnnnnnnn nnnnnnnnnn nnnnnnnnnn nnnnnnnnnn nnnnnnnnnn nnnnnnnnnn 944100
 nnnnnnnnnn nnnnnnnnnn nnnnnnnnnn nnnnnnnnnn nnnnnnnnnn nnnnnnnnnn 944160
 ccgttctctg tctctgtccc ctctctgttt ccccgctctg tctctctatg gcgaccgcec 944220
 atggcgggtca gccattacc tgttctctct cttagtctcc ccattctacc gggccttata 944280

ataaacttat agtcaatatg tctgtctcaa tatttctctt ttcttctttt taaacaaaag 944340

 aataacacaa cctaaaaaag aaaatcaagt aactaaggga atgtacattg tagcagattt 944400
 tcactgtcag gctgtcaggc tgtcaggctg tcaggctgcc aggcacactc accattgtgg 944460
 ctctcttctt ccigtcttga caggaattta atactaactc agtagccaca agtttctga 944520
 tttaatccag aacaataat gaggaattt tacaggaaca cagttacctt tctttttttt 944580
 tttctttttt ctttgagaca gggtttctct gtggttttgg aggetgtcct ggaactagtt 944640
 cttgttattg tagaccaggc tagtctcgaa cttatagaga tctgcctgcc tctgcctccc 944700
 aagtgtcgag actgagacta aaggcgtacg tcaccactgc ccagacacag ttacctttct 944760

 aacggagata ttctcagtga agatgttgct tatattagaa acacaaggga aaaggtcaaa 944820
 ggaaaagagg tggiccatct gtgaaaggat tcattgaata tatctcagtt tggcctccat 944880
 cctcacatat gaactgttga gtaagcagaa atggaaccct gtgatgtagc actgggagcc 944940
 tcatttcaga ctgaaactgg caattactca gcattacata caccttattg gtcaattgtc 945000
 ttagcaatta cttagaagac aaaatcgtc attactgtta agcttgaaga aagcataaat 945060
 ctggaaaaga tacttaatgc tctggatctc atacaactca aagcttcttg cctttcagag 945120
 caatgaagag agtttagtag ggatattaca aggataagca tcttctaata ttaagtgtaa 945180

 aaaataggta tattacattt tattagaagt catgaaaaat cagaagggtc ttaatttgct 945240
 ataaaatcag tacaagccag tgtgatatga ccaatcaaca catccaatca attttaagtg 945300
 gtattgatag agatctagtc caggatagaa gtaataatct ttctgtattg tggtcagatg 945360
 tcaacaccat tcagagaaaa gagttcatac gatctctact gtccaactat gaatttgaat 945420
 gagtcaaatg tticatgctt tgtgtcctca tctgaaaatg gaaataacaa cagctgacaa 945480
 acatattccc atagaattat aaaatcaaat gagacagttt ccaataaaaac tcttcaaaaa 945540
 atcacaagat gccattgtac tggacatctg ctgtttgcta accaacaacc attcgcctct 945600

 tactgacaag cacaatccag tattcttggg gtagcttcag tttcactctt taccactgctc 945660
 caggctctcag cccactcag ctgagaccac acataactta ggaacagcca tgccaccaag 945720
 tcacaacctg tgatgcgtaa agacactatg ccaggacctc tgagggaaga tgcttgcttt 945780
 tcctagttag gtttggccaa ataagaaat gaacttcaca atacctcca actaccagg 945840
 gaaatgttag cctaaagatg aagctcaact gtgctgggct tgggtgctca agcctgtaat 945900
 cccagtactt ggaagatgga gacaggagaa tcaggagttc aagattgtcc tcagctacag 945960
 atgagtgtga gcatgggcta acaaaaacctt atctcaaac aaacaaaaac ttggtggtaa 946020

agcaacacaa aagcaggagg aaatgaagga aacagacact tgctctcatg acctccctat 946080
 ctgaaagacc tgttcagacc tgcctctctg aagtcctctt ctgcttcaat catctagaca 946140
 ccaagccctt caactgcctc tcaagtcagt tgaacaaggt tttgtgtcct tttcagcagg 946200
 aacagaccta aaattgtgca ttcatcctaaa gtcataggag aattattcaa atatatggaa 946260
 ataatagata agtgtattca aatggagatt aagtagatac attttagatg gaaagagatt 946320
 aaaagcaaac ctataaaata aggcatgaaa gtaggtggga ctatttggga gaagaaagag 946380
 accaacaggt tgctgcagag aggcagcaac atgagagagt gacaaagata caggggcatg 946440

 catggatgca aatgtctctg taaaaccac tttttggac aatgaatgtg tgctaataaa 946500
 aaaaaagct atgtttagat ttttgtgtg ttatcagaat tatgttaggt agaattatca 946560
 taactatatt aggtatgta tgactgttag aattatatta cattatcttg gattctaagg 946620
 cttatataag gtgttatata aacacttctt tctaaaatga aattttact tttgcattct 946680
 gctcctaaga aatctgtgtc tccagtctac cccatggtgt cttccttctc cttctgggct 946740
 aatggccaga tgtgaaattg caacagtgat gccacatct gattaatggg accatgcccc 946800
 ccttctttc atagcttctt cccgttaca tttcaatcag agcattgtct aagcccttct 946860

 acagcctctc taggagcaga tctgttgaca tcctcatccc catcttgaga agggccagaa 946920
 aaatggcttc ttactccac actaagatcc atataacaca tagtgaaatc atagcatttt 946980
 ttaaaccatg gaatctacca gaatcatctg gcccaagagc tgattgtggt cacacactgc 947040
 ttactcgagt tttatttaca aatgcctttg tcaataaagt tttatttgaa ttagcagatg 947100
 actgcctatt atgttatttt tctgattcca tgtcgcagaa aaatagaata gttataacaa 947160
 agattatatt acccacaag gctaaaatat atattacatg gcttatacag gagaagttaa 947220
 taacctatga gctagtccaa tcttagtttt gagaatctta gaccatgaag actaataaca 947280

 gacaagaaga caaatctaat atateccaca acacagaata ttcaggttct gttcctatct 947340
 gcctattagt tcatagatgc tgtgtacata tgtatcatcc ctcatattca cgttgaatac 947400
 aggttgaaca ctgaaggctc cattaanaatt agttaagtag ctgagtgtag tagtgtgtac 947460
 ctataatctc agactctgga ggtttagca gaaggattct gaggtaaga ccagcctgag 947520
 caacatggtg agacaccatc tcaaaacaaa acctatctaa acaatgcagc aaaggttaa 947580
 taatgaatca tgtgatggaa acctctctt cttctgctc cacagcctcc aaatatctgt 947640
 ggccaaagtg agcattgac agacatcaaa ccaccatcta tgatatatgt cgaacgacag 947700

 cagcagcgc tcacagagct gtgagagcca gatgaaacga agagcgtgag gtacagagac 947760
 cacatttggc acaaggtaaa cactgaaata gcactaggct atatgagggt tatcataaag 947820
 atggaatatt ctgagacaca gcaggcatca ggaaagacat gtgtccacca aactagggat 947880

gtgtcttagg tccttgcaga aataatgggg acagtacaca aggtgagttc caatgtaatg 947940
tctgcaaatg actgatctca tcttgagtgc cccccccaa gcaagtgaga gcacagatga 948000
ggacatgtgc tcctgtccc aacggtgcct gtgaaactgg aaggacagaa agaagcttac 948060
tcccctgggg ctaattaagg agccttagtt atgtcaatac ttaagtgga gacctggcag 948120

tgtgccaagc agcatggcgc atgtggctgc atctgtggct gaggacatgt cacctcactc 948180
tcctcacaac tgacaagatg aagcaccaaa tactggggac ttcctctgac cacacctgat 948240
caaagtcacc ttigtctctt tgaagttggt ggctgtaact ctctgtaggg attgcccgtc 948300
aaggctcaac agcattccat gtacagtata gggagacttt tagcaatgga caaaaccttt 948360
ttgtcatctt gccagctctt ccgcaaaaaga attatgctta caatggtttc atttggttgt 948420
atgggggtggg catgtgtgtc cctgtatgtg cacacatgtg tgtgcagact caggcacatg 948480
aaggccagag gttgatgctc cttctttgct ctctatgtca tttttttata tagggatttc 948540

attgaaccta gagctcacca gtttggttag actgggtagc cagtgggccc tgaggacctg 948600
ctgcctctgc tttcccagaa ctggcattac aaacagcctc tgctttcca gaactggcat 948660
tacaacaca cgccatcaca cttggcttgt acatgggagc tggagatcca aactcaggcc 948720
ctcacgttta catggcaagc acttcaccaa ctgagccgtc ttttggcccc tataatgtca 948780
ttttatattt tgatagccct tgatttggaa atctcagga ctcataagat gtgcaatccc 948840
acgaaaaatg taatagcaaa agtcatctc ccccagcctc tcttctgat ctaagatgac 948900
aggtagtgat tcctgttaga taaactgccc catcaggacc ttataggac attcagagca 948960

atacggttta atctatcact ctaccccctg ctcaattcct tctttgatg ctaataacaa 949020
aagattttcc cagagatggc ttagcccata ttgggagttg aggcctgtgt gtgcaagtgt 949080
gtgccacat attttctct gtaatgtgct gaacacctct ctctatata gctggcgaac 949140
aggaaagatg acttggacta ataaccagtc aactcccaca atcagggggc ctttcccacc 949200
cagccgcctc cccactgcct ccatctgtgt ttgttctttt gctgcataag aactcaaact 949260
gggtgacagg cctgttattt ttaaaaagcc tttagtagcg tctatccca gaactgtctc 949320
atcacaatta tggcaccaa acgaggaaac ttcacattga gaatggatat gggtttcagc 949380

cagcaccaaa tgtctctct tctgcctttt tgtctttccg atcagtcaga acatgtgaag 949440
ccccaaatga agagtaaaca cacagcccag gttcctttca tctaggaaca tatgtcatga 949500
cgggggaggg gaaaaacct attcccagct tcaatcagcc attcttttct tgtgacttga 949560
accttaaaact gaaagggatg ttgggagagc ttgagtctg aatgcggctg actccttga 949620
agataatagg tattcgcagc atacctgagt ctggagtca ttatctcccc tgcgagcact 949680
tctgtattta tatataatga gatcattacc aggcagctat tccaatttta ttcagacttt 949740

aatatttctt gaaggaaaa aaaaactagc atacaaaagg gtttgtgatg ccaactcaat 949800

cagacgtgct gttgatggag aattattcaa gtgcaagcca gaacaggata aaaaaaaaaa 949860
aatcatttca gagaggettcc tgccaaagcc gagttctcct gcgacgatgt ttcaagtgaa 949920
tgtgcagaac tgtccagagg tgaggaggga aaataacaac gaacagaaga gagggctgct 949980
ggaggatfff aaaggaggct cagcctaact attcaggtgg ggagtgaag agcctcctgc 950040
ggagactgga gactcattcc cacctgcttt cagagagtaa ttagaccagg aaagcagtec 950100
cttcactgg agcaggtggg agcctagaaa ttaacccttt tgtgagtatt ctgttctttg 950160
gcagttaaac cctggactgc gctggtaggg gagtaattt cttcctctc ctcctcctt 950220

cttctctctt cctcctctt tctatctcc cctttcatt cttcctcct ctttctcat 950280
tcattctctt ttctataaca agctagaacg ctggggacta ggtggagctg tgggtgacag 950340
tggggagact tgtttgccac agccagcact ccaagaagcg ctctcacta attgcaatgc 950400
ctgagatgic cgcaactcagg ataacagga gtatatgatt tgtctctggg atctgcattt 950460
tatctgaga ttacaaatcc acaaagagca tctttttagc ttctctctcc ctgtcctgaa 950520
actgcagatg gaaatgagca gatggagcag gtacacaggc ttaccttccc agaaacatgg 950580
aaggaaaggg tccatgtctt ttcttagggg gtttgtaaag cacacattat cttctccatg 950640

gtactgccta caagacaaca caaaccaaca ctggggggaa agttacagaa tgtcctgct 950700
ggctcctgct ggccactgta acctgaaagt agcgttggta aactttttat attgggttta 950760
tcctactaag agtaacctgt gttgttcaga agtcaggtct ggcgaaggtg ttaggttga 950820
ggctagagac ctggctcagg agttaggagc atgtaatggt cttacagaag accagggttc 950880
cgttcaggc acccacacag tggctcacia ccaccggtaa ctccaattcc ggtgaacca 950940
acatcctctt ctggccccc aaggaaccag gaacacatgt tatgcaaaga cacacatgag 951000
ggtaaaacat tcatacatat aaaataaaag taaatcttta aaaataaagt acttatttat 951060

tcattttaaa tggaaacctt aactcataag tctagtctt tggattgcta aacattttaa 951120
gaacaaaagga aggaaggaag ggaggaaggg aggaagggag ggagggagg agagaggag 951180
ggagaaggaa ggctagagac agatgatagg aggataagat ttcatgctc catgaaaata 951240
ggaacaatat tctttaaca aatccttaat agctactgac agtaatcatt ttaataaaaa 951300
cccctggggc tggagaggtg gctcagaggt ttaagagcac tgggtgctct tgctgaggac 951360
ccaagttcag ttcccagcac ccactgcctg taactgcact cccaccagg agccagggtc 951420
ctcttctggc ctgcacagc acctggcttg cacatgatac gcataattc atgcaggcaa 951480

aacactcata cacataaaaa atcttaaaac aaaaaagaat tatttcctca aacggttacc 951540
gaatcagttc aagctagaat taccacatct caaacatag ttcgctgctc tatattaata 951600
agttgggcat atttatgtgt gtacatgagg gagagatctc acttaccagc agtatggatc 951660
ttcccaagga gcacaatggc cctctgtcct gtactacagg cactctgccc ctttgtccag 951720
cattctcacc accaccacc caccctggc tcaactcttc cttttctcct gtcatcaaat 951780
atctctgtgt tcatctcaga tgggatgtcc caggctgaat ctctggaaat gggaagggag 951840
ggagggactg gcaagactcc agggagcact gcagcttcag catcatgcac accattccac 951900

tccaattacc ctttgatgtc atcaaatcca ctctttttgc caaatcaaat agtccacagc 951960
aactctaac cccaagggtc ctggatctt gaaagctggt tctgcaggct cccacgctgc 952020
tgccctgtgg tctgctcctc cctgctccta ttttgacccc tctgctgagg ggccttcagt 952080
tttactctta gcaaggaatc caggtaacaag ggtggtggct ttggagacta cacatccgca 952140
ctcccacca ttcccatgtc caccatactt cactccttca ctctccagg ctgagtatct 952200
gactgaagat ctgtatcttt gaggtcaaga actgcatcgc ataggatttt ctccccaaag 952260
tttaaaacac ttttaaaagc ttgtgcattg attcaacatg tattagtaca aagttaggtt 952320

agtagataat taagtgttac ttcagaaatc acaaagtaca tcatgagga aacaaggcct 952380
attcctaaga atgtcagcac tattggccag tgggacaaat caaaattgac ttcaagataa 952440
taaatatatt aatgcatata gaaatattat tcccataatt gaagcaatgt aacaaatttc 952500
caccaggcct ggtcgtacac cctcatacat ccagcacttg gaaggctgag acaggaaggt 952560
ccttgagttt gaggccagcc tgcccaaaa agtgaaagac ccctgccct tagctcttaa 952620
gtttgctcc tctccggtc ggcagctgat gaggcacgag gcggatgcct cgctcctgcg 952680
cctccccgat cacctggcac cgcgacccgg ggctggggcc gagcaaggag cccgcaagga 952740

ggcacgaggg cgagcaccag gtgggccggc acgaggcga gcaccaggtg ggccggcacg 952800
agagcgaaca acaagtgagc cggcctgggg cctgcccc gagccccgc ccgatgggga 952860
aactcggtc tccgccccca aggtcagcca tctggacgca gaggggggaa ttgagtctgt 952920
tgtaccagac accatactt gagaatatgc tggctctggaa tggtctgtg cctcatttga 952980
accatccaat agaatgact ctgtactttg cctcatttga atgactctgt atttcacctc 953040
atltgaatga ctctatactt cgctcattt gaataacctt gtagtagccc tcatttcat 953100
tgaccaatgg gaatagctct gtactgcacc tcatttgaat tatccaatag aatccctgct 953160

tctcgttgc gctttttgct atataagaac cctctcct tggtctggcg cgcttggcct 953220
cacagaagct aagtgcgcc ggttacccgt gtatccaata aagcctcttg ctatttgcac 953280
ccaagttcgt ggtctcgtg attcttgggt acgggtctcc ttctacgaaa gtacctctc 953340

gggggctcttt caaaagaaaa gaaggaaagg agggaggaaa agagaaagaa acaaacaaac 953400
 aaagaaatth tctgacaac tggcaaggct ctccagatgt ccctctcaga aagtgaagaa 953460
 actatggaga aagaaggatt gtgggaactg tagttctact tattaaggtt ctgaaatgcc 953520
 tagacaacta tagcctgttg gtagacacct gtaatcccaa gtactcagga ggctgagtca 953580

 ggaagattga aagacagaag gcagagtgag ctgagctgca cagtgtgttc aaagtccagc 953640
 ctgggtaact cagtaaaacc tgaaagagct tgggggcagc ccagggccag agtgcttatg 953700
 cagaatgtgt gaggtcctgt gttcagctcc cagtagtccc aacctccaa aaaagggtgt 953760
 aaagatagct tttcttaact tactaaatac ggcagatctt ttaagccac ccctacacat 953820
 aaccagaaaa aaacggcccc agtttggggt cccgactgct ttttctaaa gatagcttcc 953880
 tctgcagttg tgctccgtag gaacctcag acctgttgcc acaaagtcac ggagcctagc 953940
 ccccgatgatt gctgttggca atcgtcatgc ttagcgccac aactctgggt gtttatttat 954000

 catagctcac tctcgatct ctgcagctgc ccaggatatt ctttccata gtcttgaac 954060
 ctagatcagt gaggaggaaa taaattgctg agatattgta tgtgagagt accaagatta 954120
 aatttccctg cctgcaggat gtacctgat acaggattaa taagattaca tetctactac 954180
 agagcaaagc gccacctta atcatttccc aagtgggccc agccaccag cctctactcg 954240
 ttaggttctt gaacaagagg aaaaagatca ctaggctgtg tcagaggtca gaacacctg 954300
 tctctgaagg cttttctt acgaagggtt ccatgaatca aagtaagggt atageccact 954360
 catatttcaa acacgggaag aaggaagagc ctgtctgttt gtaaggaagc tgggcaagct 954420

 gctcctatcc agcccacatc aagtttcaa ggagtacctg ttaagttgta gacatcgga 954480
 aacgaaactt aagtcagcac ttagcagggt gaattgtgga catgacagtg aggtgatttc 954540
 ttgggttctc cacctgttta tgagccgtgg ctagagggag aatcagctc accgtcaggg 954600
 tgccaaaaca catctcttgc cctagtaagt aaatatcacc atgaacaggg tetggagata 954660
 gaatcttgc tccccacc ggggtgagaa ataattctt ccctctaggt tgattcttgc 954720
 cctcttactg tatcaagagg gatctgttt gttgtttgt ttgtttcatt tctttctat 954780
 ctggttctca ttgttagct ctacctggcc tggagctcac tgtatagaca gggtagactc 954840

 aaacacagaa attagcttgt ccatgcatct cagtcactgg aattactgca ccaccatacc 954900
 cagccttcaa gagatcttcc tccaaaaac catagttcag gatttcttaa ttgctctgtc 954960
 tccagaaaga gtaaaccttg gttcagtagc caagttggcc tcaactgcca tatttgttaa 955020
 taaagttac tggaattcat ctgtattcat ttgtttacat gagacttct gctacaacag 955080
 cagaattgag tagttgaac acagatttca tggcctgtaa agcattagtt attcattatt 955140
 caccctatt gacttcagtc ctatattttc tggcaaatg ttgaatgatt atgataatgg 955200

tcaatgcact attaaacata ttacatgaac aatgtcatta aaccttgact tcagttatgg 955260

cagaggtact ttcgttcac ccatittcca tgggaagtac ccaggttttg tagcattaag 955320

tttctaggtc tctgaagtgg tgaagcagga ttcaagagat attgttctga ttccaacctg 955380

ggttctctca accaggaaac tataatctgtg caaatataat aacaataaaa ttagctccc 955440

tcttactagg cacttagcat gcaccagcct ttacatgtgc cgtctctatt gctcatctct 955500

agccagaata ttctttgcaa aaatcgggga acagggagtt aggctgggta aacagctcat 955560

caaaaaccag aaagctcaga gcacaagtta ctacatccaa actcaaacac caaatctttc 955620

cccttatata ggtctccaca ctagaaaaag gtagtatfff aagaacaat acaggaactg 955680

gaaagactgc tcttacagag gacctgagtt tgatctctag caaccacgtc tagtagttca 955740

taactgcctg taataccagc atcagggaga tctcaggaca aggtacttg tagtcacata 955800

aatataacct acacagatcc atgaatgtac acataattaa aaacaattaa aaagtccitt 955860

taaaaaaga aataacatag tatggaatgg aaattcctca taatttaaat ctcagtgctt 955920

agttctctat cctattttaga aagactatgg tagctgaggc ttagcactta gtgatagagg 955980

ccctgggttc catccacaga actataagca taattttaca tgtttacaca cagacacaca 956040

cacacacaca cacacacaca cacacacaca cacacgatgc tacagtttaa atattttaa 956100

aacttcaaaa tatgttgaac ttaatgcca gtatatcaat atcaaggagt cggggagggg 956160

agtgtcgggt catgagaact ctgccctcat ttatggatta gtacctata aaagagctgg 956220

gtaccttgg gagaacaggc cctgcacctt gcccaggcag cacagtagag ccaaacctat 956280

tgacagaagt gtgggttaac cagcacaaa gttatgagca tgagagagct atccccatta 956340

ctcttctgtc atgcagaggt gtggccctta ccacttacc ctaccacctg tagtgagcga 956400

gggagtggcc ctccccctta ccagttgcag tactcaggaa aatggacct gcacctgcc 956460

tgggcagcac agtagagatg accctactga cagggatgca agtgaactac cccaagaac 956520

atgagtgtgg aagatctggc cctgcacctc atctgccaca tagtggctca ggcattggag 956580

agccaacct gaggacatga aagcagaaga accagccccg ccccttgctc atggctgcaa 956640

agggtgaacc agccagggtta acacaggaga gtgcacctg atcatgagga caaggagaa 956700

ctaccaggct gaccacctc gcagctacac aggcccagaa ccagtgttat gaggttgctc 956760

acccaacat ttacccatc acaatcttct ggagcatgtg aaagggtgg tgctgcagac 956820

ccaaaactgc aggacctcca tgacacagga caataacaag agagccaagc agagtcccag 956880

tgagagtcca gcgtcaatag tgcagccaaa accaggggcc tccagccaga ccaatgactc 956940

ttgcaatga acacttgcaa gtaaagctat atggataaaa gggttcacta tgtgactcac 957000
 tgtgtcacac tacagcttcc atgatgagat ttttcttttt tttattttat tttgggtggg 957060
 ggcattgcaa gggcaaaggg tggatatgaa gggacgggga aatgaatgag atcgaggttc 957120
 atgatgagaa aaacacaaac taaataaaaa gaaagcttta caaaaggagc gggataaaca 957180
 gtgaggccta tattctgccc ttcccgact ccctgtgtg aacatgcagc agcaagcccc 957240
 atcgtggagg caaacaacag ccctcattgg acagagattc tgatgacacc caccgtgctt 957300
 ggggcttcca gccatcaggg ctgtgagaaa gtgaatttct gatctttata caattatcca 957360

 gaccaagtg ttttgttcta gcacagtgca accaggctaa gagagtcacc acatattctc 957420
 tgagcccaca cticactctt agctgtgtga gtggcctcaa gtagctaact taaatctctt 957480
 cagccctcat ttccttgtt ggcaatagtg aggagtcttc tcagatctcc cagactcaag 957540
 cattgggagc tttcagttt ctcctcact aagtcacttt cactcagtgc aaacatactc 957600
 ataaccagtg taaactctct aaaaacaaat caagccctaa tcaaaataac ttacctgggg 957660
 tggggagtgc agctggagag atggttcagc agttaagaat gcttctgct cttgcagaga 957720
 actcaagttt ggttccccac acccatgtca cacacctctg ggagatctga tcccccttc 957780

 tggccttcac atglacctgc actcacatgc acatttgtgt gtgtgtgtgt gtgtgtgtgt 957840
 gtgtgtgtgt gtgtgtgtgt gtgtgtgtgt gtgtgtgtaa aaaataaac aaaatgtttt 957900
 aaaagattta agctggggct aggtgtggtg gagaatccct ttgatacca ctctcaggag 957960
 acaatggcag gcaaatctct gtgagttaga ggccagtttg gtttcatgg tgagttccag 958020
 accagccaga gctatataat gagaccctgt ctcaaagtaa aggtttaatc agggaagggg 958080
 acagggacag aacagaggaa ggggccaat gtgtaactaa ttttaatat aataaaaagg 958140
 tggatattga atgcaggcta cctgtgtaag tggacaatgc tttccagaa gatgtgggct 958200

 attccatgag catctcagac cctggtgtgg gataccactc tgcaagttat tggatcaatga 958260
 ggccccagag gatcccagga tcacacagtg ggcagcagat aatccagaga ttcataacta 958320
 gtcaaaaagg ctgagaataa atgaccatga gtgttggtta ggtcaaggct caggaaagat 958380
 cagggaagaa gaactggaaa gaaagtatga aactgaggat cgggaggaac actgtgaaat 958440
 gctgtcttct gggcatccat ggctgttata ttctgagct cattgcagct atgatcacgt 958500
 gacaaatatt gtacaagtca acatcccagc ggacagcaag agggggtaga acgtaaagga 958560
 aggaggggac atgttaagag atgtccaggg ggtgtaaagg gaagttgaga ggcatatgac 958620

 caagatataa tgtatacatg tataaaactg tcaaagaata aataaaagat attcctaaaa 958680
 tgaaaataaa cttgagaaac tctgaatat ttaaagaata acaaagaact aaataaataa 958740
 aaacaaacc caggtgtagt gcttgccat aagcagtgt ggggagccag agataagtag 958800

atgcctgggt ttcacagcca gctagcctgg cctgcttggg aaggccaag ccagtgagac 958860
cctatctcaa aaccaaggag gaagcccct aaggaaccac aacaagggtt atcttctaaa 958920
atactgattt ggtggaaatt gattgaacac tagtcactcg caaccaggtg agagggtgga 958980
tggagtagct ggatgtcagc aacaacattc aatttgatag taagaatgag ttacagtagt 959040

ctattgcaca atggtgtgtc tacagcttat aacaacatga tatattttat aaagaaccag 959100
aagattttta atgctgccaa cacatttaaa aaaaaaggca atgtctaaag atatagaaat 959160
ggcaaacatt agccaatgag atggctcaaa attggtaaag gtccttgcta tacaagccag 959220
gtgacctgag ttcaatctgg aatccacaga aaagtaagag agaactgact ccacagggct 959280
gtcctctgat gtccacaaac agactgtgaa cacaaaggca cacacacaca cacacacaca 959340
cacacacaca cacacacaca cacacacaca cacaataatc tagaacattg aaagaaatgt 959400
caaaaccag atttgatcat cacacattgt gtcatacatt gaatagcatt ctgtgtaaaa 959460

cagtgtagag ggtggggatg tggctcagtg gtccagtct cttaaaggg tctgtcgtga 959520
ggagagaagt gcccagaaag atggctcaga gaataacagc tcttgccatg caaggcagat 959580
tattctggaa cacacgggtgg aaaagattcc tcaaaattgt ccacacacac acacacacac 959640
acacacacac acacacacac acacacacac acacacactt tcctttctct taagtagtga 959700
gactttccca ataagctact tgtatctgta tcttatttcc taaccccatc atcattctat 959760
gtagattacc aaaccttaag gaccattgaa gtcatctgag agatgtctat actaagttaa 959820
aaagtgattt atccagaaaa aaaaaaaaaa aggtttatta acattgccct tgagatagag 959880

caccttaaat agcaaccaat agactaagga tacagtgagg ttggtgaagt gcttgcctgg 959940
catccacaag gctctaagtt tgatcccaa tcacacaaa cagggccagc tggatgcatgc 960000
ctgtaatcaa agcactcaga agataaagac aggaggacca gaagagcgag gtcatccttg 960060
gtacacctat gggcaagttt caggccagcc agagctatgt gaaactctgc ctcaaaataa 960120
attattttgt ttgtttgttt ccctttgctt tactttaaat gatggcttgt ttccgccttt 960180
gcttttagcta ataggcaaaa ctgatgtaag gaaacacttg cattgagttt acttctttaa 960240
gtggcatggt ttttaaaaaa gaaaaagaaa gaaaaaggcc atcttgccaa taatecctct 960300

aagccttttt aattgcaaga ttctttttta tgggtgtcgtt gacctagcct tagcagagtt 960360
cactctgtaa atgtgctgaa gagggtacca gagctgacaa ctaaggctga gaaatgttct 960420
aagtatcacg actccacatt tttctcctgt ccatgagggtg cagggactca tcctgtctga 960480
gtcatgctg ccctttgttt atgcatgaat aagacacttc agacactgag gacaccagcc 960540
cttcaggaa aaataagacc tagcctcaaa tcagagttag agcactgact gttccccagt 960600
gccaactaat ttttaaatgt gactaaagac acattgctag cttcctcaa gtcgcctact 960660

ggcccctaac ctttagcaag acaaaaatgt cacatataat ggagcctaaa attaaggaca 960720

catcttgctt ctccctggat cagatctcgt gagaatgagg tcagtgctct acctctgcca 960780

gataagagca gtcattgcat gagagcgttc aacagtacca cagt cattag gccacagaaa 960840

atgtctgac gcttaaaaac tcagactatg gatccagaat caacctacaa aaagtcattc 960900

agccttgcc ctaaattctt gatagggcag tgtgtaaaac aactgttccc gggtcacaca 960960

aatcacttca ccagtccttg ctccctcatt aactgataac catttcttag gtccttagtt 961020

attgacacag tactattctc agtgttgggg gtgttctgaa cacactagac aaatccagag 961080

tgtaacagac ttaccttct agtggagacc ggcaataaac aaaggaggaa aatgaacagg 961140

aagagtgggt gctgcttga tgatgaaaca ggggcttga ctacaaagg gctttgggtg 961200

gagtagtcaa aagggttcc catgagctgg agatgtaggt cagtggtaaa gaacttgctt 961260

agcatgtgaa tggccgtagg ttccaatcag cagcaaaaat atattttatt tttgattcta 961320

tataaacatg aacatccatg tggagatgtg ctcccatgag ttacccatag aaaccagaag 961380

aggtcatcag acagcctgaa gctaaagcta catgttgga tgagccattt gatataggtg 961440

ttaggagtca aatttgggtg ctctgggaga gcaagaaggg tccttcatcg ctgagccatc 961500

tctccagacc ctctttttt tatgaccag taagttaat taggggtgct gggatgtacg 961560

taggtgtggg tttatttact agagcttaga tagcttgcca gtggctacac cactaaagaa 961620

aatcaattct tcctcctcaa gagccattaa cagcctctc aggggggttg agattctgtt 961680

tttattatca tatattaatt ctaatagcta gctttattat gacatgctca tgcattgcca 961740

taatatagtt cagtcatatt caccccaact caccctgtcc ccttccactc tgaggatcac 961800

ctccctctc ctaacctgcc cctcttatac tttttgtatt tcttttaact taaatttctt 961860

aagaaacaga tggaaagaaa tgaagaaagg aaagaaatga gaagtctgga aggcaggcag 961920

agaccacatc tcagaggggc cagaagacaa gtgaggactc cacttagacc tacttaatac 961980

aggatttaca gggaggtttt tcaaatgggt gccttgtggt ctagtgggct attagtctgg 962040

atctctggtt gccatagagg atgtggattg caggaatgtg aatggaagc agggaggcca 962100

ctcaggaggt gatgggtgtg gtccagatga aagatagtgg gatcctacag aggtgatcac 962160

tggtagagat gagggatgtt cagagaaaca ttttagagac tgactgactg actggcagga 962220

ttcactgatg gaattgctat ggggatggcg gagacagga tggttctcag ggttttggct 962280

ggctctaggc aactggatc agcttacttg gcatctgaaa tgggatgtt tcagccaaat 962340

ggagcccaat gcatggccaa ctgtactgtg aatttgaact acatctgagg aaagtgatat 962400

gttttgtaaa ttgtcaccag agaattatit cccacacctc cacctctcc tacatagcaa 962460
 ctgtgtgctt gtgagcacag ctccgtggga gtattcctaa cctttatit tgaatggaca 962520
 ttgaaaggac attgagtitt tgcagcctag aagcccatga gctacaaagt gagctgatga 962580
 actagcattt ggittaaagag aaagtacaat aagcaccagg gacattagct atagcagtcc 962640
 agaggactgt caaagaccta caaaaagaaa acctagacat ctgagtggaa cattcagcta 962700
 taaactaaga ggccagattt aatcatctac ctatagtgt catccaagag gactgcttct 962760
 tcttgcaaaa gcaaaggctc ctgctcctat ttttcagtca agcaggtgct ttgaggcagc 962820

 taaccagctg gctgaaacct tcaccaaagc aaaagctagt aacatgattg attaccctct 962880
 cgttgaatga gaaaagaatc tctcccagcc aatcagcatg cagaattggt aacaggttat 962940
 tgctgacctt aatgatactt agagaagatg acagaggtgc ccacatcca ggctcaggtt 963000
 ggctgggatg tcatctacca actcagttcc acttaatgca ctgatttttt aacaaagctc 963060
 agttagcttt caaattgcta agcactggct ttcaacttca gactttgaat agacaacctc 963120
 tctctccatc aatcatttta atacatctgc ttcagagttg caatccatct gccccagga 963180
 aggttctcc tccaacatc tcaagctta gggttctagt tggtcacag attctctctc 963240

 tccatccctc ttataaaaga tgcattcata catctcactt catcctaacc tcacaatcaa 963300
 gactccactg gactcctttt tatgttgtca tgcacctcaa cactttagca atgagaaaga 963360
 tggctctctt gaagaacctt caagtcagag tttttttaca caggaacca ctaagtaagt 963420
 gtaggcatg aggcgacct tggaaatcca gtgggcttcc tacttgtgtt gtgacttcta 963480
 agggcatcca tctatgattg aaccatacac ctatcaggca cgtaaaactg gggatcatgc 963540
 gatcatttcc tgtgctaggt acaagccagg tgaggcagga aaactaggag ttccaggcca 963600
 ttttcatcta tgtagtgtgc tcaagaccag actgggctaa gacagaggat gtggtggggg 963660

 tagactcttc taagctgtaa acaaaggttt caagttctctg ttgcacctcc ctactttcca 963720
 cacttaatag caatttctag ttcttcactg gttccatggt ggatgtttaa tgaattgac 963780
 cccataatc tcatagggag tggcactgtt aggaggtgtg gctttgttgg agtgggtgtg 963840
 gccttgttgg aggaagtgtg tcactgtggg ggcaggtttt gagatctctt tgctcaagct 963900
 tccctcgggtg tgaacttctt ttaacttctt gttgcctgca atatatagaa ctctcagata 963960
 ttctctaac accatgtctg cctgcacacc accatgctcc ccaccatgac aataatggac 964020
 tgaacctctg aaactgtaag caagccacc caatcaaatg ttttctttat aaaagttgcc 964080

 atggtcatgg tctctctga cagcaataga aactctaaga cacatgtaa gaaagagcta 964140
 caaaaaataa aacaccagac acagcgtag aaggcaagtg agataaatgg aatctctac 964200
 taagtgtcag gtagctcctt ctcaaacaca gtaatagaac cgtgtccctc ttctatcac 964260

ttactctaca ggaatgtcac ttttcttct tggttattgc tagtgttatg gcttgtacca 964320
 tttgctgtta gctataglac ttgaacttaa gaaggcactt gtgtcgagtt gtcacagagg 964380
 caaaaagact caattcacca cccattactc ttaaaaaactc tccttctctc cacaaacctc 964440
 aagggaag ccaagagtca tcttgtcatg gcgtaaaact ctttcccctt cagctaaagg 964500

 ttaatttact ctaaaaaact gaacatctgg gcactagagg gatggatcag cagttaagag 964560
 cacttgctac tcttgcagag gacctaagtt ctgttcctaa catcttcatg atggcgcata 964620
 gccaaactgca actccagttc caggagatcc aataccctca tctgtcctcc atagacacca 964680
 agcatatgca tggcacacat acctatatgc aggaaaaaca ttcatacaga taaaaaatta 964740
 aaataaatga atctcaaaaa caagacaaac aaaagaaaag ccctgcacat cagacttaac 964800
 aaacatttcc ccctgggcta atgctacatt tcagtagctt gttcatgtcc tagcatgcat 964860
 gaggccctgg actctactca tagtaccgac aacaaaaaag ggaaaaagga aagagaggaa 964920

 aagagaaaga aagaaagaaa gaaagaaaga aagaaagaaa gaaagaaaga aagaagacaa 964980
 gaacaggaag tacacttcca cttcttatcc ctaatggaga gtagtggg cagtttgcag 965040
 aaatacagga gtctggagag atgatcaact actaaaaaac aatcattcaa acacaacatt 965100
 gaagtttaaa atgtttctta aggtttgtct caggttaaag cttgggatgc taataacgtt 965160
 gatcttgagg atggtgatgg tgaagaaagt tatgtgaaga taacacagga agtgctgggt 965220
 tagaaatgct atcccagcct ggagatttga gcctgaagat tcaagacagg aattcaagca 965280
 agtatgggag ggaagggcca gaaaagggcc agaagccagg tgtgaaatca caagtgtctc 965340

 aggttctctg actctatctg cactctatgc tcccaggcag gaacaaaata catcttgtga 965400
 agaaatgtaa tgccagtgc aggagaggaa tccaacattc ttaagacca ggggaacctt 965460
 agctcagtc tgagattcca tgcataaaaa cgggtgggag aaagccacat tgtacaggct 965520
 ctacaaacct gtggtatgag gatggtggtc ctcttctc agtgaacaaa attcaaacat 965580
 ggttctagtt catgtaatga agacaaagga gaatgcagaa gagccctttt gtggttccat 965640
 tccacagcgc caacatccat tacattctgt caattttaga aggaagtga agggtgggga 965700
 gagatatgga gggagggagg agagaggga ggaggaaaga aaagcaggtt aaaggacact 965760

 tataaaatta agaaaatgat aaaggggtgg ggagataact cgttggatga agcatgagaa 965820
 ccagaaacta tataaatggc atctcgcta caatcccga gtggtgagct tcaggtactg 965880
 tgagaaacc tcctcttct ttgaagagca atcaaagaag actcccagtg acaacctggg 965940
 tttccacatg cacacacatg tacatgtatg cccacacaca cacacacaca cacacacaca 966000
 cacacacaca tatatgcttg ataaggaagg aagggaaggg agggatggag ggagggaggg 966060
 gaggaaggaa ggaagagaaa gtgacagggt gtatttctc aatatctta caaacctgca 966120

gtgatcactg ctgctctctg agcttctcac accagctaag tacacaagaa gaatgaagac 966180

 aaagacctgt gaacaaatcc agggcccaag agcaaaaacca gaaaagatct gaaagccaag 966240
 ttccctcaat acaagctaaa taacctaaagc ttgttggcaa caccacttgg gaaaaacct 966300
 acacaagttc ccaattgtca acccaactgc agcctgtggt tgaagatctg tgactcctg 966360
 gccagggtga cccttcagga gttcccttagt aaagggtta tcaaactgat tgcaaagcac 966420
 aattaattta tatcagatat acaaaaatgc aaatgcccc gctataaatg catgagcagg 966480
 aggaactcac cccatgttta caaatgtaa cctcctaaga atgggaaaag gtaagtgggg 966540
 gctgatatgg tactaaagta taacatccaa gggggcccat tagacaaaac tgagggtctt 966600

 aactcaggag gagatgiact agttacttgt atcattgctg tgaccaagta tctgacaaca 966660
 agcaactttg ggtgggaaag accagtgtag ggaatgatga caccacatt ttgagtggct 966720
 ctccctctt ctgttactcc tctctggaaa cacacagaca tgctcagggg tgtatcttat 966780
 aggtacacta aatccactca aactgacaat gaagaaaaac catcaccagc aacaagtgg 966840
 gggaagagtc acgtaaagtc ctcatcacta tcagaactgt ctgggcagtt ttctcaaagt 966900
 cctactcttc tccccctgg agatctgaac atcaacagag agctgagaat gcagacagat 966960
 gtgcagatgt gggacgtgga aaagtctaga tgcagaagag ttcgtttgtt tctgtctgca 967020

 gaacatcat ttacacatca ctgaactgta acaagacaca gcatacacag gcattggtgt 967080
 tttctaaggg acigtctga aggacttgca ctctaaaatt attcatattg ggacactgag 967140
 agttatataa caatgcttct cttgctgacg agactcacca cagccctgaa ccagcacccc 967200
 ggtataagct acagacaaca caagaaggga atgtaagaac tcaactttta aaaacttttt 967260
 ttccctaaca tccaaggcag gaagattctg ttatgcacaa acaccacaa gttttaagaa 967320
 aaatgccac agactagtgg aagaaggtgc tactgggaca ggacaggatg gcaaagagat 967380
 gccaggacce cacacacaca agaaatatgg ccagctecag cagcaagctg ttattgcctc 967440

 atggagagga acacttgcca ctaaaggtgg tttgtcaccg caatgtccac cacaaagagg 967500
 cactgacctg ctcccttgag ttgacctgt gtgacttcca tacctttccc cagccatcct 967560
 tcatgggacc acctcaccac aatctcgaaa cactaaacac tcaaagttgc tgcctttccc 967620
 caaattaggt aaggctgaac agtggatca ggtgaaaca accttactgg agtccaaatc 967680
 aggtcccaac agaacggtct aaaactgctg actgactcag gctcctcctg gtcactgttg 967740
 ttccctcagc actttctcca gccagcacct ggaaactttt agaactttgg tgagtgtttg 967800
 tgcattgccac aactttccta acctagattc aaggcacagc agtaaaatc tggcttcggt 967860

tgtttggtagg ttctggagg tgaatttggg tcttcctatg tgctagacaa atcctaggca 967920
 actgatccag ccccatgttt ttatgttttg ttttgacatg gggacactaa gttgcacagg 967980
 ctggccttga acttgtagac ttctgcctc agcctctaga atagatggat tggcaccaag 968040
 aagttgactc cttatacctt ctttcttggt ctgctgcctg tgtgctaccc atgggtgtgt 968100
 tacattgtgt agtgtgtggt atatgatgta tagtgggtta tgcatgtagt gtgtagcata 968160
 aggtgtgcag tgtgtttggt gtgttcgtat gtgtttgata tgggtatagg gtgaggtgtg 968220
 tgggtcatag tgggtatgt gtggttcatg cattgtgtgt ttatgggtg taacatgttt 968280

 catatgtggt gctacacagc ttacctctgt ctttcattgc tccttgagca ttcttttggt 968340
 atgagaaatc tgttctgaaa gaaacaaatc tactcacct cgagatctca tctccatcaa 968400
 cttgtgacaa gctaagtctg tgtctaaca cctgaggaca tcttcccca tctctaggca 968460
 catgtgcaca catatacact atacgaacaa tacaatgcac accacatact acataccatc 968520
 aacacacaca agtagcatac atcacacata acacaccttg catacacaat tcacaatgca 968580
 cagtcccaca cacatacagc aacagatgcc agatacatat cacaacata caagataatg 968640
 aacaacatag atcactaatt aacacaccac ataccacacc taaccataaa cacactacag 968700

 gccatacata cacaacatat aatgcacat agtctataca cacaacagaa acacactgca 968760
 ccatttacac aaacactata taccacaaac atgcctcatt cacaacacac acacacacac 968820
 acacacacac acacgtacac atgtagttcc ttgttgettt catttgcatt tectcccac 968880
 ctctcttact cctttagtag ttaaaagcta atggatttcc ccttgggcac ctagaacag 968940
 cagcacctt ctttcacagt tgctgatct gtcatattc accctcacac agtttgtttt 969000
 ggggcggctc ctgagcaagc cagctgcttt gtgaacagct tcccatttgc caccaaccac 969060
 tggatctgat gggctctgcaa tgagctact cctgtacaga ctactaaga acctgaagtc 969120

 tgtggcagtg tctccagaag ggatgtctgg aatggagaag ggggtgtgt gtagttatag 969180
 taaggcttca gaccagctga ggggagggga atgctgatga ggaacccac acagagcttg 969240
 gcagagaacc ttttccattt ggtgtccact cctgaatct tgetgctctt ggaggactgg 969300
 ggagtggcag actcttcagg ctttctgtc caatgagtga cctcaacgct gttctgtgat 969360
 gtcagatctc cctcaaagtt actgagagac agtcccggga ccttccttc actctctttt 969420
 acttaatttt tgttttgaga aaagacctct ctaagttgcc cagcctgggc ttgaccttgc 969480
 agaattttca tgaacataag aaaggagggg ggattttgat tagggattca aatgaaaata 969540

 tatacagagc aatttttgtt tgggggtttt ggtttctggt taaggcgtgt gtgtgtgtgt 969600
 gtgtgtgtgt gtgtgtgtgt gtgtgtgctg tftacacaca cacatgcata tgccatgccc 969660
 caagtgtgga ggtcagagga caatgttccc accttctacc atgtagttcc aggaattgaa 969720

ctcaggttgt cagacttggg ggcaaacacc ttactctct gagccatctc tgagtcagcc 969780
 ccagaactaa ctttggaaaa gctgtgctgc caagacctct ggggcatggg ttgaaaatgt 969840
 tcactacaaa tgcattgctca cactatcacc agagtgagaa attcacacag aaaagaaggg 969900
 cagaggggct tgggtttag tgacagttga gtgcctgact aggatgcaga agaccctgga 969960

ttcatacccc agcaciaaagg agggataaga aggaaagaag tgtaaaaggg agggagttag 970020
 tgaccatcag gaagctatgg agatatcttg cttaggttgg gagaggaact agaggccagc 970080
 catcatcccc tgctggacac agatagcatc ttcttagcc ttgatcttag ctctctcat 970140
 caagtgggga atgcagcctg gagaggcaga ggtatcccc agagaccaga atccatgta 970200
 cctcatttag gagaacaga acttgttccc tggacagaag gaggaaggag gggatgaggg 970260
 gacattgcag gtagagagac atatcctaga ccacatgaat cactacttcc tgtacattct 970320
 attccaggaa acaaagcggg aacacttctc ttatctgatt gacagtcact gctcagtga 970380

gctcagactc taacatgaa gacatgcca ggacgacctt tgacatccct tttgtaaatg 970440
 aactaagtat ggaatgatta cttaatatta tggaaactgg taaaatacca tcaaattctg 970500
 gaaagcaaaa atatcagcaa agtaaatgtg tctccttga gaaaacacag taataaaagt 970560
 caagtgttag aaatgggctg gggagatgac ttggaagtta agagcacttg ctgctcttag 970620
 agaggaccaa ggtttgcttc ccatcacctt catgacagct cacaatcaca aggggattca 970680
 acggcctctt cegacctct ccagccccag agatgcaaca catgcaactg cacacatgga 970740
 ggccaatat tcattgtagg gaacagcaaa aaccacagt gtgtgctgtt ctgagtgaat 970800

gggcacagtc gtgtcaagga cctcatagtc tcaggctcag agggaccaag tgtgagcgtt 970860
 gacagtgtgt gcagagaatg tcctccagc aacagttaca gccc aaagac tgttcccta 970920
 cagagattgc ttctgagat cagctaacce tgtcttcttg accagttgta gaccataaac 970980
 cctgcctcct taittatctg cacacaataa cctgcatccg tgttcaattg tgtacagtea 971040
 caccacctct ccattcaact ctgtataata aacacactaa gcttctaggg cactgtgatc 971100
 tctctacaga ggtctcagac cattgtttcc aggtttctg tgtgtccgtc tgtctgttgt 971160
 ttcttcatte ccttgcctgc ctggtaggt ctaagtcctg gctaggatag agcaactcaa 971220

cacataaaat ttaaaaatta ctaacctaac ttgtcacaag tacaattca aggacctgag 971280
 tctggatacc cagcacatat aaaaaatta tgaagggtgg tacacaagcc tgggtctgga 971340
 aggagacaga gactgaaagc caggacttgc ttaccagcca atccagccaa tccagccaat 971400
 caatgagctc caagttcagt gagaacat gtctcaagaa gtaaagtggg gaaaaaaca 971460
 gaagtaaaagt ggagagcaat acaaggcagg tgatattgac ctcaggccta cacacacaca 971520
 cacacacaca cacacacaca cacacacaca catgcacaga cctgcacagg cacacactg 971580

tgcacacaca cacacacaaa tggcttgcca cattcttctt taaaaatfff taggggtggt 971640
 ggtgggtgcat gcctttaatc ccagaattta ggaggcagag gcaggcggat ctctatgagt 971700
 ttgagaccag cctggcttac agagcagagt ctaggacagg ctccaaagct aactgagaa 971760
 accctgtctc gaaaaacaaa aagcaagcaa gcaaacaaac aaaactgggc tagaaaatct 971820
 tgttttgatt tctttgaaa gcttcaagac ttgtctttat ttggggaatg gcagtgtaat 971880
 agggattate ctagtffffc aatcacaaa ctatffgggg gcctctaggt agatctctgt 971940
 atctgggagc atcactgtga aacaagcagg cttcagaata tgacacctcc aaaatgtgga 972000
 aatgaacata ttctcgccat gccaggcctg cagccaggcg catgccattc actcatcaag 972060
 caggcagtga ccccactaca tcacagacgg catgccaaga gttgggcaca gcagagtgga 972120
 aatgacacce aagacacctg cccctctgc cactgtgcca agcaatcagt gtgaggaacc 972180
 agccatgagg ccacagcagc agagatgtca aaagaaccgt aacagccaaa tattaagfff 972240
 tagggatfff atffgtctg ttgcagatff tctgtffffc taatctcaca tfftgcaact 972300
 gataaaccaa gattcacca ataaggtgcc aaaaagcaca tcaaaatatic ataatcagga 972360
 tatttcagcc cffffgtgt ctgtcactac taagaaaggg attgaaatta agaataatct 972420
 gggaggcaga taacaaata tacatffata catatacaca gaaaatfff cffctffff 972480
 ctffgcatgc gctcatgcag tccaggctgt cctcaaacfc aatgtagcca gagacactff 972540
 gaactcctca tctctffgc tgtgactctc aaatgcttat attataggct tgcffffffa 972600
 ccattaatff taatgtctat gaggffctgt tctcaggcaa taccaagga aagfftaagaa 972660
 gcaggagcaa taataaata aataaataa tgfatffctg tctaccaat atfftatffg 972720
 cacactctcc aacaggcaaa tgtgtfftaa atgaaagata ttagtcactg gffctccct 972780
 taacatctct tcccaatgaa ggatatfff ggtaaactg tctctctaac ctgaagatfc 972840
 tgtctffggc aatcaatgag aaaacatfff ffgacaagtc aatgcctgt gattaaaagg 972900
 agaaatggcc cffctgtgcg agaatatgtg gcttactcat cctcagccc tcaagacatc 972960
 aatctgcatt tcaactgcaga cacagcccag gtgtctffgt caatgcacac atffaaagacc 973020
 cgtcctctgc tgcffaggag agagatffaa cattagctcg ggttagatgt aaaggaacaa 973080
 ccttctccat tgaagagaa atfftatff cggggagaa aaaaataca gcaagcagtc 973140
 actccaatgc atfftaagcc tgcattgcg tffgggattt atggtcgagg tctctctct 973200
 cctgtaagga tcttccact ctaaaaggca gaattaaaga tffcagagcc atccaaaagt 973260
 aaaagffca tggacffca gfgccatctg tffgtcatat tctgtcatgt cccaccatff 973320

gtttctcta ggaatttgaa gagattgaga ggcttggca ctgaaaaatc cgagagtct 973380
 aatgggctt ggcagtaacc agcgttggcc cacaccagaa ctgttgtgcc tggaaacagt 973440
 gtgctggatg catgacatit ccatactggc tcccagagag agctgcaacc ggatctcatg 973500
 gctgccctg ctiagtcatc tgctggaagc aagctgtctg gactacattg tgtgtgtgtg 973560
 tgtgtgtgtg tgtgtgtgtg tgtgtgtgtg tgtgtgtgtg gccacatgag gtagcctga 973620
 aatgctcca ttggcaagtg gcatcaggaa gggacatag caaaatcaca gtacacacaa 973680
 cctctaaatt taggtaatct gtcaatatcc tgcactagag agggtttttt tctctgcact 973740

 atggctcaaa ggcttaaaaa cagaagccag ttagactgc atgaaagtc aggctgttca 973800
 gggcatgaca gatagcagct tctgcctttg atggatggg acctcccagc ctcacggggg 973860
 cagcacctcc atctcacccc ttctcttca gcctacatc agaaggcaca gaagccaagt 973920
 gctcagagge ctgagaactt ggctatgga tccccctcc ttttctgtca acctcagcag 973980
 ccacatttta gcttttgtca tttgaatctt caatgtctcc ctaagaatca cattagaatt 974040
 ctaggtccca aacctgtggc actgtggaga ggtggtgtaa cctttaagga gtgggtcta 974100
 gtgacaggaa gtcaggtcat tgggagcatt cctcacagg tgctcttagg acgctgtcct 974160

 ctcttctct tcccaggctt ggaactggac ctcttccact atgtgttccc gccatggagt 974220
 actgtgagge ctcaagcccc aaagcaaagt ggccatggat ggaaacctg acaccaagc 974280
 caagcctttt tcttagaatt ttttatctt caacacagta tctgaaagct agctagcaca 974340
 gtggccctaa gctttgaggg gaaggtcaaa aagaacttg atgtagacag aacagattc 974400
 catgacactc cagccttttg gttttctgag ggagttggga gatgatgaga aaccttgtt 974460
 ggactgttaa ggctcagaac atccaggccc aaaagtcca gtcatgccag gcttgagat 974520
 gctttcaaga tccagctagt ggctgagtgt ggtcacaagc accgccccta ctccatcaa 974580

 acagaaagac catgcaatca gcaatcaccg ctgtttcatt ctgtgtaacta tttactctca 974640
 tcaccctatg ttttaataaa ttattttcia gtatatgggt aggatagata tctaccactc 974700
 ttcattctct gtctatctca tctcttagca gattgtatgc cttccataa aaagactgt 974760
 ggcttctga ttaatgctg ccctgaaaag tagggcttct taaaggacct getcactggg 974820
 ttgctgtgac gatcaagtgt gttggcgtac gttaaatgtt catgactgta cactaacia 974880
 atgtcgctg tagtactaa aactacgagc aaaaaacaag ctgggggaga catggatgac 974940
 ttgctattca aaaagccttt ctgtggttga gtgagtatat ttgcttccag aaaatgcatg 975000

 tctccctct cagacctta actccttgag aaaggtgtgg tatcatttgg tccccctaa 975060
 ggataagcct attacaacia ctttgataaa tggatatagt atcaaacctt ctaaactcat 975120
 gtctccatgc ccataattgg tgcagctttc agacctcatc agagaacttt cttttcgaag 975180

tgaacagcag ttaacaaaga tgatcataac tgttcaaagt cagagactaa agaatgctcg 975240
 gtcacaaatg ggacatctat cacatgagtg cacatgcatg agtacatgtg cactcaaca 975300
 cacacacaca cacacacaca cacacacaca cacacacaca cacacctcag aactagcaca 975360
 gaagatgggg atggaagatt tcaagagcca ggggtcagga cagagcaaaa gcaaaaagagt 975420

gtctgtggac atgacaagat cattacactc aacgaactca cagcaactgt gattcccttc 975480
 actgcaatct gaaggggatc aagccagtca aactctagc atggattggg aagaggttca 975540
 tatgcccagc gctaaactgag gagctactgg cagttagatgg cttctggggg agagagagac 975600
 aattctcttt aaaggtgtag ctctgatag atgaatgaca ctccagtggg tagaaccaca 975660
 cccataagta tatgggcaaa ataagctgga ctccagtggg taattttatt ttagtgagga 975720
 caagatgggg tagatggatg agggctcggg aggagttaga ggaaggaaga tgaggtgaat 975780
 atgattaaaa tacatttgtg gaaattctga acaaatat tttaaaaatt aactttgtgg 975840

gactctacag ccaccaaadc ccaccacaa ctccaggaggc aaagaaaatt ggaatgcaac 975900
 aggtacctaa agatcccc ttaggatca caccaagagg cccctgaggc cttcagaaga 975960
 agaagcactc actgtcagca gtagcttca cctcttgaa tttctgaaaa cccttaggaa 976020
 ccattataaa tgaatgcctt atcttctggg gcagaaccgg aatttttaac tcgatgaaaa 976080
 taactgaaca gtccactcag gagcaagatt gacagaccac aggtgggaaa cactgattca 976140
 ttattcatct tttctaggaa gacaagcagt ttcagcttag caagatgaaa atgagaagag 976200
 gcagagagaa caagcaagtg agattaaaa aaaaaaagat ggaggagtga gcagatgcat 976260

gggtggagga gagataagtt gattgatggg tcaatggagg aaaaggtata gatgataggt 976320
 aaaaatagat acacagaaga aagataactt acagagaagt agaagataca tagatgattt 976380
 gtagacatat aggtcagatg atgacatata catagatgac agaaagaaag aaggaaaaaa 976440
 aggaaggaaa gtaataaca tgataattga tgtggaggca gattataaac atagatgata 976500
 ggatgtgata cagatgataa tgaaagatga tagataaatg atagatgata gatagatgac 976560
 agacagcaca cagatacatt catatatgcc tgcaaataca cactggtacc tagtccatag 976620
 tgaactagat catcagagca ctgagaggga acagagcaag agaccagta aatcagcctt 976680

ttgttctca tctaagagac ataatggcat ccaagactcc agcctgtgca tcctccctg 976740
 aaaagctcat tgagttcagt cgagatcctg tccttaccce agagctcttg ggaaaccttg 976800
 ccattaactc ttgcaattgc tgcacctgct tgttactcc tgggaaaatg tcaagatctt 976860
 tctccttttg tggagcacag gctacgagga aggcactttt ctttactga gactttttca 976920
 gaagcgcttt ttttttccc ctctctacaa ttccacagat tttattttag acacactgga 976980
 aagcacaag aggcattcaa ctccagctgc agattgctag aaaacccttc acatcccacg 977040

gaaattagag aggcagccgc actcatcagc agccgtgtat aaatctggaa ggagtgattt 977100

 catagactca gctggtttcc caacacgagg taatgttcgt ccaccctctt cggctccagg 977160
 acgcaggccc aggcactcag ggtctaactc ctactactc actgcctcgt ttttctcatt 977220
 tgtggagcag aaacgggatg cgccggagct aaattaccag caggttggca ttcaggggct 977280
 gtgctagtaa agagacaatg tcaccgcttt ccaaggccgt gagccccagc tgccaaacct 977340
 ttcattggccc cgaagtgggt catggaccaa agtgagtcca gagagctggc ctggctgctc 977400
 ccaggccacg gactgactgc aattctgagt gttctcttga caactgcatg agacacacac 977460
 tgggtggcag acggtgtggg gggatgtaa gagggggaga ggaatgcaga tgtttgggaa 977520

 acatctttgc caaactgcta gaaagcacac aggaggtgac cctccaggac ctgtactagg 977580
 cattcagcct ttgatagcct cagtactata aagtatttt ttctaacgac tcctctgagg 977640
 aggttctgctg gaacagagaa caagggaggg gagaaaatag agaggaggtt acacaagggc 977700
 cactgcgcac agaacctgag atggagcatc caccgctgtt ccacaggag ccaagtctgc 977760
 agaagacaga ggcattggct gagggggaac ttctgggagc agccatagga gatgcaaagg 977820
 atacggctct taggaaggaa gataggaaga tgccttcagg atgggatag agctcaggag 977880
 tagagtgttc gcctggcata cacacatcac tgggtttgtt ccccgacc acataactg 977940

 gatattgaca taaactataa ttctcacact tggagatggg gggcaagagt attaaatcca 978000
 aggccatcct tagctacata gtaaatgtga ggccagcctg tgttacctga gaccctgtc 978060
 tccagaaaat aaaaaggaag agagaggggg gaaggaagga aggaaggaag gaaggaaggg 978120
 agggagggag gggaaaagga aggaaggaaa gaaggaagga agaaaggagg tctctcccag 978180
 aaggccaaga tctctcagac agctgatcca atgacacaaa gtgatagcaa aagacttcat 978240
 tttcaactaa ctagaatcac acaatgggtt gtctagttaa gaatagctac aaaaataaaa 978300
 aagcagagca ctaggttctg aaagaacagg caactcccag ggcaacagtc ttccaagag 978360

 agacaaagga aaccttcaag aagctttagg gaccaatgta aaaacaccaa gtgtctgcag 978420
 gggacacagg ggaatgccag ttttctaaca ggagcagcaa ggtcacggaa ggggagagga 978480
 gagtaggaat ggttacagaa gacagctcta tggcttcaga tctgaagtgc tcccaaaggc 978540
 ccatgtgta catgtttggt accttagaa gggagcagaa ccatagagaa gtggcgtctg 978600
 ggcgaggcct tctgtcactg gaggtcctc ctaggaggag gctgtgagat cccatccctc 978660
 tcctcccac cccccctc tcttttctta cccccctt gaagccacca tgaagccagc 978720
 agccctcact accacagct tctccatga tgacccaaa gcaacagggt caactgtgaa 978780

ctaaaacccc caaatgtatg agccaaaata acttctataa actgattatc tcaggtgatc 978840
 ttaccataat ggaagctata cacaaatgtc ctaaaagagt aaaatgtatt cttctccacc 978900
 ctctccaaaa agtataaatc aaagtttaaa ataagactgg taccttgaaa gtgccagcat 978960
 ggagctcttc agtggaaaca ttaatataaa taacttcctt tcagtttcat ctctactgtc 979020
 ttagggtttc tattgctgtg aagagacacc atgaccacag caactcatat aaagaaagca 979080
 ttagttgggg tggcttgcct acagtttcaa aaattcagtt cattatcatt atggtaggga 979140
 gcatggaggc atggaggcat gtgtgctgga gtgtagctgg gtcctaaatg actccctcag 979200

 gtgaggggtg agaaggcgag acttcaagc acagacacca ggagtcagtt aaaagggaaa 979260
 cagcagactc attattcag cagtggggag agccaatgag gagnaaccac acaatgcct 979320
 cccagtgacc aggctttgtt ctgatctggt gacattgtat ggttactcct cattggctag 979380
 gcatgatcag gacctctgac agcgctgtt gctaggtcct cacactcacc tctcagcctt 979440
 gtaggcctta tctccctaca ctagagctga gagtccctaca tcttacagc aataggaagt 979500
 caactgactg tcacactgag ggaagcttga gcgaaagaga cctcaaagcc tgctccaca 979560
 gtgacacact tctccaaca aggccagcc tctaatagt gccactcct ttgggggcca 979620

 ttttcttta aaccaccaca ccatcttagc gataagacaa catatgcata gctctctcca 979680
 ctaagaatgg tctgggcaag ggaaagtgtt gtgattagtc ttcattgtca actcatctgg 979740
 atctgggac atgtaggagc cataactacg ggtatactt tgagcccagc cttteccatg 979800
 tccagatgtc tgagaaggaa gagccacat gaatgtggac agcactgtcc catgagctga 979860
 gattccaaaa tgacaactat atactcttaa actgtgaacc aaaataaatt gttcttttca 979920
 gttgcttctt attgggtcac agcaaagaga aaggtaacta acacaaagga atacacagac 979980
 agaatcaagg acaagagta aagaagtcac ctgactgctt tcagcattgg aggacacaga 980040

 cactgcctct atgtggcagt ttggatgtcc cccacaaatc tcaggtgtct ggatacttgg 980100
 tccccagtgc tggctttctg aggaaaatta ggagggttag tcttgctgga ggaagtacat 980160
 ctctgggggc tttgaggttt cagaagactt acaacattcc agtgtgctct ctctgcttcc 980220
 tgtttgtgtt tgaagatgtg gatgtttcca gctccagcca cctactgcct getgtcctgg 980280
 ccatcacaga ctctaacctt ctggaacca aagcccaat tagacactgt cttctataag 980340
 taaccttggc catgacgttt tatcacagca atagaaaagg aatgcctacg ctcttatcca 980400
 ggaaaaaaat gactgactaa gtactctgcc cagtgcagct ggcaactaca atggcatttc 980460

 cagtgtaaaa caaacaggaa aaagaaaaaa aaaaaaaaa cagcagcctg cccttagttt 980520
 tgtgcatata cttgggggtg agggatattg gaaccaatac aaaagacaga gacaaacaca 980580
 caaccttcag aagctcttat gtaaagcagt tcccatgagg aatttcaggg tccttgggga 980640

ctaacattaa gcgtctaata tccagaaaga ttaagggata gtgctgaaag gttcagtgag 980700
 tttatccatt ctagcatgta agcagcggcc tcatcagacc tgggtagcta caacaggcca 980760
 gataaaaaca aaggaccag gaatttccca tacaatttaa gggcgggaag acagactggg 980820
 ttgtgaacca ctgctatata aatgttacia agtacatttg gctctctgct acatctctgt 980880

 tgcttatttc cttgtgttc tgtgtcccag cagtgaatgg cattcatgca aactcttgaa 980940
 acagatgttc aggaaactag aaacctagaa gaagaatctc ccacactacc ttgggtgtct 981000
 ggtaggttt ttgtcgactt aatccaagct gggtcactca ggaagaagga gcctcagtta 981060
 agtaaatgcc tccataagac tggactggag gatagtctgc aaggcatttt cctaactaat 981120
 gataggtgtg ggagggctca gcctacctgg gtgtgctacc cttgggtggg tggctttgg 981180
 tgtataagaa agggaatgga ataagtagtc acagaggca agccaggaag tagtgtgatt 981240
 cgtgacctct gctgccatct gtgcctacac gttcctacct ggaggtccca cctgacttc 981300

 catctatggt agattatgct tgggacatgt aagccaaata aaccttcct ccccaggta 981360
 cttttggtcg tggcctttac cacagcaaca gaaaccaaac taagaaaaat gaggaggag 981420
 caaaaccttc aagagaatga aaaaaaggtt gttctgagag ggggtgtgaa tgccaagttg 981480
 ttctgagagg ggggtgtgaat gctttaaagc ttggtagtt agaaagccat tacagggtgt 981540
 gaagaggac acattcagtg ggaaccaggt cttgggttat aaggaagctc cttctatgcc 981600
 ttccactgtg tacgaggca ggtctcacct ctctgaatct ataactagca gcaggtagg 981660
 attcgctcc attactgaga agttagccag attggtgggc accaaggtgg cacaaggact 981720

 gtgctgttag tagacattcc ttaaacaaca ctaaaacca aactcacca ctcagattct 981780
 tcctaaaacc atgcttcata atgaaatagt gtgaacacag gcaatagaaa gcaatgtcaa 981840
 tgctaaattg ctctttctg ccagagtgtt ttatctcatt cctcaccctt ttggtagct 981900
 tcaaggccag agagccctaa attggcagac agtccccag aagagccttc cagtgccact 981960
 caacaattac catcgattag agttacactc acagtcaaac acagcactac agaaaaatta 982020
 acagaggtgg tgcaccagc tgcagaatgg cccagaggt agagctccta atacctggac 982080
 catgtaaatg ttaccttatt tggcaacaac ttcgcagatg tgattaagtt aaagatcttg 982140

 agatgcagaa attatcctgg ataactcctgg tggccctaa acacaatcac aagtatcctt 982200
 acaagagaga ggcaagcca tgtggctggc ttggccacc actggaagct aaaaaggatg 982260
 atagattctc atccaccgcc tctggagagt ggatggcct gctgctggca ccttgcttc 982320
 aaaccaatgt tactaatttc agagtcttg cttccgagta cagaaaagg gaaattcctg 982380
 ttgtttacag cagtacagg acagcaaatg ggtaaagcaga gaaaagcaac ctccagtgaa 982440
 gggagaaccc tagttcaag gggatttctt tggatttttg agatgggttt ctctgcgtaa 982500

cagctctggc tgcctggaa ctactctgt agaccaggct agcctcaaac tcacagagat 982560

 ccacctgcct ctgectctg agtgctggaa ttaaagacgt gcaccacca cccccggct 982620
 caaagaggat ttctgtagt tggaaataat ttctgctgtt caccacacct gcattcttc 982680
 cctggagtct gaggtgttta aagcttcaga ggtgttga tttcaatatt agatgtctcc 982740
 tatgggctca tgtattgaa cacttggctc ctaactggta ggggaagattc aagagcattg 982800
 ctggaggacg tgggtgacta ggggtgagcc ttaaggttc ctacttgtc tggctaattt 982860
 tgtatcaatt tgacacaagc tagagtcgct ggagtggaga gagcctcaat tgagaaattg 982920
 cctccatagg atcaggctat aggcaagcct gtaggtatc ttaattagta attgatgggg 982980

 gagggccagc ttattgtggg tgatcatagt tcttgccatt tgctctgtt gcttcattgg 983040
 cgataggtct taaatgtgta tgttcttaca tttctagag aaccttgtt atttgctatc 983100
 tttgtatata gctctgtatc aagtctaaat ctattcttta gactaaagga gtactttag 983160
 tgagatatcc actctgcct cactgttgc actgaccaca cccgttagg cctggtgaca 983220
 agtgtgaatg tgacagggga aggctaggcc tgggtccc gacccagct cgctctctg 983280
 ggtcacattt gggtcacaga gaggcctg ggtgtgttc ctggagcag gaacttacag 983340
 gtcactgtt tctttgtaa gtgacttct cccgaataaa attaactat atttaagcaa 983400

 gttctgtgta tcttaactg tgecttaca ggtgatcca tccctggct ggtggacctg 983460
 agctctataa gaaagcagc taagcaagcc agaggagca agccagtaag cagcacccct 983520
 ccatggcctc tgatcagct cctgcctcca gtttctgcc ctgcttgtt tctacctg 983580
 atttcttta atcatgaata aggatgtgaa gtatagacca aataaaacc tttctccc 983640
 aagttgcttt ggicattgtg ttccatcaca gccatagaaa ccctaaccaa gacaacagcc 983700
 cagccccact tctgttcaa tcttccttc ctggatgct atgcagtga accaggtggc 983760
 ctcccagtc tgcctccaag actttatgcc atgatggat gtttccctc aagctgtaag 983820

 ccaaaataat ccacttctcc cttaagtatt gtcttgcag gtatttgca caacaatgag 983880
 aagcacagct aaggccagca gagactatag atgagccctt agatggagaa atgtcaciaa 983940
 cacttccaa agiggcactg tccccactg ccactcaggc gacagtcccc acggcactgg 984000
 gigtgaactt gctgccagac cagagttct gacatttggc cacctatctt ggaccaggat 984060
 gtccctgctc ataataactt cctgcacaat tctagaaag tgcccattg gctctgcat 984120
 ctgttctctg ggictggtc gtcacttgg tcagcagcct ctgctcctg ctccagtgac 984180
 agagcattgc tccattgat gaagcattc cttagtgacc tactttctg ctccacacat 984240

ggcagaaact gaaattccca ctccatgga aaacagaata gagccctgag acaaaatgca 984300
 caggttatgc ttaatacaca aatggacata acaaaagcaa cagacttacc tgggtttgac 984360
 atctctctgg gaagaaactt actgtgcagt aaaataccat gaaaaacaag gatttacact 984420
 gactcatgaa ctactgaac catgagggtg tctatagatt accccagtgg tatctcatac 984480
 gtttcctgc gatgctagaa aaaaaaacct gctggtaatg aacacatgtg actcaaacat 984540
 taagacaatt gcttactaga aaaatctccc agcgaattcc tttataatgt gaggactcca 984600
 ttttaattt atttttgatg aaaatctgaa ttcttcccat catatttgct taaggagagc 984660

 agcatattta caagtgcaaa ttcacatgtg ctctgctcca ctgccaaggt taaaagccat 984720
 cctctcaagg aaaacaagga gcccaagctt ccaactgtggc atctgcaatt gtcaacttgc 984780
 ctggtcctag cactgagtgg ctggaacaat ttccatatct tatacacagg acaaaaatca 984840
 ttaggacccc tcagatggaa aagcaaggac ccccccaata gaaaatgtgc ctaactctgg 984900
 gtgtgtaat gagcaataa taaaaggtga tatggccatt gacacagtat atgacttacc 984960
 atcctcacc tagaattcag ctagtgtgaa aatgagggg ggggtgcaac agagaaaatt 985020
 agggaagaga agtgagaaga agagaagtct aaaactaatg aatatggact agaagaagga 985080

 agagtcaaca acaaggtct caggtttgtc tctgcagcag attgtttatt cagtgcacac 985140
 cagccctgg gttcgaacc agaactagag gtaaacactc acagtggaag ctctgagaag 985200
 acaccaataa ttttcaggaa atctctttg ttctagtct cagtgttta aaaatgcctc 985260
 tcagctacta atactttaca tctggccaag tgtggcagaa cttgcctgta atggcagcac 985320
 ttggaagtt aaggcagaag gtcaggagt caaggtcacc tttgtcgact tagtgggttc 985380
 aaggccaacc tgagccatgt gagaccctgt ctcaaaaaca aacatgcctt acatctgtac 985440
 agttccaag cagccctct tctggcct catgccatca tgatgggcta acacaggtat 985500

 catacaatgc accetaaagc tctccatgc tccatttct gcaataacct tgaatcact 985560
 tccagtccat ttgcaccaa ctatgtttat cacctgtctg cgtcagttca agctgtctata 985620
 acaaaatgct tcagcaataa ggcagttctc aggactggca aaccaaggt caagatgcca 985680
 gcatattgat ctcttggttt attttctct tctgtgata aaatataccta acaaaagcag 985740
 ctaaggaag gaaggaagga aggaaggaac acatgtagct gcccaacccc ctctctatt 985800
 tatgattcc aagattccag aaagaaaaat ctaagaagg tattccagcc tcagttaaca 985860
 acatgaagat aatccttgac aagtgtacc agaggcctgt ctctagatg attctagatc 985920

 tgtccagttg acacttgca tccatcaat tggtatctgc tatcttaatt aatttgggga 985980
 agtgatggag gcatgaggat ggagccctgg ggaacaggat tatgcctttg aagaagacac 986040
 tggaggaac agtgagatgg ctctgctggc agaagcacct ctgggtgacct gggttcagtc 986100

cctgacctcc tgaagctgt cctctaacct cccatgctc actattgtag gaacacacac 986160
 acacacacac acacacacac acacacacac acaaattcaa agaataagac acttctacag 986220
 tttgtaacac ttttgcttgc tggttacata cccagctatc ctccttctga gagaccctg 986280
 aaatacagga ctgacagttc atggctacat ggtcttattt atttattcat tcatttattc 986340

 attcattcat tcattcattc atttttacat tggctcagta ccttaggttg acctcagatt 986400
 tactacgtag cccaggtcgg cctcaaacct atcatcccc agcctcagcc teccacattc 986460
 tgagattaca aacctatgcc accacacca tactgagctt ataacattc tccccatg 986520
 gctacctatg agctatgggt gtgactctac tgaaggcgt gtcactgaag agtgagcaat 986580
 aacatttcca cttaacagtt gcaacagaca caaacgcct cgtggtaaag attgtcctaa 986640
 cacataggca aagaaatagc aagtggagta tccaggagtg actgtcttgt cactcagctc 986700
 tctatcacag taacagatat ctgccataaa cagcttatga agacaagagg tttattcagg 986760

 ctcatagttt tgtttgtttt tgagaccag tttttctatg tagccttggc tggactggga 986820
 ctcaactatg acagcaggca cgaattgaac tcacagaaat cctcctgtct tggcctcccc 986880
 tgtgctggga ttaaagggt gtgccacca gcccgtgga cttgtagttt tgaaggtttc 986940
 agtttattgt tgcttggctt tactgcttct gggctctgtg caatgcaggg tatggcaggg 987000
 gttcatgatg gagcaagcat tcaacaggaa gcagagagaa gaaaggcct cactacctct 987060
 aaaatgccac accttaaca acccagaggc ctgcctttag cctccttaa tgtttcctct 987120
 acaccacaac agctccaaac cagcaactga gcttttaaca cacggacatt ccagatccaa 987180

 actctggcac tacctttgtt tctagtactg tgtatctcat tgaacgttaa tatcattcag 987240
 tccttaataa caatgatggt ttttaacagc ctggccctgt gattccaaa aatttaacaa 987300
 aggattctcc cacctgcagc catgcccctc atctgctccc aggccttctg ctttgcctgt 987360
 gtcactcatt ggggacattt ttatgtgaac tggggaacag attctacgat caaatttcag 987420
 gaaactctgc aggtaaagga gacactcctt ttctccctt gaattctctg tgttttcagg 987480
 aaagaactct accacagaca gacagtggct tcaagaagag aaccatttgg tggctgcagt 987540
 ctgtgctca acacaagcag gagcacacac tctcaagtcc acctgactcc caagcaagac 987600

 aagaaaacaa aagtctgact tgggctgtag caccattggc agcttgcctg gctggccac 987660
 acaaagccca ggattcaatc cccagctctt cgtaaacttg gcatggtagt gcacaccttt 987720
 caaccagca ttcaaaaggf agaggcagag ggatgaaaac cttaagact cctaggctgc 987780
 agagcaagtc taaggccaga cagggttaca ggaaacctgt cccaaaagag gaaaatccaa 987840
 aaaggaaaag aaaattccag tcagcatttc ttccagctac gccatgtcac tgctatacct 987900
 aagatgtttt tctcctctga attaacaggt attaccgcaa tgaaaagaca aggccatggt 987960

cctgagagca gtcattcaca tgcctcctac cacatagcta actctttcag aaaaaggttc 988020

gltgtggcctt gaaatctggg agaaaaaaaa agcaggccac tcaactctgc tcgcccccaa 988080

tgtcctttgag tagaggttta gtttcttggc tcttctttcc aaacacatgg tatgtttttt 988140

aaaggacaga agagcaggca aatccgctca tcaaaaaggc attgactttt aattttacia 988200

atgtgctctc ctccccataa ggaatagaga gaattcatta gaaaccatac cctggagact 988260

gatcccgcct geatgtttct ttctcttggc tatcatataa ttatacceca gatctctgat 988320

tacagaaact ttcccctgaa ctgctacact ttcagaatct tcttttccca tctctccttt 988380

tccagaaact cttaagaag agaagaaatg agaaactgat aagtgtgtgt gtggcaagtc 988440

tcaccttcac tctgcagag gaatgtaact gtggatgggt ggaaatccat cagtgtccct 988500

agaaaagaag acagggtctc tagccccaat ctggggtaaa ctgcactaag tgctgggatg 988560

atggacatat gccatcaatt tatggggttc tggggattga acgcagggct ttatgtatgc 988620

taagcaagca ctccaccagc tgagctatac cctgccaacc atccacagga ggcaattcta 988680

atatgagtcc ttcttgcagt gaggcaggaa ccaggatgaac tgctctgatg gatgaatgaa 988740

agagatgctg aaagaatttc atgttcagca tgcaaacctc cagagacact tgactgccac 988800

agatgccagc ctigttagata actagaccct tctcagcctg ccctaggcat tgtttggcca 988860

ctgacactga cgaggaagga aattatacag atcagcagca gttactacta gcctcaccaa 988920

aatgtttctt ctgtgcttgc tggagcaagg cctgtgtaga acaaaatcac ccatggttagc 988980

cagcaaatg gatcaacaag aaagatgatt gccaccaagc ctggccacct cagttcaatc 989040

cctagggccc acccagtaga gaaagagaaa accaatccc aaaggttgtt ctctgacccc 989100

cactcataga gtgtgtcatg cccagataca tattctctct ctctctatct atctatctat 989160

ctatctatct atctatctat ctatctatct ctatcccccc cccccccc ctctctctct 989220

ctctctctct ctctctctct ctctctgtat ttttaaaatt ttagaagaa ggctgggcat 989280

tggatggcaca cacctttaat cccagcactt gggaggcaga gacagatggg tcttgtgagt 989340

ttgaggccaa cctggctctc agagcagggtg ccaggatagg ctccaaagct atatagagaa 989400

accctgtctg ggaaaaataa aaaaaaaaaa aattagaaag aaagtgccca tggatctat 989460

gctctgtcaa gaggtttagt gtgataatcc caggggtaca agacactgaa aaccctgcta 989520

actcatgcag gtggcatctg agggatgctc cattctgctc ctttcaaatg cctccctctg 989580

ccccgcaaa gaacagcagg acaacagagg ggttgaatg tctgccttcc cgcacacaat 989640

catactctct ctcttttca aagggaat tgtctctta gctttctggt atctatctcc 989700

agtgaatgaac aataggttaa aatttctgag aatataaact acaggaatta ttattcactc 989760
 cttgccttag atctctctgt gagctgccgg ctgcatgttc tgcattcggg gacgaagggc 989820
 ccgtcccaag tgttttccca gttcaatcaa ctgtgctaag aactgtcaca atagcccttg 989880
 acgacaagaa aataaaattt agggtagaat gggagcctga cttgcattgt gattccagta 989940
 tgcacctgtt ccccttctt caccacactg ttggcaaacc ttttcatcca ccttaatgac 990000
 aaaggaagg gaatgggttg ttttccaggc ttgataatta cttctgaaat gttgtcacia 990060
 tcttccaaat gactgtgttt ctttcatgtt agaccactgt gatttcagag ctgcacaggt 990120

 tggggctttg ttaggattct ggtccgcaga gggccttcgg agctttgttt tcttctgttg 990180
 ttttagttgg gggggggcg ggcaggagg gcatgtttt gtttctttt gttttgttt 990240
 tggaaaagac aaagcaaac caaataagtc acaatgataa cttatgacag aaaaatcaac 990300
 atctgaatca aatggtaata gcaggagcct cgttggggag aggaggcagt ttgtgccagg 990360
 aaaagaaagg cccagaaagt tatttaaac tgatcaaac ccactaggag tcacaatccc 990420
 atcatgtctt ccctttggaa aaacagtttt cagaagcccc aattaacctt aattgaattc 990480
 tgccttagta atatctggaa ttttaattga ctgggaaggt gatcataaat ctctgttcat 990540

 aatgtgctta gccattagga aatccccgga tggcacacag ccttgccatg cagggggctg 990600
 agccattctg taggtgaggc tgggtttcag gtcctaagtc aaacattcgg aaaagaaagc 990660
 tgcgcacagg gagagcagcc taagattagc tccagtgggg aagttcagtg tgaagtaaa 990720
 ggactccaat agcccaaggt ttctattagt ggcatcagct tcaatgtggt cccaaaacac 990780
 aaagtatac ccacacacac acagaggggg gggggggggg ggggagggag ggagggaggg 990840
 agagagagac agagagagag agagagagac agagagagag agagttagag ttgctcataa 990900
 agaactcaac ccaagctggg ggtgtggctc agttgggaga gtgctctcct agcatgctca 990960

 aggcccaggg ttcaatcccc aacaccatat aaatctgaaa ttgtgatgca ggcctgtaat 991020
 tccatcactg gggaggtgga ggcaggagg tctatcaata ttattcttga ctacacagtg 991080
 agtttgagc cagcctggct acagagagaca aaaagacacc cagaggaaga gacactcatt 991140
 gctccatcac tcaggataaa cacagtggta gtctctggga tttctttgtt agggggaaat 991200
 ggggaagaat gtttttcaa ctggatctcc cataccaaa ctagcttgga acttgctaag 991260
 tagctgaggt ttgcttcaa ctctgattc cctgcctca cagctccctg agagttgaga 991320
 tcaaaagcat ctatgcctga attaccatgt tcattttatt ttcttttta aaaacataat 991380

 catctcacc cctccctatt ttttaactcg aggaactatc ttaggccttt aaaatgacct 991440
 aagtgtgact attttgacct aatctggtga ggtgtggga gccaccagaa tgaccaggc 991500
 gctttcttag aagctcaaga gtgtatgtaa aaccaaatga aatgtcaagg atgtacattt 991560

tgaagaaaa cagaaggaga acaacttttc tggtaaattc tgattctggt cctccttttg 991620
tactccaaac ccatcaactt gggcagagaa accaatggtt tgagtaacac caagcagtca 991680
atcagaatga ttggctcttg tttcatgaaa ctgaacgtgt ctgtggtgag atggcagaca 991740
cagacctaca ttgtcatcct cgctggcctg aggaattccc ttaatctctt atttttctaa 991800

tcgatttatt tattttatgc ttatgggtgt tttacatgca cgtatgtctg tgtatcacia 991860
gcatgaagtg ccttcagagg tcctaacagg gcttcagatg tctgccct agactttaa 991920
atggttgtgg gccgccacag ggcactggga atggaacctg ggtcctttgg aagagcagcc 991980
agtgccctta accactgagc catctctcca gcttcccctt aatcttttag ggaatacaac 992040
tcaggtaag ctgggatttg tggcttcagt tctaggaagt ttcagcaatg agcaatctga 992100
agcagagctg gagagctcat taatgatac aaaaaagaat ggcatcaaa aagacgggaa 992160
gagcatgaag agaacacgga tgtgggtttt gctaagagaa actcagaaac tacggcatgc 992220

ccaagtgtag gcatgggctc ctccagagag ttgtgacagc tttagccata cacagttttt 992280
ggtgaacctg aagttacatc acatcaagt tctataaaac ccttttctct ctctctctct 992340
ctctctctct ctctctctct ctctctctct ctctctctct ctcctctctc ctctctctct 992400
ccctctccct ctcctctct ctctctctca tttctatctc tatctctctc tcaagttact 992460
atgaaatacc tctctccctc ctctctctct tcttctgac tgagttaaaa tctgataagg 992520
tgagactaga agccagtaga gtcacacaag gccttagtcc ctgtccttcc ctgtgaaagca 992580
gaatttctag ctaagaggcc tggaaacttg cagaccaca agacagggaa gcgaaaggcc 992640

ataagcagca gaaattgtac agggttccta ctctctgttg gcaggaggct tcaggggat 992700
tcttggggag gtgtcactct ccttctcaa tctgagattt ttcctgtctt ctgctcagct 992760
ccaagtgaat gtttgggttg gctaacctca tcagctgttt taaaatcaac tggaaatagt 992820
tagcctcctt tgaagaagat attctctct tctcaggct gtctcctat gagaatggtt 992880
gtttctctga cgctgtgata aaatactatg accaaaagta acttgggaag agtttgcttg 992940
acttatagtt ccagaaggta cagtccttaa ctgcagagga cgtcagggca ggcaccacag 993000
gaaatcagct gataatgttt taattcacac acaggaaagg agggaacagg aacagagaa 993060

aggctatgaa cccacaaaac ccagccactt gaggcggcat ctcataagaa aacagagcca 993120
actggagacc aggtgttcaa attcagagc ctatagggtg tctctctgac aaaccaccaa 993180
aaatggactc ctagctgttc ttttttttt catttcaaca cctacttatg ctaccagcgg 993240
acactgtgac aactcaaaaa atctccagca tgtggagtag acattctata caccagcca 993300
ggtaaggaga tgagcaaaa aaagcaataa aattacattt tattcatcta cgtgtatgag 993360
tgtgtgctat agtgaatgtt tggagaccag agagaaacct gtgcaagggt tagttccctc 993420

taccacatga atcccaggga tggaacttgg gtttctaggc ttggtggcaa gggcttttat 993480

ccactgaggc attaccagcc caaaagtga ttttgaaga atccaattg gaacacgagg 993540

aaaaccagcc actcttgtaa agatgcacaa ctctcacct tctcacctat cectgcttct 993600

tcgaaggact actgagatgc ttgtgatcac agataaggta tggaaactgg tacagtga 993660

gctctgggctc atttcttccc agttctaatt cactttcaaa gtcagtatca acccagaggt 993720

agacaccaga ctgaaacaga aactctgcag acatcttcta aaacctggat ggaaaggaaa 993780

tagcaatgaa cattaccctt gactatttta taaaattaaa tcctgtcctg tttttttgt 993840

aactacctca gcctctctct ctctctctct ctctctctct ctctctctct ctctctctgt 993900

gtgtgtgtgt gtgtgtgtgt gtgtgtgtac atgagagaga cagagaaaga gagagggggg 993960

aatgtttctc tgtgtaacca ccttggtctc cctagaacgc tttctgtaga ccaggtctgc 994020

ttcaaaactca ctgagatcct cctgcctctg cctcccaagt gctgggatta aaggtatatg 994080

cccagctttg tctgtctttt atacacattt taaaacctcc tcatctaac tatactttc 994140

caaaaaaaga tattgagaaa aacctatta agaaaatcta gacagcaatt aattttgccc 994200

cctgcctgct gtgtaacttt tcaagcctcc ttggtagaca ggaataagaa tgtcagtgat 994260

tgatgagagc aaagaagatg cctacagaac aggcctgcat gctaattatc ctaattccct 994320

caatatccct catttagaac agaatagcaa gaccaacaga ggggattaca ttagtaagtc 994380

taccatctac actggataag cgccagaggt cgacatcagt gggttgtagc tgttcacaga 994440

ttggctagt tccaggaatg cttccagtta cctgtactga aggtcaaac acagagcaag 994500

gccagagagc agtccctaac acaccactta agaataaata ttttcagttt tttttccaaa 994560

gtgtggtcag tgaagtactt tcttcagatc catcccgggt ccttactatc acttggtttt 994620

tgagcccat accggattta ttgagtcacc ttactgaaag tggcactaag actgtgcatt 994680

taacaagctt ttcagattaa acttgtcctc aacaaagttg aaaaaccact gaggtaggea 994740

acaattatta ccatttatgg gaagttttct atccaggcaa gtcaaagcat tattctagtt 994800

gttcaaagat tgaattcaga agaacttccc ccaccacac acacatactt attccaaga 994860

tgccaaatta agtcaaattt cttattttat tctgttgtaa aaatcataag aggcaaacag 994920

atgtctgtcc aaggctagcc tgatctacag agagttccag gacaggcaga gaaacctgt 994980

gttgaataata aataagtaaa ataaaaaag tatgtgtgcc ctccaggact gcaaagtcag 995040

cagcttacag tggatggcat aagccagttc tctggccggg tgttgggtgc acatgctttt 995100

aatccagca cttgggaggc agaggcaggc agatctctgt gatttcaagg ccagcctggt 995160

ctccagagcg agtgccagga taggctccaa agctacacag agaaacctg tctcaaaaa 995220
ataaataaat aaataaataa aaataaaaaa taaaaaagtc agttctccat gggtgacaaa 995280
acagaccacc ccaataaatc ggataaaatt tgcttgtgat tctgaaggtt gactgagtgg 995340
gggattactt gtttgtttg acccagctta tatgggttaa ataactagg atagcatctc 995400
tcatgtggct aaactcctc aataccaac ctgggcttcc catacataac aaacctaaga 995460
gctgatagaa tacacatgaa tacacagaga gagaaaaaaa aagagacaga gagacagaga 995520
ggcaggctgt ggtccagcta atccagcaat ggctagctat gaatgaaaag aatccaagaa 995580

tccagtagtt gttcggtaa tgaggttga tgtttcagct ggtcttcagt atatccagaa 995640
tcttaaagaa gtaagctcta atgccagtga aggaatagac ttgccagcta aagcgaaggc 995700
aagcaggcaa agagacagct ttcttcttc atgtcctttc tttaggctgc cagcagaaga 995760
tctgatccag atcaaaagac gatcttctca tctcaaatga tttcttaaga aaaatcctc 995820
aagatgcctt ctgcctgtg ccccatcacc tgtgggtggg gagggagctg acccttacca 995880
gctgcaacac ttgggaaagt agacactgca tctgcctgg gcagcacagt agagttgacc 995940
ctgctgacaa ggggtgggggt gaaccacct aagaacatga gcatggaaga tctgcccaca 996000

cccatctgcc atataatggt gtaggtggcg gaacgtgggg gcacaccaac ctctcgacac 996060
ctgtagcagg taggagagct tgcctaaga tcataagagt gggagagcta gctgtcctg 996120
cccctacca gctgcagtac ttgggagagt ggccccgca cctggcctgg acaacacatt 996180
aaagctagcc cttatgatgt aagtatggag agccaacct gaagacatga aagcaggaga 996240
actagcctca agtcttgctc attgctgtta ggcgtgaact agctggggca atgcaggaga 996300
ccttacctg gtggtgagga caaggagag ttaccaggct aaccaacct gcaaccacc 996360
agacacagaa ccagggtat gatgtgacc acccaacat ccacccatc tatgatctgc 996420

tggagcacgt aaaggacct gaccacaga ccccaacta cagaatctcc atgacacacg 996480
gcaacaacag gatatccaag aggagtcca gtgagggcc agcattgata gtgtagcaga 996540
aaccagaggt ctgaaccag accaatcact ctttgaatg aacacttgca agtaaagcta 996600
tatgattaa aaaggttca ctacatgact cactgtgtca cactggctgc catgagatta 996660
ttttttatt ctttttctc ttaaattta ttttattggg ggagattgca aggacagagg 996720
gcagatacaa aggacagaga aatgaatgg accaagatga atgatgtgaa agacacaaag 996780
aataaataaa aagaatgitt taaaaaagtg aaaatcctc acagatttcc ccagccactt 996840

gagttttagt tcattcaaaa tgtagtcaag ctgatacaa gaatagccat cacaccacc 996900
acatttattt acccacaata aaaaaaaat catcagttag gaggcatag tagtacetag 996960
acgtcatatg gaggctgaaa cagaagatca ctagttccag gccaacctag actctaaat 997020

gagatctgat cataaaaaata aaagatacct aggcagtgat agcacacaac tttaatccca 997080
 gcacttggga ggcagaggca ggtagatctc tatgagttca aggccagctt ggtctacaga 997140
 gtaagttcca ggatggcagg gctgttacac aaagaaagcc tgtcttgaaa taaataaata 997200
 aataaataaa taaataaata aataagtaag taagtctcca ccaacatcta aaaaataaaa 997260

 ataaaaaaaa aatccattaa cctgataggc tggggttggt gctcagttga tagcatactt 997320
 gcctagcctg catgagaaca ctggattgga tccttagtac tacataaacc agaagtggta 997380
 acgaacacct acaatctagc actcagaaag tagaagcagg agagtcagaa gttcaaggctc 997440
 aactggttaa gatggctcag tctgtacagg cacctgcaat caagcccgat gacttgtgtt 997500
 caatcccat aaccacaga gagaaaggag aaccaagccc caatccaaa agttgtcctc 997560
 tgacctgcac atacatgcca agtgcacata catacatgaa taaatatgac agaaagagat 997620
 agatagacag acagacagac agacagacag atgatagaat ttcactccca aatgttcca 997680

 tgtcatcttc agctacataa caacttcag gccagtttag gctacacaag gcccgctcaa 997740
 aaaaataaat aaggccagag atatggctca acaagtagag ttatttgcca cccaataatg 997800
 caagtctagt gacctaagtt caatecctag acccctgttc aaagtggaag gagagaactg 997860
 actccacaaa gtttctgtc gacctctgtc caaattcatg ctgttactct ctctctctct 997920
 ctctctctct ctctctctct ctctctcaca cacacacaca cacacacaca cacacacaca 997980
 cacacacaca cacacacgtg catgetcaca cacactttaa aatcactcc atctggaagg 998040
 ggaaagggtc aagatctcct gagaaaattg ggagcacggg aagagggggg agggagctag 998100

 gagaatgaga aggggagaag aggagggatg cagaggacat gaggagcaga aaggttgagt 998160
 caggggaaga atagaagata acaagaatgg agatgccata atagaggat acattttagg 998220
 tttacagaga aatcaggcac tagggaatg tctggagatc tacaagatg acaccagtta 998280
 acaatctaag caacagaggc taccttaaat gcctccct gataatgaga ttgatgactg 998340
 acttatatgc tactgatag ccctcatcca gcagctgggtg gaagtagaag cagaaacca 998400
 caactaatca ctgaactcaa ctggaatcca gatgcagaga atgacgagtg aagagcaaag 998460
 ggtccagac caggctgggtg aaaccacag aaacaactga cctgtacatc agggaactct 998520

 tgttccccag actgatagtt gggataccag catgggactg atccagacc caagaacatg 998580
 ggtttcttga ggaacctcg gaaatctacg agacctctg tggtagtcca gttcgtatcc 998640
 ctagcaaagg tgggactct gggagcccat tccacataga ggaatattcc ctgagccaag 998700
 acacatgggg gtgggcctag gccctatccc aaaggatatg atagactttg atgacacct 998760
 atggaaggcc tcaccatcca gagggagcag aaaggatatg tgatagatag ggttttagtt 998820
 ggtggggggg ggtttggtag gggaggactg gagggagaag ggaattggga ttgtcatgta 998880

aaacaatcct gtttctaatt caatcctgaa aaaaatcact ccatgtggca ttgaaaaatt 998940

 ttcatatctg atglatgttt ccatectttc tactataaaa ggatagccc ctcccttttg 999000
 aagaccattt tctatctatc taaggcacac taatccttcg agatagcac ccagacactg 999060
 tgggccacct acaccctgtc gctgggcata ttatactagt tttcagttca ttgtgtgcta 999120
 tgtttatttat gatgagcaga aaacttattt ctgagagttc caaggacact gccatgattg 999180
 atgtctggtc aaggteccagt ttccactecc aagatggttc ctggaggctg catcctccag 999240
 atgtgcagag caccatccct cctaagtcac acagaagcct ttttagttg acaggaatcc 999300
 actcacctc atgacatccc cctttaggtt ccacctccca gcacgttga caactttcca 999360

 acccatgagt ctiggaggca ggtgggcaat tcaaaccaca acaactagta accccaaata 999420
 cacaacagct cacagtctg ttctaaaaag ttctgttact cgccgggcat tgggtgcaca 999480
 tgcttgaat cccaacactc gggaggcaga ggcaggcgga tctctgtgag ttcaaggcca 999540
 accttgaaac ctgtctcga aaaacaaaa aaaaaagttc tgttactcaa aatcacctct 999600
 gatgtacat attttctcat ttccccagtt cacaatccca ggtactgatc ctggactcta 999660
 tttttagttt ctgattaaac tgacacactg gttgcaatgc cttaacatca cgtgactccc 999720
 tcagctgctg tcaagtcac acccagtatg tgacagacct caacacattt tcagagtcaa 999780

 gagataaaca ggaagtggt gctggagggt gagctcagtt gctagagcac ttgcctaaca 999840
 tgaacagacc tggggtgat ccagcactg tataaatcag tcttgatggt atctacctgt 999900
 aaccacaca ttcaagagt ggaaccagaa agattagaag ttaacatca cctttggcta 999960
 taaaaaagggt gtttgacct agtctgggct aatgtgagac cctgtctcaa aaaaataaaa 1000020
 caaagagagg caggactaag ccctgccatg tcagcacatt gagcccacat caggctaaa 1000080
 ggactgtact ttggctcata atagactgg ctaataaaa tgatgcacc tactatgacc 1000140
 gtgttctgca gtattagcaa tgcaaatatg cataattcac tacctcaatt tcttctata 1000200

 taatttgaaa gtttcggga gcaagaaagt cacaatttc cccattctt ggttttatcc 1000260
 cccaatttc acaggacctg tgggtgtgct gttatctctg atggacagta tttttgcatt 1000320
 taccatgg tatttaaat tatctgatca cttttaaat tgggctaatt ttttgattt 1000380
 acttaacta acttaattaa atatcatctc cacctgatgt tatttaacta cttttaatgc 1000440
 tgccttaaaa cctatcactg tccagaagct aatcagaatc aataaaattg gtttggggaa 1000500
 atgcttccca aagtgttate cctgggtcaa caaaagacta acttagagac ttagtaacag 1000560
 tgaaaattcc cagaaacca atccaacct actaagcaaa ttcaggtcc atctggtct 1000620

cttttttta aaacaatgag tatgaggggg tgcaatcatg tcacagtgca agtgtaacgg 1000680
 acagaggaca actctcagga gtcagttttc tccttctacc atgtggatcc cagggattga 1000740
 actaaggcca tcagacttgg ccacaagcac ctttgcccgc taagccatct tgctagccct 1000800
 tggctgtaat ttctaaaacc ctctggatga gtccagtgtg gactaacatg caagaatcac 1000860
 agagaaaaat tgggaggaat agtttctaga caaatcagaa gctaactcac aagatgtgag 1000920
 ctttgtgat gaaaataaac tcttctcaag ctatggtttg catagatttc caggagccta 1000980
 gtagagaatg cagatgagta cagtggctga aatccaaatc ccttgactgg ccccggggca 1001040

 ggatatacat gtgtttattc tagatctaag gggatagaga tgcgtcatag tgtgacgctg 1001100
 tcagcaacca gtiactttta gagttgggac ttttcttccc aagtgaaaga agagtccaaa 1001160
 aggtctagaa tacactccaa agagtgcattg tggagatcag aggacagtta tgtagaatgt 1001220
 gttctctcca tccatcttta cataaattct ggaaatccaa actcaggatg tcaggtttgc 1001280
 acagcaacca cttacatgta ccgagatata ccacagatcc tatcttaaat tagaagatct 1001340
 ataattgaaa acctttcagt catttcatag agaataaaat tggcagtgtg attgaactgt 1001400
 tctggatatg taaagaggag gtctagagaa aaagagtaaa caatctagac ttctgatga 1001460

 gctgttggtc aaccaaaca acatcatctc cattcctcta agtaccgtat ccaatgtgtg 1001520
 tgggtgtctc agtaataaag gcttaacttc aagtcttggg aggtaacca gggcaatggc 1001580
 aacaacctcc ttgatgttac gagtcactaa agagtggcat tcattgacaa tcatcttgat 1001640
 atattcaagc cacagtgtcc aggcaatttt aagaggtatt gatcttaca tgaacctcct 1001700
 tcccagtccc acctcattca aaatctaaga cccaagaact tgtaaacaca tttctagaag 1001760
 agcaagcatc tttcttact gaagctccag gagaccagg gttcagctca gtaggttcca 1001820
 cccaacctac tcaaggtccc caggtcagtc ccagcacta aaaaataagt acacaaagca 1001880

 aagccaaaga gagccactgg gaagttagga accacgtgac aactggggt gattgagcag 1001940
 gaagatcagg ggtaaggct acataactct caaaaagaa aaagtatgtg tgtgatgat 1002000
 aggtttgagt ggtgtgtgtg tgtgtgtgtg tgtgtgtgtg tgtgtgtgtg ttgatgtata 1002060
 tgtctatctg tatgtgtatt gtgagtgtat gtttgtgtat tcaagtgtat gtgttcacgt 1002120
 gtctgtgtgt ctattgtgtc tcaatgactg tgtctgtatc tgtgtctgtg tatatgtgtg 1002180
 tatgcctgta tatgtgtatg tctctccctc ctttctccc gccagcccgt gtttgtgggg 1002240
 ggaggggaac ttttcccaa attctctgcc cttcttctc atcattcaga ttcaaagtaa 1002300

 tttcactgag ctgccaact gctacattat caactaaat ccaaggagtc ttcagccagg 1002360
 cagaatagge aagccttcat cagtatagcc tgcagtgtt tttatgtgt cactcctaaa 1002420
 tgccctgtcc atctgtgtga attcatctc agccaagtgg ccaactccat gaagggaag 1002480

ctgcattcat gcatggtgcc ttcaggcaaa ttctcccct ttctgccttt aaacaaggac 1002540
 atccagagtt ccgaagaaca aatgaaccac aagagaaagc tttaggccac ttggccttca 1002600
 gctaaggctc tcaaaactgag ggagacctct gtgtgattgt gtggggccta tgaggaggcc 1002660
 agaggacaat gtcacaagtc attcctcaag tgttccttgc ctgggttttt gtttgtttgt 1002720

 ttgtttttgt ttgttttgaa acaaggtttc gctatgtatc cctgaactga aacctgctat 1002780
 ataggtcagg ctggtctcca attcatagag ttccacctgc ctctgcctcc tgagtattgg 1002840
 gattaaaggg gtgccacat gactggcctc tcctagggga ttggagaaac cgggaaggact 1002900
 ttatatcaag ctctggaat ctccatgcca gattgtgtta ctaaactctg acatctcatc 1002960
 atctccttaa agagtctcct acattctatg taggacaggg ttagagcaga ggggtgtact 1003020
 gtttcttggc ccctctgtgt ctttctcagc cttgtggcat ggccatctta ttcttgcac 1003080
 tataaaaatt gggatgacag cttcactgtg gtggaaagag tcaaatcagc acacatgatg 1003140

 ccagaaagag taagggaata tataaagatg cccattata taacctttt aaaaatcctt 1003200
 tgctgttttc tgggttagt gacatccagg gtatttttca gattttttta aagacgttct 1003260
 ttggtgaaac ataaaaaac aaaagactt agggagtcag acaaacttgg ttttaacttct 1003320
 tgccctccca ttttctgtat gattctagaa gattttcttg gtctcttact ccatctcatt 1003380
 gactgtaaaa cagaatgcat gagagtagac cacaccatct tgatatcatg atgattgact 1003440
 gtgccccagt tectttttat tacatttttt tatttcaatt agaaacaatc ttatttatat 1003500
 attgatccca gtcctctctc cctccatcct cccatgcccc cccacactgg ccccatccc 1003560

 atccctcttc tgetccatag aaagggtgag gccttgcacg agcctcagtt ctataaaga 1003620
 ggttggaatc tggcctggaa cactgtaagt gctcagttaa tgttaacagt taagtaggaa 1003680
 ggtagtctct ctccactgac atgtgagact ttgtctccat cctacaaagt gagaagaatg 1003740
 gcacttgcct ctgtcacctt acgactaaa caaaatacct gacaaaagcc actgaaggaa 1003800
 ggacttcttt gggctcagaa tttaaaggta ttggtccatc taggcaaaga agacatggtg 1003860
 gtaggagtga gggaaactggc caagttagga agttaacaga gcaagaaagc tgggtctcat 1003920
 gtgatcttcg ggcctccaca tgggtacat gataagagtg cacttgcacg tacacacaca 1003980

 aaataaaca ataatgcaa tttttttaa gctaaagatg catccagacg tttgtcccc 1004040
 aggtgcttct aatccaacc aagctgacaa tgaagattaa ccataacaca gccatacaga 1004100
 attgcagtgt tagagaaagt cactgggacc cagttggtta ataagttaca actattgatc 1004160
 ttcaataac aagccattg atctgatcag cccctcctca gcttctcaa tgaagggttc 1004220
 tgatctactt aggagagttt tgtggcttga ggccccggg cctagtcaca catcactcct 1004280
 caaagacctc tctcttttag atagcatcta ttctaccta ttatgtgctt cataaaaaa 1004340

aaaaaaaaa aaaaaaaaa aaaaaaaaa aaagctaacg ttgccttagg gtgacaggat 1004400

 ttctgccttt tgacactttc tgtttttcat ggctttttcc cctttttct ctcttttta 1004460
 agtttgctat ggttagctta ttgactcta tataggacca aaaaaatga gttgtaatt 1004520
 ggaaagccta ggttctcca acaccagaa ttaaaacaat aacttgggt ccagagaaga 1004580
 aatgggtatt gattccacat taactatcag aaatgttccc ttccccaca gccagaaagc 1004640
 aacggaggga cctcctggc ttacctaac aactctcatg ctacctcaa aagcactgtg 1004700
 ctaaagccct gaagtgagct ggtcccaaag tcacactga agtttatccc ctaactttc 1004760
 aacctctcca atcagtttaa tcattcattg attttcagtc attcacaat tactatggcc 1004820

 catgtgttc tctgatagac aatcttcaga tacaaggcca acaaagccaa aatctcctc 1004880
 ccctagttt cctgaatgca gacatttgt cactaaaag acatgagatc tcaggggctg 1004940
 gagaggtggc tcagaggta agagcactgg ctgttcttcc agaggtcctg agttcaattc 1005000
 ccagcaacca catgggtgct cacaaccatc tgtaatgaga tctgtgcct tcttctgggc 1005060
 tgcagcatac atgcaggcag aatactgtat gcataataa taaaaatgaa tcgttaaaaa 1005120
 atttaaaaa aaaaaaaga catgagatct caagtcagca ctgatgctca ctgagcaaac 1005180
 ctggagatct gagtcttatt cccagaatct acataaaggc agaaggagag aaccaactac 1005240

 acaaagtgt cctgtggcct ccacatgtgc tgtgtggaat acatacatac atacatac 1005300
 acacacacac acacacacac acacacacac atttctttt tgggggggag ggggtgttctg 1005360
 agtcatggtt tctctatggt tttggagcct gacctggaac tagctcttgt agaccaggat 1005420
 ggtctcaaac tcacagagat ctgctgtgt atgcctcctg agtgcctggga ttaaagggtg 1005480
 gtgccacca cgcccgactc tctcacacac acacacacat ttttaaaac aagataaact 1005540
 gtaagtttt taaagacata agacttaaaa ccagaagaaa gaagaaagga gaggagccgg 1005600
 gagctaaagg aaggaaggac agcatcagtt ctgtgtcctg ctacagcatcc aggcctctag 1005660

 ctgaaaagga agaatcctgc cacctctggt ccctctgtag gactccagcc cagcaaactg 1005720
 gtgcttttgt ttcttttatt tctctctcgc tctttaatga aacatgcct aatcgggcat 1005780
 ctctcacaga gagaaagga ctaacattaa ctaacacat cccagggtgt ttttttttt 1005840
 ttaaagtctc ttgacagtag actatttata gatccaatga ggtcgtctg tggcctccta 1005900
 cccagctaag ttgtaatat tctgggtca ggeccacaac catgctgtgt ggttgggct 1005960
 tgatgtccca caggggctct tgggattctt agcatgcaat cgcttgtctt gatgggcact 1006020
 ctgccacca agccaccct ctggttcca ctgttgtct cacactcagt catactacag 1006080

gcaaaacctg gcacaaaaca gtgtcacagt tgagcatcct tttgtaaac aaatatgagc 1006140
attgtccata catacacatg tatgtgtatg tgcattgttg tacatttttt gtgtgttatt 1006200
tgtatctttc tttcccagtc tacttcaagt gtaatctcta agactctatc aaaagaggct 1006260
tggaagtgcc tgictaggct cccccagaat tctaggacat caaggctttt aacacacctc 1006320
acagaacaag ctgagtgtgt gtgtgtgtgt gtgtgtgtga gagagagaga gagagagaga 1006380
gagagagaga gagagagaga gagagagaga gagctattgt gtatggaggc aagtatgggc 1006440
aaatgtggac atcaggtgtc tttctcaat actctccca ttttttttt aagacaggat 1006500

ctctcactga acccagaact gatttggcta gaccagaaac aagtccaagg gattttcca 1006560
ttactgtctc tgctccccg gctctgagat tatagtcatg ccctgccaca cttgacttta 1006620
tagagtctg gggatccaaa cgcaggtccc tcatgcttag tgggaaagca ctgcttcttg 1006680
ctggactgtg tcccagccc ctgggctctc tcttcagtct gcttactca acacaaaact 1006740
atcgaggttg ttiaccaat tcccagttg ggtgaataaa aagaacaaca tcagagacat 1006800
gacataagaa acagagccac tgattaatga tatatatctt gattgactca gctatgcca 1006860
ggcctgtcca cagcttttca gttaccatat gcaagtattc aactagcttc ttagtcagat 1006920

accaccattg ctggctctcc ttctgggaaa agagacaacc attaatgatg caagcctccc 1006980
actgactcac ttctccctc cacatattcc tgtgaatagc aacctccaaa agaaaagaaa 1007040
cagtggacta ctctccctg ggacccttg gtagtctact agagggagct cettgtcacc 1007100
ctatcctact cagatttttc agaccactc aaagataata ctcatgagag catctccatc 1007160
catgttggcc agactggtgt ccagatcagc aatgcctact gggaactcta gtgcctggaa 1007220
catggtgtct agcctgatag ccagatgcca agtgacaaga tcattgggag aggagatgac 1007280
tcactcttc agcacctact tcagtgagac agacactggc aaacatgtgc cccagacagt 1007340

gtttatagac ctggaacca cagtaattga tgaagtttgc acaggtacc accaccagct 1007400
ctccaccct gagcagttca tcacaggcaa ggaagatgct gccaataact atgccatgg 1007460
ccgtacacc actggcaaga agataactga tcttgtcttg gacagaattt gcaagctggc 1007520
tgaccagtgc acaggtcttc agggettctt ggtttttac agctttggag ggggaactgg 1007580
ctctgggttc acccccctgc tgatggagca gctttctgtt gattatgaaa gaagtccaag 1007640
ttggagtct ccatctacc agtccccag gttccacca ctgtggttga acccatcaat 1007700
tccatcctca ccacacacac tagagcactc tgattgtgcc ttcattgtag atgaggccat 1007760

ctatgacatc tgtcatagaa cttgacatt gagcatccaa cctacactaa acttgaccac 1007820
cttattagcc agattgtgtc ttccataact gcttccctta tatttgatgg agccctaact 1007880
gttgacctga cagaattcca gacctacta gtgccctacc ctcaaatcca ctccctcta 1007940

agccacatat gcctctgtcg tctctgtgga gaaagcctac cataaacagc ttatagtagc 1008000
 agaagtcacc aaagcctgct ttgagccagc caaccagatg gtgaaatgtg acccttgcca 1008060
 tggtaaattc atggcttgct gcctgctgtg ctgtggtgat gtagttccca aagatgtcaa 1008120
 tgctgtcatt gccacatca agtccaagtg taccatccag tttgtggact ggtgcctac 1008180

 tggcttcaag gttggcatta attaacagcc tcccactgta gtacctgatg gagacctagc 1008240
 caaggtccag agaactgcga gaatgctaag caacaccaca gccatcgctg aggcctgggc 1008300
 tcacctagat cacaagtttg atctgatgta tgccaagcat gcctttgtgc actggtgtgt 1008360
 ggggaggagg gggagtctc tggagcccat gaggacacgg ctaccctaga ggaggattat 1008420
 taggaagtgg gggcagatag tgctaaagga gatgatgagg gtgaagaata gtaggcatg 1008480
 tgcaacaatt ctacactca ttgtcttcta tttgtctttg tataatgtgta taactgtcct 1008540
 gaactatcaa taaaggtgct tccagtttaa aaaaaaaaaa aacctggga ttaaaggcat 1008600

 tagccaccaa taccagctt atgtagttaa ctagtggata actccaccct ctgatcacia 1008660
 agcaaacctt atttgtcaga acacaagcaa aatatcacac aacaccagc ccaagcaaac 1008720
 tttgtcagaa cacaaacat atatcacaca acaccaacc caagggggag gtgcttagtc 1008780
 tacctgtgct acaatcttc agagaacagg actagctagc tttcagaagg atcaaataga 1008840
 atttgaaat cacctgctt tatgtggcaa gagctccaag aatatcaaac atttctttc 1008900
 atttgcaagc aaatgggtca gaagattctc ccacgaatat ctcttcaga aaaggcagt 1008960
 ttcaaacac agaaaatgga cattaccaag aaaaagaacc tgctttaaga gggcaagaac 1009020

 aactctgagc tatctgggaa acagaggtgg aatgatctt ccctcccaca catgggagtt 1009080
 ccaaacacag gagaagcaca tttcaagcag aacgctcctt ccagagcaca aatattggga 1009140
 aaatagacga agacatgagc gcattctaaa cacagctgtg tttgccacg cctcctgctt 1009200
 gctaggccat gtttgattta acctggcaac tcatggggag gcgaaaggcc tccgcttacc 1009260
 taacctgtga cttatctct cccatcatta ttgttgatgt tgcaaatagt gaattgacct 1009320
 cttattaaat gttgcagcca acaaacaggt ttaataatc ttttgaaatt cacagtaaat 1009380
 gtgttttcag ttggctgtaa tttgtattca ttccaaggac agagatgccc agccacctgc 1009440

 tctgagtgtg acagaatgct ccactagggg atattgctgc ccttcccaac ccaccataaa 1009500
 acatgtcagt cgcaaccatc tccgggagaa tgcgttcatt agctctggaa aacagggtgt 1009560
 aggtttgcca agcagtttac aggatagttt ttagccttca gaatcacctg agataggga 1009620
 ccacagaagt tgcagccag tataaagccc caggttgtca tcgaaataat gagcgggtgc 1009680
 cctggctgga ttggttatct tagcatgca tcaggaggct agggaaacaga cacgagaacg 1009740
 cttgtgttac aglatcagcc catccttagt tagggcctg agggtaaaag cggctgagca 1009800

tcagcatcca atagatagca acaaaagcca ttatctctcc ctggctgggc tgccaagtgc 1009860

aggggccagg attgcctggt gtttgcggtt tccatagcag cgctgttttg ttctagctgg 1009920

caaagtacac agagaggaca ggatcaacat tgcagcaaat gacacgaaca acctgagtec 1009980

tgagcctcgg atctctcagc aggctttgcc ctttttgagt aagccatggg ggtgaagatg 1010040

gatgtccaa gagatgactg gaaactaaca gcttcttcaa tcaagctcag cagctggctg 1010100

agcactgcca tccatccaag gccaccacta tgatactctc tacctcattt cccaaaactc 1010160

tggaaagtac tcggtgtcat taacatggga gaaagccctg cacaggcaga agagccccac 1010220

tgccatctcc tatctggaat ttttgaagac tttctcctct ctcagctagc cagtgaggtt 1010280

ccctgagtc ctggtcactg atgtgatggg tggcaagtga accaacttct ctaccacttt 1010340

tgctggagac caaaaggag ggcccatgag aacagaggat gctcagatat gatatttgct 1010400

ggacatagaa ctagtaattt tttgtttgtt ttatTTTTgt ttttcaaaag aggttttctc 1010460

tgtagccctg gctgttctgg aactcactat atagaccaag ttgacctga acttagagat 1010520

ctgtcagcct ctgctcctg agtgcctggga ttaaaggcct gtgtcacca acctgcctat 1010580

ataaagctac tattgctaag acgagcaaaag tcttgatccc agtctatgca ttaccacat 1010640

agttcaaat cagtctaatt ggcttccatt ttacttatgg tctattggat agacattaaa 1010700

ttagttatct tagaatagag agtagattta tctctagcat caaggacgcc tagaaatttc 1010760

ttaaagtta aaatttcatt ttatttcatt cgtgtgtggg tgtgcatgtg tgcagttcag 1010820

cagatagcta aatgatcct cctgtccctg cctctccatt acaccagat tttttgttt 1010880

gttttgttta gtttttggg tttggTTTT tggTTTTgg tttgttttg ttgtttgtgt 1010940

tttctTTTT ggtttttgtt tgtttgtttg tttgtTTTT gacaaggttt ctttgtgtat 1011000

ctttagcctg tcttggaaact ctctctgtgg atcaggctgg ccttgaactc acagagatct 1011060

acctgccttt gctceccac taaccaacct cacaccaga tttttatgtg cgtgcagggg 1011120

aaccataccc aggtcctgta ctgacctct gagacatctc accagcccct actttaagga 1011180

cgctagtga tggttacgcc ttcatctctc gtcagggtca tgacttcaca ctgacaaata 1011240

agacaaattt agagttccat taaactttgc atttgtgaaa gatcatgtca gattaaggat 1011300

gagatgtcac aagctccaaa cccagccac aaactaacc catgagtctg gtaactgcct 1011360

tttttctga tcatgtcagg aaggacttac tgcaaataga ctggctgcct gctcctccc 1011420

tgttctaaga cagggtctgt gtaatgttac tgcagcttgt gggtaaaact agatatagcc 1011480

acagaactca aagccgttcc ctatgtgaat atgtgtgtgt gttcaggtta acagccttaa 1011540

gtgcttttta ttctggtaac acagactgia tgcacgtatg tatgtatata tgtatgatg 1011600
 cagctaggtc taaatgtcaa aattaaagg gattggaaga cagagccgat atggaaggag 1011660
 ttgcaaaacc ctcttattaa acccagcaag gtaaacacag gacagatgtc tgaagaattg 1011720
 attttagctt tgatcaaaaag tcagacttca ttgatctttg tttctccaaa tcacgagcag 1011780
 ttgccaggca caccataggt acttataaatt atgtgttgaa ttaatgatgt gccttgagct 1011840
 cagcatcaga ataaagggtc tggaaatgtag cttagcacct gaggctcaca ctgcttggcc 1011900
 tctgaccctt cctgcagagt ccaggaggagg agtccagcct ctaagcaccc tgatttcaag 1011960

 gtttgtgtgc ctgttgctgc agctgaggct agaaaaaag gcaggtcaca ccttgagggg 1012020
 ggaagaatca acaatttcta ccctttgttc taaaactagg cgaggactta tttttgctaa 1012080
 ttatgagttg aaaactggac tgcttctgtc cctgcaatcc ctgaggaaac aaacctgtcg 1012140
 ccatccacac cacttcatgt tcatgtgcag ccctgggtct gagtttgcac aaagcacatt 1012200
 caagattgat tcagtagaca aaaataaagt ctaacaaaaa gcttctaacc tctaggtttt 1012260
 gacaattcaa cattagccat catgtaagag ttaataact tctatgtact aactaagca 1012320
 tgtcattaac atctaattta ttattcattc ttataaaatg tacgaagttc agagaggcaa 1012380

 agtagcttgc cctggatcac acagctagca agagctagag ccaaatttga aatgaggttt 1012440
 ggctgactgg attccagccg ggctctttcc cattacatta ggctgtcccc tccagcctaa 1012500
 ggcaagagac actactcact gtgaaatga caaatgagtc cacagaagtg ttgcaactgc 1012560
 cacttcaga caggcaggag gggaaatagt attgaaatg ctggcaatct tttttaatgt 1012620
 ttttgatag gcaaaacatt tacaggaaga aaaaaaaaaac tacaaggcta gaataaaaca 1012680
 acttattcta cctagtctc aagcagttct cttgaaagg t aaggatcttc atctgatctt 1012740
 caagtatctt ccagccttcc tttatgcaaa tacagtgcatt atgaatgagt atgtgttgag 1012800

 tgcaagtgtg tgtgtgagtg tgtgtgtgaa aatgtgtatg tgtatgagta tatgtaagtg 1012860
 tgtgtgtgtg tgtgtgtgtg tgtgtgtgtg tgtgtggaca gaatctcaca tagccgagac 1012920
 tctctctgaa tccacatag ctgagactga ccttgatctc ctgctccat cctccaagtg 1012980
 gtaggattgt aagcatgtgc caccacacac atctgaatat acatttaact ttcttgtttt 1013040
 tcacaaaatg taatgcatcc caatattgtt ctataacttg ctggttttcc ccatttgctg 1013100
 tttcgcttaa ccaagacca aagtctctcc atgccaagtc acagagactt gcattatctt 1013160
 ccattccaca ctgttctgtt gctctgatgc ccactgtact gatgcactat agcttaactt 1013220

 gttccaaagt gatgagcctt tttccattcc aaccttttgc cattacatta tattaatata 1013280
 ctattccaca catacaccag cataccata caagaaactt cacacatgga tgactagata 1013340
 aaaaagtgac tigtgtttgc taaagatggc cattggcagt taccaccata agagaggtag 1013400

caacaggcat ttigttagca gtatagcata gtgcctgctt cccagagccc ttaatagcaa 1013460
gggtatgtca aggccttagag atcctatcat cctgagcta gaccactttc ctaatccatg 1013520
tggtattaat ttacattaag gggccttgta tttccttttg aagaactcta ttttcgtgtg 1013580
ccttcacccc tttcttttct gttctgtaat ttcccttatt ttacaggaag aaagaaagaa 1013640

ataaggaagg aaggaaggaa ggaaggaagg aaggaaggaa ggaaggaagg aaggtaggaa 1013700
ggaaggggga aagaaaggaa ggaaagaaag aaagaaagaa agaaagaaag aaagaaagaa 1013760
agaaagaaaa aatagcactg aggcttagag tatatgaaag catgtgatgg aacagtctta 1013820
cctgatagga ccaggactga aatccaggtc tatctcctcc agaccctgag agtttagcca 1013880
ttaacacgta taitctttgt attatttatic cctattattg ttttaagtttt agtttttgag 1013940
acaaagtcaa gaacagccca ggctgacctt aaaccacca tatagctgag actggccttg 1014000
aacacttgat cctccagctc ccatcttcca agagctaaga ttacagacat gtgacacat 1014060

gcccatattg tttttgaact ggccaagaga gttgtccact cagagcgggt gatgaacctg 1014120
ggggacacta agaaactggg tgatagagaa agccgtcggg gacaatgttt ccaagacaca 1014180
accatctgtg caaaggcaag aatggcctgc agctcttccc actggtttta cggagcctgc 1014240
cttctgcttc taccatcct tctcactctg atgtacaacc aacctaatcc taaagcttgt 1014300
tgcaatagcc tgggtgaatt cagttccatt gcaattcttt tttcccttc tgagatttga 1014360
atgcattcca attagaaaga aagtctctgt gtaagtactc tgacaatttg tctttaagac 1014420
cttagctagg gcttagggtt atgatccaag tggtggaatg tttgcctgga atgcacaagg 1014480

ccctgggttc tfgtcccagt actgaaggaa aaatagacct tagctgatac tgattaaaga 1014540
gagaatttcc ttcagctcac cttagaagtc atcccatttc tggagaatat gagaaggaaa 1014600
agatggaagg aaagggaggt acagcttttc ctattgtctt ttctgtgaa acaatactgc 1014660
caciaagtta ggagcctaaa agaacacatg ccatctcagc ttctgtgggc caagaatctg 1014720
ggcatggttt caccacactg tcaaggtgta tacacacaca tctaactcta gcaactcaga 1014780
ggctggggca taaagatggg gcatcaaggc cagccactgc tttcgtact ttctctcat 1014840
atctcacagg caaacaatgg gatttagtag agtactttat aggctgtggt ccagataatc 1014900

caacaagggc tgctcccaa cagaaagccc aagagtccat cagtttttca gttctaaaga 1014960
ctggatgtct cagctggctc tcagaataca ttggaatcct caaaaagcag gctctggggc 1015020
cactgaagag aaagcaaggg caaaagctac tttcttccat gtcctttata taggctgcca 1015080
aaggaagtgt tgaccagat ttaggatggg tcttcagact aaaatccctc acagttgtgc 1015140
ccatcaactt gggttttagt taattccaga ttagtcaac ttgacaacca acaatagcca 1015200
tcaagcaagt aaaggtgctt gctgccaagc ctaacaacct aagttcaatt cctgaaacct 1015260

acactgggag gaaataactg ctttgagctg tcctctgacc tccatgcagg tactaagga 1015320

 cacacaagca caaaaataaa caataaattt gaacagagga cagccaaggc tacacaaaga 1015380
 aacctgtct caaaaaaaca aaactagtta atttaacaga gagaacacca tttgtcttc 1015440
 tgagtcttca gtagcatcca ttttctgca aatgtaaatg ttatgattcc atttttctt 1015500
 tacagctaaa caaataacac atatgcttgt gcgttttatt tatccattca tctgttgatg 1015560
 tgacagctaa gctggttcca ttttttagcc cttgtgacca aggcagcaat aagcacagat 1015620
 atgtgaatat ctctatggtg tgttaactag ttgttcttct gttatacac aggtataaca 1015680
 tagttggtca catgtagttc aatttttagt tcctggagaa tctctacaga gactttcaca 1015740

 ggggctgcac cagtttacct tcctgacagt tgggataaa ggttctagct gaggggagtt 1015800
 ctaaccaaac tattgaacaa atgtgccgct tcctacagac ttgtagcaaa gcttaagaag 1015860
 agaaatgaag aaagaattgc taaggaaaaa gaagatggaa cttaaagatt cagaaaaaat 1015920
 ctcagggtct tcttactcta aataatagta ataataaaga aaaagctgag aaacctctc 1015980
 aggaaagagc cccaaaagtg tggttacatg gccattaagt ggagatgaat acaacttga 1016040
 agcaagccct ccaactgaaa cactgaggag ttagatggg atgaaatgag ggaaggctga 1016100
 gagactcctg gagaccaaga ctggaccaca gagctgtgtg ctgttctcca taggaagggt 1016160

 tgctctttg gtttcaaat atatgggat gggtagctgt ggaagtagat aggggtgaca 1016220
 tccatcacct aggtttccac aggcctgcaat gcactctggg agcagcagaa gcagagtgc 1016280
 ctggagcact cttttgctg tactctcct tcttactac tggttttaa gacaacagga 1016340
 agccacactg aagaactgtg tgaggcaagc atctgcaact gaccagaga tgctaagggc 1016400
 tgatacctct ggccaagatc cagcaaagaa ccagcgggg tcctcagttc aaagcccaga 1016460
 gccagtggaa ggagacagcc aactccaaag acgtcctctg acttccacac acatacaaa 1016520
 aataatagct aatctttaa aacaaaaaga gaaagaagaa ctcttgaga ggagctaggg 1016580

 aaccagcaag ggatggataa ttgcaaagga ggaaggcagt gaggaggga aatgaataag 1016640
 aaaataaagt cacacacaca cacacacaca cacacacact tgaatctata 1016700
 tacgtcact taaaaaaaa aaataaaaca ggctcctcag ctaaatatct aactttactg 1016760
 cttccacca aatgccagaa catgaaagaa ctgcaaaggt gtcccctcca cttccagtgg 1016820
 catactgctc ctttcgcca tctgagacgt caccagaatg atctttccct tcttattctt 1016880
 tccaacacce tattcatgat tacttattgca tttccagga aaattgaagc tttcttcaga 1016940
 gataacttcc tgtcttctg agctcttgc aaacaccatt tagcagcaa agataccag 1017000

caatctcggc ttttctgagc atatgccttg ctctcagttc aaggcctctt ccacaagttc 1017060
 aggtatttgt aagaaccaca cttcttgttt ctgattttgc ttcagtctgc ctagactatc 1017120
 acaacaaaat gatatggttt agcaggtaaa gctgcttgtc tccaagcctg acaacctgag 1017180
 ttctatcccc agaaagtcca accacaccag atgtcgtcag actttctttg gactgacagc 1017240
 tccaaaagaa tgacagagac ttcttctga gtatgaaagc ttggccttag cttagccttg 1017300
 ttcccaacta gctctgataa atcaaatata cctgtttata ttaaccaca ttctgccatg 1017360
 tggctcatta cctcaacttc ctctgtgtct cctggcata ttctctgct ctcagattct 1017420

 tcccagagtt cctatctttt cctggaatc ccacctatct cctcctgcct agctattggc 1017480
 tattcagctc tttattaaac taatcagaaa gtgccttgaa gagacacatc atcacagtgt 1017540
 acaaaaagat tatcccacaa caatgggaga aggggagaca tgactcctgc aagtgtcct 1017600
 ctgacctcca ttatctgcac catggcatct gcacagacaa cacagacaca cagacacaga 1017660
 cacagacaca gacacacaca cacacacaca cacacacaca cacacacagc 1017720
 aatataaaaa attttaatt taaatttaa agccaataaa ctgagtagtt aagatagcag 1017780
 aaataccttt tcacagctct agaaaattga agtctaagat cagatgccag ttccctaact 1017840

 tttatccagc cccttcatcc tcatatgaaa cagaaagcaa gtttggatct gtcttagcca 1017900
 gtgtgaagag acaccatttc catgccact ctataaaga aaagctttaa ttggggcttg 1017960
 tttacagttt cagaagtta gtccgttctc atcatgtcag ggaacatggc agcatgcagg 1018020
 cagaggtggt gctagagaag tagctgagag ttctacatct ggatctgtgg gcagcaggaa 1018080
 gagagaaagt tactaggcct ggtttggtct cttgaaatct caaacctac cccagtgaca 1018140
 cccttctcc aacaaggaca ggcctcctaa tccttctaag taatgccatt cctgatgac 1018200
 taagcactca aatatatgag cttatgggtt cattcttatt caaacacca cattccactc 1018260

 ctgttcccc atagccttgc agccatatca ttttgtaaaa atggattcag tccaacttea 1018320
 aaagtccca tagtctataa acaatctca cactgtttaa aagtcaaaag ttcaaagtct 1018380
 cttctgagac tcatggcaat ctcttaacta tactccctat aagatcaaaa aggcagatca 1018440
 catgcttcca ctatagcata tacattacca ttccaaaagg ggggaaagga agcatagtga 1018500
 ggaaatactg ggacaaaaca agactgaaaa ccagctgagc aaattccaga ctctgcacct 1018560
 ccatgtcttg tcagagcact ccagatctct atctaactcc tttcaacctt gttgactaac 1018620
 aacatgcttc tcctcttgg gctgcttcca ctctgttag ctaccccag caggtatccc 1018680

 agcactctgg cacctcaac atcttgggtt ctccaaggca acccagctt caccttcata 1018740
 gcttcacaaa ctagcctctc agggactcca tacagagacg acctgacac atgcctgccc 1018800
 tcacctgctt tccttagcga tgaggggaga ttccccacc ccttttctca tatccatgac 1018860

tgtaaggctg gaatcatgtg gccaaagctg ccaagtctg ctgcttctg gggctggaat 1018920
 ttgccccac cccagcccat gttcaagtac attttcacc aatttctgtc tttgatggtt 1018980
 tcttccactg ctttttctt catttctttt cacaagtgg aagctcagct aggtggggta 1019040
 ttgacctgag gtcactactc ctcttatgcc acttagcatc aggcttttct ttaaactttt 1019100

 tatctccttg agcactgggc ttggctccat tagacttccg ggtgctcctt tcctctttct 1019160
 attgtacatt cgtgttttta ctgctcagc tcgttctttt ttattataga tetgcatatg 1019220
 agtggccatt aacaaccaca tgggtccagg tgttgctggc gcatgccttt aatcccagca 1019280
 ctgagaggc agaggcagga ggatctctgt gaggttcaagg ccagcctgct ctccagagtg 1019340
 agtgccagga taggctccaa agctacacag agaaacctg tctcaaaaaa aaaaaaaca 1019400
 aaacaaaaa aaacacacat ggtagagtct cagtgtctaga ccatcttgaa atctctctc 1019460
 caatgccatt agtccaaaac tctccaattc cgccttgggc agattttttg gacaaaggca 1019520

 gaaaacaagc cactttttt gtcaaatgt cacaagaatg atctctaagt cacttataaa 1019580
 tattcttctc ctctgaagcc tcttcagcca tgcatcata atctacattg ctctcagcac 1019640
 cactgtctcc cacattccaa ctagtgtgga ccatgtetta gtcagagttt ctgttactgt 1019700
 gaagagacac catgaccaca acaaatctta taaaggagaa catttaattg ggtggcttac 1019760
 agttcagagg ttagtccat tatcatcatg gtgcaacagg gtagcatgaa ggcagttgtg 1019820
 gtgctggaga aggagctgaa aattccacat ctgtagctga aagcaacagt aagtgaactg 1019880
 agacactgag tgiaccctga atatgggaaa cctcaaagcc cacaccaca gtgacacact 1019940

 tcctccaaca aggccatata tattccaaca aagccacacc tcctaatagt gccacacata 1020000
 tgaggttatg ggaacaatt acattcaaac taccatagac cattaaagca agcttaaagc 1020060
 attcaactgc tttcctaate caaaattcca aagtccacat tctaccaaca agcagcatgg 1020120
 tcaggettgt cacagcaata cccactcct ggtatcaatt tctgtcttaa ttggggttcg 1020180
 attgctagaa agatacaca tgacatggc aactcttaca aaggcacata aagcccttc 1020240
 tcataaaagc cccacctcc tcaattcacc taagcctaat tgcctccagc taggttggga 1020300
 tagggtttca gagtatctac ctcaaggtct atgtgatgaa ggcttggctc accacattct 1020360

 attgggatgt aggggacccc ttcggacctt aaagatgttc cttgggcat tgggattatt 1020420
 ctgccgagt ctgtgactac ttgcttgtt ctcatagccc cgtctgcacc aggaggcaat 1020480
 gfactcaagg aaccaccctc catacaaagc ctgcattgtg ccagtgggac tttcatccac 1020540
 taaaactgat tctaaataga cctcttctgt cttcatacgt ggctgtgtc agtattctct 1020600
 ctctctctct ctctctctct ctctctctct ctctctcttt ctctctctct ctttctctct 1020660
 ctctctttct cgtgtttcaa gacagggttt ctctgtggct tttaggagct gccttggaac 1020720

caggctgggt tcaaacctcac agagatccgc ctgcctctgc ctccacagtt tggattaaag 1020780

 gcgtgtgcca ccaactgcca gccagtattt tcttatagcg acaaaaagca acctactacg 1020840
 ctccaaaaa tctgtttaca aaacagtgtc tctggggaca tacagacatt tggactacce 1020900
 tcaatgtgag tgcaataatg ttcacagtct gtgtaggcac ctaccacaaa atcacaaca 1020960
 aggcagctta aaccacagac atgtttttctc ttgcagtcct tgaacctggt aggccaagat 1021020
 caagctgttt gattttctcc ttgccttgaa catggctacc ctaatgctct gttctcagag 1021080
 aacagccctt ttccacatct ggtatctctt cctcaccttc aaagaatatt gcctattga 1021140
 aagttgggca tgaagcctat aacgcaggtg actggacagg aggattgtga gtctaagacc 1021200

 atcttcgata cataaaacat gaaatcaaga ccagcctggg cctagtgaat tccaagccaa 1021260
 cattggctac tgaatgcatc actgtttcag aatatccaaa agaggagggg gaaaaggacc 1021320
 agctatgctt gattaagggtg ccataccttag gacctcattt aaccttaatt atcccccat 1021380
 aatcactcta ttttagactg gaaggtattg ctgaagattg agactatgaa gttgaaattc 1021440
 ctctgtcatg gcacacacca ggctgacce tctgtcttgg cacacaccag gcctgacct 1021500
 ctgtttaaat actgtcacat tggcagttag agcttcaaca tacagatttt gagagacagt 1021560
 tcaatcccta acaatgacat gccttcacca cacagcgaca tcaccaggca gcaagacacc 1021620

 atgagcactg gagggccctt ctggtttgc tgtttcttgt catacccact atcactaggt 1021680
 gcttttatcc tgagtacatt cacagggcct gcataatgcat ccgatctgt gtgtggtaca 1021740
 agtccaagg ccttgaaca gagatgatgt atccccactg aagagaaatg acagtcagag 1021800
 cgagaagaag gagccaattt gtcacttact gcagagcctg ctagtctgc agcagcgccc 1021860
 tcacactggg attgattaca aacaagatga catttcctg tgggctgcct cacgcattat 1021920
 tataaataaa taccactccc tttagcatct gcacggctat cgagaacaga ttctctctt 1021980
 gatgccttag gtgcacagta aatatcccag ggaccacaat ggccttcttc agtatataag 1022040

 aggacattg tttcacatga gacagtttca taaattaagg ctgtcacaca actccatgag 1022100
 aacagaaaac atacacagag ttggaatgac cctaggaatt catttcaag aagggttagc 1022160
 tttaaacat gcigaagttc tgttccaaag gcctgggcag atggatacag gcctggaaac 1022220
 ttgtgatccc aacctcaga aggaccacaa gttcgaggcc tgagatccac agtgatacct 1022280
 tgccaaagaa gaagaaagga agaggagcag gaggaggagt aataggaagg aactacacaa 1022340
 cctacagctc aacatctgtt tggagtttgt tttggtttgt tggggttttt ttttaattat 1022400
 taatatTTTT tttttattc tcatcagctc aagagaatca gttgttttct gggagtgttt 1022460

cctgaaaatc acaatgggat ttttaagatg gaaataaatc tgttaaattt ttgaatatct 1022520
 ctctggcctt gccctgactg ttccaaatct gtcactttat gagtttcaa taaataagtt 1022580
 attttaacca acgaaatata gagcgactgt cttctattta tttccttatg ctttgccttcg 1022640
 gtgcaagggt gaatttgatc tgccctgcgga tttttttttt catttcagta tctatccact 1022700
 cattttctat ctgccccctc accatctctc aafgttttcc tgtcttttca atcttttctc 1022760
 cctacataaa cccaagagag ggttggcatc tgtgtttcag gcgtaacatg agtgccectc 1022820
 gctgtcaaga atggtgaata gctccgcatc caggcagggtt ccaaccaatt tggcagatgg 1022880

 gaaaaaaact acatctcaag gcaaacactg gaaggattgt taaaatgaat aatttattaa 1022940
 atcgcgattg tttattgacc ggcctttcat tatttacttt tcagttatta aacatacccg 1023000
 tgaagcatct ggggtgcagc ccttggccca ctccaagcct ttttcccagg cggagatggt 1023060
 gccagtccct tgettctcc tacccaagac attttcgac tcttttgcga ggtcggggtc 1023120
 aaactacagt tgttccatga tgactttatc aattctcagt tgatagactc taaatgaaaa 1023180
 actgcccctc gctgcctcgc agccacttaa gaaggggggtt atctgtgtaa tgttctgtca 1023240
 atcgagcagg gtctgcgaca gacgcaggga gtcaagtgaa atagggaaaa gatgttttta 1023300

 atgcctttta ttagttagtc tctgtccgcc acatcgaaga ctagctgaca tccatcctgg 1023360
 actgtccttc caaatcaaaa agataaggga aggaatgtga gcgtgtgtgt gtgtgtgtgt 1023420
 gtgtgtgtgt gtgtgtgtgt gtgtgtcact cttttctgaa gaaagtcaac aatataatcc 1023480
 ttaggttaatt aattacacta gtcacacct ttcacctga agtaggtcaa ggtcaaaaac 1023540
 aacaggctac aatgggagga gcacatccca agaagaaaat ctccagattt gaagagatat 1023600
 gctattctgt accagggagt ctttgcctct aaaggacaaa cttgttttgg ttggttttta 1023660
 tacaatatgt tctgacccta cttctccct ctctcagctc ctccaacctc ttcctcagtt 1023720

 ttaccatgca ggagttccaa aacgtgtgtg tgagagagtg tggcgtccc aaaataataa 1023780
 taaataata agtgaacctc gactcaaaga acagagcaga gattaataaa tgtcattcta 1023840
 caaacccgaa ttttaaaacg aaccagacca agtgagcggg ttcagtgggg aaaggtgctc 1023900
 gccccgctg cctcaggagt ccacatcga aggaacgaac caacttctct gactttcaaa 1023960
 gcccaaatcc aaatccatc acaactatt aataacaata aataattttt aaggagaaaa 1024020
 tggaaatccc agttggtaat ggcggtactg aagctactca caagcataag aaagtctctc 1024080
 tcgccggaca ggcggtgggt gcatcgggaag tgtttaatcc cagaactcag aggcagaggc 1024140

 agatggatct ctgigagttc gagcctacag agcaagtcc aggacagcct tcaaagctac 1024200
 agagaaatc tctctcagaa aaaagaaaaa aaagaaagtc tctctctctc tctctctctc 1024260
 tctctctctc tctctctcat aaaataagtt gagccatttc tgaataactc aatagagatc 1024320

tacatcggta tgagaaaaat tatattatca gatgtttgaa aaagttaaca gtaaataaaa 1024380
 ttagaatgt catcaaaacta tattccctcc ctcaaattaa atatgacttt aaagtatggt 1024440
 ttacactttg gcatttttct ctcttagcac tgagcgttta caggctttgc atccagaaag 1024500
 ctgagggaaa acfcagaaca gggccaggga aagatctttc tgatgagaac atatgccag 1024560

ccttcagtct gcctgctaca tgtacctctg atgtctagga atgaggcttg agcatctttg 1024620
 taggatcaat gccatgtcac aatgtcaaaa ggttggacag cctcggctta tgccaaatag 1024680
 tccagaaagt tcgtaagaga aaaatcattt tagtagccaa gagccctgaa cttgaagtga 1024740
 atctgatgct ctggcttggg ttccagttgt gggttctcca gatgtgtgac ttgaactgtt 1024800
 cacatgtgaa gcitcaattt ccttgttggg aaattaagct ggtgtttctt ccttcataaa 1024860
 atcaaatggg agttcatcca gtcgtgcaaa taaatatcta acacaattag gaccatcagc 1024920
 catacttgat atatgtgcag agccttcaact ttctaccttc tttctgtccc agaagccata 1024980

ctcaagaaag ggggagcttt tgggccaggc atggtgaggc acacctttag tcccagcata 1025040
 aggaaggcag aagcatalgg atctctgtga gttcaaggcc agcctggttt atacagcatg 1025100
 ttccaggcca accagtctac acggtgagac tctgtctcaa aaaacaaaaa caaaaacaag 1025160
 aaaacaaaaa tagatgggga ggggtagagg agagagatcc taacattaaa gaaggaaaca 1025220
 gtcatctact cctaggccca tcgattttct ctggattgat taaccatttg cctgccagtg 1025280
 tctgcagtga acaggtgtgt tctctctaaa agaccaagge aggtactcaa actgccttea 1025340
 cagatcactc cccaccacca acccacaana gccaggggtg gaaccaggg cttctctcat 1025400

tccaggcaag cacaactcca gccctgcagt cagtgatctt tttttctgt caaatagctc 1025460
 cccactaggg aattcttcac cagtattggt ttctattgt tcaagctaat aaaacaagaa 1025520
 ctaaagttaa gaaacttaa tgctaagtta gaaatcatta taacagaatt gttctaactt 1025580
 tagcattgca ctacaattga aatgtttagt ctttccatta agctctaaca atgactaata 1025640
 attaccaag taacaacgag caacagagac agctagtttt taaatggtca atgcaatgat 1025700
 gaagactgtg gcataaaatt atgggagtag cagagaggaa tcctgtcct ggctgaaggg 1025760
 ctgaaaggga agaaggaagc aaggcaacct tcccagaga ctcagctgag cctgaatct 1025820

tccttcagct cagccctcat ctcaacttgt aataaatctg gcacaaatgt gtccaaacct 1025880
 atctaagggt ttgtaatgga gcaccccccc caaaaaaaaa acacacttca aagagcacat 1025940
 tgttacacat ctaagaaccg aagtcacctg caagcaaagt aaatgatcga aataatcagg 1026000
 tttgagatta tttgtatttc ttcaaagcaa tgagggatta aaggagaaga gtgagaagtg 1026060
 gagggcaagg gggaggcata gatgaagaaa gaggagcagg aggaagactg aactggtccc 1026120
 ccacatagaa acccnaaatt cacttttata cagagactgt ctcttccat aatgcaattc 1026180

cacctgatc agcactgaca gagagcaaat caccatgaac cccagcactt ctcgatgatct 1026240

 gtagcagagg aatggaggat atttatgctt tgaatatataa gtgctttgaa atttcctgaa 1026300
 tgatgatgct aagtgcaaga tgttgctatt atgtccctg catccttct cagggccttc 1026360
 aggagacttt cagatgttgg gaaggtatta taatgatgtg ggggtcaagg aaaatggtag 1026420
 gcaaatgttg gtacagacat ctacaacaa tacccatgtc atcttttcaa aactacattt 1026480
 cactcactcc acagcaaagg aatTTTTTat aagcttggag agagtgcagt aatacgattg 1026540
 tctggcagag gctgctttct tccccacct ctgtagggat ctattaaaga agcaggaaat 1026600
 ggaaagagag gcagtgcgtg tgatggatgt cacttaacat tactTTTTat gaagtTctgc 1026660

 aaaggccctt ggiatagca gacgtggaac aaggtaagca cataaataaa cgatcacctt 1026720
 gcattccagg gtcatttgc tcagccctt ttgtgaactt gctgggactt agtgaggttg 1026780
 caagagagat tctagaaga gtataatatg atcttgcac agtccaata tgtggaacaa 1026840
 aacaaaacaa caacaaaaa agatttgtgg cttttgtctg caagatctga tggattaggg 1026900
 tgttagattc ttcactgttg gtaggggaaa acgaatgctc caatccccca tgcctctgtg 1026960
 actgtttcat tgcgctttta tggatgcttt tgttctgac tggaaagtgc gtaaggctca 1027020
 gaccctccac aggccagtaa tggagctatg agaagccaca tatggccatg cttataataa 1027080

 actgtgctga tccgagtgc accagggagg atgcttagta acaaaacaaa ctcccaaaca 1027140
 agtgatcaca gtgccttatg cttgcacagt gtctttttgt ctagaagctt ctccaagcat 1027200
 tttacaaact tgtataaagg gtccctcacc agtcattggg atgcagttgc atctagggca 1027260
 gaataaaggc aacggctctg ccagaaaatg aacatgcttt caagaaaagt tgtttttag 1027320
 gctggtgaga tggctctttg gcacctgata ccaagtccga cgacctgaat tcatccca 1027380
 ttcaatcccc aggactcatt tggttggtta aaggagagaa tcaactccta caagctgtct 1027440
 tctgacatcc acacagatga cccacacaat gcatacacac aaattgtgtg tgtgtgtgtg 1027500

 tgtgtgtgtg tgtgtgtgtg tgtgtgtgta tacacactct ccgagacagg attcctttgt 1027560
 gtagccctgg ctgtcctgga actcactctg tagaccagga taaatttgaa ctcacagaga 1027620
 tccatctacc ttgcctccc gagtgtctggg attaaagggtg tgtacatca ctgcccggct 1027680
 taataaatt ttctttaagt taaagaaaa ggccttttg aaagtgtagc tgtaaaatct 1027740
 tctgatTTTT ctttttcag gtcatgaggg gaggatttaa gctagtggac acagcacagg 1027800
 actattgtct taaggaacag gatgggtatt aaagaagctg ccacacactc ttcacccttc 1027860
 ctaatgacaa gatccaaaat aaacaggtca aataagtgtc ccagctagcc agaagtgtgt 1027920

gcatctgcca gaggcagggc taggtgacag aggccacatt ttctgggagt tgtaagatgg 1027980
tgaggtctgt tagaggtaga agccccagat tctttatcag cccagctggc agaatcagtc 1028040
tcctcagaat ccgtgcttaa cccacaactc tgggcctagt caccagaaaa acctagtaca 1028100
gaagttctcc acggggctag ctttgtgttt gaacctacag gggagttcag actacacagg 1028160
gggttcaagg ccagtgtgga ctacacaaga ctgaggcttg agggaaaaaa ataataaata 1028220
aataaataaa taaataaata aataaataaa taaataaata aatctctca tgactccagc 1028280
agcatccctc aagtcaglat gaataaggat tataacctag agtcctgggc ttttatTTTA 1028340

agacagccat tctttgtaga ttggctctca actcaaaatc ctacctcagt ctctaaatt 1028400
ccaagattac agttatatgc caccatggcc atttgctaaa cctgttcagt ttccaaattt 1028460
gaatattatt gtcttagttt tgctcactgt actaaaaaca gtgtctaat ccctctcct 1028520
caaaagcaag gtctaagata ggctttatcc ttccattaaa tgttgtgtct acagtcttg 1028580
ctaagctctg gcatgacctc atgtttacaa cacattaata tgcaggctta ttctccacat 1028640
tctttctgg tggcaataat tattatagac ccagccaaga ctactcct tatcagtttt 1028700
tccaataatt ctacctgca aaaaaaggca gttttatcct tcttctggc agaaatttg 1028760

aagcaaagaa ctccagtga tctcacctg acagagtta ctgcattttt ctgaacatac 1028820
tgcaagacat ttattagtag actatgaagt atttataatg gtaattaaaa ctaagctatc 1028880
acaaatggag taaacgcaga gccagagata atgctgttac tttttattgt gtatttgctc 1028940
ttctgtaat ctaataataa aactcctca ctaagttgct aaggcattta tcttaaggct 1029000
gatgttacac aaatctgttt cccacaagga agaccataa catatacaa gtcactatta 1029060
aaagagtcc aagtagcaa tgcatagaac tctgtgctta tactgctgat agatataaat 1029120
atagattttc ttaagaaaa aaaaagaagg caagccaggc agtggtggca caggtcttta 1029180

atcccagcac tcggaaagca gaggetggca gatctctgtg agttcaagc caacctggtc 1029240
tacagagctt gttccagcca aggctacaca aagaaaccta gtctcaaaaa aaaaaaaaaa 1029300
aaaaaaaaaa aaaaaaaaaa aacagataga aaaaggagga ggaagaggaa gaagaagaaa 1029360
ataagaagge aatttgaca cggcacaaat attcacacct ttcagcctaa aacttcact 1029420
agtcttttc ctaactaatc agactcaggc atggtagctc ccagtaactg tagcggtgta 1029480
aaacaggcag acagatcttc ctaagtttga ggccagccta gtctctatag tgagttcaag 1029540
ccagccaggg ctacatagag agactctgtc tcaaaataag acaagaaga gaagagggga 1029600

gggaaagaag gggaaagaaa gaaagaaat agttactcat gaccttagca tggtagcata 1029660
cacctttaat cctggaatt gagagactga ggcaggggat caccataagt tcaaagatag 1029720
tcataatac aaagtaatt cctggtcatc attctgcgac acagaatgag gctttaatt 1029780

tattttttt taatctagat atgtagatgc ccctcaacta aagaatagat aaagaaatgg 1029840
 agcagcagtt taaaaaagca atgatatctt gaaattcaca ggcaatggat gggactagaa 1029900
 gaaaccatcc tgagtgaggt aaccagaca gcaagacaaa cacagtatgt actcacttat 1029960
 aagtgaatat tagacataga gcaaaggatt accagcctac aatccacaaa cccagagaag 1030020

ctaggaaca agggctctaa gagagacata cagaccccca agaaatggaa agagacaaga 1030080
 tctcctaagt aaattcgggg tgtgggggga ggggtgggag cgaagagaga gaggaggaga 1030140
 gaaggtgagg gaagaggaga acatgaggga ccaggaaggt ctaattgagg gaaggacaga 1030200
 gaagaacaac aaggaaaaag ataccttgat agaaggagcc attacaggtt taaggagaag 1030260
 gctatcacta gggaaatctc cagtgatcca caaggatgac ccccaataa gaatctaagc 1030320
 aatagtggag aggctacctt aaatgccctt ccctataat gagattgcca tcctagagcc 1030380
 ttcatccagt agctaataga agaagaagca gagatccaca gctaagcact gggctgaact 1030440

tgtgggtcc agtttcagag aaggaggagt gatgagcaaa ggggtcaaga ccatgttggg 1030500
 gaaaccaca gaaacagctg acctgagcaa gtgggagctc atggaccca gtctaacagc 1030560
 tggggaacca gtataagacc gaactaggcc ccctcaaagt ggggtgcaat tgcagagctt 1030620
 gagcagtcta tgggcctct ggacgtgaa ccaggattta ttcctagtgc atgaactgga 1030680
 tttttggatc ccattccctg tggaaagata ctctctcagt ctagatacag aggggagggc 1030740
 ctaggtcctg ccccaaatga tgtgacaaag tttgttgatt tcccatggga ggcctcacc 1030800
 tcctgagga gtgaatgggg ggacggatgg ggagatggtg ggaggatggg agggagaagg 1030860

aactgggatt ggtattttaa ataagattgt ttttaatttt ttttaattaa ataattaa 1030920
 acttaaaata aaaaaactag atatggcagt gcacacctat aatctcatta ctaagagggt 1030980
 agaagcaaga aaaccagctc aaggctctcc ttgacctcat agctaatttg tggccagcat 1031040
 aggcacatg agacccttc tcgaagaaaa aaaaaaaca aaaaacaaga tagatagata 1031100
 gatacataca tacatacaca cacacacaca cacacacaca cacacacaca cacacatgtg 1031160
 aaaaactaga atttatcaa gcaatattag taaatcacca gaacatgaat gctgagctgg 1031220
 aaagatgact cagtgggtaa aggcaactgc tgcaaaacce agtgagttca atcccagaca 1031280

cacgtatgta tggtaaaaga aaagagctga ctctgaagg ctctcctctg acctccacac 1031340
 aaagaccac aaataactaa tgaaactgta aaaggaagac ataaggttga gaacaaggcg 1031400
 atgacacagg cctacaatcc cagcacttag accaaaggag gagaagctaa agtacaaggc 1031460
 aatcctagge ttcacagiga gacaagagat ggatggaggt caattgggat cagtaaaaag 1031520
 caattcggte tcaactaaaga ttgagacgca cctgaatggt ctaaatcaaa agcacctaat 1031580
 gaccccaaat tcagtaggat gtgtgagcac acacacaagc atgcattcga gtgcacacat 1031640

gcagctacag agcagacctc aaggttactic cagcttgtct ttgctacaca caccctgta 1031700

ataggcatag ttagcctaga gacctccaac aaacaggttc ttctgacaac actagaaaca 1031760

agatttaatt taagttggtt ttaagtctct tccattggcc ttgggaataa aagacagcag 1031820

gctcatcatt catgaaacac ttattgcttt tgcatcaaaa tccctgcaaa taaagaattt 1031880

tctctctgaa agtgtcattc tttgggcttc tttctccttt gtcattccagt tggagattc 1031940

atacatagct ttctgttgg aaaatgctaa ttaatggaga aaaagagggg gccccctttg 1032000

ggctggtggt gagagtccca ggtggcagca tccccttatg tcttcatcag tggctgagga 1032060

aacctggagg gcacgcctcc tttcagcacc tctcacacac ctgcctgtat tcccaggctt 1032120

tagggcaggg atagaaaggc tgccaccaac cttactctc tttgctgtaa tggtttttga 1032180

agggtctctt tttcccaaag aaataatgaa tgcctctttg caaactgtcg gggaaaacgt 1032240

tctgttttga ggtaattgaa aatagtttt tgcagccgct tctgaacat tttccaaaca 1032300

gctttccttt ctaattaact cacaatgctt agctccgtga ttcaccgggt agacagtac 1032360

atctagtgtg tacagacaga gttgggagaa cgccttagac acagatttgt aagaacaacc 1032420

aaaaaaaaa aaaaaaaaaa aaaaaaaaaa aaaaaaaaaa cgatacctct attccaatgc 1032480

gggggattgt caaatgcaa atttggcatc atacaggttt gtaagcactt gaaattatca 1032540

aaggagtgtt ttctctttag acacttagaa aaatctggat gttttaaggt acattttagc 1032600

ccagcattcc taccaccca gcacttggga gataaaaggc aggaggcgca ggagttcaag 1032660

ggcagcagct acactgggga attcaaagcc atcttgggct acataagacc ctgcttcaaa 1032720

acacaaacaa aaagagccac attttatcta aagaaataaa tgacctaaaa aaaaagtagt 1032780

ttgaggatat gatgaagtca ttacacttga gagatgaaat ataacttttc cctgagttca 1032840

gaaaggaact ttcacttgaa agtgaaaatg aaaaggattg tgggtgatca gctgccctg 1032900

gatgttacag gaatttcaa gctttgcagg tatacagaga aaacttttag tagggggctg 1032960

gacatctagc tcaattgaga gagtatttgc cagcatgcac agagccttgc attagaactc 1033020

caataccaca aaaaccagcc atgacaatac aggcctgtag gtgaacactc agtaatataa 1033080

acaggagagt ccgaagtcca aggtcatgct tggcaacata gggagttcaa ggtcagcttt 1033140

ggctaaatga gaccacatt taaaaaaaaa aagaaagaaa gaaaagaaaa gaaaagaaaa 1033200

gaaaagaaaa gaaaagaaaa gaaaacattc tgcaactgac ctggacattt cttttctgac 1033260

agctagcttt cacagcacca aaggaaggct ctgttcaggc tgcggaggca gaaaagacat 1033320

caatggtctt atccggcagt gacttccggg cagggtgtgc ccactgatgc aacagcagaa 1033380

tgaatgttca agggaataac caactgctct ctgactacat gagaaaattc atgcctagtt 1033440
 ctgtaatgtg gtctaaaggc catgctggg aaggctgttg ttttgctaaa agtcaaactg 1033500
 atttctcaat aattatgac ataacttttag acagtgtctg tctcaacctt ggtcagagaa 1033560
 gtttagtttt acattaggca gcagttaatg ctcagattca aattgggtgat tgctgggtac 1033620
 tcaccctaa acagaacacc agcatcatcc aaggctctgg gaatattttg gaaaaggag 1033680
 tagagagaac gcaagagcca ggggagtggg agggcactgt aaacagctgt ctccggaca 1033740
 tgcattggcca ttatgctcat taactcacag caactgtggt tacctggaca acacttgcatt 1033800

aaactgagc ccagtcatac tttgtcatgc atgaaggaag cacatgaact agctgaagga 1033860
 ctactgcagt tactggtcac tgacagagac agagacattt ttctctaggg gtaaagccag 1033920
 taatccagta aataaaccca tagcaagtgc atgcaaccac cataattaa cctagttctt 1033980
 agttaaattg aattttaaag acctattttc tttttatgtg tttgtgattg tgtgagttaa 1034040
 taccacatgt acaagggtgg ctaaggaggc cagaagatgc cagatccctt ggagatcaag 1034100
 ttccaggtgg ttgtgagcca cctgacctgg gtgctgggaa tcgaacccta gtattttgga 1034160
 tgaccagtaa gtgcttttaa ccatactctgg ccattctcct ttcccatta aattaaatat 1034220

attttttatt tattactta cctattgtat aacagaagat cactgtcact gccacttag 1034280
 caagcacaaa tggccaacac aggtcatatg tactgtggtg aatcatggaa atccctgctt 1034340
 ccaaatataa acatgggagg tacatagagg aggggtctt acaaaaacat aaaaaataa 1034400
 aaaataagaa ctttttaaat gagatggatc aaattacaaa caaaagcctg gcagggtggc 1034460
 acacacctcc aaaccagca tatagaaggt taaggctttg tactggtttg gtttttgttt 1034520
 gcttcttttt gtcagtttga cacaagttag ggttatatag gaaggagacg tctcaattga 1034580
 gaagatacct gtgagattgg ccggtaggca agtctgtagg gcattttctt gtctgatgat 1034640

tgatgtatgg ttgcattcca tagcttctg gctgataac agaacatgaa gcaattgtga 1034700
 gcaattgtga gcagtgtcac ccccaggca atggtcctgg gggataaga aaacaggtgc 1034760
 aacaaacctt gaggagcaag ccaggaagca ttctccaca gactgttca gtgcctgctt 1034820
 ccggctcctt acctgagtt cctgcctga cttccctcaa cgagaaactg tgatctcaat 1034880
 gtgtaagcca aataaatctt tctcccaa attgcttttg ggttaaata tttatcaca 1034940
 gcaatggaaa gcaaatagg acaggcaggg aacctgaatt ccaggccagc atgggctaca 1035000
 taatgagact gtgtcttaga aataagaaca agccaggcat gagggtcaa agcctagtag 1035060

ttaccaggct gaaacagggt gctttccagc ctatgccatg tagtaagttt cagactagcc 1035120
 tggcctataa ttgcaacctt gttttaaata aaaataagat aataataatt ttaaaaagac 1035180
 atgtatggat agaaagaaa ggaatttggg gtaaggaaa tatctctctc tgtctctctc 1035240

tctgtctatc tctctgtctc tctctgtctc tctctgtttc tctctctctc tctctctctc 1035300
tctctctctc tcacacacac acacacacac acacacatac acacgaaaat cacagatggt 1035360
gaaaagatct aaggactgct ctgatcaaag agcacaata agttgacacc aatgccagtg 1035420
ttaggtaact aaaggggaga ggcagatagt gatgggggct tctttctgtc tgttttgggt 1035480

ttgctttctt gagacaaggt ctcagtgtag ctcaggatag cctggaactc actatacagt 1035540
cctggatage ctggaactgg taacagtcct gctgcttctg cctccatagt getggaattt 1035600
caggcatgag ccaccttgcc cagctcagaa gatggaatca atggatcat ctcacagtcc 1035660
ctcaaatgcc tacagaagt ccccagggga tccttgggtc ctgtgacatg gctgtatggt 1035720
tgcattccat agcttgctgg gctgataaca gaacatgaag gcaaaaaaga atagtggta 1035780
gcaatcacct atgacagcta aggaggtagg gcaaacgtgt cactgtcata gcacaggact 1035840
ggacaatggc cattacggtt gtggcagagc agagccatcc atctctgtcc tegtccatca 1035900

ttgagtgagc tctatgcaag agtctctccc tcttcagact gaaggagaaa aattgttcat 1035960
ggtgaaagtc actatctatg acctaatctg tctgcttct gggaaaagag actttctaaa 1036020
cagacctate aaagccaggt cacctctgct tgetgaagtc aagactcctc acttaaaaca 1036080
cccctgttct aaatactgta gtgacttctg ggtggaacag taagttagaa acctcccaga 1036140
taggccactg agatgactca ttgggtaaag taattgctgc accacctga taatctgagt 1036200
tggaacctg gaacccctgg aaaggggaaa ggagagaaca aatattctca catatataaa 1036260
ataaaataaa tctaaaagaa aaaagtggca ggaatgaaca cagacaaaa ggaacactta 1036320

cactccactg atggcaatgt aaattagtcc agccactatg ggaattagta aggagggtcc 1036380
tcttccatag gaccagtta cccatgtcat acctatggca tacatctcag aggtgtttgc 1036440
acatcagtgt tcatgatcag ccatttgtat gcaaaacca gacttgccga tttcatgagg 1036500
aacaattg aacccagat aggttattaa ctggtaattc attgggaata tatactcaca 1036560
tgaggaatca gtaaccagat ttggcactcc gagaagtcag gaccagatg cttccaggag 1036620
ctggctgaac cctgagagag agcgctaagc gcctctggtg ctctctcttt atcctacct 1036680
ctacatactc aaatgggtgt ggtcagcagt ataggtaacc aggtctttc cctacacccc 1036740

ttcactagta cttttgtta ataggcaaac ttaagtatta ataatgatca acagaatgat 1036800
aggtctcttc atccttgata aaagagtaat acaactgagt taggcaggct ttagaaaaga 1036860
tgaactacat tgiaagtaa atttcactaa agcataatat taaatatatg atgtttaata 1036920
tgatggagtg ttactggata gagcaaccac actctaggag tagatggcca acacaaaaca 1036980
aactcaactg tatttttgg gattttttg ttttgtttg tttggtatit tcttatctta 1037040
ctggtctttg gcttattcgt tgttttagtt tttgttttgg tgtttttgta ggggggattg 1037100

tttatttctg ctttgaaaga gagagaaaga atataaagt gggtgcatag gatagtaggg 1037160

 aagaccgag agccgtgagg ggagaaaaa catgaccaag tgtgttatat aaaaaccatt 1037220
 tgctaaggcc aagcagtgg agcacacagc ttgattcca gcacctgga gacaaaagca 1037280
 ggcagatctc tgagtctgag gccagcctta tctacagagc aagtcttagg acaaccaggg 1037340
 ataccagag aaacctata gggaggagt aaatttaaaa agaacaaagg ttagagagaa 1037400
 cagttctgcg acacaggctt ttttattttc ctagtaaatc cacttttgtt ttaatgagag 1037460
 ccagtctgaa tgaagtctg cagatcatgt aagaatgcct tcattctcac ggggtacgtg 1037520
 atccaagcga aaactggacc tcaccaaga gtgatcacat tcagaactct ggggaattatg 1037580

 aaaggttctt aaatgtatgc tgaagaaagt caagggtgga ctagtctgag ggaaatgaga 1037640
 aagacactga cctattagaa gccagccaag tcagtagccg taacatactg cacccgccag 1037700
 gattttacca gacagatttg ccagactgaa agagagattt attgcaaaga cttggcttat 1037760
 glaactgtgg atcagctaa cggttccaaa atccataggg cagatggcag gctggaagct 1037820
 gcagacctca tggaaacttc cagttctgtt ttaaggcag actaagtctg ccttcagat 1037880
 cagtgacat cattcccttt tcccaaaact gatggattgt ataagtacaa aattacctca 1037940
 cagcgacacc taagttagt gggggctgaa caaatatgga ttatagtcta gtcaagtgg 1038000

 ctacaaaaa attattaaca aattgctagt gttgttcagt gtgctaaca gcagattgca 1038060
 aagatgaaaa ctaactacct ttgaccagtt ttggctagca aagcacagaa tagagagttc 1038120
 cactgtaggg atggagtgag aggtggagaa cttcgtgcaa cctgagtcag gagcccact 1038180
 atgctgcttc cttggccttc ctatgtctta actgcatcaa cagtaaaata acaggacctg 1038240
 cctcatctca gctgtgacgc ttaaagtgg aaagtgcata gaacactact agaaacatag 1038300
 caagtagtta agtgtcaaca ctcatcactg gcattacctg gtatgactcc tgggggatgg 1038360
 gtaaaactta tcttgagta tgtgccaggc ataagaaata gaaagtacaa aggcacaaag 1038420

 gcatactgt tatgcctgaa gaacagccaa cgaagccagg acacgcactg gtgagaaaga 1038480
 accaggttgg atcggttgg tccaggcgg ctgcaagaca gtgctgaatg ctgtggaaaa 1038540
 gaacaacttt gtctgcagc aagaagtctt tccttacaca cacacacaca cacacacaca 1038600
 cacacacaca cacacacaca cacaccaacc aaatctcaa attcttgaa tcccagactt 1038660
 cagctaccaa ggcgcatcaa tgaggctaca tgtgaatatt acttcatctt tgaggcactg 1038720
 agtgtctgtt ctgtgagtct gccccacaca aacagtcac tttacacagc tatggaggat 1038780
 tggttctcag acttccaaa atcctgggat acccaagttc ctcttaatga atagtgactc 1038840

ggccatgac tcagccagga gagcactagc acagcaaaca agaagccctg gtttccttcc 1038900
 ccaactgcat ataaagtggg cagcccacac atgttatccc aggacttagg aggtagagga 1038960
 taaagttagc tctctgaggc tagccagggg cacatgggtc tctgtctcaa tagaaaagca 1039020
 aaataaaacc acccctgggt gaggagctat taataactga tggctcctgg gggagacaaa 1039080
 gacagttttc tgtaagagtg tggcctctgg tggtttgacc accatccagt ggatggcccc 1039140
 atacccatag aaaaatgggt agcagaaaac tggactctgt gggttatttt tttttaaga 1039200
 agacatgaag ttggaagga caggaagtgg atctagcagg agctaaggat aattacatta 1039260

 tattgtatgc agttctcaaa gagtaaaaat atattttaaa atggataaaa taaaagggct 1039320
 tccatataac ctacaaacat ccacctatgt tcattttatg tgtgaggtgc tttgcctgca 1039380
 ggatgtctg tigtctacac aattacctgg tgcccctgga agacagaata atgcaccaga 1039440
 tctctggat ctagagttcg agagagttgt gagttgttat gttggtgcta ggaattgaac 1039500
 ccaggccac tgaagagca accagcagtc ttaaccactg atccatctct ccagcccaa 1039560
 cctgtgttct ttaaatcatc tctagattgc tataatacat aatgtaaag cttattgagt 1039620
 tgttatgctc tattatttca gaaacagtaa ggagaaaagt ctatataggt taatacaaat 1039680

 acttggctca atgtttccca agctattttt tgaaccaca gatgtgggat taatatgtcc 1039740
 aagcattcca tagagacatt aatgtgagtt ttccattcaa tcttggtagc aatttactga 1039800
 caccatcatg gatggggcag gactctaaac ataactctga atgcaagacc taacaccact 1039860
 tcagtcttc atgcaggatc aggatggcta agccatatca aaaccatctg attacagaca 1039920
 agtaaaatca tacagacca atgaatcaaa gataactgat tgtctccaca aaccattct 1039980
 ctctacctgg ctatatgacc atgttataat gtacagactg catttccagg cccttctcat 1040040
 gtagatgaag ccagataatt tgtcaccaat gcaacatgag cctaagtgat atatgcatct 1040100

 tctagacata tatgcttga ccttagaaaa ctcacatgtg tactccctct tetatgtccc 1040160
 tcttccctca accagtaata ctggcttttg tttttgttt tgtttttgtt ttttcagaca 1040220
 gggtttctct gtgtagcctt ggttgtgcta gaactcgttg tgctagaacc aggctggcct 1040280
 caaactcata gagatcgatc ctctgcctc tgtctctga aactggaat caaaagcatg 1040340
 caccaccacc agcagctttt ttttttttt aaatacagg tagcatgtgt ggcaggctgg 1040400
 ccttaaacte actgtatacc tgaggatgat ctgaaactcc tgatccacct gtctccaact 1040460
 aacctagtgc tgaattaca gatgtgcacc accatgcca gctcagcttc ctacacaaaa 1040520

 caaaacaatg aatataatta aattcccagg caaatgacct cgtccaggaa acaccaagt 1040580
 ccctgctact gcctcagcaa caattcccag taccagagtc ctaaaggtag ctgagatacc 1040640
 tgtgactgct ctaaggggac tgggattaga aggtgggaac gagacaggac ttaaagagga 1040700

gagaccaggg attgcagctg aggtggggcc ggtacaaaca gagtccagtg tgaaccagtg 1040760
 tgggtcacct atgagggttc acccctatca tcccagcatt caggaagctg aggaggagga 1040820
 tcaagaaatt gtgccagagc ctggtgatgg tggcacgtgc ctttaattcc agcacctggg 1040880
 aggcagaggc gggcgaatct ctgagtttga ggccagcctg tgctgtagaa taaacttttt 1040940

 gtacactgtg actaggtgtc actcagattg acttaataaa aagctgaaca gccagccggg 1041000
 cttttcccca gcaactcggga cgcaagggca ggcggatctc tgtgagttca aggccagcct 1041060
 ggtctacaga gctagtcca ggacaacctc caaagctaca cagaaacccc gtctcaaaaa 1041120
 aaaaaaaaa caaaaacaaa aacaaaaagc taaacagcca atagctaggc aagattttca 1041180
 gggcagagag aatgctggca agaagggcag agaagccaga cagatgaggg atgagtcgga 1041240
 cacacaaaat gggatagagt taaaagccac gtaggttaat ttaatttata agagctagct 1041300
 aaaaacaagc ctaagctatt ggctgagcat tcataattaa taagaagtct ctgtgtctac 1041360

 aaagatgaca ccagctaaca atctaagcaa caaaggagag gctaccttaa atgccctccc 1041420
 ctgataatga gattgatgac tgacttataat gctacctgat agttctcatc cagcagctgg 1041480
 tggaaagtaga agcagacagc cacaactaat cannnnnnnn nnnnnnnnnn nnnnnnnnnn 1041540
 nnnnnnnnnn nnnnnnnnnn nnnnnnnnnn nnnnnnnnnn nnnnnnnnnn nnnnnnnnnn 1041600
 nnnnnnnnnn nnnnnnnnnn nnnnnnnnnn nnnnnnnnnn nnnnnnnnnn nnnnnnnnnn 1041660
 nnnnnnnnnn nnnnnnnnnn nnnnnnnnta gaagcagcca cccacaacta atcaactgagc 1041720
 taaactggaa tccagttaca gagaagtacg agagatgagc taagtcaccc agaccaggcg 1041780

 ggtgaaacce acagaaacag ctgacctgaa caaaggggag ctcttggtcc ccagactgat 1041840
 aactgtgata ccagcatggg actgatccag acccaggaa catgggtttc attgagaaaa 1041900
 cctcggaaat ctacaggacc tctctagta atccagtact taccctagc ataggtatgg 1041960
 actttgggag cccattccac ggtaggggtc ggggggtggg ggtgggggtg ggggggaggt 1042020
 gagggggggg gggggggggg gggggtcatg taaaacaatc ttgtttctaa ttcaaatttt 1042080
 aaaaatgtaa aaaaacaaaa aaagtctctg tgtcaatata cactgaactg aactctggaa 1042140
 cttagttgca gagagggagg aacgaagatc aaaggggttg gtaccagggt ggtgaaacce 1042200

 acagaaacag ctgacctgaa caagggcctg ggaggtcagt acaggactga tgcagacccc 1042260
 tgaacatgga tgtcaattag gaggcctcct cactctggag ggccctggt agtgatttag 1042320
 tttttttttt ccctggfata agaagggatg ttgagagccc atcccatgtg aagggatgca 1042380
 ctctcggcct ggacatafgg gggagagcct aggcccagcc caggatgatg tggtagactt 1042440
 tggggagccc ctgttagggc ccctaccctg cctgggaagt ggaggggtgga tggggtggag 1042500
 ggtaagtgg ggggagggga gaggaaggg tgagggagaa gggattgaca tgtgaagcaa 1042560

gcttgtttct aatttgaact aataaaaaaa atttttaaaa agaagtctct gtgtcatgat 1042620

ttggaagctg gctggtggga cagagaaaga ctggctacaa acctgatgta cagaacaggt 1042680

tccaggacag ccagggtctac acagaggaac tctgtctcaa aaaaacaaac aaagaaaaac 1042740

aaagaatttg agccagcctg agctgcatag ccagaccctg tctcaaaaa gaagaaagga 1042800

aaaaaagaaa agaaaccagt gagttggctc atcatctggg taatggcact ggtggccaag 1042860

cctgacaate tgagttggat ccaccatgt ggtggaagga gaaaacagtc tcccacaaga 1042920

tgtcttctga cctccacatg tccgctacta cagcaagtgc acacaaacca taaataaatg 1042980

tgtccccatt tgcttctctc ttgccgtaat aaaacattcc agccaaaaac aactttggaa 1043040

ggagagagtg atttagccta tgtgttctca tcacagtcta tcaactaagcg aagccagggga 1043100

gagagctgaa caggagcaga ggcagggaca ccaggaag cttcttattg gcttgcttcc 1043160

cacggcttgc tcaaccatt ctcacacaag gggcagggcc ctctacagc tgttgcattc 1043220

aggtaatgcc tccacatact tgcttacaga acaaaggat ctcttaatt gaggttctct 1043280

cttgctcaa attgacaaaa ataataataa taataataat aataataata ataatacagat 1043340

attgtggctg gtcaaggga atgagttacc tcaatagcag cactaagtcc attagagaca 1043400

gggctggctc ctgctcacc tcttactagc acttgactga tccttcaaa gcagatacac 1043460

ctggatgttt tatcatacca agcagcaaca cagtgtttgt aacaccggga taatgtcacg 1043520

atactctagt gtggctctac ttctactctc atttacaggt aaatttcccc ctccccccc 1043580

caccaaacac tccactccc ctctcccaca cccacccac ccccaaggc tcatgcataa 1043640

ccagctagaa ctacagatt ttaagacttg agtaaaaaga aaccacgtac attcatatcc 1043700

ctctaaggat gaatttggag taacctatca caaaccaaaa taaataattt taaaaatcaa 1043760

attcaagata tatgttagaa atcataacag aatttgggtg cacatacaca ctgtggtaat 1043820

tattaacag gaaagataac acggtatagc ccaataattg agtgttataa agtttccctt 1043880

ctgacttaaa aagtggaatg agggctagag acatggctca gaaattagaa gcactggctg 1043940

ctcttctaga ggtcctgagt tcaattccca gcaaccacat ggtggctcac aacctctgt 1044000

aatgagatct ggcgtcctct tctggcatgc agaagtacat gcaggcagaa cactgtattc 1044060

ataataaaca aataaatctt taaaaaaaa tagtggacaa gtgtggacaa gacggctcag 1044120

tggctaaagt tgttgcgcgc tgtcctaaca acctaaagctt gatccctgga gctctcacta 1044180

tagaagtgag aattgattcc tgcaagttgt cctctggcct ccccggtat gccatgaaca 1044240

aaaattaaac aaacaaacat gatgttagg gggcaagggt tctctgtgta atagttctaa 1044300

ctgtccagga acicacttag tagaccaggc tggctttgaa ctcacagaga tccacctgca 1044360
 tctgcctctt gaatgcttgg attaaatttg tftgccacca cccagcaatt ttaagggttt 1044420
 tttttcctaa gattttattt atttattatg tataacaacat tctgcttcca tgtatatctg 1044480
 cacaccagaa gagggcacca gatctcataa cggatggttg tgagccaccc agtgggttgc 1044540
 gggaattgaa ctcaggacct ctgaaagagc agtcagtgt cttaacctct gagccatctc 1044600
 tccagtcccc aattttaagt tttttaataa actattttta aacagcatga ggggggaatc 1044660
 cagatatcat aagagaggaa gtggfagac agaaaagcaa aggtcactca ggaaatgaat 1044720

 agcaatacag gtttatataa tattgtcaag aagggtaga gagatggctc atgattaagg 1044780
 gcactgactg ctcttcaga ggacctagt tcaattccca gcaccacat gacagctcac 1044840
 aactgtctgt aactgcatga tccaacaggc tcaactcagac atatatgcag gcaaacacc 1044900
 aataaaatta aattaaatta ttttctgt tttatttaa ttagaaca gttcattta 1044960
 catgtcaatc acagttccct caccctccc tcttcccctg cccctacca acaccctatc 1045020
 ccacccctt tctgtcccc agggagggtg aggcctcca tggaggatct tcaaagtctg 1045080
 tcataacat ttggagcagg gcctagacc tccccgtgt gtctaggctg agagagtacc 1045140

 ctctatgtgg agtgggatcc caaagtccat ttatgtacta ggaataaata ctgatgcact 1045200
 tccagaggcc ccatagatta accagacctc caaactgaca tctcattca gagggctctg 1045260
 aacagtccta tctgtgttc ccagctatca gtctgggtc catgagcaac ccctgttca 1045320
 ggtcagctgt ttctgtagt ttctccagcc tggcttgac cctttactc atcactctc 1045380
 cctctctgca actgggttcc agggttcagc tcagtgtta gctgtagggt tctgctctg 1045440
 ctccatcag ctactggatg aaggctctag gatggcatat aaggtagtca tcaatctcat 1045500
 catcagagaa aggcctttat ggtagcctct cgactattgc ttagattgtt agttggagtc 1045560

 aacctgtag atctttggac atttccctag tgccagaatt ctctttaaac ctatagtgt 1045620
 tccctctatg atggtatctc tttcttctc ctctctatt ctcccctga ctggattttc 1045680
 ctgttccctc atgtcttct ctcccctcc ctctcccct tctctttct ctaactcct 1045740
 ctcactccc cacatgttcc caattagctc aggaaatctt gtcctttcc ccttctctgg 1045800
 ggccaaaagg ctccctctc taggtcccc tcnnnnnnn nngctgtagg cctggtcag 1045860
 ttcaataatt gagcaagaga tcagggtccc cagctgtctc aggacagacc caaagtcat 1045920
 accatTTTT ttatttgagt tacaacacg attgaattac atgacaatcc catctccagg 1045980

 ggccaaggtt tctgttttt aggttctcc ttgttacta gtttctctgg cactgtgtat 1046040
 ttaggctgg taatccctta ctctatgttt aaaatccaca tatgagttag tacatatcat 1046100
 gtttctctt ttgtgattgg gttactcac tcagaatgt tcttcagtt ccatccatgt 1046160

tcctgaaat ttcaagattc cattgttttt tctgctgag tagtactcca ttgtgtaaat 1046220
 gtaccacatt ttctctatcc actcttcagt tgaggggcat ctaggttgct tccaggttct 1046280
 ggctatgaca aatagtgctg ctatgaacat agttgatcag atgtccttgt tgtatgagtg 1046340
 tgcacccctt ggatataatgc ctaagagtgg aattgctagg tcttgaggta gactgagttc 1046400

 cattttcctg atgaaccgcc atactgattt ccaaagtgac tgtacaagtt tgcactccca 1046460
 ccagcagtgagg aggagtggtc ccctttctcc acatcctctc cagcataatc tgtcattggg 1046520
 gggtttgatt ttagccattc tgacaggagt aagatggact ctgagagttg ttttgatttg 1046580
 catttcctg atggctaaca atgttgagca cttaagtgt cttccagcca ttttagattc 1046640
 ctctattgag aattctctat ttaggtctgc accccacttt ttaattcgat tagttggtgt 1046700
 ttgggggact actgagatag acaattaata aacgtgacct cctgaaactg agaagctttt 1046760
 gtaaggacac agtcagcaag acaaaacagc agcccacaga atgggaaaag atattcacca 1046820

 accccacatc tgacagaggt ctggtttcca aatatataca aataaattag ttttaagaaa 1046880
 agactgttgg gccttataaaa tgcctcatgt tctctggcag aaagccctgc tttacacaat 1046940
 atccttttgt ataaaaggga cctagtgttc agccatgttg atctcagcca tcttcagttt 1047000
 ctgttttgtt tglatcctat gatttcaaac acagagctgc atggtcaaag agattgattg 1047060
 catgtcccca aaattcatat tggcatgttg catgccttac ctccaccatg gctgtattca 1047120
 ttagaggacta gaaactctgt aaaacctagc tacacagaga gagggacaga gaaagagaga 1047180
 cttctagaag acattgcatg gaaagacat ccagaaacac aaccatgg aagcatgatc 1047240

 ttatctgtta gactctagat taaaaatta ctttttgctt cttaacctc ccaggetgtg 1047300
 gcattctgtt atggtagagg tcaaggagat gttgtttgtc aatgaaacaa agacagcatc 1047360
 atttgcaaca catcccatta ttttataaat cacagagcac tgaattaaa taatgtgcca 1047420
 ttaaggactg cggacatagt tcatttgatg gactgcttgc ctatcatgca caaagttgag 1047480
 ttccatcctt ggcatgacat aagctaggca tgggtgctcg ggcctataat ctgagcactc 1047540
 aaggaagtag acacgggagg atcagaaatc cagggtcata ctgagctaca gagtaagttc 1047600
 aagggtagta taggtcacat gagactctca aaaaagaaag tcaactaacta gtcagagatc 1047660

 tttaaacatg gaaaatgtgc atcatacaat agatgaaata aagagctaga gagataactt 1047720
 agccattaag tctgtccctt gcagaagacc tggatttggat tccctaacacc cacatgatgg 1047780
 ctctcaacca tctataactt cagtcttagg gcatctgcat gcatgtgggtg tacagataca 1047840
 cactcgggca aaacactcat ataaataaag taaatctttt ttaaaaaatg actgaaaaag 1047900
 aattgaatga tgaatgtta aatgtccttg gaagtatagt cttcagacca gggaaatagg 1047960
 tttagggtgt ccctagctag gagcaaagcc tctgtagatc aggtggcct caaactctca 1048020

gagatccacc tgi tctctagc tcctgagtgg tgggattaaa ggcatgcacc tggctaagaa 1048080

 aaaaagaaat ttaacaaaa ccctacttgt aat tttatcc ccaagttggg cctgaaagcg 1048140
 ctcatgtgta gtccaacac ttttaagtgat ctgggttcaa ggaaaacctg agctacacag 1048200
 tgagtccac cctaaactag acaatacaga aagattccat taaaaagaa gagaaggagg 1048260
 aggagaaaga aagaagaaaa atgggaagga ggaggaagag gaggaggaga aggagaagga 1048320
 ggaggagaag gagaagtagg aggaggacga ggagaaagaa gaagaagaag aagaggagga 1048380
 ggatgaggag gaggaggagg aggaggagga ggaagccatc gctgccacca ccagtctgc 1048440
 ttggttatag gaagtgagtg aaggcagaag caaaagaatc aggagtctaa gcctcagcta 1048500

 cagagtgagc tcaagacgac tagcctgggc tttgtagtaa gacctgtct caaaaacaca 1048560
 aaaaaaaaa gaaaaagagg gaaggaggagg aaggaggaag gaaggaagga aggaaggaag 1048620
 gaaggaagtc acaaaactgc ccacaggaca atctaagga ggcaattcct caactgaggt 1048680
 tccttcttc caggcaactc taaatttga tcaagctgac aaaactaacc atgccagtgt 1048740
 ccctaatac cccacccca cccattcag ctaagcagtc tctcaaagt ctttgcccc 1048800
 accgaaaagt atggcagagg actcctctca tctgttagt gcctccaggt gatggggaaa 1048860
 agctgggcat gtgtctcag gcctttaatc ccagcactca ggaagcagag agttagaggc 1048920

 cagcctggtc tacagagtga gtttcaagac agccagagct atatagtaag accatgtctc 1048980
 agaaaacaag agaaagagag agagagagag agagagagag agagagagag agagaagaga 1049040
 gttgcaagtt tgaaaatgc ataataaat ccattctct gtgaacttgg ttaataaat 1049100
 taataataaa ataattttat cttttaata ataaaacagc ctttctcaa cattttagaa 1049160
 agataaaca tgiatcagtg ttatagggct ggagagatgg ctgagaggtt aagagtactg 1049220
 gctgctcttc cagaggtctc gagtcaatt cccagcaacc acatgctgac tcacaacat 1049280
 ctgtaatgag atctggtgcc ttcttctgac ctgcaggaac acatgcaggc agaatactgt 1049340

 atatttaaga aacaaataaa tctgaaaaa aacaatgat cagtgttata aagccaatat 1049400
 tagacctga cacacaaatt taatgaacce ctagtctgt aagtgcataa gtggagccag 1049460
 tttggaggaa accccagtg ggaggccttc atcgcccagc attctgact tctgtctccc 1049520
 tggccggtgc tggcttctc tccagactgg aggacattt tgactcattc cacacttga 1049580
 gacactgaga aagaacaac tcttcagagc ct tactcaa gttagatcca taacagctgg 1049640
 gtctcaggag agagcacatg gaaagaacag acatgaagat gcaacttcaa ggccaggagg 1049700
 ctctggctc tgcctctaa gacgagatca ttgcacatca gtcagcaact gcccacacag 1049760

gtaacaggaa acatcagaac ccaaaacatc tctctgctta cctagactga aaatgaaagt 1049820
 cagacattgt ggctcacagc taaaattcct atatatgtag cctgggctac ataggaagac 1049880
 ctgtatcaa caggaaacag gaagaagtga gggagggaga gagagagaga gagagagaga 1049940
 gagagagaga gaataaatat acagtgacat aaggatagag atggctcagt ggttaagagc 1050000
 attggttgc ctgcagacc acctaggttt ggtaccagc atccacacat agcagctaac 1050060
 aactatctat aactccagcc tgagaggatc agaaacctc ttctggtctc ctcacacctg 1050120
 ggacacaagc acacatgtag gccaaaatac acacacataa ataaaatfff tctttcactt 1050180

 aaaaagtaat tcttttcat ataaaataaa ttcgggggct ggagaaatcg ctcatcagta 1050240
 ctgttcttgc agaggacceca ggttcagttc ccaacacceca tgtcaggtgg cccacggctc 1050300
 tctataactc taatgtacag tctgcttacc gtcttgctcc agatctgact tcttctgggc 1050360
 tcttcaggca tctgtactca tgtacacata cacacataat ttaaaaagaa ataaataaat 1050420
 tcaggaataa acigaattag gattaggata gtgtttccac caagtgtca ggggccagaa 1050480
 ctgagctcag ccattctagt cagtagctcc catcctcaag gtctgaggtg ggtaatgagc 1050540
 ctggccatta ccattgtatt tatctcagaa gaaacaggaa aaaggaagct ggacattggt 1050600

 ggcgcatgcc ttttatccca gcacttggag gcagaggcag gcgatctct gtaagtttga 1050660
 ggccagcctg gtcttcagag tgagtgccag gataggctcc nnnnnnnnnn ngaaacctg 1050720
 taaaaaaaaa aaaaaaaaaa aaaaaaaaaa aaaaaaaaaa aaaaaaacag gaaaaaggac 1050780
 acatccagag agatgcctat acttttattt acatctcagt ggccaaaatt agacacatat 1050840
 ttatcccaa aagatataaa gaatgtcttc ttttagttgg gtgacaacat gtctagccaa 1050900
 tgagctggaa gagaatgaaa tgtggcggc actaaactaa actatctcag ccacaaatcc 1050960
 tcacacaaa acaccggaat agcagcaaag caaactccta gtcagctgtg tgagtcatcc 1051020

 acctgatgac tcaactcctc ccaccgcag ctgtgcagcg caactgagtt tgaagcgtc 1051080
 atgcaactta cagattgcta aaatagtcac agctctaaat ggtatgctct tgaatgcaaa 1051140
 gagtctactt agcatttagc acactgtcta agtgctcaaa ttacatgttt cacacaaaaa 1051200
 ttactgtctc tgcaagcac taaaggtaaa cgcacttaga catcaacat aacttcagaa 1051260
 agattatttc tggctcgtag aagtgcagaa cattcttctt cgtgtttttt cattcttttc 1051320
 tgtgggtgag attccttcaa tgtgtacaca gtggttctgt actcagagaa aacaatgatt 1051380
 gcaggaggcc agccttctaa ctgcatcatt cacccattag tgaagggagt cagtcaacca 1051440

 caaccacag gaactgaagg gagaggtgat gagatctaat tgctgtctgt ttatcttctg 1051500
 tctgtactta ttgggacaaa gcttcattct gtggtctggg ctggtcttac agcaatactt 1051560
 ctgccttaga ctcaaacag ctgggattac aggtatacat gagaactctg ggcatagaaa 1051620

ttgtttgctt gtttgttttc caaggagggt agagtttttt ttttttaatt gttattgttt 1051680
 gggaggttgt agttattggt ttgagacagg atatcatgta gtctatgttg acctgaacct 1051740
 cagccatact ccttctcag ctgggggggg agggggtgtg gaaataacag ccagctgctg 1051800
 caataacatt tcacccctgc tctgctccat ttccctcagg ccacagtctt tgggttaaat 1051860

 aactctataa aaattacatc atgacctttt tcaacatttc caaactatgc tttgtagttt 1051920
 acacagaate caagaataaa tgtaaccac aaacagtttt aagaatagcc atcaagttec 1051980
 gatctgctgc tgctgctgca attctaagt agtcagagga agaagctcaa cagctgagac 1052040
 agtgftaagg aaaatggaat gcttctcttc ccagaaatcc tgagaaggaa ctccccctg 1052100
 catatttgag ctggtcatct tctggggaat tctctgcagc tgaaaataag cccagaagac 1052160
 cgggaactgc tgggtttaga ccctcagaaa gctgaggctt tcagaatctt agtccaggac 1052220
 ggcggccacc ccaaacacag aatggaggcg aaagcttgat acaaactgca tgaggcttta 1052280

 ttgtagtttt acgagctaac cccatgtag ctcggtctt tcaccaccc gccatggcag 1052340
 atggctagaa aaacacggct ccttgggtct cccaaaagat cttatagggc agcgttaagg 1052400
 gagtgtctag gggtagcacc aggtcacga ttggtgtgct tccaggcttg gagggcttgc 1052460
 cctgtgttga ttggtcaact ggttgttatg gcccataggc cctcccaggc cggttgctat 1052520
 gctctctacg tcattgctgt gtgctgttcc gtaaagcaca cccagagcca taaagcatag 1052580
 cgccaccage taacttctga ttggttctt gtccagagac aggcattctga ctttctagt 1052640
 tctaggtcaa ggtcatagaa gcacatgtt gaccattatg gctgcaaaa gggaagccgg 1052700

 ttccctcact ggcacctgg gtgctgatct ctgctgctc cagcaccacc cagccgtccc 1052760
 ctggctcacc cagggtccc agatggagga ctggttcaag agaaatatca tgaggcctg 1052820
 gcttctttt ccagagggga tgtgttaac accccaccac accacactgc ttttctacc 1052880
 aaaaggatgt ttactgaaaa tcatttattc ttgtttttt gtttgtttgt ttttttggtt 1052940
 ttttttct tttgctgctc ctaacctata gccaaaaggc tgacaaccaa tttaacata 1053000
 ccagtcttac tgaggaagta ctcaaagaca catgtataaa aagtatagcc agggggctgg 1053060
 agaagtggtc caggggttaa gagcacttga ctgttcttcc agaggttctg agttcaattc 1053120

 ccagcaacca catggtggct cacaaccatc tgtaatatga tctggtgcc ttttctggca 1053180
 tgactgtat acatgataaa taaatcttta aaataaaaa gtatagccag gttgggtgat 1053240
 gcacacctt aatgtcagca ctcaagaggc agaggcagg gtatctctgt gaatacaagg 1053300
 ccagcctggt ctacagagtg agttccagga tagtaaggga tgttacacag agaagccctg 1053360
 tcttagggga gaaagaaaag taataatagg gctggaaag atagcccagt ggttaaaagc 1053420
 acacactggt cctctagagg acccaaattt ggtggccagc acccaaatg tgtacctcac 1053480

aactgccat aactccagct ccacgggatc caggacctct gacctccatg agcacttgta 1053540

ttcatagtta aaataaatga ctaaactctt aaaataaaat aatagtaaat tcacacacaa 1053600
atcctggctt ggttttgtt cctgcagect tacagataaa aatatgcttc gatgagacag 1053660
aaggcacggt tactttttgc agaaaaata aagacatcac taataatcaa gtatgcacta 1053720
ggctctaate caaacccagc cttcaagtat gtatgtgcca tccacttgca acttttcacc 1053780
ttgcatacct actgatgcaa ggtgaaactg ataccctaca aacattaatc actagccatc 1053840
cccattcccc ttcctaagc tctggaaact accattctag tccactctgc ctctgccac 1053900
cctaggaagc tctttattga gtgggacat gtacagtctg tactttccgg atggttaatt 1053960

tccaagattc atccatggtg taacatatgt tggaaattcct ttcatcttta gtaaaattcc 1054020
ttagtatgta tacatcacag ttgtttatcc attcaccat tgatctaact gcatgtagtt 1054080
tccttacatt tatttgggtg gtgaatgcct gtaggaaaga gaattttcag tagtctgtc 1054140
ttcctctgt gtggatctta gtgtgaaact gaggtccca aactgccat gggatcttt 1054200
acagctgagc tgtctctcca gccctgtaca tattttcttt taatttaaaa taaatgtgta 1054260
tcgctgggta tggtgacaca taccettaat cctaacactg agaagacaga gacaagcaaa 1054320
tatctgtggg ttcaaggcca gcctggctta catattttgt gggatagct gtagtgtct 1054380

cttgccagta gagtctatgt gaggtcagat taacatggca ttgtaaaggg acagtcat 1054440
aactgtgaac ttgtgaggag caccataaa cagacacact tccctttgtg tcttttctat 1054500
tctggaattg ttaaatcagt tcataactgt gtggtgagag ctatcatttc cttaatttt 1054560
tcaactgctc ttgcatctt ccatgttcta ggcagtgtac tcatgaaaga acaagcttgg 1054620
gttatttccc atctcagagg gaacaaagcc acagattcag ctgcaccgca gggcctctgt 1054680
gtgacagagg aatgaggaa gtgctagtta aaccattaa aggaagggtg cctgtacaag 1054740
tgggtcaagg gacacctcc ccaggtgatc acatttaatc catgcactga aatcctagc 1054800

actctggagg cagaggtagg agcatctcag agtttaaggc cagcctgatc tacagagagt 1054860
gttccaggac agccagggtc atacagagaa atcctgtctc aaaaacaaaa caacaacaaa 1054920
gaaatattaa aaagttcaaa agtcatcctc agatacatat tgaatttgag gccagcctgg 1054980
gttatataca accctgtctc catcaagcta gcagtacat ctgcactttg aggggtgggag 1055040
gatacagggt caccatacgt agcctggct gtectggaac tctctatgta gaccaggctg 1055100
gcctcaaact cacagagatc cacctgtctc tgcctccca gtactgggat taaaggtgtg 1055160
caccactatg tccagacca tctgcattct ataaaggcta accctctcta aaccaactgt 1055220

gtgcagggtg gattagaatg agaacagaag aaaaagacag ggaagaatgg gaagatccct 1055280
 acagttcagt gagtctttgt cctgaggaat ggcttccttc tgtccacaga aacgatgacc 1055340
 caaaatctgg ttgaattcag ttaagaaaaa catctacatt tctgcacttt ggcacattca 1055400
 agctagcagg tigtgtgtg tgagagagag agagagagag agagagagac agacagacag 1055460
 acagacagac agacagacag acagagacag aaactgcttc ggttttgggg agacagtffc 1055520
 actatgtagt cctcaagctc tttattcttt cacctacaca cacacacaca cacacacaca 1055580
 cacacacaca cacacctaa gacactgttt ttgaaatgtc tgccttactg tttttgaaag 1055640

gtctgcccc tgacctgttc tagtaattta gttctgtcat cctaagaac tactaatctg 1055700
 tttcctgtct ctatggattt gcagatttga gacatttcac ataatagaa ttgtgtaata 1055760
 tgtgactffc gtgtctaact tcttcacct agcataatgt tttcaaggct cattcatatt 1055820
 ataacgata tcagtttttg tggccagctt aataatgtcc tgttgaagg acaaagccca 1055880
 tttccattc actaacctgac agacatttga actctttcta tttttgagct attatgaata 1055940
 acacttctgt gaatgtccag tatacatfff tttatgtgga tatgttttgt ttctagttaa 1056000
 tagaattcag caattcatat atatacaacc aaaggagctt ccaccctaag ttaactcggc 1056060

ttctctgtg gctttgaatg ccaaagagaa agcagctgat gtgccaaagc catcttcca 1056120
 agaaaacagg tttggtcaca gagaaagcag cagcactccg cagtgagggt gacctcatgc 1056180
 cgcccacaat tgacacaaa aggaagcaaa tgcagctcca cctccctcc tgtctctaag 1056240
 gaaggaatt ggacccaac cctcttccc tgtgaaggag acaaagtttt gctttaaggc 1056300
 cgagtttcaa gtagcccatg ctataatgca ggactccaaa taaagccaag ggtgacctg 1056360
 aacttctgat ctccctgttt gccttgccaa gtgctgagct ttaaccccag gtttttgtgc 1056420
 atgctaagca aggacttta caactgagcc acatcctcag ctccccaaa gacaaggact 1056480

tttcaaggag gaaactcaga atctcagaac tggcaactca gagtttgaca agtgtatgta 1056540
 gagttcgaac tigtacaga gtggttctgt gtacagagct tatgagaaa cactgagcaa 1056600
 cggcaatcag aaaggaagga ctcaccttc agccaaaggt caatagaca ctttcgtaaa 1056660
 gaaagcaaac aaaacttaat gcagccagtg ctgaagtaag aaagagttat gaataacctg 1056720
 gcccatgtat ctgcagatcc caggacacct cctcctccag cagccaatgt agtaaggcca 1056780
 aagtacata cagtactaaa agctccaggc tggacagaac caactgacct ctggtcgata 1056840
 gtaaatgctg tcaatgtact tgacagtgca gggagtgaga tttatatctc aatattgttc 1056900

tagcagtatt tcaccagctc tgccagccct gtgtgattag aaatagatcc tactaggtgt 1056960
 cacagctcac tcccagaatc cttagatgta tgggaaatgg ggaaatggag tgtcgaggga 1057020
 gcagagctac ctagagaggg gtgttgtgaa gcttgagcta ggagagagac taatgttaca 1057080

gtgttataga acaaaaaact ctgaggttca caagacaatg gcctgtctcc cttaatggaa 1057140
 gcttgaacc tacaaaaag cctaagcagc aacaaggacc ttaacattaa aagctgacca 1057200
 acaatattct ggagaaatca ttcaaagtac ttttttagga ctacgatgtg gatcaggaga 1057260
 gtgcttgctt gcctagcatg atcaaagccc tgggtccatt cccagcataa ataaaccagg 1057320

 gtgggtgtgc atacatgtaa acccagctct cgagaggtag aagcagggga tcagaagtcc 1057380
 aaggtcacce tcacctagg agaagtctga ggccaatctt ggcttcttaa ggccctgtct 1057440
 caaaaaagaa aaaggaagaa aaagcaaaga agaaagaagg gcagggcagg agggaaggga 1057500
 gggagggagg gaaatgctat ttttaaaaa gtatttctta ggaatggacg cagatgtgga 1057560
 gtttcatttc cgtgatgaa acaaatgaaa tgttctgtct ttacctgga gaaggctga 1057620
 ggcaataact gtgctgacc cagaccctgg tcactttcaa gagtgtcagt ctcatccaca 1057680
 gctgactgcc tgagtggctt tgggctacca cttgaggaga atttcaaatt ctctgttgc 1057740

 ttgtttgat ctttctct tgggaaaa ctgaacctag ggcctgtac aagctaagca 1057800
 aactgcaac acagagcttc acttgaagcc caagccagtc aacattggtt gtctggttc 1057860
 tgatatgctc agcagaagc ctggacatca ggcatctatc tatagagcag gtatctagat 1057920
 acggctctag tgccttcata gaaacttga gatttctgtt tagtccaag tctgctcagc 1057980
 tgtggctctc agaccaagca accctcaggc accctcagcc acagggatag taagttacat 1058040
 ccctgctctg tagttccctg acatgggcat cattatactt gtggatagcc tccataccac 1058100
 ctcttcattc tgagccctat aatgtacca tctagatatc tccagtaggc ctttcttta 1058160

 gccagtgat gtcctgtct cctgtccagt ttcactttac ctcttgcta getgcccga 1058220
 ctttgctga ggttactgta gtgcctctcc aggcactaga aatccaaagg tacagaagtc 1058280
 cactgggcaa ctggcctctg acctgtact tctgggtctc agttacatca cttgaatttc 1058340
 tttgccttc atcctttctc cageccagga ccaagcattc tgaagagagg ggaagtgttg 1058400
 gggctctcca ggggaaccaa ccaaaggag acataggaga atctccaaag agaattgcta 1058460
 ggagacatca gctctcaaa ttgtggagag taagacatcg cacagtctgc tgctccaag 1058520
 ctggaggccc aggacgtcag ctctgtagct tcaatccaaa cttagggagg agagtgaaaa 1058580

 ggaggagaag ggagtgggg ggggagaaag taatgcctta cagggcatc tagaatgcaa 1058640
 atacaaattc cttttcaac cgtctcaga actcacagaa gtgaggctca ccacatctg 1058700
 tatcaggaga gagcatggtt tccagctcac agtggattct accagacaat tttctgcata 1058760
 catgaacatg cagaagtgtt tttgtttgg ttttggtttt ggtttttttg agacagggtt 1058820
 tctctgtgta acgatgctg tcttggaaact cactctgtag aacaggctgg cctccaagtc 1058880
 agagatcccc ctgcttctgg cccactcct gtcccactt ccacaccct accccacccc 1058940

acccccacac ctgctggggc aaaggcatgt gccacatgg cccagctgta taagtgttt 1059000

 gaatgctgtt tgttctattt tattttattt attgggtatg tgtatgtgga tatgagagtg 1059060
 ccaggagca ggtatggcag tcaaaggaca acttgtgaaa gtcagtctc tecttctct 1059120
 acatgggatc tgagaattga actcaggtca tcaagctcca gagcaagtgc ctttccttgc 1059180
 tgagccatct caccagtccc tgttttgtat gttttatctc acatattaga ttacataaaa 1059240
 cactgttctt taagttggct tgatgttaaa tcagaagccc gtacaccggg getccaggca 1059300
 cagtctgtt ctcttcagca atcacagtgt taatcactgt tccattgatt caactttgtt 1059360
 tcaggcttct tctgtcttt gcaagcatgc tgcaatgagt agtgttgggg ctctccaggg 1059420

 gaaccaacca aaaggagaca taggagaatc tccaaagaga attgctagga gacatcagct 1059480
 ctcaaatg tggagagtaa gacatcgcac agtctgctgc ctccaagctg gaggcccagg 1059540
 acgtcagctc tgtagcttca atccaaactt agggaggaga gtgaaaagga ggagaagga 1059600
 gttggggttt ctctgtgtaa cgagaaattg aatggataga tgtacattct ggtgggtcat 1059660
 tctatttgc atttttaaa agacagagag tggagggggg gtgttgagtc aaggtctcac 1059720
 tatacagtea taatcccttg gctagcccat cacttccagc ttgctttctg aaactttctg 1059780
 aaaccaagac actgcctaaa agattgcaac catgaacact cctaactg aaggcaaca 1059840

 taggttttct tcttttcat ttgggggaaa ttgggaatga aacagcatat tgctgcattt 1059900
 attttctatt tcctgttgt gagggaatct ccagggtctt acctttttat tcataagcag 1059960
 ggagaatcca gaccaggca acctcaggca ccaaacgcat ggtgtcaaat gtattcatag 1060020
 caactggatt tgtatgtgga aatatgggat tctctatgca tcttccatgc ttattatcat 1060080
 gtgtaagcca ccgatgaaga tagcattata taatgatgag aactgggagc cttgagttag 1060140
 tgtctacca tgtaagtcca gaaggtcatc taaattacct ttgcttgctt gctagtgacg 1060200
 taagagttgt ttgaaatac cccagtgac ctttcaatct gagcttagtt cttgctctta 1060260

 cacttcagtt ccacatcagt tttttcttt ttgctgtgt caaatagtat taaccagtgc 1060320
 acttccatgt aaagtatga agtttacgt gttcactaaa aactcatcct agtcgtttgt 1060380
 attgacacgt aattttatt tcacatttaa tttttcagg cacaattact tggccactt 1060440
 tcaactagca taattcaaaa aagaaaggtt tagtaagat ttttagtaa actaactgga 1060500
 atataatga atagtaatt ttaaatggta ttggaaaata tgaaaagaa aattacctt 1060560
 tttcttaagt agiatctacc catgtgggtg gcttgtctgc actatcttc tttctgtgtg 1060620
 agccttacag gtgtgtgcac cataccatct acaaaaatta cattcttaa atacattta 1060680

taaactttat tatataaaaa agccctgcaa aaaaaaaaaa aagaaagaaa agaaaaaaga 1060740
 aaagggatgg gcattggagg agcatgcctt taatcccagc actcaggagg cagaggcaag 1060800
 cagatctctc tgagttcgaa gccagcctgg tctccagaga gagtgccagg acaggctcca 1060860
 aagctacaca gagaaacctt gtctcggaag aaaaaaaaaa gccctgcaat aaaaaaaagt 1060920
 tataacctg agcagtggcg cacaccttta ttcccagcac ttgggaggca gaggcaggtg 1060980
 gatctctgtg agttcgagac caacctgatc tataagaact aggtccagga cagcctcca 1061040
 agccacagag aaacctgtc ctgtctagaa aaaaaaaaaa aaaaaaaaaa agaaggaagg 1061100

 aaagaaggaa agaaagaaaa agaaaagaag aaaagagaaa agagaaaatt cagataagtg 1061160
 aatgagttgt tcaaagattt caaagaaatt atactcaaag actataagaa taatTTTTTT 1061220
 tttccctttg ttttctgttt ttttgagaca tagtctcact atgtagctgg cctcaaactc 1061280
 acagagatcc acttgcctct acctctgag cactgggatt aaaagtttgt gccaccaagg 1061340
 cccagccaag aatagatttc ttagcaaaagt gtggtggtat gaaaatgtaa tcacggcatt 1061400
 taggacgatg aaacaggagg atggtgagtt tgagactagt ttgggctatt gtaataagac 1061460
 ttgatTTTTT gttgtttgtg agtTTTTTgg gTTTTTTTT tcaatattgg gtgttttgtt 1061520

 ttgttttgtt tttttctct gtgtagtcct ggctgtcctg gaactcactc tgtagactaa 1061580
 gctgacttcg aactcaagag accacatgcc tctgcctcac aagtactgag attaaaggca 1061640
 tgtgccacaa ccacctgtt gtctaaaaat atTTTTTTaa tttaaattat atagatatta 1061700
 cgtatttgtt gtaagaattt ttaattttaa aaaatttcat tgtttgtgta tggatgatg 1061760
 tgtctgtgca ccgaaaagg catcacccct gaaagtggag ttacaggtgg ctgtgagccg 1061820
 ttatgtgggc gctggacatc cacctgggt cctcttcaa gagcagccag tgctctaacc 1061880
 actggcccat ctttctagcc cctattttag atTTTTaagc ttgggggaat aagagcctat 1061940

 gtgtttccaa gccccactat ctagtaagta aggcagaaag tgttcagaa gtggaaacac 1062000
 aacaacgctc ctccttagc tgcctaacag ggcagaggct ctagccttgc tgctgatgcc 1062060
 catgtttcca agggcacagt attagcctga gaagcctgac tcagcagtat gctgatgcca 1062120
 tacatcagtt accacacaac ctccaatgaa gtaagccagt cttcccagt ttcctagag 1062180
 actcggcagc tatttctgac caccaaacac tgttgcttat cacagcacag cttcacaatt 1062240
 gatcagttag cagtcaagcc cagggttttt aatgaaaaag taacctaat gcagaactag 1062300
 tggataagtc attgcatcta ttactgatag acctccatat tgaatgggga agaataattc 1062360

 tttctccage aaacactaac tgcaacaat atcctaactg gtaacttagc tttagtggct 1062420
 ttagtgttag ggcttttctg tggttttgta tctttttgt tttaaacagg gtctcatgta 1062480
 gccacaata gcctcaagtt cattaggtag ctgaaacttc tgattctcct gcttccacct 1062540

ctgagtgctg ggatgacagg tgtgtcctac catgccccag tttatgcagt gttgggatgg 1062600
 aatccagtgc ctactgcata agtgggaagc tctacaactg agctacaaaa tcccaaatcc 1062660
 agggttttca tcgttagctg gttggtttgg ttagtgccac tgaggattga accaggcctc 1062720
 acacatgcta gcaaagtact ctaccactgc acttcatctc cagataatga attttttact 1062780

 ttgaaacaga atcttactgt gttgccagg ctagcactgg tctcattttg tagcctgtga 1062840
 aggccttgaa ttatactct tccctgcctca gcctcctgag tagctgggat tacctatctc 1062900
 acatttatgc cagacctaga tttgtttttt aaaagattcc tttcaacttt catattctcc 1062960
 caggtaaatg actatagcca gcaaatcata aaactccttt ctaggattca aaaaccaat 1063020
 cagattttgg tttaaaagcc aaaatctgga gtagcagccc attcttgtaa tcccaccatt 1063080
 ccagaagcag aggcaggaga atcaagagt aaagtacagc caagaataca cgccaagtgt 1063140
 gagtccaacc tggcttacat gagacctgtc tcaaagcaaa aaagcaaaag ccaaactatc 1063200

 aatatggaac tcttgcacag tagattaaat cagtaatcag tgtacacagg aagctgagac 1063260
 aggggaatca caagtctgaa gtcaatctgg gctatcaagc aagtacctt ctcaaaaaaa 1063320
 tcaaattaca aagtttagta gaagaagctt gctgatcact gagcatagtg gcaggtagca 1063380
 tctacctgtg atcccagcac tcaggaaggg ggctgaggca gcaatgtcaa gtgcttaag 1063440
 ccgtcctggc caaaaagtca gaatgtgtca gattaaatga caatggacca tagtgcagat 1063500
 ccagtttgtg cctggattgg cctgtttgtg gacagcacia cctacacagc ctcaaatggc 1063560
 agtctacagg tggatttcta cttcctggta caatggagat ggagatatac tccatgttac 1063620

 accaattgac caaaacacca tacaaggaaa aggagtgaac caactgcca tctctaaacc 1063680
 atatttgaca ctctgatat ttctagggaa atcagacatc atccaaaag ggaaagtga 1063740
 aactggagat ttctgatcc ccacagtttgc tctaagtga gaccattga aaggtaatg 1063800
 aaaggaccac ccaatgggct gttgagattt tggtcagcag agccttgtgc aactcatct 1063860
 aggtgcattt agcaaatagg agctggaatc cgacacctg gggaagttt ggctgtgtgt 1063920
 cgccagcttt agggaaagca ctctctctgg gggcatgtta tctatagtgc tcacagcaac 1063980
 tcaggcagcc agcgtgaaca cttctgtgt agaaaggtca gccaggagt ctggttagag 1064040

 ctgcacaaga tcttatgcc gccgttcag gttatttccc catcatcct ccctagaggt 1064100
 acagcttcaac tagagcctgg actgtgtgag gaatgtaatt cgcaagattt atggaaaacg 1064160
 atttttcagg aatgtgctct caatttttat tgggcaaat cctctttccc tggtaagtgc 1064220
 cggagcatat gggacaggta aatgtcttaa tggacagcat aaaagtaaca tttttttcc 1064280
 tgcccaagt gatgactcac acagagggt tetaatecca tttttcactg gagcaaatgt 1064340
 tcagtgcaaa ggaaagagg ggaactcca cccttcaacc tggctgtctg cactgctcag 1064400

taatggctgg atcatttcgc agattcaagc cactgcttct ggacatcca tccttgggga 1064460

 aacaaacttt tattgaattt ctctctcca ggtgtagcc tccttctgt ctcttatata 1064520
 catcggactt gtgcctttct aagatctaata acaataagat gaaaatagcc aaaggcggtc 1064580
 tctcccgggt ccgaaaggaa agattaatgg cagaaacaaa cagtaatgaa aagtcacagg 1064640
 agagaacagt gcaggtaac atcgcacaaa cgaacacgca tgggatcact tgctcctcag 1064700
 aattggaatg attacatcca ttattaattt tggcttctat gacacaacag agctaaataa 1064760
 ccaccttggaa attggtcagt gatcagcttg aagttagaat gaaggcaatg caatccattc 1064820
 aaccatattc acttactaag cagctacggg gttttactca aaccatgctt gcctccatcg 1064880

 gacagggtgt taigttagctc aggctgacct caaactcacc atgtcactga aaataacctt 1064940
 gaactcctga tcctctgtct ctacctcca agttcatatg ccagcactcc cagccactca 1065000
 cccattctta aacatctttg ggtaaacagt atcatctctt gacacttagc gatgcataag 1065060
 agtggaggaa atggtagatt ttgcctcct ttgagtgttc atcctgctgc tgactaaatg 1065120
 aatgacagca tgtgttcaat agaataattc agcctcacat gatagacaaa atgaacta 1065180
 ctctaaggcc catgctgagc atcaacagga aagactggac atttgtgag cagctataaa 1065240
 gttaaataa cacttcctc tgccttccc tccccacc ccactctct ctctctct 1065300

 ctctctctct ctctctctct cttttctaaa cagggttttt ctgtatagcc tttgctgtcc 1065360
 aggaacttgt ttgacagagc aggctgacct caaattcaca gagatccacc tgcctctgcc 1065420
 tctcatttga gacagggtct catgtagctt aggctagcct caaacttagt atacagcaaa 1065480
 ggatgacttt gagctcttga tcctgctgcc accatctccc aagtctctg gttgcaggea 1065540
 tgtgccacat ttagtttcat gcaatgctag ggatagaacc caagtcacatca agtacctgt 1065600
 gccagtattc tgccagcaga gctacacca caaccaatg tctgtcttca ccagagaaac 1065660
 aataagctgc cttaggacc agctagatgg ctgagcagaa aagagcattt actgctaagc 1065720

 ctaaaaactt gtgctcaatc ccaggatccg ctggaaggag aaaactaact aaccaccac 1065780
 tgcaactagt tgctctctga ctgccacata agcactgtga catgcacgcg cgcgcgcaca 1065840
 cacacacaca caaacacaca cacacacaca cacacacact aattaaaaag aaatttaact 1065900
 tctagctgct cataatgatg gcgtgatggc aatcaccagc aaccgtagta ctctgaaggc 1065960
 tgaggctcaa aaatcccaa tccaaggcct gcctgggcta cacagtgaat tcaaagttag 1066020
 tctacagtaa gactctgctt caaacaacaa acaaaaacaa aacaagagag ctggggggga 1066080
 ggggcgtggg ggtgcacatc tttgatcca tcaactggga ggcagaaata gatctctatg 1066140

agttcaaggc caacctgttc cacgtagtga gctccagaac agccaaggct acctagttag 1066200
 atcctatfff aaaaaacaag aggggtgttc gcttcagcag cacatatact aaaatcggaa 1066260
 cgatacagag aagattagca tggcccctgc tcaaagatga caaatgcaaa ttcattgaagc 1066320
 attccatggt ttttttaaag attttattta tttattatgt atacaacatt ctgcttccat 1066380
 gtatactgac acaccagaag agggcaccag atctcataac ggatagttgt gagccacat 1066440
 gtggttgctg ggaagtgaac tcaggacctc tgagttaagc acctcagtgc tcttaacctc 1066500
 tgagccatct ctccagcccg cattccatat ttttaaggcc tcacctcct gaggagcaga 1066560

 aaggggatgg gataggagta gggggcaggg aaggagggga gggagaggga actggggttg 1066620
 acatgtaaaa caagcttgtt tctaatttaa attttaaaaa aagaaataaa tgtagcaag 1066680
 gaaatgggaa aaaaagagga gccaggtagt ggtatctcac tggagaggca gagacaggca 1066740
 gatctccatg aatctgagga caacttggac tattacacag agaaacctg tctcaaaaaa 1066800
 caaaacaac aaaaaaaaaa aaacaacaac aacaacaaca aaaaagagg gttgggaaca 1066860
 tagctcagtt gttgagacct tgcccagcat gaatgtgttc ctaaattaag taccagtg 1066920
 tggcacacat ctaaatccta gcacttgagg agtgaaggcc agacaatgag gaggttcaaag 1066980

 ccaacctcaa cctcagcttc atagtgggct caatgctagc ctaggctaca taggaccagg 1067040
 tctcaaaaaa aaaaaaaaaa aaaatgcca cattataata acccaaaagt aaaattggaa 1067100
 tcagggtgct aacatccttc aactctacct cagctacggc tgtgtgtctt tcaaaagcaa 1067160
 ttcacaatat cccatctct caaggaaggg cagtacaagc ctgctgtgta caaagacaag 1067220
 gccctctgct tcaccaagga ggccctcatct cgtgcctgtg cctgttcttg taactgtgtg 1067280
 gagctgagac cttaaaggac cttcacctc cttcagggtg tgaacctg tgacaaatct 1067340
 cactcaaca gttctcatca gtcctgttc ctaaacctca agaacagaat attgctgag 1067400

 tgtgatgta catacatccc tttagtcca ggaggaagat ctctatgagt tcaagactag 1067460
 cctggtaaac acaccaagtt ccaggacagc taaggatgca tagagagact atatcttaa 1067520
 aaaacacaaa gaacaaaca aacaagaatg gaatcttag aattggggag aaaaaaata 1067580
 aacaaaaacc actctttgtt ttgtttgttt tggttttcag gacagtttac ctgtgtagct 1067640
 ttggctgtcc tggaaattcac ttagagatat atcagcctac tgtgagagcc aaagttacat 1067700
 ttttaagttt taattactat gcctaagaca tccatgaac aaaaatgcct ctgatctgca 1067760
 agcccctgc ccaagcatag atagttcctg aaatacggga ggctattgtt tatgggggat 1067820

 aacaaccaca ggtatcactc ccttaacaa gtttgtttgg cttactgta ccagatgtgc 1067880
 ttgatcacat aggggtggca gtaggcagga aatatgcaa gatggatact cgcccctga 1067940
 ttggcatga tgggaaatgc aatgaattat gggttttctt tcttaaaccc ttgccatct 1068000

tgattctggg ccatttccca ggaacctggg tatgaacaag gccatctacc tgggcaatat 1068060
 ttaaataaaa ctgtctcaa atttgacttt aaactatgac agtagtctta ttctcaactg 1068120
 gtggaattag cattgcctct gcctcctgag tgctgaggtt aaaggtgagt accaccacag 1068180
 cccggcaaaa tcatcttttt ctgtatcctg atattatttg atcttgaagc aaagacttag 1068240

 atcaagttta tgctttggcc cctttcacct tgggatgggt tacttgccag aagccttctt 1068300
 gaggactgtt gcattttgaa tcttgaatgt atccccagag aaccatgttg taaagtcttg 1068360
 gtctccagcc ttgggggta taggaagtgg tgagaccttt ggaaggtagg acttagtgga 1068420
 agtttaagtc actgtgggag agttcctagg caagtgtctt accactgagc tacactccca 1068480
 accttatttt taagagtaat tgttaagtaa gaccagggtc cttcataatc tctctacaat 1068540
 tcctggttgt catgagatta aatgcctcca cacacacaca cacacacaca cacacacaca 1068600
 cacacacaca cctgccactt tgtgccaaa gcaacaaggc tcaggagagc acctgcctag 1068660

 catgcatgag gccttaagta tgattcctag ggagagaggg ggtggggtgg gttctggcat 1068720
 agctatgagc agtctctgaa gactctacct gagaatattt caacccttga atgtgctagc 1068780
 agtcatcacc aatgtaccba cgtgatccca agaacagaaa gcacagatgg aatgtatcag 1068840
 tatagaatcc atcaaccagt ttgtatattg gttctgacaa ccatcaaatt taagtttccc 1068900
 tgtccattta ctgacaaat ctctatcact tagcaatgtt atgaaaatta atccaaagtc 1068960
 ggtcagccag cacaatatg cagctgtgac agatgttcag tagatatgaa ctcccttctt 1069020
 atcatttttt tcacctgac atagatggca gacacatgca aacacataag taaaaataaa 1069080

 ttttctttca aaagaaaagc tatgtctgat ccttaaagct atgaattatt aaacccaag 1069140
 ccagcagtga gataactgag ttggtgggia gcaagacttt agaggcccaa aacacaacac 1069200
 aaactcgtat gacttggctt ttgctgcca ccagaactag atgatgagac ctgtgggtgc 1069260
 agttcagtga ggagggtacc agcctagctt accagatgcc cctgcttcaa atctaggatg 1069320
 gcctagaatg aaacagtaga ggcatatagg tcttgaatgt aatccctacc actcaacaga 1069380
 tggaaagtga aggatgagga ctctatcttc ctgctggcc ttggctggct aaagaccag 1069440
 ctgtgagggt tacattagat cctgcctcag aacaacagaa gaaaaattag atcctagatg 1069500

 ataagacctt attgttgaca ggacacacct tactgtgctg gaagcctcaa atttataatg 1069560
 ccaaaaaaca ctacacagac ttctggggaa gaaagtgtat cagtggtttt actcagttgt 1069620
 aagctttaca agctacaata ctgtcatagc aggcaggata tatctacata ctcaatagta 1069680
 gcatgattgt tctggaatga ccaggctgct atagaactgt ctatgaggtt aggagggact 1069740
 tgcaaacaaa caaacaaaa aagagcatta aaggagaaga ggagtcagga gtcattggga 1069800
 gatgcagagg aaggaggaga tgaatttggc atagtaagaa aagglaccaa gccatgtggc 1069860

agagcataga taagaaatac gggtaattt aagtataag aactagttag taacaagcct 1069920

 aagctagcag ctgaacattt ataattaata ataagtcttt gtgtggttat cggggagcca 1069980
 gaggtcccaa tgaaaacctg cacctacacc aacctctctc cacagtactg taaatccact 1070040
 caaaagtcca tggtagagga gctaattggga cctgggagag gggacttaat tctggtatgt 1070100
 agctaaacag acacagtgtt agaccacct cccaaatata tgtgtttata cccatagaca 1070160
 acactctcaa ctatagtcag agaagccttc tctctctctc ctctctctct ctctctctct 1070220
 ctctctctct ctctaggaaa ctacagtga ggcagaaatg cacaactgct gtgcatggat 1070280
 gagtgtctcaa ccataaacia aacatttata tcatcccttc caagatttag ggaacactgt 1070340

 gtaagaaggg gatggaatga tagtaagaac catcagacag gaaaaagaac taaaaaaggc 1070400
 catcttcttg acaatafaca gccaatgcaa ccatgagccc tcaacaacta cgggtgacta 1070460
 cactgggtct gcaactggaac aggctcatca atagccaatc aggatgagag agaaacctag 1070520
 ggagcccat tcctcactga tgaactgttt cctacagata gaggtaggga aagagggagt 1070580
 cattacctcc aggtttgtac ccaactggtga gccaccagg ttccaaagca tacattcagt 1070640
 ggtcacagag atggcagtga ctaaaataaa tagatcacac caatagtcac caatctagga 1070700
 gagaccagg tgaagggat aggagagtgg taggggttat tcaatcacac tgtgaccca 1070760

 gaggttgcat ttgcattaat taactaaaat taacctggg tcaggaggct gcattagcaa 1070820
 ctagttgaca ggaagtaatc atagagcctc aaagggcac caggaaagat ggagacacag 1070880
 gaagttagtag ggtgggtttt gaagtggcac agctttttct ggtttggcaa agcagaagca 1070940
 tgggtcttct gtggatgcca gcaaggagga aggcttagct agttgaaacc tctctgagct 1071000
 tgaaggtttc accccagccg ctgaatctcc agtcttattc ataactagaa tgatagaggt 1071060
 ttagttaaag ctaccttag cagctacagg tccagtgcct gcaggatcag aatacttgcc 1071120
 aggctgcage ctgagtggcc aggctgctgt ttaagaagca ggctggtaac tggagctgca 1071180

 attcctggat gagatagcag tagattaagg tgcagtcact gtgctgaagt taaagtaaga 1071240
 taagagaggg tagcagagta atccaatgt ataagcatgt atgaaactgt caaacaactt 1071300
 aaatttttta aaaaggaata gagagagggc catcagtagt ggtgggataa tatacccaaa 1071360
 gaatattata aaattgcatg caaatgacct tatataacca tgtatttttt ttttttttt 1071420
 ggctggcca tgggtggcaca cgctttaat ccagcactc tggaggaggg gcaggaggat 1071480
 ctctatgagt tcaaggccag cctggtctac agagagagtt ccaggacagg ctccaagcc 1071540
 tgtcttgaaa aataaaaaaa aagagagaga gagagagaga gagagagaaa ggaaggaagg 1071600

aaggaggaag caaggaagga aggaagaaag aaagtgttta aaatatgtat tttgctataa 1071660
ataccagcta aaaaattctc aatgctccta gatatthtgt tttgttttgg gcaaaggga 1071720
tgggggagta agctttttga cttgtgtgtg tgtgtgtgcg cgtgcgtgtg tgtgtgtgtg 1071780
tgtgtgtaca gcacatttgc aggtgtacat gtgcaacagt atatctgcag aaacaaaagg 1071840
gcaaccttgt agactcagtt ctctctttcc atgatgcact cccaagatgt caggcttaca 1071900
tgtcatgctt ttacctctg agccaattaa cacaccact ggtagaattt attttttga 1071960
tgtgtggctg agtgtgtcct gtcacacatg tggaggtcag aagataatgg tgtgggttcc 1072020

agggatggaa ttgccatctg gatgacctg ccctgggaat ttattattat tatattatta 1072080
aatccacaaa attgaggctg gagacacatc tcagtgggta agagctctta ctgatcttgc 1072140
agaggacctg gatttgggtc ccagtacca cttgggtggct cacacacatc tgtaaccca 1072200
gttccagggg atctgatcct gtcttctgac ctccataggc accaagcatg cacatgcagg 1072260
cagaacactc atacacacaa aataaaaaac aataaatctt ttttttctc cggagacggg 1072320
gtttctttgt gtgactttgg ctgtcttggga acttgatctg tagaccaggc tagccttgaa 1072380
cttacagaaa tctacctgtg aagggaccag ctccccattt cagcagccat aacagccgaa 1072440

cacgtacttg ccgacctg tcttggtcac taggaggtca gatgcctgcc tcgtggcaag 1072500
gaaccaatca gaagttagct ggtgttacta tgctttacag ctctgggtga gctttacgga 1072560
caagtgcaca gcaatgacac acagagcata gcaaccacce tgggagggcc tatgggcat 1072620
aacaaccagt tgaccaatca acacagggca agtctccaa gcctggaggc acaccaatcc 1072680
tgacctgtg cgtacccta gacactccc tataagatct ctatgcagac acttgacagg 1072740
gtctttccta gccatccacc atgggtgggtg gatgaaagac ccgagctaac atggggttag 1072800
gtcgttaaac aactacaata aagcctcatg cagtttcacc tctgcatggt gattggagtg 1072860

gccgaggtec tgggctgaga tccctggggc ctgagcctcc ggggatcttt cacctgcctc 1072920
tgctcccag tgctgggatt aaaggcattt gccaccactg ctgggctcaa aataaatctg 1072980
aaaaaaaaa aaaaaaaaaa tgagccaggc agtgggtgca cacgtcttta gtctcagtac 1073040
tccggaggca gaggcaggca gatatctgtg agttggagac cagcctgatc tacaagagct 1073100
agttccaaga cagcctctaa agccacagag aaacctgtc tcagaaatgt attcatttct 1073160
tctgatatta aagagggaca ctcttttccc tcagtttgaa aatgcttcca gtttaataag 1073220
cctcttagtt aaagggatga aaaactgata tttatttctt ccttgctacc tgcaaagact 1073280

gtagcagaga tgggtggcta agtacatggg ctgggatact ccaccactga actagatggt 1073340
gatcttgggc agctaacaga atcaggtttg ttgttctgt ttgttgagga ttttcattag 1073400
ttttagcttg tgtgtgtgtg tgtatgtgtg tgtgccaca cacataagta tctggaggct 1073460

agagggtgtgt ctgatcccct ggagtgaggag aagtgccttgg aagttagctgt gagctacttg 1073520
 ctgtgggtgc tgggaactga actctacaag agcagcaagc actctccagt gctgggtcat 1073580
 ttctccagcc atgtgaaact tagcaggttt cccaccagac atttttctct acaacctct 1073640
 gttattttct aagaaactga aactggccct aattaaagaa ataacatga ctgggagtgg 1073700

 tggcacatgc cttgaatctc agctctcaaa aggcagaggc aggtgaatct ctgtgagttc 1073760
 gaggccagcc tggctctatag agcaagttcc aggacatcca gggtataca aagaaatcat 1073820
 gccataacag cctaacacat gcttgccctga ccttgcccttg gtcactagga ggtcagatgc 1073880
 ctgcctcgtg gcaaggcacc aatcagaagt tagctgatgg cgctatgctt tatggctctg 1073940
 ggtgtgcttt acggacaagt gcacagcaat gacttgaaga gcatagcaac taccctggga 1074000
 gggcctatgg gccataacaa ccagttgacc aatcaacaca gggcaagtcc tccaagcctg 1074060
 gaggcacacc aatcctgagc ctgtgcgtac ccctagacac tccccttatg ctgcctata 1074120

 agatctctat cccgtggctt ctgcgcgtct tttcccagcc atctgccatg gtgggtggat 1074180
 gaaagaccgg ttagctcatt aaacaactgc aataaaaagag tcattgcttt tgcctcgaaa 1074240
 tgggcctctt ggtgatttgg gaattcagaa tttgggcaca acaggaggag gaggaggaag 1074300
 aagaagagga agaggaggag gaggaagaag aaaagaaaag aagaagaaga agaagaggag 1074360
 gaggaggagg aggaggaaga agaagaagaa gaaagaagaa gaaaaggaga aggaattgtg 1074420
 agattgagat agttatcaga tgtgctctaa ggcatggttg atttcaactt gcttctgtgt 1074480
 ttgtctaaat ctaagccaca caatgaattc tagagctccc tttcatttcg attgaattcc 1074540

 tgccagttcc tgetaactga accctgcagc caccaggcca cagaaagaca gcctttcatc 1074600
 ctagaagtgg ttttgcctct tgagaaatac aagtgggaaa gaattggtgt ttgctgaatg 1074660
 ccaagacaat gtgttaagca ctgtactttt ggatttactt ttcttggcat ggtaggttct 1074720
 ctttgacagg ttttccaggt gaaggaataa aagttcaggc ccattgtgtc agtcctcca 1074780
 agcgaagaga gccagtgtca gctctgccac tctgtgctcc ataagaatct ggcatctcct 1074840
 catgacatct tttcagccat cctaattaaa tactagctaa agcttaggtt ctcttgtctg 1074900
 gcaagctctt catgtcttgg ggaacacaaa agaaaacttt tattttaatg ttttttgagt 1074960

 tttcaagaca gggtttttct gtggcgcttt ggagcctgtc ccagaactca ctctgtagac 1075020
 aggctggcct caaactcaca gagatctgcc tgectctgcc tectgagtgc tgggattaaa 1075080
 ggtgtgtgcc accactatct ggcttaattt ctttttagtt taatgtacat tagtgatttg 1075140
 tctgcattta tatctgggca aggggtgttg gtcccctgaa actggagttt acagacagct 1075200
 gtgagctgcc atgtgagtgc taggaattga acttgagtcc tctggtagtc agtgctgaaa 1075260
 ggttcaggca galacctagg cagcttaaag ggccctgtgt tgcatggcca tatcatgact 1075320

acatcactca ttacagggct gtgtaggact cagtgcacat gcgtgagctc ccccttttaa 1075380

 acccaagcat tatttgctt tctctctctc tctttccagc agccgacctc tctcctctct 1075440
 cccctctccc cccccctctc tctctgttct tccatttctc tcccctcttg ctcttcgccc 1075500
 ctgtaataaa ctggttaatg tgctcttgta agaccctcgg gaagctgagg cttccagaat 1075560
 cttagccag gaccgcagcc accccaaaca cagaacggag gcgaaagctt gatgcaaatt 1075620
 gcatgaggct ttattgtaat ttaacgagct aaccctatgt tagctcgggc cttgatcca 1075680
 cccaccatgg tggatggcta gcaaagacag ttggaagccg ctgcgtacag atctttatag 1075740
 ggcagcataa ggggagtgtc taggggtaca cacaggctca ggattggtgt gcctccaggc 1075800

 ttggagggct tgcctgtgt tgattggtca actggttgtt atggccata ggccctcca 1075860
 ggggtggttgc tatgctccca ggggtggtgt gtgtcatttc tgtgtgcttg tccgtaaage 1075920
 acaccaggg tcgtaaagca tagcgcacc agctaacttc tgattggttc cttgtcacga 1075980
 gacaggcatc tgactttctg gtttctagga caaggtcata gaagcacgtg ttcggccatt 1076040
 atggctgcca aaaggaagc tggtccttc actctctata tttcacgttc catgtccatc 1076100
 tctcgaattt ctaatttaag caaaagaata acaaatgctc ttaaccactg agccatctct 1076160
 ccagaccctc aaaaagaaa atttaattgt agctctctctg gattctcca tgggaaatca 1076220

 tgccaagatt gacttaggtc ccagtgtga ttaaccact taaactggcc aggggtggtg 1076280
 gtgcacacct ttgatccag cagagaaagg tggatctctg tgaattcaa accagcctgt 1076340
 ttacatagt gaattcaa acatcgagag caacataatg agacattatc ctgtcatcct 1076400
 gtcgagcaga gaacaattcc attagagaat ttctctgggg tccaaacctc tggttccagt 1076460
 aaccccgga gctctggtct gcattgtatt gcagatgcta gctgatttgc tgttgaatag 1076520
 catagcctca gtggagaatg cctctagt tgcattctta tgggcctaag cattgaggag 1076580
 gcctgcacct gggctgaaga ctctttgtgc ctagaaactg tttaggtgga cgcttgaatt 1076640

 aatagaatca ctgatata gctatataca tcataataga tgctttctgg tactgccct 1076700
 gcccttggag aactatttaa gtggactctt caataaactc tggcttctca gtatcagcta 1076760
 ggagccctcc tgagatgata atggigtctt ctgtctcatt attagtgtctg ttggttagtt 1076820
 aaattcccc actcagaatc ggaccagggt ctgtacagct ggctccattc acagtctga 1076880
 agacagctgt ctggaacatt atccccctc aaaaaacaaa aacaaaaaca aaaactaa 1076940
 aattaataa tgataataa aaaataataa taataataa aataacttac atggaattc 1077000
 actaaggaaa tgttagcatg acttcctca cacactggca aatagcagtc cctttgacac 1077060

aattagaagt ctccaggaac acctgtgttg aactatcacc cttccttgac cegtccagca 1077120
ggccaggtta ttcgcggtc tcgaggggtg tgcacctaagggggtcatg agggcgagaa 1077180
aggaatggag accaagcggc gcaagaaagg acaagagtcc gtctgtgcaa tgtcaaggtc 1077240
tcgtttattg aaaggtaaag cttgcttata tgcaggggat ttttactcag ggcggggtaa 1077300
gggagcagga ggaatggaaa atttcaaga gaaatagag gcaaggtaaa tcttagccca 1077360
tggtcccatt gttagcgaac cgcagctatt tctgagaaaa gggagaacat ttgcaacat 1077420
gtattgtgca gcttatccgg aaaaaacatc ttgtagtcac agcagtgatt ctggatcatc 1077480

aacaatgatt aactcttgac tcagtatgag gcccttttg gccctcgaca tctccccctt 1077540
ctgtatacaa aaaggatga tgaatcttat tatcaagaga gccctgtct taggccgcat 1077600
aggctcgcgc cctggacagg caacgtgcct tgttgagccg gtcttgacga cctctgtacg 1077660
ttgttcccc ctgttcagg acctatgcat actcccgta ttgagtactc ccttctgca 1077720
tcaatctnn nnnnnnnnnn nnnnnnnnnn nnnnnnnnnn nnnnnnnnnn nnnnnnnnnn 1077780
nnnnnnnnnn nnnnnnnnnn nnnnnnnnnn nnnnnnnnnn nnnnnnnnnn nnnnnnnnnn 1077840
nnnnnnnnnn nnnnnnnnnn nnnnnnnnnn nnnnnnnnnn nnnnnnnnnn nnnnnnnnnn 1077900

nnnnnnnnnn nnnnnnnnnn nnnnnnnnnn nnnnnnnnnn nnnnnnnnnn nnnnnnnnnn 1077960
nnnnnnnnnn nnnnnnnnnn nnnnnnnnnn nnnnnnnnnn nnnnnnnnnn nnnnnnnnnn 1078020
nnnnnnnnnn nnnnnnnnnn nnnnnnnnnn nnnnnnnnnn nnnnnnnnnn nnnnnnnnnn 1078080
nnnnnnnnnn nnnnnnnnnn nnnnnnnnnn nnnnnaaac tgtacaaaa tgcaatattc 1078140
atgtgaaaca tcaaggctta aagcaaatat acagggtgtt aatcctgtgt tgcaagccca 1078200
ataggtacca ttgggtgcct caagatagta gcttcctata tagggaatta tagttttatt 1078260
gcaaaactgg gtgtaactgg agggcacctt tcctaacaa agcccttgct ctgaaactcc 1078320

gggcagggta agttggtgag ggacagccct gcacctgct gatggggagg tgatattgga 1078380
tgtactggcc ataaaggcaa tccttcata ataggggggc tcagcagaca agcagagcca 1078440
gcaatctcga gtagaattag gactggatgc atggctagct agataggctc cctgtaccaa 1078500
attgaataat ctatctacag tgcctggatc tgggctaata gaagggttaa ttgggtaag 1078560
cttaggggta gacgactggg tnnnnnnnnn nnnnnnnnnn nnnnnnnnnn nnnnnnnnnn 1078620
nnnnnnnnnn nnnnnnnnnn nnnnnnnnnn nnnnnnnnnn nnnnnnnnnn nnnnnnnnnn 1078680
nnnnnnnnnn nnnnnnnnnn nnnnnnnnnn nnnnnnnnnn nnnnnnnnnn nnnnnnnnnn 1078740

nnnnnnnnnn nnnnnnnnnn nnnnnnnnnn nnnnnnnnnn nnnnnnnnnn nnnnnnnnnn 1078800
nnnnnnnnnn nnnnnnnnnn nnnnnnnnnn nnnnnnnnnn nnnnnnnnnn nnnnnnnnnn 1078860
nnnnnnnnnn nnnnnnnnnn nnnnnnnnnn nnnnnnnnnn nnnnnnnnnn nnnnnnnnnn 1078920

nnnnnnnnnn nnnnnnnnnn nnnnnnnnnn nnnnnnnnnn nnnnnnnnnn nnnnnnnnnn 1078980
 nnnnnnnnnn nnnnnnnnnn nnnnnnnnnn nnnnnnnnnn nnnnnnnnnn nnnnnnnnnn 1079040
 nnnnnnnnnn nnnnnnnnnn nnnnnnnnnn nnnnnnnnnn nnnnnnnnnn nnnnnnnnnn 1079100
 nnnnnnnnnn nnnnnnnnnn nnnnnnnnnn nnnnnnnnnn nnnnnnnnnn nnnnnnnnnn 1079160

 nnnnnnnnnn nnnnnnnnnn nnnnnnnnnn nnnnnnnnnn nnnnnnnnnn nnnnnnnnnn 1079220
 nnnnnnnnnn nnnnnnnnnn nnnnnnnnnn nnnnnnnnnn nnnnnnnnnn nnnnnnnnnn 1079280
 nnnnnnnnnn nnnnnnnnnn nnnnnnnnnn nnnnnnnnnn nnnnnnnnnn nnnnnnnnnn 1079340
 nnnnnnnnnn nnnnnnnnnn nnnnnnnnnn nnnnnnnnnn nnnnnnnnnn nnnnnnnnnn 1079400
 nnnnnnnnnn nnnnnnnnnn nnnnnnnnnn nnnnnnnnnn nnnnnnnnnn nnnnnnnnnn 1079460
 nnnnnnnnnn nnnnnnnnnn nnnnnnnnnn nnnnnnnnnn nnnnnnnnnn nnnnnnnnnn 1079520
 nnnnnnnnnn nnnnnnnnnn nnnnnnnnnn nnnnnnnnnn nnnnnnnnnn nnnnnnnnnn 1079580

 nnnnnnnnnn nnnnnnnnnn nnnnnnnnnn nnnnnnnnnn nnnnnnnnnn nnnnnnnnnn 1079640
 nnnnnnnnnn nnnnnnnnnn nnnnnnnnnn nnnnnnnnnn nnnnnnnnnn nnnnnnnnnn 1079700
 nnnnnnnnnn nnnnnnnnnn nnnnnnnnnn nnnnnnnnnn nnnnnnnnnn nnnnnnnnnn 1079760
 nnnnnnnnnn nnnnnnnnnn nnnnnnnnnn nnnnnnnnnn nnnnnnnnnn nnnnnnnnnn 1079820
 nnnnnnnnnn nnnnnnnnnn nnnnnnnnnn nnnnnnnnnn nnnnnnnnnn nnnnnnnnnn 1079880
 nnnnnnnnnn nnnnnnnnnn nnnnnnnnnn nnnnnnnnnn nnnnnnnnnn nnnnnnnnnn 1079940
 nnnnnnnnnn nnnnnnnnnn nnnnnnnnnn nnnnnnnnnn nnnnnnnnnn nnnnnnnnnn 1080000

 nnnnnnnnnn nnnnnnnnnn nnnnnnnnnn nnnnnnnnnn nnnnnnnnnn nnnnnnnnnn 1080060
 nnnnnnnnnn nnnnnnnnnn nnnnnnnnnn nnnnnnnnnn nnnnnnnnnn nnnnnnnnnn 1080120
 nnnnnnnnnn nnnnnnnnnn nnnnnnnnnn nnnnnnnnnn nnnnnnnnnn nnnnnnnnnn 1080180
 nnnnnnnnnn nnnnnnnnnn nnnnnnnnnn nnnnnnnnnn nnnnnnnnnn nnnnnnnnnn 1080240
 nnnnnnnnnn nnnnnnnnnn nnnnnnnnnn nnnnnnnnnn nnnnnnnnnn nnnnnnnnnn 1080300
 nnnnnnnnnn nnnnnnnnnn nnnnnnnnnn nnnnnnnnnn nnnnnnnnnn nnnnnnnnnn 1080360
 nnnngctgaa cagtagggtt aattaaggag agaataaggt catcggagga gggaggtcct 1080420

 ggggggaaaa tggtcagggg tttccctagt ctggagaggc acctaaggct aaagcacata 1080480
 aaccaactat caggggggaa taggaggggg gtggtcgtaa tagttgtgga aacattggca 1080540
 gcatcactgg ctiggnnnnn nnnnnnnnnn nnnnnnnnnn nnnnnnnnnn nnnnnnnnnn 1080600
 nnnnnnnnnn nnnnnnnnnn nnnnnnnnnn nnnnnnnnnn nnnnnnnnnn nnnnnnnnnn 1080660
 nnnnnnnnnn nnnnnnnnnn nnnnnnnnnn nnnnnnnnnn nnnnnnnnnn nnnnnnnnnn 1080720
 nnnnnnnnnn nnnnnnnnnn nnnnnnnnnn nnnnnnnnnn nnnnnnnnnn nnnnnnnnnn 1080780

nnnnnnnnnn nnnnnnnnnn nnnnnnnnnn nnnnnnnnnn nnnnnnnnnn nnnnnnnnnn 1082580
 nnnnnnnnnn nnnnnnnnnn nnnnnnnnnn nnnnnnnnnn nnnnnnnnnn nnnnnnnnnn 1082640
 nnnnnnnnnn nnnnnnnnnn nnnnnnnnnn nnnnnnnnnn nnnnnnnnnn nnnnnnnnnn 1082700
 nnnnnnnnnn nnnnnnnnnn nnnnnnnnnn nnnnnnnnnn nnnnnnnnnn nnnnnnnnnn 1082760
 nnnnnnnnnn nnnnnnnnnn nnnnnnnnnn nnnnnnnnnn nnnnnnnnnn nnnnnnnnnn 1082820
 nnnnnnnnnn nnnnnnnnnn nnnnnnnnnn nnnnnnnnnn nnnnnnnnnn nnnnnnnnnn 1082880
 nnnnnnnnnn nnnnnnnnnn nnnnnnnnnn nnnnnnnnnn nnnnnnnnnn nnnnnnnnnn 1082940

 nnnnnnnnnn nnnnnnnnnn nnnnnnnnnn nnnnnnnnnn nnnnnnnnnn nnnnnnnnnn 1083000
 nnnnnnnnnn nnnnnnnnnn nnnnnnnnnn nnnnnnnnnn nnnnnnnnnn nnnnnnnnnn 1083060
 nnnnnnnnnn nnnnnnnnnn nnnnnnnnnn nnnnnnnnnn nnnnnnnnnn nnnnnnnnnn 1083120
 nnnnnnnnnn nnnnnnnnnn nnnnnnnnnn nnnnnnnnnn nnnnnnnnnn nnnnnnnnnn 1083180
 nnnnnnnnnn nnnnnnnnnn nnnnnnnnnn nnnnnnnnnn nnnnnnnnnn nnnnnnnnnn 1083240
 nnnnnnnnnn nnnnnnnnnn nnnnnnnnnn nnnnnnnnnn nnnnnnnnnn nnnnnnnnnn 1083300
 nnnnnnnnnn nnnnnnnnnn nnnnnnnnnn nnnnnnnnnn nnnnnnnnnn nnnnnnnnnn 1083360

 nnnnnnnnnn nnnnnnnnnn nnnnnnnnnn nnnnnnnnnn nnnnnnnnnn nnnnnnnnnn 1083420
 nnnnnnnnnn nnnnnnnnnn nnnnnnnnnn nnnnnnnnnn nnnnnnnnnn nnnnnnnnnn 1083480
 nnnnnnnnnn nnnnnnnnnn nnnnnnnnnn nnnnnnnnnn nnnnnnnnnn nnnnnnnnnn 1083540
 nnnnnnnnnn nnnnnnnnnn nnnnnnnnnn nnnnnnnnnn nnnnnnnnnn nnnnnnnnnn 1083600
 nnnnnnnnnn nnnnnnnnnn nnnnnnnnnn nnnnnnnnnn nnnnnnnnnn nnnnnnnnnn 1083660
 nnnnnnnnnn nnnnnnnnnn nnnnnnnnnn nnnnnnnnnn nnnnnnnnnn nnnnnnnnnn 1083720
 nnnnnnnnnn nnnnnnnnnn nnnnnnnnnn nnnnnnnnnn nnnnnnnnnn nnnnnnnnnn 1083780

 nnnnnnnnnn nnnnnnnnnn nnnnnnnnnn nnnnnnnnnn nnnnnnnnnn nnnnnnnnnn 1083840
 nnnnnnnnnn nnnnnnnnnn nnnnnnnnnn nnnnnnnnnn nnnnnnnnnn nnnnnnnnnn 1083900
 nnnnnnnnnn nnnnnnnnnn nnnnnnnnnn nnnnnnnnnn nnnnnnnnnn nnnnnnnnnn 1083960
 nnnnnnnnnn nnnnnnnnnn nnnnnnnnnn nnnnnnnnnn nnnnnnnnnn nnnnnnnnnn 1084020
 nnnnnnnnnn nnnnnnnnnn nnnnnnnnnn nnnnnnnnnn nnnnnnnnnn nnnnnnnnnn 1084080
 nnnnnnnncc atgacgataa tgggacagca gtacttacct cgagacagac cggatgcacga 1084140
 gcgatgcagg gcgtctccat tttgggtcgg ctagcctctt cttctcttgg cgctgtccgg 1084200

 agaccaccgt acctcgagcc ccacgttggg cgccacttga cccgtccagc aggccaggtt 1084260
 attcgcgggt ctcgaggggg ttgtcaccta aagggtcat gagggcgaga aaggaatgga 1084320
 gaccaagcgg cgcaagaaag gacaagagtc cgtctgtgca atgtcaaggt ctcgtttatt 1084380

gaaaggtaaa gcttgcttat atgcagggga tttttactca gggcggggta agggagcagg 1084440
 aggaatgtaa aattttcaag aggaaataga ggcaaggtaa atcttagccc atggtcccat 1084500
 tgttagtgaa ccgcagctat ttctgagaaa agggagaaca ttttgcaaca tgtattgtgc 1084560
 agcttatccg gaaaaaacat cttgtagtca cagcagcgat tctggtcac taacaatgat 1084620

 taactcttga ctcagtataa ggcccccttt ggccctcgac acttcttga ttttagagag 1084680
 agagaagcaa aaaagaaaa aaaaggctgc tggacaatta aaggfactgc caagaagcta 1084740
 tgagaataag gcagacagcg ttgatctgtt gggtttcatt tattattta tttattatt 1084800
 tttttattta tttattatgt gtacagnnnn nnnnnnnnnn nnnnnnnnnn nnnnnnnnnn 1084860
 nnnnnnnnnn nnnnnnnnnn nnnnnnnnnn nnnnnnnnnn nnnnnnnnnn nnnnnnnnnn 1084920
 nnnnnnnnnn nnnnnnnnnn nnnnnccctg ttgggttttt taattgaatg ttttattttg 1084980
 aacttaactg tagatttaca tgcaagtatg agactatttc aaataaaaata aaaggaaaaa 1085040

 aaatactata gactgatccc aagtaccttt tgcccaattt cccccagtgg taatttcttg 1085100
 caaatggta tctcagggga ctagaagatg gcacaatgtg cttgttgcaa aagtgtgagg 1085160
 ccctgagcct gactcctcag cacctctgta aaaagccagc agggcatgtc tataacccca 1085220
 gtgccagga gccagcaggg cacatctata acccagtgtt gggaaggcag tgtcttaggg 1085280
 tttctattgt tgtgaagaga cacctgact gttatgtttt tgaagaaaa gagaaaggcg 1085340
 caagatgaga catattagcc attttattat aagcccagca gactatggag actaaagaca 1085400
 gaagagaaac agggtaaatg gctgaccgcc atggccagtc gccatagaga ggcagagaaa 1085460

 gcgtgtagat gggagaagaa agagtgaagc agaagtgagc agagagaata gagagcaaag 1085520
 agagcaagca gcagggaagt tggaactttt aaagggaaga ctgtgcatgc gcactgaggt 1085580
 tccacacatg cccagagtcc tcacacatgc atggtgggtg atatggtgat ggcacgtccc 1085640
 tgtgtgtgcc ctgactgttg tcaggggct tggctctgta ttaaagagat attgccaatc 1085700
 agcattaaag ctgaacctt tcaatgacca tgaagggacc agctcccat ttcagcagcc 1085760
 atgacagtaa cacgtgctct atgacattgt cttagtcact agaggttagg tgctgctg 1085820
 gtgacaagga accaatcaga agttagctgg tggcgctatg ctttactacc ctgggtgtac 1085880

 tttaggacia gcacacagca atgacgaaga gcatagcaac caccctggga ggcctatgg 1085940
 gccataaca ccagtagacc aatcaacaca gggcaagtcc tctgagcct gtgctgacct 1086000
 cactccctt acgtgcctt acaagatctc ttgggaggcc ccaggagtgt tctttgctag 1086060
 ccatcccca tggcgggtgg gtgaaagact cgagctaaca tggggttagc tcattaatt 1086120
 acaataaage ctcatgcttt attttgcatc aagctctcga atctgctgg tgattggggt 1086180
 gactgcatc gtggcctggg accccggata cctgagtttt ccagggtctt aacaagctca 1086240

gggttccatg gttgtatagt ctgcaggaag gtgcaaagga cccctttaa agaaagactc 1086300

 cccctttaa aaaaaaaaa cccaccact tacctctc atttccctg tttcccgtg 1086360
 ttcccgtggg attaggactt ttctgtctc cctctcttt cctgtcttcc ctgtgtctct 1086420
 ttaccttta cctacctcc cacctcaata aaagttcaa tatgagttac atctacagat 1086480
 ctctgtttcc ccatctgcc gacatccatc atctactcac ccacccaac cccaccaag 1086540
 acttcaatcc tegtgggcc agaacggact ggggaccacc acctcggtta ccaaccatt 1086600
 agtatttatt ctaaacagg gttgtttggg cttttaaca atgtgtgtgc atgtgtttgt 1086660
 cacaggtggg ggcatggtg tgaaggtcag aggaggtgt cagatgcct ggagatggat 1086720

 ggagtccctg gaagtgtta gcactgggac aagggcctg ggaaccaac aaagatcctc 1086780
 tgaagagta gcaatcactc ttaatcaatt aaccgtctct tgcttttca agacagggtc 1086840
 tctctagge ttgactggtc tcaaaactac tatgtagctg aggggtggcct tgatcctct 1086900
 gcctccactt cctaagtc tgggattaca agcaccatac aattatccg cctaccttg 1086960
 tttgcctccc atgttctggg atcacaggca tgtgccacca cgcccagata acaccatcc 1087020
 ttttactat taggtaatc ttctggaatg cacaacaag aactcctagt tccaccaac 1087080
 ccaaacacta agaatgtcat cagataacat ctgagacca tagcagagat tcccacacta 1087140

 caaacccacc ttctgatgt ttccatcagg gtgttaattt ttaaattttt acattaatgg 1087200
 gtcttttctg tgcatgtgtg actgtgtatc acatgtgtgc ctgctgcctg aggaagccag 1087260
 aagaggggaa ctggaactga aattatagac cattgtgaac tgccatgtag gtgctaggaa 1087320
 tttaatctgg atcctagga agaacagcca gtgttaatta ctgagttctc tctcccttac 1087380
 tattttattt ttgaaatagg gtctctggia gccagccag ccttgaattc actttttaga 1087440
 agatgacctg gaacttctaa tctctctggc ccagctcccc agtgatagga ctgtatttgc 1087500
 cacaatgacc cattttaggc caagtggtag tgggtgcaggc ccttaatccc agcactctgg 1087560

 aggcagaggc aggaagatgt ctgtgaattc aaggccagcc tggctctacag agctagtac 1087620
 aggattgcca gggtaacaac tagaaggact ggaggcagaa ctctgtttaa tagcacagag 1087680
 aaatcctgta tcaaaaagca acaacaaaa gacaagtttt atatggtgct ggggatggaa 1087740
 cccagagttt agactatgct agataggcat tactaactga actacacca aaatctcaat 1087800
 atatcctaaa aatgtcttta atcccagcac tcaagagata gaggctgttt tgttttcaa 1087860
 cttttttcc ttctttctg tttctctgc tttcagtact gatggaagcc atgacctcgg 1087920
 agcatgtggc atgtagcagc caagctacca ttgagcaaca ttctaccta ttgttcttc 1087980

tttttgaaa taattttttt aactttactt tatgtgcatt ggtgtgaaga taacagatcc 1088040
 cctggaacta gagttacaga cagttatggg aattgaaccc gggttctctt aactgctgag 1088100
 ccatctctcc agcccctgtt gtttcttttc tttattacat gtacatTTTT gttgctttta 1088160
 acacctaggt ttgattcatg tgaattattc aacgcaggta tcccaggggc atgacaggag 1088220
 agggTggggg atggcagagc agagtggggg gaaagaggtc tattagtaat taaactctgg 1088280
 gctcatccct cctTgggttt catagactcc agaggcatag tctcccagag actcctgaac 1088340
 cttcaaaatc atcgcttaag aagaagcttg ttccaatgaa tcccagtttc ttcaggttct 1088400

 caatgatgtc atccatgctg ctttttacga gaactttctt cccacacca tcaactgcaa 1088460
 caacctccat cattctgect ggagcaaagc caaatcccc aacagaagtc ctgactggga 1088520
 gaggaagtgc acgacctgta gtacatagat gctgcttagg tccaggcagc cctcaaccgt 1088580
 ttgtattctg tagtttttag agacaaggtt ttatgtagcc taggctggtc ttaaacttgc 1088640
 tataatagtc ggiatggect tgaactttgg cctctctgt ctacactccc aaatgctgag 1088700
 attacagtt tgcattgcca cacctggttt aagaggtgct gggaataggg tcttgtttca 1088760
 tgcattgtag gcaagcatta caaactttta aaataacaga ttctttccag atttgataaa 1088820

 gagatgcata aggtaagttt aagggggaag tgccttttag caatgctgtc tacttaaagt 1088880
 gggggaagca gggctaggag gcctaacaac cacccacaca cataggagat tccttacttt 1088940
 cagagacttt agtgggaagg ggaatttaag tttagagggg aaggttgtct gagtgtagct 1089000
 gattagttaa ggtaaacaaa cttagtgaag ttttagtgaa gtgattagtg aaggatacaa 1089060
 agccatagtt taggacctaa tcttactgtc ccaccctact cgggggcagc tacaatgctt 1089120
 tagcagttta ggaaagtat tgcattagat accagatgtg ccacaagaag gggcagcatt 1089180
 ctgtgaccta atactaatca agtaacatta aattttgtta tttaatTTta agttagagtc 1089240

 ttactctgta gctcaggttg gcctggatct cactacttac ctaaggctgg cetcaaactc 1089300
 aaatcatttt gcttgtgcca ccacattagg cttaaagtta tggacacagt cttttattgc 1089360
 cctgactgac attgaactgt tggTgaagaa tctaatgaac tcttaattct cctctgctc 1089420
 ctgtaggagt gatcagactg caggatctag agggcctttt tacttagagg ccatctctc 1089480
 ttctgggaaa ccatctaatt tgggggcaga tatttttttag ataaactaat tcatactac 1089540
 acgaccagag gaggggttgt gcagagaaca ccagtgaaa gtacagctca cttgaggagt 1089600
 ggggaatagg tgggtagct agcatctgcc tttagcagaa gcatttcaga aacacagaca 1089660

 ggatctctct gccttcaagg tcgacttggT ctacacaatg agttccagc ctgccaage 1089720
 tacagaatcg agcccctatc tcaaacaaaa ccagcaaaaca aaaaagatta gagaaagaac 1089780
 aaaataaata aaagattagg aaaaagattg ggagaagaga gaagaaaaag tccttctcat 1089840

tatttcacct cccaattttc ctacaaaata gccaaatgag taagtggttc tggacattct 1089900
ctaccccctg cccaatata cagggtctca ctatataact cctgtgtcca ggaattcagg 1089960
agtttgagge cactgaagcc tcaaaactcac aactggttat agtatagcaa ctataccttc 1090020
ccacacccat gcctgggtgga actcagagtc acacacttgc tgctgagcta cacatctagc 1090080

ccgatagcta gataaagtgt cttatactag tttcaaaaat atttcaaac aagcaactct 1090140
aagccaggct tgggtggcact caggaagcag agaccagcag agctctatga cttagaggct 1090200
agcctgttct acatagagtt ccaggtcagc cacaaacact cttaagttct gaaagtacaa 1090260
cttctctaaa ctaccttcaa agtcttcacg cttcagccaa tgccttttct cagacttttc 1090320
cacactcctg ctgaagaacc caaggctttg tccagattaa gcctatgctc caactcccag 1090380
ggatggctgt aacccccaca cttactttct ccccacagtt tttacctatg acaccacctc 1090440
tggacagcct acccttaagt cttagcaatg ttaagtactg cagacctgaa acaccatccc 1090500

tcttttctc ttactgttgc ttctctttcc aggaatatcc tccctggctc cttcctctct 1090560
aaatgtacca gtccataaag ccccttctgg cttctccagt caattaagta cttcctcttt 1090620
tgctcctgag atatttctcc ataaggattc tgcatttatg agataagtaa aactatttgt 1090680
gataaaatac aacaaaaata agtactgtat ttatacaatg tttttctttt ctctaaacc 1090740
attaacagat tttgttcaat tcattttcat atgcagtaac acaatgtgtg gtgaatatta 1090800
tggctctgagc aaatgattgt tgatttgtgt gcgaatgtgt ttcacatggg tcaaacttag 1090860
tcttacaaca tgctagagaa gcaagcagtc catcattcat ctatttcca gtccctgaat 1090920

aaatttttga agtgcataag ttttaatttc tagctttctg attgctcaa gcactttagt 1090980
ttaataacta ctttcaaaa accatcctct ttgaatccct ttgagggaga ggggtgttggg 1091040
gcatcaaacc tagtgccttg tgcagctaa atatatgttt tatatttatg tgtttgttta 1091100
tggagaaggg tctcactagg tagccttggg tggcctagaa cttgctaagt aggccagact 1091160
aagtaggact ctacctact gtatctatcc aagtgtgga attaaaggca tgtaccactg 1091220
agacatatct aaacctcat taaatagtga ctcttgctgg gcagtgttgg cacaagcctt 1091280
taatcccage actttgggag gcagaggcag gaggatctct gtgaatttga ggccagcctg 1091340

gtctacagag tgagtccag gaccggcctt tggcctgatg aaaagccctt taagtttatg 1091400
tttagatgac aacaaaaata aacctaaaaa ccttgaactt gtacctgaac agtagatagt 1091460
cattacttta tcagctagca tactgactag tctatagtgg atctgactgc ctgattctgt 1091520
caagctgaca accagtaata ttacagagat ctgagaaggg tatattttat ccgaatctac 1091580
taaaaagtga cagaagccag ttagaagcca gtccatatac agttagccaa acccaattct 1091640
ctccattttc actggaggca gatgtctcaa agaacagcaa tctttgctgt gagaggtttt 1091700

ttcctctgtg gaagaggac atggaaaaga ctgactttgt tttgtctacg caaaggggta 1091760

 caatcaattt tccagtgtcc aacagctttg tccacagtct cggccaggtc gtgacaggca 1091820
 acaagtagca gcacatctga gcatctcgtc cactggtcag catcaccatc atctagggtc 1091880
 aggaactggg gtgcctcata atcttctttg gagactttgg gtcactgtcc ggatctggca 1091940
 gtctgtctga tattataaac ttttaagata acaattgaaa tgccatattc tgcagatctc 1092000
 tgaagcatta gaggtctgtt tgtctgtttt agttactttc cttaaqcaca cattaagcac 1092060
 ataagtggtc aggtaatgtc ttatttctgt aactaatttt cagtatgact gtaactgatt 1092120
 ttaacttagt aaaaatgttg aacaactgaa cttaaaactg catagcgcta ctttatattc 1092180

 cttaaacagt agctacatgt acatatttta gctgtttgct taaacttaag ttctgaggca 1092240
 gcgtttttct gtgactttgg agcctgtcct ggaattccat ctgtgaccag gctggccttg 1092300
 aactcagaaa gatccacctg ccttgccctc cgagtgtctg aattaaactt aaaggcgtgt 1092360
 gccaccaaca cctgaattt aaaggtgtgt gccaccaacg cctgaactt aacttctgaa 1092420
 aacacaaact gtaacatctt ataatagatt agcatctttt aaaaaacaag aactttacat 1092480
 tgtcaggatt tgettaaaaa taattcaaaa ttgaagetct ttaagtacaa acattaataa 1092540
 aaacaaacat ttaaactggt tttaaaaaga aatttaattc ccttaaagtc tttatgtaat 1092600

 atatagaagc gttagaagcg ttaacatttt aaatcttaat tgaaaaactt gtttctaaga 1092660
 tggtagctct aatttccatg tcaagatggc gatttaagta tcttttttaa cttcagcaaa 1092720
 atggctacca gtcagccatg ttacaaaact taggttatgc caggcaacag aacattttaa 1092780
 aacaagtata cataatttac ttgagaaata aacagaactt tttaaactga attaacttga 1092840
 tatgattaaa attttaactt atattaccaa ttttaaaatt taccatttgt agacatgaga 1092900
 aaccataaca ctttacagtt tacatttttc tctgacttgt aacaacctt tctatgacct 1092960
 tcaacaactt tectctgacc ttctacgact tgetttaacc ctctataact tccataactt 1093020

 cctataggca ttcttagaca aatttctttt ttttttcttt ctttctctat tactttagta 1093080
 tctacatctt tctctcatct cttggtcaac atatattctt atcaaagtcc ttaagttttt 1093140
 tttttttttt tttttttttt ttagaacacc cggatcagga cagatggttc ccccgcctga 1093200
 gctccatgtg ctgaggaag agacctgggg ggggggggct tctggtaatc ccagaccctc 1093260
 agccaatgca ggggtgagaa aaaaccctg cagtccccct gcataccatg tgtgtggagc 1093320
 acaaagaagg cagggcagct agctaggcag atggcgccct tgcagccatg tccctcaga 1093380
 gccgcaagcc aggactcatg gcaggagagc agttggggca gagactcccc cacttcgcat 1093440

gcctcacagc ccggcagggtg gggataggga aagactcacc tgcacgccc aggctcagct 1093500
 ctaagggtg cagcagtggt tcagaaaagc agtctcgggg gactccaaca caacacattt 1093560
 taacctgtga cacatggcag aactcctttc tcatgccaca tgcttagggc aacaagaaaa 1093620
 gaccctgac ccatgcatgc caagtgcgtg ggcagtaggg acagaaagag atgcttaaca 1093680
 aacacacaac acaaatgtga aacgtggaca gccagtacag taacacagac tagggctcta 1093740
 ttcggaattt cagatgactt gctcccagct agtcccctc ctacagattg tgcgaccac 1093800
 ttgggtcccc ttatagatgg accaggcaac ttggtcttac caggtcccc tcctacagac 1093860

 tgcagaagct gtcattcgaa cctctgcct aaacaattct tgtacagaaa ccatacagaa 1093920
 acaaagactg gaaaataaag ttacctagtg tggtgccacg tgactcaacg aaaggggtg 1093980
 tcataacttt aactgactaa ctatggtcct taactcctg ccagtggtca aaagtacagc 1094040
 tgagggtgta gggagccgtc cctgcattct ccattacaag atggtgcctg catccggcag 1094100
 aactgaatg taacaagat tattgcgcag gcgctgggta atttccatt ccttgatctc 1094160
 tgcctattcc gtggcgtcat atggcctgat gagctgcagc caatcatagg gtgacacgctc 1094220
 ccaggcggcg gctgccagcc tttattaggg gacgggattc ttggtcggg gctcctcctc 1094280

 tggtaaactt atgctctcct ctcaagacgc attaaaagct ttactgcaga aggatccgaa 1094340
 tgcctgtgt cgttcttctt ggcgagacag tcgcccggga catgaggggg gttggttacg 1094400
 gtcagtccea teatcaaat cacaaataag acaaaaacaa actcaagaca cacagacaaa 1094460
 aactatcaga tgctgtctc cacctagaca acaaaaatca ctccagaaat acttccaat 1094520
 ccaggagaat taccgtacc taccggctc ccaccggctc ccagacggga atctccaag 1094580
 cgtccctgag gttcccacag acttcttggg aagtcttcca gggtagcagt cggatgatctc 1094640
 ccaagcacat ctactgatca cactctgtct cctccagaga ccagagctct tctctctcc 1094700

 caagacacga gcgactgcaa agcacagaac cagatttcag ccggcacaaa aacacaaaga 1094760
 cacagacaat acagggtacc cgcttacct caagatcgac tccactcagg tgaggggtgg 1094820
 tcgcaaatcc cggacgagcc cccaaatgta agaccctga aaagtgagg ctccagaat 1094880
 cttagcccag gacctcgcc accccaatca cagaatggag gtgaaagctt gatgcaatt 1094940
 gcatgaggct ttattgcagt ttaacgagct aacccatgt tagctcgggt ctttgatgca 1095000
 cccgcatgt cggatggcta gcaaagacag ttgaagcgg ctgcatacag atctttatag 1095060
 ggcagcgtaa ggggagtgtc taggggtatg cacaggctca ggattggtgt gcctccaggc 1095120

 ttggagggtt tgcctgtgt tgattggtca actggttgtt atggtccata ggcctccca 1095180
 ggggtggttc tatgctttct acatcattgc tgtgccttg tccgtaaacg acaccaggg 1095240
 ttgtaagca tagcggcacc agctaacttc tgattggttc cttgtcacga gacaggcatc 1095300

tgactttcta gtgactaact tctgattggt tccttgtcac gaggcagga tctgactttc 1095360
 tcgtgtctag gacaaggcca tagaagcacg tgttcggcca ttatggctgc caaaaggaa 1095420
 gctggtcctt tcaatgggga ggaaaggag tcaatactta catatcaatt acctaaattg 1095480
 taagtcaaca ctcttatatt ttgttatagc tgcaaacatt tgctaacttt ttcactgccc 1095540

 ttgcctcac ctaatgactc aggtatgac tttatataga taagaacact tgagactcag 1095600
 ggatttcaat gaccagctaa ggaagtctc tcccagggtg ggtcatcaac ttgtcagctg 1095660
 attcatccac agcctgtggg tgttagattt ctaatccagg tctggaaaac attttgaatc 1095720
 ctttgtgata ctcttcaag gtttctttt cattcctagt tagtcattct ttacacaatc 1095780
 tacctgagat gtttcttcaa gtcactcttt tgaagttaag agttccttct attctcctc 1095840
 ctccctccc ttcccacttt ctcttaggta ccgaaagtg caccagggt cctcacttg 1095900
 ctgtgcaact gctctaacac tgagaacat ccagccctt gctgccttt tctgtaaca 1095960

 catggtatcc aattcaaca cagctctgac agtatcctag caccattca acagactga 1096020
 tagaaataca ggtattctaa agaggctcta gagcgtgtgt gtgtgtgtgt gtgtgtgtgt 1096080
 gtgtgtgtgt gtgtgtgtgt gtatgtatgt atgtatgtat gtatgtatgt gtgtatatct 1096140
 gactcttaga ctattcaag gactccaaa gaaatggaaa tttctgcag ggaaactcct 1096200
 gatgggttgg gcgttgggg cacacgctt taatccagc actccactcg ggaggcagag 1096260
 gtaggagat ctctgtgagt tcaagaccag cgtggcttac agagaccgtg ttccaggacc 1096320
 agttcaaaa acaatacaga gaaacctgt ctgaaaaac caaacaaaa caacaaca 1096380

 ctctgatgg gaaaaggaa aggtctcaat ttgaggaatt tgtctcccag aaagagattt 1096440
 cacacagttc tatctagcca gaccactta caggatgaga ttgaagactt ggactgctta 1096500
 gatgagccta tcaagggtcc tctatttaa cttaatctc actccaggac cccagagagc 1096560
 cacttatgga aaggtaagt gttgtagaat attgtacac tgtgcttggg ttaataacga 1096620
 actgaatggt caatagctag acaggaagag gataggcggc acttctaggg acaaagagga 1096680
 ctctgggaaa aagaaagaca aagtcggcaa ccagatattg agaggaagag ggggtataa 1096740
 aattggagag gtaaaagca catgtagaa ttagattaa ttaaaaatag atatggatta 1096800

 attcaggtta tcggagctag tgggacaagc ctgagctaaa gaaaacttt cataattaat 1096860
 aagatccgt gttgttattt gggaactggc ttgtgggaca gaaaagact cactacagtt 1096920
 aactatctct ttggccctct tcccagtgig gccacgtta gtcaatctcc tttttctgtt 1096980
 ttttactggt tttgttctg ttgtattttg tgtttggtt ttgagacagg acttactga 1097040
 gggctctage cgacctgaa ctctctaac agaccacag ggagatccta ctgtctctgc 1097100
 cttcagagt ctgggattaa tggctgtcac caccacagc tgctttccac tttttcagt 1097160

ggtttattga ctgggtggcc caccttggct tggggcaccg gttgtgaccc ccctctaaat 1097220

 tcggttaaca cccatttggc ctaatctgtc ttcgccacac accaacccaa gcagtttctt 1097280
 cctgatttcc tagcctccat tcccctgac gaaagagctg tttcccagg tgtgaatcct 1097340
 agacctctc ccatcatggc tcatctatct caaacacatc aattctaaca gacatttctg 1097400
 gcagtctcgt gggctgacgc cctaacgcct gctgccagtt tctgcatctg gtgcctgaga 1097460
 aactgaaaac tcttgacgc gccaccaaag tagcctgctc cttacggtga ctaatttcca 1097520
 ttactgcttt ggggcgtgga gtagaccacc ttggccagac gttctcaccg aacacgcgct 1097580
 cgcacacact acgccttggc accaacccgg gattcccagc ctgtggacgc tcccattgcc 1097640

 gccagcgaga gggaggcct cggctcacg gaacgcctct ctaacgagtt cctgtgacct 1097700
 ccgccttccg acattctcgn nnnnnnnnnn nnnnnnnnnn nnnnnnnnnn nnnnnnnnnn 1097760
 nnnnnnnnnn nnnnnnnnnn nnnnnnnnnn nnnnnnnnnn nnnnnnnnnn nnnnnnnnnn 1097820
 nnnnnnnnnn nnnnnnnnnn nnnnnnnnnn nnnnnnnnnn nnnnnnnnnn nnnnnnnnnn 1097880
 nnnnnnnnnn nnnnnnnnnn nnnnnnnnnn nnnnnnnnnn nnnnnnnnnn nnnnnnnnnn 1097940
 nnnnnnnnnn nnnnnnnnnn nnnnnnnnnn nnnnnnnnnn nnnnnnnnnn nnnnnnnnnn 1098000
 nnnnnnnnnn nnnnnnnnnn nnnnnnnncg gcctcgggcg ccgggagatc gcgtcccga 1098060

 acaggttaaga gtgggagcca gcgcggaatg aatgggcagc cggccgcggg tgccggtccc 1098120
 cgccctggc tgcggcgtcg cgtcggggag gaagcgtac gccgctcagg gtgccgggtt 1098180
 cgtatttgt atctgatcta cctaattccg ggaggccaca gggacctct cccctcccc 1098240
 agatggtcac acgttttct tcttttacc cccgatgca gagcggttac gtttcggtt 1098300
 cccagactgc ttagggacat ctttatgagg ggggaaaatg taaaaaatg aacttgacc 1098360
 gtgggtttgc agggcctac ggctctgaat cttctcaag ccgctcagt actagcacgt 1098420
 gttgctctc caacgtttt gatgggggtt tttgtttt tttttggcg ggggcccggg 1098480

 gggcttccac tccgactctt aaattcctgg gtgaagcaat tgtaaatcaa ctttccca 1098540
 ggagtcaate ctatacatca cccctcagtt ttgagtgtcc tctttctacc taaggcaga 1098600
 tttgacat cacaactac atacaatta agtatggctt ttaaatgaat agtttctcgc 1098660
 tcagatcaa gcaactatc tatgtaatat ctttttcaa cctagcaact acttcataat 1098720
 actttctag aaagtgtaat ttggttgta cctcaaatta gggtattgcc tccaacatat 1098780
 ttgtatgacc atccttattt actagggtac attttggtcg agttttgat tagttaaagg 1098840
 acagattgca caccagaaag tataggttca ttgagcctt cttgtttgtt tttcaagaca 1098900

ggttctccat ctggctctag ctgtccttta actgaattgt agacaaggct gggttgtaat 1098960
 ttacagaggt ctgcctgctt ctgcctcctt agtactggga tcaaaggagg gcctccacca 1099020
 ctgcccactt gattgaagcc aaaaccttaa gccatcatca acaccttatt ggcagacatt 1099080
 tagacttcca attttttttt taattaaggt gtttaaatgg gtgtgggtggc atatacctgt 1099140
 aatcccagca ctctggctaa agcaggagga tcaagatttg gagtgccttc ccacccggat 1099200
 acagtcahta cagtgtatca ctcagcacag gtgctttaat atagaagaca taacattaga 1099260
 gattctaagc ttaggctgtt tcagaagagc tttctttcca tgaagagggtg agattggggc 1099320

 cccaggagat ggctcaaatg gtgaagatgc ttgttaccaa acctgaagac ctaagttcag 1099380
 ttccagggat ccacgtgatg gaagaagagg actactaact ccttcagggt gtcctctggc 1099440
 aaccacatgt gcctacgcaa atataaattt atctgtttat ttattttggt tttttgagac 1099500
 agcgtttctc tgtgactttg gaaactatcc tagaactagc tctttagtag caggttggcc 1099560
 tcaaactcat agatatccac ctgccactgg ctctcaagtg ctgggattaa aggtgttccc 1099620
 caccaacgcc catcttttgg ttttcaaaca ggtgagatta aacagaagca gatgtggtga 1099680
 ctctttctg cttgttttgg agacagggtc tcagtgtagc ctttactgtc aaggaggtct 1099740

 gcatccatgc gtgggacta atgggtctgc ttgtctagga gcagttcttg aattcaaggc 1099800
 cagactgggc tgcctgtaat gaggttccagt actgtgtgtc ctgaagttag atccttaagg 1099860
 gataggggtt tcacaaaggt ttgtttcatt aagtgaaca ctttttattt tcatggttaa 1099920
 atttgtagt tcagaagggt agggccaaag ttcttgccac agtaatgaca gttcttgata 1099980
 ctttcaggac tcagaagggt gctggtgctt gagctggact ttgaaaatat ggttagggtt 1100040
 gaaaggggtt aatatgaagc attttattga agaaaggcag caaaaaggaa agaaactttt 1100100
 ttaaagagt aaagaagaaa cactttgcag agtggacagt attttctaa atattttaga 1100160

 aacaacattt gatttctaag aattaatctt tgtgtgtttt ttatgctaca tgtgtggtag 1100220
 tactgagga gaccagaaga gggcattgga tcttgggact gaagttaggg acctggaaa 1100280
 agcagcagga ctctggctac tgagctgtct ctaacccttc caccttcctt tttctctctt 1100340
 agggttagac ctgacctttt gctcttggtt agcagattct tttttctttt agagaaaggg 1100400
 tctgatgttg cccaggctga tcttaactt tgttatgtgg ctatagataa caacaaactc 1100460
 ctgattatc ttccttacc taaaaatgc aaggattaca agcatggacc actatgcaa 1100520
 gcaagcagat tgicccataa cacccagac ttgttcaaaa ggcctgaag gaactgaaag 1100580

 ctactctatc tcttaatgag gagcagtagt aactccagct atacattcat actctaactt 1100640
 gatcttgcaa ttggatgagc acagtctctt ccagttctca catactgtat tgtatgggct 1100700
 taaaaggaa ccttggggag tgatcttact agccatgttg ctttctctc caaagcaaag 1100760

acagcatcct gcagttactg tgctgcagag tagtctgtgg gcttggaaat gctattctcc 1100820
 agatccctcc tcctcgcatg aacatttgca aatcctttaa ctttggttgc tgtatcttac 1100880
 tgacagatgt catccagaaa agatttaaca catatatcca caaactttgt tgaacagtgt 1100940
 acctactgtt ccccatgcta actacagcag gaattgagaa caatctttgt ggccggagtt 1101000

 gttgggccaa aactttgaag gagccgaaga agagtgtaca ctgaagaggg gatagtagtg 1101060
 gaacagggag aacaccttca tgaaaatgca cagttacagg tttggtttcc tcaagacaaa 1101120
 cttgaattct atccagcaaa tgctcgtggt gcttctatgg gcttgggaat attttatgag 1101180
 ctttaccgcc cttttcaaaa gctcctcccc cattttattt tatgtttagg ggtattttgc 1101240
 ttgcatttat gtctgtgcac catgtacatg tctgggcctt gaggaggtga gaagacgaca 1101300
 ttggcttctt tggaaattgga gtaagccgct ctgtaggccc tggggaagag cgcaagtact 1101360
 cttaaactgct gagccttata ttcagcccca gctgctactt agaagtttga ggcgccatga 1101420

 agagcattct gaaagaagga gaagtaaggc cgttgccttg gtgtattggg aggagcagga 1101480
 agaagggaaa ctgagccaca tgttaggggt cacctacctc tgactctcag aacttacagg 1101540
 gcttccatag ccttttaaat agtggtcac atactttagg aaatacttag aacttgagcg 1101600
 tttagccctg tggtaaagcc attcggttag ctagggtgtt ctggatttat tttgtcctat 1101660
 gtgtctttgg gtttctctgt gctgaggatt gacctagggg attcccttaa cacatggtaa 1101720
 acgattctga gacactgagc tacatcccag gcccttagag ttgttgtgtt ctataatagg 1101780
 gtcttctctg ggaaggaaga agactacatg gccttgaata gaacactctt agcatgagcc 1101840

 cagcatgata gagattagac aagagtgtc aggggaaaag aaagatgaag aatacaaatg 1101900
 tctctgtaaa ccttttctt tttccggtgt caaaaaatgt cagggccac tcaggttttc 1101960
 tgaacttttg atagctgtaa gttgaacctg aacatttggg ggtgttctgt ctggcatgac 1102020
 cttgtggggg gtataagaag acttgcttca gtaaggcctt tagaagcctg cetacaattc 1102080
 ttattgatat atttcttata ccttcaaaaa ttcgagattg gtatgaaatg atagggtttg 1102140
 tgcaaaaaga aagtttaag tcaccttgag aatttgagta atatgagaag tcatgaaagg 1102200
 agtatcagag tgttcattcc cgctctatag caagttcaag gccggcctga gaggcataag 1102260

 agcctgtctc caaagtatac aataactaa agtcagagaa tgtaactcat tggtagacc 1102320
 cttcattcag tcctcagaac cagcaacagg tgtttacagt gatgtttcta ggaagtcct 1102380
 tagtctctga gcattgttcc tcagttttcc tgtgtctccc tttttatctg gctttcctac 1102440
 aactctctaa atccagtgtt gggtagctgaa tcctatacct tttgcatgct agggggacac 1102500
 tgccattgag ctaaattgcc agttgggtggc tctaaagtgga aagggcatct ggaaagtggc 1102560
 agttaggcct ctctatagaa tgaggaagcc agtggagacc atgctctatg ccagaggtac 1102620

tgaagctgcc ttctgtgtg gccatcataa cccttaattt ccctgctcag aaataccctt 1102680

gaaaagtaag caggatggtg caagcttgtg gtgcctgccc tcaagaggct gagaccagag 1102740

gatgtcaagt ttgaagcctg cctagtctgc ataatgaggt cctgtctcaa aaacaacagt 1102800

ggcaacaaaa atcaaagggg aaaggtctaa ataaatatgc cttggatgtg tgttcataga 1102860

ttgctcctga ttggtctgct tcactttgag gacaggcatg cttacaaggc ctaagatata 1102920

tcaccactt ttcttagag ctgtagctaa aattagtaca gctgtttaaa atttctattt 1102980

taaatatatt gtttgtttg ttatgtgtgt gtgtctgtgc acgtgtgtag gttcctgagg 1103040

aggtcataag aatgtattag atcagccggg cgttgggtgt gcatgccttt aatcccagcc 1103100

ttctggaggc agaggcaggc agagctagtt ccaggacagc ttccaaaagc cacagagaaa 1103160

ccctgtcttg aaaaccaag aaagaaaaaa agaatgtatt ggatcacatg gagctggagt 1103220

tacaggagggt tgtaagcctc ctgatacagg tgcaaggaat ttagcttatt gatggcataa 1103280

cttctggttc tctgacattg attcacttta attttttag atttattcat atgcatgaat 1103340

ggtttggttg aataatgtgt atgtgtaaca catgggtgcc tgggaccctt caaagtcaga 1103400

agagggtatc atctctgga gctggaatta caagtgettg tgagtcacac tgtgctaaga 1103460

accagacca ggtcctctgc aagagcagta agcactctta accacagaga tctctctcca 1103520

gcacctagtt ttttgaatg tagatatatg tgtttgtatt gctaccttat ctagaactac 1103580

taggcccagt gacttattta tagtgtgcca gataatgagc ttccatttta aaaaataatg 1103640

tagcatttta ctgagttgt gctttattgt ttgtgacata tctcattgaa tagcccagtg 1103700

gaattcactt gtgtagctta gtctggcttc cactcaatg tgtactaaag attgggtttg 1103760

aacctcttg catcttagct taacctcca agtgattaca atcatgtgct gccactcca 1103820

ggaggctttg gaaattctg tatgaagtgt ttttccttg tttcttaagt ggcagaaaac 1103880

ttggctgatt ttatgccaac tgtgtaaact ctgggtggg gagtgaagca ggtgaagaga 1103940

ccgatagaaa ggtgcactg tgtagtacta ttggacctgg aatggacagc ccaaccttga 1104000

actcatagag ctccacctgc atctgcctcc ctagtactaa gatgaaaagt atgagtaacc 1104060

attcccagct acagtttcat ttaataaaa gttaaagcaa aagttggcaa actttctgtg 1104120

aagagccacc tggtaaatgt tttagtctc tctgcccag tctaactaac ctttacagtt 1104180

ggagtatgtg aggtttcaca gacagtatgt aatatafaga ctatggacac tgaatttga 1104240

atfttact cttttcacat gtactttatt tttctcaact acttttaact gtagaagtga 1104300

tttcatagat tactagcagc agcacaatgc caggacagca gcagatttgg gccatattct 1104360

gtggatcctg gtgtagagaa ctctgtgcta tcatcagaat ctccttttgg gttttcaaag 1104420
 ctgtcaaagc agttcattct tcaaagcatt cttcaaagta ttaatgtag ggaggggatg 1104480
 tcaccagaga atgtacaagt atatgtaaaa ggattttcttt agagatattt tctaataagg 1104540
 ctgtcatgac tggaaatatg gctcactcaa ccttttctgg aacatgcttt ggcttttctca 1104600
 tctactctct gactttctgc ctgctgtgac actgtgtcta ggtgcgtgta tttttagaca 1104660
 tactagattg agagttaga ccttcactgg atatctggaa atgccactca ggtcatggca 1104720
 ctgctttgta cactttgtgc tgtaacagtg tgtgtgcctt aatggcagtg acgtcgatag 1104780

 atggagaagg tgaacttga cctctgatga ctctggcac aaaatatggg ctgatttga 1104840
 tgcttgctg ctcccagcag gagccagcaa gcactgttgg aatgctgac actcacagtc 1104900
 caaggtgcag caggtactt gctccagggc ccaaactgca gtgacatcag tatccacatc 1104960
 tggaatggtg atttacaaga ttgctaggaa gagtaatggg aacacagaag taactggcac 1105020
 tcctaacagc ttgctcttta agcccaaaag tigttttcat taagcactgg agaattgcta 1105080
 acgttaagac agtcattcag atgtgctagg tacctctatt cacagtctta cagagctata 1105140
 gttgatttat ttaataagca taatgctaga gattgaactc tgggtcttcc tcatactatg 1105200

 caaacaattc accactcctt cacacacgta ccactctatt attattatta aaacttaatt 1105260
 ttttatttta ttgtactggg taaatgccc accaccatac accaccagcc ctgccaacat 1105320
 ttgctaaage accatgctgt gtaactgtccc tgtcttacct ggtggtacac tetgctaate 1105380
 ttagcacttg ggttgtgaga ggaaaaatgg ttcaactatc caaggacatc taacgtttaa 1105440
 aaaaactggt agcagccagt tagtgggtgg gcacccttt aatcccatca tttgggaggc 1105500
 agaggcagtc agatctctga gttcaaggcc agcctgatct actaacttga gttccaggac 1105560
 atccaggact acacagaaaa tcctgtctt acataacaaa cagcaaagtc agtaatgtgt 1105620

 gggcatagac ctagacatgg gtgcttgaat attggattcc ttaaaatata ttaaatatgc 1105680
 agcatagcca gtgccctgg aggatattt gcgtgaactt taaccactt gcctgaaag 1105740
 tggccacatt tattctggaa cgcaccctaa taagcctaat gagaaaatta gctgccaaat 1105800
 ttgctgtctt aactttgagg tagttgggct catggccagc agatggcagc attgggctgc 1105860
 tggacttgt catttatagt gttgtgttat atacttact gttccacgtt tcctgggcc 1105920
 aagattgate agctttcaaa tcctctagg tgtataccta agacaatcct ggtatttgc 1105980
 tattctttac ctttagtct tttcttttt agttgggtca tgctggagat actcagctca 1106040

 aactgagaaa cattatccac taactggaca gttgggcacg aagaatagta actgggtaac 1106100
 tagagcatgg tgaggtgatt tgcttttagg actgcttggg aactaggtag gaccagttag 1106160
 tttgggtctc aactagttag attgctcca aagatctaat tagaaaggaa aagctgtctt 1106220

tttttaaate accatcttgt tccacacagc tagcagatgt tacagctcag ttaaactt 1106280
 gcctagagat acaaagtctt ggatacagtc tctgtctctg aagagaaagg actaaataaa 1106340
 gctagatatg gctttctctt gtttaagtga gtgggtggagt gtttgacctg gcctagctct 1106400
 gtaaccctgg ctgctctggg acagiataga ccaggttggg catgacctg aagcagtctt 1106460

 acctctgcct caagtgctag gaccaaagtc cctactaaca tgcccagtga taaaactat 1106520
 taagttcctt tagcaggata gaatggtaca tgccttaat cccagcactt ggagggtggag 1106580
 gcaggcatal taggaatttg aggctaaact ctgttcaaaa gtttgaagcc agcctgggct 1106640
 actagaggcc ctaagactc catttcaaac aacaaaattc tttggttctc ttagtacctt 1106700
 tgtttctctt gagacagcca agctgtcttg aactcatcca ggaatacaaa ctgggttgaa 1106760
 cttaaatgtt cctgctaca agtgccacat cttctgagga ataattgatg gtgcatcaag 1106820
 acagccttga attccatcca ccttgcaccc ctccccaca tcaataaaat gtaaagacaa 1106880

 ttttcagcaa tgtttttgca aaaatggctt tagatctgtg tggggttttt tgttgttgtt 1106940
 gttgttgttg gttttttttt ttttttttaa tcttcatgat catcctgaac ttacaaagat 1107000
 gcatcgagga aagtgtagtt agatggtaat gtcaactaaa ttacctgttg gcagacagca 1107060
 gttagaaaac agtctgtaaa atcagttacc actagataat tgagaaatcc catcttcagt 1107120
 aggagaaagg gcaggatttc ttcaactgct tgtgcatgct tgcagagtac tgggaagagt 1107180
 tttagatggt cccccaacct agtccacatg catgacttac atcagaagtg caagggtgga 1107240
 caacaggata tatTTTTGAA gctctcagtg atagtgagcc aggctgggga gtcattagta 1107300

 tgattctagg tagttgttca gttatgttaa tgtatagggc tagggatgta ctgctttaag 1107360
 gtgtgatgtg ttiagatgct tatttattgc aaggagtagt gctgttgggt tactctcctg 1107420
 gcaacgggct cttaagtta ggctggttct ccattgtgct aacttatgac taaaataaaa 1107480
 actggcattt tcttttcatg gtaagccaac ttcagagctg aggtgcaact gtcagatttc 1107540
 cctgttgttc attttttact gtcataattc caacaatagt tggcacatgg ctgctaaaag 1107600
 tatttttaat cagaaggaga aattgcagag tatgcttttc aattaaagaa aagcaatagc 1107660
 taggggtggt ggcacaccca gcactctgga agtagaggca ggtggacctc tgagtttgag 1107720

 gccagcctta tctacagagc tagttccagg acaggcttca aagctacaca gagaaatcct 1107780
 gctcaaaaa acaataaagc aatgccatct acctgcatgc cagcccttca cattccttgg 1107840
 ggtgtagctc agtggtagag cactggccta atagtttcaa cctcaaccaa taaatagaat 1107900
 ggtctctgtt acataacagc ctgcttactc tgtattcaga tgggaactt tgagatacag 1107960
 ttttaatctt gtagggtagg tgagttttca tttctcttga atacatgctt ggaagtaaaa 1108020
 ttattgtgct aacctgcttt tcacttttta aaatctttaa caaactattt caaaatagct 1108080

ataccatfff aaatffgcat caaacaacat gctgtccata ggtacttggc cctffftagtc 1108140

 tctffftatgt ctcatgctff tfgagtctat acagaagaac tctgtctagc cgggcggtgg 1108200
 tggtagatgc agatctctga gtttgaggcc aacctggtct acagagcaag attcagaact 1108260
 gtcagagctg ttacacagag aaacctgtc ttgaaaaaca aaagaaaca acaaaaaaga 1108320
 actctgtctg gcttacaaga cttffcatgt gccctffct taggagtata atffftfftag 1108380
 cttatacctg taacagcagc attgggagac tagttctagg caggtffggg ccatagtgt 1108440
 atactffgcc tcttggctga gttgtffftt agttffftcaa gacagggtff cctgtgttag 1108500
 ctttgagacc tatcctggca ctctctctgg agaccagctg gcctcgaact catagagatc 1108560

 agccttcttc tgcctcccga gtgctgggat taaaggcgtg tgccaccaac acccagctat 1108620
 gaggttgtct tffftgtgtg ctggggcatt gaaccaggg ctttctaga taagtactct 1108680
 accactgaac tgcattctta gctffgattg attgattgat tgattgattt tattgagata 1108740
 ggatcttatt acattgccta ggctggcctt gaacttactt ttagtctat gcagataaag 1108800
 aactcactgt cccctgctc cagcttccac agtaactgtg gttacagatc tgtgccagca 1108860
 gacatggctc aggcctffgt tttactffct tgtttatffft taggtffftt gtttgtffgt 1108920
 ttgtffftta tgtgtatgtc tataatgactg tgtgccacct gtgtccatg cccagaaggc 1108980

 cagaagatgg cgtcagatca tfffgaatga gaaacagtag tatgctgcct acctggtatg 1109040
 ggtactggta ctgaaccttc tcccagcct tgcttacttg aatataata tataataata 1109100
 tataataata tataataata tattcatatg tatgattgat ttattgattt atffftattct 1109160
 ctgtgtatgt ctgtffftgcc tgtatgttgc atgtgcacct catgcatgtc tggtgcccat 1109220
 ggaggtcagc agagagtgtc agatcccctg gaactggaat catggtffgt agccaccata 1109280
 tgggactgg gaactgaacc caggtcctff ccaagagcaa taaacaatct taactgaaga 1109340
 gccatctctc caacactaca taccacacac accaggttgg ttagatffftg agactaacat 1109400

 tagacaccaa gatatgggtg ccagaatgat acatgtcatt tcttagcac ttaggagtgc 1109460
 atgtffftgt acacagccac acacacacac acacacagta ttaacatccg tatctagaca 1109520
 tgtacatcat aggaaggtaa gcatgaattc tcacagctgt cgcattffftg agccagccac 1109580
 ccacctccc acccctgtc tcagattcc ctctccatct ctctcctff acctagtgtc 1109640
 ttcaccagg gacactcctg ctttaccaca ctagtgttca ttagtattgc cctgtgagaa 1109700
 agcactfffta ccaagtagag catagtgtgt ggctgctffc ctgtffftt aaccctgta 1109760
 ctttctgtt gaaacatcgt tttccaaaga ttagatcac aacttcattt tttctatact 1109820

gcttagtagt caaattcctc ttttgaagta ctctgacgg ctccaacctc cagttaatac 1109880
ttaaagtat gtgatcaaa ttattcttt atggctgctc ctgtggattt tgacatattg 1109940
ggtccttttc ttttgctatg ataaaacacc atgaccacag caacttaaaa gaaaaaagg 1110000
gtttgactgg gtttacagtt tcaaagggct ggaattcatg gtcattgaac aaatacatgg 1110060
tggcagaaca gctgagaagt caaaaccaa gcaagaggca gacagggtac actggaacg 1110120
gttttgtttt ttaacttcaa agccccacc ccaacaagge catacttcca gttccaccga 1110180
ctggaaccta gtattggaac ataagaggca ttgggagcca ttctcgttca cagcacagcc 1110240

atgtatgcat tctcctactt cacagaaccg ttcttctcct tctcctagga gtcctgtgc 1110300
tgcccctagc agccaccaca cctctccttt gctgtggttc cctagggat ctacagtcta 1110360
actttagga aggacctggc tgctttccct tagaggatag aatgcatgta agattcattg 1110420
ctctaggagt ccgctcatgt tctttctacc taatgtttta cttaatgggc attctacagt 1110480
tgttcaactg ttcacacaca cggaaggatg tcatggtcgc tagcagaatt tcaaatgaa 1110540
tgctagtttt aattaagtaa atacctagag gtgtgaactc ctggctctat agtaacata 1110600
tatatccac caagctgttt ttcagaatag tcagctacac atagaataa tacaatttat 1110660

aatgaaggca tcaggctgag ttagttatgt gttgggactt aattaatttt tttctatttt 1110720
tattttattt aaattagaaa caatcttatt ttatatatca atcccagttc cctctccttc 1110780
ccatctccc atgccccca ccagccccca ggccatccct cttctgctcc atagaaaggg 1110840
tgaggccttc tatgggggat catcaaagtc tgcacatca tttggggcag gcctaggcc 1110900
cttcccagtg tgtctaggct gagagagtat cctccatgg ggaatggact cccagtgtec 1110960
attcgtgac taggtataaa tgctgtttca ttaccagggg ccatagactg cccaggcctc 1111020
ctcactgaca ccatgtgca ggggcctgg ttccctcata tgctgatttc ccagctctgg 1111080

ggtcacatgac ctgttcagg tcagetattt ctgtgggttt ccccagcgtg gtcctgacce 1111140
ctttgcacat cacattccag agttcagctc agtgtttagc tgtgggtttc cccagcgtgg 1111200
tcttgacccc tttgcacatc acattccaga gttcagctca ggttttagtc tgctctgct 1111260
tccatcagct actggatgaa ggctctagga tggaaataa ggtagacatc aatctcatta 1111320
ttggggaagg gcatttaag tgccctcca ctattgctta gattgttagt tgggtcaac 1111380
ctttagatc tctggacatt tcctagtgc cagaattctc tttaaccta taatagctcc 1111440
ttctattaaa gtatctcttt tcttctctc ctctatggac tcaatcttc tgctcctca 1111500

tgtcttccc tttcttctc cctctctct tctcttaac cccactccc catccccac 1111560
ccccccac cctctgtgc ttccaattg ctcaggagat ctttgggact tatttaatta 1111620
gctttactgc ctttgcagg aatatctacc actttcctcg cctgaaccta agtagcttc 1111680

atgaataaat gcatagttta ttatatggtc tttgtccttg ttgagcatca gaataacttt 1111740
 ttcatacatc atcaaaaatt ttagtgtctt agaggacaga agagtggagt ttataagctt 1111800
 cctcgagctg ttgtaccgga agccagaaat aatacacttc tttagtatth actctgtcac 1111860
 cccattctca aacattctat ctcaaaaaca aaatgcctgt gctactggta cgtttctctc 1111920

 ctttttaggc aatthtttct caaaataact tctcttgtct ttcctctctc ccctcacact 1111980
 gccaccaaaa ataagaaatt tctgttgtca ctgaagtttg acgggctgct tagtccagat 1112040
 ctgctctcct ttcatcttgc ttcagttgtc agtagcactg ggcatggcc ctacatttac 1112100
 cgtcttatgg atcatttctc ccttggthtt ctctctccct gcatctgcct ttgtagagtt 1112160
 ttagctthca caagctgtct cccaccccag cccagtgcct tcaggaactt tccccacct 1112220
 cccagtgtg gtgatggagg acagggcctt ccttgccat gacagacact ctacctga 1112280
 gctacctagt ccaacaatc cgaactthtt tttccctact atcccgtgcc gggccacctc 1112340

 tgcagctgaa cthttttagt tatcatgaga caggctcaca ccaagttaac caaactaact 1112400
 gatctgaaac taactcactt ttagcaagg caaacctaga actctgaatc ctgcctcaac 1112460
 ctcccagta actggaattg catgctgca ccgagagct tctthttccc tetgtthctc 1112520
 thctatctgc ccatattgcc ctacaatgta gtggggctth ctgtgttgc tgctgtthgt 1112580
 thttgagaca gagcctcact gtgtaacct ggctagtctg gaaataactg catacaccia 1112640
 actagthaac ccagaagtct gtctgtctct gctctthctg agtgcctggga thaaaagaat 1112700
 taccactcta ggatattgtg acacacagtt thaatcccag cactgaggag acagaggcaa 1112760

 gcagatctct gagtthaaaga ccagcctggt ctacagagct agthccagga caaccaagac 1112820
 tacacaaaga aacctgtct caaaaaaaaa aaaaaaaaaa ctaaaacaa acaagaacc 1112880
 aaaggtccg ccagcgaggt atthttggaag aataagtcca ataactcaact cagaattctc 1112940
 caggaacttc ttgactcaga aaaagggcct cactactct actaagctca cctccgctca 1113000
 ctctggctac cacactaata accctthctgc ataaactgct cagctthcat acatgctctc 1113060
 cctctatcca gactctthca gtagatcca gthgggctth thttcttacc acttacatcc 1113120
 atthaaagat catctgacc atcacagaca gataagcaat thcctgtca cccacaacc 1113180

 atatctcaac thgccctgt thttccata gcactthtca ccgaatacaa actatggttc 1113240
 thtgctthcc caatacaaaa catactgctt gaaagctaga atthgggtct gthcctggt 1113300
 gtgtctgcag gaggctagag thgtctgth tacaataggc actgaaacac tgggtaggtt 1113360
 ttagtcagga gacagagagg atctccatga gthtagaggcc agctggtct ccaaagtgag 1113420
 thctctggact atgcaggta accctgtggg gthggtgctt gaactaact thgatctgat 1113480
 acacaggac atthgtggtg acctgccatt gthactaatt thgaaccagct gctthgthaat 1113540

cagtctgcc gaattttata aaagaaaact ttaccactaa agagacagca agttctgact 1113600

 ggggttctta cccttcctaa gaagtgtaac tgcagccttt aatacagttc ctcatgttgt 1113660
 ggtgaccccc aaacataaca ttattttcat tgttgcaact gtgatttcac tactgttatg 1113720
 aatggtaatg taaagatctg ataggggacc ctgtcaagat ccaagagaag cactggctta 1113780
 gcagataaga gcacataacg ttacagagga cccaagtca gttcacagct cctgcatcag 1113840
 gcagctcaca agtcacactg taacttaagt tccaaggag tccagtgcc cttctggcc 1113900
 tcctcgggta ctgacacata ctggttcatg ctcaactaaa atcaaaattg agaggacaag 1113960
 atgtggaata tagtaaagaa acccagggtc tttagctgcc tcaagaaaat gaaccacttc 1114020

 taatggtaat tgtttaaga tctatTTTTA tatgagtcac aatctgtcaa aaatgaagtt 1114080
 aggggactgg agaggtggct gagataataa accgcctacc ccataaacat gaggaacct 1114140
 ggtaccaga gtcaagcatg actctgtcca taatcctagc caccctga ccagctgtc 1114200
 tcaaaagcta aggtagaag agatgaaact caagtcattt gatggccacc agcctccaaa 1114260
 tgcactccac cccatttat gtggatacc agatgaaagc aatttaagaa agggtttatt 1114320
 ttggcctata gttccagagg gacagaggt atcatgacac agagagcaag gaaagaaagt 1114380
 atgtactgca ggagctggaa actggttcat cattatatcc acacacaaga aacagaatgg 1114440

 aaagtgggtc caggctaggg aacccccaaag cccaccttc caaacagcat caccagctgg 1114500
 gaaccaagt ttcaacaat gagcctctg gggacaattc acattcagtc acacgcacac 1114560
 tgcactaaac tacaccatc cacaccactc accacactac accacacata ccataccaca 1114620
 ccacaccaca aattggaac ctaagcactg gtaagcattc ctttcttca ggcactgctg 1114680
 cttctgcgc ctgttctgtt aggggtctaa gaaatgtagc ctgtcaggaa aagaaagctc 1114740
 ttaggaaact aacttagcag ggctcaggca tctccagcac tcccagact atgtatgcc 1114800
 tgtgtttttt gaagagagta tgttcaatgc tgatcacagg cttctccaag agactatagc 1114860

 cctgatggac acatccgaaa cctgggggac ctgttcaaac atcaaacact caccctcaa 1114920
 aatcattctc aaagaaaaat acttggggcc aggtgtgttt gtgcagact ttaatcccag 1114980
 cacttgagag gtagaggcag gtggatccct gatttgaggc cagcctgggc tacagagcaa 1115040
 gttccaggac agcctccaaa gctacagaga aacccttct caaaagagaa aaataaaaaa 1115100
 aatggaagaa gaatgagat tttgtaagc aatgctgtt taagactggg tgggtataca 1115160
 aaggcaactc caagaggtg ttgaggttag atgaactatc tagttttgtg aagagattgg 1115220
 ttaacacaga acttaatta cctgtcctga tggaaaggg aggctagaaa ctccattatt 1115280

tacagtgaat gctgacagct ggctgtgtgt cttgcttctt gcccacagtg agttccatgg 1115340
 gaaacggcac gagtaggctc tacagtgtc tcaccaagac actcaacaac agtgcagccg 1115400
 ctcagcacc ggagtatttg gtgtcagctg acccagaaca tctggaacc atcgatccta 1115460
 aggagcttct cgaggaatgc agagctgttc tacatactcg gccaccccga taccagaggg 1115520
 attttggtga cctaagaaga gattgcccc gtagccacc tcccattaga gtcagcagc 1115580
 ggaacatcct tgcccaaggt atgacctgagc cgtttagtct gctgtggctt ccttactgtt 1115640
 cctgtgcacc ccagtgcgcc tgtgtgctat ggggaggaca gagagaggtg tctttcagca 1115700

 gctccgtggg ataacagacc tcctcgtgg actcctatgg gaaggatagt ggtgtctttc 1115760
 cgcagtggga taaccttaga ctttctgttg ccagcagctt gagccacagc tctgtgacag 1115820
 cactggcagg gaacgaactg agtgggtggf gtggatatgt gtggagcagg gttgagacta 1115880
 gccttggtct gccttgccgg cccactggga ctataatcc tgcaactcaag gctgcaggag 1115940
 cattatgact gccagagitt gagccaact tgagctatgg agtaaggcct tgtctcaaaa 1116000
 cagtaaaacc agacactgct tggccaactc ctgacactta gttacttaa attattggtg 1116060
 gcaggaagg cccttttac tacacctgct gaattatgaa ctacatttct caatcattct 1116120

 cacgtgttaa tacctttatg tgtagttaa gttgtaagga aaggcagctg tctttgggag 1116180
 tgaaggata ggtcagtgtg taagagcagg tactgcttgt ccagagttcc tgagtttgat 1116240
 tcccagtacc cacaccagt gggtccagga gacctaacac ctctggcctc tgcaggcacc 1116300
 tgcacttatg tacatattcc tgttatccgt acacatagtt aaacattata aaaaatttat 1116360
 tcattttttt aaactacttt taagggtgg agagatggct cagcggttaa gagcactggc 1116420
 tgctcttcca gaggttgagg tcttgagctc agttcccagc aacctctgt aatgagatct 1116480
 gatgctctct tctggcctgc aggcatatc gcagacagaa cactgtatc ataataaata 1116540

 aataaatctt aaaaaaaaa aaaactactt taaaaaagaa acggcatttc atgtttatgt 1116600
 atctctgact taccaatctt gttagaagta tttttatttg ttccttgaca atttcctata 1116660
 tatgccatgt atgttgttta taccacccc ctccaccct tacctgccct ggcacctgta 1116720
 caaacgtgcc caccccatc tttgagtcta tttccctggg gctcgttcat aaggagaaaa 1116780
 agatatttgt ctattcatt ctgaatagta tctattttta tccgttcaca tggctttatt 1116840
 atcatcagtg ttaaaactaa tgttatttaa attgacacac ttttctatcc ccaggactac 1116900
 aaggtttctc taaacttaa aggcaaaggt ctcaatccta gaatatagtt atatgaaata 1116960

 gttttagat atattgggga aaaaaaaaa aaaaaacctg ctgcttgctt cagcacatag 1117020
 tatgaggta tttgtctgg gtaggttaac acagcatgga cctccatcc gtgagctttg 1117080
 ttcatttatg agacaggggc ttagtatgca gcctaagctg ggctggcact cagtaacata 1117140

gcccacagtg gcctcaaaact catggagatc tgccttccca gtactgcatc accacatcag 1117200
 gcttcccatt ttctttgagg tcatgatact gtggaattg acagatgctt ggcttttctt 1117260
 ttcagctctt ggagaaggca aagacaactt tgtgcagtgc cctgttgaag cactcaagtg 1117320
 ggaagaaaga aaatgcctta ttctggagga aatcttggcc taccaaccag atatattgtg 1117380

 cctccaagaa gtggaccact attttgacac cttccaacca ctctcagta gactgggcta 1117440
 ccaaggcaca ttttttccca agcctgggtc cccgtgtctc gatgttgaac acaacaatgg 1117500
 accagatggc tigtctttgt tttttctcca aaaccgtttc aagctcatca gcagcaccaa 1117560
 tattagctg acagccatga ccctaaaaac caatcaggtt gccatcgcac agaccctgga 1117620
 gtgcaaggaa tccggccgac aattctgcgt tgcgttacc cacttaaaag cccgctctgg 1117680
 ctgggagcgg ttcgatcag ctccaggctg cgaccttctt cagaacctgc aggacatcac 1117740
 acaggaagcc aagattccct tgattgtctg tggggacttc aacgcagagc caactgaaga 1117800

 ggtctacaaa cactttgctt cctccagcct caatctcaat agcgcctaca agctgctgag 1117860
 tcctgatgga cagtcggagc ctccgtacac gacctggaag atccggacct caggggagtg 1117920
 tcgccacacc ctggattaca tctgttactc cagacatgct ctgagtgtca catctgctct 1117980
 ggatctgctc acigaagaac agattgggcc caaccggctc ccgtccttc attatccttc 1118040
 agaccacctg tcaactggtg gtgacttcag ctttaatgag gagcctaag aacttttata 1118100
 aacactgtca ttttaatcat gagagtctta accagggatg ttttgggaaa ctgaagtatg 1118160
 ataagaagt gcctgaaaaa ggacaccag tttctgccac ttcactctcc atcattttcc 1118220

 agcatgcctt ggaaaagaat ttgttcacaa acctttccaa ttaaaacctg cagcaaaaag 1118280
 ggtacttgca ctccactttg ggcttgtatt gttgattttc cataccattc tccattctca 1118340
 ttttaaggca ttaaattaga cttacttgga agttgttttt gtttttttgt gtttttaagt 1118400
 tgagggtgct ataaaactca gtttgaagc ccctcagaaa taaagtatga tataggaagt 1118460
 tttctagaca acatttcaag ttatttgtgg gattttttaa tgtcagcaag aatgcatgg 1118520
 caatatttat tttttatc ttcatgtaaa attaaatgga ttatatagca ttttaggtaa 1118580
 cttagcacct ggcaggaata ggcataattt ccttaaaatt tcaaattgtt tttatttgg 1118640

 gatctaacag aatgtacatt aaggaactat attttatagc tctgaggcat ttgtgacttt 1118700
 aataagtaca ttattcacag ataatcgctg ctgtttgcta tgcctccaac ttatctgttg 1118760
 tgtttcctga agaaattcca gttcgttttc aactaaatag ttttcgctat ttagtcattg 1118820
 ttaaattttt gtactttttt gttgtacatg tgatgattac tccatgactt cttttggaat 1118880
 gtgcttttta caagtagctt taggaacagt ggctaagaat agtagtaaaa attccttctg 1118940
 agatgaggac tccagaaatc ctattgagca gccagggtgtg atcaaatct gtgtgttgg 1119000

ggccagctta gcctgtatat gaagacccat tctcagaaaa atcccaaaga cagccagatg 1119060

actgggttca aaatcttca gagaatttaa gagtagaaat gataacctag agttctcttc 1119120

gaattgctga agcctgttca aaaaaagtaa aaacaaaaat aaccactgg tggtaaatg 1119180

gtaaatgttt tattgtatga gttctaataa ttatttaaga ttaataaata gacttataac 1119240

agagtgttt tagtcttggg ttttgtttt gtttttttc ttttttcagt ccaaaaggaa 1119300

gtcaatttgg atcttgtgtt tcaaacagta tccatttcca cactgaattt tcattttgac 1119360

acttaacaga agtagctaca cattcaagct tctgggtatc ttagtaaaag gatggagtcc 1119420

tccacatggc ttactctgc attctacctc caggtccata aatgatatag tggtcaggtt 1119480

agtctcctag agtgctttag atgtttggag gcttgatgta aacacactga tactcacaa 1119540

ggccaacag cactttacta caagcccca atctcatggc tctgaagttc ctatagaatg 1119600

tgataggcgt tggttatggg acacagtcaa gtcaacaacca tagagcactt ggtataactg 1119660

aagtttaaag cagtttagga gctggagggt aactcagata aggctccagg atgatccca 1119720

gcaccaggaa agacaacaa ccaactagcc agcaggacat ggttgtgcc tgggaaagta 1119780

gaggtaggag gtcatttca actataaagc aagtgcaagg ccagcctagg atatggaac 1119840

cctgtttcaa aagccaaagt aagtagttgt tcaacagaga tttgcactgt cagaggctca 1119900

gccactagta atgtccttgt gccctaccc ttactgtctt tggcctatit gctttatcct 1119960

ccttccctta acaccactt tcttgagacg atcttgcctt ttgccagc tggcttggta 1120020

cttcagtgt agccgaaggt gagaagttg caggtctctt tgtccaatg aagtacttc 1120080

atcttctga ctaagaacac ttgttcttc tagttactct tgcacaactg cctcagaatt 1120140

ttccagtct tggcctcact caaggagacc tttctcacc tgactaaggt ggttcaagcc 1120200

tacttcagg gatttttgt ttgatgttc ttaattccag cccaataat aagaaaacag 1120260

gtggaggaga tgccatggat agaatagcat agtgagaaaa tgtgtgcctg gaatagtgg 1120320

gacactagca aagaaatggg cttgggtagg tggcatttc aagtaagatg ccattgaatt 1120380

taaagcagta acacaaatgg tgtaatgaaa ttcacatit ccttatttg gcttttggc 1120440

ccagttttag cccaggctga cctcaactct agcttctga aatcttcag aggctgggga 1120500

aaaaggatga tgagtctt gaaaccctaa accacataga ccttatcaga ggtaagacat 1120560

acaagatacc atcaatagaa gtagaaaata actacataat aatggagtga cacggcatct 1120620

gagacagcct acagaccct ggtaggtgtt atagcctatt agcactaaag ggaacagaat 1120680

ttaatccagc actcaagaag aactgtgatg ggcaattaaa atgatctaag atttagactc 1120740

aaaatctaga ccaagatgtg gtagaaataa catggcagct atctaaagaa cagctgttat 1120800
 aatgaaatcc ctttaaacad ctgctgttac atcagacact aactccttcc aacctctgtt 1120860
 ggaaatccaa aaacatttag gctgagaata agccaagcat gtcacatgaaa accaaaatgg 1120920
 ctttgagaag caaactaagg cacaagatga gatgggcaag aggaggttga agtaaggggc 1120980
 tagacagaaa gtcacaggt ttaagagcat ttgctgcttc tgcagaggag tcaggttttg 1121040
 atttttttt tttcctttgt tttgtttatt gtgaatacaa cattctgcct ccatatatgc 1121100
 ctgcacacca gaagagggca ccagatctca gaaggctcag aggttaagag cactggctgc 1121160

 tcttcagaa gaccggagt caattcctag caaccacatg gtggctcaca accttctata 1121220
 atgagatctg gtgtcctctt ctggccggca ggaagaacac tatacataat aagtaaataa 1121280
 atcttaaaag aaatggagaa attctgaatg acagctgttg tttggaccaa ggatgtgtga 1121340
 gtgaaaagcg atgcttatga acaggaggca gctccttctt gaatcagaca aggatgtctg 1121400
 ctgaggtgag atcctctgta acaaagggc cagccaaggg gattctgtag atgtctcttg 1121460
 atgatgtgga gagaagtgt cactgaaggc tagaactgct actggagtgg atctaaggat 1121520
 taaacacaag ctgtttgttc atcacagtgc aaaggctgga gactctggaa gacgcagtga 1121580

 catcaagcca ttgtttttgt agcttttctc tggaaatgct ggacacaacg tgtaacctca 1121640
 ttatatgtac ttactgttct caaagaatga gtttgcaagt ttagatttta gatgtttacc 1121700
 tgaaactttt tctattgctt ttagaataaa acacagaaaa aagtatgtta caattgagct 1121760
 gttaaagact cttagcaaa gtaacaaaa tctgtatatg ctctgtgtgg gtcaggattg 1121820
 gatgcagtta tgtacagcct tttgaaaaat gagttttatg gaagatctga ccaaaaatta 1121880
 actgtacagt attgattttg aaagatgaaa tacttagggg agattttgag gtttaactctc 1121940
 aatgggaaaa ggaatcagcc tagactctta cttttttttt tttttttttt ggtttttcaa 1122000

 gacagggttt ctctgcgtag ctttggagcc tatactggca ctctctctgg ggaccaggat 1122060
 gcccttgaac tcacagatct gcctgcctct gcctccaag tgctgggatt aaaggcgtgc 1122120
 gccaccaacg ccagctaga ctcttacttt taaaagtacc attagataag tttgtggggt 1122180
 agaaaagaga thtagccagg agagatggct tagcaggtaa gagtctgctg tgctcttcca 1122240
 gaggaccaga ttcaaaacc aaaggtcagc tcacaaccac ctagagctcc agttgcaagt 1122300
 gaattggaca cacactctg gcctctggg gcaccagtac agtgtaagt gtataaagcc 1122360
 atacatgcag acaaaacacc cacacacata ttttttttta tcaatttagt ttttttttt 1122420

 taaaaaaaa aggttagaaa gggaacttta taaaaaatct ttgctgatat aagtagcatc 1122480
 gtgttagata tacaaggcc aaaaaatatt aaacagtca tctaaatttc taaaaagata 1122540
 gacctagtta tgiatgacag taaggagttt gtgtgattct ctggcgcctc agccttcaac 1122600

tgtaaaggct ggacttactt tctaccata aaaaggctctg atggagaaac aaatggtatg 1122660
 actgaaaatg actctgtgta tgtgaggtgc catgagaaac ccaggaactt gcaaatgcca 1122720
 ggcaagcagc ctaccactag tgctgaaagt gcttccatta agtatggcca actaaaacac 1122780
 tacatttgtt aagtaggcaa ttatagttaa aaaggaatg ggggtgtgtg caggtagtta 1122840

 ccaaatacta gtataatggg acaaaaccag agtagcattt cttcatgtag taattaagaa 1122900
 aacaccagac ttctatttgt tacctaaaac gacaccetat actggcttta gagtgttgta 1122960
 aaatatcacc agagacaaa ccacaagata aatttcactt ctatatttca gaaaacctac 1123020
 ttgaatacac ttgaaacaa gagtacaaca aatagaata tacttcaaat gttgaatata 1123080
 caaactatta tagttcaaat ctgaacactg gtactttccc tcttaaatgt caactaaaaa 1123140
 agaaaaagag aaaaaaggag gaaagaagga gaaagaagaa aaaagaatga gaaagaaac 1123200
 aaacaccagg tattagagct acctgacgag ttcattgctga gtctgaattt caaatgaca 1123260

 ggagaactga tactcatgtg tctgcaagac gccaggctg acttgagcga cgcaggtatg 1123320
 ttacagtaaa gggccagagc caacagttaa tttcttcaca attaagaaac caacagactt 1123380
 aaactacat ataaaatgtt acatgtaaat tctataacaa tactgtgcta ggtacaagat 1123440
 ttttaaatt ttttcttta ataaaaagc tttacacaaa caagccatta gcttatttca 1123500
 agaaagaaaa ccgaaaatta gtctaaggcc tttgttttaa aacagcttaa gctatatgat 1123560
 atatatatc aaaaacaaaa taaaacaaga aaacacacta gatctttttg ctatectctt 1123620
 ctggagcttt tggatccact cagttcacat tctagaatac ctatattagc agagtcttca 1123680

 catagcacca gttaaagtgag tactgtgcaa acacagtaat aattgctggt atgcatataa 1123740
 aatgcatcaa aaattgctat atgtaacaat gagatcacc atcccaatcc cgccccactg 1123800
 aaaactatgt aacctcttac aggtgttagt gttccaactc ttagtgtaac ttgatattgt 1123860
 agtgggctgc ttggtccctt tcagtctttt tctttgaggg ttcagtcgtt cctagtctaa 1123920
 gaggcagttt tctgtcagca tctcaatgta tagttcactt cccactgaaa catgggatag 1123980
 gtaattattt ccagtaagtc tgattgcttt cttatatgca cagctgtttt aaagtctctt 1124040
 ggcttttctt gatgacttcc cttgcagatg tttgtcagca caacactaac agtctgaagt 1124100

 ccatggcaga gcctgtttat ttctcacatg tctactgtcc ttcggttttc atagtcacag 1124160
 gaagggcaat agcagaaggt gcactgacaa ccaactacatg gggtactgtc ttattcccgt 1124220
 ctgtccctt ttcttctacc agctgcaaag ttttcacatc atgttctctc ttttttgcca 1124280
 ctgcttctga tttaacctct ggccctttaa taaccgact gataactcga ggaggagtct 1124340
 ggccagaagc ctgttgagca ggcacagata gtctcattac aggagtaccg tgggctattg 1124400
 aaacgggggt aagtgtctc acagccaagg gggttccaac aatgttaatg cttctgatc 1124460

cagtcagatt ggactttgtc tgcagctgac actgtgcaag ctgtgtagca gggatggtga 1124520

 taatlttggc aggetgcatg gtgattttgt ctccattttc agcagaggct ggcaccacag 1124580
 tcgggatcgt ctgaatgacg acttttggag aggtggetgt agttggactg gtgctggtta 1124640
 ttaatggtgc acctgcattg actgactgaa ctgccacagt tgaatcttc tgaccacagt 1124700
 atgtcattac cacaggaact tgcattgcc aacgaactgt cctggtagat aaaaaacaaa 1124760
 gaagttggtt atattcaata ctaaataaga aatgagttt catgttaaaa agtaaataca 1124820
 aatacaaatg tataaaacca gtgccacca ctttgacagt ttagtgaag ctgagaagaa 1124880
 aatctcctg ctccctactg gggtttggac ctggtgtctc ttgcatgctt atcaagtgcc 1124940

 ctaccactga gctgcatccc caactttttg aagcagggtc ttgttaactc actgctagct 1125000
 tagaactcac tctgtagcac aggcaggcct tgaacttga attctcctgt ctgagcctcc 1125060
 acagtactta ggactacaga tgtgttctac tatgtataga taaaagtata tttcaaaaaa 1125120
 actctagcac tttaaaaaaa tttcaattt ttatgtgac tggtattttg cctagatctg 1125180
 tatctgtgtg aggggtgttg atcctctgga agtggagtta cagtcttgag ctgcatgtg 1125240
 ggttctggga actgaacctt ggtctctgga aagagcagcc aatgctctta actgctgagc 1125300
 catcattcca gccccaaat gaatltttga aagtcatcat acaatgttgg ctaaatattga 1125360

 ctgaacaagg acagttcatt tgttccaagg agcattttaa aacaaaacac tgtgtgacag 1125420
 ttaaccacct ccctcacctt ggagctgctg ctgctggcac agatgctgtg gtggtaggag 1125480
 acctggatga agcatcatga gcaggggaag tgatattcac aactctagcc acacccttct 1125540
 ctgctctgga gcagtttaca gatgagtttt ttccaccacg aacagaagtc gctgctttga 1125600
 ggaggctttc tgagacaat gacactcgtt ctaatgactt ttcatcagcg gctgctgcca 1125660
 agtcttcact gcaggtttca cttttgtcat catcaatgac cactatgttt ttgggcatat 1125720
 ccttgaactg atatacaagc ctctgtcctt caacctttgc aagaateccc ctttggtagt 1125780

 agtatctgtg aagggaaaaa tgacttagtc aattttctag cgacttccag attaaaaaaa 1125840
 cacaaagcaa aactgacag acatttactt attcctgtag atgagtggcc cttctgcttg 1125900
 gacaactcgg aagattataa atttggtgag gaagtgaggt tgggtgtgctg tgccacgggc 1125960
 cagtgggtgt taatgctgac tgtcaatttg acaagatcta gaagcgtgta ggagctaact 1126020
 tgctgggttt atctagatta gattagctaa agtgggaaga cccaacatca ctgtggggcg 1126080
 gcaccatcac aggacgcagt aagtagcagc attcatctgt ggcctggctg cggatgtgat 1126140
 gtagtgcta ccgctatgaa ttctccacc ttctagagt actgtgtcac accaatgaga 1126200

aggagctaat gcagctctgt aacctgacg tglacaaaga agttgcgca ctgaggactg 1126260
aacctagaga ctactacta agaggaaagg ctctattacc cagcttttca cccagcttta 1126320
tctccagcac cccaccacct ctatatagac caggctagtt tccaacta gactgatcct 1126380
ttttatcccc acctcccaag taataagatc acagtatgtc tgccatgtac atcttgttct 1126440
ctcttttttt ttgaaaaaa aaaaaaaaaa aagattgtat ctattatgta tacagcttct 1126500
tgctgaatg ccagcagaga gcaccagatc ttattcaagg tggttgtgag ccaccatgtg 1126560
gttgccagga attgaactca ggacctctgg aagaacctc agtgctctta actgctgagc 1126620

catctctcca gcaccacct tgttctctct ttagaaaagc ttagcctaaa cccaggacac 1126680
tttattgaca ccacaaagaa ctctgttaca caacaaataa tctgtcttta ttggaaagc 1126740
cacctcacc atgtttagca gagatgcaat ctgtggaata tgtgaacagt gttacataaa 1126800
acacaatgta ggagtggctt atgcctgaaa tcccagtatt gggaaactaa ggtaggaaaa 1126860
ttgatgcaag ttcaaagcca gcttgattat ataagctcca ggccagcccg ggctacatac 1126920
caagacctt ctcaataag tactataatg tatacattgg agagttaatg gattttcat 1126980
actgaccaa cacaacaaa attttctatt atcaagacag tcatttaca catttgcagt 1127040

aactaaaagc aaattaatgt tggaaatgc atttcattta gggtttctta taggatctca 1127100
ctctagccca ggatggcttc aaactctctc tgtaaaggca gatgactttg aactcttatt 1127160
ttctgtctt cggttgccaa gcagtagtac tgcaaagcat ataccagtac atccagtctg 1127220
ggtttaatgt ttaaaaaggc ttacaatgta acaatttcta ttacagaact gtctaaatg 1127280
caataaatat ggatcttcta atattgaaat tttatgcacg taaaccaaac ttctctttcc 1127340
ctgtctattt ccaaactaa gaaattctta tagattgttc acccaacttt aacaactagc 1127400
agacagtcta aagagacatg taagtctat ttaaaaacta gtccatgttc gttcttacct 1127460

caaagctcgc cccatagttt catagttcat atctggtttg ttcttatget ttcccaaaag 1127520
ctttgagaca gcctttgagt ccacaagttt gaatatgcc ttttctctct gactccattt 1127580
aatataactg ggacacgtat ttttatcttg aagtagatct aagagaaact cccacagata 1127640
ggttgtgttt ctttttaaaa caaagcaaaa acaatggtag gcattaattt attatccatt 1127700
aatatgatta ctgcaagta aaatattctt ctttgctgct tctttttgag acaaggtctc 1127760
attatgcage cctgctgtac ctcaaacttg tatgtagacc aagctactct taaattcaag 1127820
gccactgcct cccaaatgct aggattaaag acctgcacca tgcctagact acatgctgt 1127880

tcttacaat ctatgctttt ctacaaggaa gccgatagag gccctagatt ctatactgtc 1127940
atgtgtcctg tatacaaggc ttcaggttca gtaaaggcaa cagcataata tttagttaa 1128000
tacattgctc acctggatta cacagaatca actttcttaa cttataggca tttaaactct 1128060

gaatataata atctggatat ataactcgga tatgtttgat attctcccc aagtcctta 1128120
 aaactcatca gaagtcacta gcctcttctt taaagtggct ctacatgagg ataagtgcta 1128180
 ttaaacaat gtcccctaaa cagtgggcc caaaaacaat atggtttgca ctgtcctact 1128240
 atagactatc ccatctcttc aagacatagt tttttttttt ttaaagattt tttttattha 1128300

 ttatgtatac aacattctgc ttccatgtat atctgcacac cagaagaagg caccagatcg 1128360
 ctctacagat ggttgtgagc caccatgtgg ttgctgggaa ttgaactcag gacctctgga 1128420
 agagcagtcg gtgctcttaa cctctgagcc atctctccag ccccaaaaca taggttttgt 1128480
 ttttttttg ttttgttttt tctctgagaca gggtttttct ttgaagccag tcttggaaact 1128540
 cactctgtag actaggcttt gcctcgaact cagagattca cctgtctctg cttccctcag 1128600
 gctggaatta aaggcgtctg ccattaccgc ccaggagac actggtatth tgatcaaagt 1128660
 ttcccataat gttggccac ccttgattaa gaaatactga aatggtactc ccatatgcct 1128720

 gtctactaga aataaccctt cttacaattg caaaaatgac acacacacaa aagtatctta 1128780
 cttgcaaac aaccctccac aaattacctt ttccttctct ggctttcttc ttgattccta 1128840
 actcaggaga cccattggaa actggtgact gctgggtctt tggttttcgg ccaactgaaa 1128900
 aaaataagac aacgaaatca ttaactgaaa acagatataa ataccagact ctctaaaaca 1128960
 cttctgaaat tttaaataaa acggttggta gaagcttgac tttacaaagt cagtaatttc 1129020
 tctaacttc actatatagt cagataagcc tcaatctgct acatthctg actgctgtec 1129080
 tagagctcac aatgtagacc aggtggcct ctagctcaga tactactgcc tttgcatcca 1129140

 agtccagga ccaaaaaggt gtaccactac actcagctgt tagacaagtt ttttagtatg 1129200
 gtatttttat taattcttga agaactttat acattcatag aaagtataat ttgctcatac 1129260
 tctccctcga ttacatgat tacagcagag gatctgatca tgtgaagctc tgtgagctca 1129320
 aatgaacaaa acgtgaaaca tcacttccat tgtgagccag gaagttgacc agccaattht 1129380
 aagctaaagt gttaaactgt caacaaaaa tctgaaaat aaaacacact cctacaaatg 1129440
 actatgatg tctctgagat tgagattaca agtatgtcac cttacactgt ctactgcatt 1129500
 ttgttttctt caatgttgat tccctaagag aaaacatggt gtttgtttc ctaagtctag 1129560

 ttgttttctt ggtttccacc cttttctg caaacctgac tctttttca gagctaaatt 1129620
 gaaatgtgca cacacacata cactgtggta gcttgaatgt ttaattggcc ctccatagtt 1129680
 atggagtgtc attatcagga ggtgtggcct tgttggagga aggtgtcac cttgggggca 1129740
 ggctttgaga tttcctatgt tcaagatacc acccattgtc tgagactact tctgttctg 1129800
 ttctaataca gatgaagaca gcaccatgtc tgtctgatg ttgcatgaa cctgcatg 1129860
 ataattgact gaaccacaga actgtaagca gccacatcaa ttcaatgtht tctttgttg 1129920

ccgttagcca ggcagtggg gacacagct ttaatcccag caccaggaa gcagaggcag 1129980

 gigagttcaa ggcagcctg gtctacaaga actagttcca ggacagctaa ggctaccag 1130040
 agaaaccctc tcttgaaaa aaaaagaaaa gaaagagctg ccatggccac agtgtctctt 1130100
 cactgttgtt gaatagacga tttgtttaac tatgtaata tgtgttgcac ttgttcatgt 1130160
 gcatttgctt aactatgtaa agatgtgttg ctgtttcacc ttgcctgcct aaggcacctg 1130220
 atggttctaa taaaatgctg aatggccaat agctaggtag aggaagggga ggcattggctg 1130280
 ctgagcagaa agaaaagggg agacagccag acacagagta tgcaggaaag caggacagga 1130340
 cagacagtat aaggataagg taaacgagat tccgggcagc acatagctta gtataaatgg 1130400

 gttaagttaa aaaaaatgac agaactaaca ttcattatat attatatgct gacttaacat 1130460
 tcttccatgt atatatgact ggtatagtgg atcatatcat aaattctatt tacaactttg 1130520
 aggagtctgt aatttacatt actaccaaag gtgtgcaagt gtttaattcc cctaccacc 1130580
 atggccatt cagatgggtt tttgttgtt ttttaattgca tttattttgtg tgtgtgcctc 1130640
 caacaaagtg ttatataatgc acgtggacat cagaacaatt tgtgggagtc aatcttttcc 1130700
 ctctaccctg aggacccacc ggacagaact caggttatga ggcttgcctgg taagccctt 1130760
 tacatgctga ggcatcacac caatccttgt ctttttcttt tctttctttt tttttttttt 1130820

 ttttttccc tgttttgggt tttcaacaca cggtttccct gtgtagccct ggctgtccta 1130880
 caactcacta tgiagaccag gttggcctca aaccagaga cccacctgcc tctgcctctc 1130940
 attaaaggca tgcggcacca ctgcctact tggttttttg tttgttttg gagacgggtc 1131000
 tctctctgta gctctggttg tcttggaaact cacactatag atcaggctgg ccaccaccac 1131060
 ctggtgggtg ttttcattgt ttaaaaatag acctcaggct ggcctggcaa ctcaacttcc 1131120
 agcagtccca tcttagcctc ctatgtgcta ggatcacagg catggacacc acgcccactc 1131180
 agttgtcttg atgaagatta gacttcattc atttttttta agattttatt tatttattat 1131240

 gtatacaata ttctgcttcc atgtatatct gcacaccaga agagggcacc agatctctct 1131300
 acagatggtt gtgagccaca tgtggttgct gggaattgaa tttaggacct ctggaagagc 1131360
 agtcagtgct cttaacctct gagccatctc tccaacccta tgacaaagt ttttagtggg 1131420
 tagtgaacaa tagaataatgc tgtagtggaa ggcactgtgt tatttcacca taaaatgcaa 1131480
 acaaagaata aagaatttac aattacacat tteccaccat gacagactct tttccctctg 1131540
 aagttgtaag ccaataaac cattccttct acaagctgcc ctggtcgtgg ggatatttaa 1131600
 ttccagcact tgagaggcag agaatgctgg gtatctgtga gttcaaggcc agcatggtct 1131660

acagagctag ttccaggaca gctagggctg ttacatagag aaaccctgtc tccaaaagaa 1131720
 aaggaaaaag aaagaaaaaa attaaagaaa accaccctaaa tcaaatttaa cccttgattt 1131780
 gaatagtaaa ggaggaatgc attgtattcc catgtccttg tgttggca ggtgtgctgg 1131840
 ccccctatgc ttiaccact actaggttta tactgagaat cttagaggtt tgtgtttgct 1131900
 tgtttaatgt atacagaigt tttgtctgaa tgtatgtctg tgtaccactt tgcattctg 1131960
 ctaccagaa gaggtcatca aaaccatga aactggagtt aaaggcagtt gtacatcaga 1132020
 taccctggta acagatttgt agacagctat ggactgtcat gtgagtgtg ggaaaataat 1132080

 tcaaatatct agaaagcgc aggtgtagt ggcacatgcc ttaatcca gcaactcagga 1132140
 gtaaaaccag ggctgttaca cagagaaacc ctatctcaaa aacgggagga aaaaaaaaaa 1132200
 aaaaaaaca ctaaaaaaca agtttgaata taacaagaaa gttcctcaa agagtttaca 1132260
 atctggaaga aagataatct gaaggacttt gcacatatgt atgtatcgt gtgatgtgta 1132320
 tatgtatgta tacatacaca gcaattgggg gaattatata cacgtgtgtg tgtgtgtgtg 1132380
 tgtgtgtgtg tgtgtgtgtg tgtgtatgta tgtatcagca gcaattgggg tatcttagga 1132440
 cagctgatcc cctgcttcag tctccaatta gtggtgatta tagatcagca tcaccaggac 1132500

 tggctacaaa tgcctttgaa caacattaat attttttaa gattttattt atttattatt 1132560
 tattatggat acaatcttct gcctgcatgc cagcagaagg caccagatct aattcaaggt 1132620
 agttgtgagc caccatgtgg ttgctgggaa ttgaactcag gacctctgga aggacagtca 1132680
 gtgctcttaa ccgctgagcc atctctccag ccacaatat taatattaa gtacaatctt 1132740
 agcaactcaa tttgttctgt ttctgagtct agttaagata acattaatct gcaaggagtg 1132800
 gtggcacaca caacttcagc cccaatactc agaacgcaga gacaggcaga tctctgtgaa 1132860
 ttcaagacca gcctggtcta cagagtgagt tccatgatag ccagggctaa acagtgaac 1132920

 cctgtcttga aaacaaaaca aaacaaaaaa agattttctca tatctgataa gtatactcaa 1132980
 cctttttct ttttcgttgg ttcgtggcta tctggtgaag tgggaatagg cgaggcatcc 1133040
 attggctcag actcttccgt tgacacctcc actacagtct ctgtaatgac atctggcctc 1133100
 atcgcagcat ggataaactc tggagttgat atacaaggag ggacaaacac ttccactata 1133160
 aaaaaagtt gaaaaattaa aatttccac ccctattaca ctttctatg tggacagttc 1133220
 aatatttca agaggcaagg tttactgaag aattattcaa aggaaggtga gaacttctgc 1133280
 ccgaagaaat ccaactactg aatatccaaa actatctaaa atacacaagt gaaagacaat 1133340

 cattttggca gtaatgaagt caacctctt ttacacctt taggcacttt ttaaagattt 1133400
 atttttattt tatgtgtatg tatgttttgc tggcatgttt gtgcacttga gtgtctattg 1133460
 cctccaaaag ccagaagagg gcatcatatc ctctagattt ggagttacc tgtgagtgtg 1133520

aaaaccaaac ccaggtcttc tgcaagagta cacagtgtc ttaaccctg ggtcatctct 1133580
 ccaattccat ttcaactttt aattttatat tttttaata gagaaatct aacaaaatgg 1133640
 tcctttaata attactttca ttgcacatat ctattactat tcattaactg ggaaatacaa 1133700
 ggacaagata gaaaatttta aaaattataa atgctaggca gtggtggtac acacctttaa 1133760

 tcccagcact caggaggcag aggcaggtgt gtctctctga attctaggcc agcccagtct 1133820
 acagagtgag ttccaggaca gccaggacta tttcacagag aaacctgtc tcaaaagacc 1133880
 agacaggtag gtagatagtc actaaaatag tacatacaga ttgctatctg gtattctatt 1133940
 acatacaata atgttgcttc aactccagg ataccacatt tctatttcaa atttggagat 1134000
 ccagatactg taigcttaca tgcatataa tgctaccaac aaagccactg tttacttctc 1134060
 atatccatga agaatgcagt gaatttctta atccaatfff taatgatttt ggctggcttc 1134120
 aggaatgaaa aaatgtttta gagcactggc tgcctttca ggactggaat ataattccca 1134180

 gcatccaatg gccgctcaca accctctgta acccgctctg gcacccatgg gcatcaggca 1134240
 tgcacacggt gcagacatga atgcaggcaa acaccatac acataaaaata cccttttaaa 1134300
 gatagctgct gttagcaact aactgtaaat tctgcacaa cgaattaata aaattagaac 1134360
 agaatcaaat tagtataaca ccactattaa aatcaaccta aaaggaaaa aggaacctta 1134420
 tttcacaatc taaaaggaat atgaagcaaa ttcctttccc tctctacat tgccaggtec 1134480
 atgttttac tgctgttga tcaatgaatg ggtaaaagac tgaaagagct ataggaagca 1134540
 aatggtccaa ctgtgcaac tcttaagat tacaactact acctacaat ttatccagaa 1134600

 ccaagcaaat aaacatgata acatacacia ctgtctaata gaaaatttg ggcatttctg 1134660
 cattattat taggacatta agtacagtat ttaagatttt agaacctta acatcagtta 1134720
 ctgatatcag gtgtttatgt atagatcttt aagaactcca ggaatactc ctttgcagta 1134780
 aagtcttcat tctaatagga aacaatgtga catttaattt aaaaatgtac agatcacata 1134840
 ccaggacttc ttgactcct caagcaggta ggagattcca tatgaagcag ggcttcagca 1134900
 gcttcaattg tcttatcgt acagtgtgca ttactgtat gaactgatgc ttccactgtg 1134960
 gaaaaaaga aagtcttta ttaaaatga aaactaac aacttattac tgaattataa 1135020

 acaattctat ataaccaat gactacccat tcattaacta cttactaaag taataaataa 1135080
 taaagctaat gtctacacac tgtaaagtga atgtttattt taaaaacaac caatgaagat 1135140
 gggcgttggg agcacacatc tttaatcca gcactcagga agcagaggca gggggatctc 1135200
 tgtgagttcg aggccagcct ggtctacaga gagagtcca ggacaggttc cgaaggtctg 1135260
 ggaggggat ggatttgagg atatctggg ctacatatag gcagactcta tetcaaagcc 1135320
 aaaaaccaa cgacgctaat taaaattag tgagaagttc ctggatctta accaaaagaa 1135380

aacaaagaac aaaccttgaa atataaaatt tgcattccatt tttagtccaa attggattga 1135440

gataatcacc caaaagggtt tggaaacagg aagaaaacga ccccataggt caattatgta 1135500
atctgatgta ttgtcacaaa actgggggca atataatagc caacagaaat cagctagaaa 1135560
cattttttct aagctagcct aatgaattgc ttcaattttt atattgtgtc ctgtgagtgg 1135620
acactctcca ggcaaggcat taattttact gtcacaacat ttcataactt gtttcacaat 1135680
aaccttggtc ttttcagaat ttcaggggac ttcactaggt ttttctaaaa gaaatgtaca 1135740
tacgtggatg gatgaacaga tggatgatct tacctgaaag ccattcctga ttcaactgct 1135800
cttctatct atctctctta cacatctttc atgcttttct atcaaatggg ttgtcaaaca 1135860

gtgaagtatt caagcagagg tttgcacttt cagggtctaac agcttaggtt cttagactca 1135920
gccactaaga caatccactt aagtctctga tgcctcagtt tccattttat agagcaggac 1135980
gattttctaca aatgattgtg gaaaacacat acagtgtctg gcatgaaatg ggagttcagt 1136040
atgatgactt ctattcctg taaaatcata agctttgcat tcaaacacagg ttttgtttag 1136100
ttttgagatg ttgaggatca agcccagcac ctcccacatt gctaggcaag tgctccacct 1136160
ctaagcagtg tatgtagccc tagatttttc aaagaataca tgcatttctt ttatgtagca 1136220
aattaaagac aatcccatga tcttataaaa gaattgcaa agaactcatt atcttagtca 1136280

tacatttatt tcacactgac ttatttgtat actgaacaat ttatgtgatt agaggttctg 1136340
aaacataaat aacagatttt aatttgactg tttttctgaa gatgttctcc ttaaggagct 1136400
ttgtgaatgt tcacacagat tcaaaaggcc acgccaatt cacaagtaca gacatgatct 1136460
tctaaagcct gtctcaagaa actttaattg taaaagaatc agttagaacc ttcaaattcg 1136520
ccaaatgcta aaaccgcagc cttctaaaac aaagtcattt ggggagcatt tgttttaaaa 1136580
cttcaagcct gttttagcac ctgttacaca cgtccacac tctcaaggca aggtactctg 1136640
gtctctccag ctgctctttc catttatgga aatctgctct aagctaatgg acccgagag 1136700

gcagccaaac ctctaagtaa ttctatcttt aggtgaccct gttactctt atctgcagct 1136760
ccagtgagge aaaggattca cccagcgtct agttcagctt taaaaactta gtagtaagta 1136820
tagaggacac cgccattct tgagiatggt cttcacagag ccctataaga ctcacacaca 1136880
ataacaactc tcagaaagca aatcctcagg ttttaacat caaaccaaga gccatgtctt 1136940
tatagcgttg taatttagct gttgtcttag gtgctattaa taaactatcc tgggtaagcg 1137000
aatccttat gtaacattat gaagatatac tctaaaaacg gtacagtact acagttatag 1137060
tttcaagtat ttaacaacca tagggcaata aaattacata ttttaaaata ttttaagttat 1137120

aaacaataac aaccacaaaa atacttgcct aacagttata tattgtgttc cctaaattct 1137180
 taaatagcat aagggtgatt ttcaaaacca ttatttcaaa ttagtataaaa ttaatcctga 1137240
 ttctgttctg gtctggtttg ttctagaggt ggagtctcat gtagcttagg ctggcctgga 1137300
 actctagaca tggcagtaat cttgaacgcc caatcctcct gcctgtgctc cctaagcgt 1137360
 gagattacag tgttctacca cattccaatt agtcttttaa agtgcatttt cttgcttcta 1137420
 cttctgacct caagcttctc ttctccccc aaaatcaaca aattataacc ccaaaataat 1137480
 ttactagtac tttaaatatc cataatttta agttgccaata tagaaaacce aacgttttaa 1137540

 gtacagttag gctgtgtcag tcaaatgttt ctcatgtgcc cagtgtgtg cttcagaacc 1137600
 aagttttgtg ctgaacaggg cttctgcctc ctgcaacttc acattcagag tgccatcaaa 1137660
 acccaattgt aatgtaaaa caatcacatt actctgtaat ctaccagctt gctaaagaga 1137720
 gcagtgtttt ttactttagg agcttagttt gctgcaact caatgctaaa cataaataaa 1137780
 aatctaaaag cctagcgtcc aatgagaagt tccagaatat ttactcaat ttataaagta 1137840
 tctatacttt ataaggagta tctatacttt gttgacctaa gtcaacaggt gatTTTTcta 1137900
 aaacaatctt tgatagcaga aatttacaga ttgtgtgag ccaccatgta gttgcttga 1137960

 attgaactca ggacctctga aagagcaggc agtgttctta accgctgagc catctctagc 1138020
 ccatagcaga aattcatac ctctccattt ctgtaatttt gaaaatttca atgatgtttt 1138080
 attcagtttt attataatta ttataaata attcttaaat tattataat ttaagaaatt 1138140
 aaaactgcat atttctaaag atataaatal caatttaaca gggccttgca acctaaaagc 1138200
 aacatctgca aataaaattc cttcttacta cttccagac aagaatgaaa ttatggtag 1138260
 aaaatccgca acicagtta aaaacagaaa caaactagta agtaactgga caggctctcat 1138320
 tttctatca gttgaactcc tagccaagcc tctgtgaagt aatgtctcaa atacatttca 1138380

 aagtgattga attcttatca aaacaccatc aataaatgtg gttgtgtgctg ccatttactg 1138440
 tgggtaata tgcggctcc atctccatct ctaatcagct ggtgtttgta gtacactgct 1138500
 ccagactctt aacagctgtt acaaaaatac aaacttgta attaagtctg acaagaggca 1138560
 tacctcccag ctttgcaata gagaacgtg gcaatggatc tagttcataa caatgttctc 1138620
 aagtcagaaa taaactttac aagcaataga gtttgagagc aatggaaaa tgagaaatac 1138680
 ttcagtaggt gttagtgtt ttctctaaa cacagcgcca taaactagta ttccaaggt 1138740
 cactactcaa ccttgactg accgaccaca ttctctaag tcccagagct ctagtgggga 1138800

 cagagcagac cactgcaatg aagaagaggg tctattatcg ttcaccatta acatctgtct 1138860
 ccttgacct tcaatcaata tagctctgta agtataaaaa gacaattaaa attactttct 1138920
 aagccaaagt tatccaatta aattaaggcc ataattttaa atttctcat accacattt 1138980

taaaaagcac aaaattggta ttaatacctt ttggggaggg catatccact aagctacaat 1139040
 ctgaaattaa taccttttgt ttaacctaat attgtcatgt cagcatgtaa ttgtaataaa 1139100
 tataaagaac ttttaaaatt caactttcca gccagatctc aagtactcta tacctacagg 1139160
 tggctagtgg ctattacacc aaatgacaac ctaaagccat tcttaacctt aactttggtc 1139220

 agaagacact tctgattca aattactgag aatctcaaaa agacttttga gaataaacct 1139280
 tatctacaga tagttattgt atttgaaaaa taaaatttag ccaggcatag ttacttcacg 1139340
 ctgaaactc caacatttag gagttttagt gtagccagcc taggctagca caataaaca 1139400
 acttttaacc tcaaaaagat ttatttacc ctttacaata tacatggtac ttagatatgc 1139460
 ataattatga aaaacaaaat aatcttaagt agctttacaa gtaagtgtat gttatgtata 1139520
 aatgattgca tgtattgggt atgtatgtat atatgtatgt aggtatgtat gtatgtatat 1139580
 atgtatgtat gtatgtatat atgtaggat gtatgtatgt atgtatgtat gtatgtatgt 1139640

 atgtatgtat gtattagagg caggggttca tgaagaattg aaccagggc ctcatatgct 1139700
 aggcttctac taatctatat cctttatfff gtttaatfff atttcagaag ggggtgcatt 1139760
 tgtttgcccc ggtagctttt gatttcattc cctagcctat ataagccatg agcttggaat 1139820
 aaccctgtct cggctctccag agtagctggg gttacaacc tgtgccacta agtccagcct 1139880
 gctttatatt ttctgggaat cttttttaa tctttatfff gtttctgtac actctggaaa 1139940
 gcctcccga atctctagat cagtgtctg cctgtcttc tctaataata tttgtttctt 1140000
 tctttctttt tttttttttt tttttgagaa gaggtttctc tacataacct ggctgcctg 1140060

 gaacttgctc tglagaccaa gcaggccttg aactcagaga tteacttgcc tetgcatcct 1140120
 gtgtactggg attaaaggca tacaacaaca ccacaagtcc cattatctgt ttctaagaa 1140180
 aactgctttg aattattgat tgactttata cctgacatt acttggtaac tcaactgatat 1140240
 ataatgttaa taatactagt attacaatga attcaactgg taatttcttt aacaaatctt 1140300
 caaatgaat ttcttttcta tactggagat catatctagg gccttacct aaggcatatt 1140360
 ctccacctcc agatatttct tttaatgtgt gcatacaca atatgtgtgg ggacacacat 1140420
 gccatggtgt gtgtgtgtac atcagaggac aacctggag ttctcttcat ccaccttcat 1140480

 ctcaactcta aagactgaac tcaagtctcc aggctggcca gacttcaacc cctcagtcct 1140540
 ctageccaca gctaggtcta agtgtctgga caaaaataat aataacaata ataataataa 1140600
 taataatgct attcttttac ttttatttca acatatggta cctacttttt ctttctgttg 1140660
 tttttttttt tggggggggg gggctcaagac agggtttctc tataagcct tggcttctctg 1140720
 gaactttctc tglagaccag gttggcctca aactcacaga gatctgtgg actctgcctt 1140780
 ctgagcgctg ggattaaagt catgtgtcat caacagccag ccctactttt tcatatacc 1140840

tacatTTTTat gatTTTTTTTT ttcaagactg ataacaataa gatccaaatc tgaacttctg 1140900

aaatgctttg gagtttgcac atgctgatat tccaaaattt agagaacttg gtaagtgaaa 1140960

caatcctgtc tcaagtactg tggatatgag ataaccaacc attactagag atttcaattt 1141020

taagtacatg agaaatgaga cttctgatga gatgactagt gccgatgtgg cagctcagca 1141080

ggaagacaaa tttggtacc agcaccctaaa tgaagtacc gtgtaacaag cactgtaat 1141140

tccagtgcag aggacagagac aggaggatct cagccacttc ctggccagcc agtctagcta 1141200

aatatgaagg ctcaatgaga aattctgtct caaatacata aggacagagc attggggaag 1141260

atgcttactg tcaacctccg gtctccatta tgtacatata ttcacacaca gagagactat 1141320

tctgtatttc caaagaaaaa tttctcttc atttaagaac tgactgctg caagggtgct 1141380

atggcatttg cccatattcc tagcactcag gaggcagtca gtcaaatatc tgagttcaag 1141440

gccaccctca tctacaaagt gagttccatg acaggaagga ctacagagaa accctgtctg 1141500

gggaaagaca aaaattaag agaggaaggg agggaggagg ggaggaggagg aggaaggaag 1141560

gaaggaagga aggaaggaag gaaggaagga aggaaggaag ggcaaagaaa atgctgaagg 1141620

aaggaagaa gggcaaagaa aatgctgatg acctcccttc tcaaaagaaa tgggaaatta 1141680

atgtcagcac ttaggaggca aaggcagggt gatctctgtt gattttaagg ccagccttat 1141740

ctacatactg agttccagga cagtcttga tacaataaga aaaacttgtc ttaaaacaat 1141800

taaaagaaaa agggaggagg aagaatggaa gacaaggaga agacgtagtc aatgactgca 1141860

cactttggaa aaaagcagaa ttttttgtt ttgtttttg agacagggtt tcctgtgta 1141920

gcctgtcctg gaaccagctc ttcagaccag gctgatcttg aactccacag agatccacct 1141980

gcctctgctt cccaagtgtt aggactaaag gcatgtacca cactgtcca acaagaaaac 1142040

ataatctttt aaagtgaaaa tcttctcca aatcaagaca gtgcatacag tatatgttca 1142100

cagaaattat taggaaaata atgtcagaca tttgttttc cttattaat acacacacac 1142160

acacacacac acacacacac acacacacac tcacacttc tctctctctc tctctctctc 1142220

tctctctctc tctctctctc tctctctctc tctctctctc tccagaactg agcctcaagt 1142280

attaaactac atcaaaact tcttgtgagt tttcaaaggc tggctaaaag aatgaacct 1142340

ttatgacata ctcatggtt acattttcta aaatctctt taaaagcaag tcttacacct 1142400

ttacccttac atgaaatgtg ttggaccact cacaatttta gagctttaa agtactcaga 1142460

catcactag tcaaatgcta aagaagttag gaggttagga ttaaggttaa ccaggacata 1142520

gctttatcag tagccaactg gagaacctca acctctgtg tcatggttcc ttaagcaagt 1142580

ttgtaaataat gcagttctgg ctagectgtc tacctctgcc tcctcagggc tggattaagg 1142640
 aaagcatcac catgccccac ccaaatgcaa attagtaag aatattaagt cttgactaca 1142700
 aaacatTTTT aattttaaga tgacactaat ttgctagaag tttatttcga ttatttagtc 1142760
 actaagtTct ttccaagTgt cactcatttt acataactat caggtaagta ctacaattat 1142820
 tataactact ttttcatttg tacattatat aaatttcac tgcgtgccta tatctgatga 1142880
 attctttcaa caagataaag agatcattac atccatttac ttataaaatg tgcagacatt 1142940
 agagttgggg atgtagctca gctagcagag tatatactga atccaccagc acacacctgt 1143000

 aataaagcat ccaggaggag caggcaagag atcaaggcca gcctcagcta tatggaaagt 1143060
 tgaaggccag tctgaggcac ttgagacttg tcataaaaac aaaaaaattg aaagcattac 1143120
 tctaccagtG ccattaaaaa ctgtcagcaa taggagctgg agagatggTt cagaggtgaa 1143180
 gagcattagc tgctctacca gaggtcctaa gtacaattcc cagcaacgag atggtgaatc 1143240
 acaaccatct ataatgcatt ctgatgcctt cttctggcct gcattgcagg catacataca 1143300
 ggaagaacac tgtgtacata ataaataagt aaatctttaa aaaaaatcag caataaaaaa 1143360
 attagaagca taaatcata ttttttaaaa aaaattcttg ttttcttctc caggttttaa 1143420

 ctttgagtat accagcaaat cctcttaagt ttccttctaa aagcctgcag agacattcag 1143480
 gttacatgaa catgagaggc gaaataaaat aattatgtat aaaacagtct ttcatagcac 1143540
 actgtgattt aaaaaccttt agttataaga ttttgagagc agtactcaa aatcaagtag 1143600
 atctgaaaaa tggcatctaa agtcttagaa aaccagcatc agaagtggTg tagctctgtg 1143660
 gtgagcactt gccagcgtg ccggaggccc tggctcagat ccctggcacc acaaaccagg 1143720
 acacctataa aaagacaaaa acatttattc caaagactat gtaatatgca ctcccagcaa 1143780
 aatatctaca ggccacattc agttttactg gtaattccaa aggttcatgg aaagaaacct 1143840

 cccacctgca gaattaagtc ctgtgcctct acagtgttTc tcaagttct gactgaagaa 1143900
 actgtgctgt ggtTgcctca agtattcaca tgcaactgaaa ataatcttt tggatttatt 1143960
 aaattttttg cttattttac atgcaccata tgtgtgcctg gtgtccatgg tttagaagag 1144020
 gttgtatccc ttggaactgg agttccagat gattgtgagc atgggtactg agaaccaaat 1144080
 ctagatcacc tgcaagagca acaagtggTc ttaaccaatg agcacttctc cagcccagaa 1144140
 atgtttgtag tatctcttga actatacaca ctccacacc aaaaacaccac taaccctaac 1144200
 ctTgaaaatg tacactaact tatactgaac aaaacaagga tccaagttct cactgtgttc 1144260

 tcctctcat tcaataatag ttcttatcca aaagaggtat ttaaagccg ctcaataaat 1144320
 tggattttcc ataggaatt ttgacatgtg caaaatatac cacagactaa ccacaccatt 1144380
 gcgttatata gtacatatgc ttccattagt ccagatttta tttgaattta aagttctgtt 1144440

aaatttaggg ataacatat gttgatcttt ctctcaatc gaactgagtc agctttgtta 1144500
 gccaaactat cgaattcaag atccctacct aaaaacaata gatgggaaag actgttcaga 1144560
 tcttttacag cagtactgct tggtgactat ttctcatctt ccacatcgat gatatgaaac 1144620
 agatccagaa aaggaccgcg tgcgcttatt atttcagtaa gcaacaatgt tcaagcagtg 1144680

 ccacatcgac ctggggccct cgctgcactg tctgctagca agtaaagctg ctttttctat 1144740
 gtaacttaag tccgtgcctt tccgetgcag cagtggcgca gcacatcccc cacccccgcg 1144800
 gccacttccg tgtttacct cctcttcctt ccaattccat gcgtacattg tcagcttcac 1144860
 tccccccaa tcttcattgg ctcgctcgg gcccggtgtc ccgccccag aatcaacgt 1144920
 tcttatttgg aacatctcag agcgcagatt ggaaccgagg gcctgtcaat cgcgcgctt 1144980
 ctgtcctctc ccaggcgctt ccgctatggt gggaggtttg gggggagggg aaagggggct 1145040
 attccgagcc gagacttccc tggggccggg acgccctccc gcccgccctg catctagctt 1145100

 tcaccactg ttgacaaaa taaacgttcc ccctcactgt ccaaagccc cgggtcagca 1145160
 gcacagaata caccccgctt ctttccctc cccctgaaa caccgcctc acgaggggaag 1145220
 gaaggcgagc agcctagttt ctacaccgcc gccgttagcc ggggcaggga ggcgccgctt 1145280
 cggcgtcccg ctcagcaccg ggaagtggcc tcaagaccgt tactccggcg cggctccgtg 1145340
 aggctggaga caggaggccg ggcgcgtttt ggcgggtagc tcccggggcc gggcgtcca 1145400
 tgcggaagtg gccgctgtgt gaagtgtgag gcgaggcggg cgggcggcca gcgccccag 1145460
 ccgcgggcag gggcggcctc tcggccggac agcgtggcag gcggcgggga caacagcccc 1145520

 gctcacttcc tggttccccg gcaactgggg tgaagcgcgc cactcgcccg cggcgactcc 1145580
 ccaacttagc cgcggctccg tgcccggccc ccgccgtgc cgctgccgcg ctgcccggag 1145640
 cgacagccgg gtccgaggc aggttactct ccaggtgat cacttctga ttgtcgcct 1145700
 ccattacttc attctctccc ccctctccgc gtccgccggg ctgactgagg cggacaccgg 1145760
 accggggccc tgaccgccc gggggacgct cccgtctgc cgggcgccc ctctcggct 1145820
 gcaccgatgc accggagaaa agttcccctg cgcgtaccgg cccggatgag cagatccagc 1145880
 tggttcgtgg gtcctcatg cagagacgtc gccatgtga tcccgggctt ggaactgctg 1145940

 cttcacattg acttacacc tgaacagcgg cgacagggga gaaagcggaa cccgcggccc 1146000
 gagacacacg ccgtgcgggc ggcacacact cacgactcg cacacactcc gacgcccgga 1146060
 tctttgcgcg tctccgaca ggaagcggca gccggcccgc ctcccgccgc cgggctgagc 1146120
 agccccacca ctaacggca ggggcggcgg cggccccggc tggcaacgcg atccttccgc 1146180
 cccgcgccc gacaggaagt cccggcgcc ggcagctagc ggccgcacgg acacctgagg 1146240
 ctggggagcc gcaggccc ccgccctcggg gacgcgggcc tcggcaggaa gaggcgact 1146300

tcacgttctg cggaagcgaa gtctgcaaat gtccccctcg gaaaagagcc atgaatcaaa 1146360

 tttttcttcc tagaagegac ctaataatac ctagtcccgc agctgtacat gaaggtggct 1146420
 ttttaacttg ttttggcctc tccaaagctt atgcagegta caatcagttc agttgaaaga 1146480
 actgcacttt aaaaactcgt acctagaaaa tattctaaaa acatcactag ggaagtcagg 1146540
 agtctccaac tacttcaaag acgacttggc ctttttctcc acagaagtca gagtacagta 1146600
 gacaggtatt tagtaaaaa cagagcagtc agccagcctc agggagactg gattaaagtc 1146660
 gctcagtttc ctggatcatg aattcgtgtt cctctctttt tatttggttc acgtggacaa 1146720
 atgaacatat tcgttcatct taaacatata ctaagttatc ctttagaaga atcctgacaa 1146780

 atataacta caacaggaaa gggaaatatg cgccaatta gtggctataa attagtggaa 1146840
 atggagggga tcagaccaca taaaatgcca agtaagacct aagcaaaatg ccttgcttgt 1146900
 ttcataatth cttaacataa aaactgaaac aaaaatgtta cctgaaagt tttccacaca 1146960
 caatgtaaaa tglaactcaa gtagataatg cgttcgataa caatttatg agtaataaag 1147020
 catcttaatt gcaggattac aaatthtata tgagttagct gcttatagtt atthtcaaca 1147080
 gtaatataat acaatattat ttataagttt acccaacacc actgcagcat cagatgggtt 1147140
 tacttaagac tgccatgcat aggacaaaag gaaccagcta actgataact tttatthttc 1147200

 attgctatca acttgaaata aggatctccc attgatgggc agcatctta gcagtttccg 1147260
 tatcaggaaa gataaagaat actaaagggt aatthgttga ctttaggtgg ctctagaaa 1147320
 ctggttaaca atcagaattt ctactccagt aacatthttt ccatgtatth cctatthagt 1147380
 acaaaatgg gaaccaaagg gtgggtgggt gtgtgtgtgt atgtacgtgt gtgtgtgtgt 1147440
 gtgtgtgtgt gtgtgtgtgt gtgtgtgtgt aggtggcatg tcaacatggc ttaaaaaca 1147500
 taaaacagta ttctcaatat aggatthgtt tgaagtctga tacactthta ccttactgta 1147560
 cttcagatat atctgaagca atgtgaatat atgtatgtat gtaagcatgt atgtgctthg 1147620

 ctggttgtag atcctaatac tgtatccatg tctagcttac atthtaagca ccaacagaat 1147680
 agaagctata taccttcttg cataataatt tatatactta acacatacat acacagaaag 1147740
 taacacaaaa agactgtaaa acacaacatt ccattatatt tggaatgtat aaaagcagaa 1147800
 tccccaaatt tagtacaagt ctgccttgcc ttaaataggc tttcaaaagc caccaatct 1147860
 ttactgagaa gaataagtag aataggctat aagtagcata tatacgggca caaactggca 1147920
 ttatggtgtt taccaagcat ctaatatgia tacctgtgtg tatatacaaa tathtatctt 1147980
 cagthttcaa gaatccagca tcaagcagtt atthataagc tggatthtta ctaaatatga 1148040

atgcataggc ttgatggta gttaccttaa aataaactca attctgctaa taaaactaca 1148100
gaaagacaat actgtctaaa agttacttat gtcccagcag agagagaaaa aaaggtaaat 1148160
accagatctg actgcttacc aaataaaagc ctgaatgcta aatactttac ctcatctctt 1148220
tttatgtatt ttgtccacat ccctatataa taggcattac tattatgttc atttcattga 1148280
tgaaacgtat ctaaggatcc ttgcttaatg ttacagttgg ttatgaaagg gtcagaattt 1148340
gaacccagtg tccttactct ccaccatttg ccaggaatga aactaacatc cctacttate 1148400
tgtcacacca attttctcat tacaatttct ttttgatagt tcccccttaa agagatgtag 1148460

tctagtcttc ctctcactgg acatattcct cacagctaac aaacagaata aagctgaagt 1148520
gcctcggta caaacctaa aaggaagcca aatacctgt cataaataac ctgagcaggc 1148580
ctgtgatgtt ggggcaggaa caatagcatg ctaccaacaa ctgtaaaatg agctatatgg 1148640
gagacattct ccaaccctaa ccaaatcttg agatgactaa ccattgaca agactacagg 1148700
cagcctcatg gaagacctg agccaggacc atgtatctaa gccacatcct aaccttaaac 1148760
ctcaaaaact gtgggaaggt agatatttgg tattttaaaa tgctaaattg ggtgtagttt 1148820
gtaattaaa aatagaaaaga atgggtgggt taaaaacat tatattcttc aaatatttaa 1148880

cacttattct tcaaatcaag tctttatact gttgagtata tttatgtgtt tgtgtgaaca 1148940
tacttgagtg gcatatttgt taaataaatg tcattacatt acatcttcat tacattcctt 1149000
ttttcatgaa ggagctacac tcaatccctg ataatgtaag taaatacagc catatgcttt 1149060
ataaattcta caaagcattt cagtgaatga acttactcaa ctgtatttac gaaatttctc 1149120
ctttgttaga taaaacttcc ctctttaaaa ttattaatga ttacttctta ttattttaaa 1149180
ttagatgtat gtctgtgtgt agtatgtgca catgagtaca ggcgctcaaa gaggcagagg 1149240
aattggattc cccaggaat ggagttacag gtaggtgtaa ccactgaca tggtttctag 1149300

gaattgaact agtaacttct ggtagagcag gacaggetct taactgtaga gacatctctc 1149360
tagtttagtt tcctttctca aagagggttt ttgttttgt ttttttctt catttgtttt 1149420
atagtattag tgactgaacc tagagcctca cacatgctaa gaaagctctc tggctgggta 1149480
ggctatgctg tctttccag tctataaaat gttaacatat tctagattat aaaacatatg 1149540
tttcagatat ctctgtcag cctgctgttt aatataatc tcaaatgggt catcctaaag 1149600
aagttcaatt ttgatgtcg aattatacct attttccat acaagatata ataataatat 1149660
ttcagataaa aagtaatta cagaagaatt aagaaatatt tagggactgg caaagatggc 1149720

tcatttgata aaggccagag ctaggtccat gcacgtgcac gcacatgtat gcgtgcgcgc 1149780
ggacacacac acacacacac acacacacac acacacaaat tctaattttt taaagaaata 1149840
ttcagaaatg aattatgaaa atgcaaaatg tcaagctatg tgtgacacaa ctaaaacagt 1149900

actaaaaata ggcttcaaaa taaatgatta agctgcaatg ccttggta cacccagtta 1149960
 accccagcac tggagcgcca aggcaggcat agctctggga gtttgaggcc agcctgtct 1150020
 acaggtgagc tccaggacag ccaggactat atatagaaat gctgtctcaa gaaacaaaa 1150080
 gtaacaaaac taagcattca attcagaaaag aaaaaaagt aaatcaagag aaaggaaata 1150140

acaggaaaaa ttaataatt caactttgaa cagaatTTTT aaaaagagaa ggaagattca 1150200
 taaagacaaa aggtgatttt gtaaagactc agcaaggatc atcataaaag taaaaatata 1150260
 atatttaatg tgtgtgtgtg tgtgtgtgtg tgtgtgtgtg tgtatacaca atactgaata 1150320
 gatacctacc aatacaaca catggttttg ttgtttgtgt tttggtttct caagacaggg 1150380
 tttctctgta tagctttgga gcctgtcctg gaactagctc tggtagacca ggctgtctca 1150440
 gaactcacag aggactgcct ctgcctcccg agtgcctgaa ctaaaggcat gtgccaccac 1150500
 tgctggcac aataacatgt ttttatgaag ctttatgtta ataaatgtgg cataaaatct 1150560

gaataaagtc tglaatcact agaaatagac tcatgcttaa agctgagatg gtaaatttca 1150620
 aaaacataaa tcgtaaagaa cttaaaatct tgcctcaaat catctgtact caaaaaatt 1150680
 tccagatttg aatatctttt taggtagtac aaaattctca atttgaata atagacaatt 1150740
 tgttaccaaa catgggaaaa aatacatgaa actacctgtg ttccttttga gccagtttg 1150800
 attctaaaac tacttaagga caatgtaaga aaataaaatc atgtatgaat atacatgcaa 1150860
 aagtcaaaag acctccctaa gaacaaagaa caatgacagt gacattgatt ctgagattgc 1150920
 aatgaggtca acatttgacc atattcataa aggagggcac aacaatcata tatgcagcag 1150980

ctttaagtaa gtgattgat gtatgctaag aaacatgcgt gcacattaag aacagtgctt 1151040
 gcttaaaaaa aaataggaaa ctgagacacc taataatagt tactcaaggt ataaagatat 1151100
 ataactcagc ataatgtaa gaataacac taatcaaatt aaattggatg ctcacgtggg 1151160
 agctagacac aaagcactta tatacaaaag ataataagga ataaatcacc ttaaagtata 1151220
 aaacaaatcc aattttacat ttctctatcc ctataaatcc ttcctccaac ctcccgtgtg 1151280
 tgtgtgtgtg tgtgtgtgtg tgtgtgtgtg tgtgtgtgtg tgtgtgtgtg tttgtgcgcg 1151340
 tgcacgcgca cacacatgca cacgcacacg cgttacatct tcacttctta ttttcaaatg 1151400

tatgtctact aaatactagg tatggatatt catactctgt ttctagacc tcaatctacc 1151460
 tattaactat tatttcctg cagtacattt tttctttca cttttctcc tcttctctct 1151520
 tcctctcact tgtttggttt gggggtgttt ttgtgtgtgt gtttggtttt tttttttta 1151580
 agacagggtt tcctgtgca gccctgactg tcctggaact cactttgtag actaggggtg 1151640
 ccttgaacte agagacctac ctgcctctgc ctctgagtg ggcatcacc accaccacc 1151700
 agcttctcat ttgttttcaa gcacctgtct gtatctatct gtatgggtgt ttctaggctc 1151760

tctactcttt tctatggatc ttcttatgat aataacactt taccaccgaa gtcctgccaa 1151820

ctgatttatt ttaattaaa taagtaata acaatttaac aaatttttaa ttttatgttt 1151880

tgttttttca agacagggtt tccctggcca tcttggaaact cactctatag acaaggctgg 1151940

actcaaacac agaaatccac ctgcctctac caccacctct gctaccacca ccaggcctga 1152000

tttatttctt ttttgttgtt gttgttgttg tctgtttttt aaaataattt ggttatttct 1152060

gactttatgt acattgttgt tttgectaca ggtatgtcta tattgaggca tcaggctccc 1152120

tggaagagga gttacagaca gttgtgggct gccatatggg tgctgagaat tgaacctggt 1152180

tcctctggaa gagtagtcag tgcctttaag tgctgagcca tctctccagc cccctgatt 1152240

tattttctta aaaataaaat agttttaact actttctttt taaattttgt atgtatgagt 1152300

gttttgctg aatataagtc tgtatacaac atgcatgctt ggtatccgca gatcccagaa 1152360

gagggtgttg aatgccggga aactggagtt acagatagtt gggaatgaag ccttaggtgc 1152420

tcttaactgc tgagccatct ctgcaactcc ttttccctt tctttcttc ttagacagaa 1152480

tctctctata tccacagacc tcaacttatg agatgcatga ccccttgggg gcggggaaag 1152540

tcaaacaacc gtttcatggg tgtccaacat taggtatcct acatgtcaag tatttacaat 1152600

tcatagcagt agcaaaatg cacttatgaa gtagtaacaa aatcatttt atggttgggg 1152660

gtcaccacaa tgtgaggaac tgtattacag gtttgcaaca ttaggaaggt tgagaacct 1152720

tgctctatat agctctaagc attgaacttg ccttggcttc ccaagtactg agattataaa 1152780

atactctgt catgctgta ctttctattt cctacagctt cagattcttt tctccctctg 1152840

tccctttctt tctaagggtt aaatccaggg cgtatgtac actaagcaca cacccttctg 1152900

gccagggcta caggcacaca gctctttcgt tctttcacag aatgtctaga gcagtgttc 1152960

tcagccttcc taatgcttca accctttaa acagttcttc atgttgtgta gaccccaact 1153020

gcacaattat tctcattgct actttataac tgaattctg ttactgttat gaattgtaat 1153080

gcaaatattt tggaagatag aggggtgttg aaggattcat gaccacagc ttaagaacca 1153140

ctggtttgaa ctctattgag ttccatattt taaagtttgt caagttctgc caaaagcaca 1153200

tctgcatgga ttctgactgg aagaaaactg gttgtacat tagctggaga aggaagacaa 1153260

gatttatcat cctccgtttt ctcatatatt tttggaataa agattaaaag aataaatttt 1153320

gatccactta ggttttcaat gagtgagaca ttgctatggt aaacaggcca catgtgctgt 1153380

cagatttatt cttaggtaac taatgaagat ttttctattt ggtttggatt ttactgtcag 1153440

tttatgtttt atttcttac tgagtactgc tgtgtatatac agcaaccctg ataagtcctt 1153500

tatcagggct taatgtatgt atgagtagtc ctttagatth taattgcaaa gaatgacagt 1153560
 ttgtttttt tctcaaaacc ttttaatgta tctatgtagt actgggaatt gaacttaggg 1153620
 ctttgtgcgt tcgaggcaag cactttacag ctgagccaca cctcaacact acttattctc 1153680
 atcattaaaa ctttctccg ctgctggata gtttttatat caagttaacc aggctagagt 1153740
 cattctggaag gagatatcaa ttgagaaaat gtccccacca gactggcctg tgggacattt 1153800
 tttttctta attaatgatt tatgtgggag ggaccagacg ttgcagggtg gccactgatg 1153860
 ggggtgataa gaaaacaagc taagcaaat acaggaagca agcagagctc tccatggcc 1153920

tctccttcag ttctgccac ttegetgat cctgccttgc ctgagttctt gccctcact 1153980
 tccctcagta atgtatgta cctggcagtg taagcctaaa taagccctt cctacacaag 1154040
 ttgcttttgg tcatggtcaa gatgtgtat cacagcaaca gaaatccaaa ctaaagcatc 1154100
 actgtagtct atgttactgc agtgagtctc cactaagtga tagtaatagt tactgtaagt 1154160
 tgggttttgg aaacagtctt aagcccaagc tgccttgaac ttgatactgg ttttctgag 1154220
 tattgagatt acattcacga gccacaataa ccagtttact gtacatttct actaatatcc 1154280
 ctgtaaggt tccaattaag tctttttta attattcttt tttaaaggtt ttatttattt 1154340

attatgtata caacattctg cttccatgta tatctgcaca cctgaagagg gcaccagatc 1154400
 tcataagga tggttgtgag ccaccaagtg gttgccccga attgaactca gatcctctgg 1154460
 aagagcagcc agtctctta acctctgagc cacctctcca gccccgaca aaacatcttt 1154520
 tatcacaatt gcttttcaa actgagcaca cagtagaatt atttgaaagg cttgtaaaaa 1154580
 tacggaatgc tgcaacagag ttctaatgg aggtaactgc atctttttg agtttaagac 1154640
 atcaatggct gtgcatacc cgaagtgaca tttgacac agccctttc cttatctcac 1154700
 agttcttaca ttctccctac ctcaaatcc aaattgttc ctgagcctca gaggtggtga 1154760

tgaaaatgtc ttgtgtgctc aaacctcacc catcacttat tctcagcacc tacagcagct 1154820
 gtgggtctct acattcacca ctattctcag caaagagaag cttctctcat taaaagtaag 1154880
 gatagcgtgt atctatatgt atatagcct agacattcat aaggcatttg aaaaagaata 1154940
 gtaagtccc tccccagcca tgttttatg aagtttaag taccatata ggggtgcctc 1155000
 ctgtgtcacc gcctcaaacc aacaagagac aagtggacac atcttgtgta gcagattggt 1155060
 ttggaagtgc atagattca tgtctttgta aaactattgg gtgtctttc tccccgaagc 1155120
 agcctacatg gtgctgtcca gcacaatgaa agctagccag cagacaggaa gtccctaact 1155180

cagtcccage ttttctctac atcttacaac caaagtatac agtcttcagc aacagggtct 1155240
 taccaccta gtcaggcggg taggcaagag gaggggcaaa agccactttt gttttagggg 1155300
 actctggagt cctaatcaaa atcactcagc agtatccaca tctgacttgg ggttttgttt 1155360

agtgaaccaa ggccttagga gcagcactat cagccttgca ggacatcttc agtctttcct 1155420
 ttaataatat tattaatggt gaaaagatag cagtgtgcat atagcttttt taaaaaaga 1155480
 ttttatttat ttattatgta tacaacattc tgcttccatg tataatctgca caccagaaga 1155540
 gagccccaga tcicataacg aatggttgtg agccaccatg tggttgctgg gaattgaact 1155600

 caggacctct ggaagaacag cgggtgctct taacctctga gccatctctc cagcccaaat 1155660
 acagcttttt tatacctttt tataattaat cctcccttct gctcccacaa aaatttcata 1155720
 gttttagcat tatctgtttt ataagttttc aaattcctta gcagtagcct gttcataatg 1155780
 ttgttttgac ttacgttttt tgttgcaggg ggaaaataca acagtttact agaggagaaa 1155840
 gaaatgacct tgagttaatca gagttattag accaaagtcc cattccaaaa gggcactagt 1155900
 gatTTTTTTT taaactctc tatcgtatac ttgtattcct agtgcttatt tttccttatt 1155960
 atttttagc actccatcca tttttctggt ttattttctc tttcatcaat tttgatgttt 1156020

 ttgcttttat ctttatttgg ttggaagctt tcaccatata aacattttac cttttatctt 1156080
 gtaatcatag catttaaaaa aaaaaaaaaag gtggaaagca gggaagatca ggagtcaag 1156140
 gtcagcctcc attacacagg aaggttgaag ccagcccaag ctacatgaaa acccctctc 1156200
 agaaaaaaaa ggaggaaaac aaacctgtaa ttagttccca ttggttactt cattttgttt 1156260
 tactctgca gtgccttatt ggcatctagg tataatcata tgctcatatt aatctttttt 1156320
 atcttcaaaa atactttagg tgttttattt ttatgtgtat gtgttttgac tgcaacgatg 1156380
 tatgtgagcc acttgcaagc ctgggtcctg ctgaggtcag aaggaggcat cagatgccct 1156440

 ggaacaggag ttatggatgg ttgtcagtct caatctggga gctgggaact gaacttggtc 1156500
 ttctgcaaga acaagaagta cttacaagta gtgaaccatc tccctagctc cacaaaataa 1156560
 atttgtagct acagtatttt ccagtaggtt atttgccttt ttattatatt cattgtatgg 1156620
 ggtttgtatg tactcatgtg accatgctca tgccatggtc cacttgtgga ggtcagaagt 1156680
 caacttgagg gtgtcaactt gcaggggatc tttcctcca ccatgtgggt cctgaggatc 1156740
 aatccaggt tgccagattt ggtagcagge actttaccac tgaccatctc aacagcaaca 1156800
 acaatttatt ttatttttaa agatctttct tttttctctt tctgtttttt ctgtcttttt 1156860

 gagacagggt cccactgigt agccctggaa ttactctgt agaccagctt gccctcaagc 1156920
 tcaagagagt ttgcctctgt gtectgagtg ctgggattaa aggtgtgtgc accactgctt 1156980
 ggccagattt ctttttttaa atctatgtgt ctgtgggagt gtgtgccgta tgagtatggg 1157040
 tttctgctga ggccagaaga aggtgtcaga tcccttagag caggggtcac aggtagctgt 1157100
 gagccacctg atgtggaacc atgctagaaa gtgaaaaaag tgcacctaac ctgctggact 1157160
 ctctctccag ctcccccca ccccaaatcc tattaagca acttgcttta caacttggtt 1157220

ttacttcttc tacttcacag ctgtgtcaga tglacagaag ttaatgatta cacttcagaa 1157280

ctatttctct catctgttta ggatcccctt tgcctaatt aaagatgttc ataataaatt 1157340

ctttttttga agatttattt attatgtata cagtgttctg cctgcatgta teccaacagt 1157400

ccacaagagg gcacaagatc ccactacaga tggttgtgag ccattgtgtg gttgctgaga 1157460

attgaactct ggacatatgg aagaccagct agtgttcttc accactgagc cgtctctcca 1157520

gaccctgata aattcttttt ataaataata tttccttcag ttaatacttt tetggtgaaa 1157580

tgcttctcca ttaataaat tttatttttt gttctgttat ttatctcctg tttctactat 1157640

ttggctact tttggtgagt ctattataaa tagcagatgt gtttgattca tactattaat 1157700

tagacatggt ttaaacttct attatcatga tttatgattt caatatccat cattttccac 1157760

agttgttagg ttggatgaag tttaatttat tccttgtca aaccacaac ttagtatattt 1157820

ttttctttta agatttattt atttatgttt acagtgttct gcctgtatgt atgtcttcag 1157880

gccagaagag ggcactgatt tcattacaga tggttgtgag ccaccatgtg gttgctggga 1157940

attgaactcg gaacctttgg aagagcaggc ggtgctctta atcactgagc catctctcca 1158000

gccccaaaac ttagtatattt acaagctgtc tttgttttgt tttgttttat tttgagacat 1158060

gatctcgtgt tglagccac actgtttcaa cctcctgatg gacagaatct caagcatgtg 1158120

ctaccacact cagtgtcaaa gctacaactt ctgttctgtt cacagtgtat gatttcaatc 1158180

ccttctggcc ttctctctaa ccacacctac tgcagtggct aaactagctg aactccaact 1158240

gcatagcttg tcagtctctg aataaaccac aaatttctgg ttcatgttgt ctctcaata 1158300

atataaaaaat agtctattgt gacattatgg agcacatcat acaagtttaa tcaaatcaaa 1158360

tcaaatcata atacagctgg ataaaagttc atgaatgcat gaattcatgt aaattaactg 1158420

ttccctttga atccaatgag ttccacatcc ttgaattcaa ccacctagct gaaaaatatt 1158480

tgaaaggggt gggggctgca ctggactgga ataaccacaa acagtctctg atagcaacta 1158540

ttataaaaac atctatattg tactaggtta tcagaatgac atgatgtatg gtatacaaga 1158600

gattgtgtga aggttattca gaaactactgc cattttgtaa aagaaaattg agtggcattg 1158660

aggcttctaa ttcaagacaa gagcttaata tglagccgag gctggtcttg aactcacaat 1158720

ccttcacct cagtcttata agtacaggaa ttacagcatc acccacagaa gctggtactg 1158780

agggggagag agagagtctt agaactcagtg cgtcaaacag ttggacaagg tagcacatgc 1158840

ctgtgatccc aacttgaga agtgaagagc agggagggtg gggtttcaat aatcctctat 1158900

tacactggaa gtccaagacc agactgagct acataagacc ctgtctcata gagaataaaa 1158960

agaaaaaac tgttttccat atgctattct tgcacatcaa gaacacccat aaaagcacat 1159020
 aagcaccacc agatggcact aaaccacagc cagactttga attaatttgg ctaacataga 1159080
 gcaacttgta gaacccatca cacacatcca cacattcctt tcaactccga ctgccattca 1159140
 ctttcccat atcttactcc tctgcacaaa tgaccaagt cagttcacca atttacatta 1159200
 atagtacatt tccaaaaatt caaacattt cttgtgcttt ggactgttgg gaagtattta 1159260
 ctgcctcata tatttattat cctagtttat ctcaaagttg tagtgctagt ctatgctaaa 1159320
 aatgccaaaa caaactggaa aaatggaagg caatctgttc caggaagtaa acagcatatg 1159380

 tgggaatgaa gcaatggctc tgccattaag ggcaactctt ccaaaagacc cccactttgg 1159440
 ttcccagcac ccacatcagg tggctcacia caatcagtac gtctagctct aagagatgcc 1159500
 attccctctt ctggcctcca aattaacctg cacacatgaa gcttacctc atacaaataa 1159560
 aaaaagatac ttttctttct tcttttttt tctgagacag ggtttttctg tggctttgga 1159620
 ggctgtcctg gaactagctc ttgtagacca ggctggctc gcactcacag agatccacct 1159680
 gcctctgcct cccaagtgt gggactaaag gctgccactg cctggctaaa aaataaatac 1159740
 ttttaaaaag aaacttgggc cagacaagca gtggcacatg ccttaatccc agcagaggca 1159800

 gaggcagagg cagaggcagg aagacttcca agtttgaagc cagcctaadc tacaagggga 1159860
 gttccaggac agccaagaat acacagagaa accctgtctc gaaaatataa ataaataaaa 1159920
 ttttaaaaaa aaggaaggaa ggaaggaagg aaggagaga aactaggata tgtcaagacc 1159980
 caaaaatctt tttaaaagct tgcatataca ttttatatt taaaaattt catgactgag 1160040
 tgtttttgcc tgcatgtcaa tgcaccacc tcaagcagtg cctatggaga tcagaaaagg 1160100
 gcactagatg ccctggaact ggtagtaaac tgtttgagcc acgatacagg tgctgcaaat 1160160
 caaacctgtg tctgctggaa gacagccat cgatctaac cactgatcca cctctccagc 1160220

 ccaacacca acagaatttg gattaataga agcagttaaa agtgtgtgtg tgtgtgtgtg 1160280
 tgtgtgtgtg tgtgtgtgtg tgtgtgtgtg tgtgtgtgta gagaaggaat atgatacaat 1160340
 tcaccagaag ctggaagggt tactcttgag ctactaactc tctgggttta aatacctgct 1160400
 tctacacttg gagaaatgat ttagectagt gttgctgaca gcaaattatg ttaatatata 1160460
 aaacactcag aactattcct agcaatagaa tgatgaaact tcttatgttc gaaagatttt 1160520
 gtcttttatt tttgttctg cttttggttt tccctttact acttctaagt atgcaaaaag 1160580
 gaggcacatt caagacacia gggggtgagc ctaggccta tcccaaaggc tatgatagac 1160640

 tctgatgacc ccctatggaa ggcctcacc cccctggag agcaaaaagg atatgtgata 1160700
 ggtagggttt agttgggtgg gaggtggta ggtgaagagt ggaggagag ggaactggga 1160760
 ttgatcatgta atacaatgtt tctaattcaa attttaaaa aaatcaaaa aaagaacct 1160820

taaaaaaaa aggaggcaaa tttcagtgtc ttgagctctc aaagtaatcc taggcatagt 1160880
 aacacatgtc tataatccca gcacttgaga ggcagcagcc aaggcagcag ggaatctgcc 1160940
 aagaaaaggg ggggaggagg gggagggtaa ctgagctcta gatgcttaca tagcatttac 1161000
 aagggttga atataatacc cagcactgca aagaaaaata ataataatcc attgaacttc 1161060

 atcctgtgta caattagaac tcactttaa ggtagaagag ggggagacag agagaaagga 1161120
 ggggaaaaga aaaagacaaa ggtagagaca taccacttcc atcacacaca cacacacaca 1161180
 cacacacaca cacacacaca cacacacaca gagagagaga gagatgacat ttaggaatgc 1161240
 ttattccatg tggcttgta gctcctctgc ccctaacacc attaactgcc aaccatattc 1161300
 tcaatgatga aattattca tttatttatt ttctctttt tcttaagact ttttttttt 1161360
 gtctcttta ttagctcta gatgacctag aactggttt gtaggcctaa ccctaaccct 1161420
 aaccctaaca aatgtgacct aaggggaatg ggaaatggca cctgtgcctc cctccactgc 1161480

 ttgagaggaa agatcccag tttacttcag tctgtttcta aatgatctc ccaaagatat 1161540
 ataactgat ttatgacaag aagcctttaa gtatgtttaa cacacatgtc ccaaaatgca 1161600
 gactgcttat ctcatctgtc actgtagect gtgccttaaa gagtccctga cacacagtag 1161660
 glaaccagca ggtgtttatt agtgttggaa ggggtgccctt gccagtctga gtgtggagg 1161720
 cagaagacaa ctttaggga catttcttc ctccactac ttgggttcta aggaacaaac 1161780
 tctcaaacte acatctttag gggtaggta aagcacctt agtcaactgag ccaagaatta 1161840
 attaaaggta ataatgtatc ctttaagca cataaaagaa ttttaacacc ctctccaat 1161900

 aactactgta gtaattaa cagagtaaga aactacagtg attattgatt ggatttttag 1161960
 agtaacagca gctctcttt cctataattg ttcccagcag tcaaggagg ctatcaaaga 1162020
 atgtcttat accaacaatca ttagtatcac ctaaagacat tggttaagtc aaaccacaga 1162080
 cccactaaat tagaaacatg gcctaccaac caagtatggt gtgagctgct gtagecctat 1162140
 gttccaggaa ggctgaggca ggaggctcat ttgacctcaa atgtagaaa ccagcctaag 1162200
 taacaaacat aacaagacct catcttaaaa aacaaaatga acaaaactct gttgcagcat 1162260
 tccgtatfff tacaagcttt tcaataatt ctgtgtgctc agttttgaaa agcaattgtg 1162320

 ataaaagatg tttgtcggg gactgaagag gtggctcaga ggttaagagc actggctgct 1162380
 ctccagagg tctgagttc aattcccagc aaccacatgg tggctcacia ccatctgtaa 1162440
 tgagatttgg tgcctcttc tgacatgcag gcagaacact gtatacataa taaataaata 1162500
 aacaatgctt ttaaaaataa acaagatgtt ttgttataca gacaaaagat gaggggcagt 1162560
 taaaacaaca aatgggtca gcaagaggga tgagtagata aaggcaccia acccaaagcc 1162620
 tgagaacctg agtttgctc ccaccagac ttacatggtg agaaaggagt actctgagca 1162680

tactcaaaaa taaataaatg aaataaaaaa aattaaagc atggatgaca actggcttct 1162740

aatgaagct cacatgtcaa tttttaaatt caagcatcaa caatgatatt aataatattt 1162800

gtgacttctt gactaataat aaatgcatat ttcacacccat gctgcatttg ttatcgatac 1162860

caaagtagaa gttacagtca gcattacttt gtaatgacag cagtaaaaca gaccttccgg 1162920

gcttgatgtg ctaatggaga gacacctgct ctgacaccac aatggacagt ctgacaactc 1162980

gccttagcat gtgtgctccc tggcagtgtc aggtatittg cttttgattt ttaaacatt 1163040

ctaaaagaag aatcacaggc ttcacccat ggccaacaag ttccacaaca caggaagact 1163100

ggaaaccctc acagatgta agcagagcat caacactgtg cctgctttct tcccagtgaa 1163160

gcactccttt accaacctga acaaacattt gcacaaagat attacagat gctctccacc 1163220

ccacctcata gcaccccgac caccttaca gatatttgag ttttaaagtt gtcttgtaa 1163280

aaataaaaca tgatgtaag tatattaata attacctgct aattagtaac tataaatgaa 1163340

agaaacactt ttaccgttct actaggaag ttttacattt tagaggattt caataaaac 1163400

acttgcaac aattagcaga gttctgagtt ccttactctc ctttccagaa cactggacat 1163460

tttaaatgta gaaatctgtg aatgtagaa tgtgaatgca caccattaca gtttgatct 1163520

gaaatgtccc acacagattc ttacgtgaa tgcttggtcc ccagatgcta ggtggaactg 1163580

ttctgggaaa gttctgaaa ctttagtttg gtagtaattt tttcttctt tttagaaacc 1163640

tccccacgct ctttggctc ggcggcagaa acaagataac gaaaggaacg tcatccttg 1163700

gaaagcgtcg caataagacg cacacgttgi gctgccactg tggtcttaag gcctaccact 1163760

ttcagaagtc cacctgtgga aatgtggcta cctgctaag cacaagagaa agtataactg 1163820

agtgccaagg ctaagaggtg aaacactacc gggactgggc cgatgaggca ctaaaaatt 1163880

gtctatcgaa gattcagaca tggattccgt gaagggacaa cacctaaacc caagagggca 1163940

gctgttgtag catccagttc atcttgagga tttcagtcag tcataaaaat aaaatgttct 1164000

ggtttcaaaa aaaaaaaaaa gaaacctcac acacacacac actttatttt cttttcttc 1164060

ctttctctt ttttttctt ttttttttc ttttttttc ttttttttt cttttctttt 1164120

ttcttttctt tgigtcttgc tttgtttgt tgagacactc ttactatgta gccttgctc 1164180

gtctgtaact caccagctc tcctccca gtgctgagat gaaagaaata cctgaacacc 1164240

atctaaacac ctgttagat ttttcaaca ggacctgct atgtagctca ggctggctc 1164300

aaacctgcaa tcctcctgcc tcagcttctc aactggggg attacaggaa tgtatcatca 1164360

tttcagttca ctttggaaac gttaggaggt gggacctagc tgggggaact aggtcgtgg 1164420

aaatgggatac ttactgctat cttgttccgg tccttgtctc tgcttcttgt acaccacatg 1164480
 ctcttctc cacaatgttc gcctacacag atggagccaa gcaacataat gtcagcttag 1164540
 tggcatttaa ttttaaaatg ttttatagaa acatttgaga tgctcaggtc ccaaagtaat 1164600
 gtctacagc aaacagaagg aggctaccac aggaatcaac agactaagag tttctgaacc 1164660
 ctctcaaac ctaactcaac tcaagcctag accacattat cactaaaatt gcctcctact 1164720
 atatatTTTT taaatctctg gatttagcca ggagttgtgg cagatgtctg taatcctagc 1164780
 aactcagaag actgacaaag gagtttgagg ctcatgaact acatagttag tccaggcc 1164840

 gattgagcta tgtagccaag accctaactc aaaattacat acatagagac atacagacat 1164900
 acatatatac aaaaataaaa aacaattcaa ggaattctaa aggctaataa gcacgccca 1164960
 aaacatcagg gcaaggtgag agagagaaaa gagatgtggc aaatcagaa gggaaatgga 1165020
 gcgtgtgctg aaacaagcgt ggctttatta aatgggtgaa tgtctatgga cagacagtga 1165080
 ggggccatag aaatgagaac cggttgctta aggaaggtcc caaaagactc acaaatgagt 1165140
 aggatgggac agtcatagtc attcattcga atgttttaataa ataaacataa caggacaaa 1165200
 taagtagaca tgcctcatgc cctagtacct gcagctgttt cagtaacagt gatgcaatga 1165260

 aagaaaaagg aagcatcata gcaactcgtc tttatttaca gaaaagcata ctgttaaaca 1165320
 tctgctatgg gagctgttac cccccacca cccacacaca cacacacaca aaagccttga 1165380
 gacacatga ccaaggcaac ttatttaaaa catttatttg ggatatatgg tttcagagag 1165440
 ttgaagtcca tgaccatcag ggtgtaggc aggtaggcgt ggtactagaa caatagctaa 1165500
 gcattcatat tctgagacag aaccacaagg cagatagact ccaaatagtg gcagtctttt 1165560
 gaaacctcaa agcatccccg gtgaccaaac ttctccaaca agaccacacc tcttagtctt 1165620
 tcccaaacag tccacactc aatatatga gcctattgga gtcatcaaac caccacagga 1165680

 accatcctaa acaagccttg cacataatgg caagcacact atcacagagc tacatctgct 1165740
 actgctaata ctgatatTTT tttctagtga acattttatg tacctacat ttcaaccact 1165800
 aagggaaatt ctctctctct ctctcactct ctctctctct ctctctctct ctctctctct 1165860
 cgcgtgtgtg tgtgtgtgtg tgtgtgtgtg tgtgtgtgtg tgtttcaagt caaggaagaa 1165920
 aaaattctta agttgaaaa ctttatagcc agagaaatgt gtcactggaa taatggaaga 1165980
 aaaggctacc ccaaatacag taataaaact gattctcag gtgccaaat gaagcttcta 1166040
 accatcaaca gagaacagaa ttaagtctta acccctggc caatatgaaa ggctcatacc 1166100

 acattttag cccagtatct gtctgcatgt ttctacagac aaatgtaagg cagatgcca 1166160
 caacatctgc atatgccagg aaataaaagt aacatgaagt taagcttggga tactaggata 1166220
 actgaccctt cattttcata gaatggcgtt ctagttggga gaaagaatga atacacactc 1166280

agtcatgctt atttgtactt aaacaagatg tccaattcc ctgtacattt tgatactgcc 1166340
 ctgcttcaag gccctaattt ttatcatata tatgtatgca gtgatataatt gtttatggtc 1166400
 taacaaagcc accggggatg caaagatagt caccgccata gagt caggca gtggggatac 1166460
 acacctttaa tcccaggact aaggagatag gcagatggat ctctgtgagt tcaaggccac 1166520

 tcagggttac acaagagtga gtcagtctaa aagaggaaca gagctcacac cttaatccc 1166580
 agcactagag aggtataaga agcaaagggt ctcatgtgag atttagttta cagacacaga 1166640
 gcatttgcct ctgagcattc atatagagag cattgtctct gaggattcat ggagacagga 1166700
 ttgccatttc agcttagtag aggtaagagc tactggattg gctgctttgc tttttctgat 1166760
 cttcagtttg aacccaata tctgtctctg ggtttttatt attcgtatta catatctaag 1166820
 tcctattaa aaaaacaagt gatacaataa atataccact ttttaattac ctgaataaat 1166880
 gatactagat gtctcaccta tatttttcag taagcactgt tcttaccgtg tacacttgat 1166940

 gcttagaata catctaataa gttacttcaa gctgctgcat aaatggttgt tgtgataaat 1167000
 catgttttcc ccatctctaa gaaattgctg ttgaactcgt ttgctcactt gcttttggca 1167060
 actaaaaatgg tcatataaga tcccatacca gtgatgtagt gactccatcc cacggttact 1167120
 atgagaacca cagtacaaga gtagaaggca ccagactgag tgagtttacc cacaatcatg 1167180
 ccaaggttta tgaattccca tggcaaatca atgggcactt gttttaaata ttgtaagtta 1167240
 tatgttttta aattccaac atttttatat atgtatttta ttgtacgggc ccttaaaaat 1167300
 agccttttca tatataatta tccttatagc atatagtatg acacaaggcc caaacacca 1167360

 actcttcate atgccagtga aaatataaac atgtgattat ttgtataaag tgctaaaaaa 1167420
 tacgagaaag ggictcaaga taacttttat ttatagacat cagaatcaa agattaactt 1167480
 agctttctag cccaatgat taaaataatg tcctattac gtaacataga ggccaacagc 1167540
 cctacataat cccgacagt caacaacag aatggttctc agtcaggcgg gatgctgtgt 1167600
 ctctgtgtc tcaggccaca gtaagacct cactcaacag tgtgcaggag gagattaggg 1167660
 cagtggttcc tctcttctg catcagccct gtacacagca cccacttct tcaactccgc 1167720
 tatccaacca teactttagc tgctaccact tcatggacc tacaactgta gtccaaatct 1167780

 gcagaggcag acaacttagg gaaagtgctt ccttgtctta ctatctttc atttattgta 1167840
 ctccatagt tgggaacaac taaaattgta ttgttttaaat tggcctaaaa ctacaggca 1167900
 gttctctatt tccttttagt aaagtccgt ccttggatcc aaagctttaa aagccatta 1167960
 cttccttct cccacacca aatctcttc tgccacacag aagccatgtt cctccagaca 1168020
 ccttttaca accactttct tggggaggca ttcctgacc tccctggcaa tcccaactt 1168080
 ttatattgcc ataaactaca ctaacttgtt taatctcttc tataaagctg aaagctcagt 1168140

gagagcaaag gctcctglat gcctcatgaa agtcctctct gaactggcca gaaagaagat 1168200

ggaaggggaa agacgggtta aaagcatgaa caacataaag actaaagtta ataaaactga 1168260
cttatattag gattttcatg aaataagcag attttagctt ttagcttttc ttgtaacaaa 1168320
aagatatgtc tgagatgaca gctgtattat tctgctccaa tatagtaacc attttctac 1168380
tcacagtgtg tgtatttcat agcataatgt tgtaaactcc aaaaataggc agtaattttt 1168440
aaagtgcaaa taattcatat aaaagcctct cctcaaccaa attaataaaa ctgtaatac 1168500
atagatacac tgttttatag taacatttaa agtaacagct ttatctttac taacactttc 1168560
tgtccgtgta tgatgtgtgt atatcctgat gtgtatgatg tatgtacaaa cattcatgtg 1168620

tgtacatgtg tgcctcagta tgtggagttc agaagacaac ttcagatgtt ggtcctcacc 1168680
ctctatctta ttttgagac agaatctctg ctgtttttct gttgcatgaa ccatctctcc 1168740
agcctcctta actagtgttt ttgtttttta atatcttgaa tacaaaagaa tgttatcatt 1168800
tctgaaacaa aaaattcttt taaagtgacc tattttctaa catacttttc attatttctc 1168860
tataaaacag atttctataa aaatagtact taaagtaatt ctttttcatt gctgcttagc 1168920
aattggcaga gcaattattt gctttgggcc atttttecca ttatgtatgt ctgtatgtgt 1168980
atgcacactt gtacttgagt actcagaagc cagactaggc tttaaattat ctggagataa 1169040

agttacaggt ggatgtaagc acctggatgt aggtgatagg aaccaaattc aggtcctttg 1169100
caagaatata accttgcta ttaaccacag agcattttctc ctgccatata gttttgtttc 1169160
taagatatgg tctaacgaca cacccatgg tagccttggga ctaatgatcc tctgcctca 1169220
gcctcatatg tgetggattt aaaagcatga gccatcacac ttaggaaatt tttggatttt 1169280
tagtatcttg tcttaaaga cagtgaagaa ttctaataag aaaatgagca tacataacga 1169340
cttcacact acagcttgcc cccatttttc ataaactgga cattttaata tctaattcca 1169400
agtaaacage aattggagat ttggggaaga tcataataa taacatcata ttcactaatt 1169460

ctccgatgca attttcaca ttcgacatgt ctgaaactgg atttgtctt ataataatg 1169520
acctcttact gcatataact agaagcatct tcctctcca ctggtataaa gtaatggttt 1169580
ttaaccactg atagcctcag gttaaatgaa acttaagata ttaaataact aaagactttc 1169640
tccaataatg ctttcgagat tattttagtc acagtacaat tataattcaa ttattccaga 1169700
aagaaaactc agtaactttg aggttcatgt tttgccattt ctacgaccaa ccccaagaaa 1169760
acagacaatt gaaagaaaac attttaaagg atttggaaaa acatctgtat tggagaggg 1169820
aacagaagga aagggacaag aggtcttgag tgcagcttca aggcataca ggctcaggcc 1169880

tccttggaac tttaccagg gcaaggtaag gggacaacgt ggacagcaaa ctgcataggt 1169940
 gaagatacta ctttattatc tcttcttaag gaggagtctg tcattcttta aataaaaata 1170000
 tgacataggt agatgaaata attgfaatga aatacaatac cataaacatt ctttaataaat 1170060
 taaaagccaa cctaccagca ttgtcttcct cctggctcaa tctgtttcac cttcaggtaa 1170120
 tcctaggact ggggctcctt ttcaggtccc caattctcaa gtcgatcttc tacctcctg 1170180
 tggcaacaat attttctaata taaaagagtc cttttgtgcc acagggagga tttctgatgg 1170240
 tataacaaat acagaagtta tcacagctca ttataaagtc agacctgtcc tgacattcaa 1170300

 gacagaaatc cggtttctga tatttcaata aagaaatctg actttattct ttcaaactgt 1170360
 gtttataaat ctcaacttcc atttgctaaa aagtaacctt tagctttctt actgaattat 1170420
 gtaaaaatc ttattcttct ttcaactaac ctttaacca aattttgtt gctcactaaa 1170480
 acagttttaa ggtttttttt ttacattttt acttattgta catttgtgag tgtgtatata 1170540
 tgcaggcatt catgtaccag gacaagtga tggaaatcag aggctaacct ccaagagtta 1170600
 ttctctcact ccaccatgtg ggtcccaaag atcaaaactca ggttatcagg cttgtggttg 1170660
 caagcacttt taccactga gccatcatgc cagcccataa aatacagatt agatttttta 1170720

 aaaagtttc ttgtaatta aatacaagaa taacctttta tacttcagtg gctgcataca 1170780
 aagcaaagtc atgtgatgac ttctcagaag agatgtagga attgtaaaaa gactgaagat 1170840
 caacatattc acttgtgatg cattctaaga ccaacccaaa gaagatgaca tgacaactac 1170900
 aaaaagcagt gctcagatga gtatggtagc acaggctagt tgctccagct acctgcaaga 1170960
 ctggggcaga aagacagttt gagcccatgg tttaggctaa cctgggcagc acataagatt 1171020
 tgcatacaat aataatattg attttttaaa gattaaaaca tgtcaatacc aaatttgtgt 1171080
 tatttgaatt tcttaagaa gcaatcatgc ctactgata gtgatgactt tcagtttgtt 1171140

 cttttttgt aatacttccc aatttttcca ttgatcatat actgctttca ttgtaaggaa 1171200
 aaaaaatcaa acttaggtat tataaaagt attaaaatga cgggcctgga gagatgactc 1171260
 agtgggttaa agcactggct gctcttcag aggtcctgaa ttcaattccc agcaacaaca 1171320
 tgttggtca caaccatccg ttatgagatc tgggtccctc ttctggcttg caggcatata 1171380
 tgcagacaga acacaatata taactaaata aatattaaaa tcaacagtga gtataaata 1171440
 taactcatct acataagaca acattataga ttggttataa tgctttgtat acaagcatgt 1171500
 tcaggtattt ttagatgact ttcaaagttc cgagtaatat taggttattc aaaaaagaaa 1171560

 tgctgaagat ttcatataaa tgacaacctt tctctctcc ctttcttcc ttcatttate 1171620
 tgaaactagg tctggctcca tgtagcccag gttgaactca ctccatcc tectgctca 1171680
 gcttcccag tactgcatg gcaggcacac atcaccacac ttggacagaa aatagttctt 1171740

aactaactac aatagtaact tcagaaccta atggtttggt tggttcgat ttcctcacta 1171800
tcacacattc aacacaagga aacacagaca cactcacaca attccaaggt tacctttctc 1171860
ctcactgaaa aagaaatgga cacatataag acataagaaa gtagggctgg agagatggct 1171920
cagaggttag gagcactgac tactctttca gaggtcctga gttcaattcc cagcaaccac 1171980

atggtggctc acaactatcc gttatgagat ctggtgcctt cttctggtat gcagatatac 1172040
atggaagcag aatgcagaat gttgtataca taataataa actcttaaaa aaaaaaagac 1172100
ataagaaagt aactaaacc agataatata ctggaagatc agaagagtga ttaatgttgg 1172160
ctacaatagc tgtacagagt ttcaggtacc tggacctaga atagatattt ctgagtatat 1172220
tacaatagc gaaacagaga agaagctcag tatgctttga aaagtccttg tgaaaggcag 1172280
ggaaaaaga gcagggagag tagagttccc agagtagagt tcccacaggt aacaccagat 1172340
catgaaggac ctattctggg tggctcaaag gccactgagc ttgccagaag agtggccttt 1172400

gaaatctagc aattagctat agaaggattg acaactgcag tgaactgtag gctgacagat 1172460
acaatgagct gtaactgaca gacagacaca gtgagctgta gactggctga caagtgcagt 1172520
gagctaagaa agaatgacaa agaaaaaaat gcttgctgga ggtagagtt tgctttgttt 1172580
tgttttgttt ttccttttt taacatggaa atgaaaggaa aacacaacag atgtaacaa 1172640
agttaaatat tctgactgag tgcactgcag acctgtcaaa catgaaggca tacagaaggc 1172700
tgctcatgaa gtcaaggga gacttgttca agaactgtcc ttttaagttat ctttcatgac 1172760
gtccttacag ccttgaataa acattcttga aaagtttaaa tatcgccaaa taagtatga 1172820

ggagaaaaac tgaaggcaga acaagctaag caaaggcacg ctttctgccc acagaaagat 1172880
acttaaaagg ctaaaaagaa gctgagcagt ggaggtgcac gccttaactc ccagcataag 1172940
aaggcagagg caagtggatc tctatgagtt caaggccagg ggggatctgc aaagtgagtt 1173000
ccagggcagc caggacacag agaaatccag tcataaaaaa aaaaaaaaaa aaaaaaaaaa 1173060
aaaaaaaaa aaaaaacgac aacaacaaa aaggctaaaa agaaaatggt aactcagtc 1173120
accaggatg ctctctcaaa tttgctttta caattcttta tgtttttcga aatacatttc 1173180
taaactgttt aattctgact cattettacc caacacaaat acagccttga agtatccact 1173240

ccatagagac attctcaat acctttccc tagaaggtct agcttatttc cacagcatca 1173300
agtgaggatg atttccacat ctgtctcaac cctgttgta ctgtgctgca gtaactcagc 1173360
agcttccatc tgccccaac tcgtttccac actactctcc atcccaggag aggagctgca 1173420
tcaacagggc tcacatagct tcagactgag cttttcagtg gaggggcttt gcagggggac 1173480
tagaggagag caaggttaga ggacttaac cctggctccc ttgctatggc actgctatct 1173540
aactaggtac atctttgat caggggcca cattttcca aggtgattcc ttttccaggg 1173600

caactgcttc cacatctgag tggctaagga atccctcccc tgagcgtgg agcccagaat 1173660

agaatcatct ctgttacaga gtgctggaga actgccctcc ttcccctect ttgcactatg 1173720

cttactttcc ttcactaaaa ccaccagaa attagcetaa tttgagtatg ccatttcctt 1173780

tgtgatggaa ccctggctat tcctttatgc atctgtaaaa acctaataat tccttcttag 1173840

ttcatttaaa ctcaaaaatc atgttactat tgacaaaatc atctgcttct caagacagtt 1173900

ctttccttte atgaacctct acaggatgtc acggctctctt actgtcttaa tgtgggtgac 1173960

agttttgggt aatatgcccc tccttgtctt caggttagaa tggacatggg atgggttita 1174020

tgtagccctc tgttcctatg gccactactt taatatttct taaatcacc ttcaagtcac 1174080

aacagccaga cticcctgct ctagtcctca caatttctac ttaaatagca tttgtttgtt 1174140

tatgtatggt acttcattca gattgaacat aaggccttgg gtactagata agcactttac 1174200

ctctaggcca catcccagtc tatattttaga atctgccctc tatccatggt actgcttctt 1174260

gcataagagc ctctaagctt tgtgcctgct ttatctgctt aattactaac tcttaacatt 1174320

caataaaact tattttgtat ctatttattt tactgtgaac atgaaaaact atattgtcaa 1174380

atatctgtaa agaatecaat aaactactgg ctcccgtcac atccagctgt gagcaggccc 1174440

ggctgtgggt aagtgacacag ccctgtgagt tatttcatgc ctccctgagac aagctcacc 1174500

tccacagctc actgctgctt ttaaaggctc ttagtgatga ctgatctgaa gcatcctcgc 1174560

cgcaatgtat cagcaggtta ggttaataca tctctttaca acttctacag aacatcattt 1174620

tccttcgata ttaagagga agttggatc acccctaagc tctgagagga aaacacagcc 1174680

ttctaataaaa agataaacga catagacaat aactactatc aaaatgagaa tctctggaca 1174740

tacaaagtaa tgaagggcta ggatcctagc actcctgcct gcttaacaat gaggacagtg 1174800

tttctggcac ggatatgtac aggggaataa aagaagaaaa acttcagtgt gaccaccaga 1174860

gcttatagaa caagataaac tattatttta tgetgacaaa atgtgaatta taaaccaggt 1174920

gtagttgcac acaactttaa tcacaaacac tcaggaggca gagtagttg gagatctgtg 1174980

acttcaagge taggaggtct acataacctg cctcaaaaaa caaacaaca aacaaaaag 1175040

acacacacac acacacacac acacacacac tatagtttaa aacaagtcta ggaaatattt 1175100

cctaaaattt cacaaggaaa tcctattcat atatatTTTT aattgtatgt gttcctgtat 1175160

ttgctcatgg tatgtatgtg catgcattca catgccaggg tgcattgaca tctgaggtea 1175220

aaggacaact gtgaggagcc agttctttcc ttcaactcag cagaggctct tgggatcaaa 1175280

catgttgcca ggcttgcaaa gcaagcccga ataaccactg agccttctca ccagcccttc 1175340

attctagtct taattccctc agttcatcaa ataaaaactg agacatcgta ttcctttcct 1175400
 tttcatctca gtcagtttct ttttaagcaa gtttagaagt tcatttataa acttaacatc 1175460
 acaaggaatg accctcccat cctaatecat caccaaatgg aaatatagac tcggctaagc 1175520
 aatggcaacc ctactcatc tgtatattac aaatataaga agtaaacca cttaaagtgt 1175580
 gggcctttct taaaaaaga aacaaaataa agtttgaatt tgctaattt aactatttgg 1175640
 gggaatgagg taggtacata aaacaaaaat taacctatgg actattaatt atcctttag 1175700
 agtcattttt aaaattcatg ttcaagaatg gaactacatg taaaatgaag tcttgaggta 1175760

 ctttttcatc tattagaat atgtaagtga tttgtctaac attccaagg aaatgcttaa 1175820
 gaaatatcaa tctgaagaat agtactgaca atgggtttgg tagaacagaa gcaggaaggt 1175880
 tgtaccaagt tcaagacctg ccaagggctc cagagagacc ctcaatataa aatagtatta 1175940
 aatactttta aaaccacttg tcaaaaacaa ttacaatata tgggtataaa ggcataacag 1176000
 agtcattaca atacaaaagt aacggttttt ttctccacat gggtcatact aggcccaggc 1176060
 tggccctcaa tccacaacct ctggaggtta atctggggct gtgaagtagc cggaagacac 1176120
 acgtgcacca cggccagctc caatcctcct tttcaatate agtcactaac atctgtcctg 1176180

 agaatggagc cacactgat gccgtaactg ggttacattc atttcttact caaaactggt 1176240
 ctacatgaat tactttatta ttagttatac aatagtattt gtcaacctgc tctggcattc 1176300
 aaatacacta aatgtcctaa tatactactc tatgcaaate ctgcaactgt gttttcattt 1176360
 tttaaagttt ccaacttgat gccaaaaatc aatcgttttt agttgttttt tgttttgttg 1176420
 tgttgtttag acttttgaga cagaatctct ctatgtagct cttgatggcc tggaaactga 1176480
 tatgtagacc aggtcggcct caaactcaac agatagatct gcctgcctct gccctgcaag 1176540
 tgctgggatt aaaggtgtgc agcaccacca tgcttaacc caaaattatc tagaaattta 1176600

 aaacaagctc tctttttgta cattcagctt aagctatcat atttttttac tgtgcaatta 1176660
 gtgttttate tggttataat ggcataacag aattactaca atatctactc caaaatgtca 1176720
 ttgtatttag tacttttact tcttttacct cgataagaaa actcaggtct agagatgaca 1176780
 gtgcgtgccc tgetcttcca gaagaccag gttgaagtcc cagtactcac ataccagctc 1176840
 acaactatct gtaatgtggg catccatcaa tcccaaagca tccaatgccc acttctagcc 1176900
 tctgcaggca cgggcatac atgtgataca caaatacaca tgcaggcaaa atatccatac 1176960
 acatacaatt taataatgat aataacatta aaaaaaaaaa aaaagaggaa cccggcagtg 1177020

 ggggtacaca ctttgatcc cagcactagg gaagcagagg caggcagatg tctgtgagtt 1177080
 caaggccage atggtctaca aagcaggttc tagaacaggc tccaaagtta tacagagaag 1177140
 ccttgtctcg gggaaaaaga agaaagaaag gggggggagg gaggaatgga gggagggagg 1177200

gagggaggga gagaggagg gaggaaggaa ggaaggaagg aaggaaggaa ggaaggaagg 1177260
aaggaaggaa gggagaaaga aacaagtgtt acctacaaga acaaggcacc actgcagact 1177320
acagtcacga tgtcagataa agcaatgcmc acttcacctg agttctgcta gcacatgatc 1177380
ttgctcagaa aatcaaggca gcttctaatic ttttaagctca aaaaacacat gaaactgaag 1177440

aaccaaatga gtctagaagt tagcagtact tagaagacac catcaggcct cacagaaaca 1177500
aaacacaaag agtcaaaact tagctggaag ttgaaaaaa aaaaaagcc taaatattta 1177560
agaaattttc agacagtgag acggctcaat gtgtaaagc actaatgacc tctgagttcc 1177620
ctccctggaa cccacgtggt ggaaggacag aactgattcc tactagtgtt cctctgatct 1177680
acacacatac acacacacac acacacacac acacacacac acacacacac attcactaag 1177740
attgtaacca gtaattgatt tttaaaagaa cattaacaga ttgtgataat ttttattact 1177800
atgtaagtca ctaaatgat atagggaaaa tttttcttc atggcatag caataaaaaa 1177860

aagaaaaaa aaagattgct ctaagaattg cacacactaa ccccaataa cacagatagc 1177920
taacaaaata caagctgatg gaaacaaca gatgttaaag aagacagaaa attaagagga 1177980
atctgacagg caaagtgtct tcaaatgaa gagagaaaaa aaaatgacac tgctgcagca 1178040
atgctgacct ttaggaaggc tcaatcattg gggggggagg tactatcctt gtttggtttt 1178100
ttattagaaa atatcactcg agtactaacc cactaacttc tataattaat gagtatttgt 1178160
agtcccagaa aaaaaataa taaaacaact tctgtgtcag ataccaaaga actgtaatgt 1178220
aagactctat tatatttata taaactctct taaacgaaga ttttagacca gtttcagcc 1178280

tatgataata aatattttta aataggttct tcagtataag atttcccagc aatagtaata 1178340
ctgaaactta cagaatgagt tttggggctc gagaaatggc tcagcagtta agagcactgg 1178400
atgttcattc atccagagga cctgggttgg ctcccagca cccacttgat ggttcacaac 1178460
cacctggaac tccagctcca gagaatctga catcctcttc tggccacat tggcattgca 1178520
cacacttggc gcagacatac aagcaggtaa agcaccctta cacataaaat acataatttt 1178580
ttaaaataaa aaattttagt gtgaaaaaca ctttttgcca tgtctacctg tttctgaatt 1178640
ctcggctca acttcttgtt cttecgccac atcctgcate atgtaagtct catcgtcata 1178700

caccagaacc tgggcagcgt agccctgctc taatcttgca ctggggactg gctccacaat 1178760
cactgctgga tattcagga cattgtcacc tccctacaaa agcaaattta aagaacaatc 1178820
aagctttttg ttgaaaatt ctggatttag ttctgaattt tggttcaca aatcccatta 1178880
agtccacaca gtgtatttca agaatacata catgaatgta gaaaaacaag gaaatggtaa 1178940
ggctggctgt gataatcttc aagtcttaag agaagatgaa gtaagtaaga gaagaagggc 1179000
ttttgataa aacacctgta cttcactttt ttgtgaaagc tcaactaaac aaagtaaga 1179060

cactttgttc tatgttttac actaaggaag aactgaaac aaacaaaaag agacaagagc 1179120

 aacacaccct gaggagaatg aaaggtgtgt gaacaagtat caaatgggta cctaagagcg 1179180
 ccaaatacata gcctaacagc aaacaacceca agatcagcac accgcacagt ggcaaggcca 1179240
 cagacagtgc cagacacttt tgttcaaaaa gagcatccac agaagctggg gagagcacct 1179300
 tgagtcaate aaagtataaa acatgtgtca gacaagaagt tcttcttttg ttttattata 1179360
 gtgccaggat caaactcata gccttgagtc attaaaaaaa aatgctgggt ggtagcatac 1179420
 acctttagtc cgagcacttg ggaggcagag gcaggcagac ctctgtgaat tagaggccag 1179480
 tttcctctac agagcaagtt ccaagaaaac cagagctgtt agacagagaa accctgcctc 1179540

 aaaaaagcaa acaacaaaaa ataaacaaaa cattaatta aagaagagtt tgagctaaa 1179600
 gacagagtca atctaacaaa aaggaagaca acaggaattt tcaggaagac agaagataat 1179660
 cataaaaagta aactgggtccg ttttgcataca atgtgtttta ttaatcttga ctgtcaacct 1179720
 aactaaattg ggagacatgt aaaagactat taataaagct catgcctact gtctgtgcac 1179780
 attcttaacc ctttgatgga tttacacttt gaatagacta cagaggaact ggaaggaggt 1179840
 atggcactgc agaggatcag tgtcagtgga gacacacat tgattactaa taccacttgg 1179900
 tcctggctcc tgctgaaac tcctctgctt cccagccacc aagagacaaa cagctctgct 1179960

 atgtcatacc ttaaaccata acattccacc tceccacagg atgctgtgaa tgactggaaa 1180020
 ggctcactat gtaaaatgta aagggttgta tgtgaaatat ctctgtgac acaatgagtt 1180080
 gttaaaaacc agtgacattc ttctgaaga cacaacacct gggaaagtct gtccagcct 1180140
 gttatccatg ttgtttgccc tcacctaat aatgtactct ttctaccttg cctgatgtc 1180200
 tgagaggagt gatcaacttc tctgaactga gaaaaccacc actatcctat gcacagaaac 1180260
 aatagaacag aacctgatat ctgactatct gctgaacaga caacagcaga accatgctga 1180320
 agcactttgt caaaagetca ggatgacceca aagacctcag caagagctca gaatgaccaa 1180380

 agacctcagc aagagctcag gatggcccaa agacctcagc aagagctcag gatgacccaa 1180440
 agacctctgc aagtgctcag aatggcccaa agacctcagc aagagctcag gatgacccaa 1180500
 agacctctgc aagtgctcag aatgacccaa agacctcagc aagagctcag gatgacccaa 1180560
 agacctcagc aagagctcag gatgacccaa agacctcagc aagagctcag gatgatgcaa 1180620
 tgatctgagc aagagctcag gatgacccaa ggacctcaac aagagctcag atgacctttt 1180680
 gacctcagca agagctcagg atgacctaat gacatcagca agagctcagg atgatccaat 1180740
 gacctcagca agagctcagg atgacctgat gacctaaagga gctcctatcc agctacttct 1180800

ccgagaagct ctgtgatggt ataactcagc ctgaaacgaa gtcataTTTT acaaaacaaa 1180860
 taataaactg ctaagagta ttttcataaa taataaaacc ctaaagaaag gtacaaaaat 1180920
 gacaacacat atgaggatgg cacctctgaa aacaaagatg ggatatagag gaggggcaca 1180980
 gtctgtatac tctaaaacat ttgaaatTTT agcccaaaaat ggtgatatat atatatatat 1181040
 atgcacctat aacactagca cttggaggTg gaggaagaag gataaggagg tcaaagTcat 1181100
 cctcagctac acattacatt caagaccacc cgggactaca tgagaccgta tctcaaaaat 1181160
 aaatggatga atcaatgaat caatgactga aatactagca gttactccac ctcaacctga 1181220

 atgataagta atatggttta cattttTgtt tttttttttt tttggagaca ggatttctct 1181280
 gTatgtagtt ctggctgTcc tggaactaat tctatagacc aggctggcct caaactcaga 1181340
 gatccacccg cctctgcctc ctgagtgctg ggactagagg tgtgtgctgc caccaccacc 1181400
 cagctttatc agttaatctt aaaatagca tgtactttat ttgtgcttca ttgtctataa 1181460
 tacattTcac caaaaattta acttgcaaaa tacactgcaa aaaaatTTTt ttggctaaca 1181520
 atttctctat ttcagaaaag actataagTc cagcttttta acatcaaggt atgggggtat 1181580
 gcaaaaaaat cgtgctcca caactggaca aacagctata tcttcagcac ttctagctgc 1181640

 acagtcaaaa caacatcccc tgactgtaaa gcagatgcta tggagaagca tggccaagt 1181700
 gaagacgcaa gttttctatt tgccaaaact aaagagcaac atgctaagta gcactgaact 1181760
 gatgctgacc caagcactgg ttgtttatac atggagttaa caaattatTT cettctctca 1181820
 aatttataca atagtctTTt cattcagaga acagtcacac tatgttgctc aggctggtct 1181880
 caaaactTct ggacttaagc aatcctctc caaatagctg agtctacaag tacatgccaa 1181940
 tggTctcaac tatacaattt tagaagcaaaa ttagcacca gatggcagag acaggcaggt 1182000
 ctctcagggc tatatagtaa gactTgtcta aaacaaaaaa aattcttaa tcctggatt 1182060

 aacctggatt ccagtacTt accaaaaacta ttttcgaatt atcaataatg gagggTggca 1182120
 agatgcctTg gacctgcctc aacaagatga tggccaaac ttagtagact tcttaggggc 1182180
 cttaccctct ccaagaagca gatggggggg ggggagtagg ggagcaggaa gagaggaagg 1182240
 ggaactggga ttggaatgta aaaaataaaa aatacatata ctcaaaaaa aaatcagtaa 1182300
 tgaacatcct gTcccccat tttcttagcc ctggccatgt ccagTctgct tcttttctc 1182360
 tctgctctag actctTccag Tgcctctgg atgttctctc ttctctccc ccaatggatc 1182420
 agtcattccg gcaattTctt tattgggccc ctcacataca atctcaactt tgcagcaagc 1182480

 ccaTgcctc agcgcctcaa gtgatgggat cacagacag cctcagtatg tccggattac 1182540
 aattttaaat tttcaaatct cagacaaaata gtatttaaca agcttgaaaa tgtctactgc 1182600
 actgaatcag gTcattttac ctcacataca gacactcca tatgcacaca gacacacact 1182660

ttttaaggctc tctttggcag agttgtgtta agaaatgtag tcaagggagc tagagagagg 1182720
 aatcagcaac tgggaggaat aatgttcttg caggggaccc atgttctgtt cccagaaccc 1182780
 acatcagaca ttataacca cctgcaatcc agctccagga ttggaatgag tcttcacaag 1182840
 cacctgaaca ggatttacac acacacacac acacacacac acacacacac acataaattt 1182900

 ttttaattga aaataaatct ttaatcaagc caaacataac atacagcagg gcatctagac 1182960
 taacatgtag cctgtctgt gctcttaaac atcaaccagt atctcctct cttgtttccg 1183020
 gcaccactt tccttactac tgaagttcac cctgagtcct cttcatcacc actgaatata 1183080
 cactgcccag ttcaaagctc tcttctgagc attttcaact taacccttc cctccttagg 1183140
 caacaccagc cgctttcacc atttcactag cacctctata ctgctgagag ttatcaagtc 1183200
 cctgtcctc attcaacat atgctcaact tctcaaccta gccattttca acttaccta 1183260
 aaatataaaa ctaacatctt aaaataaatt atcaatctct tctttttctc ccattttgct 1183320

 tttctctaaa ccgtttgctt catattcaga taataagtca taatactatg tcgttagttc 1183380
 cttgaaaatc aagtattcga ggagcacttg gcacagtga taccacagga agaagcagtt 1183440
 actggcccag gctgtcattc tacaacagca gtaatggtct tcatatctat ttggaggca 1183500
 cattgtcact cacaattgga actgtcactt ttttctttgc acaaaaatct gtaatgatcc 1183560
 tgtatttgc taaaaggta aaacacaaca attttcacac ttgttatggg ttgaattatg 1183620
 tcttctatg tattgatga tattttcacc ccaactgccg tgactatgac cttatttggg 1183680
 aatgggtctt tgcagatgtt tgagttaaga tatgatcagt aggacatacc ctagcccaat 1183740

 ctgaccagtc ttatagaaa aggacaactt ggacactcag tgaaggtaga gggaaaacca 1183800
 ctgaagacac agaatgctac ctccacacca agcagagtgt gaagctgcac aagctaccgg 1183860
 cgcataagge agatgctcac agctctcaga agatgacaac acagccaatt tctggattct 1183920
 agaactgtga gactataatt ttgttttgg acaccaactga gcttatggga tgttttacag 1183980
 cagcccatc agactaacct accaccttta ccaccttac tggctttttt gctgacataa 1184040
 ctacatacaa gatgtgtgac ttagtctcta tatgaaaacc tcccataat ttctactgcc 1184100
 caaatagctt tctaaagge ttttatecc attctagga gtcttttta agccccaaa 1184160

 aggtattttt ctattcaag tcttctgac acaagttatt tgcctaatat taatgttact 1184220
 tacggcattc tattataatt aaatatttac atattcaaat ccttgactgg acagtgagat 1184280
 tattagatag caaaagttac acttaagtcc ttgaagatcc acacatcaca tgatgaagaa 1184340
 ttttaagtact tgcgatgag ttcagagaac acaacatgat agattccacc ttatctgac 1184400
 agcaagtaac ttcatgagtt ttgtactacc aaatgatgga gaacagaggt accaagtaca 1184460
 gatatgcaga atttattta gagattattt ttactggag aaaaatgagg cagagtaata 1184520

acacatcgac taicttttta ggattacttt aaccaagata ctagagtatg catgattaaa 1184580

 atagatgaac cccaaaatca gtgggtcttg acacaaccta gctagtcttc tatagctag 1184640
 ggttgccaga ttatcgaag aaaaacatag gatacctaat tagggctaaa ttcaattaaa 1184700
 cacacatatg aacaatccac gtttggggaa ctgttactta tctgaaatc aggcctaact 1184760
 ggctttcctg catgggtggag ggggctgcag gtacacatac aggcttatgt gtgtgcat 1184820
 gcttgtggag gccagaagtc cacactgggg ggtctttatc catcttcacc tgatttgtgt 1184880
 ttgtgtatct gtgtatgcac acacatggag gtcagaggac aatgttggtc cctgctcttt 1184940
 tgtaattcag gaaaccttct gtgtctgacc ccaatctcac cacagaaaca ggattacaga 1185000

 cacacaaatc tggcctggc tctatgtggg atctgaggat tcagattcag ggcctcactc 1185060
 aagcttgcac gctacaaggt ctaccctgc ccatactc cagccctgc ctctcactt 1185120
 tctgagacag ggtctccac tgaacctaga gtaacatca aggtccatca agcactttac 1185180
 ccagtgagct gtcaccaggc aactgtactg taagtctaa cagtgccctc aaaacctctg 1185240
 agatccacct gccctgcct cccagagctg agagtaatgg aatacggctc aacagtggat 1185300
 aagaaatctt gtgttcagat ttaattgctt ctaatggact tcaccaagt aatacggtea 1185360
 cttgaagtat gcaatccttg gattctcata aacatagtta tctctgtaac cacaacagtc 1185420

 aacagaatac tcaaaatctc ccctgtacc ctatcataa tcaccaacct atacctctgg 1185480
 atctccagcc ctacatttct tttctgaagt tttctaaagt tcattttaca tgcagtgtac 1185540
 ccatgcgcc acatgcagc acacacacca ttgtgcacaa ggaagtcaga ggacaacttg 1185600
 agagagctgg ttctacccc ctatggaggt cccagagaca cagtcaaaa gcacctttac 1185660
 ctgccagcc acctattag tctatacct tctaaaact gtatatggaa atcaataaat 1185720
 tgtgttttct gtgtgatgt ctacacatgc tctggctcag tcttgacca caagcatgag 1185780
 gatccgaatt tagateccca gcatccaaat ggtgacctgc ctgtagcccc agggttcaag 1185840

 aggcagatgg tatccagga caagctagct gaactgaaa ctctacactc aagtgagaga 1185900
 ccacgctca aatataaggt ggagctctac agacaagatg acaatctaca ctttaatttta 1185960
 aaagactgtc aaattatfff ccaaaatggt tcttagaaca ttcccactag aatgtatga 1186020
 gcattccaag tgctcacct ttccaacatg tggtagcag gtgcaagcag caccattcca 1186080
 gtgtgcgca cgatcttagc catttgaata tgcatttttt gatggccaaa aatgctgaac 1186140
 agttctttgt ttattagcca ttcatacaat tattcaaaga caggagacag aggacgaagg 1186200
 aaaaggggaa ggaacaagg gagaggagga ggggatctt gccctagagg gacaaaggac 1186260

tgccctctaaag taaaggagac agactgacca tcttttttat ttttaggtg tgcacacaca 1186320
 gacatgggcc agggcttttc cctaaacctg gagctcatgt tttcccagct ttctctggaa 1186380
 gccaacacat cccagtgagc ctctgtctg cacctccctc agagctgggg ttacaagcat 1186440
 atgtgctaga cacagtacgt ggggtgtggg ggctgaacac aggtccttgt gattacacag 1186500
 caacttccca gtctttctc ctattttaat aggacacctt tgtcttactg tttttatat 1186560
 tctgaagatg tttgtggctt caataagggt tcagtgcac ctaaaagggt caagtaatgg 1186620
 aagcttggtc ctcagtgtgg caacatcaag aggtagaaag actgtgtgac agtggagtct 1186680

 gctggaatgt tttcatatca ttaagagtgc cactcttggg gctggagaga cagctcagca 1186740
 gttaagagca ctgactgctc ttccagaggt cctgagtca attcccagca accacacagt 1186800
 gactcataat catctgtaat gagatctggg gcctcttct ggcctgcaag cagacatgca 1186860
 ggcaaacgc tgtatacaca ataaagaaac cataaaaaaa aaaaaaaaag aatgccactc 1186920
 ttgaaaagga gtgaagtagt tctgtgtgac acaatggaat tataaacaat aagcctttgc 1186980
 aggcgggtgt ggtgcacacc ttaattcca tctactggat taaagtacag gtggatctgt 1187040
 gacttcaagg ttagccact ctacagagtg atttccagga cagcccgaac tacacacaga 1187100

 gtagtgtgtc acaataaat aaataataa atgaggaaaa tatttatgtt gtaaataatc 1187160
 ttctgttcca ttactgggt ctcttttca cattttttt tttaactttt tcaaggcaga 1187220
 gtttcgttct gtaacagcct ggctgtctg gaattcactc tgtagaccag gctggcctcg 1187280
 aactcacaag agttccact gcctctgcct cccaagtctt ggattaaagg tgtttgcat 1187340
 cacctccaga actattaagt tttaggtttt gttgatacag tcatactatg tgatcaacac 1187400
 tagccctcaa gttcttgcct cagcttccca agagatgtaa ctacagtctt gcatcatatc 1187460
 cataagtttc tatttttatt gtttttacac atatgattag ggttaaattt atcatattgt 1187520

 tctttgctta ctgtcctaaa tattttaagt tccaacttcc ttgccttaga tacatgtttt 1187580
 tacttcaatt tctcagtgat tgctttatat ttacacat gcttttttt aaattcatca 1187640
 atatatatta tatggcttta tgtttaatat aaagatctca taacagtatt actctaattc 1187700
 tctactgaca ttatttgttc tgctgtgatg catttactgc catgcatttt ctatcatatta 1187760
 taaattgcac aataactttt atttctgctg attttcatg ctgggtataa taacacacac 1187820
 cttaatccc agcactccag aggcaggac aggtggatct ctgtgagttc aaggccagcc 1187880
 agggatatgc agtgagacac tatctcaaaa aaaaaaaaaa aaaggatttc atatacctta 1187940

 acacattaca tattgtttac catgagcctt atttttcaaa ataaaatttt ggtttacctc 1188000
 atagtaacca tttctccagg cctcttcaact ttgcatagaa ccaagtttct agatagaata 1188060
 attaacttcc tgctaaaaa atgtatttgi aatatttccac agtgcaagca tattgtctct 1188120

cagcctttgt ctgggtaaa aactcatttt gatgttgttt tattactatt acatttatgt 1188180
 gagtgtgcca tgcactcatg gtgcagatgc agaagtcata gtacaatctg cagaggttgg 1188240
 ttctttcctt ccacctgtg ggtcccagaa ttggaccag gccatgaggt ttagtgatcc 1188300
 aatgggcat cccaccaaca caggtattta tttttactag atgtgtaact aaaaactgag 1188360

 agttttacce tctcagcatt ttttaaga tttattttta ctttatgtgt atatgggttt 1188420
 tgcttgaatg taigttttca ttccaggtat gtacctagtg ttctgggatg ccagacaggg 1188480
 gcacttgatc ctgtgggact gttatggatg cttgtgagcc accacgcagg tgctaagaac 1188540
 cttaccagg tctctgagc gagcagccag agctctaac cccagcattt cctcagtatc 1188600
 ttgaaggttc tgitgtctc tgcaatgctc atcttcattt tgtactgact gagcttcacc 1188660
 tttggctgct cactgccggg cagtgggtgt gcaagccttt aatctcagca ctcaggaggc 1188720
 agaggcaggc agatctgtga gttcatggcc agcctggtct acaaagcgag ttccaggaca 1188780

 gccagagctg tatagtgaga ccctgttcca aaaaaagaaa aaccataaaa ccaaaaaaca 1188840
 aaacagaaaa taagtattat ggagaacagt tatgtataga ttgttttttt tcaggagggt 1188900
 gagcagtatc cggggatcta gcatggtctt gcaactgctt gacatctaca acccaaggcc 1188960
 ctgaaccaat ttttaaggct catttttaa acttttcatg gtagacttca actatcttta 1189020
 attctagagc taatttagcc ctgctatgta agacacaacc cttatgacgg tttttagccg 1189080
 ggcatgtgtg gcaatcgctt ttaatcccag cactcgggag gcagaggcag gtggatctct 1189140
 gtgagttcga ggccagcctg gtctccagag caagtgccag gataggctcc aaagctacag 1189200

 agaaaccctg tctggaaaaa ccaaaaaaca aaaacaaaaa caaaaaacaa aaaacaaaaa 1189260
 accttatgac ggtttttaat gaatgccctg agctttcaac aaggactctc ttgcccgct 1189320
 gactggaatg ccagtatcta ccagacaag gactgagtcc tgctttctg gccagtctt 1189380
 tcttgcttc atggagtccg agttgcctaa accactgagt gttccagcca gtcaatggga 1189440
 gccccggcaa tacatacagc tctttctttg ggaagggtgc ttcttcgct tttgatagt 1189500
 atattcataa gagttcattt gaacctctcc aagatttgtt tctttggttc aaggaagata 1189560
 gctactttgt tttctattcc tttttacttc caattgttcc cctagtagca gatgtcatct 1189620

 agaaagtctt attcaaagtt tttaaatat gacttaacca cataagcaga actttagcc 1189680
 aacatgtaaa tactttcacc atgagcaact gcaacaacc agcacggcat cagtgaatgc 1189740
 agacctggga ggagaagaca gctggctctc atcctggctg ccggaagaaa gctgccaact 1189800
 gcaggttaact gattcaatg tttccacaga atttacctgt ctttctattc ctgcctctca 1189860
 gcactataga atgcaactaa atagcacaca catttcttat aaaggctcta atttaaattt 1189920
 tcaaaactta ggggctaaag agttggctcc atggttaaga gcattgtttg ttcttgcaaa 1189980

ggacctggtt caaatcccag caccacaac tgtctgtaac tccagtcct ggggattgga 1190040

 tacctcttc tggctcttac atgcacagt cacaacatg cagacaaaac attcatacgt 1190100
 ataaaacagg tgcctggagct gaggetatga ctccaggtgtc aggtatgcag tgagccctgg 1190160
 actcataccc ggctccacat gagggtggt gcatgcctgt tatctcagca ctccaggaagt 1190220
 agaggcagaa gaaccggaag ctccagatca tctggctac acacagagat caagaccaga 1190280
 ccgatctaca tgggaacctg tctcaataa caaaaataa aacaaaact aaaatatttt 1190340
 attccagtgt gtgcacatga ataacagcct aactatact ttttctaaa aagattttat 1190400
 ttatttatta tgtatacagt cttctgctg catgccagaa gagggcacca gatctcactc 1190460

 aaagtggta tgagccacca cgtggttgc aggaattgaa ctccaggacct ctggaagaac 1190520
 agtcagtgct cttaacctct gagacatctc tccagctcct aactatact tttaatTTTA 1190580
 gagatttga aattacattt aattgtgtgt ggtggggagg agttgtctat gtagaagtea 1190640
 gaggacaacc tgccagtcaa atgtcaaat cttctacct tgtatctct tggcattaaa 1190700
 ctccagtcag aggcttgcca aaagcgcct tcaagctggg acatctcatc agctctgtaa 1190760
 aacttgggt ttagcagaaa taaacgacta ttttacttct gttatcagct tttatgtgta 1190820
 taatagctag taaactggca ttctccacag cacagatcct cccatccatc ccatccaagt 1190880

 gaaagtggaa tttctttatt aaagtttgg tgttttctt tgttttgctt tttctgtgt 1190940
 ttgttttag atagtatctc aacattgta tcaagacac tgattttgtt ttgtttgtc 1191000
 ctgagttctt tcaagacagg gtttctctat gtagccctag ctatactgga attcactctg 1191060
 tagacaagge tggccttga ctcagagatt tgctgctc tgctctctga acgcatttga 1191120
 tttttgagat agtgtgtcat tattgagtg tctctggatt tgaactcatg agcctcctgc 1191180
 ctccagcttc aaatgctggg attacagacg tgcgttaaca catctgactt ttaaagtctt 1191240
 atccagcagat agcttgttac aactgttaag taagaaattt tatcaaaaat gtagatggac 1191300

 attataaaa tccatttta ctaagaatct tctctcagag ccagagaaat tgctcagcac 1191360
 ttaaaaatca cttgctggct ggtcagtggt ggctgtacac acctttaatc ccagtactag 1191420
 ggaggcagag gcagtaagat ctctatgagt tagaggccag caacatctac aaagtgagtt 1191480
 gcaggacagc cagagctgtt acacagaaaa acccgtctcg aaaaaaaca acaaaactat 1191540
 ttgattcata ttaagtattg attaacattt gttaaaagga tagaggaata gatgtgaaag 1191600
 ttgaacagca agttgttccc acactggtac cacagcattt caaatacca ctaagtacac 1191660
 tggcttcttc tgacctcctt ccataaaata taactacct tttataccac ataaaccatt 1191720

attagtaaca atttgataaa ttcataatgt ttttctccg tgctaagtcc taaccaggaa 1191780
 tccttgatgat tccatgtgaa ggaggaaaaa ctaaaggagg ctccagacaa accttggtcc 1191840
 tcttttcccc atactgcttt tttttttttt aacagtaaaa tgtaaaactac tctgaagtac 1191900
 actcttcatg gcagttctcc tcacaagata aaaacacccat cactacaaag ttatagaaga 1191960
 cagaaaaata atttgaaaga gaaacacccat gtgctgggta ctatcaaafg agagagagag 1192020
 ccttcatctc tgttgactca taccagagg tgatatacag aaagtgaatt gggcttttgt 1192080
 tttgttttgt ttttgagaca gggtttctct gtgtaacagc cccagctgtc ctggaactca 1192140

 cttttagac cagacttgcc ttgaatttag agatctgact tectctacct cccaagtgtc 1192200
 gggattaaag atgtacacca ccaccaact aagaaagtga atcttagagg aagaagtga 1192260
 ctttgaagt atgttctact gtgggtgctt tttctaattg actctgcatg catttaagaa 1192320
 gcagctctta aatacaaagg gaacatgtag gaatttgcaa gccactgac ggtagaaaag 1192380
 tacatcctat aaacatgcc acagcagatc tgagtcttac agactgaaca gacaccaagc 1192440
 aagcaaggaa aataatccag accacagaac acacactagt gtgtcctcac tgtcatcagg 1192500
 catctccctg ttccattatc ctggcaccaa ccccagtgac agtagcatct ttcacagaga 1192560

 gaaaagaaac ttccatgata ctgaaaactg tccattttcc caaggtgtct ctaaccaaac 1192620
 atccacatga cagcactgct ataattttgt ttgatatcca cattcagtcc caaacgaatg 1192680
 gtaggaatag aaaccaagac tcaaaaatcg tttcctgttc ccaactctta ttcttccgag 1192740
 ttttctttct gtgacaagaa aatgaccaga tacactgaag actcaaaatc ctacctcaa 1192800
 tttcgaatta tataaacaat tgcacatatt agatctgaat tagacataac agaacaagaa 1192860
 agaaagatga tacagaaagc aaagataagc ttctaactta agatgacagc aatntagta 1192920
 tttagataca atgtatttct cattctccat tatctaagaa aatgggcaat atcagaaact 1192980

 taattttttg tttccagtca gaatttctct gtgtagecct ggctattctg gaactttctc 1193040
 tgtagatcag cctggcctca aactcacaga aatcccgcca agttctggga ttaaaggcat 1193100
 gtgccaccac caccagcca gaagattaac ttttatctaa actaacataa catcattctt 1193160
 tccatctctt tgettctcc aaatecatcc taatatacac atcttatatc acccaggtga 1193220
 gcaaccttct caccctact aagttacatg aaaatacatg gacaattttc tgcattgtac 1193280
 atttctactc tcaataacct gttttgtcat tcatttcaag attaattcat gtactgattt 1193340
 ctatgatttc tattaacaaa accgatgata aatacattaa attcctaacc tcttgattct 1193400

 ctactccatt gctggaaagc tccagaacag aacctccact gtcaaccact gccgatgtca 1193460
 ttgtttatc cctgaggaag ttgtgtatgg ctggaaagct ccaaaacaga ccttccactg 1193520
 tcaaccactg ccgatgtcat tgtttattcc ctgaggaagt ttcaaatgct atgaatcagt 1193580

gtaattagga ctcatagatg atggccaggg ttataggttt cattttcatg gtttaattca 1193640
 atagagatgg agtagattag acatccagaa gtccagcttt ctaaagttga ttaaccagag 1193700
 ggtctaaaaa gagcaagaat tgggaattgtt aagaatatat aggaaagaga gaaagcaatt 1193760
 taatatttaa cattgtttaa ttaaaaagga tataggctac ttaagagctt aatattcaaa 1193820

 ttcattaact ggtcaaacia tattttacta agctattgta tatgggtatt atattataaa 1193880
 agatataatg ctaaaatttc ctggggccag agacattcct cagcagttaa gaacctggc 1193940
 tgctcttcca tgtttgattc ccagcaccca tatggcagct cattaccatc tataactaca 1194000
 attccagggg atccagcacc ctctcttggc ctccacacca ggcacacaca tggtagacag 1194060
 acatacatgc aggcaaaaca cccatacaca atgtagcac tcctctctta tggagatgca 1194120
 atattataca tggaaatatt taacagattt tgttatttga gacagggttt ctctgttag 1194180
 ccctgtctgt cctggaactc tctctgtaga tcaggctgtc tcaaactcac aaagatccac 1194240

 ctgcctctgc ctctgagtg ctgggatttt tattttaata tgggctggag acatagtcca 1194300
 ttagttaaga gtgatgagtt tggctgagcg gtggcacata cctttaatcc cagaacttgg 1194360
 aaggcagaga caggaggatt tttgagtttg aagccagcct ggctacaga gtgagttcga 1194420
 ggacagccat ggctacacag agagacacta tcttgaaaaa ccaaaaagaa aataataaga 1194480
 gtgatgagtt aactaaagaa tagtggcaca cacctttaat cacagcactc caatccaatg 1194540
 ctctcttctc ccttccgttg acacctgtga tcacaataca tactctcaca cagacacaca 1194600
 catgtaatta aaaataaatc tttatttga acgatttatt tattatgtat gcaatgttct 1194660

 gtctgcatgt atgcctgcag gccagcagag ggcactgggt ttcagatag atggttgtga 1194720
 gaaattgaac tcaagacctc tggaaagaca gccagtgtc tcttaacct ctgagctctc 1194780
 tctctagccc aaaataaatc tttttaaag aaacttttaa actcttttaa acctgcaca 1194840
 cattggagct aaacttgtgt tgtagggatt acacagctgc tgctttttaga aacatctccc 1194900
 tagaggggct tcttaagtct ttttcttct cctgtctctt ctttcttaa atgtatttat 1194960
 tttatgtgca tttgtgtgtt agcctgcagc tatgtctgta tgagatatcc gaatccctgg 1195020
 aacttgagtt acagacagtt atgagctacc atatgggtgc tgggaattga acctagatcc 1195080

 tctggaagaa cagccaatgc ttttaacctg tgagtcatct ctccaatccc tctctcttct 1195140
 tatgaagatg gattattaat gtgtcttctc tacatttaat ccttacgtta ctttttattt 1195200
 gatatttgtgt tgiatttcat acagagaaaa tacaacctt tctgacagga ttttcttttc 1195260
 ttttctttaa tcttggtttt ttcaaagcag ggtttctctg tggctttgga ggctgtcctg 1195320
 gaactagctc ttgtagacca ggctggccta atactcacag agatccacct gcctctgcct 1195380
 cccaagtgtc gggattaaag gcgtgcgcca ccaatgcctg gcaggatttt tttctaatgt 1195440

caaatTTTaa ccatgcagaa aattTaaata cattgaaaga aatatatact ttgccgggca 1195500

 gTggaatagg aataaataat aaggaatttc tGtaaagtgt tacacaaaa tgaaaaagta 1195560
 gaaactTTat cTtaaacata tttatTTTat tTaatgtcca cctgattata tGtatgagca 1195620
 ccacatatgt gcaaaaagcat gcagaggcca gaagagggca tcagatcccc tggagtTgcc 1195680
 agctgccaga tGtGtatgtc aagaactgaa cccaggtccc ttgaaaagag cagcaagtat 1195740
 tctccaggac ctTctTTTtc atctTcacaca gaaagtTaaa taggaagtgt ttatatctta 1195800
 agaatattaa aggggctTtc ctatttatga gcactTggct gctcctccag aagcctgagt 1195860
 tcaattccca gcacccacat ggtggctcac aaccatctgt aatgagatct ggtgctTTTt 1195920

 tctacatgca taTctgcata catgcagcag gcagaatagt gtatacataa tTTTtaaaaa 1195980
 tctTTtaaaaa aagaaaagga aaagaaattc aagaaagatc cacaatcca tcacattaaa 1196040
 gctccctTTt actTTTccta aaacctgTtt tccaaacata tataaaaaaca aaaataaact 1196100
 ttactTaca tTtgaatgtt aagtagtcta agcatccttc attgTTTtcg caactcgtca 1196160
 agagctaaaa tctaaaccag cagtTctctg gaactactag tggaaagaaa aaaaaagaaa 1196220
 gcattaacat aatTTtatTTt aaaacaaaa acacaaaaa aacatTTTgc ctTaaataag 1196280
 tatgactcga acagTaaata ctTaaataaaa caaatcctct ccagcgcaga tggcacacat 1196340

 ttacacaatg taaattcaca gatgactaag gaatcagaaa ctattTaaaa aatcagtgtc 1196400
 gcaatTTTaa gTtaccacta aatgattaag aaaggtcaga tccaacatac acagactatg 1196460
 ctccgtGtta tggagtatat tacaattaac caaaaggctt tttagttatt tTTTtaagg 1196520
 gggagagaat gcatccctg aaactagagt tacagaaggt tctgaggcat catgtatgtc 1196580
 aagagtcaaa cacaggtcct ctTggaatg ttctTaaactg ctgaaccatc tctgaagccc 1196640
 caacaaaaag gTtctcagag cggTggTggc actgtgactt ctTgtcctgg ctagttagct 1196700
 ctatgtcaat ttgacacaag ctagtactg gacaggaagg atcctaaact gagaaaatgc 1196760

 ctcagtaaga tTtgggcagg ctTgtagagt atttcctTaa tgagtgactg atgtgggaag 1196820
 gccagccca tTgtggattt ggccaccctt gggcaggtag tcttgaattc tGtaggaaag 1196880
 cacgtgagc aaggcagggg aagcaagcca gTaaagcagca cctctccatg tctctgcact 1196940
 acctccaggt gatgggggat gTcctTctgt atatatattt ctcttattgg ttgatgaata 1197000
 caaactgat tggccagtag ccaggcagga agtataggtg gagctaccag atgagaattc 1197060
 tggggagagg aagcagagag aggccaccag ggagacccca tatagccgcc aaaggactaa 1197120
 catgctggag taTtctccag taagccaaaa ccacatggag atacacagat taatagaaat 1197180

gggttaataa ttaagcagag ctagtaaata agaagcctga gccgttagcc aagcaattta 1197240
 taattaatat aagtctctgt gtgcttattt ggggctaaac agcagcagga ccagacagga 1197300
 cagaaactcc gtttacatcc aggttctctgt cctgtttgag ttctctgcct gacttccttc 1197360
 aatgatnnnn nnnnnnnnnn nnnnnnnnnn nnnnnnnnnn nnnnnnnnnn nnnnnnnnnn 1197420
 nnnnnnnnnn nnnnnnnnnn nnnnnnnnnn nnnnnnnnnn nnnnnnnnnn nnnnnnnnnn 1197480
 nnnnnnnnnn nnnnnnnnnn nnnnnnnnnn nnnnnnnnnn nnnnnnnnnn nnnnnnnnnn 1197540
 nnnnnnnnnn nnnnnnnnnn nnnnnnnnnn nnnnnnnnnn nnnnnnnnnn nnnnnnnnnn 1197600

 nnnnnnnnnn nnnnnnnnnn nnnnnnnnnn nnnnnnnnnn nnnnnnnnnn nnnnnnnnnn 1197660
 nnnnnnnnnn nnnnnnnnnn nnnnnnnnnn nnnnnnnnnn nnnnnnnnnn nnnnnnnnnn 1197720
 nnnnnnnnnn nnnnnnnnnn nnnnnnnnnn nnnnnnnnnn nnnnnnnnnn nnnnnnnnnn 1197780
 nnnnnnnnnn nnnnnnnnnn nnnnnnnnnn nnnnnnnnnn nnnnnnnnnn nnnnnnnnnn 1197840
 nnnnnnnnnn nnnnnnnnnn nnnnnnnnnn nnnnnnnnnn nnnnnnnnnn nnnnnnnnnn 1197900
 nnnnnnnnnn nnnnnnnnnn nnnnnnnnnn nnnnnnnnnn nnnnnnnnnn nnnnnnnnnn 1197960
 nnnnnnnnnn nnnnnnnnnn nnnnnnnnnn nnnnnnnnnn nnnnnnnnnn nnnnnnnnnn 1198020

 nnnnnnnnnn nnnnnnnnnn nnnnnnnnnn nnnnnnnnnn nnnnnnnnnn nnnnnnnnnn 1198080
 nnnnnnnnnn nnnnnnnnnn nnnnnnnnnn nnnnnnnnnn nnnnnnnnnn nnnnnnnnnn 1198140
 nnnnnnnnnn nnnnnnnnnn nnnnnnnnnn nnnnnnnnnn nnnnnnnnnn nnnnnnnnnn 1198200
 nnnnnnnnnn nnnnnnnnnn nnnnnnnnnn nnnnnnnnnn nnnnnnnnnn nnnnnnnnnn 1198260
 nnnnnnnnnn nnnnnnnnnn nnnnnnnnnn nnnnnnnnnn nnnnnnnnnn nnnnnnnnnn 1198320
 nnnnnnnnnn nnnnnnnnnn nnnnnnnnnn nnnnnnnnnn nnnnnnnnnn nnnnnnnnnn 1198380
 nnnnnnnnnn nnnnnnnnnn nnnnnnnnnn nnnnnnnnnn nnnnnnnnnn nnnnnnnnnn 1198440

 nnnnnnnnnn nnnnnnnnnn nnnnnnnnnn nnnnnnnnnn nnnnnnnnnn nnnnnnnnnn 1198500
 nnnnnnnnnn nnnnnnnnnn nnnnnnnnnn nnnnnnnnnn nnnnnnnnnn nnnnnnnnnn 1198560
 nnnnnnnnnn nnnnnnnnnn nnnnnnnnnn nnnnnnnnnn nnnnnnnnnn nnnnnnnnnn 1198620
 nnnnnnnnnn nnnnnnnnnn nnnnnnnnnn nnnnnnnnnn nnnnnnnnnn nnnnnnnnnn 1198680
 nnnnnnnnnn nnnnnnnnnn nnnnnnnnnn nnnnnnnnnn nnnnnnnnnn nnnnnnnnnn 1198740
 nnnnnnnnnn nnnnnnnnnn nnnnnnnnnn nnnnnnnnnn nnnnnnnnnn nnnnnnnnnn 1198800
 nnnnnnnnnn nnnnnnnnnn nnnnnnnnnn nnnnnnnnnn nnnnnnnnnn nnnnnnnnnn 1198860

 nnnnnnnnnn nnnnnnnnnn nnnnnnnnnn nnnnnnnnnn nnnnnnnnnn nnnnnnnnnn 1198920
 nnnnnnnnnn nnnnnnnnnn nnnnnnnnnn nnnnnnnnnn nnnnnnnnnn nnnnnnnnnn 1198980
 nnnnnnnnnn nnnnnnnnnn nnnnnnnnnn nnnnnnnnnn nnnnnnnnnn nnnnnnnnnn 1199040

nnnnnnnnnn nnnnnnnnnn nnnnnnnnnn nnnnnnnnnn nnnnnnnnnn nnnnnnnnnn 1200960

 nnnnnnnnnn nnnnnnnnnn nnnnnnnnnn nnnnnnnnnn nnnnnnnnnn nnnnnnnnnn 1201020
 nnnnnnnnnn nnnnnnnnnn nnnnnnnnnn nnnnnnnnnn nnnnnnnnnn nnnnnnnnnn 1201080
 nnnnnnnnnn nnnnnnnnnn nnnnnnnnnn nnnnnnnnnn nnnnnnnnnn nnnnnnnnnn 1201140
 nnnnnnnnnn nnnnnnnnnn nnnnnnnnnn nnnnnnnnnn nnnnnnnnnn nnnnnnnnnn 1201200
 nnnnnnnnnn nnnnnnnnnn nnnnnnnnnn nnnnnnnnnn nnnnnnnnnn nnnnnnnnnn 1201260
 nnnnnnnnnn nnnnnnnnnn nnnnnnnnnn nnnnnnnnnn nnnnnnnnnn nnnnnnnnnn 1201320
 nnnnnnnnnn nnnnnnnnnn nnnnnnnnnn nnnnnnnnnn nnnnnnnnnn nnnnnnnnnn 1201380

 nnnnnnnnnn nnnnnnnnnn nnnnnnnnnn nnnnnnnnnn nnnnnnnnnn nnnnnnnnnn 1201440
 nnnnnnnnnn nnnnnnnnnn nnnnnnnnnn nnnnnnnnnn nnnnnnnnnn nnnnnnnnnn 1201500
 nnnnnnnnnn nnnnnnnnnn nnnnnnnnnn nnnnnnnnnn nnnnnnnnnn nnnnnnnnnn 1201560
 nnnnnnnnnn nnnnnnnnnn nnnnnnnnnn nnnnnnnnnn nnnnnnnnnn nnnnnnnnnn 1201620
 nnnnnnnnnn nnnnnnnnnn nnnnnnnnnn nnnnnnnnnn nnnnnnnnnn nnnnnnnnnn 1201680
 nnnnnnnnnn nnnnnnnnnn nnnnnnnnnn nnnnnnnnnn nnnnnnnnnn nnnnnnnnnn 1201740
 nnnnnnnnnn nnnnnnnnnn nnnnnnnnnn nnnnnnnnnn nnnnnnnnnn nnnnnnnnnn 1201800

 nnnnnnnnnn nnnnnnnnnn nnnnnnnnnn nnnnnnnnnn nnnnnnnnnn nnnnnnnnnn 1201860
 nnnnnnnnnn nnnnnnnnnn nnnnnnnnnn nnnnnnnnnn nnnnnnnnnn nnnnnnnnnn 1201920
 nnnnnnnnnn nnnnnnnnnn nnnnnnnnnn nnnnnnnnnn nnnnnnnnnn nnnnnnnnnn 1201980
 nnnnnnnnnn nnnnnnnnnn nnnnnnnnnn nnnnnnnnnn nnnnnnnnnn nnnnnnnnnn 1202040
 nnnnnnnnnn nnnnnnnnnn nnnnnnnnnn nnnnnnnnnn nnnnnnnnnn nnnnnnnnnn 1202100
 nnnnnnnnnn nnnnnnnnnn nnnnnnnnnn nnnnnnnnnn nnnnnnnnnn nnnnnnnnnn 1202160
 nnnnnnnnnn nnnnnnnnnn nnnnnnnnnn nnnnnnnnnn nnnnnnnnnn nnnnnnnnnn 1202220

 nnnnnnnnnn nnnnnnnnnn nnnnnnnnnn nnnnnnnnnn nnnnnnnnnn nnnnnnnnnn 1202280
 nnnnnnnnnn nnnnnnnnnn nnnnnnnnnn nnnnnnnnnn nnnnnnnnnn nnnnnnnnnn 1202340
 nnnnnnnnnn nnnnnnnnnn nnnnnnnnnn nnnnnnnnnn nnnnnnnnnn nnnnnnnnnn 1202400
 nnnnnnnnnn nnnnnnnnnn nnnnnnnnnn nnnnnnnnnn nnnnnnnnnn nnnnnnnnnn 1202460
 nnnnnnnnnn nnnnnnnnnn nnnnnnnnnn nnnnnnnnnn nnnnnnnnnn nnnnnnnnnn 1202520
 nnnnnnnnnn nnnnnnnnnn nnnnnnnnnn nnnnnnnnnng aaaggcgggg gaagcaagcc 1202580
 agtaagcagc acctctccat gtctctgcac tacctccagg tgatggggga tgtccttctg 1202640

tatatatatt tcicctattg gttgatgaat acaacactga ttggccagta gccaggcagg 1202700
aagtataggt ggagctacca gatgagaatt ctggggagag gaagcagaga gaggccacca 1202760
gggagacccc atatagccgc caaaggacta acatgctgga gtattctcca gtaagccaaa 1202820
accacatgga gatacacaga ttaatagaaa tgggttaata ttaaggag agctattcaa 1202880
taagaagcca gagtcatggg tcagacagtt tataattaat ataaatttct ctgtttattt 1202940
gtggctaaat ggatttggga ccaggcagaa catctataaa ttgacacact gaaacatgaa 1203000
atgtggagtc acctaaatct gtgtttccac atcatcatca cagtccttcc gtcctcaact 1203060

ggctttttgg tcatgatgtt tcatcacaga aatagaaacc ctaaataaga cactcccctt 1203120
tggcagcaag aaataaagtt taaaaaaca aactagggag ctggagagat ggctcaacag 1203180
ttaagagcac tggcagctct tccagagggc ctgggttcaa ttcccagcac ccacatggca 1203240
gctaacaact gtctgtaact ccaagatttt gacaccctca tatagacaca tatgcaggca 1203300
aaacaccaat gcacataaaa aaaataaaat aaattttaaa aactaaggct ggggtgtgctc 1203360
atgcacacct ttaatcttat taaggtccat aggcagcgag atctctatga gctcaggaca 1203420
gctaggatta catagttcaa accctttcat agatagatag atagatagat agatagatag 1203480

atagatagat agatagatag atagacaaaa aaatttaagg atgggtatgg tggcccatgt 1203540
ctttttgttt tgttttgttt tgttttgttt tgtttttgga agacagggtt tctctgtata 1203600
cgcttggttg tectggaact tgctcttttag accaggtctgg cctagaactc agagatctgc 1203660
ctgcctctgc tcccaaatcc tggaaataaa ggtgtgggct accaccacc agaagcggct 1203720
cattcctctt taatcccagc atccagaagc cagccaggtc tacacaactc agacccttcc 1203780
tcagaaacaa agaaattttt caaaaaagcc aatgaaccaa gtaactgaa ctgagagaac 1203840
cacacaataa cacaatatat aatcatactt ttaaaaacaa cagacatggc tggaaagatg 1203900

gctcagtggt tgaaaactgt atatgaccaa ggttcagttt acaacacata catggcaact 1203960
cacaggaata tglaactaca gttccaggga tccaacacca tcttttttct ggccttgtca 1204020
ggcattgcat atacacactg cacatacatg caggccaaca ttcatacatt tatacttaaa 1204080
aattataaat cctagcctgg tgggtggtgaa acatgccttt aatcctagca cccaggaggc 1204140
agaggtagtt ggatctcagt gaggttcaaag ggcagcctga tctataaaat gaggttccagg 1204200
acaggctgct acacagagaa accctgtctc gaaaaaccaa aataaataaa tagataaaca 1204260
aataagttaa aataaataat aaacctttaa aaattaaaga caaaaataca aataaaaaat 1204320

aaataaaaa taaagacaaa cttggaaaca agagaaatga tttgtcacac atgacagatc 1204380
ctcaaaaaaa gtaccaggaa atatgtcatc agatttgtga tcacaagact agcaaagata 1204440
ttcaagaac tcaagaaaa aacctgttg acaagaacc cttcatcatg cagaactgtc 1204500

cttcaaaagc agaggtacga aaacgtcgtc agcaaatcta acagagttca tcaactagtaa 1204560
 gcagggccac acttcaggaa ctgctccagc gagccaacaa gatagagcag gaggaccctg 1204620
 gacctgaagg ctctgtgaag aaatcagggc caggacacag aatgcagaac ccgcaactgta 1204680
 gtgaagtgct gctgcaaatg gtttttattc acttttgttt ttctgtgtgc tttgagagac 1204740

 taacaaactt gttcaaaaca tcttttgtcg aagagctaat atactactat aaattccatt 1204800
 taactacagg ttttattttt catttaattt aatgagaaaa ttcattttta aaattagttt 1204860
 gttttggagc acacatgcat gaaggcaaaa atcctgtggc atccaactga aagagatgga 1204920
 ggaatataaa ggagtttttg tttttctggt gttggagact gaacacaggg ttttgtgcac 1204980
 aaggcaagtc taccactgag ctagctctat caccagccta gaagtagagg gcttttggtt 1205040
 ttttatttta tigtatttgg tattttgcct gaatgcatgt cttctgtagg gtatcatatc 1205100
 ttggcgttac agaaagtgtt aagctgcat gtggatgggt ggaaatgaac ccaggtcgtc 1205160

 ttgaagagca gccagtgtc ttaacagttg gaccagctct ccaggcccag acaagagttt 1205220
 ttatgtcact aaaaatcaca ctgccaat tcaagttact attcaaatcg gattactaca 1205280
 gattaatagt aattccaata gcaaacagaa agaaaatagc tataggatat ataataggaa 1205340
 atcagaagct tgaagattct actaaaaaaaa ataattacat gcaaaaggaa acaatggtac 1205400
 aaaaaaaaaatg aaggccaac attctgctgc tgcatagacg atatgcagga aaattactga 1205460
 agtatctctt tattactaaa cactacaatc ttgatggtta ctctaaagat ttaatgagca 1205520
 cagagtcaag aggacaaaat caacatgaca tggctgccag tatttaccat cagagctcaa 1205580

 gatgaagcta ctgcctggct tttagcccgc ctaacctttc acatatgtc aaactctggg 1205640
 gcagaagggc tgagagtcag gaaaaataca tggagaaggt gcttgataat gtgaccccat 1205700
 tacaagttaa agtttctcat ttatttgggt tggttttttt caaacaggg tttctctgta 1205760
 gtggtagccg tectggaact tactctgtac accaggetgt cctggaactc agagatccac 1205820
 ctgcctctgc cgccaagtg ctgggattaa aggtgtgcac caccagcaa aattaaagt 1205880
 ttattcaaaa tggatattga tttttagtaa acttttttga tttttagata aagtttatgg 1205940
 aaatttcag aagaaaactt attttctctg ttattcetta taagacaaa caccatttac 1206000

 atgaaatcct attatafaca acatttacc atcctctact aaaaagaaga aaaaaaaaaat 1206060
 cctgctataa attaatctc tagcctggaa tgaagaagtc ctacactact tttctgtgg 1206120
 ctttctcaac acttggaaaa aaagaaataa acaaatgttc cttcaaagct ctttctctc 1206180
 ctgtggccag ctgacctctg acctcacagt cccctctac ctgggctggc tgatccagge 1206240
 acagagcact cacacaatc cccacaagca ctgggttctt ggggctcttg ctcccctgcc 1206300
 tggctcttc aaattataac aagatggaca acatttctt cactttccac cttctetcaa 1206360

cacccttcc cccaattac atttcattta cccgtagccc tcttaccatc ccctatttaa 1206420

aatcatattt tagattcatt cactgtttta tgctgtatc ctcttccaaa atataaaacc 1206480

catgagaaca gtaaaataac gggtacttca tctatgtcca aaaaacctaa aatgctattt 1206540

tgttcaagga tagttttatt ttttaataat tgtgggagcc aggtgttggt ggcacacacc 1206600

tttaatccaa gcactcagga ggagaggca ggtagatctc tgtgagttcg aggccagcct 1206660

catctacaga ggagtttcag gacagcctcc aaagcaatac agagaaacce tgtctcaaaa 1206720

aacaaaaat aattaattaa ttgtgggtat gtgtccacaa gcgaggtat cgcaccagcc 1206780

ctgggttccc tacaacagca gtacaaggc tcttagtgta taagtcagct ctccaaacaa 1206840

gtggacagtt aggaagattt tgacacttta gaacaaacce cattcatggt ctcttcagct 1206900

tcttcagtct cattattcct ctggtttgct gtgctacct tatacaggat actaatcaac 1206960

agcaggaagt agggagcaac aagtggctac atatacttta tttccagttc aaagactgat 1207020

gagattgcaa aatgacctat cttctttttg tgtttgtttt gttttgtttt gttttgtttt 1207080

tcgagacagg gtttctctgt ggctttggag gctgtcctgg aactagctct tntagaccag 1207140

ggtggtctcg aactcacaga gatccgcctg ctctgectc cctagtctg ggattaaagg 1207200

cgtgcgccac caatgcccg cggacctatc ttcttttttag attctttgtt ttatgtgat 1207260

gagtgtttt cctgagtga tgttaaagg ggcatggat cccttgaac tggagttaag 1207320

aatgactgta agccaccatg tggatgctga gaactaaacc tgggtccatt tcaagagcta 1207380

caaccgttct taacagctga gccatctctc caggtccctg atagatcttt taaatctata 1207440

agggatctta agggccaaga caagtctcag aggctagaaa tgcttacagc aaagtctcac 1207500

ttcccagatt ctatcccag gaaccccaca gtgaaagcg agaagcaatg cctgcaagtt 1207560

gttttctgce ctccacatca acgcacacc attcaaaata aataaagta actaaaactt 1207620

caatgtttta aatataatg ctgttctctc ctatcaacta ccatgagtaa ttatataaaa 1207680

gctgaaaact gtttttaaaa ctatcatgtg agccaggcaa tcatggcaca tgcctttaat 1207740

ccaacactg aggatgcaaa ggagtcgga tctgagttca aagattgcct ggtctacaga 1207800

gctacatctg ggacagtaat gcatatggag aaaaccagtc tccaaaacaa gaaagaaaat 1207860

aaaattcatt tccaaataaa taaaacctat gtttaataa tcaaagcaga gtaaacagc 1207920

tatgcattaa attaggcaat ctcaataaag gtctgaagt tataaaaatg aaccaaata 1207980

aaattatgtt gaaaagcatt acactaaaat taaaaattca tgccaggtgt ggtggatgat 1208040

gactttaatc atataactca ggagcagaa gcaggcaaat ctctgtgact ttgagatcag 1208100

cctggctctac aaaaagagct ccaggatagc cagagaaatg ctgtctcaa aaaaaaaaa 1208160
aaaaaaaaa aaaaagaaaa gggggggggg ctcccacttt taatcccagg actcaggagg 1208220
cagaggcagg cgatctctgt gagttcaagg ccagcctggt ctacaagaga tagtaccagg 1208280
acaacctcca agccacagag aaacctgtc tcaaaaaaaaa aagggggggg gtagaaagaa 1208340
ggaaagaaaa ttccttcagg ctgaacaact caaatccatg aacagaaatg catacaaaga 1208400
aatagatata aacctatata aagaaataaa catgcagtaa atataaaatg ctcttttaca 1208460
agacatacaa ctgaaagagc aaacagcaga agtcctgagg agaatgacag agctggtgat 1208520

acctgactag gggttcagct gtacaggagg ctgacttgag ggtcacacat gcaacagttc 1208580
ctgactaaca caggccctgc acctcaagac aacaaagga aaataaacac agaagactgt 1208640
actattgtac attaactact gagaacagac aggatgggag ggttgcatct agactgaagc 1208700
caagtttcta tgtcaaaata aagttgttct taatctgaag tagttataat aaattaaaaa 1208760
ctatatgtcc gcatatggtg gcacacactt gaagtgccgg cactcagcac attgagacag 1208820
taaggttgtg ctgaattata agcaaaccta ggctacacag tgagcaacag gtcagtctgg 1208880
agaatctctt ttttaaaaa acaaaaacaa ataacatagg aaaagagact gttaggtata 1208940

aaaaaggttg tcctctgac acctacgtgc tctgtagcat tcgtgcccta tgcatacaca 1209000
aatgtaagta tcaactgatt gctgattggt atgaggactc gccactaag ggtggaagga 1209060
tttcttgca caggcagttct agacagcata aaaaagctat ctagagtcag ttcttgccg 1209120
gcagtgatgg catacacctt caatcgaagc actcaggagg cagaggcatg agttcaatga 1209180
caagctggtc tacagaaaga attctaagac agccagggt acacagagaa acttgtgggg 1209240
gacgaccccc aagtttcagt tcagttccca gcacctaaat caagtggctt acaaccacta 1209300
taacacagac acacacaag aattaaagt aaaaataata atactaaaa aatgacacaa 1209360

gtagaagtca agtagagaac aagcctgtaa gcagcattct cctatgcttc tgcttcaagc 1209420
tgctgtcttg ctttctcc atgaactgtg acagagtaag accaatctc aaattaattc 1209480
ccaaagagaa aaaccaggg aagacagtaa aatttctactg gtaaattcta tcaaatgtat 1209540
tcaaacagta acaccagtcc ttcacaaacc ctcacagtaa atgagaggaa gaaatactca 1209600
acacaccct caaggttagt gtaactctag aaccaacca gaggaacat cacttctctt 1209660
ggctaaaatt aagcataat caaaatata ataaaatgaa aaaaattta aaataagtca 1209720
aaatcactaa atcagaatcc atcaatgtat aattgtttgc attgactaag ggagacttat 1209780

cctggaacc cgcttcatac ttgaaatgtc aaatgacata atagcatg ctactggaat 1209840
aaaggacaaa ccatactatc ttatagtac caatcact gatttgtgta ggactgaagg 1209900
gctttccaag atgcaaaatt tttgtgctaa acaaggcag acccaggtaa actgtcacag 1209960

ctggtaatgc caatatcagt ctgtgactgg tctaataccc atgcatgttt aaaaaacaca 1210020
 acagaggagc gcctgtctaca aaacagccac ggccagcctc ctatgaacct ggcaaatgcc 1210080
 accaacctag aggatgccat caatctggca gatgccatgc aggctctcgc ccacttctaa 1210140
 tcagccttgg acttcctggg ggttctactc aaaggaagga aagaaaagag ggaaaacgag 1210200

 aaatgtattc tgattagaca atgcaaagct accttcactc acaggctata tggatttgta 1210260
 cgtaaaaaat actgcagagt tcgcccacaaa tactggaaga ataattactt cagagagatg 1210320
 aaagtataca agatcaatat gcaaaaaaaaa aaaaaaatca gtgcagcttc tatacaccag 1210380
 caataaaact ggcacaacat tttaaaagac aactacatcc atgcaccag gagatgactt 1210440
 aggggtaaag gcacttgctg ccaaacctga tgccttaagt tccatcccta ggtcccacat 1210500
 ggggaaagga gagaacttag tcccaaaagt tgtcacacag tacatcatgg catgtgcaca 1210560
 cacactaac aaatgtgaag aaaaagaact aagacaattc cattcacagt atcacctaaa 1210620

 agaataaaat actcagaaaa tactctgaaa aagaagtata aatattatac atacataaa 1210680
 tggaaatatta gtgagccttt aaaaataaga aaattctgct atttgcaaca tggataaacc 1210740
 ttgagaacat tatgctaata gaaataaggc agacacagaa aggcaaatat ggtcacatga 1210800
 gttatctaaa atagccaaat tcaagcagag aacaggggtc accaggaact ggcagcttaa 1210860
 gagggagatg cctagctatc catcaatgta cataaagttt gagttttaca aaatgaattc 1210920
 tagagatctg ctataccaca ttttgatcat agtaacaat actgtattat aactttaat 1210980
 acagctactt tttttttca ttacaaggta gccactcagc ttgtaggttc tcttttaag 1211040

 tatgaggttt attcactgaa aaatataaat tctaaatact acttaagatc agtaaatgaa 1211100
 attctcatgt tcaatgtggg aagaagggaa ttcttgcca ggcatgtctg gcacatgcct 1211160
 ttaatccag cactcgggag gcagaggcag gcagatctct gtaagttaa ggtcagcctg 1211220
 gtctacagag ttctaggaca gcccagtcta taaataaaaa ccccatctca aataaaciaa 1211280
 aataaat tttt aaaagggggg gtgggggctg gaaggatggg ttgtttatta gcatgtttaa 1211340
 ccaagacat gagaaaaag acaggagagg acaattatga ttgccgacta tgaacaata 1211400
 acatcactct gaatcgaag gaaaactcaa aacttcaatg agctagccac tccatatcca 1211460

 ttaacatgac cacatcatic ctactataac tgaaggagc agacagtcac aagtattgac 1211520
 acagagctgg aaagatggct cagcagttaa gagcaccgaa tgctcttcca gagagcccag 1211580
 gttcaattcc cagcaaccac atgtcagttc acaactgtct gcaactccag ttcctgagga 1211640
 cccaacacce ttggcaaca ccaatgcaca taaaataaaa ataaataaat ttaagccgga 1211700
 cgttggtggc acatgccttt aatcccagca ctggggagc agaggcagc agatctctgt 1211760
 gagttcaagg ccagcctggg ctacagagtg agtatcagga taggctcaa agctatacta 1211820

gagaaaccct gtcttgagaa aaaaaatgaa taaataaatt taaaaaagta agtggtgaca 1211880

 gtatgactgt ttgagcatgc aacttggttac tgccactttg agaaacagtt tggaagtttc 1211940
 tcagaaaagct aaacaagaca cagtagttcc attcccattt gtttactcat aaaaaggaag 1212000
 ccatacatcc atataaagac ttgtaatcaa acattcatgg tgtatcattt taaacggtct 1212060
 gaaactgcaa acaatccaaa tacctatcaa ccagtcaact gacaaatgta gtatatccac 1212120
 aaaatatata ttactttcca gcaataaaaa ggaataaagt cccgatacat getacaatat 1212180
 agaaaattct cagaagtgtg ctaagtgaaa gatgtcaaat ctaatatata tatatatata 1212240
 tgattccatt atgcaaaatg gccagaggaa gcaaacatag gaacaaatg gtgacagcct 1212300

 aggtagggct ggggctttgg ggtttgaggc caacaacaaa taagctgaag aaaattttgg 1212360
 gggtagggcat aaaatcatat tctaagaaa gctcgggatg ttctcaatcc catacattta 1212420
 ttaagaaata ctggattata cactcaaaat ggatgaatta tttttgctat tgagccaaaa 1212480
 ggctgatttc tttaaaaaat accactcaa agagaaatga aagaatatta ctcataatag 1212540
 ccaagaaatg gaagctcaag aacctaacag ctgatgaatg ggtaaatatc aggaagccta 1212600
 tgaatgcaaa ggagttatta ctgagcaaaa tagtaacaat aaagtactgc cacatgctac 1212660
 aacatgcata ttttaaaac tttatgctat gtgaaaagga ccaatcacia aaggttacet 1212720

 tgtgtactcg tgfacttaca taaaatactg acagatgaca gagatacaaa gfacatgagt 1212780
 ggttccctag agccagaagg atgggggcag aaaggagtag gactgctcgt gggtatgaga 1212840
 gttggtcgt tagtttcttt gactggtggc actggggatc gaactcaaga cctccccat 1212900
 gcaaagcaaa cactgtacca ctgagctgta ccacatgccg acctatgta ctgttttaga 1212960
 ggtaagaac atgcttttta aatttgagia cagtaattgt gcaactctga atataccta 1213020
 aaacctccat tgaacttgta cattaataat caactaaatg gcatgtggtt agtatttcaa 1213080
 taatgettct acctctcccc acctcgacc attcacaaaa aaaaaaaaaa aaaaaaaaaa 1213140

 atacataacc tggaactgg taaaactatc aactttaatt tggtaggcc actacaacca 1213200
 ctgaagagac ttgggattga aaaacctcca aattcttccc aagcatactc tgggtatggt 1213260
 gtaattattt atgccttcaa agtacaatga ttaattcaag caatcaattt tttaaaaaag 1213320
 ggtaacattg caagccttta aaccagcgc ttgggaggca gaggcaggca gatctctgtg 1213380
 agtttaggc caacctgac tacaatgcaa gttccaggac aaccaaagct acagagaggc 1213440
 cctatcctgc ctgaaaaca aaaccccaa acaaaatatt aaactgaa attttaaatg 1213500
 ttgaagagc tttaaattc tacttcttgt atttactaaa tgtatcaact gcggccacat 1213560

gaatgaactc tatacattgt cttctataaa cttattccc agtctcacat gaagtcatc 1213620
aacctatga agacaaactg taaccacaa gtatacaatc ttatctcagt aaggcccga 1213680
cggacattgt tccgattctg gcacttaggg aaagtaagta attcgactct taaccaggcc 1213740
tcggagaaaa aagaaaagca aaaatctgaa gatcaaagga gcgctttcta ttatagtctc 1213800
tactgccgg attaaaacag aaaccacaga gtaatgtcat caacacgaga cagatgcccc 1213860
agggtccag ggacgcggcc ccatcttact ctcacttgat aagagtaeta agaactaaa 1213920
taaaggctat tctgttgagg acgtggctcc tctgaggaca gcccagcaag ttggcccatg 1213980

agggcatcg gaaactgcac tgggctgac tcccggcacc gtgggttatt tttctgtcct 1214040
ttgctgacag agtgaatg tcccactgaa gcctgagtg ggtccgnnnn nnnnnnnnnn 1214100
nnnnnnnnnn nnnnnnnnnn nnnnnnnnnn nnnnnnnnnn nnnnnnnnnn nnnnnnnnnn 1214160
nnnnnnnnnn nnnnnnnnnn nnnnnnnnnn nnnnnnnnnn nnnnnnnnnn nnnnnnnnnn 1214220
nnnnnnnnnn nnnnnnnnnn nnnnnnnnnn nnnnnnnnnn nnnnnnnnnn nnnnnnnnnn 1214280
nnnnnnnnnn nnnnnnnnnn nnnnnnnnnn nnnnnnnnnn nnnnnnnnnn nnnnnnnnnn 1214340
nnnnnnnnnn nnnnnnnnnn nnnnnnnnnn nnnnnnnnnn nnnnnnnnnn nnnnnnnnnn 1214400

nnnnnnnnnn nnnnnnnnnn nnnnnnnnnn nnnnnnnnnn nnnnnnnnnn nnnnnnnnnn 1214460
nnnnnnnnnn nnnnnnnnnn nnnnnnnnnn nnnnnnnnnn nnnnnnnnnn nnnnnnnnnn 1214520
nnnnnnnnnn nnnnnnnnnn nnnnnnnnnn nnnnnnnnnn nnnnnnnnnn nnnnnnnnnn 1214580
nnnnnnnnnn nnnnnnnnnn nnnnnnnnnn nnnnnnnnnn nnnnnnnnnn nnnnnnnnnn 1214640
nnnnnnnnnn nnnnnnnnnn nnnnnnnnnn nnnnnnnnnn nnnnnnnnnn nnnnnnnnnn 1214700
nnnnnnnnnn nnnnnnnnnn nnnnnnnnnn nnnnnnnnnn nnnnnnnnnn nnnnnnnnnn 1214760
nnnnnnnnnn nnnnnnnnnn nnnnnnnnnn nnnnnnnnnn nnnnnnnnnn nnnnnnnnnn 1214820

nnnnnnnnnn nnnnnnnnnn nnnnnnnnnn nnnnnnnnnn nnnnnnnnnn nnnnnnnnnn 1214880
nnnnnnnnnn nnnnnnnnnn nnnnnnnnnn nnnnnnnnnn nnnnnnnnnn nnnnnnnnnn 1214940
nnnnnnnnnn nnnnnnnnnn nnnnnnnnnn nnnnnnnnnn nnnnnnnnnn nnnnnnnnnn 1215000
nnnnnnnnnn nnnnnnnnnn nnnnnnnnnn nnnnnnnnnn nnnnnnnnnn nnnnnnnnnn 1215060
nnnnnnnnnn nnnnnnnnnn nnnnnnnnnn nnnnnnnnnn nnnnnnnnnn nnnnnnnnnn 1215120
nnnnnnnnnn nnnnnnnnnn nnnnnnnnnn nnnnnnnnnn nnnnnnnnnn nnnnnnnnnn 1215180
nnnnnnnnnn nnnnnnnnnn nnnnnnnnnn nnnnnnnnnn nnnnnnnnnn nnnnnnnnnn 1215240

nnnnnnnnnn nnnnnnnnnn nnnnnnnnnn nnnnnnnnnn nnnnnnnnnn nnnnnnnnnn 1215300
nnnnnnnnnn nnnnnnnnnn nnnnnnnnnn nnnnnnnnnn nnnnnnnnnn nnnnnnnnnn 1215360
nnnnnnnnnn nnnnnnnnnn nnnnnnnnnn nnnnnnnnnn nnnnnnnnnn nnnnnnnnnn 1215420

nnnnnnnnnn nnnnnnnnnn nnnnnnnnnn nnnnnnnnnn nnnnnnnnnn nnnnnnnnnn 1215480
 nnnnnnnnnn nnnnnnnnnn nnnnnnnnnn nnnnnnnnnn nnnnnnnnnn nnnnnnnnnn 1215540
 nnnnnnnnnn nnnnnnnnnn nnnnnnnnnn nnnnnnnnnn nnnnnnnnnn nnnnnnnnnn 1215600
 nnnnnnnnnn nnnnnnnnnn nnnnnnnnnn nnnnnnnnnn nnnnnnnnnn nnnnnnnnnn 1215660

 nnnnnnnnnn nnnnnnnnnn nnnnnnnnnn nnnnnnnnnn nnnnnnnnnn nnnnnnnnnn 1215720
 nnnnnnnnnn nngccgcgaa gtaactcaag tcccgggatc ttcggggcca gggatgaagga 1215780
 gcgcgtgtga gtggagaagg gagactatgt tgtccaagt gtccgcgaat tggggaggaa 1215840
 aaaaaagga agccagcaga agctgcaggc ttctggttg cacactttca cacaaagggg 1215900
 agcctctgag cagggcactc tcacgcgctc tccaggcac aaaagccaat gacacggtgc 1215960
 ccgggatgtc ctgcgttttg cagcggctcg ctaatggtct ttcttaggct cagttagca 1216020
 tgcaaagcc cgggtctctc cccccacca ccaccatcc cgcgccac ggctgtatt 1216080

 cgtttcttta acaaagagca tcggcggctg tcccgggtcg cgcggggct gatcctgctg 1216140
 tgctcagact ctgacgct cctgcggga gactcagctc ttggaacagc atccaccagg 1216200
 ttaatttctg ggetccaacc ggactgtttt tgatgctcta caaccggttt ttacgaaac 1216260
 gaaatactga gctgtttgat agctgtttta atgaacgtgg gaaacgtgga aatgaccctg 1216320
 gaatagggtc caaatgttg agacaaacgg aggctgctgt gttttaaact ccttgatgaa 1216380
 cgtaagaatt taacctcatt taaaaagctg ttaatgcta gttggaggta attcttctga 1216440
 atcataaaaa gcaactttt aacaagacat tctctctctg agctgtagta gaaacctgaa 1216500

 ttcgcagagt ggtaatcag tgatcctctt aactcgtggg aagtttctag tcttgagttc 1216560
 aaaggcttgg tgaccattga caccctctg aactacatgt atggagtctc agtaactttc 1216620
 agaccttaa tatataag ggtactgcac acacagcatg ctttctgga ggacagtgtt 1216680
 tctctatctt ctataaaat cagttatec atatgagaac cactgcccac tttggcactt 1216740
 tctgagtaag aactctgat ctctcacatg gcaggagctt gcttcttta gttaaagata 1216800
 aatctfacat gcaggaacat cctattctg ttagctactt tcaaaagaaa tgttctccc 1216860
 atttccate tagagtaagc tggaaagtcc caggcaaaaa acttctgct cttgattttt 1216920

 tttttttca ctgttaaat gcgcatata cttttgaaat gtagatctga gagctgaaga 1216980
 gatggctcag ccaacctcat gatcttcccg aaaacctgag cccaacacc cacattatga 1217040
 ctcaaacca tcigtactc cagttccagg gataccaatg ccattttttt ttctagcttc 1217100
 tgtggatacc aggcacatg atggtgcaaa gatacacatg taggcaaac actcacacac 1217160
 ataaaataat aaaacaatgc tctttaaaaa agaaatgtag atctgttgta actcagattt 1217220
 aaaacattcc tccacctgt tgatgtttaa ttcagataat tttatttctg tctggccaaa 1217280

gtaacatggg cagaagtac agtataagga ttctgaaggt cctggcctca agagttattg 1217340

 catgtttctc ctgcctccc tagcacttct ggcttacaca atttgaagaa catgtctggg 1217400
 gagtctgctg gtccaagaaa gattgattac acacacacac acacacacac acacatacag 1217460
 ggaatggccc ggaacaattc tgagcttata gccaagaacc tgtatgttgt gcaacagttg 1217520
 aaaaactcca tctgaaggg aagctcctta agcaggaaga ttaacaactc aaaagagctt 1217580
 caggaagtcc ctgaaactga ccagattcac taggcccctc cctgaaagag taagcaataa 1217640
 aaggtaaagag ttctctcag aagagcaaag ccaagctgca gagaagactc ttaacaccag 1217700
 agcagctgcc tggaagaagc agaaagcagc tgagctgtct ggaagagatt tagcccaacc 1217760

 gaggcacctg gaaaggacac gctccaacct gttgagctgc ctacaggctg tgcagtgtgc 1217820
 tccaagttcc cagctttgtg agctgttacc tctgctgggg tgggctttgc tgatacagct 1217880
 gcctttgagt catttctgtt cttgtaaaga acccctcacc tatccttctc taagtaacce 1217940
 aataaaaactc attggttcac cagattggac tttggtgata gctatacttt ggtctgtgta 1218000
 ggttctctaa ctcaggtggt ttgtcacaca acattgagga atataaggtt ttttttgttt 1218060
 gcttctttga catggtcctt ccaggtgtgt ttcttagcat aggccccaac ataaaattec 1218120
 taagattata gatatgccc tcaacacacc tatgtagtac accctgcttt ttgagtatgt 1218180

 tgagtatgcc agatgaaatg gtctgctgtc tttgtactag ccaacatggt aaagaatgag 1218240
 gatctctgag agagctctta ggaagcaggc attcgaaaga cacacctttt gtagaagaa 1218300
 gcctagtaag aaatgagaaa aatttaccac aaagggtttt ttaagacccc agggtcaggg 1218360
 ggaaaggttg tctgatgaag ccaggaatcc cagcagcaag ctaaggatca tgcaacagat 1218420
 agctatgtta taattgcatt gatthtattt ttttatatca cataattcat ttcttgattc 1218480
 tacatgtgtg ccattaatat attgcatca ttgtttttca aatactatac aataaacata 1218540
 ttacgaatte aagtctaaga caggaggtga tggcacatgt ctttaatctc agcccttagg 1218600

 aggcagaagc agacagatct ctgtgagttc aaggccagcc tgctctatag agcaagtcc 1218660
 aggacagcca ggactacaaa gagaaacca gtctcaagaa accaaaaaag aataaaaagg 1218720
 aatccaagtc tagggagata gttcagttgt taaagtgctt gctatgtacg cctcggggac 1218780
 agggtttgag ccccagaacc cacgttggtt tttttttttt tttttttttt ttttttatg 1218840
 atcattggta ttctgcctac atgtatgtca gaagccctgg atctggatgt acagacaggt 1218900
 gtgagctgtc atgtgggtac tggaattga acttgggtcc tctggaagag cagccagggc 1218960
 tcttaactga taaacctcg caccagcccc cagaatctaa gttttaaata aaaagtcagt 1219020

catgagctag gcatggtggc acctgcattt aatctcagcc cttgggaggc tgaggcagca 1219080
 agagctctgt aaattcaagg ccacctgtc tacatattat tgaactgtag gccagccaag 1219140
 gtgaaacct gcctcaaaca aacaagcctg gttgttgttg gtggcacaag cttttaatcc 1219200
 cagcactttg gaggcagacg taggcagatc tccatgagtt tgaggccagc cagcctggta 1219260
 agttccagca caactagggc tgtcacacaa agaaacctg agtctcaaaa aaccaaaca 1219320
 aacaaaagtc aggtaatggg gacttgtaac tccagcacag gtcaagatct ggtctagggc 1219380
 tcctgaggaa aaacacctga gggtgacccc tctagctggc tccacgtgca cacacaccag 1219440

 agggggagaa aaagttgaat ccaactccct ctatacttag ctttcatac ttttccagtc 1219500
 attccacacc tctcctcttt ctcatagtc cataaaaata gtttagcatg tgccggagtc 1219560
 ctctgaaaga gcaaaaagtg ctcttaggcg ctgagccatc tctccaggcc cagtttcaga 1219620
 tgttttagct gcacatatat acatatgcat atgcgaaggc aaattaaaca tacacgggat 1219680
 tatataacat gtgctgggta aatattttta tatcttttct ctgtgtttat ttcccctctg 1219740
 ttctctttaa ttacacagaa agtcttttta aattttagcc tgtcttctgt aggacaagct 1219800
 gagcaaaaga agaggttttc ctgctttaat atcagtatgt taaacgggag aaggactagt 1219860

 tagggcccat tgtgggagta gcagtacaa ttgtcaggaa aacacaagag gaaactaat 1219920
 cctcagactt ggccaataga ctagtccct ctactaacca ggatatttgc ttttgggtga 1219980
 tcagagttat ttttaattaa acaaaagctat gttattttat aacctcaaa gtcagtccaa 1220040
 gaacaaggta taggctattc tgaccttgc tgggactca cacacggtca cttctaacac 1220100
 attcagttag tggcctacct cagtgtggga gaccactact caaatatctt aatacaaaaa 1220160
 gctgagagtg gtcagggacc atgcacacaa cagtgagtgt gacttaagca gtgtttaaac 1220220
 tcatgtctct ttcatctcag gctgggatag tcctggatgt cagtgaccac acacacttta 1220280

 taaaatcaat cagaaaaaac tcttatttgg cccccctta aataaatggt tetgagtgac 1220340
 cagccagttg aattctggtg ttgacctacc ctgcctactg tggacaggta tcgataccct 1220400
 tcccactctc ctttctgagc ttctgcagag aagataggat tccttttctc cattgcaaag 1220460
 gaattcagtc tetgagtcca ttttttgatt taggtattat ctggcctttt ttttctttt 1220520
 ttttttatg tglaagagtg tattgactat agggtgaggg gaagtgaggag gaagtggcac 1220580
 ctccctttaa tctagcact caggaagca gactcaggag gatctctgta aattcaaggc 1220640
 cagactggtc tacagaatga gttccaggac agcaaaagct tctcaaagaa acctgtcttg 1220700

 aaaaaaaaa aaaaaaagt gtttgcctg ctgtatgcc tgtgtaccac ttgcacacct 1220760
 attgtccaag gagaccatta gaatgaatgc atcagatccc ctgagtctga gattacagac 1220820
 agttgtgagt tacctgggg gttctgggaa ttgaacctat gtcctctgga agagcagcca 1220880

gtactcttaa ctgctagagt catctctcca gcccttttc tttataaag cagaatcttt 1220940
 taaaacctat gtagtgatca aattacaaac acagctaggc agtggtagca caagctctgc 1221000
 tctcaggagg cagaagcagg tgaatctttg agtttgagtt tacagaactg agttccagga 1221060
 caaacagggc atacaaagaa accctgtctc aaacaaaaca aaacaaaaac aaaaaaaga 1221120

tctgtctcag atattcacia aaccaaatg cttttgagag gacatgtaa atttctagac 1221180
 tacaaggaga aacaatattt ttacattta ttatttgtgt gttcctgttg tgtgcaaaca 1221240
 gatgccagga cacacttgag gaggtcagag gacaactaa gagactcagt tctctccttc 1221300
 caccatctgg gattgaactc aaatcatcag acttgacagc aaatgccatt acttgctgaa 1221360
 ccatctcact gaccttaatg aagcattttt tttttagttt gttcataacc ttctcccacc 1221420
 tggaaatttc tatgcatacc tggctgccct cttcaattc atagagacct cctgcctctg 1221480
 cctctctaag tgctaggatt aaaggcatgt gccacatag ctagctcca atgaagtaat 1221540

ctttcaggat gaaatgtgta gcatcaaatg ccatcagata aaatcgtag gaagtataaa 1221600
 gtattcgaca taaaaagaa gttaggctct caggattatg tccacataat gtcttctact 1221660
 aaaacaggct gtcatttcat atttgttctt ggtgttcttc atatataat acacacacac 1221720
 acacacacac acacacacac acacatata atacacacat atatatagta caacctatag 1221780
 tatataacat acaatatata tcatatcata tatcatttgt ttataatata atgtatacct 1221840
 atattatata atatgtacat tatatgatgt atatgtatcg tataattata tacattacat 1221900
 gataatata atacacacac agggtttttc tgtgtcacca accaccctgg cagtcctgaa 1221960

acttgctcag tagggcagtc tggctcaaa ctctccaga atgctgggtt taaagatgtg 1222020
 cgccaccatg gcccgctcc cttttggttt ttgagacata atttactct acatcctagg 1222080
 ctgtcttaaa ctcaaatga agcccagggt tctgacctc atattcttgg caatctctct 1222140
 atctcggcct cctctggag tcttgggatt aaaggcttat tttatctgtt catgtcaacc 1222200
 accaaggaca acagatacgg tctctgtctc cagccttcac actagcatca cattccattc 1222260
 ttccaaatc atgtatggtg ctacceact cacttctgcc ttgctgcct gctctgctg 1222320
 ataatccaag ctctgttga aaggccaggc tcctagctc cagacatcgg tatttgccaa 1222380

cagagtcctc tgctccgcc tctggttct gtatctgct cttccttcgc cccttctgt 1222440
 ctgagcacat tctttctgt aactctagt taactgttac tagggagaga cggggagtag 1222500
 gaggagtggc agagagagtc aagataagcc agccaacatg gtggttaact gtgctccctg 1222560
 gaggtccagg attaaacatg aattccaac aagaaacagt tggaagaaat gagaagaagg 1222620
 ctgagagtt gtaaaatata atgaaggcca gtgaggtagc tccatggata aaggcacttg 1222680
 cactgagcc tgaagacctg agaccacat gttggaagaa gagaacaaa ttattctct 1222740

tcatatatgc actgtgtcat aaactcccct acccatacac aaaataaata gatgaggggc 1222800

 agtggggacc cacaacttta atcccagcac tgaggaggca gaggtaggca gatctctgtg 1222860
 agtctgagac cagcctggtc tacagaagaa gttccaggac agccaaggct acacagataa 1222920
 accccatctc aaaaagaaaa aaaaatgaat agacagatag atagaagcat gtatgtgtgt 1222980
 gcctggtgcc cacagaagtc agaagagagt gtcaggttct ctgggaatgg agctcaggtg 1223040
 gttgtgagcc atcatataac tgctgggaat cgaactcagg tcttttatca aagcaacaaa 1223100
 aggtgttagc tgcagagcca tctctcaagc cccactgtgt aatgattctt ttttttttt 1223160
 aaagatttta tttatttatt atgtatacaa cattctgctt tcatatata gtacacacca 1223220

 gaagaaagca ccagatctca taatggatgt ttgtgagcca ccatgtggtt gctgggaatt 1223280
 gaactcagga cctctggaag agcagtcggt actcttaacc tctgagccat ctctccagcc 1223340
 catgattctg cagcagtatt tcttagacag actagaagga tagctaatta aaatttgggt 1223400
 tttgttattg ttggtctaga aaagcttga tcggcctcac aatttgaat ctataatac 1223460
 ttatgaactc ttaggtttat cgttgattta agaaaacatc tgtcacattt cttttatcta 1223520
 gaagtatttg gggagctggt gaaatgtctc tcgaagatca ctggctgctc ttcaagagga 1223580
 tcggggtcct attcccagaa gccacatgga agttcacacc agtatctata actccagcct 1223640

 gaaggattct gatgccctaa tctgaactgt aggggtgcctt tacggtacct gtatgcatac 1223700
 aacatacccc cacagagaca caaatacaca cacatacaca tacacacaca cacacacaca 1223760
 cacacacaca caatTTTTG ctgttgtgtt ttttgtttt caagacaggg tttctctgtg 1223820
 tagtctctgc tgcctggaa ctgtctctgt agaccaagtt ggctggaac tcagagatec 1223880
 acctgcctct gcctccaaag tgctgggatt aaaggcatgt gccacccaaa gtccaacttg 1223940
 gtgagccaat gaggttgatt aggaatatgg gtgagggatt acttcaaaa gcaaaaatga 1224000
 ctcaaagaca gatgcatcaa taaagcttac cccagcatgg gtgacagctc acagcctgta 1224060

 ggcagctcca caggttgag ggtgtcctt ccaggtgcct catttgggtg aacatattcc 1224120
 aagtcattca tctccttct gcttcttcta agcagctgct ctgggtgccg ggtcttctct 1224180
 acagtttagc ttgctcttc tgagagggac tctcagagct tattgcttac ttgggccagg 1224240
 aggggcctag tgaatctgat aagtttcagg gacttctga agctctttg agttatcttc 1224300
 ctgcttaagg agcttcctg caggatgaaa tgttgcaatc tagataaacac tgttacacaa 1224360
 ctctggtgca aattactgca atagtctaaa acctcaaca tcgaggaagc agattttctc 1224420
 acttcaaatt cctcccacg attaaaaaca aaaataattc tgtgtgtgat gttactctt 1224480

cctgggaatg agtcaacaaa tatctgttta taccagttag ggaaccaagg acagctcaag 1224540
 gtaatgattc caccaaagtc caacttggta accaattact ttgttggcct tgcttaacaa 1224600
 acatgagtaa gggtttactt agagcctcat gggtgacccc agaacaatgt caccaacaaa 1224660
 gtctcacacc atcataatat cgacctctgg gaacttgcac cattaaggac caaagttaac 1224720
 cttcctcttc ctttagaagt gctaagtgtt ccttggatcc cttgcagctg gcaggaggtg 1224780
 ggaaaagtgt agtcaggagg tggtagggct gtaacgtttg gaattccaga ttccaaccct 1224840
 gttaacattc acttcccttc ctaactaaag aatgtcaata gtcctatagc attgtcagag 1224900

 gcctacctat ctccacttat ttcattgctt gaattatgag gaaatcttat accccagtat 1224960
 ggcaatggga tgcccatgtt ataccacaaa ggaaaagcta tattgcagta tactgtcttg 1225020
 cacagacttc aggaatgtgc aactagagag atggaagtcg gacacaggct atggttaaaa 1225080
 aaatctcact tcacagttta tggaaatgct ttgaccactc gcatagacag atttcaaggg 1225140
 cccaccacaa ttcttccct aaagtcacca gtttgagagg ccctgatgtt caggttcaaa 1225200
 ctgatctgag gctcatctgt ctccaaggg ttctccagat cactttccgg taatatactg 1225260
 tcatttctca cttagttag atattcacia cccaaagtgt ctattcaaa ccagtattag 1225320

 atagtgtttg cagattgttg aattagaacc tgcagcatgg gaacagagac tggaaagcct 1225380
 actacacctg gtgcatctta caaccctggg gaaggggggtt gctgtgcaat gatttgaac 1225440
 gcatgggtct catgccaac tactatntaa gcttttcttt ttttattaaa gatttatnta 1225500
 ttgccgggcg ttgtggcac acacctntaa tcccagcact cgggagacag aggcaggcag 1225560
 atctctggga gtttgcagcc agcctggtct ccagagcaag tgcaggatag gctccaaagc 1225620
 tacacagaga aacctgtct cgaaaaacca aaaaagaatt atttattnta tgtgaattgt 1225680
 ttgtctgcat gtatatctat ctgtgtgagg gcgtcagatc ccctgaaacc gagtgagaga 1225740

 tagttgttct aggtgctagg aattgaacc agtccctctg aaagagcagc cagtgtctct 1225800
 aaccactnta tctctgtagc atctaaggtt ttcttttagc tcaactagcca actccattc 1225860
 tcagtgttct gtttctcaat aaactgtgag ggttttttcc tttttttttt tttttttttt 1225920
 gagacagggt atctctgtac ctttggagcc catcctggaa ctactctgt cgaccaggt 1225980
 gacctcaaac tcatagagac atgcctgcct ctgcctcctg agtcatggga tttgtttct 1226040
 aaccaagtgt ccctagtcta actcttctgt tggtagctat acacagatgg accactgtac 1226100
 atgatattat ttcagcatg aatgcaaac cacaactctt accccaaagg ggataaaagg 1226160

 tggataaatt tggagccaaa tatgaatgac cacagccctg gaatttaagt tactccaaat 1226220
 tctatatttc aacatggaag ctgttttagg gagtttttat ggtaacaaaa caaagttaga 1226280
 catcaagaca cttaaaaaa aacagaaaca aatgaaaaa aaactntnta tttgtttct 1226340

aaattaaagt cactcatttt attttatggt gttttcctgt gtgtatgtat gtgcaccaca 1226400
 ttcatccttg gtgcccacag agatcagaag atgtctttaa ctggaggtag aagtggttgt 1226460
 gaaccactat cagtgcctggg tatcaaatct agctcctttc tctccaagag caacaagcac 1226520
 ttttaactga cataccacct ctccagcctg actttgtatt tcctatttat gtggatatgt 1226580

 gcctgtgtga ggttatgagt accactgggg tgcaggagcc cacagaggtc agaatagagc 1226640
 actgaatccc ctggaaccac agtagagacc tttgtttact gccataggg tgctagaacc 1226700
 aaaacctggt cctctgcaag agcagtaagt tctctaaact gctgagccat ctctctggcc 1226760
 caaaacacct tttaaatacc ttgggtgaaa ttaagtaggc acacagcaga gaaatctcag 1226820
 ctctaaccct cagatgttac ctgacaacat tcttaggttt tattttgata aaagctagtg 1226880
 tctgctaaaa aaacatattg caaaaggttt ttttatttat taatcacagg atgttaggac 1226940
 caacacttag gtgggtaagg aagggtatt tagggagcct aaatatagca caagataaat 1227000

 agtagttagt ttctggactt gcaatattcc aacctctcat tattactgca gttctcattg 1227060
 aacaaaacaa cccccacc tccaccccc acccccgcca ttttggcagc catgacagge 1227120
 taacgtgctt gectgacctt gctgggcctg cctgggtcac taggaggtca gatgcctec 1227180
 tcatggcaat gaaccaatca gaagtagct ggccgggcta tgctttatga ctctgggtgt 1227240
 gctttatgta caagtgcact acagtgccgt gcagagcata acaaccacc taggagggcc 1227300
 tatggggcat aaaagcagtt gaccaatcaa cacagggcag gttgtcctgg aagcacacca 1227360
 atcctgagac tgttgcatcc ccttagacac tgcctataa gatcctgtc tcgtggtttc 1227420

 ttggagtcat tctccaacca tctgccacag tggatggatg aaaggtccaa gctaatgagg 1227480
 ttagctcgtt aaacaactgc aataaaagac tctttgcttt tgcatgaaa tgggcctctt 1227540
 ggtgattttg gggttcagaa tttgggcaca acatcagaca cagctgcttt ccaagaacaa 1227600
 tcagagcagg atgccttggg ttgagctgat cctgccattg aagatgtcta cacacagttt 1227660
 aagtcagccc tagcctacca ggcagacctc ccaagacttt tcttctccc ttcttgctc 1227720
 tttttgagg gtctcactat gtatcactgg atagccttga acttggagtc tttctgcctt 1227780
 tgctcccga gaactgagat taaaagagga tgcttctgtg ctggagagac agctcaatgg 1227840

 ttaagagcac tgctgttct tgaagaggat caggttcaga tcccagtatc acatggctgc 1227900
 ttacaattgt acaattgtac aattgtcagc tctggagact ccaacacca ctctggtctc 1227960
 tttgggtata ctgcattcat gtgatgcagg ctcacacgca tgaattttt tgttgtttt 1228020
 ggttttgatg gttttttcc gagacagggt ttctctgtgt aacagctctc actatctcgg 1228080
 aagtaactct gtagaccagg ctggcctega actcacaag atctacctgc ctctgtctcc 1228140
 caagtctag gatataaagg gatgcgccac caatgcctc cggctgaaaa atggatgctg 1228200

ccacttgct cacttttca ttctcattct ctctctctct ctctctctct ctctctctct 1228260

ctctcccttc cccctccct ccttctttt ccttttcttt ttgtcttggt ttccgagaac 1228320

agttccagct gtcctagaac tcactctggt ggccaggcct tgaactcaca gagatccacc 1228380

tgcatctgtc tcctaagtc tggaattaaa agcgtgcagc accactgccc ggcccttctt 1228440

ttcttttctt tttttaaatt aatttatttt tgccatttga atcccagttc cccctccctc 1228500

ctctctctctg tetaccccca cttecccttc accccacctc ccatctgcta ccttaggaag 1228560

tctactaagt ctgtcccaac atgtcagtga ggccaggtcca aggcaccttg ccaaccccca 1228620

caccctcta tgtcctttct ttcttttttt tttttttttt ttgttttttt tttttttttt 1228680

tttnnnnnn nnnagaattt ctctgtgtag cttaggagcc tatcctggca ctgcctctgg 1228740

agaccaggct ggctcgaac tcccagagat ccaattgcct gcctcccagag tgctgggatt 1228800

aaaggagtga gccaccaacg cccgactatg tcctttcttt tcttatcttt tctttcttta 1228860

atagtttatt gagtaactct tttattatta tcattattaa ttatatgtat tgacttttca 1228920

tctgcaggta tgcaccacta gtgagactgg tgcccaagaa caccaggaga aggtatcaga 1228980

gccccggaa ctgggtgctg ggaattgaag ccagcggagc cacctctcca tcctcaaga 1229040

gttttctcaa gggagtctag ggcctcatt ggtcacacct tggaccttcc catctgggtg 1229100

ccctttcaga aggtgttctt aggcaaaatt cctcccttg cctgtctgt cagaggtact 1229160

tgctttttag agtcaactat ctcaaatatc acaccagaa agcctttctg gtttctaacc 1229220

acatccctca acttcccttg gactcaccac agcttctggt ttttgcttac ccaccagcac 1229280

tgtattttac cttagtttat aattgttga atcagtagcc ttaaacttca gtctctaaag 1229340

gcagcaagca agggcaaggg tggatgggat atgttcaaag tgattactgg aaatttctta 1229400

agaaggtact aatttaagga acaacttact ggctgcact ctctgtggg attgaagaca 1229460

gcactgccac agcctacatg aaagggtctg actccagggc ctggagagtc catttagcct 1229520

ttaaaatctc cactgttctt gcctcggatc tgtgctggtt cccagcacc acgtggtggc 1229580

tcccacatgc ctgtaactct agttcgagag gatttaacat actctctgat ctcttttagc 1229640

atcaggtaca tacatggtgc acagacaaaa cactcataca cataaattat atatattaat 1229700

taaagattta agatctgact gcacagaggg ccctagtata ctaactgcaa aatcttcaag 1229760

gcagagtcaac agggcccaac acacctaac cccagacatg tgataagatt gctgatccat 1229820

ttaaattctt ctctccttct cttagagaat gcaattgaac ccatgtactc taaaagcatt 1229880

tacaatggga ttttacagta cctaaagtag atttaggagt gactaagaca cagactctga 1229940

caataaacta agttgttcga ttcctagcac cagcacttac taagatgtat atagccttgc 1230000
tgaggtaactt aatgcgctgt tttcttacac ctccacttat gtctacaaaa tggaaatagta 1230060
ataaggccaa gtttaataagc ttgtttgaag gataaagtca gttaatccat aaaagcatag 1230120
tacttacctt ctaagtctct gtggctctct tctgttggta gtgaggctct tttgttctgt 1230180
agtcttgctt gtagcctgga actcagcctg tagctcactc aagctgacct cagattttca 1230240
gtaagcctcc tgaatgctga gattcatagg cctacacat gcgttgccag accctttata 1230300
ttttgaatga aagttacagg agttaatata tacatatatt atacactcgg tgctgtgtt 1230360

gacactcagt agatatgagc tggattact tgtcctgtca gtgtctcagt gttctcatct 1230420
gcaggaggag aagatagtaa tgagacctct ctcatctact tgtgaacaac taaataagaa 1230480
gtactacata ggctgctgg ctttactca cagcactcct cctgtctagc ctctgaatg 1230540
ttaggattac cataatagct ttcaagttcc caatattcct gatttaggga atgtcattgt 1230600
gtggatgtg tggagtcag acagagacac acagagagac agaaagaggt atgcacaggt 1230660
gccctctcca tgcagggtc atggtggcca gaggctggct tccagtgtct ttcacaataa 1230720
ggtttctata gcttattttc ggagccatgg tctgtcctg acctgaaac ttgtgattt 1230780

ggctaggctg gcggccatg gaaccggag gattatctgc tgtctccacc cccacctcc 1230840
agcagtagga ttgcaggtat gttctgctgt gcctggctct tatgaagatg ctaggggctg 1230900
acggaagatc cttatgttta tgtttgtgca gccagtactt taccatgga gccatctccc 1230960
tagccctcaa caccttttt aaaggtcaaa aaaacagaac aaacaaagaa accaaccaag 1231020
tttgcttget ttctaattag agcatatcac ctgttttgtt atgtaattgc tggcatcttt 1231080
tatctctcct ttctcaatgg gagtcttaag agtctaattc aggcttgggt ccaagtgctt 1231140
ttccttcagc gagccatctc acctcaagt ttgggagaca ctattgttag ttcaggaag 1231200

cctgaggaat gcagtcata gtcaggcaag cacagtgaac tgtatcctgc tcttgacttc 1231260
cttctgtga atgggaggca ggggtacagg tgagtagtgg gttgcccttg ctttctggt 1231320
ttcctgatg ggcattgctg cctctgtcc atcatgccag cttcagaca cccacacta 1231380
ccatatatgc tactgtgttc caagttagct atgaaataga ggatgacctt gatgtcctct 1231440
taggtcctcc ttgctctact tccaagtgc caccatgcc atcacaagc acatatatat 1231500
attattttaa aagcttgagc aggagaagga gagagactaa ggtagatata ggtccttctt 1231560
gtactttgtt tggatactg ttcatcattt tgaaaaaatg agctgggcag tgggtggcga 1231620

tgtctttaat cccagcattt gtgaggcaaa ggaaggtgga tctctgagtt tgaggccagc 1231680
ctcaaggaag aaaggaagga aggaaggaag gaaggaagga aggaaggaag gaaggaagga 1231740
agagaaaaag gaaacctgtt aaattctgca cttccctttg tgctctctaa cataacctg 1231800

cctggaaagt cagccacttt tctgacatgt ccgaccatct gtactgtaca ctaggtaggt 1231860
 catatgagac tggaaaaatc gtgggctcag cagctcattc gtttatgcag ccaaattaac 1231920
 aaaccctaga aatccgatgt gaattgtgga atctgtagta attactgaac taaccagatg 1231980
 ctttttatct cattgctggc ggggtggggtg gggtgaggag agatttcagt ctctgggctc 1232040

 gttggtctag gggtatgatt ctgcttttgg gtgcgagagg tcccgggttc aaatcccgga 1232100
 cgagcccagt ttttttactc tccatctttt ggaaaaagct gtgaagttcc tectgttaag 1232160
 accccagaaa acagcaagac aagagaagag aggatagcct ttccgtgaaa gttgattggt 1232220
 tagaagtacc ctaggaactt ctataattgg tgcctttgaa ctacagatcc agagactggt 1232280
 cgaccagat ctactggata ttccgaggtc aaccacacct gcagcggaga ggaatttcca 1232340
 actctgaact gagtaccggg tcccgcagag cggctaggac acagtgactg tctggggga 1232400
 gggaggagaa tcgcaggcgg ggaccagga gtacgacctg ctgggtggtc catctgcacc 1232460

 acccgtgtgc accctttcgt cgggcctgag gtcacgcgtg cgacgagcgg ctagtccagt 1232520
 cagtaggctg gcggctctca gcagctgcct cttatccagg ttttggcctt tctggtgggc 1232580
 gaggagggac tcacaagcgg gaaatgctac agcagcttcg ctataccaca ggatgcctcg 1232640
 ccgccgactc cgtggccggg atcttgaag gaccgtctgt cttgagcagt gactgtgacc 1232700
 tctagagcgc gggcttccac gtggcagcga gaatcgccag ccaagcacca agtagcatcc 1232760
 gcgggcccag atcaaggga agcctcacc gcgaactaag ggtttctcaa tttgtcgtg 1232820
 atggagaggg accagagcga tagagtcct cttactaca atctgaattc aaacttcag 1232880

 ggcgtgtctg aaatctgact ctcttccag ctctgtcctt caggtcccgc cctagacgt 1232940
 ctgaatggtc ataaaatgga ccaggagggt aggtttgtgt ggctcgttgg tctaggggta 1233000
 tgattctcgc ttagggtcgc agaggtcccg ggttcaaate ccgacgagc ccatacttat 1233060
 gtaaattgta ccaggctcgc aacctactat actaaccttt taaagaccta aaactctcgc 1233120
 gcccagtgtt acttcataga aaacagctaa gtcttgccag gtgatggttg ctcaattctt 1233180
 taatccccac acgtaaagta gaagtgtga atctctttga ggtttgaggc caggctgatc 1233240
 tacaagatt ccaggacaag aatgaaagt aaacaaaaac aaaaccagca gcacgtggtc 1233300

 caggaggaca aagttgtaac ttttgtttg ttttgtttg tttgtttgtt tgtttttcaa 1233360
 cacatggggt ctagataaa gagtcccgc tctaataccg gctataatgg aactaaactg 1233420
 tagaccaggc tgcctcaaa ccacgatccg cctgcctctg cctccaaagt gctagaatta 1233480
 aagatgtgca ccaccactga gggtttaaca tttaaaaaaa atatgttttgg ttttattatt 1233540
 tattgggggt ggggggtaga ccaaagaaca catcatggaa gtgggttttc cettaccacc 1233600
 atgtgcgtcc ctggggacgg aactcaggtg gtctcccag ggaaccagag ctgatgaggg 1233660

gagctggagc ttggatagaa agagtggcat gttagaatga gagagcccta gttccacaag 1233720

agggtttatt taggtttaat cataggggaa agttgggcta gggaaagcct actggttggt 1233780
agttttgttg ttaccagact ttgaatctag gagctcaagt caagcactac ttcttccage 1233840
agttttctct tcttcttcc ttccttctt ccttcttcc ttccttctt ccatcttcc 1233900
ttcttcttt ttcttcttt ctttcttct tcttcttct tacatttct tatctctgtc 1233960
cagcgtgtgc atgtgtacat gtatgtgtgt atgtgcatgc atgtgtgtgt gttcgtgtat 1234020
gtttacgcat gtgaaagtca gtgggcaact ttgaggaact ggctctgtcc tccagttcac 1234080
catgtgcagt ctggggactg aactcattca tgcttggcag caaacgcctc taaccacaga 1234140

gccatctcaa agtccctgtt ttgttttatt ttttgttta tttatctatt ttttattta 1234200
tatattttga ggcagcattt ctctgtgtag ctctgactgt cctggaacac gattttagg 1234260
ccagactggc ctggaactca gagatctacc tgcctccacc tctgagtgc taggattaaa 1234320
ggtgtgtcac tacactcagg tctatTTTT taagtagtac attgaaatat tacctggtac 1234380
atTTgggagt cagaaaagtg attaactaat aagttattaa tttatatttt ctTgagggaa 1234440
aaaagttct ttgaagggca aagcttctgc cccatactct agctatgtca tttgtaaggc 1234500
ttagtgtaaa atgaaaatgc agggcctttc atataacaat ttagagattg tcagaggggg 1234560

gtgggaggtg gagggTgggg aaaggaggat atgggggtgg gggtacatgc cttttttcc 1234620
tcagcactcg ggaggcagag acaggatctc tTgagtttg aggccagcct ggtcctcaga 1234680
gtgagttcca gaacagccag agctacacag agaaacctg tctcaaaaac acacacacaa 1234740
gaaagaaaga aagaaagaaa gaaagaaaga aagaaagaaa gaaagaaagg aaagaaagga 1234800
aatacctTgc aaccagattt tatggcagca ttttctcaat taaagttccc tcttccaga 1234860
taactctagt tcatgtgtca agttgacata aaatgcgcca gttgcaaggc agtagtgaca 1234920
cacaccttTc atcctagcac tcaggaggca gaggctctca gatctctgtg atttTgaggc 1234980

cagcctggct taccgagtga gttccaggac aggttccaaa gctacagaga aaccctgtct 1235040
cggaaaaaaa gaaaaagaaa gaaagaaaga aaggaaggaa ggaaggaagg aaggaaggaa 1235100
gaaagaaaga aagaaagaaa gaaagaaaga aagagactag ccagcacagc acagcaggtg 1235160
ccagtgatgg caattatctc ctcaaagagc attcaagggt atacctctct gcaagagaat 1235220
atgactgtct agggcacacc ctgcatgcca ccatttagag tttcacctga gagtgcaaaa 1235280
tgtaaaggca gccattTgtg aagccatggt aaagatggga acgtgtaagg ttctgcccc 1235340
gatagacct aaaaatcaa gtagtactga ctgctgctt ggaagtctag gctgaaatca 1235400

cagaaacttt caaagagctg gaaacattag aggttacttg cccaacccaa gggcctttct 1235460
 acagctggta tgtgacctgt ggagatggca gacagatccc agagaagact ctggatatag 1235520
 agagttaaat aaggtaagca cccccattta taccactgtg cccaccattg ttcttttgac 1235580
 aggacaactg aaaaagtcat gatatctttt catgttgtgt tggacctttt ctttctttct 1235640
 tttttctttt ttgtattttc ttggtgtctc aattccaag gctaatttgc atttagagga 1235700
 gcattggggc actcatgcaa gattaccttc atacactatc tatttggcaa ggaagaagg 1235760
 cccaggacct cgttttcttc tgcctcctct cctttttgaa aaagtttcac tacatacagt 1235820

 atagtctctg aaggatttat ggtgtgcacc tcaaggaggc aggatgagca gtcagcccac 1235880
 aaaatgcaca agggcagagc tcagctgtga aattcctagg agtatTTTTT tttcccagta 1235940
 aatgcatat cacacccaac aacttagcta aaaggtactg tgtgtgtggt tggtgccaaa 1236000
 ataaatcat aaattgctca agaggtact gagtaagcta agagcctcga aagatcattt 1236060
 gtgtagaaa tcaccagaag ttcaggagac tatgggaaaa aatgacctga gcaaacagtc 1236120
 ttaacagggt ttgggtccca gacatggaaa ggaaggaag cagtacacca tgctagaaca 1236180
 gcaattgctg acgaatgtga aacacttcaa aaggtgggac ccgccaccgc aataacagtg 1236240

 aaggctgctt atctgcctga aggccacaac tcttactcca gtggcacaga atcaacttg 1236300
 ccaaagatgg catgcctagt tacagcactg tgagtgtggt gtctgtctc taataccatg 1236360
 caggctgtgc taggaccagt gttctttega gcttctgtac cteccccagt gattgtccca 1236420
 agagctaaaa cagataaagt gctaagagaa acaccatctg tttgtacatg cctgctacat 1236480
 ggatggcata ggtaaggga ctaaacagga ctgggcagct gatgaaatgc aatgaacac 1236540
 tgacaccgtg tgctggaga gagaaagaaa gcttagtcag tgggctaagg taagagcaga 1236600
 gtgggtaata ccagttcatg agctttacc tgtgacaatc tgtattgaca gttgttgggc 1236660

 tctattcagg aaggctgac tttatggata tcccagtggg aaaagaactg gcaagtctg 1236720
 gttctaccac catggggaca gcagatgctg aagtttataa tggagtttgg ccagagtcag 1236780
 tagttttcca tgtggcagcc ggtagctcat tgagttttgg aatcaggac gcagacgcac 1236840
 ttaccaaaact atacgccatc ttccccaca gaccactgga ggcgctttac agcgcttgtc 1236900
 taaagtctgg tcacaggctg gaaagtagct gaagctacca acattcccat gaaatattct 1236960
 gatattctgc atgataacca aaaatgtgag gcatgttcca aattatgaca tggagagact 1237020
 atacagggcc tgtaaagtgc agtaggtctg caaatacgtg ctcacctgag gacactgcca 1237080

 caagcccact gaaaacattt ttggtattt gtgtggaag cagtcagtgg ggaagcacat 1237140
 tggtagtate caaatcagta ttacataaga cacacccac acccagaaaa tggataaaaa 1237200
 ttaagggcag tcatttcaca atcactggtg caaagaactg agttaagac accaggacta 1237260

attctacttt catttgTTTT acaactctac acaggctata ttgattgaaa taaataacgg 1237320
 gtaattgaaa caaaagttaa acaggGCCaa acagatggct cagtggctga aggcacttac 1237380
 tgctctttca gaggacctgg gtcacttcac aaaaccaacc tcatatagat cacaactgct 1237440
 tttactcca gcccctggg tccaatgcct tcttctggcc tatgcagaca ctgaatgtac 1237500

 atggtacaca tacatgcact caggcacaga cacgcacaca ttgaataagt aatgaatac 1237560
 ttatgaatac ttttattttt actttattta ttttgTTTT tttggggggg gataggattt 1237620
 ctttTgttaa cagctctagg tgctcaggac cttactttgt agactatact ggcttcaaac 1237680
 tcacagagat ctgcctatct ctgcctctcc agttgttagt atgaaagtg tgtaaggtea 1237740
 gtatgtacct ttttttttt tttttttga gacagggttt gtctctgtat agcagtcctg 1237800
 gctgtcctga aactcactat gtagaccaag ctggcctcaa actcactgag atacacctac 1237860
 ctctgcctcc caagtgcctag gattaaaggc atgagccacc acctgggcca gtatgcactc 1237920

 ttagccattg aaccatccca ccaaccctta gacaaaagta gtttttaaaa gaaggcactc 1237980
 ccggaggtea taaggttatt gaatgaaaaa tccaatgtc agaagtggac ttcctgtgg 1238040
 gtTgtgggccc cctgaggctt cacattctgt aaaggctatt gccgttgata tgggttgat 1238100
 gctggagctg gacattacat tccattgca gaagacagca catgcttttg ttgcagagca 1238160
 tggagaaatc aagctgagac ggagctagag gtgcctctc cactgattgg ctttctggt 1238220
 tctggaagge actacacagg ctgctgagca aaattggttg ttgacagtcc aatttaatga 1238280
 cggacactgg actctgtgtg ctacactatt gtattactta gcatttctat tgctatgata 1238340

 aaacatcatg gccaaaacaa cctgggaagg aaagggttta tttctttta cagctcgtaa 1238400
 tccatcatcc agggaagtea gggcaggaac tcaaacaggc aggagctgat gcagaggcca 1238460
 tggagggtgc tgcttactgg attgtctc ctggcttct caacctgctt gcttgcttcc 1238520
 tttcttctt ccttcttcc ttccttctt ccttcttcc tttctttct tecttcttc 1238580
 cttcttctt tcttcttcc cttcttccg tcttcttcc cttcttctt tcttcttcc 1238640
 cttcttctt tttttttt tttttttct tttttttcc tttttttct tcatTTgaat 1238700
 tagaaacaag attattttac atgacaatcc cagtTcctt ctcctcccg tecteccta 1238760

 ccaccccc ccaactaaaa ccctgcctat ggatggtgag gccttccatg gggtatcatc 1238820
 agagtctatc atactcttg ggatagggcc taggcccacc tgagtctgc agctggtttg 1238880
 gggcaggacc atttctctt agtgttgag caagtgagg gcaggtccaa ctctatacag 1238940
 acctatctc tcccgtacc aggagccaca gacatcaaca caaactgcag cagggccatg 1239000
 gaccagagt gggTcccagc ttcagctcag tactcctcc ccataatcac catggagggg 1239060
 ggaggagcaa gccactcacc tcagctgct ccttactgct ttaaccttt cacatatgcc 1239120

tctttccgca ggacatgaac cattctgtct ttctttttat ttatttattt atttatttat 1239180

 ttatttatta gtatacaaca ttctgcttcc atgtatatct gtacaccaga agagggtacc 1239240
 agatccagat ctcataaggg atggttgtga gccactatgt ggttgctggg aattgaactc 1239300
 agggcctctg gaagaacagt cagtgtctctt aacctctaag acatctctcc agccctttta 1239360
 aattacttct tttgtgattt ttatgttgct tttttaaaat tttatttatt tattatgtat 1239420
 acaacattct gcttccatgt atatctgcgc accagaagaa ggtaccagac ctcataacag 1239480
 atggttgtga gccacatgt ggttgctggg aattgaactc aggcctctg gaagagccca 1239540
 acccccccc ccattctgtc tttctttcac acatacattt gcttaccata atagttacca 1239600

 gttgcccttg ttttctctc tgctcccagg gcagactgcc aggcattgcat gtgtctcctt 1239660
 gtcccactca gtcatagtct taagatttat tttattttat ttttattttt attatttttg 1239720
 gtttttcaag acagagtttg tctgtgtagc tttggagcct gtectggcac tgcctctgga 1239780
 gaccaggctg gcctagaact cacagagatc cacctgcctc tgcctcccga gtgctgggat 1239840
 taaaggcatg tgccaccaat gcccagcaag atttattttt ttaaggtgtg tgtgtgtgtg 1239900
 tgtgtgtgtg tgtgtgtgtg tgtgtgtgtg ttgcctgcat gtaaatacag atgctaccag 1239960
 ggaagagggc aciggatccc ctggagctgg agttacaggt agttgtggac cggctgatgt 1240020

 ggggtgctggg aactgaactc aaacctatgg agagtggaaa cagcaaggga tgcttggaat 1240080
 ttgttttggc atttatactt aataattgct ttatggcatg atatgtgctc attttaacaa 1240140
 atttgaatgc aggaaaaaca caaaatcaa aataaaaagtc atctagattc ttactacca 1240200
 gacactgtgc taatcataga tataatggaaa cgattttgta taaacaaatt catgatttca 1240260
 ttccgtgacc tactgtaatc aagcacagca tgaatcatgc caagtcaata aatatgatgg 1240320
 gacgtggtea ttatacttga ttaacagtgc aattctgaat atatgtatta taactcattt 1240380
 acccagttct gtttctgccc aacttttgat gctactgttc tagttagctt taacctcag 1240440

 ctttacacag cctagagaca cccaagaaag gaacatcaat tgagggattg cccagaccag 1240500
 actggcctct gggaatgtct ataaaggatt gtcttgattg ttaattgatg caggaaagcc 1240560
 cagtccattg tgggcagcat cctcccacct aatcaggtga cctgaattgg agaaaaaatc 1240620
 tagctaagcc tgaatgagca gtcagaatgt ccatgttttc cactttaagt ccctactgga 1240680
 gttttgctca acttacctca gtgatggact gtaacttgta agctgaaata aaccctttcc 1240740
 tcccctgtgg ggggggggcg ctaaaaatca attatggtat tttggataca gggcctcaaa 1240800
 ctctatccca ggagctcgaa tctcacattg ccttttagat ggcagctggt taccaccaga 1240860

tggcttggcc tcagtgagga atgtctccta gtttgcctaa caacagacct aggccctggg 1240920
 tgagcccaca cctattttga gggcttgtat acatgcctag ggactgggtga gaggctgggtg 1240980
 aagacatgca gttttagggg tgcctctagg attaaaggaa atatttgata tcagctttat 1241040
 acatgataat agatgtcttc tgatatcacc cccccatgg ttggaaagct atttaagagg 1241100
 atgcttgaat aaacatgga ctccagtctc cagcatggac tgagagccct cctgagatga 1241160
 caagatatgt ctttgtctca tccttaacac cgcgaggtag ctaggagttt ccccaggtec 1241220
 atactctccc actcagggat ggaccagggt ctgtttggat ggctccaatt gcagcccaaa 1241280

 agacatcagt ccagaataga tggcctctgt aacataggac tgatacaggc agaaccctgg 1241340
 ctctcccctt caittctttt tgtcagagtg tttatcacag caacagaaag caagtagtac 1241400
 aggtaccaat atgtgttalc ctcaactcat agctcacagc tcacaattgt tcagctattt 1241460
 gatggtcgag aggtagtatg ctttcaatag aaaccacttc tggattttga tctttttccc 1241520
 aggtgtgata gcittctgac aagggtgtgt gaatgtaaat catgttagga tttctgctgc 1241580
 tatagcaaaa tacatgagtc gtatacattt atataaatgt acacagagag aagtttcatt 1241640
 ttggtccaca attctggagg tttcagccca tatctgaata ggccctgttg ctttggactt 1241700

 gcagcaagac agcacaccgt ggcaaggaga gcatggcaga gccaacctct tcatgatgga 1241760
 aagaaaagag ggagaggggc ctagcttctt tttagccctt tcaagtgcac aatgaacca 1241820
 aaagacccca ttgcataact cccactctt ctaagtagca tccagttaga ggcaaacctt 1241880
 ttaaaactac atggacactc aggggcattc agcatcaaac tgagcaccaa gctaagaata 1241940
 tgtgatagtg cttgttcaat atgccgagtg gcagctctca ggcagcatga gatcaagatc 1242000
 aataactgat gctgtgaagt atgctgtgtt gtcagacat gaggttgggt ggtgtattag 1242060
 ttatatgtgg ttttattgga atatcttaca ggctgatgtc caacaatgac tattgtgaat 1242120

 gggaagtcca agaactctgt agctgctcta ggcccacagg gctgggtgtc tcagctggaa 1242180
 tggatgtgct gacaaggcga gggaaaatag gagaagggtg agcacatcct tccttcttcc 1242240
 attattctta tataggcttc caaaggtcta catgcatgtc tgtgtactaa gtgcatgcag 1242300
 tgtctgtggt ggccacaagg gggcattaga tcacttagaa ctggagttac agaccactgt 1242360
 gagctatcct gtgggtgcaa gaaaacaagt ctgaggtgct cttagattct gaaccacctc 1242420
 ttcagccctt aaaagcattt ttgtttcttt gagacagggt ctactatac cgttctggtt 1242480
 gtccctggagc tcaactata agccaggctg gccttgcaat catagagatt cacttacttc 1242540

 tgctcccc aagtgctggg gttgaaggca tafgccacca ctgccaggcc tttttttcca 1242600
 gcagtttttt tcaggatata attcccacat ttacataaga acaactgagat aaatactttt 1242660
 gtgcatatata ctgtcaccat ttttaggtgt agaagccatg acggaggtct cagtgtcac 1242720

agatgagcac taggggaacc ataaacactic agggttgttc cttgaaagga aggaatgcag 1242780
 tatatgttat ctgccagaa agcagagagt ggacatgctc tctagcttgc tgacttctgc 1242840
 tctacttgag tgggtgggaga ttcttccagc accatcagat cctctccaga tccttcttgc 1242900
 aaatttgttt tccccagaat ttatagaacc catctttatg gactttaaaa gggttttgat 1242960

 gcagtcatgt ctgttctata tttagctttc ttgttcccc aaagagattt atgtatgctt 1243020
 tgttggaac cagggatgga gctaatac c actagaataa attttgctaa attgtgctat 1243080
 gcttaaatag ccctaaaata aactacttgg ggtcagactc ccaaagttg aaccaatact 1243140
 ggcatctgag tctgtttaa cctaacttca ttcttgctta ccttggatca tcacattcct 1243200
 ggccctggag gtcacagga gagaccctg catttaagaa cattcatata tgccaggaga 1243260
 tggctcctga taactttaat cccagcactt ggaaggcaga ggcaggtggg tctctttgat 1243320
 ttcaaggcca gtctggtctg cagagggagt tctaggacag ctagagctac acagagaaac 1243380

 cctgtcttga aaaacagctc ttaggagctc gagacaaagc tcaacagccg aaagtcctta 1243440
 ttgctcttgc aatatggata tagcctcagt tcccagcacc cacaaccatt ttaactctag 1243500
 ttctagagaa tttagcagaca ttttctggcc tccaagetca ccagacatcc acatacatac 1243560
 atcatttate tatttatgc ttttttgag acagagtctc tctgtgtagt catggctgtc 1243620
 atggctgtgt agtcatgaac tctcattgta gaccagctg gccttgaaca catggagatc 1243680
 cacttgctc tgcttctgga gtgttgggat taaaggggtg tgctaccact gcctggatag 1243740
 attttggttt ttcaagacat ggtctttctg tgtagtcctc gctgtcctgg aactcactca 1243800

 acaccacatc tcaaatatgt ataactttta aaataaataa ttatttattt ggatggctgg 1243860
 catggtgga tacacctta atggggcag cacctgggag gcagaggcag gtggatctct 1243920
 gagttcgggg acagcctggt ctacagagtg agttccagga cagccaagc tacacagaga 1243980
 aatcctgtct caaaaaacca aataaaataa aataattgt gtattttaac tggaaaataa 1244040
 tatttgtgta ttatctgggg tctatttgtg tttttatct ataatgacat ggtagaaaga 1244100
 gtcagcaag ctatttacct tgcctacttt ttttttaag gtgagaaca caaaaaacta 1244160
 ttgtagcaat ttagtctgg ccactagggg gaagagtgga aagccaaaaa tttcagatgt 1244220

 cttccagaga tgtgtcctgt aattaagtgg tgttagcttc tcctgtaata atagtacat 1244280
 agagacattc ttctctgttt ctttcatgaa agattgattt taaataaagt ccattcccca 1244340
 tgcacacaca ttctctctg aaaataatgt agcatgttga gtcaaagagg tagatacaag 1244400
 agatcatata ttgtgtaatt ttgttaaatg agacatccag agacgacaaa actgtacagg 1244460
 cataaagtag attggcagtt ggatggteca gaggtcaag aactaggggt cacagttctc 1244520
 tctctctctc tctctctgtg tgtgtgtgtg tgtgtgtctc tctgtctctc tgtctctctg 1244580

tctctctc tgigtgtc tctctgtc tttgtctg tctgtgtc tctctgtg 1244640

tctctctg tctctgtc tctctctc tctctgtc tctctgtt tctctgtc 1244700

tgigtgtc tctgtgtc tctctgtc tctctgtc tctctctg tctctgtc 1244760

tctgtctg tctctgtc tctctctt gtgtgtgt gttaggtt gctagagac 1244820

tagctcagca attaaggga tttattctc ttacagaaga cttagtcca gttccagca 1244880

tccacgtag ggcataac aatccaac tccagctca ggtgatcaa tgcctctc 1244940

tgcctctg agacgtagg tacctatgt gtgcacagac atactgcta gaaaacacc 1245000

catacacata aaataacca gaaacaatg ggcctggaga gatgggtg tttatgagt 1245060

tctggatgct ctccagagc tcaggctcag ttcccagtac aacagcagat aatagcttc 1245120

tgtaataca gctccaggag agatgatgcc ctctctggc cgccacagcc accaggcata 1245180

ttcttgtag atgcacagc gcaaaatgcc cattcacata aaataaaagt aaagaaagt 1245240

ttacataaa aataaaatg attcaggcc agtctgtct ccagagcag tctaaggata 1245300

ggctccagag ctacacagag aaacctgtc ttgaaaacc aaaataaata aataaataa 1245360

ataaaataa aataaagcat gttatttct ttcgtaggac cttacaaat gtgggttt 1245420

gtttattgt ttgctttgt tttttgtt tgtttgtt tgaggcagg tttctctg 1245480

cagctttga gaccagctg gcctcaact cacagagatc tgctgcctc tgctcccga 1245540

gtgtggaat taaagtgtg caccaccgc tggctcaaaa tgtatttag atgtgaaatg 1245600

ttcccgcga ggcttatgt tttgaatac tggctcccag ctaacgatga agtttggaa 1245660

aactgtttg agttggaaa ctgtagtgg agcgtggga gaggaagtac atcactggg 1245720

ctaggcttg aggtcttga gtccagact acttctgtt ccttctctg aacactgact 1245780

gctgataca cgtgacaagc tggcctgtg tgatagact tatctctat gaacgtaag 1245840

ccaaaataa ttcttctca ttacattgc tttagtcaga atattttta atgattatt 1245900

tatttattac gtatacagt ctctgtctc atgtatgcc gcaggccaga agaggcgcc 1245960

agatctcatt acagatggt gtgagtcta ttgaactcag gactctgga agagcagca 1246020

gtgtcttaa cctctgagc atcttctag tcccctagc agaatattt atcacaaca 1246080

cagaaaaca gacaagagta ttactgtcc aaaatccaga tcttactta tccctagc 1246140

tatatattac attctgatg attaaaccg aaattcttc aaggaaatc ctggaataa 1246200

agagaatat ttcaaacat tcaaggaat ggaattttt aaagtaatt agaattggc 1246260

agaggggaa tagaatcaag taatatctga ttcttaaaa gccaaacag gtgaaaggaa 1246320

atagttacga ttcaactatc catacatcat gtctggacac cttgcagaac tttttattat 1246380
 ttgtatatgg gagaacaaca gggcttctc tgacctctg tatccaggag accaatgaga 1246440
 gggaaagctg atggcttctc gtggtttttg ttttcttttag tttttttttt tttttttttt 1246500
 tgaagaaaga agggcatggt tgaactcaga acctcatgct ttgcttgcta ggcaagggcc 1246560
 ctactactga atcagagccc cggcatttgc tttttagtct gggtcagggt cttactaaat 1246620
 tgttcaggct ggccttgaac ttagaatcct ttgcctcag cttcctgggt aactgggttg 1246680
 gcaagcctgt aataccaggc ccagttacta tgttcttctg tgatctgact gtggagtcta 1246740

 ctttagctgc cacattctgc ttccaatat ccattgctgac tggaggcagg ctttactgcc 1246800
 ttaatctttc gtggatgigg agagtgcagt cctggattgt ataccaggat ggcctcaaat 1246860
 ttagagagct ctctggcag gtctttaatc ccagcacgca ggaggcagag gcaggatgag 1246920
 ctctttgagt tcaaggccag cctgatccac atagcaaat ccaggcagcc aaggctacat 1246980
 agtgagacct tgggaagaga aagggaaaaa aagagagaga aaatacatat ccaaatatgt 1247040
 tgccttctg accgctacac ttattgcaca catacacttt ggcacacata gacacacata 1247100
 catacctaac aaataaatgc tttacaatc ccataaatac aggcctttaa tcccagcact 1247160

 cgggaggcag aggcaggcag atctctgtga gttcgagacc agcctggtct acaagagcta 1247220
 gttccaggac ccaactcaaa gccacagaga aacctgtct cgaacccct cacccaaaaa 1247280
 actcaataaa tacataatgc aatatatgat aattatataa tgcaagtta ttttatttat 1247340
 ttggggataa taatgaaaa acagaaatag attatagtag gaggagtaat ttattttcaa 1247400
 atattcagaa tatcctctga aaaaagccaa gaggataaaa aggagagggg aattgaggca 1247460
 gactatgggc gggagtggg actgtggaaa aaaaattaaa gctaaccct gatggctatg 1247520
 catgtctgca aaacagcac ttgggaagtg aaggcaggat caggtattca aggctatcat 1247580

 cagctgcaca gcaagttaaa ggctagcctt ggtacatga aactctgtt caacaaaaga 1247640
 aaaactaagg aagtgggctg gaattgtaac atatacggta gatcatctat gtagtatgtg 1247700
 caaggccatg ggttcaactt ttatcactcc tttcccaaaa ggaacaaaa acaccactg 1247760
 gaattataga ttgtgggtca acaataaat gatggctagt ggaaccatt aagatggcca 1247820
 gctggtggaa agtgctgaag cctgcaagca tacttttctt cattttgctt ttaaattcta 1247880
 attacactta tttatttatt tgtgtgtgtg tgtgtgtgtg tgtgtgtgtg tgtgcatgtg 1247940
 ccacagtaca tgiatggaag gaggtcagaa gacagcttc agaagttagt cttttctcc 1248000

 cgctatggga gtcccagaga tcaaactcag gtccttaatg gtaacagcaa gggctcttct 1248060
 ctgctgggcc atctcatgc ctttttattt tcccacata tttttagcta gaaaattcat 1248120
 ccacagccgg ggtggggggc ggagaggatg cagacagttg cgatgatggc caagttttaa 1248180

caggagaaat tctgcttcag attaataggt acaaagaaac aggaaattaa cttttgggga 1248240
 gaagcaggaa ataccggta gccgaaaaca gtcaacagga aagtaagaat gaaggcagcc 1248300
 ttagaaaacc aggcctcatt actgtcctca cgaatcctc ttttgaagat gcctaccatt 1248360
 ggacaaaaac caatgggctt gcaagaactt acgtaagttc tcacagtaac tttattttac 1248420

 tgatTTTTCT tgaatgcgtt ttaaggtata ctatgacacg gggTgtttgt tcaactagag 1248480
 gagagctagt cactctgata tgaagagtca gttttgaaa tagctgggaa catctcttga 1248540
 gggacagtga agctaaacta attcgaagcg gcagatgtat tcacactggg atgcgcctgg 1248600
 cctgcgggca gcagcagctc ttacataagc tgattaggtt gagctgcttg ctggaccgtt 1248660
 cagagctctg ctgaaccac gccctgcatt tgcctctctt ggtttagtga agacacatca 1248720
 agggcagtgg actagaggag aacaaaataa taatacatca ataatatca tgtctctcga 1248780
 aaataagtga aaatccact tagaatataa caaatgggct ttctactgag aggggaaaca 1248840

 taggctcact cttttttttt ttttcttaa tactcagttt gaaaataaat tctatgtata 1248900
 ttggtgtttt gcctgcatgt gtatatctgt ttcaggatgt agattcctta aaactgatgg 1248960
 gtgctgggaa ctgaaccagc atcctctgga agagcagcca atgctcttaa ccaactaagcc 1249020
 atctctcaa tcttacttct ttagcaaaa cgtttgtatt tgtatttgag aattctttag 1249080
 ttgggcacct gtataatctg aggaaagttt aactggaag ttataattat tttagtgaag 1249140
 ttatTTTTTT ttcaaaatt taacctttc aaatagattt aggttgaatg ccatgaaatt 1249200
 tctgatttct tttttattc tacttttact ttttctttt accaatcca gtccctctc 1249260

 cctcctgtcc ttccattccc ccccaccatc tctccattcc tgcctccca ttcatctctc 1249320
 agggaggggtg aggcctgtca tgggggaatc atcaaagtct ttcacatcat ttgggggtggg 1249380
 actaaggccc tccctctgt atctaggctg agagagtatc cctccatagg gaatggactc 1249440
 ccaaagccca ttcttacct agggataaat actggtttca ctgccagcag ccccatagac 1249500
 tgcctaggcc cccagctga caccacgtt cagggggcct gaaatttctg atttttagc 1249560
 caataaatga tgatattatt cagtgttcta taacagacca gaattctaaa ttaagtccta 1249620
 taatttcate caacaaactt tattttcttt tttttttttt ggggggggtt caagacagga 1249680

 tttctctgtg gctttggagg ctgtcctgga actagctctt gtagaccagg ctgggcttga 1249740
 actcacagag actttgtttt cttttgaggt tttgttttc gagttaattt tgtttgttgc 1249800
 ttgtttgtag acaaaaatct cacagtgaag ccctgtctgg cctcagacat gatttttctt 1249860
 gggatgagat tacaagcatg ggccattatg cccaattca acaaatgttt ttatttgtgt 1249920
 ctcagtgttt gtgtgtatgt attcttacct gtatgccatt gtggatggag ttactgttc 1249980
 cacctgttcc tgttgccatt tagcccaaaa taaacacaca ggagacttta actaatggtt 1250040

caggcttctt attgactagc tctctcttaa ttgttaacc atttctatga atctaagtat 1250100

 acccacgtgg ttttatctta tcagagaatg tccagacctg ctactccttc ctctcttgca 1250160
 gcctctctct gcctcctctc cctagaattc tctgtgtctg gtagcccagc ctatacttct 1250220
 tgccctggcta ctagccaatc tgtgttttat tcatcaacca ataagagaaa catatatact 1250280
 gaaggacatc ccccatcatg ctacaacca tgtgtagtag aggtcagagg acagcttgca 1250340
 ggagtcaatt ctctttttcc atcatgtgga tccaaggat agaactcagg tcattgggct 1250400
 tggaaagcaag tggctttact cgaggagtca ggttacttgt cctcaacaat ctttctgac 1250460
 agccttaata taatctttat tctttttttt taagatttta tttattttatt atgtatacaa 1250520

 cattctgctt ccatgtatat ctgcacacca gaagagggca ccagatctca taacggatgg 1250580
 ttgtgagcct ccatgtggtt gctgggaatt gaactcagga cctctggaag agtagtcagt 1250640
 gctcttaacc tctgagccat ctctctagcc cataatcttt attcttgagc aatttccatt 1250700
 ttaatctcgg cactcgggtg gcagaggcag gcagatctct gtgagttcga gaccagcctg 1250760
 gtttactaga gctagtcca ggatagcctt caaagccaca gagaaccct gtctcaactg 1250820
 ccccccccc cccgaaaaaa cccaaaatgt aaatgagtgc aaagcagaat gataagtgct 1250880
 atggtagaga caagtataag atggcacagt aggagatgtg gctgatttca ctatgaggag 1250940

 aagaaaggtt ttgcagagca gaaggtggct agctgtttga tttctgttgt ggtggtaaaa 1251000
 cactctgaac aaaaagcaac tggtagaaaa aatgtttagc ttgcaggtta tagttcattg 1251060
 tctaggaag ccagatcaag aactcaaggc aaagggctgg agagatggct cagaggttaa 1251120
 gagcaactgac tctctttcca gaggtcctga gttcaattcc cagcaaccac atgggtggctc 1251180
 acaaccatcc gttatgagat ctgggtgcctt cttctggtgt gcagatatac atgaaagcag 1251240
 aatgttgtat acataataaa taaataaaat cttaaaaaaa aaaaaaaga acttaaggca 1251300
 agaacttggg ggtagaaaca gaaaccatag agcaaccctt cctggcctgt ttccaggcag 1251360

 ccgcttcttt tctccttcta ttttgtttt gtttgtttgt tttgttttg tttttcaag 1251420
 acaagatttc tttgtatagc cctggctgtc ctggaactaa ttctatagac aaggctgacc 1251480
 ctgaactcag agatctgect gcctctgcct cccaagtgcc accaagtctg gctttcagca 1251540
 agcttttttc ttttgtttg ttttgtttg ttgagacggg gtttctctgt gtagccttg 1251600
 ctgtcctaga actcactctt tagaacatta gcaagcttc ttatatgget cggacctgcc 1251660
 aattgggagt ggctccacc acaatggccc aggcctttcc ttgtaaatta gcaatcacia 1251720
 aacctggag catctttcca gcccccaca tatgcacaat tgaggcataa atagggtgtc 1251780

agtttcagaa ctcatgtgaa atcattttgg atgtctacat tgtggggaag gaaaatggtt 1251840
 gaagactaca gggaaacaca ataacaaaa taagaggttt tattactta tttgtgtgtg 1251900
 tgtgccactg ctgagaggtg catgaggtga tagtggggag gggtgcatgt gtggagatca 1251960
 gaagactact aggggccggg cgttgggtggc gcaggccttt aatcccagca cttgggaggt 1252020
 agaggcaggc ggatctctgt gagttcgagg ccagcctggt ctacaagagc tagttccagg 1252080
 acagcctcca aagccacaga aaaaccctat ctcaaaaaag actactaggt ggagtcatTT 1252140
 ctcttttacc tttcatggc ttcttggtat tgaacttagg tcaccaggct tgctcagcaa 1252200

 gtatattcac ttagttatct tgctttctcg gatatatctt gctgtccagt gctattaat 1252260
 agatatggag cctgccacaa aattttatca tttcaatcac atagtatgga agggaaatga 1252320
 ggtttttagc tgggagatat atgatcaaat ccacacttta ggaagtatta gttgctttga 1252380
 tatatagttc aaattttgta tgttttggtt tttgagacag ggcttctgtg tgtaacagct 1252440
 ctagctgtcc tggaactcac tctgtagacc agactggcct cgaactcaca aagatctgat 1252500
 ccgactgcct ctgcctcctg agtgcctggga ttacagcat gcgctgcca ccaccactg 1252560
 gcttaatTTT ttaatattag ttactttcct tftagttgtg ccaaagtaac aatgtaaaa 1252620

 tgaggaaaga agggtttgtt tggctcaggg tttgagatta cagtctggca ttttagggaa 1252680
 gttaggaagc cagagcttga ggtgattgat cgcattgcat atgcagccag gaagcagggg 1252740
 agccagtgct gtcaactgct gagecatctc tccagcccca taaacacctt aataacacaa 1252800
 tacagtcact gaaagactga atcagtcctt gccatcttg gctcaaaaca aatttaacaa 1252860
 tcaggataat tggatcatgct agttggtttc tgcttgagat agatttgacc acaaccttaa 1252920
 taaaatTTTc tgttctaag gacgagtga aacatttcta acatgtgaag aaaagtctg 1252980
 ggcaagcaat atgacttagt aggtaagtgt ttgcaaccaa aacctgatga cctgagttca 1253040

 atccctagga cccacatagc gaaagagaga actgactcct gtaagttcta tetgacctec 1253100
 acacatttag tgtgtgtgtg tgtgtgtgtg tgtgtgtgtg tgtgtgtgtg tgtgtgtgtg 1253160
 tgcagcacat atgaggtcag tgggtatttc acaggaatgt ttggctttat gcctggcaga 1253220
 agcaaagctg tgggtttgat tgccaacact gcaataata atacaataat ttggaactag 1253280
 agagatgatg gctcagagct taagagaact ggttactcac ccgagcgggtg gtggcacacg 1253340
 cctttaatcc cagcagaggc agaggcaggc agatctctga atttgaggcc agcctggtat 1253400
 acagagagag tgacagaaca ggatccaaag ctacatagag aaacccctc tcgaaaaaca 1253460

 agagagagag acagagagag ctggctgctc ttccagaggt cctgagttca attcccagca 1253520
 acacatgtgg ctcaacaaca tctataatga gatctggtgc ccttttctgg tgtgtaagca 1253580
 tacatgccag tagaacattg tatacataac aaataattaa taattaatTT tggggggcgc 1253640

ggggtgggttt tgagacaggg tttctctgtg gctttgtagg ctgtcccga actagctctt 1253700
 gtagaccagg ctggtctcga actcacagag atccacttgc ccctgcctcc tgagtgtctg 1253760
 gattaaaggc gtacactgcc accaccatcc agcaaataat taaatcttaa aaagaaatac 1253820
 agtgatttgt tagtgtagt atttatctca tcagtgatca aatctctcag ctaatctatg 1253880

 aggggtttca gcttgtgaaa tgtctctaac aagctcctgt ttgtacagt ggtctcccat 1253940
 cactgggtgct gtattggggc cagtgtagcc tctgtgcagg aagtgtgtct ctgggaacca 1254000
 gcctcagtgg acctacattc aatgctgct tcttatgcaa tgcagccatc cccagcccaa 1254060
 gtctcattgt cgttttacat acataggttt catggttgtg gtttgactgt agaaccaatc 1254120
 tcacatctgg tattagctac aggcagggcc taagacaggg tggttgaagg caatggggga 1254180
 agtaggaaca gaaggtttac cagcagttta cagttggtaa atcttctgt agggcacatg 1254240
 atgttttatt acactcttct tttgtttgag gtttttctac aacagagtat tgaaaagaga 1254300

 agttcacatt taaggtttgc tttctaagac aagagaactt ccttttgtga ataggatctg 1254360
 tagcactttg gtgatgtgtc ctgtgactat taggaaaact tgctatgcac atagcactgg 1254420
 ctggcctgga gctctctatg tagagtatgt agagtatgta gagtaggctg agctactcaa 1254480
 agagattctg cagcctctgt ctccaagtg ctgagattaa aagtgtgcac caccatgcct 1254540
 ggcttgccaa acattctttt ttaaaatttt atttattat ttattttcc tctcagtctt 1254600
 tcattttate tttccctaga tttttttat ttaaattaga aacaatctta tttacatat 1254660
 caatcccagt tcgctctccc tccatctctc ccattgctccc aaccaacctt ccatcccatc 1254720

 ccccttctgc gccccagaga ggggtggagcc ttccatgggg tatcatcaac gctctgcata 1254780
 tcatttggag cagggcctag ggcctcccct gtgtttctag gctgagagag tatctctcta 1254840
 tgggggaatg ggtccccaaa gtccattcgt acacttggaa taaatactga tccactacca 1254900
 gaggcccctat agactgccc ggcctcctaa ctgataccca cattcagggg gcctttttaa 1254960
 aaaatatatt ttattttttt atttattat tgagacagga tttctctttg tacccttgac 1255020
 tgtcgaattc actctgtaga tcagttgtt ctcaaactca tagagattca cccgcctctg 1255080
 ctctcagat gttgggacta aagtcatgca ccaccacca gctttatgtt ttatttttt 1255140

 tatttattta tgtatatgtg tatctgtctg catatgagta gggacagagg gatgtcagag 1255200
 cccctgaagc tggagtact ggcagtgtg agctgccaga tgtgtgtact ggaagttagag 1255260
 ttcagatcct cggtagaaac aatactctct taaccactga accatctctc taggccaggt 1255320
 gccaaacatt ctgattgat agcataatga taaacatccc ggctcttgat ttctgagtca 1255380
 cagaaaccag cctggaggc tttgttgtgt gatgacagcc tctgtccctg aatcattgtc 1255440
 aatcagtgtc tctccttgc agaagaaat atcccaacta aaatagtaac aaagattgt 1255500

gcagaggtgg tgcataccgg ggacagaggc aggcggatct ctgaattcaa ggccagccaa 1255560

gcctacagag tgaattccag gacagtcaag gctacacaga gaaacctgt ctcataaac 1255620

aatatgataa aaataaaatt aattacaaaa caaagcaaag atagtttctg tagtgcttct 1255680

gtgtgtttgt gtgtgagtg actaaggagt gtgtgtgtgt gtgtgtgtgt gtgtgtgtgt 1255740

gtgtgtgtgt gtgtgtggta aataaggagt gtatctgtgt gtgtgtgtgt gtatgcacta 1255800

tgagtgcate tigtgagag tgcactatga gtgtatctgt gtgtgtgtgt gtgtgtgtgt 1255860

gtgtgtgtgt gtgtgtaccg gggagtactt ctgttacatc tcagatgatt cagtgaatga 1255920

tcacctctaa tccatcaggt ctcagattta tggatctcat gaagaattga tactgagaca 1255980

aattaagagg caaatacaag gtgtcagtcg gtcctcaaag tcgtgattaa gccctgtagt 1256040

ttctgtgtct ctacctttca aatcccaggg gcattagctg gtcagtctat aaatttgatc 1256100

catctattcc tttctaact agacacacc accgccaatc atccgaggtg aaattccttg 1256160

gatgcagagg ttctgagca ccgttactgg aagaatggag aatggggaga gggaagcagg 1256220

aaagagcagg aaaacgtgtt aagcaggatg taatctctcc cagggactag cttcagttct 1256280

gaaagaggtg gagctctggg gcactgtact tgagctggtc ccatctttta tectgctatg 1256340

atggtcagtc attggttacc aactgcctgg agtgaggagg ggggctggag agggacgtga 1256400

atagtcatag cagctgggag caaatgttcc cagttaaggg gatcaaaaa aaaaaaaaa 1256460

aaaacgtcat cagctgccgc atttaagtct agtaatgccc caaatcttgc ataactctgt 1256520

gttatctagg ccatctcccc ctaccccacc cgccttctct cttgaagcaa ggttcttcta 1256580

tgtatgtage taaagctgac cttgaactca tgaacatcta tcctcagact ctgagtgcta 1256640

ggataaaacg catcatcatt gtgcctgggt tcaccactc cattcttttc tgggacatct 1256700

ccagaaaagg acttactcct cttcacgcat actggtcacc tcaaaattcc ggaatttccc 1256760

agcatgcttt ggetgcagat catttgtgt tttttgttcc ctcacctggc atgacttccc 1256820

ctccagacac cttcataaaa agacttgctc tgctggcta tgggtgcaca catctttaa 1256880

tgtagcactt ggagagaagc tgctgttgcc aataaagggc cacttccca ccccgtgca 1256940

gtacttgggg ctgataccca aggactgggt gaaggtcatg actgtgaact acaacaggca 1257000

caggagctg ggagaaggtg ccagattctg aggagcaggt gctggtagt gtggagacca 1257060

agagcaaaa agagatcatg gagcacgtaa agaaaattg gggcaagaaa gaggagacc 1257120

tgagggagga ggagctggag aagcagcagc aatctcattc agccagcctt gctccccac 1257180

cctccttagt actgcttgca ggaatgcccc gtgggaagtg gaaggtcagg tacgctgccc 1257240

tggcctgggtg cctgctctga aagctagcac ttaggtctga ggaagatcat tgggatggac 1257300
 tgatggagct ctgcaatgga aaggcctgat agcacgcca ttaaaggac atagggagaa 1257360
 ggccagggtc accagctgct gaacagatgt ccataaaaga tttagtcttc ctgtttaaaa 1257420
 aacaaaaaac aaaaagcaaa acaacaacaa caaaaaatag cacttgagac actgaggcag 1257480
 ggaaatagaa tttgaaggtt agccttagag ctatatagtg agtttgaggc aaaggctgtc 1257540
 tcacagaata aaataagact ttttttttac tgcataatct aaaatgacaa tttcacttcc 1257600
 agctgaaact tgaaaactct acttaactct tatatctaata tttatttgtc ttgttatcta 1257660

 gtctaataa tatttgatt atctaaaata caagccgagg atcactcaa acagtggctg 1257720
 gtaggctgaa ggcaactctgt gagtatttgc tgcatacata catgcatgaa tgattcctgg 1257780
 caggaagtgt aaatcctcag taagcactga actgaaccag aaaagcatgt accctcctt 1257840
 atataacaaa cagggaagg gcagagctct ccagagcctt gctcttcctt cagtaatatt 1257900
 acaaagcttg gtctctttgt gagaggatgt atgcatggag gttaatgtgt aatatatgta 1257960
 cttctatatg tacattgtaa gaatagaaac tccaggcctg gtgagattgc ggctcacacc 1258020
 tataagccca ataccagca aggctgccag cctaggctaa gtagtgagct ctaggtcagc 1258080

 ctgggtcata gatatcgta tcctaaccac aagtctcctt ccccaacaa taagaagaa 1258140
 tagaaacact taagatattc taattttatt taaatgagtt cacatcaaac tcaatagtcc 1258200
 agtcttacac ataacaaga gaaaggcaga gcagaagtca aagagataca gtttgcacag 1258260
 ataactcaat ttctaaaaag gaaaatttaa acccaaagtt aatcctgttt aagctcttta 1258320
 cacagcctga tcttagagg tagaaaacta ttaagacatg taaaatatca aaccccacc 1258380
 aaacatctat tagtaaaagc caaattcttt aaggatatatt aaattctaga aagaaggtct 1258440
 aaggctgcta aaaatacaaa agcaactatg gaattttaca gatcagcctt ggggtgaggc 1258500

 tgcttctgct gtgacctgg tttcttactg tgaatcacac tgggcagagg gttctgagcc 1258560
 caaggagggg ctttcttcta gttcagcact ctcttcgag ctctgcttcc catcggtatc 1258620
 ctcggtgctg acatcagcct ggtcctgagc tgagctctct gcctctgagc tggcttcagg 1258680
 agctgtgctc tcacctctg tagtgggttc aggacctgcg ctggccacct cttcagtggg 1258740
 ttcaggagct gcgactcca cctctgcagt agattcaaga gccgagttct ccacctctgt 1258800
 agtgggttca gggactcct cagtgtctc ccacgggcaa gtctcggtga tcttcagctc 1258860
 aggtcctcc ctaatatgg acgtctccac tagggcatcc tcgccagga tcaggaggc 1258920

 ccctgaggca ggagactctt ctggaggccc agctgccaac tctgggactt cttcagcata 1258980
 taccaattca atttctttt cagaaatttc tcaactcct gaactgtctt teccagcttc 1259040
 tgccacattc tccttttcgc ctttaggatg tggttcatta agcaaagtat taattggaag 1259100

aacatgggaa tagagtggaa taatgcaatc agtttatttt atttaaatc aggagaaggg 1259160
gacatttttt gagacaacat ttaaaaacag ccttgcttag tcatgaatct gccatgtaac 1259220
ctgggatgac cttcaactcc tgatcctcct gctccatfff ccaagtattg tgattatcct 1259280
tatcctccca agccatcctg ctggctctaa tactgtttcc tagtaccaa ataaaaaatt 1259340

aaaactgaat gcccgcctt gtggcgcaca cttgtcagtt ccagcactcc agaggtggcg 1259400
gcaggtagat ttttgtgagt tcagggccag cctgacctac atagtgaaag tetgtctcaa 1259460
aagaacaaaa ccaaacaaaa ccaaacaaaa aatccacact accacaaca caacaacaaa 1259520
aaaaccctca aaccaaacc aaacaacctc tccccgaaa caaaacaaat aaaaccacaa 1259580
agcaaaacct gactcctgag ctgctaataa ctctgttctt aaatagtagt gaccacagta 1259640
attgatagta acgtcatagt ctagatagaa aaaaaaaaa cgtataattt aaagtaatta 1259700
gcttggcgct ggagagatgg ctcagtgtta agagctcggg ggtgggggga agaggtggct 1259760

gctcttacag agaactaggg tttgttgccc tgcaccaca tggaggctca caaacatccg 1259820
taattcggct ctgggggttc tctcttctga cctcttcggg gagaggggga gggatgcaga 1259880
aggacagga caggacacta tgacaactgg gtatatgata tgtagcatac atatctccat 1259940
gcaggcaaaa cacacacaca cacacacaca cacacacaca cacacacgca tacataaaat 1260000
aaaaatgaat cgttaaaaat ttaaaaaatt taaagtaagc tgtttgagc aagaaatgga 1260060
tgtagggta aaactgtaa gtttctgttc ccacgggtgc cattttccag gctcaggggc 1260120
tcaggaatga ttcaactcat gtaaagcata ctttgagaaa gacacatgga tggctgctggc 1260180

caaaaccaga aaaaaaaaa aaaagcttat aatttaaac aatatggggg gagtgaaacg 1260240
tcaaactgct gagacagatg ctaaaattat gcttgcatga atgggtgtct ggtagt agaa 1260300
ataatattac catacagaag aatggaact gcctctcagc aagcagaata cagagaaact 1260360
cgctcattta ccaaatgcac tcatcatag ctagtaactc taggggactg tgatcttct 1260420
tctgagtga atccctacac atagcaactc ttgattaagt tactaaagaa atgaaagaaa 1260480
gaatcaagtg gtggttcata tctgtaatcc taggtcaaga agtggaggca ggagtatcac 1260540
aagttcttg gattcatgag acctgtttct aataagtaaa caataagaag ttcactttac 1260600

ctgcaagtgg ctgtaaccct ggttttgtct gttctctcac atctgtgaca cgttctgtat 1260660
gtctgacttg cttgatgtg acagccttgt aagtctgaaa gaaaatgtgt gcttagcttt 1260720
ctttctccct ctctaagatt catcatattc aattccctat gcaaccacca ttagaagttt 1260780
caagaacaat ttcagtatcg cacagaagag aatcaatgc ctgctcacca cttaaaccaa 1260840
ccccctctt tggagacaaa cctgtcteca taagggtcct ttgctggtct ggaacttggg 1260900
atgcaaacca gaatgacctt ggactcagag cattggatta aagctgtgag ctagcaagcc 1260960

aggcacatga attctttaat aggtctttaa gcacttacat aatatccacc agcactgact 1261020

gtcacaccta caaccaggta ataaatcata ttggaccagc atgttccagg gaatttgctg 1261080

gatgacactc gacgaagaga tgctaggaaa acaaatttta aatatggta cettcaccac 1261140

ataagtatgg gcgtcttcag taattacagt ttttggcatt ttttcccta gtgaacttgg 1261200

aacctattaa cacagtggat tttcacttta gggaaacacag cattagaggt ggggtagta 1261260

atttcatcca aacagcctct agtctatttg aggaaagatt tcgaagcctg ccatcttgat 1261320

attaacatc agtatgggaa gatgcagatg aggagacatg atagagaaac taaacaagct 1261380

tagtggccaa atgaaatgca aaagaatac agtctcccat atatatcca aacagacatg 1261440

agtagaagta attatcttc tttttctctg tttttcttc agctgtccac ttgagaaaga 1261500

aggaaatgat tgctttaaaa agttaattaa gtacacttat acctaaagat aaagcttgca 1261560

cttaatgatg ggtggaacac atgcttagaa tgcaactgac cctaagcctt gtccagaaaa 1261620

gatctcactt ctggctgaa gccagtcaaa ctctcttgc tcagccccct gaacacaggg 1261680

atcacagcca catggctggt ttgcagtgag actttctttg gcttaaaaac aaatctgtga 1261740

tctggatgtg catgcccga gccacactgc tgaggacagt gtggcggggg atgtctagaa 1261800

tctgcctcta ccccataatg aaagttcact ttttcttaag ttaatttag catgtgtga 1261860

gaggtcagat gacaactcct gggagtatt tttctcttc tgtgtggatc ctggagataa 1261920

gattccaggt catcaggttt gataatgagc acctgtacct actgagccaa ctactgacc 1261980

caaatctcat tgctaaaaga aacaaccccc ccaagcccca ccacacatat ggtagatcat 1262040

gtgtctaata tgcaggaggc ctgagttcca tccccagaac caaaaataa taaataaata 1262100

aaataaaacc aaaccaaac aaaacaaaac acctacaac tttcagcca ccatgtggct 1262160

gctgggaatt gaactcagga tctctgaaag aacagccagt gctcttaacc tctgaacat 1262220

ctctccagcc cacctcaaa ctcttgacac ttgtttetta tttgtccag gattttttt 1262280

tttttttaa tactaggagt caaacccagg gttcttctgct tgctgggtaa gctattcgc 1262340

atgtactcca gacagatctt attaagtagg gagaaataa attatcagta atgggatgtg 1262400

gtggcccatg ctttaatcc cagcatttgg gaggcagagg caggcagatc tctgagttca 1262460

aggccagcct agcctacaga gggacttcca ggttagtcag agctacacag agaaaaacct 1262520

gtcttgaaaa aacaagaaa acatcagcaa tacaagtaga cttaaaactg tttcatctga 1262580

gtattttaa atagtataa gagaactttc caataggaat taattaaca tattttagta 1262640

gacttataca atgtacagac taggatttgc ttatatgca aaaattttat ttttttttag 1262700

atttattatt ttatgtgcat gagtgttttg cctccatgta tgtatatgca ccatgtgtat 1262760
 gcctgatgtc ctggaagtc aagggtgggct tcatgttccc tggtaactag agttacagat 1262820
 tgtttcaaga catcttgtgg atactgggaa ttgaatccag atcctctgta ataacaagtc 1262880
 ctctggattg ctgagacagc tcttcaaact acaagaaaat tctgtcatac attatgtgaa 1262940
 aatccatagc aatatacctt gtggcagatc ttagatctaa gaagaaaaag atcttcagtt 1263000
 gtgcatgtg ctgactcaca ccttagtgtc agtactggg aaggtgagc agggggattg 1263060
 tttcatagca gtctgggtat ctgaccttg tttctataaa gcaaaaacaa cacaaatctc 1263120

 taaaaccaag tagattaacc ataaacaatg atatttactg aatggaagaa ttagaagtga 1263180
 tttatatatt atatttggtc ttcttggtat tttcccaatg aactagtcta agcctaagct 1263240
 attcattaaa aagctaaatt tttgaaaagc caaaaaagtt acattttgca gcaaaaagca 1263300
 taatcaaact taatgatagt taaaacgtgt ctttcaacaa caacaacaac aacaacaaca 1263360
 acaacaacaa cacactgaaa caaagctatt tttaccaaa gtaggaaata ctaataaaac 1263420
 attaataat gccacaaaag gaagacacgt ttaagattcc agtcaatgcc agattggtgg 1263480
 tgcacgcctt taatcccagc actgggaagc agaggcaaga gaatctctga gtttgaggcc 1263540

 agcctggtct acagagtgag ttccaaggca actagggcaa cacagagaaa cttgtctca 1263600
 aaaataggta gatacaaaaa tgaatgaaca aataaaagta gtgattatgg ctgtggctgt 1263660
 agctcagcac tcagtagaag caaatttgcc tagtaaagtg atgggcctta gattcagttc 1263720
 ttagtaccat aaaaaatgaa agcaattaag tgaattaga tcagttacct tgcaccagg 1263780
 acttctaacg caagtttaga atgttaacac tgccattaat ttgatggaga atgggggat 1263840
 aggggattaa aaaggtgtgg tgcagatgac aggactctgt gggtataggt gtctgcagcc 1263900
 aagcctgaag acctagtcca gtcctgaga cccactgact cttgcaagct gtctctgaa 1263960

 cacatgcagg ctttggtag tgtgtgtgtgt gtgtgtgtgt gtgtgtgtgt gtgtgtgtgt 1264020
 gtgtgtgtgt gtgtgtgtgt gtggtcagtt gactcatctt tctccttctc tgaatatcag 1264080
 aacagcccca tcaactttag cttaaactaa acagcttctt cctacctcat cagtgatgaa 1264140
 aatggctatc ttacgaggtg tacagagagg ggaagtcac ttaatacgtg tgtgaagact 1264200
 tctttcaagt agcattttaa agaacagggt gatagatata tccctctcat cctccacat 1264260
 caacacagc ctaatcaag ctggggagac aagtggacaa accaaaccag acaaaaacca 1264320
 aaaaaacaa aatcaaac aaaacaacaa caacaagaaa ccctgtggct catgaaattt 1264380

 tttctatctc tcgcttaaat cctcgtctg gatgctgct cggatgcctc agggagtgg 1264440
 gtgaagcaca gcaagaatta actttctgtg cctcagtcag tgatggacaa ggggtggggg 1264500
 tgggtgggg gctgaggact ggaactgact ctgagaggaa ctgcaaacag ttccagatcc 1264560

acgggtgcga cacttattaa gcacctactic tgttccagga ggcttactic ggtgctttcc 1264620
 tcttttgaaa atttccacga gcccttcctc atgaattccc taatccaaag ttgatgaagc 1264680
 tgtgagcttc tcagcaacgc cagaacaatg acccgaggcc acccacttcg gagggatgct 1264740
 caggactggg agatcccagt gttcagcacc acctgtgttc actgcacca gactgcgcct 1264800

 ggagcccact tgctagcgtg tggacacctg gtgtccacag gtttctttac ctctccggg 1264860
 agcctagaga ttattgaat agtcaacgtg ggaatctagg agtgagtcag accctcttca 1264920
 aagtgatfff tcactttaca actattaatf acaactcaca gccactgtgg tgctctctta 1264980
 aaaaatgaag aaaccttact tgacagagat aagactggaa cccaggaagg ctaatttggga 1265040
 ttcagaggcc aaactggaaa agttccctat ttccaaagt tccaaggact tcggagcgct 1265100
 tgcttgagac cctccctcac tgttcttcac cctggctcag gcgtctgaga ctgggtgctg 1265160
 gcgggttcgg ggtgctggtt ccagcctgga cccacagaga tatgcagggc actcaccgtc 1265220

 cttccccagt ggcgtagggc aggggggagc cctcaggggc agcgccagag tcttgatac 1265280
 agccctgcgg agatacatg cccgacgtgc agggatgcag cggcggagca agcaactcaa 1265340
 tctcaggggg tagagctca ggagtgcccc gcctgggggt ggagctctag atcccgctgc 1265400
 tctccgaccg gcggcacgtg ggaggggggt ctcggttagt cggcagcacc ttggtctcct 1265460
 aatcctgctt tagtagtct gctttcccgc gcctccagca accacctccc ggcagccgct 1265520
 taaggctgt atctcggaag agggagaggg aatttagaag taattgttac gtgcatgacc 1265580
 cgctctgttc catggagtaa ctctccttca gaacacgtg ggcatattta ggaaatcgca 1265640

 ccagattcag taitcagaca cggtttatcc tccagggtga aagccatttc atcccacct 1265700
 tttctaggat aaggtagcgg gaaactttac aggtgacagg cttatgccta aagacagcgt 1265760
 aaggtttccc cctggcgacg gctgagttct aaactaacta tggtttccaa gacctaaat 1265820
 acaaggtaaa gtgcttacct agcgtgagat cgataccag cagtgtgtaa aaccaagcaa 1265880
 gctggctcaa ttgagcagat aatcccagca ctcgggggga ggggggcagg aggatcggaa 1265940
 gttcaagatc tttggcaaca taaatttacg gacgccgtgg gctatatgag accctgtctc 1266000
 aaacgaacaa acaaatcact aagggtatta gttgggggga aaaaaataaa acaaacctc 1266060

 taattaggta aaggttactc tgcagtagca agagctttta aacaccaagc catctctcca 1266120
 gtcagagttt tgaatcttag tttttcgaga cagggtctct ctgtgtagct ctggctgtcc 1266180
 tggaaactct tciatagacc aggtctgcct caaactcaag agatccacct gcctctgcct 1266240
 ggaatgaaag gtgcaagcca caaccatcgg gtcagagttg taaatcttgc aggaccgagt 1266300
 gaagtaactg acgacctctg aagcacagtg gacgtgaaat gtgctcagcc agatgggaga 1266360
 ggcagtgtgg gcctcaagct cagattcct ccacacctt tcagtctggt gtatgacaat 1266420

attggttata tctgcctcac ctggccatcc caaatgccag taggctatat ctcagggcaa 1266480

 agggggtttg gtgggttctt ttcctatfff aatgagttag tttcaaaaa cagaacaaaa 1266540
 attcaaaaac cccatgcctt ttggttatca aaagtgetaa atttctagct gettccctcag 1266600
 aaccacagcg cagcatttta acgttagttc ttgcttttagc tgactgaagg ctcaaacatt 1266660
 tccttgagge teggcttctt cactgccctt gagagaagcc ttgacatttt tctggtctgt 1266720
 ttaggaaaac atctagggtc agagatgatt ggcttagctc agatgacctc cagcaaatct 1266780
 ttgcttgctg gaaaagatac taattttgaa aatattgtaa ggggtcagtg ccaacaatag 1266840
 ttattatttc atggcttatg tacagggttg attttaaagt atttcagcac cctgtgtgaa 1266900

 ggttcacact ttiaattcca gcacttggga ggtagaggtt agacattttc ctgtgagttc 1266960
 aaggccggcc tggcttagat gctacatacc gagagcctct gtctcaaaaa gaaaaaaaaa 1267020
 atgttttttt ttttttgaaa aaatgacagc caggaagatg ggaaagtagc tggcaatcct 1267080
 gaactcacat ggtgtaagga aaagaactga ctcttggagg ttgtcttctc atctccacat 1267140
 gcccagctat ggcattgcacc caaacatata tctcacacc taaataaatg tacttcaaaa 1267200
 aaatcatttc tcaacaata cagaatgctg gaaacgggtt ggagagatgg cttagtgat 1267260
 aacagtgcct gtgtctctc cagaggacta gagggtgggt cccagaacct cctcttaac 1267320

 tctgaacac atacacacac agagaaacac ataaacataa aagaaagcta gaaacaattg 1267380
 aaaagatfff tggaggagg gaaaggattt tgtttttga gaccaggtat ctgaaaccac 1267440
 agtatggatg gaaccatgcc aggtttgcta gtttctgttc tccagtaacc tttggcttga 1267500
 agatacccat tatcatcaca ggtggatctg tgagtcaag ggcagcctgt tttatatagg 1267560
 agtctctggc cagccggagc tacacagtaa gattctgtgc caaatffff tctcaaaaa 1267620
 atcctttgat ctaagtcctt ttttaaaaga tttttttaa tttattatgc atacaacatt 1267680
 ctgcttccat gtttatctgc ataccagaaa gggcaccaga tctcataaca gatggttgtg 1267740

 agccaccatg tggttgcggg gaactgaact caggacctct ggaagagcag ccagtgcctc 1267800
 taaccttga gccatctctc cagcccttga tctaagtctt tttgggaatt taggattaga 1267860
 atgattcttg cticatgtgt cagctcttga tttgaggtga aaacctgga ctatttgctt 1267920
 ttccttatca tgtgggtggg ggtgggagc agggggaacg ctgaggagtg atgtccacac 1267980
 atagttagca tagctaatac taagagtctt ttttttttt ctttctgagg cacggggtct 1268040
 cactggcctc aagttcaca tctcttaca tcagtgtgct gacagtgggc ttacagcgtt 1268100
 tctgttatg gtagaagttc taccaccaca gcccggtta tcaggaagg ctctctctag 1268160

agttaaaacg gatacaaagt acctgcagcc tcaaagcctg acatgtgcag attctattta 1268220
 ttaaaagtat gcttggctgg agagatcgct cagtggftaa gagcattggc tgttcttcta 1268280
 gaagtctga gttcaattcc cagcaccac atggtggctc acaaccacct ataaagggat 1268340
 ctgatccctt ctctatcat gcagatgtac aggaagagag aaaactctta taaataaatc 1268400
 tttttttttt tttttaagta tgctttaagt ggctggagag atggctcagt ggtaagagc 1268460
 attgctgctc ttccagaaga cccaggttca atttccagca cccacatggc agattaaact 1268520
 gtaactccag ttccagggga tcaaacaccc tcaaagacat acataaaggc aaaataccaa 1268580

 tgcacatata aaataaataa atctttttta aaaatgctct ttccaactaa aaccttctgc 1268640
 ttccaaaatt gcaggcatct taatgttttc tgagctttta agtgctttgc atgtgtgtgt 1268700
 gaaaagtgct attaatttgg agttaactga ctttttggcc tcaattttta tgtgatagca 1268760
 ccagtttctt ataggtgctc tagcaaatga agcaacctga aacagcatgc acttattaac 1268820
 tcgaagcttt atgggtgtgt ctcaactggc ttatatcaat gggagcactc acttttttct 1268880
 tgatattctt tagctcttaa cctccctcta ccatcaaac cagaaatggt ggagatggag 1268940
 ctaaggggtg cttgtatggt aggtgcacgg ccctagattt gtcactcata tactatagca 1269000

 aacaccccag caatagcagg ttagacttta tatagccatt tgtaaagatc tgtgtgatga 1269060
 ctcttgata tcccacgtaa ttacatctca aggttgacct actggcgact ctaattccac 1269120
 ctgccatfff aactcctctt ggteacagag tctaacatff acacatgttc tagggaggac 1269180
 ttgactttgt tggacttctt tctgacaga ttgctcttct ctgttactgc atttgcatga 1269240
 acttgattta caatctgcca agtttttccc tccaacagga atccaaactg acacacacaa 1269300
 gctaagttac tattaactff gacttttcat ggcatctgtg tattttcaaa tactataatt 1269360
 ttgaatffff gtacataagt gacatcaaaa gacactaggc catgctffff ccagccccta 1269420

 aacacatgca atgccaacta taatggtctt cacagcagaa attattttaa gccattatct 1269480
 ctttctcctt ttatcatttt ttaaagattt tatttattat gtacacaaca ttctgcttcc 1269540
 acatacatct gcacaccaga agagggcacc atagcccatt acagatggtt gtgagccacc 1269600
 atgtgggtgc tgggaattga actcagtacc tctggaagag gagccagtca gtgctcttaa 1269660
 cctctgagcc atctctccag ccctcctfff atcattttta tgatacttgt gattaaacc 1269720
 agggcttcaac gaatgctagc caagggtttt attactgtgc tatgtcttca gctttttgag 1269780
 acaggacctt gttatgtagt cctggctagt ttcaaggtca ccatgtagtg ccccccacct 1269840

 ttactcattt ttagtttact gctaactatg tgtgttgtgc tcagtggaaca atcttgtcaa 1269900
 ctcttttcta cctttttgag aagtctagag atcatactct ggttgtcagg ccggcaagtg 1269960
 cttttctcac tgacaatfff gccagcttag tccccttctt aaaaaaccta gttcgtgtga 1270020

acttgactga aagccaatgg aaaacttcat gtggccataa aagtgagtag aaagtcacta 1270080
 tggggttaga tggcttgcatt gttaggagca ctgctgttc ttgtggagga ctggggtttg 1270140
 gttcctagca cccacacgga gactcacaaa catctgtaaa tccagtttca gaggatttga 1270200
 tgccttcttc tgaccttcca gggcaccaag aatggatatt gtgtgcacac acatgtaggc 1270260

 aagcactcct cattgacatt aaaacaaaca cgttatgtc aacaaaaaac aattcaaatt 1270320
 caagcaaatg gagacagagg caactctgat aacagggttt atctttactg tetgatttat 1270380
 cccctcttca tcaacaagat ttatatatta agtaataaag tagtcttgtc tctttggcat 1270440
 ctaaatgttt tgataagaga tgaggagggc tggccacagt ggtgttttca ggaggcaggt 1270500
 gggcttaggt cagttaaga ccagtttga ctacacagtg agttctagaa cagctagaga 1270560
 acttcagtga gacgttgtct caaaaagaaa gaaaagctga tgagagggtt tcagcagtta 1270620
 gaagcacttg gtgcttttgc agaggacca agtttggttc ccaatatcct tgtcaaccac 1270680

 ccatagctcc agcttaggct tctatgagca ctgaatgtac atggtaacaca tacatatata 1270740
 caaacactca cacaaacgct gaacagagcc cattagcagt gattatggaa ttcactctca 1270800
 catgtggaga acctaagat ttttatattg ttaataatga aaaatgcaca tgtgaacttg 1270860
 actgatacat attcacatat aactttccc tcatatcaa acttgacaga ttggatgaatc 1270920
 cagaagaatg gccacaatca tcatatgcag cagacctaca aggaagaaga ggaggaagaa 1270980
 ggaggaggag gaggaggaag aggtggagga ggaggaggag gaagagaaaa aaaatcaatc 1271040
 caaagcaatg atcagataat gttgaaactg aatttctctg aataattcac cttagagcat 1271100

 cagaaaaaaa tctagaaaat atatctatta aatacaatca gtaactgaga ttactatggt 1271160
 tattatccag cagattaac catggaaact gagatatttt gtgtgtggtg tgcattgacc 1271220
 tgcattgaaa ggcctaaggc tgatgctcag agtctcacc aatggcttcc cactttatta 1271280
 atcaaggtag ggtcttctca ttgatccctg agctgaccag tggttaatca gccatcttac 1271340
 tctggggatc ctctgttctc cttcagagtt ttgaaatcac aagtggccag ggctatgagg 1271400
 atctgagctc tgccctcat ggtgtggcag ctgctgtaat tacagagcta tctctcaac 1271460
 ccaaaagctt aggttttttt ttgttttttg ggtttttttt tttgatggat ttttcacttt 1271520

 ataaagggtg aagcatttct ttcaataat tttcagaat aaagcataaa cattccatat 1271580
 atttgtgtaa tatacatatt atacatgta tgtttatgac acatgccctc tcccattctc 1271640
 tcttttaaat tagagcatgt aaaatagtt atttcattaa tattaggttt cacctgaatt 1271700
 cttcaattgg atgctagtta tagtgagaat cataatgaaa tagttaagca gaaaaaaact 1271760
 ccagaattca ttgcctttat acttgatttg ttctatgaac attaaactcc tagaatggct 1271820
 gggtaggtat tcagcgcagt gttgagaaca aaacattaat acaatacagg agagtctggc 1271880

tgttacagaa tccacactta agtataagac atggcaaata cacacaaatt atgccaattt 1271940

 atcctaagtg ctatgaatac aatgtgtaa gtactagtaa agaaggtatg atttaagatg 1272000
 attttggttt tactgttgtt tttccttctt tgtttgggac caggtctcac tgtgcagacc 1272060
 aggttagcct caggctaatt atctccttgc tacagtctct gcagtattag aattataggt 1272120
 atgtatgacc tcatccagta ctaaagttaa tctacaggcc aggagtattg gcatactcct 1272180
 tgaatctcag cagttaggag gcagagggtt gggcaggtgg accctggctt acatagagag 1272240
 ctgaatgata tagggtaaga cccccatctc tctcactttt tggagacaag gtctctcact 1272300
 tagccctggc tgcctagaa ctactatgt agaccaggct ggcctcacag agatctgtct 1272360

 acctctctgc ctccctagcg ctggcactaa aaaaggcata tgttattatg cccagtgggtg 1272420
 agactctgtc acagctacaa acagataaat taacttctat aatctatata ctctataage 1272480
 atacttacta tattaatate tccaaagttt attccaatcc atttcttctt ttatactcca 1272540
 aaacatcttc atcatgttgt ttgatgagct acaagttaat agttaaacc agaattgtaa 1272600
 tcttctggc agcttaaaga ggaggaaacc aactaaagat ccttgtttca taagagaaat 1272660
 agggtaggtt aaaacagtta ctattttact agaataaaaa gcctaagaca ttcaagaatc 1272720
 attagtagag tacattgta accacaacct gacattacat ttgagaatga tacaatggaa 1272780

 aacatgatgac gacagaagaa tcataaaaca tgacactttt tgtgtacctg tgtgtgcaat 1272840
 gtctatatat aggtatgctt gcctgtgcat gctcacatat ctttctgtgc atgctatatt 1272900
 ccaatcttag aagctgaca gtgtgaatga tcaaccaat cctcacttc tctgtgtgct 1272960
 attagaate aaagaacagc tacttttttg gaaccacat aactcaaca acgattgata 1273020
 catgatgaca gtcaaggaa ttaaagacct aatttcaatc cttaatgctc ttggcaacaa 1273080
 ttaaactcc caaaaaatt tcaaaaatga atataaagtt ggggctgtac agttaagagc 1273140
 atgtactgct ctcgaggac ccaagtttgg ttccaagac caacaacagc cagctcaaa 1273200

 ggtttgtaa ttccagctcc agagaatccg atgggtaggg tactcacata aaccacagg 1273260
 aaaaattgtag tgcccaagt cagcccaact tccagccagt taggtttggc attggcgcc 1273320
 tcccggacat agaactttga ccgtgttga gctgaaaaa gagagaatat gtatcttact 1273380
 gactttagc gaggaaaact taacatttac tagtactaa catttactag tgtactact 1273440
 attgcatata attctctcat ctgagatagg ggttattgta gccaggctg gtcttgaata 1273500
 cctgccagtc tctggaate ccagtcctgg ggaggattc caggagagcc ccacatccc 1273560
 tggcattaca ttgcattha tactctatct gccaccccc aatctaaaca gtcaaggaaa 1273620

cagtccagag aattgaagta actcgtctga ggtcaccagc ggagccacag gtcggtcctt 1273680
 gagattccgg acgccttcaa aacctcgtga aggtgtcgcc ggccctcaca ggctcgggag 1273740
 tgggaggatg agtcgcagcc cccggaagga cctccctgtt ggttgtctcc tgggcatatt 1273800
 tgaagagccg ggggctcttc agaggccagg aggtagtittg gaggaggctt ggccggccgat 1273860
 gttgcggagt ggaaaaccca caccgaggcg ggttgaaggt cactcgggga ctgcctgcgc 1273920
 cgcgacccca tctactacg gaggttccag gatggttccct gctgggtggg agtaggccga 1273980
 gggccgagcc ggctgaaga gacacactca ccgcagctcg gaagccgggc gggggccaag 1274040

 agcccgaaa acgagcgcag agcattgggt agcgcctct tccgcccta gactccgcc 1274100
 cttctcggcg tgagcgtctt gtcgggaggc caccgccttc tccctgcgcg cgcctctccg 1274160
 gaaggtggcg cggagcgcag tccccctgg cagcagaagc ggaatttgcg ggtgggcca 1274220
 agtctacct tcaggacaag gtttctaga acctggattt aggggtctgt ctgtaaaaca 1274280
 gcggatgcaa agaggcctgg ggccgggagc gcagtttctc cactcctagg gcgctcgtca 1274340
 gaggtttaat aaagtgtttg ttggtgagcc agaaaattga aatggaagt gtcttgaaga 1274400
 ataaaatttg ggttgaattt agtgttccag gtacagtaag ttaattcatt gtgtggttta 1274460

 cagtcacat tttatcgcta cattggctac aggatgtgcc gtaattatta gcatcaatta 1274520
 acagatgggc tcaaagcaaa cttgtggaca aaggaacttt gtatttgcaa aggctctta 1274580
 ccagttccta aaatccaatt atattcaaga tcacttcgat gcctctcaat cctgtgagat 1274640
 agaattctgc tatttactag ggaggcaata cagggtctcc tacatcctag gcaagtcct 1274700
 taccactgag ctacaactcc ctacatagtt ttgagatag gggctcacta agttacgcag 1274760
 gtggccatga atttgatcct cctgcctcag cctcttgagg agctggggtt ataagacctt 1274820
 tccaccagc ctagtaaaa ttctttaga tgttacatga aagtgccctg actggctcag 1274880

 gaggggcatc cagatggcaa agggatccag ttagctgacc taacaagggt ggactggcta 1274940
 taatgccatg tgtctatgta gaacaggatc caaacatcg tgtctcaagt atcatttgtg 1275000
 tccactatat gtcaacacta tgatttttag tegttaatct taccacagtt tcacaactgt 1275060
 aacataaaac ctatcctgta gggtttgttg ggaagcttag gagttatctg ggagtagtaa 1275120
 atacgtttgc ctattcgaca cattgtacta atcagctggt ttgttttta cctttgtaat 1275180
 ttttatgtgt aggcacatc tgtgataagt gtgtgtgtgt gtgtgtgtgt gtgtgtgttt 1275240
 ggaaggtgac aatgaaggtc agaggcattg gatcaacctg actgatcagc tgatttaaac 1275300

 atttttattt ttaigtctgt gttcgtgcct gtttgtcaag tgcatgatgg tgctgcaac 1275360
 tgcccatgga ggtcagaaga gggcactgga tccccggta ctgtagtat aggcagctct 1275420
 gagttgtcca gtgtgctctg ggtgccagga aacaaacca ggtcatctgt aagagcaaca 1275480

agcactctta cttgctgagc cttctctctia gtgcatgadc agctcttttt tatgttgcac 1275540
 aattgacaga ttctgtttca ctggtatcca aagaccatgt tttaaaaact attggttaata 1275600
 gatgatacat tctttttgat ttgataagat tttattattt ttaataatat gttcatatga 1275660
 tgggtgggta taigaatgaa gctccccttg gagatcagag gagagcattg tttccttga 1275720

 agccggagtt atagatgtct gtgagccaac tgggtgtgtc tgggaaccaa acccaggtct 1275780
 ttgctagggg agtaagctgg ctttaaccatt gagctatctc tccagcctgc agaagataca 1275840
 aacttacct taaaagccat ttgttaaac taaagctgtt taggtctact ttaatagcaa 1275900
 aataagtgtt agcattttcc tttagttagt attagtatta gtgttagtag ttttagcaat 1275960
 attattttaa aatcttttta gtaaaacaaa aagtcattag cagagtgtgg tggctcatgt 1276020
 ctaatcccag gtcttgggaa gcagaggcag gactgactct atttgatag aagtttgagt 1276080
 ttcatagtaa gtcccagacc agcctgggct aatatgagac cctatcttag aaaaaaaaa 1276140

 aaaaaaaaa aaaaaagggg ggaaaaaaaa aaaaagcaaa aacaagnnnn nnnnnnnnnn 1276200
 nnnnnnnnnn nnnnnnnnnn nnnnnnnnnn nnnnnnnnnn nnnnnnnnnn nnnnnnnnnn 1276260
 nnnnnnnnnn nnnnnnnnnn nnnnnnnnnn nnnnnnnnnn nnnnnnnnnn nnnnnnnnnn 1276320
 nnnnnnnnnn nnnnnnnnnn nnnnnnaaaa aaaaaaaaaa ggggggtaca gaaagataag 1276380
 ccaaaaccag ggcacctact gtcaagcctg atgacttgag ttcaattgct atgtccatt 1276440
 taatagaagg agagaataga cttctactaa ttttctttg acctccagat ggggtgctctg 1276500
 acaagcacac atatatacac acatacacac taatacatg tattaaaaa aaaaagaggg 1276560

 gaaaagaag taaattacca atagaaggta aaataatgac attgtgcatt gtggctaac 1276620
 atgttactaa cagcctgagt tactttagtt tgtaacctag tctgagcctc ctgggctcat 1276680
 gctcaagtaa gcaaacaccg ctactaatgc gctgagtcag ttgttggtc ttagcttact 1276740
 ggcttcttgt ccaactcagca agagtgtgat actctttcta cagcacaccg ccagagcttg 1276800
 tctgacaca gcttttgcta gtcttcaaca agttgaaaca gatgctacct tttgtcagag 1276860
 tgtacagaac cagtaagcac attgccagct tcaggatcta tgctgggaaa gtccattttg 1276920
 tttccagaa ctctgatcct tgtgtccttt tctagtgtg tagtttgag agcaatgaag 1276980

 tatgagcaca acgttctcag tatgttagag ctactggac ccctagagtt ggaagaagca 1277040
 gctaaagatg aaactcattt tgaagaagac ctagctggga gctaatagct attctagttt 1277100
 ggtaggcac tttttaaca tttatttaa ccatatcctg aatttaaatg ctaaaatcct 1277160
 gatttgtgac ctaggtgaag ggagatttaa cacctagaaa acaagtttta gccttgatt 1277220
 tttccatgag gaaacatctt acttgactga tgtgtccaag ggaggggta aagaacaaaa 1277280
 cctaaagaag gatggcttct tgtatacata agttttatta aacaacatt aaacaacat 1277340

cccaaaatgt ggctgttatt ttgttaagtc tgggtggcag gttcctttaa tgttgTTTT 1277400

 ctataaaatg taagtaaact ggcctctggt cttccaaaca aggtaatctt cctgagtgct 1277460
 gggctttact atggTTTTga agtccttctg ccttagtcgc tcagtactgg gattccatgt 1277520
 gtgcaccatt acaccagct ggaggaggaa gcctTTTaaG cacagtgatg gggaaggatg 1277580
 caaggtcctc agcagctgca gtgccataca accttggtcg taacttccca gaagcacaag 1277640
 aagcactcaa ggcccaactc caatttcttt ttttttccca ttcatttata aataaagtca 1277700
 tgcacaatta tgatccaatt caatttctat ttccaagta gtagtgattg gagtctatag 1277760
 tttatctatt actgagttca ggctatcatg tcattgactg tgtggtcaga ctattatttg 1277820

 taggcacatt ttaactcagt aacgaatctg atcaatattg taatcagacc agtattcact 1277880
 gaaccttaaa aactgctgtt tgggcctgga gagatggctg agcagctaag agaactcact 1277940
 gctgttccag aggatccaag ttgggtgctt acaaccactg taactccagc ttcaaggat 1278000
 gacactttct tctgacttct atgggtaaca gtatccacac acttgcacac gaacatgaat 1278060
 aaaaataaaa atctttatat aaaaacaaac aaaagctccc cacccaaaac cctgctgttt 1278120
 agacttggat ggggcactat gtctgcaatc ctgacattta aaaagcagag gaggaagtga 1278180
 gatcagggta agcttgggct acttagcaag accaacaac aaacaaaatt gctatttagt 1278240

 gggaagagga ttgacagcag tagaggcaga caagagatgg taaggggat atgtatatgt 1278300
 gagaataaga ttgaaatata tcatgtacat atatgaaat aatgaaaaac atcgtgtata 1278360
 attaacatgc taataaaaca ttacaactta aaaaattgta tgtacaattt aaaaaaaaa 1278420
 aacagtgggt tttctagtgc tgtgggtata gctaaactca tggtagaagt gcttgtctgg 1278480
 caggcatgag gcaccagggt agagctcaa cagcacacac tcgaagaaaa gctatttatac 1278540
 tatgtctttg tatgtgttga attttatttt atatgtatga gfactttgcc tgetgtgtgc 1278600
 cctgtgcaca gctgggtcct tcagagggtc tggggcccaa cccaggtcct ctgcaagagc 1278660

 aacagggttc ttactcaatg agccccatct cgacagcccc ataacttcat ttattattta 1278720
 tatgtgacaa tatggagagc agagaataac tttgtggggc ctttttctt tttccatctt 1278780
 tatgtgagtt cagggttcaa actcgggtgt caggcttgca tagtaagagc ctttaccac 1278840
 catgccatct caccaacctt attttctaa atctttatcg agagattaca gtattcaagg 1278900
 agaccetaag gtttgacctc tataatcccg atctttcgtt tttttcgata cagggtttct 1278960
 ctgggtagcc ctggatgtct tagaattcat tctgcagact aggggaagtta aagaacaatt 1279020
 tgaaaaccac aaagtatgtg tttaaaaaag aaagattgaa aaatgtcaaa ctcttgacaa 1279080

tctttatgat tcatggtgca aagaatactia caaggcctgc acgagataat tgagggtaaa 1279140
 atggctctta tgactcaatg gcatgtcact ctgtaaaggt tttattgtca agtgtaaatg 1279200
 aaatgtctgc tgggtgggagg gatcctcttc actttcaggc ctaatcttgc tgagtggagt 1279260
 ttggcctcta aggtttaagg acttctggta acaggtggtt caacagttac aatcctaagc 1279320
 atgaattaga agtcaactcc aggagtccg accctcgact ctactacatc aaggtgactc 1279380
 acacagctct tacttcaacc cattatatga cttcagcaat gaaataaaca catacttcaa 1279440
 cttcaaaagg ctctttggc agtacaaca tgcttttcg aatctggcta acgaccttc 1279500

 ctggctatct taacatagt caacagaacc acagataccc taccagtca agtccatttc 1279560
 aaaggccaag ctctttgacg ctttcaaaag acgattaagc cctcacctct tcggatcggg 1279620
 tcacaagtcc ccacttaggc gaaggttttc tcacttacc cttcgctct gctcaaatat 1279680
 aggcacttgg gccttgaacg actacatctt cttaaaacac ctccgtcggc attttggcat 1279740
 ttgaggctca agctacgatt acaacacctg ggcgagctca cccaatgag tgaaaggccg 1279800
 gtttagcgag gaggagcaaa aaggctgttt gcgacgaaga ggcggcggaa gcaccgctgg 1279860
 ctgcctccc aggagctgag cactggaagg accggcagag ccaaccaga atcagccgtt 1279920

 ccgcaggccc tgccggcctc cgcgttcccg gcaggctccg gtgcagcgag ggtggggaga 1279980
 gagggtcacc gcgctgcgc gttgggaggt gtgaccggg tgggaaagcc ctcgagctcc 1280040
 gccatthtgg ctgcctctgt cggtcttttc agttaccacg tgaaccgcc acggagacct 1280100
 gtgagggggg aggtggcggc agcgtaagt gagaaagggg gggaaaagaa aaaaaaaaaa 1280160
 agaaagagga gaaaggggtg tcaggacagg gcggcggcgc gacaccgag gcctagtggc 1280220
 ggcggagcgg attcaaggct gaagcgagct tgagaacggc aanntntntn nntntntntn 1280280
 nntntntntn nntntntntn nntntntntn nntntntntn nntntntntn nntntntntn 1280340

 nntntntntn nntntntntn nntntntntn nntntntntn nntntntntn nntntntntn 1280400
 nntntntntn nntntntntn nntntntntn nntntntntn nntntntntn nntntntntn 1280460
 nntntntntn nntntntntn nntntntntn nntntntntn nntntntntn nntntntntn 1280520
 nntntntntn nntntntntn nntntntntn nntntntntn nntntntntn nntntntntn 1280580
 nntntntntn nntntntntn nntntntntn nntntntntn nntntntntn nngaacaggt 1280640
 ggtgtggctg aggcccgact cattattgc ttgaacgcgc ttctcctcc acggcccgtc 1280700
 ctctcctctt ctctcctacc tgggattcac ctgtcccgc ccggccgggg tcaccgtgac 1280760

 tcagagggg gcaaggaagg aaaagcgaag ggagctttgc agtctgcaa ctccatgtag 1280820
 tggcttttat aatttacaca caagccccc cccgctttt ttgaaacca tgtcttagtt 1280880
 tgagagcaaa ctgcccac cccgcatcc ttctcggag gtgggactca tttctagggg 1280940

gcggtccggt ccggtccggt ccggtaggaa gttctagtag ttaagtactt tacttaagac 1281000
 tgtgaagttt taaaacacc tatacaaaaa cttagccgaa acgatataag aatcttttga 1281060
 gatggatctt gttgacgcta gctctgtgtt tcagatattt gcagtttgca taagaaacgc 1281120
 atgcagtgat acttacagag gtactggatt gaagctgttt acattgtaaa ctatgccag 1281180

 tcgtcttggg gctgtcatta atacattgta gcacttttgt tgttgtttgg tatttagtgt 1281240
 atgagtcgct tcttttacac aaacagtctt ttaaagaact gtatttgcca attttaagac 1281300
 ttgaatggcg gtgggttttc acacctgtaa tgccggcact ggagaggaag aggcaggtga 1281360
 atggatctct tgagttcgag gccagcttgg tctacagagt tatacagaga aaccagggct 1281420
 atacagagaa aaaaatggaa gagggagaga ttcgtgtatg tgtgtgtgtg ttagcctttt 1281480
 agcttgcagt tataattcac ttgtttgaca aatatggaga tctagggttt gtttgtttgt 1281540
 tttttctttc tctaataaac tcagcagttg agagcacttg ggctctcaac tgcttgagag 1281600

 ccagaggtct tgagtttaat tcccagcaac aacatggtga ctcataacca tctataatgg 1281660
 gatctgatgc ccccttttgg cgtgcaggca tacatgcaag tagagctctc aaacacataa 1281720
 aatacataaa tectaataa ccatttatgt cgaggtaatt gattttacag aaatatccat 1281780
 gttgtagatt aatgaattg tgttgaaaaa cgatagtcac atactattta gtggtatfff 1281840
 gttttcatac catttgaagt ggaattgtag catagtttcc ccccctatgt tctgagacat 1281900
 ctttttccct gtctgtctgg aaaaaaaaaa ttaaaaagac ataaaccaga tttggcagca 1281960
 agtgttttca ttcactgtgt cgtctcattc actgaagaat aacagttgct gttatttctg 1282020

 tgctggaagg ctttgtgcat tcgaagcagg tgatctaccg cggagttaca ctcaattatt 1282080
 ttaggactga tigttaggta gaactatagc atagttttct tgcaacattt acccaccac 1282140
 ccctgtccc cttatttttc tttatctttt tttataatgc tggaggttgg accttgtgct 1282200
 aaatacaage agagctatgt tcccaacccc ctcatcctct gtttatactg atgggggggg 1282260
 gaatctctga aaaaacgaga gtatcgaaaa atatttgtct tttaccgata ttaacaaat 1282320
 tgccaagatt actttttctt tccgtacata gaaaaaaga aaactgtatg cttatgcttc 1282380
 actccttaga aataaagaca tggecctgta tagttataat accattaaca gttttttct 1282440

 aaaattcagg cttttcaact gttagtgaca ctttttcatt gtttttgtt tttgtttctg 1282500
 tttttggaga ctggttctgt gtcactttgg agtgtgtcct ggaactcgat ttgtagacca 1282560
 ggctgtctt gaactgtcag agatccactg cctctgagtg ctgggattaa aggtgtaggc 1282620
 taccagcca ggctcagctt ttctctatat ttcaggcagg cccccatttc ttagtattcc 1282680
 ttttcttca gccttcagct acttggatag caggtgtgat ccaccattct gggcacaatc 1282740
 aagtgtgtgc ctctgtgtaa tatgcatatg ttgggttga ctccagggtg ttgcacatac 1282800

tgggcaaata ctctacctct gagtagtata tatctcctcc cctaaaatta ctcttatfff 1282860

 gagagagtta taaagtcaaa tgtagtttga gatattcttt gtatattttg cttacttttc 1282920
 caaatattat atcttataaa tcttatagtt gattgtaaca ttgataatgt ctaccaatff 1282980
 tattcatatt tcccaagttt tattttagt tgtatatgtg ttcatttcta tacagtagct 1283040
 attacatgtg taggttctgt gtctgcagtc aaaatatagt tctacagtaa cacaaaggag 1283100
 cactgttttg cccttttaga actacaacca cctatacct tcccatcctt ttctctcacc 1283160
 ctccagcaac tigtattagt gtttctcta ttgaagtaat tttaaaggac tgtttcctaa 1283220
 agagactcac agagtgtata taacttacag attggcattt ctttagtgca gcaggatttc 1283280

 cttgtggttc atctaagttt tcacttgat tagtagtctg ttatatttta ttgcaaagta 1283340
 atatgctata atgtagattt agatttagta gagtttgttt aactatttat ggaattacag 1283400
 ttcttggttg tgatgggtggg acaaaaatct ttaatgttgt tgctaaaatc acggtgcaaa 1283460
 aggattaatt attttaaagc aatttttct tttattaga aaattatttt acatgtcaat 1283520
 cccaggtccc tctccctccc ctccgectcc ccccccccc aactaacacc ctaccatcc 1283580
 tatacccttt ctgtaccca ggaagggtga ggccttccat agggggcctt caaagtctgt 1283640
 catattcttt gggatagggc ctaggccaac cccttgtgt ctagactcaa ggagtatccc 1283700

 tccatgtggg atgggctcct aaagtcatt cctatggtag cagtaagtac tgatccatta 1283760
 caagaggccc catagatttc caaggtctcc ttactgacac ctatattcag ggggtctgga 1283820
 cagtcccatg ctggtttccc agctatcagt ctggggataa agcaatttta ttgtgtgttt 1283880
 gtatgaatgt gtgccttctg gccaacacac acatgtaagg gtcagagaac agtttcccag 1283940
 aattggttct cticctacca tgtgggtccc aggcataaaa ttcagatctt taggtggcaa 1284000
 gtacttttat tcaactgaaag gttttgctag ccagttaaaa gatttatttc cataagactt 1284060
 aaacaagaaa aatgtgtaaa tctctaagt aaagaagaaa aagagataca atgtttttat 1284120

 tgttgacaga cattaggaat gaaaaaatg ttaccaagca aaattatagt tttgtttcaa 1284180
 aatttcagct tttacagtg tagctcttgc ttgatttttt ttttttttt ttttctctgg 1284240
 aactctgacc tcaaagttac agagatccac ctgcctctgc cttctgagtg ctgggattga 1284300
 aggcattcac tacaattctg gagagctctc ttgattttca agctttctct tccccactt 1284360
 tttctgtct gataaaggaa aagtgggca tactccagtg ctaaaatcaa gtgttgtag 1284420
 gttgctgacg gtagcactcc ttttgttg gttgtgccata cttagtaaac ttacataggg 1284480
 ccagttcatg cttcacagaa ttatgaactg tctctggctc agtattttag tgtaaaactca 1284540

tgtaatagta tcactttgca caatttcata atttctacag tggatttact tgacttagtt 1284600
 cagtttgttt gatacctgca ataatatttg ttacatattt gccctccct ttctccacag 1284660
 tgctgttttc tgactaagca ttgttataaa ttgctaaaaa tatgtgcaaa atatttcttg 1284720
 tctctagttc atctagagag aaagaagatt aactgggtgt ctattttatg tgagattttt 1284780
 gcttgggtgc ttaccagtc ttttaaaatt tcacatcatt ttaatatatt tagaaaatta 1284840
 aatcatttaa aaaattgtag cctctgcata cctttcctgc tgtttgttca tctaaatcag 1284900
 tggttctcaa tcacctaat gcttcaacc tttttgttca tgtgatggtg ctccccaacc 1284960

 atattatfff ctttcataac tgtaattttg ctgcttttat gaactgtagt gtaaatact 1285020
 gtattttccg atggtcttat gcaacctccg tgaagggtc attcaatcct caaagggtc 1285080
 atgaccaca ggttgagaaa tactgataca gaatagttg agaattgtcc tagaattgtc 1285140
 catcattcta tttgattttt ccaaacagag tttctctgtg tagcctgtcc taaaactcac 1285200
 tctctagatc aggctagcct caaacccaga gatctgcctg cctccatctc cccaagtgt 1285260
 gggattaagg gtgtgagcca ccagtccca gctttattca ctttctggg atctaggttt 1285320
 atggtaggaa agatgtgctt gaaagggtg gccaaaactc acacctttca aatttcagcc 1285380

 cacttgaaaa gtggaacctt cttaatgcct gaaatcacca agattgttat tgctattgct 1285440
 tcaccttgt ctcttactct ttatatgta atgtgagtga tacgaaaata aaaccaagt 1285500
 tgggaatact taccactgt taataagtgt tgttttgggg ctgcagagat ggctctccga 1285560
 cctattccag aggaccagg tttaaatacc agcaccata tggcagctta cacctgtctg 1285620
 taacttcagt tccagaggat ccaacacctc cacacagata tacatggaga caaacaccg 1285680
 atgcacataa aataaaaatt aattataaat gttttgagct ttagtttgag tgatttgttg 1285740
 ttaagtcca aggacagaat atttcttaga aaaaggtag gagccaggca atggtggcac 1285800

 atgcctttaa tcccagcaca ggggaacag aacagaatt ctgagttcat tgccagcctg 1285860
 agctacagga atgagttcca agacagccag gactacaca agaaacctg tctctaaaaa 1285920
 tcaaaagga caaaaaagag aaaaaaaaaa aaaggaaaaa agaaaggtat ttcgggctag 1285980
 agaaatggct cataaccaa aatataagaa aaaggtagg agaaggtga caactaggtg 1286040
 atagtctgtg attattgaa caccttccat ttcttagct gtgctctgga cccttcagag 1286100
 tagcctcaga tttctgagta ctagattgtg ggtgtgagcc accatggttt tctctacagt 1286160
 gcacttttga gagtctttc ctaatctcaa aggcttcaa agcagacttt taatttacet 1286220

 atttatgtg gtattcttgc atctgcatgc ccacatacac atgtggaagc gaatgtggtg 1286280
 atcagaggca gtttgggga gctgggtctc tgtttctacc atgtaggctc tggggatcaa 1286340
 actcaggtca tcaggcttgg cagcaagcac ttttaccag tgagttatcc tgctggactc 1286400

agcaggattc tccccccca cccacccca gacaggttc tctgtagctt tggagcatat 1286460
 cctggaactt gctctgtaga ccagctggc tttgaacata cagattgcct gcctctgcct 1286520
 cccaagtgct gggattaaag gcatgtgcca acaccactca gtttcaggca gatattttta 1286580
 ttaagcaaac agaatgaatg aagttaaatt agggttcaca cgtagagctt ggagtcagga 1286640

 atcagacttt atttttcag ggtaattaaa tcatacttat ctaatattha ctatttgggg 1286700
 gagagatatg agaggagaga ataaaaaga aggaaaagtg tccttataac taatgacaat 1286760
 taggttaatt ttgttgctga taaaattcat attggaatta ttaacaagta gattttctata 1286820
 tacacaggaa aggtcacctg ccttttttat actatgtctg tccaacttgg agatcaaacc 1286880
 ctggcacat acatgacagg ctcagctatc atttaaattt cagggtgaca ttattctagt 1286940
 tttgcagtag ggtctaggca gttactttga aattggtttc cttttcctt ttgaaattag 1287000
 ttttaataata tttctgcctc cctgtactac atgcatgtaa aaccagggtc gctaaaatct 1287060

 tttccacttg tgacctcctt ttgcctgaaa aattgtatac aatttctta tggagatata 1287120
 taaggtagat gctcatcata ctgacataa acacatttat ttatttaaaa aaatgatggt 1287180
 ggggctggag agatggctta gtccttaaga gcaactgactg ctgttccagg ggatctgaca 1287240
 ccttcacca atgcacataa aataaatgt taataaatt taaaaattg taatgtcttt 1287300
 attagcatat cttagttata catggtaatg aatttcatta aaataataa gaaatttac 1287360
 atttatttat ttttgcagt ttggggtgca tgcacaata ctcagtggga accagaggac 1287420
 agcttttaag tgatgttct tttactttgt gggttccagg gttcctattc aggccttctg 1287480

 gcttgggtg gtaagtgc atgtacctggc ttaagttgtt tttgtttta tgtagcctag 1287540
 aatttgcctat gcagacaaa ctggccttga actcacagag atctgcctgt ctttgtgctg 1287600
 gaattagagg catgcaccac caatgccagt caagaaaatt aagacagttc tttggtacac 1287660
 attaactta ccagttatta aagaggaaag cagattgtaa actgtgatgg ctggttttaa 1287720
 ttatgaacat gacaactaga attacctggg aaaagagtgt caatgagaaa ttgtctagtc 1287780
 ccagcacttg ggaggctgaa gcaggttgat ctctgagttc aaggtcagct cccaaataa 1287840
 tacattgagg cttatattaa ttataaattc tgagttgata gctcaggctt attactaact 1287900

 agctctcaca atttagatta acccatttct attaatctat gtgctgcccc aaggctcctg 1287960
 gcatttgtct ctctggaatg gcttgccttac tceccacctt gctggcaact tctctgactc 1288020
 cagttttctt catcccagca tctttagttt ggttgcctg cctatagttc ctgtgtggct 1288080
 actggccaat cagcttttta ttaacaatga aagcaatata tgtttacagt atacacagat 1288140
 tgttctatag cagccagcct agtctataga gttccaggac agccagagaa accttttctt 1288200
 gaaaagcaaa taagggggct ggaaggaggg ggcttattga gatcaagttg gcttgtgggc 1288260

agcaagtggg agataatgtt gatttgata attgagatgg gagtatctgc ccaaaatggt 1288320

 ggcatcattc cctaggcagg gttaactcca attgaatgca agcatgaaaa ctaatttatt 1288380
 gctctgttcc tgtttatgag tataaacaac accatagctc tgtgttgccct aggtctgtgt 1288440
 caacttaacc caatgcagag tcattttgga agagagaatc tcagttgaga aaatgccctt 1288500
 ataagattga cttgtgggca gtccctgtgtt acttttttga ttaatgattg ctgtgagagg 1288560
 acctggatca cttgggccat accacccatg agcagggtgtt cctgagtgtc gtgagaaagc 1288620
 ggactgagca agccaaacca gaaggaaaaa gccagaaagc agcactcctc cttgggctat 1288680
 gcatctgttc ctgcctccag gttcttacc taacttcctt gtgtcatgaa ttgacattat 1288740

 tcagggaaaa aagatgaaat aaatcctttc ctccccaagt tgtttattgt caagggtttt 1288800
 gatcaagcca gtagaaacct taagatagct cttgctgtga cttccctgca gtaatgtatt 1288860
 ataacctaga attgteccaa gttgtctttg tcataattaca gcagcaggaa atgaagttaa 1288920
 gatatacact aatgagatag atgtgcttgt ttatttttac atgaagaatt aattaagtct 1288980
 tgattgattc tcaactgatt gattcccacc cccactcccc agaaagggtt tcaactgtcta 1289040
 acagcattgt ctgccctgga acttgctttg tagaccagge tggccttgaa ctcagagatc 1289100
 tacctgcctc tgactcctaa gtgctggaat aaaagtgtgc accacatgc ccagctattt 1289160

 ttttcgatac taatagacaa tactgtgttt ttacagaagc agacaaaagc tttgtaggaa 1289220
 ctgaatttac agttacattt ttagatata gcaaagctat acagtccaag atcatttggg 1289280
 gtgctcatat agactcattt gataatagaa ctgccatctc agctattgtg aagcaatgac 1289340
 tggagttttc cagaggggaa cacttggcac cctgcaggat tggaggtctg gagtgtctgt 1289400
 gaccaagtgg tcicaactgg gtgggttact ttctagtca ctatcttatt tcctttaata 1289460
 tttctgcttt tgagaatgta cacacgatag aggattgatt caaatatata tatatatata 1289520
 tatatatata tatatatatt ttttntnnnn nnnnnnnnnn nnnnnnnnnn nnnnnnnnnn 1289580

 nnnnnnnnng aatttctcaa ctccatcctt cctcctctc ctcctctct cctcctctc 1289640
 cctcctcttc ttcaaacagc gctttctctg tftaacagtc cttgtgtgctc tggaaactcc 1289700
 tttgtagacc aggtgtctct tgaactcact gagatctgcc ttcctctgcc tccttgggtgc 1289760
 caggattaaa ggtgtgcacc accaccgctt ggcaacttaa tttctttctt acttccttca 1289820
 aggttttctt tttctctgat ataattatga ccatttgata tatacttagc tgtatattta 1289880
 tcacatatct ttigcaatta aagtgtgggc tttttttaa acattttatt tatttataca 1289940
 acattctgct tccatatata tctgcacatc agaagagggc accagatctc ataatggatg 1290000

tttgtgagcc accatgtggt tgctgggaat ttaactcact acctttggaa gagcagttgg 1290060
 tgctcttaac ctccgagcca tctctccagc ccaagtgtgg gctttaaaaa aagatttatt 1290120
 taatgtatat gagtagtcta actgcatgta tgccctgcaag acagaagaag gcatcagatc 1290180
 cattatagat ggittgtgagt caccatgtag ttgtttgtgt tgtttgtgac ctctgtaaaa 1290240
 gcagcagttc tcttaacat tgagccatct ctcatccctc taaaatgtgg gttttatgat 1290300
 agggactatg tttttgttaa ttgttatggt catattgggt aatgtatata gtactataat 1290360
 atgccaaata aatgttgcac aaaacagatg ttaaaatagc aattacagag caagagaaaa 1290420

 ggctctttgg attgtgtttg catgagtatt ttttggagaa gatagttgag ctgggctctt 1290480
 ggcatgtgctg actatattat tatacagggt aattgtaaga tattgggcag aacctgtgtt 1290540
 tggtaagacc ttggagattg catttatgaa tgaatcatgg tattagtcca tttgggtggcc 1290600
 tattgttata aaagcataat aaaaggaaat cttagtcatt atttcatttt tgcttgtttt 1290660
 aacatagaga aagtgtgtaa agttaaagga gtttatgtc aggtgcctga tgaattagtc 1290720
 tctaaaggtt aagacagggc catatgttta taaaactcta caagtgattt ttacacagct 1290780
 agagtggggg ttattatgta atgttataac catgaatata aatgttcag tatgtgttgt 1290840

 catcatcccc cctccaccc tcccataggg tttctctgtg tagccctggc tgtcccagaa 1290900
 ctcaactctg agatcagact ggcccaaac tcacagagac ctgcctgcct ctgcctcttg 1290960
 agtgctggga ttagtgttga gcaccaccac caccacatgg ctcaaaaatt gtgatgtttt 1291020
 tcatacaatt taaaatcaa attgaggttt ttgggtgat gaccattgtg aagttggtgt 1291080
 aggaaagagt gtaagctgtt gatttaactt agtgtttagt tgagccagtc ttcagatttc 1291140
 acttcctttg caggcagtat catgttgatg agagaaaact gattcttagg aatgcttgtt 1291200
 ctgaaaagaa tgcattttg tagttctgct gtttaaatgt aaaagtgaag aggttttgag 1291260

 agtgacattt ttaaatgtga tattaggatg tggaggcacc ctaatgtggt tgtaactctg 1291320
 acttttgagg atttccttgg actagcagat tacagctagt atctaaagt tgctttgcct 1291380
 tttgcataga tttatattaa gttgtaactt aaaaagacaa aacagggtctg gagagatgag 1291440
 atggctcagt ggtaagagc actggctgct cttccagagg tcttgagttt gataaccagc 1291500
 aaccacatgg tggctcacia acatcatta tgagatctgg tgccctcttc tgatgtgcag 1291560
 atatatatgg aagcagaatg ttgtataaat aaatttcaa gtcattctaa gttatgtagt 1291620
 gagatcctgt ctcaaaaacc caaaggttag ggatgttatt cagtgggaga gaatttactt 1291680

 cacatgattt cagtttctag caccitttca tcctctgtca aaaaaaaaaag aaacaaaaca 1291740
 ccaaaccaga agcaaaacct agttaatttg ttgtatatag gtccttcttt ccttggtggg 1291800
 tgatggcatc cgcttgaat cccagcactc aggaggcaga ggcaggcgaa ttggatcttt 1291860

atgagttcaa ggccatcctg gtctacaggt tgagttccag gacagccctg ggctattcag 1291920
 agaccggctc tccaaaaaa gaaaaaatta aattacactg ctagcttctt ttaagacaat 1291980
 gtttttttaa cttttaaac ttctttatta ttatttttta tttagtaag ctctcactat 1292040
 gtagtcctgg ctgtcctaga actcacaatg tagatcaggc tagcctcaaa ctcaaagaag 1292100

 tctgtctgcc tcttgagtc tgtaaataaa agcatgtgac atcatgccca gcctcctttt 1292160
 cctactttag agtaaaacaa aagttgtgca gaaataaatg atggagctag tgttttctaa 1292220
 aatttgtttt tgattaagaa agatttattt taaatgtatg agtattttgt ttgcatatat 1292280
 gtatgggcac catgtatatt cctaagtctc acagaaacca gaagaggcat tggattcctt 1292340
 agaactgaag ctacagatgg ttgtaagctc ccatgtagtt gctggcaatt gaagaacttt 1292400
 ggtcttttgt gatcaaagcc agtgctctta gctgctgaat ttggtttttg agacaatctt 1292460
 ctgtagctca tgctggctcg gaactcacia tttagcccag gctaacaatca gacttgtagc 1292520

 aatcctccag cttcagcttt ctgagtgctg gagttatagg tgtttgcat tatgcttgac 1292580
 tatagctaata cccctccat attgtctact gtgattatct tttttttta attttattta 1292640
 ttatgtatac aacattctgc ttccgtatat atctgcacac cagaagaggg aaccagatct 1292700
 cataatggat ggttgtgagc caccatgtgg ttgctgggaa ttgaaccag gacctctgga 1292760
 agagcagtcg gcgctctctc gagccatctc tccagcacct actgtgatta tcttttgta 1292820
 gtataaaata acaaaaactt tagcttaggt aatatggaat gtcatgtttc ctgaggaaac 1292880
 tataaaggcg cttgagtttt ttgaggtttt atcttgtttg gataaaagga aaaatgaaag 1292940

 ctgcttttt tatgaaggca gaacatactc tgaagatgga tttttctact ttcaaatatg 1293000
 ttgctgtacc aagtaactaa atagcaatat taatttcctt ctctatgata atagttctac 1293060
 ttaaaatggt actgtttgtt ttccagagag attccattgg ctattacaag atctcctttg 1293120
 attatcaatg tttgagaact gcatcaaagt gaagaatgaa ataaactagt atttattgaa 1293180
 tatctgtctt gaaccagaat gatagttttg tttttctttt tataatgttga tgggtctaaa 1293240
 ttttgttaca ttctttaca aatttgtaag ataggtaggt ttgttgttgt ttttattttt 1293300
 ttttcccag acaagatttc tctgtgtaat agccctgtca gtcctgaaac tcattctgta 1293360

 gatcaggctg gccttgaact cacagagatc ctctgcctc tgctgagtg ctgggactaa 1293420
 accatgtgc caccacttcc tggtaagata ggtagtgtt acaattaaag gtaccttctt 1293480
 tattgctttg tatttgttct atctgtatca ggacatacat gttcctaaag acattgtatt 1293540
 gfgcaagttt ggaataaaaa ctacagggtc tgtggggaga atggcctgg cacagcatca 1293600
 caaatataag caaggtagta cttgttaata atctcagcaa tccactctgg aagccaattt 1293660
 ccagactagt ctgggtata tagaaagatt gtgtctcaaa tcaagtcctc aataacagca 1293720

aaataggact ttaataaaaa tgataacatg gggctgaaga gatgatagct cagtggacct 1293780

 gaattcatca tttcaaggaa ctgcacaata atcatacaan nnnnnnnnnn nnnnnnnnnn 1293840
 nnnnnnnnnn nnnnnnnnnn nnnnnnnnnn nnnnnnnnnn nnnnnnnnnn nnnnnnnnnn 1293900
 nnnnnnnncc acccaccac cccaggaaaa caacttgaag ctagcttggt tcagaagtga 1293960
 gcatccaaag gactgtagtt tgccagttac catgaagtgg taggtttttt gaaatctgat 1294020
 acaaggtagt atcagatgtg ggtagatgtg gcatagattg actcagagca cacagggtga 1294080
 actgaggtaa ctggtagatg tttgatatct ttgcagcaat atgctgtgca tgcccacagg 1294140
 acttgtttca gctggctatt tttgtattca tttagttttc tggctgggga aatcccacag 1294200

 aagcaaacac aaagtttgaa gagattaaaa catcctttaa tactttaatt ctagtggagc 1294260
 aaatgtgat attcaaaata agcattacta cagagttgcc tattccctgc ttaacagcat 1294320
 tgtagagacc atacatgac tttgtgtgag ctcttctgtc cttgcctgtc cctcttgtag 1294380
 atagcacctg aggcaccttc atggttttgc ttttttagtt gccagtgtat gggaactctg 1294440
 ctctgtagac caggctctgg cctcgaactg ttaagagatc tgccctgctt tgccttctga 1294500
 gtgctgggat caaaggcagt tgtggtggcc tgcacctca agccttcttt ttaagtaagg 1294560
 tccgtccttt tctttctgaa gctatgtgtt gctaaaaacc tgtaattttt atcttagcag 1294620

 atgttcagag tcttttgtaa ctccccagta gccaaagcta acacagttgt gtgtcagaac 1294680
 tgctgccaat tcttctctc tcatagggga ctctctttg agggcaaatt tcagggtcta 1294740
 ttataggtgt actatgtgta ggacctgct gtattgttct ttggacagtt gccattgaag 1294800
 tttctttggt atatataca aatatata tgcacttacc tgaaaattca gggttttagt 1294860
 tgttttctt atattgfatg gtcacctgtg gttgtagtga gtctttctgt gtccagcttg 1294920
 caaataacca tggggagact tctcaaatga tgacagcttg gccaatagct tagacatggc 1294980
 atgtttctaa ctaactctta caacttaaat taaccactt cttttaatct gcattctttt 1295040

 atgtggcttg gtaagcttta ctttgtgatt cccatgctgc ttgctcttcg tctggtgtc 1295100
 tttccccctt cttcccagtg ttctctctgc ccccacatat cctgcctagc tattggctgt 1295160
 taaacctgcc caagtgatgt atcttcacag tgtacaaaaa agattatfff acaatatgtg 1295220
 gttgattgta tttattcttt ttgggtctgt atagttttta aaaaagattt aatttctatt 1295280
 tgtgtatatg catggatata tgtatactg aatgaattta tgtgtgtata ggtgatgta 1295340
 cagtcagctg tgagctgctt gatgiaggtt ctgggacctg gagttgtgtc cttgacaaca 1295400
 gcagtaagct ctttttaaat actgagctct tgtgcagcct caacatggac agttcttttt 1295460

gaggatattat ggaatgttta ttagaaggta gtaatcttct tagacagtat tgtatgtttt 1295520
 gcctgaaaac agtggatattt cctttaaaat aatctttaat tgctgggcgt tggaggccca 1295580
 cacctttagt cccagcactg gggaggcaga ggcagggtga tctctgtgag ttcaagacca 1295640
 gtctggctca caagagctag ttccaggaca gcctccaaag ccatagagaa accctgtctc 1295700
 gaaaacaaaa caaaacaaaa caaaacaaaa caaaaaaaaa acaaaaaaac tttaatcag 1295760
 gtctctata actgaattgt ttatatattt gttttgtgt cctctgttct tcaaaatttt 1295820
 gcaaaaattt aggaagtttt gttacaatca tacctgagt tttgtaggta aactaataa 1295880

 tacttagaaa tcataaac cacttcagct agctagccct cctgcccact cttccttttt 1295940
 agtttctttc ttttctagct tggcctttaa ctcattttga agccaaagct ggccttaaat 1296000
 tcacttttat tactcctcag tcttctaagt actcatagtg tttggctctc cccctcccc 1296060
 cacttcttc ctttcttttt tttttttttt tttttttttt tttttttttt tttttttttt 1296120
 ttgagacaga gtttctctgt gtagctctgg ctatcccaga actcaccctg tgtaccaggt 1296180
 tggctctgggt ctgttactgc ctctgctggg attaaaggca tgcaccaccg cacctgtttt 1296240
 tgttgttgtt gttttgttt ttgttgttgt tgtttttgtt gttgtttttt gattttatga 1296300

 ggttttcgca tcgtgtatct tcataccatt cattctcagt cctttgcat ctgttctcca 1296360
 cccctcccc caatgaaaca atatcaagag aaaaaaatga agaaaataaa aatgagaaac 1296420
 atgttttgaa aaaggaaga aattaaat ctgtcatag aagctgcagt gcaaccaac 1296480
 aagtcaacac tgtataacc cttaacgta cagttttact tgcaagtgtt cattgcagag 1296540
 tcattgagtc tggttggagg cttctggctt ctgttacct atagatgctg ggcctcact 1296600
 aggactctct ttggatagtt tgttgttct ctgtgtttg gagatcctgc agctttgggt 1296660
 ctgtgggtca ggttcctca tgtgtccta ataatagatg agatggatgg gtaggccaac 1296720

 tcataactct gggcttaggc ctgagcaact gccagatggg aaatgggaca getatacaat 1296780
 tttggggctg gctcatctac acttgtgctg aatgtgttg ctttaattata ttgccctggc 1296840
 aaggtgcacg gcctggtctt ctgagtgtt cagctggtgg ggggtgggggt ggctctcca 1296900
 cactatgacc acaggacacc tggctttttt ttttttaact actatttttt aaacaattta 1296960
 ttttcttag gtgcattggg gttttgcatg catgtatgta tatgtgaggg tgtcatattc 1297020
 cttggaatg gagttacaga cagatgtgag ctgccatgtg ggtgccaagc ctctggaata 1297080
 acagccaggg ctcttaacct gtgagccaic tctctagccc ctactgtttt ttgtactaaa 1297140

 tgtatatggg tgtttgtct gcatatacat ctgaacacca aagagttcat ccaatcccat 1297200
 gggctctgggt ctaaagttat agacatttgt gagccatcat atgagttgag tgctgagaat 1297260
 tgaactcagg acctctggaa gagtaaccag tgctctaac tgctgagcct ccaacctcct 1297320

ttcccccttc ttctcccat caccttctct ttattccttc tttttcgac tctcttttca 1297380
 aataacataa ttaaatgcca aaaaagaaga gaaaaactg gtgaagtctg gcatgtttta 1297440
 tgatacatga atgggactgt agtgctagaa agcccgtggc aactgtcacc ttcagtctca 1297500
 ttaagattga atctatagtt ttttgtttg tttgtttgtt tgttttttg agacagggtt 1297560

 tctctgtatt gctttggagc ctgttctgga actctctctg tagaccaggc tggctttgaa 1297620
 ctctgcctcc caagtgtctg aattaaagc gtgcaccacc attgcccagc atgaatctgt 1297680
 aatttttcac ttttttttaa aaaaaagatt ttattcattt attatgtata taacattctg 1297740
 cttccattta tatctgcaca ccagatgagg gcaccaggtc tcataatgga tggttgtgag 1297800
 ccacaccttg tggttgctgg gaattgaact caggacttat ggaagagcag tcagtctct 1297860
 taatctctga gccatctctc cagccctagt tttttacttt tgagctcaa acctacagag 1297920
 acctccccct cccccgcaa aaaaaaaga cccctaag ccatcattct gcaaaagtat 1297980

 tgggtgaaaa ttcccacaga tttttgtata ttatcctggg actacatact tgttgcttta 1298040
 aaaaatattaa gatgtgtagt catagtgggt cacacctagt cccagggcta gggaggcaaa 1298100
 gtcagataga tctctgagtt gaagccagac tggcttgaat atcgagtctt aggccagctc 1298160
 catagtgaga ctgtccaaaa aatattatct taagggtcat tttgttttat gaaatggtaa 1298220
 taacattttt ataaactgta cttagaaaaa ttagaagatg tattctaatt cttcagtttt 1298280
 cttttgaaac ttgacaagct tttaaaacat gggaactttg cgtgggcttc agaaaatgat 1298340
 ccagagaatt aaggagattt gaagctttca tataaggaac agctaaaaca ataaagatgt 1298400

 ttggttgaaa taagcagggt gggagaggag aagctcttaa agagctagag tcaattatga 1298460
 agttataagg aggtgtagtt tagatcattt cttaaaatta ttttgctaaa tgctggcatc 1298520
 aggcaccagc tgtggctact tccagcagat gagatttaag gtctctttag attaaggat 1298580
 actgtaaaac acttgacttg ttaaatctta ctttagcggg tctttccttt ttggggggca 1298640
 aggtttcaca atgtggctgt ggctggcctg gaactcaagg agatctgctt tcctctgtct 1298700
 ctttgagtgc tgagatatgc accaccatac ttagcctaaa tttcccacc tccacccccg 1298760
 ggacagagtt tctctgtgtg gatgtcctgg aacttcaga acagactggc atcatattca 1298820

 cagagatctg cctgcctctg cctcccaagt gctaggatta aaggcatggg ctaccatgcc 1298880
 tgttttttta agacttattt ttgattgtat gtgtaggagt gttttgcctg aatgtatgta 1298940
 agtgcatgca gtgctgggtg aggctataag aggaacttca gatcctcaga aactggggtt 1299000
 acgtcgtatg ggttatgcta ggaactgaac ttaaatcttg tgctagaaca ggaagtatct 1299060
 taaccactga gctgtctttc cagcccccat tgtgggtttt gatgcctgt tttcttttta 1299120
 ttttgttttt ttttgtttgt ttgtttttgt ttttttttg agacagggtt tctctgtgtg 1299180

gctttggagc ctatcctggc actcactctg gagaccaggc tggcctcga ctcagagatc 1299240

cacctgcctc tgcctcccaa gtgctgggat taaaggcgta tgccaccacc ggccttgatg 1299300

cccagtttcc aaggcaccat actgetgttt agttcagtca tggcataaaa gatagtgggt 1299360

acccgtttgt aagtcattcg atgtctcaca tagcttcttt ttactacctt ttataacca 1299420

agttgagatt ttctgtttt tgaatgatac ttttcatact gactcttggt ggtgtcctgt 1299480

ggaaaatgtt gatgattttg ttcagcaggc cagttaggct caaactgcat gtcctaattc 1299540

taatgtttgt tgttttttgg ttttttttt tttttttgaa aatccttatg tttctgcttg 1299600

ggtctatcct tcatatgcc ctcctcacct catggccata ctgttcttcc aattgtgctt 1299660

gcttgcttcc tgccttccct ttttttttt ttttttttt aatatgtttt ttaaagacag 1299720

agtctcacta ttagcccta gaacttaact gttagacaa gactggcctc aaaccatctt 1299780

tgtctcctga gtctggtagc taaaggcatg caactgctac attctgaaag acccccagag 1299840

gctcaggccc ccaggatctc agtccaggac ttcacagacc ccaatcactg ggtggagtgg 1299900

aaagcttgat gcaaacagca ggaggcttta ttgcagtgt ttaataagct aaccattag 1299960

ctggggcctt tcatccatcc accatggcgg atggctagaa aagaaggcta gaagccactg 1300020

catagagatc ttataggca gcagcgtaa gggagtgtct aggggtatgc acaggctcag 1300080

gattggtgtg cctccagact tgcctgtgt tgattggtca actgattgtt atggccata 1300140

ggctttccca gggctattgc tatgtctgt gtgtcattgc tgtgcacttg tccgtaaagc 1300200

acaccagag ccttaaagca taacaccacc agctaacttc tgattggttc ctgcccaga 1300260

ggcaggcatc tgacctcta gtgaccaagg caaggtcagg caagcacgtg ctagectgtt 1300320

atggctgctg aaatggggag ctggctcctt caattcagct tctgagttt aatttgcttt 1300380

tatttttcta atttcttaag gaataagatg aattaattaa aacttttggg aatagacttt 1300440

ttccctccc tgattgcttt tataattttt ttgagacagg gtttctctgt agttctggtt 1300500

gtcctggaac tttataggcc aagctggcct ccaactcaga ggtctggatt aaaaggatgt 1300560

gctaccacag ccagtgtttt tacaattttt tgcctttact ttccagtggg tggattgcaa 1300620

tagaacattt gtttgctttt tttggggccg gggacagggt ttcactggac tcatactctg 1300680

taaggctagg attataaaca tgtgtcacta tgcttggtt cagtattttt cactcatttt 1300740

ggtctttatt ttctctagta catgtgttaa acttgatatt gttgttggaa ttctattttt 1300800

cattactttg aactatttaa gcttccattt agattctgtt actgtggctt caagttttcc 1300860

atagtgttc tacaatcaca atggcttcaa catcactgtg atgctggta atattttaag 1300920

ttgttataag taacttcatt tttgttagtt tccatttttag gatttccatt tttctattga 1300980
 cgttttttaa gtttctgac tgtgttcagg ttttcttcaa ttcctacata ttatagaaat 1301040
 ttccctgaaa gtctttgctg tttccatcat tatttttgag tgtgaaatgt gttactcttg 1301100
 taggctatgg gtcactttcc tgtgtacttc tatttctagt aatactgtct tctcttcata 1301160
 atttaagata cgatggacag gcagttgaat gtgtggatcc tgcatttatt aatagcattt 1301220
 tgttttgga ggcagttctt tttgggaaga ggggatgtgc attagccttt tcatgattgt 1301280
 ctttttctt ttgttttttt tttttttttt tttttttttt tttttttttt aaattatcct 1301340

 tttccagaca gggtttcttg gtagtcagggt aggcctttggt tgtaggcttg tactgctttg 1301400
 tagttgtgct ttcctggcc taagtgtggt gtagaccgc aaagatttct aggaagtttc 1301460
 taaagcttat atctgtcgac ttctttgctg cccttcccaa gagagtctag ctattcagca 1301520
 gtttctcact ctatagctgc tcagattgtg acacttctga acacccttaa tctgcagtag 1301580
 ggaaaatgac ttiaggcaaa agaggggatt gacctcgctc ctgtaatcac agtcctgtgc 1301640
 tgtgtttgt tcaacagctg ctaacagata tcttcaaatt tttatacaat tttttataaa 1301700
 agtatacact tttatacttg gcataatggtt aagctgatgg cagttataca tttggaggca 1301760

 gctatctcaa gagtgttga tgggtgccag agatgaggct ttacttatta tctattagaa 1301820
 tagttcattc tggtctctt tcccctgttt tctgagaagg cagatcattg tctgtctctg 1301880
 tctttctctt tctctctctt ctcccttact cccttacctt ccaataaact ttccacataa 1301940
 gttatgtcca gaaaaaata gttagaata ttcttgcttt attatgcttt ggttttgcct 1302000
 gcctgcctgc ctgctgcct gcctgcctgc ctccctccct cctccccat agctgtcctg 1302060
 gaacttgctt tgiagaccag gctgacctca aatttacaga gatctgcttg cctctgtctt 1302120
 ttgagtgtg gattattgt tgtgtgccgt tctgtccacc ccttcccact gactctcagg 1302180

 ttttaaaaaa ataatagcag ctgggtggta gtggtgcatg cctttaatcc cagcactctg 1302240
 gaggcagagg caggcagatc tctgagtgtg aggccaacct ggtctacaga gttaggtcta 1302300
 agacagctag gactgtttaa tagagaaacc ttgtctctctg aagaagtga agaaccgtct 1302360
 cttcaggaag aagagcaggc ctcccaggaa ggagggatta cttggctgca gtacaaagag 1302420
 aacgaaagca gcagtgagag ggataacgaa caagaccagc catgagctga tgcagcctgg 1302480
 gatgttcatg ctggatggaa acaacaacct ggaagatgac tccagtgtga gcgaagacct 1302540
 agaagtgact ggagcctgtt tgatggcttt gcagatgggt tgggagtggc agaagccatc 1302600

 tcctatatgg atcttactta catggtctctc gaagagcacc ttgccaggt gatggagact 1302660
 actcttgtgc acctggagtc tctcggctt gatgtcgagg tggetaacc acctacaagc 1302720
 aaggagagca ttgatgtgct tcttgagatc ctgatcaccg aagatcatgg tgcagtggac 1302780

caggaaatgt gctgtcccat ctccgtggc taatatgtga agggggaggt ggcaactaag 1302840
 ctccgggtgcc accactatct ccataagcca tgtgtgtcca tctggcttca gaagtcggc 1302900
 acctgcccag tgtgccgctt catgttcct cccccactct aaaggccaag actctttact 1302960
 ctggcctgg ttatcttccc tatctgaaac ccacaatact acaggagccc tctttcaaaa 1303020

 ttaacaatgg cagtgaaatc agtcgggtcaa ttaactaaa ctgtgtgatt cctgtgtatt 1303080
 gtttccaatg tgaatgtac aattacattt taaatcacc ctttctatta gaaggtaaaa 1303140
 aggggaaact aaacttacta aatgctactt gagattgcag caagaacata aatcttctaa 1303200
 cctgaaagt gaaacaaatc atattgttc tgtagactgt gttgtacttc ctgttgata 1303260
 tcaagttat ctgctaaata tgttagaaag acaaaaataa ctgtgttc aagttatggg 1303320
 ttaatgttc tgtattaat ggtgtaaaag ctattaaag tctgttaa agtctctgc 1303380
 ttattagaga gagagagaga gagagagaga gagagagaga gagagattta gtctcaacc 1303440

 ccccaaaaa acaattaaa acttattgtc tattgtatg tttttcaga taatttcctt 1303500
 ttcttttag agtcagagt tcaactacaca atcctagcta gcctgaactt tctatgtaga 1303560
 cagtgtgac ctgactca cagagatcaa ctctaccac ccacatgtt ggggctaag 1303620
 gcatgtacca ccactctg tgaattaat atttttattt gggaaggagg attttaaaaa 1303680
 tacatttta tataggacct agcatgtgtg tgcacacatt catgcatgta tgctcttaga 1303740
 aaaactggg aagactctc gaggaattg ctcagtagtt aaagcacttg ttatecaaaa 1303800
 ataagattcc tagaccgta caaatactgg gtgagagggt acatcccacc tggaaattctt 1303860

 gcactccaaa ggtggcccca ggggatctc ctctcccct tttgggggg gcatttaagt 1303920
 gtgtggcact ggaaaaacag tactttcaat agtagagaat gaaagaaatc cattagaagg 1303980
 aagagtgagt gcagagtcta ttctggagaa ctcccaggat ttctctgctc tacaagctga 1304040
 gtgagcagcc acagaggctt ggagccatgg cttaaagcag gctatttctg ctgtattttc 1304100
 agtaacatca tttaaagagc agaaagaaca gaaactgt gctggttctg ggtgggcaga 1304160
 ggtagaattg gtgctaggaa gatgctaac ctgagcagtg acaagcttac ttcatgtcag 1304220
 gaactcagag caggtatcat ggactgtatg ttaagacct ggcctataaa attcctcagg 1304280

 gtaatgggga acaacttttg agtaacaact acagtggccc aagatgtaga atcctggtct 1304340
 gagctataga cctgggtgga ccactcaaag cctgtttac tagaggattg gaacaaaggc 1304400
 aggcttagtg taigtgcct gcctagggtg gaaactggaa agagataaga ttgagttggc 1304460
 tccccactga ctacacagaa taggtcact tcatgtgct ttctgacaag ggactgcaga 1304520
 ggacacttc tacatecccc caagtccccc tctccccagc tcagaagcag aatgggctgc 1304580
 ctgagtagca cctgtgtggc agaagacctc aggctcaggc aaagaccaca tagatggttg 1304640

tacagctacc tcattctctt ttccttcttt gaaaaaatat tctgctgggt ggtggtggtg 1304700

cacaccttta gttccaacac ttgggaggta gaggcaggca gatctctgag ttcaaatcaa 1304760

ggttagcctg gtctacagag ctagatccag cacaggetat gctccaaaat taaagagaaa 1304820

ccttgtcttg aaaaaccaac tctcctcccc aatattttct tcctttgta atttcatgtg 1304880

ttaatagtgg ctttagtggg ctggagaaat ggctcagagg ttaagagcac cgctcttcca 1304940

gaggtcatga gttcaattcc caattcccag caaccacatg gtggctcaca accaccgct 1305000

atgaggtctg gtgtcctctt cttgtgtgca gatatacatg gaagcagaat gttgtacaca 1305060

taataaataa taaatctct aaaaaaatag tgtatttaga tcatatata ctcttcaacc 1305120

cctcccctcc atcccatttc cacttttct atgattatca gcctcctctc cccccattt 1305180

agtgtctctc ctgtgcatga gagcatagtc tatcataggc tccctagtgg catttagctg 1305240

ctgtcctca gctagatgtg gagcttggta aatcccttc ctctccatgc tgcagtgttg 1305300

actggtttaa ttcttgtgcc aggcagcttt attttaatat ctgtcttcag tttaatgggc 1305360

tgactttgtc ctgccccaaa tgaagattct cctggaactg ggaatgggtc tcgctgatga 1305420

gtgtgagat catttaaggt tgtttagtta tacttcttt atcttccctc cctcctctct 1305480

gactagttta agatttttgt ttgtcttctt gttgagacaa ggtctcacia tgaaccctt 1305540

ggctcaaatg gatttcacta tatagatcac gctggcttaa actcttaaga gatccatctg 1305600

actctgattt tcaagtctg ggattaaagg agtatactc tacacctggc ttttttttt 1305660

ccccagaca cagacaggtt ttctctgtat agctttggaa cttgtcctgg aactcactct 1305720

gtagatgaag ctgactttga actcacagag agatgcgcct gcctctgcca ccagtgcctg 1305780

gccccacttg gcttttatga tttattttta ttaatatatt ttgaggggga gagggagagg 1305840

tgagttagg cgcctatggc agctagacgt tggatacct tagagctgaa ttacaggtg 1305900

cttatgggcc acccagtgtg gatgetggga acctacctca gtttctgtgc aagttcagta 1305960

tgagatctta cactgtgtc atctttccag cttttctctt tattctttct ttaactggag 1306020

ttaccttatt tctccttctc tttattatc tctgcatttt ttcacttaa aaatttcttt 1306080

taggggctgg agagatggct tgggtggttaa gagaactggc tgttcttgca gaggaccag 1306140

gttcaattcc cagcaccac atggcagctc aactgtctg taactccagt tccaaggaat 1306200

ctgacacctt cacacagaca tacacataca ggcaaacac tgatgtgcat aaatagataa 1306260

atcttttaa aaaactaaa aaaatttcta gatataaaaa catacttatt ttatgtgtgt 1306320

attttgcta tacatgtata cgtgcaccac aagcatatct ggtgcctgta gaggtcagaa 1306380

gagggtgttg gatcccctgg aactggaatt agagatggtt gtgagctgtc atgtgggtgt 1306440
tacttgatt caaacctgta tcctctgcaa gaacaagtgc ttttaaccac tgagtcatct 1306500
ttctactcac acttttcttc tttctgttcc ccattttggt taatttctgg tcttctgttt 1306560
ttttctgttg ctctaatact aatcttcac tgcacatata accaatctta atctgtatgt 1306620
gtcctttcca tttttacttt tagttagtga gtaccttagc atgcattata atgtcctttg 1306680
tcctttacct cctcccaaat tattggagtt gaagggatgg atttttatgc tcaactgtatt 1306740
ttcatagtag acitctttgg ttgtgtgttt atgtcagaaa aataatattg tattctcaaa 1306800

ggaatactag agagcaaacc tagtgcattg actgtgagct gagggcttag atgtgagctg 1306860
cacctccagt ctagtgggga ggaactctgc cttactgtaa tttagtcct ctggaatatt 1306920
gtagatcttt ctactgaaac aaccatgtga ttaagtaaaa atacaacaat ttactgtatc 1306980
tcaactgcaga gacacatgaa acatggannn nnnnnnnnnn nnnnnnnnnn nnnnnnnnnn 1307040
nnnnnnnnnn nnnnnnnnnn nnnnnnnnnn nnnnnnnnnn nnnnnnnnnn nnnnnnnnnn 1307100
nnnnnnnnnn nnnnnnnnnn nnnnnnnnnn nnnnnnnnnn nnnnnnnnnn nnnnnnnnnn 1307160
nnnnnnnnnn nnnnnnnnnn nnnnnnnnnn nnnnnnnnnn nnnnnnnnnn nnnnnnnnnn 1307220

nnnnnnnnnn nnnnnnnnnn nnnnnnnnnn nnnnnnnnnn nnnnnnnnnn nnnnnnnnnn 1307280
nnnnnnnnnn nnnnnnnnnn nnnnnnnnnn nnnnnnnnnn nnnnnnnnnn nnnnnnnnnn 1307340
nnnnnnnnnn nnnnnnnnnn nnnnnnnnnn nnnnnnnnnn nnnnnnnnnn nnnnnnnnnn 1307400
nnnnnnnnnn nnnnnnnnnn nnnnnnnnnn nnnnnnnnnn nnnnnnnnnn nnnnnnnnnn 1307460
nnnnnnnnnn nnnnnnnnnn nnnnnnnnnn nnnnnnnnnn nnnnnnnnnn nnnnnnnnnn 1307520
nnnnnnnnnn nnnnnnnnnn nnnnnnnnnn nnnnnnnnnn nnnnnnnnnn nnnnnnnnnn 1307580
nnnnnnnnnn nnnnnnnnnn nnnnnnnnnn nnnnnnnnnn nnnnnnnnnn nnnnnnnnnn 1307640

nnnnnnnnnn nnnnnnnnnn nnnnnnnnnn nnnnnnnnnn nnnnnnnnnn nnnnnnnnnn 1307700
nnnnnnnnnn nnnnnnnnnn nnnnnnnnnn nnnnnnnnnn nnnnnnnnnn nnnnnnnnnn 1307760
nnnnnnnnnn nnnnnnnnnn nnnnnnnnnn nnnnnnnnnn nnnnnnnnnn nnnnnnnnnn 1307820
nnnnnnnnnn nnnnnnnnnn nnnnnnnnnn nnnnnnnnnn nnnnnnnnnn nnnnnnnnnn 1307880
nnnnnnnnnn nnnnnnnnnn nnnnnnnnnn nnnnnnnnnn nnnnnnnnnn nnnnnnnnnn 1307940
nnnnnnnnnn nnnnnnnnnn nnnnnnnnnn nnnnnnnnnn nnnnnnnnnn nnnnnnnnnn 1308000
nnnnnnnnnn nnnnnnnnnn nnnnnnnnnn nnnnnnnnnn nnnnnnnnnn nnnnnnnnnn 1308060

nnnnnnnnnn nnnnnnnnnn nnnnnnnnnn nnnnnnnnnn nnnnnnnnnn nnnnnnnnnn 1308120
nnnnnnnnnn nnnnnnnnnn nnnnnnnnnn nnnnnnnnnn nnnnnnnnnn nnnnnnnnnn 1308180
nnnnnnnnnn nnnnnnnnnn nnnnnnnnnn nnnnnnnnnn nnnnnnnnnn nnnnnnnnnn 1308240

nnnnnnnnnn nnnnnnnnnn nnnnnnnnnn nnnnnnnnnn nnnnnnnnnn nnnnnnnnnn 1308300
 nnnnnnnnnn nnnnnnnnnn nnnnnnnnnn nnnnnnnnnn nnnnnnnnnn nnnnnnnnnn 1308360
 nnnnnnnnnn nnnnnnnnnn nnnnnnnnnn nnnnnnnnnn nnnnnnnnnn nnnnnnnnnt 1308420
 ttatagatca ggctggcctc aaactcagaa cctcctgagt gattaagggt tgcactacta 1308480

 tgcttggctt gtacctttta aatcatatct tcacttttcc tatgactcag ttactagatt 1308540
 ttttttttaa atgagcttat gatttttcaa atctaaatct ttcactttgt ctgctttta 1308600
 gtttttgtat ttaagccttt caactttggg tgatagagct ttgggtgtat gaggcaagtg 1308660
 ctgtgccact cgattacatc ctagtgcctc tttgggtgact gttttatttag ttggacttag 1308720
 aagaatctga aaatagcatt ctgtttaata gcataaaagc ttaataatga acttggaaag 1308780
 tttctgcatt taitgataaa ctgacatact tctttttttt gacagagatg ttatgaacat 1308840
 aaacaatata gaaatggatt aaagtctgt aaacaaatcc tttccaatcc caaatttgca 1308900

 gagcatggag gtaaggatac actatgcacc ttaattaga tttgatatta ttgaatgact 1308960
 ggctttcctt attttgcctt gctattcagc tgcctttatt ttccagagta gacctttagc 1309020
 tcttaaagga agataaaatt taataataaa ttttgagtta aaataccaag aaaatgatag 1309080
 cacatttgat ttaagccttg gttacgtctt ctaacagagc caatggaaag gcagaagagc 1309140
 ccatttaggc caaatgtttt ttaattaat gtgtttataa gaaaattttg ctttaaaact 1309200
 tggaggtgga cggattttat tctttacat aagcttgttc agaaagtgc catttacttt 1309260
 cttatctata ttatatctta attagctcct caccactgag tcttaagaca tttgtattta 1309320

 cagccagatg tatagctttt gtccaataa tgggtgggtga ttagatattt gcagaacagg 1309380
 tggtagatg gtgacagaac ttgtaaagaa ataaaaggaa aataacattt tgtgggtctg 1309440
 atttctatag atttgggaaa catgactcat tagtaattaa ttgacattgt gtattgagga 1309500
 ggggagaatg acagttcact attaagtttt taccattcct tctcttcag tattatgttt 1309560
 ccctatgttc aaggttttac ttatgctgca gtttgagtt gaaagcaatg agagtaaaaa 1309620
 tacttaattt gatctccttt cgtattgaaa acctgtcttc agtttttaat ctggatagta 1309680
 ggttctttta tattccattt ctgaagtatg tgttttggta acagaacttc taaattaat 1309740

 atggtagttt cattatcaag aatgaattca taattttaga gtagttttct ctcttttatt 1309800
 ctaaaacatt ttaggaaaaa agaatactt ctgtatttt aacagactga aattaggttg 1309860
 agtatcaaat ataaattcca agctaaatgc cacatgcctg gttaggtttt atcttacatt 1309920
 atttgtttaa aaaacaaaca aaaatctatg agaacctaca agaacagcat ctagaagttt 1309980
 ttgcttactt gacttgttgg tttttaaaaa cattttaatt cattacaaat ctggaaatgt 1310040
 ttgtactggt tgcttttgag attatagttta tttcttattg attactttct tctacattct 1310100

ttttttcttt cgtattaaac cagaaaccct ggctatgaaa ggattaacgt tgaactgtct 1310160

 gggaaaaaag gaagaagctt atgaattggt tcgcagaggt ttgagaaatg acttgaagag 1310220
 tcatgtgtgt atccttttga aatgtatata agattgagtg ggctgttccc tettaccaca 1310280
 aggaagtgct ttttttctta aattgaacac cgcaactgtc atcattcaga gaacccccct 1310340
 ccccccata taccactgc attttaacaa tacatgttaa gtgaactgtg atctatggaa 1310400
 gtcttctca ctggggggg gggcattgct atggcttgag tatttatgtt cctctaatt 1310460
 cacatgttga agcctgttca ccagagtgat ggtattagga ggtaggtttg tctgaaaagt 1310520
 gattaaggtg tggggataga gccttcagga ataaaatctg tgtaacctgc cccttggcca 1310580

 catgaggata cagttagcc atctgtgaag gagagaacaa gactcactag gtaatggatc 1310640
 tatagaagta gtatgagcag cagatgtctt ttgtttgtaa actaccaggt ttaagtaaag 1310700
 tttttgtta tagcagacta aatggcccaa gggagatacc atgctgattt cactcatctg 1310760
 tgatcataac ttagagaaa ccatactaaa aggaatattt tttaaagatt tattcattta 1310820
 ttaggtatac agtgttctat ctgcatgtat gcctacatac tagaagaggg cgccagatac 1310880
 cattataaat ggttgtgagc cgctatgtgg ttgttgggaa ttgaaaccag gtcctctggc 1310940
 agagcaacca gtgctcttaa ccctgagcca tctctccagc ccctgtcata aggaatatta 1311000

 aagaatcacc tactatattg agtaagaaca gaggctgtga agtacaggtt tgcattgtaat 1311060
 gaacttcact cagacctgag gccctactta gccttttctt gttatcttag gactcagttt 1311120
 cctcatttgt gaaatgggga tattcactact ctactggttg tagtgactta atgttgaat 1311180
 atataaaaaa aaattatgtt ttgttaagtg attgataagg actgtatctg agtagaaatg 1311240
 tatgagggaa aacataaaaa aatgactttt ggtagttttc cgtctctaac aaggatacct 1311300
 gtacctgttt tgtgggttag cataatttaa gagctgagtc atttaattta gcacattttc 1311360
 aagtgtttaa cagtctagta ggacagtaca ggtgaagtca ataatgtgtt gtagataagt 1311420

 actagatcct atatatgttc tcattttgag tatatttaa acatggcttc ttcaaagaag 1311480
 taccactggt tgtgcaaagc agaagtctgt cgattgatca gaggactaga aaggtaagcc 1311540
 agggctcaac agtgcagttg tagaaaccct cctactctgg atgttgatat gtcagtattt 1311600
 tgctctggat ttacttaacc acagtatag taactagctt aaattaatta ttttagattt 1311660
 attttatgag tatgagtctt ttgcttgcac atatacattt ataccatgtg ccaacattat 1311720
 ctgggttttt atcatttggg ttttaaaaaa gaagtaggat agaaaaaaaa aagacaaatg 1311780
 gggcagttagg attgattgat taatgtgata tagtaaaaag ggtttatagt aggtgagata 1311840

ttgcctcctc cttttattgt atccctctct ccctctcatt tctctgtgta gccccagctc 1311900
 tcctggaatt ttgtagacca gactggcctt gaactcatag aaactgcctt acctctgcct 1311960
 cctgaatact gggattaaag gcatgtacca tcctcatgcc tagctttata gtattcttat 1312020
 caccaattgt caatttcctt ggcttatctt tttttagtgg actataaggt ctctgaatgt 1312080
 aggaaataaa cccaattat tgagagcttg tatcaataat tttttaaag tagtgttttg 1312140
 gttttatatg tgattgagtg agttttggaa acattgttcc atttgaaga ttttctaaa 1312200
 gaacttttag ccaaaggaaa gcccctcagg atatcatata aattatata catgggttta 1312260

 gttctctctt tttcttttaa tgctaaagat ttttcttat atttacttgg tgtttgtttt 1312320
 gtgtcagcca gtgagcactt tcatgaatgt ttttcagtt accattattt tgttccgctg 1312380
 ttaggtatt tttatttacc ttctgtaatg agaaatgaaa taaagctaat ttgtttgagg 1312440
 ttataacatt aataaagggt agatctaatt atctatagct tcaaatactg tgttcttttc 1312500
 tgttcattaa attctctttt ttcttgtat tctttcccag tgtccctggt tacattcaga 1312560
 aatttaciaa tgttagcttt ctaagtattt aggagattgt ttggtgtgta tgtgtaaac 1312620
 attttttttt ttgttttgag acaagggttc actttgtatc cctggctgac ttaaaaactta 1312680

 agtctgtttc tctgcttctt gagtctgag attaaaggca tgtgctacca tacctggctg 1312740
 ggaataatat ttcttgacat acaggttata tccttaacta agttacttta ggttggcatg 1312800
 tttatggcct tcttcagagg tcagacaaga aatcagatga agctattaag tgctatcgaa 1312860
 atgactgaa atgggataag gacaatcttc agatcttaag ggatctttcc ttactacaga 1312920
 ttcaaatgcg agatcttgag ggttataggg taagtaaaat tcatattgtt ttattttatc 1312980
 ataagagaaa aatcttatta cttagaactt ttaatatatt ttggtaaaga aatttttctt 1313040
 tgcatttttt tgaaaaaaat ttaaccgact gcctccctta gtgaatatac ctgtgattgg 1313100

 agcagttagg tcttaaaaac aatcgttttg ttgtgagata gagtaggagt actgtatagg 1313160
 ttgttactca ttttgttaaa cattaatact cagaatattg ctattaatat tttgtaactc 1313220
 tagtctgtc attttctgta aagtaagttt ttaagttttg tgtttgtcta ttcatattaa 1313280
 tatagtttag tagcttctgt ttaaccctta aatcagctt gggtttataa tttctctttt 1313340
 aatctatttc ttcatgttag ttctgccac agtgttttct ttacaggcct taattaagtg 1313400
 cctagaaagt acacatattt ggggtgtact ttctaaacag tttcatttgc tgcatttgc 1313460
 gaaggatatac tggatataag tttaaaaaga tactataaga ttaacactgg aggcttcaaa 1313520

 ttatttgtca caatacagct atataaact agatgttgaa attttctaa aatagttacc 1313580
 ataattgtgc tacagaatga ataattgtgg agcaaattaa tgtgatcttc tgttttctta 1313640
 gggccctgag aatataatcc atggccttgt atgctagtca gtagagaagt atttgcttta 1313700

actataaacc taacagtaag tttttttttt tttttttttt ttttttttcc ctgcccttg 1313760
aaggaacaa gataccagt gcttcagct cgacctgcac agagagcatc atggattggt 1313820
tatgctattg cttaccatit actagaagac tatgaaatgg cagcaaaaat tttagaagaa 1313880
tttaggaaaa cacagcaggt aataacaagc cagtttattg tgtctgatt gatgtgtaac 1313940

tgaagaaaag aaatttatgt agtttaacca acattttatt tggaaaatag cttcaaactt 1314000
attcacaatt gaaagagtag tagaaaataa ctataggaat tacctatatt atctaattggt 1314060
aaacctgtgg tacatgtact tttaaaagtc tttgtgtca atctgtgctt acattttctt 1314120
ccttaaaaga ttgcagacat gttcttttac atacttcacc gtactcctaa gaatactcct 1314180
aacaatgcaa ttgttataat tgcagatggt atcacagatt atcaaaatta gacttgtttc 1314240
taaggtatag tacatgggta aaattatctt aattttttcc tctaacagtt ttgttttcaa 1314300
ttccattgtc tggtttttaa gcatacctgt catgtgatca tttcttggga atgtgtctga 1314360

actaatttta aatagtttat attttctggg gctgcagaga tgcctctgtg gttacaata 1314420
ctgactactc ccacaggagt tcaatttcca gcaccacac ggcagctcac aattgtctat 1314480
aatftaattg tccagttcca ggggacccaa cacccatggc aaaacaccaa tgcacataca 1314540
taaataaata gtttgtatit tctgttatta attatttggg gaacatacat taatgttttt 1314600
ggaatgttcc tgactttgga tttgtttgcc tttcctcatt gttaactgc actcttcaca 1314660
gaaatccaca gactaatgat ggttgccttct cagttcagca catcaactgg tacataattt 1314720
atccgttcca ttttattact gtgttagggg ggtatttga actgtaaact tgtttcttta 1314780

tgaaaaacct aagacaaaat agctcatctg tcatcacatt ttgaccacca gccttcagta 1314840
ttcactgcct ggctcagctg ttaaaatggc aactttgaag tagggattct ctcactccca 1314900
tttttttatt tttctagatt tttttgtttg cattctgtca ttagcagatt tccctttcta 1314960
tttgtatate aaaacttaag cagatttccc tttctatttg tatacagaa cttatggatt 1315020
atfttattca atttattata agctgttctt taacatttca taaacagata tttaggaatt 1315080
ttaaagat tgctattaac cacatattat ctttttgttt ggggtgtgc agataatttc 1315140
ctaatacaaa aataaaattc ttactgataa tattccttgt gtctacatgc agacatctcc 1315200

tgataaagtg gattatgagt atagtgaact ctttttgtat caaaatcaag ttcttcggga 1315260
agcaggtctt tatagagaag ccttgaaca tctttgtacc tatgaaaagc agatttgtga 1315320
taaacttgct gtagaagaaa ccaaaggat tttaaaaaat atatcattgt aacttacagc 1315380
caagagtttg ctgaaaattc atagtactg gtgacagttg catataatgg gaaaaatcta 1315440
tcattcatac atfttgaata acttgtgatg taggaaaata tacattaat gatgaacatt 1315500
gttgattgag gagaaagggt cgcaaaattc atftgataaa acaactttgg taaagtgttt 1315560

gttttgaatt ttttattgtc tttaaagggg gctgtgctat gtcttcttca ctggtctcaa 1315620

 acccctgggc tcagtggctt ttattctgta gctgggagta attgatacta cagagttaaa 1315680
 ctaacaccca gtgtaagcat ctactctgta aagtctecct gtttttgaag atacaggggt 1315740
 gttgggggga atcactacag gatttggcca aaacatagga gataattgta attttataaa 1315800
 acaagattaa ctattttaga aataactcaa tggaaaaatt acagctctta agtactatat 1315860
 gccagatfff tttttttttt tttggattta tttatttagt atacagtgtt ctgcctgcat 1315920
 gccaaaagag ggcaccagtt accattatag atggttgtga gccaccatgt ggttgctggg 1315980
 aattgaactg aggacctcag aaagagcatc cagtgtcttt aacctctct gagtcatctc 1316040

 tccagccctt gtatgccaga ttttattacc agtagtatat attataaat tagtccttac 1316100
 taacattcgt agagcaagct ggatgtaatg gtccattcct acagtcctat agtgaaggga 1316160
 ttaaggcagg gttaggagtt taaggccagc ctggattcta gagcaagatc ttgtcttaac 1316220
 cccaaacccc caaaagacca acaacaacaa aataagaaaa taacaacagc aaaaacaac 1316280
 taaacgaatt cccagatctc tttatggttt atctgagttt atttgagaaa atgggaaggc 1316340
 cataaattcc agatggcaag gaacaagatt tggatttttt tgtgatagga atgctaggtc 1316400
 cttaaataaa tgcctccaaa tgctgccgtt tttcctagg ctgagaaaaa gagagttttg 1316460

 tagttcctat ttatttgta gttgattgat ttgagaccag gttcttttat gttggtatag 1316520
 gttagccctt ctagggtgtc tgttgatggt ctggccagac ttattaagac tggatatctc 1316580
 ttgtgtgcat gtaggattgg tgctttacag tattcagcga tttgtcctgt tagaggaaca 1316640
 agcaaaatgt ctttaaatat tgtcaaatgt actttggttg agagcccatg aaagtctaat 1316700
 tttataact ctctgcaaga ccttcactt atatctcct taaaatactg aatagtagtg 1316760
 actaatttga taattctaaag catgataggg aagctgggaa ctcaggataa cactattcac 1316820
 tgtcaaacat taattcaaaa agagactgtg aagagaatft ttgagggaaa gttttcctgg 1316880

 gatgttttaa aaaattactg tgtttttgtt aaataggaga acttctgtta cagttgtgtc 1316940
 gtttgggaaga tgctgctgat gtttatagag gattacaaga gaggaatcct gaaaattggg 1317000
 cctattacaa aggcttagaa aaagcactga agccaggtag tgtggtttga tagtcaactgt 1317060
 tttcgtcctt ttttctttct tcctcttttg cttcttttaa agacagtgtg gccctggttg 1317120
 ttctagaact tcttctgtag accaggctgg cctcgaactc agagatctgc ctgcctctgc 1317180
 ctcccagtg ccgagaataa aggtgtgcac caccacagcc tgattttgtt ttgttttttt 1317240
 ctttcttcat ccttaatgta tgtttttaac gtgctgccgc aaaatctaga gccagataca 1317300

tgtttaatag gtgaattcta caccagccag cgctacattg tgagactatg tctcaagaaa 1317360
 actaaccata caaatatgca aaaataaacc agaattggtt caaagtctag catgttagat 1317420
 tttgttagtt catgcttata atctctgtac ttgaaagaat gaagtaggag aatcttgagt 1317480
 ttaaagccag ccigagttaa aaagiagtgt caaggcctga tttacatac tgatacccag 1317540
 aatgacaac caagcaatag attcaaaatc taaatgtata agtttacttc ttagtcatat 1317600
 aaaagattga gaatattctg aaatccactt ttacaagata atagaattgc ttaataaagg 1317660
 ccagtaagat gacttacttg gtggaagaag acacttgact cccaacctgt gacattaaaa 1317720

 tgtgtagtgg aatgcaagtg catgtgtgtg catataccac accacatcac acacaaattt 1317780
 taagtaaagtc tcataaagtt aatTTTTTat gtatatgaat gtttgcctgt atgtagagtt 1317840
 ctgtaatttt aaattagtta ctttgggtaa ctaatgaata tttaaaatat gaaattattt 1317900
 ggaaataactt taaaatgatt gttgatatgc ttaattggca gggatacaca attttcttgt 1317960
 acaactttgc tgttacttt tttgtttgtt tgagacagtc tcgctgattt caagcaaatt 1318020
 tgcttgaaat ttgttatgta gaccatgctg gccttaaagt cacagagatc caactgcctc 1318080
 tgatacatta attgtaattt tattgtagtt gtagtgtttt acttagattg taattgtttt 1318140

 tatttagtaa actgtttatt gggtagaaat aagtaatttg taattatata taaaagaaa 1318200
 tccccctt tttgtctaca gctaatatgt tagaacggct aaaaatctat gaggaagcct 1318260
 ggactaaata ccccagggga ctggttccaa gaaggctgcc attaaacttt ttatctggta 1318320
 agtagagtaa ttgcaaaaga aagaaaaagc tattgtgatt taagtatgtg tatgaaggct 1318380
 aatgtatgca ttgtatgagt tgtcaacaga atctttctct tccaggagag aagtttaagg 1318440
 agtgtttggga tagattccta aggatgaatt tcagtaaggg ttgtccacct gtcttcaata 1318500
 ctttgaggtc tttatacaga gataaagaga aggtaaagac aaccacaact attctcagaa 1318560

 tctgcctgge tgctctcca ttccctgggc tcagcactac ctcttttggg aacctgtt 1318620
 agtctcctgg ctgacagtgga gaatgtttct ataccctttt ctcttgtaat ctgtttgctc 1318680
 tttggtgctg tagtgacatc agtatttgcct ttctttcatt tcttttagct cataactaaca 1318740
 ttttttcta accccctttt attgtagaa gtcagaagtg atttattttt tctttgcctt 1318800
 gaaactaaat tttagccttg taatcctcca tttttattta gtaaagtgtt gtcagaagca 1318860
 ttgtttttt ctttttttt tctttctgtt tttttgagac agagtttctc tgtataacag 1318920
 ctttgactgt cciggaactc attctgcaga ccaggctggc ctggaactca cagagatctt 1318980

 cctgcctctt ctgcctccg agtgcctgga ttaaaggcat gtgccaccac ctcccagcct 1319040
 tcaagtgcct tttaaagggg tattttaatc tttatgttga ttatttctt gcaagaacaa 1319100
 ttttatcaag ataatattggg ttaaaaacat gaaagatcat tgaaaagaat tagaaaggtg 1319160

ggagaaattg agcatgtgta atacataatg tgcatttgtc agtcttttgt tgaagagccc 1319220
 aaggtatgta tgggcttaat tgattgctcc ttttattttc ctgcatagg tcacatccat 1319280
 aagaatctaa cctattctag tttttataat ttccttcaaa tcttttcata gtatccaact 1319340
 taaataattt ttgactttta ctaagtttac atgatatgg attaaattct gcgttatgat 1319400

 agtctttcag ttgttattaa atgcacctaa ctcaaacagt ttgggaatgt catattgcac 1319460
 ctgggtgtaa gtgtgtagcc taacttgtga ggagagcaca ggtgatatca gaataacctg 1319520
 gctgtgacaa ttccgtgctt atagtccact cacaagaaaa cctgcagtaa tctgttcatt 1319580
 ggtcatttaa gcaaatttct atagtaacaa atcattaagg atgaattaa taaataaatc 1319640
 atgtttttta aattttgttt ttagatttgg tgtgggtatt gcgctatgtt gcccaagctg 1319700
 gctagaattt ctgggctcat ttgatcctct tgccctcagac acttgaatag gactacagac 1319760
 acctgccact gtgctctgct taaattaggg aattaatgaa atataaaagt actgcatgcc 1319820

 tccgagaaag ccagaagtgt agttaaatt taggagaaag tacaatctgg acagacaggt 1319880
 attttctgg acttttagca cccactttg ctggaattcg aagttaatga tcttttctt 1319940
 ctgaattatg agacaggttc atttatgaga tacttacaata aatgccccct tcacataaca 1320000
 ttaattctt tttatttacc tgaggccaga ctttatgtct caagtctcag gcttgctgca 1320060
 tagttggagc tgacctgat caaactctg atccttctgc ctcacctcc tatgtgctgg 1320120
 tattacatgc atgtgccacc atgccagggc atggcattta attcttgatc ataaagagca 1320180
 agtgataact gttggtatc tctatatgtt ttaagataaa aattaattta gacataagtt 1320240

 acagcattgc ctctgtccaa cattcatcca ctgctggttt agtgatgttt tatttctat 1320300
 catacaaatg aaggtttag gagatgagta ttaatgtgtg ccttttattt ttaggttttt 1320360
 tttttttttt tttttttttt tttttttttt tttttttttt taagataggg tttctcagtg 1320420
 ttttcttggc tatcctggaa ctcgatctgt aggccaggct ggtcttaaac tcaaagatec 1320480
 acttgactct gcctccctag ttctgtgatt aaagggtgtg gcccagctta gactttgtag 1320540
 gtcttctct agaggttaaa atactcataa agggaggaa tatgtgtggg aatatttatt 1320600
 taatccttta gtataaggaa tacattttgc ataagagcag taacttactt tcaactaaat 1320660

 gigtgtgtgt ttgtactcta ggtggcaatt glagaagaac tagtagttgg ttatgaacc 1320720
 tctctaaaaa gttgtcgtt atttaacccc aatggtaagt acatacatgt ttgatagact 1320780
 atgaaattag catttagttt tgattatttt gatagcaagt atggatgatt tagtttcttt 1320840
 ttctattatg tattcttttt ctattatgta tagccctggc tgtcttgaa ctccatctgt 1320900
 ggaccaggct gtctcaaac tcacagagat cccccctc tgcctctgcc tetgtctcag 1320960
 gaatgctagt attaatggca agggccatca tgcttgcta tcctctaatg ttaaatcca 1321020

agctttacat tatttcatga atttttcaac atgtcttaga gaagagtaca tttcaaaaa 1321080

 agctgtaacc tagtgaagt ggcatgggct cataatccca tctattcaga gtatttgaat 1321140
 tagggaatt taagaagtg aaggcctctg ggcaagtaag aacctgtgaa gatggagttt 1321200
 cttccagcc tggcccttt agcccttag ccccaataa acaacatag gcttataata 1321260
 actataaact gtttggccga tggcttaggt ttcttatgg ctactctct ctacctatag 1321320
 ctattaatct atgtatttct acatggcatt atcttacctg agaatgccca tgcacctac 1321380
 ctcccagta gctacatggc gtctccggtg actgattctc tgcctttcct cttcccagaa 1321440
 ttctactggt ctggtagccc cacctatact tcctgtcttc ctactgacca atcagcattt 1321500

 attcatcaac caataagaga aacatagtgt caaagcatac agaaggacat ccccatcat 1321560
 ctctctttt ctgtctatat aaaaagaagg ttaatttaa aattttatat aaaaaagt 1321620
 atcaagcaag aattatagtt actaaaattt agttcattaa tatttagcaa aatttaaga 1321680
 aatatctta tcatctatcc tctctgggtg agtctaaagt tttatatgta cttatcttt 1321740
 tatcataatt cagaaaaacc ataacaatct gtctcaact ccatcaaata ctacagaagg 1321800
 ataatatata aactctagaa ttgacagaga cactgcctgg acagccacce aaagtctctc 1321860
 tgtaatgttg gggcatccat cttcagcca tagtccatag tgtctggcag actttttaat 1321920

 gaggcaggaa gcttgaagaa ccatgctgtc ccttggcaag tctagcagtc acttttcttt 1321980
 gtaacctgct tgcaccgttt tgacagcgtg ctgtcaagca gtccaggcaa gagcagctct 1322040
 gtccaatggc tattctgccc atgtaaaagg caaactccat aacgagtttt cttcaatgcc 1322100
 catcttctc tctgatgtaa ttgggtgtgc caggagctgt tatgtctcat tttcatgaga 1322160
 aaccttaata aaccattttt aaatgccata ttctgtagggt ctttgaaaaa ttgaagtat 1322220
 gcgtatccat ctcaaatata ttactttttt ttttttttaa agatttattt attatctata 1322280
 cagtattctg cctgtgtgca ggcctggttg tgagtcacca tgtggttctt gggattgaa 1322340

 ctcaggacct ttggaagaac aagcagtgtc cttactact gagccatctc tccagcccta 1322400
 aacattacat ttttaaatga gctgtataaa tacaatgtct aaacaagagt agaaatacat 1322460
 atataacaaa attgacctta aatttgtatc aataaaccaa aatccatacc aatgcagagt 1322520
 attcatttct atalcaacct tgtttcaaaa ttttgaaga gggttgctgg tacagctcag 1322580
 tggtagagtt tttgcttgg gtgtcttacc aggccatggg gttcaatctc aagtatttca 1322640
 ttttcccc aaacacacac catacatata caccccatc acacataacc taggatgata 1322700
 ttatgtttgc aaatcagtac tttcatggat acagagttag ctcagtctgt aaaatatag 1322760

tgaagggtc cccaagtttg atttcagtc tcacatgaaa aaaaaaaga aagaaagaaa 1322820
 aagcaaggcc tcgttgcattg tgtttatatt cccagtttgg gggaggatct gctagatagc 1322880
 cagcctaacc taatttgcaa gcctcgggtc ccagtgaggg accctatcct aaaaaccagg 1322940
 tacattgcaa ctgagaaata cttgttact gtatcaccaa catgtagatg tacatgcaca 1323000
 caaaataaat atgtctttag ttattaataa ccagtttaca atcacatttt cagttgtatt 1323060
 atattttgtc tttccctccg ttctaattca gtccctttgt ctttctctc ctttcttct 1323120
 ttttctctt tcctttttc tttcttccag attttgagac agggctttac tttataatcc 1323180

 aagatgttct tgaaccagg acagttgtct tagttgggat ttctgttacc gtgataaaca 1323240
 ccatgaccaa aaataacctg aggagagggt ttgttgcagt ttacaactca gggactgaga 1323300
 gaagttagga aggagttagg taacaacat tttgaagtca ggaactgaag tagaggtcat 1323360
 agaggagtgc tgcttactgg cccatggccc gcttcttaag gcttagcctg atctcttata 1323420
 caccactgac agtgggctgg accctcccag atcaatcact aatttaaag ccatagtgca 1323480
 gactgcccac aggccagctt ggttcgaggg agtattttct cacttgaggc ttttcttcc 1323540
 caaatcagtt tgtgtcaagt tgacataaaa ctatccagct cagcaatact ctttctttac 1323600

 cacaccagc ctttctttt atttgaagat caagtaactc ttaacagaaa taatttgggt 1323660
 gttgtctctt ttaattcatg tttatcacct ctggaacctg tgattattgg agagtgaatt 1323720
 ttcttaatct agattttgat gaatatattt tacgtatatt attttctgc cttataaaa 1323780
 tattttttt aattggtagt tagatgaaga aatggatagt ctttctgct tagcattagc 1323840
 cacatagaaa aaagtctggt tgacataatc tcaatcttca taatgctgtg accttttaat 1323900
 tcagttcctc atgttgggt ggcccacaac aatccataaa attattttgt tgctaactat 1323960
 aattttctac tgitatgaat tataatgtaa atatcttctt tcataatggt cttaggcaac 1324020

 cttttaaagg gtcactaac ccactaatgt ttggggttgt tteccatagc ttgagaacca 1324080
 ctgatctatc tagttcttta tagtacagtt caaatgctgg ttagcagcaa catacataca 1324140
 gctaattgtc gttctactga acaggacagg tgagaaacat gctctgttct ccagaacctt 1324200
 gtaacggaca gactctagct aatggtttga tgaaggttga ttaattgggt tctctctgtg 1324260
 tctctgtctt acctctctgt ctctgtctct gtctctcttt ctctcttctt tcttaataa 1324320
 aaacataaac taaatgagcc aaaatcattt tcttctatga gtaggcaaat actgttattt 1324380
 tgaagctaa atttatttc acttacaait tggtttacia aagtttcagc ttgtatggag 1324440

 aaagacacaa aaatttttt cctctatgt tatactttgg tctttacca agtttcacga 1324500
 gattagactg gttcattgca ttctccatcg tggcaagtag ttttattgaa aaaaaaaaa 1324560
 tgaattcagg gcctggatgt ttctgagttt agtccctgga tccccatgg taaaagaatt 1324620

gaacttactt gaatgataag ttgtcctttg acctgtttat gccctgtggc aggcatgcac 1324680
 ccagacacat atactcacia caaatataac aaatgttttc aaagaaaata atttctattt 1324740
 gggctggaga gatggctcag cggttaagag cactgactgc tcttccaaat gtccctgagtt 1324800
 caattcccag cacccacagg gtggctcaca accatccgtt atgagacctg gtgccctctt 1324860

 ctgggtgca gatatatatc gaagcagaat gtcatatata taataataa ataaaatctt 1324920
 aaaaaaagaa aataatttat atttaagcat tctgatatt tatttaattt tatgtggctc 1324980
 catctttcaa gtactgtggg ggtaggatgat aacttactca atgacaataa ctcgagcacc 1325040
 taacttgtgc actaccactg aagatctgga atcatttttc ccacagagtt ctggcttccg 1325100
 tagtggacta gccaccatg tgggacctgg ggtacacatt gctactaagc tggccattgt 1325160
 ttctaggtct cagattaatt ttaacagtac ttttaaaaag gcatagagtg gtttcattgg 1325220
 ttaattgtca tgatattcct ttgattatca gcatttttct acatatttta caatgtggaa 1325280

 gaggtcagc gacataccca tgaatatgca gcacttttgt tacagatcta tcagatgagg 1325340
 agttggtag ttccactcct attatttgtc cactgagcca tcctgttctt actagggaaa 1325400
 agataagcaa atagaatttg agagcaata tgattctcag gttatagaga tttatgttta 1325460
 aggacaaaat tttgtttgtg tgaattttgt gtttaacttt cacattatta aaattacatc 1325520
 ttgaaaacgt tacatcttga actgaatat agaataaatg ttttttttat ttttcttatt 1325580
 ttctttagat atagctctta ttcagtctat attgttgatc tttacatgtt tggcataata 1325640
 ttaagaccta aaaatgtcac caaagataaa aatgttcaca tcacaaatat atatgtgggt 1325700

 tagtatatta cttagaaaa taggcagtca cacttttctt aaaatcttac tataagtaag 1325760
 gtatgctaag gtgcacttaa gatacagaat agaaaatgtg cttagctgta gattacatct 1325820
 agacacatgc ataaactact ttaaaactac tttccttata aatagagggg ccattatggt 1325880
 ggttggatat tctcttaatg tttgtaatgt ctaatcttga tttttttttt ctttttttcc 1325940
 ctttcaagat gatggaaagg aggagccacc caccacatta ctttgggtcc agtactattt 1326000
 ggcgcaacat tatgataaga ttggctcagc atctattgct ctggaataca taataactgc 1326060
 tattgaaagt acaccaacat tgatagaact ctttcttgta aaagctaaaa tetataaggt 1326120

 aaaaacttta tccttcttt ttttgaacg agatattagt catcattttt gttgttttac 1326180
 agcttctagg tagagtaagt aacattgtat gagaaatata aggctgatgt attcttagag 1326240
 ttgtaatggt aatgtttatt tgttcattta tcaataacta tacaacaat acataagaga 1326300
 aatactgtgt gtggggggac tcatatgttc ctacttgaat tgttactgaa tgtttaatag 1326360
 ttatttactg taaattgtgt gtttctgcta acagtttaagt atgatcacat ggagagatac 1326420
 tctctcagcc tagacacaca tgggagggcc taggccctgc cccaaatgat gtgacagact 1326480

ttgatgattc ccccataga aggcctcact ctgtggggag tgaatggggg caggggagga 1326540

 tgggaggag atggaactga gattgatacg taaaataagg ttgtttctaa ttaagttta 1326600
 aaaaaattaa aaaaagaaga agtatgatca gtgtaagtat ctgatgctat ttaagtгаа 1326660
 ctagtttatt ttgaatgtac atgctacat ctcttgactc agtttctgag ctatgcatga 1326720
 gaagctcctg ttacatgttc tcaagtcata aagtttctc ttctctatct tatttgccag 1326780
 tagatccagt aataggattt ttttaagga gttaatgtaa tatatttaga aagaaatata 1326840
 aacatataag aatataatgg aattaaata tattccaag tacccccct ttttttttt 1326900
 gcttgactg ggtttgaat gtagagcttt atatgcacta tatagacatt aacaccaagt 1326960

 tgccccatc tgcaagtttt gtttatttat tactgtattt tatttgagc atggcttgg 1327020
 tagtaggctg agcttгааag tgggacttct cctgattcat cctcttaagt gctggtatta 1327080
 ccagtgtгаа ccaactgtgg ccagaacttt aaaaacatgt ctaaaattag attgattatt 1327140
 ttaatggagg cagcatgttt ttgttgtgt tttgttttt agacagggtt tctctgtggc 1327200
 tttgggtgct ctctgгаac tagctcttat agaccaggct ggtctcгаac tcacagagat 1327260
 ctgcctgcct ctgcctcctg agttctggga ttaaaggtgt gcaccactac cgcctggcta 1327320
 cagcatgtgt tcttaactgt agcatgtaca tgtaagtgg aggacaactt aagagagttt 1327380

 tctttctacc ttttggtag aaacatctga acaggtcacc aggcttggca gcagtttctc 1327440
 ttaactgct gagtгagcca tcttgtttgc taccccaaat gttttaaagc caagttttac 1327500
 tgctttcca gatgtcctag cгаaatгаат tataattagg atagtggggg aatgtccatt 1327560
 aatagctgtc tgacctggtg gttgactgtt ctgcaaggct aactgatга tgggttccag 1327620
 gaatattcct gtcttaacct ctcccagtaa taggatгаа gactcaagct actacaactg 1327680
 gctttcttac atgggtgctg ggacctaac ccaggtcttg agttaaаага gtatctttc 1327740
 tttcatttgt ttaattatt ataggtcata aattacttaa cacaataaaa tgatcaaat 1327800

 tgttgatttt cttttctac cttcaagcat gctggгаata ttaaаагаgc tgccagatgg 1327860
 atggatгаа ctcaggccct ggacacagca gacagattta ttaattcaa gtgtгcaaaa 1327920
 tacatgttaa aagccaatct gattaaagag gctгаагааа tgtgtccaa gtttacaagg 1327980
 gtttgtatgg ctaatgttct ggagtгааа taggacatag ttgacttctg gttcatacct 1328040
 ttctctttea aagttagttc ttttatgtgt gtagatgttt taccttcatg tgtacggtct 1328100
 gtгаaccctg tgcatgcctg gtgcccacca aggccagact tgggcattgt ctttгcttta 1328160
 actгааgtta agacagtcgt gagcagccat gtcagtгctg acaattggac ctгаатcttc 1328220

tggagagca ccctgttctt ttaaccagca agtcattttt ccagcccctt aagtttcttg 1328280
 tcagtatcac agtltgtccag atattaaatt attgtattag acaaagaata gtcaacatta 1328340
 gataaaaatat tttcttttta tattatctta tttttgttg actttttttt tttttttttt 1328400
 ttttttgaga cagggtttct ctgtgtagcc ttggctgtct tggagcttac tctgtagacc 1328460
 aggccatctt tgaactcaga gatccgcctg cctctgtctt ctgaatgctg ggattaaaga 1328520
 tgtgtacctc acagctgtag tcatctaac tcagacagtc atggtagttt tttgtttttt 1328580
 gtttttctta aagattttat ttatttatta tglatacaat cttgtgcctg catgccagca 1328640

 gagggcacca gatctcattc aagggtgttg tgagccacta tgtggtgctg ggaattgaac 1328700
 tctggacctc tggagagca gtcagtgtc ttaaccgctg agctatcttt ccagcccctg 1328760
 gacaatggtt tttaaaatta atttgtagct ggcaatgatg gcacatgcc tttagtcca 1328820
 gcactcttag gaggcagcgg caggcagatc tctttgttca aagccagtca ctctatacag 1328880
 agtaagtgc aggacagcca aggttacaga gaagccctgt ctcaaaaaa caaataatca 1328940
 aaacaaagac ccccccccc caaaaaaaa aaaaaaaaa aaaaaaaac ccccccccc 1329000
 aaaaaaaaa aaaaaaccaa aacaaaactg gcttgtagtg attactgtcg agaaaaatgt 1329060

 tttaggagt aaggaacta gtatttatta cttatctgcc atatgctatt atttattgtg 1329120
 ttattccctg ccaccagtt attgtagatc ttttgtggag tcaactgcaa aattattatc 1329180
 cctagtgggt agaaaaagaa cttaagtcag gtgggtgggg cacatacttt tattcttggg 1329240
 acaggatgta gaggcagcca gatttctgaa ttggaggcca gcctggtcta cagagctcca 1329300
 ggatagccaa gaaagacct gtctcaaaaa ttatttcaga aatgtcatca attgactatt 1329360
 gtccctttt aaatcttatg ataccgtgat gtatttggg gggattgtct ggaatcacta 1329420
 tgtgattttt catttaggaa ggaacatcag cagtagagaa cctgaatgaa atgcagtgca 1329480

 tgtggttcca gacggagtgt gcccaggcat acaagcaat gaacaattt ggtgaagcac 1329540
 ttaagaaatg tcatgaaatt gagagagtaa gtatctaaca tatgtgaact tctaattttg 1329600
 tttgatcaga tattgaagcc tttgtgaaag ccatcatatc tccccactc tcccctccac 1329660
 atttgtaatt cacagcatat attttagaat agtaatacca tattcagatt ttgtaaatga 1329720
 aaacatctgg tatgatcttt tattccttta agaatccttt tcaaagactt caggaaacct 1329780
 ttgtgtcctg atgatgtttt tactgcatgc agttctaact tttgaattgc tgctgtctat 1329840
 ccttgataaa gatttgact tggaaacttt tttgctatct ttctatatgc agtgcagtta 1329900

 ataattttct tacaaaataa ttttcagcc tgggtatgct aatgtgtact tgtaattcca 1329960
 acatttggga tcttgggaga tagaggcagg aagttctgga gttcaaggcc tatcaccact 1330020
 gtgtgtttga gggcagcttg ggctatgtaa gaccctgtct gaggctggag agatgactca 1330080

gtgattaaga aactacttgg gtcttaagtg gtcctgattt caattcccag caaccacatg 1330140
atggctcaga atcatctgta ataggtctgg tgcctcttc tagcctgcaa ggatacatgt 1330200
aggcagaaca ctgtatacat aataagtaaa tcttaaaaac aaaaaaagga ccctgtctgt 1330260
acaccaccac cticcagatg aaaatcattt tttttttttt tttttgtag tcttcacgat 1330320

agatttctat gactagtgtt ggggtgtgtg ttgttttata tataaacata ggttctgtta 1330380
ataagttgac atttgaata tcaaatgtag aatatcttc ttggttgaac tatgaggttg 1330440
ctgatttctt gacttatagg ctacttaatt tttcatttac ataaaagtgc atcctacata 1330500
gagttcagat ttagagcctc aaaaaaattt ctgtagtata tgtgccaact gtatagtagc 1330560
attgtcatat ataccagtta gtgggtagt ttgcagaata gttttactta aatatgactt 1330620
aagaaggaaa tatgtatgaa gtgttattat ccctttaac ttatttcagt tttattttca 1330680
ttggtgtcct gcatttatgt ctgtgtgagt gtgttggatc ctccgaaagt gggtacacag 1330740

acagttgtga gctgccatgt gagttctggg aactgaacct ggatcctctg caagagcagc 1330800
cagtttctctt aaacattgag ctatctttcc agcccctgcc aactatattt tttatttcat 1330860
attccaaata tatcaaatta ttataatttt atatttttat ttttcatgct aatgaagcaa 1330920
glaatcccaa ggttttgctt ttatagtttt ctggacaat gttgtactcc agtgtgataa 1330980
taaaaagata attttttttt tttagcattt tatagaaatc accgatgacc agtttgattt 1331040
tcatacatac tgiatgagga agatcacctc tagatcatat gtggacttat taaaactaga 1331100
agatgtactt cggcagcatc cattttactt caaagcagct agaattgcta ttgagatcta 1331160

tttgaagctt catgacaacc ctcttacaga tgagaataaa gaacacgagg ctgatacagg 1331220
tataacattc agagatttat cattatttgc tctttgtgtg tgtgtgtgtg ttttaaggat 1331280
tttatttatt atgtatacag tgttctgcct gcattgtcagc agagggcacc agatctcctt 1331340
caaggtgggt gtgagccact atgtggttgc tgggcattga actcaggacc tetggaagaa 1331400
cagtcagttc tcttaaccac tgagccatct ctccaacacc cacgctgttt gtgtttatag 1331460
gtacttaagt taatgaataa tgtagctccc ttgccccag agatttttat tgagtatctt 1331520
ggtaggggct tgtgtccac gactagaaaa tgatgggtgt tttgtgaatt tgtctaagta 1331580

atagaaggaa aacaccactt ttatgcttc aaaataagtt aagacttaat ttgatgtttg 1331640
attttgtttt tgttttgaga agtttttttt ggatatttgg tgggtgtcta aggatccaat 1331700
gacaccacag ctcatthtaa aaataagtgg ttaaaagaag actaggaaaa ctgctgggac 1331760
tcatttttca ctttaccatt ttttagtgag glatcaagat ttctaggag aagtgatccc 1331820
ttaacactta ttagagaaag aatctcaaag taaaggtggt ctttcatata tggatataat 1331880
ttattatag tataaatatt ttaagttat gactttactg tagtgaactg acatgagtc 1331940

cttaaagata atggcagata tatatgacca cagtctcttc acaggtatga agagacacca 1332000

 taaccaagct cttataaagg aaaacattta attgtggttg ccttcgtagt tcaggtattt 1332060
 agtccattgt cattgaggta ggaacccatg gtgttggaga aggagctgag agttctacat 1332120
 ctggttctcc aggcatcaga aagagacagt gagccattag gcctactttg agcttctgag 1332180
 atctcaaage ccatccccag tgacacaatt cctccagtaa ggccacactt cgtaataatg 1332240
 ccactctcca tgggcctgat ggggccattt tcactcagac caccacatat agtaagactc 1332300
 tgttagaaga gctaaaaatt ggaaaagtaa ctcaagtggg tcttttctag cacgtgtaag 1332360
 gccttgcagt atagttcaaa aaacacaatc catttgataa aatgttatta gagcataatg 1332420

 aaacatatct ttttttttaa aagattttat ttatttatta tgtatgcagt cttctgcctg 1332480
 catgccagca aagggcacca gatctcattc agagtgggtg tgagccacca tgtggttgct 1332540
 gggattaaag gtgtgtgcca ccactgcctg gctacagtgt tgtttaatat gtaaacatg 1332600
 ttactatata caaataaag ttagtttaga ataaataaaa aattaaaagc agggagtggg 1332660
 taagatcata tctgtctctt ggagaggacc caaatgtgc tcgcagcact catgttgggt 1332720
 ggctcacaat tgcccatatc tctggctcca ggatgtctga cattgtcttt tggcctttgt 1332780
 aggttttgca ttcacatgcc tctcacctt taaatattta gttaaataac taaagccttt 1332840

 gggggtaaaa attagagtct ggtgcgatag ctcagcagtt aagagcactt gctactccag 1332900
 caaatcatct aagattagtt cctttgcaca ctctgtttt aggggctaca gtactctctt 1332960
 ctgacctctg agggcacctg ttatacatgt ggtacacata acataaatac agacaatgca 1333020
 tcttatctta gtcattgttt tattgctgtg aagagacaca atgatcaaga ttactattat 1333080
 aaaagaaca ttiaagttag ctttcttgca atttcagtct attatcatca tggtagggag 1333140
 tgtggcagcg atgatagtaa aatagtaaaa tatatcctgc ttttttaggc accagacaaa 1333200
 gagaggctgg tcttggcatt ggcttttgaa acctcaaagg ctaccccga gtgatacact 1333260

 tccttcaata agccttatct cctactcttt ctcaaagtg ccactctgat gactaagcat 1333320
 tcagatatag gtgcctgtgg gtgccattct tattcaaacc atcacacacc tataccaata 1333380
 aaattttgaa tgttgccagg cgggtggtggc atacaccttt gatcccagca ctcgggaggc 1333440
 agagacagcg ggatctctgt ccgttcgaga ccagcctggt ctacaagatc tagttccaag 1333500
 acaacctcca aagccacaga gaaaccgtgt ctcaaaaacc aaaaaaaaaa aaagagaaag 1333560
 tttctcaggt agttacagtg agttttgtta atatgtttat aattctgtaa cacttacttc 1333620
 ctacagcaaa catgtctgac aaagagttaa agaaactacg taataaaca agaagagcac 1333680

aaaagaaagc ccagatagaa gaagagaaaa aaaatgcaga gaaagaaaag cagcagagaa 1333740
 atcagaaaaa gaaaaaggat gatgatgatg aggaaatcgg aggcccaaaa gaagaactta 1333800
 tcccagagaa attggccaag gtatttcata gttgtgccta gcacaagtgt gtgagtcca 1333860
 cggcaaaactt ttggctttga aaattccaat tatctttatg tatttgtttg tgtgtctttt 1333920
 gtgcagatgt gtatgtaigt gtgtggctgt gctttagag attagaggac aacttgtgga 1333980
 agtctagctc acctaggcta cctaaccaag acctgtctg aaaaaaaaaa tttatTTTT 1334040
 aaaaaatcag actctggctg ggcggtggtt gatactcgag gcagaggcag gcagatctct 1334100

 tgtgagtcc aggccagcct ggtgtacaga gcaagttaca gaatggctcc aaacctcag 1334160
 agaaacctg tctaggaag aaaaaaaaaa aaaaaaaaaa aaaaaaaaaa accagactct 1334220
 gatttgtgga tttaatcat tgtacccaaa cctaaatact taataattat taccatga 1334280
 gttatTTTga ttaataacct ttctttgac cacagcaatt gtatTTTatg ggggtaatgg 1334340
 ttgtgtaact catgtgttaa atggatagaa taaatgcatt ttagcgtcac taatcatttg 1334400
 aaatttgaat ttcaattcct ctttagaaa gtttctga gtctgagctg cagtgtgtt 1334460
 tttgtccag gtgtcacaat atggcctaat gattattagt agctagggtt atagattttc 1334520

 agaactaagt ttctgagtc attgtttgag aacatagaag gaaccctct catagattgt 1334580
 ttctgacttc atagtattat tacttgcaag gaacataagg gtcctcttt tctagtata 1334640
 agtagctcaa agatgctctt atccagtagc attctcactt atttgtagt gtcaaggcta 1334700
 gattacatca agccttccat aattagtagt tgcaactga aggatattct aaaagtcaat 1334760
 gccaaatagc ctaaagtct gtgtgtgtgt gtgtgtgtgt gtgtgtgaat catctcaaga 1334820
 tagcatatgt atgacataga acaataccat taaatcagta attcctcca tggagaaatg 1334880
 gaaaatgctg tgggtttagt taataagttt ggtactcagt cagctaaaga taaacctaaa 1334940

 atttcatga aagcttgttt gtttgtttg agcaggggct catcctagcc caggctattc 1335000
 tcaacctgt ggcagtctc cttctcaag tgctaagatt acaggcaaga gccacatgc 1335060
 ccagcatatg atcttcaat tacaattgc cttgaaatct aatcttcag agacagagac 1335120
 atactgtttt attttatatg tatgtgatt tttcttgtgt gtatgtctgt gcaccacgga 1335180
 gtgcctgggtg ctggcagagg taagaagata gtgttgaatc ccctagaaat ggagttagca 1335240
 catggttga agtctttatt tgagtctag aaaccaaac tgggtcttct ccaagaatag 1335300
 cagttgctct gaactactga gccatctctc cagcacctag ttgatttgtt taaaattgtt 1335360

 cttctagaag attagcatcc atttgtggc ttacagaagt ctgaactcca ctcccaggat 1335420
 atctcact ctctggcct ctcagggcac tgcattgata tcatgtacag gcacacatgc 1335480
 aacaacacca atatacctaa aaataaag agtttttaa aatcatttaa gaattctaga 1335540

gaaaaaagtt gtcttatgaa aggttaaaat ttgacagtgt gtttctgggt aactggtaa 1335600
 tgcttttttt ttttttaac ttttggcaaa agaaaacagg agtttaaat aagttcatat 1335660
 tcctcaagaa tcttacttcc ttttgtataa tgtcttttat tttgttaggt tgagactcca 1335720
 ttggaagaag ctattaagtt tttaacaccg ttgaagaatt tggngaagaa caagatagaa 1335780

 actcatcttt ttgcctttga gatttacttt aggaaaggta ggatattagg ttacagtggc 1335840
 cctgataaaa ctgatectc catttttttag gattagtgtc acccaccact gttgcatttc 1335900
 ttggcagagg ccaatataga tttctttag aaatgcatgc tatgcacaga atgttgggg 1335960
 agaatacagt gatactattt gacttcttcg agaacacaaa gccaacagt agctgcatac 1336020
 ctgggattaa gtcagaggta gtaatcacgt catgtgtgat tcaaggaaca aatttaggat 1336080
 tttgtggata aaaattctta atataaatgt aaagcttagc caggcagtag tgacacatac 1336140
 cttaaatccc agccttttgt aggcagaggc cagcttgttc tacagagtga gttccagatc 1336200

 agccaaggct gcacagagaa accctgtctc agaaaaagaa aagaaaagaa aatgtaaaaa 1336260
 atagtgggtt ctacagttaa gcatcaaata acttttatct gttatgagct gataacataa 1336320
 ataaaaagta gtttctgagc tggatcttta gtcttcatga ttgtgaaagc gagtgtccac 1336380
 taaaaataga aaatgtcagc agtgttgggt ttggcgatat tgggaaggcc agaagaatgg 1336440
 tcttgtcttt cacttttaga atgctcttgt gtacacatgt acatacatat gtacgtacat 1336500
 acacacatac acacagtttc ataataatga atttgtgtaa ttcattggaa aagtttatta 1336560
 tggtagtatg aattgaaata aaaggaaat ggttattagt aagatcagac taaggctgtt 1336620

 acatcaataa gtagttttg tgaagctagt cccagctact gggaagtiga ggcaggagtg 1336680
 ttgtggccca tgagttaag gccacatgg acaatacaga tagactgtaa tgtaactttt 1336740
 attttgaat aggatgcaaa acttagtatt aattgaatgt ttaattgttt atgaagacaa 1336800
 gtccctgtgt tttcctgact gggctggaac tcagtgtgta gaccaggcta gacttgaact 1336860
 tgtcagcagt tctcctgcct ttgcttctg agtctgggat catgggtgtg tgtcagtatg 1336920
 cccagctgtt aacatattg tatagatata taatacagaa gtggctagga agaaatggat 1336980
 caatagattg cagtgtttc ttgatacatt ttaagatgt taaaatttat cttaactata 1337040

 ttttctattt ttcacaatta aaactttgaa aataagtta ttaaataagt aatttttata 1337100
 ttttaaacac ttaaccctcc ttttggggag gggcagggag ataggatttc actatgagca 1337160
 atggctggcc taaaactcat agaggctcta cttgcttttg cctcctgagt gctggattta 1337220
 aaggggtgca ccatggtgcc tgactaacc agttatttt aaaattaatc ttagagggcc 1337280
 agcaagatgg ttcatcagat accccaagc aagacattt gagtttcaat ctcagaaacc 1337340
 atttggaaga aggagaaaac ttactagtat aattcagtga cctccactag cacacacaaa 1337400

atcaatacaa ttcttagcac agtagtacag ttagcaact gttcctgtaa tctcagcagg 1337460

aggcgaatga gttctagccc agccaaaaca tagtgagaac ctcgtcttaa atgtaaatta 1337520

aaaacaaaag tgtttctagg tggaaatctc agatacacta aagttttgct gettaaaggg 1337580

ataatggagg gcctctgtga attggcttct tggtctgtgt ctaatttcaa aggtgcctca 1337640

gcatctttca ttgatttcta atagatgatg attaaagagc atggcaggaa ttttaatggt 1337700

ttctgagttt tggggccatg ggaaaggaat tatttcagaa taacttaggg ttttctactt 1337760

tgatatttga aacatgatgc caaattagga aagtctcaac aaagaggtga ctatcaagaa 1337820

gactcagtgt aagtttctgt ttaacaggtg gaggcaccgc tgagacttgg gaaaggtaa 1337880

caggtgggaa tagggatagt gtagagcaat tagaaaatat agtctgggta gatggcatcc 1337940

agagatggca gaggagtcag agatggacag agtcaggtgg aaaggaatt gtgtgtcatt 1338000

gaatacagaa aaggagagtt tttctatgga atgtaacatg tctttgtttt tattaaagga 1338060

aactggaac aaattggttt taaattttgt ttctctgttt atatgatact agttcatata 1338120

tcacagaatg ccgtgtaagt tatttttgtt ggaaccactt gaagaatggc atatgaacat 1338180

aactgacatg tagccaatg gaaggaaaat gtttgcttca aagatgttat agctccaata 1338240

tgattgagtc taaattcact ttttgtgttt ctaaggtccc tggcccttcc aggaaggata 1338300

acttatitta tcaaattatc aaaatagtat ttttttctct ttatagaaaa gtttcttttg 1338360

atgctacaat cagtaaagcg ggcatttgct attgattcta gtcacccctg gcttcatgaa 1338420

tgcatgattc gactctttaa ttctggtagg tttttattcc catacttcac atatttgatt 1338480

agtagctcat attgaatgtc agactggagt gtggctcatt gggtcagaga ttttgcctgt 1338540

cctccagagg acttgagttt gatttacagg acccacatta gacaaatacc tctaactcca 1338600

gctctgggct aaccaatgcc atttttaggc cccaagcaac atctaaaaac acatggcata 1338660

cacgtacata agtaaaagca aataataaat attaaaaaat taaaaaaaaa aaagtatggg 1338720

ggctggagag atggctcaga ggttaagagc actggctgct cttccagagg tcctaagttc 1338780

agtgccacc aactatatgg tggctcatga acatctataa tgagttctgg tgcctcttc 1338840

tggcatgcag acagaacact gtatacatac taataaagtc tttgtgtgtg tgtttgtttt 1338900

tctgagacag ggttctctg ttagctttg gacctgtcc tggagctcac actgtagacc 1338960

aggctggcct cgaactcaca gagatctgct tgcctctgcc tcctagtgc cgggactaaa 1339020

ggcaagtgcc agcactgcc ggcctaaata aatctttaa aaaataaaaa gaatctgaac 1339080

taaactcagt cattttaag gaattgcata ttcagttagc taagagaaaa atattgttct 1339140

tttgtgatga agatttaatt ttaaagtcca taaatgctat gtagtgttgg tatacaattg 1339200
 tgtggttcat gtatttgaga atcttttggc tctctttctc tgtttctgta atggagattg 1339260
 aacctagacc tcatgcttgg taggcaaac atgcttctgc taagttacaa cctatctata 1339320
 agtaaatttt gtiactttaa aatagtcacc taaaagctgg gcattggtgg cgcacgcctt 1339380
 taatccccag cactcgggag acagaggcag gcagatctct gtgagttcga gccagcctg 1339440
 gtctccagag tgagtgccag gataggctcc aaagctacac agagaaacce tgtctcgaaa 1339500
 aaccaaaaaa aaaaaaagtc atctaaaagc aatcatgtgc ttttcagtta ttttgacaat 1339560

 cagatcaata cattgatttc aatttgattt agaagcttaa aataaacact gttttcaagc 1339620
 cttttccctc caictgggat agaaatgtta gtgttactga tgtgcctgac tgtatttggc 1339680
 tttttaacce aaggttcagg aattgagctc aggtccacag gcttgtttgg caagtctttt 1339740
 tactactaa gccatctccc tggactttct ttgccctttt ttactttatt tattttattg 1339800
 ttgaggcaag ttctttgcac gttgicacga ctgtcctaga actcagttaa tagaccaggc 1339860
 tgactttaca ctacctgct tctgcttact gagtgtctggg attaaagaca tgaaggaaaa 1339920
 tctacttact gttttcaaaa gtatggtaaa atgataagta taatttatg aatgccaata 1339980

 acataatfff agagcttga cacatagtag cttttcctta aggcattctt taggttactt 1340040
 ctccacctct ttcaagttta aaatgaataa ccccatccat ggttcctgaa gataaagatt 1340100
 agtgaagttg gtcatatttg atttttgctt taactagtaa aggtgctttg ggtgtagaag 1340160
 acgatgaact attacaagct ttatcagagt atcaagctgc taagagttgt ctttttaatt 1340220
 tattcaacag tgtgtgaaag taaagactta cctgaaacag ttagaacagt attaaaacia 1340280
 gaaatgaate gtctttttgg agcaacaaat ccaagaatt ttaatgaaac ttttctgaaa 1340340
 aggaattctg attcattgcc acacagatta tcaggtaate actttatttg gtccttccag 1340400

 tagccttctt gaacaacttt agtatftta tgaatcactg tcaagtaag gtatatattt 1340460
 tgctcaaaat ggcaatatgc actacacttt tttagtagta ggaaaacagg cagcgtgtag 1340520
 ttgcttcttc tatattftaa atttttgtga aacagaatcg ttacagtaaa acaagatatg 1340580
 ttgtttctac tggttcagaa ttaacataaa taagtacaac tgattttttt tggggggggg 1340640
 agtaaggtct cactgtgcac ccctgcctga tfgaaaagtc actgtgtaaa gaaggctagc 1340700
 ctctaattca caaagatctg cctgcttctg cctccaggtt ctgggactaa aggcttgtgc 1340760
 catctcactt agaagtacaa gctgaattaa gcaggtttta tctccagtac ccaccacccc 1340820

 aggttgaatt tgtatafatt ataaaactgt gcaagtaag cttgtgttct tctcatgctt 1340880
 ccattattgt gattataaag ctcacttaat gtgattttga tttctcatgc ttatgtattt 1340940
 atcagacttg gtaagctaaa cacctgaaaa ccatcttaca tttcagaaag tttgaggcaa 1341000

taagagtcag tcacagtga caaagtctgg gctttattac tgtgctttta taagattgtt 1341060
 gtcacacact attaatccca gaactgtgga ggtagaggca gatggatcct gtaccttctt 1341120
 tgtctaccta gcaagttcca ggccagagct acacagtgag ctctgtcaca gacaaaacaa 1341180
 agcaaacctg gctaaagcct agagctttgt atgccattgt aggaaggtga atgcaagctt 1341240

 tcacttagg ccattaagct catgctgtt tctctcattg ccttttccca tgtgaaatta 1341300
 ctgaaccatt tgaatatgat ttacaatcct attacacca cacaggtatt aaagagtgtt 1341360
 tgtattgcct catgttgttt gattatgtat ggtttaacta aaattctgtt ccattgggcg 1341420
 gatctcttat gtatcttaat cctttaacag tagacagtcc gatcctctta ggggtttact 1341480
 gtaataacag tgctctctc ccatggctat aacatatagc actgcttgtg catacgttct 1341540
 attttaaatc agaatgagta gatgccaaga ctgttcaagg ttcttaact aaggcgctc 1341600
 ccctttccct ccatttagc tgccaaaatg gtatattatt tagattcttc tagtcagaaa 1341660

 cgagcaatag agctggcaac aacacttgat ggatccctca acaacagaaa ccttcaggt 1341720
 accgggtcta cttatttatt tattttaagt aatctctctg taagagaaac taactactct 1341780
 tttacttctc actaaaagtt ttaaggggtt atgtgtttgt gtgtgtgtgt gtgtgtgtgt 1341840
 gtgtgtgtgt gtgtgtgtgt gttcttatgt acaagtatgc caggttagtt ggtatatagt 1341900
 aaatagtttc gtgtatataa cctgaataa ctttacttaa aaaatatgtt atgataaaat 1341960
 tacgtgtact caggctggag agagggctca attcccagca cccacatggt accctcttct 1342020
 gcctgcagg catacatata gacagaacac tgtataggta ataaataat aaatgttaa 1342080

 gaaagaaaat gaggaatgca cataacatga aacattttaa aatgcagata caagtgtgtg 1342140
 aaagaagtgt gtgtgtgtgt gtgtgtgaga gagagagaga gacagagaca gacagacaga 1342200
 cagacagaca gacaggacct gtttttctaa tcaacttgta ctggacattt ttctgcttat 1342260
 tggggttgtt tgtgcatcaa ggattgctct tttaaaaat atatttttgt atttgagtgg 1342320
 ttttgctgc atgtatggat atgcaccata tgtatgcttg gtgttcttaa aggtctgaag 1342380
 agggcttttg atctctaga actcaaggta gggatagttg tgaaccaccg tgtggatgat 1342440
 gaaaacaaa cttgaggcct ctgcaaaagc aacaactgct gagccatctc tetagcctca 1342500

 acattccttg atttgaattt ggggtttaat gataacagga atagattttg ctatttgttg 1342560
 agagtacct tggctggaat agaactcact atatataaca tagaccacac tggccttgaa 1342620
 ctcataaggg tccacttgct tatgcctcac aagtgctggg attaaacatg ggccaccatg 1342680
 tcctggccag tatttgcgt ggctcattgc ttccccaaaa gaaggaaagt taatgtccta 1342740
 tatgcagaga ctggcagaga ctggcagaga cattgtaagt ttaacattta tacatagggt 1342800
 aaattaatgt catttataa ggttgtgtac ttgctcaaag taccctttta aaaaacagta 1342860

cttttagcct ggtggtagtg gtggcacaca tctttaattc cagaagcagg tggatgtctg 1342920

 agttcttcga agtaagccag ggttatacag agaaaaccac cccctccctt tttgttttgt 1342980
 tttttgtttt ttgttttttg tttgtttgtt ttctagagaa aacagtgttt ctctagcttt 1343040
 ggaggctgtc ctggcactcg ctctgcagac caggctggtc tggaactcac agagatccgc 1343100
 ctgcctctgc ctcctagtg ctggattaaa ggcatgcgcc accaacaccc agcaccatt 1343160
 gcttttttaa tgctgtgta tctcatcaaa tgtacatact cttgtctttg ttttaatttg 1343220
 ctataaacc ccatttcaac cccatggttg aaatgtctca taagacctgt tttgtgctga 1343280
 attctaacat gaccttttct ttttagact tgcattggagg tattggaagc cttgtgtgat 1343340

 ggtagcctag gagactgtaa agaagctgct gaagcttata gagcaaattg tcataagctt 1343400
 ttcccttatg ctttggcttt catgccccct ggatatgaag aggatatgaa gatcacagtt 1343460
 aatggagata gtctgcaga aactgaagaa ctggccaatg aaatttgaac atcattaaac 1343520
 agcaaatgga atgactttgg accatatcta gtgtataata tttttgtcac gcacctgctg 1343580
 cattgctcta acttacacag aatgagagga gtaaatgttc ttgccttcaa atagtctttt 1343640
 acgtttttta tectgtgaa aactatatat aaaatatcta acattacagg atataggttc 1343700
 agtttcttaa aaattaaaag ctgctaaaat tgaggggttt aaaaaaaaaat tccatatcgt 1343760

 actcctacct tccccgceca tgttttttaa ctaatttata taaaatctgg aggctattac 1343820
 agctaacata gcagggtgtg ggcagaaaata ttactttaaa tttgtcttgt gagattttac 1343880
 tatactcag acagcataaa tgctgtttta gcaactggatt ctttactga gcacaaagag 1343940
 ttgttggggc tttagcatct gactgatttt gttacggggt tgattcttga ccataggaag 1344000
 tatgcaatgt gaatcactat gtacagagcc atctacaaca gacgcttgac gttgtagaga 1344060
 ctgggacaca tagctacca gcagattata tgaaacctag aagggttca gtacgtgtgt 1344120
 tgtgtttcca aaatttctg tacatgatca gtttgggtt cttgtaccac agtttttaac 1344180

 cgaaggaacc agttggaaca atctcaattt taacaaaaac ttgaagaact aaaataacaa 1344240
 tgcaaatctt tagcattgtt ttggccaaac ttgttaaac tgtaatgcaa gaaccaaag 1344300
 cactgtgatg tggcaccaac taattagcaa gcatgaattt ttcacctgag agtgaaaaaa 1344360
 aaaaaaaaaa aagaaaatct accatggctt gaagttaaag agcagaactc ctgactacca 1344420
 ttctatgact gatcaagaga ctaatagcta aaaacctcag caggccttgt tcacgatatg 1344480
 cagaaaaaag tgctgcagtt tagatacttc tggaactttt ccacagtgtc acaggtttgt 1344540
 aatacttgaa gcccttcatt tctaagaata ttttcttgc tcagttgttt caggcaagcc 1344600

caagactttg taattttta aggtcccaag attttcattt caataacaga ccagcttctt 1344660
tttcctgcag ttacaaatgt aatttctttt ttgttgtcaa acataaggta ccaaatatga 1344720
tgcaataaat tgttttgaaa aacagttgtg tgaatatctt cactaatccg agttgggctt 1344780
ctgtgaaata cacaggtgga aacagagggt gcaagccaga ggcaatgaaa tgcactgtag 1344840
agtttagtaca gatgggagct ttttagagtg ggctaattga tgggtgcagg gaagttccag 1344900
aataaagtag aatgctgctc ctttgttcag atttactga gggttaggat tgtggcaggt 1344960
cctatgaatg taattcataa tctgaaagga aaactaaca cgactatctt gattgggaaa 1345020

atgagcctta aacatgtcaa acctgtacac tgagaactag cctcaggctc aatattctct 1345080
ttatgtttgc aaggctgag caattaagtt taagtaaaat gaattaagtg tatataaaat 1345140
tgaacttttg tagtatctta gttatagata gttcatacgc taaaggaat tttcagaaga 1345200
tcaaatcctt ttatttcata gtacatgac tgcattccac atcccagtct aacaggttag 1345260
tgatgcaaag ataactgtag tctgaaactc agtgccttgc tttaacaggc cctgtctcag 1345320
gaacatctta acagatggca aaaaaaaaa aaaaaaaaa aaaaaaaaa aaaaaaaaaac 1345380
tcttcttaaa acttaaaaaat ttctcctatg agtggcaact gagactctta ttgtatggaa 1345440

aaaacactag tgcttcctct gccactaatt cagtgttga ggaggacca gccatatagt 1345500
aggcgcgagc gcgcgcgct gtgtgtgtgt gtgtgtgtgt gtgtgtgtgt gtgtgtgtgt 1345560
gtgtgtgtgt gtgtgtctgt gtgtgtgtgt gtatttgttt aagctctact gtatatcaca 1345620
atgaaatccg tctatttgc ttgacaatgt tcaacaatg tagattgtct tagaaggact 1345680
cagaaggact gagactctaa tgcagatgcc acccgagagg agctaaatc ctatcatgta 1345740
tattgtattt caaccaaat ttactggaac tattgaataa atcttttatt ttctttcagg 1345800
tttacttgat agtgtataca ttgtctgggt tcaaaggacc ttgactgggt tcacctaaaa 1345860

cattgtactg tactctctga gtatatcaac tggatcattt cacatttgc ccatccatat 1345920
tcagttaaaa tccagtgata ctgtggggga aaacagggtt agataaaca gttggaaaaa 1345980
tgcagtgtga tgttgaatc taacaagtg ctttatgttt attgctaaga actggtgtta 1346040
tcaacccttt taataagaag gggttctctc ggcctgtatt aatataggaa agtaaagatc 1346100
cttttgtttt tctttatatt tcttattgt catttctcat tgaaaagcta aactctgact 1346160
agcttagttt acttagcttt aattagatag ttgagtcata catttctact atttttctg 1346220
tatttattat gcacaacaat aaaatgatct ctaatagcat gactaaaagt agtgccgatg 1346280

tcaactggaaa gctttctggg tcttattagg cctgtctttt tccacctga ttgtactgca 1346340
tgctctattg ctctcggagc tgtgaaatga aaactgtgat tgtatgaaga gctcagagaa 1346400
ccatggtcca gaatcaggtt ggttgaaca aactcagaga aatctgtttt gatcacttgg 1346460

taagacttat ttccattgcc atgcatagca tccatttggg gaaagcttaa aaaggagagt 1346520
 attgaatatg gtacgtgttt cttttaggta attactgtcc ttgaattcta tagataatga 1346580
 agctaagaga attcagacca acctttctga tggacggggt cttccttttc tgcctcatgc 1346640
 ttgatttttt taattgaaag attcttaata ccattttgct attgtccaag ttttgctaaa 1346700

 tcaattaagt ctaagacaca aactctacga aatagctatg tcacaccaca ggaagcagaa 1346760
 attgtctcag tttttgctgg ttagaaacta caattttag caataagttt tgggaaagg 1346820
 tatttatcaa gtttcacttt tcccttctac agctatgaaa tgcataatgga aagtcttttt 1346880
 tagcgtgtag gaggttctgg agaacgctgt tatttaacaa ataatgtctt acatatattc 1346940
 tagttcatat agtaaaataa ctaattccat gaagacatac tcatgaaaat actaaaaaca 1347000
 agcaaagggt gctgtgtgtg aggatgcatt cctgcaacc cagcacttag gagatggagt 1347060
 tgagggccag tgtgaaagga aagaaagaaa gcttagggga aaggatttaa gagtctagaa 1347120

 gctctcagtt tgttagttca tgcagttagc tctgaggcat cttttggga tggtagctag 1347180
 aagaaagaga agtttgggtg aaattggaac ccagtggtc tgtgtaccta aaccagacta 1347240
 tagcctttgt ttcaaggttg cttataccaa atgtaaggat attactagca gtgctacaaa 1347300
 accattctga ggctgtcat atttttgag acagtatctc actatgtacc actgcttgcc 1347360
 tcaaacataa aggtctgaat tccctcctg agtgccggga ttaaatacat gtaccattat 1347420
 gcctagctat gaaggtttaa gatgagtggg ggtttgcaca tttgtgtgaa aatgcatgtt 1347480
 gtggaggta ggacaactta ggaatctcac catccacct tatgtgtgtt tcagggatca 1347540

 aactcaggtt accaggett c atggcacctt aacctgctga gacatttcac tggcccataa 1347600
 gtgaggcttt ggictctagt tcaagaaact atttcgtgca agatggtttg tttctacatg 1347660
 ttggtaatct cattgtattg taaagatgtc tggctcctc gagaatgcac tgtcttctca 1347720
 tttaggagga acaggaagtg aggtgatttt gagagtgtgg tctagatctt gagttgattt 1347780
 caactaatga tgcctgtctt ctatgtttac atgtatatga ctggcacagg gaccatctgt 1347840
 gctgtctgtg gttttcatt atttggctc gaatgaattt gccacctgtt tacattgtaa 1347900
 ttggagtttt tcagaacaca ctcaaggcta cattgttctt ccaaactggc ttttcttagg 1347960

 agctctacct atcaaccctc aagtaatcat attgctgctt tgtttctttt aaaatgaaaa 1348020
 agttgccatt taaagtagat ggtaacaaga ctatcacctg gattctggaa taccaaatac 1348080
 tcataactct tctgttagtt aacttagttt ttttaaaaaa gtgagagtaa tacacattta 1348140
 agaacatgta ttcagcatta cttgttcaga agttcattaa aaaggaccta agaataataa 1348200
 gccactgct tcagttgttt tttttttttt ttagagtga aaaagtttta agcacttcat 1348260
 tttcagctta ctgactagaa ctatgtaaat gaaatgtcca gttgtatcat gaaattacgt 1348320

gaccactgct ttggctcaaa ttcctttaag tccacacaca cctttaatcc cagctctcgg 1348380

gaggcagagg caggtggatc tttgagttcg aggccagcct ggtctacaaa gtgagttcca 1348440

ggatgaccag ggatgttaca gaaactgtac acccccaccc cccaaaaaaa taactcttct 1348500

gtaagtccat tttaaaattt gcctttattg tatatttgtgt gtgaacttgg agatcaaaga 1348560

acaatttga gggatcagtt ctcttcactc atcatgtagg tcccaggatt tagattgcca 1348620

ggtttggagg caagtgcctt taccactta gtcaactctc ctgtctgtaa atctataaaa 1348680

atcttaaac agccaggtagg tgtggaggca cacagcctta attctagtag tctggagtca 1348740

gaggcaggag ggtatcaatg agttctagga cagcctggtt ttcagagcga gttccaggag 1348800

agccaggatt gtiacacgga gaaaccctgt cttgggggaa aaaaaatttt tttaaaaaat 1348860

tacatagga tgagaacaat gcataataga tattcaaact cttaggaagt agcaatgatg 1348920

gtgaacttag gtcatctgca aaatcttaaa ttttctatcc ttttatctgt ggttatagaa 1348980

gagtcactct galactatct gttggccata agaaatcatc tcaaaatatt acagatacat 1349040

atattatgat gttatcagta tttttccaca tgtaattttt gctctttttt tttttttgt 1349100

cagaaatggt tgtggcttac tttgtagggc acaggtgctg gaagtacat ctgtttaatt 1349160

ttctccattg ttgtgatact ggttggcagt gaatgggttc atcttatatc tttagcaggc 1349220

tctacttagg tactgacatg cctattagaa gtgactgact gcaaaggatg ccaactcaaa 1349280

gaatataagg cattgggtgac agacatgcta catacctaga cttttaatgg tctagtagct 1349340

ttaattttct agctttccca caccatagtc agtcaatgac agccatcagc tctagctgct 1349400

cagtgccctc ctctatgtga ttcagtcctt aaaattataa gcttaacact ggttctgtat 1349460

tcaactccca ggagaaatct gaaaacacct gtgtttccca ggcccactag gaaagttgat 1349520

taaaatgac tgcagctagt attaataatc agtattgaca gctgcctgac cctgaccttt 1349580

ccaagagatt gtaaggtaga tccaaagttt agaggcagtc tcagtctaag tgtgtgtatg 1349640

cctttaatcc tagcactgag gactcagaag caggtagctc tcttaactt tgaggatagc 1349700

ctggtctaca gaatgaattc caggagggcc tagagtacac agagaaacc tctctctaaa 1349760

aataaaagga aaactatgga agtacagaga ttgtggcttc tcttacta agtaaatgaa 1349820

tccagaattt ttgttaacag cttctgatt ggtttccat ccactgat ctgatacttc 1349880

aatcatgctt actatactga gatacagtag gagaacaaag aaaaagccaa cctatttact 1349940

tcattgaaac aactttaaat tttccaagg cacagcactt tgtaagtgga cgcttgagct 1350000

tttaaatagg tagatctagt acttctgaa aacaactgag tctggccctt tgttttcct 1350060

ataagattgc atttgctata aatgaacat tattacaagt gttagttgtg acaggaattt 1350120
 tggtagagtg tttggaagg aggttgacag gctctagagt catcaagtaa acttaccttt 1350180
 ggggggtgtt gctcagcacc ctcagatcta gctagtattt ttagttaata aaaggaagat 1350240
 aacttgtcac caagcctcat ttgtgtctgg ggtgttttct gctggctaata agttactgga 1350300
 caagtaggat tgatgctatt cttgcccatt cttgggttta tgtcttttgt tcctcacctt 1350360
 ggcacacctg aaagtctaca cttgcccatt gctttcacag aaggttctcc attagtaggt 1350420
 aaatctcttt gatgttga atcaactgtc aagtaccagt acaaacctc tgaggtttag 1350480

 ttccccgca gtataatgga gttaggacag cttgtagatg acttagatct ctcacacact 1350540
 gtacaaaaaa ttcttaggtc aaatagttgg aagagttaat gtagatgggt gtttttgtcc 1350600
 tgtttagtcc caaataaaca cacagcttat attaattata aactgtttgg ccgatggcat 1350660
 aggcttctta ctggctagct ctctcttaat tattaacca taactattaa tctgtgtatt 1350720
 tccacgtggc cttatcttaa caggagaatg ctccggcatc ctacctccc agtagctaca 1350780
 tgaagtctcc ctgactttgc ctctgtccct gtttggattt cccacctggc tgaatcctgc 1350840
 ctgtcccttg gccgaaacag ctttattcat caaccagtaa gagaaacatt cacagtaata 1350900

 ggacattgcc ccatcatctt tgccctatg tgtttatttg caactgaact gctgcaggac 1350960
 caggcaggaa agaagcatcc acctacaagt taacactttg attactgcag cccaatacag 1351020
 agtaaacacc cactttaaaa aatgaagtta ttctcatcag tattgcaatt tttattatc 1351080
 ttgatcatca ttgtctactg tggtagattg ggccaatatt tcaggaagta gtttattttc 1351140
 tgatgcactt caattttaac tattaataat tatatttga taaaatgcaa gagtatctaa 1351200
 aagggatgga taagtaaat ataccttggg aggttctgta gctaaaatga atggattgac 1351260
 agaacttaat taagaattac cttccataga gctagcgaga tggtttcatt gtaaggcct 1351320

 tgccatgcaa gcatgaggac ctgagttcac actcctgcat ctacatgaaa aactgcctc 1351380
 ctttcagtcc tttcaggact tagagatgga aggatccctg ggggtctgct gccagccag 1351440
 gctttaaatg ggtgatttcc tggttcagcg agagaccttg tctcaaacac taaggctagt 1351500
 gagatggcta caggtaaca cattagatat caacccgat gacctgggac ctccataatg 1351560
 tgtgttga tgctagcc cacatgtaca caaaaatgta attaacaga taagatggat 1351620
 caggatcac cattctgcag acagaggcag gaggatctgt gattcaagc taccctggta 1351680
 tacatagtga gctccaggac agtcagtacc cggtctcata aaacaaatgg caataaggca 1351740

 gaatgtgggt gtgtgggtgg acatcagttc cagcacttg gactcagaag caggcctagt 1351800
 caacataaca agttccaggc cagccaatga tacatagtaa gagattcaaa aaaaaaaaaa 1351860
 aaaaaaaaaa aaaaaaaaaa aaaaatttcc ccctcaaaa aaaggagcta cctgacattg 1351920

acctctgact ccacattaac atatactata catagattta aacataaagg aaaaatgcaa 1351980
 tgcaactgat acaaaatatic ccaggaagaa gaaggagtag ggtgggggtg tcaaagtcac 1352040
 cacaagggaa tccacagaaa caactaagct gggctcatag gtgctctcaa actctggacc 1352100
 aacagctagg gagcctacat gggacctacc taggcctct acatatatgt gacagttgtg 1352160

 tagcttgctt tattttagg actcctagta gtaggatcag ggcctgtccc tgtggtgata 1352220
 ctttcttaa gatctaaca ataaagcttg cctgaagatc ggagtgcaaa getagccaca 1352280
 ctagttagcc atagaggcca gacagtggtg atacacactt ttaatccctc aggagcactt 1352340
 aggagacaga ggcagatctc tgttaaatca aggctaccct gagctacaca aaattgatcc 1352400
 agtctaaaag agaaacagag ctcaaagatg atctcagtat ttgggatccc ataccttaa 1352460
 tcccagcact agagaggaat ataaggctgg aggagacagg agctcagcgc agtctgaggc 1352520
 ttggtggaga cagatgcagt ctggagatgc agtctgaaga caggatctcc tttcaatctg 1352580

 agcattgtta gaggtgagaa ctctctagtg gttggctgct ttgcttctct gatcttcagc 1352640
 tttaatccca atatctgctc ctgagttttt aattattaag aataattaga attcttgctt 1352700
 catgtcccta atgcaccagc tggctctttg gaacctattc cccctactag gttgcctcac 1352760
 ccagccttaa tacaagggga ggagctcagt cctacctcaa ctttaattagt atgcatgct 1352820
 ttgttgatac ccataggagg cctgcccctt tctgaacaga agcagaggaa tggatggggg 1352880
 gcagggcaaa ggggagggga ggaggaaggg gaaattgtgg tcttggtgta aaataaatga 1352940
 aaatttttaa ttaaagaaa agccaagaaa atattccagg aggaacaatt tgtacctagt 1353000

 taaagaata cacgaagaat gtgaattgta acgagaaatg aagtttcaac cagaaagaag 1353060
 tctgagtaga ggcttgccac aggaatggg tagagtccag aggatgatct tgtttatctg 1353120
 attgcccagc tccacctccc aagggccagg gttcaagtgc atcaccatgc ccagttttat 1353180
 gtggtccttt gagtggggc tttgaatatg ctctgtaggc tctaccagtt gagctacatc 1353240
 cccagctgaa taagtgtctt ggatttttta gtattttta aaaatgacta tttctggtac 1353300
 tagagataat tctgtgctc acacatgctg agcatgtgct ataccattca gcctggcatt 1353360
 gtgtcacaag tctattagt tttactgaaga tggtagtggg aaaactagag catccaaacg 1353420

 ctgtagccac cagagggcgt gagtgaaaag cttagtggcc atccatcct attttggaga 1353480
 aatctctttt ttcactaac aaatccactg taggaaaaaa ccagatttag tcatttataa 1353540
 acattgttct aagactgttg acatttttaa ggcgttttct tcagcattgg ggatctttgt 1353600
 gaggcaagtg ctactgagcc tcatcctagc tctgtgtga cattataaca tttcttcac 1353660
 atatatTTTT tttatttga cattatgtgg acacattagg tatactgttg ttgtgtggac 1353720
 tctgttgggt atactgtttg tttattttag agcagatctt gctaaattca gcaggttgac 1353780

tttgaacttg gcacccctct gccttaccct cccaaggttc ccagctatgt gccacctaac 1353840

 ctagttgaca aacttcaaca aatTTTTTtTc ttcttttaac acaatgtatt gaacccatgc 1353900
 cttttatatg ccaagcatat gttctaccac tgtcttggca atgcagatag gattttaaaa 1353960
 aaaacctttg gtatTTTtTc tagttgcata ttCaggagta tttccagaat tggaaTgcct 1354020
 aggcaaagcc catgtgcttt ttttTttTgc gttgtttttg ttttTttTg tttttTgtaa 1354080
 aaaccaccaa gttgtctctc actatgtttt tTgTgcctggT agagcatggc cccttatcat 1354140
 taccatcctt tagactatga caggccatac caaagtgtca gatttcttca tGaaatctga 1354200
 agtcattctt ggatgactcc ggcccttgct ttgacagttt Tgccgccatg acaggctaca 1354260

 gaaaagaccC cacaagatgt agccctgaat caacaggatg TgctTgTccc ctgaccttac 1354320
 ctgacctTgc cctagataat gggaaaaaat acaagatatc ccccatgtgg taaagagcca 1354380
 gtCagaggct aggctaacag gctctggacc cGatttactg ataaggatag aatgtagtaa 1354440
 ccacagcaac cGccaccaga TgccctTtTt gTtaaccagt caccttagaa taggtacccc 1354500
 cagtctggag atgtgccaat cctgagacag ttaccatgca gcttacaggc cccaagatcc 1354560
 ccctTgctct atccctaata aatgtcctgc atgactgtgg ctcaatgtct ctctctgct 1354620
 tcaccacttt atTggaagga caagagacct gagtTcaaac Tcgcaattaa aaagactctt 1354680

 TgctttTgca Tcggatctgg TctctTggTg gTttTggggg TgTgggtcca aactctgagc 1354740
 acaacaatcc TgTcaaattt Tgcaccttac tTtctctat aaattccatt tattTggcta 1354800
 TatatggTgG agcatgactt taattccagc attagggaga cagaggcagg aggatctctt 1354860
 ggagTtcaag gccaacctga Tctaaagagg gagtTccaag atagtCagaa ctccatagag 1354920
 gctctgtcta aaaaaaaaa aaaaaattca tttattTgtt Tgtgacatgg Tcagggtctg 1354980
 gctatataTc TgaggtTggg ctgaaagtat Ttagcccatg ctttattTgg gagctggTtg 1355040
 Tgggcaaaaa gaaatgcca actacagTta Tcttctgccc Ttagtatcct aagtgtgag 1355100

 attaaggcat gCactacat atccagatct acattTccac agaattTaaa Ttggatccaa 1355160
 acctcaagac aaaaTgtTca aactgcccag gatgtaatac caaattactg agcacacaaa 1355220
 gaatgaggaa aatctcagtt ctccTagaaa caatgatgcc aacctgaat gcagatggca 1355280
 gaggTtatctg atgaagtgtt aaccactTaa TgaaggTtaa Tctctactgt Tctctcaagt 1355340
 ctgcagatTc aggcaaaggg atcatctggT agTgggggct acaagatgag aagaatgctg 1355400
 gggagaggag gcagaaagaa gctgccaggg agacacacca TgtagTcgct aaaggaatag 1355460
 catgctggag cctttttggT aaaataagac aatgtagaaa tacatagatt Tgtagtatg 1355520

ggtaataat taaggagag ctagcaata agaagcctga gccattgacc aaaaatttta 1355580
 tagtaatat aagtctttgt gtgtttgttt ggggcaaagt ggctgtggga ccaggtggga 1355640
 caagaaactc catgtacaaa atagcaccca atgtgaggcc tgaaccaca tccttgagat 1355700
 taacagtctc atgctctact gaccgaagcc tgagccagtg gccaacagtt tataattaat 1355760
 agacaactct gtgtgttcat ttggggctaa acagctgtgg gaccagatgg gaaagaaact 1355820
 ccatcaaca agcattatit atgattcatt aaagcttgcc tgaagattca gaaagcaaag 1355880
 ccagccacag gccatagaag ccaggcacat acctttaatc ccagcatcga gaagctagga 1355940

 ggtagtggta cacaccttta atcctagaac tgaggattaa gaggtacgca gatctctgtg 1356000
 agtacaaggc caccagatc tgcacaagat tgaatcagtc gaaaagagaa ttataatttg 1356060
 cacctttaat ccagcacta gagtggctca aaagccagga gcaggaagtc atgatgaggc 1356120
 atttgttctc cagccacact aaggagaagc agcagtttga gacttgggta agaggtcgtg 1356180
 tgtggatcag ccctttcagt ctgagctaaa ggtgagagct agtgaccagc tgctttgctt 1356240
 ttctgataat cagcttaaaa ttttaataaa tcatttatat tactacaact atcactctcc 1356300
 acgataaaga tgtgcagatt tgtctgccac ttatgaacag tttcctgcag agccattgct 1356360

 ctgtaaagtc actacttact taaggcaggt atcaccaggg tctcaaagca tccatgccgg 1356420
 gaatggggca tacatgctga tactctgcct ctgatgatag gtgccctttc tttctcacc 1356480
 aagagtctca tgctctctgt tcattactgg cactcaaact tgtaactta caaagttaat 1356540
 agatcagagt tcttgactct aaaaattcta catgtaacca ctagcattgc ataggtcacg 1356600
 caggccttga actcacaatc tttctgtccc agccttctca gagctgggat tataggcata 1356660
 tgttattata ctgcactca gtagcatttt gaagccattg gaaaaatcca gccaggcata 1356720
 gtgctgccat ctgtagccct agttctcagt gggctgagac aggattcca caaattcaga 1356780

 gctatttagg ggcatattgt gagttctagg ccagcttcag ctacaatatg agactttttt 1356840
 tgggtggggga tgagaagatg acttagtggt tagagtgttt gcagagcaag taagaggctc 1356900
 cgaatttggga tcccagaac ctagagcaat gctgagcagg tatggcagct ctctgtaga 1356960
 tcctactttg gaagattgag acaagggatc tccagagcaa gctagatacc aagaggcctg 1357020
 aaaatcaagg gttgtagcat gcgccc aaag attactgta atccgtgatg gtaaagtttc 1357080
 tttattcaag aaagcaccag ggcaaaacgc aggccggagt gaggttataa ggaccagca 1357140
 agcgcggcca gaaagagggg gctagggctct ccacgtgcag tcttaagaa gcttcctat 1357200

 gtcaccttgg ctttcttca ccacgccctt atggcgagtc cgggtctgc ctggtacctg 1357260
 tcccaggact attgggcggg gctaggggtgt ctcctacaa tttccctttt agtctaaaag 1357320
 aggattaaaa cttaatagtg taaaatatcc aaaactaaca atcataaagg tgaatataa 1357380

gaagatacaa caatctgcta tgacacatcc tatgtctatt ccagctaagt tttaaaatca 1357440
 tgtggaaaag gtgtttaact tgaacacctc cttccaatcc caactctaaa caataagaag 1357500
 gtnnnnnnnn nnnnnnnnnn nnnnnnnnnn nnnnnnnnnn nnnnnnnnnn nnnnnnnnnn 1357560
 nnnnnnnnnn nnnnnnnnnn nnnnnnnnnn nnnnnnnnnn nnnnnnnnnn nnnnnnnnnn 1357620

 nnnnnnnnnn nnnnnnnnnn nnnnnnnnnn nnnnnnnnnn nnnnnnnnnn nnnnnnnnnn 1357680
 nnnnnnnnnn nnnnnnnnnn nnnnnnnnnn nnnnnnnnnn nnnnnnnnnn nnnnnnnnnn 1357740
 nnnnnnnnnn nnnnnnnnnn nnnnnnnnnn nnnnnnnnnn nnnnnnnnnn nnnnnnnnnn 1357800
 nnnnnnnnnn nnnnnnnnnn nnnnnnnnnn nnnnnnnnnn nnnnnnnnnn nntgggactc 1357860
 aaacataagt gtcacagag aagtgttcgc ttgttcatgt atgtgtactg ggaaaggaaa 1357920
 tccttgaaaa acaacaatta tgagagggtg taggccttga aagaaaaagc caagaaaaga 1357980
 caaagatagt cttcttattc ttcatttatt ctgtattaca gcaattggct tcttgatata 1358040

 acacagaaac ttttaaatgt tgtaaataa catgcttggg ttttagagta ggaaagccaa 1358100
 atccaactct aaatcccaca tcgatttaat tgaataggga ctaggaaatg aagagacata 1358160
 gagttatitg agagacagct gtaaattttg taaattttgt aaattttatg gcatgttctc 1358220
 tttgttcgat ggttatagct acattctttc cttaanntnn nnnnnnnnnn nnnnnnnnnn 1358280
 nnnnnnnnnn nnnnnnnnnn nnnnnnnnnn nnnnnnnnnn nnnnnnnnnn nnnnnnnnnn 1358340
 nnnnnnnnnn ngaatcttga tcaattttga tggatccaa agattttctt ttcctgtgga 1358400
 gacaaataca aaaccctac cccaacgtaa ctcatgtcca ggtttccata ccgaggtcag 1358460

 cacatctttg aaataactg gttggttcag ttcagcagtt ttttccgtag tccagtgtct 1358520
 ttccgcagct ataaagcatt atgcaatcfa tgtttcgggg gtttcgactt accagcttgc 1358580
 ctatggagca tctccttaag tgtcctgtta gacctttcaa cgactgcttg tctttagggg 1358640
 ttgtgtggta tacctgtgac atgcttaatg ttataatatt tgaagaactg ttccattttt 1358700
 gtggagacat atgctggagc attgtcagtt tttatctgcg ccagtatacc cataactgcc 1358760
 atcacctcca gaaggtgtgt aataatggaa tcagcttttt tagagttgag agcagtagcc 1358820
 cattggaaac ctgagaatgt gtcaatggta tgtatgatgc acatatttca aatttccaaa 1358880

 ttctgtaaag tgaagatat ccattcctgc gttatctttt tttcagcctg tcatggctgt 1358940
 agaattgtca aagcaagggc ctgggtgagg gcctgagtca ttcaaggatg acttcagatt 1359000
 tcatgaagaa aacttttggf atggcctgaa atagtctaaa ggatggcaat gataaggaac 1359060
 cctgtttctac cagacacaaa aacatagtga gacacaattt gatggttttt acaaaaaaac 1359120
 aaaacaaaaa aagcacatgg tttttgccta ggcattccaa ttctggaaat actcctgaat 1359180
 atgcaactag ataaaatacc aaaggttttt tttttaaaaa tcctatctgc attgccaaga 1359240

cagtggtaga acatatgctt ggcatataaa aggcattgggt tcaatacatt gtgttaaag 1359300

 aagaaaaaaaa tttgttgaag tttgtcaact aggttaggtg gcacatagct gggaaccttg 1359360
 ggagggtaaag gcaggaggat gccaaagtca aagtcaacct gctgaattta gcaagatctg 1359420
 ctctcaaata aacaaacagt ataccaaca gtgtccacat aataacagta tacctaata 1359480
 gtctccataa tgtcactttg agttcagagt ttgactaaga gatcctgcct caggctgggt 1359540
 tgatggctca gaggttaaga gcactggctg ctcttcaga ggttctgagt tcaattcca 1359600
 gcaaccacaa ggiggctcat aaccatctat aaggagatca ggtgccctct tctggcctgc 1359660
 aggcatacat gcagacagaa cactaaaata aataaataaa taaataaata aataaataaa 1359720

 taaatagagc ttiaaaaaat tgcctcagag agtaaggatga gaaagagt ag gcatgcatgt 1359780
 gccactgcc tatgcaaca tgtatcacat acccaccaca tacatacaca tgaactggag 1359840
 taaaaagga agaattgaat gagtcaccaa agtggcaaag aagtgaatat gtgaagaaaa 1359900
 aacattgtt tcgtttttt ttttgtttt ttttatggca gcatctgttt ggacctggat 1359960
 gtcttggaac tctatgtaga tgagaagact gtcaaaattc aagaatcct cctgcctctg 1360020
 ctcccacaa tctggcatta aaggcctgtg ccacctggtc cagtccaaac caatattttt 1360080
 gttttgtttt gttttgtttt aagaagaaac aaatttagct gggcatggta atgcacattt 1360140

 ttcatcccag cctgggaggt agagacagga gtttctctgg gagtttgaag ctaacctggt 1360200
 ctatgcagag tgccaggaca gccaggacta cacagagaaa gacctgtttt aaaaaaaaaa 1360260
 aagtaatttt attgatttat tcttgtttgc attgtttatc ctctgtgtgg gaggtttttg 1360320
 ttttcaagat aggatatctc tgaatctgtg tttattttc caatacagac tttctcctta 1360380
 tagcccttc tgcaacttgc tgtagacaag gctagcgtcc aaactcaaga gatccacctg 1360440
 ctgggattaa aggtgcatgc cactaggctt gatgaggtag aatctcttat agccaaagct 1360500
 gccctgtact ttacaaaatt tcccacatat aattttagc ccatTTTTatt agtttcaagc 1360560

 aagtttattc ttctactaa attcagcctt tcattaggta attcctttct actactacta 1360620
 ttttttttta agatttatTT attgagtata caatgttctg cctatgtgta tacttgcagg 1360680
 cccaggaggg cactagatct cattacagat gattgtgagc caccatgtgg ttactgggaa 1360740
 ttgaactcag gacccttggga agaacaggca gtgctcttaa cctctgaacc atctctcaa 1360800
 ccccccttct acttctagta acctgttttt ctgccaccac gacaagctag attgtcaact 1360860
 ctttgactac acctgtttgt ttgtttgttt gttttgtttt atgatgctgg gatttgaaac 1360920
 tgggcttctg gtatgcaagg aaagcactct accaaatgaa ctacatccat aacctgcttg 1360980

tttttgaag acaggtctc tatagtgtg gacatgggtt caagcaaata gaaagtcttt 1361040
 atttgggacc cgagtacagt cccaagcctt tctcaagtg agtttttaac cacagaagaa 1361100
 agaaaaaaaa aatcctaggt tgacatactt tacaagaaca gttagccgaa ctacagtagc 1361160
 cgaaaagcaa ggttactaca ttagagaatt tcccagaact atggatgttg atggattagg 1361220
 tctttgtttt ctctctctc ctccctcctt cctctgtct tcttttttg gcagatattg 1361280
 ctgcctaagt gctgggctcc aaggcttgag tgatacttct atcatactgt caactgtgct 1361340
 aaggtgcgag ggcctactga gctcggcggg gggtgggggg gtttgtaag gtcttgctg 1361400

 tcctggagct tgcaatgtag cccaggtgg ccttgaattc atagattc tactgcctct 1361460
 gcctttcaag tgcaggatta aaatctagc tccaaccct gaggactccg gacttccat 1361520
 cttctctg cctccgctga aactagcagg ctttctaacc gtgggttacc acgccagct 1361580
 gcgtaagaa tttgatttc ccaaggtcc cacagagata tctacgggat cgggatatt 1361640
 taaagcaagc aaggcttggg tgccaagatc cgaggttact acccggcgc cgggaaaggc 1361700
 tcgggcccag gggctgagca gcctgcact ctgctgccg cgcggagtct ggaggaggcg 1361760
 gtgagcgtgg gtaatgcgcc ggcccggctg ctccctccca gctgctggca ctggccagtg 1361820

 gcctttgcca ctgcacagtc gcctctcgcg agacagggtc cgggccgcac ctcttctc 1361880
 tctgccgact ctctccccgc cctgaggag ctgcgccgt tctcctgag cggggaaca 1361940
 ttggacgtgg cggggccggt ccgagtcnnn nnnnnnnnnn nnnnnnnnnn nnnnnnnnnn 1362000
 nnnnnnnnnn nnnnnnnnnn nnnnnnnnnn nnnnnnnnnn nnnnnnnnnn nnnnnnnnnn 1362060
 nnnnnnnnnn nnnnnnnnnn nnnnnnnnnn nnnnnnnnnn nnnnnnnnnn nnnnnnnnnn 1362120
 nnnnnnnnnn nnnnnnnnnn nnnnnnnnnn nnnnnnnnnn nnnnnnnnnn nnnnnnnnnn 1362180
 nnnnnnnnnn nnnnnnnnnn nnnnnnnnnn nnnnnnnnnn nnnnnnnnnn nnnnnnnnnn 1362240

 nnnnnnnnnn nnnnnnnnnn nnnnnnnnnn nnnnnnnnnn nnnnnnnnnn nnnnnnnnnn 1362300
 nnnnnnnnnn nnnnnnnnnn nnnnnnnnnn nnnnnnnnnn nnnnnnnnnn nnnnnnnnnn 1362360
 nnnnnnnnnn nnnnnnnnnn nnnnnnnnnn nnnnnnnnnn nnnnnnnnnn nnnnnnnnnn 1362420
 nnnnnnnnnn nnnnnnnnnn nnnnnnnnnn nnnnnnnnnn nnnnnnnnnn nnnnnnnnnn 1362480
 nnnnnnnnnn nnnnnnnnnn nnnnnnnnnn nnnnnnnnnn nnnnnnnnnn nnnnnnnnnn 1362540
 nnnnnnnnnn nnnnnnnnnn nnnnnnnnnn nnnnnnnnnn nnnnnnnnnn nnnnnnnnnn 1362600
 nnnnnnnnnn nnnnnnnnnn nnnnnnnnnn nnnnnnnnnn nnnnnnnnnn nnnnnnnnnn 1362660

 nnnnnnnnnn nnnnnnnnnn nnnnnnnnnn nnnnnnnnnn nnnnnnnnnn nnnnnnnnnn 1362720
 nnnnnnnnnn nnnnnnnnnn nnnnnnnnnn nnnnnnnnnn nnnnnnnnnn nnnnnnnnnn 1362780
 nnnnnnnnnn nnnnnnnnnn nnnnnnnnnn nnnnnnnnnn nnnnnnnnnn nnnnnnnnnn 1362840

nnnnnnnnnn nnnnnnnnnn nnnnnnnnnn nnnnnnnnnn nnnnnnnnnn nnnnnnnnnn 1364760

 nnnnnnnnnn nnnnnnnnnn nnnnnnnnnn nnnnnnnnnn nnnnnnnnnn nnnnnnnnnn 1364820
 nnnnnnnnnn nnnnnnnnnn nnnnnnnnnn nnnnnnnnnn nnnnnnnnnn nnnnnnnnnn 1364880
 nnnnnnnnnn nnnnnnnnnn nnnnnnnnnn nnnnnnnnnn nnnnnnnnnn nnnnnnnnnn 1364940
 nnnnnnnnnn nnnnnnnnnn nnnnnnnnnn nnnnnnnnnn nnnnnnnnnn nnnnnnnnnn 1365000
 nnnnnnnnnn nnnnnnnnnn nnnnnnnnnn nnnnnnnnnn nnnnnnnnnn nnnnnnnnnn 1365060
 nnnnnnnnnn nnnnnnnnnn nnnnnnnnnn nnnnnnnnnn nnnnnnnnnn nnnnnnnnnn 1365120
 nnnnnnnnnn nnnnnnnnnn nnnnnnnnnn nnnnnnnnnn nnnnnnnnnn nnnnnnnnnn 1365180

 nnnnnnnnnn nnnnnnnnnn nnnnnnnnnn nnnnnnnnnn nnnnnnnnnn nnnnnnnnnn 1365240
 nnnnnnnnnn nnnnnnnnnn nnnnnnnnnn nnnnnnnnnn nnnnnnnnnn nnnnnnnnnn 1365300
 nnnnnnnnnn nnnnnnnnnn nnnnnnnnnn nnnnnnnnnn nnnnnnnnnn nnnnnnnnnn 1365360
 nnnnnnnnnn nnnnnnnnnn nnnnnnnnnn nnnnnnnnnn nnnnnnnnnn nnnnnnnnnn 1365420
 nnnnnnnnnn nnnnnnnnnn nnnnnnnnnn nnnnnnnnnn nnnnnnnnnn nnnnnnnnnn 1365480
 nnnnnnnnnn nnnnnnnnnn nnnnnnnnnn nnnnnnnnnn nnnnnnnnnn nnnnnnnnnn 1365540
 nnnnnnnnnn nnnnnnnnnn nnnnnnnnnn nnnnnnnnnn nnnnnnnnnn nnnnnnnnnn 1365600

 nnnnnnnnnn nnnnnnnnnn nnnnnnnnnn nnnnnnnnnn nnnnnnnnnn nnnnnnnnnn 1365660
 nnnnnnnnnn nnnnnnnnnn nnnnnnnnnn nnnnnnnnnn nnnnnnnnnn nnnnnnnnnn 1365720
 nnnnnnnnnn nnnnnnnnnn nnnnnnnnnn nnnnnnnnnn nnnnnnnnnn nnnnnnnnnn 1365780
 nnnnnnnnnn nnnnnnnnnn nnnnnnnnnn nnnnnnnnnn nnnnnnnnnn nnnnnnnnnn 1365840
 nnnnnnnnnn nnnnnnnnnn nnnnnnnnnn nnnnnnnnnn nnnnnnnnnn nnnnnnnnnn 1365900
 nnnnnnnnnn nnnnnnnnnn nnnnnnnnnn nnnnnnnnnn nnnnnnnnnn nnnnnnnnnn 1365960
 nnnnnnnnnn nnnnnnnnnn nnnnnnnnnn nnnnnnnnnn nnnnnngcccg ggaaccctgt 1366020

 cgcggaggag gcgccattcc cgaggctttt ctctccgca tcagctcgga gagagtcggg 1366080
 aggatggctt cggagatgga gtcgtctctg gaggtcagct tctcgtccag ctgtgcggtg 1366140
 tcaggggcgt ccgggtgtct gcctcccgc cgtcccgca tcttcaagat catcgtgata 1366200
 ggagactcga acgtgggcaa gacatgcctg acttaccgct tctgcgccgg ccgcttcccc 1366260
 gaccgcaccg aggccacgat gggggtggac ttcgagagc gagccgtgga gatc gatggc 1366320
 gagcgcacatca aggtgagccg atggcggggg tgggttgggg gctgtcactg cggagggctt 1366380
 tgcaggtatc tggaccgcac cgtggctctg tgcaggagtg tgcgcctgt gtgctgccac 1366440

gctggcgtgc aaagtgcgtt tgtaagtagc aaacttctga ggcaactgttc ccacactcct 1366500
aacgtgcatc agttttacct ggggcatctt gtttttcaaa aaagcacgta tgatttggtg 1366560
agctcccaaa tgacgcatc gcaacgagtc tgtggaccac actttgggtg tcaatagtg 1366620
aggggagagc cattaattcc ccacccccat tacctgagtt aagtgtggg aaatattttc 1366680
aagcatagaa aactcagta tttctaagaa ttcatgtgaa cattgcatca ttgctaagta 1366740
ttgtgaaat aaagcctgtt gagtttgagg cagtttctgt atgataatca attgttttag 1366800
gaaaaaatc tatattttcc tattgaagca ttatatatgt tatggttctt aagtgagttg 1366860

ccaaaatcat atctcttgat gcaagcacag accctctccc aggtggcttc taagacatca 1366920
gacactgtag tcatagtagg ataggccgag acagccagga ctgggattct gaagggttga 1366980
gctcctggga ctgcagaata aggatccttg tcaagtcagg aaccttccga tgggtgaaac 1367040
cttgacactc tattgcaaaa ccaactaagt tacttaatag aaatcctaa aacctgtgaa 1367100
gtggggttgg aggactgcag tgagacccca tctcaaaata tgaaaacaaa tcaaacctg 1367160
cacaagaaac ctaagaactc cgctgacttc cttagcaact gcttttactt tgctttacat 1367220
tgggtcctct acctcagctt acttgggaaga gctttgattt gctcctccta ctttctatcc 1367280

ttgaggcacc gagtttcttt ctttctttct ttctttcttt ctttctttct ttctttcttc 1367340
ctttctttcc tctttctctt ctttctttcc ttctttcttt ctttctttct ttgtttcttt 1367400
ttttgtctgt ttgatttttg agacaggggtt tctctgtgta gttttggagc ctgtcctaca 1367460
actcactctg tagaccagcc tggcctcaaa ctcacagaga tcttctgccc ttgcctccc 1367520
aggagtctg ggattcaaga catgagccac caacaaatgg ccaaagtctt tatttctttg 1367580
ctcaccacc ctcctgccc tcaaagagct ttaccctt gtaaagaaat gggggagtta 1367640
tctgagtcaa gagaccact tctctaggcc ctttggcttt tccatgtcca ttattttta 1367700

agtgtgtgtg tgcacatgtg tgcataagtg tgtgtatgtg ggtgggcta agtctagact 1367760
atatgttcat gccagtcttc tgaagttgct ctctgcctta ctttttgag gcagtctccc 1367820
aatgaatctg gagctcactg attctaata gacctatctg actaacaagc ctgaggatc 1367880
ctcctgagtc tgcctccta ggtctgggat tgcagggtct gaggccaaa tttagtttga 1367940
caagtgttt ctttaatttt atttttattt ttttgggata gggtttctct gtgtagtttt 1368000
agagactgtc ctggaactca ctctgtagac caggttggcc tggaaattcac agagatccac 1368060
ctgcctctgc ctccagagag ctgggattaa aggtgtgtgg cactactgcc acaaccacc 1368120

agcagcaagt atttcttga ctggacggat catcttgttc aggcctccag tactgtcat 1368180
ttgggtacac tgtagtataa agtaaaggga gatttatgag actaaggat gattcagttg 1368240
taggtgtcct actagcatat gcaggccag gtgttttctt cttagttgga gctgaggaag 1368300

gagatttga tacatggcaa gaagagctag atgagtagaa ggtgattttt ttttttttt 1368360
 ttaagcaaaa ctaggttaga gatggaagt ggtggcagga gaaaagattg aggcttccgg 1368420
 tgtgtgcatg tttagcctgg ggtaagcagt tgtggggaag ttgctcaggc ttaggagccc 1368480
 aactcacaca ggiacaagtg tgagctgctg aaaagctttg ggttgtgggg tagcttgaat 1368540

 ttgtctcctg agttcacgtg ttgaaactt aattccaag tccataaatt aatgagactt 1368600
 ggagatggga catttgggag gtgattgggt cctttggact tatgaatggg ttaatccctt 1368660
 cgtagattaa ttaatctaat cttttgatgg ggcaagggat tagttcattc ataaattagt 1368720
 ggattaatct catttatgga ttaaagggtt attgggagtg gcttgtccac ttataaaact 1368780
 gtgaacaaaa taaaagcctc tattctcctg attagtcagc cttggaaagt tttgttatag 1368840
 caacagaaaa cagaccaatg tatagggtg tcaggctttt tgcttttctg tttttttta 1368900
 ttatatTTTT tgtatttacc tatttaattt tgagtctttt ttaaattaa atttatttat 1368960

 atttcttgtg cattagtgtt tgcctatatg tatgactaaa ctgggtgctg ccatgtgggt 1369020
 gctgggaatt gaacctgggt catgtagaag ggcagccagt gctctttttg tttgtttgtt 1369080
 tcaagacagg gtttctggat gaaggctcta gcatggcatt taaggcagtc ttcaatttga 1369140
 ttatcagaga acggtattta aggtagtctc ttactattgc ttagattctt agttgtggtc 1369200
 atccttgtgg atccctggga atttccttag tgccatgttt tcattaagc ccataatggc 1369260
 tccctctatt aatgtaattc tttccttget ctctctctct gttctcccc caactcgacc 1369320
 tttctgatcc ctcatgttct ccttcccccc tcccctctc cctcctttt tctcttct 1369380

 ctgtccctct tcccccatg ctccaattt actcaggaaa tcttctcctt tccccctct 1369440
 cagggactcc atgtatgtct ctcttaggtt cctccttgtt catccagtaa ctaatggaag 1369500
 cagaaacaga gatccacagc taagcattga gccaaactcc tggaatgcag ttgtagagag 1369560
 ggaggaatga tgagcaaagg ggtcaagacc atgctgggga aaccacaga gacagctgac 1369620
 ctgagcaagt gggagtcat ggactccaga ctgacacctg gggaacctc gtgagacaga 1369680
 accagcccc cctgaacgtg ggtgtcagtt gggggcttg gacagtctat ggggctgctg 1369740
 gcagtggaa cgtatttat ccctagtgca tgaatgggct tttggaacce attccctatg 1369800

 gagggatact ctgttagcct agatacaggg tggggagggc ctaggtcctg ccccaaatga 1369860
 tgtgacagac tttgatgac caccatggga ggcctcacc tccctgggga gtggatgggc 1369920
 atgctgtgca tggaatggga agatggggga gggagaatgg gaggacagta ggagaggatt 1369980
 agtatataaa ataagattgt ctttaattta tacttttgggt tgtgaccta acctttaatg 1370040
 gctgagccat ctctccagc ctgttttttg tttttttgtt tttgtttttt tttttggttt 1370100
 tccgagacag agtttctctg tgtgctttg gacccatcc tggcactcgc tctgaagacc 1370160

aggctggcct cgaactcaca gagatccgcc tgcctctgcc tcccaagtgc tgggattaaa 1370220

ggcatgcgcc accaatgcct tgctccagcc ctgtttttaa tttaaattaa aaaattaaaa 1370280

agaaaaaaga caaagtctct ctgtgtaaca gcctggetgt cctcgaactc gattttgtaga 1370340

ccaggctggc ctctgagtg ctgggattaa aggcatgtac catcagccag tgctctaac 1370400

ccctgagcca tctccacccc tgagacagtc tttctatgta gccctaactg tcttgaaac 1370460

ctctatgcag accagggtgg cctctaactc acctacattc acctgccttt gcctttaatc 1370520

ccagcacttg ggaggcagag gtagacagat ctctgaattc ttgcctagcc tggtcacata 1370580

gtgcagtggc tctttttgtt tgttttattt tgtcttttga gacagggttt ctctgtgtag 1370640

cagtctctggc tgttttggaa ctgcttttgt agaccaggct gaccttgaac ttactatgat 1370700

gtgtctgcct ctgtctccca agtgcctggga tcaaaggcat gcaccactgc tgcagtggtt 1370760

gttaacctgt gggttgcaac ccctttgggg aggggtgttg aatgacctt tcacagtac 1370820

aagactatca gaaaacacag atatttacct tatgatcact aacagtagca gaattacagt 1370880

tatgaagtag caatgaaaaa catttgggt tggggttcac cacaacatga agaactgtat 1370940

taaagggttg cagcattagg aagggtggga accactaaca tagtgagttt cagaaaaaag 1371000

aaaattcaca ggtatgagga atagtctttt acacctagga tctgtttaat tcagtcattg 1371060

gctcagaata aagaatgtac tttcttttat gaaaaaaaaa tctcacaag ttatggagcc 1371120

aggggtgggt gtggtagtgg ccatctttaa tctaacact caggaggcag aggcaagcag 1371180

atccgaggtt gaggtcaacc tggctctaat ggcaagtct aggacagtca gggaacagtg 1371240

agacctgtc tcaaatgcct acctgcacga gagtgcgtgc gcacacacat gtacacacat 1371300

acacacacc tctccatctt gtccacctgt tcagtgaatc tgatagatca ccttagtctc 1371360

atctgctaga gaagtatgta ttggtgtgg tggcgttgg gttagggtc caaacatac 1371420

ctgttaggtg agtgctctac cacttctaca actaagetac accctggca cttaaaaata 1371480

tttttatat tatgtgatt ggtgcttct gcatgtatgt ctgtgtactg tgtgtatgca 1371540

gtgcctacag tggcattggg ttcttctgga actggaatta cagatgattt taagccacca 1371600

tgtagtgct aggaatacaa tcttggctt tggggagagc agccagtgtt cttaacctct 1371660

gagccatcac tatagccttc tatgccttt ttaaaaaagg gtctcatgta cccaaaggtg 1371720

acttcaaagt ctatataatc aaggataact tcgaactctg aatttgtatg tgtgtgtgtg 1371780

tgtgtgtgtg tigtgtgtg tgtgtgtccc aactaaaacc ctacctatca cataccttt 1371840

ctgctcctgg ggacctggat ggtgaggcct tccatagggt gtcatcagag tctgtcatat 1371900

cctttgggat agggcctagg cctaccccca tgtgtcttgg ctcagggagt attcctctat 1371960
 atggaatgga ctcccaaagt ccccacctat gctagggata agtactgaac ttctacagga 1372020
 ggtcctgtag atttctgagg tttctcaat gaaatccaag ttctctgggt ctggatcagt 1372080
 cccatgctgg tatcccagct atcagtctgg ggagcaagag ttcccctaatg tccaggtcag 1372140
 ttgtttctgt gggtttcacc agcctggctt ggacaccttt gctcttctact tgccttctc 1372200
 tgcactcgn nnnnnnnnnn nnnnnnnnnn nnnnnnnnnn nnnnnnnnnn nnnnnnnnnn 1372260
 nnnnnnnnnn nnnnnnnnnn nnnnnnnnnn nnnnnnnnnn nnnnnnnnnn nnnnnnnnnn 1372320

 nnnnnnnnnn nnnnnnnnnn nnnnnnnnnn nnnnnnnnnn nnnnnnnnnn nnnnnnnnnn 1372380
 nnnnnnnnnn nnnnnnnnnn nnnntgtgct atcaatttgc tcaggggatc ttgaccttt 1372440
 ccccttctcc aggggacct gtatgtctct cttaggttcc tccttgttta ctagtgtctc 1372500
 tggcagtggt gattgtaggc tgataatcct ttactctatg tctataatcc acatatgagt 1372560
 gagtgcataat catgtttgtc tttttgtgat tgggttacct cgctcagaat gcaattcttc 1372620
 tgcaaattc aagattccat tgtgtaaatg taccacattt tctctatcca ttcttcagtt 1372680
 gaggggcatc taggctgctt ccagtttctg gctattacaa atagtgtgc tatgaacatc 1372740

 gttgannnnn nnnnnnnnnn nnnnnnnnnn nnnnnnnnnn nnnnnnnnnn nnnnnnnnnn 1372800
 nnnnnnnnnn nnnnnnnnnn nnnnnnnnnn nnnnnnnnnn nnnnnnnnnn nnnnnnnnnn 1372860
 nnnnnnnnnn nnnnnnnnnn nnnnnnnnnn nnnnnnnnnn nnnnnnnnnn nnnnnnnnnn 1372920
 nnnnnnnnnn nnnnnnnnnn nnnnnnnnnn nnnnnnnnnn nnnnnnnnnn nnnnnnnnnn 1372980
 nnnnnnnnnn nnnnnnnnnn nnnnnnnnnn nnnnnnnnnn nnnnnnnnnn nnnnnnnnnn 1373040
 nnnnnnnnnn nnnnnnnnnn nnnnnnnnnn nnnnnnnnnn nnnnnnnnnn nnnnnnnnnn 1373100
 nnnnnnnnnn nnnnnnnnnn nnnnnnnnnn nnnnnnnnnn nnnnnnnnnn nnnnnnnnnn 1373160

 nnnnnnnnnn nnnnnnnnnn nnnnnnnnnn nnnnnnnnnn nnnnnnnnnn nnnnnnnnnn 1373220
 nnnnnnnnnn nnnnnnnnnn nnnnnnnnnn nnnnnnnnnn nnnnnnnnnn nnnnnnnncc 1373280
 atttatcaat tgttgatctc agtgtctgtg ctactggtgt cctctggctt gaggacagag 1373340
 tcctccctcc atgagaatga atttggtatt atagttttat acttaaagtt attggettca 1373400
 gaaacttga tgaatttacc cacaaatgag gcagaattct tcctattta ctatcaaaaa 1373460
 agaatcagct gcgcactttt tgttgaacaa tcttcttca tatatatata tatggattgt 1373520
 ttgtcaaaga tcaggtgttt gtaggtgtgt gggttaatat cagggttttc aactctattc 1373580

 cattggtcta cctgtctatt tttgtgcaa taccaagctg tttcaggac tatagtctg 1373640
 taatagact tgaagttagc gatggtgatg cctccagaag ttcttttatt gtacagggtt 1373700
 gttttggcca tcctgggtct tttgtttctc catataaagt tgataattgt gctttcaaga 1373760

tctgtgaaga attgtgaagg attttgatgg ggattgcatt gaatctgtag attgcttttg 1373820
 gcaagattgc catttttact atgttgatcc tacctatcca agannnnnnn nnnnnnnnnn 1373880
 nnnnnnnnnn nnnnnnnnnn nnnnnnnnnn nnnnnnnnnn nnnnnnnnnn nnnnnnnnnn 1373940
 nnnnnnnnnn nnnnnnnnnn nnnnnnnnnn nnnnnnnnnn nnnnnnnnnn nnnnnnnnnn 1374000

 nnnnnnnnnn nnnnnnnnnn nnnnnnnnnn nnnnnnnnnn nnnnnnnnnn nnnnnnnnnn 1374060
 nnnnnnnnnn nnnnnnnnnn nnnnnnnnnn nnnnnnnnnn nnnnnnnnnn nnnnnnnnnn 1374120
 nnnnnnnnnn nnnnnnnnnn nnnnnnnnnn nnnnnnnnnn nnnnnnnnnn nnnnnnnnnn 1374180
 nnnnnnnnnn nnnnnnnnnn nnnnnnnnnn nnnnnntga tttctccaag acctttatca 1374240
 tgaaggggtg ttggatttg tcgaaggcitt tttcggcatc tagtgagatg atcatgtgtt 1374300
 ttgtttttt ttcctcagt ctgtttatat ggtggattac attgatggat tttttatgt 1374360
 tgagccatct ttgcatccct gggatgaagc ctacttgatc atagtggatg atttctctga 1374420

 tgtgttctta gattcgattt gctagtattt tattgagaat ttttgcata atgttcatga 1374480
 gggatattca tctgtagttc tctttcttag ttgtgtttt tgtgtggatt gggatcaag 1374540
 gtattgaag ctcataaaa agagtttggc aatgaccctt ctgcttctat tgtgtggaat 1374600
 actttaagga gaattggat tagctgttcc ttgaatttct ggtagaattc tgcactgaag 1374660
 ccatctggcc ctggcctttt tttttgttgg gagacttgtt tggtaagggt ggataaagg 1374720
 ttgtctatgt gtctggatc ctgctgtgga gatcgaatcc ggtgggcaaa tccctggggt 1374780
 cagatgtctc tgagcagggc caccaaacca catgccttca atcttagcac tctgaagca 1374840

 gagatagata gatgtatgtg agttatagcc ctgccagagc tgcaataatt gaagttgagc 1374900
 caggaggatg gccttaaatt caaggctagc ctgactactt aatgaattgt ctcaaataac 1374960
 caaaaaact gagccagaca tgataacaca cctttaattc cagcactcac agatctatcc 1375020
 aaaaagggt cctcagacta tgcagctagg cagttgaact gtgtatcaat ggctaccaag 1375080
 ccttaaaaa tagtcttct ttttaattcc aggacagcca gggctacata gtgaaatcgt 1375140
 ctaaacatag gcaatacaaa agaaaacaaa actacagaaa gtctgtactt gctaattgat 1375200
 ttctgagtgc tgaatacata cgcttgaaag agggaaatct tgttcacaga attttgcaa 1375260

 ctgaattaaa atgaattcct taaataaaaa tacatttgac tttcaaattg actgtcttaa 1375320
 tccatattgt tctctcttgg ctgtttagct gtgttctct ctcaacagac attttgcct 1375380
 ggcagtgct tcagtaaagc ctgatattgt gagatttaat ccagctttc atccaggat 1375440
 cagcagtcac tatttaata tgtcagttgt ttatagttgg agaagagaga ttttgccatg 1375500
 ttaaaaatga gatgttaata ttaactaagg agaacaact gagatattc ctccccataa 1375560
 atcaaatata tgaagcataa agaattgctat tacattgtaa ggagtaggaa actgacagtc 1375620

aagtgcctca cttttgtttt tatgtggcat gccatctaag aatgagtttt gtattatfff 1375680

ctgtgctggg gttgaactca gggcttcttc attacatgct acacagccag tactcttate 1375740
actaagctat acccccagcc gtgtttttgt atggttggag aaaatgaaaa tgatataaaa 1375800
ttcagaatct accaggtcat cctgatgtaa tctttaactt ttactcccta aatccaactg 1375860
gcttctact gcagtttttc ctattactcc tctcattaaa attctagctg caatatttct 1375920
tftaacctc cctttgaggt gatggagcac tagtgtgtct ggcatgttca ggacaatgaa 1375980
tttcatctc agtactggga aaaacttcag acctgacttt gaacttttag cagctcagtt 1376040
gatcttattt aggaacagtt aacacaagcc ttcctttgtc ggggtcctgc tgcctcttcc 1376100

ttcagtcac cctgagtga gccaaattat tggctggttt ctactgttt gcttggaaata 1376160
tccctctgc ctgtattttc ctgaaagagt ttcaacttct ctttagaatc ccagccattc 1376220
tgctttctc tatgggaacc ccttagcact cctatcaaac atgaccatct tactgtgta 1376280
tgcatctctc tttcctgta gggcaggatc tggatctggt aatgcctgca gtattgggtt 1376340
aaagctcagg acctaaagt tcaattatgc aaacaggtca gttgacaaag tgacaaagaa 1376400
agctaataa aacacaggtg acaaaagcaca aaataactagg tgactgttga agctaaagcc 1376460
aaaggtttca gtatctgtct tttgttgatg aagggcgccc acctaggcaa gtcattgtaa 1376520

ctggaggtga caactccaga acagaggtca tgagagttag gtggaacatc aaccttagg 1376580
atfttaaga aagtttgggt ttatttttat tttatgtga tgagttagta tgcataat 1376640
gtgtgcctgg tgtccaccaa ggggctggaa gaggatgttg ggttcccaga actgagggt 1376700
aggtggatgg tccaatggct agaggcactt gacacctgc atcccacaag tgttagtgga 1376760
gagccaacct ctgagtcgac ctgacctgcc tgtgctcacc atggcatgta tgcacctta 1376820
tacctgatg tgtgtgata caggataaaa attaaaaacc acttactcag tacatttgac 1376880
tcggtgttgg cctctgatag ctccagccta caaatattct gagtgtttg taaccttcc 1376940

ccctctattt tctttaaaaa actaaacaaa acaaagcatt atfttaaga ctgtactttt 1377000
cagatfttat aatctatatt taatagccac atgatgacta gactagaatc atgaagtcta 1377060
gactccgag gtaacacaga aaagacaagc tcataagtgg caaggtatta gggagcaggt 1377120
agaggtggtt aagttgcttg tgtcactgga ctgaactgt tgactttgct tctgtttcc 1377180
caccctccag atccagttgt gggacacagc aggacaagag cggttcagga agagcatggt 1377240
tcagcactac tatagaaatg tgcatgctgt cgtctttgtg tatgacatga ccaacatggc 1377300
cagcttccac agcctgcat cttggataga ggaatgcaaa caacacttgc tggcaaatga 1377360

catacctcga attctggttg gaaataaatg tgacttgaga agcgccattc aggtgcccac 1377420
 agacttggca caaaagtttg ctgacacaca cagtatgcct ttgittgaga cctctgctaa 1377480
 aaacccaat gataatgacc acgtagaagc tatatttatg acattggctc ataagctgaa 1377540
 gagccacaag ccaactgatgc tcagccaacc gcctgataac agaataaacc tgaaacctga 1377600
 aacaaagcct gcagtgcctg gctggtgcta agtcacaggt atgcccgta tgggactgac 1377660
 tgagtctgaa gggacacttc tgagtaagtg taattaagtt tgtaagatta atcttaata 1377720
 taatggatca tcccactggt agcgttggtg cctgccttt tgtattttgc attctcttaa 1377780

 taagtttgc atttgacaa cacaagaaa aggtcagttt acagctggga tggaaaatga 1377840
 agcaaagatg gatgagccag gccatatttc cagtgccagc caggtgaagc aggcctcctg 1377900
 tgagcatgat acaacttaaa ggcgtggtct tggttccact ccatgtccct ggactgtgaa 1377960
 agaaattcgt gtaggccaca ttactgagc agagctaaag gcaagtgacg agttaataag 1378020
 gtgcttttaa ttactgtgg catccaagca ctaaaaaact aatcaaaaga acccaaacac 1378080
 ttggagtttg ttttagccac gacttttaat tgaatgtca aagcaggttc ctggtgtccc 1378140
 ttgcctctg ctctatcag ttgggagatt cagggtgat tctgtcagta tctgtttggc 1378200

 tgagactct gagggcctgc ctcaagttgc tgagtctaca tgtattcctg taatagtatt 1378260
 gttgggtcag gtttttttt ttttttttt aatgtctgaa ttttatggc acaaaactgtt 1378320
 ctatataaa aaatgagtta aatattgaaa attatgtgc cctcactggt gaaaggaatt 1378380
 ttgtttgtt gttgtttgt ttttgagac agggtttctc tgtattgctt tggagcctgt 1378440
 cctagaactc ttagaccag gctggccttg aactcacaga gatccgcctg cctctgcctc 1378500
 ctgagtactg ggattaaagg catgcaccac caatgtctgc cgaaagaaat agttttgaaa 1378560
 aatttttgtt ttgccctgaa tacttttagt ttgaatttaa gactttgcac aaagcaagta 1378620

 gcacattctg ttgtttgcag aatggagtgt aatcatggt cggcctcatt ctgacagctt 1378680
 acagccctgg gcaattttag gggaaattaa gccaaaatag actttactta aatattttca 1378740
 gaatgtagga acaaaaggca ctcagacctg gtttcagatt tttgtttcat tattctgaat 1378800
 gtctcaattg gaaacttcag ttacaaaagc aagtttattt tacttaataa attactaagt 1378860
 gaaagtaaga ctttaagaa atggtgttac aattttaaat attagggcc aggttgctt 1378920
 tatttgact gagagagatt tttcttttc ttttttaaaa tagggtggtc tcaacttgta 1378980
 ggctgattg gcctgggacc agggcagcct cagaccacct gcctcatccg ccaactgctg 1379040

 gggattaaag gcttgtacca tcagaactag cctattacat gtttcttaat catgctagaa 1379100
 ttaaagatta aaaattgtct tacctaaatt aatgctgact cgtgagctat ttttctagt 1379160
 aaacatggct gtagtagctg gtggctgtag aagtttttac agaaggaat ctgttcattg 1379220

tttttcacac tgiacaactg gggaaagagc aggtaggatt tcccaacaca tctgtgcttt 1379280
 ccttctgtac tgcctcagt gtttttttt tgttttaaag taacagactg tttctttttg 1379340
 taaggagtta atgagcattc tttacaattc tgagaaaagt ctcatttctt cccttttagta 1379400
 tttattaatt taaacatttg tatcttagtt gtaacaacct atcactttag tagtttcttt 1379460

 ttttaaaaag atacttatct ggagagcaag attctgcctt tagatgtatt ccaaagtgtt 1379520
 tgtgaaacac ttgattgact gttgacacca cttccaaaat gatggtgagc tgtagtatt 1379580
 aattttttaa gcacaaatca atattttgta cctctgtgaa tttattttat ctgacattta 1379640
 attggaagta tcatatttta aaaaaatctt aatttgagaa cccaaagcaa actactttag 1379700
 aatctgttgt gtttggctac agactgcttg attgtattgc tctttcatgt ttcttcaaca 1379760
 agttcagtag ttttgcata tgaaactctt acatttctcc tatgaagtaa aataaatcat 1379820
 ctttgccatg aagaaatcgt gttctgtttc ctttgttttc tgtgttgaat atgaaattga 1379880

 agaacatacc tcctctctgt ctgctgtagt ttttagaaaa tataatagc ctacatttcc 1379940
 ttaatttgaa aatacaaaaat ctggtattta tttcatttag aaactttcag attttggatt 1380000
 gggatttttt agattgggta ttctgaactg atgaagttga tgtagataac taaaaacaaa 1380060
 tccaaagtgt aaaacataag ggggttcttg taatgataac tcttcaccag cctcctgaat 1380120
 tctgccatca cgttagggcc ccaaaaataac acagagagtc ttatattaat tacaatactg 1380180
 ctggccaaca actagtattt cttatttgcet agcccagtct taattatcaa ccataactac 1380240
 taatctatat attttataaa gacttatcga ggacgccggc cttatgcac cgttttctct 1380300

 gggatcacat ggcaactcct gtccctacta catttcccag aatcctcctc aactcctagc 1380360
 cccacctaac ttgctttctt attggccaac agtgccttat ttatcaacca ataagacaaa 1380420
 catatacaca aaaggacttc tcccatcagg ttctcaagaa tacttgggtgc agacagacca 1380480
 agctctaaaa atggctggta tgtttttagc agagtgaaca attacttgag atggagaaag 1380540
 aagagtttgt ctcaggcaca agactaacct ggacccttg gagagtgcag tgggtgcttt 1380600
 tcagtggata ctgcttctg ctggtcagct gcattaagtt actcttgtgt ttgaatgctg 1380660
 gactgcatcc agagacagct gtcttcatca gttactgggt tcatcagttg gccacatcct 1380720

 tcagacacgt atatgcaggt gtctgcagcc cagaagacag ggtcagatca cctggagctg 1380780
 tagttataga tgcctcagcc acccagcatg gttacggggg acttaacttc ttggtcatca 1380840
 attggccatg tccttctaga tttgctagaa ctagcatatg ctaatttact tgggtgactg 1380900
 aactaatctt atctatccat tgtttaccaa attccagcta tgtgttctcc agtggtggtta 1380960
 ggctgtggag ttacatgaac aaataggatg gtctttgaag agttttaaata gtacataagg 1381020
 gactagggag atggctcagt ggttaagagt gctgggtgtc tcacaaccac ctttaactac 1381080

agctccaggT gatatgatac cttctgggct ccacaggcac ttgcatacac atggcataca 1381140

 cacacacaca cacacacaca cacacacaca cacaataata ggtaagtgca tggatgtcac 1381200
 acttaggaac aaatcaagct tcctcttgta atagtttgac caagagaaag cacaaatag 1381260
 aattcccat ttctctcctg gtgtcttcca tctgtagttg gtggtttctg acctgtctgt 1381320
 agcccttgTg ttgtgtgtct gatctatccc cattgcctgc cctgtgtttc ctgtgtgtta 1381380
 aacctgtcct agcaaagggc tttgttctgt atttattgac cagcacagga agcatagtat 1381440
 gggaagaaa tgagggtttc ttacagaac tcttaacag gttacatgg gaagaaacca 1381500
 ctgacctcag ctgaccaca agaacactca aaacctcaca catgttatca accgatatca 1381560

 ctgcttcta acatttatgg tgatattcgt tttgtttaag gttactttct ttttttttt 1381620
 ttttaagatt tatttattta tcatgtatac agtgcaggcc agaagagggc accagatccc 1381680
 ttacagatg gttgttagcc accaagtggT tctggggaat tgaacgcagg acctctggaa 1381740
 gaacagtCag tgctctaac ccctgagcca tctctctagc ccttaagggt actttcaacc 1381800
 cactggctac tttcagtaaa cacacacaca cacacacaca cacacacaca cacacacaca 1381860
 cacacacact ctactctggt tcatggaaga gtacataaatt ttttaagagta aagctaggtt 1381920
 gctaggttgt aaaagctgat tgcatggaaa atccaaagca tattaagagt ggttacattg 1381980

 tgttgagca ctggctgctc ttgcagagat tctgaggcag aggcacctgc ctctgcctcg 1382040
 aaagtaccag gattaaaggt gtgcaccacc actgcctggc aaagcacata gctttaaag 1382100
 gcctccaggT atattattaa cttggcttcc aagcaaccac atggcagccc ttggcagata 1382160
 ataagatctg gtgccctctt tgagtgtgta gtcagaatac tgtgtacata ataaataaac 1382220
 aaatcttaag aaaaaaagat tggttacatt gttttcttaa aggcagatta aacaggctaa 1382280
 gcacacagta ggacagcagg tgaagcacat agtcgtttta tttatttatt ttttcaagac 1382340
 aagatttctc tgtgtaaaag cccttgctgt cctagagctt gctttgtaga ccaggetggc 1382400

 ctgaaaccac agagatgcac ctgcctctgc cttgaaagta ccaggattaa aggtgtgccc 1382460
 accactgcct ggcaaagcac atagtcttaa atggcctcca ggtatattat taacttggct 1382520
 tccaagtcta ataaaagttc agtctctttg aaggcaagag atattttcag aaaacatctt 1382580
 gaaataggta agtaggactg ccatcacagt gaggtaagtg tgattgattg gataagcata 1382640
 taccagaggg cggatatacag agtggagtag tgtgaagcat tctgaggccc gcatgaagta 1382700
 ttttctaagg ggaagaagca cccagatgat ggctcgagga gttggatttt gtgcagtggT 1382760
 ccaggactgt tgggtacagg tatcaaaaa tctaaaccag gccctgatat agttgacaga 1382820

atgcttgcct aatgtgctca gagccctggg ttggagtgcc agcactctgg aatcccactt 1382880
 ctctggcggg aggagcagga agatcaggag ttcagtgtta tggittggcaa cttagttagt 1382940
 tcaatgccaa cctagactac aagagagcct acctaaaaaa caaaaattac aaagggaanaa 1383000
 aaagtgaanaa gcatttcaga aggagtttgt aggaatatga gtcctcccct tggactcaca 1383060
 gggaagtga ggttgacctt gactttctga ctgagattca cactgaatgt tctccatttt 1383120
 tctggctcag tagagaggaa attgtggca ctgaccattt ctgatgctgg atactgcaac 1383180
 tatgtagaca gaaataaact gtcaagcagt ttctagaatg gactgttgat cagcctggcc 1383240

 aatcagatgc ttgccatgc ctatcatctt aagatgaaaa aataaataaa caaataaggc 1383300
 agcattcaca ttcaggaga gaaggaattt ggggttaagg gagtaagaaa aggagttagt 1383360
 gtgacaacct cacaacctt ttgagcttta ctgtaaatgg gtaataaatg agaccgttta 1383420
 gcaggtagg gacgtggtca tgtgtatgct gggaaattctg tggcaatgaa gggtagtggt 1383480
 aatgaggtc atggtgacaa ttgacttact gtaatagcct agaagacaaa gctccaactg 1383540
 agacactggc agaatgcact gtacacctat aatcctggca ctaggagat ggaggcagga 1383600
 ggatcagaat ttaaaggta ttctcgcta cacagtgagc tgagaccagc ctgggttgcg 1383660

 attctgtctc aaaactgaat gagtgaatga atgattaata aaaatctaga aggttagcca 1383720
 gacattggtg gcatatgcct ttattcacag cactcgggag gcagaggcag gctgatctct 1383780
 gtgagttcga gaccagcctg gtctacaaga gctagttcca ggacagcctc caaagccaca 1383840
 tagaaacct gtctcgaana acgaaaaaca aaacaaaacc aaaatctaga aggttgatag 1383900
 tactgtgcca cggtatgcca cttgcctagg atgcttgaag tectaggttc aataccctgt 1383960
 gcccaacaca ataaatacat aaaataaaaa ggacaggact tagaggattt gggtagctt 1384020
 tcataatcat taggtggacc caggaaagaa gtatgtgga caaacacaag aacagcagca 1384080

 tccaagagaa tattcaactg tcaactactgc tctctcagc accggtgaca tetaggcct 1384140
 gtcatcaaca tgtcccaga gttgtgcca agtactaaag ctttaacat tgtgctgccc 1384200
 aagagatcca ttcgctgtt accatgtccc tgctgcata cctcacagt tgacctataa 1384260
 tttattgtat tgaatatcat gagcacagac cagcagacgc gtgtatctgt gtagagaaaa 1384320
 atcgctattt taatattgg gattattgtt ttacttattt tagagtgtg agggcagaag 1384380
 cccatgcctt gctcgtgga ggcagacttt cagcctcatt cacctcacc cccctggcca 1384440
 gcataactgc caacatattt acatgactct ctgtccat ttctagttct tccatctaaa 1384500

 tatgtcaata tttgtcaagc tggacacatt ttgctaagga atcatgcgtg tgtcagccca 1384560
 gtgatgtga cctgagagac cacagaactg agctgattgt cctgtgttc ctgtctgct 1384620
 tgatactag agctctgcta gctctggcc ttgcttgtgt ggtttctaat cttgtttgtt 1384680

atcactgggc atgcgtgat gtgtactgcg gagggtatg gtggtcagag gacaacagcc 1384740
 ctgtagaatc agtcagtttt ctccttccac atttatgagt tccagtgacc aaagttaggc 1384800
 ttccaggttt gcacagtaca cctgctgagc tataccactc tcaactgcctc cagtctcctc 1384860
 attttatttt attttttttg tttttcgaga cagggtttct ttgtgttgcc ctggctgtcc 1384920

 tggaactcac tctgtagacc aggcctggtct tgaattcaca gagatcctcc tgcttctgcc 1384980
 tcccagatgc tgggatcaaa ggtgtgaacc accacagcca gcatctcttc attttagaaa 1385040
 agagactgac agcaactctt ggggttattg tgacaattaa atgacttaat atatatgtca 1385100
 tatctattgt tgcatagcaa atttctaga aacttagttg ataaaacaat tatgtattgt 1385160
 ccctcagttg tgggtgggga gggatagcaa gctgttcagc taggcatttt cggtttgggt 1385220
 gtccaggaca ttatcacctg aagggtagta tggaaaggta ggacatctgg ggtgattgca 1385280
 gccattctct caaggttggc tttccttctc tccatgtggc agtttcaagt caggcagact 1385340

 tcttgtactg taactggaaa agtggctcaa ggcaaatctt catggctcta ttgccacttc 1385400
 taagtaggca caaatgtctc tctgaagagc agttggaaca gcttctctg gcttatgggg 1385460
 gtaaactcta tcagattggg aggccaggca taaacggtgg ccttttaaca tttccacagc 1385520
 gggactgtgg atagtactg ctcacagtgg tctcatctgt gccatgctag agccaattaa 1385580
 aagccttgtg aaggggaaag ctatgcatg cttctgcaga gtgcacttat accaaggagt 1385640
 atgttacctt aatggttctt tttttgtgtg tgtttttga gacagggttt ctctgtgtaa 1385700
 cagctctgac tgcacttga tctgtagatt aggcctcaaa ctcacataaa tctgcctact 1385760

 tctgccttct gagtgtctgg actaaagggtg tgtgtacca ccgctggtc tetacacata 1385820
 ttttacaca tattctctct gtcactgtct ctctgtctct ctatctctct atcactctct 1385880
 ctctctctct ctctctctct ctctctctct ctctctctct ctctctgtct ctctctctct 1385940
 ccttttctg ccatcacct taaggttctt ctccatctgg gcccctttt ggtttctga 1386000
 cccacatata ttttaatgtg tatacacaca cacatacaca cacacttta aatcaaggat 1386060
 cctcatgtga gagaagacat gaggtatttg tctttctgag tctggcttac ttcctcagc 1386120
 ataatatccc tagttccaca tattgtcttg taaatgttat tttacttaaa aaaagatagg 1386180

 atgtatatat gatgtatgta tgtatgatg tafgtatgta tgtatgatg taggtgtttt 1386240
 gcctgcatgt atgttgggtg accatgtgta tgtctgatga ctgagaaggc cagaagaggt 1386300
 tgttgggtcc ccgaaactg gagtttcagg cacttgtgag ctaccatgtg ggtaccggga 1386360
 attgaaactgc aattgtttta aagaacagcc agtgccttta accactgagc catccctata 1386420
 gcactacatt cttttttttt aaaaaaatac ttattgtatc cttcctaag cttttccctt 1386480
 cctatttcat gtactctctt tttgtgtgtg tgtgagccag cagggtactg ttgggagctg 1386540

aaccaggtc ttctgaaaga acagcaagta ctcttagctg ctgagccatc cctccagccc 1386600

ctatgtagtc tttttaagc ccactaagtg tagctattgc tgccaatatg tgcattagcc 1386660
tctcaggggc cacattcaaa gaaaaccgat tcccattcct ctccatgcat caattgccaa 1386720
tagtgctca gctacagatg gttttgtga acccttcttg aatctatgct ggaattctgg 1386780
gtagcttgac cttaaagtatg caatcacagt tactgtgagt tcatgtgcat gacagcctgt 1386840
ggaacactgt tgaagtagcc ctccctctggc tctggccctt acagtcttcc gcctcatctt 1386900
ctgagatgcc ccctgaatac caaggggagg ggttgtgata gagatgtccc atttagggtc 1386960
tgagtgcctt acggttgaat agaattccat ggccctgcat cacatttctt ttatccattt 1387020

accttttgat ggataaaaca aaacacctag tcagttggtt gtggcacaca cctgcacacc 1387080
tttaatccca gcaactcagga ggcagaggca gaggccgatg gatctctgtg agttcagggc 1387140
cagcctggtc taaagatgta gttctgggac agccagtact acacagagaa accctgtctt 1387200
ggaaaaaaaa aagaaatgaa aagaaggaaa aacaagcaaa caaacactta agccatccct 1387260
tcctcagggg ggtctggtct gatgtgcttt tgtatctgaa gtctatgcta tgtcgaaaaa 1387320
tgtaccagg ttgatcttgg catattaaaa gttagaatta tctatcttgt tgaaaatcct 1387380
tccaaattha gacttgcat agactctgga cccatttgtt aaaaagaaaa atgtgacacc 1387440

taattagtgt gcatgagcac gctgggagag aggccaatcc agcaaatgaa ttccagtaaa 1387500
gacacttttg catagcttat gctgtaatag aaaactcaga aacagggcta agcctggctt 1387560
gagacggata taaactgagg aagccatgca tggcaaacca gtaagcagca ttcttaaca 1387620
gcctctgctt cagttcctac ctteactgcc ctcaaggatc aagagtgatg gggatgtgta 1387680
agccaaagga acccttctc ccccatgtcc ttttggttat agcaacagaa agcaaaactg 1387740
gacagtgtgt attgagtatg ggcacacgta gaagtcagag gataactttt gggaattcaa 1387800
ttctctatga tgtgtgttcc tggaaatgaa ctcaagtctc cagccttggc agcaagcacc 1387860

attactcata gccatcttgc tgagaatatg tgacctgaag agtttgaaga ccttgacaaa 1387920
acagcattgc tagtggtttg taaaccactt tcaggtgct gtcttttttag cttacagcta 1387980
tgcgacctgt gactctgtag ccttgtgatg ctgtggcctt gtggcactgt gccttctcac 1388040
agtgggaggc acagtcaagg gcttctgctt gcaggttctg atcaataacc tcccctggct 1388100
cttcgtggtg ggaaggagaa gcggcttctg tgattctggt tgtaatagcc ttgattgtaa 1388160
cagttccac atgttaggc cagtatctg catttgattg ccacacaatc atccttctc 1388220
cccaaagcat ttgacattca aaaatcactc cttaaatggt tcctcttgac tctaccaatt 1388280

tagctccaag ggctttacaa gaggaagtgt ttcccgatgt gatggttgaa tcacgctttg 1388340
tgaaaatgag caatctctgc ccagcatgat gctctctggc tttattgcct tgggattttt 1388400
ctgggaacat gtgccttccg agagtttcat tacaggaaaa gcgaacacag atgcattctg 1388460
ctgttgactt ctctgctaag ctgagtgagg tagtagcatc ccttcctttt agaaggatgat 1388520
ggaggggggc atggcttaca cacccaaaac ctcaacactc agaaggctga gggagaacaa 1388580
gcaagtgtga ggctagcatg ggctacatga taagaccctg tctcagaagg aaagggaatg 1388640
agaataaact aatcttcca ccttcttaca tgtatttcca caaccagcaa gggcctcttc 1388700

tgcttgtaa atctctgtga gatcccagtg gatgttgctc tcagcctcgg ccttcttctc 1388760
tggagacagg taccacct gcctctgtaa ttctcaagat tcttattctt tattgggctg 1388820
acctttatta attaaagtct ctgagacaca taaatggaat ttcgttcttc tgtaactcat 1388880
aaggctattt cttacataaa cacatcctaa ggtgagcact ttaatgtaga gctgtctaca 1388940
tatccagtac tcttctctt taaatttttt ttaaagattt ttatttatta tgtgtacagt 1389000
gttctgcctg catccatcct tggaggtcag aggagggcac cagatctcat tacagatggt 1389060
tgtgagccat catgtgggtg ctgggaattg aactcatgac ccctggaaga gcaggcagtg 1389120

ctcttaacct ctgagccatc tctccagccc cttataattt ttaattttat atttcaaagc 1389180
aggagctcac tgagttgctc aggctaacct gaacacactc tgtagtcaag gtaggtcttg 1389240
aactcatgca ctccagctt cagcctctgc agcaagtgag acagaagaac cagagaggga 1389300
ggcaggcatt gagctgtgca gtgtgggtct agacaactat ttctgccag gacagaggac 1389360
agaggggtgg gctctggaga ggcctgcta acttctcaca gatatgcca ccaaaactaa 1389420
tttattttca ttgggtgttt gcttgcattg atgtttatgg gagggtgtcg gatcctggaa 1389480
ttacagacac ttgtgagctg tcatgtggct gctgggaatt gaacctgggt cctctggaag 1389540

agctgtcage actcttagcc actgagccat ctctccaggc ccagctggag agaactttag 1389600
ctttctggcc ctgcttctct cttccctgtc ttcacggcct cagatcatct cacttctct 1389660
ttggttcagt ttgagcttg tggctagcag ctgctgatg gaggaggtgg ctctggcctc 1389720
cagctgggtg ctatcttgc actgagctgc cttctcactc ctgaccteta caaggcctct 1389780
ttaatcatta gttttgaaag accaaggagc ttccagatgg cctatgaaaa tgttgatgac 1389840
tcagaagaaa acaaaaagga ttgaccccaa aatatgaata tgaaaataaa gtgaatataa 1389900
gaaactaagg atttaactaa atatctataa gctaaaattc aactgacat tattaattga 1389960

taaatgttag tataccctta ggatacagta tgttgggaat atgtagctta gtgatagacc 1390020
acaagaaage tagtattcat gaaaatagtg attatattta gagacagaga atggcacatt 1390080
acattatccc ttttcaaaag attgacaagt atccatcgtg catgctaaga aactgactac 1390140

aatttttttt ttcgagacag ggtttctctg ttagctttg gagcctatcc tggcactcgc 1390200
tctggagacc aggctggctc tgatctcaca gagatccacc tgtctgcctc acaagtctg 1390260
ggattaaggc gtgcaccacc aacgcccagc tgaactgac tacaatgaa aaggtttact 1390320
tgaactaaa ttattttaga ggcaaaaagta ttttaaaagt caggcttgca tggcaaatgc 1390380

ctttacccat gccagccac agaggcaaat aaataaataa aattttaaga aaagatttat 1390440
aatagcatgg gtgcatgata ataaagttag atccttcagc ccaagaatgt caaatctat 1390500
ttatttagct tttttaagt atctttttt ttttttttg agacaggatt ctctgtgtaa 1390560
aagctctagc tgtcctggaa ctactctgt agactaggct ggcctcaaat tcacagagat 1390620
ctgcctgcct ctgtttccca agtgctggga ttaaaggtaa gtgttaccac tgtccggtga 1390680
tttttaattt ttcaattgct tgttgccaat gtagggaagt agaattggct ttagcatttt 1390740
gatacagtac caaggagcta aatggaacat ttttttaaaa aaaattcatt tatttgtcta 1390800

ttttatgtat atgaatgctt tgttttcac cataccagaa gagggcatca gatttcatta 1390860
cagatggctg tgagccacca tgcggttgc ggaattgaa ctgaggacct ctggaagagc 1390920
agccagtcag tctctctctt aaccctgag ccactctcc agctcctgaa acatttatta 1390980
attctgaaaa ttiactgtc cattctttat ggtactgtat attagtaacc atataattta 1391040
caagtattaa tagctttaac atccttccca attccatac atttgatatt tgtattttg 1391100
aaaaagggtc ttctatata gtccaggcta acctcaatct cccagtcctt ctgcctcagt 1391160
ttcctgaatg ctggcattac agctctgtgc caccatgtgt atgcagctc ctatgtttt 1391220

ttaatttttt ttaatttttt ttaatttttt tttttgagac agggtttctc tgtgtagccc 1391280
tggttgtcct ggaagtcaact atgtagacta ggctagcctt gaactcatag agctcctcct 1391340
gtctctgctg agattaaagg tgtgcaccac catgcccagc ttctacgca ttttttaaaa 1391400
ctcttatctt gtttctttgt aataatttta tcctcatca tgattattat tgtgtatgta 1391460
tgggtgtgat gtgtgtgtac atatgccagg gtgtgtggag gccagatgtg tttatggtgt 1391520
gtgtgtgtgt gtgtgtgtgt gtgtatgttt gtgtgtctgt ggacatgctc ctgggtgagc 1391580
atgtggaggt cggatgtgtg tatggtgtgt gtgtgagtgt gtgtgtgtgt atatggtgtt 1391640

tgtgtgtgaa tgtgtgtgtg tgtgaatgta tgtgtgtgtg tgagtgtgtg agagtgtgtg 1391700
tgtgtgtgtg tgtgtgtgtg tgtgtgtgtg tctgtggaca tgcaccaggg tgagtctgtg 1391760
gcagtcagag gacagctttg cactgaaggt tgaagagag agctgactcc acaaggctgt 1391820
cctcctaaca ttgctttatt gtcctagacc agatgtttac cacagtagtt catagaataa 1391880
tggcccagca ctcccacta cctagtactt ccattcccat ctcaattgct ctctgatgt 1391940
atcgatcgat tgattgatta atcgattgat tgatttttgc cactttggct ccctgatta 1392000

cctcttgctg ggagtcaccc aaccactctg tgtgtctgca ttcacactca ttattcctgc 1392060

 tgtgactac agtttaggcc cgtgtttcct tactaaaga acaatcacta caagtgaaga 1392120
 ttcccaggaa agaccattc atggtttcag tcagtatcga gtgagaatct ccagggtttt 1392180
 aggcaccata caaagagcta atgaattcia gtgagcaagc aaatgctgta gctcagcgtt 1392240
 tcatgtatca cagcagcaga aggcgtccag ctaggaataa gggaaaacaa actggcaata 1392300
 atggagtggg ccagtggagg atacctatgt cctggaaggc atctctcatg aggacatggt 1392360
 actgagtgca gagggtgggg agggagaagc tgtgtggaga acaacactgg gggagatgag 1392420
 caggtgtcgt ggctgtcaa atatgagata atgaaggcag gagcatagtg agaggaacag 1392480

 ggtgtgtgtg tggggaaggt aagagtagag atgtttatca tctcagaaaa tctttcttgg 1392540
 ccaaaggcat ggaacataga tgactctctt cctcctcctt ctctcctca tttatttatt 1392600
 ttttattcag atgtgtgat accacacaca cacacacaca cacacacaca cacacacaca 1392660
 cacacggcat gtgtgtgtgt gtgtatatgt gtgtgtgtgt gtgtgtgtgt gtgtgtgaaa 1392720
 gccagaaaaa ggtgtcaggt cccttggagc tggagtaca ggcatittgt aactgcctga 1392780
 tgtgggtgct gggaattgaa ctgagccct ctggaagagc agtaaatgct cetaaccact 1392840
 gagccatctc tccagtcccc tagaacctgg atgttttgtc tgcatgctat gaatagctct 1392900

 acctttgagg acagatctat taacaaaact cgtaaagacca atgttcagaa ccagaattcc 1392960
 agtgtagtca cagacagtga aaaatgtgac tgctacaggg accaaggagc tgggcaaaca 1393020
 catctaacac tatccccaa aggcaggggtg acagccagag agcagcctaa tgagcatgaa 1393080
 tcagatcgta gggttctctg atatcagtga aacatttaat gaaacctgac tcatccattt 1393140
 cacaataggg attagatgcc accaggccca agaaactta gaaaggcaat tggtcagata 1393200
 gaattatgac aggtaatgtt tgccctcaatc aagttcagtg atttttgac ttgatatgtt 1393260
 tatagttaat aacctttggg agtcttaaaa ttgttttatg gttttttaag ttccagattt 1393320

 gaaaacataa aatcaggcat tataatataa tgaactcct tgtgccatc tctcagcttc 1393380
 cacatatggc cagtctggtt ttatctatgc ctgagctact tctcccactg tattatctta 1393440
 aagaaagttc caatcctgtc cttcttggtc tctgatgaca tcagatatcg ctgcttggat 1393500
 cttaataggg ccccaggag cagtttcaag acagtcacca ccatcattc tgtttacttt 1393560
 taatcttttg ttaattactt gggaacacta ccatgaacat caattattgg actccatagc 1393620
 aagcagagc tctgggtttt tctgtttttt ttggggggg ggggctgggg tcccggccag 1393680
 acaactccat gcagctgtgg gctctctgag actagagatt gagaggcgt acacttaaca 1393740

aacccttatg taaagttatt gactctactg aagttggaga gtgaactcag gaatgttgc 1393800
agtgattgat aaggtacaga ggtggtggct gaggtgctca gaacaatcgt ggagacttct 1393860
aaaaaaccaa ctgcatttcc atgatgctcc cctcccctc cttttgctgg attttatttc 1393920
tcctgatcag aggctctgag tctcatatct gatgtttcat ggtggccgtg tcaagggcaa 1393980
gtgcatgata tttgaaatag tgattgattg ctgtcagttt tctgactgta tgccacattc 1394040
tgtcgggtgt atagccatta cctatctaag agttcttgtg cacacacatg tacacataca 1394100
taagcatatg ttgatagatg cacataggct gaatgtaatt ttaatatgic atgtggcatt 1394160

cataaacta taaatatata agcaagtctc ttttaggaat ttttagttgc taaggggtgg 1394220
ctgctactcc ctctagtata tattccactc aaatgacaga ctggaatact gtttttgttt 1394280
ttattttaaag attttattta tgtatacagt gttctgtctg catgtatgcc tgcacgacag 1394340
aagagggcat cagatctcat tatagatggt taggagcgac catgtggttg ctgggaattg 1394400
aactcaggac ctctggaaga gcagctagtg cttttaacct ttgagtcac tctccagtcc 1394460
ctatTTTTTA tttttattta tttatttgag acagggctca tgtatccctg gctgtactag 1394520
aactcacttg tttttattgt ttgtgatgic tgcgtgctg cgtgctgctg tgcgtgctga 1394580

cgtgctgctg tgcgtgctg tgtgtgttgc tgggatgaa atccagggcc tcacacatgt 1394640
tgagcacttg tctggcact cagctatacc ctaaccccg cagacttctt tctcctctc 1394700
ctctactttt ggtttttga gaaaaggctc tatgtaccga aactagcct tgaactcaag 1394760
agtgtagccc aggatgatct tgaattgctg attttctagc ctctgcttcc caagtgtac 1394820
ttgcctggcc tttgtgttc ttctcaaggt acagcagaag taagtcatg ttttgtctta 1394880
ttgccagaaa catgagaata aatcctcacc acaaggggga gctaagccac agagaaaagc 1394940
tgagggtgaa ggctattctt gcgagagtag tcatcaggtg ggagacactt ccaactactg 1395000

tagttttcag accccagcca cagggttgc tcttcaetct cttcccagt acttatttgt 1395060
ggttctggag atcaaacca ggacctaaca gttgatgtga gtgcgctgc cctgagctac 1395120
atttccagtc ctgcgctca gttttgtctt gatggacagc ccatggctgg cgctggaggc 1395180
tctggctggc cagggcactc atttctaca actgcaaacc ctaaactggt ctttccatg 1395240
caaatcaaca caccagggc ctacaacttg agtcatctcc acacagtcag aggatactc 1395300
cccttctct catcccagag tcagggtctc gaggaggta ttggataaga tcaactctg 1395360
ccttattcta gggacaggtt ttctactga acctggagct ggtctggtgg ccaccaagcc 1395420

caaagtaate ctctgtctc caccctgtcc ctgctcctg ccgaacactg agatcagcat 1395480
tgaggtagag gccacaccag ttttatgtgg gtggtagga tctgaactcc ggtgatcttg 1395540
ttgtcacct attaaagcat tccctggcc ccaaatctgc atttttaaag cctaacccta 1395600

cagttcataa ctgttactgt taatctttaa gacacacctc aaattctgcc tctcttcaac 1395660
attacttctt actactacct gggcctccat tcctactcca gtcttgacac cagtgtctgga 1395720
gcaaaagtgt tgcacatagg aggaaggtct caggaaaagt gcagccatgg ctccaagagc 1395780
atctctgagg cacatatagt gatacatgct tgaatccca gaacctggga ggcaggaggc 1395840

tcgccacag ttgaggcca ctctgagcaa catcatcaga ccctgactca aaactaaaa 1395900
ggaggctggc aagacggctc agtgggtcaa ggtacttggt gccaatcctg acagectggt 1395960
caatccctgg agaggttgat tggaggagaa gactaactcc ttcaagttgt cctctgacct 1396020
ccacacacat gcacaggcca tggcgcagac gtgcttgctt catctctacc ccccagtaaa 1396080
taagtaagt taatttaaaa tattttccca acaagcaaac aaaacaagac tatttctgga 1396140
aactgtaata cactcagttg aacaaaattg gttttcaaag acaacatag ctttactcta 1396200
ttgggtgttt ttctgggtac tctttcatct gtgacaggac ctccaggtcc tttggaacac 1396260

aattacctgc tgctcactgg gcatctgtgg tgttttgaag gaaaatgacc atcatagga 1396320
gtggcgctaa tgggaagtgt ggccttgtgg aggaagtgtg tcactgtgga ggtgggcttt 1396380
gagatctcct atgctcaagc tacaaccagt gagacagacc acttctgtt gectgtgagt 1396440
caagatgtaa gactctcaag tacttctcca gcacatgtc tgcctgcatg ctgcatgtc 1396500
ccacatgat tatcattgac tgaacctctg aactgtaagt gagccactgc agtgaaatgc 1396560
tttctttat aagattgcc acagttctat tcacagcaat agaaacctc actcccactc 1396620
ctgctcattc atctctgctg tcagctttga ctctgaggt tcctgcaagt ccacacacac 1396680

ttatttcagg atcggggtct ggatgtctct cccagcctg ggatagtgat tcatgatttg 1396740
tctttacct caggaagtaa gggtttcct gactccccct tacaaggctc accctttccc 1396800
caactcttc attccttctc ctttgeccag gcttaccac ctgtgacat ttgcttctcc 1396860
tggcttgtea atgacctgtt tcccacttcc tgtggaactcg ggcctactct gtgtatagct 1396920
gaagagaagt tggatggaca attagagacc atggttttat attctgcat tgattactta 1396980
aaagtacgcc ctacacacac aggaagatac ttatctctga gtacctgtca tcaagggggt 1397040
cctagtcage tgcagctgtc aacctgatgg agtctagagt caaggctctt atagaaagaa 1397100

acagggagt atgattttt ttttaacta aaattttatt attactggca ggggttgtct 1397160
gtacatgga atacatgtgg aggtcagagg acaactgta gaagttagtt gttttctttc 1397220
taccatgagg gtcccagga ttgaactcag gccacatgc ttggtggcaa gcacttttac 1397280
ctgctgagcc atctaaatca gtcctcataa taagatttta ttttaagat tcattttatt 1397340
tttaattatg tgtataagt tgtgtctatg tgagattatg cacacatgag tgcagagcc 1397400
tgacagggcc agaagaggcc gtcatgacaa tcctggagt tagagttata ggcaggtgtg 1397460

agccaccgga cacggttgct ggcaattcca gtccctctgga agagcagtgt gtggatattt 1397520

catttgtttg gttttggttt ttcaagacag ggtttctctg tgtagccctg gctgggccca 1397580

agctcacaga gatctatctg cctctgcttc cttaatgctg ggacagggtc atctctgtgg 1397640

aatcctggct gtccctggaat tctctctgta gaccaggctg gtctcgaact cagagatcta 1397700

catgcttttg cctcccaagt gctgggactt aaggcctggg ctaccacctg gcttcagtga 1397760

gtgatcttaa tggaatgagt accactgagt catgtctcca tcaactgcgt aggatttcta 1397820

aacagattcc aatgtaaatt tcatttagta atttaatagg taggcacacc atagacattt 1397880

ttgctgtttt tcttccctag acaaccaaaa aaaaaaaaaa aaagacaaca gaggattgtg 1397940

tattttgttt aatacttga ttttttctat agcgaatta tagcaatctt taagtttact 1398000

tttcattaca aatatttgc aagttttgtt tcagaaacag ttttctact ttcttgccaca 1398060

tgccccaga cacactaaa aaaattcatt cataacacag taagggcaaa cattactcat 1398120

gtaaacatct tccattaatt tcccataatt aaaaaaatca tagaattata gatattgaat 1398180

aaggctcata gatthagttt aaattccaca aaagacaaa gatgggtggt ttttttttg 1398240

ttttttttt ttttttgaa ctgtgatatg gttgactttt ggttacaatc aaggccggaa 1398300

agcataacce ctggcttcca ttctgtaaac atacctcaca acccaataaa tgtatttttg 1398360

gatggaaga gaacatagaa aaccaggag gaaaaacatt tggagaagg agctacaaat 1398420

catggatata acttggtaac tttcttatgc aaccaccagg catgacatac atagtcctg 1398480

tagtatcaag ggtaattatg gaaaccaagt agaggagtag gatgcattgg ctcagtgtc 1398540

atattgctag tglacacagt gaaaatttgt cagattattg tttcattata tccaggcca 1398600

aaggcgggtt ggggaacgca ctcgagtggc atatcactgt taaaggattt tttgtttgt 1398660

cttgttttc agtagcatca gaagagtgg gagcatgtc ttaggtacat gaatgaatgg 1398720

tcttcatatt aaaaatgacac ttaacaactg cgcataaagt cacagacagg aatcaagggt 1398780

ttccattatc cgcggaagtc tcctctctg gtgaagtgg gtccagagct gagacaggat 1398840

acggactgtg ctgagaatgg cccccacc agcggtgcc cgcctctct gggagaggga 1398900

gggcagaagg caaaaagcat tggtaaatct gtgaagtccc accccgggtt ctggaccca 1398960

actccactga ggtagcctc cctgacattg tgactaggca gttaggggtg gcgagagaag 1399020

gtggccggga aaccagttc tgaggtccac acggccatgt ctggtttctg attctgttc 1399080

cctgcaaaga aattgtttg ctccgataac tgcaccgttg tctctaatgc ctcgattcgc 1399140

tctcaggccc ctgggaggcc tgtagggat cactaaaagg taaacacacc tccattagca 1399200

ccgaacttac caccagaaag cggctgaggc actggggaag cctacctcac atcagacacc 1399260
 accccaccag gaggtggctg ccaatcagag gactttgtag gcttttgatt tctaaaaatg 1399320
 aaaattgatc tgcattatat ctcaatagac tcagataatt ctcacaaaaa attttgcatt 1399380
 gtgtttaaat agcactggaa taattcaact tcattttaa atattcattc taccatgaaa 1399440
 atatttcata caaacatcta tttacataca aacacattaa aatttgtgaa aagggtttcc 1399500
 acccctgtgg ctgtatggct tgaaatagtt tcattgcttt gaatatgtat gcacacgttt 1399560
 ggcaaataaa acttttaaaa tttagtattt ttgaaaacaa ccaaaaaaaaa aaaaaaaaaa 1399620

 cccaaacccc aaaacaaaca aaaaccctc aaaaatctcc acaagaaacc ctcaaaaaaa 1399680
 caaaaacaaa acaaaacccc ctgacaccaa ggcttaacat ttctgaatgg aaaaaaaaaat 1399740
 ccaaggtgtg tgttggggaa tcaatcaagg tacctcaagt acctgaaaat tgaatatatt 1399800
 ttgtgaacct ttgatctgca gcaataaac atcacaacta tccatcttgc aacatagttt 1399860
 tgcttgtttg tctaaaacaa aagatgtctg gattctaaat cactactctg aagacagaac 1399920
 ttgaggtggc tgttggagaa caaataaaat ccagaatfff ttactttctt ggaagatfff 1399980
 aagtgcattt ttglaatgag aaatttata tttttaaatc tattaagtga aggttaataa 1400040

 aagtgcaca tactgtctca ctaagacaaa ctttaatta ggtattcata attgatctcc 1400100
 cctgcagtat tagggatgta atccagggcc tctagttgct aggcaaatgt tggaccactg 1400160
 agctatatct atacagctca atgcaatfff aattgtcaca attaaatgct gtatatggcc 1400220
 ttgtcagttt gcatgcttgt gtgtgtgtgc gtgtgtgtgt atgttgtgat aaggaaaaag 1400280
 tttttcaagt gtgataaatc tcaaagggtg atgaatctga actctagttc cagtcaggtt 1400340
 caaagaggtc ttgacaaaat atttccttct tagttgctag gggagatctg ggatcaagca 1400400
 ggttaaaata agaataggtg ctaagaaact caagtcctcc ccacctgtta cgttttagcc 1400460

 tcattattct tttgtgtcct aaattcaatc cttacatctg cttgttagtt cgaatggatg 1400520
 cccactagg ggacatgctc tgtagactag ttctattcc taagtctaac acaaggtaat 1400580
 agttcatcat agaaaagatg ctaatgatgg atcaagtcac gcagggttga actgagatag 1400640
 ctctgaatga atcccttggg gaccatggcg tcagggagtg cacaggctcc agctgtttgg 1400700
 aagacagcag aagggtaat ctttttccc taccgcgtag aatctcaatc atgtctgttt 1400760
 gtgattttga tctgatgga agaccagatt tacctgcttc ctattttctt ttacaacaga 1400820
 tgtgaaatag aagggtgaatt ctgaggcttt tccactttgc gccaaacaag gaacaacaaa 1400880

 accccaagcc cctcagtag ttaattctct aagcaacctg gaccctgctg acttctctac 1400940
 ctccacaatg actcttcgct ccttttaaca gttgcaactt gagacaaagc cggatgtctt 1401000
 ggggaggggg caaaaagaat gactggaatg agcacgaagg cagtgtagca agagaggaga 1401060

ggaattcaag acataaagag gcagagcaat ctgctgggct gccattctgc agactccaag 1401120
 ggttctcaca tagcagaagt aagagagctg aaagacaaag gaaacataca gggaaaagga 1401180
 aggcaggctc agctgtgtga actgtttcct gtgatttgtc taagggtcac gtacacagca 1401240
 ctgggcttga agcccagact gtcttcctcc agtatggaat gtgaaacgta gattagctag 1401300

 ctgcccagcc acagtctctc aatcctgcta tatattttta aaaaagattt tttttgtgtg 1401360
 tgtgggttca tgcacgcat actctgtgtg gcagaggaca gctttcagga gttggcttcc 1401420
 tccttctgct atggaggctg cagagatgaa actcgatcat agggttggca acaagtacct 1401480
 ttacctgcta aactattttg ctgacctca agccacaaa atttgttttt gatttccatt 1401540
 tgaatgagat tgctagagta gccctttaag atacaagttg agccccact gcagctgaga 1401600
 ctaggttctg tctccagggtg tgggcacacc acccaagggtg gggcctgacc tctctcctc 1401660
 tgctcatct ctcaacctg tccaacaacc tgactgatgg agctgtagga agccatcttt 1401720

 ttcccgaagg cagccaactc tctttggaca catttacag aaagcacctc tcagaattca 1401780
 aatccacaga ccccatcctt ctgtcacagt ttactaaaca gtctctttct acagaataga 1401840
 agcaatccta tctgggtga cttgtagttt aaaaatgatt cagtcatttt gcaggagacc 1401900
 tccttagaag ttctgaggat atttctctg agtgaattat cttcttaagc tttcaaacag 1401960
 tgatgtgacc agctctctg gaaagtacca ccacctaaat gcagagactg aagctgggtg 1402020
 tgtcaggaag cttagagacc cagggtgtgg ctatcatage tgagggcaga gtctccatt 1402080
 ctggggctgt ttgatgggga tcatttggga aagctgttgt taagagcaat gtgcaactga 1402140

 caaaaagage aaactgcctt ctacctatcc cctctctcca tttctacctg ctcttgcaa 1402200
 gcatctctat gaacttttag ctcctcaaa agcctaacc caccaggcc tctcaggtag 1402260
 cactgttgac agtgacaggc ttcagcaact gttgtccta ggctttctgg tgatggagcg 1402320
 acgccttggg ggagggtgcc cccaacceca gaattcattc agagcaatcc agttaggtaa 1402380
 tagatcta atgtctaaact aaaatagtg gcttttctct gtattcctgt ggctgtgatt 1402440
 acatatggct tacgagggtg caatatgcta ttattgatag aaactgcaca ggtgtgaact 1402500
 tgtggcttac agagcctgga agcagttaag tgcttgaga tcaactgtgt gaaaagctta 1402560

 gctacagatc tgatttacac ctagtaatca gcatgtctgt cttcttgca ctgattttaa 1402620
 agagaattct gcattctgtt ttggaatgca cattgactat catattttga attccatgag 1402680
 ctgtgtcaca agccagactg cactaggttt tgtacaatga atgggtacca gaggagaaaa 1402740
 aattgccage actactgaat atactgcaa attgccacaa tgactgctta gaaatactaa 1402800
 tttctctc tcttctga aagtatatct tacaactctt ttgtaactta atgcaaaaa 1402860
 agtaaattca tttctctca catctgaaag caaagatct tttgtttaca tgcgagaata 1402920

ataagcttat aacaacagtc tggcctatg agccagttct ttatatcagg acataagaat 1402980

 gaaatgatag agaaagaacc agagagacct gtacactgct atgaatgcaa aatccatttg 1403040
 gaagctttct cttgtaaagg atagetaaga tagggagtga ggctaagaa aagactcaaa 1403100
 agcctgggct ttgattcact agaagagtaa caacaaaaac aaagccattc tattgcaaga 1403160
 tacagatcaa aggttaaag gcaaatgacc ctacatttat ataaagatgt aataatcctt 1403220
 ccaaccctgc aggtggcaac atgcaagggt gatcgaacac catttgcaat agccatagaa 1403280
 aaaacatcat taaaaaaaa aaccttcgat gaaaaatgac tgaagaatcc catttcctt 1403340
 tttcagccta atcatttggc atctctgaac gtggtccaga tttagacttc aatcatcaaa 1403400

 gaacatcatg ctgtctacag ttcgacagta cctctcagta gggcgttgct gcaaggctag 1403460
 ctaattttaa atctggfatg agtaatacag tcaaacctag ttagtacgcg agaaagtcgt 1403520
 tgctaacgca gggtagagagg atgtgatgtc acagatgaa cagtccttgg ttgtccatt 1403580
 gtcagataaa tglagtgcag agatccaagt ttctattcca ggtctgtgga cccagggcc 1403640
 aggtctttca cttttgctgg gtggcctgga aggccttcag ctccacctgg taccactcag 1403700
 gggcttcagg accactcttc cctggggggc tgtggtcata gccataagca acggtcagct 1403760
 cttcctcagc ctccacagct tgcagggtgc ggatgcactt gataggcca aaacgggggt 1403820

 ggacaaaact aagcatcaag atgagaaagg tcattacagt gccaacacag gacctcaggg 1403880
 gcgaagggga acatctcacc catatacaca ggcatcactc ctgtgttctt agagtatggg 1403940
 taaagctcta tcagcttcag ctggagcttg taagaggagt gtctcagccc tagccccaga 1404000
 tctgtgggt tagaacactc caggcagget ggagatgtag ctcagttggt agagcattga 1404060
 cttagcatgc atgggatcct gggctctctc agtatttcat aaaccaggca tgggtgtgta 1404120
 tatgttagga ggtggctag gagaatcaga aatgcaggtt atccttggtt tcataatgag 1404180
 tttgaagcca acctcgata tataatattc tgttttaaat tccactatgt gggctctggg 1404240

 gatcaaacct aggtcttcag gtttgggtaa tgcctttacc tgtggaggca ttttgctaga 1404300
 ccgtgtctgc atttagatcc ccatgacgaa tgtaagacag aggacacatc aatgggaag 1404360
 gagccagctt taaaccatat cggctctctg gcctgatgg ggctaagcat ttggctgtct 1404420
 tctctgtttg tgaagtaag tgcctgacc atgcactcag gaattcttgg ttattgtggc 1404480
 ttttgctga ggatatact agtggttagag cacttgctg gcatgtaaaa agccctgatt 1404540
 ttgattgcta gcaccacagg atcacaattc tgtatgatg tacttataca tgcattgatg 1404600
 tgtctgtctg tctgtctgta tatctatcta tctatctatc tatctatcta tctatctatc 1404660

tatctatcta tctatcttct atctgtgtat ctatctataa acaggcatgg tagttcgaat 1404720
 gaaaatggcc cccatagcct cacaggaggt ggcatctactg ggagatgtgg ccttggttga 1404780
 gaaagtacat cagtgggggt tcaagaagccc aagccaggtc cagtgtcatt ctttttttct 1404840
 gctgcctgtg atatgaatgt agaactctca gctacctctc cagcacatg tctgcctgca 1404900
 tgctgccatg ctttctgcca tgatgacaag gaactaaacc tctgatcggt aagccagctc 1404960
 cagtgaatg ttttctttg taggagttgc tgtggatcatg gtgtctcttc acagcaatag 1405020
 aaaccctaac taagacagaa gtgtattact gtgtagctct ggcttgctgg gaactcacta 1405080

ggtaaaccag gcttgctttg aacacagaga gattcacctg cctctgcctc ctgagggcta 1405140
 agattaaaga cctgagctac catgccaggg aattttgtct ttaagctgac atgcttcatt 1405200
 ataatttga tcatatgatt tcagtatgaa aatgaaataa tgctcctgaa atggagcttt 1405260
 gattaacttt ctggaacatc cactggcgtg agggagggga atctgatgtt gaaattttgg 1405320
 gcttaagact tcttttccaa tgttttata gctttattct catgttcatt gtcacctgtc 1405380
 atcttttcat tttgatgtgt tttttgttgt tgtttatfff taaattaaat taaaaatfff 1405440
 ttttcaagac agggttttct tgtgtgacca gctctggcctc aaactcaaga tctctctgcc 1405500

tctgcctccc agcactggga ttaaggaact cattctctc ctgcctcagg agctgggggt 1405560
 acagggtgggc ataaccacac ccagcacatt attagtttgg gtagacagaa taaaaagaaa 1405620
 gaacttggtt teagatgta aggcttgccc agggcagtca gtgcacactg cactgggcca 1405680
 ctttcttcc agagctgagg cctgactggg aattcctggg aggacagact gagacaaaac 1405740
 atgtaaggca tccagagtag ggctagggta catggacaga gtatgagttt agcagtgtga 1405800
 ggccctgggt tcaatctcta accctcgtgg aaggaagaag agaaggaagg gatgagggga 1405860
 cggagggaga gcaggacca gaaagaatga tcagaggcct tggctacaga agtagcaatg 1405920

accccaaac tgtgggacct tagttgacat gctaccatatt tacaggtag ggaagtactt 1405980
 gtgttatgt cactgggca tttcatgcca gacttccgtg caagcagcat aaagaagtgc 1406040
 tgtttcactt acattaatgc atatactaat gccagtgact tgagaaaaca cacagatgat 1406100
 aggaacttgg atctgaagta tgcatttggt tattattcaa ggagtcacta cccatataa 1406160
 gtgagttttg gccatgctgg gcttgcaaaa caaatactaa caacaaaaga aagaaaacag 1406220
 ccaggcagtg gaggcataatg ctttaaatcc cagcaccag gaggcaggat ctatgagttt 1406280
 gaggccagcc tggcctacaa agtgagttct aggacagtca gggctacaca gagaaacctt 1406340

gtctcggacc cccccccc aacaacaaa caagtaggca agtaaacac caaaaaacce 1406400
 tactaccacc accaacaag aaaacaaca gaaaaatcaa aagtaaagcc tgctgagcag 1406460
 aaactgattt tgaacaaca aaacttctct tgtttccagt tctctattgc gtttgaaga 1406520

agagctgtcc ttgcagtgaa gtcacagaca ggcttgattc aaatgaaggg tctgagtgg 1406580
 attaggggtg gttagttaca ggcattaaga gaccattgtt tatgccagca cagctgagaa 1406640
 tgagtgtcag ccaaatgcac actagctgtg aaagccccga agctttcaca gtgtcagtct 1406700
 catttcacat gacacatgtc ctttgccatt tcagccagcc ctttagaggc agctggagca 1406760

 ccaatactta ttattggctg ccaaggagag ctagtcatg ccaggacat ttccagggca 1406820
 tctcaaggac gagtctcagg acatttccca gcaagctcca gatcctggca aggtctcaga 1406880
 tgaatgccc agagtgtgat cttgcacagc agaggactga agctatggca cgaagcaggg 1406940
 aagagatgct ctatgacat gctacgtgc tatatctatt gtgtgtgtgt gtgtgtgtgt 1407000
 gtgtgtctag gctaaaggcc aacttcaggt gtggtcctca aacagcatcc accttgtttt 1407060
 ggggcctggg tctctcattg gcctggaact tctgattag tggcccagc tttcgttctg 1407120
 tttctgcttc ctcagtgtc agattctaag tgccttccc cacattcagc tttttatata 1407180

 ggtgctgggt ggggactgaa cgcaagtctt catgctgggt cagcaaacac ttggatgata 1407240
 actcctcctt cccacccag tctgcaatg cgatctttaa atgagaaaa aaaaggcaa 1407300
 ataaggacag cagtaaaaca tatttctatg atagttctgc ttttgaatc accttttcat 1407360
 ctcaaagcta gaaagcaggc tgtttagatc ttgaacctta gacgacaaag ctgaggctca 1407420
 tggcaaatgg gccacttttc ccatgcctc ctgggtcctg gggcccctag gcatagatcc 1407480
 atccagtca tagcatccta cttacatgtc atagatgcag tttggagtaa aggagtgatt 1407540
 cgcttgtgt cccaaggagg cacagtactt agatacgtgg ttatagggt caggcacatc 1407600

 aatgactgtc tctcatcaa gggagagagt gttccattc agggcccaat ctctgctgtc 1407660
 gacctgcaga acacagggaa gtgggtgctag agaaggcctt tctcacagaa gctcaatgca 1407720
 cagcagagge aaaaactcat ttatcttagc acttcatagt ttgagcactg cagacatgaa 1407780
 agccagccaa gacatcttc cacacaagga tggcgcaacc agacagctca acttactgct 1407840
 tattgtattt tctcatttt atatagaaga aaaggatttt gattctttac aaagacacac 1407900
 aaaaatatca gataaacttg aactaaaaat aaatgaagaa gagactgttg agatgtctca 1407960
 gtgcgttcag gcctgacta ccaagacaga ctgtctgagt gttcagtcca cagaattcac 1408020

 atggtcagag gagagaactg actcctggaa gttgtcctc gacctccact cttgatcttc 1408080
 caaataaata aatgttttat tccctgagac agagtttctt tgtgtagtcc tggctgcctt 1408140
 ggaactccct ctgtagaaac aggctggcct ggaacttga gttctgcttg tctctgctc 1408200
 ctgagtgtta ggactaaagg catgcaccac tgcctaacca tcatgttttt cttttttttt 1408260
 tttctttttt tttttttttt agtttttttag tttttcgagg cagggtttct ctgtggcttt 1408320
 ggaggctgtc ctggaactag ctctttaga ccaggctgggt ctcgaactca cagagatcca 1408380

cctgcctctg cctcccaagt gctgggatta aaggtgtaca ccaacaactc ccagttccat 1408440

 cagtgatattt aaaatTTTT ctataaaaag tcccacacct ctgcttact ggaggagtca 1408500
 gggtagtag gaggcagtct ccaagccagc gtgctatgag tctacat getaggattc 1408560
 atggctata gcataaccaa ttggcttctt caggttggac attgggaggt cagcagaata 1408620
 gcctaatggc tcttataaaa aggatcaagt tttttagaa cttgtaaatg tagcaggcat 1408680
 gttaacctt ctgtcagtga gacacaactg tcatctaca ttcattgtt tgagccaaac 1408740
 aatcgagttt aaaaataaaa caaaacaatc tctcttaagt tttcaataaa cttacaactt 1408800
 tgtgttaggc tatgtctgta gacatccttg gcccatgta gcctgtggtt cagaggatgg 1408860

 acacttctag ataatcaac ctttcttct atacattaca tttatgcatg acagtcaata 1408920
 aaatgggtag ctgccacagg cagcagatc aaacatgaga aagtccct taggtctcat 1408980
 tattcccaag ctatcatgta accacataac tgataggctg tgtggagtgt tgtttgctt 1409040
 aagctgtact aggtatatag cagaatctaa acctcactgt gtgcaaaggg ttaggaatc 1409100
 acacagcagc aaatgctagc cttacttga ctgtccatct tattgcattt gtgatcttg 1409160
 gcaaattgct taatctctt aggttttcat tttctcatct gcaaaatgta tgaatgaaga 1409220
 agcacggttt aatatttaa agtctagaat gcttccaat tcaaaactt tcgaggctga 1409280

 tatacgattg gaagaagccg cacctgacce catatgacag gtcacaggca aaatgcagac 1409340
 acaataaaaa tatagactaa ttgcctcca gctatgtaca caggaaacac taaatttcat 1409400
 ttagactatg gtccattcc taagatgatt ataaaaatgc aagcatctaa aacaccaga 1409460
 ttgctaacat ttttggttcc aagcatttca gttaaggggc actccacctg taatgcacc 1409520
 ttatccaaa tccaccctc tctgtgagt gtcttgggcc tctggagggt gggtgaagt 1409580
 acggccacct gtgtggatgc catctgctcc acctgagcat tttgtgtct tcccctgcc 1409640
 cagttgcttt gaatgtgta ctaattgga catttctgtg aacgttctct tattatccac 1409700

 aggaataagt gacaatgtgg agacctgatg tgagatatca gcaatgagcc tgagccctgt 1409760
 atatttatta aaagtgtgac cgtgattgtg ctgggggtgc agactggccc ttagacagac 1409820
 accgaggagt cagctacagg atgaggatga gccatttatg aagctctaaa atatgctaaa 1409880
 gactttgtct taaagcgag aggtggtgca tfgccacaa atacatttg ggaggccaga 1409940
 gagcaacctc aatgtcctta cccagggttc cccatgtttg tttctgctt tagttaaacc 1410000
 ctttagtcag ctaggtcgac gttcacctct ttccacttac ctcttgggtg gtaattcgga 1410060
 ctccattata aaaagacatt acagtattgg gtcccactgc taccttggaa aatagtcctt 1410120

ctccagcact ggagatgaga gagtcggcaa cataaacctt aaaataaata aataaataaa 1410180
 taataaatga aatgtgagtt tcccagtggt atgtgacagt gttgatgtca atcactacaa 1410240
 ttccattatg gttactaaat cccaaaggac agtcccaggt tgttcaacaa agaaggaagc 1410300
 aagggtgaaga aattaaacca cagtatgttg gtaacagtca tggaagaaat aacttttatc 1410360
 tctttaagag ttgtattcaa aacgacctct accacctcct ttagctcagg tatctggctc 1410420
 agggtatctg cctcagactt gctctgcagt caacgacaat caggaacttg gtcacttttt 1410480
 tttttttttt ttttttgaga gagggtttct gtgtgtagcc ctgactgttc tggaactctc 1410540

tctgtagaac aggatggcct caaactcaca gcatctgcct cctgcctctg tctcccaggt 1410600
 gtgggattaa aggtgtgagt cactgggcct ggcaacaacc acctggtgat aactagggac 1410660
 ttctgaacct gccagtttt ctgtggtgtt ggagctcaaa cttaggactc tatgaatgct 1410720
 aagtatgcat tctatcaact gagctccagc cccagcctc aaatgtcttt tccagggttg 1410780
 gagagatggc tgttcttcca gaggatgttg gtttgattcc cagtacctac atggcatccc 1410840
 atatccatct gcaacttcag ttccagggtc cttttttgaa aaagattttt atttatttat 1410900
 ttatttattt atttattatg tataaaacat tctacttttg cacaccagaa gagagcacca 1410960

gatctcataa tggatggttg tgagccacca tgtggttgct gggaattgaa ctgaggacct 1411020
 ctggaagagc agccagtgct cttaacctct gagccatctc tctagccctc cagggatctt 1411080
 atagctggct cttatggggg catttctta attgaggttc cttcatctct gatgactcta 1411140
 gcctgtgtca aggtgacata caaaccagcc agcacagtac ttgatattcg ttttgaaaag 1411200
 gaagctaattg tttatagtta atgacaagaa aacattttcc aaagtttatt aacactgtgc 1411260
 tcaaatttct cagatgacag aggaagacta ttgtttggtt aaagccaaga tgtttataca 1411320
 aaaaaaaaaat gagagttaat gagatatac caacaagtat ttctcaaca aggggttaaa 1411380

gtagaggtea gttactaca ggtcaaatct gactgctgcc catttttgtt gataaagttt 1411440
 tattgaggca cagctgcctt ccccagtttg ttttaagactg tgtcaaagc agaggctgag 1411500
 tctgtacaat agataatata gggctctgtaa gctcctgaat tgttacttgg tgttcttcca 1411560
 tagaaaaagt ttctaaaca ttgctttata agaaaagcat cctgtcagc agtagtgga 1411620
 catgccttta atcctagcat tcaggaggca gaggcaggtg gatcactgtg agtttgaggc 1411680
 catctggtc tacagagcta gttctgtagc tctggtgaat ttttgctgt cttgaaacac 1411740
 ccgccccccc ccaaaaaaaaa gaaagaaaga aaagcatcct tggctgtgga atggaggtaa 1411800

taagagctta tgttctacca acaaatcttt aatctcttcg tttctttgtg cactgtgatg 1411860
 gatggcctg ttaggaggtg agcatctgta attttgctt attttatgga ctggaaatct 1411920
 gaattattgc ttttaattct gcttgcctcct ctctagtac agaagatac atgtcacc 1411980

ttgcccaggt gacctcatga cacttcttta ggtgcagggt gggcatacat ccccacctg 1412040
 ctgactctgc tagctggaca tggaaagagg ccttgctgct gggctcagg tgttgagaga 1412100
 catggtgagt ttttgccagt ctctgccagt ttctattgtc tccaggagaa gaatatatcc 1412160
 tgggaattgt tgttccttta gccagagtct tggaaatgaag agatgtgaaa cagacctgaa 1412220

 cccaacttga atcctggagc ccagccta at cggctgagc ctggtgaaaa ccaagtaaag 1412280
 atggctgaac ctaagcctac ccacagaacc atgagtataa caaacaccg acctcggtaa 1412340
 acagctaagc agtttcagag tattgctata caggatttca caacagacta gattgataga 1412400
 tttcagttgg gcttgtgggt ttttggggcg aacacagaag ccagtctaca cccactggcc 1412460
 ctgggccaga acctctcgtt aaaaatgagg acattctctc cctgcctgtg gcaactgtggg 1412520
 atcagtgtg tcatttagac caggaagaag cttgtttctc agatgggagc agaaagtaaa 1412580
 caagaggtaa gccacgcccc cgggggctgt ccttactcag ccaaccagtc gaaggagaat 1412640

 tctgggcact tagaattcac gttagagggc agccatctc ataggttagg tatagaaagg 1412700
 acagacctga catggaggga tgcttttacg cttagaaagg acagacctga catggaggga 1412760
 tgcttttacg ctgcccatta ctgcttttgc ttatatectg tcttccctta tgaataaaga 1412820
 agttgcttag tgttccaaag gtcaggctac agagaaaagg agttgtgctg gaggttagg 1412880
 ctagacttga aagagcatgg gttgctcccc tagaagactg tctcatcaag aaccctgaga 1412940
 gggcctggaa gattgcagtg ggcaaaagcg cctgcttgta agattgagcc ttttccacat 1413000
 ggtggaagga aaaaacagtt ttaaagttg ttctctgatt tctacctgca tgcttctcca 1413060

 acttcccaga gtcccagaaa aggcgtgtctg acccaaagct ttacctgag aggtcattct 1413120
 aggacgagag acggaccttc ttgctaactt agaaaccttc tgtggacagc ctctatataa 1413180
 gaatataatt agtcttctc agaatacaca aatacttctt tatggagggg cttggcttga 1413240
 gcaggagccc agcctgagca gagagcagca gaagctcacg agtggccacc accagggcat 1413300
 aaacagtaca atgaacgcca caaggaaaga gttacctctc ggactcataa ggtctggaa 1413360
 ggagagcadc actagagatg caggaggaag tcgatttadc aaagtgttac acggaaccta 1413420
 aaaggcaaac caacatgca gtttaggtgc agacatggct cccaagtcac aggatcatcc 1413480

 aaacagtcac aggcgccatt ctggttatgg cagctagaag agctaagtgg gcatttgcca 1413540
 ggtttactct ctgattatgt tctcaaatct tgeccttttt ctttttctt agtgagatag 1413600
 gatcttccca agttgccag cttggcttct gggttgggat tacaggcca catttaccag 1413660
 gacttgttta ttaagtctt aatgtgccac caccagacta aacacttaag attcctattt 1413720
 gttgattttc ctttattcaa atgtcttaaa ctatttttgt gtaacttaaaa ctttaagcaa 1413780
 aacacgttgt cacagaattt tcaggtttct atggctcagag taactcggac tttagttttg 1413840

aaatttcttg gaggttttct ccctaccgga cagtctgtaa actgtacagc cgagcccatc 1413900

 aggtgactcc ttgggtgaga gtaatctcac cctcacagag tatggagaac aacagctctc 1413960
 caggctgcat taagagtcac ggtggctcag aacctgattg gtaatcagtc cccatgacaa 1414020
 ggtatgcaac tgcctagaa ttactggggg ctttctgttg accctggcaa atcctcacag 1414080
 ggcaacaagg atgtaggatt ctctgagtgt tcataaacia acaagatttg gaaccagaga 1414140
 gtgaactcct gcaaagccaa tcatttttag cactgacacc attaaccatc ccatcaatct 1414200
 tctgtaatca ccatggttac cagaccctt tctgttatt caaaatacaa tgtaaaccta 1414260
 aatgaattcc tcaaacctaa gttagaaaat ggtccaaacc agtcaatgac tgcctaggaa 1414320

 acagaccact tgagtatttc aggaggaaag ggacttggtt atataggaga caggagagcc 1414380
 atgaagtcaa acagagagcc aggaagaatc tacaagtga cgagagcagg aagcttctctg 1414440
 cccactaage tggggatggg agaggagggtg gagtgtgttc ttcctggcc ccataatgca 1414500
 tgtgcagata gcagcctcgt gagggtttaa acaaaactcag aagtcagata gatacacagg 1414560
 agccggggga aaggagcagc tgcctgcaga agaagcaggc agaggaatac aaaggatagt 1414620
 gtgacggcta ttcttgggtg ccaacttgac tacatttga attaactaag acctaggcgg 1414680
 ctaggcgcac ctgtgagaga gttcctttcc ttttccctt tcttttttt tgtttttga 1414740

 gataggattt ctccatatat agccttggct gtectagaac actctctgta gatcaggctg 1414800
 gccttgacct cacagagatc tgcctgcac tgcctcctca gtgctgggat taaagatgtg 1414860
 tactaccact gccagctta gggtttttt tttttttta atttaattt tttacaaaag 1414920
 aacttcattt taggattaaa tgaattaatt taaacatgtg tgcctgtgtg tctgtgtgtt 1414980
 gttatgaatg ccagcagatg tgtatgtgaa gacaacctc agggttttgt cctcaggttc 1415040
 tgttcacttt ggttatttta ttttatttt ttaagacagg gtttctctt gtgtagcct 1415100
 ggctgtagac caggctggcc tcaaaactcag agatttgtct gcctctgcct cctgagtggg 1415160

 attaaagggtg tgcattacga cagctcagcc acctgtttt tttagacagg gtttctcagc 1415220
 ctggtgctgg ctactaggct ccagggatct ccagtgccat gtagataggt tttagagact 1415280
 gaacctggt atttaagctt agatgatgag cactttgtca accgaactat atctccctag 1415340
 acctggaat aacagtaaat acatagaaaa attcaaagaa agaaactg ttcccactat 1415400
 ttctcctaaa gttactatt aaaaggggtt ttacattat tatatgtgtt tttctatgca 1415460
 tatgtctct ctctctctct ctctctctct ctctctctct ctctctctct gtgagtgtgt 1415520
 gigtctgtgt gtgatgcatg tatgaagtca gactacaact ttcaggagt gacacttctc 1415580

attcactatg taggtccctg agattgaact caggttatca gcctttgaag caagctccta 1415640
 tagcctcaga gctatctttg gcttaatcag ctatacaatt tataccgatt ttgaagtcta 1415700
 tctcatittg ttcttttagta acataaaaaat gatgactcca tgttttagag atacagatat 1415760
 ttgaaactgg ttgcattgcc tgtcacttct tagtcctgta cctacttaga gtcacctatg 1415820
 gatgccttct catgggactt cttagcatal ctactgaag tacatgctat agtttctctg 1415880
 tctcactcat gctgggcttt gtectgtgac ttgcaacaca aatgggggaa agttccaggg 1415940
 tgaggcttta ggaggcacca ctggtatctg cttatatgct gacacatctg tagtccactt 1416000

 gagaaaacat tgtccaaagt ggctctgtg ccttcagact ggaccccaga gtaagacaca 1416060
 gactagccta gactggctga accttgggac acagcagacc tgtggttgct gccataaaca 1416120
 gggaggggtt aaggcgggg gatctgtttt ttgtttttg tttttcctt ggcaaaagct 1416180
 ggctgacact ccattaaagt gggttccaca gaggaaaaga aagaaagaaa gaaagaaaga 1416240
 aagaaagaaa cctcatcata gggcaatgtg gtgcacacct ttaatcccag tactatagaa 1416300
 gcacagacag gaagttcttt gggagttaa gccagccta gcctacctag tgagttccag 1416360
 gacaactggg ctacacagag aaacactatc ttgaaaaaca accccccccc ccccgaaaaa 1416420

 agaaacctct ttaacctgtc acccactgga caacttactt ccagatgtca gttcaaagtg 1416480
 tggcctccct tcttcagtag ccatgagggt ggccagttc cctcaatca tctctccatc 1416540
 aataaacctt ccatagagtg cagtctctg atcagggtag acataggcta tcttctctcc 1416600
 agtcatctcc ccatcttcat tgacttcccc aacgaggctg cctccatcct ggtgggagaa 1416660
 accacaactg gagatattgt gtaaaaatatt catctatggg atgtgagttt aagaagtctg 1416720
 tttctgaaa tgcgctctgt gaagaatact gacaccgaca ataacggtat aagaatccag 1416780
 agcttttgag aagagtgaga ctcttcatgc ctctgcaggt agtaccttta ctacatgtaa 1416840

 atacacttct ggaatgttct atgcactgga acatgcatgc ctcathtag ttaggagact 1416900
 gaaatttact ttgtaattct ggactagtta ctggcactct agtttgggtg ttatctaaag 1416960
 aaacaaacac attattatca gaacagactt gcagacattt aagggaata taattaagca 1417020
 cacacctgta atatattaag ggaaatata tataggataa ctatatcaca aatatattac 1417080
 agcacacacc ctgtaatctt agcactatgg aggcagaggt aggcggatct ctgatttccg 1417140
 tgagtttgag gccagcctaa tctatctagg acagccaggg ctacatagag agaaaaacaa 1417200
 acaaatgaaa aacaaacttc agttaaatag tgettttctt tttcttttc ttttcctttt 1417260

 tgcagcactg gggigaacct agagtccagg accttcagg attgtacatg ctaaacactc 1417320
 tactctgag ctaaactttt atgcttttaa atgtacttaa gaattaattt ggtctacce 1417380
 actaaaaata gaattgcttg tattttccga gtgataaaca aaggcccttg tgtctcccac 1417440

atcagttctt cctttcattc ttcattctcg gctctccagc ctcctccca gagaagggcc 1417500
 agctttgctt cattccacag gacaaatgct accggaattc tatgtcccac taagtgtctg 1417560
 gtcacagcag gtgactcaca aatacctgat acttttattt tgtgtgtatg ttctcttaga 1417620
 tgcgcatgta tctgtgtggg tgagcacgtg ccatggtgca tgtgtggagg tcagaggaca 1417680

 acttgacaaa gtcagttctc tcttccacc acgtggattc caggggacc atcacactgc 1417740
 caggcttagt gacaaacacc tttattcatg aagccacctc acagacacct tttagttgaa 1417800
 ctaggatacc cacagcatta tggctaattt cgtttaagat gcaagagatg ggcccctccc 1417860
 ctggaagtcc taactgcgta acttaccat ctaagtcctt tgtaagcttg ctaaacaatt 1417920
 tgataccatg gcacgtgggg tagcttggat aatgtcctca ctctagtatc tgggaacagc 1417980
 tattcaaggc agcaattcag ggtgacctc agtgtctctt actgagacag caataagtga 1418040
 cattacaaa gcattacaat ttgcatagct caccacataa actaaaattc ggaacttttg 1418100

 aagaaaaaca cacagcatta ttttcatag gcaggaagcc cagtaggggtg acacttgttg 1418160
 cttgttctcc tctgaagtt aattcttact aatgcagtgt aaatggggat gaccttctg 1418220
 tgtgatctgc cttcagctg ctgctgagcc tcagagtgtt agagcatggg tacttctttt 1418280
 acctgccata actaacagaa cccaccatgt tctgtctcat ttgaagcaga agtctgtgtt 1418340
 tagggcctct cgccttttcc ctcaaaagt gaatttattt ctttggactg acaaaataga 1418400
 aatcctttga ttttctaag ttatgaatct tttaaaataa aaaagtgcag tgggaagttaa 1418460
 aaacaaaaac agaacaaaag ggcttagtgg ggctgcagat gacatctttt gtaggacac 1418520

 tcagctagca catgccaggc cctgggtttg aatctcagca ctgaacaacc tgggtatggt 1418580
 ggtgacactt gtaaccctgg aacttaggag gcagaggtag ggggttcaga gtcacctca 1418640
 gctacacaga gaatctgagg ccagcctggg ccacacaaga tggctttgta agaccctcgg 1418700
 aaagcccagg ctccagaat cttagcccag gactgcggcc accccaatca cagaatggag 1418760
 gcaaaagtgt gatgcaaatt gcatgagact ttattgtagt ttaacgagct aacccatgt 1418820
 tagctcgggt ctttgatcca cccaccatgg tggatggata gcaaagacag tttgaagctg 1418880
 ctgtgcacag atttttatag ggcagtgtaa ggggaatgct taggggtatg cacagctca 1418940

 ggattggtgt gcctccaggc ttggagggtc tgcctgtgtg tgattggtca actggttgtt 1419000
 atggcccata ggccctctca ggggtggttc tatgctttct gtgtcattgc tgtgcggttg 1419060
 tccgtaaagc acaccagag ccataaagca tagcgccacc agctaactc cgattggttc 1419120
 cttgccaaa gacagggatc tgactttcta gtactaact tctgattgtt tcttgtcac 1419180
 gaggcaggca tgttactttc tagtgtctag gacaaggtca cagaagcaag tgttcggccg 1419240
 ttatggctgc caaaaggaa gctgttcctc tcagtctcaa aaacaaaac atcaacattt 1419300

ctatcgtggt tcttagagtg atcctataag tatgacaggg agaatggttc tgtttttcct 1419360

acccttattc ttgccaatgc acaaacatgg cccaattgct ctatcaaggg gtattgaatg 1419420

ggaagaggcc attgccttgt ttcttctgct cactggetcc ctctgtcaga aggaggcgtt 1419480

attgtgattg gtgagaaggc aggtcaaatg cttgctgaca acccatttct ctgctggtgg 1419540

ggattaacaa aataaaggca gcttttggcg tccagtttta cttttcactt accctctctc 1419600

ccaaggttcc taggcactgc cttgtcaacc ccaagaagtc ccatatctct caagagaagc 1419660

ttatttcttt tctttctttc ttttagtgct ctgtctgcca gaagagggca tcagatctta 1419720

ttattgggat ccacaatgtg gttgctagaa attgaactca ggacctctgg aagagcagct 1419780

actgctttta accactgggc catctcccca gcctgctcaa gaaaagcttt agcagtgctt 1419840

tagcagcaga agggactgag aggccagtig tggctttggg ttcacacat gcctccaatc 1419900

caaaggtatt acaatgaaaa ccagcaattc agtcttgac actactgcct atttctttat 1419960

tgattcagac tccagacagc agaagggtgc aatcagcccc ttctactgtc atccgatacc 1420020

acacttaaag caggtgcat tgactattct gaaagctaat tatttcccaa tgcttccttc 1420080

ccaagtgga tttgataaga ccacagggca aatgttgct atagcagctg ataggtggcc 1420140

cgactccag tggctggccc cacctacgta cctgcagcag tgcttattgg acacgggatt 1420200

ataaaaaat gagaaaagag gttggcggt ggtggtgcag gcctttaatt ccagcattca 1420260

ggaggcagag ataggtggat ctctgtgagt tcaaggccaa gcctggtcta cagagtgagt 1420320

ccaggatagg ctccaaaact aaacagaaac actgtctgga gaaacaaaat gagagagaga 1420380

gagagagaga gagagagaga gagagagaga gagagagaga gagacacaca cacagagaag 1420440

aacataaagg tgggaactcg agctgacatg ttggggatag ctgggggatt gggaagcaga 1420500

gttggggta catatgatga agacatgttg tacacatgtg tatcaaatg acaaagaaca 1420560

caaatattc ccaaaaaatg tcgctgtata ttttaagttt caaaatttgg ctccagtcag 1420620

tgagatgaat gcaaggaatg gtctcagtgt accttgatc tcatcacagg acttcggttg 1420680

atcctagtca gaagtaaaat gacagggagt gggaggctct gggattcctg tttcgtctct 1420740

ctcccatcct ctgcctacac agggcttcac tcgttcttct gacaactccc tctttcaaat 1420800

gtcagtagct cccagcaca ggcagcatgg agctcagcct ggccactctg gaagcccact 1420860

ctcagccttc tggacctgta gateccttgg cacctgtcta tctgcttctc tgcctctacc 1420920

tagacagtca cctaaatgat atctcaggga tcagagctga acaagaggag acttgcatgt 1420980

ttgggcaagt cttagacaa agagtagcca cattcttccc ttggagtata gtttcttttt 1421040

aaaattctct ctctctctct ctctctctct ctctctctct ctctgtgtgt gtgtgtgtgt 1421100
 gtgtgtgtat gtgtgtgtgt gtgtgtgtgt gagacagaga gaaagagaga gagacagaca 1421160
 gacagacaga cagacagaca gacagagagg tattggatcc cttggagccc cttgtgtgga 1421220
 tgttgagatt caaactccag tccttatgat agaacatcag caactcttaa ctgctgatcc 1421280
 atttccccag tctcaaactc ccaggtttaa gcccagttgt ctcaggctct cctagtagct 1421340
 ggggccacag gtgtgtaaac tgtgccaagt ttaaccaatg aaaaacacga ttgtgttttc 1421400
 tgggcacagt gtgggtgtgtg ttcctttaat cctagcacta gggaggcaga ggcagttgga 1421460

 tgtctgtgag tggctctacac agtgagctcc cgtactgtca ggaatatgta gaaaatccct 1421520
 gtctcaaaaa ttaaaaaaca actgtatttg gatgacattg gatgccctgc tctgtgtctc 1421580
 tgccttattc cctgaagca gggctctcatt gaacttggag gtgtgccagc ctcagattct 1421640
 caggaagggt gtgtgagtg cgtaagtgc caagacaggc tttttacttg gtttccaagg 1421700
 atttgaactc aggtcctcat attttagca agtgatctta tctgatgagc cacctaaaca 1421760
 gtttctaaag aataataggg tgggactgaa gatagatggc tcagtgaag agcactggct 1421820
 gctcttcag ggtcctgagt ttgattccca gcaaccacat ggtggctcac agccatctac 1421880

 agtgacatat gatgccctca tctggcacta agtcgttcaa gcagatacag cacttatata 1421940
 cataaataa ataatgaat cttggaaaa agtaaaagta tgaacgttgt gtatgttgtt 1422000
 taaagcaaaa aagagcaatg tgagctgggt agatggctca gggaggggggt tgggggtggg 1422060
 ggaaagggtc ctgctgtaca agactggaga cctgagctca agccccagaa cctatgtaaa 1422120
 gttggggatg gatcctacaa attatcctca cctgtcatac atatgcatga cacatacatt 1422180
 cccacacacc atgcacactc atacacaaat aatacatcaa gaaatataac aatgtgtaag 1422240
 tacatttgcg gggatcact tttctgttt tacatgtaat catttgcctt tttgggacag 1422300

 agttttacta tgtatgtagc ccaggctgac ctcaaactct gtaggtcgtt gagactgacc 1422360
 ttgaactctt gatcatcttg cctccatttg aaaatgctgg gattccagca agcaccactg 1422420
 tgcttggctt gttcttacta attcagagta agcaaaaagg tattttcagt taagctctgg 1422480
 atatgataaa acagtaaa aagtatatct gaaggtttat tcctttcaaa acacagtttt 1422540
 aaattcatca acaacagatg gaggatttga aatgcaaca aaagtatta attccaacc 1422600
 atgggctttg ccatatctat ttgctgtagt tgactcaaaa ccagcattgt taccaaacac 1422660
 ttaaaggcaa gttaggataa atcatcttaa tgctagcaat acaatccatg acacaccttc 1422720

 atagtgaggg gattgtaaaa atccagctgc agtgggtgag tgactccaaa aggattcagt 1422780
 ctcaactaaa gagactagat aaaattaagc aacagctggg tgagatgggt catgccttta 1422840
 atatcaatac ttgggggcag aggcaggtgg atctctatga gtttggagac agcctggtct 1422900

acagactaca tttaggtca gccagattac acagtgagag cctgtctctc ccccatagta 1422960
 tttctttct ctctctctct ctcttcccct cctccccctt ttttttttt tttttttggc 1423020
 acaaggtctc tctgcatact cctggctgtc ctggatctta ctacattctg ggattagagg 1423080
 catgtcatca caccagcca tccctcatat gtatttcaac aatgaaatat cctaccactt 1423140

 ccttctacat gccaatagag ttaaaagcaa cttatctttt actttatatt tttggttgtg 1423200
 agcctagcct ttaacagctg agctatccct ccagcctatc ttttacttta taaatggtac 1423260
 aataaaacta gtttgtgcca gtgatgagta aatactcagg aatatgctat gagtcaagaag 1423320
 aataattaat aaccatctaa agcctagtca tctaagtcac ggagaaccac agcaggtagg 1423380
 tgggcatcag aactctcag ctctagcgac tgacccatgg cttcacagtg aatacathtt 1423440
 actgtttatc atgagaagtc aaaacattgt ctttagacac attcctttcc cttagagcga 1423500
 taggtgccag cttactgggt aatggatcca acacactcca tgtcgaatgt tgtctttgta 1423560

 ttgcccttg aagatcagcc tcccatcggg gtcatactcc tgggctggtc cattcagctc 1423620
 accatcgaca tatgtgcctt ggagaacacc cccatcctca taggtgtaaa caccctggcc 1423680
 ctgcaaggca tcatccatc aatatccttc cagggtgctg tcagacaagg gagaacagaa 1423740
 aggaacagtc agattacaca gcactatcca tagttctctc tctcattctc tctctctctc 1423800
 tctctcccc tctctcccc tctggcatac atgtggggg tagaggatat tttgtgtct 1423860
 ttggttctct ctttccactg tgtggggcac agggatcaaa ctcaggttgt caggettggt 1423920
 ggcaagcacc tttactggct gagccatctt aaataaaggg tcaggtacaa gggcccat 1423980

 gcccagctct gtgtccaccg tttcatgtat tcaggacaag atctgatctg gaattcccat 1424040
 agatgggtga ctaggaaaa tgcagagagg tgaataatag ttggtgatat cggctcattg 1424100
 gtagagtatt tgcctagcat gcccaggccc tgggtttgac acataacaca taacacataa 1424160
 tctcctaac acataatctc ctgattctc agaatctctt ctctttttc tttgctaaaa 1424220
 taaagagaga aaaaagcccc agaggttggg ctgagaacaa gtctcagcta cccatgtctc 1424280
 catggccagg cagatgccca gcttacctg ggcactggca tttctactgt tacactctac 1424340
 ttaacagtga ggagcactat gcttctctt ggggttctt aggccctctt aaacagcttg 1424400

 tatacagggc tcttcagca tactactaag gtttagctta tgcaaatggc catcttactt 1424460
 tcaagttact aatattttt tctatagtag caatgttaat tggcatcaa tcaaaagact 1424520
 ctctttgac cactttggaa gatcgacgag gacttatttt tgtgttatac agtcatgtgt 1424580
 cccttaatga cagagacagg ctctgaaaat glattgttag atgattttgt cattgcatga 1424640
 acaacacaag tatgcacaca caaatctaga tgetatagct ggctccatac tgaggttaca 1424700
 gggtaatctt gcaggacttt tgtggcatat gatgttgatg gactcatgtg tgtggcactc 1424760

agctgtacac atgtgctcat gtgcaccatc atggacaaaa ggatcagtgg gataaaggag 1424820

 ggagattgta ggctcaaccc tgcttgcct gctagtaggc tgataaagcc caagcccat 1424880
 ggctggacca gaagaaagct cacagcatac tcaaggatgat ttaactgttc ttctcttatt 1424940
 gctgtcctca gaaaacacgt ttggaagtgc agaaatatga tgtctatatt cttatgaaat 1425000
 ggaagtaagt gtatcacaaa taccatttgg aataaaggga agggcagctt aaaccatttt 1425060
 ttaaaattha aatgtaagag ttaaccagat ggctcagtgg gtaaagggca cttgctacca 1425120
 aatctgagca tctgagttg attccctgga cacacgtcat ggaaggagag aaccaactga 1425180
 ggcaagtgtt actctgactt ccacaagcag gcctatacct ccctacacat aacacatata 1425240

 cacaaaatga acaaatgtaa tttaaagatt aaaaaaaca atgttatata ttcagaaaca 1425300
 aagatggctt gattaacacc cagcttttag tcacagattc agctagtaag tatcttaagg 1425360
 tatgcattct atagtaggag gattgtatgg ggcgctagcc agcatggtga acaggataac 1425420
 tacagcccaa cagtactgcc tagtaagcac acgctgtcga agaggccacg caggatagac 1425480
 cacaatacat actaggtagg cagggtaaac acatgcctta tactgggaca cgcatacact 1425540
 gtgtactgga ttaagtagga caagcaaca tcatgtactg gcttaggtaa gacaggcaca 1425600
 catttgttcc ccgggcaggt agaatgcaaa gtgacacaca gggtttgagc agcctgtccc 1425660

 tgactgccga gtgacatctt gtcttatgat tgagaatgat ctgtaattat taaatgaaat 1425720
 gcacagcctg aacagtgaca gcttctcatt tcattgtaat tacactatct gtggtctccc 1425780
 aaggagataa atagttctct ttcccgtttg ttgtattat caatgacaaa taggcttatt 1425840
 aaaatcatga atggaataaa gtatacttta acatagcttt tgcaataata atcaaaactc 1425900
 taaattcagt gaaactgaat taatgagatt caactgtcat tagattcaca caattaagag 1425960
 aaggattgct aatcaacaga ctgggtgatg tgtgcagtgc aggggaagcgg ttcagtcac 1426020
 tctctccatt tctgggaggc attgtgaggt aagatacaag aacagccagg tggtagtgg 1426080

 gcatgccttt aatccttcaa cttgggacac agaggggcag aagggcagag gggcagaagg 1426140
 gcagaggggc agaggcaggc agatttccat gattttgaga ccagcctggt ctacaaagca 1426200
 agttctagga cacccgggc tacacagaga aaccctatct tgaacctca acaaaaaaag 1426260
 atagaatatg ctcagtgaat tctgaatttt aggcaggtta tgaactttag caggagcata 1426320
 tcccaaatat tgaatataag atacaatat agacatgttg tgtctgaagt tttgatttaa 1426380
 ccaagtgctc tcagttttta tttgctagtc ctggcaacc atttgacttc agatttccag 1426440
 cagcattcag aatgtatatt tgggtattht cccaacagac aagctgcaa gtaactctca 1426500

gactcatgat caaatctaaa agtcacaggt ctctcagaca agttaaaaag aaaagaaaag 1426560
aaaaaaccag cacagacttg cacatgtttt tftgagtgtt aagttcacga atgccagggc 1426620
tggcacacgg aggtaagagg acaacttttg cgaagtagtt cttccttcca ctgtcgagct 1426680
cagataaggc aagacactga gtcatttttt tgtttctttg gttttgatct ttcgccatac 1426740
agggtttctc tgtataggtc tggctgtcct gaaactcact atatatatag tccaggtgg 1426800
tctccaactc acagagaccg gcctgcgtct gaggctggg actaaggag gtgcctctat 1426860
accagctcc actgagccat cttattttga tctcagtcct aacctgtct gatggcttgc 1426920

tattgcctct tcgctgtga gcctattctc acttcctct caagaaacag tcattttct 1426980
ctttgcacag ctgacttact acacacagtg cagtttaagg caggacagca aaatgctcta 1427040
cagcttagct aaattccaga gccctcaaag ccacctttt agggaagtaa gaaagatgct 1427100
tctccttctg cagtaattta taaatgatcc aatttgaatg gaagaaggaa ggaatggata 1427160
cctttaatgt tagaaataaa aaatagtgtg tttttttta acaaaataaa ctaagiatca 1427220
ccaagctaca gaaagtatac agttttacta ttcttgtact aagtatttga ctgactttt 1427280
atgtaaacat tacacatttc cattctcct ccccatctc tttcttccc tectccatct 1427340

cttttttgt tatttggctc ccctgtgtag ctcaggctag cctcaaactc attatccttc 1427400
tatttttcc ttatgttggg attacaagct tgtaacacca tgctcagctc tgtattttgc 1427460
tgttgtttgt ttgagacac gctcctgtgt actcaggcgg gccttgaact cactatgtag 1427520
ctgaggagga ctgtgaactc ttggctctcc tgctctacc tcccaagtgc tggaaatgta 1427580
ggaataggcc accactaaca gcccttgcta ttttaattt ctttttctt tttatgtgtg 1427640
tatttgggt gtgtgtgtgt gtgtgtgtgt gtgtgtgtgt gtgtgtgtgt gtagaggcca 1427700
gaagagggtg tcagatctct tggatctggg gttacagga gttgtgagcc atctaagtg 1427760

ggtgctggga aatgaacttg ggtcctctgg aaaagcagca agtgcctta accatggagt 1427820
cctctctcta ggcccagctt gaatgttctt aagccgtgct ccctaataac attttggcag 1427880
actcctcagg atgatagtaa gaaataacaa aaatggccat tgggttgttt aatttttct 1427940
ggcaatggca tctaagcaaa caactggaaa acttagggga tatgaaaaca tcagttaac 1428000
tacatttctt tctcctctac atatttaact cctctacagt ttaactacat atacaggccc 1428060
ttttatttta tcaggtgcta agtttccaaa aacaattaaa caggaaatat aacttcaaat 1428120
tgtggagaaa ttiagcagct tctcacccea attgatgcac ctgtacttaa tttaaatact 1428180

actgtttcat tgacagccac ctctgtagt tttgaataca caagagcagt tgggaagctt 1428240
ggcttttctt catggtttgg ggactgagaa gtttctgtcc tteccacctc atgggcctgc 1428300
ctaacagttg ttcttttct ctaacagctg tgcacaacct gtagtttgg ggctgtgtat 1428360

ggccctgggac agctttgcat gtggccaaca ccaaatctca agcatgctta aaagttaaga 1428420
 ttttggggag aggtgatata ttcttttct tttggtaact attatattgt gtttttcaag 1428480
 tctgaacttt tgtagatgat aacattgtgt ccaatacaaa aggttggaca catctgctag 1428540
 tgtattctca tcaacataag ccttgagaag gaaacttaaa aatgaaccag attctacttt 1428600

 aaggacctat ctctaacgat tcaaaactgtg gcttagtgca aaacactgtt ctaggaatta 1428660
 tctcatgtgg ctgaattatt atctcatact gcaagccgat gaaggcaaag gagccctaac 1428720
 ctatctgtta aagtacttc cagtggacac cttccactt cagaagtgtg atgggcaagc 1428780
 agaaggaagt actttctgca ggtcctctgg ccatatgctg gacactttca aagctgctct 1428840
 tgtctttgtt ttiatecttt cacagaggac atgtgagtct agagaatctg atcagcacia 1428900
 aggctcaaaa taacagcaat tagcaaaata tagttctctt ctttaaaaga acaccctaaa 1428960
 aatgtactgc tttggactga atgttttagc cctgtaaaa tctgaagcct tatttcccaa 1429020

 tgtggtggtc ctaggaggtg ggatgttggg gaaggtatta ggttatgaag tcagagccct 1429080
 tctgagtgca ctactgccc ttataaaaag acacaaggga gcttgcttgc tctggctccc 1429140
 ttctccatte tttgacaagt taagcaacca tctgtaagcc aggcagcaga tectcaccag 1429200
 acatcagtct aacagcttct gatctcaaag ccctcagccc tccagaacta tgagagatga 1429260
 aactaccct aggtggacat gacagagctg aattgcaatg tgtgacgat gttggtatct 1429320
 ggtactggat tgcttacttg atgatggggg ctggtgtgtg tgtgtgggaa aaccacacct 1429380
 tttggagtag ttgattgttg tgtgagtga gcaacattaa agacatttga cacttgcaag 1429440

 ttttccctaa caagtagtct tctaggccat tgtaatcaac taagattaga gtaacatcag 1429500
 gattggtcac catcatcatc ctccccctcc agcagacact tgccaggtgt gctatgtctt 1429560
 ccaagatctt tatggctttt ctattcaag catttatccc catctacia atgagaaaac 1429620
 aggagtttgg agaggeccact actaaaaatg accccttagg aacaccttcc atcaacctgc 1429680
 tgggcttcca gcaaatgcta aagcacctat agaaaagcag ctggccaggt ggtggcagca 1429740
 cataccttta atccaacat taggtgcaga gggttggggg aggggggggc agaggcaggc 1429800
 agatctctgt gaattcaaaag tcagcctggt ctacagagca agttccagga cagcagagct 1429860

 gttacacaga gaaaccttgg gtcagaaaagc aaaacaaaac aaaacaccaa ctaaccaact 1429920
 aaacaaacaa actaacgaac aaaaaagtta agaagtgatc ttaaagaaaa taagaaaagc 1429980
 aaggaaaaaa ggaagtcgac ccatcactat ttctcactt atggtcagaa tggagtggca 1430040
 gatglagaaa aaaaaaaaaa aaaaaaaggt tgcctctaaa agtgaattta gtcagtgttt 1430100
 cattctgtga atctcaaaa ctggaaggta gaggcaggag ggttgggagt tcaagatcat 1430160
 gctcaactac accatgagtg caagactatc ctgggctaca cgacaccctg tctgagggta 1430220

gtggggagaa agcaaaaagga aaaaaaaga aagataataa agaattgaat tcacatcaac 1430280

tctaactctt actaactagg ggactctggg aaagttattht agcctctcca agccttagtt 1430340

tcttcataaa tgaaatggga ttgtaaacc aaatatattht atttgctgag cttgatggtc 1430400

aagaacacag aaaggattht gcctcacatg agaggctgga attcgtgact tcaaaagttc 1430460

atttccactg cagcttctcg gaaatgtgac caagcacctt ctaacaacct gggaaatgtc 1430520

accatctgcc ctcagcaca taggatccct ctcagcagga cacagcagta cagggaacca 1430580

gcgttagaaa acaactttgg gaggccgat gatagctcaa ttgtaacct gcttgccttg 1430640

caaacagaag gatgtgcatc agtcccttag aaccactta caaaacaaag ccaagtgtga 1430700

tgcatggat tcgtaatctc tgtctagcca gagagagacc ctatctcaa acaaacacaa 1430760

aacacaccag atggctcatc aggtaaagca cttgccacca aacctgataa cagctttatc 1430820

tctggcacc acatggtaga aagagaacca actcttgcaa gttgtcctgt ggcatggtta 1430880

gctcctccca aaaaataaat caatgtaata aaaaaaact ataaatcaa gactcatggc 1430940

aatgaggagc aataatggag tttttatcc tccacacatg tgcaccacac atcatacaca 1431000

atacacacat gtgcatcata tatacactta tcacacacat aaacttatat atacacatgt 1431060

acatacacat gtacatacaca cacacacaca cacacacaca cacacacaca cgaaatgac 1431120

ttgggtacag aaaactaaag gtatgcagta gcaaaactt tgaaaactag ttggcatagc 1431180

taagaaaagc atcaacaata aatattcaca ctctgggttc tatggcacac aacgatgctc 1431240

ccagcattht atgggatgag gcaggaggac agcaactgtg aggacagcca ggtaactaga 1431300

aacagaattg aaatagcagg agatgaagct tgggtgtaga tcaactgcct ggcatcatga 1431360

ggctctgggt tcagtcccca gtaactgaaga acaatcattc atataataaa ttacctcact 1431420

tttaccttgg gtaaggaca acattactcc ctaatatgac cattccaaag cctcaaata 1431480

gatgctgctg ggtttgtttg tttgtttgtt tgttttctt ctcttttccc agttctagc 1431540

tagtgacaag ttctagctct aggtttacaa atthtggtaga cacagagaac agctaaactg 1431600

tacaaaacat ccagattaga ggttacaatc aatcagaggt gcagatgtca aagcattctc 1431660

agtaccagag aaacattcct acaatcctc caggaccatc cacgtggta ggctccagac 1431720

cacgtggcac ctgatgggga gctccatct ctacctgcc actaaaggtt cagtttcttg 1431780

tggttaacgg ggagtgtatt ttggcacact ggtcaaatc ttcagggtag ctatattaatg 1431840

ttcttgtaga ccaggtctgt aaagctgata ggtaaatgcc accaaataca accaatttga 1431900

tggattattht tcctaagagt cagtcaattg ttggctatct ttatctaact accaaactta 1431960

aaagatgaat atgctcatgt gtatgagtgt gtgtgtgtgt gtgtgtgtgt gagtatgtgt 1432020
 gtgtgtgttag ccatctggat aaattctaac ttgctttcag ctcccacatc cacgtggcaa 1432080
 ggactttatc attgttttaa agtatcacat taagggaaag tgtcataaag tacagtagaa 1432140
 tgtcatagat agagaaactc tccttaggtg gggaggagaa ataagacatt tacaaaaaca 1432200
 tatattgttg aatgaataca aatataatcc cagcataaag taaaaattgt tatttcccag 1432260
 taaaagagct ttggttaaat tgtcatgcaa atggaacagg agaattactt ttaggacaga 1432320
 gggattctga aagaggaggc aacaccctga aagagacccc tgggggcccag tgtgtgtgtg 1432380

 tgtgtgtgtg tgtgtgtgtg tgtgtgtgtg gtgtgtgtgt gtgtgcaatg tgtgagtatg 1432440
 tgtgtatata tgatgtgat gcctgtgcac attgagcata tgtgaggatg ggcatggtac 1432500
 atggggagggt cagaggacaa ctttgggggt tagttcttgc tttccagctt gtgtgatgtc 1432560
 attgagctat gttacagttt ttgaactgta ttgaaatga atgtgtgcaa gatggggccc 1432620
 cctgaatctg gcttggcaga acatcactga acagacacat gccagactca gcatacctta 1432680
 gactggcttc tgcacagcca ccaactgtcat ttctggtcac caaagccttg catacatggt 1432740
 gggattactc tcactcacct ttacatgag gggatatacag actttgaatt gaattcttgc 1432800

 atttgtatca ttctttgatt tgaataaatt ggagacaacc cccaccccc actgccagcc 1432860
 ccaaactaaa cagaacagag agggctacct gccgtcaaag aagaagaact tcccacgtcc 1432920
 attcttttct ceatgcacaa agttgccctc aaatctgtct gtggaggagt aggtgacagt 1432980
 gcagaatccg tigtgtaatc catcatcatc caggtgtcct ggggaaagag aaacaggcca 1433040
 taccttaaca ccagactcag gatgcaaccg ccattggctc agaacttcca aaggtgcccc 1433100
 ttctttgtgt gggggccaga agagggcac agatctccct gtatctggat ggctgtgagc 1433160
 tgttggaatg ggtactggga actgaactca agtcatttgc ttgagtaagt agcaggtgct 1433220

 ctgaagtgct gagccctcgc tccagcccgc tttttctgtg tcttgaaagg actaagcatg 1433280
 cagaacttga tgttttgat actttcatgc atgggctggt ccacacagaa aggcctgggc 1433340
 atgtttgaag acacggagtc tgtaccgctc tgccttttcc ctgggattgg gatttattat 1433400
 cagtagggcc atctgcagca ctagttacca ctteccaage ttecccatgt ttggagtgaa 1433460
 gatcccagct tctcatctta actgaaatgt ggctcagatg gcaactgagtt ataactttat 1433520
 tcttacatgt tgcaagcatg caatatgatt ttacatgtta tcttagagta tgatattgag 1433580
 tactagtaga gtctggatgc accattttat ttacattca gacaacaaag gagtcatgtg 1433640

 cctaaaactg ccctagtgtt tgttttttaa atggagatga acatgtgcac actgccactg 1433700
 aatatgggat cttggacccc agaaacaatt ccttacgctc accttgacc tgctggtgct 1433760
 tcctggttac acagtacaca tctggagtca gcactaaagt atctaggttc cttgtaacta 1433820

catgtttcac aaactcagga gccctcatt aacatcccc cttcatctgg gggagtagat 1433880
 ttgacagagg tgagtgagaa taaaggcagc aattactcta ttgtcttttc cctagagtta 1433940
 acaacctgga tcatgggtga aaatattaaa tactgtgcat tgcacaaaaa tgtgacttcc 1434000
 agaaggctca ctggcataaa accacaaaacc ttgccgccac aatgaattgc tttaatctcc 1434060

 taaaactttt attttaagat gatagagtac caggctgagg atagaactta gtggcaagtg 1434120
 tttagatage atgcctgaga atgtaataa tccccagcac tcaaaaaaaaa atagaaaaat 1434180
 atagaagtta caaagaaagg agtagtcata aagaaataaa atgttctttt tattattgac 1434240
 tactgaaatg ttttaccgt ctacctgact ctatgtggaa tgagttacct atgttgaact 1434300
 aagtacaaca atacatacta ttacttattt gtttatttat gagtgtgcct gtttgagttg 1434360
 atgtgtgcca tacacatgta ggagccgtcg gtggccagaa gaggccactg gatcctctgg 1434420
 aactggagtt acaggtgggtg agccatcatg tgagtctctgg gaatctaact aagatcctct 1434480

 acacatgcaa gcagtgctct taacatgagc tgtctcttca gccctatat ggctatgcaa 1434540
 acacaccaca gacggccata tatggctctg taaacatacc acagacagcc atatatggct 1434600
 atggaaaac accacagaca gccttatatg actgtggaaa cacaccacag atgggttagt 1434660
 tcctttcttt aaacacaacc ttttctaca agggctcaggg aatcaatcat cagcagggaa 1434720
 ctagcacaaa attgctttat tttgtagaa aaaatgaatt acatgatata attctgacac 1434780
 ttgagtcata agaatgttt tggacaagtc tttctaaata tctattgatg acaatctttc 1434840
 attgaaacag atcaagtta gtttttctc ttttaataaa aaatactcaa tatagggcta 1434900

 aaagctttct cttatgaaac attgaaatca attaagtga gccattagca ttccaatgaa 1434960
 tgtagtgtcc tactttttag ttaggtagag atatcagaat aattaggtta ttctctcagg 1435020
 agagttaatt ctggcgtggt gaaaatgctc ccacaataga aaaggttcac aacttcaga 1435080
 ttttaaacag cagttgttaa taaaactggt tctcttcttg aaatcaagag aaacacgata 1435140
 aacatgaaca cagaggggaa agaaaccagt gaaatcctcc ctactttgct tcctcccttg 1435200
 tcctatttct gaaccaaaca ctgaaggtat gccacactct gcactgaact cagatatgaa 1435260
 aagaaaaacc ggaagttggt gtgtaactga aagcaggcac aggtcacttc tgactccagg 1435320

 tgagagggca cccaaatctc atctctgctc catttgacc cttctgcaa caaccaatg 1435380
 gaaaagggaac ctttactg tttctagag ggtgccaaa tgacagacac ttctcaggtg 1435440
 accttgtgca ttiagaagaa gatacatgga tgggtgaccg ttctctgcta gtctggctgc 1435500
 atatgcaagt tctcaatctg taggacctca gcaggagttc catcttgact tgttctcttt 1435560
 tgcactctta gatgcaggca atgaaaagca ctagggtctg tgaactagag agagtgtctg 1435620
 gaatttctgt aggtttctgg gcagtgtaaa actgagaagt agctaccca tacatcagca 1435680

aaaccaacaa gctgggtatg gtggcaaaaag cttgcattct tcctgctggg gattgggagt 1435740

tcaaggagga cctcagcaca taggaggttt gaggccagcc tgggctgccc aacattctgt 1435800
ctttaacaga aaacacaaca gaacagaaca gaacaaacag ccccagtcaa aacaataaca 1435860
acaaaaagac ttgcaaagca gaaaaggcta gggaacagat tagattgtta caatcctgtt 1435920
gccttggtag ataagtctg tggagatct cagcacaatt cttcttcaa tgctgctgag 1435980
acaacaaggt tatgtgttat cacaacctta gtagcaagcc tatggggagg aggctactat 1436040
ccagagggaa aaaaaattg tgaagctact ctttggggca gtgcatagct agactaagtg 1436100
ctttcttgtt acctctttta aacctcaca cagatgacta tacactacca caaaccttc 1436160

aagagaatgc tgatcacttt aaatgaaaag ccctgcctc gaacacacca attcactttc 1436220
tctctagaga aaggcagcca agattggtgc tcttttctct tgctgatggc aagagcggga 1436280
ggtaccacac agcagttaaa gggctttctg tctatccag catcacattg ggctgcttac 1436340
aatgcttgc aactccagct ccagggatcc caaccctct cctgccttc cagggcacca 1436400
ggaacacatg aataatagga gcaatctaaa aagaaagtga aagagaaact gtttagggaa 1436460
acaaaggaga ctaaagggca ggcaggagac tatggggcaa tatattcaa gtaactaca 1436520
tacgactatg aaaatactct tacataacc agaaccaagt atgatgaaa ggaaaaaaaa 1436580

tacggtaaaa aaaatcattg tttcaagttt tatgaccgtg taaaggacta tgcactattg 1436640
agccaaatag tgiactgtga tttggtatct tctcatataa ctttcaact taaaaattta 1436700
tctttaaaa caacacaaca aaaaacaacc cactagcaat gccaggctc tttatagtga 1436760
aatgcaagga gtcttttgg gctggctgca gagaattgcc aagactgtca acatcagacc 1436820
ttggttgcaa attcctagcc cttgctgtg ttgcctaact ccgtgtggaa actctagtct 1436880
ttgctgaaga ctacagaatg tgccagtgca gccaccacc ttccaggcca gttcccacta 1436940
cacagaaggt gggcatcagg cccacaaaac aggccaagtt cactggaatg accactttgt 1437000

gctaataaca cagcctcagc aggcgagcca ccagaatct atctgcagac agcctgaatg 1437060
gtagccagag aaaaggggaa gtaacatgcc tcatctcccc ctccccatt ttgttctaga 1437120
tatttttctc taccagaaga atacaaaggt aaaattttcc cccgaagtta cctctgagca 1437180
gagttttgtt ttgtttttt ctttaactga taagattagt ctgttatggt gctcactgtg 1437240
gagcagagat gggccccga ccactcctg ctgaccaca gagatctgac agtgctgtgt 1437300
ctatttccct cagagcaaga gaccctgacc tatgcatact gctagttttg ctgacaaaac 1437360
actgctctc cctcccccc acaaaagtca ttaagaaaa agcaagttta ttaatgcaag 1437420

gactgtgcct tctttatgac gtagtcacag tggctgtgaa aggcacacga gctcaaatgt 1437480
 gagggtcgta gttttcatgt aaatttcatg gaatgggtgc agtcagaaca cagcacactg 1437540
 tcccaggcat acaacacaga tgcgtgtaag agacaggcag gatcggacag ttgctaataa 1437600
 aaagaatcca tactgttttg aggtgattgg gacagaagaa catggagctg cttgcttctt 1437660
 tcttgctcc ttgttctgag gattctgata ctttctcatt ttgaacactt ttccttagtg 1437720
 tgtcttatgc atttccagcc ttttctttt tctcttttt ctatcctcat aactgcacat 1437780
 ctggtaccac aagatccttc aggtgaaggc ctcagctatt gtttcagccc tccaactgcc 1437840

 tactgcgtca gacaatggaa cttcctgagc agccctctgg cctgtcattc ttcgctctat 1437900
 ggccctcatt ccaacataca gcctacgctc tcagcctgtg accctttctt ttctcatctg 1437960
 ccccttgggt gtcatttctt ctttccagcc ccatgtttca gctagagtga aagtattttc 1438020
 tggatgggcc aaacaattcc acacctctct ctttactca ccaaactcta ctcttagctc 1438080
 aatgctgcca ctctccagg gcagctttat cccatctgct tctctaggct gcaaggaatt 1438140
 gtgagcctca aggtgctctc acacgtgcat gcctctgtgt gtgtgtgtgt gtgtgtgtgt 1438200
 gtgtgtgtgt gcgcgcgcgc gcatgtgcat gattcttgta gagaactggg gttcaattcc 1438260

 catcacctac atggcggttc acagatgtcc acaatgccag ccccaggatg cacatgatac 1438320
 acagatgtac atgcaaggaa aacatttata tacataaaaa aataataaat ctaagcaaaa 1438380
 taagtttttt ttttattttt ttaagggaaa tgctttaaaa aagtaagaag atgtaggtgg 1438440
 gtatggtggt tcatgccatc attctgcatt caggaaagtt gaggctggag gactgggtta 1438500
 cacagtgagt tccaggctgg cctgcgctac ataatgaatt ccaggctaga ctaggcaata 1438560
 aaatacagaa tgagacattg ttgagaaaga aaggaaagaa aatgtaggta gacaatcaaa 1438620
 agaaagaaca gtaggacaat tgacaaagga atttctgcag tctatcctgt ctcccttctt 1438680

 tgacagggtg tcttaacttc tctaagtttc tctataaaat gaggataata tagtatccac 1438740
 ctctaagac tggatggata atgtctgaga agcacttagc acagactgca cataataaga 1438800
 gctaaacaat tacagagatg atggtaataa tagctgtgac aaggaaacca gtgagaagac 1438860
 aatgtgtatg cagagttgag tagctgggtga agaatcatca agacaccag acgagtttct 1438920
 atttaggaaa gaatcacagc cgtttatacc agttcagaga tgtgtgtag attttaagca 1438980
 gtgcaaagtg ccaaggccaa cagtatctgg agaaaagccc aaggatacag tttcctgtga 1439040
 gtacacactt gciccaggca acctgaaaat ctcagcctga gttgagtcta aaggcttttc 1439100

 atttcagatt tattttattt tatatgtgtg agtgttgggtg tccacagaac tggagttact 1439160
 ggtggttgtg ggttgccgtg tgggtgctgg gaaccaaacc caggtcctct gaaaaagcaa 1439220
 atgaaatggt cttaagtacc aagtcaattc tctagcctc tctcttttt ttttttttt 1439280

tttttttgag atagaatgta actattgggc taggctctgc tggcttaact ctgttagttg 1439340
 ggtcccagcc ttaagtgatc tgttcctct cagccctca agtaactgga actacatgaa 1439400
 tgtcccactt ttcttgctt ttctaaggac tttaaaatct taaaagtac tttggggctg 1439460
 gggatgtag ctcaaggca tattgcttgc ctaaacacaca cagcaaaata aataaatgaa 1439520

 attttgtgt tgttcttta aaaattcagg tatagttgct cacacctgta atcccagcac 1439580
 gtgggtagag gaatgctgaa aggtgaagcc agtgtgggct acagagatct tgtttcaaat 1439640
 caaatcaaat caaatcaaat aaaaccacaa aaagttaaac aagaaagtta ctctactttt 1439700
 ttacttttag aaaaattgag tgaactgcca agacatgccc aggtttaagc ctgctgttgt 1439760
 agaataatta ttaatgggct ctttcttctgct caaatgaaca cctgattaat agtaaccctg 1439820
 ctctattagt aggataatgt ctgctcatcc tatataacaa gcctccctgt ttatggaaag 1439880
 aaactttagt gctttgaatc cactggaata actcataatc aacatggaaa cataacttta 1439940

 aaaatttgag acagagctgg cgttggcggc tttaatcca acaactcggga ggcagaggca 1440000
 ggccaatctc tgtgagttcg aggccagcct ggcctccaga gagagtcca ggataggctc 1440060
 caaagctaca cagagaaacc ctgtctagaa aaacaaaaaa acaaaaaaac aaacaaacaa 1440120
 aaattcgaga cagggtctcc tctagttgag gctggctttg aatttgctat tcagctgtgg 1440180
 atgaccttga actcctgatc ctctcctgc ctccacctcc atatgcaggt gtgtgtcacc 1440240
 acaaaagggt tttattcaca taccaatgct aggagcataa atagcagcgc ccattttcag 1440300
 cacagaagca ctggggaagg tggctcagtc tgccgcacta tctgtgatca atggtttgtt 1440360

 tttcaaat taaagaaaaa cgaaacaagt aaagttgtaa gtaaaaaaca acaaaaaaca 1440420
 aaacaaaca acaacaaaa caaaaaacag aaggaggagg gcctggagag atggcccagt 1440480
 ggttaagaac attggctgct cttccagagg atctaggttc aattcccagc acccatatgg 1440540
 caactcacia ttatctgtaa ctccagttct agggatatcca acaactctgca gacaaaaac 1440600
 catagcacat gaaataacaa taaacaagt taaaaaacta aaaatatatt gataaaaaag 1440660
 ggaggaaaga gagcaacact agcaatttgt taagaacttt cccccccat cataacagaa 1440720
 aggtacaaga agtcaataac ttgaaagtta aagaaggatt cctgtgggtg atttctctgg 1440780

 gcctccctaa atctcaacat tgagtttct ttgagagata taagctctgt gaattcacia 1440840
 ctttctagt ctctctgaa gttacaagca aaacctgca gtttaaaatt gttttttaa 1440900
 actaaatgaa gaaataagtt tcacaactta aattagaacg gatgccttc caagaattaa 1440960
 aaagaaaaaa ttattctact tcatcacag ctaagcctcc agcagcctgt aaagcagtta 1441020
 tgtttttgag cacatcaaaa tgggatttct cccaaagtag cactagcaaa tgcatatcca 1441080
 tatgcattgt gaaacaccgc cactttattt ttctttatcg tttgtcagaa cctgttcata 1441140

caaattagat cgaaccaga ttcaaccagc agcttaaaat tatttactgc gacgctccgt 1441200

 ttaacaaatc ccggaacgac actactcaat cttgcaaaac atcacgggaa cattatctgg 1441260
 gatagggtaa aataaataac aaatacgtt aagagcgttt tacagtgttc attgttacia 1441320
 aatcataacc tctcatgaca caaacaacga gattgtataa cgtccccacc gtgtctttta 1441380
 gaagtgggg gcttaaaaaa aaaaaaaaaa aaaaaaaaga ggcggagaaa ctcagcaaaa 1441440
 acattgtggc gacaaaagtc gggggagggg cgctcgagaa ggggcggaga aacctgacac 1441500
 ccaggcgggt ataccaccg cagccaacag cccggaattc agaaagtaa gtgtcaccca 1441560
 gcaatttcgt tcccggctcg agtgcccga cctgttcgg aagcaggag ggggagggag 1441620

 cgggtggctg agtgcgccc ggggcggcgc agccctggac tagccacctc cggagcggc 1441680
 agcgttcgag cccggtgggg agcgcgggtg gactaccta gcaatgattt catctttttt 1441740
 ttttttcgga gggtggccc gggctgceat gtgcctggtg tgcagccggg tgcgttcgca 1441800
 tgggagacc acctagacac gaccctggtg gccaggggac gcagcgactc agcttgaaa 1441860
 gggcagaggg tcagagaggg gaagtcgagg tgctgaaag gcagcttctc ctcgagatc 1441920
 accggtctaa agggactgcc ctccggcgc ctcccctct ccatcccctc aaggaccgag 1441980
 gccaaagtgc tggggcagct tcacaactcc cagggaggat gctgctgtgg cccgtcggga 1442040

 tgcaggggccc gagccttccc agggccgtgg aaccgcggg gctccattcc cgtctgtgc 1442100
 cccgcccgcg ccggcgcgct cccggcggtg tggcggggc tggggccaca ccctcccnnn 1442160
 nnnnnnnnnn nnnnnnnnnn nnnnnnnnnn nnnnnnnnnn nnnnnnnnnn nnnnnnnnnn 1442220
 nnnnnnnnnn nnnnnnnnnn nnnnnnnnnn nnnnnnnnnn nnnnnnnngt tccagtccct 1442280
 ccgggtgctc gcggcagctg agcgcgctg ggggctaagc cctgcgagtt tggaggagga 1442340
 ggaggagggg gaggaagagg aggagcagta ggggcggatc gcgatgcctc ccctacagt 1442400
 cctttcaatt cctcggcctg ccgcggatgc cgcagccgcc gtcctctctc cettctccc 1442460

 ggtccccgag gctccggggt gcagccgccc ctgcaacttt ctctgtgat accccctct 1442520
 ttgttatgga gcagctgac cgctgacatc acccgcgccc ggtgcgctcc ctccctcgtt 1442580
 gattgacagt tcctgtcct tcccagaag tgaggatcct tagaacgaa ggcacttcgg 1442640
 ggtcgcgccc cctctgctag gctgtgggca gggccgccc cggttcctt ttggcttggg 1442700
 gctgagaggg aaagcnnnnn nnnnnggtcg ccgccagctg ctgatagcc ctgggaatcg 1442760
 cgggggtatc ccggggggg gttggcgggg cctcgagag cagctaccgg agactgggaa 1442820
 atgctcggcg cagggttttc ccaccactac ccccctccag gatagctaga gctcacgagg 1442880

agctaaggaa gcctttctga tgctctgag cctcgactat ccctctcgcc cggcgctcc 1442940
 cacttaccac ggcttgccac caccggcaaa gtgcctcgca cacaggagcg caggtgcctc 1443000
 tcccccccc ccccatggc ccagtggtgc ctcacaagc cagtttccca gactccaggg 1443060
 agcgacctgc gctccagatt ccgcccgaca gcacgtccca cccaggtgic cccagictcc 1443120
 acctctttc gtatctctag gccctggga agatccagga attcacaaa cacaaatggc 1443180
 agcaggctgg taatcaggcc tcaccaagg cttggcaggt tccctctagc ccttgtcttg 1443240
 gagatggagc caccaagtgg agaactggag ccaggacccc gtgcttagcg catctcctca 1443300

 cgcttctgt cctgtctag atgtttttct ggttttccca agtgccagcc acttctcaga 1443360
 ttcacgcatc ttgagcgaa gaaaatccgg gttcccacc cagacactta aaaatgtcat 1443420
 tatagcttta cctttacag gtggcagtaa aggacctctt taaatagcgg gttaaacgga 1443480
 tgcagatgta cacaatgtac cgtggaatta ccgggtgctg gtctggcctt ctgccaagaa 1443540
 cagctaccgc ggcgggtggg aggggtgcag caggaagcga agaaaagttg ttccatttga 1443600
 tttctgaac aatgaatgag ctaggatttc agagcacttc caaggcctgg gagagtcagc 1443660
 gtctcaact tcttccctc gcttcttaaa tgeccctccc cttatTTTTT aaagacacga 1443720

 tctcctgtag cccacggcct ccaactcact gtggaggata atcttgaact aatggctctt 1443780
 cccccatctc cccagcgcag caataacaag cactggccag catgctgagt tcatatgaca 1443840
 ctgaagaate aattcaggtt ttgccacgt agcacatact ctactagctg agctgcatcc 1443900
 ttggcatta tggtaggttt aaaaaacaaa caaacaacaa acaaatgg gcattggtggc 1443960
 gcaggccttt aatctcagca gtgggaaggt ggaggcacac agatctctga gtacaaggca 1444020
 agccagatct atacagctat acagcgagtt ccaggctcagc caggggcaga gaaatcctgt 1444080
 cttgaagggg gaaaaaagc gtctaagaga acaattatag agtcccaat actatcaaga 1444140

 cgtttaggtc catgctgacc cctttgaaa gcagagggtg gtggaagatc agttaggatt 1444200
 agtgaccctc tgtgccagag agactgcttt agcagtctgg gttcctcttt ctgggcatta 1444260
 gctgttctgg tcatcagc agacactcct ctggtttagg ctacaccct gtagggacct 1444320
 atggctcagg ctatactgtt ctgaactttt ccagaccttt cttgatgtct atcttaggct 1444380
 tgacttctt aaggtcttcc agggcaggca cctgggcccc taggctacat agaaatctgt 1444440
 ttctgcagtg aaagtcgaaa gaggaccttc cgattataat tgaattttta attaattata 1444500
 aactaaatat aatttaaac atcttttaaa aaagatttta tgtgtgtgtg taagagagaa 1444560

 agagagacag agacagagag agaaagagag agagagagag agagagagag gagactctgt 1444620
 gtctctgtga ctggatactg tgtgtatgaa ggtacctaac ggggccagaa agcatcagaa 1444680
 cctaggagct ggagctacag acagtagtga gcccttggat atgggtgctg ggaaccaaac 1444740

ttgggtcttc tggaatatca gcaagtgtc ctaactgatg agccatctga ggccccattg 1444800
 tgcatacttt taaaacatga actaccgaaa caagatttta ctgagtgtgt acatatatat 1444860
 gtatgtgtat gtatgtacct atgtatgtat gtctgtgcac atgtatgagt gtgtggagcc 1444920
 agaggacaac ttcagatttt ttttttagat ttatttattt attatttata cagtgttccg 1444980

 tctgcaggta tgtttgcagg taagaagagg gcaccagatc tcattacaga tggttgtgag 1445040
 ccaccatgtg gttgctggga attgaactca ggaccctctg aagagcagtc agtgctctta 1445100
 acctctgagc catctctcca acccaatgtg ttttttgttt gtttggttgg ttttttcag 1445160
 gggataggct ctcttacttg cctgggactc acagagtagg ctaggccttg gaaatccact 1445220
 tatttctgcc ttcccagtgg ctgggattat acccctggtc ctccgaattt gtctctattt 1445280
 cttttaaagc atgcattctg gagattgaac atcttcccg gtctcagttt gatTTTTTga 1445340
 aaaggcattt actgcttcat ccttttcagg ttttgagcta tatgatattc cctcttattc 1445400

 tcagatttta catatcacca ctttcttac acatgatgct ggtgtccaaa gaatatcaaa 1445460
 tactcatctc cttcaggtac tggacaataa agatgctgga aactgaagga agaagcaaaa 1445520
 ataacatatt tctttactga aggcggggta atgtcagggc aggaaacgtc tectcagtaa 1445580
 acgagtgtga cagagtctca tgggtgggaga gtatgtgtgg tgggaaggct gggtagaggag 1445640
 aagggtctgt cacaagtgtt acctctgtc tttggtttca gagnaagtc ctcttgaagg 1445700
 agtgagcttt tccagccta tgttttctga gcagtctacc tgtgttatgg gccttcctg 1445760
 tgctactttg atagggtccc actccctcct ggaagggatg ggtggagagc agcccgaacc 1445820

 ctttctgggt tgttgcagga ctaggaagga actcactagc tctttccaca aggcaggctg 1445880
 cagttgggac agtgcactc agctccctta acatttatcc ctcttggctt tagaccacaa 1445940
 atttaggcca aatgtttttg ctggttccct ttttgggtgt tcaaacctt acaaaaaaaaa 1446000
 tttttttttt gtgctaagtt tctagcctga tagatcttta tttgtagt cagaacccaa 1446060
 ctgagcatct ggaactaaat gtaggatgaa cgtttattct atttctgtc aacagtctg 1446120
 agttttctc agacttgacc ctcttctgt gatttggeca aacgcttgt ttcaacacag 1446180
 gtctgagcaa catcttttgc attgtctgc tggccccatc tgtcttgtt tttcttatag 1446240

 agctcttcat tgagagctca tttggtgaat tctcttcca accagcttcc cctgttgtcc 1446300
 tctgtctta ccaatggggt catgggccag aaaaccaata aagctctta tcagagacac 1446360
 tgtgcagcaa cagtagcagc tggccgttcc aaacctatag attctagtat ggtaagatat 1446420
 gcaaaagata gtcaacgggg agccctggta tgagacttgc ttgcatgctc acatgcagcc 1446480
 tagcttttct gcttttattt attaatatt tctggttaat ttgttattgc gatgttgagg 1446540
 ctctgtacat agtaggcaag catgctacca ctactctaa ccccttgcgg tggagt cagg 1446600

aaggctcctg tciattagct gagcacaccc tcagtccac aggtggattt tagacaggac 1446660

ttgtcatca agccactact cctcaaccc ctatctccta ggagcattcc actgctaage 1446720
cattatccca atgcatggaa tgacttttct aagttttctgt ggttcagctt ccaactgtccc 1446780
taccatgtg gcccatctct ccagactcag tgtgggaaac ctaagtcct cctccactgt 1446840
ccagctactt tgagtcatgt cccacccag agctttcccg aaagaactca caggattcat 1446900
ttccttgcaa aagtgatagc acggtcacag tgcaaatagt tctgtgatct ccctatattt 1446960
aaggcacttc ccatatccag ggtaacaag cttgtgggtt agcagctgtg cattcggagc 1447020
accctgggga aacagccagt gtggcttccc ttgtcttggg ggtagtgaa gaaatactcc 1447080

taccctgccc cagcagatca ggataggaag accccaagca tccttcaggt ccaggigtgc 1447140
ctgggtgttt aggagcatcc taggattgaa accaggagct cttttgaaaa aaaaatattt 1447200
tatgtatgta agtgtatgcc ttcttgtatg tatgtgcatc aaatgcatgc ctgggtcctg 1447260
tgaaaccag aaaagggcat tggatcccct ggaactggag ttacagacta ttgtgaacgg 1447320
cagtctgggt tcaactggaat tgaacacggg tcctttagaa cagccagtgc ccttaaccac 1447380
tgactccaac cctagtgcag agctctagaa agcttctgtt ttgagaaagg ttttttttg 1447440
gggggggggg tggtttgac cttgtgatgt aatcacaagg tttataggtc tagtcctacc 1447500

glatctaacc cagtgaaggg atttttttta atttaaattt tttttctaa tttttaaaaa 1447560
tttgcttttt gagacagtggt ctcatataac ccattttggc ctcaaactac tgatcctcct 1447620
accttaacc cgtgagtgtt gggttacagg tgtgtgccac aacctgtttt atgctgtgct 1447680
ggagatggga ttcagggcct agctatgttc ccaaccagg aactcttaag cagteaagtc 1447740
ccatttgact ctggttatta ctttaacaaa gttgttttct gggctgggga gatggttcag 1447800
tagttagaaa catgtactga tcttcagag gctcggagtt tgcttctcaa catccatatt 1447860
aggaggctta caactgcctg taaccgagg ggatcagatg tctcttctg getcccattg 1447920

cacccccctc acaccacagc atatgataga taacagagac acacatacat aatgacaat 1447980
aaaatagtgt gattgaattt tcaacttgtg tgttttgggt cagctaagaa ctagcaacta 1448040
ggtgatagaa tgctttgtac agaggtagat tgggacatac caaactctg ctcaaacta 1448100
ttcagtatag gttgggaggg cagggtaggg gcagtgagtt gggggctcat ggtttaagca 1448160
aagtaaatca gcaaagccca gcaccataag agaaggaaag ggctgcatac aggctgactg 1448220
acaaactgag cgttcacttt ctcgtgcaat cttctcatag tatgaaggaa aacaccaagg 1448280
gagagcctga gaggccattt tcttgacccc tgggagggat gcataggctt ttataggac 1448340

catggttctt gggttctgaa tcaactaaatc acactaacc agtgcctaac agtgacaact 1448400
 gcaaaagctg gaggggaggg gagaggggta gggataggag tgctggggag aagggcattg 1448460
 gggggggggg aggagactgc atgaaaaggg ccatgctgag ttgtggccag ggagaacaag 1448520
 aaccgagggc accacatgac aatgtccagg gagcaaggga ggggaggaga aatctcatcc 1448580
 tgccggaat agacatgact acagtttaga gaagactcat aaattcaggg tggcctgatt 1448640
 tgattatgac aacaggaagt gcagggaggc tgggggtggg tgggcagaat agcctgatcc 1448700
 gaggaagtga attaaataat agggaagact tcacagttgc catggcgtta aaatacctcc 1448760

 ggccacatta aacgtcttcc tcttcttttg cttggttctt gttcttccaa caggctcatg 1448820
 tctctgcagt gtatctacta aactaaattt agaccctcca gggcagcgag gaagggaccg 1448880
 ttagctcag atctctgtct tctctacta tggcccgcat ctccatccat gacatgtttg 1448940
 ggtcttttgc cttctcagat ctgaaaacgg tttagattgc atctaataaa gctgccagca 1449000
 caacttggga gagggaggaa aaggccaaat tggaaactgt gtaggaactg ccttagcagt 1449060
 aacttcagaa aaatcaataa gatgcagata ggaggagaat aagtataatt tccatcaaaa 1449120
 ccaaacatgc ttccttaagt actatttggg ttacttagct tttaaagtgt atcgtcttgg 1449180

 gctacagtta caatgattag gggctgggga ttagcttag gtgtaaaagt gtttgactta 1449240
 aagtaccaga gtctgactca gtcctcagaa tccatattaa aaaaaaaca aacaagaaaa 1449300
 agaaacaac aaggtaaaag caaaataacc aaacaggctt agtggcacat gattgtaatc 1449360
 ccagaactgg ggggtgggaa agacatgggt agatgcctgg ctcagtgatc agctggctaa 1449420
 actaattagt gaaccccagg tcccagagaa agactcggtc tcaaacaca ggtgggcaga 1449480
 acctgagaaa tgacatcaga gtagacctt ttcctccata cacatgtgca cacacactca 1449540
 ctcatatgaa tacatagagg taactggctc ttgcaatctc cctgtagaga tgcagacatt 1449600

 ggaggaggca atcagtcaat tgcatattct tgcgtttgtg agacactggg attagaacc 1449660
 aaagagtatg taactcctt tagctttgga agactcagta tggagctggg tgggtgtagc 1449720
 acatgccttt aatctcagca ctccagaggca gaggcatgtg gatctctgag ttcaaggtta 1449780
 gcctgttcta cagagagagt tccaggacag tcagtgtctac acagagaaac cctgtcttga 1449840
 aaaccaaggg gaaaaaagga cagtattaat aaaagatcag ttccatctga tatattgact 1449900
 acacatgttg aaacactctc ctggactcac acaaaactaca ttccagattg atgtacatat 1449960
 ctgagttatg actgacagtt aagaatattc atgttgcatt agggcctagg cctgctctgg 1450020

 gatgatatga cagactttag aggttccca tggaggcct caccctcct ggggagcaat 1450080
 gaggttggg ggagttgta ggggtggggg aggaggggat ggagaggag ctgggattga 1450140
 catgtgaagc aagcttatta ctaatttaa taaaaacta attaaacaaa gcaaacaca 1450200

aacaacaaaaa gaatattcat gttgcatga taagtacaat cctatnttga agatgaatgt 1450260
gttttgagaa tacaagtttc tttcctttct ttttttctt ttttttttg agacagtgtt 1450320
tctctgtgta gccctggctg tctctggaact cactctgtag accatgctgg cttaaactc 1450380
agagatcttg ctgcctctgg aactggagtt acaaatgtat gagaggcact atgtggatgc 1450440

tgggaattga acctgaggtg tctctctaga cccactatat tttcattttt aaatctcttt 1450500
atctttctga tattagcctt gtcactttag gggaatgaga tatccacact tctttccatt 1450560
ccttaactgt ctiggcttac ttctgctgaa ttctagccaa attttagcat gccagttttg 1450620
ctaatagata tttctgaagg caaactggtc ctcccaatct ctgtgaagca tctcattatt 1450680
attattatta ttattattat tattattatt attattatta ttattattgt agtgtggtgg 1450740
ctaatactga caacttgaca ggaacctaac atcacctggg agacaaacat ttctggacat 1450800
gtctgtgaga gagtgtctag cctgggttaa ctgtgcttat gtgtgtatgt gtgggttgg 1450860

gcttgtgtgt cacagtgagt gtgtgaaagt caaacaattt acagaagtg gttctctcct 1450920
tccaccatgt gggagtaggg atcaaacctca ggcttgggtg caagagcctt tacttgctga 1450980
gccatcactc cagccctgag tagttttcta acttgactga atagctctta agcttgactt 1451040
tggtagagga cagtgtcatg tgcgaatgtt aagcgattgg acaaacctag atgctgtcat 1451100
ctatttcttc ctaggatgta ctttactagg ggcatgcca gtttctgtat ccagagtgtc 1451160
cttttagttc atttaaggtc ctattgattc tctttgctga ttctatagat ccattctctg 1451220
gaaaaatgtc tctggccaac cttctggaat attttccagg cagatttaa gagcttagct 1451280

caaatgcttc tgtgttcagt atggagggat acaaaacaag tagtccaag acagctttg 1451340
tactgtctcc ttggcctaag gcccatttat cagccctgcc atggcagtgg gtcttctgca 1451400
agtcatcage cctctttcta atctgtcacc tgaggaatcc tggctgggat atacttgage 1451460
tgctcagtag agtgggtgtc tactggcctg tagagggtcc tctccatac ttccttgccc 1451520
ctgctgaatt ctctggaatc ttctcctgg acaaacacag caagaggtg gatgcaaacc 1451580
atggtcattc gtgggaagat atagatgaga taagaggtag aagtaattga catacttctt 1451640
cctctcccag acagtcctc tgaaaatggg ggctcagagt ttggggatta tgggtgtgt 1451700

gtgtgtgtgt gtgtgtgtgt gtgtgtgtgt gtgtgttctt gtaataagg ccatttttat 1451760
tccaggtacc atttctatg ctgcatactc tttcaagctt tggaaagat ttaacctgat 1451820
taggaagtca ttgacatct ctgttcttt agacctcatg gcagtctca aagcaaggga 1451880
gacttcaaaa acttttccca ggatctcaca actaagacat gaccagtgag acataaacta 1451940
ggactccttg aggttcaac tgccccctct cattcttcat aaataggacc tggagcctc 1452000
aaggggttgg cagggaagc aggactaaag tgaggaagg atgccacta gagacagtct 1452060

tcaatgccc agcagtttgt ttcgtaagac ttaattctag ccaggtggtg gtgatgcaca 1452120

cctttaatcc tggcactggg gaagccgagg caggcggatt tctgtgagtt cgaggccaga 1452180

ctgatctaca gagtgagttc taggacagac tccaaagcta cacagagaaa cctgctttg 1452240

gaaaaacaaa aaaacagact taattctaaa gattaccttt tcaaatctat ttatagtgga 1452300

ggaatccaga gactcaatgt taaataattc ctggggttgt gtacctagtg agaatgggac 1452360

tgcataggtc gtaaaactga ggagacacag agcatagcag tgtagctgtg aagaattcat 1452420

tctagaagat gactgggcaa aggaaaactt ctagaagata aattacatgt gtgtctgtgt 1452480

gtgtgtgtgc atgtatgtgc ttgtgtgtgc gcatgtgtat gtatgcatgc atgtatgtat 1452540

gtatgcatgt gtgtgtgtgt ttgagtgtgt gtgcacatgc gtgcaactgta catgctatgc 1452600

atgcatacat gtggaggcct gagctccgtc taggatgcct ttttctacct ctacctaata 1452660

atltgaagca ggtttctcac ggaatttgtg agttctcttt aggtacacct gaattccaga 1452720

agaggcgtc agttcttatt atagatgtga gccatctaat tgaacggagg acttctaaaa 1452780

gagcaaacag ccagtgtctt taactgttga gccatctctc cagtccccta agcttagctt 1452840

tttatgtggg tgetggagag tctgaactca ggtccttgtg cttgcaagca cttaccaac 1452900

ttagccatct ccatagcttt ttttctttt ttgacagtg tttcactccg cagccctggt 1452960

atgtagacaa agctgacttc ttctaatttc tgtttgatcc tctaagtgc tgggaatata 1453020

ggagtgagcc atcacctgg ctttttttca cactaatatt tatggtgcca tacaagctgg 1453080

ccttcagcag gtaacgfaat cataaatgct acaggctcac actgtgaatg ttttgctctc 1453140

tatlttgaaa gttctgggaa ctttgggaag taggacctaa tttgtggaag tagaccatta 1453200

ggggcagaac ttigaggact gtatcttacc cctggtttta gcctggctct cagcttctctg 1453260

tctgagagcc atggcgtgaa caacttccat ggcactctct ctacccatga cctgaacgac 1453320

tcgttgagge ctctgcacca tggtaaaatg atacctctg aaactgtgaa ccaaagtgtt 1453380

tatltttccc cttatgttgc ttctggaaag tatlttggtc actgagacgt aaaagaaagt 1453440

gatatagagc cacacacctg gccacagctg gccaaaaaaa gtgttgaata taggtacagc 1453500

ttcatggatg catcccaagt gacctccgta tttgagatga ctctctcttc tttgagacct 1453560

catatltctt gttgcttctg ggcatcattt cttttatag taatattgaa attccagtaa 1453620

tttctgctcc atagagagga gattgggact tacciaacaa acacaagcaa ggcactttac 1453680

atacatccac acacagggtg agtgtccagg acaggacagt ttccattatc tttttatcca 1453740

ttatctccat taccaccagg ctacattct tcttcttggg gtaagagagt ggcatttcac 1453800

aaatcagggc cctggatgag accctccaat gtccctggcac ttgggggtcaa atctgaattg 1453860
 gcacactaga cccacttaa cctctttgag ctgccctctg gcacctggcc tctatttagg 1453920
 ctttatactc cagctacact ggcccttgat tccctgatta aatttaaatt ctageccaca 1453980
 tcagagactt tgcggacact gttctgtctg cttgggttgt ccttctcatt gcctcccata 1454040
 gttggttttt gttttagcac agagggtgct acctcagatg ggttttgta atcccattat 1454100
 ttaagaataa gaccactacc agaatttaaa gtcaaatttg aagcaagctt taattaaata 1454160
 ttggcaaggt ggatgggttc tgtccagatc tgtacctgtg ttcccaggaa atggtctcag 1454220

 tcacattttg ctggggctta agaaggcaaa acccatttcc tgaaagatcc aatcaggagc 1454280
 aagtatacat tctgatgtac ttcttgctg catatctccg gcctacaaca atcagggggc 1454340
 aagggtacat tctgacatat ttctgtcca catgggatta agcacatcca gtgcagatgg 1454400
 gttaaataaa cttgttttagg tcagtgaaaa tatgtggctg ttatgacca taaacaatag 1454460
 ccgcaagcat ttcaggaact atcttctct gttgggcaag gggcttgacag atcagaggtg 1454520
 ttttgttat ttgtttgtt caaggatctc tcaggcatag taattaaaac ttaaaatgta 1454580
 attttggcac tcacagtffc cctcaatgtc cagccaagag tcacctctac aaacacatat 1454640

 tattcaagat ttccttctg gaatttttat catgacactt gtcattacct tacatagttt 1454700
 tgtgtacttt ttttagtctc ttacctggtg tcagtctccc cacactcttt gcttgcctg 1454760
 ttagagatgt cacctgaaca cttagaacag ggccaggggt ctcatagggt ctcaaccac 1454820
 catgggtgat aaaggaatg attaaacttg attcctttct accacctcag agtgggacta 1454880
 ctttcccaag gaagaagtca gctagagact ttattgcat accccacttt ccatcccct 1454940
 ccaattagga agaggattta gagcaaacca aactgaaaca cctgtttctc agatcctctc 1455000
 tcctatgtaa ccagatttga aaagagaacc ttgcaagcct ttaacactga tactggcagg 1455060

 ctagtacagc agtccttact ctacaagag aaaagtttcc tgggtcacac tgggaacaat 1455120
 gctctgggtc aggtccacga aagcctattt aaccacaat gcaaagtaga aaaaaacgcc 1455180
 ttgaaattct aggaaatgta acatggaaaa tgaatgagaa atatcattg catgcttctc 1455240
 ttgaatgta ctgctggagg aaagagggaa gcgctttgag gagggtgggg atgagggagc 1455300
 caggtctctg aggaacaggt cttagtttgc ctaaggaaac atgcctcac attcacaagc 1455360
 cccagagatg gccagaggct ggtgccaatg cttgtacca ttgaattcta gaggtggaa 1455420
 tgaacacaag aggtttatc cggaacactg agatttctct gtgcaatggg ttgactctcg 1455480

 agctttgtag ggaaccctg ctggagcact ccaaggataa acagttggac agctttaaaa 1455540
 agaacaggtt caggtccgag aaccggagct catctgagc tctgggttta atctgcagct 1455600
 caaaaacta ggagtgagt gttgccacac gctgtaatcc cagcatttga ctggtggagg 1455660

gccacaagtt caaacttcag agcagcgtgg gtctcgacct tggtaaggtc acatatacaga 1455720
 tatcctgcat atcaaatatt tacattacaa ctcataacag ttatgaagca gcaacgaggg 1455780
 gatttcatgg ttgagggacc aggttcagtt tgttttcacc atagtttct acaaaggat 1455840
 ttgattttcg tgctgcatct ttgaggcaaa agtttttctc tcttgaaagt cttccgaaag 1455900

 caagagcaat attctaacat gggggagtga ataaaaatta tgatgttgtt tttgaggaag 1455960
 tgctcttttt gggaaagacc taccaacttg gaatgattcc agtcaacact ttggaaacct 1456020
 ctgtagaaat ggtcagagac aaagaaagt aagttccagt ccttattgtt tcttttgaa 1456080
 tgtgtatag tgctatctg agtgggtatg tgcactggga gagctagcag aatccagaag 1456140
 gggagagcag atcctctgga gctgggtctc caggcagttg tgagcagccg gatgtaggtt 1456200
 ctgggaactg aacctactcc tcttcagag cagccagcgc tcagactatt gagacaactc 1456260
 tccaggctct caatgaagtg ctttaagat caccaaaaca ttgctgagca tgggtgtaca 1456320

 cgccittaat tcaccattc aggagacaga gacaggcca tctctgtgaa tccagcttaa 1456380
 gatagtgaca ccccgcttta aacaacagca gccaccaagg agaaaagctg ctaattatca 1456440
 ctagcagtgat gagatctgga ttttagaggc aggggtgggga tgtagctcaa tgggtgaaaca 1456500
 cctacttaga atgtgtgaga ccttgggttc tatcccaga gccaccaaac aaataagcaa 1456560
 gcaaatgaat aatcaattca ggggacaaat gcaaaaacaa gataacattt ctgatgacat 1456620
 tgccatattt ggaatttcaa atgcttagac aggagaaaca atactctctt gaaaatgctg 1456680
 ttaaatgatt ccagaacagg ctgtgtgatg attaagatgc taatattatg gctgtacatg 1456740

 aagaaatttg aataaaattt tcatgagatg tgagttttaa aaatagcagt ttgcctaag 1456800
 atggtggcga atgcctttaa tcccagcacc cagaggcaga agcaggagga tcttgtgagt 1456860
 tcaaggccag cctgttctac agagtcagtt ccagaacagc caggactaca cacacacaca 1456920
 cacacacaca cacacacaca cacacacaca cacaacaca tatacccga ggagcctatc 1456980
 ttctgtacc cacagcatct acttaggtca ttaaaggta ttgcttctcc ctttgagcca 1457040
 ggtccccata gtgctaagga aagcagtcag gctgatactg gaaaatcaa gttaaaattg 1457100
 cttcacttgg ttcatgagcc agcaagtcaa acattagtaa tgaagaaagt gtcagcagaa 1457160

 ggtatgtcac aacagtgata actgcaacag tcacacacta gaaacaccgt aatgactgt 1457220
 ctttagtaga atagtaaat tgtggtatgt ctgtacgata gaatactagt cagtagtgaa 1457280
 gacgaagcac acatctcagc atgaagaaat cagtcttatg agagatggaa accatcagtg 1457340
 caacaccact ccttgttgta atgtgtgttt taaaatgagg ctgaagacat gactctgtag 1457400
 tcaagagtag cattgatctt gcagggacc agattcagtt cccagcacct atgttgggca 1457460
 gctcacaatt gcttgaact ccaattcaa gggaatctga tgtctgtggc ttctctggc 1457520

acctacattc acaagcacat accaacccca gacacacata attaaaaata ataaaagtta 1457580

 aataaacagc atactaaata ttaatgtggt ttgaatgtga gatgtctctc ctggatgcct 1457640
 atgtttgaac gcttggctcc agttgggtgag ttactttagg aaggttgagg aacatttagg 1457700
 aggtggagcc tagctacagg aatgagtca ctgggggagg gccttatgca ttataacctg 1457760
 gccctacttc ctgttcacgc tctacttctt gaatgtggag gccagttaac cccctgcacc 1457820
 tgccaccatg cegagcctgc ctgctgtcat gttttttccc caccgggagg aactgtacgc 1457880
 ctctggaact gttagccaaa ataaactgtt ttccccctta agtcgttttt gtcttgtgtt 1457940
 gtagcacagc aatgagggag taactatgac aactacaggt atttgacttt ttccatgtac 1458000

 atccctaaaa gttgatattt ccagccaggc taattaaagg aagataatgc cattctaaaa 1458060
 ccagaagtca aattctgtaa gtcacttctt tgtttgggag acacaggtgt cctatttcaa 1458120
 tagcagtttg tttctgaaag acacagagcc cacgggagga ggagcaggct ctgggactat 1458180
 cacggtagct gtaccttctg ggaacttact tgtctctccg tgttttatca gatggaaaaa 1458240
 atagaaacag tcacattttt aaaaagtcac ttataaggt cttgttgtat aattgggttg 1458300
 atcctgaacc agctatatgg actagaagag cccaagctt ttagtaatcc cctagcctca 1458360
 ggtttctgag tattgggatt acatgtgtgc gccactatgt caatcttctt gcaattgtac 1458420

 aaaaaaaaaa aaaaaaaaaa aaaaaaaaaa caaaaaaaaa cccattggct gagcttttgt 1458480
 gtaatgttc tttcaggct atccggttct tccagaaacc ttttctatag tattggcagc 1458540
 ttcagggccca gatgactggg caatcacagc caagttcaaa ccttttcaa agctgtctga 1458600
 tttcttagtc ttacttggtc atgtctgcct caccctgaga tggaggtgat taggatgtct 1458660
 gcttactgg gtaacagaga acattaaatc tgctgtaaa tccagaaata attgacagcc 1458720
 attattatta ttaattattg ttattgttac tttattctg attttgtgtg gtgggtctc 1458780
 atgtatccca ggttggcctc agactcacta catagctgag gatagccttg aattcctat 1458840

 cctctaacce ccaactgcacc accaatgaga taagcttaca gctgttcata accattgttg 1458900
 gcctgattta tcatttgtaa gatagatgga cccaaaccaa ggcccttttc ataaaaaaag 1458960
 caacggttat gtcttttgt gtgtgtgttc atgtgtgcac accaccatgc ctggtttatg 1459020
 tgggtctgga attgaacca ggtctttgag cataatagac aagcactcta ccaatgagct 1459080
 acatctccac ctttgattaa ggttcttgag aatgtttta ggtgactctg aggatgtccc 1459140
 ctttctttgg agctttgtaa gtagactaac tctggcagga ctcaggttga actttgggag 1459200
 ctgaatggca tcatccctgc ttcaaaagt ctctatttt cttttggact ttgcagtga 1459260

gttatagtaa cgggggtgcg tggggagaag gggcactgca tgtgagtctg gtcctcatcc 1459320
 ttcaatgatt ccacaaatcc actatctggt tttgaaggct ctggattcct tgatggagtg 1459380
 gttgtcactc aataacatag catatcaaca atgaatgttc tagaccaggt acagactcag 1459440
 gtaatttgtt ctctgagcct ggtttactat gcaaaagaaa actaaaaaca atagaattct 1459500
 acattgcctg tagccatgga catagaatgt gtgtgttggg gattaacact gagccagtcc 1459560
 agtcagctgt taagtcccaa gcateccttga tttgatgtg ggccaagtac atccttacag 1459620
 gggagagtta gtiactcttt tatctttcct ttaatagatc ggtagtaaac acccagatgc 1459680

 agcaagggat gaatagttaa gcagcagctc tggttgacta ggtttcccta atgtcagcaa 1459740
 ggtgtacctg attgggaagc ccagtggcct cttgggtggg ggctagtgtc ggccggagaga 1459800
 ttgttcagga ggtggcaggg caactgatgc ccttcctagt gactccatag tttatcttca 1459860
 tttgttagac cctgtacctt tatttgaggt tccccaaact ttcaccaagg tagccatgga 1459920
 gtaattgaga atcctgaaaa accaccgttt ctcttcctct gccttctcag agtcaaaaga 1459980
 acaaaccaag agtcaagtg ccgaagtgc cttgatgtg ccccgtaac cactaggtta 1460040
 tgcattggca gaagttagcg gtgggtcttt aaagtactag tcattgtcgt atctttccag 1460100

 gtccagagca ggaggcagag acctaactaa ggaaggccag ctctgtctga ggtctccagg 1460160
 ctcatlagag gatcccact accagtgtct aatgaaggag agctattgtc atgcctgttg 1460220
 cacacacagc gatataaagc tgctgaaagc tgcagcagca ggtccggtgg tcacgtggtg 1460280
 aattagtaac taacacagga aaagggcca gcgttctggt ccttccagtt tggtgcctc 1460340
 tttaaatcct caaatccagt tatagcctgg ggctgtgggt gtgaacaggt tccattacta 1460400
 ggggaaaggt cctcatcttt cccaatcgtc tactgcaaac ctgcttttta atttcagga 1460460
 taaaggccta gaaggagtc gaataccacc ctgtccctca aacacgcaa cgcgtttgtt 1460520

 ctctcagagt ctggtatttc acagcaactg ctgatggagc ctatatgagc tggaaactgca 1460580
 gctgctggtg agcaactgtg tgatatttat agctctctct ctctctctc tctctccct 1460640
 ctctctctct ctctctctc tctctctct ctctctctct ctctctctct ctctctctct 1460700
 ctctctctcg ctctctctct ctctctctgt gtgtgtgtgt gtgtgtgtgt gtgtgtgtgt 1460760
 gtgtgtgtgt aaagggatgg attttttcc tcttgagaag cattgatgcc acaacaggaa 1460820
 gtgatctcag ccagagacaa tgcaatcaca ggaatcaagt ctactgttct caaacttgag 1460880
 aatgagtcag aatcacctgg aggcgtttgt taaagcatac tgcatgggag aagatacagg 1460940

 caggaacatc acaagttcaa ggtcagcctg gcctacttgg aacaacaaaa caacaggaca 1461000
 caataccaca tgggctgggg agagctcagt gggtaaagtc cttcaagcag atgtgaggac 1461060
 tggagtctag attcccagta cccacaaaaa tgtcaggtgg gtgtggtgac cctctgtaaa 1461120

ctcagcactt cgaaggcaga gatttgtggtg tttgaatagg aatggtcctc cgtagatgca 1461180
 tgtgtttgaa tgcttggfca tagtgagtgg cactattagg aagtgtggcc ttgttggagg 1461240
 aagtgtatca ctgagggggc aggctttgag gtctcctatg cttcagttat gtccagtatg 1461300
 gcacacagtc tcctcctgct gccttcggat caaaatgtag aactctctgc tccttcagca 1461360

ccatgtctgc ttgcatgccg ccatgtttcc tggcatgatg ataatggact ggacctctgg 1461420
 aactgtaage cagggtcaat taaatgtttt cctgtataag agttgtgtgg tcatggtgtc 1461480
 tcttcacagc aatagaaacc caaactaaga tagagatggt tcagtggtt aaatgttaat 1461540
 gatcttttgc tgagtttga tgctaaggat aatccatgta agttgaggtt ggctgtcttc 1461600
 ctctgaagga accagcttcc ttttggcagc cataacagcc gaacacgtgc ttgccataaa 1461660
 cctgccttgg tcacgtagag gtcagatgcc tgtctcgtga caaggaacct atcagaagtt 1461720
 agtcactaga aagtcagatg cctgtctcgt gacaaggagc caatcggaag ttagctggtg 1461780

gcgctatgct ttacgacct ggggtgtgctt tacagacaag cacacagcaa tgacatagag 1461840
 agcatagcaa ccacctggg agggcctatg agccataaca accagttgac caatcaacac 1461900
 agggcaagcc ctccaagcct ggaggcacac caatcgtgag cctgtgcgta agcctgtgag 1461960
 taccctaga cattcccctt atgctgccct ataagatctt ttgggagcct gtaggagccc 1462020
 tcttttcta gccgtctgcc atggcgggtg gtgaaagacc cgagctaaca tggggttagc 1462080
 tcgttaaatt acaataaage ctctgtcagt ttgcagcaag ctcttgaatc cgcctggtga 1462140
 tttgggtgac cgcaacgtg gcctgggacc ccgaatactt gagttttcgg gggcttaaca 1462200

cctctattgc tctgagacag gatctctaac tggacctgga gctcaccaac tggctaaact 1462260
 gactggccat ggaacccttg aagccctctt gtctctctc ccatcgatgg gggaaatgct 1462320
 ttcacaccta atttatacc tgggtgctac agatctgaac tcaaaccctg atgcttgggtg 1462380
 tggcaagctc cctttacct atgagccatc tctctagccc acaaatgatt ccttttgtaa 1462440
 gaattgcact tttcagggtt ggtgagatgg ctcagtggat gaaggtgcct gctaagcctg 1462500
 aagacctctg ttaatctacc ctgaccatac agtagcagaa gagaactgac tcctgcaagt 1462560
 gctcctgtga tctctacaca agggccatgg ctcatgcata ctacacaaa gacacacgaa 1462620

ataaaaaaaaa acttttaatg taattaaana acaaaaaatg gtactttaaa gccaaagcga 1462680
 atgtggggtc aaagctagat tgataacagg tagtttatta aagaatagta ctcacgcaag 1462740
 ggagccagtg accaggcttg cacaagatgc ctgcttgtcc actcagccag gcagaagaga 1462800
 gaaaagaggg ggcccgtgtc cgcacctccc aactacttaa accattgtta cgtcacccaa 1462860
 gcggaagtgg tcagtgttac ctgtaaacag aatttctccc tatactactt tectatgtgt 1462920
 gtgtatgtca atccattttc tcaattctca ttttgtgtgt ttagtattcc tttttttct 1462980

tggttacgct agtggattat ttactgttgt tgctcttttg ttgttttgtt ttgtttttca 1463040

 gigattcatt ccttcctttc cctcctctgc cttaccctac ctttcctgt ccttttttcc 1463100
 ccattgtctc actttcagct tatactgggt tagaacaat tctgtagccc aggttggctc 1463160
 ctactctgtc ctggtttccc taattctggg gttacaggca ttattacca tgactagctt 1463220
 tgagaggcat tcgttatctt aggaaacttt gctgtacaaa ccttgaaaag ataatccaca 1463280
 acaaagacag ctggtacaaa acccacataa aattatctct cggcagtcag ttcttctggc 1463340
 tttgtataca agttcattac aacaggcatc cttgggtata cacaggagga tggattccag 1463400
 ataccctaat ctgcagggtc tcaagtctct aacataagtt ctcatagtat ttacctataa 1463460

 cctacacaca tacttcttta tactttaaat tgcctcttga ttatttaaaa tatctcaaac 1463520
 aatgtaagtg ctgtgcaaca gtttttatgc tgtattgttt agagaataac gataaaacat 1463580
 ctgcatatgg ctcaaccttg tcagtcggta gttggacca cagatgaaga acctatgggt 1463640
 atagatgacc gactttgggt ttattttaat tctgcctttc tgtatccttt agattttaaa 1463700
 acttgttttt aagttgaatc atttcctca gattcattct ccttaaacga tttttaaaat 1463760
 taaatttatt tatttgtgtg tgatetaatg gagcacagat ggaggtcaga gaacagctta 1463820
 tgagagtctg ttctttcctt tctctctgtg gatcttgggg atctaactca ggttgtcagt 1463880

 cttggcagca agtgcctgat aacctgagcc atggtaccag cccaacaaat gattttttaga 1463940
 atttggtttt tccttttaac acacacacat acatacatac atglatataa aatctttgat 1464000
 tatactttac agactttaat aataggggt ttccctatta tttgctaata atctagtctt 1464060
 ttctttgttc acggaatga aggtgtgaga cacaaatgat gaatcatctt taggtcttgc 1464120
 tgttctgcga tcttggctct cgaacgactt tgttttctct tagcatctgt ggattaaagc 1464180
 aataaagcct ttaaacagga ttctgtgtc gtgtgtgtc catgaggtta aattacactc 1464240
 ctctgcaatt tgaagggaaa tggaaactgga agatggaagt tcaagccca actctgccac 1464300

 tttttattgg taaccaata aataactgtg taaagctata aggtcgcac gcattctctt 1464360
 ccgtgcaatt tgggactgca agggacatgg aattagtctt aattaggctg gattaatgac 1464420
 ttctaggctt gcttgttagt tgagtcagct tggccacggg aactggagat gctgagtaca 1464480
 gttctctgca tggcaagtt gatgccttg cttcctcaca ttttcttgtt tgatgcagag 1464540
 gagaaaaaca tccagacaac tctggggact cattttctt cactttttgg aagatggacc 1464600
 ctagaaatgg ctggagggga tggcagctgg atgccagagc aggttctgtg gagactctc 1464660
 ttctggagg ggcctgtttc agtcaaaaag ccctgtctgc ctggttatct ggatgatttg 1464720

gcattctctc ccccatgctt ggagattgic caggctcttt ccctggtgtg gctgtccttc 1464780
 tgtgacaggg acttctctaa gggctgaaac ctctctaggg gctttaggt aggtcttctt 1464840
 aataaatcaa acaccacaac acatgtctgt ccctgttgtg tagcccatac aatttgatga 1464900
 ccttagagac aaactttata aataattggt tcttgtacta cccaccacaa gcttgatgct 1464960
 atggaacta ttcctctct tacatggggg acacctggtg ctgagaaaac atgagcaatc 1465020
 cccccaagaa gcagagacag aggtaaagcc ccagctgctt ggtttggcct aggatttcaa 1465080
 ctgcagagtg ctattccctg tgtcacagac ttcacagttt tcctgtaggt ggtgctaaag 1465140

ggtctgattc agtctgtcta tgatgacaag atttcaataa aggaaaacaa agtataagga 1465200
 acagcttttc tcctttgtcc accagtccca cgggggccag cagcagctcc ggggtaacat 1465260
 gatgatgtca cagaaaaaag atcaacacag ggtgatgaaa acatttcctt gaggagagat 1465320
 ttaattctag gcatgttctg cttccacaga aagtcaaacc tagtttcagg aggggaagga 1465380
 agttagagc cagaagcagg aaggctgcac cttccatag aggtcctagt gtgtagtga 1465440
 agcaaccatg acttctctc ttgtttataa ggcatttgtt tcatatagct caattaaaac 1465500
 tgtaatgtat aattaagaaa cacagattag tagatagtta tatataataa acttacagtc 1465560

atgtagttt ggttttctag atatgcatat gcagagatat atttcagaca gagagtaat 1465620
 ctccaacac ttcaaaggcc tacagaatat ggcatttcaa gtgtcgtaag aacttagact 1465680
 tttcttgaca atgagacact tctgtctctt gcagcaccaa ttacttgaaa aggatgatgg 1465740
 gcactgaaaa agtccttat ggagcttggc ttctatgtgg caagactagc catttgggca 1465800
 agaaactgct cctgcttggc ctgcttgtat gttgtataaa ctggacatgg aggaccaca 1465860
 ggaaagtgac tgctaaactt gtcaaaacaa gacaggatgg cccttcagcc ttcctgcttc 1465920
 ccagaagaaa ctgccagaca ttctacagga cacagaggaa aagctgacaa actttgccac 1465980

cacaaggcag aacagatctt caaattttct gcttcattga aaagtctgct gaatactatg 1466040
 ggcctatagg ctgaagatgg atgcccacat gttacaccag aactttgggt gactgtccag 1466100
 gaagccagat atctctgtca tctctaacat ttggaagtt gcttacaatg cacttccagt 1466160
 ttacttaagt aatattatat tcttctgggg tttttgatgg agttgaagac agatagtat 1466220
 agctttcctt agttatgatt agatataaaa ctttagacgc acaaaataag atagatgata 1466280
 gagtattttc ctaattttta tcacatacaa atagactaaa tattataact gtaattctta 1466340
 cttgataaat tttttatat gtaattttac tatgttaaag ttaaacctt ctttttcaat 1466400

tagacagaaa aggggtgatg atgtgggatg tccttatgta tactgtgaaa atgtgttct 1466460
 tttattgggt gataaataaa gcttatttgg ccaatggcca aacagagtag ggtcagatgg 1466520
 gaaatccaaa caagataca gaaaaaaaaaaa aaaagaaggc agagtcaaag agacaccatg 1466580

tagcctccat agaagtaaga tgtcagaaca ttaccaataa accagttgca tgtggagata 1466640
cacggattat tagaaatggg ctaacttaag aagtaagagc tagccaataa caagcctgag 1466700
ccatcagcca aacaattata agtaatatta agcctctgag tggttattca ggaactggca 1466760
gatgggacag aaaacatcca actacattca tgggtaacaa agtaatgtag ttctggggtt 1466820

tcccaaattt ctctctttct ttctttcttt ctttctttct ttctttcttt ctttctttct 1466880
ttctttcttt ctttctttct ctttctttct atctaaaate ccgagcaciaa tttcccttec 1466940
tttctcttct cccatccctt ccctgcctaa cttcaccac cctgcctcga tccacttttc 1467000
ctctgtttct gttcagaaag gggcagacct cccatggcta ttaacaaaac atggcatagc 1467060
aagttgcagt aggactaagc accttccctt gtattaaggc tgggtgaggc aatccaatat 1467120
gatgagtaag ttccaagag ccagcagaag cattaggac tgcccctgct cccattgtta 1467180
agtgtccac aagtagacta agctacacag catgtgtgtg tgtgtgtgtg tgtgtgtgtg 1467240

tgtgtgtgtg tgtctctgtg tgtgtgcctc agtgtgccag tgtagaggtc aaaggacagc 1467300
ttgcaggagg tggttttctt cttctcttct ttcttcttct tcttcttctt cttcttcttct 1467360
ttcttctttt cttcttcttct ctctctctct tctctattct ttttttagat ttttaaattt 1467420
tattttattt aattaacatt ttttctattt attttacata ccaaccgtag tttcccctc 1467480
cccccttcc tctgtttatc acctcactt ccactatcc cacttccat ccaccttcc 1467540
tccatctcta ttcagaaagg ggcaggctt ccatggcctt ccacaaagcg tggcatatca 1467600
aattaaggta ggacagagct cctccccctg catcaaggcc gggcaaggta atcaatccag 1467660

catggaagg ggagcaggtt cccaaaagcc agctaagcac caggacagg tctgatccc 1467720
actgctaggc accttacaaa cagaccaagt tacacagctg tcacacacat acagagggcc 1467780
tacttggtec catccagctt ccttaggttt tcttctactc aggttatcag gcctggaagt 1467840
aggtgctttt aaccactaag gcatcttgc tgccttctct agatttctta aactctagt 1467900
tcacagtttg aaatctagga tctatgtatg actttctgtg attcctggc acaactcaag 1467960
caaggagaga actttgatct cacaagaccg cccaagtat gaaagaagtt ttgtctcagc 1468020
tgcaaatg cttttgaaat ctatttattt attattctgt tcttttttgg ttcattcttt 1468080

tgagccttct aatatcacct ggctccctga gagactgctc cgtaagcact gctcatctca 1468140
acagaacttc agtaattatg aagatagctc tgtttggcat ttttggggga ttttcccaaa 1468200
ggaaatatta aatcagtttt atctctcaca gtaaaataat aaatgttttc tagttataaa 1468260
ttagtctcct gacaatttgg ctataaattc actcagtaga gtttggacta agaaaattga 1468320
gtttattttt aacagcaggc caaaaagtac ttctcagaa catttatctc taacttttgg 1468380
gaaataattt catggcattc attcattcat tcattcattc attcaaaatt tgccaacaa 1468440

attttcattt agtgtctaag atgtacaagg gcttctttta tgtacaccag tgaacagata 1468500

 aacaagcttc ttgtggttct cttgttcttg tcaaaactgt atcttggagc tttacatgat 1468560
 gtgtgtttat tcatttgtgt gattaaatat atattatttg atttttgttt tttatattct 1468620
 tacctctctc tcctctctc tctctctctc tctctctgtg cgtgtgtgtg tgtgtgtcag 1468680
 gggcaggagg gtgttgtttg ctatggggca tgtggaggtc agagggcaac ttttgggtgag 1468740
 tcacttcttt cctaccatat gagtcccaga gaatgaactt gggcatcag gettgatgga 1468800
 agatggcctt atcctctaag ccatctcca ggtctttaa ttattttaa actaataaa 1468860
 aaggacattt aagctacaca tactagtagg gtaccaagta tgatgaatat tgatcatcac 1468920

 attttttct tctcttgtaa gacctatgig gatggggcca gtgttgctaa tgattgtcca 1468980
 tctagtctc acacagtgcc atttataaa gaggctttca aatatttgat gaacaaagtt 1469040
 tctcaaggct tcatactagg atactgggtc tccagtaact gatcctctga gcctatcact 1469100
 agttttcagg cttagaaatt actcatgggc attactgtct tgttctaaga tttctgtcag 1469160
 tcagtttttg gtgaaggaat aggaaataaa agtgacggtc tagctagggt ggcctgagc 1469220
 ttagctttct tgtactctca gagctggatc ctccatgaac tctgggtgag gggcatcaca 1469280
 gtagggtttg gggtaggcca gttagccagc tggagaacat ggaagaagcc tgggcttctg 1469340

 tagtagaacc aggatgaatt gacaaggaca gagcccctct cccttcatc ctgtcattga 1469400
 aactgataaa ccagcaggcc ttgagccaca gtggggagag gaacatggtc tagagacat 1469460
 ctgagataaa cctagagcca gggctctaca ctacactcag ctctcttctg gcagtcatgc 1469520
 tcatgcatgc caaccaatca tggcagagac agatcagaca agcccttgaa ctggctgctt 1469580
 ctctgccatg gcgtgggtga tgatgtgaat gagtaagagc ttggatggca acaaagacag 1469640
 aacttgaac acagctcca tggggcaaac ctttgaaca aataacaaa ttttgggtgct 1469700
 ggagttatct taaattaggt aactcttttg ctcccctcta ggggaggcaa accacaattt 1469760

 tgtgttgggt cacatccata gctatcctag ccatgggtta ggcacatctg cttgggtggt 1469820
 gtctcttta agtcagagta ctggctgtgt tctgtgctag agaagacaag cccatcagcc 1469880
 aggatctgta ttaggagaaa gttggggaga gaatgtgtga aagaatggag ttgttttatt 1469940
 ttttttttt ttttttttg agatatagtc ttgctgcata gtacagactg gtggcaaagc 1470000
 cccatgtct tgatttggcc tctgtgtgct cccataccca ggaactttgc tttctataat 1470060
 caactttact gagaaattta cacatgatga agccttagat ctcaggaatt cagagctggg 1470120
 attcaatgca ttcttctgac tccaaagtca agtgttgagt ttgttgatt agtggctctg 1470180

aacttcggag atcataccag aggtttgcaa aactatttca aagggtatgt ggcttaaagg 1470240
gctttaaaga tgagctgctt tgctcttcca aaccagctt gaacagtatt tctgatcaca 1470300
tgcttttctt gtectactcc catcaggaga tgcccagatt gcccttgat cctgagtagg 1470360
cctccgtgaa tgictcagct gaaagagttg gcaaaaggga ttctctgaaa cttttgaggc 1470420
tggatgcaac aaagtattat agctgacct tgggtttctc ttaagatgct tgctcttga 1470480
acttgccac catgagtgag gaggccaga cctcatgctg catcagagat cctggagact 1470540
acacttatga tggttcactg gaggccaaca gggctctgtg ttagtggc attatggctg 1470600

atccagtaca gcaaaaggaa gagccatgta gggtaaagct aggtagaac aaggcacatg 1470660
cttcttgctg gtcaaacatc ctgaaaacat acctctgggt gtgcctctga gagtgtctcc 1470720
tgaaggcctt aactttggag ggaagactca tcttgaatat gggggcacc attccatgag 1470780
ctgaataaag agaaaccaag tgaacatgg aaatctcccc cgccccagtc tggactatag 1470840
ataaagtgtg acaagctgcc tcacactcca tggaccacc tactggacag ccatgctttc 1470900
cacaccatca cggactgtag ctcttcaaa ctttaagtta aaataaacc ttactttaa 1470960
ttgtttaaca tcaggcatg tctttgggtt cctattgctg tgaagagata ccatgacat 1471020

ggcaactctt aataaaggaa aacatttaat tgggtggctt acagttaaca ggtttgtcc 1471080
attatcatca tgggacaagg tggcatgatg gcagacatgg tgttgaagga gctgagagtt 1471140
ctatgttttg atacgcaggc aacaagaagt gaactgtgag aactgggca tggcttgagc 1471200
ataggagacc tcaaagccca cccccagat gacatacttc ctccaacaaa gccataacct 1471260
cctaatagca ccactccta tgagattatg ggggccaatt acattcaac taccacaggc 1471320
atgtgtcag agaaatgaga aaagatacaa ataatttctc cagcaaccac ttgaaacaac 1471380
acagtgaaa tactatccac ttgggggagt gcataacaat gagtgtctct aaggagcttc 1471440

cttttacta cttacagatc ctagaccagg aggaagaag gtgttcaaca gtccaggcta 1471500
tatcatttgc caacctccc aaatctcagt accacaaagt caagcaaagg ccacccttgc 1471560
acatggcctt aaagatagtc aggtctgcca tctcccacag cactcttccc aatgacaga 1471620
tctgtgagca gaaaggttgt aaagaaaggt agacaagaaa atttagcggg gaggtgtgga 1471680
gaggcaaaga gttaatggtg gtccttgttt ggaccagggt tttccagact tttttttct 1471740
cttccagaca gggtttttct gtatagccct ggctgtctg taactagctt catagacaag 1471800
gctggcttca aacttagaga tccaactgcc tctgcctccc aagagctggg attaaaggca 1471860

tgtactaaa tcgccaact gtgtttccga tttttggtt tttgttcaa agaattgaag 1471920
aagtgcacac aatcaggaa gaatcttatt cagaagcaga gcaaaagtgc aggtgcata 1471980
cactacatga gggcagcggc tgagtgggtt ttactcacgc atgactgggt accgcttaga 1472040

acatcttttt ctgggtccct gaggaggggt tggttgctag ggatggagt taggaggctt 1472100
 tttgttttga ttgacagcct tggtttataat aagcctttgt tcaactgtgca tatccttttc 1472160
 cacggtgcat ctgattttag tcatatgcat acccaatcat gcatatgcat atgatgataa 1472220
 ataggggagt ctccctaaaa gtttacttag aggaagcagt ttactgtgtg tgcaccccta 1472280

 ggtagattg agctactatc cccagttcct ggatgtattc tgggatgtaa ttggccacaa 1472340
 aaggaagtt actaagggtt gctaggtagc ttagctctg agtaacctgt tgttggttag 1472400
 agaagagggt gcatatagct caatgcagat ctggctctga agggataagt gcaatgttca 1472460
 aaaaagggtt atgtgcatag ttgagccaa tggggaccca gactgatgac caagcttttc 1472520
 ttgtgctagc ctgcatgaga aggagccctt cactctgtct agtctgaaga ttcttaccag 1472580
 ctgagagtta ggaattcaag cacaactaat tagtgagaga gccagtgcct ataactgagg 1472640
 tgcctctat ctcccttgt ctgatctttt gaaacagga ctcatatagt ccaggtgat 1472700

 ctgaaacca tacgtagca agaatgacct taaacttctg cttttacttc caagtgggat 1472760
 ttcagccctg taccaccagg ccaggcacac agattaattc tatttctacc tatttaccac 1472820
 tataatagtc tccaatattc cttctaaaaa agaggcataa cattcacaag caagcctgtc 1472880
 ttgttttagt aactagtaat attagtaca agtgacatg agataattga aaaaggaaat 1472940
 tctatttcat caagagatat ttttcaaca aacaatactt ttggtcttta atagtcatc 1473000
 agcaaaatc atatatattc attttttgt tgatttgata ggtgtcttga taatgtaaac 1473060
 cagagtaaaa ttataaata ttcagagtgt caggaaaatt taatttctgg gtatattcat 1473120

 ggcagagaca tatatgaaaa tgattcaaaa tactgttaac caaagctgta ttatattgt 1473180
 gtaaactttt actggagaag aggcattgaa agaaaaattc aaggagaaag aagaacaaaa 1473240
 ttttccaata accaagaaga acttgttctt gtatttcgga aacagatcat gggctctctc 1473300
 agactgctgt aggtttaaact taccagcaac atttaaaga gcaagctgac atttttattt 1473360
 ttaaactca atatttgcaa cacttaggc aagcagttct caagccagct tcaactggga 1473420
 ttttccagga gtgcacatta tcaggcccca gccagacct gccaatccag aaaccaagaa 1473480
 caggtgacag tctgtgcttc accaaggtcc cccaggtgat cctcctgcaa getteacaca 1473540

 ggattaccgt gtgaagaatga cctcctctgc agccccctta atttattatg caggttggtg 1473600
 gggttgttta aaaatatgtg agcaagtcta cgtcttacc gaagctcaag cagaaatatt 1473660
 caaacactgt agccttctgc acttcacagt gagaagcctg tcatgaagcc aaaccaacg 1473720
 acaaccttc cgaagtgac taaagccagc aggtttgttc gtggcatttg tttcaggtac 1473780
 agatgcatc taactcagga ttgaggtatg aaaacagagt gggaaaatgt aactgacctg 1473840
 aaagaaatag caatattttg aatgattact tgggaccctc ccttgggcta tcagactatt 1473900

ttaaaaagca ttccaagaaa tcaggacttt cccaggagtc tcatgatgaa gaaagaaaa 1473960

 taaaaggatg tcttgggtct agacagaggg agaacttgtc ttccaagag gtttcacacc 1474020
 tctgtatate tectgctttg actaaagcct aaaccttctg tcaggccccc aaagatagac 1474080
 atgggagtca ccagacattc ctgttctttt ttacaaatgg ccacattgag taaattcatc 1474140
 tctacatfff tccatcgtgt ctctagttag cctaagtgaga ataggctctg accctaacia 1474200
 ctccagaagt ctgcagctca ttacagctta tactagatag agttccttcc ttctgaggag 1474260
 ggaggatggg gacaggcatt aaggagatg ctggatggca tttgaacgtc catcactgta 1474320
 ggcagtggag caagaacaag gccagaggt ggaggagtga gtgtgaatga aggaatggtt 1474380

 gggccaggct ggacatgat gcagaagacg gtagctagaa ctaaatfaga atgagaagat 1474440
 gttttccttg gctgtgtca gaggfggga tagctggaag tgcagtgagt ctaagaaacc 1474500
 tcagcagatg ccaggggaga cccctggagc ccatctgtgt cctcagaaag gtggctactc 1474560
 actttataat ccgaagaggt cctctctggg catcactgag aagtggagtc tgataaccct 1474620
 agagagcaac gttctgagg tagccatagt ccatctgttg ctttgggttc cagccctggg 1474680
 ccacgttcaa attcttactg ttttgaagt ggaaccgta cccattgcga cagtgaggtta 1474740
 gttggagtgg ctcaggctga aggaaccac aaattcctgg agaagaatf tttttctgt 1474800

 ttggtcaagg gcaatccagg gagaaaagc attacatcat cgaagctgtc tctcattggc 1474860
 tggccattta ctttgaatt gcttagttct gagagttcta tgcattgtgg aagcgtgttc 1474920
 tgcagcttca gtctctggat tcaaagcctc caatgtcatt aggttacagc catcgagtaa 1474980
 gataacacia tgaggggtt tttagatgac ggaagcatg gaccctccgg tggaccgctc 1475040
 ggaacactgt gtcgagtcac tttggactct gcatcactac atgaattcat aatgcaatat 1475100
 tctgtagaga caggataat ggaactgtga caccctctct tctacttggg tccccatgaa 1475160
 atgggatgca aataaattga tttttttta aatcacatag tttcaatgca tagctcctga 1475220

 aggattcctg tctttgtgag tctcagggtc catttccact ctcatgtca gtcttatttc 1475280
 ttgaaggtta ataaccggaac tgatttctct taaaaagaa aaagtcacac aattatgttg 1475340
 aggaaatgga ggaattgtc atagttgctt ttcttcagac tcgaatttga tgttcttttt 1475400
 tggatgagaa gaattaaat gaatacctac ctcatctctc tctctctctc tctctctctc 1475460
 tctctctctc ttgcatttaa atagcagcat aattctaaag tgaagtttta caaaatccat 1475520
 caagtagttc caaccattg atgagagaga gagagaaaa agaacaaatc ttccaaggga 1475580
 ttttatttga aaatagccat taggcattga ctgtaataaa aaatttfaat ggccatttta 1475640

tatttcagtt cctagttcat ttttagtgaa attacttggg gacaaatgga agctgagtga 1475700
tccactggga ggcagagctt gcgggtttct gaaataatag agtggcctct ggtgacagaa 1475760
tcctccccgg gaccagcacg tgctggaagg atcctaccgc agtctccctc tgggtctctt 1475820
cttgctggtg ataggagcat taccagcct gctctggggc ttggccttct agatgtggtg 1475880
gaggaaacce tagtctgcc tccagtttcc tgactgtaag atccccgaa agctgaggct 1475940
tccaggatct tagcccagga ccgtggccac cccaatcaca gaatggaggc gaaagcttga 1476000
tgcaaattgc atgaggcttt attgtagttt aacgagctaa ccccatgtta gctcgggtct 1476060

ttgatccacc ctcaatgtcg gatggctagc aaagacagtt cgaagctgct gcgtacagat 1476120
ctttataggg cagcgttaagg ggagtgtctc ggggtatgca caggttcagg attggtgtgc 1476180
ctccaggctt ggagggtttg ccctgtgttg attggtcaac tggttgttat ggcccatagg 1476240
ccctcccagg gtggttgcta tgctctgtgt gtcattgtctg tgcacttgtc cgtaaagcac 1476300
accagagcc ataaagcata gcaccaccag ctaacttctg attgattcct tgccatcagg 1476360
caggcatctg acctctaagt gaccaaggca aggttatgcc aagcacgtgt tatggctgtt 1476420
atggctgccg aaatggggag ctggcccctt cactgacaac acccagattt cgaatctccg 1476480

gagaccaggg acacagggct gcagggcaga gagagccctt gttgacctgc tctcctcatg 1476540
gagtcaacac cacgtgactt ttgtgtttct agggcaagga tgccaagtcc cttatggcct 1476600
cttagcatct tagttcgcaa agagetgatg atacaggggg catttttctc ctatgataaa 1476660
tttctaaaag gcaaacagg ttgcaatggt gtccaatgga acccttcggt gaaactgttt 1476720
tgtgaggggg tttgttttt gcatcaagag attggggttg atattgtcaa gagctaatgt 1476780
gagggttggg gagatgattc agtggttaag agcacttgtt gctcttccag ggaactgggc 1476840
ttccagaacc cctggggcag cttataacct gtaagtccag gcttagggga tatgttcccc 1476900

tcttctgacc tctgaggaca ccaggtacac acatggtaca cacacacaca cacacacaca 1476960
cacacacaca cacacacaca cacaaaaggg aaacagtcaa atgcaaaaag taaaatgaat 1477020
aatTTTTTTT taaagagcta acatggtgat gtgattaaaa ccccaggcct ttcatttaag 1477080
ctgggttggg ctctctgctt taatatctgc taatatttgc tctcattggt aaaactttct 1477140
agacttcagt ttagtttctt gtaacctgcc ataataaatt cactcctagg cctggtgtat 1477200
agatgaaatg atagtgtaca tacataccgt ccatgtagta aatattcaca tgaattaact 1477260
ttctttcttt ctttctttct ttctttcttt tttttttttt ttgtttttgg agacagggtt 1477320

tctctgtatt gtttttgagc ctatcctgac actcactctg gagaccaggc tggcctcgaa 1477380
ctcactcgaa tccccctgcc tgctgggatt aaaggcatga gccaccaacg cctggtgaat 1477440
taactttctt gtttttttta ggaataacce tattgtgaat gtgacctac attgaaagc 1477500

tctgaattgc tgaatctttt cttctctgct gtctaaccg gtagaacaga cctgaggggt 1477560
 ttgggtgagg aacaaaacac ttgtgggtt ttactgaaga catctcttc tttatttaa 1477620
 attttcaggc tggataaag cagtgatgtg cccgccctgg tgatcaagtc tcaggtttct 1477680
 ctcatgtcgg aggatatgga tgcctgactg aaaatgtgct ctgaggggtt ctaactgctg 1477740

 ctccatttc cataaaatct ctgtctgttg ctggaattgg aagcaatctt cctgagaaga 1477800
 acagaacaga acatttccaa tccccaaaaa aaaaaaaaaa aaaaaaaaaa aaaattttcc 1477860
 aacccaaaaa aaaaaaaaaa aaaaaaaaaa actttctaaa gaaatgtttt tgctggagac 1477920
 aaggatgaac ctgggctgtt tctggaatga ggccattccc actcgggttag cacgattcat 1477980
 gcctgaggag gaagagggtt ttgtgtgtga actgaaagag tttaggacac agtgtgtgac 1478040
 atttaaggct ccagaaagct cgtgtgtgtg gcctccaag tgagtgaac caggagggtt 1478100
 tctttcaaa gggagactgt ttctccctgt tgtggagttt cagagccaga tccaagatg 1478160

 gcgatgtga gaggaactcc atgagcatcc caggtggagc tgtggctctg aggagcaga 1478220
 gaagcgtgc gcaactgacag gttcctttaa gacagggtt agctggcgtc ttactagga 1478280
 cactagtaa gggagggaag ggagggaat aaaaaaact ttaaaatgtt atgctggttt 1478340
 gaataggct agcccccta aactttaga tttaaatgct tggccaccag ggactgttac 1478400
 taticgaag catggccttg ttagagtagg tgtggacttg ttggaggaag tgtgtcactg 1478460
 ggggtgggtt ttgaggtttc agaagctcaa gccacgcta gtgtcactct ctctctgctg 1478520
 cctctcagct ccctctccag caccaagtct gcctgcatgc aggtatggtt cccacatga 1478580

 tgataatgga ctaaaccact gaactataag ccagttccaa tgaaatgttt tcctttttga 1478640
 agagttgctg tggatcaggt gtctcttcat agcaatagaa aactaagtc aaatgcattt 1478700
 taatatagaa aaccaccaca cagtattaaa tctatactca ccatttttcc ttctgtaaag 1478760
 ccatgcttct tttttaatat ttaaaaaatt tatttcetaa gaatttctg caaacatata 1478820
 atgcccttcc aaccctctca taccceata tcttgcccc acatctcact ccttttcttc 1478880
 tttaaaaaca aatagttttc taaatccaat cagtgtgca tatatgtgca cctgggcgag 1478940
 gttcacccct ggagcataca aggccaaatt acttgaggcc actccccaa agaaggggat 1479000

 gatttacaga taaggtccc ttctatagct ctggatgact tggaacctc catgtagccc 1479060
 aagcaagct tggagtggca caccatgtcc ccaatgacce tgggaggaga attttgatgt 1479120
 caagatgatg gagactgga attatgcaga ttggcttta aaaactttgt tgttgctgtt 1479180
 tatattaage ttacttattt atgtgtgttt gtgtgagggg gacacaggct tgccatggca 1479240
 cccatgggtg ttttaccctt ccagcatgtg ggacctgggg gtttggact caggtcgtca 1479300
 ggcttgggtg caglacctt atcctctgag acatcttccc agccctggat tcagatttta 1479360

atactgatga aatgcattta tggtcacagg ctagagaagc ctgagatttc tgactataga 1479420

 gacacagaaa cagtcctcga aaaatgtatt ctttagaaca tctcactcaa ttctctaatt 1479480
 tagcgtccat tatcattggc ttttaateca tagaaactac tgaagatttt tetggaagcc 1479540
 tagtgagcag gaaatccaat caatcaccac cttacactgc tcttcaccac gaggtaactg 1479600
 aaagacttaa aaattagcaa agaaatatag cccagataag gaaactctcc aaacagaatg 1479660
 tagggcggcc taaccagaa actaaggcca ctactatgac ttagtgccctg gaatttacca 1479720
 gctgccagca attactcctt tacaaggcca taagataact gggtaccaag aattcccaga 1479780
 tggccaccct ccctgagggg ctcatgaagg aaacagattg tcccactgc caatgtgtca 1479840

 ataattaaca gttiaagggtc cctatgaaac aaagagatag ctaccatttg ctcaggcaag 1479900
 attagttagc acatcctgag gtctgcaggt tttacaactg gtgggtcagg aggccatctg 1479960
 attcccagcc ctcccctcaa gacaaagggc ctctaggaa cctaagactc tgttcatgta 1480020
 ctcaagggac agagagtcca ggcccctccc taagcttgtg gttttgcct gggggatggg 1480080
 gctgctctgt agcctgcatg ctgagagggc cgtttgtaca aacgtccacc tttcattaaa 1480140
 gcctcttgtt gtttgcgtca agtttctgcc tccgcatggt gactggggtg gccacggtec 1480200
 tgggaaaaga tcctggaggc ctgagcttcc aagggtctta cagtaacaag cagctaagtc 1480260

 tgtgtgctga gccacaatct actgattgtc tggcattgtg caatggactg tcaaccaaga 1480320
 tggcagaatt taggcagaat ttttacttig tcaaaactat tgtcttggtt cctgaggaga 1480380
 ctatcctcca gcaatagttt acagtctttt aaaacagttt acctgagtgg ttttctcac 1480440
 tcagccactg gtgtccatgt ccttcaggac gataaaacat tgacctata gttggccatg 1480500
 gtggttccca ccigcaatct gagcatttgg gaaggaaagt ttgaggtcag cctgagctct 1480560
 acagtgagat atctctcaaa acaaaaacag gtaaacaaat gagagtttac ctcaggaatt 1480620
 taaaataagg gaaatgctag gattccagac ctgagggagg atagcccagg gettagtctc 1480680

 aagggtttct ctgaatgagt cttggaagct ataggacct tgggctgagc tgagtgggga 1480740
 agcatgtgag gctgatcata aggggcaact ctcagagccc agagtctgag gagcagcagc 1480800
 caggagaggg gaatcaggaa ctcagaggtc ctggatgcca agggaagaca ctgcattaca 1480860
 aagggaagga tagctcctgt ttgcaggctc tctagctttt ccgggagaca ttgaaaataa 1480920
 ctctgcagct gcctaaaata agagtcctc ctatttataat gtctcctctt tcatgacatg 1480980
 gaagaatggg tgatatctgc tggaaatcac tgtaatatcc ctcggttaca ataaactatt 1481040
 tgaagatccc tgggggagga agagccttgt ctgctggaag acagggcact caataactgg 1481100

ggataaaagg acataaaaag agcattttat taaaaacacc tttcttctct ctttccgttc 1481160
 tcaacttcca tttccttttc cttctttctt ttctctcttc cttccctccc ctctccctcc 1481220
 cttctccctc ctcttcttta tattttgaga tgggggcttt gctaaattgt ccagatcagc 1481280
 cttaaactaa ctatacccaa gcagtccttg aaatgataat gctcctccct ccattcccag 1481340
 ggagctgggg ttatagatct gtgtcactgg ctgctgtaac aggtttgttt ttggttttgt 1481400
 ttttacgtgc caggcaactgt tctgaggact ctataacaac gagtctttta attctcacag 1481460
 aaacttaaaa acattttttg tttgttttta cattttaaag tatttagtta ctttgtgggt 1481520

 ggggtgggct gctccatcat gtgtgggggg tcagaagaaa gaattgaaga tgcttcactc 1481580
 tttctacat gtgggctctg gggatcgaac tcaggacgct ggggtttaag tgtcttgacc 1481640
 tgatgagtca tcctggggct tatctcactt gaacttttga gcataggtat tgtgtttaca 1481700
 atttccaat taaggaatac caggcacaaa gcaagtgact ttctcaagga cacagaagaa 1481760
 caaatggcag ttttactctg gctcaggtag tcggccttta cctcagtcct tgccccattc 1481820
 caacgtcatc tccccaccc ccaacccatt tctctctagg aaaaaaata aataaaaaaa 1481880
 caaaaaatgg agcaaaactaa acaacagggc tggggctgta gttcagtgca gagcatgtac 1481940

 ctagtattcc tgaggccccc gatgagttcc cagaacaaat tcgatgcaa atactggaga 1482000
 attatttcac aaattgtttc atcttccaga aagccaggct attgtaaaaa cctgactggg 1482060
 accattgggtg atgtggaat ttgtagacat tcggtgaaac ctagtgaacc tgacaaactc 1482120
 agaagatggc tgtttgatt ataaaaggat tctttggctt cagggatggc tcagctgtta 1482180
 agagcacata ctgctctccc acagaacctg agttctgttc ccagcacca ctttgggcag 1482240
 ctcaaaactg cctgtaactc cagctccagg ggacctggtg ccttttctg gtaaacatgg 1482300
 aactgaact cacatgcaca tagctacaca cacacacaca cacacacaca cacacagaca 1482360

 aacacacaca cataactaaa aattaaat gagctctgtt aaaaaaaaag aggcggggac 1482420
 tctttgagac tggatgaggt gtttacttct ctgcatgag gccctgggtt tgatccccac 1482480
 taatgcatac actgggcatg gtgatatgta cctataactc cagcactcat tggagattgg 1482540
 aggactaaaa gctcaaggct atccttgact acataacaaa attggggcca gectgtgcta 1482600
 tatgagatcc tgctcaaaa aaaaaaaaa aaaaaaaaa aaaaaaaaa agaagaagaa 1482660
 gaagatattt tgatttgaa aataatcaaa ttctgtaaa tagtagcttg tttatttgac 1482720
 aaaatgcttg ggggtgggtg gaaaactctc caactaaaat gttcacagat cagtttgtca 1482780

 ctttgaagac caaccagagg ctctctggca aattattcct aaaatgcatg taagcagtga 1482840
 gaaaagacat ttgtattcac gacacccttt caaatcattt tacagtgaca ttcggaaaaa 1482900
 tgtgtctctg gcatgaagcc tagcctgctc gtacacacgg ctgccacgtg aacagtctgg 1482960

catggcgact cacaaggcat tagaattgga agacagcatg gcggggcatg ggtggtttca 1483020
 ctggctcggg agatgaagca cgtcttttta ctgacaggca gctagaccac agttctcatt 1483080
 acaaacagca agcggctgtc ttctttatgc atgtgttttt ttaaagtaac cacttgcttt 1483140
 tctttcaaaa aatttattta tttaaagaaa cccattttta aacatttatt catttttttt 1483200

 tttttttttt ttttttcacc atgctgtgcc tatagatacc aggggatgat ttgaaggagt 1483260
 aggttctttc ctctgcaat gtggggctcg gggattgaac tcaggttgcc gggtttggca 1483320
 gtaggtgtcc ctgtctgctg agccatcttg caggctcaca atttactttt cgatcatgat 1483380
 taaggtttac tgtctttaga aagctctaca ggtctccagg gatggtcagc agtcacttgc 1483440
 aatgttagtt tccccaaact aaaaaccata gctgtttaca gagaaaagt gtagaacca 1483500
 gtacaagccc atattcagca ttccataaga acaattttta aattgaaaat agattcttct 1483560
 ctcatataat acacctgac tgcattttcc tctccctcca cttgtaacag tectcctcc 1483620

 cttttcttc agaaaagagc aggcctcaa gagacagcaa ccaagcaata taaaacaaaa 1483680
 taggagataa ggcaaaagcg ctcttatcaa aaatggacaa ggcaacggaa caggaggaaa 1483740
 aagagtccta gaatcaggca aaagagtcag aggcatactg gctcccactg ttagagttec 1483800
 cacagaaata ccaagctaac agccataaca tatacacaga ggacttgatg tagaccatg 1483860
 caggcaccat gcctgctgtc tcagtctctc agcccatgtg agccctgctt agttgattca 1483920
 gtgggctatg tectctggt gtctctatg ccctgactc ccacaatctt tcagectccc 1483980
 tcttctcag gatttcctga ggtctctgag ggggtgggacc tgaaggagcc ctctattta 1484040

 gactctctgc agagtgtcat gctgtgggtc tctgtgtctg ctctcateta ctgcctatcg 1484100
 caggaagctc tcgatgacc acaaggcacc aatcatattc gtctttctag gtctgagtta 1484160
 cctcactcag gatgagattt ttttttctag ttgcatccat ttgcctgcaa atttcatgat 1484220
 gtcatttttt tttaacagct gagtaatact ccattgtgta aatggaccac attttcttta 1484280
 tccattcttc gattgcagga catctaagtt gtttctagtt tctggttatt ataaataaag 1484340
 ctgcaataaa catagctgag caagtgtctt tgtggcatga tagagtgtcc tttgggcata 1484400
 tgccagagag tggatatagct gggctctgag gtagatggat tccaatttt ctgaggaacc 1484460

 acccttttga tttccatggt ggctgtagaa gtctgcactc tggccagcaa tggaaactg 1484520
 ttgcccttgc tccacatggt tgccatcatg agctgtcatt tgtggctttg atcttagtca 1484580
 ttctgacaag tgiaagatga aatctcaaag tagttttgat ttgtatttcc ctgatagcta 1484640
 agaatgttgg ttcaacattt ctttaagggt ttcttagcca tttgagattc ctctgttgag 1484700
 agttctctgg ttagatcctt accccatttt aaaattggat tgtttggttt gttgatatct 1484760
 ggtttcttga gttctttata tattttggaa attagctctc tatcagatgt gtagctggtta 1484820

aaacatcttt cccattctgt aggcctgctga tttgtccaat tgatgggtgc ctttgcctta 1484880

 cagaaaattt caatttcatg aggtccatt tattagtgt tgatcttagt gcctccacta 1484940
 tctgtgttct gttctggaag ttgtcttggtg tgccaatgtg ttcaaggcta tttcccactt 1485000
 tctcttcaaa aggttaagtg atttatgttt attaatttga tccacttgga cttgagtttt 1485060
 gtgcaggttg ataatatgg atctattttt attctacttg cagacatcca gttcagccag 1485120
 cactatttgt tgaagatgct gtttttatcc attgtataat tttggcttcc ttgtcagaaa 1485180
 tccgggtgccc acagggtgga ggattttcaa tgattccatt gatcaacatg tctgttttgt 1485240
 gctaacacca ttcagttttt attgctgaag gctcttagta caattgaaa tacaacagtt 1485300

 cttgtagatt gttcaggatt gttttagctt tacagggttt tttgtttttg catatgaagt 1485360
 tgagaactgt ctttcaaga aaagaactgt gttggaattt tgatggagat tgcattgaat 1485420
 ctatagactg tttatagtag gatggccatt tttattatgt taatcccact gatctatgag 1485480
 cacgggaaat ctttccatct tctaatactt tcttcacttc ctttcttcaa agacttgatc 1485540
 cttttatcat acaagtcttt cacttgctag aatattttat attgtttgag gctgtttgta 1485600
 aaggatattg ttcctgatt tctttctcag tctgtcattt gtacttagga gggctactgg 1485660
 atatttttta gtttaatttta tatccagctt ctttgctgaa agtgtttacc atctgtagaa 1485720

 gttctctggt agaactttta aagtcactta tgtgtactat agtgcacatc tcaaatagta 1485780
 atactttgac tttttctttt ccaattatat cccttttacc tccttcaatt gctttattgc 1485840
 tctagttagt acttcaagta gtatattgaa gagaaatgga gagagagagt ggataacctt 1485900
 gttttgtttc tgatgttagt ggaatagatt tgagtttctg tccatttaac ttgatgttgg 1485960
 ctataggctt gttgtggatt gactttatta tgttttagta tgtcccctgt attccaatc 1486020
 tctctaggat tttatcatg aagaggcatt ggattttgtc aaggcttttt ctgcactaa 1486080
 taaaatgatg attttttttc agttgttgat atgggtgatt acattgacag attttcatat 1486140

 gttgaatcat cctgcatct ctgagatgga gcctaattga tcatggtgga tcatcttttt 1486200
 aaggatattt tgattcagtt tgcaaatatt ttattgagta cttttgcatc tatgttcata 1486260
 agggaatttt ctctgtaatt cttttcgttg aatctttatt tggtttgggc atcaggataa 1486320
 ctgtggcctt ataagttggg caatgctcct tctgtttata tttttagaa taatttgagg 1486380
 agcattgata ttaagttttc tttgaaagtc tcgaggaatt ctgggctaaa atggctggtc 1486440
 cctggcccc gtcttgtaa actttaaatg atgctttgat tgcactaagg gttacaggtt 1486500
 tatttaaatt gcttatcaga tcttgattta attttgtaa gtggtttcta tcaagaaaat 1486560

tattcgcttc ttttagattt tccaattttg tggagtatgg gttttcaaag tatgtcctta 1486620
 tgattctcta gatttccttg gtgtctgttg ttatgcttca ttgittctga ttttgtaat 1486680
 ttgggtatth tctgttcatc ttttagtttg gataagggtt tgtctatcct gttgattttt 1486740
 tcaaagaaac aactctcctt gtttcattga ttctttgtat tgttctcttt gtttctattt 1486800
 tattaatttc agttctcagt ttgattattt ctgaccttct actcctcttg agtgtgttta 1486860
 ctctcttttt gttctagaac tttctttcag gtgtgttggt aagtgtctag tatgagatat 1486920
 ctccatthtt tttttattht aggcagtttag tcttaagaac tttcccctta acaccaatth 1486980

tacaaatthg agtatatggt gtattcatct tcattgagtt ctagaaagtc tttatthtct 1487040
 ttctgtcttg acccattthc attcattaaa gagttgttca gtttccatga gtttgaagc 1487100
 tttttgtggt ttccattgct gttgatatct ggccttaatc catgggtggtc tgatagcatg 1487160
 cagagggtta tttaaattht ctgtatctg ttaagacttg ctttcatctc gaatatgtgg 1487220
 tcaatthtg agaaacttcc atgtggtgtt gaaaagaagt taatthtttg tgtgtthggg 1487280
 tgaaatgttc tgtaagtatt tgttaggtcc atthggttta taatgtctth tagctccagt 1487340
 atthctgtth agctthtgc tggataacct gtccattggt gatagtgggg tattgaagtc 1487400

ttctgtctac agtgtgtgac agtcaatatg tgatthaaagc tgtagtagtg tttcctthac 1487460
 aacaatgtgc accctthtgt ttgggttata atgttaagaa ctgaaatgtc atthttgttg 1487520
 ttgtttgtt gtthttgaga cagggtthtct ctgtthtagct gtgggtgtcc tggaaactctc 1487580
 ttagagcac actagcctca aactcacaga gatctgctg actcagcttc cagaactctg 1487640
 ggattaaagg tgtgtgccac caccactgg cttaaaatgg catcttgaat tttcctthc 1487700
 atgagtagt agtgtthtct ccatctctth tgattagtht ggtthgaagt cthttgttaa 1487760
 tattaataa gctacaccag tttgtctcct aggtccatth atthggaata tctthtccaa 1487820

ccctthacac taaggtgata tatactctac ctgtatgttg aggtgtgtth ctcatatgca 1487880
 gcagaaggat ggatcttht ctthgaatcca ttctattagt ttgtatctth ttattgggaa 1487940
 attgtgtcca ctgatthga gagatgtcaa tgacaaatga tagthgattc ctgtthtgg 1488000
 tgtthgtgt gatgtgtgtg tgtgtgtgtg tgtgtgtgtg tgtgtgtgtg tgtthtccc 1488060
 ttctthtgg ttgctgatg tgagattat tctgtgggt taatgggtgc acttagcttc 1488120
 cagggtthg aatthtctt ctatgatgtt ttgtagggt ggacttatga ttagatthg 1488180
 tttaaatthg actthtcat ggaatatctt gttthtcatg aaatatctg tthttthtcc 1488240

atctatcagg atthgaaatth tttctgggta ctctagtctg ggctggcatc tgtggtctgt 1488300
 tagagtctgc aagacatctg tccaggacct tctggcttht agagtcttca ttgagaatth 1488360
 ggtgtgaatt ctaatagatc tgcctcata tgttactthg catthttccc ttgtagctth 1488420

aacattcttt ctttgatctg tatgtttagt gttttgatta gtatgtggtg gggactttct 1488480
tttctgggtg tctatattct ttttgattc tgtatgcttc tttttgttt acttgttttt 1488540
tgtttgtttg tttgagacac ggtttctctg tgtagccctg gttctcctgg aactcactct 1488600
gtagatcaag atgtcctaga actcacaaag atccacctgc ctctgcctcc caagtgctgg 1488660

aactaaaggT gtgcactacc actaccagc ctgttctgta agcgtcttgt aatTTTgtaa 1488720
gcatctcctt ctttaggtta ggaaaaattt ctctatgat tttgtgaaa tattttctgg 1488780
accttaggc tgggattctt cttattctc tgtttccatt attcttaggt ttggctttt 1488840
cgtaaggTcc cagatttctt ggatgttttg tgcaggagt tttttgacca atatatccat 1488900
ttattctatt gactcttcaa tgcctgagac tctctctcc gtctcttga ttctgttgat 1488960
aaagcttGtc tctgtagTtc ctgttcaaT tcctatttcc atttccaggt cttgagcagT 1489020
tttattggct tcttttctt aagggattta ttcatTTct ccaatTTTT gtatgtattt 1489080

tctggatttc tttatgggat ttattcattt cctctttaag gacctctatc attttcatat 1489140
agttggTTTT aaggTTTTt tttctgtgc ctCagctatg ttggaatac caggGcctgc 1489200
tatggtagga tagctgggct ctggTggaga catgtTgtcc tggatgttat tgattgtgct 1489260
tttatgctgg catctggatt tggagTgatt ataggTctag gtgctgattt ctggacaaaa 1489320
ctcatttctt ccataattta aaatactata cagcaatcaa gcactTgtc cattttaagg 1489380
aacatttaga tttagaacaa gagtcaatca actactgtca ccagaggGca ccaatgttca 1489440
agttgctagg acaactgcaa actatagggt cacagcatca gggaccagaa gggTgtcatc 1489500

tgggTctgt gcactggTct catttaattc tGtcagaaga ctgagTtctt tcttcagGga 1489560
aggTctttcc tGcatgcttt cacggctctg tctagaattt aacaactctg ctgccacaca 1489620
ttatcaaagt agaccatagg ttcttcacc tccatgcat gcattgagcc ctttctgtgt 1489680
aactagtaaa acagcagtag gcaacacagg cagagTcctt gTctcagga gettgtactt 1489740
caagggatag aatgattttt aacaaccac ccagccaaT acaagacaga ttccagaaag 1489800
ggcagagtaa acgtggTggg aatatctgat tggaaTgagg tcatggaaT ataggatttC 1489860
ctggggacat ctgtaacaaa ttgtgtagct aaagacaacc aaaagtgact gttctctctc 1489920

acaggttctc atgtagccca ggctggcttc tcttctgtta catagccag gatggcttgt 1489980
cttctgtgtt aactgagaat gacctgcac tctgatccca cagagtGcta gggttcacaa 1490040
atgtgcaggT taigcagTtt atgcatttct ggggatcaag cccaggGctg tGttcatgct 1490100
aggcaagtac tctaccaaca gagctatgtc ctCagctctg tattccatgt ttatttaatg 1490160
tatgtgtgtg gtgggggagg tgacactttg tcacagTgcc catgttaagg taggagagca 1490220
gcttaaagga aaaagtTctc tcttttata ctatgggttc tgggtcgtta ggTTTgatgg 1490280

caggtaacctt acccaactgag tcatecttcc agcaaccccc acccccttct ttttggtttt 1490340

 ggttttctga aacagggttt tttttgtgtg tagccctggc tgttctggaa ctcaactctgt 1490400
 agaccagact ggcctcaaac tcacagagat ccacctgcct ctgcctctgg agttctggga 1490460
 ttaaagggtg gtgccactac caccagggt catcttctta ttttaacta aaataaataa 1490520
 agaaataaat atatTTTTTg agagtgagtc tcactatata gctcaggctg gtctagaact 1490580
 cacactccca ctgcttccac tcaggaatac tggggtecca ggcatgtacc atcatgcca 1490640
 gatcttttaa aggtctgtga aggacagtgt ctgcaatgaa acatccttag acccctccca 1490700
 gagagctttt ccacttgtgg tgggcccacc cactccctct ctgtgctgcc ttttttgtc 1490760

 ttctggtgcc catggtacc tgatactgcc tgatggcact tagaactcat cagctgagct 1490820
 ggtccctcc tccaaactgt tctgctgaag ccacaattct cagtatagct ggatttcaat 1490880
 ggggtagggg aatctgtgga cacaacaaag cttaaagtag gteccaaggg tcaggctcta 1490940
 atgctgtaag atigtgtcct caggaagaaa gaccaactcc actcccgcc ctcctgcac 1491000
 agagggtcat atgaggacac ggaggaaaaa caactgtctc taagccagga aaagtctca 1491060
 cctgaactca accttgatgc tggattcag atttcagaaa tgtgaggaaa aaaatagtct 1491120
 gctctttaag acacacagtt atttgcaca acagccttgt agaacttaca gtgtagatgg 1491180

 agattgcccc cctgccttcc tgtataagct gctcctcttc aagtagccac agtaggatat 1491240
 tcatgggttc agagttagga cacagaacag cacctgaggt ggggagaagc aacactggtg 1491300
 aattcactac agaaagggtg ggaggacgtg acaaaaaaag ctgagcccaa gtaagggcta 1491360
 gaggcaaga gagcagggtg tagtgtgtgt ttgtggggac ctttccaaga gttgaaggaa 1491420
 ggcccagcgt aagtggaggg gtaagtgcaa aggctaaggg agtaagtaca ctacaggaag 1491480
 agtaagactg ggctggtgca gagggtgaa gggacaggtc agtggagtcc tgtgagccct 1491540
 gtgggcatg agctgtgagc cctgtgggca tgggcagggt ctgcatcttc tettcaggea 1491600

 gtgtcaagtc ttaggatgag ttggagtga gccaagaac tatacagagc tcaggggacc 1491660
 agggctacat cttggatcca gaatatactt ccaagggtcc tgttctacag gtttctctc 1491720
 tagacttcgg tgagaaatgg tgaagccttt aagaggcggg gcctaatagga caggtcattg 1491780
 cgggagggcg gtcctttga agggagctag ttggactcta cccctatcac ctcatgctc 1491840
 caccagaacg tctgctgca gteccaaatg tagaggctg agccagaata agtctttctt 1491900
 ccttagatgt tgttatcttg tcccaaatga ggtgtctata tcaactgaca cacccccata 1491960
 gggactcagg gaacatctca gaagaggaag tgtaaagaat gtaggagaat ggggagaaga 1492020

gctgggaaat gcctgtttct ggacatggcg tggctgttgt actcatggac ttgcggaagc 1492080
tgggggtacc tgcacagaac tgtacaaaat cagccaaaat tctggcatag atgggtaga 1492140
tgatctttgg gacatgccac ttactgagga gctcctggca actggctgtt tccaagggaa 1492200
ggacagtctg catttttcac tctgtaccac ttgtaggatc ccatgtccca ggggatggtt 1492260
ctattcccat gcacatacgg gctgcactaa ctggactggc ttaatggtaa ttaaaaaaa 1492320
aagatgaagt tgggaggggg acatgtttag gggatatagg agcaattgca gagggaaacg 1492380
aagcacagtt atggccatat ttcatgtgtg acttgtatgc agttatgaag aacaaagaat 1492440

tttttataaa aagtgggtta tcttgggtat ttgccacaa caatgatgag cttactaaga 1492500
acaagtagg gatattttag aattgactca ggaagggttg gtggcccgga attttcagag 1492560
gtgcaggaaa gaggacaggc acccagaggg aaagggtctc cttggaaatg tgtgtctaaa 1492620
gtggagttaa gagaattggc catttatcag atctgagagg gacgagaaag gaaggcctca 1492680
gcctagttta aggtttgtgc tgaacggggt ggtgaaagca cagctggcac aaggaggcag 1492740
ccctgaagct gagatgggag ccttaggaag ggttagccga ggactctgag gatgctggct 1492800
ggagggctga actgggaggg actaatgatg agtcagctg gggcaggatg actgggtctg 1492860

agcatgatga ctttgcagga gcagctccag gggagggtgc tgggtgcagg cagctgtctg 1492920
aagccagcag gaagcagcag ttaggaaaaa gagtgatggg gtggccagat ttggagtgg 1492980
aagtgaagaa gttcaggtcg aaagagagcg ggctgaagga agagaccagg acagagctcc 1493040
agaaaaatgc aagatgaaga aggagaaaga gaaggtaggt gcagacacac acacacacac 1493100
acacacacac acacacacac acacacacac acacagagag agagagagag agagagagag 1493160
agacagacag acagacagag agacagacag atagagggac aaactattaa caccaagatg 1493220
gagcatgcat tatagaaaaa ggatggggaa ttgtttgtag caggaaatgt tgcctgtagg 1493280

taagacacac tgcctacag aactecacc agtggctcta gtgacagcca ttttgtcatc 1493340
ctggcttga atgagggatc cgggagctgg ggagacaaga taactctca ggagaggaag 1493400
gaaggtgttg ggaatagagg agactgggga gtgagtgagt gagtgagtga gtattgagtg 1493460
tgcgtgtgtg tgtgtgtgtg tgtgtgtgtg tgtgtgtgtg tgtgcatgca cactgcaca 1493520
cataggccaa aagttgatgt catgtgcat actctattgt tcctcacctt agttcttgag 1493580
atagctgcgc tcacctctg cttatccaga gttcactact ttggctaggc aggctggcca 1493640
gcaaccccca gatctttgcc tccagctccc cagtgtctggg gttatagaag tgcctggctc 1493700

tgcttagctt tcacgtgggg gctgggatcg aactcaaac cttatgtttg tgtggcagge 1493760
actttctga ctgagccatc tccctgctt ctggtttgac ttacaaggca gtctgttate 1493820
gactcctctc attactgtgg caaaatatgt gacagaagac atgatttaag ggaagaactt 1493880

ggattatggt ttcttagact tcagtcact gcttttactt tcgttcgta tggtaatggg 1493940
 agcatatgga ggagtgtgtt cacttaacga tggacaggaa gtagacatga aagaaggac 1494000
 cagggaccaa ttccaacctt cacaggcaca ccccagtgat ctgtttactc cagctaagcc 1494060
 ctgtctcctg aaaggtcctc cacctcccca aatggcatca ctagtcatgg catcacctga 1494120

 ccctatgggg gacttttctt atccaagctg taacgaagga aaccaaggag tgaaaatgcg 1494180
 acgtgcttaa tgctgatggg gagagtcttt aggaaagaga cgaaaggga gcggtgggc 1494240
 atgcagcttt ggigaaggat ctgactggca tcctcttcta ggtgcttctc ttttctctg 1494300
 ggtgaagtgg attgggggtga tctgctggag gagagacctg cagtgtaggt agaggcacag 1494360
 gtcaggagag aaccaactcc agagaccagg gaaggctgag cagtcaaaga tgacgtctga 1494420
 gaagtaccg gatgtgagct gatcagaagg taggaagctc caggcctgtg gtttcagaga 1494480
 ggtgaccatc tggatgaca gggtaagggt tgtgtcctg agttcaggct tccgaaagag 1494540

 agagaaaaac agagaagtga ggtgacactg ggtgggatac caaggtcatt gaagattcag 1494600
 ataggacttg gaaactagca ttcaaatgga gaactaaaac ctttgaggaa tcagtaactc 1494660
 acacagactg gggttttgac gtaagtagca agagtctgt gatgggagat gtccttctgt 1494720
 gttctgtgaa tatatgttc tcttattggt tgatgaataa aaatgtttcg gccaatggat 1494780
 aggcaggatt tagcctggca ggaagtatag gtggggctac cagactaaga gaatgccggg 1494840
 aagaggaagg gagcaagtga gttgcctgag agatgccatg tagctactgg gaaggtagga 1494900
 cgctgggca ttctctggta agataaggcc atgtggaat acatagatta atagttatgg 1494960

 gttataaatt aagagagagc tatccagtaa gaatcctaag ccatcagcca aacagtttgt 1495020
 aattaatata agcctcagtg tatttattta ggactaaacg gctgagggac tggttgggac 1495080
 agaaacttcc atctatagac ctggaaccaa ggcatcagac tgaatagag aacgatttcc 1495140
 ctctggttga tgaagatttg cacagccttt gcaagggtct gtttcttca gactatgacg 1495200
 aaatgtactt agtcagatgt gctagagtaa ggcatcacc aaatactacc acatgatcca 1495260
 accaattgtg tagtcaatga atgcaacttg cccaaggaaa gtcagccca caagcaact 1495320
 aagtcaagaa tgcactcca aagtggcacg gtttcccttt aaaataatta atgtttagtt 1495380

 ttgattttat atacttctac ctgactaac tcaaaccac atgttagctc tggataaatt 1495440
 taacatttt ttcaggtatt ttatttcttt gtgcatatth atatgggcag gtgctcatgt 1495500
 gtgtggatat atatggagc cagaaatcaa ccttgggtgc tgttcttctg tgccatcta 1495560
 catgtttatt tttctctata aaaagtgatt tttttatcac acacacacac acacacacac 1495620
 acacacacac acacacacac acttctactg caacttttgg gactcaatcc tttaactata 1495680
 tggatccctg ggatggaact aggggtgtca ggcttgatag caagtgtctt cacctgctga 1495740

gccatctcac tgggccacat cttgtttatt ttgagatag ggtctctcac tggcctggag 1495800

 ttgaccaagt ggtctagtct ggtggtcagt gagccccagg gacacacctg tgttcacatc 1495860
 attagtgtg ggattacaag tacatgccac actccccggc ttctttactt gtgttctggc 1495920
 agtcatactt agaagcccac gttggtaatg caagcacttt accgactgag cacccggatg 1495980
 ggttttaaca ttataaatg gtctgtagga cccattacaa gacttccttt cctgggtgtg 1496040
 taatctagag ttggtggaat ctctgcctca aatggtacac cttaaatcc atttctgtct 1496100
 tagtagaatt taaccataat agattttaat atctttattg aagactgata ctaatctcac 1496160
 atactctgat ttcaaatca aagtaggctt cctcttgta tctctttcag agggactatt 1496220

 tctctattcc ttaccactt ggaaatgtaa acccaaagat cttcttatta aaaagcaaca 1496280
 gacttagctg gatggagggt gcacatacct ttaattctag cactcaggaa gcagaggtag 1496340
 gcagatctct gtgagtttga gcccagcctg ggtgagcagag caagtccag atcagccagg 1496400
 gctacacaga gaaatcctgt caaaaaacaa aacaaacaaa caaaaaaac caaaataaaa 1496460
 acacagactt aatagaaccg tgtatttatt atgagtgtct acagatgggt cggattttga 1496520
 atactggaga tgetattcta gaaaaactgt cactgggaca agcaattatt attagtctca 1496580
 acagataaaa cccttcttgg gatctcctct gatctcctaa atgaatttct gtttacaagt 1496640

 gcttcgttgg tagcaagata tagacttcag agtcattcca gaccattaga tgagaattca 1496700
 ttattccagg ctctggggta acatttgata catatcaaat ttaaatcat gaagtccca 1496760
 taaggtattt aaaaaatta atactgttct atgggctggg aagtagccca gagagtctgt 1496820
 gtacttgcat cacgaacata accaagtgag caaaacttaa attctaggtg gaccagtcta 1496880
 aatccagaat cttttcatca gttgtgataa gaatgcatgt tgcacacaca catacacacc 1496940
 acacatatgt gtgatgtgtg tgtatgtaa taaaaaattt tgggacaaaa gaagcaaaaa 1497000
 tggtagagaca tcattgtaaa gagatctgtt ttctcaattt tattatcaga tccccagaaa 1497060

 cccacgtaaa tgctgggtgg cctgtctgta cttctggccc tggaaagcag gaacagggga 1497120
 cctccaggac aaactgctac tgggattatt gctattatta ttattttgtt ttttcaagac 1497180
 agggtttctc tggcatgct tggctatcct ggaacttgct ctgtagacca ggctgacctg 1497240
 gaactcaca agatctgct gtctctgcct cataaatgca gggattaaaa gtgtgtgcca 1497300
 acaccacttg gcttactgag actgcagaat aaggaggaag aatgatcaag aatgattcca 1497360
 aacactaata tcgggtctcc atgcattagt acaatcacac ctglatgcac cctgtgccta 1497420
 cacacatgga aaagcatgca aacacaatac ttgtacaaca cacacacagg catagaccaa 1497480

aagaaaatga tgggaaaaga agaaaaaaaa gtctagcttg actgagacat cgtgttcacc 1497540
aactgctact tttttcccc aagacagggt ttctctgtgt agtcttggt gtcttgaac 1497600
tcactcagta gaccaggctg gccttgaact cacagagatc tgcctgcctc tgcctcctaa 1497660
atgctgggat taaacacatg tgctaccatt gtctagccaa ttgctagatg ccgcgaccgc 1497720
ctggaccagc aaggatgacg caacaccgga gctcttcttg caagcagttt attcaggacc 1497780
ttgaacagcg atctctctcc tgggcaagc ctctccaagc ccttaaatag gtatggacca 1497840
ccaacctgg attgctacgt aggcaccgtc cataggtcca acacatacgc aagcgcttac 1497900

gatcatctgg ccttagccat atgtggagt gtttttcgaa gagagcgtg gctttcagga 1497960
tcgcgagggg cgggaggcag cgccatcttt aaagcgcggc tccacgcagc tctctacagc 1498020
tagatattat tcagtgttc cattttttt gaaaattaac atggtgacac ctttaatctc 1498080
accatttggg aggcagaggc aggtggacct ctctgagttt gaggccaacc tggtagagacc 1498140
ttatcttaa acaaaaaataa ggtaaaaaa gaataggcac aggatttga ctcataacc 1498200
ctttatttc ctatttttc cacttagcca ttatcttgt ctgtcttcta gaagccacag 1498260
agattttaa ttcttctag agactgccag cacctgtagc accctattt ctgcatctag 1498320

ttacccttga actttcattt cttaaatgaa ataaacttat ttactacata agtaagcttc 1498380
cagcttccct tctgtccag tggcacctga ttacaaaaa gggggactat gttgtttca 1498440
cttagaagtt ctgatccac tgacctcaag gtggaggtgg aggccactct gagaaggaat 1498500
ggagaactgt aagcacttct ttttttgca ggcacaaaac tacacatgtg cattttggaa 1498560
caatgtcagg cctatttctg agtctgaag ctcttaagat gccagtaagg gatgtggaaa 1498620
tgcccatat ttttgttg ctaggttaa agtatacata aactggtata tatgattctt 1498680
accttattga agaagggtct gaaatggcac ctttctcca aacatgaaca atactatta 1498740

tatttatgtt gctgtaacaa aacaagttag tgaagacat agatttattt cttatagttc 1498800
ggagagctgt ttaggtcaag gtttaaggcca acatactagc tgattcagtg tgtgtgaag 1498860
gcttgtttgc tgtttacaca gtagcaccag aaggactctg tgctcacatg gtagatgaca 1498920
gaaggacaaa agctcatcta attcccctga gctttttcac acaggtgttg atttccctga 1498980
tgagagccgg gcccttcatg acttaacag ttattaaagg gccctgcat cttaatcctg 1499040
agtttaact ttggcctaca tccaacaat agggattttc tatatacaag atatttctc 1499100
atgtgagttt gcgtatttgt gtgtgtatat gtgtacacag gtatgtgtgc atccatgtgg 1499160

aggtcagagg ttgatgtcag ggaatattct ttgatcactg tctacctat gttttgagac 1499220
aggtctctc actggaactg aagtgaactg atgtctaga ctggctagt gtcaaacccc 1499280
aggggtcttc ctttcttcac ctctcgaca atgggattgc aaatgtgata ccatgcctgg 1499340

aattttaatt ggggtgctggg gatccaaact ctaagtgaac catttcctca gagccaacta 1499400
cattagatag tcatgttaat atcatgagat gttaaaaaaa aacctaagat tgtgtagata 1499460
taaaagcaat gtccattcta ggagcaagag acctgccttt tctggctaac ctgatggatc 1499520
taggtgaccc acagctatac aatttggcca tgctattggt aacatttggc atttttcttg 1499580

gggttgata aagtctccca gtgactacag ttcccttggg ggccatttga gtcacaggga 1499640
agaaaaataa tctccagaaa gcacagaatg aataatggca gcatggggaa gagatgctca 1499700
tggttatgac cactcacag attttgaaa tataggtcag atggagagga agtgaaactt 1499760
cctgttgaag tttcatttat agcatgtgtc tggaaatgc taaatgtaat ttcttgggtg 1499820
aaaataaact gcagaaatct gggttgtgtc cgtctgctgt atgtttatgg aagccattct 1499880
gtctgaagct gagatgctgt gaaatataat agtggcatga acagccacaa ttagtgaac 1499940
agatgtgacc ctctttcca actcagaagc tgtcaggatc tcagcaaccg gatccagaaa 1500000

ctatctggga attcctaaaa tccatacaat gctacccatg tgaaggacaa catcaacgtt 1500060
ttatttgcta cacattcgtt tgtgtgtctt agtactttct actttccttt tttagtgact 1500120
taaaaaaat aagcatgggg ctagaatgat agttcacttg gtaatgtgtt agcattgagg 1500180
ttgagataag aggattttag gtccctgtcaa atggatgaat tccaagtccc agtgagagac 1500240
ccaatctcaa aagtaagggt gtaaaaaaaaa aaaaaaaaaa aaaaaaaaaa aagggcgcca 1500300
gaaagatggc tcagtggata ggatgtctgt tgtgggagtg tgaagactag agtttggaca 1500360
tctcaaacc acataaaaga caggcagaca ggcgtggtgg tcacttgcca gccagtagt 1500420

ggggtgggta gggacagggg attctcaggg caagctgaac agccagacta gctggaatga 1500480
caagtcttgg gtictgtgag agacctgcc tggataaatc cagtgaagaa caactaaata 1500540
agacacctga tatcaattta gggcttcaat atacatgtgc ttacatgtgc atgtgcatgt 1500600
gcattccac acacacgttc ccccttgtc aatgtacaca cacacacaca cacacacaca 1500660
cacacacaca cacacacaca cacacacacc catacatgca catacacaca tacacacaca 1500720
tgcatgcaca cacacacaca cacacacatg catacacaca cacatacca cacacacaca 1500780
cacacacctg gactttcaca ctctctctgt gtatatatgt acgttctctc ctacaaagca 1500840

ctacccaaag agaataaca tctagaagat ttgaattggc tgggaccct tgacatctag 1500900
aggtcccaaa tgggtggttc acaataaaga tgggtttgag gaaaaccata taaatttctt 1500960
caatttgatg tgataagcat cacccttgac ttgcctaca gtacattgca gtgcctggtt 1501020
taagggaggg ctctgcagga actagtgtta gcactctggt gcttctggt gccaggatct 1501080
ctcacctgga aagtgaattt acatcaaat ccaccttagt ggccacatat ctggttcccc 1501140
aaccttttc ttgcctctg ctggagcctg ctggcaggct tgtgctgtgg gaccttctct 1501200

atcctcagaa agatacaata ggggccgcct ctgtcactgc tgcctcctgg gctctggttc 1501260

ttgggttag agacaccacc acattgtctg tgtctagagc tgggtctga actgtcctca 1501320

gagtccccct gccatgatgc tgtctgtctc tctctttgcc cgctgtcca ctgcactgaa 1501380

taagtctctg gaccttaggg agcaatctct gtctcagtgt tctctatcac atctgagacg 1501440

ctggtctaac aacgcagaag tgctccagag gctcctggcc aaaatgtcct ctcatggag 1501500

gctgctgtat ttgcagttaa taccetgaag aatgggcacc atatgtgact ctggcacaaa 1501560

acgcacagaa tggaaataaa atgggtcctt catactaaa ccatcaaac gtggagcaac 1501620

ttgtgtggaa atctttggga agaattggg agaatgaatg aatttctctt agcatgagag 1501680

tcagagtcaa tgagcactgt ctgttgtttg ctcccctgga cactccagct aatgcagcat 1501740

caggaaaagt atctttattg ttataattat tattgttatac attattattt tggtttttca 1501800

agacagggtt tctctgtgta gccttggctg tcttggaaact cactctgtag accaggtga 1501860

ccttgaactc agagatccac ctgcctctgt ctctcaaagg ctgggattaa aggtatgcaa 1501920

caccaccacc cagccagcca gccatacata catacatata tacatgtata tatattttta 1501980

agattatttt attattttta gggccaagtg gtggtgatat gtaggaagcc ggttctctgca 1502040

ttataatgct gcctgaagac accaaggtgt gaattacttc acaggcgccg ggttatctcc 1502100

attcctttga tctctgccta tcccgtggct cattttagcc tgaggagctg aagccattca 1502160

tagggtaata cgtcccaggg ggctggctcag ccttttatat agggatggtt ttcttggttc 1502220

aatgtctctg ctcagctctt gttcagctca atgcattaaa gcttgtctgc agaaggatcc 1502280

gagtgtcctg cgtgtatttc ttgctggcga ggaatacaga gcgggcgcgg gacannnnnn 1502340

nnnnnnnnnn nnnnnnnnnn nnnnnnnnnn nnnnnnnnnn nnnnnnnnnn nnnnnnnnnn 1502400

nnnnnnnnnn nnnnnnnnnn nnnnnnnnnn nnnnnnnnnn nnnnnnnnnn nnnnnnnnnn 1502460

nnnnnnnnnn nnnnnnnnnn nnnnnnnnnn nnnnnnnnnn nnnnnnnnnn nnnnnnnnnn 1502520

nnnnnnnnnn nnnnnnnnnn nnnnnnnnnn nnnnnnnnnn nnnnnnnnnn nnnnnnnnnn 1502580

nnnnnnnnnn nnnnnnnnnn nnnnnnnnnn nnnnnnnnnn nnnnnnnnnn nnnnnnnnnn 1502640

nnnnnnnnnn nnnnnnnnnn nnnnnnnnnn nnnnnnnnnn nnnnnnnnnn nnnnnnnnnn 1502700

nnnnnnnnnn nnnnnnnnnn nnnnnnnnnn nnnnnnnnnn nnnnnnnnnn nnnnnnnnnn 1502760

nnnnnnnnnn nnnnnnnnnn nnnnnnnnnn nnnnnnnnnn nnnnnnnnnn nnnnnnnnnn 1502820

nnnnnnnnnn nnnnnnnnnn nnnnnnnnnn nnnnnnnnnn nnnnnnnnnn nnnnnnnnnn 1502880

nnnnnnnnnn nnnnnnnnnn nnnnnnnnnn nnnnnnnnnn nnnnnnnnnn nnnnnnnnnn 1502940

nnnnnnnnnn nnnnnnnnnn nnnnnnnnnn nnnnnnnnnn nnnnnnnnnn nnnnnnnnnn 1503000
 nnnnnnnnnn nnnnnnnnnn nnnnnnnnnn nnnnnnnnnn nnnnnnnnnn nnnnnnnnnn 1503060
 nnnnnnnnnn nnnnnnnnnn nnnnnnnnnn nnnnnnnnnn nnnnnnnnnn nnnnnnnnnn 1503120
 nnnnnnnnnn nnnnnnnnnn nnnnnnnnnn nnnnnnnnnn nnnnnnnnnn nnnnnnnnnn 1503180
 nnnnnnnnnn nnnnnnnnnn nnnnnnnnnn nnnnnnnnnn nnnnnnnnnn nnnnnnnnnn 1503240
 nnnnnnnnnn nnnnnnnnnn nnnnnnnnnn nnnnnnnnnn nnnnnnnnnn nnnnnnnnnn 1503300
 nnnnnnnnnn nnnnnnnnnn nnnnnnnnnn nnnnnnnnnn nnnnnnnnnn nnnnnnnnnn 1503360

 nnnnnnnnnn nnnnnnnnnn nnnnnnnnnn nnnnnnnnnn nnnnnnnnnn nnnnnnnnnn 1503420
 nnnnnnnnnn nnnnnnnnnn nnnnnnnnnn nnnnnnnnnn nnnnnnnnnn nnnnnnnnnn 1503480
 nnnnnnnnnn nnnnnnnnnn nnnnnnnnnn nnnnnnnnnn nnnnnnnnnn nnnnnnnnnn 1503540
 nnnnnnnnnn nnnnnnnnnn nnnnnnnnnn nnnnnnnnnn nnnnnnnnnn nnnnnnnnnn 1503600
 nnnnnnnnnn nnnnnnnnnn nnnnnnnnnn nnnnnnnnnn nnnnnnnnnn nnnnnnnnnn 1503660
 nnnnnnnnnn nnnnnnnnnn nnnnnnnnnn nnnnnnnnnn nnnnnnnnnn nnnnnnnnnn 1503720
 nnnnnnnnnn nnnnnnnnnn nnnnnnnnnn nnnnnnnnnn nnnnnnnnnn ngatatgtag 1503780

 gaagccggtt cctgcattat aatgtgcct gaagacacca aggtgtgaat tacttcacag 1503840
 gcgccgggtt atctccattc ctttgatctc tgcctatccc gtggctcatt ttagcctgag 1503900
 gagctgaagc cattcatagg gtaatacgtc ccaggcggct ggtcagcctt ttatataggg 1503960
 atggttttct tggttcaatg tctctgctca gtctctgttc agtctaagc attaaagctt 1504020
 gtctgcagaa ggatccgagt gtctctgctg tatttcttgc tggcgaggaa tacagagcgg 1504080
 gcgcgggaca gtgatacaca cccttaatcc tagcctttgg gaggcagagg caggtggatc 1504140
 tctgtgagtt caaggccagc ctggcttaca gagcaagttc tgggatagca agggctacac 1504200

 agagaaacct tgtcataaaa aacaataaaa atcaccaaac aaccaaacaa aaaagattta 1504260
 attttttgtg taiggggtgtt ttgtatgcat gtatgactgt gaaccatgtg tgtgtctagt 1504320
 acccaaggag gtcagaagag ggtgtcagat tccttgaac tagacagaca gttgtgagtt 1504380
 accgtgtagt gctaggaatc gaacacagat ctgcaggaag agtaacctgt actcttaacc 1504440
 actgacccat ctccagcccc tataattctaa gtactaagtc tttgagatcc agttttccac 1504500
 tcctagtgea tctcagttca cactagtatt gccagaagtg caaagcagcc actggttaaa 1504560
 tgtttattgt agtggacatc aagctctgta tggttcatca tcacacaaat tctgattcag 1504620

 tgtgccccaa ttcttttagag ctgtgggtgag agtcagaatt gccaatgaaa cagacctctg 1504680
 ggcatgtctg ctggggagtt tctggatggt gttactaag gtaggaaggc ccaccetaag 1504740
 tgtggcgaca ccatttcttg ggctggaatc ctttctgag ttaaacagga aacaagctga 1504800

agagcagctt ctctcacct gcttctgac tgcacacaca gtgtgaccag tgcctctcc 1504860
 tggaccatgt attctttgtt atgatggact ataccctcaa actgtgaagc aaaataaacc 1504920
 ctttcttct taagttccca ttgtcaggtt ttttttttt tctttagtg agaagaataa 1504980
 ctcatccaag tgtttttcaa actcttggat tttcccatga gacatttgt tagtttcttt 1505040

 tctgtggttg tagtgaagca ccatgaccaa aagcaactta caaaagagag tttattgggt 1505100
 tacagttcca ccagagtaag aatctgtcat ggcagggaga catggcagtg agtgacaggc 1505160
 agtgagtgac aggcatggaa gtgagtgaca agcatggaag tgagtgacag gcatggcagt 1505220
 gagtgacagg cagtgagtga caggcatgga agtgagtgac aagcatggaa gtgagtgaca 1505280
 ggcattggcag tgagtgacag gcagtgagt acaggcatgg cagtgagtga caggcagtga 1505340
 gtgacaggca tggcagagag tgacaggcat ggcagtgaat gacaggcagt gacagtgagt 1505400
 gacagacatg gcagtgagt acaggcagta agtgacaggc atggcagtga gtgacaggca 1505460

 gtgagtgaca ggcattggcag tgagtgacag gcatggcagt gagtgacagg catgacagtg 1505520
 agtgacaggc atggcagtga gtgacaggca gtgagtgaca ggcaagtgag tgacaggcat 1505580
 gacagtgagt gacaggcatg gcagtgagt acaggcagtg acagtgagt acaggcagtg 1505640
 acagtgagt accagcatgg cagcaggagc agggaactga gaaaccacat ctttcatgc 1505700
 aaatatgaag cagagagaga aaacaaactg gatgtgggga aagactatga gatgcttaa 1505760
 tccagctttg agtgatgat tttgtccagc aagatcacac ctctaagcc tcccccaaa 1505820
 gagccaccaa ttgggatcaa gtgttcaa actaagccta tgcagagcat tttattcaa 1505880

 accactacag ccactctgac ctatgccaga tatattgtaa gttacatgca ttatgcatag 1505940
 ttaacatata tttatccctc taattgggtg ggtccattga tgtaattctt ttgtcgtatt 1506000
 actatgacaa ttatgtgat tagcatactg ctgtgactgt cttttcttc agagcagcgt 1506060
 tgattcttct cttttgtgtg tctctcttc atctctatt ttgttccagg attatagaaa 1506120
 gtgaggtggg gcaatcttc ttccttagt ggttcaggaa gggagtccac atctcttgc 1506180
 cgcttccag tatgcacatc tcacctggg gcacctctgt tctctgtgat gaagtccaag 1506240
 ttaccactcc tgggttcaaa gcacaggctc tgagaatag cacagaagga gccaaagatg 1506300

 tcagagggaa gcttgaact gctgagaaag caccttccag aaaggctttg gcaggagaaa 1506360
 agaaaaggaa aacaaccac cccattattt tggagactaa agaaaaggat gtaatagcac 1506420
 aatacaaagc acatgcaaga atatggatgt agttttgcac acagccccag tggctctgag 1506480
 atgataatgg aagtttacta tgggtctgat tacaagggtg atgggctgga tagaattagg 1506540
 gattaaacct gaagttccca gcccatatcc agcaatagga aacttgacaa gtcacgtcac 1506600
 cccaagatcc ttgaaggagc acagcagcaa gcttattagg gaaagggtgt tgggggagtt 1506660

gcccatagcc agctagtcac catggcacca aggatcaggg agccttctaa gaggtaatgt 1506720

ccttttcttt gttatatcag ctggcatctt gctaggggtg gtgacttgtc aggaagcaga 1506780

cctgttgcta ggcaaccaag gaggetgagg aaattccct ccccaggag acagaatgcc 1506840

aggggcctca agaaggattt gaatattaac aaacaacaa aaatgtgctg ccttagggag 1506900

gaaaaaaatt ctttaagaa gattgattca tagaaaatta tgacctgggc atggaaggga 1506960

aggaaaagaa gaataaggac aaagatgaag aaggagcagg tgtcatgtta gacacacaca 1507020

cacacacaca cacagacaca cacacagaca cacacacaca cacacctcat ctatgtatat 1507080

ggaggtgcgt ggattgcagc aaacattaga ttattacttt tcttgggtgct atgacaaaat 1507140

acctgtaag gagcttcagg aaatacacac tggcttgctg tttaaagtaga cacagtcac 1507200

tgtggtggtg aagacacaag ggtggctttg tggtagcagt gggggtatgc aactgggact 1507260

tctcgtctcc ttggatcttg gggaaatagg aagtggagag agatggattt ggggtgttctt 1507320

aggcttctc ccttttattg ttatcagcct ccagtttatg agatgggtgct gccacattc 1507380

agggtaggtc ctccctcagc taagcctctt tggaaacatc ctacagaca cgttgaattg 1507440

acaatgaaac tcaccacaca gtctgagggg actctgcagg tgtcaaatca agcaatgaac 1507500

catgaagaga gggcagcaca aacctcctgc agagaccaa cttaggtgct taggcttgg 1507560

agaaaatgtt tttaccacc gagccatctc aatggccatg gaatttctta aaggcttct 1507620

tttataccat agagctgtgt cgatccagcc aatcatgtat ctgggtatca gaattcttc 1507680

agaagaatgg gctttctgcc catcccatt gtcagctcag ttgagagttt cacacatagc 1507740

tggtagctgg gcatgcagca ccaactggag ttgatctatt ccgagggaca aaccttaacc 1507800

tagtgagtct ttgtaaatga gaaagaaat cattttggaa tggttcttca gtatactgt 1507860

agttttagca atgatgaaga taaaagcaaa ttgctgact gagaaggatg tctgtcacia 1507920

ttctaacaca atgcctcct gctggggaat gacagttggt aaacactaac tagtattaaa 1507980

agtcagcctt ctgcaattga accatcacat tttataaaa gtgaggtttg tttcacagt 1508040

aaaaactg tgattcatag cataaatggt cttagtctg aatgttttag gcagtctcc 1508100

ttggtgtgtg gtgtgacagc atgcacagtg tgcacagttc atgctgtgtg tttagatcaa 1508160

gtctgtccc aagtcatgtg atgcaacacc ttcaagtct cccagaaatg cctcaaatc 1508220

attacattgt tttctttttt tttttttcca tctctgtgtt caattatcac ctatggttta 1508280

agaagcacct agatctgac tttctaaagg agagctgatt ctgccagga aatggctcat 1508340

ccttagttga aggagagaat gaatgaaaaa ccccagggtt catgttttta aagggcatt 1508400

cctaaatggt gacttttga cagaaagctc tgctttcttt tccatgtttc agaatttgag 1508460
 gagggacgat tctttathta tttaggtttg ttttttttcc aagacagggt ttctctgtgt 1508520
 agccctgggt gtcttgggac tcaactctgga gaccaggctg gcctcaaact cacagagatc 1508580
 tgcccctttt gcctccccag tactgggatt aaagatgtgt ctctaagat aagcagaggt 1508640
 ttaaggactc agggacagtg ctgtacaaat tgaatgtaaa gaaaaaaaaat aaaaaggaaa 1508700
 ggaggacat gactgccctt aggtacagtg gaggagaaag ttgtagacat gtggaaaaga 1508760
 ctagtacagag gcagggacct ctgggagagt ccagagtggg catgagtggg ctgagctggg 1508820

 ccatgtggga gacaggggaag ggaagggaga aagaagaaag ggagagagga ggaaggggag 1508880
 aggtgcagca gccaggaggc caaaggtccc aaaaggggaag ggtaactaaa atatccgat 1508940
 tacataggga agagcctctg ggggaaggga ggagagccca ggctagaggg tgttatacca 1509000
 gtcatactct acaaacaggg tgggggctga gggattctgg gagagcctgg cagcaaggtc 1509060
 cagctttgat gtgttaataa ggcatcttag ccagttgtcc caggcttaa acttaacaca 1509120
 agccaggcag tgggtggcga tagctttaat ccagcactt gggaggcaga ggcaggcaga 1509180
 tctctgtgag ttcgagacca gcctggtttc caagagctag ttccaggaca gcctccaaag 1509240

 ccacagagaa acctgtctc gaaaaaccaa accaaaccaa ccaaccaacc aaacaacaa 1509300
 aaaacccaaa aacttaacac aaataataat ttcaggaaat acagttttca aatgacaatg 1509360
 ttttagtggt ttagataaaa ttgtaaacca aagttcccag gagagaagct ttccttaggc 1509420
 taaggattct acaaggctga ttgattagaa tcctaagatt atggagagct gcagtgttc 1509480
 aggtccagga ccaggttacc ctgctctgcc taagagcctg tatccagtcc acatccttc 1509540
 aactatcagg taaaacctct gggatgtact gaaataacca ccagcagcgt ttatcagccc 1509600
 catagctatg gatgtcagca tctaggactt ctaacagtgg ctcccactt tactgtcacc 1509660

 ccacctgcta tttctacat tgcatttgat aaatgctttg gcttatgact tactttgttt 1509720
 tataattata acagcaatat ataactgctt ccattttgaa catgttattt ggataacctg 1509780
 gatccctgct ctaggtcac ttagaataaa gtctcttctt acctttgaag taagaagagc 1509840
 caggttttgc attaataaaa atcaaaggcc aaacaaaaca aactggaaa gttcatcctt 1509900
 ggctaagatc tagtggagcc ggaaccctt tgaaagtac catcctgtaa aataaggtaa 1509960
 tttttatggt tgctataatt tctgaacaca acaaaaccaa agggatgatct ggaaatcctt 1510020
 agccagatca gaagaaaaga ctggaacaaa accaagatac tgttcttctg aacatgctga 1510080

 caccaccag ttttaaagag tgggcattta tattccagtt gcaagccagg atagtaattg 1510140
 ccttgtttaa acagatactc ctagtaagac cacttttctc tcttagcaga ccaacctgct 1510200
 gccctaaga gagacagcct ctgaaggaag atgctcaact gtttatcaag gcaggtcttc 1510260

ccccaagggt accccactag gaatttgtga gcactcaggc attttaggcc atcatgtgct 1510320
 cagagagtgg cagaggaagc tcgggggaaa ttctttaact cccgtggaat cttccttaag 1510380
 ccccagcatt gcagaggcca tgggtgggctc tttgggtggct gagcaagctt gcaacagaga 1510440
 tcaggggagc ccaaaaagat tcttttgatc ctgactagaa tcaagaggaa tgaaattctc 1510500

 agtgcttacc atggaattct aagaatctaa actggggtgt taaaagctga tggggtcagg 1510560
 gctggagaga tggtcactg gttaacagca ttacttagtc ttgcagaagc cctgatttgt 1510620
 tttttaagt cctttgaata actccaggca tatgaatgca tgtggtgcat acaaactcat 1510680
 tcagacactt acacacatac acaaaagttt aaataaaaca aaactgaaga atagttttga 1510740
 aaagtatagt atagaaaagt acagtataga aaagacttgc ctttgtgcc tgtcctgaca 1510800
 catagatata caggtcccca ctgggccacc attctgcctt tccccttctg tctctcactg 1510860
 ctctagagct tactttatga aggaaagtgt agccccagta tccagaaaca cccttggttt 1510920

 tcttgaatc acctacgac caatggactc attggctcag gctgtgtagc aaaatgctca 1510980
 gaatgggtgc tgtaatcagt aagcttcatt ttccgttctg aaggctggaa gtcaagacgg 1511040
 aagggtacaa ggataggtgg atggtgagga ccttctggc ttgcaaagca ctgcctttgg 1511100
 ctgtgtactc atggaacctc tttctgact ttccccct ctcttgtaaa tgtctatcaa 1511160
 aggcagcagc tttgggctaa ctgggcagga gagagatggt gaaagaggaa ggggcccaca 1511220
 agcaagatc tggccgaagc ccctcagcat tgcaactggg agtcaagaat tccagcataa 1511280
 ttaacaaagc ttgctggttt gcctaagag ggataatfff ccttttatat gtagagtca 1511340

 accaagaatg ttaaaatagt aacaaataac atttaaggtc taagtgtgta tgaccaatta 1511400
 tggcctatgt cttttatcag ctgtaaacct accgtttttg gttttttgtt ttgtttgtt 1511460
 ttctgggct cttacaaca agtctatgaa taccatttac agtaaagggt aggtcttaat 1511520
 ctcttgtgt agtctttgtg acccacagt ataccatata agattgaaac tatcctatta 1511580
 tctcatttat gaagaataga gaaaaagtgt agggagtct ttagaaacac tttgaagaag 1511640
 gctgtgatgt cggctcagta aacgtgctt cctgggaacc tgagtttgat tcctagaact 1511700
 tatgttcaaa ataagcccca gacttgggtga ttcaaacta taaacctggg gatgtagaga 1511760

 caagtaaate cctggtactc tctgcccaca gagcctagac taatgggtat attctaagaa 1511820
 agtggacact gtctcaaaaa agacaagtgg acaatgcca aagaacaaca caaatggtgg 1511880
 tcctctcacc ttcatgtgca caggcataka tacacactg ctcaactat taatcccact 1511940
 gacagaggag aaagaccact gactcaaat atagccaaag caaagcaagc tttcttcata 1512000
 tacatgggag ccagcagggg gctgtctccc ctaagggcag ggttcaagag atcaggtgtg 1512060
 agccagtttc tcaagccctc ttaaaaggac cccctcccc cacagcgtat ggttacagaa 1512120

gcaaggccag gcagttagaa aagtctcttt tggaacaatg gatacacagg aacacatgta 1512180

caaaaggtgg gaaaaaggaa gtcttttgaa caatacaatt tcaggaacct caaaaactga 1512240
tatgactgat gcaaaaacat gtcagtgtga ctcttttgaa aaggccatgc cccatccttg 1512300
ggttagtaca gtcttttacc tgagcatgtc ttttggttg ccttggcagc cagagtcact 1512360
cccttagcca ttgcagaatc tcttgtgtgt tgaccaatg tcacaagaaa ctgaatgctg 1512420
ccaattggat aaatctatca ctgtgtttac aaacagatgc cccttcctg ggaatgaaaa 1512480
tggccaggct aatagaacat agagctgcag gagggggaag ctaaacttc catggagggc 1512540
cactcagcct aatgggaaga ggatccactt ctgtgaaacc cactttagg agaaaaaggt 1512600

ccatacatta gtggatataa aacaccaagc agccagacct ggtgttacct gcctgttaac 1512660
ccaactactt gggatgctaa gggaggagag tcacaagatc aagaccttct caggtttcag 1512720
ggtgagtta aggtcagcat ggacaactta atgagccact gtctcaaac aaaaaataaa 1512780
aaggttggga tattgctcaa tggtcagtgc acgctagcat ttgtgaaaca ctaagttcaa 1512840
tgcttatac ttcaaatfaa tacagcaaat gaataaataa acagctaagc atagtggcac 1512900
ctgtctttta tctcagcact caggaggcag aagcagatgg atctggttta catagtggtt 1512960
ccaagccagc caggatactt ggtgagagcc tgtctcaca agcaaaaaa cgaacaaaa 1513020

cagaataaca acaacaaca taaacaata atcttgcaat ttagaggtat ttccttatcc 1513080
cctcaagcta gttattgcaa cccacgtgac accatcaatc aacaagacac caaaagactt 1513140
ctagaataag ggcattggctc aattggccaa ttggttgctt cagataaaaa tggccatga 1513200
gatccagggt cagggtgagg gttggacaca atgctcctaa ttcttagagg aatgtaagaa 1513260
cctgagtctt atcacctaac tacctgtggc tgggtgttgg gactctggct gaatatgcct 1513320
acaggcagat ggtaatgggt agagttggg gtctggttcc tgagcataca attgccttcc 1513380
cttcagatga atttcttcc tgtattactg ttttagagag ggatgccaca ctgtactgaa 1513440

gccagtctct tttctctgtt agcctctgtt tactctgatg gcacacttcc ccaatgcgct 1513500
gcactgcagg ctttcttcc tctcttctca ttgcttgagt tegtccacc ccaactgtct 1513560
cctttctctg tggatcacag tggcagcttt ctggtggct tccctgcctc aagtcccagc 1513620
acctcctta aattcatcat aatacaagac cctgtgatct tactcttctt gaatcaattg 1513680
cattttttt ttttttactt gagaggcgtt ctctccacca agaaccata ctcaactatt 1513740
tttcaatcac agtgagtcag ttctcagccc ccaaatgtac cacacctcac acacattat 1513800
gcttttgtgt gttcttctt taaaaacaaa caacaatgaa acccctcca aactctctct 1513860

ctctctctct ctctctctct ctgtgtgtgt gtgtgtgtgt gtgtgtttca gaggacaact 1513920
 tagggggtca gtcctgctt tccaccttga ctgagacagg gtctcttgct gctgtctctg 1513980
 ctgggctggc tgggctgtga tcttccagga actctcctgg cttagtctct catcttgcca 1514040
 tgggattgtc aagattgcag atgtgtgtgt tactgactct tgagtctgg agataggaac 1514100
 ttggcaagag ctttggccac tgggcatct cccagccct gccagtgtct tttcccctc 1514160
 ctctcccca ttcatctca cacagacttt aaaaccaagc tcatgccacc tctctgtctc 1514220
 tatccagccc tctcatatag acagctacc cccaagtctt cctcaact cagtgcaaac 1514280

 agttcccatg ttaattcac agaaggctc taataatggg tttccttgc catctttgtc 1514340
 accagaatgt gagtctctg tctcaactgt cttgagtcct caggctctcag ggcaacactt 1514400
 gacctgttct aggtacacaa taaaagtgt tcatggataa tggggctat ttccttgaa 1514460
 gaaaaatctg tctaaacct cttcccatt taaaattagg ttacttatag gtatttgagt 1514520
 tgcaggagt tgttgatac tctggtagc atcctctcag cagacacatg atttgtgaac 1514580
 acattttccc actctgtagg ctcagtgcc atgttttgt tacatttgt agctctgacc 1514640
 tctctctatt cttcttact caagcctctt ggcatggtga tttcttctt atatcttgat 1514700

 ggtttctaca tatcttctgc tagtactagt attgaatctg tgacttttct cttcctgtg 1514760
 acaaaaagcc tgacaaaagc aacttaaggt aggaagggt tgtcaccact ggaagtcag 1514820
 gcagcagagg gtcaggttgc tggtcataat gcaccacag ccaggaagcc aggagagctg 1514880
 gatgctggtg cttagcttgc tttctctctt ttctgagtc tgggaatcca tgagcagtat 1514940
 actagccatc aactatctt ggatttttcc acctcagtt accagatctg gagactgatg 1515000
 cataggcatg cctggttccc acctcagtt acccaattca gagactgatg cataggcatg 1515060
 cctggttgtt tgtctccact gtcattctag atcttttaag aaaattgtta gcaaatattt 1515120

 taggattgat ttacatgtag ctgtagggt ctgtgtgtgg ctatgtgtcc tectatgtga 1515180
 ctgtggaggt cagaagaggg tatgagatcc tcagagctg ggattatagg cacttgtgag 1515240
 cctccctatg cagggtctga gaattgaacc tgggttctct gcaggagtag tacttgcctc 1515300
 tagtcaactga gctgtcttcc cagecctgac agtaaacatt aaccacctgt gttggetaac 1515360
 ctcagtttc aactgacat ctagaaccac atttgagcca ggcaggcctg ggtgtctgcc 1515420
 tgtgcacatt agattcatta attttgatta gattgactga agtggaaagc catgccactg 1515480
 tgagaggcac catgatagc tgtaactccc cctgtgacce actttcttc ttcttctct 1515540

 tcttctctt cttctcttc ttctctctt cttttttgag atagggttc tctgtataac 1515600
 cctggtctg ctggaacttg cttttaggc caggctggcc tcgaactcac agagatccat 1515660
 ttgcctctgc ctccagagt ctgggattaa aggtgtgcac caccactgcc cggttctct 1515720

ttcttcttta agttgctttt gtcaggggtgt ttttattaca gcaacaggaa aagacatgaa 1515780
 gactgcactg caagtgtctt tatggcttgt tgatatttct tctaggttgt tgtgatgtgt 1515840
 tgtactttta tgtgctgtac tgtgatatgg gtgttctata acttgccatg tgtatgttgt 1515900
 aatgtgcatt atatatatgt gtcttgaat gtgtgtgtta tatgtgttat gtgtatgttg 1515960

 tgatttgctg cattgtggtg tgatttctat gttgtgtgtt gcatgtgttg tgttgtgata 1516020
 taatgtggta tatgtcttgt gatgtgatat atgtattgtt atgtgtgagt tgtatatgtt 1516080
 cagatttgct gtccgtgat gtatgttga atgtgtgtgt tgtatgtgtt gcactgagag 1516140
 gtgatgtaaa tgtgggtgat atcttggat gtgtgtgttg catgtgttgt catgtgtgtg 1516200
 tgttgtgatg tgctgtactg caatgtgatg ttttgtgaca tgttgtgtgt tgcaggtgtt 1516260
 gagatgtgat gtgggtgtgc tcttggatgtg atatgttcag tgtgtgttgt atgtgttgtg 1516320
 atgtgtgtgt attggttagg tgtgcaggca ggggtgtgcc agggaaaaga ccttccagta 1516380

 gctacagggg agtagtgaag cgttgagcct ctccaccacc cagtttgctg ctgccctctc 1516440
 tctttagaac attctattca gtgacgtggg tgggattaac gctctgccct gtgtcagggga 1516500
 tggagagaaa atagaatcaa atgtgggtta gcagtaggat gcggaaggaa gaaaagctaa 1516560
 ttcacttata gcctgtcag agccaaccaa gtatcccggg gggagacagg ggcagacaga 1516620
 agacttcact ttcttaata gaactctgtt ttgacattct ctttctgca gctccccac 1516680
 gcatgtctgt ctcaagagca ccagtgagag gcaggagttt gcctctctgt gccceatctg 1516740
 gtggcgaacc tggagggctg caggctgttg gagccctgag ccaggtcaac cccaactgg 1516800

 gtcttctccc aggaccagga gcaagcagag gaagccaata tacctggagg acagcaatga 1516860
 caaagttcac tgggctggag tgagagacga ccggacttaa cgtcttatca atttggtcag 1516920
 cttagaaat tctttgtctt tttgtacttc attttcttct tggaaaaaaa gtgggttact 1516980
 gtgagatfff gtgaagtgt gtcaaggtaa aagcaccag aagagcaggc agtggatcct 1517040
 gtggctcag taaaggagtc acccctcttc cttgtttccc tccccacctc caccctgtat 1517100
 ttcccccta acacgactgt gtatctggcc agaagttact tctgctatag gactatagc 1517160
 tgggaacaag agtaagaacc tgttgggaa tagtaggac aaggcatgga gcctcagtg 1517220

 gatctgggac accaccaagg tctgccttt ctgcaatgtg aagccttctt ggaactttct 1517280
 gtttcacaag aggggggaca ttctccatca ctttagacat ccaggcatag gaaattatat 1517340
 gtttctaatt tgggagtga tgggtggatt tgaacctggg gctgtgtgct tgttaggttg 1517400
 ttctatatta ttattattat tattattatt attattatta ttattattat tattattacc 1517460
 attatttagg tccagggtca ctttatgtag ctgtagctgg tattaagctc atacagatec 1517520
 tctcttctc ttgaatgctg gcattaagtg tgtgtgccac catacctggc tgtatcacta 1517580

atttataagg tcctgtccag gtctgggcta ttactaattt tatgagctaa agcaacattt 1517640

 acaagaacaa aagtcaaaag cacaagtgac tgaatatctt gaggaagaca agcattacac 1517700
 acatatagac cttatcatgt gggttaaagg tgagaggag ggcaaatgat tectacatat 1517760
 tggaaacaac aaaatattaa tttttctc tcatggattt ttcttaaaca aaacaataga 1517820
 atggtctctt gacagaaaac tttgggatct aggcattgtgt ctgcctgcag aaggtggctt 1517880
 ttgcaggaat cttgctcttc ctgtagctgt tgcctctgtt cttctagag actatittgg 1517940
 aaatatatga ctgagctggg gaacattccc aacctgggat gtggaaaata cctcccaggc 1518000
 gaggagactc acacaaacce cgagtcttct ccaggggctg cagtgttaaa atctgtgact 1518060

 ttgccatggt ttgggtggac tggatTTTTG ttgtttctgt tttgagacag ggTTTTctctg 1518120
 tgtaacagct ctggctgtcc tggaaacttac tctgtagacc aggcTGGGct cgaactcaca 1518180
 tagatcccc tgcctctgcc tctccagtgc tgggattaaa ggtgtgtgcc accactgccc 1518240
 atctattcta tttgtcttaa ctgagttacc tgcattggc cagctttcat cttatcaagt 1518300
 tgcatgtca ccagaccacc tagtggctca attgagaac cagaaatgac acatcctgcc 1518360
 tacttcctc tctctccatc gtccacacca aggtatctct tctgagatta ttgacctcac 1518420
 ctctgtcag agctcactgc ccaatgtttc tcctttgttc cactgtagct gacgagcttg 1518480

 tttgaggtgt ggggtatggg gtgtgggggtg tgtgaagtcc ctaagtTgtt aacttgcaat 1518540
 gggaccttta cagtgactat tctagtgtga caaatcacac ctaaatttag ggctggaaac 1518600
 aacacttaac tctgctcatg ggttatgtgg gtcagtggga ctggcttctc tctcagctgg 1518660
 ggtcacccaa tggctaggag tgactgcatg gtggctcagct agaatcatgg gaaaatatct 1518720
 tcagttaggat cgagcagatc ctgttagctg ttggctggcc tttaccactg accatataca 1518780
 ggggctcttc atgcggccca cacttcatct ccagcatggt gctttgaggg aggaagctga 1518840
 ctctctacag ccaaaggTtc catgtttgtg tacgccactg agcaaagcag acgctgtgcc 1518900

 agttggtcct ggaagtcaca cagtgtcacc tctgtctagt acagtggta caagtgagtt 1518960
 aaggccactc tagactctca aagctgatgt attcataaca tcaaactcac aaggagagac 1519020
 atgttcaagg gtgtggagat aggttttaaa gctgctacag ggagattgtc cagtaggagg 1519080
 caggcatag gattcgaatc ctttctctcc tgcctcca gggTggatgc tgtggctgca 1519140
 ctgttctgca gaaccatttt cccacacagt ctatccaaag acctactgag aggctagctg 1519200
 gggatgcctg ttcagtgacc ggttctcaca gctcatccga acagtggctt ggcatggaca 1519260
 cactgtttt ctgctgggt ttctgggtccc tcattctcc tgctctgttg atagaccacc 1519320

cacattgaag tgttgcctga ctgctgcccc cagtcccact gatgtgaccc tccacatcct 1519380
ccatgccctc taatcccact gatggggtct tccaaacctc tttctcatcc attgactttt 1519440
tgtgtccatt ctgacagtcc aatggccagg gtaccetaat acactttcct aaacagaccc 1519500
cttctgatgt acagtggcaa tactgtctca ttaccataa tgatgtcacg gtgactcttt 1519560
ttttttttt ttctttttta gtttatcgag acagggtttc tctgtgtagc cctggctgtc 1519620
ctggaactca ctctgtattc aaaacgatcc acttgccttg cctcctgagt gctgggatta 1519680
aaggcatgtg ccatcactgc ccggcatcac agtgagtctt agggcaaacc tcctcacaa 1519740

atthccagc taaatgtccg tggatggctt tgcaagctc ggcacatgg acattgtgag 1519800
caggatcttt cttgtttgtg ggccgtactg agcattacag gatattcagt agcatcccgg 1519860
cctctacca ctaggtgcca gtagcatccc actcctcagc tgtgagaaaa gaaaagtctc 1519920
tgacattgtc cagtgtctag ggaggggaac tgacccaga ctgagtgcct ctggtatgag 1519980
gtaagcatgc ttagagtggc cctgtgtggg cccatcctgg ctctctgcc ctcccacatc 1520040
tccaggattc ttgaccatg acatatactt tcctcctta agcattttta ctgctgttcc 1520100
tttttgctg cactccaaca cacacacatt ctgtctctca cacactcata tacacattca 1520160

cacactcata ctcttttata ccctactca cattcactct tacatacaca tgcttgtgtg 1520220
catgaattca tgcacgggca cttacacaca gcacgtgcac acacacacac acacacacac 1520280
acacacacac acacacacac acaccctct ttgcaagcca ctacctagc tgacatcttg 1520340
ttgctagtcc tcaactgaaa tgccacgatg catcttctc ggcttaggtt ttccctgcc 1520400
tgctaagtct actcttgtgt gacaaccact gctgcctgg acctggaat ctctccagac 1520460
tctgcccagc tctctgctt gctcctctcc attgggttta tgcaaagtcc tagcagagct 1520520
ctttatttt attttttaa tcaaggtagt ctagaacca gaggtcaaag tccacagtga 1520580

agtattggct tectcaaac gttttcaaga aatatagtat ctagcacatg tactgctttt 1520640
tattttttg tcttctctt ttccacacag accccaacag tagctttcag atatgaagag 1520700
tttctggat ggcttgttct tggggatgtc tctgtgttga gctctgctg gtcttgttag 1520760
ttctgggatg gtcagggcca aggattcagt cctaacgctt ttgtattttc ctatttgtgg 1520820
tattaagcaa ttgtgaatgc tgttgcttgi caaggactct tgtttgttga tctctgaaaa 1520880
cctgcatttt tatagattat ttagaatga ttccggcaga ctttgtttct ttttctttc 1520940
taacggactt gctccaattt tgctgacata catcctcggg aacctcgag agtgggaaca 1521000

cggtagtaat acctgagaga ctatagagtg gcttggcttt aagtggcagc tacagagacc 1521060
tggtactccg ggcactctcg ccctcttgtg gtttgacaaa ataggttatt atgaccaca 1521120
ggacagaatt gaaggtactg ctcccagtct gaacagagga ctcttagtt tcctcctct 1521180

cctgcaaac act aggggtgtac caagtgtgac gagaagaaag taagaagcag actcagggag 1521240
ctttgttggg aattccagtc ccagatattt ttgaggtgag aactgtcaga gacagaaatt 1521300
ccgagaaggc ttgccaag cctcagaaac aaaggccaga atcatgcaca gcctgagggga 1521360
atcaagaaga gtgaacaaaa aggaattaaa aaaaaaccaa aaaacaaaa agcgggtgcct 1521420

gacctcgag atccattgga cagccccagc tggcctccg gtgttagggg aggccccctc 1521480
cctccccggg ctggtgtgtt tgtttttcag ggttgctttc cttccagctg gcatctactg 1521540
ggcctggatc cggtcggatg ggtattttcc tgagtcatgt ggtaacagc ttgtgttgca 1521600
attaactgtt gacaggccca tcagccagga tgcggctta gcaccgatt tcaaagtgag 1521660
ggagagctgg ctgattttgt tcattcttaa ttggccaact tttctgagg gctggggata 1521720
gcacatgact tttttcttt gccttaaac ccaccctct gcagagtcag ggagaaaaca 1521780
acagtcccc acgtttttct tagcgcaatt gctatgtgcc attcacatgc agatgtcttc 1521840

ataggctacg tagggtgcct agtgaaggga ttgggcaatg acttcacagg agacaaaata 1521900
atatcttagt ttgcacacag gtgcaaagga ccttttaaaa gaaagatccc cgcccccttt 1521960
cctgtgttcc cctgggtgc agagaggact cccccccat cttctgtcct ctctgtgtct 1522020
ctttccttt tttctcttt cttccccctt cctgcccttt ctaataaac ttatcgcttc 1522080
cgctctgtct gcctagcatg ttgtcccc cacctaggtc actctcacct gccaaaggaat 1522140
ccgccaacgt tcctgaaca ctttatcata acaagacaa aataacatgt aagtctgaaa 1522200
gacacactga gcaagaggca ctgttttagg ctcagagtaa tggagcatag gcgcttcagg 1522260

aagttctcta gccattcctg tgtcgaaaaa tccaagagat tcttgagttc catggatgtt 1522320
tatttaactc cttccccca ttgaacatga gacctccac actagattcg aattccagcc 1522380
tactggtggg aggataccgg tgggttgagc taagactggc tacagccaca ctgacctgtg 1522440
gggcagcctc aggtctcttt cccatgcctg tctgctctc atgtctccac cagatacctg 1522500
gatgttctc caaagaaaac ctggactttg ctctagcatt tttctgggt tacattagta 1522560
aggtttctct tctctcttc tctctcttc tgacctgtg gagcctgtta aggtggaagc 1522620
ttcacccag ccctggcat ccatataacc agagtctgaa tgtcaagggt gaaattccac 1522680

cgaagctctc tccccatct ctctccaaac cctgcagtat ctcagccac caaatgatga 1522740
ccctcccc agagatgctc aagactgtta gatccctgaa actgaaagta tccagggtcc 1522800
caggccacgt tcgcggtcac ccaaatcacc aggcggattc aagagcttgc tgcaactgc 1522860
acgaggcttt attgtaattt aacaagctaa ccccatgtta gctcgggtct ttcaccacc 1522920
caccatggcg gatggctaga aaagacagtt tgaagccact gcgcacagat ctttataggg 1522980
tagcgttaagg ggagtgtcta gggatagca caggctcacg attggtgtgc ctacaggctt 1523040

ggagggcttg ccctgtgttg attggtcaac tggttgttat ggcccatagg ccctccaagg 1523100

 ggggttgcta tgctctctat gtcattgctg tgcgcttgtc cgtaaagcac acccagagcc 1523160
 ataaagcata gagccaccag ataacttccg attggttccct tgtcatgaga caggaatctg 1523220
 actttctagt gtctagggca aggtcataga agcacgagtt ctgccgttat ggctgcaaaa 1523280
 agggaagctg gttccttcaa agaccactcc cacgggtatt taaactgccc cccagaaacc 1523340
 agactggatga ttttctctgt ctccctttcc catctctct ctggggggct gggaggtcat 1523400
 ccagaagagg tgtatctatt aaacgtgggt tttttctaatt ttggtttgat ttggtctgat 1523460
 ttgaattggt gcatcagcag agaggcttat ctgggtgtag aaacttttca gaatgtcca 1523520

 tggacttctt tattccttcc tgaacaccag tgatgccctg ttggtttcta tcaacttgtt 1523580
 catcctctgc aaccctacta cccagatctt ccactctctgg attgtagtaa actcagcata 1523640
 gtctagaaat ggtacagact aggagtctcg attgtgtttc tctgtcagtt aaagaattaa 1523700
 aaagcccaaa aggatacaca ctcacatgta gggagacacc ctagccccc ccaatagtct 1523760
 tgggacaggt accaggtgga cccgggactc acccataagg gcatggtgaa ggaaagccgg 1523820
 ggtgacgtaa gggagcttct taaggtgctg cacgtgggga cccggcccct tttgttttgg 1523880
 ccgtgcttgc tggggtctat aacctagctc tcgctgtgt tttgccttgg tgtctttttg 1523940

 aataaagaga cttaaatccg acacgtggcg cccaagaact ttacgacct gaagagccaa 1524000
 cgggcaccca gggtttaaat agtgatgaag aatcacatgt aaatggtaaa aatgacaaat 1524060
 gcatattttg gcaagcttct attaatgata aaaggcctca attgaaaatt acaattaaca 1524120
 ataaagttaa ttcaggetta gtggacactg gagctgatgt gactattatc actcagaaat 1524180
 gttggcctaa aaaatggcca cttaagagg ccaatgtaca attttagga attggaactc 1524240
 tatctagagt tcgacagagt gttaactcaa tggtttgtat tggaccgaa ggacaaaaag 1524300
 gaatactaaa accttacgta gcagatattg ctataaattt atggggtcat gatttattac 1524360

 agcaatgaa tactcaaatt aacatccctc caatgtcaga tatgaattct agacaatcac 1524420
 tagatagtag aaaagatcgg gtaagatgcc atggaaaatg gttaccaact gtccaggctg 1524480
 tacagacact aaatacaaat gacaggccgt cagaggaacc aaaggccctg tcattaaaat 1524540
 ggcttacaga taaaccagtc tggatagggc aatggccttt gacctcga aagcttgagg 1524600
 ctctagaaaa gttagttcag gaacagctag aggctggtca catagagcaa tctaccagcc 1524660
 cttaaaattc tctgtatatt gtcacaaaga agaagtcagg taactggaga atgctgacag 1524720
 acctgagagc cataaataag gtaattcagc ctatgggcgc tctacagcct ggaatgcat 1524780

tgccttcctt aatacceaaa ggatagccga tcatagtaat tgacctaaa gactgctttt 1524840
 tcactatacc attacaagaa agcgatagag agaagtttgc atttacagtg ccaactctta 1524900
 ataactcaca gccagttcgg agaaaccagt ggaaggtttt gcctcaggga atactaaata 1524960
 gccctacttt gtgtcaacaa tttgtacaac aacctttgga aataattcgt aaacaatttc 1525020
 cacaatctct tgttatcat tatatggatg atattctttt agcagattct aatgaggaaa 1525080
 ctttagaacg tatgtttact atggngaagg aggttctgcc tagatggggt ttacaaattg 1525140
 ccccagaaaa gatacaaaga ggagattctt ttaactatth aggatataag atagacttac 1525200

 aaagaatcag acctcaaaag gtacaaatta gaagggaccg ttatcaaact cttaacagtc 1525260
 ttcagaagct actgggagaa atctctcaat tacagacgat tattggtgtg gaaggacatg 1525320
 acttaaagca ttgaaaaatg aactaaaag gtgataagga cttaacagtc ccacgaatat 1525380
 tatcggctaa agcagaaaaa gagctacaat gggtagaaaa cagaatatg gatgcatg 1525440
 tagatcggat aaaccttgat ctagattgca ttctggtcat cttgccatcc agagaatacc 1525500
 cttctgggat tctgagtaaa agggaagaca ctatattgga atggatattc ttgccacata 1525560
 agcagaacaa aaagttaaag acgtatatag aaaagatttc tgatttgatt ttaaagggca 1525620

 aattaagact tcgtcagttg actgggaaag acccagcaga gattatagta cccttaacta 1525680
 atgatgagat ttcttccta tggaaggata atgaatattg gcaaatactc ctcactgact 1525740
 ttttgggaa aattagtaac aactatccca aaaccgacag aattaattc ataaaaaaga 1525800
 cagtttggat tcttccacgc attgtaagac aaactccat ttctggagtt cttaccttct 1525860
 aactgatgc taacaaaaca ggtaaggctg gttataaagc aggtgaggtg agtaaagtag 1525920
 ttcaaagtcc atatacatct gtacagaaaag cagaattata tacaattctt atgggtctta 1525980
 tggatttaac ggaatctctt aatatagtta ctgattccca atatgcagag agagtctct 1526040

 tgcacataga gactgcagaa ttcgtccctg ataatactga actaacctcg ttgttcttgc 1526100
 agttacagga aacaatcaga aacagaagta acccactgta cattatgcat atcagatccc 1526160
 ataagggtct gccaggccca ctggcacatg gcaatgacga gatcagctg ttattgattg 1526220
 gcactgtgct agaagcctca gaatttcata aaaagcatca tgtaaatagc aaggagatgc 1526280
 tccataggca agctggtaag tcgaaaacc ccaacatag attgcataat gctttattaa 1526340
 cgctaaactt tcttaatgcc agtgacagtg gacagacagc tgtggaaaga cactggacta 1526400
 cggaaaaaac tgctgaactg aaccaaccag tgtattacaa agatgtgctg acttcggtan 1526460

 nnnnnnnnnn nnnnnnnnnn nnnnnnnnnn nnnnnnnnnn nnnnnnnnnn 1526520
 nnnnnnnnnn nnnnnnnnnn nnnnnnnnnn nnnnnnnnnn nnnnnnnnnn 1526580
 nnnnnnnnnn nnnnnnnnnn nnnnnnnnnn nnnnnnnnnn nnnnnnnnnn 1526640

nnnnnnnnnn nnnnnnnnnn nnnnnnnnnn nnnnnnnnnn nnnnnnnnnn nnnnnnnnnn 1526700
 nnnnnnnnnn nnnnnnnnnn nnnnnnnnnn nnnnnnnnnn nnnnnnnnnn nnnnnnnnnn 1526760
 nnnnnnnnnn nnnnnnnnnn nnnnnnnnnn nnnnnnnnnn nnnnnnnnnn nnnnnnnnnn 1526820
 nnnnnnnnnn nnnnnnnnnn nnnnnnnnnn nnnnnnnnnn nnnnnnnnnn nnnnnnnnnn 1526880

 nagggagagc ctgggaccca aaatattcca taacagatag tcggtcccc atacaccctc 1526940
 tcataattgt tgtttttcaa ggattacctt ttccagtaca catacatgta caagtgaaca 1527000
 tttctctgat gacacttatg tttgagtccc atacagccaa caagaaccag cctgacagca 1527060
 atccctacaa gctccggaaa aaaaaattgg actacacctc cccgactata ctggattcaa 1527120
 ctcaactcgt ttcgattgac actccaacca gaacctcgag taatgacttc aatcaagttg 1527180
 aggatttcaa catagatctt caatcaaaca aatctcatct aacatggact agacataact 1527240
 cattagaggc tttccctata ctggcatttt tttccacag ggccccaca tgactatcat 1527300

 tgtccattt cagcaggaag taacctagaa gatgctacac ccccgttccc cattattgtg 1527360
 tattagggta gtgtaagtct agttaagaat gaccttctta ttgtttagag ttgggattgg 1527420
 aagaaggtgt tcaagttaga cccaggaagt aacctagaag ataactagcc cctgttcccc 1527480
 atcatttgtt attaggatag tgtaagtcta gttaagtata accttcttat tgtttagagt 1527540
 tgggattgga agaaggtgtt caagttagac actttttcca catgacttta agacctagct 1527600
 agaatagaca taggatgtac catagcagat tattgtatct tcttgtatct cacccttatg 1527660
 attgttagtt ttggatattt tacactatta agttttaatc ctcttttaga ctagaagggg 1527720

 aattgtaggg agacacceta gccccccca atagtcttgg gacaggtacc aggtggacce 1527780
 gggactggcc cataagggtg tggtaagga aagccggggt gacataaggg agcttcttaa 1527840
 ggggtctcac gtggggacce ggcccccttt gtcttgccg tgccttctgg gttctataac 1527900
 ctactctgg cctgtgtttt gccttgggtg ctcttgaat aaagagactt taatccgaca 1527960
 ctacacaag gacatttctt caactatgtt catagcagca ttattttaa tagtcagacc 1528020
 ctaaaaataa cctagatgtc cctcagctga agaattgata aagaaatgt ggtacattta 1528080
 tacaatggag tactactcag ggagggaaaa aaaaaaaca aaaaacaatg atatctttaa 1528140

 atttgcaggc aaatgatgg aactagagaa tgccatctg agtgagataa cccagaccca 1528200
 gaaagacaaa tgtaatatat actcactcat aaatgggtat tagacataaa gtaaaggaca 1528260
 accagcctac atacaggcca caaccccaga gaacttaggt aacaaagcga gacatacatg 1528320
 aatccaccaa gaaggggaaa aagacaagta aattgggagt aattgggagt tttggggggc 1528380
 atggaagagg atgaaagggg agaggggagg cggaagcag agtggggaaa atgcatagct 1528440
 cagtttaaaa actttttaa aaagcaacaa caacaaaat tgaaaagcaa tgcaggcat 1528500

ggtggtacac tcctttaatc cccagcttca ggaaggccga ggccagtgga tctctgagtt 1528560

 caaggccaac ctggtctaca gagtgagttc caggatagcc agggctttta cacagagaaa 1528620
 tcttgaaaaa caaaacaaaa caaaaagcag gaaaaatctg gtagcagcag cagcagggaa 1528680
 atctcactca ctttagacag aattagcaac tacggcaggc atttattgta gcctggggaa 1528740
 acacacaaat gcagctcaca cacagagaaa aagaccactt gtgaagcaaa cccaggaagc 1528800
 tgaaaacaaa caaacaaaa aacaacaaaa aacaaaatcc agtctcttgt tgagggtgtg 1528860
 gtgtgggggt aagtcctctg tagagtcttc cttccctact ttagggttgc tgaattagaa 1528920
 gacaggtagg atggctgact ggtccacaac tgttgatga cttgtcctga ccaggccttg 1528980

 aacttgttga gcagcaagtc caacaacagg cttttgtctc aagtcaggag ggtgaagaag 1529040
 aagccggtea ccttgggaat ttgcaactctt tattacctaa ccatggctct tctccctatc 1529100
 tgtctaacte ctagtctctg gaactcaaat aataaagcaa gccctggaag ctcagtgggt 1529160
 ctcagtttct ttatctgtaa gatggggagt gtgagtaacg tatggctgtg tgtgatgagt 1529220
 gaagcccagt aaggggagcct ggaaggaggc tggaaatctg cccatttcta ccaactcaag 1529280
 tgatgcagat gtctgagaag tcttggtaga cagtggctct ccaccagct gtgcatgagg 1529340
 agctgtagag atggctcagg ggttaaaaat gtgtcctgct cttgcagagg acctgaattc 1529400

 agttctctgc acccatgtca gctgactcac aactgcctgt aactccagct ccagggagtc 1529460
 aaacactttc ttctggcctc tatgggcacc tgcacacatg tgactcacac acaaaaacaa 1529520
 actaaaaatg agtcttctaa aaattccttt gaaaaaaaat cagttgctca gctggaatgg 1529580
 atgccaatta aatcagaagt tccatgtgtg tggaaagtat cccataatgt gaccaaagtt 1529640
 aaacataaag gctttacagg tagcaggttt ggtccagtag ctaacctctg agccttgggtg 1529700
 tagccatctg aaaaacagga ataaaatag catttagctt tttacaaaga ttcatgaga 1529760
 tgattttgtg cctggctcagt gcatgtcagt ggtggaatgt taataccttg tcttcattgt 1529820

 tttgttatct ttttaagaaa tatgtttctt aaagatatat tttcttttag gcgcgtgatg 1529880
 catgtgtgtg tgtgtgtgtg tgtgtgtgtg tgtgtgtgtg tgtgtgtgtg tgtgttcaag 1529940
 tgcaggtgat ttcagaggga agacagagat gtcaaatccc ctagagttgg cattacaagt 1530000
 aattgtgagc tatgtggtat tatgcccaga tcttgagtc cctcaaagac cacccaggag 1530060
 tccatataca aaagcaaaga acctttatc aagctggagc ttggacctc cacgtgtcca 1530120
 tgagattgga gagccttgag ctcagttggg gtgggatttt tatcatagca gaggctgggg 1530180
 ggaggggatt tctaaggttc aggacctctg actgacattt gtctaggggt gtcttgggtga 1530240

gaggggatgg gtatattcgg gactaaggta catctggtga tcatatctac aatggctgga 1530300
acattaggta ttttctttgg aatattaggc attttctccc tttggatgct gattggtcca 1530360
ttcctgagtg gtgtctgagt ggtttcagtt tgtggtcttt cttggagtta ggtgttgccct 1530420
tagggtaaac tgaactcag acccactttc tgactggcct ctattgagcc tatcatggca 1530480
gctgtgtggc caaggagcct tgggccccaa gctgccatgg accccacagt ggcactggtg 1530540
ctgggaactg aacttggagt ctctacaaga gcagtacatg ctcttagctc ctatgccatc 1530600
tctccatgcc ctttccttt cttttaagac agggatttct atgtaactca agacagcct 1530660

caaaactcgag tatatggatt ataagcctga caccagcaa tttactggga gctagtagca 1530720
tggacattgg gaactctggg cccatcctag cacctcagcc tgtgggtccc agattttcca 1530780
gtctctgtt gctttgagcc tagttgagtt tatatattg actctgtcga caacctcag 1530840
ggaacagagt agaatgctca tgacaattct attttaacce atgtaatcca gaacattgtc 1530900
cagtttcaac agicatattt gagactaagt ataacattag ttagagacaa attataacat 1530960
tagttccatt tgctattgtt gttgccaat caccagaatg cagcatgtca cccactttgt 1531020
gagccaaact tttgtttaat gtgtggtaat atggaaactg gccacccttt gtatgcagga 1531080

gttctgtgcc tgagagggta tgggtattga gtgaggacat gcgtatgggt gtgaatgtgt 1531140
gctttatgtg tgtctaagag caggaaagg catatgtcgc cttaggtgtg tgagtgggag 1531200
tgtgtggagg gctgtagtcg tgtggggcag tcttcaggaa gacttctact acttctctc 1531260
atggcttctg ggttcctttg tctcatccc tctaatctt taagtaact taagatgact 1531320
cagtttgaga ctttctacta ctgtcaaaag ccatttgaag gaattcaaat gctatttcca 1531380
gtcttctggg gggaactcat gtatgtctgc attctgggcc tctctgttat gatataacat 1531440
ccttgtaac acacagggct agtctctctg tcgctattgg aggcaggcgg ccatggggtt 1531500

atggtagcat gagtgggtgg tgacgcctat ggacaatata ttgtttactt acctcatgtt 1531560
atttcatttg catgtttgag gggccctgta aggtcacaat tgcctttaa gaaacatgt 1531620
ccatggaat gtagccacta gctctgacc agggtgtga gtttagtca cttctcatat 1531680
ctggacttt tecttactgc ggtggaatgg ctttctttt cctacgtttt getcttttat 1531740
cctttggctt tgacatgaca ctctggtgcc tagtgacagg ctaaagcttg ctctaaggtg 1531800
actatctgcc cttgcccag ggcagatgac tctcaaac cggtaaaat ccctggtctt 1531860
ctttagtcca gtttcccca cttaggatga tagagcaaaa tgcctccatt tctgagaagc 1531920

aagaaagata ttttgtgtt atttagctta gtgttactct aataagattc caaagaaat 1531980
cagttaaaag ggagagagga cttttggct catggtctga gaagtttag ccgtgactgt 1532040
tgcttgggcc tgttttaaca cagtacctca gggcaagg atgccacaaa gaaagcctgt 1532100

tggctgggaa gtaagggtgg ggggtgagca aggtctcact atctcctta agggttgctc 1532160
 tcacagagac ctggcctaac ttcttcccaa taagccccac ctctttttgg ggggggtgag 1532220
 acaggatttc tctgtgtagc cctggctgtc ctgaaactct ctctgtagat gaggctgacc 1532280
 ttgaactcag agatacacct gcctcttctt cccaagggtt gggactaaag gcatgcacca 1532340

 ctacctctg gctaggcctc ataaagattt gcccaccacc tcccagtagc actaggggat 1532400
 ggaggtcagg cttcaacac atgggccctt ggagaacgct taaataaatg atggcatatt 1532460
 ctatcacatt gttctgttc ctcaaatttt tacagaatga gaaaaaatgg gcacaattcc 1532520
 tatttcattt acccgagttt ttctttaaaa ctgagagttt ggtatgggct ttttttgact 1532580
 ggccagaact tcctcaggat catgcagtaa acttgaggca agtggagagt agccactgtc 1532640
 cacttttcaa tcaaacacat tgaggtcacc gacagaacct cctctttgat tatttctggg 1532700
 cagctccagg aaggagatga ttttctgtct ctttctctgc cacacaacat gttggcagct 1532760

 gggagagctc tgccaccatg ccctacacac tccaggatga tggacaagct gtcacatcg 1532820
 ggaagctgtt tttatttttg aaggataggg aggaaaaggga gaggatgggc cagagaacag 1532880
 ccagggttgg tgcaatgaag gatgttttct tgagaaaaca tttacttcat tetaggtatc 1532940
 atttcttttc accagttatt agaattatgc agaaatagcc atatgtttgc tttgagactt 1533000
 gttttactgc attgcccaga cagaatccca tttttttttg ctgtgggagt caattccagg 1533060
 gccctgcctt tgctaggcaa gtgcagtatt atggagcaat attcccagag ctgtgtcttt 1533120
 aggtctgtgt gaccaggtcc agcttcccaa atgcttatat ttaatgttc catcttgtaa 1533180

 aatgactttg gtgagaaggt gagaagctag tgagtgaat actctgagtt cttacagagc 1533240
 cctttgcaca ctctaagagt gcttagccac tactgccagt gtgtgtttg ttcttagtta 1533300
 cctcatctca gacaactgct aggaatgtta aggttgctgc tcagtggtgc atggctagca 1533360
 tccacaagge cctggattta atatctagca ctgaggaaag caaagagaag aaagggacca 1533420
 cattctaaac aattgatgtg tccttcagaa aaatgttttt cttcttcac cagggaatgt 1533480
 tacaacaaac tctgtgactc agtaggtaaa agtgcttgct atgcgtacct gaagaccga 1533540
 gttcactccc tgtacttcat agtcagagga gaaaagecaa ctctgacctc tacatgggtt 1533600

 ttgtagctct ctctctctct ctcttctct ctctctctct ctctctctct ctctctctct 1533660
 ctctctctct ctctctctct ctctctctct ctctctctct ctctctctct ctctctctct 1533720
 cacacacaca cacacacaca gagacacaga tacatgcata cagagagata cagacagaca 1533780
 caccacaca ctcagatata cacacacaca cacacacaca cacacacaca cacacgcaca 1533840
 cacagacaca cacagagaca cagatacatg catacagagc aaaacagaca gacacacca 1533900
 cgcactcaca tacacacaca cacacacaca cacacacaca cgcacacaca gacacacaca 1533960

gagacacaga tacatgcata cagagagata cagacacacc cacacactca gatacacaca 1534020

cacacacaca cacacgcaca cacagacaaa cacagagaca cagatacaca catgcataga 1534080
gacacagaca gacagacaca cagacagaca gacagacaca caacacacac acacacacac 1534140
acacagaagc cagactaatc caagactttc tccaggccct aatgaaaagg acaaagggaa 1534200
ctttagttaa gtgtttttgt tcagcagtgg acttgccaat gcctggctga cccctgagcc 1534260
agtgcctaa aggagtcaag gttgtggctt ctgggacctg actctcccct gggctgtagt 1534320
catcagtcct aaagcaagct gtgtctgtgt tatctttgcc aacattgtct gacttagttt 1534380
cctgctgacc ttggccatta ttccccctga aagtacttta tatgatgcta cgcttcttaa 1534440

taagctttct tggcacaagc tgtcagcttt atgcacgacc tcccagtgt agccattgct 1534500
tttgtcattt ttgtttctca tgcctggctc tcccactcaa aacctcattg tttggcacce 1534560
ttctttctgc gggttcaggt catatacata caataaaaca tattagaaat taaaataaaa 1534620
ttcttaagtt ttttggaggg ttttattgac tgtacagcaa tgttttcgtg gaaggatcat 1534680
gtagaaattt gtctctgcag aagggtata aatgttccat catgtaactc tgcattgttg 1534740
tataccttcc tagaggtgga agctacatga actcaggatt aagccgcctc agagcagatc 1534800
aaagcggttt ctggtgggtg gggacaggtt catgacaaga ctgccatctc catagacacc 1534860

agggaaactg aggacctgt tggtaacaagg tcaaggacat cttcaagcct tcttcttcaa 1534920
gcctgagaag tatgagagtt agaggcatga cctcctaggc aaacatgagc ttcccatcca 1534980
gacagtata cgcagcacca gccacagtag cctgcttggc ttttctaca cctacatgtg 1535040
cttaaaacct caggaccagc agtaccaaca agtgagtgag gaccaaaggc ctgatgtccc 1535100
caatgaaaaa agagctgagt ttcaaaaaa aaaaaaaaaa aaaaaaaaaa aaaaaaaaaa 1535160
agcaagcaaa tgcataagggc ttaaggtcat gttaagcttt tatttattt taattttaat 1535220
ttgtctttta ggagctagag ttgaggaatt gggagacatc agtgggggtg aggggatgtc 1535280

ccaggatttg ttcaacagga agacaataac ttagtaggca gccaagagg gccaatctgg 1535340
aatcagtggtg tgtgtgtctg tgtgtgtgtg tctgtgtgaa tgtctatgtg tctgtgtttg 1535400
tgtatgtgtg tgtgtgtgtg tgtatgtctg tatatatgtg tgtgtgtctg tatctgtgtc 1535460
tctctgtgtg tgtctctgtg tgtgtctgtg tgtgtatgta tgtgtgtgtg tgtgtgtgta 1535520
tgtatgtgtg tgtgtctgtg tgtgtgtctc tgtgtatgtg tgtcagtggtg tgcattgtgtc 1535580
ttgtgtgtat atttgtgtct ttgtgtgtgc ttgtgtctct gtgtgtgtct gtttgtctgt 1535640
tgtctgtgtg atgtgtgtgt ctgtgtatgt atgtgtatgt atgtgtgtgt gtgtgtgtct 1535700

gtatctgtgt ctctgtgtgt gtgtatgtgt gtctctctgt gtgtgtctgt atctgtgtct 1535760
 ctgtgtgtgt gtatgtgtgt ctctgtgtgt gtgtctgtat ctgtgtctct gtatgtgtat 1535820
 gtgtgtctct ctgtgtgtgc ttgtgtctat gtgtatgtgt gtgtgtgtgt gtgtgtgtgt 1535880
 gtatgtgtct gtgtgtgtct gtatgtgtgt gttgtagggc aggtttggaa aggaacagag 1535940
 ctggctctgt gccagcagcc cagcaggcct tgcttagctt cctggttttc tgttccggtg 1536000
 caaagttgt tactcagcct tgaatcctgc cttctttttt tttctttctc aactctgttg 1536060
 attcaattct gttgactctg taaggagct agatcagctc cacagggtcc taaaagccta 1536120

 tgctcttcag ctggcttctt acaaacagtt ctgtgaaata gaccagggat ggcaggcgat 1536180
 tcagtctctgc tggccgcagt ctcccttctc tctgcctgtc agcaaagtaa gaacatggga 1536240
 atggtgtgta tgtgtgtgtg tgtgtgtgtg tgtgtgtgtg tgtgtgtata agtgtgatgt 1536300
 atgtgtgtga atgtgtggta tgtgtgagga tgtgtgtat ggggtgtgcg tgtggtatat 1536360
 gtgtgtgtgt gtgtgtgtgt gtgtgtgtgt gagagagaga gagagagaga gagagagaga 1536420
 gagagagaga gagagattgc tctagtggtc ctagtgttg ggtttcagcc ctgaatttgg 1536480
 ttagtagtcc tgggtgcccc gcagggtgtg gattgcttag ggtggttgtg ctctcttcc 1536540

 gtgggatggg catgttccag agattagctc tcacagggat gtggtgggcc tcagagctct 1536600
 gcatcattta tgatgacagt ccacatgcc gtgtggagga gcgttaggaa tttcaggcgg 1536660
 agatgtgagc acttgagagt ggcaatgaca aacatccatt aggaatttgc agcaggaaac 1536720
 cattctgtt tctaaacttg gttgtaaact tttagtgtgt tttcttagag aaactgcctg 1536780
 tggcagatat catcaagta aagctttgca gaatatgcag tttggatcaa gtaatgaatt 1536840
 ctaaacatta caacatctcc cttccagggt gactccacac cgcctgtctg gttaaatgga 1536900
 ggctctgact cccccacagc cacagtact caatttggg tatctgccct acatgcctag 1536960

 tgaacagagt ttcttaactaa gaatgcctgt ttattcttcc tgggatgcac gtatccggaa 1537020
 ccaggctga gcgctgggga cagtgcaggc cacacactgc aggaagcaaa agactgctta 1537080
 tgctcagga caaagtcagc tcttcacatc cactcagtgg ctagcctagc gggctccgctt 1537140
 tgtggatgag ggaaaacctt agacctcag acatgttttg tgtatcagct tttgtagaac 1537200
 agagcagggt ttgcttcca accaaagaag aagctgggtc taagtgatca ctgggctgtg 1537260
 atctgtgaa tgcagagcat ccagggacag ggctacatgc ccctactaca gaggctgtct 1537320
 cccccacagag agccttttgt gtgctggctg atgctgagga cactgtgaac tgggaccaga 1537380

 agctaagcag ttcaatggtg agggaggaag gggacaggaa gagaagagag tggggaatg 1537440
 atgtttgccg taggaaaatg ttcaactgtg gggagtggag cacagagaga cacagacaga 1537500
 gagatactgt ttaactggct gcttcagaca tttgttgttt acagaattag gacaccttgt 1537560

gccaaaggtagc aaacaactca gccttgtgaag acagaccac ccgtatctgt ctggtagcagc 1537620
 cccggagcag gatattctgc tcttccatgt gctcagcaca gacaggatcc tggtaggaa 1537680
 atgcctccag ggtcactggt ccttaacact gttcctatcc tgaacctctc acctgcagag 1537740
 agaagtgaca tccccaggga agggccatc tgtgacagag tcacaatggt ggtggtggtg 1537800

 gggttccttt caccatttct agaatacaag cattccccta ccctgggaaa gaggaaatat 1537860
 gggcaaaaca aaggtagca taagaagaga aattcagtct ttccacagaa cggataaaat 1537920
 gttttattca cacttattgt ggtcattgac agccacaatc ttctgagagc cctgagccct 1537980
 gagagtatag gttggggctt ttaccaccaga ggttggcacc aaacccaaat attccttccc 1538040
 attgtgggta ttcacacacc tctcccattt accgatcaat gtcctcacat tggctggtgt 1538100
 ggcagacagg tgcctactgg atgtagttca cagtgttgag agaaactgaa cttggttagg 1538160
 gttagtgtaa cagttaggag ttagggtta gggtagggg ttaagggtta ggggttagtc 1538220

 ttaggagtta gggtaagtg gttagggtta gcagtaaggt ttaggggcta ggggttaggg 1538280
 ttagggttag gagtaagggt caggggttag gggtaggggt tagggttggg gttagtggtt 1538340
 agtggtagg ggttagggtt ggagtagtg ttagggttat cgactgtttg cttattcaca 1538400
 agccctttt aagccctatg ttcttgtgcc actgctcatt ggtcaatcta ggagcacaca 1538460
 gccttcattg tttccagtcc ctaggtgttt ccttcagggc catgaaaca attagaagcc 1538520
 acagtaacag cacaggggtg ggagggggaa cagtgtggc cagaaagacc aagttccaag 1538580
 tttttccta atggacagaa tcctcccct cttttgtct cttgtctgaa attacagtgc 1538640

 tcagaaagggt tgaagaagaat caatgtccac ctccggatt gtttcagtcc taagacagca 1538700
 catacttagg tgccttttt cacagtttaa ctctatgct acagctaact gggagccaaa 1538760
 gcgaagaaaa ggagccata aaggagccc ttctaagcc aggcctcagtc ctgacttctt 1538820
 gtccaagggc aggtgtgctc tgaatcagga tgaagaagccc ctctacaagt actcaccca 1538880
 cagagactga aaccacagac ttggtatggg attttaaac agtgagtgag tcagaagtgg 1538940
 ttggtgagat attaaaatga gaccaagtgt tgtttcaggc aacagttaag gacacgaaac 1539000
 tgggagcgat aatgggaagg gaaatgatag actgtgggag gtaattatga agaaaggagg 1539060

 agatgaagga gctgggagat aattcagggt gtaagaact tgctttgcaa acacaaggac 1539120
 ttgagttaga tccccagaac tcatgtaaaa acaaaacaaa acaactgga catggtggtg 1539180
 ctggcttgca atcccagtgc cagggaggca gagatggtta ggtacctggg gctcactggc 1539240
 cagtctggtt taatttgatg gtttctggta agtagccatg gtaccaact atactcacac 1539300
 tttgctgatg accagtgatg tgccatactt taacaccaca ttctttccc ttgcagttta 1539360
 ttttgctttg catgttgagc gaacaagatt aaaatacaag attgcagccc cggcagctctc 1539420

cggggctcca gagtttgaga gaatatctcg tgcacagtaa gtaatgcttc tcacacaggc 1539480

 aggtattggt ttttaaccaa gttgttctat ttaccaataa agactcagga gtcagatgct 1539540
 aaggtgaaaa cctgctaggt cagagaggcc caaaagcaac cagetgacct tectttttgg 1539600
 ccagagacc agcaagagac tgtttctcca catgtctcaa accaaaaat gcccatgaat 1539660
 cttaaatcct ctctactcct tcccgtgtgt ctctctatca atcttctga ctactcctta 1539720
 ttctctatgg ctaattcctg tgaactagtc gctggctctg cccctgatc caaggtgat 1539780
 tttgtttaac atagtcttgg ggtttcacag tgcaatcaca catcccaaaa taggcaggcc 1539840
 agccacaaac agacagattc tgattatggg aaagagaaat agagaaggcc ctaagttcat 1539900

 ttcagttagt aaccacgaca agtcactctg cacccatctc aggttccgcc atcatgaatc 1539960
 gtccagtgta tgttatctac ccaactttgg tacagatcta gtgatctagt tggattggcc 1540020
 tattcaccca aaagctgca acttgggaag agcggtagtg tctctcaagc actgtggatt 1540080
 ggccaaaggg acctctccag cccctgaggg ttcagtagat tcaagtggaa ctattttata 1540140
 atttcttttc atcttctgcc aagtcttca agaaccattt cctaagatcc gaagcatgta 1540200
 agaacaagct gtcccaagtc acatgagtcc tcagtgtttt ttagcattct gtgctgctg 1540260
 cttttcaga cacacagtac cttctgcat aaacacggtg cactttcctg tagaagttag 1540320

 ggtaaccttt acacatcacc ccaaagccta gtgcttggga gagcattgtc tttatcaata 1540380
 tttactcatt gctgggttct tctttatgt ccatgagtaa ggttcatctg tattttttct 1540440
 tgcatagttc ttgtctcatt ttggctattt aaaaaattac acttcacttt gaattttggt 1540500
 tggtaaggca agcccttgag ctgacaacat ggcctcttgg tcagtctctt gctctcagaa 1540560
 gggttttata gactgatctt ccccttggct tcaaagtga cagggaatgc ccacaagaca 1540620
 attttaagta acatcaaacc atacaaggag aagccattcc caccctagtt gtctttaaat 1540680
 acctttggta ggtcaagtag caagcattgg tttggtgcca gtgtgtttta tacctaagag 1540740

 taaatgttta cttatgcca gtgcacagcc tggaaacaga gtggaatgac aagtcttatt 1540800
 acaagtcact gtcccttggt cctgtcaaca ctgtgatctc actgatgttt atttgtccac 1540860
 agtttttaggc ctgctagtc acattattct ctctttttaa tcccctagtt ggtctatagt 1540920
 cactttgctg tgttaacct ggagccagtg tttgtacat tgtaactaag taacaatgt 1540980
 tggaaagtaga gctgcatagt actctgtggt tatatttctt tcttgtgcag gttttatttt 1541040
 tcttaggct aataactgct tctttgctgc ctttaattca ctctcaggcc tctatagaat 1541100
 tgaggctccc tgtgagtatt ttcagatgaa ctggaagtct gctggcatcc tcttctgct 1541160

ttgagcccat ctgcctgaat cctcctccct ttcactacag tagaggatgc tcttagagct 1541220
 actgcaaggc tgttattctg gtcttcctgt tgccttccta gaatttgctt atactctctg 1541280
 gatttggatc tctgctacc tggactacaa ttctttttgc attgtttttg tctcttaatt 1541340
 ttagtggagc acattttgta tctttctgtt acagtgatca atacatgaga tcagcaactt 1541400
 agagagaagg aagatttatt ttggctcagt tttagatagc atgctttgga cattggtggc 1541460
 acatacatca tgcattgggc agcatgtgtt ggggcaaacc ctgttcgcct catgggcaga 1541520
 tgcaaaaaag aaagagtcta ggccccatca tcctttcaa gggtatatca ccaatgaact 1541580

 ttaccctctg actacctca gtctctgaag actacaccac caactctgta acacatgggc 1541640
 ctgtggggga acittcagat tcattctagg acatgtctaa acacttcctg agaggatctc 1541700
 aggactgtag aattttgagg ctgttctat ttggatacag cctaccccca gcctcacatc 1541760
 actgatggct gggtaggctt atataattcc atattaaatc attacacctt cagaattgtg 1541820
 agacaattgc tccatcactt tctagtgact ttgggtattg ttgacattg ccatgtggtg 1541880
 tgggaacagt tgagaggttc tgggtgctc tgtgccccac agacctctc tgtattacag 1541940
 catgctgaat tctagagcag gcctccttgt ggtccagaaa ctcatgttct tctgtcccag 1542000

 agattaaaaa agtattctcc cccaatttct tctttgtgtt ttattcttt tttgaacat 1542060
 gctagtgtct cttgagctga ctctttagt tctttttatc ttaagttctc atatttgggtg 1542120
 actcttgttc tttctggaga atttccaaa tttctacttt ttaccagctg aaccattttg 1542180
 ggaggtcatc attccaacc caggagtga ttttactct gcttttcccc tgccattggt 1542240
 gatgatgta aatcatatgt ccttgggtct catgggcaca gttttccatt tggggattac 1542300
 attaactact taaaaattgt ctgtcattat tctgttttaa ataacattta acaaatttta 1542360
 ataatatcaa accacacaag gtaaatccta cctatttcaa tttccaagt ccttatggtc 1542420

 ttcatgttca agttagtacc tgttttgaac tttggcttcc atgtcacaca ttaaacaaaa 1542480
 atacacatta aatatttatg agtgtctcca tgtatagctt agcttgatc agtgaacaaa 1542540
 ccaaaagggt gaacaaacct tacccttttg gattatatag ccaaggagga ccaaagatca 1542600
 ccattgggtg gctttccttg accaagggtt gtgctttgaa aacctcacat gagagcctgg 1542660
 gatgggatgt agccacatga attggagtgg attgaaattt gaactagggt ggctgctgta 1542720
 agcaaggcca gcctgaacca cacagtgagt cctgttaacc aagagctggg gacagagctc 1542780
 agtggtgaag ggattgcttt gtgtacagat tgccttgggt tgcaccacaa aactatactc 1542840

 cctaccccaa acaaaaggaa accacaaaag ggactaaaca acccccaaa ccaaccaacc 1542900
 ctaacaactg atttatagaa aactagtaag tggatatgac acaggctgaa ggtggctgct 1542960
 gtgataggct catgctctca gactcaaacc atttataaca tcacctggg ggagacctca 1543020

gcttccctca ctctacctct gttgaaactga gagctgactc tgtctgtgtg aggcttccag 1543080
 caggtagat ctgagggcca ctcttgggt ctatttcatt ctactgttt ccacacattt 1543140
 gattctcttt caagttagtg ttttctcct cctttttttt ataactgggc tcctttcgtc 1543200
 ctagaacaaa agttggacac catttccaaa ttttctctg aagtattta taaaataagt 1543260

 acacaagctc aattcattca tcagaactta attttttgtt tgtttaacct tagtgaaga 1543320
 gtcataggat taaaataata tgctcattgc cgggggtggg ggcacacacc ttaatttca 1543380
 gcacttggga agcagaggca ggcagatcta catgagtcta aggacagctt ggtccacaga 1543440
 gtgagttcca agacaaccag ggctacacag agaaatcttg tcttgaaata ccaaaaacaa 1543500
 acaacaacc cccccaaaa aaccctaaaac caaaaatcca aagcaacca aaaaacaaca 1543560
 ctccccacca accaaatcaa accctataa tatcaagggg aatttagagt caagagatag 1543620
 cttgatggat ggtgctggca taactggatg cagacatgta gaagactaca gatagacca 1543680

 agcctattac catgcacaaa actttagtca aaatggatca aagacctca cataaatcca 1543740
 gccacactga acctattaga agacaaagtg ggaataaacc ttgaatcaat tggtagagga 1543800
 gacagcttcc tgaacattac accagtagca cagacactga gatcaacaat tgatgaatgg 1543860
 gacctctga aactgagaag cttctataag gcaaaggaca cagtcaaaa gacaaaacag 1543920
 cagcccatag actgggaaaa gatattcacc agccccacat ctacagagg gctcatctcc 1543980
 aaaatataca aagaactcaa gaagtattc tccaaaacac caaacaatcc aattaaag 1544040
 tgggtatag aactaaatag acaattctca atagaggatt cgaaaatggc tgaaagacac 1544100

 atgagaaagt gttcagcact ttcccttagc catcagggaa atgcaaatca aaacaactct 1544160
 gagataccat ctiactccta tcagaatggc caaaatcaaa aacaccaatg acagtttatg 1544220
 ctggagagga tgtggagaaa ggggaacact tctccactgc tggtaggagt gccacttgt 1544280
 acagccactt tggaatcag tatggcgaca cctcaagaaa atgggaatca gtctaccaca 1544340
 agatccagca atttactct taggcataa ccaaaaagaa gcacattcat acaacaaga 1544400
 catctgttca accatgttca tagcagcact atttgaata gccagaaact ggaagcagcc 1544460
 tagatgcccc tcaaccegaag aatggataga gaaaatgtgg tacatttaca cagtggagta 1544520

 ctactcagga gaaaaaaaa tagaatcttg aaatttgcag gaaaatgcat ggaactaaa 1544580
 gaaaccattc tnnnnnnnnn nnnnnnnnnn nnnnnnnnnn nnnnnnnnnn nnnnnnnnnn 1544640
 nnnnnnnnnn nnnnnnnnnn nnnnnnnnnn nnnnnnnnnn nnnnnnnnnn nnnnnnnnnn 1544700
 nnnnnnnnnn nnnnnnnnnn nnnnnnnnnn nnnnnnnnnn nnnnnnnnnn nnnnnnnnnn 1544760
 nnnnnnnnnn nnnnnnnnnn nnnnnnnnnn nnnnnnnnnn nnnnnnnnnn nnnnnnnnnn 1544820
 nnnnnnnnnn nnnnnnnnnn nnnnnnnnnn nnnnnnnnnn nnnnnnnnnn nnnnnnnnnn 1544880

nnnngataac aagaatggag ataccataat agaggagac attttaagtt tacagagaaa 1544940

 ttaggacta gggaaacgtc tggagatcta caaagatgac accactaaca atctaagaat 1545000
 cagaggagag gctaccttaa atgcccctccc ctgataatga gattgatgac tgacttatat 1545060
 gccacccgat agcccctcatc cagcagctgg tggaaagtaga agcagacacc cacaacttat 1545120
 cactgaactg aactggaatc cagatgcaga gaaggacaag tgaagagcaa aggggtccag 1545180
 accaggctgg tgaaacccac agaaacagct gacctgaaca tgggggaact cttgctcctg 1545240
 agactgatag ctgggatacc agcatgggat tgatccagac cccaggaaca tgggtttcag 1545300
 tgaggaaacc ttggaaacct acgggacttc ctgtagtgt tcagtactta ttcttagcat 1545360

 aggtgtggac ttgggagcc cattccacat aaaggaatac tccctgagcc aagacacacg 1545420
 ggggtgggcc taggctctat cccaaggat atgatagaca ctgatgacac cctatggaag 1545480
 gcctcacat ccagggggag cagaaaggat atgtgatagg tagggtttta gttggggggg 1545540
 tggtagggga ggatgggagg gagaaggga ctgggatgt catglaaac aatcttgttt 1545600
 ctaattcaaa taaaaaaaa aaagagagat agcttgatgg aagggcaaag tggggcagtc 1545660
 ctatccatt cctcctgt attttctg gtattttcta ttgactagt caacttctg 1545720
 ccttgaattc taaggttcat gacaaatctg gctaattcag atttcattg tcatgagtat 1545780

 ggcatataga cttttatga ggtacctgac agaactcctt gggctttcca agtctttgca 1545840
 aagccggcct ggctatttat ttgtctctc cacattggct tccttgatt ctgaggaagg 1545900
 aatgactct gtttctct gtctgggct gaggcagga ttccttttag ctgtccgtga 1545960
 ctttcacaga aatctgcctt ttctacaact tctgtttaca gcatagcctt cagcatggcc 1546020
 aaaatgca aaggcactgc tcagtccttc tctgagtaga aactgcatct cagcagcatc 1546080
 acttcaagat ctttattgtg gcttctgtgt gtctctgca gcagacctct tcaggtggg 1546140
 agtcatctgt tcagccgaga tggctgagat ggtgtctctgg catcctaggg tgcagccag 1546200

 acctccttc ctgagtcctt ttccctcacc cagggagaag ctgtggagat gactacagtt 1546260
 tttctgtgt cacaatacag tttttttttt aaatcatgag aacagcaacc acaattatat 1546320
 ccagacccat ttttatgct attgctaaaa cttaaaaaaaa ttctatactc attcaaatgc 1546380
 tgtgatgact ttttctatcc tagttcaaat gtcttgatga ctttagagta aaggcttttg 1546440
 taaaatctac gcagtagtc caaatagtaa attgataatg ttgcagtgt aacacatttc 1546500
 ctgggccaga gaggtggctc atcaggtaa ggcacaggcc atgaaacttg atatcctatg 1546560
 tttgagtccc aggatccaca agatggaagc agagaatgga taccattaaa tgcctctga 1546620

ccgccacatg cacactttgt catgcaagt catatgcaca caggcctgtg gacttacaca 1546680
 cacagacaca cacatacaca tatacacaca gagacacaca cagacacaca aacacacaga 1546740
 cacacagaca cacacataca catatacata cacagacaca cacacagaca gacagacagg 1546800
 cacacacaca catatacaca cagagacaca gacagacaca tacacagaca catagacaca 1546860
 gagacacaca cagagacata cagacacaca gacacagaca gacacagaca cagacagaca 1546920
 cagacacaga cacagacaca ggcagacaca cacacagaca cagacagaca cacacacaca 1546980
 gagacacaca gagacaggca gacacacaca gagacaaaga cagacagaca gacagacaca 1547040

 cagacacaga cacacacaca gagacacaca cagacacaca ctcacactaa ataatgtaa 1547100
 aagggtcagt gtttttctc tgagtctgtt tctacaagga agggagatga acaactgacc 1547160
 agttgttctt atttttcttg gggtagggga aggaagctcc aatcttcag tttctttct 1547220
 caaaaactta aaaaagata ctttggttgt tctgttaca caaaaaattt tattgtaatg 1547280
 tataagcctg gatcccaaag tacaacact gcagtataat gtacaaccgt ggttttgtt 1547340
 gtactgggta ggactgaagg acagcttcgc tctctgtta atgctgaaca cttagatttc 1547400
 agactcaaat taaccttcgc acatgcaaat tggctcatcc tgaatccagc tactccagga 1547460

 atattagtct gtgcttcctc tgctgtagt tgtgtctgtt gttttattct accagtgtgt 1547520
 gtgtgtgcat gtgccacagc acccgtgcat aggtcagaag acaaagctca ggatttagtt 1547580
 ctttccacc ctggggattg aactcagct tcacagcaa gcactttaac tcacagagcc 1547640
 ttctatgtt ttgttttaa tcaggattca ctatgtagtc ctggctggcc ctgaactcaa 1547700
 tgacatctc ctgcctaagc cgagtgggtg tcattaactt tttagactca tttaatattt 1547760
 gaagcatgga atttataaa tgaaattatc ctaatgggtg tttaacccag aaaaactaaa 1547820
 gggaaatcca caagataag agttttcctt tttctataa ccatgggtg acgcaggcca 1547880

 ctgatttttg tagtaagtga ggcaggaata aaggagggga agaaagaaa agaggggggg 1547940
 ccgagagcat ctttctctc ctctgtgtgt gtgtgtgtgt gtgtgtgct gcgtgtgtgt 1548000
 ttgcattgta taatgtgtgt atgcacacac atgaccgcac agggatagag gaaaacattg 1548060
 gggatcctg ttctatgtgt gtgtatgcaa gcacggggca gaggaagaca tcaggtatct 1548120
 tgctctgtgt gtatatgtgt gagagcatgc ttgtgtgtac acatatacac acacatgcaa 1548180
 acagggcgag gggaggcatt atctgttctg ctctctctct ctctctctct ctctctctct 1548240
 ctctgtgtgt gtgtgtgtgt gtgtgtgcta gagcacgctg tgtacacaga catgtgcaca 1548300

 taaaaggca gagaaggata tcagggtgcc tgcttgctgt gtatgtgtgt gtctgtgtga 1548360
 gagcacgctg tgtgcacaga catgcaggga aggacatcag gtgtctccat cactctccat 1548420
 tttattcctt taagacagag catttcactg acaccagac ctaggctggt agccagcaag 1548480

ccccagtaga caatatctct ggccttcac atgctggaca tgatggcgtg catacaatca 1548540
 caactgtgtc atttctctga acattcctga ggaagcttac agttctgggt agtagctgga 1548600
 agccctaaaa tgccttcat ccaactgagtt atataaagag gatgaccaag aactgaatg 1548660
 gctctggtag gttcagtac cggcaggggt atctggagag ctgtaagtct tggaccctca 1548720

 tgtgttcac ctgcttctac cagttgttca gttgctgggt gacagtaga cttagcccg 1548780
 gctgccacca ggtccacct cctgetgtat tgccataggg gactgcctcc aaaaggaaca 1548840
 atttaactaa ttaattaata aataattctt atttttgag gctctcactg tgtaactcag 1548900
 ggctatggct gctgctctcc aatgggggcc atgacaggaa gctggcatgg acttttaaaa 1548960
 cctcaaaacc caccctcagt gacactcctc ctccaataag gccacacctc ctaatattc 1549020
 ctaaacagtt cactaagca gggaccaagc atttggacag atgagccaat gggggctcat 1549080
 caaacacca cagtgggtgg tggaaagtca atgttcaact aaagtcaacc cgagacagtg 1549140

 gttcttgagt tccttgttc atacagatga agattataaa gcggacatgg gtggggttag 1549200
 caaatggagg tgagctaagg aaaagtgaga gaaatccccg agagtgggag gggttcccag 1549260
 agaggaaaac agaaattatc taattgtttc atgtaggagt ttttaatagg acttatggta 1549320
 agacaatgac caatgtaatt tctgttgcaa ttggttagtt ttctgggcta tcatggcgag 1549380
 agccaatggt tctctctccc cacacatgtc ccccaacc aaccaggag atgacaactc 1549440
 tgtttgttca ctgctctccc agttaaggat ggcgaagtcc tccctttgtc catctctgac 1549500
 ttatccttta ttagccactg agcttgactg atcacctca gcctgctggc catgggcctt 1549560

 gcaggtgtcc tgggtgctgt taattaaact gtgctgtttt cgttctcata tatacatgag 1549620
 cagcttgatt cacaactcgc aagatggagc tatagtcttt tttcttctt gctcatgggt 1549680
 ggggctgtag tctgtgtgt ggggtgtct gtgtggcctg ggggtgtctg ggtggtatcc 1549740
 tttctagact aggtagacat ttctcgttag aaacaattct tctccacaat ttccttgtt 1549800
 atatgaaagg gcaattgtgc cttgcatatg ttctcaagg aatagggtga ggttggggct 1549860
 ttaggggagc cagatggctt gctgacactg gctcagagcc ctgtccttcc tctcatctgg 1549920
 tctgcttggc tctctcttag ttgctagecc tcttcttat cttcccaggt gttctgact 1549980

 tcaactgttt aagcctaact ttctattac tctgtgtct gttctctgtt ttcactgtaa 1550040
 tattcattat caaataaagc ttttcaacta caggttcttt tcttctaact cttacagcaa 1550100
 gctagctctt gcctctaagt aaccacaga gaaggacag tattgctgct tctatttata 1550160
 tttatttatt ttatttatt ttatttttt tttggtttt caagacaggg tttccctgtg 1550220
 gctttggaag ctgtcctgaa actagctctt gtaggccagg ctggtctcga actcacagag 1550280
 atctgctgc ctctgcctcc cgagtgggat taaaggcatg cgccaccact gcccgcctt 1550340

atatttattc ttagaatccc atcttttttt ttggtctgtg tgctctataa cacatacaaa 1550400

 tattgttttc cagttgagtg gttaacacaa tgaagtctat gccttagtcc ctgctctctc 1550460
 tgggtgtcct tgtggggggt gactttggca tagtcacaga tgtccagget cetccacce 1550520
 ggtcctcagt ctcttttctt cctatggctc taaaaggga atatgctaca acaattactt 1550580
 aaccaggtgt cccagaagtg acatatttaa ctctctcac cttccattgg taataagaag 1550640
 gctggggata tatgggtgct aatggaacc cagcagcatt ctgatggagg acacacatgt 1550700
 acatactgtc atggagctta cactgtgatc agacaggtgt ggagactcct gtttagaaa 1550760
 taggaccagg tttggaactg caggaccaca atttgatacc tectcccca ctccaaaaca 1550820

 tgatcaaac tttgtagtct acctactgaa gcaaggtccc agtggactt ggatcagagg 1550880
 gtctcctage ttccagctct ttgatccagg tgtgagttt caggggcat atatccat 1550940
 gtcaggggac ctaggtccc tggcaatggg gcattggaga aatggggcaa tggggcaatg 1551000
 gggcaatggg gacttttagc actgccagg gttagtctcc accagaatat cctgaggat 1551060
 gatgtgagtg tatcatgcca gaaacatagg catgtttggg tgtttgcaca atgtcagaag 1551120
 gcattgagca atgaattctc aagctacatc atttgttgg ctgctatttg ccaaacagtc 1551180
 cttatattac ctttctagct ggccattggc aaccacaaag ttcctttact tcaatgtaa 1551240

 ttactaatat taacttggaa attatataat ataacacaca cacacacaaa cacacacaca 1551300
 cacacacaca cacacacaca cacacacaca agaatgatta caaaaagatt agaagaccac 1551360
 aaagtcatg gaggtttgc cagaggcaga gagctgagac agatgcaaag agggttgctg 1551420
 tatgagatca gatgtggcat caaagaacgc acttggacag ctgctgaagg caagcagagt 1551480
 cctaccacac agggttacat ggctgagccc cagaggtgta gggcagtgta ggtgacctac 1551540
 aggattgact acaacaattg agtgggtatg gactgcctga tacaatgggg gtcatttca 1551600
 gctgtactcc aggggacagc cagagctatc tgettgtggg cccctagatg cccagagtgg 1551660

 gtagttggat gactaatggg tgggttatag tcagagaagt tctaggtgta ctcttttat 1551720
 ggggtatagg tgaggaatt tcagctttca ttggtctagt gtgattgta ggtcctgggc 1551780
 ctgatggttt gactcttccc aggcacacat acgcccctgc tttactttga taaacataaa 1551840
 agtgctacct ttgaactcgt aggttaaatt tgctcttagt ctgtcccat ggatggagct 1551900
 ggacagctgg tggagtctg ggggtggacce agagctatct tctgctatat atgcaactga 1551960
 catggagtca aaatccctgc ttgctagtig gaattacct gggcaaggca cagcctgagg 1552020
 ccaactgtcc acctcatcga ggaacacagg gcacatagga acatcacagt gccagtggt 1552080

ttcagctttt ttiagacctt ttctatTTTT tccttaaac ctcacatata ctaaaacatt 1552140
 ttagcaccag aaaaacaagg acaatgatg ggggtcggta ctggtttcaa aacttaagtc 1552200
 cccattctga aaagtatctc aagtgcaggc caagcaggac acttgctccc cctactggcc 1552260
 ctctagttaa gacctttca gtttctctcc ctggtgtgga atttggcacc ctggtgaca 1552320
 tctgcttaa acaatgaaca tcctctccc ccatatttcc ataggggcat cagtgtgcaa 1552380
 agaactcagg gttgttacac aatgaaggct gtgatcagaa aatgactcaa cacagcccat 1552440
 ttttctctat gtgggcatgc aggggagggg acagtccaca gataactata accaactgta 1552500

 ttcataagga acaattgaca caggaatttt cctcaggatt cctctaagaa gagaccaggg 1552560
 ttagctgtt caggtagtta gaaggaggct aaaatcattt atgtattgga ttgtcctaca 1552620
 tgtgaaaata attagctgct gtttgcacag tcaagcagtt ttctgtattt ggtcccctta 1552680
 agttgactgt atctgttac agtttacagt ggtggttata atgggggcac accaagcttt 1552740
 accatcatgc ttcaggggc ttgatgtagg agctttcagg ggctcagagg tactgctggt 1552800
 gggggaaggg tggtcacagg gtgataatga gcagatagac tgtgactcca ggtgtttcaa 1552860
 ggtgaagcaa tatttccagg cagacagaag caaatagtgt agattccaac cagcagtcag 1552920

 aattattccc aggtctgaa agatgataat gaaaaacgga cgaagatgca aatgatggcc 1552980
 aatccttgta aatggcctgg atttgaatc acttaggaga cactcctctc agcttgtctt 1553040
 tgaagatgtt tggagaggtc taactgagag ggaataccca ccctggatgt gtgtggcacc 1553100
 atgggtgtg gccccagact aaattaaagg taatgaagga agaatccagc taacaagca 1553160
 gcattcatcc ctctctgctt gttggttggg gaggcaatgt gaccagttgt tccatacctg 1553220
 tcaccaggcc ttccttctg tgggtgactg tacctcaaa ctgtgagaca aaacacatcc 1553280
 ttcttcaat tacttttctc aggtactttg tcatggctat gaggaaagta aatgatacac 1553340

 tgcactcag aggaagcaag gctcaaggca tgtctgcaa taaggacata gggttgggtg 1553400
 agtccaggag tgactcctgc ttgtaagggg acaagggagc cttttgtgg gggattaaga 1553460
 tgcagaatgt agagtaactt gccctagtag gctaggcttt tcttttccgt aagcacacat 1553520
 gaagctgcat ctattcttgc ctgatctcaa tggctctctat cccacccac ccccaatcc 1553580
 tgctcacctt gcatcttatt gccagcattt ccattttctg gaaattaggg tgctaccatc 1553640
 gaccagtc cagcttcaat cagctaaatg gtgggctca gtgcatatgg tattctcctt 1553700
 gggttctgta gcattgtcca tacctgggtg tctgctagt tttatgtcag tttgacacaa 1553760

 gctagagtta tctgaagggt gggaacctca actgagaata tgccttcta agatcaggtt 1553820
 gtaggcaage ctctaaagca ttttcttaat tagtgattga tagggggagg acccagccta 1553880
 ttgtgagtgc tgccatcctt gaagtcctgt gttctatggg aatgtaggct gagcaagcca 1553940

tgggagcaag caagtaagca gcacctctct atggcctctt catcagctcc tacctccagg 1554000
 atcctgcctg tttgaatttc tgtactgact tccttcagt atgaacagta atgctgaagt 1554060
 gtaagccaaa taaacctgtt cctccccaat ttgtctttta gtcttgggtg tttgttgag 1554120
 caatagaaac cctatctgag acactgggcc acgtccttgg gctgctctgg gtgctgcaat 1554180

 gggaggaggt gagattcagt gccctctctc caactatgtc ttgtcacctg aggctgata 1554240
 ctctttatat ctggagtctc actaagccct tcacaaagge gaccatcca cacctaggt 1554300
 gttctccagc ttgagcagca gggaaagacc cgcaacagcc cctccatgct cgtttctctt 1554360
 ttcttccaag agactttctt cctctttcag gcagtagcac aaaaacacat tttcgtgca 1554420
 gcttctgtgg agagacccaa agagaccaca ggctccccga ctgtcctccc tatagtggaa 1554480
 ccggggtgtg gccagaagac tctgtgcagt atctctgccc ctcaaatgca gcaccaaggt 1554540
 cattagtcca ctgcacagaa agtctctgca atagactttt atgaattgtg gtgatatt 1554600

 gtttatgatt tattaaagtc actggcgatc aaaatagcaa tagaagctag gcacatgtct 1554660
 ttaatcctg gactcaggat taagacatag atagatctct gttagttaa gtccacactg 1554720
 accacataaa attgatccag tcctaaaaga aacatctcac ataaaggga tetcagcacc 1554780
 atggagggtg agacaggagt ggtgtggttg ggtggagaaa ggaataaaag gaggaggaga 1554840
 caggatctga aagccttttg cccctgaaga tttgtggaga caggattaca ttttcatctg 1554900
 ggtagaggta agatttaccg ctttgctgc tttgcttctc tgatcttcaa ctggaagctt 1554960
 gaaccctagt atctgtctct gggctcttta tttatcatgc aacagtggat gatgcttctg 1555020

 aggtgtttaa aatgtcacag ctgattttga ataagaagat gtggagtaat tcagggtgta 1555080
 tcatgaaacc taataaagga tggagcaatt atgtcctggt tccagaaagg gccaggaaat 1555140
 tgcaactggc gaaagggtt agaaccctcc tgtgctgttc tctctgttc cctggaaaag 1555200
 attctctgga tctagccaag gaaaggaaaa tctgagaaa taggtcttta tttttagctg 1555260
 tcattgtttt tcctatagaa acttagaaag catctttca cttaacctat cgtagctaat 1555320
 tacaaactta ccaaacatc agaagcaaaa ccatgccaag gacgcagaga aagacacatc 1555380
 ttagtccctt ctctgagtac tagtgggctg tgcctctggc tctgttaag ctccagagca 1555440

 gtgcttctt gggccactca cagccttta ggccttaaag aatgattag atgatagaga 1555500
 agaaagcgtt tctacttag taccactcat tteccatctt caggccccta gagagcaaaa 1555560
 ggggtcctt gcgtttcca cttgacttc aggattctgc atcagccatg gtctgtatgt 1555620
 gtgggtggga tttgtcaact gttcactttt ctatttcta ataaggggt agggattgaa 1555680
 tttagagccc tgcgaatgcc aggaaaacac ccaaacact aagaaacatc ccagctctt 1555740
 aaaaaatta taattatctt tatttatgtg tgtggctatg tatgatgta tgtatgatg 1555800

tatgtatgta tgiatgfatg tctatgcaca tigtatggg tgcctacaga ggccagaaga 1555860

gggcactgag tgcctggat ctggagttac aggtaggtgg ttatgaacca ctggcatgg 1555920

ctgttgggaa ctgaaccag gtcttctacg agtactaac catcttctcc agcccttcca 1555980

ccccatttt gtggttttca ttttgagaca aggtctccct aagtgtcttg ggttggcctt 1556040

gaattcactc ttagcccag gctgaacttg aatgtgcaaa tctgcctcaa gcttcccaaa 1556100

tagctaagat gacaagcctg tgttaccaga ctcaaaaac acacattatt ctggatggg 1556160

ttcaagtgat gctaaaatga ctattgagaa ctctgtcttc tttggtttg ctatttgta 1556220

ataaactga ccaactaac gatgactatt ccatctcacc tttctcttc tctggtaggt 1556280

acagatgaat taattgtagc tcttgagaa ctattccctt gtgcttaaaa aatagiacca 1556340

aattttccac ctgagtttcc catggagtag aggcaatttg atgctactgt ctactaattt 1556400

taatttttgc tttgcctatg attgttttgc ccacatggat atctgtgcaa cacttgtgtg 1556460

cctgggcccc aaagaggcca gaaggtccag actttgtgag ctgccatgtg ggtgtgggaa 1556520

atgaactcgg gtcctctgca agagctatca gtgatcttaa atgcacacag gtcaattggc 1556580

tctcgggtca actggttctc aggtcagctg gctctctcag tcccactata cagaatgaga 1556640

attaaatgta ctatttctt tacctcagaa tgttttaggg gattattta aaggtcacct 1556700

gaatgacca agtgactcaa gtggaaaact acaggtgtca gggacatttt aaggagaatt 1556760

ctgttttagta gttgagtagc ctcttgagtt acttgataa gccacagacc gatatgtagg 1556820

ctctggaggg ctgtcttcca gaaaaaagg ccacaacttg ctccactagt gacaacttgt 1556880

gtgatgaga atgttttcgg ctgggctctg cagttgagca atgttgaggt ctacacttga 1556940

agactccttt taaatggaag gctctttaga tttctatgt aagtcttgc attattttt 1557000

tgtttgaata gattgaatgc tcacctgtgg atggaaaac aatacattag tgtatgtttg 1557060

ttcatgaatt caacttcatc ttaatttttc tcctgcagt caaaactctt tggatctta 1557120

ttccgtatc atcatacac tgtggatggc tggatggtat ttcaatcaag gtaattataa 1557180

gaacatgta actcatcca aagatgaccg tgggttttaa aaacaattaa agggatgaata 1557240

gatgaccata cagctactga tgcctgataat gactttaaat ataagaacca atacctgtg 1557300

acatccaagt tataggtgat ttagttcaat aattaaanaa aaataaatcc aaactactgc 1557360

atctggatat agaggtaagt actggagatt ccagtgtctc tgatctcgag gcagagctgt 1557420

ctagtgagac tctgtctcaa aaagcaggga ttaaaactaa cctgggctca taggggctca 1557480

gggattcata gaaatgacaa ccaggagcct gcattggact gacctaggcc ttgtataact 1557540

tggcttcat gtgagagatg cttaacagtg agagcagggg ctgtctctga ctctgctgcc 1557600
 tgctctttgg acccattctt cctactgtgt tgcctcctct agccttaata gaagaggaga 1557660
 tgcttagttc cattgtaact tgatgtgccca gggccagctg atgtccatga gagaccctcc 1557720
 tgtaactgaa gagaaacagt ggaggaggag tcgatggagc ggggaagagg agagagatat 1557780
 aaaaacaaca acaaagcaag agttaataat gcagctcagc ggaagaatac ttttctggca 1557840
 tgtacaaggc caagagtttg ggtcagaaca tcctcctact ccccatcact caaggctcatg 1557900
 tggctatagg ctatacataa cttgaacaa actatatgct agataatcaa ggataaaaat 1557960

 gatatgaacc ttgtcttcaa atctaataat ctaatttaac caaaggagca gaacacaaaa 1558020
 agcaattcac ttttacaaca acgtttatgg gacacttatt gcatgcccgg ttatttcttg 1558080
 aacctcatag acttgtagga tttaacttt catatgaac agagtcaata attgattcct 1558140
 actttacata tgagaaaact gagatgcaca aatgttaagt tgtccaacct gatgatattc 1558200
 accaatgtgg agaaaatctt ccactcaagg gcatagcagg tctattgcta tttgcccaaa 1558260
 gtgttctgaa ggacatggtg ctgctctttg aatgcagcag gtctgcaagc atgtactttc 1558320
 tgtttggctg aagtttctt gctgagctga gggcttagtg taccatgta tttgtggggt 1558380

 ggacctatat ggacactcta gctggtgaaa tagaatcccc tttgattcct ggtaacagta 1558440
 atggcctcat ttgggtatgc atttgattgc taagatttaa ataaactaa atccagctgc 1558500
 ttccaaagaa cttcatcaa tctctttctt gcaattttta ctgtcaaccg aggaatttca 1558560
 gaaacaatga ctttagaga atgactttta aactttactc aactcatact tttgttcctt 1558620
 aatggcatga gtgaaagtag ctgttccttt tcatctaagg gcatattaac aactaataag 1558680
 agaagtcctt ttggataatg ggattgcac tctgtcactt gaccctcgg attttccat 1558740
 gatgggctga atgaggtgga ctgccgagca ggaaaggggg gcatggatat catcattctt 1558800

 ttctctccca aagtaagctg gttcctgagc tacatctggt tcttgggtat catcattctt 1558860
 ttctctccca aagtaagctg gttcctgagc tacatctggc tgttcattgg ctttgggaga 1558920
 ataattcagc aggtcggggt agtaattctc aacagagagc atgccagaa tgtaacatc 1558980
 ctcaagaagc aggcagctct gtcactactc tgggtcctt tgttctcacc ctctggtgcc 1559040
 tcctccttca acagtgtcct ccagacgcct ttctaagaag acagcactcc tccagttcct 1559100
 tctgtccac attgtccac actttcaagc ctgcaatctt cctgtctttg tctcttgtct 1559160
 ttattaacgg aataaaaactc cattggggct ggtgagatgg ctcaagtcctt agaaagccag 1559220

 ctataaagc ttgagttctg accccagcat ccacacagaa agcctggccc agaggccat 1559280
 gcatctgtaa cgcagtggca agaaggggaag aaggggacag gctctagcaa gtgagctcca 1559340
 agctcgacga gagaccctgg atcacaataa acaaaaacta aaactaaaa agatggggag 1559400

agtggggtga gggtagtgac agaggatgat agtggacatc agtctctagc ttccatatgt 1559460
 acatgcatgc aagcctgtcc acatgcacac atttacacga acatgcacat catgcaacac 1559520
 atacacacac acacacacac acacacacac acacacacat ctataagata aaggatctgc 1559580
 tatgggtaga caagaaggtt ttttttttc cctcttcatt ttatcttctt aggggtctga 1559640

 ggatttaacc caaggaactg agtgtgctgg ctaagctctg tctctctcta ttgagctcca 1559700
 gccccagctc tagaatagta acttcataga agcaggcaac tgctgaccaa atccttagaa 1559760
 aactcctggc atatacagga aattaaanaa aaaagtcttg gtgaccaagt aaaatagtga 1559820
 cttaacagt atgtcacagt ctcagacaga ggctctagac cttcagtttg catctgtgtg 1559880
 gcgctgagga aggggcctca tttagagaag atatacaat tttgactggt caggatgcca 1559940
 gcaacatcaa tattgtgctt tgcatattct ggggataaaa ctttaagcgtg ataaaatgta 1560000
 cagatctcag gtgttcaacg gagtttaaca cgagtgactc aattccctat caaggtgtgt 1560060

 aatgcggcca cactcaaga agcctactct tgccccgca cccatccatt cttgctcctt 1560120
 ccatggctct gatTTTTGCA cagtttgggt tttccattc tagaacttca tgtgaatgga 1560180
 ataatacagt acacccccgag gtgtaacgca acagtccaca gcaaagtgtc actgagatec 1560240
 accatgttgc tgcaaataca tttctctcat tctactgtga gtgtcagtac actgagttac 1560300
 tatactgttt ggttatcaag tcttcccaat gacaaacttc cagactatc catctcttgg 1560360
 ttgttatgaa cacataatc ataattatga tgaccaatca cagttttcat gaatgttctc 1560420
 gaatgggtct ttttatgcat atgtgtctct ctgtttcttg agtaataca taggaataga 1560480

 attgttggat taagtgatat tttactttca catgaaaatt ccagaacttt ccccaaagtg 1560540
 gctgtgtgat ttiacatcct actaaggatg ggtgtggatt ctagtgttc tatatcccta 1560600
 ctaccattt tatattgtg atcttaaaat tctagccatg tctatcatgg tggcacacgc 1560660
 ctttgatccc agcattcaag gaggcagaga caggtggatc ttttaagttca aggccagcct 1560720
 tgtctacaaa gtgagttcca ggacaggcaa ggctgttaca tagagaaacc atgcttgaaa 1560780
 aaacccaaac aggggctgga gagatggctc agaagttaag agcaccaact gctcttccag 1560840
 aggtcctgag ttcaattccc agcaaccaca tggcggetca caaccatccc ttatgagatc 1560900

 tagtgcctc tctgggtgtg cagatataca tggaaagcaga atgtgtgata cataataaat 1560960
 aaataaaatc tttaaaaaat tatttaaaaa agaaaagaaa aaacccaaac aaccaagcaa 1561020
 ccaacaaacc aaataaaca acaaccaaac aaaaacaata aaatattttt aaaaaattct 1561080
 agccattctg ctgggtacat gaagtaaca tctcactgta gcctaaaaac atttaaatg 1561140
 aattattttt gcttattatt attattagtg tgtgtgtgtg tgtgtgtgtg tgtgtgtgtg 1561200
 tatgctcagt gcatgtttaa gcatgtgcca catttccaca tggaaactcaa aggccaatgg 1561260

tgtggaatct gcctcatct tcctcctcct ggagcttgac ctcaatagcc agacttgagc 1561320

 tgcaagcttg cctctacca ctgagccatt tcaactggctc tcaactgcagt ttttaattag 1561380
 cagtttgctg accttgaatt gtgtcgaaac attttccatg tgattactgg cacacttatt 1561440
 tatcttcttg tglaaattgt gtattcaaat atttcacttg cttagcaaag ttgttttct 1561500
 tttattatca taaggattat ttattctggg cacaaaattt ttgtcagga aatatTTTT 1561560
 aaaatacttt ctcaactcacc acactttatt ctgtgaaaca ttctttaagt tetgtgcatt 1561620
 ttctttattt tatcccttgg gtagtTTTT gcaacttgctt gggctcctgt tacatatacg 1561680
 cccgtcacia gtacttctgg ggctatgcag aaactactga cggaaggtaa ggagaaccgg 1561740

 ataatggtat gtttgtgcaa ggtacagcag ggtgtgtttt ccgttcctga gaggattaag 1561800
 aaccaatgga gtattggiga ccaaagtac ccgcgttgcc tgaggccagt cttgccaac 1561860
 cacacaatta ggcatgagat gagaaaatgg aggtgggaat ctgctcaatg cacaagctgc 1561920
 aaacccagc aagaattctg catcgtttct agaatgttta ggtgaggggc tggttgacct 1561980
 cagtggcgtg gcatccctc taattttcac gatgagctaa gtattttaa tggcctcttt 1562040
 ctgaggttct gacagctcc aacaaggagc aagcagcctt tgccaggacc ccaaagtct 1562100
 gttcgcagcc caactagcca cctcaccct tcattgctac cctgcaggat cactggtttc 1562160

 aagctgagcc tgggggtttt ggcttgttg attgtcctag ctgtcctggg attagcaagc 1562220
 agattcctgg atgaatacct ggacctccat gttgccaaga aactgaggca tcccttctaa 1562280
 ggttgtctct tcctcccat gctggccgag gctttgccac tctaagaca atgtggtgct 1562340
 ctgtgtttaa taaaactttt aaaactttc atttgtttgt ctcctgtgg ctttgtgaaa 1562400
 acacccatt tgccaacct gcttaagaag tgtgcttctt ggtgtgggcc cacctgcaac 1562460
 attgttgcatt cagtgctggg ctctggcttt ggcattgtct ttgaactgt gactgtttct 1562520
 gtgagaatga agcttgacc acatgctggc attcatgtga atcatcacta cagtctctga 1562580

 cacagcttct gtccccatga ggagtccag agagaagcag ctcaaggcaga tgggccctca 1562640
 gcactggcta cggcacagca acaaatgcca ggagtaagag atgtcaaaca catgagatag 1562700
 ccagagagga gagccattga cgaaccacac aagagggtga cttcataaag aacaaaggaa 1562760
 aaagaaaaga aaaaaacca accttatttt aaggatccac ccaggacat ggatattcac 1562820
 gcccttggc aaagggaggt ggatcctgct gacagtggta aatctaatic cggcttccac 1562880
 tgcgtatctg tgccttggg gacttgggc ataattgagg acacagtgga agctgagtg 1562940
 ctgttctatc ttgatgtgca gtcactacct ggcaccactc atttgatatt tcagttttc 1563000

atctgagaac caggagcgat tccagcctac agcctcagag accttaggaa aagaggacct 1563060
 gggctccacc accaggcaga gtcctctgtc agctgggtggc cccatctcca gacaccctgt 1563120
 actatactag aatatgaata acaggcaagg aaataagaag caacagagct tccagaatag 1563180
 caggagctgg caaccctgg acagcagtgg taaggcactg gtttggaaag gggatatttg 1563240
 cactgaagtc ccatttcccc attgctaggt gaccgactgt ggacaagta ccctcaatgg 1563300
 gaagttgcaa ggcaaacact gagttctctt cctgtcacct gatgggcaca gcattggacc 1563360
 ccagcactct gtagctctga ccttcatttt ttttccttag gcaaaatagg gttaatcctt 1563420

 aaaaattcca agctaagtgc aacttttttt tttttagcac tacatcatat ttatcgaatt 1563480
 cacatgtcat ttggaagaag aaaaaaagc tttccaagtt tttactatct caaagtaagt 1563540
 tctattttgt attagtttg agcatgctca tgcatacaca tgtacactca tgcacacgca 1563600
 cacagatggt taaacacatg tggaaacagg caaagggcgt gccaggtttt caacacttcc 1563660
 catcttcaga tattaccatg ggatttgttt ttgttctaat ccattgccac caggaaatgt 1563720
 ctttattatt ttaattacta ttaaattggg ctataagact ctgggtagag ccagcctcct 1563780
 ccatagtaga ttgcatttgc ttctggccaa aaagctgttt ttgtgttgtt gagacagagg 1563840

 ctcagtctgt ccttgatttc atgatgcac tgcctaacc ttccagtgc gggcaggtag 1563900
 tgtctgttca gtagtctgac agttgttcc acatgctttg attagtaaat ctgaccaatt 1563960
 tacactcaga aaccagcttc atcctgacaa cagtgtcatg agaagagggg cagaggaggc 1564020
 aggcctttcg tctgctggag aagtcttaga aggagagaag agcaaaggc agagagatcc 1564080
 ttgaggaatc ccatacagag aaaaaagga cagctgtggg aaacctttgc gagatgactg 1564140
 tcactacctg gatgtaacat ggaataagaa tagaaatgat gagggaacac cgataactgt 1564200
 tgtaggtgtt ttaatgacac cgtggttaag gcggagaacg tcccctgcca ttgcatgctc 1564260

 aggtgctgag gggggagtgg ttgaaggcac gtgatttct ctgaaatgct tcccaaattc 1564320
 tgcataagaa gtaattattg caaagtatta accacggtta aattgagctg atgactgtga 1564380
 gacagctttt ctgtttcccc aacagtttgg agatgttcaa agttttaaac tcttaaagaa 1564440
 aagttgaaat aaacaaacaa atcaggtttt ccatagetgg gaagtttctt ttgttctgtg 1564500
 ttagagatgt gatgggggac acagtggcaa tgcaggatcc actagtgttg gtctgtccct 1564560
 gatggcccat gtatggcgac ggtggagggg ggtgagtac atggaagcag cgtaattcc 1564620
 tcctcctgct tgitatttga agtgagatgg acacctgtgt cagctgggct atagaatatt 1564680

 agagtaagaa tctcatgtcc tttgaacaga gagagagaga gagagagaga gagagagaga 1564740
 gagagagaga gagagaatg aaagaagaca ataaaaagaa actgtgaaga taagatatgg 1564800
 gtcacatatt atagtctgt tcttctctgc tttgtttcca tggttgggcc tcaaaaaata 1564860

tgttcaaat atcactaata agaaaaatat cacactgttt gtccctcac cccagctccc 1564920
 cttttctcag acacagtcct cgaaacaact cccttagtc tgggaacatt ccttaatcca 1564980
 cagagaagtt gaatatgtct cacatgcca gtgactttcc aaaagcctag acatgttgcc 1565040
 tcttcatctc ctactacag actgccacgg gacttcttaa cacccagatc acacacggga 1565100

 agcatgtttt ttgagatagg gttttactgg tcaaccaggt agccttacac tcagtgatec 1565160
 acttgtttct gctgggatta aaggtaggig tgtgtgtgtg tgtgtgtgtg tgtgtgtgtg 1565220
 tgtgtgatat ccaacaagag agcaaaaaga tggactaaca agacacatg acttgatata 1565280
 gaaccataca tcggaaggag aaaggtagac tctaagtctc gtggtgcagt gacagttgcc 1565340
 ttgcctgtgg tataggtagc agatgggagg gcgtttattg tgctcagggt ggttgctgct 1565400
 acagcaaggg gtggatgata accatggctt gtgactgtcc ttggaacaaa tgatttcaaa 1565460
 accctggctc caggagacta actttcacat tgggccttga cacacaaaaa tcttatgccc 1565520

 tagccacact ccaatactgt ctgtggcag aagatccatc atccagttct gggcattgtc 1565580
 tagactggca tctacaatca tctttagaa tcctctgagg cacctggcag gtaggtgcct 1565640
 gtgaaaatgt ctgagcatga acttcatacc acacattcag ttttatctta ataaaattat 1565700
 agatttattt attttttaa gaagaaaggt attccactca tccagcgccc aacagatttt 1565760
 agtataaatt tgaagtgag gagccatcgt tcttctcgag cttcatgttt ttacctgtt 1565820
 gtcaactctc tctctatc tcctccaac caaacaatt cccctttacc atcccttat 1565880
 ctgctaaagt ctgcgctcat acaacagggg ccagcccagt ggaggctact ttctcatag 1565940

 cactgtcagc caatctggaa gcacagccca ctgtggtag ggctagcctc ttcttcaca 1566000
 gtgaaattca ttctttctct tggttatgt atttaaact cgcctgtttt ggaactgttt 1566060
 ctactgatga tgtttcttg tggctatatt tctgataaac tcaagagttt tgaacattt 1566120
 tactgtgttt taagattaat ggggttatct taagggcagg tcttctcaa gaggagaaat 1566180
 ggattctcat gtatgtgata tattaatgag gggattgaag aaggtggagg aaaaaaaaa 1566240
 ggagtggagc aacagcgga ggacaggaag aatcaagca agggggcaag tggagccag 1566300
 gccccagtct ctgcctgac ctgcagcaag ctggggcacc attcatcctc agagtgtgc 1566360

 cagacaagtt actggccttt tattatctg cagcagcgag ttattggcta gagttagagg 1566420
 agtataaact tgaagcattt tcagctcagg gcagttacag gaaaagctgg gagagacct 1566480
 gttttgacag atgtatcgtg ggctagcaga aacaaggggc acaggaaga gaaggtgtca 1566540
 aaactgcca ttacagtggg caagactact gaattgtgtc tccccatc attccaatt 1566600
 ttttccatcc aagttttact atccattttc tcttcattat atttttatac attaatgtgt 1566660
 atgtgtgtat gtgcacatga accatggagc tcataacag gtcaaaggac aacttgtggg 1566720

agttgtcct ctctacgac tctgtgggtt ccagggattg aaccaagtc atcaggcttg 1566780

 gggcaagtg cttttatctg atgagccatc ttgctggccc cattattttc tgaatgctct 1566840
 gactgagcta gttttgaatt gttctgggtc tggatctatg aatagacttc ttcgtgttag 1566900
 atctcccgc ctttctactc ccgtcccttt actaggatgc tctagtaaac tcagaaagtc 1566960
 tctgtgtgt ggttgaatta agaaggcttg agagtattg atttctactg ttaaataatt 1567020
 ccgagaaagg aatctgcagt tagtccatga gaacccggga atgatacatc tgcttaacta 1567080
 atgctggagc agaaagggca ccctaaagtg aactatgcca tggattgatt cagagagtga 1567140
 catgttattt ccattgtttg ttttttcttt aaaagtgggtg tgtcaacatt gcttcgctct 1567200

 tacatttcag agttctgtac attacttaat ggaaatgagc aatgcttgct gcacaaagta 1567260
 aaaacagaaa gctagaaacc tctgaattaa atggaggaag ttgccacagg tcatacagta 1567320
 taaccagta cttagatgac atctgaagtg tatgtcacct cttcaacgat gagttgggga 1567380
 ggaaataaaa atactctatt ttaacaaac attatatata tataatata ttatatgtat 1567440
 actttttaca tatagtagac ccagtgatat ctgtagcatt gtaaaaactt atgtacaaat 1567500
 aacttttttt tagacattac atatacatca gcaccgtagt aaaaacaaaa caaatgacc 1567560
 tcattaaaat ctaccatcta ttagttggtc cttagactga gcactttcag gaggctttta 1567620

 aaggacaatg gagcccactc tctccactc cagttcctcc tcattgctta tatacttttt 1567680
 ttttctctgt aacctggcag gaaaagggtga taaatttga tctgttttc tcactttact 1567740
 atttttttta tttttgggtt ttcactgtt tcactcagt tttcttagtg gcagtaactc 1567800
 cccattctgg gaggttcatg tcaccctgcc accacctctt tggagaggcg cacagctcct 1567860
 caccctgggt cctccagctt tacttctgt cagagcaggt ctggaactct ggaaagatgg 1567920
 agaacagcta gctccagat gccctgctc gggactttcc cttctgtgga ctttcttggg 1567980
 tatggccggt gcagttccca cagcttggg tttctggagt aagaagtatg tgaagacata 1568040

 gaatgaacca gttttaggg tgtgtctgt tgtgttcgtg tgtgcttgtg catttgggtg 1568100
 gttaggagga caataaacac catggataaa agtcacctga cctccaagat gggattgttg 1568160
 gaggtgaggt aaagagcaag agacaaggct tgggcatg gagactgtta attccttctt 1568220
 cgtttacact tcaggcaact ttgtgtgagt taccaagaga actgcggtgt agcttttgaa 1568280
 gtagactgct ttcaggacia ggaacatac tccctctctt taacatcaa attggttaaga 1568340
 tcgagtcatg aattttcagc atttccatct ccagcatttg atatttgctt tctgatgat 1568400
 gggattgata aataagcaag actgattctg gagtgtcatt gttggccca tctgaagagc 1568460

tgggatcttc agaccattct tccctgggga tagcagaagt atgggtgtaa ctcttataaa 1568520
 gcctgcagct tttatcagtg tagcccactt ggctccagtg gagacctttg tatgccagac 1568580
 agtgtctaaa ttctctttgc actgactttg actttgcccc agtgcttcac ctcttgggta 1568640
 gtgtgtaggg agaagcaaag gcaaggctgg catacaggcc aggaggacta gaggcagtg 1568700
 tgagggagga aggggctggg ctggcagaca ctgaattcag caggggtctt tccatgctat 1568760
 ggccataaac agacgaaaac cagctatatg tgc aaatgg atgaggactc tgggaagctc 1568820
 agtgcaacct agagtaatgg ccacatggc cactggcaga agctgacctt cagggtatt 1568880

 ggatgggccc ttctcaagca ttgttagcta tcctggtaag ggggctggca gcaacacctt 1568940
 accattcctg aggaccatcg ctgggcagga gacaggtgaa cctgcaggat ccttgcctgt 1569000
 ctccctaggg ccagctcagg caagctcact gtctctctg cctacctca aatccaggaa 1569060
 catgtctgga agtatacatc tcctccatc cagcatccag agcattttgt acctatgac 1569120
 atggcctgtg tgctcccag catcctctgc tgggctttct ctggctgagg ttccatctct 1569180
 gaggtctcgg gacctgaggc aggacgtct aaggggacct catcttgggc catagtccct 1569240
 ctgggctgga acaactcctt ctgggccagt agatcccagg ggtgcttagc agaggaactc 1569300

 ttgtgcctc gacttaccca cctgctctcc atatcgcttc tctccaagca ggtgtctgtg 1569360
 tggcctctgt acttgattgc tctgtggaag gcaggtggaa tgaagccca cggagctggg 1569420
 ggttgacacc tgiacctct actgtcagcc agctgtctgt ttctcagttt acgtgggtca 1569480
 aaaaaacaaa aaacaaggat ggggagccat cctgtttctt tcttctctgt gaggctgcca 1569540
 ccactacaga tcttggcccc ctctgacta ggggttacca aatagttcat caagctcttg 1569600
 catccactca tccccgggc cacttttgat gatggagtcc acgaggtctg tactgtctgg 1569660
 gaggccaggg aatgaagccc cagtactctc accgctataa ttgtatgaca tgcctgagc 1569720

 agggttccgc tcataggcct ggccctgggt gcttgcagca aagetgccac ctgctatttg 1569780
 ctgctgtgct gggggctggc tgaatgctgc catgccaggg acacctggc tcagaccaga 1569840
 catgacaaa ggctgacct ggctgtacc ttgtgcctc gcgagtgtg gcatcatctg 1569900
 acggcccata gctgctggat tgagggttct cactgtgcca gtgttagcat ccatgactga 1569960
 ctggctcagt ccctgtggga agtgtgttt tgcagctct ggctgaccag cttgaagtgg 1570020
 atagctggca ccattgttga atgggtcccag ctctcacta gtctccctg gaactcctg 1570080
 caagctctc tgttccagc tttgtgctc ttgctggacg gttccatga cgctctgaag 1570140

 ccttgggtgg ccttggggcc tcggcaagc ctggcccac ggtcctttca actgctggtg 1570200
 ctgctgggaa agagccgagt tcaccagcat gctctgtcca aagccactca ccatgccac 1570260
 cccttggcca gaggcaggct gcctgggtcc ctgggcttgg ttgtgtggga tgctcatgcc 1570320

actttggttc gggtagctgca gcatttgggt cattcctgtg ctcatgttgt acattccagg 1570380
 ttggctggtt ggaggggac tgtaaggcga cagtcctatc tctgactggg cggctgctgt 1570440
 ggccattgtc cccgggttct gagagggtcc cattcccatc atgcctgcat tctgtgcat 1570500
 caaccttgac gttagcatgc tctggagggc tgcttggttt ctacagctg ctatgtcctg 1570560

 gggtagaacct acaggggaga aaaggacagc catcacccat tattctctgt atcagtatgt 1570620
 tgtaagatgt tgctggaatc ttctcttggg aatgacagtc ctgtatatga aagatctact 1570680
 gcagaacatc gccacaaaag gtcattactt agatgattat aacaggtagg ttgtgaaaac 1570740
 ttgcaaatg atttgaagat acaaatgacg aaattaaagt cacctgaatc ccagcatcca 1570800
 gagaagatcc ctgccaactc ttatttatat ttaaatagac acagaaaatt gaggtcatac 1570860
 cccagcgttc tgttgttca cgttcagatg caagtcattt cctattctgg gtatcatgcc 1570920
 atcaagtccg tggggcacca tctttttgag tgttaggaaa atgtaccatg ggctaagttg 1570980

 agtgtggtag tacatgcctg caagcctatc aacttggag acagggagga atgaggattg 1571040
 ggggctcaag cttaggctat acagtgaact ccagtgggat tctgcctagg aaaggaggcg 1571100
 aagaatgaag aaaaggagga gggcaagaa gaataaataa tgtctgttca atgcatatc 1571160
 tctgtgagaa gtggaattca gttcagtagg gaatccattc aatgaagtcc ccatttgact 1571220
 tttttcttt aagacttga taggatttga ggcacaaggc cactactgct gcctacaagc 1571280
 tatgtgacca atgagatgga ttttagatcc acctgtage tctccatgag cactagagtc 1571340
 tgactcattg gcctgtgtct gcagctagaa aaagaagaca tcctgtctct tgttacttag 1571400

 caaagaatct catgtcttgc tgtagcaaag cccacccttt tggattggca actgctttgc 1571460
 atgcgtccct cctccccc accctccctt cctctcacc ctactccca aaccctctc 1571520
 ctctgtcact aagatgacta tctagccaag caaacaagac tgatattggg cctgacagca 1571580
 ctagcttgtc cttacaggtt gctcagctat caaaatactc tgtagccttg acaatgaaga 1571640
 atgatgagtc ttgctgttac atttaccct gggctggcta gaacttctct atgaccacca 1571700
 aggatcagca gacctcacg gggctctcca ggaattcttt gtggttactc tttttagttt 1571760
 gccaatatt aggtttgctg gttactaacc agatataaac agagcatgga aagcaacaca 1571820

 ctggccccag actctcggga agtcaggacc agcaggtaca cgatggcctc accttggaa 1571880
 tgattgacct gctgactgg gtatggagtc cgtgttctg ggaggtgctg gcggggcaga 1571940
 tgagactgct gtaactgcta gaatgacaca agacaagaga agccagaggt gagatgggga 1572000
 cagcacacag ttgagtatct gccagttttg atgaagcag tgtatcattt ccccccaat 1572060
 ctagattttg catggaaaa caacatgcat ataggcaagg gctgcgtaaa gtaaatgagt 1572120
 gagtggattt ttactaagtg ggaacacctt gaaaactact cccaccctca aatccagaaa 1572180

cagatgctgt cagaagcctt agtcattccc ctctcttgac ctagagcatc attagcttaa 1572240

 ctttgaacca catggactac gaatcaccga aaggagcct gacggtttcc atctcttata 1572300
 agatggattc ctcatgctg agttgtgtgc ttcgtcttca ctaccgacta taattctatc 1572360
 atacagacat accacaattt actcattcia ggagagacag tcacttaggg tgtttctagt 1572420
 ctgcgctgt tgcagttatt actgttgtga catatcttct acagacactt tcttcatttc 1572480
 taatgtttga cttgctggct catgcaccaa gtgaaacaat tttactttg attttccagt 1572540
 atcagcctga ctgctttcct tagcactatg gggacctggc tcaaaggac aagcaatgac 1572600
 ttttaatgac ctaagtagat gctgtgggta caggaagata ggctcctcgg gatatatata 1572660

 tatatatcat atatatacac acatatagac taatcatata tatatgtata tatatacata 1572720
 tatatatgct aatcttaata ccattatgic acacgacctg tacaatacat gtctacaagt 1572780
 aaaactctcc aaatttggat gggcagtggt ggcacatgcc ttcaatccca gcccttggga 1572840
 gacagaggca ggaggatctc tgtgagtttg aggccagcct ggtctacaaa gtgaattcta 1572900
 tgatggccaa gactacatag agaaacctg tctcaaaaaa caaaacaaaa caacacacac 1572960
 acacacacac acacacacac ggagggaggg aaggaggag ggagggagg agagagagag 1573020
 agagacagag agacagagag agagagagag gagagagaga gagagagaga gagagagaga 1573080

 aacaaaaaa aaaacccca aacctctga atttgctgcc ctgaagcaga catgtgggat 1573140
 tccagctatt ccaggagtcg gaggcacacc tctagtcttt cttctttggt cgtggggatt 1573200
 ttgttcaca agcatcatta ccggcatgct gggcagcctg ttgggatcat tatcatgtaa 1573260
 aggaaagaga cacagggcaa ggggaaggag ctttgagttc tcagtggcc atcaagcatc 1573320
 cacgtgacct tggatgcccc taacctcttt ccagcagccg attaataattt attaagaact 1573380
 tctcttccat gagggcaaaa gaacatgcaa ccagatcccc actcttcaga gtgcctgcta 1573440
 taaaaaaaa acaccaccg gccacttctt accacatgtg tacttctatt ttctctctea 1573500

 tgtttgctcc tgggcaggcc tgcaattttc tgtttttctt tcttttctc taaaaggcca 1573560
 gccagcattc tggcatccaa aggaaaaaaa ccagaaacag cctctgcct gttagccca 1573620
 gcctgtgtgt ctaccgtggg actatacaca aaaagagatt aatcaatgca tagcgatta 1573680
 tgagcacagg ccagaaacca tgcaaacctt tcaggcaata atgcgaggac attattgaga 1573740
 gcaagctgag ctttcaaaag tttatcttgg cctggggaga gagctgagtc agcaaagtaa 1573800
 ttaactgcct cagaagctga ggccctgagt ttgagtccta aagcccaggt ttaagaaaa 1573860
 aggtgtaatc ccaggctgg gaagacagaa gcagatggtt ctctggccaa acagtctagc 1573920

ctgctctgga agtccaggt ctggagagat tctgtcttag taaaggaggt ggacagtgcc 1573980
 agaagaatgc cacctgtggg ttcctcgctt acacacacac acacacacac acacacacac 1574040
 acacacacac actttctcct tgtcaaacct cctatacaat atacaagttc cctcatttat 1574100
 agggagcact aagtgtgtag caggttaggg tgtggtttgg agtcaggatt cactacttcc 1574160
 cttttctaag ggtgtggtct ccgaaccaca ggagctcttc cccagctcca gtcttcccac 1574220
 ccgtaaatga agggctctta taatcattac tgtttatctg aaactcaaat gggaagttct 1574280
 gttcaacctg tgtgaatgga tgagaggac atgctacatg cttgtgagag gaaggcatta 1574340

 gcctcagtct ccacctgctt ttaaccttct tggctctgat ggccaggtca actgagttcc 1574400
 tgaagacagg caggacctca aatctttctg ttgtccttca catgggcttt caggaaaaac 1574460
 aatgtttcc aatagtgtg attccagaat tgaagtgtc ggggcttgtt caatgctgca 1574520
 agactgagaa aatcagaatc agcgtggtgc tgatgtgaca atcaatattt actctcaggg 1574580
 ctggggttca ggcagttaca gagcacttgc ctaacaggtg tgaggtcctg gtttccatcc 1574640
 ccagcattgc caacaacaat agcaagaaa tctcaaggca gaaagccgag accatcccac 1574700
 agaggagccc aagtctactg cactcataaa caacacacag ggcaggtact ggcaagcaga 1574760

 atgttacatt gacatggaca gcacgcgggg ctgtagcttt tctacaacaa tcctgatgc 1574820
 tctcactgtt tctgtgagcc attcccata tcatgtgtgt atatggttcc ctaaggagtt 1574880
 tgcataccat tatctcaagt aatctttaag acaggaaaat caggcaaacc taacctgcta 1574940
 cacgaagaca gttttttct ttttaattg tgcagttcgt atcttctcac ttacacacac 1575000
 acacacacac acacacacac acacacacac acacacgttc ttatgtatgt gtgtggtgtg 1575060
 tgccaacgca cttatgtgga gggtagagga caaccttga tattcgtccc caccttctat 1575120
 cttgtttgag acaggtctcc tgccttgcctc tgtttatcct gagtgtcccc acattctccc 1575180

 atctcactgt agaatgttg tgattataga caggcatgac tgcacctggg attgaatgca 1575240
 ggccittgtg caaacatttt acccatctct tcagccttac atgatttatt cctctgttca 1575300
 aatcacaat aacttcaaaa ggatggacaa gccccacc tgagccaagt aatttcaact 1575360
 tagtccctca gtttctgtt tctcctatgt ttcttaggta gteccatctc gccatagttc 1575420
 tgaggggttt gttccgtctc cttgtccaca ggcatgggtt tgacataact cttcctgcaa 1575480
 tcttccactt ccttttcat ccttcccaca gggcttggct gagtgggctg tgggtgtggt 1575540
 tgcaagcaca ccctgggtg ggcaccagac gagtctgtc tgcttacct gactgcttct 1575600

 gtccttgtt tgcagcacat gtatcagaaa tcatttctca ggcaccagg cacacctgaa 1575660
 aatgtcctgg gtttgggtga ggagagattt acaaaagccca gagtccctta gcagctccat 1575720
 ttatcactgc cggagagata ttagcacagc tccttctcac acacctatg cagggtgaga 1575780

gggatagagg gttgtttgta caatagctgc caggtaggccc actgacctg gtaaaaagg 1575840
 agataattac atagctgctc aggaacaaaa gcaaaaaaat aggaacataa gcaagctatg 1575900
 ctcaacagta caccttcttc tctttggagg gtgactgggtg ttttttgtaa ctgctgttct 1575960
 tggtagggtag ggaccttgat gtgcctgtat cctactcagt gccctgaaga gagaattcca 1576020

 aaattctaata tctattagga acaagaatga gcaagagtca aagcattgct gggcctccga 1576080
 ggacagtctg acacctgtga tacagagcct gtctgcagggt cccacaggg gccatcaggg 1576140
 atctctctctg gacagtctta ggcagttcct tgggataaca ctaaatcagg caccagcatc 1576200
 tctaaaaaca aaacaaatca aagattacag gggctgtctg cagggaaggc tctcttccag 1576260
 agctggagga gttatatggc tggggtaggc aaggaggcct aaggtaaaga cacatttgta 1576320
 ctaggccttc cttaacca gattgcctga gctctaggta aagggtcgg ggctttctcc 1576380
 agctgcacc tctctccac cctttccag ttcctgata gttctgtgcc cactgtaaca 1576440

 ttgccagtct actatttata actaattcag tacaattctc cactcttctg nnnnnnnnn 1576500
 nnnnnnnnn nnnnnnnnn nnnnnnnnn nnnnnnnnn nnnnnnnnn nnnnnnnnn 1576560
 nnnnnnnnn nnnnnnnnn nnnnnncttt tttcccccc ccccgagggtg tgtgtgtgtg 1576620
 tgtgtgtgtg tgtgtgtgtc gtggggaggg gaaagacag ggaggagggg gagggggagg 1576680
 gagatgggga gagatcaacc ctgaacttta ttactcaggg tccatctacc ttgtttaatg 1576740
 agacaggacc tggcttgcac accccacgaa tccacctccc cactgctgga atgatggtta 1576800
 cacagcttct gcaggtgaac tgaggtcctt atgcttgcac ggcaaaccct ttaccaactg 1576860

 aacttcatct tgetagetca caaatgttt gtatcactac tattttgctt aatgctagca 1576920
 atatcagggc ctatggtaaa tgtgagctag cccccaccac atgctggtaa taaagacccc 1576980
 tgtaccagca accaggagaa gaggagtcag gcatgaatgg aagaactgtc ttcaggaaac 1577040
 aggccttcaa attgatgact ggaagcttgt ctttaaagaa ccaactaatt cactgagggga 1577100
 taaaagccta gctaatgaa agggcataaa ttctacaggt tcttctatgt tactatgaag 1577160
 agttggtcta tgagcatctt gacagggaca gctgaaaaac ctgttctca caaacagcag 1577220
 atgccaata agtgccagct gaattgatgg ctcacacctt ggaggggggt gttacctacc 1577280

 tgctcagcca ggatctgctg ctgttctgctg tgctgctgcc tctgctccc aaggaactgt 1577340
 tgcttctgat gctccattag ctgggctcgt tgatccatta gcactgctt catgatggct 1577400
 gcctgtggct gccaccgag gaagccaaga cccccaggac tggctcctga gacctgctg 1577460
 cttgaccctg ggggcacaga gttctgcatg gggccggtgg tcttgggaag accgactgca 1577520
 tgctgctcct acagggacca gaagaaagca atttagaaat tctgcttggga cacctcctgc 1577580
 catttcatag gaaacttctg aggggaatgg cgtagaagtc ctagttaggg attccacat 1577640

tccacctcca gaaaaccatc ttgtaatfff ccataaaaac cattgtgttg gcctcacat 1577700

agtagaactg gagaggccac agagggggggg aacagtaaca gtaacagaga atgggtctgg 1577760

gaaatgggaa gccaactcat ctgtttctga tgggatggca tagtggctgt gcactgggat 1577820

ttcaatactc tatttctcca aagaaaggaa atatccctc aggctgggct cgccataagt 1577880

ctcaagggtc cttaccttc ctgatatcca attccttact gtctactttg ccaaacaga 1577940

catcttagta aacaggagag acatacacag aacacatatg ctgctagaat atgatcacca 1578000

acaaacctga tgttggacgt tagtttagcc aaccaagaca ccagcttttt ttttttttt 1578060

tttttttttt tttttttttt tttttttgtg tgtgtgtgtg tgtgtgtgtg tgtatgcgca 1578120

cactagtgca ctttaaattc tgctagagt tggtagtag gaactgaaat gttttgtttt 1578180

gatcaaagct atataatcct cttttgtttg tttgtttttg agaaaaggtt tctctgtaac 1578240

cctgtcctag aactcacttt gtagaccagg ctgacctcaa acttaagaga tccacctgcc 1578300

tctgcctctc gagtgcctaga attaaagggtg tgtgccacca tgcctggtca aagttgtaaa 1578360

atcttaagag agggttttct tgggaagaga aaggggttca gttggagggg gaaggacatg 1578420

agaagataat ggtgaagcaa tgtgatcaaa gcattgttta tatatatgag aaggaatata 1578480

tttttaaag caatgtaatc tctaattctc tttaaaata gaattgtgtc tcatgtgtct 1578540

gggataattc tagcaccggg gactggattg ggactcttga ttctgtaatt atttgccaga 1578600

gaactgacaa caacttttag ggactgacct atagggaga gagataatgg ggtaaatagc 1578660

taatcccaca gaggccaggg gatatctgaa gaacgccctc agaaggaag gctatgcagc 1578720

tggacagtgg aggctaccag ggggaaaaag ctaacaggca cagtgaaaag tttctacata 1578780

ccgataagcc tctccactga tgcagcaacc caaatcagac caaatcaaac caaatagaa 1578840

aaagcccacg tttaatggat acaatgctcc cagatggcct tccagtcccc cagtcccca 1578900

gagaggagac aggccagttt aaataccctg tgggagtggc cttgagcatc tctgggggag 1578960

ggggtcatca tttgggtggc tgaatactg cagagtttga agggagatgg gggagggggc 1579020

ttgggtggaa tttccaccat aacatcccag actctttggg taaatggatg ccaggggctg 1579080

gggtgaagct tccactttaa cacacagaat gtgtgtagac acaaaactca atttctatca 1579140

tttctatcaa cacttgga atggtgaaca ctgtctgaat gctctgtgga atcagtcctt 1579200

ccagttcact ggtgtcaagc aaccaatctg agcacagaga cactccactt aaacggcata 1579260

tgagggcagt aacagcagta gcacagaca ttctcatgga gcctaataca aagagtcaat 1579320

gtaggatct actcttattt taaggtataa ttcaaattgg actttaatat atgtccctt 1579380

ttaaaagttg ctgctgcttt aatataaatg tggttgacca caatggcaac tttctcttaa 1579440
 aatgcagaaa taagcttatg tttgctttc cagggtcatt ttggggtcga atccccaaa 1579500
 tttctggcttt gcagggcctc ctgcttctc tttgctggtg ctgltgcagg caggtggtec 1579560
 gtcctggcca agttccatct acactgcgtc gccagactcc ccacctcct gcatccaaac 1579620
 aaaatggcat aagcaaaaaca aagtgtatca cttttattgc cccagaaaaca gtagcagagg 1579680
 gagatatgat tagtttgggt agtttgggct acacaagtaa ctggatggtc tgaagagata 1579740
 accagggttc tgactttgag tctacctcag tattctttcc actctggcct tccctcaact 1579800

 atgagtccac agtccccgc acacatatca gaatagcttg tatactaaat attaaatag 1579860
 ttgcttgtaa gcatactgtt ttgtatTTTT gtgtgtgtgt gtgtgtgtgt gtgtgtgtgt 1579920
 gtgtgtgtaa atgctgggta tatacatatt cctatgtacc agcaccaca gaggttcgaa 1579980
 gagggcattg gatcctctgg agctggagt acaggcagct gtgagcctcc tgggtgggt 1580040
 gctaggaaca aaactctggc ctgagaagag cagtttaagt cttggctgct gagccatctc 1580100
 tatagttcat gacaaatgct tttatttacc catgtgctct gcagtcaggt agagagctat 1580160
 gaaatatttt taatgttaat aaaaagcctt atgctaaaag atggctgca tggcttcaga 1580220

 gatctaggta caggacagag ttccttacc ttccagtct gtgggctacc tgtctctgtg 1580280
 ttcacttcc tccagggca agttgtttct tgccacctg agagacaaat ggctgaccaa 1580340
 cttaacactc tcacaaatga ggtaactctt gaatggagct ggccaactc caaaaggaca 1580400
 gataatagat ttgtttttt tttcatgtat ttcaagtcta tttgatattt cctggttttg 1580460
 atgaggagag atttgaaggg aaaatgagac ccaaggaaat ttccttagct tgtttgtgaa 1580520
 agggctgttc ttgctggcct tgtttctctt gctgacttt tgagatttta ttgcccactg 1580580
 gaccctctgt atagttgagg aatgtacca ggaggtggag gacctgcttt tccagccttc 1580640

 tctcccctgg gaaaataagt atggcaata aggtgatgat gctcatacaa ccagccacat 1580700
 tttgtccctg cagacacagt caagggatta cctctggcgt tactttcatt ccccaaatgg 1580760
 tcctgtcccc aaagttctta gtgaagatga caagaccag tggctagaat gttccccttc 1580820
 aaacacaaca tctttagggg ctteccagca agcacacagg tgtgtgtctc aaagcgtgaa 1580880
 agtgcaccgt gactggtttt ccaaatgaag ctggtacagg cggctgttta tgtcacacag 1580940
 cttcttttaa ctagaatct aagagggctt aatgagaaag agcctgtcaa attctaggac 1581000
 tctaagcccc agctcttgtt tctaaggagg ggacacactg ggttgtgcaa ttagagaaaa 1581060

 ccagagttag ctttctcat gcgacatgta atgctcaga gccaatgat gcagtatttt 1581120
 tagttttaat tactggtttg ttctcactc tcagccagcc cagcgacctc cettgctttc 1581180
 caccagaat ctttaacag tctcttcca tagcttcaa tttgctatgc agatcttctg 1581240

ggctctccaa acactctcac ttttttgcct ctccagtaaa acaaggagag gcaaaaaaga 1581300
 gatcaaaacc aaatacacat gcaccttccg ctccaggac aagagcttaa caattttcta 1581360
 agggctagag tgaggtagga ggggtgtaaaa aacctgtat cctccccca agaggcagtt 1581420
 tccgacttca aaaatcagag gcgataaaaa tatcttccga gaacagccag ctgtttattt 1581480

 ataaacctac ttgtggggaa acttgccttc tctgaaggga tttttttttt ttcacgaaca 1581540
 tgaggcgttt ggatgctagg ggccagagat gcagcggata aggaggatga tggattcctg 1581600
 ggagggacag tataagacat cctgggtatt tggatccagg aggcctggg cttcagcctt 1581660
 ttctactggt ccccaagagg accctcttga acagctgctg ttctgccgt agcccagcag 1581720
 atggtggtgt gagcccagga ccgcactcca ggctcgcgc tgagcccgcg cccccgccc 1581780
 atcgcatg gctaatcag ggctcggctc cccgccccat cagggccgcg gctgcggacg 1581840
 tggagccagg cagtcaagt ttactgcgta cagcaggtag cctggcaact gcgagcataa 1581900

 tacggagcag atggtgttcg cacggcgtga tggacatcac acacgacgc ctgagacaat 1581960
 ccaggaattc cctggtggct cagggccctc ttgacaaaa atgagtctc tctccatgga 1582020
 cctgcctctt ggtggtggtg gcgcgcgggg gggggggggg ggcggggggg gcnnnnnnnn 1582080
 nnnnnnnnnn nnnnnnnnnn nnnnnnnnnn nnnnnnnnnn nnnnnnnnnn nnnnnnnnnn 1582140
 nnnnnnnnnn nnnnnnnnnn nnnnnnnnnn nnnnnnnnnn nnnnnnnnnn nnnnnnnnnn 1582200
 nnnnnnnnnn nnnnnnnnnn nnnnnnnnnn nnnnnnnnnn nnnnnnnnnn nnnnnnnnnn 1582260
 nnnnnnnnnn nnnnnnnnnn nnnnnnnnnn nnnnnnnnnn nnnnnnnnnn nnnnnnnnnn 1582320

 nnnnntgctg ttgtaggga cagggttct ctagccagag cagcacaag cctgtgcagg 1582380
 gagggaggaa ggaacctcag ctactttat gcaccgcgtg gcctaccagt cgcccaatg 1582440
 aaatttaggg ttttcgttaa aaagtccct ggggcgtaat ttagcctctt caactccage 1582500
 ctatctgctt acaagtctc agggggctcg ggctaagcag gagtggggcc gggagctcca 1582560
 ggcttggccg agagaggctc actgcttggf aatcctaaca aagaccagga gctctagggc 1582620
 agggcgggtg ccctggggct ccctggagaa actcagcctt gagctctggg gcgggcacac 1582680
 tgcccagtgt cacaactccg agattacctg tagcctggag aacaccgat aaaaggacac 1582740

 ataaacagag gtaggcctgt tgtgggtata aagagttgga ataaacaat aagcaaacag 1582800
 aaaggatgcc tagaaaaca atctctcccc cctctccca cacaaaccga actagggcaa 1582860
 gtaataaaag aaaaaaatc aaccaatctt gggcccaat aaattttga ctaaattcta 1582920
 tataatcaaa gatttaatat ccagtactta gaggctgtct gcaaaggcaa gttttaagtt 1582980
 tcagaaggct aggtctfaca gaaggtgaga gctaggtcac acctgccag caaggtttta 1583040
 gcacttccac gtcagctagc agcagccagg atgaattcat cacccaaagg acccaggttg 1583100

tgacttcag aggcacaggc aggctatctt gtctctatcc agagtcctt gaaatgaaaa 1583160

 tcacgtttaa aagtggfcat tgacaatgaa aactttggag atgaaaaaag ctaagcagat 1583220
 gtgaaaaact ccacgttctg caggagcaat ttgtgtactg caatgggcaa gagcacagct 1583280
 tctcaaagtg tggcccaggc tcaccaacat tagcattccc caggactatg gcagaaatgc 1583340
 agattctctg gctccagcag gccactgaat cagaccaagt tctccagtg ctacctgta 1583400
 gtagtccggg aattactgga gcgagtaatc ctggctgatt gccgcctggt cctgatttga 1583460
 ttgcaaactt gcattttcaa aatcaagcct gagtgtgggt ttgctctggt tttagtcaa 1583520
 aatcttctgc atttagactt aaaactcccc ctccctgcac agggttggtc gggtcagcga 1583580

 tgtttgtcat ggagacctaa gaattctcaa gggaaccagg gatcataact cttcctagaa 1583640
 ggatggtatt ccagttcagc tgtgctctgc aagccaaagg gtactcaaga ctaaggaatg 1583700
 ggtggfctct tctgagggga cagcaccaag aatgccctga attcccctag gctagaaagc 1583760
 tactactggt tgacaaatgt cccctttggt ttgaaagggt tcttcaaata aagagaggac 1583820
 agggccacaa tagaagatga taaagaactt gtatgaggca cccaatatag gtataccact 1583880
 ctgctagggt catttaccta tgtaatcaaa tgcattccgt tgattagaaa gcacacgtcc 1583940
 ccgagagggt aaggaacttg tctgattatc ctgcagctgg tggcagcatc tttgggattt 1584000

 gaacttttct accaccaaaa catacatctg gtcgtaattg agcagaccac ccaggaggac 1584060
 tctggagtaa agagcaaggg gaaggcaagg gaaaaggatg gacacagact aaaaaggag 1584120
 gaactattag aatcaaaggt caaagaatga aactaaatgt gaacaaaaaa gacatttttt 1584180
 tattgttgc tgagattaca aattgggatg tctctgtgtt atcaacttcg acatttaaaa 1584240
 aaataaaagg gcagaagatt aggccattca accgtaagtg ggaagatgaa acaaaataaa 1584300
 ttaaaatccg agttccctct gaagtcctc aagtgtcagg gcagaagcat ggctcagga 1584360
 tgggtgcaat ctgtacaaa ttctcttttt caagaacatt ttttccactg tgggtttgga 1584420

 aagcaactta ttacaaactc ccatgagagc cccaacagcc acccccaaac acccctgttt 1584480
 cataagatta ctcaagaagg ttactttgaa aggtttgttt tgatctgggt gtgctggtat 1584540
 gtgctttag cagtagaact taagaggcag aggcaggagg attacaggtt gaaggctatc 1584600
 ctggactaca cagtaagacc cctgttgttt gtgtgatggg tgggtggtgt atccctcaa 1584660
 acagttgagt ttaagactc tgattatcaa tttaggaagt atttactca agcagtagta 1584720
 actaaggcct ggttctacta ccaagaagct gttttcctag taattcaggt cctctttggg 1584780
 tccatgatca aacatgttga tgacagaaca accttctct ggttattact ctattgttg 1584840

gagcatgac tcctcagag agagatagag agagacatac agagagatgc acagagagat 1584900
 acacacacag agagacagaa agagagatgg ggagacaaag gttgatgcag gctcactact 1584960
 ctattgttct ctgtattatt ctggacacat gggttgggct agactggctg accagcaagg 1585020
 tcttctgtc tccatctctc catacctgag attataacct ttttagaacc tgggaagtgg 1585080
 ggatggagct caggttgica ggcttgcttg gcaagcattt tatccactga gcttcctgag 1585140
 gtgttttct cctccaggat ggggtgagtg ttgtgcttcc agctctgttc taccgaagag 1585200
 gaccaggact ttcaaatgg ttttcttct agatttcaat gagcagacgt tgtctactca 1585260

 cacaccaaag agaaaaagt ttagtcaca aaatttcat ctacatattg gaactacctg 1585320
 aaacaaacta catgcatatg tacacagact tttctcttac tactattccc taacaataa 1585380
 tccattaaca actatttata taacatttac acttttaagg tattacaagt gacctaaga 1585440
 tgattcaaag tatatgggag gtttagtaag gtatatgtat aaatctcata ttttatctac 1585500
 ctatcatcta tctatctatc tatctatcta tctatctatc taatcatcta tttttgcttt 1585560
 cttgagacag ggtttctctg tatagctttg gacctgtcc tggaaactcac tttgtagacc 1585620
 aggctggcct caaattcaca gagatccacc tgeccctgcc cctgagcac tgggattaaa 1585680

 gacatgcacc accaccacc cacatgtgta tctcactt tagataaaag acttaagcat 1585740
 ccatacattt tgcgtgtgtg gagtgtgtgt gtgtcctaca cccaattccc cgaagattcc 1585800
 aaggagcagc tgtattgaaa acatgcatgt tgagctggag agatagctca gcagctaaga 1585860
 gtgagtgtg tttttgcaa ggaccgaaat ccagttcca tagccatacc aggcagctca 1585920
 caaacaccag taacttcagc cacatgatct agtccccct tctggccacc acaggcactt 1585980
 gtactcacat gcacagatac acatattgat gtgatctaaa acaaaaatct ttaaacagg 1586040
 cctgcttcca aacacagaag ttttaaaagt aacgtagaaa agtagaaaa aagaggtaat 1586100

 gcttgtttat aatattcaa ggtaactgat gttaatetta caattgcatt caacttccc 1586160
 cctcctttcc ttaccattta aaaacatac tttatgctcc tgatcatgac atatgtacgg 1586220
 tagtacatcc taccaagtca aaccagcaa aatgggaaaa cagaaagttc caacttcca 1586280
 aatgcttaca agttacaatt tattggcagg atgatacttt attgactcat tccagcaggg 1586340
 tattttgttc ttggaggata aaggcctgtg ttttttttt ttttgttttt ttgttttttt 1586400
 gtttttttt cctccagcat ccagcacact tagaggcaca gttgccaca gctaaacttt 1586460
 ctgaatccag ctaactgccc atgacgaatt ctgcccaca ccaacaaggg tatgggagaa 1586520

 agatgcctt ataacagac tgcttatttg ggcactctgt ggggcctctg gtgaacagta 1586580
 agaaagggtt aaagtggca gcactctgtg aagatgtgag ggtatgcaac caagggaag 1586640
 ggcaggtttt caaggacatt cttggacatt agaaaaaca caaataccag ttttcttgt 1586700

cagtgtttg accaaagtta caaacctgc ctgcagtaga aacataactc tgagagttag 1586760
 gcctttctc tgcctttgat gtaaattata gaggcctttt gatccttttg tctcatttaa 1586820
 ttccaccacc aaagcaactc taaattgggt aaaagttcat tagtgtacaa caatagcagc 1586880
 ttgattaaat aaattatggc acatccatac catgaatgtg aggcagtcaa taaaaatcat 1586940

 gcctcttggg ctgtctaate atgtagagga agcttgcaat atgcagctga cagagaagaa 1587000
 ataaacaaaa aaaatatctg aaacactagc cacagctaata attgtcaggg attatgagca 1587060
 actttttttt ctttttgaga caggcttcc tctgtagccc aggcctggctc gactctcgat 1587120
 atgtacatca ggctagctct gagctcacag agatcctctt gcctgcctcc taagtctgg 1587180
 gattaaagat atgcttcaat gttgccagct tcaattttta tccitttaatt tttttatc 1587240
 atgaatgtat gatactttta attttaagt cacttaattt attcatataa tttatttatt 1587300
 tgtttgttta ttatgtgtat gtgtcagggc atctgtgagc caaggcatga aatagagcc 1587360

 cagaaaataa ctctcaggag tgagtctct ccttcttggc atacgatcat ggagacttaa 1587420
 ctgagtggt taagcttggc agtaagaacc ttgacctgct gagcatgaat gtacttgatt 1587480
 tttaaataaa tgttactatt ttgttgtttg tttttgtttt gggacaaggt ctctgtagc 1587540
 ctgatttggc ctcaagtctg ctgtgtagcc taggataacc ttggctctcc tgccttcac 1587600
 tccaagtgc tgggatcaca gatactgtc accatgcca cataagtgtt actagtttga 1587660
 caagctcatt aagagtgagt ctaaaactgat gtggctctga acatagttag ttcataaggg 1587720
 acccaggtca cgtccagcac atggctgcct cccaagtcta ctttctgctc tgcataatgc 1587780

 aacagaaagc tttcaaggcc tagaacgtct gtggagctcg gtctggctac cagatccata 1587840
 gccacctgc tctcaatact tcttcagaaa ggctcaaat gccagaaaag gctcaggaaa 1587900
 ctgattgtct tccaacaca gctcatctgt agtggaaacta ttctgctctc ttagctttt 1587960
 ctctattata ggtcaaaac aaagagatgg ctagggecac agagtgagcc aggcattggcg 1588020
 gtgcatgctt gagatcccag tgcctgggag gtgggtgggtc tctaagagct ccaggctgga 1588080
 tcagtttctt tctatggctg tgacaaaata ccaaatgga aggaaggaag ggagggaggg 1588140
 agggaggaag aaaggtgtct tagttactgt tcattttcca cgaggaaaca ccatgaccaa 1588200

 ggcaatttac aagagaaaca ttttaattggg gacttgctta cagttttaga gggctactcc 1588260
 atgatcttca tgggtgggaag cagacagaca tgggtgccga gcagtagctg agagttttac 1588320
 cttctgattc acaggcagca ggcagagagg ttgggcctgg catgggcttt tgaaacctca 1588380
 aagcccactc ctagttagac acctgacaag gccacacttt ctaatcttc ccaaaggtt 1588440
 ccattcttgg atgactaagc attcaaatat attgcctat aggggcatc tcattcaaac 1588500
 caccacagaa ggggtcattt tgccatagc ctgaggggac agtccatcat ggtggggaag 1588560

tcattgcagc aggagcccga ggcagctggt cacaccacat ccgtagtggg agggcagaca 1588620

tataaaacac tgatgtgcat cttgtttact ctttctcatg aattctggga tcccagccca 1588680

aattcagggt gcgttttccc acctcaatga acccaatcta agaactcct ctcgatga 1588740

gctgggaagc ttgtctccta agtaattgta aagtcagtca aattgacaat attagctgcc 1588800

acagaggta acttggttag ttcaacatag ttagttcaag gtcaggaggt ttacatagag 1588860

acactttgtc tcaacaaaag ttgccccgcc ttggtggccc acacctttag ttctgtact 1588920

cgggaggtgg aggcaggaag agctctgtga gttcaaggct agcctgttct acagagtgag 1588980

ttccaggaca gtcaaggcta cacagagaaa ccctgtctcg aaaaaccacc accaccaaaa 1589040

caaaacaac caaacaacc aacaactaa attactagt cgaagattc aggaagatag 1589100

ccacttggat aagtcttctc tagactgtaa cagaacctga gcagccagg ctcaggacaa 1589160

tgctgcaaag gaggctagcc cagcttttga ccccatccaa gaggtgccc tccggagtea 1589220

ggatacacag actgtaaatg gcttgtcaac tattgttagg gtctccacc atccactttc 1589280

aactttctt cttcgattta caaacaggga agggaatgat ctcagctgtt gtctgcagct 1589340

aggaatttt tttttcttc ttgagctctc tctcataatc cagacctcc tetcccggcc 1589400

ttctgatgga gtctcaag ccaaggttgc ataacggata cacaggccta tcttgttta 1589460

tactgggaga ctggccaatg tttccattta tagacaagag cactaccgag ctgccaatg 1589520

gagtgtgtg ctgtgtggc tacaagatgg agaaaggaaa gagcaggagc ccaagactta 1589580

aagggatgcc ttgaacctc cgcaccgct ggggacagtg actgaagaga cttagctcta 1589640

tgcatctcag agcagcttct tccaaatagc tatccactca atcccccaa aactgccac 1589700

aggacactca ggcagcctg ctctgtggc ctcatgacaa caggaacct ctaggcag 1589760

actatgggag cacatgagc tgaggagagg gctactgtgg accgctgtcc tttgggtaag 1589820

ccatggtgtg tgccttctg aactcagtag ctgtgattag cagaaggtaa catgcctcag 1589880

acaggacttg ttaacattcc attgtgcaag ggggtgggct cacaaggtcc caccctctg 1589940

tgataaaca aattctgtg ctgggaaagt gagagacatt ttctttggtg gaatagctgc 1590000

ttgtaagtgg ccacactcc tcaaaaacc tctcacctc gctcctgtaa gtgccattag 1590060

ttaaattcat tggttacca aaccagaagg ctggtgaca tgagaaggct gggcctcaga 1590120

catgtaaac cctttgaatt tttagcttta tgcatactc gaacatgtgg tttgacaaca 1590180

gggacatctt ggigagattg aaagataaca agcattttcc tactttacac tgtgtcctc 1590240

gttactcacc aggtgttct atgtctatta tcaactaac ttcttctgtg tatgtcatg 1590300

tatgtgcagc tgcagggtg tacatgtagg agcaggctaa ggacaacctt ggggtgttgtt 1590360
 ccctaggagc tgtccatctt gttttctaga aatagggtat tccctagaac ttcagcttgc 1590420
 aaatttagac taggctggcc agccataaaa caacagggat cagcttgtct ctgtctcccc 1590480
 agtgctggga ttaaagtaca caccacgtgc ctgactgatt tatttgttat tatatgtaca 1590540
 catacacaag tgtatgtgta cgtgtacaca tgttgtatgt gtgtgtggag gtcagtggac 1590600
 aatttggga gttgtcttcc tgcataagaac cttttcacat aggttctagc atcaaatagg 1590660
 tttttaggct tigtgtgacaa aaaacctgct ggcccatccc tagtattttt ttatgtggct 1590720

tctgggtgtg accaccgtga ccagctttta aagaactgaa tcctgggaac taaactcagg 1590780
 tccctgtgtg tgcaaggcaa gcacttcgcc cactgggcca tctctccagc tctcaactaa 1590840
 ttttctttct atatgtgctg catgtagag aatgaaatcg gtgctttctc ccacccttct 1590900
 tagccctaat agcatttttt gtccatttta taaacataca tatgtagtga atctaagaa 1590960
 tcaactagt ccaagcattt tcttaacctt gagacttggg ggaaaaaata ggataaaaaa 1591020
 cagtttggga ggaatgtgg acctcaatga gagtttctta gtcagttagt gatggttaga 1591080
 atagtacatg gtggagcctg gatggagggt taggactctg gactcaagag ctagctggcc 1591140

tggttggagg tgcaggcctc tggactcaag ggctagctgg cctggttggga ggtgcaggcc 1591200
 tctggactca agggatagct ggctttgcac aagacagaaa accctctgct tctatttcac 1591260
 agcaggatca aggctaagg agatctgact gggatcgtag atggaagtgt agatttctat 1591320
 tccaggggag gacaagagaa ggggtagtta ccgaaaagca aggggtgaggt gtttgtctag 1591380
 gcgtgtggga aaccaaactt gccagtgggg tggggacaat gactagcctc acacaggcct 1591440
 ggacacaggc aagacaactg atgtgaccaa cgagcaacag gagcctgggt aggctctcag 1591500
 ggagtcgata agacataaa tgcacgctc taagattgtc aagtgtcagg tagggcagag 1591560

attagactgg gtctggatga ggaggaaagt acacaagaag gatggggagg tagcacttgg 1591620
 ggggtgtctg gccaaactgt gagggaatc tggtttctta ctgtggaac tgagaaggat 1591680
 aatcaagcc tcttgcaaga tattatccag taaagctgca agacctctt atcacatgca 1591740
 aaggccactt tctgtccac tgagtccac ctctcatgc tcaactctg tetgttattt 1591800
 ccccttggg aagccatgt gactactaga gatgtggcag agatggtaag cctacctac 1591860
 agatccattg tagacctagg tgtggcagt catgccgta atccataact caggaggctg 1591920
 aggtaggagg atcatcagtt taaggtcagt ctgtgttaca cactgaagcc ctgtctcaaa 1591980

attaacaaa taaaacaaga aggtcgtatga aataatccta gtgttccatg tcctttccag 1592040
 tcttaactag ctcaagtcat gaactgggga gatagctcaa ggggttaaagt acgtgcctgg 1592100
 taagcacgag gcatagagtt tgtgtcctga gcaccatac gaatgccggg taggtgttgt 1592160

ggttcactta ctattccagc aacaggaagg tggagatggg atgccagag caagctggcc 1592220
 cgctagtttg ctgattagat ggttagctgt actgccaagt tgtggattca agttgagaga 1592280
 ccctacctca atgaaaaatg tggaaagtga tcaaagaaga tgggcctcca tatgaatata 1592340
 cacaaatgca agtgggctta tgaacacaca tacacatgca cacacactca catgcgaata 1592400

 catgtataca cacacccatg cacacacaca cacacacaca cacacacaca cacacatgac 1592460
 aatgtgtgtg aaaatacaat taccacacca tgtctaaaat actgtgtgtg ggtggctttt 1592520
 aaagggacta gaaagtatat agcataagta ggtacatgtc ctgagtgttt tcaaagccct 1592580
 aacagtattt cctggggatg aagggaagcc gggaaacaac aggaaatcag atcaaaacta 1592640
 atttgagagg agggcaactt ttaatttgtg cttcttttac ttggctcccc aactttctac 1592700
 ttcatgctaa atactttggt taatgcctat caaagcctgg caaggcataa taaaagtgtg 1592760
 ggggctgccc aatttgggtt ttaacaaagt ggtcttcata acaaatgtgg taactagtta 1592820

 tttcctaggc ttaagctcac tcttgagag aacagccag aaaagtactt ggttcttatt 1592880
 gctacatctt gttcacaaca gaaatattgt gctaaatatt tctttttca tttaaaaat 1592940
 aatgcttaag ctagcacgag gcatgctgta ttttatggga tagtgttgcc cttttccact 1593000
 aatttttaa actcaactag agatggtgat taaaaaata tttgaacaaa acagtaaat 1593060
 agaatggggc ccctcaggtc actgaaaat cctaactgaa gctaagaatc tgcaggaggt 1593120
 tctaggtaaa gcttgttttc taatttaagt tggtggecta gagtcttcca ttgaaacaca 1593180
 aaacatttcc ctttgaaaa atcttccctt tcttagatga cagtggggtg aagcaaagcc 1593240

 tgccattcat aacactaaaa ctctcttget ttggcagcac ctgcctgggt ctcccactca 1593300
 gagaggagga attacaaatc tctcaggctc cccaggtccc tgctgccagg gtctttccca 1593360
 cactggcctc ttaggaaca aaattcctca gatggttgac accagccaat ttgttttct 1593420
 ttcccctccc cttctttta cccctccctt tetaataagc tatattctgc ccgagcctct 1593480
 caaagtagcc aggggccagc agctacagcc tctccttgtc tgaatgagcc tcttctattc 1593540
 tgggttctgc ctagtctgtg ttctgaagga agagaggagg cttgagctca aaatatatgg 1593600
 gcagacaaa tigtgtcttg tttctttctt ttctctgaga cgaagtgttg ctgtatgacc 1593660

 ctggaacttg tggttctttg ggattgcggg aatgttctgc agcacctagt ttaaacatta 1593720
 tttttgtatt atggacctac ctttcacgaa tctgaggag ctgaaggaag taggcaagtg 1593780
 ggaaaataaa acccaaaggt aaacctgtac cactgaggaa aacaactcag ggtgggaggg 1593840
 agaatggaa ggaacaggag aagggcacag ggcacaaggc aacagtttcc ctcttcagga 1593900
 taggatgtcc cctctgagca tttgtgtgtc tacttttagag atggatttgg ggtgtgcata 1593960
 tttgaaaatc tcgtatgagg gctgggcata taggtttaga tgcacaatga ttacctagca 1594020

agggcctaga ttccatcttc aacaccacac acacacacac acacacacac acacacacac 1594080

 acacacacac acacacacac acacaaagaa ataaaagtaa aaaaaaaca ataatactcc 1594140
 ccccaatac tgtaggatgat atttattcct tgtccacagt attagtccta tgcctgttac 1594200
 ttaaacaaaa tgaacaaaa ctgtggatgc ctgtgtgtgc ctgcagaatt cagaggtcag 1594260
 ttagggttgg gtgtcctgct ctgttactct ccaccttaat ttttgagaca ggacccctt 1594320
 cttaatctgg agccattga ctgtctggat gactggcaag ccctctcca tetctggcct 1594380
 tcccttcggc gctggcttca cagatgtgca ccgcatgcc cagcttacca gtaaaggctt 1594440
 tcccagctga gtgatcccc tagctattat gcctgatact tctaacaaaa tatttttta 1594500

 aaattctttc ttctttcata tattgcagac tgactgcggt ctctcctcct agcctcctcc 1594560
 cccatatacc ctctcccca aattaagtca aactacctta ggaaattggg caattcttag 1594620
 attgtgagaa gactgggtta ggctggcggg ggtggggggg gttagaggaa ggtctcaatc 1594680
 cagggtatgc tacaggcagc cattttgaaa gactgcaaac acaacatggc tttgtgtttt 1594740
 ggtcctcaga tgacagatca tcttgggtgac tcagtgtgtg caccatttct ggtcctgcat 1594800
 tttgggtgac agagggtgga taagacctgt aggtgcatga gtcatgctct taaagtcca 1594860
 gagtatctaa gttttgtct gagttctgtg acgggggtcaa caacaacca gcatttctac 1594920

 acagacttca aacgtaacac acatacacac acacacacac acacacacac acacacacac 1594980
 acgtgcgcgc atgcatacat gcatgcacgc atgcactata tacttataca tgtagactcc 1595040
 catgtgtgta tggaggctga ggaccacttc aaacattatc atgcaccgtc tgcttttctt 1595100
 ttttaagac aggtctctca ttggctgccc gctcatcaag gtacaatggc tagtgagctc 1595160
 cagggacctt ccigactctg cattcccaga gcaggggtta taatgtcatg ccaccacgca 1595220
 tagctttttt ttaigtgggt gctgggtatc aaattcgtgt ctcttgaagg actttattga 1595280
 ctgagccatg ttaccagctc tgtaactaat attttctccc cagaaaagac taggaatttc 1595340

 ctcaaatgg gagaaaaatt aaggaatggt ttataaatat atagtttcta tgttcaaaag 1595400
 actgaacttc tgattataaa aagtaagggc gatgtttgga tctgacctta tggctctaat 1595460
 ttagtgtttt aaaattttta atgtgtatga gggttttgct tgcaggtatg tgtgtgcatc 1595520
 acatgcattc ctagtaccta tgaggtcaga aggattccct aaaattgggg ttgaacttga 1595580
 gtctatgga agagcaacaa gtgttcttaa ttgctgaacc acctctccag accttatgct 1595640
 ttcagttttg aggtttcttt gcaattacac agatttttga aaatgaagca tacagtaatg 1595700
 ctaaaaatatt gaaaagtttt cactaagaga tgctactact caagtacctt ggggccacag 1595760

cacaggtttg gcagcatgaa cagtgatgtg cacacagctc ctttcttgcc tgttttctca 1595820
cagatgcaag tgagactctg actgttctag acctgggccc cacagagact gtcttgagg 1595880
caactgtaac cttttcttt ggctcatgag ctctagctac tatctatggg acagagaggt 1595940
gcccataaga ggaatttgag agacaggaat ctgtcaggac atataagagg gctccacact 1596000
gaggtcatgt tcatgtacaa gcatgcagca ctctgagca aatgctgtcc tcacgtggaa 1596060
tcctcaaacc tgaggcagtg atgttaactg gtgaggattt cactcaactg tggtaaaaaa 1596120
caggagctat tgctcctcgg atatgaatca tacagagtct ctaagtattt tacagttaat 1596180

ctatattact gtcatttctt tatctctttg tgtactccat agtggagctg aatgagaaca 1596240
cccatgtcc tactttgcat gccctaccc ccagagtgga attcatgtta cttaaaaaaa 1596300
agttagatgg caaagaaaca atttggatgg tgacagttaa tttggttgta acctgaagtg 1596360
ccaatagatg gccaaacata actgcggaaa gcccaagaaa cacagaacgc tctggaattc 1596420
atctgtaaga attattctct ggcatgatga ggtagcctgg tgcctccac agctctatgg 1596480
aactgggaag cgagaggaac agcccttcag ccctagatga cattagaagc ttacaaagt 1596540
taatgtgggg tgcacacctc cagtttcagt aaaaatcagt gaaaggaggg aaggagaggc 1596600

ctcctaggcc ttgtggttgg gtgggtggag gtactagct ttcctgagga cgtgccagca 1596660
gttgcttctt ctgaattcca gctgaattca agccaggccc gctctagtag tggcctctgg 1596720
ggcagttggg ggctctttgt tccttagaga cagtgagact taaatcccag ttgaacctca 1596780
gacttagcaa ctgaacctca gctaaccat gttgtacat gtgatgaaac ctgacctct 1596840
ggaatccacc ctactctgtt cactcttcta accccccat cccatgccta cttttgtgga 1596900
gcccataaga aaataaatta aaagaggag ttgggtcttc ttcagctcc attaatctc 1596960
ttgtatata tacctagaaa aatgtctcc ctaagacctg ttttattat tttgagaaa 1597020

gggctcattt agcataggct ggtctcaact cttaggtagc agagagatct ttttaactct 1597080
gtccttgtc tctacttccc atgtgtcagt gttataggcc tgggctacta tgctggcctt 1597140
gtacatttta aaatggaagt tttcacatgg gggggctgt tttgtccta gtctcagatt 1597200
aagatgaaaa catacagtgt ttataggcag gtggagaaaa aggcaactggc ttcagtttgg 1597260
gacaacccaa gttttctcc aggatctaac tactcctcc caaagcagca gcctctgcat 1597320
gtggacagca ctctcaggt gggaggttct cactctaggt tgccatggag tttaggccaa 1597380
gaacaagtgt gtttatttgg aggagggtgg gtgggagggg gtgcagggtc tcactaaagt 1597440

agctcaggct ggtcttctg ttttgatctc tctgcctaaa ccttctgagt tctgagatta 1597500
aaggtgatg ccaccaagct aggtgagga tggatcttaa atatgagcgt agtatgattt 1597560
accaaatgac aaactactac tactttctct tcctcctct tccttctct ctcttctcc 1597620

tctttttctg agatagggtc tctatgtagc cctggatatt ccagaatttg ctacgtagac 1597680
 caggctggcc ttgaactcaa agagatcttg cttctgtctc tcgagtgtcg ggatttaagg 1597740
 cgtgcaccac catgcctgac taacaaaaat gcttcttaaa tctttgtccc acttctttgt 1597800
 cttaatgcaa tattttcccc ccaaatgaat ttagaacctt tagaagattg ttgtacctca 1597860

 aatattactt ggaatgtaag aagatgggct ctaggtaccc agagatagga ctttgtgcag 1597920
 ggaacgagat gtgggttagg atagggtggg tagggaaggg tgggatggac aggggatgag 1597980
 ggggtgcagtg gatactgaca taaacccac ccaagccaca atttcaacct caaaagatcc 1598040
 atttttgatt tctgcatgcg agactacagt gtgtctcttt ttggtaaata aaggtaccca 1598100
 cccaatgcag tgacctcaa ggaacctgat gtagaaggag gcctttcttg cctttatttc 1598160
 cactgtgatc tgggccaga acagaagctg gaagtctaca atttctgcc tgatcctgga 1598220
 ataagaagag tcttctctt ggctgtgac ttggaggttc acaattgccc ttaccaatag 1598280

 atattcaaca gtttctcaa aacatcacag atggctatgc tcaggcctc cccagtacat 1598340
 catatttaat cagctctgag actcacgaca ttgaaggcac aactctgta ccactagaaa 1598400
 aggctacccc taactatggc atagcateca ttgtaggatg cttactgaag agtggagaag 1598460
 agtgtttcag gatcatttag agaggcccct tagtcatcac aatctcagag gccttttagc 1598520
 ctctaacca caactagcct ggagtggta cttggatctg gctggctctg ttcccgcctt 1598580
 tgcagctgtg gaaagtggc aaggctctga ggacactca aagccgggtt ctcccctcat 1598640
 ggttgcatc agagaagtgc ttggaaaaac acattctgca cttctttgtt gaggatcaaa 1598700

 cccaggatct tcaggatgct agacaaactt tctacaactg tagttttcgg aatgatagca 1598760
 aaacaagaca aaaagcccca tataatgttg tacatatttc cccaagagaa catgtgtaca 1598820
 gacaagaagt agtaagaaaa aagatgtggc atttcttact cagaagagaa caggaccagt 1598880
 ccctaaatga tactggcttg attctagaag aatgaatgac cctccacatt tccagtacc 1598940
 agctgcttcc ttatgatggt ccatccaag ggctcaagga aggaaagaaa atgggatggt 1599000
 tgcacatagg ctatctgcta agtcaagata acgggctaca cacaacctg aggaatttat 1599060
 cttttctgct ttcacaaaga cacagtagtc tgagtctaac tcagaagagg ttcaactagt 1599120

 aaaaaccaga tatataggaa gaatgggtgt cacatgattc aatttctgtt tttcttct 1599180
 tttcacattg ctaaaatatt cacaacataa aacctttcat tgtaactact tttgagtgt 1599240
 caatttaata acgtaagtg gatccacaat actttgtaac tatttctact actttcagga 1599300
 cttttcatca ttccaaacag aaactttgta catttcaagc agcatctatt tttttgtgt 1599360
 tctagaagca ttttaactgc tattaagggt actgatataa atttgaaag gaatgtggga 1599420
 aatgcatgat gggaaaaaac tcagagtgaag agttaaaat gttttcaaat cttgtaagt 1599480

aactatcadc aacgaccttc ccagtagaat ctaaaactta acgtgaaaac aaaatataat 1599540

tttacaaaat gactaaggga gaattgggca acttcaggcc ttttgcgac cttccttaca 1599600
aactcctgtg aatcgggggt tggaagtcac gagttcataa ggatgtttaa ggcaaataga 1599660
gctgacaact aaagcctggc tgatcaattc tcttcccat ccaccactg gtccccctcc 1599720
cctctgtcta cacagggta ggtgcagccc atgctaggca caggggctac caagaacat 1599780
ggccactggc tggtctctca ggagagctcc cacataggag ataacggatt aacaaagagt 1599840
gtctaagtac gaaaacacag atgaggggggt ggcaaattat acctggggac taagatgggt 1599900
aggaaggag ttactaaaaa cctcttttgc ctagtgcaga gttaaaatct gagattacct 1599960

acttactctg agigtatgtt atgagctgca aatacgacca ccttggagtg tttgtgacaa 1600020
cgacagtaga tcagtaact ataatcagg tatagtgtac aggcctgtaa tcccagtgt 1600080
tgaggagtag aggcaggggg atcaagagtt taaggctacc ctaggctaac tgaggacttg 1600140
tctctaaaaa aaaacacgaa aaggaagaa gagtaacta taaactgggtg tgtgccttgt 1600200
gactgcaact gcataaaact gaaaggagt cttgatataa aacaagccag gcagggagtc 1600260
tattatgggt gcttaattaa taattatfff tttttcaaga cagggttttt ctgtgtggca 1600320
gccttggctg tccaggaact cacaatttaa accaggctgg cctcgaactc acagagatca 1600380

tcccaagtgc tgggattaag ggcatgagcc accatgctg gcttaataat tttaacatgc 1600440
acttatattt atttttctga ttataaattt ttgtttgat tttttgagac agggtttctc 1600500
tatgtagtcc tggttattct ggaacttact ttgtagacca ggctggcttt gaaatcacat 1600560
aaagatctgc ctgcctctgt ctccagagt cttggattaaa cacgtgagtc accactgccc 1600620
agcactgact ataaatttat ttgatatgga aaatctgaac aacacagaaa aacctaaaac 1600680
aggaagatag aaggtctaca aaagattacc aaaaaacagt aatgacttaa tctctacca 1600740
ttattctcct gccaaatatt cacctgaatg aaacaaagat tgtggctgta ttattccatt 1600800

atactcagct gttattactt gcttaaccaa tggctgttta ctggacattt tgaatatttt 1600860
caatttttca ccattgattt aaaaactatg ttttttggg tgtgtacatg tgtatgcata 1600920
tctttccatg cgtatgcatg catgcagagt ccagagacag atgtcaagtg tctttctcca 1600980
ttgctctcca tctatffff gagacagggt cctcactaa gcctgaagac cacaggtttg 1601040
gcttgactgg atagccagt ataccagtt atcactggat aacagtgata tcaactgttc 1601100
tgctcccca ttggtggaat cacaggtgtg tgtgtcatg cccagatttt tacgtgggtg 1601160
ctggggatcc aaattcaigt cctcatggtt gtgtggcaac tactattcat ctcccaggtt 1601220

cttttatcac ttattttaat atgggaagaa acctcactct tgtgtataat aaactttttg 1601280
 tataatcac tgatgatttc cttctagtca gttccaacaa gtaaaaattc tgcatacaaa 1601340
 cctgtgaaca ttttgttgct ctacataaatt atttttatta ttagtttttag tgtataaaag 1601400
 aattgtttcc atggcatttt cacaaacatt gttctttctc atatatgctc atccctttcc 1601460
 tcctttctcc aaacaggtcc tctctcccc agcactggta tttttttttt aaaagattta 1601520
 tttatatac atgtgtacag tgttctgctt gcatgtcaga agagggcacc agatttcata 1601580
 gatggttgtg agccaccagg tgggiactgg gaattgaact caggaccttc ggaggagcag 1601640

 ccagtctct taacctctga gccatctctc cagcccaagc tctggtattt ttaagggtct 1601700
 gttttggcat ctctttctaa acagctctcc ccagagtttt tcccaactta catttccatg 1601760
 agaacacagag aagtctctg aattatatac cttggactcc aaggagctct ataatgatca 1601820
 tccagacaaa ctgtcttcta tgccttcttc ttaatgaaca taacggaaga cactgcaaac 1601880
 aagatcactg tcaaacacat ggtcatcaag cccccctt ccccgctca ccccttccc 1601940
 aacctaccc cacttccaa caccctgggt gcaggcgtga tctttgcat cactcagcag 1602000
 ctagacacc tctctctgca gggaggtgaa tgacaaatg ctacaaacac tcttcccag 1602060

 gtgtgaaccg ggattccttg gctctctgta ctgcagccag cctccatgta acagagcaaa 1602120
 aggacagact ggtttgttct tccactcaac agctgtgagc caaagtaaca cctccctag 1602180
 gctgtgggaa tgagaagcac ttggacaagc ctggagaaag cctatctact tcagttattt 1602240
 ggctgtaact ttcaaccacc gtagcatctt ggaccagaag gaaccatgcc aacagtgaca 1602300
 gcagtgaact tggaaccac tcttcagtta taatggcaac agcacagatt caggatttca 1602360
 aattactttt ttctcctc catggatac atttactgta agagcacttc ctgtcccct 1602420
 cccacccca aataaaagga aaacagggat gaatgtgaac tattgcatct cagttttaa 1602480

 tgaacattga ttgacacatc tgggtttgct gatagaacta ccaggggctg agaaattcca 1602540
 tagaaaattt tagctgtgtg aattttattc agtggatcag gacacggcaa taggtaaaaa 1602600
 aattttaaga catgaacaaa tgaaaacaag cagctggaga gatggctcag tagttagaac 1602660
 actcgtctct cttgttgagg acctgggtta agttctctgc acccacacgg tgcctcaaa 1602720
 ccattggaaa ctgccattg atgggacca atgccttctt tcaacctcct tgggcacccg 1602780
 gtacgtatgt ggtacacaga caaacatgct ggcaaacact catacacata acatttaaaa 1602840
 aatattttaa aaaccacaac aaaccacaca tcgtgcaata tatcattcaa gttcttttaa 1602900

 gaacagattg gtattttggt tttttaattg tgtgtatatg catagtctta ggtgtgggtg 1602960
 tgtgcatgta cctacagaat ccagaagatg gtgtctgac ccttggact ggagttacaa 1603020
 glaattgtga acatagaaga aaagaccaa ggagtctctg tagaatctaa tcttctgttg 1603080

tttttgctaa aagttaaaga tgtggctacc catctgcatg tttagagatt ggatgggta 1603140
 ttcacatgtg cttagccatt ctcatgacca gacacacact tggatctgtg acttggacct 1603200
 cctggaatgg cccttttaaa gtcagtcttg gatacatggc cagaacatgt ttccttcac 1603260
 tgtttaggct gcaggatgat gttctccatg ttaccacact ctggttccct ctgccacttc 1603320

 ccttttcate tttgctatct gctgacttgc ttcctcagt tcctttatat gatttacatc 1603380
 ttcctccagg ctctgatgg acaaaacaaa actctcatgg agactgtcac gaactgacaa 1603440
 atatccaag tgatactcct gcttccaaaa tatcaatcat gcatccaaag gatgactgag 1603500
 ctggaagaga cctctgggca gtgtggtagc tgaactctc ttgatgagaa cagacaggag 1603560
 atttttgtta gatgtttgtc catccatcca tctgtgaaaa attactgtga tgggttgaaa 1603620
 gactggttct aaactgaaca caatgcattt ggagacagat gtccaacaca tcacagtcac 1603680
 ccagagagaa ccttctcgct catatgattc ctctctaate cccgatgttc aaactgacat 1603740

 gcaagggatg agagaaatgt gtccagacaa aattcaggca ggggtggagc ccaatgggga 1603800
 tgacagagaa ggaaaaaac cacaacggca gagtggcca gttatatccc tagggaacaa 1603860
 atattgagag ggttgggttg caaccatgta ctgccttgca tagcatatca acacagcaaa 1603920
 gtatgcaaaa taacagact aaaccactg cagcacacat gctggctcaa atggcagga 1603980
 cactcttccc tgccaccctt tatattcacc ctgtactttc cctggggctc agccttcctt 1604040
 ctaccttga gtcagattc ctttttcaaa aacatagctg atattgggct attgccctg 1604100
 ctctggtgtg ggtgacaaag cctaggacat gccacaaatg attaggcag ccaggcaagc 1604160

 agcctcagag ttactaaaat gaattgtagt atcaggggct atctctaggg ctatgggaca 1604220
 gttttgtttg tttttcttt atctttttcc ttttctctgt aagaagtatt ccataaagt 1604280
 ttaatathtt ggggtgggaga ggaaagtat ctaagactta acagtctaca tctgtggcaa 1604340
 cggaagcaaa gttgatgctg agaatgaatg actaatggga gatcagagtg aaccataaac 1604400
 acagaaccaa ggtaacagcc cacactcaa tgaggaggaa ggtggccagc ttctggagtg 1604460
 ttttaggaca aaagattaaa cacaggattt ttgaaatgt aggaagaaa gaggccagtt 1604520
 tgtgctgtc cctggcacc gtcagtcatg tgaactgtct cagacctagt cctcggatcg 1604580

 atgctgactt gaagtctct gatggtagg atgaggcctt gactgatgtg gacttggatg 1604640
 aaggcggcag atatgatga aagatgaagc gaaaaatctgc ctatggagtc agggagatgc 1604700
 tgggcatca agaagaaact ctgtcaacag tagagttaat tcagaattta ggtgaaaaaa 1604760
 aaccaacca acaaaaaaaa caaaacaaa accaaaacaa acaaacaaac aaacaaccag 1604820
 gcatgtgagt ttgggatgat tagatcgaat atagattttg aataataaca agctagattt 1604880
 aatggcagc atgttgggta aactactttt aagcttagcc ttagagtaag aaggagaact 1604940

aaggaaagca gacagcaaac acttagaagg gcacctggac catgggcata gggcattctc 1605000

 aataaccagg ggatgtcatt atcatcatta ttgctattag agacagggtc tcaactccatg 1605060
 gccacaggctg gacctgggact caccatctat tgcctcagtt tctgagtgac taggatgaca 1605120
 agtatatgct aciatgctca cctccagctc ctattataaa gattagaagt gatctgacac 1605180
 aggtttgtgg tatgtagaac acccacaaga gcaggaagag tggaaagagc aataaggctg 1605240
 taacaccaac aaatatgaac ttaggctgca gactcaaggg aattgtactg cctgtgccgg 1605300
 tcagagtcac gtggagtact gtttagcttg ggacactgat gatttaagat gtgtgaggag 1605360
 gcctacgggc atccatccag agctgtgtga catgacagaa actggacaca tctggtaagg 1605420

 aaaaatgagt gtaacacagg ccataactct cttgagatcc tcaaggagct attattacac 1605480
 aggaggtaga atagcattat tccacggctc taggagaaaa aaatttaaaa gctctttagc 1605540
 tgagtttgcct taacagaaga gtaggttttt cagtaggggtg gacagaggaa taggctgctt 1605600
 gattctctat tactgcatc gctcagagag cctaccgag aatcacttag aagtgaagag 1605660
 ggtggagagg acattctctt ctttccttgc aaaatggaag ccaccacggc tcagtctcac 1605720
 aagacctttg cttgteccat taaatcctgc caggaaggac actgtgttca caaatctttc 1605780
 ctatcaggat agagaaggca cagtgtcatg cagagataca cgttcatcca acaggtgctc 1605840

 actgatggaa gtccacagtc actgtgcaa gtgacagatc ttcgaaaatg aatgaaatag 1605900
 gtctcaaggg catgtgggtg gtaagtggag ccctctttgg atcctatgta gaggcaagtg 1605960
 ctgaggtaga gagtagcaca agggagcaca ttggaggttc aacttcctag tgcgacaggg 1606020
 tccaggttgg ggttctgagg tagaagatct ggaagctgaa gagggcttga gtaagtagat 1606080
 tgttcgtggc attatggca gtatgtgcaa agtatcagag gtaggaagca gccctgtggc 1606140
 caggcagtc ggtgtagcca ggctgaaagg tatagcttta ttggaattg ggtgagaggg 1606200
 tcaggagggg gccggagacc agagcactca gtatacactt ctaaaggcct gcatgtcaca 1606260

 cacaatcaca aggactattg atcaagcttc aaaattccaa ctagtctctg gcctctagaa 1606320
 attattcaac tgtttgttta gtggctctat tagtcaatgg tccatgacta tgaccaatag 1606380
 aggggatact caatctagcc agagaatagg cttattcttg ttcatagttt tgagggtttg 1606440
 gctccatggt tacctggcct cactactttt gaacttgggt aggcagcatg ttatgatggg 1606500
 agcacacagc agatgatag ctgctcacta catgagatgc caatacagag aggaagagga 1606560
 aggggccaaag gccttactgg tccttagaga gcacactctt atcaaccagg tccccactct 1606620
 agaggattcc ctaactccaa gaagaccatg ggtctgggac taagcccttt cacacaggcc 1606680

tctgaagaag atttagccaa accagagcag ttaccctgtg tggccttc atgagcgag 1606740
 gagcctatc taactcattg ctatattgct gttttgagac tggcctgaa aaacaaatgt 1606800
 gaggaacag gaaggatcca acctcacagg gtttcaatga ggattcctga aactaaatgg 1606860
 cgcacactta gagtagtccc tgtgcctagc aagcttggat aggtgaaagc cactgttatt 1606920
 attattcatt tgcctttctg gtttaccctt ccttttgtgc ctgtacttgg ttaacacact 1606980
 tttgggaggt ggtgctggga actgaactca gggcctcata caggcaaggt gagtacctta 1607040
 tcacagaact atagcctcat aacttgttct ctacccttct attttaaac agaggcccag 1607100

 agatggtggc acacactttt taatcccagc agttgggagg cagaggccaa cctggtctat 1607160
 aaggactgcc agagctacat agagaaacc tgcctctccc cccccaaaa aaccccacaa 1607220
 aatagacagt ggagttcagc gtaaatcct tgttctgaag attcaggat gacagacaga 1607280
 tctttctttg agaatccaag gaatttctta gggatgactc taacttggga gagatttctc 1607340
 ctccaacagg ataaggcctg gaaagacctt gaacattttt cttctcattc aagcccaga 1607400
 aggtgatctt ggggtgtctt cctgtgacc aggcccagg caaagttgaa gaatagttg 1607460
 gaatgaatgc ggtgtcagct ctgagctgac agtcaccatg ccatttgttt aacagcacag 1607520

 tccaaaatgt atgtggcatt aaaccattct ggttcacact ctaggccttt tgaccagttt 1607580
 ttgagtcaga agagaaaagg ctaggtgttg aaggccgggg tgggggagtg gggagaaatg 1607640
 gaaatgactt caatgtctaa aataaaccaa attacttaat ctaactgaaa caaacaatg 1607700
 aaaactgttt agtattagat taaaacaaa agcaaaaaac aaagcttgtt gctgtccctg 1607760
 tttgtgtggc tggaccagga gggatattt agtgtcatac gctgcagggt tgcatttgc 1607820
 agcccacag gaagtatctg gagtacagc taaagatc cctgcatgtt tggaaattta 1607880
 cgagcagcta taaagtggct ctatggggg cagaggctg gaacaggctt ctttcaat 1607940

 gagagaggcc gctgaattaa aactcaaat acaccaggtt cgtggcagc agagcacacc 1608000
 tgacacgcta aaaataacca cagtagaagc ttctgttctt aaaataat ttagctgata 1608060
 tgtgccttc cctcccaac ctcaaacagg cagatgaagg ggtggaggct gggcctgag 1608120
 atttcacaaa ggtgctaga aacctgtaga aatcaaagg agtcatttcc tagatttggc 1608180
 actttccaaa aatgaccagc ttcttaaaa ttaggcaacc aaagtccggg taatcgatat 1608240
 attattttct aataacaaa gacagaaatg gctgaaccaa acagaactta cacaccagtc 1608300
 ctgctgacga gctgtgctgt agacaggtaa gccttctcca tcttgccaa gaaccagtta 1608360

 ttttgaaca tccttttctt ggcttccctt atcagcagcc cccacacct gctcactaat 1608420
 gctcggctgg aaagcccac ttactccatg cacacagct gcttgccttga tgatatggaa 1608480
 aagggtgagt gtgtgcaatt gcatgtggct gtggtgcagg ccaactaacct ttacaggatg 1608540

atctatatat ccagggacaa cctaacttct aaactttcat ttttgatca aagacgacat 1608600
ggcttcattt tttttcctct tccaattggt acctttggtc tggggataca gtgcctgctg 1608660
cataagcatg atgaccaag ttcaacctcc acaaccaca taaaaacat gattataatc 1608720
ccagcaacag ggaggcaaga gaggggtgtct caaataaaca gatgacaatg acaatcaaaa 1608780

aaggcagact gcctgggaaa gaatgacact tgaggttgcc ctatggcttc tacaagcaca 1608840
catgtgcatg tacgcttggg cacacacata cacacacgta cacacaataa tgcacatgta 1608900
tacacacaca cacatgcaca tgtacacaca catgtacaca cacaataatg tacatgtata 1608960
cacacacaaa catgcacatc tacacacaca cacacacaca cacacacaca cacacacaca 1609020
cacagacgtt attttgcttt ctgagcacag tggaaactgat aaagaatacc ctgggtgacct 1609080
caaaatttct tgggtgatg aagggaccaa tgcattcaga agcactgctg ggtctgaggg 1609140
acgtgctgt taccaccatt cctgggcac c ttagtcaagg atgggtcaga ggacagcaga 1609200

gagcactgag cacactgatc tccatgtttt ctttttgga gtggtgacat tttaaaccgg 1609260
tcagagcacc gtttggatgt ctctctgagc agtggggctct gcaggaaatt gacctgcttt 1609320
gccctctct tgtctcttta ccatctttgc tggctctacac tctgcattcc tggcagctca 1609380
ctgtaggcag ggctgggtct ggttttact gtggctcgca caggctctgc aggctactta 1609440
attctctgat ctgggaagaa agtccccaca ttctctgaag tgggtcttcc taaaaacttt 1609500
tgctttagt gccaattaa tagggagggt atcattgagt ttatttggtc ctttcctct 1609560
caacatgttc cacttaagt aaaaactgta acttcacat gacagtacct gtgacacatg 1609620

gtcatgatca cacattctgc ctctgactgg agcttagtgt gacaaagatg aatgacttg 1609680
ctgcctcaga ggatggggcc acgaaggttt gtttccttg ttccttttt gcactgtcta 1609740
aggttgttac acagtcttta caattttttt aaaacatatt ttatttttt gtgtagtgtt 1609800
ttttgectgg atgtatgct gtgcaactgt tgactacagt gcctgtgaag gccagaagag 1609860
ggcgttggca ctatagtac agttgttagt tgccatgtgg tgggggggaa ccaaacctgg 1609920
tcctctggat gcacaaccag tgctcttaac tgctgagcat ctctccagcc tcattaaata 1609980
gtctttaaaa ataaagaaag agtaactgcg gttttaacat ttttaaggaaa tgccacacag 1610040

gctaaatcat ttcagtgaag gaattaaatt ctgagcatct aaaatattgt agaggtagcc 1610100
catttcattg caagtttttg ttctgagaa tftagtaaga ggcaaaggat gtgcctcacc 1610160
taaaaacttc agatcaaatg atggtttttc taattagaac ccttcagta ctgaaatatt 1610220
gaagttgaaa tttttttaa ttgtcccca aaggagcata agttgaaagg ttggccttca 1610280
gcctctgttg atactgggag gtgggggaag ggccaagtgg aaggaaagga gcacgtgag 1610340
gacatgtctt tgaggggatg agaagacccc gggctcttct cttctcttc ctcttctct 1610400

gcttcctggc caccatgagg tgagcaactt ccttgatcaa aactcccac tcagatgat 1610460

tatctccac aggcccaaaa gcaacagttc aaccaacat ggacacaaac cttcaaatct 1610520

gtgagccaga agaaggtttt tacttttaaa agtgcttcat gccaggcatt tactatagct 1610580

ataggatgct ggctagcaca gaagtcgaca atctttttat tcaatgaaga atcacgtcgt 1610640

tgctcgcat ctgttagtg ctgaacaatg cacagtgct aggtatttac ctttctccag 1610700

cttctccac agagtaccaa cacaggttgc tgatagggga tgccttctg tatatgtgtt 1610760

tctcttatta gttgatgaat aaaactgt ttggccaata gaggcaggaa gataggcagg 1610820

actaggagat gagaattctg agaaaggtag gcagaggag acccctgaaa gatgccatgt 1610880

agccaggatt aacaggctctg gacccttctc tgtaagata agaccacata aaaactta 1610940

gattaataga aatgggttaa taattaagac agagatagcc aataagaagc tctagccact 1611000

gggcaacagt ttataattaa tacagcatct ccaggtgcct atttgggct aaagcagtgg 1611060

gacctggcag gacaagaac tccagcaaca gtttgctttg tcaggcatca ggagacaaca 1611120

tctccaggt atgactttct aagctctaga tgccaagata gcatttga caggaaccac 1611180

caacaatgtg cgctccttg aagaaagaag cagccatcaa ggcttataaa gtgaagcttg 1611240

tgatgccttg tgggcaact agccactctt cactgtttct tcagggtgt aatagagtgg 1611300

gttctgccc agaacttttt tcttcagatg gctttgaagt cagcagctcc tctagcttgt 1611360

tttttacag aaaagtcctt gactctgaca aagagaagta gatgaagtca ggtgaggtaa 1611420

tggtagcagc tgctgggcat tcaacagaca aacagtggaa aggagaagag agccgatgct 1611480

gggtggtatc cggaccaga ctgtgagccc tgggactggg gttgtgtagt attactaac 1611540

atcatgaagt gtgaggtgtg gctcctcata ttgtcatgtc catgcataaa aaactgggga 1611600

tcatcatgtg tgctactccc atcctccaaa ataatacact gtgacctca ttattgttca 1611660

tttcataatt acaccaaatt ggttaattaa ttggcatctc ctttgcctct acagaaaaca 1611720

taccaataa aatattcaca ccacaataat gtccagtggg tactggtgat taattttaat 1611780

aaaataaagc tccaactgg atcaacactt ttgggtggca ccaagggaca tgttatgaga 1611840

gcaagcttgt cagtatcctt cacaaatgt gagagccca cccaggcca cccagtctcc 1611900

tccaacatcc caccatgcac cgggcgtaaa tcattttgga agctgttcat agctgtgttc 1611960

ttccacttg taagttagtg aagtcccaca agcttggaa aatagccacc taagtatga 1612020

tgcttttatt ctttccctt tgaatgtgcc cctttcaggt gctgtcctga ggatatcatt 1612080

ttaccatact ggaatttagt ggatgtgtcc atagctctga catttgaga ccagagctcc 1612140

aatcaactcc ctgagtcttt acaatcaaga caggagaatc caaactttta aatctacccc 1612200
cataaagaaa tcaatttctt taggagactg gcttcagctg cccaactttg ctgtggattt 1612260
gcattaaaaat caatgcaaat ctgtatgtgt atacaggcat ttctctggag tccatctctc 1612320
tacaaggtt ggaaactgtt acccttcac ccgaggctcc ttctagaatt ttccttagtt 1612380
ttgattagtt aattattgag accgaatagc caggatgata tccactagtc caaatgaggc 1612440
tatgtcaaaa attccaaaa agatggtttt ctctgtaacc ctccaccaga ggatgcctgt 1612500
tatttggagg atttggagtt acagcagctg ccaactgcatc caggtctttg gggaatggtg 1612560

tataatgac ctcatgtcca tcttccgagt ggaatattat tatccatta gtacaaccta 1612620
atitggattc tttccctag atacactgcc ttgtattttt ccacactggt tcagctgctg 1612680
cctgtctacc tcttggctgc catcctgtca gatcttcagg aatttacata atgtggactt 1612740
ggctttatgt tgtgacattg tctctgcaa acgtgtggtg cttctgttac ctccctgaac 1612800
aatgtttaa caaggaactg tccatgatgat agtgacagcc acacatcacc ccaaaacatg 1612860
ctcctgtgtc cacaggaagg ctccggctgg gcagagtcta cctggcagag accacagtgc 1612920
ccaaaccctt tgtgtctaga tgggtccaga gaaccagtct ttgcagggat gtaaacagag 1612980

gtaaaaggct ggtgaaacat agtgtgtgtg tgtgtatgtg aatgtatgtg cacacaccgt 1613040
gtgttaaata tatgtacagg catgtgtatg agtgaatgta tggcatgtgt gtgtgtgtaa 1613100
atatagtac atgcatgtgc ctatggctat gtgtgcataa atgtgacat gtgttctcca 1613160
ttatcttccc ccatttgata ccaggacaga acgaaccctt tgaaccacc agagtcaaaa 1613220
gtggggagga aactaggttg agtcggtgtg acaccctggg gggtaggct gcctgctctc 1613280
tggggcgcca cattgactgt tggcagggtg gaaataagca tgcggtatcc caaaccccaa 1613340
accgtggtgc agcagacagc aggcaggggg ccaactgttg aatatttgc ttcacagaga 1613400

gttcccgctc cctccctct tegtcaacc atgtccatgt ctttttctca tccagaagaa 1613460
caaggccctc tttacatctg aagcacctta atctgttca gaaaggattt tgtcaagat 1613520
atittttgat atitttatgcc atgagtttaa ggtatttacc taaatagcaa ggttttagtaa 1613580
aagcttacac acctgaaaag tattttgatt tgacataaac aactcattc gagatttcca 1613640
tgtgttagta tttattatgt ggctgaggct aatttggact tagcagtaaa caaccacgt 1613700
tttgactgac agtcgcaagt gcctctgcag gaaccaaaa catagacaag cagtaccatg 1613760
tcttccgact gcctcggag tgtttagaaa tgatgcagca tctctgtgag ttccacaata 1613820

gaggtgcttt ttgtgtatg ttgtactgac gtagcgtgg gctcaggta gagagacttc 1613880
aggttctgag agctgtctgt atcctctgag gccaacaaga atccttgata tttcctctgc 1613940
agcaaccac ctctccttc ctctagtct tctgataaga gtttaaatcc cttgctctga 1614000

ccagcatcta cacagagcac acctcgctct atcagaagag gacatggtgg gatggagtct 1614060
 ggctgagacc gcgctgtagc tgtggccact gtgggaagag cctggagata aggatgaata 1614120
 gtccatgtct cctttaaacg taacctcttg gggaactcac tctaggaatt ccatgtccat 1614180
 caaaaggctt ggagaatggt ccagatgggc aaaaaaaaaa ttctgggggc ttcctacttc 1614240

 ctggggtgtg tccttcttgc acagaagggtg acatccagag aggttctagg atgatggttc 1614300
 acacttatag tgatgtggta agttaaaca cctcccaca ggacaaatct taggctcatg 1614360
 gaacagaaaa gatggtgctc caattatgtt ctctgagga gtttgtctg agctctacag 1614420
 gaaagtgaca atgcatggc agggacacc tagttacca taacaagcct tttctagga 1614480
 aactaccttg agagcagcat catccagaag aggaagagac ctaatggcac aatcacagga 1614540
 aatcaacag ggaagagact tgcttacc aaacaaca agcttgctga tttcaaagac 1614600
 tttctacatc agggctcctt ctctgctgtg agaattcaga gacactcca aaggcacct 1614660

 cattaccttt gcctatgaat aaagcaaatg gcggtgatga ttctggcagt ggtgatgtgg 1614720
 ctctcttttg gaaacttctg actaagatgg ttaggggtga aactcttagg agtccaactg 1614780
 ctacttccac agatgggaca gtgaccacgg aaggaaagga gacatctcca tcacctagt 1614840
 tcttgctttt aaaagcactg ttcagtttgt gttgccatta acaagcacc ccaggctcct 1614900
 ctgggggcat caggaaaaga gacaaggggt ggttaggggt ggagctggac agaatcggat 1614960
 gctgatggca ggggacaagg cagtcaactg tttggaaaat tgctttgttt ctaaaaagaa 1615020
 acctgacatt ttgggggtgg ggttagggca gggtaggac aggccttctct ggagtgaagc 1615080

 cagacaactg ccatcttctt tttagaagta tcttagtctt ccacagtcca caggtgagca 1615140
 ccgcaggccc tccagatcct ccattctttg ataaagtga gtaaatgaca gagaggtagt 1615200
 ttatcttaac agaatatggc tggcatttct attgtaaagt aaaacaggtt ctgaagaaag 1615260
 aatggactag gacatggagg tgactattga ggacagagag ggaatgcttt ggaagctgtg 1615320
 aaagctacac agagaaactc tgtcttagaa aaaaaaaaaa aaaaggtgaa caatgagatg 1615380
 tggcaatgca ctttaggaaa tctctaaaga cggttgggtg aggtgaggat gctactacca 1615440
 acagtccctg tgttagtaac ttgtctcata tgaccaaata cacaataatt agataagaat 1615500

 tgaaagggag aaaggaaggt ttattggttc atggtttaag aatggattcg ggctgttata 1615560
 tcacaggaaa ggtgtgacag tagaagcata agaaggctgg tcacgcagtg tctgaaggca 1615620
 ggaagcaggg agcagaaagg aaatggcct gagttacaca tctcaaggc tctctcctgg 1615680
 tgaccactt cctccagaaa ggtgccatct cctgaagggt ccacaagctc ccaaactgtg 1615740
 acactgctg gggcccgaat gtccaatggt tccatgtgcc cgtggggggc catttcacat 1615800
 tcaaaccgaa tcactttcct gaggttccat actacatcct tcttctctat agtacactca 1615860

atctttaact ttctccactg ggttccttca cctaaagttg cagctataat ttatagcggc 1615920

atgctgcatg ccttagaaat acaggggtct gaattcttct gctttgaaa gactatttgg 1615980

gggtcatcac ggggcaaccc tgtatagact gacaatatac tagtttgggt ccaaggaaca 1616040

aagtgttttt ttaagagctt gtcataattga gccttgtgct atgaattgct ggccttggcc 1616100

acaaagagct tttacaaaac acccctgctt tttgtattgt tttaaaaatg gtctcacatg 1616160

gcccaggcta tectttacct ctgtatttga aatgactata tgcacaaggc aaacatgaaa 1616220

tgatgttctt tttcccctag gaggggaggc agtgtgtggg ccttattgac atgctccagc 1616280

atgcttcccc agagccttgg aagatttgcct agggcctaca tcatcattct ccatatagat 1616340

agttggagct aaaagggtga aaatactgga caaaatgtct cactagttca tctccactcc 1616400

acctttgagt tcagttgttg gaaacaacag tctggctggg aaaacaggtg taatcagttt 1616460

ctgaagacct ttccaagcct aggcaagagt ttcttattca agagagccac agagacttgc 1616520

agtatcaatg attggtgctt tgaaggtgca gattccacag gcttcagga ccagaaggga 1616580

gtgtggtcat cagtaaccag aactggctca gctggggatt cttacacaca ccgagcctgg 1616640

ggaattatta ggctcttttt gttcaattgg ggtttttgag acagggtttg tactccgtag 1616700

ccaagctag ccttgaagtt ttggcaattc acctgcttca acctttcaag tgctgggatc 1616760

atggcatgag ccaccacact cagttataga tttctgcctt tttttttttt tttttgtcat 1616820

cacatttctc tggagtagtt cttgctcatt gacttcacat tcttaagacg ttatattaac 1616880

atcatttctt ccattaattt ttacatatac cctagcaaga cgtaaagcga tgaactgtcc 1616940

caaaatggaa gggtttagga aattttacaa cactgaagct gttgggactg aggctggaaa 1617000

accacttacc agtaactctg ggaagagaac tcaagtatca tttgagggtc caaattttga 1617060

aacaatgtat tacatttctt ctatctctag gaacctacga taacattgta acaaaatcag 1617120

cttactatg tcaagaagga catattttaa aaatctccac actcagaatt cttatttgta 1617180

gtttttaaaa gcagcaagaa tattagcctg taaaatagga aggccacaag ttgaagacag 1617240

agcaatcaat ggactttggg ggttcttaag cttaaatttt agctttgaaa cctatttagca 1617300

aacctgaac acaagcagat aaaaggcaaa agagagccgg ggtggtggcc tgagcctgta 1617360

aatgctagta gtcaggaaga ggtagaagca ggggatgat gtgtttgagg ctagcctggg 1617420

atacatagtg agacttcac tccaacaatg acaaccacta cccaacaga gcagacaaaa 1617480

gaaaagactt cagctatcca cacccttcca ctgaggccc ataggaagga agaccgcct 1617540

ggctcaata aatgaaagg aagatcttgt aagtcctca tgaagtcagc tgacacttca 1617600

gactcacagg gtgaataaat ttgtaatcta ttacataga tggagacaac catgtgactg 1617660
 ctgtcttacc catatgcggt acacattggt tggattgtgc acttgtcttg acagcgttgg 1617720
 gcctcagaac tgaccttggc actaagataa ctgaggaaaa aaaatactca atatgataag 1617780
 aatcacaca caacaggact cctgtgacat cacatttatg gactgttgtc agtcgggcag 1617840
 gagattactg aaacagtttt caagtctgag aacccaaagc aaacggttaa gctctgacac 1617900
 aagacacacc tggacctcct ttgcagcagg ccaggtgacc ttcactctcc tgaaaaatga 1617960
 tgcacgggct tagagaagtg ccagcatcat aaaatggcac ggcaccagta cttggcatgc 1618020

 cttctcttca gaaagctacc cttcaggggt gagctttggt tcaactgctct caaatccctg 1618080
 aatcagaaag agctggagtc ttcctgttt gtgtaagtcc tcccagagt cgcacactgg 1618140
 gcaagcattt atttaattga actacagttt atcacaatct ttggctcacc tacaggcacg 1618200
 agggcaaaga ccatgtctgt tttgttact gatTTTTctc ttgtacataa aggtggtggt 1618260
 acataaaggg tgttcttca tccctggaga gtggaggatg ctgtgctctc ccttgcaca 1618320
 tgggttctgc tactctcaac taattaaagg tcttaagaa accatttcat tttttctac 1618380
 aatgcattct atcatctgat atttactata tcaactccagt gtgtcaggta ctgatcaagt 1618440

 cttgaggaga ccaactgtcat cagctagata aggctcccaa tctcaaggta agctcacttc 1618500
 tggagccact gaaagtctc tgtgttccat agcatcacta aagatgagat gaggactcag 1618560
 cagagactag gagccggagg acaacaaggg ggacagtggg cattgtaac taagtgtgaa 1618620
 ggcactcatt tttgttctgg aaggcagctg tcttaagagt ggttgaccac tgaatatcct 1618680
 caagccttag gttcaagaaa gtgataatga ctgcctggat tcagaatgaa tgaatggata 1618740
 acaaaagaag taattgggtg tcaatcctga ggccccctct tatgagtaat tgtatttaga 1618800
 gtatccata ttttagttc agagagtggg aagaataatt ttgtgaatta gggaaagaat 1618860

 ttaaattctg tgetgtcca ttaagaatca agacaaggca tgtcttaaaa agagaatcag 1618920
 cagcagaaaa acaaaacaaa acaaaacaaa aaacaaaaca aaaaaccctg ggagaggaaa 1618980
 ctgttggggg aggatcatgt ttgggaacta actgaagatt tacgacagta atttttaat 1619040
 catagacatg aattagtctg aacctgatg gctgaattca ctacacaca cattttagg 1619100
 atgatatgaa cggttacatg atattaaat gagcctccat gttacaaaat tgttggaat 1619160
 taagctgttt gtaacttctt ttggaggcaa gagaaatag tgtgcaaat ttaatcaggc 1619220
 ccccgacctg tcttttggtg cagtttgata gccatatctg ggataggagc caaactctct 1619280

 tttgggggag aactagcagt cccagagcc acagtgatga attacactgg tctgagaaca 1619340
 agaaaggaag tcaactagggc tagaacaaag ggctagtctc tcggaggggg cttggctccc 1619400
 tgtggctgca tigtgtatat gattctctgg tttttatacc attccttctc cagccctcag 1619460

aattcttaat cciattttca ctgcacctagg taaacctgga aatatttctt tcttgactgc 1619520
aggttactca cacaataaac aggtaataaa cattttactg ccccagagcaa cctcctgctg 1619580
ggcaggcagg caggagaaaag gggctgcaga gggtgacccc ctacaggaca aacggcaggc 1619640
gacaaaaggag gctagtaacc cttaacagt gctcacctca gttgttccag gagagtgacc 1619700

ctgagctgct ggtgcgcatt agccggcccc cagcgtctg gagtctctcc tgetttaggc 1619760
tagtaaggaa gatttgattt caccaaaagg taatttagtt gccatttcca agctctgtct 1619820
ggctaatta aggatgagga tgaactgag ttacagtct cccagttta accacgagca 1619880
gggagcccg aaggcaggaa gaacagggca cgcagggtgt tcaggcatca gagaagtgt 1619940
tctgggcccc atggttcttt ttccagctca caccttgctt gtgaacacaa ctttattttc 1620000
ttatgcttgt tgcatatcat attgtgtaat ccttatgac tttgacttgt gcaaacaca 1620060
gtggatatct ttcttcccc atttcccctc ccccctcctt tcttcgcttc cttctcttgc 1620120

tttactgaac atcaaacca gggaattgta catgtcaggc atgtgttcta cactgagtt 1620180
acatcccaga ccaacatcct attttttga aacatttcat ttacattta ttattttatt 1620240
tgggggatac ttagagagtc agaggacaac ttccaggagc cagttctctc cttccacctt 1620300
gaggatttt aggatgaatc tcaggctatc aagtttgggt gcaaagcacc ttgaccagct 1620360
aagccacaca tggctgtgcc taacatccta tttttcaatc acctcaagt ttccctcaaa 1620420
agcttgttac caggctgggg agatggctca gaggataagg ttcttgcct gcaagccgga 1620480
ggctcacaat tcaaaacccc caaacccata aaaggacaga tgcgttagca ggcatctgta 1620540

ctcttagtte acttatggtg gaatggaaag cagagatagg gaagaatctc cagctagcct 1620600
gccatctgca gcggtgacca acaagaaagc ctgtctcaaa gcaagctgga agacaaggac 1620660
tgacacctga gattgtgctc cagtcttca atgtatgtac tagcatgtat atctgcattc 1620720
tcaaaaatga ctacacacgc tattgcacgt gtgtgtacac acacacacac acacacacac 1620780
acacacacac acacacacac acccctccc aaaagactgt taccttcagc tcagtgaaag 1620840
cttttttga ttccaactg cctgggaaat atttcagttt tctttcacat tgaaggtata 1620900
actcatgacg gcgaggaaac attggacctt cccccattgt agggtagaaa aagcatagcc 1620960

aaatagaacc gaaaactcc acccccacca cgccattca acttatttat gggaaattaa 1621020
aaccttactt acataaatat ttcccacaa atagcatgcc aagtctgaat atattagccc 1621080
agggcaaatg ataatgcat tggcatagat aattttcaa ttcatgtagg atgaaaaaaa 1621140
tgattatttt ataatcaac acttctgtga tgccagctgc agttaattta tgatatctgg 1621200
ttctaactt atttcagaat attaatctt actgtatttt gttgcagagc agtaagtact 1621260
ggccagcagg tactgtgaca cactgcccag tgtatctttt cttgagacct gattggccat 1621320

ttgtgacgta gctactgtct ggacacaagg cttcacatac tcccacacgc catctctgct 1621380

 tttgattttc ttttaaatatt tttctggagg ggttaaggga gtgaaggcat tctgaagaat 1621440
 gacagagcca tagcctgcag cagggtcag gggacatfff ggacatfff gccgagggtt 1621500
 tctagtagat tggggttttc cctccattgt cctgttagga agcctctac agagaaagga 1621560
 tagaggtaac actcaaagtg aaagacttca agcccaaac aaagagtga gaatagtaca 1621620
 gcatggatac acacagcaac aaggggaaag aggtcacaga agaattggaa tcggccaggc 1621680
 agggtcaca tgagaagggg agtgcacccg tggatgactt gaaaagagcg aaaggcagga 1621740
 tgcaaccctt ttactttact ggcattagac ttttattagg catctgtcct gatcagcttt 1621800

 atctgtcaac ttgacacagc ctagaatcat ctgagagtag agtgacaacc taggaattgc 1621860
 ctagatcaga gtatgtatgt gtgcaattgt cttgactgct cattgagata gaaaggctca 1621920
 gctccatttc taactagggtg gtccagaaca tctctattg tccctgcacc acttcttgggt 1621980
 tgtgaagtga gticcgcggt ggatgtgatt ctgtgttagga tagcgagcag gcatgccttc 1622040
 acgttcctac ctgcaagtcc ctgccttgag tgactcctct cagtgatgga ctatgatctg 1622100
 gaattgtagg ctgaaacaaa ccttttcttt cctgggtgg ctttggacag ggtatttgtc 1622160
 acagcaacag aagtgaaact tgaacagtca gtctttgact gtggttcag agttacaaaa 1622220

 ctctcataga actgggcatg gtgtcataca cctttaatcc cagtacttag gagacctctg 1622280
 tgagtgaag gccagcctgg tctacaaagt gtgtttcagg atagccaaag ctatataga 1622340
 gaccaggtat taaaaaaca taataataat aataataata ataataata taataatgaa 1622400
 tgccacacag aaaatgacag aggacccatg gctaatggca gtggctacag agataaaaag 1622460
 gttcttgaac taagacgaag ggaaaagggt aaggatgatg gggtgggtgt tgaatgcagg 1622520
 aagggcttta gaggggcacc ccttaactct atggtatact gggcaggtgg ttctgacaaa 1622580
 gagcaacaga ttaagtaaa aaccaacaac tttcagtcag attgaagcaa gatctgtgga 1622640

 atggcagggt taaagccata ggcagacaga taggatcct gacttagaat ggccaacatt 1622700
 aaacttttg ctttgtctg accactctg aaatacaaga ccaaggctac tttgttcaact 1622760
 aggtaaaaga tctcagcac tgttctact cccttccct ttgctaagca caccatccag 1622820
 gcctttggca gactttgtaa ggaagagggt tagatgcctg tgttcagtac ccaccatcac 1622880
 cctgacaacc caagcatca ttctcatttg ctgaaatcca acctggagga tctgtgtcc 1622940
 tctcttcat gctgaggata gcagctctac actaccagg gtctaccagt cacactgaga 1623000
 acaaaccta ctcttactg gccttttggg ccaggtgtct tcaggcttct tagaggactc 1623060

ctcagtgggg tctcatccc atccttacc cctcccagc cactctcttg ggctacaagg 1623120
ctgctttgtt ctgtctttgt ggcagctgct ccttcagctt ggaccctctt gcctggctct 1623180
tcacttggct ggctcctctc agcagccaag gctcagctca gatgtcacct ctcaggtgct 1623240
gagtggaac ctcatcctaa atacaatgtg gtccagcctc aaacaggtgc ctttccttac 1623300
acactgggta acacaataaa tatcagtcca atgaaagaat aaatgggctt caggggcagg 1623360
ttgtctctgg ctagattgag agagtggcag gtgagaaaat aaagaaacca ttgtggggga 1623420
ttggggcaat aactcagctg gtgaagtgct tgccatgcaa atgtaaggat ctgagttcaa 1623480

ttcctagcac ccatataaaa agctgggtgt ggtggtatat gcttgtcatc ctagcactgg 1623540
ggaggtgagc acagttagtt tagcgggatg ggcgatctcc aggcctagt gagaaacct 1623600
gtcaaaagat aaagtggatg gcacctgagg attggtactg gaggttgacc tctggcctct 1623660
acacacatgg acacacatgt gcacctgcac acatacacac atacactctg cctgggactg 1623720
gatgatgttt ggggtagaga aagagattta caggcctatc cacctttgaa gtgagcttct 1623780
cactgcctcc atcatagtct cagaaagaag ttgaaccaag gctcagggga catgcagaaa 1623840
atggagcaga aagactataa gagccagaag ctcagggagt ttgctgtgag agagtgtcac 1623900

ctagtaatat cagaagccca acccataagg gccaccaac acgactgccc aaacatgtgc 1623960
tgaagaagga tgacaccagt gaacttgcca aactccatgg ggaaaaactc atgaggcctc 1624020
aacctccac aaagaactgt agacaaccga gggaaagcat agaagagtag aggtgcctt 1624080
tccaagggaa gagcaagcca atcatagtgc cacatgtca tcctggaaac atacatacag 1624140
gtagcattat acagacggaa tgtgttata ttagaaatat gcatgtcaat atattcatgc 1624200
agtaacagtt tigtaaaaag aggccatgga ttgaaagtag agagaggagg ggcttatggg 1624260
aggttttga aggaggaat ggaagggaga aatgttgtat ttatagata accctccac 1624320

tcccaccta tcccccaaa gaaagaaact tgtgggttg ccaacagcat agtcaccaa 1624380
ggcattggct ttgcaatctg acacattaga atcccagctt ggttccatgt tacctacatg 1624440
cagattacct ggcttcatga aatcctgttt cctcatatta gagaagaaat gatggtgctc 1624500
gagagatggc tcagtggita agaaactgg ctgctcttgc agaggacca ggttcgattc 1624560
ccagcaccta catgtcagct cataaccatc tataactcca gttccagggg atctcagaca 1624620
gacatacatt caggcagaac aataatgtac ataaaacaaa caaacacatc tttttgttaa 1624680
aagagaaaat acaaaactgt atgttatttt gtggatatag acaggtaca tgcaaagtac 1624740

ctgtttgcct accagcttgt ggtgatctga aagaaatgtt cccatgagt gtatgatta 1624800
gaatacttga tcctagtgt gctgcacatt tcggggacac tttgctgaag gatgtacatt 1624860
attgggagt gtcttgagt atttaagcc tctatccac tcccagttg ttttctctgc 1624920

ttgatgcttg cagtaaaaga cccagtatct cagcttcttc atcccgtgc catgcatgct 1624980
 gttggctgcc atgcttctct gccacggtga actttcatcc ctttcttcta tgggtttga 1625040
 tcacagaaac agaaaagtaa ctaatataca gccataatgc aagcaaaaca aaacaacaaa 1625100
 aactaccaag ttgtacagtc catcaggata aactgagcct tccattgtcc tcataaagg 1625160

 atgctaagat gtcacctcat tcttctgaa gctgcagcat ctctccctct ctatccacc 1625220
 cggacattta tcctatggt tctaggttct tagaagggtt tgagctgtcc taattttacc 1625280
 tggacagtgc ctactttgat ttgggatggg attataagat tcccagacat ttctcacgaa 1625340
 gcagcttacc aaggteccag ccagttagcc aaggcatttc tagggagact ggtgtcttct 1625400
 gttttacttt tgcccctaat ttctgtaaag agttgaaggg cagcctttga gggttctata 1625460
 aatgttaatg gttgactgac atacagatct cttggaatgt ttttactagg gctaggtggt 1625520
 atttgttggc ctttggttga aaaatgcaa agtgaaccg ctcagttgct tgatagaaat 1625580

 tgaaaacaac tcigtacatt ttgagathtt attttataaa attaatttat gattcctgct 1625640
 cccaaaagcc tagttagttg tcacaathtt agttgttgtt tctaaaaag caataaacta 1625700
 ttttctttta aatccaggaa tgcaggttaa tatttatgct ctgttgaaag aaataaatca 1625760
 aagactctgt ctgtaccctg agatttgctg gcattacacg tgaccattgg tgatactgac 1625820
 aggctggaac atggagaggt tctttataag ttagtaactg gaggaggggt gatggtgagg 1625880
 aggggtgggc tttggtgatt tcattcccag ccacagctgg caaaattgct tattggaaaa 1625940
 taaaagtcat ggtaaatga gcttgacaat aaccaggctt gactatgtag accccttctc 1626000

 cactcaaagc agttagagtg gggggggggg aggcgggggag gtggcaggga aaggaagccc 1626060
 ctgtcacaca tccatcttcc ttatcttgca gggcactagc catatgctgt ttgtgtgagt 1626120
 gctgctctct gacggctctc gggctctgta cttttgcagc ttctggacat ggggtgaagt 1626180
 gtagtcattt tacctttctt attctcaag aggggacgaa caatcagagc catgctgtcc 1626240
 aacacagtaa ccatttaatt ttaaaaattc acaggctgga gagatgtctc agtgtctcag 1626300
 agcatatact gcctgcaga ggacctgcat ccagttccca gcaccatac ctagtgacce 1626360
 caaatggtct geatcccctg atccatggga gccaacacac ctggcttctc cagataacta 1626420

 cctccaccta tacacataat taaaaattc tttttagtct taaaaatgca gtcactccag 1626480
 ccaactacca agtgtccata gccacatgga ctaatggcta ctatactggg ggctacatgg 1626540
 ccacaaatca acccccactc cccagaatgt tctatcagac agctgcaatt cagaaaacce 1626600
 aattggcacc aagaagccct tcttttttg gccccaaacc ctgaggtcac ggtgacctct 1626660
 gtggtaaaga tgtaactga acctttgaga atgtggatgat cctctagtgt ctcatgtctt 1626720
 cccaaacagt gggaaacaaa tattgtgact tggggtgtgg ttcaaacatc ctgattccat 1626780

agacaaactc tgaactttac atttcccat acgaatcgg aacagcaacg ggagacctga 1626840

 ggggtgcttt atttttatg agctccctcc cactgttaca agcagttttt tttttctta 1626900
 acaaacctgg tttttatcat ctgtgtgact atgcaggtgt catgtgcttt gaggaccaag 1626960
 tatgacggag ggctctggctc agaagacagt cagcaaagca acgcagctgc ttacccttg 1627020
 tcagggcact cagtctcccc aactgtcctt ccagccaatg agctttacca actgcaaate 1627080
 tcaagtgcac caccctctgg atattgcttg caatatgtac catgaattcc tattttattt 1627140
 tcacctttga gacaagatct tgctttgtag tccatgctga ccttgaactt gtgatcctcc 1627200
 tgccgtagca tctaaagtgt tgggattaca ggtatagcac ctccatacct ggctcttaaa 1627260

 ttcttcattt atttacaacc ctcaggatca ttaattttaa aaataaaatt gtgaggaaga 1627320
 gttgctaaga atcctcagaa acattctctg atgtgaagca atataaacct gccttttctt 1627380
 atctggggca gcatttttgt gagggatagc cccgttactg caattttagg gcaagcacag 1627440
 caaagagaga gcctttctgc cttccaacag acataagaca ggagggtcac acagtttgaa 1627500
 aggcaggggc atgctgttaa aatttggtaa acttcatact gtctaatttt ggtgagcctc 1627560
 aaaaatccct gtgctctgac tggattgggt ttacagcaga ggctttcttc ccatggtccc 1627620
 agagcacttt tatgcatata atctgcattg cacaccacc ctggctcctt tttctccact 1627680

 ggctaattt gttctctgc attaggcagg attaattctt gccctagttt gctaggtagg 1627740
 aaaacggacg aagccgtgga agactctggc ttcacacagg gcagtgaagt gtggctttac 1627800
 tttcaggtca ctgagcaca gccaaagctta tttcacggct ggaacacgtg acattctgca 1627860
 ctgtttcaa caccagetat tccattcatg gtgatactgc ctctcaatga aaactccata 1627920
 aaatctctga cactttcaag tcaagggaac tgcagaata aagagtgtaa tgttaggat 1627980
 gacaaaaaac acttcatgac atttttttt aaaaccaggc aagaacctgc ctgtctcttg 1628040
 tcaggggtta ataatatggt tgccaaattg gtacatgtta tgagtgaat atggaatgct 1628100

 cccacaggc tctgtgttt gaatcttagc ctccagatgc tggtgccatt tcagggggac 1628160
 ctggacctag ctgatgatag atgtgggcca ccagaaagca ggccggctta aggattgcag 1628220
 cttgacctgg ctccaatcc tctctcatt gctcattttc caggatgcga acaaaccaca 1628280
 gcacaagctc ctgcatcac agaccacagc tccccgctg ctgcatctc cctaccatga 1628340
 gactgtaagc cagaatgaac ttctctctt ttgggtgtt cctggtaagt attccatcct 1628400
 agtgatggta aaataatata gtccaacgga agccgaaagg ggctgggtgg atggaagga 1628460
 aggtgccgtg cagaactgca tcttagaaca agagcactgg gaaaattttt tgagaagtgg 1628520

aagagaaagg gaaaatgatg agacttgaga attaaggtca gatcactgct ttgaaacccc 1628580
aaactgtgag tgctgtggtt tgggtgaatg ttcctaatag gtccattggt taaaagattg 1628640
gttccaagg tgatgggacc tttaggagt tggagatggt gggagtctt aggtcattgg 1628700
gggaacctga caggctcatg aagttagccg agccgtttgc tctgccttgt gctctcagtg 1628760
cgggtgatgt gctgcccttt ctggatagtc ccaacatggg actatcaggc ttacctgatt 1628820
gcctaccatg tgcaaggccc tgggttcaag gtaccacaca aaatgagtag ggaagaaaga 1628880
taaaaaggaa agaatgagga agacggaaga agggaaggat aaaaggaaag aaggcagctc 1628940

gccagtccgc agatcttgac ttagactgga atcctcagaa ctgaggcaaa ataaaccctt 1629000
tttctttata agttggctgt gtcagatatt ttgtcatagt aatgtgaagc tgactaatac 1629060
aattagtcag gccagttttt aaggacattt tatggaataa tcccacctt tttttctttt 1629120
tctttctttt tctttttttt taaccaacca ggcatagtga cactttcagt tctcatggtc 1629180
acagggatag gagacttaaa tatagtagga cagccttctt tggaggactc tgtagaaag 1629240
agcacacagg cactactaat gtaggtggcc ttctgtctag ttctttgggt tgacttgtaa 1629300
tgaacggcca agctgggcca gggagcagcc gacaagaatc agttttcctt ggaactgagg 1629360

agagacggtg agtctggctt ctctgcaggc aggtggcctt gcttcggagc cctggctttg 1629420
ggccatcagg gtcttatatg cccccctct ccatcttaga ggaagatttg actcctctaa 1629480
ggaaggacct tataatgta tttactgcta ttcctatgc tccaaatttg gctttgggca 1629540
gcccattttc agtatttggg aaccgtaaga cccaagcaag gcatgaaacc aacagttaat 1629600
acaaaacttt ccccagggtt tggcatttag ctgcagcccc agcaggcatt ttgaatttaa 1629660
aaaaaaaaa aaaaaaaaaa aaaaaaaaaa agtccatgca ggctctccaa gtacggggcc 1629720
ttaaaggcaa tgcaggctctg aaagccctt tgtgctgtgg agctgtgga agagacaatg 1629780

aaacgtgcc tggatttct atgtaaatgc cacctcgagg acagagtttt cgccaggcag 1629840
atggctcatt tctgggctgt aacctcattt ttccagtgtt cctgttctt gtgaagtctt 1629900
gccccggag tcaggctcta attggtgtca aacgctcaga gacaaaagtg aagtgtacac 1629960
atcattcatg ggaaggctgt ggaggctatg gctacggcag tggtgtggt ataaagcttg 1630020
tggccagcag gacaggctgg tgcaggcctg ctcagaactt atttctggat gccaagctaa 1630080
cacggctctc gttgtcaaca cttccattcg cctgactcta gcatgcccc acctccccac 1630140
gccttcccag agacagggtt tctctgtgia gcctggctg tcttggaaact cactctggag 1630200

accaggctgg cctcgaattc agagatccgc ctgcctttgc ctctgagtg ctgggattaa 1630260
aggctgtgce caccaccatt gggcttctag tatgtcttca tgcctgagtc ctcttttaggt 1630320
tatccatag ttgacttcag tctggctcag aaaatcttgg gtaggattaa atagaggctc 1630380

catttatctc atcacagatt tgggggccccg ctcagaagcc ctgctgccac ccagcagaca 1630440
ggtaatccca tagccaggac tctgcagtca gcgaacggcc gtctgattgg atgcacattc 1630500
atcttcaaat tatgtttgtg gacagcctgg gctgcagaac accatnttaa catgcagatt 1630560
gactcctcgg aggctcttca ttatgcattt agcggcctgt tttcagacta accagcatgt 1630620

cagagaggcc ctatcctttt tccacctggg tggaggaat cacttgctga ctgtggggga 1630680
gctgtggata ttaaaatgca tgtttatntt tctgagtatc cacatacaac actnttcccc 1630740
atgcaggagg agagaagaaa aggagcagac agctntgact ctgaagcaaa gaaaatggct 1630800
atgccaacaa gccagtctcg gtggaagaca ggggctgaca aggccaggcc agcccagtgc 1630860
cttctggcta ccttggctgc ccgaggccg gcttgggtgt gtccacacaa atgctcttct 1630920
aagacagcac agactctctt tctctgtaca cacagcccaa gtatnttaag caacacactt 1630980
ccaatntcct gnttctaaaa ttgtcccga tctccaatgg cattccatgc aatcctggca 1631040

agtaacaggc agaggggctg agccaagtcc actccaagga cagtgagggt gccttgtctg 1631100
ttgaggggac agcacatcag ggcgctgggt cactcacccc tcttctcttc ttggtgtgac 1631160
ttaatntcag tctgctgggt ctgtgtctct atgacctctc tatgacctcc agctgttact 1631220
gggcaagcac agccttattc cgttccccct gtgtgtgtgt gtgtgtgtgt gtgtgtgtgt 1631280
gtgtgtgtgt gtgtgtatga cctgctgcta ctgagcaaga acagccatnt cctgtgtgtt 1631340
tgtgtgtttg tgagtgcctg tgtgtgatg tttgcatgtg tgtgtgtgtg tgtgtgtgtg 1631400
tgtgtgtgtg tgtgtgtgtc acttggtatg gtgtgtgtgt gtcctntcat gatgatctct 1631460

ttccctntct taaaaaggaa ctgtatntgc attggctnta aggtntcact ctcatntcac 1631520
taaggccctc actgtggcat tntctccatt tgtntgaaag actcctcaca ttctagacaa 1631580
ggactctact actggattat atccgcaggc agcctntcact tcttgagagg cccctgtntc 1631640
ttcagccctt gctgtggatt atgctctctg ttcagatagc aaaccctctt gtcatntcaat 1631700
ttgggaggct ttcggatgtg tagtcaggcc cagctgattc tnttctntgt tgccatgaaa 1631760
gaacagntct tcaggggctt ggaaggttgg cttgggcaca cgaacttaga ggccaggctt 1631820
gacaccagcc actgccagtg tccccagagg gcaggcatgt gtgctgaaca getntctagc 1631880

cttgcagggt agtgccgaat gctgctatca acgatgcagc cggggctntag ctatntacat 1631940
taaaatatta catagtatnt tcatagggct ccaggcacia aataaaatgg aaggcagagc 1632000
tgtactccgg atntctccgg cagggctgtg agggggaatg aaatgnttca gatgctcggnt 1632060
ctgggactgc agtattcctg atgagcgaac aatggtgcag aaactgcggc cntntatntg 1632120
cacatggaat gcggtgatcc ccaccggcag gaacaggttg catgtgnttg tgaggctgnt 1632180
gctggctggt gtcacactgt ggagtatnt ctgaaaaggt ctcaaccagc aagaacaaata 1632240

tggcaacccg gtgccagagg caatgcttag tgatctgtcc cttcattcac gcgtctcgct 1632300

 ggccatttat ttatttattt ctgtgactag acacaaggta attcttaatt ttaagatgct 1632360
 actgaaggat ttgtcctcga actactgttt ttgggaaaat ccttgaaggg gaactaaagg 1632420
 gactagggga gaggggaggc ctgagaagtg ggacaggagg gggaaatagg ctcaaagtgt 1632480
 attatataat tatatgaaaa tggcctcttg cacaatagtc aatgattta gggacacaca 1632540
 cacacacaca cacacacaca cagagagaga gagagagaga gagagagaga gaggttgagt 1632600
 aggaagtaag tagggaacaa cttgcagttt gcaagcttct tataggcaca gaaaggggat 1632660
 tgaatttcag tgacaacccc tttaggttcc taacacaggg accatgatgg tacagtaggg 1632720

 gtgctgtttt gaactcccat catccacgaa atccccagc acctcagaag gtgactgttt 1632780
 agtgactgag gctaaaggaa gtaatgagta cccgccata tccaatgtga ctggtgttca 1632840
 tatctgagga ggggatttga aaacagaagt gggggggaaa ttgcactagg acacaggtaa 1632900
 aggtgacat ctctacacc aagaggcctc agaagaaagt gagcctgtca acatcgtgat 1632960
 cttaggtttc ctgcctctca aactccaaga aaacaaggtc caccacact tcagtacttg 1633020
 gttactcca caaagcagg taagtagaag tgtggatgag ggggccagtc agagcatttt 1633080
 agggatttcc agcatcattt tctctactag atcttcaaga agtggctcat aaactgcaag 1633140

 ccagatgcta atttcacagg gatcaggtgg aaattgggtt gttctgtctt ggaaatatct 1633200
 ccacagaagc ggatttgctc tttagcttct tgtgcatacg gcagaactga cttttgaac 1633260
 tgagaaaatg ccacgaagga cctatctggc ctctcaaata aatctctaga tttttctttg 1633320
 aaccaatcaa ttggctctct gaggtgtcag ccagtaacag acacatccgt cgataccaca 1633380
 gggcagtcag ggctggctat gcttacactg ggcagtgtgg cggagcggat cctcagatgt 1633440
 agagcacaag agaagactgt gtgtttcagg aggtgagggt aaagtgggt gaagaccag 1633500
 gtgatgcttc actctccagc agaggaagac agcgtaatgt atggactgtg ggggtgcat 1633560

 gggctccagc ttttaagac tcctgtctc cttctactg agacatccat gacagtgcag 1633620
 gacacaaact gtgtctgaag gttcacttct accacctagt tctacagtg ataagtactc 1633680
 atgagagtac agttggaggc aaaaataaat attccaatct atcagaactg caatctaata 1633740
 cagtggcaca ggcctctcca cttagcctca ggatagaagc agaaggattg ctgtgagttt 1633800
 aaaaactaat tgggctacat agcaaacatc aacctagcct ggaccacaat gcaacatcct 1633860
 gtcttaaaaa atcctgaaca aaactctcca aaagctcccc tcccaccaag aactaacgag 1633920
 atcccaaag aaacaaatc acgctctctc ctgagtttg acccctgaac ttgttggttc 1633980

ttgtctctgc ccagcagtga gcagccctgg gctgtactac tcacatccaa agcttggctg 1634040
 gacntagcat cccacagaga actccattat cctttactta ctggctctca gctgagcaga 1634100
 cacaaatggt tatgtaatcc tgtgccctt aacaaatata tattcctacc cagagcaggg 1634160
 aaatctccag tcaaggaatc ctgggaaaga gtacatctgg gtgttattgc tgcattcact 1634220
 acatgctgtg ttcctcacc aaggacagta gaaccaaggg gaaatagcct tccaagtccc 1634280
 tcgctgtgc tctctgaat gacacgtccg ctctcttctt ccaagctaca gtttccaaat 1634340
 cagtacactt ctataaacc caaaccttac ttcttttcta aatgattttc aactccctt 1634400

 tctgggattt aatttctctg tggataacct agactggaca cagaatagcc ctaacgtttt 1634460
 atccgttacc ttaagtttcc aatgatgatt ccttttcttt taagcccca gcataccatt 1634520
 ggctttttaa attgctgctg catattagac aggtatcccc caagttatca accatgactc 1634580
 taaacttact ttactacgag ttccagagctg atgagagatt atgagtagtt tacatgattt 1634640
 ctcccaaagt gcaactgttt gcacttaacc aaattaaatt tcactctgct tcacgtcct 1634700
 cagtccctg gtttgttcag ctttgccca agtatctcat agtaatcctt aattgtttta 1634760
 ttaactgtgc ctgttcgtgc tcagctctcc acttgggtgc cttggcctga gactctctc 1634820

 atactccggg aactttaaaa gggatgtcat gaagctggca gaactctgtg gacatgtaa 1634880
 tgattcccc aaacttatag ggagactcct gaggacaaac tctggagtca cttttggccc 1634940
 caagaagcct catcctggct gagcaaaaag aatacaaaac tgtttccca tgttttagga 1635000
 tgtcatgtgg caaacttggg gaggaatctc agaaggctgc tgagctgcct acagatcacc 1635060
 tttgcctctg gcttctttt gtgactatga gtggcagcag cctggaccac tggagaccct 1635120
 gaactccatt catccttccc ttctcttctt gaggcataac aaaaatatct tctttgtgtg 1635180
 tatctgaatc gtgtgtgtgt gtgtgtgtgt gtgtgtgtgt gtgtgtgtgt gtgtgcaagt 1635240

 gcaagaggct tatactatag cttgcatgtg gaggtcagag gacaacttct cttgcccata 1635300
 gagatggacc caaactcatg atttggcttg tgtgatgtaa tgtcactttg ggtgagtttt 1635360
 taaagacatt tccacagagg aagagtact gctccctgtt cttagaacag ataacctgcc 1635420
 tggaaactcac atgcacttat agcaagacca taagccattc tagatcatga gcaaggagag 1635480
 cagagatggg tagaacaaa gatttatttg cttattatgt atacagtgtc ctgtctgcat 1635540
 gtatggctgc atgtcagaag agggcaccag ataccattct agatggttgt gagccaccat 1635600
 gtggttgatg ggaattgaac tcagccagtg ctcttaatct ctgagtcac tctccagcc 1635660

 ctgaaacttg cattcttgat ggctgtagct acttcaatag ccctgaacc ctcacttctg 1635720
 aacatcccta tgagaggcaa gaacaaactc acctgttaaa gacactatc tgggagtcag 1635780
 ggctgggagg aaaaatgaggt tgaagattat gcttgggttt ctttcatgta gccaaagcct 1635840

ttttaatgac acacagtatc attagaggtc aacaaattaa ttcttattca cttattgaa 1635900
 gactgcatat aaaacatcat agactgagaa aagggagaga aaaatgtttc tgttattccc 1635960
 ttaagcaaga tttgatcaca cagtgagcag taatacaggt gtgtgtgtgt gtgtgtgtgt 1636020
 gtgtgtgtgt gtgtgtgtgt gtgttaaata tcctaagaga ggaagagtcc tgcaatgaaa 1636080

 tgggggatat ggtatcaaaa tcagggccat gggaagggcc taggccccaa atgtgcagca 1636140
 agtagaaagc ttggatagga gtaggcaggg tcagaaatgt ccatgaagaa gtctttcatc 1636200
 atagcctgaa agcttgttgt ggcagcaaag ctttctgtcc aaaaaacata taatcagctt 1636260
 ttttgttttg ttttgttttg tttcgttttt ttgtttggag aaggggttgg ggtttaatta 1636320
 ccagcaccca catcaggcag ctcaacaacca tctgtagcaa tagctccagt ggatataaca 1636380
 ctctctttgc tctctttggc ctccaagggc actgtactca tgtgcacaaa ctcagacaca 1636440
 cacacacaca cacacacaca cacacacaca cacacaccta gctaaaacac tttacaaagt 1636500

 aattacaaa ttaacacaaa ctaaattggac taatctatat tagcttagtc tggaggcaa 1636560
 tttgatagge attttctctt taaatatttt gaaactctca attatgaagg ttgttttatg 1636620
 gagatttcag aagtgttaca accatagaac cttaacctta cataaatctt taaagtttat 1636680
 gaagttatca tctcactctg gaattaagca ggacactcac cattcaaaga gattatctca 1636740
 ttgtcttate aagttataca taaacctgct ctgaaacagt ataaaagaag ctttgcagag 1636800
 ggtcagtgtt agagcgtttg tctagcacgt tgaggttctg gggtcagcac atageacctt 1636860
 aacgaacagg gtttcattac aagacagaat tccttccact acatacagtt tttactttac 1636920

 acttttccat tttageaagt aatcaagtct aggctcctat atacactagg caagtgtgct 1636980
 atcttttggc tacatacatc ctcaactctt taaactctta aattttaaaa tgggtgtgaa 1637040
 gggagctttg ttcataaac agattaatgc cctcctggga attaaccatt tagttctttg 1637100
 gttacaaaac acattattct aaagecaata ttattccaga agtctgggta gcactttagc 1637160
 ctgttttatt ccagccgtat gttctccatt gcttccttaa tgatgtaagc tactgtttag 1637220
 taaccagctt cctggcatta ttgtagtata caaaggtgtt ccttcttagg accgcatcta 1637280
 gacagatggg tcccaccatg aggtctctctg ttcataggca tgcatacact ggagtcctctg 1637340

 ttttaaggcag actcaaagta tttgggcaga ttcattgtct aggtgagagg gaacattaat 1637400
 tcagacaatg tgatgtaagt ttctgttct gtgagtgaat caactcaatc caaccaacat 1637460
 ttcttgagcc ctigctatgt cttagctggg ctccaactgt gcaactgtgt tgggtgtagat 1637520
 atggacaagg cagatgaaa cctgtcatac acaaagaat gaagcttaga tggacactgt 1637580
 attaaaccca agaaagacaa gagaggccat atactccagt tcttcttaga ccaaagaatt 1637640
 aatgatatcc tttacagata atatattaa aagactacat cggagtttgg tttacctgtc 1637700

acccagcact caggaagcca agggaggagg attgttgagt tcaatgaaag cctgggctac 1637760

 atagcaagat tctctctgaa gaaacaaaac agtatagata tctttggaga ctaaagatga 1637820
 tatctggaca ccaatcaggt ttcaaatctt tgaactagaa ctttgatatt aatttatgtt 1637880
 cctcataaat taaaatggta tgagttagaa acagtctacc ataatacctt ttcacagagg 1637940
 ttaagagaat taactgagat gacacagcta gtctgttctg gtcctgttta tacagcatac 1638000
 tttacatact tgctacttgt agattcctgg aaaagaccaa caccctgttt gcagtagaga 1638060
 tctaacaga cggatatgat gtggctgggg gagtttcctt acaggggaca tttacagatg 1638120
 ccagtcagtc tgcattccatc tccttaaggg ctccccagct tectcatcat cagcactgac 1638180

 tatgaaactg ccaaatgtgt gcagctcacc tctggccatc tgaacattag tactaagctt 1638240
 tgaattcaaa cagacaagga gataaaaatg gcaggaaatg actcattttg gtggttgga 1638300
 tcttgatagt ctcagtaaca tctcatatta agtctagaag gacctttatt cttctgtttt 1638360
 ttccaggcat ggccccctggg gttctggaaa ctggctaaca atttcaagt ccttgtgtcc 1638420
 tgatcacctg agccacacac acacacacac acacacacac acacacacaa tttctactgc 1638480
 cctcaaagca cccaagaat atactgagtc catacacaga gctctgtttg cagatgacca 1638540
 ggtataaactc ctctaaaaat tttgtttgat tagtgaactt ctttgtgttg tatggtttgt 1638600

 gtgtgtaagt gcacagctat gaagaggtga gaagacagct tgggtattgt acctcactgg 1638660
 cctggaactt gctaaagtagg ctaggatgag tggctagtga accctgtgga tccagctatc 1638720
 gctgactccc cagagctggg attacaagta tgtgctacta tgcataatta aaaaaataaa 1638780
 taaaacaaaa ctgggtcctg ggaattgacc ccaaatctgt aagtttcaaa ctaaatattt 1638840
 tatcaatcta gctatctccc agccctagaa tacctaatta ctacaggctg atgctcaaat 1638900
 actacacctg tgcattctac tggagatttt gagaatatca ttgtggtttt taatactgag 1638960
 ggtgtgttac tttgatgata aacacaaaaa gaaaaaacac cttggctagc cccttttagc 1639020

 aaaggctgga actccttgtc aggacatggt gtttaaagag caagtatttg tagaagatca 1639080
 atactcttgg tcaagactcc ctggtctctc tatgacctga ggtaacctat aactcattat 1639140
 ccaagaaaga ttacataaaa ctcccttcat tttaaagtga ttgatcttct ttgaaaaaaa 1639200
 tcacaatatt cctattcagt gctctgatta ctccagtaag attaagcagc aactgtctg 1639260
 tctagaaaag ctggataaca gacgaggtca gcagacactt ttggccaaag aatgccctc 1639320
 ggccattgct ctgttttctt gatttgaagc taatgaggct cacaaagtg tgaggagggt 1639380
 ggagagacag ccaactgagcc cacagggtag gtggtctgtc aggagctcaa ctcaccttcc 1639440

caagacagct ggiggattac taggcaactt tccagtcttg cctgcatggt tacctgcaaa 1639500
 gccctgctta cacatgctgc tgtttccagt ttcttccatc tgtgccacag caggctcttc 1639560
 actctccaac atgaactgct gggacctact gaggtgcctt caaaacaagc caggctctgag 1639620
 ttctctcccc gttacaaaa tgacttcttg agggaaacgt cagctttgtg actaaaatgt 1639680
 agcttctgag gacaaatctt taccctgggc tggaaagacc catctgaatt tgagtctatc 1639740
 taatggcact gccataatc cctgctctc tatggagctg accaagacca tactgctcat 1639800
 agactggggt cagggtgcaa ggggttatct gcccacaagg catccttctg gaagagaggt 1639860

 gggcaatgac acctagaaac ttccaatag ctaaagtctt tgagagagag gaaaaaact 1639920
 cttctgcctt agcaatatag ttctctctat ttagaaagtg gctgaaaatc aacacactgc 1639980
 ttcttgccca gggctctgaa aggggtggcca cactgttagg ggaaaaggca cagttaaagt 1640040
 gatgcaagat atgcatggca cctgtcaagt atgtcaataa tacattctga actctagggg 1640100
 agcctgagaa actgtctaag ttgaagtatt cattagtaat actaataaaa aaaaaccctg 1640160
 cctaacgata accctgcaca atgtaggatg tcacagacat ttgcccagg agaaagtcaa 1640220
 gcaagcaaat ttgaagccc cttaaaatgc agacttctgc ccacttttaa acaacaacc 1640280

 ccaaagtga aggggggttg ctagatttga atccagtgg gtgggtcatg ctttatgtgc 1640340
 tgtgtgtatt gtacataaaa catttgtgaa tacattttag tgagtgttag gggcgaatt 1640400
 agaacatctt aacactctga ggcaatttcc cgttaaattg tcatcatcta tttgttata 1640460
 ggagtctctg gggaatgtt aaagcacat cattcctgca ttctcttta taagaaacag 1640520
 aagaagtgga gagatcttta gaagctcca tttcttgga aggaaaggac tccattttc 1640580
 agaaaacagc cagaattcct cggtaacagc ctgacaaaacc tctgcctcag agttgaagga 1640640
 ttcaggcagg aaaggaacat ccacagtcat gactgatctt tcctgaggac acttcaggct 1640700

 gttcccactg acaacctgca ggactgggtg tgttagtata taaaacattt ctggaagatt 1640760
 ctaaagtact ctagaagagc tatccagggtg tgttctctt cgggtacatc catacagata 1640820
 tgctcacggg taaagacaga agcctgtcac agagtacac ccatctcaga caaatacccc 1640880
 cctcaaacac ccaggctttt actcaccact gggatgtcta ccttcagtga ctatatgtca 1640940
 caaccacag acatctgggt ggggaaggag ggtcctagtg ggtggagacc tctgaggctg 1641000
 gaaaactcat ttctcttggc agataattg aggtgagatt ttagagaaca tggacacggg 1641060
 ggcagggtt acitttttct tgtagagtgc ctgctctgta agttttttt tggggggggg 1641120

 ggtaaacaaa ggacaacctg gtgtttctg ctgaagctga ttcgttctgc gttataatcc 1641180
 ttggcttact gacatgatgg cgttatgggg gctttaggaa ccgcttctat ccactagggc 1641240
 tttagagagg gaaaacttt gaaaaaaaag aagatatatt acgcttcaca tgtctgacaa 1641300

ggggtgtgtgg ggccaattta cagcaggggc ttaatatatt tttgatgaaa attgctgcaa 1641360
 tgtggcacac agattaaaga gaaaacagct cttttgtaat gacagcagtg ggctctgaaa 1641420
 tgaagcccag ctggtacaaa gatcctacat ggatttcaag agatgtacce tcttcccagg 1641480
 cttcacccag catggaagag tcttccaggc tgcaggcctt attgattttc tgtgggagcg 1641540

 actcccagga ttccacttc taaagaatca gtcggtcatg gaaaactcta atgacacaaa 1641600
 tgtgttgaaa agccagccaa gcaatctgga caggctcacag tgaggatcat caaacccaaa 1641660
 cctctatcag acacctaagt tcatatacag ggatccacc agcagcagtg acagtggat 1641720
 ctctctatag aggcaatata aggtgtttac agtttgtatg ctttgaaatg attacattat 1641780
 taaaaagaa agtattttct ccaggactgg gaatatagct cagttgctag agtgctttcc 1641840
 tagaatgtac aaagccctgg gttccaacca tgcaaacctg gagtgtagc acatgactgt 1641900
 agttctacaa ctctagagtt gggggcagaa acaagttcaa agttttcctt atttacacag 1641960

 ggagcttgag gtcagcatga gatagaagcc ctgtctgaaa aaccaaagcc aagacacaaa 1642020
 aacaacaag caaacaaaag gatattcact ggacctttgg gtatggcaca gaaagaccaa 1642080
 agaataaatg gtggctccat ctaaggctca gaaataaggt tttccagagc tcattttata 1642140
 tataactcca ggagccttct gagaatggac tctctctctc tctctctctc tctctctctc 1642200
 tctctctctc tctctctctc tctctctctc tctctctctc tctctctctc tctctggcac 1642260
 tctgagcctt gtgcatgta ggcaatacac tctactaata ggaagatgat catcttaata 1642320
 acattagtc atttaatttc cataaatcca attttctcat ctgtaaaatg ggttgacacc 1642380

 tcataggatc accagggtac ctcacagtga taacatcaaa gcactcagct acctaaggtg 1642440
 gctggttctg ttigagctta tttgtggaga tggcagcctt caattgggtg ttacagttca 1642500
 aaatacgtat gttgtgtgaa acctcagttg tagagtttat atcaaagtta gcatcatttt 1642560
 acatttattt atttgatgca aggggtcact aagtagtctt gtctagccat gaaatcacag 1642620
 agatctgcct gcctctgcct cccatgagct gggattaaaa gcatgtgcca cctctctctgg 1642680
 tagttttcat tattgtaaag gaataaaagc cacgtaaga tacatttata tctatgtggt 1642740
 gacatttaac taactagagt ccagtcaggt tgaagtctgg gctctcagag tattagacat 1642800

 gigtcagcag gttcatgcta ctgtgtgtga cactgagctg ggtatctgga aagccaggtg 1642860
 acaggccctg gtgaggatca cttgacagct aataacgtca cagggcactg cgcgtatcaa 1642920
 ttcaggccat aacacaagc aactgacaag ttccttcaac aggctgggag cacataatac 1642980
 aacaggaagg agtgcatttc ccctgtgac ttaaaggaga tataattgtg atgctgcate 1643040
 ctgatggga agccctgtct ttccacagta agactctgag cagagagcat catgggttgg 1643100
 gctgtgaaca caagaggtg gaggatcca gcagaggca ttgtactgtt tgagaacaca 1643160

ctctgtagag aagggtgagc gtgatggctg gaacttgcca cctacatacc ttaacatgag 1643220

 gaaaggaaga acacatgact tataatgttc ctcaatcctt gaccttacca aagacacttc 1643280
 aaagatgtaa cacttaaatg taacaggtgg aatttacaga ttgcctcctt aaaactaacc 1643340
 ataccaaca ttttgagatg atctaactat agacaagaca cttcctacaa attttaatag 1643400
 ccgtgataaa gattctgata cttagaatta ctgatatac ataatatgaa ggtggtgaag 1643460
 ctacctgaag cccaaagtct gcttgaaaac acccagatgc tgacacacaa aggaggcaga 1643520
 gactgattac agaagtgtgg cactatctct gtaactgaat ttccatgtca tgcttagggg 1643580
 ggctcaaaaa gaaaatccat ttattttgag cactgggcc aaatatttat ttaaatggt 1643640

 aagccatgga gaattgctat ctttgtaaga aaaacatgag ttaatgctga ctattttaa 1643700
 atgctgaact aggagctggg gttgtagttc atggtagag cacttctcca gcatgtatga 1643760
 aatctgtggg ttcaattccc caacaccata aaaacacaac agaccaacca acaacaacac 1643820
 aagaccctaa accctcgtaa ccctcgtgtg tgtgtgtgtg tgtgtgtgtg tgtgtgagag 1643880
 agagagagag agagagagag agagagagag agacagacag agagagagag agagagagag 1643940
 agagagagag atgtgttacc gtctatgagt gtgcatatat gcttttgtgc atgtggtggt 1644000
 cagcaacctt gggcctcag gtattgtcaa cttataatt ctgatccttt actcggctca 1644060

 tttataattt tcaccataa attctgttaa actcaaata ctaagaagt tacttttctt 1644120
 atctgggcag attaaaagca gatacatctc tgggtctcta agtaattagt ttaagcagtt 1644180
 aatccaattt agacttaagc atgagttcta gagattcttt ccatagcttt cttctgttct 1644240
 gtggctagca ggagtattgc aacactcgc agccctactg ttggttccag gccctgaga 1644300
 gccaaccttg aagaatgtag tcaaaagcat gacctggctt gtattccttg aacagaattt 1644360
 tgtgtgtgaa agggatcacc agctctcaa gtgattcaag aacataagaa aatttatccc 1644420
 aacactatgg acccgattca tgctacaagt ggctgatga tcaaagtac cattctgctt 1644480

 tcgaagctga agtaactgaa ctctgaaagt aactagagaa atgtccatca agtgtgcact 1644540
 gtgtgtgcat gaagggaaaa gagtgtttga gaaggaaacc cccaagtcca aagaaggga 1644600
 gtagcaacac tcigtctgt cttcattaga tacaacatta tcagttcctt gttaggaaaa 1644660
 ctgaaaagca acattgtgga ccaggctggg tgggtggcgc acatgccttt gatcccaggc 1644720
 gtgggaggc agaggtaggc agatctctgt gatttcgagg ccagcctggt ctacagagca 1644780
 agttccaggc cagttaggc tacacagtga aagtgtgtct ctaaaaacca aaaagaaaa 1644840
 aaaaagaaag aaagaaagaa aaagaaatg tgaaccagac tgagcatgag gcaggagcca 1644900

gcaagcgagg gaaggccaaa aggaactgga cggcatcttt actcgacact ttctgtagaa 1644960
agcaatgact aacaggcagt cagagtcaat cacttccttc ctacgtccat cgaggaggac 1645020
aagggcagct acagctgatt ctgattgtgg tcctctatga ccccttttcc ccagggaggc 1645080
cccagggcag ccigtgactc aacatttaaa cagaagcaaa catgtttcca ttttgacctc 1645140
agggaaaggg gaggaaaagg gaaccacgaa accaaatc tacgtcagga agaaaagtgc 1645200
aaatctctac atgaaacaaa atggfactgc caaggattgt acttattcta tcattcaaca 1645260
acaacactat caaattcatg atgcaaactt ttttcatttt agtaaacagc agaatccagt 1645320

tatttttctt tcagatcctc acagtcaaca ctcccttttt tttttttttt tatgttacac 1645380
atgtctccaa gagtggaca ggagcctggt tggctcagc aatcacgaat tgtattctaa 1645440
agactttgtt ttccttatg taaagcctgt gtatggatga tcacagatgc tgttgtgctt 1645500
agtatgacta agggaggagg ggaggaggag agagaggagg ggaggaaggg agagaggagg 1645560
agaggaggag caagatcag ccattccttt tcaggagtgc ctcagaactt aatcatgcag 1645620
gagtattatg gtttggatcc taaacaccac aaaggcaaac gtgctaaca ctctgtagcc 1645680
agcctgtggt aacaactcag ttactagcct gtgctaaca ctgggtgtgc agcttgtggt 1645740

attactggga ggaggaatg gaaccttaag aggtgggccc agtgggaaga aggtaaggag 1645800
ttggaggcat gccctegaag ggcctcaact ctatccctc ctttctctct ctctctctct 1645860
ctctctctct ctctctctct ttctttttgc ttctggattg tcataaact agcagatgct 1645920
ttgtattctg cactccccac ctgatgtgtg gctttgccac agacccaaag tgactgggcc 1645980
aagcaacca gggccaaaac tctgaaatca tgatccaaa taacccttcc ctagctgtaa 1646040
gctgtttatg ataggtatct tgtcacactc atgaaaaagc caactagcgc agaaagaagg 1646100
ttctcatccc tggaagacta tgtgcaggca gaaaacaga gtcagaaatg cccttgttc 1646160

acttgaatt gaaagcccaa cccatcttta attttttaaa agaatgggag ttaatgactc 1646220
caacatggaa gactagtttt ataaatagtc acttgcccag aatgagtcac aatcttggag 1646280
cgctgagttg taaacagcag tcatctcact tgttttgcaa gcagtcacce tggtagtcc 1646340
aggcaagctg gcagattatc tccatggccg aaatattttt ggtccctatt tgcaaagttg 1646400
gaggaatc ccagcagaaa gacatcaaga tgcttgtaac gagatgtatc cggtaggtca 1646460
ggtactcggg ggaccaggct tagtaccagt gggctgcaga tgtctggttc cactaacaaa 1646520
gacaagccag ttgtggtggg aaagaccacc ctcaactagc acagggttgc atcatctcaa 1646580

gactcttct caagcaatgc tgagtgaca aacatggctg ctaaggcaca ccaactaagt 1646640
acatggagga ttctcagtta aacttgacct tcaaaacaat ttatacteta cacttacaca 1646700
cataccaaga aatgatttgt cattcattta cctgaggttc gaattcaatt agacaacatt 1646760

tttttggggg tgggtggtgtt tctgaatatg cagcttgatt cattcccaag acaaggctgt 1646820
 gagaacacac gagaacacaa ggcagaagga gggggagagc agagcaaaaa acacaggctc 1646880
 agaaacaatg gacttttgcc ctttttagtgg ttggaacaag gatggtctcc ataggtttat 1646940
 atatttgaat atctggtgcc aagtgggtgg aacttttggg gaagaagtgc gaggtgtggc 1647000

 tttgttagag gaagtatgtt catgggagca ggctttgagg tttcaaaagc ccacaccatt 1647060
 cccagttage tcaacttctt gtggetgtgt ctcaagatgt gaactctcag ctactgtcta 1647120
 gcaccatgcc ttcacacctg ttgccatgcc tccaccatga tagctgtgga ctccaacctt 1647180
 ctggaacctt aaactttaa taaactctt tttctacaag ttgccttggc catggtgttt 1647240
 aatcacagca atagacaagt aactaagata caaccctgag aaaagtctg acatatgtct 1647300
 cagtgaaaat ggtagatgtg ggaacagatt tcagacttag attagcatcc aagagagacc 1647360
 caaactgaag ggagcagaaa caaggggtgt gtgtgtccac ataggctcac ctgtctggtc 1647420

 atgtctgaaa ttcagggtgt tcctataag ggaagtgggc agcgttcaat gggagcagac 1647480
 agaaaaggcg cacattccag gaaatagctg tttctatacc agctctcagg caagatgcca 1647540
 caggtctcag gtctccatc atgggctcct cagataccca ggagactgag gcaagaacag 1647600
 tggacactta agacttttcc ctttagagtg ggtctaggta tgtgtggcag tttcaatgca 1647660
 tttggccccg ataactttac agggagtggc actattagga ggtgaggttt tgttggagta 1647720
 tggccttact ggaggaattg tgtcactatg aaggccactt ttgaggtttc ctatgctcag 1647780
 gatactccc agtgtttcag tccacttcac gttgcctgca agccaagatg tagccagccc 1647840

 cacatctgcc cacatgccac catgctccct gccttgatga taatggactg aacctctgaa 1647900
 actataagcc accatcccca attaaatgtt ttctttacaa gaattgccat ggccatggta 1647960
 tctcttcaca gcaataaaaa ccctaactaa gacagcatgt ggcatagaga attgtggtct 1648020
 ggttaattct gaacatcaag gatgctcttt gtctatagag tacctgagtc ctgggctcag 1648080
 attaacatca ccttagatgc tcccaaatcc cccaggtgcg tggtagaact tcaactctc 1648140
 agcatcactg ggtccagctg tggcaaatgc acataggtgg agtacaagag ggactgctgg 1648200
 agacaccttg taactggaga tttttgacat ggagtatgtt gctttttaaa atggctacaa 1648260

 cttcaaaata tccactttct catatgatg tctgctacg gctgggtaag tgtctgccac 1648320
 tgcggfctct ctccatctat ttctctgctt atctttactg cacagagtta catttggccc 1648380
 gtttgcctgt gtataactcc tcttctatit ttctttatcc taattattag aataatacaa 1648440
 cttaagatg aaaggacaaa taccaaaaat caaacttagt gcaactgttt gttgcagggg 1648500
 caaggtttct tcaagttccat ctccccgggg tggcgcactc ttggagacaa ggctgtctag 1648560
 atgcttcaga gagatagatg gatggacaga cggatggatg gatggatgga tggatggatg 1648620

gatggatgga tctggggctt gtcctcacag tactaatgtt taagcatcca ccttaaactg 1648680

ctcaaggctg gagatggctc agtggttaag ggcctttgtt actcttacag aggacctgga 1648740
tttgggtccc agaateccaca tggtagctca cgaccattga taactccatt tccaggggat 1648800
ccaattcctt cttttgacct cctcggatac caggcatgca aagactgcag acagacattt 1648860
gggcaaaaga ctcaatatat aaaacaata aatcttaaag gactaaaaac taaggacaat 1648920
cattccttca taataggact gctgggagga ctggatgaaa tgtatattta tacattgcta 1648980
gtgttatacc agtgcttgag aaattgaaca gcacttccaa aaattagtta ttagtgtgta 1649040
tgcgtgtgca tgaatgagtg tgtgtatatg tgtgggtctg tatgtgtgtg agtgtgtgtg 1649100

tgtgtgtgag agagggagag agagtgggtg tgtgtatgtg tgtgtgtgtg agagtgtgtg 1649160
tgtgtgaaag agagtgtgtg tgtgagagtg tgtgtgtgtg tgtgtgtgag agagagagag 1649220
agaagagggg agagaataac tgtggagtag gttctctcct ttcaccttca tatgtcttct 1649280
ggggattaca gtccaggaca ctagatgtgt atagcaaacc cctttacacc ctgaaccatt 1649340
taacttcttt ctggcccttg agcagcaatt tcaaatgca aaatatcatg acctacatga 1649400
caaaaatgtc ttacaactta cttttttatg taacaaatag tgttagacac atggatgta 1649460
gggtgttgag aaatggtaga acttgtcgtt gtaaatgttc ttatctgaag tttgtgttct 1649520

cagttgcttc ctgatagatg ctaatgaact ccacactgtt tcttttctgt attttggctg 1649580
acacatatgt atgtatgat atagtatat atgtaactta tggggtacc tatgatgttt 1649640
ccatgcctgt aaacactgga ccaattttaa gtccatgtt tctggatata attaagtact 1649700
tatcttgcaa gcatgaggag ttgagttcaa tctccagaa cacaggttta aacaacaaca 1649760
acaaaaaaga cagggtgtgg tgactagggt ttgtgatacc aatgctgggg agacaataa 1649820
agtttttttt tttattttct ggccagccaa cttagcttaa tgggcaaatt ctaagccagg 1649880
gagagaccct gtctcaaaaa acaaggtacc tgaggagcaa cagccgaggt gtcctcagag 1649940

ggtaccctct ggctttttaa tatactcgtg cataagcgt cgtacatgtg cacctttgtt 1650000
cacacagaca catagcacac aatataagaa gacaaacaaa aagatgtaag ccatagtttg 1650060
cagtgccctt ttatagactg atgaccaagt tgcagggggg tggatttcat aaagaaaaaa 1650120
aaaaacagtt ctctgtttt gaatttgaa gagttaatgt gcccaggcat agtgccacaa 1650180
ggaagacttt gtcagcacat gttggggaga tataggactt aatgactgtg ctigtatca 1650240
aaacagtgga gagggctaata tagcgcaggg aggctggctc tggaggagg tgcgacactg 1650300
gigaacacgg ggtggcagct gaaaattact aatgctgccg cctgactcca ctctgttttc 1650360

cttacctcca tcctcccaga gttcggatga aaacagccag taccaccag cgtgtcacag 1650420
 tctagaaagc agccaggttt gtatgcatgt ccaccatccc attacaagcc agctggaacc 1650480
 ccacgaggca gatcttatgt ctgcaaatgg tctttataga agaggaacaa tgtgccaggt 1650540
 gggagggggg atgtacacaa gtggigagcc cagagccaaa tctactgtag ggacttgtct 1650600
 ccacacacc acgttgggt ctccactccc agccagtgcg atgcagactc cccaggatgc 1650660
 cagcctctgg tgcagccttc acagggagaa cacaggaagg tgttacagag aagttgggt 1650720
 gaggaaaccc agctttctgc catggagttc cactgaagag tctggcaaat ggtcctcaac 1650780

 agcttgggcc ttgtttgctc acttgatgat taagaagggt tgagttgctc agtcttaggg 1650840
 catttggtaa ctgaaatgct acagtttga tctcgaatct tttccaaagg cccaatagtt 1650900
 gagacctgg ctttgtgta ctggtagggt gtgggaactt taggcatcta atgagagata 1650960
 tgagtaatt aagggacaat gtccagaaag gcaactgtga gtcgggtct ctctctccc 1651020
 ctccacttc ctgccaaga aacgtgggat tttctttaga aaaaaagcaa aaaatatttt 1651080
 attttatgt acgtatgat gtgcacatgt gtgtggtcat gggtgtacc tgtggaagcc 1651140
 ggaagagagc aacagactct ctgaagctca caacaggtag ctgtgagctg tgtgacgtgg 1651200

 glaccgggag ccaaactcca gttctctggg ttctctgcaa gggcagcaac tgctcctcac 1651260
 ccctgcgcca tctttccagc tcccacacaa atgactttct ccactcttc cactgtgatg 1651320
 tatctcccaa ggaaccaagc attagagtta acttaccagg gacagaaacc tctgaaacct 1651380
 tgagccaaag tgaactttt ctctttataa agttgattgt cccagttatt tcctttttct 1651440
 tcctttttt ttgttttgt tttgtttt tttgagacag ggtttctctg ttgctttgga 1651500
 ggctgtcctg agactagctc ttgtggacca ggtggtctc gaactcacag agatccgct 1651560
 gcctctgct cccgattgct gggattgaag gcgtgcacca ccaccactg gcaggtattt 1651620

 cttataccga tagaaatctg actgacagct gggtgttggg ggtgcatgct tttaatccca 1651680
 gcactcggga ggcagagaca ggcgtatctc tgtgagttcg aggccagtgt ggtctccaga 1651740
 gggagtgcc g gatagctc caaagctaca cagagaaacc ctgactcgaa aaaccaaagg 1651800
 aaaaaaaaa gaaatctgac tgacatacaa gagagatttt tctgctcaga caaatgcaca 1651860
 tatataaact ataaagccac gggaacctta ctaacaatac caggggattt gtggatccta 1651920
 gagagaagag atggtttgga ttaggcgatt tttgaagtct gtttccagtc taaatttctg 1651980
 caagccacce ttgccacct ttctgggaac ccccttctt cttgttaagc cacatgtagc 1652040

 ccagctggc cctgaatttg gtctctgag tagcaggaa tacagacga tgctactgtg 1652100
 cctggttaga cattttccc acaaccatgt taatctagat ctgettacac tttcatatgt 1652160
 aggtgcagat ttaaggggag caagaaggct ttcaccctt taaaaagcat atgtgtgtgt 1652220

gtgtgtgtgt gtgtgtgtgt gtgtgtgtgt gtgtgtgtgt gtgtgtgtgt gtgtgtgtgt 1652280
 gtgtgtatgt ttcaggaagt caaaagaaaa gattcactgg gctaagcctg gggagctgac 1652340
 ttgtgagtga ggcgtgactt cagaagcaga gaacaatgca gccgaaacat tgccactttt 1652400
 gcaatgacaa ataacaattt gattataaat gaatttgta taggttaaaa gttcatttat 1652460

 ttccatttac tactaagtg ggatatgact aaggaaagtc actatcagaa cagcgcttgg 1652520
 gcatttcttg tctgaagaat aataccttaa aatgagttaa tttaatccaa ttagttttca 1652580
 aatgaaatta ttaattact aatgacttct gccttgtcag gttctgttgg gttttcacag 1652640
 tctaacccea attagctaa tcaggacct ctttttaaaa tgccactttg caatgatttc 1652700
 agaaacagaa ataattaat acttgcttta tccaagaata acctagtaa gaaatgaaga 1652760
 ggaattatat gaagaaaagg aaagagtcac aaaaagatga gcagatggag atagagttca 1652820
 tttctgagtg gggtgacatt tgctacacta aagatgtcat ttaccccaaa ttattctgta 1652880

 tatttattgt aacttaaac aaaatcccag atttttttt ttttagacia gatccctcta 1652940
 catagtcttg actgtcctaa aactcactat gtagacctgg tttgcttcag attcaccttt 1653000
 gcctgcctct ctctctcgg ttctgggac ccaaagggat ttaatacatt ttttagagtt 1653060
 attttagaaa tatcaactgg aggaagagct aaggagcca aagaggagt atgtgagaga 1653120
 ctgaaacctg cctgtaagca gtaagaatgg agagagagag agagagagag agagagagag 1653180
 agagagagag agagagagag gtgacggcac agaaattgtc ttcagagcta ttatctgcta 1653240
 ggaaatatga ggagaggagg ggttactagc aatgcaagtt ccgtgcctca taattcgatc 1653300

 actatccatg tttctgtatg tgttcacatg tacatatgtc caaggatgta gaagtcagag 1653360
 ggcaactttt gggagtcagc tctgtagtgc catcatgtga gtgctggggc taaactcagg 1653420
 tcgtcttct caacagcaag ctctctacc cactgagcac acctacagac atttttacia 1653480
 atcatataat tactgtaaaa aaaaaatgag cttccctaag catttagaaa gtgaatattt 1653540
 aaaaagtttg gtagagagga agtctttata agcattaaat atttgaaat taaaaatgaa 1653600
 gaagatgatg actaaaaaac ttaaaattaa ggaactgatt aaatactaaa atcttgcaaa 1653660
 agcatgtaca tttctggtgc ataggccttt aagtatctat tgtaaacacc aggcaatagt 1653720

 tatgacaaga aaacagttta ttaatgaaca attaggcatt gaccatagt cttttggggt 1653780
 tttgttttgt tttgagacac agttgtacta tataaaccag ggtgaacttg aactcacaat 1653840
 gctcttgct ctgcttctg agttcaggga ttataacat gtgctacaag gctccactca 1653900
 ctcaaaatc ttaatggtg cctagtctt ctataatgg tacaataag aattaaaatt 1653960
 tcaaaagggt gtatgagtgt gtagctcaca gggagtactt aactagtat tggaaggctt 1654020
 tgggtttagt cccaccttc gcaaaactaa ctatctaac aaacaacaa acaaacacac 1654080

aaataagtaa tatttgtggtt atattccaat ttaaaaagaa atcatagctc ttaaaatgag 1654140

 acaaaggtat ggtgatcaac atttagatgg tgtgtcttgg ctacttttct gttgttgagc 1654200
 cacaataacc tgccaaaacc aagtaacagg agaagggt atgattcata gttcagtcac 1654260
 agagaggaaa gcaagtctaa ggagtaggaa catgactggt cacgtggcat gggcagtgag 1654320
 gaagcagaga acaaacagga agtggggcct ggctatgaaa cctcaatttg tgacccagc 1654380
 tatgtccttc ctccagacag gctccacctt ccaaagggtc tacatccttt ccaaacacca 1654440
 gcaccagcta gggaccacac gtcaaacatg tgagcctgtg agagacactt cacacacagg 1654500
 ccacaataga tgctagaagc cagttacaaa cacacatgac ccaaaatag ttcaaatagt 1654560

 ttccaaccta gaaattttct ttctaagaca caatacaaat aatcagaaat tctactgaaa 1654620
 atttatctag aaggatgtcc ataacaataa aatgtaaca ataaatgtt caacaagaag 1654680
 ggacagatta aattttaaat tattgatggt ataaccatac caagggaat tatgtgggca 1654740
 ttaaaatcat gttttataaa taatgtttaa tgacaaagaa aaaaatctcc cataagtgaa 1654800
 agaccaaaga aactaaacga aatgctgtat gatttaatgc aatgaaaatc cagatttcac 1654860
 attagtctt acatgatag aatgactgg agcaaatgct ttccaatga taactgagga 1654920
 accatctgg atggtatgat catgtatagc cctaaaaaca tggattattg gaatgaagtc 1654980

 cacaggagcc tggactaaag ggaagtcagg ttatttattg cagagtcact cacaaatgac 1655040
 aaataaaaa gagaccacc aaggcttct gccaggagt ggtgaaagcg gcaatcagat 1655100
 ctggccgcc atgagagaga gagagagaga gagagagaga gagagagaga gagaggagag 1655160
 cctgtttcca gtatacatt agcacctaag accccggccc agaaggagtc agtacctcaa 1655220
 agactattgg ctgaatgagt tcccacaaca tgtatgatg tatgatgta cacacacaca 1655280
 cacacacaca cacacacaca cacacacaca ccccttctg aaatacacgt tttcaggatt 1655340
 gaaaaggcaa gctaccttag ctgaectatc actgtacatg attcatattg atcatggtat 1655400

 tgacatgccc atgctggtct tccccaaatg gctaattgat ccataaccaa gaaaggaaatg 1655460
 acaagtaaca tctaggtgag gcagacaaga gaaagttttg accaagaatg gatgtcctgg 1655520
 ctgacacagc acaagtatga cacctgaaaa gggcacacat gtgctcaaac atgctgtacc 1655580
 ttggaggcaa gagaaactcg tggtaaatg aacataccta cctttatgca cagggcacat 1655640
 cggaaggac atatctctta ccaacggtgc cctgcaaaag ctggaggtca ttggcaaagc 1655700
 aatttaagag gttgactctg tgcttaaccg gaaggtgaaa taggctctgg gaacttgcac 1655760
 gigtggcaca taagtaatga cagtgtgcac tagttggatg cttttctta tcaacaaaa 1655820

gaaatgacct agcttatcaa gtcccctggt caacaggagc atggattcat agccagtgct 1655880
 gttctataat caggactgag gcatatagta gggctccagc tgttcctaac ccatttctcc 1655940
 tctctagcca tgggcatctg aggatagtta taacttagtt tgtggagaag gcccagtcat 1656000
 ttgtcagaga agttgggcaa tccgctcccc ccacattctc agctatgttt ctaacaatat 1656060
 gccaagctgt gttcaagctg tgttatccat catccatcca tctatccatc catccatcca 1656120
 tccatccatc catccatcca ctactcttc aaataatgt gtgtgcctaa aatagcccct 1656180
 ccccatacc tctggtgact ttactcttc aatgaagatg taccagtgtg taagtgaagg 1656240

 atgagtatca caggcccgtg gccaacatt gcaggtagca taccatgcct aagcccagag 1656300
 attttattat cactgtcttt attggccaca gaggggaaag ggtattgtag ctttgtggct 1656360
 tctgagagtt catccttag cgaactgcca agcctcttgg cagcagctcc cagatcacag 1656420
 gaaggggat ttttttttt atgactacac tgcagttttc gtcagaaaag caaaagagag 1656480
 aagcagtgta catggaatac acggcgatag ataagcctaa caaagctgag tagcggcat 1656540
 tttccttctt acctctgtgt tctctccctc ccactcctct gtcaactctt ctaatatccc 1656600
 ctcccaaacc agactccaga agaactctaaa ttggcttcac ctcaaaaaaa taataaaagg 1656660

 gaaacataga gttgtttatt atattctatc atgctttaaa aaatatggct ctcagagccc 1656720
 atctcagtgt gaggcagctc tctctgtgag ctctgggggt gggaggagag tacagtgtgt 1656780
 gtgtgtgtgt gtgtgtgtgt gtgtgtgtgt gtgtgtgtgt tagagagagg ggggagcaca 1656840
 gtgtgtgtga gagagatgga gagtgtgtga gtaggtgtat gtgtgtgtgc ctgtgtgtgt 1656900
 gtaagagaga gagagggaga gagagggggg agtacagtgt gagt aggtgt gtgtgtgtgt 1656960
 gtgtgtgtgt gtgt aagaga gaagatcaca gtgtgagtag gcatgtgtgt atgagagggg 1657020
 gagagacaga gagagagaga gagagagaga gagagagaga gagagagaga gagggagcct 1657080

 atgaatggca tcatgtgagt ccctctctg tgttgagag ctgagtggct ctctctctc 1657140
 agagcaatta ctacaaatga tttatgtggc cagtcaagag ggcctgccag gtttcttatt 1657200
 tcatctccag aaaaaggaac tctgtgga tgttatcagg gagcttggga ttaaactgac 1657260
 agctgccttt tgttttcccg tgaaagcttc tcctctggac tgtggcgctc ctgcacttcc 1657320
 caccagaga gccagaattc taggctgtaa agccctgcta ggaaagagcc acagtaaggg 1657380
 aactggggag gagaggtctc cttctccct ctgtatttat cttcagttcc attccagatg 1657440
 cagctggctc tgcaggctgg aagattggct ccttattgaa ctgtgcacac acaagcaggg 1657500

 caccacatct tgactcctg ttaccaagct catcttggct gtgccggggg aacaaaggct 1657560
 ccttgcaaat ataggtcagt gaaatgtgac cctggctctc aatctctgcc agactggcac 1657620
 atgtcaggtc acagggaatg aaagtgtgtg tgtgtgtgtg tgtgtgtgtg tgtgtgtgtg 1657680

tgtgtgtg aagaaactgg gcaagaagca aagacaccag gttggggcag gcagagacga 1657740
 gctctggaca caaacacac aacctgtaca tcttctcadc tgcagacatc ccaactctaa 1657800
 gagactgtgg tgctaacttc aaggcctggg tcatataggg gtggttggt atagccttc 1657860
 ctgtccaacc tggtttctg gatgaaggga gggagcaagg atctggccag ccctgaccct 1657920

 gatttaaaaa atgcatttac ttgcacttat acaaaagtat gcacacacat acatatacac 1657980
 acacatacac acatgcatat acatatacac acagatgcat acacacatgc tatacacata 1658040
 catgacatac atgcacatgc atgcacacaa agatgcatgc aagcacacac tacacatcct 1658100
 gatgttcgga tgactgcatc acaaaattct ggagataaat aatagtaaat acaaattaaa 1658160
 gaaactctca agggaacaga gaagcatatg atgaaaagag actagggggg gggatgaaaa 1658220
 tgaggaagcg attataaaga agaggaaggt ttaaagtaaa ataatggact gtaaaaatca 1658280
 tgtttatgag tttatatttt ctgtcttagc cagagacatt ttggcttttg atttccaact 1658340

 tttgttctta agtaaacct tgccaagcgg tattgagtaa tgcctaacac gagattaatt 1658400
 tttatcaagt cacacataac tatttagctc tccacagtgt gtatagatac aaggctgtgt 1658460
 gcgcatatca aactagaggg ggtgttttgt ggttatgggg gatctctgat ctcagaaggg 1658520
 aattcatact gatagagaca tatgataggt tagttatgct gctacacatt ttctgtacat 1658580
 tttcccttta ttctcagta cagctctatg aagtattct agtctccctt tacacctgtt 1658640
 agagatgaca agtgagatta aataactcat tgccatggtt gacagatac agtagctgcc 1658700
 cagctaatat tcctttcatt ttcttctta gaatttgat ggtgtttgaa gaaggatttc 1658760

 ccagctcct ttgcagtttg ggttgggtgt ctatctgagt tatggctaat aagatgctg 1658820
 cagaagtctg ggaattcctg attggccac cccttctcct gttgctttct aatttcttct 1658880
 ctagtctaga gacagataa ggttgggtcat gaaaatatgt ggatgatgta acaacctgtt 1658940
 tgctaaaggt gatgggaaat actgtatacc ttcgatgagt tacaatcccc ttcattgtgcc 1659000
 cctcactggc ttctgactac aggagaaaaa ggagacacat ttatatcgtg cctctgtaat 1659060
 caaccctcc ttacacagag aaaatgtaat cagaactgac agcctacaaa ggagagctag 1659120
 agctggaacc aaatcttact acataaggac ctccatcadc ctctgcaacc actctagagg 1659180

 agcacagaca tggaacaag tatggtgagc cctctgcagc taacagtagt tatttgtctt 1659240
 aacttccac gttactatg gtcatcaaag gaagtcagga caggaactca cacagggcag 1659300
 aaacctggag ccaggagctg atgcagaggc gatgaggggt gctgcttctt ggcttctcc 1659360
 agatggcttg ctgacctgc tttctaatag aatccaagac taccagcca gcgatggcac 1659420
 ccaccacaa taggctgggc cctctacaa caatcactaa ttaagaaaat gccttacagg 1659480
 ctgtctaca gccagctctt atggagacat tttcttaatt gaggtccct cctctcaatt 1659540

gactctagct tgtgtcaagt tgacataaaa ctatccagca cttgttaaga accttaaaaa 1659600

tctcaggaat tggagaccct gggtagcaga acctctatga tggggttaac catgaaactt 1659660
accacacagga gaggtaggtg acataaatgc catgcctctg gtgagctctg gaggcatttc 1659720
ttggaagat aacctgaaga gggacactcc ttttgcagag ggggaagcac cttccagata 1659780
taaggagctg gggagaacag cgcatctttg cttgccttca cttctctctg atgagtaagt 1659840
atctctctc cttgctgcc ctcaaggtgg gctgaagtcc atggctctcc aggaatccct 1659900
ctagactttt aaggtaaaag tggaaactgct gaggcaaaag acttgttgac tgagcagcta 1659960
ttgtgttcat ggcctcttca gtgtgcagac agtcattatt ggacaggcca gactgtgtca 1660020

tgtaagccaa ccaataaat tcccttcgta ttatagatac atcttatcag ttctgttctt 1660080
ctagacaatg ctgaataatc caggctctat cccaagaca tctcatcact gtaagcactc 1660140
caaaatctga aacagctcag agataactca acctatattt gctctccatc ctggaaacat 1660200
ctgtggaat ctgcaactca gcagtaagat ggtctcattt tacaccaat caaccacac 1660260
agtttcaccg ctcccact ggctgcagca cactgcatag tctcaccgct tcccactgg 1660320
ctgcagcaca ctgcacagtc tcaccttcc cacctggctg cagcacactg catagtctca 1660380
ctgcttccca cctggctgta gcacactgca tagtctcact gcttcccacc tggctgtagc 1660440

acactggcag atggccttgc tgcttctaga taggagctg gtatctcctt tgggaaatta 1660500
gcctgactat gagaatgaca aatagagcct gtattccca aggcttagag gctaaggatc 1660560
accacttgag agtccttaca tataaatagc agcctcctag ttagagtatt aatctcttat 1660620
tctatgaacg tagaggcaag aatcaccaca catttgagaa agcttctaac aaaaaatcca 1660680
gcaccaatt aacagatgga aaagagaaca taaaagcaat gaaacaatac catgtctgtc 1660740
tagtggtagt tgtgtgtgtg tgtgtgtgtg tgtgtgtgtt gtggtagtgt gtgtgtgtgt 1660800
gtgtgtgtgt gtgtgtgtgt gttgtgatgt gtagtgtgta tgtatgggtg tcgtgtgata 1660860

tgtatgtgtg atgtttatgg tatacgtatt tgaagagag gtgtgagtgg tacatgtgtg 1660920
gtgtagtgtg tgtgcatgtg gtatgtgtat agtatgtgtt atgtgtatgc atggtagt 1660980
gtgtatgtgc atgtgtgtg tatgtatgtt aagtgtacc tgtgtgtaag gtgtagtgtg 1661040
tttgtgtggg gtgtgtgtgg tgtgagccac agtactcttg gggtagcagt tttctgacag 1661100
gaactgagga ggtcaggtga agcatggaga gcttcaaact tcctttttaa atgtgtttgc 1661160
agtctggcat cctgcatcca gtcggacatg agctcaactt gaatctattt ctccacatgc 1661220
aagacctcaa aataccatc tctcttccct cctcagttgc agctcacaga acctctagcc 1661280

atgctccttg ccctctctc tgggatagag ttggtaagat ttgctgtggc cttgaagcct 1661340
 tgctgtcctt acagatgtag gatgcactca gggctctacc tagtgaagcc tttcatgtct 1661400
 cctggcacac aggctaggtc aggcaaggtc tcatggtgtg ccccgaaacc ttctaagaca 1661460
 agaatgccat ttgttatcac aatctgaagg gaaccaaggg atcgagagcc cccagctctc 1661520
 atctagcagc ccccacagct gcttatggcc atgtttctat gtctcccctg atcttcggag 1661580
 aattaaaggg tctttctccc ttcaagactc catttgctg gtgggtgtgc acaccttga 1661640
 tcccagcact gggagcagag gcaggtggat ctgtgtgttc aaagccagcc tggctctacag 1661700

 agtgagtcc aggacagcca gtgctgtcct gtctcaactc ccaccctcaa aaaaggacc 1661760
 attacactgt ctatagtca gttctctctc tctctctctc tctctctctc tctctctctc 1661820
 tctctctctc tctcgcacc acacacacac acacacacac acacagacac atcacacaca 1661880
 cacacacaca cacacatccc tcccacttca aggcctgacc atggctgcct gtggcattga 1661940
 ggctctctct tctaataaag tccttgaagt gtaacttgct gtcagctcct ttccatgaac 1662000
 acattttcta ggtatagcag tcaggaagtg atcacagaga acacttact aaaatgagtt 1662060
 tctaagctaa gctagaagag acacagaatc tgagaacaag gggccccaca caggagcaac 1662120

 agaacaaagg ctctgccacc agctccctag tcacctagca cctctccaga agggaattga 1662180
 aggtgtgtgg gccctggga gaacagtctg caaatgagtg ggaagtatcc agcgaagggt 1662240
 ctgtggatga ttttagccta ggaacagagg aaacagaaca gcacagggaa aaacaaaaca 1662300
 aaacagcaat gatcaaaaa tccttaagt gacacctagta gaaatgtcat caaatccac 1662360
 tattcagctc actgataaac tatttaacta ccaaatgcac agacacatac acacaaatac 1662420
 aaatctcact caaagttgtg atatatatgt atgtatatgc acacacgata tatacatatg 1662480
 tggatgtat acacacatac ataatatata ctattcatgg tgaaggggga aggaaaggaa 1662540

 ggtagtgtga gaagtagaag agcagagggc aaactcctga cttccatgct ggagtcaaaa 1662600
 ggtagcatca aaacagagat ccagaacaa ctgcagaaat gctctctttt agaaggggat 1662660
 tcattccagg agaaacagct ggaatatttt caagctttgg agaacagaaa ttaggtgtgg 1662720
 cagaaggatg ctgtgaggat taatgctttt atcgcacata ctactagcc tetcatatta 1662780
 agtaagtgt atgcctggat aatgacacag atcaaaaacc aagggtgtga gagatagatc 1662840
 agtggttaag agcactgct gctcttcag aggtcctgag ttcaattccc agcaatcaca 1662900
 tgggtgatca ccaccatctg taatgagatc tgggtgcctc ttttggcatc caagcatcca 1662960

 tacaggcaga acacagtata cataattaac aaacaaaca ataaataaat ctttaaata 1663020
 ataaagaagg aaaagaaaa caaaagagcc aagtccttgt cttgaacac ctactcagga 1663080
 tgaaggatgc atcttactat cctcctgtga gcatttcca cacaggagat ttggtacctt 1663140

gttctctcta acictgtgcc caagatcccc agagtcttgg tttgtggctt cgggtgcaggt 1663200
 acagcacact gcatgaagtt cagacaatgt tttggatagc tggaaagtgg gtgtgacctc 1663260
 tgagagatgt taagtcacat gcttagtgta gtttctggga ctcacagggt ggctggagtt 1663320
 ttctggagac tgcttgaatc ttacttgtgt ctgggttctc tgactttcct gtccttggat 1663380

tccaaccacc cacccttcaa ttagtaaaga tgcagggtc agaagtgatg gagagacca 1663440
 ggtgataagg acaaaggaaa actttctgct attttcatgg ctgcactata gaaaagaaag 1663500
 agcatcatta gagtttagtc taatgagggt acattagata agacaaggaa aagtcaccgc 1663560
 atgtaaaata taattatctg gagaagatgt aacatgcaag tgccttggga tttagaacac 1663620
 aaaaaccaat tctgatgaaa tgagaataaa attctaggaa aggcagagtg ggaaaagcta 1663680
 gaaggctctg ctigtgatg aaagacaaat aggtttgttc tatagcacag gattcccgtg 1663740
 gtctatgtag aaagatggct tgaaaacgca gaaaaaaggg aaggcaacaa cctgaggtgt 1663800

tctgtgctta ataaaggaga acttgtgtgt gtgctggaga gaggtgtgtg tgcattgtgtg 1663860
 acagacagaa gtgtgtgtgt gtgctgtgtgt gtgagtgaga agtgtgtgca cgtgatagtg 1663920
 cacgaatgtg cttgagggtg gtgtgtgtgt gtgtgtgtgt gtgtgtgtgt gtgtgtgtgt 1663980
 glaagccaga agaccacctt gttcttagac actgtctatc tgatttcttg agactgggcc 1664040
 tctcactgtt atttggagct caacaagtag gctaggctgg ctcatcaggg agtcccagga 1664100
 taccttctec ttccaacag tgccattgta agcacatc acagcctctg gcttttcatg 1664160
 agaatagtgg ggatcaaaga ggtcccatg cctgagcatt ttactaactg agctgccact 1664220

ctggcctaag aaaactctta aagactgaat ttttttctt aggacagata tgacatgatg 1664280
 tagaataata gacaactttt ttttttttag aagttattat gtgctggtta agttcctcct 1664340
 gaaaactaga tttttttaa ctttttctt taaatttaga tataatgatg atgttcatgg 1664400
 ggttaacgct tccaaattta caaacagaa acaagataca aagaaatgac atatttaggc 1664460
 tgtcgagatg ggcagcagct taagagcttc tcttttggag aagacacagg tttggttccc 1664520
 agcactcaca ctgggcagct cacaatcccc acaactccag ttccgggggg aatccagcac 1664580
 cctcttctgg tctctgtggg cacctccaca tgtggtacac ataaatacac tcaggcagac 1664640

gigatcataa aagaaaaatc ttaaaaatag aaattaaca atcagtcgaa taatacaagc 1664700
 agcaagcaat agtagggtgg gactccaatg gaaggctcca aatttccaag cactcagcat 1664760
 gcctatgtct atgaaattaa aaaatttaa atacttatca acatgcagtg atctagccag 1664820
 gaaaaaaaa tccttcatca tcggggagtt ttttttaaaa aggtagtact actatattgt 1664880
 gtttagtttt tgccttctac agattccagg tcagggttcc tgaattcagc tgggatggag 1664940
 ttaaaagttt ctgctcagta ctgaagtttt cctgaagat gagtttcaga aacgagatcc 1665000

aggctccctc ccttgtctgt catttatctt agacctcagg aggtaacagc agcttgagct 1665060

gtaacacagc cacaatgaag atggcagtga acgtaataa ataacacttc caacgcttgg 1665120

gccctgtgca tcagaaaaaa atggaaagcc actcaaggct ttgaatggta gatatgccac 1665180

atctgtgcat atattcacc tggatccaac acaagtcttt taagatgcca ggctctgaga 1665240

cctagccgtg gtgcgtcagt ggggagggga gaagcagaga taaaaataga gatgttgatt 1665300

gcattgttgc taattcagcc cagctcaaca gctccagccg gggtagtca acagcagcgg 1665360

ttcaaagaca caaaaaggag aggagcaggg tgctctgtgc cactgagcaa aggggactcg 1665420

gtcacaccag cacctctctg actaaataga cccatgacac tgaggctgtg tgggtgtgagt 1665480

tcaaaaacga acaagtggaa agcagtgagg gacaaagtgg ctgcagatcg atggacagca 1665540

gagggctgac ccaactggcaa aaaagctgcc ttttgaaga ctctgggct gtgggggatg 1665600

ggcgaagag actgagctta gaggccaact tccactcttc aaacacagta ttgtttctc 1665660

tggggcataa ggcttactgc cattccagac tggctccat ggcagcaggg gaggaggagg 1665720

ggagaggagg aacagatggg ggtcatggag gtcttaattc taatgcagag gtccctcctg 1665780

ccagcccctc tctccttgag gacctgtgac atgttgacc atcttggggg cccaggaagc 1665840

ctctggtatt agttcaattc aactggccag atcttgggaa cctactttgt gttagtcgtt 1665900

cgcttcta at tggcaggagc gtctgttcag tcagtctctg cttggttga aagctggaaa 1665960

tgaggaaaag acctacttctc tgttcttta gctttatctt ttccaatcc taggctacac 1666020

ttcttcaaa actgaagata tgctgccagc atgttggggg agcagaaaagg aggaatgcac 1666080

acttgcctc ttgaccaga tgctagctaa ccttacagca ccattggaaa gggtagagaga 1666140

gatagtcact ctgcagcctt agagtctctg ggctgctccc cctctttcta gctcctttgc 1666200

ttgtgtacga tactgcagga tgggtcaagg tcaaccgttc agaaacaaac tccagccatg 1666260

acatttctt cactatcatt aatggtgacc ccaaacact atcttggaa tcaagatctg 1666320

ccctgcctg gccttctca ctcttaataa tcattctctt ctatctttg aatggttca 1666380

tggccttggg ggacataata ggttgaatga atgaatgaat gaatgaatga atgaatgaca 1666440

aacgagcaaa cggacatcaa agaactcact tttgtctcca ttttttttt ttttgtttt 1666500

gttcatgtt ttaccatctc tcacccttga aaataaactt tctcctggct ttacctgca 1666560

atctctatca aggtctagtt catagctcaa atgcaactgc tacttcatat gattcaaatg 1666620

aaatacatca tgttttacct ctaccctctc agggcctgga gccatcacta tcaactctgtt 1666680

ttggaagcca ggaaccactc tcctcagge tccattttcc actatcagca aggcctttt 1666740

ccttcctcag tgictgttg actgaattcc attcactccc tectgtctct atttctcctc 1666800
 acccctttcc ctcagccttc aaattatagg actaaagtig cttccaaata agtctctcca 1666860
 tgtccactcc cctccaccag ctgtgtggtc agatggagga tttcaaatg caaatataat 1666920
 cctccataa cagcctgtct gtaagtcttc agtggcttcg cttcactttt agcatggtgg 1666980
 gtacagtcct tgaatcaaca tgaccttagc ctattttcca gcttcacccc ctcacttttc 1667040
 tctcttatg agctgtgttc cttggagccc tgggatctca tgacactatt tcttctagtt 1667100
 acaatgttct gcctctgctg tttgaacct ggttccaaa cttcaggatt caccctagct 1667160

 atcttactat ctcatggtga acaggggagc attactttgt tgtataatgc acagtctgt 1667220
 cactttagt aacaaggctg gagtgggggg aataagttag gaatagaaca gcatcctgct 1667280
 cgaacataca tggagcaaaa agagtgtctc tcacagaaac agagagcaga agagtggttg 1667340
 ctagagcctg ggagtgggag agggaggact ggagagagga tgcttaacgg ggacaggaat 1667400
 acccaccact gggtaggaag aaagaacttg ccaacgttct ataactgcta tggcacaaca 1667460
 atggctgata acagtcctt aaaatttcaa agtgggttac acaaaggatt ccagatctt 1667520
 ccccaagaa ggaggtgacc tttgtctgaa gtgacaaata tgccagtcgc cctgaatcga 1667580

 tcattataca ttgtatacat ggtgttactg aaatgtcata gtgtaccctg tatgtatgtg 1667640
 caactactct gttttggcat ataaaaacat gccaaaacaa aagcatgtgg tgggtggcac 1667700
 atgcctgtaa tctcagcatt tggaaagcca aggcaggagg attgccatga atttgaggct 1667760
 agcctgggat acagagtgtt atctccatgg cactgtcctt tgcaggggct ctacctgggc 1667820
 atatgcttgc ttgttttatt ggtgtctttc tctgtggata caaacatggg catgaggcta 1667880
 ggggccatct tcatttgttg tccccgtcat ttgctaacga tctggcacac agcatataat 1667940
 tataaactat tatccaaca agaatcatgt cgttgacatg ggaaggcctt aggcctggcc 1668000

 taggatgatg tggtagactt tggggagccc cttttgaggg ccttaccctg cctggggagt 1668060
 ggagggggga tggctagggg caggtgggat gttgggagga ggggaggag agggagaagg 1668120
 gattgacatc tgaagcaagc ttgttcctaa tttgaagtaa taaaataaaa taaaattaa 1668180
 aaaaagaate atgtcattga tgaagctttc ttagtcaac tgaggatata ccaccactgc 1668240
 ttcccathtt actggaaaa gccagcttg cgcagaatga tatatttta gaggtcctt 1668300
 ggaataggaa aagcatcaaa tactgttgaa tatccgttaa gagctggaga aaccaccaca 1668360
 aaacatcctt ctacccatca tgaagccac ctcttggct gggacaatct aatgatacag 1668420

 tgcactggag gagtttagtg tacagtccag actgtagcac aaactcaaaa gtgtcagcta 1668480
 tcattatggg ctggcattag aatggcctgc acaatcagaa tttttaagct ctgtctaatt 1668540
 tcaaagactc tgccttaagg tcacattcct tgactttaat ctggaaaaa aaaaaagga 1668600

tcacgcatac agactctatc aagtcagatt cctgtagtat gctgtctgtg tctcgatgta 1668660
 gtagtcatta agtaactgct gtatgagatc acttgacctg cacacagagg agtaagaacc 1668720
 tgtctcagtc cctccccatt ttcacccct ttatatgctg ctcccagaag gctgatagta 1668780
 cagagtttgt ctagcatgaa caaggctttg gctctgatcc ttaccactgc cccaaaccga 1668840

 aatcagacag gtacagaaag accagcta atgtgaggca gaatgaaatt gcaattaaat 1668900
 ggagggacac atgaacatct gggaaaatgg aaaagacaag tgatttctgg ataaattggc 1668960
 atctgattgc accagggcag aagagagaaa tctctggagc cgaggacagc agtaaagtat 1669020
 gccaaagacat ccaggaggag agaacttact gggctgaggt tctgactcca tgtagtgtgt 1669080
 gggtcaccaa tggaagagaa gaaaacactg tgcattcatc tgtgagatag ggaaggaggg 1669140
 aaggaggcag acagccaatc actggcagct gatgtacacc tgtgaacacg aggctaagag 1669200
 gcagtctggc atctaggtag cttgtttcca attcagaagc tgcacagtct ctcatcat 1669260

 tccttctta gaggtgactg aggaaggaca ggtgtaatgt ccacagtcac ttagatggct 1669320
 aggtgggcaa ggctagctca ctttggcgg ttatttctc ctaactggct tggatggcca 1669380
 tcaggtatat ggccacagga ggggacacta ttttctgaac actccactat tctcagagag 1669440
 aggattatga aagcaagatc agccaaacc tagggtaatg acgtagcttt ctcaaatg 1669500
 ccaggctatg atttctctcc aatttaatcc tgcccagcta ggcagaactt cccaccaac 1669560
 cctcattctt ggtattttat acgttaaatc aaaagtctt gtaggacaaa gcagttttca 1669620
 tttacaccag atttccagtg tgttgaagaa gaagctcttt ttctgctctg atcccttga 1669680

 tattaagata atatctgagg attggacttc gtcattccac tcatggtgct gtgttcagca 1669740
 cgggaagctc taigtcttc tgtttcataa cccatgttta gagaatgacc tcttttattc 1669800
 tcctgtctcc caatgccatc ctcccctctg gcaaaaagcc aaacccaac ctggtgggtt 1669860
 gatggcatcc tttcacacct tcatcgctaa tttgatgtgt catccaactg gccactttt 1669920
 cttggtatct tggatgatgaa gcaacagtca tacaatggt accaatcct ctgcttttcg 1669980
 ctgaaagga ttgattttga agggacatga aactacacaa atgcatagct catatgaaag 1670040
 tatagcttcc agtgaagtat gctttaaggt caagaagaaa attaagaac catcaagtaa 1670100

 tttaaagccc gatgtttggg tattctacca tttcttctt tttttcttt ttcttaaaaa 1670160
 ttatttattt gaagtgtgtg tgtgtgtgtg tgtgtgtgtg tgtgtgtgtg tgtacagatg 1670220
 ccataaacat atgtggaggc cagagtacaa cttgggggta ggatctattc tttcctttca 1670280
 ctacctggga ctgagggact gaactcaggt caccaagctt ggactgcat gctgctaccg 1670340
 atgagctatt atggcattgt cccctattct gtcaccttac tggaaacttag gtagttaaga 1670400
 aaaattaatt ttccccatt gttaaattt tcctagggt acttcttaa atctctagtc 1670460

ttgatttaa gatgaaaaa tccttcattt ttcattttgt taaaaccaa catccaatct 1670520

 caagctgttt acatcgctgt tctttaagat aatgaaactg ctctgtgtga tgactcatgt 1670580
 ctgaaatcct agcactttgg aggctgaggc aggaagactg ctttgggtta gagataagcc 1670640
 tagactacac agaggccttg cttcaaaaat ccagcgaaca aacaataaa agacaaaaa 1670700
 tattgggatt ggagcccatt ttcgtgatgg ctgcatctg tgttctccta gactgtaatc 1670760
 ctcaactagct ccaataaat ataaacttcc cttgtcetta aaaaaggaac aaaaatattg 1670820
 gaatcatatt ttataattc tccttcttc acttactata ccatggacc ccacggcatt 1670880
 aaacattatt ttatggtatt ttaatagcag cttaatgtcc cataatttag tcaaatcccc 1670940

 actaagacc tcctcaatta tttacagata tccatactat gatgagcatc ctttatctgt 1671000
 atgcattctt ttctttgttt ccttctcttc ccttccctct tctttccttt tgggttgaac 1671060
 tgagccagga aagcattcca ccatgaaget gtattccagc ccccatTTTT acctattatt 1671120
 ctgagacagg gtctcactga gggactcatc ctgtagtcca agcaagcctt gtgcttgcaa 1671180
 taatcctctt gctgtagccg ctcaagtatc tcaggtcata ggctgtgcc accagattct 1671240
 aaaaccacat ctgttcattt attgttttat ttatttgttt attgttcat ggctgggaat 1671300
 ggaattctgg gtcttccact ctagacaggc attttaccac tgagccacat tcttagctct 1671360

 ctgatcatac tgttaaaata gctttctttt agagtcacca tgtcaaggaa gaagagcgct 1671420
 tggaggagct cctccacct gcactagcaa tgaagaacaa ggaacaacca gtgagatgca 1671480
 aagggagcag agaggtggct gttctagcat gattctagaa tgttctaaaa tgacaaggcc 1671540
 atttctactg ctcagcttaa cgtcagtctt cttttgtaac cggagccaa gacaacactt 1671600
 ttgggatagt ttigtgtctc ttgtcagcat ttccacaggg gaggaagaga gcatatgcca 1671660
 cagatctgcc taggttcggg actgtgaggt aaagagatgg gcacacactt gaacaaggtg 1671720
 actttttttt tctggtatgg gtaccacat cagttttatc attacctca tcacaacat 1671780

 tactgtcact atcaccacca tggtgacaat aaggatctgg gaggtcctag aaacaagggc 1671840
 ttggcaactt gagagggtg atactggagc taactgtgct tagcatggag ttctgttgg 1671900
 agttctggac agaggcctcc tgccagcttc acatggtttc tcaggcaaca gtttcacagc 1671960
 aggaacaatc caccctcatg cttttcggtc ccaggaggcc ctttattggc tctagacata 1672020
 tggccaggcc acacgttctc cacccttaa cacagcatct gccctgtcag gaagagggt 1672080
 tcctttgagt ctgttcttt cactgaccac aaacaaggag aaagcagctg cagaacggca 1672140
 cgcagacact aggattccgg ctggatgact gcctacacga ggcagtacag gcccccttc 1672200

gtgctctgcc ccacatgtca aaccctaatic aggcaggag ccagtcgtcc tcattgcagt 1672260
 ctgagttaaa gaatgggaaa ggagcctgag aactgtgttt tgctttttca ctagatgata 1672320
 ccatcagcat tacagcagag agggaggcac acagcccagc agcagaggtg tgtctggcat 1672380
 ctttgggctg cacatgtaga acaaatcac aagagaagga aaagcacaga gttagattta 1672440
 ataacatggc ccctatagaa ggcaggcctg gacaactgcg gagttttgtc ttcgggaaac 1672500
 tcaagtgctt ggctcattgt ccttagaaca tccataagtg attctctgtc aactagattg 1672560
 gagaaaatgt aatagccaca cctgtgattia tgatcattgt taggaggcca cagggcaaat 1672620

 cagcatggag gcagaaaagc aaccaggaac tccaggagtt ccaggcttaa tgcagtgtgt 1672680
 gtgtgtgtgt gtgtgtgtgt gtgtgtgtgt gtgtgtgtgt gtgtgtaaag aggaggagga 1672740
 gaggaacacc tgctaacaac agaccttacc acaaaggcag gactttcaac aacttcttac 1672800
 ctgctgtcca actcagacc tttcctggtg tattcaaca cagacagaca gacagacagg 1672860
 cagacaggca ggcagacaga cagatggaca cactcacagt cagagctgat gcaaccaaga 1672920
 gggaagtaca gctgctggtc tctgcctct catgggtctg cagcttcagt gtgtgtgtgt 1672980
 gtgtgtgtgt gtgtgtgtgt gtgtgtgtgt aggtgcatgg tgattttcca taccctctat 1673040

 gtttgtgtgt gatcaggatga atgtggcagc ttgggatgaa actgaagtca ggagtggctc 1673100
 tgaggtcatg tgcctggtc tttttctcca tcttcttca ctgagcttac tctctctctt 1673160
 ttccactgtc ttacatgctg tgtaacatat atgtggctcac tgttatctgc ttaaatggga 1673220
 gtaactgcag ggtagagttc ttcattttaa gcacctaggt cagtggctgg catgaaagag 1673280
 gtgcttggta gatttctgtt taaggaatga atgcttatta gccattctaa tttagactct 1673340
 agttaagtgg attgatgagt gcagagactt actcatctgc ctgaaatatt tccactcccc 1673400
 ctctccccag ccctcaggct cagcacagct cccctgtcc aagtcacagt tgcttctgac 1673460

 acagccaage aatcactgtc acttggccaa attgaggagg aagtgaaata tttactggag 1673520
 cagaaattcc aggggtcagt agcctggctt gtctccat aagtaatgat ggtagcgac 1673580
 acccagcct accttagtgt ttacttctga agcacaactg gccagagtgt ggtttcagtc 1673640
 agtgattcat gaatattcaa aattgtttca catcttcaaa gtcttcatat tgtcaccaga 1673700
 aaaaaaaaa tctacctta accgtcttc tagcctcaga atgccttata tacttacttt 1673760
 ctgtatttct ttgaaaatgg tcttgaaac tatgcaagaa aatggagaa taaaattaaa 1673820
 gtcacagact ggcaagatgg cttttgtggg taaaggcatt tgctgctaag cttgactact 1673880

 acttgaaaa tcagtcttga gaaatgacat agttgaagga gggaaatgac tcccacaage 1673940
 ataccacaca cacacacaca cacacacaca cacacacaca cacacgaata aatgtaacaa 1674000
 atggaataaa tataatcgat cacaatgaaa caagggcctt attagtatct cccagttgct 1674060

gagatacaaa gagtaaatag tttgccagcc aaaccaagac aagcggcata aactctgatg 1674120
gacggtttga ggcagagttt atataggaca ctgtagagac agtgcctat gtctaaccag 1674180
gttccatcac aatagaagat gggaaagggc taacaatgtc caagccctgt gatttgcac 1674240
ctactcagtt tgaatcaaag ggtcatggat gttgaatcca atattcatag tgtcgatttg 1674300

cactaatttc accagtttgt aagtatcaag caagtctgtt caatagtga cctagcaaat 1674360
taatctattt ccctattag ttttccactc tttagcatga caatatcaga tacactgtta 1674420
aagaaaaggc cagtgcaaac ttctcctca gggatgcatc tgtctgcttg cactcccac 1674480
cagcccacag ataatcccc tccccagttg cagccaggtt tctattttc aatttctaac 1674540
cacaatagaa aaaggaaga aggactctga ttttccggag ggaccacaca atcagaaaag 1674600
gtacttttc aacatcatta gcaattcatc tctgaaacc tcagggcagc ccctaggcag 1674660
ccctcctgc aacccccact cccacccta cccccccc taccctctc ttttgggtgc 1674720

ggcttatcaa attaatgaag cctatctaga cagaggaggt taggatagaa ggcagcagct 1674780
taagagcaat ttaatgcaaa ccctcccca cttacaaaa taagcatata ggggggaaaa 1674840
atcagaatat ctttcataga atgagaagaa caaacagggt gttgggggtg ggggtgatgg 1674900
ctgagattgt ctcctgttt ggtgaaggag ggagggatgt gtggtgactt tctctggctg 1674960
gacatttga tggtaaaaag gtgccattca tttgtgtaca ggaacagtct gggccacact 1675020
ttctacttgg tagtgcaaga ttcaggctaa ggacttctgg taaagagtga aacaactcct 1675080
tgcaaccttc cctctcatct tttgtaaca caccttcct ctgtcgtgct gaggtggcca 1675140

gggatgagat ttctgtgaca ctgtgcattt gtgcagagca ttggtgggtg acagatggct 1675200
gatcccactt ggggcagcag tgagctgcaa ggcacagggc agacgacagg ggcctcagag 1675260
cctcccattt tgcctgtatc cggagagcca attttcaatg tgagttaca aacatcaaca 1675320
tctctcatca catcactgac ctaaatatag acaatgactt caaggaaaaa aatagtgtc 1675380
atgttctttt atacctgtga atgctacaga gctcctcaa caagcaccag gcaatgggga 1675440
acagatgagc agtgagatag gaagtcagaa ggcagagat gtgcctgttc tagaatgatc 1675500
actgcaataa ggccattact gtagctcagc ttcacatcaa tctcatgta acccaaggtt 1675560

gagacaatag tttagaaacg gttttgtgc cttgtcagc ttttccatgg ggagtgatgg 1675620
aaggggatgt ccccatcccc tgcagatgtt tctagctaag ctgctctggc caccagcttg 1675680
cagaggtctc tgatataaag agaaaggctc atccttgacc aagtgccat ttttccac 1675740
ctgagaagac tgagctgtgg tgccttgtgc tagtctgtga gagtgactc cagccattcc 1675800
caatgccttt gtcacaatgt ccaagtccct tttcacttgg taacactgag gtgggcaggc 1675860
tcaatagtgt caggcagggt tactttgtct ttctggatg agttcagagt tgggtccaat 1675920

gtttgaatgc tigtgtcata agagttcata cctaattctt atcatccac tgcctgaata 1675980

gaaggctatg ctggaagctt ttatgagcac ggatctcaca tcacatcaag ggaccttggg 1676040

aaaggtacct gaacaaaaca ttaagtacag acagcgagcgt ggtatcagcg attaagactc 1676100

aattgtgggc aatccatctg agaaacagtc acatgcctct cacatatttc taatgctctt 1676160

cctgttcaact caggcaacta tctgcatgag aacaactgcg cagaggctcc ctgagtgtag 1676220

cataattgcc tgetgttagg gaaccagcaa gccacttcag acttaagctg cccagaactc 1676280

catcatttag ctaaaaacac aaaccacgc tcttttgtgt cagcaaagta ccccaaatg 1676340

cagccatcaa tttgtttctt cagagaacat acacacaact ctggcagaaa catattccac 1676400

cactataaaa ggagccttat ttcttgaaa ataatagcag agaatagtgg gaaggcact 1676460

gactgcacac aagctaagga agccaagcca ccaggacacg tggcaaaaac ggagccaaaa 1676520

ccaaaaccaa aaaaacaaac aaaacagaaa acaaaaaatt cccccacaa aatcaaacc 1676580

taacaaaca aaaaacgaac aaacagacct gcagtagaaa cccagcacta gtaaatgaga 1676640

agacctaat aaaaataaac aaacagcaat ttttctgct aatggagagc ctttaagtgc 1676700

aaggtaata gtatctatgc atggctgtgt gggctggaac acctggccca gtgagactct 1676760

gttatcaccg ctcttctgtg catcatggct aagttaaagc atggacaaag gtcagaggtg 1676820

cacatttaga aataaagaca tcagcaaagg tgatagacac agcagctctg aagtgcaggt 1676880

accacaactg gaacaggaat ctagtgtcc tgtgatgtgt aggggatgat actgacagcc 1676940

ttgctcttca gcaaggaagg ctggctgctg aaagttccta caaaggacct tgaactgggt 1677000

ttgtgtgaag atccagaaga tgctgacagc agtatgcttc gctatagggt cttagcttcc 1677060

ctacatagac ttttgaaat agcactttgc tagcataggt gaggcaaaa aaaaaattat 1677120

aaaagacttg ggggaggagg agaaaagcaa tttggtcatg aagaataca cccagagtca 1677180

ttttttcca atccaatatc tttgtaatt aagcattttt ccatcttaca atgagaatac 1677240

gaatagcaat cgaatactat accactcatt actaataaaa catatttatg aatggaaat 1677300

ataatgtgcc tatttccaaa atgtggttat aaatgactga ctctaagcca caatttaag 1677360

tggtttgaga aatgagtctt taataaagaa ttgatgagga tgatgactgc tgaataaat 1677420

tctatttggg aagattatgt ggcttgctta tggcaatttg agctgaggtg atgcctcaa 1677480

atattacagc aagtaactaa tataggaaa ttttaattgat gataataca tgggttgtgt 1677540

glaattgaag aatcctgcat cctctcctgc actaattaca tccagtcatt tcagtctgt 1677600

caaggtgtta tttatctggt atatgtgcac atagtagggg tttaaaaggt gagtgaataa 1677660

gtgcctataa ttagtcctca atgtgggttc cttcgtacaa ttatggttaa gcagaaagcc 1677720
attaacatta aggaaaaata taatacggct ccagttagag ccacactgca tctgcatgg 1677780
tgaaacggaa ggtcagcagc tcagaacacc cagatcttag gacacattag ctctccacca 1677840
attaaagcac agctgtattt ttaatgatat ttagaactac actaataggc acttgatata 1677900
acttccttgg ctatctatcc ctttgactgg acaaagaaag ttctctgtca gcatagacat 1677960
gaatagatct ctctctctgt ctcacacaca cacacacaca cacacacaca cacacacaga 1678020
gagagagaga gagagagaga gagagagaga gagagagaga gagagaaaga gagaggtctt 1678080

aggttgtggg actacagaga acaaaaagac ccagtgttta agagactgaa agaccagtga 1678140
gaaagatggg tgaatacaca gcagaagggc cagctcagaa aacacaaggc caaatgagaa 1678200
tggccagag aagcattttc aagagagatt ttattttttg tattattatt attttggttt 1678260
tttgagacag ggtttctcaa aaattgcttt gagagcctat cttggaactt gttgttattt 1678320
tgtaaaagt taaaaattag aagtctcgag atggaacctg gcgcgatgga acacgaacca 1678380
tagagaacat aaagagtata ttaaccgggc tggagagatg tctcagaggt taagagcacc 1678440
aactgctctt ccagaggfcc tgagttaaat tcccagcaac cacatggtgg ctcaacaacca 1678500

tctgttatga gatctgatgc cctcttctgg tgtgcagata tacatggaag cagaatgttg 1678560
tatacataat aaataaataa agtcttaaaa aaaagaagtt taaaaagag tatattaacc 1678620
atagagtta ttaagagaca gaatgagaga gaggagacag gaaggttaaga cagcgtgaca 1678680
ataagagaag agagtgttaag tgggcggggg tctgtctttt aaaggggtcc ttaccctt 1678740
cgtgcagact tagttcccat ggaacctgg gctgaccagg gtactgcctg agtggtttct 1678800
gtcaggtaac tgggcaggc cagcataagg cctgaacctt tcagaactct ctctgtagac 1678860
caggctagcc tcgaactcac agagatccac ctgcctctgc cttccaagtg ctgtgattaa 1678920

aagtgtgtga caccaacgcc cagcttgaga taatTTTTTA aattaaatga tatttattat 1678980
tattgtgtat gagagagtgt gggcatgcca cagcgttctt gtgtaagtca gggagcaatg 1679040
cttgggagtt ggttctctca tccaaggta gaacctatgg atcaaacatc aaccttgctt 1679100
agcaaggaag tacctttcgc ccattaagct gtgtctctctg ctgacctaaa agataatTTT 1679160
tacttgcttt gggatgggag atgttaatga atgaatagtt tttccatgac gtgaaacaag 1679220
gtaaagttaa aatacacatg ggatgtcggc cccaggggtc tgtgggaacc atctgctttg 1679280
ccttcccta atgatccaca acatcagggt acaaaaaagg cgacttgagt caaacatga 1679340

gcggtagctt atgagttaga tcaatgctgc caaaggctcc caagaagaga aatagcctgt 1679400
gggaagacat gaagcttctg tgtttgaaca aatgccccat tgaacccat aggatgcaag 1679460
aggcagagga aggagaggac actgcctggg gtgactaatc aggcagatga tgaagttgtc 1679520

tgacaccgag ggictgcagt ctactgtgtg gagatggatg cctcagaagg agtcctgctc 1679580
 tccatttcta gtgatgtttt tgtatgctgt cataatgagt agaaaaaca caattatata 1679640
 taaaaaagg gttttccagg ccaagagaga tagtattaat gtgcaaacat atactcataa 1679700
 atactacctg ctcttgtgct atggtagaaa aaaaacttgt ctactatggt ttatgttaa 1679760

 agataggaag tctgtaattt atttaggcat cttaggctgc agacaagttg ctgtcatttt 1679820
 aaggaactct gcaccggaat tttatctgca aatctgagaa ccctcatttt aaagaagaca 1679880
 tcaattattc taagccatac cagagagagg gcggcctttg tgacaatggg tcagataagc 1679940
 gtgctggcgg gaagagttgt agaaggcggg aagagttgta gaagggactg gcaatgcctg 1680000
 gggtcaggaa ggagccaagt gagaagtttg aaggctttct caggccccca gaggatgtgt 1680060
 gtaaaacaaa agaacaaca aacaacaaa aaacaaaaca gtttctactg cttactaga 1680120
 tgtgtggaca ccgtacggac acatttcatt tgaatgtcta atcactccac atcttaaac 1680180

 agaaagtgtt gacaagcaag aacttcacag ccattctcac agtcttgag gggattctca 1680240
 attttgcaa gagtcaagct agatgaacct gacacccttt ttagcccca gctcatctaa 1680300
 aaggccagca taccctgacc atcacaggcc cctataatgt caaaatcacc aaatggtgta 1680360
 tatgtctagt ttccacatca aaataatcaa atacttttgc atatttgcc agtgtttgag 1680420
 aaagagggaa aataggatga taggttctg ttatttctct tttcctggaa gattcaggca 1680480
 atgccatccc atggatgcc actgacttct catgaaactg gggactgagc gtaaattagg 1680540
 cattggttag gaaacagaga ttagaaaga gttataatgg agggcacaaa ggattccaga 1680600

 gttatgagcc ctgatcaaca gaagtgggtg gagtgagtgc tgctggggtg aaatctcaga 1680660
 ccttttctgg tccaatgtg tgcctatgac acagccatgg cactactcc atccccttat 1680720
 cctgctcaga gaatagagga ggtatcattt tcatagaca agggacagcc gatgaggta 1680780
 tggaggggag gtttctaag acttgttct aagccagtct aagatcaag ttcacacact 1680840
 agagatctat ttctatctat tatttccat aaagtcctca gggtaaaaaa taaaccacgc 1680900
 tgttgatttc acatttttaa taactttta aggtcatag gaagctcttt ggatttgttt 1680960
 ggggaagaaa agaccactcc aagtattaaa agaaatctgg attaagtgtt tccagacttt 1681020

 ctgataactt atcagtccca aactcaagcc cagggttggg cttgggacct ttaagccaga 1681080
 tgacaaaacc cgaagcagc cgggttttca tacaacacat ctttctcat ttactggaaa 1681140
 acactcatgt tacacagcaa ctttttctg actaagaggg tgtggtctgt tcattccact 1681200
 gaccaagaag agcacagaaa gagtatttct cacctatgaa gcgccaactg tgtgttatg 1681260
 ctgggagcac actagccctt ggcatgggaa caccttctct tatgtgtgac caaagctgag 1681320
 atcctgacca tgtggtcagg agagagagag aaaaaaaaaa aaaaacaatc tacagggaca 1681380

tgacaccaca aggaacaaag gccatcgtgg ctctgggagt tgatcctctc tctctgtatt 1681440

 ttaaactggg gatttggcaa aagctgggaa gatttaccat cagttcctct cactccctta 1681500
 aagtgaagcc cataaccttt gttctgtttt ctggaccact tttcctcctc tgcaaatgga 1681560
 tctgtgtttc ccaatcttct ctttggcttt gatccatcag caggcatttt gtctggtatc 1681620
 tccttcttaa atcctctgct tcagcaatca gcatcacaaa agtcagtact taaaaaacat 1681680
 tctaagggtt gaccttcagg tgcctataat catgtactct gtgtaaccta atgactggtt 1681740
 ctttggtagt aagtttatgt gtctaataat tgtgcacatg accctgtgac catcatggat 1681800
 cttaaacaat aaccttggaa ggaggggagac accactcctt tatttctggt taagaaaaac 1681860

 aacagtccag agagcact agtaatttat gattttgctg gtgtattatc atccagtaat 1681920
 aattgcaacg tgaactgcc aattatctcc taagaggggt atcacctttt ctgttgcgaa 1681980
 ttactacatc aataactgtg ggttcagcac tcttactttc ctgtgtcact agcagttttt 1682040
 cagcagaaga attgagccag aaaagcacag atcacacaca cacacacaca cacacacaca 1682100
 cacacacct cagtcattcc agtttcaagc ccaggaatac atagagggaa caagaagata 1682160
 cacacacaca cacacacaca cacacacaca cacacacaca cacactccac tggtagccag 1682220
 agagggccaa ggaagacaga caaggaaggg ggaggggtgg tgggattgcc tggagcagtc 1682280

 aagaggtcac aggcacaccg tgatcagcag caaactcagt ttacaaagag acatctgttc 1682340
 cattgtcca gtgcattgtg gctaattaca tcttggcccg tctgtgaaat gacagccact 1682400
 tattctccag tgaacctaa aatctgtaca tgttcgattt tgggagtggg agagcaaagg 1682460
 cgtggaggct ggagtggggg gaaggggccc agccaaaggg aaagaaaagg caggagggac 1682520
 tactttccca caagagagca tgataaggta caagaaggaa gggtagaatc agaggcttgg 1682580
 caccaccgag cagcatggag atgaaggcag gacactctga ccagactgct attacccttc 1682640
 ctctctatc aacgactaca gtgccaagta ttggtgcctt gaaattctcc attatcattg 1682700

 ccctaagggt gtggcttggg gacagactta ctatttctg gtagtttctt ggggtttgaa 1682760
 aaagaggcag ctggtaggaa ccagggtgca gcccagatg ggcagggcaa gtttctccca 1682820
 taagctcct ctaagtgtag gtcacagcat ccatttccac cggaccctg ctttcacagg 1682880
 aaagcctctt taccatacac tgaggatgga ggctggcctc catggagaca ggaattagca 1682940
 ctaagcattc ctaagacgga aaaattcata gaagaagccc tacagtcaa aaagactttc 1683000
 cctatgattt tgattgacat taaaacttta tcttaacaaa agtgacaaca acaacaaca 1683060
 caaaaaccag taccattat atatcttggg gacaaggacc aggggaatag aaacagggac 1683120

tagagacagg accatcttga aaatagactt caatcgactg tggggtttag tgggggtgct 1683180
tatcattctc acacaaatgc tcttccaga agagtcgtac agccttctgt tggaatctgt 1683240
gtaaaaccca actggcgata tgacagggtt cagctaaggt taaactcggg tctttcttcc 1683300
tctcggaaaca atgctgggtt ctgtggatca catgtacagt cataaaagtc ctggagaaaa 1683360
gggttacctc aactttctac tggctcccat ctgtttctc atgtggagat ccaggctgtg 1683420
taccccagac ctggtgcaat gcgactcgg atcccaaaag ttaaggttgg ggcctttgtg 1683480
gcttcatgat ggtgtggagg ctgctggccc caggacagga gggctctgaa gtgctgagac 1683540

agctagcacc tctgtcgagc ctttaggctg gcctaata gta aggggaggca cagtcagtgt 1683600
gccacgaaca cgaggcaacc catgaaaatg ttgtagaat ttttactgat tttgagtcaa 1683660
agtaaacac tctgtgttaa cgactgcac atcataaat taatgagaag gtaaccaacc 1683720
gctgtctgag agaggaggctc cggggagtta aacataatta gagaaaagg gtgagacaca 1683780
gaataagcct tgattttatg cgaaccccaa gaagttaatt ttgttcagt taaaagggga 1683840
aggcactctt aaaagagtc tgaattttcg ctccatcct gccagtacat tgtcttttg 1683900
accaaggaaa aagaaagagc tctaacaaaa atataaggcg agggagtaaa agaaagacat 1683960

ccataccctg atggaaatc ttttgtttg ctttgcttg cttttaggat ctcacatgt 1684020
atccctgact gggttagaac ttcctatgta gagaaatctg ggaccaaact cacagagatc 1684080
tgctgcctc tgcctctgt aaattatgt atttatcct actgtccaga gaagtccaga 1684140
gagagattgg acaccccc cctcacataa ctggagtac agacagttgt gagccccat 1684200
atgggtgctg tgaattgaac cctggtctc tgtttatgt atacagtctt ctgctgcat 1684260
gccagcagag ggcaccagat ttattcaag gtggttga gccaccatgt ggttgctgg 1684320
aattgaactc aggacctctg gaagaacact cagtgtcct aacctctgag ccatctctcc 1684380

agctctgcag ccattgttct taactactga gccatctctc tagccctgg tataaattct 1684440
tgagtagtag gttagatcca agtaagtta aagtttatgt aaaggtttt tctaagagca 1684500
gaaggcaaag agagatgacc cctgggctca cagtgtgtat aagaacctg gtttgggtgc 1684560
acatttgtat ttctgtgcta tgtgagtgt ggatgtagct ttggctgtag gtttctgat 1684620
agaatgttat aaaaacagt tttactaggt ggcactaact gactaaacac agagttcagt 1684680
gctcatttat tttgaaggc acatggcatg gcttttgtt tgggtccatgt catctttctt 1684740
taggactctg aaccgctcag tcgctaagaa ccagacaccc gtgagtggcc agtgactgag 1684800

ttcaagaatt cagtcagcac tgggcagtag cttcaaact gccatggagt acaattagtt 1684860
tcaaggctga tggagtctag agatgaagta cgttgatctc tccaatttat caatggagtc 1684920
tgtgccatt tttactcagt gatctttgag taaaactta gctggtatga gcacttcaaa 1684980

gattcaactt cccaatcctt gcttgagttt atctggttaa ttgctgctgc tgcctctaac 1685040
tcaaaatgtg taatttccta ggaaagtcct taatgtcctc aaagggtgac agaagaacag 1685100
aagattcaag tattatttct tttctttcac ttttaaaaag gatataaac attttaagt 1685160
gtgtgtgtgt gtgtgtgtgt gtgtgtgtgt gtgtgtgtgt acagtgtgca catgtgagca 1685220

cagaagagcg catgggatcc cctggaggca gagttatagg cagttgagag ccaatccacc 1685280
tagccatgcc acgtgccttc aaaaataaat gagcactgaa ctctgtgtac ctaacttggg 1685340
tcctttgtaa gaataagatg tgtttttaac ctctgggcca tctctctagc cccttaggta 1685400
ttatttctat gaaggaatta attgtggctc aaaagaagta aatgcaaatg ataatgtgag 1685460
aaactccact gaaaagatgg aagtgggtaa cgttttaatt aagggaatcc atcttcagca 1685520
acatgtcctt gcttattcac aaaggtacca tcaggtccta tactagcggg gcggatggag 1685580
ttctacaaga gagggaatga cattgaaaca tgtcaggggt gctggggcag atggccttcg 1685640

atactctgtg actcaaattc taatcagaag acagcaagtc tccccactg tgtctcttta 1685700
catttatgga gtttctatag atcaagttac gttgtaaaat atacaaaaca atggctacaa 1685760
aacagagaaa taccagctgg ggccaaaagt gtatttctaat gaccagatga ccatctacat 1685820
agcagccacc cactctgctt cagccttata ttgtctgtga actcattgaa aatgaagca 1685880
agctggagaa ggaagtctg agaaagacat caatagaatc aaaaaccaga ctttgtgcaa 1685940
gagtgcggga gcggaagtta tgtgggttat gaagagtgt tacagaaacc acttccaatg 1686000
caaatggcat ggccaagttc attcagttat caaatgtctc cgtcttcatg ccacatattg 1686060

ggctggccag actacaaaat aaaaaatgaa ctctactatg gatcctatga acaggetcct 1686120
ggagtgtaga agaatgttgg ggccgtcctt ttttttttt ttttctcag attttttct 1686180
aaatttgaat tagaaataag attgttttac atgacaatcc cagttccctt ctccctcca 1686240
tcctcccta ccaccccc ccaactaaaa cctacatat cacatatcct ttctgetccc 1686300
cctggatggt gaggccttcc atggggagtc atcagagtct atgatcctt ttgggatagg 1686360
gcctaggccc acccccatgt gtcttggctc agggagtatt cctctatgtg gaatgggctc 1686420
ccaaagtcca aaactatgct agggataagt attgaactac tacaggaggt cccatagatt 1686480

tccaaggttt cctcactgaa acctatgtt cgtgggtctg gatcagtccc atgctggtat 1686540
ctcagctatc agtctgggga gcaagagctc cccaatgttt aggtcagctg tttctgtggg 1686600
ttcaccagc ctggtctgga cccctttgat cttcactcat cctttgagtg aaggacagta 1686660
tatcttttg cagtgctttt ttctctccat ctccaggggc acacaaatag ttgacagcc 1686720
ttgttgaag caaatgctt gcgctatcct ctttcattat caggggaggg catataaagt 1686780
aacctctcct ctgttgctta ggttgttagc tgctgtcacc tttgtagatc tccagtcatt 1686840

ttccatgtgt ctgatttctc tataaacctc aaatgtttcc ctctattatg gtatctccat 1686900

 tcttggtatc ttctattctt cccctgactc cacgtttctg ctccctcatg tcctctcac 1686960
 cccctctctt ctccccctct cattctccta gctccctccc cctcttctct gtgctcccaa 1687020
 ttgctcagg agatattgac cctttctctt tctctagggg accatgtatg tacctcttag 1687080
 ggctctcctt gttcactagc ttttctggca gtgtggattg taggctggtc atcctttact 1687140
 ctatgtctaa aatccacata tgagtgagta ataccatatt tatcttttta tgattgggtt 1687200
 acctcgtca gaatggtttc ttctagtcc atccattttc ctgcaaattt caagattcca 1687260
 ttgttttttt ccaactgagta gtaactcatt gtgtaaagt accacatttt ctctatccat 1687320

 tctttggttg aggggcatct aggcctgcttc cagtttctgg ctattacaaa tagtgctgtt 1687380
 atgaacatgg ttgaacagat gtccttggtg tatgaatgtg cttcttttgg gtatatgctt 1687440
 aagagtggaa ttgctggatc ttgtggtaga ctcattecca ttttcttgag gagtcgcat 1687500
 actgatttcc aaagtggctg tacaagttgg cactcccacc agcagtgag aagtgttccc 1687560
 ctttatccac atcctctcca gcataaactg tcattggtgt ttttgatttt ggccattctg 1687620
 gcaggagtaa gatggtatct cagagtgtt ttgatttga tttccctgat ggctaaggat 1687680
 gttgaacact ttcttatgtg tctttcagcc attttagatt cctgtgttga gaattgtcta 1687740

 tttagtctg taccccactt ttaaattgga ttgtttggtg ttttggagac tagcttcttg 1687800
 agttctttgt atattttgga gaccattcct ctgtcagatg tggggttggg gaatatcttt 1687860
 tcccagtctg taggctgctg ttttgtcttg ctgatggtgc cctttccctt cagaagcgtc 1687920
 tcagtctcag gaggtcccat ttatcaattg ctgttctcac tgtctatgct actggtgtaa 1687980
 tgttcaggaa gcagtttctt gtaccaatta attcaagggt atttcccact ttgtcttgta 1688040
 ataggttcag tgtggctggg tttatgttga gatctttgat ccattttgac ttaagttgt 1688100
 gcatggcaat aggctcaggt ctatctgcag tcttctacat gtectcatcc agttatgcca 1688160

 gcaccatttg ttgaagatgg ttccatgtt ccatcatata aatttgatt gtttgtcaaa 1688220
 aataaggtat tcataggtgt gtgggttaat atcagggctt tcacatctat tccattgttt 1688280
 taggtttcta tttttgtgcc aataccaagc tggatgatag ctctgtaata gagcttgaag 1688340
 tcagagatag tgatgcctcc agaagttcct ctattgtaca gggttgtttt ggctatcctg 1688400
 ggtcttttgt ttcttcatat atagttgaga attgttcttc caaggtctgc gaagaattgt 1688460
 gttgggattt tgatggagat tgcatggaat ctgtagattn nnnnnnnnnn nnnnnnnnnn 1688520
 nnnnnnnnnn nnnnnnnnnn nnnnnnnnnn nnnnnnnnnn nnnnnnnnnn nnnnnnnnnn 1688580

nnnnnnnnnn nnnnnnnnnn nnnnnnnnnn nnnnnnnnnn nnnnnnnnnn nnnnnnnnnn 1688640
 nnnnttgggt ttcgagaca gggttcctct gtggctgtgg aggctgtcct ggaactagct 1688700
 ctgttagacc aggctggcct cgaactcaca gagatccgcc tacctctgct tccagaaaaa 1688760
 tatgtcggga ttaatggcgt gcgccaccaa cgcccagctt ttttctttt ctttctttct 1688820
 tttttttttt ttgagattca aaattcttaa agtacaggtc tttcactttt ttggtcagtg 1688880
 ttaccecaag gtattttatg ttgtttgtgg caattgtaa gggatgatgt tctctgactt 1688940
 ctttcttcac cagtgtgtca tcagatata gtagggctac ctatttttt gaggtaatct 1689000

 tgtatcctgc cactttgctg aaagtgtta tcagctgtag gaggccctg gtagcatttt 1689060
 ttgggccact gatgtagact atcatatcat ctgcaaatag tgagagttg acttcttctt 1689120
 ttccgatttg tattcccttg atctcctttt gttgtcttat tgctctagct agaactcaa 1689180
 ggacagtatt gaaatttgtt caaaggcttt ttcggcatct agtgagatga tcatgtggtt 1689240
 ttttttcccc tcagtctgtg tatatgggtg atgacattga tggattttct tatgttgaac 1689300
 catccctggg atgaagccta cttgatcgtg gtggatgatt tctccgatgt gttcttggat 1689360
 tctatttggc agtattttat tgagaatttt tgcataatg ttcataaggg atattggtct 1689420

 gtagttctct ttcttagttg tgtctttgtg tggcttgggt atcaaggta tggaaagcctc 1689480
 ataaaagcg ttggcaatg acccttctgc ttctagtgtg tggaaatgctt tacggagaat 1689540
 tggatttagc tgttcttga atttctggta gaattctgca ctgaagcctt cttgggcttt 1689600
 tttttttttt ttttggttgg gaaacatctg atgactgctt ctatttcatt aggggtaata 1689660
 ggtctattta agttgcttat ctgttcttga ttaattttg gtnnnnnnnn nnnnnnnnnn 1689720
 nnnnnnnnnn nnnnnnnnnn nnnnnnnnnn nnnnnnnnnn nnnnnnnnnn nnnnnnnnnn 1689780
 nnnnnnnnnn nnnnnnnnnn nnnnnnnnnn nnnnnnnnnn nnnnnnnnnn nnnnnnnnnn 1689840

 ntgttttatt ctctgctgtt tggtaagttt ggataaaggt ttgtctatct tgttgatttt 1689900
 ctcaaagaac caacttgta tattgattct ttgtattgtt ctctagttt ccattttatt 1689960
 gatttcagcc ctcaatttga ttatttctg gcgtctgctc ctctggggtg tattggcttc 1690020
 ttgtttttt aaagcttca gctgtgctgt taattctcta gtgtgattat tcttctgttt 1690080
 ctcatgtgg gcacttagca ctatgaactt tcctcttagc actacttca aagtgtcccc 1690140
 taggtttggg tatgttgtg ccgaattctc attgaattct aggaatctt taatttctt 1690200
 ttttattct tctcaatcc aggaattgtg caattgggtg ttacttaatt tccatgagtt 1690260

 ttagttttt ctgtagtca tgttgtgtt gaattctaat ttaaaagcat ggtggtctga 1690320
 taagacacag ggggttactt caattttttg tacttgttga ggtttgctat gttgccaagt 1690380
 ttgtgttga ttttacagaa cgttccatgt ggtgctgaga agtaggtaaa ttgttttga 1690440

ttggatgac atgttctata gatactctgt aagtccaatt gtgccataac ttctattagt 1690500
 tcctttgttt ctttgtaag tttcaatctg atgttcctgt ccagtggtga gagtggggtg 1690560
 ttgaaatctc ccaactataag tgtgtgcagt tttatgtgtg agttgagttt tagtaatgtt 1690620
 tcttttacia acatggatgc ctttgtattt ggggcataaa tgttcagaat tgagacttca 1690680

 tcctgatgga tttctctgt gatgagtagg aatgacctt cttcatctct tttgattgat 1690740
 tttagtttaa agtccaattt gttggatatt aggatattac ccctgcttgt ttcttggatc 1690800
 catttgattg gaaaatcttt cccaacctt taattcttag gtaccatctg tttttgaggt 1690860
 ggaggtgagt ttcttgaag aagcagaagg aaggattctg tcttcttacc cattnnnnnn 1690920
 nnnnnnnnnn nnnnngcttt gctgggtata gtagtctagg ctggcatcca tggctcttta 1690980
 gtgtaggtag aatatctacc caggaccttc tgctttcag agtttaccatg gaaaagttag 1691040
 atgtaattct gataggtttg ccattataag ttacttgacc ttttttcttt gctactctta 1691100

 atattttctc tttattctgc atgtttggcg ttttgattat tatgtggtga ggagaccttt 1691160
 tttttttttt tggttgagtc tatttgggtg tcttaggctt cttgtatttt cattggcatg 1691220
 tctttcttta ggttgggaaa gttttcttct atgatcttgt tgaatatatt ttctgtgctt 1691280
 ttgagttggg tttcttcacc tcttctata cctagttctt ttaggtttgg tcttttcatg 1691340
 gtatcccata tttctggat attttttgtt nnnnnnnnnn nnnnnnnnnn nnnnnnnnnn 1691400
 nnnnnnnnnn nnnnnnnnnn nnnnnnnnnn nnnnnnnnnn nnnnnnnnnn nnnnnnnnnn 1691460
 nnnnnnnnnn nnnnnnnnnn nnnnnnnnnn nnnnnnnnnn nnnnnnnnnn nnnnnnnnnn 1691520

 nnnnnnnnnn nnnnnnnnnn nnnnnnnnnn nnnnnnnnnn nnnnnnnnnn nnnnnnnnnn 1691580
 nnnnnnnnnn acgtttctct tgagagattt gttgatattt tgcatttttt gttttgtttt 1691640
 ttctttctct ttttcttcc ttttaaggat tttctcatgt cctctatcat tttcatgaag 1691700
 atgtttttaa ggtcattctc ttctgcttca tctgcattgt gatgttcaag tcttgcctgt 1691760
 gtaggttcc tagtctccag tgatgtcata ttgggttttc tgttgttga tgtgctttta 1691820
 cattgacctc ttctcatctt ttctctggt ggggtgacca ggagtctctt tctctctctg 1691880
 tgggtatggg accaaagtcc ccttctggta gatgcaaaca gttccaatac tetgatgtct 1691940

 gtcctcttgt tgtggattga ggtggcactg ttacaggggc cttggcagtg tctgggtgtg 1692000
 ttagatccca ctgctgagtt cggatccagt cagcagacct ctggagtcag gcacctctga 1692060
 gcagggtcgc tgaaccgaa ctggaacca ccctggccc acccggccat tggatggagg 1692120
 cggaaactgc actgcccct tggcagtgc catgtgtgtt ggatcctgcc gcggagctcg 1692180
 gggagcaaac ccctggcgc aggtgcctcc gatggggccg tcttttgatg ctgatgactg 1692240
 agaactcttc ctgacttttc agccccagcc tgttttgttc gacttataaa aacaactg 1692300

ttttcattat taictgatca tttctgggag aaaatatgaa gtggttactt aatgtgcttg 1692360

 aatggctagc tctaattcaa cacaacaccc tcctgtcaa tatcccttcc cctcccgaag 1692420
 cacagttcag acaccaggaa ggatgagatc acatcacaca attattttgt aacttaccac 1692480
 taataattta ttaattaaag gagtaatcaa aagcagattg gctggctaataaaaagccatt 1692540
 ctggttttca tttaatgaaa agtggggagg agaagatggt caagagattg ggcagtggta 1692600
 gactatataat agaaacacag acacacacag aggcaggttg gaccagggaa ggtaaggtt 1692660
 gttgtatatt accattccta tggtaaggtg gctggaggcc attcttaaca catgtccttc 1692720
 tgtgaattat ggaacttctt catttgacct aaggatatac ttaatatagg tatatggata 1692780

 ggtactatgc atatgttggg ctgatgtttg tacttgtatg tacatatgca gatgctcaca 1692840
 tatttcttct gcagataatg gtatataacg gtgcatatgc agaaatgcat gtggaggcca 1692900
 aggatgtgac tcagatgctt tcttcatta ctcaccttgc aaattgaggc aggtctctct 1692960
 gctgaacctg gagctcacca atagtaagct aggcagacta gatggctctg gggattcctt 1693020
 gtggagggat tacaggctgg tcacatgct tgcctggcct ccacatgggt tccagggatc 1693080
 cagactctgg tectcataac ttgcaaggca agcactttac caagtaagcc atctccagct 1693140
 ccatttaaca gtgataatag catgcatgcg gatctactgt catgtcccac caggctccac 1693200

 atttttaact ttctttttc ctttctttt tagtgatttc tggaaaacac tccagtagca 1693260
 gtccccacct tccggatatt tctcttccct tgaatcttc cttttgtct cacatcaggc 1693320
 tgacactgct tctcaggagg agggttccca ttagctattg cttagttcat ctttttctt 1693380
 caccactgag cactctctt tgtgtactga ctcactttgg ggaaagcaga acatctttct 1693440
 tagaaaaatg agtcttaggc ttaggaagat gtatttccga gaaagagaga atctacaagc 1693500
 attagtctc aggttccca accataagtt tttatcttg gttctcattt gatttttcta 1693560
 tctttatttg tgcaacaagg atgcatttcc taccattaca taggaaaatg ggtgttaggc 1693620

 atggttagaa ccttctctt catcttagaa cagaaaatac atttaattgt tattactatt 1693680
 gcatctttaa tgattattaa aactaattg ctctcttgaa gttatcttca ttgacttaag 1693740
 atctggtgtg cctctgcctt ccaaggtaag gtgagccagg gtgaggctgg cgcttggtc 1693800
 ctcttcttac ccttggcgaa catcatttga aaacattcac tattaaattt tcaggaaggg 1693860
 ggctgtaaag acagctcagt ggttacagat acatactgtt cttggagagg acccaagttt 1693920
 agttctcagc acctatgca agtggttcat atttgcctgt gactccagct caaggggttc 1693980
 ctacacttct tctctccaca ggcacttgta cacacacaca cacatacaca cacacacaca 1694040

cacacacaca cacacacaca cacacacaca cagataaata tatatnttaa ctagggtgga 1694100
ttgagcctca gctaaggttt cagtgtagcc agaagttctc ctgagagcag attctcaaaa 1694160
tccaggcagc ttgcacatct gtttaactca agaatttctt tcaccatctt agaccttcca 1694220
gtatcactcc ttcaaaaaca acttgagatc ctctctcact gggtcctccc tgctcctcat 1694280
tgggaatgat gtcaagafta agagaaaaca agacacagca acagtcttgc ttagctaaga 1694340
aagtccatca ctgtccactg ctactcaaat cagatcttac aagagcaagg gtctcaaggg 1694400
gctaaagaat tcttgagaaa ctccctttac cagagcatgc gactaagaac cagcactcat 1694460

taataggatc cctacacttt ctcaactca gcaatcacia gagagcttgt ggtctactgt 1694520
acagcactgc attattgtcc aacaaatcaa tttctntttt catggaaggt tctttagttg 1694580
gcctgccttt gcccttcccc catgaggac cgagttcagg agtagatatg cagcgtgtgt 1694640
gtgtgtgtgt gtgtgtgtgt gtgtgtgtgt gtgtgtgtgt gtacacgcgc gcacgcgcac 1694700
ccaggacaca gtcttgttcc caccctacat tgtttgtga aataaatatg gaaatcaggc 1694760
tgagcaagcc agccaagcca gccaaactga aataaatca tcactcatgg attctcaagg 1694820
gagggcaatg gtgcattttt ttctaataga ttatttctga agcactgaag gaatggctat 1694880

atcactaatg aggctgtac gccatgactg ctgattataa atgaccgca aagagacaag 1694940
gagatggtgg gtatggagac acacatggga ggagtggagg aagcaactgt aagtggaggc 1695000
tgctgccacc ggggccaagc caaggagatg caccagaat gcactctctg ttttctaat 1695060
ccaatcacc actccagaac agcatgtgac tgattctgtg tgaattcagg tgaatggaaa 1695120
gttttcaaat gcctctcaag atagcaaagc agctcatggt tatgttctca aggtaccatc 1695180
ggctgcttct gtctgtgcat agaagtctt agcagtaaag acgatctgca gaagatctaa 1695240
tggggactca agggacacia accataagat gacactaagt ggtggctgtt tcccactag 1695300

ggactgtctc ttgatagctg tgaactggga atataggca tgaaggtgtg gaaagaaagt 1695360
ctgttctggc accagatagg aagtgtccac agggcagatg gtgacatcca ggccaggcag 1695420
acgacaatgg actcaciaac taggaatgtc aatgcttggc ctgagaaaagc cctgagtgat 1695480
ctcaacaaaa ctctgagctt tgtgactcag cggcagtatt atcatggcat gggatgattta 1695540
aagccaaagc atctcttagc atgatctggc aagatgttct cagccagtag aaaagatcca 1695600
ccaagggctg aagaatggc tcagcagta aggtgcttgc tgcacagtca tgaggatctg 1695660
agttcaaatc cccagaagc atgtaagag tgggtgtct cagtaacaag catctgtatt 1695720

tccagagctt ctatgatgag gtgggaggta gagacaagag aaagcttaag tccagctagt 1695780
ctggcatatg caacagtga caagagacc ccatctcaaa caaagtggaa gatgaagact 1695840
gacaccaag gttgttctct cattgtaca tgtgtgtgt ggcatgtcca tgctgcatag 1695900

ctgcacacac acacgcacac acacacacac acacacactg cattgaggcc ttgaatggct 1695960
 acttttgaca aacaacatgg cctagtctct gagagcataa gaaccacaaa atatatgctt 1696020
 tctgttgctg ttgttgtttg acatggttct gctatgtagc ccagtctagt gtggatccc 1696080
 ttatgtagtc caacatgatt tgtgatgatt ttctacccc tgcctctcaa atgtatctgt 1696140

 gagcttttaa ataagaaaag tgcaatttaa aatgagtga tcacttattc caattgctta 1696200
 ccctaaggtg gacaccctta cagaaagtac aggtggaaga aaagaacctt ctccgacctg 1696260
 tcatgctggg aactgaggc aaggcgtgag atatatatca gagactgtga tggatccaga 1696320
 cctcctgagc ttatagaaga gtgttgctct gtttgcccag ttcgtgcctt cctgtaacat 1696380
 ccaaataaga ttccagaaat agcttttcat atgtcccatg catacttcag catgcacatc 1696440
 cgtacacgca gagtccccg ccactcacag actaagaggg aagcctgcac atcagctctt 1696500
 tctgcaaaat acccaagctg ttctaggata cctgcaacca gtcacggtga tcttaaaatg 1696560

 agccaaggat tctggctgag caccttcaat ttctaataa acaacactag acacaacacg 1696620
 aggcttcaag catgatggag gaaagtgtgt tcaccaaatt tgttaagaca gtcttcataa 1696680
 aacagggagg agggaggagg agacagagga ctaattataa acttgcactc agtttacttc 1696740
 tgcttctcag cctggctgcc attgcaagaa agacacgtgc tgtgttagcg cctccctgc 1696800
 agccctccag gcaacaaaga gccacatggc agcttgaga aaagcaaca acagcaggcc 1696860
 ctacgcttct tattcttcat cactgggggtg aatgctatgc tccgatctgt ctttctctct 1696920
 catcttctcc acctagggtc aaagaacaaa cagggtcttc caataatcta acaaagaaaa 1696980

 gaatcaaaag tcacceaac caagatgcaa gctctgagcc ttgctgcttc cagagagggg 1697040
 cagagagggg gcagaatgat tcccaccaga tgctgcctca ctctgtgca gtgttctcta 1697100
 atgactctta ccccgctgt cattcttaa ggtgcagca gcatgctagt gtaaacagct 1697160
 aaaccagtg tcatgtcaag tggtaacaag gccactgctg gttgtttatt tatttattta 1697220
 tttattatt tatttattt tacaagcacc atgcacttag cagataaaaa cgagcatcct 1697280
 atcgtggct tcacaagtc acactatca accgtgaaaa aaaaataaaa caatgctttt 1697340
 gtttgacagg tgtgctcgg tgcccgtggt aggaagtca ttttttttc ccaggtgcc 1697400

 cattagcadc atgaaaaggc gagtaacagc tgcattcaca gggctttct gcagtgtcc 1697460
 actggtgagc acagcagagc atcctgatgt cccctccaat aaagagaact aattaccctc 1697520
 caccgtacca cctgggcttg agacaagctg tgcaggaaa gggctttgac aaacacattt 1697580
 atttgtccag gaccaaggcc agggccagca accgccattc ttctgatat cagaagggag 1697640
 ccagatgca acaggatcaa taaaaggctc agagttcact gagggtcag ggcagtacct 1697700
 gcagacaagg catctcctgg gagacaggac atgggcttcc aacatggagg cagtggtagc 1697760

gcaatgcaag tctgcataga gagtagcctg gcgtgtacac caggatgctg tactggttga 1697820

agttcttttc aaagaaagct gaaatatttg aaagttgtca aagagaagtg ggtgttgaag 1697880
agggaaaaat gttgttttct ttatgctaaa gtagttgatt tatagaataa tggtagtgagg 1697940
catgctgatg aacatgtgtt gacatgagta tggttgtttt atacacaggg aaactgcacg 1698000
tgagtgaggt gaacaaatgt atcacataca aaaaaaggca gagaactcaa gtttcctaaa 1698060
tagccccccc catgcatttt cctaggaagg agatagatac acacacacac acacacacac 1698120
acacacacac acacacacag agagagagag agagagagag agagagagag agagagagag 1698180
cttaaaaaga ctcatgaact caaaggacca ggatccttct gacttcagtg ctcatctgat 1698240

tctaactgc tcaatgccac aggatttagt gactaagggtg accaaagtgg ctttcttcag 1698300
ctgctgggca ttaggaagc tcttaggaac cctatgttcc aggccattt gtgaagtttc 1698360
aatgtggcaa acaagcaggt ctctgtctat tagttgcaat tctcccttta atttctttc 1698420
cctctgaagg gaaggtagga aggattaac cttcaattac tgataactgc cccatcca 1698480
agctctgtgt atacctattt gacagtgcag ctttgattat tgcctagtcc ctccctgccc 1698540
aatgccttag cctactgtcc agctcagtca gcaacagaaa gaacattcca tcagtcttct 1698600
gccaaagatg agtatgcaat taggacatgt ttctctctg gggatatagg ctacattta 1698660

acaactcacc tgggctgctg agatggccca gtttgcaaaa tgcttgccac acaaggacaa 1698720
ggactcaagt tcaaccccag cattcacata aagacaaaca aatcaaaaac aggcccagtg 1698780
gcacttctta gtattggagg atctccggag cccactggcc agtcagacta gtcaaatgg 1698840
tgacctgtga gafactctat tggaaaaaac gaggtcgaca tctcccaggg aatgacacct 1698900
ggatttgacc ttigacctcc ataagcttgt gcacacacag aattcaccac acaataattt 1698960
tactacatc aaaattcaat tcaagaatta tgaactaaaa tgccaaatta tacagccatc 1699020
agctcctaat tatccatgca tctgaacaat gcaaaaataa gacctcaaac ccgattaaaa 1699080

ttcaggataa tttcatccag cccattttgt aatcttctca gtcacaagt catttgttgg 1699140
aagtttatag actacctatt cacagagaca gctaattata cgcagttaa gcaagtccta 1699200
gaagttagtt ctaagctgag gcaccttcac tcttttgaga cttgtcgtga actagttact 1699260
agtaacaggc aaattattac tgcctgtctt ggccggtcct gtccacatct gtagtccagc 1699320
ttaggettca aaacaatggg cactacttca tctcctgaac tttctcgact ggggcttgat 1699380
gaagtgatgt cctgtgggtg gcatcacagc catggagaaa aacaccaccc accaaaggga 1699440
aaagctttgc ccacgggacc cctgggagga gccatttct cttctggtgt tccgactga 1699500

catttttaaa ttataatgac tccatatccc aaatgagtac taagaacatt ctgaatcagc 1699560
taattaataa atcaattgct cttcaggatg gcatttatca aattcacaac taatatgaga 1699620
gatgagatta gagtgggaaga cggcagctgc tcttccactg cttctagtag gaccatgctt 1699680
gagttctagc agggcccaca accttagccc tacgatgtct acatgcaaag catgtccatg 1699740
ctacctgggg tccaagtcca gtgtcagagc cattttatga aataacaaat agctgttgag 1699800
gtctgatgaa cagtgggtgt cctcttaacc agatcctgag catccatgga gtagtatatg 1699860
ctgagacagc ctcatggagg agccaaacta ggcaccgata cctagacatt ggcggttctc 1699920

acatggtttt taccctgttc atacagcaca gagatggcac ataagtcca aggtagacat 1699980
ggagcatgct ggigaattct tcatgccctt aacacctggt tcttcttttc taacctcag 1700040
aattgctgtc aacacgttct tgggtgtgtg gcatgggtgt tttgcgtggg tgcattgtgt 1700100
cacgagactg ttaggcaca gaaaacctta acttgggtgt tattccttag gtgctgccca 1700160
ccttttcttt ttttttttc ttaacttcca ctgcaccacc ctctcccaga tacagctttt 1700220
cattgacctg gaattcaaca tgtaggtggg ttggctagc aggccagtca gtcccaagga 1700280
cttgtgtatc tctgcaccgg tataacaagt atgtgtcaca tgctgcat tttttttaa 1700340

ggtgattctg aggcctacat gcaagtctt gtacagtcaa gcattttacc aactgagccc 1700400
agtgtgcact gctcttaact gtctacatag tgactccttc tcagacaaaa catcacaacc 1700460
acatgctggt agggggctgg tattgacagt gtgggctaga caaaggaata gtggcaaat 1700520
cccaaatgcg ttattcatca ataatggaat gacatagaac tagactagaa ggggagagag 1700580
agagaaagag agagagagag agagagagag agagagagag agagagagag gtccactgct 1700640
tggagaccaa tgggctaagc aaaggctcat tattggttga ggcctagtct gcctcacact 1700700
gatcaccccc actccttctt tataatcatca gtacgttttt ctctggagg agactttttg 1700760

ccttgtggag agagataatg ggccttgact ttgcagtcaa atagttaact aagcctaattg 1700820
gctctgcaaa ttacttagac agaactaat ctggagtgtg gatatcgagg gtataatgtg 1700880
tgtgtgggga atcagaaacg gcacattgtc ctacagagtg ggcatacaca aggactcgag 1700940
aagagaggat ggtgacagag ggagacagaa ccaggctacgt gactgtacta gactacagag 1701000
tgggtgtccc agcgctgtga tggaaacaat gtgaaaagag agccagaagt ccaccaatgc 1701060
aagtggctga gggatgagca tcacaaatgt gtggccagct tgggatacat ataagacct 1701120
caaaaaaagg tagggacaat ggaaagatag ttcagttggc aaaatgctta ccatgcaggc 1701180

gtaacaccta tacacataaa aacaaatgtt taaaaataaa aataaagtag gacctagaga 1701240
ggtgtcctag tgcataagag tacttctgta gtaagaagga ggacctactg tgggaggaca 1701300
gcgctcatgt aaaaggctgg gtgtgtctc acgagcctgt agcctatggg ctgtgtggag 1701360

accagatggg agaatctttg gggcttgttg gtcaccagct cagctccagt ttagtgagaa 1701420
 attctgtgga gaatgataga gcaggacaca atgctcttct ctggctctac atatgtacac 1701480
 ctgcacactc atgcgcacac atccctccca acacacacac acacacacac acacacacac 1701540
 acacacacaa acacaccaca cacacacaca cacacacaca cacacacaca cacacacacg 1701600

aatgaaaaca aaggaagcaa tttttacca aagtcagggt gtctgaatca ggccacattt 1701660
 acagagacac tcagaagtca agggtagaaa agtttagtgc aaagaaatca tttttatcca 1701720
 ctctctcac gactgtttag agatcttata acagacacta tctggagtta ggctggctgg 1701780
 agaccaaggt gaagcaggaa gctacttggc atgagtcatt acccattcat tgttgggat 1701840
 ttttaaccagg ctctctcac agcattttct aggactggat ttcttgtttg tttgtttgga 1701900
 gacaaggaga ggtgtgtgtg tgtgtgtgtg taacattggc tgttctggaa ctactcagg 1701960
 ctaatctaga actcagagat ctacctgcct ctgtttcccg agtgcctgga ttaaagggtg 1702020

gtgccacat ggctggcta gggctagatt ttgtatttct tcttctgtaa aatctatggt 1702080
 ggggtgcaga taatagtttt gcaaataacc tcactcctt atgcttcaca ttatgctaat 1702140
 tctgagatac aaactgaata aatacacagg tcatttccaa aatgatTTTT atttgcctga 1702200
 cagattgaat ctgtgcactt gtaaaagtac agttggttaa gtaaatcttg aggcagaggc 1702260
 aggtttagca gggcagtgtt gctctttaac ccttcatct agaaggcatt ttttagggtg 1702320
 tgaggaaacc ccaacatctc tatcaacaga gatgtcacag agtcaaaat gctccaagca 1702380
 ctttctcaca gttattttaga agacttgaca gtgacgaaaa gttggggagc tggagtgtgt 1702440

ttccctccat tctaaagatg actattttgt caagcctgct tgatcatttg atgctttaat 1702500
 ttccctacct acatgttgcc aggaaccttg ccaacaacat cagggactgt aataagccag 1702560
 ggcaacacgg tatttttagt ttatctgcca aactctcacc aaactaagat tttatttttt 1702620
 tggttgggag actcttgatg actgetccta tttcatttgg ggttataggt ctgtttaaat 1702680
 tgcttatctg tttttgattt aatttttcta actgataact atccagaaaa ttgtccattt 1702740
 cctttagatt attgaatttt gtggagtaca cgttttcaaa gaatgacctg acgattctct 1702800
 ggatttecte agtgtccgtt gttatgtecc ctttttcatt tctgattttg ttaatttgea 1702860

tgttcactca ctctctgcct tttggttagt ttggataaag gtttctctat ctgtttgatt 1702920
 ttgtcgaaga accaactcct gtftacgttg attctttgta ttgttttctt agtttgtact 1702980
 ttattgattt cagctcacia tttgattatt tcttggcatc tactctccg gggtagtttt 1703040
 gcttcctttt gttctagagc tttcagttgt gctgctaatt ctctagtgtg actattcttt 1703100
 agtttcttca tgtggacatt tagtctatg aactttctc ttggcactgc tttcaaagtg 1703160
 tcccataagt ttgagtatgt tgtgtcttca ctttcattga attctaggaa gtctttaatt 1703220

tcttccttga cccaggaatg ttgcaattat gcactgttca atttccatga gttttaggg 1703280

tttctgcaat ttgtcttggt gttgaattct aactttaag catggtgatc tgataagata 1703340

tagggggtta gtccaatfff tttttgtacc cattgagggt tgctatgttg ctgaatatgt 1703400

ggtcgaatfff agagaaagt ccatgtggca ctgagaagta tattcttttg tgtttggatg 1703460

gaatgccag ggccagatag tttcagtgca gaattctatc agaaatcaa agaagagcta 1703520

ataccaatac tecttaaat gttccacaca atagaagcag aaggttctat ttttacaggg 1703580

ctacaattac ccaggtacc aagccacaca tagacacaac taggacagag aactacagac 1703640

taatatccct catgaacatt gatgtaaaat gatgtaaaaa tactcaataa aatactggca 1703700

aattgaatcc aagaagacat ccaagaaatc atccaccatg atcaagtagg cttcagccca 1703760

gggaagcagg gatggttcaa cacatgaaaa tccatcaaag taatccacca tataaacaaa 1703820

ctgaaaaaga aaaaccacat gatcatctcg atagatgctg aaaaagcctt tgacaaaatc 1703880

caacatccct tcacgataaa ggtcttggag acatcaggga taacaggaac atacctaac 1703940

ataataaaaag cgatatatag gaaaccaaca gtcaacatca aactaaatgc agagaaactt 1704000

aatgtgatte ctctaaaatc aggaacaaga taaggctgtt cactctcttc atatctcttc 1704060

aatattgtag ttgaagtctt agcttgagca acaagacaac aaaaggagat caaggggata 1704120

caaatggaa aggaagaagt caagctttca ctgtttgcag atatgatagt ttatgtaaaa 1704180

actctaccag ggagctccta cagatgataa acaccttcag caaagtggca ggatacaaga 1704240

ttaactaaaa aaaaaaaaaa tcagtagccc tactatatac agacaataaa tgggcttaaa 1704300

acaaaaatca gagaaacatc accctttaa atagccacaa acaacataaa atatcttggg 1704360

gaatgataac tgaacaagtt aaagacctgt ataacaagaa ctttgagtct tcacagaaag 1704420

aaattaaaga aggtaccaga aactggaaag atctcccatg ctcttggata ggtaggatca 1704480

acatagtaaa aacggcaatc ttgcaaaaag caatctacag attcaatgag attcccatca 1704540

aaatcccaca caattcttca cataccttga aagaataata ctcaacttta tatggaaaaa 1704600

caaaagacc agactagcca aaaaccagg atagccaaaa atccctgtac aataaaggaa 1704660

cttctggagg catcacaatc cctgacttca aactctatta cagagctata gctttgaaaa 1704720

cagcttggta ttggcacaaa agtagacagg tagaccaatg gaatagagtt gaaaaacct 1704780

gatatlaacc cacacacttt caaacactg atttttgaca aaaaagctaa aattaaaca 1704840

tggaaaaaag aaaccatctt caacaaatgg tgctggcata actggatgct gtcattgaga 1704900

agactgcaga tagatccata tctgtcacca tgcacaaaat ttaagtcaaa atggatcaaa 1704960

gacctcaaca taaatccagc caccctgaac ctcttagaag agaaaatgag aagtaccctt 1705020
gaacaaattg gaacaggaga ctgcttcttg aacataacac cagtagcaca gacactgaga 1705080
ttgacaatta gtaaatggga cattctgaaa ctgagaagct tttataaggc aaaggacata 1705140
gtcaacaaga caaaatagca gtccacagaa tgggaaaaga tattcaccaa tctcacatct 1705200
gacagagggc tgatcatcaa aatatacaat gaactcagga agctagccac caaaacacaa 1705260
aacaatgaaa ttaaaagtig gagtgcagaa ctaaatagag aattctcaac agaggaatcc 1705320
aaaatggctc aaagacactt gagaaagtgc tcaacatcct tagctttccc ttagccatca 1705380

gggaaatgca aatcaaaaca actctgagat accatcttac tctgtcaga atggctaaaa 1705440
tcaaaaacac caatgacagt ttttctgga gaggatgtag agaaagggga acactcctcc 1705500
actgctgggt ggatgtcccg cgtgattgtc tcgccagcaa gaacaacaca ggacattcag 1705560
atccttttgc agtaaagctt ttatgcgtct tgagagagag agcataagct tacagagcgg 1705620
agaccccgag ccaagaatcc cgtcccctaa taaaggctgg caaccgctgc cttggacgtg 1705680
tcaccccatg attggtgca gctcatcgga ccatatgacg ccatggaagg ggcagagatc 1705740
aaggaatgga aagttaccca gcgcctgtgc aataacttgt ttacattcgg tgcctgccgg 1705800

atgcaggcgc catcttghaa tggagaatgc agggacggct ccctacagtg ggagtgcaaa 1705860
ctcgtacagc cactttggaa atcagtatgg cggttccaca ggaaaatggg aatgagtcta 1705920
ccacaagatc cagcaattcc aaagcagggt gttggtgggt cacacctta atcccagcac 1705980
tcaggaggca gaggcaggcg atctctatga gtttgaggcc agcctggttt accgagcgag 1706040
ttccaggata ggttccaaaa caatacagag aaaccctgtc ttgaaaaaac aaaacaacaa 1706100
caacaaaaaa aatccagcaa ttccactctt aggtataagc cccaaagatg cacattcgta 1706160
caacaaggac atccgttcaa ctatgttcat agcagcatta tttgtaatag ccagaacttg 1706220

gaagcaatct agatgccctt aaactgaaga atggaccaag aaaatgtggt tcagttacac 1706280
aatggagttag tactcagtag ggaaaaaac aatggaatct tgaattcac aggcatatgg 1706340
atggaactag aagaaccat cctgagtgat tacttcactc agtcacaaa agacaaacat 1706400
ggtatgtact cactcatata tggattttag acatagggca aaggattatc agcctacaat 1706460
ccacactgcc agagaagcta gtaacaagg aagaccctaa gagagacata catggtcccc 1706520
cggagaaagg gaaagggaaa agatctcctg agcaaattgg gagcatggag ggaggggaga 1706580
ggaagttagg agaaagagaa ggggagaaga ggaggggaga agaaggtatg agggagcagg 1706640

aagattgagt caggggaaga atagaggaga gcaagaaaag agattacata ataagtttaa 1706700
agagaaatct ggcactaggg aaatgtccag agatctacaa ggatgactcc aactaacaat 1706760
ctaagtaaca gtgaagaggc taccttaaat gctcttcccc aataatgaga ttgatgacta 1706820

ccttatatgc catccaagag ccttcatcca gtagctgatg gaagcagaag cagatacaca 1706880
 cacctaaaa cactgagctg aactctggaa tccagctgca gagagggagg agtgatgagc 1706940
 aaagggatca agaccaggct ggagaaacc acagcaacag ctggcctgaa caaggggttg 1707000
 ctcacagacc ccatactgat atctgggaaa tcagcatagg accaaccag acccccacc 1707060

 ccaaatgtgg gtgtcagtta ggaggcctgg gcaatctatg ggcctctgg cagtggatca 1707120
 gtatttatct tcagtatagg aatggacttt gccagcccat ttcacataga gggatactct 1707180
 ctcacctag atacacagag ggagggccta ggcctgctc cagatgatgt gacagacttt 1707240
 gtaatccacc atagaaggcc tcacctccc tggggagcag aaagagtatg ggacagggga 1707300
 ggaggggagg gagggggacc tgggattgac atgtaaaaca agcttgtttc taatttaaat 1707360
 taaaaagaag gaaaaaaga tttcattttt tctttttaat tattttttt gtctgtaagg 1707420
 gagttgaagg aagaaatgat ctactaggaa tagatttaa tagtatttcc catttaaaca 1707480

 tgtattttaa aaagaggcac tgggttctat gacgtttggt agcaaatgga gtttctcct 1707540
 gcagcctttg tgatttcatt tgtgtgtgcc ttaggcaag caagcagagg cagagcagga 1707600
 tggcaggtgt ttctcttag agcggacct attattgcct tgagatggga tettttagag 1707660
 gactgaaagc ttggctttct ggccaggctg gctgtccagt aagtgctggg gaatctacct 1707720
 atcttccctc tcccccaag cattggggct ccaggcatgc acagccatgt acagtctttt 1707780
 atgtgggagt cagggattcc aattcaggtc ctactctcac cctctgagtc atctctcag 1707840
 cccaattcg tctgaaaaac atagccgct gcactttgt ttctggcctc ctccatact 1707900

 gaaaatactt actgctcact gttatcgaga gatcctgtaa tctagaaat caagatgatt 1707960
 cattctgaca ttttggggaa aacctggat gggttttcca tgccccactc agctctttga 1708020
 taagtatagt ggctgggggg tagggacacc gaagtgtat aatgagactg gatggctctg 1708080
 ctctttttca catcgttcca ggagattttc acagttcaca ctgaggattt tetgaatcta 1708140
 tgaaaaggca ggccagagac agaataatgg gattgagctg tttctgactt gcaaatggtg 1708200
 cacactacac cactccaaga atcctgcccc ctcccttctt ctttctcca tcatttaggg 1708260
 tgtgtgaaat tgcaacatta aagaaacacg catgctgttc ttccttctg ggtcagtatg 1708320

 ggctgctgct agttgtggca aaagtgaaga gtggggcaca gagggcaggg tttctaggca 1708380
 agttcactcg ttgattcagt ctactcgta aatcatgaaa gcagtttgca gtgggttcta 1708440
 caacagtccc aggtgcaaat ttcacatgca tttccaggtc acagggagct atctccgaa 1708500
 caggattttg agtctacata ccaagccttt taactgtgat ttagggagct gaaacagat 1708560
 taagacacag tgcagtggct ggaagatgac tgcattggcg aacacaacaa ttaaacacag 1708620
 gagtagcctt caagatgct tctagccatg tctgtctact gatgacaaa ctcacagtaa 1708680

tggagggata cagtcttagt gactgggact gtctatgatg cttccattgc tgtgagacat 1708740

 ttggctgaaa agctaagcta agttcttctt ggaggaatga gtaactagc agcaaggtct 1708800
 ctcaaaagc aaggggcctc atcatctagc agcctgttgg catgggactt gagaaatgga 1708860
 attcaggga gtttgtttgt ctatttgttt atttgatagg atggttgatt tgggcagggg 1708920
 agtatgtag cattttctaa tcttatccat ttgatctaat ttcctcttaa gcataaatgt 1708980
 tagtaaatga tatattgtaa gtgaccctgg ggtgtgcaat ccttttctt ttaatacact 1709040
 tttccattcc gacaaggagc ttcagtggct tggaaatac ctcttcaatt gacaaaggaa 1709100
 gccccattt ctaagttttt aaaccattag tggctgatca gttgtaacaa atacggcacc 1709160

 actactgctg ctgcacctaa tgattgaatt ttaaataatc atgatggatg gctgtctgtg 1709220
 tgtgcacacg gaaatgacag ctctgacggc tgcttctcac cagggcaccg ttacagcaca 1709280
 ggcagaagct gcatatgtca gatatttttt ttttctggct aaatattcca gccattaaaa 1709340
 aaattattct atcatataga tacagcagca tttagcgtgtg agatctatgc atctacacat 1709400
 acaacaatgc agaaatggaa aggaccatt ctactgcct cctctgaac cccaaatggc 1709460
 cttttaatga ctgagagaaa gcaactgagcg gaccagcaat cctggaagtg getactttgg 1709520
 cgtactgtga ttttcagtga tttaaatttt cataatttta cttatttgca ttaaaaatcc 1709580

 tctactaac aacacattat aataagataa aagttcatta aaaaatcca agctaagcaa 1709640
 aatcacaatg tcataatcaa attctgacc aattgaaaga ttttgggaaa ttgtactcac 1709700
 aatttatagt tattatggaa agatagtaag ctgtatctaa cttttagctc tgaggctata 1709760
 agtgaggttt ttatttttct ttaagacaat tagtttttgg aagaattcaa tagaggatat 1709820
 agtaattaga aaaggagat gtaaaatag tgtatgtgc aaactatatt atagcaaatg 1709880
 tatctttggt tactatttgt ggtccagatt ataaagaagt aagaaaaatt acccaagttt 1709940
 cagactgagg gggagccct agtctcattt ttccttctc tttccttctt agcaattcct 1710000

 acggcccctt cacagcctcc tccagcaatg ttcttctgga tatttatatg aaactgtg 1710060
 gccagtctg tttctagatt gtatattcag accatctgat tttcaaatgg attcatggtt 1710120
 aacagtatat atggccatcc tgaccacaga aaaggagtgg tgaagagggg aagaacaaca 1710180
 cagatatcgt agagagcaaa actacacaca ctaaaactgc tctatctgtc gagctttcaa 1710240
 gaccagtaat taagtggta agagggaaaac agtataaatt gcttgctat gatcagttcc 1710300
 tggggttccc tgcagaaaag gattagggta aaatacattg aaaggaaggt tcagcctcta 1710360
 taacatagat gtggaaaac agacaagatc tgacccaca gctgaccctt aggtacacta 1710420

tgggtatggg ctgggcttgt atcaagtgtt tgttcaaggt aaaaaggagc aaagcaaagt 1710480
 tgggaatgat gaagaaaaa ggagctcctt ggagaaaaa acccaacaac ttcaaactt 1710540
 gaatgtgaaa ctttgaatg ctttgaatg ctgtggcgcc tgcctactac acaagcccaa 1710600
 actactagtc aacccaaatg aaactgtcat ttgttacatt ggctccatct tatcaaaaga 1710660
 gcccttaatg ctgcatttgt gtttcagagt atttcctgga aatgtcacat gaaattcaga 1710720
 agaatcattt ttcccttaat tgttaccatt tccaataata tttgttcttg tttcataaaa 1710780
 cacacatccc atgacttaca tctgatttat aagcaaatta cattgatatg gctaatcatc 1710840

 tctttagtct gcttaatatt ttcacttgtc taatagcaaa ttttatttac attgcgtatg 1710900
 tcctcctcg acicaatttg tggctagctg gttatgcat acctggaact agattaacac 1710960
 aaataaaatt taaaaataa agtggctctt tatgaaatct aagctctata gaattctgta 1711020
 taaaagagtt atatgaacat ttaaatgata gcaaaatagt ttcaagacaa cttcaagtca 1711080
 ttactgtctt agcatctggc taggctcact gtgtaattaa agcaccaga tgcctgact 1711140
 tgtcaaaaga atccttaata ctgtagttgt tctggtgaac cctttagtta aggaccctt 1711200
 acatcctcaa aggtgtcctg gtttggatca tacatccaat gttttggcgg tgactttcta 1711260

 ctagttcata agggctaagc tgggtttcca acatgtagta ctaagggact cctcaacctt 1711320
 ccatgttttc ttgcttcaa aacagactaa tgacaataga gcttcaagtg tgtgtggggg 1711380
 ggtagagaga gagagagaga gagagagaga gagagagaga gagaaacaca gagagaaaca 1711440
 gagagaaaca cagagaatgc taaaggctaa tgtcagatgt catcagtttc tctccacctt 1711500
 atttttgaga caggttttct ctctgagcct ggaacttact gattaagcta gactgtctgg 1711560
 ctggtgagct ttgttttctg ccttctcag tctgggggtt acagacctga tcctggaggt 1711620
 caggatttga cgtgggtgct aggtatcaa actcacatgt tgtgggatgt tgtacactgt 1711680

 gggagatat gttgctgtga ttggtttaat aaagagctga acagccaatt tctagtagg 1711740
 aggtagaggt ggaacttctg ggcagagaga gagaggaagt aggagatgaa tctagatgcc 1711800
 tgggagacac tgaagaggtc acacacattg tacagagtag gcgtaactga gccacatgac 1711860
 agaatgtaga ttaatagatg caggttaatt taagttataa gagctagtgg gggacaagcc 1711920
 taagctaaag gccaaagcttt cataatcaac aagaagtctc cgtgccatta tttgggagct 1711980
 ggctggcagg acagagaaag actcattaca ctcaagtttt tatggctatg tggcacttta 1712040
 gcaactgagc caictcccca gtgcctgaga gcatagcctg tgaggtgcat acaggcctct 1712100

 gttagaatg aaggaagact attttgcaag ataaagagag cactctacca aagcatgagg 1712160
 tatgactggc ctgatcttc agctttgatt acaataaatg tcccactt atgctaacc 1712220
 tcatgttctt gtggtccagg gaagggcaca tggtagaga caggatgctc ccagaccct 1712280

gccaggccta cagaatcaat gatgctaaat gacagattat acaaaacgat gctttccatg 1712340
 gtccatgtca ccatcagaga cattttcatg gacaagccca tgtagaagtc tcaactgtcca 1712400
 ggagtagcaa ctgaagagga ctaaaccaga gtcctcaggt caagaaatft gtgtctcaag 1712460
 ggatcacagt gcaatgtcac ttagaacaaa tgcttttgag agatagaggc aactcttgtg 1712520

 ctgcatgttg gtggggacgt gggttacctg gggggtttat ctagatgaca gctgtcacat 1712580
 aagttattct ggtaggacat cctgetgtgt tgctggctct aacctaggtg gggaaatcata 1712640
 gacttacctt aggacatatg gttgtggttc taaatctcca tccacagcct tctaacattt 1712700
 gctaagtcat ctatgtgctc tcgcccagaa gaaagggaaa tcaagcttac ttaatcacta 1712760
 acccccatct acgttcaatt taaatcaatg gatctgagct ggaagctgtg catctcaggg 1712820
 gcctttacca ctagagatgg gcacactgag atgtctgagg tttccaaaag agctgcttga 1712880
 ggatgagcag ggtgcagctg gacaggtgtt tatatatata gtgatcctgt tctctttcta 1712940

 tttgaatatg aacttcttcc tatgtacat gctggtaggt aataaatctc aggacctgac 1713000
 acctctggag gtctggcgca acgaagctac ttcaagataa aaaatatttc aggcaaagag 1713060
 atgaaaggat gtcagaacaa aaagtttatc aatgtatatg ttagagaaaa gaaatctgtc 1713120
 ccagcaaaat ggcttcagga atgttttaca gtgagagtca tttccaaaag gccctcttc 1713180
 attctcttcc ttttttaca cacacacacc aggcttatca gcctgggcac acatctgcag 1713240
 ccatagcagc cactcatctt tccgtacgat tacttgaagc accagagatt taacaaagaa 1713300
 ggaaaaataa tcaaacatg atgtttctta gcgctagaat gttgtgtttt tgtggctgcc 1713360

 tttgtaaagt gtgcttatgc acaggatcgt ctctttgtcc cactcttcca cagtttctat 1713420
 cattcagaga gactggctca ggttgggtgga gaaggaatta ctagttttaa ttttcatctg 1713480
 gcagtaaaaa tttttatgag gccataggaa tacaaaataa actcataatg agaaaaataa 1713540
 ttataggttt ctcatataa gatccttata aaaaatggtt atatcccaa ttagagctca 1713600
 ggaaactctg agtcaccag tagggctgtt tacattatac tccttctgag ggcgtggcca 1713660
 ggttctgtct ctgccaggt gtttctggg gaactccaga ggctcaggcc tctttcagaa 1713720
 tcagttcatg caggcagcac tgcccccaag catctgcttg gggcaacccc atgcctttct 1713780

 ttacttccag ataggagttc agtatatgtg tgatgagtgg aaaaaagaag agcagacgaa 1713840
 gcagccaaat gtattcgga caaagtgtat gtgtgctgca aactggaagc ctggttggct 1713900
 agttgcaggc tatttattct gaaacagaaa ggtgatgaag gctttggcca catgtgaagc 1713960
 tcatactcaa atgggctaag agaggagtac aggagggaaag gtcaccctg atggtgaaac 1714020
 catatctgta aggatctgag atgccggaag cctgggtgga cctcagctct ctctccagc 1714080
 ttagagtctt tctgggaggc ctgagtgagc aggctgctc agtccatttc cactgaggag 1714140

aaaggaatg aatggcttct ccctgatggg catgtagtaa ggttgactaa aagtcactg 1714200

 cccaaatcct gtggagctgc aaagtgggtg agttggagtg agtgacacag aagccatgca 1714260
 agggcctgca cctttcagaa agcaatcctc cactttctaca ttctggggag aattagggtta 1714320
 ctctggcacc ccatctcacc cacccaaagg tagtaaatca acaatcataa cctttactat 1714380
 tattgaggaa tataatctgt aactcttaat aaacatatac tgaacgatgt ttataacat 1714440
 taacatacac ttaagtcaac aacaaatcta acacacaaag atgaggaaaa tcaacagctt 1714500
 tctaagtgtg gatgtagttc tgaattttaa attctagcag ggggaaaact gatgaaaacc 1714560
 accaaaagga aacagaaata caacatcaaa gggcagggtt aatcagcata acaaagtact 1714620

 gtgatttaaa caatacaaag gacctgaagc aaacgggcac tacaacatc agtgacatta 1714680
 ccacccaaaa gaaagagggc agaaaggcag ctttgcctct gcaactggct cactgagggc 1714740
 aagagctga cagacattta aaggagattc acgaagatgg gcaggggagc tgtgattccc 1714800
 tgggctgtgg gcatccagaa aagatggggg tctcagtttg tgctcatgac ttccaacacc 1714860
 tgcaaagcca ggagacaggc aatgaaggaa ggcttgcccc tgcatatgat gggggtgttc 1714920
 ctaccccat gaaaggtcct acccccatga gctgaatgg aacgacttct cataacagtc 1714980
 tcttgctggg ccaggcattg gtggctcaga actttaatcc cagcatttga gaggcagagg 1715040

 taggtggatc tctgtgatt tgaggctagg ctggtctaca gagcgagtgc caggacaggc 1715100
 tccaaagcta cacagaggaa cctgttcttt gaaaaacaga acaacaaca aaaatagtct 1715160
 cgtgttgga attaagaaat caaacaggg ctggggagat ctcggtcag ctcaaacaca 1715220
 ggaacctgag ttctgatctg cagaatttat gtgaatagaa ggtcagggtg ggtgttgcac 1715280
 ccctgtaatt ccaaggcagg acagtggaga tgagggtggac ccttggtaac tactgtccag 1715340
 ccagcctggc aaattccagg caaaagagac tgtctcagac aaaatcatgg tgaatagtga 1715400
 ctgaggaaga catgtaaggc taacctctgg cctcacacac atgaccacac aactgagcac 1715460

 acacacttgc agtctcataa acaggatcag tacacggatg gcaagtttcc ttgctcattg 1715520
 tctcatctaa tagtcagccc catgtgtctt cgcaattaca gaattgccga gattgaacat 1715580
 taggggacat ggaggccacg catcaattca tcaagtggcc atccagcctg tggacctctg 1715640
 gtgacaaggt cctcatttcc tctgaacag gttgctacca cccctgagca gctgtgaata 1715700
 ttagctcacc cttctgaga cagagcccaa atttgtcttt ctgaaggatc cacttttggc 1715760
 ccctgggtag aaaataaatc taaacctctc ccgatacagag aacctttcat attagaaaat 1715820
 gctattatgc actagcagag tctttgctac ttcaggcaaa atacactcaa ttcctttaac 1715880

ctccatcac gtgatcttaa gtttttcaac ttcaccagtt actctcctct cagctcagtc 1715940
 tggttcttac agctctttac taacagatgg taagggcctc cctgtgaggc ttactgtatg 1716000
 tttctacgag gctgaacata gtacctgcaa catttcctgc atgaatacaa tgcacagcac 1716060
 cttgatagcg tgatttcagt gctgagtctc aactgatgc tggaacattt atttttggtc 1716120
 agttccaaat tacaagtatg ttttagatct gtttccccac catcagtaaa ctgtattgat 1716180
 tccattcagt ctcatgtcat atccgactaa taaatgtgcc cttataactc aataacctga 1716240
 attcatacaa atatttgcca ggatattact atggctgact tgcctgggta ctcttgacgt 1716300

 ttctgctggt gttgtaatac caaaggaaat gattgtgttt agtgaatta caagatttag 1716360
 gtttaaaaag gcagttgttg tcagttggct gaatgctgaa tgcatgaatt gcacacaagc 1716420
 agtgtgtgca atcaaaacca ctgaaagaag taccgtgctc tgagatgtga aggtctcagg 1716480
 tggcgctgtg gccgcccgc attttggggt cctgggaaaa gagcctatgt agatgctctg 1716540
 catggtgctc acatgtgctt tcctccttta gcagatgctg ctctgtgctc cccacgtgct 1716600
 agcaacactg aacatacaca ggaagtaaca cctgctagac tggagaacta accagtcatg 1716660
 gagaaacca gaaaatgagc catgttcaag atggaaagaa accactgctg gaccagaagt 1716720

 aactataacg aaatttttag gatgacaggc tcattccagg gctgcatca aggaacaaga 1716780
 gcaaaacaac ggaatctgg ggtgggatat tcctcactct tgaacacaag ccatggacac 1716840
 aaacctatgg atggacacac accttcatat ccactaagat ttgggaacac aaaagagtca 1716900
 ttttatccca tgaatatgtc atctatctca taaatattg tgaaaacttc tttaaaatc 1716960
 ctcagaactg tgccacttaa ctggttccag gccagcccc ttcagtttct catttgaatg 1717020
 catgttttgc ttiactaagt aaacttctgg ttaaattgtc tgtgtctctt gagtgaattc 1717080
 tttcctctga gcagagaagt acgagaaacc tctgtaacat gtccactcat gtggttctct 1717140

 acccctgcct gtggteccft gggctacatg tgatctagct gtgccagat gtgctgggtg 1717200
 agagtggatt tgcctcttaa tgattcttta tccgggggac aagatctggc aaaggagatg 1717260
 atctgcagtg taccacacac agatgaatga gtggctggta agtctgtgcg tgccatata 1717320
 ggaagaggaa agcaggggct ccggacacca aactcttaag tgtcagtgat gatcttacga 1717380
 tgtgaagcaa tacagaccgg gtggatggca gccatgcaga cctgataggg gaccagcaaa 1717440
 gcagcagatc ctgaaagatg agctagaaca ttgttaggct cactcctgg tatgcctggt 1717500
 cctgctccta gccttccatt cagaatagct gattactcat agctggcctg ttggcttgac 1717560

 ctgggctcaa cgatcagttc ctgaacactg aaagccaaca gtctgctttg ttccactgct 1717620
 tgctgctggc gtgtttggga gtggggagct ggaggaatct caagcagttc acttctgagc 1717680
 tgagagtgga tgaggctaag catggacagg ggtgctttta ggacaactga gaactctggg 1717740

tctagatttg tgccgcaaag cttgactggg tctcttact tatccctcga aaatcactcg 1717800
gtgtttttga ttctaacc aactaatttg tgaatggag acatagtcta atgttgaact 1717860
accatcaggg ttttctgcag ctctgcacag tatatttcgg cataactgga agtgcctatt 1717920
cttgagctct acaaatagca taacttcaaa tgcagcaaca atctttctcc atttggttag 1717980

actgtcgatg agctgttcca atctcacttt tctacaaagt tacccttcc tttttctctt 1718040
tggagaatta aaattaagct tcccttctgt ccttctctag ggggcgtgac caggtggaat 1718100
gtctgttggg gaatgagtc agggccagca tctagcagga gggggagggt gggaaataag 1718160
atggtgccag atgacctgg ggggaattca ttactgtcat ccctgctttt agctacaaa 1718220
ccatcattct tggccttca tattecttgc cattgaatca cagagccgcc tggcctctgt 1718280
aaaagacct ttcttcatt cttaactaa acacaataat agattaaaag gtctaacctc 1718340
tgtagagctg ggctggggcc ttaccttctt tcccttctc catttactct ccccaacat 1718400

caactgagca ctcttgaagt ctgtgcctca atctccatc ctttcttgag ttgtgcttct 1718460
tggagccttg tctgtctggc cccaccctg ctttagaac cttgactgac tgggcctttt 1718520
tctggccata ctactccta tagtctgcag ggtcaaggta ggagacattg tccacttec 1718580
agcccatgct ctggatacag gaaaccact tccaagttt ctcctgagg cctgtcttcc 1718640
ggcactggta acattgctaa cccaggatga gatggtgtt gtgatggacc ctggaggtgt 1718700
aggtaigtgt gtctcagtg gggaggcctc tgtgtagag cacagagcca gagctgtcca 1718760
gggaagctct gtggtcacac ccaggaggca aacatttcac attcaaagct gccgtctgct 1718820

ggctctctga aggtatactt gtcaaggact gttagttgag caaactttaa ctgggtggg 1718880
ttttagctca atgtataatg attcaataca aggtgtatgg tatttact acggcttag 1718940
cttcataaa tgttagggac atgactgtct tacctgccc ctccccaga aaggttcca 1719000
catgtcttct gactacatta ctatggattc tggctctgta ggacagaaca gtcaggcca 1719060
ggatttttag ccccttctc gtcgcccac tcttcttct ctcctgttc agccactgac 1719120
aaggcacagt ggttaactgg taacaagga agagaagtc ctgggtgtcc ccagagaggt 1719180
tttcatgcgc ctgggtgctt tcaggtcagc ctctgcccag tatggaatcc atctgcagca 1719240

ctaaccacag acacacagtg acctctttt ccccgtatt gatcttctc tcttcatgc 1719300
tgtattattt caccctctt ttctgaactg tgttccagac agaggagag actgtgatgg 1719360
aagtcggcca agcaaagac aagggtggg gagccgtgg caattcccgt ttgacgctaa 1719420
tgatttgtgt acaattcaag gtcagagaat gatatgtgag gcttgcgcac ccaccacac 1719480
aagcatacac aatttagtac ttgattatat cagcatatag cactaataca tctcataccg 1719540
cctgttact tgacttcca attagaaga aaacgtggag ggcaggacc acatgtgaag 1719600

cttccattgt tccccatcac acccaccacc ttattaggca cataataggc atttgataaa 1719660

taagttttgt taaaagaggc ttgcctctgt taatgaaata aatgtgttct tgaaatgttc 1719720

tgaataaagt gagtttctgt aaatggggat gtgattttaa tgacactggg agggttgcaa 1719780

caggagtatg gcaataaatc cttctacaaa ccaataaacc attacattcg gattgttata 1719840

tgttttttac cgtcttggac ctgaaccagg gaatccccag ttgtgatctg tgagtctttc 1719900

ataactacaa ccacatttat ttgggggaat gcatgcatac tttttgttg attttcccc 1719960

tcagctttt attgtattct caaagagatg tactacttct aactgccacc cccccccca 1720020

cacacacaca catcatctct ccatctctgt gtaatctggg ctggccttga gttcacggct 1720080

ctcctgctgg agictcccaa agtgcctgaga ttacaggcat gaaccaacac acttggtca 1720140

agcaatgtgc tacttagaac agaaaaagcc ataactcatg ggcaactgaa gtgggtctag 1720200

gtttctgaa aattaatgca caagtaaaga gaaaacaata gtcagaacta acattttattg 1720260

agcgtctttt gcatacgttt gtatgcaaaa ggcgctcagt aaaagtatca tatgcagtgt 1720320

ttcctacaag gccaacattt ctcatgttaa gataaagaaa ctacagattt acccccagta 1720380

catacactgc taccagacac tgtgtgtgag atttgaacca ggaatctgct ttcaaatctg 1720440

gaatcttttc aacaaaatag tctccaatct tatttaaat aacaagaagg ttcattgtaa 1720500

tgagaaatga ttaggtttaa gactatattg ttgtatgtgg agctgggaat atgaatgact 1720560

cagtctataa agigcttgca gtgtaagcat gatagccgag tttgatgctc agaagccacg 1720620

tgagaaaagt tcaacatacc cttggggaggc aggggcaggc tgatccctgg ggcactctgg 1720680

ccaacttgcc tagcctattt gtgagctgca ggccactggt ccatgctgtc aaaacaacaa 1720740

caaaacaaaa ccaaacccag atgaacaaac aagcaacat gatggggaat tggagaaatg 1720800

gttcaggaca tgggggaggg gaggaagcat gtgccacaga aacataaaga cattcccaga 1720860

atccatacaa ttgctgggtg ggtgtggcag tctgccaca attccagcac taggaagtta 1720920

gagatggggt tctcctaagc atgctggcta gcaggactag tcattaggtt cagctgagag 1720980

acactttctc aaagaataat gtggagagtg atcaaaaaga ctctgacgt taacctcagg 1721040

cttctaacac ttgaatttgt ttttcccaa catacatgta aacatgcata cctgtgaaca 1721100

taaacatata tggttagaaa aaaaaaaga tgggtggatc ctgagcagtg acatctgagg 1721160

ttgtcctttg gctccacat atgctccac acatgtacac ccattctcc tctccagtga 1721220

gtacattata ctcatgtcat aagtaagaag gtagacgtta aatacatgga aggtgctgag 1721280

ggtatatctc aagtggcaga atgctttttt ggcacactca aggtcaggga tttgatttct 1721340

gctacaagta cagaagataa cttggtacag tctctacatc tggctgatga atggggccag 1721400
cagctgaatc ccagtccttg cgttggccaa ggccactgct ctctaccctt ttactgatgg 1721460
aatggcctgg cttcctgaag atgcacacat catcagtgtt ctgactcttg gaaccaacat 1721520
aacaccatga ctgccctaga attgaattct ttctcttcaa attcctttag agataagtcc 1721580
aatcctcaa acattaacaa aatatttact cctaaggatg tgttaggtag catatgaacc 1721640
tcacctgtg tgtatgtgtg tgtgcatgtg tgtaaagtaa ccatactttg aaactataat 1721700
ttgggggact gtttctgact ggggctatct ataaaatcgg tgattatgta tttgatctgt 1721760

gcaaatgtgt gcccttccta tctagacaat cctctagaca atccacttct atacttagca 1721820
gggtcttggg gacaatgctg ttgataccta atatatatag aaagtggct atccaatcac 1721880
tcaggagtca ttgataccta attcattcca ttccaccatg cacctcaata ctacaagagc 1721940
aaattagtgt gtgaaatgat gctagctcat tgagagaaaa taatattgaa atttaggctg 1722000
aacatagaag cciggaagat actttcacc cagaaggaag gaaagcccaa gctttgaact 1722060
gaaagggccc tgagttcaaa tctctatcct gccatttact agctatatac tctggggga 1722120
aagtcacatg gcccttctaa gcccagctt tctggaatac aaaaggagat gacacctata 1722180

tgatggtgtg agaaaaataa atgaggaaat atataggctt catgcttaac ttcgtgttta 1722240
aagatgggat atacaaaaca acgaatggct tgtttctcca aacaggagaa atgatgcaaa 1722300
caaatttctc ttctctgtga gtgagtgtca cttctagggt tgaaaagaaa ctccattctt 1722360
acagtaaagc tacaggaagc aatgctaaa ataagtctct tcctgtgcat aggtttatcc 1722420
aaatttctt cccaatttta tttattactg ttgacatfff attgcttaa ataatcttg 1722480
gtgatccag gggagacaca gaaaggggtg ggtgctcttt cttatatgtc aacactggaa 1722540
taaattgtct caatctcatg tttgtgtgca aagcatgcaa ggaactggca gatgaagccc 1722600

ttgtggtatg ttgcaattct gcctcatgac cattagaata ggtaagacaa aactgtaaaa 1722660
atcttagctt gcagcaaaga caggggtgaa tgcctggcagc acagcagaaa catgtgattg 1722720
ctcacaagtt cctggggact tagctcttga ccagcaagcc aatgagacce atggagctgg 1722780
gaaatcaatg ttttcgaggc cccatggaac ttggcttccc aaaatcaatg aatTTTTTgt 1722840
tttgatatgc agtgccttc tgtgaaaatg acaaggaggc tgtggcagct ttaggatgtt 1722900
gcagacaaga attctttatc ttgagggaaa gataaatcta ggaacctggg aaagaggaat 1722960
tgaaaaatac ctgcttagat ccttgccaat gtcaggctag aaagtattaa ttctcaaaaa 1723020

gtcttacatt gcttgcctca tgaccctaag aattacagag cagaaataca acagcaccca 1723080
tatgcacact cagccacatt ctaccctaat ccaacagaag ataacagtat tcattagaaa 1723140
caaaaggtga gatgggtgga agagtgaaga ggaagatagc aggagtcttt tttcatctat 1723200

tcattacatt ttagtggaag ggctaacttt ttaggtgcaa gtgggaaact gaggccagtg 1723260
 tgggtgtgac accttcaggt ggctttctcc agccatcttc ctctatgcat gtgcacatac 1723320
 aggcaaaatt acatcatgct tctgagctca gatitggatt cagaaacctt ttctttgggt 1723380
 cctaggtctg gagctgactc tatgggtgtg gacagtcttc ttaatgcttg atgcccaagt 1723440

 ttcaagatca ctgaaaata ttggcacaga atatttcagt aatatgttcc tcaactctca 1723500
 tcagagtacc ttaacctctg cactgctggc attttgagta gacaattctt agctgttggg 1723560
 gctgtcttat ggcagttga ataattagta gcacatctga tttctacata ctagatacca 1723620
 gtagcagtat gtcctgtcc ctacagtggg gaatatcaaa actaactcct gatagtgtta 1723680
 aatgttcagt ggggtgaagaa catggctttg gcccaatcaa cttctgaaag atgagcataa 1723740
 ctccatcttt ctctttgaca aagattttaa tgtctacttt agaagtgtaa gaaatttcat 1723800
 aagtacagtt atcagggctt tagtttctc atcatgagac cattattttc aggccctctc 1723860

 ttgttctaaa ttctgtccct gaaaattcta ttctatctc atcaagaact caagataatg 1723920
 aatctccaat taaaaaccta tacaagtaat atatgtttta ctagaaaata ccagaaattt 1723980
 agataagcag aaaaaaatga agcaaaagac aacgaagtca cagaaaataa ggaagagaat 1724040
 tattacttat aatcaccta ctcagaacta ggttttataa aacacatgta tacacagata 1724100
 taaaaaatac acatatgcat acacattcat gcaacatccc aaatatttct catttgatta 1724160
 tcattgatgt cattaattct agcttaacct atatttttac tattgttact agtctgtcta 1724220
 cacgcatggg cgcacacaca cacacacaca cacacacaca cacttttctt cccatcatat 1724280

 acaatatact tcaaagaata actgctcaaa gtgggttagc atagaagcgg atgattatgg 1724340
 aatccacacc cttttctcc ttacagaat ttagcttta agtgaataaa cgggcaagcc 1724400
 aaacagagtt gacaattgct cacattggtc agctctcctt ctccagcaa ggggccatcc 1724460
 tcagtgttcc aaatcaaggt gtagaagtcg gacggggccc tctcccttc atacttaatg 1724520
 ctacctatgg tcaattcact tttctgtgac tttttcttg gatctatctc cagggtctca 1724580
 tgcagtgcgg acctaatat tttgttccag gtgtgctgca tctagcatc tctcctgcca 1724640
 ctcaatttga tcaagatagt tctcaactcc ttttggatgc ctgaaatggc ttctcaactgc 1724700

 ttcttggatc acaactaga tcttagtaat gtgcgctgga ggcttctcc tctccatgc 1724760
 aagccctccc aggacctctt tgtttgttc actattcatg ctttttactc tttaacctt 1724820
 acttccgagc ccaactgctt tccactcccc ttattgatga atattccatt caaagttagg 1724880
 taaatcaaag cccaggactg ccatctctca aacaaggggg gaaaaaaga acataaatga 1724940
 attatcttc tgttgacatt tcagttgcca gatgtagcta attacctgtc atattaatag 1725000
 gacatatttg tgttaaagat tatcgatcaa ttatttattt attttggttt caaaaccacc 1725060

aaactagggtg aagtgtgtca acttcaggta gcaattgtct tgtaacagtc tctcccttgc 1725120

 agcctatgca tagacttaat ccaaaggaga gcttgctttt tcccattaag tgggtgtacaa 1725180
 aggaagagcc ctiggatttt atcattcaag ctctggatg ggatagcct cagtactcca 1725240
 gcatttgctt acatggcaag agctctctgt ttgacctta gcaccgaaaa acaaaaaaat 1725300
 aatctaataca ttgtatctcg gataacatgt cactcttgaa tataaatagg actttgcatg 1725360
 ctgctatcat tttatgaaat cttttaaatc cagcttttag gagaggataa atttcttaag 1725420
 ggcaggggcc atgctttttg cttcctctgt gacgcttga gttgctggga acacagctgg 1725480
 gtgtgctgtt agtgggtccc gaatgaatgt tgctaggtga ttcagacttg aagaagaaat 1725540

 gaagagaaaa gccagggtc cagaggattt gtttgcacgc attttgcctc gaagaaacac 1725600
 aaatgtggag agaaatgagc atgtggacaa ctgagggtc ttggcccagc aatagtctga 1725660
 agcaggaagt tacaatgcaa ctaagagcca cagctgggtc gtggcctgga aaacagagga 1725720
 caaggggtaa aaacaataaa caccttcaaa aataagaagg cagagggag gacttttaaa 1725780
 gaggaatgg aaaaatcctg tcaataactg acttgggttt agagtgaata agacacaaag 1725840
 gtctctcca gtctgtttc ctgctttaaa taaaggcaaa ggtttcacat ttagccatag 1725900
 aattatactc tgiactgtga ggcataactt tgacaccagg cctgaagcta ctaaagagaa 1725960

 gggatagaaa catagcatgc ctgggagggtg gtgcatatt acttaaaacc tagcagtaag 1726020
 gagacagcag caggaagata tccaaggctg aggccagcct ggtctataga gttccaggac 1726080
 atccagggtc atacacagaa accctgtctt gaaaaacaaa caaacaaaca aacacacaac 1726140
 aacaacaaaa gaaaggaaga aggaaaggag agagagggag agagagggag gataggaggg 1726200
 agaaagaaac ggaaggaagg aaggaaggaa ggaaggaagg aaggaaggaa ggacggacga 1726260
 atgataggtt ggttggctgg ttggctttta tatgtttgga accagtggct ctgctcaacc 1726320
 aagcgagtct gaatgttctc accactgcca gttcaggtct ccccttccgg aacctcctt 1726380

 taccaatatc actttatgaa atgtcaaaag ccatcctgg caattatggt gttcacaat 1726440
 atgttcacaa attcttgaca ttctcttctg aagagagaat ctaatctccc ttccctagag 1726500
 agtaactgga cticattatt ttgctgctaa tgaatggaat aatgaagaaa gtaaagatgt 1726560
 gtgaccttga cagatcttg tgataggtc catggccttc tcttgatct cccttgaatt 1726620
 acctctcag aggaagacat ccacatgtc tggagagcag ccagggaggt cggctcactc 1726680
 tggaaagcac taaagccgct atgctgacac ccatttgagg gtgttaggat ggaagtgatg 1726740
 cttgagcccc agtgatgcaa agagatgaac tcggtctcag tggcatcatg agtataacct 1726800

atgtgagcta tgagccaaga acccccagcc acaatgtctc tggattcctc caccccgtga 1726860
 agctgctagt ttaaggata atttgttaca cagcaatcca taaataagat gttttccaat 1726920
 aaagcttttt tttagctttt agtttttagat gtttaaaaaa gaactttaaa ttgggggggg 1726980
 gaccctagtgt tcattattta ggaacacttg ttacactact tttagtaaat ctaaaagtat 1727040
 atatggattg ctgccaagac tgacaacacag aattcaatcc ccaggatcca catggttgag 1727100
 ggacagaaca gacttccata gctatcctgt gaccttgaca tatatgcat gacaggtgtg 1727160
 tgtgtgtgtg tgtgtgtgtg cgtgcgcgtg tgcgagtgcg tgacaaaggg gggtgacaac 1727220

 acagccactg ttttgtggcc cacacaaatg atttcagata tttatgatca tatttctcct 1727280
 agaacttttc ctcttagtg tgctcagtac ccagattata gatataaac aaatgcctag 1727340
 tgaatgaatg aagcagtctt tgaggaacgc tgaagcttac acatttctc agagaattg 1727400
 gacagtgtgt agatcataag aagtgattcc tacttttctt taaattacac gtgaaaacac 1727460
 acatactgca tgctaagggc ctgtttagt ttaaattgta aatgtccacc atttgctca 1727520
 tatattagga catttggct ccgactagt gactgcttt aggagtgtga agaacctgta 1727580
 ggaggtagag cctagaggaa aaagtgcac actgatccat ttctatcta ctgtgcctct 1727640

 tggtcggcca agatacaagg aggtgagggg tcgcctctat actcctctcc acatgaagct 1727700
 gatggccaca atgccttccc ctctaccatt agctgtatcc ctttttaacc atgacgtcat 1727760
 aacctttct taigttaggc attttgtcac agtagcagga aaagtaactc acatgggatg 1727820
 taacactatt taaatgttt tacagacaca aggatataac tttctaataa gactgttact 1727880
 atttctgtgt cctagatgga aacctcaagt tcagagaggg tctgtaaact gtgcatggtc 1727940
 tacaggacca tggctctgct ctactgatga tgaagtgtg tcctacattc agggctagtt 1728000
 ctgactccac ccagtgtccc caccaatca aggtccttct gcccttgct agaccacacc 1728060

 aggaagtcc caagtgtga gaaggtgggg gagtggggaa gccctcctt taaaacctgc 1728120
 ctcttgggt ttaggaata aactcgtgtt tattcacgag tttctctcac tagaccacca 1728180
 atttaacact ctgccaactg gccaatatt ccagttcatg tagagctaag caggttcttc 1728240
 tccagctgca caccttctct gctcaacata attaacaag ctcatcaaaa cctggaaaa 1728300
 caagcccagc tctactagccc ctctgactga tgtgtaaca gggggttggg gtgttccac 1728360
 ttcacatgg gatgttatgt ttatgtggcc ctaaggctgc tcacaaatgg tatgtgtga 1728420
 tgacaggggt atggccagt gagggctact ttactttca taaagtagcc aggtccccag 1728480

 acacacacag gattgtagca ggatctgatc agttctggta aatgatgatg accagggctc 1728540
 aagacaggct ggggaacgac agattattcc cgttggttca gaatgacagc ctttaaggg 1728600
 tgatgcagag gcttgacagc agccaacaaa acattttccc gctgcttcac ctctgttggc 1728660

gagcacgcct ttctgatcac agagcagatg tttttgttgt ggtcctatgt cttgctgtcc 1728720
atcacagtgg ctgccacca caggaggctg ctgagctctt gaaatgtggc tgctctaac 1728780
ccagtgtgtt gtgagtgtaa agaacacatc caaaccccaa ggtttgctaa gaaaagaata 1728840
caacatattg ttcactttta catagattac atgttgaaga aaccgtatit taatatattg 1728900

tgtaaata ga caatatatta aaatcagtta caacagttc cgttttacct tttgtaacat 1728960
ggccatagac atggctcgca tttgtggctt ggactatgtt tttattgggt agtgggtgtt 1729020
tagaaattgg gacatctaaa actgacgcag aactgggagg gatgcaaagg ccaaagatt 1729080
tccatgcctc tcccagggc tttttctgcc acactaacgg gtgttattga aatgagtatt 1729140
accacggcc aagtctgctg tgtgctcaga tggaaactgc ctcaagtcc atgtggccat 1729200
ccttcagccc caaggcatca caagacaggc ttggacttgt gcaggcacac ttgggtgctgt 1729260
gcagaccgt aacttactct tcccacacag accggaag cggactgctc tgtatttagt 1729320

ggtttttttt agggaacagt tgtatggccg taagactgct ccctgtgtcg tgagatgatt 1729380
gcaaagggca ataattgaca aaagagggtta caaaagtgc tgccatgaaa ctgggggctt 1729440
cacttccct gcttaggact ggttttggat ctgggggctc tttacagcaa agctgagcct 1729500
tttcttga tcaactgctt acttctggc actggatgtg cccctggaat aacaagccat 1729560
gaaaacacct agaacctctg tgtgtgaaat ggctgacatg caccaccaa atgcatctc 1729620
aatgggtca gacctaagag caattagaga atgcaggtt gtggagtgtg cccgaacctc 1729680
tctcagaaa cacactact atcaatgagg attattagtt tggatattca ctgaggccac 1729740

tagttactgc tcagcagata acaactggta ggaaaacggc aagatcttat gtaggttac 1729800
taatcaagaa taccacactg gaaatctctc tttgtgttc atcgtctgag tatgtatit 1729860
atcaaatgca acaatagct gtcataacgt tcaggcctgc tgggtggtgg tgatgcacac 1729920
ctttaatccc agcactcagg aggcaggtag atctctgtga attcaaggcc accctggtct 1729980
acagagcaat tcigggacag ccaggctct acagagaaac cctgtcttga aaaacagaag 1730040
aagaaaagag aaagagagaa agaaagaaga aggaaggaag gaaggaagga aggaaggaag 1730100
gaaggcagg cctgttgaag ctgccaagt agtaggatac agtagaagat tattctactt 1730160

tataaaaata gaaaagtta gtagtttcta gaaaagcca gaattgctat gaatagtgt 1730220
tcagtataga catgctactt tattttatta tttttatit tatgcatgtg cctgagcgcg 1730280
cgcgcacgca cagcacacg cgcgcgcgca cacacacaca cacacacaca cacgcagtgg 1730340
agccaggcg aggtgtctga tctctggag gtggagtac aggtgattgt ggatgctggg 1730400
aactaaacte agaagcact gttaacgccc acagctgtgt tcttacttgc taacaaaaga 1730460
gccatcttta gggagtact tcttcaaac atagacacaa tcagttaata taataaaaac 1730520

accaggtaaa gagaatacat gatactgggtg tttattattg ttttaataa ggaaaacaaa 1730580

tgctttcata atgctatgaa tctatggggg gaaaatcaat gcttgtaaag caaaaaatct 1730640

aaccacaaaa taggagtagc tatttgggc tccagtagta caagctgaaa caaatgctag 1730700

cagctaactt cacatttgc tgcatagtat cagaacatca acagatggga atgttcattg 1730760

gaagaataag ataaaagggt gggatggctc atcaggtaat ggactctgt gtcaagccta 1730820

atgaccaggt tcaatacctg ggaccacat actgaaagga gagaagccac cccataggtg 1730880

gtcctctgac ttccacacat gcagaacaca gcatggcata cccaacatg ggcatgcaa 1730940

cacccccga cacacacatc cacatacaca cccgatataa atgaatgcta aaaaaagag 1731000

taagaaatga tagcagggtt aaatagcaag tgtttcaatt gcttttaaag taaagataca 1731060

gcttgatatt tagattaaca tgcaacatgt cattcagaag ccatgatatt ctaatattca 1731120

gcatatgate ataatactc acattatttc ccttttattt ggtcatattt tcagtactg 1731180

aattgtatta gtgatttct ctgactgact ttcaaccag tctgcctaata ctactactt 1731240

ttctattgtt ggggagcaaa tccaagacct tgtacattct aggcaagcac taccactgaa 1731300

atcttcttta aaattctgct ctctgcttat tagacagtct tactacatag tccatatttg 1731360

ggcatataac tctttatag ccaaggctgt cctcaaactc atggacctc ctgcctcagc 1731420

cttctttaa tatcaatgct caggtaaata ttcttactgc atcgctagaa gtagtagaaa 1731480

gagccctaac taictattct cctgtgccag ttcatgcac tgtttcctgg tgtgaatgct 1731540

gccctctage ctggctgigt cctgctaca atctgaattg ttctctgaac agttcattta 1731600

agaaacatcc tttgtttcc actagcatgc ctgctcacc actcttatcc agagcctgct 1731660

cagcctgggt ccatctggaa gctgctccc cccatgggac tctgtttgc tcaggccatg 1731720

ctgaccactg tctgtgacct ggactgcct ttgcacacag aatTTTTTgt ttgggtttgg 1731780

TTTTTTTct tttgattta atacaggacc tctggaagg tagtcaatac tettaaccac 1731840

tgagccatct ctccagccca atgtttttgt tttctgaga cagggtttct ctgtgtagac 1731900

cagggtatcc tagaactgc tttgtagacc aggcttgct tgaactcaga gattctctg 1731960

cctctgctgg gattaaatgc gtgcaccatc actgccacc tgcacacaaa atttagtatg 1732020

TTTTATTca acttgacaca aggcagaatc atctgaggag gggccctcag ttgagaaaat 1732080

gcctgatata gacaggccgg taaggcattt tcttaatgag tgattgatgg gggagggacc 1732140

accagtgctg atggttctga gttctataag aaaacagagt ggcatcttca tctcttgca 1732200

gcagacggga acaataaag aatccacag ccagatgata tgcaaagagt gagaaacctt 1732260

ggaacactca gtctaaaca gggctttgcc atcaaattcc tacaatcagg gctcagggaa 1732320
 cccagtggaa gaggaggtgg aaagaatgca agcccatagg ggagggaggg caccaagaaa 1732380
 acaaggccct ctaaatcaat ctgagccaat ctctatgaa ctcacagagc ctgaggcagc 1732440
 aagcacaggg tctgcatggg tctcaccaga tggggcccta gagaagaagt ggacacctga 1732500
 cccaacccta acccaactga taaccacctg caaatgaaac tttagtttct ttcattgtgag 1732560
 tctcactggg gaaacaagct actcttaagg gtaagctgta ggcccagagt aggtggccaa 1732620
 cacaaaatga actcaatggc gtctctgggg attccttggc tcataatggt gtgtcaggct 1732680

 ttaaacaaaa attatccctt tttaaaattc tactttttaa tttcttattt atttatttta 1732740
 tgtctctctc cctcttccc tatcagtcct ttgagtagct gttatggctt tcagttttgt 1732800
 gtttttatgg gattcctggg tgtgccaaca agcgggcctc tgcactata tctgtttctt 1732860
 gtgcccttcc ggaggctcct tcttttctt ctgtttattt gttttgtcct actcttctgt 1732920
 gttagttttt ttctattct attctacttt atactatata ttattttatt attatccctt 1732980
 agatgcctat ttgctttcta gtgagagata gaaagagggt ggctttggat ggagggttgt 1733040
 gtgtggaggg actgggggga gtagtgataa agcataccat aatcatgata tattatgtga 1733100

 gaataaattg actttcaata aaagaaaaaa tgggaaagaa ggaaagaaaa aaagaaagca 1733160
 ggctgagtta gccatgagga gcaagtcagt gaacagcata cttccatggc ctctgcacca 1733220
 gctctgctct ccaggttctt gcctagtttg aattcttggc ttggcttccc taaatggagc 1733280
 gtgattcaga atatgcaagc caaatgcacc atccccccc aacacacaag ttgctttttg 1733340
 tcacagtgtc tcatcacagc aataataacc ctaagacagc aggtgatacc ttacttaatg 1733400
 cccagcatta atatgggacc cactttatct tccagacagg actttctggg gctgtacact 1733460
 ctggttgaca ggatattggc atctcttttt agtctattgg tcaaatttta caattgtcca 1733520

 taattttgtt gaactaatga ccagtaggct tctgttaggg agcaaagcta gacttgctct 1733580
 ttgtctgtaa ctacaaaaga tgctcttggg gggttctgga ttggagtcca tgggtctgaa 1733640
 gaatatagtt tgaatgaag ggaacccaag attcaagagg taaagtgaaa ctgggcatgt 1733700
 ggtccatgtg ttatcacttt caaagcctaa gaacatctag gaaagtgtt cagctgcat 1733760
 acttgatata accaagcaag cgcattcaga gccgtgttcc taccaataca tctgaggagt 1733820
 cttgtctggg gatgatct caagaggtg ccacatacgc ctcatgttgc ctctgcatg 1733880
 tgtgctttcc acccactgc cagcttttat cctgcagat cctggggaag gtatctcagc 1733940

 acacatgagg tcttaagaaa agagaagagc catccagctc ttggaggatt ctaagctttg 1734000
 caccattccc aatttactct ctctgcttcc cgttttgggt tcaagatgtg aactcccagc 1734060
 tttcctgcta ccatgactgt cacctgccac catgatggac tcctatcctc ctggaaccac 1734120

gagcccaagt gaactctttc ttctctaaga ctcccttggtc atgatgtctt atcacagcaa 1734180
taggggagta actaatacac tgccataggc aattgtatta cacattgaac aatgaagtaa 1734240
acacaggcca ctttactgtg ttctgctgtt atcttatgta ccgtttctcc agtatgtacc 1734300
attttccatt ataaaatggc aacagccagg tgggtgtgcc acacaccttt aatctcagca 1734360

ctcaggagge agaggaaggt ggatctctgt gagtttgagg ccagcctggt ctagaaggag 1734420
agttccagga cagacgggac tgttacacag agaaactctg cctcaaaca aacaaaaca 1734480
aacaaaataa aaatggcatc agagtggta gcagctgtgg ggggtataaa ggggtcactc 1734540
ccaggcctca tcacagattt gctgattacc tgcctctca acatctccct ggggtattct 1734600
taggtccata aacgctccag aacgctgctt gatgggctgt aagctctctg agtaaacagg 1734660
aatcttcttg tcccacagca ctttcaaga gcagtctcac agaggaccaa ttaaacctc 1734720
ttgctcccac agtatattat acaactaatt ctttcccgc acacttcttc tctttggctg 1734780

tttttctta gtctcatatt cgcagactct gacagaatgt caatcaggat tttaaaagat 1734840
cttccaggat gtgatggaa atgattttat ttatccatc aatagaaacc tttcccttat 1734900
tatgtggatt ttgagcact ttgcctgcc tgttccetca gctgggagge ctggattgag 1734960
ccagtgatga ggattctgtc aatactttgc ctggcacctg agttaccggg caccacaagc 1735020
ttagtcgggg tcatggaatc taaattgttt ccacagctct tgaagtaagt caatgttttc 1735080
aagattctat aaaaagactc tgtgggtata atcatgagat cttaccccaa agtggctgga 1735140
ggatgatgtt ggcatttctg tccccttaa tatatacatt cctgataaga aaacttatgt 1735200

cccgaatgtc atcctggttt tattttgttg cagtgataaa aataccgcc cccatagcac 1735260
agaggtgagg aagggttcat ttgacacaca gttccaagtt atagtcatt attgtagga 1735320
agtcaaggca ggaatttaat gtgtcacagc cacagtcaga agctgagga gagtggacac 1735380
gtggctcttt gcttgcctgc ttctcaatgc ttagccagct ttctctactc ttacacactt 1735440
tggggctca actcatcaa tgctgccacc cacaatgggc caggctcttc tctatcaata 1735500
aaaaaccaag acaattccc acagctaat ctaacctaga caattctca actgaatctc 1735560
ttctcatgag attttaggtt attgcaacct gacaatcaa aactcacat cacaaggta 1735620

tcaagtttg ttagtgctg ctttgctca ttaatggcca aaacgttgga aacaatcatg 1735680
caaatttgc tgcaataat ttcagtatca ggcaatatt gatattcaa cagaaaggtg 1735740
tcaaagcca ttgcagaagt ctagaatggg cttggcattt tcaagtgtc cagtacagtg 1735800
tcgatacagg agtaaaatta atataacat tggagaacga aaggaagag agatggcaag 1735860
atatgcatag ctaggcagtc atgatccagg cgtggctctg ctcatgtcat ctcgcttta 1735920
ctctgtccag caaagtgatc tgaaaagttg ttcaaagtc ctgaaatctc ttcgggagag 1735980

gcaagttcct ccctcggctg gtattaggaa gaggttctgc ctttctctg cccagtgatg 1736040

agattcccaa gaaattcac tagtctgata gccaaaggc acagtatctg tttagatgat 1736100
ccccacagag ctgcacaggg aaatgggctg aaggtccaca aagtgaagag ttaagactct 1736160
tgccttccc caaggaagga aggttctga ctctatagag atggagctat caggctcagg 1736220
agccctgaga taccagcat caaatgaaaa cagaggtgt aagtgaagt ttaccagtgc 1736280
ttagagatac aaccctcag gtcagcaaca caaccacaa ctcctttca tgctcggttt 1736340
ctaggccag caatgagctt gggaatctca tctgtcctt tcaaggaaa gtcacctatg 1736400
gacactgac caggaacag gctgggctct aaccagtta tcccaggca agtgaactcc 1736460

agtacagtgc taigtctcta aacagacggt taaggaaaag cttgtgacat tatagaagca 1736520
gaatgaacac aaggaagaga gtaagcagag agcagaagaa aacctcattt caaatgata 1736580
attagtgttc ttgggttata aaggacaagc cagagaataa gaaggagctt atagaaattg 1736640
aaaatgtgga aatataaat gaagtattg atatcaaggt tgggagacaa agttaaggaa 1736700
atctaataga acatgggata agaagacaaa gacatggaaa atagaaaaga aatgagaatc 1736760
agagagcagt cgaggaagt cacaatgcaa aaggagaagt tccaaaaagt tcaataaaaa 1736820
gaaataaaag gagtgagaaa gtatcaaaa tatcttaac cccagatata ttaggaacat 1736880

acattatcag atgttaaat aaatttctta ctaccaaata gcaaggtag gcaagcggt 1736940
tgggtggtaa gagtgtctcc tgccaagca tgagaccag agttcaagtc tcagactga 1737000
gtaaaagccc tgctcaactg cacatgcta tctactcagc actgtgaggg cagagcagg 1737060
ggaacacagg ttcagtgaga aacctgcct catgtgaata aggggaaag tgatatagca 1737120
ggacaccaca catcattctt tgcccccaa gcaccacac acccagacc acaagataaa 1737180
tacatttcat ggcattcagc ataatgtggg aaagaagcca cactaagatc acaaatctt 1737240
aaagattcaa aaagccctct gagtaaggt gtagacacac atcactgggc ctctcaatgc 1737300

tgtggatgtc acaggatcag gaagaaatgc ctttaaggta ggggtgttcc taagggtga 1737360
aaaggaaaa atgccatacc tggggaatca ccaagaaat gacttagtga agtcaagtgg 1737420
ctgtcttcat ggagaggggc ggggaggct gctgttctg gttttgttt gtttgcctgt 1737480
tttactgaa gtctgatagc actatctgaa ctgggtgcat gcgttcttg gaaaagtaa 1737540
acacatgtat ttaagcaatc cgacgaaaga ggctcctggc ttgtaaagtt aaggatgtt 1737600
aaagagattc cccaagatgt ctgtgaatac tggaggcctg agcttctgt ggagatgcta 1737660
caggtaacag gttatacta gcagagctta cacatattg aaaaataaaa gggaaagtgg 1737720

aaagcatatc gacttatgac acacacagag ccgaacacgg aacacatgca gataaaacaa 1737780
acagagctga gtacattca gccctcctt tcgctgctag gactagaagt tagaagcctc 1737840
accttctgga aacctgtatc tctgcaactca tctgtgcagg aattgtactt gggctctgag 1737900
ttgcctgtgt ccicctttgg ccagcctggg gccgtaggcc tttgggttcc tictgcatag 1737960
ctgcttcctt gttttttgtt tgtcagtcct aatggttgag tttgccttcc cagcaatctc 1738020
actggaactc caccctcaa aggtgccctt ttaaactgct ttgctagtag tctctcttgc 1738080
tcttaaaac acctttttgt cacttgtacc catgcgttct ctggggaagc ccacagcgag 1738140

ctgaaaacat atctctggcc cacatgttgc ttttttcat caaatggttt attaaatggt 1738200
ttagacacg gttgggcaat gtgcaaaaaa ctagctgggg gtggaggctt tgttcttgag 1738260
aaacagcaaa attaggaat tataacaaac aagagcaaag taagaactgg ttgcttcatc 1738320
tcagaagtac atattaaaa aaaaaagta gatctcaatt cagaaggctc agttatgaca 1738380
actgggtaca gaaatgtatt tttacaaggt gggaggcaca gggaaagaga cacaatcaaa 1738440
gaaataacat tgggacgcat cctggagaag actggtccaa gaactatggt agaaatttg 1738500
gtggtatfff cattgctgaa gttttagctt tttacaggaa aaagaaaagt tgttaaagga 1738560

tggagaaagg atgtactaag aaaacggaag agtattggga ggtgggatgg ctaaggttat 1738620
cctggagcag gaatttaca ctaatacaca ccaactagag aacgatggca tgatggcatg 1738680
aactcattca aatgaaagtc aatttgactt aaactgatcc tctaaaaaga gaaaggatcg 1738740
acttttgctt ttaaaaatag ggatttttcc ctacttaaaa aatactttcc tgggtggcaga 1738800
aggaacatac acacatgaga gcaatgaaaa taccattca caatcagata aaaatctgaa 1738860
atggtgtatt tgiagataga ccctcacatg ctctgtgtaag tatcttgaaa cttgtttcaa 1738920
atgctaggca gttactactt cattaggaag catctacat tgccctgtctg tgctctgtgc 1738980

taagaagcat ttgttcta at gageccttgc caggaaagag tctgtccacc ctgaaagcac 1739040
ctctgagatg gacagtgttt catgcagatt taatccagac actgcttcag ccgactgaac 1739100
cctttcaaaa cacaaccctt gtagctaaag gcctcaggga cccacttgca agcattagga 1739160
ccccaaagga tctctttaa aaaacccctt gttccagcta cgactgttcc tagttatcat 1739220
acttagaaag gggttagtgt gggctctccga ggacagagag gtatcattgc acccaaatgt 1739280
ctacagaacc tgcaagtgg aattaatcat ctttgggtgg gctcagaaga aatcctggcc 1739340
taaaaacagc ctgagtagaa gcataatttg tattaagatt aacaacggat cttttgacag 1739400

catgcaatct catgaacctc ctggtgctc tgagctccta caagcatcct tgcacaagcc 1739460
tctatttttg cttgcttctg aacttaaagt gtataaaagg ttgcatttcc attgacatat 1739520
atctctatat ttaatttta tttctatatt ttaattttgt ttccgtatftt caaagatggt 1739580

tcctactagt tcccagttgc agttgatgta aaatcaagcc acacttttat ttattcagac 1739640
 aggacttctt tagatctagc tggcatgtga agacaagaaa tcacagggaa gggtaggggt 1739700
 tggaaaggctg cgaagggtaa gaatgaagcc atggagcttt ggctgtctta tacaggctag 1739760
 caccatctcc agcctttag tagctactaa cttcaggggt cgggtagag aatgggggtc 1739820

 ataagtggga gccacaaaat gccgagttgc ctagtatcta cctacaggac actgtctgca 1739880
 tttcacaagg agggcacaca gacaacaact gaaagtaaag agacactccc cacccctca 1739940
 cacacacaca caccatgaat tcaactagca ctcttgctga aatccagcta aatgtctcag 1740000
 atagggatgc catactccta agtcatgtgg ttgagatata taactgttgc tggcaaatg 1740060
 gcaaatgtta aaacattaaa cacccctaca agaccgctc tccacttac tctgaaaata 1740120
 caaaaatgct ttgattttta aaggccaaga gtccatattt tccatcactc atagcctgtt 1740180
 aagacagctg atgatttgc ccgaaggtat aaaatggcga taggtaggcc tgagaacccc 1740240

 tggcctccta tcacccttg gctaatgaac cagaagaaaa actatagagg catgccatgt 1740300
 tgggtcatgt gacttctgca gctgtcttc ctcacagtga aaattggaca taatttaaaa 1740360
 ttttcttggc tgcagttagg aataggatgt taggttcta ggtattcaag aattcaaggt 1740420
 ttattggacc actcttttc caactctgag gaaaaaaaa aaaaaaac gcacaaggat 1740480
 gtacaggaga ggaattctgg tggcagatcag gctccctcc aggccaagcc tggtagctgg 1740540
 tacacacagg acagtctggc acgtagggtaa gaacggctcc cacagtgtgc tatttctcac 1740600
 ttacctggct gtgggctgga agcgcagcat agccatggg cggattcact actccttct 1740660

 gcttaatgag aagcatgct tttctgtcct cactcagggt cgctctggga gcttgcagct 1740720
 gtggtggagg ctgctgctgc tggggaggct ggggctgggg ctgtagctgg ggctgaggag 1740780
 gctgctgctg aatgtagggc atcaaggggt tttgttagg gttggccata gggggtgtca 1740840
 ttctcggact caagtcgca ttaaaatggg tcagaggctt agtgttgcca taagtgagea 1740900
 tattgtgctg ttgtttaag gagttgtac ccaagtatt ttgctgctga ctgatcatat 1740960
 tcatgtgatt tgaagggagg tagttgtca tggctgtctt ctgcaggcta ttggcattg 1741020
 caggcactat agtgtttgg ttgttaaagg cttgggggta catcattggg ctatttggtt 1741080

 tttctgcagt aaaagctgct ccataaggac ttgacggagg tcctaaggga gaccaacttg 1741140
 aagtctgatt tgagtggggc tgcctgctgc gctgctgctg ctgctgctgc tgcctgctgc 1741200
 gctgtttnn nnnnnntga agtgttggg ttgtgggtgg cgtcatcctt gtgctggtgc 1741260
 tgcttctgct gctgctgctg ctgttctgct tgcagatggt tcgacctctg ttgttctgg 1741320
 gcagccatct gtttagctg ctctgctggg gacatgtcag agctgggcac tgccactgag 1741380
 cctgaccctg aaccagatag cgtcaccgag attggattaa ggagatagcc attgcccaggc 1741440

cgagctgggg cttagacctg agtatgggct tgcgttggag tttgggggga ctggacagca 1741500

 cagttagctg gtgagctggc agggtttga gccacgggag tattggccac ggatggtaaa 1741560
 ctagtggctg tggatacagt agcaaaggga ggaccagaag atgaaggtct ggcctggggt 1741620
 gatcccatag agacgtgtgc aaaaggagaa tgagaggcat cgctcttcac gctcgactc 1741680
 tcgtgggaga gtgggtctc catggttgc tgtgagaatt ccggtcctt ctctcttca 1741740
 aagtcttcat tgaacaggtc ctggatgtcg tcttctggaa ctgtgttggc cagttcgtct 1741800
 attagctcct gccactcttg gtcattcagg ttaatgtcag agaacagctt gttctgatta 1741860
 gaaagtgacg tttctgatgt gtctatacag gcagggtcat caagaggctc ctgtttgagg 1741920

 tccttgctct gcaagatagc aaagctatcc tccagatccc cgcagccatt gacagggagt 1741980
 ttaatctcag ggagcctgcc attcttacc agatcttcca gaagcccagg agtgtgagca 1742040
 gcgctgttct gcaagggcaa agaaggcttg aggtcaagtt ggtgacaggg tgaagcgaa 1742100
 ggcatggca tgttgttggg caaattgttg atggcttcca tgcctgtggg aagatccttt 1742160
 cggatgcgct tgcttgttgg agagaagctc ccacgcaag cccattctg ctgctccca 1742220
 ttaagtgggt atcgggcccc ttccagcttc cttttaccg tctcctggag ctggaaaaga 1742280
 aatgggagat aagatgactt aatctcatac caaactctta aatattgtga tgtgtgtgt 1742340

 tatgaactac ctttgtgagg acgcatgttc gtgtgtatac atgagcacct gtgtggaaga 1742400
 caaccttggg cactgtccat tctacgttga gacagggtgt ctattggcc tggagcacac 1742460
 ccacgagctg aggttagcct gtgaggccct gggacctacc cacttgcttt ctgtgtctg 1742520
 ggataacaag tggacatgtg cctgaatfff ttggttgttg ttcacaggtt tttggaatag 1742580
 aactcagata ctatgatgaa taaccattta cccctgaac tgcatcttaa gtgctttaga 1742640
 acacgcaaaa aggaaaggat gcttctagct tcaaaatcag gtgacccat gatttgaat 1742700
 ctgtgagaaa agtcttcatc taaaagcggg gttcagagag ccaagagata cgcagggtag 1742760

 aggtcacagg gaaaggtcac ctgtgagcat tttccaatg agaagaatcc atacttgaga 1742820
 tgttgactaa aacacctcat acctgaaaag gatattctat cccaatctc accacacccc 1742880
 cataattgaa accatcaagg aattaaatca acaatffff aagaacta acaatgtcct 1742940
 ttttaaaaac gtttgttata aggaactgaa aaaaatacac acagagagat taacatagca 1743000
 ttttcccaga tccaaagtct acaatggact acagagttaa agcagccaat tagaagctgt 1743060
 ggaacttgtc actagatfff acacttcat tatcagtcac atcattatgc acttaccac 1743120
 cacaagaaac agaaaaatca agaagagagt caaaactaga aaaaatagtt ttatatcctt 1743180

ttgtgacttt acttgaattc tgtccctcct cgtctcccaa tagtagcctt tectgttctt 1743240
 actataccta tactataggg gcacacacac acgtatatat tatagaatag atccccaatg 1743300
 aggaaaaaca tgcaatTTTT tcttgagaat ggataactct cacttagttt tatactttct 1743360
 ttgtgttttt aaaaatttat tcacttctta tgcacattgg ggttttgcct gcatgtgtgt 1743420
 ctgtgtgagg gtgccagatc ccctggaact ggaattacag acagtcatga gctgccatcg 1743480
 gtgtgttggg aatcaaacct gggtccttcg gaagagcact cagtgtctct gaccactgag 1743540
 ccatctctcc agatcaagtt ttatactttc taagtccatt tccctttgtg gttcattttt 1743600

 tcttttagagc tagacagtat tccattttat gtatgcagca gattttcatt acccacttgt 1743660
 aggttgatgg acaactaggt tggttccatt ctcttgccat agtgaccaga gcagcaaaaa 1743720
 tttcttatga atatggattt aacacattac caaatagcag gcaatgagga ttaatattaa 1743780
 acatagccca agacttgaac ctatctcttg atttatctca tttgcagcgc catctgatgc 1743840
 ttggtgtgtt tccatcctct tctgtgagtc cacacttggg gagagtctct ctccctcact 1743900
 atcatgtatt cttgtttgta aatgatggga ttcttcagg tttcttctta aacgtttttt 1743960
 ctctgttctg tttatatgat ttctgggca tctccctcta ctccaagatc ctgaccatc 1744020

 ttccctaggg tgatggtcac aaacagtga gccagctccc tctctgcaga gccccactaa 1744080
 tgccaacttt ctgagacaca gtttaggagc gcctagaatt caatacaatg ctcatttgtt 1744140
 caccatctca gttacctagg acagaaatgt gagcatcata cactgatatg ctcatctcat 1744200
 gtctatccat atcatcactg ccccagacca ggggaccatc tctagttgac ccaactctctc 1744260
 ccttaactgt tectctattc attgtttage tctctctct ctactctatt tactgtcacc 1744320
 ttcttcaaaa agatacattg tcaagtgggt cctgcttaca agcctgaagt aatcagacta 1744380
 aaatgtcaac tgtcatcttt gcatcttctt cctatcctgt ccttctccat cctcgtatc 1744440

 cttatccagt gtatgtacat cttctataca ttctcctaaa actcttttta aaatttgctt 1744500
 gtgtgtgtgt gtgtgtgtgt gtgtgtgtgt gtgtgtgtgt agtagggatc aaaccaggg 1744560
 ggcttgccc atgctagga agcactgccc atcaagctgc acccaggct tcttcagcct 1744620
 ctgtaagtte cctaactatg tcaagcttcc ttctgtctcc aggcaaagca atgttttctt 1744680
 tgcttggaaa aatctcccc tctctcccc tttctctggg cagtactccc taaccattcc 1744740
 cctttcttg gttagcacc cctatctct cctttctctg gttagttctc ttatcccat 1744800
 tatagacttt atcataattt gtgcaaaaa gttaggatc gtggatgact tgtttcttgg 1744860

 gtatctgcag tggtcagggt ctgagcaata gtttaataagt agctgcaaaa tgagtgaaaa 1744920
 atcctattgt ctagtcagag atgtgacaag tgagttttga atgacagtag aagccagcct 1744980
 ggtcgcata aggagtttct gattgagaat cttcattcct ggtaatggat ggaacgatct 1745040

cttgctccaa agagtataa ctcttgctaa ctctatgagt ttattagttt tataaccagt 1745100
 ttatgtcttt gtgaccttc tttctgccag aaagggatat tcatgtggct ctggcaaaag 1745160
 agtgtttgc ccagagtggg agctggcgaa atacctgttg tgtgggtgaa ggttttcct 1745220
 ttgtaaattt cccactgggt tgcataaagt gtgcagggtg gagtccagtt ctctaccta 1745280

 cttaccccggt tcttggcaga gacactatat tttagagacc ctataagtga gaggtgtcag 1745340
 attccctctg agctgcatgc tgtgtagttg gcagggtcc agaggagccc ctcggttgt 1745400
 aacaccatc tgctgatgtg agtcttaagg agtacctgct ttcttgaag cagggaactc 1745460
 cattcttga gagnaagcag cgtcaaagg gactctgagc caaactccta tttaatcct 1745520
 ttccccaaat cttagtttta ataaaaacca gagcctgtca taactactca gttgaggctc 1745580
 ttgaacagct gaaaacaagg acctactgg aacacactag aacttgactt caaagaaat 1745640
 gatgcttcaa tccatcatgt gaggggaact ctgctaggaa acaacgttat ttatggaaca 1745700

 aaccaggaaa ccatgatggg atcatcgttg tgacaggtgc gcaaatgtat gtcgctcaag 1745760
 gtgcacagct gaaaggccta acggagatga ggccccggca cttctgaat ggatgttaag 1745820
 gtgccccggc acctcttga gggacattat gcttcagaaa atgagaacat gcttttttt 1745880
 ttttttttt ttgggtttt caagacaggg tttctctgtg gctttggagg ctgtcctgga 1745940
 actagctctt gtagaccagg gtggctcga actcacagag atcctcctgc ctccgctcc 1746000
 tgagtctgg gattaaaggc atgcgccacc aacgccagc ctatagaaca agtcttaaaa 1746060
 aacaaatctg atggcagttt agaacttaca ggccccaat tctgttctag gtcattaat 1746120

 ggatgacttt ctactgtcc ccctataaaa cagagggtggc caaggtgcca aaggccaata 1746180
 gttctgcttg ggaaccact cacctctaag gggttaagta ggtgaaacac aagagtcag 1746240
 cattgttga gtaaaagcga ggcactggag cgagaaggat gtctcaagac accgctccc 1746300
 caaccatgc attaaaatgg tgtacagcac tcagtcatgg atggctgtgg tgcctaaagg 1746360
 accacactga aggtttctgt tctgcttct tctgagtccc cggcagctct cagctgacac 1746420
 ttaaaggaca aatttgaga aatgtctata aattgtccca agttcagttt catgagttcc 1746480
 caaatgggtt agtagcgtta gctcacagag ttactgtgag ggtgagttca taggagataa 1746540

 tgtgcaaaca cacaattttg cacgtgggac ccagagtcag cactcaccat gccttagctt 1746600
 ctctattttt aaaattcagt cagcaccgcc atggggacag aatgttctct gaatttcaa 1746660
 gacacagata ggiataatga caatatttct gttccctagc tggccaaacc ttaatgtttc 1746720
 ccaggcatct ggagtggctt tcttaatatg aacaacaaaa atcaaatgtt caattcaagc 1746780
 ctgagtccaa gtgctaagc atgcgggggtg tctagattg tagaacaggg gagactgcat 1746840
 tgttcaggtt caaaccaat acattcccag agcaccacct gaaaggggct gtggaataga 1746900

ctcgtttccc caggggcttc acattctcca ctgctggcct tttaaccaaa tcttgatata 1746960

ttttatcat gtattagcat ttgcgagtat gagaaagaca gcatcgaaga tgttatgcca 1747020

tggtttttat gttcggtttt gttatgtcca aaatagcaga gcaatcttca catcaattct 1747080

ctctgtctca tcatcctttg ttttatggaa aggtggctctg aaaatctaata tccctcttta 1747140

tgtccctcgt gggagaagga gctgtgggga gggagacgtg gagccggctg tgtgttgagg 1747200

aatctgacaa gcagctcgtc cagtgagtgg gagactcctt ggctgcacac gagcaattgt 1747260

cctgggagtc cccactctca gagactcggg tcaatctcag ctctaactgc ctatctcaac 1747320

aagactctgg cctctttgcc tcccagagca gaaaacctct tagtacactc tgcctcatg 1747380

aacaagcatg gaagctttag tgaggcttag ccctcttggt tccatgttac caggcttaca 1747440

tagagatggt ttctccatt aaggaagct gagctgccag gagctgaagt gtgccgttca 1747500

gctaattgct gtgacaatat gggttgctat cagggtgcaa gtgctttgga gacataattc 1747560

cccttcaga atgctctaga gatggcctcc tctgcagtat ggcttgatag ctgggttita 1747620

tgttaaatta caggatatag atgaggtaga ggaagtaaga gaagagaaaa ccagaggttg 1747680

agaggagac aatggcatgt gccctgagt gtattgtgtg tcccagatcc acagtgataa 1747740

gaatagcagg tagctacaca tcattgttta ttgcaggcta gccacaacag ccaagatatg 1747800

gaaacgatcc ttcaacagag aaatagattt ttaaaaacaa tgtgatatag gcctgggtta 1747860

gatgggttag tgggaaaaaa caaatagaca aacaacaaaa acctgttgcc aagcctgaca 1747920

agttaaatta gattcccagg acctatgagg tggaatcaga gagaaggcac ccaaagactg 1747980

tcctctgacc tcatgtgtgt gctgtgacac agtcacatgg catatacatt ataacacaca 1748040

cacacacaca cacacacaca cacacacaca cacacacaca cacacgcgag agagagagag 1748100

agagagagag agagagagag agaatatgaa tatttttcag tcatagagaa gaatgaataa 1748160

aacatttgaa ggaaaataga tgctagtaga gagtatcatg ttaaatgaag aaatctagtc 1748220

ccagaaagtc aaatattgca tgctttccct aatttgtggg tcctagactt tatatagagg 1748280

tacagaaaaa tcacatatgt gcaggtgaca gaaaagcaga agtaagagtc tggggaacaa 1748340

agcagataaa tgggagaggg ggagtgaga gggaagtgca gacgatgctt gaagtatctc 1748400

atgtacatgc atgggatgg ccttatatag cctggtttaa taaaataatt tctgagtgaa 1748460

ttgctgtgcc ttttgagtta cacgatcaca aaggataact gttatctta cagcagactt 1748520

ttgagccagt ggactgatgg ttctatgctg gaaagagac agtgtttgca gggaggtgga 1748580

agagaatgag tgggtggcac ctgtttcaag gaaaaggatg gctaaggtca ccagcctctg 1748640

ctgacatagt gaagtccatt cctagtagag tcctgtggtg tcccctgaca ccacaataaa 1748700
 caagacgcta ttcctgtgc ggcgtccacc cttgaccagc aagaagacg ccacatcgag 1748760
 gaatcttctt caaacacagt ttaatcgga acctctttgc tttgtacaat gtataatggc 1748820
 ggcgccccg ggccgagga gacggggcct gatatagtct acatctacca atcacctaac 1748880
 cctacgtggc gcgccaggat aggttgtctc caagcagaat taaggagata catgaccttt 1748940
 gcctaatttg gatttgttta ccacagagag cgctcgccgt cgggctggcg gagggcggaa 1749000
 accggcgcca tcttttgggt gcggttttct gcagctccct acatccctgt aacaagatct 1749060

 ttttctcttt agactgacac agttcctaca agctcaaaga aactctcatt gcagtgtccc 1749120
 tgattgagga agaagttatc caggatcagt gagcttggga ataaagatga cagtccctacc 1749180
 cataataata aagacccaaa taaaataata ggtgtgggtg aggcctgtac tcccaacca 1749240
 gagaaggcta tggtaggagg atgaagggtt caaggctaac ctaggctacg tagtaagacc 1749300
 tgtttaaaac aactaagga aaacaaaatc agctccctgc tggaagacct ggaaatgaac 1749360
 cacatggtc cctgccctct agtcctaagg agtgatttta aaagacagat tcaatttgtt 1749420
 tcattagaca ggacttgaga catcatgaga ctgaacagtg tttgaggctc acatcagaga 1749480

 ggtggcctaaa cccatattca aattcaaac cagtctgact ctgtagttgg ctccacatcc 1749540
 tcatccagga ctggccaag tgccatcata ccttctcaa agatagatgt actcaaatga 1749600
 caagtgcaca gtacteccac tgactatgct tttcaggagt ccttggttcc accceatgca 1749660
 gttaagtctc aagaaggatt attcttaggc atggatctga ctaccattct ctacaggtca 1749720
 ctgtctctgt tgagacagtt tccaaaggat ctctgcagca accaccaggc acttttcagg 1749780
 cagctctaac tttcttctc cagtgtgact ctgatcatgc ctttcttca ttccagactc 1749840
 ttccgaactg cctgtgcccc ccccagcat tgtttaaaag aggtacacac agcccctgac 1749900

 ttgatcctcc tcccaccca agtccctttc tctttcttgc ccacggacat gaagtaacct 1749960
 caacattcac tacatagtta cgtgagtgtg agcacatgat ataccttgag atctgcacca 1750020
 tttgctgatt ttgttactga agcatcagag taacgtacc aagtcagggg atcccactgg 1750080
 atatgcagtt cagtatgact gcgagggctc tctgtggttc ggtgctatat tcagttattt 1750140
 gtggctccag cacaattat gtttgtttc cctctgatct ttttgcata gtgacacctt 1750200
 cttcagcttc ttattgggc catcatggtt gctctgacag cccctccca tgactcctga 1750260
 ccttggtagg gtgaccttc atgtgtttcc ctgacctgg ggtgcacatc aactgcagg 1750320

 actgctttcc ttccttcat gagtgaaaa caaacagttc tacttaacc acatcaagtt 1750380
 tatagcatgg ctcttagat caggcacaag caaatgctga actctgtgag gggatttggg 1750440
 tcgaacaatt tcttttgggt atctgaagat gctttctct ctttaatgct tttgagaact 1750500

ccaaaggccc aaaggatcct ctgtgggtgc tataagagga cacacaaggc aacttaagat 1750560
 gagaaaaata gagtctaaaa gtcagaatct ttaagggaca ttgccaagga catctcttct 1750620
 ttattctatt ttatgtttat tgggctttgc ctgaaagggt gtttatgcac catgtatgtg 1750680
 cctttagacc agaagagggc gccagatfff gaggaactgg agttagaca gtagtgagct 1750740

 gctttgtggg tgctgggtat tgaacctggg tcctctagac aagcagccgg tgctctaac 1750800
 agctgagtca tatctccagc cccccaagga tatattttca caaacatgta gaccccaag 1750860
 gctgaacttc aaatattctc aagaggcttc ctgtgggttt tccctcctc acagctgtcc 1750920
 cctccccgg tactagtttg tgtgactttc atttctaac tgttggcgac atggctcctt 1750980
 ccctgagatt tgggatgga ttcaaatcia tgctgcagat gttagcgaac tccaggagag 1751040
 cgtcgtgatt attttgtct attctgggca aacctgaaga tgattcacta gcatcaatca 1751100
 tcgcatggtt attctctttc cattctatga gtagtaatac atctagggtc acatgaatga 1751160

 atctgacttg cttattttgt ctttgatgga gtgacttagt atacacatat gttagatatt 1751220
 ctgtgtgtgg atatgaacaa tgttgaacaa ctccagaat gttccacat atgtaaatac 1751280
 tcttacaacg acttgaagac ttttagggat ttggcttctt tttttctgt tttcaagctt 1751340
 tgtttgcaa taagttattt taattattt ttatcagcat atgttaattg ttcagaggtt 1751400
 tccacggtgg catttcata tagacttata atgtacactt gatcatagtc aaggaattcc 1751460
 atttcttta gtgccccctc cccttagtg gggctgtgaa gctgttaata aggcagatgc 1751520
 cctgattctg actccacaat ccatggctaa gcagctccgg gtgctaagac tggaacacag 1751580

 ggtgggtggga ggggctcaga catctcagaa attaatgag ttcctcgagt tgtcctgaga 1751640
 tagctggatt acaatctctt gcatttagac actgggtcc agacttcagt taccgctgga 1751700
 ttctgttatt ctggcatctg tgattagatt ttgaaagaca cacacccaaa caacatggat 1751760
 tatttctac ttgctccggg gcatctcata agtagaacca gggaactgta ctctagaatg 1751820
 agatcttctt gacctcaggg gatcatgaat tgaatgcaag attgatggat ttccatcatt 1751880
 ttttcatgaa aaggatgca catatftaa cactttgggt ttttctgagc atagcaatat 1751940
 ctgttactat tcccatacc acacaaccaa tggataaagg gcaactatgca tetatctttg 1752000

 cgggctctgc agcttcaggg tcaatccatg tccaagaaca tggaccatcc cagaaaacaa 1752060
 aaacatccac aaaggtgctg acagaagtcg gatacatftg tttgaaagag atcttcccaa 1752120
 caggcagaac ggcacagaaa gaaaagagaa aatcataacc taactfttg aagcccttgc 1752180
 aaatctcaca aactctcaga aatgagagag aaaacatcat aaacaaactt aacatctgac 1752240
 aatataacta tatgccataa acatatagtt tgaatgtaat tgeccccat aagctcatag 1752300
 agagtccac tattaggagg tgtggctftg ttgcaatagg tatggccttg ttggagaaag 1752360

tgtgtcactg tgggggtggg ctttgaagtc atatatgctc aagccacacc agtgagacaa 1752420

 accacttctt gttgcctgct gatgaagata tataaccccc tgctccttct gcagcaccat 1752480
 gtctgcctgc acgccacaat gtcccacat gatgataatg gactaaacct ttgaaactgt 1752540
 gagccacca actaaatgtt ttcctttata agagttgctg tggatcatgt gtctcctcac 1752600
 aacaacagaa accctaacta agacacatac ctagtatata taaaccaga gattaaaatt 1752660
 ctgcttgtga ggaattcccg aatggtagtt tcttggacct gtttggttga aaacgctggg 1752720
 tctctggaag agatacatac tcggaaaatt ttgccgttc cattttgaaa tgctttggga 1752780
 aacatgggat ttcctcaaa gggctttgcc cttagtggac atcaaaaatg tcaaagaatc 1752840

 cccttgaag gcctgtagac atggaacctg tgccaaggag ccagcactac ccacagcatt 1752900
 tcaaggccat tgtgtgctga tggacttct tcccagttt tggaacacag acacccaaat 1752960
 ctggctgtga ggtccttaat tcattagttt tagacttttc taaatTTTTT tatgaacaat 1753020
 ggaatTTTtag ggtatgcttt tatctttggt tatgcttaaa tgtttagtaa gcaccacaac 1753080
 aatggatgcc aacacactgg gagcagtgg agacaaggtc cttgacattt agaaacacta 1753140
 gtccaaga gctccaagt tccaagtaca tatatgtcca tataggctct tggctttctc 1753200
 acaactgaag gaatacatta catttcatcc cggccgcaag ggacccgggt actctttcta 1753260

 tgtgacattt aagtagtttt catgagcact gatgaaataa tgaaccactc attagacca 1753320
 agatggcaat ccctacagtc accaaggctg tgtgattctg caggagtgtg gagtgtttat 1753380
 cagataacte aatttatgt ttagtaagt atttaaggta ttgttggat gcagtttcta 1753440
 atggactgaa aactgccagg catcatgcta agggcattgt atcttaattt tttaaattta 1753500
 tttttattgt gacaggtct tactatggag ctctggctgg cctagatctc aatatgtaga 1753560
 ccaggagggc ctcaactca cagagatgta tccacctgcc tctgtctact gatttgtgag 1753620
 agtaaaggca tgcactacca tatctgatcc atttttattt gtctatttat tttgagactg 1753680

 ggtctcatgt agcacaggct ggatccaat tggggccaat tcatgcctt ggcctcaggc 1753740
 tccaagtaa ttatattata gggcttagca ccatctttgg ctggtgcttt tcatttgcca 1753800
 ccttgactaa tcatcatcat aactgttatg gtggaagttc cacccaagcc cgcceccca 1753860
 tctcctcca aaccctgctg catctcagaa agcccatcag ataatggccc ctccccaga 1753920
 gatgtcaag atcactccca cagggtattt aaattgtccc cgggagaaca gacttttctt 1753980
 gtctcccttt ccctgtatcc tctctggggg actggaaggc catccaggag ctctgtatcc 1754040
 attaaacgta ggtttttttc taatttgatt tgatttggtc tgatttggat tgttgattg 1754100

gcagagaggc ttatccaggt gtagaaactt ttcaataacc tgtgatggct gggaatgctt 1754160
cagcaaggac aggtaactca cattctctc aaaggctgct cttaccatt cttctctga 1754220
tgactcagca aagcctgctg ataaattcta ggtgcttttg aatctgtcat ggaagcatcc 1754280
caaggaggat ctgcccattg ctgagtcaga tctgcctgct tcacagaaag actggtgatt 1754340
ttctgcgaga aagacgctgt accacaggtt tatcactaac tagtttaggg agtgatgcct 1754400
gcagcatcag ctgggcagca tcatcaggca gtgggtatit gcatccagag ggttcttaca 1754460
ctccagagct ttctcaggaa aatctccaca gggaccagca gctgctgtca aaaccagtc 1754520

agagcccaaa aggacacaca cggacacaca cggacacaca cggacacaca cggacacaca 1754580
cacacacaca cacacacaca cacacacaca cagcatttac ttttaagga caagaaacaa 1754640
tatccttagg ggtctctccc agtagttttt actagaagtc atgcatacat tttctattcc 1754700
aacataacctg taggcatgac cttgtgttat tttctgaatt ttctaattggg attttattta 1754760
tagctgtaaa gaaacaaaga aaggagggtg ggaagaagga agagccataa ggaaggaagg 1754820
gaaccaacga gaagacatga tctgtgtcat tcccggctgg agactctac acacaaggag 1754880
ggcgaagtg cagcaggcca gggccaggcc gaggttctgt ttgtttgctt tctgggaagg 1754940

acgaggcagg aggagaaaca cttcacagag gttcagtgat tttctctccc ttgggttga 1755000
cccaagaata tttttattcc actgtttact caaaatgtcc tctttctcaa tgaggaattc 1755060
tcacttttgt ttttagcccc ttgtgagatc ctcccctcct ccttctctct ctctctgtct 1755120
ctctctgtct ctctctctct ctcccctct ctctctctct cctctttcc ctcccctt 1755180
ctctccagct ctgaagtct gcaccagctt aggagatgca aatagcccag cgcttcaga 1755240
tgtgaggaga cacttttgaa taaaaccag cacacattca tgtctctttg gaatgcaaaa 1755300
gtattgaaat aggtctataa aaaaatctcc agtttcctc aaagaggtca agagctccat 1755360

tttctatcca gctgtcattg tgttactggg tgagtgcacc taggcagccg agagtcaacc 1755420
cccaatgagg gcacataaat tccatattct cccattccc cacaaccta tgcgagtgtg 1755480
caaacgaaca tgattcttac tactagacag cacctgacgc ctgaccccc atttcatcgc 1755540
acagttttgc tcagatgtg aaggetgagt gcctgggctt tcattatcaa ccaggggatt 1755600
tgctatgta tggctgtgtc tttcagcgtg tgcatgtatg tgcccttgtg tgcaggccta 1755660
tgctgagca tgcagaggcc agacattgac gtcggtgtt atcctctatc tttctctgcc 1755720
ttttttttt ttttttttt tttgagtctc ttatttaatc tggagctggg tgattctgct 1755780

agacagactg gcctggcaag tttggggtgg ggggtgtgtc ctggtccac ctctgaacac 1755840
ttggattact tatgagcata gccaaatgcc cagattttca catgggtact aggaacacaa 1755900
catgggttca taggcttact cagaaagccc tttacaagt gattctttag actttttcca 1755960

ccaacaggac acaaggcagg ccaggaggac ttttctcttc tgagtcaatc tccatgcaaa 1756020
 gggttaagaca cccacataca tgtgccatag gaggcatggt ctcataaacg gacaaatag 1756080
 aaggttgcaa tgtccagttg ggtggcagta cataccacca attgacatgg aagcagcagc 1756140
 agcctggagc ctgccagctg agccttcctg tgtggggaga tgctgctcag cttcatccca 1756200

gctgaaattc atttttcaaa agaaattaga cagaggtact gttgttatag caacagtcag 1756260
 agtcatttag gcacacagtt tcttttccac aacctcactg acttctgcgg gcagtatttc 1756320
 atttatgcaa ggggagtgcc taaggctgag cctgcacgga ccctttatta gcctttaaga 1756380
 tatgaaagcc tgagtectct atggccaatc taaagcccca tgacaatfff atgtgttcca 1756440
 gagggtgagc agggaagccc agcaaaaacc cctcgaatcc agtattttcca tctcctgggt 1756500
 taggaactga atgtgtcagg gatgaatttc ctggcttacc caaagactgg cagccccgag 1756560
 gaggaatttc caagagcatg gtaatgcagt cagtgaactg ggaagtgact tcattatttc 1756620

agttctatag gactttgggg catagacttc ctaatgtgat agcccacacc aacctgaa 1756680
 aacaatactc tacccecaaa cgatcttgtt ctgaggaaaa tgtgcatctc ttaaggaatc 1756740
 ttcattgcaa aggacttccc agaaaagtgc caccagggtc atacaagggt ggtaaaagcc 1756800
 tgagcctatt gctcatggcc aatgttacag aacaactgtg tctcccacca cacaccaatc 1756860
 cgtatatcta agtcccagcc accagaaact cagctgtgat tatattggag tcagagcctt 1756920
 tataaggcta ttaagacaaa ataaggtttt ttaggatgtt ggtgactgtg tgcccttaca 1756980
 ggaagaaatt agggcacaca cagaaaggac ttgtggggac acagataaag aagcacctgc 1757040

cagcccaagt gagatggctg tcttagtcca cttgcacaat tgcagcaaaa tgccagcctg 1757100
 gataacttat aaaaagcaat ttatttgtca caatcttgaa tgtttggaag tgcaagatca 1757160
 agagactgga aaggtcaggg tccagtgagc cccactctc tggaacagtg tccaagtctg 1757220
 gtgagccctg ttctatgga atgacatcat ctagatctcc agcagaaaag taaaagagaa 1757280
 aaacttgttc gctttagcct tttagtctat gccaacccgc acagagtgac ttactcaact 1757340
 ccagagacc cactgttaag cattaccaca tggggattca gttcagcact gaattccagg 1757400
 agacattcag accacagcaa gggcccagaa gaaatcaacc ttgctcatac cttgagttgg 1757460

acttcaaage ctctagaact atgagggggt acatttctga tgcttacata gtctagtata 1757520
 ttatactttg ccataagagc cttggtggac aagactaaca atttgattca agcctatccc 1757580
 tgtcctctca gctaggtcaa gctcttaatt actaccacaa aagaccatct tgcacagcct 1757640
 tgtccaggct ttggtttaat tgaccggtag gcaccgggtc tgcatctgac ctcaacaact 1757700
 ttcaggatgg agacaacagg gaagcaggca aaaggcaaca gtgtagtagt ttgtgtgtct 1757760
 cttggtctat ggaggaaagg ctccaaagat ttgaggagtt cgtggtcatg gagcaactgt 1757820

tcaggcagtg ggaacacatc tttgttcaga aaagaaagaa gcacatttgt gagcaagacc 1757880

tcaagcactt ttgtctgtct ttagccacag tttcagagt gcaaactgg gtaagagagc 1757940

ctagagaaag aagcaggggc cacagggatc atgaagagct gacctgtgtc agggagtgtg 1758000

gtccagaaga cactagggaa aatcactaa cttgtgatgt tagtttctga tttgataatg 1758060

ataaaaaat acaataagt accaaagatg aaaccttcac agtgatccat actgtcttgc 1758120

tagggctccc atatcaagat agctacagtg taatgtggag tgttacccca aaggeccata 1758180

tgtaaaggc ctgttcccca gcctgggtca gtattaggag gcagaggac catcaccagg 1758240

taaagctgat ctagaggaag tatttgtttt ctgccccaca gccagcatga agtaaaagct 1758300

tcctcttcta cacatttcta catggtgtct tatgtacca cagacccaaa cagtggcacc 1758360

aagtgacat gggctgaaaa caccatcaa aatcaatcct tcatcattct gaatggattt 1758420

ttctcaggtg tctgcatat gacagaatgc tgatcaagac aggctaaaac aatctaaac 1758480

ttcaccttc tggcagctgg atgtttgagt tcaaagggtt cttgaactct ctgtagaata 1758540

cagagggcta cttttccct ctgtcctcac atggctctc ctctgccata ccacagcttt 1758600

tgtgtctgtg tgtccagttt ctcttcttat gaaaacaggg gtcataatgt taaggagtgc 1758660

ccaccttaca ggctttgctg taatttaaat ggcctatct ccaaacacgg tcaatctctt 1758720

aggacttcag cctctgaatt tgagagagge atgattcagc tcatacagaa tccaatacca 1758780

tttttgaca gcttattaga gaaatgtcta aaggtactct caagttataa atcaacagga 1758840

tatggagtgt acctaaagaa aacaattgac aattactgct ttaccgcaat ttaacaatgc 1758900

tttatittaa aagtgtctgt ttgcttgcct tcattacttt tctcactgct ctgacaaaat 1758960

ttatggcaca aaaacaagtt aagggggctg gagggatgga acatctggct aagacaccca 1759020

ctaccaagcc tgaagacctg ggtttgagtc ctggaacaca tacagtagag tgagagtaac 1759080

cagcgccca gagtggcctc tgaccttcac aatgtgagtt gtggcacatg ggagtgtaca 1759140

cacatacaca aataatagca aaattattat tatattataa aagtgttcc gattcacttg 1759200

ttaacatcct aactcctgac aagccctcag acagacagag gtgggtctgc tgcagttcaa 1759260

gaggccctga agagattgcc ttgttccctg agaacaagta aatgttcctt cacagtgaca 1759320

cctgacctca gagggataca acagagagaa aactgaagca gagaagat gggttccca 1759380

ctccagccca gtatccaca gtaaatcaca gggctcaca taggtttgtc accttctgct 1759440

ccagactgtg gtgcactgtc aatgtcctgt aaaactgtag agccaagcta agcatgccag 1759500

tgattttatc ttaacctag ccaacaagac attatttatg ctgtttccat tagaatgcta 1759560

cagtcaagtt tgcatagtac ttcctataac tacctactag tgctcagtta tggctctcat 1759620
 aaaactcccc agggacagat ttttttccat ctactctca cttcagaagt tagaaaaaat 1759680
 ttaacaacag atgatgattt tagagatatt tttgaagttg tttgaatggg aaagaaagta 1759740
 ggtttttttt tttaaagcca caatgaatat tttgccacct tttgtccaat ctagcaccat 1759800
 aatcaaatg aactgatcat aaagccacta ggcaaggcga tgtaatagat ttcactggcg 1759860
 actgcccaca ctgccagact gaactaaatg aggtctgcat tcacgtggtt atcagtgttt 1759920
 aaaaatacc cgagtgtaga gtgtacacaa cacaaaatgt caggaacttg aaaagcaaaa 1759980

 atatgcatgt ggtgttttcc aaatctctct atagcccagc aactaacaac acttaattat 1760040
 gtgaccaagc agcagctatt taacctctcc agacctctgc ttcctccgtt ataaagttaa 1760100
 agagttgtgg tatgtggtct ctgagaattg ttccagctct gagagtctct cttcaggccc 1760160
 tggattcaga tcaatagctt acattcaca ccaccctgga aggcaccgtt aactcaaagc 1760220
 cacacttgaa ctggcaggt tcttactcac tgagatcttt gtggcataaa gcaagcagcc 1760280
 attgctcctc tgcaaaggtt tttttagat attgggaaga aaaattatac ttgagactta 1760340
 attacaagta tttcaaaaa tccggcaagt aaacgaagtg tgtaaattac atgattaatt 1760400

 taaaagtaga ttattttctt cccctgatgg cacacctggt atcaggtgct gagctgggta 1760460
 cagaggatat gaaagctgca caggactcag atgttgaagg acttgagcc tgctgctagc 1760520
 tcttacttag ctccccagtg ttgaacagct cctgccatgg gtcatactag tctgacacag 1760580
 ccagcactgt tgcattggct ggcagccaca gcaacacaac tgtttgtggt tcctctccat 1760640
 tgaacggttt ttaataaatg cctttaagt acacgaagag cctgaacata tcaggtttag 1760700
 gtaattagat accaggccag gttataagaa gatgtcaagg gcctaagatg tggctcagtg 1760760
 tggaaacag caagtacaag gttcaggggt tgatccctag tacttcagtt agaaaaata 1760820

 attaatcaag ccagatcagt ggcatatact acctacaatc ccagcattct ggaggetgag 1760880
 gtagcaatac aaattagagg ctagcctgaa ctacacaatg agaccctgtc tgaacaaaac 1760940
 aaacaacaa caagcaagca agcaagcaag caaacaacaa aaccatatct gtagttattt 1761000
 ctaggcattg tntagtaaca cctagctaag tttaaactct gataatattg cctctagctg 1761060
 taacttggca aaggccaac ctgatattc tccttccta caaagagctt accctgtaaa 1761120
 aggatcggtc taataaagac gataagggaa atgcttaacc tacttaagac agaaacgagc 1761180
 ctagaagact caaggactca agagactcag atttaataa acaattgata cacacattct 1761240

 aaattctct catatattag agtagttccc caagggtgtt tatttactaa cagtttgaat 1761300
 tgctcttgat acttctaaaa tatatcacac tcgatatata tttaccacga tacttcaatt 1761360
 ccaattttc tcaattcagg aagctttttc cccaaattag tttgaattag ggagcgtcta 1761420

ttgtattcat aaactcttca tctaaatggc agaaatggcg acgataacat ccgtcttggg 1761480
 tttgctggaa gtctgcagtt tgacttccag tctgagactg gggaagaatg aacatgagct 1761540
 gattaatggc cattactgat ttctcgcagc tgtaacttat cggaatatgt atactctaat 1761600
 actgtacca tggttaattat ctcaattacta tgaagtgtca cagaaacgca ttatgcgaag 1761660

 tgagcgttga atcacagtta gcaatcttct tgggatatga agcctgagga gctttgtcac 1761720
 agctttgatt ggetgccatg caccagget ggagtcctt ggagctctg tcacctggct 1761780
 ccctttgtga aacttttctg cacctcagtc tctaatttga aaatgggaag atttgtgtgt 1761840
 gaccagagag atggccgaaa agctagctgc tcatctcaa caaaagcact gaggtataac 1761900
 tcagcctgca cagtgtcac tctgactgca tcaatattta atatagaatg agcaaggcca 1761960
 cataatatta agcagacata ttccccaac attgctaacc caaagacatg acagtctgg 1762020
 aaatgtggct tgggtggaag agtgcttctc ttgtatgcat gaggcctgg attggatacc 1762080

 cagcacctcc taaagcaggc atggtataat tcctacactc aagaggatcg gaagttcaag 1762140
 gtcatcctta gcaacagagt gaggttcaagg ccaggctggg ttgcatgaaa ctctgtctaa 1762200
 aacacaaaca aaatgaaaaa acaaacaaaa tgaaaaccca aataaatgac aaacaaagca 1762260
 ggaccataaa gtcatccatg cactggcaca agaaagccaa aactgatgat aggccttgtt 1762320
 ctgtacatca tagtgtttga gcagggtggc aggtaaaaaa cagttttctc tcaactcaga 1762380
 agatgtggcc ccagaaagga gctggtgagt acttgattgt cacccatcaa acatataagg 1762440
 ctgcctaacc aaagtaggca catcatggga aatggacacc attgcttaga tgagagaagt 1762500

 cagcaaagac aagcaatgta tcaatgacag accaaaggaa aacaccagga ctgaggagat 1762560
 ggcacagttg gtaaaatggt tgacttacia gcatgagaat tcaagtcaa tacatcagga 1762620
 cacataaaca aagtcagctg tgggtggtatg tacttggaac ccattaggg gaagcagaga 1762680
 tagggattcc tgggtctct agccagactg ctccctatt tgccagtccc agtgggggaa 1762740
 ccttgaacc ctgcatttcc atcatttggg aaatgattag acatgcagtt tgtcagctat 1762800
 tcccacatt tctgaatccc taacctact ctccagatgt tctcttagaa gcagaactca 1762860
 ttgtaaagag ttatagaga agatgacatg tttccatct gtectgatgc ctccatcaga 1762920

 gatacttgtg gtcacctgag ctttttaaat tctattaat tgccaggatg cacttgggga 1762980
 ggacagggca ggaggatctc agtgagtttg aggccagcct ggtgtacata gtgagttcca 1763040
 ggactgccag agtcacatag tgagactctg tccccaaaa aacaaaacaa aacaaaagaa 1763100
 ccaaacaaaa acaacaaaac aatttaatta taaaaagct ccacatgcct agcatgacca 1763160
 cactgggcaa caaagcttta gaacttgeca gtggatcagt aaagggaac agacggttct 1763220
 gattagagat cagagttgtg actcttgcac ataagaacc tgcttggaaa agccagaagg 1763280

gcaaaaagtca ccatgtatgt catgaggtaa agtaaaggct ttttcaggaa ggcaattatg 1763340

ggtatacagg acaaaaaagg tcaacgggaa ggagaggctg gtgtgaacaa aagtacatta 1763400
gggttgggca atccaggagg cctaccggag gtgtcttatg tataatccac ttggaacaat 1763460
actagcaaca taaatttcta tatgtgtgtg tatgtcacgt gtatgcatac ctgcagaggc 1763520
cagaagagga ctccagacc cctggatctg gagttatagg tggttatgag ccacctgaca 1763580
acgggtttgg taacctgggt cctctggacc cagcaaggat tcttaaccac tgagccacc 1763640
ctccaggatt ctccatctt gcaatgcaa aagtccaagt ccatagtcag ctccccattc 1763700
tgcccaacc ccagccttta acatctggcc tctatgattt agctgacta gctactgact 1763760

agctagctaa cagtaaattt gtctttcatg agtggaaat tttactcatt ataatgcct 1763820
taaggttcat agatgtgata tcagaatttc tttctttttt aaaactaata tttcacagta 1763880
tgatgcttta aggtaaatgt ttgcattttc ctgcaatggt cctatgttga aatcctaagc 1763940
tcctgggtga gaggcataag aaacgtggct ttggggagggt catatgggtt ctatttcattg 1764000
agtaagatta gtgccctgat aaaggagacc ccagagagca ccaccattcc ctctggcacg 1764060
tgggacacgg aaagaagaca attatctgat tgaagacagg ttctccctgg gcggtgagtc 1764120
tacttgact ttgagttttg aacttgctag cttctaaaat cctgagaaat gcatttccat 1764180

tgtttatatg ccaccagact gtggfattct gttatagtag cacgcgtgga ccaaacgga 1764240
ttgcaaaggc ctactctgc ttctccattt atctacggat ggacatttga ccctttccct 1764300
gggtcaaca gagctgataa cgaacacagg ggaacaaata cccaaccaag accccacttt 1764360
cattctttca ggigaacact gagcagtggg attgctggga catatggtaa ttctattttt 1764420
aacttttttt gagaaactga cataccgttt tcctttgcaa atgtgccatt gtgcatcca 1764480
tggaggtctt tgtttttgag ataataaaga acagcacatc aaagctatca gaaagaacga 1764540
ttaaaagaca aatgtggggg agagggtctt tggaaagga aggaacagca cggcttgag 1764600

cttccatttt ctcagtacc ttggttcaag gtcactctc ccggaagcaa gccataccat 1764660
agaggaggag aacatgggag cttgccttac agcattggtc catcacaagg caacaacact 1764720
tcctgaaggc tgacaacaga cacagatcca ctgctggggg tgagctccta tcccataata 1764780
cctcagaaca tgctttttta aaaaaacgtg gtctctgcag atgaaatcag ttaggatgaa 1764840
gtcacaccgg agtagaatga gcccgaagcc attacagctt gttcatctta gaagcaagt 1764900
gtcatgtaa cacaagtac acacaagtga aacacaatgc tacaggacag cagagtcagc 1764960
aactgcagga tacagttaca agtcaagcgt gctagagtcc actggcaaac tccaggagga 1765020

caggaaggaa tccatgactc ttacaaagga gtcttacagg gcgcttggcc ctggtcagtg 1765080
 cccggctttc ccaacaccca ggactgtgag gaaacacatt tttagggttt tctaaccac 1765140
 actgtgcacc ttgttatgga agctccagga attcatcaag ccatggagca caagtctgca 1765200
 gttggccaag gtcatcccat gtgaaggcca aaaagagcat ttgcaaatta ctgttcgtct 1765260
 cacttatgag taatatgttc cccgacctcc gtgataatct aggcagtaag tcaacataat 1765320
 acatactttg aattgcagtc cttactgaaa ggttttctt atgcccattc caggcagaac 1765380
 gggggcatgc acagaaacac actaaattct ctgcttctaa gaaccaatga acagaaatct 1765440

 cagcacccaa agcatgcaag ctgaggctat ctatcaacag ctgtcctgtt tagatgctct 1765500
 gggctttatt tcacacacac ccctctgaac tataatcaca agtaggcctg actattgttc 1765560
 cacctgtaaa tgcataaaat ctccctgatt ttcaaagttc tataatgtc tgcttttgtg 1765620
 tactttgttc tttatcccaa gccccaataa ggttttgttg ttgtttggat actggatgta 1765680
 acccaggcct cacctacgt aagtacatgc tttccatcc taagcactcc aggaatattt 1765740
 gttgaaaagc agtcataatg ttgtttctg atgtccacac ttgtgtttct tggaaaaaac 1765800
 tcagagataa agcaataatt acggatggat gaagccattt aggaaaggct gctaggaacc 1765860

 aactcctggc cagccctctg aggtaaatgt gcaatgctga tgagagctac ggggtcaagg 1765920
 ggcttgtgg ggtcagcatt ttcatgact tcagagtcag atgagggtg aagtccttc 1765980
 caaggcctag cagggtcggc ctggatgcat ggccccgtg ctgctgatat agaagcagtg 1766040
 tagattattt ggttaaacag cacaaccttg aacctggcc aagtcaaagc acaaatccat 1766100
 aacaaagtct ttctctgca gtccatttgc tagccgctt ctaaaccaca ctctagcttt 1766160
 tgtaaaaatt acctctattc tagtgaaaga cgaggcacta caaagtgcca ttgcagaaaa 1766220
 acaaaacaaa caacaacaaa gctccgctct tcccccaaa aaacctctgg acacaagaaa 1766280

 acaacagcaa caacaaaatg agtaacacat tccttctctc cctcccacat cccctcata 1766340
 tttaaaaaa aaaagtattt agattttggc tttcatgaa agaaatttct taaaagtatc 1766400
 agtgttccca aattccaaag taatttcaca accataaaga aacgaggag ggaatggttt 1766460
 cggcaaggcc ttcaaaacaa tcacctatg ctctatgtg gagtatctt ataatgata 1766520
 aagggtttg caaaaattaa cccaccctt caatggaaat gcccggaaca ttatttatgc 1766580
 actggggcct gtgtgagaca caggatgaa gagatgagta aggttgaatc acctgaaaga 1766640
 acttgttaca gagggaagca ggtaatagtg ttattcactg taatgttccc aggcttccag 1766700

 tgctgtgat ttaattcat aaggaacat atgtgtgag ggggatagg gagagtgagg 1766760
 gaagaaggta gggttaaggga gaggggaacg accacagtaa atctcataaa gttggcagat 1766820
 cgctccggat actgctgcca tctgagccga ggtctcttct gaactaaggg caaggaaaga 1766880

ggagacagca gaatgcctaa cagaacccaaa gctcagcgat cacaggacgc aacatgaggg 1766940
 aaattcacag tggattggat gaggaatta tagatgggac caaatcaat taaaaggaa 1767000
 aatgaaaca gctggaatga agtcaaaagc atcctttcct ccagaactgc ccctgagtat 1767060
 cagctgcaga gagacacggt ttcacagaca aagagatcca agcctggcac taataccaca 1767120

 atttgacat attttgggtt caattgagct gagccaatat gaataccaaa ctgaggttta 1767180
 cagatgtgac tacaggcttg ctttaacca caggctgaga agcaactaca catgtaataa 1767240
 atctgaaatc atccaatgac cttcagtcaa ctgggaggct tatatttacc ccaaataagc 1767300
 atcagccttc cctattaca agatatgcaa atgactccca gactccatg ttgcagaatc 1767360
 attctgggta gttgatgact ctggctcaa ctgtcagga gcaagggaa ggtttgagag 1767420
 agtgatcagg aaaacactac agctgtcagt tggcaaaagc aatgcgttaa cacagcctgc 1767480
 attaactgct accggaatgt cagcattcag gaagagggga aaaactcctc tttggaaca 1767540

 gactctttt gcaaaatftt ctgagttaat taagccagtt ttcatttag caaagagaga 1767600
 tggccatgtc tagtcaacat gcagtgactc agagagtgac aaggttagtg ggcctgtgtc 1767660
 ttttttaaa tgtaatttc ggatagtctc acagagcttg cataggcagt aagtgtcttt 1767720
 cccattatta tgttctactc cagtacatat tcaagggta gaccccaat gttcctcct 1767780
 tccaaccatt actgatggag atcaaggac tgatagattc ccacaaagaa cgcttcactc 1767840
 cataggggta taigtctatg cccaagtac ctgtcaage tggagtctaa atagcattgg 1767900
 ggtattcttt gatctccac atcaaggat aaggcacctt gaatggagca tggtttaac 1767960

 ttggataaat cctaacctct tcatctaaa tacatcatgt gtgttgggt gggggcagg 1768020
 ctggtgagac agggaggaga tgggtacaga attcctttgg aatcaaactt tggtaaccc 1768080
 ctgaagtacg gctgacagca ggtcagaacc aaactagccg taactcagat gctcagcaat 1768140
 ttggctctt ttcaagttat catcagtcaa tttttaca gagagacaga gagaaagaac 1768200
 gaatatatga atttgcata tacttggcaa agtaagaac ttttactccc acaccaattt 1768260
 ctgaggtaa ttaataagca tcatatttc aaataaggag cctggaactg agatagacta 1768320
 aataaactac ccaaggtcac agagetagct ctattgagtt gagattttaa ttccaagtc 1768380

 catgcttccc atcataggcc tctctacttg agagtgaat gaatttctca gtccccagtg 1768440
 aaagcatggc tctaagaga gacgagaagt ggagaacagc ctgcctctga gcagactcc 1768500
 ctcccaggac acaggaggaa gagctatata taagtggatt ccctgtcagg atggacagtt 1768560
 ccgtcaggtg ttcatatgac aattctacag ttgtttcatt tgcagaggtc taactaactg 1768620
 tacactggcc actaatccag ctageccaat ttcaaagaga atgatactgt acttggcaaa 1768680
 ctactcacgc aggccactgt ggtgatggat caggcagcac tttctagga catcactgta 1768740

gagtcaccaa cagaatcaca cacttcccag gaattccaat cctctcacca gcatctggaa 1768800

agctgtcacc ttctagctc acctagcct caacccttaa aacccttaa agtagacaca 1768860

ggccaaccaa cacctcatg tcatcactgc caaaatecac actatgctgg tectaccttc 1768920

acactgctat gccacgttct cttgttggta ctttaaat tcattaggct cttttcatgg 1768980

tttggagtgt atgtataaag gaggggacaa cctcaggtac cctcgacctt gctttctgag 1769040

ataggccctg ctggcctgac tcaccactag ccaaggetga ctgtctagt agtcccaggc 1769100

atctgcagtt tcagcactgg aattataaat gtgtgctatc atgccttgct ttttttgtg 1769160

ttggttccag agactgaact caggttctca tgcttttgag tcaaacacct taccaactga 1769220

gcattctttc caggctgagg tttgatctt aagtgtctcc caaagtcca agtgcaaaag 1769280

gcttgtttag cctgcctgtg gcactactgg aacctgagga aatggggctt aatgggaaga 1769340

agttaggacc ctggcctgtt gagactctgg cccccactc tcctcttct atttctcata 1769400

tgatgagcag tttgtctgca gcatgcacga tgcaatgctg taccatgcca tcaaagcccc 1769460

gaacctcagg accagggaac catggactga aacctccata agctgttctc ctttgagggg 1769520

acttttctaa gttacgtat catgatgcaa gatgctgact aatgagact gggctgatgt 1769580

ggccggtggt ggtggaggca cagtgaggtc acagaaacaa accaccacc aacacagctt 1769640

atagatgca ctttctccc tggetagtag ctgcactata acctcaaca tttccagag 1769700

tgttctgaac acctgtgga tattctgcca tagacactga gataataatg cagatgtaaa 1769760

gttttgagt acacaatcag aattataaaa tattggcaca ggtgatttct taaaatgaag 1769820

gtttatacaa aaaaaatgga cttcaggaac tctgaaaact ctgaaaagt gtatgtagag 1769880

ttttgctggt ggtcttagaa agatggctca ttggttaaga gttttatggg tgtattttt 1769940

tttcagaaag caatcaaaa ctttcatcag attcttagtg tggtggtga gtctctgaaa 1770000

gtttcaaac aagtctccta gagttagcag gaacaaacaa gatttgctgg gtacaactgt 1770060

aaagtctgt ggtaagtca agaattgtct cagcaacttt ggtttcctc aagtcaactc 1770120

tcttgtaatt gtaggttga ttaatgaatg catgttctct caatccagg agacaaatga 1770180

atgtgtgttc taccacggtg gcttctgtga ggctgagctc tgtatcagga gccatgaaaa 1770240

gccaccagg gaacaatcac atgatggaga actgaaggag tctagggtat taaacctgag 1770300

aaagagaaga ggtatggtt ggttctctc taaacagttg atgatcccta ataggaaaag 1770360

aacagggttt aacctgtgca ggtccagaat ataaagtaag atcaggttgc ctgtcagtg 1770420

agaaaggatc catccccaca aggggaactt ggaacaaaa caacaacaaa agccctatta 1770480

gggagattcg gccaccttct agggctaag agcatcccgt ctcttaactt ttctaccaa 1770540
 gtttacacat tcacctgcca gggatttgca gaggttttcg gggttttttt gttgtttgt 1770600
 tttgtttttt attggtggaa ggtaggagaa atgacctcta caattgcttc ttaagctatg 1770660
 atccatctat taagttttca tatctcttat taacaatfff agtcaaagat ttgcaaatat 1770720
 tttcaattg tggaaactt aaggcagatc cctctaataa gagaataatg actaagtgtt 1770780
 gagttttcca tttttgtta aatgagata tacgtgggtg tggtcagtgt gcatgcctcc 1770840
 cacttgtcgc tcctctgagt ttccattgic ttttctgagg tgaccctcct atcaaccaca 1770900

 gttattgcac tattcacctc aattcccacc ctctccggtc taccctctac aataaccatc 1770960
 aagaaaaata tagaactggg catggtggca cataccttta atcccagcac tagggaagca 1771020
 gagatagggt gatctctgtg agttcaaggc cagtctggtc tctatagtga gtctcaggac 1771080
 agccagggaa acacagagaa acctgtctct aaaacaaaaa aaaacaaaaa ccaccctttc 1771140
 aaaagagaga gagatagaaa aaaaagaatc agatcatgcc tttctgccta aatttcaca 1771200
 gatTTTTTtG gttttcttga agccaaattt gtcacatggc ttagaagatg tcaggtgccc 1771260
 tagtatctcc aaactcattt ggccccacc tcctataaac attgcactct tgggaagatg 1771320

 acctctcctt ggctctcctt acctctgcag ttcctccat gtgtgagga gctggttcag 1771380
 ctttccccag gaaggaagtt gccctgttca cccaattca ctcctacct ttctetacca 1771440
 cttcagtttc atcttgattg taccacttgt cacaatttat aatcatcttg ctttgaattc 1771500
 ctcccccttg gaccatctc ttctcatag gagtgcagac tcagtggcaa cgacctgtc 1771560
 tgcttgactt tcttctacat ttgagtctca ggcagccagc atctgagtgg tgtccaggaa 1771620
 gtatttggga atgaatgaat gaatgaatga atgaatgaat gaatgagtaa tctgtggatc 1771680
 agtgttttgg ggggtgtgtg aatgtgact tgtgttctcc taagtctgaa gcatgaatat 1771740

 ttactcagtc ttcatcetta tgaagtgtct atacatatcg caagccaag agaattttgg 1771800
 aatgaccctt aagaagctcc ttaccaaac agaaattcta agatcagaaa gaactctttc 1771860
 actggagagg ggggggggag acctgacaa cacctctggt ttctctctct ggtttttcca 1771920
 gagggtaaaa tctaaaggg tcccgatttg aagatagttt gtcttttttc ccccttgag 1771980
 ggctttcata aaatattctg gcagtaagga acaagagatt ctgggacggg tgactgagga 1772040
 ggtgggagag actacttctc tggatagctt taaaaataga gcagcatct gggatggttt 1772100
 agatacgctt ctctgaaggc gggggaactg gaggggaatg aaggatctaa gtaccatctc 1772160

 atcttgattt ttctgatatt tcattttgga gttttattca tggcaaaagc ctgagaggag 1772220
 ctagaaatc actttttctt ttcaaccaa cattaaatcc cattttattt tgagcggcaa 1772280
 ttctgtgtc tcactagccc ccattcttca gaagggaat ttggatgtca tgcatttttt 1772340

gtctcgtagg aagtttggat gaaagttaac tttcactctc tttcctagag acgcagcaca 1772400
 ggagtttaga tgggaggtgt gtttagatgt tgggaactga tggctgggga tgtgtaaatc 1772460
 tctacttggg ttttggccat gccagtggaa aggatagagc agacagaatc tatacctaat 1772520
 ggactgccta gcatcttgtg agctgtgcta catcccaaac ctggacctgt tgcaggaggc 1772580

 taagccctgg aagccttgtt tcattgtaac tactgggtct tcctttcatt tgtttgtgt 1772640
 tggtttgatg aaattaatct cagtaaagtc aatatgcaaa caagtatatt ttctgacata 1772700
 aagccatttc ctgaccttgt tcccattatt cttgcttatt gcatcaaaac tcattgtca 1772760
 aaagcttaat gtattgtaag acatagaagg tcataattta gcatttttac catagagacc 1772820
 aactgggga aaaaaggggc cttgtgaaat ttgtttctca gcagtattg catgcctaa 1772880
 ctgcttttta aaaatccaaa taaacttgat tgtgcttacc aaatacatta attttaaata 1772940
 gctcattaca ggcacttttg tacataaaaa actaacaacc agtgtgagcc aagttattta 1773000

 tccccacaaa ggaacacaaa cagcttacia tgatgacatt aactttttg tctttttgaa 1773060
 agttaatgaa taatccatat tttagcagaa aattaactta aaaagctgga acaatggctc 1773120
 agccgttaag agtattctct gcactttagg aggacaagac ctcagtttct agtaccatg 1773180
 tcagatggct cataattgcc agctcccagg gctctgacat cctcttctga cctcctaggg 1773240
 tactgcaca catatgtccg tatgcattca catagatata cattattaa tgtaacatta 1773300
 ataaataaat ctttaaaaaa atcattgcct taaagcaagt ccttcagggt tttcacaac 1773360
 cataattgga aacggatctt atcatgtcac atgatgtcaa tcacacacct acatttattt 1773420

 cttcactcct tgattgttct taggtcaagg gttgagtgtc tacctatgtg ctccctctgtg 1773480
 cattgtgcta gaaccagaac ttcaatatca gagagtctaa ggcagaaaca aagattcctt 1773540
 gtgctggtta ttttctttgt tttactcctt ttttttttct ctttattttt ttgtcaattt 1773600
 gacacaagct ggagtcacct tgaaggaggg aacttcaact gagaaaatgc ctccatcaga 1773660
 ctggcttgta ggcaagctag gggatattgc ttgattactg attgatggca ccaccactat 1773720
 ggggtgtgcc atccctggac aggttttatt agaagaaggc tgagcaagcc agtaagcagg 1773780
 gtttccctat ggcctccgtt tcagttcctg ccttgagtgc ctgcctgac atcccttcat 1773840

 gatggactgg aagaggtaga taagattttc aaaagttttc ccaagttgct tttggatcatg 1773900
 gtgtttatcc cagagataga aagcaaaacta ggacactcca gaccctaaca ctaaccctgg 1773960
 aatgtaattc agttggtaaa gcagttgtca aacatgtctg agactctgtg ttcttccgt 1774020
 agccttgcat aaaccaggca tgggtgtaca tgggtggaatc ccagcactgg ggaggtggag 1774080
 gcatctttgg gtacaaagcg agttctagtc tactctgaaa ccccatctca aaacaaacaa 1774140
 agcaagtaag caacaaatg aaacctttca aaaaacgaaa ggcagaagtg aatagtctaa 1774200

aagaatatta atgaaatgaa tgactttaag gtgttttctg tcaaaatcga cagactgttt 1774260

gttacactgg aacatcttgt tacacaatgg cctcttgta agggatggag gatgaggata 1774320
tgtccacatg gacatttaac agcagaatgg aaggcttca gggaccttgc cctttgagat 1774380
gcatggctcc aacttccat ccctaaggct ccagtcactg ggggtgagtg ctgggcagga 1774440
gctgagctat ctctggggtg ggatacttac ccctcggtg agactggact gatttggacc 1774500
cagccatgtc agagcagaaa acaatgaaga caaaagcaga ccttctgcct getgtagaat 1774560
cttctttgtc tccacttacc caactgaggc aactgagaac acagctctcc cactttctct 1774620
ggatgaacce tgatgctccc tttctctcc cttttaatcc agtttgcctc tcatttcttt 1774680

ctgaccatca ggagttcagc atacccccc ccacacacac acagagtttc caggcttcag 1774740
gatggcccgg attgaggctg gctgcaatgt gttgatttca ccagctccct ctccccctcc 1774800
actctggctg gcacactgga agctggccac tttgtgtatt tacaaccac agttctctgt 1774860
ctgcctccct ccccaagcg gcttctgct gttactcctg tggggtttcc ctcacagccc 1774920
tcctcacga atttaacacc accactccct tggtgcaaaa caagcgtggg gagcttgttg 1774980
gggcttgcaa aaagcagggg tggggctgc tttctcggg tccgttcatt gccaccgcca 1775040
atgttaacag caatctgtgg ggagatggca attctaacat aatgagatat taatgagttt 1775100

tgcacgtgtc cctagccaca acacacttct agtccctcc cctttacct tctcttctag 1775160
aaaaccacag agaatgggct ccatccttga cagcaggaat tctatgttcc tccttggggc 1775220
tcatcctgac tggtccaat aggggcctag ccacctgct cacctcaagc catcagcact 1775280
acagaacacc aaatgggctg gcatcgctt gtttccctggc ctaatggatg ctgttttaa 1775340
caccggagct gtttgattg ctgcggtca ctgctgtta aacacagtcc tctgaaacct 1775400
tatgccaate caataaaggt atcagcagtt cagtgtgggg aggcaattac tatacagtcc 1775460
caagtgtgcc ttctaagctc taggaaggaa aatgtgatcg aacaactaaa aggaaaatct 1775520

gattcggctc agcatcacgt ggaggacaca aggcttaact gcagccaggt ctgcagaggg 1775580
cagagggaaa tcaatcggt agcaagcaag cacacattgt taggcaagca ctaagccagc 1775640
cggttagtaa cactgtcccc tgcgcttggc agaggcactg ccagtccaag ccttccgctc 1775700
cctttggcct gctagctcgc tttgtcatcc caaggctac acttacttat attttaatga 1775760
caaaagtca tttttctgaa caccctgtat ctctctctc acctttaatt cettaagcac 1775820
tcacataaaa atggcttttc ttgtgcaaga tcattacat atcaaaggag tcagagaggg 1775880
agtaaaaatg atagaggggt aatacacaca ggcaggcagg cagaagaaga caagcacgct 1775940

tcagagaggc ctcaggcccc tcacctcgaa ctaatgatag cagtcaataa ggcaatggat 1776000
ctgtgttctg cctcagctaa ggctgaagtc aggggaatta gacaccaggt ttacgtgatt 1776060
tctctcccaa gaagaagttt tgggaaaatg aattctttcc tgtgttacga agttctgagc 1776120
acagtgggaa tgggttgctt tcccctctgt tccattttaa aagctgctcc aaaatggccc 1776180
tcctttctct aggaagagtg agaaacagca atgcatgtgt ctggcaacac tggggaacgc 1776240
tatccacaat gtcactggg gcgccatcca tttcctagga atctggccaa atccctgtct 1776300
attccccaag gttcctggca caggggacag agacatgatg gagctgaagc cttgtagtca 1776360

gcatttgcca ggcagctcct gcacatgggt gcgggggcgg ggtggggggg gagctatgcc 1776420
tataacgggc tccatgagca gcatggattt cccgtcatcc ctgttgtctc agtgctggga 1776480
gcatggaggg agctgggccc atgatggcac tggcagtgtt cagccgact cagaatagca 1776540
ttcaatcctg caggcttatg gggctggcac actgacttcc cagaatatca gccatgtacc 1776600
ttcactagct acigtcttct ctgtgctggc cttggacaaa actccagtcc catccccag 1776660
ttccagaag ggtgggtggtc acaggcagta aagtccacc agacagacag catgactcta 1776720
ctgccactct ggaagaagca tcagactctg tcactttctc ttgtcactca acagctatga 1776780

caactaatta aaaatggta tcttcttggg ggctggagag atggctcaga ggttaagagc 1776840
accggctgct cttccagagg tcttgagttc aattcccagc aaccacggtg gtcacaacc 1776900
attcgttatg agatctgggt tctcttctg atgtgcagat atacatggaa gcagaatgtt 1776960
gtatacataa taataaaa ctttaaaaa aatgctcacc ttcgacacct gtatctgtaa 1777020
accaccaata catgttcttc atgatttctt gacttaacat tcacagaaca cctctttat 1777080
tttaggcctg gaaatatagg tatggtgtac atgctgaaac tacaacaaaa ttatgatgga 1777140
tgtatttctt gtctaccta tggggaagag aatgttcta cttaaagagt tctctctctc 1777200

tctctctctc tctctctctc acacacacac acacacacac acatacacat catcatcacc 1777260
atcatcatct caatatttta tttaataact ttcttattt ttgagattaa aatatgaata 1777320
tattaaata taatcatttc ccttccctc caaagtctcc catgtacccc tcttgtttcc 1777380
tttcaaatte atagcctctg ttttctttaa ttgtgttac acacacacac acacacacac 1777440
acacacacac acacacacac attcctaaat acatgaacac aaccttctca gttgatataa 1777500
tgttagttgt atatacatat ccatgttttc agggctgacc atttggtatc cttctcttgg 1777560
gaagactgtt tcicccactt cagcagtcac tggttgtcta tagtttttgt ctggagtga 1777620

ggactcatgg acattcattc ctccatccac ttttagcatg tccactgtta tctccttgt 1777680
ccagcttatg tttggccagt catactgggtg ggactttatg gatgtagctt ttgatatttc 1777740
taggagacac aatctcacag caaactcct gatcctctgg ctctcacaat ctttcaccc 1777800

ctcttccctaa atgatgcctg agcctcacac gcaggagttag tgtttagag gtatccactg 1777860
 gaactgggct ccacaactcc gcattttgat tagtgggtgt tttctgtagt gatctctgtc 1777920
 tgttgcaaaa aaaggcttcc ttggtagagg gtgaagatta cacttatatg tttagacct 1777980
 ggagaaggat ccatcttaat attttaaagg gcaacttaca tgtgcatgtg catgtgcggg 1778040

 cgtgcgtgcc tgtgtgtgtg tgtttatgta tacatatatg tatatatatg ctaagtttaa 1778100
 aacattacca tgttatata cacacacacc cttcctttt aataaattac tcaaaactaa 1778160
 ctttaaaagc ttctaagcct ctgtgacaag accttgctgc acccattctg ttacttgctt 1778220
 ggtttctctg caggtagata attaaccttt tctcataact tactggtcat aagttactgg 1778280
 ccttgttatt ggtgttatgc ctgctgtttc tttgtctaag ggggaaaagg ctagctattt 1778340
 gattaacagc tacctttctt tttgtatgt atgcatgtat tgtttttgca caacaacaa 1778400
 tttccctcc ctcttctcat cccagcctct ccccccccc cccaccccc ccccccccc 1778460

 cccacacaca ctccatttct cttcagaaca ggacaggcct cccatggaca tcagccagcc 1778520
 atggtatata aagttgtagt gagactaggc acctcctctc ctattaatgc tgcttgagge 1778580
 aaccagtag gaagaaagc tccccaaagc aggcaacaga gtcaaagata gtccctgttc 1778640
 tcaactgttag gagtcccata agaagacaa gctacacaat tgtgaaatat atgcacagga 1778700
 cttagaccag tcccatatag actcctgat tgttggttca gtctctgtga actcctgtaa 1778760
 gccaggta gtagttttg tgtgtttct tgtggtgtcc ttgaccctc tggctctac 1778820
 aatcattcct cccttctgta ggattccccg agctctgct aacgtttgac tgtgggtctc 1778880

 tgcactgtt tcatcaatt gctgggacca ttggtctagg caccaatcta tgagtatagc 1778940
 agaatatcat taggaatcac ttcatgctt ttttttttc tatcatgttt gattctacc 1779000
 taggtctcta ggctatccag cctctgggtc ctggctatcc aggcagtgc caggtgagct 1779060
 ccctctgtg catgacatgg gtctctagct ggaccagtca ttagttggcc actcccaca 1779120
 tttctgtgcc acctttacc cagcacatct ttaggcagg acaaatgta ggtcaaaggt 1779180
 ttttgtggtt gggttggtgt cccaatctct cactggaag tcttgctgg ttaagggaga 1779240
 tggccagttc agccttggtg tcccccttg ctaggagtct tagctgggtc acctcatag 1779300

 attcccgaga gttccattg cactagctac ctttcttaag aagagaactt tgcaaaagat 1779360
 ggtgaaacaa tgttttgtg agacttctc ttgacctgt tctgggacag tacttagctg 1779420
 tattccagg atctggagtc agcagtggtg ccagaactga tcctcaataa tgtgtaatgc 1779480
 tcctacctc actcagcaga ataaacatgc tttatttct tctccagtg tttggtgcat 1779540
 tgccttaaaa aaaaaaaaa gcagactcca aacttctta aactgtttc tttctctca 1779600
 aaccagagat agaaactcat aacatctctg ctctataat gtcacctac tctcgagata 1779660

gcaggtgagc tgtaataaat cacaggaaga aatctactcc acagctagag aagcatggta 1779720

aaaggaactg ctgggaccc aggggatgac tgtggtgtaa atcctagcac tgaaaggctg 1779780

ggacaggagg atcatggact tgaggccatc ctgggctacc tagtatgaat ctgtctcaaa 1779840

aaacaaaaaa cacctgcaag caagaaaaca aaccaaacag agagagtgat tctgagatgt 1779900

taaagcagag gcagtcacag aaggatatgt gacacactcc tgtgaggctg aattttcaat 1779960

gtgtgtaaag aactacttta aatatacaga atcatctctg gaatccttaa atcttcactt 1780020

ctcatttaca taaagatttc tattttctc atttgcaca tgtttttat ttattttgag 1780080

acatggtctc tctctatgaa gcctaaactt gctgtgtatc tcaagctggc ctcaacatca 1780140

agttctctct gtctgtttct gctttccaag tgctgagatt acatatgtgc accactatgt 1780200

cgggttcaca catgaggttt ccctgtgtgc actctgaaat gtgtcatttt gaggttgagac 1780260

ttggtacctg tgatggttaa tcttctgtgt caatttgatg ggatttagaa cctggaggga 1780320

agtctgactt caggtatgtc tatgagggtg ttttgaata cccaccctaa acatgggtga 1780380

catcatccca aggtctgggg tcccagaatg aatgaaaaag gagaaagtac atggatggct 1780440

atcattcate tctctcttct ctctactgtg aatgcaatgt gaccggatgt ctcatgctca 1780500

gctgccatgt ctctctgtt atggggctg tgagccaaaa taaactgttc cttctaaagt 1780560

tgcttttgtc aggtatttag tgacagcaat tagaaaaata acatttgctg gttggcctgt 1780620

ctagctaaat cagtgaatct atcttcaggt gcagagagag agagagagag agagagagag 1780680

agagagagag agagatctgt ctcaaaaaac atgatgcatc atgattgaca gtgacctctg 1780740

atattgacct ctattccac aagtccccgg tctcaccta cacatacatc agcacacaca 1780800

tgacccaaa atacaggtaa aaatgtaaaa ggtgagtttt gggattacac taaaagcata 1780860

acttaccca tgggcccttt gtaaagcatt aaaggaatca cttttcttt aaccatcttc 1780920

agaattaggt cagtcttctg aaaatgggga ggggaggaaa gatctttgaa tctttgcatt 1780980

tttaataaaa taaagtggcc gaaagaaggg aaaaagcatt actcctaat ccatgaaat 1781040

taaaaaaaa tcatgaagaa tggtaagaat gagccacatg ctgcccttc attctcgcta 1781100

tggatgaaca tctaaattta ggtacttgtc tggttcagat ggacaagata tactctactt 1781160

ttctgtatac ttgaacattt tcaaaatgaa aaaactctct tcaaaagtat gatggctatg 1781220

gaaaagaaga tgcctaaggg tggaggaagc catacatcac agtccagtcc attaagatgg 1781280

agagccctga gcagccaatc tgaagttgc aatgtgagga gaagaggagc acgatgcata 1781340

gaagatgggc catggtccaa cccagaaggc atcacaggat gccagggagg cctaagacga 1781400

cagcgcctcag ctggttaagt cctgatctca gaagaggact agcagaacca gtttcacttg 1781460
 aaaaacaaaa cagccactga cagtgaaga aatatggttt tttatcaagc ccacagaaag 1781520
 gacttctttc ataggggctc ggctctacat ctcgaagtga gtgggaacac aggatagaag 1781580
 acaaaggaaa ggataactaag tgagaaggat aaagacaaaa tgtgagtgc tggctttctt 1781640
 agaaggtaga ttgggtcttc tttggttaa gaaatacact attaattacc ttagttcct 1781700
 cttaaaaaa attttgtaaa ttgtacctt tttttactaa caaaaaaat gtgcaaaaca 1781760
 gcccaaaagc tctttttgtc cttcaggcaa gtttctctaa tgccatctta cataacctg 1781820

 gtccaatfff caggaacagg agattaactt tcacacatat tattaattaa tctatagacc 1781880
 ttaatagaat tciactctac tttccatcat tttctgtcgt ggggtccccta ctcaggattc 1781940
 tcccacagtg ccttattgat tttattctcc ccagtctctt cctgcctgca gaaattcccc 1782000
 agtctcagtg ggctgggtgca gtattctttt cacatgtgga aggagctttt gcatttttag 1782060
 aaaggccact gtaaagtgat gttgcatccc cctcgggtga tcacattgaa ggatgcgtga 1782120
 tgccaatgtg ccttttgctt tgatgcttct caagccttgg gctaaatggt cgtgcactgg 1782180
 taacctgct ataaagtcaac cgctctttcc ttttgtggcc aatcatatct tcaggaaggt 1782240

 gtgttgagac tgtttgtgc cgatttctcc ttacaccact gtccacttgt tgtgtgtgca 1782300
 tcttggttct tatgatgttt catgcctcat ggagaacctg tttcttgtga tgctagtat 1782360
 tattttgagt tciacttagg aaagagttga tccttctcc tttgtaaaat tatttatatc 1782420
 agcatcatg ctgagtattt atttgtctt atggtttaca actcaatgct gccattttt 1782480
 ccctttggtg gggaaagggg ggctgggatt ggaccaggg tctcatataa acaaggatgg 1782540
 caaagccagc ccttgggttt tgagacaggg tcttctatat atgtcacctg tgcctcaaag 1782600
 tcactatgca cctgcctcat cctcttaatg ctaagattat aggtgtgtgc caccatactc 1782660

 acacagaagc actaaatttc cagtagggtt gaaaactact aaaaagcaaa cattttaga 1782720
 tggttataca atgtaattta ctcatggtag tgatcagcca ctgctactga gttatcgctt 1782780
 agtgcctctt tctgggacac ttggtagaca gcatttgact aggaattgtc cacattttat 1782840
 ccattatcac tcaacaccta ttaaacacc catgaagctt gagccagtaa gtagttttag 1782900
 aacatctagg ttagcaccaa gcattgcaac aactttatta atgtagatgc aattgtttgt 1782960
 cttaggggac agctaaaact gaaatacact tagtgtccgt acaaccatca acagcatgtt 1783020
 actcagtgtc tcatttacag gcaatggctc gactgcttgg agaatttca tttttcaaat 1783080

 tcaagaagca accaagagtt gactgctatg tcgcaggcca cgtttatgat gttattattg 1783140
 ggcatacaag caaatgtgg gccgaggaca tacctcaggt ggtacagtga ttgtctagca 1783200
 tgcactaaga cctaggttag attcccagta ctataacca cagtccatg gctcaggagg 1783260

tggagacaga aggatccaga gtgagatcat cctccactat atggtgagtt tgagaccagc 1783320
 ctggaataca tgagattctt acacacacac acacacacag agagagagag agagagagag 1783380
 agagcgcaaa gggctctgtt tttctttgca ttcagccatg ctgacaggca ataggaaagg 1783440
 cacatgtgtg ggccaagaga tagtagtttt tttgtttttg tttgtttgtt tgtttgtttg 1783500

 tttgtttttg tttgtttttt cgagacaggg tttctctgtg tagcttttga gcctatcctg 1783560
 gcactcgctc tggagaccag gctggcctcg aactcacaga gatccacctg cctctgcctc 1783620
 ccaagtgtcg ggattaaagt cgtgcgctac caacaccag caatagtttt tatatattag 1783680
 gatggataac tttggagaca tagacctgtt gggaaatcca gcatggatgg acagccctgc 1783740
 ccagttaggg aaccagaca gggacaggct ggatccacaa atgtcctccc tgtccttcat 1783800
 ataggtgagc aagcttcaag ccttatttca gacaaagtgt cccttgctac ccaaggctct 1783860
 ctccaagtga agctcctgaa atggttctaa caacagaatt tttttccac caaatcaga 1783920

 tcattgcaat cgtcagcaaa gaaaatgaca tgtaattgaa ttatgctctt caggatatga 1783980
 aagtaccacg tgaagatgg aggctggcta ctcttttct tcaggggagt ccaaagggcc 1784040
 acagtggaga acaggtctcc acccacaanaa agaaaacctt tgggatcagc aaagtgttcc 1784100
 actgtcagaa tcattcccag gcagattgtg aagatgaact tctatggcga actcatagag 1784160
 agactgagga aggctgtccc catctcagca gcaccaagac atgctgaggc tgggaaataa 1784220
 ccctgcctag ggacagctga gcagctgtgt tgtccgggaa ggagccccct agttaagaag 1784280
 ttgcctact aggaatcaca cttgaaagt agggaagcag ggtcggcagg atggagggca 1784340

 aacctcacgt gaagcacact gatgggacag ttaggagcaa agctaccaat ggctgaagat 1784400
 acatcttcac tgactgtcc tcatcgctgc agcaagacac tcgtcccagc ccctagtgg 1784460
 ccaactgtgtg taaagaggaa gagtcccccc ttccttctt ccttcttcc ttccttctt 1784520
 ccttcttcc ttccttctt ccttcttcc ttccttctt ccttctnnn nnnnnnnnn 1784580
 nnnncccc cccccccc cccccccc cccctctct cctctctcc ctctctctct 1784640
 ctctctctct ctctctctct ctctctctct ctctctttt ttgagacaaa tttctctatg 1784700
 ttgccttggc tctctgtgt agatcaacag gcctccaact caagatcc gectgtctct 1784760

 atctcccag tgctcattt aaaggtgtac aacaccacct cccggagcac ctagtggata 1784820
 gctttgtttt ctccacaagt tttctttgt gtccttgggg tgcatatgta tgtgggtgca 1784880
 catacatatg gaggccagag gtcaacctga gtggatacct tcctcagtca ctctctatc 1784940
 ttaattattt agcttaaac atttttactt attattactg tgtggtggtg gtggtggtgg 1785000
 tgggtggtgt ggtggtggtg tgtgtgtgtg tgtgtgtgtg tgtgtgtgtg tgtgtgtgca 1785060
 tgtgcgcaca tatgtgcat ggtgcatatg tggaaatcag tggacacctg tagaccaggt 1785120

tctcttcttc catctgcatg tagatctgga ggttgaactc aggtcatcca gcctgcatct 1785180

ctaccaact gagccatctt atactcctac cacaggtcc ctcagtgact ctagaactca 1785240

tgactgccag ccccagggat cctcctgtct gtacctctct agtgtaggga ttacagccaa 1785300

gtaccaccta gcctcactat gtggattctg gagatccaaa cattcttgtg gaccaagcac 1785360

tttaccace aagccaccgt ccgagccct cacacactct ctctcttgtg tagctgggga 1785420

atgatgtgac cctagatctt tgtttattaa tcacatttta gtgtgctgac ttgttagact 1785480

accatgttat caactgaatc gtcgatgatt ttctttgctt ctggcatga aactgaaggt 1785540

tctattactt tctcagtagg ccagtaggca ggtgaattg tgagtggtaa tatatctaca 1785600

gtatcatggt caatttcaca aaaaaaggca gaaaatatgg aggagagtga ggagaaaggt 1785660

gggtcccacc ttcttttacc tccttcgggt agtgaggtcc tggagctgtg tcctcaattc 1785720

taacacagac tctccaaggt caacaggaca caattaagaa tcttaatgat ggggctggag 1785780

agatggctca gaggttaagg acactaacta ttcttcaga ggtcctgagt tcagttccca 1785840

gcaaccacat ggtggctcac aaccatctgt aatgagatat agtgcctct tctgttgtgt 1785900

aggcatacat ggaggcagaa tgttgaagc ataaaaaata aatctttaa aaaatctta 1785960

ttggtgccag aagagcttta aactaagctg gactactagg tgccatgtgt ccttgccact 1786020

gtgcagtggg gctcctttct ttttgggtc tgtgccctgc tcccttggt atctcttcta 1786080

agctctcact ggtgagaga tgggtcacc atctcctcc actgaaacta tcaactgctt 1786140

ttcttccag tgtggactgc ctagaacagc aagtgcata caaacgctt tgtgtcctt 1786200

gttctataa tctaacaggc attttacgt tcaacatgat gcctgatgct ctgaaagtc 1786260

ctaagtcct ctgtcagttt tctacatcca ggttcctgaa cacttactga gtcaatgaaa 1786320

catctatctt ttctcaaagg aacagcagct ccttcggct atccttactg cgtctaagca 1786380

cctggccatg ctcccaccag tctctcccag catgcctatt gctgcaatag ccttctggag 1786440

ggtgagacca ctacgaaaa tgcctgatt tgcatactag tttaaatagt ggttctgcct 1786500

gctcttcttt gtctacattt agatgggaaa gacactcatt cgtctctctt ggaagttttt 1786560

aattgtgat gtgtgtgtag tgtacaactt gtaagaactg gtttctacc atgtaggtct 1786620

caaggattga actcaagctg tcagaccagg aaatacat ctttactccc taagcctttt 1786680

ggcaggccca ttcttctctc atcacgggt gctaatctag ctttctctg ttctcacatt 1786740

ttgactattt ggigtatata ttagttttcc actggtttat gaattttgt tagcttgatg 1786800

tgcttgctca cgcgcacaca cacacacaca cacacacaca catttctcac 1786860

taatttgcac tattagaaaa tggcggatg ttataatatg agaaacaatg agagcgtact 1786920
 ttaagagaaa tgaagtccta ttgatctcag gaccaggcaa gctaaggta gctcaatggt 1786980
 gcttagttaa caggctactg gagccagtta agtgcttaat aactagataa ggcttatttg 1787040
 taattagcat attgattggt gacatgtgag tgcttctaaa gtgctggagg ggagctgaaa 1787100
 atggcttgtc aggctttggt tcaaatagcc tcttacaggc catttatttc aataaaatca 1787160
 acactgtttt ctagccatgg tcattgctga acaaggaaac atccacaaa gtttccaagt 1787220
 aagtatagtt aaataatgat ccttgttcct agtacaatgt taccaaagac ccccttaag 1787280

 gagttcatct gactgaccag ccattgaaag atgtgatgct caaggacaga gcttggttca 1787340
 gtcagtgaag agaatagccc ccatacactc atgcatttga atgcttggtc ctcaactgggt 1787400
 ggaacttttt ggaagaact aggaggtgtg gccttgttga aggaggtatg tcaactgggt 1787460
 ttgagggttt caaaagctca tgttattccc agttatctct gcctcctcct tggggataag 1787520
 gatataagct ctcaactaat gctccagcac tatgcatgcc tgcctgttgc caagctgccc 1787580
 agcatgatgg aatggactct gaccctcaga gactgtaagg tctctttctt ctataagttg 1787640
 tataggtcat ggtttctctt taaggctaca gaaaagtgt aagtaactaa aacagtcagc 1787700

 ttgacccaa aggaaagaag tctttgccca taactggtgg aatgtggtta ttctcttaag 1787760
 atggcaccat ggcaggttgg gtaggagtca aactgtctga aggacagtgg gaaaccaaac 1787820
 gatggcaaag gcctgtggtc tcaactgaagc aaaagtgtt gggagagcag ttgtctctc 1787880
 ggcttctgaa atgtattgga aacagagact cagatgtaag ttctactgac agtagaactt 1787940
 acaggtcact gaagaccaa gggcaggtgg gtgagtccta agtgccaaca cctaaggacc 1788000
 ttactgtgag gaaccagaga tgatgaaaca gaaagaacaa agaaggaag actacagaag 1788060
 agaaagggag aggaaacaag aagggggaaa ggacagagga agatgggtg gatggaggca 1788120

 cgataggaca gaggataagg caactgtgac tgaccctgag gaggatgcag tttgaccctg 1788180
 gagactccct ttttggcctt ttctactctg gctcagctta taatcctcct tcagagtgac 1788240
 cctctctgtc cttggagctg agctaagctg agcatgtcct tgctactgct taggaacctc 1788300
 ctggtgtact ctaacctacc ttctaaaaag ataaggcagg tgtgcagggc tgtgcatgtg 1788360
 gcaggataga gacaccat gcaacactgc gaaatctgtc tgccaagacg gacaaacctc 1788420
 ctgaaatgct tctagacttt gagacagaac acaaaagtcc ccagcctgcc aggatccca 1788480
 aggcctaca tccttacagt gaagaaagct gtcagtcatg gactgccttg acccgatgcc 1788540

 agtgacagca cgagacgcat cacactcctg taaagttctc tgtcaggaca gctctccttg 1788600
 ctgcatattt atgtaatcca attgccaat caaacttcaa ggctaatgaa tgattactgt 1788660
 aacagacagc tcttgaccag cactgccttt ccactttccg aggtcagcct agagctgtgt 1788720

ctgcaaacag gatcagcagg gaggaggaaa cctggggagg acatgctcat gtgtgagcaa 1788780
 gtgtgcagtg agtgtgtgaa catgtgcgtg ctagtgtgca tatggaaatg tgtgtgagta 1788840
 cataagcctg agcatattgg aaaattgtgt tagttgtcat ctatgtgtac caatgtatga 1788900
 gtagattga acacatgcta atttgtact gggcaaacag atatgccatg tttatatgct 1788960

 aatgtatgcc tgggtatgta ctcatgagtg tatcagaatg tgtgtgaatg tgtgtctgtg 1789020
 tggcttgagt gtatctgagt acagtgagta tatatgaata tgtatgtgag tgtgtaata 1789080
 tatacggcta agtgtatgaa tatatgtgac tatatgtgaa tgggtgaaca tgactgtgtc 1789140
 tgtttgaggg gaagggacaa gagcaaatg aaaggcacag cctgggaagg ttgtgagact 1789200
 gtcttccctc agctggagat ccaggctcct gtgcaggaaa agagcgagcc tttttctgaa 1789260
 tgttacagag ctttctacc catcagagag cagaagctgt tgtctccaaa tggccttcat 1789320
 ctttctcca agaggagagc caggaagact gccactcata tgccaatact ttctacacac 1789380

 accactggtc aaaaaggagc catggatgcc ctccaccctg actcaaaagt atgccagct 1789440
 tggagacctc agtttcaca ggggaagaat ctcaggggtt ggaaaaccag agcagagcat 1789500
 ttccctaaa tgcagggaa atactctggg ccacgactgt tgtttttca aacctgtttg 1789560
 ctccccctc actctgtacc tacacagaaa gcaagactct ctgactgcag cgagaaaata 1789620
 aagccaagg cacacagtaa ttttctgctt gttgaatctt gtgcctggtt tgtttcaata 1789680
 aagccaggtt tctgtggcat cacctggcca atctttagag caggcacttc tgagagagag 1789740
 tggagtgggt tttagcaca gatctctgct ttgccagcta ctcaatgtca tgggcaacat 1789800

 actgctgtea gcatccactc aattagaagg tattaatcat ctcttactg ctgtactctg 1789860
 gtactgtcac cccctccctc agagagacac tgtgtcagcc gacttctgca atgcagtcac 1789920
 ccgctggca accacaaaac cacatctttt tatttatta ttttctcgg actgatattc 1789980
 tattaatcct tagaagtta ttagttctga ctcataacag tccatcagct ataagtgcaa 1790040
 taaatgatgc ttggaaatta ataccgcat ttcggcaaag gaggtttta catattaaat 1790100
 tatccttaag gttataaata aataacatgt gaaatagatt taagcaataa acatatattt 1790160
 ggcaacaat cttcagtaag tttaatattc tgcaagetag agctattttg gcaatatctt 1790220

 tttaatagge tctccactcc ccgcttgcct tttcttcct ggtaaatca taaatccatc 1790280
 atatcaata ttggagccgt tctttctca ggaaaactag ggcttctgt aatgcttctt 1790340
 ctaaagtctt catcttcccc atattgtgtt ttattattta tttttgact tttgttcttg 1790400
 ttgagtgact tagggctttt gttcttaatt taaattttta aaagttttat ttttacagct 1790460
 tctgttattt ggtgttttcc tagctttctt cgagtatgtt tggcaataa aactgtatat 1790520
 atttaaggta tgaagcatga tgtttgatcc atgtgcacat ttcaaatga tcaccacaat 1790580

caagttacta aacatatcga tagcttcaca cacttgcctt ttgtgtgtgt ggtgagagcc 1790640

cttgagatcc actcttgggg actggagagc tagctcagag gtaagtgttc ggctcttctg 1790700

agggacctga gtttgtttct ctgcatatac aatggttgcc tcacaacttc ctgtaactec 1790760

aattcattgg ggatctgacc ttctagcctc tgagggcacc cacactcaag tacacacata 1790820

cacacacaca cacacacaca cacacacaca cacaggagag aaagacagac agatatacag 1790880

agagaggctg agagacaaaa agactaagtt attaaaaata aaatttttaa aaatecactg 1790940

tcttgtcagt ttttaagtat aagtacaatt gactatactt accatgttat acattagatt 1791000

ttcagaatth acttatcttg taagctgaaa gtttatactg ttgacacct ccctatthtc 1791060

ccagcactag ctctggaaa tgactattct actgtctgct cctgtaagtg cacatthtta 1791120

aattccctgt gtaagtgaga tcatgaatca tgaagtgttt gtctthctgt gtctagttha 1791180

thttgtctc atcattgtcc tccagctthg tctgtattat tgcaaaaaaa aatgtctgaa 1791240

tctgtgtgtgt gtgtgtgtgt gtgtgtgtgt gtgtgtgtgt gtgtgtgtgt 1791300

gcgtacttc acttagtaga tgattagact gataccactt cttgaccatt gtgagcaggg 1791360

cttcgataaa ccaaggaggg acagacatct ctttgagata ctgactthgt atctthtga 1791420

tatactthc aaagtaggat tgctacattg tgctatagct ccgththta tthctthgag 1791480

aacctccac atggttatcc ataatggctg tactaatcta cattccatc aatgtcactt 1791540

aaaaaatct aattcagaaa aatgtctgag atatgttccc acctctctt cththtctc 1791600

tatccatcaa tgaaccact tcatcgctt ttgaaaagg aatcttactt agatthtgag 1791660

thththaaat actgaaaaca ttgaaaagt gtattggggg gcggggaggc tggctcagga 1791720

gccaggaggt thgtthgttt gthtctata ttatgaaagg agggagagaa cagthtctac 1791780

agatatacaa gaattacatc acagththt ccaaaaataa tcagaaaaaa cctgtthatt 1791840

atgctthtgt thatctatg agaacaagaa aggcacagta tatagtattg thtgtcaaag 1791900

ctatathct tattatatta attctctaaa agattcatcc aaaagthth tagtgatatt 1791960

ctthththca gtactgaatt aaatctgtat aatththtca cththtagccc ctcatgaaaa 1792020

tgcaattatc aaacctthgt thcatataac taatactth attcattatt aaccttactc 1792080

acagacttaa tgtacaaaaa ggaaacgcca caagattcat gtcagtggca atthaaagtg 1792140

aattaggtt aacgatgaag gtctgatcta ctctagtctg atataataa ataacacaca 1792200

ggcaatagac ttaagtgata aacatatact caagtcatga gatccatcaa gggcctthc 1792260

tattgtthaa catcacagc aaccaaagct gggattcaga ththcacca cacctccgt 1792320

tttgtctttg gtcccatctt aatggtcag tgccttctgt gcacagacat gctctctact 1792380
 tacagctgca gagagctggg tccataaatt acatcacaac tgcctgtctg cacacaaatc 1792440
 ccaaactcag aaatgtcaca cgtcacacag atcaagtgc atggctgtcc gatctctatc 1792500
 cctgtctggat gatggggctg gagagatgag agctagtta gatactgcaa acctagagtt 1792560
 ctgtgtttct cctagtggca gcatgcatgt atgtgctcat atccctacca tgcttgtaa 1792620
 caatagggct aagtgtagcc ccagcatcaa ggctgaccaa atacaatgac gtgtccttaa 1792680
 gaaatgacag caaacattag agctcccttt agttttgggt aagggttac tgcagatctg 1792740

 gggcctcagt agcaagaat tgtctaacga gtgggttgag tctaatagacc acatatacag 1792800
 tategttatt ggcttgtagc aaaggacact aaattacagt cacaatgtga ttgtctcagg 1792860
 tcacacagac tcatatcagg gtctactttg cactagaaat gcttctgaca ctaattcaag 1792920
 tcaggctacc agaacagaat actcaaacaa tcaggaaata taatgggttt ctaatacatg 1792980
 cattcatatt ggattagcca gggatattgt tacacactta gattactaac actcttggtta 1793040
 aacaaggga aagcctgtct ccaactaag ggatttccat atatagacat tcatatgtat 1793100
 tcaccataaa atagtggatt tccttttgtt tcaagggtc cccaatggct caagacaaaa 1793160

 acataaatca aaaacgaact catctttttc ttgaaaaaaaa aaaaaaaca gatataact 1793220
 atacacatta tgtgaaaaca ataagactaa atttgatggg ctgtattatc cacagtgttg 1793280
 agccaatcta tcaacatgtt tagatataataaatcaataa ataccataat ctctaagtaa 1793340
 ctactggct taccaactg ggtggaatca tttcactggg ctcttgttgg tgcctatct 1793400
 tggatgaaga gacagttaat tgttcaaat ttgttctacc caggaaact caacaacaca 1793460
 attataaatt gctggatgac aaataccct gatatctctg agtaaggcaa catatagggc 1793520
 tctgtgtgtg tgtgtgtgtg tgtgtgtgtg tgtgtgtgtg tgtgtgtgtg tgtgtgtgtg 1793580

 agaggggagc ttattacaa ttttgtatgt gtggtatgtg gcgggggttg gggttgggt 1793640
 gagtgtgcca tggaaattcat gtggaggca gagaacaact ttgtggagcc agtcctttcc 1793700
 tttccttctc ccttaagggtg gttcccagga atgaactcag gttgtcaage ttgcagaage 1793760
 gcccttacct gctaagccat ctgectecc ctcaacaggt atttttggag tgaagtaaag 1793820
 atctatctgg caaaaggat gctagtattc tgattccca gtctctacac acttctctgc 1793880
 tgcaatggtt ggggtggtttg tagcatctt acagtcacct gccctctct actacgacat 1793940
 ggctcctct cccattctt tccttagttt cacttgccga gagtagctcc acttgggttg 1794000

 ctgccacttt ctttctccat atgcatgcca cttatgtgt gtgtggcgtc tgagttacac 1794060
 ctaaagcttt actagaatgg ttagagtggg cctctctcc tcgccaactt tgtgacttea 1794120
 aacatggcac ttgtctaaag tattcttct cacctataca gaggtacta attcagttct 1794180

gtgatgactg cagagacagg aaactcaccg ggtctgcaga aggcaactcaa taaatactgt 1794240
 cagatattgt ttatttcaga ccagggtgcc aaggggatcc cagggtttcc gaaagctgcg 1794300
 taagtatct tagaatcctt atacatattt tcaagacttg gcctcctttt ggggacccac 1794360
 ttgcttttcc ctgggaacac tagatttctg gatgctttct tcagtagcca tctacttacc 1794420

 cccctcaca caccacttct cactaagagc acagtgcagg tcagatttta tctcactctg 1794480
 catcaataca cagagagact atggaagatg ctgctgtcag gactgagtgt gatggcacat 1794540
 atctgtaact ccagccctta gaaggctgag gcggacggat ttttgagttc aaagccagcc 1794600
 tgagtacac agggagtccc tatctttaac aacaacaaca aaaatgtatt accaggaatt 1794660
 ggttcaattc ctagactttg ttattaatga tattgttctg cgatctatgt taaatataga 1794720
 tcatgggtga tgctgacgaa ttggctggct ctcacatttg ggtagttca ttttatgctc 1794780
 acaccattat aaattacagt gttctccacc cctactatgt agatttggtt taggatttca 1794840

 ttatgatgac tgatactctc ccgttttcat aaaaaacatg ctggcttttt aattttgctt 1794900
 tctatttcta ggttagctgt acattattga caacttaggc tgtccagatt ataggatttg 1794960
 gcaatattgt atatttagaa tacattttaa agttcttttc agagaagatg atttttttt 1795020
 cctagtctta gttgctatgt atgtgttaga ccttggctct ctacataat tatgaagatt 1795080
 ttgcaaacg acccactgac ctatgaatgt gtagattgt aattctctaa aataaagtca 1795140
 tggacaggat ggggcaggaa gagacaggct gaggcttagg tacaatcct ccaatagtag 1795200
 ttagcgtgtt tgctaaatgt tctcccatg tgttggctg tagctgaagc ctctacaca 1795260

 actgatccta ggacagcagc tgatcatcag aattcgtttt gttgctatag tagtactgag 1795320
 ctgccgggga ggattctggg agcaaagagg ccagacatca tctgtgtaca ctgcctgta 1795380
 tgggtgtgaa tgatgtgtgt gtgtgtgtgt gcttttagag gggttgatac atgctaaact 1795440
 ctctctctct ctctctctct ctctctctct ctctctctct gtgtgtgtgt gtgtgtgtgt 1795500
 gtgtgtgtgt gtgtgtgtgt gtgtgtgttt agaggggctg atacatgcta aaccctgta 1795560
 ggagctgtga atctcagtc ctagaccttt tggtttagta ctatatataa ctgaatgaat 1795620
 gaccaaatat tcttcatgtt agaaaccttt aatgctgaaa caacctagag atttactat 1795680

 attcactggt ggtcaagcac tatgagatgt ggaaagccaa taacctgct atctatgtat 1795740
 aggacctggt ctgaaggctg ctgaggacag ggatggggct cagcagtttc ccattcttgg 1795800
 ctctctgct gacatgcat ggcctggaac ttttctaact actaagtctt aggattaacc 1795860
 tagacatage actgtccaaa agaactcagag cagtcacttt gtccatgtca ttacctgtg 1795920
 gccatggtct aaagtactg ctccccacca accttaggct tttagttaaa ttgctcacca 1795980
 gaaaaattat ttgaacaat tccaacata tgatttcatt attgtttttg ttaccaaagt 1796040

atgtcatcat tgiacagtcc tccactataa acttcagaaa actcaagaat atagttttcc 1796100

atgtaaagaa actctacatt aatgtgtaa actatataga cacaggcaac attaggaaat 1796160

ggaaccgtca tttggtcatt ttcatctcca aagctaaata aagcaggat tggatgaaata 1796220

acaaagagac aaaagatfff cagcttttta ggttaattta ggcaagcttt gtttgggatg 1796280

gggtgggggt ggggagactg tgctgaaaaa taatgactga aactcaaac aacagataca 1796340

tactgcaaa agtaaatgtt tacatatgca tatttgatt tcagacctt ttcagtaagg 1796400

acatgtaaaa gtacatgatt ttttagcaaa tgtataaatc agcatttatt ttatttctag 1796460

atgagaata tgagttgaaa aaaatgcaaa agaatgtctc accacaggtt taaaacaac 1796520

aacaaaaagc ttctaaatg aaaaactaag ttgcacaatg gtgttttgaa gagtgcctct 1796580

ctgctaactg tgatcacaag acttcacagg gctgagagct gcttctctg tagagagaag 1796640

ggcaaaaata tcatggtgtt acctacatgt gtgaaagaag gtacttctgg agacaggcag 1796700

ggtcagcagg aaggaatcaa gaagagatcc tgcccttatg gaatggcag aggctggaaa 1796760

aggaaaagat tcaggctttg gaagtagaga gaagcgaagc tgtaatcgga gccctgggag 1796820

gccaccagcc aaggaggcca ggccctgtga ggtgctggc ggattaaagc gataagcctg 1796880

cggtagcatt ctggaattc taggtggtga ccagctctgc ttgctagga ctgcatgtgc 1796940

aggatcattc tgtctaaac cgaaatgta agaacaagg tagattttgc ttttaaaaca 1797000

tttgtttta tagtatgtg gtgggtattt tgtctgcatg tgtatctgta taccatgtgc 1797060

ataccagcta cccaaggagg ccaggaaaga gcatcagacc ctctggaact agagtaaca 1797120

tgattgtgag ctgcatgtg ggtgctggga attgaacctg ggtcctcagg aagagcagcc 1797180

attgttctta actgcagaaa catctctca gcccaagagc tgaattcttt tcctgaatct 1797240

ctcaacttag attcagtaac tgacacaaat gaagacattc ttatgcaggt gacagattcg 1797300

gacaatcttt tggttatcca ttgcagaaaa catgggatat gacttgggtg ggttgtaagt 1797360

acagagtcat tttcaaaag acgtttccac tttccctacc tttcagtgc cagtactgaa 1797420

acagtttcta ggagatttg ctttggggtt ccctactct cctcgcttt tgggtgatgc 1797480

atgccagcaa acccgactc aggtggtttc tctttgttt gttcttttga ggcagggtct 1797540

cctgacctgg aactcactta tttgccttg gccaggtaaag ccccagagg ccctctgtct 1797600

ctgcatcctg gtgttacagg caggccagtt tgettgttt ggaaatgtgg attctgggag 1797660

tggaatttag ttctgcttg aagcacttta cctcctgggc tatctctca gccctaagac 1797720

ttactcttaa ctctaaggtt ttattttgat gttaggggct gctgactgct tgggttcaat 1797780

tcctcttttt aaatagcggg gcattcatca aactagaag ctaactacag ccaaggcagc 1797840
 atgtcccaca gcactctgta gtctttctac acatcactta accaaagata cttaaatgtc 1797900
 aacaaaccct ccaactaatt ttcagcgaag ttcatagact tcaactgattt taaacagccc 1797960
 ctgagaagac atatttaata aacatttgc taattcatac tttcccacaa ttgataaaag 1798020
 aactgattga gactgtagtt ctcccagtt ctggcttaac cagcacaggt tcctctttct 1798080
 gcctgtgtaa aatgtcatag gaaacatga atccaaccag gagtttttag tcaactatgtg 1798140
 aaccagatgg gaaaggacga aggtgctgcc tgggagcaaa cagccttctc agggccccag 1798200

 ggcaccactc ctaatagatg tgtgtgcagc tcacatccca gccctgatca gctacatccc 1798260
 atttcagtac taggtatctt tgaatggaaa catgttgagt ttctccacat ggcatgatgg 1798320
 gagaatcaga atgggaaaca ttaataaacc ttacacacac ttttcccacaa caaagcatga 1798380
 gctggaaca gttatctttc tttgttccac ctgatttctc ttggagttag ccattcaaga 1798440
 cagacagtac tgaanaatg cctcatgtaa ggtgtggtaa attcttacgt gcagaagcta 1798500
 acacatctat atctatatcg ataataaaaa ttgttttga aagcaaaggg tttattaatt 1798560
 atctcaacac accatctagg ctgattcttt cagacgcagg gaatgtgggc tttagcaaat 1798620

 tttcacggtt galaggaagg actcaaggcc agaccgcaat acttttcagt ctgtgtaatg 1798680
 agcctgggta tccgagtcac ctcaatgcag taacttctca gaagctaac atacaggggt 1798740
 gtgtaagttc acaaaagcaa ctctgaaga ctcatgtggt aactatccca catatagctg 1798800
 ctggctctgg gactagcata atgaataata actgattggt tctctatttg gtaagtgtat 1798860
 agtaagtata tgcgcacgtg tgtgcagcta tgtgtgctca agcatatgtg ggggaagtac 1798920
 aagatgacac cctgcgcat cattgtccat caaactgcct tgagacatgg tctctcactg 1798980
 aactaggagc aaagctggtg gatagtcac ccagcaatcc gttatccctc acccccacca 1799040

 ccaaactcat gacatactca gctctttcca caggttttga agatttgaac ttgggtcctc 1799100
 aagcttgctc agcaagagct cttaccatt gaaccattc tccagcccct aattagtgat 1799160
 gttttaaaaa tataggtttt tactctggaa aaaaatattt ccaaaagaat tagtacatta 1799220
 tttaaagcaaa atcaaaatga aagccttcta cacatctag atggcattct aggttctata 1799280
 ttccatcaac tctgatctg atgttccaaa agggaaatga aaatggcaca caaacttctc 1799340
 cagacattga tatgtacatc tctctctctc tctctctccc tctctctctc tctctctctc 1799400
 tctcacacac acacacacac acacataact ctgagccaca ctgagaaact ttctcacaca 1799460

 ctttctcaca cacactctca ctcatatata cacactcttg catacact aactcacaca 1799520
 aacacactct ctgacacaca tactcagaaa ctcaactact caactctctc tettaacaca 1799580
 cacacacaca cacacacaca cacacacaca cacactttac aaaagaaat tttcaacaca 1799640

ctataattca gttcatttcc tgagggaaag cctacgttt tattctaaat atagaggagg 1799700
 cctctgtcgt gttcagcctc ttgtattggt ttgtttttaa cattagtcac gaatatggca 1799760
 gtggctcttt tgcataaaaa tcatcatttc tgaagataca tacataggag gtgtggaaat 1799820
 ggggcacata tacgccccac acacacatac cttggaatag attttcttaa aatctttggt 1799880

 ccatttggg ctgccttggc tttctgaatc cctaaaccaa cttcttttaa atggtctgtc 1799940
 tcattgcttt ccaggtcatg cagtatagtt tgctacacag cccacttact agacttccac 1800000
 attctataag gctgcctccc tctccccagt gatgatgctt ttaagacaag ctatacacac 1800060
 caggatgtcc tgctctgtgc agtactgaag tattgtcatg aaaacaaca attcccaggc 1800120
 atgttggctt agcctcagtg tcatttaata gaagtagcag aacctcatct tgccaaccac 1800180
 ctagaggctc ctagtaggaa gtagggctaa ttttaataata tgaggctaaa agatgctcct 1800240
 tacaagtag cttaaaatgt ttggcatttc gtattcctgc tatttgagac cctgtaactg 1800300

 ctacttacca ggaacaaatt aatctaagct ttagccccct caaatacaga attataatta 1800360
 tgctgcattt cattggatta ttttgaagat taaaggtgat tatgcatgca tttatgtgta 1800420
 tatataaata cacaaacaca tcctatagtg cctggcatgt agaaaaactc aaagctaact 1800480
 attaataatt tagggatagg atttttatca caatagacac tactagaaaa ttcccact 1800540
 atttaaaaga tcaatgagat gcacaggagg caaacacact cctgatcagc ctttctctc 1800600
 tagccatata ccttcaactg accagtgaga acaattgatg ggccctaaca gaaaacattt 1800660
 cggctttcaa ttaactgctt ggaaaagcac taaaactgt attcaactgc tctcgggcaa 1800720

 ttagaccatg accattgcca catctgctat ttgctcatca ggaagctgct tccaagacat 1800780
 ttaacattca taggtatatt agctcattat taatacccta gaaactcccc atggcacggt 1800840
 taactacggt gcaggatttg gtatataaga aggtccatc ctggctcca ttcactaag 1800900
 aggattatga atggagtctc cctaactgta taaactgatc ttaaacatgt aaggaattat 1800960
 agtaaagctc tgaggataaa aagtttttcc agaaactgct tttccacat cacaactctc 1801020
 tacttatatt ttatttcatt gtcatagcaa atgcttacac agaactgtgt agaaaacact 1801080
 ttgatgcaat gaatctgcac aagatcatac aaggagaaaa ctatgcctgc caccctttgt 1801140

 atgtgtgagg aggctgaggc actagataga taatgcaata gcagagtcac agctcagact 1801200
 tggagacagg tggtagcatc ttggggataa acttttacct agggctccca ctttgtgtat 1801260
 ctgatccat tctgcaagtc cccaggtagg gactgaaatc cattcctctc ggcccttacc 1801320
 agagggtgcc attatcagga ttgagttcct actgtttcag gtctccctgt acttgtcttc 1801380
 tgacatcaag gtagaataaa aaaaaaaaaag accatttcca atgaataccc attatatcag 1801440
 agattatgcc acacgtgtca caagaaagcc agccagtctg tcaactgagac agactggtcc 1801500

attacacaac ctttataccc aagacatttc caatgtttga cctatgtgaa ttttactaaa 1801560

 atgttccact ttcaatgtac aaatttataat ttgtaaattg tttgataaaa tgtatcatac 1801620
 gatagcctaa aaatatcaat tcaaaaatcac cttgattact gactggggag atagtctcct 1801680
 gaattcttca gggagggctc atcttttata tcaacctggc cagtctacag agcccagtag 1801740
 ttggggccaa tactaattta atcttgtcat agttgtatgt ctataatcat agcagctagg 1801800
 agactaacag gggactatat agcaagtttg aggccagcct gagtgaagtc tgaaaaccta 1801860
 tttccaaaaa caaaacaaa caaatgaaga caaagcaaca tccaaaaatt aacatcctaa 1801920
 atatcaacta aaacaaaaca aaacaaaaat cttctaagtc aggtgtttgtg aaagtatttt 1801980

 tctagacatt atcaacattt acatcagcat ctgtcatgcc cattcttttg gcctgcaat 1802040
 acaaccattt catctgcaaa atttaggctt gcaaacttcg tttgtaataa gtctacaatt 1802100
 ttgtgtcagg ctgcctccat agccattttt ggctctgtgc agcctgaggt tagagttaga 1802160
 ccagaaaggc aatgattttc cataatgtaa gtgggtctca tccatgaatt gaaggcgttt 1802220
 ggagcaaaga ttgataattg caaaagaaat aatattctgc cttaaagccgg tatcacagaa 1802280
 aaacctcaga gcttctggcc tttggaagac tttggagtca agactgtaac atccatgctt 1802340
 atcagaactg cccaccagcc tgctctacag gctttgaact tagtaacatc cccacactac 1802400

 cattaatgaa ccaattcctt ttaaaaatat ctttcatcct gtccaaccet ceatctttcc 1802460
 ccagctcatg caaagtgggt agtttccaaa gagcataaat agaactacct tctaagtctc 1802520
 tttaaaatg aaccctactt taaatgttt ttatttttat ttcatgtgca tgggtatttc 1802580
 acctgccatg tatttctatc acctgagtgt agtaacaagg aggccagaag agggagttag 1802640
 actccttggg acaggagtta taggcagctg ggggctgccc tgtgggtgct gagaattgaa 1802700
 gctgggttct ctgtaggatc agccggtgtt cttgactgct gactcatgct tccagcccca 1802760
 gctctggttt ttgtaggtac ttacaagtgt ttggcaggtt gtgaacagag ctactctggg 1802820

 gtctatcacc ttctgttcaa cagtactgag acaaagcaac tgtattcttt ctggagagag 1802880
 agaactattg gctctgtgtt tctggagcac tataaggacc ccagcatctt tctgtcatta 1802940
 cctctcatgt tggtaggctga agcaggaggc cgtacagatt ccacctccat catgatttcc 1803000
 cagttgttcc tgtgggggaa gatgtagtgg ctacttctctg tgacaattca aaagcaatga 1803060
 tctatctctc tagaactatt tgttagtctc ttctgtctcc cagggtctcat ggcaatagat 1803120
 ttgaatcccc atgccctctg ggaacgactg tggtttgatg gctacaaaga cacaagttct 1803180
 ggtctgtgga tgtacccaaa cagggtcctt gggaccacaa ttgactgtt caagagtgtt 1803240

tagccccagtc ctgttctgct tacattgtgg ccttctgtgt tttctggggc agccagaagg 1803300
acatgaaggg gcagttcagc tgacagatgg ctttttgata accitttcct tccaatatga 1803360
agagaactac gtcacttctt tgatggctcc tgtcttccat ctgtatcctg gtttgattgt 1803420
tacactctca ttttccttgc tagcaaggat cacaggcccc agaggtaagc cccagtaggg 1803480
gagtacttgt ttccttaaga gaagcctcct cttttccttc cctccccttc tctccagcct 1803540
atgctaagta caagtctagt ggcttgtaaa gggtcagctg ggaggctggg gaccagggac 1803600
aggctcacgc aggagaatcc accaaggcac agagctcctt tccttgtggc tggctgtaaa 1803660

cactgaagag tgtttatcat ccacagttct gaatgtgcca acatggagaa cagaggccac 1803720
agcaagtatg gaagcagtgg ggacagaaaa acagaagcag acattccagg gtgtgtgtgg 1803780
gtgcatgtgc ctccatcctt ttctctgcac tgatggcccc agggaggcag cagaacaggg 1803840
aactcactgt tttccccca tcttcttctt ttatcaaac cactccatcc ccactttct 1803900
atctcagggg ctgaagtagg cagagttgtg gaggaggag ccattccctc ctgaacttca 1803960
ggtttcctt ccagctgctc ctgcatttgt gggggaggaa aggctagggc tgccttgatt 1804020
ctagcagttg atgaatgect ctccaggtcaa tgtttacttt aacaagagtt cttttactgc 1804080

tgatctctct ctctccctcc ctccctcct cctccnnnn nnnnnnagga aggggggcat 1804140
gaaaactgaa gcttggaaag gatgactgta atgtgtttat agaggttgac aggcaggctg 1804200
ggctcagagc atgtcagtg ctctctgctc tgggtacctc tgggtttaac tgaagaaaag 1804260
tcatttagtt agaggacgtt caagaaatga tcaggttagg gtgcagagac agctcagcag 1804320
ggaagtagaa ccatgcttca aaacacacac acacacacac acacacacac acacacacac 1804380
acacacacac acacacacac acacacagag agagagagag agagagagag agnnnnnnnn 1804440
nnnnnnnnnn nnnnnnnnnn nnnnnnnnnn nnnnnnnnnn nnaatgaat aggtgggggg 1804500

ggggctggcc agccggccag cctatagcat cagtaagttc caggtcttta caggccttgc 1804560
taaaaagaaa gcaggtgatc ataataaatg acagccatgg ttgttctctg actttcacgt 1804620
gtatactatg tgcacccac cacaggagcg catacatgca tgtgcccctc ctccaggcca 1804680
gcgttctgcc tacagacacc atcatagecc tggggcacac taacctcaca cgtttctccc 1804740
atgttccaag aagaaataaa acccctcttg ctgcaacaag aaggaaagca aatccattta 1804800
agaacagtga ccatcagaaa tggctactaa aaaaagactt gtgcaccctt ccagcgactc 1804860
tgtggagtgc agactggagg atgggtgtcc accgaagaga ttacctttca cagagccct 1804920

glatcaaaa ctttttttt tttcttcaa gaatgtgggc agaaagggtg catgccacct 1804980
ccaggttgg cacacaaaga cctccaacaa gactcccctc agatccteta gaccctcttt 1805040
gttcccaaac atcagctgga agccccaaat cccaagattc cctccggcac cccccaggag 1805100

ctgctagaaa aggagctgtg ttgccgtgaa atgccc aaat ttcattggtg catgagagaa 1805160
 aaataaactg atacaataaa acactggggt tttagtgttt ctctgtaaca aaagttattt 1805220
 taactgtgca agatcaatac acagtttcag aagaaaatga tcaattagac cgagtgcacac 1805280
 agaccttaag catgatatgc ttgtgttgta ttttctttaa agcatatgcc tacaataaca 1805340

 tttatagtct tgggacgttg ctggcagaag cacaagagga cccttgggtg cctagaggga 1805400
 aagaaactga aaaaatgggaa ggacaggata tggtttgtat acaagtgtgc atgtgtgtta 1805460
 gtgtatataa gcatgttgag aaacacatgt ataggcacat atgtgtaggt tgacagacac 1805520
 ctatggacat cacttctcag gtgatggctc ccccccttc ttttctttc tttctttctt 1805580
 tctttttttt tggagaaagg ccaatgtctg tcaactggcct ggaactcatt aagtggagcc 1805640
 tggccatgga gccctaggga ggaagttgtc tcttctcccc agtgctggga ttatagccac 1805700
 acaccatcgc caagcttatt taatgtgggt ttccagattc aactcaagtt ctggtacttg 1805760

 tacagtgacc acittatgga ttgggctatc ccctgtcccc caaactgtt gttaaccttg 1805820
 tgaatttgtt ctgtgagcat gtattactta ctcataaatt acatgcagaa aacacaaatt 1805880
 ttgagagaac cgggtttgca ttgagagaat tcttgacagac attgttggtc cccggggtct 1805940
 cttttaaag ccaatgttac agagtgttga ctttataaaa tacataaaac tgtacttttc 1806000
 tggaaaactc aaggagtc gacacagctgt gggacaagtg ctctcatcct tccaggggct 1806060
 ctgtctagtg ctgacaggag gcccccacc tgattatccc taaatgtgag tccatgtgtt 1806120
 cacaagtaga tctttcagaa aaggagctc taagctggag agatggctca gcaagtaaag 1806180

 gtcttctca ccaagtetaa caacctaat ccatcactta gaccacatg gtgaagaaga 1806240
 ctgactccca cagctatctg ttatagccia ttttgcgcg cacacacaca cacacacaca 1806300
 cacacacaca cacacacaca attaataaat ggatgtgatt gattttttta agtaaaagag 1806360
 actccataga cctctttctt cctaagagtc ctgattttaa ggcaaagccc aggaaaacat 1806420
 cctgttacca gtgtctggga agagccctct tctcattaga actgagtacc acaggctccc 1806480
 agaaactg ctttttccca acattttaa cactggatag agatgagaga ttgacctcta 1806540
 aaaccaagt gtgtttggg acaattcttg gaaagatggg tggatgtctc agcacaaga 1806600

 taccatgtgc aagtagcgac atgatcacat ttactattat aagctggtgc actttggatt 1806660
 gggactttat gttttgaaat ccattttacc aaaaagacta aattttaaaa agaaagacag 1806720
 gggttggaac ataccagtgt ttccatggaa agcttcaaga aggattcctg atgcattgct 1806780
 aagtatttgg tagcgagttc acatgggtgg gaacctccat tcaccatagc tgttcccaga 1806840
 atcacacaag gaataagtta caaggcaagt gccacaggta ggctcagtggt ctggaacaat 1806900
 ggcatcttaa cacagggaca gacaagaatg gcagatacc catgggtgat cacttttcag 1806960

accaggggtg gctgtggaga tgcacttcac aagagaagtg gcttgagaag tctagggtgg 1807020

ccaacgagtt gcacccttat ctctgaaaac actaacacca tttggccaaa tgctattcaa 1807080

atcctgcccc tctctgtaaa tgaacaagt gcttcatata attttcteta aatcaatfff 1807140

ccaaacacac agaggggaac tatagaggtc tgacttactt ggaaataaca caattagcta 1807200

ctaaagactt aggatgactt gccaaagttcc caggaccccc aggacactgt gtggaattgg 1807260

tggagcctgg atgaaggaag tgacatagct gcagggcatg cccttgaagg gaacactcag 1807320

accagccca gtctctttc tcttcgctca tttggcccc aaacagaaag aaggcatcct 1807380

ctgccacata acttttttgt tctctggca gactctcctc ctctgttggg cagctggtct 1807440

accacatact tctgccataa tgcgttgtgc taccataggc ctagaacaac atgacatga 1807500

ccatggacta aatgctctga agccatgagc cagaaccaac ctttctctc aactagtat 1807560

ttgtctcagg tgctttgtca cagtgatggg aagatgactg acacagggca ggaggaggag 1807620

aaagttagta tcacatatag ttaaggtac ctatttcatg gcaaccatac tttttagac 1807680

acacacacac acacacacac acacacacac acacacacac acacaaaaga tgtctacaaa 1807740

aatttctgc cttaaactcc agtaggaaga aacaagetaa aatatttaa gcctacaca 1807800

cactgaata ataatacaat gatggtttac tgggtggtgat gcaagctatg gagaaaacca 1807860

acatgtttct ctattgctgt gatgaaacac catgaccaag gaagcattta atttggcgt 1807920

cacatcccag aaggttggag tccatcacca ccatggcagg gagcatggca gcatgcaggc 1807980

aggagccata ggctgagagc ttgcaacttg gtccataaag acaaggtata atagagtcaa 1808040

ctaggaatgg cctggacttt tgaaacctca aagcttacc ccaaagatat atcttccaa 1808100

caaggccaca cctcctaate ctttccaaag agttccacca actgtggact aagcattcaa 1808160

atatatgagc ccatggaat cattctcatt caaagtacca cacacattct agagttggtt 1808220

tcactttaa gcagattggt aaaggctgta ctaagaaggt gactgattag tgaaggggag 1808280

aggtgcgctg gacaaatgct cagcacagtg ccaccaggaa gtgcaaagac cctgtggtag 1808340

gtaggaggca aggttgggag tgtgagtgag ttagagatgg gggaggacac aggtgttat 1808400

gtgggggcat cacactgtgt acagcctttg agttatgggg agggcctggt tattctcgag 1808460

tgaagtgaga agcagatgaa acaccatgct acaattcatg ggcagtgagt ggggacagag 1808520

aagaaggaca gaggtaggaa gactgtagtg tgattctaac aatgttggag caagccctgg 1808580

taagtcatg gcatggaat gccatTTTTG ctactgtctg aagttagagc tgaagagact 1808640

tggtgactca gacacagaat gtgagagaat ggtgaaaagg atgccccat atctaggaa 1808700

ggaagcttaa aggggtggta tggctaaata gcaagtcgga gctcggggac aagaaggact 1808760
 ttctggctga ggaacacag ggaagaatg tagcactaac atgtggctgc gtgtgacat 1808820
 gccctccca cagaccctga gggttttctg aggctggggg catggtgaac agacattgaa 1808880
 gaggtgggc tggagccaga aagatggcct ggggaaggct ctgtgtagca cacagtggca 1808940
 tggagacaga gtgagtgagg gatggggagc catgaggcct aagtgagaga accaagggga 1809000
 ggcgtgggtg aggatggact tcctgtcag agccatcctt ctgggcacac tacagggacc 1809060
 ttgtgaagag aatggatgag aacagagtgt ggcaggccca caagagatgc ttggcgagtt 1809120

 tctcaaatat cttaaaagtg aacctgata tttcctattg aaaatcttta agattattgt 1809180
 tagattctca tttatttgtt tgcttgtttg ttgtttgaaa cagggtctct ctattatgta 1809240
 gctctgtctg tcctggaact ccctatgtag atgaggctgg cctgaaacat acagagatcc 1809300
 tcctgectct gcctcccaag tgctgggatt gaagttgtgc acccacacc agcaattgtt 1809360
 agtattttta aatctaaata ctgctctgta aaagcattca acttaaatca taaattttct 1809420
 gtctatcttt tgggggagac aaggattttt aggagcacag gccacagaat tgaggtaac 1809480
 atgatctatt gcatttctcc ccateccctc ctttctgatg gccatctccc acaaatttgt 1809540

 aaattcactc cccactctc cttcccaggc acacagcatg ccatttgctg ttcttatcat 1809600
 gaagctgcct gattccaat agcttacca tgtaccctg tatatgggga ggcattccag 1809660
 gctcctgtga aagtagctaa ctgggaaata catcgcaac tttggccaat ggggagcaga 1809720
 gaaagagcag atctgggggt tctcagcact cacttctctg caaagctgga actcacacag 1809780
 gacatggcag atggagcttc tgctgtctctg gagccctgag tgaacaggca gaggacacca 1809840
 ctgatctccc gaagacctgc tttgaaatg tggatgctgt tgtttaaagc cagcgggaagg 1809900
 gaggtgactg catgtttcct gatgaataa aagcaatcgg tcattatct cttccagttg 1809960

 gaacactgaa cctgceatct gtacaacttt agagatgtcg cctaatccat ctgagctccg 1810020
 tctcgtcccc tgtcaaatgg gccaatgatg tctgacctgt ctaacatctc aggacatgta 1810080
 aggatgcaat gagatctcct ggaagtggct gtgatctcaa atcacagctg cagatgtaaa 1810140
 atattcattc tattgttatg tgtggagact caaattgtgg ctgtagatgg ttaactcttg 1810200
 ctctgttctt ggatggaagg ttatttaa at tgcttctctg ttcactcagt cattagaact 1810260
 catcaggttg gagtggaga gatggttttag tggttaagag cactgactgc tcttccagag 1810320
 gaccctggtt caattcccag cacccacatg gcagctcaca actgtaactc cagttcttgt 1810380

 ggaccaatat ccatggcaaa aaaatttaa aatgcacatt aaaaaaaga acttattgcc 1810440
 tcatggttct acaaaagcca tgtgacacat tcaagtgatg gaccacttg agaatcgtgt 1810500
 ttcttttaa atgccagggc tagaagaatg gttttggagc ctcaccccc accatttacc 1810560

ttggcatag aaagtaaagg gaaatcgagg cccagaatgg aaggcttggc actgaatgct 1810620
 tccctcctcc tgaggcttgt cagtaaagag agggaggaat agaggggccc agacattcca 1810680
 gcctctacc ttatgcagac caaagcaaca cacattcaga aggggtgcaac aaacctattc 1810740
 agatgtcact ccaggaaaaa cggataagga agagatggtt tccatccaca ggacatatgg 1810800

 aaggcaggca ggaaaaggcc tgtgcattcc acactctgct tctaactcag aagaagggct 1810860
 ccctgaccca ttgagcagct ggcagcacia cacagacgga tttgtccctg ggacattttc 1810920
 atccacctgt ttagataagc agacattaca gctgacctt tttccaggta ctgactaaat 1810980
 gtcaagtact tgacatttta tgtatcaagg agctgaaaca cagcaaggct atgtaatcgc 1811040
 ctgaggctac ccagctggaa tgaagagaga gagagtcatg cattctagtc ccaaactatt 1811100
 caccactgtt tctaaggagg ggacagaaac aagaaagtgg gaagcaacc tactacatgc 1811160
 tctgaagtgg ggtttagata caccaccttg ctgtgttctt aggttctaca atgagcagta 1811220

 gcctcacctt gtttcacagg tacattaaca gactcagaga ggctgattaa tgtgtccaaa 1811280
 gtcacaaagc caaaaagtaa caatgggacc tagaagtcac atgctttcca ttcggggatg 1811340
 aggattgggg tttgatccct aggaccatg aaagacagtc atggtacatg cttgaactec 1811400
 ttctgtgag tcagacagat agatgggtcc ctataggact tgttctata gagtcatctt 1811460
 agcccacttg tcaagtccca tgtcaatgac ttcttttgac tctgtctcaa aacaaaaacc 1811520
 atagggaggg tgcaggagga atgacagctg aggttcattt ctggtttcta catgeatgta 1811580
 cacatatgta tataccaca cagatagca tgctcccta cccaaaagt gacagatcca 1811640

 gcctgaatgc tagacacagt ggagagtttt atagctaaaa agtaggtaac aactggaag 1811700
 acaaatgtca cgcaatttca attttatgtg taacttagaa atgatgaact tatggaaaca 1811760
 gagagcagaa ttgtggctat taggcttcat tgtgggtctt ttaacaatgg gaaaacgatt 1811820
 ggtttaagga tataaacctg cagttggaca agagtcatgg actctgtgat gtcttgaggt 1811880
 ctactgagag catgataaat atggttgata acaatatgct atattttaa agttgtgaga 1811940
 tagtatactt taagtgttct caaaacaaaa acgatgaata tgtgtgatat aacatgttaa 1812000
 ttggtttaat ttagccatgc cattgtgaac atactgtatt ctgtatcata attgtacatg 1812060

 actttattta tgagctaaat aatgaatgg aaaaaaata ggtaagcctt ttggggagaa 1812120
 aacaaaatgc attcaggaaa gagggaaaga tatcaggaaa atttctgtgc tctctgcaaa 1812180
 aacctgtga acttagccag atgggcattc ttgttctctg tcttctatc ctctcacacc 1812240
 gcatcatata atcacacact tccacattc ttaaacttaa gaatcaccga ataactcca 1812300
 gtgttttttt tttttttcca acatttgcta atccacagct agaatgttcc cccaacctga 1812360
 agctagagag gagccatgca attatgacac aggagccaga caatctcatt aacatatccg 1812420

tgactgacac agcggatcat taattaggca ttccaagcat aagtatatat gtataaatta 1812480

 gcatctattc accatttaaa ctgtaagtga tttttcatat ctgaatatta actatgttgg 1812540
 aaaattacta agtttttctg agtgaattcc acaacaata cccaccctg atatcaagaa 1812600
 caaaatgcag agaagagatt ctatgaacgg aactggactg ggagagaacc aatgacgtc 1812660
 actgctcctc atctactggg accttcttgg ctctgcttcc tgtttcgtgt acttgcaatt 1812720
 attctctgtg ccaggagcta caagtgacc ttaactgtg gtcagccctc aggtataaag 1812780
 ttgttgcaaa cattctggag atgccctgcc tatgtctata gattgtcatt gttcacttgc 1812840
 tctttctaca cgtttattgt gtgtgagctg tggatagtgg aggaagtgag tacacagaaa 1812900

 tattgtaagt tggaccttgg agaacttggg tgtctatttg gcggggaagc tgagaacaca 1812960
 tgtggacagt gaccgctgtc taagttcaag agcacctcag aggaggaaca gaccctgctg 1813020
 gcagtgaggag aggcctgagg aatggctgtg aaagaggtgg cacttccagt tgggtggttg 1813080
 gcgtggatct ggccaagttt gggatgtaa agtatcatgt agttgggaaa gcacagcaaa 1813140
 gccaaagtct cacattatat ctagtctcca actgtgtgac ttctgaagcc aatagagccc 1813200
 tccaagtctc aacactgctg acaaaactat ccttccaggg tttgaaaact accagcccca 1813260
 ggataacaat aacagtatgc tatcatcctt cccacgtgtg acaaggacag tacctacact 1813320

 aaacagctta tgtgggtacc tactttcctt gtggtagtct tggattcatg ctagcagact 1813380
 cattgttcca cactgaattt tcttgtgacc agtggcacac attgaggatg tggctgtcct 1813440
 caatgacggc tggacttagc agctgagtcc atcctgcaca ggaagagctt actagtittgt 1813500
 gtggagactg caccctacat cctgggctta ccacccttc ggttctactg aagcatctct 1813560
 ttctctggtc ataccaatgc attttagccc agtctcttct tttaaagtagg cagcctggaa 1813620
 acaggctaga cctgagaact tctccagttc tgacatctat gtataaaaat cactcataga 1813680
 tccagactcc tgaagagtca ggagcaatgg gccttttctt gtcagtctat gacatatcag 1813740

 actgagcaaa atttgggagc agaaactcct aggcccttag ttcttgagat gccttggagt 1813800
 ggactgaaga ccatctcctt ttctctggac actgttatga cagaggtcac agctgctagc 1813860
 catgtcggat ggatagcaag tgcatccca gaataacaac caaggctctc ctaggiaggg 1813920
 gttggagtct tccccacttt ggaaattggc agtttctgag gccttgacgg aaacaacag 1813980
 ctgccaaca aatggcgtaa tctaggagaa caccagctat tactgaggaa agaaccatct 1814040
 agaatcaggc tgcttatttc ttctatgctc tcagctaaat aaatatcgat ctctacttgg 1814100
 tgaggtcaat tcatgtgtag caatacaaac gttccatttt agtgggatga gaagtatctc 1814160

tgtccatgaa tactcatgat ttaagcagta cagtgattct tgatgtctgg actactgtgg 1814220
 ggaataacaa ttagttaatt ggaaagctgt tcattaagat ggtgctctgt actcgacct 1814280
 gtgcctgaca tgcagcagac acaaacagct tagacagcag aggatgccat ttggttaaag 1814340
 agaccaggg gggtccaagg ccatgttagt cctaggaatt cagaggaaaa caaatcaaga 1814400
 gggatccaag gtcatttcaa ggagcttgtt tggagagaag attcggactt aggtctcaca 1814460
 gataaagagg atttaaatga ccctcatgat agagacaaag cacaaatatt agaaaatgca 1814520
 cagaggaaag gaatctgaat taggtaacct gaataaaaat gtcttaaatt caattattca 1814580

 tagaaataat atgcacatct tgtcctgtac tctgctgaca tggactagtt ttaagaggta 1814640
 attgggtggg ccagggatgt agcttgggtg gcagagtgtt tgggtagcat gaaggaagcc 1814700
 ctgggttaga ctcttagcac cacacaaatc ctccggtatg gtggttcatg cctaaaatct 1814760
 cagcacttgg gataaatcag gagagtccagg agttcaaggt catccctagc cacatggcaa 1814820
 ttttgagagt agcctgagct gctgagtagc ctaggggacg aggagggata tcagttttag 1814880
 tttcagttcc tgttctatc ccattactat catttaaaaa tggacaaaagc tttccccacg 1814940
 gtggcctctg acaaaaaaat aaaataaatt aaaaaataa aagaggccct ggatttttat 1815000

 gcctgagttc ctctgttga ctaagggtc cctggtaagg ctgcacacaa agagatcttc 1815060
 tgaggccaac ctatggagac acgttccaat ttaggctgtg gaatgaaaat tacagggcag 1815120
 acacagagge aagtttaaaa ttaggacaaa cttcactttg ggcttcttaa gtctcaaaga 1815180
 gttagtagat gaggcaaaga aaaatggaag gaaaaaaatc tgtaagaact tgaagcaaa 1815240
 aatcccccaa cctctctct tttctacagt ccccgacatt cctgagcttt cggaaactt 1815300
 ggtaagcagt ggaaagggt ttttcagtcc ctctgctgct tcatggggga cactactcaa 1815360
 ggcaccacca atgaggagag cctggagata cagaggtctg gaaaatcctg gcttgggaagg 1815420

 aataagaatg gcagtgaggt agacettacc tagcccaagc ccgttctctc cettaagtec 1815480
 taatactcag tgcaggttgg tgatggtggc ttggttctat gtgtagacac agtcatcagt 1815540
 caatctcaag gcagaggcag atgacagtct tgccaggcac atgaagcctt ctgcaggagc 1815600
 gctgaaatca caagtctgt tccccagaga gtctgggtg cgagggtaac taataggact 1815660
 cctctggaca ctigcagcta atgagcaacc actgtcctcc ctacaggat gggttctcag 1815720
 gaatgactca aatgaccag gaaaccaaac tgcactttct ctttctctct tcagtctcac 1815780
 ttgttctcc aagctgggac agaatcacct acacttctgt tctcttgaga ccactttgat 1815840

 ttgggtgctg ccgttgtaaa aggtcataat gaaaccatt atttgcatg ctaagaaaga 1815900
 tgttttaaaa tgatgttct tcacctatcc ccaactaaaa gttgcaactt taaggaaatc 1815960
 aacaatcccc aaactgaatt atttctacta ttgcatgaaa agatgtttgt cacctgacac 1816020

tgcgttttta ggaagctcta gggactgcag acacaaaccc caatagtcaa tattcagtta 1816080
 gattatcctg aagggaactac aagagtctga atgggaagga gccagtcaca tgccaccctt 1816140
 ttgtcaaagc cccacaatgg gtctgtcacg cctccctccc cccacccccc ccccgctctt 1816200
 caaaatcagt tccaaaatca ctccctgagg agaactgcct cagaagagta tgtttccaga 1816260

 tgcacattcc caagagctag gaataaataa aacatgggga atggtagctt tcatgtgtga 1816320
 ttcccagtga cagcctgaag cccaggtgcc aggctggttg caggagtacc cacatgttct 1816380
 gtctgtctgt ctgtctatca gagctttaag tgaacaggaa gaggaacaag tctacaagtg 1816440
 gagggtatta cactcctaaa caccttcacc ccgtaagtca agaagtcaag agtttcacca 1816500
 gaggaattta ctcatgggag ctgggcatgt taagcctcca tcattttagt ccagcgtggt 1816560
 gtaataagc agagtcattc tctcagggca cctcttcaac aggtgttgcc tttcggatcc 1816620
 acaactcact ttgtcagagt gatttcagca ctgcttggag cacaacgaat tccgaaactt 1816680

 gatcccattg aaatatttag tgcctgctga tatgttcaaa caaattctcc agatcttgat 1816740
 tatgttctgg caattaaagc tattaagtca gtagacagac agcgggttat ttcattgctg 1816800
 gtgaaaaag ccagcgttct ccccccccc cacacctctt atgtgacaga actgtaatta 1816860
 gccttaatca aactactatt gtgctctgtg cagtaacggt gcttccttag ccaggaaca 1816920
 ctgccaatct aggaaaagga gaaatagac cctggtcaga aagcaagaaa gataggcatg 1816980
 ggggtgtctg gaacgttttt ttctatcttt tctatgttct tgtaaatcta aggatgttgt 1817040
 acaataaaaa atttaattta aaaacccgc aggggtgcagg gtcagttagt tagctcagtg 1817100

 gtagaacttg tgcttaaca tatgtagggc actcggttct actctgtgag tgtgtgtgtg 1817160
 tgtgtgtgtg tigtgtgtg tigtgtgtg tgtttaacag ggtctcatga agcctatcta 1817220
 ggctggcctg gaactcatta tgcagctgag gctgaactct gaagtatgag ggttacacia 1817280
 gtgtgtacc acatcagcaa aataataaat gcatttttaa gttttaagtt atttaattaa 1817340
 aagtataaaa gaggtgagaa taaaggaagg agaaaggaat gctgcttagt ataacttga 1817400
 cgtttagagc taacatgtca aagacagcct tggaaatcat tcagaaaata tggtcacttc 1817460
 tgaggttac tgccttgcca cattggggac actcaaatgc ttcatagtcc tcaactgcaaa 1817520

 taagtttgta aatgactgga aggaaggaca atgccccaaa cagagctgat tctttcacat 1817580
 ggatcccaac ttctagtcca tttctctgtg taagctaac atcccgttta tttaaatata 1817640
 tccagaagga ggagtttgc ttggagaacg atgctgatga acaggtgagg ggagggagtg 1817700
 gcggtgcttt taaaatctta ctgtgcacac aatcaccta gggatctagt gaaaggtgt 1817760
 acatctagcg cagccttcaa ggtttgtctg ctgcaaagc ctagttgaca ttgaagctgg 1817820
 gccattcttt gatlacaaat actgctagga ccagacatca cagaagtaca gacagacaga 1817880

agacctaaa tagtttgtct aaaaggttga cagtgagaaa tctggccaag tctgccaacc 1817940

 aagagataca cacttgtatt ttcttcagct aataattgct ggtatcaaat tttcaaaca 1818000
 tggtagtaaa aaaagcaata tgttatgagg cagactgtct gtgagctcag agcatcccaa 1818060
 tgatagcaga aactctattc ttgcccaaag tgccccagct gcaatagga gcaagcaggg 1818120
 acaattttaa aagcagcagt atgaccttcg ttattatfff gtctatttgt ctcttcacac 1818180
 ctcaaacagt ttigtatttg tggaacatta tctattggaa ctggggtttt gttttttaa 1818240
 cattcctaga aaaagaatcc caggggtttc cttccaatat gttttagtct ggctttgtaa 1818300
 actatggtat cagctgatgc tgtttatgag atcaaactgc taacattgga aggatgggaa 1818360

 cacattaatc tgccatttcc tacatctttg agttgcatgt ggggtatggg ggtgtgttac 1818420
 actgtttatc cttcctctaa gactgacagt cttccaaca ttgtggtcat tggtgattca 1818480
 aatctatcat gtgacctga ctcatcacta cagtcaaaaa ccagacagta actttgagcc 1818540
 tgacctaaa agctggcatt tgctttgttt tgagattagt tgaggatggg gagctcatca 1818600
 gttggaatat tctattcac cactatgtca tagcctggaa agatggcaga gggacaagaa 1818660
 ccagcgacac taggagatta aggatgactc ttactctccc ccagaagaac tatatcattg 1818720
 taggagatga tcatatgtaa gttccagaga aagctgaaag aagatggggg accatcctgt 1818780

 catatggttg aacttagcc gacaaagatg aatcacctcg ctccatcaa catggcaaga 1818840
 ccaggtgatt tggacttcg aacaccagga aacaatcctt gcaagtcac gacatgactg 1818900
 tggttgtcgc ctcaaatacc acattgctag ttctccttgc cgggttttt aagccttga 1818960
 acccggttat aaaaaggcaa gcaatggttt ttctgcttag attctgtac atcttaataa 1819020
 atgcaacaga ctgggcttt gaaaaaacag caagtctgg cgtgtagctg ttgtcaattt 1819080
 gaggttagga attcctccac cacagtttat ttcaagtcca aacctggctg gccttactga 1819140
 acacagaatg ggaagaagac atatatagtg acaactgaa caggatggtt ttgttcaaaa 1819200

 gtaatagcaa ctgcctaaa ggaaggaaga agcattggct tttgtttgtg tgggagtttg 1819260
 tgtgtgttc ctaggaagc atccatgtat ttctgacaca gggctctca ctaggctcta 1819320
 gggctacca atgaggtgaa gctgacaagc cttgagccc caggatcca ccaggctctt 1819380
 ccctcccagt actgggataa gttttacagt cttttgtctg gttccagggg cttacacacc 1819440
 tcatgcttat atagcaagca cttgtcaac tgagccctct ccagagcagc aacagtgtct 1819500
 taataattaa gttcataaca atttaggagg gtaaaagcat ttttaagtca ggatagcatg 1819560
 cctcttttta aatattttca tttgttgat gaaaagtaga agcctgtaag cccgtaagcc 1819620

cttctgtttt tatacactca tcttaaatga caacctcgca tgtataacca gcacagaatc 1819680
 ttataaagta agccatttga atcataatga gataaacaca cagcaagaat ttttctacat 1819740
 gagcttgagc attgaacttt ctacctaggt gctttgctca tcacagtgtg tcctggtgtg 1819800
 aaccctaagg ctccagtcaa tcaaccccag tggctctcaga atccacagag agggctaagg 1819860
 catcacccca ttacttactg ttccctacaa gtgcctctga tggcagctta ccacctttat 1819920
 gtcttgccca tatctcagct gatttgcttt gaatagaaaa aaagtgatct tagggcagag 1819980
 aagatggatc aatcaggaaa gcacttgcca tgggagcatg ggagacagga ttttgacctc 1820040

 agcactttca tgaaacacgc cagtcatagt ggctcacact taaaatccca ggactaggaa 1820100
 ggaggaatcc aagggtctggc cattggtgtg ggaatccatt tcaaaagaag ggggacagct 1820160
 cctgaagatg gagacccaag attatccact gggacacaca cacacacaca cacacacaca 1820220
 cacacacaca ccatacacac acacacatac acacacacac cacatataca cacacatgta 1820280
 cacacataca cgcatacaca tacacacatg cataccacac accacacata acatacacac 1820340
 cacacacata tacacacagg caagcacaca catgccccac aatgatttca tataaaagga 1820400
 cactagaatg ggaatttatg taagattcta aggttggtat attttctac agctattgaa 1820460

 tataaactg acctcttacc cctttactta atttactctt accttgttt ctctatggt 1820520
 tccttctta ttaatggaga ggaactttta agagtctaaa cactaaggga ctagagctca 1820580
 caggcagggg aagggagaac ccagtgatgt atttaatttg aagaaaaaca actgcatcat 1820640
 gactgtactc atgtctctcc cccacaagcc aaagccacac aaacaaaaag ctaccaccac 1820700
 tcagccagta cctccaacac aaatgacca gttaacatgc aaaaactg cttgaaacac 1820760
 aatgaaagga caccactcca aactgttgct tcacatcagg ccctaattgc ttgtccttgc 1820820
 tggatcgcc tttgaacctt cacaattttg tgtacatca taatcctgtg tagctataaa 1820880

 ttcttcacag gtggcactat cttctaactg cttcttaagt tttgaacttg tcattttcac 1820940
 tgaggatgat ggctttctg ataaatgcct aagagtataa gacatagact gtgcagcagc 1821000
 ccctccctca actttgccca ggtgcaggac accagaaaca cttgagcatt tttggtgtta 1821060
 gaatgatggt ggaagtgcgc ccaccgagc agaacgggca gaatgtgcac ctgcttttgc 1821120
 ctttctcagg atgcatttaa attccccagc ttcatcacca ggtgtcaggg ttattaatag 1821180
 gatggttgat ggctcgggtt gctgaatctt ctagacacag gaatggtgcc caccatccct 1821240
 agtgtttcat accaatgccc ggcattactg cctaactctgc agctcagcca cagacagcag 1821300

 atgtcttact tatttttagt ctgtctgtct atctatctat ctatctatct atctatctat 1821360
 ctatctatct atccatccat ccaaccatcc atccatccat ctatttatc ggtgtggttg 1821420
 ggggagaggg aggtaacacg cccatggagg tcagagacaa cattcttaag ttggtttcct 1821480

cttccacca tgggatttt cagaatggaa ctgaggtcct caggcctggc accctttacc 1821540
 tactgagcaa tttactgac ctgtttgggt gtttttaatt ttaactttag tgtgtgtgtg 1821600
 tgtgtgtgtg tgtgtgtgtg tgtgtgtgtg tgtgtgtgtg tgtttgtgtg tgttcacaca 1821660
 cagattggct cagtaagtac tttaccatt gagccatttc cccagccctg tttggtttta 1821720

 ctttacagtg aagtatggca gctttatfff cactaaatta atatataggt agttctgttt 1821780
 ttaggatttt ttccttttt ctacaagagt tttactetaa gtcaaagtct cttgcttttt 1821840
 caggctttaa aaacataact acatgggtgct gggtagatgg ctcatgggtt aagagcatta 1821900
 gctactcttc cagaggtcct gagttgattc ccagcaacta catggtgacc tataaccatc 1821960
 tctagtgcga tctaatgccc tcttctggca taaagacata catgctgac gagcaactcac 1822020
 ataatgaaat aaataagtct taacaacagc aacaaccag acatacatat aggagagata 1822080
 aattattcat aatactggat cttctggaat gatcacagta agaccccagg ttctcacagc 1822140

 tcctggacat atgccgaagt cacaccaga gatttaaaaa gagccatgga taataatgat 1822200
 ctatttgaga catagatata gatacaatat aaccgtgggt ggacacctgt ggatatagtc 1822260
 caataaatte aaagtatttt aaccattaca gataaatffa ataaacttaa getcaaagta 1822320
 acagcaaaaa aaacccact aatatcaaga tggaacaaat gataaaactg cattaatcac 1822380
 aaaaaaacga cagctcttc cagatattat gggttcgtca ccattcagta aaaaaggga 1822440
 gaaagcgaca gttgcaggtg tttagtgtcc ctggaaaaag attatagcac agtctgtggt 1822500
 ctgtcactgt ctgcctcttc ccgggggcct gtctgtggg tggcatttaa gaacaggag 1822560

 aaggaagaag atgaaaatc atgataacaa caaatataa ccttagctgg tcttggtctg 1822620
 agcctgtaat cctagtctcc acaggatgct gaagcaaggg gaccaaggtc aagttctgtc 1822680
 tgcattagag tgagctgaag gccagactga gcaacttggg gagaacctgt cttaaaataa 1822740
 aaggtaaaaa taaaagtgg ctctgttgta gcatgtgcag gccccagatt tgttccccag 1822800
 tactgaaaat cctactaata aaacaaaaat agagcctgac tctatatccc tgaaatgtag 1822860
 aagatatgaa aaacaaaagc aataagccct ctgtgtgtct agtatgtgtg aacctgtatg 1822920
 agtgcgagca tgcacacgcc aagttgctca cataggagtc tggggacaac cttggagtta 1822980

 atcctggcaa tccacttttt ttgaggctgg gtctcttatt gttcgtgct gcgtttgtca 1823040
 ggctagctgg tcagaactgc cacaattcac cttttgtgcc ccatctcacc taaggaatgc 1823100
 tgggattaca ccacgtgcta ctgcgtatgg ctttgggga ttctgggaat ctaaaccag 1823160
 gigtctctaa taatgcagca tgttatccac ctgccttct ctctcagcc cctgaggata 1823220
 tgtatgcctt tgagaaaata atggaaaaag tcaagtccgc tttcttttta agaaacacac 1823280
 atacgcaatt tttcatgcag acatttttct caaaggagtt cctccatctc gaaggttgtg 1823340

agctacatca ggcaatgaga gacagagcat cctaccagat ccaaagagtt cctgaaggcc 1823400

 tttaacagtg aaatcactta gcaaaacaca gatgcaagcc aattacaaaa tcacagtgtc 1823460
 ttcaagattg gctgcaggct ggcactggct tgaagctggc tatcccatcc acctgagggg 1823520
 aggggaaggg gacttgactt ccatcattcc tgggctacat tcagacctca ctcttttcca 1823580
 tacttgtgtc taaatttacc ccattcccaa gaaaaacaca cagcatcaca tgagttttga 1823640
 gtcacttttg gggatccat ctgtatgaac ccatggagct gaggtacagg agatggctga 1823700
 atgagcaaag tgcttgttgt acagccggag gaccaagtt tgaatcccca gacctatat 1823760
 aaagctgggc atgtagtga cttttgtaat cccagtgtgt ctatggagag atgggaggag 1823820

 acaggagaac ccatagaagc tcactggcca ggttcctggc aaccaatgaa gcagagagcc 1823880
 tgtgtcaaag tggacctata cccgaggttg tcttttgacc tccgcaaatg cacacacat 1823940
 cgtataaact cacacttctg gcccggcggg ggtggcgcac gcctttagtc acagcactcg 1824000
 ggaggcagag gcagggggat gtctgtgagt tcgagatcag cctggtctac aagagctagt 1824060
 tccaggacag cctccaaagc cacagagaaa cttgttttca aaaaacaaaa caaacaaca 1824120
 aaaaaacaaa aaaccccaca ctccgaccc cacatacaca cagagagata tccaaacctg 1824180
 gttcaggcca acaccactgt ggatgaaacc taaattacag ctactttatc tcaacaccgg 1824240

 tttgtccttg aggcaagaag gctctgaatc aagtaccata aactgagctt ctgagcagcc 1824300
 gacagcaaga ccagcacaga gcctaagcca gtggaacaca ttcaagtgac tgtgaactgg 1824360
 attagacaga aacataaaa gaaaacagag catgatggca tattcctgtt atcctgtgtt 1824420
 gggaggcaga ggaagaagc tggatgaatc caaggtctgc ttgagctgtg ttgtgagttg 1824480
 agttcaaggt cagattgaat aacagctgaa agaaaagact gagagtagag agttcagtgg 1824540
 tagagtgtc gcctggcact caggaagccc tagtttcagt catgaataca cagagaggaa 1824600
 agctgtaaag aggcaagaa aggagtgtg ggggaggaaa gagaaagaac caggtacctg 1824660

 gatgctcaca gagagggtga gaaaaacca gtaatagagt ggggctggta gaacaagcca 1824720
 atgggaagtc tcttgtgatg ttctgaggc tgacagctta gaccatgata aacaagggcc 1824780
 tgaatacaca ggaagaagcc atgtgagtgt agaggagga agacttacc cttccgcca 1824840
 ctccaacct tccagaacct gccagaaaat gctagaacaa tcagatgctt gaataagcgc 1824900
 ctcccatagg taggcagatg tgtgtgtgtg tgtgtgtgtg tgtgtgtgag agagagagag 1824960
 agagaggaa ggagagaatg tgtgtgttaa aatactgaag cctgaaccag taattcctct 1825020
 ttttactct gggctccct ttagtctccc cacattttg catcagggtg ctatacttcg 1825080

aaaaatgaac acacacacaa tcttctttca gcattctttt gtcaagggtc tttataagca 1825140
 tgagggattt ctacattcca taatttataa caaacttttc atctgggcat taaaacgaag 1825200
 gcctctggaa agctccctga cgacgttca tctggcaatg gtaccatatt tctgtagcag 1825260
 aacttgaaac acagacttta tgttaatacg ctttaatctt tacttcttac atttcaactt 1825320
 aaccttctc aaaggaaatg gcttccagaa tcctcttcaa gtattcatat ggtctattgt 1825380
 ggacactaca gaaaacactc tccatgtaac atccatttcc tgactcctc ctcagccttc 1825440
 agcctccagc agagggtgga atcaggacaa tactagccat tctgtaccac tggctcacag 1825500

 agatgtactc ccaaggcaag cagatgttgg agggatgcat acaggggatg gactggaatg 1825560
 tctgatcttg aagtaagcaa aaagaaatca agtttggaa cttgatatca tcctcagacc 1825620
 gaggatgaca tccaaaagga tttgatgcag agtttataaa taaatattgt tacactttta 1825680
 tttatttatt ctgcgtgtgt atgtggggaa catgccacag tgcccacatg gagtcaattt 1825740
 tctcctggta ccgtgtggga cccagagggt gaactgaggt ccccgatta gaaactcttt 1825800
 taccctctga gcactcaaa gaccaagat cttttttta ttaatcatct gagagaagaa 1825860
 tgatggatta agagagatag agttccctgc aaatatatga gggcatttac aaacaccaac 1825920

 catagtggta gcagaataca tttattatca gagaaactac aaatggatat tgcaaaatat 1825980
 atagagaatc caccattaag ttgaagtggg agaactctgag caggcttcat gggagaaatg 1826040
 gcatttaaga taggctttga atgaatgaat taggttttag tagatggaga atgagcaaga 1826100
 aagaaatgtt tgaataatta gaaggtagga gagtggatgg atgtggagag tagctaccgc 1826160
 atgggagact catagcagta aggactctgg gctgattgtg cagtctgtga agagccacgt 1826220
 ggtgcttctg aacatggacc agagttagcag ggcagttggg aggatgctta aattcaggaa 1826280
 cttcacatga ttttctttc ttcagataag aggctaaggt ccatcaggaa cctctgagcc 1826340

 cagctaactg gagacagagc tggggatggt ctctgactcc tacgtaactc cgacatataa 1826400
 cttcattaca gaaaattccg ctgatccact aggtctcttt tccatcacia gcacctctg 1826460
 acctgggctt tctaactcc atctccagag gctcagctat tgctcgcca ttcactcct 1826520
 ttagctttcc agatgtggac aggaaatctc ccagatcaca gatgagcaaa caaaaagtct 1826580
 agccatttgg cttattatta ttgtaataca gataccacct gactcaggct ttgcaagctt 1826640
 tgtagagctg gacatgagct ctacatttta ggaacctagg agctggttc ccaatgctg 1826700
 cataatcag tgttcctta gagttctcag aagcagccac ctcagactgg gtacctctg 1826760

 agctttctcc tcgcattagt ggcgttccc acagagctgt gtctatgaac ccacaccagt 1826820
 tcactgggtc tctctccatc agcaacceca gtgaccgtaa actaaacggc aagtgccta 1826880
 agatgctcct caccttaagt gacgagattc cacttctaac acgtcaacgg gcctcctat 1826940

tcttagaagc acagtgagca ttttgtttga tgggtgcagt aatggtttga ctatagcaaa 1827000
 aatactgagt gaacttcggg gttcacgaat ctcccaatt aaaaaacaaa acaaaaaaaaa 1827060
 cacaacaaca acaatgacac atggcaagag tgggtgttcc tgcctgaaat tccagtactc 1827120
 agaaggctga ggctgaagga tcactctgag ttcaaggacg cgttaggtta gagcgaacc 1827180

 ctacctaacc acgtccac aaaatagtgc agtgacgtgt aatatactc ctgtttcaca 1827240
 atagcataaa tatgaatgag tgtgcgagcc tcttcagccc tgttagatat gagaggcttg 1827300
 tactcttgaa accatttttt tttctcattt ctacacagca acttcagtct aaacctagcc 1827360
 tgtctgaacc ttaatgtgc cccatgtttt cttttgttgt ggttaagaac actttttccc 1827420
 ttcttgctta gcittttttc cttctgtct ccagaactag aacttgctt tcttttgga 1827480
 cgccatttc tgatgaagat agcatgtctt tatcacacca tgaaaatgac ctcacctgg 1827540
 gatgggtaag taacataatg acttgggtgg tgggtaatt ggcagtgggc ttggctcatt 1827600

 cacttggtaa ctcatgccag cttgtaaatc taaaatcaa atttctccat tggaaaagct 1827660
 gcaaatttct ttccatccc gacacttgag gttttttgtt tgtctggttg tttttatggt 1827720
 ttgatgtat gtgctagaat gtgttgggtgc acaggtatga acatgtgtgc agaggccagc 1827780
 agtcaacctc ggggtgttgtt ccttaggagg cacctgcatt gtttttttag gcagaagctc 1827840
 tcactggctt ggaactcaac aagcgttaa gatagctggc cagtaaactc cagggatctg 1827900
 tctgtccctt ctccccagt cctgggatga caagtatgta taacctgcc tggttttggt 1827960
 ggcggggggg ggggtcttaa atattctat tgtattttat ctatttattc atttgttga 1828020

 tgttgagggg ttggtgggtt ggtgttgggg gccatagtat atacaccaga ggtcagaggt 1828080
 cagaagagtc cattctctcc tagtactatg tgggacaaag ggatcaaact caagctgtca 1828140
 ggcttgggtg aagatgccct ttaccattg agctacctca gcagcctgtt tttggtgtct 1828200
 tcaaatacac aaaatactac atctgaaaac acaaaagatc cattcaggaa taaaacaaaa 1828260
 aaaaatcctt cgcttgaag ccacactgat aacatactaa ggtttatgac aaaatgatgt 1828320
 ccagtccatt gctcaaaagg cttatggaat tcaccacaga aatggccatc agaacaagtg 1828380
 tacagagcgc ttgagaaagc agttctagca gctccaaagc tacactttgt tectgccatt 1828440

 ggtctgttca tgggccatg gtcattgcat ttgaccctt ctgctttttc cttgcccata 1828500
 aaactcattt agcacagtaa acaatgtgct aaaatgagag aactttgggg gaagatgcag 1828560
 tgttctatat cataattgtg gcagttgtta cagaaataca ttattatct gaactttata 1828620
 gaatttttgc actaaaaat tagtgagttt tgtctgaggg tcaataatat ctgaatgaag 1828680
 aaacatgaaa tctgaagaaa atttccaaag tcataattgta tcctaagtat gaaaatacac 1828740
 atgcaaagct ttgacactc ataaagggga gttttggatt tagacataga tgtaccacaa 1828800

aatgtgagag acttcctaga atatataatc caaatataag atatttcatt ttatctttca 1828860

gataaaaaca ctatctggat tgtctttcag ccagactgtg tctgatgagt tcatggacce 1828920
ttttctatth cggctctggat ttgtgaccac tagtattcat ctgttacatg actaattgga 1828980
gtaagaggct agtgtgtagc cataagtcaa gctacttggc tcatctgggt attttgcctt 1829040
ttttaaaaca gctgtaatca caccatggtc agctaagtga gctggcttag tcatcaggcc 1829100
agacactggg tcaactaacac tggacctgaa gactgaatgt gttctcaaac aagcaggatt 1829160
tctccaacaa gtcatttcaa acctcaggag ctttgcttgg ctgcaggaca tgcatagcca 1829220
gggcaaacgg aattcacttt ccatactctt gctctgtggct ttggctgtta taggagtcaa 1829280

gctcaaaaca gtgcttagtt tatttgcaaa gattaaaaca gtgtctgggt ggatctacac 1829340
tgtaaagggt ccagataata ccttcgtgtc ttggaccaga aacttttga agtctgtttt 1829400
gtaagcaag tatccctggg cctcagcatc actgttactt agagctgcac tgtcaggctt 1829460
gagcttatca gggcattaat tagatctcca gaaagggtgg ggtgtggaca gcaacatcca 1829520
tgaacaatcc aagttcatgc ctgaagttaa aactactaat tttccaaaga aacagctgaa 1829580
aggaggcaat tctgccatga gagcctttgc ttatgggcaa agaatggaag gaaaaaatc 1829640
acttgctttc aatccaaact gctttgacaa atcctgtctga agcaccatga acaacaacaa 1829700

aataggtata tcatacagaa atatagaatt acctctgtat cattttatg gggttaagggg 1829760
actagaaaag cacaactttt tcatctttc acctaacctt aattacaagc aaattcctca 1829820
aaccctaaag caattcacat agaagtattt tgcacggctt tctgcatcca gaatatgtg 1829880
agttcaagat gttgttgacg gattaaaagc ctatcatggt cttttgaaaa caaactaacc 1829940
aaaaattcaa ttiactttta catttaattg aacttaataa gtatctgtta ctacataacc 1830000
atthtaacta taatcacagg gattctgaca aatataagac atggcttcat ctcttcatgg 1830060
ccttctaatt tcaactgagaa agactataaa cacattaaac tagctgagca actatgagca 1830120

atctcctaga ctgactcag ttttccgact tgtaaaatga aagagtcaa atagatgatt 1830180
cctgaatcct ccaggcttg cacaaatth taaaactctg tgtgtgtgtg tgtgtgtgtg 1830240
tgtgtgtgtg cgigcgcgcg cgcgcgcgcg cgtgcacgca cacgcatgct cgagcactat 1830300
atgaccaaag gacaatgctg ggtgtcagtc ttccacttcc acctgtttg agacagtctc 1830360
ctgtgacca ctgcatgggg caggetagct gtctctgtaa ctttggggaa tctgtctct 1830420
acctccatg ttgtgtagg aatgtggga tgacaaacat gtactactgt gtctgtctct 1830480
gagtggcttc tgggatcag aacacagatc ctcacacttg tatggcaagc actttaccta 1830540

ctgggccatc tcttcagtc ctacaaagct tttatctaatt atttgcattgc cctgcttagg 1830600
 aagcaatgta acagtgtaac cattaagctc aaatataatca ttaaataat caatacaaca 1830660
 agaagtctga actgagagaa atcagcccca ggatgtgaca aaggatactt ggaaaagcag 1830720
 aaacttttagc ttggacttgt gggtagaatt tggaggagca atgggagggg ccatccttc 1830780
 cttggaatgt agaagacttg ctcagcagga ctgaaatggt tcttgagcag gaccaggaaa 1830840
 atcaagtttg taattgcctc tgggaatgaa agggtcacat gttgtcaagt ggtggcttta 1830900
 aggaagggaa ggcactcaat gacttgatga cacaatcctt gtacctata attcaggtca 1830960

 ctcttctcag gccgtccagc tgtatctcac ctctcttaga taaagactat gcccttgcaa 1831020
 ggctctatat cactttctcc aactgtccca cacactctca tctgtctctt gcttttctcc 1831080
 ataccactcc cctcagtcg atcctcagat acaaggcaca cttaatggat ttacacctgc 1831140
 tttgttgaag tttggctact gaatttggct atgccttctt atacttgctc agaggtcact 1831200
 ttcccagtct atttatttgc agtactagaa gcagaatcca gtctcatcca tgctaggcgt 1831260
 gtgctctacg agcagcacca tatttaaaat tgcagccac actcatacac acacacacac 1831320
 acacacacac acacacacac acacacacac acgtttcaac atgctttatt tttatttaat 1831380

 gtctaatacat attccttcat actctataat ctatttgttt tgtaaaatgt ctatctccag 1831440
 tgtttaagtg aaatgatccc tcttagaaaa cagtgaaga cagctgtagt agtttgaata 1831500
 gatattggccc ctacagactc atgtgtttga atgctgttcc cacagggagt gcactattag 1831560
 gaggtgtggc catattgaa taggtgtggc ctttttggag gaagtgtgtc actctgggga 1831620
 tgggctctga ggtctcaat gctcaagcta tgcacagtgt agcacactgt tcacatcatg 1831680
 ttgcctgtgg atcaagatgt agaactctca actccttctc cagcacatg tctgcttgca 1831740
 tgctgccttg ctcccacca caaggataat ggactaaact tctaaaactg taaccagcc 1831800

 ccaattaaat gttttcttt ataagagttg tgggtgcat ggtgtctctt cacagcaata 1831860
 gagactctaa ctaagacaac agcaacagtc aagtctagat acataataaa aatagccaat 1831920
 acaacaagag gtctggtaag ggagatagag ggggagtga gtggggagag atttttctct 1831980
 gcttagaaca gcacttgca gaatagaggc ctggatttcc acatccagtg aatcacatgg 1832040
 atacataaac aaaagaaagg tctgaggtca agcacacagg ctgaagtata cgggggtggg 1832100
 gctaccaaga atgcagagag catgtgtca tgaagcttt cactgaagaa gtaacaagg 1832160
 agagctatgc cttgctctgg gtateccat gaagcattgg caagcagaag gggctgcaact 1832220

 aactcacat ccaggtatag aatgaagaag gttggccagg ggaattaaga taatgttcag 1832280
 ggggtgagaga ggaataaaag atgtgtgga acaacaac atatagtttt ataatacaagt 1832340
 gtcagttgt acaacatcag ttgtttgtga acacatctga ttgctgtttt cttcctgcta 1832400

gcatttcagt atatggtagc aaggaagtta caggcatgga agtagaaagc acacagtttc 1832460
 cttaaagcaa ttcagcatcc agggcaagtg gcctggaaag gtttgtacac tctggtcctt 1832520
 tccttctgct tgaaggagcc agaggcaagt ccaggaccaa gtggccctgt ttttctggtt 1832580
 ttccctcattt ccattttatt ctcatctgt ttcccttctg cagaacagtg atcaacatgg 1832640

atgacactca cgatcctacc actggcattt ggtacaatgt cacagtagaa atgagaaggg 1832700
 aagagtatct gtgacagtct ttgctagtig aagaatcttt ttttactggt gtggaagtgg 1832760
 aaccagagc ctigtgatg ctggaaaagt gctctaccat caagtcacac ctgcagcgca 1832820
 aaagatgact gactaaggct gatttctttt taaaaatgct tttattaata ttcataataa 1832880
 ttccttaagg ctctatata tgcattgcaat gtattttgat cctattcact gcataacata 1832940
 gatcacactc tcatctgagc tctcccagg tccactcca cactccaacc tttccaact 1833000
 ctgagttcaa tctgcgctgt ccatatactc atggtgatgg ggccagttac tggagctggg 1833060

ctgatgtacc aaggccaca ctaaggctga tttactatga atgtgttct taagaaatga 1833120
 tgaaaacatg gcattttaac tcccagtcac ccagcatcac ttggatccac atgtgtgtc 1833180
 ttcattgggga aagcacatct tcccttattg actgtttaca gaatcaaaag tactgtggat 1833240
 ggtagggata aatacagaag ctttgagaga cggcctacac ttctgcactt tcattttagt 1833300
 attgtttctt taaaagttt ttcaagagcc attttcttaa ttaactttc ttctatcttt 1833360
 tttttctgcc atttaagcat ataccccaga gtagtctat tgcctatagg actcatcggg 1833420
 caatgtctaa aggaagctat ggaggagaca aagagggtca tacttttatt taatgggcag 1833480

aggccacatg ctatggtctg aatgcttgtg ttctccctgt ttagtcattg gtaaaatcta 1833540
 tcattgggag ttgattagct taggaggctg gaatctcaca aatggggtta tcaccctata 1833600
 acaaggaag agcctgcctt gctccgcctc cacgtgaagt tattgttaag ggatacacct 1833660
 gtgggatgga agcagcgtct caacagatac cggatgctaa ccttgatttt caacttgac 1833720
 ctccggaatt gglagaagta aatttctgat atttaaagc taccagttt attgtatttt 1833780
 attgtaactg ctttggggaa caacactggg tgtaactgaa tatacgtgta tagaaagatc 1833840
 agctctatt acacagaggt ctctaattta accagtcagt aatagtgaaa gcaagcgaat 1833900

ttgccgcaa tcaccaata gtgagccccg gattatgata aagtaacaac cttttttagt 1833960
 ctaagtgtcc ttcacaaaag actaatgcta actaattagg aacattttaga ttagatcttc 1834020
 agatgcgctt gagagggtat ttcatgctct tttctgttcc tacacagaaa atctgcagaa 1834080
 atttagccat ggaatcagga aatagaaaag ctgagaaggg atatagttta tggccagaaa 1834140
 ctctcacctt actgttggtc gaggaggaaa ttaccacag ggcccacaac tgcttagttg 1834200
 cagatctggg acctgaactc acctcaacc tcagtctgtg tttcttctac ttgaatctc 1834260

agcaggtgtg aaaaccgggg gccagtgag gtcacaaata agttcctgca ccaaagtcc 1834320

 cctctgatgt cagtatctaa gaaaactatg gcaggggctg gtttggcc catgtggctc 1834380
 aggagaggat tcagtaccga ttctgcctgc ctgtcatagg cccagctact getagtggag 1834440
 gcctctcaag gaggcctata gagggagtga gaatggcctg aagggtggca agtggccttt 1834500
 tagtaccatt tttctctgaa tggaaagtcc cagaagagag aagatccaga aataaaatac 1834560
 ttaagactc cctgagtggc acaggatggc cactctgctc ttactcctag acaccagcac 1834620
 cctgccacac ccatcacgtg cttctcatta aatctgaacc acagaagaac aaaagaaca 1834680
 agatggaaca ccacttcagg ctgtgtgtta tcttctcct ccagggcatg tgggagaatg 1834740

 gactgtgggt ctctttctgg tcagcattcc cagcccatc caatgattcc ctttggggtc 1834800
 ctatggctgg tggccctcca gaaacctggc ttattggccc tccccttcc agctgccacc 1834860
 tccagccttc tacaacaaaa catctagaga gttggaggca ggtagctac ttgtcatttc 1834920
 tagatgtcct ggaacaggca cacatcccct ttgacttca acaggtttaa tgactaacta 1834980
 cttatacгаа aactgacaac aaggaaagag acaggccttc cttcccatgt gacattagtg 1835040
 aatcctatta ttggctatgg tgtaactacta ggcatcttgc atgtgattag ctgactatga 1835100
 gatgatgtct ttgtgttacc cataaagctt cccacagttc ttcaaggaag gtaatttcgt 1835160

 tcctatttta aaggcaaaag aactatggag tggaatgatt tatgatcata aaggctgtaa 1835220
 ataaaacttt taaaacattc ttgccttatt tatttttcag catgttgtga atcaagatag 1835280
 acataatgag gtagagagag tgggaactcc caacatatga tacttgggtg ggaagaacac 1835340
 agcacagcct atgtaggata gaggtgaatg ccaacctgcc acaacttatg atcacctggg 1835400
 aagagaggta ggggtgtgtg gtgtgtgtgt gtgtgtgtgt gtgtgtgtgt gtagtatgt 1835460
 gaaccacatg tgtgtctagt gcctgtggag gtcacaaggt gttgaagccc ctggcactga 1835520
 gttacaagtg ggtattagaa accaaacatg agttctctgg aagtgcagca agtactctta 1835580

 actgctgagg catttctcca gctccaagga aagagttttt ttgtttgtt tgtttgtttg 1835640
 ttttgggggg ggtggttttg agacagggtt tctctgtgta gctttggagc ctatcctggt 1835700
 actcactctg gaaaccaggc tggcctcgaa ttcacagaga tccgctgcc tctgcctccc 1835760
 gagtctggg attaaagggt tgcaccacca aagccaggaa atactggttt tacgaagcaa 1835820
 aatgggatag atactcatgc ctgaaagggt gaattgaacc actctgtcac taacagcta 1835880
 caggtttgaa gcttgcacc cagaccactg aggatcatct gagcccaaca gaagagtttt 1835940
 aattgagtag ttgtctttat tcagttggcc agtatgtctg gtgtgtggga gggattgtct 1836000

caatcattaa ttgctgtagg aagacctagc ccattgtggg tgacaccatt ccctgggcag 1836060
 gggtcctgaa ctgtatagga gaggagaaag atggctaagt agcagcaggt gggaagcatg 1836120
 ggtgctttcc ctgctctctt cttagctatg catgggatgt gacttgttcc agccttgact 1836180
 tcctgaaatg gtccactgta gcctggaact ataaccaag taaaccttcc ctccagttag 1836240
 ttgtttttgg gcaagatgtt ttaacacagc aacagaaata aaactagggc accatgacaa 1836300
 gtagtttcag ggtaaaagt ataaagttaa catagactgt cctataagct tgggcaagag 1836360
 gtttctctg ttacatcttc tattagcacg ctacatctgt cacagctaat ggaccaccac 1836420

 tgacacatta ttattaactg aactttacac tgtattcaga tgtccttcat ttccttagga 1836480
 tcccatcaa gacgccacac tgtactgcat cactcagtct tgttaggctc ctcttggtt 1836540
 ggatggcttc tccaagatgg ggcagctact tggagaagt ttcacacag ctaactggc 1836600
 attatggagg gccacagaag caaagtgtgt gtgtgtgtgt gtgtgtgtgt gtgtgtgtgt 1836660
 gtgtgtgtgt gtgtgcgct gcgcgcacgc gtgcgctgt gccatgtgtc tcacttattg 1836720
 ttctccacct taagataagg tctctcactt gctatTTTT agctagtctg gtgaccagca 1836780
 agccccagt atgctattct ttaatgctgg ggttacaggt atgcacagt acatcctggg 1836840

 ctgtttgtt ttgttgatgt tttgtttat tttttgaaat agggtttctc tgtgtaacag 1836900
 ccctggcaat cctagaactc actttgtaga tcagcctgtc cttgaactca cagagatctg 1836960
 ccagactctg cccccaaagt gctgggatta aaggatgcg ccaccaccgc ctggcaacat 1837020
 cctgtttttt gttgtttgt tttgttttt aatgtgggtt atgaggatca aacttaggca 1837080
 ctcttgcaat tgcttatct ccctaacct tttccatct cttctgagga agggctcatg 1837140
 atggcaatat cactgtcac tgctgaagag aacctcaca tctggctgag gtagaagtgg 1837200
 ctctgtttcc tgctgtaaa gtgactattt ccttttctc ttacctgta cccttcagaa 1837260

 ggaagtcatt cccatgtccc ccaagtgggg aattaagtcc cacctccatg acagtgaact 1837320
 atccacaaaa atgatttggg attcctctgt gtgggagata tgtctttctc tccatttatt 1837380
 tatgtgttcc atcatttatt tatatcagta tgaacttgg aatgtttatc ttatactttg 1837440
 agttattacc taagctact ttatttattt ttgttcagtt tgttctagct ttggccaccg 1837500
 ggagttcttt tagttggctc ctttaacat aatgcctctg tggggggggg ggggggggaa 1837560
 ggagggggat ggtgctcttc cttaattctt cattacaaga ttcctcggg cttgttttct 1837620
 atatttctg gcctgctat acaacagcc atttctcaa gtatctttag ctctgtgag 1837680

 tcctggttgc aggtgtgtct gttgctgtgg ggtttcaatt ctaggagctc tcagttgaca 1837740
 aagcaagggg gcgtatttgt gtatggtaac tggcacacac acacacacac acacacacac 1837800
 acacacacac acacacacac acacacgtac gtctatttct gtgtgtcact catgatctgt 1837860

actgatctaa acatcagatc atgttgacgt tttaaactct aacctatgac catgtgatca 1837920
 ttagagtctt cactctttag ttgttaattt ttttaattat tatttgtaga tgtgtgtggt 1837980
 tgtgttggga tctgtttaca tgagtgtaaa tgtccaaaga ggccagtggg gtcagtttcc 1838040
 atggggctag agttataggc agttgggacc tgcctgaatt gggtacaggg aactgaattc 1838100

cagctctctg taagaacagt acaggtctct aaccaccaa tctctccagt tgcaagtctt 1838160
 ccatcttggg cataactaaa aagggaaaaa tctgcctccc attgtctacc atccacttat 1838220
 ttaattgttc agttctagtc tatgtatggt tgcctcagga tgcttaatat ctgcatgggt 1838280
 gctaaatttg agtgaagtga ttaggtacac ctgctttgcc tttgggggtg tttcgttttg 1838340
 ttactaaagt aggttctcac tatgtaacce aactggcctc aaataaatga tccttctctc 1838400
 ggccctggaa gtgctgggat tacagctgtg catcaccata cccagatctg ttttcagttt 1838460
 tatgggtgccc attcattacc agagtgtgac aggccagccc cttcacctcc aatcacttca 1838520

atcatttcat atatttgga tagattttct tttgtcaca tctatgtgtc ttctgacagt 1838580
 catctgacct gctaaatatt ttcttaaat tgcgtacagg aaagcacacg ttgctataa 1838640
 cacattttgt acaaatcagg tgcctgtgtt ttaccattac agtattatc agaatagatg 1838700
 caccacttac atcttctgga cctcatctct tcaacccttc tcatccccta aaccctgta 1838760
 atgactgata tttatatccc tacagcttcc cttttataga ataccataa aatagaatca 1838820
 tcaagtgcgt gggcttttcc gatcagtttg gatgctgtga tgtggaggtc acagecagtc 1838880
 tgttgggaagc tgctgggggt aaataagctc agaaaagtga ccattagatc tggtaacatg 1838940

gagggcatta agagaagggg agtgagaaaag tgtgaaatac tgtttggaaa gtgaaaaggc 1839000
 acacacagca gggaaggaag cattagtgtg ctgggccatg gagcaacct agggaatctg 1839060
 ctgtcaagaa tctcatgaga gaatggccag aggatggcac cggactttct atatgcatg 1839120
 tgatttctta tatagacatg tataagcttg atgtctgggg tgggtggcata aaccttaat 1839180
 cccagcagag gcaggcagat ctggcttaca aagtgaattc taggacagcc atggctacac 1839240
 agagaaacce tgtgtgaaaa ataaacaaac aaacaaataa ataaataagc aaataaatac 1839300
 ttaatttata aagtggacag agtgagaaaac taacaatatt atatcagtaa caattctaaa 1839360

atgcaggcat gtgttgcac aaaaagctat gtgaatgtg gatctttctc aaaatatctt 1839420
 gtcattggggg tgggaagata ggccgcaaag cacttgctgc atgaacctga gaatctgagt 1839480
 ttgacactta gcacccatgt taacagcaac agggcaagtg cagtggaatg tgcttagcac 1839540
 gccagcactg gggaaagtgg atcttactgt acaaaatgaa gagccactgt tttccttgtc 1839600
 ccgctaagge tcagagaaca ttaaggaaaa tgagaaaaga ctgtaagagg cagaggcagt 1839660
 ggaagacagc agcgggaagag ggttttttgg gtatgacaag gaaaacacat gaacttacag 1839720

catctttttt taaaaggaat ttttaatttat ttattttatg tacattgggtg ttttgccact 1839780

 ggtgtcaggt cccttgaac tcaagttaca gacagttgtg agctgccatg tgggtgctgg 1839840
 aaattgaacc caggteatct taaccactga gccagctcga cagcatctat gattgcacat 1839900
 aagatcaagt aagtcagaa tccaacatg caaagggtgg ggctcatgaa gaccacctc 1839960
 tagctgagga gctattggca gttgctgggtg gagggtgtgg cctctatag tttgccatg 1840020
 ctacagtgga tigtgtccta caccactat attctggcat ctctgtttgg actctgtaga 1840080
 ttataaagaa ggaggaactg cagcaggagc acctgaagtt gggaaagaca tatggggaag 1840140
 aaggggtctt ggaggagtgg ggggttgagg gaatggatat ggttgaaata tatcatgtac 1840200

 atggttgaaa tcctcaaaga ataaacaaat atgtgattaa aaaagagagg tgggagtgtt 1840260
 gagaaattct tgatctaatt aagttaagta aaatgcacta ggatcactgt gacaccagtc 1840320
 agaataaact ggagacactc acatcagcta tctgtcattc tgagaaaagg ctccaaatga 1840380
 ggaatgtgca tggataagga ttagatatct gcctctgtc aacattgctt gtgcaggaag 1840440
 gtgccaaaag aaagcctcat tcgcagcaca atgcacttac ctggccgtgc ttgccctagc 1840500
 ctgcggagaa ttagctagaa ttctaccatg tctctggga gcatttaaac aaacaagcaa 1840560
 aacactccaa aagaagcaac agagatctcc accgagacc tcagagcaat ttctttaaat 1840620

 aagtttgaga atgcaaagac ttcgagagcg cctgtgaaa tagcctggat ctgtctgaga 1840680
 tgattctcct tcacactgtt cacaaagttg ctgcctctgc tgccgccttc ccaagttcac 1840740
 tggccaaate ttcttcacg aacacagatc cttatcaca cttacagaag gcaatgccta 1840800
 ggccaatgga gtaaaacaca cctgagcttc tcctgcagc agctctcact getcctggag 1840860
 atcaatcagg acaaagcagt cttctgcttc tttccttcag acttggctca tccataggat 1840920
 tatcaccagg catcagagtg ctaacacacc taacagtcac gtctctttgt tttcttctc 1840980
 ccagtggate tctcttctt cccagtggat ctctcttct tctttatagg getgagtatt 1841040

 aaaggttttt ttttttttt ctttttttt tttaaagcac acaccagga caggccagtt 1841100
 tgcccagatc caaggataag catcttggaa gaagacagta tagctctcga gtatccactt 1841160
 ctttttctaa attcttttag gcattatcac tagattaagc acagacgggtg ttcacactgc 1841220
 acaaaactga ttagttgiga ttgttgttca ttattctccc acttcttgtt tctaaaaaat 1841280
 ttgcattaca aacaaccctc caggttctca tccaatcaa cttctcaagt ctccgatta 1841340
 atattcctaa tataaccacc atgccgttca actcttctt ttgtaagtaa caaaaccaat 1841400
 gatgatacca aatcacaat ctccatgaaa agacagcca aagaggttaa ctgcagggtg 1841460

aacttgacat tgcaaaagct agagctcccc tgaactaaca cagtcaccag agctggtggc 1841520
cctggttaac acgggaaaca gcaaaagacac agtaaatgt acacacaaag cagccatcgg 1841580
caatttgctt ggtggggtcg gatagcatgt ggctgatagg tctcaggaga tggggaacaa 1841640
acagccatga tggattaagt gattgctatt ggctgtgtgc tcgcctgaa tatttcacca 1841700
tggacagtaa tcaattacca gagaccagta atgatacaca tcaaacgcac ttagcacttc 1841760
tgcaccatca accctagggc tgctgacctg ccagctgaaa aaggetcagg gctgctcaag 1841820
aatgatatg tgggctaacc atggaacagc ttgtagacgg gggaaggcag gcctctccgt 1841880

tcatgttaa aagataaatg gctaaattag ccatttacct gctttacagg aaggtttatt 1841940
ttaaagcaag caatgttctc tctccctccc agggggcacg aggggctagt ttataaatat 1842000
tttggaaca tctgagtggc cacaagattt ttgccgaca acagcctcaa aaaaatgact 1842060
gaacagaagt cacagtgcag ctgggaatca gctgtcccat tgttccaaac actaccagtc 1842120
actgtggagt ggttgcctat ttggcaattc gcatccttgc atcctcgggc agaaatgcca 1842180
ggccatgtct gtctgaggcc agaattctc tgctagaat ctgttctttg gagtgtccat 1842240
gagacaatga gaaagaaaag caggttgccc gtgtttctga cagacaaaa gacaagccag 1842300

ttctttgggg ggaatctggc atcttttctc tcttcttct aggtggtctt tatttacatg 1842360
acaacagacc tgagcaccac cggttggaac ggacctgcag gttactgggt tggcactg 1842420
catggcatat ttacaaggcc tctgaagcca ctttgttcag ttcgaatctc tttccatgta 1842480
gtggtggctt gtccaaggag tgccacttca gtgggcaggc acgggaacta gcagtaaggg 1842540
gaattcatca aaaccggctt gagaaaggtg ttccacactg cattcctgac atttgctcct 1842600
gtacatttt agcaactgtt ccaagaaaaa agtctcattt ttttgaagc tgcagagacc 1842660
agaaacatct atatctatat aaactccact aagctgcat ttgcaagtca actcactttc 1842720

tcaggtgacc tgccttaaac atgaagaaca taggaatagg gaacagtaaa aaagaaagtg 1842780
ctgtggaata atcctcttgt acatggtgaa gatttgtcac tgtgatgggt ttaataaaga 1842840
agctgactgt ccaatagctg aacaggataa agttagcag aaaaaccaa ttgagaatgc 1842900
tgggaaggag aagggcagag tcaggagtgg ccagccagat gcagagggaa caggagatga 1842960
acatgccatg ctaatacatg gcagagtgt aataaggaat atggattaac ttaaaatgca 1843020
agagctagt agtaataagc ttgagctact gaccacacat ttataattta tatcaagtct 1843080
ctgagtcagt taittgggaa gtggctgcgg ctgccaggta tttgggagca gacagtcagg 1843140

gctgaaagct ctgcctaca gaaagctttt aggagagtgg aaatattcta aatattgatg 1843200
tcctagtttt ctccctatt gctgtgataa aactatgac caaaagcaac atggggagga 1843260
aagggttatt tcagcttcta gtccatcatg gcaagaagcc aggtcaggag ctcaaggcag 1843320

acaccagag gtataactaa agcagaggtc aaggaagaat gttacttatt gccttgattt 1843380
 ccatgacttg ttcacctac tttcttataat aacctaggac ccatatgccc tgtgatggta 1843440
 ccaccacag tgggctagcc cctagcacat taattattaa tcaagaaaat gcccccttgg 1843500
 acacggccag agaattatgt gatggaggcc actcctaatt gaggtttcca gatctcaggt 1843560

 gactctagtt ttgtcgagtg gacaaaacta gcacaattgg aatcatggtc acataggtga 1843620
 atatatcaa tacaacatg caagaatggt ccatttattg tatataagtt ttaggtcaaa 1843680
 agagttaaaa taaaatgtg ctaataagca acctcaattg acacgcaaaa tcattggatt 1843740
 cagaagtgtc aagaacatgt acttagcttg ctcttgctat cttttcagg tgaacacat 1843800
 tccacgggtg catgcttcaa atcaaagata gtgctacctg cctcaatctg ttccttctca 1843860
 ggctgcccc ggggcagcag agctaggtag agcattacca aattgcaagt cacctccatc 1843920
 cccagatcta caattctcag caatgaacaa actctgtcca tccaaggctc tgaatggcac 1843980

 agagagcagg actcatgggt gagactataa gcctcctgat acctcaaag gcactgcctc 1844040
 cactgaacaa ctgctcttaa cagcatgcat aaccattgct atggggcaag ttgcattcat 1844100
 gatgagaatt caagaaatca caaggtacct ggaacactgg caagataatc aggccctgcc 1844160
 tagccccacc atcatttcaa gatgaatac aactgatgggt ttctgctggt gtctacctat 1844220
 tgtggtaatc ctatcatgca attctgcacg aagatttttg caaatggatg tgtctaactt 1844280
 ctccattgag ccactctcag tgtgggattc tattagtcac ggcttatgag taacggtgcc 1844340
 cacaggactt actgtgaaag ccagcaacac tgtctcattc ttagtctact aacagaacca 1844400

 ggtgacacac gaacagcttc ttcttggtat acagggtcat attctgactt tctttcttc 1844460
 tagctgcctt tgiagggcta atcttctagt caggctactc ttccaaaagg tcaatggcct 1844520
 gggttttaga tgatgggata ttagcaggga acacaaagat atgctaactc tactgccaga 1844580
 agcctgggtg tctaataatt ttgtaagttt ccaagggagg gaagcaacca atagaattat 1844640
 ccagctatga gcctatgaac cacatcaaga aacaacgtgg catcataacc ctaagggtgc 1844700
 agtggtgga cacatacctt ggtggttaacc aacagctctc ttattggact taagcccgtc 1844760
 agaccctcac aacaagaatg agactgtgtc tggattataga aacctagcta actactggtc 1844820

 ttagccagtg aagtcatggt tattgaaaaa aaacttacia tcaactctct actaatcag 1844880
 cataatccct aacaataatc tataaacgtt tccacagtaa aatgtagctt tcacccttca 1844940
 tcaaggaaac ctcttttga acagattgag accataacag aaactacaac caatcaaaat 1845000
 tcagagtgtg ggaattccca gtcccaatgg atactgtata agacactctt gcactctattg 1845060
 ctcagggaaa attgcacaag aggggtggaa agattgtaag agccaaagga tcagggagtt 1845120
 tgctatgaga ttgtgtctcc tcataatc agatgttcat cagcacggct acccaaatgt 1845180

gagctcaaca aggatgatac taatgggcac gccaaagtgg atggagtaaa ggctatgatg 1845240

 ccttaattct ataghtaagg attaaggtga ggaaggctga gaatgagaga cttcccaaaa 1845300
 ggaagagtac aactgatcat ccagtgccaa atagtcagtg ccaatgcagg aagtgttata 1845360
 caaactaac aggatacaca cacacacaca cacacacaca cacacacaca cacacaatcc 1845420
 atgtaataac aattagaaaa aaagagtggg ggaggggtaca tagaagggtct tggaggtagg 1845480
 aaatgaaggg ataatagtta caattaaatt gtaatctaaa tttttttaa taattttgtt 1845540
 catttggccc ctgcctttag tgtcaataag aatttctttc cagaataatt tgaatactct 1845600
 atatgcaaaa tatgtttaaa gtcaattgac aggtaaaaga aaagagatca taactttgag 1845660

 aaaagggata gaatcagaag aaacctttaa ttcgttaaac gttactatct tctgttttga 1845720
 tgcttacaga aagtcttctc tccagttagt ctgtcaactg agatctttga ctagtgttag 1845780
 gacattgttg tttgttctcact cagttctgtc cactccaggt tcatgcactc tgaggtctca 1845840
 tctgtaggta catatgcata gatagctgat atctattcct gctacaatga tcctttcatc 1845900
 tttcaatttg ctccatctgc acaatttact gctggccagt ggttggagag ggactgtggc 1845960
 caaacaccte aagctgatga gacttccata cactgttgac ggatctgcat gtggacgggg 1846020
 aagtacaggc catttgcatc tatactcag cttttgtttt ccactagacc tttccatc 1846080

 ccttcagaag atttgtttg ctatgggata atgctcttgc aactgaaaa gatttgtcac 1846140
 tCGtattggt ttaataaaac actgattggc cagtagccag gcaggtagca taggtggggc 1846200
 aaccaacta ggagaattct gggaagagga aaggcagaga tgcagtcacc agtcagaagc 1846260
 ataggaaca agatgagaat gccttactgg gaaaagatgc caagccacat gattaaacat 1846320
 aggtagaat taigggtaa ttaagttgt aagagcttgc tagtaataag cctgagcaat 1846380
 aggtcacaca gtttataatt aataaaagtc tctgtgtgtt tatttaggac tgaacagctg 1846440
 cagaactggt ggaacagaaa cttctgtcta cagtacttag ccagaggact gggcaagagt 1846500

 acatgggctg ctgggctct ctttggatc tttgtacat gtgggcagcc tcatctagga 1846560
 ataagcatac tcaagccatg actacaatat caggatgcta gagcaactga ctgtaccac 1846620
 acactataac caggatccta tgttcaggga tcatgggcac aacctgatat tccaaaccaa 1846680
 gtgagcctcc tgtgacagca gtagtaacct gtaactcttc ctggtttatg ctttctttat 1846740
 cccaagattc ttcatacaa ctgagttgga caagatgcag gttcagataa gatttccttg 1846800
 gattcctgtt tttttgtag ttcaatcaat tctgaagtac aaactctct tggatagttg 1846860
 gatgccttta gtttacaatg cactgatgtg ttcacttct acctcagata tgcttcatta 1846920

aaggaaggac tgttgttgac ttacttctgt aactgggcta gtctcacctc aggtattatt 1846980
ttaaagtctg tgagcactac aatgaacat ggacatctgg atcatctaca ggctatcgag 1847040
tatgatctta tcacaccaag tgttatgcac attctataag tcaaaatfff atcttttgtg 1847100
tgactagagc ccicttgaaa ctgtaggtat ttcttttatt tgcagtgatg gagatcatat 1847160
atactaatac aacactctac aagggagcta cattcctaat ctggattggt ttcttgtatg 1847220
aaaacaataa taccatagat aaaaatftaa gtcaagacat tcaggggctc acttccagat 1847280
ttgcaacaaa tgattcacat tacataggca tgaactattc cacatatttt taggagctat 1847340

gtcttagttt cctgttatac ttaggatagt tctgtttcat caaccatttc taccagatct 1847400
cacatgaata tgaagaagt gtgtggtgtg tgtgtgtgtg tgtgtgtgtg tgtgtgtgtg 1847460
tatgttacta cactctccca tgaatgtgca tttgaaggtc agaggccaat gtcaactgtc 1847520
tcctcagtt gtcttctcgc ttatcattat gagtccagt ctctcactga tcctggagct 1847580
cacataagta ggctagcctg gctggtatca gcctatcgct tcattccagt gtgaggtgac 1847640
aggcacaagg cactgtgccc agcttttttg tgggtgatga agatcagttc ttcattgctg 1847700
tgcagcaagg actaagccat ttctacagct actttaagaa acccctctc ttttaataa 1847760

ctcttgtaa cacacaaaa tgtctctaaa aacaaccaac tgcatgttcc attttggcac 1847820
catcttctt ttggatgtca caataggttt tccaggtaat ctgagacaag catctgatag 1847880
agacactgct gatattaaag aacaatgcca tttgatcata cattccacct gtcacagtca 1847940
tcttccaatg gctctacgtt gctataggct tgagatgacg tgctagaaac agcaaggaaa 1848000
gccaggaaat ccatagtctc tatttccta ttcttggtc aaaacaatac agcactatgg 1848060
caacagtcaa ctctgggata taacagcct tgectacatc aactaaaagc caccctagct 1848120
ggtgaagcaa aatcaatc cagtcctta aaggaacata aacctattg cctgagatca 1848180

tgaacaaat tggtaaca gccagtaaaa tggccctgaa tgcctgcct ttaatcacta 1848240
catcccatga ttctctact gatataaaa ccaaacata gcagcagtt cccaaacctt 1848300
tatccctga tccactcat gcttgagaat tttcttgcta gagcagagga atggctcgtg 1848360
gaagagggca gagactggct caatactcca gctgtgttga tagcattctc catggagaaa 1848420
ggaagggtta agaaaagatt tagccttctt tttcgtaag ttcaatgcaa gtatgatcaa 1848480
agagccggat tgcagataaa ctgacaaaac ctgattgat tttgctgttt ggcccagaat 1848540
ggaatggatg tgtgttaaaa ttgtgacaca cgactccaat tttctccatg agcagttggt 1848600

ttcagctacc atcagttctg accatgttaa aacacatttt cagagcttct tcccgataat 1848660
gaaaccagtt tgaagtcc aattgtttt ctatggggg atgttgccc atatatcctg 1848720
glaactgttg tgggactcat ggaaggatgg ggacagcatg cattgtaact ccagtcaagg 1848780

gaaccactta agggacacct tcaagaactic caggtcagga aggagcacag aacaagtaaa 1848840
 cattgcttaa gtcggcacag agtggcatct aacgaacagt tctcatggcc ttggattat 1848900
 ccctttactt aagaatagg tcaaaaatca caggtgacat gggcccaaga gagggatcac 1848960
 tcagtgttta agagcctttg ctgctcttgt agaggactgg agtttgcacc acgtcagaca 1849020

 gttcacaatc acttgaact gtagctccag gggatttgat acccttgtct ggcttcaca 1849080
 ggcaaccaga cccatgtact cacgccttta atctccgctc tcttgaggca gaggcaggtg 1849140
 gatctctgag ttgaggcca gcctagtcta catagtgagt tccaggacat ccaggactgc 1849200
 ataacagaga gactgtgtcg caaaaacaaa aaacaaccaa ccaaacaaac aaacaaacia 1849260
 aaacccatag gcaaaggcca gaggaacatc cttcacctgt ctgcacacac gtgcccactc 1849320
 acacatattg gtttgtcaac agttatgttt tacatattaa ctaattcaac agtgccccag 1849380
 tttatcaaga tgatcctata aacaccatac caagcccttc cccgtgtcct ctaacttggg 1849440

 gaaatctata tatgcttcac aaaggtttat cactatitaa tcacactccc agcctaaggt 1849500
 acagtgttaa tctatgacat gagcattttt cttcttcctt aaaactaaca aaaataacta 1849560
 aacaagcaaa aagcacaaca cagcaaaaca agatccatac ctgagtggcc aagccatttc 1849620
 caaactaaca gataagggtg actatcattc aaatgaacac cactatitit cctttgaatt 1849680
 tttaaaaatt aaattttttt attatttagt ttttgagaca tgtctcactg tgcagcccag 1849740
 gctggctcca aatttgggat atttctgtct cagcttcttg agagcttata ttatcagcta 1849800
 gacaaccact ccaagttcat ttatititaa ttgacaaaat tgagtagagt tagaatgaac 1849860

 acagaatgca gtgttttcta ttatacatac atctctgatg gctaagtgag cagattaata 1849920
 catgaattac atcatgtttt tatcattttt tgtgtgtcta tttgtgtgta catgtgcaca 1849980
 tgtgtgtgta cgggggatg gaagctgga ggataactgt ggatgtcacc ctgagaata 1850040
 ctctaacca ttgagacaa gttctcccac tggcctggag tgcatggatt aggttaaatt 1850100
 ggctgttcag aaagcccatg ggtctgtctc caccacctca gcaactggac tggaaagcatg 1850160
 caccagcaca ctgtatitit tatgagattg cagaaaacca agctcaggtg ctctgcttat 1850220
 gagacaagaa ctgaacttta cctattgagt gttctccacc ccatcctcat tgtgtgtgtg 1850280

 tgtgtgtgtg tgtgtgtgtg tgtgtgtgtg tacgtgtgtg tgtaacaac acttaaagt 1850340
 ctaccatcag agccagtga atggcttagt aggtgaaagg gtttaacatg caagcttgat 1850400
 gtgctaagtt atccccagat cccacgggtg aaagagagaa cactgctgac ctccacacac 1850460
 atgttgaggt acacatgagc tttcatacac acacacacac acacacacac acacacacac 1850520
 acacacaaat aacaacaaca acaacaacaa taataattaa aataatitaa atctgctgtc 1850580
 aggttgttat taactacagc catcatgttg ccacacagat ctctgagtt tactcctctg 1850640

catgctttga ccgctgtaac cccagccctc agcaaccctc acgctactct ctgaccctat 1850700

 gagttagttt tcagattcca caagtaagtg agaccacgaa atatctggct tcctgtgtgt 1850760
 ggcttatttt aattcttttc ctctacctgg ctggagtctg ttctgtttaa cttacactta 1850820
 catctggaat agatataaag gcgaaaatgt atgtcagttg aggtctaagg tgagaaactt 1850880
 gcataggcac agtggcagaa aacatgaatc atggttttta ataagtcaca gtgggaaaga 1850940
 gttagatcag ccaacttctt atcaaattha ttttcatgat gtactcgtaa atattcataa 1851000
 aaataatgac tttaaagtcc atcagactat aggctctaaa aactagactt cagacgggag 1851060
 agcctggact gactgtcatt aattatgaag tggtagctag ctgcctgaca ctgtgtcctt 1851120

 gacttattgc ccttaaggag cctccactcc agggaagcac atcacaatct tcacatacca 1851180
 tagaaaagcc acacagcata gccacaagca tcatttgact tgttcattca atgcacttaa 1851240
 actaacttgg cagaagagga atttgtgtgt attaaaattc acttccaat gacagagcat 1851300
 cctctttacc aaggcttccc aggggttttt tctcagccac tcttgtcccc tgagttagca 1851360
 ctagcaaate ccatgggaat ggctcttgct agggctgcaa gaggtaaagg cagagtcaaa 1851420
 ttctgattgg gtctgtactt caatttacct cctcaaaatt tctctaggca aactgacaag 1851480
 accatgaagg attctagagt tgcaaggaac gtggcaaggg aatttaataa gacttatgag 1851540

 ctggcacagt accaaggttg acctgctgtc cccaggeccg ctctgccttt gctgtgtcac 1851600
 cttaggctga ggacatttag aatgatggt agcattgctt ctttggggac actgatgagt 1851660
 taactcaggg aaaattctgg aaggaactgt agacagagtt ccagatatag caaggagaag 1851720
 tatgtagagg aaaaattaca ggacatgtct ttatataaag atgaagaacc aagggactag 1851780
 agagatggct caatggttta gactacttgt ggctcttgca gaggacctgg attcaattcc 1851840
 cagcatctac atggaggctc acagccatcc acaaccccaa tttcaggaga tgacaccctc 1851900
 tcctggcctc ctcaggcacc atgaatataa atggtgcata tatagacatt caggcaaac 1851960

 actcataaat acaaagtaaa taaattttta aagcgaata agtgaacggt attaagggga 1852020
 agcagaaaca agaactacc ccttaattca gccaaaggaac tggtaggcaag agggtaaatc 1852080
 ttgagtggct taaaagagct ttggaaaaga tcacgaccaa tctcattggc tttgtcacia 1852140
 agttgactta gcaattctct tttcccaggc attaccatt ttaaactggg ttactatcat 1852200
 tctggaagta acatctactg aaggagacta aagtactaat gcatgctcaa attcaaatct 1852260
 ggactttgct ggccgctgac actgtcctag gcaacatact gagcattcct ctgatccagt 1852320
 ttccaaacct ggaagagigt gactctgggc ttcttgggtg gaacctgccc agagatacca 1852380

tttctatttg taaagctctt taaattctcc caaggatggt ttctgaaaa aacagaaatg 1852440
 gctttaagag ccttatcaag ccaacctttc acccctccct gttctctca gaacatgcaa 1852500
 gggaaccact taaaaagcag tgtgagcact gggtaatgga agagagtgag gttggaaaag 1852560
 gactctacag aggaagcccc ccacccaag ccattaacac tttgctttgc acaaaacaga 1852620
 atgtgtggtg tgtgcatgcg tgtgtttccc agtggcctcc agcaatgcac cacacctggc 1852680
 catttaaatt caggagatct ttgttgccac atttctacct ttataataa agacacagaa 1852740
 gcaggagaac actgggtggtt ttgcaacac accagaattt ggggtacagt ggtttttaac 1852800

 agcagtttct ttacttaata tgactgcact tctgaagggc tagttccacc tccccatcac 1852860
 gccccctccc acacacacct ctagtgttta gcactagaaa atgctacctc atgagcctgc 1852920
 ccattgggat ccacaaaggg cacagtcagt gttaaaggca tccctgtagg gtttatTTTA 1852980
 cttctggga gctcattaaa accctacctt tcgagtcttt ccttagccaa aatgatctca 1853040
 cagatctctt gaatcacaaa ccactcagaa aggattaggg ggggggggag ctggaagaag 1853100
 agaaagaaag aaaatgggat tcacaggggc tgagtgagac tgtctccagg agtgtgtgag 1853160
 acacaagtca cccacggcag acaaaagaaca ccatgagact gggagggaga caatgacagc 1853220

 tggagaggag cagggaagg cagatcagaa tacagagcca gaggggctag gagggaacce 1853280
 tcaaaggctg cacccaaact caatgttga cccctgcatg agagagacag ctctgactcc 1853340
 cagcaactgc ccaatatttt ctagtgataa gatttccact agtttaaga atagcagccc 1853400
 cgctccgttc tcccccatg tgtatggtat atgtgtgttc aataaaaata acaacaaca 1853460
 agaaacaaaa ccaaacttct ccgtggctgt atttccaac tccagctgta ttcccaccta 1853520
 cagagaacca gcaaacagaa tggaatggtt ttaggttctt taagaattta gaatctctg 1853580
 tgcagtaaaa caatgacta aggggaagaa agcacctgtc tgaaggacaa catggaacc 1853640

 agtgagtgta ggtgctacce tgcagaagcc aggggctcct cagagctgtt tatcctgctt 1853700
 aatttctcaa agacaatgga aggtgggaga gacgctcacg cgagtgcaca cacaatcaca 1853760
 cacacacaca cacacacaca cacacacaca caccagttta atacacttag gtttcccaat 1853820
 catcctgac agaacagaaa ttgagggttt gacaaataat ttgtacaaaa tetcccttaa 1853880
 cctagaaaac actcagggga ggggcaaaaa tctactcaga agaattgagg ttttaaagt 1853940
 aaaacatagg aaaggggaaa tcagatcatg ctcagccgac acatcaggct gcaggagcta 1854000
 ggggcagcac ggggccagct cctggaacca cactgtttac aggaagaaaa aaaaaaaca 1854060

 aaactatgga gtggatggca gtgacatcag gaaaggggac ttgctctttt aaataacaag 1854120
 aggtcggaaa gatacttccac tatggtcaga caacacatta atgaaacatc ttttctacct 1854180
 ggagaaatgc agagcaagtg agctgggaaa actgatctcc acccaccctt cagcctccct 1854240

aaaagaggtt agaaagggaa aacagacata gatcctggag atgaacttag ataatgagcg 1854300
 ccataaacat tagtagagag atgggctcct atttcatagg tctgaaagac aagtggactc 1854360
 tgcacggag tcaggttgaa gtcaaatgca ttggaagttt aattgttttc atgctctgca 1854420
 aaaagagggg acacaagccc tgtcactcat actcccagtc atctgcaaaa cacattgcc 1854480

 tgtgatggaa ctcaagactg cctgagggaa acaatgcatc aggtaggtaa agactgtccc 1854540
 ctgaccttgc attttagct gtggacactc atcttttgc taaaggttac cagagtatct 1854600
 gtgtagaggt tttctagatt gaagtgact ggacggaata agttgactct tttattagaa 1854660
 gaaatgagat actgaaaaat aatcttctac cgtggcactc attctcagc accattgggtg 1854720
 agcagagggg acaagggaga gacttgcaac aggctacaag agtaaacatg aagtcatttg 1854780
 gggacatttc aagacatccg aggcagagca gggggaaagg ctgttggcat gttttctcat 1854840
 tcagctgagc tacttccact aacctcaaaa ggtcaaaciaa ttgctaactg agctaacaac 1854900

 gcaaatcaga attcgatatt ctgcaaaat aaaacaacia aacagataat gataatagta 1854960
 catgatagca atatcagctc ctttcatgga gcttgcctt tgccaggcac tgagagacce 1855020
 gcatctatta acatatttaa tctttccaag agcccatgc acaagagact atcaacttag 1855080
 ttacacctga gaaattaat ccttgataaa gttggtggtg aagtggatga ccccagaag 1855140
 cccatgtgtt aaggctcagg aagtggtaga acatttaaga gatgcaactt tggagaaga 1855200
 aactaagcca ttgggagat gcccttgaca cctaggacc ctggtccttc ttgggtctct 1855260
 ctttcatttc caatccatc gaggtgagaa gtttttctt taacatatt tctccaacat 1855320

 gctatgctgc ctgtcacag gcccatagac aatggggcct gaccatggac tgaatccttt 1855380
 gaaactgtag agtgaacct ttcgtctttt attgatgatt gccttgggtg ttttgcgaa 1855440
 gtgaggaaaa gctgacacia ctgggatagg ggtaaggtat atctgagtc acagatccta 1855500
 taacataaag tgttgcctg aatggtatta ggcaaacgtt atatgaagaa aacgcaaagg 1855560
 gacccttate tccattttgc tcacaaggtg cttcagacac tgatctgcac acagagaaaa 1855620
 ataagacacc aaagagacca ggaataaaga gggcacatga ttaagtgtga ggagacacgg 1855680
 ctgcagataa aactctacca tcaactgaa gaaaataatc tgtactcatt agagagcaga 1855740

 aatccaagt gaaataaaa caagaaaaa ataagctgat tcttcttaga aatcatgatc 1855800
 attacagctt ttgcttctg gtaactcact aatgccagtt cctagttgtt aaaataataa 1855860
 gggtttgaaa cacacagcaa agggagtata agaaatgta gtttatttca ttatttcagg 1855920
 gaaggtcatg tcagagatct agaaagaaga aatggccact ggaaaatgag tttctggatc 1855980
 tgttctttt ggcttctcac ccattttgca tgtggatata tgtgtttaca taggtgtgta 1856040
 catgtgtgta tgagcacttg ttcacaagga agccagggga caccttcac gttgttctc 1856100

gggagtaatc caccttggtt tgtgagacag ggtctctcac agggacctgg agtttgcta 1856160

 gtgagttgat ttggctgtca attgagagcc acacatcctc ctgtctctgc ctccccagaa 1856220
 ctgggcttac aggcctgtgc cactgtacct ggatTTTTgc gtgggtgggt aggtcctcat 1856280
 gtttgtatgg caagcataaa accgaggaag ccatcacctc agcccccttt tcctgtcttt 1856340
 aaattgaact gtttgaact gaacaggata tatgatccag tgctatttta aagccatcaa 1856400
 atctggcagc ctgggaacaa ccggettcca tccacagtta agtgagagtc aggaaagcca 1856460
 gctactagtc ccacagagtc ccagtctga cctgtacct cctgccccac tctcctggag 1856520
 aagccatggt ctttcatccc ctgaaaccac tgcctgttg tcacgataaa gctgcctgcc 1856580

 tttttaaag caagcttctg aggtcacctt aatccagtaa gtcagtcatt tatttgcct 1856640
 tactgtcaga gagaattttt catcagtaag aaatggcatt gttaggtggt actaagtcag 1856700
 tttataccgc tgagaaaaga gattccaaat gctcgggggt aatatttgtg atatttacc 1856760
 agggcactct caaaatcaga atattttaa aatgttctg tagggtgttt acaggtgat 1856820
 gaccttgtgta aaggttgtca cgtgaggacc aaacattttc tgaccaaact ttttttttt 1856880
 tccttcaaat aaagtaggtt gattggaaac acattttacc tcataccact ctccgactg 1856940
 gtccctgcag ggggagtga gtcaagcaaa gagcttagga gagaagaaaa cacagaggac 1857000

 agatcttatt ctttgtttc tccaagtcc aaagcctgcc ttctattga ttttcagatg 1857060
 tgagtacaca cagttcatct tctggataat ccccatgtgc cttactcca taaacaata 1857120
 caatttatga gatggaaaaa aagagatgaa tctatatcga taaacaacca tcctctccc 1857180
 ccaactccagc cacagtcatt aaccagcac cctattgcac tcctgtgata aagccacat 1857240
 tcctgtcagg cccactctgc cagcatccac acaatgtaaa tcttccggca tatttgccca 1857300
 cagcaaaate tctttacaaa ttaattgac aggaaaggaa ccgtgaaatt gtccataaat 1857360
 tatagtatgc atatctggct taatattgag ttctttcaat ttttatttg ttttgtatat 1857420

 atgtgcatgt gttcctactt gtgtgtgcac acaaacggtc atgtgcatga gaccagaggt 1857480
 ctaaactcagg tgtcttctca atcactcccc atcttatttt tgagacgggg tctctcgtg 1857540
 gacattgaag tcaccgattc agctacactg gctggtcagt gagccattaa aatagtcgta 1857600
 tctccagtg ctgggattat agacacagcc accatgcctg actttttatg tggatggctg 1857660
 ggctcctcatg ccagcatggc tctttgaccg agtcatctcc cctcggcag actcttttaa 1857720
 tttctactag agtcattatt tcctaaacac taacacctt caggcagtga tttaacatta 1857780
 gcatcacgtt ggagctctta atatagtacc aagatagact caaaaaac agcacacgtt 1857840

tgcatttgtt cccgaggctt gacaacagcc gaagccaagg tgcctgtagt accaattttg 1857900
 gtcactagaa gttcgggtta ctaaatgaaa atcgccagag agccacagag gagtacatt 1857960
 tggaaagcagc aagccccagg atcccactgg gcctcctgct gcggaagtg tctgatgtct 1858020
 ctgcagaagg agtcttgctt tggctctccc tgtgcatccc gctccccagc cctctctgtg 1858080
 cctccccccc ctgagctcct gaccagttt ctgtattctg cacacagttc agtgacaag 1858140
 gtgttctccc agcctttgtc ttgggccttg tattctcact agcaagagct aatttttctt 1858200
 gtcctcaatt acccactg aggagtgtt aagaattgtt acatcagccg ctttctatt 1858260

 taactgcaac atgtacttat aataagagaa ttttaaagtt tttaaatc taataggaga 1858320
 gagagagaga gagagagaga gagagagaga gagagagggg aatatatgca caagggccag 1858380
 tgcctcaga agccagaggc atcaggcttg tctgcaactg gtattaaagg cagttagag 1858440
 ctacttgaca ggggtgctgg gaactgaatt caggtcccct gaaagaacat tcttaacgac 1858500
 tgagccatct ctctatccca ataactgcat tttaaatacc acttcactat gcagtctcc 1858560
 ccaagtcaag gaaagtattc tcaactatct agttaccatt ttactcaggc aatatctaat 1858620
 gagtgcctac tacttgtgtc tagactactc aatgactcca agataaggaa gtgactagaa 1858680

 agataaaaat cccagcccc acagagctga catccagtac tttccaagag tcacagaaac 1858740
 tcagacagcg atgttaagtc acaagatact gtaaacttac actcaaggac ggacttctct 1858800
 gctcactgca teatctgatg ggtcctgagg ctgagggtac cagttcttgt gcaagcagct 1858860
 ggacagcaca gaagttatgc agctttgtat tcaaagaaat tgttttcagc taagacagag 1858920
 tggcagcagc tattgctctt actggggcac gttttctaaa caagggatgg agtcacggga 1858980
 agcactgggc tgiactctct gccatgcttg cttagatagg aggtagtctt agatcttgg 1859040
 gaaaagcgac ttgtttgtg agattttaa gtacatctct ggactcggg aagggaacag 1859100

 atttaatta gatgtctga ctgaggccac tggaaatttg ttctatgac aagtatttat 1859160
 atttccata tggcatgcaa gtgttttctt ctctttgcg tatgtgtgca cacctgtaca 1859220
 tacaggtggg agccccaga attgactcca ttccattctg acttaagtc agagagtctt 1859280
 tacctgccct tgetcttcca aggtgaaaca acaaggatgt caggcctaag atgtgaatgc 1859340
 aacaggatac ttggccaag gtgctgtcgc tacatgtcct gcctaacaa cagaactt 1859400
 aactcgggat atagtttctt gatgttttgg gtactgaaga ggtaattact ctgttcctg 1859460
 tatcattgga aaggaagtct tttgcttct cccctcttt ggattggggg tataaaagaa 1859520

 ttttgaacaa taaattgag cagattcaat attcactgaa tgccttccg accctatctc 1859580
 ttgtttcttg ttgcttctt tctcagttt gcactcccct tctcaggtac aaacctggat 1859640
 tatctggcgg acccagacac acatgtatgc atgtgcatat gggcagaga ggggtgtcca 1859700

ttgaatcata gtctctctgt cttatTTTTg aggtgatgtc ttttattacc tacagctcat 1859760
 ggatttgggt gtgttgggga gccacaagtc ccaaagcgta gcctgtttct gttccctagc 1859820
 actgtgtttg cagacatgcc taccCCCCac ccccaggctt ggctttgtca tgagtctgg 1859880
 ggaactaac taggatcctc atgcttgc atgcaaatgtg ttatcaactg agccatctcc 1859940

 ccagttccag ggtgtttacc aaatgttagc attcatccca agtaaatctg caactctgag 1860000
 tgcttgtttg ctaggagagt gagatctgct ttttacttca ttctctctcc agggagcaga 1860060
 tctattgaaa ccacttgaaa atcagaacta aggattttaa aaaattaaag agatactgtt 1860120
 tattttcaag cacatcgccc actagaacga agtcaataaa cataactgtt ttcaagcatg 1860180
 tccttgagg tactttgtc actatgttca cacatccaca accgtttcac aggatctgat 1860240
 catgtcagga aaaacCCCGc agatcaataa gaacaaaaga agtgtcaaaa tattttgaaa 1860300
 gggggggtga tacacctgat gaaaaaaatc aagatatttc taatttgaat taagggaac 1860360

 acacaaaata atgatcccat ttgacagtat atagaagacc taaagctaaa cttagatgac 1860420
 tttacaaagc aaagaaggaa aagggatatt aaatagtttt actacaagtt tcttcacata 1860480
 catacatgta tgtacatgtg tacacacaca ccacacacac acacacacac acacagacac 1860540
 acacacacct atctccactg aattaatggc tctactgaag tttattagtg tttaaagatt 1860600
 gtctatttat gtgtaacctc tacttgttca cagatgggca agttactata agtggaaga 1860660
 tagcatagtt aacaatttat tctactattc aatctatctt gaacatccca cctctgaaaa 1860720
 gagggcagaa aaatttctat gagaattatg atggaaatat cttccaactt aaagtatcaa 1860780

 aaattctgaa ttagcgagca tgttaatttc tactctttat tagagaagtt gtgtaaactt 1860840
 caaaggggaa agaggcctag agacgcttca agccattacc tattatttaa tagctcttca 1860900
 atcagatgaa ttttcttGCC agccaaggat cttaaaatag caagttttga aaaacaattc 1860960
 ttgtgagttt tgcaaccaa aaagaattac tttggaaata gttcagagga gaaaggaaga 1861020
 taaaagaatc agtGCCcttt agactcaaag gcaggttttg cttgtggaat ccaagtctta 1861080
 ctttcagga ttagaaaaag cagctggctca tagtgtgtgt gtgtgtgtgt gtgtgtgtgt 1861140
 gtgtgtgtgt gtgtgtgtgt gtgacaggtt gtgtgtggtg acagccatcc atactgaga 1861200

 gggcagtgag atgcatgCGa aacctggtct tgactcagct gccagcccat cagctctgtc 1861260
 ttctaccac acccttctca gttttacttt ctctctctct atccaaatcc atctcttaga 1861320
 acttcacagc tacatttcca aagtccccac aaaccagcc ttctgtcctt tctgaactt 1861380
 cacctccaga caaatgttcc tgaagtctat cggaggcatt ctgccactgc tcttacagag 1861440
 gtctctttgt ttaacaaaga acatccaaca tgatctaate aagcagtgag gttcccagga 1861500
 actgggcctc caaatggcat tttctagctt taggttctaa ccttctctt ctctcagac 1861560

ccagtgatat gaacaccctg gaaccatccc atagggggca ctgacacacc actgacaatt 1861620

 gagaaccata ctgcaatta actcaggttt ctaccttct gacattggtc aaaggtaac 1861680
 caaatctact cctcaactga aaagatgcta tggatgaagg gacctgtacc actatccaca 1861740
 aaaaatatcg ctctatcaa tgattaatgt agctaaccat acccaattaa gagtgatgaa 1861800
 aaacatctat acaataaaag acaagtcaaa actgttaaaa tgccaggcag tgttcagagc 1861860
 acttaataga cactttattt gaacctgtgg aaaggtatag ctcttttctt ggcagaaaat 1861920
 ctttttcta cttactttc catctagaaa atatcagtca aatatttgaa aagctaaatg 1861980
 tttagcatgc caggggcacc catgtgtccc aggcaccttc acccttgcca tgctgcctat 1862040

 ctatctatag cacaagcaca cacactggca ttcttttct tccatgttca catgtcattt 1862100
 cttccttggc catttgtaat tctgactgtc ctttaaggct taaggctcag gtgactctct 1862160
 acctcaataa tatcttctt cttcccaatt agccataggc tcccctctgt cctgtggatt 1862220
 ccccctatct ctacacaag accattttgt tttcataaa gaacaactgt ctatctacct 1862280
 catggcaaat catattatag aggccttatg aattctccaa agtaactatg ggtcttattt 1862340
 cacttttga gataataagc tgaggttaaa cgaatcaga taacttgctc aaagccttac 1862400
 atcctcaggc cctcccaagg aactgtgtac atacacaggg gagacacaat ggtccataca 1862460

 atcttctatg aaaagaatgg caagggttgt acagggactg gaagtagatg tactcatcta 1862520
 ggcaggcaga cacatgggtg tctgggttgc aaaccagggt ctgcattatt tgagattctg 1862580
 agcacttate accatagaac ttccgtctta ctcccccac ctttagtgaa gtttttgaag 1862640
 gcaagcacat actttgggca tctgggttct tcccaccctc tgttctcaat cttagagacc 1862700
 ttgtttgact ttaaacctg tgctgacact gttaacgatg gtctcagaca cctttccttt 1862760
 cccacacaag tgggtgcaaa tggcattcaa cctccagctt cccagggagc atttccggtt 1862820
 tctataagge ttctacacat gtgtggacaa agtcattctc tccagcgaat ttccagaagt 1862880

 ttcataattt ggaactgcct tctcatatgt tctgctaac tggtttcca agttttaatg 1862940
 acaacttaac agtttttccc agtagctttc taaagggtc aacatctaac agtggttctga 1863000
 cttcctaaca ccagcataac agtagagctc aaggctcgt atctatcagt gctctgactt 1863060
 cttagcacca tctaggacag tagagctatg ccataagcac atttgttaag caggttgaca 1863120
 taacatcca atgaaaacta gaagagtaga gtggaaatga caaggaacta tgaatgaact 1863180
 gacaatcagg gctgccctaa agcctattgc agatatagtc tacaagaaca tggttcatca 1863240
 aagcaggaat gtcagcaag agttaggtac atgagtcaca gtatgaaacc aagggtcaac 1863300

taaatgttca atgtggagag atttcataaa tagcaatgtg tccaacaacat gcgaggcttc 1863360
 acagcaatca ggaactgttc cctcaagaac tagttataag gggacagaga ttgttagaag 1863420
 ccagaagaag gactgctgca aaagagtgtt ttctggacag ggcatttcac acatgtgaac 1863480
 tcagagtggg cactgcatgc acaggcctgc acctagtaag ccagaatccc aacatgaatg 1863540
 attaaggaac cattgacgtt gacggatgct tcggggaatg tcatttttct ccatgagtat 1863600
 ggctctcat gttagcccat gttccagtgc atggccctgc acccatgtac atactgggaa 1863660
 caccagtaga ctcggtgggt cttttttaa acagtgagtg aatgaagtta gagggggtgt 1863720

 agtggtagag ttatgggagg agttgggaga gtggcgtggc gatggagtg acgaaaacac 1863780
 attataaaaa tgiataaaat tctcaaaaac caagtttaag agggaacatt tattgggtgt 1863840
 cacctactga cacatgcaact ccagaagaca gtgctgggct gaaaatgtca aacctacaca 1863900
 gacaatgtaa ttcatgtgac tctttaaaat ggaaaaatta tagaaatagg ggaagtgtt 1863960
 gaggagtagc atgaagaata ctagtggctg tggaaacggt ctgtgttgat cagatccaca 1864020
 ttcagatcct ggttctcaga ctgtgctgaa gcttttcac atgctggaag gaggacaact 1864080
 ggaggtctac acacatctta cagttatgcc aatggttctc acccttctg atgctgcgac 1864140

 tctttcatac agttcctcat gctgtggctca ccctcaacca tgacattatt ttgctgctac 1864200
 ttcttaacta caattttgcc accgttgtga atgtaaatat ctgatatgtg acccccaaat 1864260
 gggctcatgac ccacaggttg agaaatgctg actttattca aatataacag ttattaaaaa 1864320
 gtaaatgaat aatacaatg cactatttct ttaagtcaag tgactttcca ttaaatcaa 1864380
 gggggcttgt atagtcaatc gggggtatag atattccaag ttcagttaat cttacagttt 1864440
 taatttgaga actgaacctg attctaactg aaagcttgag gatggctccc tccaccagaa 1864500
 gggcagtgtc tgcaggtata tgtatcacat aaaacagga cagaaactaa acaaatgaat 1864560

 agcacccaat gaaaactgta aaacctttg cacaccaaca ttaaaatcga aatgaatgt 1864620
 gtgaatatag aaaaaggcac atatatgaac tcagaggata acaataagt cagacaaaat 1864680
 acagtttgtg gcaatagtgg ggtaaatata tggtttagtt aagaaaaaaa aaaaacctgt 1864740
 ttctcttaat atactaatgt taccagacag aaagacgatg gggaagacag cacggggcag 1864800
 ttatttaagc cggaattgct gattccaaat aaggcactgg tcaaaatact gtgtcaactt 1864860
 cccacaact cttttcttg agataattct ctgtaaaaag gaatatcaa taatttgtct 1864920
 caccaggctt aattttctc caatcattca ttaacatagc catgggaatt gtttatagtt 1864980

 tacaatctgg tatggcttgg aattgaggaa caaaggaaga tgaactagaa atgattactt 1865040
 gtgcttata ttttaatgat ttgtgtgtgt gtgtgtgtgt gtgtgtgtgt gtgtgtgtgt 1865100
 gtacattgtg tgiactggtt caagaagtgg ccaaaatagg gcatctggtt ccttgagct 1865160

gagcaaaagc ccattgtgaa tgacctgatg gggacagaac cacagttccc tggagaagca 1865220
 gtcagtaacta tctctagctc catgatttta ttctctctct ctctctctct ctctctctct 1865280
 ctctctctct cgaaaagcag ccagtgcctt taactgctga tccatctcta cagccctgat 1865340
 ttcatTTTTA aacaacagg ctgaaaaatg aatggttcca caatgaatgt ttttgcact 1865400

 tttctgaatg tggagagtag tgtctacaag tctactacaaa ttacaaaaca catccctaca 1865460
 ggctgcacgc acatgtaigc atctTTTTTT tcagcttttc atgatcatca gtaactcagt 1865520
 aagaaccaac aatgaggtaa aaatgaaaa gacaaaagaa cagaaaaaca tcatttaaaa 1865580
 atagatgaag tctgtgctct taacctctga gccatctctc cagaaggga gttgggagga 1865640
 gaacaagagg actgagccaa gggaggaata gaggaggga agaaaggaga tgccttgata 1865700
 gagagagaca gtacaggttt ttagagaggt ctggcacagg agaaatgta ggggatccac 1865760
 agggatgacc ccaactaaga atccattgat gcccttcccc tataacgaga ttggtgtcta 1865820

 ccttggttac cattcctaga gtcttcatcc agtagctgtt caaagcagaa acagacacc 1865880
 acagctaagc actgaacat agtcttagaa tccagttgtg gagagagagg agggatgagc 1865940
 aaagtagcca agatggtgct gcagaaacc gcagaaacaa ttgaccaac ctactgagac 1866000
 catggagacc ctagtataa aactgcgga acagcattgg accgaacaa gcctctgaa 1866060
 tttggttgc agctaggagg ccaagccagt ctatgggacc tctaacagt gagccagtct 1866120
 ttaaccctag agcacaatg gactttggga gcccttccc tatggagga tactattata 1866180
 atccagatac agcaagaag gcctaggccc tccccaat gacataacag actttgaagg 1866240

 tctctggtgg agggcctcac taccctggg gatgaggtgg gggatgggtt ggggggattg 1866300
 gtggggaact tgggaggatg ggaaggagag ggaatggggg gtggatatgt aaatatgaat 1866360
 agtaattaaa gaatttaaat tttaaaaaag attaggtcct acatcttggg ttaatgtata 1866420
 tatagcaaat aaaaccct gtcataatta caaacataa ctagagaaat aaagttggtc 1866480
 cttacaaaa tgaggggat tgaatgttca aaaaaatag atgaagtc atgaaacctc 1866540
 tgcttaaat gctaataat attaatgtg taactggagg gtttttgtt tgtttgttt 1866600
 gtttcttct ctccaaat gtttgaact caaccctaa gccacttggg tctctgatgc 1866660

 tttctgttga gcaatctcat ttcacctta gcctgtgga gctggcctca gctcttctca 1866720
 gtagccagt tcttctcag gcaccagta tgtttcttg atcttgaat tttctctcat 1866780
 tcagtacttt gaccaactac atcctaatgg atcttcaata acacttggg tgagtatatg 1866840
 aaacttccag gtcctcaga aaactgtgga aagcactt taaagacca cagttatTTT 1866900
 acctcttcc ttcactgtca ttcccactt gacacttga caactttta ctgaagaaga 1866960
 gccctggcct atagcatgt ctcagtaaac atccaaagag agatttaaaa aagtgaatga 1867020

atgaatgaat gaatgaatga acaggtagat tcctatattt ctgcttcagg tgagtgttat 1867080

gigttagac tggcaaacag catagggaaa gtcccagcag aggtcctgaa tgcattttag 1867140

atfttgagtt tcatcttttc attgtggtac aaatcaagga gcctaaggac ctctccagaa 1867200

aataatatgc agtctcagac atgtctcctg agagatactt tttgtttctt tgtttttttg 1867260

ttttttgtct ttttgagaca gagtttctct gtgtagcttt ggagcctatc ctggcactcg 1867320

ctctggagac caggctggcc tcgaactcac agagatccac ctgcctctgc ctcccagtg 1867380

ctgggattaa aggcttgtgc caccaatgcc cagcgagaga tactctttaa gtacaaaat 1867440

ccatcttggc agatgctcca aggcccataa acagacacac ccggtacctt cagtattcag 1867500

caaccactgt ctiattaggg cacctagcac acattatcta aattacttga cctgcctgct 1867560

tgatttactt gaggaagggt ggaagcccta gcaccttcag gggcttctta gaacctatac 1867620

ctacctaaag gtttccatct ttttcatatg gagattgcac acctaaatc accaattcta 1867680

agcaaagaag cagtgtttcc aagacaaaga acttaagaca caggatgcag gcttgcctcg 1867740

tgtctcattt cagaaagacc atcccaccac acacagcagc cctaagtctg tccgccttcg 1867800

ggcctttgtg ggcttgtttg gggcagacat tgggaagtat taacaacagc catggcctgc 1867860

actgtttatt cagagttaag cattaacaag gctaagccct ctaacctgcc accgtcttcc 1867920

tccaggaaag aagtgcctat gtaaatattc taatgcaaac accccagctt tccatagggga 1867980

tgggaagacc agcagacagc taggaggaca gaagggagct gtggctattt ggaaagtact 1868040

gcgccatgga acttgattcc aggtgactt tgcacacttg gtcagcctgg tgttacctag 1868100

tagagaggca atgaggcaca tctgctgga ttcgttcac atggcttcaa atagtctgat 1868160

ggttaggaaa tggggcccgg atcttttaca gcatagatgg gggaatcttg tcatggaatt 1868220

ctctgttcag ggcttgcctg tttaggtttt ggcattggaa cagctgttgc caagtgttg 1868280

attctgttct gaggagacgg gaatgctgac aatattaact caagcacaaa gaaggccaa 1868340

gagtttcatt agagctcccc ttagatactg cttgctggac actgaaattg caaaacttgc 1868400

cacaagacc aacgctgcag aagaagtcaa atacaatac aaataaataa gtaaatagag 1868460

tcagattttc tgggaaatt ggcccacttt catgaattta cctaaattga tgcttgggtg 1868520

aggtgacaag aaaagaaatc caaactcagc cagttgcctg tggacaagt tgaagtaag 1868580

cacatgttct ctctccaga tctgaggaga gagaatgcgt aggtcacctt ttcgctcttg 1868640

aagcatcaa gcaattacgc aaacatgcaa gcgaacacca tggagaacag aagacagctt 1868700

gtctcctgta caacctgaga tgtaaaaacc actacactgc cacttgcctc ccgctggaca 1868760

cctctgtgct gtttagggag gctgccccttg gagttttact tgctttgaat cccaatttaa 1868820
ccattcctga tctgtgcgag ctcagacaag ctattctgac attttaaatt gtgtgtattt 1868880
cagaaaggag cacagatgac tgaaacagta gaaattaact ggggatggga tgggagagaa 1868940
aagaatgctt tgctggatgata gtaaccttag taagaacaaa tgccaatatt tgttagggag 1869000
gcaggggtca ggtgccctctg aagcactgta gccatccctg tacatccctg caaggtcact 1869060
actattattg tctcaggcta taacatgaga aaactaagac ctaagaagga atcacatcta 1869120
ggtcttgaac tgctgactgg caaaaccgtc tacctatatt ccctacttca ttttcccctt 1869180

tatttaaaaa tatgacaacc caaggtaggg gcaatggctc agtgtctaag gctcagttaa 1869240
ggcaatggct cagtgaaga aagaggtcct gagtttgaat caccaacacc tatataaaag 1869300
ttgggtgtgg ctaagcagat ctggaatccc agcatttgtt ctgggtggaca cagggtgatg 1869360
atggctgggg cttgctggcc accgctccag ctccaggctc actgagagag cctgtatgaa 1869420
gagaatatga cagagaatga cagagcagga cacccaacat gctcctttgg ccttggaaaca 1869480
tgcccgcaca tacacacaag cacactgata caaacagct tcttctgttt aagtgtgat 1869540
gtgcagtttg ttagtgaacg ggggagggag ggagtggggg gggggggggg agttttgatg 1869600

ggacaatatg ggagtactgt gttttgagaa cacagattct gtgtgccca gctaataac 1869660
tgaacaagc tgttcataaa ctgagggctt cttttatttc cccttgcagt aagtaaaaag 1869720
tgtgggagac aggaaaaatt gtagggatgg acagatgccc attcctgtgg atatacacc 1869780
tgggggtggg gggggacaac aaagcaagga ataccacgc cagctttcta agtatactcc 1869840
caaatagaca tgagtgaata ctaataacac agaaaatcaa taggagacct cacaaggaa 1869900
aatggattag tagggacatt tgtggaggcc agaatagaag gatggcagga ggcacatca 1869960
ggacagaaaa gagacactca ttgctggttt gtagggacc atctcttttt gcctcggccc 1870020

acaatagaaa gagtttgttt agtcagtttt catctctcct tcttggctct catgtgctac 1870080
ggtaaactta gtagaacaat gaacggcttt aacttgggca gaggtcagga gggtgtgat 1870140
aaagattctt ttctccttta gttcttcagt tgttttctat ctgtgagtaa gggcaagaag 1870200
atgtatttaa taaaacaggg tgtaactgtga ccaataaat ctgagaaatg cttcctgcat 1870260
ccctctctta agatagttaa gtctcaagct ggagagatgg ctgagaggtt aagagcactg 1870320
actgctcttc cagaggtcct gagttcaatt cccagtaacc acatggtggc tcacaaccac 1870380
ctgttatgag atctggtgcc cacttctggt gtgcagatat acatggaagc agaatgttgt 1870440

atacataata aataaaaaaa agaattttt tttttttaa aaaaaaaaaa aaagatagtg 1870500
aagtctctgt caggggaaggc atccactcaa cacataagcc attgttccca gggcattttg 1870560
atcatcttgt ctattaatat acctatgcag agagactcta agaatactgg aacaggtgga 1870620

gatatcacca aactcttact ttcctttcct aggtgacttg aagaagtgac tgaactttct 1870680
ggacttgagt ttctgactg atctgaccac gcttgcgttt gcaggctacg ctagecctcat 1870740
ggctcttctt catctgtagc tgggtctaca gcacagaaac cggggtcaac agagtcactc 1870800
tacagcccat ctcagaagt tctccagtca tcagagacac cgagacaatg gatcctttac 1870860

atgttcatcc aggccttcat ggcccagctg agcattaatg tcccaaagc tgctgagaac 1870920
ataagcagag gcagggaatg tgcagggaat tgttaataca agcttctact tgttctctga 1870980
aacatgttgg cactcagaca tggatTTTTg ttgtatattt ccatttaaat atgcaagctt 1871040
aataaacatt attcaccaa aacagagaaa tgaacaaaag tcgtgtaact gattcttagg 1871100
cgacattctt agatgttttc ctttcaaatg tcaattctga catttcaact gaaaaaaaa 1871160
aaaaactgat tacaatctag aggattcttc ccaatattaa agaaatatgt cttttattca 1871220
aatgtacaaa attttgactt cttatattta ctgtatgct attttgcttt taaacagggga 1871280

taaaatataa ggglatctgc ccaagttaa gacagatttt tttcattct tgtttttaca 1871340
gaaagaatat attaatggca taataatagc aataggaat gctcaataaa gaccctagta 1871400
tatagccage aagatggctc agtgaacaag agcttgcagc caagccttga tgacctaaaca 1871460
cagaatccca ggacctactt tttggaagga gagaggctac ccctaggagt tgtactgtag 1871520
catgtgtgca ctccatgtat gcacacatat gtaataaat aatgtaatt taaaaaatat 1871580
cctagcttgt gatagagcct attctagtac tgtacatgtg tgaccaat ttagaaatgt 1871640
gacaccccag gaacagagag aaaaagaagc ctacagacca aactattaa gtggggagac 1871700

taagatttga aaccaatgtc ccatcctgaa tcggttcacc ggctttccac cggctttctt 1871760
gtttactttg tgaacaatg aaacatggc catcaaaaca cagagggcta tgatttggaa 1871820
agacacggac tctgtaatac aactaaagt ttgatctct ggctcctgct aagcaagagt 1871880
agaggagaag gcctagcctg ttagagaaac agatccctga gctgggcat ctgccagget 1871940
cacctaggac tgggaacctc cacttgaagg gctggaaagc aatgtgagag aagcacttga 1872000
aattctgaaa aattctcaca gaagccaata caagctaat tgactgtctt caacctcga 1872060
tgccagtgcc tccactagt tttcgaagac actgaaagga tacgtgtcca cgggagaagg 1872120

gccaaaggaa cagaacaggg attaaaaaga ctccagaat ataacaataa agatagactt 1872180
tgctggtatc tcaactgtaa atacaattt gcaactatat ggggtcttag ggtctttgct 1872240
tatggattat gtaccagatg ttgccaagat actattgcta atgggaatgt ggttatatgg 1872300
caaaacccca cttcaaaaa actacgtatt ttatgtgat ggatgggtgt atgcctgggt 1872360
gtaaacaaat gcgccaggtg cctgcaagag actctggagg ccagaaaagg ttgcaggatc 1872420
acctggaagt ggagatgact gccacaagga tgaatactgg gaactgaacc ggctcctct 1872480

gcaatagcag caagctctct taataaccaa ggcatctctc cagccccaga aatcaccttt 1872540

tagagaagca acctgaaatg aacaaagga tgggtgtgg tgccttctc gttttaatta 1872600
aaaccagata gatggaacaa gttgaggaaa tctcagtaac cactgaatct gagtgatggc 1872660
agttaggagg gtgtatgttt gatgtttttg tgataaata ttttgataaa cagggaagaa 1872720
tttcatcatg ataaaaagaa ctatatggta gctaaagtgg tttgaaaata aaatacttga 1872780
gaaggagtca gatacgcact tgactactct cttctacaaa agcagaaaag gcagggagag 1872840
ttgactgtga gaacaggggg tgaaggacc acagtaaagg tgctgacctt cagggcgatt 1872900
ttaacaggat tcaactgtcca ttctcaatga agatactaga tgcaggagtc tggcttccat 1872960

gaccacctga tgiagtgaga cttcattgct gaggtctctc catgtacatg tgcattgtg 1873020
tctgtgtctc tggggtcagc tcttctgtat tgtattatat tgtttgtttt ccaactcataa 1873080
ggtgacagcc ccataaagcc atcaggcaca cagttctctt tgatattcaa getgtgcttc 1873140
ctatacatga atcttttaga cagataatat cttcaataa tcaggaatta ggcaagatca 1873200
agcacgttca aggtgagttg ggcatagatg ataattagga attagatctt tttttcccc 1873260
aagaaaatgg ctcatagcta atcattacac tccccctaat tgcctttatg ggaggetctg 1873320
caaagcctat gtcaaaaacg caaataaaag catccagagc catgaataaa tatcacacia 1873380

attcacagat cagactctac aaatactcag ttttctagtg tctctccac ttcccatgtg 1873440
gacaactggt ttgtttctaa agatgagctc gttcattgct tataactaca cttgagaata 1873500
aattctgccc ttgttatctg aattgaaatg tgattatttg cagctggaga gatggctcag 1873560
tggttaaaag aactggetgg tcttcccaag agcccaggtc caatttgctt gcaccacat 1873620
ggcggctcac aaatatcagt aaccccagtc atagaggact caaactacc tatggaccac 1873680
cttgggcagc aagcacttat gtggctcacac attcaggcaa aacatctatt cacataaaac 1873740
aaaaataaac aaatgtgata tttacctgtt ctgggtttat tggggttttg ggggatttgg 1873800

ttttttttg tttttgttt tttgttttt gatactatt aatggcggga gattaccctg 1873860
ccaggtagaa atagtaaact tttctgttg ttctattat taaatatcag gttgttgcca 1873920
tttgtttaat attattaat aaatgaccaa tacatgcttc taaatgact gctttcttcg 1873980
atacttatga gcaattctaa ggtattgttc cttggatcat tattcaaaaa acaaaataga 1874040
aaacggtatg taatgtcacc ttaacacaag aaagtttttag gtccagagag agaccagtc 1874100
tcaaagtagt ggtaaagagt gatagaagt atctgggtgg tggggcagc ggtgaagcac 1874160
acctttagtc ccagcatttg ggaggcagag gagaggcaga tgcctgagtt caaggccagc 1874220

ctggtctaaa gagagagttc caggacagtc aaggctacac aagagaaaac ttgtctccaa 1874280
 aacaatcaaa tgatgatgat gatgatgatg atgatagaga ggaagaccac cacacccgat 1874340
 gctctctttt agtctttgcc acaaatgtac acacacacac acacacacac acacacacac 1874400
 acacacagat aatgattata atgataacag tactaatata aaagacactg atgccactga 1874460
 ggagtgtggc ccgggtgagt tcagtgacc aactctgttt tctgtgactc acactttgct 1874520
 cctgacctga gatagaaatg tctttctatt tcaggctttg tggaaagcct cgaagccctc 1874580
 cctgacggga caccctcca gtcccctttg tggtttttgc tccagatgtt tcccttaca 1874640

 gaataacaaa aggacctgc catcatgact ctgttatttg gaattacacc cccacctcag 1874700
 cccatagcag ctgctgggcc tcaatacag tgccttctcc atcttacctc agcaatagtt 1874760
 agatgcttgc atgatcttc agctgaaact ctctttaaa tcttaatta attaattagc 1874820
 cagtgttggg atcaaaccca gatcctcata aactctgagc aagcattgga tcaactaagct 1874880
 accctgtcag ctctgctgac tctctgaaat ctaccacct atagtgcctg agactgagct 1874940
 gggcccaaag tcaagactgc catgttaatc agatcatgaa caccactcag tccggagca 1875000
 ggtaagctcc cctatcatgg tgcgtgcaaa ccagctctga aaaacacctc tccacttagc 1875060

 ttctacaaat ttaatgaata ggctgtttac atcctgtccc agataattaa tgaagactgt 1875120
 aaaaagaaaa aaagaaaag aaaaagaaag caagactcgc tgagcacaga tccccacctc 1875180
 ctggaagcct agtgtctgc tatttateat ggcactttcg ttccttcagg cagttttcaa 1875240
 tcaatctgac acattcgact caatctgaat tcatttctgg gctacatttc atgagacctg 1875300
 ctatcaattc ttccattgat ggctgggtgt acttggaaat gataatgcag ccagtgtcct 1875360
 ctttttgtct attgttttgt gattttttta aagctcaaaa atcaattaat ttagagcaaa 1875420
 aaacaaaaag gctatataaa tctgtttgtc cgtggctcat agctacaacg tcccactcac 1875480

 tttaatatgt ttcttcttc caattgttct attatttggg tgcaacgtag tatectaatt 1875540
 tatttatgta gtgagcaaac actcattgaa tacttagtga gggcaggtac catgtctggg 1875600
 atagtttgat ttagaaatta attattcagg ggatcttctg tgaatatta cagagtaggg 1875660
 tctctcctaa actgatacct gtgctacata ttattgatac tgagacacag aaggccggaa 1875720
 gaggaagaaa tctgtatggt ctcttactgg ctggaatgct caacaggttc cccgggtaag 1875780
 aaatctggac aggatagcta atggaagcaa acagagaatc tgtgctctga ttgccttcca 1875840
 gggctattct ggacacgta gggttgagtg tgcacctct ctcacctc acctctcact 1875900

 attcttcccg atttccacag gacatctgcc ctgttttgat gaactcatta ctacttgcct 1875960
 tagactggct aacacatcat ccccagatct ggectattta tttcttttgt ttgtcatgat 1876020
 cacagtttct ttcttctcc ctctctccct tcttccctcc ccttctctct tctctctct 1876080

aaatgaaaaa ggicttcatt actgtttaat tacccttatt tatcttctta aaaggccagt 1876140
 tttaaaaagt agttcagaag ctacagctatt ttgccatcaa tagctcagtc atttgacat 1876200
 aatcattaag cttatctccc tgtttgttaa tgccaggccg cctttatttc tgctgtcccc 1876260
 tcctttctct tctttattat gtttgtatta ttaccctctg ctccagtgat catcataaat 1876320

 acttctgggc tgcaactctg gaaccttttt gatgattcat atgttcttag gagagtctta 1876380
 tagacagatt teatattctt ctctctctct ctctctctct ctctctctct ctctctctct 1876440
 gtcactctct ctcccttctt cctctctctc cctcccctct accctgcccc cacatctcca 1876500
 tcttcttgta ttgttgcaaa gttgtcatta tcacttggtc attatctatt ttttccattg 1876560
 atatctggcc tttgtggta aagctctggt gctgagtgaa acacctgctc aacttacaag 1876620
 gtgagaggag ctgcagagag aggtcctgga caccgagccc ctggacacgg agcccttgac 1876680
 tttcccctag gggaagaggc ccaccttctc actaggaaca aactccactc cactgaatag 1876740

 cacctttggc ctcttccagt gacagccctc ccattcatca attatgcctc aaagtccagg 1876800
 agtggaggga agtggtaaat accctctctt ctccagggtga cacactaatg tttgtactaa 1876860
 gaagctggcc acttctctct agacctgtt cctgtggttg atgcatttgc cctatcatt 1876920
 tgtggtactg aatgaatccc tctctgaagc acacaaatac cactgctccc caacccccac 1876980
 aaaaaaaaaa acaaaaaaaaa caaaacaaac aaacaaacaa aaaaaaacca gggtttcttt 1877040
 gtgtagcagc cttattgtcc cggaactcaa tctgtagacc aggetggcct tgaactcaga 1877100
 aatctgcctg cctctgcctc ccgagtgtg agattaaaga ttaagacac ctgtggtctg 1877160

 tatttttaaa tagaaactat ttggagaaaa agatacattt taaacagtcc agtgaggatg 1877220
 atatcccaaa ctggggaaaa gaactggtta ctgtattagt aataatattt tgtgacacac 1877280
 ccatctctcc agtttaaagc tgctttttaa aggcaaggag aaaatactct ccatcattat 1877340
 ggaaatgcta tttttatgtc agcttaccac ataagcactt tttctactc aaacagggtc 1877400
 caatttactg catcctgcaa aattcacacc agataaagca gcctaagttt tttgatcca 1877460
 cacgtgcagt ctaacagaaa ggctctctgt ttgacgtctt aagatgacgg acacaaacta 1877520
 agctgacttt tcccctcggc tgctgagca cgcattctac acattctccc ctatgttgc 1877580

 ataggagtgg gcacagcaat ctttgcagga agaaaccagg aaggcaaaaa ggaaagccat 1877640
 gatcggggat ccgtctctc tttgcccctc ctgacacccc cagccctcat ttcctataa 1877700
 tcattttctt cagtctaac atagaccctt ccaatccctt ccgcccctac ttacaggtaa 1877760
 ttgtttttct ctttttgaa tactgaacta gccacaagac atggcagcaa ctttaaggaat 1877820
 cttcgagaag acagggatit aaatgattta aaaatcacag ctactgatgg ataaatgacg 1877880
 acgcatatgg ttttggataa caaatatcag ctgaaggggc tctaacaggc tcaggcctgg 1877940

caaagatggc tctggcaggt cttgatttcc tcctcattt tctttgataa agactattag 1878000

 attgcattcc taaaggtagc cagcaaggtc tggctcttta ttgaccact tcctctctct 1878060
 gagaatgacc accaaggfcc ccatectctg actcctgcct ttgtccctta tccctgccc 1878120
 tttgtccctc taaggtaaat aaatctcctt tgtgttgaga acttggctctt ggggtgtctt 1878180
 gtgccaatgt ccaggctcctt tccccagct ctggttaaggg acctgtgcta aactgtccaa 1878240
 ctgacggggg gtggggggag cctgtcttct ctaggaggag actaacacca tgggaagcca 1878300
 aaactcagct ttcaatagaa ggacagaaga aaacggagcc aggctcagaa tagctactcc 1878360
 aaagcatgtc attcttagcc catttacctc ctccctatcc tcccgtcccc cctgcatttc 1878420

 tccccatttt gtctgtgtct cctgaaaagg aaagattcct ttagctcatc tcagcctgtg 1878480
 cttttctcca tctctataag tattctacta cccctcctgt tcggctcacc atcctcatct 1878540
 cctagctcac tgagaaccaa atgcaggctt ctgaccctg ccagctaagt gettgagggg 1878600
 gagctgtgcg cttaccctt gccactgggc cagcctcatc tcggaagaga cattttaaac 1878660
 cccagggatg gtaaaaatca tcatcattat tacctcccta ggcaccgtgg tgtcagcaga 1878720
 gatggagaaa ctctaaaatt acacaggttg gtaatgccac tccggcatac aagatcatct 1878780
 gaacatcgat gatctattgg cagcaccaga atagatgaac caacaaggaa gtaacagcag 1878840

 ggtgttctca tcttgggtct ctgctgcagg ttagtgggta aaaataaata cttatcttc 1878900
 aaaatggcca ctagttagga cgatgtgggg gggagacaga tattgagggg cagaaattta 1878960
 agcttaagta gattaacaac aaagaaaact tctctaggat ttttctaag cttgctcatc 1879020
 tcatgattta aatatttatt cttcaaacgc agccagtgtg tccacatgaa gtcagctgaa 1879080
 cactggacct tgggctcccc tccgaggggtg aaagctgaga ttttgtgtgt ataatattat 1879140
 tagagaaagg ataaatattt aaaaaggaac cagtaatttt tccttatgga ctaccataag 1879200
 ttctccatac acgctgggga agatgggtgcc atgttctaac aggacagaca gacagccctg 1879260

 ggagcttgac aagttttcct ctgaaatttt gttgtgttac atttgactt aatcagcaa 1879320
 tctgtcagta aaggctttgc catgttgcct atacaaagat cttcagttag tgacatttgt 1879380
 tgaagtggga ttiaatttaa atttgataac agccctatgg tgacatggaa acttccattt 1879440
 ccaccagggt catcacaata tttgaaagg gctatagtac cgtggtcaca cactgccttc 1879500
 agatgcttct gtccacaagg gggctgctga aaagtaggct ttgggttttg ttgtttaatg 1879560
 gagatttttt tccttatctc tcaactgagt gtgatctctc cattttatga agatactcaa 1879620
 acttgttttt gaatatcttt gcagccttgc ccttgtccat gcttttcagt cttgactgag 1879680

gcaacactgt cagtcagtc atagtccttat tctaccttgg ctggctggtc acaaatcttc 1879740
aacagcaagt accaaatag taaaaagcat cagaagcaaa taatgaaaca ttgggccta 1879800
tctgtatcta gatgccttcc acccttctcg aaccaaaagt acctttccag gtgtctctc 1879860
caggtgtacc ccigttagt tagattgggt gtttaagaac cacaggcttg gaaatggttt 1879920
cacatagaac ttagttgtc ctcttgtttt caagaccaa ggtggagctc aaagatgta 1879980
tgtgccctct caccacagt acagacagga ttgaaagtgg ctgccccac ctctttctgc 1880040
agcactgact tgcceaagaa ttactgaac ctcaaagtag aggatcaaat tcagagagaa 1880100

agaaaacatt agatttgaag aagtcagtcc ttgccaggca tggaggccac accttaatc 1880160
gcagccctgg ggaggctgag gcaagtggat ctctgtgagt ttgagaccag agtgatctac 1880220
atatcaagtt ccaggacatt gagaactaca tagagacct gtcccctgtc tcaaaaaaa 1880280
aatgttctta aggaaagcta aatttgaag tagttatagt caagggggca tttaaaatag 1880340
tcttatttct aciatgttcc ttggaaaacc taagcagcct caacattctg ttcttaatt 1880400
atcaataatg ttgttacctg aaaatcatct taggatgtaa acactggagt gtcacattca 1880460
cacagtcatt gctggaagg gcaggtgaga ttttagattc tcgtgaaagg cttttggcag 1880520

tataaattaa ccggggagac ttggcatca ctctaaatg ttattctctg aaataggcat 1880580
agtaaggat ccacaaatag agtcagttt gattcttcta cctttctaat tgttgataaa 1880640
attctattca aagaatttat gtcatttctg tgttctagtc tgcttctctg ttgctcgcg 1880700
aaaaagcaa aaccaacca acaaaacaac aaaacaagca aaaaaccaac ttaacaaaag 1880760
tgacatgggg aagaaagggt ttgtttttgt gttgcagatt agagccaatc attgaggag 1880820
gctaaggcag aaactcaaga ctgggcttga atcagagact ctgtaggaac actgcttact 1880880
ggcttctcc ctctggcttg ctcaactgcc tttcttctat atctcaggac ccaggggcag 1880940

cacagctcat agtaggetga gctttccac atcattcaga tttcaagaaa atgccccata 1881000
gacatgcca caggccagtc tgacagagag aggcaagcct tcaattgagg ttccctcttc 1881060
ccaagtgtgt caacttgaca ctctgccatt gagaaataac attcttagtg tttgtaaaga 1881120
atgaaaacat gaattgctg tttacacacc ccagggtccc ttttgatct tatgctccag 1881180
ttgatttctc tctctctc tctctctc tctctctc tctctctc tgggtaacag 1881240
ttacagaaag gaagaaaca cttgtttatt tgtttgtatt ttttcttc aggaaaagc 1881300
aagcttgagc agatgtttgg atttcatag agctttggaa gaataaggct ctaacaggtt 1881360

ttctataacc aggggacctg aagatcctgg ttgagtatgt tctatgacct tcaacttacc 1881420
aagagatgga aatgacagca aggctttct catgctccc atagcagtgt ccaattgaag 1881480
tgacacaaac atgtgaaagt tggctataga tgggagcttg taattcattt ccacacaaa 1881540

aataaggaat gtgaagaggg gagaacttct acacatgagc tgacctctga gagaagctac 1881600
agaagagctc agaaagacat gggatgaaga ggcactgtcc ttgaagggtg tgggctgagg 1881660
aatgaggatc acatacagaa agacttaaat ggccacattg atgcacttta gttctctgac 1881720
aacagtgcca tcaatgtctg tctggtgcta gatgctacat gaagcacacc acacagtgat 1881780

taagagtgct gatagttagg accagcaaga tggcacagta ggtaaagaca tctgatgcca 1881840
acttgatgac ccaagtccaa cccctgggac cccagtagca gaaggacaga actgactctc 1881900
acaagttgaa ctctgacat cacaatgtgc actgtggcat gagatcaact cccagaaaat 1881960
gtaattttaa aaaatgtgc cctgagctca gaatcagggc actgagatgc tcaacgattc 1882020
taaagtttac tagctttttg atgaaggcag tcaaccttga tctcagtgtt tgcagatgta 1882080
aagtgagaac agcagcagga cccacatgga gaactgactc atttacaagt atatagtggg 1882140
taaatgttac aatacatcaa agtaccagt ctaaaaaggga atgatgtctg ttttatcaa 1882200

tcaatgacct aagactcttc ctattcttat ttgaaaagt ttatgaaata tattaactta 1882260
tttgcccttg gaaacaaaca caccagtctg aacataaata aattgtttgt gatgactaac 1882320
catcctgtga catatcatca ttgtacacaa ttcttacaag atggaccaac aatattaata 1882380
ttagtattaa caatcacaaa gccagagaga tggctcagtg ggtgtcttac ttagggtttc 1882440
tattgtctat aagaacacc acggccatgg caactcttat aaaggaaaac atttaactgg 1882500
ggctggccta cagtttcaga ggttttctct gttatccttg tgggggaag catggcaaca 1882560
cacaagcaga catggtgctg gagaaggagc tgagagtctt acatcttgat ccacaggcag 1882620

tggaaggagt ctgtgtccca aattgggcat agcttgagca cagaagacct caaaaccac 1882680
atccaaagt acacacttcc tccaacaagg ccatacctcc taatagtgcc actccctgtg 1882740
accaagcatt caaacacatg agtctggggg gggggcgttc ctattcaaac ctccatcgtg 1882800
ggtaaagcat ctgccatgaa agtgtgagga ccttggtttt gatcccctga acccatgaaa 1882860
agtacacat gatggcatgt ctgtaactcc agttcccctt tgcaagatgg gcagttaga 1882920
caagagaatc ctgcaagt catggtcaac tagtctggca ttttccatgg ctaataccat 1882980
gaggtactgt ctcaacaat gtggaaggca aagacagaca cccaaggctg tectctgtct 1883040

ccacacatat gctgttgtat gtgtatactt gcaagtgtgt acacacacac acacacacac 1883100
acacacacac acacacannn nnnnnnnnnn nnnnnnnnnn nnnnnnnnnn taaagagaga 1883160
caaagagaga acagagagag aatactagca acaatgacca ggacaactac cacaaattca 1883220
accacagtaa tacctttgtg tagcacctat gttttcaaaa ggctcctaca agccaagtgg 1883280
tgggtggtca agcctttaat cccagcactt cagaggcaga ggcaggtaga tttccagctt 1883340
ggtctatata ttgagttcca ggacagccag agctatgtag agagaccctg tctcaaaaat 1883400

ccaaccaacc aaataagcaa aactgctcct acagaatcca caagaattct gtgatgtgag 1883460

ctaaccaaat accaggatgg agacatgcct aggaccagg agtctgtcc agagtgtaac 1883520

agctcatcaa caatctctcc tgaaaatatg aactgaataa taactatata cttagactccc 1883580

ctaggaagcc aatcccttac aaatgggcat ctgatgtgac atagtctggt tgtgatttga 1883640

ctttgacaga aatgggatag attaagaact ttaaaccctt agcagttact gaggttttat 1883700

gatcccatgt tcaactatgt ataaactcag ctattcaata actgaacaca tgtttgtctg 1883760

gctttggatt tgaagaggag ataattaaaggcattgct attatttaat tgtatttcca 1883820

ttcccagtaa acttatttcc aagtcaactc cagttcatga taagtaacca aataacataa 1883880

acatatgtgt gaaactaaca catgggtaaa agcgggcaga gaagcatgga caacccttac 1883940

tggaaaacag ttaccacatc caactcaaaa atgtgcttat tacccaaca catgagccaa 1884000

agaatttctc agattaaacc ctcaagttta acctcaaga aatgttcag gcccaaatac 1884060

ataaaagcaa catagctctt ctcagatctc atattgaaa tcaggacca tgccttttct 1884120

tgtttcattc tgaatcata cttaacta catgtatgtg gagataacgc atgtttttta 1884180

cctccaggta atggatgtga agtgetacca ctaaagtgtt ataaaatact aaaatttaac 1884240

tcaaaattgc tcctctgag gctgagggct aaagctgtac tttgggtctt ttacaacct 1884300

ctatctactt tttcatgggc tgttcttct gacaaactca tagataaaca aacggcccag 1884360

gggagactat aatgagatga agtcatgcca gaaatgaaac acatctgtga aagaaaagat 1884420

tgtacaagaa agctaggatt gagacacaca tatttttctc aatagctcgt cactatatcc 1884480

ttgccttatt ctactacagc ctatttaaaa atgtggatgc cagtacttct atgatgaata 1884540

gggctcacat acctgtcagt caaggtattt agaggcaaac acatgtaatt atccagtgca 1884600

cttgaggat cctgtcatag tttgtgctga catgagggca gggaaatctt ccagttgctt 1884660

ataccacagc cagtatcatt gctttcccag taccatttgc ctcaggtaga tatagcagtt 1884720

gatgtgaaag atggagtggg aggctttagt cacccaacac caagaacatg gtgttctga 1884780

actttacctt caatggaagg atgctccaca cagagaatga aagattacag ggacttaaaa 1884840

acctatcctt ccigaaaaat gccaacacac tgctgggcca cactgagacc tttggaagtc 1884900

atacactaga ctggcagctc tctccaaat cctctgctga aggactatag actggctggg 1884960

cacctgcaac atcccacaca gccccagggt ctgtcctaga gcagaaggag caggggaaac 1885020

aagagggaac agtgcctct tttccacttc agttgaacca atgtgctcta gcttggtgt 1885080

ttccattgga ggtaacatgc ctatcttctc tcttctctcc ctcctcctt ttttccctcc 1885140

ctccatccat ccatatatcc atccatccat ccctttctat cccctcctt tectctattt 1885200
aataggtcc catgtagccc aagctaagt cgaacttact acatagctca gcctaggcca 1885260
gccttgaatt cctgatctat ctgcctctac ctcttaagtg tggattacag gcatgtacac 1885320
cattactatg cccagcgcct tttctgacta ttaaatagtc acacagacat ttggatcgtg 1885380
aggaaaatcc tgctttttct ctgctttctc tcattactta tgaacacctt caaggtgaca 1885440
ggggctcaag agactctggt gtatgctgtg ataactacag ttctcatac ttttcaacc 1885500
tgctttccag tgiaaaacag acttgctcca acacagaagt ccatactaca ctgataaccg 1885560

ccctgccaca ggttccaaag tttcagggga taccactatt ggagctattg aaggagaaga 1885620
taccattatt aatgtttttt ttatttagat tatctcatat agccaaggct aacctcagat 1885680
cagatatgta gctgaggatg accttgaacc tctgatctgc ctgcctccac ctcccaggaa 1885740
tgagccacca tgcagccta gtgtatgcaa tgttgggat agaattcggg gcttcatgca 1885800
tgctaagcaa gcactccacc aaatgagctc gaagacagca tattaattac cactttatcc 1885860
tctgctgtta cggaacacaa cctagtacat accaggaaaa caaggaactt agaaccctca 1885920
gttttcattt ctagaaaaaa ctcaaaactga ggggtatttg tagggaagac tgagtgattt 1885980

ctgaccctct agttttaaaa acttacagtg tgatcaagaa atacctcaga ttaggcttca 1886040
acataagtta acacattatt gtatttccac tctgaaactg ttagcacttt aaacagagaa 1886100
ttcagtaaat gactgcaacc actacaatg gcattggactc tatttaaatg aaaggcagg 1886160
tgacctaatg attatttctt ctaaacagtc tgcacaacat gcaaagaggg aatctgagta 1886220
atgccccatg tctactgatt gtctccattc aagtagattg tgtctccctg tgatgtgact 1886280
catagaacac cagcagctgc aggggtgtag gctgtcacc agcacaagc agcctggagt 1886340
aagctacaca gtaaacaggc tacccaagcc tgaacatat tcaagaccg tcttcagtaa 1886400

gacaaggccc gggcgagctc cggggtgacc tgacacatga atttcaaagc atggcaagct 1886460
gttctttcca gaaaatcatt ttgtttaaca aactctcaac tgaacccta actagctaca 1886520
atctataagg gccttttctc tcagcttca cagctcagct gtgtgggct tctctgtag 1886580
tggtaatgg tttgctgtc cattccacc accaggtgat agaaaactat caatcagcat 1886640
aatgcaatg tgagggaagt ctcttagcc aattagtcag taatgagaac attagccaag 1886700
atatcttctg cagagggcac cttagccatt ccacgagagt ctgaggggat ggcggtcct 1886760
gcgtgattaa taaagatcac aggacactta agacatctta catggccaa gaagaaaacc 1886820

agaaacactt ggaagagcta tgttttcatt gttgagtcct tcaagccaac acaggtgaag 1886880
gactggggct ggggggtggg ggatagaagg tagggaatgg cagggggggg ggggtgctgtg 1886940
gagggagtat ctctggattc cattccccta gttacagata agacaagaat gcaatgactt 1887000

gtccaaggtc aacaccttga tggccaagtg tggttacctg taatcagagc atggggaaga 1887060
 tgaggcagga gaacagtagt gaacaggagg tcaggcacga gttcaaggtc acatagcaag 1887120
 gccctgtatc aaaaaactaa gaatgagggc agggagatat acctgtcaac aaaagtgcct 1887180
 gccaccaag cataaggacc tgagctcaac ccacagtcc caagtaaaat gtaggcatag 1887240

tggtgcaggt ctgttaccce atctggggga aagaagtaga aacaggcaga tctctggagc 1887300
 tcattggtea gccagcctag ctgaagttat gagccccaga tccagtggag agactttctc 1887360
 tcaaaaatta agatggggag caatggagga agacagtga tgtctcattg acctctgacc 1887420
 tctacaagca catttatagg tacacctgag tgcacacaca cacactcacc aaggactacg 1887480
 gatgtaactc agtgggaagag tacttaacta ccgtgtacaa ggacctatgc ttgatcccca 1887540
 aaacagaaaa aaaaaaagtg gagcctgcag aaagcagcaa agatgaccgt cagtaataga 1887600
 gagaattctc caatacttgt gatacttcca tatctgtgtg tgtgtgtgtg tgtgaatgtg 1887660

tgtgagtttc taigtgtgta tgtgtgtgta tgtatatgtg tctgtgtgag tgtgtctgtg 1887720
 ttgtgaattt gtgtatatgt gagtgtctct gtgtgtgtct gtgtgtgtga atgcatgtga 1887780
 gtgtgtctgt gtgtgtaaat gtgtgtgtct gtatgtgagt gtgtctgtgt gtgtctgtgt 1887840
 gtgtatgttg gtctcgagtg aggataagga ttttgtgtgt tacttctgtg actgctgggg 1887900
 cccagcatga tggttttgtg tcttgagaaa gtaccatata tattaagatc taggcccctg 1887960
 atgggctac cacgtcagct ccaactaagaa gtagatatgt gacttcagac aagtacctgt 1888020
 ttccccacat gtaaatgtg cataacaata gtctccacct tccaatgctg tctgagaat 1888080

tcagtacatc tccacaaaac acaaggacta gaccttcaca tgccagctcg ggtacaactg 1888140
 cacagggatg tgccctgggg aggggtgacgt cttaatgtgc aggaataata accaggtaaag 1888200
 ttaaagcaaa ctaacaatg ctgcaatgtt ccttggcagg atggtagtag aaaagtaaac 1888260
 tccaagagag acagccaagg tgaggctgat gaggttgatt tgtggctgga tcaactgtcg 1888320
 ttcaggtgac attgccattg tgtcccgacc tgtctgtga gatgctttct agcagaacca 1888380
 cctggcacag taaggttctg tccccacct acctaccagc caaggggcca gtaacagatc 1888440
 tttatcccat gcacacagta gcctcateac tccatcggag ttaccatgtc ctggacttga 1888500

tgtgatgtc ccctttccca gaggttcta catctactcc tctactgag cctggcagct 1888560
 ctttagacat agtgaggcac tatgtgtat tgfcactgt tgtgtgccc tatttgtgta 1888620
 cttectacce ttcccagtc ctccctaaatg cagggccagg cagattttga caaaagggcc 1888680
 acctcagtga ttgtcccaat ggaacacatg ccaaacacag gcaccatctt gacatggcac 1888740
 agcaataaaa tgtctttcta ggcatctct tccgtccctc cctccctctt ccctttcttt 1888800
 cttcctttaa aggggaattt tctctatttc ccaggctggc cctgagccac cgtacttaag 1888860

ctcagcatgg agactatagg catgtcactc acaggctcag agaaaaggaa gggacacacc 1888920

tgctctgcc ttgatgggc tgtgcacatc tgtctcctat gaggggagac atgagacaaa 1888980

gccttacagg attctccaag gtcaggatgt gttccctctt tcacagctgg tcctcactc 1889040

accgtgctga gggctctctg tgtcagtgat ttgctacaga gcaagaaagg aaagaacag 1889100

accttgaate taggaggfcc aatcaaaaat tgcctacctc tctagagaaa gtttctcaat 1889160

gtagttttca gccaccaggf agacttccca caaggaccaa ccttcaggta gagaaggagg 1889220

aacccttcca cgtgagagac atctgcagcc cctccgtctc ctattcaggt cagtattgtg 1889280

gaggcccata gccatatggt ttgctacagc ccatctaate ctctgttcaa caaaaactag 1889340

gactttcaaa gcatgccctt ctaaaatgct agtcaaagga catcattgca ttgtgaaaac 1889400

agaaaatgta aagcagtcga gagagaaact gccatattta caccttttgt actggcctta 1889460

tctaatagaga gcaggaaaa cagtgccagg agccatctct tccttgtttt aactagggtt 1889520

cacacacatg ttgtgtataa taatagtatt cttcactggt acataaacat aaacgatcac 1889580

acccttctca ttcttcagac atcgtgacag tccgagctaa aacaggtaac tcaactcaag 1889640

tccttgaag cacagacaat tgctatttat caagtggctg agccattaca cttgcctctg 1889700

acacgaagtc tttagaactt ctgtgggtta caccatctga tcatcgtgtt gtgatacaca 1889760

gttgctagtt tttaaacttt taggttccca atattcaaat taatacttta ctttgtctta 1889820

tagtgacaga ttttaaatca ccaattccat ataaatgcaa actgatttat cccaatttcc 1889880

aagaggtaaa ttatactatt gtgtgattgg atcttagaac agcatgaaag agcatggcta 1889940

cacacacagc agtagctcag gctctgtggg caacaaagtc acaaaataag agagctggga 1890000

gaaagggtat atggaggtag atgacaacgg tataaacggg aaggctggat gatgagctac 1890060

tcaaaatcaa acatacaaaa ctgaatcctg acccttctt ccaaaagact aaaaggtctc 1890120

acgtccagca ttgtttttaa aaaaaatcta ttctttaaaa aatgtctag acaatcacac 1890180

acacacacac acacacacca caaaatctgg taaggtcgca attctgtcat tcacaaagat 1890240

ggactttttg taaaactaca tgtgtagctg tttcttattc aagagctcaa taataaaca 1890300

gctaactctc agggaagtcc aagtcaagg tcttcttcaa acacctctc actcacctca 1890360

tccttcccc caagtccagt gaagttagta ttgtgtttta ctaatagcat gtgaataacg 1890420

tccccaaatt ctacatgagc ggcatggtgg agctgggatt ccaaccaggg tgtctgtgac 1890480

tccagacact gcactactga ccattttatt aggatgcatg tagatggatg gatggatgaa 1890540

caggtggatg agtgacacag ctatagtggc cgtgtcttcc ctgcgcttg aagagctgct 1890600

ggcaaagctg cgtatacttt ttaaaaagag ctgggtaaat aaccacacat agtccttccc 1890660
 catagcacc cagttttcat ctacagcacc ccgtttcaaa ggagcaatgt caaaagaaat 1890720
 gttggtgtct tttttgtttc cagtcacaca aaagccacat gacaacagtg ttgcagggat 1890780
 gtgagggaca ggaggaagac gtgtggggga ccgtggagct tcctgtgggc cccgggtgct 1890840
 tcctgttaga gaagaaacat ctgtcccgt gctctggcac aaactttaca tacaatctca 1890900
 agtttcagtt agtggtcggt ctccacttcc tgtcccgaac tattgggcaa gacttgggct 1890960
 tcactttcct gagacctcaa gactagggta gtagaatgcc ttgaatagct cagtgccac 1891020

 caggttgggg gaattcgggc aagaaaaaca ggtacacctg tagggagtg gcaacaagtt 1891080
 attcagatac aggactgtcc ccagacatgc cacagcacta tggacagggc aactgtaca 1891140
 gactctacac attttctggt tggatctctt cttctgtga ggtctattaa agccatattc 1891200
 atttacetaa gactctgttc agattcttcc ctactcatt gtgcagtga ttggaagact 1891260
 ttactatcca aaagcaaca tgtgtgttt tatttttatt attattttta aaaacatggc 1891320
 agtggaaaaa gccaggaag ataatattgt tgcatttga gaccagtcac ctggggcatt 1891380
 tgtgaccaga cagaatttct ggtggttttg gacatccaac ttctcacac tctctcccc 1891440

 ttaccacata tactgagct agtaaaaaat tctgaaatga gaacattgga aatatccaaa 1891500
 agccaccaga atttgtattt taaaatcagt gttggccctg gcacagctta tacaagtatg 1891560
 cacagtgagt ctgaatcaca tctctgtgc ccaactagct ctagcccatg agagaattca 1891620
 gaaaaagacg acaccaatc atcttaaaat agagaattgt gctgggcagt ggtggcacac 1891680
 acctttaac ccagcacttg ggaggtatag gcaggcagat ctgaggttc aaggccagcc 1891740
 tggctacag aatgagttcc aggacagcca gggctacata gagaaaccct gtctgaaac 1891800
 aaacaagcaa acaatatat gtatagtga tcatgacagg taagacacac tgggaggact 1891860

 cattcacaa atcaacttca tctctatgga gaataagtaa atacaaactc attagggtag 1891920
 taaactcaa tatgtaata gttctgacat cactcttagt gctaagaaaa acacacaagc 1891980
 tcgttgatgg atatcttgaa aacctaaag caaagagagt tgctttctaa tatgctcctt 1892040
 gtgaaaaagg aaaaataaca catatgcat tcctttttca tagagatgtc ttaagaagaa 1892100
 ataagtaatg gttaaaaata cttttggttc tgctgggcaa gtcactacc aatccaaga 1892160
 gagtggggtt ttttttttt ttttaaaaa aaaaagcaaa tagagcagta tgttttctac 1892220
 agtttcagtg aggtctctggg cccaaaatgt tttaaaagca gaaaactggt aacactagag 1892280

 atattgtcaa aatagtttc cctctggctc ggaatgggg agaggaggct ctagaagggt 1892340
 ggagtgggaa gggattgtcg tcaaacatt gttaatatga actgaattgc accacaaagg 1892400
 cgatgcttca acatggagaa tgaaaattgt tctgtattat catggattga caatatgaca 1892460

atcgttcatt gaaaatgggt gacagctgia gcattatagc ttcgtgcaca aggcaagatg 1892520
 aatgagtgtt acaagttctt ccagaatggg ccctatttc acaagagtcc atctcttccc 1892580
 caaataaata cacgccagct ttctactatc tcagcaaatt tagcatctct ttacaaagca 1892640
 acctgctacc agtggcctca aagtgccaat gtcaagtccc tgcttggagg atttgcagca 1892700

 gctgggaaat gccaaagtcaa aatgccatgc aagatctatc catctcctca gcagaggaaa 1892760
 gggcaagaga taggaaaatg accatgceca gatgtatgtg aactgacatc aaactacccc 1892820
 cagatccacg ggagcagttt ctggtatcag gctcaggaca ctatagtgtt agggatgcca 1892880
 tttattccaa ctactaacc aaaaagaaat aacattatgc attattcatg caaccttatg 1892940
 cctcttacac caactacta accaaaaaga aataacatta tgcatattc atgcaaccta 1893000
 aaagaacata ctcaggtaga ggtagtgtca ctagtcctta gctatgacag aaaccagtcc 1893060
 tgcttaccgc acacgcacac acacgcgcac acacaccggg gtggaggagc acagaggcag 1893120

 gcgaactgga gagacagctc agtttgtaaa gcatttgttt atgctacaag cacaaggaca 1893180
 tgtgtgcaat ctctagaaca cacataaaaa caagccaagg tggggcacag gcatgtaatc 1893240
 ccagatcctt gggagctgac agtcagcctg gcttaattgg tgaattccag tgtccaatga 1893300
 gagacttttg tctcaaaaac aaacaaaaaa aagtagatgg attatacctg acaaatggta 1893360
 ttaaggatgt cttcttggcc tccacacata tatattctta catacatatg aacaagcaca 1893420
 cacaagtaca cacaaaaggc aaaggaaaaa aaagacaaaa tccacataca atatgaaagg 1893480
 aaaagatatg tccttttcac actcagatgt tagtatTTTT attttagct tcaaatgcat 1893540

 ctaaacacat ttfacagtgt atctctgaca ccttaaacac attaattggga tatggagata 1893600
 tttggagatg tgiatacatg acaaaactaa gttaaattat ctgcttctctg taagacttac 1893660
 acatgtgttt ggagaaacat gcaaagccat ttctcctact tttttccaac agacaatatg 1893720
 gaatcacctt atagtgcaca acacctaca acttcttggc tcttctctt gcagcttggg 1893780
 acccactggt cagcccttct tctccccacc atcttcacc ctcatagcca ttattctgtt 1893840
 ccaagtcc acatgtcttt aaaagacaga atactacatg ctttgttctg atgcttgcct 1893900
 ttcttaaac tagcaattag aatactataa acatgtttgc atctcaagta tttttcaata 1893960

 gaattccaat ggtcacagat acccttccc ctacacatag cacaaagcgc acaattccct 1894020
 attgttggac atttagactg cgtccagtgt ttcacagaga aaagtaatga gactattaca 1894080
 tcacagaata cttttgtaa acctgtacgg attgtctgtg atcctgatgc atcagagaca 1894140
 ctctgaata tgggagagaa caagtgagga ggtgtcaacg gtgagcagc tctctatctt 1894200
 gaatttaac acttaccaca cttgttccag ttttctccag tteaaccgaa cagtctgtct 1894260
 tggggaagga gtagaaaaac taatatatga aaaggaaggg gaattctgtg gatctcctcc 1894320

atgcttccaa attcattttt aaacataaac ttcccctgac acatttgagt aagctgacgg 1894380

agttactgac ttactctgt gtatttccag ccaccttcta ggtatgctac aggttcacag 1894440

tagaactgca cctcccaggt ctgtgtgggt ggctggcacc atgggacttc ttttgaattg 1894500

tgagtggaat gacaggtagt aacctccaag attctctctt gtcttacaaa ccccagtaga 1894560

agatagtggt tgggtcgggt agaagagacc ccgatttac catgacaagt agagtccta 1894620

tttcccatg agctcacagc aagtatgaac aagaggacaa ttgttctta aacccccact 1894680

tcatttatta gtatgtatcc tcacttctcc tgcttgcca attcaacaac atttagctga 1894740

tttctctgtg atctctgtt ctaatctgaa atgttcacaa aaattccaat ctctctatt 1894800

cgatatagttt gaaaatgtgg caaatgacaa gagagaattt ttcaggttc cagagttcat 1894860

tacaggaggt attttctctg gtggcaattt ggggaatgga gcacttagtt acattgtttt 1894920

agaaaagtct ctggttctgc tagtactatt cctgtaagt ctgtactaga aacttttttc 1894980

actatagggg cctggagatg ggaggggggg gctgccttag gtgactgggg cactgcctt 1895040

tggaaatggc tgatggtatt ctcatagaac cctgattagt tctaagaca gtgagtgct 1895100

attgagcaag cttgacctt aaactttctg gggggttctg tgcttgcttg ctttaaaaaa 1895160

aaaaaaaaag aaaaaaaaaa gaggctggca aagtgacca ggctggcctt ggactcactc 1895220

tgtagccag gaaggcctaa atcacaatct ttctgcctca gtcttctaag tagctaggat 1895280

tacaagcctg tgcctccat gcactcacac cattgctacc ctattgatca tgaagccttc 1895340

actagaatgg gccagaggag atttggtcac actcacaac ctccaaaatt aaaagcactg 1895400

tataacctag ctggcctaga acacattaag taaagcagcc tgccttgaa ctcacagaga 1895460

tctatagcc tctgcctccc cagtgtgga attaaagggt catgaaacca tactgggctg 1895520

taaaacttaa ataacttttt aaaaatttgt tttatgtgta tgggtgtttt acctatgat 1895580

atataagcat actgtgaatg tgtctggtgc ctttgagat cagaagaaga ccttgatta 1895640

cctgaacctg gttatgagct accatttggg tactggggac caaactcagg tcctctgcaa 1895700

gaacaagtgc tcaaatcac tccaggcca gtaaaactact tttagtgaat catctagcct 1895760

tgtatatttt gttatggcaa taaataagag ggataatgag gaaatgtgaa gataggaagg 1895820

acaaaactct ggcctaaat aacttaaaat ggaggagata tagtttttaa tattccacaa 1895880

agtaggcact gagagttaac aactggactg cagagggtac ctgggccagg ggtgtcgaga 1895940

actactgggc tacaagggtg gctgggtggg tgggcaatca gactacatgg ggtacctcgg 1896000

cagggttcag tctgaaactg tttgaacagc aagctcgttg catgtcgttt tgtgcttacc 1896060

tgaagtggca tttcagggat gctgaaggga ctatgagatg gaggctagag acatgctcta 1896120
tctctataca gaggctaata ccagctgct gctgctgctg gcatgaccaa gaatgtaaga 1896180
ggttcaacc agaggagaag atacaaagta ccaaaggaga aggaaaagca tggccttagt 1896240
acttgagaag actggcagaa acagagatgg ctcacagagg aatctgagat gtgcttgtgt 1896300
ggccaagatt tccacaagga aagagacagc gtggaaggag ggactgctg aagtgaacac 1896360
acaccagaga caaagcatta caaggatcag ctgtgcagaa caatcctgca gaaacatcac 1896420
acctagcgtc tacaaggat atcaggcaag tgtgaatctt agggcagaac acctagggac 1896480

ttagagggat ttgtgcttgg cctgtggagt taggagatgg gtgtgaagcc aggattttaa 1896540
gcaggaatt ctcaaccagg aagaagagaa gaaacagaac aggtcctcgc aggttcctt 1896600
ggcaagagca tggcacctat atctgagtaa tgaagtcaga gcctgattcc cagatcagct 1896660
ctgaacatgg ggtgggggta gtataacaga gctgagctga aggagaatc gctggttgg 1896720
ccttttctt tccttttatt tattttaaac tccatagccc attttttga gcctcacttt 1896780
gtcattcata aaacagacac agtagaagac aaagatgta catggacctg acattctagg 1896840
acctgtgcac acctctggtt tagcctagaa gaaaccagaa gcaggtagaa caagattcgt 1896900

cgcgagtttt gtcttcaaat gctgtcaagg cagcaggccg cactggctat ctttgcctt 1896960
cagactggaa gggaaacatt ccagttctc aacctttgta aacatttccc agtggaaacc 1897020
cttcagctga atctcacttt agctgtgctt ccttctccga aagccattta gctttgcttc 1897080
aaacaaaaag acaaaaattt gtataaaggc ttggaaaggc agatggggag agagaagggc 1897140
ctctctctgt ggaatccaa gggaggggtg ggacagactt catcctttg acagtgcacc 1897200
caaatggcaa ctgcaggaag aggcaagaag aaatgcacct agtgaccaag tgaagcagca 1897260
ctcagcaaaa ggccagggga caatcaacc cacacaagaa ggctgcttgt acttgagcta 1897320

caaaagcagt ggetttctct ccttttatcg ccaaagagag caaacatgct ccatgaaatc 1897380
tgtgctgtcc taaggtcaga tctacaaagc tataattatc caggtaactc ggtctgatg 1897440
tttctcaaaa tatccaggtta attataggag aaaggtcatt tcctctatat aatatcaacc 1897500
ctagaactgg ctgtctacgc tggcagtttt ccagccgaga tctgcctgic atttcattct 1897560
tgtagaacag gctgtctacg ctggcagttt tccagccgag atctgcctgt catttcattt 1897620
tgttcttgaa tacaatttgc tgaagactaa gaagaatcct aatggggacg ttttaaaat 1897680
tacttttgta cgtatgctc ttccttcacc ctccaacccc cacgttctga tgatgctctc 1897740

acaagatggt atgigaaaac accctctgct aatttttaac attcaaagga attgcattct 1897800
gggaagaaga tattgtgaga cgcaaaggaa aggaggaaag tgaagaggag gaacggacag 1897860
agcgggccca aggtctccaa aactgagggtg cttaactgct gggcccttcc caagtaagaa 1897920

agagcaggag tctgcaggtc aacaaccagc ttgggctttg gcagcacggg tagtttgggg 1897980
 acaggaggaa ggcacatctc ctgaggaagc cactgttctt ttgcttcaca aaggaaaaaa 1898040
 aatggcattt atcccaagta cagcagagcg tggtaggatt cgcctcccc atcctttctt 1898100
 cctcttctt cctcccatcg ccctcgccgc cgcccttcc tgtcggaga gaaaaggtgg 1898160

 gagggggagg aggaccacc ggtcacagtc ggcgcggtgg gattctcttt cttcgcttt 1898220
 taccagccga tgggggtcag gacgetattg gttcagcctc atgtcgcgagc tggcgcctct 1898280
 cgcttagcaa cagcgagcag cggaggcagg aagcaacgcc acctggcct gcgagtgtgc 1898340
 gatgctttaa aagggaaca gaaggggaga gagaaagagc aatctagctt aacatattgt 1898400
 actctcaaga gcgaggcttc atcaggctgc taacgacggc cagccaggca aaaagtggac 1898460
 acagctctgt cccatgggca tctctgtatc accctaggta gtccacacgt agttcttgtt 1898520
 ttaaagaaca atctactgag ctgcatggga ggtgggtgga gagacggttg tctgagaggt 1898580

 gggggtgaat ccacaactct cagagagttc agtcagctt gatttgtttt cacaccaggg 1898640
 tattactaga aaagacaag taaaattggg tgtacttgaa aaggcaattg gctagtaat 1898700
 aatcatggct ttcttegttt ttttttttt tcttttttta aaattagtca acacagtagc 1898760
 tgtttctaaa tgctaaattc tatcttagtg gttgacaatt agcttttggg agagtcgaaa 1898820
 atggcaaaaag agaaacctg taaggtgtgc tgtgtgtgtt tgagagagat agtaatatgt 1898880
 atgtgatgtg aggtgtggtg tgtgtatgaa atgggtgtgtg tgtgtgtgtg tgtgtgtgtg 1898940
 tgtgtgtgtg tgtgtctctc tgtctctctg taatgatttt tgtttttctc tttgctgctt 1899000

 ttagttccaa gaggtactct aaggaggctg gggtgagctc tgaagctctc cctgtccaag 1899060
 tgaggcaggg ctccatgcca gtgacaatac agaaatgcat ccagctagtt atgtcctttc 1899120
 aaagagcata attacccctt ctggttctag atctccatac catactttag aaggattctc 1899180
 tgacttgcgt acccaactaca cccaattca ccataacatc caaggagggt cttcgactec 1899240
 aaattacaaa ggataaagta tctttctatt ttcttaggga aaaatgtagt caacatgggt 1899300
 ctttcaaggg tgtcaattgg tgccccagga caaagaccaa cactatggag ggcacagatg 1899360
 ggctacacce ccagcactgt ctcaaccaga cccagttaac cccttctgtg ctgagttgaa 1899420

 gaagccactg actatagiga cacctactgc tcaagagcag ttgtacatcg ttctccaacc 1899480
 aggttctcaa aggcagccat ttgtccact cccagacacc actgcacacc cctctcaaac 1899540
 aggctggcct cagtgcctca cactcaggcc tcctatgcag tgatacaacc tcagcagaga 1899600
 tcctccaaa gaaggacaga aaacaggttg ataaacgtcc gcaccatctg cagaatcact 1899660
 gcttaggtga aaccatgcta ttcacactcc aggaaccaga ctggtttctt ctgggaggaa 1899720
 ctgagtacac gctgaatttc acagagaact cacggagtaa agctctagtg ctaggaacag 1899780

ggttcatagg aactgctttc cacgggttgt aggggagact tccagctaata ctgtatttct 1899840

 ctgtcctgt gtagtttgc aggtgccagg gactccctcc catttggagg aagaagccat 1899900
 ttaattagga aagcaagta cagttttcta aagcctagca aaacgtctgt getgctggca 1899960
 acaaaatccc caagtgaag ggtcctgttt ccaggtaaga tcagaaacaa caatatgaac 1900020
 aatactggtt acacacatca caccacacac acacatcaca taccatactt acatatcaca 1900080
 ttccatagtc atcacacata acacacacac acacacacac acacacagat accacacaca 1900140
 gataccacac acagagacac acacatatac acacatcata cacaccacac atacacacac 1900200
 acacacacac acacacacac acacagatac cacacacaca cactgtcaaa aaggtactaa 1900260

 gcttaaagtc atattaaaag tggtgataac agctggcttg ggtgatgata aacagcggct 1900320
 caggagtctt ggctcctttc atcttgagca aagactatgc aagaagcctt cacccaaagt 1900380
 gactgcttga tgaacagaac acatagcaat gcaggaagct caagcatgac cacatatattg 1900440
 gctttttatt cccaacatc tcaccagga caactggata ttgggcctta atacatactc 1900500
 tcatttccca gacaggaaac agcgtcgcag ttcactcagg attccagagc aagccagtgg 1900560
 aagctcagag ggctcagact ttctgactta aacctgecca tggcattgag ccaccagagc 1900620
 caggtgccta ctgtgagcag cctctctcat ctctgtgtgt tcatttgtgc caatgtttct 1900680

 gagtcaactg tgcctgttt acattcctca tgaagcttgc catgctttcc tgaatgggt 1900740
 taaagacaac taatgggat gcagaaggct ttagtgaac acagaaggt tcaaacacag 1900800
 ggaaaatgga agctgaacc tgcccacca cctgcatttg ccaaattctc caatgtctaa 1900860
 acacggaagc atgtggagag tgaagagcta ctcagaaagg aatcatactc tctctccacc 1900920
 gagacaccga tccacaaggt ggtgctgccg ggaggtgggg gggttgccag ctcagaagac 1900980
 taattaagca caactgtgat ggtttctttc ttgacatata gtggtagaac acacctggac 1901040
 acaagtctat gtgacatgtg cagaacaaag ctgggtttgt gccatgggtc atccagccca 1901100

 tgtgtgagag tctatccagg gagtgacaa cgttaggaat ggcagcctcc aatgccct 1901160
 caaaaacagc tttcaaaact atttttaaata ctctaattag tttcacttaa caggaaggg 1901220
 aaataagcag tgaccagtgt atatctccct tgccttttc tttccagaa gtttctaagc 1901280
 atgaggtttc agtgagcagc actaccctaa ctgacaacac gtagtccctt cattcaaaat 1901340
 gtcagtcata tctcatggcg tcaacactaa gagagaaagg tacatagtga ggggctacac 1901400
 agtctagctg tcgatagctg gtggctctgt cacagcctg gcaagataca atttgtttta 1901460
 agaacatcac attcctggga atggagggag caccttggat gtacccatt ttgctcctt 1901520

ggagtattct agaatgcatc acacctggct ctgcttcttg ctccaagtc aggatgtcta 1901580
 tttttggagc acagtagcat acacctgtag tcttatgagt gtcacaaagc ttgtccttgc 1901640
 ttttccccac tgggccctct ggcttccaga cactgttgat ccttacagcc agcaggagct 1901700
 cctacttaag ttaagcattt caggccctcc agcctttgtt acaacatggt tcacacagtc 1901760
 ccaccacct gtatgtgcgg gggttggggg tfgtggggg ggagcgtata tgtatttata 1901820
 cacgtgtgca tfgtgggta tgcctcaatt taagttcatg tagggcacia gttaacatga 1901880
 ggatgtcttt ccccgtttcc cacctttttt tfgtataaaa aaaatatttt atgtgcatga 1901940

 gtgttttggc tgcatatgcc ctttttaaaa attttttctt aaagtgtatt catgttttgc 1902000
 ttgcaagtgg tttgtccatg tctggcccct gaggaggaaa gaagagggtg tcagctcccc 1902060
 tggagatac agctattcag acatctatga gctagcatgc cgggtctggg aactgaaacc 1902120
 aggccttcgg aagaacagca gtgctcttta accaatgact ccatgtcact ccagccccc 1902180
 ccacctggt ttttgagaga gtctctcaag gaaccagaag gtcacagatt gagagaggag 1902240
 ggctggacia tgagcttcca gagatccact tftctccacc tctccagtgc tgggattaca 1902300
 agcagatgta gctgcattca acctttttca attaagtggg gggccagtga tttgatcatg 1902360

 ggtcataatt tggtagcttt caactacaca tcaagcagtt aaagctgggg gtagggagga 1902420
 gaacagcatg attttttct tcatctctt tcttcttctc tgttttttgt ttgttttgtt 1902480
 tgtttttcaa gacaagtttc tctgtgtagc tttggagtct gtctctggaac ttgctctgta 1902540
 gaccaggctg gccttgaact cacagacatc tacttgtctc tgcctccaga gtgctgggat 1902600
 taagtcatg cgcacatccc acccgcttc tcttcacttc ttaataaaga tttctacggc 1902660
 agtaccaggc tgtttttatc actacagttc tftagataaa cttgaggtta ggtataataa 1902720
 tacttcccag ctgtgttctt actcccaggt tttctttggc taccatggg cttttgtagt 1902780

 ctacatgaat tcttggattg gtttttccga atgtgtgaaa tatgacatca gaattttgat 1902840
 gggatttga ttaaaccat aatcaattt aggtattata accattttca caattttaat 1902900
 tctgacagtc caggagcttg gaaggtcttt tcattgttta tcttcttga ttttctttt 1902960
 caaggcttg aagttttcat tgttgaagtc tttacttct ttgattaggt ttattcctgg 1903020
 gtactttatt tatttattt tttatttatt ttttattta tttagaacta ttgattatga 1903080
 atgagatatt tcccctaatt ttttttctg agttcgtctg aagcacatac atacatacat 1903140
 acatacatac atatatacat atatgttaat atatattat ttatttattt tgaatectac 1903200

 aactttatta ttttcaactag atctcaaagt ttctaagcag attctctaga aaagacttgt 1903260
 gctatttatg tctacttac gaacaaggat agtttgattt cttcaattct tgttttcatc 1903320
 ctttttatgt ctttcccttt ttttaactatt ataggtaaga gtttgagccc aatattgaac 1903380

aagacagggg agcaatggct tcttgtctga gttctaattt tagaggaaat tctctcagtt 1903440
tgcctccttt tagtacaatg ttagcttttag gtttgttaca tacagtcctt atgattttga 1903500
gctatgctcc aactactcct aatgccatga cagcatgttg aactttgcaa aatgcttttg 1903560
tggcataaac agagatgact gtgtggtttc tctcttaaag tttacttata tgggtgtgta 1903620

cttttattgg ttacacata ctgtggcata aacagatag actatgtggt tctgtcctt 1903680
aagtttactt acatgggtg ttagctttat tggtttacct atactgaact aaccttgaat 1903740
ctccaggatg aagctcacat ggttatgacc ttagtgtatt cctaaattca gttggcaaga 1903800
atctcattga aaatTTTTTc agctatgttc atcagataaa ctggctatag tttccttttt 1903860
tatgatagca aagaaatgaa cccaatctag atgacatca acaaacgact agataatgaa 1903920
aatgtagtac atatgtaaaa tagaatatta ttcaactgta aagaaaaatg agatcatgaa 1903980
atctacacga aaatggatgg acttgaaaag tataatatta aggtaggtga ctgaaactca 1904040

gaaagaaaac catgtatTTTt ttctcatatg gatcctagtt tataatatat acaagtatgt 1904100
aggttaaaaa aatggaagta tgggtataat atgacattta ggaagaagac caagagaagg 1904160
taatatcaat gatgaaaaag agtagaaaatg catgcaaaaa aatataagtc acaagagaag 1904220
atattaaact aagaattTgt tttagtttca actccgacat agttgttttg attgtttggg 1904280
tgggtaaggg aaattaaaa gtagataagc cagacagttg tgggaacaca tttattccca 1904340
gcagtcgaa ggcaagaggc aggcagatct ctgagttcaa gaggagctc caggacagcc 1904400
agggctacac agagaaacc tgtctcaaaa aaacaaaaca ataaaaaaaa aaaagtgaat 1904460

agtgaaagt taaaacccta agttagctc aatggcttca gaatggccat tatgcctata 1904520
cagaagtcca gtgagataca cagagtttta ggctaggcca ttgtttgaac ggcttcctta 1904580
aactagttag tctgttctt atttgtgagt taatcagaac aaagtcttt cactatttta 1904640
ttttttatgt tccaacttcc ttcaagattt tcttacctat gacagtatga agaaagcttc 1904700
agtcatgtgg cgtcattcat tggctagtgt agaatgtatt taatctagta tctaatcag 1904760
tccatgagct cccagcaggc aggggccctt caaaaccatc catgatctcc aagacaacaa 1904820
ggactctcca ttgaagactc tgtaagtact ggagagccac ctatttggtc attccatgtg 1904880

aaaatacagc tatggaattt ctttcaactg tagagtattt aataaatatt ttggatcagc 1904940
agatggaagc tagaaagaca gaaatTTTgt ctttatgtgt gaaaatatta ttttttaac 1905000
ttttagaact gtccaacaat aaaatagct gcctcttgaa ataacacatt tctgacacc 1905060
aaaaagtatt caaaacacaa gtgtatagcc atctgtcagg gattctgtag atggaattcc 1905120
tgtattatTTt aggtcagacc acatggctc caaaatccat tctcactcaa gaactcgtta 1905180
ttttgactga ctactctcct tgcctctccc aggcagcaca tttatctgtt aaaattaagt 1905240

gattcagtga gtttgaggcc agcctggctc acagatcgag ttccaggact ggatccaaag 1905300

 caatacagag aaacctgtc ttgaaaaacc aaataaataa ataaataaat aaataaataa 1905360
 ataatttaa gaaagatagg ccatgagttt acaccaaaga tgatcaaac cttccttgtt 1905420
 tgccattttt tgataaagta tatggatata atattaagat agcattcatt tgtttctttc 1905480
 aagatttagg atatttgcca cattccaac agtaatctga agaaaacatc ccatagcagt 1905540
 aagatttttt ttgccctat ttgacagctc cctgaagagg gtctgctcct tgtttttgtt 1905600
 tattttattt gccttgtaa aggctgctgg agtggagcca ctcatcaact gcctaaagga 1905660
 tgacatgta aataaaacag catctccatt cctcttgtct taactttaac tttctagaac 1905720

 ctgtacaatc ttaggaaagc actaaattga aaaggaactt aaaaacattc ttacctccct 1905780
 tgtggaggta aaaatatgat tcctgaaca cgcaattcca tatgactata aaaccacaca 1905840
 ggttcaaaat aacaagaatg tcttctttg agttctcata gagcaactac cacaggctag 1905900
 acaagactga aagcaccggg aacagtaagc agaagacca atttccatca atgaggtaca 1905960
 ctggccacct acaaaagggc cacttcttg ttaaaaaaca aaatgggtgg ggggtgttat 1906020
 actgactggt tttcagtgc tccagtgeca tattaagcct tcattcagtt cagcaaatta 1906080
 accagtgttt gaacaagga atgagctccc taagtttctg atccaactc ttttcagagg 1906140

 gtgctgctcc actgagggca cacagtgtac cccccgctaa cctgtcatag tctccttgaa 1906200
 tgattcagga aagaataaat cacacactgt atcttctgat cctaaacaca ggccagcact 1906260
 aataataatg tcttacaatt attaagcaat tactgtgtac aggcaccaa aggatggtaa 1906320
 atggttttta ccagcaatgg catcaaaaca gaagaaagg tagaaacagc ccttgccag 1906380
 caagactgtt caaagtcggt ggcaagaatg acacttcatg agggtttcgg gaaaaacagc 1906440
 actcaacaga gcgaagccca gcctggtcgg aattgctaat aacatctcag aaacatggca 1906500
 gcttgetatt cctgttttct taaatagaag acatctcatg gatgtccatc attggcataa 1906560

 atgtcagtaa tagacatcca ttcagggtca ggtctaaaa ccaacagagc tctttgatct 1906620
 tactgttgtt ctaacagact tccagtaact gactcacaac tcagcttttc ttctgttct 1906680
 cttctgacct acttctcatg gctgttgtcc tggatcgca aaatggtcac atgctttgtc 1906740
 atggttaaat gtgaaactgt cctcaccaca agttggtttt ttatttgttt gtttgtttgt 1906800
 ttttcatttc tcgaacgat tcccagcttc cagatggtgg agactggtaa agtaaaagta 1906860
 taacctcatt acatgcagag ttactcgtgt gatcttttcc ttttctttt tcttttttcc 1906920
 ttttaaaact cccttctgg aaagtcagaa tacagtctag agaagtttta ttttattacc 1906980

tgccaaaata ggiaccatat tttaaaaagt taaatattaa cccacaatgg aacaggggga 1907040
 aatgatgagt ctttagtaag taaaagtagc attaagtttt cccitgaatg ctttatattt 1907100
 ggtggaagac cttcaagtct ggaaggttag aaaagcgta atttaggcta gtttgttacc 1907160
 aagaagaacc tgctgtcacc aggacactct ctccctctgc ctgcttgact gctgtcagtg 1907220
 agtggaagc agatagcaga tgctgttcgt ctctgcatcc tgccctgccc ggtcttatga 1907280
 cgtctgggtg ccatccttaa tgcagcttga gctcactacg atacagatct ctacaatctc 1907340
 attatcttaa cctactcctt ttgttgtctt ttgccatfff tcaaactggt tttgttgttc 1907400

 ttcttattgc tgttccaaca ggcacaataa aacttctttg tgtaaattcc cagcctttct 1907460
 gagtaaatc tttggatgta aacatgaatt atcagtttgt taccaagaag aacctgctgc 1907520
 taccaggaca ctctctcctt ctgcctgctt gactgctgtc agtgagtgga aagcagatag 1907580
 cagatgctgt tcgtctctgc atcctgctg tccgggtctt atgacgtctg gtgtccatcc 1907640
 ttaatgcagc ttgagctcac tacgatacag atctctacaa tctcattatc ttaacctact 1907700
 cctttgttg tcttttgcca tttttcaaac tgtttttgtt gttcttctta ttgctgttcc 1907760
 aacaggcaca ataaaacttc tttgtgtaaa ttcccagcct ttctgagtaa attctttgga 1907820

 tgtaaacatg aatcatcatg ttactaactg aatacgaat ctgacccga agcagagact 1907880
 aaaggaagta catgaaaagg ggaatattta tgcgtcacgg agaggggagt ttggggatgc 1907940
 tctgttttcc acagaagcct gcatctgca tgaaaactct ggtaaaaaga aaagaaaaga 1908000
 aatcttttt ttcttcatgt gttcggcaca gttctggtaa aggagattgt cttccgtcct 1908060
 gttttctctc attgctaaca ctgtccatgt gcagaacaga atcagacaac ggtgctcttg 1908120
 agagctcctg ctgtttctac ttgaacttca ctttcatttt tgaatctttt tttatatttg 1908180
 gcattttttc agacattctt tgtcggaaag aaggagataa gtaggtaaac catcatcaga 1908240

 agcttccgga acaagaaatg aaggaaagaa aacagtatct cctgcctgtc tgaccagctg 1908300
 caatgccctt ggcattgtca caggacaga acaggaatta tacaataca gcccggtctt 1908360
 gggaagggtg ggggactgaa gaaagagaag tgtgtcga tgggcccaa gcacagtttg 1908420
 ataatgtgat tcagtctggc attctagagc atcatgaagt caattattag atattttgaa 1908480
 gtggccagaa gaaaagatct tgactactcc caaaaaaga aatgaccagg gtttaaggtg 1908540
 atggatgta caagtactat aatttgatca ctctgtatcc acatgaagaa atatcatact 1908600
 gtagcccatg aatgtgcaca acacttctgt gtttaattaat aggtaagtgc ctcataggaa 1908660

 cattgaaaga ttccaaagaa aacatttctt ggaggaatgc ctattggcag agaagatggt 1908720
 cttttctcgg aggaaattca catccacttc tgtgtcttga cttaggtaac ctggtaacce 1908780
 acagtctcta aaagtacaaa taggagcatg tgtgaaatg gtgatttcag tcaaacacca 1908840

aaagaaatgc tggaaacatcc taatctgggt ctttaaggaaa taaatacatt cttattataa 1908900
aaataattag gggctatggg attactcagf gagttaagat gcgtgtcacc agcctaataa 1908960
cctaagttcc attcccgggt gactcaggaa atagaaggag agaactaacc tccacatgtg 1909020
aatcttagca tgggttcccc caacataaac aaagatTTTT aaaattcact acttaaaatc 1909080

TTTTTAAAG acataaaata agtagctgta tgttcaaac agggattacc atatgtgaac 1909140
cagaatacag cctatggfcc cattaattaa tttgtgtaaa tataatgtaa agaatcaatc 1909200
ctccagagg ctggttggtg gattggcctt gataattca agtttgTTT taaaaagtag 1909260
tggccaagaa aagagatggg aagaatattc aaagatgttt agttttgtag aaactatcag 1909320
ggtttctatt gacattgtaa tgatgaagtc aaatatgcat ctttttttc agatagaaat 1909380
tgaaagata tctcaaatag aggtgcaaat gctttgcttc aatagagcag tttgtagact 1909440
tatttggAAC ttcaaagatc cctaagTTTT tttgttTTTT tatgtaacac caattgttat 1909500

tttactgt taaagtTctg gcaaccaata gctgggattt ggcaggaaat gaatgaatga 1909560
ataaatgaat gaatgaatga atggcaggat agcctcaaag tgacaagcc tgctggttgt 1909620
ggtggcccat gcctttaatc ccagcactcc aggaggcaaa ggcagaggca tatctctgtg 1909680
agttaaggcc agactggTct acaaaggga ttcaggaca atgagggtctg ttaccagag 1909740
aaacctggc acaaacaca cacacacaca cacacacaca cacacacaca cacacacaca 1909800
cacacacaca cacacacag agacaaacct gaactcaaag tcaaaactgt gaaccaagt 1909860
gggctgacct ccctaattt aactatagt cctgtccct gatacaggtc agtggcccag 1909920

atcttggag cattgagaag cattatttgc cactgaag gccctgggtt gttgatccc 1909980
taccaataac aaaacaaaat aaatcaaaga tttccttgac tggggcatta gaacaggaat 1910040
cactgcagac tactgtaca tgcacagaaa gtcactTcaa aggaaccaga cactaaaagg 1910100
aaagagatga gtctggtta tttcatgaat ttctcctaga aagtatgccc ctgcaccaat 1910160
gtataaagc aatgtttgaa tagtgctgtg ctttgatata gtatctctaa aggttaaaat 1910220
gtcaaaggct aggttctggt cccacagcat tattgacaga tgggtggacc tttgagatag 1910280
ggttaatggg agaaggTtag atgattgggg gcagggttg ttaggatag aaggaaggag 1910340

cagccccTcc tctctactc ttgggtccc cagtgcgtgt gaaggagca accaatcaca 1910400
cactcttacc agtatgtact gcctcaccac agatccaaaa gcaatatggc caattggtca 1910460
ttgaccagat cccctttga agttcattat ttgggtattt tgttgactg atggaagct 1910520
aacagaata gtcattgcct acctcaaca tcactgat attctaatgc ccttaagcgg 1910580
tttgcaatcc atttaagaac agacattttg tattgttcac atgettaatt acaaaattta 1910640
tacgacacat aaatggaat gtatctgcac aagccactgg atttgggca gaggattcaa 1910700

attctagcta aaatccaaag ctaggaaaac agaataatct gttcatcgaa ataggtggga 1910760

 gaagcaggat gtgctcagag aaagccatgt ttttatttca ggctaccaga aaggaataca 1910820
 atggcagatt tcatatcatc tggagctacc aaatggtagt caccttcaaa gcagattctg 1910880
 tgtagcacct acaagcaggg gttagttttc aaagccctac tcaactgtcct tctttctacc 1910940
 tcctcaatcc tcaacaccaa acctaaagac cagaatTTTT cagtgaacag tcctcacttt 1911000
 ttactagaat tgaattcaaa agaaaatgtg gtcttgagtc gttaagcagg tcagtgcac 1911060
 aaggcaactg atcacagaga gaagtctgca caatgaaaat aatccttcaa ctatgacatg 1911120
 gaaggctgca ttctctctct agttaagaga cgtactgctt cccgtacagg agggagatta 1911180

 acaagaaca aatattcctc ttagaatttc ctgtacggga gaatccaaa tggtttcagt 1911240
 aataaaagca atgaacactt ctaaccacaa tgcaaatatt ccagtaggcc aactcaaggc 1911300
 aggttacaag accaatttta taccagttta ccaaaataca ctgtggccag cagtaatttg 1911360
 tgtcaacca ggtacacctt tcacctattg aatgaacagt aaggaaatat aactgtcaga 1911420
 atggaaatgg gcttcatgag gaaggctgtt gtctctttcc cacagggtca ccttggcca 1911480
 cagcttgta cttagacttc atttggtatt ggcaaaagtc cctactagct gccagcgaa 1911540
 cagaagaaga tgacaatatg gtgcctgtat atgctgccac cagagcccag tgttttgaca 1911600

 ttgttactga acaaaactcc actatttatg aaagctaagt tgaatcaaac agttggtgtg 1911660
 gcaggaaaaa acatctgttt ctgaagtctt tttgtttagt aaggcactac ggaaggagag 1911720
 gaagcatggc actcacacca acataaatac ctccaaaca acctatgtgg gtagtccat 1911780
 atgggatcag acaccaacc agtactcacc tggcagatgt gactgatttg aaagtgggg 1911840
 cacatctctg ggggtagttt tctggatact ttcaactctc cctttataga taccaaaagt 1911900
 agtatgaate aaatagaaaa tctgccaca atggagcata tgcttttttg tcttcttaa 1911960
 cagagaatat ggacaggagg tgtaggtcca tgttagectg atatgtatga gaatattcta 1912020

 gcacatgact gccatgataa aatttacgat aactgccagt catggtggcg catgccttta 1912080
 atcccagcac tctggagaca gaggcagtg gatctctgtg aattcgaggc cagcctggtc 1912140
 tacaagagcg agtgccagga tagagagaga catagagaga ccctgtctca aaccctacc 1912200
 ccaccccca aaaaacataa caataactga tcactagaa tatcatgact aagaagtgtc 1912260
 ctttctttt ttgtttgtt gctggggggc cggggtgata caagtctct tctttgggt 1912320
 ctaaattttt gctaaatgca cagttaaact ataataacc atgaggtact ctctgacaca 1912380
 tttaatatac aaatacttc ttttaagtcac aaggggaatc actgggagag aggtactta 1912440

agaacacact ttccaagctt caggcacatc tgtatatatt gaagttgcta ggaaaatgcc 1912500
 atggctctta ttcctactg agaaaactca gcagcaact ttgaatttga ataacctgat 1912560
 cataatccat atttaatcac acaaatggac ctgtaatcct tgtagaggta ttttggggtg 1912620
 ggggagttgg ttctataaag tgcctccaga agagactgga tcaagaggca aatgatcacc 1912680
 tacttcataa gtaaaatggc attctgataa gtcactcatg acagcaaaaa tataagaagc 1912740
 acatatgagc aagatatata aaatggagtt gtaacceggc cacagtcgtc cagagtttcc 1912800
 cacagtcagt cattcaggct ttcccacact ggcggcatgt tcaagggtt tgctaatttg 1912860

 caagtgtagt tgggctagag gaggtctgtt gactttccat acttaagcac tagtttattt 1912920
 tttaaatgag tcctcagtg gaggtaaaca ctaacatga tgctttgaac ccgtattgtt 1912980
 atgcaacta acaggggcag aacctgctgt ggtctgtctt cagaagcccc agtcctgagg 1913040
 agtatgcaat agcccttccc attccctgct agaaaatgcc atctccctga tgccctctc 1913100
 tcctcacctc accaagcccc taaagttaa gtggaccct taagttttct ttctttgacc 1913160
 tctcctctaa ttactaggtt ttcaaaggc cttttgcaa ctgctgcaag atgatgggaa 1913220
 gccatctcg tgataatgaa aatctcttgc caagattttc aaatagagac ctttaaatca 1913280

 ctcgatgac atttgtctag ccatcattca ggctggagta aggcagtctc aaccaacgta 1913340
 gccttgcta gccctagcga gtaaaggcac ttaggtgca agactcttgt gcattaagat 1913400
 gtcttaccac ctacatacca agaccagaaa caaagcagaa gtaaggagtt gttttctaaa 1913460
 aagggtgtgc tagcacagtt ccaaaccac tttgtgaaga catacataag atgcaaaact 1913520
 ataaattctg ctgacattat gtagtaggtt atatttgaac atacaattta cttttctttc 1913580
 ttgtataaaa gaatggacct ccctttttaa gttttgttt gttccatcca agactggaaa 1913640
 taaatgtaac acagcaacag agccctggct tagcatttgg aagtagcatg gtaaacaaac 1913700

 aaagtaggac tggaaaaaa cagctcagtt ggtaaagagt tcttacctat tttttacaaa 1913760
 ccctggtttc agtctgtagc aaacatataa acgaggcaca gagatgtgca ccttggaatg 1913820
 ccaggaggat caagagttca aggccatcat tctcagtata caatgaattt gagggcagcc 1913880
 tgagaccata atatctgtc tcaaaaataa ataaatttct ttacatctgg ctaatctgtg 1913940
 tcgtactgta gtagaagggg aagcatgcaa ttattgtaca tatcagctgt ctgcctgagg 1914000
 gagctcttc tctacactg agtaactgat tccttctaca ctggcaatct acagcagccc 1914060
 tttactttca gagtgggaac ttgcacatcc atgactctac gctctgceaa cttcaaaatc 1914120

 ttcgagatta aacctcacc agacagtctc tgctcacctt tacaaccacc tgagttgcaa 1914180
 acagagcaga gttcattgta agattctgga cctggagtt tctgtattaa gatttttaag 1914240
 cccttagaa gagcttgact ttcaaagtct ctccatattg gaattgtaa gttcatccct 1914300

ctttcaaaaa aaaatgtcat ctgaagccat ggatatggct cagttaggaa agtgctgcgt 1914360
 gagcacgaag acctggtatc actccccagt gtgtgtctac agcctccaac atgtacacac 1914420
 acacatcaca cagacagtgt gagaagcaat cattttctc ttgaatgggg tgtccccagc 1914480
 tgacctcccc tcaacaacac caccctagca ctcccctgaa cagaaagctt tgtgaggaaa 1914540

 gagactgcaa agtggttcct ggcatgaaaa ggctgctcaa taaacacctg ctcagtgaga 1914600
 atgtgacatc ttataacttt gtgacaggat ttccctcaagg tcttctctct tggacaacct 1914660
 ctggggggcac aggattacca gcaactggct gaaacacaac atttatatgt gtcttgggag 1914720
 ttagtctgac caaaaaagac agtccaaaat gaataaatca gatacataa acatcacaga 1914780
 ctttgacctt gtgcttttca agactgactt gatttataaa gccttaatta caaaaagacc 1914840
 tgagtctgag gcctggggat gtggctcagt tagtagagcg attggctagc acatccagtc 1914900
 cccagcacca catggacctg gctgcggagg tacacacctg tgatcccagc attccctgta 1914960

 atctcagcac tgggagggtc acacaggaga atcagaagct cggggtttac ctgagataca 1915020
 tagttggaca ccatcctggg ctactgagac cctgtcttaa aaacaaaaca aaaaacaaaa 1915080
 aacagcacct tcatcacaca gcaggtctgt gctctgaacc tactctaac aatgaaggtg 1915140
 ggaatattac cccaaggagg aggctggcag tgccttctgc acacagcagg cctgtagcaa 1915200
 aggctgttcc cgagcataca gctagtgatt gacctctgca cagctctgct cctgtctgt 1915260
 ccatgccaat gctgatcctt acaaggteaa gttttctctc aagtatagac atcctagacc 1915320
 acacaggtca gcttgcccaa tttggtgctg atgtgaaaac atgcgccctg ggaaggaatc 1915380

 caggaggaaa gagctgcact tcacaccaga atactagtct attcacaatgg gaaagaaagg 1915440
 gaggaaatga acagggggga atcatattgc tgaactatct ccatgggtgt cagggatgca 1915500
 aagagaataa ttatgaaaat aataaacaat tgaattccag ctctcctacc ctccaaggtc 1915560
 accagggggc acgcagagcc gcacaggcct gtgcagagat gctcccacag gtgacagcct 1915620
 gacctggtct gaaggctaca atgggcaggc agagccaaga aggcctggat cactctggc 1915680
 caccagctgc tgcttctttt ccaggagatg ctgtccaatt gcagccctat agagccttgc 1915740
 ttgaaaccta atatctggag accggcattg agaggcaaac cacaaatctt taagtgccaa 1915800

 ttatccagac tctgaacaaa gggatttgat aatacactgg ctatttttaa tctccaaaac 1915860
 ttccaatctc ttatgtaaat gggttagggt taagactatt tacatgagta acctcaaaga 1915920
 taatgttcac acaccgttcc tgagtgatgc actgtggcat gcctttgctt cagtagcaaa 1915980
 gctttctgga atgtctgctc taatttacag gaattccaga tagtaatcga ggtaactgct 1916040
 aatgttctg acccccaggc cttcaggagg aggccttagg gaagacagag aatgaaaagc 1916100
 actaggggca gggagaggaa gaggaagaag aggaacaggg aaggaggagg gaagggaaga 1916160

gggaggagtc taaagcgatg caaagctctc agttttcatt tcctctaccg ctcagggatt 1916220

 caacttgaga ccagttatga gaagggccaa gattttgcaa gtgtcttgat aactctagag 1916280
 aagtgcctgga gacagacagt gtcaggggagg gaggctgcac acatggtgtt gtagcacatc 1916340
 cgactaacia cgcttatgtg ttattagctc atgtcccaga gcataacagc aagcacctgg 1916400
 ggtagtgagg gaggggtatg agagtctatg gtaaatcct aacacagcag tgtttctgta 1916460
 ctgtctctac agtgacaaaag catactcatt tgcattcaa ctggagacaa taaataaaat 1916520
 acggaacctt ttcaacattt aaagtgtatc attcagggaac taccacata caatgttaac 1916580
 cttttaaaat ctggctttca tgaacagaaa ggcctttccc gacttagtct tagaagtcat 1916640

 agaaggagca ttgacacgtt gcatgtacc tactggtcca agcagtcaca agcttcccca 1916700
 ggcaaacagc aaatggactt cgtaatctca agagtaggaa tgtggtaaag tcccaatact 1916760
 gtgtatggaa tattcaactg ggcttctctc agcctggcac ttctaatc ctggaagata 1916820
 gctgactctc ttgtaacct gaagacgagg gctctcacac agtgggtgtt caaaaaacag 1916880
 tttagaagg gcatcatgaa ttctctgtc agaggaaagg aacgatgtga cactaactt 1916940
 gaattttata tacaagatg tcaaagattt gtagtaagaa agtgcttgca aggtctctg 1917000
 cctaagtacc ttcagacca attggaccag ttcttaaatc tgtaaaaata ggaaagcaag 1917060

 cactgttcag tagtgagaac tctatgacct gagatgaggg tgagagaaaa acatagattt 1917120
 aaacctgac tciactactt atgctctgca tcttacctg ctgaagaact agctcctcaa 1917180
 ttcttttgt tctctcttc tttctttct tctttcttc tttctttct tctttcttc 1917240
 tttctttct tcttcttcc ttcttctt ccttcttct tcttcttct cttttttcc 1917300
 tttcttctc aatcacagggt ttctctgtt agtcttctg gtcctagaac tcacgttgta 1917360
 gacagctga cctgaactc agagatctgc ctgctctgc ctctgctcc caagtctgg 1917420
 gattcaagge ttgtgccatc accatcagge tccagctcct catttttaa acagtagcaa 1917480

 acaactac ctggctcata cacctgggag aattcaatgt atcagtcct gtaaaaggca 1917540
 agactagagc tgggcacaca ctgggggtcc caatcaacac acgctgact cgaatcattg 1917600
 ccacttaaaa gtcttcagac cattcattc ccggcaggca gtaagctctt ggtaaaccac 1917660
 ggctcttact cactgtctgc atttgtcca gcctccatct gcctctctc cacctactc 1917720
 caccaaatag tgaaggagct gctgacaaaa tgcacaatgt gacaaatcaa acattatgaa 1917780
 ctctctcatt gtcaaaaaa aaaaagagtg aaaagctcct gataatgaga ttgatgacta 1917840
 attcatatgc cattgtatag cttcatcca acagctgggtg gaagtagaag cagacacca 1917900

cagctaaaca ctgaactgaa ctgaaatcca gttgcagaga aggatgagtg aagagcaaag 1917960
 gggctccatac caggctggtg aaaccacag caactgctga cctgaataag ggagaactct 1918020
 tggccccag aaggataggt gggaaacgag cataggactg atccagaccc ccctgaatgt 1918080
 ggtgtcagtg aggagacctt ggaaatctat ggggggccct tgtagtgcac cagtacttat 1918140
 ccctagcata ggaatggact ttggggagccc atcccacatg gagggatact ccctgagcct 1918200
 agacacannn nnnnnnnnnn nnnnnnnnnn nnnnnnnnnn nnnnnnnnnn 1918260
 nnnnnnnnnn nnnnnnnnnn nnnnnnnnnn nnnnnnnnnn nnnnnnnnnn 1918320

 nnnnnnnnnn nnnnnnnnnn nnnnnnnnnn nnnnnnnnnn nnnnnnnnnn 1918380
 nnnnnnnnnn nnnnnnnnnn nnnnnnnnnn nnnnnnnnnn nnnnnnnnnn 1918440
 nnnnnnnnnn nnnnnnnnnn nnnnnnnnng ataaatacat ttgggggtaa agtcaggggc 1918500
 tagggaaggg gttccattgt taagatactt gccatgcaaa cataagaacc tgagctcaga 1918560
 tccacagtac ccgaagaaaa tgctagagtg gatcaggcct gtaatcttgg tgttcataag 1918620
 gaggaaccag gaagaccctg aagctcctgg ccagctccag gtcttgacaa atcatgttct 1918680
 catttaaaca ataaagaccc aggaagaccc tgaagctcct ggccagctcc aggtcttgac 1918740

 aaatgggaaa cagatttaaa caataaagtg gatgggatgg caggatggct cattggctaa 1918800
 aggaacttgc caccaagcaa gaaagaactg acacctccac atagtgcagt ggcacacaca 1918860
 cacacacaca cagcacaca caggcacaca cacacacaca cacacacaca cacacacaca 1918920
 cgcacacaca ggcacacaca ggcacgcaca ggcacacaca ggcacacaca ggcacgcaca 1918980
 ggcacacaca ggcacacaca cacacacaca cgcacacaca ggcacacaca ggcacacaca 1919040
 cacacacaca cacacacaca cacacacaca ccccaaataa aatgtacaaa caaccaggtg 1919100
 aaaagcaata gacaacaga tacatagatg tgtgaacaca ccaaacaccc atgagcacac 1919160

 atatatcttc atgtatatga atgtatacat ataaatatga gggagagaaa gagtgagga 1919220
 ggtggaaggc tagggtgaga gagggagaat gtgtagtga attatactgt ggggaaaagc 1919280
 cacactggga ttcttcttgt tgttgttttg ctttctttta ggaaggaaaa aacaaaaaac 1919340
 aaaacaaca aacaacaaa aaaaacaacc ctaacctgac agtgagccag actgtgattt 1919400
 tggttgtgtg aacagggcta tcgcctgtct tattcaatgc cacatttctg attgtggctt 1919460
 cagcactcag cactcagaga gtacttcaga ataattgtt gaatgagttg ctttcattca 1919520
 catgaaatca atggccggga aaggatctct ctaaatattt tagcctaagt aagtacttca 1919580

 actttgaagc tggaggtaat cgtattttaa tctataataa tcttgttttt ccattatgaa 1919640
 aatgttcccc cactttggga agtgagctta ctttttctact tcactgatga agataatcaa 1919700
 aatacagcag aaaacactga agaggggaga aatggggaag gaaggtcttt ataaaggaaa 1919760

gcaggacca caaaaaataa cggggatgag gagataggct ttgtaacaag ttcaatcctt 1919820
glaatgccag aactagagag acagaaacag gcaggggctc tctggccagc aagcttagac 1919880
cactgggcta tctgcagtg aaatcctata tcaaagagag gtaagcagca cttaaggaac 1919940
aataccaag tctatgcctt ggcttacaca cacatgcaat gtacattcac atgaaatggg 1920000

aaaacagtaa tcatgtatgg tcttcttgca actgacaccc acaacttaat tcaaactggc 1920060
cttttcttag ggatggtgcc agagtgagac ccacgcacac aataaagcct aactatacaa 1920120
tagtacctcc tccatgagaa aggacagcac taaaacaaat gctttccgat ggtcccctaa 1920180
ggagggcaga taccaccag gggttaacttc tttatgcttt agctcatgct atcttactcg 1920240
gatgtgcttg agacctgcac tcccacaaat gcttcacca ctccagtcat tagcagtgag 1920300
atgtggggat ctctccctg ctaataacca ctctgggcat ctggccttgc tagctggtgt 1920360
ggtttcaacc tggccttggg tactgatgac aacgactaag cttcccacat cagacaagca 1920420

catgccactc aagactggat gctgtagtct tcagctgaac accagctttg gggactactc 1920480
gcctaacttg cctctgctgg agccatcttg gtctgtcaag tatgttctgg tccttgccat 1920540
tgtcaggagg aaaaaactg atggtttctt aaacagctgt ctgagaggga tgggtggggag 1920600
ggcacatgtg tgcttaggct cctccctcct ccctctcacc ccaccagtgc aaacagccag 1920660
gctgcctgaa ctgttccat ccagctgact ccaactggcct cttcctggaa gcatttctgc 1920720
agctctcaga agcctgcag aggcacttgt ccagtgcctt aaacttcaca acttgatctt 1920780
gaggtgggaa ctcataatcc tacacatccc attactcatg tcaattcaca tgttaaaggt 1920840

agagggcaa caggtctcag ggatctattc cgaggagaag gccaaagacag aaggggtccc 1920900
agcgcctgaga gggggaagta gacatgagtt cccatcccta accaagatac tatctccaat 1920960
tgaggaccac ttgcaaagga aaaatagtc ttctcaaatg gactctcact gggatatacaa 1921020
accacaaagg gaggcccaca gccagtagt agattcgaac acaaaatgaa ctcaatggta 1921080
tttttgggag atttgtatct catattgatt tgttcaaaca tttttttttt ttgcctacat 1921140
atctttcact tgtatattat ggtttccaat tttgaatfff tatgctctct ctctctctct 1921200
ctctctctct ctctctctct ctctctctct gtgtgtgtgt gtgcgtgtgt gtgtgtgtct 1921260

gigtctgtgt gcgcgcgcgt gcgtatttct catgctgttt gttttgcttt cttctttttt 1921320
aatttgctg tttgttttct aaagagagaa gggaaaagtg tggagtggga agtgtggaga 1921380
agtgggaaga atctggcaga agatgtggga aaggaaacag tgaacagaat atattgtatg 1921440
aaaaaatatg ctaacttcaa ttaatgggga aaaaaagcag agggccgaga cagccacttc 1921500
tttttaatgt taagagatcc aaagtgacat atgagaataa acacaacat acacactagc 1921560
ctaggatgaa aaaaaacaaa acaaaaacct tcctttttta gccccaaagc cttatgggac 1921620

tcatgattta taaacaacag caacctaatic taaatctatc cataaaatgt actgagagcc 1921680

 ttactctttc cagatttggg aaaatgataa tctttacatt tatattttat gggactaaga 1921740
 tgaaaaagaa gtgcacatgc atcagcctat gttctcagca accagctgga cagatggtca 1921800
 agaatatcat tagttaagaa agcttccatt cattaccaga gagtccctgg gcaggctggg 1921860
 gtggggtgca agaatgtccc agaatgtgtt atttgaagaa tgtgttcgtg tctaagacat 1921920
 gagtccccgt ggtggatgtg ggggagtagg aacagacagc ctgttgtgat ccaacagcag 1921980
 ccaagagttc ctcaacactg gtgcgtccac cagacacttc cggctcccat tccaccact 1922040
 tggttgacag tactaactaa tggtaagaa gaaaaccagg aggaggtccc agtaactatc 1922100

 atgatccctc cattctaggc acaattccac ccaaacagaa atctatcata gacggaagag 1922160
 aaattgctgt ctgttggtc tcccttctca gctcataaag attgtgagac gagaaacaga 1922220
 cagcaaatga aggggtggcg agtactgagt caatccacaa gaggacccat accaggtcac 1922280
 acccaccttt ccagctcagc tectcattca taccaccag aagggactct gacagaaggg 1922340
 tgagtcccc tgcctagtc atctttctc cccctcagct cccacacce tgcctgagc 1922400
 acctactggg tatgagatgt tctgtcagac acccacaggg ttacaggaga agtgagaaag 1922460
 tggagacact cagctcagct cgtgacttta gagaggagtt tgtgagtga gatcaatcga 1922520

 cattcacagc ttctgcacaa atcagtcttc aaaatgatcc aagcattgca cctcactatc 1922580
 agtgcccgga atiggagagg tctatggaag aaatcagaga tgccttgagg atagatgaga 1922640
 gagcagaatc aaccaagagg caggtacaga gactggagca ggaaatcaga gaaaagaggg 1922700
 acagggactg tgatggaggg ctcttctatc ctctctggtt cccaccgctg cctcccttct 1922760
 ctcagccaac tactctggg ggtatattat cctagccac ttccttttgc tccttggttc 1922820
 ctacatctct tttccccat gtgtctcttc tgtcatgatg tcccgcagaa gcagctgggg 1922880
 ccaaatgate atgcacgtgc tgaacctecc gaaaccataa gccacagcaa accttcctc 1922940

 cctcaagttg cttttctcgg gtgtctgtca cagtgatgga aaatgtaact aatccattaa 1923000
 ctttattaaa gaatttagaa aagtacatac acacaacaag ttaacaaaat atcagcctgt 1923060
 gctcctaata ccaaaatcta gatatttagca aatcactaat caattaacca agtgттаaga 1923120
 taacatata tgcttcatat attttaaac atgctataaa aatgacctat tagtctttct 1923180
 agaacaatc ccccccttt ttccttcca acctagggtt gtgaaagtca aacaagacat 1923240
 tatggtggtc gaaagctctg ccttctatct gcttcataat atgaaaataa taacatactc 1923300
 aatattttat gtcttcaaaa tgaagataa tgctattat aaattaacag tagaaacaaa 1923360

acttccttgt ctgtttgcaa catcaggatg aggcatgaat acaacaatga ggaaagtggg 1923420
 accctgtggt gacataagga tgcctcccct gtccctggtat cctgtggcat ggtgtcatgt 1923480
 gcttttaatc ccaacagtca ggaggcagag gcaggcggat ctcttgagt ctaagtcac 1923540
 ctggtctaca tagtaagtc caggacagcc agggctaaaa gtaagagtct gaaaaatgat 1923600
 gatgatgatg atgatgatga tgatgatgat gatgatgttt gttataattc actttttcca 1923660
 ttctgtagat agagtctgg aatccaacag aactgaattc agcttcacc cctcataaat 1923720
 cctcgacta caggaagtca taaacagcca ggctcccgtt tgcttattct gaagcagtgt 1923780

 tataagacta tcttacagtt gccatgggat tgaatatagg gataaatgat gaaagaaaga 1923840
 aactttccag ggggcaaca cagaagcaag ctggtgacat ctttcatcaa agcgcccca 1923900
 gcccttctga gcaaagcaga gttgaaaaca aggtcgagcc tttctgcttc cagagcttct 1923960
 ggaagtgaat cgcttgtgac agcctttctt agacgtcaga tctctccctt ccatcctctt 1924020
 tcctgcactt cccaagaggg actgagaaca caaggaatgc caaggatgag aaagcacaac 1924080
 acaggcaacc cgggactgag ggggtggagat cagatctgag ggaaaagaat actgtcaccc 1924140
 acattcatgc caatcattcc caactttatc aaactactaa gcacgagcat tcagactcct 1924200

 acattagttt ggacatgggg acaaacagga ttctttcagt cattatcatt tttttatgac 1924260
 accttcacac ccctgcaca gtcccagggg taatccaaaa gtaacagggc tcaagattgt 1924320
 ttgatgtaac accagctaca tcctggtaac cagagaccac tctggactct atcagggccc 1924380
 cacctcctg aggacaaatg agcagaagac cctacgtgcc atccagcctg cctctacctg 1924440
 ccctagtaat ctgtgccttc tgaaaaaat gtaagtgatg gaaagctaac tagaggaggg 1924500
 aaagaggggag tcagcaagag tggataagcc aggcataaac cagcacagag cacagactac 1924560
 tgtggtcaca gaatccagca ctgtctctgg tttccaccac ccagatgaaa ggaactcctt 1924620

 tgtgggttgg agggaaggga ctccctaag ataccagaca caccaaggtc catcctgatg 1924680
 actagagagg agactgatgg gtggcctaga gaccactgtc acaagagagg aagcagccac 1924740
 agaggaaggc ctgggtggct gcttagctgt aaacctggt cacagaagca tccaagcaac 1924800
 tgagagggcc ccagtcacc agaaacagta accagcttt ctgaggcagc ggggtgaggg 1924860
 tgtggggggg gggcactggg aaggtagaca tgccaggaat ggagagctca gtgctctcgg 1924920
 gttactgata cagacaccat tgcctcagtc tctgatatga agggcatcct aacctgctg 1924980
 gtcttttaa gagccaactg tgggagactc tcaatcatgg acgaatggcc ttctgaaagg 1925040

 aggacggaca cataagaagt aaacaacagc tatgcacatt tatgctttgc ctctttcct 1925100
 ggagaaactg gacactcaac aatcttctc ctctcaaca agtttccca gattcctgaa 1925160
 aaacagtcaa gtttcactg tagatgagca ggcagctaat gtttccaat ggctcaatac 1925220

tagtgggtgt gaattctgca ttagtccatg tggccagcac acaggcactc aaggccagag 1925280
aggaagagga ggaagcaata cattgatatt ccgaattgtt atgaaatgt ttcaggctaa 1925340
cctggaaaac attcgaatc ccaaaggat aaatccgatc taaaataagt ttttacaaaa 1925400
agcaagacag atgtttggat ttgtttccaa tgcattaaag aaaataacaa cacgttactc 1925460

ccttgaacaa agaatttcac agtgtaaatg gtagctaatt gtgaggcagg aaaagagtgt 1925520
ttagtcactt acatTTTTga agtaaaggTt aattTgcgga aaatgagaag ttaggacgtg 1925580
tgtaatgaac ccaacagtat acaatataaa gaaccagagg caacgactac tcaaggatta 1925640
aaacaggagg caaagaagta agagaagcta aagtacattt cattcaggct ctttctcca 1925700
ttagtcatg ataggcagat atgcctctag tgatgagcat ggtcacccac aggatgctac 1925760
tcaaactata gtcactagac tcatgccctc agaacactaa caacgtttca cagaggctgt 1925820
gggtccagc ctgcattaca taatgagaat gnnnnnnnnn nnnnnnnnnn nnnnnnnnnn 1925880

nnncatgaaa cactgatttt tactaaaacc aacacatatt tttatgtttt ttagctctcc 1925940
catataagge aaacctcac atgatctctt ttttgtttg tttatagaag gaaattctga 1926000
actgagcact ctctatggg gagagcggca ttcattcttt taattattaa gcatagccaa 1926060
atatttatac atccttaaac cccaatata tgagcagtta gatgagtatt tttttcctt 1926120
tttgccttac tataaagggc tatgtttcaa ttcattgata caatgtgatt atataatata 1926180
tccctttcac tgatataatg taacatagtc ctctctagta atatttcag acactttat 1926240
ttgaatatct gtgactttat caatgccact ttgtatcttc taaacatatt ttagacttca 1926300

tttgcctaca ccctccaca aacacagaga actgtttctg aagaaacata ggacagaaga 1926360
aaacgcctc ttctcatga gattaaacac accaagaaaa caaaactata tatatacaca 1926420
ggaacttgaa cacaaatgta aacaaatag catgatccac tccttaacac catcaatcaa 1926480
atccccactg gctagctgtc ttctcaccia atagtaaaact atgatggctg gagagatggt 1926540
tccttggggt aatgtccttg ctttgcaagt gtgaggacc aagtttgaat cccagcacc 1926600
cacataaaaa gctctgtaat actaagttcg ggaggcagac ccaagcagaa cccgaatgca 1926660
atggttaact gaaataatga gctccagttt cctgagaga cattgtctcg aaaaataaag 1926720

tgggttgaag acttctgac gttatctctg gcctccacat ataccttcaa gactcaatac 1926780
actcgeccac acatatgat aacacacaca cacagagaga gagagagaga gagagagaga 1926840
gagagagggga gggagggaga gaaatagacc caaacatcct caaattacag acttgttatt 1926900
taccaatact atatgtttac tgcctggcaa gttgattcca agttcaactg gtaagtgtaa 1926960
atctccctgg atgtgtcaca gtgatgcact gaagaaggga gagtctctgg caccaggcaa 1927020
gctgcacaag aaaagacagg tcagtgggtg ctggatttga gaatcccagt agtcaacagt 1927080

gaagtcttac taatgtgagg tcacattaag agacagatgc aggcccatgt ccaccacctc 1927140

 ggaggccagg atgactgcac catcctcctg gtcctcacag gcgaggcctt ttcccatcaa 1927200
 aggctctggg ggacggcact gcagatTTTT atgctgettt cttttacatc aggtttattt 1927260
 tccccatggt aaaccccgtc aagtttactg ctcagaaacc catcttagaa aaggacacctc 1927320
 ctcactttga agaccccttt taagaaatgt caaggggcag taaacatgaa atagtatcca 1927380
 tagcaccacc aatgacaaca aaagcagagc aaagctaate agtcattccc ataaaaccac 1927440
 accctgtagt ctctcagtag caaccaatg agatTTTgtga ggggaggtag gcagtggagg 1927500
 actaggcagc tgaagacag acttctctgct gcgatgtccc tctgtgcct ctgtcctagt 1927560

 caaaagggtt ttgggggaaa agaattttt atggttcctc tgctgttcag gacccgaaca 1927620
 gcaagtttat catgcctggg gccctgtgtg ggatggattt gctcatcttc aagtttgcaa 1927680
 agtgaaaactc gaccttctac tgttcagact cagtctttaa atcaaaccac acagacaggc 1927740
 ccagcataag ggcaccttcc tctcggctg gtagcttctt ggtgaacagt gaggtgatca 1927800
 aggagacaaa cacacacagt gtaagatttg gggccccaac ctcaagggtc ggggcctcag 1927860
 gagctaaagt ttgaagtgaa gcaggcagat ttaccccaaa agccgcaaaa gcggccaaca 1927920
 gatgttctct aggacagaat gacacattc aaagatttaa gaaaaggaga tgaaaagaa 1927980

 aggaaactgg atatgcaact gtcacaactg ggtacaaata taccctaaag ttgtagatta 1928040
 gaatgactcc atctaactag taataactgg aagcagctag gctgcctgct ctgaggaggc 1928100
 ttgtttgcta ctactctaaa gaacacttta cctgttaata cactatttaa ctgttgatta 1928160
 atttaatttc ataacaaca caaatccaag agtgagaggg gtagaaagta tccctcctcc 1928220
 taggctgagg atatagctgc attgctagcc tgctttccca acatgcatga agccccgggt 1928280
 ttgatccca gcaactgacag ggcagggtca actttagcta tagagtgtgt ttgaggctag 1928340
 cctgggatat aaaaattctg tctgataaag aaatgagaag gcctccaag ccacagagaa 1928400

 accctgtctt gaataaaca aaaagaagag agagagaagg aagggaagga gggaggaaga 1928460
 gagggaggga gggannnnnn nnnnnnnnnn nnnnnnnnnn nnnnnnnnaa 1928520
 gaggaaggta gaaaggaag agggagggga ggaggagggg gaggagggaa gagagagagg 1928580
 ggaggaagg gaggaagga tggttactcc cttttttgg agaaactatg gctcagactt 1928640
 gctagtgat ctgcagaaac aagcaggga ctgaaaatac aagtgaggtc ttgcctcttc 1928700
 cctcacatct cagctcatct acaattctct cagatgggaa agaaaattga ctctcagctt 1928760
 atgcctgtaa ctgiggcatg gtggatgcc agcttccgga taaatgaaca cgcactcct 1928820

gacactcttc ggigaacctt ttcctttact gcctgggcc acagtgcgtt gggcctgaga 1928880
gtgtcctgtg gaatcttaag aagtcagaaa aacagggcct tgtggggaaa gctggctccc 1928940
agggtgaatg caaacgtcat ctgccttgcc ccacacagct ccagaacttg gaccagtagg 1929000
aacccccagg tgctccctg ctgcacaggc cactccccct gctctttact tccatttctc 1929060
tcagttttac cagaagattc tacctagtct tcctgcttt tatctaggcc aagcgatggt 1929120
ttgccaatga cagactctgg ggattttgtt ggtttagaat caacttgctc tcagcttctc 1929180
ccaggttggt aacaggcatt tggccaagc cacacctct ctaggcctga gctctccac 1929240

acaccagctc ctgctggctt caaagaagag tggcggcaaa agaaacaccc agattaaaag 1929300
acaaacctg ctgaagtga actccctctt ggtgggaacc aggtgcagcc attgctaacc 1929360
ccctccctaa gaaggtcaa atctccctag tcttggtcat tctgagaga ttggtttggg 1929420
tgaattatct gttgttctg ttttttttg tttgtttgtt ttatgacctt aagaattgaa 1929480
ctcagggcct cacaaatgct aggcaagtgc tctatcatca agctataacc ctattgctcc 1929540
tttttacttt ctgttctgt ttttctgaag acggggtctc tctatacagt cctggatgct 1929600
ctggaaatca ctgtgtagac caggctggcc ttgaactcac agagatccat ctgtctctgc 1929660

ccctgagtg gtagaattaa acacatgtgt cacaatgcca ggctttcttt ttacttttac 1929720
tagacaggat ctattagat tgtctgggct ggcttcagac ttagcttca gctgagtag 1929780
gccttgaact tgctttcctt ccacctcagc ctctgaata gcaattattt caggectggt 1929840
ccacctggcc cagcttttga tcatctcaga tgtgttccaa tctactgca atgtgatgac 1929900
aggctcctgc aaggccaac ttgaggagga aactttatca aattctacag agcaatttag 1929960
acaagcaaaa ggaaaaagc ccctcaacta ttggctcctt agtgatatgt gccaccttaa 1930020
agccaaggcc ttgacattac atgatagtcc tcagatgctt agtttgtaa aaacgctcaa 1930080

atgatttcca taatttctg ccatgtgagc agcacacca gtgtgcttgc agacacaagc 1930140
caggagtgtg tgccacattg ggctctcatt ctttgaaga gcagactact cattacaatg 1930200
ttctttattt catcatacat ctteactaca acaacagcca ttttacttt tatttctcca 1930260
tcaaaatggt caattttcca tatctgagtt tcagtctcaa actccccata ctcttcttc 1930320
tctccatctc atttctaata ttccactttc cagctgaagg tactccaaag cctgacctat 1930380
agtcagcatt tacttcaga cctctgaat gaaaaagact cactaaaaa gaaggcagcg 1930440
gaagacatgt tagtgactat ttttgatca cataagcaaa actctatttt tccagagaaa 1930500

aggaatcctt taacctagtt tgaagatgga aaaaaaaga gttagatata ctgtgttcaa 1930560
agttttgttt attctctagc aaagatgggg gaggatgcat agttccaata tttaaaactg 1930620
gatccattt tcctccaca ttaacctatg taggcgaatg gtaaccttaa agcaatgcaa 1930680

acaataacag ccataaagtt taacaaaggg tctcggtca tgttgctgtt gttgcctgga 1930740
 gatgacttga aaatgtttcc ttaaatgcc cctaaagga tatggggttg tgttggttg 1930800
 tgttgatgt ctgctccagg accacagtga atctgttagc tggttgggaa cagaactcag 1930860
 ccaattcagg aattgctcac atgccagcac cgcatagga aacaggaagg cctaagtggc 1930920

 tgttgcttaa cctgttttgt gttgctttg cttacttctt cccaagctct tagcaaacag 1930980
 gtaatgggag ttaataactt actgtgcagt cactgggctg gcccaagtgc aacagccagt 1931040
 aacttcaaag gacacactag cttggatgtc ttccacaggg gacagagcac aggccccagg 1931100
 gcttattata aaactggagg aggcagtgac ctcatcgctt ggcccctggt cacctgagcc 1931160
 aactacatt ctctctctct ctctctctct ctctctctct ctctctctct ctccctccat 1931220
 tgtacattgt gtgtccttat accaccttct tggaaaggtc atggtcccca ggctcctcca 1931280
 ccaaagcagg aaaacacaga actagagacc aagaatcctg aacatcctgt tcatttcttc 1931340

 ccttgcatct acatgaaagc atgcatgaag tacttcttta ttttaattta caacacggtt 1931400
 tcacaacaaa caagatagaa tccatgttac ctgaaatgc ccaaaggcat atagctatag 1931460
 ccgaaacact gaaattccag ttgaattgaa aagtgcatt aaaaaataa taataataa 1931520
 aaaaaagca agacactgac ttaactactg agctacagta actttacaga aggaagcctg 1931580
 ggccggcacc tatggtcaat ttccaacc gctgtggcac tttctgtct cagattcagc 1931640
 atgaggcttc tctcatctat gaagetgctc ttgaatgtcc tacacaagtg tttgttttc 1931700
 actatatccc tctggtctgc acaccagaa agcagtagta gctccagcta tgcaccaat 1931760

 gctgctcaag tctgggagca actgaactcc cttggcagat tcccactctc cacactccct 1931820
 tcagcctcat gagtgtgctg tgcaaaggac ctttgggtgcc tccctgaact ccactttgat 1931880
 acactcgttt gcttggactc ttaactctca gcagttcacc tccagtatct gtccccttca 1931940
 tctccccttg tctcagagca gttaaagaac gcactggtct aagggtcaga atccttctgc 1932000
 gcttgtacgt gctctaggcc actgatctca cctccactg agaacagagg accaggaaat 1932060
 tacagccact ttttatggga gaaatTTTT ttaaaaaagc aagtactttg tgacaaacac 1932120
 aagggtgtgt ggtgatcgag gcctaaagca ccagagtta caggctctgg cagacatcat 1932180

 gaagcctctc cactactctc tgggtagaga caattctgtc aacaagagac agaactaaag 1932240
 aggagggtgg ggaggggact aacatgtagg aaaggatttc ccaagaaatt attttcattt 1932300
 tgactcttgt tccattgat tcactgagga agagaaatgc aaacatgaag tagctctttc 1932360
 tgctaacctg caccctgat taatgggtgc tgtgtcaggg ctggccggat ggcacagtgg 1932420
 ttaagatccc ttgctgttct tccagaggat tccagctaag tccaacacc catgctgtgt 1932480
 agcttgctac cacctgaaat tcatctcca ggggacctaa tgctcctgat gtacatgcat 1932540

cacacacaca cacacagaca cacacacaca cacacacaca cacacacaca cacacacaca 1932600

cacacatfff ttaaagtttc atgtttatag gaagccacaa ttaaagttaa ggaatcagtc 1932660
ctggtgttcc gttacacaga agcatcaata caaatgataa cttaggata ttccaagaaa 1932720
gtcggaaagt atggctgttt tgtttgtttg tttgtttgtt taatgccct gaagtaaaag 1932780
tttcaacagt aaaatgaagg aaaaaatgaa gctacacaca gaaaatccaa gaaaagtcta 1932840
atccaacagt aaaataaatc ccccatattg ttgcaaaaga ctgtcaacta aaacgctttg 1932900
ttataaacac aaaatcatgt atcgcacaga acagattcca atgtcctaaa gtaacagaag 1932960
tgggctatca aatctttcaa agtacactgc acaaatgact agtgtttaga aacacttctc 1933020

ttataaaaca tgggcatgt gtcttcacaa actggtggtg tgatgtcca ggcagcgggtg 1933080
tgtattgcta ctgggtgggg cacagcatcc accccttgaa tgtctcataa ctttgcctt 1933140
cctttctatt gaagttgaat gaattcacct gaccactgg ccaaccaagc ttgcttaaat 1933200
ctaaaaatta aagtagaaa tttagaatga ctgaaagtta ttgaagtcag tgaagacaac 1933260
taccagtttc acaagggagc taaaatctc tcaaatgtg tagtctcaa tccaacacag 1933320
aaacgaatgc tataatctac gttgtcacag ttaggttgca gttctgaagc aggtaaaacg 1933380
ggggtcaaga ggtgactttc aggactgggt tctagctcag tgggttaagt actagcctga 1933440

cctgagtcta atttacagag cccacatgaa aagcccagag tggggctgg agagatggct 1933500
cagaggttaa gagcactgac tgctctcca gaggtcctga gttcaattcc cagcaactac 1933560
atggtggctc acaacctcc atcatgagat ctgttgccct cttctggtgt gcagatatac 1933620
atgaaagcag aatgttgat acataataa taataaaat cttaaaaaga aaaacaaatt 1933680
taaaaaaga aaaaagaaaa aagcccagag cagctatgtc ccagtgttca tgaggcagag 1933740
gcaggggaca gagaacggag gacaggggat ggggtctcta gagcttgcta gccagcctaa 1933800
gctgccaggt gagatctaag tcgatgaaag actctctttt tctgtaatta taatcagggg 1933860

tccacacttc tctgagcat gcttcattc cgtatcactg tacatacaca ccccagacac 1933920
agtagccat atttagtcaa agaaaatagc ttatggtgt ttaggataa tttctaataa 1933980
ctattctcat catgatgcta gatacttaat tccttacaat ctttggagt ttcaacctgc 1934040
caatggtggc acatgccttt aattccagta ctcaagagac aaagacaggc agatctttct 1934100
gagtcttagg ccagtctggt ctacaaagca agtttcagga cagccagggc tacacagaga 1934160
aacctgtctt gaaaacaaaa caaacacctg gagtttctta tgacatttag gctatgcaaa 1934220
gctttagctc tctgtaaat attaccagat tcagttggaa gtggtgaggc aggtggaact 1934280

acaggacttt gaggccagcc tggctacaaa agtgagtcc aggacagcca ggattacatc 1934340
 gtcttgaatg aatgaatgaa tgaatgaatg aacgaacgaa caaacgaaca gacagactga 1934400
 ctggtaaata aataaataaa taaataaata aataaataaa ttgttgcaag attcttctct 1934460
 gagtatgttg gaacagcaca gtgtaaataa aagtgtttgc ccatgtcttg atcatgctga 1934520
 gtttagactt ttttctaatt attaggcag ataactacat tctaaagtga tacaagtatt 1934580
 taaatatata tatatatagt caccatgtca tttttgtca actgttgcc tcaactactta 1934640
 gttgattcct tctaaagcat agaatcatgc catctgggga aaaggaaccc aaaaatattt 1934700

 gcttaatcat aactaacatt gtaatcagga caaaaaaaaa gaaacacatc tattccctac 1934760
 tgaaggaaaa tgcaattata attagccttc tgaatatgag taacaatcaa gcataaatac 1934820
 ttgttaatag gttcacacat aagcacatga aaacaaaatt gaccgggtca aagaaagaac 1934880
 acctttctct ctttcttagg cctcagtcct actgtctacc cccactccca cttctccagg 1934940
 gggaaaccca ctttctgag catggtgaat ctacctcagc atcctagggg gtacagtcct 1935000
 agtcttctct gacccttttt cttgtatccc gtaggtatct ctctaacca aatctatctt 1935060
 cctttccatg actgctgccc acggcctgcc tcacatctgc cccagctgcc agtttctctc 1935120

 tatcccatgc tcttagatct gcctccagga gcacagcct gacctggtcc ctcccacagg 1935180
 tttgtaggtt gcactttgtg caacctacaa accaagtatc ccctggttct caccaacaaa 1935240
 gcccacttcc agcgcgtca tctggacttc tttaggtgtc agcttatggc tcccgggact 1935300
 ttagtgttcg tggtgcttaa aaagatgcta agtatcctaa gaactttagg ttgggatttt 1935360
 aagctagagg tcttgctgtg cccatttcat ggcacttagt cagtaaatgt aaatttacta 1935420
 aagctaaagt cttcattcta tctttcagcg ctcagtcct tcataggaga acctgcatga 1935480
 attactaatc aacagactaa ggaaccaaca gctccatgac tgtcagacc accagcttgt 1935540

 cttttagaat aatacaccta gaaacatcag taacaaactc aaggaaaaat agcaatgcta 1935600
 agaacactct catcaattag tcactgagaa atgatgtgga atgcaaagt aatgttgggc 1935660
 cttcaaagtt taggctctgt tatacaactc cacctacagc agtcagcaa agacacagat 1935720
 gtgcgccaag aaggaatgtg ttagegagtg agactaatct acacacttct aaaagaaact 1935780
 aattcttctc aaactgttat cataggtgag cctcagttg cctaataaca attataaaat 1935840
 gagtggaagc ccgctgaca agcagccaca tgtcctaate ccatcgtaat gtggctggtg 1935900
 tggcctggac tgagcaaagg ggattcccag ctcagccagc gttctttaat tagcttcaca 1935960

 accttgggca aatcaccca cttcagcag tctcccctc ttcaagagg taataagaac 1936020
 ctttgactct gattgttttt aaagattttt atcccgttct gaggtttgac ttgtgacgta 1936080
 tgagtgttag atataagtg ttttctaaca cacaggatag actgagggaa actcaaatgc 1936140

attgtgctaa gtgaaaaagc cagataagtg gtgtgtgatt gtattcacia ggcaaacgaa 1936200
 gagatgggtg gaggaggctc aggggtcaat aggggtttga ggtatggggg ttgtatgtct 1936260
 gcagtagggg agcataaaaa tgcctttttg ggccggacag tggtagcgca tgcctttagt 1936320
 cccagcactt gggaggcaga tgcaggcaga tctctgtgag ttcaagacia gcctggctca 1936380

 caagagctag ttccaggaca ggctccaaag ctacacagag aaacctgtc tcaaaaaacc 1936440
 aaaaaaaaaa aaaaaaaaaa aatgtccttt agggatgcag tgatggaaca gttccatag 1936500
 aggcggttac atttgtcaaa gttcccagag cagcacacca aaaaagagt aacattattt 1936560
 cttacaaact aaattattta agtcaactgaa aaactatttt ttcccattct gtataatttt 1936620
 taaagatctc aacacagagta cagtgtccca agagagttac actgctctcc agtatttgct 1936680
 ataaccattt tgttgaaga atgatgagcc gatcaatgtg tcccattagg tggctgtttg 1936740
 tttttgtgg ctattgtctt taacctttcc gcatagccct ctttctcagt atgttacacc 1936800

 taatgatgaa gaacggaag aaacaaaagt ggggaaactg ctgggtcacc cagacctgtg 1936860
 tggctttcat gcagtactg cttttgtacc cctaaagtat ggggtactag acatgaccga 1936920
 cagccgtgcc acagcagta gcagcagcgt gtaatgttta atgagcgttc agtgtgttct 1936980
 tagtgtgtct gtatagtctt attgagtgtc aggaaaaatc ctactaagtg ctaagaaaag 1937040
 aagctcattt agttctcaga ataggcctcc agtgggtaat actgttatcc catttgcag 1937100
 ttgaaacaat caaatgacta gcagatggca gagtcaaat taaaacctag acagtctagc 1937160
 ctttaccac aaagatacta tactgaaaat cttcattttt aaaagggggg gagcgtata 1937220

 tgactgtggt agaggacaac ctacacatatt gttcctggga caccatccac cgttttttga 1937280
 agtctgagtc tcattttttt tggagctcac acagtaggga tctacttccc cagctcaggg 1937340
 attaccaaca ctggccacta tgcctggcct tcaaaagggc tcatggggaa tcaaactcag 1937400
 gtcttcagge ttgcaaagca agaactttac tgactgagcc acctctacag cctagaaaa 1937460
 gctttatcga actaacttac tctccttctt ggaaagacta tggcaactag tacacaaacc 1937520
 atgaattctc atctgcctt ctttcagagg acagactgaa gcccttctct aatagtaca 1937580
 agccagcttc tctgccaaa cctggtgaca tctggagag gtctacagtg gggaccttc 1937640

 aagagccctt ccaagaagat ttttctctgc caggcacagt ctcatacca gcctccttc 1937700
 cctactccca gaccgtgaa gaaagcttcc tgaatgcct tcaacaccag gcagatgaag 1937760
 acttgaactt ctgttagata ccagtttctt ctctggttac tctggtgttg catgcaagtc 1937820
 tggcctctg gatacaagca tgcctaaag cacatccatt cctattctgg aatgactag 1937880
 ctctctccta aggtaagaca agccaataaa ttctataac ccagggggaa tgctcagtaa 1937940
 aggggcaaga gggcaggcgg aaggaaacac aaacaaaaac cgggtaggcc attagacagc 1938000

acttgtaaag tgttgggcct tgcagttcca aggcagtaga aggcagatga ctggagagaa 1938060

gggggctcag ctctctcatg ccttgtttag tctgcttacc tcaagtctaa actaatcacc 1938120

ttgatggttg tttgtggcca gaatagggtt tagtggcctt tcagatgggc agagaggcgc 1938180

agcccagttc ttactagact ccccccaagg atcccacatt cctcttttagc aagcatgtct 1938240

actgggaaag caaaagagaa ttcatagttt tattgatttc tgcaactcag actgaaaagg 1938300

ctacgaacag caggaagggtg tcacctctgc tgtttattgc tacacctaac tgagagatca 1938360

gttttggaaat agaaacttaa tagaaaaaaa aaaaaaatca gagagttaat tgctgcctg 1938420

gtgggaaaga tggcaggctc ggctgaatta aggtccttca tggacaccaa accctagtga 1938480

ctgacagtta ctacatcacc tactgcaaag gaacttttta cagaatctcc aaattaaacc 1938540

aaactatctga ctaccagaat caaggacaca aatctcacct ggaaggggga gggggtgggg 1938600

ctgggaacta gatgataggc caccttgact ttctccacc cctccctctc atccctaag 1938660

tagagtcaaa tgagctgaga agggagagaa taagccacct tgactttctc caccctctcc 1938720

ctctcatccc taaagtagag tcaaatgagc tgagaagcca ggcaaggcct gtaaccag 1938780

aagcccgcct ccaattaatg tgtttattgt cctttaaacc ctctagaac ggctggctg 1938840

ctctgatcc cggaggctga agcacagtaa ttgtcactta gccacttaac tccccgcagc 1938900

ctgtctcact cactccttgt ggtctatctc tcagccaatt actgtgtca tttgcgtttc 1938960

aatgtgtgga atcagaggcc aggcccggtt atacagcaca agagaaacc ccttggggga 1939020

caggaaccta ccaagaccca caggctgacg ggtgagacac aagcagcccg ccagtgtggg 1939080

aacagcaaag gggctctctg gaaggggagg tctactgagc accagctgtg ttccttttc 1939140

gcctcttcag tggggcaacc caagaaaaga aaacctcct taagatgcca catcagttac 1939200

aaataatggt ggcaacattt aaaaagctgt agtgtgattg cagacaggag gcaagatgtg 1939260

ctgaggatta gtcaagacaa gcaagagcca cagatgtcaa ggcaggggag tctctatcc 1939320

agccacaggg ctcttcaagc aattggggag gggagagagg gggttggggg aaggataggc 1939380

ataggcaggc ccttatccct ttctggagct gcctaaagt cccagggaac tgggagcct 1939440

cctcagctag ccctacatga acacttctag aaactgtttt tgtgatctct tgtattttag 1939500

gtcgttgcta tgtgcggcat agtacagggt tgatccctc actgggctga ccaaggctga 1939560

agaatcagga gtcacaggcc agcctgggat tcacagagac tatctcaaag aatccctacc 1939620

ctctccatcg agaaaagatt ccttaaagca tagtttcaat cgaatcagaa agtcccactg 1939680

tcccccccc caaaaaaag agccaaagag ccagaccatg gtggcacata cctttactcc 1939740

caggtggata tctgtgagtt tgaggccagc ctggtctaca aaggtacaca gagaaaccct 1939800
 gtcttgaaaa atcaaaaaaa caaaacaaaa aaaccctaaa aaaaaaaaaa aatgtgaat 1939860
 ccatgtgtct agagtcagga ttggcaaagt cactcctggt gactgagtgg atcagatcct 1939920
 ggTTTTTTTA gggTggTtcc ctctgcctcc ccaataaaag caaaattccc cgcactgtat 1939980
 tatggctttt attcAAAag gtttaacca ctctgtcag cccaggtagc ttcttagctg 1940040
 aagttaatta acttagccca ttaattggaa cgcacttgct ctacctaagg gagacacaca 1940100
 gagcctgacc actggaggta gacaaggaag ctgaggcgca ggcagggtct ttgggagcag 1940160

 agctaacaca gtacgagtaa gactactgtt gagccaacag ggagatagag gaccagccag 1940220
 aggggtgggg agccaactaa ctccagtttg tatctccact gagtagcaag gaggccataa 1940280
 acagtaagct tcctcagaca ttccattctc cacaactcgg caaccaccag aggaggcct 1940340
 aagccggaag agacctgttc tagctggatc tatctccgcc tgtctctagg ttgaaaataa 1940400
 aactctgaac ttctctgcca atgagctctg ccaggcccga tgacgtcctg gtgcgtcagt 1940460
 tctatttga ggcaaggtcc ctgtgcccc aagtggagg agtctgggaa gaggactcgg 1940520
 ggaaggtggg cttctgtgc acagacgaga ttgagaaag agccgctggg gtgccagtaa 1940580

 ttgtctacgt cagcaagggc tgtgccatgg agagtgggcc cagagagagc taattgctat 1940640
 cctcgggcta tgtctcctc attgaatacc agagcgggaa atctgatctc tgcaaagcaa 1940700
 aggaaaaatca ccagtgaatt aaagcaaggc agcagtctgc ccacaccgac cacagcctcc 1940760
 catttgcctg gtcttgttat taagaaaatc tataaatctg gagctactag atttcttgc 1940820
 catttctgtc atcacattgg tgacaattga gcatggagac tgactccca tataaaaagg 1940880
 tggTcccagg gtgaacttca taaggacccc atgagtctaa ctttctctc ctttccgctc 1940940
 tgagtttga aggtattttt tattattatt attattatta ttattattat tattattcca 1941000

 gctgaacaat catgcaacc gctcctgect tgetttctcc ctcttctcc gctgtttct 1941060
 cagctcatta atagctgggt ctctgggtcg tgaagtgtgc aataagctgc tcttttctt 1941120
 ttgtctcacg gccaaagagac tctggagagg caagtctctc tcctctggcc ctccccactg 1941180
 tgagtacag ccagtgagg ctttggcagc ctgccaccga tggccaagaa catcgagctg 1941240
 tccaatcagc agcacggatc cccgcccact gagaacaagg gagcaagcag ctttcttca 1941300
 gcttggctgc tgccaccaa ggtctcaga gctgcctcca cctgtgttcc tgcccgttc 1941360
 tcaaaggact tcacagagta cctgccttg ggttcatcct tctgcctg getccgtcag 1941420

 attcaattg acacaccggg aagagcctta gtcctccca ctttaccact ccagcatttt 1941480
 ctgctctccc agtcttgaca gaggaaaaaa aaaaaaatca atggtctgt catttgtggg 1941540
 ttatccatgg tgttagaaa agcctatctt ggacttcagt gcctctctgg gccccacag 1941600

ataccccaca gatacacagg agacgatggc ttctatctaa agagaccctc tgactgatgt 1941660
 tccccaggct aggctcttac cccctcctca tcttcactc cacctgcaag ctttttgcac 1941720
 tttatttcac tcacatttct caaatccagc tcccagaatc cagagatgag atcccagccc 1941780
 cttagcccaa gccttcctcc tccatgtctc ttacacaaca ccaggagaga gttaaggctc 1941840

 aagatctact ctgtcactgt tccaaacccc tcagtgtggc atctgaaagt ggttccttc 1941900
 cacagacacc atgctgactc ctgcaccaat ccctgttcc actgggaatc ccccagcccc 1941960
 tgctcagtct ccatcatccc cacagatcag gcctcctac cacttcaccc agctaaaccc 1942020
 atgagtttgc tcaggcgctc cccatctgga ctaggctaca tgcttctcct ggctcctata 1942080
 accctgaaac acatttcaga cattgcactg agttcacagg gactgcgtcc aatatctctg 1942140
 ctgagtctca gaaccagtg gcacacatg gacacctgtt acaaacagta gattctcagc 1942200
 atttgggata ttggatttgg actttttgga ctttcagatt actggtggat gccatctgtt 1942260

 tcttaccaca gtgcaatcaa tcaatacctg agtctgaatt agatccactt gggagtatc 1942320
 tatttaaagg cagcagactt ccagacacca aagaccgagc ctatgtaacg tattttgtct 1942380
 ggcaacgtct ttgctttggg gtacttaaca tgatgaagac aatgacagtg acaatgacgt 1942440
 cagccatgac aggaagtggg agatgattag acatcccttt attctctgag gctgtggaac 1942500
 tgcttaaaac agcccaggat gagtacaga aagacagctc acttatcttg aaatctaac 1942560
 taacccaaat ccagcctgga tcttcagtca gccatgcttc tgagaagaca agatatgtac 1942620
 ctgaaagtac acacaccaga gcttcagttg agaactcatg gaggagtgc atagcctgcc 1942680

 ttcagagtac ttttcttgc tttaaagtct ccttgaggga ctgaggagtc agctcagtgg 1942740
 ataaagaact gagtctgagg actagggatc gtatccccag cacctggata aaatgctgga 1942800
 caggcatgat agcccactg taatcccagc atgcaggaaa taatgacagg atccctagaa 1942860
 caagctggat agttacacta gtcaaattaa tgagctctgg cttcaactgg gagaccctgc 1942920
 cacaatatat gaagtagtca aactaacca atggagtgca catacacatg tgcacagacc 1942980
 tgaacacata cacatacaca cgcctgctc cacacctgca catacacaca attatgtgct 1943040
 tacacacata tacctacata catataaaca tgcagacaca tataatgca cacatacaga 1943100

 cactgaaagc aaaatccata tccccttcat tagtgtaatc tcattcccca agaacaaaa 1943160
 tagcagagga gcagagtaga aattggctcc cagggaccac catgaacttg ggagaagtat 1943220
 taaccacaag taaaagggga cagagacaaa ctttaaggga ctacaaagac agcatgctga 1943280
 gacatttcac atttagaaca acgagttcta cacagaatct cagacccaaa tgacagcagc 1943340
 acatgctgtt acaggtagaa tgctttctcc acagcgatga cagagataat gagagaggcg 1943400
 atgcttctgc agtactctgc ttacaaagga catctagagt agtttgttcc tatcaaggag 1943460

gcttcatgaa atcgtgttta tcattaccaa agcagcctgt atttatactg acatgacaga 1943520

ggcactggag acatgagcca ttactttgct tcacctgagg tttggagagt caccattcca 1943580

caggccttgc ccatcaagag tatgcagctt aaaggaaagc aatactcatg ggaatgcatt 1943640

tgggtaggca tttatttta atgcatgaag aaacaaaac ctaccaaata caagatgagc 1943700

tcctgatcca tgaaaaatgc aaagggacca tggggataag ctgatctgat gaaagagcaa 1943760

gagatgaaag tatttcaagg cagttcaaat tgggaaacaa ttttctgtta atagaagagt 1943820

ctcatgtagc ccaggctagc ctgaaacttg ctccatagcc aaagataacc ttgaactttg 1943880

gcctccatct cacaagtctt tgaaaaatgca ggcatgcatc gttgtgcctg cttttatgag 1943940

gcgctgtgga ctgtaccag gaccttgcaa atgctaggtc agcactccct ctgtccactg 1944000

cactacatct ccagaccttc tctggtagct ctgtcttctt cattctcttc accccacccc 1944060

cttatctcag gtccctttgtg tacagaagca gcttgggaaga gggaaatgat gaaaaccaga 1944120

ctttctttac ttcatgagag tcacacagcc gccatttccc catgcaacca aagaaaacac 1944180

aaggaagaga ccacaaggga cacctggtta ttgttcagca aagggtgggat ggaagacgtt 1944240

aacagactct tgaattttac aaaggagaaa ctcccaaaca ggatatttca agaaggaatg 1944300

aaatacagtg tcggcagggga gagagagaga gagagagaga gagagagaga gagagagaga 1944360

gagagagaga gagtccctta aatgatatgg agagagaagt ggagagaatg aagggaagaa 1944420

gctgaagtta ggigtcttact gacccttctt acaaaactgg aaacttcatg gctgtgtctt 1944480

tacatccact tttcttctct gtgacaagat ggaagtaagc atgtgtcata aggtggggaa 1944540

tacacatgac tgcaatgttt tcaacactgt atctccagtg gtgcttctga actggetgtc 1944600

actaactggt gtigtctttt gttaccctgc ctgcattaag aaaatggtct agaaaaataa 1944660

cttatttaaa gtaacaaact tccaaatctt ccacacttta ttttcccctc aacaacaaag 1944720

tataagacta aaagaaatga aaatatgttc tgtatttggt caacactgtg agcttgatec 1944780

tgagagtctt taaaactctg attttcaaat tgaggtaaat tctattttgc acatataaag 1944840

tgtgccaatt tacactgaga taatattttg atgaagaata tttatggtgc actcaaaaca 1944900

tctgcagatg tgccaaggtt tagagctaga gaaatctgag ttggaatcct ttgttatata 1944960

taagctgcca gccttgctct ggtcactcaa ctctctgga cactgatctc ttgatctgtt 1945020

gaacagagaa ctgagtttgt tgtcaggaag atttaatgag agatcagatg ccaaacggtc 1945080

agtagtttgg catgtggcca ttaagcatca gtcagtcagt acatacattg agcatccacc 1945140

atgtgccagg ctttatctga ggcatgtacc tgcaggcgac tcaacaacag aaaagagaac 1945200

caagatccct tccttctctg ctcccttcat aagccatccc caggagctaa caaacccacc 1945260
 accaaaacca agatttcagt gtagcctgaa acaagggttg tatcttcaag tgagctctag 1945320
 cctatggccc agaggctctga gcacaaacac cccgtggcta ctggttctta ccagctatt 1945380
 cacctgagaa caggaaagta gaggtctgga gagaccagc ctgggtgcag acagtacag 1945440
 aactcaggag ataggcattg ctgtcccttt tggctcttaa aatgagaaag gcgatttatg 1945500
 gggggcagga tatgaagtgt gtgtgtgggg ggtaattgt ggctctactc agaggaagct 1945560
 ctcaaatgaa ctgtccatt gtttctgaac tctctgagtc atttcaatt ttctcccca 1945620

 ttcttccca gctctcctt tgggtctctg tgtgttcattg tgggacacaa gagagtcttt 1945680
 gtaagactct actgtgcaat aaagccagat atcagggcaa gaataaatgt gcaaacaga 1945740
 gggacagtaa aattgatagg atttgtgtat tttctatact ttcttatcta caacattca 1945800
 cttaatagaa ctggcaact tgcaacaaca acaaatgtac atgtttataa aactaactat 1945860
 atgcaagagc tccatgtgct tgatccacat gcaatacaca cacaactcaa aacagaaaac 1945920
 atttctgcaa agccaaaaca caattctgag tccttttttc ttgttactaa cacaaccca 1945980
 gccacctcat ttcacaagta agaaacttca attcttttca ttaggtgagg cagtaaggga 1946040

 ttatgggaag ccagaggcac tgtgaacca atatacttgg tcttagatct caaccctgtt 1946100
 cacttctcac tatctaccat caagaaaggt tttaaatgtc accagacctc attagcctca 1946160
 tctgaaaacc aggtttttgc aaagaactaa gtaaaaagga cacaaggaga ggctcctaaa 1946220
 acagctgtct tccaaacacc ctttcccaa tattcacct caaaacctt aattccctcc 1946280
 attttcaccg ttgctctctt tgcccatagt cctccaactg gtcttcagcc tcttgttggc 1946340
 aacctttcta cactacttag ggtctgctat tagaagcatc tctccaagct tagaaatttg 1946400
 atgacggtac tctctgcctc agctcttgct atggtaatca tactcaaac aagtctatat 1946460

 tcagaacaaa atccacatgc ccccagteca tccgtccagg tteattcttc ctgccccta 1946520
 tgtgaccatg gtccccagtg cccctaagca tcgttctctgg gacacacat cttctctgtt 1946580
 gcaactgact gtactttccc ccaatgggtg agaccatcac actaccctc ccatctgcag 1946640
 agaccttgt cccctttaag gctagcteca gttccattc ctctataaaa getgattaca 1946700
 aggggttaaa ctigtgact ggtaatggct tctgtatta actacagagt tatgtgtaca 1946760
 acgtcactta actatgggtt cctgtaaaat caaaatfaat tcacattctt tcttattaca 1946820
 agaggaaaat accagagcac agatagaatc aatcaaagc aaacccaat ctagcaatgc 1946880

 aaatagctta gttccaaca tctggaactc actcaggatc agctgggttc caaagcactc 1946940
 aggtgtccta tctctgcagc tctggcagcc acaacacatg tagcttgtgt cgtgcgctca 1947000
 gtttggctcc tactctacac ttgctgctat gcttggcggg tctccacag tctgtgctac 1947060

tccccatgc tacaacttca tggcaactgc atcttcacca gtggcctccc ctggcctctc 1947120
 acaatgccag gcctcagttg ttctccatga cctcttcaat catgcagctt ttatgcagcc 1947180
 caaaccagca tcatatggga tacctacaga ttatcaagtt ctgctgacag cttgagatgc 1947240
 agccctgacc ccctcggagc acagtttcta tgtgttgatc ctaaggaaat acttcagaag 1947300

atttcaactc aataattctg gtctcttatt aatcacagct ttttctgag cctcagcaaa 1947360
 ccagcatcca ttgttctagt aaagcaaaag gtttcacttc catagtctta atacaaatat 1947420
 cgtacaactg accagcccag agggagtctg cttccctctg aaactacttc acaatccagg 1947480
 cctccattgt ctgcatttct caaaacactc ccattcttca atctcccaca aaacagccca 1947540
 ttaacctaca aacacacaat ggcttttcca gcccaaaatt caaaatattt ccataatcct 1947600
 ccctaaa 1947607

<210> 34

<211> 391790

<212> DNA

<213> *Cricetulus griseus*

<220><221> modified_base

<222> (704)..(794)

<223> a, c, t, g, unknown or other

<220><221> modified_base

<222> (9078)..(9244)

<223> a, c, t, g, unknown or other

<220><221> modified_base

<222> (44693)..(44963)

<223> a, c, t, g, unknown or other

<220><221> modified_base

<222> (45342)..(45477)

<223> a, c, t, g, unknown or other

<220><221> modified_base

<222> (48698)..(50192)

<223> a, c, t, g, unknown or other

<220><221> modified_base

<222> (51138)..(51155)

<223> a, c, t, g, unknown or other

<220><221> modified_base
<222> (64010)..(64165)
<223> a, c, t, g, unknown or other
<220><221> modified_base
<222> (64567)..(64612)
<223> a, c, t, g, unknown or other
<220><221> modified_base
<222> (65959)..(66278)
<223> a, c, t, g, unknown or other
<220><221> modified_base
<222> (90948)..(91074)
<223> a, c, t, g, unknown or other
<220><221> modified_base
<222> (108207)..(108269)
<223> a, c, t, g, unknown or other
<220><221> modified_base
<222> (167041)..(167465)
<223> a, c, t, g, unknown or other

<220><221> modified_base
<222> (182712)..(183553)
<223> a, c, t, g, unknown or other
<220><221> modified_base
<222> (184965)..(184996)
<223> a, c, t, g, unknown or other
<220><221> modified_base
<222> (207113)..(207168)
<223> a, c, t, g, unknown or other
<220><221> modified_base
<222> (209614)..(209643)
<223> a, c, t, g, unknown or other
<220><221> modified_base
<222> (229668)..(229719)
<223> a, c, t, g, unknown or other
<220><221> modified_base

<222> (275283)..(275403)

<223

> a, c, t, g, unknown or other

<220><221> modified_base

<222> (299067)..(299339)

<223> a, c, t, g, unknown or other

<220><221> modified_base

<222> (308102)..(308148)

<223> a, c, t, g, unknown or other

<220><221> modified_base

<222> (339612)..(339638)

<223> a, c, t, g, unknown or other

<220><221> modified_base

<222> (389339)..(389395)

<223> a, c, t, g, unknown or other

<220><221> modified_base

<222> (389699)..(391687)

<223> a, c, t, g, unknown or other

<400> 34

ctgcctgttt ctgcctcctg agtgctggga ttaaaagcat gtgccaccaa cgctgcct 60

gtccacact ttttaattgg attgtttgt gttttggaga ctagcttctt gagtttttg 120

tatattttg aaatcagttc tttgtttgat tcggggttg tgaatatctt ttcccagtct 180

gtgggctgcc atttgtctt gctgactgtg tcctttgcct tacagaagct tctcagttc 240

aggaggtccc atttatcaat tgttgatctc atgtctgtgt tactggtgaa atgttcagga 300

agcagtctgc tgtgccaaat aattcaaggg tattatttac cactttctct tctaataagt 360

tcagtgtggc tggatttatg ttgaggtctt tgatccattt ggacttaagt tttgtcatg 420

gtgccatcac catgaatcta tctgcagttt tctacatgtc agcatccagt tatgccagca 480

ccatctgttg aagatgcttt ctttattcca ttgtataaat ttagcttctt tgtcaaaaat 540

caggtttttg taggtgatg ggtagtatac agggttttca actctattcc tttggcttac 600

ctgtctaatt ttgtgccaat accaagctgt tttcaggact atagctctat aatagagctt 660

aaagtcaggg atggtgatgc ctctggaagt tcctttattg tacnnnnnnn nnnnnnnnnn 720

nnnnnnnnnn nnnnnnnnnn nnnnnnnnnn nnnnnnnnnn nnnnnnnnnn nnnnnnnnnn 780

nnnnnnnnnn nnnnacacga taacaagaat ggagatatca taatagagg agacattttt 840

ggtttacaga gacgtcaggc actagagaaa tatctggaga tctgcaaaga tgaccaaac 900

 taacaatctc agcaacagag gctacattaa atgccctccc ctgaataatg agatggatga 960
 ctgattcata tgccacctga tagcctcat cctgcagctc gtggaagtag aagtagacac 1020
 caacaactaa tcaactgaatt gaactggaat ccagttgcag agaaggatga gcaatgagca 1080
 aaggtgtcca gaccagcctg gtgaaacca cagaaatagc tgacctgaac aacggggagc 1140
 tcttggtacc agagtgatag atgggaaact agcatgggac tgatccagac cctaggaacg 1200
 cgggtatcag taggacacc ttggaatct atggggcctc ctctggtaaa tcattactta 1260
 tccttagcat aggtgatfff gggagcccat ccctcatgga gggttactcc ctgagccaag 1320

 acacatgggg tgggcctagg acgtatctta aaggatatga cagactctga taacttcta 1380
 tggaaaggcct caccatcctt ggggagcaga aagggtatgt gatagtaag gttttagtgt 1440
 ctgggggggg gagctgcaat gttgctcga ctcactgagc tctgtcttc tcttgcctt 1500
 gtattcatct ctagtctgg ggcttaggtg tgggatacca agtctctgaga tcaccttgt 1560
 gtgagctctg ctctctttt agactgaatc aatttcacgt agtcaagggt ggccttgaac 1620
 tgacagatc gtctgcctc gcctcccag agctgggatt aaaagtgtga gccaacaatg 1680
 cccggcaca tctgtttct aattcaaat aaaaataaaa ataaaaataa aagctttact 1740

 aaaaattgt gttctttgg tattaactc atactcttg tacttaactg ccaacttttt 1800
 ctgtatcatt tagttttgta ctaacttgt actgtttgt tcctcatggc tttgaggacc 1860
 tcaggcaata ttttgaacc ttgtcatata atatgctatg tcatcacagt ttatattagg 1920
 tacatactgc catgataaaa ttgtctactg atgattttc acaatttaac ccataattaa 1980
 ttgacctatg actatattgc ttttaatgca gatattctcc ttgtgtcttt catgctggct 2040
 ttgttcatg aaccctgag catttgtat agcactttca agaatgttt ataactttt 2100
 cagtttaact ttatatttt ttgttttat tgtatgaatg tttgtcttca catgtgtgtg 2160

 ttctttgcat acatgcatga tgctctata tgcagaaga cagcagttcc cttgaaacaa 2220
 gttaaataga attgtgagcc attgactata ggttctggga agtgaattct aatcatctgt 2280
 aagaacagaa agttcttta acttttgaga caactttcta gtcacacact tcatttttaa 2340
 agataaagt gcaataataa caaacatga gtcaaatac aagaacaaac ataataatta 2400
 tgagctccg agagagtata acacatagta aagacctag attttctta atacgtcac 2460
 ctctacatct acttcagatg catgtattcc aaggatgaa tgtttatggg tgcaggataa 2520
 tattcttcaa gcagtaagtg tgtatgacta atattcaca aatgtgtcta gacagaaat 2580

ttgcaaagtt ttcttgaatg tagggaatga atgagttagt gtttggttta gaccactatg 2640
 catgaatag atacatatag tctatcttta atccaaagca aacctgggtgc tggacttgtg 2700
 tgtaatcttt tttatttaa ttccttaatt attactcata tttacatatc tgttccccca 2760
 ttcccttgcc ttcccatcct cccaagttcc caaccaaccc ctcccaaccc atcctccaac 2820
 tccttaccag ggataatgag accctccacc ttcaaaatct atcatatcat ttgggggaag 2880
 gccgaggccc tctttgctgt ctctgggctg caatagtatc tctccatagg gaatgagctc 2940
 ccaaagtcca ttigtgctgt cttggcctcc tcctggcac ccacattcag aaggcttgg 3000

 ttggtccaat gctctttccc cagctttatg actagggtct ccatgctctc actaggctcag 3060
 atcaactgtt tctgggagtt tctgcagccc tgccttggct cctttgctca tcctcctcc 3120
 ctttcacaa ctggattcca ggagtatggt tcagtgtta tctgtgggtg cctgtttcta 3180
 ctttgaacag ctactgtatg aaggttctag gaatggtaac caaggtatac catcaatctc 3240
 attatagggg agggacatca atggcatctt caccaccact gcttggattt ttagttgggg 3300
 tcatctgtgt ggatcactta acatttccc tatgccagat ctctctaaaa acctgaactg 3360
 ttccctcta tcaaagcacc tcttttcttg cctcctcta ttctccct gtctcagtct 3420

 tgttctccct cctccccttc ttcccttccc accctcttcc tctccaaccc cccatgttcc 3480
 cactttgttc aggggttttt gtcccctct cctttgaggg actatgcaat ctcttgggg 3540
 tactcctgt tttctagttc ctctggcact gtggattgtg gactggtaat cctttccttt 3600
 atgtctaaaa atcatttatg agtgagtaca taccatgttt atctttttgt gactcagtta 3660
 cctcactcag gatggtttct ttttaagaa gcatggagt t aaggagattc ttaggtatgt 3720
 gtatgtgctt gcaaggcagc cactttgtaa gaaccaattg ttgaattcat tgaagtctct 3780
 agaccatcta ccaagaagct atttagaatt ttcttttagg tgaagttgac aatgagagga 3840

 atcaattcaa gaagccagtt ggagtcattt cattgtacaa caaaacactg ctcttgccea 3900
 gcttagtcat tatcaacaa ccaagcagcc ttaccttgg ggtcagatgc acaggttga 3960
 ggcaggagca agggttcttg ggaaattctc tgttctata ttttctttt cagatgctat 4020
 atagaggtag tcaccacatc agctgatgaa accagatggg ttggggctca tgtaataata 4080
 tacttcagat aattaaaaca ttttaacaat ctattttcag aaagatagtg agtaaatggc 4140
 aacatatctc aaaaaataa agtcaagtag tatccactat tcatttgaat tgattggaaa 4200
 ctttgaatat atataaatc agtaatgaca caatttatg aaaacattt tctagttaa 4260

 tttcaataaa atgtttgcca tattttctgc attctgctgg ctttagatct cctgactctt 4320
 gtctccattt gaagattgag aagtatttca catcttttca cttgttgaag agaacaata 4380
 gcaattgggg ctgcttttgt gatggatgaa tgaacttcat ctccctgaat cctgtatca 4440

cttgagtcca ttigtittct gcagcgtgct tggctgccac ttccatgccc ccaaacttgc 4500
 ttcagcacc tctctgtgt ttgccttctc tcaactgatt gctgaaaagg aagcagctgg 4560
 tatttccaat tctaaccatg gctgttcagt gctaacctca ggttcagact acagatctgt 4620
 tgctggttgc tcttttctct ttttctggaa aatggcattg caactcttgc tgctattttt 4680

 aaactgttga aagctcaata gtattttctt attcctatga gaaagtagta gataaaataa 4740
 ttaattgaca ttaacacaat gagcatttat ctcatgggt ttacaaaata ttcttaatta 4800
 aattaatatt tatttcaat gacatctaac aagtcttttag tgccaaacaa taacatagca 4860
 gagacacata agaaacctca gagagaaatt gtggtgtgtg tataatttgc tatgtggttt 4920
 cagggttatt aaatctagtt ttgagagaat ttactcacca tgttaagaat tctggaaaat 4980
 aaagttagta acatttgtgt aatatggata tagttcacca atccaaagct tgttaagtaa 5040
 gtacaaagat ttcagtctgg atccctagaa aatatgtaa aatgccaaagc gggcttgggtg 5100

 gttgctgtta ttatagcctt aggaagcgat gataggaagt catcagaatg aattgcttca 5160
 caagacaacc acaatggaga gcactgtgtg tgatcagtga ataaggcaaa gaacattgat 5220
 aatttgtgge atggaacttg gatctctaaa tggaagaaga catcatgtct catacctgtg 5280
 tactcacacc tgcataagca tgaataaata tactcacata aaacacacat gaaaactgga 5340
 caaagtaaga aatcatgaat gttattattt ttcatcatcc aacaaaaaat tgctgttate 5400
 acttccatat acatgcttac tctgaaccag aatttctgat tctcatcag tgggatttat 5460
 gcattttccc aaagaatcag tccaatggca tagttgtata caatcatagt taggcaatc 5520

 catgttcttt cctttaaacc tttgtcctat aacatttctt tagttagcaa cataattcca 5580
 gttcatttga ttatcaggga actagagtct tgttttagtt ctctaaattg atcactgacc 5640
 aagtggatca caaatgcaga aattgatttt ctactgttc tgaagactgg aagtctaaaa 5700
 tcaaggtacc agcaaggttg atttttttta aagcctttat ccttgactag taaatgattc 5760
 ctttttacct agctgctaat caatgtatgc atccgtagca cttatattat atctaagat 5820
 gatactgtgt ttcttgggag tcttgataca ttcaatatac tgtttagaga aagaggaaaa 5880
 gtgccatct gaggatgaga ttgttttcat gtacatgtgg gtttctgtgt ttctgtgtgt 5940

 atgccctgt gtctatgact ttgtgaatat ggtgtgtgtg tgtgtgtgtg tgtgtgtgtg 6000
 tgtgtgtgtt tgaagtggag gattttggga ctgagagaa caacttacct gaaatttaca 6060
 atttttcttt tgatttcttc attttcttct tattcatggg tgtttctatt ctttccatct 6120
 actttgcttc cctcttttca ttttttcaa ctctctttc tttcctttca agcacagtat 6180
 atgctattta gaatatgtag caatgatgct gacagcagaa tgaattata tcatgtaaaa 6240
 attaaaggca agataactgc atgtggtata gggcatgagg tcattttcga attaatatca 6300

catttaattg ttttaaaatt tagaatgctg actaaccaag tgtgaaagct agagtgagac 6360

atcttttaa gataatgct ttaactttgg tttttatac aaaccgatt aattggttat 6420

agcatgataa aacattaat tctcttgaaa tagaatcaag aggtcttagt aaagtctttt 6480

cagaattttc aatacacaaa accagcaatt ttgaaaagaa ttgacatgct tttgtgtttt 6540

ttttctttct agacagatgc atagacttta ggtgggtgga atccagtgct gctatgaaca 6600

caagttacaa ccatatagca caaaatftaa actaaaaatt ttatatgtta ttgagcaatc 6660

tgtacataga attagcaatg caatgagagt atggaaatat ctaccgactt tctgtcaaaa 6720

ttggctcaa acatacaaac aaacaacaag atatcaatta tgaacatggc attgggaggt 6780

aatttcctat agiatgctaa aacaataaaa actctaggat attiatcatt cagagataat 6840

ttgttgatg atgtgaagaa aatcagata aaacaatgct tgtgaaaaa atttatctca 6900

ctgtgaagaa aatcatatc acattattta ttttgagtga tgaaaacaga aacattttgg 6960

catttagttt gtttttttga tggaaatcaga ggaacaaca ctatggaaa ggatcagctg 7020

actgcagaat tatgattctt ggagaatgaa ccaaagacag gggatcatgg ctctctgtgtg 7080

aaaccacaga tectgacagg acaaacaaaa ggggggaggt gcgttattgg aggactagtc 7140

acataggcat gcagcatcca caatactgac atcagctatt caaaatcaat ggccatcctt 7200

ggaggagagc aagtcaatgt tcataacata cactgttagg ataaggtcat ttcaatgtag 7260

tactacacat ctagcttcag gcccttctca ggtagaatag agcttggatt actgagtcag 7320

tggccccag agaggatgat ttctacccta aagagaacat tgaccagagg catttttgag 7380

ggtgttgatg cagtttatig ttgcattaat gataatgaag agtgtctttt taattcttcc 7440

aggggatagt cactatgcat ggatgtgtgt gctgggggtg ggttcgaatg ttctttactg 7500

tttattaaca aaaactttag tctactagtc ctattttatt aggattctgt aaatattgtt 7560

tttaatttta gttaagtgaa tgtgtgtggg ttctacatt tgagagaagg tgcccacata 7620

agccagaaaa attatggaaa ttctataaat cattttgatg attattttgt gtttattttg 7680

attttaccaa ctgaaataaa ttagtgggtt ctccaagttt tttgctaata aattattaat 7740

tccataccag gtccaactgg ggacattttg gtcacattat gatcatattg gcatgttatt 7800

tataaaaca acaagcaaac aacaacaaca aaaacaaaa caaaaacaaa aaaccagaaa 7860

atacgggtgc tttagaagta gatatgagaa gactaatgct gttgtcaact ttggtgttca 7920

actttgatgg atctggaagg tctgtaaagg gatttgctga atggatttac tgaaggggga 7980

atccccatca tggtgcatgg cacttttggg agttatcaac acaggaggag attcaaaaga 8040

agtgggatta gcctacacg tcctcacttt cagtaatgag cacaacatgc tgtggatgca 8100
 ctgttgctgc catcctttgc ttatttcaca acccagattc ttccagtggg gactgagtac 8160
 cagtatctct ctagcaatct cacaagctct cagcaccaaa ctgtgattgc tgagggtgtct 8220
 aggtttatga actgagcagc ttccaaatct cagccattcc accatgaaga tgtaagaccc 8280
 cccagaagtt caggcctcca gtatcttttc ccaggacttc ggccaccca atccacatga 8340
 ggaggcagaa acttgatgca aacaacaaga ggctttaatg aaagtgatg atttgtacaa 8400
 atgggctctc tcagcatgca ggctagagag cagccccgtc ccccaggcac aggccttttt 8460

 aaaggcaaaa accacaagtt tagggagggt cctcaactct ctgtccattg aataagtgac 8520
 cagagtcatg ggttcctagg aggccttttg tcttgagggg aggcctggga atcagataga 8580
 ctctaacc caccagtgt aacacctgaa gacctcagga tgtgctaact aatgatagct 8640
 atctctttgt ttcatagga ccttaattg ttaattattg acacattgtc aggtggtgca 8700
 atctgtttcc ttcatgagcc ccttggggag gatggccatc tgggaattct tggtaaccag 8760
 ttatcttatg gccttgtaag ggagtaattg ctggtggctg gtaaattcca ggcactaagt 8820
 catagtagta gactttgtca gtttctgggc tatatttctt tgctaatttt taagtctttc 8880

 aaagaaagct ccgttgggc tacacagcat ctattatgaa ggccaatcta ctaagtacca 8940
 tattaataac gtatattgtg tatatgcaat atatgttata ttaaataata tatattaata 9000
 tatattatac attatgtata cattaactta gatataatca tcccattcct tctcttctc 9060
 tagacaacc tgacaaannn nnnnnnnnnn nnnnnnnnnn nnnnnnnnnn nnnnnnnnnn 9120
 nnnnnnnnnn nnnnnnnnnn nnnnnnnnnn nnnnnnnnnn nnnnnnnnnn nnnnnnnnnn 9180
 nnnnnnnnnn nnnnnnnnnn nnnnnnnnnn nnnnnnnnnn nnnnnnnnnn nnnnnnnnnn 9240
 nnnntctcag tcagaatggc aatcccatcc atttcttaa gccattcctg ttgcattag 9300

 cctgtgttac atgcactgtt tatgacttaa ccatattttc ttaggcttta cctttgcaga 9360
 atatagtcgg tctagctgtc cctccctttg aggccttcta tagtttaaaa cctcagtatc 9420
 ttctctcaca gctggccaga gaagctcaaa aactgtttca tgtaaacac taacaactga 9480
 ttacagacgg cattgatata caaaaatect gctttaactg ctccttattt gaaagaatgt 9540
 tgagccatgc attacaaca ctatctatag ttccaaggg cagtgttatt ttcttagtag 9600
 taactggtgg ttagatcacc tcattagat ctgtccttcc ttgtctgatt gcctcaggac 9660
 cctctaagt ttctcaggat cttttgtgtc cctgtgtgca caaacaatca ggaagaaaac 9720

 atgcagacac agaaggcaac atgcacaatc tctactaaag acagggagtc attttatcta 9780
 ttttatgcaa agaattaaa attatacttg aatgaagga accagcttcc cttttgtag 9840
 ccataacggc cgaacacgtt atgcttctat gaccttgccc tagacactag aaagtcagat 9900

tcctgtctcg tgacaaggaa ccaatcggga gttagctggt ggcgctatgc tttatggctc 9960
 tgggtgtgct ttacggacaa gcacacagca aggacataga gagcatagca accaccctgg 10020
 gagggccaat gggccataac aaccagtga ccaatcaaca cagggttaagc cctccaagcc 10080
 tggaggcaca acaatcgtga gcctgtgcgt actcctagac actcccctta tgctgcctta 10140

taaagatctg tacgtagcag cttcgaactg tcttttctgg ccatccgcca tgggtgggtgg 10200
 gtgaaagacc cgagctaaca tggggttagc ttgttaaatt acaataaagc ctctgtcagc 10260
 ttgcagcaag ctctcgaatc cacctgggtga ttaggggtggc ctcaatcttg ggctaagatt 10320
 ctggaagcct cagctttccg agggctttac agaaacacta gttttggtca tagtgctttt 10380
 cagctggaag aactagacag caagttagag gtcaagatca caatgatcag tataaaaact 10440
 ggaaaataca caaatgatg gatgcctaag tattttttat aataaaggac tgcttgagaa 10500
 atgcaaaatc attgttaaag aagaacatac agagtattca gctatactat atacaacata 10560

ttaatatttc acacaagatt aaggaattag tttcattata gagtgaatgt attttgcaaa 10620
 atcttaccat taacaaacaa tgaatgtggg aatactccct aatttacctc tctctgtttt 10680
 tcatccttaa tgatggcatt tctgccatca ccttctatga aatcaaaatt tgtgtaatct 10740
 acctattagt gagaccaaat agtattggtc tttccatgat tggattatta aataaacata 10800
 atggttgaca ggtccatctc tcttcaatat ttcatgtat atgtgtaaca catttttgta 10860
 cccacagctc acttgatggt tacatgattt gttcctgatt tgaatctatt tgtgttatct 10920
 aagtataggg gctgatagga attagcatac tggttattta tttggctgtc tgtcaaggaa 10980

tgggactgct gaatcaaaaca ataaacctat gttacattta ctaaagaact tccaaactgt 11040
 agtaatttaa atttttaata gtgggtaagc actatttttc ccatatcttt atcagaaccc 11100
 ctctctttt gtgttagtgt ttggtaataa taattgttat tggctgtata tgatgaatgg 11160
 ttaggtata gtgggaaatt accaatacgg agtcaggtag aaatataagg gtatttaata 11220
 gggaaaagcc ttacttacag agcgacctag ccagctgggtg gatcagcagc ctgtaccgca 11280
 agtaccaaag agaaaccgaa accgaaaacg cagtcacact acgtcactct gaccacgcc 11340
 tcacaagcct ggtcaggcac acctgtagcc agcccctaag aaggcgtggc tacagcttec 11400

cctacattag ggttatgatg acattatttt attctctagt gatgtgacc aatttttct 11460
 agtaccatta gagaccagtg acttgtctac agaaatttac agttttctgt gtaccaaatt 11520
 gaaaattatt ttaatgtatg tgtctgtggt gtgtatgaga tagaggaggg ggggtaggga 11580
 gagagggagg gagggaaaga ttgagagaga gagcgagaga gagacagaac acacctatga 11640
 aggtcagaaa aatttagaaa gtactgttct gctatttcgg ctctagggat caattttgag 11700
 ttctagtctt gacaataagc ctccttagca gctgttctat catatcaaac actgttacc 11760

ccattttaa tcaagtaatt gaatatattg ctagttagtt ttttgagtt tcttattaa 11820

gcctttatta actctcgtct aatgtatgga cftaagagta tttacatcta ttctgtgtgc 11880

tttcttcaca ttttgttctt tcctttgect cttgtgectt gttgagtttt ttaaaacatc 11940

accagcatg ccaggtggc acaagtgtt aatcctagag aggcagaggc aggcagatat 12000

ttgagttga ggtcagcctg gtctacagag tgagttctgt gacatcaaag tctacacaga 12060

aaaacctga agtaatgcca tgtaatgect tttagtttga acacaggttt tgttttgttt 12120

taaggataaa ttttgtattg tgacatggc tcaagagcac gctttcagta gaccaggtt 12180

tgatcctcag caccacata gcagctcaca atcacctatg tttccagttt cagggactat 12240

ttgtcccttt ctggcctctg aggggactag atatgcacat agtaaacat ttgtagcaaa 12300

actatacact tataattaaa cctattttta aatggctttc attgattgag tttttgtgtt 12360

ttcatataaa ttttaagata ttttaagata aaggagagct tcattactat tttgatagtt 12420

ggtattctat tttctgttag aatgtctttc actttttcaa aagaatatt ccaaagtatt 12480

atttttgtag ctactggagc tagcaatctc tctttattct tttttcagac catgcttggc 12540

tcatataaaa gctattaatt aatgtatect acaattttta acaattgttt tattaattct 12600

aatcatttta attctaataca ttctaatacat ttctaatacat gaagtcttta gagtgtttta 12660

gctgaaaaat acaaccatct acaaccactg aaacacttgc ttcctttccc atcaattatt 12720

ttttgcttat tgatcttgcc tattggctct gtctaggttg aaactggcat tcttgiaggg 12780

ccccagactt tagactgctt tcagctccct tcattcattt attttatggt agaagttgac 12840

ttacaatata aaggctttac agaaccaatt gtcttcagtg cttgtacatt gcaagctgac 12900

taaatttcat caaatgcttt tctgctctg acaaatgttc ttatgttctt ttttcatggt 12960

tgctgtgatg tatcatatat atttgtttgc acataagcca ttatctttgt atccttgagg 13020

tgaattccac tctgtcttac acaaaatgtt ttaaatgcaa ttcagaatc tgttagtgtt 13080

ttgatgaaga ctgttatgag attggccagt agcttactgc tttggatacc aagcccaatt 13140

ttgttacagc agcaatgctg acttcacaca ttgtgcacaa aatagttcct tcaacttcac 13200

cttttttttag gaacaattta agatagaata tggtttttct tttgtctctt taaaaact 13260

tagtaaattt cagtactgaa tctatgggca tttctttgat gagaagtgtt ttaagaagat 13320

gcactcttgc taattgttct ttttcaaaga ttccttttaa ttatttacct gtgtatgtat 13380

glatgtatgt atgtatgtat gtatgtatgt atgtgtggaa tagtgccttc tgcactcaga 13440

agactgcact gagcctcaa gaagtacagt tataggtgct tgtggtagtt tcacaggacc 13500

ttaggtcctc ctcaagagaa gcaatgattc ttaactatgg gcctttcaag ccctatTTTT 13560
 ggTTTTatatt tttggTTTTc tcatgatttg ttgatattga aggcatatgc acacacacgc 13620
 atgtgtgtgt gtgcatgtgt gtgtgtttgt gtgtgtgtgt gcgtgtgtgt gtgtaacatt 13680
 ttcacttcta tattatgaag aaggttgatg tttgatttcc atagtaattt catagatcca 13740
 actatgatgc cagctgtaac atctttgttt tatcttgat tttatTTgct gaagccactt 13800
 tttctattat aatccattgg ttggacaatt tttcttagc tattatTTtg taccacttat 13860
 aaacctcaat ctaattaatt tttatgttta tttttcatca catctgtttt tgggtttgat 13920

 atgttgttct tttttgttcc tcttaaaatt aatgacagat aatatagttg agtttatcct 13980
 ttgttttccct tggTgggtat ttttctcttt ttacttcata tttcatggtt tcataaact 14040
 attttcaagt ttgcttccac atactctcag gatacttatg tctttataac ttaacagaat 14100
 cagaaagaaa tgaagagaca tataaaacag caagcatatg aatacaactt tctaaacttt 14160
 aattcattcc ttgccagact taaaatgttt gatgccgcac taatttctct attgtcttaa 14220
 tatatgagat agattaattt aactgaatt tttgcaatga ttatatcatt tctataattt 14280
 tatcttttaa tcttcatatt agagatagga gtggtttatg tcttacattt acatgattag 14340

 aacattccaa aattctcttc acttattctt actcaagagt gttacatctt gtggcatttc 14400
 attttcttat taatgcttag atctttctgt ttgaggaatt tctgttaggc acagggaaat 14460
 tactcagcag gaatcacact tgctgcacag gcatgaagac ccaagctcag attgccagca 14520
 ttgataacac attatagaag ttactgtgtg tgtaatcca ttgctgggac catacagaga 14580
 caggaggata actgggactt gctgaacatt agtctagctc tcacatgaac attagtatca 14640
 aaagaataag ggagaaaacg atagagtagg gcatcaaaag tcatcctctg ctctttatcc 14700
 ccatacagct ctctctctct ttctctctct ctctccctct ctctctctct ctccacacaca 14760

 cacacacaca cacacacaca catacacaca catgtacaca tgaatataca cacacaatct 14820
 cattcagtat tcataggatc aattttgtga gagacattct attacctttt gttggattgg 14880
 acatactttt actctttcag ttttaaagga tagttttacg agtagtatat tctcatctgt 14940
 aattgtttcc tttactgcag aaacctcatg tcagtctctt aagaggatct ttattgagct 15000
 tgaataatta cagaattaat tgtgattact cacagaactg cctgtaatta cttaaagtga 15060
 cagacatagt gcacatgaat tatgttaaaa aatatcattc atatacatga ttaggttat 15120
 tcgaatacaa tgtgtggttt ctttcgtttt ttttcaattg cttaacacgt tttattccct 15180

 aacatggttt ccaaatcaga caagctgtaa acaacaagac tttctgagta aaataatttg 15240
 gaatgcaaag gtaacaaaga atttagggat gcagttctca gaggtacat tttcttaaga 15300
 tgccaacaga gcaggagata acagacttac tttcagattt ttgcagaaac actcatgaaa 15360

gtcagtaaaa catgtgatgc atgtacttat ggcttattac agggaaacag aatggtttca 15420
ataccagag ggagagagaa ctgcttgact acagcctatt ctatgtgtac actgactctc 15480
caggtgtcca ttcttcatag agtaacaggc ttcaataatc atttcactga ctgttatgaa 15540
ctgcagatgt ttatattata cttagaatct agaaccttta atgctccact atccaggcag 15600

gtttaaatgt ccatctagtt gccctcagaa ttccttctcg caagaagtca aggcagtgca 15660
ttgtggctta aactactcac cctaagctac attttaatgt gatctgagac ctgctgacaa 15720
gttgtctcgc tatatgacat tgtggttact taggcatcac tgacaagatg tcaggaccaa 15780
tgtgcaatac tcttttagga caattactga ctatggaagt ctagaatga gactgtggac 15840
tcttccaact ggcttgatgt agcttgctta gcacaggtta ccaagggatc attttgaaat 15900
ttgtatttta tattatata gttagctcta ggcaatgcgt tcttaataa tttgctgaag 15960
aaaataacat ttgaagattc agcttcaaat tgaaaattct gttttacagg ctttttagaa 16020

attcttgatt tcaaacataa atgatgttgt actttcaaaa taaagaggaa atataaata 16080
tgcagattaa cataacatgc attttcaaaa tgaagtatta ttagttaagc aatcatcaat 16140
atagtcttat gtatagtcac tacctaaaaa aataacacgc atcacattgg ctttcatttt 16200
ctttaaagcc tacctgtatt cattcaccac atacttattt catattacta tgagttaaat 16260
atcaaatcca ctttctagaa aacttaacat aaggacacct gcaattcagg atagaacttt 16320
aatttatatt tattacata atgtttcttg ctttctttgt ggcaatatgt tattcaaac 16380
tctaatacacc ctctttagcg tcaaacactca gtcatTTTTa cctggcaaaa tggttctggt 16440

ttatactggt ccttttgttg ttaatccttc caggagtttc atatttctc tttgaataca 16500
gtctcaactc tcigtgtttc aacctgctg taccttttac taagaagtat gaaaaggcca 16560
gaaccccagg tatgtgaaga actgcatcag atatccttgc aacttatgtt taaaacattt 16620
ttttttcaat ccaggacaga ggatttgggc aaaataatct ctttagtcac ttgttattct 16680
tgtcaccatt ttatcagcat ctgtcaggca gggacacttg ctgtctctgt tttgtatgac 16740
atgaccatcc tggctatcta gcaaggatga agcaattccc acaagcgagt acttatcatt 16800
gatggcaatg ccagcactga gacctgctca tcaaccttcc atgaattaca aatatttcaa 16860

gttggattca ttttattttt aatgttttcc aaatgcctgg agatctcagc atggtagaaa 16920
tctccttgga gtaacagtgt cttttcttgc agttctgagc aatcaaatgt gtgcagtac 16980
tcttgagtga ttgtgctaac cgtgatattt ttgagaaaat gctagagtta tatggcttag 17040
tggctattca accacagatt accatatgta tttacctttt aaaatcagc acttttcatg 17100
ttaaagccca atggagtcat aaatatTTTA aagtttgttt cccaaatttg ttatctaate 17160
tcatcataac atgaaaaaaa atgtgtttga tagagtttgt ttccttgaag ttctcttate 17220

tctaagtaat aatgaacagt ttttaattgca agtaggcca ggggacatct aaagattaac 17280

tacattgtca atttaattga cctcttgaga gttttcttca gagcatgtgt tggataaac 17340

ctggtcaaaa tcagaagagg aagagacatg gggatagtgg aaaatgggct gatttgcac 17400

aggaaactca ggtttcattt tccttctgta gtatttactc atgcataat ttaaacaca 17460

gatgaagtgt gagagagata actgtggcta agaggactta ctgttctccc agaggactgg 17520

gcttaattcc cagcacatca ttcacaaata ttttaactaa attcccaggt gatcttctgg 17580

cctttatggg catcagacaa acatatggta cacagacaca tatgaagata ataataaat 17640

aataataata ataataata tagtaataat aatttcaagg aacgaaagt catttctgt 17700

ctttaacat catagtttaa acaacaata tcagaatag tatatggcaa tatatccagt 17760

aaaatgtcat gtaactaca gaactatta ctgtgaatta taaagcattt ctcaacacac 17820

taggagagge acagaagcca agtgaacc acatataaat tttacttgtt tcttttttc 17880

ttccatttt ttttattga gttagaaga acaaaaattg tttacatgt caatcccagt 17940

tcctctccc tctctctc cctccccca caactaagat cctaccatac catttctgt 18000

ccccagagat ggtgagccc tccatagggg gccttcagag tctgttatat cctttgggat 18060

agggtctagg cccaccctgt gtgtctaagc tgaggagca tttctctatt tggatgggc 18120

tcccaaagtg ctttctatg ctagggataa gtactgatat actacaagag gcccataga 18180

tttctgaggt ctctctctg actcccatgt tcattgggtc tggatcagtc ccatgctggt 18240

ttcccagcta tcagtctggg accaagagct ctcccttgtt caggcagct gtttctgtgg 18300

gtttcaccag cctggtcttg accctttgc tcatcactca tcttctctg aaatttgatt 18360

atagttcagt tcagggttta gctgtgggag cctgattcta cttccatcag ctgctggatg 18420

aaggctctag gatggcatat aagttagaca tcaatctctt taccagcaga gggcatttaa 18480

ggtagccttt cctctgttgc ttagattgtt agttggtatc atctttgtag atctccagac 18540

agttccctag tacatgattt ctctttaaac ctataatgct tccctctatt ttggtatttc 18600

ttatcttget ctcttctgtt gttcccacag ctcaaccttc ctgcttctc atatctctc 18660

ctaaaaattt caaattgaga aaaatattt caaacacatt tccatctatt ggatatacaa 18720

ttatgcttaa atcttaagtt ttaagactgc tactgtcata tgttcattct tactctagag 18780

aaactcatta actaacat tttgtgctca taatcagaac agttattcgg tcaggatgac 18840

tttgtcctca gattcaaggg tatgccagga tgagaatgaa ttaatgatgg tatcttgatc 18900

acctgtgatg ggattgatta aatctagacc tgtgatgcag atataggaag aaaaaagagg 18960

gtgtgtgggt gaattggtaa atatagatag atagatagat agatagatag atagatagat 19020
 agaagagaga aaggaaagaa agaaataaag aaagatgatg ttatctcctg ctggattcct 19080
 gaaggaaaag attaaatcct taaatcttgg ccaccaata acttagtatg ggagcaaaaa 19140
 taaactctgg gccaaagata tagctcaatc aatagagtgg gcattaagca tgtaaaaagc 19200
 cctagattag atccccagct ctacatcaac aggaatttgg tgggtggaagc agaggtatca 19260
 gaagtccaag attgtctaca gattgttaga gaatttgaaa tcagccttca atatatgaga 19320
 ttctttctga aaaatataat ataacaaaat actaaaacac ttcaacattt acacttatga 19380

 gagcttgatt ttctgtgctt tgcaagcaaa atcatcctgt gctattatc tgatgcctta 19440
 tgtaattatc tgatattcct gggcctatgg atattgaatg actgcttctg agattttgaa 19500
 tgttcctctg gtcacaatga ccacagccat tgtgatgatc actgtttcaa tcactttcga 19560
 tcctgagttt ctaaaaatag aatattgttg acagtgtgaa tagaacatga atatttgaca 19620
 ttacaaatga catgcatcct cggtctttta attacagctt aatctagttc aacttcattt 19680
 aatagatata ttatggactg ttatgtattc ccttaaaaat atgttgaaga tttaaattcc 19740
 aagtcctctg gaatgtgacc ttgtttgtac atgggggagg tggagagtaa ccagccatga 19800

 tttatgaaga tgaatcatg ctggagtgt atgggcagtg cagtatgact agtgtactca 19860
 taggaagagg caatgaagac agactcacat ctttgacag attcatctat gccttaccaa 19920
 caaaaatcaa caggagatca gaaagaaata caagaagatt aggattgcat cacacaatgt 19980
 agtgctattt gtattatttg gatattgtcc caatctgtat tctgctgtgg aggtctacgg 20040
 gcatcttcaa ttagtcagtt ttttttctt ctaccttga ggcctctaaa tggaaattcct 20100
 gttatacatc tcagtggaac gtgcctttat ttgcttgcca tttcacagat tttagaatta 20160
 ttttaaatg cccacttaa tttctacata ttaatatcac ataatacag ttcaccacta 20220

 tgcagaaac tattgtttt taggaagggc tgtattgtga ggaggcagtg tetctttcct 20280
 gtatctcaac tgagaacaac tcacctgga ctactacctg aggactgttc tctgatcttc 20340
 caagtctagg gttaggtagg ccatgcattg tgcctagaaa acttcattga caccgaatat 20400
 atctttctta aactcaggaa gtggtattcc cctgcataag gctggaacca tcaacacaga 20460
 gtgtctatta atataactca ctggacagaa gccaacctct tagaatttgg cagaacaatg 20520
 ctagctttta gttccttctt taatttccac tgagattaat taactttggg tcattttata 20580
 aaacccatgc ttctaggtg aataaaagaa aatgattca gatatcctt aaccctttat 20640

 agattttcta ggtttctct cttataaggg ggctgaatag ggtgaaggtt tttcattcag 20700
 aaattatttg ggtcttctt aatattttac aagttttgta taaagagatt tgagttcttt 20760
 ctcaatagt tcaaggaaca atatagata aagaagtggg tgactaaaa atgatctgat 20820

ccctgtttta tacagtaaca agttttggaa acattatggg gcattttcag atctcaaatg 20880
 taagactctt tcttaaagga cataatgata ttactcttat aattgtttgg attggattat 20940
 ggttctggga aattgctgat ctgtcatact ttacattac aatgaattta atagtgaata 21000
 ttatattata taigctcaga attgctaact agactagctg ctttgggaaa catggagttc 21060

 agtgaagat tatgcttcat taaatagaca gttggatatac tgacttcaac tagtgatcta 21120
 cacacacaca cacacacaca cacacacaca cacacacaca atgcatcagg ctcaaaaacc 21180
 tgtatttata cacacttata aatataaatg tattataaat aaaaatcatt aacctctaaa 21240
 atggcttcat caggttcttt aaattgggta ttttaaggac actagtccat tcaagtattt 21300
 tgctctgcca ggcctgctt atctctccta cgacttctgc tttgataaaa ttcattgagat 21360
 tatcatcatg cacaaaactc aagtacaaat ggatcaaaga gatcaatata aatccatcta 21420
 ccctgaacct catagaatg agtgtgggga atacgtttga atgcataggc atgggagata 21480

 acttcctaaa tagaacaaca gtagcataga ctctgaaagt aacaattaat aattgggacc 21540
 tcctgaaacc gagaagcttc tgtaaagcaa agaacacaat caacaagaca aaatggatcc 21600
 ctacagaatg ggaaaagatc ttcaccaacc ccagatctga caaaaagctg ttctctaaaa 21660
 tatacaagga actcaagaaa ctagacctca atctacaaa taatccaatt aaaaatggga 21720
 tacagatcta aatagagaat tctcaacaga aaaaaatctc aaatggaaga aagacactta 21780
 aggaaatgct caacatcctt tgctcatcagg gaaatgcaaa tcaaaaaccac tctaagattc 21840
 tatcttacac tggctcagat ggttaagata aaaaatacca atgacagctt aggctggaga 21900

 ggatgtggag aaagtggaac actcctcctt tgctagtggg agtgcaaact tgtacatcat 21960
 tgtggaaatc agtacagcaa tttctcagaa aattaaggat caacctacct caagaccact 22020
 caataccatt gttgggcata tacacaatg agaaacattc acaccactag gacatttgct 22080
 cagctgtgtt catagcaaca ttattttag tagccagatg ttggaaaagc ctagatgccc 22140
 ctcaactgaa gaatgactaa agaaaatgtg gtatatttac acaatgaata ctactcagtg 22200
 gtaaaaaaca atgacatcct aaacttggca ggcaaatgga cagaactaga aaaaaaaaaat 22260
 cctaagtgag ataaccceaaa accagaaaga caaatatagt atatacttat gagtgcataa 22320

 gttgattcca gacaaagcaa aagttacaca gcctacaatc cataigccca gagaagcttg 22380
 aactctcttc ctgaaataga agcaggtaca gaaatccata actaaccaat gggctaagaa 22440
 ccaggagtac aatgaactg aggaaggagc aagaatttga acaaaggagt catgaccatg 22500
 atgaggaaac ccacagaatt aggtaacatc agctagttag agatcactaa ctgaggtctg 22560
 aaagatgggg aacctgcaca aaacccaaact aaactccatt aatatagggtg acaatactgt 22620
 ggctggaaca atatatgagg ccaattgcag tgggtccaag atctaagtct aatgcacaaa 22680

ctgacttact ggagcttatt ctatatggag agatacattg ctcagcctag acacagggtt 22740

gtgcaggtag agaggtgcca ttgtcctgtt tcaactagat aatgggaccg acttagtaga 22800

cttcctagtg gaggccttac tctctccatg gaggcagttg gaggaggggg cagtggaggg 22860

agtgggacga gaacagagct gggtaactgg gattggaatg taaaaaatat atttaaaaag 22920

tcattggatt acatccctga agctagtctc caaggatata tccttatttt tacaatctat 22980

cctctggagg ctgctaccaa ggttcagcta ttaaattact aaagtccagc aatgaaacct 23040

cttttgctc acctaattag catgcccaat taaaattaaa cacctcatcc taacatggtg 23100

tttctattt tacctccata aactgccaat ggtctatgtg ccatgtatgt cttctcacia 23160

tccagaggca ctctttgtc tcactgatgt aggcagacct tctgtatgct ataaatgt 23220

gctgctttta ttggctgatg aataaatttg ttttagccaa tggataggca ggattcagct 23280

agaggggatt tctgcacaaa gaggcaggga aaagaaagac aaaggagaca ctatgtagct 23340

actgggaagg taggatgctt gggcattctc tgtaagcca agcctaagcg gagatacaca 23400

gattaataga aatgggttaa taattaagag agggctagcc aataagaagt ctgagccata 23460

ggctaacacg tttataatta atataagcct ctgtgtgttt aaatgggact aaattgttac 23520

cataaatctt tccgcaaaa gccacctgag cccaccacc acgcgtgaac tttaccctag 23580

ctgcccggcc gagttaggcc caaatgaata cacagaaact tgtattaggt ataatgttgt 23640

ttggccaatg actaggattc tcactgtttt gctcagtcct aactatcata aacttatata 23700

ttttataaga tttatcttat tggatgcttt attgccatcc ctcgttgctg gtggatcaca 23760

ttgtgctgct ggaggagcaa aagggacctt tctgtttct ccttcgctta aatagagtc 23820

tccttgctat gccacttctt gcttagatca ccattcctct attagatttc ccagaatcct 23880

ttttgactcc tagtcccgtc taacttgctg tctcattggc caaaaagtat tttatttaac 23940

aaccaataag ataacatac acagaaatac tcccccatc actaatggc tacagcccg 24000

ggcgtgacag aaactttcct cttcagtccc actgtaggac aaatgtcca tactgtgatg 24060

gttgacatag gactcagagc taagatttta acattaatga aaacaaagat tcccacagcc 24120

caaaatttgc tatttgaagc tgcagtcaca aattgcaaaa taattacatg atgataaaaa 24180

tgtgtcaaca taaacatgaa atgtcatgat tttacagcta agcaggcaat agctctaagt 24240

ctgctaatac gctaagagaa tcagtttggc aactgcctta cttttgtag gcattggaac 24300

cccacctaa tggaggaaaa tgatgatttt ctgtgtatgt tcatgcttat ttaattttca 24360

ttgttcttt tgttcaatct tggttgtcaa ttacctatac taatatagta caacaacaac 24420

aataataaag atagttttac gttttcttct tccaaatgcc tcatcaatgc atagacaa 24480
tatcactccc tatgtttctt acctcaccac catgatattt atatgccttt atggccagag 24540
ctctaagat tgaagagggtg atattattct ggccaacact caggtaatgc ctatgtattc 24600
ttatcttcat ttaaaatata attcgtctct gtataaccaa atctttgtaa tatattttct 24660
ttctgaaatt ctgatattcc ttagagattg ttttttctt tcattattgc cccctcatt 24720
atthttagct ttgaatgggtg tctactcagg ctaggcctac aaaatgtagg ccaactgtcct 24780
ggatcaatat atctgcagtg ctaagcaggg aactagcata gaaatgttgg ctttttacia 24840

cagaggattc tgccattaga aaggctggta aaaaccacag agtgccattg gcaggttttg 24900
catatacttg acattagagg taaaacaaga aagtgacact gaacatttag attctgtgtc 24960
aatgtcaaga tgaagatgac tttcaaagtg gaatcataga gggaacattc tataaaaaac 25020
attccatgtc tttctagaaa aatccagtg aagctttcta cctacttggg agagttttgc 25080
caatgataac atattttaga attcctggaa tagctcaagg caaacata ttttgaagct 25140
gaaaggattt ctatttcttt ctctttttta aattttgaaa tattattttc ttttctaca 25200
atatgttctg atagttttc cctcccagc tctcccac tcccacc acccaaatcc 25260

atacccttc attctctctc tcattagaat aaaataggta cctatagtaa cagcaactgt 25320
aataagaaat aaaacagaat aaaattcata agacaaaatt aaggaaaaaa gtataaagag 25380
ccaaagaaaa agcacaagaa acacctacag atagtgaac acacacaatt acacactcag 25440
aaaagaaata aaaacaaaat aggaacacat aataaataag caaaagatct ctaaggtaa 25500
taaagaaaaa tcccgatggg tgttgggtgt gcacaccttt aatcccagca ctggggaggc 25560
agaggcagac agatctctgt gagtttgagg ccagcctggg ctctagagca agtgccagga 25620
taggccccaa agctacacag agaaaccctg tctcgaaca acaacaaaaa aaaaaaaaa 25680

aaaaagaaaa aagggggggg gtggggggca ttcctctct tggttatgg tatatgtgtg 25740
ttggtgatg tatatgatg tgtatgtgt tttgtgtgt tgcatgttgg agtatgtgtg 25800
ccagtgtatg tatgtttgta tatatgtatg agtgtttatt cttttgtaca tgtgtttag 25860
ttcacataaa atctctctt gggeccacc aagctttac ctgactctgt tagttttcag 25920
gaccgttaca gaaacaagat ggtttgaggt gtgcctttag ttaaagtcta gtgagaaaag 25980
caaggcttca gtgtttgta ttctaattagg aacagtaagt gggccatgaa atgaaaacac 26040
ttcacgtgc tggttcattg tataatggtt accactctga actctgaaaa tactttcatc 26100

ttgcttttaa aaggccttca ccacacagtc cagggtcaga attcttctg aatagaaga 26160
aaaaaaciaa atgtcaaaa ttgcactttt cctaaatcc aaaacaaatc atgttggata 26220
atcgtaatg aaaattctt aattttatat acaattaaaa acctgtgaac aaaggctggg 26280

ttacttggta aagtaatgc ttctttcaga ctattagtta gggaactagt ttaagaaata 26340
 ccagattatt atcaatttag aagcaaaaat ttatgtttac actttcaaaa taatttatca 26400
 attacatgta tctaattaag tttactttca catcccattc tactgaagtc acataattac 26460
 actcacatat gtcaagcaat aaagaaattg ccttgggtca ccattatfff tagatctcag 26520

 tgtagcacac agtaaatggc taacacagca ataatgctta attatactac agtaaaagtt 26580
 gaaaagtcag aggctagfcc atgatcctgt tttttagaag tcccccaagc ataggtatta 26640
 gaaaccagca agttccaggg gttcttcacc tcagagtcac aaaaagacaa tacaatcaga 26700
 ataccttatg ctttgatgtg gctgtttcag tttgtttgtg aacaacagtt caacagtttg 26760
 ttgtttcttc tggtaaaacc ttttcttggc cacaaattta aatcaaattt agcaaaaatt 26820
 ctgttaagag aaagacaggc agatgtccgc ttctgcatc actgggtgctg cacaaaagcc 26880
 tgaagtgaag tctatactct tttttgattt ccatgtaggt tccatttcta gattgtttcc 26940

 agcacactgt ccattgtatc tttaaacaaa gactaggtca aagatgacat gtgttcccaa 27000
 taacttacia agaacctacc agtagaagaa tcacctctg ccttccccta cagtcctttt 27060
 aagccagggg ccagtgttgt acacagatgt ttcccttagcc aggaagatcc caaatatgat 27120
 tgtggattta caaatgcaat caatttagca ttttggcac acataacaag agcaatgatt 27180
 gtggtaaaga atgagcagac aaaatgtttt attaatgtct gcttctgggtg tgatgcatat 27240
 gccacatgaa acttggccaa actattgcag gataatgatt ttccaaaagc agcagaaagc 27300
 agatgggaag catgattcca aggtcaatga tcacacctag gagatgggta taggtcttaa 27360

 catatfffat tgcctatagt aaattgtcag caaaatacct cttggtaagt tttaatfctt 27420
 atcagaatta tttattgata tttacatata tatatgtgca catacacaca cacacacaca 27480
 cacacacaca catatatata tatatattaa ttcatfctaa atttatctta gtataatate 27540
 ttattagtta tttgagaatt taatacaata tactttgate atattcacct gccattatff 27600
 ctctaaatt ctgttagatc taccaccct ttttaatac caccaagtct atcctgcatt 27660
 gtctctgtct cctgagtggt ggatcattaa ctggagcatg gftaacctat gaggaaggag 27720
 gcacaacctt agagaaaact gactctccct acgcctgaag ctattcattg ccaatagatt 27780

 tctaatacaga gaagagtgtc tgttaaacc cccccctt tccatgctgg acttgatctt 27840
 gttgaggtct tgtgtagata tacacattta ctgtgatate ctgtgtacag tagtactgtc 27900
 atgtctagaa gaaaaacttg ctctactcat ccctggcctc actcttacag tcttctgcc 27960
 attgctgctg tgggtgtccc taagccttct ggttattgta tagatatccc aattgtagat 28020
 aagtattcca cttaacactt tgtatfffga caagctgtga actfffatct tgtgatgttt 28080
 tgtttgtttg tgtttgtttg tttgaacaa gatttcccca tatagccttg gctagtttgg 28140

attctaaaat gtagaatatg ccaaactcaa attcatggag gtctgcctgc ctctgcctct 28200

 cacattagga attaatgcta aatgccacca tgtgaacaag ttgtgaggtt tgtaaaaagt 28260
 tttttttttg agaatttcat ccatgaatac aacttttcca tgatttcaaa agaaactctt 28320
 tatccaataa acaatgcttg tccatcatcc ttgaccttg aatcctggaa acagccaatt 28380
 gtatttctct ttgtacaatt ttgacaaact cttatatatt ctctaagtgg aaaaacacaa 28440
 tattggctct attgttcata agaatgctaa aaacagtctt ctaaggctgt gagtggaatg 28500
 tagtgctga gagctggatg agcaggccag agaactttgg ttgatctcc tgcattaaaa 28560
 ggcttttata aagtggtttc aggtttctag gaaactcaga agacttttag caaatgttgc 28620

 tccttcttca gcaacaatt caaagataac aataacatac agtatcatac agtaacatac 28680
 agtatcataa caataacata caatagcaag actttgtttt ccatccttac ttggcttttt 28740
 tattactcta tttcttttac ttttatTTTT tctatttttt gagataggtt tctctgtgca 28800
 actttggctg tcttggaaac tactctttaa cctaggctgg cctttaaacc acagagatct 28860
 gcctgcttct gcctcttaag tgctgggatt aaaggattgt gccaccacac ccagctactc 28920
 tatttctttt actattattt acttttttat tttatatatt tataattata attagaccaa 28980
 ttttaaatta gaaacaagct tcttttcat gtcaatccca gttccctctc cttccctcc 29040

 ttacctccc tcaatactat cccaaccct tctgctccc cagggagggt gaggccttcc 29100
 atgggggatc ttcagagtct gtcacatcat ttggagcagg gcctagacc tcccccttgt 29160
 gtctaggcta agagagtac actcttttg gagtgggatc caaaaattca ttcgtgtact 29220
 aggaataaat aataatccac taccagaggt cccatagatt gaccagacct ccaaactgac 29280
 atccacctc aggggggtct ggaacagtcc tatgctggct ttgcagctat cagtctggtt 29340
 tccatgagca actctttgtt caggtcagct gtttctgtac gtttctccag cctggtcttg 29400
 acccatttgc tcaccactcc tccctcttta caacttgatt ccagagttca getcagtgtt 29460

 tagctgtcgg tttctgtttc tgcttccatc agctactgga tgaaggctct aggatggcat 29520
 gtaagataat aatcaatctc aatactggag aagggaattt aaggtagcct ctcaactatt 29580
 gcttagattg ttagttgggg gttaaacttg tagatactg gacatttccc tagtgcaga 29640
 attctcttta aacctatagt gcctccctct attatgatat ctcttttctt gctctcctcc 29700
 attctctctc tgactaaate ttectgcttc ctcatgctct cctattctcc acttctcttt 29760
 cttctagctc cctctctgtc agaagccagc cttggctagc taaccgccag atagtctggc 29820
 atcccacgat gtcgatgca gaagccagtc ttggcgacc cccatgccta gctagccacc 29880

agccagtcta gcatcccatc tcttatcaca ggagattcct gctacctgcc tgagaagcaa 29940
 ctaacaccta tccttcccc cacttcctta acacaggaga tttcggatac ctgcctgaga 30000
 gcaattaaca ttcateccctc cccccacctt ctttttctct gcttcctcct ttctctataa 30060
 aaaccccttg taataatcaa taaagtggc cttgacaaaag gaatctgctt ggtcccactc 30120
 tttctttccc gccattatt tgcaggcgtg atccacctca gactcacaaa ttaccagagc 30180
 cccactggat ggggcccctc tcccctcccc acatgctccc aattagttgt ttgttgcttt 30240
 cctctttgct gaagatgatg tggagaaagg ggaacacttg tgcactgatg gtgggagtgc 30300

 caactcatac agccacttg gaaatcagta tggcggttcc tcaggaaaat gggattcagt 30360
 ctaccacaag atccagcaat tacactctta agcatatacc ccaaagaagc acattcatac 30420
 aataaggaca tcttttcaac catgttccaa gcagccttat ttgtaataga aagaacctgg 30480
 aagcaatcta tatgccctc agctgaagaa tggatggaga aaatgtggca cattcacaca 30540
 atggagtact actcagcaga aaaaaacaaa aaacaaaaaa caaaaaacaa tggaatcttg 30600
 aaattcacag gaaaatgtgt ggaactagaa gaaactatcc tgagtaaggc aatctattca 30660
 caaaaagaaa aaagttgat gtacatcctg atacatggat ttcagatata gaacaaggga 30720

 ataccagcct ataatccaca ctgcaagaga aactaagaaa caaggaggac cctaagatag 30780
 acctacatag tccccctgag aagaaaagga ctcttttct tttataagga ctttatcttt 30840
 ttttaatfff teatcccaag cctatgtata ttttaacaa cactagaggt taaaaacatt 30900
 agaggttttt ctffcacaag gacatcccc atcaatatct tttgccttac agaaatatct 30960
 ctgttttcag gaggtcccac atattgaatg ttgatctcag tgtgctactg gtattatatt 31020
 taggaagtgg tgcctgtga cactaggtaa gcaatagtgg agagggtgtt tgaatgggcc 31080
 ttcctcttta atcagatttg tgactaccag aattgttacc atagaacctt cagatggaat 31140

 ctgacttaca gtcaaatatt gagctgagct cttggagttc attaagagag ggaggacct 31200
 ccttgaacaa agagggtcaa gagcatggtg gggaaaacct caggacagc agactcaagg 31260
 tattgggagc ttatgaacta tggactgaca gctaggaac ctgaaatggga cttactagg 31320
 ccctctgaat gtgggtgaca gttatatggc ttgatggggg ggggtggcag cggcatcagg 31380
 acctatccca agtgcaggaa ctgacttttt agatcccatt gtctgtggtg agataccttg 31440
 atcagccttg tacctgggga aggatcaagt tctgctctaa acttaataag tcagatattg 31500
 ttgactcttc atggaaggcc ttaacctctc taaggagtgg atgggggtgg gaaaggggag 31560

 gigtagggtg ggggtggaag aagggtaggg attgggagct ggggtttgta tataaaatga 31620
 aaaataaatt ttagagaaaa ataaaaacaaa aatagggata aaggaacttg aaatacacac 31680
 attgtcagca ataaagcaaa tatcctgact tcaattcaga agaacctga aagcagatgg 31740

tgaggtcac agcctggact ttgtccatgc aaatgttggt gagtaccggt ggcttcatgg 31800
 cctttctgac aatttcatt cagtacagcc atagcaggga ttcttacata agtccaaatt 31860
 ttgtctgatg tgtctatcta gagagtctgc atctaaacac aaaaggagta atctcttctt 31920
 acgtttcact ttcacttact ccccatcatt tacttacatt tctaagtga attctctgtg 31980

 gaaatacaat ttgaaaaag aaatgtgtgc tgtgtggtta tatcttcaa actgttagtc 32040
 acttgtaaag tatatttgt atggttttct tttttctttt ccttctttct gttttttgtt 32100
 tgtttgtttt atttttggaa aggcatattg caggaggagt tgattgtaga cataattctt 32160
 cacagcttag aaatgggta gtatgctgtt ttgctcaaca atatgagtaa ctttaagtctg 32220
 attttcatat caatcagagt cctttacceca atttcacctg acagccttaa catttatttt 32280
 tntagacat atagaattac ctttgaagc ctttgcttgc aagaataaat catttatttg 32340
 ttgttttata ttttgagga atgcacacaa cccttctgga acacctggaa ttttctattt 32400

 taatattgaa attccattct catctaaact attgtcttca atttcttaca aaacaatgtt 32460
 ttgttataaa tccatgaata tcttgaaagg cattaaaaga gccacattta tggaaagaaa 32520
 agatatttat tacattgttt tagaaaaatc attgacagtt aaatcgatac aaatcttaac 32580
 ttgtctaaat acctatacat gactgaaatc tccagtgtta taatacaaaa tcaatgatat 32640
 ttcttatgg agaattatga tgtatgcata tgtatataca tgtggaagtc cacttgtccc 32700
 cttgacgttc tgggggagt catttatgag cataaaagta agaggttatt atggaggagg 32760
 agctatgggg ttaaggaag gcaataatct tagtcattta atcgaagttt taagtggcaa 32820

 gaaaattttc ccaatttttt cccaaatatt cttttaagta tcacatgtgc tectgatttc 32880
 tgaaatcaa atttagatca atagaatatg ccattatttt taatcatcac tcaatattat 32940
 aataattatc atcaacaaca atgtaagcat cactacagtc agaggtagta gttaaagga 33000
 atctatttca ttacagttat atgttcagtc atcatctcat tttataagtc aaacatgact 33060
 tttatgtggt ttcaagagt ctgaattact gttctattgc tgagaagaga cgccaagact 33120
 cttacattga aaagtatata ttggggtgca tacttacagt tttacaggct tcataccta 33180
 ttatgacagg aaacaggcat gtgctgcacc aggagctaag agctttatat cctgttccac 33240

 agtcagttag tggagaaaaa gtgacactgg ccctagtga agcttttgaa acctcaaacc 33300
 ctacecccg tgacacacat ctttcaacaa ggecacacct cttaatcttt ctaatctctc 33360
 tcaacaatt ctactccta gtgattaagc attcaaatta tgagcctatg agggaccatt 33420
 tacatcacca caccaataa ccacacttc cactgtttta acaagtcaa catcactctc 33480
 ataaggtctt tttctttatt gtttatagc aggatttacc tggcagctac aaccacaaa 33540
 agacatcaga agggaaatga tgacaaagga accacagaag ctctgagttt aagtcacata 33600

ctactatctc tggacaaatc tattggttgg aattagaacc ctggcttgac accagtgcac 33660

atgcaaagtt ttggaacac tagtggctcc ttctgtatcc ttctctacat tccttgcac 33720

cttctccaaa ctctaccttc tgtagcacct tctacaaagt cttcaccatc tetcaatgag 33780

aaagtagttc acatggagcc gtgatactct cattcctacc atcttttgcc ttaatgattg 33840

gtgcttgttt tctgtgaatc acaaatttat ttataattt ccaaacaga aatgggttta 33900

tatcaggaaa gtctttgact ggctggtttc caaatggctt taccacactt ctctttaatt 33960

gagcctatta attttagatt catttaaaag tctttttaca tgtaataat ttagtagat 34020

taatacaaat acttcaatga cttcataaga aacgagcgaa agaaaatgcc ataatacaaa 34080

ttagcaattt taatgagtg aatagactgc attttactg agatttatac cttttaaaac 34140

aaagtgtct acatctcatt aaatgcacaa cagaccacct gaggtcatt agtgtttcca 34200

ggtataagaa gataaattag gatgaaggaa tcaagggact tgcccaaaag caagacaaat 34260

tatgttacag aatctggatg ttcagtgtat gtttgtgcaa attcttcatt acttatttta 34320

ctttattgaa caggcattag gagaaagttt ctggatccct taaattgcat ataaaagaca 34380

ccacctactc tgagcaaatg attaataata ctgataaaag gtgtcctttt attcttagtt 34440

glaattgaga aagtaaaaga cagacaaact ggcaaagaac atgttataaa agtcctggaa 34500

aatgaagaaa aaccacceca aacttaatga gattctgaga accagaggac gataacgcaa 34560

cagaaactga acaccaatcc aatgtgccta ctgtgaaaga cttcatgaga tgccaacaa 34620

acaagaatgt ggaccatgac aaaacacaaat ttatttacta gaattctatg agggaagatg 34680

gaaacaacca ttggaacaat aacaaaatgt tctcactgac atattttcaa ctatcaaaat 34740

ctgacaaaaa ggaatttgt tttatggatg aactgatca aggcttcaa accccaggtg 34800

tgtgcaaaact ggctgggag tagctgtcac atcatcagac agcttatttg ggaacatttc 34860

aacctcagac cagcctatit ttagaaggac atttctata actcagacta agaatggatc 34920

aaaaatgggg tggcttaca aaagaatac atttcaciaa gtttgatcag ttcactgctt 34980

tccacattga tcaggtggaa tatgtaggtc cattaatcct taataagata aaagtggttg 35040

tctgaagcta aaaggttatt tgtgagacat gatgctacta ttaactcat gaactcacia 35100

tggctgtgac tgcacacaca acaggactgc accagacaca aaccagtcaa aatcttgaa 35160

tggacaagga aagcattcat gaagtcattg gctattgttt tctccaggga tatggcccat 35220

gaaagtctat ccatgtttct gtagatggtc ctatactcaa tgcaaaaaa ggcattggcta 35280

agtggactca gttttatggt tgttgatac tgtttgttt gtacagcatg taaagttaag 35340

aaggaaaagc ggcagaaaat gcaggagagg acttagaagg gaataggat ggatccaaac 35400
atgttatatg atatatgaaa tccttgtaaa ataaaggtaa aaataaagaa acacaaggaa 35460
ggaggacttt ctgtgtctaa ccttctagta tgtcagtgga agtgggaggt agagaaaagga 35520
tgctgagaga tctacattta aaggaattga gcaggatttg gcatttttgc catgagccat 35580
tattcagtgt acaaggacat gggagggcc aactacagtc caacattttc aaaagtctgc 35640
atctccatca taagaaagag tagttttcaa agcagaactg atgttttcca gaagactact 35700
gtcaaataga atatatntag gacatcattt gctgtttatc atgcatacat gacattttct 35760

ggatgatggag cttgtatgac tggtagattt gcctctttgt tctgctagat cgacagcttg 35820
gtagattata aagtagtagt aaaaattcaa cctgtgaata tgcataggta aacctgggaa 35880
ttttcaaat attttatgat aaacagaaaa atcagcgact ttataaggtt gattaatatag 35940
tatacagaaa tttaggaaaa gactctttga tatctcactt caaagttcat ctctctttca 36000
caaattcact tattaagggt gaatccactt acattaagggt atgaatgcat tctcaagtat 36060
actggaaaat tgcctttaaa atggtaaatt ttagttgata gaaagcaatt tgcctctag 36120
gattcctgat atgtttgtga gtectctctc tttgtctttt ttctctgtgt ggtgtgtttt 36180

ttttttatat acagaatgta tgtgtacaaa tgataaatgc atgacatcaa taaacatatt 36240
tttctctct tttgacttgt catgatatct gccagattat ctactaaag atgattaaaa 36300
tctttataaa ctattagtgt tcatgggact gataacaatg attfacatct taaaggagat 36360
aggaaacaca aggtatttta agccatcccc aattttcaaa cattagaatg agtttttcta 36420
agttagtttg tctgcttccc ccaaagaatg atattttatg cattttcttc tgtatttccc 36480
ccaataatth tgaggagatg ggaaaatacc tatgcatggt ctccccatgc agagaggaag 36540
ctggcaatct gaaagagcat ttctcccag agagtaaac agatgggtgt ttacagggtc 36600

tattcagacc tgcctctttc atcttgaagt tcttgtctgt tagtcttttt ctccaaataa 36660
ttgaacttgg atgatgtttt cctgaagtgg gagagcaggc acactttgaa gtgtcactgg 36720
gagctaaaag gagagagact aagattttct cagaggcaaa gcgataggag agaatgaagg 36780
atgatgagct tcagctcagg gatttgagga cctggatgaa gagatttgat tagctggttc 36840
agggagaaaa aaatcgatag gaaaggtgag ccatttgaaa tcatgaattg agggaagccc 36900
tggatcaatc tgggctagga attacttttt ctaaggctca gacattctat tttcagtcag 36960
ataggcttag aataaaatca taactagtct gaaataaatt catggatgtc taccttataa 37020

aataaaaaca aaagtttga attgagttgc taagaacaag aagattctta aacatagtac 37080
ttctgcacct ctctatattt ttgaaggat attaaaaatt attgacaaaa tggtecaaag 37140
gttaaaactg agggtagcagg ttgacagggt tgaatagtgt ttatataact gaatcatcca 37200

aattcaagac tggattaaaa tggacagttt atttttcaag gagttggcaa ggctatcatc 37260
atlttggtgaa atgaaaagca tggttgtaat tttttgcatt gaagtatagc acacatacaa 37320
taactactca tcatcaataa aaaaataactt aaaatcttaa actttctcct tcatcatcaa 37380
gattctacct ctaaaaagtg tcaatttaaa caaagcagga ttttggaggc aggagctgat 37440

acagaggcca tggaggagag ctgcttacca ggttgccccc catgttttat tcaaccctgt 37500
tctcttatag aacctaggac cacaagtcta gggttggccc aactcacaat ggactggggc 37560
ctcccacatc aaacactaat ttaaaaggtg tcctacagat ttgcctataa gcctgatatt 37620
atggtgggat tttctcagtc tagatgactc tagcttgtga caagtagaca taatgagagc 37680
tatcacaatc accctttaga ttattccact accaaactcc aacaaatgag atatcaaaaa 37740
taagaaaaca aaatcaaat caaggacaag caattagaat taatttttaa tttttaagtt 37800
aattttattt tattattttt ggtttttcga gacagggttt ctctgtgtag ctttgaacc 37860

taccctggca ctgctctgg agaccaggct gtccttgaac tcacagagat ccacctgcct 37920
ctgcctccca agtgctagga ttaaaggtgt gtgccaccaa tgtctggcta gaattaattt 37980
atagaagcct tttttttta aataaaaaga caagaggagc cccatagatt tcccaggcct 38040
cttaactgac acccacgttt agggggtctg gttgatccta tgctggcttc ccagctatca 38100
gtctggggtc caggagctcc ccttgttca gatcagctgt ttctatggat ttctccagcc 38160
tggctttgac ccctttgctc atcaectctc ctctctaca actggattcc aggagtctt 38220
ctcagtgttt agctgtggag cctctggcaa atagatcacc atttaccct agtatccaaa 38280

tggactttgg gagcccatc cacatagagg tatactcttt cagcaaagac acaagtggcc 38340
acctaggccc tgctccaat gatgtgaaca gactttgaag atcccacatg gaaggcctta 38400
ccctccctgg ggagccgaaa ggggggtata ggggtttggt gggagcagga gaggagggaa 38460
gggagaggga actgggaatg acatgtaaaa caagcttgtt tctaatttaa acttaaaaaa 38520
ggagaaaaag acaagaggaa gaagcatttc tcaaaaatat ttaatttcat tttattgac 38580
tatatgaatc actaattttc cacaggctga tactgcagct atcataatag aactaaacc 38640
aaatatttta tatcaataat tgagaagtga tcacaaaac ttttctca ctaggtacca 38700

aaattactaa ccaaatgaat taacttctt ttttagagga gaaggacctt agaaatgaaa 38760
aaaaaattaa ttttgggtat gtatcagctt ttaaatagat ttttaaat aaccattaa 38820
tttgaggttt aaaaaattcc tactgcagct ttttctcca tcattttatt taaattagaa 38880
acaagattgt tttacatgac aaatctagtt cctctctctt cccctctac cctgaccccc 38940
actaacatcc tacctatccc ataccaatc tgettccac agagagtgag gtcttccaaa 39000
cacaaaagaa aatacctat tttcagcacc ctatggaatc ttttctaaa tcaaccacat 39060

actcggaac atagcaaacc tcaacaggta caaaaaaatt tcgataacac cctgtgtcta 39120

atcagaccac catgctttaa agttagaatt caagaacaac acaaattgca gaaaacctac 39180

caactcatgg aaactgaaca atgtacaatt gcaggattcc tgggtcaagg aagaaataca 39240

gaaagaaatt aaagacttcc tagaattcaa tgaaaatgga gacacaacat ataacttacc 39300

ttttatcata actaaggaaa accataacta tcggtctgta actccattaa agagcacaga 39360

agggtaatat ataacctcta gtttggacag aatgctgtaa agcagtccag acaaaagcag 39420

ttttttgtcc aaatggccag ttttgctgc tgtttctgtc attacttgca ctttaggaa 39480

ggtgcactct tgcatttctt gcttaccta gtaatgtgt tttccttctt aggctttga 39540

tgaggtgaa gactacataa taccctctct tatcttatat agaaaacaat aggtataata 39600

ggcactaggg aaatgtctgg agatctaca agatgacaac aactggcaat ctaggcaaca 39660

gaaaagagge taccttaact gccctccct gataatgaga ttggtgactg gcttatatgc 39720

catcctatag ccttcatcca gcaggtggtg gaagtagaag cagacagcca cagctaatca 39780

ctgaactgaa ctcaaatcca gttgaaaaga aagacgagtg atgagcatag ggtccagac 39840

caggttggtg aaacacacag aaatagatga ccagaacaac agggagctct tggteccag 39900

actgatagct gggaaaccag cactgcactg atcccgaacc taggaatgtg ggtgtcagtg 39960

aggagacctc agaatccat ggggcctctt gtagtagatc agtacttacc cctagcttag 40020

gtgtgtaact tgggagccca ttgcacataa gggatactcc ctgagccaag acacacgggg 40080

tgggttaggc ctttcccaa aggctatgac agacattgaa gacccctat ggaaggcctc 40140

accctccctg gggagcagaa agggatgtg ataggtagag ttttagttgg gggagggtga 40200

taggggagga tgggaggag agggactggg attgacatgt aaaataatct tgtttctaat 40260

acaaataaaa aatgaaata aatgaaacac ttaataaaat tttcatgaga ggttgaacc 40320

tttaattatt aaatgggttc ttttgattac ctatgtatct taaaaacaaa ctgtactaaa 40380

agtttcagat ttctagctt caataaaacc tttattattt ataataaaag aagaaaatac 40440

taggtataat acttagactt tctagattag gacagctatg ggagtaatct cttagcatag 40500

ctaatacctt gggaatggac atgtagaatg tgcgattgc tcattgttgc tcttgctggt 40560

tgtaggtcta aatttgtttt tacctctctt tctcctggtc tatacttgaa gtttgttatt 40620

gtatatgtt ttcatatgag acttgaacc ccctattta gatgaaaggg gaattgtagt 40680

ggcatctgt tttgtcagt aacttgtgt tgtggccaca ctctgggcat gggtttagg 40740

ttcagatatg accccttgta aagtaatgga tggactggct ttcagtctct tgggttcag 40800

taagagcatt gaaagggcag agactgcatc ttctggagca ggatgacat gaagtgttat 40860
 ttactcttat ctgtgtaagt gattccctaa taaacaccta actatcactt ttcagggttc 40920
 tgctagactc atttaaacct caccttcatt ttctcttttc ccatcaactt ctaaataaga 40980
 tatatttctg aataaatttc gattttcttt aaatttccta tttatatctg ggagaaaggc 41040
 taatatgttt taaataaaa gtgaatcatt aggagtcatt ttaataccat gtgcatttaa 41100
 gtaaataatg gtattgaatt caatgctcat caaagcagca ccttctatta gaagactgtg 41160
 aacacaagat tcicaaatgg tcaaaactct cagaataaga gaggaggag tgctcagtcc 41220

 taaagagaac atgcttattg taccacttcc tgaattctc agggaacatg gcagaagatg 41280
 gatcagatgt gggtagaagg tagaagatga ccaagaaacc aaggccgtta cacttctgaa 41340
 ttcacaagag ttttaacaat attcactcaa actacacaaa ctcaagccag acaaaatttc 41400
 agcacagagc acaaaagatg ggtgcaaaat tccaccactg actgaagagc tattggcatt 41460
 tgatagctac taggaaagga agtcaatttt cttcaaaaat gtgacacttg gttatttgac 41520
 cacattctgg aaaagatccc ataccaaga atatttgcc aacacacatt ggaatccatg 41580
 aagaaaaaca aataaagaaa agagctggat gcttggggaa tgagggtggg attaagggat 41640

 gttataggat gctttgtgta acattctcaa atacttaata acataataat aactaaagg 41700
 ttaatcatct ttgaatattt tcattaccta taaattgttc cattaaaact catttgtact 41760
 agaatttata aggtatttaa ttttaataaa ataactttta gttggtatta agctatattt 41820
 ataagaagca tctagacgtc ttaattttca ttcataaata tactcaatat ggaattctga 41880
 atcaattcat tcatatattc ctgtagttaa gatattcatt ttgggaaact gtatgagatt 41940
 agtgtgagat tgaatgacac aggaattcaa ataattatcc actgtgtggc aactgttatc 42000
 atagtaaaag gtatagtac ttactattgt tatttagaat gttgatttct gtacctgttt 42060

 ttaattttaa attattttaga cctcatttta agtgaatggt cagacttttc agttctatct 42120
 ttgttagta actaaatgta gagttcatga ttagaaggca taagatcctg gttcattctc 42180
 cagaaaataa aaagacaaaa tggaaaggaag agacagagga aatgagagtg aaagtacgaa 42240
 agggaaaaaa aggaaaaaag gcaattttat attgaaggaa ccagcttctt tttggcagcc 42300
 ataacagccg aacacgtgct tgccataaac ctgcccttggc cacgtagagg tcagatgcct 42360
 gtctcgtgac aaggaacctt agtcacttag aggtcagatg cctgtcttgt gacaaggagc 42420
 caatcggaag ttagctggtg gcgctatgct ttacgaccct ggggtgtgctt tacggacaag 42480

 cgcacgaaa tgacgtagag agcatagcaa ccaccctggg agggcctatg ggccataaca 42540
 accagttgac caatcaacac agggcaagcc ctccaagcct ggaagcacac caattgtgag 42600
 cctgtgcgta agcctgtgtg taccctaga cactccctt acgctgcct ataagatctt 42660

ttgggagacc caaggagccg tctttctcia gccgtctgcc atggcgggtg ggtgaaagac 42720
 ccgagctaac atggggttag ttcgttaa atacaataaag cctcgtgcag ttgcagcaa 42780
 gctctcgaat ccgcctgggtg attgggggtga ccgcgaacct ggccctgagac cccggttact 42840
 tgagttttcg ggggtctaac aatattacaa taccactttt tctccaaacc tacaactaaa 42900

 caaaaaacaa aaaatctgaa taatcttcaa aggttttagaa gcatgtaaga taattttaaa 42960
 ttattgtatt ttgtagaaca tatgtatctt caattttaaa tgttcttggg agaatgtgta 43020
 aaatgtgaac attaaattg aagatacata tactatattt taagggatc gtacctcacc 43080
 aatcagtaaa tcccaaagaa ctttattgat aataacagtt gtaacacatt aaataaatgt 43140
 attaattaat catatccatg tcttgcattg gacataatac ctcaaagatc tgttgaanaa 43200
 ctaagttatt aaattttgtg ataactaat aaaatcttta atatggcttc ttaagatttt 43260
 ttttcctttt tggaaaacaa tcttttcata caatgtattc taatcatggc ttcccatacc 43320

 tcaactcttc ccagatgatc tctactgcc ccactcctca cctaccaact ccacatctcc 43380
 tttaaaagta caacaatag atataataaaa gttcatgaat gtatacttta cacaaaagtt 43440
 ttgaaattat tgcttttag taattcaaga aatgccttgt aaattagagc atgaagaaaa 43500
 ctgtttta atttcttctg cctatagtga cacataggac actgtaaatg aagttttgaa 43560
 atgtttttagc attgtaatta ataaaatgaa tacaatgaa aatggtcatt tgatcttccc 43620
 acctgaatta agactgctac cttttctgaa gttaaacagg tggcatcatg cattgtttat 43680
 agtcatgggt ctgatcacag tcttctgct gcttacagac ccatgagtgg acctctaggg 43740

 gatccattac tcttaaaagt ctctcaaaaa ccaggacttg tcttcatgag gcctgagagc 43800
 acatattgtg taacctgct cttgggtccat aatattgctt ccctctcacc tactgatgctc 43860
 ccaaatctat ttttttagt cccacactac atacaggaat tgccctgccc agtttctctc 43920
 actagctaga ttcatctcta gtgatgagtc cttaggetgt aatatctgta cctgttgctt 43980
 cttcagtcag aactgatga gcacagatgc tcataccaat gtacaaaaat gaggaaaaaa 44040
 attggggaga aatgaagtat gtattgctta tatgaagatg atacatatct cctgtcttct 44100
 tactctgtt ttcctgtgg actatgagac agtatttttg tgtttgattt tagaagatgg 44160

 gaagtccata ctgactatgg aggattgatg catataggag aaaagtacta gaatatccgg 44220
 tcattgttaa gtgaccatag aagccttgc ataattgaaa atgataaatt gtttgatttt 44280
 ctacttgatc attttcaatt attgaataat caaaaaccaa aaagtaaac agaggtttga 44340
 atctcaactt aacaaatgct gaagagattt ataattgtcg ctatcaagga gtgttcaaat 44400
 attgccactc atttctctg ttaattaata ttactaata tacacataat tttctaatg 44460
 tagaatatgt atttactttt taaagataaa gcatttaac tggggctcag ttttagaggc 44520

ttagtaagtg actatctata ggtaaataat ttgaaaacc actatgtaag tgacagtagg 44580

 gaacaactat gaaaagatcc ttccacatct ccatgatgaa aaaggaagga tgggtgaggt 44640
 aacccaatcg caaaaagaca aacatggtat gtactcactc atatgcggat ttntntntnt 44700
 nntntntntnt nntntntntnt nntntntntnt nntntntntnt nntntntntnt nntntntntnt 44760
 nntntntntnt nntntntntnt nntntntntnt nntntntntnt nntntntntnt nntntntntnt 44820
 nntntntntnt nntntntntnt nntntntntnt nntntntntnt nntntntntnt nntntntntnt 44880
 nntntntntnt nntntntntnt nntntntntnt nntntntntnt nntntntntnt nntntntntnt 44940
 nntntntntnt nntntntntnt nntatagagg gagacat ttt tggtttagag agaaatcagg 45000

 cgctagggaa atgtctggac atctacaaag atgacaccag ctaactaatt cagcaatgga 45060
 ggagaggcta ccttaaafgc cctcccctga ttatgagatt gatgactgac ttatatgtca 45120
 tcctatagcc ttcatcagc agctgggtgga agtagaagca aacaccata actaatcact 45180
 gaactaaact ggaaccaga tgcagagaag gaccagtgaa gagcacagag gtccagacca 45240
 ggctggtgaa acccacagaa acagccgacc tgaacaccgg agaacacttg ctcccagtct 45300
 gatagctgga ataccagcat gggactcatc cagaccccag gntntntntnt nntntntntnt 45360
 nntntntntnt nntntntntnt nntntntntnt nntntntntnt nntntntntnt nntntntntnt 45420

 nntntntntnt nntntntntnt nntntntntnt nntntntntnt nntntntntnt nntntntntnt 45480
 gacacacagc ggtgggccta ggccctatcc caaaggatac aaaagactct gatgacacc 45540
 tatggaagc ctccatcc agggggagca gaaaagatat gtgacagatt ggggggtggg 45600
 tagggaagga tgggtgggag aagggaacta ggattgtcat gtaaaacaat cctgtttcta 45660
 attcaataa aaatgttga aataaaagga aggatgggac agaaaaaag aatgagaga 45720
 gaaagaaat aaggaagca aacatgaagg aagacaatgc tgcttgacac taatggaacc 45780
 aaaatagcc aagaactcac aatagcacc aactcaaaga aaacagcaac aaacttaca 45840

 aaggtgtgaa taattgaaa ttatcattt ttatttaca gatgttattc ctaatgtgtg 45900
 tcttccatt acctaatgc atctaattc ccacaaaaat aattgacttc ctctctag 45960
 tattcaatta atctctcaac attctctacc tgtggataca tattgaccc acacatgtca 46020
 gctatgtgga ctccacacag cacctttgta caatcagctg tcagggattt ctcttgaagt 46080
 ctataaatgc attcaaatca ttctctgagc tctgagatac atcttactac ttigtactaa 46140
 aattctatca actcaacttc attcttttca ctttctttt actcttttat tcatgcttgt 46200
 catactatag tcttataatg tctggaagca ttgcaaattt tactcacctt ttaaaat ttt 46260

gaatattatt ccctttaaatt attgcttca cccttattt ttccaatgaa atcctactca 46320
 ttgtcctaac aggttttaag agtgtcaatt caaacatcgt tccctccatt gaggagaaaa 46380
 catgtttgct tactagtata ttcagtaaaa acatataaag gaaatattat tttctgataa 46440
 tgatgtgagc acigtaaaac cagaggcaat ctaaacatca aaatttcctt catcacttca 46500
 tcattgcatt aacacaccta tgtggggttt gtacagtaat cagaacaga ttattgtaat 46560
 agccttttat atggagaaga gcactttaaa atcaactcat gacagttgga attctctaag 46620
 aacctgact aaagtattta tttgaatgac aggtgtcctt catagacttc attctatgaa 46680

 gtcataggcc ctttaaattt tgtccctgaa tgatggccaa atgatgttca tgcactttg 46740
 atgttatgat taacagggt cccttgatat caatccctat attattatca gaaactatag 46800
 gttctatcaa ctgcatccaa aggactctag catggcaatt tgaaaatgct cttgagggca 46860
 acacatgaac agaagttag aaggttaagat gtttttaaat tttccctttg ctctttcaat 46920
 tgtaaaacta gagtgagitt aattcccttt gacagaggtc tttgccaat gtctctgcaa 46980
 atgtaccatc atacattatt tagcaaggac catgctctaa ttcattgcagt cagcatatc 47040
 ttatgttcat tagagtctc atactaagtt actaagtgt ctgtgcaata gtctctcttt 47100

 aggtattggg ctcttaaga gctcacact tagaccattt gcatattttg atttaatgtg 47160
 aaatgccaca catgaattca catgcttaaa cttttgtcc acaagtgtg gtggcatttg 47220
 gcaagtcctg gaacactgaa gagacagaag aaataggcct tttgcctggg tttgaagttt 47280
 tctaattcag tgtggggacc aaataattgt tatgaaatat tttggggccc agcctccagc 47340
 tccagcaaac aggggcgtgg gaaagtccg gactattgta ttgttaattg ccagtagggc 47400
 tgctattgtt taccatggcc tcagggtaaa atgccttcta tttgcacctc tgtgggccta 47460
 agcatctgaa taggcctgca cctgggcaga ggtgggaggt gagtgagtaa ctagggagga 47520

 ccgagttagg ggccatagac cccgcagaga ggagaatgag gagagaaata gttcccttgt 47580
 ggtcatgaca ggacagttaa gaaacaccag aaaagatggc taataaagaa atgattctag 47640
 ttctacaaca tggaactaag agctctctaa agatgacaag atgcctgtgt ttgatcttta 47700
 tcgccgttgg gttgctgagt tcccccccc cccccccgc atggattaag getgagacat 47760
 gctgggacag gacaatccag ttaccttct gttttccact tccaccaaga cttgagaaga 47820
 tgagacttga gaagagcatc tacatgccac gaaggatg gagggtgcca tgacttctt 47880
 caggacaga ctgtgtctc tgaactatg taaaaacaca cagtttctt caagtcttc 47940

 ttgctgagta tttgatcaag gaaacaaaca agtaccagtt ttgtccagaa ggcccagaag 48000
 gtagagatgc ttgatccaga tgccatattg gaggaaagga ttaaattgtc ttctaaccce 48060
 tacatgtgtg ccttagtgtg tgtgtgtgtg tgtgtgtgta tgtgtgcatg cacatgtgca 48120

tggacatggt ttagtacagt cactatcact aaataaatc aataacaaaa gaaaataaac 48180
 taagaccatg tacattacat attttctagg atcatgcatg ataaaggatg ggtggtcaat 48240
 atagttttct ctgatggcct gcatagaaaag caatgtatat ggcttctctgc atataaggca 48300
 ttatccatag cticctgcat taaaataaga atattttccc tgatctgttt ttatttaggg 48360

 ttgtttttct ttttgtgcat tttaaatgtt tgtgtgttag tcttgaagga accggttcc 48420
 cttttggcag ccataatggt cgaacatgig cttctatgac cttgtcctag aaaccagaaa 48480
 gtcagatgcc tgtctcgtga caaggaacca atcagaagt agctgggtgc gctatgcttt 48540
 atggctctgg gtatgcttta cggacaagcg cacagcaatg acgtagagag catagcaacc 48600
 accctgggag ggctatggg ccataacaac cagttgacca atcaacacag ggcaagccct 48660
 ccaagcctgg aagcacacca atcctgagcc tgtgcgtnnn nnnnnnnnnn nnnnnnnnnn 48720
 nnnnnnnnnn nnnnnnnnnn nnnnnnnnnn nnnnnnnnnn nnnnnnnnnn nnnnnnnnnn 48780

 nnnnnnnnnn nnnnnnnnnn nnnnnnnnnn nnnnnnnnnn nnnnnnnnnn nnnnnnnnnn 48840
 nnnnnnnnnn nnnnnnnnnn nnnnnnnnnn nnnnnnnnnn nnnnnnnnnn nnnnnnnnnn 48900
 nnnnnnnnnn nnnnnnnnnn nnnnnnnnnn nnnnnnnnnn nnnnnnnnnn nnnnnnnnnn 48960
 nnnnnnnnnn nnnnnnnnnn nnnnnnnnnn nnnnnnnnnn nnnnnnnnnn nnnnnnnnnn 49020
 nnnnnnnnnn nnnnnnnnnn nnnnnnnnnn nnnnnnnnnn nnnnnnnnnn nnnnnnnnnn 49080
 nnnnnnnnnn nnnnnnnnnn nnnnnnnnnn nnnnnnnnnn nnnnnnnnnn nnnnnnnnnn 49140
 nnnnnnnnnn nnnnnnnnnn nnnnnnnnnn nnnnnnnnnn nnnnnnnnnn nnnnnnnnnn 49200

 nnnnnnnnnn nnnnnnnnnn nnnnnnnnnn nnnnnnnnnn nnnnnnnnnn nnnnnnnnnn 49260
 nnnnnnnnnn nnnnnnnnnn nnnnnnnnnn nnnnnnnnnn nnnnnnnnnn nnnnnnnnnn 49320
 nnnnnnnnnn nnnnnnnnnn nnnnnnnnnn nnnnnnnnnn nnnnnnnnnn nnnnnnnnnn 49380
 nnnnnnnnnn nnnnnnnnnn nnnnnnnnnn nnnnnnnnnn nnnnnnnnnn nnnnnnnnnn 49440
 nnnnnnnnnn nnnnnnnnnn nnnnnnnnnn nnnnnnnnnn nnnnnnnnnn nnnnnnnnnn 49500
 nnnnnnnnnn nnnnnnnnnn nnnnnnnnnn nnnnnnnnnn nnnnnnnnnn nnnnnnnnnn 49560
 nnnnnnnnnn nnnnnnnnnn nnnnnnnnnn nnnnnnnnnn nnnnnnnnnn nnnnnnnnnn 49620

 nnnnnnnnnn nnnnnnnnnn nnnnnnnnnn nnnnnnnnnn nnnnnnnnnn nnnnnnnnnn 49680
 nnnnnnnnnn nnnnnnnnnn nnnnnnnnnn nnnnnnnnnn nnnnnnnnnn nnnnnnnnnn 49740
 nnnnnnnnnn nnnnnnnnnn nnnnnnnnnn nnnnnnnnnn nnnnnnnnnn nnnnnnnnnn 49800
 nnnnnnnnnn nnnnnnnnnn nnnnnnnnnn nnnnnnnnnn nnnnnnnnnn nnnnnnnnnn 49860
 nnnnnnnnnn nnnnnnnnnn nnnnnnnnnn nnnnnnnnnn nnnnnnnnnn nnnnnnnnnn 49920
 nnnnnnnnnn nnnnnnnnnn nnnnnnnnnn nnnnnnnnnn nnnnnnnnnn nnnnnnnnnn 49980

nnnnnnnnnn nnnnnnnnnn nnnnnnnnnn nnnnnnnnnn nnnnnnnnnn nnnnnnnnnn 50040

 nnnnnnnnnn nnnnnnnnnn nnnnnnnnnn nnnnnnnnnn nnnnnnnnnn nnnnnnnnnn 50100
 nnnnnnnnnn nnnnnnnnnn nnnnnnnnnn nnnnnnnnnn nnnnnnnnnn nnnnnnnnnn 50160
 nnnnnnnnnn nnnnnnnnnn nnnnnnnnnn nnttttcagt taagatttaa aatgttaatg 50220
 ctctatata ttacagaaag accttaaggg aatttaaatt tctttttaa accagttttc 50280
 aatgtttgt ttttattaat gtttgtactt aaagagcttc aattagaat ttttctaag 50340
 caagcctga caatgtaaag ttcttgtttt atgaaagatg ctgatctatt ttaagatgtt 50400
 acagttcatg tttttaaaaa ttaagtttaa gatgttgga acacacacct ttaagtttag 50460

 gacgttggtg gcacacgect ttaatcccaa tattcaggag taagaggtag atagatcttt 50520
 atgagttcaa ggctgcctg gtccggcaga tcgaattcca gaacaggctc caaagtcaca 50580
 gaaaaacct gcctcagaaa gaagttaagc tactgtttaa ggaatataag gtagctctat 50640
 acagtgttaa gttcagctgt gctgtttcaa actttttact aagttaaacc cagttacagt 50700
 cagactaaaa attaattaca gaaataagac ttacctagc cacctgtatg ctcttctgat 50760
 gcgtaaggca agtaactaaa acagacagac agacctetaa tgcttcagag atcttcagaa 50820
 tatggcattt aaattgttat ctttaaagtt tataatgtca gacagactgc cagatccgga 50880

 gagtgacca aaggctccaa agattatgag gcaaccagct ttctacacct ggaccagtga 50940
 gcgagatgct cagatgtgaa acctgccgcc tgccagaacc tggccaagaa tgtggacaaa 51000
 gctgctgggc actggaaaat tgattgtacc cctttgccta gacaaaacaa ggtcagtcct 51060
 ttccatggcc ctcttcaca gagagaaaat aaaacctctc acagataggc ctggcgaaga 51120
 ttgttgttct ttgagacnmn nnnnnnnnnn nnnnngagaa acttgggttt ggctaactgt 51180
 atatggactt gcttctgact ggcttctgtc acttttagta gattcggata aaatatacce 51240
 ttctcagate tctgaaat at tactggttgt cagcttgaca gcatcaggca gtcagatcca 51300

 ctatagacta gtcagtatgt tagctgataa aatagtaact atctattggt caggcacaag 51360
 ctcaaggttt ttaagtttat tttggtgtc atctaagtac aaacttaaag ggcttttcat 51420
 caggccaaag gcacctctgt ccaatccata cctggctctc tggacagaag aaaaatatac 51480
 atgcttatag cccaaactg cagtttttgg ggtcttaaca gtctaacttt tgcctatcc 51540
 atagtagtta catggttga aaatatatgt gtgtccctg aatatcagtt gtcctacgta 51600
 agtttaagca tgctctgatt atttgttacc aagttgtatc tagtaactgc atactctgta 51660
 ttatccagca tttttgagta tataattatg ttggcactag aagtatggcc cgaattatcc 51720

taaagtaatg agaccacaaaa agtattttata gtaatatctt gtgcgaagtg agggccattt 51780
 ggttcacagc atattctgca aatcaagttt ccacagtttt tttgtacata gatttttggt 51840
 agaaacctga gtcctcagaa ggccctggaa aagaagaaat gctgactcag gaatctactg 51900
 catggcagta ggagaaactg cccacacagtg atagcaatgt ggttcagtaa gatcctcaga 51960
 tggcatttta aacaatgct gttaattttg ggctttattg gttttatagt tttcctttat 52020
 ttaatgcata catttgtttt agtttatagt tgcataagac tataagattg gtagtttata 52080
 ctttatattt aaatgtattt aatgacattt ttgtcaatgt aagtcaactc aacactggga 52140

 ggttgagact tctttctctt tcaccacagt aaattacata ttaagatgaa atagagacag 52200
 tgtccaagag caacatattt acttccaaaa tcaaatattt caagggtgtc aggaagcagg 52260
 ctccaaagct acaataactc cacgtgattt ctgctgagca ttggggtagc tgcaagctcc 52320
 ttcaaatgtg ttttatgtaa ttacattagt gtcagttttt aatttatatt gtatcccaa 52380
 gctaatatct cacataaaat gtaacattca tggtgcttta aatttagttg acatttttct 52440
 ttattaatgt gtcatacaca attctctact ttagtttaac ttggagatat taaattggtt 52500
 gtcccttctt aaaaaatgag atgagatatt tcaaaatctg tgtatttgaa gaaaaaaga 52560

 atcattttaa ttcttctata aattctattt ttattattaa cattatattt atcatatgta 52620
 tatgagtgtt tggaatgcat gcaccacttg tatagcctgt gcctttggag gtcagaaaag 52680
 ggtgtcagat tcctggagc tggatttatt atagttacaa tggatatttt acttttgagt 52740
 tcattataat gaaattattt tttattaaaa atcacttgta ggatttctgg gactcataca 52800
 atatttaaat gaacgatgtt ataagttgac tgcagtaata tatccagtgg tagtagaggt 52860
 cagggtcagt gacagtagca gaagaagcat ctttggttgg tgactaattc tcttactgtg 52920
 ttaagatttg ttatgcttgt aatgacactg agtagataag aattgcattg ttttgccttt 52980

 gaagacaatt ggettagttt ctcteccatt tctttgacaa aatacctgac aaacatcatc 53040
 attttttgta caaatggctt attcagacaa acctggaatt ataagaaaca cagtgtattg 53100
 gtcttatagg gaagagaagt ctgtccttgc agaaaagtca aagtggcagg aactagagac 53160
 agctgatcat attatatcca cagttaagaa gcagagagca aagaatcaga taacttcatt 53220
 ataaaatagt tgaggggggc aaaggatata aatgtatgta tagcatgttt tatctcactc 53280
 cctttttccc tgctataaaa atcaatgcaa ctctctctct ctctctctct ctctctctct 53340
 ctctctctct ctttctctct ctctctcatt ttacctattt gaaatttgta taagtatagc 53400

 caaaagaaat aattgcatca aatgtgttga aaaataagaa aacacttaa aatcattggt 53460
 ttataaatte cataatgaaa ttttactata tgcaatgaaa tcaaatcaaa gatattaagt 53520
 catatttcaa gcaccacaca tgcacaggtt atgacattat attgtaaatt aaagaagctt 53580

ttgattcagt gacatcagtg gggcagcaaa taacttgata gagaataat atattttcat 53640
 ttatgctttg taaatthaat taagtataaa aaggattagg gaagaaccct aataactaatg 53700
 aagaataaca atgagtgaca tacaattatc tttgctttaa aatgaaatcc tatcccagag 53760
 acataattha tgcicccaaat tttacttttg taaaaaaca tggtttttg aaaagaataa 53820

 atthtaataa aaaagggtta tatttagagt agttctttat actagcctct taaaactt 53880
 cagatttctt tcaggtgta ctcgtgcaag taatttatta tcaagggtaa taattatgaa 53940
 gacaacata aaaagaaaa tgagcagaaa aaagaatctt ctacactatc ttagcatgca 54000
 tgtctgtctt caggataacc aaaattgtgt gatcagattt aatctgtatc ataaaagaag 54060
 cctctcttca taaatttcat ggatgccatt actgtgatgt tgtgaccctt tcagaaacta 54120
 ccttatthtt ttaggaacac acatacatal atgaatatat attaacaata tatatgttca 54180
 tatatacatg tattcttata tacatttgaa atgaagtatg tgcattgcctc tctctatctc 54240

 tcactctctc ggtatgtgtt ggtagttgat aggcattgta aagggggaat ggcagggatt 54300
 atggcagata ttggtgacag taagacattt cagtcttctg tacattgtta ttattagaga 54360
 ccgtgtgatt ctgaaactca tagaagccac tttatgacca tgaattacct aaaatttagg 54420
 ggtcaaatca aatttccacc ttgccagagg ccttagagaa gaacctaatg ttatcattta 54480
 gataaattgg tacaataaca aagtcctcc tagatctcac tttatatcct tagtttagtg 54540
 aacctcttaa cactccttga agatgcttca tttgctgtgg atgtaataa atacagaaga 54600
 tcaggaagtg gccaacacaa aaagaataaa aaactggaca tctcagttca aagttagaca 54660

 tcattatcac aactgacttt caggaatcat cttagaagaa gtggaggga gatttaagag 54720
 gcagagggtc tacacatttg tagcaaaaaca gtatttgtac tgcatacaaa agactcacac 54780
 atgataaaaa caacaataat ctcaacatgg gcagagggag ggctcatgaa gccccacaca 54840
 catctgagga gatattggct atatatgtct gttgggggag gaaaattcaa atggcaccag 54900
 tgatgtagtt gcagagaagc aacatttact attgcagaag ctattacatc catgcacaga 54960
 caagtacaac taagtggact cagtaggtct caaaaaaga acatgcaatt gagagggaaa 55020
 agtggtggtta aagcagtaga agaactggag tggaagagat agggactgga tttcatcaac 55080

 aacctthttat gtatagaatga gactctgaaa caaacaaaa ataaaagaaa gaaataagtt 55140
 tattcaacag ctctaatgtt tggaaccaga cacagtgcta attggactgt gctgatcaat 55200
 tcatgctctt gccatttccac taaaaccaat gctaatattg cataagcccc cagaataata 55260
 atgcagaagc atctagaat gaaaatgtcc ttttcttagc aaaagcaagg aatgcttgta 55320
 ttttgcctta caacataaat gtttcttgat atgaaaaatg aaggatggat gtgctcaacc 55380
 ctgttataat tatgaaggca tccacagaaa gctacaacat gcaggaacag gaacatgcca 55440

agctctgtgg ctagtgacag aaggcaacgc cccaccccag ccccaaat t ccaagactgg 55500

 taatgaaga acagattgat agctataaga aatgttgtgg tttagtttct gttgttgcaa 55560
 agtataaata tatacattta ttaataggac attgcagggg gtcaaaaggg agaaagaagg 55620
 atgaagaaga aagacaattc aaaatgagat agatcttaaa cttacagaaa gcctagatct 55680
 ggtgccatgt ttgttgtgca aaaaatgaga tcacttccat acaataaagc ctttcagttc 55740
 aggtttttta ttcaatatta atttgaagga ctgagaatat agttaatata agctaacaaa 55800
 acaggggagg gaattttaac ctacaatact taggtagcaa gataggacat tatagagatt 55860
 aaaaataata gacaagagag aagcattttg ggtctgtttt gtttttagaa agggaagggc 55920

 taatctctaa tcaatgatta caataaggic aattagaag aaaatgctaa gacatgcctt 55980
 tattctagtc agttttgtac cactaaagga tttttctgtt ctctatagct gtttcagaac 56040
 acagtcaatg aatagaatgc tttgtagtgt aaataaaggg tgaaatattg tatagcaata 56100
 tttgaatgag gaaggagtgt taacataaaa ggaggcattg ggtgtcaaga taacttcaaa 56160
 gtgtgtcaag tctaaattaa agagttagga tagaaacaaa gattaactac tccactacct 56220
 ccacaaaag cattatagat gaatcatttc atgtctttgt tggcaccagt catgtcagaa 56280
 gcaagaaaat gaattcatat atttcttttc agtgatggat ccattatgta tttcccacct 56340

 tagatcaaag atgccagaa atattttga gtgctgaata aatgatctgt tgtttccctg 56400
 gcctgtaggg gcataacaaa tgtactatac ccaaaacact ggtgacaaca aattcagttc 56460
 tgacctgcac tgctctaac accaacttgc tttgttttaa agcttgcaaa gtgaagctgt 56520
 ctgaggtcag ttctgtggga ggagggatgg tgtgtatgtg tgcttctgct tgggaaaaca 56580
 cattggccaa caggtgctgg gtattgaacc catgtcctct caagacgagc aagtacttat 56640
 aaccactgag ccatctttcc agctcattta tcatgcttta aaggagata ggaaaacaca 56700
 tagattctat gaagattgat cacaaaaata tttttaata taatatecta actgttgaa 56760

 gctgagaaag tactgaacaa aaggtttgac tgaaggcagg attaatggat atgattttgt 56820
 ctaagtatgt gactgattta gccactaagt aagcacctga gtgaagagat ggctaaggag 56880
 tgagtcttaa gagttaatag aatgtgtgtt gttattcttc ttcctttcat ttgcttttgt 56940
 gfgacacat ttttaaaaca tcaaccatct gacctgaaaa tgaggaaact cagactttat 57000
 ataatttaac aagtaaatgc aaacatcaaa tctgaagaa tggcagtaag aaagatagg 57060
 cttcctagaa ttcaatgaaa ataactgaac aaaatacctg aacttatgag cttatgggac 57120
 acaatgtata tattactatg gggaaagttc ttagcattaa gtgcttacct taaaaattg 57180

gagagatctc attgtagcaa cttagtagca cacctgaaaa ctctagaaca aaaagaagtt 57240
cactcaagag gagaagagag caggaataa actgaggac gaaatcaata aatagaaac 57300
aaagaggata ataaaacaat caaatgaaac aaaaatatac aaatatatac aatgaaaca 57360
aggagatttg tctgagaaaa tcaacaaaat aggaaaaaac ctgtatccaa aataactaaa 57420
agatgcagag agaatatcta aattaatacc atcagaagtg aaggggtta tagcaacaga 57480
tctgataat cattaagtca tacgttagaa gcctgtactt cacaaaatg gaaaaccaa 57540
aaaaaaaaat tctaattgcc tcaaaagtta acacttatca aagttaatc aagatcagat 57600

aaacaattta aatagactca taaactgc agaaatgtgc acattcatta aaagtctccc 57660
aaccaaaaaa gccagggtta acatggattt catacagaat tacaccatac tttcaaagaa 57720
gagttaatgc taatccacct caaattattc cacaaattat aaacagaagg aacattgtca 57780
aattaccttt atgaggtcat ggtcacctg atatccaaaa cacacaaaga tttacaaag 57840
aaagagaatt acggaacaat tttccttatg aatacagagg caaaaatact caataaatta 57900
tttgcaact aaactgaaga atacatcaa aaagataatt taccatgaac aagtaggctt 57960
catccaagag acgcagggat ggttcaaac aagaaaattt gtcaatgtaa tcatagaaat 58020

gaaatcaaag aaaaaataa acaaacata agatcatctc actagatcct gagaaacct 58080
tcagtataat ccaacacat ttcagtataa aaagtcttgg aaagatgaga gacaaaagac 58140
atttaactaa aaatattata agcaatacac attaacata cagccaacat caaattaagt 58200
ggagaggaat tcaagcagt tctattaaa tcagggacaa gacaagcctg tactttctcc 58260
ctatatctat tcaatgtagt gcctgaagtt tcagctagag caataagaca actaaaggag 58320
atcaaggaat tacaatcag aaaggaagaa gtgaaagtat ccttatttgc agataaatg 58380
ataatataca taagtacca aaaaaattt atcatgaatt actatagcag atatacat 58440

tcagtaaagt gactggatc aaaacaaaac aaagaaaaac ccaatagcct tectatatac 58500
aatgaaaaa tcaactgaga aagaagttag gaaaacaaca cccttagcc acaaatgaca 58560
taaagtatca tggagtaact ctaaccaagc aagtgaaaga cttgtgtgat aaaaactgta 58620
actctttgaa gaaatttaag aagatatacag aagaaggaaa gatcttccat getcatgggt 58680
tggtagaatc aacatagtaa aatgtaatg aaattttgtt tatgtttaa caataaagc 58740
ttgcctgaaa gtaagaatgc aatctagcc acacctgtta gccatagagg ccagacagtg 58800
tggttacaca ccttaattc cagcacgtgg gaaacagagg catatggatc tttattagtt 58860

catggccacc ttgggtaca ggagattaaa tctgtctgaa aacgaaacag agctcacaca 58920
aaattgatcc cagaactggg gatctgatgc cttaataacc agcactaaag tggagacaga 58980
gttatatggc tgggcaaaga gaggaatata aggcaggagg agacaggagc tcaatgcaat 59040

ctgaggaaca gagcagtcta agaagtctaa ggatgcagtc tgaggacagg atcacctctt 59100
 tggctctgagc attggtagag gtgaaatctc tagttgctga cctctctgct tctcttaact 59160
 tcagcatcag catcaacccc aatatctggt tctgaatfff aattattaag acatattata 59220
 attcatgcta cataaaaatg gctatgctac aaaagcaatc tgtagattca gtgcaatccc 59280

 tgtcagaatg cctacacagt tttactgatc tftaaagaca atactcaact tcatatggaa 59340
 aacaaaacca aggttagcta aaataagagt gtacaataaa agaacttctg gaggcacacac 59400
 catccctgat ttcaagctct actaaagagc tagagtaata aaaactgcac gatattggca 59460
 taaacacaaa cacactgaac aatgtaattg aattaaagac caagatataa atacacacac 59520
 ctatgaacac cttattatft ataaagaagc cagaaatact caactgaaag aaaaggaaag 59580
 tctcttcaac aaatggtgtt gtacaaactg gatataagca tgtagaagga tgcaaataga 59640
 ccaataacttg ttaccctgca caaaatcaag tccaagtaga tcaaagactt caatataaat 59700

 ccagaaagaa tgagcctgat aaatgacaaa gtggggattg gccttgaaca cattagcact 59760
 ggagaggact ttctgaacag aataccagta gcacaggcac taaaatcaac aactaatgaa 59820
 tggaaactca tgaactfta aagcaaacga cactgtcaat aggacaaaac agcaggccac 59880
 agaatgggag aagacctca ccaactctaa aattgataaa ggactaatat ctaaaatata 59940
 cacagaactt aaaaaattag gcctcaacaa cccaaatagt tcaattaaaa ttgcatagc 60000
 tagggcctag ttcaactfta ggctgggtgg ctgggtagt ttatggggcc actagctggg 60060
 aatcagtat ttatccctaa tgcatgaact tgtgttttgg agccattcc ctatggaagg 60120

 ataccttget cagcctagat acagcagtga gggctcttgg cctgcctcaa ctgatgtgac 60180
 agatfttgtt gatttcccca tggaaaggtct caccctctca gggcagttgt taggaagtgg 60240
 agtggggaga aggtccaggg agcaggaaga caggaggaag aaggaacact aggatftgta 60300
 tftaaggtaa gattgtftta aaaataaac aaaaggaata atgggttaca gatgtacaca 60360
 tagaattcac aatggaggaa tftcaaattg ctgagaaata gftaaagtaa tfttcagagc 60420
 ctgcatgggt ctatgttagg acctctgcat atatgttagc ctagtatftt tftggggcta 60480
 ctagcattgg gaatagggtt atctftgact cfttctctg ctattattag tctfttct 60540

 cctactgggt tgcttggctc atcattgata ctatggtfta tgccaagtct tattataact 60600
 tfttatgctg tfttcagttg atatccctga aaatcctgct cfttctca gggaaactga 60660
 ggaagagtgt ccctggggga gagggftggt ggftaactgg gaggatgtg gaatattggt 60720
 gactgggggg agtggagaga ggggaagcta caatcaggat tfttagaaaa caaaacaaaa 60780
 aacaaaaat attataaat aaaaatataa aaataagata tftgactfta ftacatattg 60840
 atgaaaaat taacatftt gaaatfttct catcactftc agaagtactt atatcaatga 60900

cacatttaga accattgcaa atgccatgaa atataatgca ggataaaaat taatgagata 60960

agatgcctgt ggtttcaaat gtggcaaaca aagtttcaca ttcagtgaaa tgctctcttt 61020
tggaaagtga gtcataatg gattaataaa gaaataaagt caaggtaaaa tatctggaac 61080
cttttttag tatggctatc catgagtggc aaagcaaaag aggaaggaaa aaggggccag 61140
aaacagggat caagagaaat aaagaataat ggcaagatat ggggttggtc taaaacttgt 61200
tttacatttg ttcagcattt tacaatttac atttacattt gttcagcatt gccttgaaaa 61260
ttaaagtact ttacatagca cttcatttta aaattggtag ctgttaatct cagcactcac 61320
ttgggaggca gatggatatac tttagtttg aggccagtct ggttaaaaaa ccagttccag 61380

gacaactaca gtiggatat agagaaatcc tgtctcaaaa aaccaaaga aaaattaatg 61440
aaaacaaagc ttttaaggac aatgttagg gcaatctggc ttgctagact attttaatgg 61500
cacacttcta gatcagaaga gaattcctac ctcaaagact aaagttgagg agagccattg 61560
aagaagacac tgaagtcaat ttctgtctc cctgggcaga tatgctcagg tgtaccaca 61620
ctttcccagg ctccctcca tctctcttc tttctaactc tgtctctctc tggcagacac 61680
cacatactca tgagaaaaa ataaagaaac aaacaaaaa caatcttcac caatagacat 61740
atgtctaate cagaagaaag aattctaaa cctagtactt attcaaaat atattcatat 61800

ggttgatttc ctataaaaag acattatact gacctaacac attaatgagg caatccaaga 61860
gataaaagt agttttctt aagagactaa cctaccattc attaacttcc caggaagtta 61920
acataggta acagccatct tgctttctc tcaactcca ggaagcttc cacccaacce 61980
tgagtagaag gtcgtcaacc tcccagtcac ttaaatcatt tcctttcca gccatcagct 62040
tccaagaatt tataatgtct aggaaccca gagctcacta agtctaaaga catgagcatg 62100
tctgtctcca aatgctgtgc aaagaaaac aggaaccca atcattgaat ttctttata 62160
aagtaatcga aatgctgtt ttcatgtgtg ttagttgagt tctgagtga catgtcagca 62220

tcaggggtg taggttgag tcacaactca gacttctgtc tgcagtagac tgagttttt 62280
gagatggttc cacttgtgtg aaatgttga tctcaactaca cacacacaca cacacacaca 62340
cacacacaca cacacacaca cacatataca cctcaccatg tgcctgcatg agcaagtatt 62400
gagatgatcc tgccagccag cttattcagc ttactctct tggacctggg actagggctg 62460
catgttcttt ttttctctt cctcccctt tttttattat tatttcaagt tagggaacag 62520
gcttgtttca catgcaagtc ctttctcct cttctcccc tcatcccat cctctctccc 62580
cacctccaac ctatcccca cctccaact acctccacc ctatccacc accactcccc 62640

aggcagggtgta gggcccccaa caggggctcc gcaaagtcca ccaaatcttc ctgtgctggg 62700
 cctagccccc tccccatgtg tccagagaca gagtgcaccc cttcacgtgg gatgggctct 62760
 caaagtcgac ccacacacac cagggaaaaa ccaccagtcc acctccagag gctccccgga 62820
 gtgcaggggc ctccccattg gcatccatga tcagggcgct ggatcagtcc tgcactagcc 62880
 tctcagacag catctggggg cgatatgtat agtgggaaat taccaataca gagtccagta 62940
 gaaatataag ggtatttaat agggaaaagc cttacttaca gagcaacctg gccagccggc 63000
 gtggtagtag tctgtacatc aagaagcaaa gagaaacaaa aagcgcaaac gcagtccacac 63060

tacgtcactc tgaccacacc ctcacaagca tggtcaggcc cacctgtagc cagcccctaa 63120
 gaaggcatgg ctacagcttc ccctacaatt cccttttag tctaaaagag gattaaaact 63180
 taacagtata aagtatccaa aattagcaat cataaaagta caacaatctg tttatttcac 63240
 atcctaacta taactaaacc ctaaagtcac ctgaaagagg tttccaagcc tgaacacctc 63300
 ggttcaatcc caacaaaaa caataggaag caatccctaa ctaggtatat acactatcct 63360
 aatgacaac aatggggaaa gggggcatag cattctgcaa gttactagta caacaatctg 63420
 tttatttcac atcctaacta taactaaacc ctaaagtcac ctgaaagagg tttccaagcc 63480

tgaacacctc ggttcaatcc caacaaaaa caataggaag caatccctaa ctaggtatat 63540
 acactatcct aatgacaac aatggggaaa gggggcatag cattctgcaa gttacttctc 63600
 gctgaaatgg gacgatgata gtcatgtgca gtctcttagg aagaaaatgt tagtatccag 63660
 tccatgtag atgggattca cttgattgaa gatctcgtt gaaatcctca acttgattga 63720
 agtcagtacc cgaacctctg gccggagtgt cagttgaaat ggagcaagtt ggatctagtg 63780
 cagtcgagga ggtgtagcct attttcttc caggggtgcc agggattgct gttatgcttt 63840
 cccttttca ggccaactgt ttctgtgggt ttctctaacc tggtagacac cccttcaatc 63900

ttcattctc cctatctca actaggttcc agatttcagc tctgtgtatt tetgtggatg 63960
 tctgtctctg ctccatcag ccaactggatg agggctctag gatagcatan nnnnnnnnnn 64020
 nnnnnnnnnn nnnnnnnnnn nnnnnnnnnn nnnnnnnnnn nnnnnnnnnn nnnnnnnnnn 64080
 nnnnnnnnnn nnnnnnnnnn nnnnnnnnnn nnnnnnnnnn nnnnnnnnnn nnnnnnnnnn 64140
 nnnnnnnnnn nnnnnnnnnn nnnntatct cgtatcctgc tctctctcct ctattttca 64200
 ccctactcaa tatctctact cctccatttc ctctctcct cttctcatc tcttattgtg 64260
 gcagcaccct cteccctacc ctcatgcttt caattagctc tggagtcat gccacttccc 64320

attcctgggg tctatttagc ccttagaatc cttcatgatt cctagtttct ttggtgaaga 64380
 gattatagge tggtaaacct ttgctctatg tctaaaaatc atatatgagt gagtacatac 64440
 catgtttgct tcttttgga ttgggttacc tcactcagga tggtttcttc tagttccatc 64500

catttgcctg tgaatttcaa gattccattg cttttttctg ctgagtagta ctccgttgta 64560
taaagtgnnn nnnnnnnnnn nnnnnnnnnn nnnnnnnnnn nnnnnnnnnn nctgcaccc 64620
tactttttaa tttcattggt tgggtgtttg gtggctacct tcttgagctc gtgcatggtg 64680
acaggatgg atcaatctgc aattttctgc atgtccgaat ccaattgtgc cagcaccatt 64740

tgttgaagat gctatctttt tccactgtat agattttgca cctttgtcaa aaataaggtg 64800
ttcgtagggtg tatgggttaa gatctgggtc ttcaattcga ttccattggt ctatatgtct 64860
attcttgtgc caataccaag cttttttcag aactatggct ctatagtaga gcttgaatc 64920
agggatggtg atgacaccag atcttttatt gtaaagagtt gttttggcta tcttggtttt 64980
ttatttttgc atataaagtt gagtattggt ctttcaatgt ctgtgaaaaa ctgtgttggg 65040
tttttgatgg ggattgcatt gaatctgtag attgcttttg gtaggattgc catttttact 65100
atgttgattc tacctatcca agagcatggg agatctttcc attttctggt atcttcttta 65160

atcttcttct ttaaagtctc aaagtcttca ttgtacaggt ctttcccttt tttggttagt 65220
gttaccceca gatattttat gttgcttgtg gatttttga aagtaatgt ttccatgatt 65280
tcttctcat tgggttgatc atctgtatac agtagggcta cagatttctt ttgtgttaat 65340
tttgtatcct gccacctggc tgaaggtggt aatcagctgt aagagtttcc tggtaaagtt 65400
tttcgggtca ctaatgtaga ctatcatgtc atctgcaaat agtgaaagtt tgacttcttc 65460
ctttccaatt tgateccctt tgateccctt tcttcttctt attgctctag ctagaacttc 65520
aagtacaata ttgaagaggt atggagagcg tggacatcct tgtttgttc ctgattttag 65580

aggaaaagct tgagtttctc tccatttagt ttgatgttgg ctattggttt ggtgtatatac 65640
gcgtttatca tgtttagata tgttctctgtt attcctgttc tctccaagat ctttatcatg 65700
aagggatggt ggattttgtc aaagctttt tcagcatcta gtgagatgat catgtggttt 65760
ttctttttca gtttgtttat atggtggatt acattgatgc ctttaggagt ttcctggtag 65820
agttcttcgg gtcacttatg tagactatca tgcactctgc aaacagtga agcttgactt 65880
cttctttcc aattttagt ccttgatct cttttgttg tcttattgct gctctagcta 65940
gaacttcaag gccgatainn nnnnnnnnnn nnnnnnnnnn nnnnnnnnnn nnnnnnnnnn 66000

nnnnnnnnnn nnnnnnnnnn nnnnnnnnnn nnnnnnnnnn nnnnnnnnnn nnnnnnnnnn 66060
nnnnnnnnnn nnnnnnnnnn nnnnnnnnnn nnnnnnnnnn nnnnnnnnnn nnnnnnnnnn 66120
nnnnnnnnnn nnnnnnnnnn nnnnnnnnnn nnnnnnnnnn nnnnnnnnnn nnnnnnnnnn 66180
nnnnnnnnnn nnnnnnnnnn nnnnnnnnnn nnnnnnnnnn nnnnnnnnnn nnnnnnnnnn 66240
nnnnnnnnnn nnnnnnnnnn nnnnnnnnnn nnnnnnnntt ctctggattt ccacagtgtc 66300
tgttgttata tccccctttt cgtttctgat tttgttaatt agtgtgctct ctctctgcct 66360

ttgggttagt ttggctagag gtttgtctat cttgttgatc ttctcaaaga accaactctt 66420

 tgtttcattg attctttgta ctgttttctt agtttctact ttattgattt caactctcag 66480
 gttgattatt tectgggtct actcctcctt ggtgagtttg catcattttg ctttagtgct 66540
 ttcagttggt ctgtcaattc tctaagtga cttttctcca gtttcttcat gtgggcactt 66600
 agtgctatga acttccctct tagcactgct ttcagagtgt cccataagtt tgggtatggt 66660
 gtgtctgcat tctcattaga ttctaggaag tctttaattt gttttttat ttcttctca 66720
 acccaggaat ggtgcaattg ggtgttattc atttccaag agtttgcagg ttttttgcca 66780
 tttgtattgt tgctgaattg tagctttaat gcatgggtgt ctgataagat acaggggttt 66840

 atttctattc ttttgaact atggagggtt gctttgttgc ctactatgtg gtcaagtta 66900
 gagaagggtc catgtgggtg tgagaagaag gtatattctt tttgagtttg aatggaattg 66960
 tctatagata tccgttaacc cctgttgggt cataacttgg ttctgacagt ccttaatctc 67020
 tcttttcagc aggattcccc acttttagct agatgtttgg ctgtgggtct cttcatctgt 67080
 ttccatcagt tactagtga aggttctctg aaaacttaat tgacaatgga ttgatctatt 67140
 ttctttatta tgtaataaa taaagtctga aatttcaata tatgttctgg aaaacagctg 67200
 aagaatagat ctcctaagc catgtagct cacagtcta ccaccagaac acatacttct 67260

 tcaagtagat catgcctctt ggaggagaaa ccaatctaata ttaattgctt tcagatagtt 67320
 gagtttttta ggicttccag agttgtgcat atgtattgt gcataatggg gaggggttcc 67380
 ttactagagc gcacatgta aatgagggg gaaaacttga gtgaacctgt ttttctcctt 67440
 cccacatgtg ggtcctgaag attgaattca gctcatcaga ctcagcttgg tagacacagt 67500
 cttactatc tgagccatgt ctctccccga ctccctaaaa caatactact cagtgtgttg 67560
 atttgctgag ttcatgtga acaacaatt cattttacta tgttgaagtc cttctaage 67620
 ctcatacaaa ctgtaatgct tgcttactat gtttgaact ctgaaaccaa attttgtccc 67680

 agcaagtttt ttattaaact tctcaaatat ttgagtgttc aagtgacaat gaagtgaaaa 67740
 tataaatcat ctctggcac atgctcttta ttaactgcta cagaatccag tggagagatt 67800
 gacatttccc ctagtccctg tcttacatat gcttccatta gactaaattc caggttgcat 67860
 agaacttatt actcatgccc cagttgattt ctfgaatcat aaagcagtat aatatttga 67920
 tgcttaatt agatgctctc acttactgga agaacaattt tagtgcttaa aattagaaac 67980
 acaacatata gactagaatg gatgaatggg gaatttgttc tttacctgtt ttgaaatgaa 68040
 aggaagaaca gaatataaaa agatcagcaa tactatttca gccagatc acagaggagg 68100

gcataggccc tccccaaaa gatgtgacag actttgatga ttcccatgg aagacctcac 68160
cgtctttggg cagcagggtg ggaggggtca gtggtattaa tagggggcat tggaagatgg 68220
gagggagaag gaacggggga ttgctatgta aaattattgt ttctttaaaa aaaaagagcg 68280
acaaagtgtt cccatgaaaa ttatgttaac tctctcgtgt ttgctggat tttctgattt 68340
ataaagtcta caagttttat tctaaactgt agagtcaata aatattatta gttaaataac 68400
tgtcttttat atattatatac attacttaaa agcatttaaa aacagctatt aatgtgaatc 68460
cttttcgtat atgcctaaga gtggaattgc tggatctcaa ggtagactga ttccaattt 68520

cctgaggaac tgccatagtg attttcaaac tggctgtgca agtttgact cccactggaa 68580
gtataggagt gtctccttt ctccacatcc tctcgagaat aaactgtcat tgggtttttt 68640
aacaccaata caaatggca tctcagagt gttttgattt gcatttcct gatagttaaa 68700
gatgttgaa actttcttaa gtgtctttca gccattttgg attcctttat tgagaattct 68760
atatttagtt ctgtacctta tttttaatt gggttgitta gtggtttggt gactattgtc 68820
ttgagttttt tgtatagttt ggaaatagcc ctctgtcagt tgtgggctg gtgaacatct 68880
tttcccattc tgtgtgctgc tgctttgttt tgttgactat gtctttgccc ttacagaagc 68940

ttctcagttt caggaggac aactgttcaa ctatgttcac agcagcatta tttgtaatag 69000
ccagaacct gaagcaacct agatccccct caactgaaga atggataaag aaaatgtggt 69060
acaattacac aatggggtac tactcagcat gggggggggt ggaatttgaa attttaggc 69120
aatggatgg aactagaaga aaccatcctg agtgaggtaa cccattcaca aaaagacaaa 69180
catggtatgt attcattcat gtatggatat tagacttaga gcaaaggatt tacagcctac 69240
aattcacacc tacagaaaag ctaggaaaca aagaggacca taagaggggc atacaagttc 69300
ccccagaaa gtggaaagag ataagatctc ctgagaaaat tgggagcata gggggaggaa 69360

ggtaggaaaa agaggcaggt agaaggggac gggggaggaa gacataagg accaagaaga 69420
ttgatttggg tgaagaaaag ggaagagcac aaaaagagat accataatag acggagtcat 69480
tacagttta aagataaata tggcactaga gaaatgtcca gagatatagt atgatgacc 69540
caataaagaa cctaagcaat agtgtaaagg ctaccttaa tgccttccc ctataatggg 69600
attgattgct accttatatg gcagcataga gccttcatcc agtagctgat ggaaagagaa 69660
gcagagactc acagcaaatc aatgaacaa attcctggaa ttcagctgta gagagggagg 69720
agtgatgaga aaaggggtca agactatgct ggggagacca acagaaatag cagacttgaa 69780

catgggggag ctcatgttcc tcagcctgac agcttgaaaa ccagtacaga agagacacag 69840
gccccctgc atgtgggtgt cagttaggag acctgggcag tctatgggac cacacttaat 69900
ggaatagcat ttatagctag tgtattaatt gactttggga ggccattctc cacagagga 69960

tactgtctca gtctagacac atgggggtgg gcctaggccc tgcaactgaat tacatgacag 70020
actttgatga tcctccacaa aagacctcac cctttctatg gagcagaaga gggatgggat 70080
gggggcccctg tggagccata gaggaattgg agggagagag aatttggatt ggtatataaa 70140
acaagattgt ttctaattta aataaaaagg gaaaaaacta aaaacagtta ttaaaagaat 70200

catacaatta gtttaatgat tgaatgtag gcattccagt agtttgaag aatcaatatt 70260
ttcaatttgt ttaaatattt ttctctaaaa tagcaggata caaattctta ttcccattaa 70320
tattgataat tatcaatgta tactgagtag ttatattaca aggtatatgt ttctttgatt 70380
ttcttaactc gaattaacta atatcaacca attagcagct tactacagat ggaaaacaaa 70440
ttaaaataaa atagaataaa ttgtgcagct atttttgaaa actatgtgtc tctgtgtgtg 70500
cctaagtata tgctgtgta ccatgcttgt tcaggaacac tcaaagcaa gactaggcac 70560
aagatttctg aaaattgagt cacaggagac tgtgagcttc catgtgcatg ctgagaacca 70620

aacctagaac ctcttcatgc tcagccagtg ctcttaata ctaagtcaac tgatctccag 70680
tccatcttag atttcttttg ccttcgttcc tgtttgcatt gttgtggatc aaacttcggg 70740
cttgcacata ctggatagtt gttctatgag taacctacac tctcaggcct taatgacttg 70800
attagatgat atttaataga ttcccagttc tttagtgaag tctcagaata taaacctga 70860
aacaggatca tctacagaaa cagtttgttg agagtgaagc aatgaagta tatgcttgtc 70920
ttacaatat ttattttcaa tttaaatgga taatttaacc tgtcttcttg tatattatat 70980
ttataaatga gaaaagagga ggcttcatga ggtatgggtg ttggtaatgg gtatacattg 71040

attccatgta tglagcattc atttttcaaa acatgagata tctaggaatg tgcacaactc 71100
tactatttat acacagagtt tctgctatga ctatggagtc atagcaaata atttccctga 71160
gttatttctc ctgtccat atctaaatat ctgtcatctt gtaaatacac accacagtca 71220
ttctagtacc aaatttgaaa aacaaaaaag aataaatgct gaatttttct ctttatcact 71280
tttatcttcc cttttgggtg atgaaagctt tacttaggag aagagaaaa taaaacattc 71340
tgctaatgc cttagaactt ataaaaagaa gctaaagtca tttaaaacce tattatatat 71400
ccatagaaca caacttagtg atgtatttaa cgaggagatg atttgggtgt aaagtatatg 71460

cagctgagaa attctctgc ccaatgactc actagttaca aaggaaagta tcaaatgta 71520
atggcagtgg caatagtttt tgtcacaaga tgcatttgt atgtcaagat ctcaagggat 71580
gtgcatattt tatttaaatc taaaagggat ttaaataaat cagggggaca gccacagcat 71640
tatgttccag aatgtatgtg tgtggggtaa aaaatatcaa ctacctattt ctggctatc 71700
aaacctttat tgtaatgcac ggatgtgtac atgtatgtga gattgtttta tgtagatctg 71760
ttcctatgtg tcactactgg tgcatgtgtg atacatgtgt ggaggtcaga ggacagccct 71820

gggatgttg tctttgccac aaactgtgtt tgacatggtg cctttttatt ccatgttgta 71880

 tattctgaaa acctgagcta tgagcttcag gagtctctgg tctctgcctg tcattctact 71940
 atagaagtgg atggtaacttt atatgttttc gaggactctg aactcaatcc atcacgtgct 72000
 ttgccctttc cagagatcca tacttgggtgc tctaaggatg aataaaaagc agctaagtgtg 72060
 tctggagaga aaggcacctg ataagaagtg tgaagagagt gagataagga acaactttgg 72120
 agcctgaaca cacagccata aaaaccacca gaactttatt tttcctttga ttgaggttca 72180
 aagccaaatg aagtcctgaa ctgaagcttt gagaagtgaa gttaagtgtc aggaaattat 72240
 ttttattact acacactgaa gagttgatgg agttaagca cataggcagt atactgagca 72300

 gagttaagtg gaagagatta gacctaaagt atgttttggg atgctgatat agggctggca 72360
 cagatagtat tctcaatggg gcagatgtac tccatcaaca actgggtgggg ccttctttcc 72420
 ttagctgate cagcataaca gagactacct gctttctatg cttcttgggt ttctagaatg 72480
 tttgcatata tgactttgaa cttaagtttt ggtatttaag tattttgggt aaaataattc 72540
 ttaaactctg tatgagtcac cagaactgaa tcataaaaat ctataaatct ttgtgtatag 72600
 gattaagcaa tagagcttct tgacatctct tgggcagtga gtgtagaatt accaacatta 72660
 gaaactgtgt cctgtgaatt ccaaaatctg tgggtcaggg gtgtaaggaa gtatcagcag 72720

 atggtggaaa aatgtccaca acctggggag agtggaaagt cataagatgt cagccaggtt 72780
 gttgaatcat aaaaagatac caagtcctaat tccattggta ttcaaatcag tagcagttta 72840
 aatgaaagag tagagaatat gttggtcaga ttagctaac tggcttagat aggcgtaaac 72900
 tgggtggggg catcaatgaa tttagtaaat tggaaagtcac tggtaaaaata agaataaatt 72960
 acaatgtgtt aagtcagact tgattatgat cagaataaag ggatgaagag agagtgtaca 73020
 caggatgctt ccactatcag ctaaaacaaa ctaactgaat gataattagc tagaatctag 73080
 ggtgacatgc aatatcatac atgtcacaga tatgtgcttg tatcttaata agaggctaaa 73140

 atgttacaaa gaaatagatg gaagatatgt agtatctata ttttctacta gatcctaaaa 73200
 ttttctactag aattctatat gtgttgctat tcaaaacttt tatattacag atctatagca 73260
 tggtaatgca tcattaaata tttgctgtat caaagaaaac cacattgggc ttatttagat 73320
 tttgtccaat cattcctct gtgtcctatt ttttagggca tggctccta aagttgactt 73380
 taggagaacc caacatattt ttacactagg ttcttgate tgctttgggg taagtttaaa 73440
 gaaaatagga aaggaacaa attaaaaacc aaaccaaac atacaacaa ataacaacaaa 73500
 agaaaacct gaatccttcc acaacaatt tcacagaatc ctatggagat aaaactttct 73560

gcatgctctg acatataatcc aaacctcggg gactgtcttt cctctcccct cattatgtta 73620
 ttagaaaata cagtggttgt aattgttagc agcagttggt aaacaatfff aaaactgagc 73680
 ctgaggggac taaaattgaa gagctaagaa aatgtgatcg aattagaaag agcatggcta 73740
 gacattaaca ttgacagaga tgaatgttt tctttgtagt tagaagagag ttgtctggcc 73800
 tgagtatgtc attctttact gaatgtggat aatgggaatc tgtatttcaa actacagatt 73860
 gtcagttttg cgatatgcac ctgatgaaaa aaaaaatgga tgaatgaaca aatccattga 73920
 tctaaataca ttgtgatata tttccatatg gaactgaaga acaaacatff ttcaaagtga 73980

 gatcataaag gagacatttg agttcacaaa cccaacatt aaagtgtctt gaaaatgagt 74040
 tatgtttgaa aatgttaatt gtatctaaca aatffatgtt ttccacactg cagttcagac 74100
 agtgtcatca tatgtagctt cattctttgg aactctggat tctgtaaggc tgtattctta 74160
 agatffttatc tgaattaatt gctgtacttg acatffggat atcgaaacaca gagaggacat 74220
 ttaaagaaaa taataaggaa aaaagaacat acatffcaca aacaaggaaa agagatctgg 74280
 ggaatatggt caagctctct tgatfftaga gactctagtg agagttgtgt atatacctt 74340
 caaacttaca atatffaaat aatffatccc ccgtgggagg actcagcttc cctgagaagt 74400

 ggatgggggt tgggtgagag ccatgggagg ttgggagggg gagggaaactg ggattggtat 74460
 atgaaataat tfftaatgca aataaaatff tafftaaaaa atagcagaat gatgggcat 74520
 taagatggct cagcaaatag aggcatcagc agctatgtct gtgaaactga acttgaacca 74580
 aaagtctcat tctccaagc cattctcaga tctcatatgt gtcctfftca tgtgcaagca 74640
 catatgcaaa taffttcata tfaaaataat tgggatacca cttacactaa tgtctgaggt 74700
 agaaagaata aaacaatfff ccttctffgc cctgatacta atgttcattt aaagtaata 74760
 tgattgttct agaatgactt catttaagac cftaagaaca tctffgaaag aaacactatc 74820

 agtaaagctt gaattcttca tgaactatgt gggctcttac tggettaatg gaacaggaca 74880
 taaagatgtt catgtctaca gatactgtga cattagtffa agccaaacaa aatcaaata 74940
 taattgatat aaaaagaact attctgtcct gtattgaata tgcccagcat atffttctac 75000
 cattattcca taaatagtta ctgaaaacta taffttctca gcatctatat tgtataaggc 75060
 atcatacaat atctacaat gttagatata aaggcacaca tacatagacc aatgtcaaa 75120
 aactacatca tfftatagaa cagatffcac tacctgtcaa tffttgcata tgtatatacc 75180
 atgcaaccaa cactctggat ttcactaaat atacacagtg ttgcaaacff tctgtgtag 75240

 aaagtaatca taffaaccta gttggaagat ctagttgtcc tgataagaac tctgttctta 75300
 ctaaagggaa atgactffca aagctcattg aagttgtgag gaaacagaaa ctcatcttc 75360
 gftaactgca aaacattatg atggttctag gattctctat gtaagcaata gcactcactt 75420

tgttcctact tcaaatgtaa gtgatggaca agtttttccc atgttaactc ttctacttat 75480
 aaagtgtat ataaagaggg gagaggaagc tacaagagtg agaagggag aaaaggaagg 75540
 atgcagaggt catcaggaag cagaaaagtt gactcaggtg tagattagaa gaaaggacat 75600
 atgctaggta ggattttagt tggggggtgg tagaggagaa agggagggag acgggaactg 75660

 agatcatcat gtaattcaat ctgtttgta attcaaata ataaaaata ataaactaaa 75720
 aaacatgcta ttttgacca gttcctaaaa tttgtttcta taactttaaa aataaaccac 75780
 tttcacttta ctcttgata ttctcatgt cagctcctgg atttttatat ataaaacttt 75840
 aggctttgca ttatattctt tctggcgca atgcttgttt tgattaggca tctggtttag 75900
 taagaagata gaatatagtt taatggtcct ataatggatt aagatttctt gtacaaggag 75960
 tcaagacat gctgggaaa cccacagaca cagcagacct gagcaagtgg gagcacatgg 76020
 acacaagtct tacagctggg gaaccaacat aggactgaac cagcgcccct gaacatgggt 76080

 gtcagctagg aagcctgggt agtctacagg gcttctctca gtggaaccag tatttatctt 76140
 agtccatgaa tagacttcgg gagtccattc ctcatggagg gacactatct tagcctagat 76200
 acatggggga cggcctaagc cctgcctaa atgatgaggt aacagaattt gatgatccct 76260
 cattgaaggg ttaccctcc ctggagagta gatgggggat gggatgggga gttattgggg 76320
 ggggatggga gaatgggagg gacagggaac ttggattttt tctattttaa aagatttctt 76380
 gtatacaatg gagaatattt tcagtgatat gtatttcaca gagaaagctc caaataaaaa 76440
 cttctttcac tattgaaaga tgtgtgtaa gctagtgaac aattggacaa aatgacaca 76500

 tacaccacac acacacacac acacacacac acacacatgc acacacacac acacacacac 76560
 acacacacac atgcacacac acacacacaa cacacacaca cacacacaca cacaatgctg 76620
 tatttgaaca ttggcttgtt gtcttttgct caaatattat ggtttccaat tgtgtgttca 76680
 tgttgagttt tgggggattt ctgtttgagt ttggggggat ttttttttt ttttggtttg 76740
 ttgttcttgt ttgcttgttt ttttgtaaa agaaaagaaa gaacagacat ggagtggat 76800
 ggggtgagtat gtggagagga gtatgtggag agtatgtgc aggagtggg gagggaaaag 76860
 cataatcaga atatatttg tgaaatgaaa aacatgcaaa caaacaaca aacaaatcac 76920

 ccttgtgctt agttacaag ttaggaattt ttcacaggaa aggatattta cattttggct 76980
 accacacaag agaagccaat attctattgg cagtgctaat ttgcagttgt ctttttatgc 77040
 tcttaataca tttatgctca gctactttca aagactcaca caacaattg gtttctgtgt 77100
 catcctcacc caataaaaca aagggaatgc tctgtctcaa tgaaatgtca agcaaatgta 77160
 tagcacaatt tgetgagaca gatggagaaa ataatttcat tttgtttatg acatccatta 77220
 aatttcttta aaatggatgt ttgtccagta agaaactcaa attagctggg ctatatatct 77280

gacttgagta acaggtttat taaggcaaaa atgaaactga agggccatt ccatccaaga 77340

tgacaaagga acagaaagct aaaatgtttc cataccaaac tacaataaa gaagagcaaa 77400
actgaaagaa ctgaactcaa atctaacaat catgagetac attaatatat ttcttgcag 77460
gattgtgcag aaatttcaa atcatctatc tgggcacaac acctgctcac aggccagtgt 77520
ctgaagtaag ttgaacacat ctgtgggat tttagatgaa atgaaggctg tctcaatata 77580
agaaacaagt gaccttcagg aaatagtctc ctgtgccaat tcattcaagg gtacttccca 77640
ttttctctc taagaggttc agtgtggctg gatttatgtt gaggtctttg atccatttgg 77700
acttaagttt tgtgcatggt gatagatatg gatctatctg cagtcttcta catgtcagta 77760

tccagttatg ccagcacaat ttgttgaaga tgctttcttt tttccattgt ataattttag 77820
cttctttgtc aaaaatcagg tgttcataga tgtgtgaatt aatatcagga tcttcaattc 77880
aattcctttg ctctacctg ttgtttttgt gccaatataa gttgttttca ctactatagc 77940
tctgtagtag agttttaggt cagggatggt gatgtctcct gaagttactt tattgtgcag 78000
gattgcattg actatcatgg gtaatttttg ttttcaatat aaagttaagt attttctcaa 78060
ggtctgtgaa gaattgtgtt gggattttga tgggggttgc attgaatctg taaattgctt 78120
ttggtgagac tgccattttg ttatgttgat cctacctata taagaccagg ggagatcttt 78180

ccattttctg atatcttctt taattttttt ctttaaagtc ttaaagttct tgtcatacaa 78240
gtctttcact gcttcggtta gagttcccca agatattttt atcttgtgtg ttgctattat 78300
gaagggtgaa gtttctctga tttctttctc agaccattta tcatctataa ataggagga 78360
tactgactct tttttagtta atcttgtgtc ctatttggtc taggaattat agatttgtaa 78420
agatgtattc tccagctagt attcctttgt gaatttagag aaacactggt ttgaattcat 78480
aaaataggca ttttcttttt gtctctgaat gccttatcct aaacacctg ctaagtata 78540
aaaataatca caaatttact tgagaagtgt tcacaaggaa gaggtctta tgtatattac 78600

ttgtaattca agaagtcaa taaatacct tcttgacaat accagataca gttacatact 78660
gcaggaggtt gcttattttg ttggattgct atgaacaaag tgtattcatg ttttaaagt 78720
tttttgatgt ccagttctta gtaataataa tatccaatag gaaatggcaa gtaccactta 78780
tgcattaatt ttgggaattt aaagatggca tgatcatgta ttattcctgg catctattga 78840
cctgaggata gcatggatga gatgttcagg aattttctc ctattatttc ttccagaaag 78900
aggaattctc agagtttaat gtttaaaagt taaaaataca ttatttgttg aaattatfff 78960
acatctcttg aaatattatt gtttttcaac aattcatgaa agtatctttt atatctctat 79020

aaaatataat gatcaagtgt tataaccttt acacttaaat ttaattcaat gtatctatat 79080
 tctaaggtaa agaataatga atttgatata tttgagaacg aaaacatggg catttgatac 79140
 atggctatgg ctttctggaa ggatcaatgc aattcctttt tatattgatg atgatgttga 79200
 gacaagggtgc tttaaactatt tctctttaac cctcgactta tggtagagtaa tcatgggtgtt 79260
 attcacatac atctttctgg ggagtcaaga gtgggatacc agcatatgaa taaagaagta 79320
 gggaatgaag acttctcagc atcctgggga gcttttccat tggttaagtc atcaatggat 79380
 gaatcctcac tagtttfaat aaattctaag catggaggct acccatggat taatcatgat 79440

 tctaagatta attcttagtt caatatttgg caaattaaga atttgaacat gataagaata 79500
 atatgtaaac atcatgttaa ttcaaattga gtctttcttt tttttttcca gatgagacaa 79560
 tgcaagtatt aacaggcaag atgagttttc ctaaagaaat tgttagaatt ggctttgctg 79620
 gattctgaga atgctttatc ttcaagaaac tgttggfcat ttcacagct ttctgaccta 79680
 gctcagtgtt agtgtatttg cttaggatgc agaaagccat gcttttaatc cccagaatga 79740
 aacataacct ctcacacata ctttctcagt ttttctgctt ccctctctct caaacacaca 79800
 aatggtaata atggcaatag atggcacatt ttagtatatg ttctgcaaaa gtgagcacag 79860

 atgccatfff taaaaaatag aattgtttaa gtagctatga gagtgaggag caagaaaata 79920
 aaagaaacta aaagccaatg ttctttatat acaaacatac aaaaatttta cccataagca 79980
 cactttcatt tacattttat tcatcatgtc aattaataat tcaatctaca cacactgtac 80040
 atagatgtta gagaacaaa cctgaacata aatatagaa tatgtcacct cagataacat 80100
 ctttctgaca tccatttttt ttgtcctttg tgtcacctta atatcagtta tgtacctttc 80160
 taataatatt taagagaaga aaagactata atctagtcaa tggacagaga tgaagaagtt 80220
 gagtaaggaa ggaggccact cttgacagat glaagaagag gaagtgccctg aagataaaaa 80280

 tgactagatg tttctgggaa gaccaggtga ttcaatcact cattattcaa taataactgc 80340
 tgacctctag tttctgggaa ctctttttga ttttgactc tcaagattat aagattatgt 80400
 ttgcatttct tcagaaattt actatctata catttttagaa gaccattata atttgtagca 80460
 tttcccagac acaaaggat ctctgccagc tttcacttac agtttatcat getgtgttag 80520
 ggacacacat cagtgacagaa ggtttgtaat agctgaactt ggactaaatt ctacctgca 80580
 gctcttttat catgaataaa ataaacatat ctgaaaacat ttcacatttt aaactcttcc 80640
 acagagacta tagggaagca aagggacttt cttgcaccaa aaacaacctt atcaaaacat 80700

 acacatgtat ttttaactca ctgaggtgtt aacaagtat caacttaata aaaaagacgg 80760
 aagtttatta cttattattt tgtaggtcac aagactaaaa tagatattaa atcacaagag 80820
 ctggctgtat gtctactttt ctgattaata tgaagatttt ttttctcact tgatttgtca 80880

ttctgttg gaggtaaac ttcttcta accatitgt ctattagt tctgatcccc 80940
 tggcttcat ttataagaaa gattttattg tattgtgtcc atagaattaa tccaggataa 81000
 ttctcagga tcttttagcca tatctacaaa gctcctttta ccattagcat aatatgttca 81060
 caaatctct caattgggat gtgaacattt gcatgtcaat tattcaacca attataatct 81120

 tctatgtgct ccagagattc ataactggct ttttgcaaa actcaattat catatcccc 81180
 aaatttttaa ctctgtagca ctgtcatctt aatatcatca ctgtaaggtc tcaaatcaca 81240
 gcacctaaat gaatcaagat aaggcttaca atgattctcg ggaaatitc atttcttct 81300
 cagacttgtg aaattggaac ataagttagc ataggtgaaa aaaattgtat tatctagaat 81360
 gaatggacta ccaggtatag aaatggcat tcttattatc aaagtaatct ctagtctcag 81420
 ataactttta aaatcaaca gggtaaattc taggaggttt aaaatctag aaatttccat 81480
 ttcaaatctt tcttttctgg gtctgcccct tggttttgt ctctcccta tagggaattc 81540

 ttgtcagaa aaacataagg gcaaaaatat ttgcagacaa atagtittat cagcctctt 81600
 ccacgacct agatattgg acatcaatag atttctatg cttaatgtct tttctgatcc 81660
 tttatgtgca tcatgtattt agtttccatg atattatcaa agcatagtgg atcttctgtg 81720
 tgtattgcag gaactcatcc attagtgtg tagttttaga cttttctaa atgaaatgag 81780
 aacatitit cttgcccit tgagattctg gagcttggct tcattattca ctctggttc 81840
 tctttctcag tattcaaca tgactagtta aatcttcccc aaaatagtc atagtgatgc 81900
 tgacttcate ttcaagtctt ttttgtctc tgattcttct ttgtcttgta catttaaggt 81960

 tctctgagaa ttcaattgac ctacctaaat tatcacaat actatctta atgcattata 82020
 ggctagcaaa tagccataat tccaactgct accttaatta tccctttta tttacatca 82080
 tatttagtgt gttttcttag tgttgtgatg tggacatcca tggcagatgg ttttctt 82140
 cttagcatgct gttactctc agcaggccat gaagtacaat tttaatitac tttcaggac 82200
 ttctcagttc actgtttgtt gcatgttgta aatacaaatg tacgcacact gagttggaag 82260
 aagtaggtaa gaaggtaca gatttctgaa aaaatgtaa attgtatata cacaagacaa 82320
 tgaaactit cttcagtgta aaaactgt tacctacact tcatgcttat tctctaaagt 82380

 aaactctgc tctcagact ttgacacatt gctggtagaa agatgctcca ggtagccat 82440
 tgctgatact aaatcaacat catctgaaaa aatitgtgt tttatgataa aagtatgctc 82500
 tatgataaaa gaatitctgc ttaaagaaca cagaacaaat aaatcatat gctaattaat 82560
 aaagtttca tgcaagggtt tttctcatgc tgcagtttat gtggttggga gctacaggaa 82620
 ggctggattt ttagcatgaa tagtggaggg atggaaatga gataaataat gatgcaaaaa 82680
 gaaaaaaaa ctgagaaaga attaagaaaa atgatctttg acaaaggtga gttacatag 82740

agccaagcaa aacttattac catagattgt aatttccata gacacataaa taaatcaatg 82800

tatattttca agataafatt tagaagactc ataataaaca cattaaatca gttttctttt 82860

caacacatca ttgacaaga ttgaatttga catatggagc acctgaattt tgaaaaccta 82920

ttggcaaggg aaaaggaagg aatggggaaa gaaaaataag acaaaaaagt aaataatttc 82980

taagtaaat ggatttaagg gtatagcaaa tgaagccat ttaagtaaa gtgaaatgga 83040

tttgaatta tagattagg gctgttgaga gagttcaatt gttaagagca ttttgcctt 83100

gcataggact ggccttcatt tcctccatg cataccagga agatccagga ttccaatgc 83160

tggtcagtgt caacacacaa agacacatac acacatacac acacacacac acacacacac 83220

cacacaccac acacacacac acacacacac acacacacac acacagactc agacaaagca 83280

agaggtctgg agggggatga atgaagagaa aggaatataa taaaatttaa atattaataa 83340

attagtgtct ttgagattg taatttaate ttatccctct ttgtcttccc ccttccaaac 83400

ctttgtatat acccttcctt gctcaatttc aaaaatacat catatataag tatgtataat 83460

ataggcaaga gaaagcaac tgtgtggtgt tgaatatgt tttctcttac aaaatatcaa 83520

atgctgtata gtcttatatg actttattcc tataaatfff tcttacttg aaattagttt 83580

caaatttga tigtctataa tatacattt ttctttgggt ctgttttcaa gtctatttta 83640

taaaccfaat cagaaggga ggacagaagca atatatggc tgtagctcac agagtacagt 83700

cacagacaga agagagacta ctgatttaca taagcttact tatgattttt gatagtggat 83760

tcaggcaggt catcgggata ctgccagtca aattcagga ccacttaatt ttgcctccat 83820

gtattattaa aataccattt tatgttagca tagtgctca gaggaccagc tctgtagcac 83880

aaataataaa agcccagaga cagatattgg gtttcaagct gaaaatcaga aaagcaaac 83940

agccaaacca ctggagagtc cttacatctg ccaagactca gaataaagtg gtagcaatgc 84000

tgtcctccga gtgactgtag acactctaca gaatgctcac tgtcaaaatc atactgacca 84060

gaggctgtac tgagctcctg tcttatattc ctctctagtg ctgggattaa aggagtgtat 84120

cacaaatgct aagatcaaag ttgtgagctc tgtttctctt ttactctgat tcattctctt 84180

gtagaacaag gtggccttga attacagata ttcactctgt tctgtctcat gaggctggg 84240

attaaagtgt tggctccac tcctgaact ttatggctaa gtagttgttt aggtatgtga 84300

ctaaatagt gcttagtgtg tatgtgacta actagtagct tagctctaac taggtgtgtg 84360

gataaccagt ggcttagctc tgcactctga tcttcaggca agctttattt attagattac 84420

aaagaaatg ccaactacaca tctctgtgaa aactttgtcc ttattcatca gcaatgattt 84480

aaccttaatt aaatcaacta tgctcttacc acaactctta tggatatttt tatcagttct 84540
gaaaatcagc aattattatt ttaagttttt cctagtaact ctcacttggt tacatattaa 84600
ggttttgaat ttataattg ataatgattg ctttaatttt aacaactggg aagaactttg 84660
ctatgaacag tactagttcc tagatagggt actagggtta tatcagattt aacaaaggag 84720
aaaaatggtg agaagaatc caggaattca atgaaaagt ttgaaagatt atttacctat 84780
accataaaga atcaacatac ctaattccaa cctacacatc atagctacat ataaatacct 84840
atttccaaa tatgatgaca ttgaatataa attaattcag tatcagtttc tacaataat 84900

aaaaaaatt gaagcataat tttaaaacct ctatttggtt catcctactt gatgggggaa 84960
gtacttttgt gtatatgttt gtcttattgg ttgataaata agcacttttg gccaatggg 85020
aaccaagtta ggtggggcta ggagttgatg cagtttctgg gaaatgtggt aaagaggaaa 85080
gtcatcatgt gatccagggg aagagaggat gtatgctgct ggcgacatcg ataagctttt 85140
ataaaatata tagattaatg gttatggttg atacttaaca cagagctagc aaataaggaa 85200
tactagtcat tggccagcag cattgtaact aatattaatc tctgtgtgtt atttggggac 85260
cctaataatg tggcagaact cagggtggctg acagaaatag ttatcgttac acctaataatg 85320

ttctcact ttagtatttt aaaaaataat tttttcatt gagacttctt cctgatgaat 85380
tttttctgtg attaatatga aatgacctc ttcactatt ttgattgatt ttggtttgaa 85440
gtctaacttg ttagatactt ggaatatctt atccggacce tttactctgt gataatgtct 85500
gtctttgaat ttgaggtgtg tttcttata gcagcagaag gatggattct gtcttctcat 85560
ccaatctgtt agcctgtgtc tttttatagg caagttaaga ccattaatat tgaggggtta 85620
gttcaatata cataaatcca tcaatgtaat ccaacatata aatagactga gaataaaacc 85680
acataatcat ctactagat gccaaaaatg cctttgacaa aatccaacac cccttcatga 85740

taacggtctt ggagaaatca gggataacag gaacatacct caacataata aaaacaatat 85800
acagcaagcc aacagccaac atcaaattaa atggagagaa actcaatcca attcctataa 85860
aatctgggac aagacaagc tgtccactct ctccataact tgtccttgaa gttctagctt 85920
gagcaataag acaataaaag gagatcaaag gaattacaaa ttggaaagga agaagtcaaa 85980
ctctcactat ttgcagatga tatgatagtc tacattagtg acccgaaaaa ctctaccaga 86040
gaactctac agctgataaa caacttcagc aaagtgacaa gatacaagat taactcaaaa 86100
aaaaaaaaa atcgtagccc tactatatac tgctgacaca ttggtggaga aagaaatctg 86160

agaagcatca cactttacaa ttgccacaaa caacataaaa tacctcggag taactaac 86220
caaaaaagt aaagacctgt accataagaa ttttgagtct ctaaagaat aaattaaaga 86280
agataccaga aaatggatag atctccatg ctcttgata ggtaggaca acagtaaaaa 86340

tggcaatctt gccaaaagca atctacagat tcaatgcaat ccccatcaaa atcccaacac 86400
 aattcctcac agaccttgaa agaacaattc tcaactttat atggagaaac aaaagaacca 86460
 ggatagccaa aacaacccta tataataaag gaacttctgg aggcatacacc atccctgact 86520
 tcaagctcta ttacagagct atagicttga aaacagattg gtattggcac aaaaatagac 86580

 agatagacca atggaataga gttgaaaacc ctgatattaa cccacagacc tatgaacacc 86640
 tgatttttga caacaatcca aatttatata atggaacaaa gagaacatct tcaacaaatg 86700
 gtgctggat aactggttgc agatatgtag aagactgcag atagacccaa gtatatgcc 86760
 ttgcacaaaa cttaagtcaa aatggatcaa agacctcaac ctaaatccag ctacactgaa 86820
 tctattagaa gataaattgg gaaataacct tgaattactt ggtgcagaag accacttctt 86880
 gaacattaca ccagtagcag agacactgag atcaacaatt gataaatggg acctcctgaa 86940
 actgcgaagc ttctgtaagg caaaggacac agtcagcaag ataaaaatgg cagccgacaa 87000

 gctgggaaaa gatattcacc aacctacat ctgacagagg gctgatctcc aaaatataca 87060
 aagaactcaa gaagctagtc tccaaaacaa caaacaatct gattaaaatg tggggtacag 87120
 aactaaatag acaattctca atagaggaat ccaaaatggc tgaaagacac ataaggaagt 87180
 attccacatc cttagccatc agggaaatgc aaaacaacat aactccaaga taagatctta 87240
 ctctgggggg gaccaaataa ttctcatatg aaatatcttc gggcccagcc tccagcttca 87300
 gcaaacaggg gcaactgaaa gctccggccc actattgtat tgttcattgc cagtagggct 87360
 actattgttt accatggcct cagggtataa tgctctctat ttgcatctct gtgggcctaa 87420

 gcatctgaat aggctgcac ctgtgcaaag gtgtgatgtg tgtgagtaac taggaatgac 87480
 aggagttagg ggccaggacc agaggagaga tgagaacaaa gagagaaatg gttccctctt 87540
 ggtattggca caatggttaa gaaacagcag aaaagatggc taataaagaa atgactctag 87600
 ttctacaaca tggaactgag agcactctaa agatagcaag atgcctgtgt ttgatcttta 87660
 tcaactgctgg gttactagca gtttccaggt ccacgaacc ccaactcagc agaacctcat 87720
 ggattaaagc tgagacatca tgggacatga cattactcct gtcagaatgg ccaaaaaaaaa 87780
 aaaaaaaaa ccaatgacag ttcatgctgg agaggatgtg gagaaggagg aacaatttc 87840

 actgtggtgg gagtgccaac ttgtacagtc actttgaaa tcagtatggt gactcctcaa 87900
 gaaaaatgta atcagctcac caaagatcca gcaattccac tcttaggcat ataccggaaa 87960
 gtagtgccgg ccagcagggc tctggttaatt tgtgggtcag aggtggacca ggcctgaaaa 88020
 taatgggcga gaaagaagaa gccagaccaa gcagtgtcct tgtcaaggtc taaatcttat 88080
 tgataacaag gggtttttaa agagaaagga ggaagcagag aaagaggtag tggggagagg 88140
 aatgaatatt aattgctctc aggccagggc aggtgtctgg aacctcctgt ggttatctca 88200

aacactaacc tagggggggg ggtgcttgac taattggcag tttagcaagg aggtcgccag 88260

cctctgtaaa gaaggacttt ttatatctga ccagagctgg ctctgacaa agaagcacat 88320
tcatacaaca aggacatctg ttcaatgatg ttcatagcag cactatitgt aatagccaga 88380
aactggaagc agcctagatg cccctcaact gaaaaatgga tagagaaaat gtagtacatt 88440
tacacaatgg agtactactc agtgggaata aaaacaatgg gatcttgaaa ttgagggga 88500
aatggatgga actagaagaa accattctga gcgaagtaac ccaatcacia aaagtcaaac 88560
atgatatgta ctactcata tgtggatttt agacatagag taaaggatta ccagcctaca 88620
atccacactt ccagagaagc tattaacatg gaggacccta agagagccat acatgttccc 88680

ctggagaagg ggaagggtc aagatcccct gagcaatttg ggtgcacggg tagagtggga 88740
agggagctag gagaatgaga ggggagaaaa ggagggatgt agaggacatg agggagcaaa 88800
aaggttgagt cagggaaga atagataata acaagaatgg aaataccata atagagggag 88860
gcattttagg ttacagaga aatcaggcac taggaaatt tctggagatc tacaaaaatg 88920
aactagctaa caatctaagc aacagaggag aggtacctt aaatgccctc ccaggataat 88980
gagattgatg actgaggag aagggatctg tgattgtcat gtaaaaaat tectgtttct 89040
aagtcaaatt taaaaatct gaaaaaaca taattatit tttttaaaa tactttagt 89100

ggttaattgg ttaaggatat atagtitttg cttttcagt agatatatta ctaattctgg 89160
attaggaagg aatitittagc tcctagtita tactctatat ttgattggtt tcataaaatt 89220
tataaaatat ctcatitaa catctattgt gtgtgtgtgt gtgtgtgtat gtgtgtgtgt 89280
gtgtgtgtgt gtgaatgctt atgtititgc acacatgctg aggtccctgg tcaacatgct 89340
gcggtcactg gtiiaatagc tgaggctact ggtcaatatt gggtagcttc cttaatgct 89400
tgccacatgc tctitgaagg tagagtcttt cactgaattt ggagtctta ttttaactct 89460
actggtgccc agtcagctct attgatctgc ctgtctctt tctgataca gggtttcaga 89520

tgtataccac ctgagcac tttacatgg ctctgtgga ttccagatca ggtcttcatt 89580
attgtgtaac atatactgta tatgtatatg tatatgtata tgtatatgta tatgtatatg 89640
tatatgaata tgiatatgta tatgtatatg tgggctctgc aaagtccacc aaatcttct 89700
gtgctggtcc tgggcccttc cccaactg tactatctct tttccctcta gttttactct 89760
atitccata taccttacca atgtcacaga cccctgaaag tgagactatt ctataacat 89820
ggtttctaag ataatgttca tctccagttt gcatatgatc ttgtgaaaa gaagggtctt 89880
catttgatga ctcttgat actttcattt taaggattat agtgtgtta ggaatggaaa 89940

gctttgtaag tacaaaataa actttttggt tgtttctgca taaagcacta tcatctctgg 90000
aaagaattgc catccagga ttctaagcaa acacagctgg gctgctaaag caacaattag 90060
taagagtatg caggaaagat aaatttgacc cagatcaaag acgcctctgc tttggccttc 90120
taataattga agigtgcttt gtacctaaata accagagggc ctttggggga ctgcctttaa 90180
tttactttta tatgtgtagt aaatagatcc tttggtttgc agttggtgac tgtgtcattt 90240
gaaaaaacat tttaaaaact gaaatcattt tccatggcaa atggcaaatc attttccata 90300
gaggggcttt tgttttatgc ctctgaaaa ctccaactca tgttcacaag cttttgtagc 90360

atgcactgta ccccttgac acttctcat gctcacaat gtaagcccc tccttggcgc 90420
ctggcatgtt gtgggttatt tgacagatgg aaaaatggtg tgtgttttag tcaaaagga 90480
ctgattaata aagtaataaa ccaggattta attatgagtc tttctctcaa gtttgtttc 90540
attccaattt tcctgtagc ttctgatgct cagaaggaca ctgttgactt ttgcagaatt 90600
tcatgacatg tctagtcaag tgtgaacaa tcacagtaca taggcgtatt tacttagaac 90660
tcaagtagac taaacctgaa gctgactgct tgtctgtac tttccttccc attatccacc 90720
ctcatgtcaa aagggtcatt tagcatgact cttattctt ccttccaag ttaaccagaa 90780

ttttgtatat gccctcatgt tccatctagt gttttgatgc acctataaa tcattaggaa 90840
agtttttttt ctttttttaa aatttattta ttagttctag ttaggaaca agcttgtttc 90900
aagtccttc tcctctccc tcctgtcacc cccaacctc ctecccnnn nnnnnnnnn 90960
nnnnnnnnnn nnnnnnnnn nnnnnnnnn nnnnnnnnn nnnnnnnnn nnnnnnnnn 91020
nnnnnnnnnn nnnnnnnnn nnnnnnnnn nnnnnnnnn nnnnnnnnn nnnngacagc 91080
atctggggtc catgtgctct cccttgggg tttctccaac ctggtacaga gcccttcgat 91140
cttcattctt cctctcttc aactaaattc cggatttcgg ctcagtgtat atctgtagat 91200

gtctgtctct gcttccatca gccactgggt gaaggctcta ggatggcata aagagaagtc 91260
atcaatctca ttctagggga agggcttttg ggttatctc tccaccattg cctggattgc 91320
cagatgtgct acctttagt gtctctggag atctcctgg ttccagattt ctcttggac 91380
ctatagtggc tctctctgat atggtatctc tcatectgct ctcttctc tattcttccc 91440
ccaactcaat atttctgcc ctcccttcc tctctctac tctcttctc ttgctcttat 91500
tgtagcagct cctcccccc taccctcatg ccccaatta gttcaggagt tcatgctatt 91560
agtaaagctc ttatatgtt ttttctctac tctgtcttg attgtgacaa tttctttacc 91620

tatcccttta gatactttta gatggccaaa tttgtgatga cacaagatat aaaatgtttg 91680
tagaatccta tagtaaggaa gcagaataaa caccttctgt gctctcatct ttctgctagg 91740
ctaatcatgg gtttagttg ctcagagaaa gatttgaag gtacagttga gatccctaaa 91800

caggcagtaa tatgaatcct tagagaatgt tctaagtggg tagtgcagaa tagttctgaa 91860
 tttttttggt ttgatggatt tgtgaaatgg taactcatat taagagttct gattccattt 91920
 gcttttagcat tctttgtgga aaaggaaggt aatggtaaaa cataaaaaat ccaatgtaat 91980
 catctcatta tgactattaa ggaagacaat aagtgaacat tataatcctc catgttctac 92040

 catagactac taatgtcttt ttgtttctg tcacttcacg aagctatctt tggaatagta 92100
 tgctattgct atgacattaa ggtgccatag aagtatgggt ttagagtgtg ccattgaaag 92160
 tatgtttgag tttccttaaa atactcatgc cctttgagtc ttaggatccc agggttaatg 92220
 taggaaacac attgtectac ctattttccc tgcttaatta aggataggca ttggatattg 92280
 gccatcagta tgcctgcta aaggccccgc tctgttgaat aaatcacatt aataagacct 92340
 acacaggtgt tcaggaggga aagatgcaac actttcctat cttactaaca tctttcccc 92400
 cttggccttg ggacattaca gtacttgta ttgttggc agctgccata aggttatgca 92460

 agactgaagt ccaggagct tggcctcca attttacttc ctctgtaggt tctagtgtt 92520
 aaaaactaca acctaaaagg aatftttaa ttttagttg cacaagaatt tagctgtggg 92580
 ctgtctgtat attagttta tcatgttgat atgtgttcca tgtattcttg gattctctag 92640
 gactttttat catgaaggat gtcagatttc attaaagatc ccttgttatt ctaccagggt 92700
 gctcagatag tttccatctt ctagtctatt tgtatggtat attatgttta ttaatgtaca 92760
 tatgttgaac cattcatgta tctctgagat atagcttgct tgttaatgtt gaataatftt 92820
 ttgatagggt ctaatfttt ttatacacat gcctagaat ctatcaatta tgaagtctgt 92880

 ctgtgtatftt gtctactttg ggcatgcca ttctatgtgt taagtaggat aatagaaaa 92940
 attatcacat tgiatatcgg ttgcatatftt ggaagaaaga tattgacata taaatfttaa 93000
 aatgaaatgc aaaatfttt gatgtagaca aaaactgtag gcatttcaga cagtctgagc 93060
 tgaagttaca ggttagtaag gttaggcaat gtttgaactg gatatfttact catgtatgca 93120
 aatataatga ataagatftt agtctgtctg aaatcattftt attagaaaga gtggtttctt 93180
 gtctgacatt ttcagattct tgcctcctaa tcccaatfta tagtfttttt cttcttate 93240
 caaatgtga cacatgccat ctgtctgaca ctgaggggtg attctacaac ctageaattt 93300

 cagagaagtt ttgactaaat gagtggggct ttggaagttt gactatagtg agatttgggtg 93360
 ccctagttae ctttaatagt catcttgaca cagcctacag gcactgaga gaagagtttt 93420
 tattctcaa ttaaggattg tctagatcat attggcctga ccatgttgtt gggggactgt 93480
 gatgtttatt aattgatatt ggagggttca tctactctt gacgatacca tctttatgca 93540
 tctggacctg ggtagtatag gaaggctaag ctaagcaaaa gcaagtcagt ttttgagcca 93600
 tccctccaaa gttcctgctg tatttctcag cagcagtgta actacctagt tagaggtgat 93660

gttctgtgaa atagcaagca gtcatacttt caggttctctg catgagttcc tgtcttgatt 93720

tatttcagtc acatactgtg acctggaagt gtaagccaaa taaatccatt tctctccata 93780

gttatgacag aaaggaaaat agagcacctg ggtttaaggg atggccaggt tattccacat 93840

cataatgctg aagtggcact ctctttctca agtcccttag cacaatctgc tttgcatatt 93900

tagccctttt tcttcagagt caagatcttt tttgcaaata ttctaataaa gtatccatt 93960

aacacatgga ttctttactg attatccgtc taatggaaca aaagatgaag ctttcttcaa 94020

tcacttattg tgacaatatt ttttgtcaat caaagtctctg tatttcattt tttctatttc 94080

tcagtttgcg gtattatttc agcatactgc atagcaaaca agcaatactc ctttatcccc 94140

taagagtgcc atatacagct tgcattttcc tgtgtattga gctttctgtt cctgccatga 94200

ctttcaagag gtacaaaatt cccatacat gcagtagtta gagcttcata cttggagaac 94260

tggatgaatt tactgagaat gtccataact taattaattt tggagacaat cttcagagac 94320

agaaatagag gcctgtagca tcagtgcatac ttaaagcaag cagagtcaga ggagagacac 94380

tggcattaca tttccccct agtccctata gactttcagt gcatattcct tgatactcag 94440

taaataaaat atacattaag cagaactecc aacaagtat ttgtataaat aaattagaag 94500

gaagtatcaa ttcataaca aatacaattt taaaattac aggagagtaa ctaattataa 94560

agatgattca gagagcaaac cctagatgaa taatccttta aactccagt accagataaa 94620

tttataattt atgagcttcc catgaggtta aaaattagga aggatttagt acagctgcta 94680

atatggtaaa ggtactatct tgaattcca aatggattc tttttttct ggctgctcaa 94740

atgacattta ggatttctct actgccaaat acttgtaacc tcttctttat gttttattat 94800

aattctgtaa atggcaccgc tctcttattt tgctctgcc tcatatata gaaggaaagc 94860

ctcatgcctt gtgggtcttt ttatttaacc tcttcaaag aatgacatc tttgggtgtt 94920

gcccagtaga atagccatag aggggtgtgga ggtggaagga ggactgagct ccagctgtca 94980

gtaattctca ggaaaggata ttaaggagc acataagaaa gctggagtgg ccaactcag 95040

aatgaggtct acagttttct tcaaatgctg gcctcctcca cttacagtgg agacatcata 95100

cctcagatta gcttttactt ttagtgtgtg tgtgtgtgta tgtgtgtgtg tgtgtgtgtg 95160

tgtgtgtgtg tgccttgcca ccatgatgtt tgtatactac atatacgacc aggaaccttc 95220

tagcagatca accactgac ttaaccactg agcaatctct ccagtcctat gattagtttt 95280

taaagagaag ctcatgtaa tgaggcttat ccttacttta actagagggc aaaaaatatt 95340

ctttcactgc attttataat attatttaag ccattcgcag gacaatcaca aggtctcttt 95400

ttcatgttt gaggcaagga aggttaggcc aaactctttg atatcttact gaatacaata 95460
 caggatttta agatttttta ttactattac ttattgattg attaagatgg gtctgttcta 95520
 aatgccctgg ttcttctcag acccatggtt ctcccacctc ggtgtcctga gcaccaagat 95580
 tntagacata taacacatg ctggattgaa gatgttctag aatagatttg attctagaat 95640
 aggaagtgtt ttgaaaatga atggctttta aacatatgat ctgttcaatt atttaaagat 95700
 cccaaataaa acaaacatcc gatggcaaaa cataaactta ctgtgtttgg tactcatgaa 95760
 gaacacatcc acctctctct ctctctctct ctctctctct ctctctctct ctctatctct 95820

 gtgtgtgtgt ggggtggtgg tgtgggtgtg tacttatact ttacaatact gtgtaggaag 95880
 atcaaacat gaaagaagac actccaaata tcctccaac cctaataatt ctgatattt 95940
 gaatgatctg ttcaaataa acaactaaa atattcaatg gtgatatttc aaaagatatt 96000
 atatgacaaa gtaggggctt aatgtcacca acaaatggg aaaaggtcat caattacttt 96060
 aaaggctact tcaaaagtga ttctaagat atattcaaag taatatctca gactctaattg 96120
 ttaaaaaatg gatcaatttc aactataat ttaattgaac ctgaaaacat atacttcaa 96180
 gaaaacaata cttataaata agattatttt ttctctgat ttattaatt taggggagga 96240

 tatcatcata taiggccagt atgtgtatgt tctctttttg tgtaaaagt ataaacagt 96300
 gattacacag caccatttac agggaaaata taactatgga acgataaaca attatattcg 96360
 agtgacttgg attaattaat taattcattt attttacatt ccagccactg tttcccttc 96420
 atcttctct ccaagccct tctctccaga ccccttttg tttccaacc ccaatacact 96480
 cccctctgt tagttgattc tgtgattttt ctgtggtga ccttgaacc tctggctctt 96540
 acaattcttt attcacctt tcaacaggat tcccgaagct ccacctaag tttggctgtg 96600
 ggattgcac tgittccac agttgctgaa tgaacctct ctgacaccaa tctgtatgta 96660

 tagaagaata atgttaggca tcattatatt gacctttttg accctccag ttatgtttag 96720
 ttctacccta ggtctctggt ttatcaagcc tgtgggtgt ggtgctccag gcagtatcag 96780
 cagtggactt actctctgg caaatgtttt aggctagacc tatcattggt tagctactcc 96840
 ctgagtatct aggtcacct taceccagaa tatctcatag gcaggacaga ctataggttg 96900
 aaggttatat ttctgggttg ttttctact ccatccaatt gaagcttgc ctggtcacag 96960
 gagatggcca gttcgagcaa cttatccatt attactagag gtcttaggt gttttatcct 97020
 tgtagtctc tgggtgattg ctttgtgcca agtttttacc tgacctgta accacctgcc 97080

 ccttctctga tcacacatgt ttttatttga cctgtaatg ccattccctt ttctagtagt 97140
 ttctttcagt attctctgc tccatctcc ccacaaacc tgattactca tgtttcaatc 97200
 cccatacaac agcaacagtt cactcagaaa atctcttcca tttcccttc ccaggagat 97260

ccaactgttc ccccttgaac actccttctt aagtagtctt tcttggata tggattatag 97320
cataattatt cttcatttta catttaataa ccccttagga gtgagtacat ataatgattg 97380
tctttctggg tatgggttac ctcaactcagg atgacttgat tcttgttcca tccattttcc 97440
ttcaaatttc ctggtgccca cctttttaac agttgagtaa tactccactg tataaatgta 97500

ccatattttc tttatccatt tcttgtttga gaaacatggg ttttttttcc agtttctggc 97560
tattacaaat aaagccactc agaatgggat aagatcttca aaaaccaat atccaaaaga 97620
atgaatttca aaatgtatga agaagtcaag aaactcgaca tcagcaaacc aaatgaccca 97680
attaaaaatg gggtagacat ttaaacagaa ttctcaacag aataccatca aatgtctgag 97740
aaacacttaa ggagatgttc aacaacctta ggtcgcatga gccatgtgat ttctttgggg 97800
agcaaggcct gaaaatagct ttaatgtctc tcagggtgga agaccctgga gccctgacc 97860
cagttggtaa agacctatgg acaattttct gcataattct ggccatgact ctggaagcat 97920

atgtgctacc ttctctcctt gttattacca tattgctggc ctgaatgagc catagagggt 97980
catcaagttt attattagac atttgcatta ctgttctgaa aagaatgttt ttagacacta 98040
gagtatatga gaaatgttat taaatagctg gtttttaata ataggagtta attggagcag 98100
tctatgaaga aglaatgaaa cagaattata gaaacctaga gttccctgtt ttctaataac 98160
tgtgccaata ccctaagaaa ttatgagaga cagacatgag aacaagggat atacactgac 98220
aactattaag agtaagtttc ctagtgtgtg tgcttatagg ataaaaagac aaacctcata 98280
ttccccgga agaaacagag tagtacagaa tgtagaatga attgatccag ctttggctgg 98340

tgagttgatt gtgagaacc agacctacc agatattaac cactagagge aaagctctct 98400
ttcacatgc atgacactgt aactgcataa gtatatgtag ttctacctgt aggtgtgcct 98460
agttagaaaa attccttggg gctttgcac actgcctcta ctctaacag tagatcaaat 98520
ggctaccagt gggaaagtgg ggaagaacc aaagtaacaa actggttaact attgtaacca 98580
ttttatttta tttttttta gtaacttggg aaggaaaatt gattgtaaaa ctgttcattc 98640
aaaccattaa agctacataa ataaaaacat cccagatgt ctggaagaca ctgttttgaa 98700
ttacaacaag tggtcacaat ttctecatgg caccaacttt tcacatccat accaggtcat 98760

tgtacccttc tggagcaagg cttacagcac ttggctacga tggaaatgca aatcaagggg 98820
actctgagat tttatcttat atctgtcaga attgctaagt tcaaaaacac aagtgatagc 98880
tcatcctgaa gaggttggg aatgaaggga ggattcttgc attgctggta agagtgcaac 98940
cttgtacage tactttggaa gtcagtgtgg tggtttatca gaaaactagg aatcaattta 99000
ccaaaagacc ccgctafact actcttgggc atatatccaa aagatgctca atcatatcac 99060
aagggcactt gctcagactc acattttcaa atcactgtac ttaaataatg ttaccttcta 99120

tttcttctaa ttctatttaa tttttaagtt gttttgcaat tacaatctta tgccaacaga 99180

 aagttatcat aaattaaagt gtgttcactt gacaaatcct gtgagagata ccttgggtga 99240
 atggtttatt agactttttg tgctttactc attacaaaat aaccaaatca actgccttga 99300
 taaacctcca acattgaatt aaaaaaaaaat gctgtgttac tttcagtata tgaaaagcat 99360
 tcactttgtg gtgcactgag tttcattttc tctctgcctt ttccccagtg ttgtttatat 99420
 ggctgagtggt gctgttttga ttgtttgtta ctaatgacaa gtatatgctt acttggccta 99480
 ggtgaggcctt ttaattcact ataacatttc tggtttggaa ttccccagga tataaatcaa 99540
 tatecctaact atatttggat tgtttgacag aacatgcttt ttcaaatgct caaatcctta 99600

 ttaagatga tcicatgcat gttccttttg taatgtgaag gatttcacag aaaaccactt 99660
 gttgacagta ttgcagtatg gcatcattac tgggtcagga caagaagagt tcacatgtgc 99720
 aaactgctag catttccatg ttgtgggtgg gagggagcac agatttcaga agatggagcc 99780
 tcattttgtct cacaataaac ctgaaagtt acttgaggtt taggttgatt tttcaaatta 99840
 attggtatth ggaagttgtt tttgttatga cagctagaag aaattgagtt tgaaaatata 99900
 agaatttgaa aacatgaaca cttccaaatt atgtcagcat taaatgtata ctaacaatgt 99960
 ctaactgggtt atactacaaa aagaacatt aaaatgacac agttgatcaa caattaaat 100020

 ccacagttga ttgatacgtg atcacacata ttgatccttt atgatgaatg actctaggaa 100080
 actaatgcac atttaacta accctctgtg gacagttatg ttttgtctta ttcagacatt 100140
 ttataggaat cagcacatgc agatatatga gcctcacatg cagaattht ctttttaatg 100200
 tatgttactt tgacaacaac actgacagct gagagggagt ctcatatc ttttctttta 100260
 cattatgtat ttgttatgct tatttggcca ctactgagt ctactattg ctgccaatat 100320
 gctcatgagt ttgaagctaa gtgtttatta acaatacttt gtttatttta tgcatagaat 100380
 tttttaatct caagtatgtg tgtactagta atgacagtac aactgtttga taggaacttt 100440

 cttaactat gaagaagaga caaggttccc acagaggtat agaatatttc cagtcctagg 100500
 atthttgttt atttcaagta tgcaattaac ccccaatctc tttaaaacca catacagcaa 100560
 tttcaggctc ctctgaagt atthtccacc acattatctg aattctaaat aaattacttt 100620
 gtttcaatgt aatatctcac tgtaatgctt taggatacac ttattatgat acacaggcat 100680
 gtctctttta gcctttacgt cttttgtcac ttcttctag aaagtccaaa aaataggtcc 100740
 ctgttaggtc aatctcaaa ggcccccaacc tagatgaaga gtgataggca actgatgact 100800
 gctgagaaa gaaaataggt ttaacaagg aggagtcact taattgctta tccagggttt 100860

atgccggcaa agaaaacaaa agtcataaaa ttaaccag gaaacaaagg aagtaattat 100920
tctcttttgg agatgcctaa ttcatttga cacttctcat atcttggtga tctgtggaag 100980
ttattctgtg tgctgggata ggaataaagg ccagtgggga aaaggttttt agaaacaaca 101040
gacatcttgg aatctgaatg attatcattt atgttatgtg atatgctagc tgactttgta 101100
catttccaat ggtattttag tgtctatgat tattctggat aattagttag accaagaaaa 101160
tccaagaaaa gttacttggg tcttactaat atctctgaat tgcttggtct ggtggaacaa 101220
aacctagata agttaatttt acaactacaa agttgatatg atttgttgc tgtgtctgag 101280

caccattggg atattttacc ttctgttatt ctataactat gactggaacc aacacatgta 101340
ctttaagtac acctggctgg ccacaagcca taccagactt attattcatt tgtatttgag 101400
gacatgaaac aaaacaacat gtgaaagaac ttattaaaaa ttataatga taattataat 101460
gataataggc tatgaccacc ctctcaacat atttaagtta tggaaatfff tcaaatattt 101520
ttggagcctt caggataaat acccagatgt cttaactga atttgcatth ttatggcttg 101580
ggaagacagg acgtgaataa tcatgtccta ctgattctcc tgtggctaac aaaggtaaaa 101640
tcaccaattc ttggtggttg tttacatatt tattccatcc ttttagagat ctacacaggg 101700

tggacatctg ttagcttaat actttcattg taccctctac catattttat ttctttataa 101760
aaaagacttt actgtgaagg tcatgatcag aaacaaatcg aatgctcata aatattctat 101820
gacacactca ttgaattaca agtggagaaa gtagtatgtt aaatttgag tattagcata 101880
ttaaacatgg tcacaacaaa tgtgaagaaa taatatctgt aagtttaca tggggtcagg 101940
ctagcacaat ataaaatcaa atcttttacc ctattctgtc tttatgttac ctgtgtttat 102000
gaatacagca caaaaagtag acaaaaatata ggacttccat tgctcaaggc ttttctttta 102060
ctttataata tacattcaaa gcaaattctc tttatacttt attaattatc caccaagaaa 102120

aatcatattt ccaagacagc ttgctcttgg gttaccaagt tgtatgttta atttcttctc 102180
tcatataacc ataaacaatg aaatctaatt tcgattttca aacatctaath gtaacaaaa 102240
ttaaacttgg aaataagtaa atatggaact aaatataath tgtgtctatt tatttctttt 102300
cagaagcttt atgtactata attctccagg ataagctctg tgctatgaga gtagttggac 102360
tgatcacaca caaaaatta atttgatacc aagactctc ctttgaacaa acaagtctga 102420
cgagtcttta aaattattta ttttattatt tgagattata atataattaa taaaactccc 102480
ctttctttt ccicccctca aatctttca tacacccac cttggcctcc ttcagaacct 102540

ccccaatca gggctcagtg agccctgcag aagatgaggt aaaaagagta agaaccagaa 102600
gcaatggagg ataccaggag aacaaggctt tctaaatcaa aatgtcaatg caatatgaac 102660
tcacagagat ctaggcagca tggacagagc ctgaaaaaag tggttacatg tcccattccc 102720

taagaaagaa aciatctcca gttgataagc tcttccaagt gaaaattcag ttttttttaa 102780
 agaagtctca ctgggaaaa gaactactac taagtgtagg atgaaagccc aataataaat 102840
 aaccaaacag aaaaataaact ctctctctct ctatatatat atatcatcat aacctggaac 102900
 tgagtccaat gcaatcttac tcctttagtc tgctgttggt aggggtgttg ccaaacaaca 102960

 acaaaaaaga agcttgtaag gtaaatcaat aataattgaa agagaagaat aatataaatt 103020
 tatgagacta tatttataaa gtcataaaac ataatgggtg aattaatac atgaggttta 103080
 cactaaaaaa acacacgatg tatctaataa gagttgtaaa gtgaaaataa attaaagaag 103140
 gagaagcaat tagtatgtac ttttaaaatg gccactagca acctgcattt ttattttgat 103200
 gaatctaata atttattgga aactaagtaa ataccacatc tagaagaatt attttgatat 103260
 atgggtgcag acacacaaaa atgagagaac ctagtctgaa aatttagtta aaaagagaaa 103320
 gcatctctaa aaaaaactaa aaattatata attccagtta taataacaac aaagtacata 103380

 tacatatagg gaagataact aatggaagaa tttagagaaa cttaaatgaa aatctgagaa 103440
 ttctagtagt catgtatcaa ttaaaaaact ttgtttgtgt ctctagatga ttatttaggg 103500
 gtggaaaaat ggcagacaag gctataattt caaaatgaga aattagtga tattagtaag 103560
 tttaaaaat aatttactaa gccgggcagt ggtgggtcac gcctttaatc ccagattcc 103620
 agaggcagag gcaggcagag ctctgtgatt tcgaggccag ccagttctac aagaagacag 103680
 catccaaagc caaagccaaa aacaaaaaca aacaaacaaa caaaaaaca caaaaatctt 103740
 tgctatgaaa atgtaaatgg cttaagttaa agtaattaaa atattaatt aaaaacta 103800

 gaaaacagaa ttaagatatt tgggatttga aattgtcatc ttatttattt cttagaagta 103860
 gatacttaat acattttgat tggaaatca gttatttttc ttaatatat aaatatctaa 103920
 gatgtaaaat aataaagagg tacaagagaa attaaattaa aaatttaaat ttaaaaagtt 103980
 aaaaaatttt ccaacaaata taaattgaat caaacataaa ataatttaat gtttcttaat 104040
 atatcagaaa ttaaaactaa cctaatttg ttacatacac ctaatggaag aaaatggttg 104100
 ttttaccttg ctaatgaagc atctgaaatg tttgatttgc tatatcaaaa ttattttaaa 104160
 ccaatttagt atgcatact aaaaatttca caagaaaaga acattgacag acttatttta 104220

 aaagattcaa attcataat catttaaggt agtaataatt ggactatcaa cagcaaccag 104280
 tctcatttca gaataatgat aaaaacaaat attagtaaat ataagtacta tgcatttggt 104340
 tatctaaaga ttattccaca taacatgaag agcttttgaa actcactatt cagaaacaac 104400
 gccaggagaa attggggaaa agacatgaat ggatgtctaa gaaatggatg ttcaggaaat 104460
 actcatctta actcattttt ggggatttgt atctcacaca atattgtcat gaatcactgt 104520
 gagactatag gacttcttca aagcattaag aaaaacatg ctgggatttt gttgggactg 104580

taaaaaggaa ggactcgggt ctttctgaca cagcacaat tagtagaagt taatgacaaa 104640

 gatgcaaatg gaagcaaaca tatacacata tgcactata gcatcgtatt catacaactg 104700
 aattgtggat aaaagaccca aattagttgg tgccatacat gtctacaaac tcacatgtgt 104760
 gtgtgtgtat gtgctcgcgt gtgcgtgcac gtgtgtgtgt gtgtgagcgc acacacacac 104820
 tgcaacagta tttctgatca taaaatgaaa taatgctgtt gacttagaat acatgcaggt 104880
 gaatgagata gggcaaatat aagtcaaaca tgccatattc actaattaac aagcttgggt 104940
 actgaagggt ccaaagggtc atttttcat tgacatagta gctttttta aatgaacaat 105000
 gtaggaaatg ggatattaag atacacaaca tagatctttt ctagccatcc gccgtggtgg 105060

 gtggatgaaa gacctgagct aacctggggt tagctcgtta aactataata aagcctcgtg 105120
 ctgtttgcat caagctttcg aatccgcctg gtgattgggg tgaccatggt cctgggctga 105180
 gatcttggag gctgagctt ctgggggtct tacatttggg ggcttgcct ggatttgcga 105240
 ccaccctca ccigaatgga ttctatcttg taggtaagct cgatggagct cacaacttat 105300
 atgttcaatg ttatgtccat gtttgccttg tatgtctctt gctgtattgt tggtttgggt 105360
 caaagtcaaa cttaaatgtg atctgtgctt gtgacttcta tttgtaatt tggacctcag 105420
 tgggagacag atgtgtcctg tgactctgat gatttctgcc ccggacgaaa ttccgagggt 105480

 tgtgtgattt ggaccatagg gaaagcagac gtgcctcaaa ggcagacgtg tectgagacc 105540
 ccttggctct gccttgaag aaactccaag ggttgtttgt aattttggtt tggtgccatg 105600
 tctgtaattt ggtctgccac gcggtttgtc ctgtctgttg tgtctgtcct tctgtttttg 105660
 ctgtttgtgt ctgtctccgt actaaccacc cctccccgg attccacctc atctgtgatc 105720
 ggcagatgtg ccaggtggat cacaaactgc tgccctagga caccaggag gtatggacag 105780
 gggccaagga cacttggacc ctctcagtt agcagcgatt gtagctgcct ggttctgccg 105840
 cccgccttc cagagccatt gccttataag tggcgtgaat ggattaggtt ggtgtatgtt 105900

 ctttctgtc tattctgtct ctctgtttc atcattggtt ttcaattcag gatctacat 105960
 gacacccctt tctgtttagt catatggtgc cacactaagt aactttcttt accagtcttt 106020
 gtttctgtac ggtttctata aagcctggag ggttgaaca ggctgggtga ctaggcagtt 106080
 gagcagcagg gttgctatct gtggtctgat gtgttcagc ccataccctc cctgtctgct 106140
 tttaggtggt gtgtcagtt tgtgttttca ggtctgttgc ttctgttaat tttgttctgc 106200
 ccaagtttca ttacatttg tgctgtgtgt ttgttaagca tctctttctg tcctactgc 106260
 ccacgcagct ggcattggac aggagttcct ctgcatgcg ccatgggtta gagtgtgctg 106320

ctgctggagtc ccctgaggct gctactctga actccaacca ttgctgcggc cctcacagct 106380
 gagcctggcc tatgaagggt agtctgtttt tccatcctca tatgccggtc tgtgaggcat 106440
 gtgaagtagg gctgtctctg ccccaacttc catcctgcgg tgggtcctgt cttgtggcgg 106500
 ggggttttca ctgaggacat ggctgcaagg ccaccatttg ccagctgcc tggcttctc 106560
 tgtgtccaca catgtggtat gcagggaaac catgggggtc ttttccac ccagcattg 106620
 gcagagggtc ttcgattacc agcagcacct cccaccccca ggtttctacc ctgagcatat 106680
 ggatctggcc tgctatggac attctaaga aacagcctta aagtattaa aaaatataaa 106740

 agggactttg ataagagttt ttatgatgac tgaaaaatga gagagaatgt aggagactaa 106800
 aataataaaa aagaaaaaaa agaaaaaatt gtctaagaat gtctaaggaa atcagagaaa 106860
 tgaactaaag gtatatagaa agttataaag gattaaagca agtcatggaa ggtcagaaga 106920
 aaggttgtta aaagtgagag aaaatgtaa ctgtttgcta cggtttctca tgtcttcaaa 106980
 tagtaaatth taaaagtgtt aatataagtt aaaatthta ccatattaag ttaattctgt 107040
 ttatttctca agtaaatat gcatgcttgt ttaaaatgt tgtttcctgg tataacctaa 107100
 gtctgttac aaacatacat ctaaaacaaa tgggttaggt caccaccatt ttgtagccag 107160

 ctacatggca aactggcac atggctgact ggtagccatt ttgctgaatt tgaaaaagt 107220
 tacttaaaact gccatctga ctaaagatga ccacatggaa attagagata ccatctaga 107280
 aacaagtttt tcagttaaga ttaaaattgt taatacttct atatattaca gaaagacatt 107340
 aagggaattt aaatttcttt ttacaaccag tttttttaa tgtttatatt ttaaaatgt 107400
 cttttttatt aatgtttgta cttaaagagc ttcaatttaa aatcattttt aagcaaagcc 107460
 tgacaatgta aagtcttgt tttataaacc tgctaactta ttataagatg ttacagttha 107520
 tgctttcaga agttaagttt aggggttgg tggcacatgc ctttaatccc agcactcggg 107580

 aggcagtggc aggtggatct ttgtgagttc aaggccagcc tggtcagcag accaaattct 107640
 aggacaggct ccaaagccac agagaaacc tgtctcagaa agtagttaag ttaaaacaag 107700
 cagctaaaat atgtacagt agctactgtt taagaaatat aaggtaacct tacgcagttt 107760
 taaattcage tgtgctaagt ttcaaatatt ttactaagtt aaaaccagtt acagtcaggc 107820
 tgaaaattaa ttacagaaat taattagacc ttacctagcc acctgtatgc ttaatgtgtg 107880
 cttaaaggca gtaactaaa catacagacc tctaagtctt cagagacctg cagaatattg 107940
 catttaaaact gttatcttha aagtttatat tatcagacag actgccagat cctgacagtg 108000

 acccaaagtc tccatagaag attatgagge accccagttc ctgcacctgg accagtgagt 108060
 gagatgctga aatgtgatag ctgctgcctg ccataacctg gccaagactg tggacaaagc 108120
 tgctggacag tggaaaattg actgcacccc ctttgtgtag acaaaacaag gtcagtcttt 108180

tccatgtccc tcttccacag agagaannnn nnnnnnnnnn nnnnnnnnnn nnnnnnnnnn 108240
 nnnnnnnnnn nnnnnnnnnn nnnnnnnnnt ttgagacatc tgcctccagc ggtaatggag 108300
 agacttgggt atggctaact gtatacggaa tggcttctgt cacttttttag tagatttggga 108360
 taaaatatac ctttttcaga tctctgaaat attaatagtt gtcagcttga cagcatcgga 108420

cactcagata cacaagacta tagtcagcat gttagctgat aaagtaatga ctacctagtg 108480
 ttcagtcaca tgetcaaggc ttttaggttt attttggttg tcatctaatt ataaacttaa 108540
 agggcttttc atcaggccaa aggcaattct gtccaatccg tacctggctc tctggacaga 108600
 agaaaaatgt acatgcttct agcccaaatc tgtagtatt gctaggaatc aaaattataa 108660
 atgtgtttct gcgtttttaa cagacatcca gatatctgct tttttctaca ctatgggctt 108720
 cagtaaataa gttttaactt ctgttctac tttaaacatg tcttaaacag gtttctgctt 108780
 ctggcagata ctctgagta taccagttgc tgactacagg ccgttctat ggagattgca 108840

aaccctgtac ttgctgtgga tgtgaaccag tccagctgat atggacaccc cctgtctctg 108900
 caacagagge tgccaacagc tccaatgga ttccccattg cctaaattcc ttttttttg 108960
 cttttgacta gcatttcagc cttcttgggt ccctaacttc gtecccaaat caacaggaag 109020
 tagcatgaga aagaatatgt cacccaattt ccctggtaa aatgctaagt cagaagaaac 109080
 tcctttgcat ggggatgcca atatatctca ctccctgatg gggacgctgg agagacagca 109140
 attccatgat gggaattaaa aaaaaatgag ggaatgaagg gaccagcttc ccatttcggc 109200
 agccataata gccgaacaca tgcttgtctg accttgtctt agtcactaag atcagatgcc 109260

caccctttt ggcagccata acagcagaac acatgcttgt ctgaccttgc ctgggtcact 109320
 aagaggtcag atgcttgctt cgtggcaagg aaccaatcag aagtagctg gtagtgctat 109380
 gctttatggc tgtgggtgtg ctttatggac aagtgcacag caatgatgtg cagagcatag 109440
 caaccactct ggagggccta tgggcataa caaccagttg accaatcaac atagggcaaa 109500
 cctccaagc ctggaggcac actaatctg agcctgtgtg tatccctaga cacgccctt 109560
 aactgcctt ataagatctc tatgcataca ctctgagctg tcttttctag ccatccgcca 109620
 tgggtgggtg atgaaagacc caagetaaca tggggctata aagcctcgtg ctgtttgcat 109680

aaaaaaaaag aagatacaat acatagtttg caagatggct tattgagtaa aggtgtttgt 109740
 acccaagcct gtgtttgac tttgagactc aaatgtttca aagagagaac caactcctga 109800
 aagctgtccc gtaacacctc atgtatgtga tgtttgaatg tgtgccttcc ctctgcaaca 109860
 taacataca ctaaataaac aaataaaca tggatagata ataaatgat tttttctttt 109920
 aaaaagtac acaaatatc cagatttaag tgcagattct cttatatatt taaattcttt 109980
 tatatatctt ttcaaaattt cattcatatg tgcattgcat tttgtatat ctgccctca 110040

atctctgtcc aatttccttc agagttccat cacatcttac tctcaacttc ttgtacgtgt 110100

atattttat ttattttatt atttatttat ttattgtttg tttgtttgtc tgtttttaat 110160

ttgaactatt gctttaatgc actaagccaa gtatctgtat gggaaaaagc aataaatttg 110220

aaacatgaag ctttgtgtac ttccttcct ttaaatctcc attcatcaa aacctcaaac 110280

catagaatgt agattgaaca tatecttacc aaaaagtaaa cagtaataa gtaactgagt 110340

cagttttttg cagtgtttcc actatcctgg gaagaacaaa ggctatatga catagaaatg 110400

gaatgatfff agtgaatcat gatgtgaatc atgaaccaac tttcaggagt tggttctctt 110460

tttgaacat ttgggtccca aagatcaaac acaggcttgg gtgcaagcac ctttactcaa 110520

taagccatct tgcaactcct actaatttat gactgttttg tgcacatgtg aacacatgag 110580

aaagaacag aaaacgaggg accaaagaga aaaagtacac ttcactttag gatatgtaat 110640

tcctatfff gatactgtgc atcatgttta cattttgtat tatctctgt caaatatgtt 110700

atccctgggt tgagatgaag ctagaacaaa aaacttaag tagtgggtg gtaacattca 110760

aatttacctc tgaacttatt ttatatatcc ttaaattttc tttgccaac tgaagattca 110820

catgtgacat gggtttaatg ctgctagctc tttcttgatt agaattagat ctcatgaaat 110880

agtgtctfff tgctattctg cctataacac cctactatct atgaggcata aaaatagatt 110940

ttaaagatta acacaataat gacagaatag aaacagtttt aagcaaccaa acttcataga 111000

gaaccctcca attatgtgtt attatfffft aatataagtaa tgattactat tgattagtgc 111060

ataaactga ctaatgaaat ctatctffff aaagagatct tatcaaaata tgagtatfff 111120

ctatgcagtt gtagatattt tattgtttat atccctggtc aatgaaacag gtggatcaca 111180

cagaggagaa ttaatttcct gattttaaag acaatataca gtgtaaagag atgactcagt 111240

agttaaagga gattgctgtc tctgaaagt ccagagtta atctctttaa cttacatgaa 111300

gcagtacaca cttcctctga gtcaagctcc aggggatcta acaatttcta gaatgctaga 111360

gtaaacacac acacacacac acacacacac cacagacacc tttaaaagac agtagaagta 111420

cagatgactc ttgtgtatag gcctataaga gttaaatcaa tcaaataaca tttagataac 111480

aaaattatta caaagatgaa tgggttgaat cacctcactg catttgcgac agccagttct 111540

ataatgattt tgtatctgta tttagggttt ccaatcttga cagagaatat cagcatttta 111600

tgcatgagtg aattctcatg tcatttttat tgttaatgaa ggcatatgca atgttcattc 111660

tcatgatfff ttaaagctg tttaaaatgc caattgcatt caacataggc tctgatgtat 111720

ttttcataa caacttcatt attgaattat tcagtatfff ttttaattt ggccaatcat 111780

tgaaaaataa tcctatatag actaatatit ttgagacagg atttctctgt gtagccactg 111840
 tggctgtact ggaactcact tttcagacca gggtagcctc agattcacag agatctgcct 111900
 gtctctgcat tccaagcact gaaattaaag gaatgcacca caactgccag accaatacat 111960
 cctaattttg attaagacta gaattactta tgccaacatt atttgcattt tagcttgta 112020
 ttattactct taacttccaa actaaaggac aatgagaat tataagtaa atacagcatg 112080
 ttaccctgg gaccacaagc agcaataat cagttaacta aggcaagtgc aacattactt 112140
 tttatgatgg tatgtctctt taagatitit atttaaata tcacacccat tctgcttcat 112200

 acatttcaga gcatttttaa gaaatgatat ccattacagt ggatttatcc atgaatgtca 112260
 ccatgaaaac atgctttgtt cttttttit tttgagacag ggtttctctg ttagctttg 112320
 gagcctatca taacattcgc tctgtagacc aggctgcct tgaactcaac aagatctgcc 112380
 tgctctgcc tccaagcgc tgggattaaa agtgtgtct accagtccc agtgcctta 112440
 tgggtttta acattctaata tattaattaa caggaaagt gagagaagca gcttttagtt 112500
 tttggatctc taggaaaag agttggattt acatgccagg actgagactt caatctatc 112560
 attagcatt aatattccct aatctaggat attttaatgt ttaacaagt tttgtgctc 112620

 attgaactaa tggccttgtg tacaatgggc aaaagatcta ccactgagac atatacaggc 112680
 tctaaatit atttctgtt tagttttaa tttcatagaa aacagaaca agttgaatgg 112740
 ttaacaactg cccaagaggt atttcaggca gtggagagat ttatgagcaa aggtgttac 112800
 aatatgaggg atttattct ttaccctgt atctttgctt tagtcttcag cattactgt 112860
 gttgcttgag atagacagca caggattcc atgagcctgg ttgatcctag ttaataatgc 112920
 tttgttcca cgaagattct ggattccatg gatttctctt tttgttatt cctctaagtc 112980
 tgatttctct aatgcttag aacaaggaat gaaagccact gacatttca tcatgtacct 113040

 gaacactaaa gagaacaaca acagaacaag gagcctaagg gcttagcttt tgatggatct 113100
 ctgaaatgac aggacattc tctgagaat tctccagtcc ttgtcatatc agagacattc 113160
 acagcaacta ggcaacctg taacttgtga aataattacc ttagtcaata tttcatattt 113220
 taaaattgtg tttgttaat gaattttaga aatgtctca tatacccat tttgtctca 113280
 gatttgcata ttagccaagt gtgatctga actcttgacc ctctgtctc tatttccaa 113340
 ttcttaggat tgaagacaag caccatcaca ttcagttgtg tacagctctg tgaagaagt 113400
 ccacagttt gcicactcc ttcaaatgt ttaccaagt agctatatcc caagaccaag 113460

 ggtgttctt ttttaccat tatttatta taattgtat ttgtatatat gcatgtgtg 113520
 tgtgtgtgt tgtgtgtgt tgtatgtgt tttgtgatg tgtgatgtca tgatgtgcag 113580
 ttgaagtcat gggctctcc ataatatctc ggttctctgc atcaagtcca tgtttgggg 113640

gttttaaaa caagcacctt tacactataa gccctcctg acccaaggac cagtttaaaa 113700
 catggactct gaaccatttg tttatgtatt actaatgaga taattctaaa tagaatagct 113760
 tgttcccaga actgtagaaa ttaattttct ccatttcccc atgactcagc tatttaaaaa 113820
 gaggacaaag cttcactata tttgctctaa tgaattatt tcatttgtat acttagtaaa 113880

 agacctgtgt acatataaat tacatacaag catacaatat acattcagtt ccacaaaacc 113940
 aaaaccact attatttcta tctaattttg aattgaaaca ttcctccta gagctgggaa 114000
 ggaggctcag gaacttaggg acttattggg ttctagaagc actgaaagt ccaggattca 114060
 tgaggctttt taccaatgtt ctatcaatag taaacaatta ctggggggag agaaggtttc 114120
 ctgcagtagt gctgcctgta atttgattag ggggtttcag gggttcatat tttgtgattc 114180
 ttcaccatta catgctagc cttttattga taaagtgca cttgagtcac ctttgtttct 114240
 gaaagtagcc tcttgcctcat tcgatgttta atcacaattt ttaacatcat cttgcagttg 114300

 gagattatcc tcatggggcg ttttctggat taggctagtt gagatgggaa gatatgccca 114360
 gtaggcaaca ggcactctcc tgtgtagtc aactcactgg gtcactgtgc agcttggaa 114420
 tattttcact ctctgttctg aggtatttga agatttaate acatctgtcc aggaaagctc 114480
 atagaacaac aaaacatct gtcattctta acatagtca catttaacct tagttgtccc 114540
 tttctggatg aaattgatgg gtgacctcac tattctaaca cacaagtctt tcaacagttt 114600
 gattctaattg tgttaccca gttatgggtc agaataacat ccatgttctc agactgcact 114660
 ttcaggatgg tgtgtgtgtg tgtgtgtgtg tgtgtgtgtg tgtgtgtgtt atttcagtg 114720

 tctttcttct cctttaaagt cctgtcctca gttactatct ctctggaagg ctttaattca 114780
 tcattcaaaa ctccaaatat acttctagta tcactttgtt taacttagta atatagtca 114840
 tttccatttc tttcatttg aatacctata attactctt taggttactt gacattacat 114900
 atagtggac atagaaatta ttcttctggt tgcaaagatg tcaatttcta taaatgtgtg 114960
 agcttcttca aactcaaaga gatttattac aactaaagaa gaaaggcttg cctatgggat 115020
 gaaaattttg ggtaagcact gatctcgttt cattagtatg aggatgacag cacttaaggt 115080
 ctatgtgctg tgaagagtta tataatcttc atatattagg atacagactc catgttatgc 115140

 tttataaatt atacacaaa tgggagggtca tgagtgcaca attaattttc agtacccta 115200
 accctcaaa aggatgatag gacatttgc tattgacacc gtgtccatag aggtgtaata 115260
 gctaaagaat tttatgtaac agagagaggg aaatgaaat gagttattta atggctcagc 115320
 cacatcactg tggatgcag agctgaaatt taactagaga gatggaagt catgacaaa 115380
 agacagactc aaaatcagat agcaggtatt tttttttta atgaaatcac tgggatagcc 115440
 atgcagtgtc tacatataaa agtagaggaa gtggttgttt ggataaattt aggtattta 115500

ttatctagac ttgccttact ctaaattgag cagcaggatc agaagccaag gaaagaggaa 115560

 gttacattat gcaattgaat acccattaag agagaataaa aactgaattg gcattatgaa 115620
 cccagcctac atttctgctc agctatacag attatggagc ttatttgctg ataggettgg 115680
 agattaatta tgaagaaata tactgtgaat cagagttttg tgagtctgac aggctttgca 115740
 agtcaatgaa gtgttttagta agatgaatga attatgcata ggacgttttt cagaggtgat 115800
 gtaggagtat aaaaatgatac tgcaaccctt cggaactaag gataatcaag gacgttagaa 115860
 ttagtgaaaa agacagagat tactgacttt tcaagaaact taagtaactt taaataaat 115920
 gtacatatt ttgtttgctt tcaaactttc atttaaagaa ttttcattca agataaagcc 115980

 taaaggtaag gaaggagaca tgagiagtag attctttata taatctcttt gaatgctaaa 116040
 gtaatgaaca taagtactca ttataagata ttaacatct cttatccaaa aagaagtttt 116100
 aactgacaca gcaaagcaca aaagacataa attatgtgtt gatagtcatt ctattctcac 116160
 ttttcaaac aaaaatgtaa ccatccttta ccataaatt agaccaaact gattagaag 116220
 attctagcca ccctacaata agtatTTTTT ttctttttat gtcattttaa gatccatggt 116280
 tcaagaatca aatcagtctt tatgccaca gtgtttctag ctctatgaaa tcatgtcttt 116340
 agggattcag tccatcataa ttggTgcact agtgagaatc acttttattt tgatccaatc 116400

 tcttagaaat ggtaattgtg cattgcatgt gtctctaatg aacatcacta tttttctctt 116460
 tttttcattt atcatataat atatcctgat tatagttcct ttccacatct cttcctattt 116520
 ggatctatac actttctgct tcttattaga aagcatacat agttttaaat ataaacaaag 116580
 tataataaaa caaaaaccaa tatattgaaa taagacaaaa caaacagaat aaaaatatec 116640
 caagagaagc cacaagaaac aggttcagac attcaagaat ctcataaaaa ctagaaaaca 116700
 catcatatat gcaaaggact cataggataa aaagaaagaa aaaatataa taaaataaaa 116760
 attttaaatg agataaataa gaacaatcaa tatcttattt tactttaatg cccactccaa 116820

 gaactgaaac ctacaattta cagtgccttg gtgaacaata accacagact agatagccca 116880
 gacacctagg gaaaaacaaa atactaatga ttttaaaaaa atactactga taaaataact 116940
 cctagtacta ttctgcaatg caaaggacag tgttttattc accccaaata atggaagttt 117000
 tctcttccat tagatagaaa aaaatatact gacctatagc cacacattac tcatagagag 117060
 aggctttgga acacaaagct ctaaattggtg tgfctacata aaatcccttc cetaagattt 117120
 cagggaacct tcaggaagtg atggtaaaaa gaatgtaaga accagagggg ataaagaaca 117180
 ctaggaaaac aagTctattt aaattaactg agcaaagctc atatatgctc tcacagagat 117240

tgaagtagca agcatagggt ctcaacaggt ctgtaccagg tcctctgtgt atattaatag 117300
ctttgagatt agtattttat gggacttctg agtgtgtgaa gttgtgcgtc tctgattcct 117360
gtgcctgccca ttgaactcct tccttctgtt ggcttgcgtt gtccaaatc tgtataatct 117420
tcaataaatt cattgagtat tattttatta tatattgcta taatttctta gaggccttatt 117480
cttttataaa aaagagacag aaaaggaatt gatccagaga gaagaggaag tggggagcag 117540
ctgggatgaa tagaggaagg agaaattata atcagaatat attgtatgag aaaataatct 117600
gttttcaata aaaggaaaaa ataaaaatgt attaaataaa gttgaaacaa gcagcagcaa 117660

cagaaacaac agaagctgta acagccatga caggacagca tgagacagga agccttcaat 117720
gaccctgtta agtttgtttt ctgttggctt tctaaggctg ggaatgaagc ccacctgtaa 117780
gagtagtttg ctttcccatc aagactccct tggaaaaaaa gtaataacta ttacaagtg 117840
gatatcaata gctcttgcat tagagatggg gtgcatatgt ttatttctac ttacagtgt 117900
agcactttat ttgttgcaaa cactgcaatc tgcttcagta tctgtgtgtt catatgtgca 117960
tcaacaatgt tgagatcttt gttttcttga ggtcctctat ctctctgtc ttttatataa 118020
tactttctgg ctcttctggg gcactcctg agcctttaa agaggacttt gatggagaca 118080

tcttatttag agttaagtat tccaaggtct cttactttct gcataatgct tgtcatcagc 118140
tgcaggagga agcttctctg atgttggctg agtaaggcac tagtctgagg atagcagaat 118200
gtccttagga gtcagtttgt tgctacagat ttttcttgt tttacacaga acattattat 118260
ttggttttac tctgtgtatc tgggttatct agtctcacc aagtgtcaga tatggggtcc 118320
atcttatata gtgggcctta agacaaatta catattgctt tatgcccaca aactttgtgc 118380
caccattata ccagaatata ttatgagcag gataccattg tgtaccaa atcttgtgtct 118440
gggttggat ttatgttttt ctttggtaa cattcagagt acctgcttgg acaaaagaca 118500

ctaacacata cggaagaagc ctccatgaag gtaccagttt gccttttctg tattcaatga 118560
gttgtacatg tgttgttttc atcaatgggg cattgctgtc tcttgttga gagcaaccta 118620
tagttttgga aatagccttg gttcttggg atttcccctg ggacttgctt ggccaataac 118680
tgaattagat ggaatccaat cttgagactg gaagcttctt ttggtgacat gectagtgg 118740
tgcttttttg ccctgttat tttatgattt ggtttacatc tccatagct tttatatttt 118800
tggaaacttc tactatatta gattttcata ctaccctca aatgtctta ttttatctat 118860
tgctgtattg cciccctact tgatcttctt ttaagtcct tctcatctag ctgtaactat 118920

cccttccatt tcctatcct agggagattt atccatcagc atctagcctc ttactctaca 118980
ctgaacctct gcagttctac aggttgaaac attgctatca ttgtcctaac tacatacaag 119040
tgaaatagat atcacatttg tgtttttgtt tctggagaac cccactcagg atattttct 119100

aaccagatcc atttacctga aaatgtcatg atttactttt ttaatgtcta atatattcca 119160
ttgtgtaaat ataccatatt ttctttatcc attcatctgc tgatggacat ctatgttggt 119220
tccagtttct ggctgtcagc aatagattag caatgaacat ggatgagtaa atgcctctgt 119280
ggtaggatga agcatcctgt ggatatatgc ctaaaagtcg tcattggcat ttctattgct 119340

atgaaaaaca ccatgattaa aagcaagttg ggaaggagag ggtttatttg acttaaactt 119400
acacattgta gtccatcatt gaaggaagac atgagaggaa cccaacaag gcaggagcca 119460
ggaggcagaa cctaattgaa aggcaatgga aaggtgtggc ttactggctt gccagcata 119520
gactgctcag cctggcctgc tcagcttgct ttcttataga acccagacc accatcgcag 119580
ggaaatgtat cttttgatt ggtgggcctt tctccattaa tcaataatta agaaaatgcc 119640
ctacagctgg atcttatgag ccattttctc aattgaagtt ccctccttc cgtaagtct 119700
agcttgtgtc atgtgacat aaaactgtct agcacaagtg gtatagctgg attttgaggt 119760

ggactgattc ccatcttcat gagtaactag cacactggtt tccttaatgg ctaggcaagg 119820
ttgcattccc accagcagtg gattagtat tcctcttctt ctgatctttg tgaaaatgag 119880
ctgtcatttg tcttattatc ttaccattcc aataggtata agatgaaatc tcaaattatt 119940
acaaaacctt aagctttaac aagcactcaa gattagtgt aggtgtcttt ctaggactgg 120000
aatagctctg tgacttttta aacaaaggaa cgtctctgt caatacaact gagaaactcc 120060
ccaatgactt catcatgtgt tatagtctt tgcttagaaa gtcaaagcca tcattctca 120120
cagttttgta ggactttcta aacattctga tttggcttat actagtgaaa cttccaatta 120180

catctcatga gaagacaaga gaagacagag atctttaggg cctttaaagg taaggatgca 120240
catgtttatt gttcagaaac tgaagataaa tttaggggac acaatttca taaacagaga 120300
attagcatat tttatttcta aaaaccttt tagaccacac aatttattga ttattttat 120360
ttttaagtga tagttaattt ttaagaatta aaaataaac atatcatttg aacttgagag 120420
atggctctgt gggtaacagtg tttgctaac aattatgaag accagaattc agatgccag 120480
agcccatgta aaattaglac attaatgct tgtgtctgta acccagaga tggtaggcag 120540
gaatgggaag atccttgggg tttcttgaa ttcttataaa ctagaatagc aattcaaca 120600

agagactgtg ggtcaaatg caagggagt catgatagag gaagattcc aaaatctacc 120660
tctgatctcc gcaggctctc atccaggtaa ctgaacatcc cccacctcac atacaaaaat 120720
cataaaaaga aaaaatgttt taagiatgca catatttatg actcatctgt gcttatgctt 120780
tttgggatg tcaatccta aatacatcag taaatgtcct atctgaagag tgagactctt 120840
agcctctgtt tctttctct ctataacatt actactctgt aaactgata atttcttata 120900
ctgagctaaa aactagaaac catatgttgc ctggtcaca ggctttctgg ctgagtattt 120960

ttatttgttt atttttaatt ttgatttggt ttttgatttt ttaatagata gcaaagaata 121020

 ttgtcaagtt ttcttactaa tctgtgtcca gtatcactta agatgccac attttcacaa 121080
 gaaactccca gggatggctt ttgggaggat tatagacccc aagcctgaag tetctgaatc 121140
 tctggatggt ctatagtcca tgagactgag cagcaaccta atgcattccc gaggaatac 121200
 agaaattggt cttttccca gtatcccaag gaatgagtac acattcctta agtgtactag 121260
 gaaattcacc tcctcgacaa cccagagaaa gaaatcaaac aggcctcctc ggtatgttct 121320
 ttacttaatg actaaacatt tttaggcaat tttgtgtgtt tttcaaaaa tatcttcaga 121380
 gtcagagaaa aaaaactg cagtaatcag aggtagatga ctcatagga cttgtgctct 121440

 gcaatatttg aggtcacata actttaaaca aaacaattac tttgggtccc atgaggaaat 121500
 atgcctcact acttatgaca tgcatgtgtc ctggttaagt gacaataaaa accaatttga 121560
 cacacactac agtcacctga gagaaaagcc tccaatgagg aatttcctac atcagaatgg 121620
 ccaagtgcac gtctgtaaag gattgtcctt attgttcaat taggaaagca caactcatac 121680
 ttagaagctc aagtactggg caggtgggtc tgtgctgtat taacaaaagc cacataaagt 121740
 tgaacatgtg aaagaaccag agagtgagcc aacaaacagc attccctggt ggtttctgct 121800
 tcagttcttg ccttgggctc ctgccttgtc tttcctcaat gataagttga gacctgaag 121860

 tgaaagataa aataagcact tctgccttt tagacacttt tagagtactt catatcagca 121920
 gcagaaatgg aaatgagatc agcagggaat tctaaacct tgctgttcag tgtttttcca 121980
 tacaactaat gtgcttctcc tgagagcttc aagaaaatga accatctcac atgagaacaa 122040
 acaaacttcc caggggatct gttttgatat ttgcatttgt gatatttctc tgaatcaagg 122100
 aattacccat gagaatggct gatcaaatag gctccaaaa cagaattcac tctacatgt 122160
 tgacctactg cacattagat gacaatttcc accacaggag aatgaatcca ttttacctca 122220
 ctgacaacaa aagtcttctat gaaccagaca aactcaaggc aaacattctg cggcaatgc 122280

 atttttaaaa cattaaatga tgttttctt ttgctttgta gctttggatg ttgttaaacc 122340
 ctagggcaaa acacctcaat gaaaattttc ataggtaaat atggctgtgt gtgtgtgtgt 122400
 gtgtgtatgc atacatacaa gtatatagac acatatacta tttttgttgt tgttgtttt 122460
 caagacaggg tttctccgta ttgctttgga gactgttctg gaactctatc tgtagactca 122520
 cagagatcca cttgcttctg ccttctgagt gctgggatta aaggcgtgag tcaccaatgc 122580
 ctggctaaaa tttttatgat attttctga gaaataatga tatgtgtctg tgcaaagagg 122640
 cttataaaca aagaacatt aatcatctat taccagactg ggatttaata gctcaagaga 122700

ttttgagtta ccicatgaac ttgacaatg ctgaattagc cagctcacac tgtctaataa 122760
 aataacgctg tigtactttc agaagtaat acatgatata ttaattttcc tttatttctg 122820
 atggctgaat tigtagtat aggatccatc atgatccttg gcagaaatga agagaaaggt 122880
 aggggtgctag gggaaatcaca taaccaaaga ttgatgccta gtcagtattt aagtgtgata 122940
 tgttctgtac ttgttctcca gctgggtgta ttctttgggg gaagttatga gaactttgag 123000
 aaatagagac ctgactgatg cgaagcgtgt ttgtgttagt ctttaatgat atagtccaat 123060
 ctgggtctag tgiagtgttt ttgcttcttg gtatgttatt cgtggaagtc ccaggcatat 123120

 tctcatgata ttaggaatct gctgtgctat acttcccttg tcaggataag cttcatgtct 123180
 tcaagccatg gggctcttcc attctgttga atcttcaggt atttggtttc aaatatgaaa 123240
 aaaatccctc tcttcttctt acagcctcat tcaatatcat tgtctctcca aagtccttaa 123300
 gttcaatatg attgcatgga atattagggc tccaatacca acaattaatg aggtaattta 123360
 gtgtgtagta accatgaagc tacatacaga aatcagaata accaaactaa taggaagtac 123420
 tggaaaaatc aaataaaagt tcattttatt taataaaatt attaaattag ttgataaaat 123480
 acctccttat attcctcctt caaccagaa ttagaaataa aataatatag atttagatgt 123540

 ggacatatta taaaagtat tttacttaa atactcgtct attgttttct agttctatta 123600
 tttttcttt aagctaataa gtctattaga atatatgttt tgagcactgt aagtttttta 123660
 tagttccttt caaactgttt tcttttattt ttaagattat aatacaatag cgttatttct 123720
 ccattccctt tctcctctcc aaacttcta tatatgccac ttactctctt taaaatcatt 123780
 ggctctcctt ttcattaatt gctattagaa acctatatgt atgtgtataa aaatatatat 123840
 tccatataca aactactcag ttgaaataat gtttcatgta tgaatgcatt cagggtctac 123900
 cactgagttt tggataaaca gttgtacttt tcctaagga agactgtttc tccttctctg 123960

 ggcatttctg agttgcctgt agttctttgt gtcgggttaa gtgcctgtga actttttcct 124020
 gttcagtatg tctattggtg ccatccttat tcaactcata tttacagcc agacatgaga 124080
 ttttatgtgt gtaagtgtgt acatttttat gagacataat gtacagcttc tgacattact 124140
 aggagaaaca attfacagca aaatecctgg tctctgcct cttgcatatt tetgtcccca 124200
 ctgaaacaat attcctgaa tcttaggtag gagctgtctc cattgggact agggactttt 124260
 caactcttct tattgattga ttgtagtttc ctatagtggt cttccctgt agcaaagaga 124320
 agtttctttg atgaggggta agaattccag ttacctatgt gtgtaaggac aaaatattga 124380

 gattgctgtt ggagattatg ctggtttctg aaagtagaga ttgtatattc tccttcaata 124440
 actatgactt tactagcact gaggagttaa ctatgtttct agtaccttct agttcaagga 124500
 gtcttaaatc caattagaga actgtttgat accatcagtg tatgaatgct actgttgttt 124560

tcctaaagca taaaatatgt tcactaagaa aaaagaaagc attgttgatt tcacctttat 124620
 tccttaaaat acacttcaaa tgcaaacagt aaaacaatcc agaatgcacc cagctgttca 124680
 gctataatta tgactgttgt cataggaact acacctgtat aagaattcaa tacaaggat 124740
 tatagttttg attttgcaag taagatatct tatttactca tggataaaat agaataaatt 124800

 tcatatattg ttttaaaatt cttcaaagtg ttatctgtct ggttttgaga acaacatgat 124860
 catggaaaat aatctcaaaa gtcttcttaa gtacccatgt tgcttgtttt tetttatgca 124920
 tttgttatat gtgacagtct tagtgtttct attgctgtga aagagacacc atgaacatgg 124980
 caactcttat aaaagaaaa atttaattgg ggctgtctta caggttcaga ggtttagtcc 125040
 attattgtcg tagcaggaag catggtggct cataggcaga catggcactg gagaggtagc 125100
 tgagatttcc acatcaggag gggcaagcag caggaagggc tagagagaca caggatttgc 125160
 cttgggaatt tgaattcga aaggetgcca gcctcctagt aacacacttc ctctaaaaaa 125220

 aatctacccc ttcttcaaca aggctacacc ttctaagcc tctccctaag ctttcagata 125280
 tgagtctatg ggggcaattc ttattcaaac aaccacagag actgtccaat gtaaaattgg 125340
 acagtcttga atacaagtac tgtcctaagc atcttggctc atatatgttt aaagttttca 125400
 ttacacaagt ccttacctg aaaaaagtga agatgacatg gcttcaaata cattatgccc 125460
 agtgcattac acgaaggaag tctctgtagc aactgaact caatgctggac aggattaaaa 125520
 tgcattgact aaagggtctaa gagacctgct acagtcccta ttcagggtcc caaagttgaa 125580
 atcctgctta ggagcaaagg agggtaaaag atttctatag gcaacaatct gagggctcatg 125640

 ctctttattt catgtgatct ttattgttct gtttctctc caaaattatt ttctacttc 125700
 taacttctcc attcttctag attcctctat tctaaaacct tttcttctc aggagccttg 125760
 aagtataaa gaaatttctc tcaattgttca aaagcacatc caagaacaag agataaggag 125820
 ctgagccatt taccaggaca acacaagttt ccaagcccat aagaactaaa ccattaccag 125880
 aaaggggagg gcatagtacc caatggcaac ttaagacaa ggacctattg ttagtagact 125940
 gacaaatgaa taattggcat gctattttta gtaacattgg tggatatgtg tgactctgat 126000
 cttgtgcaag ctgtaaagat tttatttgtg tgtttttgt ttgtttgttt gttatacaaa 126060

 aagtctttag tctagtttaa cttgctctga ggtgacagtg aactaattgt gtgtagtgt 126120
 ctgagcaaga gatcaaggca ggatgttaag agtacaaggt ccttgggga caaatagatc 126180
 ctgttatgag gcatgtctca gtatacattc taaatatcaa aactgtgtag ttaaatgaaa 126240
 agacatctc cagaccatca cagagtatgt gccagtaaa caattaacac agtgttaatt 126300
 ttatcagctt ctataatgtt tagttactga gacagccatg aaaatgactg tggatactt 126360
 tccaattca ctctgttggc acttatctat ctactcaaa aaacctcagt ttttgtttta 126420

agttatntaa gaagaactaa gcatttaagg gtatggtaac atttgataac tgtcgattat 126480

 ttttagtggt ttaaaattta gatttttctg ggccatatgg aagtngaacc tgacaagtct 126540
 tttgataaga tttgaatata tcagagagaa aatggaggag gaatagatct agggaagagg 126600
 ggaagggtgg ggacaagga ggaatggagg gtggtgaaac tgtggttggc atgtgttgaa 126660
 aacaaaatta aagacctctc tgccacatac acaaacaccc tcttctcctt aagagttata 126720
 gaaagctcac ctttcaaagc agaatgtcca tgaggctctga tatttagcgt cttcatgtg 126780
 ttataaatat ttgtttttgt atttatagat gtatgtatntt atttatagt ggatttacct 126840
 gtgagagggt ttgaacaaat ataaacactg tgtgagcagg ccagaagaag gcacagggta 126900

 tcttcagaat taicctcttg tacatgccca ttcagcaagc ctcagcaaat ctcttatctc 126960
 aacctacat ggagctgggg ctaaagacat ttgtgtggat gtcttcttca ttatttacct 127020
 gctgggatct gtattctggc tcttctgatt atggagcaag tgctcttaac aatgagcca 127080
 tttctcctt ccctgtacaa ccatttaaaa gaatgggcat aatagaaat tgaaagtgca 127140
 gggcaaaata catgattttc tgttctcagt tattggaaaa actgttggct ttctagtac 127200
 attctggacg atgtttatca atcactcata aagggtcttt ggcatatct gagatctcag 127260
 ctataaatat aaaaaatgac cagggtttta aatcagccca aagtttccca acctatntt 127320

 ctggtacctt cttacttate ctgctttgtt gttcctttag tcatacactt cataaatact 127380
 ctctttcttc cccttcacca tgctcatcct tgttctttt tgttttctc aggtgagcaa 127440
 tcttactntt ccccatgga aactgtgagt agtgaatgat gtcaatgcca gtcttctgct 127500
 gagttatggg tctcactgtg gaaaaacctt tactcagaat atggaaaatc actagatgat 127560
 aatgtgactt atttggagaa agaggcttat gatttcaata tggacatcat tagcaggata 127620
 ttctaagcac ttgccacaca tgccattgat agaaatgtga agaactgcct tttcatttgc 127680
 ttgattctgt ttagtataag gaaggctttg agatnttact aattgtagtt ttcacttccc 127740

 atctacacag gcttgtaaat gcatttcccg gatatttttg tccaattaga aatcagntaa 127800
 tttcaatgta gtatccactt attgttatat ccaactctt ctccaactcc ctactgtgac 127860
 aaggacatta aaaggcttat aacattttgt ccacgagacc tgactatact cccacataca 127920
 aatcaatntt ccaaaatgaa aaaactcact tgcacatgaa ttaatcaaat tcttgttctg 127980
 ttctgtgaaa cacaatgagg ctcagaagac agagtacaat gtttaccctc atgtcttatg 128040
 tataaattta cataatacaa aattggatat tttattctct atcattnttag ctaccaatta 128100
 gtaaaaagaa agcattaatg ttaaaagtat tccttctcct tttactcaa gtcttgtntt 128160

aatataaacc atgaaaataa aatgaaggag aggggaagaa ggctcagaaa gaaagtgct 128220
tgtgagaaca tgagtttaaa ctcatgaacc catgaacaaa taggccagca tggtgcatg 128280
catttaagat accagctctg tgaatgtgga aactcttgag gcagccagac tagcataatt 128340
ggtttgtttt tgaattttag gaacttgtct ccaaaagggg aaagggggac agtgtcttaa 128400
ttgtctccta gcctctcac acatgcacgt gtgtgcacaa gctacacaaa cagatacaaa 128460
aattttcaat taatcaaagg aagattaaca ccagccttgg ctgtcctgga attccttctg 128520
tagaccatac tggacttgaa ctcaagatc cacctgcctt ttcctcctaa gtgttgggac 128580

taaaggcatg caccagcaca acctggccca gcttacagtt tttttaaatt ttatgtgcat 128640
ttgtattttg ccatcagtat cctgtctcct ggaactggag ttagacagtt gtgagctgcc 128700
aggctgggtgc taggaattga acctgcatct tctgaaaag cagtcagtc tcttaactac 128760
tgaacaatct ttctgcctc cacccagtt tatgattttg aaaataacat gcaaatgact 128820
ttttcttttt acictaaagg gcattgttgg tggaggttta aaacatctga ttgtttatgt 128880
tttcttagct caggaataa tacctgctgt cattctacca tggctctcga ctttgctagt 128940
ttagaggcaa taatattgag agtctatga gaattgatat agaagattat acacagagta 129000

ggcaatagca ggaacagagt gctgtgacct gaaatgctga gatttggcaa aacatccagt 129060
agccacacct ctgtaaagca agtgaatct atagtagatt ccactttgtg ctgtagaagc 129120
atggataaga acaaaaatca aggcaagaa gcaatagttc ttattagtct gataatcaag 129180
agaggctcta taacttagac ctacaaaggt atcacccctc tattttcaat aactcatttt 129240
cttatggaac caaattaat acatttataa ttgataaaat aaaaacaatg agtctgcaaa 129300
atgagtgttt cactttattt agatgtgatt tgcctttgta tatgtaaact cacatttcat 129360
tactttaagt aaggcttaca gttatgaatg attattccta cagacaaaca gaaatcttgg 129420

tttctttata cattttgta gtgcctaagc taaccagga aatagtacac cagcattttt 129480
gcatgcccag tagcaaccag agtctcagtt taatcagaaa ctatcattat tttgtacata 129540
atataatgt aactttccaa aacatcgtct gttttacaaa ataaaaagct gcattcttca 129600
gcattcctct gttattgaaa gaagcaatag cagatcattt gagagccagg tgtggtatga 129660
ttttaatata ggtgtttata tttatttggc ttgatatag aaacaatctc ttgaggaaat 129720
cattcatttg atttactaat attacaaaag ccacacaacc ttctcctgac atttttattt 129780
tcccatttca aaattatatt gcttttggag actatttgat tctgtgttt tgtcaggtat 129840

gagctttgat gtgtattttc cttaccagca ttgaaaaatg aggaaaagag aacttggttc 129900
tcttcaggac aatctttaag aaccaggttg tagttctcca tgccttctct gccacagttc 129960
ctgcagtgtt ggcaccagga ctctgcccag cacaggttct agcatgaaga gagtatagt 130020

tggaaacagc attcattggc agcagagagc agaccctttc ttggcagtgg tattcaggca 130080
 gggtccttct gagatacctg tgtattattg tgccatgatt tgactcggag agtcagtgtc 130140
 ttttaagaaa agtagacctg aagcaaaaat ctacgatgtt tagggaaaaa agggacattg 130200
 aaaagtgcta atgagcttta tctactcaa gaaataacca agaaaaaagc caagatttag 130260

 ctaatacctt ttactataca tctactgttt tatgcatttt actataatca ttatttatac 130320
 ctttagattg ttttgatagc cccctattca acaaacatgt agtgaattc tgctgaattc 130380
 ttgtaataa actagtaggt aaattgttca aggcataagag attctaaca tgaggagggg 130440
 ccatataaat gttcttacc gaaagaata gaaatacaa gtattattaa aatatgggga 130500
 aagagaaatc cticattctg atgagggaac aagagggcac aatagtcacc ctgaaaatga 130560
 aagaagaatt tgagggataa aaggcagtga accaaaaagt tacacagcca ttataaaga 130620
 ggaactgtag ttaatatcta cagcctgtct caggaatttc aattttctca tgcaccagat 130680

 atgtttgaa gaaagcatt ataagataat acttgataga caatgtggcc tagagtctct 130740
 gtcaggaagc actccatatt tgggaattct catcatgat catcttctat atacctcctt 130800
 ttattttatt agcaaggta gcacaggaat cagacagggt cattaatttt tcaaccaaga 130860
 ccatgattag tatcctttga aaatgattct atgtatgttg tttctgtggg aaatagtaaa 130920
 catggggatt gtttcaatg ctgataatca aaactctaaa gctagcagtc actttttcca 130980
 attagaaaat tgagacatat tgaaagttaa tggcagtgat attttcagaa agttcaagag 131040
 aactgaaact acataggaaa gcaccaacc aaactctaaa taacagaaga atgacatcac 131100

 aactgacatg cctaaattta tgattttcag atggcacatt tatggtatgc atttagtaaa 131160
 aacattatgc ttgaatttca tgttgtgac ttttttgggg cttgtattgt aagggtgat 131220
 gttctcttga aaatagccac agcatcaaac cactcttcc ccctcacaca aacaatag 131280
 ggggggggac aaactacact ctttctattc tgcagtaat ctgggatgtt atgtaagtgc 131340
 catatgttaa ccacaatttt cactttgtgt agtgtcagtt tatgagttat ggatatgact 131400
 ccatcctaca taaataagta ttcatacaaa gagtcaaatg gacatctatc taaatgaatc 131460
 agaaattggg tgactcttag agtgcaagga atgtttaa atgacatgctg attcaatact 131520

 ggaagtagac tgatacttc caaccctaa ataaatcttg agttgtttct gggatttaga 131580
 cccagaatct caccatagc tcatcatgaa gacacttaat tttgggtctt ttgttatcta 131640
 aaaacaaaac aaaaatcatc actgtttaac acttaagtaa aaaagattac aagcctgatg 131700
 attctggtag ctgcaaagta cagaccagca taaagccagc atctgaggaa aggccttctt 131760
 ttgaatgtgt tgaacaaga cagagcagca acacattgaa aattccctta tggaaaggtg 131820
 tcatgctcac agagtgggtt tatattataa aaatccttgg ccataaaatc aatgcatcc 131880

ttaggagttc cagcccatc agtgagcata gcaacatccc attaacctca tggactccac 131940

 atttggtgta atattaaaac actgttcac aagataccaa tatgtgagtc ctcaagaggc 132000
 acaaccatc ctcgagcaaa ccacatcagt gtcataaag ctttcttaag gtctggcaag 132060
 ggaagtgtaa aacaactcaa aatattctca gacaaagcct gcattcttag cctccaggaa 132120
 aaagaaactc atttactcaa cttaagctct tctttccata tctttcaca tgagcagaca 132180
 aaatccttac tgaattcag tggcataggt ccactacaag taaagagttt tttcttctaa 132240
 gatatcaaac ttaactcat taatgtttta cttcatacc aacagctgtt attacaatag 132300
 tatttgaatg agctataata aacagagggt ttaaagagac agaaatggtg gaggttgaaa 132360

 aaagtgtgt gtgtgtgtgt gtgtgtgtgt ctgtgtgtct gtgtgtctgt gtgtgtgaga 132420
 gagagagaga gagagacaga gagagacaga gacagagaca gagagagaca gagagagaaa 132480
 gagagagaga gtttgtgatt tacatgaaga aatgaacagg gaagatgact gtaacaaagc 132540
 atttaaggac ttaaagtaat ttaaagtggg ataacaccta tgccactgca atagcaaaaa 132600
 aaaaaagca aaaaacaaaa actaagagag aacagaatag aatagaagaa aatgatggtg 132660
 gctatTTTTT taaatgtgta ataagtacca aaattccaat tcaagatgct caaagaatac 132720
 ccagtgaagt ggagagcaaa atattaagtc agactaaaaa aattacttgg acctggggag 132780

 gtagctcagt cagttaagca cttgtcaaca aatataagaa catgagttct ataccagca 132840
 cccatttaat tgttttctact ttgttatctt ctctctatgt acattgtaat gtatgaatga 132900
 acatacttgc atacaccgt aagcatgttt aaacacaaac acataaaaatg cactttggca 132960
 tatgagtga gcccagtttg aaagtctata ttttgcataa tatattggtt ttgaggtagg 133020
 aaaatttaga acgatgaagc ttagaaattt tagtataaca aaaaatgatt ctgtgcaaca 133080
 ctgtatgtat ggaatcacta tatacctatt aaaacaatta ataatccata agatacaatg 133140
 cacagacata cacggtttta aaaagaggat agttatgagc ggtagaatgt atgtctcagg 133200

 gaagaataaa tataatagat tctgggagga gacttggggt gggtgggatg gaagtgggag 133260
 atgtcaggtc ataggagggg gagggatgga gggaaagagt tctgagaaag acaggtggaa 133320
 tttgggaggt gatgtgaaa cctagttcag tgacaactgc ctagaatcta cgaatgtggc 133380
 cctagtgagg actcctagct atggagggtg tagagtctga actggccatt tttgtaggca 133440
 atcaagagtt cctgtagtga gactgggatt tattgaccag ggaggtcctg tgaataatcc 133500
 cattcaaac agcctaagtc tagggcagaa ggtcagcttc agcgggtccc attgctgagg 133560
 acaactttca cacagctcat tgaacacaga tcaagatggt gcagatttgg aaccctcacc 133620

ctatgttcta gtctctttgg cataagaggt actttgtagg ctatgggaag agaaacctca 133680
 aactaaacc agacacaaaa caattcacct acaaaatggt ctgctgcaa gatgtgtttg 133740
 gaaaatggtt acagaacttg tgggagtggc caataaatga tgagttaat cttaggttcg 133800
 tgccaggaga agcccatata ctacactgcc tggggggggc aggaaacaga ggctgaataa 133860
 gccagagaca ggatttggc catgtccagt caccatgaga gaggttcct tttgcagcag 133920
 atgggataga catagagatt cacagccaga cactattcag agggagactc caaacttaag 133980
 gtccattg ggttctcac ctacagagatt ggagtacccc agggaagcca gggatgaaag 134040

 acagtaggaa tcagaggaat gggcaacacc aggagaatat ggcccactaa atcatctaag 134100
 caggcccaca tgggttcaaa gattgaaaca gcaagcaggg gctccaaggg ccttactag 134160
 gttctctctg tgtatatgct atggctgtta gtttgggtga ttttttgc agactactac 134220
 cagtgggatt atataccaat tagatataat atcattggaa gcagggtat ctctcattct 134280
 attgctggct ctgagactc ttttgtcct actgggttgt gatatgaatg agtttacctt 134340
 gtcttattgt atcttgtttt accctgtttg gccttagtat attggaggcc tggcttttc 134400
 tgaagacaaa atggcgggtg aacagacctt ggggagtggg gtggtggagg ggaggatctg 134460

 ggaggggtgg agggaggcga aactgtggtt ggggggtatt gtatgagagg agaactctgtt 134520
 ttcagttata aaacaagtgt catttctaga aggaagagtg aacctcagta tatacacatt 134580
 ttcaaaaata atagatgagt aataccagta ttcagactat aaaaataaca ttaatacatt 134640
 tatttatggt tcattgaag tggatagtaa gaaatattat tgataaaatt gcttcagaag 134700
 ttagtggatg ttaaaaaat aaatgtaaaa agaattgaaa ataaacacta tggctctggt 134760
 tatggtgttt tttacagtga gtttatagtt atcagtattc atcatttaag tcagaaaatg 134820
 tcagatggta aaaggcaatt ttttttctaa aggagtgagc agagaagtga gcagaagatg 134880

 ttagaaaagat caatgcattc atagattgca gattgatctg tcagggtca cttgtagatc 134940
 cagaagtttg catgctgaca tgtttagaga tctgtgtatc atacaacaa atgcaagcat 135000
 tagttctggt atccctcttt agaaggactg ttatcaattc atcagtagca atgagcatac 135060
 ttggcatccg tatctcagtt catcaatatt ctccacaaac agaagtggat ttccatggat 135120
 aagtagctga tttgtgggaa ggagaataaa tgagatgaat tgaaaacata ttttactgtg 135180
 agagcatata aatgacatta gaaacaattt acatccagtg tattttttga aagagacagg 135240
 aatctatata agtgcctga gtagtagaaa ctggaataaa cagaataact aaatggttgg 135300

 tgttgtttta tagtacgaag aacgaataa tggataccat agttctcact gttataaata 135360
 tattattgaa ctggtcagtg gttggagaag acaaggagta tctactgcag aagaaggcca 135420
 aatgattcat aaggctacta agctcttttg aggacaggta tagttcttga tgcttaacta 135480

aggattgaga ttigatttca taaaacacaa caaggaaaaa gttgacttta tggaggctaa 135540
cataatatgt ttaactgaag gcaggtgatc aagttaaac tcagtgcat gaatgttaa 135600
tgtaatgtaa ttaagatga caccttttct ctatgaactt tatctgctat cccatgttta 135660
acatgcttta atccatgcaa aagtatacta taaatcctaa tatggaaaca ttctacaaag 135720

taccagcaa ggacttctaa aatctatgaa tgacatcaaa atcaaggaca gtctgaatca 135780
cagtcgcage cctgcgacag cgaagaagcc ctgataaatc acagccattg ggtttactaa 135840
atcatgtgct agaacagaag atgacattga cattaattat ggtaaggaaa taagaatata 135900
gatttgagtt aataatgac agttttcttg actataataa ttacagcaca ctaatataag 135960
gtgtgtataa taggaattat ctaaatttat cctagacata atccctacta aacttaaaat 136020
gttatttgtg gttgataaaa gcataacatc ctcagtgfcc aaggcaaaat aatgcttcaa 136080
taaattttgc tttttttaca tctatatgaa aataagacca tgtctatggt tcttatgttt 136140

ggcttatttc tctagaaaat ggccatcctg atttatttat gacattaca tgaacagct 136200
tctcttatta aaatggttag tattctattt tcaacatct ctagaaatgg atacattgct 136260
ttcatatccc tgatcttgg tcaattgtgag taacattaac aacagtgatg cagtgatctc 136320
tgagatactg tcttaaatg caaatgtgaa cagaaatagg gtttctgggt tgcattgtac 136380
atcttaattt tccgaatta tcattccatt tcaacatcaa gaatgtgtaa ttttttcata 136440
gccttctgag catttgatt aacgtcagtt tcatectggt actaaaatgt atacatcaag 136500
gtgtgcaaga catggcatac tttacattt cttggagatt atttggactg ataatcattt 136560

catatgcctt ttagtcaatc aaaatatttc tttgagaaaa caagaaatct tctttgctc 136620
tctcttcca ctctgagga attgaggtgg aaaatatttc actgatacat ctgtatcctc 136680
atttactgat tccaattcac caacatttta ctcagaaatt gaaacaccta tcaaattccc 136740
acactgaaat tcaaaaacca tcctttacag gcacccttcc tccatgact gtgttgccag 136800
aagagatggt atcagttaaa atacaggcct gtatatccct gcttaatcct ctatgacatt 136860
atcttcttc ttagtggtat ttattattgt actattatc ctcaatttca cactgatgaa 136920
atcttatttt ttaaagagaa aacaaaagct gcaaaacaca aaacaaaggg aattatgagc 136980

acctgatgta aagtgatgcc ttaaaaatta tttttggaga aggcctaaaa aatggccata 137040
gtagactatt caataaaaaa aaaatcagga aatgtttctg tgggtttctc cagtctggtc 137100
ttgaccctt tgctcatgac tcttctctct ctgcaactgg attccagatt tcagctcaat 137160
gttttggtgt ggggtgtctgc atctgcttcc atcagctact ggatgaagcc actaagatgg 137220
catataaggt agtcatcaat ctcatattg gagaaaggca ttttaaggtag cctcttggtc 137280
acttatattg ttagttgggg gtcaaccttg tagatctcag gacattctga tagctgggaa 137340

accagcatag gactgttcca gacaatctga aggaggaagt cagtttgaa gtctgggcaa 137400

tctatggggc cactggtagt gggtcagtat ttaccctgg tacacaaatg gactttggga 137460

gccctctcca catagagga tatctcagcc tagacacact ggggagggtc taggcctga 137520

tccaaatgat atgacagatt tgaagatccc catggaatgc ctcacctcc ctggggagca 137580

gaaagggttt ggggtagggg gcaggggagg aaaggagaga gagagaactg agtttgacat 137640

gtaaaagaag cttgcttcta atttaataa aaaatcaaaa tcaggaaatg gacatgcatt 137700

ggcactgagg aggttacgag caaggggcta atctcttcag cactgtgttg tttcaaca 137760

gaatttttaa tactgctaaa ttctacggtg atcttgggtg aaatagacc ctcttttca 137820

gtaactttgg ggaatgtaat taaaatttag ttctacatt gacgtcttca tatgcaatat 137880

caacttatac agataagttt tattttctg cacgtatgta ctgatactta ttagagcta 137940

ttcaaccatg aagaaaaaaa tggtaattt atgactaaca tagctgcatg atatgacaga 138000

tttgaagatc cccatggaag gcctcacct ccctggggag cagaaagggt ttgggtagg 138060

gggcagggga ggaagggaga gagtactata tatagtactg attatttact aatgcattga 138120

aaacatattc atttagtaac ataaaataca acctattgc tcaccactct gagaagtga 138180

atgtgtctcc aggatgaact gacctcatc tcagcaaatg tcaggcttta actaacagat 138240

aattatgggc ctaatattag tctgttctt ataaaaaaaa aaaaaaaaaac agtaacatgt 138300

tttctctcta ctttatgat ttgatacatg ttaataaat aattatatga atttgatacc 138360

tgggagctat aacaaaatgg aaactacatg tcaatattat ttatgtaaaa aattttaaaa 138420

ggtcactttt atgctatgag acttatttga agcaaaatat aaagacaggt tacatttata 138480

cttttaacat taggaaaatt caagtaaagg ggctttgtct ataggcaaac aggctttgca 138540

tagaaaacca ctagtaatgt tgatatctaa atgtatttt gtatttcagg catttaatgt 138600

cataaatatt ctttgtgcag ataggtttaa tgaagaagcc cacttgttgt tcatacaaca 138660

actagtccag atacctgaa gtgaattgtg tgtgtttatt agattttct caaatcttct 138720

actgctttac tgacaatgaa tatacctttt taaaaacgaa gtatatgagt cacttttctt 138780

taccttaaaa cgttattgag tgacttccac caggaattaa agaataaaat tctttaaaat 138840

ctgtgtaata tttattttaa aattgttatt atctgttctt ttgttggttt cacaaaattt 138900

cctagaaagt agttaatcct ctagctacta ggacataaat atcaatgttc actaagttaa 138960

tgtgggatca agggccacat ataaaatgca tgatttctgg ttagtctttt aaagattatt 139020

tccattataa gtacaatttt aaaactaccg ggtgggtgatt ttataatttc cgagttttac 139080

tgatttcagg aaattgtttt atctagatgt ttaaattgatt ttcaaaattt tcttcttctt 139140
 atttatgtga tgcttctacc tgtgtgtctg gttatgtacc atatacatat gcatgtgccc 139200
 atgaaagtga gtagagggtg tcagattccc tggagtgtga gttacaagag gctgtgaacc 139260
 acttgatgtg agigtgggat ttcagctcag gtccctctgga agatcaacag gtactattac 139320
 tggctgagcc atctctccag ccccagggtta ttgtttatta tttttgtca caatttcaca 139380
 atgtactgtc atttgaaatg ttaacatttt tatgcctcat ttgtttttgg ttgacatacc 139440
 aatcttgtat tattaatct gttagatatt tccagaagac acatacttta catgatatta 139500

 aaatttccat atgagcttaa atttgaaaat gacttatatt tatactttgt ttaataatca 139560
 ttgaaacatt ttgacaagtt tctttaaaaa tgtgaatcta tggttatcaa aatatacaca 139620
 tttttatgta atctatctt accccaaga tcataatcc taatatttta tttccttctc 139680
 tattaatta atacgttttc taatgtttta ttttaacaa aatgttgtgc taataagaca 139740
 tggctcaaat ggiccaaagag atgccagtca atcatgagca gctgagttca agcccaaaag 139800
 gtctggtgaa aattttgccc tttatcttta tcagcagagg gaagtgggtg agacaaaagc 139860
 atagttggag ctcaatggca agccatggcc acattggtct ctcagcttca gtgagagact 139920

 ttgattcaaa attaaaacag agagcaattg aggaagacaa aagacattgt atctggcttc 139980
 cacaggagtg tgtatacatg tacacacaca tcttcatgca cacaagcaca cacagataca 140040
 tttaacattc atgcacatgc aaataaaagt aagataaaag ttattaaatt aaaaaagact 140100
 tctttaagcc aggcgttggg ggtacacgcc tttaatacca gcactcggga ggcagaggca 140160
 gactgtgagt ttgaggccag cctggtctcc agagcgagtg ccaggatagg ctccaaagct 140220
 acacagagaa accctgtctc gaaaaaaaaaaa aaaagacatc tttaaaagat acatcttaga 140280
 aaatcttcta ttgctacttt tattatttaa attggacatc atttttgttc aattcattac 140340

 gtagatatga aataaagtth cactaaagta gtaggggaga atgagggaat gaggtatgaa 140400
 aagctttaa aagagattaa ggaaattctg atttttatgg agggttaaaa cagaaatgga 140460
 ggctactttt tatgccacc tagagccctc atacagtggc tgatggaagc agaggcagat 140520
 acccacagat atgcactgaa ctaaactcgg gaaccagtt gcagagaggg aggaatgaag 140580
 atcaaagagg tcgggaccag tctagtgaaa tccacagaaa caacttgctt gaacaagggg 140640
 gagcacatgg accccagact gctgctggg aggactgaac cagaccctg aacatggatg 140700
 tcaatgagaa ggccttcaca ctctatgggg ccctggtat tggatcagta ttttttctt 140760

 ggtgtaagaa gggactttga gacccatcc caagtgaagg gttgctctct cggcctggac 140820
 aatggtggt gaaacaagct tgttctaat ttgaactaat aaaaaatta tacctttttg 140880
 gaagaaaaaa agtctgtatt ataattgact gctttataag ctaatgaaaa tgtaatttaa 140940

aaaagtgc at gccaaaggagt tatttttttg cagatgagcg attctcccat aagttacagg 141000
 tattttta at gcaattgcag atatgggata ctccctatga aattctgtcc agaaagcctg 141060
 gaggcgcccc agaccatgta gatattgcta ctgttccttg tctcccataa gaaatgaatg 141120
 ataagacccc attactgaag acagcattaa acctgtttat aggacacaga taaatgaagc 141180

 tggcactgac ccggaagctg tcttcttggg agctagtttt ccttattcca gaggatgcta 141240
 tgaaggctac ttggggagaa agctcatcaa tgtctcaccc agatgtggac tetacacggg 141300
 acagactgac ctgccatgaa aatatatccc aaagctgcaa ttaggatatg aatctttggg 141360
 agataatcag tttcttttag atttgtgtcc cactttatag caaagagtgc gaactgagaa 141420
 gtcaaaccta ctgaaaagtc ttctggggag gggaggttcc ataaagaaac ctactactat 141480
 tactttgtta agtgaaagct tattaggatt ttgtctaaa tatttatatt tataccacag 141540
 actggtgctg ctgcaggctc aggacagggg atcttttgca atgattgatg gttaatagag 141600

 aaactcacat ctggccaaag tgctgaaaat aagtgactac tgagtgatta tcctaaatg 141660
 ggagctctat atcatcccct ttaagactga gaaaacagta ataaggaagg ggcaggaaga 141720
 atttaagagc caaaaaatgg agaggagtgt tgagacacac tgccttctaa cagtggccat 141780
 tgtactcaca agcacacagc tgccaagaga cctggacagg atttcagaa gatcaggccc 141840
 tacaagattg tcatgaatga gagagaatta catggtacac tgtttctttc tgagaagata 141900
 ctggcattaa tgcttgccaa tgtgtgcaca atttcttca gtaactctac taatgtttgt 141960
 accagtaacc ctgattaag tctgtgggcc aaaagagaaa aggacatata gaaaactcat 142020

 acatatcttt ctcatgaaa gataaccatg tgcattgaca taaatcaagt gctatctaat 142080
 gttttaagtt tgaagaaatg agagaattaa ttgtcataa aatatctaca ttcgtgacaa 142140
 gaaacattgc ttttataaag tttcattggt tattctgtat gaaattacta taaattcttt 142200
 attcaagaac taccataaat ttactaatct accaccaaga tatttgaac tattctgaac 142260
 tctaacctat ataactcttt agtaattgat tagtatttct ttttgtttcc tgattacagc 142320
 ttcctcctct ttattctctc catctggatc cagtccattc tgtttctcat ttaaaaaaga 142380
 gcaggcttct gagctggatg tgggtctctg catgtttcca tctgcttcag gaggaagctg 142440

 tttatgatga aggctgaata aggcacttat ctatgagcac aacagaacat catgaggagt 142500
 catttgatca ctactttatt tcaagaccag taatacttga ttttacccta ggtaactggg 142560
 ctatttaate tctggttctt gttcactctc ggagtatcat gcttgggttc catctcatgg 142620
 aatgggcttt agccaaatca aatacttgtt ggttactctt acaatttctt tgccactatc 142680
 accgtagcat atcttgcat ccaaacagat tgtgggtcaa agcttttttt ttttttttt 142740
 ttgactcagt tgggtgttat gtttatgttt attttctttt ttcctttttt ttgggtgtgtg 142800

tgtgggtagc ctgcagactg cccagacctg agacactaaa atgtattgac aaaggctgca 142860

 taaagggacc acattgactt ctccatagtt aatgatttgt gggagtattg tccttgacaa 142920
 tgggggacag ctttcagttt gtagaggaca gcccattgcc ttagtaacac cctgggtagt 142980
 ttggggatat cattgatacc ctcttgttta acaactcagt tgaatgcaat gcagtcccag 143040
 tactggggca cctcatttgg tgacaagaaa tggccagttt agactttgtc actcccgtta 143100
 ctaggaggcc tcatttggat caaattcaca taatttaggc agtttccaat gtagtagctt 143160
 tccataccac cccgcagata cctctcaatt cctgttgtct cttccagtat tcctctacat 143220
 caacctatc tcccctctct ctccatacct gaacctccct ttaataacta aaaataaaca 143280

 atatatgttt ttgatggtt gataattaac agtaaccatt ttatgtctta aatggatgat 143340
 tctttactaa tataaactcg gggagggtcg gtggctaaca gcacttgttg cacaagactt 143400
 tgattcccag ttctgaacc ctagccccc acaagagcag aattagctca tacatttatg 143460
 atccttggct tgcttgggag gagatgaggg atggggaaag gaataaagct ccatgtcctg 143520
 gcccttgccc tetgacttcc acatatgtat tgtgttccat gcatgtttgc aagcacacaa 143580
 acttatctcc cctgctctc tttggagggg cttaatcgtg gaacttcagt tgatataacc 143640
 ctttgcctcc aagctgctat atgtcagaag gtgaattttt tattgttgtt tttatcacag 143700

 cagcagaaat agaacaatgg gaggtattaa actctaaaca tgattaaatt gtaaatcaca 143760
 atggagactc ctatataca taatagagcc tttttagata ttgtcttact tattcctttc 143820
 tgagaaaggg tctttttggc ctattcagag tcagcacccc acaacattca tgccatttta 143880
 catgtgatgt gagagtatt atttgaatta gtcacatag aattatcaag cattgctcat 143940
 tgtcttttga aattattact ttctcttccc agaagatgta taagcagtct ccttagctca 144000
 cagcagattg cacctcagct ggcaccaaca aagccttcgg agtcacaagg gcttcagaaa 144060
 tgtttgtcag gtgagtaaaa tgcaaacata aattggtata taacagcttt actcacagaa 144120

 ttaacaataa tttatgaagt aaacacccat cagtcaaac taaataggtt acacatgtaa 144180
 ttagaggttt ttctatacct gatthtgaag aataggaat ataacacctc tcaaaggaga 144240
 aaaaagagga tggccaacta ctttctctca ggtaacattg tgtgctatag aatcacgta 144300
 taggaaaaaa agaagaaatg ttacctttct tcaagttaat ttagggccag atctctccaa 144360
 ttccaataaa cacctgactc ataacctaca ctggcatgac acagaacag gttccaaaat 144420
 cccaatcaca aatgtgtcac actctttagg gatagactcc aagtaacctaa gggacatgaa 144480
 tgggtgcaag aaaccaagaa tggccagaag aatatttaga acaactacat aaaagccatg 144540

ggtgcctgaa ttaaggccat cagagttttg gtaaacccaa agtttctaca aagttctgca 144600
 agtgcattat tcctaggcac aattagtag tttatatcat ggggccata actagacaaa 144660
 taatttcac ccatattccca aagatcttag tcacagacac caaagttaaa gtcaaggctc 144720
 aaaccaagac gcaagcatag ttgcaagatg taacttcatt tcctccttcc atttgccaca 144780
 tgctgcagag acaagagttc tgtcttctga ctacttgta cagaagtctg gtgatctgta 144840
 gttctgcttg aacaataaaa tctgggatag aagaaaaaac aaagaactaa acatcttata 144900
 cacacatctg tgcatafaca tacacacaca cacacacaca cacacacaca cacacatata 144960

 tatatatata tacaatata tacacagaaa taacatata tattatata tatatataat 145020
 atgtatata atataataa tttgtgtacg tgaattttgt aagatgggca taaaaagaat 145080
 gctttatcat acattaaaag actagaggca tataacaaa tgtgtatata cagttgttta 145140
 taactttaga aatcttagac ctgaacctg atacttagtt atctttaaaa taacttata 145200
 gatatttgtg tggattaaaa catcattgaa actaacgtca gctgcagtga caaatccatt 145260
 agcttctaac ataatcttg tgaaaactta taccataatt cttcactggg taaggtcatt 145320
 ttgttcattt tgagaggctg aaagatttaa aacaaacagc taaaacctaa gtcaactgaa 145380

 caaagttgt gactataact tctagttatt caaaattcta tgcactcttt taaccttct 145440
 agtgaacac aaattgcaga cttttaagta atgtaatagc tcaataactt ttacatttgc 145500
 ctcaactttt tttctcctg atcaatecc taaaacatct tcttaaacgt ttttattttt 145560
 gaaatgttat ttgaaggata ttaattctat ggtaaataat ttaatatgac cttattgctt 145620
 cttcctatgc ctttctctgt tgccataata aaacaaaaac ctgcccaagc agcttcatgg 145680
 ggaaaagggt gtaggagcta gaaaatgtag gccatatttt gtctatactt gggaatatta 145740
 tattttcatg attaattgcc caaaatttta ctgcatttta tcctgctgca ttattggtaa 145800

 cgttctttc ctttcttctg acttttctgt gcatcctgtt ttcttcttga atgtgaatgg 145860
 gctgcttctg ttttctagtt gaaagacaaa gaaatctttc tttacattcc acttcagccc 145920
 cacacacttg actactatgg cctatggtat agaaccctgt attcattat gtacaaacaa 145980
 ggcttccact tccacagtc tcttttagct actcaaaacc acagacctga gaagtcttg 146040
 ttgagcataa atcaagtctc ctttgcagat ctgtactgtt ttgtttgtgg aggtactgct 146100
 gataaaatc aaatctggct agtttgatgt atctgctcca tgcaattgga aatgttgttg 146160
 caagatgact gtatttctct gtgtttaaaa acctacagaa tatggcattt aaaatggttt 146220

 aggggtttc ttgacagiga gactcaactg ctctggcaa taccaattac atctgagagg 146280
 aagatgtact tcaagaaac tcatgggtt tgccttcaat atggcaagaa tagtcaattg 146340
 ggcaagaaac cactcttggc tggactgttt gataaactgg acatgcagga tacacaggaa 146400

agagactgct gaacttgatg ggaaagtcct aaatggatc tacttcatgg aaaagtctga 146460
 cagacattct acagaactca gagaaaaatg actgacaaac tgccaatgca agcagacagt 146520
 ttaaaatfff ctgcttcatt gagaagtcct ccagactcac ttcagtctat gggctgaaga 146580
 tggatactcc aacgttaca aggaactttg ggtgactgtc caggccgaga gatgtctctg 146640

 tcaattctag agtttatata acatctttct gtggtctttg gtggagtga agacagatag 146700
 cgttttagtt ttccttagtt aggattaaag ataagttaca tataagattt tagactcata 146760
 aagataggat agatgataga atatfffcta taagttttac caaatgttaa tggactaatg 146820
 atggggaatg ttctttcggg tatgtttgtc ttattggttg atgaataaaa ctctattagc 146880
 caatagaaga acaagatagg taggactagg atacaaggag gattctggga agtgtaggca 146940
 gagaggagtc atcatgtgat cccaggaagg gatgtagctg ggcagaaact agctaacata 147000
 ctggtctgga ggtctgtaca gacagtcagg acatgacttc gttgggcaga atcagtatat 147060

 aaacaggac aaacaggaca ttgctctctt ctctgatgag atgctgagca gttgagatgt 147120
 aggatgccag aggagaaaca ggtcccgaga cttttctcca gtaagataag actgcacgga 147180
 aatacttaga ttaatagaaa caggttaata attaagacag agctagccaa ataagaagct 147240
 caattctcta gccaacagtt ttataattaa tatagcatct gtgtgcttca ttggggcata 147300
 gaggggtggc aggacctga aggtcaagaa aactcacatt aaaactffta ctacatttta 147360
 agcctttatt ctctttagaa agtcaagaat tgtgagcctc tgctttaata attcaagtga 147420
 ctgaactaag gtatatgggg aattaaaata aattcacttt gaaattacat gaagtgtcat 147480

 tcgtggtfff aaggaggggt aaaatgatgg tagcaagtaa tgccaatatt ggcctctgag 147540
 ttttactatt tgfffaca atatfffcat aaaaactaag ctattcaaca attcaaattt 147600
 aactaaaata atacaaaata tattcttgac tgtcaagcat tgactaatga ttaacagaaa 147660
 ctctatata ctcagaaatt caaaaattca aataatgtgc cagttagaga aacattaaa 147720
 agaaaataga aacatattta aattaataa aatatagtaa atcaagttgg ttaaatatac 147780
 ttagactttc tgtattgaaa acttataaaa ttatttatga atataaaaat aaagaaaatc 147840
 tgaatgata atatctatga aacaatgtag aaggaaaatc agaatgatag gaaatattaa 147900

 tgctgaatac aagccattgc tgaagtaaa aactaaaag gactaaagcc taagcatata 147960
 agtgtacaag tttaatagaa aagatctcca ccacataaac aagctgaaaa agaaaaacca 148020
 catgataatc tcagtagata ctgaaaatcc aacaccctt catgataaag gtattggaga 148080
 gatcaggaat aacaggaaca tacctaagca taaaaaaggc aatafacagc aaaccaacag 148140
 ccaacataaa actaaatgga gagaaacaca gtgattctc taaaatcagg aacaagacaa 148200
 ggttgccac ttgctccata tctctcaac attgtgcttg aagtccttgc tagagcaata 148260

agaaaacaaa aggagatcaa ggggatacaa aatggaaagg aagaagtcac actttcatta 148320

 tctgcagata ttatgatagt ttacataagt gacccaaaga attctaccag gaaactccta 148380
 cagctgataa acaccttcag caaagtggaa agatacaatt taacttaaaa gaatcagagc 148440
 cttctatata atagacaaaa agggggctga gaaagaaacc atagaaacat cacccttcac 148500
 aataaccacc accaacaaaa aatttcttgg ggtaactcta ataaaacagt tgaaagacct 148560
 gcataacaag aacttttagt ctttaagaa agaattaaag aagataccg gaagtggaaa 148620
 gatttcccat gctcttagat aggtaggatc aacatagtac atatggcaat cttacaaaa 148680
 gcaatctaaa gtttcaatga aatccctaag aaaataccag cacaatactt cccagacctt 148740

 gaatagataa tactcaactt tatatgaaa aacaacaaac ccaggatagt ccaaacaacc 148800
 ctttacaata aaggaacatc tagaggtatc accataagtg atttcaagct gtactataga 148860
 gctatagtag tgaaaagagc ttggtattgg cacaaaaact gacaggtaga gcaatggaat 148920
 caaatcaaag gcctgatata taacacacac acacacacac acacacacac acacacacac 148980
 ctatgaacac ctgatttttg acaaagaagc taaagttata caatggaaaa aagaaatcat 149040
 cttcaactaa tgggtctggc ataaccgaat gtggacatgt agaagactgc agatagatcc 149100
 atatctattg ccattagtca tgcacaaaaac ttaagtccaa atgaatcaa gacctcagcc 149160

 aactgaacc tcttacaaga gaaagtggga ggtacactta aaagaattgg tgcaggagac 149220
 agcttctctga acattacaca agtagcacag aactgagat ccacaattat aaatgggacc 149280
 tcctgaaact gagaagcttc tgtaatgcaa aggacacagc caacaagaca aaaaggcagc 149340
 ctacagaatg ggaaaagatc ttcaccaacc ccacagctga cagaggactg atttctaaaa 149400
 tataaaatga acacaagaaa gtagtcacca aacacaaaa taatttgatt atgtgggcta 149460
 cagaagtaaa cagggaatc tcaataaggg aatctaaaat ggctggaaga catttaagaa 149520
 attgctcaac attgttagcc atcaggaaaa tgccaatcaa aacatgtctg agataccttc 149580

 ttacacctgt cagaatggat aaactcaaaa acagcaatgg aagtttattc tggagaggat 149640
 gtgggaaaag gggaacacac atccattgct ggtggtagtg caaacttgta cagccacttt 149700
 ggaaatcatt atggaggttt ctcaggaaga ggagaatcag tctacctcaa gatccagcaa 149760
 ttccactctt aggcatacac ccaaaggatt caagttcata caagaaggac atctgttcaa 149820
 ctattttcat agcaacattg tgataaccag aacctggaag caacctagat gccctcaac 149880
 tgaagaatgg ataaagaaat catggtacat ttacacaatg gagtactcag tggaaaaaaa 149940
 aaaacaatgg aatctttaa ttagcaggca aatggatgga atgagaagaa accatcctaa 150000

gtgatgtaac ccagtcacag aaagacaaat atggtatgta ctctcacat attgatataa 150060
gacatagagc aaaggattac cagactacaa tcaacacctc cagagaggct aggagataag 150120
gaggccctta agagagacag acttggtcac atggtgaagg ggcaagtgac aagagctcct 150180
gaacaaattg ggatcatgca gataagggig agaaaggtaa gagaaagagg agggcagaag 150240
aggagagagg aggagagcag gatatgtcag gaagattgag tgaagatgaa tactgaagaa 150300
caagaaaaga gacatatcaa ttaaaggagc cattatatgt ttaaagagaa atctggcact 150360
aagaaattgt acagagatcc acaaggatca cccaactag gatcctaac aatattggag 150420

aggtgacctt aattgctctt cccataaaat aagattgagg actacctta atgcatcat 150480
agaccctttt tccagtagct gatgggagca gaagcagatc acagctaac actgagcaga 150540
attcctggaa tccagttgta gagagggaaa cacacagaaa cagctgacct gaacaagtgg 150600
aaattcatgg acctcagctt gacaactggg gaaccaacat aggacccaaa ccagtacacc 150660
tgaatgtgga tgcagctag gaggactggg cagtctatga ggcctctgtt agtggaaacca 150720
ggaggtttcc acagtttcca aaggacttgg ggagctcatt ccccatggag ggatattccc 150780
tcacctaga tacatggggg aaggcctagg cctgcccga aatgactcca cagattttat 150840

gatccctcat tgaaggcctc actcttcttg gggagtgaat gggagatgag atgggggggt 150900
cgggtgggagg tatgggagga tgggaaggag tgggaactgg gattgatatg aaaataagat 150960
tgtttctaat ttaaacaaaa cttattttaa aaaagactta gactttgata ttgctggatg 151020
ttccatccat ggaagttgta attcaggagt tggcattgag atgtaacat ccttgcaagt 151080
gtgcataatt cacaatgtca gacttttgaa gaagatttta atttgaactt tcttgagttt 151140
gcagacttta aagtttcttt tcattataaa gaattccgtg ctcttaagct tggccagttt 151200
tctaaaagct tggattagta aagagaacct ggacaattat ctggttcata ctattttggt 151260

atatactttt ctgcgacta tattacttta tgaattagca gaaataaaag atgcctttag 151320
aaaaaaattc taigtittaa atctgcatag aattaagtgg gtcaaataat ggtgttttgg 151380
taagctgatg agactcagtt acattcaaaa ttgacagtg atagaagcat acagacagaa 151440
tagccaacat tataaaggac agatgaactt atgagtagaa aataagacaa tgaagataa 151500
ataaaaataa gatcataatg gaatattagt tcatagtcac taatgatact aaaatcaaaa 151560
gaatgatttc accaaatgct ggaagaatat gaagaaaatc gatcaattat cagtgggaga 151620
ttaaagact gagcacagag gaaaattaac tttttttta tttttcaaga cagtgttttt 151680

ctgtgttctt ggaattgatt ctgtaaatga gcctggcctt gaactcagag atctgcctgt 151740
ctctgcctct tgagtgetgg gattaaaggt atttaccacc taattctctc tcctccccc 151800
tctctcttct cctgtgtgtg tgtgtgtgtg tgtgtgtgtg tgtgtgtgtg tgttttgaa 151860

ggagagagca atttccatag tggccacaag agggcatctg attcaattca gctgaaatta 151920
 caggttactg caagcttctt gaaattgaa cccaggtcct atggagagcc gtgttcctag 151980
 cacctaggtg ttttaatttta attgtgttgg tacttacaga atttacataa gcaaaaagcat 152040
 gctaaaaacta ccatatgtgg catgtgatat cttagtccat aataaatgag gaaaaaattg 152100

 gaaaaactca catgaaagtg tatttaaatc atgtcctgcc attattgaaa ttttgttagt 152160
 tgataactgt ttaagggtgc aacattttta aaagtatctt gctggaatta gaagacattt 152220
 gtaataatta gtaaaatgat gtcataataa ttggcagatg agtaaaatgt cttgtgtata 152280
 aatattcggg actagaggtg tacacataag ggactgtgca cattaanaatt tagagagact 152340
 gctatgggga taaaataaat tgatctacaa gccacatata tagtgtaatg gtgaaaacaa 152400
 aagaaattaa aacctttctg taatttgatg aaaagtgcatt tcaaatcac aattaactat 152460
 ggcagcttgg tatttattct aagttttctg tatgtcatga aaggtacctg gtcttatggc 152520

 aaatatgtgt tctgttcaaa tatggcaagg cctctgattta agaagcctgt gagagcttat 152580
 gtagggcact tcccatgcag gagagtaact gagtggggac atttgtaagt aattcctgat 152640
 tggttgggtg agaccacaga gtactcaatg gcactttgag atgctccctt tatttacatt 152700
 tctgatatat gtcttaggaa atgcacaggt cagtagttct tctctgctct acccctacca 152760
 ccacagttct taggttgac cctcagaaaa gagcataaaa ttaatttaca ctaaacaca 152820
 aattaaaaag agctaaagaa tagctgtggt ctttgctatg acttaactgc ttgatattgt 152880
 gagcacattt taagaaaagt gtcttgacct tttaggggtt tataacttt ggctttgtgg 152940

 gtgtatttaa atcatttcaa tatggttaatt ttttttactt ttttcagttt atagtittgtt 153000
 aactcttttt aacataatca ccaacagagt ctataattta attgaatgca tgggtggaca 153060
 ttatacactc tagtcaaaata attggctggc ttgagagatt aaattgtgct gctgaaattt 153120
 aacaattcgt agaatcatag aattttcatt gttggttcta aaaagacaag taggaagctt 153180
 gcagatgaga gaaactccca agagcagtaa aaaggggtgt tggtaggggt aaacacttag 153240
 cagagtattt gaagtattct actgatacga aaaattcaag agaagctact attagggttt 153300
 taattagaaa ttgggcagat atgtaaagca ttttatactc tgaacctatg ggaacgggct 153360

 ttccagccta ttgtatgaca aatctactta atacattagc aaattagatg tttcttagta 153420
 attacgtagg catatcaaat gccttatttt acctttctga aggttttctt aagagaggag 153480
 aaaaatattc attttcttg tttttcaatg ccaagtctg taatatact gcaactaatt 153540
 aaaagaata ctagattatt ttgaaaatgt agttctttgt atagacgaat atagagaaaa 153600
 taaagattaa tggatgatgg aactaatttt gtttctactc cccagccctt gcatttctta 153660
 aagtgttcca aaatactaca tgaatccagc atggaatgta agcaaagtga atcacagagc 153720

ccatctgcat gctgggagag gagctacaaa accaggaagg agattatagg gccttgacat 153780

 agcccatgcc tgagggtagg aaaaatgtcc aggttcaaaa aagaaagtgt acaaagaaag 153840
 aaaagaatgc ttaacaacca ccacattatc acagatacaa gttgagtaga aatgatgatt 153900
 cagttataaa atcaatcatg gggaaagtat acttgtaaaa cggtactgaa ctggtgaaga 153960
 ataagcttcc actttaagaa tttgaagtgg gaagagagat gtcccagaaa ttaagagtga 154020
 ctgctgttct tgaggagcaa gatgicattc cctgcactat agttatgcag gaaataactg 154080
 tctacaattg ctactccgtg ggtaatgatg aaatattctg gcatccagga gcaccacat 154140
 aagatgtgaa catacacaca gaaaggcatg aatatacaca aaaggaaaaa catatatgaa 154200

 tgtaacaaca attaatgaaa aagaggacat gaacttgcaa agagtgggtt ggggtacaca 154260
 taagggtttg aattaatgag aaaagagagt gatgtaattc tactatatga aataaaaaga 154320
 aatgactaaa atgaaaaatt ttttagcaaa acacaaaaca catcaaaaga tgatttcttg 154380
 cattaaaaaa tcaccagaat tctgtaataa tgccctctga tattaattg acacaatata 154440
 aatattttag aaattgacaa agtaattagg tgttatgatt ctatttttaa tctgaggaat 154500
 ctacatgggtg aggcagttag atgatcttca ggttgctctg cggtagggcac ccaaactca 154560
 ggtgagtctg ggtgctctc ccaaaaaaac aaaacaaaac aaaacaaaaa acctgctcgc 154620

 cttctgcctg agaccacacg gataaggggtg tacctgceca gactggaaga cacaccctta 154680
 tctgaacaca ccttaccctt gtccactttc tgccctctgt cctgcttcgg gtgcgtgagc 154740
 ctgaggtgag aatgggact gctctgcttc ccaaccgccc ccatcaacce ctgcttgctt 154800
 ctgcctgagc ccaactggggc aagagtagac ctgcccagac caggaaggcc caccctgagt 154860
 ccagacacaa gtcactcttg tctaccact gcctctgcc atccagctgc caccagaggc 154920
 tgagccctcc accagccact ggagagagcg agagatccca aatgactct ctggaggaag 154980
 ggatgggaag aagacaaagt aagaacacac tgaaaaacag aaaaaccaat atgacaccac 155040

 cagaatctag ggactccaca ccagcaagat ctgaaaagcc caacacagat catgaagaag 155100
 agatggacct caaaaattat cttaggaaga tgatagagtc ctttaagag gtaacaagaa 155160
 aatcccttaa agaataaaa gaaaaaaca gaaaattta catgagatgg aggaaaagac 155220
 aaacaaaaga attcaagaag taacaaatc tcttaagaa tctaagaaa gccaaagaaa 155280
 agcaacacaa caagtgaggg agcactagaa acagttcaag gcatgaaagc tgatatagaa 155340
 acaataaaga aaacacagaa tgaggtgatg atggaaatag aaaggctgga taaatgatta 155400
 ggaactaaag atgigagtat aaccaatagt tgtgaagac tttctagagg atatacagtc 155460

attgatcaaa gaaaatctca agtccaataa atccctaaca caaaatatcc aggaaatag 155520
 ggacatgggt aaaggccgaa cctaagaata ataggtaaag aagaaggtga agaaatcacag 155580
 ttcaaaggta cagaaaacat gttcaacaaa atcatagaag aaaacttccc caacctacag 155640
 aaggttatgc ctatgaaagt agaacaagct tacagaacac caaacagatt ggaccacaaa 155700
 aagaagtccc ctcgacacat aataatcaaa acaccaaac tacagaataa agagaaaata 155760
 ttaagagcag caaaggaaaa aggctaagta acatataaag gcagacctat cagaatcaca 155820
 cttgacttct caatggaac tttgaaagcc agaaggtcct ggatagatat tctaaaacc 155880

 ctaagggagc atggatgcca accaagacc agcaaatcaa taaagtataa actaggaaac 155940
 attacaaaga ataatgaaa catagagttg gttctttgag aagatcaaca agatagacaa 156000
 atctctagcc aaactaaca aaaggcagag agagagcatg ctaattaaca aatcagaaa 156060
 tgaaagaaca atactcaact ttatatggaa aagcaaaaaa cccaggatag ccaaaacaac 156120
 tctgtacaat aaaggatctt ctggaggcat caccatccct gatttcaagc tctattatat 156180
 agagccatag ttctgaaac agcttggat tggcacaaaa atagacagat agaccaatgg 156240
 aattgaattg aaaacctga tattaacca cataggtatg aacaccttat tttgacaaa 156300

 gtttctaant ctgtacaatg gaagaatat agcatcttca acaaatggac ccagaaatac 156360
 agaacattgc agatagatcc atactgaca ccatgcacaa aacttaagt caagtggatt 156420
 aagatctcaa cataaatcca gccacactga atattctaga agagaatgtg ggagatacce 156480
 ttgaaggaat tggcacagga gacagcttgc tgaacattat gccagtagca cagacattga 156540
 gatctgcaat taataaatgg gaccccctga aactgaaaag cttctgaaa gaaaggacac 156600
 agtcaataaa gcaaacgac agcccacaga atgggaaaag atcttcacga accccacata 156660
 tgacacaggg ctgatttcca aatatataa tgaactcaag aagctaacca gcaaaatacc 156720

 aaacaatgaa attaaaaagt ggggtgcaga actaaataga gacttctcaa cagaagaatg 156780
 tgaaatggct gaaagacatt taacaaagt ctcaaagtca ttggccatca gagaaatgca 156840
 actcaaaaca actctgagat accacctcac acctgtcaga atggctaaaa taaaaaacac 156900
 caatgacaat ctaagttgga aaggatgtgg agaaaagga accctcctcc atgttgggtg 156960
 gagtgcgaac ttgtaagacc actttgaaa tcagtatagt ggttactcag aaaaatggga 157020
 atcagtctac ctcaagatcc agcaattcct ctcttgggca tataccaaa taatgcatgt 157080
 tcatacaaca aggacatag ttcagccttg tttatagaag catcatttgt aatagccaga 157140

 acctgaaac aacctagatg ccctcaact gaagaatgga tagagaaaat ggggtacatt 157200
 tatatattgg agtattatc agcagaaaaa aatcaatgga atcttgaaat ttgcaggcaa 157260
 ttggatgcaa ctagaagaaa ccatcctgag tgaggtaacc cagtcacaaa aagacaaaca 157320

tggatgttac tcactcacat atgagtttta gacatcgagc aaaggattaa cagcctacaa 157380
 tcctcttcac caaagaaact aagaacaag aagaactcta agggataaat gaatggacct 157440
 caggtatggg aaggggcagg aactcagcta attgggagca tgagagtagg gcatagggag 157500
 ctgccagaat gagaggagga gaaggggata ggagaggagg aaatggagga gcagaaatat 157560

 tgagtgggg gaacaaaaga ggagagcagg atgagagata ccatattaga gggagctata 157620
 ttagagtccg aggagagatc tggcactagg gagatttcca gagacctaca aggatgacac 157680
 aaactgacaa tctatgcaat ggtggagaga ataacctaaa cacccttccc ctataatgag 157740
 actgatgact actttttatg gcatcctaga gccctcatcc agtgcctgat ggaagtagag 157800
 gcacacatcc acagatatac actgatctga actctggaac ttagttgcag agagagagga 157860
 atgaaaatca aaggggtcgg taccaggctg gtgagacaca gagaacagc tgttccgaac 157920
 aaggaggagc acatcaacc cagattctat ctggcaggct agcacaggac tgatccaggt 157980

 ccatgaacat ggatgtcaat aaggaagcct ctgcactcta ggggtggccc tggtagtgga 158040
 ttagtatattt tccttgggtg aagaaggac tttgagagcc catcccatgt gaagggatgc 158100
 actcttagcc tggacacatg ggggaggacc taggcccagc ccaggatgat gtagtggact 158160
 ttggggagcc ccatcaagg gccctatcct gccttgggag tggagggtgg atggggtgag 158220
 ggggttgggg caggaggggg aggggtgggg ggaggggtgg gagagtggag gggggagcga 158280
 ggaagaaaaa gggattgaca tgtgaacaa gcttgttctt aatttgaact aataaaaaaa 158340
 ataaaatcaa aaagaaataa gagatgatct tcagtttggg gccagctgaa gctatataac 158400

 aagatattcc ctctttcaaa aatgaagcca caaattataa tatttaacat aaaaattaat 158460
 tctctgaaag tgaaggagaa gacaagaaaa ttttgcaaat aataatgagt tgaaaaacat 158520
 tagtagattg ctcttagttc tttaggtagt aaatagaac acaaaaaggt tcagaatggt 158580
 caggtggat agtgcagtgg ccactgagct tctttccaag cctgaaacct gagactctgg 158640
 agagtaacaa aaagaaagga cagaacatc tcctacatgt tgtcttctga ccaccacatg 158700
 tacattatgg catgaatgtg cacacatgtg catatgtgtg tgcgcgcgca caagcgtgct 158760
 cacgcatgcg cgtgcgtggg cacacacaca cacacacaca cacacagaga gagagagaga 158820

 gagagagaga gagagagaga gagagagaca gagagaagag agttaataaa tgtaaaaatg 158880
 taacaattgt ctaatgcccc taatggtttag tcactaggat atgccaaatt aagccacagt 158940
 tattcagtta tgiaccatta tgaacatgic agccttatta aaattaagag ttcaacataa 159000
 ccaaactg gatagaacat agaacaatga caacttgaag tgcaagtga atgctgagtt 159060
 atcccatctt gccttctgtt ttttaaggcaa tcccgaaggg ttctgtgtga gtatcaatcg 159120
 ctgtctccac ataatacatca tcttgcaaaa tgtaatgtaa attattagac atttatttc 159180

taactgccac taacttttga gagactcaaa caataagaaa aatggtaata caagtccata 159240

 tttagagctt atgcataaac attaaacgat gcagactttt aaaatcgtga agtgaatcag 159300
 agtccatctg cttatcttaa aagcattttg aaacagacgg gattggaaaa tetatacgaa 159360
 gattagcttt tatgactagc ctaagcagac tacctttgaa aagtgtggag taattgtgtt 159420
 tgaattcttt ttttataatt tattttattct tttaaattha attttacatt ctaagcacag 159480
 ttctccctgc tacccttcac ctgeccceca ccccccaccc cagtccactt ttctcactt 159540
 gtaagggtc ccatgaggag tcaaaaaggt ctaaacactat agattggggg ggggccaagc 159600
 ccctcttcca tgcattaagg ctgatcatgg catcccacca tagggaatgg gctacaacia 159660

 gatagtcat gtaacaggat taaatcatag ttctagtgcc actgagcatg gcacctcacc 159720
 ataaggatg tgcaccaaca agctagctca tatactaggt ttgtgtcatg atcttactgc 159780
 caggacatc tctgatagc caagcttcaa aactgtttcc cacacatgga gggcctagtt 159840
 cagtccctg gatlattcac agctgttggf ctagagtca tgagtttcta taagcgtggf 159900
 tcattggctc ctgaaaattt ctccaccatg atcttgacct cctttgctga tacagtcctt 159960
 cctccctctc tttcattgga ttcccagagc tcagccagat gcttggttgt ggatctctgc 160020
 ctctggttcc atcaatttct gtataaagtc tctatggtga tagtaggat attaccaat 160080

 ctgattacag gggtagttcc agcatcatc cactattgc tacttttctt agctggggta 160140
 atcctttag atctgggga attacctaa cacacggttt ctcttaacca catagtggct 160200
 ctctataaa agatttattt ttcatgttc ttccactgca tcccctccc tagacgatc 160260
 cattccctcc tggccacctg tcccagttgg cccagtacag ctcactaat atccctccca 160320
 agggttatcc atgtgtccct ctgggttcc tcttgttat ctacttctc taggctgagg 160380
 attttagtct gtttactctt tgctttatat ctaatatcca ttcattaatg aatataacc 160440
 gtgtttgtgt ttctgagtct gagttacct actcagggtg tttttttgtt tgtttgtttg 160500

 tttgtttttt ttctacttc catccattg cctgaaaatt tcatgaggtc accattattt 160560
 ttacagtga gtagtacttc attgtgtaa tgtaccacat tttccttatt cattctcag 160620
 ttgaggagca gctaggatgt ttctagcttc tggtgttat gaataatgct gttatgaaca 160680
 ttgttgagca aatgtccttt tggattatc atgcttcgtt tgggcataag tccaagagtg 160740
 gtattgctgg gtctttaggt agattgattt ccaattttct tagaaagcag cacactgatt 160800
 tcagaagtgg ctgtacaagt ttgcattccc accagcagtg aatgagtgtt tcctgactc 160860
 tatattctct ctgacataaa ctttcttcag tctttttttt attagtcatt ctggcaggtg 160920

gtaagatggg ttctcagac ttgtgatttt cttccctga tgattaagga agttgagcac 160980
 ttccctaaat gtcttttggc catttgagat tcttctggtc agaattctct gtttagcgct 161040
 gtacccatt tttcaattgg gttattatgt gtttcgggtg ctagtttctt aaattcttta 161100
 tatattttgc agatcagctc tcttttgat gtagggttgt gaagatcttt tcccattcat 161160
 tatgctgtcg tttggtctta ttgatagtgt cttttgcctt tcagaaaatt ttcagttcta 161220
 aatacctatt aagataacct tcgaatagtg tatcattaat cttttatcaa agcagctttt 161280
 tttttgcaa taaatgaaga acattctaga aaagaaaacc agtcaaaaaa gaaaaagcaa 161340

 aggttttcat aagttttctg tccccagttg ttaaatttgc aacatggaac ttatatctaa 161400
 gctttggaaa acattgtggc actgtgtgtg tgtgtgtgtg tgtgtgtgtg tgtgtgtgtg 161460
 tgtaaatatt ggagaagaca aaaaccaatt atacatgcta caagatggtt tcttcaatat 161520
 atgtcagaga aacatcacct ataacttccc caaaatattg tagcctaaac aaaactgaac 161580
 atatgacaac atcagtaaac atgacaacat ggataggga gatctcacia tgctccagac 161640
 atagacaaaa atctagagac atttatcaac tgacagaaaa ggaatacact gtctcagga 161700
 atgagcaatc taattgggtg tccaatactg ccttagttat tttgtcttg tcaagacaga 161760

 aagactaacg caagttataa aagaattaat ttacttagga gcttacattt ccagaggta 161820
 gcagagtcca cgactatcat ggcaaaaagt atgaagcagc cagcagacac tgggtcagta 161880
 gctgagagct tccacttgat ccacaagaat gtagcagaga aagagagata actttgagtg 161940
 gtaggggatt tgaatttca agtcccacc ctactaagac actttctcca actaggctac 162000
 acctcctaat actttccagt tttaccagt gcagaccaag cattcaaata tgggacattt 162060
 ggggctact atcattcaaa cacccacaaa tatcagtggt cagtcctgaa attgtgtaca 162120
 tataatgaca ctaaatggag tatgcagctt gtatttttgt agttgtattt gtgtatgtat 162180

 gtatgtatgt atgtatgtat gtatgtaata aagaaaagga gaaaacagat tacaatgta 162240
 tatgactaca tgcacaatta aaagttacat atacatcaat tcttaatatg cctataactg 162300
 ctgtcctgcc tgtcatcatt tcaactggaa atttcattgg atacagtcaa tcagtactat 162360
 tttttctata gtagtaacaac attgaattga cctattttct tttgttataa aataaatgat 162420
 agccaatggg agactacatc agttttataa ggaaggtag taaatataaa aatatgaatt 162480
 taacatttag tcattctggt cagaaagaaa attattcttt aaagattaag tttgcttagt 162540
 ggtttataga tcaattttag agtagaaaaa tggcaaaacc aatgcttttg tcatatgtag 162600

 taacattgc attgctatat aacaatatac aatgaatact attttcttga aatcttttgg 162660
 taagataaat ttttctctc ctatccaatc ttctatttgt gctacttcta caaaaacaaa 162720
 aattaacaaa gtaacaatgt atatggtaaa atcaataaaa ctaactttca aaacaataa 162780

gaatattgac ctaggtatatt tttctatcct tgtggtttca aaaagtttta aagatgtaca 162840
 catgttatac ctttatcttt acaaaagtat gtatatataa ttcggaagaa tttgttaatt 162900
 attttagtca agcaagtgtt aaattaaggc ttcaaattaa atatgattag aaggatTTTT 162960
 gctgttttcc tgatggggat attctccttt aaaaataggt gattggaaat atgtggatga 163020

 aaagatatct tgggaagtta aaagaactag gtgggctctc aacatccaga gtttgcttcc 163080
 tatttcttaa ctccagatcc agagggtcag acacacatga ctgacttctg ggggcacaag 163140
 cacatataat gtgcctacaa atcttttaaa aatttgcaat atatttagga ataaaatcca 163200
 attatagtgt gatgttggct ctgcattatc acactttatt ctcggggtga tgggtgcacg 163260
 tttggaaggc taiggactct ttttcaggta tagcttaaat ggacagagata gatcaccatg 163320
 ggtcttagaa gaaataactt agatcctatt atacttcatg ctttcagatc tgccatgagg 163380
 gagaagctac tctcacacct ttactgacag tagtgtctac atcacctcga aaccataatc 163440

 caatagatct ccgactctc ttatactgtg tctgctgtgt gtcattgtca caaaaacaaa 163500
 aatggtaaat aataattaat aataacaata ataataaac cctacattga tagagggat 163560
 gtgattcata taattaaaaa cccaaggagt agatagattc aagtttgttt tactgtgaga 163620
 taaaaaatgg aagaacaca ctaaggtaa catacagtct gaaacagact tagaagcttc 163680
 cccagtcact gagtcatctt ttagtgtaa ctcaagaatc aataattcaa ttccttgggt 163740
 ttatatTTTT atTTTTgt tttttggaca tggTTTTct gtgtatttcc ttggctgtcc 163800
 tggaatgtgc tctgtagatc atgctggcct tgaactcaca gagatttgc tacttttgc 163860

 tccttagtgc tgggattaag gtgtgggtca ccaccacca acagtaactc agttcttaat 163920
 tcaaagaact ggatacactt gaggagctta tcagtcaatc acatgagatc tgtggcttct 163980
 gttttcacag tatgtttcca ccacttgaat ttaaattttg tctagattgg tatttgtatt 164040
 aagataatTT gtgccttatt agatttaca agaaaaatct tttctcctaa tgtttttact 164100
 cagcaaaatt aatctatgcc ctaaactaaa ataagttcag aaaattacca tagtgaatga 164160
 gtgtttggct atatctttga caaaatTTc tctgcatgct atgaaaatTT ttacctgatg 164220
 agtgaattgt ttgccctgat tcatttctct cagatggcat aatctcttcc tatgcatcta 164280

 ctcaactagg aaacagaaat taatgtaatg attatattac tattttctat ttgttattat 164340
 ttaaattggT taaaaattct ctttcacaaa catattaagt gctataattg tgcaatataa 164400
 attcattaga ctgatttcat tttttctttt tttaaacttt ttaaatttta attagaaaga 164460
 aaattatTTT atatgtcaat cccaggtcct tctccctcct ctctccct gtccccca 164520
 ctaacacctt acctatccat accctttcta ctccccaggg aggggtgagc tttccatagg 164580
 ggtcttcaaa atctgtcata ttctttggga tagggcctag tccaaccccc ttgtgtctag 164640

gctcagggag tatccctcaa tgtgggatgg gctctcaaag tccattccta tggtagggat 164700

aagtactgat ccaactacaag aggcccccaa agatttccaa ggtctcctca ctgacacca 164760
cattcagggg gtctgcaaaa gtcccatagt ggtttccag ctgtcagtct ggggacaata 164820
aacaatggt atggcaaatt ctctctcat ccaaacattc ccaagcatta tgagatagtt 164880
ctatgactaa agaaaagtga aacaaaattc ttttagttac aggcccttc atgtctcatt 164940
ccacactcat agtaactcaa gctcatctcc tttattttgt tttcatgtac atgtatgtgc 165000
ttctatgcat gtcatactg gtcctacag agaccagaga agataccaga tagtgagcag 165060
ctggagtgag agactgtgtg ttacctgatg ctcagaactg aactctgttc ctctgcaaga 165120

gcagcgaatg ctctaacca ctcatcttc tcttcagccc atccagaaac ctttatagtt 165180
ccacttacac aaactccat aagagctgaa gtatgatatt catggtttat aacattttca 165240
tgaattaaaa tagatactgg taagaaaaga taactaatga aaagagcttt caaattctga 165300
catgtattat tgaatttttg ccatgtacat aaatgcacac ataaacttag cacatactgt 165360
attggcaaac agacttgcaa ataggtaat ttgatgaaat tagtagaaga aattgttata 165420
tattttgcac agattgacaa atataaaatg aattttcctt gttatgtgga ctgattctgt 165480
tcaaaatgct atatcttgaa ttaattgggg atctatctat ctatctatct atctatctat 165540

ctatctatct gacatctatc tatcttagta tctaccatct aactatatct atttataatt 165600
tcttactgaa attataaaa ttcaaatttt tgagctcctt ttattttcat aaaatttggt 165660
atcctaaaaa aagaataaaa actttcctgg gggaaactat tttagaaagt agtaggaaaa 165720
ttgacctttt agatgtaatt caaatactaa ccatctaate tccactacta caagattact 165780
aaaattcaca taaggactgt tacccaatac catatgatgt aatatatata gtaattcatc 165840
tctaactact tattcagtag catacaatga tcagaaatc aatctttttt taagaatctt 165900
aattcaggaa tgtttttata gtatcatctg aaaaaaatga cctttcttgg tgatgagatt 165960

tctcaagttc aattcattag agccacaaaa actctacaca aaccacagca cagagacta 166020
taaaacctct aaaaacattc ttgggtgcgc taagtatagt caaacccaaa ctcagtcctt 166080
attacttagt aagtactatc atattatata taaagatcat taaatctttt ccaagaacat 166140
aaaaaatca tgtgtacaat ctatagtttt cctctgagat ttctaaaatc taacacatca 166200
ttgctgagct ttagctaaga tattttttaa tatttataaa attaaaaaca atcacatttt 166260
acaaaccaat cccagttcct tctcctcca gtctcctcat cggccaacc atctcccat 166320
ctcaaccacc atccactcct cagagagcat gaggcctcct gtgagagatc atcaaagtct 166380

atcacatctt ttggggcagg actggggtcc tctcctctgt gtctaggctg agagagtatc 166440
 ctttcatagg gaatgggctc caaaaatgct tttgtaatct agggataaaa actgcttcca 166500
 ctgccagaga ctacatatac ttcccaactg acaccactt tcagagtgtc tgattcagtc 166560
 ttatgaaggt tccccagctg tcagactggg gtcccttgaac tcccacatgc tcttgtcagc 166620
 tgtttctgaa gatttcccca gcatggtatt gacccttta ctcatctctc ctccatcttt 166680
 acaactggat tccaggagtc caacttagtg cttagctgta aatctctgct tctgcttcca 166740
 tcagctactg gatgaaggcg ccaggatggc atttcaggta gtcataaatc tcatcatagg 166800

 ggaaaggcat ttaaggtagc atctccacta ctgcttagat tcttagttag ggtcatcctt 166860
 gtcaatccct agagatttcc ctagtgccag gtttcttga aagcccatga tggctccctc 166920
 tatcaagata tcttttccc agctctgctt cctctgctctt cccccaactc gaccttcta 166980
 atccctcatg ttctctctct cctttctctt tcccctccct cctcctctcc ctccctcct 167040
 nnnnnnnnnn nnnnnnnnnn nnnnnnnnnn nnnnnnnnnn nnnnnnnnnn nnnnnnnnnn 167100
 nnnnnnnnnn nnnnnnnnnn nnnnnnnnnn nnnnnnnnnn nnnnnnnnnn nnnnnnnnnn 167160
 nnnnnnnnnn nnnnnnnnnn nnnnnnnnnn nnnnnnnnnn nnnnnnnnnn nnnnnnnnnn 167220

 nnnnnnnnnn nnnnnnnnnn nnnnnnnnnn nnnnnnnnnn nnnnnnnnnn nnnnnnnnnn 167280
 nnnnnnnnnn nnnnnnnnnn nnnnnnnnnn nnnnnnnnnn nnnnnnnnnn nnnnnnnnnn 167340
 nnnnnnnnnn nnnnnnnnnn nnnnnnnnnn nnnnnnnnnn nnnnnnnnnn nnnnnnnnnn 167400
 nnnnnnnnnn nnnnnnnnnn nnnnnnnnnn nnnnnnnnnn nnnnnnnnnn nnnnnnnnnn 167460
 nnnntatat atatataat atatattcaa tggtttaatg aaaatgatta agcacatagg 167520
 acaattttca taggttgaca cttgttttta agtccaaaat tctaacattg ggaaattaga 167580
 ctagggttg taatcttga aagtctgaat tcaatagtag ctttccttgg agtcactatg 167640

 attttcttta cttatcttt tgatgtccta ctgatgtaa cagtatgtag aatacctctt 167700
 agcctgagta tagcatgtct ggcaatagaa aagtataatc ctgtctttag catagtgggt 167760
 atttatctta agctgactt gttggtgata catgaataat ataagcatga agaggggttg 167820
 tttctttcta gtcttcttc ccaagtagtc tgtacacaat ctttgtcaga tttgacactt 167880
 tgatggtaga tgtattctg tataggtttc tcttattggt tgatgaataa aacattgtgt 167940
 ggctagtggc caaacaggaa gaataggcag ggctaccaga tgaagagaat tctgggagga 168000
 gtagacagag aggagtcatc atgtgagtgt aagaagagag gacacaagtc aggaattctc 168060

 ctgtaagata agaccatgta gaaatacata tattagtagt tatgggttaa ttattaagac 168120
 aaagatagcc aataagaagc acaagacatt ggctacaat ttcataacta atacagcatc 168180
 tgtgtattta ttgggatct caagggtggc aggacactgc caggataacg aacacttttt 168240

tacaacactt agttaatgaa gatttaaagc aagactttca catgaatata atctaacgc 168300
 ttggatttct gaatagtatt cacagaagga gcctttcaga ctaaactcta ctaaataaaa 168360
 tatgcctcaa agagtttttc atcttttact gattggcatg atttgcctaa atagcaataa 168420
 attgtattgc ttcattcaaa gttgaaggat gttgtaacat attttctatt atactagcag 168480

tgttttacag tttgtcaatg catcctagaa caatgtcaac ctgcttcctt tttcagtcac 168540
 atgttattta attagaactg tcacactcag tcttgaggac agaaaggatt caataagacc 168600
 aaagcgtgaa aatgcaaaat cgcaaacagc acatttgggt gctagaaaca tggatattga 168660
 gtcagattta gatcaaaagg agagaagaca gtaatgttg caaactgggt ttttaaaatt 168720
 ttgaatacaa ctataatatt catatcactt ccatatatgg aaaggtaact atccacactg 168780
 tcacattcca tttcattttg ttttcctcac tcaactgtgct tccccatta aagagaagaa 168840
 cagattataa aatgtctttt taggatcgga atgctcgggt gtacagagca cttacagctc 168900

tgtgtcagga atcttgggtc gattccaac actgtcatcc agtggctcag gactgcctaaa 168960
 aatctcagtt ccagagaatc ccacactaag ttatagtgtc ctctgacacc accatgcaca 169020
 tgaggcacag aaagtgattc aagaactcat acatatacaa atacaataa aagaaaaata 169080
 aatacaaca aaatactaaa agtatcctct ccacaagat tctcctcaag acacaactca 169140
 agacactgat gcaactgaaa ctcttgccca gtgttttaaa tcaactgactt ctgaagattt 169200
 tccaaaggag aaattaatc ctactcctca acatgatgga gtttttaatg agtaccttat 169260
 atagcattct tctgttcat gtacatttgi aatagctgat gcagggactc attgactcaa 169320

gattcctgag ttttagagta gtttatgagt atttttaaat aatgtttaaa tttgatgtea 169380
 caacaattac tttcaaagtg cccatatttt acctgcattt ctgctctaata tccctcttt 169440
 gcactccea acagctgttc ctccctcttc ccaactgatct tgtttcataa gcactactaa 169500
 tgagcctctg agaagtgtgc taaatgccct aaagctgcaa taaacaggaa gacagctttt 169560
 aaacttactt ttatttgtat tccatttaaa ttttaagtcc aaaataaac acacacacac 169620
 acacacacac acacacacac acacacacac acacacacac aagatgagaa gaaaagatta 169680
 cagaaattaa ttaccccat ttttattttc cttttacatc ttaaaaacaa tgcatttttt 169740

ctatacaagt gcattacatt gtgtttaaag tatagtacac atataaaagt taagtagaat 169800
 taacacaaaa tatttgtgca cacatggaca tatttcacat gtgagtgttc aaagctagta 169860
 tttactaca tggaatattc tttgaagctg gaaagatatt caataattaa tattattggc 169920
 tgctcttgca gagaacttgg gttcagtttc caagacctgc atttgtatc ataacagtct 169980
 ccaggtttag ttctaggggt caaccacct ctatttaaat ctgaaggtag acagacatgc 170040
 acataacaa catatccaca cataaaaaaa taaattagga ggtatttgtt tttagaaaaa 170100

gtaagtatac tcttcagatg gaaactatat tttttgaat atgcacaaaa aatctccttt 170160

 cttcttagag aagttatatt ttttatgtt tatccatagt taagtcttgt ttatttcate 170220
 ttttgattct tgtaatcttt caggattctt attgtaagca tacatttaca acaattaatt 170280
 tttataatta ttctgacaat atctaggcat cctatcttta ggatggtcta tatggtacca 170340
 tctctaacct tcacaaacat tgtatactgt ctaattttta gctaacaaat atatgattgg 170400
 gtacctgagg caatgactca ggtgtcaaaa agcatgtatt tgttacaat ttgttttcca 170460
 gcatgtagta agaggcttag tgttacctgt gactccagtg cctaggcacc tgggtccttg 170520
 ggccatcata gggacggaga tgatggagac acaattgaat cagagcacag aaggaaaagg 170580

 tggattttta gtaataatg ataatttata aaccatcaaa accttagcaa ctaacatttc 170640
 cgtttttagga caatgcatat ttcagtgaaa ttgagatcac taagttttct cagattcttg 170700
 agagacaaaag gaaactaagat ttgaagtcta tctatactat tactctagag agatacagat 170760
 atctgaaaat caatgttaag gtctatccac ctggagaatt aattgttaaa accataaaga 170820
 accatggata cactgacttc aattttgatg aatttcagga aatgaccca aaggatgcca 170880
 gaaacttgcc ttcagaggag atctgaggaa aaaaaaagg acttgcagtt ctagcaggca 170940
 atgaagagaa acacctcaag ctttgtttat attgcaaatg taatctgtaa aaattcttga 171000

 gagtattatg tcagttaaaa gaagaacctt gcttctctag tcccttccag agtctctgac 171060
 tgcattgaagg gtaggaagat gcaatcattc cctgaacatg agtcaatfff aggaaaatga 171120
 atttgaaca caacaacttc attaaagatg gggagaaaata aggaaaaaaa aggctgtatg 171180
 tgttcttgtg aaggatgatg tccagttaact ggggcctcta gcaactgtac aaagcattca 171240
 agcatagaca accttcccac ccctgaaata ttcatatttg taaccacaca gaagtctaac 171300
 ctgcctcagt tcttagtaca tgctacatgt ccatctttta acaaaacca gggggttact 171360
 aaaggcaaga tgaacaatc tggagtgtca aaaaaactag tcaacagtgg tggcagagac 171420

 ttcaaaggtc acaagaatca aatgaaaca ttagaaatca agcagcagga agagaaatga 171480
 agatcatggt taaagaactt aacagtaaat ttgaccaaga caatggctta gtaatcagtg 171540
 aacttcagtt gatgtattaa taaaaatgic ttcaagtga atgtcaagac agaaaataac 171600
 agataatga tgaagaatft aaaaatgtat ctatatatgt acatatatac atacacacat 171660
 atacatatgt aagtatgtat gctgtggatg gtatgtgtgc atatatatat aattatatat 171720
 atatatatat aattaacaa agcagaaaaa caacttgaat aagtagaatc caatgtcttc 171780
 agaagtaatg attatcatta aatcacagg tataaaatft ttaaaaaata aaacacacaa 171840

aatttcaggt gtgtatagca catttgaagc ctaggaaaat taagtttgaa gcaacaagtc 171900
ttgacagaag ctgttttga tatacaggaa aacaccttgg tcctttttat gttcctgtcc 171960
cacaacaac atgattaaaa aatcagaata aaatatagtg atgatgtata ggtttatfff 172020
tttagcatta cctaaaaatg attatacaaa tacttacata aaaatfffca gttataatta 172080
attcaaggtg gtttaaatag aactggacat gcacataact tttacaagta ataataatff 172140
tcaaataata acatagagcc tctgtggatt tgggtatatg ttgatgaaat aattcatgff 172200
aactgacaat ttgaaagaac ctagaatcac ttgagagata ggcttctggt catacttgtff 172260

ggggagtatc ttgattgtat tttttgaagt gagtgggaaa gccacctacc atgggtggca 172320
acattccctg aatggaatff tagatttga agcaccgagg tggttattga gcaggaatat 172380
tcattffttg ttcttaccta cttttcggtg gctccaatgc cattggctcc tcttactgtg 172440
atffccacc aggatggacc ttaatttga agacagaaga aatgctffgt cttffgagff 172500
cctffttgaa gttatffta tcacaggaca ggaaaagaaa ttaagactga gaggaatcct 172560
ctaaccagta acccctgtac caagagatga atgtataaaa gcaaaatffa taaaacctgc 172620
atatcataag catatgaaca tggagtaagg tttatctcat ctgggacaaa taatgcaaat 172680

tgaaaatff acccaatca gtaatctatc aaaagffat atctccactt taagaatffa 172740
gaaaaataat agcttaaac ttaataaat caaagaaaat aagctgaaat agtctacaca 172800
acaaatffga ttacagatga aatggagctt gagtgtffaa aaactcaaa agtcacacaa 172860
agaaaaacac atcatttgag cagtcttatg cctgttaagg gaatfgaac aatgctffga 172920
tagggaatgt cattctgtgt gctgtgaata tatgtffctc ttatffgttg atgaataaat 172980
gctgattggg cagtagccag gcaggcagta taggtggagc taccataata ggagaaagga 173040
agagagagag ttaagagga gatgccaggt agctgctgaa gtagaactaa catgctggag 173100

cattagcagt aagccacagc ctgggtggcaa tacatagfff aatagaagff gtttaataat 173160
aagtaagaag tagccaataa ggggcctgaa ccataggcca aatfftttac aattaatata 173220
agcccttgtg tgtffatffg gtactaaaca gctgtgggat tgggcaaaaa gtaacctctg 173280
ttffaaatgc ttagtactc tffctcaaa aatcttaagt gccatgtgat tacattgata 173340
aatfftgaa aaggaaacct cttccagaaa atagaagcag agacactaat ttccaatca 173400
tcctattagg tcaaaaatca aagctagata aagatffctgc aaaaataaat accatgtatff 173460
aatataggct agtatactg atgatataaa aatatacaaa atatgtggtff tcttaacata 173520

taaaataga gctatffffa cctffgtcct taatcaggat tattatactc atgaaatcac 173580
agaagctgtg gttgacatff caagatcaag ccattcaaaa tataacatgc cacaaagatt 173640
ctffaacaag accccaacaa tatctgtgag gttatfgaca atfgatggca tffgagggg 173700

ggaaatccag ttttctttaa ggtgttctcc actcttccac tttagagtgg atcatcccac 173760
 actcttttat gtgggcaaca caatttatac ttggtgggtt attaaaaaaa acaaaaacaa 173820
 accactgtca gtgaaagtgt cctaagctaa aggactctat cttagaaaac agaatcctaa 173880
 aagtgggttt tcigtacc aggaacatcc ctccatctgc caggacctcc cttagtcttc 173940

 cctcaatata aaatacctcc caacagtcta taagctcaaa gacttccatt ctgcagattg 174000
 ttgtataaaa tigtcttctt tttccccat tttgtttcac tttgtctccc acagtggtaa 174060
 ccttgttagt ttaacctaca ataaccttt ctttctacga tgtgtccaag ttcagtgatt 174120
 tcatagaacc ctactcaca tatacaaat ttggattaga tggaaaggag agcatgggta 174180
 tttataatth atgattgtc aaacttgcct gaggattcag aaagcaaagg cagactcaag 174240
 ctatagagat caggcaatgg tagaacatac ctttaatctc aggactcagg attaagaggt 174300
 agatagatct ttgtttgttc aaggccaact gaccacacaa aattgatcca ggccaattht 174360

 gatatcaagca gactacagct tcaaggaag ctattcacat ctttccctg gcatattgca 174420
 caacacctct gacacttaga aattctgggt agtttgagaa ttgtttctat atgccctgca 174480
 tcataagcaa ggtgtgtctt aagcaatagg ttcttcttt ctagttagg cttgcaacta 174540
 agaacaatga caatagcctc tgttgattgg agtatttatg aagcctcaa atthtaacac 174600
 aaagtatctt aatatcaaaa tatttcttga ttttccctc aattthttac tttctctgat 174660
 tttcaggagt aaagaaatc attttagctc caaatagagg ctacaattct aacattttc 174720
 caaaggaatt aaattgtttg tgagtggga tggatcatatt cttgaagatc tcctttgtca 174780

 gagaatattt tctatttccac aaaatttata atgccacaaa ttgcttccag tcagtatagg 174840
 aaatgcttcc catccctgaa cctatactga tgtaaatgat tactgattca aagaagactg 174900
 atcatcaaat aaaatacaca gtattcctaa gctgggtggcc tcagactga tggaaatctca 174960
 ctcttatact tcttctgaa actgtaagat ttaacaatga agtgttataa gtgctttgat 175020
 tctccatgat tacatgtgaa ttggaaggat tttctttta taattaaact tcagatcatg 175080
 atthcaaagt aactgcatg ggtaaatgt cctatgctgt tttagctcac tggtaagctt 175140
 gccctagaag caggcttctc ttctcccat tttagatcta agttcctttt cttaggttag 175200

 tctcattagt tctgtgacag agtgaagag aaaacaacaa aaaataacaa caacaaatta 175260
 tcccccaat aagaacatct tgtcttttca aacagctaga aggaaagtca tttccaaaag 175320
 atgttactat atthtagccc atgatatgag tgcccatatt ggcataaagt agcagaagtc 175380
 cagccttggg acgggcattc atggagcata tctcaatca ggaattccag ctgactggct 175440
 caacttccct agttagtgtc cactgaatgc tgaagtacc caatttgat gtgtcatttt 175500
 tttgtggcat gttaccctgc ttggacatcc ctttggggag ggggtgagaa gaagcagcac 175560

caaggactca ggcacatga gtcagcgagt agtagagcat ggtgcagacc catttattca 175620

ggaagttagg ccttccttta taccctctcc caaggctcta ttagctcagg cggctgactc 175680

tgctgtatgt ccttttctca caaatttctt tttgacagac tactgtgcta caaggcaaaa 175740

taagagacct taggaatgat gcaaactctc accatgcctg actctgtctt ctctggatga 175800

gcagtagtct tccagaagaa gaagctgcaa attttatagc catagagatt atcaactttc 175860

atgaaaacca caagttattt cctaaaaaat gattcttcat atctgcctct gccacacatg 175920

tgttcccatc agtgttgga agtacagacc aacttaata tgctaatttc atttaaatat 175980

ttattaaggt atttgtatt aaatttcct agtaagtcc caaaagtaac tgattccatg 176040

gcaagatfff atgaaacgct gccaatcata aattgcattc tagatcttcc tttctgtgcc 176100

atztatagtc tcatcttaaa ggttttttaa aatacacctt tgtttatgtg agtctgtgtg 176160

agggtgggtg ggtacacata accttgcata cacatagagg agacagtagt agttgggtga 176220

cttctttatc cttccact tattcctttg aagtagtgtc tttccctgat tccatagcaa 176280

ccaatcttaa acgtaaagtt atactttctg tactttattt cttatttaaa aaaaacaaag 176340

atgctcttag tcattaaaa tagattggca ctttgtatt gaaagagaag tctctgacac 176400

gtcacaaat ctttgatfff ccctttgtgc attcaagaaa cttattgcta gtctcagatt 176460

tagaccagaa taaaaacata caggagtffc tatgatctca tcttgtttgt gfatgcataa 176520

tagtttgaat tataaagcaa gagtcttggga aattagtcc tggigaatta atcagcaagg 176580

agagcaaagg tgaatttct gcacttgaaa ataaaagctt gcattggagtc actgaacgct 176640

gcctctgttc atgttaatca tttgtcttga gaattggcta gaataattcc tatgatgata 176700

caggatgcaa acaagtagct aggatcacag aagactcacc aaaactctaa gtctttgtga 176760

atgtggaaga agatactgtg tgtagatgat cctgagagag agagagagag agagagagag 176820

agagagagag agaggaggag agacaggtag aaaggttagc aaataatgag tacaccttgc 176880

taaagatgta ttaggtcaa acaactatat tcagaacaga ttttatgtt caatcatatt 176940

catttgaata taggtcttat tagaggtagc tctatgtgac ttattctatg tagttatgat 177000

atccttgtct ctgtaattat ataaaagtta gaaaagaagg acagttttcc agatctctgt 177060

actagtcagt tatatccaac atcatgcctc tctgaattta ttcctttcat tttaaaaaaa 177120

cattgtcttt aaaaatagc aattaagaag gaaaataaaa attccaaatt gttcactagt 177180

tggatcacct tctgctttac aataattatc tgtgtaaaat tatccatttt gtcaatttca 177240

acattttaag tttttctaaa tatttgggtt gaaaagagat gactataagc caggggtggc 177300

agcacatgcc ttcagtcttg gcactttgga ggaagatgca catgccaagg tgatatatgt 177360
 gacttcaaga ccagcccagt tcacaaggaa tttgggggca ttcacttatt acctaaaagg 177420
 caacgtgcct cagtttctgt ctggaagctt gactactcat acctaaaga aacgtaatca 177480
 aagtacaaac ctaacctgtt gatttccatg tttattcaat tctttttat ttacactttt 177540
 ttttctggct taatttaggg ttttgggtt gttgttctta ttccttcttc atgttgccaa 177600
 cattttcaat tattcactat gactattcat tgcctactt tattctttta ttagtttctt 177660
 ttaaattcta agatgctatt ttgaaaattg agttttgcc aatgggctta ctcagttttc 177720

 aaataattca agaatttgag gatgctgaat attccacaat cccttttgag gaggttgtta 177780
 gactgtggtc cacttttctt tcattgtatt gcaaacaaat atatattgt cgctttatat 177840
 tttatgtgtg tatatgtata agtgtggttt gtgcatgtgt gtgcttggtg aacatgatg 177900
 atatgcttgt gtgtaggcac atgccacagt tccgtgtgag agaacagaac ataactttg 177960
 ggaggtaggg tccttcttac atggctctgt ctatgaatga aatgatattt ggcttcttag 178020
 tttcagatca ttctctcaa tcactacct ctccatagca aatatgcatg ctcagctgtg 178080
 caaccagggt ttttcatgg attcagggat ctggctcagg cagccaggct tgcaccacia 178140

 gtgattttac tcattgaggc atctctctgg ccttgaattt tctttcactt tggctgctgt 178200
 actgctatat tttattttag tattgggcaa gtgcttcatt gtgtagctca ggctaccctt 178260
 ggatccttcc aatccttctg acaagtgtag agactttagg agtgccttag aataaatcat 178320
 ctacatttat acttttccgt gactcttctt caatctattt ttaacattgt ttggaatatt 178380
 tttctgtaga tcaggagtaa caaactaata gactcaggaa atgtgtcagg acacaggcag 178440
 gacttgacaa gattaaagcc tactgagtcc ctgtacagag aaaggaagca gatacagggt 178500
 cctactccta acccataaag tgttacagggt tcattttct ttcctttctg ttttgctttt 178560

 tgagacaagg tttctatgtg tagctttgga gcctatctg gaactagcag agcagatcag 178620
 ggcagagaag aattgtttaa cactttcact ttccaagggg aaactttccc ctactggagc 178680
 agagtgata gactcctggg gaactaagaa gagctttaa acttttctgg agcacagaag 178740
 agctgagctg caacaacttc acttgggaaa tcctccctg cccaaccaga gttgttacac 178800
 tgggaaaaca ctccctgga gcagaactgt aagtgtgata ccttatactg actttatggt 178860
 attccttggg ttccagctac caggataact atccatctga gatgcaatgc ttactgagag 178920
 tccatgtcc atctgtggag tacacaaatg tcttcagggt tgccttgag attaaattgt 178980

 cctctctgta tatcttctt atttaccaa tgctattgta ccaagcccc atgcacaact 179040
 gacacatgg taaaagaatc attcacagga gggaagaggc atgagggacc aggaatattg 179100
 agtcggggga agaataagagg atagaagaa tggaagatat cttaatagat ggagcaatta 179160

taggggtgcca ttataagttt aaatagaaat ctgggtactgg agaaatgtcc agagatttgc 179220
aagtttgatc ccaactaaga atctaagcaa taggggagag gctatttcaa atgccattcc 179280
cctataatga gattgatggc taccttatat gccatcatag agccttcac cagtagctga 179340
tggaaacaga ggcagagccc ccagctaagc actgagccaa atccctggaa tccatttga 179400

gagagagaga ggagtgatga gcaaaggggt caagaccatg ctggggaaac ccacagaaac 179460
agctgacctg aacaaacagc tcatggacc cagactgaca gcttagaaac cagcatagga 179520
cagaacctgg cccctgcac atgggtctca gttaggaggc ctgggcagtc tatggggccc 179580
ctggtaatga aacagcactt aaacctagtg tacaaatgga catttgaagc ccattcccta 179640
tagagagata ctctctcagc ctagacacat gggggatgtc ctaggcctg ttccaaatga 179700
tgtgacagac ctigtatgata ccccatatat gccttacc tttctatggt gaggatggga 179760
tggaggttgg tgggggcatg ggagaatagg agggagagga tactgggatt ggtacataaa 179820

ataagattgt ttctaactta aataaaaacg gaaaaaaga ttattcaga cttggatcc 179880
taatagttg gcatcaacac cttccaaaat aagaacataa accacttgc tattttggct 179940
tctctagttc tgetttctgg taactgctct tgatcattg gatgtgtcat gccagcaagt 180000
agtttttgta ttigaaagcc caacctgagg aagactcggg gctccaatgg ggtcctgaac 180060
accatccact actagcctca caaaactatc ttattgtctt tgtgcttaga tattctttgc 180120
aatgcTTTTT ggigtatctc ctactttttg tatttggtaa caggaatta cccccagaat 180180
gaagtctgcc cttttctgct ctttgagatt tctgattcag ttcctattc ttttgtttg 180240

actagtttct ttagttttac agtgttcttg aatctgtggt cctaatttcc attcttgct 180300
ctgtctccat ctttttagtg atcacaatta gaacttagtt cacagaagct acattgtctt 180360
ggttattatt tcgaaatata gtgtatagtg cccttagagg acagaattgg gcaactcacc 180420
tcctgggact agagctatag atggetgtga gctgccatgt tgatattagg aatcaaattc 180480
aggtcctatg gaataatc tagtgctaat aacctgaag tcatcactcc agttcaatat 180540
tggtcattat tgatcatatg gtttaatttta tttataggtc cttttttata gtttagaaaa 180600
cagaagtgct gaattgagag gatgtgtgat tgcctatatt gctgcagacc ctaaattttg 180660

aaccaagact taaatcagac aatctgtctt cataaacct gccttcattt tcagccact 180720
ttgtccattt tgtccattag accaaaaact gaagaggtga ctctccagtt aagagcactg 180780
gctgggcttc aaattccagt acccactgagg gaggtcacia ttgttggca ttccagtcc 180840
aggctgtaga atactcacac atatatgcat gcaggcaaaa taccaatgca cataaaaata 180900
aatgaaaaa attaaaaatc aaagaaaaac aatctcatt tggcagtata tcccacaaga 180960
tgaacaaatt ggaacacatt atctctgaaa ccaaatctgc agtctctatt tttcttgatt 181020

acttgattgt gagcaccatc cttttagctc actacatgag agattggata tattatgatt 181080

ttctctgcta ttccttacta cattctatca gtattcctta atttctgtga gtcttctgat 181140

aaaattactt tatggacatc catagtaagt ttccagtgt cctgcaagtt ccacggact 181200

tactgagtct tccacacttg tgtagagaa gttaccacca ccttatacct gtgtccatcc 181260

tttcttate atctgcctta accatgttaa tcttacagga tgaagtaact gcattatc 181320

acaaatatte aggtgtttta cactatTTTT cctctgtact actgtcagct gttatttgac 181380

agatgtttga gagtccatc ttataattt tctctacaaa gatctatgca tatataagct 181440

tatatgattg tcagtgaatt ttcttgttcc tagtaaatca tcttcattta tatatgagca 181500

tcttcattg ttcaatata tttatctctt ataaaacaac atatagtaga ttaactagaa 181560

taataagttc ttcataaagc acagaattgc atgatgaaag ttaaaggaaa ataaaggagg 181620

ggtggaataa gaaggggaaa gcataaaggt cacttaaaaa ggagaaaagt aagagaagta 181680

tggatataca cagaagagta cagagtatgc catatgcaag catgagaaaa gtaaccatt 181740

cctctgacc atctttgaac agacatcttg gaatacctgg attgcaacag ataattagca 181800

aagtcaggga aattttctag ataccttag agtttaaatc agaaaagatg gttacatctt 181860

tataagcata ttcagaaag gatgattttc tctacaaatt caagtgtgtt attaaagtca 181920

gttgataaga atttgaatc aggaacagtc ctatgctggt ttcccagcta tcagtctgag 181980

gtcctcctct gagcaacctc cttgttcagg tgagctgttt ccatcctggt cctgaccctt 182040

ttgctcatca ctctcctc tctgaaactg cattacagag ctcaccttgt tgtttagctg 182100

ttagtgactg ttcagacca cctgaggatt tcagtttga ggtctgggca atctatgggg 182160

cctctggtag tggataagta tttatccctc gtacatgaaa gactttggga gccactcca 182220

caaagaggga tactctctca acctagacac atgggggagg gtctaggccc tctagccctt 182280

atgacagact tttagattc cccatagaag gtctcaccgt cctggggag caaaaaggat 182340

ttgggatagg ggttgggggc tcaggggagg aggggagata gaaatgtgat tggatgtaa 182400

aagaagcttg tttctaattt aaaattggta ttatttcaat tattaataa aaaataaaca 182460

ctatagcata gttcagataa aaaaaagga aaagaaaaac aaagcaaaaa caaaggaatt 182520

tggaatcagg atatcaaaa tatacagaat taagcccaa catttggcat taaattgaaa 182580

tcagagcac aatcaaagag aagctgttag aaaattactt gcatgtacat gaggacatg 182640

taaaatgcat ttiactggtg tttcataaat gggggaaggc tgaagagaga agacaattta 182700

aaccttatct gnnnnnnnnn nnnnnnnnnn nnnnnnnnnn nnnnnnnnnn nnnnnnnnnn 182760

nnnnnnnnnn nnnnnnnnnn nnnnnnnnnn nnnnnnnnnn nnnnnnnnnn nnnnnnnnnn 182820
 nnnnnnnnnn nnnnnnnnnn nnnnnnnnnn nnnnnnnnnn nnnnnnnnnn nnnnnnnnnn 182880
 nnnnnnnnnn nnnnnnnnnn nnnnnnnnnn nnnnnnnnnn nnnnnnnnnn nnnnnnnnnn 182940
 nnnnnnnnnn nnnnnnnnnn nnnnnnnnnn nnnnnnnnnn nnnnnnnnnn nnnnnnnnnn 183000
 nnnnnnnnnn nnnnnnnnnn nnnnnnnnnn nnnnnnnnnn nnnnnnnnnn nnnnnnnnnn 183060
 nnnnnnnnnn nnnnnnnnnn nnnnnnnnnn nnnnnnnnnn nnnnnnnnnn nnnnnnnnnn 183120
 nnnnnnnnnn nnnnnnnnnn nnnnnnnnnn nnnnnnnnnn nnnnnnnnnn nnnnnnnnnn 183180

 nnnnnnnnnn nnnnnnnnnn nnnnnnnnnn nnnnnnnnnn nnnnnnnnnn nnnnnnnnnn 183240
 nnnnnnnnnn nnnnnnnnnn nnnnnnnnnn nnnnnnnnnn nnnnnnnnnn nnnnnnnnnn 183300
 nnnnnnnnnn nnnnnnnnnn nnnnnnnnnn nnnnnnnnnn nnnnnnnnnn nnnnnnnnnn 183360
 nnnnnnnnnn nnnnnnnnnn nnnnnnnnnn nnnnnnnnnn nnnnnnnnnn nnnnnnnnnn 183420
 nnnnnnnnnn nnnnnnnnnn nnnnnnnnnn nnnnnnnnnn nnnnnnnnnn nnnnnnnnnn 183480
 nnnnnnnnnn nnnnnnnnnn nnnnnnnnnn nnnnnnnnnn nnnnnnnnnn nnnnnnnnnn 183540
 nnnnnnnnnn nnnnatatata tatatatata tatatatata tatatatata tatattaaaa 183600

 ctaattctat atttactga aaaatttta cctagtatga aatattacac agttccttga 183660
 tgacatgggg aacctgaaaa tgtatattta gggtcaggat ccacaatac atattttaag 183720
 ttatttatac acigtaagat tatgtatgtg accattgggt cttcagactt aaagtgattt 183780
 aatcctaaga acaacttctc acacctacag agtttgcgct gttaatgac acagacagta 183840
 gagtcattta tgcaatcaat gaacagtgtc tttcaaaga atatgcttct gaagtcagta 183900
 atttgatgg aagatctttg cttctttctt agattctatt tggacattgc aatgttcata 183960
 tacattttct cacctttaat tggaaagttt ttagtttagt taaacagtgc acattaaagt 184020

 acttactaat ctttagtgaa acatttttaa atatattat tttattttat gtgtatgaag 184080
 atttgctct ctatgtgcat ataaagcatg tgcattcctg gtgcccaagg aggacagatg 184140
 aagatgtgga taccctggta cttggttctg gggttacaga cagttttgag caactctggt 184200
 gatgttagga atcaaactg gatcctttgc aaggacataa tttccttaac cactgagata 184260
 gctctccggt ccattttgaa acattttgaa tcgactaagt ttattttaca actacaaca 184320
 ccaaagcaga aaagaaaggg atttaactt ctcagatttg ggatttgcct catttagctt 184380
 ggaggttaagg atccatttta tctattaact ctatctagtt ttcaagtagg atgttgttaa 184440

 ggtaaagtgc atacattcag caaaagccta gataaaaaat aaaagtttat cgaacattaa 184500
 gagtttgaaa atagcttgga ttaatgatca acatatectt tttcagatgt tttatttacc 184560
 aggagagtct cataacattt tatcttttat tataagttat tatctcaaat cctcaatgga 184620

aataattgat agacaataat ttgatgtttt tataatagaa acaaattcct ttgatgacta 184680
aaattacaga acataaataa caaaggcaaa tgattagaat catctaattg tttctattta 184740
tgcatttatt ttgagagtca gaaaaagaca gctaaattgt tgatatttat ttaaattccag 184800
ggaagatagt tctgattaag aaacaacacag ttgtatcaaa gataatcaag gaatatttta 184860

aacatagaa caatatacag catggcaata tagttcaatg attatgagca ctgtctgact 184920
atgctgagga tgcgaacttg attcaccataa gtgatagagt gcctnnnnnn nnnnnnnnnn 184980
nnnnnnnnnn nnnnnnatct gacttacaca gagtatatgt tagaagttag aggggagcat 185040
atggaagggt tggttttcaa gtaattttga ctttcacatc catgaaaatg ctatccctaa 185100
tcctgatagt tttagcattt aagataatgc aaagtactga tgtacaaaa cgcttcacat 185160
ggagtcccaa aagaatgttt tatatattat aaacacacac acacacacac acacacacac 185220
acacacacac agacacacac acatatatat cctatctccc actaacata aatgctccag 185280

atggtttcat aaaatcttg tatcatatat gtatgtgttt gaacatatgc ataataatgg 185340
taagaataa cattaatgtg tgtgtactgg tgataggac tttactattt agctttcaca 185400
gtgggtacat gttgactaaa agaaagacaa agacacatgc ttagaggcca cataactctg 185460
ggatctttat tttaggcata caatcaatca taccattga tttttatcat agtacacact 185520
tgatgtgaaa tagaaatttt aaaatagcag tgggccacat gtctgttcca atcatataca 185580
ggatttcctt gttgatgact gttggatagc aggaacagct gtaagacaaa gagactaaca 185640
cctcattttt ctttaaacat ttgcttatag tggagtataa gtgggtctg tcgtttatct 185700

atttacacaa agaaataataa tggcagacag aaatagagcc atcagtgggt tggctacatt 185760
ttcagttttg aattagtaaa gatgcttgag ttgtgtatat ctccatgaca gaagagaatt 185820
tttaataat tattcgttcg ttttcataat ttcaaatcct tacaatactg tgccttaaga 185880
aagatgtgat cattatattc attttataga tgaaggtttg aatatacagt gcagttaaga 185940
gactcacaca cacctggcaa actatgaaca tggggcttgt taaatatacg aacactattc 186000
tgtaatggct ttttttttc ttttctatta tagcttctc aagattctaa agtaattcat 186060
gaaaaattcc atttccatag agtgaaaata acagccaacc caaagtaatg gaacagcaat 186120

aaacactgac acttatafat tgctatagat ttcccaagc acttcaacaa acattaaaga 186180
ctataacatt gctaaattgt tggctgcata gatttggtac tataagctta cccaattctc 186240
agctttgaca ggaaaattaa ccttgaagcc agccagtac aaaagctctg cccttctgtg 186300
ataaagtgct gtgttgataa tgttgattg tagacacaca tcaatagcta gggatatact 186360
gtgaacacag tgtgaaatca gaggtaggta aagagttcac accctttgct atggaggaga 186420
cagcaacccc acaaagcaat ggctttcatt ctactgcat atgcaatttt ctctgggaat 186480

tttaggatgat ggaaaatgat aaatattgaa tgtaatatct gaataacagg caaatcatga 186540

 aacaagtatt agcagaaaaat gctactaata ctaacactaa acaagacatt agagtaatgc 186600
 tttgaataaa aaacaataat gttaatgata atgatcacag ttaccattgt tattaatact 186660
 attatgatga ctctgttat aatggcattt aattatttat taagggtttg ctagagactt 186720
 tgctaagcat ttccacataa aatatattac tagattgttg agacagtcca ctgatttgca 186780
 tgtaaacac tttaaaactg aaatTTTTtag tggagttaaa taatttactt aaagtaagga 186840
 ggaaagtggg gcaaaatttg attaaaacca agttcatttg cctgtgactg gagagtgttc 186900
 tcaaagacct gaaattatgg aaaagcaagg tagccccctt gtatgctaca tgccccctcg 186960

 agttggcttt ccctgagtac ttctgcctca atatcctgaa tggaatatta ggcagggtgc 187020
 ctgctcacc ttgatcacta gaacacagct ttataattga ccttttttct ttgcaattgg 187080
 ctgatagaga tacacatata ttattactta cttttgaaat tgttcttaca aaatatccac 187140
 aaaagcaacg tagctgaggt ttctattgct ttaatggaac actatgacta aaaactatgt 187200
 tgggaggaac agatttcttt cacttactct tccaatttca ttatagaagc cagccagtgt 187260
 aggtcaggtc ctgaagtgga agccatgaag aagtacaaca acatattcct ttctttgcaa 187320
 gcctatctag aggctcacat gtaccccaga ggctcatctcc tacatgatct taaatccagt 187380

 catgttgact attaataatc agtattactc attacaaatt ttttgttcat tagtcaagat 187440
 gcattcagtc tcattagact agtcaactcc tccagtgtct ttctttcttt gaactttctt 187500
 ccttccttte tttcttctt ccttcttcc ttcttctt ccttcttcc ttctttctt 187560
 tctttagca tttgaacttt aaactgctaa cagattcttt gacatcac taacgcaaca 187620
 agtatttctt gggaatcatc cattcaaaag aagaataaat gagctgggtc ctagaattgg 187680
 gtacttaaat gatattagaa ttaagtcat atttgtaaaa atccaagatt ttatgggtac 187740
 ctggaatgaa tcattataat tagacagtct tgccttcttg cttaccatta tgataataac 187800

 aatTTTatat tctatcaca tggctttaat ttatccaat ttcacaacca atggaaaacc 187860
 tgagaatgtt ttacattgt aagtagttta ttgtcattta ttaatgtgct aacactactt 187920
 tcagttccac tgaactttat ccacaagctt ggattccaga agagctaggg agtttattca 187980
 aagtggcaga aacatgagaa aatcagatg gatttatctc aggaagtttg gtgcaaatag 188040
 tgactgcaga gtaatctcaa ggagttgaac ttacagcaat ccaaccacta tctttggaca 188100
 acttgcaaa ctttaagtta ttgcaatagt tttacaacat atatttctgc agtcaagctt 188160
 cagttctgat atactgacta tgagacccaa taactggcct aacatgaaat tatagaatc 188220

catgaaggag cacaaagtaa cagttatagg tgagaaagta gtagaggat gccatgtaac 188280
 ttgatttttc catttccac tcaactttat ttttctgta tatagagtat catttaccta 188340
 cttaatctct tcttactgga ttcttagttc ctaaataata gaaaacttaa tgttcagtg 188400
 taaaaaagta tcaccattag taaatacatg agttttcatt ttcctctata aaagaattac 188460
 catcaaaaaa cagagaaaaa ctggaatcca ggaattgtgt ctcaagtact ttgtgctgtg 188520
 aatggtcctt tatctaattg aatattttctg aacacactct tgagaagtga attgccctct 188580
 catgatatta cgiaaaactg aatgaaaagc taagtagact taacattatg aaggatgaca 188640

 aattttcata ataagaaata ggaatgtatg atatgttgtg acacaaaaat aattacagtg 188700
 taaaaatata ttgggttga aagattgtga tacagggaga aaataacaaa aataactaag 188760
 ttgtcagaaa atgtagaagg aaaaagcaag caatgtatac tgttttattt caagagtaaa 188820
 atgaacaata gagaatcatt gagccaaatg tattgaatgg gtgggagcga accaaaagaa 188880
 aatagataaa tgggaagatc catcaatagg agcacaatct cgctgttgac tgaggccctg 188940
 tgtaaaaaca aacagagaaa atagtgttaa ctttctaact ttggcgtgac atataaaaaa 189000
 ggcagaaaga attgccataa tcatgtcttc agattgaaag aatctgact gcctatcaaa 189060

 tgaaaggttg tagtcttgtg aaagatttga ggtctttaac tcacacactt aaactcaaga 189120
 gtacagatta tactatctag cacagtgaga cacacaatag agcagaagca ccaacaaaat 189180
 cccagtgtgt aaatctgcac ttctttgagt attgtattac aagtgtgtat gtgtgtgtgt 189240
 ttgtgtttgt gtgtgtgtgt gtgtgtgtgt gtgtgtgtgt gtgtgtgtgt gtgtgtgtgt 189300
 gagagggaga gagggagagg gagaaagagc gagagagtga ggcgagggtg aaggtgatct 189360
 gtgccttcca ttgttttgc agatatatat atatatatct gcaaaaatat acagcataca 189420
 aattcctggg ccgcaccctt gatcctgctt ctaacgaggg actgtttgtc gacaaggctg 189480

 ccaggtaata ctgatgtctg tggttctata cctcaagcca gttctttctt ccctatgttc 189540
 tggaaataaa ttcagatttt cagacttgat tgcaaatacc ttcactcttt gcctactgac 189600
 ctttccatt gaatatagct atgatatttg tacctaaggc aacgtgggaa ttctctgaaa 189660
 tacaatgact ggtctttaat tgcctgggtt ggaggatga tgtagtccat gtaggacttc 189720
 ttgcaacaat ccaatgcata ggttgatcct aaattgagta caaggaccaa gagaaatgca 189780
 tcattatatt ttcataatgc aaatttaaata gcaatctaga ttacataatt tttatggatt 189840
 tgacacgcag caaagaaaag agatatatca tacacaaatg gatttactta gaaataaatt 189900

 atattttatg tgatgtgaaa gcaatattct ctcatcgttt aagctaattt gagaaacaat 189960
 agcagtgata aaaagtgata tccacctcac tggtttttat ggaaactata atgcatgtaa 190020
 aagaatgaca taaattataa cataacttgi ttgtgtgtac aagataaatt atctcttttg 190080

ataactatca ggccatatga taaaggacat tttatcatc gtatcttggt ctttgatgaa 190140
 aaggagtatt taaattgtac tgcagctctag ctacaattag ttaattaaag tagtatttct 190200
 tctttgtgta tatgtgagag atagataagt gggctctatgt gctagtcaca ggacaatgct 190260
 aggtgtctcc ctcaattgct ctctacacta tttactttcg ctaaggcact tatccctgga 190320

 tttagaattt acttatttgg ttgactgtct gtctctgttag ccagttctgg aattagaggc 190380
 agatggttct gaccctagtt attacctagg tgctgaggat gaattcaagt cctcatgctt 190440
 gtgtagcaag cactttatgg actgtgtcat ctctttggcc tcatggcagc agcctcagct 190500
 ttcactattg actgaatgga aggacttaac tcagcagatg tctttcttgt ggaatcctag 190560
 aaaagagctc taaattttta ttttcccttg cttgcattat atgaagatgg cagcatattc 190620
 tgataaatat gcaaccaaag agaggtgctg agttaacaag aagtgcacca gggtgcctt 190680
 tcccagatct tactgcagta ttaaggtttc ttggctctat taatactatc tcatgatgtg 190740

 tgattaagtg gcctgtttc aagattttct tcaagcttac acagcatgag tgtcagcctt 190800
 accagaatta tgtaagaatc aggtaatttg cgtatcacia cactgatatt ctggctgag 190860
 tattacagt acgcaattat ggatggcaac aggcagctaa agagatttca taaacttctt 190920
 aattcttttg taaagattta ttttactttt taatgactgt ggggtctttg cctgaatgta 190980
 taggcacgac ttgtatgctt ggtgcctgca gatcctggaa gagggcctca gataacataa 191040
 aactagggtt agagatggtt gtgagctgcc atttgtttgc tggaaatcaa aatcaagtec 191100
 tttggaagac tagacagtat tcttaacctc tgggcctcct ttccatcca attactgtc 191160

 tttttttca catctttgcc tcaatcttat ttttctctta ttgacattag atttttctca 191220
 cataatatac tctgattacg gtttcacttc cctcttgtct ccctagtttc tccccacatc 191280
 accttcttc cagagctatc cccattctat ctctcatttg caaacaaca ggcttttaat 191340
 ggataataat aacataaaac aaaacaata aaagaaaaag aagcctaaga aaaaagcacc 191400
 ggaaacatat agatgcagat acactgatcc ttacaatcag gaatcccatg aaaagcaaat 191460
 gtagaagcta taatatatac aaaaaaagaa cttcaggat aaaaatagag gcaaggaagc 191520
 ttcaaagata ctgctgttat ttttgtttc ttttggccat atactgctgt gcatgcaacc 191580

 tacccttaag agtagtttgt tcctccaggg atactcttcc cttagagaaa actaaatttt 191640
 catttgcaag tgtttatgaa ttgaaagtag ctctctgatt tacaatgtcc agttgaattt 191700
 ctttagtctt gagaaaatgt tgaacagtaa cttaggggtt gaagagtaaa attaggagca 191760
 tttttgaaca tctatatgta ctgttctgag tattctcttg tctatattag gctgttttga 191820
 gatttctctt gccaaaggaa ttatacaatt ctcttcaacta cagcctcagg cagacccttg 191880
 ggacaaggtc aaaaaagagc gactttctc aaaagtatct ttaagcatga tcttaaggca 191940

acatactaaa atttttatc tgaaatctct tgagacaggc ccctgcattt caaatattcc 192000

atgatcctac tagtatgtct tattaagtct tgtttaaagc ctttactgt tttcttaacc 192060

caaagtacca aaatccaaat tcttccaagt agaaacattg caggcctatc tcgaaaataa 192120

cacaatcctt ggiaccaact tctctgtctc aggatttctc ttgctgtgaa atgataccat 192180

gaccacagca actcttaata aggaaaacat tcaattcggg tggcttacag tttcagaggt 192240

ttcattcatt atcatcttgt gacatggtgg catgctggct gacatggtgc tggagaggga 192300

gttgagcgtt aaacatctca attcacaggc aacaggaagt gagctgtctg tgtccatgct 192360

ggacatagct tgagcacagg agacctcaa gcccaccccc acagtgcac aatttctgca 192420

aaactataca tactccaaca aagccacacc tccaatagt gcctctccat atgaacttat 192480

gggggggcaa ttacattcaa attaccacac aggtatttt gttttcatt gctacataca 192540

tcaggtgcc tggttccctg cataccaggg atacttctat ctctgccctc catcttttca 192600

taggggatta cagggatcac agacagggtc tactaattgt gaatttatat gggctcctggg 192660

catctgacct taggtactga ttcttatgtg gaaagcaatt cacatacaga cccatttcca 192720

tttgttctaa cttgtaactt ttgatacaga gtaaaaactg gggaccacaaa ccacgaatct 192780

agtgaaagac agttgagtgt tttgaagtgt atgtgtacat aggttgacat ccttattagc 192840

tgtttcaaat atcaggtagt tggtagcagt gaacttttag cattctatca agatctgcag 192900

tgcaactcta ataaaaggag gtcagattca ctcaggctcat agagattcca acaacaaaac 192960

agtcaaggac actgcattac cttactttct attgctgtga taaattacca tagcataaag 193020

caacttgaag aatatagtgt ttatttcacc ttacagtta tactgcatta tgaaggtagg 193080

tcaggttaag aacctggagg tagaaactga agcagatata actgatgagc aatgcttatg 193140

agcttgcaaa ccatggcttg tacaacctga tttcttgtag cacccaagac caggggtggc 193200

actccccacc ctgtgatatg ggtctctcca tatcaatcat caattaaaag atgcctaaa 193260

gatttgcta taggacagtc tgatggaaga attttctcaa ttaaatttc tcttcacata 193320

ttactctaca ttgtgtaag ttgacaaaaa ttgctaagca acagagatac agtagagttg 193380

aaagtagagt tgaagtggtg agggatcaac tgaaaattca taacctctgt aggttggact 193440

tagtggtttg ttattgcagc ttccaagggg agaggtacaa caaaagaatg aaagaagctc 193500

ctggcttgtg acttcagaga gattggcaca tgggtgcata gaaaatttgg tctttaagtt 193560

aagtgttga taaaaatag aattttttt agagcattaa cctgccactc gtgaaattta 193620

tctgaaagag aagcatgata caaatgctag tttatcagta tgttatttga cctttccaac 193680

aaaaagcata tcigtaccaa aaatactaaa tccatttaat atgaattccc tgaactatgg 193740
 gcaccaataa ctgagccata ttaatgtaag tggctaaaat ttgcaaattt tgctatatgt 193800
 gtttattaag tagtaaaacta ttttaaggta taatttcctt ttatattttt tccaggatcc 193860
 atgtgtttgc atttaatcaa gaattgccaa ctctaactga atcttacaaa agatatgttc 193920
 agttgagatt atgatgttgc cattttgtta atgaactcat ccaattcact aattaggaca 193980
 gaaattcaag tattatgcc a ccttaataatt ttttataatt tatgttatct actgtataaa 194040
 aatcttcaat gtacacatca agaaagggca tttttggatg tcagcactaa ggagaacctg 194100

 gacatatgcc ttcateccta acctgaaagc tattgccaat tgataatacg aggaaagtta 194160
 ctttctccaa tgaagtctca ttgggtatgc aaaacacatt taaggagagac cccacaccca 194220
 gcagtaaatg gccaatataa aatggatata aaagtatttt tagagatgtt ttgtctcata 194280
 ttgctttgct tgggcacttc ttttccaagt tattgttttt tatttaaaaa gaacatgttt 194340
 agttttatat cccaatctca ctccttctcc tgcctccac ccttctcacc ctgatccact 194400
 cctcagaggg gtaagaccgt ccttggggag tcaacaaaat ttggcatacc aaattgattc 194460
 aggatgaatc cctccctgc tgtatcaagg ctgagtaagg tatccaacca tagccagtgg 194520

 gctcccaaaa agccagtta tgccttcag tacttttaaa ccttaattgc tgattttca 194580
 gttttataag ttttttgtgt gtgtctttgt gtgtgtgttg tatttgtgca tgtgtgtttt 194640
 gtgattttta atttttgtt ctctctctcc ctccctccct ctctctggat attctatcat 194700
 tggcctgttt ttttcaaag ttgaggaaga aagcttgaaa ttggatgggt gtatggggac 194760
 tgtctgagag gaaatgaggg agaaaaact gtgatcagaa tatattgcat gaaaaatatt 194820
 ttcaataaaa agtttaaagg atacagaaac aaaaagaggg aatgttctgg atattttct 194880
 aacaattac atattglaga agatgtaata tttccactgt tcttcagttt tgatggggca 194940

 gatataattt atttgtcaat gtagttgaca cctaacaaat aggcatat 195000
 cactgtacct gagactaaag tgcttattct aactaagag gagagagcaa attaaaacta 195060
 aagacaaatg agttaaaagt taaaagttaa agacaaataa gtcagaataa aatgtattg 195120
 attgccacca ttccatgtgc aatgetaata tcttcaaacc tgtgccaact gecctacaat 195180
 tacatgtctg tattttaatc tctaagagat tcataactct aactggaaac aatcctcac 195240
 atatcctaca atctcttcc ccccttgata acagacttca gtcacagaag ctattgttg 195300
 caacttgctt gaaagattca aatgaaatga cacattgtga gcaaccctt gttcaagtca 195360

 gctgtttctg tgggtttctc cagccaggtc ttgaccctt tgctcatcat tctctctct 195420
 ttgcaactgg gttccagaat tcagctcaga gtttagatgt ggggtgcttc atcagctact 195480
 ggatgaaggc tttatgacat aaaactttat tttgcattgt tacagaagtt cataacttga 195540

caaattatta aatgcttaag tcctaacatc tccatataaa tttgccttcc caaatagtcc 195600
 tcacctacac ttgttgatt aattgtaagt gattatgaga cctagctttc ccatattctg 195660
 aaagctataa gagaaagtgg aagcatttta aaattatfff gatgagacat ctaaataatg 195720
 gaaaggtttg caaacacata tacagtgcac aaccccagcc ctagecctaa atcactcttc 195780

 cattgctggt agtagtaca acttataaaa ccacttagaa aatcagtatg atggttcctt 195840
 aggaaaattt gaatcagctc accacaatat ccagcaattc cactcttagg tatataacca 195900
 aagaatgcac atcatccaa caaatacatt tgttcaacta tgttcataaa aacattattc 195960
 ataatagcta gaacctggaa gaaaactaga tgcccctcaa ctgaagaatg gataatgaaa 196020
 atgtggtaaa ttiacacaat ggggtactac ccagtggaaa aaaaaatgga atattgaaat 196080
 ttgcaggcaa atggatggaa ctagaagaaa ccacctttt ggaaccaatt cttaagaaa 196140
 gtcatttaaa atgacagttt taaagtcaaa aataaaaggc aaaagtaaga gaagaagata 196200

 catcatctaa taaatacag cacaagaac aatgcatagt gaaaatagaa aataccaat 196260
 ctaaatacaca gacacattat ttaagtgata atcataacat gcagatcaa ataataatgtg 196320
 ataacaagaa taataacaac actatttaat atttatatga accttaatac ttgattggaa 196380
 ctatttgcac tcattgtatc atttacctca ggactgctta gtgaaatggt tgtgtcatta 196440
 tcaattccat cttaaagaga agatggagac agatgaaaaa ccatgtaagg agtggagcag 196500
 ggtttgcaat gccataaag atttcaatct catgcagcat gattcaggaa ctgaagagaa 196560
 ataatttacc cacccaagc aagagatgta taatcaaca aaaattgtac tagagatgga 196620

 aaaatatgtc agtagaaaca tatgatftaa tttaaaaagg caggggcaag cagaacctac 196680
 aactcaatta catgaatatt tagatcttca atgaaataat taaacattct aaagttaaaa 196740
 gaattacac atagatattt aagaatgaga agaattgaga acaataaaat gtagaaaatt 196800
 tattattata catttatcat ataaaaataa aaataaataat gaagtctcag gggatftttt 196860
 gatttatfta attataatgt acacaggttg gattcagagg atgctcagca tataccaatc 196920
 cacttccaa gaattaactg taattatgaa aatagcatac tftaatccta tctttctct 196980
 ttcttaactg ttcttggtct tccctatctc ccagcttage caacttcag tctttttct 197040

 cccttgact ttcctgacc aaaaaaaaa aaaatgagtt gacaacagaa acctaaatag 197100
 aaaacaacca ataagcaaaa gaaataaata ataaccata tagaaacaca cacacacaca 197160
 cacacacaca cacacacaca cacacacaca cacacactg cacacacaca cactctcca 197220
 cacatggaat ccaactgtata ttggtcatct gctcctgact gtggggacta cactaactgt 197280
 ggataaaaga gtgagaagt gaaaaactgt gtccataaata ggatgtcttc ctcaaacccc 197340
 tcgatagcca aggttcacga atctatatgg aagaagaaag tgaatgattt tatgaaccag 197400

aagttgtaga tgaatcagaa aaaagtgtca tccagacaca acaggccgga tacacatatt 197460

aactcagtca ctgtgacagc acataccaga cctccacagg ttccaaccta gaactgtaat 197520
ttaattgtaa cagaattata agtggaatca ctttcagttt gtgctcattt aggatactgt 197580
tggttatgga attttattat ataataagag ctatatagct cttcttgaat tcagatatgt 197640
tctttctata ttgtcttaga gatttcatca tcagggcacg gtgaattata ctgaaaatat 197700
tttcaacatt gtctgtcaaa aatcacatat ttgggggtgt tcattctgct gatgtgatgt 197760
tattatcttt atgttcatct aatgaactat ttttctatth ctatggcaat gactacatgg 197820
tgatagcata tggacttatt atttgtttgt ttgggggaag ggtgtgtgct ttgggggtact 197880

caggtaacac agcacatctt ttgagatcag aagacaactt ctgagcctgg atttctctt 197940
tccatcatgt tggttgctga gataaacactc agggtttcag acctggcaac cagtgtcttt 198000
actcactgaa ttgtctccgt gcttccatat aatcttggag tgtgttgttg gctttgattg 198060
ctaactctat caaatgttt gaatttatcc tcctataggt tattgatatg gtgttatttt 198120
tgtcttgatg tctagatacc attggcatca gacaaactct agactacacc aaaagagttc 198180
cccttttggg tcttttagaa tagattgaaa atacttagtg ttctgctgt ctagagttha 198240
ggaaaaatct atcactgaac aggtcagggt cttgatttat ttttcttagg aaaatttatt 198300

ttgttctat gggggaggtt ggtatgctgt ttgtgggga gagcatgggt gttgttgac 198360
ttgtggtagt caaagaacaa ctttcagtaa tttttcttt ctttactact tgttgaagta 198420
gtatgtgaac ttctgggta gtcttaaac tctctgtggt cttcccaaag ttctgagact 198480
gcagatatat cacacatag actttataca tggtttctgg ggattgatct ctgaccctca 198540
ggtttttgtg acaaggtttt ttatttgaag catcatgcca gctatcataa agtaatattt 198600
gttatcagtt caatcatgac atctttgttt ggagatcct ttctgttagt ttataattat 198660
tcaaaagaat tccaacgat tttctagatt tctatggtgt ataagatgag ctaatcatac 198720

cagttaacag aattctact ctgagagtga ccatattcaa actcattcca acagcacaaa 198780
ttttactgtc taatattttt atgtcagtga gtaatttctg ttacatggt ctttacttca 198840
acagtttgat ggatatacct cttaccatt tcttagttgt tctatccaga gtgggcaatt 198900
cttgtcattc ctaacatgtt tcctcagaag catatcaaag tttctctcat atgctttaa 198960
aaatacgcag gaaaatacaa ccatgtgtgc gtgtctgtgt gtgtgtgtgt gtgtgtgtgt 199020
gtgtgtgtgt gtgtgtgttc aatttvtgaa agaatggcaa tttttttatc tggtgatttt 199080
tgtaatagaa acatattaat gctatcaaaa ataagtacca cacattccac tctctttaga 199140

atggagagta tgatgtaaca actcaggtta ttgtttctaa aatgaagatg ttttagatat 199200
gaagccatca gtcagaagat ttagtgacac tggagatatt tttgtagact gtttaagaat 199260
gaacatctgc taagacaatt gcaaaaattat gccaattttg aaatttagct ggcttgttct 199320
gatgttgaaa atgtttagga agaggacttg accatgtgtc tgaaggctga tttgctagat 199380
aggtacaaaa ttttagaatg tctaaatact tcatagtgtt atttctaatt acttttcaac 199440
athtagtcca taattgaatt ttacattaac ttttgctttg aagacttgtg ttaggatatc 199500
acttacctta attattatth agtagctcat tagatcttgg cctctgattt atatgaaaat 199560

atthaactta tgtgaaccac attgctacca atcatacaat gcaacaaata tttgtaata 199620
taataaagga tgaatagtca gtcattaat cttctgatta tttgaggag gaatataatt 199680
aaccatthtt ttatctgtca gagacaaggc cttttatgaa agtctactca tgtttttatt 199740
gacagtgaat tccttcgggtg cccttcagcc ttttactgc cctccattht caaattatc 199800
caggatthta gaatcttaca gaactgtcag attgacttct gtgttcaaaa tggatgatgg 199860
cagtacaata agcaaacatc caaacaaaa caaaaattca aaatttcaa aaattataag 199920
atthaataac tataaaacat tttgtttatc tcccccttht cttttctct tccaatactc 199980

ccatgtcctt tctcttcaat acatcccatg atgcccttcta cttactctta attccattgc 200040
ttatttgtca ttgatatatg taaccatgat aatattacat gtgcccatcc cggctgggtt 200100
cagcccagcc agagactgtc agccaacacc agagtccctt tctctgcca tgggatgaga 200160
taagcttggc ctatthctgg ccaaacttgt ggtaccatgt tcagagacac ctgaggcctg 200220
gggaatgtgt gctgtggatc ccatccagcc cagccagaga cttccagcca gtgccacagt 200280
ccctthctct acacatgaga caaggaagag gcgagccaac agagtattgg agttgcttcc 200340
acacaccaga agggaacctt gggctctgtc ctaccaggag aggaagagaa tccttctgca 200400

accacaggaa gaagagatgg gaagaagaca atataaaatc atattcaaca atagaaaaac 200460
caatatgtca tcaccagatt ctaccacagc aagatctgta catcccaatg aagatgaagc 200520
agaagagaag caccttaaaa acaacttgat gacaatgata gaggcctca aagaggatat 200580
aagaaaatcc cttaagaaa tggaaagaaa aaaacaaaca aaaataaata caagaaatca 200640
acaattctct taagaaagc caagtaaaa tcaatcaaac agatgaagga aagagatcaa 200700
gacctgaaaa ctgaaaaaga gacaataaaa aaactgaggg aatgctggaa atagaaaagc 200760
tggaaactaca ggaactacag atgcaagtat aaccaacaga atacaagaga tgtaagagag 200820

aatctccgtt gttgaagata caataagaaa aatagattca tcgaccaaag aaaatcttaa 200880
atccaacaaa ttcttaaac aaaacatgac aaactaaaga aacacatgcc aaagaaagta 200940
caaaaagct tacagaaaac caaatagaat tgaccacaaa aatgttacct catcacataa 201000

taatcaaac tccaaaacat agagaataat gaaagaatat taagagcatc taaggaaaaa 201060
 agtcaagtag catataaagg caaacctatc agaattatac ctgacatctc catggaatc 201120
 cagaaatcca gaaggccctg gcaatctata gggcctctgg tagtggatct ctatttttcc 201180
 ctagtacatg aatggacttt ggtagcccat tccacatagt ctagacacac agaaaagggt 201240

 ctaggccttg ctccagatga tatgactctg aagatcccc atgaaaggcc tcaccctccc 201300
 tggggaagag aaagaggttg gtataagagt taaggggggg caggggagga gggcaggtat 201360
 tgagaacttg gattaacatg taaaaactca tttctaattt aaaattgttc aacttacaat 201420
 aaaaatgaaa actctaatat tatatgcaaa aatattttac atacattata tataatatgt 201480
 gcataaatat aaacacaacc ttgggagttt gtttagattt gcttgtgtgt atatgattac 201540
 agggatgtcc acttggact ggataaccaa ttcaggggtc cattcctaga agaagccaat 201600
 tctcctctaa gtattcatta gttacctgtt gttctttgtc tagaggtggg atgccataag 201660

 atttccctta ctgcattaga atctcaactg atattacat tgctcaggtt ttatttttaa 201720
 gtattaaatt gtattgtcat atcctttaag tgcatgagc ttaaattcta gtcatttcaa 201780
 gaggacagac tctcaaagca gatttatttg tcttcttggg atgacaactt tetaccctc 201840
 ttacgcttc catgatgtt tctcagccta agttatatga atttattat ggaggtatcc 201900
 agtgcagctg cacaaccac aatcagttga cctctgcatt ttgacttggg gtggttttct 201960
 ataattttct cattctgcca taaaggggaag cttaggcaat gagagacaag agctactctt 202020
 gtctctgtat gaaaggataa gttttagaat gcagttagga atttgctga tctaaaagtg 202080

 gcatgggttc tctaatccat gagcctgttg ttgcctaggt ttctagtgtg agacatcatg 202140
 tctccagtt aaatagacat tatgtccaat tagagagggt ttggttactc acaaatatga 202200
 aggctactat tgcactttaa gcaaaagctt gccatgttag tcagtactgt gattcatagt 202260
 tatcaaagtt gcttagggct atttattgct tctctccact ggcaccttgt atagagcagt 202320
 caaaagctaa aactcagtaa ggagctttta gggcagatcc tgtcatgtct tcatgtcct 202380
 gtgcaaaagt gtgtaatgtc tccagaaata aggacttact tactttcaac ctatgagagg 202440
 caacaaagaa cattgacaag tgtctttgct attttcagge tctcttgggc tactcagaaa 202500

 gaaatttctc aaatggcata catatataat gcataatata atactttca tatgatgtaa 202560
 atttattcaa ttataaaaa atgatataat tttaattttg tattcttgtt tgtgaaaaat 202620
 ggagtagaga aagaatgagt gtgtgcaglia tgtatgaatc ccaagaaga ccagaagaaa 202680
 gcatcaaate tcttggagct gaaaatacag tcagatatgg gctagccaag ttgggtatca 202740
 ggaaccaaac tcaggtcttc tggaagagca gacagcactc ttaatcactg agccatgtct 202800
 cctggtecca gttttttagt atacaatac atataatata taataatata tacactgtac 202860

aatatattat acacacatgc aaatgtactg attccatatt atatttaatt aatatgtgag 202920

tagaagatac agttagatga tatactggaa ggtatatatt atggttaaaa ctgaaaactt 202980
ttgttgaatg tatttgtctc ttacctcttc taccataaac tcaagttgct acttgtcaat 203040
aataaattat aagtcttagc ttacaatgtt cacagtgatc agtttcttaa tcagccatgt 203100
tcacaacttc ctttcttggg ttctaagtgt ggataaggcc tcaaacacag cttaaagtca 203160
ccataggage ctttcaaatg acattttaaa ctgtccttca tgtcaaaagt caaacttact 203220
catccttcac ataaaggcat atatagatat gttgagatga ctcaacaacc caatgatagg 203280
ctttctatga gcgataaatc ccattttata ttatgtttaa attttatagg gctaatttac 203340

tattaacaga caggaaacta ttttaactt aatttctac tgcatattga atgtgcataa 203400
aaaagaata tagcaactca taaataaagt ggacataatt gtgggcatgt gatttaata 203460
cactggtcat ctacattctc cttttgctta gcattgctatt ttcttacctt ctctgtaggt 203520
tactgacata ttttaacttt agtatggcca tacaagaatc tatgggaaag atttaagtta 203580
atcattgttt taaaattaac tttctgtttt tcttgattta tccacaaaaa gaggaaaatt 203640
cagtcacttc cacaactgga cttttcttct cccaattatg tacttccctt tttataaaaa 203700
ccactttttg tigtgtgtgt aaggaaactgc catattgtgt tgactcttta gcttgaggaa 203760

tttgcaatgt gctgtacatt tctttccaca ggggaacact gaccttcagt agcaacaag 203820
gttagaggga gaaagatgaa gtctaggtaa tctggaaagg aagataaaca agaataattt 203880
cataggacct cagtccttct atctgaagta actgagttac tgtcatattc cttctttcaa 203940
acacatacac acatactcaa cacatacatt gaaccttaag ttttatcata acacaataac 204000
aatgcattaa atgaacatta tttcctaaac ctgtgtatct cccaactgca tctaaatgcc 204060
cattcttata ctacagata agtgttcct catcccttac aaaagaatct tctttttgaa 204120
gtatcagaaa atatcgaaca cattcacagg cagttacaat gcagagaaca actgactttg 204180

ggttgcccca tccaattga tacatcaaca gctcaagtaa taaacataag gctgatggaa 204240
catcatagaa gagggagcag aaaaattata acatctagag gaccagggca tcttctttca 204300
gatagaattt tctacatata ataagaactt aaactcatga aattttaata atatgattat 204360
ctaaacaaga cctgtaaaat gacaacacca ttgacattt caacctgaat tgggaaaatt 204420
tcacattgcc ccatctctgg atgaagacct aaaaacaatt aatgagtgtc aagaaagggg 204480
taatcagttt tccccaggga taagccctct gatattttat ctaatctaat ctaatctaat 204540
ctaatctaat ctaatctaat ctaaagtgtt tgggtctaaa cacatacca cagaagcaac 204600

accaaatgga gtcagcagtt tgtatttatg tacatgtatc cacatctgtg tgtgcttacc 204660
 aagaataatt aaatcaggag tttccacgag tttgagagtg ggtgcataaa atgggttga 204720
 aggtggtgaa agtggagcag aaattatgta aataccatac aatatgtagt aaattctcaa 204780
 aaatgtaaat aagtaaaact gagtgggtgta tcaactaagc taagacttat gatgaagggt 204840
 ctaaacaga caagtaaaaa aaaaatcata aaatttagac tttgaaatgt ttgtatagtt 204900
 taaagaagaa ttaagatgat taaatgcata cataaaaaac aggagaggtt agtatcacct 204960
 ctgtcagtta tcttataaat ttaaaatfff gcagaaaaaa ttcttctgt tttgcaatff 205020

 taaatctgaa ttatttatta catattttgt cgccattttc aattccataa ttatacaatt 205080
 taaaattatt aaatgaatat agtagctatc cccagacacg gagaagtatg tcttttacta 205140
 agaacaaaag ttcagctaat gatggaatgc agttttgcaa aataatgtaa aagatagagg 205200
 ctctcaacta gaaacaatgc tatatatagt caagtcctaa ttatatgaat ttgaaaagt 205260
 agtcccatgg ttatgaaatg ctcacactta ataaatagaa tgtaatgtat atggattata 205320
 tgcactctggg tttataaatg ctgacaataa gattttgaac tctcattcca ctgttataaa 205380
 atacatgaat tttctataaa gtcgtgtatt gaggatttaa attggagaaa actcattcct 205440

 agaaatgcaa atatgagata agacacaact tacttaata aataatagat ggataactat 205500
 gaaaaatgct aaaaagataa gtctgtatca tgtctgcttg cagtggaaat tctgtctcca 205560
 gtgcagaatg aataaaaagt cagtttaagc agagtcatca cctttgcgag ctacagccta 205620
 ggttctcttc ttaagcgcag tatcctctct ccagctagtc tttgctgggt tccaaaata 205680
 tgtcaatcag tgtgctcgt caaggcacct aggagtccaa atccttagca aaatgtcttt 205740
 gatttcatta aagtatgaa agggaacaca ggcaggaaaa agttgtgtgt ctcttctgct 205800
 tcataatttc atttttatgt tattaatfg atttaacata tgggaatcat ttaacacaaa 205860

 tatgattaat gtgatgaaaa ttgaagatat tacacctatc atagtatatt ataaaaaag 205920
 tggaaactta tggataatat cagtcaactg aggtgtgttt aagaaagaca aggagtcatg 205980
 caataggaac acttcagtta cacctaatat tttgatgatg gtgatagaga agcatgagtg 206040
 ttaaattgct agtcatctta aaatctcttg tatctatcat aatatgttt atgcttcaac 206100
 tgaatataca aattgacttg aagataacat atttttgtat tttacaacta taaatagtg 206160
 tttcttagtt gtccatagtt tcaattaaga agaataagcc cagagatagc ataagaatca 206220
 ctttgcataa atagtgtgag atatttaagg caaacattta aatagacaa aatattataa 206280

 gaaattataa atgaatagaa gaaaatacca tttgcttgag ataaatgcta agaaattaag 206340
 atatacatgt aatgaaacaa aataaaatgc agtttttatt tataaacaag ttgtcattaa 206400
 caataatgct tcaagaatta tctttggatg aatattctgc ccaggaaaa tacaaaatga 206460

aatgatcaat aaacacaaac aattataaga taccctgtaa aggccaatta tgtttatata 206520
ataatcaatt tacaactaac accacagaaa gttcactg ttatgcctgc tcttgtagt 206580
ggagttttaa tgaggtgaat agatttctaa tgaagcaacc gaatttcca ttgagaatac 206640
tgtgcaaaat atctacatat tgacttggaa ttttttcatt aaataaatgt tttatttaag 206700

gcattgatat aaacccgggg taacaatfff ataataatca tttatattaa tttttgagg 206760
aacatagaca gggaaataaaa tgcataagtt catgcctcaa cccaacaac tttattcaat 206820
aatthaaca ctgtttactg atcccctaat ggtattatgc ggaaatgtac tggtagactaa 206880
gtttacagt gaaaacagga cacaacagc caatagtac caacaatatt tagtaagctt 206940
ttcctaggtc ctaggcagac attgttttat tttgtttta ccacaactct gtctctgtct 207000
ctgtcactca gtcacacaca gacacacaca cacacaagac acacacacac acacacacac 207060
acacacacac acacacacac acacacacta tatatatata tatataaata tannnnnnnn 207120

nnnnnnnnnn nnnnnnnnnn nnnnnnnnnn nnnnnnnnnn nnnnnnnncc tttccaaggc 207180
tctgttatca gtcgatgagt tagttaatgc tagtggataa actcataaca gaactccaaa 207240
tttcattctt ctctctcca tactggcctt ttctggaca ttaaagtctg gtgggttaga 207300
aagataaca cagtaagata catgtttcat gttgtcttcc aggatcattg gagagatact 207360
ctagggctag ctgatctttt ttacattaat gttttaatta tttcttgaac aattcatgta 207420
atctatattg acaacattta gtctctgaac attggaattg tatccatgag tgcctatga 207480
agggtcactt ccagtgatt gtagagacct ggtgggatgc tgattgcctt ctgttgctta 207540

ccagagtga ccaagtgggc tcagagcaac ttgtaatcct actcatcct gatgaggctg 207600
aaattcaata atcgatgca ataaaggtgc agctgattac acagatctat ccatgggatt 207660
gtgagcctat ttaaacata cattggaata tcacattctt attcattata atgtactgga 207720
attatataatg atatagtcag tagggaaact aagtgaagt tacatcagac tectctgtag 207780
aattgttca acctgatgct aatgtatctt ttaaacac ataaatccc cacaaaattc 207840
aaaaggaata aataacagg gtgacttttc aggggaggca taccaattg aagaagatct 207900
cattccata ctatataaac tgttaccaa attaattaaa gacaggcaga aatataatac 207960

actagacagt aatttctaa atggatgat tcacatacat aaattgtgag atttgcacaa 208020
cataattagt tattaggaat gtgaaaatta aaatatagta atataggctt ttgtgaggat 208080
gtggagaaat gtgttttctt aaaatgctga gaaaaacaca aacatgtatt acatcatggg 208140
aaataattac ttctttatgt caaggttaa catatggtaa gttattataggaattgta 208200
ctgcagagta tatagctaat agcatttaca tatgctaaaa taaggctacc tgtttatata 208260
cagaattgtg tgatggatat ccctctactg gttattaata tttatcaaag caacttaag 208320

aaggaagggc ttgtttatc cttacagttc taaggcaaag ttcataatga caggagtgtc 208380

atggtaacat ggatatgagg catttgatca catgatctct acagtcagga aaaaaagtaa 208440
tgaatgcaag tgcttatatt gctttctatg ttttattcag ttggggagca cagtccatgg 208500
atgggtggga accttagtga acctgggtct tcttacctta cttaacataa ctttgtaag 208560
tgctcataag tatgtctata ggttggtttc ctaggaaatt aaagattctg tacaaagaga 208620
ttttctate ccacattgaa aatgaaaggg ataattatat ggatattgaa gacagcagtt 208680
ttgaagagag catttgaagt tcactttaa cactggacc taacagttct agaacaaca 208740
ctacagaacc caataataca catcttctca taaagtgtt aatgacatt ctacagaata 208800

gattccatat caggccaca aataggcatc agtattttat tgaagacaca ttttaataca 208860
atatacaata cattctgac ctaatgtatt tttcaaatca tgcaaagtct atgttagttt 208920
tcctttcttc atttttcaca gaatatctct ttgaagccca ggcttgccac cactagagat 208980
tccttggatt ctacctctca aacgctcagc atcaagccta gctaatacaca acaagatgaa 209040
actgggaatc aataggaggg aaaatataga aacacatgac atttaattgg acattctttg 209100
ggccatcgat tgattacaga aagaaaaaaaa aacagttaca aagggaatta gaattacctt 209160
gacacaaata caatcaaagg agcatacca aaccttcata atgtaacaaa ataagcaatt 209220

aatcaaatg tatcttatta aaatggctaa taaaaagaag aaacatttaa tggccacaac 209280
ctatgcata ttataaggca caagtgaact tgggggaaga tgtaataat ggattttgaa 209340
ttaaataaga caattactaa caagggaaaa gatcaacaaa gctgtcttta tttcaaaag 209400
aaaaagaaaa aaactacatg gaaatgataa atatttttt ttcccacaaa ataaaggaaa 209460
tgtacaatgt actatggaca ttcagtgttg ttaatatcat attgtgtgca tcatggcaat 209520
tatggcaaaa tatccttttt gtaactaaagc ctagtcttac tttttactc tctctctctc 209580
tctctctctc tctctctctc tctctctctc tctnnnnnnn nnnnnnnnnn nnnnnnnnnn 209640

nnnatgggat gtgtacacac ggcagtgtgt ctgtggaggt cagagaaggc atctaggaat 209700
cacattcacc tgtcttgga ataggtacct ttattagcta tctctctaa ccttggaac 209760
cctatcttgg tacctttatt cctttattag ctatctctcc taacctgga aacctatct 209820
tgaatcatct ttactggcag gcttttctgt ttctttctt tctttctta gatttgtgtg 209880
tgtgtgtgtg tgtgtgtgtg tgtgtgccgt gtgtatgaat gtatgtagt catcatacgc 209940
atacaggtgc ctggaatgt tgtcaaaaat cctgggtctg gagttacagg tggctgggcg 210000
ctgccacgtg aattttagag gctgaaacc aagtcctctg taagagcaga aagtgtcttt 210060

aactgctgag acatcactca agccctgtga ttcggttttg aatttggaca gggggcattt 210120
taggtagtat taccaatcta cctgtacata cactaccagg tctgtcacag aagccaaaca 210180
acacatatag aatgaaatgt tctcactatg tatttctgta ttattttatg ctaatatata 210240
acataggtaa ttaaaagata gttaaccata ataaataata aatataaaaa tcaactgaaa 210300
tgagagtggc ttgaaattha tgaattacat atccatggaa tttccaactt aatatttttc 210360
acctgaaatg gtcaagaata ctggaaactg aaaaatgaaa ccagaggcca ggatgtggga 210420
ttactcaagt atactagtth tctgtttaa atttggtgag aaattacttt ctgctatgta 210480

tcatgataaa cttttattht cttttccttt tttttattat taattcaagt tagggaacag 210540
gcttgthtca catgtaagtc ccctctccct ctcctctctc tcaactacat ccctctctcc 210600
ccacctcaa ccaatccaa ccccatccac ctaccactcc ccaggcaggg tagggccccc 210660
cacaggggct ccacaaagtc caccgaatct tctgtgtctg ggcctagacc tctccccatg 210720
tgtccagaga cagagcgcct cccttcacat gggatgggct ctcaaagtac cccccacac 210780
acaccatgga aaaacaccag ttcacctccg gaggtcccg ggagtgagg gcctcccca 210840
ttggcatcca tgatcagagg gctggatcag tctgcacta tctcccaga cagcatctgg 210900

ggctgatatg ctttcccttt ttcaggaca ctgtttctgt gggtttctcc aacctgtac 210960
agacccttc gatcttcatt cctcctctc tccaactaaa tccatattt cagctcagtg 211020
tatttctgtg gatgtctgtc tctgttcca tcaactactg gatgagggct ctaggatagc 211080
atagagagta gtcatcaatc tcatctagg ggaagggtt ctaggctagc ctctctcca 211140
ctgcctggac tgtcagatcg tgcatectt gcagggtct agagatctcc ctagtccag 211200
atctctctc agacctatg tggctccctc tgataggta ctttctcta tcttccccc 211260
tactcaatat atctgtctct cctctactct tcttctgtg ctctattgt ggcagcacc 211320

tctcccctac cctcatgtc tcaattaget cgggagtca tgccacttcc cattctgtg 211380
gtttattht cccttagagt ccttcatgtt tctagttht tttggtgaag aggattatag 211440
gttggtaaac ctttctcta tgtctacaaa tcatatatga gtgagtacat accatgtttg 211500
tctttttgtg attgggttac ctcatcagg atggthtct atagthtcta ggttctctc 211560
aggttctggc tattacaaac aatgctgcta tgaacatggc tgaacatag tcttgttgt 211620
atgcacatgc actatthcgg tatatactca agagaggaat ggatggatct tgaggtagat 211680
tgattcccat tthtctgagc aaccaccata ctgatttcca aagtgtctt acaagttcac 211740

actcccacca gcaatggagg agtthtctt cttctccaca cctctcagca agatgatgga 211800
gacctcaaa gaggaacaa gaaaatccct taagaaata gaagaaaaag caagcaaaaa 211860
atgacatgaa atggaggaaa agagaaacca aaaaatcaa gaaataaaca aatctcttaa 211920

agaatctaaa gaaacccaag ataaaacaac caaacaagtg aaggaagctc ttgaaacagt 211980
 tcaaagcatg ataaactttt ataaagtcca aagacttgaa acattttggc aattgaaat 212040
 tggtttcaga gtgtaacttg tagtgagaca ctaaattatt gttcattaag agaccctct 212100
 gagctctcag aaaacatagc cattaactag ccagtatcta tttctatta accagaaatt 212160

 caaacacaac aagtcatttg acctctgcca tcaactctggt catcatgcta agagggcaat 212220
 gtgtttaact gcatgaatat aaacctattt taagttgggtg acattatggt tggatgaccc 212280
 tgctatcttc caacttctca cttaatttgi gaaaaaatct tggaatgggg actcctttct 212340
 aggccatttt attcacgtaa atgatgagat ttcaagggac catacactct gtgtctttct 212400
 ttgatcctaa gtttctctgc atatctctgc ttactgaagc cagctacagt gcctgccaac 212460
 aattaccatg tgggtcttt cacttatgaa tacaatatat cagtttttta aaacaattaa 212520
 cccttcatgt acatcttaag cctataactt aaataagaga aacagatgaa gtcttgagag 212580

 aattgtgta tcacatgag aaagcctgtg tcaagaacc caaggcctca aactttgaaa 212640
 aggcaaacct ttccatggt aaagatgat gctgatgcat gactgatggt taagcaaaag 212700
 cagtgtttgc agaaagtatt aactgcagct tctccatga ggatgattgc aaccttaaca 212760
 cattccctta cagaaatcta tctctactt aacatactta acatagcact tcccctgcca 212820
 tctctgtaca ataaatacca tgtactcatt cagctgtaga caataattcc atctcttcac 212880
 tcagcactat ataataagca cactgagctt gctggctgct agtacttctc catctgacag 212940
 ctctgtcccc cagaccccag attttctaca tgcataattct gtgtgtttgc cctttctca 213000

 ttattatctc attgccccag tcaggtcaag tccaatgctg ttcaggttcc agcacctagg 213060
 gtattttaca catgatttct tcaactaattc atgttgcatg gctaataactg ttcttttacc 213120
 ctgtccgctt gagattagca ggatactaga tactttattc tctgtaccaa taacaaggaa 213180
 ttttattttg aaaacaatgt gccagagttc accccagtac catctaatga ctgcttttat 213240
 tttcttgatt cactatttct tttaaatggt agaaattaa atatttgagt tctcctttta 213300
 ttatacagta atttcattag tagatgatct cccaggaatt agtgatacat atgcaattct 213360
 aagttggtaa taccaaatgc tcaaatgcat taatactttg taaaaaacta ctgtagtttt 213420

 ctgttctaaa gtataaatca tctacaaact tccttcatat ttctacttaa attactctct 213480
 atataaagtt tagtacgtg cagattccac agatatttga acaccaagct gaaaaatacc 213540
 acagcaattt tctgccagat gtaatttgggt atgctataaa cccttgaaaa atcagagatg 213600
 atagtgaata tgacaactga cctttagtta taatatcaga aatgtgatcc cataaagata 213660
 tctgggcttg ttttctctg tgaggccatt tggggaagaa aaagaaacta ggtctgaata 213720
 tttactagga agggccataa gtttatgctc tatgtttccc tgacaatgca cattagaata 213780

gattttgtgc tgccaagcat ttatcaaatc tctctgaaaa gcaaaaccac agctttgttt 213840

ttattttggt tgattttttc agcaggcaga taaagtatca tttatcatag tatgtgagaa 213900
aagcaacagg gcagacaagc tgtaaatctc agcagggtgct ggtgggagag agatgaatta 213960
atagtaagag agaaagtctg tcttttgagt aatgtttta gaaaaccagc aagcttagca 214020
atggacttgt tccttaaagc aacagaattc aacctggat gatttgtgct tcttttaata 214080
cagaacctaa atgtttcaca tgccattcac tagagaccag gataagacaa ataaataata 214140
tatttatata gagatgatgt tgtgattaga atgtgaaatg tcttatatgg actcatgtgt 214200
ttgaacatgg tgatgatggt tgggaagagt aagtgagtcc ttgggagtga tccttaaggt 214260

taggattagc atctgttccc acttcttgig tcattgacct tgatattttt tgccaatgca 214320
aaattcattg tttgtacttt tatcttgtgt ggttcccact gacatacgtg gtctccctgt 214380
gggtagtgcc aaagacattg ctgtatgggt aagtctaata cctatgaatt ttccaagaac 214440
caatacatat gaataaaata aatgaaatta tttggatttt gatttcttgt ttatgactta 214500
aagtactgaa actattaaga ctccccattt attcttcttt atccattctt tacttactta 214560
tgttaacttg ctatatatgt tggaaaatca gaatatgcct cttggaaata taattttatt 214620
aaataagca aaagaaacaa attcatgaga gtgctctggt ctttatacat acataggata 214680

taaatgtaca aaagttgagt gctgggagct agttcagtgg ttaagagcac tgctactctt 214740
tcagaggact gaagtttggc ccccaaaact cacatggggg ggctcacaac tgctgtaac 214800
tccagatcca gggatccaa taccacattc tgacctccac tggcatctgc ccatacatgt 214860
gcacataaat aatacaataa aatgaaggac agctataaat tttcatcagc ttagagaaga 214920
ttcaaggaga attcatatga acaatccggg ccagctactt tcttgctact tgttttctt 214980
cctcaaaca gctgtccatg taaagtcata ttttttcttt ttataatagt tcttctgtgt 215040
ttgtttcctt tcccaaggc tgtgagtata tacttgaaca taaaagaaat gtaaggaaag 215100

aaggttctat ttagacttga acctcaagga aatataattt ttaatgactg acaatgcata 215160
gtgacagaaa caagcattca gctggtcaca ttacagtcac actcaagaaa agagaattca 215220
cagagaaaga ggggatgtat ggaaccttaa gttctacttg ccaggacca cttcttctag 215280
ttagagtcgg cctcctaaaa aatccataat gttctcaaac accaccacta gctgaggact 215340
aagtatgcaa ccacaagaga caatgggaca catttcatat taaaactatg acatcagctc 215400
tataaaggca taatgaattt ctgcagataa aatataaact agaattctag gtgaagcttt 215460
aggaacaact cttctttgag tagctctcat tcatattata gcacatacat atatgtgaga 215520

aactatTTTT agcatacata aaacataata ataacatg tattgcatgg tatataatgc 215580
ataaaatata ttatatatga aacataattg ttacatagc taatacatca aataacatat 215640
gttaataaat ctgtgcatgt taataatata tgtaaatata tgtaaatggg taatagcaaa 215700
tatatgtaa taagcttctt cctctttagt gtcaatcttt atttctaaca agggcacatg 215760
tcaattatta ttctaaaag gctgctactt ttacactagt aactcaagga ctgaatacag 215820
tggtagcgga cacagcatca taggttctaa atagaaagaa aattgtgcat caacaactgt 215880
gccaaagcaga caaagaagat aatgtttcaa agaaatacaa ctcaaatatt ttgcaacaa 215940

aattgagaaa gaagaaattc tctctcaaac aaatgcaatt cattaatat ttcaagtgga 216000
aattttcatt cactttcata tgtaaatcc ttgaactgga atctttaaat atttgttata 216060
tttttgaat tataattata aaattttcac ctcccttta ctccttctaa ctctacat 216120
tcactctca cctttcttg tctcagattc atgaccactt tattctaca cagttatgat 216180
gcttatgaac cacaacagtg accagcatgg cacaataatc ttcagggtac agtatgggca 216240
tgcataactt gtagtgacc aacagttttc ttattggcct ctacatcagc tcaacaagag 216300
ggaaacaatg agtgatgctg caaaccagc cagaggcttt gggatactga tgccatggat 216360

cttggaggag aatgtattta gaaccacttt actaaacaaa cagtccctac ttactttcca 216420
taactttata ctacatata agtagagctc ttgatcttca taaaagaaac ttccactttc 216480
aacagaatth acctataggg tcacttgagt ccttggccat catgttcatg aagaagtat 216540
agacctgctt tctgtgttc tctgaatctt attatgtaga acatatttat ccttgcaaat 216600
aatatgacct ttaactgaag caattaagta ttgatatgc tatatgaaag cagttcagga 216660
actgaagtgt tcaatgttga gctacagcag agaaacatth attattcctt tgtatgttgt 216720
cttgtttatc agaaatttct ctctgatga gagtgcacatc atataaaaat tctactgtca 216780

tgtaaaact tctatafaca gggaaaaaat aattgggcca tttcctttga ttttcttcat 216840
taggactttc caggataccc agaaggttct tattctcctt gagccacaaa ctctagctcc 216900
ttaaagagag gggatgaaga aaaacaaaat cttgttatta tttaaatth attgtacaat 216960
ttaaaggtae agaatafaat gcacttaaag aaacaaaaac ccaaatgct aggatttgaa 217020
ctcaggcctc acatattcca ggcaagaatc ctggctttta agttaaagac caggacctth 217080
taaaacctth attctgagat ggagctttth atcattctct ctcccatct tcttcttcc 217140
tttgttcatt ttttcttctc tatttaaggt tgettacagt attaatttga taccatctcc 217200

ctgtctacca tctttacct tctcttctca catagactth cttgtttgta ctctgagccc 217260
caataagaac acttctaat aattgcatga tttttgtgt ttagtttgt ttttatcact 217320
tccaaggaaa tggggcatcc tgaactgag aagattttgt aaggcaaagg acacagtcaa 217380

caagacaaaa tggcagccca cagaatggga aaagatattc accaacccca catctgacag 217440
agggctgatt tccaaaatat acaaagaaat caagaagcta gtcaataaaa caccaactaa 217500
cccaattaaa aagtggggta cagaattaaa tagagaatac tcaatggagg aatataaaat 217560
gactgaaaga cacttaagaa agtgcacaac atccttagcc atcagagaaa tgcaaatcaa 217620

aacactgaga taccatctta ctctgtcat gatgggtaaa ataaaaata ccaatgacag 217680
ccaatgatgg agaggatata gagaaagggg aacactccta cattgctggt gggagtcca 217740
actgatatag ccacgtggca aatcagtatg gagattctc aggaaaattg gaatcagtct 217800
accacaagat ccagcaattc cactcttagg catttaccca aagatgcaca ttcatacaac 217860
aaggacatct gtictatcat gtctatagca gcattatttg taataaccag aacctaaaag 217920
caacctagat gaccctcaac tgaagaacag atggagaaaa tgttgtacat ttacacaatg 217980
gagtactact cagcaggaaa aaaaatggaa tcttgaatt ctcaggcaaa tggaaggaaac 218040

tagaagaaac cgtcttgagt gagtaacc attcacaaaa tacaaaaatg ctatgtactc 218100
actctgcat ggactttaga caaaaaaggt ttaccagcct acaatccaca ccaccagaga 218160
agctagaaaa caggaggagc cctaagagag acatacatgg tccctggag aagaggaaag 218220
ggacaacatc tcatgaccta attgggagca tggggggaag ggagaggcac ctagaagaaa 218280
gagaagggga caagaggagg ggagaggaag acatgagaaa gcaggaagat ttagtcaggg 218340
aaagaataga ggagagcaag aaaagagata ccatactaga gggagccatt ataggttcaa 218400
agaaatttat ggcagtagga aatgtccag aatctaaaa gattgacccc aactaacaat 218460

ctaagcaata ggtgatagat taccttaaat acccttctcc aataatgaga ttaatgtcta 218520
ccttatatgt catcctagag ccttcatcca gtagttgatg taagcagaag cagacaccca 218580
cagctaaaca gggagctgaa ctctagaatc cagttgcaga gacggaagag tgatgagcaa 218640
tggggtcaag accaggetta acaaacacac agaaacagct cacctgaaca agggattgct 218700
catgaaacc agaatgatag ctgggaaacc agcatagtac tttgccagtc tccctggatg 218760
agaatgtcag gttgtaggtc tgggcaatct tggggcctc tgatattagg tcatgattta 218820
tcctactat acaaatggac tttgggagca cattccacat agagggatac tctctcaacc 218880

tagacacatt ggggaggttc taggcctga tccaatgat atgacagact ctgaagattc 218940
ccccatggaa ggcctcacc tccctggaga gcagaaaggt atagagatag aggggtggggg 219000
taggggagga ggcaaggcag agggaaacttg gattgacatg taaaagaagc ttgtttctaa 219060
tttaaaattg gttaattac atctataaaa attaaaaaag ataattttct aaagaaaaac 219120
ttgggtatct caatctgact tcattccatt gaagcaatga atctgcaaaa aaaaatggaaa 219180
tttcccaag tatctcatal taggagaaag aaaaatgaaac aaaaagtgg tactttgttt 219240

cacagaaata cttgtagac agtagtatca acttgactca cctccttata ggatacaact 219300

gaagactata cagtgatagg tcaatggtgg gtagaccaca tattggcctg actgcttaga 219360
tgtacatfff cttgacctct tatttaaaact ttaacatcta tttaggacac cagaaacaga 219420
ctggaagaga ttgctgggtt taattgtccg tctttccaat atattcatat cgaatgattc 219480
tcctttttct gctttacact attaatttgg cacctctaata tggtttattg aacatgggtg 219540
cctgagccag acttaggcca aagtcttgaa accaaagtgt gaaaacaaat ttacatttca 219600
tttatttgtg tttagaacaa atgaagagaa aatgatattg taataattta aaagaatcat 219660
gatttatttt catgaatatt tgattaacaa acattggctt aagtcagatg atttctttta 219720

aagattatgg ctcttttct gaacaaaggg attaagaact taaggagttt ttaaatatgc 219780
aaaaatgfff tgfatacatt gcttgaata tctccatgta acgccctgta tgagaggcag 219840
atagataccg tgatacgtat cagggacatg tctccagtgg aaaccatagc aatgcgatgt 219900
cagggctctg tttggccatc tgcatggaag tttgcaacaa gctggaaata ctgatgcctt 219960
ttacacacct ctaggaaaat gtctacagtc catcagttgc aggtgtttat gtctgtttg 220020
gactgttaaa cctagattct tctgtaggaa aggggaatag gttgttggaa ctgagctgct 220080
gccaagggcc ttacagattc atctctgctc caaaagact ctctcttctc aaagtctgct 220140

tctgatgagc tgatatgttt gtattactcc taattctccc atcctatata gggtgcaacc 220200
tgacaccagg caagtggcat agatcacatg ttcatacaata ctgaccaaag tttctgccta 220260
gggattagga tagctctccc cactagagtt gatgtttttt agtgcaactg aagcctctcc 220320
catgctttgg ctctctgcca cacaattttg tgccattaat aatttctgaa agctcttatt 220380
cgaaggagct gctactaagt acctcttgag acctttctct tagacctatc ccatttctgg 220440
tctctccatt tacctaacag aggtattgct aagtcagagt ctgaatgaaa tgctcttgaa 220500
gaacatata atcatggca ttggttttca taaattctat ttaatgtttg aagtcagtaa 220560

gcatgataga aaaataaaga cttagctatg atatttcctt ataaggaagt tgtctatgca 220620
catgagggaa atgaagcaca gagttcatct tagcttgata aatgatgatg agtataatca 220680
gagatttaga cttatagtct acactgaact atgtcttctc ccttgaccct ctcaacaatg 220740
gctgctctta gaaaaaaatt ataacaactc tttcagtttc tgtttaaact actgggtgat 220800
ttagggaaaa acaatggggg atataaggga gattttggtc ccagagacta agccatatgt 220860
tgttgcatt tcatgaacat ggaagttaga tcttatgctt cagcttcca cttagcctgg 220920
aatgcagagg cttcatctgt ccttcttgat gattgctgtt caaaggataa ctctcaggtc 220980

tctaagaaag acigcctcta ttgaaaagct agcaagatat ttttaagaat gttaacatat 221040
gaggcagaga aagaagtaat tagaaaatgc tttccaagaa agacacttga caaaagtga 221100
ttccagaagt agaaaagcaa gaccaaagt gtcatggaga gtaaagacat cttagtact 221160
atcacatggt tgggaattat gtagacagg caacttccat cacattaagc tacctaaaca 221220
gatcacaagg tccatatgaa caaactgtaa gtgtcagtac ttccaatcat ttcacacata 221280
caaaagcaaa agtttacta gttcacctcc aacaatttaa atgtgcaaaa gctgagtctt 221340
ttctaggatg attactaatg tcatcttttc atccaaagca atgaatttgc atcctggttt 221400

attcaaagcc aaggcaataa ctccatagac ataaagcagt agagaaaaac tcattttctc 221460
tggcatgtag ggagagaatg ggaatttctt ctaaagcaat gccctcagag acccaaagaa 221520
agcataagcc tggccattc ctaagaatgc tctattgagc tgtacattcc attttaagtt 221580
aatgacataa tttagaata tctaggagat gaattttatg gtatgcttgg cttaatgcct 221640
taaaacacac atttaaaaat gtaaaatggt agatgttgaa atctctggga atgctcagcc 221700
agcaccatat agtggtagtt gaaaataaag gatattttga aggtgttatt atggtcttta 221760
ggatcaaagc ctgagccata gtggcccaga gacactagac tttaccaact gtcctcaatg 221820

cagcagtgg agagctaagt actagtcaa acaggaagaa tgttttcaa tgtggtcaca 221880
tggggaagaa gaacaaataa aagctacagt gactcttga agtttgtgtt tgtggtagt 221940
acataagatt ttgtttacag agaaggggag aggtgtgcat aactaggcat tccatgtagg 222000
ggatgctgca gccatgcctg cttaggggct ggctacaggt gtgcttgacc acactggga 222060
gggcatagtc aggatgacct agagtaagg acattcaggt ggtggcttgc ttagggttt 222120
actgcccacc agctgaaaag gtcacactga aagtaaggct tttccttatt aaattccctt 222180
gtatttttac ctggctccat attgtaatt tcccacatta tctggttgtt aggaatggga 222240

tattgtaaac ctaggeccct ttgggatagc ctgtggttcc accagtacag tggcctagc 222300
caggaaagca ccctctctcc acaggtgctc ccggctcaca gctgacctgc tgtgccaca 222360
gtgcatctcc actgctgctg agctgctcag aaccatccgc ccagctggga gacttcaca 222420
gacttccca cagtactgt cgcagtttct agctgagtgc atgggacctg ttcagactgc 222480
tgccaaacc agcctctac ctggaagctg cctgcccttg agccaagtag gcctgaggag 222540
taggccttgg ctttcagcag ggtctgccc tcccctggc cacagccct ttacagctgt 222600
gcctgtttta gtggttgag ctgcaaggca gtatactctc taagcccagc attgtcacat 222660

ttgtgacctc tctccactct tgtcaccatc ttgctgaca gacctctgc aaaagtcact 222720
tggactaact atacacctct gtcccctgtt gatcaaagat acttactcat ctggagaaga 222780
actcaagtaa aatcatggtg gaatatttat catttgctaa aattggaat atttttgctt 222840

attatgtgaa ttcagtgttt gaggaggaca ctaatctgcc aattactggc ctatatgcag 222900
 tgatggcagt tagcttactg gtacaataa ccttcctagc cagatccctc tggaacaggg 222960
 acaaagataa cctcaccacc tacttacagg aaataacagc tttatgcact gaggttttgg 223020
 agaacagatt aggtcaggcc acaattgtgc ttcaagtgga acagaaattg gatgataagc 223080

 ttggctctgt gtccaatata ctaaagacaa acttgtctgt tacccaagat gagatgcagc 223140
 atatttatga taacataaaa acagagagat gctccatgtc tgaggcatta gaggataggg 223200
 tgtcagagga ccgtgatgaa ctaaagaata tctgtagcca gttggaaact cagataggct 223260
 cggtagccca gaaattagat gcaaagtac aaaataccca agatagggtt gaagaattgg 223320
 acaatgtcat tcaatcaatt attgaagcat ctaaagtagc agatcacaaa tttctatcta 223380
 tgtttggaag ataatttaca atacagggct gatagattag ataggtccat atggtcgatt 223440
 gctgaggact caaaatcagc aatcatgac ctcaaatcta gtctctaata actaggaggc 223500

 agtttccatg ccatccagat cctgcctaag gatgatcata ttaaagacct agaaaaacat 223560
 gcagaggagc agttagagaa atttacagat tcactaacat gcttggaaac ttttaagatt 223620
 aaggagattg aaacttttca taagttatc attactagggc ttaaagatca ttgggatgcc 223680
 tcagaggcag aatcactcca atccaagaca cctactccac ccaggtatca tgactattct 223740
 tctaagatta ttaccgatat gcctttagtc taccagctc ccatggtaga aaagccagct 223800
 tctaagaaac aactcagag acagatggct tatgtatggc aacctatact gatgaaggat 223860
 ctgaagaata ttaagaagc agttgtctca tatggtctcc atagcccata tgtaaacag 223920

 ctattacatt catggtcaac ctataacagg gggacacca catattggga atgattggta 223980
 gcagttgtac ttgagaattc acgcaaatcc agtggaaagg attggtcagg aaagaggcaa 224040
 agtccttgt gcatcaagc ataaaggaag gttaaagaag ccctctagat aagattcttg 224100
 gtaagggtat ttgtgctaac ccacaggtc aggctgaata tgatggccat atacagtccc 224160
 tatgcaggaa agcagcatta aagcctggga taaggttcat gagccaggag aacacctaga 224220
 agcttatacc agaatagaac agggacctac agaacagttc caggtcttat ttggaaggtt 224280
 aactagggca gtagaattac aggtaacaga tcctgaaaca aagacaatca attatatata 224340

 caatagctta tgaaaatgca atcctaatat gcaaaagaat acttttgctt ttaaagaaca 224400
 gatcagctcc actagaagaa tgagttttgc atgaaggcaa cattgacaag ataccagagc 224460
 ttgggaagga gaagctatct tgaaaggttt aaaaaggcaa gaggatatta aaagtcttag 224520
 aggtgaggcc acaagggtt gggaaggaga agcaacttac agaggtcaac ataggtacca 224580
 aaaggctaga ggttgcact actatgaacc agaaccttgg gtaggaagag ccttccccag 224640
 gagaccacaa aggcgccagg aacctagatg tttcagctgt ggtagaatgg gacatatgaa 224700

gagaaattat agactaacga attctaacaa tgcctcatat ggaaggccac tgccttctgg 224760

 attgtgtaga agatgtggta agggcaggca ctggaccaat gaacgtagat tgaccagga 224820
 catgcaagga aacctctttg tttctacaat tacaggaaac aatcagaaac agaattaatc 224880
 ctctatacat tacaatatc agatccata ggggtctgcc aggcccacta gcacaaagca 224940
 atgttagat tgatcgttta ttgattggaa gtgtcctaga agcctcaata tttcataaga 225000
 aacatcatgt aaatagcaaa ggtttgaaaa aggacttctc cgtcacctgg caacatgcca 225060
 aggagatagt gagaaactgt cctacttggt ccttttataa tcaaattcca ttgccagcag 225120
 gttgtatttc taaggaatt cggagaaatg aggtttggca gatggatgtc tttcactttg 225180

 cagaatttgg aaatttgaat tatgtgcatc aactatata caaattctca gagttccaat 225240
 gggctactgc tcttaattct gaaaaagctg attctgttat taaatgcctg cttgaggatga 225300
 tggcagttat ggggtgacct gcacaaataa aaactgaaaa ttctccagca tatgtctcca 225360
 ctaaattgga acagtttttc aaatattata acataaagca tgtcaccgtt ataccacaca 225420
 atctacagg acaagcagtg gttgagagat ctaatagaac acttaaggag atgctctaca 225480
 aacaagcttg gaagattaaa ccccccaaac ataggttgca taatgcttta ttaaacactaa 225540
 actttcttaa gtccaatgag aaaggacaaa cagctgcaga aagacactgg actatggaaa 225600

 aacctgctga actgaatcag ccggtatacc tcaaagatgt actaacctct gtatggaaac 225660
 caggacaagt ggiacaattg ggtaggcatt ttgccttggg tgccacagga gaataacatt 225720
 ggataccatc aaagttagc aagatttcag ttgtgaagga aaaacctctc gacgaggata 225780
 aatgacaggt atttactaa tgtatacctt ataaactaaa tagaaacctc ccaaaggaaa 225840
 ttgaagtgtt ttgcttttat cttgacagat aaactcatct ccagaaggca aaggacactg 225900
 catgggtaga tacttaagaa gagaaggtag ctataacat caaacaaaag gaacgtgcca 225960
 tacggtaage ttcatagctg tctccagag aactctatit ctctttatit cetagtccct 226020

 attcaataa atcaatgttg gatttagatt tagatttggc tttctcctc taaaatcaa 226080
 gcacgttgtt taaacttttt ctgaggtttc tgtattatat caagaagcca attgatgtaa 226140
 tacagaataa gagaaaaatt tgaggactat gtttgtcttt tcttggctct tctttcaag 226200
 gigtatacce tttcataatt gttgtctttt ctggtatgca tacttacaca agcaaacatt 226260
 tctctgctgt ttatgtttga gttccacaca gctaatgaag acatgctga cagcaatccc 226320
 tggataccgt ggaagaaaaa tgggccacac ttccttgact gcaactggatc caacttgctc 226380
 cattgcaaag cacagctcgg ccagaggttc aggtactgac ttcaatcacg ttgaagattt 226440

caagtgagat tticaatcaa gcgaatccca tctaacatgg actggataca atacattcaa 226500
 gactttcact atacaaatat tttctttcta catggcctca caaggctgtc atcatcccat 226560
 ttctgcagga agtaacttgg aggatgttat gtccccttac ccccatgttg tcacttagga 226620
 tagtgtataa cctagttagg ggtagcttcc tattgtttat ggttgggatt ggaaggaggt 226680
 gttcaggctt ggacacctct ttcagatgac tttagggtat agttaaata gacatagtta 226740
 ggatatgaca taaacagatt attatatctt cttatatctt acctttatga ttgttaattt 226800
 tagatacttt acacagttaa gtttfaatcc tcttttagac taaaagggtt attgtagggg 226860

 atactgtagc catgcctgct gaggggctgg ctacaggtgt gcctgaccac acctttgagg 226920
 ggaaagttaa agagtgaggc ggctctgctt tcactttcgt cttcagcttg ccgtatggac 226980
 tgctgccgag atcgctctgt aagtaaggct tttccatatt aaattacat gtatttttac 227040
 ctggctccat attgggaatt tcccacatta attccacatc acagtgtgat cctgaacatc 227100
 attggcccat cttttctca gctgcgggct gccttcaagt cctcagcatt gtgaaatctc 227160
 tccctgctaa tatgctctc tctgcctgg cataagggcc ccggcctctc tgtttctct 227220
 gtgtaagagt ccagaagaag ttcaattaac cagaatctg tttcaacagc ctggtagaca 227280

 acaggagga cacaatcctc tctcagaat atttctctc ctgttatgtc acttacaag 227340
 gcacattaat atatattatg agtatgccc taacaagttg aaccactta gtggtataa 227400
 acttcagcag agaagttctt gtttcataa aaaatattc tcattttat aaagcattta 227460
 agcagattaa ttaatgttta tgagatttat tggtcattga ggcagatttt aaacaatatt 227520
 tgagtccac attaatgaaa gatacaattg caagtcaagg agtcactttg ataaactacc 227580
 tttcatttag cttgtgagtc agtaatgtca aagatgattg ctgctaagta actgaaatgg 227640
 tttcagatat tggcagttga tggatttggc aataagcttt gctgagatcg tcaatagcct 227700

 tgaccacct ataactagat ttgcatatgg agattcttat aagtcaaag ttaaagacaa 227760
 aaaagactat cactctaata acataaatgc aggttcagga aaggacatga gaattcctt 227820
 caaatgagc tttattagga gggagagaga tggggtggaa gagagagaga gagagagagt 227880
 caaatcaca ctggccatga tcagaaattg aagaaagaga tcattagga tatgtaacct 227940
 caccctctaa acagaataat gaacatgtga agtgagagaa gtggcctacc gttcaaagc 228000
 tgactaggag caaccttagt agagacagat atcatgtaca atatgatggt ggacctaaag 228060
 gaaggagcct ttaaaccce caaataaagt tgatttctga gttgggtgtg agtggcagaa 228120

 gttctgaaa gcatagttaa gttgtgccta tcacatatgt cacagagta ggccttaggt 228180
 aggactataa cttttcttg gagttacaag gaggaaggct aggtttgtt tttccagttg 228240
 agagttaaaa gatcttacta gtctcagaca gacctgtca gtcctttgtt ttaaagaga 228300

aacctggggg tcttgatgtt ttatttggag aagagtgaaa ggcaactata tgtctatggt 228360
ctgacagttt tatataccaa aataatatct cctgtccaga gaattctata ggaaaacctt 228420
accattggga attttggfcc tatgctgagg tagaaccact gcaggctaaa gagtacgatg 228480
tctattgga attaagacat cttcatgtga gataggaaaa accttctgca aatagagaag 228540

atggaggcaa cctgagggcc attagccctc ctctcagaa aggggcagtt gaactgtcta 228600
gtcactaatt gctcatcagt gcatcatcag tctttgtccc attgctttat acaaacctata 228660
agacaccata caaacagtag agagactttc tctctcaca ttaataactt ttgtgattca 228720
taattctttt gaaatatggg tcaatcacgc aatggtttat ggacctacat cattggttagc 228780
atcaacaatg tgttttgta gctcatagat aattatttgt cttttcttgg tgtactattg 228840
catgactgct tgggcaagtt tgtccagcca gtctctggag acttaatcag ggcaccttct 228900
ccttgcagtg caatatagga gggtgagtct acctaccttt ttaatgcttt tcacaaagta 228960

ggaaaagaaa taaggcatca aaattacatt taactgctac agtgatccca ttgttagaag 229020
cagagtgaca catttgtgtc tataatgtca taatctattg aatatcaata aattaaaaag 229080
aaatattgac tctgttgctt ggaagtttct aagaggttct gctatccctt gacagctggc 229140
tgttagaaaa cactggctct tttattcaag ccttagttag caatattaat gcccatca 229200
caaattacac cttacctagt aattattgtt accagggaaa ctggattcca atttttgggt 229260
tctgagtctc attaatgagg ggaattagaa atggactcag aaggaagctc atggaccatt 229320
tgattagagt ttgaatgaaa agaaataata caggcaggct gaaaaatctc gatagccacc 229380

agagagaagg aaatggagag aaatccatgt ttttaagtca ggtagtcaa aggtctctgt 229440
tgatggttca agaggacac agagatggat tatggagga aaggcactta ctagaagagt 229500
tagtaatacc actgaaagat agttatctaa atcagcactc tgaggagaga gttcctatct 229560
cttgccagaa acagatactg tatatggttt ttgaggagag gattagattc cttggttgta 229620
gttatctttt tttttttttt tttttttttt tttttttttt tttttttnn nnnnnnnnnn 229680
nnnnnnnnnn nnnnnnnnnn nnnnnnnnnn nnnnnnnnnc tcgaactcac atagatccac 229740
ctgcctctgc ctcccagtg ctgggattaa aggcattcac caccaacgcc cggctggttg 229800

tagttatctt aatgaagaag gtggtttatc ctaggaaact gcaggcagga atttccaggc 229860
aggaatcagg gagtggggct gggagaagga tatatggcca ccaatacccc ctttgttgta 229920
aattaactta cctagatgag acagictagc acctgaaagt ttgtcatcta gaggattcat 229980
acaggaaaag aattgtatct gggacacata atagaaatag agacagtta tcaaaagggg 230040
aaaagtgctt ctgacaatag gtgtggcctg gtgaacttgg ggggaatttt caaagccctg 230100
agccagaaga accattatcc tttacagtac atttatttaa caccctccat ttgtaccatt 230160

atataacatg aactttgctt gagggtgctc tgtttattgt atgaagctct gatgaagaag 230220

 actacaatgt tttctaaaca aatggatctt tcattttgtt actcttgatg ggaaagcccc 230280
 cagtcactga tttcataact gatctatagg aatctatgta tcatttgcta gtattcagtc 230340
 atctgtactg acagaatcta tgtatcattt gttagtattc aggcccctgt actgacctgt 230400
 ccttgggggtt ctgaaaggaat atgccctcag cttcagccac taaaagcact acctgcgcat 230460
 attcattatg ttccctttta aaaaggccct gcctacctcc catatttctc tctttcttcc 230520
 tctccctctc tctgtctgtt cccctctcc cctctctctt accctctctg aaacctctct 230580
 cctctctctc tctctctctc tctgtctgtc tctctctctc tctctctgtc tctctctctc 230640

 tctctctctc tctctctctc tccctcttcc ctttctctc tctctactg ctctctctc 230700
 cagaggccag tctcccaaca acatttctc cttttataat cttccttcc ctaataaaaa 230760
 accttctgc ttaaacctg tccatgagg tcttctctc caatgccact taaattacaa 230820
 catcatttgt ctatcatctt tatttttatg taaattacta aaacgttcta caagtattca 230880
 gaatagtga aggattttta agggatacta cttgagatag acagagacag gtattaatac 230940
 cttgatattc acttcaggga atggacaaca aactcagttg gaggctctgat agaaatatta 231000
 ccagagacag aaccaagcca tgggttatgg cttgtgccta acttcagaat tgatttgaac 231060

 tgtagaagca aagtgaaga caatgtaggt caaaaaatga ggttcagggc caagtaccaa 231120
 caaatttagg aatgggtgga tcatctgggt atattatagt agctttgaca gtactaagaa 231180
 ctgagaagag ctgaaggaat ggtggtatgg ggaggatgt ttggtatata agataagaaa 231240
 ataaataaaa ctttttaaaa gttgcaatcc ccatcaaat cccaatacaa ttcttctactg 231300
 accttgaaag aacaattctc aaatttatat ggagaaacaa aagatccagg atagccaaaa 231360
 caacctgta caatagagga acttctggag gcacacccat ccctgactta aagctctatt 231420
 acagaggat agtctgaaa acagcttgggt attgacacaa aaatagacaa gtagaccaat 231480

 ggaatagagt tgaaacctt gatattaacc cactcaccta tgaacacctg atttttgaca 231540
 aacaatccaa atatatgcgc tggaaacaaag agaacatctt caacaatgg tgctggcata 231600
 actggatgca aatatgtaga aaactacaga cagaccaag ctttctctcc tgtacaaaac 231660
 ttaagtcaaa atggatcaaa gacctacca taaaccagc caccctgaaa ctattagaag 231720
 ataaatagg aaataccctt gaattaatg gtacaggaga ctgtttctctg aacattatac 231780
 cagtagcaca gacctgagg tcaacaattg ataaatggga cctctgaaa ccgagaatta 231840
 gacaattctc aatagaggaa tctaaaatgg ctgaaagaca cataagaaag tgttcaacat 231900

ccttagccat cagggaatg caaatcaaaa caactctgag ataccatctt acttctgtca 231960
 gaatggttaa aatcaatgac agtttatgct tcagaggatg tggagaaagc agaatgcttc 232020
 tccactgctg gtgggagtgc caacttattc agccacttag gaaataagta tggtgactcc 232080
 tcaagaaaat gggaatcagt ctaccacaaa atccagcaat tccactctta ggcatatacc 232140
 caaaagaagc aaattcttac aacaagaca tctgttcaat gatgttcata gcagcactat 232200
 ttgtaatagc cagaaactgg aaggagacta gataccectc aaccaaaagaa tggatagaga 232260
 aaatgtggta tatttataca atggagtact actcagcagg ggaaaaaaaa aaagaaaaac 232320

 aagggaatct tgaatttgc aggaaaatgg atggaactcg atgaaacat tctgagtgag 232380
 gttatccaat cacaaaaaga caaacatgat atttactcac tcatatgtgg attttagaca 232440
 tagagtaagg gattaccatc ctacaatcca cactgccaga gaaactggta aacaaggagg 232500
 accctaaaag tgacaaaactt tgtcccctgg agaacgggaa agggctacta tcccctgaac 232560
 aaattgagaa catgggaaaa ggggagaggg agctacgaga atgggaaggg aagaaaatga 232620
 aggatgcaga gatcatgagg gagcagaaaag tttagtccag gtgtagatta gaagaaagga 232680
 tatgtgatag gtagggtttt agttgtgggg ggtggtaggg gaggaaggga gggagaatgg 232740

 aactgggatt gtcatgtaat tcaatcttgc ctgtaattca aattaaanaa aagaaaaaag 232800
 tttaaactta tgctgcagag ctttcattaa aaaacaacac tgttttttca atcatgctgt 232860
 gaaatcatta ctgttttct cactccatg tttttgtat acaaagccaa attacatacc 232920
 tgggaaagaa atacattaaa tggaaatcta ggactaatta tctatcacct tcgtcagtag 232980
 aaatttaaga tgaanaatcc atcctcctgg gagctattac actgtataat ataaccagct 233040
 ctgacttatt atcaggcaga catcatttta aattttaagt gttcatatag aatacttggga 233100
 gtctaggtgc tattgtgttg gcattttata atctttcaaa agaaataact gtctgtatgt 233160

 atatgcatgt tccataaatg tgggacttct cagtatactc ttaatggta gtgtaagtct 233220
 gattctgcat ggcagtact cctaaatgct cctcataaga gatcacacia aactgcctct 233280
 accagtctcc ttcacactgt gtggcattat caacactttg atagaccaga gcaatttatt 233340
 cttaatgagg tcaatcagtt agacaacaaa tgctaagtgt ataagaaggt cattgataag 233400
 gtacagtga cagtagccag gaggattact agaaagaata tattgtgcc tttgttttat 233460
 tttattttta catgctcagg ttcagaggtc tccctctgga tgaacagtaa tccgaaaaag 233520
 caggaaggca ggcttaatta ttatatttag ataaaggctt gtttcaacta tatcataata 233580

 atgatgtgat taactcatat ttgtccacta ggatggctga atgtctgttt gcttaactct 233640
 gtgtttatct ctaactcctt aaataataca ataatgctat taagttagagg ggaactactt 233700
 cgttgccttc agaaaaatcc cacctgtgac ctctggagtt ctttctgagg gacatgtaag 233760

ctcttaaaca ggccatgcat atcctttctia ggcaactcaa catctggat atgctctata 233820
 aatacgaaaa tactcttaaa atatittatt agcccttttt gaattttttt acaatgagtt 233880
 ttgaatatat tcacccatit cttaccagat tctcccccac ttcttcaca ttcaattttg 233940
 tgtcatgttt ggitttaaac ccatctggig taattttgct gcccacatat ttttgatct 234000

 gtggcttcc accgatcat tgttctta atagaggcta tccttttaga gaaaactgtc 234060
 tctttttate ctatcaacta gcaattgcca atagatcctt gggtatgggt gggattctat 234120
 gaccaactcc ctttttggga tatagtctgg ctgagcttg cacgggtctt actcattctg 234180
 tcacaattgt tgtgaggfcc tctgtgtagc tgcctattg tgtccagaag atattatit 234240
 cttattcact acctctggct cttgcagtit tgctatgccc tctttagcaa tggttttaa 234300
 gcattctgag gaggttgata tgatatatac attcaattta gaatggagca ttacgcagtc 234360
 acttattctc tgcctgttga atagtgttag atctctgtgt tgattatcct ccaatgtaaa 234420

 tctaagcttc tcagatgagg gataggagat attttaacc atgggtgtag tgataagtca 234480
 ctagaactac agggcagctg aggtcagcag gaatttacc atgaattata acccaacttg 234540
 cagagactgt aagccaaagc caaaacagaa cagaaatcaa aaggagaaat gaattatgtg 234600
 acataaaaaa gaaatccttg catatgttaa aagttaaact gttatttgat tatctattga 234660
 ctatttctag agggatttaa tttgccaat aaagtittga tttcattcac aaaagtcttt 234720
 ccccttttc agagcgtaat tttgaactga aaaaacaaac aaataaaca aaaaactca 234780
 tgtggagagt tgggaaagcc ccaaatggcc attgctatgt cagataaatc acaactactg 234840

 ttttgaatt tttactatta aaacatatta agaaatattg cctgtcattc ctttgctgg 234900
 aacacatgat taagcagtg agtgagcaga atgagcaggt gtcacagtag aatcagaaag 234960
 accatctgtc ttcatittcc atggaacaa tccttttgag gctttcagaa aggagaaaca 235020
 ttgctatgtt gtacaggaag tttaatgctt tgtgggattt tcttttctct ctttttgaag 235080
 actttctttg actattttat gcaaagtaa agtgaacaat cacagcattg tttactaca 235140
 gaatacttcc tgtctcattg ttaaagtgtc ccaaacacaa atctgggtga ggtgaagcct 235200
 tatacttgag tatcctcaag ttctatccat ccattttgtc ctaagtgata aaattagatc 235260

 aagaacctg aatgctggig catgtcgtt tccttaacat cagatgttat ttccacaaaa 235320
 taactatcag gactattatt tgaatgagaa tcaggaatat ataaattagt aaaatatata 235380
 ggaatatccc catcatttat cctctgtcct tggaaatgtcc tcttgggaag gtccaaagta 235440
 aatatagcaa tgtcaatttg ttcttacct tttaaaaata ttttttctaa aggggactct 235500
 ctctgaccac acaccccac aaatgccagt ctctccacc agctatitit gtaccatctg 235560
 tacactttat tccaatagaa ttattttaaa tgtgtttgtt cctgtgattg atctgtattg 235620

ttagtagaaa gattatTTTT ttaattctg tctgttcttt accgaacaag attatataat 235680

 aggctttaat acagaaaaaa agctatgaat gattagatga atggaagaag atgtggtata 235740
 ctttatacac aaattcacag ataaaacttt aagtaaatag gatgtggcat taatgtaatt 235800
 atcagatgaa tlgatcttt cagctttttc taattacatc tgctaacaaa gaattcattg 235860
 tcatacacct aaatcatgaa aaatgagaga gagtgaagaa tgatatttag cacaattgct 235920
 gctgcaagtg caatcacagg gctaaattct tgtctcattt ttcaaatata atatagagaa 235980
 tttcagaact aaagaataga aatgtagtcc agatttggaa tacacatctt atcccaaaca 236040
 aagtaaaatt ccaaggatat aatttcattt gttttttttc cttcgtaatt tatgtaggat 236100

 aatatgatgt gccttagatt tagtaactca catcaccaat gtgtttttaa aactacaatg 236160
 aactttggta tactgacatg aagtatactt acaaagtca aatggaagat ggcatactcc 236220
 tatggacatt ttagaagtag tacagaggga cagaatacce catttatgaa tgtaacccaaa 236280
 ttaaaataaa gagcatatgc agattgctca catagggtag agggtcattt tctctaagat 236340
 ttattgctta aggattgcag aggtttgggt ggtgagaaaa gaattttgaa agttgactta 236400
 agttttgtga gtataaattt gttgtttata gctcatcata aacttttagg ctttatgaga 236460
 atcattgtct ttaagaact tgtaatttat tacaataaaa aacattgcaa gatacaaagt 236520

 gtctacatc acagggtaat aggtaatgaa atgtgaagat ctccagaaaa tctctcagca 236580
 gcccaagttg aciatgcaga cacggacaat taaagggtgc atatttactt ttctattgct 236640
 gtaaaaggac agcatggta aggaaagagt ttattggaga cttacacttt caaagggtta 236700
 tatcatgacc atcatggcag gatcatggca gcaggttggt aagtatggtg ctgggacagt 236760
 agctgagaac ttacatttga tccacaagca caaggcatca tgagctgact gatattagtc 236820
 ttctaaaact ttccagatag tccaacaac tggggatcaa atattcaaat atgcaagctt 236880
 atggggccat ttgcatttaa accatcacac agggcaacat aaaatTTTTg tgatgtactc 236940

 tctcaacatg atggcttacc agtttttagc ttcttttgggt ctgcttctcg ttttctttgg 237000
 tccaattcaa taagtttctg aatttgatct ctttcatca ggtttataga tgatttacac 237060
 agctatttaa ttaaactttc ctaagctatt tgtttattaa attttattat ttatttattt 237120
 gtataactc agagaccata gactatattg tggaacatt ttcctgaca ttttctcaat 237180
 gtgaagtgtc ataaattact aaatagtccc tatgagagtg taattcttta gcatttttgg 237240
 atattgttct atttatttag aacacatcta ttgtcttagt tatttttctg tttctgagta 237300
 aaataactta agggaggcag ggtttatttc tgctcacag tccaaggtgt agtccattat 237360

ggtgaggaag cctggtagac aggagctggt agggaccaga tggagaggaa tgtttgtgcc 237420
 agttcctttt ctccatttta ttcaattcaa gatccccatt taggatacca tcccagccct 237480
 acttgctttc aattaatata gcattttgct cagcactcag aagacaaaagg atgatgaatc 237540
 tctaattca aggccagctt ggtctacaga gtgagttcta ggtcagccaa aagtagacag 237600
 tgaaagaacc cattaanaag agaaaggtaa tgaagttgta attcaatgag gggccctggt 237660
 acattcccag caagcagcag aacttagcag atttagccac aaggtttagg cttagagtc 237720
 aagaatggaa gaaatgggtt atggaatcac cctctgtgac taaggaaaac tgctgaggcc 237780

 aggcattgtg aaggggtgtc cctgtatgga ggcccagaga aaccattgtg taaagctgta 237840
 aaggtggaac ctggattgcc tttgagatcc caagatgta gagatgcaa agtcatggga 237900
 taccttcaa gaaagctgc tatcaggag taaaccagc ccaagagaga gaagtgtgat 237960
 gcagtcaata gaggtgaaag aagttggaga tctagagaat actctgacat cagacatgga 238020
 gatgaagagt ttgaaaattt cccagctagt tttgcttttg ctatggtctg tatttctca 238080
 ctgtgcccc ttcctacat tttggaactg taatgtaac tcacggccat tatatggtgg 238140
 aaatatgtga tctgcctttt cattttaact ttataggtga ttacagttaa gagattgaat 238200

 attggagaag aaatttttaa ctttgaatt ttaaacaatg ttgagactat tagagactat 238260
 agagggactt ttgaaattga actaaatgta ttctgcatta tgatatagtt ataagcctat 238320
 ggaagccaaa gagtgcaata tggtagtttg aaggaaaatg ccccatgtg cttctagtga 238380
 ctggcactaa tagaattgtg accctgttgg agaagggtgtg gaatttttgg aggacaagtg 238440
 tccttgaga tgggtattga gatctcagat gtttaagcca ggcttagtgt gtttctttct 238500
 cttctgcta cctgtggatc tagatgtaga actctcagtt cttatgaag caccatgtct 238560
 gtctgtacac tgctctgatt cctaccgtaa caataatgga ctaactctct aaaatggaag 238620

 ccaaacccea ttaaatgttt tcctttataa aaatatacag cattttatca ttcattagcc 238680
 tgatcaagtc catctgtcac aatgtctcag aaacagagat taatttacgt aatccctgac 238740
 aggtgtgcct gaagtcttct ctcatggttg attctctaat ctgtcaggtg gataattaac 238800
 actaatcacc aacctacag cttgtatect ctaatgaaat ttacagtaca actcgtgtcc 238860
 ttaattaaa tcaacaatct attccttcaa actagaaata tttagttaac caacaaccc 238920
 tacttttgag aaaatgtatg tgtccctctt tccatgtcta cttttaagga actacacaaa 238980
 tattctgaat atagaaatat ataaatataa gaataaatg acagttaaaa cacagagcta 239040

 tttcaaata aaggaaaaat tataggtgaa aggcaataaa tagactatgt tgcttaggag 239100
 ctgtactcat gcagagacc tttactgtgt ctgaaggaca catctgagca taatttatct 239160
 gcatagagat cattaacaca ttaaagccat caatgatatg cccaaaatct cttttccaaa 239220

tacaggtggt tgcacatat tcttaccaca aatcagactt tagatattag tagttcaata 239280
 tatggaatct acataaatgt gtatagctta aattgagtta acaatggata gactcactaa 239340
 atcccctaga aaattagaac atctgttact ataataccaa gtctatcaaa tgcaaattha 239400
 gtgggttagt gagaatagat gcacatagag tataaccaag ttgatcaaaa ttgattagta 239460

 aattaaagct tgatgtgtct agatctttaa tattaaaaag acacttgggg catgttctcc 239520
 acatactaat ttctcagagt acataaaatg caacttgaaa atactagcag gagggcagaa 239580
 ataacttcaa agggagattg attctaattc tgctggcaca gtttactttc caggaggaaa 239640
 accatthtcc atgaaacaca cattcatgta aaactcccaa aattaaaaaa aaaaaactgc 239700
 taaaaattgg ggtgcatcat gtttaacccc aaagattcaa taaataagtt aaataaaaga 239760
 aagaaaaag atctgactat tagaaagcct ataaggtatt ttcttaatta gtgattgatc 239820
 gggggaggga ccagcccatt atgggtgaga acttccctgg gatggtggtc ctgggatcta 239880

 taagaaaaca ggttgagcaa gtctggatca agccagtaac cagcatccct tcatggcttc 239940
 taaatcagct cctgcctcca gatgcctacc tgactthttt atatgatgac cagthtttgc 240000
 aaagtgaag aaaaatcctg cccccacc ccaggaaaa aacgttaaaa attccaggt 240060
 catctttaca aaaacaaaca aacaacaaa cacaaact aaatattcag catgcaattc 240120
 aaagaaagtc taaagaaat atccaacata tgatgttga tgatacaaca gacatagaat 240180
 gthttccagt ttggtgthtt tgthttgthtt tagggataaa thtcataact gtageccaca 240240
 gcaggtaggg tcacactgtt gccctccat ctgcatactt ctaaattgct attattctta 240300

 aatccetaag aaaccacttt atgaaactca tgaagtthc aaagacacta taaccagaaa 240360
 agctgtaagt thtcttctt taacatcga cactactatt tacagaactc acacctacat 240420
 tggtaggaaa aaaaattht agctatagc ctaaattaac thtthttct thtthtctc 240480
 thaatgtca tcaactgaaag gthcatgtct gtctcagcaa tctctthtt cthtthttta 240540
 aacaaaaca taacaatcac taaatgtgt gactgtcttg aggacttct gthtthtct 240600
 thtthtgac cacactgca thtctthtct thgtctthc tgcactthc thgacaccac 240660
 ctggctcata thctcactc aaagtaatta ctctaggctg agthctggtc cththtagctc 240720

 tgaacatat cthtactth atatactta thcctact atacagattg cthgaattc 240780
 thtctgca tagaaatcaa gctthttata thcctctgat ggctatgct gctthtctc 240840
 thactgtat ctgaaatgaa ccaccattca gaaacggatc ththttgat cthgagtag 240900
 ggagacacat gcctthtatt tgaaccacac thtctgctgg aagctatth aaggacatta 240960
 tagaaggaaa gattthctth thgcatgct gactcact thctagthata thtthtctc 241020
 acgagaatta aagctactt cthgggatt ccagcaagta cagaagacca gctgagaaac 241080

ctagcatcct gggactttat tttcacaact agactttatt agattagtgt gactgcagcc 241140

tgттаagcca ttcaaataaa atcccattat gtatgtatgg aacctgact aatatgattc 241200

tcttgaagtt ctcttagaag atgggcacac acaaatcaat gtgttcacta ataaagctat 241260

tatcacatat taatatctga ctgggtaag tttatagaat gtagtattgg aatgagtatt 241320

taggcagtgg aagaactctt tcttaataag tgaagactg agagtttggc tccaaaactc 241380

aaaaagaagg taagcaata aacaaaaacc ataactgatg atataaaatt taatactttt 241440

caattaagtt tcgaatacct ttcaataag aatgatactt tggacaggta aggaagaatt 241500

gaatgtagtt agtggccact gagggaggag tcattcctct ttcataatct gaatactggt 241560

aggtttctca tatccaaatg aatgttgaca cctgcatgca tacagatact agtaattgga 241620

cgcagggtt ttttttttt ttaacaacaa tgaaaaaaga aaccattaac ctgggagaat 241680

gaaggcgtat atagcagtag caagagttta gggaagatag tggcagctga gtatcgtcaa 241740

tacacaaata aaagttttat tatttctaata aataaagcaa tattatatga aaaagacaaa 241800

gctgggcagt ggtggcacat gcctttaatc ccagcactca ggaggcagag ttaggtggat 241860

ctctttgagt tcgaggccag cctggtctac agagtgaatg ccagaatagg ctccaaagct 241920

acacagagaa acctgtgtc gaaaaagcaa taaataaata gataaataaa taaataaata 241980

aataaataaa taaatccaa taggaacag agatgtcatc atatttaaca atggtttttc 242040

aaatttaatt gtaattgctt ggcagcaata tataattttt tcaatcataa caaacaact 242100

agaattaaga aaggcattcc tagctctttg tttctccttt ccctaggac ccaacaatat 242160

cttcaaatg actttaagat tagacatttc agtatggaaa cctaggagcc aactttgcac 242220

accagattct aacacataga agatataagc aaaagagact ataacttcaa tgactcactc 242280

aacttaactg cccacctgta ctcttattcc cactgaaggc cccagtttaa gaacttactt 242340

ttaaaatgag aatgaaaga aattaagggt atctttgcaa aattcagggt ttggtccttt 242400

tgttaaatag tcctactata agcctattac atttagcatg aacatataga aaattaatga 242460

ccatagaaca cagtataat agagatgaac tcattattca cagttcaata tggaaatfff 242520

ttctaagtgt gtgcttgta gacgtttagg aggtcatcat agagacaggg tggcttttat 242580

ctgttggtct acattggggg caagtgacag tggttaattca aatgtatgac tagacgattt 242640

gcttgccatg ggagtatcac ctgctcctga gattccagac tactgtccca tcccttgggg 242700

ctgcagaaaa accagagtct actacttggg tgcgcctcc actttatgtt gagctaaacg 242760

aatttgaac agagcagata caataaattc agtcaaaaac accttgcctt gggaaacaga 242820

tataaaaatt tccattaaa aaggaggccc tatctatagc agaagaaatc caatacccat 242880
 ggaggtatat aggacagaac attctataca accaaaacct ggttaaaatc actcttcctt 242940
 ttgcacctca atatgcttta ttttcataat taccttcttt cattcaacac attacaata 243000
 cattttacat ttttctatit ctgattattg cttttctcat gagggttccc atataatgta 243060
 aaactcacat gaaatTTTTG tgattttgcc ctattaatct agtaatacca atttaattct 243120
 tagacacatt tggggacctt agcagataag agatgaaggt gtgcattaat aactaactc 243180
 ctcaaaaagc ctcaacttct tttagttagg aatgttctat aaaacagaaa tgaaaacaag 243240

gacataggat attaatatga atttttaag agttcttact attcagtga ggccaatatt 243300
 ccatattgag atcattttac tgagagacag aatagcagg aaactacca attccctaag 243360
 ataccatgat gtggataaaa ttattttcat ggatatcagc ctgtcttttt ttctgtagac 243420
 tggatctgaa ggattaaaaa cctcaaagac agtgatcact aacatatttg atattttaaa 243480
 gtttcattat taigtacaa aaagcaaaga ttttcgtta ttttcatctt ttttgtttt 243540
 ggttcaaaaa tgttttatc tttctcatct ttccacagat agggatatata tacctacaga 243600
 caaaacatgg tactgttttc tacattgaga gactactatg tgccctatc acagattctc 243660

ctgtgccctt ggacaccta tattgaggtt tccttattca tttctaacca ccagaggaga 243720
 atattcaaaa catgtaaagg ccattgtttc aattaacaat agttaatata gacttctgtc 243780
 tagagtgtta gaatatgttt tttttatata ccagtgat cactggatgc tcaccaattg 243840
 tctgcctttt ttgttttata ctgtagagta tggttgacat agggctcttc tgtgtatccc 243900
 tctctatcct ggagtttggc gtgtagacca ggctagtctc caactcacag tgaactgctt 243960
 gcctctactt cctatttgtt aggactaaag tatgtagcac catgctcagc taattttatg 244020
 tcttttcaaa ttaattatac aagacataga gcttagaac aacaatgtgc tacctaatgg 244080

tggatacatt ccaaaaacta tgatattgca cagttttctc atgagcatga cagaatgtac 244140
 ttgtattgct caaatatata gtggtgccca caataaaac aagatgaaat atgtcatgac 244200
 tcaataaaat tttttttct aattagtaga tatatactct aatgtaatga aaaaatatta 244260
 ttttgtaaac acataagtct gttggattga tattgaatat ttttatcagc taccaggcat 244320
 aaagtatgat tgtttatgac acagttttac atagttactt ttatggtagg cttgcccata 244380
 ccagccat tagacgtga tatagtaagt ttgttttacg ataagctttc tcataccagc 244440
 aatactatac ataggtatag ttagttgggt ttatggtagg tttactcata tcaacaatac 244500

cacacaggta gagttggttt attttagaac tgttcatgcc agcaacacca cacacaggtt 244560
 atcactactgc agtgtagat gctatgattt tatagtgttt ataacctcat taaaaacata 244620
 aaaatttcag ctccactatt atcctttgga ttagcactgc atacactgta agctgtttac 244680

caaacctctg agttaggtag gtagtatatg accctacatc aatgtgggct tcagaacaaa 244740
 tgataggcta catgtactca aggttattct gtgtcaggaa aactaaagc aaaaagtatg 244800
 agaacactat accctgctgc atcatggatg gaccaaagat gacttatgga agaacttcta 244860
 tgggtacatc atgtatttcc tccagctgtg ctcttgggaag catttcttag ttgatgaaat 244920

 ctctaccctg ttaggttaca ctcttgactt ctgctaaaaat tctttttttt ttcttgagaa 244980
 gaaacttact gagccaaaaac aaactctaaa tgcataatct gccaattagc actgtgacct 245040
 ttctgaagtc actctccctt tcttggtttg agctttgttt ttctacagcc tcaaacattt 245100
 gctacagcct ggtagcttct ttatgttgat tcaaaactgag aaatttaact tttagcatta 245160
 agctggaaag gttgaagttt tagttcttta tgaatttttt attataagca tttcattttt 245220
 cctccagtca ctaaatttat gctaatactg acaagatggg aatctatatg atgtctgcaa 245280
 ctacaaggag ctaaaggat tttgagctac atgcttctgt ggaccagcat tacaaactct 245340

 gccagatggc agtgaatttg tcatgggtca tgctatgggt tcatgattgt acctaggcac 245400
 aggcacaaga agaatccagt ggcaaccaca ggtaatcat ttcagtgatt gggctctgga 245460
 accaactaaa atgatcttgc tagattattt aaacatatgt agaacttag tggtaggttt 245520
 gaatattcat agcaattatc tagttaatat aatcttgaag gggggaagaa taactgtatg 245580
 cacctagctg gaaaattatt ttaattaatg aaatagggcc tatcaaat tcaaaaattc 245640
 tcaatccttg taaactcatt aataaaatat tctaaacaag attagctcaa gactctggca 245700
 ttgcacctga aatgagctgg atagtacag aggggtgtccc catttctgaa ttctaactga 245760

 agttctaaag tggtacttt agcttcata taaaggga gttatggata aatggagttc 245820
 tcattgtca cttattctc agttaattca ggcagaaggc cttttcata attttctacc 245880
 cctgttgata gacaccttt aattacagca acaacctga agtatcctgg ttgtttatac 245940
 ctcttagaca atgaacaaat tgatgttcag gagagcgtct tctttcttc tecttcaact 246000
 ccaattctc tccagatc tgctgtattc atgctgagag aaatgtcact tgaactttaa 246060
 aacacaggaa gcaattgagg ctttaaatg ataactaaa atgatccat ttttgacaaa 246120
 tttgtcagac acttttgta gcagtgaag tttgtagtta ttgcatttct ctgaaacact 246180

 taagtgtcac ctgagatatt tcacctaagc aacctgctt tcacattgt ctgtccttag 246240
 tgaacaact ctctcacaag agtgtgcatc cttttcaag caactacctg ctatccagt 246300
 tatacgtttt cagcattaaa agggctctga tctaccgga catgactctt tctgacat 246360
 tctttctg ctacacaaat aacctgcaa actgattttt cctcctctg ggccatcagt 246420
 tgcatatctt atttctgtg attattttgc ttattgctc agtagaatc aatgatgcc 246480
 aaaccaggct ttccattctt ctaactaaa gtgggttaga attaatgtt ctatgtgata 246540

ttaaggtatt aatacatatt tcagttttaa tatgattaaa aactaatgct gacaattact 246600

 ttaagcttag ataagaaatt tactttccta cattacatca aataaaactt gaaaaatacc 246660
 gagaaatgct actttagggg actagatatt gagagattta accaaaagaa gaaggtctaa 246720
 aggagttagg ttctctgtag ttcacacctg cccaaatgag ccaatcctgt gcttttgacc 246780
 agaatagcat taaactacca ccatctctgt acattttgca tgtacaaacc agcatcttca 246840
 gttttgatac tcaaattcta gacaattagg cataccaaat tcacttatta tttttctcac 246900
 atattttatg cacttgggaa aatctcattt agaaatattc tctgaatata ctgggggaaa 246960
 atctatgtat gtatatatct acttatctat atatcattta gcacctgtct atttaccata 247020

 tatcatataa ctagcaatft atctaacatc tagttgtcat ttatctgttt atacgiatat 247080
 acagacatgt atgicaaaca atatacataa ttaagtaagg gacaagatgg tggaatgttg 247140
 aaaaacacaa gagaatttaa attctggctc catggatcat ttgcaaggt cagatacctc 247200
 atctttgctt ttacttttca tattaatgat acagagataa tggaacctaa acgtagggca 247260
 aacagtttta gagtgtttaa ttccataaag ttgtaaaat ttaatgttca agtacaataa 247320
 ttttttctg aactacttta aagtaaatac gtttagtaat gtaagcttga aagtgaatgt 247380
 gagcctgggt acaccatatc ctcatgtctg ggactgcgtg ccttttgttg ttcactctaa 247440

 catgtttatg aattatgcta cactaacaat aaattataac tataacatta gttataaaac 247500
 tgttctcctg atggaccatt tcttttcttt gatgtggcaa ccttccttat attttcaatt 247560
 ttgctttgaa ggctgcttgg taatatataa ggacagctat tcttgtcagg atctttcttc 247620
 tacttgcttg gcatagatgg tgttagtctt caaattcatt ctcactcttt ccagagagtt 247680
 gtgtctctgc aaataccgag ttgtatgttt ttgtatcac attaaatgaa gtaacatgtg 247740
 agcaccagtc ccatagtttg gggctattga aatttgtatt attcctcaga gatttttttt 247800
 ttactgggtc ctttcatttt gtttttgttg ttttatgggt ttgtttaaat getgtttgtt 247860

 tgtttgtttg ttctgtctta ttctatctta tatttgatga tttattgagt tgggtatftt 247920
 tagtctgtgt ttagtttagc ttattgttct atgcttttca ggaaattata tttcctatgt 247980
 ctttatgttg cacccatttc tgttctcttt ctgagtgtag gttttctgct gtgctcttga 248040
 gaacttactt ggtaatgaat ttctaacaat ttgcttctc ttgtactgtc tttgtttgtc 248100
 catcagttac aggtgtttgt cttatgtgta ataatatgt ccagtgtttt ttatactttc 248160
 agaaataagc ttttccatgt ttatatgtaa ttggaatatt ctttggatga tcaaccagat 248220
 cccaaataaa gactccatga attattatta attgtgaatg cttaatagag cttaggcttg 248280

gcccaccagg gcitttaact taatttaacc tgttgctatt ttatttacct tttttcaaga 248340
gaaaatttac atttttcttt cttcaagga ttctatacat taattaagtt tagagagtat 248400
gatattagag aaatgcctaa ctgctttgtg tacaattat acacacagta gcatgagtga 248460
ctattaagca ttttcttttt tttctttttt cccaactttt tttattaatt agaaacagga 248520
ttgttttaca tgacaatccc agttactttc tcccacctgt cctcccttta tttacatttt 248580
tctccagtc tgtttacctt tctttcattc tgtgtgttct actttctgc tttctctatg 248640
tctggctgga tgccccctag agtctccctg ttgtttgatt ttttttttc ctcaattcta 248700

aattccccac tttgcttatt ttccctgcct ggaaattctg attgtgcctc ctccctcact 248760
attagccatt caacttttta ttagaccaat cagggtgcctt agacaggcaa ggtaaaacag 248820
caacacatgt ttacatgatt aaacaaatgc accttgcctt tacatagtta aacaaatgca 248880
acacatcttc acatagttac acaaatgcaa cacaactttg cataattaa caaatactct 248940
gcaacatttc gacattttgt ttgaataaaa agacagtat agctttaaca tagtaagatt 249000
atatacaata aagtaattat caagcaagaa ttgcatttaa aatatccagc ccacttgtat 249060
ttggcaaatt cagagaaact atgctattat ctatcctatc ttgtgaatcc aaagttttgt 249120

acctaacca ctttctattc taacttgtat taccaacca aatttatatt ctcaaaactc 249180
taaacattat cttagataaa catattatgc cccttatatc agtttagggc atttcttttc 249240
tgaatttgtt aacaaggaaa actgtaagat taactatttc atcttcaact ctaccagaga 249300
cctgagaatg ttatactatt acctgagcta agagaatagt gcagggcaag caacttcaa 249360
aatcatagaa atgacaaaag cagctgtctg actggatagt cattggagt tcatgtgacc 249420
ttcagatgaa agggcatctt tctttgattt acaggcttag aatatctgac agactttttg 249480
tgaaacatga atttgaaatg actgtcccac cttttctttg caaagttagg catgtatfff 249540

cctttgtata ctgattgtcc actttgtaca atgtgctgtc agcagtcaag gcaagggag 249600
tttcttgctt aaatgtctaa ctttgccaca atgaaaggtc catacgtgga ggttcttcag 249660
caccataat ctttctatgg agtaaattat tgcctccaga agtagatgtg tctcactgtc 249720
atgaaagcct taggtttggg tgggatcaa tgattagtgt tgggtgtcag cttctacttc 249780
caccagctgc tggatgagga ctatcagggtg gcatataagt cagtcatggc tttcagttag 249840
gaaaccttga aaatctacag tacctccttt agtagttcag tacttatccc tagcataggt 249900
gaggacttag ggagcccatt caacatagag ggatactccc tgagctaaga cacacagggg 249960

tgggcctagg ccctatccca aaggacatga tgactctgat gacacctgt ggaagacctc 250020
accatccagg gggagcagaa aggatagtgt gtaggtaggg ttttatttgg gggtaggtgt 250080
agggcaggat gggagggaga agggactgg gattgtcatg taaaacaatc ttgtttctaa 250140

ttcaaataaa aagaaatctg caaaaaaaaa cccaaaaaagc cttaggttat taacgatcat 250200
 aaatgcaaca ttctttaaat atctgaagca tttaaagata tcctatcagt ttctggctat 250260
 tacaataat gctgctatga acatggttga acagatgtcc ttgttatatg agtgtgcatc 250320
 atttgggtat atgcctaaga gtggaattgc tgatctagtg gtagatagat tcccattttc 250380

 ctgaggaact gccatactga tttccaaaga ggctacatga gttggtacta ctaccaacag 250440
 tggaggagta ttccccttc tccacatect ctccagcata aactgtggtt ggtgtttttt 250500
 tttttttta ttttagccat tctgacaggf gtaagatagt atctcagagt tgttttgatt 250560
 tgtatttccc tgatgctaag gatgttgacc actttcttgt gtttctttca gccattttat 250620
 attcttctat tgagaattat atatttattt ctgtacceca ctttttaatt ggattagttg 250680
 gtgttataca aactagcatc ttgagttctt tgtaaatttt ggagatcagc cctctgtcag 250740
 atatgggttg ttgaatacct tttcccattc tgtgggatac cttttgtct tactaacccc 250800

 agactgatag ctggaaaatc agcatagcac tgttccagac cccctgaatg tagaagttag 250860
 tttgaatgtc tagacaatct atgcggccac tggtagtggg tcagtattta tccgtaaaac 250920
 atgaatggac tttgggagcc tactccacat agagggatgc tctcttagcc tagacacatg 250980
 ggggaagggc ctaggccctg atccaaatga tatgacagac tttgaaaagt ccccatgga 251040
 aggcctcacc cactcagagg agcagaaaagg ggatggggg atacagggtt ggtgggggca 251100
 ggggaggagg aaatggagag ggaactggga ttgatatgta aaagaagctt gtttctaaca 251160
 taaaaaagaa gatatcctat ctatctaaaa tatatctgtt taatgtttaa aacatacctg 251220

 aatccatttt ttattgttat caatgaataa ttactaacct gcattattta attatactaa 251280
 acacattaca atattagatt ttaaggacta gaatgtggtg atatattatt tatgattcat 251340
 taaatcttgc ctgagatttc agaaagcaaa gtcaaccaca aatcatagaa gcctgacaca 251400
 cacctttaat cccaggacta aggattaaga ggatctctga gtttaagaa caccattggc 251460
 taccagagag tgaatcagtg ctcacacctt taattccaag gtttgagagg tataaaagtt 251520
 agaggcattc attctccagc cacactaaag ataggaagac atagagtctt gggattttcc 251580
 agccatggag aggagagcat agcaatttga gattttggtg gagccgggat cacctttcag 251640

 ccttaggtag agagagggat gagctagtgg ccagctgatt ttctttctg atcttcatct 251700
 tgaagcttga accccacatc agtctctgta tcttttattt attatgttac actacaattt 251760
 tgtattatata ttttaagtga gctgcatagt tataatacct taaatagagt agaaacatat 251820
 gaatggtata acaaaataac cataaatttg tatcaatata caaaaattca tacgaatgta 251880
 aattatttgg gatgaatagt tgtcatttta ttctatattc ctatatctgg actaaataat 251940
 gacaaacatc catagcctgt taaattacca aatacaccca cctcaactct tgggaatgtg 252000

ggcatgtgt tcictagact gcttccagtt gtcttggaga aacaacatcc tcaggggacc 252060

 atgagaaaat tgagataatg gttaagtctt aagaaaacta gttataacat tttttgtctg 252120
 gtccctgtgt aatgggtctt ttttgaagtc cttgcttggga tagtctgtga ggctagatca 252180
 tatcagccag cggccttgaa tatgttctga atgcagaact ctgagaaaac tgtaatagag 252240
 gtactctgaa aggctggatc acctgaatga tctgttttca ttgttatgtt gttctgttgt 252300
 actgaaaata cacatatctt aaaacaaata ctctgcaaca attgcctgct tttgaagaag 252360
 gtgtgtccaa tttactttgg aatataaatc tctttatatg gatgtccaca gctagcttta 252420
 aatttttgaa atattgtgtt ataatttcac tgaacagtat tcttatccct ttctctcttc 252480

 aaatttcatt ggttggaggf gtggctttat gtttagactt taaagcacat cgctgaattc 252540
 ttgtaggttg taatcatgtg ttattatatt tttatacttt acaaatatgt aatttcatta 252600
 acattgttat attaatctgt gatatttttt ctgtgtctgc acttcaggtg tggtttcagg 252660
 tgccttgtc attttcagta tcacagttgt ttgattcatc ggctaatagc ttgatagtga 252720
 gttaatgaga ggggcctata agtttagaac tacaaaaata taaaatattc tctttcccta 252780
 gtagaacaat ttgaaagtag aatttctacc aggaaaatga catgttcata tactttcata 252840
 tattatactt caaactttaa aatgaaaaaa ctgtaccaa tgtaaagaa caaaaacatt 252900

 ctaaagtaat aacatatttg gaagatagta tgacaaaatg ttgtgtattc aattatatag 252960
 aacaaatata atcctgagtg taagggggaa atgaccttta tgctaacatc tgttttacag 253020
 aagaaaaaaa atactcctgc agattcttgt atattttaga ctattataaa tttgtaata 253080
 ttgacaatat tgcaattaaa gtatgtgcat caagaacaaa ctatacatgt cccatgtctc 253140
 acacttagtg gataagtcaa gatactgagg tagttttctg agtggttgat caagtctcat 253200
 ccatccaaac ttccccttct ttccaatgat aattgtctac ttttgaacac tagagagaaa 253260
 tttattataa taaacacaca tattcaattt tatcttcagt attttcattt gatgtcttaa 253320

 actcaaagag aaagaaaaca tactttgttt aaaaatagaa acgaggaaat gtggtattta 253380
 aatttctcaa gatggtatct gaaaagacag aacatttctt gtaaagaata atttctaacc 253440
 ccaaactgtt gacttttgta caagtttcag aggataatta tagggaaaga tttgttccca 253500
 atacaaaact ggtggtggtg agagaaacct agtgtctact ttgatctgaa gcaccacact 253560
 gtaccttaaa tactgcaagg ctgaaaccaa aacaaaatgt tgcttataaa tttcagtaat 253620
 ttcccacagg tgiagcatga ttttatctta agttgaagga tgttaccat tctgatccaa 253680
 tgagttgaac aagactaaag aaaatggtgc tataaagaca catgttgact ggtctaagtt 253740

ctacagagga caatatacat tttagaatgc agtttgaggc aattttttaa aatccagaac 253800
 taattttata ctgtgagggtg aaccattcag ttaagatadc ttcaaaaggg tcaaagattc 253860
 aagatgagta caaaaaacac aatcacagat cagtaaatgt aggatgcaaa catctttaa 253920
 ataataagca actaatctaa ttttaagtgg aaaaaataat agaagacttt acattaatga 253980
 ttaaaagcta ggattatata aatatatcag ttaacaact aatattggat gcttataaag 254040
 agcaaagctt cttccagga gaattacaat agggctgttc tggactaaat agttgttttt 254100
 cctccatttt taaattttaa atagaacaa gattgtttta catgtcaatt ccagtttctt 254160

ctccccgctt cccctacccc cactaacatc ctgcctatcc cataccattc ctgctcccca 254220
 gggagagtga ggicttccat gggagggggg gtcttcagag tctgtcatat cctttgggat 254280
 agggcttagg ccctcccttg tgtctaggct gagggagtat tcctccatgt gaaatgtgct 254340
 cccaaactcc attctgctag ggataagtac tgatctacta caagaagccc catagatttc 254400
 caaggcctcc tcaatgacac ccacattcat ggggtctgga tcaatcccct gctgctttcc 254460
 cagctataag tctgggtgcc aagatcatct acttgctcag gtcagctgtt tctgtgggtt 254520
 tcacaagcct tgtcttctcc actttgctca ttactcttcc ttctctgcaa ctggattcct 254580

gttcacttct gtgtaagct gtgggtatct gctaaaggct ctaggatggc atataattca 254640
 gtcaccaage tcattctcat gggagagcaa ttaaggtagc ctctccactg ttgattagat 254700
 ggtagttgg tgcacctcct ttagatttct ggacatttcc ctattgcctg atttttcttt 254760
 aaacctatac tggctcccta tatgatggta tttgttctc ctctattctt cccctacac 254820
 aaacttctg ctctttata tcttctcac tcttctctt ctccccttat caagctctta 254880
 gtccctctc ccatccccc acgtccccaa ttatgtcagg agatcttgc cctttctctt 254940
 tctctggggg accatgtgtg tctctcttag attctctctt gttgcctaac ttctgtagta 255000

gtgtggattg tagactgggt atcctttgct ctatttgaaa aatccatata tgcagagta 255060
 cataccatgt ttgtcttttg gtgattgggt tacctcgtc agaatggttt ctctagttt 255120
 catcgatttg cctgcaaat tcaagattc attttttttg gctgagtagt attccattgg 255180
 aattaacaa aattccat atgttttccc tcaggacaaa gccttgaaga tcttctttgc 255240
 tatatccctc taatgacatg gatggagtaa agttctctgc ctatcatcca ggtttgaatt 255300
 gtaactgact tgaccagag aacatgacag aattgacact ggacgaattt gggatcaaac 255360
 aacctgcaa taatttgat tgtcatgctc catgatatgg tagtaaacct aaactataag 255420

gigaacttac agagagtgag acaccatgat aaagagggat cagagcacca agagaagcaa 255480
 gccatagag tcaatcaagc actgaggatg tagagcctca atccagagta caacagtggc 255540
 aaagtcttga gcctgccag aggttttaag gtttctatga tgtaaaataa actcctgaat 255600

aaagtaactg cattatcatc agatttctct agttgaatac aaggattaga tgattgaata 255660
caattctttc cagtgagtga atggtttgta gagagctggg tactatctgt atcacagagt 255720
acatgctaaa ttcttctga aaaaaaatca actactttac agaagttggt atcagactga 255780
atatataaat atgtcaagtt ccaggaacaa agatagccaa ccgactctgt cttctatgga 255840

gagaataaaa aatgataaat aaaagaaaaa taataaata ctaaggagga gatgtaaggc 255900
acatttatag gaatattctc ccggagtgtg aagtcatatt catacatatg tatatgtatg 255960
aatatataat ggcacatata catttataca catatataga cagtcataga gcaccaaagc 256020
tttattaact tgaatgaaa aactgactaa aaatatagtt ctgataaact taaatccact 256080
tccttatgaa aatgtgattt ttcttttttc tttcctgtta ttgactaatg ttatttggg 256140
gggaatattt tccattaatg tgttttaaaa tgcaagagca cactggtata aaaagtaac 256200
tgtatacaaa agtttcttg gaaatactat tttccaagca caactaattt ttgctaagac 256260

catgattgga gccagatgtt tcattgggtg tagagaatga tattgcca atgccattt 256320
cggtttctga aaaaaattaa ttaaaaattg attctctctt actggaaaac atgttcatgt 256380
atttggcaga acatttttag aatggtagat tctaattgat tttattctag tccacagtga 256440
aggagcattt tccttttagt ccactagaca gacaaaaacc ttcaagcata aatggttctg 256500
ctgtctcttt ccactctcca cataactctc atagtaacag acaaatcctt taaagctttt 256560
agacagatac tgagaggaca ggagagtgtc cagtggtaag tgtgcttgtt gggtaaatag 256620
cctgctatcc atagacaag ttcatggaga tcaatgggtg gggtggcaaa aacaaggaag 256680

gttcctaagg tatgcaagcc acctgcattg atacagagtc agtgagaaat gccatttta 256740
aggaataaaa tatattatga taatctaaga atctgttgtc ctcctttggc ctcttaattc 256800
acttgacag gagtaaatc tggagtactt atatgtatgt atatatcatg tatacatata 256860
caacttatac aaataaaagg aaaagaaaca tacaagaact ataatgaaac aaaattaaat 256920
aaaattattc catcaatgac ataacaacag tggtctgtac aatacattaa aaaattgtta 256980
tttggcttag tcatatcact cttaaatgta agaccatgtt gaagttatag taaaataacc 257040
cataaaaact gatataaagc tgatatcata aaagattaat tgtaacttca attattttat 257100

ttctcatata tgtaataatg gaaacaatat agatgtttag ataaatgtta tgctttgtaa 257160
ctaaattgct ttaaaatgta taaatttgt tttaaaacaa aaagatactt atttttttat 257220
gtgcatgtgt ttgcaccata tacaatcctg ttgactggag agaccagaaa agaaactgct 257280
gttgtgaacc accatgtgga cgcaggggca ggagaacagt tctgtggtga tatactgctt 257340
attatttaat aaagtcaaat gcaaagctac ctacagtcac agagccaggc agtgggtgaca 257400
cacatttaat ttcaggactt cagagacaaa gacagaagga tttctgttag ttcaaggtca 257460

cactgaacta actacatgaa ctcgatccat tctaaaagag aaacatctca cacaaaggtg 257520

 atccctgcac ttggggtcac atccctttaa tcccatcaca tggaaggtag agacaggtgg 257580
 atctctgtga gtctaagacc atcctgggct acacgagagt gaatcagagc tcacaccttt 257640
 aatcccagga ttigagaagt ataaaatgaa gaagccaaca gttagttagca tgtgacattt 257700
 actttccaga caggggaaggc ataggaatgt agtctaaggc ttggtgggaa gcagtgcagt 257760
 cagcattgtg cttggaggat tttcaaggac aggacagccc tttcaatctg aggtagaggt 257820
 aagagcaagt ggccaacagg gttgatttct gatcttcagc ttgaagttg aacccaata 257880
 tctgtttctg tgattttatt atttgtttta tataggtctc tgcaaaaaca gcaagtactc 257940

 ttcagtgatg agicatctct ccagcccaca gtgaactttc aaaatattga atattgtcaa 258000
 atagttaatt aggaaaagtg gtatttttgg ctttgaggtc tccatccatc ctgtgatggt 258060
 ccttcatgtc cctactctat ggtgacctt tgtcttgata gtttctatcc ttgatttttt 258120
 caatcaaca cgigtggca ctttagtcat ttgtataatg tctatcaact tccttttgaa 258180
 ttagtgagtt ctttattca agacagagca aaaattttgt accatgttta ttatgaattt 258240
 actcctgtt ttcttttgag caggacatcc cagtttgaag ttacatgac tcaaagttgt 258300
 tcctctcatg tagtgcatat tgcttttatt cagatacaga tatttatggc aatgatntaa 258360

 tataaatatc aagtaataat ttctgtttat tccaaaacta gccatacctt ctcttacct 258420
 tgttaccaca acaattttct tttctaaaat atgttttatt gtctgagtgt gagtagggtg 258480
 tgccattta cctgcatatg ctagtataa aaacgagagt aggagtgatt aatgaagttc 258540
 ttacaagctg acatggtttc taggacctgt tgaatggcat actccactac cattctgctt 258600
 gctcagaat acatatcaat gacaagaagc acaagtggg tccacttggt tcacacctag 258660
 aattacaate aactctctct cacagctcta agtatcagac tcactcactg ctacctgctc 258720
 ctgcagagat attcagtc tgctagctag ttactcattc cattggcttc tatttttgaa 258780

 tcagatgctg aaggatacaa ttatttctgc tttaacgtat catatatacc tccaaatagt 258840
 ccttttacac atggaaatta tattttaaca ctatgatcac tccattgtgc ttttatatgt 258900
 ttgtgaattt atacatttaa ttgctggtaa atttttcagc cagacacaga atgaaatgag 258960
 tctacattgt agtacttgag taacatataa agcagtaata tatagggtt tgaggttagg 259020
 gttgctttca ttctttaaa atgcatgatt gacttaggtt aggaatgta cctgtgtaga 259080
 atcaaaatac acctgtaata agaagtcagt gcccttcggt ttgtgtcaca atgaactcat 259140
 gccctatgct tttattaact aaaaaaaaa aaaaaaaaa aaaaaaaaa aaaaaaaaa 259200

aactaaaata taagtacaca tttctctttc tttcctttcc ccccaaatct ctctcactc 259260
ctgccaggaa agttgtgta tttaaactat gaagcaggaa aaactgattc ttacttttga 259320
acttacattg cttctatctt atagattgtt attagggatg ataatcatat gtatcatata 259380
tatatatata tatatgactt aactatacag taagtataaa accatatact atctatgcac 259440
attcctcaag gattttatgt gtctatgtt tcatgtgaag tcatttaaat atataaatta 259500
attagtaate atgtcattta tatecttagc ttttccagg atgttgctat ttttaggttt 259560
aggctaacag gaggcagaaa agtacaataa aataaatgtg gacttataat tccattatct 259620

cagattatat gagcagagat gtaagtttac attttaatga gtatttccat gttctgtcca 259680
tctttcaact ctgtcaacta tatccaatga taaaaaatat aaaatattga aacttttagga 259740
acaatttaac tgattccatg aatctattcc tgtaacaata tttttggttc tacctgagca 259800
atTTTTTct taaggtccca ccattaagat ttatttcttt agtttggctc aaataaacat 259860
tttgtctttt ttacaatagc ttcttcagaa caagaagttt tcatgcattc aagctatgat 259920
ggacaatate cataccagac tcaaacagc ttggggaaga aagaacacag gggaaactaa 259980
ttagaaacaa ttgccaataa tatattaacc ttttcatgac ttctattata agggaaataa 260040

aatgtccttt catcagcttt ttttttttag gattggctca ttctccaac attttaagat 260100
aatttgcage acaattagta gccaatgtta attgcagttc atgctatcat tggagtgagt 260160
aacgatgaat gacatcttta aaaatcattc taggattttc atctttttca ctgattcctc 260220
catcatgtca gttttaaata taaacttgat taatttaca tgagaaataa gtgtagcagg 260280
cataactatg ggactaattc aattgttttt tttttttgct ggtcagtga taagcaattg 260340
gataaaattg attagactat tgcacaatct ttttaagtc atcaagcaat aggccaggct 260400
tctcacactg ggggtgttaa attcatcaca tgatttctgg tatgtctaac caaccaaaaa 260460

catttttata actttatact aacagccaaa gaaggaaaga aaactcaact agatacaaga 260520
catcattatg tagtatatat ttccatttgi tatattcaca aaaattggaa gatactagga 260580
atattgccag gaaagcaag agaaaaggag acatgaggct tcatccatgc ttttctcttt 260640
ataaggatga cagtcaacta acttcaaata agatttgcaa acaggagcca agtgtttaga 260700
tagtaacat gatccttatg tagctgtgca tctaattttg aagacattct tgtgcctgga 260760
aagtttacta tataaatata tttgttgatg aaatttgtgc gtgatggatt atgatgtggc 260820
aaactcata tactgaaatt cactgtacat agtcttttaa agtatgttct aaattaatgt 260880

gacatgcaag ggatcatc agataaaaga gagacagaga gcaagaggca gagagagagg 260940
ggggagctat ctgcttgagt taggaaccac aatgaaggat tcatggacta ctgtgatttg 261000
gatatgaagt gttcccttaa gtggcttaca agtgaaggc ttgttttcca gggttattga 261060

gaggaaggcc gcaagatgag aaagctatct tttagagtta atgctgaata cctaattagg 261120
 aggcacacc taaaggaag aatgagtcca atagagatgt gacttcaaag agggatctg 261180
 gtctccagat gcttcccctt tctctactt ctattcctcc ttctttcttt ccctcacacc 261240
 atcctcttta cctattttct cttcgtcccc atccttggcc agtattcagt tagacgcctc 261300

 tctgacagat tatttcacag ccatgatatt ctgattcacc tttggactaa tgaagtatat 261360
 ctgaaacttt gctctaagat aaacctccct tcctttaaag agattttggc agataccatg 261420
 tctcagcaac gtaaagatga tgagctcact cacatttggga ttggcctatt tattcactta 261480
 aaaccaatgt aactgcttag aaatatttta tattttaaat attcttgttg agtgttttta 261540
 agggaaacca aagtgagagc attctgttgt cccttactta atcctggccc agctcttttg 261600
 cacagaatag agactttccc tgtgagatag acgctaaaat gcactggaga gaaaacaata 261660
 gaacatttct gcagtctgag aacctgcatt cacaaagttg ccactgctct gctgatttac 261720

 tttggcagac tggaattaga attttgattg ccctacgtcc ctctggatct ttcttcagat 261780
 tctgtgacct tgtgtcatgt aggaatgttt gtgtgtgtgt gtgtgtgtgt gtgtgtgtgt 261840
 gtgtgtgagc gtgctcatgc gtgcaagtgt gtgtgagcaa gcatgttgtg tgtgtgttta 261900
 tttgtgcatt tggttcaatg atagagatct caagatatgc aaagatgtca aagcaataaa 261960
 aatgcatatg gatgttgttc ggtctattct tagagtact gtacatgttc atgaggttgc 262020
 tggcttttcc atcatgcctt ttttatttaa attctttaat tactactcat attacatat 262080
 ccatccccc catccttctg ccctcccatg ttcccatta acctccaac ctattcgaca 262140

 acttctcccc agggatagtg aggccacagg gttccttcac attctgtcat atcatttggg 262200
 ggagggccta ggccctcctt ggtgtatctg ggcttcaata gtatctctcc ataaggaatg 262260
 ggctcccaaa gtccatttgt gctctagggt taaggactgg cttactgtt agaggtcca 262320
 tagactgtct tggcctccta gatggcacc aaatctaaca gctgatggaa gtagaagcag 262380
 atatccacag ctaaacactg aactaaactg gactctagtt gcagaggagg aatgatgagc 262440
 aaaggagtcc attcaaggct ggtgtaacc atggaaacag ctgacctgaa caagggagag 262500
 ttttgcctt agactgacag ctgggaaacc agcatggaac tgatccagac cccatgaatg 262560

 tgggagtcag ttcggaagcc ttgaaaatct atggggcctc ttgtagtaga tcagtactta 262620
 tccttagcat aggaatggac tttgggttcc atttcacata gaggaatact ccctcatcat 262680
 agacacatgg gagagggctt aggcctatt ccaatggata tgatagatgc tgaagacccc 262740
 cttatggaag gctgcacat ccctggagag cagaaagttt atgggatagg tagtgttga 262800
 gctggggatg ggggaggagt ggaggagaaa agaactggga ttgacatgta aaacaaactg 262860
 gtttcttatt gaaataaaaa aattgagaaa aaacaaaaac aaaaaaaaaa caaattataa 262920

aacacattgt ctttgtcact aggagagaag ctttttctct tttcattgcc tcacctaaaa 262980

gcctctcact ttctcctgaa ttgaaaatg ctagttaaac ttgactgaca acttattgat 263040
ttgaaaagta cctttgatat tagtaaaata ggagtttggg tctgtcagtg aaggcaactc 263100
ctaagggatt ccctaagagg agggggaagg gatggttagt gctgtcacat tgacagaaac 263160
tagaatgac ttggagatgg ggttctaate ataccaatgg gggttttatt atgctaatta 263220
gtacagaaag atccatctta attgtgggtg ttatcatcc ctgttcatcc ctagactgta 263280
ttaaataagag aaatggagct ttagagcatt attcttctct tcctgcttct tcaactatggg 263340
tacaatgtag tcaactccct caagcttatg tgggctgctc cctcaagctc ctgctgctgt 263400

gccttccta gaaaaatgga gaaaacttgg aagtgtgagc caaaagtaat gaaaacaaca 263460
aaacacatgt tcctctccct ctctttaag ctactttcat gagagtaatt attacacaat 263520
ggggctataa actctaattg tgaacctgcc ctgaatgtgg accacatgat ttcattgggtt 263580
cagagttga attgaaacta tgagcaaata actccccat tagttgttcc cttgggttatt 263640
tcaactgcagt gatgaaaggt ctcaagtaagt catttacctg tatccctcaa ctatacagtt 263700
cattttttat ttgataaata tgaaaccaat tcaaatatg tcatttttag acaggtttcc 263760
ttatttcaat ccatagaatg tattgatttt ccctttaaa cttcaggact aataaagaaa 263820

acacagagaa ccatgaagac actatagagt aaagggtgaa aatataacta atttttcaaa 263880
aaattttaag tatattaaca aaatcaaata ttttttact aattgacaga tatttataaa 263940
cattctgagt agaaaafatt tgtaataaaa gttaaatgct atgttaactt gatcaacaat 264000
acaggaacat aattatcaaa gagtgaaggg gaagctgtag ccacgcctac ttaggggctg 264060
gctacagatg tgctgacca tgcttgcgag ggcatggca ggggtttgta gactgactgc 264120
cttttctctt ttggtttacc ttgtgtactt gatggacaga atgctgccac gctggctggc 264180
taggtcgctc tgtaagtaag gcttttccct attaaatacc cttgtatttc tacctgactc 264240

tgtattggta atttcccagt ataaaagagt aatgaaggaa tcctttatc tgtttccttt 264300
tctttcttat tctctccctc cctctttct ctctctctcc ctctctctct tctctctct 264360
ccttctttct ttctttgtct cacacataaa agcacacact ctatgtgat tttttatatt 264420
atattctcat tataaagata agagcattgc taagtaattc aattttcaga taaatggggt 264480
cataattatt aacatataca ggatattttt gtgctacttg agtataaagg gtaatcagtt 264540
ctttaacaga ataatgtctt gctttgtctt gatagtttgg ttcttcaaga ctgtttccat 264600
gttttgaaaa gtctcttagg acctctagct ccttgggctc atgaatatga acttgttacc 264660

tttctcatta tttttgttgt tttgggacag tctcatattg taaccaagc tgatatggaa 264720
 tttagcttac agcattgtaa gcctcctact cttattaatt gtctcccttg ttagagagat 264780
 atagctgtgt accaccagat cctactgttt ctccttcaag agacaaagc cttttttcc 264840
 agttgacttc tgagacattt tctcatgagt acatagattc ttgagaaatc ttttattcta 264900
 taattaagtg gacatttagt aaacatagcc tcttaaggat ccatggtaaa acctttgaag 264960
 tgaagcaagg tgaatggcta atagaagtta gttatactcc aggcccagta taggaaaata 265020
 agggcacttt ggggagaaag ctggctgaag gacacttga cccaggatt aaagacagga 265080

 catgatgatt agtctatcaa atagactatg agtttgecta gaattctgtc tcctttaaac 265140
 atagactacc acagggaaat cgaatagctg aatctgaaaa cattccaaag ccacactaat 265200
 gattagagtg aacacaggtg tcagacaact gtggcttccc tgctgttgtt ttttggaga 265260
 ctatgttctc tgatgatagc tgatcatgaa gaacattcaa ctaacaagtc cttgataact 265320
 tgtgcatcct ctaactgaaa attccattgg ccactctgta tgtttcaaat ttgtctctga 265380
 atcttcagat ttgctaagtg caattttcat atataactta attcacttta gtcttctatc 265440
 tttagagaat ccagactcac ctctatccag tctttctccc tgatggaatt caacatttat 265500

 ttaatacaaa gccaacattc tgaatcaatt ttttgggttg tctctgcca ccagtcttac 265560
 tttgccactt ttctaataa ttctgaaata ttaggaaaat cccctggcta ataaaacaat 265620
 ttccatatta ttgaaacagg aagaaaacaa ttggaatcat caaatatgtt tgtcaaagc 265680
 ataaaacaatt gtattctttt cataggttat atggcagatt ttctgtaagc atttgaaca 265740
 cacatacatt ctggagattc cagcactttc tagaccattt cctttctccc tctatggaca 265800
 taaacttgat tggttagtgt tccacttacc aactggaaaa tttagtatgc aagttagaac 265860
 aggccatcct gtctgcaac ttctttaga acagtgtta ttttcatca tacaattaaa 265920

 aaccagattt agtgagcttt caacactaat ggcaattcat ggcaactccat caaatcactt 265980
 ctcatcattg tcctcccttg cgaattcagg catgccatgg gctttataat gtattttaat 266040
 taacacattc ttctcaatat ttaaaattac attttacaca gtggagtttt tattgttcag 266100
 tttaccgaca ttactcagaa tgtgcagtag tgaaggaga gctctctgtg tttaccata 266160
 cctatgctta acttctttct tctttagaat gttccaactt ccctctcttt tctttctttt 266220
 ttttaagaaa agtatectta ttggttattt taagttaggg ctactagtgt taaattcata 266280
 actgaatgct aaattggtaa ttgtgtggaa gtttgggttt gttcttcatt tcagaagaat 266340

 atttacatga ttgtttctc tcgggactgc taaataccat gatattttct tgttctatga 266400
 gatttctaat tagagatttc agtggttttc tttgattttt ctcctttaca taatgtgata 266460
 tttttctcaa gcgtcccta acattatgct ttaatttta atttgtttct taccttaaat 266520

ctttacaagg attacacaga atttatctca agtcatccag gctgtcttca aaatcacaat 266580
 gtggccaagg atgatcttga aatcttgatc catctacctc tactccttgg gtgctgggggt 266640
 taaagatatt catcaccaca gtcacataat gtggtatagg attgaatacc tggccttgtg 266700
 ttgtctaggt aggcactata ccacctgagc tacacacaca cacacacaca cacacacaca 266760

 cacacacaca caatgacaat caaatgtaat gctttatgg gtaattattg ccctgttcta 266820
 cttttcaagt tcattaattc tatactttct ttcagctctg agtctattct cttagctttt 266880
 gatcttattt tttcctcttc ccaggttttg atctttttaa tttttgtatg attaatttcc 266940
 atatatgat catagtgttc agtagtacat aaaaggaatc ttaggaaata tcaatatctg 267000
 tctatataat cttagaagtt caccctaaaa catttaaatt atgaattggt ttattccttt 267060
 tttctcttc tttccacctc cccctctcc ttccatcatt ctcctcctt tctttcttc 267120
 cctcctcca ttactctcc ctctcctctt ctctccttc ttcttcttt ctttgaatt 267180

 gcagaatagt ttctgtaatg tacaatcaa atagcttctt gaaatccaat tcttaggttg 267240
 gtttatattc actcctattc attttagaac acaattcaat taacttacat cagtaccct 267300
 gtataccaac ttttaggggt atagttttg aacaaatgaa tttacataaa atcccatgt 267360
 ctttaacatg agtattttt tatagagcat tgtgtgcttc acatgtaatg attttataa 267420
 tttagctgat tctttctaag acatttgggt aatgagtccc atatccagac acagtggat 267480
 gaagaaataa taacttcttt tacattatct ggttattttt agagcaccca acatattga 267540
 aaattgtaga aaaatgatca tgtattattc aatttcagga atttaaatg tttcatgttt 267600

 cataaccaat tttcatatgc attttatget tccaattaat ttgattaggt taaatcaatt 267660
 tgcttagtat gcaaacgaa cagtttggga tttagttagt acattttagt tatgtgtgct 267720
 tatgattgtg cactactctc agtgtttcta ctctatcttt ccctagcctt tcccagetca 267780
 actctctttg tttatectac ttcagagggt tctgcttgt ttgttcttgt tttgtttgtt 267840
 tgttttcaa aggccactac tttgcttcaa aatgtcctgg aattgtatgg agacaggag 267900
 ccctcagaat ctctgattag agaagggaaat gatttctgtt catacgcagt tgctgtcatg 267960
 tcctgtatgt gttctgaagc ctcaaccaac accacttctt tctggattct tgtcacctg 268020

 atggcccttt tagtgaagac taacaattca gtcttatttc atcctcatca aatccactgc 268080
 tgtagctggt tttcaactca gaaacactgt cacttcttac cagccataga tcatttctga 268140
 gtggctcaat agcattgat ctgtgttaa tttttttgtg tttttattcc agcttcaggg 268200
 gaagttagac acttcttgg aacattcaac ctcataaaag cctgtgtgaa ttaacaatc 268260
 acatagaga tttttctcg tttaatcaga tgetccacag catctgaaat ggggtatagg 268320
 cagaagataa aaaaaatct tctttgtaa taatatcttt gccagcaat ttgtttcatt 268380

acatgaaaag ttcaagattc tactttcttt aaggattcca tagtgaatac aaaccacatt 268440

 ttctttatta atccatatgt tgtaggatat ttagattggt tccatttctt acctattgtg 268500
 agtaaaacac taatgagcaa gaatctgtgg agtagcatag tcacacctaa ggacagatgc 268560
 aaaggagtga tglatctagg ccatatggta gatttagtct tagctttctg ggaattcttc 268620
 acaatgatat ccatagtctg ctatctcagc aactgtgaat gacagttccc ttgtaccaat 268680
 atcccctcca gcatttgta tgggttggtt tgttgatcat tgctattctg atggggaaag 268740
 ataaaaatct caaagttgcc aaaagtttga ttgcacttc cttaatttct agggatggtg 268800
 aacattttct aagatatttc taactacttt ctttctttat ttacaaactc tctattaagg 268860

 tcctagagac attttagaa tggctcattt gtgtttctga atctttgttt tttgggttct 268920
 tgtatagctg catattaac ctctatcaga tatagagctg gctaagattc tgtctcatgc 268980
 ttcttcacce tgtgggcaga aacttttttag tttcttgaag tcccatgtat cagtttttgt 269040
 ccttaagtct taggcaaata gagtctatt caggaagttc tttctacac gtatgtttgtg 269100
 tatgttactg cccgtgattt ctactaacag cattagtgtt tcactgttga agttcaagtc 269160
 ttaataacac ttggagttaa tttttaagca aggtgataga tatgggttta attccaatct 269220
 tctacacatg aacatccagg tttctctgca atgttttccg tcttatgttt tcagcatctt 269280

 tgttaaatat taaacagttg aaattatgtg tgctaagtgt tgggtcttca attttcttcc 269340
 attggcctaa ctgtctgttg ggttttgctg ttttgttttc tgagacagta ccattttttt 269400
 tattacagt tccatafact gcattttaa aattagaatt gtgatcctgc cagcactgtt 269460
 tgtttacttg ttgcttttt gtctttgttc aggatgcttt tggatcctgt ttatgtattt 269520
 ttatttttct cgtttctt gaatattaga atgtttatat ctatttctaa gaataatgag 269580
 atgtgcattt tgattgggat tgcactgaat atgtaaaaga acatttgata aaaatggccc 269640
 ctctttatgt ttaaatgggt ataattaaca tcctatcatt gaagttttcc ttccagaata 269700

 tactgtaggg ctgggttagt ggatatgtat tgtttaagtc tggttttctc atggaatata 269760
 ttgttttctc catctacagt gactgaaagc tttgctgaat atagtagtct gggcttgcac 269820
 atgtgttcca ttaatgttgg tagaaaaagt acccaggatc ttctggcttt cacagtttcc 269880
 atagataatc acagtttacc agcagccaaa agaaaaaaag aggaggaaat ccacacaaaa 269940
 tgccaccaca accaccaata caaagcaaaa aagaataaac actcaatgat cactaatatc 270000
 cctcaatatt agcagtctta acttacctaa aaaaagacac aggctaacag aatggtagca 270060
 agacagaatc catccttctg ctgcatacaa gaaacacacc tcaatttcaa agcagtcagt 270120

acctcagagt taagggttag aaaagatttt ccaatcaaat ggatccaaga aacacacagg 270180
 tgtagcaatc ctaataccta acaaattaga tttaaactaa aatcaatcca aagagatgaa 270240
 ggaagtgatc tcacatttat cataggagaa atccatcaag ctgaagtctc aattctgaac 270300
 atctatgccc caaattcaaa gcatccacat tcacaaaaga aacattacta aaactcaaaa 270360
 caaatattaa accccacaca cttttattgg aatagttcaa catcccactc tcaccattag 270420
 acagaaacac cagacagaaa cttaccaaaag taacaaagga actaacataa gttaaaaacc 270480
 aattgggatt aacagacttc tatagaacat tccatacaaa cacaaaagaa cataccttct 270540

 catccccacc tgaaaccttc tctaaataa accacaaact cggcaatata gcaaacctca 270600
 acaggtacaa aaaatttggg ataaccctt gtatcttctc agaccacat gctttaaat 270660
 tagaatttat caaaaacaca aattgcagaa aacctacaaa ctcatgtaa ctgaacaata 270720
 tgtaattgca ccattctggg gtcaaagaag aaaaaaaga cattaacat ttattagaat 270780
 tcaatgagaa tgaagacaca acataccaaa agttatggga cactttgaaa gcagtgctaa 270840
 gaggaagtt catagcaca agtgcccaca tgaagaaat ggagggtagt cacactagag 270900
 aattaacagc acaactgaaa gctctagaac aaaaagaagc aactcacct ggaggagtag 270960

 aagccaggat ataatcaat tgaaggctga aatcgataaa atagaacaa aatacaaaga 271020
 atcaatgaaa caaagagttg cttctatgga aaaaacaaca agatagaca accctaatag 271080
 cttaatattt tgggtgaaaga aaattaagc gctctttctc tacttcaata aaagaagtag 271140
 tcaatacttt tgagggtggg agctcacaaa tggaagtgcc ataatgtca tgtactggaa 271200
 atataatagt aaatatattc aaaattcaat agcttaaatc agaattactt ttgtaaagat 271260
 accatatctt cagagaggag aaaaaaact ggatagcagg aatagttaga atcatcacca 271320
 gaggaattat tcctttgctt tgctagaata ttctaaattt gtctgagtat gcaacattta 271380

 catgcctttg ctactctat ttaaggcaat atcatgaatt tggatccacg tetttacatg 271440
 catatgttta calacaggtt gttagtaaca gggatgtttc ctagataata ctttgtttgg 271500
 gtgatgtctt catcactgtt ctattgctgt ggagggtctac tatgatcaag gcaactgtta 271560
 taagagaaag cattaatttg aggctttgtt attgttttgg aggttgagtt cattgtcatc 271620
 atggcaagga gtatgctgac atgcagacag gtagtggagc agtagcctag agctacatct 271680
 tgatccatag gcagagagaa aaatgctgag catggcatgg gctctgggca cacatgctcc 271740
 atatcatcca gaaagccaca cctaactaac tctttaatct gtttaagag taccattccc 271800

 tggatgaagca gcattcaat attagaggct gtggggccat tcttattcaa atcatcacag 271860
 gtaatgaatg tatattttaa taaatatagg gaacatgctg ttcaagaata aagttatcag 271920
 aattgcaggt gctttgtgta atctttcttg tgaataata aattaattca taatttgaag 271980

aatagacatt ccattcaatg gaaaatcttg aatagagtaa gagacatcac tcattgtcag 272040
ttagttagca aacattaag tatataataa ttaatttaaat gttgattcct tcacactttt 272100
actacaaaaa attaagtctt tacctcagtg tggtagcctg gaattttcat ttataataga 272160
tatacttgat ggiacttata gctaggtttg ttattttata tttattcaac atttttcaaa 272220

tttgatactt aagttttaat tatcttatag cacttaaaag aaactgatgc aacatttact 272280
atttttacac ctctattat tttgtcactt attactctgt gagctgtggg ggacccaaat 272340
atttccgata tggaaatatt tgagatccag ccttgggttt tactaaacag gaacaccaga 272400
aagctctggc ccaactattg attgctaag ccagtaaggc tactactgtt taccatggcc 272460
tcagggtaat atgcctccta tttccatctc tgtgggccta agcatctaaa taagcctgca 272520
cctgggtgga ggtggtaggt gtgtgagtga ctagggagga caggtgtagt tagggaccag 272580
tgactagagg agagaggaga acaaagagag aatggttcc ctcatggtat tggcaggatg 272640

gtaagaaac agaagaaaag atggctacta acgaaatgac tgtagttcta caacatggaa 272700
ctgagagctc tctaaagatg acaagatgcc tgtgtttggt ccttatcgct gctggtttgc 272760
taggagtttc caggteccaca cacecccaact caggctgaac ctcatggatt aaagctgaga 272820
catgctgggt cgacacttgt aagacccccg gaagctcagg cctccaggat cttttctcag 272880
gactacagcc accccaatca ccatgcagag gcagaaactt gatgcaaaca gcaagagttt 272940
ttaatgaaag gtggatggtt gtacaaacag gcctctcag catgcaggct agagagcagc 273000
cccattcccc caggcacagg catttttaa ggcaaaaacca caagcttagg gaggggcct 273060

cgactctctc tcctcagat acgtgaccag agtccctttg tcttgaaggg agggctggga 273120
atcagatagc ctctgacct accagttgia aaacctgcag acctcaggat atgctaacta 273180
atcttgctg agcaaatggt agctatctct ttgtttcata gggacctta atgttaatt 273240
attgacacat tggacaacct gtttcttca tgagccctc agggagggtg gccatctggg 273300
aattcttggg acccagttat ctgatggcct tgaaggag taattgctgg cagctggtaa 273360
attccaggea caaagtcata gtatggcct gtttctgggt catagtcagt ttctggttta 273420
ggccgccta cattcccttt ggagattttc cttatctggg ctatatttct ttgctaattt 273480

ttaagtcttt cacactgagc ccaatttttc tggagattaa aaaagggtgt ttaaaaacta 273540
gaataagggt tggagggact gctcagcagt taaaagcatt tgttctctt gtgcatgttc 273600
caaaaacccc catttgactg tcaactacat gttgttggg tccaagaga tcaaatatca 273660
tttttctgc tctgtagtta atatgatgt atggtgcaca aatgtaagtt cacacacaca 273720
cacacacaca cacacacaca cacactaaat aaataaatat tttttacatt aatgaaatca 273780
gtgaattgag aatgtttgt aattagctta gcatggtatt tatgaaattt tatttttaa 273840

tgaattaga gaattgttta tatacttttg gaaatttgat tggattatg ggtaatactc 273900

 aggacgtaaa gaaacttagg agttatcttt gctcattact aattgaaata attttagaaa 273960
 aaagatgttt catgggggag gggagggaga gttagaagaa agaaaagggg agaagaggag 274020
 ggaagaggac acaccgaggg agcaagaaga tatagtaagg ggaagaatag aggagaacaa 274080
 gaaaagagat accataatag ggcagccatt ataggtttaa agagaattct gccactaggg 274140
 aaaggtccag agatctacaa ggttgacccc aactaacaat ctaagcaata gttgacagtc 274200
 tacattaaat gcccttctct gataatgaga ttgatgtatg ccatcctaga gtcttcatcc 274260
 agtaactggt ggaagcagaa gcagaaaccc agagctaaac actgagctga actctagaat 274320

 ccaggtgcag agagcaagga gtgttgagca aaggggtcaa gaccaggtgg gagaaaacca 274380
 cagaaacagt tgacctgaac aatgggttgc tcatggacc cagactgata gctgggaaac 274440
 cagcatagga ctattccaga cccctgaat gagaaggcca ctttgaatgt attgacaatc 274500
 tatgggacta ctggcagtgg atcattatit atccctagta cacaaatgga gccctttggg 274560
 agtcctttcc acatagaggg atactctatc agcctagaca cattggggag ggtctaggca 274620
 ctgctccaaa tgatatgaca gactttgaag atccctcaca gaaggccttc ctctccctgg 274680
 ggagcagaaa gtgattggga caggaggtca gtgggggcag gggaagagag gagggagagg 274740

 gaactgagat ttacatgtaa aagaagcttg tttctaattt aaataaaaaa taggaaatcc 274800
 acaattagaa aaaaagatat ttgtgtttat tgtaaaatct acaagaaaaa tctctttcca 274860
 tattaagtat gctatgcaag aaatgtatat tgggtatatt tatggtagat gtgggtgagt 274920
 aaaaatagttt tgaagacct cagaaagagg tactttcgta gaaggagacc cgcaccagg 274980
 aatcagtga accacgaact tggatgcaaa accgaagag gctttaatag tggcgcggt 275040
 accgggggac ttagcttctc ttaggccaag ccccgagccc aggaagaggg gtcttatat 275100
 agcaaaagcg cagtacagaa gcgaaaagca tagttacagg gattctattg gacaatttaa 275160

 tgaggtgcaa agtatattca aatcagcact ttctcaaggt ctagtatca ggcgaaacgg 275220
 ccttggtctt acttatcttc ttccgcgtcc agatggctga ccttgggtcg gagggagcgt 275280
 tcnnnnnnnn nnnnnnnnnn nnnnnnnnnn nnnnnnnnnn nnnnnnnnnn nnnnnnnnnn 275340
 nnnnnnnnnn nnnnnnnnnn nnnnnnnnnn nnnnnnnnnn nnnnnnnnnn nnnnnnnnnn 275400
 nnnccgttcg cagctctggg acaaagcagc accactgctc tgccctctcc agctcaagtt 275460
 ccccttcag gcgctgcccc cactgcactc tccagccct ggcccatcc tggccctgcc 275520
 ctgctcagtc cccgctgcgc tgccctcggt caactgctcc ggactctac cctatctgg 275580

gcggcccttc tgggtcagca gccgctgcmc acaaggacga tcagcggggt tacttcgccc 275640
 cagaagccgg ggacctgggc ggcccagggc gcgagcccgg gtgatgtccc ctgccagca 275700
 tgccgcagcg ccccgttttc tctctggcca actctctccc cgccccacc cgatccccag 275760
 cccatcctgc ctgctccaga gagaataccc agcaccggca caggcgggga agacagagag 275820
 gcagcgggca ggggacatgc agaagcattc cgagcaggtc tttcagtta atctttcaat 275880
 atgttatcta acatctatca aacatctatc atttgatfff tatctaacta acctaataat 275940
 tgttctttca gcctacaaat gaccctagtt tattcaaaga aaacatcagg tattttctctt 276000

 ccaaatttga aagacatata atatgtataa ggtatcaaag gaataattgt ttcgggtaag 276060
 cttttaatgt tcattctttt ttttttattt cttgtctgtt gccaaaatgt gataggcaga 276120
 aggtaataaa aactgcacca cttttgatta tcaagaaaat ataaaaatta tataaacct 276180
 atgctttgag ttgatgcata ttcatfctca accaaactgc atctaatttt atgcaacttt 276240
 ttgtttttta atttgattac tgtctttatt ttactcattt tttcatttaa attagaaaca 276300
 agattttttt acatgtcaat cccagttccc tctctctcca cacctcccct acccgccact 276360
 aacaccctac ctatcacata tcttttctgc tccccaggga gagtgaggcc ttccataggg 276420

 ggtcttcaga gtctgtcgtc tcttttggga tagggcctag gccctcccct atgtttctag 276480
 gctgatagag tttccctcta tgtaaaatgg gctcccaaag tccattccta tgctagggat 276540
 aagtactgat ctactacaag aggecccata aatfcttgag gcctccacac tgacaccac 276600
 attcatgggg tctgaatcag ttccatgctg gtttcccagt gatcagtctg ggggccaaca 276660
 gctccttggt gttcatgtca gctgtttctg tgggtttcac cagcctggtt ttgaccctt 276720
 tgctcatcac tctccttct ctgcaactag attccagttc agatcagtgt ttagctgtgg 276780
 ctgtctgctt ctacttccat cagcggttgg atgaaggctc taggatggca tataaattac 276840

 tcatcaatct cattatcagg gaatggcatt taagatagcc actccactct ttcttagatt 276900
 gttagtgggt gtcaccttg tagatctctg gacctttccc tagtgcctga tttcacttta 276960
 aaactatcct ggctcccctct ctaatcgtat ctcttaattt gctctcctct attcttcccc 277020
 ctacacaaac ttctgtctcc cttttgtect cctcactcct cctctgctcc tettttcatt 277080
 ctcttagctc cttatcccct ccccctatac tcccaatttg ctcaggagat cttgtctctt 277140
 tccccttcca caggggacca tgtctcctt gttgcctaaa ttctatagtt gtgtggatta 277200
 taacctggta atcctttgct ctatatgcaa aatccatag tgagtgagtg cataccatgt 277260

 ttgtcttttt gtgacttagt taccgcctc attatttagc ctacaatata ttattagcca 277320
 aaacatttct aaatgaaaat tattaagcaa taatccacat aaaataatca agaatccaca 277380
 gtgggaaaat gtagacatgt agatcatttt ggtagaaacc tagctaaaat tttctatgta 277440

aattctgtct catgctaag tgatgcaaa gaatcacagt agctaataag catattcata 277500
ttaaattact tggctcttagc atttgagaaa acacaactta tttcatagc ctcttctcta 277560
ttatcctaag gtttgtgta agctctgttg gttattatcc aaccatttta gtggaatcca 277620
ttattttcca gaattacaat accctcattg ttggctaaaa gtgattaatt actggttgta 277680

taattacatt ataatgaac acaagaagg ttgaaataa aatgcttgg tttgttctct 277740
ttctctgtt tattttggaa ttaaccttgg agttttatta actattatta aaacaagttc 277800
aatattaaca caaataaca tatttaaaat gtcagcatgg attaagcca agcaactata 277860
gatatctaac tttagaattt taaatggtac aacaaaatgg tttgcttatt aagtaggtcc 277920
tgggattata aaaggaaata cataataaac atgaaactgg agaattgatg gtttttaatt 277980
atacttagaa taaatgaatt aaatctttaa gttttaagag gacatttcta ttaataagat 278040
catgactccc gtcagcttaa aggaatcaac tttgttccat aattctagat aaaatcttat 278100

atagattggt ttagaggagt tttctcccta gtaactctcc attctaattc ttttatatca 278160
tcacataaaa ttaagtaaag taaatccaga gactttggct tccccatttt ttaaataagag 278220
attttaaaaa atattttaa tataaattat tatgtttttc agaataagta acatgagttt 278280
tcaagttcta aatattacct cttaacatat actgcccta ctcttttcaa atccatggat 278340
gcatttttca ttcattttta ttacatgtat atatgtaaat gtatgaacat atatatatat 278400
tttctaaat ttaateggct caatgtgtat aacattatgt tatttgtatg caatcattca 278460
gaaatgaaca tttttattgg ataattaatt ggtatgctgt tacctagaga agactatttc 278520

tcctgctctc agcattcctt agttgcttgt agctctttgt gtagggttga tgcattatgg 278580
gcttttcccc atctatgtaa catgagtaca aataaagat tgtctttatt ctttcttata 278640
aagagaaca tacaagtgat acatgatgaa gtccttggtt tagaatgtgt cattctttct 278700
agataacct aaattaaata ttagattttc tttctgattg gcatgtattt gacatcggaa 278760
ccattatact tttaaatttt cattgctaaa aatgcaatga actgtgaacc atgaaattac 278820
tttccagata ttctgtcacc aatattgtga ctagtcaatg tttggtgaga gctttattta 278880
cagcatgctt atatttaagg caaactaca catatttctt tagtagctta ggtatatttc 278940

taaaaatgtg ttttctgaag ttcttacatg aaaatgtaga attcttctcg ttgaaaagat 279000
acaataaggg ttaagaaagt attttaaga ttaggagtga tgatattaga aagaagacag 279060
tgttactcca ttggagaaaa ctgattttcc ctcttcagc atgtataaat tacagttcag 279120
ttgttatcat ttaccttagt ggttagattt tcattcatta atttttttt tggttttttg 279180
agacagtttc tctgtgtagc ttatgagcct atcctggcag tcaactctgga gatcatgctg 279240
gcctggaact cacagagatt tgcctgcctc tgcctcctga gtgctgggat taaaggcatg 279300

tgccacaaca ctcggccttc attcattaac tttaaaatta tataagaaaa gagcccaaga 279360

 gaaagcataa aagtcagaga tccacttggt cttattcaca cactcagaaa tcccataaaa 279420
 aacaaacact gaacttggag ccacaacata agcagaaaact ccagagaaga cttcctgttt 279480
 aggaataatt gaccaatata taaggacttc attttttttt gtgtgtgtgt gtgtgtttat 279540
 acatgtactt atatttgggt acagtttggg ggggttattt ttttcctttt tggatgatat 279600
 tttattttgt ttggtttggg ggagttttgt tgatatactg gatttatttg ttttgaaga 279660
 aagagtggg gggaatgaag gggaagatct gaaaggaaat gagagagagg aagaatattc 279720
 tcaaacata ttaatgttg aagtcattat aaataattta aaatataata ataaagaaga 279780

 gaaagcttac tgagtctgtt tttgaacagg atgatgaag tcgagcaatt aaaatggatt 279840
 cagctataga aatgatcctc cacattcaag acagtttctc cattttgttc tctagtggga 279900
 tttatgatct tccctcaggt taatagtttt ctgtatccag tccctgttct tatgagcctt 279960
 gtctgccttc agcttgtgga tatgtcccat tagaatctat tttgttttgg acacaccccc 280020
 tttcattca tttttatgta tacatatata caaacataca tacatacata catacataca 280080
 tacatacata cacacacaca cacacacaca cacacacaca cactccea aaacatgact 280140
 tcttataaaa gtttcttata tgtgaactta caaagtatat gtataagaag gactatacaa 280200

 ttcttattgt ctttttcta taaccaggaa ggaagagtcc tgacataagt tatctatccc 280260
 aaaatgagtc agagaattga ctttacttaa gataaaatat aaagaggcaa gattgaggaa 280320
 aacagcctaa agtttgggt caactaatac ttagactttt tagttactaa acatttagta 280380
 acttcaaaaa ttttgggtgt acagcacatt tacaagtaaa tgatcaaac caatattctc 280440
 cccaatcttt tgagagaaaa gaaattttta aggtaattat tggatgaaat tggagacaac 280500
 tgagtctcta aaactgtcaa cactactgtt ataacttagt gttgttatta tactactatt 280560
 aatagggagg agaaagaagg aagggagaag gaacagtagg atatttgaaa gatgaggaag 280620

 agaaggagaa ggaaagagaa caggggtttt aaagcataca ttccaacaaa gctaaaatat 280680
 catggaata ttataaagaa attaatgatt atgatagaat ggtcagtcta actcaggatg 280740
 gttcttatga ttgccaagtc caggaggctg agaaaggctc ataagctttt ctagggtgct 280800
 gagatcagtc agtcactaaa tactactctt agaatttgaa accctgggat aaccaacat 280860
 gcagttcaag gatgactatt caccacagtc tgagttttgt aaccggctca tggggaaaaat 280920
 ctgaagatta attagccggt acaaatgcgc tgtgtataat tgcttttatt ttgtgtgaa 280980
 tacaagaaaa aatgcatttc ttaaattagt aagaactgag aaagaaaaga tgatctaaaa 281040

tacagcactg ggtgcattag attaatgcaa tcagcattct gtttaacaac ccaatztat 281100
 taagcttcta agatggcagg ggaacctgaa gaaaaagtcc atgtgctgaa ctgaagtta 281160
 ttgaccaga acaactcctt gtactgaaga aaagaaataa cttgaccttt taggcccctg 281220
 gaattataaa gccacctttg aattataaatt ttctcttggg gaagttgatt gatcactact 281280
 aaaaatgctg tcagtaaata ttataatttc ctaatacttt gtgtaggatt cctgtaaaga 281340
 tggagattgc cattgagaca caagtagaag aaacattggt tgtaacctca ggaaggaaaa 281400
 ggaataaatt ctaatttatt tgcaaaataa caaatatgca taattcatct cttctggctc 281460

 aattagttaa aaactgaaga gtggatgagg aaaatggact taatatact atgtggttaag 281520
 cacatggttg gtgtttccaa atggagtaga taatggcttc attaatggtg tgtgaatttc 281580
 tcaagttcca catgagcttc tctatggtct tgtctccaaa gcatgtaagc caaacctcat 281640
 atcacactag aatatcatgt tgaagactca ctgaaaatgg aatatgact tcagactcac 281700
 aataaaaca taaaagaaaa cattaacttg tagctaaaat ttctattgca ctactaccag 281760
 aagaataata ttaaatgtaa attgctaatt atctaaatgt attttgtgt acctttttt 281820
 atttctcct ctctcttatt cteccccct catctgtatc acacatacag atgcaatggt 281880

 gaatattcac ttacaagta attatcaaat gatttaaatg catgaaggct atttatatgt 281940
 ctatctttaa tacttttgaa aatagtggca cacatagagc aggttacatt taaacacca 282000
 gcatttccaa ttgctataga catggggcga ctttgcact caatgcaaaa ccaaggtggg 282060
 catccagctc ccacactta acaaaaagc accgtatgac agaaagtagg aaatttgcag 282120
 ttggacaagt aagcatgttg tctaaatgaa aaaaagagaa atgtatctcc tgctagctct 282180
 attgatgaat ttgtattat gaatggggat tctagacatc tttagagggt tgagctgtgt 282240
 ataaccaggg gttgaaaatt tccaagcctt gacaagcctt aataacttca taatgcaacc 282300

 cctcatatag taaatttct ttaataataa tcattttctac tacaggtttt tactttcagt 282360
 ggaacactaa atttttgtag ttgttttgtt gccttgatag acaaatggtt gcatttttgt 282420
 tttgtaattt tgtggcttcc ctgaaagtgt gaaattaatt tccttactta agaacacttt 282480
 tgaaaatate tctccttagc catcaggga atgcaaatga aaacttagtt ttctccaatt 282540
 gtgtcacact ggggaaacaa aacattccta atggttggcc ctatgctcag cagtagatgg 282600
 ccaacacgaa atgagctcaa tagcatcttt gaaggctcac tgtctcatga tgttgtatca 282660
 ggacttttct ctctctttaa ctttacaggt cctttgcata taattatggc ttctatgga 282720

 atcctgtgtg tgaatgagtg tgtttctgct tctgtgttc ttatattttt ttgggggggg 282780
 gggctttttt tcttctgttt attttttgt cctatttata tttgtttgtt cctgttttat 282840
 cttattttac ttcattttta ttcctttgat gcctctttgt tttctaagga gatgcagaaa 282900

tgtgtggata cagatggaag ggagtcggag aggaactgtg gggatttggg gaggagaatc 282960
 agttatcaga atatatttta tttaaagatc tttttgttt attatttatt tttttgcttt 283020
 tttacttaat ttttcttatt ttttattagt tcaaattagg aacaagattg cttcacatgt 283080
 caatcccttc tcctcttcc tccccttccc caacccccta cctgctccca tcccatcaac 283140

 cctccactcc ccaggcaagg tagggcccta gatggggctc ctcaaagtcc accacatcat 283200
 cctggaccgg gcctaagccc tcccctatgt gtccaggcca agagtgcac cettctcatg 283260
 ggatgggctc tcaaagtctt ttcttacacc agggaaaaaa tactaatcca ctaccagggg 283320
 acacctagag tgcagaggac tccatattga catccatgtt caggggtctg gatcagtcct 283380
 gtgctggcct cccagacagc agtctggggt ccatgtgctc ccccttgctc agtccagctg 283440
 tttctgtggg tttcaccagc ctggactga ccctttgat tttcattcct ctctctgcaa 283500
 ctaggttcca gaggtcagtt caatgcata ctagggtgtc gcctctgctt ccatcagcca 283560

 ctggatgagg tttctagggt acttttaact aaaactacag aaagatggag ttcattgactc 283620
 ctgtcttctg agtatcaatt ctgagatcat gtgtttaaaa tctgaaattg cagaaacctg 283680
 ccatgctctg aaatattacc tgagccttca gtactctgat gcagtacctt taatcatgat 283740
 gctgttctgt gatacacaat ggacataggc aaggacaaca aacctcgggt ttatctgtca 283800
 atcggtacat tagtattatg tgcaatggac ctatttaatt atgattctac taagtacat 283860
 gcggctgtgt tigtaaaaga cttgaattta ataccaagct ctgaagaaga gaaagcagga 283920
 gaggctgcca agtatgtgag aaacacagtc ttgtacacaa gctcaaaaat ctacacttaa 283980

 aaattaaaaa aaaaacaaaa acaaaatgga gggaaaagtg ttaagcaaaa attctaagag 284040
 gcagttctaa gcagtacttt catcctgaga agtttgggta taccaacata ggcaaaaaca 284100
 caatacaaac atgatattcc cattaggttt ggtgaacaca ctgagctaaa ctgaaatggt 284160
 catacctgag tgtatcaata aacaaaacat gcatttttac tgcacctaa aatatttata 284220
 ttattgtaaa taatatattt acaagggtat ctcagaatat atttgtcaa ttatgagtgt 284280
 atttgttttg tgtgaatatg gaagcatagc aagcttgtgt acatgattaa gttgatgttt 284340
 gtatgtgtgc atgtacagat acatgtgtgg aggacactca gaggctctgt ctgttacatt 284400

 ctgccttatt ccttcaagta gaggcctctt actgaacttg gagctaggct gctagccagg 284460
 aatcccagc gatgctcatg tctttgcac caagtatgct agagttaagc gtggatccta 284520
 aatcactagg catctttat tctttaagca tttttctat atttgcca tatgattgca 284580
 ttgtttcac ataagcatga ataatacatg ttatattggg cccatagagg tcagaagatg 284640
 tgctgcaccc ttctaactgc agttccacat aaaaatgaga taacctatg ggtgctagaa 284700
 atcaaatgtg ggtcatctgc aagaagtgc aatgttcta actactggac aaccttca 284760

ttctcagaat tagttcctta tgtgggtact ggtattagaa ctcaggctcc caggcttttt 284820

 cagcaagtgc ccttaccac tgaccatta tagttcattc ttttaatact agcattattt 284880
 ggatggacat cagggaaaca tgagtaattg atttgaacgt ttaattacca cttctggatt 284940
 caggtataaa ttaaacagtt gaactgactg catagttttg cagcatatac aacatctcat 285000
 ttaatcttca tgattctctt caaatcactg accatggctg aagtgtgtta aaggacctaa 285060
 ctagaacatt aacatctata aatggatagg ctatgaagat aaacagattt cagagaacaa 285120
 cccgaggcag tgcaccagtg atgacctgcc tcctgagaca tcagcaattc cacagtactt 285180
 ttctgaatgc tggaaaagaa gaggatggac agtagattca ctggtgggaa atataatctc 285240

 tgtaatggcc ttigtcacac ttgacagctt ataaaatggt cctgtgagac aatgtgaca 285300
 cacttagttt tgcagtgagc tctttagggt ccatcagtct tcagcgatgt gtcaggaaag 285360
 aactaaagg catgggtggag tgtgttctc aggggagttt tatcagctct ttaataaagc 285420
 agccatttgt aaaatgctgc tggagaaaac aataatttag aagaaattca tcaagagcaa 285480
 tggcacctta ctttgaaaag gcagtgcaaa tggagaaagg gaatccagtg ctgagtgctt 285540
 cattttagge ctgaggagca atcacaaagg atcaggggca agctaattgt gggtttgcta 285600
 ctctgtatac aatggagtat gaaacaggtt ttccaccac aggtcactgc accttgaact 285660

 tcaaggggac aatgatgect gcaaactttc tgtgtaaaat gttagtataa aaacttattc 285720
 atggggcttg agagatggct cagccattaa aggctaggct cacaaccaa aacatattca 285780
 tgaatgttcc tgagacaaac aagtgttccc ttccattgaa gttttttttt gtgtgtgtat 285840
 taataatgta acatcactgt ttagaacaat atctccttag aacattatgt tagatgtgta 285900
 ttttattgag aatccaggac taaactagt t agtatgaaac aggtagaaag attatcagta 285960
 aaatttcttc tcttaaaatg tttttagatt tgtgttgaga tatcataaac acataaaaat 286020
 gtattgatac aggatgtcat gtatatatgt atatatgcat atatatatat gagagatgat 286080

 tactatgatg atagaggaca gatagatgaa gatatatata taatatatct agataagtag 286140
 gaagacagat ggtagataaa tagatagatg ataggtagat agataaatgg atagatggat 286200
 agctcctttg agacagagg tttgtatgta gtccaaagtg gcctagaacc attatattct 286260
 aggtgaatac ctttgcagtt ctccattctc agcctcaaaa ttgctgggtt tgcagacttg 286320
 tgttagttca cctgggtgtaa tgccctcattt taaacaatat aatctttatc ctattaccaa 286380
 atgtcaaatt taaagtacag tgtttttaat catctcgtg ctataaatta ggtacctaga 286440
 gctgtctctt acattaatga aagattttgi cctttgatca gcatttcca atcccccttt 286500

attccaaact gttggtaata actatccaat tctctgcttc tattgatttg agtatttcag 286560
 attccattat aaggaggatg gtgtggcatt attttctttc tctggctctg ctaattttgc 286620
 ttaacaaact gagttcagat catctatgga atttgcttta gtttgctttg tgttgatatac 286680
 atgaagatta tgactcaaga aaagaaagt tgtttgcctc acctatccta tcaaccagtg 286740
 aagtaaaatc agcagctcaa ggaaggatct aaagcagggt acgtggagga atgttttta 286800
 ctgactggct tectatggct tectcagctt gcttttaata gaaagcagga ccccacctct 286860
 gcacctgccc aggattggca catactccag tgtgttgac actcatacat tattccttaa 286920

 gcaagacaat ataatatat tggcattttc tcaataaaag tttcttttcc ccagatgatt 286980
 ctaattttgc taigtggca agaaacaaac taacacaaac caaaagtctt aacctgtat 287040
 gtttgatgc atttttatat tcattcaatc cccaaaagac atgagaagcc catgtcaggc 287100
 tttaaaaagt aaaagaaagc ttcacacaat ctttttaatg atattatgtt tgaagctgcc 287160
 agtgcttttt tgtttctgca cctggcttgt ggatccatgg cgaattttgc cactatttgg 287220
 ccaatggtgg gggagagttc aacgttctcc ttgttaattc ctggggaatg ctggggagtt 287280
 acaagtgagg tcgtggaatt aggaaggtta aggttgacaa tgatactaag ctggctctgc 287340

 aatgcaggag ggtaaggaga tgtggatctc aagagtgatt cctatcatga gacttttagt 287400
 cctgaaaaaa atccctgtcc aagttgccac tcttgtcatt tccacttttg ctttttgaat 287460
 gagccagaaa tgttttcagt agtttctttt attctctttt tccaaaagga atggtgatgt 287520
 agatctaata taatgtttag gaatagaata tacatggggg ctgtaagtga gacctggcaa 287580
 agaattgagc tgtgtagcta acacctctgg atctgtagtt atgctcagag gcctttctga 287640
 aagctgtctg aaagctgtcc tgtcttctca ttcttctcac ttaaccattc attgacaaaa 287700
 tgtttctttg ttttgggta ttttatggga catttattga atgctggaat ttccacttca 287760

 gtaattattt ctgctactgc agtgttggtt tctgattcta cagcaagtac agtgttttca 287820
 atatcattct gttgtgacat aacttcaatg tcaggaaaga tggctgtatt tctaacaca 287880
 tgctgatggt cctgtgtctc cgacactgct gtccaatgct catttcaacc cattctacac 287940
 attccctgaa aatgacctca atgacaccga ctcaacgatt ggcttggctg gettccctcg 288000
 tatgggaaaa taacctcctg ttactccttt tggcttcctt ctaccattc ctactaatc 288060
 cccatgatta atcacctcc tccctccct ccttggacct ttgatagggc tectcttget 288120
 aatgcctttt ggiccttgag tctttaatcg acctgtggcg tttgtcaagc aacaagtgga 288180

 ctctgctact aagcctgtcc tgatacaata cttaaacct cctcttcca ggatgacttt 288240
 ggccctcta atataaaca ttttgggctg tccctccaa agaggaacta acccacttcc 288300
 tcactgccag cttcagaggt gcagacctgg atggtactta caaggagacc tcattttctg 288360

aggaatatcc ctgtgtgcaa cggggttgat gtcattaggca tccagtcggt cctgcctttc 288420
 agatggctcc aagaagccat cccaaggctc acagaaaaat gtcctttata aaataacat 288480
 agattctcca actgggggcc aggcctctat cccctctac tgaaaaattt ggtcacttct 288540
 tttatacaa ggaaggggga atatgtaggg agccaaagct aacttggcat gagatcccag 288600

 gccatgcttg gcaggccaca tagtttacat agcagctcct tagaacctca gctcaagaaa 288660
 agaaacaacc tgaccagtc ctccaccac aggctccgtc acctaagcaa cccttctctgg 288720
 acctcttact cataaactct ttactctgcc aaacatctc tttgtggctt cctatatcct 288780
 gcataacta acacctggtg cacaacaac ccattttgcc cctcccata tctgactat 288840
 attagctagc cagagaaaaa taaagtttgc cacttgatca aaatcctgcc ttgtggtcgt 288900
 tctttctgca tctttatcc ccattcccta tcctgactc tcttgccca cgttgatgtc 288960
 ctgcaggtca ggacactgca acaataaaat aaattagtca aataagacta agccatgtag 289020

 aaataactgt taataactta gtagagaaaa ctttatggag aattggcaat aattgtatct 289080
 ggtcactctg gaaagggtaa ttacatagaa agaattcata ttcaaggcaa atttaagaaa 289140
 gataatctgt gtgttgattc aacctttgga ttattattac tattattaac catttattaa 289200
 acacctctgt ttttttttc taggcctttg gaagtgctag aaatatggac atcagtagca 289260
 aaacagtatt tgtttggcat tatagaagaa tgccacacag gaacttatag ttgctatgaa 289320
 ttcatacaca agacaggtac atgatcatgt gactcactat cctagtatgg gcatgggaaa 289380
 gattaaaaaa aattccattc ctaggtaagc agcttttttt gagagattgt ttctggagaa 289440

 gagagagtaa attttctaa gaatatggc cttcaaatct agatatgctc tagtagatgg 289500
 tccaatata ctacacatat ctagcatgca aagaaacca attaaaaat gtgaatttga 289560
 tttgggatca caaagtgtg gagggatagc ggacactttg aaggggagc taatacttga 289620
 agagtgttca tgggctttgg atctggagac aggcttgtgg gtttcataa tttagattta 289680
 gatttttttc tttcttttag tttgagatta taatatagtt acaccattga ccacttcct 289740
 ttctgttccc tgaattctcc catgtacacc atcttgttct ctttcaaatt catgaccctt 289800
 ttaatgatta attgttgta aatgcatatg tgtatatgca tatacattcc taaatatatc 289860

 catttcagtc tatacaatgc tacttagata catgttttca gggttgacca ttcagtatta 289920
 gaaaacttat tgggtgatag ttccttgggg tagatgatta ctcccattct cagaatttat 289980
 tagtttctta tagtactttg tgtagggttg gggcctgata gtccttttcc tggtcagtgg 290040
 tatttcttta ttttgtcgt tgattagctc atgctttagg tattcaagtt ggtaagattt 290100
 tataaggtgt agcatctgag attactaggt gacactatag caccaagctc cgtgatcctc 290160
 tggttcttaa aatatttctg cccctctct tctgcaatat tcccttatcc ttacttggg 290220

gagttgtttt gtagatggt atgacaggag tatgtgcat gtctcagcat tgtgactggt 290280

 tgtagttttt gtaatgatct ctttctgttg caaagagact cttccttgat aaaatgtgag 290340
 cactgcactc gtctgtgtgc ataaggacaa acatttaaaa tatggttaga gattatacta 290400
 gtttgtaat tatttcagta gtcctttata gttgtctagg ttacctgtac aaggcatgat 290460
 ttcccacttt tggggaaggt cttaagtcca actctagagc tcttggttac ccctaagca 290520
 tacatataac actactgcat ctttagggct actatgcat gctggtcaat gtcattggtc 290580
 acaggcttca tagctgtgta gctctgttga ctgcatctct cttttggaag gttgcattac 290640
 ttaaccactg ttaagtaat gagggatgaat ttgactaaaa catatcattt gcatatatga 290700

 aattttctag aaatacaaaa gacaattaa gcatttctg tagagccttg tttcttcaag 290760
 gaaggggctc tattgattct tttttatctg agtgtatgat ttggcccaag tcatgtttct 290820
 aacacacctg actgcttat aagagatcaa atagcatttt cttctgcaga ttctgattat 290880
 agctgaggtt tglaaatcat aaagggttgg tatctcagtg ttaagcctt gattaatttg 290940
 ggaccctctt gagttcttta aggatccatg tgtaaagaaa tcatctttct ttataactaat 291000
 atgcaggact cttcctgac taattcaaga catattactt gtcacacagc agataattat 291060
 atgagtgata ttgttaatat acaaggactc ttgcttgttt ctcatgattt atttttatct 291120

 gcattgtttc ctaaggacca ggctcttagg tgacatgcta gcccagcata cacacaaaca 291180
 gatggataca gtacatagat catttcttc cttgactttc agggactaca tattcatgca 291240
 aatacaattg atcttgata catgtcagaa aagttcattt taataaaatc atattaaaag 291300
 tctcttttaa ggaatggtg ggatttctgt aaagatcagc ctgttatgag ggaagaagta 291360
 gcattgtggt ttiaggagt ttacaagcaa aataatcaag atcaatgcta cctggctttc 291420
 atttatttt cagagaatag accattttgt cctcacattg atttttgtg acactgaaa 291480
 tgtttccatt ttatgatgtg tgtggtttat ttatatccag gcactgctag acataccagc 291540

 tttcaagga aggagaaaga cagcctgggc atgctgtcat tcagttctac cacttccatt 291600
 cttatttaca atgcaaatgt ccctaaggac cattggcttt aggaaagaaa gatatagaaa 291660
 agtcattttt aggattctct ataactatag acatattcaa agtttacctc caaggagttg 291720
 aatggagat tttaggaagc cttttgttt ttagaattga gctgtaaggg aaaaatgtgt 291780
 acagctgtgg ggtcagagag acaactctcc ctgaaaagta cttgggagga gattatgaaa 291840
 atgggaattc aagtcaccag gacatgtcta aactttggga gtttagtat ggagcctacc 291900
 tgtattccca tcccacagga gtaggagaa ttcctctgc tagattgtta gtcagctca 291960

accaagtgat gaactccaga ttcagcaaga gaccctccct caatgtatag ggtagagagt 292020
 gatcaatgaa gacacataat gtctttcaca ggttggcttc acacattcga aagtatatat 292080
 gtgtatgtac ttacacatat gggagaatac atgtacataa accatacaca catataaact 292140
 ttgagagaga aattaattaa acccaggttt gaggcctg tttactagaa acaatcctta 292200
 aatgcatagt tattataatc aacaagaggt ttagttgta aggcattgt accattataa 292260
 gtgatgagag agggatagat agagtaattc atagcacatc atttgattcc tgcagataac 292320
 tggattatac ctccaact gttctcctt acatttcttg cttttatctt cttttcaat 292380

 gctagcagtc acacttattg catgtacca atatcagata agatctgtac aattgcaaca 292440
 cagtgattag cttttcctg ttgaattgtc cttaatcag gctgattaga agaatgatg 292500
 ctgtgtgtcc agcttcagtt ccagttctta ggacactagc tactttagcc agattgagct 292560
 tttctcagac aaaagtctag atttctttgc tttccatttc cttcaacca aatcacaaga 292620
 atttctgttt ctatttactg gactagaatt tgcctcaaaa tactttgtga aggagacagc 292680
 acatatttcc aatgtgtgtt gtttcttagt attaaggatt taatgttttag atatattat 292740
 tttatgtgta tgagtgtttt tactgtagtc aaaagagggc ataaaattcc ttgaaagtag 292800

 agttatggat gattgtgtgc caccctgtgg gtgatagtta atgtaccag ctgattcca 292860
 accagcaagt ggtcttaacc tctatgccac atcaaaagct ttattttaac accttctgca 292920
 acattagtgc cttgatgga ggacatagat ttcagacatg caaagcttc catagcatag 292980
 aataaact acittcaaaa actgatcatt tgcttcaacc tatgtcaact tgaggtaaat 293040
 ctttttaag ttttgaact cctgtaggag tctcagaac tcttctatg acacagtgc 293100
 cccactataa tccattcttt ctgactact tttccatagc tcttaattt catcactcat 293160
 agctatttgt cacacagat atgtgaaact aaaatagagg tgatattttt ttcttactgc 293220

 ctctgagcta ctaagtagta cagatcacag tttgaaaaa aatctcctaa tagatccttt 293280
 cccagaaat ataacttctc ttacagtggg tttgatggaa aatttagcca tatcaattgg 293340
 catgtcatta atttgagtc atttcaaggt gtttgagtc aattgagtc atcttcatt 293400
 tttacacat cttcacttcc tcagacaaaa tgatcttaaa ctccaagac aacaaaactc 293460
 cataattact tgcctgttt catcctcttg acacttcttt cgattggga ggttgcaat 293520
 atagtaaaaa aatattaact ggttttgttt ttgtatttt gagatagat atcatgtagc 293580
 ctagactggc caccagctca ctgtagtga gaatgacctt gatttctga tccctctgtc 293640

 cacattaatg gttgtgtaag tgctctacca actgggttac atccatagtt tccaaattgt 293700
 agttattctg ttcacaagag agatatattc tgtttctaga ctttaagctat cttcataatc 293760
 tatgtgtact tcagtgtggg gcaataaacc aacgttaagt aggagtttta tgtcaggtga 293820

cacagacctt gtgagaccg agagtccacc taacactccc tttataccat tttgcatgca 293880
ttatatTTTg gaactcactag atttctacat tcattattaa ttgatataat gattaatata 293940
taatttcaac ttaactggat caagaattcc aaagagacac atatagagtc ctgtgtgtta 294000
agatatTTTc ctaggaaact gaaggttgag gtaccagcat aaagacgaca aataacaaat 294060

aagcaaacca gttgaatact agtgttcac tctctttat cccaacagga gatctaagt 294120
tactgagtac ctctcactac ttcacccata cctatcttgc catgatgggc tgcacatct 294180
caaattttaa gccataatat gccattttcc ctttaacttg cttcttcttt gaaaataat 294240
catacaatgt gaaaaaaca ctagtcttc aattatctgt aataatcact cagaggagca 294300
caatattatt tgaaaatgac agcatcattt cacatacaag tttcaaatat tgagatagca 294360
attatTTTct tcttaaatga ttactacaag gggccatagc caccactcat atattgtatt 294420
tactagtTga ggtaacagtc tactcttcaa ttcaaatgca taattgtcag gatagagtag 294480

atTTTcttct ggaaggggac atgactaaga attgtgtTga atataaagga actgactagg 294540
ctttatcaga cagccccct ttatcgcaga gataaaaagt agctcttata tctcatcca 294600
tgtccacaca acagcaaggg aaatattgtc aagatgcatt ttgactgcca gacttccaac 294660
ttagcaagaa attacatctt caagaaagca tacccaaagg tcattctgtc tcatggagtt 294720
tatgatatca ccaacagagc actttaagat tggaaagaaa taactctaga gttggtattc 294780
cctccaagca caccaaaagt tattttaaaa gagcttaatg agatggaaca gtgtagcagt 294840
gtaggaatag ccaactagct tgggtgaatt ttggactgat gtgtttattt ttaattatta 294900

atTaaattga tcttttaatt aaattgatac tgagTTTTc tacagtatac tgttacatcc 294960
tccaaaatca aatggattta tcatgcagta gaaataatag tcaggacaat tttctgtgt 295020
ttgccaagca caagaatcct tataaggatt tcaacaggga aagtgtgaat taaaaagaa 295080
aaatagaaac ctggaaaaga agatttcagt atacagatta acacagaatg taggaaggca 295140
aaagtttcca gttaggtgct agaagttctt ctgtccaaac tggaaatagg ctcagtaatt 295200
ctcagcacag ttgcttgatg atatataaaa ttgtctgcta aaatacagtt aatgctttca 295260
agtatTTTc agtgtgtTaa atacagttt atgttatata agttgcattt gttaggactg 295320

attatcagat tttctTTTaa gagaatcact gggactTTTta gagtTggacc tcagaaaaaa 295380
tatttgactc acagaaaaac aagatgcatt taatctccaa aactTtgaa ttacctaacc 295440
atccataaga aaaggtgca ggatgtcctg ggaatatgg ggggtcttt gttcttacca 295500
tactttatag tgtaacta ttcagtataa acaacattag aacatgaatt taatgttaat 295560
gtaattatga attttgcTta tcatTTTTat ttttctTgt ataaaagaaa aaagttgaag 295620
ttaattaaat tigtTgtat tttatccact ataagctgtt atcattagac acataacat 295680

aaatttattt tatgttgcatt ttttattata agtaattgaa ggtctatgtg agtgtcaatg 295740

 actctttggt atagctttgt ctaagctact tttcttttgg tgtaaggga taccatgaaa 295800
 aaaatcaatt tgggtgggga aagggtttgt tttaggttag aattcttaag ctatattatg 295860
 taatgagagt tagggagtgt atgccagcaa gaacaagcac aaatcttgtt gttcacattc 295920
 atttgtacac aggaagtgga gacaggaaag aaacaaagag tggacatgct caaagcctgc 295980
 ctacaactat aaacatagcc cagaaaggct ccacctttct gggtaggagt tetacaacat 296040
 tcccaactag ctctgaatc tggtagcaaa gtgctaaaac atgagccttt aggagacatt 296100
 tcaagttcaa accacaacag ttagctctct ttgaatttca gttattatgc atcacacaaa 296160

 gtattatggt cactgagge attttcaaac ataactgct tcccaatcac tctatgtaca 296220
 tcttatttcc tcttccctag cagcatcaca ttttctatta cctgtctgtc cttcaaaacc 296280
 attttttcca tcttggggtc tcttttctgc acacacacac acacacacac acacacacac 296340
 atacacacac acattaaaag ctaatttgca catatgaaag tacatgcttg cttattgtct 296400
 ttccaagttt attacctcac tgatataatg atttcaatag cctccctttt tctactaat 296460
 ttcatagttt ttttttctt tacagctgaa taaaattgca tgaagaccta ggctgattct 296520
 ctttcttcag tattgtgaat agagcagaat aaacatatga tgggatgtc cttctgtatg 296580

 ctatgtacat atgtttcacc tattggctga tgaataaagc caatggacag gcaggattta 296640
 gccaggcagg aagtataggt ggggctagga gactagcaga atacaggga caggaaagac 296700
 aaagagacac caggtagctg ctgagaaaagc aagaactcag gaatcacctg taagcgaaga 296760
 ccaggtaaag atacatagaa atgggtttaa taattaagag ctagccaata agaagcctga 296820
 tccataggcc aaagagttta taattaatat aagcccctat gtgtttattt gggactgaat 296880
 ggctacagga tggggtgga cagaaacttc tgtcaacaac atgggcattt taatatatag 296940
 aatacttaat aagtaataata gctgggttct actatatatc tataatctact tgtttttttt 297000

 gtttgtttgt tttgttatg gtttggcttt gttttgcatt ggttgagaaa caccacact 297060
 gatttccata gagctatagc catttgaatc gtaagtggcc tatatggtcc catatgcagc 297120
 aggtaagtgt tcagcatctg gtgctattgg ggggtaacag ggccaatagg agtaggacca 297180
 gctagaagga atttaggcta taggtgtgcc cttcttgtct tttcacttcc tgagcaccag 297240
 gaataagca cttttgttct gccatacatt ttctatgtgc ttattgacat gatcctcaa 297300
 acaacagaac caacaaattg tgcatggat cttttgcaat aaagcaaaa taaatatttc 297360
 atctttataa attgcctata tttgttata gggatattg ctacagaaat tgagaacata 297420

catctttgaa atgtgggata gatatatata tgttcacatg ttgtatgtgt ttatggaatt 297480
gtacaatgaa attgatggga tatgaaattc cttctctaag gtgatgtcca tgtttaataa 297540
ttatttgaca aagtacctta tgatctggtc atatttgatc agctacccat tagcttgaca 297600
caagaaagaa acttgaaatg tgctgctcaa cttcatgata gaagaaagca tgactccttt 297660
ttctcattt cctcattctt taaccataaa caaagtaaat caaaacaaaa caacaaagaa 297720
aaaagttaa caaatgcaac atgttaagac aaagacatca aacagttcaa ttigtatttg 297780
ctgactattt actttgagca aaaaatatgg caaaatcaaa tcctatgacc ttgaagagca 297840

taatatgaag caatggggca tagacatatt ctgaaaacta accaatatta attaatgcaa 297900
gtgactacca aaactgttct ctggagataa agtgatacag agcttgagaga aagaaatcaa 297960
cattaggatt cagggtagcc ttcttgatta aagaagtggg tctcggctga gtcttaggga 298020
tgaccagtgc ttccacatgg tgcagacaaa cgttagcaaa attaacta gctgatattc 298080
agtgatTTTT ttcattgta aaaatatttt ggattgcatg tatattattg taacttattt 298140
tactatttat gctattgcaa cttattttac tatttatgtt aaaagaacaa cttctctagt 298200
tggatcataa aaatgcaaca gacttggcag ttacaaccac agggatgaca agtgtcattt 298260

gtacattcct gtacagtttt gaactgtgtc ttctaattt tatagtcacc aacaaaaatg 298320
ggcacctgtc attgctgag gcttacctag aagcttgttg aatcaggtaa ttataattga 298380
aattagattc ctgtatcaaa caactgtgct gagtgtttct tggcctaag cagtagagtt 298440
caagctgaga atagaggta aatgaacaga ctgtattttg tataagaaca atggtaccac 298500
atgcttcgac ttaggttgtt tacagtcaag atttaaatct ctaggaaaat ttacaaatta 298560
ttagcagtat aagatcaaag actttctggc attttatgtg gcaatcagat tctatcataa 298620
taaggaatag aaaagtlact gaggattgtg ggaagacatt aaaatatagg aaacaaagat 298680

gttttcttta tgaagtttga aagtgcacaa ggattgaact attagcataa gagccagagg 298740
atcaggaacc agacttctaa ctaagagagg aaactgtacc cacgaagtat aaattaagct 298800
gtcataatga ccacaacaga tgacatgcct acattgacag gggccactct aagagtttct 298860
gctcctacat gtttttttaa tggctgataa gagagggaga atcagtttcc tccaaggaca 298920
aactgctgtt ttggttgttc cattccaaat ggttagcact gaacatgagc aatgataaat 298980
agactcagta gggtttgtgt gtgtgtgtgt gtgtgtgtgt gtgtgagaga gagagagaga 299040
gagagagaga gagagagaga gagagannnn nnnnnnnnnn nnnnnnnnnn nnnnnnnnnn 299100

nnnnnnnnnn nnnnnnnnnn nnnnnnnnnn nnnnnnnnnn nnnnnnnnnn nnnnnnnnnn 299160
nnnnnnnnnn nnnnnnnnnn nnnnnnnnnn nnnnnnnnnn nnnnnnnnnn nnnnnnnnnn 299220
nnnnnnnnnn nnnnnnnnnn nnnnnnnnnn nnnnnnnnnn nnnnnnnnnn nnnnnnnnnn 299280

nnnnnnnnnn nnnnnnnnnn nnnnnnnnnn nnnnnnnnnn nnnnnnnnnn nnnnnnnnna 299340
 gagagagaga gagagagaga cagacagaca gacagacaga cagacagaga gagacagaga 299400
 gacagagaga cagagagaca gacagagaca gagagacaga gaggggatgg aggagaaggc 299460
 aggagatgaa gagagagga aaaaggagag aataataaaa gaagccttgg attttgaag 299520

 gatggccaga catgagagga ggtagacaca ggggttgaat gcatatattc ttatgttagt 299580
 cagttctcaa ttacagtaat caaatgtttt agacagtcaa cttttaagg aaacaagttg 299640
 tctgtagctt acaggtttca tgatttcagc ccaggacata ttgaaatgac tgttttggtc 299700
 tgttgtggat aatttcttag atataatfff gaagaggagc aatggctctc acctcaaagt 299760
 ggaaaaagaa aatgtgagga gactggtgtt ctgcaatccc attctgtggc atgctgccag 299820
 tgactcagag aactgccagt gggctccaca ttgaaagt ttcaccacc tccagcactt 299880
 gggggcaaga cttccagcat cttagctcatt gtgggggat ttaacattca aattgcagca 299940

 atgtcctaata taaatgaatc tggataaact atacagtffc tatattgtat ttgaaaaat 300000
 ctagaatgat tagttttaga aatataattg cttgccaaaa atttgaggtta ggaaggagga 300060
 agtgaattga atggtgttct aatgtagtaa attagtgcac ctgaaactat cacagaggat 300120
 acatgtcttc acataattgt aaaaaagga atttctgtaa cagaggggta agaacaatgt 300180
 atatfffga tgatagtaat gatggataca tacacattca ctaatffta caaaatffc 300240
 caaacaatac cacctgtatt caagaaagca ggtggtgctg atggttacac aggactccat 300300
 aaacaggttg tacctgaac ctataagtgt ttggtgtgct ccagggccta tcctfffgc 300360

 taaatctgct gatgcctgat acccttacet gaaaggatgc tgtatffca tffaacctat 300420
 gcacatacct gtatagttga aattacgtta tgctatffa taacattaag tctaaagtaa 300480
 attctattca tagttffgt gtattacttg ggtcatgcca gaaataaaca ctgtaatggt 300540
 cagaacagac aaatfffgt tccaagtatt tgttgatca tggttggtta gattffatgga 300600
 tacaataac atacacattg gaggctagct ataacgtctg ttcaatggt ccatatagt 300660
 acaatfgcat caaaaaagt ctactaacta atfcaaaaat aagaagagg aaaaatagc 300720
 agtcctatgc agttagggtc taaacatgaa atgtaacaat aggcffaaag actaacaata 300780

 ggcaaacctt tgcttffta ctgctaatgt tactgtctg attgfaaatt gactctatc 300840
 ataaacagcc tffacattg tgaataaat ctctggatt ttatgcatgc taaaatggt 300900
 tcttagcatg taaatggct cctffattc ttgtataaag cccataagct tctaatgaga 300960
 caataaatca aatgtafgt tattaagaaa tattggattt ccagaggttt gtcaccctt 301020
 aagacttct gatggagaaa tgtgaaatta aggcaatgaa tffaactact gctgaagatg 301080
 gacagtcagt cttccagct cffaatctca agcgtactga ggttattgct tfffiff 301140

ttagacaggg tttctctgtg gctttggagg ctgtcctgga actagctctt gtagtccagg 301200

 ctggctctcaa acgcacagag atccacctgc ctctgcctcc caagtgtg gattaaagc 301260
 gtgcaccacc aacatctggc gaggetattg attcttacct aatgcttctt cetaccaagt 301320
 gtaaggcaga gaacctatgg tactataaatt tggctctgca agcagggggg cagctccatt 301380
 gaggattaag tatttaacat ggaggacact ttctctaaaat cccaaaataa ttttcccaa 301440
 tacttgatcc catgtgtgaa actctatagt ttattttctca taacaaagcc actgacatga 301500
 caagttataa agaaaaaagt gagcccatag ttctgggagt tcactgtcta tatgccccat 301560
 ttggtgatgg atttctgtac tcacagattt ctcccttatt atggagtcat gatgaatgta 301620

 ggtccatact gagaccctca tgtgacagt atctaactct aatgcccctt cccaaacccc 301680
 agctctctc accatcttag tatcttgcga tggttattta gactgtatta gtacatgaa 301740
 aaaaccccat aattttgaca ttctgttttc aaatctcact ctacaccttg agaaaataac 301800
 agtgaggaaa gagcacagtc aataaccata cacatacaaa aaatgtgctg ttacaactt 301860
 tcttctgtat ttgtcagttt taatggatgt attctttatg tataaacacc ttgcttatat 301920
 catttctaataa ataatgtgaa aagttaagtt gtagtctcact aacattcata agtggcacia 301980
 atatagacaa ttaaagaaaa aatgtttttc acaatgtctt ttacacaaa attgctgttt 302040

 tctcatacca ttcttggaga ttactttag aaatgaatat tgattgccac tgcaattttt 302100
 tctgttttct catatgaaac acacacacac acacacacac acacacacac acacacacac 302160
 cccccatgt attgtaattg cctccatgtc ctgttatttc tcttaacctc tgttccccag 302220
 agtttttctt taaaaataag taacataggt ataagaaata gtgaggggta gaaaacacca 302280
 caaatgactg aggaatatgg caaaaaataa aataaagtaa caagacttat cctcttttat 302340
 gtatgaaatc actatatagg atgtatgctg aaatctttaa taataaaatt gaaattgctg 302400
 aataaagatg gagaagaaac ttcaatttct tatccccaca tacacagagg atggtgaact 302460

 ccagatgtac atttctattt acttatcttt tgactagtat tttcatcaga tactactcta 302520
 aacctggat tatatttga cattgctatt atttcacatc atataaatta ttttccaata 302580
 ccatatttta tgcaattaaa atgttctaaa aatgacttct aatttctggc atatagtagt 302640
 agtggtgcaa aaatatttgc tcagtgaatg aatgaatgaa tgaataatta aaaatacttc 302700
 tggcaagttt tgccttggat cattagatta agctgtgttt tttagtgaaa tttcaaaaag 302760
 caccctgact acicctcata atttttctat attagtttta aaaatccagc accatgtttc 302820
 tgtaattata tgtcaagtag aacttaacat taaaattgat ggaaataatt aaacacctct 302880

ttgcatatac aaatctctcc taagacattg atttgcaccc atttcaaggt ttattatgga 302940
 tggagaagaag tactgagctc atttggagtt tacatgggta attatggaag cttttctaag 303000
 tgcacatcatg tgctcttgaa caaagttatc atatttactc atgattttgtg ttctttttta 303060
 caaatgtaaa ccctgaaatt cattcatggg gtaggctaca tgccagcata gtataaatac 303120
 tatgcatcca tatgacacatt aaagcaataa aaagaaatgt tattttgcca tataatctcgt 303180
 atgctatagt ttaaattttt ccttcttaga tgtgcattaa agacttgttc cactgagatg 303240
 gagtgatatt tcagttgata aagtgtttga aagcatgagg gcctgagttg tacccttagg 303300

 cccaacataa aaagggcctg agttgtattc tggcccctct gcaggatctg tgggtgacct 303360
 gtaatcctag ggtttaggaa gcagaatcca ggatctggga aagagaacct gcctgagtaa 303420
 atcaagttga aaacaattac aaactattta aattcaatct ttgttttcca catgcatttg 303480
 caaacatag aatacacacc tgacacatag ttagccaca cacatgtgga tatacacgaa 303540
 ctacaaaatg cacatgaata gaattgcaca ctgtattagg atgtaagacg ttggacctct 303600
 aagctgacca agaggatctc acattctctt agtctttata gcacatatgt tggaaacta 303660
 taattgcata ttatttccat ggccatttga gaggaaaact ttataaccagc ttcttgccac 303720

 tttcctgaca atccaaaaat agcacacaca tttcattatg ttattttcaa ataaaaattg 303780
 ttttgtaac tgccttcca ctcccctca tctgtctacc aataacctg ggcactttga 303840
 tcgaatgaat aaccctctg ctgccatggt atgtgtgtgc acatgtgtgt atgtgtatat 303900
 gtgtgcagtc atggctgttt gtgtgagtac acagatgtga tgtatgtgtg tatacatatg 303960
 tgccatgtgt gtgctgtgg gtacacatgt gtgtgtttgt gttctgtttc cccatttttc 304020
 tcagtctttc tttgttcaat ttccttggtg tcctttcaag tttcacaaga aatgtctttc 304080
 tgaagcacct catgaatggt tctttaactg gtctaaactg tgcaaatgta gtagaggcag 304140

 gttttgacct ttaccctttc ctctcccttg ctaattetaa gattacatta ctaaagctgg 304200
 cacccaaggt ctattcttta ttttctcca attcattct gagactaac accaagattc 304260
 agcaatcaaa attcatcatt tggctgcttg agctaaactg tccatcagg acttactgac 304320
 taatcetaat atagacttct tttctcttta aaattcactt ctaaagaaac acctgtttca 304380
 gtctttgtcc agtctagaag cagtcacct ttttttcta gccctatga ttgtccctcc 304440
 tgactactag atttctttt ttgctgacaa ctgggtgtct attctttgct aagaggttgg 304500
 ccctaacacc taagttttga aatattgcca ttaaagtatg gtgcatctaa ctacatttct 304560

 ggggagaatc aaagttcaga caagcagaaa acagcaaggt cagatcacat atttactg 304620
 acaaacatca ccagaaattc ttccagcctt ttctaccagc tcactcacta ttttttctct 304680
 tttgttgaat atagattttt acctcaata atatatctc atttcccta gctctattcc 304740

ttggtttccc ttcctctac tctttccaat tctcctcac ttcctccc tctatcttt 304800
 tttccatfff ttattagaga gcagttttct aagaaacaat aataaaatga caaaattaaa 304860
 aggaggaaac aaaagcaaac atcagaacag tacaaaacaa acagaattaa aagatcccaa 304920
 gaaaaataaa agtacaagta gtatttgtac actcaagaat cccataaaag caaacctgta 304980

 gggttaagaa gagaaagaga gaataaataa ataaataaat aaataaataa ataaaaataa 305040
 aaaatatccc agagacaagg aatcttcaat gatgcagttg agtttgtttt ttgttgacta 305100
 tctactgctg tctctacttg ttttgttttc aacacattcc agtctctgtg taatatctt 305160
 gatgaagact gctgtagttt cctgacatgt tcaacctgac ttttctctgc ctgtttctgt 305220
 ttttaagtcta aactattca gaattttctt atagtttact gaaaatttta aagacagaca 305280
 aagtgatgtt acatttcagg atagcaaggc agattggcat ataaagcaag gtcaacatgc 305340
 ccattgtcaa aaagtgata atcatttgaa acatgtcagt aaagatgaca ttgtcacatt 305400

 tgaagcacat ttgaaagca gaatttgtca agtgctttgt aagacaggtc cttcattat 305460
 gccatttga tggtaaagca agtaacttat tatctaataag gtaagagtaa gaaaacagaa 305520
 caattaatca gtcatgtgtt atgggttga gtagcactct taggaagtgt ggccttgttg 305580
 gaggccacac ttgtgtcaca gtggaggcag gttttgaggt ctcatatag atcaagccct 305640
 gcccagtga acagaccact tctgttggc tgcatatcaa gatgcaaac tctcacctcc 305700
 tccagcccta tttatgtctg catgctcca tgtcttacca tgatgataat gaactgaacc 305760
 tctgaaactg caaacattc catcaaatgt tttccttct aaaagttgct gtgttcttag 305820

 tgtctcttca cagcaactga aacacgaact aagacagaaa ctggtaccaa ggattgggga 305880
 attgatttga tggtcctgat catgcttttg tgtgaaggaa tatggacctt gggactgtag 305940
 attagataat cagttgaaag ctttaaatgt tgcctttattg gaacatccta gtaggagcat 306000
 gaaagacagt ggttttgagt gtgatttga ctgtgggtgg ctggttcaag aagtttcaga 306060
 gaagaatgtt aglatgtggc ctagacattg atcttatatt tggtaacaa tgtggatgcc 306120
 ttttacctt gcacagagtc tgcctgagac taaagtaaaa atatttggat taattacact 306180
 ggtagaggaa atcttgaac agcctagtac tcaactctgt gtgtggcttt tactggtgac 306240

 tcttatacag atttataatg aaaaagtaca agctgagcaa ggaaaaata tttaaagaga 306300
 aaagaaatg caagccatcc cactaatgt tttcctttgt aggtgttct atggtcattg 306360
 tgcctctcta cagctacaga aactgtaatt aagacatggg ttaatgagga aacctcatg 306420
 gaaaatatta caagccaaa gtaggcacaa agtaccaagc ccagggtctt taacacacag 306480
 gatggaatc tcagtctga ggctatatac aaaatgtgaa tctacatttt cctgaaggca 306540
 ccttatatct cctgttccat taccttttta catacaaat acacaagtat aatctttggg 306600

tggcacatgg tacatattgg ctgccacctt ttcagtgtct ggatatatca gctgatcaga 306660

 aagtttacct ttggagctcc ctgatttaga gaaacaattg cactactatg taggtcatga 306720
 tccaggaatt tcagagtgaa ttctcaaggc catTTTTtagt aactctgttc ccccaaagta 306780
 aaactttgat agagaataaa ttgtagtatt tagtttaaac caggaagaaa atccccatTTT 306840
 ccttatcaag aatagaatat aaaattatct acatattcct gctttatctt cttcaattac 306900
 tgctctctgt cacatttca attatatagt atgtggaatc ctagcactct aaacacattt 306960
 tgatattgta aacattttca aaaacttttc aaaatatgca gaaataaata taattgcata 307020
 ctatgatgag tattattggT tgtcaagtta cagaacatag aagtatctag aagaaaaacc 307080

 tcttgttgtg acagtgagaa ttttagact agttaaattg agccaaaaat gttctaaatt 307140
 tgggtggTga aattccatgg tctggggTtc tgaactaaat acaagggatc cagcaagagg 307200
 agcaccagtt ctattcatta tgtttcttga ctgtaaatgt gataagctca gcctcccca 307260
 gctctgtcca ccattccttc aagggtataa ttgaatatac cctctaactg tgtaccaaaa 307320
 taaactatc cttccttagt tatttttggc aggttttcac agcaatgaaa aagataatga 307380
 atatgatgt ctcacccat gtgttttct ctcacttta agaattttca tcatgggcaa 307440
 tgtcatttgt ctaccagaca actgtcaaat attttttcag tcccagcaca accagcattg 307500

 ctcaatattg tcagaaatgt aggattcttt acatcttaga tctgaatcat gagctctaag 307560
 gtggatgctg catattgatt tgtattttaa caagtcacct tggtaattct aatatactgt 307620
 gatgactgat gtctattgat atagttcac accattgcc ttaccagat agattaagtt 307680
 gtaattgatt tagatggcat gcatcatttc attttttagtg taaacatttc agtgtgaaga 307740
 taaatacaaa aaacaatag ttatcaatat atgtaagcat cctgctactg ttcagctttt 307800
 tttgattttc cgagacagg tttctctgta tagctttgga gcgtatcctg gcactctctc 307860
 tggagaccag gctggcctcg aactcacaga gatccgctg cctctgactc ccgagtgtg 307920

 ggattaaagg tgtgacccat caaagcccgg cctgttcagg ttatttaaca cattttatgc 307980
 ttctttgctt gactcagaat cccaataatg actttaaata aacctggct ctatgccata 308040
 aatgtttagt ttatgggttt tctatttcct tctgatacac ctatttaagg tgtatattta 308100
 tnnnnnnnnn nnnnnnnnnn nnnnnnnnnn nnnnnnnnnn nnnnnnnnta tggatata 308160
 ttatttatga tttattaagt cttgcctgag gatTTtagaaa gcaaattcag caacaagctg 308220
 tagatgtcag gcagacgtga tacacacctt taatcccagc tgccatagag gtagttgtgg 308280
 tggTacctac atttaatgcc aggactcatc attaagagat agaaggatct ctgttagttt 308340

aaggccacac tgactacaca aattcaccaa tgcctaaaac aaagagctca catgaaggag 308400
atctcagcat ctagaatcac atgccttaaa taacagagct atggaggtag agacaggagc 308460
gatatgactg ggcatagaaa ggaataaaaag gcagaagggg acaggaactg agagcttttt 308520
tgcctctgag gattcatgga gacatgattg ccatttcagc caggttcttg gctgctttgc 308580
ttctctgate ttcagctgga tgcttgaacc ccagtataag tctcagagtc atctattttt 308640
catgttacat atacatatgt gtgtgtgtgt gtgtgtgtgt gtgtgtgttt gtttagaata 308700
tagttgcctc cataaattgg aaaaatgtcc aatttcctgg atccaaagaa acaagttggt 308760

gtaagaaacc taatgtgggt tcaaagtccc aaactcttgt ccactgaagg aatatcaagc 308820
attcttaate actgaacat ctctctagct ctgtgatcat tccattcttc tcaccaatat 308880
ttctctactg atgacacat ccctctgttc ctatcatctt tgtctctata tacacacact 308940
cctagcatca ttgtttacta ttttcacaaa tgtatgttgg atggaattaa ttacctgtct 309000
ttagtatttc tagagtgttt actgaatctc tatgaatggg tttattttta catgtgtata 309060
gaatcccttg atctattcct tgtgtttctt gaatattttt aaacaggtct attggcttct 309120
acttaatfff ttctgtacat actttcatgc gagtcttgtc atctttaggg gaaaagaatg 309180

gataaaggaa gaccagtttg ggaatgcagc atatagattg taaggacaag gtggattgga 309240
aaagtcatag actagtcagc aaatcagtaa atttctaaga atgataacct tagctcctaa 309300
tttgaataaa ctggaaaaaa aggggaaaatg agaaatatft gaagggtatg ataggaaaaa 309360
tagctttggt acctgcctga ccaagaagaa agtgatgact cagtcaaaga taaatcttgg 309420
ctttaatcct tgetgcttga gactgggtcc atttacagaa tattgctttg attaacatta 309480
gaagcaggga gcactttggg atttcaatgt tgetcttaat ttatagaaaa tttgtttatg 309540
aaaacaatcc ccatgagcca cagaaagctg caaagtgttc agatatgctt tgcagtattt 309600

tctctcactt ttgattcttc aataataggg cctctgetac attgtttcat ctttgtgtcc 309660
tgactgacaa ctaaaaatta agctttttgt atatccaggc agtctgggaa gagcagttgt 309720
tctttgatta tgcagtttct tttagtttgc aatfttaate ataagggact ctattacac 309780
attctggate ctcatcaga gagtctctcat tttatatatg aggactctca tttcttcaac 309840
cttttgttca tatacatgaa cacatttgac acataaataa tgtgggaaag ttgtcatttg 309900
ccttgaagag tctatcctc tgtttcaagc atatttatgt caagtgtcct ccaaaactcc 309960
ctatgctgtg tcagactgat acaagctctc taccagggag aaaggagaac agcaaacact 310020

taaggatgtg gaaaacattg ccttctcaag aaccctaga atatatattg tttaaaatgg 310080
aggtaacaat tgtttatftt actgtattaa gatacctggg gagggactta taagctggaa 310140
gctcattcat ccagaaagct ctctggtctt cctgatactc ttatfttggg gacttcaaca 310200

tggctatttc aggatggctt cctttaagtt tctataggca gatgcaagca tctaactga 310260
 tattattgcc taggatgctc tgtcaggtag gctgttccag ccctctctgc ttgatgctgt 310320
 aagtgtgtgg ttggttgcta gttatcttct gcctctctct gcttgttctt atttgtgctt 310380
 ttactgtgtc ttgctgagtt cttaatgaat tcactcattg atggctatga tgaccattc 310440

 tccacataaa acaccattaa gagtcttttt ttcttataaa ttgacataag agaaatggag 310500
 acataatttt tctcatcata gaatctatat acatttctat atgatataaa tataagtga 310560
 tttcgtgggt taattaaaat acaagcataa atgtctattt gtaacttaat tgaatcaat 310620
 attcatattt cctttggfac aaaacaggtt ttaaaatcag attcaagtaa atcttatgtg 310680
 ccatgtctat tgaattgtgg gagctatata gttatcttag tatgatcctc ttagaacaaa 310740
 gctagagctg gattccattt ccttctcaa ttccattcca gaattgttag agtttactta 310800
 ttgaaaagag ggcactaggc aggatgtgtg gcaatatcc caggctgtct ctcttccag 310860

 agtaaagctt cctctggctc cacttcagag caattaagcc ctcaaaaaa aaccaacata 310920
 acagtaacaa tacgaggcca aaagaatgga tgtgtacttt aatatgtccc tcatcagaaa 310980
 gtcagatgaa taaaagagga aatccaagat gtggaataa aggaaacatg aaaataccta 311040
 taaataccta ttaatatct ataagcacct acttaattta tttgtagcta acatgctgca 311100
 atgtctgata ttcctgatt gaattccatc taattccatc ataattctag aaacttgtgc 311160
 ccagaaaaa tcacaagtaa cttattgaga taacagatat atttctattt atgttctaga 311220
 tcttgaaaa gataaggaat ctctccatc atctgcagcc ttccacttcc ccttctgtcc 311280

 tttgctctct ctgattctga tgggccttga gactgaaagg aagaaacctc ttttctctt 311340
 agaggtgga aatcaaggtt caagtgttc atccttcacc ctgagaaaac aatcacattc 311400
 cataattcat actgatagat aatgtttaac atttgagtaa aactaacatc atgaatgat 311460
 acttctctgt aagatatctt tgtagaactc attcattgat ttttacataa aataaacctg 311520
 aaaaagaaag attttatta tattgctgag atgcttcaat gctcatgaga ataaaaata 311580
 atcagctatg gcaatactct ttgtaacca gatgaagtca gcaagggcac tgctatatta 311640
 aaggatccta aaagaaaata taaagtctcc ttcattgitta cctcataga gataaatagt 311700

 tgtgcagagg agtgtacctc agaaatgtct atatcattta taaaacctc atgataaagt 311760
 ctctctttgg ttcacagtat tatttaata taattttata gctgaagagt ggcatctgca 311820
 aacataaatt aagtcattgt gatgatattt tgtttatgat ctaaaaaata aagcttgtct 311880
 ggagatcaca atgcaaagct acccactata gttatccata gagccaggag agtggtagca 311940
 cacaccttta aaccgagcag ccacactagt taggcacaaa ggccagacag tcatggagac 312000
 agaagcagag ggatctctgt tcaaggccac catgggctac agaagactga atctgtctaa 312060

aagggcaaca aagctcatat aaaggtgata ccagtacctt aatcccagca ctaaggaggt 312120

agagacagga gtgataatgg ctgggttaag tgaggaacat taggcaggag gagacaagag 312180
agagatgcag tctgaggaac agtgcagtct aggcactctg aggaacagtg cagtctaagg 312240
aagagtagag tctaagcagt ctgaagagca gtgcagtctg aggcagtcag tctgaggatg 312300
cagtcagggg ctgccagtct agtgatacac tctgaagatg caattggagg acaggatcac 312360
ccctttggtc tgagctttag tagagataag aacactctag tggtcagcca ctttgcttct 312420
ctgatcttca gcattaacct tgataggtga ctcagatfff attaagaaaa attagaattc 312480
atftttctttc aaagtgttat ttagagaaaa ataactctga ttttacctat caaaagtctg 312540

aagagcagca tgittgcaca tcacaggttc actgaaggag ggagtattca ctttttcccc 312600
agttaaagaa tattcaaaat tttaggaacc aacctaacta cataattgta acttggctca 312660
caacactgtc atattggcag ttgtaattat accttaatat tcattgatga agaacagatt 312720
ttatcaggaa gggctcatca catcccatta ctgattttgt actgtatctt aggatgaact 312780
taaaaacaca gtgggttgat ttctgaagca ctagtgggtc aatggttaatt tattttgtgg 312840
atgattatgc atccattgtc aacggtgtta gtttgacaca aatctgcctt gattggaagg 312900
gctctctatt aaactttaca agcatcttat tatttgggta gttactatft attagtggaa 312960

atatcatttc attaaatatt ttcaagtgat ggcaaggatg cacaactctt cacttaatta 313020
ctgtcttaac ctgtatcaat taacacagaa gtgaagatag agatttatgt taataatatt 313080
tatttttctt ttttagcaat ttttaaaatg agtaccfaat gtataaatga gggaaagtag 313140
gatggttaaga ggaaggetat ggtttgaggt agaggctgaa cttgggcttg cctggagctc 313200
tggagctcaa attgaacct ggagtctcc tgttcagtgg ctagtgggtt gtttgcatft 313260
atcccaaacc tgttcagcca ttgacatcca atgcttttga tgcctacctt tacaatctaa 313320
agactaatga tggcatcatt ttgtgcaagt gtaacatftt agaaaatatg acatatatga 313380

atcaagagcc aaagtactca cagcctctgg caatgggcac aaagcaaata agaggatagc 313440
ctccagtcac tctgaatcg aatagcaatt gattatgtft ttattccca agggaaatft 313500
tcacatttca cfttattttc ctaaagtaat tctgctftft actgaactga tgtttgatta 313560
tcctgtttac acatccttat tatgatgaag tgggctgtga atgttctca aggaccaga 313620
cacacagaag agcaaataga ggtttgatct tcagcttga gcactaagag gacttggtaa 313680
aatcccctgg gttggagctt agtttgaaag agatgcagtt agtaggaagg gcttagtaag 313740
aaggcagtta gaccatttca gacatgcat tgaatggggt gcaggtgctt tgcctfttgg 313800

ctcttttggc ttgcttcca aggctgaatg aaacaaacag attgtccctg ctatgggcac 313860
 ctgtttatga agcactgaac gagccagagg cactacaata ccagccttaa agtgaaacct 313920
 ctgacatggt gacttacaca aagcaaacct tcactctctt ttggctgatg atctcaagaa 313980
 gaaatctgac attcacaact atttttgtct gagaacacaca ttgaaaggat gtggttagta 314040
 aatatatfff ccattttatt tgtatatttt aattatcgat gacagtggat tcattaggac 314100
 acattcatgg gagcatatga tgtatgctga gaatatatac tccacattcc ctttcttgtc 314160
 ctctttccac actttctcct cccaacacaga gtcttcttac tcccagtttt ttcctatatg 314220

 cagagaagta atttccctgt tttccccgcc atgagaattc agcaaagcac agcagtgata 314280
 gattgatatt gattactaca aaattataga gcgttcagga agcagatggt ttgtttagat 314340
 ttatcaaagc aagacataaa tagatcccaa tgaaggtcac tcttttgtgt caagagcaaa 314400
 aactgtttat ttcactctat gacttctaga aatgctaaca tgttataaat attcagatag 314460
 ttttggcagg ttggttaacc tggattagac tgatactgcc tctgaaacgc ggttactttt 314520
 attttgggtg gttcccactt cttccatttt caatagataa accttctctt tgccctattc 314580
 taagacaccc ttgcccattt gcagataaag agaatctttc tgaaaagaaa ctctctcctg 314640

 gtcttataca catgccagga acctacactg ctgctagggt tgactgtttt gtcactggta 314700
 ctgctctgaa acaacagaca ccagggtaat atgtgtatgc aattacatcc atgtacagct 314760
 cagaattctc ccaaatgcag gcttttgcct acttcagaag aaatctgttt ttctctgtgt 314820
 tgctctccgt ttctgcccct gtgtgtgttg tatatgggaa tgtaagtgtt cacgtgatg 314880
 gatgtgagca cacatgtgtg ttcatatgtg cataggccat aggttgagtc aagtgacttc 314940
 ctctgtgttc tccttatttg tgagtaagag tcactcactt gacttgcac tcactgattc 315000
 aacaagacta ctggccaga gaacctaat gatattgtct caacctactc aggttttagga 315060

 ttaccagtgt gtagcactat gtcttgctca ttttacctgt ttgttaggca tccaaactca 315120
 ggtcctccta cttatatggc aagtgtttta cagactaagc catctctatg ggtcccacag 315180
 aataaactga taagtttgtt tttgttttcc tctacctgtg actatttaca atgtaacatg 315240
 aataaagaaa agaccagaa tctgatattt gggttcaagc ttcaagctga agaccagaaa 315300
 atcaaagcag ctgggcaacta gatcacattc tacctcagac taaaatggct gatccaggag 315360
 ctctcccaaa cctcagaatg aagcctctcc ccagtgtggc tagagaatcc tgagacttca 315420
 atgtcttctt atctcaatg tggctggagg atttacactt gatagtgaat actgaagacc 315480

 ctttttctat ctttatttgc ctgagtgct ggaattacag gcatgtgttc ctaggtgctg 315540
 agatcatctt tgtgtgagca ctttatcttt aggactcaat caatcttgtg tagatctggg 315600
 tggcttagga ctcagagagc tctgtttacc tcttaactct gagtctagg gcattaaagg 315660

tataacat cacttcctag tttctagctc ctgagattaa aggtgtatat catcactgcc 315720
 tgatctttat agatgaaagc tgactttcct ttttgaatcc tcaggcaaga ttttaataaat 315780
 tatacataat atatcaccac attacaatag tgtgtttatat ccataatcag agtagtactg 315840
 gcaataactag cagtctctac catgtaacaa ctatatgaca aataactact agcatactat 315900

ttactggatc aatctttaaa agccataatc tgtttcaggg caatatatgg tggtttacac 315960
 taatgatcct taacaggagt gggttaaaaa tcatttgaca tccttctgag gtagttttga 316020
 tcattatgtt aacagtggag tgagtactat ggccatctag tgagttgacc ctaagcctgc 316080
 tgatgggatt cttgtgactc atataacagt ccttgtggca aatgatgatc agatctgaaa 316140
 tttcagtagt gaaaattttc agaaccttga gtttaaatta aggcttctg accataattt 316200
 aatagtgga taaaattgat ttgttcttaa atagcttctt tctgttatta aaaagagaca 316260
 tccttactg ggtatgatga tgcattgctt caaccctgac actacagaca ttgaagcaga 316320

atgttcaggt caacctggtt aaataataaa caggaattta gcctaggcca caaaaggtta 316380
 ccatggaaac actggtccac tgcactctgc ctctctattg tcctattcaa ataaacacag 316440
 ccaaaggcaa cataaattaat gtaaaaatga tctgtaagaa tcaaaatgat tgcatttget 316500
 gaaacaggct ctatacttc aaacatagtt tctgtattag ttgcacagtg tccatcctct 316560
 tgtattaatg taatagaacc caagaatata gctttttctg tatecttgat ttttttcaact 316620
 caatctgtct gtctgectat ctatcatctg tctatctate tatctgtccg tetatctate 316680
 tatctaccta tcatttatct atgtacctcc aactatcacc tatttatcat caatggttat 316740

ctatctacat cattgcatgc atctcgteag tattgttttt tccatatgtc ggtttcagac 316800
 ttctagaacc caatccattt gattcaatgc ctgacctcat tcagtaaaat tctcctctgc 316860
 agtaggtcaa gattgtgttg taatgctcag tgtaaaggat ggatccccac attattaatt 316920
 aatttcattt aacttctga ttggetgaac agtcactaat taggagaaga acttggtaaa 316980
 gtgcattatt ttctatgact aaatcaatca tgctaacttc taaaaagcta gaccatgtgc 317040
 cccttaate aatgttctaa tttatttttc ttttatattt aaatttgtaa caggattggt 317100
 ttacatgtea gtcacatttc cttctccctc tctctctccc ttgcccccta ccaactaaca 317160

cccataacce aaaaccttc tgctccccag ggagtgtgag gccttccata gcggtcttca 317220
 caatttgtea tatcatttgg gatagggtct aggcccttgc aaatgtgtct aggcctcaggg 317280
 agtatccctc tatttggat gggctcccaa agtccattcc tatgctatgg ataagtactg 317340
 atatactaca agagtccca tagattttctg aggcctctc aatgacacc acattcatgg 317400
 ggtctggatt agtcccatgc tggatccca gctataggtc tggggaccaa gagctcccc 317460
 ttgttcaggt cagctgtttt ctgtgggttt catcagcctg gtcttgactc ctctgatcat 317520

cactcctcct tcctcgcaac tggattccag ttcagttcaa ggtttagatg tgggtgtctg 317580

 cttttacttc catcagctgc tggatgaagg gtataggatg gcatataagt tagtcataaa 317640
 tctcattate aggggagggc atttaaggta gcatctctc tgttcttaga ttgctagtgg 317700
 gtgtcatctt tglagatctc tagaccttc cctagtgcct gatttctcct taaaactata 317760
 atgtctccct ctattatggc atctcttate ttgctctttt ttcttcccc aactcaacct 317820
 tcctgtctcc teatgtctc ctcaectctc ctcttctccc ctctctctc tectagctcc 317880
 ctctccgcc cccatgtccc aatatgctca agagatcctg tccctttccc tttctccaag 317940
 ggatcatggt tgtttttctt aggatcctcc ttgtttctta gcttctctgg tgggtggat 318000

 tgtaggctgg taatggttg ctatatgtct aaaatccgta tatgagtgag tacatagcat 318060
 ttttgtcttt ttgigactgg gttacctcac ttagaattgt ttcttctagt tctatccatt 318120
 tccctgggaa tttcaagatt ccatTTTTT cccactgagt agtactccat tattgtgtaa 318180
 atgtaccaca ttttctctat ccattcttta gttgaaaggc atctagggtg cttccagttt 318240
 ctggctacta caaataatgc tgctatgaac atgtttgaat agatgcctt gttgatgaa 318300
 tgtgtctctt ttgggtatat acctaagagt ggaatttctg ggtcttggg tagactgatt 318360
 cccattttcc tgaggaatcc tcaactgat ttccaaagtg gctglatgag ttggcactaa 318420

 catcagcaat ggaggagtgt tcccccttct ccacatctc tccagcataa attatcattg 318480
 ctgttttttt ttiatttttag acactctgac aggaataaga tcgtattttt atttactttt 318540
 aaatctgagc atctatttaa ttaaatattt agaaaatgaa agttgtcaca aaccacattt 318600
 gtaatttggc tgatgcaaaa gttgagttta tctctgtttt gtgttcactg aatgaatga 318660
 atcaattttg tttcaacaa cagcacagtg atgtagaaat caggctctgag ggcttagctg 318720
 ggaagccaca accattcaa ccatccaggg ttaattctg aatagactg tttttgatat 318780
 ctattttgca taagcaacaa tcctattctt actcaaggag cagcaaaaag taattagtgc 318840

 ttttgacaca tgcttcttgg actccttgtt cctcttctc tccitttgat ttcaaatctg 318900
 ctaaagaaaa caaaactgct caaacaaaag gcagctggca gaagcagtgt cttaaatatt 318960
 caggagagga gctaaagcata ttgttttctc tgccattca tggtttgctt ttatagcagc 319020
 aacaccactg aaaatatgaa ggtaaatcat tglagataat atttattaac atccagcctc 319080
 atcttccatg taagccacac agtcagatgg acaaggagct cacttatctg ctttcttct 319140
 tatatttccc cgatccattt ctatgggaag aacaaggaat ctgcaccact gaggagctgt 319200
 agtgagtctt ttggcaaggg ccttcttctc acagctcagg aaagtagatg ctgaaaactg 319260

tcaaagactc acaagggcag agtgtgcaga gagttagaga tcttggata atcagccttc 319320
 agtgggatgt ctccatcaaa tctcttccc cagagctcaa ggatttctgt agaagaggaa 319380
 gtggcaatat tgtaagatgt agtagggaga gaagaaatga aagaactagg gtcttctaga 319440
 tacaagagaa ctgaccaca tctaaactga cagagacttt gacagcattc acaaagtaat 319500
 actggtaaag tctaagctag atggtgtccc agtgcctgaga gaggaagcag acacaagctg 319560
 ccatccctaa cctgaagct atctacaaat gacaactttt cataaacaaa caagtcgttt 319620
 tcttcaaggg agtttacta gatatacaaa ctgctcttaa aggtgggctc catgccagg 319680

aatagatggt gaactaaaa agaactcaat ggtatnttgg gaggttgtct caaatgctt 319740
 tgtctgggct ttcttctta caggcttgc tctgatttt gtgtttttat gggatttcta 319800
 tgtgtgcaaa tgctgtgtc tctgtgactg tttcttgggc tcttttttt taatcagttt 319860
 gttttatcct attctgttta ttttgttgt ttttgcctgt tctttttcta atgagaggaa 319920
 aacgaatgtg gatttgggta agtaggaaga tagagaggat ttgcgatgtg ttgaggtggg 319980
 ttaaactat tatcgaattt attatataaa aatataatntt aaataaactg acaataagaa 320040
 gaaaaacaaa agtttaagat aagacataac ataaccattt aaggacaca taataaggga 320100

aatctatgac atatttcaga atattctatt atttgtttat acttttaaaa atagaaaatt 320160
 tcaaaaatag atttatatac aatttttaaa gtcccaaag taatacagac actgccatgt 320220
 agctctgcca geattcttaa ccactcagct ttatttccag gcttgacttt gttaaaaata 320280
 tgtttctct attttctctc ttctgtctc ctgccacatt agttattcac attttaact 320340
 atctgatggt gtctgcaca ctagggagcc tcttttatgt ttttaagcttt tcattctata 320400
 atgttccatg ctggaatttg gctatttctt ttatgtggtt tttatttgaa ggctaaattg 320460
 tttcactct caagaaaaa tgagtccatt tatttgctgc ttttaatcaa atagttaata 320520

gtttgaacat ctacatttac taattcccat atcttaatat cttacttgtt cttaaagaga 320580
 cactgctttt acagttttac tttagtctta ctaagtgtgt gtgtgtgtgt gtgtgtgtgt 320640
 gtgtgtgtgt gtgtgtgtgt gagagacaga caaagagaga cagaaagaga gagaatttag 320700
 gcacatttgt gccaagacac cctcatgaaa gttagagaag agcttttggg atttgattat 320760
 ctctttctac actgggtttg aagctaatgt tgtaagtccc tctttccct cacaggctat 320820
 agctatatct attctaagcc atttgaatct caaatatagt gaactgtgtg ttagccatac 320880
 tgcttctct ttaagcctt tattcaacat gaatgtaggt gttactgttt tagtacatac 320940

ctgatttctc agtactgcag actaaacaga ctgaaaataa ttctctgtat tcattgggcc 321000
 ttctgatcct tgaatcagc tccaagccaa tgagttacat agctacaagg aaccctggag 321060
 ggccttgcta actgaatctt ttatttctga tgtttccctt tatattttga gaagctatag 321120

agtcagaatc ttccctttaa cttttcaatc ctcagtttta tttccatgca tctgaatctg 321180
 aaccactttg tcaactgttag tggcttggtt tcagttgaaa accagaagac ttgtcaactt 321240
 aacttgtgcc tctatctttt cagctggctc ccattcttat tgtgcctgcc ccaaccatat 321300
 tgtcaaacct tctgtataac atatgtagta aatttccttt tcatgataat tttagttagc 321360

 tctgactttt catagacttc actatagtga gcattcttta gcataagctg gtgaaaggcc 321420
 aacattagtc cctgtaggag aaatacttgg tagaatcttt gaggcaaaaa atatectgct 321480
 ttctaaagac tttttaaat tgaagctggt cagacttgtg ttttcatga atgtttagca 321540
 ttgaaagatt ctggtatgag gacttgcctc tctgtggtgt gtggtagcac atagctcaat 321600
 gctttgaata acaaggcaac agcacatgic ttccaggaca aattctctcc aggaattctt 321660
 atgaaaatat aacattatca gcttatgttt tactgatggg gtactcccaa gcagaccatt 321720
 tatgacattt tagaataaaa gcatcattcc tctggtttat cctatgtact aaatgtgagc 321780

 ctgagcatga gatatgcttt ctgatacctt tgcctcaga ggtccacttt gtcttgataa 321840
 gtgtcagcat aaaagagtgc cacagctatg acagatttca ctactattc ttgaacatgc 321900
 aactatttgc tctctgtttt taaaaatagc cagtacaaaa agaaaagaaa gattcaaaat 321960
 cataatctcc tacacaatat ggttatttta tcaagccaat ttaattattt ttaatttaaa 322020
 ttttcctttg aaaacaatat tggcattccc catgcttttc tgctgagaa ttggaaataa 322080
 cctactctat tacttactag tgcttttaga acatactatg aactaaaaat gatatttata 322140
 taaatgttag tcaattgaat atagaatat taatgttgaa ggcaagcaaa tgcttctttt 322200

 gtactgtatt taaaaggcaa cttggttaag aaacatctgt aataggatct gatgcctct 322260
 tctgacatac aggcatatgt gcagacacag cagcatatc tacacatcct gttttacata 322320
 gatagataca aatcgctaga aaattgtgaa actttctgt caatagacat cataacagcc 322380
 gtgagtcaaa gatacttgtt atttctgagg tgatttctag ttaaagttac ttgtttagat 322440
 aaatgctaaa gaactttatt aagatgaaat tatcataatg agaaagtaca ctgtccttct 322500
 ttgagtggat ttgagagtt taacacatct gttgcatttt tagacatcct acaacattcc 322560
 cttagaatta cccatctcat aatccacatg attagcttcc tcagtcacatca acacacctat 322620

 ttcttatttc aaagtggaa gtttacccta caattcaga cttgttacta tgcatttata 322680
 agaacaggta acaagcatc cttatttttt gaagaacata atcccaaaaa tgagtatatg 322740
 attaaagaat gtagaaatc tccaaaattt ctttcttgc cacaaaacat tgcctcccgt 322800
 aaatgtgcat gtgaccgca tcaggtttca tgttcaattg atgaactata tgatctcttt 322860
 ggttggtatt aactaacttc tttgggtaag cacaaaatta cccccaaaat ctttgccaat 322920
 cttcttacac ctgaaagtc actttctgag caacagctac catatcctaa agtctcaggt 322980

ttgatgtata cticaagaca ctatcaagca tgtttcattc atgaagaaca ttacctctgt 323040

 ctcttactaa cactttgaaa tagaaaacac tcaaatgctt ttgttgtcac tcatgtgaaa 323100
 gtgacacagg attcacagaa attagagggtg tccagaaaac aggctgtcc taaatacaac 323160
 caagtataga atctgttctt taggggtgtaa atattccaag agtttgattt tacatattag 323220
 agagagtatg agaatgatga aggacathtt gatggcgat taacctgatgt tttcagcaa 323280
 aaggtagata gtagaggagg attcctttca tgtgccaaaa catagcagga gtgcaaatca 323340
 tgacctgaat ggattgacag ttcagagcgg agctctgatc aaatctgaca ttttcctttt 323400
 ttgtctcaac attgagatta agggacataa ttctctagga gtagattaat gatttagtac 323460

 tcagagagac attttcttta caatcatcac cactatcatc ctaaaaactg acatttgggt 323520
 taatttccca agcacttcac tgccacaggt gacaagtggc ctcttacatt ctggaactct 323580
 tctgtgttca aacatcaatg aggccttgaca taactttcca tgtttttttt cttcttttct 323640
 ttttttttct tttttttttt ttttttttgg tttctgagac agggtttttc tgaatagtaa 323700
 aggggcccgat cctggccctc gctctggagc aggcctggctt caaactcaca gagatctgtc 323760
 tgctctgcc tcccagatc tgggattaaa ggcgtgcacc accaacgccc agcttataac 323820
 ttttcatggt taaagaattg agatttaaac ttatgcgtaa ggctccagcc catgatgttt 323880

 ctaaaatag tcaactaatt tactctacct ataattggca ctgaaacaac ttatctctac 323940
 tttttattat taatgtgaaa tgcacttgat ttttaactatt gaatggatgat tccctattct 324000
 tgaggaaaat catgagctca tatcatttga ttttttattg attttatgtg tatgagtgggt 324060
 ttgtgtgcat ttatgtatgt acaccacatg cttacctgtc acctgtgaag ttcagaaaat 324120
 aatgtcttag ccctgaaat gaagtgtgtg ctgacaagca agcatgggtc ttctgcaaga 324180
 tcaacaagtg ctcttgacca cttaactatc agttcactcc caaggctgat taataaaga 324240
 tatgtactta ctgctaaatc agataaaaat aactactgt gcttctttgg gtgggttaat 324300

 taggctactt tctttgtgat ttcaacttg cttctttacc aagatcttcc ttctgtgat 324360
 tttatcctaa aatgatgttt tctatatcca ttttcatga tagaatcaga actggaccta 324420
 agatggacat atacaatgtg gtatttgttg tgaacagtg agaatttact tactatgtgg 324480
 aaaacagcag ggggaaattc acacaagcat gaaacttcta caaaccaaag aaaatatcaa 324540
 ggaaaaattc atctgttaa agaattttt tgagatgatg gcccataata agctgcatat 324600
 gatgacttta ttgtttgtgt gagatcatat tcagagctgt ccacctttc atgtaaatca 324660
 gcacagcaa taactcagta aactgctga aattcaactg tatctctcag tagcttgagg 324720

cctacagaag tcicaagctt cagtgtaaac ttccaacat tattgtagag agagaagcct 324780
 ctgctagatt ttctcccaac cttccactct cttgctggct tgttcccttc cttccttct 324840
 tcttccctct cttctcttat aataaccaga gaattagaaa tctgtgggat ttgttttgaa 324900
 caagagacat cccatttttc tatcattggc caaagacaaa tggtaataa acttaatgtg 324960
 agcctaacag taatttaagg gttcttgcct gttactgtta ccttaagacc cttgtcagct 325020
 gtataacctg ccaagtaatt gaaataactg ccttgaggcc ctattcatat ttcaactgtg 325080
 ttgattagag ccigtgagtt ccaaacctga aaggttttaa aaaatacatg ttgagttgca 325140

 aaagcaaact tacaacatta atatttgatt taggatctat ttataagttt aggacagacc 325200
 ataaaacttt atttcgcatt ttacagtcg gcactgagaa ctagagagtt tcatgtgtga 325260
 aattttctgt gctgtgtctc catctagtat tgaagagcct ctgaagtaat aattttttat 325320
 ctgagtacct attgttaata ttacaggcctg tcctgggggt tctgagagct gtagccacta 325380
 agagtaccac ctgtgcatat tcactatggt cccttttaaa agggcccccgc ccacctcca 325440
 ttctccttta tctctcttc tttctgtccc tttctgtcta tccccctctc tctgccctc 325500
 ttctctctct cctgttactt ctgtccctgg aggccagtct ctctctctt ctttttatga 325560

 tcttccccc taataaaaaa tcccccttg cttgaacct atcgcatggt gtctttctct 325620
 gtcaagtgga tttctttaa ttacaacacc tatgtaccag aattatctaa aatgttggtt 325680
 aatgtaatag ttcttgggt gacagttctt gtactctctc agagtcagaa agaaaatgc 325740
 atctgaattt ttgcatggat acttaattat ttaaccaca gattactgaa catacatggt 325800
 ttagcaaatt catgctgaga ttcatcaat tctgagtatt atattaaatt atcatatttt 325860
 ggactatcat attttatatt ctgaaagatt ttctaagta tctcagaaca ttcttactgt 325920
 aggggcagtg gaaactgaca gaaggtcttt attgaagaac ggcctacctg tcatctctct 325980

 agcaatgctt tttttttcc tttagcaaag aaattttgtg taaacataac acattttctt 326040
 aatccattct ttggttgagg aacatcaaag ttgtttccag tttctaacta ttatgaataa 326100
 agatgttatg aaaaaagtgt ctttgtggta ggatagagca tctctgagta tatgcccaag 326160
 agttgaaaag ctgggtctta ggtagattgc cttttctaa ggaaccacca cattcattc 326220
 catagtggct gtgcaagttt gcactaccgc atacaatggc agagcatttc cccttgctcc 326280
 acatggtcac tagcatgagc tgtcacttgt gtttttgatc ttagcaatc tggcaggtgt 326340
 aagatggaat cttaaagcag ttttagtttt tgetaccctg agtgcagcag gatgttttgg 326400

 gctgccagtc cccaaatcat gatacagtga ttaattataa aagctcatta tatagcttag 326460
 ggttttccaa ccagctcctt ttttaattt ttattattga tatttttaat tactcatatt 326520
 tacatatgcg tccccatt ccctaaacct ccctctctcc catgttcccc acccaacca 326580

ccccaacca acatccgtct acactccagg gatagtgagg ccctctacca aggaccttca 326640
 aagtctgtca tattgtttgg ggggtcttag accctccatg ctgtatctgg gctgcagtag 326700
 tatccttcca tagggaatgg gctcccaaag cccatttgtg cactagggat aaagactggc 326760
 tccgctgtca gaggagccat agactgtctt gggctcctag ctggtacat attcagagga 326820

 tttggtttgc tccaatgctg cttcccaga tttatgacta ggatctccat tctatcagta 326880
 ggtcagggcc actgtttctg cagatctctc catctctgtc ttggtcctt gcctcaacce 326940
 tttccccct caacaattga attccagtag tatgattcag tgcttagcta tgggtatctg 327000
 tttctgttc aaacagcaac tggatgatgt ctctcttcc tcttctgcc cccgggctcc 327060
 aatttggta gaggttctta tcccacccc cttcatcgaa ggctatgca atcttctctt 327120
 gtggtcctct ttgtttccta gctgtttggg cagtgtggaa tgtaggctag tgatcctttg 327180
 ttctacatct aaaaatcaaa aatgagtgag taaaaacat gtttatctt ttgtatttg 327240

 gttacctcag tgaggatggt ttcttctagt tccatccatt tgcctttgaa tttcaaatt 327300
 ccattgtttt atttttttc cgctgagtag tactccattg gtaaataac cacattttct 327360
 ctatccattg agaaatggat ctatctctt cagttgaggg gcatctaggt tgtttccaag 327420
 ttctggctat tacaataag gctgctatga acacggatca acatagtcc ttgttगत 327480
 aaagtacgtt atttgggtat atgcccaga gagggattgc tggatcttga ggtagactga 327540
 ttccatttt cctgagaaac taccacactg cttccaacg tggccatgca agtttgcact 327600
 cccaccagaa tggaggagag ttctctttg tccacatct ctcacgcta gattttcatt 327660

 ggtgctattg attttagaca tagtgacagg agtaagattg tatctcagtg tggtttgagt 327720
 tccatttccc tgatggctaa ggatgtttag cacttactca attgtcattc agccattttg 327780
 gattctctgt tgagaattct ctatttagtt ctgtattcca tcttttaatt gcattgtttg 327840
 gtggctagtt tcttgagttc tttgtatatt ttggtgatta gcgctctgtc agatgtgggg 327900
 ttggtaaata tcttttccca ttctgtgggc tgggttttc tcttgctgac tgtgtccttt 327960
 gctttacaga agcttctcag ttccaggagg tcccattat taattgtcga tctcaatgtt 328020
 taagctactg gtgttatgtt tagaaactg tctcctgtac cgatttgttc aagggtgcca 328080

 cctacattct ctctagtag gttcagtgtg gctgaaatta tgttgagga tttgattcat 328140
 ttggatttaa gtttagtaca tggatgata taggatcaa tctgcaatct tcttcatggt 328200
 tgagttcagt taigcccga ccatttgtt aagatgcttt gttttccat tgtataaatt 328260
 tagcttcttt atccaaaaa acaggtgttc aaaggtatgt gggtaatat cagggttttc 328320
 aatttgatc ctttggtaaa cctatttatt tttgtgtcaa tagcaactg ttttcaggac 328380
 tatggctcta taatttaact tgaagtccagg gatggtgatg ccaccagaat tttctctatt 328440

ttacagggtt gttttggcta tcctgggatt tttgttttc catatgaagt tgagtactgt 328500

tatttcaagg tctgtgaaga attgtgttg gattttgatg ggaattgcat tgaatctgta 328560

gattgctttt ggcaagattg tcattttag tagttagtc ctacctatcc aagagcatgg 328620

gagatctttc cttttctgg tataattctt aatttcttc tttaaagatt caaagtctt 328680

actaaacagg tctttctcat ttttggtag tgttatccca agatatttta tttttagt 328740

tcctattata aagggtgata tttctgattt ctttctcage acatttatct tctgtatc 328800

gtagggctac agatttttt tgagttaac ttgtatactg ccactttgct gaagggttt 328860

atcagctgta ggagttccct ggtagattt ttcgggttac ttatgtagac tatcatatca 328920

tctgcaaata gtgaaagctt aacttcttc tttccaattt gtttcccctt gatctcctt 328980

tcttgtctta ttgctctagc taggacttca agtacaatat tgaagagata tggagagaga 329040

ggacagcctt gtctgttcc tgattttaga ggaattgctt tgagtttctc tccatttagt 329100

ttgatgtgt ctgtttgtt gctctatgtt acttttatca tgtttaggta tgttcctatt 329160

aatcctgac tctccaagac ctttatcatg aagagatatt ggattttgtt aaaggctttt 329220

tcagcatcta gtgagattac catgtattt tctttttca gtttgtttat atgatggatt 329280

acattgatgg atattttat gttgaacagc cctgcattc ctgggataaa gccaactta 329340

tcatgatgga tgatttctt gatgtggtt tggattagat ttgccagtat tttttgaata 329400

ttttcatgct gaigtctatg atgcatattg gtctgtaatt ctcttttctc gttttgtctt 329460

tgtgttgctt gggtaacca gtaattgtag atcataaaa agagcttggc aatctcctt 329520

ctgctgctat catgtggaac aatttgagga gtactggtat tagctctctt tgaatttctg 329580

gtagaattct gcagtgaaaa catctgggcc tgggattttt ttggttggtta gatttttgat 329640

gactgctct tttcattag ggtttatagg tctgtttaac ttgcttatct gttcttgatt 329700

caattttggt aagtgatatc tatcaagaaa attgtccatt tcttttagat ttttgaatec 329760

cggggagtac agttttcaa agtatgaact gatgattctc tggatttctt cagcgtccat 329820

tgatcatgct cttttgatat gtaagcaggg gttcatgggg gaggttgggt ggctgagcaa 329880

agcccagact caccggagg tctggtgcca cccagaggac agagggagga gtgtggacce 329940

caactacctc ttataattta aattaaccaa tttctatgca tctaggtgtt accatgtgat 330000

ttgtgtttt accctcttc ctgaaactta ctcctctac atctggctag caactccatc 330060

ttctctctt gagagtccg tgtcccaga agtcccact aacttcttc tgcctcgta 330120

ttggccattc agctttttat taaaccaatt acagtgacac atcttcacac agtgtaaagg 330180

aatattccac agcacctaag ggataaggat gccgatcatt tcatgtgttt cttagccatt 330240
tgagattact ctgtattgaa ttctcatttt agatatgtac tcaataaaga atagaaaaag 330300
aaaaatgtggc acatttacac aatggaatat tactcagctg ttcaaaaactg gcatcatgaa 330360
atthtcaaat ggctgaaact tgaaaacacc atccttaatg aggtagccca gaccctgaca 330420
gacaaacatg gtgtgtactc acttataaat atatttagc tgttaagtaa agaaaaatca 330480
tgctacaatc caaagaccta gagaggctaa gtaacatgga agcttcaatg ccacatacat 330540
ggatctccct ggggaaggga aataaagtac tagtgactga tccaacttga gaccataacc 330600

atgagaaca gctcatgctt ggctctgcct ggatggccac gaaccagaaa caggtcatcg 330660
caggggcccc agatataatt aaatacaatt ggccaataaa aatgttaatg aaattattgc 330720
ttatgatatt ctgctataca catagattgt tgcccagcac aattgtcatc agaaaagttt 330780
cagccggtaa ctgataggag cagaggtaga gaccaacagc cagacaattg gcatatccat 330840
aggaaacctt cagtataaac ggaggaagtt ttagggagtc agagggttgg aggaaactat 330900
gagagcatgg gccacagaat ctactaagaa gggatcaaag gaactcacag agactgaaat 330960
tgacaaaac ataccctgta tgtgtgcgtg agcttcatat gccttatgta tgtgtagctt 331020

ggtgtttttg tcagactccc aagagtggga atatgtatgg gggctctctc tgactcttaa 331080
gcttgtgcct aggactcttt tacttctact ggttttctt gtccttcttt gatatgaagg 331140
ttgtgacgag tctttttgca aattgttagg cgatgttcag tggatatccc ttggagtctt 331200
gctcactgtg ttggaaacct agaagacaac cttcaaaatc attccatttg ttttgataca 331260
gtctttctt ttctgaaat ttagcaaata gtctccatag actgcccttg aggtgtagga 331320
tcaattgtct ctgcctctc agtgctagga ttacaagatg gaggttgccac tcttgggttt 331380
gtttatgagt tctaagaatc aatcatgtc atttttcttg caagggaac acttcagtga 331440

ttcaactctc tctctggttc tctctctgtc tcagtacata cgattttggg tttatgtgta 331500
tgaatttttg tatgcatgta tacgtgtgta cccttgtgta cttggtatct gaggaggct 331560
gaagaggtea tcagaatccc gggactagag taacataaat ttgtgagcca caatcgcag 331620
gaatcacatt cagatactgt acaaaaatgt tagtattctt aacctcctaa ccatgtctec 331680
agtcccaaag aacaatgcat tgtctttttc tataatatct atgcttattt aatthtgag 331740
tataatgctc aactattgca ttttaattata ttactataag ataattttg cagagcactt 331800
tttgatata attatthtg tatttaccac atgatataa attctthtat tatttaccac 331860

tctgagcatt ttgaaatgaa tattgagtat gagttaataa tttatactgc tctgtctttt 331920
ttccctgaaa tcaatthtct atataagcat cagtaaaata tactgatgtc ttcaaaaactg 331980
cctatgtaac ttacagaaat gttatthtct ttccctthtg ttgagtatag catttggaaa 332040

tgtttattca ctttaattaat tttttattta tctgtatgtg gatgtttggc tttcatgtat 332100
 gcctttgaac ttcattgtgtt ccttagtctt caaagactag aaaaggctgc cagataccct 332160
 gaacctacaa ctcaaggaca gttgtaagct gccatgttgg tgctgggaac caaaactgtt 332220
 tttattggaa gagatgcaga tactcttaac tgctgagttg tctgtccagt tcctaaactt 332280

 acattttatt tggataatca acaatacca tggcaagttt gaagtacatt attattatta 332340
 ttattattat tattattatt attattatta ctttgtgtaa tttaaagaaa catattgtgg 332400
 tttgaaagat gactaagggg ttaaaacct gcactgttct tccagagtag cagaggttga 332460
 ttcttggtac ccacctcagg cagcacatga ccatttgtaa ctacagataa atgaggaatt 332520
 gatgcctctg gcctctgtgg acacctgctc aattatgcaa aactcaacc acagacaaat 332580
 gcacataaca cctaatttaa aattatgtat aaagaaacat atgtacactt tcataactg 332640
 gcatatggca gagtgaagag ttgctcttat gagcaaagga ttccagcatg gaattcacac 332700

 caaaactgta tggatatgct atgctgagaa attcattaca gatatacaat taattaaaga 332760
 agaactgagg aatataatth atcatgtgaa caaatgtaga tttgaaactt tcattgaaac 332820
 ttgttggtaa ctggtgatta gcattgggta catatgaagg agaaaattgt aaatacaaca 332880
 gaaatcattc atgtaattta tatgctgctt gatttatattc acaaactgta attaggttta 332940
 tgataaattt tataagttac gtatthtata catagattat tagaaaatat ccatataatc 333000
 atttctagca ttatattgtt tacagctata gctttatcca cttttgctc attttaatgt 333060
 gttcctcttt tcaattaaa tttcaatgag tagctatgtg attatatatt tttatttctc 333120

 atttctatt tcttagggaa atcatttaca tatgtggtta tcgataggaa agtagccaca 333180
 tgtactaaat tctaatgtt ggcattttga tattcaggaa gacaaataat atttgagatt 333240
 ctccacagaa caaaattata cattaanaag tgatthtcc ttaacacaca tatataagag 333300
 caaaccttat gggccatagt aggttagaga gatatatgtg tttgtgtgta tgtgtgtgta 333360
 catgtgtaca tctgtaacat tattaattat agagggagtc atgagcaagg aaggagtgg 333420
 ataggggaga aggaagagta aaactggcat caataagaca gttttacca caggagttt 333480
 tcaaaaaata ttttaanaa aaggctcaa agagggtgatt tattgttct caattacaat 333540

 aataatggat tcttaggaat ttttaanaat atttanaata caggaaatgt gtctactatc 333600
 ctctagaaat tcatagttga acatagaaaa ctctctatag atcaanaat gtgcagataa 333660
 tgaggcaaat cttaaacac atgactgaat gaagaacatt aaagacataa agagatgcac 333720
 attgcaggac tttgacatta tcttctcat tctccattc tgaactgcaa cagcaagtac 333780
 ttttacacat ttttaatat tccaaagccc tgtgttttat tgcttctta atacaaaggg 333840
 tgttctacc attgattatt aagaaaagac ctataactg ctccaat actttgttag 333900

actgacctca ctcagtactt ctatttatgt actcctatth cgcaatgtcc gaagtactat 333960

ttcaaggaca aacaagtaac acattctggt catatgaata aagaatgcaa atgaatgaac 334020

aggggcaaga gaatcttgaa atggttatga aacttcttat attttaactt gaatttcatt 334080

atgagttttg ttatatactt ctaccatcac ttaatacttc aatattgatt actcctttga 334140

ttcaagaaca aaggggtata cattgctacc acctctttgc agttaatttg atatthttatt 334200

ttatthttgtt tcatgtgtga tgtgcacgta cacattcagg tgtatattaa agccagagtt 334260

agtatcttct tacacacatt thtatttacc aagactgtgt ctcttcctaa acctgggcct 334320

ttgaattatg gtcacatctg ggattcccta thtccacctt tcaattgtgg ataatacaat 334380

tgagccctca tacctatcca gcattcacat ggattcttgg aatctgaacc caggtgttca 334440

tgcttgcata gaaagcactt tatacttaag ccccccttt tctaaactca aacaaatagc 334500

atgcatagca atgtaacaat aaactthttc aacaagccgc tagagcccca cagccataca 334560

gagaccagaa taacacaaga gacttatatt aattacaatg tggatgtcca atgactagga 334620

thtcttatct gctgctctgt cctaagcadc aaccataatt attaatctat atagthttata 334680

aagacttate tgatcgagaa caccagtgc acacatectc tcttgccagg ctcacatcga 334740

gtcaccacct ctactacatt thccagaaac ctcttcaact cctagttcca cctatcttgc 334800

thtcttattg gccaacagtg cthtagtcat caaccaataa ggaaaacata tacacttaac 334860

aacatcccc atcacagcgt ctgtggatat thtthtctat atthctcagt actaaatgat 334920

gtggthtttc agthaaatagt ggttgagcac agagtagaca gaaagttgca cataacaaaa 334980

ttatcactct gtagaattct tgttctgtct aathththta agagthgata atgattgctc 335040

cttgataaat atactaagat acattcagca atagththtag aatcataca gattggtaat 335100

gaatgcccaa gtatthtgag aaagattatt gtgtatggta thtgcataa atatgatata 335160

tgatatgtct atgtctaagt taggthttct atthttatga agagacacca tgaccagtac 335220

aactcctaca aaagaaagca thtaaththg gctggcttac agttcagagg attagtccat 335280

thtcatcatg gcaggaaaca tgggtggcatg caggcagaca thgtgctgca gaaataactg 335340

agaathctat atctggattg ccaggcagca agaagataga gtgacactga gcatgacttg 335400

agththtgag aactthaatc caccacaca tctattcca caaggtcaag tctaatagca 335460

ccactcccta tggaccatg gggaccgtht catthaaacc aacacaatgc atatgtatth 335520

tcaagthact atcagattcc tgatcaaaaa gactgcaaca gggatataat gtagagcatt 335580

atcaaaaaag thtcttgtat taccaththta tgctgcadc atctgcattc atctcaactt 335640

tatcaataac taatgtatTT gttgtttctA atatTTtatt tcaataaaaa tataaatatt 335700
cagagtacaa ctTTaagTat taattcttca tattcagctt aattgttgat ggtttatttg 335760
gattgctgtg Tgtatcagta gctcaatttc tttttcttga caaggaatac ccttctgaag 335820
gatatagtga agttgtgTaa gccctgtctA tgaatgacat ttagatTTTT acaaataaag 335880
ctattaagaa ttctgtttg Tgtgcagact atgacatgat cacactttca attctgtgga 335940
gtaaaatgta gaaaataaga ttacatgttt gtatggaaga caaatatatt tTaaattatt 336000
ttgtatgtt cagaaactaa acataatcat accacccac tttcttgccc tccagtcaaa 336060

ctttccatt taatccatct tttctcctc aaattcatga tttgttata cattaatatt 336120
ttatatatgt tagggatgta ttatgtatTT ttcttttcat ggacagctta Tgaaagatcc 336180
agttccttca tatgctcacc agtattcagc ctttatttta tattaataaa Tgtgctatga 336240
aaattcatgg ttttttaaa gtacttctt acaggcaaaa acatataaaa tattttatta 336300
tgctaagttt ttgtgttatt tttcagcgtt atttatcttt gtgttttttt ttttctgtt 336360
tcctaataTg agtactgagt gttggatttc ttgagcagct tcactgttat ggtatgtgta 336420
caggagtTat acagatgata gcagttataa caataaaaaa aaaactTaaa agaccctaag 336480

taacccctg aaaaacattt aattatcttC atgctgcatg attagtagga atacattgaa 336540
ttgactcatt tagatagact agtatgagaa agggttatat atgaccatat tataaatatg 336600
cataagttta ttttgatttg gcacacataa atattctatt atgcattagt tactttcaga 336660
Tgcattgaca ggataattaa aaaagaaact agacaaaaga agtacaattt ggttcatagt 336720
ttgagattat aaagcatggg ttgatgggaa aaagcatggt ggcagaagtg tgaggTggct 336780
gatggcatta catcattagt caggaaacca ggaaaaagag ataatgattc ttagcttatg 336840
gtcaccttt actcactgtt cttgtctatc tcttcacctt ttatttatc cctgaatcct 336900

agcctatgca ttactgacc tttgtgctc Tggtttcacc tgeccacag agaccatagt 336960
attgcataca ctTcattgtt ttggTtgact agaagTaaac acaactgaaa gaatacatga 337020
tacaatcagt aattaagTta gctccaccac ccacaaaaag tttatggaat aataacagaa 337080
atcctaaate cagcattggt atgcaatagt acatgatatt tgctagactt caggaagatg 337140
aacacagtct gagTcatgct gagtcttcca acttatgtta agcatttcta aaaacacctt 337200
catgataggg aatgtcttct gtatatatgt ttgtttcatt ggttgatgca taaaacactg 337260
ttggccaata Tggcagcaag ataggtggga ccaggatagT agaggattc tgaggTgtag 337320

gcagagagga gttatcatgT gatctcagga agtTacttag ctgggcagaa actgccacta 337380
gatggTtaga ggtctggagg tctttacaga caggaagtga tatagctggg cagaatcaga 337440
atataagcag ggacaaacag atggagcctg tcactagcta accatagaag actggaggtc 337500

ttacagaca agcagaaagt gatatagctg ggcagaatca gaatataagc agggacaaaac 337560
 aggaaattgc ttatcttctc tacataccac tgagcagttg acatgtagga taccagagaa 337620
 gtaacaggtc ccttgacttt tctccggtaa gagaagacca tatggaaata cttagattat 337680
 tataaatggg ttaattttaga cagaactatc cagccaccag ctaacagctt cataactaata 337740

 tagcatctgt gggtttaatt tgggcaggga aggttagagg gaccagcag gccagaaaa 337800
 atcagattac acctttacac aatgcccaaga attgtatcat ttagtcaagt taatacaaaa 337860
 ctgaaccacc atcaccagta tagcatctta tataaactat gattatgata atgataaaag 337920
 taatacttct ctcaagcaaa gtttggcatg tataactttc cattaattaa taaggaaaat 337980
 gtaatttaat taaccaagat catgaattac ttttttggaa acaggttctg taaaccattt 338040
 gtaactgaat aggggttaca agaaaatgag tgatgcataa gcatcaagat gtattggttg 338100
 tgtattgatt ccttcaagga actatgatgg aatcttaagg agaaaacaga aactcctgt 338160

 tcacaatfff aagctagctt attgttcatt aatttaaatg attcttgfff ttctcaaact 338220
 ggtaatatta atagtaagaa aattattcac aatatcataa gcaagagaaa caattctgta 338280
 cgcaagaaga gagagtgaga atgctgacac tgtgtgctg ctgggatcaa ggatggaata 338340
 aatgtcaaaa agactttgga tttagaatct tagctaacag ggaccaaagg caccttgggt 338400
 attattaaga agcaaaaagt ggtgcacct gcaaaattag ttagactggg gcattgcttg 338460
 gtgacaagtt ctgagacatc ctgagaccaa ttgcctccaa tgtgcataca attcatgact 338520
 ttgcttagaa gaagtaagca aagctaaaag actacaagct ggaagccaag gagctgctgt 338580

 atacacatgt acctcaggaa gaaagtgaa gaaatfftaa gacacagata acaagtatga 338640
 gtatcaatag gtggaatttg cttatctttc tgcacatgaa attgagaagg aaaatgtcca 338700
 ggcaaatgca gaaagcatc acttggtttg gaagccaatg ctttcaaaaa caaaagggaa 338760
 aaacttaaga ctcatgtfff gtttcagtaa aatgccaata tgaaatfff acttaaatg 338820
 caatagaaat gactcaaggg ataaaacact tgtatgaaag cctggggata tgagttcaga 338880
 tccttgtac gcatttaaat attgcttctg ggatagagct gcttgccaat aattctaggt 338940
 cttagaagtc agaacctgag tgtctggagc aaattggctg aactagctgt gtaattagaa 339000

 aagaatcgtt agactagttg gataggagag ttttgggtgt acttgacaga cttgtctcac 339060
 tgagttaagg gaaaaatgct tgatgtcaac ctaagcttct acaagcacia gcatgaacat 339120
 acatagaaat gtcaatcaca tagtcatgca tgccatacaa agatgcatcc aaaaaacagc 339180
 atatgatta tttcaagagt tgcataagtt tggtagcagc atctaagagg acatcttaat 339240
 caatagagga ataaactata attataggga ccccaaatag ctgaggagca caaaaattaa 339300
 aagatgaaaa aagaaactaa atagatcatc acacacacac acacacacac acacacacac 339360

acacacacac acacacacac tcacacacac acacagcttt caaaatgaga atgtgtcagg 339420

 tcctatcttc ttccaaccaa atttaattta aattaagaaa actctggaga caacctgta 339480
 caaaggtcca acacagaaaa gaaaagataa tctgtccag caggtaaatt aaaatatgtt 339540
 ttaacctgtg gtaactagtg cgtgcgtgtg tgtgtgtgtg tgtgtgtgtg tgtgtgtgtg 339600
 tgtgtgtgtg tnnnnnnnnn nnnnnnnnnn nnnnnnnnag acagagagac agagagagac 339660
 agagacacag acacagacac agacacacac acacacagag agagggaggg aggagagaga 339720
 gggagagata ataaataaag tttgcctgaa aatcagagtg cagaggtaag tgacattttt 339780
 agcaatagag gccatgaagt ggtaacacac acctttaatc tcagcattca acaggcagag 339840

 gcagaggcag aggcagaggc agaggcagat ggatctctgt gaggttcaagg ccaccctggg 339900
 ctacactaga ttgatccagt ctttaaaaga aacagagctc acacatttga tttctgtact 339960
 tgggattaca tgcctttatt cccagcacta gggaggcgga gacaggagtg atatggctgg 340020
 gctgagagaa gaatataagg ctggaggaga caggatctca aagcattcag tctgagaatt 340080
 cttagggaca gaacagcccc tttggtctga caattcagta ggtataagaa ctagtagctg 340140
 gctgttctgc ttctctgac attcagcatt aaccctata tttcactctg gatttttatt 340200
 attaaaataa attagaattc atgctacatt agtctgtgcc tcatgggtct atataaattg 340260

 ctaagatagt cacagacaga gtgagcagga aaacattcta ctaagtctta tcaacacaag 340320
 acacagctct cacctcaaag gtaagaagag tagatatctt ttgagccaaa tatggattga 340380
 ggttatttct ttttaaatca ctttcatta aaaaataaag ttagttcaa gaagatagta 340440
 gacagttcat atatgaaaat gaaaattaac atgctgcatt tatttggtaa taatactgtg 340500
 aggagaactt tgctttctaa agaaaagacc tcttgttttt attcaacaaa cgtgctttgg 340560
 agctatgcag actgattata aggacccaaa acaagggtct gagattgttg ggatgttctt 340620
 atctgccaaa gtgactttgt ttactgttcc taagttagaa tgtctattga tatggctgaa 340680

 aatatcaacc aaatttgitt ggattatttt gtttttatag tgttgggaatt atcacttctt 340740
 gagaaatctc ccaggagtg aatcccagga gactgaagtg aaagatctta atcttaatat 340800
 aatctgctca taattgagtc tatatttgtc tttgtccat agttaacctt tctatttagg 340860
 attgtgtcca ttgccaatct catgggtagt cctaagagct taaagaaaac cagttctgtg 340920
 tgcttagata aattatgact aaagattctg tctttctatt cacttcatta tacagttcaa 340980
 ttgaaactcc gaaaaaaga aagaaaaact atatctgtga ttaaacacgc ggtttatatt 341040
 tataatata atctcatgaa tattaaaatt ctaaaactat aattgtgctg caacatatgt 341100

taacttgtaa ttttataata catattaagt aaagattcat atgcaaacta gcattataaa 341160
 gccaaatfff gtagggagtt gattcatttt attgagcaag aaactgctta agaaatgtat 341220
 tttatacaaa ctctactcat aaaactactga ttctaataatt cttattcttt cattaagtta 341280
 aattcaacag tatttctaag cagcaagata ttgctggctt ttattttact cactataaat 341340
 acttgtaagt aatacaatta taataatgtc tafgaaagca ttttataacc tcaagaatat 341400
 tatgcacatg gcatttatgt ttcaggcctc taaatgtata ctgtaagttt tgctctcacc 341460
 cagtcaagcc tcaattccaa aattaataaa gacttactgt ggaagtatgt gttaattctc 341520

 tttgtcattt atttctactg caactacttt cccctgacag ttcagagcta cccgttgtag 341580
 tgtatttttag actgtgtagg cattatcttc aatgccataa acaaattcaa ttttgcataa 341640
 aagatgatat atttttattg atttttcttt taataactaaa aggaaattgt gactatgaac 341700
 gtatttcttt ttctttcttt tttttctttt tttttggttt tttgagacag ggtttttctg 341760
 tggttttgga ggctgtcctg gaactacctc ttaggcccag gttgttctgc ctgggcatat 341820
 ttcttttaa tacaatccaa aacagtgact gtaataataa gaataaacag tcttctctt 341880
 ctggattatg ttatttgta gatggtaaat cctatgggtgc tgggtagcta ctgggatatt 341940

 agaacatttg aaggatgttc aggatatacc cataatactc ataatatgg cctatgaaac 342000
 caaaactaga gctgtaaaaa tctcattaca catcagagaa atgaagcacc aatacagact 342060
 ctggcatcaa tacataatag aggagatgtg gcactctggat gccattatg ttagccagat 342120
 aaacatgggt ctcagagacc tgaaccttat cagaaacttt ctgatgtaga gcaatgatca 342180
 ttagacattg tgtttaaact cctgatgaa tgcaatgcac agaatcaca tggctcttac 342240
 aattgttatt cactcttccc cctgctgagt gcctcattca ctctgataaa ctctgctatc 342300
 atttacacca agctgtgtat cttgtcttaa ttatttaca taactaagga gtcaagcaga 342360

 tagagtgagt cccaaggca ttagtactta ctgagttacc aacacaaatg tgttgttgat 342420
 atttggatgc atgctattct ttctcactat tttgtggctt tgaataatg tatgtaatta 342480
 gaataaatg aattatgtga aatatcaatg tacttcacaa caaaaataat tcttagccta 342540
 atattttcta gcaattcaat gatgaacaga gtatctcagg gttcacacac tttgagtta 342600
 acaaagtga aacagctaat tattagagag caatagaaca gacacttagt gccttctact 342660
 tctatgataa agcaaatata gtaagacttc atttcattat ggttatcact catgagaatg 342720
 acaacagctt tgaagaaaat ggtttttgaa aagtcataga tagtagaaat aatcacaca 342780

 atgaggaaaa aaatccctat gttactaaca tcagctgacc tcttatactc ctgatttgt 342840
 gactatagtt ttgtggctct ttatgaagaa gaaagttgca cagccttcaa tcacactatg 342900
 ctgtcactgg cagcaggaaa tatttttgct atattcatac ccatctcaa ggtaactcca 342960

gactaaataa taaatTTTTT tccttgtaag aaccttgaaa tattcaacct atcttcttcc 343020
atgactgagg aaacttactg tccttgccca attgcaaaag aacttcatga taaatggcct 343080
ttgttaacat gtgagtttgt actttaaggt gtttctacc aggactacta caaactaacc 343140
ttctgaagtg tatcctgaag ccaattaaat gtcttctctt attagaggtt ctctgatcat 343200

gatgtctctt cacagaaata aaacactgac taagacagaa atttgtaaca gagactaggg 343260
tattactagg ataggttcaa ccatgctttt gtttggagga atataaactt tggactttc 343320
aattaggaag gcagttgcac actttaacaa ggatttaatg accatcctat tagtaacagg 343380
gaataccgtg gtgtagtggg tgatttggac tatggcaggc ccaactcaag aagtttcaaa 343440
tgcaagaac acagcatgtg gcatagagaa tattcttgtt atatTTTTT aaagaatgtg 343500
gctgctcttt tgcacttgc caaaaaaaaa tcttctgag gctaaattaa cagttagta 343560
ttaacagttt tgaccaagaa aatttctaga caacttagta ttgatggtgt tgtttggtta 343620

ctaattgcca catttctgca gatctataat gaaaagaagc aagccaaaca aggagaaaca 343680
aagcactggg gaacagttta aagaaaaatc tgttccaaaa tgaataaca ggcaagactt 343740
gatcatgcta agcttccaat ttgtgaaaag gaattaaaga aaagcttaga gctatgtttg 343800
gtgggacaca ctctttaat tccagcacc aggaagcagg gcaggaagat ctctgacttc 343860
aaggctagcc tggcttacag agaaaattcc agaacagaca tggtaaggca gtgaggaaaa 343920
catcaaaaag agaactctag taaaaaatg tttttaaagg aagggtccat gctctgacca 343980
cagagagcaa tagaacatga cagctttggc cacatggctc tagctctaaa gtccaggatg 344040

caagtaagga gatcttaaat ctccctctgt gattaaggaa agctactgag atcacatgtg 344100
tggtgaaagt gtctttag agaggccatt gcatagtact ctggagatga attctggatt 344160
gccttgaaga gctagaaaag ggaatggaac ctactcaaga gaaagaaatg tgctagagtc 344220
aatacggcat gccaacggac actcacagag ggccaggttt ggtcttatac tegtcccca 344280
gctatcagac aggagtctt gagctccac ttgctcaggt cacctgttcc tgtctcttcc 344340
cccagcatag tcttgatcca tttgctcata gctcattcgt ctatacaagt ggattccagg 344400
aattgcctc agtgcttagc tatggatata tcttctgct tccagcagcc actggatgaa 344460

ggctctatga tggcgtttaa ggcagtcac aatctcatta taggggaagg acatttaagg 344520
tagcctctcc actattgctt agattcttag ttaggattat ccttgggat ccctagtaaa 344580
cctagtaaac ctagtgaag gtttattgtt aagccataa tggcttctc tattcaaggt 344640
atctcttctt ttgctctctt tctctgttct tccttgtgat atcatccac attgccttct 344700
ccctctctt ttctctcacc ttctaccct ccccatgct cccaatttac tcaggagata 344760
ttgtccctat taccttctg ggggtccata tgtgtcctc ttaggtcct ccttgttcc 344820

tagcttctct tacctcgtgg attgtaggat ggttatcctt tgctgtatgt ctaataacca 344880

cttatgagag agtctgtatc tgggttacct cactaaggat ggtttcttct agttccattc 344940

at ttgcctgc aaatttcgag atgccttttt tttttttttt tttttttttt tttttttttt 345000

ttttttacca ctgagtagta cctgggtgtg aaatgtagca ctttttcttt atccattctt 345060

tggtttaggg gctcctaggt tgcttccaga ttctggatca tacaataat gatgttatga 345120

acacagttgt gctttgaatg tgtacccttt gggtatatgc ctaagagtgg aattgttgat 345180

cttgaggtag acigattcct attttctga gaaaccgcta tcctgatttc caaagtatct 345240

gtacaagttt acattccac cagcaacaga ggaatgttcc tctttcatca catcctctcc 345300

agcataagct gtcattgta tttttatatt ggccattctg acaggtttaa gattctttct 345360

cagagttatt ttgattttca tttccctgat ggccaaggaa gttgaggaat ttcttaaatg 345420

ccttttgcca ctgtatatt ttgaagatca tcccactgtc agaaatgtgg ttggtgaaga 345480

tatttctct ttctgtaggc tgccattttg tcttgttggc tgtgtccttt gccttagaga 345540

agcttcctag tttcaggatg tcccattttt aaatattggt agcagtgtct atgctactgg 345600

tattgtgttc aggaagtagt ctctggggc aatgtgttca agggacttcc cgacttctca 345660

ttctaagagg ttcagtgtgg ctgaatata gttgagtctt taatccattt ggactcaggt 345720

tttgtgcatt catggagaca gatatggatg tatctgcaat cttctacata tcagcaatat 345780

ttgttacaga tgctttcttt tttccattgt gtaacttttag cttctttgtc aaaagtcagg 345840

tgttcatagc tgtgaggatt aatatgaggg tgtcaattc aattccattt agacaaatgg 345900

tctgtatttg tgccaatacc aagctgttta ccttactata cttttatgat agatctggaa 345960

gcatggatg gtgattcctc tggaagtcc tttattgtaa agagtgtttt tgagtatcct 346020

gggttttttg tttttcata caaagttgag tattgttctt tcaaggttcc tgaagaattt 346080

ttctgggatt ttgtgggga atacattgaa tctgtagatt gcttttgta acatagccat 346140

ttttactatg ttgatcctgc ctatccaata gcatgggaga tcattccatt ttctgatatc 346200

ttctttaatt tctttcttta aagatttaaa gtttttgtca tatgggtctt tcaattgttt 346260

ggtttagatt acctcatgat attttatgat gtgtgtgact attataaagg gtaatatttc 346320

tctgatttct ttctcaccca tttatgtct atatatagga ggactattga ttgttttag 346380

ttaatcttgt atcctgccac tttactgaag gtgtttatca gctgtaagag ttccctgacc 346440

aaatttttca ggcacttat ataaactatc atatcatctg caaatagtga agtcagactt 346500

ctttctttcc aacttgtatc cctttgatct ccatttgttg tcttactgct ctagctagaa 346560

cttcaagtac aatattgaag agatattgag agactggaca gccttgtcctt gttcctgatt 346620
 ttagagaaat cacaataaat tttgctccat ttagtttgat gttggttcctt ggtttacttt 346680
 aaattccttt attatgttta ggtatgttcc cattatccct ggtctctcca agaaaattta 346740
 tcttgaaggt gtgttgatt tcatcaaaga atttttcagc tctagtgaga tgaccaagta 346800
 gttattcagt ttgtttatct ggtggaatac attggcagat ttttcatafg ttgaaccatc 346860
 cctatatctc tgggttgaag cctatttgat catggtggat gatttttttc tgatgtgctt 346920
 ttatgtttga ttggcagga ttttattgag tatttttgca tctgtcttcc tgagggatct 346980

 tggctctttac ttttttttc ttggttgtgt ctttttggg tttaggtaca aaggacttgg 347040
 tagccttgta gaaagagttt agcaatgaca cttctgcttc tattgtatag aacaatttga 347100
 ggaatattgg tattagctct tcattgagtt tctggtagaa ttctgcactg aagacatctg 347160
 tccttaggct atttttggat gggaaaattt tgatgactgc ttctatttca ttataggtta 347220
 tagatctatt taaattgctt atctgttctt gatttaattt tttatatgat acctatccag 347280
 aaaattgtcg atttcttta cattttcaa ttttgggag tacacattta caaattatga 347340
 tctgatgttt ctttgatttc ctcagtgtct gttggttgc ccccttctc atttctgatt 347400

 ttgttaattt gcatgttctg tttctgcctt ttatttagtt tggatgaagg tttgtctatc 347460
 ctgttgattt tctcaaaagc caactctttg ttccattgat tcttttcttt tttctacttt 347520
 atttatttca gcctcaattt tgattatttt ctggcatcta cttctctctgg gtgagtttgc 347580
 ttcttttatt ttagagcatt cagggtgtgct gttaagtctc tagtgtgact attctccagt 347640
 ttctttatgt gggcacttaa tgctatgaac tttctcttta gcactacttt taaggtgtcc 347700
 cataagtttg ggiatgttgc cttttcattt tcattgaatt ctaggaagtc tttaaattct 347760
 ttctttaatt cttccttgac ccaggagcaa tgtttttgag cattgctcaa tttctatgag 347820

 tttttaggct ttccgcaatt tgtgtgttgg ttgagttcta actttaaacc atttgtatec 347880
 agtaataatac aggggatttt ttcaatttat tttgtatctg ttgaggtttg ttttcttgcc 347940
 tagcgagaat gtggtagact ttagagaaaa tttgatgtgc ttgctgagta gaatgtatat 348000
 tcttttgtgt ttggatggaa tagtctatag atgtctgata ggcatccca gtgataagag 348060
 tggggtgttg aagtttccca ctataagtgt gggggttttt atgcatgatt taattttaga 348120
 aatgactttt acaatcatgg gtaccttga actttggaca tagatgttca gaattgagac 348180
 ttcatattga ggiatttttc ctgtgaagaa tattaaatga ctttcttcat gtcttttgat 348240

 tatttttagt ttgaaatcta atttgttaa tactaggata tcttcaccag tttgtttctt 348300
 aggccattt gattaggaat tcttttccca accttttatt ctgaggtaaa gtctgtcttt 348360
 gaagttgagt tigtatctt ctatgcagca gaaggatgga ttctgtcttt atatacagtg 348420

tccttagcctg caicctttta taggttaaata aagaccattg acattaaggg gtcataatga 348480
 acattgattg ttgattcttg ttttttact tgttgctatt agtggtatta tgtgttcatt 348540
 tcccttttgt tttggctttt ggtaaatgtgg ggttatctgt tgcctaattt tgtgattgta 348600
 gctaactctc ttgggttaga gttttccatc cagtactttc tataaggctg gattttgga 348660

 tatgtattct ttaaactcgg ttttgcacg gaatatcttc ttttctccat ctatactgtt 348720
 tgaaagcttt ggaaggata gtagctcggg ctggcattca ttgtctttta gtgtttgtag 348780
 aatattatc caggaccttc tggcttttag agttcttttg agaagtcaag tgaattttt 348840
 ataggtcttc ctttatatat tacatggcct ttttcttta cagctcttga tattcttct 348900
 ttattctgta tgtttgtgt tgtgctatta tgtggcaagg ggacatgttt ttgttctaat 348960
 ctttttagta ttctgtaagc ttcttgtact ttcatggca tgttcttctt taggttgggg 349020
 attttttct atgcttttgt agagtatgtt tactgtggtc ttagctgggc tttttcaacc 349080

 ctcttcttta cctattatc ttaggtgttg tcttttact gtttccctta tttcctgggt 349140
 attttcttt aaggattgtt ggatttaatg ttttcttgg ttgatgaatc tatttctct 349200
 agtgtatctt caacacatga gattctctt tccatctctt gtatctgtt ggctttgctt 349260
 gcatctgtac ttctgattg tttaccaga ttttctttat tttccaaga ttccttcagg 349320
 ttgtgtttta tttatggcct ctatttgagt ttttaagtct tgaactgttt gaattattc 349380
 ctccactgt ttgattacat tttcttact ctctttctg tctttaagac atttgttgat 349440
 tacttggatt ctttttggtt tgtcttttct tccatttatt cattttttgt tagtctttt 349500

 tccattgctt taaggagatt tctcatggga gtttctcatt tctctttta gggcctctat 349560
 catgttcata agttattta aggttacttt tttctgcttt atctgtgttg ggatgttcag 349620
 gcctgcttt ttagcattc ctaggatctg tgggtgcat attactctt atattgttga 349680
 ttgtattctt atattgcat cctccatct attctccag tggttacagg tggggtctct 349740
 ctatggtggg ttgggggcaa aggctcagat agtgcagagt agtgatgat ggtttgggct 349800
 gccccgaggt ctctgggat ttggtggca ggacgaggtg atgtctcaa gtcaagggcc 349860
 tccaaggatt gttatagaag ggcaggagaa ggccaggtgt tcacctctcc ttgtgggtgt 349920

 gggccaagg ctctaatggc agcaaattct ggatggtgtg ggctgccctt gcatctctgg 349980
 gactttttaa gttgactaa atgcatcttc cattaaactg tggttacaaa ccaatggagg 350040
 caggaaatgg aaagtagaat gttgaatgaa aatgacttct gtagctacac agagattggc 350100
 attattagga ggaggggct tgttggatta ggtgtggctt ttagtagga agtttgcac 350160
 tggggacagg atttgactt tcagatctg gaaccaggca cagtttctct tctctcttc 350220
 ctgctgcctg ttgtctaga tatagaattc tcaggtatcc ctctgaatc atgtctgct 350280

ctgtaccacc gtgcttccca ccatgacaac aatggactaa acctctggat tataatccat 350340

ccccagtga atgttcttct ttataagtat tgctgtggtt atggigtctt tttaaaatcc 350400

taacttaaac actaacctag cctgtgcatac attatagaca aacaacctca ctcatattg 350460

tctcaacttt gglaatgagt gctgtcttgc taactgtctg aatgttcagt tttgtgtctg 350520

aacagctgct actccacata gtgaggatga cacacacaag gtaactttta caagcccact 350580

agtgatttag tacacagaaa ccttggtagc ttcaaaaagct caggtgagga acttagacca 350640

catcctgtcc ataacttctg ttcatgatat attaatagac ttttatacat agtataaaca 350700

gtaagaagat gccacgaaat gactttcttt tcccactcaa tgaatttcct tctgtcacia 350760

cagataggtt taaatttcta aagatgactg aacatagtaa ggtcttgttc ttatttacct 350820

tacctgtca acctccttgt atcatctccc ttgtccctc acttttgcta ttattcctaa 350880

aagttgttac catgtaatct tttatctaaa cgccattatc ttcaaacacc attatcttct 350940

tgagtagtga aaattcaagt acttgacact tgtcacatgt ccaagaacct gatatttggc 351000

cttggcaggc tgtgggccta gagggaatcc aaagactgtt gttatgctga agtaacagta 351060

atgaagtgac tctttagggc attttcatat actcatagca cagtgagtca ctcaagtcat 351120

cagagaagct tcattttgca gtagatggtg acagagagac tcacaactga acaatgtgca 351180

gagagtgagg aactttggaa cacttagtcc aaaatggcat atctttcaca ctcaaatcta 351240

ctctcaggtc tcagccagtc ctaaagaaga aaagaaagga agattgtaag agtccgagga 351300

aatagaagag acataggaag cagtggcttc aagacacaac aaaattcaca cagatagact 351360

cacaaagacc atgacagcat gcagatggtg tgcataggtt cactctagat gaagtctaag 351420

cactgagaag tgaaaagctc ccatccctaa ccaagaaact atggcaactt cttgcaaaag 351480

agaaaatagt tttctgtaat agcttcactg ggaatacaaa ccacacttaa gggtagacaa 351540

ttgtgcagta atcttttggc acattgtgaa gctgtgtctt tggcaaggta ggttctgatt 351600

gattlaataa agaactgaat ggccaataac tagtgaggaa gaggttttgg gcagagagaa 351660

agaagagatc actctaggtg tggaaaagat gccagagaag atggagagaa agcaggatat 351720

gcaggaggag aggtaaaagc tatcagccac atggcagtat gtagattaac agaaattcat 351780

taatgtaagt tataagagct agatacaaat aagtaaaagc taagcacaag ctttcataat 351840

tactactaag tctctgtgct ctgatttggg ggctgatggt ccaaagaaga ctccagtggt 351900

aggcccctta ctcaacagta gattgcaaaa acaaaatgaa cttaatcatg tattttaga 351960

ctttttattt tcattttgcc ttgtttggct attttttggg gtttttttgg ccttactgat 352020

atgttgcttg tatattacag tttaatgatgt tatctttgta tgcttctatt tttcttatgt 352080
 gtgtgtttct tgtgcttttt ccttttttct tttttgttt actattctgg ctgggtttt 352140
 ctttgtttat ttatttgttt tctgaaggga aagagaaggt gtggagtgg tggaggtaga 352200
 tagaaagagc tggaagaagg aaaatcataa tcagaatag gtgaatgaaa gtaattttca 352260
 agaaaaataa agaactatga aaaatattta agtattttgt gtttgcatac ccctgacatt 352320
 attcttacat gtctgagtca ttcagtacag aaatttgaat aagaaatctt tcagtgtcaa 352380
 acctaacaca gaaaaggacc ttcagagatt gctcagaagt taaatcattc atgcttttgc 352440

 aaggcacctg ggttcagttc ccaggaccaa catcatggct cacatccata tacaactcca 352500
 ataaaggagg atttgatgac atctectacc tctataggca tcaaacacac aagtggtag 352560
 tatacacaca tgcaggcaaa acactagcac atgtaacaaa aatacatcaa aatatttttg 352620
 aaaatttaat gtacaccatg ggccctaatg tttgccagtt tttttttttt tttttttttt 352680
 tttttttttt tttgacaatt tttttctggt tgcaacatcc agacaactat gggtaaaata 352740
 gtcattttat tttgtccat tcttgggttc tcttttgggt tgcaaatata tctaaaatta 352800
 ctgtcatatg gagattagaa tcccacaaag cacagaaaac actatctctg tattttctag 352860

 ttactacgac ttgtataatt atttacagtt tattctttca gattttattt tataaaactt 352920
 aatattgtta gttggtaaag aagtaaaatg ttgggtagtc actggaattt atactccttc 352980
 ttctcagata aatacattgt atactttatt aactgctcaa tactggaacc agcatcttgt 353040
 aattgtcctg tgtgcatgaa actttgattg gaattttata agctgaggtg gaataacagg 353100
 aaccttcttg gaaatgagga aaacagagtt aacaatttcc taacctgaca acaagtggat 353160
 tctctgttga tataatactc tatccaacag tcatcacttc tggggttcaa tctggggaga 353220
 aaatagcca ctcaactcct agtgatgaag tacttttttt cagtctctga gtccctaaa 353280

 tatatcttgg acttctcaaa atcaatcatg tagcaccagc aatccagagt aatggttcat 353340
 ttcaaaaggt tattgaaacta atgaaaggtt tagggaagga aactaattca ttggtggtgt 353400
 gcaactcaag catatcttcc ttttcttctg ttgtcagact aaacttaaaa aataaagctt 353460
 acctacaaaa aaagaaaatg aaacaaatga acaacaataa caaagacaaa actgtgaagt 353520
 atttataga accacaaatg acatctgtat aagtggcatg tatattttat cagagagaat 353580
 aagtaaagct tttgtttatt attttaagt attaaatatt acctttatat atttattttt 353640
 cacctagctt acaaagtcc agatttccit atggaacttg tctcaatctt ttattttggt 353700

 tggttttctc ctttctactt ccccttatct tcttgatcct tcttttctg atgtgacctt 353760
 tcacagtcat taatccatct tctttctget gaatctattg tctttcatgc cctacttccc 353820
 ttaaagcctc ttatattcta gtctcaagac ccttccttag ctttctggac ttacattggt 353880

cccacctaga tgcactgttt taagaacaga agttactttc tgcatatgtg agaacacaga 353940
 gctttttgtt gttttcctga gtcagggtta tattttttta aatatatttt ctttgaactt 354000
 tttaatcadc tttctaaact tgtggctact tctaaaataa agaaatctcc agcttcaatc 354060
 ggtgtaacat tgttaggcac cacatccatg aaggacaagt atggtctaata gtagaaactc 354120

 caacaaggag gaaaactact ggatcacaga tttttgacat gatttttttt tttattttta 354180
 tacatcattt tctcatttta cataccaatc ccagttcecca ctcctttctc tcccctgtgt 354240
 ccccactta ctccaccca cccattcag tctcagaga gggttaaggct tcccatgtac 354300
 agtcaacaca ttttggcaca tcattttgaa gcaggactaa gacccccca tatctaggct 354360
 gagcaaagta tcgctccaaa gagaatgggc tccacaaagc cagttcatgc actagggata 354420
 aaatcttggc cccactgaca gtggcccccac agactacca agccatacaa ctgtcaccca 354480
 cactaagagg cccaatttg gtcccatgca ggctccccag atgtcagccc agagtcaagt 354540

 agctccatt agcttaggtc agtggctctc gtgggtatcc caaaatggt cttgaccct 354600
 ttgatcatat tatctctct cctctcttc cactggattc cgggagctca gccagtgct 354660
 tagctgtgga tctctgcage tgactctttc acttgctgga taaaggttcc atgatgaaaa 354720
 ttcaggtagt cattgctctg attacaggtg aaagacaatt caggtaccct ctccactaat 354780
 atttaggtc ttaggttatt tttgtggatt actgataatt ttcttagtca caggtttctc 354840
 ctaatgactc tctcaatcaa agtatctctt tcttgetct cctctctat ctccccat 354900
 ctctaccacc ccattccctc atgttctct tccccctct cccctcccc tcctttctg 354960

 ctttctttc tctctccca ttatgctccc tttttctta ggatattctg tetatttctc 355020
 tttccagga gaatacaggt attttagggt tcttgttaca tatcttctct ggggttttgg 355080
 gctataggct ggttaccct tgctttacat ctattacaca cttatgagt aatatatgcc 355140
 atgggtttga gttacctcac tcgggacagc tccccatgtt ttatctcata tttaccatgt 355200
 agagctatat taacaataaa attcactgtg gaacagtggt ggatgctga aaggaacgca 355260
 ctccaggaaa taacttgaat attgcattt gctattctca tttctcaaag tctgtgaatc 355320
 tttaaagttg gttcatacct ggccctgcaa attaatatga cttttttc taaaatggac 355380

 attttattga cctcagaatt gattttaatt tcaatataat ttaatgtata cacaataatg 355440
 attgttcga aagaattatc ttcaggactt ctgttcgac tctgatgcat tctttttaa 355500
 tttattttat ccaactgtat gacacattc cattctttca tttctatgg cccaatttat 355560
 aattctatcc tttactttg tctttcaat tcacctttt cctttgcaa tcaatgtcta 355620
 taaatacctg aagattttat attggataaa gatctgtagc atacattggg gtttataatc 355680
 aatatttaga tttaatgggt gtgtttaag agtaacaaa caagtactt attactataa 355740

ttcacactc aaactatagc aaagcattaa tacattgagc ttctaggca aaactgttaa 355800

 ttccctctgc cttaaaatgt tagattcttt agctttgttt tatttatatg tattttgtca 355860
 tcctttgtaa agaatecaaa ttaaaaccac atagaagata atatccagtg ttcaaatctc 355920
 tcccagtatc tccaggtatc agacaaacct agaatggtac acatgttggc agtacgagtt 355980
 ctaattgcta ttaatagtaa aaaccagag tcagatatca ggataaatgc taaaagatca 356040
 gagagacaag ggagcaagtt gcagetacct cttacctgcc caacctctta accaaaaaga 356100
 gcaaagtcc tgcctctcc ctgcattatc actttctctc tcctcccagc catatcatta 356160
 attgattctt cttcttaggt gctgggatta aagtttccac cactactttg cctccatggt 356220

 taactcatag ctatctttgc cctctgatct tcaggcaagc ttcatttgtt acagtacaaa 356280
 gaagatatcc ccacatttcc cttttttggc tgaataaaaa aagattataa ttaatagaag 356340
 aaaaactata tataatagga acaataacaa tatacaatat atacaggcaa taatacatc 356400
 aacaatgtct actccatgaa caattgacaa actcagacaa aatattctat atctatccta 356460
 ccttggtag tccaaatggt tgtacataac tagttttcta ttcttacttg tagtacaaa 356520
 actatctttt tatgtctctc aacctatttt actttacatt ttttactgaa tttcttttct 356580
 gaatctggta acaagggaaa ttataaccgt aaatatgaag tcttcaattc catcagagat 356640

 acaggaaga aatattatgc aaataagcat caagtacagg caagcaaatt caaataatg 356700
 tgagaaataa cagaaatate tagtttccia aacagtcaca caaggttctc ctgcaatgct 356760
 ggggcatcca tctttgactg aaaggcatag tatatctgac agaattttct gtgaagcatg 356820
 atattctgaa ggctgtcct actttgtctt ggcaaagttc agaaatcact ttattttgtg 356880
 tcctgcttgt caaatttggg caccatactg ccagcaatca aggcaagagt attttcttgc 356940
 ccagtggctt aattttgtca caaagaaagt aaaattccat gtggagttga tttggtacce 357000
 atcatcttct ccaaagtaga ttgatgctgc caagagaaaa aataactcaa tgtcataaaa 357060

 agaagaactt atgttattaa aacctctaa ttgcatatt ctgtagatct ctgaagtgtt 357120
 tgaagacagc ctgtctatit aaattatate tctgtttgac ctaatatgac tacacatttg 357180
 attgtagtag gtgactaatt gctaacctgc tttcaagggt aaaaaattgc attaatttgt 357240
 taaatgagtt gcatattaca atacctttaa caagattaaa aatgtatata ctgtatgttc 357300
 taacaaaate ttgaatattt atcaatatac aaaaatccat atcaatgtaa aatattttaa 357360
 tctagtagtt gtcttttggg ttaaaagtag attcaataag ctaccattat cctaccatgg 357420
 ctatactcct ctttttttct tttcagacaa agattcctga atattccttt gttcaacttt 357480

tttttctgat tattgctaataataacttgt aaccaactac cctaaattgt tacagatatic 357540
 cataatccac tgaataaaca acaaaccatc caccacatct cttggggatg tgggtactgt 357600
 gttcttaaat tcaacttccag ctgtcttggg atgacagcat ctttaggtta tcctgaaaag 357660
 aaaatatgaa ttaattgtca agtcctggga gaggtaacta tatcattcgt catccagtct 357720
 ctgattaatg cgaagtgtca gggcttctct caagtctgg ctagagtagt ttggaaggtt 357780
 ggatcatttc cactagccac ctcaaaattg tctgagcag tttgtagtcc aaagcagatc 357840
 tttttatgt ggiatttttc agcttagttg tgttatcata gtcttgggtg aatcaacatt 357900

 tggggcccta tcatcctttt ggagacttga aaggtttctc ttaggcattg ctatggttca 357960
 ttacagaaaa tgtaaatgat ttaaatgtga tatgtagcag atctcaaaga ggttaaaaga 358020
 tcaatatttg ttatgtgtat ccagagaaca aaattctaatt tcctagttaa ctgatagaga 358080
 ctcaaactg aaattatgtg cagaaagcag aatgaagcct ttttctagaa ttagtactct 358140
 atatgaccat taatatcatg acaaaaattt aaaatatgtg tatattagtc ttataaatta 358200
 tgaagtagta tttatacctt aaggaaagct ttgagtgtca aaataaaac caatggatta 358260
 tgagatcact gacagtaaaa tagtccttat atttgtttt ttcttctgtc ctatatcagg 358320

 tagcttcttt gacttgaggc agagatcatg gattttactt tagcatgcat acttgggttt 358380
 agagaaggag agagccacac tccaactttg atttttaatt ggaccaggaa tacaaaatga 358440
 ccatttgcatt tatatgtttg tagagaaaag cagaaacaaa catttgggaa aatccataaa 358500
 tatttattct gttggagatg tgatatacta aaggccaatt tattcatttt cttgggacat 358560
 tttttcatgt tgcttcacat gtcttatttg tctagcaatt ttcagattct gtagctggat 358620
 gccttcttc tcttctatgg aatcccaca ccaataagac actcagttcc tgactcaacc 358680
 ctgccttacc acttctctc tctctctctg attttgcca gccatcttat ttcttgtttc 358740

 cccccccag ccaactagat taaaggtgtg tgtcagcact gcctggcctc tatggttaat 358800
 agtggctagc ctctgatctt taggaaagct ttatcaccac acatgtccac atacataaac 358860
 caatagaaac agtctatctt caataccac taaaacttca aagcagagcc cacagtgtgg 358920
 taatgttctg ttctttagc tcttattatc tagtacattt cctaagtgtg ccacctttct 358980
 caagtaataa atgttcacat gtcaactttt ctattacctt caaatgcaa tacaattctt 359040
 taaagattta ccacccccat ctcttaagtt tagatggaat ttcttgatat gacagcattt 359100
 gtcttataa aaagagaagg tttaggaagc atgtacatat ttgtcctct tctttcttaa 359160

 tggtttaatg attgacacaa acaaaggtgt taaaactgag cacactcaa gggaaagaag 359220
 ctttaccaaa ctatttcatt aaataattc catttagcca cagaaggggg ttgactttca 359280
 ttgaaagttt tattctagct agatgtattt ccaaaaaaaaa ttttctttc caaaataatg 359340

ttgaaggatt tgatccatag ttagacatag ttgaagatgg atttgaattt tttgtcttct 359400
 tgcctcaacc caccatgcac tgggtttaca gttaccacca cccttgattt ataaactgct 359460
 ggaaactaag cacagggctc catgcatact agataatgac tctatctact aaggtgtata 359520
 gtttgcctca gtgtctattt attttgaata attctacttt ggccttattt tacatgtatc 359580

 tatattctaa agttatataa cctcacagag atatgtgtgg aagccattta cattctgtta 359640
 tctcaacat gctaggaaaa ccaactctaa tattacccta taccacaat tatattgctg 359700
 tcatcaagac acaaggcaag aagctcattt tctgtctgtc cactaatttc aagattttag 359760
 aatgtgagg ttacattctc ttatttatca taaaattggc caaaagaaca gacacatcag 359820
 cattttgctt attttcaaat aagaataaat ttattcaagg ctctagaaca caagttttga 359880
 ttattgtcat ccaacagcat aaaaagtaca aaacagatcg gtgtatttct aatatattaa 359940
 aacaaaatgt acagccat at acagtacacc ctataggcag agaggagggg taagagactg 360000

 tggttggggt ctagtaatca tttatcttca cttcaaaggc tgttcaagta tttaaatcca 360060
 tatgtaatat ttcagcaaga cttctaggta tcatttatcc cttgataact tttatatact 360120
 aaattacctt aaataatata tatttcatat tgaagagtta ttgtataggg gatattttta 360180
 ctaaagaaga ataacagtt acctaaaaac caagaaaagt ataccacact gaactaagca 360240
 tagttttcat tttttataa ccgtgattcg gttttcatca cccataaaac attaagagta 360300
 gataaaaatg tctagcatgt gtgacaggag aatggctta gtgattaagg gcattttctg 360360
 ttgtggaagc tgactgaagt ttgcttctca ggctcacaaa tacctctgaa actggtctgt 360420

 aagggcacaa gcatgatcg taaatgaata tacacagaca ggaacacata aataaatgta 360480
 aaacagatca gctttttttg aaaataattt ttctctcat actatacatg ccaaccacag 360540
 tttccctcc cctactcat ctcactctac ccactctctc tctttccag atgcactcct 360600
 cctctctgt tttcttttca gaatagagca ggactcaaga gatgacagcc aacagaata 360660
 aaacaaaata aaaaaatga cttttggag tttggtatat ttgtgggact ttttaacaat 360720
 ggatcaggg gctgggtctt gggaaccaac tcctcttact ggattgcctt gctcagcatt 360780
 aatacaagga gagtactta cccttacctc aacttgatat gccttgctgg ttgattccta 360840

 tgggaggcct gcctcttttt gaacagaaac aggatgaatg gattgggaaa taggaggaga 360900
 agagggaggg gaacctctag ttgggatgtt agttatatag atagatagat agatagatag 360960
 atagatagga aaaacaagc aaaggctctc ttttagagta cagagaagc aacccaagtg 361020
 gaggaaaaat ggataaagag caggcaagag tcagtgatat acccactctt gctgttagga 361080
 gtctcacaaa gacaccaatg taacagctat aacatatata caggggactt ggttcagacc 361140
 catgcagggc ccctccttgc tgcttgagtc tgtgtcagca cttgtgagcc ctgattaatt 361200

gactcagtga tacatgttct cttggtcctc cccaccccct ctgacttcta cattctttct 361260

acctgtttct gtagagtcc tttcctgagg ggcagtagca gacagagaat tctaaattag 361320
actctgcata tattgctgtg ggtctccaca tttgtccctg tctgtttcca gaggaagact 361380
ctctaagac ttctggagaa ggcagtgatc tatgagtata acagaatatt attagggatc 361440
taagtgttg tcctttcaaa agaaaaata gataaacaga tcaactacct taatagctaa 361500
aaggaagaaa aggaagacct aagttaacag gactaaaagt gaacaagaaa atgttacaac 361560
aaatactaaa gcaattctga atagtgttt ggtttttccc cactcaggtc tgctggtcat 361620
cttgtgacta agtgtgacgt gctgtgccct tccacattgg agtctgctga ccatcttatg 361680

actaggctag agggagaata cttgaatata ataaaagctc tatctaagaa acatacagtc 361740
accattacc taaatggaga aaatcttggc aacattctac taaagttagg agtgacagtg 361800
gtagttcatt gtccccacat cttttttatg ttgtgcttga attactatct gtagaaatga 361860
cacaatgat ttaaaagaaa gggatataaa tagaaataga aaagcaaata tttcctatct 361920
gcagatgaca tggtgccata cattaataga tgcccaaat tttccagag aacatctaga 361980
aatgatgagc aaattcagta atatggcagg atacagagtt aaactgcaca aatcaatagg 362040
tttcttatac accaacaatg caaatacaga aaaagagctc atagagacc catccacaac 362100

aacctccact ccaaaaatct aggaataaac ctaagcaagg aatgaagtt actttacaat 362160
gaaaacttta attctctcta gaaagatcta gagcaaagca ctaggaaatg gaaagacatt 362220
ccatgctcct gattggatc aattaatatt acaatcattt taccaaaaaa aaaaaaacat 362280
ttagactcaa tggaatccca aatgatgcc tgatcttatt tattatagaa atacagaaaa 362340
atattttat attcatatgt taccaaaaag gacccagat atccaaaata atagagtg 362400
aaaacaatag tactagtatt gcagagccat ggtgacaatg attcctcca agagacaaag 362460
actttatctc aaaaactcta atatcatgca tgagaatatt tcttttgat tgtttatcaa 362520

agttgtcaa aagattctca aacattata tacttttgct actgccctg attacccat 362580
agttggaatt taaatttata ttgctgaaga gaattttcac ttctaataca gggactagag 362640
gccctacac aagaactgaa ctgtgagcct tatacctcat gattagctta cataacacca 362700
tcgacgttat gaaagcttc aaaggaggta ggcaaccaac agtctacca gatcaatgac 362760
tgtgatccag aacaaggatc tgcattggtat gatatgtagg ggaagctgta gccacaccta 362820
cttagggcat ggccagggtg acatagagtg agaggttcag gtggctggtt gacttttgtt 362880
ttcccttca gcttgctgta cagactgttg ccacgcgggc tggctaggtc actttgtaag 362940

taaggctttt ccctattaaa tacccttata tttctacctg actctgtatt ggtaatttcc 363000
 caatatatct ggttgtcagg agtgggatat tggaaaccta cacccattt gggacaggct 363060
 gtgggttcaa ccaggccagc agcctaggct gggaaaagctc cttttctcca caggtgctcc 363120
 cggtccag ccaacctgct gcaacacaca agtgcattcc tgctgcagct gatttctca 363180
 gaaccatcca cccagcttgg aggcagtttc tatttgctta cagtcgagta ggctctgct 363240
 ttcagcaggg gcttccctg gccactgctg tggtaaaacc acatctattt cagtggttgc 363300
 agccacaagg cgttataatc tctaagataa ggcagctac tttgtgacc tctctccatc 363360

 actgaccaac cactgccaaa cgacacatgg agtagctgaa cgcctgtgtc acctgctggt 363420
 caaagatagt tactgcatct ggagtagaaa tcaggtaaaa ttatggcgga atatttatca 363480
 tttgttaaaa ttgtaatat ttttgcttat tacatgaatt caatgtttga ggaggatgct 363540
 aatttgccat ttacaggcct atatgccata atggcagtta gcctactggt acaaataata 363600
 ttactagcca gaggactcag gaacagggac agagataacc tcacaacctg cttgcaggaa 363660
 ataacagctt tacgcaatga ggttttgag aacagattag gtaagaccac aattgtgcag 363720
 caagcagaaa aaaattggat gataagcttg gctctgtgtc caatacteta aaacagagct 363780

 gtctgttact caagatgaga tgcagcatal ttatgataag ataacacag agagatcctc 363840
 catgtctgag gccttagagg ctaggctgcc agaagaccgt gaaaagctac agaatatctg 363900
 cagtcagcta gaaactcaga taggcaatgt taccagaaa ctagatacaa aggtgcaaaa 363960
 taccaggat atggttgaag aattgtacaa ttccaatcaa taaattattg aagcatctaa 364020
 ggtagcagat cacaaatttg agtctagatt tgaatgtttg gaagacaatt tacagtacag 364080
 ggctgacaga ttacatagtt ccatacagtg gattgctgag gactcaaaat cagcaaatca 364140
 tgacctgaa tctagtctt aataactagg atgcagtttc catgcatcc agatcctgcc 364200

 taaggatgat catattaag acttagaaaa acatgtaaat gagcagttag agcaatttac 364260
 agattcacta acgtgcttgg aatcttttat gattaaggag attgaaactt ttcaaagga 364320
 tatcattgct aggcttaaag atcaatggga tgcctcagaa gcagaatcac tccaatcca 364380
 ggcacctact ccacceaggf atcgtgacta ttcttctaag gttgttactc gtacaccatt 364440
 agtgtacca gtlacctgg tagaaaagcc agcttctaag aaaaaccctc atggacagat 364500
 ggcttatgaa tggcaacta ttcagctgaa ggatcttaag actattaaag aatcagtgg 364560
 ctcatatggt atccatagcc cataagtaaa acagctatta cattcatggg caacctttaa 364620

 caagtgaca cccacagatt gggaatgatt gtagcagct gtacttgaga attcatgcca 364680
 aatccaatgg aaggcattgc tgaggaaga ggtgaagctc cttgagcatc agggaataaa 364740
 ggaaggtttt gaagcccctc tatataaaat tcttggtag ggtatttatg ctaaccaga 364800

ggctcaggct gaatataatg acgatatact gtccttatgc aggaaagcag cattaatgc 364860
 ctgggataag gttgctgagc caggagaatg cctagaagct tataaccagaa tagaacaggg 364920
 acctacagaa cagttccagg acttatttgg aaggttaact agggcagtag aattacaggt 364980
 aacagatcca gaaataagac aattaattat acatacaata gcttatgaaa atgcaagccc 365040

 aatatacaaa agaatacttt tgccittaaa gatcagatca gtcctagtag aagaatgggt 365100
 tttgtatgca gccaacattg actataatct gcaagacact agagcttggg aaggagaagc 365160
 catttcaaaa ggittaaaag gcaacaggaa attaaatggt ctagaagtga ggatgcaaag 365220
 gcttgggaag gagaagcacc ttacagaggt caaaataggt accaagagc tagaggttac 365280
 tactactatg aaccttgtgt aggaggagcc ttcccctgga gaccacaaag gtgccaggaa 365340
 cctagatggt tcaactgtgg taaaatggga catactaaga aaaattgtag acaagcghaa 365400
 tctttgtttt tgttttgttt tgtttgttt tttccaagc ggctagaggt tactactact 365460

 atgaaccaga accttgggta ggaagagcct tcccctggag aaaatgaagg gatcaggaac 365520
 ctagatgttt caactgtgtt aaaatgggac atactaagag aaattgtaga caaacgaatt 365580
 cttaacaattc ctcatgtgga aggccactgc ctctctgatt gtgtagaaga tgaggtaagg 365640
 gcagacacta gaccagggac atgcaaggaa acccgtaag gctgggaatc cccgaggggt 365700
 gcctcaagaa gtccccaca tcgagaaagg tccagtcgtt cccagtagca gtggaagaca 365760
 atctgtcaca ggatgaatag atagtcttt gcctattgtg aaaaataata cggctctaga 365820
 tggtagtttg aagagtgatg aagaatcaaa tgtgaatgga caaatgaga aacgcatatt 365880

 ttggtaaaat tctattaatg gtttgtcaag ctctattaa taataaaagg actcagttga 365940
 atgtgaaaat taataataaa gttattactt tcttgggcag atgtaactat cattacceca 366000
 aagtcttggc ctcaaaaatg gcctcttaga gaggcaaatg tacaattttt aggaattgga 366060
 actctatcta gagtgttaac ctgggtgtct gcattggacc ggaagtacag aaagggatac 366120
 tgaaccata tgggcagat atacctataa atctctgggg tcgtgatctc ttatggtaat 366180
 ggaatactca gattaatatt cttccaatgt tggatacaaa ttatatataa tctttagata 366240
 gtagaaaaga gctggtgaaga cactatggaa aacgtttact gtacagaaac taaataaaaa 366300

 tgatggacct tcagaggaac caaaggccct gccattgaag tagcttacag atgaaccagt 366360
 ttgggtagga caatggccta tgacctctga ggagctagag gctttagaaa agttagtaca 366420
 gaaacaacta gaggctggac atatagagga atctaccagt ccctggaatt ctctgtatt 366480
 tgttatcaaa aagaagtcag gtaagtggag aatgctgaca gacctgagaa ccataaataa 366540
 ggtaattcaa ccaatgggct ctctgcaacc tggaatgcca ttaccttct taatacctaa 366600
 agtatggcct gtcacagtca ttgatctaaa agactgtttt ttcacaatgc cattacagga 366660

aaataataga gaaaaaattg catttactgt accaactctt aataattcac agccagttag 366720

 gagatatcag tggagagttt tgccacaaga aatgctaaat agtcctactt tgtgtcagcc 366780
 ctttgtacag aaacctttgg aaataattct taagaaatit tcacaatctc ttgtttaacc 366840
 attaaatgga tgacattttt ttatcagatt ctaataagga aactttggaa tgtatgtttg 366900
 aaatggtgaa ggaagtctgg cctcgtttgg ggttacagat tgccccagaa aagatacaaa 366960
 gaggagattc tattaactat ttaggttaca agatagactt acaaagactc agaactcaaa 367020
 agttacaaat taggagagat cgttatcaaa ctcttaattc tctacagaaa ttattagggg 367080
 aaatttctca attacagacg attattggtg tagaaggaca tgactgtaac gcatttaaaa 367140

 atggccctta aagtgataa ggacctaac agtccgagaa cagtatatat atacaattaa 367200
 tgaaaaaaag aaagctgtga attttatgga gagaaagatt tagcacatgt ctcatatit 367260
 ggagggttgg ggaggaggat aggggaaggag gacatgatgt aatatatit atctaaagat 367320
 actaaaaat taaaagtaga tactagtccc taaactgtca tatgatgtac ctgtgaaaac 367380
 gtagactgca ggccttaatt gtttctatgt aggcccagta ctcaacaaa gaatctgcaa 367440
 tttttgttat tccatgatgc taatgcagct agtctgtggc ccaccctit acttatgtaa 367500
 agttctatgt aatgcctit tattctitit ttgtttgtct ctattctitc ttcatagtit 367560

 ttctaaatgc cagaaagcaa gggagattit cctataaaat tctagttcct ttatttaaaa 367620
 aatattctgt gactaccact atggcattag aactcaaatg tctaggggct agtgagctgg 367680
 ctcagcttat aaaatactca aagttttggg gagttaact tagatgtcca gttttgttta 367740
 attgatggac atggccccag gctttgtaac ccaggactca ggagctagag agctgatccc 367800
 tgggtaaat gactatgtct actagctgaa tagggtgagc attgggttta tgcattgtctc 367860
 aatacatttg gtaggacaat caaggaagac tatgtgaact tctggtctcc attcgtacat 367920
 tcatatgaat atgcagagtg aacctcatag atgtgtgctc atatacatta aactcatgta 367980

 cacatataca tattcaaat catgcaaat aaccccaaaa taacaaaaa atacaaatat 368040
 ccagcttgtg ccaatggatt caaaagtaat accacatit tttgcagcta gatggaaagt 368100
 tctctcttat ttacagagg t aagacagttt gttttattta cctttttgca tgcaaaaaa 368160
 aaaaaacctc ttttaaatct ctcttcaact ctgagtttca aattcaggtg tcaatgttta 368220
 ccatttctgg caattagact cttgatttgg gtgctttatc taattcaaa ataataaatt 368280
 gggatititit gatgtititit tttaaattag aaaaaatta tatatgaatc ccaccagtt 368340
 cctcttctc cccattctat catgcccctc tctgaccca atccatccc tcttctctc 368400

catagaaaag gtgaagcctt gagagtttgt ttggaggtta tagaaggga gtgcagctac 368460
 tcatatacta ttgatggaag actggtcctt agcagaggcc ttaccctctc cgaagagcag 368520
 aagggaggtg gggggaggag tgaggcgagt tggaggagag gaggtagggg gaactgagat 368580
 tggaatgtaa aaaagaatta ataaaaaaga aacacaaaca aaacaagggtg aggccttcca 368640
 tgggagatca ttaaagtctg tcacatcatt tggggcaggg cataggctct ccccatgtg 368700
 tctaggctga gagagtagcc ctctatgggg aatgagtcc caatgtccat ttgtgcacta 368760
 gtgataaatg ctgttccact accagaggcc ccatggactg cccaggcctc ctaaatcaca 368820

 cccgatattc tgggggccaa gttctgtcct atgctggttt ctgagttgtc actctggggt 368880
 tcatgagctc ccctttttt caggtcagtt gtttctttgg gtttctcag cctggcttg 368940
 acccctttgc tcatcattcc tcctctatg aaactggatt tgggtatttt taatccattg 369000
 tataaagcag aggtctttga atatttatgg tactgggggtg gagaaaaaaa atgactggat 369060
 ttaaatgaaa tctgagatcc ctggctagaa agcaaatgat gaaacactgc acccaaatta 369120
 tctagattcc aatgctctgt gaagaggaat tctttaaca ataaaattta cagtcatagg 369180
 gcagaactga aatgagaggt gaccccatgg actagtcagt gccacctaac tctggagatt 369240

 caagtctgc tttcttaata atcaagcact gtcattgcat ttaacttatt tttcttaaac 369300
 agaagttaca caaatatgag tgttcttccc ttgtttact tcagtggtg tggtccttg 369360
 cagttgtgat gatgttgagt ttgagccaat ctgcccctct gttcatatga cagtgatatg 369420
 aagatgcagt cctacacttt gtgacttcca aggaatcacc ctctccata gggtaatgag 369480
 cagctaatac aagctctgcc cctagtttat atttataaca tcaacaaaa cattttcttg 369540
 atgattcctt ggggcaccag gaaatttaca acatgatatc cactacaaag atttcatgaa 369600
 ggaaacaaca aaatgaagt gaaaaaaggt gcaataaat gaaataatga aatgaacaag 369660

 gaacaaacat agaaacttat cttggtcttc tgctaagatt atggttaagat ggaggcaagg 369720
 tctccagaag tcttcatagt gaatcaacc ctagtgtctc agttatagca aacttggcag 369780
 tataaataaa agctggaat aaggatctca tatcaaaagg aaaaaaaag ttttactttc 369840
 tttaaaagtg ctttaagcatg tgaagaagag aaacaatatt gggacagcat ataaaaggca 369900
 cattcattaa aagttaatgg tgtaggatac agataatgag aaatagaaat ggaattcata 369960
 gagacatatt atctttgcag tgcgtggcaa aatataatgt ataatacaca ttactgcaga 370020
 gtccaaggg ctatttttat accagggcct ttagaatcca aacacattaa agattcatga 370080

 tccccaaacc atgigttttc cacagttaga agcatttatg tcaagtgagc aaactgtttg 370140
 ctaactgaaa cactagcttt ccccatgtga atagatagca tcgctttgcc tgactcattc 370200
 atcctgtaag cataaggtga atccgtgtga ctggatgctc ttttttttt tcttaaaccc 370260

acaaatttat tgctattctc taaagttaag tcttctcagt ttccagtccc cacaaccata 370320
 gtgaccatgg ctctgttctc tgtctgtcat ggattcccac agtcctcatg actgtggatg 370380
 gcatggctct gttctctacc tgccatgagc tctcaactgta tgttcatttt tgacacatca 370440
 ctgatttgtt ccttggccat cccttccctg actacttcta ttacttggcc cttgaacgtt 370500

 gaagatgtaa tactctctgt gagtcctcct agttggttac atctgtgtct tgtattcttt 370560
 ctgtgacag gtgggtcatg tattagtcc catccccagg gctcactttt actcatgttc 370620
 attctcttaa caaatatgac atttttatg gctgtctcta acatgccaag caaaaatgat 370680
 cacttccaaa gaatgtaga tatactcagt gattaatttc aatgattaga tattaataaa 370740
 agaagcaaac acataaatat agaagtcagt ctgtggccag tgtcacagag cagaggtatg 370800
 ttgtgtaag agctcataga tcttattggg acagacagca aacgtttatg gggaagtcca 370860
 tgttgttgtt ttcactctgt atttggatga cctgtacatg attttatttt taaatttttt 370920

 aaaacatttt atttatttat tatacatg acattctgct tccatgtata tctgcacacc 370980
 agaagagggc accagatctc ataacagatg gttgtgagcc accatgcggt tgctgggaat 371040
 tgaaccagaa gtacagccag tgctcttaac ctctgagcca tctctccacc cccacatgat 371100
 tttatttgtt aataacttgc atcatgtttg aaatgaaact gtcatttctt gatggccagt 371160
 gtaccagga attttagatg ggtgaaattt cagcattcca tccctcctac agctcatcaa 371220
 acaaatgctg cattttgttc ttttttttc ctttttttat atttgagtta caaacacgat 371280
 tgaattacat gacaatccca gttcccttct ccctccctc ctcctacc acccccaac 371340

 taaaacccta ccaatcacat atcctttctt ctaatctata cctgtctcaa cttttctgct 371400
 ccctcatgac ctctacatcc ttcttcttct tccttctca ttctcatagc tcctcggcc 371460
 ctcttcgcat gatgtcaatt tgctcagggg atcatgacc ttttggatgc tctttttaa 371520
 gtgagaaaag ttcataacta gctatactc aaagaaaaat caaataagtg tatggggcat 371580
 ggaggaaaa cagaggagga aggaaggtgg cagaatatag aacttctcaa gcaattttgg 371640
 gaatctggct gggggagtat ctagatcaag ttaattgaca tacaanaata ccacccaaaa 371700
 tgtggacagc accattctct tgacaatgtc cccagaatat ttttaaaaag agaaaaaaca 371760

 tctcttctg agtgtggatg caatggaaca agttgcctca cattcttgat accttatctt 371820
 ctctgcccc ctcagactat gagacaaact catgctcttc ttcttttcag tggcttctgt 371880
 caggtttttg ccacagcaat gagaagaggg gccaatcag atactataga gactggagaa 371940
 ctataatgct ttttaatgca attttacagg agaaggactt tggagatcaa agtgttgtat 372000
 attttctcag agttggtaat catcacactc cattcttctc ctgagctgtc tgatgtgggt 372060
 gctgagaact gaaatctagt tgcctgcaag aacagtacaa tgttaacca cagagctatg 372120

tctgtagctc ttggcttttc acttctaata agtgagatgt aaagatgagt tagaaatgaa 372180

aatgatgga tgatattacc accgagtttt acggatgtaa tacagcagct tcagtagagt 372240

actgttgtgt ttccagacct ctctaccact tatacttccc accetaacct tacatgctct 372300

tccagtttgg atcaagtttg gaacttctat ggtattcttc actccttcaa tatgtaggat 372360

aaaattagca ttctctctc tcacaattct tttatttatg tatatgtgtg tatgcctgta 372420

tgagtgtage ctgcatgggt agggactca aaagggtcag aagaaaggat tagatgcccc 372480

ccctggatct gacgtttaa aggtcataag atggctgaca ttggtgctgg aatccactct 372540

gtgttctcag cgagagcagt taagtgttct taactcttgg gcaaactctt tagctgctag 372600

acagcatatt ttcaattcta attatggcca tctcatttta cggacaaat taatatttaa 372660

gtttgatata ttaatafat gattccattt tcaaaactgc aataactagc atttatgaaa 372720

taacagactt attttgttaa aaattttagg agcatattac ttttgactta atttctacat 372780

tagaccacaa taaatcattt caaatgaagt aaaaagtga gttacttaat ctgatttaca 372840

ataaaactga agctttaagg aattagttaa agcataaata ggccattttg catttaaatt 372900

caggaaattt tatttactt gtgtctatat agtagatgtc attctgtttg acccttacac 372960

aaaaagcaag ttgaatttga gcagttagt tttttctc ttgttatgtt tctttgcctt 373020

ttcattatat gactgattat ccatccatat acaagaaaaa ggttcttatt gttttcttaa 373080

aggaggtagg taacctgtg gccattttta ctttgggtat tttttctat aggacaatgc 373140

cacgtatatt tgtggtcaaa gtggtttcaa ctaattacag tacatagctt atttttattg 373200

tcatgatcac atatgtatca tgtgtttagt tcagtttgaa ttccttgga ataatgaga 373260

tgaacagttt tgggcagtat gttgattggt atatttgcag gtgatacact aataaagggc 373320

agaggaagac aggaattgag cttagaggaa atattcatta tatctgaaaa ttagttctca 373380

acaactccag aagagaagaa tagttctgca gatgattgaa ctgtccataa caggcctgag 373440

ttttactgtc tcttaactta ctttcagaa tctgtctctg aatatggttg atactgaaaa 373500

attttctagg aaggttgtca actgtgagat cccaccacca atgtttagaa aagaaaaatg 373560

tgtgaagaag tgattaacct taaaagtgga ttcttgggtg tttagtgcatt tgacacatg 373620

ctaaaagaaa aaaaatctat ctaaaaggat gataaagttc tcaataagta tggctaagaa 373680

atggagacaa gaccttgga gacttggttt ttcagttcac cttcattctg caccttttgt 373740

tccatggtaa ctaactctta tgggtgaaag caaaagtga aatcttctac agttgaaatga 373800

ttaggaagtt tgggtttcac aaacatgtaa ttttagttct ttctctcca tagaggtgat 373860

atgatctaga agttgagaaa tttataattc ttgactaatg tacatcttgg ttttaattag 373920
 aattattagc attactatga ctattaatag aaaagtgaac aaaataatgc tgaaaatacc 373980
 agagggagaa gagtaggtag attttaaaat gttatgaaac tgtcaaaata ttgaataatt 374040
 ttttagtggt tciattacaa atttatgggc aaaccagaaa ttttactat tcctcttcat 374100
 tctgtcagaa agctgaagat cagaagaatt taatcactta acttgactct cagattactt 374160
 aggaatttgg taaatgatgc ctaaatcatt ctaaatttca gtgaggtata catctgtcag 374220
 tcatctgcta cagtcaaaga aataaagatt tcaagctcag aagttttcag gacttcttct 374280

 ttttttcttt caggacttct tatacaattc atatctgaag tttatatcac taccttggtc 374340
 cataagtagt attccctctg gtaccaatca ttttgctagt atgagttaag atctgatgtc 374400
 tgttatttgc atatttttac agcatccagg aaattgaggt aaaattcctg atttttgaga 374460
 gttcttgggg aaataatcaa atataataaa ataaaaggga taaaaatatt caatatcaat 374520
 atatatgaag cagaaataac aatataaaac aactacattc ttttcttgt tctcttattg 374580
 tgactttact gattagtatt tgttctttac atccataaca tacaaccaga agcataacct 374640
 acattgtaat ttggtatatt tatttgtaa aaaacatatt cagaattttt atacagtgat 374700

 acttatctgc atttgtttc ctttagttca ttttcttat attgtcttg gttttatggt 374760
 aatatgactg tcataaaatg aggcagaatt cattcttctc tacctttttg aaagattata 374820
 ggtaggatgg atattgtttt ctacttaaat aacaaagaaa attgacatga gaagttacat 374880
 gaaaatgta tcatgtgtaa atttccaatt acaaagtcatt atttcaattg atcaaatcta 374940
 ataattttta tgttttctt ggacatctg taggcaatac ctgaaatcat gctttattat 375000
 attctttaca agcctgaatt gatataattc ttgtagtca atttctatag taacttaatt 375060
 aaaagtattg gtattgtcta ttattccctt tcatcatga gaatggaaat tttattgttt 375120

 ttattatfff ttaaattfff atttatfff tatacatgta attagaccaa tttaaattag 375180
 aaacaagctt cttttgcatg tctatcccag ttcctctctc ccctgcccc cccactccc 375240
 tatcccaaac cttttctgct ccccaggaag ggtgaggcct cccatgggag attttcaaag 375300
 tctgtcaaat catttggagc agggcctaga cccactcctt tgtgtctagg ctgagagagt 375360
 atccctttat gtgaagtggg cttctgaagt cccttcatgt actagggata aataccaatc 375420
 cactaccaga agcctcatag attgctaga cctccaaact ggcatcctt ttcagggagt 375480
 ctggatcagt cciatectgg tttaccacct atcagtctgg ggttcaagag caaccattt 375540

 tccaggtcag ctgtttctgt gggtttctcc agcctggtct tggcccagtt gctcatcact 375600
 catccctctc tgcaactgga ttccagagtt cagttcagtg tgtagctgtg ggtgtctgct 375660
 tctgcttcca ccagctactg gataaagggt ctaagatggt atataaggta gtcataatc 375720

tcattatgtg agaaaagcat ttaaggtagt ctctgaacta ttgcttagat tgttagttgg 375780
 ggtcaattct gtagatact ggacatttcc ctagtaccaa aattctcttt aaagctataa 375840
 tgtctccctc agacatgtca ggatggtttc ttctagtcc atccatttcc ctgtgaactt 375900
 caagattaca ttgtgtaaat gtacaacatt ttctccaccc atccttcagt tgaggggcat 375960

 ctaggttgtg tctagttct ggctattaca aataatgcag ctatgaacat agttgaacag 376020
 atgtccttgi tgiatgaatg tgctcctttg cgtatatgct taagagtgga attgcttgat 376080
 cttgtgatag acigattgcc cttctcccaa ggaatctcca tactgatttc caaagtggct 376140
 gtaccagttg gcactccac cagcagtgga ggagtatcg cctctctcca catcctctcc 376200
 agcataagct gtcaatgata ttttgattt tagccattct gacaggagca agatggtttc 376260
 tcagagttgt ttigattgc atttacctga tgactaagga tgttgtgcac tttcttatgt 376320
 gctttttatc catcttagat tctcctttg agaattctct ttttagttct gttcccact 376380

 ttttaattgg attacttggg gttttagtga ctagcttctt gagtctttg tatattttga 376440
 aaatcagtag ttcataattt gactgattct gacctgggtg ttatggcaca ttcctttatt 376500
 cttagccctc aggaggcaga ggcaggtaga actgtgagat aaacatgttg tacacaacaa 376560
 tttccagga tagataatgc tacacagaag cctgtctca aaataataat aattgtaaat 376620
 aataataatg ataataatct gactcttga ttttaatgtt tcttctttc ctccctgtt 376680
 atatgttctt aacctaagct tttactcatt tatttagaaa ggagggtctt atgctcttgt 376740
 ctaggtttac acagaactaa ctacatagt t caggcttata tttataatgc tctccctgcc 376800

 ccatcttccc aggaaagggg tttgcagcaa taagacatct catctggcaa tttattcaac 376860
 cttttacttc tttttccta ctttatgttt aatttcttca attataaagt gaaactgcta 376920
 ttttagaatt tatgtatfff ggaaacaatg catgataata ttctctaac actactatga 376980
 tgaagatgtt ctgaatcaaa gctatgttga actatgtgat cattagtcac agcaactaa 377040
 ttatcaaatg tgaagatta taatgaaaac ttcttataat ggtaagtgtg aactcattgt 377100
 atatgagtta catggtaac cagatactaa agtaataaac attgcttgga gttcttatgt 377160
 ggtacttaga cttcagcttc aaatgcaagt atgtagaaag acagaagtga agatctcaaa 377220

 tgcccttgga aaatgatact ctgaggtaaa acaacagtga tagcctataa catgcttggg 377280
 ttgtgtttga gttgcaggtg gttttctgga tctttgaatt catagctccc taatgtttga 377340
 aaagtttctc tccattttca accatataa atgtttgtaa ttacttttcc acctttattg 377400
 agaacaacac ttgtatctat attaggtat ttgaagtct gcttagctgt gagcattgtt 377460
 ttaattactt tgttgaagaa atacttatta attttcttt tgtttgcttt tgaatagctt 377520
 ttgtctgttt ttcaaattha ctgatttttt ccagattgta taacttgctt tcacctatca 377580

agagtgcaca tgcagttta tatattgtta ctcatltaaa atatttaaat ttagcttggt 377640

 tatacttcca ttatgtcttt ggagtttct gaatacaatt gatgcctttg tggcaattgt 377700
 ttaaatgtgt ttgggagatg gatataacat tgtgtcattg tacaatctct attgattgag 377760
 tttcctcttt tcicaagttc ctttatttgc aggatttctt tgattatagt aaacactgta 377820
 ctttttaaat taatgccaag ctatttatag tattacatcc tttgatctac aatataaaga 377880
 acttttgta tttattaaat gaagacagag gctgctttag ttgaaaataa tttatctcta 377940
 ttactaaggc aagacttctc taagtgttgc attccaagaa tttactgaat ttatgtattc 378000
 tttattcttg ttagtaagga taggcactgt tcatgaccag caggtatgtt gccatcttag 378060

 aattctcaga gactcagtc ttcacagtgc cttcctgaat ctgccagaaa cactgagagt 378120
 tgatttttct aatattgttc aatctttgtt tftgaacatt tattatttta gaagataatt 378180
 ccaactacga gatttcaatc tcatacaatg ggatgaagat agaagtaaat gggttaaagg 378240
 gaaaaagat cagttgatca ttgatggata ttgactggat aaataatgat gctggtgaga 378300
 ftgaaatgtc atatgaacta caatcaaagg gtctttttgt cagtgtgta tattgggttc 378360
 agaagtaaac actctgcaga taatgatata taatgtataa ttgatactgg tgattaaagc 378420
 agtggcaaat catattaagg attagtaata tatgcaatgg gagagtgtca gtttaggcag 378480

 gttaaaatgg agcagtcaag ttgctcaaat gtagctggaa tgaggttcag gtcacaatgc 378540
 cagatttttc ttggcgaca tgcaaggttc ttgatggcaa gaaacctgct ggaagacaca 378600
 cattaacaac cttcaaagga ggaataatta gaatttatta aacatggtaa actatataat 378660
 aaacttatgt tgatgttagc agaagaaaa aaaactccta tcttcatacc aaacctgaat 378720
 catacttatg agacacttgt gacacatcta gtgatatgca tggcattggc tagaaggctc 378780
 ttaaggatga agggattatc tatgaatatg tactattttt agcttgttat tgacgttggg 378840
 attagattat tttgtaattc tgttaggata aaccagaaaa tgtaattat atatatgata 378900

 ctcttgaaaa taaactttgg ctaaaattgg taaaaatgat ttctgacacc aagtaataac 378960
 aatccagaaa ttctggattc atcacagtga tgaatgctgt gaacatgtta gtcactttat 379020
 ttgtattctt tgcctaact aaatacacgt gattctgtga ttctctttaa agtaatcgca 379080
 ttattgtata ccaattatta taaatgttta aatatttta caatttaact ttctctaaaa 379140
 ggcaaagagt ttacatttta cataggagac agaattattt ttaacttggg aatgtatat 379200
 aaaatagac atccacatat gaaaaccag aaggctgagt aattacagga acatcttcca 379260
 agtcattgtt tatagcagca atttatttaa tttgtacttc caaaatcaa gctttgcatc 379320

attaaacttc agaattagca tagaaataga tacttgttgt gaaagtataa aaggatgttt 379380
 aagaaccatc acaaggctca acactgtcat tgagaaaaat gcccttacat caaaatagaa 379440
 aacattggaa gttaaagtcc cataagacaa ggccttataat ttatacaaaa ttttatatat 379500
 gattatctat ttatctatat gtgtataaag ctttaataag catatgtaca tatatgtgta 379560
 catatatcat aaatgtgtat atatgcata acatatatgc atgtctaccg gtatgattgc 379620
 atacatgtgc aaatgtgtac acatatttac atatctaata tatatatatt tatatatata 379680
 aagcatatgg gtatatttat atactgcata catatatgat tgtatatata tatatgtcta 379740

 tatgtttgta tatatttata aagatattgt atgtatgtga tctcagaata atattacacc 379800
 tattcactag tctttgagta gaatatacag atgtttgccca atatcagaag cactggatat 379860
 ttcattagta ttaattccta atttacagca gtacattttc tttaatcatc aatgaaataa 379920
 gtgttttcta atcagtgtac tctattaatg ttgtatacat atttaattag tttggaattt 379980
 gtatcatatc aggaaattta tattgaagaa tgattgcaat ggtaatgagg tattttaatg 380040
 gcatgagaca ttgggatgat gcgtactcag caagctgaag atcaaagccc ttgatatttt 380100
 gaatgaacag agattcataa gacagttagt aatgtaagct tctgcgagaa agctctctga 380160

 ttctaagaag agaagagctg cctagtttta tactagatta tggattcaca ctctattcat 380220
 ttcaacaatg attttggat ttctatggtt tgctaagtta atatttctga tattttgttg 380280
 ctctctgtct ctactttgat ctaattttca tccagagttt tctacacca gatactcact 380340
 atgcatatgt aattattgga acagaatat acaaaaagga aagcaaaaca tctaattaat 380400
 gttaaaatca gtttcaacc agtttttttc ttgatgattt tcttatttat tctctctect 380460
 ttttctctct ctctcatgt tttttttcac agcttttata tacgaacaga atcttccaga 380520
 aagtacaaga gtcaaacgg ttgcattcca tttgttaagt gaatgattat aggtaaaaac 380580

 acgtttttca tctccatcac atgagtaagc attttatgta ttacaggtga taaacaaatt 380640
 attccaagaa cacacataca ttcatacca agcaacttgt tatagattta ctgtgtgggg 380700
 aagtaagttg tttttatcag gtctttaact ggcaggctgc attttgcagt tactaacaaa 380760
 gggccaatta cttgattact tatcttgaaa cataatcttt ttaaattttt tattattttt 380820
 gattactcat atttagattt ccatcccccc atttctaac actaccctcc tccgatgttc 380880
 ttccccaaa ccacctcca ctcatctcca gggatagtga gacctctac caaggacctt 380940
 caaagtctgt catattgttt gggagaggct ctgaccctc cttgtctgat ctgggctgca 381000

 atagtatcac ttcatagga atgggctccc aaagtccatt tgtgatctag ggataaagac 381060
 tggctccatt gtgagaggag ccatagactt tcttgggctc ctgactggta cccacattca 381120
 aagactttgg tttggccaa tgctgcttcc ccagctttat gactaggatc tccgttctat 381180

caataggtea gatccactgt ttctgcaggt ctctccatcc cegtcttggg acctttgctc 381240
 aatccttctc ctcaccaca actgaattcc agtaacatgg ttcagtactt ttctatgggt 381300
 atctgttctt gctttgaacc gcaaatggat gaagaatctc cttcctctct ctaccccctg 381360
 cctccaattt ggcagggat tcttatccca tctcttctt cgaggaatta ggcaatcttc 381420

 ccttggattc ctcttgttt cctagctcct cggcaatgtt gaatgtaggc tagtgatcct 381480
 ttatgtataa aaatcaaaaa tgagtgagta cataccatgt ttatcatttt gtgattgagt 381540
 tacctcactg aggatggttt cttctagttc catccatttg cctgtggatt taaagattcc 381600
 attgtttttt tttctgtctg agtagtactc cattgtgtaa atataacaaa tttactcaat 381660
 ccattcttca gttgaggggc atctaggttg tttccagggt ctggctatta caaacaatgc 381720
 tgctatgaac attgttgaac atatgtcctt gttgtatgga agtgatttat ttgggtatat 381780
 gcccaagaga gggattgctg gatcttaagg taaactgatt cccatttttc tgagaaactg 381840

 ccatactgct ttccaatgta gctctacaag ttgcaactcc caaaagcaat ggaggagagt 381900
 tcctctttct ccatatcctc tccagcatal actgtcattg gtgttattga ttttagacat 381960
 agtgacagga gtaagatagt atctcagaat ggttttgagt tgcattttcc tgatgacaaa 382020
 ggatgttagc cacattctta agtatttttc agccatctta gattcctctg ttgagaattt 382080
 tctatttagt tctgcattct actttttaat tgcagtgatt ggtgttttgc tggctaactt 382140
 cttaaagtatt ctgtatatt ttggatatca gccctctgtc atatgtgggg ttggtaaaga 382200
 tcttttcaca ttctgtgggc tggcattctg tcttctgac tgtgtccttt gctttacaga 382260

 tgtttcccag tttcaggagg aaggicccat ttattaattg tcatctcaa tgtttgagct 382320
 attggtgtta cattcagaaa gctgtctcct gtaccgattt gttcaagggt gccacctacc 382380
 ttctcttcta ggagcttcag tgtagctgaa attatgttga gttctttgac ccatttggat 382440
 ttaagtttag tgcattgtga tagatatgga tcaatctgca atcttctaca tgtctgaatc 382500
 cagttacacc agcaccattt gttgaagatg ctttctctct tccagtgtat aaacttagct 382560
 tccttgacaa aaatcagatg ttcatagggt tgtgggttaa tatccgggtt ttcaatttga 382620
 ttccattggt ccagctgtct atttttgtgc caataccaag ctgttttcag gactatggct 382680

 ttataataga gcttgcagtc agggatgggt atgcctccag aagttccttg attgtacagg 382740
 attgttttgg ctatctggg ttttttgttt ttccatatga agttgagtat tgttctttca 382800
 cgttctgtga agaattgttt tgggattatg atgggaattg cattgaatct gtagattgct 382860
 tttgacaaga ttgctatttt tattctgttg atcctatcta tcttagagca tgggagatct 382920
 ttccattttc tggatcttc ttttaattct tcttttaaag actcaaagtt cttagtgtac 382980
 agatctttct catttttggg tagtgttacc ccaagatatt ttatgttgtt atttgctatt 383040

gtaaagggtg acgattctct gatttttttc tcagcacatt catcttctgt atatagcagg 383100

 gctactgatt atttagttaa tcttgatcc tgccactttg ttgaagggtg ttatcagctg 383160
 taggagtacc ctggtagagt ttttccggg tcgcttatat aaacaatctt atcatctgca 383220
 aatagtgaag gtttgacttc ttcctttcca atttgatcc tcttgatctg cttttgttgt 383280
 cttattgctc tagctaggac ttcaagtaca atattgaaga gaaaaggaga gaggtagacag 383340
 ccttgctctg ttctgattt tagaggaata tccttgagtt tctctccatt tagtttgatg 383400
 ttggctgttg gcttgctgta tattgctttt atcatgttta ggtaggttcc tgttattcct 383460
 gatctctcca agtcctgtac cgtaaaggga tgttgattt tgtagaaggc tttttcagca 383520

 tctagcgaag tgatcatatg gtttccctt ttcagtttgt gtatattgtg gattacatag 383580
 atggattttc atagtgtgaa ccatccctac attcctgggg taaaaccaa ttgatcatgg 383640
 tggatgattt ctctgatgaa tttttggatt cttttgcca gtattttgtc aaatatattt 383700
 gtgttgatgt tcatgagga tattgtaatt ctctttttt caatttgtct ttttggct 383760
 ttgatacca tgtaattgta gccctataaa aagagcttgg caatgccct tctgttgcta 383820
 ttttggga caattttgtg gccctgtaca gcaactaggt ttagtaacc ttaaagatca 383880
 tttgtgacta ccaatcagga catggtggct gattcactac tctggctccc cgtattttat 383940

 tagaaataag cttctttct atggcaaacc cttttcttc tcctgcctt cctgcatgc 384000
 tcctcagga gaggtaggat ttccatgggg gaagtcaaat ctgcatatc atttgagca 384060
 gtgctagaa cctccccat gtgtctaggc tgagagaata ctgatccact actagaagcc 384120
 ccatacattg gccagaccta caaacttaca tactcactca ggtggtctag atcagtccta 384180
 tgctagtctc caagctatca ttctggggtc caagaacaac cattgttca gattagctgt 384240
 cattgtggtt tttccagtc tggctctgac cttttgtct atcactctc cctctctgca 384300
 actggattcc agagtacagc tcagtgttta cctgtgggta tccacctctg cttccatcag 384360

 ctactggatg aaggctctag gatagcatat aagatagtaa tcaatctcat tatcaagaa 384420
 ggccatttaa ttagcctgt caaccactgc ttagattgtt aggtggggac aaactcatag 384480
 atattgaa atttccctag tgccagaatt ctctttgaac ctataatggc tcctctatt 384540
 atggtatctc tttcttgtt ctctcaatt ctccctga ctaaattatc ctgctctctc 384600
 acgtctgct atctcattct cttctccac tctcttctt ctatagctt ctcccttcc 384660
 ccatactccc aattagtca ggagatcttg tctcttccc cttttctggg ggaccatgca 384720
 tgtctctctt agtctctcc atgtttccga acttcttgg tggatggat tgcaagctgg 384780

tactcctttg ctctatgtct aaaatccaca tatgagtgag tacataccat ttttgctggt 384840
 ttttgactgg gttacctcac tcaggatggt ttcgtctagt tccatccatt ttctgtgaa 384900
 cttaagatt ccattctttt tttccccac tgagtaaagtg tgtaaagtg ccacattttc 384960
 tccatccatt ctttatttga ggggcatgia aggttgcttc caagtctggt atattacaaa 385020
 taatgcttat atgaacatgg tttagaagat gcctccttg taagaatgtg catcttttgg 385080
 gtatatgact aagagtggaa ttgctgggtc ttgtggtaga ctgagcceca ttttctgag 385140
 gaaacatcat gctgatttcc aaagtgactg taggagtgg cactctcacc agcattggaa 385200

gagtgttccc ctttctacac atcctatcca gcataagctg tcattgggtg ttttgatttt 385260
 agctattctg ataggagcaa gatggtatca cagagggtt ttcatttga tttccctgat 385320
 gactaaggac attgagcact ttcttatgtg tcttttaggc atttagatt ccgctattga 385380
 gaattctcaa agtagttctt taccctctt ttaattaga ttatttgggt ttttgtaac 385440
 tagcttcttg aattgtttgt gtattttgga aatcaggcct gtgtcagatg tggggttgg 385500
 taataacttt tccattctg tgggctgcct tttttgtgt tgttgacagt ttcttttgc 385560
 ttacaaatgc ttctcagttt caggaagtcc cattcattaa ttgtcaacct cagtgtctgt 385620

gctacggatg taatgttcag gaagatgtct cctgtaccaa ttcattcatg ggtaccacct 385680
 acttcttttc taagaggttc agtgtggcta gatttatgtt gatgtctttg atccatttga 385740
 acttaacttt tgtgcatggt gatagatatg tatctatctg cagtcttcta cacaccagea 385800
 tccatttatg ccagaacct ttactgaaga tgctttcttt ttcattgttt aattttagct 385860
 tctttgaaaa attcaggttt ttgtaagtgt ctgagttaat atagagtttt tcaatttgat 385920
 tccattggtc tacttgtcta tttttgtgcc aataccaagc tgttttcagg actatagctc 385980
 tataatagaa ctgaagtca gggatggtga tgctcctgc cattccttta ttgtacatgg 386040

ttgttttggc tatgctggtt catttggctt tccatataat gttaaaatga ttctgtcaag 386100
 gtctataaaa aattgtgatg gaattttcat tgggattgca ttgaatctgt agattgcttt 386160
 tggaaacctt accattttta ctatgttctt cctacacatc caagagcatg ggagatcttt 386220
 ccattttctg gtatcttttt aaaatttctt tctttataga ctcaaagttg ttttgataca 386280
 ggtctttcac ttgtttgctt aacattactc tatggtattt tatgttattt gtggacattg 386340
 taaatcatga tgtttctgat tttgttctca gctcatttat attctgcata tagcagggta 386400
 ttgttttttt aagtactct taaaacctgc cactttgctg aagatgttta tcagctgtag 386460

gagttgctg gtagagtttt caggctactt atttaacta tcatatcatc tgcaaatagt 386520
 gaaagcttga cttttcttt tccaatttgt ataccctga tctccttttg ttgtctaatt 386580
 gctatatcta gaacttcaag tacaatattg aagaggtatg gatagagtgg acaaccttcc 386640

ttcctgattt tacaggaatc atcttgagtt tccacccttt tagattgatg ctgcctgttg 386700
 gtttactata tgatgctttt attaggttta ggtatgttcc tgttattact gatctctcca 386760
 agagctttag aatgaattga tgttgcatth tgtcatatgg tttttcatca tctggtgaga 386820
 tgatcatgtg atttttatat ggtggatgga ttgcattgat ggattttctt atgttgaacc 386880

 atccctgtgt ccttgggaag aaacctactt gatcatggtg gatgatttcc ctgatctgtt 386940
 ctgggatttg atttgccagt attttattga gtatthttgc atcaatgttc atgagagata 387000
 ttggctctga gttttctctt ttagttgtat ctttgtgtga cttgggtacc aaggttatga 387060
 agtctcataa aaggagtthg tcaatgacce tctgctttt ttgtgcagaa aactttgagg 387120
 agaattagta ttgactatth tttgaatttc tggtagaatt ctgcactgaa tccatcaagt 387180
 tctggcctth ttatcttght ggaagactth tgatgactgc ttgtatttca ttatcagtha 387240
 tagatctatt taaattgctt atctgtthtt gatthtaactt ttgtaagtga tatctatcca 387300

 gaaaattthc cctthactth agactgtcaa atthgaagag tacaggthtt cthttcttht 387360
 thttaatght ctagtgactt thatttctat ttgtthttgc atgtagattc atthaacagga 387420
 thcttaattg taaattaatt ctggtagcat thctthgcaa actattatga ctaattctta 387480
 thattthcag ctcagaaat ataatcaaca ccttagatat ttggthcatt gtgttaccat 387540
 ctgaaactct taaththttt thcatgacaa tccaaththaa tagccatgac cataaaccca 387600
 taaaaathth aagthtaatt tcaatggaat taagaaaaat thattggtha tgctthcaga 387660
 atthctgca thgtthtaga ccatctthtt atggctthttg thaaaagtht gcaataaaag 387720

 gggthtagtg thctthgaaga cthaaathata thfacatatt tgaathatga ththccagtha 387780
 atthaccatt aagaaathatt aagctthctct thatactthgc thgaaaththt gthththattth 387840
 ththagthatt ththcatgtha attagaaaca ggaaththtt acatgacaaat cccagththt 387900
 thctthccacc thctththcc tacgthccct thctthaaac cththththgc acacaththt 387960
 cctgctthcc ctggatggth gggctthcca tagthgtgtha taagacctth thgtatctth 388020
 thggataggg ctaggctct caccgtgthg thcatggctga gggagthatt tacatggaat 388080
 gggctthccaa agthccacacc ththgthaagg athaaathctg ggcctthctaca ggagthccca 388140

 thagththctg aggththctc agagaaacc athathctgg agthctggatc agaccatgc 388200
 thgtatthcca gctatcagac thggggagcaa gaththctgt aththcagth cagctgththg 388260
 thththccca gcctthgctg gacctgthg ctththctg ggcctthctc gcatctgggt 388320
 thcaaththcag atcggtgatt agththagth gthctgthct actthccaca gctgctggat 388380
 gaaggcaaac aagthcagtha tcaathctcat aathcagggga gggaaathth gcctthctc 388440
 cathgctgag atththtagct gatthctatct ththgathct cagacathth cctagthacc 388500

tgatttctct gtaaaccaaa aatgctctcc tctattatga tatctccatt cttttttttt 388560

 aaattttttt tattagtcca agttagggaa caagtttgtt tcacatctaa ggccttctc 388620
 cctctecctc ceetacccc tateectctt ctcccacct aacctacccc ccaaccatc 388680
 caccgaccac tccccaggca gggtaggacc ctcaacaggg gctctgcaaa gtgcacaaa 388740
 tcttctgtg ctgggctgg gcccttcccc atgtgtccag ggccagagtg tatcccttca 388800
 ctgggatgg gctctaacag tcccttctta taccacggaa aaatgctaata cacttccag 388860
 aggctccctg gagtgcagag gcctccttat ccatgttcag ggggctggat cagtcttga 388920
 ctggcctcca agatagcatc tggggtctat gtgctcttcc ttgtccaggc caactgttc 388980

 tgtgggttcc tccaacatgg tacagacccc ttcgatcttc attcatecct ctcttccact 389040
 aaattctaaa ttcagctca gtgtatttct gtggatgtct gtctctgctt ccatcagcca 389100
 ctggatgagg gctctaggat ggcataaaga gtagtcatca gtctcatttt aggggaaggg 389160
 cttttaggtt atctctctct ccattgcctg gattgtcaga tcgtgtcatc cttgtaggtc 389220
 tctggtgatc tacctagttc cagatctctt ttcggacctt tattggttcc ctctaataatg 389280
 gtatcactaa tectgtctc tctctctat tcttccccta actcaatatt tetgttcenn 389340
 nnnnnnnnnn nnnnnnnnnn nnnnnnnnnn nnnnnnnnnn nnnnnnnnnn nnnnnttcag 389400

 gagttcatgc cacttccatt cctggggacc atttatecct tagagtcctt catgttctct 389460
 agtttctttg gtgaagagga ttataggctg gtaatacttt gccctatgtc taaaattcat 389520
 atatgagtga gtacatagca tgtttgtctt tttgtgact gggttacctc actgaggatg 389580
 gtttcttcta gtctatcca ctttctgctg aatttcaaga ttccattgct ttttttctg 389640
 agtagtactc cattgtataa atgtaccaca ttttctctat ccattcttca gttgagggnn 389700
 nnnnnnnnnn nnnnnnnnnn nnnnnnnnnn nnnnnnnnnn nnnnnnnnnn nnnnnnnnnn 389760
 nnnnnnnnnn nnnnnnnnnn nnnnnnnnnn nnnnnnnnnn nnnnnnnnnn nnnnnnnnnn 389820

 nnnnnnnnnn nnnnnnnnnn nnnnnnnnnn nnnnnnnnnn nnnnnnnnnn nnnnnnnnnn 389880
 nnnnnnnnnn nnnnnnnnnn nnnnnnnnnn nnnnnnnnnn nnnnnnnnnn nnnnnnnnnn 389940
 nnnnnnnnnn nnnnnnnnnn nnnnnnnnnn nnnnnnnnnn nnnnnnnnnn nnnnnnnnnn 390000
 nnnnnnnnnn nnnnnnnnnn nnnnnnnnnn nnnnnnnnnn nnnnnnnnnn nnnnnnnnnn 390060
 nnnnnnnnnn nnnnnnnnnn nnnnnnnnnn nnnnnnnnnn nnnnnnnnnn nnnnnnnnnn 390120
 nnnnnnnnnn nnnnnnnnnn nnnnnnnnnn nnnnnnnnnn nnnnnnnnnn nnnnnnnnnn 390180
 nnnnnnnnnn nnnnnnnnnn nnnnnnnnnn nnnnnnnnnn nnnnnnnnnn nnnnnnnnnn 390240

nnnnnnnnnnnn nnnnnnnnnnnn nnnnnnnnnnnn nnnnnnnnnnnn nnnnnnnnnnnn nnnnnnnnnnnn 390300
 nnnnnnnnnnnn nnnnnnnnnnnn nnnnnnnnnnnn nnnnnnnnnnnn nnnnnnnnnnnn nnnnnnnnnnnn 390360
 nnnnnnnnnnnn nnnnnnnnnnnn nnnnnnnnnnnn nnnnnnnnnnnn nnnnnnnnnnnn nnnnnnnnnnnn 390420
 nnnnnnnnnnnn nnnnnnnnnnnn nnnnnnnnnnnn nnnnnnnnnnnn nnnnnnnnnnnn nnnnnnnnnnnn 390480
 nnnnnnnnnnnn nnnnnnnnnnnn nnnnnnnnnnnn nnnnnnnnnnnn nnnnnnnnnnnn nnnnnnnnnnnn 390540
 nnnnnnnnnnnn nnnnnnnnnnnn nnnnnnnnnnnn nnnnnnnnnnnn nnnnnnnnnnnn nnnnnnnnnnnn 390600
 nnnnnnnnnnnn nnnnnnnnnnnn nnnnnnnnnnnn nnnnnnnnnnnn nnnnnnnnnnnn nnnnnnnnnnnn 390660

 nnnnnnnnnnnn nnnnnnnnnnnn nnnnnnnnnnnn nnnnnnnnnnnn nnnnnnnnnnnn nnnnnnnnnnnn 390720
 nnnnnnnnnnnn nnnnnnnnnnnn nnnnnnnnnnnn nnnnnnnnnnnn nnnnnnnnnnnn nnnnnnnnnnnn 390780
 nnnnnnnnnnnn nnnnnnnnnnnn nnnnnnnnnnnn nnnnnnnnnnnn nnnnnnnnnnnn nnnnnnnnnnnn 390840
 nnnnnnnnnnnn nnnnnnnnnnnn nnnnnnnnnnnn nnnnnnnnnnnn nnnnnnnnnnnn nnnnnnnnnnnn 390900
 nnnnnnnnnnnn nnnnnnnnnnnn nnnnnnnnnnnn nnnnnnnnnnnn nnnnnnnnnnnn nnnnnnnnnnnn 390960
 nnnnnnnnnnnn nnnnnnnnnnnn nnnnnnnnnnnn nnnnnnnnnnnn nnnnnnnnnnnn nnnnnnnnnnnn 391020
 nnnnnnnnnnnn nnnnnnnnnnnn nnnnnnnnnnnn nnnnnnnnnnnn nnnnnnnnnnnn nnnnnnnnnnnn 391080

 nnnnnnnnnnnn nnnnnnnnnnnn nnnnnnnnnnnn nnnnnnnnnnnn nnnnnnnnnnnn nnnnnnnnnnnn 391140
 nnnnnnnnnnnn nnnnnnnnnnnn nnnnnnnnnnnn nnnnnnnnnnnn nnnnnnnnnnnn nnnnnnnnnnnn 391200
 nnnnnnnnnnnn nnnnnnnnnnnn nnnnnnnnnnnn nnnnnnnnnnnn nnnnnnnnnnnn nnnnnnnnnnnn 391260
 nnnnnnnnnnnn nnnnnnnnnnnn nnnnnnnnnnnn nnnnnnnnnnnn nnnnnnnnnnnn nnnnnnnnnnnn 391320
 nnnnnnnnnnnn nnnnnnnnnnnn nnnnnnnnnnnn nnnnnnnnnnnn nnnnnnnnnnnn nnnnnnnnnnnn 391380
 nnnnnnnnnnnn nnnnnnnnnnnn nnnnnnnnnnnn nnnnnnnnnnnn nnnnnnnnnnnn nnnnnnnnnnnn 391440
 nnnnnnnnnnnn nnnnnnnnnnnn nnnnnnnnnnnn nnnnnnnnnnnn nnnnnnnnnnnn nnnnnnnnnnnn 391500

 nnnnnnnnnnnn nnnnnnnnnnnn nnnnnnnnnnnn nnnnnnnnnnnn nnnnnnnnnnnn nnnnnnnnnnnn 391560
 nnnnnnnnnnnn nnnnnnnnnnnn nnnnnnnnnnnn nnnnnnnnnnnn nnnnnnnnnnnn nnnnnnnnnnnn 391620
 nnnnnnnnnnnn nnnnnnnnnnnn nnnnnnnnnnnn nnnnnnnnnnnn nnnnnnnnnnnn nnnnnnnnnnnn 391680
 nnnnnnnntgc ttaagggtgtt tagcagccttt aggagttccc tggtagagtt tttcatgtca 391740
 ctattgtaga ctatcatgtc atctacaaat agtgaaagtt tgacttcctc 391790

 <210> 35
 <211> 299915
 <212> DNA
 <213> *Cricetulus griseus*
 <220><221> modified_base
 <222> (13250)..(13534)

<223> a, c, t, g, unknown or other

<220><221> modified_base

<222> (13911)..(14388)

<223> a, c, t, g, unknown or other

<220><221> modified_base

<222> (14737)..(14802)

<223> a, c, t, g, unknown or other

<220><221> modified_base

<222> (15246)..(15845)

<223> a, c, t, g, unknown or other

<220><221> modified_base

<222> (16787)..(17421)

<223> a, c, t, g, unknown or other

<220><221> modified_base

<222> (18086)..(18095)

<223> a, c, t, g, unknown or other

<220><221> modified_base

<222> (21804)..(21813)

<223> a, c, t, g, unknown or other

<220><221> modified_base

<222> (26981)..(28006)

<223> a, c, t, g, unknown or other

<220><221> modified_base

<222> (28248)..(28369)

<223> a, c, t, g, unknown or other

<220><221> modified_base

<222> (31491)..(31713)

<223> a, c, t, g, unknown or other

<220><221> modified_base

<222> (56827)..(57662)

<223> a, c, t, g, unknown or other

<220><221> modified_base

<222> (57859)..(59029)

<223> a, c, t, g, unknown or other
<220><221> modified_base
<222> (151817)..(151913)
<223> a, c, t, g, unknown or other

<220><221> modified_base
<222> (152822)..(152840)
<223> a, c, t, g, unknown or other
<220><221> modified_base
<222> (157086)..(157160)
<223> a, c, t, g, unknown or other
<220><221> modified_base
<222> (157291)..(157378)
<223> a, c, t, g, unknown or other
<220><221> modified_base
<222> (161790)..(161817)
<223> a, c, t, g, unknown or other
<220><221> modified_base
<222> (175685)..(175697)
<223> a, c, t, g, unknown or other
<220><221> modified_base
<222> (199034)..(200558)
<223>
> a, c, t, g, unknown or other
<220><221> modified_base
<222> (219251)..(220607)
<223> a, c, t, g, unknown or other
<220><221> modified_base
<222> (228162)..(228171)
<223> a, c, t, g, unknown or other
<220><221> modified_base
<222> (228773)..(229720)
<223> a, c, t, g, unknown or other
<220><221> modified_base
<222> (243173)..(243327)

<223> a, c, t, g, unknown or other

<220><221> modified_base

<222> (288565)..(288820)

<223> a, c, t, g, unknown or other

<220><221> modified_base

<222> (289272)..(289303)

<223> a, c, t, g, unknown or other

<220><221> modified_base

<222> (289625)..(290055)

<223> a, c, t, g, unknown or other

<220><221> modified_base

<222> (290441)..(290553)

<223> a, c, t, g, unknown or other

<220><221> modified_base

<222> (290691)..(290700)

<223> a, c, t, g, unknown or other

<220><221> modified_base

<222> (290963)..(291039)

<223> a, c, t, g, unknown or other

<220><221> modified_base

<222> (291549)..(291611)

<223> a, c, t, g, unknown or other

<220><221> modified_base

<222> (292019)..(292222)

<223> a, c, t, g, unknown or other

<400> 35

cggatcatcag gaaccatgga acctgcaatc tacagccaca ctgccctgga tgcaccaat	60
ctcatttgat ctcagaagtt aagcggagtc aggcctgggt agcccttgga tgagaaaatt	120
ctcttttttc tgattgaaaa cataaatttt actgatggac ctccatcctt cctaaagcac	180
tggcattgca tctgcagaat agggctctgc aatccactga cagcttgga ttagcaattc	240
tttattgtgg tacttgetat aagcactgaa gaatgtctat cagtgttcag gettcggtat	300
ccacaggcca atagccctgt ccaggtagcc ttaagcaagt tacctgaatt cccagagtct	360

cagttttctg ataatacaat attcatcccc tggatgactg tggagattta aaaataagat 420
 ataaaaatcg attagcatag tgtcaccagg tagtatgcac agaatccatc ttagctgctt 480
 ttcatTTGGG tttgagtagt atacattaca gaattgagct aaaatatttt catgtctttc 540
 ttggccagtt tcccaaatca gagtctcttt tcaaatttca tttaaagtaa aacacaaatt 600
 cagtggcatt ttatagctat cctagcaata tttattccta aaataagaaa aaccaggaag 660
 gatgaccag agaagagaga ttgatactgt aatgagtatt gttccatttt agtgataat 720
 accctactct tgcaccaat ctcatTTGat ctCagaagt aagtggagcc aggcctggtt 780

 agcccttGga tgagaaaatt ctcttctttc tgattgaaga cataaatttt actgatggac 840
 ctccatcctt cctaaagcac tggcattgca tctgcagaat agggctctgc aatccactga 900
 cagcttggga ttagcaattc tttattgtgg tacttgctat aagcactgaa gaatgtctat 960
 cagtgttcag gcttcgggat ccacaggcca atagccctgt ccaggtagcc ttaagcaagt 1020
 tacctgaatt cccagagtct cagttttctg ataatacaat attcatcccc tggatgactg 1080
 tggagattta aaaataagat ataaaaatcg attagcatag tgtcaccagg tagtgcac 1140
 agaatccatc ttagctgctt ttcatTTGGG tttgagtagt atacattaca gaattgagct 1200

 aaaatatttt catgtctttc ttggccagtt tcccaaatca gagtctcttt tcaaatttca 1260
 tttaaagtaa aacacaaatt cagtggcatt ttatagctat cctagcaata tttattccta 1320
 aaataagaaa aaccaggaag gatgaccag agaagagaga ttgatactgt aatgagtatt 1380
 gttccatttt agtgataat accctactca agattgaaa gatgggacag cagtctaagt 1440
 aatgaagaa gactgacagt tttcctaaaa tgatttgtgt gggggcttgc acacatgtgt 1500
 gactactcat gaatgcagg gtggaaagt gaggtcagt ttggatgcct gtagggagag 1560
 accctacac acctgtggcg ctgaccacac ctgtttgggt gtggccacag gtatgtaagg 1620

 ggcatgtggg ataaagtta gaaaagagg ggcacttgc tctctactg gttctggtea 1680
 ggtttggaga gcigttagt caaacctggg tcttcggatc ctacgtaag tgacttacc 1740
 ttagtaaat aaccatctat atccgtattc cgtgtatgt tattttctc tacaggtgcc 1800
 tacctttttt ctctccact tactttatta aaaatgcttt ttattgaaat aaaataacat 1860
 tttcccactc ttttctcc ctctgccct tccagttat tctctctta gcctctcca 1920
 tatccccca cgtcaagca gatagtctct ctttgattat gttgttaca tgtacacaca 1980
 cacacacaca cacacacaca cacacacaca ctgattcagg tagactggat ggctagtgat 2040

 cccagggate ctctgtctc tggatccctg gaattgcaag cgcaaactgc catgcctggc 2100
 tttttacatg ggtgttggag ataaaaacc aggtccttgc ttgtaagca aactaacc 2160
 cactgaggcc ctaaaatgaa cctgtacaga ccattctct tagacagaat cttaaaagaa 2220

tactgtactt cttttgcatt caataacaaa gaatatcaga actctgtagt ttaaagtga 2280
 tacctaaaat tttagtgtt ctaaaagata gtgtattctg aggccagtgg taaggctcag 2340
 cagttaagga cacatggagc aaggtttgag tctcatcccc cacatggtag ctcataatta 2400
 tctagaactc cagctccagg aaatctgaaa ccctcttcaa gtctccagtg tgcacagat 2460

acatacatgg tacacacaca tacatccagg caaaacactt atgcatacag aaataaatat 2520
 attttaaaag tgtattccta aagctttcgt tgggctaaac caaggacaag ttgttgcctt 2580
 taaagagtga atctctgagt gtttgtgctt ttgagtagat caggttttct ctcttccttc 2640
 ttcatcatct ctcatcccc acacaaaacc tggagtcaact gaggttgtga gttatTTTT 2700
 ttctcttaag gtatatcaac acacaaagga gaaatgccca actagagtaa ataatttgat 2760
 agactgtctt ggataaaata ttaattttca gtacctgata aatgaatgat ggcagtggtt 2820
 tataatgtga ttggagcatt acttagataa aagaataaag aagggtatgt aagtctctgg 2880

tgatgataaa tggcagccta tcaacttaga agaatccatc caggaacaca acaaaaagat 2940
 cagtattaag tcacagcata gggcttagca agaactgaac gtttgtttct ttcagtttgt 3000
 attaaaattg taagcctcaa gatgaccaca tcatctttgg gaggtaataa agttccagtt 3060
 tatgccactg tgggattagt gccccaaac tgaggccca cagggttctt tcaccactgc 3120
 catcatatga ggctacagtg agagaaagt attaaggaaa taggtccata gataccaagt 3180
 ctattggcac ctcaaccttt ggtttccagg ctctgcaac tgtgagaagt aaatttctgg 3240
 gttttttggt tgtttatttg gttgattggt ttggtctttt ttttcttgt tgttgttgg 3300

agttgatggt gatggtggtg gtggtactag gaactattga acgtaagacc tgcacttca 3360
 agacaagcta taigtctagc ccatatTTTT gctggTTTT tagaggtagt ttgaagtatt 3420
 ttgtcatcat gaatagagca agaaatgatc ttaacaatac atattgcaa tgtcatcatt 3480
 ctaaactt atgcttattc ccacagagaa acttattttg gagaggtcaa agaccattac 3540
 agagatccac attagtcata atgctaagat caaatgacaa tgggtttccc attcccagct 3600
 cacacatgta tggatcaagg acatatatat aaaaggggac aaaggattgt catagccaaa 3660
 gccctcagac acttatttg agataattc ctctataaaa agaaagagga catgaaatga 3720

ggtggacata gaggacggag tagatctgga aagaggtagg gactgaatgt gatcaaata 3780
 tgttgtgtga aattctcaaa aactgataaa atattatatt atttaaaact ttaagagaca 3840
 ttgactggct aggtactagg aacagaagaa cagataagga tatggagtaa atgggtttgt 3900
 gaaaaatagc aatattaaga aataaagaat gtcaaaacgg gaagatgaag tctaataat 3960
 ttggaataa gttcattttc aaaccctat atttaattcc atccattaa taattcagca 4020
 cagctgggaa aagcatttgg atgagagtag tacttaaga gatttaata tgatcatgat 4080

gaagcAAAA aaaaggtaga tatgagtttg ccaagtgaac ctggaaatat tgctaagtgc 4140

atctgggcca cagattctgc cagccatgga catggagata agttatttaa acttgctttt 4200

tctttgttct acggtatctg ttccttgcac gaaaatetta gtcaaaaact tgaagtatat 4260

tatatcagtg acigtatgg ccaatcttca ttgttagctt ggccagtttg agaatcatat 4320

agcagacatg tctttgtgac tgtgtgggtg tttctagagg cagaataatt aaggagaaag 4380

aaggaatcta gctttctgac agcattcacc tctctgttcc tgactgaggg tgcaatgtag 4440

ccagccaact catgcttatg tcaatatgcc ttcctcttc ttaaccagg agccaaatta 4500

aacctgcatt gccagagtt gctttttgtt ggtattttgt tagagaaaag ataagaaagg 4560

caattaatac agiacctaag caaagcatat tatatatgca gtgaataatg aatacaaaat 4620

tgaaagtgtc cctttaaacc ttgtccagat gctatgtctt ccctcttctt aaaccaggag 4680

ccaaatataa ccagcattgc ccagagttgc ttttggttgg gtattttgtt agagaaaaga 4740

taagaaaggc aattaataca gtatctatgc aaagcatatt atatatgcaa tgaataatga 4800

atacaaaatt gaaagtgtcc cttttaaact tgtccagatg tggcgattga ctgaggaaag 4860

agtgccttct ggacactgca gagcagctgc acatgtgaac tcacagaaat tgtaacagca 4920

caccacagcc tigtgaaagc caggacatat cccaacaggg agaggggagt tgtcatgaag 4980

ttccacacct gaaattgct attggcagtt gttaagtact gggagagtga gagtaaattt 5040

ctttagtgtg caatcctcga tagactgacc aactccaat gggcagtaca cactgaactt 5100

agtattgttt tttttgtt ttgttttctt tttttttaa gagggcaca agccaaacca 5160

gtggacagag ggagtagatc taaggagga taggatagag acgaatacgc taaaaatgaa 5220

tgaaattctt aaagaatag ttataaact gtattaatcc aagtctctta gagtaacaga 5280

acttatagaa agaatafata gatatagata tatagaaaga gaaaaggat ttattagaat 5340

gactaacagg ctgtaatcca gctaaactaa caatttctag ctatgaaat agaaggttca 5400

glaatccagt agttgctcag tccatgaggc tgggtgtctc cgctggtctt cagtatatgc 5460

tggaatcttg aagacatagg ttctcatgac gttgagggaa tggacttgct agtgagggca 5520

agagcaagca gtatgctgga atcttgtgaa cgtaggttct catggcgttg agggaatgga 5580

cttgctagtg agggcaagag caagcaggca aagagtgagg ctttcttctt ccatgcactt 5640

tatataggtt gccagcagaa ggtgggatcc agattaaatg tgcgttttcc taccaaaaa 5700

gatctcgtt aaaggtgtac cttcacacct caaggtttca gattagaaaa ggatcttctt 5760

acttcaagtg actttaaataa gcaaagtcc ctctaggtg tgcttagccc ttttgggatt 5820

ttagttaatt ccagacatag acaaactgac agcaaactag ccctcacaaa tattaacaca 5880
 ttaatattgc atgttatcta taaatttaa tatatatgaa cttatcaatt caggtaaag 5940
 tattgtgta ggcacagcaa tggcaaaaat caatagtaat ggaagcatga tgaatgagtt 6000
 cttaccatt cagagatcaa atttgagtta acaaacagg tatttcata aaatggtttg 6060
 aatttatgta gcaagtaagt ttaacattct tcagggacaa aagaatggg ggcagtcagt 6120
 aattgtaggg aatattaag ggaaagaact tacagaaagt ctttaataa aaacatagac 6180
 agataaagga cacttagaag gtagattgag actttaagg agattgaggg aacagatagc 6240

 tgagaagtgg gtaggccaca cacacacaga gttcaggatg aagggcagat ggaggtcagc 6300
 ccagacaagg gaaagacaat gacaactgga gagacaatct ctacagacaaa tagcagaaag 6360
 aatgttctca tgggaaatac cagaacagct cttaaaataa gaacaccata atttcatag 6420
 tcaaaaaggg tttgacttg gaaaaaatta ttgatttaca ctgtacttct gtactttatt 6480
 ataaagccca atctataac ttcagcaata gcagatgata aagcagctta atacagagaa 6540
 acagtagaga gtagaggaga aacatgggtt taggacaagg ggtgggtgga tactacctct 6600
 gggcaactag atttcagag ccagtgtttg tgccttctaa aaatagagaa tgcttggaat 6660

 tatattccta aaggatatat ctccatcaaa tcctccac tagcgatcag aaaaccaca 6720
 gaagaggatg cagaaagagt aaaagccaga ggggtggag gacaccaagg aaacagggtc 6780
 ggaaatcaat ggggtctatg cacataggca ctacagaga ctgacgcagc atgcacagga 6840
 cctacacagg tctgcaccgg atgggttct agagctttaa ggaggaatgg acacatgcac 6900
 ccatcctta cccaaaagct ataacagttc cttttcata atgcatgtc agagttttt 6960
 tttatcttc tccctctt ttaaatttt accttttaa atttaacct tctttctgt 7020
 ttttactct acaggccctt tgcataatt gttgatatt atggctcca gttttgcatt 7080

 tttatgggat tectgagtgt atgaattagt gggctctctgc atctgattt gtttctatg 7140
 cctttcttg ggctctttc cttctgtttg ttgatccta ttcaattgta tttgttttg 7200
 ttttatatta ctatattta ttttagagag aaaaattctt gaaacaggtt atgtagtaat 7260
 gcagttata aggttttga tatagtatta ttaatagat aagtgttcaa tgactagtat 7320
 ttgtttact gtgtataac ttttctaac cacttgatgt tggcattaac taggaaaaa 7380
 ttaacatcat agaattatt gtgaatttct ctcatctcc aatgcttgg gttttcttc 7440
 aagaatgaaa tgatcactaa cattcatta ctatgttagt ttaagaaaca ttgaattga 7500

 taccatgga tctaaaaaa attttgccct ttgagaaaa gttttattac tcttttatt 7560
 ttttacatta taatataatg acattgtttc aagctgggtg ttggtgtcac acgcctttaa 7620
 tcccagcact cgggaggcag aggcaggcag aactctgtga gccaggatag gctccaaagc 7680

tacacaaaga aaccctgtct cgaaaaacca aaaaaaaaaa aaacaaaaca aaacaaaaca 7740
 aaaaaaccac aagacattgt ttccccattt ctttccccc atccaagccc tccaatataa 7800
 ctctccttgc tttctttcaa ttcattggcct cttttttaat aatttctgtt acatgaattt 7860
 atagatgtat gtgtatatta gtaccctgct cagtctgtat aatgttacta giatgcatat 7920

tttcagggtt gactatttgg tattggataa ccagttggtg tactcttcct agggtaatat 7980
 tatttctcct gcctcaccac ttgcttagtt gcctgtagtt cttgggtgtag ggctgaggcc 8040
 ttgtggattt tctcctatcc actggcatgt ctattgttgt cgtccttgtt tagctcatgt 8100
 tttggagcca tgttggtag gctttatggg tgttgtttg acattactag gagacaactc 8160
 tgaatcctct tactcttata atctttatat ctactccttt acgatgttcc ctgaacctta 8220
 gtgtcaggaa tgttttatag atatatctgt tgggactgtg gctccacaat tctgtatfff 8280
 gattgggtgt ggttttctgt aatggtttcc atttattatg aagagaagt tctttaatgt 8340

gggaatgagg actatactta tctgtgggta tgaagacaaa tatttagaac atagttaagg 8400
 tgttatgctg gtttggagaa attgatggtt gtaggttctt ctccaagatc catgtcttca 8460
 ttggccctag gcatatactt ctctgatact cagatatgat caatcatttt gtccatgtea 8520
 ctgtgatfff ctcacttga ggtaaatgta gcttgacata ttgattatff atcttggct 8580
 atgggatgag attttgcct tattgatcta actgtttagg gatgtttgtt tatatagatg 8640
 tcatatgatg ctcagaaaag gttatggttc aaagcaagat gcaacccac taaattatgc 8700
 actactatgt tttgcacatc caataggaaa ggagctgggg ctctgggtct gccttaggaa 8760

gggcttccct cctacctgt gcaggggtat tgagtctgt tgaaaaacct ggctctgtcc 8820
 aactaaagta actctcctta agaatatttg ctgtatcttt aacttaatff tttgagtcta 8880
 taattfacat gtcatact gatttgtfff aagattacaa ttgaacagtt tcttcaagtt 8940
 tactaaattg taccatcacc aacacaatct gtcttgggg taccgtctgtc atctcaataa 9000
 gactcctcgt gtcattttat ggttagttct cgttccatt cactaacttg tgcaacaact 9060
 gtctacttca tgtccccaga gatttgcct ttatatgcgt tttgtataaa tgggaatgca 9120
 tattaataat gtatccttta tgtctagctt cttttgtat tctttggtag tttcatatat 9180

tcatagaaca tttgtagatc acaccatcc tccactctcc tctacctct tcaagcccca 9240
 taactgtctc agttagtagc ttttgataat cactcatgct ggtcatgcct cagcatgttg 9300
 ttgacaagtt gtactcatta cttatacatg tgggtggctt tctggatact atgaatagt 9360
 tatcaattc ttttaggat atatatfff atttctttg aatgaagaca tggagtggaa 9420
 ttgttagtc atattgaaac tctagttfff gttgtttgtg ttttgggtg tatatgtgtg 9480
 tgtgtttgtg tttgagaaaag ggtttctctg ttagccctg gctgtcctga aactcactct 9540

gcagattagg ctgacctggg aactcaaaga tatctgcta agtctgactc ccaagcgctg 9600

ggattaaagg catacactac cactgcacat ctgtaactct agttttaaca tcttaagaaa 9660

ctggaaaact gttttcaaag tggctttagt attttgtatt ctgattacta tatgagggct 9720

ctgattgtcc catctttgtc aacatatttt actgtatttc ttagagttaa agctttttgt 9780

aacagaacaa aatgatatat gatttctttg ttttagtttg catcttgcta ttgacaaatg 9840

ttaaattttt aaaattattt tttttacttt attgtgtgta tgtgcatgtg tgtacatcaa 9900

atgaaaactt gtgtgagttg attctcttct tcatcatatg tctcctacaa cccatctcac 9960

tggctctgatg atgttaaata tcttttcttg tagtttttag cgaaaggttt tcattgttct 10020

tggatgaaca ttctcaatt ttttgcccaa ttttaaattg ggtatttata cttcatcatt 10080

gtgttgtaaa gcttgtttat attttctttg tagaaaatat tttatcgggt aaattaaatt 10140

atgtgtaaat attttatcct actctgtaag ttgtcttaaa ctttgttgat catacctcat 10200

gaagtataaa agtttttgat ttgatgaat tctaatttcc attttattgt tcatgatatt 10260

tgatattgta tcagaaatct ttgcttgact tcaaactctc aatttttatt atgtagggtg 10320

gcttgatta tgtgtgtgtg tgtgcttgtg gtatacctgc atgtgggtag agtccagaga 10380

ataatggagt gtcatgttct agaaaccatc caccttgggt ttttgctcgt tttgttttgt 10440

ttttgagaca gggctctcgca ttgacttga gctcattcat taggtaaaac tggctaacca 10500

atgaatacca agtgttttcc tgttactaca ccaccataaa aagtgttcac tacatggatt 10560

ctggctatca agttcagatt tttatatttg cacgcaaata cttttttgac tgagaaatct 10620

atattctttt tglattattt tttatttatt tcacataage aaccacaagt tcccctccct 10680

cttctctctt cattccctta ttccacctcc tttctatgcc taccatcaa cctcagaaa 10740

gggtaaggcc tcccatggga atcaacaaag agttgattcc atalcagcac tgggctgagc 10800

tcctctttct cttcagcttg actcctgeat ctccagccag tgcctggctg tggatctctg 10860

catctgcttc catcagatga aggttctgtg ataactatta gggtagtcac caatctgagt 10920

acaggagaag gccagttcag gtacctctc cactattgct aggaatttta gctggggtta 10980

tccttggtga ttctatgag tttccctggc accaggtttc tccctaacce caactctgcc 11040

attccaatgc ctcaagttcc catctccat tccacctt tacccecaa ccccaccaat 11100

tcccagttta tccagatat atcatctgtt tccccttccc agagtgatec atgcatcct 11160

cttagggctc tacttgttac ctacttctt tgggactgga gattgtagcc tggttatctt 11220

ttgctttaat ataatatgca cttatgagtg agtacatacc gtgtttgtct ttctggggct 11280

acatttacct gactcaggat gatttttctc cagttccatc tatttgtctt tgaagagaaa 11340
tctatagtct tagttcatac atttagctct gtcgtctggt tgggattata ttttaataa 11400
ggatggat gagtctatgt tctctcatag tttaggatat acagatgtct tagtgcatt 11460
tgtcaatgag gtggttatca accccattca attgccctga ctctgtggt gattgccaac 11520
tgatctgaaa cattaagagt ttatttcaag atctcaatcc tgttctgatg agttctatgt 11580
ccatctctgt gccattgcta cactgcttta gtaagatttc agagttagat gaagcttaa 11640
ttaagagact agaagtcagt gctggattia ctttgcattt tgaaacttca gaaaatacat 11700

cagttaataa ataactaat acaagaggat aggaaattac ttacaaaaa tcctaaagta 11760
gagagaagtg aagcagataa tattacataa cctctacatt gctggctctt aatattgtca 11820
ctcaaagctt gccacaatg aagaaaagaa taggaagatg tccataaaat aagtttaata 11880
aaattgtact aaattcctta ggtatacaca actacttttg tctcttgcac tttaggggat 11940
ttttctgtg ctcatgaaac tggggataaa tattataaaa aacaacaccc ttctttgaat 12000
ttttgctggt aatgaacat ttacattgca aattttctt gacatatact gtattaaat 12060
ctttatagat ctcaacaaa agatatttgc cccaaatttg gctgaacttg atgtagatgt 12120

tttactacta gccattgtct cataaatttt atttttttaa aactgatct aatgagctgg 12180
gtgccaaaaa tggcatttcc cttctggtat gagcatgctt tctagctatg acaagtaggc 12240
tggactcacc aaatctcatc agcatggctg actaacccct ggttggttat ccaatgctaa 12300
gtggtcagct ctggcaacat acctcttcat tgaagagcag actcagcagg ctgtattcca 12360
tgtttgttcc tttatagaaa tatgtaacag caatggttaa agaagagtg tcatggattt 12420
gggatgagct gggaatgcag acaggaaggt atgtaaggaa agaaaggag aggggaaaat 12480
gatataatta tatttttaat taaataaaaa caatttaaag tacagtgaca ctatgacctg 12540

aattaaaata aaaatttcta ttaataataa actcaagcaa ataagaagct tgataaagtt 12600
gcttacctag ttcagataac taaccctatt ccttactgat agaattaaag aaaacctatt 12660
cttccaagge agtcaaatta taaaaccaga gaggcagccc ggcctccatc cgccggccca 12720
gatagccag gagctgtttc tggctcctgt tcatcatcgc tgctcagtca tetgacacaa 12780
gagacctgct gcagcgggtg gatcctacac accaaggccc agtgacagct ctgccccaa 12840
ctgctggccc ggcaggacc ggcacgccag aacctgccg acaccgagt aacagtgaca 12900
ctccattca cgagaagagg accaatatca gagtattgga tctgtttgaa tctaccagaa 12960

gagaaccttt gtcccacacc caccaggaga aaaagaaact cttgctacac ccaacagaag 13020
aaaggatgag aagaggacaa ggtaaaagca cattcaacaa caaaaaactc aatatgacac 13080
ctccagagaa taggatccat acaccagcaa gacctgaaca tcataacaca gttgaaccag 13140

aagaaaaatga ccttaaaaac atcttcagaa aaatgataga ggacctcata gaggacatga 13200
gaaaattcct taaagaaatg gaagaaaaaa caaaccaaaa aaatacaagn nnnnnnnnnn 13260
nnnnnnnnnn nnnnnnnnnn nnnnnnnnnn nnnnnnnnnn nnnnnnnnnn nnnnnnnnnn 13320
nnnnnnnnnn nnnnnnnnnn nnnnnnnnnn nnnnnnnnnn nnnnnnnnnn nnnnnnnnnn 13380

nnnnnnnnnn nnnnnnnnnn nnnnnnnnnn nnnnnnnnnn nnnnnnnnnn nnnnnnnnnn 13440
nnnnnnnnnn nnnnnnnnnn nnnnnnnnnn nnnnnnnnnn nnnnnnnnnn nnnnnnnnnn 13500
nnnnnnnnnn nnnnnnnnnn nnnnnnnnnn nnnnaacaa aaccaaaaa aaaaccttc 13560
ccaacaaaa gaaagacatg ccaatgaaaa tacaagaagc ctacagaaca ccaattagaa 13620
tgacceaaaa taaaacgtca cctctccaca taataatcaa aacaccaaac atacacaaca 13680
aagagaaaat attaagagca gcagaggaaa aaggtcaagt aaactataaa gccaaatcta 13740
tcagaatgat acctgacttt tccttgaaa ctctgaaagc cagaaggtcc tggatagata 13800

ttctgcctac actaagagac catggatgcc agcccagact actatatcca gcaaagtfff 13860
caatcattat agatggagaa aacaagatat tcataacaa aaccagattc nnnnnnnnnn 13920
nnnnnnnnnn nnnnnnnnnn nnnnnnnnnn nnnnnnnnnn nnnnnnnnnn nnnnnnnnnn 13980
nnnnnnnnnn nnnnnnnnnn nnnnnnnnnn nnnnnnnnnn nnnnnnnnnn nnnnnnnnnn 14040
nnnnnnnnnn nnnnnnnnnn nnnnnnnnnn nnnnnnnnnn nnnnnnnnnn nnnnnnnnnn 14100
nnnnnnnnnn nnnnnnnnnn nnnnnnnnnn nnnnnnnnnn nnnnnnnnnn nnnnnnnnnn 14160
nnnnnnnnnn nnnnnnnnnn nnnnnnnnnn nnnnnnnnnn nnnnnnnnnn nnnnnnnnnn 14220

nnnnnnnnnn nnnnnnnnnn nnnnnnnnnn nnnnnnnnnn nnnnnnnnnn nnnnnnnnnn 14280
nnnnnnnnnn nnnnnnnnnn nnnnnnnnnn nnnnnnnnnn nnnnnnnnnn nnnnnnnnnn 14340
nnnnnnnnnn nnnnnnnnnn nnnnnnnnnn nnnnnnnnnn nnnnnnnnat tctcctgtgg 14400
tggctttatc agaccacat gctttaaaat tagagttcaa caacaacatg aaccacagaa 14460
aacctacaaa ccatcaggat gaagtctcaa tctgaacat ttatgccca aatacaaagg 14520
catccacgtt tgtaaaagaa acattactaa aactcaaatc acacataaaa ccacacacac 14580
ttatagtggg agatttcaac acccactct caccactgga caggaacacc agacagaaac 14640

ttaacaaaga aacaaaagaa ctaatagaag ttatgtcaca actgtattta atagatatct 14700
atagaacatt ccacccaat acaaaacaat ttacctnnnn nnnnnnnnnn nnnnnnnnnn 14760
nnnnnnnnnn nnnnnnnnnn nnnnnnnnnn nnnnnnnnnn nngaaaccac ccccccccc 14820
gigtcttate agaccacat gctttaaaat tagaattcaa caacaacatg aaccacagaa 14880
aacctacaaa ctcatgaaa ttaagtaaca cccaattgca cagttcatgg gtacaggatg 14940
aaataaaaaa aaagaaatta aagatttctt agaattcaaa tagaatgcgg acacaacata 15000

tccaaaccta tgggatactc tgacagcagt aagaggaaag ttcataagac taaatgccca 15060

catgaagaaa caggagaata atcacactag agttaacagc acaactgaaa gcttttagaaa 15120

acaaagagge caatacacc tggaggagca gatgccagga aataatcaaa ttgagggctg 15180

aatcaataa aatggaaact aggagaacaa tacaagaat caatataaca aaaagttggt 15240

tcttcnnnnn nnnnnnnnnn nnnnnnnnnn nnnnnnnnnn nnnnnnnnnn nnnnnnnnnn 15300

nnnnnnnnnn nnnnnnnnnn nnnnnnnnnn nnnnnnnnnn nnnnnnnnnn nnnnnnnnnn 15360

nnnnnnnnnn nnnnnnnnnn nnnnnnnnnn nnnnnnnnnn nnnnnnnnnn nnnnnnnnnn 15420

nnnnnnnnnn nnnnnnnnnn nnnnnnnnnn nnnnnnnnnn nnnnnnnnnn nnnnnnnnnn 15480

nnnnnnnnnn nnnnnnnnnn nnnnnnnnnn nnnnnnnnnn nnnnnnnnnn nnnnnnnnnn 15540

nnnnnnnnnn nnnnnnnnnn nnnnnnnnnn nnnnnnnnnn nnnnnnnnnn nnnnnnnnnn 15600

nnnnnnnnnn nnnnnnnnnn nnnnnnnnnn nnnnnnnnnn nnnnnnnnnn nnnnnnnnnn 15660

nnnnnnnnnn nnnnnnnnnn nnnnnnnnnn nnnnnnnnnn nnnnnnnnnn nnnnnnnnnn 15720

nnnnnnnnnn nnnnnnnnnn nnnnnnnnnn nnnnnnnnnn nnnnnnnnnn nnnnnnnnnn 15780

nnnnnnnnnn nnnnnnnnnn nnnnnnnnnn nnnnnnnnnn nnnnnnnnnn nnnnnnnnnn 15840

nnnnntcatt gccaaactct tttatgagge ttcaataacc ttggtacca agcaacacag 15900

agacacaact acaaaagaga actacagacc aatatcctc atggacattg atgcaaaaat 15960

actcagtaaa atattggcaa attcaacca agaaccatt agaaaaatca tccacatga 16020

tcaagtaage ttcacctg ggatgcaggg ttggttcaac ttatgaaaat ctatcaatgt 16080

aatccacat ataacaac taaaagaaa accacatcat catctacta gatgctgaaa 16140

gagcatttga aaaaaactaa tacctcttca caataaatgt ccaggagaga tcagggataa 16200

caggaacata cctgaacata ataaaaaca tgtatggcaa accaacagcc aatggtaac 16260

taaatggaga gaaactcaag gcaattctc taaaatcagg ctgtccactc tetccatc 16320

tcttcagtat tgiacttgaa gttttagctg agcaataaga caacaatagg agatcaaggg 16380

gatacacatt agaaaagaag aagaaaaagt ttcactgttg gcagtttaca taagtgacc 16440

aaaaaactct acctgggaac tcctacaact gataaacacc ttcagcaaag tagcaggata 16500

caatattaac tgaacaacat cagtagccct attatgtgca gaagatataat gggctgagaa 16560

agaaatcaga gaaacatcac cctttaaaat agccacaaat gacataaaat atcttgaggt 16620

aatgctaacc aaacaagtga aagacctgta tagaaagaac tttgagtctt taaagaaaga 16680

aattaaaga gatactagaa aacggaaaga tctctgtgcc cttgatagg caggatcaac 16740

atggcaatct tgccaaaagc aatctacaga ttcaatgcaa tccccannnn nnnnnnnnnn 16800
 nnnnnnnnnn nnnnnnnnnn nnnnnnnnnn nnnnnnnnnn nnnnnnnnnn nnnnnnnnnn 16860
 nnnnnnnnnn nnnnnnnnnn nnnnnnnnnn nnnnnnnnnn nnnnnnnnnn nnnnnnnnnn 16920
 nnnnnnnnnn nnnnnnnnnn nnnnnnnnnn nnnnnnnnnn nnnnnnnnnn nnnnnnnnnn 16980
 nnnnnnnnnn nnnnnnnnnn nnnnnnnnnn nnnnnnnnnn nnnnnnnnnn nnnnnnnnnn 17040
 nnnnnnnnnn nnnnnnnnnn nnnnnnnnnn nnnnnnnnnn nnnnnnnnnn nnnnnnnnnn 17100
 nnnnnnnnnn nnnnnnnnnn nnnnnnnnnn nnnnnnnnnn nnnnnnnnnn nnnnnnnnnn 17160

 nnnnnnnnnn nnnnnnnnnn nnnnnnnnnn nnnnnnnnnn nnnnnnnnnn nnnnnnnnnn 17220
 nnnnnnnnnn nnnnnnnnnn nnnnnnnnnn nnnnnnnnnn nnnnnnnnnn nnnnnnnnnn 17280
 nnnnnnnnnn nnnnnnnnnn nnnnnnnnnn nnnnnnnnnn nnnnnnnnnn nnnnnnnnnn 17340
 nnnnnnnnnn nnnnnnnnnn nnnnnnnnnn nnnnnnnnnn nnnnnnnnnn nnnnnnnnnn 17400
 nnnnnnnnnn nnnnnnnnnn nacaagatcc agcaattcca ctctaggca tatacctaa 17460
 agaagcacat tcatacaaca aagacatctg ttcaacgatg ttcatagcag cactatttgt 17520
 aatagccaga aatgaaagca acctagatgc cttcaattg aaaaatagac agagaaaacg 17580

 tgatactttt acacaatggt gtactactca gcagaaaaaa aacaatggaa tcttgaatt 17640
 tgcaggaaaa tggctggaat gggaagaaaa cattctgaga gaggtagata tgtactcact 17700
 catatgtgga ttttagacat agagtaaggg attaccatcc tacagtccac actgccagag 17760
 atactagtaa acaagaaga ccctaaaaga gacaaacttt gttccctgga gaaggggaaa 17820
 gcatcacat tcctgagta aattgtgaac atgggaagag ggggaggaag ctacaagagt 17880
 gcaaagggaa gaaaaggag gatgcagaag tcatgaggaa gcagaaattt tgagttaggt 17940
 gtagattaaa agaaaggaca tatgacaggt aggattttag tttgtttctg tgagtttctc 18000

 caacctggta cagacagacc ctttcgctct tcattcctcc ctctcttcaa ctaaattcca 18060
 gatttcagct cagtgtattt ctgtgnnnn nnnntctgc ttccatcagc cactggatga 18120
 ggactctaga atggcataaa aagtaatcat cagtctcatt ataagggaag ggcatttagg 18180
 ttatctctc caccactgcc tagattgtca gttcgtgtca tccctgtaga tetctggaaa 18240
 tctccctagt gccagatctc tctcagacc tacaatgact ccctctgata tgttatctct 18300
 catectctc tctctatctc ttteccaac tcaataatc tgetctcca tttctctc 18360
 tctctctc tttctctgct ctattctgg cagctcctc tccctactc tectgetccc 18420

 aattagctca ggagtcatg ccatttcca ttctggggg ccatttatcc cttagagtcc 18480
 ttcattttc ctgaaaaact aaattcttat acttagtaaa taatatataa cetaacatac 18540
 cataagtca cagtatgagg agataattat tctaaaatcc tggttatfff tagttaatta 18600

ataccaaatt ttiagttaat taataccaaa attttgcag aaaatataaa tacatcaaga 18660
 atcttaattt cacaatafca atfcattaca gatgtaaaga gtactcattg tgtaaagttg 18720
 cagatfctcc aggcagaaaa aatgtacaa ccttattagg ctgcttaaca aacagatgaa 18780
 ttcacaatta ttiactgca tctacatct gaacatcaag gtcagtgaga ggaagtttta 18840

 gaatgggaaa gactgggttt tctttttgcc aatgagcaat gaagactatt tgtctccagc 18900
 actgagaaag gagnaatatic aaacataga ttaagccagc tcaaatgcta tccaccttt 18960
 taacaaagac aaagaaaata gttctcttct tcagcctggc caaaatgctc tataactatt 19020
 ttgtgtaaat ctgaaagaga acccatgatg gaatagtaac taacattgac gaagttatac 19080
 aatggaaact gaagaaaggt gtataaagca tcataatgac ctaggtagc caccctaaga 19140
 aataataacc tgaatataac atcagtcttc tcaatfcttg gaagctagat tcagtcattc 19200
 tcacatgtaa caggaacttc ctgaggggtg ctaagccaag ccaacctcat tatgcctctt 19260

 ctcttttggc tccagtttgc tgggtgaata actaatgttc caatctgaat tctattaaga 19320
 gtttttctaa aaagagttag gctgggtggc aacactttca gaagctgac tctgctttat 19380
 attgaaaatg aagaacctca tgcctcacc cagatctagc aaatagagg gtttaagagt 19440
 gatactttct gcattctgca ttcagcaaat ccttcagagt atttatatgt tctaacagtg 19500
 cagaaatatt ttatttcttt tttctctgt catgtgcagt acacaccaca ctctcatgtg 19560
 taaacatgta gaggccagag cagaacattg tttttcttc ttctagcact gttcacatta 19620
 tcggcttgag gaggtgtccc ttactgaatc agatgttcac tgtgtgggtt aggttggtg 19680

 agaaatgagc ttiatgacc ttctgtctc tgtttctgct agtgcgaag tctcaggcac 19740
 atacagcaa gcctggactt ttatgtaggt tctggagatt caaactcagg ttctcatgct 19800
 tgcacactga gcaatccca agcctatgaa aacattcttg taagataaac agaagagggg 19860
 cagaaaaaat atgacatgta atattagtcc gtatfctgatg atgactataa aatagccaat 19920
 atcaaaggag ctcaataaaa cagaagaaca ataaacaaag taagtcatat catagtatat 19980
 cataattaag ttcttaacta taggtgatga ggggaaagtt ataaaagtag ccagtaaaaa 20040
 agcatacaag tgcaaacaga gtaaaaacta acagagtgac tgaatattgc ttttttghta 20100

 acaagatcag tgaagacaa tataatattg ataacataat aaacagagaa aaagctatag 20160
 tttagaattc taaaccccat aagaactatc ctttaaaaat aaagtgaaa agccaggtgt 20220
 tgggtgcaaa caccttfaat cccagcactt gggaggcaga ggcagatgga tccctgtgag 20280
 tttfaatcca gactggtcta tgcagggagt tccaggacac ggcagactac acagaaaaac 20340
 tctgtcttaa aaaaacaaaa caacaaaaca aaaataaagg tgaaagcatt aatgatttta 20400
 agcaggttta gaattcatat gtgtatggtg tttactagtg tgatcaatat tcggtggaaa 20460

cttttcaaat agtagatgat tttctgacat ttagtgaggc aaacatcata tgacttatga 20520

gccagttcag agtgcctttc atctagctcc aacatctcca ggaggcttat gtcactggag 20580

ctttcacctt tctctaaatg ttaagagaga gacatttgag gtcataatct gtacagacat 20640

catttggtg caagctcctc gaagactata aatagcaaaa aggagtgaat ggtagcaatt 20700

aatagactga gaggttcatt ggcagatcga tttttaaaag gtgaatttag aaaatcccaa 20760

tgttcaccta gaaattaaga tatgatcttt gtatagcaat tctgaattc tctctgatgg 20820

gctttgcaat catcaaagac ccagcagttg aatcactttt catcttcaca ttttcaacac 20880

ccccacttac cactaaggat gcagaaagaa acaaccacgg caagtctata cttaaatctg 20940

catttgatgt cagcttggtc tccgtttctt tccttcctct gctaccctgg gcatctgctg 21000

aaagtcttga ggggaatctt attgtttgtt agtagttatc tttattgtta tatgcctgca 21060

cattcctggt tattgacggc tgtattacca aacattactt tcattttaca ctcttctaa 21120

atgcctttat tgiattggag atttcagtag aatttactta gtcactcaa cttagcaagt 21180

ttttttaaac tagaggttag tggatgttaa gtactttctt gataaggaga ctgttttcag 21240

gtttacattt tigtgtggaat tgtacagacc catgtacaca ttttctttct caagcatagc 21300

cagaatagtt gactgaacta agaactcaa tgtctcctgt gtagaaaaa aaaaaactg 21360

ggtatatgat gattcatctt actggttccc atatctgtgg taatttttgt ctttgaattc 21420

agagttagaa atcaaatat caatattttt ggaatgcttg agcatgaaaa gtagatagct 21480

tgttcaaacc agaattctca aatttcgagt atttgcctta acatggtttc tttctcgagg 21540

tgctccaatc ttttctaatt attgctccaa ctagtgactt cagaaaagta gactttatec 21600

atactaaa ttgacaagga gataaagtig ttagagacag ccacctaag aacctgct 21660

ttctgaaaaa taaaatgta attaaaaaga agctctttca tggagaaaat gtataaatta 21720

tgtttatctt gagggcatta atatagtttc ccacctgata ccatatccaa gatcattcat 21780

ttgtagtaag caacttaac attnnnnnnn nmntgtgtgt gtgtgtgtgt gtgtgtgtgt 21840

gtgtgtgtgt gtgtgtgtgt gtgtgtttac agttttatca aactggtta catacttttc 21900

actgcatttt caaaaattca atgtatcaga tgcttcttat gtcctcaaaa tcccctcacc 21960

atctgtccta tctacactaa gaccgatact ctactcttgc tctggtcatt ttgtcttcac 22020

acattgcagc ggctctgtct gtagctttaa ggcactgtgc tgtgccttg aacgcttgct 22080

tgcccaggca ttcctccca ctatctgtc tgcattgttc ttggcttttt ctgactgggg 22140

gattccagga agcaatgaga ctatctttct tgtttttacc ccagaaggga aaattctgat 22200

attctcttca gaaagttcct cagattttcia gatctttaag caagtaatac ctagtccaaa 22260
 acatggtttc ttcttaatgt tcctcttttt ctttcatctt ctctttttgc caaccctctt 22320
 ttcttccagg gattacattc tcaactgtcaa agtagctatt ggcttacatg tattttgtct 22380
 gaagtagatt ctgagactgt agacggctta acaagcatta tggctagaca tagtgatcca 22440
 tacatgttat tccaacctg aaacctgagg ttgaaataga aagattatgt attcaaggcc 22500
 agtcccatta catgtgacga ccctacctca aaagaaaaat aaatctgctc tcagataccc 22560
 aactaacttc cagttgggca taagcttgc tagatctttg ctgtttaga atttggtgat 22620

 tgtggcatgc atattgaact cctatcagg tctctgtggtc ccctagtgtc acattctgtc 22680
 taatgtctgt ttgagagcat gtctcagttt gctttctgtg tctgtgataa acatcacgac 22740
 caaaagcaac ttgtggagaa gagggtttat ttccccac agcttatagg ccttcacgaa 22800
 gtatagttag agcagtgact ccagacagta tcctgaatgc aggaactgga atcaagacca 22860
 tgaaggctac ggcttactgg attgctcttt atggcttgtt caaatttgtt ttcatatagg 22920
 atccgagacc acctgacctg aggtggcttt cccacagtga gccaggccct cccacatgaa 22980
 tcattaatca agaaaaacct ccacagatgt cctacagacc aatccagtag agacattccc 23040

 tcaatggagg ttcttcttc ccagatgggt ctctaatttg tttcaagttg acaaaaaaca 23100
 taagtagcac aaactcttta taaaacttga atgcattttc tttccaagta gaaatatttg 23160
 cattatttcc aaaaataatg ataatatctt ccaagaatcc actgtgtcca taatgaactg 23220
 acatccatag tctttcctta ccaccatcgg acgttcacca gtcacttgct accgtgttct 23280
 taaatagtgc ttttctgaca ggttgcatac aacctgtaa gatgatagcc agtaactccc 23340
 actctttaat gatctctgct ccttgagtgc aggtaggacc tggaaatatg gtgtgaaatc 23400
 agccttctgc ttatattgct tgaagaaact aaaagcccct agtcaggtca ctacacacta 23460

 acaaaaaagg atattattct ggtgggtctg atttattaca gggaccagaa agagggtta 23520
 gggttttgct aggttgagaa atgctcctag tacatttaac ccagcaagct gtcataaatt 23580
 ctgtaactcc aaataaatta attgttcaaa acatgggggc ttggaaaata gtgtaagatg 23640
 agattgacac tgactctggt caatacttca attgaagcag ttgagactct ggaggcagga 23700
 tccagttata ttgtgccag actcctgact gacagaaact acaaaatgag agatgtgtgt 23760
 gttgcttttg cagctttgcg accctttgtt atacagcagt atcaatagct tttgtttgca 23820
 ttagcatttg cctaccagge aaagtccga aagggcagtg tctctttttt tttattgatt 23880

 acttcaatat ctagcacagt gctttcaaaa caacaaacat ataataattt tttgttaatg 23940
 aatacctaat agctaacatt ctgaaaatga aaaaaatag aaaaggtcta tttgggtttt 24000
 ggtagtgtct tccacattaa ctcaaaaat tcaaatagca acatatcttg ggaaatgcaa 24060

tgaatcacat ttggttctca aagttttttt ttcattctggt aatcatgaga cctagtaaca 24120
 ccatctattg caacaatatg tgctagatcc aggggaaggg gctaactggt taacagaca 24180
 tcccaagcca tgcttactt ctatagtaat gctcacaaaa tcaatgaaac agatcttcac 24240
 tgaaatacaa aatgctagtg gggcctgcac aaattggtgt caggggctca agaaaaggaa 24300

acttgaactg aaataactta atctttttta agtgagaaat tgaagatcat atacacgttc 24360
 accatactga attttcaagg tattaaagtt taatgtaatc tatgcatata gctcaggagt 24420
 cattgcatga attaatatct ttagcttact taagggtact tcaattaaat atgtcagaac 24480
 aacacaaaaa tctaataccc tagtaaggtg atagcagagc tatctaaaaa tgaaaaacat 24540
 aaataagtaa gaatttcacc aaatgggaat actcagtgtt ttaaaagaca gcatctgtgt 24600
 ggtttcaggt gggacgactt ttaattctta aagtcattta gcaaaatcta ttgctgacaa 24660
 ttagttgaat tttttatata ttgttactct tattcttact ggaattcttg cttgtaatgg 24720

agttaaagat taatcaggtt gtccagatag taaacatgtc gttatttga caaatatggt 24780
 aagttcagac ttagacaata gtctcttaga tgtaacctgc cctatattgt ttccttgctt 24840
 aatttcaata cctaatttta gaattgcact ttgataagtt aatttgtcta taacttcaga 24900
 atgaaggact taggattagt tctcccgatc tgtttagaaa gcacttcac acacttctgg 24960
 taacacttga aactcatgga caagagtga atactgagat cagagataaa agtttccaaa 25020
 ggaaaagaaa ttaaagctat tttgtaagtg agagataaaa aaattattac aggctaagcc 25080
 tttcttgtgt taatttctta aatgtgaaaa gtatccaatg aaccattaa atacatttg 25140

acagactaac agcaggaggg ttgttgacct ctcacctcat attgatttcc tettcagtec 25200
 ttttcttgg cgatttctac ttttctgca tatatttgc ctgcagctct attctccaca 25260
 cgccactgt gtaatcactg gcagaggaaa ccacaaaagc cctgagccac acagatattt 25320
 aggaggatct cgaanaattta ttccatctg tcagtaagtt ctttagtcag caaatacttc 25380
 cataaaaaa tttcccagc ttttcaata ggtgagtcaa aatggtcatt aattattatt 25440
 tattcactgc tcatcaattc caccagcact gggtgacaaa catgaaaact caaagaaagg 25500
 aaaggacggg taacctctt tattcagct tttagaaata ccatctgtaa ggaaaatc 25560

tactaatgag aaataagcaa ccaagataga atttaggtac tggggggagg ggtggtaac 25620
 taattgagaa acccatatga actgcctaa agccaataaa gatacaagct ggcttgata 25680
 caaggggttg gattactcaa gttctgaatt ttgaaagtcg tctttgatgt catgtctgag 25740
 gtcagtaaag aatgtcagag atctcagcag taactattac taagatgagc cagagtcctt 25800
 aatgtgcaa ccaaagcatt agtgaatggc caaggtttgg gaggtcaga gtatgaacac 25860
 agagttgtga cagttcttca atttgaaata acatgcactc gctatctgca aagaaaacta 25920

aaccttcaaa aatgaccctt agtcaagatt aaatacattg ttttgtgagc agccgtatag 25980

ccccaacttg tagttgtctt cctctgagtc catgtgatgg aaaaacaaga ctcccttcac 26040
tgttgcctct aaaaaacagc aaagccatcc caaatggtat taaagtgcac tgtgtgtttg 26100
gctgaggatt atcagggaga gagaagcagc tgtatatttg caataggaag aactaacac 26160
atactgagge acttatgtcc ttgtgggagc ctcactttgg ctgccactca agtcattacc 26220
atcttttttc ccttgtttct cccttatctc tggcctactt tatgcagcct acctcacctg 26280
tgatttggct tcaagcctta tctacttcca aataaagagg tcattaggtta ccaggatcca 26340
cttaacaaaa tatctggaca gggacacttt atgctcattc ttccattgac aggaaagtta 26400

agtcaagggg gticgatgaa gcaatagaaa ccctaagaca agttgataaa cactattgtc 26460
ctttatgctc attctccat tgactggaaa gctaagtcaa gggggttcga tgaagcaata 26520
gaaaccceta gacaagtga taccaggatg gggttacgtc tctgtcagac ctccacatgt 26580
tttttgggag aattctggaa ggactttgga actttggact agaaaaacca tggaatgttg 26640
gattttgggg aggattctgg aaggactttg gaactttgga ctagaaaaac catggaatgt 26700
tgggcactca gtgcaatgtt ctgtggaaga tgagaatgtt gagattagtg aagaggatgg 26760
aggcctggct tglgaaacac ccttgaatca atcggtagag gagaccactt cctgaacgtt 26820

acaccagtag cacagacact gaggtcaacc attgataaac tgctcctgaa actgagaagc 26880
ttctgtaagg caaaggagac agtcagcaaa acaaaatgcc agcccacaga ctgggaaaag 26940
atcttacca accccacatg tgacagaggg ctgatctcca nnnnnnnnnn nnnnnnnnnn 27000
nnnnnnnnnn nnnnnnnnnn nnnnnnnnnn nnnnnnnnnn nnnnnnnnnn nnnnnnnnnn 27060
nnnnnnnnnn nnnnnnnnnn nnnnnnnnnn nnnnnnnnnn nnnnnnnnnn nnnnnnnnnn 27120
nnnnnnnnnn nnnnnnnnnn nnnnnnnnnn nnnnnnnnnn nnnnnnnnnn nnnnnnnnnn 27180
nnnnnnnnnn nnnnnnnnnn nnnnnnnnnn nnnnnnnnnn nnnnnnnnnn nnnnnnnnnn 27240

nnnnnnnnnn nnnnnnnnnn nnnnnnnnnn nnnnnnnnnn nnnnnnnnnn nnnnnnnnnn 27300
nnnnnnnnnn nnnnnnnnnn nnnnnnnnnn nnnnnnnnnn nnnnnnnnnn nnnnnnnnnn 27360
nnnnnnnnnn nnnnnnnnnn nnnnnnnnnn nnnnnnnnnn nnnnnnnnnn nnnnnnnnnn 27420
nnnnnnnnnn nnnnnnnnnn nnnnnnnnnn nnnnnnnnnn nnnnnnnnnn nnnnnnnnnn 27480
nnnnnnnnnn nnnnnnnnnn nnnnnnnnnn nnnnnnnnnn nnnnnnnnnn nnnnnnnnnn 27540
nnnnnnnnnn nnnnnnnnnn nnnnnnnnnn nnnnnnnnnn nnnnnnnnnn nnnnnnnnnn 27600
nnnnnnnnnn nnnnnnnnnn nnnnnnnnnn nnnnnnnnnn nnnnnnnnnn nnnnnnnnnn 27660

nnnnnnnnnn nnnnnnnnnn nnnnnnnnnn nnnnnnnnnn nnnnnnnnnn nnnnnnnnnn 27720
 nnnnnnnnnn nnnnnnnnnn nnnnnnnnnn nnnnnnnnnn nnnnnnnnnn nnnnnnnnnn 27780
 nnnnnnnnnn nnnnnnnnnn nnnnnnnnnn nnnnnnnnnn nnnnnnnnnn nnnnnnnnnn 27840
 nnnnnnnnnn nnnnnnnnnn nnnnnnnnnn nnnnnnnnnn nnnnnnnnnn nnnnnnnnnn 27900
 nnnnnnnnnn nnnnnnnnnn nnnnnnnnnn nnnnnnnnnn nnnnnnnnnn nnnnnnnnnn 27960
 nnnnnnnnnn nnnnnnnnnn nnnnnnnnnn nnnnnnnnnn nnnnnnnacc cgccccctgc 28020
 tagcctctgg agaccacaag tcttgacctc gcagggcgctc cttacctcgc aggactgtgc 28080

 actggtatth ttaagctatt agttttgcgg acatttaaga tacagcaata gaaaactaag 28140
 acagaaaaa aaaaaaaca tccacacggc agtcagtgc aaaacacgtg aaaaaaaca 28200
 aaaaggaaga agaagaaga gaagaagaag aagaagaaga agaagaannn nnnnnnnnnn 28260
 nnnnnnnnnn nnnnnnnnnn nnnnnnnnnn nnnnnnnnnn nnnnnnnnnn nnnnnnnnnn 28320
 nnnnnnnnnn nnnnnnnnnn nnnnnnnnnn nnnnnnnnnn nnnnnnnnna attgtgtcac 28380
 tgggcttggg aatgtgtaag ggtcacttag gtagtacttg ctttgaaggc atgaagggtg 28440
 cgtggaaagc agctgaggct tggcactatg agaggccagc aaaggccatt ggtgaaggtg 28500

 ctgcctcagg ggcagtgaag gtctcaggat gaaaagtgtc atgcacagaa actgaggctt 28560
 ggcaccagaa agagagccca tgaggggctc ttggtaaaag tgcagcccag ttgcagcgag 28620
 ggaccccagc agtttcagaa acgccagtgc catagtgtct tagttagggt ttctattgct 28680
 ctgaaaagac accatgacca cagcaaatct tataaaggaa aaacatttaa ttgagtttgt 28740
 ttacctttt agaggtttag tgcatatcc tcatggtgca acatggtagc atacaggcag 28800
 acatgatggt ggaggaagag cctaacttac atctcgagg caacaggaag tggcttgaga 28860
 cactgagagg caccttgagc acatatgagt cctcagagcc cgcctccata ctgacacact 28920

 tctccagca ggaccatacc tactccaatg acagcaatac ctccattag tgccacctec 28980
 tttgggggct atttctttc aaacatcac attctactcc ctagcccca aagggttgt 29040
 agccatata taatggaaaa ctgcattcag tccaaattca aaagcccca tagtctgtaa 29100
 taatctcaa cttaaaagta taaagtcaa aatctcttct gaaattcatg caatctctta 29160
 ggattagatt ttaatccct ataacatca aaataataat aataatattt tttaaaagat 29220
 cacatactcc caatacaca tggcaaggga tatacattac tgttccaaa cataggaaag 29280
 ggagcatagt gaagaaacat cagaacaaag caagagcaaa atccaggtgg gcaaactcca 29340

 aactctgcat ctccatgct gatgtcaaaa cacttttcag atctccaact ctttcatct 29400
 tctttgactt ggactgttcc cactgttagc agtactctc atcaggtatt cttgattct 29460
 gacatctcga acatcttggg gtctccaagg caatccaggc ttcaacttca cagcttcaca 29520

caatggcctc tciaggcctc tattcagggc caccctgac agatgcctgg cttcagtggc 29580
 ttttcttagt cccagaagca aattccatag ccctctctt ctgtccttaa ctccagagcc 29640
 atgtggacaa agatgccaag ttctgctact tacgagggt gtaacatggc cttcttgttc 29700
 aattatgcct tcaccatctt ctattttcct tcagtgccta tgcttggtg tcctttaact 29760

 tgctctgtag accagctgac ctcagactca gacatcttgc tatcgtctgc ctgccagtg 29820
 ttgagattaa agatattcag cactataacc agctcatacc ttttcttaa tttctttca 29880
 caagtggaa acttatctgg gtgggatctt gtctgaggt taccactccc ttattccat 29940
 ttcttaatct gtttatctcc ttgaacacgg gatttagctc cattctatct ctggtgttcc 30000
 ttttctctc aaacagtttt ccttgctcag ctggctcctt tctttatat atattctcta 30060
 gagttgatgc cagtaaccgc acaacagagt tatgtggtta tatactcttc caacagaatt 30120
 aatacaaaag tcttcacttt agctccagct aactttttgg atcaaggcaa aaagcaacaa 30180

 cttttacat caaaatatcc aaagaccaat ttctaagcaa catactaaaa ttcttctcct 30240
 ctaaaactta ttgagctagc cccccacac acacacacac gcacacacac aaatacttct 30300
 cgaatcacte ttagaaccac agtcttccat tetgctactg aaatggccat taagcagtgc 30360
 ttacagcatt caagtgcttt cataaccca aatcccaaag tccaaattcc tccaaacaaa 30420
 aacatggtca ggctgtcat aataatacct cagtattaat aatacctga tcaacttttt 30480
 tttttcgaga cagggtttct ctgtgtagct ttggagccta tgctggcact cgctctggag 30540
 accaggctgg cctcgaactc acagagatcc gcctgcctct gcctccagag tgctgggatt 30600

 aaaggtgtgt gccaccaatg tccagcgacc aacttcttcc ttagggttta tattgctgtg 30660
 aagacacat gaccacagca accctataa agaaaacatt taattacagt ggctctctta 30720
 catttcagag attcaatcca ttatcatcat ggtgcatcat ggtggtgtgc agggagtcaa 30780
 ggtgttggag aagtagccaa gagtctaca ttgagaca acaggaagtg aactgagaca 30840
 cggagttagta tcttgagcat atatgagaca tcaatgcca catccacagt gacacacttc 30900
 tttcaacaag accacacctg ctccaccaag gccacacctt ctaacaatgg catttggagc 30960
 cttttttttt caaatcacca cacatgagat gggcaccaag atcagcagtt gccgtggagt 31020

 ggagacacce agagcctaga atacaagctg tgtgtgctgt ggagggcaga gccagagaaa 31080
 tgaccaaacg ctttgggtgg gctccagaaa atgataaggg atccagaca cggacagtt 31140
 ggaatatggt ttgctttga tttgtgtgtg gcagtgcctt gatttttccc tcttgaagta 31200
 aaaagtattt aactggagcc tacaattgag agactttgaa ttttaaaaga gaatggctaa 31260
 tttaaaggaa cttaaatatt tatgtgtttg aatttgtaaa tactgtggga cttttaaagt 31320
 tatttatatt ttaatgtgag atcttgggtga tgaataagaa aagaaaggtt atggctaat 31380

attgatgtgt ttgtgtgtca agttgacaag gagccagttt ttttctctcc attttttatt 31440

taaattagaa acaagattat tttacatgtc aatcccagtt ccctcttctc nnnnnnnnnn 31500

nnnnnnnnnn nnnnnnnnnn nnnnnnnnnn nnnnnnnnnn nnnnnnnnnn nnnnnnnnnn 31560

nnnnnnnnnn nnnnnnnnnn nnnnnnnnnn nnnnnnnnnn nnnnnnnnnn nnnnnnnnnn 31620

nnnnnnnnnn nnnnnnnnnn nnnnnnnnnn nnnnnnnnnn nnnnnnnnnn nnnnnnnnnn 31680

nnnnnnnnnn nnnnnnnnnn nnnnnnnnnn nnnagatttc cgaggtctcc tcaactgacac 31740

ccaccacctt cgtggagtct gaatcaatcc catgctgggt tcccagctat cagtctgggg 31800

agcaagagtt cccccttgtt caggtcagct gtttctgtgg ttttcaccag ctgggtctgg 31860

acccctttgc tcatcactcc tcttctctcg caactggatt ccagttcagt ttagtgttta 31920

gctgtgggtg tctgcttcta ctccaccac ctgctggatg aaggctatag gatggcatat 31980

aatcagtcga ttaatctcat catcagggga gggaatttaa ggtagcctct ctgttgttta 32040

cattgttagt tctgtctatc attatagatc tacagacatt tccctagcac ctgatttctc 32100

tttaaaccta taatggctcc ctgtattatg gtatgtctta tcttctctc ctctattctt 32160

ccccagtcga accttctgt tctctcatgt ccttctcacc tctctcttc ccccttctc 32220

attctctag ttcctctcc ccttcttca tgctctcaat ttgctcagga gatcttctcc 32280

ctttccctt ctgggggtgg ggcaatgtat gcctctctta gattattcct tgtttcttag 32340

cttctctggc agigtgact gtaggctgggt aatcctttac tctatgtcta aaatccacat 32400

atgagtgagt acgtgccctg tttgtctttt tctgactggg ttacctggct cagaatggtt 32460

tcttctagtt ccatccattt gaacaagggg gtagttttac tggetgggtt tgtatgtcaa 32520

cttgacacaa gctagaggca ttggagagga aggagcctca gttgaggaaa tgtctccatg 32580

agttccagct ttgagcatt tctcaatca gtgaccaatg tgggagggtt cagccttctc 32640

gccatccctg ggetgggtgt ctctgtttct agaagaagge aggcagagcc agtcatggtg 32700

aagcaggcca gtaagcaaca gcaccgctac aggaactctg catcagctcc tgactccagc 32760

ttcttgccct gtctgaattc ctgtctctgac ttccttcagt gatgaacaac aatggggaag 32820

tataagtcaa aaaagttttt cctcctaac ttttttttg gccgtggagg ttcacacag 32880

caaaagaaac ctaactaag acacccttg caattttat cagttccctt tttcatttct 32940

tcaacaata tcaagagctt tttctctcca taaccecta ctatgagata aaagtttggc 33000

ctccttttaa attgatttgt ttaaatcttg accgatagca gggttcaaat gtgatata 33060

taccctgtaa ggtagtaatg gagattaaac tggatcacia gatgaatccc taatccagta 33120

gagatggtat catccaaata atggaaatit ctctcctgat gccatgtgag gacatgaagc 33180
aactagaaac caactagcta gtaccttgat catgtgctta tagccttttag acgaggacat 33240
gaagcaaaga tagcccttac tagaaaccaa ctagctagta ccttgatcat gtgcttatag 33300
cctttagaac tcigaaaagg taaatttcag ttgtttatgt cacttggctc actgtattgc 33360
actgtgacag attaagctgg ttaataaaaac cctgtattgt acaatttccc atgcagctta 33420
gtagatgatt gtgcctttgg ctccattaag aaaacagagg tcttcccatt tttactcatg 33480
cattctgtta ctctaactcc aagtgtccac acttctacct agacttgctg ctttcccatc 33540

tcagtggtag gtgggttagc agtgcacttt gtggaaacca ttcggcttgt attgagacac 33600
tttctatata atctcacact tgaaggtagt ctcttgccca aagctgttgg tgcaacacaa 33660
tgaagttaa ataatctca aactccttac agtggatag tgggtgatg ccctaatctc 33720
ctgatitctt gaatcttgg aagataaagt tgatatacgt aatagctta ctgggagtct 33780
agtatttcta aaacaccatt atctctttgt ctgggcacat ctgtaagaa tggcagagag 33840
ccaattcaac atttcacatc tgagtatgag tctatctttt ttacatatgg tgatctttat 33900
gatgttccct ttatgctggg gtccaggcaa gaagtctct ttttcatttc tccataattct 33960

tcctatgta tgcagttgtt gtttttttt tcttttttgc tgtgatgaaa gactttatat 34020
aaacagtgtg cagatacaag aaattgtggg ggaagaggct gttcatcca tggcagacag 34080
gaaacaagat agagaagggg ttcggagaca aaatgtggg gtctgaaaga aaatggctcc 34140
caaagggtgt agcactaat ggaggtatga cctctgttgg aatagttgtg gtcttattga 34200
agaaattgtg tgtcactgtg gaggtgggct ttgaggctc atatatgctc aagatagaac 34260
ccagagtctc agttcacttc gtgttctctg caagagttag aacccttggc tacttctccg 34320
acaccatgac tcctgcatg ccaccatgtt gcccctgat gaatgataat ggactatagt 34380

gtaagagagt caccccaatt aaatgttttc ctttgtatga gttgctgtag tcacagtgtc 34440
tcttcacatc aatagaaacc ctaactaaga cacaagacat acccttcaa ggcatataca 34500
atctaataaa atagagtggc ctacttctc caaccaggat tcaattcca atagcccaat 34560
cagctctgaa ttcatecaat aatgaggatt acatcctgtg acccgattac ctctcatcag 34620
tagcaccaac tcigaccaa accctcattg gtgggtgtgt ttaggaaca aggctggctc 34680
cctaagtctc cctggaaggg tcatctctct ttagtttcta tcacagtcta aaaccaaac 34740
ctgtaatit tcccttctgg atttttgcca tggctcttta ctaaattatc agcctcatgt 34800

atcaatccat ttttttttt tgtatitttg ccaaagtgac cttcccaaaa tgaaatit 34860
atcatgctac tcttccattt gggaacattc caagctttcc actgtgtgta agaacttaca 34920
gatatacagac ttgatcctta cctgcacttg ggctgtttgc gtctaatgtt ctcaattctg 34980

gcccttgttt tagctattct ctgtgacttt tatctcttta ctgccagtcc aaccatttta 35040
 ggggtctctc tctctctctc tctctctctc tctctctctc tctctctgct acctttctca 35100
 gggtaaagcag tgaccttct agaggccttc cctgacataa tgatctcacc tcccctagag 35160
 cctaactaaa gaaatgtcta cttcacttgc aactaatgaa aaaagaccaa ggcaaatatt 35220

 attataggag aaagaacaaa aactctagag aattggcatt ctttgaaatt acagaaaaat 35280
 gaaataatag agtaatatgt gggtaaaagg gggacatcta actgggtgat ttttacttaa 35340
 aatactggtc atttggaaaa atccagcaat aataaaaagt ttgagctcat gaccacttag 35400
 tttttaaac atctgaatga aattatgtta gacatatata taaaaactta tgagtggcaa 35460
 gtggcccata tgcttggcca tacagatttt gcctggggca aaaatcctta ccaaaataaa 35520
 gtctatgcaa cagaaaaaaaa acactcattt tgataactaat ttgataaatt caacggtgtg 35580
 atagaatcat attttagac attctttaag atgtctcaag aactcaagca aattgttaat 35640

 ggcatctata aaacccgaga cctacatttt gattggtatg attatttatg tttgtataca 35700
 tacatagtta ataacctac catatactca cgtatttaca agtgaacaga aaacacatta 35760
 catgtcacca ttttcttatg ttcttagaaa atgtttgtgc cactggccca aggcttttca 35820
 aatttgggt ctccatccac tgatggatca aaacgttaag atggctccta tcataacttt 35880
 aaaaatgaat aaaagtagaa gtgagaaaaa cataacagaa atcacaataa gagagtact 35940
 atttctgcaa acatggttga aagtccggtg aatgaggact gaggcttagg gatgaagttt 36000
 gaaccctga acittgagga atcctgattc agtgctgctg ctagctgctc agaaatgtca 36060

 gacccatta gagccatgag caaagacatc ctcaactgcca ttatgtcacc tcccacttg 36120
 ttctgtgtta ctgagaaaaa acaaatntag attctcctag taggctaata taccatgtgc 36180
 tgtttagtga tgtgaatctg ctggtcatt tgtcaactgga cacaagctat agtcaccgga 36240
 gagggaagca tgtcaactga ggaattgctt tcataagacc tggtgcagg taagcttata 36300
 tgacattttc ttgattgata attgattggg gagggcccag cccattgtgg atggggccac 36360
 cacttggctt gtgtctctgg gtgctataag aaagcagact gggcaagcca caaaaggctt 36420
 gccaggaagc agcactggtc tatgacctct gtaccactc ctgtcttcag gttcctgccc 36480

 tgctgaagtt cttgcctaac ttccttcagt gatggactct gatgtgcaag taaaagtcaa 36540
 atgaatcctt tctacccaa cttgcttttg gtcattggtt ttcaatacag caatagaaac 36600
 cctaactaag ttatctgttt ttctcttcta gttgctagca ggtatgaagt aagttcagca 36660
 cttttgaat tttcatagcc tcatggattc cctataatcc cttgattgt cttatctgg 36720
 ctacttcate ctctctccc aaaacatatt actttaagtc atgtttaatg ctatttaagg 36780
 gtcttcagtt agctcttaac cctgtaaat tattatatgt acctcagaac cttcctgaaa 36840

atgtttctaa gttacttatg agatgaggct atcaattctt tctttaatta atgagctaca 36900

tgacaaaagt ataaaaataa ctatatacat aaaaattaga cttcccttc ttactgatgt 36960

aaaactcaat gtccatagaa atgattatct gtcctttaat ctacatagtt ttcacttggt 37020

atgattacat tgaaaatggc aaaaagtgg aaattttaac tttctttca ggggtaacac 37080

actgtattaa atctataagg tcatatctac gtgggtttga ttacaaaaac taataaagta 37140

ttctctaaat aaaaaataa aaaaataaca gttccaaaa ataaaagaat aagtaaaaag 37200

gaagggtcta ggaggaggag acacctgggt ctctctggaa aatagaataa attttatgag 37260

aggtgggaa tggaaggatc agataggggg aggaggggag gtaaggtaga gggagagaat 37320

atggagtgta gtgatattta gtttatgatc taacaaataa tgcttgctg aagatcagag 37380

tgcaaatcta tcgacattag ttcacaatgg aggccaggaa gttgtagtcc actccttaa 37440

accagcact caggagatag agccggacag atctctgttc attcaaggct acccaaagct 37500

acacaaaatt gatccaatct aaggagaaa cagagctcac acaaaggtaa tctcagtgct 37560

tgggatccca cacctttaat ctagtactag agaggaatat aaggcggggg tggcaggggtg 37620

gggaagctgg gagctcagtg cagtctgagg ttgggtggag acagatgcag tetgacagga 37680

tcacccttta ggtctgagca ttggtagcga tgagaactct ctagtgaatg gccactttgc 37740

ttctctgatc ttcacttta accccaatat ctgtctctgg gttttatta ctaagactaa 37800

ctagaattcc tgctaccgtg aagagagaca tctggaattg ggggatattt gagggacgat 37860

atgggaacag tgtaatgaga actccctaaa atagaagggtg atcctcatga ggtgtaataa 37920

tgggggatat ggtgtctcaa caggccatct ctgttcacaa aaccaagggt ccagtagtgg 37980

gactgggttg cacgcaattg cattgttggc caaggaggtc ccatggaaat ccccaacaa 38040

tccagacat tgctaaggca aagggttggc ctccacagat tgacagcaag gccccactgg 38100

tgaggacaat tactgtcaca actcacagac catggagaag tcgagctggt acctacacgg 38160

agccttcacc ctacattcta gtctctttgg tgtgggaagg tactcagaag gctacaaaa 38220

gaaaaacaaa aatgaaagaa agaaaaaga agaagaaaag taaaaaaagt tagaaatttt 38280

aactttcttt tctagcataa agaatagtta aaggcgacac tgaatttat tttgctgtag 38340

tagagtactt ctctcattc atctatctca agaggcagtt aaataaaaga tgcactatt 38400

gctttaattt attaaaataa ctctcaagt gtgaactgaa gattgctttg tgatttttaa 38460

ggatgttaca tcttacatgt atctttgggg agctttctaa ctgtaaaagt gactttttca 38520

catttttcgt gtgtgtgat gtgtgtgtgt gtggtatgat gtgtatggtg tgtgtgatg 38580

tgtgttgat gtgtgtgta tgagtgtatg tatgcatgtt ttatacatat tgagtataca 38640
 tgcatttata tigtctagga gaagcttctt gtacatgttt ctcttattgg ttgatgaata 38700
 aaacactgtt gaccaatagg gaagcaagat aggtgggact aggagtggag gagaattctg 38760
 ggaaatgtag gaaacagaag ttgccaggig atccaggtag taacagtata taagcagga 38820
 caagcaagaa attgctctct tctcttctct gtggagacac tgagcagatg cgatgtagac 38880
 ctcaacagag taagaggcct ggacctttcc tctagtaaga gaaggccatg aagaaatagg 38940
 gccagaaaaa ctcatgctac atgtatgtgc agatgtatgt gaaggcctgt tgtcatgtag 39000

 ggaatcatct gctaccattt ttctgcctta tgcattgagg catctgaagc aaaccagag 39060
 ttttgccgtg tgaanaatcct tcctagctac cttgctctta caatgcaggt agacagccac 39120
 acccattgaa tgattttgaa tcagttaatg tgaactgtt agctctggat catatttaca 39180
 aaatgtttcc atcgctcttc ttgccctcag gtgctaccaa ggtgatcact gggcttgaat 39240
 tgattactag gcccataac attgcatctt aatggagata atgcaagtgg atacttctc 39300
 gtttacatta atcgaaccag aaggcagtag aactgaaat atcagtgaac tatcaaacca 39360
 ctactacagt tgatatcttg gcccatTTTT tagctaaggc tgctaattat gcagaataat 39420

 gtccacctac ttttctgttt cccaataatg ttaatgataa gaagctgaaa tgagaccacc 39480
 attacatgac ctttctggaa aagaggctaa tctccatgga aatgtttaga ttccaattgg 39540
 ctcaattcat tggttcattc agaataggat tattattggg agcttctagg aatttgggtt 39600
 caagtgtcca aggaaagaga agttgttttg ctgtccaaa gcaccagggc cgtctaccgc 39660
 acaagaaatg gggttgatga gtgtgctaca attaatccat gtctattgtt gaaattattc 39720
 tcagtggaca tigtacattt ccttcacttt gtctaggagc atatagagaa ataccaagtt 39780
 ccacacaagc caaggggtgg ggaccactga ttgctttgtg aactgggga agttactgag 39840

 accacgggta cataggatta ggaggctgct ctttcttca aattgcacca tcagacatag 39900
 caaataaaaa tccaagagac aactaaatta ttccaaaat cactgggtg atattttagt 39960
 gcttactaaa tactgtatca aatactgtat attgctacaa ttacttgctg ttcgtatgaa 40020
 attttaactg tigtctctgt attttatgtg gcagcagtat ttcaaggggt gagtagtatt 40080
 tctcatgcca ttagtatttt cagtggcatt agaaatccta gttagaata ctgataccat 40140
 cttaggctta tttctattga taaaagattt tttagaaaat atttcagatt gtgagaatct 40200
 ttattttcag taaaataaga catggtgata tattatttat aatttattaa agcttgtctg 40260

 aggattcaga aagcaaagac agcatcaagc tacagagatc agcagtggta atacacacct 40320
 ttaatccag cagccagaag tcaggagggt gtggtacaca cctttaatcc taaaactcca 40380
 ggattaagag atagacggat atctgtgact ccaaggccac ccagatctac acaagattga 40440

tccagtccta aagagaaaca gctcacacaa aggtgatctc agcacctgga atcacatgtc 40500
 ttttaattcca gcactagatg ggtacaaaag atagaagcag ggtcttcagt agtcagtacc 40560
 aggcatcctat tctccagcta cattgaggat aggaagacat ttaagatca gtattctcca 40620
 gccacgctga gaagaggcag caggaggagg ttgggtgaag ccaggatcac atctgggtct 40680

tttatttate gtgctacaat aagagcagac agatggagac acagatagtc ctcatcttcc 40740
 ctgcaatgg gcagaatgg tagacaggaa aatgaggtac cactctgatt tccttttgta 40800
 attctttgtg aatcaaaagt atatctagtc cgtggtgaaa cagtgcagca aaattgcact 40860
 gtacagatgc tgcattccaa ggagcagtga tgcctttcat ctagagatac ttgtgagag 40920
 aactgtaac agtgactcat gcccactctt ctctataga attgcatgca agcctcaaag 40980
 tgttgagcat taaacatat gtgtacattg gtcttgctt gtaaatattt catgcttca 41040
 aattgcttga tcattttgta ttacaagtag tcatggagac tacagggaca ttagttctga 41100

aagtaacttc atggtgttgt atgcctctc atgataacac ttgtcagcta cctggccctg 41160
 tgagtgagag tgcaccac tgattagaga agaaactcag ctgactta gcatattgat 41220
 tgagactgtt ggatgaaaag gtggttttg taagaaaacc cctcagatct tcagcccca 41280
 gtgcacaggt cttctatta ggtcaaatta tggctctgtg aatgagtta aattttatac 41340
 ctgggatagt ttgagaatg tgccactgaa aaggatactg gcatcttcc tgagtcatg 41400
 aagactggtta cctcactagt tgtttgctt taccctgact tgatctcctc agagattca 41460
 ctaaaatgta gatgttccag tgtctctgca taccagatt gaacctgcac tgcagcctc 41520

acacttggct cttcatacc tcttcttcc ttggttctc agcatgctgc acctacaaca 41580
 ttatctccat agactttctg agatgcaatg acaggaaatt aatgaaaaca aggatggtaa 41640
 gggatacttc tgtgtttca atcttctg tactttaacc tcttctctt tacattgtct 41700
 ctttaccatc agacatactc cctgcccctg attctgattc agtctctta ggcaaatgct 41760
 ctaggtagct tgagccacag taagtttgta aaatatgcag caatattatt tcaagtctcc 41820
 acattccca gagaccctc actaactct agccggtgtg tccaaactt tgacactgtg 41880
 atacttgtt cctacagagc ccaggctcaa gaactgcaca gcagaatttt ttaactca 41940

tatgttgagt atgtttctg tgtgtgtac tgcattccta ggtatctgca gtcacatgca 42000
 gcctataaaa cacaggttgg acataactac aacttggct caataaagt ttaacaccaa 42060
 aactaaatgt aatagtatat catatattta catatattta ctatctatt ttgaaagtg 42120
 gcaatagaac acatagact ttaaaatgat acaagaatt aataaaagt gagaaataaa 42180
 gatatccctg gctgacttt ggaacctaac tcatgtgtcc actatcaatc ttgacagtgt 42240
 atcccactct gatctgcact attacttcat ttgaataatg gtatcttgtt actttgagaa 42300

aaaaaaacat taccaagcta taataatgaa ggagaaggca accaatggaa cagtagacag 42360

 ctcagaatg agctcatacc ttgcaatcca ttgagttttg aaaaatttgc caagaattat 42420
 gatgaaggaa ggaaaatctc ttcagctact gatattgaga aaactgaata ttcaaatgta 42480
 gataaaagaa tgacattgga tgcttgtctg atggcctata caagtcaact gaaaattggt 42540
 taaaaactta agcaaatggt ctatggcagt gggctgagca aacagctttt ctagatatga 42600
 cctcaaatgt acagacaaca aaatggaagt ttattaaaat aaaaagcttc cacatatcca 42660
 aagataaaat caacagagat actacagaaa tggatataat tttcaacta tgtatctgat 42720
 aaggactgat atccaaaata tataagggat tcaacaact caataagaat aaaataaaca 42780

 ctccaattga aaatggatga acagcctaaa cctgtacttc tcaaaggaag gcatcatcat 42840
 ggcaaatggg caatgaaaag aatgctcaaa gccacacatc atcagagaaa cccaagttaa 42900
 aaaaaatcat aaagccatca ctctcatatgc actcaaatgg caactatcaa gaaagcaaaa 42960
 gatgagtctt gatgagctgg agaggtgctc tgtactctgc atgctattga tggatttga 43020
 acttgatata cccaatacaa aaaaaaaaaa cactatagaa gtttctcaa ttattacagt 43080
 gagaactgtc cattgatcta ggaacccac tactatataa acattcacag gaaatgaaac 43140
 caatatattg aagacataga tgtgctctaa tatttactat ataattaac atcataatca 43200

 agacatgaaa tcaaagtcc cattaaaaga cagagtaatt gtgtttatac acaacttaat 43260
 gatatttggc tgiaaaaata atggaaatcc ttccattaaa aaaatgaatt ctgagcttat 43320
 gttaagtгаа aaaagcccag aacaggtaac acatgatctc atttcatgt gatacataag 43380
 aagttgatct catagaaaca gagcatagaa tgatggttac caagggctaa aataatgggg 43440
 aaaagagaat atggtgacag aattaaana taggggccta gagagatggc ataaagttta 43500
 agagcactgg ctgctcttcc agaggaccag gctgaatgtc tgacaccac aaggtgacgg 43560
 ctcacagcca tctgtaactc cagtcacgtg gcgaatcact tataaatggc geccaagcag 43620

 gacccaaagc caaaattcca ggagggtgag agagtgctgt gctttcatgg gcctcttctc 43680
 tatgaagcaa agtgtgtaaa ggttgccata aagaacaaac aagtгааata ctttatccat 43740
 tacagtgggt ggaataaaaa tagtactgtg aggcctaggc gctctgaaaa atatttgaag 43800
 gcacgtgagg atattgtagc cttttgcct gttcctgaag gagctccctc agtacaccac 43860
 cccctcttga cctctagtgt ggatgaatgg gttccagaaa gccgagtact taaatatggt 43920
 gacatcaatt tgcagaaaca gtgagagctt caaaagccca atcaggaaca gtatgcagag 43980
 ggcaagatga gaggggctgc ttcaggaaag aagacatctg gtctgcaaca gaaaaacgtt 44040

gaagtgaaaa caaaaaagac caagcagaaa acaccctgaa aaggagatag tggcagtacc 44100
 agtgagacac ctacgctcc taggaagaaa agagcccggg tagatccact gttgaaaatg 44160
 aagaaacatt cgtgaacaga gttgaagtta aagtaaagat cccggaagag ctgaaacat 44220
 ggcttgtgga tgactgggat caccagacaa aaacagcttt tttatcttcc tgccaagaag 44280
 aatgtggatt ccattttgga ggattatgca aactataaga agtctcgagg aaacacagat 44340
 aataaggata tgctgttaac agttcttcaa tgfaatgctg ggcactcagc tactctataa 44400
 atctgagaga ccaaagtgtg ctgagattct tgcagatcac cctgatgtgc catgtctcag 44460

 gtgtatggag cgccacattg actgagatta tttgtgcaaa ttggagcaat gttggcacct 44520
 ctagatgaga aaagccttgc tttattactg aactatctac atgatttctt caagtacctg 44580
 gtgaagaatt tggcaacttt gttcagtgcc agtgattatg aagtggctcc tctgagtaa 44640
 cattggaaag ccgtgttaca ttatatataa tacacattgt attatattaa attgtatgtt 44700
 atattatata tagtacacat tatattatgt tacattatac ataatatata tattatata 44760
 atatatata tgtacaaatg tattatataca tatgtgtgta taacagttga tgtttaatat 44820
 atgtatata acacataata atatgcata acatcaacaa tttaaaaaag agaccatgaa 44880

 tttgagagag aacaaggcca tgcaaggagg tttgagtaaa gaaaagaaac ttggaaagtg 44940
 atgtgtttat attataactt ttaaaatact attttaaaaa accaacacat ttttcagaag 45000
 atctgtgctc caatagtcac ccttcctta ttaaggcca tcttgtactt ataataaaat 45060
 gattctcagg gaagatttta ttattcccgt attatatggg aagcactcca gaagacaaat 45120
 gcctgttctt tatctataaa ggctttcaca tggcagatcc atagctctg gctctccata 45180
 ttgaatgctg ctactgtgg ggacactaat ttcccttact ctctaacaca atgtgaaacc 45240
 acttaggaga aacagttgat gtttaattct aaagaaagt ctagaacact ctgatttgtt 45300

 tttctgcttt tattcagctc gaaacateca tcttgctctc cttttgcttt ggggttttgc 45360
 tagctagccc atcttttctt ctgtttatag agtggatatac atatacctta aaccacttcc 45420
 tattcatagg ccacaaatat aacctgtgat ctcttacgac aaaatagagc tattttccaa 45480
 ccatagcagt ggatagtta taatatcttt tcatcttaaa ggacaaagaa gatagagtga 45540
 aatgtccagt tatctgcctt gcaatgtctg aagtctgtat ccttaaatgc ctgcttgttg 45600
 gggaggcaag gcagccttcc cgaaatactg gcaggcatgg ttttcccttg tgggtttaat 45660
 tctggaagca caaaagatgc tctaaccctt ctggccatct atgtggtacc gcagagaggt 45720

 ccaccagcct aactgatca ctgagaagaa ataaaaatga ccatgactgt gagagctgag 45780
 ggcagagggg caatccatgc ttcccacgc agcagagctc tgtgattctt taaatgtaaa 45840
 ctgagggttt ggctggatag ccagccgcct ctgcagcctc agaaacatgg tattagttaa 45900

atgtcagctt gcgtaagat caccagtggc ctttgcctg cacatgcttc catgtttctg 45960
 cacaagata ggggagcgcg gccatgcctc tgccccagag atcgatcggc cttcgtgtct 46020
 gatattacct tacatcgctg gggccaggtg ggtgtgagag ggaggaaggg cggggagcaa 46080
 ggggagcatg ttiactcact gaaccttgag tgcagcttta gcaagtggcc aggcggcggt 46140

 tgaatcactg aactcactgc tgctggaagc cctctgttag ggtctgaggt gataagaaca 46200
 gatctctgag gagtgaatg tctgcatgag ctaaactcag ggcagtcagg ctgaagacga 46260
 tgtgtgctct aacctgtttg cactgaatac tctccataaa taatttacag cccggactgc 46320
 tcgctattat tgcaaagata ccgattgca ttttgacaca tgcattccagc ttgtaagtcg 46380
 atagctacag ttcacccag tgtgtgcaga cttggcttaa gtcacccatc caagtgtgtt 46440
 ttccaataat gtaattaac actctcaaac cagagtggga agagagctct aagaagccat 46500
 tgccctccat gagacaatag attgtccttc cagtctgtat tctatttttc ctaataaatg 46560

 agtttatggt tttctcctac ttggcattaa catctttatg aatacaaagc cattttcaca 46620
 taatggtaaa acaaaattat ttggatgtga aaaatactct tttgttctcc tgattcaagg 46680
 aatgtcttcc atggcaacac ctgggtgttt cctgagaca gccttgatcc agagagcatt 46740
 ttactatggt cagttttagc ctctcccc ctttaccatcc aaaatagtta tagatgtccg 46800
 caggcactct gtcttccat gggatgatgt agtttcccca tgaagactaa acctgtgagt 46860
 ttttacgttt teacgaatgt gaaaaacagc ctgcactgtc tgtactctaa gaaaacttag 46920
 ggtaaacat ctaataagt aagcaagaga tgagcctcat taatgctact caggatcact 46980

 gataaagtta cttaactcct tccaggttat tttttcttaa atgaaagtgt gaaatgctga 47040
 ctctgatgct gcaactgtctc taggatcaat caaccacaga gttgcagtgt ctcccttgtt 47100
 tttttcagaa ggcacattta catgcaacca gggattgcat gcatttttaa taagaaactc 47160
 cactctatgt acacgtggca ggaagaaaat agatgtttgt gttgggtgta ccaatagtaa 47220
 tacatgcatc taaaattatc tgctagagat ttaaaaggag aatcctgggt ggaggacaaa 47280
 agagtgata aacgatggtt gcaggtgagg tgatactaaa atattgacat gtcaaagtag 47340
 aatgtgtttg aaagtaagca gttaatagca tacactatit tctcagtaaa atatctattc 47400

 tacaaggggg ttcttacaac acgaagaaag catccttggg gatgggaaga gttttccatc 47460
 gcagtgtttt ctagatctac tccatggat actaacagta cttgtgatgg ctaactttgg 47520
 ttgctaactg cttgtgaaac aaaccagagc caagctgctg agtgccttg tgagggattt 47580
 tctgagcaga ctacattga agcagtaaga ccaccctga atctggaccg caacttcttg 47640
 tggcagccca catagatgaa tgtggaagaa ggaagcttcg ctgtgtgctt gettccctc 47700
 acacttgctg gcatgttcat ctattttgtt gttgctgagg tattatttaa ccaatttag 47760

aacttctttt gggttccaaa attgacaaga agaccactgg tagcccgtaa gtcctttagg 47820

ccttcggttc cagacttggga ctgttaagac tgctggcctt ttgctctgaa gaattcctct 47880
gttctcagcc tctccagtac gagttagecca ctgttgggct atccagactg cattctgtat 47940
gccaatttat gatttccctt ttaacatata tctcttctat cagctctgtt cctttagaga 48000
acctgaata aaaaacagtc tttcatgaaa cacatgtatt tcttgacaga ggcttaataa 48060
acagcccata ggctgtgta ttctgcaaac atattttag tagtgccctaaa agaagtaatt 48120
ttgatcttcc tgctccctta tgcctcctc tcccctcctc ttctcccctt ctctttctct 48180
taattcctc tcccctccca caatgttccc aatttgetca ggagatcttg tcttttccc 48240

ctattgagtc gggcgtaaaa ttcaggagag caagaaaaga ggtaccataa caaaggaagc 48300
cattacaggt ctaaagagaa atctggcact aagaaaatgt ccagagatct acaagttga 48360
cccaactaa gaatctaagc aatatttcat attaataata aatgcccttc ccctataatg 48420
agattgatga ctaccttaca tgtcatccta gagccagtag acaccacag ctaaacactg 48480
aactgacctc ctggaatcca gttacaggaa gggaggagtg ataaacaaag gggccaagac 48540
cagactgtag aaaccacag aaacagctga cctgaacaag ggagagctca tggacccag 48600
acagatagct gggaatctag cataggactg atccagacc cctgattgtg ggtgtcaatt 48660

aagaggcctg ggctgtctat gtgtctctgg caatggagca gtatttatcc ttgggtata 48720
aatggacttt gggatcccat tccacataga gggatactct ctgagcctag atacattgaa 48780
gagggcctag gccagctcca aatgatgtga ccgacttga agatcccat gagaggcctc 48840
acctcccta gggagcagaa aggggatgag atgggggatg ggtcgggtggg ggggctaggg 48900
gaggaggaga ggaagtggga actgggattg acatgtaaaa caagattgtt tctaattcaa 48960
attaaaaaaa ttatattaaa aacaaagtaa ttttgaata tacaagttac tttttatgaa 49020
taataataat gataataata agaaaagaatc ttgctaagta attcaggctg gcatcaagct 49080

caccgtctc ctactccagc cctctggatg ctagggttgc agtcatggaa gtcctcacct 49140
ggccactaat gggttaatca ataggtctga gcaactaac tacttatcag ctctttcaa 49200
ggtgacaaaa acaaatcagt atcgacaaat gccatctagt agcattaagt tatttataag 49260
agaaaattat gtgctaaggg ttgttcagtc taatgtctg attaagaaaa atcgtggaaa 49320
aaaaaagaaa agaaaagaaa aatcatggca tgcagttaag gcaagagacc accttggaa 49380
tgtttttaat aaggtagtg tgcttccatg catatttatg tctttgctct ttattcccat 49440
tctcatgggg tctatctcaa gctgttttct ggatgcttgc cttactccc gttgccactc 49500

tgtgtgtag tcttctgggg aggcactcct ctccagccag cctaccgggtg ggctttcctt 49560
 ggttgtttcc agcacaagga ctcatggctg cccttagccc tacctcaact tctgttaaaa 49620
 tgataggttc tctcaacaag atcatcttta ttattagaat tgatttagta caaggtggct 49680
 ttagggtaaa tcagttttca tatagggctct caaaacttct cagagctcat gcctaaccba 49740
 gcatgcagca gtcaaagcat ttgtatccca tcagcatcta tctgtcctct gctaaactct 49800
 ccctcgtttc aggcaagaac agctgttagc tgtgatgagt aagatgtctg tctgttga 49860
 gcaggtaaaa cacgtggtaa ttaaaataag gagttaaact tggtaacattt gagaatacaa 49920

 gtctccacag aatagtaatt ctaaaaggaa aagaaaaaac ataatcattt gctttgtcca 49980
 tttgttgaa agggaatttc agagttaaca gcagactatg gattttcaat cagaatagca 50040
 ttatgtagaa tgaaaaatgt tgctggctgc acttataatg taataccatt gcttttcttc 50100
 acagcatttc aactatcccc atcctaatga gtctcagtaa acacagaggc tctcaaatag 50160
 ataaagactt caatgtataa aaatatgctg actatgagat tcattgcaca aatacagatg 50220
 tagtaaatcc tattttaaa gttaccttga gaagaatgtg agccaccgtt cactggtcaa 50280
 tgtataaaaa tatgctgact atgagattca ttgcacaaat acagacgtag taaatcctat 50340

 tttaaaagt accttgagaa gaatgtgagc caccgtcccc tccctttgct tttttttct 50400
 ttctttttt tctttcttt ttttttttt ttttttttt ttttttggt agcccttct 50460
 tttctcata atcaaaacca caagaaggac agaagaatga tctaccaca ggtcttggtg 50520
 ctgcctccag aagtcttccc taagcaacc cctacgttg aaggatgcag agggcatctg 50580
 ggatgctctg tatgattcca gtgttaacat ggatcacttt gctaggtctt ctacatgta 50640
 ccctcaaaga cacagcatac ccaggctaga gatggagaga aggaataaat caatatattt 50700
 caaagtgaa ggttttgcat tcccagacag agtgcaagag ctttgagtgc ctgtacttga 50760

 acagtaaatg ctgaactgat gtttctgag taactatctc caaagagaga aagcaaatgc 50820
 tgcggccct gtgggttcta aagagccaca gtggttactt agaagaaggc attcatgctt 50880
 ttcatatgtt caagttaate cgttttcatt cacaatttg agatttgtc ttccctttt 50940
 aaaaaatgga atttaaatga aacagttaga aacgtgaate cctgttctca aaagtcctta 51000
 actcagctgc atgttgcat catatgttg tttgtaattc acctaacaaag tgctgtgtgc 51060
 aagacagcag caagtgtgtg ctctagagaa tgaacccgat tccaatgcac gtttactaag 51120
 tcatcactat acctttttgt tccatattgg aggacatgaa gaaaatagga ttttctatc 51180

 tgcgagtatc ggtcctctgt tgccccgag ttgtatctct aattaaactg atctctttcc 51240
 tttcgcgaat aaagccctg tggcttttat attaatcccc agtacacata caaagaaact 51300
 acttgtgaca aaatcaccaa gcatatgat cgctggacgc cactgtctca gttcctgagt 51360

atttatattc cattttccat cctctttcca ttttcatttt tcttttcac ttagtittta 51420
 ctttccaatc tcagtaggtg agttgggtgt agcttttctaa agtaaataga aagtattcta 51480
 cattccctga ttctccgtgg atggcacaaa aggactgtta ttgctacatt caggctgcac 51540
 ttaattgctg ccaaattctg aaccacaaa acgggcttga tcacccaaag acgtgggtga 51600

 tggatagcta ctccagccat ctattcagcc atccatctct gtagaaaaa tggatgatcgc 51660
 tggagacagg ggagctgaca tcagcagaga tgaccacagg agtcagatat aaaggcagct 51720
 gaggaagga attggtctgc aatctgttct ccgaggcttg atgtgaaaga gggaatfff 51780
 agtcactfff gttcagacac tttgcagatc gttcagtgca aagaaatgg catatctcta 51840
 gagggtaggg atccacaaaa atttagtaga gctttaggtg caaagctatt gatcatataa 51900
 ctttgctaaa atctgaaag atggaaaaca cacccaagg caaactgtac acacatcaat 51960
 ccatcagctg cttgagtcta ttttatggat tggaacattg ttattgaaaa aagcttctac 52020

 tatgtccaca acaaagccaa tgaacgtgtc atggttatta cccttaatat caatcctgat 52080
 aatgtcttgc tatctaaata tagaagaaac ttctgggatt tgagttagca tacatcaaaa 52140
 attgaattgt atgatgagtg agcttgatgg ttttaagcaa acagaatctt ataatgctac 52200
 ttgtatgagt aagtagtaaa aatatcaatc cttcacattt tttgttgggg gaggttfaat 52260
 aatatcccc caaatatag ttcacataaa acttaagatt gtatgtgaat tcaaaaatag 52320
 tatctttata gatatactc gcctaagtaa ctcaagtga gactatactg ggttagaata 52380
 acccctacat ccattgacag gtgtttttat atgaagacag aaacatacaa gaggaaaggt 52440

 tatgaagaca gaggaggcag aagttaggat aacacatctg caaaccaagg cacaagcaaa 52500
 gactgatggg aaatgacgct atgggaaatg aggaaagagt acagtacaga ctctccaga 52560
 acttctgga gaatccgacc catcagccat cttgatgtcc gacttctgat ctctagaaat 52620
 ataaaatcaa tatatttctg ctaactgaag atactcagtc tgcattttgt atagtagtct 52680
 tttcagccca agttgggtgc aaggctctat cttctggttc ttagcccaaa ctgcctaaca 52740
 tcatattccc acttggttat tgtattagtc atgtttctcc agagaataa aaacaacagg 52800
 aggtgtgtgt gtgtgtgtgt gtgtgtgtgt gtgtgtgtgt gtgtgtgtgt tttatttaaa 52860

 gggactggct cacatgatta tgggaggtag cagggtgaa atcagtaggg caagctagcc 52920
 ggttggagggt ttggatgggg gactggctca catgattatg gcagggggca gggctgaaat 52980
 cagtagggca agctagccgg ttggaggttt ggatgggaat tattgttga atctttactc 53040
 tgaaggctga agtctgtgtt gcagtaagga aatagaattc cttctttag aaattttag 53100
 tctacaaatg atgaataaaa caacatttaa aacatgattt tatactcaaa cctagattga 53160
 tgtttgaata aacaactgat caccgaagcc tagccaaatc gatataaaa attaatcatc 53220

acagaagcca aaacaatact gtggtaacac agtattacct ataatctgat gttcagaggg 53280

 gaaacatggt caaacaattg tatttgtatt ttcaacttca aatcaaaaat aaataaaaca 53340
 acaaaaagtt ctcaaagaat caaaaaaatt gattgccaca aaaaaaacag aaacaagcaa 53400
 aactgtccat ccctctctc cacttctatt caacacaatg cttgaggtct tagctagtag 53460
 aataaaggaa gggagtaaaa gaaatgcaaa tactaaaaga aatcaaagta gagattgcag 53520
 ataatatgaa tctaaatgta agaggcattg tccactggac tacaacttg ttagagctgc 53580
 taataaggtt cagcaaagtg gcagtacaca aagtgaacac acaaaaaca cacacttctt 53640
 aatatccatg acaaacatac ttttatcatt gacactgaag agtaaacag gcaaacaaac 53700

 aaaacaatcc cattcaacac acacacacac acacacacac acacacacac acacacagca 53760
 gagcacatac acataattaa agacactgaa taaggccaca gtggcacagg aaggagtatc 53820
 aacaatcaac agacaagatc ttatgaaact aaaaagcttc tgtacagcaa aggacacttt 53880
 cccacagaat gaggaaaaaa aatacacata attaaagaca ctgaataagg ccacagtggc 53940
 acaggaagga gtatcaacaa tcaacagaca agatcttatg aaactaaaaa gcttctgtac 54000
 agcaaaggac acttcccac agaatgagga aaaaaatctt tgacagctat ctttctgggt 54060
 gtggatgatt ggtgactaga acatataaag aactcaaaaa gtcaaacatt aagaaattaa 54120

 acagttcaat ctaaacaatag gctatggaac taaacagaaa atccttagaa gaaaagaata 54180
 tacgtgacca gaaaaaatt cttaaagtgt taaacctccc tattcttcag ggaaaagcaa 54240
 actataatta ttttaaaatt ccatctcacc gcagtcagaa aggctatcag caggaataca 54300
 aatgtcaacc agtgctggtg tggatggagc aaaaggaac acttttggga aatagtgtaa 54360
 tcagtttgaa aggttcttaa aacctggaca tagaacttgc gtatgagcca gccacacctt 54420
 cctgggtatc tacccaacag acttctaacc ccttagagga actcccactt gcaggtacat 54480
 tgccctgcca agctctcaaa ttctgggggg gatttgtttg ttagctgaat ttcttgtttt 54540

 attttctgta tgitttgttt ttggtcacgg atcaccacag tcgggtatag gagtccctag 54600
 gattagggtc ctcaagaat aggtgggtaa ggattcggtg gtgacaaaca gaacaaaca 54660
 cagaggcagt taaatcaga gttctcaaag aaggtttttt atagagatat tttctcaggg 54720
 gatgtttttg ttaacaaac ccaacatat gacattgttg ttacttggca cagtgacact 54780
 gaaatccaaa acatagaatc atccaggtt aatcaaaaca aaattgtcct tgattaatca 54840
 aaacataaga ctgtccttga ttaacatagg atcatccaag gctaaccaca atttcttaaa 54900
 tcaaattaat atattttatg gtaagttatt gtttaacatc tattacctag ttcttgtgag 54960

tttttgaagt attgagctat ttttactatt ttaactcttt cttattaaaa gcttttgttta 55020
 ccagacactt aagcccactt tcgatgacac atgaacagcc atatgaaatt ttattgttgg 55080
 gaaagctttt actatttgta cttatgtgaa tgtcgtgaat gatttgghaaa gtgctggttt 55140
 ttcttgagat ggggtcatgg ctagtgaccc cgtctcaggg gatggtttct tatctgtttc 55200
 ttttgtttaa aacatcagca taggtttgta ggaacatfff gttaatgcgg aaaaaaaaa 55260
 agaatagaag aacaaacaga aattgccacg agaatcacag cccaatattt tttctctggc 55320
 tgagggttcc agaacagttt caggagacct cttctttttg aagtgtctc ctcagtctgt 55380

 ggaactgtc acacagaatc tactggattt ggtgtggcag gttttttaag tttgtttttt 55440
 tcattttgca taccagcccc aactccccct tcctccccct cccctacccc tcttctcat 55500
 tccactgcat ccaaaaagtc tggcatacca agtgaagca aaaacaagcc ccccccccc 55560
 ccccccccc ccaaacctg agcagggggc ccacccaaa aaggccagtt catgtactca 55620
 ggataagtcc tggctctgct gccagccccct ccccatcagg ccacataact gtcaccaca 55680
 ttcagagtgt ctagtccagt cctgttttaa acgtctctg gatggcaaag agatgcaatg 55740
 acttcatttc actggggaaa ggtggagccc tagggcagca accctctcac caatcatttt 55800

 catcaaagct cacctgtacg atccccatgg cctgggtgtct cccagggctc ttggcaagtc 55860
 ctcaaatttc cttctgttt catagcatac ccatatattt gtctcttagg atattaatc 55920
 gtgaatcttt aaaaatacat tttttttct gatccttga ttcactttgg ggttttgctt 55980
 ctgggtgtgtg tgtgtgtgtg tgtgtgtgtg tgtgtgtgtg tgtgggggt gtggggggg 56040
 tgtgtgtgtg tgtgtatgtg gtgtgtgtgg gatgtgtgtg tgtgtgtggg gtgtgtgtgt 56100
 ggtgtgtgtg tgtgtttgta tgtggggtgt gtgtggggtg tgtgtgtgtg tgtgtgtgt 56160
 gtatgtcagg tgtgtgtgtg gtgtgtgtgg tgtgagtgtg gtgtgtgtgg gatgtgtgtg 56220

 tgtgtgtgtg gtgtgtgtgtg tgtgtgtgtg tgtgtgtgtg tgtgtgtgtg gtgtgtgtgtg 56280
 tgtgtgtgtg tgtgtgtgtg gtgtgtgtgg tgtgtgtgtg tgtgtgtgtg tgtgtgtgtg 56340
 gtgtgtgtgtg tgtgtgtgtg tgtgtgtgtg tgggtgtgtgt ggtgtgtgtg tgtgtgtgtg 56400
 tgtgtgtgtgt gtgtgtgtgtg tgtgtgtgtg tgtgtgtgtg tgtgtgtgtgt gtgtgtgtgtg 56460
 tgtgtgtgtg tgtgtgtgtg gtgtgtgtgg tgtgtgtgtg tgtgtgtgtg tgtgtgtgtgt 56520
 gtgtgtgtgtg tgtgtgtgtg tgtgtgtgtg tgggtgtgtgt ggtgtgtgtg tgtgtgtgtg 56580
 tgtgtgtgtgt gtgtgtgtgtg tgtgtgtgtg tgtgtgtgtg tgtgtgtgtg tacatgtgga 56640

 agcagagggt gctgtccacc gtcttttttg agacaaagtc tttcactgaa gttggaattt 56700
 accagctcag ctaggctgag tgactggtaa gtcctcacc tcctcctgcc tgtgcctgtc 56760
 ccgcgcgata gtctcgccag caagaaccac acaggacatt cggatccttc tgcagtaaaag 56820

ctttaannnn nnnnnnnnnn nnnnnnnnnn nnnnnnnnnn nnnnnnnnnn nnnnnnnnnn	56880
nnnnnnnnnn nnnnnnnnnn nnnnnnnnnn nnnnnnnnnn nnnnnnnnnn nnnnnnnnnn	56940
nnnnnnnnnn nnnnnnnnnn nnnnnnnnnn nnnnnnnnnn nnnnnnnnnn nnnnnnnnnn	57000
nnnnnnnnnn nnnnnnnnnn nnnnnnnnnn nnnnnnnnnn nnnnnnnnnn nnnnnnnnnn	57060
nnnnnnnnnn nnnnnnnnnn nnnnnnnnnn nnnnnnnnnn nnnnnnnnnn nnnnnnnnnn	57120
nnnnnnnnnn nnnnnnnnnn nnnnnnnnnn nnnnnnnnnn nnnnnnnnnn nnnnnnnnnn	57180
nnnnnnnnnn nnnnnnnnnn nnnnnnnnnn nnnnnnnnnn nnnnnnnnnn nnnnnnnnnn	57240
nnnnnnnnnn nnnnnnnnnn nnnnnnnnnn nnnnnnnnnn nnnnnnnnnn nnnnnnnnnn	57300
nnnnnnnnnn nnnnnnnnnn nnnnnnnnnn nnnnnnnnnn nnnnnnnnnn nnnnnnnnnn	57360
nnnnnnnnnn nnnnnnnnnn nnnnnnnnnn nnnnnnnnnn nnnnnnnnnn nnnnnnnnnn	57420
nnnnnnnnnn nnnnnnnnnn nnnnnnnnnn nnnnnnnnnn nnnnnnnnnn nnnnnnnnnn	57480
nnnnnnnnnn nnnnnnnnnn nnnnnnnnnn nnnnnnnnnn nnnnnnnnnn nnnnnnnnnn	57540
nnnnnnnnnn nnnnnnnnnn nnnnnnnnnn nnnnnnnnnn nnnnnnnnnn nnnnnnnnnn	57600
nnnnnnnnnn nnnnnnnnnn nnnnnnnnnn nnnnnnnnnn nnnnnnnnnn nnnnnnnnnn	57660
nngggcagca agtgcctgtg caaccactac cttacctttt ttgtttgggt tttagtcta	57720
cacacagtcc caagcataaa caccacacca ctgtagagaa ttgtgcaaaa aagtcccacc	57780
cccaccatt ccttagcata ggagacagcg aagcgatcca tgatgacaat ccctecgtea	57840
aggacaggag ttaatctggn nnnnnnnnnn nnnnnnnnnn nnnnnnnnnn nnnnnnnnnn	57900
nnnnnnnnnn nnnnnnnnnn nnnnnnnnnn nnnnnnnnnn nnnnnnnnnn nnnnnnnnnn	57960
nnnnnnnnnn nnnnnnnnnn nnnnnnnnnn nnnnnnnnnn nnnnnnnnnn nnnnnnnnnn	58020
nnnnnnnnnn nnnnnnnnnn nnnnnnnnnn nnnnnnnnnn nnnnnnnnnn nnnnnnnnnn	58080
nnnnnnnnnn nnnnnnnnnn nnnnnnnnnn nnnnnnnnnn nnnnnnnnnn nnnnnnnnnn	58140
nnnnnnnnnn nnnnnnnnnn nnnnnnnnnn nnnnnnnnnn nnnnnnnnnn nnnnnnnnnn	58200
nnnnnnnnnn nnnnnnnnnn nnnnnnnnnn nnnnnnnnnn nnnnnnnnnn nnnnnnnnnn	58260
nnnnnnnnnn nnnnnnnnnn nnnnnnnnnn nnnnnnnnnn nnnnnnnnnn nnnnnnnnnn	58320
nnnnnnnnnn nnnnnnnnnn nnnnnnnnnn nnnnnnnnnn nnnnnnnnnn nnnnnnnnnn	58380
nnnnnnnnnn nnnnnnnnnn nnnnnnnnnn nnnnnnnnnn nnnnnnnnnn nnnnnnnnnn	58440
nnnnnnnnnn nnnnnnnnnn nnnnnnnnnn nnnnnnnnnn nnnnnnnnnn nnnnnnnnnn	58500
nnnnnnnnnn nnnnnnnnnn nnnnnnnnnn nnnnnnnnnn nnnnnnnnnn nnnnnnnnnn	58560
nnnnnnnnnn nnnnnnnnnn nnnnnnnnnn nnnnnnnnnn nnnnnnnnnn nnnnnnnnnn	58620
nnnnnnnnnn nnnnnnnnnn nnnnnnnnnn nnnnnnnnnn nnnnnnnnnn nnnnnnnnnn	58680

nnnnnnnnnn nnnnnnnnnn nnnnnnnnnn nnnnnnnnnn nnnnnnnnnn nnnnnnnnnn 58740

 nnnnnnnnnn nnnnnnnnnn nnnnnnnnnn nnnnnnnnnn nnnnnnnnnn nnnnnnnnnn 58800
 nnnnnnnnnn nnnnnnnnnn nnnnnnnnnn nnnnnnnnnn nnnnnnnnnn nnnnnnnnnn 58860
 nnnnnnnnnn nnnnnnnnnn nnnnnnnnnn nnnnnnnnnn nnnnnnnnnn nnnnnnnnnn 58920
 nnnnnnnnnn nnnnnnnnnn nnnnnnnnnn nnnnnnnnnn nnnnnnnnnn nnnnnnnnnn 58980
 nnnnnnnnnn nnnnnnnnnn nnnnnnnnnn nnnnnnnnnn nnnnnnnnna ccctatatga 59040
 cgccatggaa taggcggggc taggcagtgg aaaaactg ggacatgga taccaacgtt 59100
 gtttacttga tccggcagtg gatgtcagcg ccatcttga atggcgaatg tgagtgcggc 59160

 tcctcacatg tgctgcca gtgctgggat taaaggtcac accacaatgt ctggctttca 59220
 tgtgagcact gggcttctga acccaggtcc tagctctggc ctgatgggtt ctgtactaat 59280
 ggagcccate tcctggcct ggttttgcct tctttttgtt tttcaaaaac ctcttaaaat 59340
 cttcctctat tttcatctct gttcattttc tctttccttg tggtaagaa tgtttgtaaa 59400
 tatttacta ctgtctatac cagatctgtt gtgtaaagag acaagtatct gatagcctgg 59460
 gcaactcate cttttcttc cactaacaca ttttgattc ttttaaaaca ataaaagcct 59520
 acctggttta aatgctcaga tcctgaattt ggggttagat aaaccgttt taaattctag 59580

 ggttgttatt ttacagatg gtgattttct gcctgtcact caactgtcct gccaaagtcta 59640
 gcagtcacct aaaaatgcat tgattgaaaa gcactctattg aattggataa ttagaaggtc 59700
 attggtgacc ttcactgggt gcctccata gagtgatgag ggcagaagcc aggcttctact 59760
 gggactcatt cattaattgt gtttctgcca ctggattgca tgctgtctc ctccagcagt 59820
 cccagcaga gctgagagtt acctgaacct tgggtctct gcttattttg ccagatgctt 59880
 tagtatttcc atgtgctgcc aggttgaag catgctttc cttcaaggct catatcagcc 59940
 agctgttgca acaagcttca aatgetcct gcaaaactgac gggagtctga aagccctcag 60000

 aggtctgaag ggagcaggaa agcaaaagag cagcaaagca aaagttgct tagggaggca 60060
 gtgtggaagc atgaacaggg gtggagaata tcttgacaat aatatgaca aaaagaaggg 60120
 aaacctgaa ggaaaaatat tccagcaaga aaaggaggga gggaaaagcc attctcagaa 60180
 ttctccacct ggcctctct ggtttgcaa acccctgta attagcagga cttccaata 60240
 taaccttgc ccaaagcaga gaagctgatg gctaaagac tgccatgatg gaaggcagac 60300
 gtgaatcgga tagttcactt tgtatcactt gcagttcttc ctgggcagga gctgcctgga 60360
 gatcgtcctg ctagggtca cttgcaggag gcttaggtta cctttgatg gaaatttatt 60420

tcaaggctct aagttctagt cagcactttc gaccctcaca ggagatcgtc ctgctagggc 60480
 tcacttgcag gaggccttagg tcaccctttg atggaaatth atttcaaggc tctaagttct 60540
 agtcagcact ttgtttcctc aatcctaaag gactgtttgt ttgttttctg gttttactac 60600
 acaatccatt ttcataaact attgccagc tgcacacggt gctagaaaac tagcagaaaac 60660
 aaaatgtcct tatttgttca gctcagaaaat aaatttaaaa ttctctagac ttgggaacag 60720
 taaatgaaag gctgaaaaaa tacttttttag tacagagatt caatgccaac ttagggatct 60780
 ttgtacctga gaaataattc ttatgaatcc cttttttatt aaaaaaagga ctcatatata 60840

aattgatata attggagttt attctagtac tttctaaaaa atcataatat tgcttataaa 60900
 attctccatg aaagtcctca tcttaatcat cagtcagcat tttattatat tatcatcctt 60960
 aattgattga cgtttaatca cagtctttgt attttactat cccttgtctc ataagaggca 61020
 attttctctt tactgtagtt taacagctga tgaaaaagat ttaaggaaac ctataaactt 61080
 aagattgggt aatggctcct tataaaagaa tattatactt ctaggatcca ttgcacagat 61140
 gtgatgctca attgtagaaa tgtgcatggg gtttattaaa ttacagcaca aatcttcagt 61200
 ctctgagtt attgtccatg ttgggattgt taggcaaatg gggagacaca ttattgcttc 61260

cagttgttcg cactactgtg gtgcgagaca gctggcgcac tgctgtaggc aagtgtggca 61320
 cttcagcagc tgctgagaac tgggccaag tgaaggcca gctccgctga gtcagtgttg 61380
 accacttcat caagccttc cagaacatgg gaaataaatg aaccaagctg gctgtcagag 61440
 agcgggggga cagcagtgag gaagagggt gacaaccgtg ggggtggggg agtgggaatt 61500
 accttggatg catagagctc cttgttacac tggcattact tctgggagc cctgccttcc 61560
 tgtgcagagc tgattattta caaacgcct ttagacttta gttggttggg tttggttttg 61620
 agacaggatc tcattctgta tctctctttg gctggaactc atcatcttgc ccaagtggcc 61680

ttcaaaactct tggcaagtcc cacttccgaa gtcagaccct taagtactag aattctgtga 61740
 ttgattgatt gagcctttgc ctttggacat tttcatgagg aagcacttta actctgtgtg 61800
 ctgatacttt gtgttaaaaa gttgctgttg tgttttctt tgctttggct ttaaacactgt 61860
 agtacctcca gatctcaaaa taagggaaga taacaagaca aacagaagtg cttttggttt 61920
 tggaatctga acaacaaca caaaaggccc tgggtgaaat atccccattg atattgataa 61980
 tgggtgatt gctcctaaaa cccattttt ctatttga gatgagctat gtacctatg 62040
 aggtggcat gtcacagctg tgagccctta gcatgctgcc tgggattcca catgtaagca 62100

gigaccacca gttctttcac tattgtagtc actgtcactt aatcttttta tttgttttta 62160
 tgtgtgagct gtatgtgcat gtgttcatgt gtgtgcccac agcatgagtg ctcacgggtg 62220
 tacctgatgc acatctggag gccagaggcc aactctgtgt gcctttatca ctgtctacct 62280

tatTTTTga gactaaatct cccactgaac caaggtctat tggttcacta gactgcctgg 62340
 acagtgagcc tgagccatct ggtgctcagc cttctccatg ttgggattgc agatgtgtcc 62400
 accacccact ctcagtatTT catgtgggtg ctggggaccc aaactcaggt tctcatgctt 62460
 gtgtgtagca agcactttac caaccaagcc ataccctctc cccattgttg aactgtgat 62520

ttgagagaat aaaaccaag ttctaaaag ttagagtggg acttggttat acccccacac 62580
 aactaaatt atttaaaagt atctacaaag tctcactcaa aggcagaaaa atgtcataac 62640
 aaagaaagag cccaatttta attcaciaat aagtctctac ctatatgatg cctagaaagt 62700
 aactctctac aggctttact gtctcattcc tcccacagaa tgggaacaat aataatgcta 62760
 cttgcctact gtgattgttc tggaaattaa agttcctgta tgtgtgcaca ccatttatca 62820
 tgggtgcaat aaaataaaga gcatctagca aatggtatct acttaacgta agtcctaact 62880
 cttggattgt attctccagt tattataatt ttcttacttt attatccgag actgagttat 62940

gtttaaatac ctgtttctgc gtgtcctttg cttaggttat tcctagtgtg accagaaatt 63000
 tttagcaaaa tttaggacaa aggtaatgta aagatcattg tctggcaaac actcagtcac 63060
 ccaatactaa ctgaaagact atttattgta ctgcagagaa gttccagggg aagatagggg 63120
 gaaaacacac ctgggaggaa ggaaaaacag ggtcaaagt aaacacaatc aacatcatat 63180
 aaaattctca aagaattaat aatttattaa taattagtaa aatatattaa aaacatctaa 63240
 atTTTTgaa atactactct actccagaaa ctgtgttgag ttctcagaac acaaaaatga 63300
 gttacagaac gtcggtgtgg tcaggctaaa taattgtcca gataaattta gtctgaaaa 63360

caatgetgtt gctctgaaag ctgctaacgc aggaggttc agagtccca aaaatgcagc 63420
 tcaaacctac agccgagggf tattaatgt ctattgtgca ttttcttcgc tgtctctcca 63480
 ctggcctgta ttccactct cctgtgggga ttgtctctca ggaaggtctc cgggtgtgctt 63540
 tccactgacc aagctagcaa acaaagcagc gtggatagtg cattttttgg tgtgactttc 63600
 caaggtccga agcagatcca aaaggagctg tcctttcttc ttgtcgcgaa tcctttctag 63660
 aatattctaa tctaaagggc aacctccctc agtttctctg gaagtggctt ccacctggac 63720
 cccactcta atgactgac ccaagcacaat gaccatggaa actgctggtt ccattgttta 63780

tttgcTgttt cctccctttg cacctgtgcc taaaataact gctgaccacg caagtactta 63840
 ataaatatgg atcaaatTtg ggcaaggact cactattagg gagtCagTta cagctattac 63900
 aaataataat tgcataaagc tgcaaatcct cagagaagta tttgctgaag acttgaatc 63960
 agtggttaact agagcttgag ttgtggagcc ttgaaagagg agccagacct acggggcaca 64020
 ggagagaaaa accagctgt ctcaggaggg taagcaccac aggaagctga gagctatggg 64080
 caaatgagtc acacaacttc ttgtccaag tcttaattta ctttctaact accaccccg 64140

cccgccctgg atttatccct agtgatgtcc attgatgcta tcaaggtcca ttgatgccac 64200

 gtctctagtc aatggaccaa tctttggagc ggtctgaacg gagcgtgaac atgtccagcc 64260
 acattctgcc ctgctcttga tttccccttc gcatcttcca gccagtgcaa aggccttggg 64320
 ggtgtccagt tcctctattg tgtctcccaa ccaccatttc acctttaaac taccacctgt 64380
 ctttggttat agaaaaggaa actaagataa aagagggggg ggagaaactt ggctaattta 64440
 gtcattttgt ttgaaagatc aatcagttcc ctaggaaaga tttttctggc aggagaatcg 64500
 gagtacctgg gatccaaaag cagcgtctcc ggccctggca ctccgttagc tgtcagcagt 64560
 aatcacactt acatcctcgt tccgggcctc cagctaggag gggatgcctt tacactctcc 64620

 ctgccggctt gcaaagctct ccccgacaca tgcacacaca gacacagctg agtggagctg 64680
 ggaacaagtg cctggcacca agatccctcc agcaggtgta taccaactcg cccattctgt 64740
 gcttggcaca gaccatcaag acccaggatg ggtccagggt tgaggaatit gtgtacagct 64800
 ggataaatcg actgcaagtt caggagtaa gaccactgct agaacctgag gaggctccac 64860
 attaaccaag cacgggtgtc tcccatttcc gtttgcagtg ggggtggcctc gccgtaacag 64920
 acctctgcct tgacttggac ttttcagga acgtgctagc ttgaaaaacg caccaacceg 64980
 cgcacacaag gttacagtct ggtgcctttt gccctcacc tctaataatt tcagtgacct 65040

 agcacagact tcattcataa tgagtccct gaaggaagcc aggcagagct cagaacatgt 65100
 tgggttaact tttctcctg ggcgtctgct ttatggaata cagctcagct ctgcattttc 65160
 atagcagagt gtctgtgctt ttgactgag cccggagcag gagcgcctta ttaaaaagga 65220
 ctcttaggta ccttgggct ggaggagagc ctcaggccag ggtaattaaa atgtagcctt 65280
 gaacaacatg accatatgat gtgtgacctt tgatgagaga ttatcaaatg attttaattg 65340
 cagggagaaa agaaaaaggc atacacgtcc acaacagtaa actgcctcca cggccgcaact 65400
 ttggtaaatg aataactgtt agaggtgaat tctcacacac agaaaaactc ctatacactc 65460

 cgaaatacce ccttctact agtatttaag tgttgctgag tcatgtcagg ttttgccact 65520
 taattcattt ttattcctat taagttttgt ttataagttt tctgtgatta tcaagcataa 65580
 aatagaaata ctctctctgt ctctccatac ccaactgtcca ttttgaagg agttaacact 65640
 tggctcttgc ttcttctcgc ctttgatttc agcataaaat gaagagcagt ttcttcaca 65700
 aatggagcgt cctgagtgga acgcccactg aggacaggaa gggatggatg gggactgagc 65760
 gttctgagtg gaatgtccac tgaggacagg aagggatgga tggggactgt ggaaaactat 65820
 atgactgaac aaaagaaaca gcagttgcca ccatcaacca gttgtcgcta tgttcagatg 65880

cgcagtcctat gattttcaag aaaagccaga gacaaagatg aaaagtcaaa atggagtcca 65940
 aaacttgtct gaactattca tccctgatta ctgcatgaat caaagaaagt cagtcttcat 66000
 actcaatttg acatctttgc tgcctgtatc gggctctaatt ttcaaagaaa tccatgcacc 66060
 acatccactc ttcgtgttta cttcataagc agcatcatgc aacagagaga aagagagaga 66120
 gagagagaga gagagagaga gagagaggac ctgggaacag tgccttgcta tagtgggaaa 66180
 ttaccaatac ggagtcaggt agaaatataa gggcatttaa tagggaaaag ccttacttac 66240
 agagcaacct agccagccgg tgggtcagca gcctgtaagg caagaagcaa agagaaaccg 66300

 aaagtcaaaa cgcagtcaca ctcactctga ccacgcccctc acaagcgtgg tcaggcacac 66360
 ctgtagccag ccctaagta ggcgtggcta cagctttccc tacaccctgc acttcagcac 66420
 ttcagtcctc actggccatt atctttcttg tgatgggtgt gaacttctct accttctca 66480
 ctttgcgcaa aagagagtag aggaaatfff atttgacctt ctacgtatgc tgcaaggctc 66540
 caatgtccaa gacacttaag ctcttctcct ctgtgtcctt ttatcacttt gctctgggtct 66600
 acattttagc ctgttgacca gctgaaagta ttgattcaca tcagtatcaa agacctcttc 66660
 acaccagggg cacctggagg actccttcaa acagacttct gagatccgcc cctgcaattc 66720

 cacaatcaat aggccctgagg tggcccccaa aatctgcatt cagctgccag atgctgggtg 66780
 tctggagacc acacattgct ctgctcaggg ccgtgggtgt ttatgaacag ctctccagtg 66840
 ctggcacggt gaatacccc tccatttaca gcatgaatgg cagccacttt ggcttctctg 66900
 tattctgat ctgtccatgt cagttagaaa gtagtggatg atccagagat gccttgcag 66960
 agaattctca tatctcaaat gcatgtagaa tcaagaatct tggaaattct ttcattgcca 67020
 cgatcacata attcaatgaa agcattttat aaatggagaa acacgttgta gcaattggat 67080
 catcagtata agagccaaga ccctccagca tctttttctt ctaattggct aaaaagcata 67140

 gttttcttct aattggetaa aacctatgat aacaattagg aacttatttc tggactatat 67200
 aaagtagatt aaaatgctgg gaatgaagca aatacattct caaaatatgc tggacatcca 67260
 acagagcaaa atattctgca agtccactct catgattggc atttttcttc tgttactaat 67320
 tccacatgcc taggaacct gacaagacaa aaaaaaaaaa aaagcaaaat atacctactt 67380
 aagatgtttg tgtttccctt taaataacag agctttcttt gcaggactgg agagaataat 67440
 tattgtatgt gcaaacata gtaatgagtt acattaattt tcaactcaag aatagataaa 67500
 ttctataaag taaaagaaaa ctgttaaaat attatatggc aatccttgcc caaacagtct 67560

 ttttctttg ttcagctcat tgaaggccat tgccacctca ttccactcc ttccagact 67620
 cgagaggatt tcatctttca tggatttgac cagtgtctgt tattagccga gcctgtttt 67680
 ctgtgcatg aatctagtag tcaatcaagg agttttaaca tctgacctg agaagtttct 67740

ggctttgtgt gtactacagc agttttaaac aagcaaagag tgcagttgta gaccattgca 67800
 agctctgtaa aacaaaaaca gagggtaaat gatagcaatg aggggagggt cctttaatag 67860
 agagccaaag agtggcattt gatctgcctg agatggagac atgccagggt ccagccttgg 67920
 ctcggttca ggcctgaga tgaggaaggg atgtcacctc agggaaaaat tctgatcatc 67980

 cgggtgatgc actcaagga cctgaataa ctcaagctct ctttaattata ctgaaaccga 68040
 gtttttttc taccaggatt acatgaacag ctttattatt gactactttt cacttttaag 68100
 aactacatca taattattat aaaagcacca ttattcccct ttatgcttcc ccaaatacac 68160
 ctcccacc cctgaataac ctactgtag acatagagtt caggattttt gcagcctta 68220
 actgagtatt gagccagaca catcctgccc ttgcagcact tatgtcagct ggcagctact 68280
 tgtggttaca aagttaaaaa gtaatagaca taggtacaat gctttaagga caacagtatt 68340
 caaagccaac caattctttc acatctgcaa gatatgcttt tatgcagttc ccatttctac 68400

 aggagggtcc catgactcag tctctctgta aaaggcagac ttggacaagc actcttttcc 68460
 catctcatta taccatgctt ctttcaccaa tacaagctac tgtattggtg ggaaggatct 68520
 acccttccca tattttacat tgcatttccc cattgaatct tactagatcc tattattaat 68580
 tctatatgct tgggtgtacag ggtacttaac tctcaacagt tggcactatg tgtattcctg 68640
 aagctttttc cctattctct gtatgcatgc ctactctcc tttccagaac tgacagacat 68700
 ggctaagtgt ccaagtgtg ttttctcata tgtacctaac tgtctctatt tagagtcaga 68760
 aaggctccca ggattaggag ttgtagttag taattccaga tgagaaattt gagaagcatt 68820

 agccccctgc tgattctaag gggaaagcat ttgagaaaga acagaatgtc cagagaaaat 68880
 tacatctggt gcctatgta cttacaaaat aaaactaaaa actgacaaaa aatcagcaat 68940
 ataatgagag agaaaagagt tgcatgaatt tagcagagtc ctgtgctacc ctgcagtcta 69000
 ctggtctttg ccaagtgaga gacggtcttc catgggtctt gcctcatgga gaccaattgg 69060
 acaggcattc ttggctgct ccaatactag gctgcatgga tcccaacaga aagagagga 69120
 aacctggaca gaggactgtg agaaccaggg cctgggtag aatgggcat gccattttta 69180
 gaagatgatg aaaaggccag tgtagatgag gagtgggagg agaggaggtt tttatgtgtt 69240

 gctgtgataa ataccacaac caaaaacaaa ctagggagga acaggtttat gtcagcttac 69300
 gcttccatgt aacagtccat cactggggga tgcagggca ggaagtgaag cagaaacct 69360
 gggaatagtg acaactatgg tcaacatttt cctgaggatt ttagtacaca caacataaga 69420
 ctgaaaatat ctagattcca atcactgcta tccagtcttt aaggaacttg aaaagtgtga 69480
 ctacttctaa acagaaacac tgtcaaaatg tctcagcctt gagctaaact agctattaga 69540
 agtatcagac agtggctgtg aaacagctct ttactccat aaggtaaagc taagagctct 69600

ataaataagt gagaatggaa gttcttgcca atgattatca agtataagtt aacttttaaa 69660

 aaatacatgt aaatgtatta tttattttaa taaaaaatat ttgacatta aaatttaatt 69720
 atatcatttt cccaatccct ttctctttc tgacccttcc caggtatccc tttctctata 69780
 tatggaatta catgcacaca catgtattca tatatatccc ttagtatata aattctgtct 69840
 gcctatgatt tcaggggtg acatatttgg ataatccttc cacacttcta ctgtgcaact 69900
 cttaacaca gtccaatcag tctttttctg tcttagtaac tgtttttact tectctactc 69960
 ttcacttctt cccctcctta tccccctttt ttctacatat gctcaattta ttttactatt 70020
 agtatatttt ttgtttcagt caccatccat tcttttagtct attgttttca agactttaca 70080

 tttaaaaatg taiggaata agtctatgt aggtggccag tgaattcct tcttgctaag 70140
 tgcaatgaca gtatcaccca cactgttctg tgaatgtgc tttatggatt acaatgccag 70200
 tgaaagaaga tggtcacctt tccatgcctg tcatagtatt atcacaatag caaggaaatg 70260
 gagctaggct agataccat cgacagaaga acagatacta aaaaagtatg tgcatagata 70320
 tataacagga ttttacttta ttacttagaa agatgaaatt ataactttgt atggacctga 70380
 aaaggaatac aggagatgat cagtctcaga aaaactagac atcttgctca tatgcagaga 70440
 ttggatgagt agggttgttt ggaaattaca tgtaacacgc tttggctaga gtttaactg 70500

 tgaggcagga aatgaccata aataagtctg gtgaatctgg cagataggaa ataacatagc 70560
 cttgggggtt atttctcaca taagttcagc tgtatgattt tttaaaataa atattttatt 70620
 ttacttttaa tgtgtgcatg cgtgtgcaat tttcttcat ccaatctcca caaataccgg 70680
 cccttacaac tgatgcttgt taaacatctg aatgcatctc agatgtccct tgctctcaat 70740
 atctcattgc atttattcct cagaagtacc ttgagacaga tattatagag ctgctgtaac 70800
 catcatttta atgatccaaa gcaaagaaac aagagggggt taagtattg gcatgagaag 70860
 atgaaggatg aagaatctaa atgcagggat ttaatecccc aaaacgttcc attgtgctca 70920

 aagaatttct ttccacctat gcacactcag cttggacatc acctctggag cactgagcgc 70980
 catcatcttc taagattggt tagaaacctc tggggggtct ccctactcac ttgcacctct 71040
 cttataatag ggatgatttg gcagaataat tatgttgatg tacaaccaca aatatagctc 71100
 ctaggtagta tagattctgt ttatagaact tgatatctaa agcaccttgc aaagtgcttc 71160
 ccacagtagt caccctgtaa gtaactgttt tgetagcgtt aaacagcttt ctttatgaaa 71220
 catctgtgct taataaacac tgttaatccg tattcaagtc tcctgtcagt actcaagtgt 71280
 gctttaata aaaagaaact tgtacagtcc cctcctatt tccaagatt atgcttaatg 71340

ctgtgatccc tttcttgatc aaagtctgtc caattaacca aacctaaaat ctagggatca 71400
 tccactatth gtctctctgt atcaataact gattaatcag acaccaaata ctgtcaaata 71460
 catctttggg tcttttgaac ctttcttctt cctgttaaac ccactctgcc tgtgtttcca 71520
 tccattccag caatattaca aggcatgtg atcacttaca catgttatca tttccctctc 71580
 ttgccactga gctgcagiat tcttgagaaa aaagtggata ttgctttacc cctgtatccc 71640
 tacatcaagg ctttttgagt aataacttgg ggcatggacc aaatgatcca ccttcacatt 71700
 ctaatgacta ttagctcaaa cttttagtgg acctaaggag aaaagttctc tcagcaggaa 71760

 ctatgcgttt gatacatggt acagatgttc agaaacatcc cgtctattct ctctgctag 71820
 gtgttttcta ggattgcatt tccctgcca gttgaaagt atgtgagcat gacttgacct 71880
 cagtcaatga aataaagtta gataaaggct aaagagaagt tttaggagac aatatgtgca 71940
 ttcacacaca tggctctcta acttcagtaa tcatgatcag ggaagtgtgt gagaatgaaa 72000
 ttctagtac atgaaatgta aattagaaac ataaactcat gttgaaacce caatgggttt 72060
 taggattggc agtgcaatgt gccttagcct gtcatacca gtgtaatac ctttaagtgt 72120
 ggtgtgttg ttttttttc ttttttggag tccccatggt taggtgagaa tttgtgttg 72180

 ccccttctt gtcccacaga tgttcttct catgtgaatt aaaagaagtc ttgaattggt 72240
 actcaagttc caatctggca atatacagtt taagaatcat acatagaagt tgggtgtggt 72300
 ggcacacacc ttaaatccca tcaactcagga ggcagaagta ggaggatctc tgtgagttg 72360
 aggccagcct ggtctacaaa gctagtttcc aggacaacta gggctgttaa tagagaaatc 72420
 ctgtctcaaa caaacagtat gcacaatgaa aatgtcaacc atattgactt gaaggataat 72480
 tatggctgtt ggtatgtaag aaagaagagt gggatggctc tttggtttat gtcagccttt 72540
 accgtcttct gacttgaagc atgtatccag agaagaatga caaatgttag atctgggtta 72600

 tttgattatt acaacttcaa gtgggaagca taatagcata actacacctg ttaagcattt 72660
 ataatttcta ctgatggcaa ctgtctcag aagaagctac ataggagcca gtatttctca 72720
 tcaccaggtc ctcttgcta gaagtaagac ataatcaca atttctactc aaagtatccc 72780
 agaggctta attttttaat taaaacataa ttgtatataa ttttccctgg cccgtttctc 72840
 cctccaacat ctaccatcta ccaacttgc tctctcaaa tctttagctt cttttcaatt 72900
 gttattgcca tacacacacc acacacaaa accacacgtc cttcttagtc cagtgttact 72960
 tgtatgtata ggatttcagg gctgaccatt ttatattgaa taaccaatga gaaggetcat 73020

 tcttgggaaa actgtttctc ccagcttag cattccttag ttgcttgcata atctttgtct 73080
 aggggtgtgg cctgtgaggt tcccccttc gtgttagcag tctgtgtgtg tecttcttc 73140
 ggcttgttt agcagccaaa ctgttgcggt gccgtgggtg cagctcccct gtgatttgtg 73200

ggagcaggaa ctcatagtgt gcttcccagt tcttgactct gggcatcttt cccccattcg 73260
 ctttcttgat gctccctgca ctgtaggtgt aggaattgtg ctgtagatgg gtcaactggg 73320
 cctgggcacc tcacgatcag ttgctctctg catTTTTGGAT gggttgtggt ctctctaat 73380
 ggtctctggt gcaaagagaa gttcattggt aagtggtag agatttactt atcctgtatc 73440

 tatcttaact gtatatctat cttaaactgt atattgccag agtatgaaga taagtattta 73500
 aattgcagtt aagaattgtg ctggtttagc aaagttagtg tagtaggttg tectcaaga 73560
 tgtataactc tgiagccctg atagtcgggc taggcttgca gcaccagacc tgacttcctt 73620
 cctgggtggt ttgaattcag ttagatttcc gttggttacc accaagatac aagtgccact 73680
 ctcaacaacc tagggaaatc ttgccatggt gagcattggt acgatttata ggcattactg 73740
 ccaggtagga catactgtca ctgagtttta aggcagtaat aaaaattata gtgaatacac 73800
 tttgcatttt tctaagtttc cacttatgtg ctcagtagcc ctactatata cagatgataa 73860

 atcccatgag aaagaaatca gggaaacatc acccttcaca atatccaca gcaacataaa 73920
 atatcttggg gtaaacactaa ccaaaaaagt gaaagacctg tacagtaaga actttgagac 73980
 tttaaagaaa gaaattaaag aagataccag aaaatgttcc cttagagtttc taatectttt 74040
 ctatttcatt ttattctta ttttctgct tatgggtggtc tgcttctggt ctttatatgc 74100
 ttgccttttc tttgatgtaa cagaacaaa tagctggcag gaagcaacct aagggcagaa 74160
 gtgtttatc caigcaacga ttttaagggga tccaatcgat catgtcgaga agacacagca 74220
 ccagccaggt gaggcagctg gtaaacactgc acttgcagtc aggatgcagg aatgacaggt 74280

 gctgggtgtec agcctgcttt ctccatttta ttcagactag gacctctgcc cagagattag 74340
 tgccatccac attcagggtg ggtgatccca ccttacagac ctaatctcaa aatttctca 74400
 cagatctacc tagaggcttg tttctccag gactggagtt cctgccaggt tggcagtcaa 74460
 tataaaccac cgcactcact ttctgcctgc actcacagaa ggtcggacag ctcttctct 74520
 ctgtgaaata ggtcattggt cagaagaggc ttgccattgt acttcagttc aaacaaccac 74580
 tccttgaagg aatacaagcc aagctccaca tagcactttt tgttgggttg tgtgtagcag 74640
 acgtaccctg teaacaccaa ctccattaac tcttggttcc ctacagacaaa actatgccta 74700

 tgttaaaca tttgttcat ctccatggt aataccattc tgctttgcct gacttgcctt 74760
 ctgaaaata tttcttctc ataactcaga cacagacttc cctaaggaca ctgtttgttt 74820
 tattttatt tattatttg tctgtttatt tattattta tttatttatt tatggttttt 74880
 gagacagagt ttctctggt tgctttggag cctgtcctag cactcactct gtaaaccagg 74940
 ctggcctcaa actcacagag atctgcctgc ctctgcctcc caaatgctgg ggattaaagg 75000
 cgtgcaccac catcgcctgg ctgacttctg gttttatttg tctttgtgct tctgcttgc 75060

cagagcctaa tacaccactt tcagattaga atgcatgaag tcacactaga cactatggaa 75120

 cagaaacagt atgaaatccc atcacctgca tftaacttca aagaaactga aaagtttcgt 75180
 cttaaaaaca attgggcacc aattgtatgt caagaagaga atccataatt caaagattaa 75240
 ctatcttgta tctattggag ccagatggag aggaagaaca cttcttaaag ttttctaaag 75300
 caatcaatgc tatattctgc aggaagggaa aatcatctcc actttgttct cacagaagcc 75360
 agcagcttc accagccatt ggatggcact aggggctct aattcatgat tcatatgcca 75420
 ggatgaatta gtgaaattaa tggaaattct tgaaacactt ccagggtgga ccacctattt 75480
 tcagccatgt ataaactgga cttcgatcct cagaggattt ctttggattc agctctgacc 75540

 cttgagacca tcaccacata gaagcctggc tgggtacct gaagcccagt atgccctgg 75600
 gtaacatgca ggcttgtggc catatggtgt ccccagagcc tgctgtctc tgatctatgc 75660
 cagaatagge atatgctggg atatttcagg acctgaggg gagagtgaaa tgtcatagcg 75720
 tgaggatgat gaggtgagc ttccatttct cttgtttatg gcaggagtag aaattcaagg 75780
 aggagaagta aaagacactg ctcttgattc taaagcttgc atagttcagc ttaggaaaca 75840
 caagacagaa cttatgggtt ccctggggaa caaccgtttt atttatttta aataagctta 75900
 aattttaaaa aatgacagca gaatccagt tgaatttta gtcactgggc ctctctcagg 75960

 tcttgatgta ttcattgctat gaacaataa atactggaa tatagtttac tggatgagc 76020
 ttttccctt tgctgtttgt ttggtgggga cttaggtcag gggaagagat gcctgaggaa 76080
 tggattcatt acttcaggag tttgtgtgg ctaaaaagca tagactttt accattttcc 76140
 tctcaagttc cttatgaaca agtgactgtt ccattcagtt gctttgagat gctctgagc 76200
 ttgtgatgg ggctaaagaa gcccgtcca aggggtcac ccttccgac aagcattctg 76260
 acagacaatg aaggtgggg gaaaccacag cttggggagt ctgtcagatg gtgaggaaga 76320
 aagcttataa cgaaacccat ttcttgagaa gatatgagca tggacacata gaggatcact 76380

 ggggagagag ctacacaggg gagcatcaa aagcagcgc tgtgtttgca cctgaatgag 76440
 tgagaaaca atgcaagaaa gtacagcaca gaagttgatt ttattctaa ctgaaggtg 76500
 cctgattcta gaagttccc ttcactgctt cagaagagat ggtcccattt gcgagcgttc 76560
 acaagctgtg actgcacatt gatcatttgt ctaaacactg tttagtgtgg ctaaaaagc 76620
 ccgtgatgca tgctaaacc agtttcatac agtgaatgg tgggcttcc tctcgggat 76680
 gaaaaaaca aaacaaaac tacttttaga ttcattgctt tttcattttg gtacagtgaa 76740
 gcattatata aatccaattt ttgccacatc tgaacgttg gctgtcattt taaaataata 76800

cacatgtaca ttttgtaa tgaccaaata aacaaacaaa gacagaaccc aaaataaatg 76860
aactcttcta gtgactggat ataaaagtat ggtcttcttc atatgatggt tacaaatcag 76920
acagagcaaa attcagagca caaggctctg tgtaggctct gttagccaac agtttcttgc 76980
aggaagataa ttagggcctc actagaatct ttctaaagca taaagcaaaa taagggttaa 77040
gggtacatat atacatagta aaggacttgc ctgacaggag cagggtcctg ggttacatcc 77100
ataactccac aaaaacaaaa ggattttact ttatTTTTTg tttgtTTTTt aatTTTTtaa 77160
ttttaattag aaagaagatt attttacatg tcattcccag gtcactcttc tccctcctct 77220

cctccccctc ccccgaatta acacctacc tatcccatac cctttctgct ccccagggag 77280
ggtgaggcct tccgtagggg gtcttcagag tctgtcatat cctttgggat agggcctagg 77340
cccacccctt tgtgtctagg ctgaggagat atccctccat ctgggatgag ctcccaaatt 77400
ccattcctat gctagggata agtactcctc cactacaagg ggccccatag atttccgagg 77460
tctcctcact gacaccaca ttcagggggt ttggtcaatc atgctggttt cccagttatc 77520
aatctgggaa ccaagagctc tttctgttc aggtcagctg ttgtgtggg tttcaccagc 77580
ctggtctgga ccctatgct catctgtcct ccttctctgc aactggaatc cacactgcca 77640

gagaagctag taacaagga ggattttaaa atagtagaat ttcatcttac ccatacatca 77700
aatgactcgc gccgttattc tagcattcag gaggggtggc atgaggattg ccatgattgg 77760
aggccagtct ggttccgga attagttacc agacaatcca agttgcagtg tgagaacttg 77820
tctcaaaaa aaaaaaaaaa aatcccaat caaataagag tatgacatag atgtgtgtgt 77880
gtttaaaaag agagataata aaaaaataa acaagtagtt ttctatttct agatatgtaa 77940
aagagattgt gttatgtagt tgtgaacaga cgcaaaagca taaattaata tacacagtcc 78000
aagaagcagt tatctttata aataaatccg ttaggattca acattgacgc tgacagtctt 78060

tggtcaatgt taagaccgcg ccaccttctg gtcgccactg gtatgacagc tgcattttaa 78120
cagactagca tttttgcttt atgtaaaact tatattgaag gaaaacaaca aacagtcgac 78180
ttgtgcggtt tcttctcccc cggggatgca gtgggatagc aacacaattc ctaaatgtac 78240
tccagtggct gctgtacttg aaaacccgag acttgcttcc gagcttactc cactgtaatg 78300
gttcacaaca gaccacacac aaccagacag ggctgcgatt ttaagagcta gagggtttgg 78360
ttgcctgtct tttccctggt tgtcagctct tgaacttctt acagtctgag aaacggcact 78420
tcaacaaggg aagtcgagcc tttgccaggc agggaaagca gatgctggagc atgcatgtc 78480

tctccaaage aaaacaataa aaaacatgta ggctatTTTt tgaacaactg ttaggacata 78540
attgtggaca aatgacgact tggggaatta tactctgctt aaattcctcc atagttacag 78600
ttagataagt agtgttgcca cggccttcca cgaccagct gtaaaacaag gagggaatga 78660

catacctttg ctaacaagct tagcggacct atgacctgca attttgagca tgcttctccc 78720
 ataatttgca tatgaaaact agtgcttgaa aaggcaatca cagccaggca gtgatgtcac 78780
 atgtctttag gcctagcact caggaggcag aggcaagcag atctcagtga gtttgaggtc 78840
 agcctggtct aaatagcgag ttccaggaca gttacacaga gaaaccctgt ctcaagcaac 78900

 tgaagaaaag aaggaaggaa ggaaggaagg aaggaaggaa ggaaggaagg aaggaaggaa 78960
 ggaaggaaaa gaaatgacta tcacaaaggc aaggatattc cccatgtgca ccccatgtgt 79020
 attctttagg atttgtatat cttaatcaga aatagtatca gaaaccttga aatcttatat 79080
 tcataaatat gtatgaagag gcaaatacat tgacaggaga acagtaaact taattcactg 79140
 ttttggact ttcccctagt aaattgcttg agatttcttg ggtaagtggc cctgtcattc 79200
 tgcttctgc ccgcttcagt ttgtcacccc taaaacaaa ccagaaagtt gatactaaag 79260
 aacagaaaac actgtgatct tactgtaacc accaagatct tttcctaac tttccatttc 79320

 acattaacct gtagacgaaa ctttagcttt cctaaagaaa acccacttat gaatctaca 79380
 gtaaaagaat gtaggagtgt ttggggaaag gagggtagag gcttaatcaa aactgcaaag 79440
 tcattggctt tcaactggtg tgggatattg ttcataaag atttaattat ggctgggtgg 79500
 tggtaggca cgcttttaac cccagcactc gggaggcaga ggcaggagga tctctgtgag 79560
 ttcgagacca gcctggacta catagtgagt tccaggacag cctccaaagc cacagagaaa 79620
 ccctgtctcg aaacccctca aaaaaagatt taattatgaa gagtaaatat ttcaaagga 79680
 agtttcaaaa gaacacccca tggctaccaa gatggctccg tgtgtgaagg tatctgcccc 79740

 taacctggta accctggaac ttacatggtg gaaggagaca accaaatcct tcaaggtctc 79800
 ttttgacctc cacacactca cactaaac aaataataa aatgtaaaa gactacctta 79860
 attttaatt actgcttga tggcattcta tctgaagga cgcacaggag tgctttatac 79920
 cacagaacta aatgaccaa gtgtgagact gacagggatg aatgcaccag gtaaatatac 79980
 cctcttaaca tacaccaac acgggtgcaa tgtagaagcc aagtgaagga actcccacca 80040
 tttgagaatc aaggttaccg atgatagaaa cagtcttcat tagtcttcag cagaatttca 80100
 caggttcttg gcaatgtgaa tataatcaaca aacaaggac gggaaatttt tectctagtt 80160

 agaaaggcaa ccgataaatg tgaaggaagt taggaatttc catttgaaa ctgtcagaaa 80220
 aactggttca gagatgagtg attaccagc cctacaacca ataggccaag gtttctggt 80280
 atgcaacaca ggaaggtgaa gtgaagaaac atagtaagtt cccctggcag tcaccaaagc 80340
 ctgagcagca ggcctgcttc acatctcttt ctcttaata ccaacagagc tttctaaatc 80400
 cacggactac atgaggtaca ttctatgaaa cagttggctt atgctaaaaa ctaccaagtc 80460
 agcatcaaaa agtgcaaatg aaaacctaaa gtctgtccca gatttaaaaa gactacagag 80520

acctaacagg caagtatagc caggaccact ggtttcttcc tcaggacatt aagttaattt 80580

ggaaaatctg tccaatttt actctcctgg ctttattaac taagctatgg ttccataaaa 80640

attactatit ttgtaataa caagctaaaa tatttagaag taaatgagct tectctttat 80700

aatcagttga aaacaaaaca aaaagccaga gcaaatattg atgttaatgg aattatgttt 80760

aagagaatc tccaggcaa atggatagaa ctagaaaaat gccatcctga gtgaggtaac 80820

tcaaatccag aaagacgaac atatgtattc acttataaat gagtattagc tgtaaagtaa 80880

aggatgacca tgctaaaaat ccacagtccc aaagaggctg ggtaacaagg agggcccaag 80940

ggggacatct gaatctccct gggaaaggga aatagagaag atttcatggg tgatctgggt 81000

gcggggtggca acgggaacat gagggagcag gtgggggtgg gttttgggag gagagiactg 81060

gaaaagtcca ctagaaaggg ggggcgggca ttccagagtc agggagaaaa ctggtacaag 81120

ggaaactcca ggaatctaca aggatgacct cagccaagat atgtagcctg aactggtcat 81180

ctcctgagac caggcaagac tcaagtggga ttgggacatg acacaaccac ataaacttca 81240

acatacagtc tgcctgcct acgggatgta ctggggtcag ggtaacacag agactgtgga 81300

aatagccagt cattgactgg tccaggagtg aaccactcc tgacactgcc tggagcccca 81360

ggacacagag cctgggtggc cagagaccta ggaaagacga aacaacggga ggaaaaagtg 81420

tcaatgtaac tatgcctaataaatatcctgc tgtgatcata gattggagcc cagtccaaca 81480

gtcatcagag aggtctcatc caacaactgg tggaaacaga tgcagcaacc cacagccaaa 81540

cattagacaa gacttgggga atcttgctga agagagggaa gaaggattgt aggagccaag 81600

gggtcaagga catcacaaga aaaccacag aatcaacctg ggctcatagg gactcacaga 81660

gaccgaaca acagttaggg aacctgcatg ggactgacct aggcctctg tacatatgtg 81720

acagttgctt agcttggctt tctggcagga ctcataacag tgggggcagt ggttgtctgt 81780

gactctttgg ctggcttttg aaacctatt cctcactctg gattaccttg tccgacttta 81840

acataaggtg aggtgctgag tcttactata acttgatagc ccatgttttg ttgatatcca 81900

aggaaggcct gatcttttct gaatagaaat gaggaggagt ggatcagagg ggtagagggg 81960

aggtaagggg gaaggactgg gaggagagga gggaggagaa actgtgactg ggatggaaaa 82020

taaattcatt aaaaacaat aaataaagct aactgataa ttttctttc aaaaaagaat 82080

tcttcagatt ttttctagca atctttctac aagtctaaga ctttcaaagg ataagtttag 82140

taaaaaaaa aaaaaaagtg ataaaatgac cttgctttca ctgatgagta aaggtggcac 82200

acacctttaa tccagcact tgggaggcag aggcaggtgg atctctgtga gtttgagacc 82260

agactggtct acagagtgag tttcaggaca gcaggactac acagagaaac cgtgtctcaa 82320
 aaaaaaaaa atcaagacaa aataaaaata tactttactt tttattingt taggtaaaac 82380
 tctgacaact agaaatccat ctttaattca aaagatgtgt tattttagtc tcgcatagac 82440
 cgaacttcaa acagttaggt gaaattggaa agcatgtcca tgtctttttg aagcaacttt 82500
 ccacgccag ctgtgtcagt gcttcatcat gtatttcatt caaaaatcct ttggatgtcc 82560
 catttgaac cagccagtga gtcagactcg gttcccctgc ctaagacaca cacagctact 82620
 tctggagagt ctatgtaagt gtaaccaaag tggaaacacc aatgggaaaa aatagtcggt 82680

 gatgttaagg agtctggaaa caacatcctg aaggcacaag ttagggaact gaagtagcta 82740
 gagggatagc aggtgtgtgc tttgtgctgg gttctccca aaacctgtta ttgtcaatgt 82800
 gcttggcca agggactgat gagaattgca aagcatgctg ggtatggacc agaacctgtt 82860
 cttcactgta aatctgacc tgttggttgg tagtgaggag cccctgaagg ttccaagcag 82920
 gacaggatcc tgccagggtg gtatatcatg gtgcttactg ctccgccttc cacgttggtt 82980
 ctttactca cttatcaact acttccttat caaatgacc tttaatga gctgtacac 83040
 catggaacac atgacaaaa caaagtatga ctcccttttc aacattatg cccatcctag 83100

 aatctctgtg catgtttttc ctgtaggaca aattacttat gtttaaatgc ctctgtacat 83160
 tgtactttaa tctgttttaa tgagtgtgta tctctgtgta tgcctttgag tttgtgtgtg 83220
 tgtatgtgtg tggcaccatg tatgtatgca cgtctctgtg tgtatgcatt tgtgtttgtg 83280
 tgtgtgtgtt tggcaccatg tggcaccatg tggcaccatg tggcaccatg tggcaccatg 83340
 acttgcgtgc tttattaagc tgatagaagg agaaagcact tgaagctaac tatggggcat 83400
 gtaaggcaaa atgtattttc cctagccagc cttagggcag ccaatttaaa ttttacagag 83460
 cacttacact cagtgccagc aggtgatgtt ggaagtatag atttccttaa agcatctttt 83520

 cagttcattg acttaacaac attcctgtca cttacgtata taacataaag taattgtttc 83580
 atttatataa ctttgaata taattagctc atatttaatt atttatcaca atgtggcaca 83640
 atcatttata tttccttctt aatatactaa ttatgttaac agcctctaag ttctaagtac 83700
 tgtagcgttc tgttttatgg tgtttgaaag atagcaatgt acagaacata aatttcacta 83760
 tgtgaattca catattgtcg ttattttcaa aatgatctt ttattgcaag ggtcagcaga 83820
 ggggaaatta ctgatttag atttctccat caaagattcc attgtatata aatgtttgc 83880
 ttggcaagag cagtaaatgt aaggatgtga gcatgcagag ggtggcccca gggagatggg 83940

 ttgggtgctc aggaaaacag cacaggcttc tctaactgac aacatacata agggaggttt 84000
 gtttgtttgc ttgtctgttt tgaagctgag ttggaaatct gttaatgaca gaacattatt 84060
 ccagaaaagc ataaaagat gcgtattcca gataataaat gttggtgttt caaagaatt 84120

ctagtgcatt aaaaaccatt ttaatgtcca tgcattttga ctttatattt gaatctttgt 84180
tctattttcta tcagacaatc cagacaactg ctccagccacc tgtggcccag cttccttgta 84240
tataaaatgc aaagcagagt ggtccatcct tggctgtcta tcttcttgtc tcttgacacc 84300
tgtcttggga aaatggggat taaaaggctg ttgagaagaa cacactcatt gctgcaactc 84360

acagtctgga cttttgcctc gtcttttaac cctctggctg gaatcatcta gtcttgaaat 84420
cctacttcaa attttaggta ttctagctca ctttcaaatg acttttgata gcatcaaatt 84480
tctgccttaa atgttaggca tataaaataa tgttaatagt tgtgactagt atgtcatgaa 84540
ttgacaaata caccatgatt tttgaagtcc atagtttttt tggctctgtc aagatagcac 84600
aaggagtttt ttttttcat ttggcccacat ctgacttctt cttcattccc aattatgggc 84660
tctcatgtac aaagaggaaa caaacggatt gactaaagat taatcatcag cagaaagtat 84720
ggcaagggat aacagtatct catgtgctat gaacacaatg gcagatgtca ggcccaggac 84780

tcatatctct ctigctatgg ttgcaagtta tttcccaggc tctgaggaaa gggcctcctt 84840
gaatttcatg aagaacacag agggcttgc atcttgtcca tgccaattca atgtatctga 84900
gatcctggaa gtctattggc actttattgt gttatgggta aattgggtata agccaattta 84960
agactcccca ttccagtttc cttgccatgg tctcacttt ggtgaattta ggcctctata 85020
tcagaggtgt cacagcataa gtcacagttt tcagtaattt caagctcaga gaagaaactg 85080
ttgtctgtgg tccaagctga cagctaatac ctgggtggagg aagcatcaag gcccaggccc 85140
ctctctgttc ctctctttcc ccactgtgtg tggaaagtta cctggcctct ctgaactgtg 85200

gtagtgtgta ttcatcattt gtcatittga gatggcaaaa ccaactttaa tgtcattgtg 85260
agagttttca tgaccatctt ttcttggcaa tctggcaaaa aataataatc tcttactaa 85320
gtctcagtta cactcttgc gttgttttaa tgccttgcga gtttgaacce tctaatgtt 85380
gcacttcaaa gatgagattg agtgtctttg ttaaatttta aaaataagtg acactcctat 85440
acaccactac gtatgcgaac attgattttt caaggtaatc ctttccctgg gataatagga 85500
atggagcggga aagtgccgtt tgttactctc agagggccgc gacacttcca actgagagga 85560
aagcattttg attccccacc aaacattttc ttctccctaa taaagataca ttttgcatat 85620

ttaaggtttt catttttccc agtaaagata ctgagggtct ctaatatctc aggtgtgagg 85680
gtgtcagacc ctccagctccc acccaggaca ggttctcaac ctgltgggca tcataacatg 85740
tcatatcaca gcatatcata tcataccata tcaggccatg cccattatta ttgtatttca 85800
atatgagttc ctgcagggtg tggccatacc tgagggcaga ggataaattt aatgacctct 85860
tgatgtctat tccaactgaa tgattcccta ctaagtagtg atagtgtcat ggtactgtga 85920
atlttggagg ccattcccag gtccacgtgc taacaggga aagataacta gataaaacaa 85980

ttgttgca ctattgctc aagtggttac tgaggctaag atttccttc ttttaaaga 86040
 tagttactcc ttaatgacat ggaaaatggc ataatctcca taggctgtat tttctctac 86100
 ttgaaaccac gatcattaat tcctacceat ttacataaaa gaaacacaga cttagtactg 86160
 aaaaaaaga gtttctctg atatttgtat atttgtatac cctccctgtt ggaaacagga 86220
 gttcgggccg ggttgtaggc tgagtctcag ggacctaaag gcactgccac ctccacaggc 86280
 atgctctgaa gccggcactc cagccttctc tgtgtctgac aaaaccgag ccctttccaa 86340
 gctgtttaac tcacgattat ttctctgtt gccttttctt tgaataataa tttcagatgt 86400
 gaaatggcca tgtttaataa attcattaataaaaataaatc cagaggaacg tggcaaaggt 86460
 agggagaaac ccagcgaagt acaaagcagg ggtcgagtgg gatgtggctg tctgagagaa 86520
 tttcttactc cagagtgttt aattaggcct gcctgtctgt ttggccctgg gttggttttg 86580
 ttctttcaag agagctgttg acctaaactc gcagtaaaac acacggagag gtagcttctc 86640
 atggttcagg aaaacatttg taaatgctgt gattttggca ttgaaggaaa aaaaaagac 86700
 agaaaagtgc gcctctaacc gagggaaatt catacattta taattgcatt ttttaatagt 86760
 ataggcagct tttcagcttt acccattata caaaccagtc agacaacatt gttaaatgta 86820
 agcaactaaa tgcccagaag aaccttaact ataaagccaa gcgcttctgc aacttttcca 86880
 gaatcttcca gccagacaat taattgaact aacgcagtga agtttatggc ttctggcact 86940
 gttgccatgc ttacagaagc attttaaatg ttacattctt aaaccttcta gatcaattag 87000
 tttgtgatag aagccaatct ccaggctctaa cattactttt ttgtgctgat gtatcatttt 87060
 ccataataag ctttttttaa aagaactaat tagtacctac ttgcctaga gaaagtgaca 87120
 tattgattag acattcacc ccacgttgg aggagactcc aactaccatc ttcacccct 87180
 agctcaagtt tgggtggcca tctagaatag tacaaggag gggggactca accctgttgt 87240
 tgggaaagaa atcagaggggt ctgttgtctg ataaactagc tatacgtctc actgttttta 87300
 caatcaaagc tgcccaaaga cacaccacct caagtactca ataagccat ttaatttcc 87360
 ctccaggaa aacaccatgg tgtttctct tttgcataat acaaatatgt tctgtctaa 87420
 tgctctgta ctgaaaacac agtcttcaaa gttactgttc aaaatatcca tctggctgga 87480
 taagtgtct gctgtctgt tttgttttcc caagtctctg atgaggagat gttgtcatt 87540
 taattgtctc taaggatcac agatgatggt ttataggttt aggcaaatg tggacagcac 87600
 tttgttcaca aacacaagag catgccggt caccataatt atcctataga gctcaattgg 87660
 ctcttaacag caccgcccgc gccagcttca gggagtcttg tttcacaca aaggctcctt 87720

cttgttaatt aacctgtgta tgctcattac aaatgaaacc tatttgttgc cagttaatat 87780
 atttgtctgct acttgatata ttcatattt cttatccttg ttaagtggag gttggagggg 87840
 aaacatcatt tgggtgactc agatccctgg gcttgaagag agcagcaaat agactgacat 87900
 atcagttgga ttgccctgtg ctacagtggc ccccaaatct gcttaagaat gatgagtatc 87960
 tgtctctcaa ccatgaaaac aaaacagggg caattgagaa gcaaggcatc catgacagaa 88020
 accagagact tttcattagg ggagattctt ctaagcaatt catgtgacgc ttgacttcat 88080
 ttctctgtct gcctcctgac tattatgtac gcacgtgcag aaaagattgg atgtgggcaa 88140

 atggtttga ctctcttac ggctggcctc agccaagaga aatcacatgt ttgctcttgg 88200
 tgatgtagta agcaaaggta gtctgaggct gacgagggct tcagaatagc atatgcatg 88260
 aggatagcaa ttgaaaatca aagagagaca atatctatcc ctttcttagc agattttata 88320
 taaaaccag atgtaaagta gctaattatc actcaaaatt ttatactctt agaacttaca 88380
 tttttccact gcttattttt aaaatagtct tagggttttg gcgatttgaa attgttttta 88440
 catgttgggt actcttcttc caaatttatt ttgggtatat tcttgccatc catcttttc 88500
 gaggtaaaga aataaactat ttacaaaatt atcttaaatg ataaagactt ttcgcaagtg 88560

 gaaggaagag gctcctattc ctaccaatat gaagtactaa aaatacaaaa ctttgagcat 88620
 tgctgtccag aatattcttt atgctttgtt gcgtcaaaag attgtgctta tgtgacttca 88680
 agtaagtgtg cttaaactga tacagtgttc aaaacacact taaatattga tggacaaaca 88740
 ttcccacagc caccaatcaa ttactttgat tcttggattt tagaattggt ctgataatgc 88800
 attttagaat aggtcaatac tgccttctac atagagtaat atgtctaatt tgtttctatt 88860
 catcatgac atgtagttaa gaacgatatg ctttaaagcc ccaatttgc actgagaaga 88920
 tgactatgga aaattgacaa aaattacagg catcattttg tcaaaagaca acatgttctc 88980

 atggatatgt gtatcccatg tgatacttgg gatagagtat ttcatttata ttttttaaaa 89040
 atattttatt atttatttgt gtgtgtgtgt gtgtgtgtgt gtgtgtgtgt gcatgcctgt 89100
 gtttgcatgt atgcatgcct ttgtgtatgt gtgcctgtgt gtgccttctg tgcattgtgtg 89160
 actgtgtgtg tgcctttgta tgtttgtctg tgtatgtgc tgtgtgcctg tgtgtgtgtc 89220
 tgtgtgtgtg tgtgtgtgtg tgtgtgtgtg tgtatgtcta tgtgtgtacc tgtgtgtgtg 89280
 aggccagaag agggcatcaa accctctgga tctagaggta cagatggtta tcaagatcta 89340
 gtatgggtgt tagaaacaga cctctggcac tcttaagcac tgagtcattt ctttaccct 89400

 cacaccta at acccaacaca aaagaaacca gggctatctt tctgtgcata gactgaagca 89460
 ccatttaaag aagctcatga ttagaggaga tctgtgact cggaccttcg gagatcccat 89520
 accttctgaa cacaagtctt tcttagcag tgccaggtgt ttactgtgga cctgcatggg 89580

aagtgttttt gtccagaaac tctglatgac atctgttatc attgtactat tgttactttg 89640
gtactacca ctttgggact gttagcataa aaggagcccc caaaaaggga gcatggaggt 89700
tcatcctgcc tctttttaa aagcctcagt cactaaagaa gtcagagtca ctatgtaacc 89760
tgcgaaatgt gctgagtttt gaatctgaat gtctctctgt tttccttgtg ataacagcaa 89820

tctttgtatc ttggttgaat atttttgttt tgtcatgtcg tgattttcct tagcagagct 89880
gtggggaaag gaggaaaact gaactcactt gactcctggg acacatacat atgtggtaaa 89940
gttataactc tttataaaa ttgggtgctga atttacttca ccgtaataag cataaaattt 90000
tattctccta caaaatccat acttacaaga gtgttcttat atcttttagg atttcttttag 90060
tacatagaaa gatacttaaa attcatctag acctatcact tatatgaacc tttacatcac 90120
ccactacca caccgttctg aggagacat atgctgcctc aaacacctat gtacaactgc 90180
acctacttat gtaacacaca atgtaggcat tttatctatg cagacgtttt gtcacctatt 90240

aatagcagta gactatataa atctagccct caaatgtaaa tctaacaatc acgtagtatt 90300
agtaagaaga aaattttaac actcaattgt attcctgtaa ctgggtccagg cttagctctt 90360
agctgaatac tcataactgc tatggtttct agacacacac acacacacac acacacacac 90420
acacacctca ataagcaagt atcagggcag gcagagcatg ttgcaccatc taggtagaaa 90480
acaccaagag gtggtatagc aaacaaccac aggaggcgct caacttgagc cagactctgt 90540
aagaagtta gagggtagca gcatggagtg tagtagggag gcattccaag cagggagctg 90600
acaaaacttc agagatggaa atgccttagg caagctctca tggtttgaa gtgcactttt 90660

ctttactcac atcatcaaa ttccaacaac attttcaaca taaggagcat tatcatcaaa 90720
ttatcgggtg ctiagcagcc atattgccac aattaatcta ttctaatagg ccactcaggc 90780
atgaagattg gagattttct gtttttatag gcaatttgat ttttcagcta gaatatttta 90840
tgacctactt cctacaatat gaagtgccat gagaacacta ctctcatgtt getgcttaaa 90900
tagcaaggtc atgacagttt tctccgtct accatgtagt cattcactaa tgcattcaga 90960
cattcggtea gcaaccaga tcaaacacct actatgtgtc atgtctacac tgagccataa 91020
gcagtttggg caattcggaa gaacacctct caccatctct accagcagtg getatgaaga 91080

tactgacggg attaggcaat tgtccaaatg accagcccaa agaatttcag atggtggcag 91140
taatggtatg agatagcaaa gggcagtaac tagccaggaa atattcatga ctgaggtcct 91200
cgtgctgcaa aaatttagat gatttcctat tggtgactgg gaagattaga actgctttgt 91260
atcctatcca aacagacaac ttctacaaag tagggttgtt tgggaataatc aactgattt 91320
tgaagcagge ttgtgtgttt agagtaaaga ccagctgtca tctgtctcca tatagtattg 91380
actctcatct tgcaaggtta ttggggcaat cagtaaggga caccagccct gctgtctgta 91440

ccagcagaaa gcttagcttc taggctttgg ggtaatctac taaaatccta aatggggttt 91500

 tccaggtatg tagttattaa taatgacatc taatcttctt ctgtgacata caaaaattac 91560
 acagtcacat taacactcac tgaattctgc taatttggc aacaaagct gacagctgat 91620
 atgtcagaga aatggatcgc catggcctgg tagtcaaaag ggaaggctag agcccaggcc 91680
 ttcaagtca cctccctcat ctgtaaagta tgtgacaaga acaagtgtct catgccctct 91740
 ctaggcttc aatgaggact tatgaattat tatgttgaa atggctagaa tggtgattgc 91800
 catattgtcc attgtatcac gaggaggctca ctgcagcata aagtagaagc cacgattaa 91860
 ctgtaccttt aattgagcaa tctaaagacc tttcagtagg atagaggatt tttggtagtc 91920

 tataaaaatt gtatattgtt atttaactaa aatgttgatg catatattat aataaaaatt 91980
 tggtgacaaa aacactgatg taccctgtgt gtttgtttac ttaacacatc aaccacagaa 92040
 gaattgtttc ttacactccc atctttatga cttttaagga ataaaagatt ccaatgtatt 92100
 aataaggtaa aglatcttaa ttgtttcttg tcttttcata ctacgtatt ctaaaactgc 92160
 ctttgaacat aagtcactc tgtttctctc caactatgtg taaaagataa caaagatatg 92220
 ttgtatttgg ctgtgccaca gggttggata aaattccata tacacagtag tgacaatgaa 92280
 tgtataactt gaaaaactgc tgctgaataa taggacacat taattgata agattgact 92340

 gttggcactt gtgctgggca ttgagatctc aggaagctcc ctgaagtaaa taccttgata 92400
 gaaggatcac catggacttt agaaattaa taaaaagat tatgttaatg cggcataaagt 92460
 gggaacatga gaaaatafca aagtgaagt tttagttgga aaatgaattt gaaatgatcg 92520
 cttatgcata tgcaactttt taattcatgc tctctgaggt acatttacac tcgcatttag 92580
 aagtctaatt agtaataaaa agggaaacgt tcctaatgat ggcacacctgc tcttaggctc 92640
 cccattatag attctgaaaa caaactcatt aatattctaa tctacacgat gccattttct 92700
 gtacttaaat acttcagcct agaagacata agctttacgt ttttatttgc atttagtctc 92760

 aaagtcagag gccatggat tctatgtctt ttaaaaccaa acttttgaca tattttcccc 92820
 acaaaataaa acattcaaaa agagaagtag ccacgatgtt ttggaatgtg tgtctttttc 92880
 taatttttcc tgagaaagct aacaggcatt tgaactggga gtcatcagaa acatcacttc 92940
 taaggcttct cttacagtct gttgctggta gactgactgc tccttacct tgaggcagct 93000
 caacaattga gtttaaggagg tattcatgta tctgttctgc ctgtcttatg gttgcttaa 93060
 cttcaggata tactttgcca ctgaaggctc atttcctca atagttaag tgcttaatta 93120
 taaaggttca caaagaatt gacacaagcg agaggggctg tctactacca gcctcccaa 93180

gagacctgta caagtgtcat ctgtagaagc agggcacaaa ttaacaatg gccgttaaca 93240
 ggctgctat agctcagggt ataatgaaaa tagagttttt gcaaaagaac aaagccagct 93300
 gtaaatgtga cttttcttcc tctcttttcc ttattttcat tgacatctag atcctatagt 93360
 atgtcatgcc ttttaagttc tgtttgaaaa ttatttttaa acccaaaactg taacactgag 93420
 taaaatcata atttgtacct atgccgggac ttagaatttc attgtacttt ttgtgatcag 93480
 ttagaaatgc ctgtaaagtt ttaaaaagct ggaattgttt cctgaataat cacatattct 93540
 aaattaaagt aattcaaac aatgagcaaa atatgagtat tctgtgaagt aagtgtacta 93600

 tgagtccatg ttttcgtcag acagcaccag gtgtcctggt tttagcagtg acaggtattc 93660
 taagcaacag ctttctagc atttgaaaag catgaacaac aaagagaact tcccttccca 93720
 gggctctgagt gaggtaatgg aacagactgg aatggctgc attgtttcta ctgctcatca 93780
 aaacatctct gtgcatagta gtcacgtcat tatgtaagac atttgcaaat atgtataatg 93840
 ctttagccta tgggaaaact ctctgctct aatgtattcc tgaaagatga atgaacattt 93900
 ctttaggtat gataaaaaga ttcagagggc tggatacagc catgatatta aaaccacaag 93960
 ctcatcattt aattttttta atgccaaccg ctaacatcat aggtctatgt tttactttca 94020

 ctttttttc tctgcaaat caccattct cttccagttc ccattctgat tcaagctcag 94080
 caccatctg tttgcttgag gctgctgct ttgatacttc agcggggatt ctgtgaagtc 94140
 agaagtattc tttggcttca gatctctgat cagggtttct gcttgatctc cggattttct 94200
 gttgcctctg aaacagcttc gaaatttggc cagcagcaga taccacccc attgtgttgt 94260
 ttacctgatg aacttagtat cagggaaga gctgtgcttt ttaggacaaa tgttctactc 94320
 agaaattgtg aaataatgca aagttttcat ttggcttctg aaagatagca aggagaggcg 94380
 atgggaggct aactcagcta tacaagcatg aggacctgaa tttcatctca gaacctatgt 94440

 taaaaaaaa aaaagctgag tgtcatggca cacacataaa atctcatcga tagagagatg 94500
 gagatacata aatccctggg aacttggcct atcctatgca gtgagtacca tgccaatgag 94560
 actgtctcac aaacaaagcc gatgactcat gaggaccagc actggcagct gtctctcca 94620
 cacacttgtt catgggttta ctgaagagat agtgatggat ttagcacagt gaaagaaact 94680
 gagatataaa tgttggcaga gatgtggtta cagcacaggt aaactaaatt gtcccataat 94740
 tcccagaaa gtttgaggaa atagcaata tctgatagat agaaagccaa gtagataggt 94800
 tagagtgaag gaacagcaac agccactgaa tatattatct cccggggaga ttataggatt 94860

 tcatttgggt tggggtatgc attgtacgtg tgtgtgtgtg tgtgtgtgtg tgtgtgtgtg 94920
 tgtgtgtgta agggatata tgtatgtatg tatgtgtata tggatatgtg tgtgtgtgtg 94980
 tataagggtg tatatgtgtg tgtgtttgtg tgtgtgtgtg tgtgtgtgtg tgtgtgtgtg 95040

tgtgtagggg tatatatgta tgtatgtatg tgtatatgga tatgtgtgtg tgtatgtttg 95100
 agtgtgtgtg tgcgcatgat gtgcttgggg cttgttttgt tctgttctgt tttgcttcgg 95160
 gaaaaagtga acagagtctg cttctcacag cctcatctgt ggcactcacc gatagcatgg 95220
 aatcaccagg catttgtgaa aatacttcac tatgtaacat ataaaataat cacgtaagca 95280

 aaggaacca gagaagactg acaaggcaga aacataagca agcattggcg agttaagaga 95340
 ttgcacctat gaagcacaaa ttggatgctg tgagaaggaa cagagaacac tagcgtaga 95400
 gcaatgataa cccttgagtg gacaggggaa ttgagaccag ctgcagtta gaatgagctt 95460
 tcttaggaga ggcagcctca gtaacagtca gtcattgtca gaccttgaga cgagaaagct 95520
 tttagaacc ttatgaggag gaagagcaag aagaggagga ggaggaggag gaggaggagg 95580
 aggaggagga ggaggaagat gaggaggagg agacaagcct tcagagaatt ctctcaaca 95640
 gagtgtgtcc tgacttttac gggtttgatg aaactgcact tgcttccccg gcctcctcgt 95700

 cccccagaag ggacgtgtgt gttcccagtc caggccctgg ttctttgtgt catagtcaaa 95760
 ctgcagagtc tatagcctga ttccacagat gggcactaca gcatctgcga tttacaatt 95820
 ataaaattaa aataaaaaca aataatagga ataagacaca ttaattttcc aaagtgtgtc 95880
 agaaagacaa aacagtagat gagtgaaaaa taaattaatc aaagcaagta catgttttgg 95940
 ttttctgttt gtgctttgat ttttattaa tgtgttttgt tcatattaac cactcacccc 96000
 ctaattcacc ccagagctgc tttccttccc tattcacca actttacatc tttaaaaag 96060
 aaaaaccttc aagactaatt tgtgtgtcac aaatattctt ggatgtggtc ttctactgga 96120

 gaaggggtct gctaacttaa aggggtgaca atcttaaaag aaactgtctt tctttctatc 96180
 agcagctaat aactgccaat aattccatac ctagggggag gttttgtgtg cccaactcct 96240
 ctttccatgc tgggatttgg tctcgtcag gctttttaga tgctgtctta actactgtga 96300
 gcgcatatgt gcaggtttcc tgtgtgttcc ggaagataat gttttttgca gtcacccca 96360
 gcctagtcat ccatttcaat cacttcttcc acaaggattc cacagtcttt cgaaagggt 96420
 gtgggtgctg cattcccttc aaggctgaga gagagctcta caatctctaa tcttctcac 96480
 cctggccagg ttaggccac tgttcaatca ccatctctg ccaagagaaa cttcttagat 96540

 gtgagttaag agattcacta atctatggtg tagtagaatt acctatggct tcttgtaat 96600
 ttctgatat ctgtgggcat tccaaatgaa acacacacac acacacacac acacacacac 96660
 acacacacac acacacacac acctagatat ccaaagctaa catcaccaga tgagagaaaa 96720
 catgtggcat ttatcttaaa gagataatgt aagaactagc aaaagaaaag cattcacaac 96780
 tgaaggatat ttgtgttcaa gttataaacc ctaaatccag gggggagtac aaaccaaaaga 96840
 aatcacatt attataaatg ttaggatat caaagaaact cttaaatatt ttaagaaaaa 96900

taataaaaga gatgaataga gaagcaaaag acagaccatt gcataccaaa aaactcaaga 96960

 ccagaacagt attacagttc tcaaaaccag cactagaatg tagaaattga aaaactgctt 97020
 tcaaaattct aaaacaaaat gactatgctg cctaaatfff atgttattga tattctcaac 97080
 tggaaattgag aatagaatag atacttattt aaatagaaca ggactccaaa aatgctatta 97140
 cattagtttt tatggacaat ggaagttata attcagaaaa agtgaagtga cataaatata 97200
 agtcatgaag atgttacat taaagtaaaa aagattttgg ggttatttgg ctgggggatc 97260
 ttatttttagc ttigtctggtt tgaaacagct gttagtagca cctcttttat tctcacaaca 97320
 agattcaacg tttaaacgat agaaacccaa tctcatattt tatgacattt aagacttaaa 97380

 atttctccat ttttggttct gtgtgaaaaa tgtaaatgaaa ccagtagatc aaattatata 97440
 tgttctgcaa cgtatcagaa cagaaacaca attatcttga ggctatgaaa taattatggt 97500
 gtgataaacc tctcattaat aagtcaatt ttcttgaggt aaagacagta actaaatgaa 97560
 ataagaacac atgaaactat gttttcagca ctcaaaacttt atgttctatc actcacggag 97620
 gtcaatagaa aatgtcagtc ccaagattcc cctcagaaca gaagatttaa aagtatgctt 97680
 gcactatgag cttaatccca atagtgtact taagttcttt aatgttgttc ttagctacct 97740
 ctgcagaagt taagattctc ttctgaaaaa aaaaatataat tgtaaatgta cacctttttt 97800

 tcaaaggtag tctgggaatg gagagatata tcaatggtac tgctcttact taggacttga 97860
 ggtcagttcc caggaccac ctccagactt ccacagacac ctgcactctc atgcacattc 97920
 ccacagagac agacacacat atacagacaa aaaaaataaa tctttaaaaa acagtaacct 97980
 acacagagct ttattagttc agagatttga tgcatacaac ctccctaggc tcaggactta 98040
 gtgttttcca ttcaacagga gggatggtta cttttatcag ctccacagta tctggctgac 98100
 agtgattcag tacatggttc tgcctcttat tagctatgag gtaaagaaac ttacaaaaaa 98160
 aaaaaagccc ttctatgcta cagtttttgt tatatggctg tttctccagt acaggatata 98220

 actaagccct tcttgaatt atcctcataa tattagtggg ttagtttatt tttctccaaa 98280
 aattggagga aacaacatat acagttaaaa tgttactttc agtttagca ttatattcaa 98340
 cagaaattag catagaaaga aagataatgt ctccatcccc ctgtgccttg aattttcaat 98400
 gacttccaat gacatgcctt gctaaagctc agtcaccagc tactgggagg taagaaacta 98460
 gagagcgggg ctggggagg gaagttaggt ccttgggagc atgtccttga agagaacttt 98520
 aggacctttg gccatgcatg cctctccatc tgggtttctc tgcttctga ctacttccaa 98580
 agcaagcaac tttctctac catgtgagct gtcatgctgt cctgccatgt caaagtccca 98640

aacaaccatg ggctacaatc cctgaatcca tgagcccaga taaatatttt ctctcttca 98700
ttggttgctc caattgctac aacactagca attttgacta actataaata atttttccaa 98760
gacttcacaa ggctgctaga agaatccttg gatatgaacc tatttttacc tctgcaaaat 98820
aatatagcca ctaagagact agaaaaatga aggagaacaa aaagataccc tggcaggcac 98880
aatacattc tagctggfac tcattgtttg gggggcctat tgtaagaagt tccgtgtccg 98940
tgttttataa ccagatagta ggattatgct agcaagtctc tttataaaga tgaacacgtc 99000
actaaatggg tactcatcag catctacaga atgcccaacc actcttgtca tttcctttaa 99060

gatcttagag tttgctttct gttttattta tctttctggt tttttccttt tatttattta 99120
tttttttggt cgigaaacaa gagatgatta aagaattgaa gttttctggt gaatgaaaca 99180
gccagaccac tttcatgac aaagtggta attagaaggc caatttaatg gtgaatcagg 99240
cagaaatatt caaacatga caaatgactt taataatgca gcttgcaatt ctggaactga 99300
aataaatttc acttctcaa actctgcct tttgctgcct gcctggaaga tagaactgtc 99360
caggaggat tttgtaccct ttattcagta aagcttttac taggttttaa gcgaccaaat 99420
agcttgcaaa tgcaaaacat cactcaactt ctatgatatt tttttcctg aaggtaacac 99480

gtgttctgaa ttctgagaag tcaggattta tttttcttct gttctgctta gcctgcaat 99540
cgtgttttat tgttgccact ttgacttgaa gtattaaagg gagctacatt ggcctcaaaa 99600
ttgaaagcta attttgggt ttgtcataag ttgttgaaga ccacatgcat tccacagttt 99660
gaaaaatttc attattctgt ccatgctggg gcttcgtaat tggatagtaa ggatgttcaa 99720
agactaattt agtgaattgc acaatatttt aaatggaatt atgcaggttt atgggtcctt 99780
aggggatcgc actaggagcc tctcgagaaa atctgtttat cagtaaatga tattagcagc 99840
ttcacctag cttttgtctt cattaaattg ctgctctccc aattgagggt cacatctgag 99900

gcctgctttg ataatttgc attattgtct tgtttattgg agcataaagt tgatacaggc 99960
tgggctgcgc tctttctaca tgatgtgcaa agaagttttt attaacaatt ctaccaatgc 100020
taaatcaagg tggaattttc cagggtttta gaaaaagaat catttgtage ctctctattt 100080
ctcctcaaat tcctcagta gtttctgtat agccacctct gtacagataa ttttaagtgc 100140
aatcttatca gtaaaactaa agtggaaatt tgaacatctg tctatagtat tgacctaaaa 100200
gataagaca aatttacct ccttaaaca taacatgtcc gtgtaattac cattaacact 100260
ttatcttaag gccttttaga ttgtagtgg gatatgaaaa ttatgacaaa gcatattaat 100320

tgttgcagca cagtcaaggg tactttacat ggcactcgga tcctctacat agacaggagg 100380
ggattccctt aagagctgac acacagccct gctgaaagta atattgaggt tggctaagtc 100440
tgctctgac tgctttttat attaatccac atggttcttc atctctcagg gatgatgtgg 100500

gatctaaaac atggaaacag gatagctaca ctatcctcca tcaaacctgt agttcttgca 100560
cttttgggtt aacctgcaca ttccgggact gctcttctcc atagagactc atctgatggc 100620
tatcgctttc tcaactgcatg taagttgggg ttgtgctact cacttttagg ttcagatgtg 100680
tcaccatfff cattgctatc ttccaagcct ccaccctcca ttctcattcc ttattgcccc 100740

tcgaggggaa aaaaatgtgg actcttctca gagagacttg gcccaggac agggaaacaa 100800
gaatgtcagc agcagaggta gaccacgctt ttgtagacca caagatagaa gaaatagagc 100860
aaggactctg tagtaccact aagggggatt caatttctcc tttggagttt gccttgata 100920
acctgtttag ccatccccag gatggaggtt aggatgggca gaggtcactt gaggacctca 100980
ctaggcaatg tgcataggtt tggtaagat gccagaaaag aaagtgccaa tccttcaagt 101040
gtcacgacaa atagaaagtg ttcatgacac tctctggggg ctcaggatga tggctaggca 101100
ttccttatga aagtctcag gccaggaact gagccaactc atttttatac actattacct 101160

agcacattca cagcgttcaa agatttatgg ttcttattgc catctactta cccacataat 101220
caccagcctt tcactttaaa atggttaaaa atgtttcat agattgcagg tcattaatgt 101280
aaattagact atttctatat ttgatttctt aatttttaaa aggaaaagaa tagctctcat 101340
acacacatac tcctctccc tttccacttg aaatttttaa atggcctct agacacctct 101400
ttcaataatt cttacctcc aaagctgggc tgccttttaa tttcacttta aatagctac 101460
attgggacca taatagatt agaactaatg aatattgtgg agagaagcaa aaaaaatfff 101520
atftaaaac tftaaaagt ataaactt catgtgcata aggacctgtg gtttatcgca 101580

gcccagtcaa gagctcagct tggattctgg gactaaatca tcagagccca tcaggcctca 101640
ccttcacgt ctccacaaag aggtcacggc tctgaggct tctgtacaga acagtaggaa 101700
gcaacgatac gaaaataacc ttcatgcca ataagagcaa cagtaacaac agaaataatg 101760
aaaactgtca ctgccctaag atgcataaaa ctacttgtat tttgaaggcc gcatctaata 101820
cagtcttct tctcttacc ctgggggggg ggtctggaca caggaaatct gaccacaatg 101880
gaatcagata gaaattgtac aaataattac agttggactt tctttgggcc atcatcacac 101940
aaataatgac atggagattt attattaatt atgaaagctt ggccttagcg cagggettec 102000

ttggctttca gaaaatftat ttattcttca ctggtttctt ctttttaaac taatatatca 102060
aatttattct caactgtctg gaatfttcta gtgaatcaag tttacttccc tctatctgtt 102120
actgacctgc tactctgaca cttatggtag tttaccaga aagagctgga ggtaaagaat 102180
gtggcattct ttaggaaatt tcttttgaa ttactgtca accctaagac agttctacct 102240
ttataaggcc tttgtatata acaactactc tccatecac ttttttgetg tagacatctt 102300
actcttatcat ctttgaccca gctccaagt cctaaactat gagaaaacag tgaatactat 102360

gctttccttc tactacccat gcacccaccg tctcaagagc aattttacca caaaacgttt 102420

taatccttga attaagtatt ctgcatgaag aaaacaagag ccttctgaaa atcatgggct 102480

tattgttaca tctttagagg ttttgcagct atccctgtga cgaccctaa catggetatt 102540

accctagatg ccaggaactg aatgcaatt ttgattatgt aatgatgagc aagtgtgctt 102600

gcactagtcc agtttctct accatggaat gacagagcac tttttgcct tgtgttttcc 102660

ctgtggcaaa gagcacctca gatgttcaca gagaaaagga accagtattt gccccgttgc 102720

tcacattgga ggggtgctttg taacagatca gcggcggagg gcagagtgc ccatgacagc 102780

agtaggaagc accaagtact gcaggatgcc ctgacctaaa gagaagtct caatcagctg 102840

atataagagg agcttccttc ccgtttcgtc tagtgtcagt gttcttattt tctgcttagc 102900

agtgagctta cttaatctg caatggaatt ttaacagcta ggcacctctt tggcagttct 102960

accatttagt aagaacggat gaagacacaa aatgtgtctg gctttcaaca ttagatattc 103020

cgaaaaagca atatataggt aaataaaatc ctgaatttgt tacaaaagta ggtttaaaag 103080

ttctatttct taacctataa aactgggaaa gagatattct cttttttttt ttgcaagatg 103140

tacttctaat tttcttgtat agaaatgtct caggagagaca ttcagaacct tagtataatc 103200

cttttgtaa attcaatttt ttaattttt tgagactctc atatatgtt agtgtattta 103260

catcatttcc actcctctcc caaccctct catttctcc actacctc aattcatgac 103320

ctcatcatac tattgcatat atatatgaac atatatcat atataactg tgtatacatg 103380

aatgtatata gtgtatata ataatacata tatataatag tgtatttag tatatgtgta 103440

ttgatatctg aatataaaa tgtattatgt atattatata taatatgtat tttatgttat 103500

atattttctg tgiataatg tgtatataa ttcacacagt ctctgagtt cacttagtgt 103560

tgctcatatg tcaacctgt gatctaaca aaacatata atgatgacct gccagcatgg 103620

gtagaaaaaa ttcacatctg gatcatttcc ctgacagctg tgaactttgt agggacctct 103680

gtacacacc caggctttga ggtataaaaa tgcaagcaaa tcaatgagac caaatattat 103740

tttcatgacc aatcaagtc ctctagccaa aaagacttat ctagtgaatg atttctaaac 103800

agccacatct tcaaggcacc atgtaccag cagtacaaca atgtaagagt tccagtcctc 103860

attacctga agagaacaca acttttata tctgtgggac tgaattttgt ttctttttc 103920

aaggctacct tgettagaga aattggacaa tttatcactc ggtggcctgg agcaaattta 103980

gtatatgcaa gtgattagtt tgtctcttcc ccaagcagcg ttgatatgat tggtaagaga 104040

ggctgcagga agggaagtc gcttataaca cacatctct ggggaactgc taatgagcta 104100

ttgacccttc cccactgtag gctgatgtgt catatcccat tcgattctgg ctctgagat 104160
 gtaatttcta agtgggtgata tttgaagtct atgtgagatg tgttagtcta tcaagacttt 104220
 tttaaagccc agtgttattc acaccaagaa tggcaggtgt cagttgattt aactggacat 104280
 aatttcacca tticcagctc tcctccaagg tgaagagaaa gtaggtcagt tgtaataaat 104340
 ggacataatt tcaccatttc cagctctcct ccaagtgaa gagaagtac agtattgaca 104400
 acattagtta aattagtaac cacatataaa tcatatcttc atcctgtact taactatttc 104460
 tatggctccc ctcaccttgc ccatttgc atgggtcagag aaaccaagtc aacatttttt 104520

 ggcgtgtcac ttgctatatt atttaagaca tactttatag ctctcttgcc tgccaccaa 104580
 tggtttttag tgcactgctg tcaaaagctc tgtgaaagat aaaaagacca tttcagatga 104640
 aatgtgaggc tcagtcagca atccacagac tgaagaggcc tagagccaat cacccaaact 104700
 gtcaaatcgg ccaatttgc tccttgctta attttaagt gtaattgttt gtccttgtt 104760
 aatttagttt atacttgtat actccaaaaa gaaaaagtaa acttggtaga cattttta 104820
 taccttcaa tcaaggtaat taaattgcc aggtagatca ttcccctaag aatagaggag 104880
 aaaatgaaga gcattctggg aggtttgagg gagccagggc atcaatgaaa tacgtctctt 104940

 cagttcactg tatgctaata attatgaaat tggctgggga gggctctttg ctgtataaca 105000
 gtgtataaca gtgtaggttg tagggcgaag aaataccaca ggaataagac gaagtcggt 105060
 aaggagatc cttacagtc aaaaggtgtg ccatccttc ttattgcca cactagtaca 105120
 tgccacggag ctcaaaaat gagtaattc tcctcacact cacaatgtga acctcagagc 105180
 cagggaagaa taacatacag acagcagggc aggaagtaga aaaccagcca caggcattga 105240
 aatgaaca tcctcttacc gtcacaacc aaaggccatg gcagtaaca cagaagcgg 105300
 tatatgatac gtctttccc cttttaaca tgaatttat ttcgaaaca tcagtttaga 105360

 aattcaaggt tttagttttt ccaagacct ctaaattaat gaaccagacc aatttatgat 105420
 cttctatgtg ttgctgaaag aaaaaaaaa tctccctgca ggtaaactgt ctatctggag 105480
 ccagagatat tagaagcaat ttcatgagca ggatcattaa ttatgacca tgaatttta 105540
 atagttgcct tcttcagagc tcttctagga gctgagatca aagtggctgc aaagcaccga 105600
 tcctaactcg gttatcaggg agtctggaga gcttgggagg gtttaggatc tccatgtgta 105660
 tctttatgcc ttgtgatgt gatgtgtgga agatcatatg tacacagcac aatatataa 105720
 acacacatac ctgggagccg gtacctagga gctaggtacc caattcattt acccaattct 105780

 gatgattatg tcacacctgc tgatctttat ataactatat ggctaagggt gctactttc 105840
 tttcttaatt ataatttaga gaaggcatgg ttagttgaa agataaatca atgtgaactg 105900
 acctacattt atcccagctc tgtactataa gagaagcatg ccctggggca acaaactta 105960

gtggctctgga ccttggagtc ttattcatgt gaaatgctgg tgtgggtgtga gggctaattg 106020
gaaaacaggg ctacaccttt gctaacacac ttcatatatt aaagtctgt ggagaaat 106080
ttccttaaaa atgaagatgt tcatagtgcc tacccttaa gattgttga aagacagaat 106140
aggataatcc ttgcaaagaa aagtttctag gacatattac atgtatattc ctctgtcatt 106200

attcttgata tttctggtag taaatagggt ccaggggaat gaagggaagg gcgggaagga 106260
agtattacta aattcctgtc tcaggattct gccaaaattc attgacagaa cataagagag 106320
aaatcgaac catagaactg atatgaccag ttcatatgt aaccagcagg tcatcaaaa 106380
aaccagcga cagacttttg agataataca tgtgatcaga aatgatgtca ctgtccatgc 106440
tgctcccag tctccttgg aatggcaca tcttctattg tgtattgtag acagaagttt 106500
ctgtcctgcc agtctgaat ccattcagtc ccaataaac acacagagc ttatattaat 106560
tataaactgt gtagcccggt gctcaggatt attactatta agctcttgca acttaaat 106620

accataatt cttatctatg tttagccatg tggcttgga ctttctcag taaggaattc 106680
tcacttctgt tctctatgt ctggctagca attgcttctt gccttctc tcaccagagt 106740
tctctagtc tggtagcccc gcctatactt cctgcctgac tctggccaa tcagcattgt 106800
attaaccaa taigagtgc aatctttac agtgaacaag agcattacc cactatgtcc 106860
agtgtacca ggacaatttt tctgttttg aactctgcta gatgtctta aatgtcatca 106920
catgtcttt taigtcttg aactctgta agttctgtc agaactctt gttcattaa 106980
aatcactccc attattttt attaactacg tttcattca ctctgagaat tcatacttc 107040

atcactgca atttggcat atccacccc cccacacaca cacttctcc tgcaactg 107100
cccacatccg tccagcctc cctatcctt ctcaactcg tctttttaa tattcatatc 107160
aattcctga gaatcctgta caatgtgtct aatcatttc actctccat ccaactccca 107220
gtccaccctt ccttccctt ccaactcag atcctattt tttttcaca tcaagaccaa 107280
tgtatactt ccaataactt gcgaaggtgt agtcttccat tggagcatgg ttgattatca 107340
tactcttcca gaaaactgac ccttctcca gcagctgaga attgctaaca tctctccaa 107400
ttggagtaga cttcatgtc caagtcctt ctccatgctg tggttgtca tagcccagag 107460

cttctgtcgc tattattcct tggcctggct ccattctcca tagttctcc cacagcagg 107520
tttctgctt tcttctcgc cacagctctg gaagcagcta gaataagact ctgctcttaa 107580
tcctgagct acttagatta gtgtccatat ctaggctaac aacttggctc tggcgacag 107640
taaacttate gacacctgat gttacctcc tggataagtt tccaacctgg gtctgcacat 107700
gtgaccctc agctactggc cacgttcagg gacaccatac cagtatctt gggcctttgg 107760
ataagaccta ctccctgaaa ccagtttct tactccaaac tctttctta cctgtctat 107820

gctcttctta ccaccaagtg ggatgtcaca acacagtatg ctaaaggaga gtttagaatc 107880

tttcgccct tctccacatc atctaattca tcaccgcaa gccttaggtt tccgccctgt 107940

aatgctaaca taacacttca aattctcttt tatctatttc tctctctgc aacttctctt 108000

gatggatgtt acccacctc attcaccaca gattccttc tctactgatg cttttctatg 108060

gccttctcc atcttcgtgt tttggacatg aactccacag aaaatgggat attaaataaa 108120

tgaaaaataa taccatttcc taatttcttg gatgattgga ttaatggata tgcattgggtg 108180

tcatttcata gtgatgtaaa ttttggtaaa aaagcattgt ctttgaattg cacaatctat 108240

tgagtgactc gcactaaatt atgtacataa aactgcttgt ttatattcat gcaataaata 108300

ttcagtgatg ttgcacaaca tccattcatt actaatttta gtttctaatt tagtttctaa 108360

ttcttattta cacagctttt gtgataggca cttttctgg aatttggaca tactgaagaa 108420

aaagagagga gagagagaga gagagagaga gagagagaga gagaggttgt gtcattgactt 108480

taatctcaga atttgggagc cagaggcaag aagatcacag atttcagcta tcttggttta 108540

catataagat cctcccagct ccagctaagt gaaaccaatt ctaaagagct aaggtgagtc 108600

catttctaaa ggactcagtg gcagaacct ttctggcat gcacaaggcc ttgtctttga 108660

tctacagaat cagcaagcaa gggcatgggg agacatgatt tctctagtcc aacccatgt 108720

ctgcttgac cccatttcta tctggtggca aagtgcitta ttttctgaaa tgcccacagt 108780

tcattccttc aggatctagg gaattatcat tcaggctcat gggagagaag gcaagagagc 108840

aattttgtag ttgaaactga cgtagacct gttgccacc tactggtacc caagtcttc 108900

tcagcgtaca gctatgtca gggcaccttt gcccattgaa cattgtttcc ttatttggat 108960

tgacttatag aaataacatt gtgctctaca agagattata aaacctgcag tcttaggtat 109020

tgaatattgg tacttctgtc tacactggta ctccatgttg gcgtttttat caccccactg 109080

ctccacattt ttgaagcaaa ctggttaciaa tctgagtcatt tatctccata acccaagggg 109140

catggttgtg gttttgttg gttcactagt tggtaggttt tctttcttt ctctatagtg 109200

tatggaggta tagcaagggc tggtagtgtg catagaggag catgcaagca tgtcattgca 109260

cgtgtataga ttttggaggc aactttgtga aattggttct ctccttccat ttccatgtgg 109320

gtttcagggg atcaaacctca agtcatcaat tttgtacaac aatgccttta cccaccaagc 109380

catatcacca gcactgatt tgttatttct ttttcaaac taaaggagga aaagatttct 109440

gttctactat ttggataacg gaagctttaa ggccattta ccaatgcca agctctatag 109500

ctgaaaattc tgctctgaag tcaatgctca ctattaaaaa ccacttcagt agtttataac 109560

tcaccaactg ttactgttct tgaatgggc actgtgtccg ctgcatttgc taccttcagt 109620
 gagggaatgg atctgaagcc aaaatgttct acatatagtt tgcattagag gttacaaaag 109680
 gacaaatatt tataaacccc atttatctat gtacttgaca tatatgact ttacatacaa 109740
 atttatctta aacatgttca aaacacacac ccagagagga gggagagggg gagggagggga 109800
 gagaatattg cgattaaaat aatatcctgt tcaacttgtc aaatccactt tccttcttcc 109860
 tggataagca agttctaact gcattataaa cactggactg caccttttcc aagttagaac 109920
 tattttccct tctagaatct tctagttctt gattttttta agagggggaa gatttacttt 109980

 cttgtgttca gaggattcag tgtgttgtgg cagcaatggc agaacagtgc caggaagctg 110040
 agaaaggaag ctgccagggc tctaattcct ttggtttttt tttaatgtgt tctttgtcat 110100
 tttcaagaac agatatggtc attctgttca cactcatctc cataactttt cttttttatt 110160
 tttacaaaat tataatttta catgtcaatc ccttctccct tcccccaac ccttaaccac 110220
 cccctctctc ccctccctt tcccccttca ctccccatat agggtagggc cctccacggg 110280
 ggatcccaa attccacaac atcatcctgg gctgggctg gccctcccc catgtgtcca 110340
 gggcaagagt gcattccttc acgtgggatg ggctcccaaa gtccttctc acaccagga 110400

 aaaatcctga tccactacga ggggcaccct aggggtgcaga gccctcctca ttgacatcca 110460
 tgttcagggg tctggatcag tccagtgatg gcctccaaga cagcagcctg gggatccatgt 110520
 gctccccctt gttcaggta gctgtttctg tggattcaca agcctggtcc tgacccccat 110580
 gatcttcatt tctccctctc tgcaactggg ttccagagtt cagttcagtg tatatctgtg 110640
 ggtgtctgcc tctgcttcca tcagccactg gatgagggct ctagcatgcc ataaaaagta 110700
 gtcacatcatt tcattaaggg gaagggcatt taggttatcc tctccacat tgcctagatt 110760
 gtcagttggt gtcacctta tagatctctg gaaatctctg tagtgccaga tctctctctg 110820

 gacctataat ggetccctct gttatgatat ctctcattct gctctcctct attcttcccc 110880
 caactcaacc tttctgtctc tccatttctt cctctctctt cctcttctcc tctctcatt 110940
 ctgacagctc cctctccctt gccctcatgc tccgaattag cttaggatg gctggccctt 111000
 cccattctcc agggaccatg ctttttctc ttagtgcctt tcttgcttcc tagttccttt 111060
 ggtgaagagg attgtaggct ggtaatcctt tcttaaccac ttttatcata ccaatcacct 111120
 cctctagcaa gttcaaatcc tgtaggatct tttgttctg tttgctgtgt aaagcactaa 111180
 gtttaataca ggagagctat gcactggagc atagctaacg caccagtggc aacatcactg 111240

 aagacaatga cttccttggc ccatagctcc ccgaactggg tgagacaccg tgatgcgctc 111300
 tgattcttga tttgaaatgt tagtgctaaa tcaccttcca tttcattgtt atttcttctc 111360
 cacaacttag agatttgatt ggtttatgtt agctacttct tgctctatgg aatacatgtt 111420

gcgtagtttc ttacataggc atttgtgctg agctgggtga ataatagtat actctggaga 111480
ctactgaaat attctaaatg caataattca ggtctttgga ctggagagga aatgatttag 111540
acagtagggt cccctgcac aaccacaca gcatcagtgc tcagtcctct atggtaatgg 111600
ccattcttca tgtaataaac tttttccca ataaaattta tgcaagctac tctcatgttt 111660

tctaaataat ttttgacttc aaatagctac tcaagacatg caaaacaaga tgaataaat 111720
aaaacgggcc tatttggggc ttggtagaga tgagggttcc aatatccatt tgtgttttct 111780
acagaaaagc ttaggtctta catctttttt aattctacaa ttttgattg agaaaaatag 111840
gtcaaaatgt tataactgaa aatattcttt tcccttttct gcatgtgatt ttttgagttc 111900
ttagtgcata aciattctgt gtaagtggg gaagatcact gtaaaagaaa tcaactgaacc 111960
tcattttcta gctttttgtt ctcttacctc ctttgcaatg gcactggttg ccagatcag 112020
ctttcagga gttggagaga attggggaat gtaggaaata gataaaacca gaaagacttg 112080

agcggccaag ttgtcaaat tgactttaa aatgctaaca cagagccagg cagtgggtggc 112140
acatgccttt aatcaatccc agcactggga aggcagaggc aggcacatct ctttgagttt 112200
ggtgccagcc tggctctgaaa aagcttttca ggacaggttc caaagctaca cagagaaacc 112260
ctgtctcaac acccccaaaa aaatgctaac acaacatgta aaatgaagat taccactaaa 112320
tcatttacta aacagccaaa tgggcattat acttacttct actggaagac atttttgata 112380
ctaaacaact tttcagtat tgctattggt gattcagagt ccccagtgaa tcccagaggc 112440
tatttgagcc ttatgaagta tatgtagact tgctattgat acataaagta gtatttcttt 112500

tacaattttc aactcaaaaa tcacacttta gaattgagag gtgatgaatt gaatgattcc 112560
catttaattt aaactatccc cagggaaaaa ttgactcaca aaatgcaata tattgttacg 112620
agtaactata gggaaaaatg tttgtatctg atgctacatt gagactctag gtcgattgga 112680
attaactaga gaaaaatcct catatgttca gtattttatt tcagccttat gtataattat 112740
tgaaaaatag ggtaagatt gtgaaccgg tagtgttcta ttcattgata gcttggatgat 112800
caaaagagtt gcaacagctt atttgtccat ataaaatgag aatttatctg taccagaaac 112860
acgttgtaat tttgaaagaa tgatgaaata tttccaagt agttttcaac tattctcaac 112920

ttctcaactc aagatcgagg ctgtagccga gttactagc aggctagcct tatacctaat 112980
ctgtacagtt atatttcaga gatgagaagt catcattgaa ttttgattg tatttatgaa 113040
aacacagatg aaatagtcaa cacaccataa atcacaatcc tccctctttt ataatatatt 113100
agatgcccaa ctttcaaagc aacatatttg atgggatggg ccctagaagt tgttttcate 113160
ttaaaattct caagattgag aaaaaaattt aaaagcttcc aactcattaa aattaatttc 113220
aagtcacata aaaaacagtg ctctgataag ttcaaatata cctagaaata ttataatcca 113280

ttgccccatc taicattatt agcatgtatt tcttctgtgt gagatttcat tgtaagacat 113340

 gcatactatg gctttcctca ttgaagatct gtgataccca cagtctcatt cggggacata 113400
 tattttttaa atgaaaaacc ataaggtttg atagccaagg acaactctgaa cacagaactt 113460
 ttagaagaaa gaagaaatga aaactgactg actagctgaa ccacatgac acaatgttcc 113520
 tttcggataa gctggaattg tttattctgg ggtattctca aagaaaccta aacagaaatt 113580
 ggttaggcta tacctggcca gtacagtatc aagaagctcc tgcaaagaaa cacatatgg 113640
 aaaagcccat ttaaaccttc cacacactag tgggtctgat gggctctaaa ttagctcgca 113700
 cttctacca agaagacct aggcacatt atgaacagct caattaagat gtctgtgagg 113760

 tgggtagca ccaggccaaa aagcaaatag actgttcgga tggattaata aaggaagaga 113820
 taatatgaa attgatgagt atgatctgt gtcaatacat ctttcctaaa ttagacaaa 113880
 taaatgttt tttttccc atcctgaatg atttgattgt tttccaaaac aagtctctgg 113940
 gcgtagcttc ccigaaacc gggcagta ggcaggggc tttaacagt tgattcatca 114000
 cgctcgctcg ccacatctgc tcagctgctg gtgcctttga atgggatctg ttcaactgtt 114060
 tccttttgac teactecatc aggcctctg cctatctgta gaatgaaagt gggggagagg 114120
 aaaatgtgag ggcgcacaga agcctcgct cccaggagca gcgtacttat aaaccttca 114180

 tggatttata atcctgtcct ggagatgtgt tcaaaaagct ttcagatgca tcaaatttc 114240
 cccatttaat aaaaaatata tttccacag taaaatataa aaaacgcatt tcatttaagt 114300
 catgtgttg ctctcaaca gccctcgct cacagcagag ggaaaaggac acagtgggtg 114360
 ctgaggcagc gctatcagga ctccctaagc tacttctat gagagaaaag ttgcttccct 114420
 ttccaagaca aacctaaact gaattaaagag aaagcaggtc agcattcaa catgagctga 114480
 accgagagga caccaataaa catagtgaac tgtatgtgg ggagggggga agccacaag 114540
 tcctcaacce aaagaactgc aggcaactga gcaaaactgg gagtgggaga ggtggcctc 114600

 cccaggaag agcaccagac ggttcacatc agcaaaccat cagccctgaa aacatacatc 114660
 caagtaaac tgcatgaact caatgggtta ttttttagga atatacacgt atatgtatat 114720
 ttatgcaata gcaattaata aaaaaggaga gccgaaagg gcacctggga ggattttgag 114780
 ggagtaagg gaaggagaa atgttctaata taaaatatca tcttgattt ttaagtagtt 114840
 ctcaaggagg tcgcacatgg ttttgacagc tgcacatact ctctgtgtgt cgggttacac 114900
 tcttagtttt gtgtgtctg ttgggatga cttcttccga cacagcagtt aagaaatcac 114960
 tttctggagg acagaaaggt tgagacagg gaagaataga agataacaag aatggagata 115020

ccattataga gggagacatt ttaggtttac agagaaatct ggcactaagg aaatgtctgg 115080
 agatctgcaa agatgacacc agctaactat ctgagcaacg gaggagaggc tgccttcaat 115140
 gccctccct gataaagaga ttgatcactg acttatatgc caccctagag ccttcatcca 115200
 gcagctgatg gaagtagaag cagacacca aaactaatca ccgaactgaa ctagaatcca 115260
 gttgcagaga aggacgagtg atgagcaaag gggccagac caggctgggtg aaaccacag 115320
 aaacagctga cctgaacaag ggggagctct tgcctcccag actgatatct gggataccag 115380
 caaggaactg atccagacc caggaacatg ggtttcagtg aggaatcctt ggaaatctac 115440

 cggacctcct atagtacttc agttcttacc cctagcatag gtgtggactt tgggagccca 115500
 ttccacatag aggaatactc cctgagccaa gacacatggg ggtaggcctc ggccctatcc 115560
 caaaggatac attagacact gatgaccccc tatggaaggc ctccatcc aggggggggc 115620
 agaaaaggata tatgataggt agggtttttag tttggggggg tggtagggga ggatgggagg 115680
 gggaaggaa ctgggattgt catgtaaac aatcttgttt ctaattcaaa taaaaaaga 115740
 aattatttc tacagaaat gttgaaagta atgcattgca gttgcatcaa ctaaccctgt 115800
 tacacattc cccatcagtt tataatgctgt gtttggaaaca ctatgaattc agagcttcaa 115860

 gaacccaag gaacttaaaa cccaaaaca aacaagccat ggccagagaa tcttagaaaa 115920
 gttacaggat ctaacagatt cctttgact ttttcggcat ctgagaagag tttccgagct 115980
 gttcaatcat ggtttagtc attagaccag tctattcaa attgtctcgt cctgactagc 116040
 acagaataca gtgtctcatg ccttttttag agattttgta ttgcgtgact accaaaagaa 116100
 ttgttcagta ttttgctaaa gtccactctg tgatagatca gagattaaaa acaataaat 116160
 acagaacata cctccacca taggtccct ggatgctgag attccaaggt acccaaggtc 116220
 cccgaaaga gctaattagc attgcagtca ggtctctctg caccttgctt cagcctcaga 116280

 agctccgggt tagggagaaa acaacaaac ccatgtgaaa tccaacaca accacatggg 116340
 gaactctggg attcgccttt ctgtacttca acacagtcca atgtttcaac tgcctgtttc 116400
 tctccagcag tcatcattc gtaagactga gaagagagcc tgggagaaca aaggcaaaa 116460
 gcccaaatcc accagggggc tgtcttccac tcaagttgga gataaaatgt ttgaattctg 116520
 tttggtgttc ctgtttgatc tggttttatt tctgtttgct ttttaacttg tagggttacc 116580
 tgtcacattt aactatcttc agtaaacgt tacgattgaa agactctgta atatgacata 116640
 tatgcatatc tacatttggt ttagttattt aagatttaca aatactccat atgcacagaa 116700

 agagaaagaa ataataaact atcatagaga tttgggaaac aaagaaagat acacatagct 116760
 atttcacttc aaaagcgat acttggtgta ctattggcag atgtcaaaca gttcaccttt 116820
 gctttttgga tcagggttg ccaaaaatgt gaatgcagac ttggtcttaa gtgtgtcct 116880

ccaagcactg tcaataaagg aaatgcaaaa cagcattgat ttcactgctg ccaaagtgcc 116940
caggcttcga tctgtgacca tategacccc acccctagaa caaaatgtag caaaatttac 117000
acaacaacat caaatagctt cactcataca gactataatc atcaaagaga agttgatggt 117060
gcagattgtg tgaatccatt acttctatctt agaagactac acttctctgta aaaataaata 117120

aataaactg ggagaaaaca gtacagatac actgacaatc agtttttctt tttcttgggt 117180
aaaagtgtaa agcatatcct cctaccatag gtacactgag attttgacag ttcttgggtg 117240
tggaaataga gaagggatgt gatgttgagc tcaatgataa ttcctacatt catatttagt 117300
aatgcagaaa tattcttaaa tggttagtgt gaagctagtgt aaaaatagca cacatgttgt 117360
gaattgtata tgaattggaa aagcaggctt aaggaatag tagtccaaat ttcaaagaac 117420
accattttct tataggtagg gttatcattt ttctttctat tctgttttct tactctatca 117480
tgtgtatgga tttttggggt ttttttaagg ggaataaaat taaattcttt gtaatgagag 117540

attctttggt agctgggtccc acagctcttg ggctccaaat aaacacagag acgtataact 117600
ggttatagtc ctgttagccg gtgggttggg cttcttattt ggctagcttt gtcttaatta 117660
ttagccatt tttgttaate caagtatttc cacgtggtat tatcttactg gagaagtgtc 117720
cagacctcta actcctttgg cactcacatg gcgactgttc cggcaggccc tctctgccta 117780
tcttccccag aattctcctt gtctctcagt cctgcctatc ttctgcctc attggccgaa 117840
cagtgtttta ttcattaacc agtaggaaaa acatatatac agaaggacaa cgcceatcaa 117900
tacgttcatg tctctctggg atgggtggtat gatctacatg acctgctgtc aacatgacct 117960

gcctcaaaat tigtgcatta tgtcataaat aaaggaagct aaaaaaatca cgcacacttt 118020
cctaccactt caggttacag aacctcccca tgtgccagaa gaagcattaa cagtattcat 118080
taatcaaatc actacaaaaa caggaacaa aatctgggct tttaatcaa gctactcaaa 118140
ggctgagaaa caagaggatg ataagatcaa ggctaggcta ggctacacag tgagctcaag 118200
gccagcctag gctacacggt gagctcaagg ctagtctggag caacttactc agtgacagac 118260
acaatgtcct aaaataaaag gtggaagag ggctagatac atagcccaat gtataaactc 118320
gagtaatttg cttggttaac atacatgagt gactatgttc agtccacagg gagaataaaa 118380

gtagaaaagc atgtgaatgt gcttagaatt gcctcagaag tagatacaga gaatgctcta 118440
ttgtgtgttt taagatttat tttctttcac ttgcattat ttgggtgtga ttctgtatgt 118500
atataccaca tigtatgat gctcacagag gccataagtg gaaggcagat ccctggcaa 118560
gttgattta cagttagag ccacctgact tgggtaatgg gaactgaact tgggtcctct 118620
ggaagagcag taagttaact gttgagccaa gtctgcagcc ctgaaaacc caatttttag 118680
aatcaatgaa aatgtagtgt gcttgaagc acatggttag tggctggaga gcagagccac 118740

aggttttagga actaggcaga ccttgattag attccatgac caatgcttag cagcaggatt 118800

 ttttttatgc ctctgagtc ctgttgaagg tcaataacaa cagaagcatg gggtttttag 118860
 aagggaagac agcgtctgtg ttgagggttt cctatcctgt ggggtgagac gtgagtctgc 118920
 ttgtgtgagc acaggtgtgc gtgtggaggc atgaaactga cgtggagagt cttcctcatt 118980
 tatctattga caaagtgtt attttttagct tgccccagtg agcccttgac tccactagga 119040
 ttgcagagag tcaactgtacc tgcccagctt ttacctggat cctgggaatc tgtactttgg 119100
 tcctcactct tgaggagcaa gcaactgcc actgagccat ctctctagcc tctgtgctga 119160
 aagaatcata tgacataatg acacacatgt taaatgctca acaattagtt ggcataaaag 119220

 taaacatacc acttaaagga caaagaaaac tataaagcag catacaatta atgtgaaatg 119280
 gaggggtggt ggggtgggtaa aagaggttat gaagacagtg ttgtgatcag agaacaatat 119340
 atacatatct caaatcagtg aaaccacta atacatacaa ttaatagag ctgccaattg 119400
 taattaaaat ataactctg ttttagagt gccccttgct gttggcttcc gcagtctcat 119460
 caggacaaa tgctatgctc ttcccttggc cttcttctt cttggggcca catgagcatg 119520
 ttgtccctg caccacgcta tctgcacaca gaagggaagt catcgctctc cttttactag 119580
 ctttctctt gggggaaatt caagacaaca cactctgct tcatcaaac aaaatgtcac 119640

 tgcactagt gcaccagag gaaagaaata acacaatgt tgaatttta aagcaagtat 119700
 gtatcagtg ttaatcaaag atggtaggat gatccacaca aactctgtg taagaattac 119760
 tgaagaagta gaaaatcctc caaaaaacag gaaaaaattt aaatgtcact ttacagagct 119820
 tgcaagcatg ttacagattt taatttagcc aatttgcca caaatattc ttatgttgc 119880
 ttgttcagta agattggctc tgaacaatc tgaggtcagt gaaaggactc tacttctatt 119940
 ttacattgc acaactttac aactaacaaa acatgcccac acatttatta aataatcatt 120000
 catcctaagt aatcctcaaa atacttcata aagtgcattt tgtgaattcg gggttccttt 120060

 aggcaatfff gagatatggt aatattgtgt aacctaattt ctatcaccta atatttgaa 120120
 ccaggaaagc actaatcctt ttaagccaat tgctcagctc agaatagcca gtgaataaag 120180
 gtagtggcta caggcaagat tgcagtctca ctattgttc ataggaggga aggaaggagg 120240
 gfgggacctg cttcaatfff cttatacttc aacttcacag agagaagcca cctctgacct 120300
 tacttaacca aactacaagg gtgtcactcc tcccccaaca aaccatgtgt ggcattcatt 120360
 atataaaata atatcttatg ttaggtggaa ttgggatagt ttattatact gctgtctcta 120420
 gaatgtgacc tgctgtaaa ggtatataat aactagccat gcagagaaca atccactgtc 120480

tctatactga agcattatag gttattatat cagtgccttg tagtaaaagg aaatctaaca 120540
cagttgaatt aattagagtt tggttctcct gacactgtg tataatgagtc cagcttggca 120600
aggaagtgac aaaaagaaaa gcaagcattt tggatatccac attccacatt cagtggcctt 120660
ggctcattaa tctagagatg gttatcattg aatcatccgt caattgtctc cagactcttg 120720
ctaaatgtcc tttgatctg gatcattttc cagaatctga tttgtcattt ggccagaatt 120780
ctcacttctt ttacatcatg acaggtaaag ctgtttggaa atatattgta taactagtaa 120840
tatccaacc gttttcttgg ggataagggg gtggtgtctt tcatcttgat ccaagaagcc 120900

ttttagagcg gaggtatct cctaaacatc aaaactgccg cttcatatt ttgcaccagc 120960
aaagattagt tttatagtg atcgactcca tctatgtcag taaagtagaa ccagtgggca 121020
tctctccact tccttctatg tgagaactgg tagatctgct tctaattctg cctgcgtgtt 121080
atcatttgcga aggatgttgt attacaagaa gatccatagt ctgtaaggtt aagatatctt 121140
tatttagata aacaccagcc aaacgcaagc cagagcgtgc caggggcagc aaggcaggca 121200
ggccagagag aagggtccc atgtgcctta cagcccctta aaaacatc acaaatcctc 121260
ctgacctcac cttgaccag ccctgacagg cgtggtcagg cacacctgtg gccagcttct 121320

agcaggcgtg ccttacctg tcccctaaa tgttgaatg atgaagagca gttattagaa 121380
tgtaccact gccttccgac catattgtcg actgagccta cagcatagta taaagaagac 121440
tactgggctc agctataact tgggtctgta cttattgacc actggtttcc taactgcttt 121500
ggagatatgc tgtttaatcc ctttgaggag gttttgctta tccttattct ataaatgaga 121560
tggcaagtca tgaaggaag ccacatgcca gcccgaagcc tcaacacagt cctctctact 121620
acacatggat gcctctgtca cgacttcggt caatgtcagg cccagacgtt tcttccacac 121680
tcagcctcag gttcaggaaa tcaagaggga atgggtgata ttgcctaaag actaagatat 121740

tattaaatcc ccttttgttt tggttccatg cttacctcat taaattattt cataaaatc 121800
caatttcctt gtgtcatcaa ataaataaaa attaacgtat caaaaactca gcatgtgacc 121860
tgtccaaagt gtagatatct ttgttagtcc ctccacaga ggttttcttc tgtctctatg 121920
ttatcccaa ttccactgga ttttaagat ctacgtagca accccatta aatattcctc 121980
tttaagcca ttaacaagt gtgtaatttt aagaaaaact acttccaac ttagaaataa 122040
tatacagatg gagacttttc tcataacatt ttgtaaaaa ctgtatctgg gtgcagacat 122100
actttgtagc cagaagcttg aaacactcac caacttcttc taaaacacat tatatacctg 122160

caaatgaaaa gactgagtaa tagtatttta ccctaaggag tgtaacttg gataaattct 122220
caaggtaccg cagtatagac acattataac acagctaagt gaacaagact aattgcaaag 122280
gctcaatact aaaatactga acagcagcta tagtaattct aagtatttta tttctaataa 122340

aattcaataa attacctatt tagagagata aaatcttaca tgcagaaaag tctacgtgag 122400
aatgttcaac ccactagaat ttgaatattc cctctttagg caataaaaagg catagatgac 122460
ctatthttgtt gtttatctgc atattctagg tathttacatt aacatgggat tccattatac 122520
acaaagtaaa gggaatttga cattaaaaga aagattgggtt acgcaaagtt gagtatgtgg 122580

ctctattgct ctagaccgtt gtgaaataca ttgtttttct gtataagaga cttctagcat 122640
gaggggtgtg caaagggatt ttccaaaca gaagtctttt cgaggacata aaaggacctg 122700
cttagaggcc ctggcctgct gaaggttggg tgtgtccaca cctacctcct tgtgtttgga 122760
agctctgaca aagaatttc tathttacaac tctgcagcag tgtggccagc ttcttagttt 122820
gcacctgta atacacaaca tathttttcc ttacctgcag acgctcagca gcaaccctc 122880
tagactaaa aggaactgta aaaggacaaa cagtgtggcc aggagtgtgc tggtcacttt 122940
aggagactt cccagttat gtgaaccaga gtctacaggc aaactccatg tgagcacaca 123000

tttgtttct gctcagactg cacagactgc ccacctctc tgtccaggct tcctatcttg 123060
tcttcaaac ccaatttaa tathctttt tcagcctcac agggcccaca gggcagactc 123120
agaattaatt tctttctct gtgcacagcc acagcactgt tttcatgccg ctaatccaga 123180
gtgaatcata atgcatgat atagatagct tgccggggca ctcttcttg cccatcagg 123240
agagcaggag aagaagaata tgacaccaat atthattcag cctctagtgt tcattaagca 123300
ccatctgtaa ttgatgctt taacaacttg cattathctc aatgcatgt actattgtct 123360
tcgcctcaca ataaaggaag tgaacattca gcaaagttac acttggtcac aggagtgtg 123420

caccaaacg tttctccca aaatctttat gttgaacccc caatgtcgtt atttagagat 123480
agggttcttg ggagataatt aggtttggaa gatatcatgg gggtgcaaat ccttattatg 123540
aaattaatgt ctttattat aaaaaaaaa gagaaacttc ttccccacc atgcaagaca 123600
cattaagaaa acagttaact atgtactgca gttcacatat aatactatca ctttgaggga 123660
aagagggtca gaaattcatg ctgcaccttg gttacttagc aagtctgagg ctagcttgac 123720
ctatggaaga tcagtctcaa tathatagca gcaaccaata gttttctgat tgaatttaa 123780
accactcca caagacataa tgcttgtcta gttctgttaa gtgagtcaa agctcatagc 123840

tgactaggct ctatgccata ggagagaatg tagtaccatt actctgttag gaggacatat 123900
tgttaaacg ccccataagt tcttathtt atgaacatag athattgcat tcttaactct 123960
aatcagaaag agcttcttt tgcagtaggt ggtgactaat acctacaatt atgaatacac 124020
agagaataag actatagagt gctaagctct agatggtaat ctatactat acaacaaccg 124080
acaaccctg gtaccatcaa ggaagaagg gtggaaatac agtaagatcg ccgggtgttg 124140
gtggcacag ctttaatcc cagcactcgg gaggcagagg caggcagatc tctgtgagtt 124200

cgaggccagc ctgctctcca gaccgagtgc caggatagcc tacaagcta cacagagaaa 124260

 ccctgtcttg aaaaacagaa agaaagaaag aaagaaagaa agaaagaaag aaagaaagaa 124320
 agaaagaaag aaagaaagaa agagagaaag gaaagaaata caataagatc cagaagcagc 124380
 agacctctgc agtaaacacag tacttatttg ctagacataa cacagctgtc acacacatga 124440
 acccagcagc gctgtccctg cacacacaag gcctgcataa gaaagcagtc aaaatcccag 124500
 catggaccag aggggtactca tgaagtaagt tttccttagg gatgtggctc ctgggaggct 124560
 acccaggctg catttgatga cttacatcca tgaacatatt ggtagcacta agtagattca 124620
 gtgagttaa aacaaaacaa acaaacaaaa aaccccagga agttgggatg aaaagcagtg 124680

 gagaaataag ggaggtttgg aggggagggga atgagaggga gatttgatca aaatacatta 124740
 tattcataca tgaattttc aaacaataaa atgttaataa ggaaggagaa gaaagagaag 124800
 caagaggaaa ggaagaaggg ggaatgaaa aggggagaaa atgaagggga aagggaggag 124860
 aaaaggggga ggagacggat gtctggatgg tgcctggatg atttgtgctt tctatattgc 124920
 ttaagcaaaa acatttgaa agttcaacat atactagcct tttgagatta gttggtggtg 124980
 taacagact ttgataatat agacaaagga gatacaggtc atacacaatt aggctaatt 125040
 aagcaatcag ttttagaaca gtaactatca taaattgtac ttcagtaatt gtgctcacag 125100

 cctgtactgg ctggttttat gtgtcaactt ggcacaagct agagtcacca gaaagataag 125160
 atcctcaact gaggaatac ctccctaaga tccagctata aggcattttc ttaattagtg 125220
 atgaattaga gaggtccag cccttgatgg atggtgccat acctggactg gtggtcctgg 125280
 gtctctgtta ggggccaatag caatagtaac ctggacctg taagagaagt ttgggaggtt 125340
 ctgtaagaaa gcaggctgga cagctaaaca ctgagctgaa ctctggaatc tagttgcaga 125400
 gagggaggag tgatgagcaa aggggtcaag accaagctgg agaaaccac agaaacagct 125460
 gacctgaaca agggggagtt catgtacccc agactgatag ctgggaaacc agcataggac 125520

 tgttcagaa ccctaagt aggatgtcag tttggaggtc tggtaatct atggagcctc 125580
 tggtagtga acagtattta ttctagtac acgaatggat tttgggagcc cattccacat 125640
 agagggatac tcctcagcc tagacacaca ggggagggtc taggcctgc tccaattgat 125700
 atgacagact ttgaagatcc cccatggaag gggattgatc ccctggggag cagacagggg 125760
 ctaggacagg gggccattgg gggggcaggg gaggagggaa gggaaaggga actgggattg 125820
 acatgtaaaa caagcgtgtt tctaatttaa attttaaaa aaggaaaaa aagaaagcag 125880
 gccgatcaag ccatgaagag caagtcagta agcagcatcc caccatggcc tctgcatctg 125940

ctcctgcatg acttccttct atgatgaaca gcaatatgac caaataaacc ctttcctcct 126000
caactgtgtt ttggtcatgg tgtttcataa caataataga aaccttaact aagacaaagc 126060
ccaactggca tctcaatgag atgaccttca aaaatatcat ggttctatat accgaatcat 126120
cttctttaca aatacatttt tattttatgig tatgagcgtt ttgactgtac gcaacgtgtg 126180
tgtgccttat gccacagag gccagaagag ggcactgaat tccctgaaaa tggagtaca 126240
ggagggtgta aatgccctgt agttgctaaa accaaacctg atctctctgc aagagcagca 126300
agtgtgttta actgctgaac ctggcttca gcctaataa gtgtgctttt gtgactgcaa 126360

tggcaaacac aagtttctta ggactttgat catgggttca agcaggaag tgaagcacag 126420
gtattcatat atccttgatg caaaaatagt ctttctctac tggagggtg taaatggaac 126480
ttcctgaaaa gaaggagaca cctgtccagc catctatcta gtcaacaata ttgactagtg 126540
ggggacagat agatggacct tacattcaac atgtttcttc tattttcatt atagcacagc 126600
tttaaattta tatagaaata taaaaattgg gagtatgcag actcaacgct ctttcatcaa 126660
ccaaaggcaa agcaaagatc aagtcaggat ggtcctcagg gtaaggagtg atgagaagag 126720
aacaggtcag ttgggttctt tagagctgtc aaaccaggg attcaactct gtgtttataa 126780

cagtcaaagt gagaagagga gatacaatct caccctctga gccacgaaa tctaccctg 126840
ccttcaaacc ccaatacaag cagtttctt caactctcac atcctcttgt catgtctctc 126900
aatcctgtct cctgagaaga gttctcagta ccctcagcat gcacagtact tttttcagtt 126960
gctggtatgg aatgaatcag aatatgctgg gactggcatt gggtagcatt tgatccctgg 127020
ctccctccat gctgagaagt gctaggaaat taccagaggc aacttcttgc tagctttaac 127080
agctttaaca gaggtagcaa ctagecctcg gtatgcttgc aaactagaaa ttatcaaata 127140
tggttaatta aaaattaaga taccagaac tegtctttta ttttgcattg ctctgtgtgt 127200

gtgtgtctgt gtgtgtctct gtctctgtct ccatctctct ctcctgtgt gtatgtgtgt 127260
gtgtaaaatc acaaagctga cacaatgtct tcctttatca ctctccactt actttggcag 127320
agtctctcaa gaaccagtg ttctctaatt cagcaagtgt agatagccag ctgtctctgg 127380
tgtgatgttc tgaagaaaaa tggtecccat agggagtggc actattagga agtgttggag 127440
taggtacagc ctigtggaa gaaatgtgtc actgtgggta tgggctttga gatctcctat 127500
gctcaagcta tgcccagta tacagttcac ttctgttgc ctgcagatca agatgtgtaa 127560
ctctcaactt tttctccaga ccatgtctgc ctgcatgtcg ccatatcctg ccatgatgat 127620

actgaactga acctctgaaa ctgtaagcca cccagttaa atgttttccc ttttttagag 127680
tttcctgggt catgggtctct cttcacagca atagaaacgc taagacacct gggtacacc 127740
tgtctatgtt cctgaaggct gggattatag gcagtggcct aacctgcctg cctatttttt 127800

ttttcagtct gtttttgctt ttgttttctt taagagtcca gcatttaaaa taaataaaat 127860
 ttgaaagctt cccatgcttg actataacat gcatcatggt tcttcccttt ttagagaaac 127920
 tgatatgctg tggtttgctt tgcaattgca tcaaatcatg ttgaaacagt gactttgggt 127980
 ctgtcacgtt acttccagtt cctattatac ataaacatta taggagccag ttttccaaat 128040

 ctcttgatg ccatgcatta gcgctagtct ttaaagaagt gctctcaaag aacagttcag 128100
 gatgagaatt tcagtgggct atgagctctc ctgtctcctt catagtttgc agtccgagag 128160
 cagtccttag ctcagacttt aagacagatg ttatcagaga aactgactgc ctacgacagt 128220
 ggaaagagac aaatcaggcc tcatctatgt actcttcac cgtctaaagt gtcacttctt 128280
 tttatgtgtg ttcatcaaat tctagctccc aaaataattg tgtttccctc tagtaacata 128340
 cacagctaac tagctcaacc tttttcttaa ttcttgaaat atgtcactgt acatgaatgt 128400
 acttgaatc tactctacta cccaacttgt ttctaacgat gtaaatgagg ggatttttta 128460

 aaaaaaata gataagaatc atatacagaa gccattaaat agggacactg ctgaaagatt 128520
 aaaggtaaat atatattatg agacacacta ataaggtggt cagacactct tgaaattgag 128580
 ttgaaatgta atatacagag atgaaaggaa attaaatag aaaccctgcg atacttatta 128640
 agccgtcagt gggaaatctag atgatgatgt cacaaccaga agaggagaga caaccatgc 128700
 aaagtggac gagatccagt tctgtctgta gatttatgca gtttaatttcg tcccttgact 128760
 gcattcagat gagcgtttct ccccgacata caccaagaaa attgtctgat tatagctgtg 128820
 ttaatggtta tcagcatgct aatgagcgtc agaaggtcgt tacagcgaag agaggttcaa 128880

 agatgtataa cctacaggaa acaagagcgt aattcttcag ggactgtgag tgtcttgttt 128940
 gtaggtcata gattatttgt ttgtgtcact gcagtgacaca gggacttta ttaagctgg 129000
 gaaaaaatg aagccttttg aattgtggga gcagccctgc ttaattaagc aaagtaatac 129060
 cagatagctt taaatttgtg gttttaaaaa attatatata aaattccagg atagtattaa 129120
 aggatgcttt ccagtgtgga attagtcttc tgtggttagg cagaatggga ggtgcttatt 129180
 tgtttttatt ttttaaggca gaaagtgtt catggctttc tgtcaagaat ggggtcaaag 129240
 tatcagaggt gaaaaggggg caatatccag aaattaagtc acatcatagg caataatct 129300

 cagagtcttg gcctttgggg gggggggata aaaagatatt tcattattta cttcaagtgt 129360
 gtgtttggct tcgaaaggtt aagtgtgtat tgatactgag aacagaaggt attcaatcag 129420
 aaatgctgtg gtctttgttt atgaaaagc tctaggacac aaacgctgtg cagtccttag 129480
 actaagctag gaagctctag aacgtcccc agaagcttcc tctcaacaa agatttgtac 129540
 attttaatgg tagaaaaaaa tcttaatgct gctcggttgg attatgcaga ttttgtttga 129600
 atgtcctgtt tggctagat gctccttggg tgggctctat aagctaagaa gacaccttag 129660

gggtagcag tgacaacctg catttccctc gtctgttggc agtgggattt gccagtgtat 129720

 tttaactaaa tattttccca tcccacaaag aataaataag atggctcctc acatacacct 129780
 acacatgcag aacacacgca cacaaatgtg taactcacag aagtgatgat agaaataacg 129840
 accttctgtg atggctgccc tgacaattct cagggtagggg gaggcctgaa ctttcttgt 129900
 ttatcagtct tcccagatta accaccttct tgtgtgaatc agaaaccttt gttccatggt 129960
 cacaagagta agcagagaga catctagctc ctaaagcttc ctgcctgtac agaaaagcat 130020
 tcttgaactt taatctgtat gtaaaggcta tcctctttcc tcaggacagc catgacacac 130080
 atttgctcac acagtctccc acctgtccct caggaactat tttcctgggg aaaagtaagt 130140

 ttgtatgaca attaaaaaaa aaagccaaaa ggggaatgag ggaaggaggg aagaaaggaa 130200
 ggaaggaagg aaggaaggga gggagggagg gaaggaggga gggaggaaga aaatatagca 130260
 atgcaggaat ataacgttaa taagagttaa taatttacca atataacaat atagtgtcat 130320
 aaaaataaa ttaaaaagca aatacttctt ccacatagaa aatctcccac aatgctgtca 130380
 aaacagacac tggatatttt gtttgaaac tggcaaagta agtaagaatc acaacccttt 130440
 ctatgtagct atgaacagac aacctatgcc atagatgtca ccaagatgaa gcaatcacgg 130500
 atcaagcagg tacacttgat ggtccctca gtcacaatga tccttctagt gtctgaagct 130560

 cacactccta aacatacctg gtgcttgggg tccttagcta agttagcaac atgccttcat 130620
 ctagaggaaa cattagtgac tatctctaca gcagatgctc ttacagcttg agaaatctca 130680
 cctaaggtat cccccagcc tcccacagaa gctggagggg ggcttggcac tctttaggac 130740
 agcattcaaa gacatagatg acaagtctt gagaaaagag tcccaggtca tgaagetgcc 130800
 acaagacctg tctggtcttc taaaggactg aaaggaaaga aggagaataa tcttgccct 130860
 ctttttagt aatgagaatt aagcctctcg gtgaaatctt gtatttatcc tcatttaacc 130920
 caaaataact ccctgggct acataggttt gggagcagga ggtgcaattg cagccttttt 130980

 gcttgaagaa tcccagctc gcaatgcacg gtgaccctct gaggccctga gaatccagct 131040
 tagcagctct gtagcttcag tatgcacagg aatcacctgg ggtcctcaca acatgcagat 131100
 tacaatttca actctggggt ggggcccccc atctctagtc agctctcaat atacttagaa 131160
 gctgtacgtc taagccccag gtgaaggtgg ggtgctgtc acaggccgca ctcaaagctg 131220
 cttctgtgca gtggattgct ccaggtctca gcagtagaca tcccaggctc actaggtgcc 131280
 taccctgaa ttaatcccc aggcgctttt ttatttttaa tttgaggaaac cccacaaatc 131340
 aacaatacta aggaaagatt ctgtctcaga atagtataaa gtttagacct taggagggta 131400

agagggcaca ttaatcccca aggagggggg ctgacaacca gggtttcatc tctggggtca 131460
 aactgtaga aaaagaaaaa ggaatcctgc acgttgtctt ctgatctcca cacattcgt 131520
 gtggtaactg cacatctgta cacacatatg cacacacaca cacacacaca cacacacaca 131580
 cacacacgtt gctcatgccc cttaggtgga gacacaatcc atcttctgca ttgttgcccc 131640
 attggccctg tttatgcat ctagaactag agaacacaat aaaaatgggg agtgctaaca 131700
 tctccacaaa accttagaa ctccaggca attttctgac ctgagatttt atcaacacaa 131760
 ccctttacat attcaaatcc aactatctgt ttgttaccac tcatgttagg actcacctat 131820

 tttagaagaa actccctata gagctccagc ctctctgtac ttctatttcc ttcctgatt 131880
 aatatagttt ctagtgcctg ctatttaatt gagcacaat ttaattaatg gcaataaagg 131940
 agttagtcct tatctcagaa aatgttgag taaagacttc ctgagcaca acactttcat 132000
 ttgcttagct tatcggtctac attagccata agtagggatt tctgagcagg aattaaacaa 132060
 aaagcatatc cttatagggc atagtagcaa tgggtgtaaat aagctgtgca cccagcaggc 132120
 ctgctggaaa tatttacgtc tagcagtcag ctcttactac aagacctaag acattaatga 132180
 ggaagaaaca tttatgatag cctacacctt aggagtctat tacaggtcac aagcaatgct 132240

 tatatggaag gcagtactta gtctattctg gatgctataa caaacaacc ataccctgga 132300
 taatgtatag acaacagaag tttactcttc actgttctgg tccaagatca aggtgccgtt 132360
 aggtttgggg tctggtagc ccaacttctt ggttcccaga cagctgtcct ttcattagaa 132420
 cctggataca aagaaagagc accagagttt ttctttcacc tttaaaaaac aaaactaata 132480
 atgacactca ttacatccct gaggttctc ctgtgactgg gtaacttcca aaatacttct 132540
 cctatctgta gtttcaattt tgaagctggg aatccagcat acaaacactg aggggacaga 132600
 gacattctga ccatagatat ggtaacttat acttcatctc agctgggtgca actctcagaa 132660

 aacaaatgct tccttgcctt ctaceccaaa tctagcttcc aaatataaag aggaagagag 132720
 tgtgggactg ggggagacca gctctatcta ataggctcct cttcaacctg cctgtctgt 132780
 gctgccagtg actcacagca cgcaaacctc accttcgctg agaagtctg agtctggaaa 132840
 tcttgcaggt agagaatttt gagttattgc caggctttct ggggaaatcc gaagtacaat 132900
 gttcactata agttgtctc atgggtcatt cagttctctg ttttatggcc tccaagatgg 132960
 gtccgcata tagcaatgag aatgctacac tgcaggaaaa tagagaaagc ttcaacagta 133020
 gcaggtgggt cttgttctc agtgactcca ctctgtccc ttcaaagtga gggcttagag 133080

 cattgttct caacctgagg gtcatgacc caggggttcc catacagac agcctgccta 133140
 tcacatattt acattacaat tcataacagc agcaaatca cagtgatgaa gcagcaacaa 133200
 aataatttta taattttatg cttgggggtc accacaacat gaggaactgt attaaaggtt 133260

tatagcattg ggaagggtca cggcgtaga aggtagaag cgcctcttct aaatctcaat 133320
 gtcctggcag aattccaaat gggggcagtg gcctatgggc actgagctct cactgttccc 133380
 cgacacccat cgcacttcc tcacacaaa cccaggatgg gaaaacagaa tggcacacat 133440
 gttcttctct ctcattccc ttggaaccaa aggtgatgtc atctctaca tccttaacca 133500

gcctgaacct gctttacaga caactctccc ccattggccc tgcctcacag acagtagagg 133560
 agtgaacaaa ggggcacatg taacatgcca ggaagaaacc tagacacatg tgaggcaggt 133620
 aacactgagg atggtaaac tgagagagcg aagaaatatt cctggataag gccatcgagc 133680
 tactaattaa cccaggtgta gcggggactg actttgattt cagtgtaaat cgataaactt 133740
 gcctctctgt cccagctgtt tctatttggg gtctttaagt ctccaaacaa atgtgctatc 133800
 cttctgaaat attcctaag tccagcaaga cagatgaata gtctggtgaa tctggccaag 133860
 atgttaaaag aactattgat gttaatactc ttgggatgac aagtacaaaa gccccagtt 133920

accttcttct ccatgtcctt tctcatagca atttgggata actgcttagc ctgcctccat 133980
 gccagctggt acctctccc ctgccaatta tgggtcttg tactaaagca aaaactacat 134040
 gtgattcggt actgaaaact tgttaactca acctactttt catggttgac aaagttcata 134100
 acctggtctt ccigtcttct cagcttctgc ccatcttga ctgacatcct gtgtctcagt 134160
 cagccctggt tgagagtccc aggattcact gtgtcattct tacctttgag cttttctggt 134220
 ctttcttgg gaacaatttc ccaacactaa agtgaacaa aactcattc ttcattctt 134280
 acctgatgaa ctactttac cagaaatat ctcccacatg tatctttatt ttatttcatt 134340

catgtctgca tacgtgcaca tagatagca caagttccca tgtagactag acaggcatgg 134400
 gatgcctggg cactggagtt aaaggcattt gtgagctgcc agataagggt tctgggatcc 134460
 aaaccccagg cctctgatag agtagcaagc agtctcaacc actgtactga gccgtcttcc 134520
 catctctaga agtatacatt aagaatgagc ttctgaaagc ttctgtttca getcctgcta 134580
 gatgctgggg tggatgagg atcccatgaa catgcaggag ggttaaaagt tattaacag 134640
 agagttgatt tcatgtcaca tcatagcaca gtcaggaag actcctacce gcatcagaaa 134700
 acagtcatag gaattgtcat cataagaagc cacttagcct gaccggtcca gttcctgtgg 134760

gaaagggaga caaattcagc cttctccacc tacttacttc ccagggcagg tgtgagagtg 134820
 gcttcaggaa gcttggcctg gtgaggcctg actaaaacac caatacagag gctaagtcag 134880
 aaggactcaa agtgagtcc aagccagtct gagctatgtg gtaggacctt gtctcacaag 134940
 aaaaagcagg gaaaaatgaa gggagagagg ggggtaggga agtggataaa tcagagcaca 135000
 cgggtgtttc tagggcttg ctaatttcac catcaattt cctctccaaa ctcttagca 135060
 tcggcttgac cttcagaagt atgccctgt tacaggcctc acatgagcat agtgcagca 135120

tgcacacgtg ttcaagcatg tccacatatg tgtggatgcc tgacatgtct gtctactctc 135180

 catactgtac ttcaaatcct aagaattcaa gttacttatt atattcctag caggagcaaa 135240
 ataaaagcat tttctctaata ggcaatcagg cagagaggag taaaattagc ttcaaatgag 135300
 catgaaagag cataatggtt cagattgcag gaaaacagta catcccgcag ccttttcctt 135360
 ccttctcatt ctttgtggg aagcagagaa tcatgccctt aggttttcca cacaatatgt 135420
 gtagatggga gcagaaagga gcagcagggg tgtggatgca aagacggtgc aattaaaagg 135480
 acaaaggatg atttgtttgt ctttaacacg ctgcatcttc ccttcaaagt caccacaag 135540
 ccaccgtcgt cacgtaatgt aattccaaaa aaaatattat tttaggcaaa agaaaattct 135600

 atagacggac acatattgga tgaagtattg cttgtgggtg aattttaatt ctgaaagatc 135660
 ttgctaagag ggcttattta aataggcttt ccttgagatg aatatttagg agaaaaattc 135720
 ctacaggatg atttatagca aaattatatg aacagaatga aggacagaag aattttatta 135780
 gaaaagggtc tcatttcac aaaatataaa ttataccttt tagaaaatat attgaatfff 135840
 attaatatc ttagacagc ctgaagtgtt aatctccacc cctacctata agagtttcat 135900
 tatgatgtac aagggtgatt taccctttaa ccaaatcatt ttttgagcaa ctcagtggag 135960
 tctccagttt acatacccta caaaatattt ttattgcatt taaaaatgt atattttgt 136020

 attgttggca acttghtaatg gtctatgtgt gggagctatc tttttatata aatattcatg 136080
 cttttgtcat taccatgcca gcacacatat taaagatgaa cttctgtctt tgatagccaa 136140
 agaagaatat ttgttcaata actcctgtca atgttattat catattaact tccttttaat 136200
 aggatataca tttgggcttt ttaatgctgt tattaaaaat tttcctttta tcatgttaaa 136260
 gtttatagtc agaagaatta cttggagtat acaagtgatc accatattta ttctggcat 136320
 ttgaaaatga cctcatttag acctcgttag ctaaatattt tgataggaa attgacttat 136380
 tgtgatgtaa aggacttggc cataaatccc tttccagtct ctatcagtct tgaanaatga 136440

 gtccttagg ttgatgactt tgttghtaagg aattataggc taactttcat agatgaagtg 136500
 caggcttcag caaggacaag ttcaagttha gactccacac catttgcagt ttggctcctt 136560
 ccacagaaat tccacttgg ctttgtttgt ttatgtattt atttatcacc accatattcc 136620
 aaaagtatt tgatgact cagaagctag ctacccatgt tgtcagttt tagcatgtgt 136680
 cggctcagac tcatattgga ataagaccac aggacagttt aaccggaggt catgcatgcc 136740
 gacatctcct ggagacccat cactacttca tgctccaagg tctggacaaa gcaggaatgg 136800
 tggttaatgc ctataatccc agcactcaga aaacagagga taaagaattt aaggtgagtc 136860

tgagctacat agagaggctg agtctcaaac aaaacaaatc aaaacagatt tgtccaaaat 136920
 aaaatggacc tgtgaagtca caggttacta atataatgga gtttcttacc caaataatca 136980
 aaactgcctc ccttaggttg catacatctc cttagaagtg acccaaatga tagagctgtg 137040
 attattcatt cctaagtta actcttgtga gttaccagc taactcagca tccttgagta 137100
 actttgaacc tccactgta ccccttccat tgaactctt tctctgctg gttagattg 137160
 cattgcttac cttcattacg gcaagctact gttgtgaaaa tatgtaataa caaaggaaaa 137220
 gaagaaaaca gaaactattc tctttggcag ctttgggga cttgaaaatt aaaacctccc 137280

 cattcttct gctatacgac gacctcaaag cagcacatcc ctggcatcct ctcatagggc 137340
 cccaactgta cctcccttt ctttgattta tcctctgct ggccctgcag gagagcatca 137400
 ttttccgcc tgcctctgt cctctatatt tcattccagg tgtctatcga ggcaacagaa 137460
 gataaagctc tctgctttcc cttgtacaaa agttctagat ggaatcagtt cacctgtctg 137520
 tcaactcctca ttaaattctt accctcttca ttcacatcct gatctttgca aatgaacatt 137580
 tgcttaataa atgttccaa gactaacagt gccgagtga aatcccacac agcagtaaat 137640
 tattaactca gtcacagagg gagtgccata tatgactttt cagaatgagt tattatgtgg 137700

 atcatcgtgt aattatgaat ttttcaagcc atgatagagg aaaattgaat atttaatt 137760
 ttatggacat attctacact gaggacatct ttcaaaattt tatgataatt tttagagtga 137820
 gcgaagagca gaacaaaagt taaaaataa ttgcaaactt gaatattta tcaactagga 137880
 cattgttggc tattttcaa attatatac gtaaccaagg ctgtgaactt ttaatcatag 137940
 tgaattcaag tgggggaaaa gtacattaaa accaagtac aaatatgttt taagtgttt 138000
 aagaaatcag aatacagggg ttaggttgt caaattcagg tcttagagta taaatactcc 138060
 atttctgtga gaggtaatct ttagtgttt gtctaaagt agctattgtt gaagcaaca 138120

 agtttgtaa ataacactt taaaatgtt caaaaccaat actaagatac aaactccaaa 138180
 atcattgaaa cgctttgtaa gtaataaaa ctggcatctg caaaagaaa gccgattttc 138240
 agctttgatt taaacaaag gaaaaagtta agcagcgcac gtgcaatagt gcacagcagc 138300
 ctcatcttct gaattctgag tagggtctgg gactcctgtg tcccactg cegactctg 138360
 caccctgca tgatgtgaca cttggctcct cactttttaa cttgaaaaac tggaacgttt 138420
 gctgatttca attttctct gtaggttttc ctggttctg aagagatcca tttcttgggt 138480
 gctactgcag gaagctttgt ggggtattta aaagccgagg gcctcagccc tgagctaaat 138540

 aaataacaca tgtattctgc tcaccccggt ccagattcc aaactgatta gtgaaatgat 138600
 gctgggcata gactttttt ttaagctcag gacatttcca tttcatcca gggtttaaaa 138660
 tcactacaac ctacaattct tctgcagaa ttaccattc tggtgaaatg aattgactgg 138720

acagtatccc tgagtcatgg actctcaaga aaccatttac ggtcaacaac ggcttttctt 138780
 cttttgtgtc tacaaaagtc catggctagt aattttctaa ctgltatggc ttagaacggg 138840
 ctcttataaa atctagctcc cactcagata ttctagagaa gccatgcttt tgcaggccta 138900
 tgtttttatt ctgtttgcag actctgccag aattcctggg tctcacatgt cagttacctc 138960

 agaaagattt tcagaaatgt ctatgaccaa caagtccatg gggaatatac gtgggcagat 139020
 tcctcacact gctgagggca gccacatgtc ttaggagctc cggttgaggg gacatgcaaa 139080
 gtgtaccaag ggacactgag aaggacgcac tagcagagct ctgtgagaca ggtggaattt 139140
 ccctggagca cagaggcaag ggagagcctt taccacagag ctgatggcaa atccagtcgt 139200
 ggaagcagag cgcgaaatgt gtgtctggcc cacttttagta atagtcagga atccagacag 139260
 tgggtctccc atcctctttg acttacagaa ctatgaaaga acagtcacc agacattctc 139320
 ttcaagtggc caagaaggct agtcaagact ctgcaacag aagaaatatt aaactccatt 139380

 cacctgaatc taaaggcatg ggattttatt ttcttatttg ttttaacctt gacctgagtg 139440
 aatggcaact tggagttccc agttagttaa gtttgtcaag gagttgttta cttactttg 139500
 ccaaattagg ctctccctt cccaaagagg atagggcagg ggagacaggg gagctgagtc 139560
 cttccttgat tacacttcaa agtgatagct ctgaagttgc taacattttc aagtgggaga 139620
 aaatttgcat ctcaaaagag caaagaatga atttacaatt gtcctttctc taaagtaaaa 139680
 gtctccccc aaaaagtgat gcagagattg aagccagagg gacagtttga aaccgttatg 139740
 ctcaactgca cagccatac tgaccaact gtttttagat tattcgtag tctgcttata 139800

 cctaagatcc ttctggcaat gcaataaaac aaaagtgcta ttagctgatg tggatattgg 139860
 cagcctccca ccctcttgat gagaatggc atttactatt gcctcagcaa acgtgagcta 139920
 gaaaatgtaa attgcctaca atggcctccc tctcttct gtccaagtg tgtctattca 139980
 cccctttatt cagcaaatgc cagccttgt gctgggcaag agagtatgct tactccaatc 140040
 aaagtacata cgcttagtgc attatgctta ctaatacac aaactctagg tatcataggt 140100
 ggttatgata ttatcttagc ttggttctt ttgctgtgat aaatcacca accacaagca 140160
 acttggagac aaaaaggttt atctccacat acactttata atccatcact gaaggaagtc 140220

 agggggcaga aaccttaagc agagaccagg gaggaatact gcctactggc ttgctctcca 140280
 cggctggggg gggcaccttt tttttttaa acagggtac agactgtggg ctggaatctc 140340
 ccacatcaat tgtaaatgaa gaaaatgac catggacttg cctgtaggat aactaatgga 140400
 ggcagttgat gaccctacag aaggagaca tggtaactaag gaatgtagat cagcaagaga 140460
 ttatcaaggt aatagtttgc ctttggaaaa tgccttgagg ggccactcaa aagccctag 140520
 gccgaattca actcagctt ttcttgtcac tgtagaagct actttccaga gcgattaag 140580

aacctaatac ttattggaaa aaacacactg atctggatga cagaacagct ttaggagaca 140640

aaaaaiaaaa tatlcallga aactgtaaat caaaactgat aaaggaaact ccccaaagt 140700
agggtcgggg aaaggtttg gtttttttc ttttcaggaa attaaaaaga agcatcttga 140760
agaatttaa gacctttga caaataagca tccaaagaag aagtacaat tacccaaaa 140820
aaaaaaaa aaattacca gaaaccatct gacctcaaa aacaagattg aatctaaact 140880
gggtggaggt catatatgc tttaatcaca ccacttggga agcagagtca agcagatccc 140940
agtgagttt aggccagct tgtctacaaa atgaattca gggcagacag ggctgtaac 141000
atggagaaac cctgtcttga aaaaiaaaat ggaataaaag aaaaggaaag gaaagaaaa 141060

aaaaagaaat tggaaccca catcaatttc accagaacta taacaacaaa attaaagtga 141120
acaactcaa ctaaagatca gctctggact acaaaactgct gctctgaaca gttttgaggt 141180
gaccgactga gacgatccg cctcacagac tactctagcc aggacttgag acaagccctg 141240
cactttccc ttatgcagag cctggacaaa aatgatacag cttgacagtt aacctaaat 141300
ttttctttc aggatcccgt aaagatgctg tcacccccag acagcaggaa gtaacttta 141360
gaacatgat ccaacattcc caagacatgg ggtgggtggt tttttggtca ctcataggt 141420
tatggatatt tgcattgtt taggggtatt agtttcaaaa atgttgatgg ttactgtcag 141480

gaagaaagt aaacaaagg gattagattc aagttcttg ttttgaaaa aaaaggaag 141540
acagatatag gataaaagga atcttattga atcttcttt taaaagcaac tactagtttt 141600
aaatatttta cattggattg gacttttga tattgtttat aaatatttg tagtgatata 141660
aatttgagat taattttgc aaaacatact gtatatacat ttctaacttt gttcaagata 141720
ttgtacaaa aagctcattt aacaatgcaa tacaatttc tagtcttga aagttattat 141780
taccaactat ataaagtaat gaggaactgt aggttagtaa ctagtcaact attacaatca 141840
aacttgaat catattaggt atgttttcaa agtcaaacag agatatatt taggtagaca 141900

agtcatctc aaacactta gagatctaca gaatatgaca tttaaatgt ttaataaca 141960
taggtcaatg ttttgacaa tgagacatgt ctgctcctgg cagcatcaat ctacttcaga 142020
gaagataatg gtcattgaag aaactcacat ggaatttatt ttctttgtgg aaaatgtaag 142080
cccctggaca agaaaatgac cttgtcttga ttgatgacag tatgctgtcc aaattggaca 142140
aacaggacac aaaaaagag tgaactgaga ccgtgccaag acaaggcggg gcagtcattc 142200
aaaaatcctg cticacaaat aagtctgtca gatatgctag gtctacaagc caaagataga 142260
tgcctaatag ttgtagagga accttgggtg actatctagg cagccagctg tttttatcat 142320

ttctcacaat atttggaggt tgcttgttca cgatttctgc ttactcagtt aatattattt 142380
 ccttctcgag tctctgaggg agttgaagac tagatagtat ggttacagtt tttattgctt 142440
 gccagactca gaaaagaaat tcaactaaaga tatgtagagt atataaggtt gagagacata 142500
 aaaagataat ttgacaatgc aaattaaaat agaaagtaaa ttaagtacaa gactttggac 142560
 tcaccaagaa aggttatata taaagtatat ttctgaattt gtcaaatgca aatgggttag 142620
 atactttctc tgaatttgtc aaatgatgaa cttgtcacct gtatatattg tatatactta 142680
 ttatacttat tgiatatagt tttcttatat tagatgtaat tttccttttt gtattagaca 142740

 aaaaagggga attgtggtga tatattgttt atgatttatt aaaggcactg gagatcaaaa 142800
 tagcaaagta gccatacttg tcagtcaaag aagccaagca cacacattta accccagtac 142860
 tcaggagaca aaggcagatg gatctctctg agatcaaggc catctggagc tacaggagat 142920
 tgaattagtc taaaagagta acagagtttg tgcctttaat cccagcacta gagagatata 142980
 aaagagactt ttatagtctt cagtagtcag tctcaggatt attcttcagc catgatgagg 143040
 agaagttaca gtctgaggat ggtgagagct cgttgagaca ggatcagccc ttacagcctg 143100
 agttggaact aagagctagt aggccggctg ctttgcctatt ttgatctcca gtggatttat 143160

 taaatcatac acaatatact accatatacct actttctgtc aagttacaaa aactaaccag 143220
 catggatatg gctagaaaaa ctataagtgt ttggtaaag tttgtaataa gtccctgtgga 143280
 agttctttct gtcgtttaca ttattateag tgtttcttat cattctatct gtgcccatta 143340
 ttgtcctgca ggttcaatgt atctttatta tcaaatggct gctctgcaca tgaggaggct 143400
 aagtaccagg gcagggaaat aatcttccaa ggtcacgtga ctat taacag gagattggga 143460
 ttctgaccta catctgtgtg actctagggt gatagtgata gcaagttgga caatacatag 143520
 aacatcacag atgtctgtag atcatcacia atgtagacca tcacagatgt ccatagacca 143580

 tcacagatgt agaccatcac agatgtccaa agactatcac aggtgtctgt agagcatcat 143640
 agatgtccat aacctatgac acagcatatg aattcagaat ctgtgttggt ggtaaccctc 143700
 aagacaacag cagtacacca agcattttca gcacctagca gggcatacag acatcttatt 143760
 gaaacaaaga atgctggaca cctggagcag agtcaagcac ctaatgaagt ctttctgtcc 143820
 tgtgtctcca aatacagacc atattcacia gctttgctat actcttatag cacttgacct 143880
 atataatttg ttcaaatatt tataacgaac acccactata catcaccaca gagaatggaa 143940
 ggaagaaagc caaatcagc cactgctatt aactgaaata agggtaaac catcacagtg 144000

 taaatagta tatctgtgtt acctacattc gccttaaata cctcactcgt ctttggtttc 144060
 cccctccctg tectacteta gacttcattc caattttttc cagatgcagc tgtttctctg 144120
 tgaagatgtt ctacatcttg gctgttctgc actttcattc taccaggcac tccactaac 144180

ccatcagtga gtggtctggg tacctgact cagggcaact cactgaacag cctgatacaa 144240
 tgacttttca agaaggtgtt catagatcaa tggctatcag tcactagaaa agagcagtga 144300
 gccaaagaact ggataagggc ttgcatggaa catcttgta accctcacia tgttctgatg 144360
 aagaagacac tagtcctatt tgaaggcaga tgcacaagaa tctacctacg acatcacagt 144420

 taacaatfff cagggtgtga tacctccaaa gtctgtaaat cctagagcgg ttatttccta 144480
 tagcacaatg actgggggccc aatgttttca gctacgctgt atctcatagc agactgccct 144540
 cccatctcat cctccccac tcttagtaac catccagagt tcagctgcca ctacccctca 144600
 tagatatcct tctaacagaa atcaaaagca aaaacacaag aaatctctct ttctccctgt 144660
 ctgcatttct attgccaaact accccaacca tcacaacttt ctgatgggtg gcttcccact 144720
 gcctacagaa catagaacaa agcttacct tctcatagta gtcagcgtc tcacaatct 144780
 ggctgcaacc cactctctc gcattcttcc tccccgtctc actgcctctc tgtacaccac 144840

 ctagctccca gcaggacagg cttccttgct ctggaacagc agccaataac aaggcctga 144900
 aaggggagca gatcaacctt caaatccaa aagctggcag gttggttgg aatcggtgcc 144960
 tcctctgtaa tctcaaaagt gggaaacaaa tttgttctct ctattctaag gtttgaacta 145020
 gttatcacia ccagagcaca acacagtgcc cagtgtctgg cactgcagc agaacctgg 145080
 gggcattcag gtctgtctgc tggcagccct gtgtcaggc tgcataatga aaatacctcc 145140
 tctgcccagg gaagagcctg ttctttcagc tgcacctct tagagggagt ctatctgagt 145200
 gtcttccgta aactcccac tctcttccc ctacttctg cagcactcag ctttggcctc 145260

 tattgtaaca ctttaaggta gatttcaatg tctagcttaa attcttaatt tcaatctctg 145320
 ttacttgctt ctctctttaa ttaaaccacg agtctgctag agcccttccc tatgtctact 145380
 aaacacaaga ctttgtacct agtgagtttg caaatgcttg ttgactaact taatgttttt 145440
 ctctgtttac tagattatta ctagtgtccc aacaatattt tagtgtgaaa gcagggcca 145500
 tggcgagtgg aggaggagat ttctttccta aattccaaag cacatccatt ttccatgcaa 145560
 aagtcatfff ggctccagaa tctttgtctg caaattgtat tggcttctct ttagaagcat 145620
 gagggaaatt ttatgacagg aaaagctaatt gcttacaaaa cttttcatt gtaaacgttg 145680

 attatztatg aactcttaca ggaaggagac cctctggacg ctggcacatg ggagaagcca 145740
 tcccccccc aatttataat gaatgaatgt tggagtaaat ctcttctta gccagataga 145800
 gaaaggaact tacctccaa agtaatcact catctcttca accacaaatg ccccataga 145860
 ctccactctc tggtttctct catgggacag acctcttct gacctgtga gtgcaaagat 145920
 tctggtgcca ggtagactcc ccaaagctag ctctctgggag caaatgcggc cacagtctctg 145980
 gaaacccatg ggtggctctg gctggcaaaa tgcagtcctt taagcaactg agtcaggagc 146040

ccattaaagg tgtaatttt acatgatgtg gcacaacaag cctataaata aataaacaat 146100

 gatcccccc agttcctccc gctgcatttc ttgtacctgc tgcagcctca gccacagcgg 146160
 gaagctcctg acatatacca ggattgcctt aaaaaacaca aaaaggaagg aaggaggcat 146220
 ttctgtcacc aagataacca agctacaagg acctctgatg tcttcagcac cggattcagc 146280
 cacctttagg aaattcccat caacctgcct tctgtgctg gatatgttca atttaagatc 146340
 atcattctga actgcaagaa caaacacag atgttaggat tttagaaaaa tgtactgttg 146400
 agggccatta gaaaaaata ctgttataaa tatataacat atgtaactat taaatacata 146460
 aaaatctcat gtaccaagag gcaaaacatg atggaagtg ctgaatattt taagtaccta 146520

 tattgctgcg taaatgggtt ttgtgccata gaattttcta ttgcagcaga tttatgaaac 146580
 tttgtcaaca tggtagatca tgctgaagtc aggggaaata ctagcgact ttaggttgct 146640
 ttctattttt aattaagttt gaggetgcat ctttgcctt gtgagtgtgc atgtaaataa 146700
 atacatgtaa gcgctgggtg gattaacacc catgcagatc tgtgcaaatg cccgatgta 146760
 ctgtaaact gaccctcca actgcacaga ttacttggg ggtgggtctg tttaatggtt 146820
 atacttggte gaataacaaa actccacttg ctggtcagc cccactcatt ctgggaagaa 146880
 agccccagca agtccttctt gggttctcgc tcaccaacgt aatcaggta gactaagggt 146940

 ttgagacta gccatgttta cccatgtact taaagatgga agcagattga gttttcgtaa 147000
 ctaactaaaa tccacctgat gctaattcia ggtcttctg caaaaacact cttgagaatt 147060
 aaattattca ggatacaaaa tactaagcaa acataaacta atcaaaaca aaacaactga 147120
 taaccaacag ctcatgata cataactgag ggcctaagggt gaagaaagaa agagaaacca 147180
 agaaccgaga atccccaaag gacacaactc aaattctttc tgtccataag ctgccctgct 147240
 gcctacctcc atgettcagt ataaactccc aaccttgcct acttgcacac atagtaaac 147300
 atactatgta atttggcatg gaattgtgta cttttctatc ttgggcagat getttctgtg 147360

 ttgcttcca tccaaacata accggaccac tctggaggtc atcaactcca tctcacacat 147420
 ctgtgtttct ctgggttcta gtagagagtg agacacatta gaagtctgt ggatgagcag 147480
 ttggtgagtt gtgggggtt ctctagcaat cccctcggc atttctcat cccactgcat 147540
 ttgcaccgtc agctgaggat gcaaatctc atacctgagg agtaggtttc tatttactat 147600
 ttaccttatt cttaccctt ttaacacaaa attacatgta tgtctaatac taacataaaa 147660
 ttccactgtg aagtctgtc acaatgtatt tggttccttc cctattgggtg aaggaatatg 147720
 ctaaccattt ctagaatgc cataatggta ttacacaaa taaacatcta tgtgtacttt 147780

tgttctagtg tcctatttc ttcagactct aggagtggga cagaggtaat ggtcattttg 147840
 aatTTTTtca cattattagt gatattaaca atttagtttc ctgaaatggt tcaaagtcag 147900
 gcacacacaa tattgagtgt tttttttttt caccacacac ttgacagtac ttgtacctt 147960
 caatatTTTT acaatttagc ctcataaatg aaagggtctag gttaaaaaag aaagaaaata 148020
 ggaaggaaga aaataaagga gttatcttgt tttgttttca gttcctctga ctgctagtaa 148080
 aattaactgt tttcattatt catcagtaca tgttctttta aaaactgagt tttcttttga 148140
 ctttttatct ttaatgtaaa ggcaatcata gtactttagg gatgtctttc acttgtaaat 148200

 gacatacata tcattgctcc agataaatct tacacctgt aaacttcag aggacaatca 148260
 ctgcatctta gagtttgtct tacaagccca ggcttagcat attttttga attttttta 148320
 gttcatatta ggaacaagct tgtttaacat gccaatcct tctcctctc cccccacc 148380
 ccaacctcac acccaggaga catgggatgg gctgtcaaag tcccttctta catcagggaa 148440
 aagtacaaa ccaactaccag ggacccccta gagtgcagag gcctcctcat tgacatccat 148500
 gttcaggggt ctggatcagt cctgtgctgg cctcccagac agcagtctgg ggttgatctg 148560
 ctcaccttg ttcaggtcat ctgtttctgt gggtttcacc agcctgctat cgacccctt 148620

 gatcttcatt cctccctctg caactagggt ccagagtca gttcagtca tatctgtggg 148680
 tgtctgctc tcttctatca gctctagggt ggaataaaaa gtcacatca gtctcatcat 148740
 aggggaagga catttagcg atccttcca ccattgccta aattgtcagt tttgtcatc 148800
 ctgttagatc tccgaaatc tccctagtgc cagatctctc ctgaaaccta taatggtcc 148860
 ctctgagatg gtatctctca tctgctctc ctcttcccc aatcaacat tctgctaca 148920
 tttctctc tcccctctc tttctctct ctcttctgg cagctccctc tcccctactc 148980
 tcatgctccc aattgtctca ggagatcctg ccccttcca ttctcagggg tccatgcatt 149040

 tttccetaaa attcctggtt gtttctagt ttttttggg aagaggataa taggctggt 149100
 atcctttgct ctattctaaa attcatatat gaggtagtac ataccatggt tgtctttttg 149160
 tgactgggtt acaaacatca ctcaggatgt tttcttctag ttccatccat ttgccacaa 149220
 atttcaagat tccattttt tttctgctga gtagtaectc attgtataaa tgtaccacat 149280
 tttctctatt cttcttcag ttgagagtca tctagggtgc ttccaggtg tggctattac 149340
 aaacaatgct gctatgaaca tggttgaaca tatgtccttg ttgtatgaac ttgcattatt 149400
 tgggtatata cccaagagag gaattggaga atcttgagggt agactgattc cttttttct 149460

 gagcaaccgc catactggtt tccaaagtag tcttccaagt ttgactccc accagcaatg 149520
 gaggagtgtt ctttttctc cacatcctct ccagcataga ttgtcattgg tgtttttgat 149580
 ttaaccatt ctggacagtg taagatggta tctcagagtt gttttgagtt gcatttctct 149640

gatggccaag gattttgagc acttttctaa gtgtctttca gccatttcag attcctctgt 149700
tgagaattct ctatttagtt ctgcaacca ctttttaatt tcattgtttg gtgtttcgg 149760
ggctagcttc ttgagttcct tgtatatttt ggacatcagt cctctgtcgg atgtggtgtt 149820
ggtgaagatt ttttccatt ctgtgggctg gcattttgtc ttgctgactg tgcctttgc 149880

ttacagtagc ttctcagttt caggaggtcc catttattaa ttatagatct caatgtctgt 149940
gctacgggtg taacgttcag gaagcagtct cttgtgcca ttcgttcaag gttatctccc 150000
actttctctt ctagaagatt cagtgtggct ggatttatgg tgagatattt gatccatttg 150060
cacttaagtt ttgtgcattg tgacaggtat gtagattact tttggcaaga ttgccatttt 150120
tactatgttg attctgccta tccaagagca tgggagatct ttccattttc tggtagttc 150180
tttaacttct ttctttaaag actcaaagt cttactgtac aggtctttca ctttttgggt 150240
agtgttacc caagatattt tatgttgctt gtggatattg tgaagggtga tgtttctctg 150300

atctctttct cattgcattt atcatctatc tgtatatagt agggctactg atttttttg 150360
agttaatttt gtatcctgct gctttgctga aggtgtttat tagctgtagg agttccctgg 150420
tagagttttt caggtcactt atgtagatga tcatattacc tgaaaatagt gaaagtttga 150480
cttcttctt tccaatttgt attcctttga tctcctttc ttgtcttatt gctctagcta 150540
gaacttcaaa tataatattg aagagatatg gagagagtgg acagcttgtc atgttctga 150600
ttttagagga atcacttga gtttctctcc atttagttg atgttggctg ttggtttgg 150660
gtatattgct tttatcatat ttaggtatgt tctgttatt cctgttctgt ccaagatctt 150720

tatcatgatg ggatgttga ttttgcataa ggatttttca gcatctagt agatgatcat 150780
gtggtttttc ttttgcagtt tgtttatag gtggattaca ttgatggatt tttgtctgtt 150840
gaaccatcgt tgcatactg agatgaagcc tacttgatca tagtgaatga tttttctgat 150900
gtgttcttgg atttgattgg ccaatatttt gttgagaatt tttgcatcaa tgttcatgag 150960
ggatatttgg ctgtagttct cttttttagt tgtgtctttg tgtgtcttgg gtatcaaagt 151020
gattatagcc tcgtaaaaag agtttggtaa tatccctct cttctattg tgtggaacaa 151080
tttgaagagt actggaatta gctcttgttt gaatttctgg tagaattctg cagtgaagcc 151140

atctggccct gggctttttt ttgttgggag gcttttggag actgcttcta tttcattaga 151200
ggttataggt caatttaaat tacttatctg ttcttggctt aattttggtg agtgatatct 151260
atctagaaaa ttgtccattt cctttagatt tttgaatttt gtggagtaca ggttttcaaa 151320
glatgacctg atgattctct ggatttctc agtgtgtgtt gttatatccc cttttcatt 151380
tctgattttg ctaattagtg tgctctctct ctgccctttg gttagtttgg atagagttt 151440
gtctatcttg ttgatctct caaagaacca actctttctt tcattgatc tttgtaatgt 151500

tttcttagtt tctactttat tgatttcagc cttcagtttg attatttcct agcatctact 151560

 cctccatggt gagtttgctt ctttttgctc taaaccttca attgttctgt caattctcta 151620
 gtgggactct tctccagttt cttcatgtgg gcacttagtg ctatgacttc cetcttagca 151680
 ctgctttcag agtgcctcaa aagtttgagt atgttgtgct tacattctca ttaaattcta 151740
 ggaagctttt aatttctttt tttattcctt tctcaacca ggaatgggtgc aattgggtgt 151800
 tattcatttt ccacgannnn nnnnnnnnnn nnnnnnnnnn nnnnnnnnnn nnnnnnnnnn 151860
 nnnnnnnnnn nnnnnnnnnn nnnnnnnnnn nnnnnnnnnn nnnnnnnnnn nnnttgccaa 151920
 ctatgtggtc aattttagag aaggttccat gtggcactga gaagaaggta tattcttttg 151980

 tgtttgaatg gaatgttcta tagatatcia ttaaaccagc ttgggccata acttctgtta 152040
 gatcctttga ttctttttta agtttctgcc tgggtgtcct gtctagtggg gaaagcaggg 152100
 tgttgaagtc tctactata agtgtgtgtg gttttatgtg tggtttaagc tttagtaatg 152160
 tttcttttac aaatgtgggc acctttgtat tgggggcata gatgtttagg attgagactt 152220
 catcttgatg gacttttctt gtgatgagta ggaaatgccc ttcttcatct cttttgattg 152280
 attttagttt gaagtctaat ttgttagatg ttaggattgc tacaccgget tgtttcttgg 152340
 acccatttga ttggaaaatc tttccaagc ctttattctg aggtatcacc tgtctttgaa 152400

 gtggaagtggt gtttcttggg tacagcagaa ggatggtttc tgtcttcata tccattctat 152460
 tagactgtat ctttttatag gcaggttaag accattgaca ttgagggata ttaatgtcca 152520
 ttgattgttc gttattgttt gttttggatt tattgttggg agtgcactg tgtgtgtatt 152580
 tcacctcctt gtttcttttc gtgtttggta aaattggatt atctattgcc tatgtttttg 152640
 tgagtgtagt taictttgtt gggttggagt tttcctttca gaactttctg tagtgctgga 152700
 tttgtggata tgtattgttg aagtctgggt ttgtcatgga atactttgct ttctccatct 152760
 atagtgattg aaagttttgc tgggtacagt agtctgggtt ggcatccatg ctcccttagt 152820

 gnnnnnnnnn nnnnnnnnnn ggatatctat ctcaggagtg attctgcctt tatatgttac 152880
 ttggcctttt tcttttctg ctcttaatat tttcttttta ttctctaggt ttggtgtttt 152940
 gattattatg tgcgagggc acttcttttt gtgggtccagt atgtttgggt ttctgtaagc 153000
 ttcttgtact tcataggca tatacttctg taggttgggg acgttttctt ctatgatttt 153060
 gtggaatag ttttctgtac ctttgactg tatttctca acatctatac ctattattct 153120
 taggttgggc cttttcatgg tgcctccat ttcctggata ttttgtgtta ggaattgggt 153180
 gaacttgaga ttttctttgg tctatgactg tatatcctct agagcgtctt caacagttaa 153240

tattctctct tccatctctt gaattccaat ggttatactc acatctttag ttcctgatcg 153300
 tttatccagc ctttctattt ccagtatccc ctcatctctgt gttttcttta ttgtgtctat 153360
 ttctgctttc atgccttgaa ctgttttgag tgccttcctc atttgtttgg ttgttttttc 153420
 ttggctttct ttagattcgt taagagattt gtttatttct tgaatTTTTT ggttcgtctt 153480
 ttcctccact tcatgtaatt ttttgcctgt ttttcttcta tttctttaag ggatttttct 153540
 tgtttcctct taaaagetgt ctatcatctt cctaagataa tttttgaggt ccatctcttc 153600
 ttcacctttt gtgttgggct tttcagatct tgcctggagtg gagtccctag attgggtggg 153660

gtcatattgg tctttctggt gttgagtgtg ttcttattca gtcttcttcc catgtcttct 153720
 tccagtgggt gcaggtgggt tctctctatc tcatcttctc acccgggtga gtgtgtgggc 153780
 caagacttca atgtctgcag ctctggatgg tcttgccttt cctggtagtc tctcacttg 153840
 gtaagggttg ggctggcaga ggaaagggga aggaagagtg aggtgttgc agactcaggg 153900
 agcttttccc tgcttggcg ggtccactct aagcaggtgc acgcccagag agatccagtg 153960
 tgaatgggaa gttgggtagg aaaaggacag gagcagaggg tacactcatc ttggtagggg 154020
 ccaggccggc ggaccaggct tagcttattt taatgtttcc actgagggat atttaataaa 154080

tccattccac aaatttaacc aatacttagc aacagtgatt taggcacatt ttctgagcca 154140
 ttatttagtt ccatcatatg aggatggaac attcaatagc atcagtttcc tgaaagatca 154200
 agtgaagttt ttctttttgt aggccaaata aaatcccagt tttgtgccta acactctgtt 154260
 cagttccctg caccttaggt ttggaaagca gctgtctcag aatgcattag agcccaagca 154320
 tagtattgag gctatagctg taaagagcat tagcagtggt tagtgacgaa tggagtaaaa 154380
 agtagttctg ggcaattgca aatatgggtg tgtacacaca caccaccacc accaccacca 154440
 ccaccaccac caccatcatc accaccatca ccatttcaga ttggtagttt aattagagca 154500

cacatctccc ccattttatg atatagagac cagcctttgt caatgcagaa aaacagaaca 154560
 cttaaaaaca cacaaatgca aataaatatg aaataaagcc agtgagtgtt tacactatgc 154620
 ataccagaag ggaggttgat tttatgtaat gacaaggcaa gtttttaagg tcttcagcaa 154680
 aatttacagt gacttcgggg atttaggaaa gcatttggag caaagtaggg tttggggagt 154740
 ttgtttaatg aaacaagaaa ataactctgt agatttagga ggcatgctg tagaattact 154800
 gtactgtggg agtttgaata aagaaagcag taagtatcag aaaattcagg tgatctggag 154860
 cagttttgag gtttgaaacg aggcagacaa ggagtcaaag tctgggacaa taacatggag 154920

gcctagtcat tttcatccta atggatgtcc cctgaatctc tgtcactagt ctccagtctg 154980
 acaaaaactaa gccagacctg aagctaataa cagactctga atttcatttc aacagagaac 155040
 acaccatcca ttttaccat aaacaaaaag aaaatgccac aaactgtcga gctgctgctt 155100

cagtggaact accagtcatt tttatnttac actntntctgt tatcttaaag atatntntaa 155160
 ggctggctat tcttaaagca gcaaaagcca atgnttgaca aacatgctct cgtatagcct 155220
 atntatagct ggtgcttggc taatgctaca ctctgccatg ttctgaagtt caggatnttc 155280
 taaactaatt aatcagaaat cagagttctt cgtgccaaag attccactct gtcgtggctct 155340

 taactgcctg cttcagttgg tggggaccaa gagttcacac gtctaccatt cattctccat 155400
 tcccaacctt tatggatntt ctagcatatg acaaaaggcc agnttatgca gagaaaacaa 155460
 ttatgaaatt tgctntcaca cacatnttgcc cactatacct ttgtctntat ctttgagaag 155520
 tntntgntt tntgnttggc tntntgntt tntntgntt tntnttagat ttaaaaaaa 155580
 agatgntnt aaaggcatct ctgctcacct atgccccag tgctagggct tccagggatt 155640
 cataaagact gaagcagcga ttgtggagcc tgcatgggtc tacatcaggt cctctgcgta 155700
 tatgctatgt ttgttagctt tgtgctntt tgggactcat aactgtggga gtgggggtgt 155760

 ctctgactct tcatatgct cttggaacct tntctccta caagttccc tcatccagcc 155820
 ttgttatgag gnttntgcc tagtcttatt gtctatggcg gnttntgnta gaggcagct 155880
 gntntctgaa gggaaatgaa ggagggggtg atctggggag aggggacgtg agaggagtag 155940
 agggagggga aatgggggtt gtgatataat cagaacaaaa agtaatntt ttaagtgggg 156000
 agtaattgga aagactcca cagaaatagt tgaactcac aaaagnttg cctatntgat 156060
 tgatgaagga gataattaca tccaacatat tcaaaatc tcttgatgt cttaatcac 156120
 tactaaatta aaaaagcaag tgaagactat ctgtagaat acacagaagg atttcatcac 156180

 atggaaaatt tacactgtg caatctatg tggctnttgg ggcactcact cttaatgntt 156240
 agatnttggg agacatntta caacagctag aggatagctg cccagaatc ccctacatcc 156300
 acccctgcc cttctctt gnttccctaa gaggcagcca gaatctggt ggcctgnttc 156360
 atagctaaat ttatntgtgt tctgaaaacc caatgcctca agaatctcag agcactctt 156420
 tgagacacta cagaaaaatc cagagaactc ccaggagctt agacatctt attactcata 156480
 tntggtatga gntgntgcag ctagcaagca gggagtaggg gctaagagta cctgcaaatg 156540
 ggtagnttc ctacnttca cacctaactc cacaatatt cattcattgg tntgnttca 156600

 ggctatgcaa cctgtaatac tntaccacat ttaagatntg tgaaagtaag aagtctaagt 156660
 ggaatntgaa cttnttntg aatnttacc aaaaatctta ttgctgaaat ctcaaatntc 156720
 agaaaactgg aatctatntc tntcctntt ttgctnttga tntntacntc tcatgggatt 156780
 catactgaa tgggntnta gagaaaagaa aacnttagct ggcagtcagg agacctggac 156840
 tctgnttag tntgntcga ggataatntc tntctatag gtcattctc aggccctca 156900
 tcagaaaatg acaggtgaga caaatgntc ctgactcgat acatctgaaa ataatctctg 156960

atcttccag caagttcga aaacaaggag tgtctgcaca cacagggatg tatctgtgta 157020

tgggcgactg tagggaggtt gtctgtgtgt gtgtgtgtgt gtgtgtgtgt gtgtgtgtgt 157080

gtgtgnnnnn nnnnnnnnnn nnnnnnnnnn nnnnnnnnnn nnnnnnnnnn nnnnnnnnnn 157140

nnnnnnnnnn nnnnnnnnnn gtgtgtgtgt gtgtgtgtgt ctgtgtttgt gtgtgtgtgt 157200

gtgtgagtct gtgtgtatgt gtgtgtgtgg gtgggagtgt ctgtgtgtgt gtgtctgtct 157260

gtgtgtctgt gtgtctgtgt gtgtgtgtgt nnnnnnnnnn nnnnnnnnnn nnnnnnnnnn 157320

nnnnnnnnnn nnnnnnnnnn nnnnnnnnnn nnnnnnnnnn nnnnnnnnnn nnnnnnnntg 157380

tgtgtgtgtg tgtgtgtgtg tgtgggtgtg tgtgtctgtg tatgtgggag tgtgtgtgtg 157440

tgtatgttcg tgcctatgag ccctatactg tacatatgac ccataatgta aacatgtgaa 157500

gtgagatatt ttcaggatga gaccatcaga aagacattta taaacagctg gggaacctgc 157560

ataagactga accaggccac ctgaatgtgg gtggcagttg gggagcttgg gcagtctatg 157620

gggctgctgg cagtggaacc agtatctatc cctagtgcac aaactggatt ttggagcccc 157680

attccctatg gagggatact ctctcacctc aggtacaggt ggggaggggc tcctctcca 157740

ccaaatgatg tgacagactt tgatgattcc ccatgggagg cctcgccctc tetgaggaat 157800

ggatgggggg tgggatgggg gattggtggg ggaatgggag gacaggaggg agaggt aact 157860

gggatgggtg tgtaaaataa gtttgttttt aatttaaatt taaaaacaa taaaaatta 157920

tgtccagttt tcttacaatg tcaaagaacc tcaattgttt acagttgtta atagtattga 157980

tagaaatfff ttcacataca cagattcctt taacctttag taccagagt gtatacgca 158040

tcactaaagc aaaagcagaa agacggggtt cttctgaact gctaataccac agaggagcg 158100

gttattcgtg accctaaata gcagcgggtt caaacctcaa taagtctgtt tgctgtgatt 158160

atgcaatga gatacatctg tgtcttttat cagttcttgg aaagaatgta attaatctct 158220

gatttaaga caagtcctca caacgcagtg ctgtctgtct gtcttgtgta cagtatgggt 158280

tccatggaga ttcactagct gggatattga cagttgtaga tgcttggccc tgactattct 158340

gacctggttt taaattactt ctctgtccac aatgctcagc actgtcatag ttgaagcaca 158400

gccatgaatt gaatagctcc acttcaaaaa gacagttggc ctgtgtctca aatcaaaact 158460

acacatggaa aatgcaagat caagtcttac actcgctctg tgagggggat gtatttgctt 158520

ttaacacacc tgccttcag cgacatctct cccatcacga cagataacgt ttgaaatcc 158580

tccccacaca taaagtgctt ctgtgtatct gtataaagtc atttgacttc atagtccatt 158640

caaaatgtgc ttcaaagaca ctcacctaact ctatttcttc taaacaatga agctcgtttg 158700

actgcagaaa aagaaaatat tgaagaatct actccagtgg ctttgaacac tgcccagga 158760
 aagggcgcct taaggaaca gttgagactt tgaaaacct aaggagcttt gtagctgaaa 158820
 tagccttgta acctctcaac agctttttac aaacaaaatc tttcaagctc caactaaaag 158880
 agaggtgagc aacaatttga agaattgggt tttcctttgt gccagattat agagcttggc 158940
 ggttccaacc tttttgttgt attatattc tgatctaat aaggaattat ttattacctg 159000
 aaaaatggtg tattcagatc acaagtctcc tcagagcact gactttgatc cccaactgta 159060
 cgtggagggt tggggaggac agccttcctt catatttga gactctaaga gccatcctca 159120

 gaagtgcct ctccaggcaa aagacatgag aggcctctgt ctctaacatt gaacctctct 159180
 tgcacgttct tgatctcagt ttgtttttt aacgcttggc tcctcagtag cttcatgctt 159240
 tattttattt taigtattt tattttaaca cagatggaag tcccccccc acgagaaaaa 159300
 aaggggggat atctattaaa aattttggaa caagcatgga aacacacact taaaaattta 159360
 gcaccttgta ggctaaggca gggatgatgac aagtccaagg acaaccttga ttactgagtg 159420
 agtctgaggc ctgtgtctca atagtaact acacatggga aatgcaggat caaacctaac 159480
 actcagcttt gtgtgtaagg aggttgtgtt tgcttttaac acaagagcta cacaaagctg 159540

 tctttataaa aaggcttaat tccacaaat tctgtctgtg gttatcaaaa gcttatattc 159600
 tgccatctat gttgcttgtt ggtgtgacct aggaagtcag tactcaccat agagcagaat 159660
 gaagtcttct gactgtacct gttacacaac tgcatttgg taccacagga aaattggtgc 159720
 cattgtaaca cttagcccta gagtcattta aaactttttt tcctcttttt ttaatttaaa 159780
 ttagaaacaa tcttgtttta catgtcaatc cagttccctc tcctttccct cctcccctgc 159840
 cccccactag ccctatcct accccctttc tgcctcctag agaggttgag gccatccatg 159900
 gggatcttc agagtttgc atactcttg gaggagggcc taggggtcat cttttagat 159960

 ctctgaacat ttcctagtgc ccagacttct atttaaaaca ataatggctc cctctgttat 160020
 ggtatctctt ttcttgctat cctctattct tcccccaac tcttagaaga gaaagtggga 160080
 ggtacccttg acaaaattgg tatagcagac tgattcctga acataacacc ggcagtacag 160140
 acactgagac tgataattaa taaatggaac ctctgaaac tgagaagctt ctgtaaggca 160200
 aaggacacag tcaacaagac aaaatggcag cccacagact gggaaaagat attcatttaa 160260
 aattttaaat aaagtagctg aaaaaatta taatttaaaa tcaacatctc atattcactg 160320
 aacactgttt tgaagcaga ctattccttg tgttctggga aaccaatcaa agttccttca 160380

 gttatgaaaa tgaagtcaat gcacattctg taagaggctc tagaaacctg tctgaggtaa 160440
 gaaagagtgg gtgaggatgt gacaggagtg agcaatgggc ggtgggcctg agaacttggg 160500
 aacataaaga calacctgta gagtcaaatg catggcacag gcctggaaga tgaatctctg 160560

gcatccacat gcttggttct aacaggtgct accatacttc atcatgccgt catctttcca 160620
 aaactcacag cagtgatcat taacaataa ttgttataca caggaactgt agtcagaaga 160680
 gaaggggagg gggggagaga aagaaattag gcatggtagc tcccagctac catagcagta 160740
 cttgggaggc tgaggcagaa gggtttcatg gcttagaagg tagcctgggt tgtgcagtgg 160800

 atgtcaggac attcgggcct aaacagtaag attctgtctc aaacaaagga acaacaaaa 160860
 gctaataatt gtaacagtag cagaagcaac aacaacaaac aaaaaatc tgatatcaac 160920
 aaggagatgg cctcttgcta accatggcag taagaacaac ctgacaagca tctaaagccc 160980
 ttccagtttg ggttgtttaa gtagatattc tgtataccag aaaacgtttt ctgcaaaagg 161040
 ccagtgagta aataattcac acctgggtgt catgtggtat ccattactat aacacaaaa 161100
 agagaagaag aagaaagcca ttgacaatac acaaaggaat atatgtctct tttccaatgg 161160
 tagttacttg aaaggtaaat agaaggccct tggccaatg ctactgtttg gaattcccta 161220

 gtgtagtcaa tagcatcaga tactagaata acccttaaag gcagtgctgt attgaagtcc 161280
 agctctacag ctgatgctga taggcattgt ctttaattcaa caagaaatga tagtgcatgc 161340
 tccatgttcc ttcatcaata caaaagaaaa acagtgaaaa attatgttat aaaaagtata 161400
 tctagaatta gaaataatat tagaacttag ggaacaaatg tgaagtaat caggaaaagg 161460
 tttcttataa aagaatacca ttctcatatg tgtgagtgc tgaagatttt actcataaag 161520
 taaagtatgt gtgagcatat actacatagt tttggtcaag attagcacgg ttcaactcag 161580
 tcactactat caacataagt agttggtaaa actacagagg agcaggatag ttagctctat 161640

 ttgcctttag tagagctaat tttaaatttg aaaatagatg ttacattcaa tttttgaaa 161700
 ctttaacat atgtgtgacc aaacttcaa cttttcagtg taactgatat atatatatat 161760
 atatatatat atatatatat atatatatan nnnnnnnnnn nnnnnnnnnn nnnnnngtt 161820
 aagtgtacaa tgcacacgaa tttcaaaacc agtagaaatg aagaatggtg ggtcatgttg 161880
 actatittca cattgattaa atactgaagt catagtatgt tgaattaaat aaaatatttg 161940
 tgttgatta agtaaaatgg attttcaatt actcatattt ctttttattt tcttttaatg 162000
 tgatagtttc ttttaatgtg tcagtcgac agtgacagaa gtcagggcag gactcagaaa 162060

 tcagaggaat actgtgactg gctggctctc tggcctctca gatagctttc ttacacagtc 162120
 ttggtccagc tgettagecc tgggtccacc cacaatgaac ctaatctcc tgcgtccatc 162180
 accagtcaac acaatctctc acacatatgg ccacaggcca gtctgatcaa gtcacttctg 162240
 caatacagat tgtatcaggt tgaaaattaa aactaatcaa actagtcagt acactctctc 162300
 tgtgagaagc tgggaaagggt gagaacacaa gctgtttgta gcacgaatca gttggagata 162360
 agtgagtaag tccacagtcc tgctgtttct atggttcagc ttgacttggt gaactgagat 162420

gcctttctgg aaacaaatcc ctcttagata gctttaaatt tctgtcattt agctgatgcc 162480

tgatgataaga ccaatagctg aaaccttcag ttttgtagc caggigacca agccacttct 162540

cttccacaaa ctcaaagaca ggggagttgc tggatgaaag gagctcaagc aaacatgcaa 162600

ctctaggttg tttatittta tttatitttt ctattacctg gaggagaggg tgtgtgtgta 162660

ccacagcaca catgtaaagg tcagagccca acatttggaa gttggttttc tccttccacc 162720

acaagatcaa ggattgaact cgggttgtgg agctgacaca gcaagcttgt acctgctgaa 162780

ccacctctct gccccggaca ctcagttcct tctgctgctc cgagacagaa ccaacttttc 162840

cccaaatctc atagaaacaa aatgtctcat gacaaaactt cgccagacaa ggaattccaa 162900

cagcctgctc tgctttaatt ctctctccta cttttctcca gtgtaaagtg cacaaaagga 162960

aaagtcaaaa agaatgaag aagagcggga atcaatttgg ttactaatt tgaacttca 163020

gtaaaaaaag ggggtaaat ttacaatgaa agttgtaatt ccaacaacac ctttgtctta 163080

taataagcca gaagaataat actattcaaa ctttagcagg ttgcaaagat ttgtagatct 163140

gggagaagag ttagaaaaaa agacaacaga ggagctggga accaggtcag gcaggaagag 163200

tgctggtctt gaaaccataa gaagctaaat ttgaccecca aatccatgt gagggggaaa 163260

ggcaggggat gtaaagacag tcaggtttcc ggggctctct gaccagccag cctaccctac 163320

tcccctactt ggcttgccgg gtttaggacc agtgagagcc cttgtcccaa aactatcaaa 163380

ggttgacaga gatgctatag ctacacctga aatgaggcag ctttgccttt atattttgca 163440

tattcacaga cacacacaca cacacacaca cacacacacg gaagaaacaa 163500

agattaggac acatttaaag agacatttg gaaacaatgc tcttctgctt gcctgagaat 163560

tgactgtgtg ggagaaatca tttataatc atataatga gatgtattta tgacacgtat 163620

ttttctgtat gtatgttgca ttctgataaa aagttgagaa atatgttttc taatcattaa 163680

aacaaattaa actcaatatt ctgtgaccag ggataatggt tctcaagtgg aagcatgaca 163740

tgaggacctt gacttgattg aggtctcact aacacactag tagaagtttc attactataa 163800

agttggccct tcaggcccaa tgccagtcaa ttgatggcca gtacaaaaag aactcagcag 163860

tacttttggga attttgttta tttgtttgtt tgcctcatat tgctttgctt ggcttttttt 163920

ttttaacct tactagctt ttgcttgat gatatcattt ccaattttta tagattttgt 163980

gtgtgtgtgt gtgtgtgtgt gtgtgtgtgt gtgtgtgtgt atgtgtgtgt gttactagtg 164040

ctgcattttt gttgcttctt tgttcttttt agtatttttc taatgtttag ggaagaaaga 164100

aagaaagaaa gaaagaaaga aagaaagaaa gaaagagagg aagagaggaa gagaggaaga 164160

gagaaagaag gcatggaact gggtaggtgg gaggcaggaa gaatctggga ggagatgagg 164220
gaagagaata tattataaaa aattattttc aatttaaaaa atcttgagtg aaagaaatat 164280
agacacagtt tgagaatgag gaagtgtctc ctccagaatt attttatttt tgtaaataaa 164340
atthttgtaa ttttatttaa tttagaaaca atttcatthtt acagatcaat cccagttccc 164400
tctcctccc atctcccac accccacacc ccatcccca tccactccc agggaggtaa 164460
gacctccat gagagatcat caaaatctgt caggtcattt ggggcagggc ctaagccctc 164520
ccccgtgtgt ctaggttaag agtgccttc cattggagat gggctcccga agtctattcc 164580

tgcactaggg atacatcctg gttccactga cagaggcccc atagacggcc cagtgtctct 164640
agctgacaac cacgtcaggg gtcctggttt ggtcctatgt tggttcccga gctgtcagag 164700
tgggtccat gatttcccac ttgctcaggt cagctgtttc tgtgggtttt cccagtgtgg 164760
tcttgacccc ttggaattat ttttaagtaag agaaataaat gtctatttta ctgaaagaa 164820
gaatgggaga aagaaagaaa gaaagaaaga aagaaagaaa gaaagaaagg gaaggagggg 164880
aaggaggaag gaaggaagga aaaaagtac attcctgcag tgtacaaatc tggacaacaa 164940
gtatggcttg ggtgctagct catctcagag tggaaatatt cagcacaaga agtctggagt 165000

cacggtgcca ccagttcatc atcatctcct gctcctatgg gctagtccac tttcttctca 165060
actataacca cctgaccca aatcagaga ctgaaagcaa caccactgca acttgtctctc 165120
aaattctgta ggtcagggtt ttagggacaa gctcattttg tgatacttct gtgtctagca 165180
ctgacaaggt tcaactcagtg agtctcagct agaggatggg atagtctgga ctgtctaaca 165240
ccacctcact tgcattgca tgtttgacac tagaaactaa acagaaggct atgacagctg 165300
gccagagcat ggagcatgac tccctgtggc tcagcttcta cacaacacaa tggcctcaag 165360
gtaatccatc ttttcttta tcaactcaag tctcagggca caactgtttc agcgatcaga 165420

gtagaagcca gtgccttcta tttctagaca aagtccatc acacagattg ttaggtgaag 165480
ttaccattaa ttacccagg ttgaaaagga agggagatat acctgagccc ttaacaaaag 165540
actggtgggg tcaacaaaag tgagaacatg ccagagctat tgtggtacct tctatggaaa 165600
ttatctcttt cattaaagat cttctctcc cccacctct ctctctctct ctctctctct 165660
ctctctctct ctctctctct ctctctgtct gtctgtctgt gtgtgtgtgt aactaaaga 165720
ataaaaccaa ggccatgaac atgctatgct aagcaagtgc tgcactaagc aatacttca 165780
actctggttg atcttttaa actcatgaga acataattat cttattttaa aaaatagtaa 165840

taataaagt cacttaagga ttgttttaag gattggcaat aaggcaacat atgcttggtg 165900
cattgtcaag ttgtaggaaa actcagagcg acatgctctc cttcatccca ttttaagatg 165960
cagatgctga gaaaagtag aacaaaaga tggctctgag aagatgcagg tagaatgaag 166020

cagagacaat gagagtgggg gcatcccaag atggcaatgt agtatagcaa tccatgttgg 166080
ccaatggcta aatggaagca ttctcagctg ctcaattttc ccttaggactg cccttggat 166140
tttgccaagc aagccatggg agatgacttg ttataaaaag tcactttcat tagaaacaac 166200
agattgtctt cattcctagg gttactgagt aaaaataaaa gagggacccc acttttgaca 166260

catcctgaca ctgtctgcaa agagtaatct ttcttgagtc tctaacaaa tgaacaccag 166320
cctttctggg ccatgatggc accttgggat ttagcacaga gatggaagta tgtaacaaac 166380
ttaagtgaa ataatggat ctcatccaaa caaccccaa tgggcagggtg gagggaatct 166440
gtatcgcaag atgctttatt aatacttgat ggaaagagcc taaacccta taccacttga 166500
cagttttgaa ataaccttt gtataaaacc ataacatag gaagctatgt aaattaatac 166560
ttggcttagt ctaaagcaa tattttctac tgtaaagcca ttttaacaaa catcagttga 166620
cagccagtca aatgatgttt tgtaccattt ttaattgcaa aaaatgcaga aatgcatgaa 166680

agacaagatg ttagaaaac ataactgtgt gtttgctacc cggatttaat gtcaattact 166740
gaatatctac tagatattaa attagcatta tatggagagc ataatatgtc aaccaccttg 166800
taatgaatac aaattcatgc attccaaaag tcagggtaat attactttta cataaaagga 166860
gttggataga gtcttgact tcaagctttt aatctagtga acataaaaaa gcctacaat 166920
atgtacatat tttctaagt gggcatgggc cctgataggc acagagggat atacacagtt 166980
aaataagagc caattgctat tgtcttgagt gctatcatct tgtggagcag acaaaagtac 167040
acatcaataa ctctgttatg aagctcataa agatcaataa tcacaataga gatgaaacat 167100

cattctttgg ggatgtttgg aacagacgga ttcagtgtaa gaggttcaata aacataaaag 167160
ttttcttgaa gaagtggggg tggaaataga ccttaataa caggtagaaa gcacattaaa 167220
aggtctaata cctgccaat aggaacatca gatgaaggaa agctctagaa gcaggaggat 167280
atgaagaata ttccagaaag aggcaaatga ttacgggtgtg agatccatga agacagggat 167340
ccccittaca cattccaga atcctgccag aaattctaga aatttgaatg ttaaattgtg 167400
aaaatttggc agtattcatt tctttgtgca aagcaatata cttatataca acaatgctta 167460
catacagcaa aaaaagcaat atttaatatc aatatcaaat tcttccaaaa ttgcataaag 167520

tgataattta cacatcatca tggcattaat acttagggaa actcgtggaa atcttaacat 167580
gcatacaaaa aagccatgaa aactaaggtc ctaattcatg aagcttgata taataaaagt 167640
gcaaaagaga taaaagtag agatttaaag aaattaattt caatgtattt gtaaatga 167700
aaatctggga aagaatttag cacatagtta ctgagtaaca ttctacactg cttaccataa 167760
cagttaagaa agctaagagg atataattac tgccattccc aacttgccca agacagaatt 167820
cactgctctt atagaaaaag caagtttcat gtaagtctca tgacaacaac aaaacagaag 167880

ctacagcatt tacacaaata ggaaggagac aagaataaaa ggtagcact atgggacata 167940

gagcatagag acaataagaa agaaatggag taacaaaata tctaccagga cacagaaaac 168000

gcttagccaa ttagtaagta catatccatc aatgacacac ttaaattata tgtatgaaac 168060

tatcctatca aaagacatga agtgactgaa tgcacttct gcttcaacta tctgtgcct 168120

atgtgagacc tatctgagtt ttaaaaccac aagttagatg aaaggaagg gttagaacag 168180

tggttctcaa cctatggttc aaaaccctt cggaggttgc atatcagata tccggcatat 168240

cacatatttt cattatggtt cataacagca gcaaaattac tgttaggaag ttgcaatgaa 168300

ataattttat ggttgggtg gtcatggcaa tatgaggaac tgtattaaaa ggccacagca 168360

ttaggaaggt tgagaaccac tgggttagaa ggtatccac acaacttcta ctcaagagaa 168420

gagggtagtt gacaccaagg gagaaagga gccatcaacc cagctgcaga gcttttgatc 168480

tacagctgtg ttctgctgt gtaatgtgct attgcaatag tgtcacaat gttgtgggag 168540

taaccaacca ctatctaatt ggatttaagg ccctccatg agatggaagc cttaccggac 168600

actgctcaga tactcaagaa catgtaata gatagccct ttacctagg gaaaacaaa 168660

catgactgtt ctgctaacgg aatgtagcaa tccaataac tctgaggac atcctgctac 168720

acatttagat cagtgtcttg ctcagccacc atcagcaaag attcctccag cagtagatag 168780

aaacaaatgc agatgcctac gaatgaatga tgtgcagagt gcgaaacctt ggcacactca 168840

gacctaaata aaatatttc aaccaatccc tccccctccg ggcttcagga actatgtgga 168900

agaggaagta gaaagattgt aagacttgt acaagcctt gtagacacaa ctgaaccaac 168960

acacatatga acaaatggag accgtggctg catgtgcagg ccctgcacag tccaagccag 169020

acgaggtccc agcactgaga ggggaaatgg gcacaagcac ccctccctaa cctagaagct 169080

gcctccaatt gacaactgtt tgcaaaggga aaagtgttt tctctaacag agaaaagtag 169140

ttttctctaa ctctctaagc atacaaatca cacttaagga cagactccat acccagcagt 169200

tgatagccca cacgaaatga tgaactcaat ggtatttttg aggtgttttg gttttttgtt 169260

tgttttacct tacaggtctt ttgtttatat attatggttt ctaactttgt attgtgttga 169320

gtgggtaac ctaaaccag acctggaaga ccaatgccac gtgttctcct tcatttggg 169380

tttctaactc caaatcttca gaatgagtaa ccacaatgcc taagaaagta gaaggggatc 169440

atgggatggt gtggaaggag ctcttaggag gggaaatagc aggatacaga tgacacgaaa 169500

gggacaatgg gaaagattgt tcctgattgt ttaggaatag atgaaaatc cttaatgaaa 169560

taaaggtggg gaaactcata gctaatactt caaccaatcg gaaacagccc aaacttttac 169620

tactaaaaca cagaacaaaa taggaatgcc cactcttgcc ccttctactc aataattctg 169680
 gaagtataag tgtgtgtgtg tgtgtgtgtg tgtgtgtgtg tgtgtgtgtg tgtgtgtgtg 169740
 tgtgtgcata tatatgtata gtttcatatc aaaaaagaga aagggttacc acagtagaaa 169800
 ggaagaagga aacctgtccc cattgtcaat gagatgattt tatgtctaga aaagtacaag 169860
 gacttcactc aaaattagta gaattaatga ataaattcag ttatgtcata gatttgtgaaa 169920
 tcaacatgca aaagacagta gagtttctcc acacttattt acaatagcat acttatgagt 169980
 tgggtgagacc aggaaataag agacacatat acttgtaact ataaaacatt gttgacagaa 170040

atagcagcag aaatgaataa atgtgaagat atctatgttt acatacaaga agaactaata 170100
 atactataat gticattctt ctaagagacc tattgatgta gtagatcctc aattcctaat 170160
 gctatcattc acagcagaca aaatgtatgt gaaccataaa aacatcataa tacctaatta 170220
 atgtgagcaa aagaaaaatga aacaaaaaca aacaaaagcc acccaagcat catagtattt 170280
 cctttaaaac atattataag gctattgtaa ttaaaacaaa atggtagcag tatgaaacag 170340
 atatgatgat caatgtaaca agatccaaaa ctcagaagac cctggtagttt attgtcaatt 170400
 atttttaaca acagtatcaa aaatatacat tggaaaagga caggatcttc aataaatagt 170460

attggagaaa ctgtatacac atgcatgcag gaaaataaaa ctataccttt atttcaagac 170520
 ataaaaacat aaaaatggct taaaatgaaa agcttaaat taagacctga aaacataaga 170580
 atattaaaag gatagctggt aaaaaaaatc tcaattatat ttcataaggaa atttttatat 170640
 aacactcaaa gtatagtcaa cataaaaagt aataatcaaa tgagattgca ccaaactaaa 170700
 acatccccat acatcaaagg aaacaacaga taaaggagat agctcatgaa ttgggagaga 170760
 gtctttgata actatctgac tcaaattcaa gtgattcaac aacaacaaca aatgaaaga 170820
 acaacctagt taaaaaatga gtaaggactt gagcagacat gtttcaaaga cagacatgtg 170880

gtctaggttc agtggctcat gcctatgctc tgagcacaaa ggcacccgag gaagaatcat 170940
 gaagacattg tattctatat accgtattct aggtcacagt ttcataaaac aaaaaggaga 171000
 aaagaaaaga gatataaag tgatcaaaag acacaaaaaa cataatcaga atcatttacc 171060
 aggaaatgca aattaaaatg actatgaggc aggaacaccc ccttgtaga atcagtataa 171120
 acagtcttta taagtactgg tgaggatggg agaaagggga aatgtaatac aaggtagga 171180
 atgcaatta gtacaggacc taaaaaaatt gtactagaag ttcctaagaa cagcaaggat 171240
 agaattccca cctgggtccca tactgtcaaa tgaggattac tatccatata gaaagagaaa 171300

aattgaaatt gatgtgttaa aaacatatct gtcctttaat gttcatttta atgttattta 171360
 tctataatag accaagttat ggaagcaacc taacatttct atagaagagc aaataaataa 171420
 agaatgtatt atattaaaat aatggaatat tatctggcct tggaaagaaa gagatcttgc 171480

catttgccat gtagcagcaa actttaagga tgttattatg aaaagtgaat taatccatac 171540
 acagaagaa aaatcttgaa tgctatcatt tgtacaagga actgtttttc acaaaaagtc 171600
 aaatgcagga ggctggagag atggctcttg ttgctcttgc agaagacctg aattgtattc 171660
 ccagcactca taictgaggg gttcacaaca tccagttatt catgaaataa aaaactaatc 171720

 tgaaactttg catctctccc accccctttt ctccatcadc tctggttcat tctcctgctc 171780
 actctctctc tttcccacct cctcaatctt ccctttataa ttatcccctt aaaaaagtct 171840
 tttttttct gtattgtata ggattccctg tgagcttccc tgctttctct gctgtaattc 171900
 tcaagtgtt ttcaatatgt gtgatattaa ctaatcctaa ttggctgagt aacaggagcc 171960
 agcagcctat acagtattaa gccacttcta caccacctat tttctgtatg caaatcagac 172020
 agaaacaaat gtttggcccc agctgggcaa aacgtcccat ttagaattct tttcctcttc 172080
 tttgttcttt gatgttctgc aaatgagctt tagaactcca ctcttcacac aattcaattt 172140

 tacagacca ttatctgaga tataatgtgg aggttaaata taccaggca gccattatgt 172200
 gaaaataatt aacagtaatg aataatgcac taatcccact gatgagagat ggttatatgt 172260
 gtaatgaagt gttggggcag ccctgacaaa tgaattaaa atatttaaac actgttttat 172320
 gatattactt tgctcatata atttccttta cctacgatga gccacttgga ttatcgtcat 172380
 tatcttgaca gctctgaagg atgagatact gcgggttaat gtgacagcga ttagtcagag 172440
 gggaaatcca taccctgg cagaacaggc tgaggcagaa aaaggccct gcaactgtct 172500
 gttccaagc gagaagaatg atactatcaa catcacttca atattaatg gatagaatta 172560

 tcttgcatt cagttacagc ctctgaagaa ctacctattt gtacctgcaa aggaaagtc 172620
 agcctttctt aatcacccat aaaaatacgt tgatggatcc ctctgatcaa taatagtac 172680
 agaacagag acagcgaagg cacatgacaa tttaaaagca agaagttcct ccctgaacte 172740
 tttaaaatt cccccttccc tgtaatttct gattacatta aaacagaatt cgaaggttc 172800
 atctgaagag gaattcgcta actcactcgg ctattctgt gatcacttca tcagactcca 172860
 cgtatgaaag caggttctgc tctgttgaac tttatgaata ttattctta aataattact 172920
 cctcctccc aagatgccac atgtgtaagt cttagggtc tgatgatgca ataactagc 172980

 tgtctattag agctgataca aaatgaactc taaaatatat gatggagaat aattcattga 173040
 taacttgaac agaagtgatt acatcaccga tatccattca catgacccta ttctagttta 173100
 tacactggca ggagagtat catttccaga aatcttctgg aaaggcacia aatatattt 173160
 caactagctt aaaactccag ttttaagaaa ttctattttt gctttaaaat aagaatttgt 173220
 gagtgaagaa gccaaagtta aaacaagttc ccagagaatt ttgaccaat attttctctg 173280
 cttctgatga ccagatggct ctccacaatt tgcttctgag aaagtgagac aatggagatg 173340

ctgatctgag agttaggcc aaggctcagct ccaccttccc ttaactaatt gcaacatctt 173400

gggaatcttc ctaccaaaaca aggaatcctc atttagactg tagaacacag catgttttgt 173460

ctggtaatat tgatagetga gtttaaaaat cttttttatt tagaatcaaa atccagtgc 173520

agaatagcaa aaatatcagc tttgtaggca aaactttctg accctgtcct gctagccttg 173580

ggatctaaca gcacgtcagc ctatcacata gtaacaaata ctttaatgta tgaacacaaa 173640

agcttagtgt ctcttctact gtatggatat agcaagtgtg tgatcactcc taacatcaat 173700

gagagaagta caaagatatc aggaagtcag gcctagagac agaacagtc attattgtga 173760

gggcagacag ggtgtttgga gaacaaagca cgatataaat atataatata aatatataaa 173820

taaacctttt ggiagcaatg gtactggaga atgagttaac actaagagca agcactggct 173880

tcatgacatg aatgtactca taactgaatc tgttgttcaa aatagcaata gccactttgt 173940

aagaggcagc gttgggtgtg atagatttat atgaacatat aattggactt gcaacactat 174000

ttttgagttc tacttcattg tcacttatgc agatagagct gaaaaattaa atacacactt 174060

taaattatcc tcatttaca atgttttagag tttatgatgt gagtatctg tctctctcag 174120

cagcaaaaga tecttgaaaa aatcatagaa cctgcctgt gcttcttgta tetgaaaaaa 174180

aaaaattaca attacttca attactgac aatgaagtgc cttggcaata aatctaacat 174240

taaaaaatca tttccagcaa attactcaa taaaatcaat gaaggtcagg ctgagctgta 174300

gcaacaaata aatgacatgc tattgacagg ctagtggact tcattgtcat ttataaagg 174360

taaggggata aataatctaa cagaaagcag atgtttacta aacaaaaaat ggaagcaagt 174420

gagataaatc cagagggtaa gttaggcatg aagaggcttt ggcatgtgct ggcctagtec 174480

catgacaaaa ttactagtgt ttcgaatact tggcagcacg catgtttgac tgggtcaata 174540

tttatctgct ctgggctact tcgtgatctt tctacctttt atatattgaa gtcagaaac 174600

agattttctc ttaatagaaa atgaagaatt gataaaattg aataacagta gtcaggttaa 174660

aagcagtttg acccatttca aaattccagt aacagcatct ttgagaataa caaacattaa 174720

ggtagaaagg ttgtcatttc tccactatga aaagcaaatc tctaattgtg gctttttaaa 174780

accgatataaacctagatt tcaaacattg gtatttggtt taaaacttct gtttgcacac 174840

aaactctgtg aaacagacca gaccaaata gcaaggccat tcccaggtaa tgaattccct 174900

cttgcacatg tcagtaatgt gtgcagtgtg taaacaaat tgtattatct gtccagattc 174960

ctcacaattt gccttacctg gtaaggccta aggttctatg aatcaaaatg ggctctcaaa 175020

tataaaagga ataataacat ttggaagaga ttcagtcttt ccaaaaacca tggcttcata 175080

gaatitcaaa aagtgcaaag actcacggat cattggatct gacctctttg ttttaaggag 175140
 aaggaaaaag aaccagaagg agtctttgcc taaggaatct cagacataac taggtcagaa 175200
 ctgccccaa gtcacctgat tcccaggaca atgatctaac cacacagtct ctgtatctga 175260
 aatattaatg gggaagaaat ggcagtatct atttcctaca tacaaaataa gaatcacctc 175320
 ttacattaaa ctataggatc tggatcctc aaatgtgctc acgattatcc gatctcttgg 175380
 ctcaaagagc tagggtcaag ctactcaaat gaaaatcttc ctcttcttca cagaatacac 175440
 tggtgacttg aaagcatctt gtcctgcttt atacatgttc ccagacatat ccatgcctca 175500

 aaatagtgtt tgtggagcat ttgctggagg gatggctcag catttaaggg catgcattgc 175560
 cttttcagag aaccaagtt cagtttccaa gcaacaatca catcaaacctc cagcttccag 175620
 gaatcttgtg ccctcttctg gattctatat gtaattgcac acacacgcac acacacacac 175680
 gcgcnnnnnn nnnnnnnaca cacacagaga gagagagaga gagagagaga gagagagaga 175740
 gagagagaga gaacgagagg aacactttaa ccttatttta aatatcttgt aaaaggggaa 175800
 agggagaaaa ggagtttgta tttcctcatg ctgaatcttt gttagcttgg ctggcttggg 175860
 aattgctgta gctaataaag acttcccaca atgaaataca gtaggtgtga gttttatgtg 175920

 tgtgtgtca ataccttaaa attattcact ttttcttagg aaaatgtttt aattgggtaa 175980
 ttctaaaaag aaataactat atcagaaaag atatatag attccagaaa atgacttaat 176040
 ttatttggga caacataaac ctaatattat gtattcttct accggctctt ctcatgttga 176100
 aaatttaaaa tcgtggacac tcttcaatg gctaataaga aaagtgttca taattcaagt 176160
 attagtccc aatccattgc cttttgcttt tggatcccat atgatacgtc atttcattta 176220
 taaccacagt ttaaaagtaa caatattttt atgcattgaa ggcacagttt gtaaatagca 176280
 ttgctgatta aggattcaat gttacattca gggacaactg aggaaaattt cactgaagca 176340

 aatacttgtt aatagaattg ccctaggaat actcctaaag agcacttccc agagacagcc 176400
 taagtggcag ggagcactcc catagacagc ctaaatgaga gggagcactt tcccacagtc 176460
 taagtggcct agggaaattg ctcttttaaa catatatatt tatttcatta ttcattttac 176520
 atgccaacca caggtacctc tccctcccct ccttctctc cteccccacc aacctctec 176580
 attcctcaga aagggttagg gcacctatgg ggagtcaaca aagcctggca cattcagttg 176640
 aggcagacc aagccccctc accatctggg gaatttgttt ttaaatggg catttcatta 176700
 taaaattttt ataccccaga agtaatacat caacctgca tgtggaggaa agtaaacctt 176760

 tgggggagtg gataaaatct cactttgagt agccttgta attccttcta taggtggaaa 176820
 tgaaaattat ttttctctc tttgtattcc atttggattt tatgtagatt tagcactacc 176880
 agcatattgg tgccaaacgg taccgaaagt tctagacaac gtcctgaaat catcataaat 176940

ggtagttgc tcccactgaa cccctcagag cctacttcca atattgcctc cacacacatg 177000
 gatttatacc gcactacttc acaaagaaat agtgtcccaa gaaagcggcc tccagtattc 177060
 tctccattga ctcagctctgt cttgtacatg tccacaaggc acaagcttca agctgaagat 177120
 cagaaaaaca aagcagtcag ccgctagctc tcaacttacc tcagactgaa aggctattct 177180

 agcttgacca aacctcagac tttgtgtctc ctgagcgtgg ctggagaatt ctgagacttc 177240
 aatgttgtec tatttctcaat gtggetggag aatgaatgcc agctctgaga cctgttctct 177300
 gtcttaaatc tctctcatga gtcctgggat taaaggtata tgatcccaag tgctgagttc 177360
 atctttgtgt gagctgtttc tcttaggagt gatctatatt tcgtgtagct cagtgtggcc 177420
 ttgaaataac aaggatctat gtctacctct taattctgag tcctgggatt aaaggtgtgt 177480
 gcctggcttc tgggctcat ggctgacttt gctttctgaa tcctcaggca agctttaata 177540
 aatcataaat aatattgtcac cacatagaac tggacatccg cctaccctgc ttccgaactt 177600

 aggaaatgct ttcttgttat ttcctacag aatctgtgtt ttatatcact tgccttttct 177660
 atacttcggg actttcacag tttccaaca catacctacc acccctggt cagtagtcaa 177720
 ctcccataat agagaacaac agagcacatc tcccagttt tgggatgac cctcccctgg 177780
 tgtgcaaaaa ccctacctat cttcaaaac tattggaatg gctctctctg ttctctactg 177840
 gcaataacgt ttgcacttgt ccagtgttga ctttgaagt atctattatg tgaatgatac 177900
 caggtcaggt actatcagaa aaagtaata aatgtctctg tgaagcaggt gaattatc 177960
 tctgaagatc ttcttagtat ttctggcata agtaagaac accatcagaa aagagctgct 178020

 ctgatggaag tagaagcaga cacccacagc taaacctga actgaactgg aatccagttg 178080
 cagagaagga ggagtgatga gcaagagggt cgagaccagg ctggtgaaac ccacagaaac 178140
 agctgacttg aacaaggggg gctcttggcc ccagactga tcactgggaa accaacatgg 178200
 aactgatcca gaccccatga atgtgggtgt cagtgaggag gcctgggagg tatatggggc 178260
 ctctttagt agatcagaac tgattcctag cgtaggatg gactctgggg gccaatcca 178320
 catagaggga tactccctct acctagacac acaggggaagg gcctaggccc tatccaaag 178380
 gacatggcag actctgaaga ccccatggaa ggcctcatcc tccctgggga gcagaaatgg 178440

 tatgggatag gttgggtgtt agtggagggg caggggacaa ggggaggag agggaactgg 178500
 gattgacatg taaaacaatc ttgtttctaa tttaaattaa aatattaaa aataaataa 178560
 tcaaacaaaa aagaaaagag ctggtaaaag ccatggaggc tgcaaggaaa cagaaagtct 178620
 gttggatgga gaaagtggg caacttgaa gtcaacagca aacattgttg tttgaatc 178680
 aagctaacac caaagatgca gaaaatgatg ctgcactcaa atagccttgg ttgtcagggg 178740
 aacagctctt ataaatcagc ctaattatga taactttctg aagaaggggt actgcttgac 178800

aactgtggtg tggagaccag aaagaactgc acagggcagg agtgaagggg tgtccaagg 178860

cgcagtgctg gaattcactt catagttata tgggtgtggg aagactctac ccacggacat 178920

ggtgccatta tgaagaggtc attcttattc tcatcathtt cagatccaga cttctttacc 178980

aaactctgac ctcaggtggg caatttgaga cagaccagca caactcctca tctctataac 179040

caggtttctg tagggggaga aatthttcca catagattta aatgaggaag cttaccctc 179100

aaaggcaaac tgetgctggc tgctttctac caacagcadc attcgattgg acattgtgcc 179160

tgcaaaaaga ctgagagaaa gaataaagaa gtaaggaggt gaaatagaga gagaaagaga 179220

aggagagaga gaaagaaagg gagggagaga gggaggaatg aaaggggaga gagagagga 179280

gagacgtaaa caaggggggg gatttaaaga ataaattcac cttcgattgc aatthtttta 179340

aaaaaaaaatc agccaaatca thttatccgt ggttcatggt gtattattga agctcttcgg 179400

gaggttatgt taccagatta agaattctgt acataaagtc actcgtccag tgaataaggg 179460

agtcaagatt cattcttcca agtgaatcag aattgctaag cagattctcc atgacttata 179520

cagattcaaa ggcaagtagg aaagtgagca caaaagaaaa aataatgatg aattcaaaag 179580

gtaaagaata cacacagaaa tgtagccctg agggaaattc tgatctctta ctaaaactct 179640

ttgtaaaggt tcatttgccc tgaacattgc accagctaaa ggcgaggcat ctggaaaacc 179700

tggaggtgaa gggctccaga attgcttcaa gaaccacaga aaccaagaag cctattgtct 179760

gggacaccat ggiccttgct gttcttggtg tgaaaactgt agtttcagta catgatctgt 179820

gtcaatttaa gtccaagaaa atgattcttc tctctaatta attgttatgt ttctcttata 179880

tactttgtaa aatgggtggc ctgcttgtct tggcattgag agcaggcttg tggatgtagc 179940

tgtctggctc catcttcaa ccaggtgttt gttactaagc cttgctgcct agtctgcgtc 180000

ctcccaaca caggagcgtc ctcagattca agtagctctt gttcagagag gaactatccg 180060

gggacaaaag cctgggatta tcaatgttgc tatccaaata aaactgttgg ttgttagcaa 180120

gaggaaagac tgittcacac aaggactctc tgctcttct taaaaatcta tatttgaat 180180

caatgcattc cttgggtctg acatgagaag ccccatcca cttggctctt tgaaaactca 180240

cgactcactc tcccatcta tccatctact thtcttgaa aaaggaaaga gataaactac 180300

cagtgagaaa ctttactata tcaaaaataa tagtgggaaa cacagaagc ttaaagtgag 180360

cactgtggcc attgatcat agggaggtt ttactgaca gttctctggg gacaatgtgg 180420

ccttactaag taaatgaaa gagttagtgg gagacaaaac caggtgcaga ggcaaaccac 180480

ctagaattcc tgetgtagat ttatatttc atgtctctac acatcgttca tcataaacc 180540

aactatctgt agttaaaccg tccagaatth tgaaaatgca gagatagccc tgctgatata 180600
tccaacaaga aaaaatattg gaacacatat tttatgattt tcttttcaa aaattgtttt 180660
taaaaagtta taaacatgth ttttgatatt tggaaattha tgaagaacag agtgthctgt 180720
gacacatga aagaaaatag atthgtatth gagaaatgca agccagacta ctgagaaaa 180780
atataatcag aaaaaataat aacatcattg gtaagacaat gtgaatcaa gcatcaacca 180840
ttcagaaaag ctgtggagga ggtcagtagt tgfacattgt aaccaatgac caatcagtha 180900
tgaataactt acaacatgct gccttaatag gtaaatgtca ccctctaac atccagtht 180960

actactatat cagctthtaa acttggaaht cagaacttga cthttccaa caggtthaa 181020
atgcahtggt gaaaacagca cagattaaaa acatggacth gaatgaagaa ccaagthggg 181080
accagththg tgaaacccac agaatcagct gacctgaaca agggggagtg catgaacccc 181140
agactgctag ctaggaggcc agcatgtgac tgatccagac ccctgactat ggatgtcaat 181200
gaggaggcct cggcactcta gggggcccct gtagtggat cagthththt ccctgthgta 181260
agaagggact thgagagccc atccacatgg agggatgctc tcttggcctg gacacatggg 181320
ggagggccta gcctggccc aggatgatgt gtagacttht ggggatcccc catggagthc 181380

cttacccttc ctgggatca gaggggcct gaggthgggg ctgctggggg cthgagagga 181440
gaggatggga gggagagggga gaagggathg acatgtgaag caagcttht tctaaththg 181500
actaataaaa aathtaaaaa aaataaagca tggactthg actcaaggc aatggagtht 181560
taagthact ccagcathth ctagththt gacctagagc cagthththt thththctga 181620
gatactctth ththcathth atthgaaatg cththththt caaataatgt atctgthth 181680
cagththcct thctcttht atthctthta gthctththt atththctc ccatctgcat 181740
ccactccctt ctgtctctc atthgcaaat aacaggcttc taagagataa tagthaaaca 181800

aaatataatg agataaaa aaaaactaaca cththgathg atagthcaat gcaaacatac 181860
agagggaaag agaccaatth aagataaaaa cagatataag atacagaaag ggataagth 181920
taagaagata taagthataa gatataagc ataacagata taagthataa gatataagth 181980
ataagaaca gagaccat ththcacaca ththgactth ththththgaa aagthththth 182040
atagctgtht tgctggaaht ctatcagggt thththctth atthgththth thththgca 182100
cathctatg ththaaagaa gactgtgcat ththththth ththththth ththththth 182160
ctgthactgt gaatagaaat ctgthgathh acacagagaa agthththggg gththththth 182220

ctaaacata ththcagathh thctgcatga aatgathth gaataact thcagaaactc 182280
ccatagaagc cagaththth thctththth aatgathgag ctgactactg ththththth 182340
thggctgtca gcagacacat ggcatacaga thctthgaa atctagacat ththctgct 182400

atccccactt cticcagcag cactaaaaca acataggttg agcactcadc tcccacagac 182460
acttagggat tagccaggct tcctcataag gaccccatct ggatttttga attgtcatca 182520
tatagacact tgagtgagct cccctgaacc cagcctggca tctctgaccc tcaatcacgg 182580
tggaataaat gatagatggt tacagaactg ggtgataggc aaaggTTTTT aggggtattt 182640

ctctggcaat aattaacatt ttttggctg ttgtactttc agagtttctg tgggcacatt 182700
catctatttg tgtgacagtt ttaaagacat atctttgtcc tttaccagga ccatagaaca 182760
aatggaattg gtggtttgag aaatagatga aaaacttgca atctttaata taggcatata 182820
tttagagtca atgtcctaaa ttggagaata aggtcttcaa atggctctat gatctaacag 182880
ttctttagga ttcaagctc caatgaaaag acaagaaaat aaacacaaaa gtgtaacata 182940
ttctctgcc cattcacaaa tgtttaacag caacttctc tcaattaaaa ccattgtatt 183000
tccaagaca gtaaatatgt cttgcctatc aagtgttttt gaaaaaaaaa agtagttgct 183060

ttgagtaaca aaaacagttt aggcaataa ccaagtaaaa gtggatcaga aataaataca 183120
tcagaaacat tttacttttc ttgccgttgt gtggaagct caggctcctg gagacattgc 183180
agccaggtgt catgcaagga ttgtgggcta cagttctgat ccagtgtagg gcaaagcaat 183240
atgatcttgg gagagaaagt tggaagacat gttcataaat acagaataat taaaggtcta 183300
ttcaattggc ttatacagtt agaaaacctc tacccattgt cttgaggata tghtaatcat 183360
tgcattgtgt tttgtctagg aagaagaaat tgcattaat aacaataaaa aggctaactt 183420
catgccttgc ataggtgtgg tgggctaaat ttgcataccc tctatgataa gaaactgaaa 183480

ctcctaagat ctggcaagga aatggccaaa aaagtataat tgtcatacag aaaaaatata 183540
ttatgtccaa tatatacaga agtttctaaa aataatagtg gaggtagaat aaggagactc 183600
atztatcaaa tacaactca tatttttaaa aaaaaggaaa aatcatgat ggggaaatgc 183660
gggacaaatt caggaatggc actacaagta aaattattta aagaaaaaat gcaaggaagc 183720
catgtgttgg tgggtgcagc ctttaatccc agcactcggg aggcagagc taggtggatc 183780
tatgtgagtt cgagaccagc ctggcttaca agagctagtt ccaggacagc ctccaaagcc 183840
acagagaaac cctgtctcga aaaacaaaa agaaaaaat gcaaggtgta cttaaaataa 183900

ccaaattata acagagacaa atcatgtgac caaaaatgaa caattaaaa taccacatt 183960
ttctgggtgc cattcacaat ggacttgcag ctgtaaagat tgaataaaa gctaagaaat 184020
ttgcaggtaa gtggatgaac tgggaaaaat tatacttgag tgagtcctc caggctcaga 184080
aaacctaaca ctctgtctg tctctgtat gcggaaacca cctttgaact tttaggtttg 184140
tgggttttaa cttagaatc ccatggtaac tagaaagagg ccaactggggg tcccaagagt 184200
gtttctaagt gatggggata gtaagtgtt tgaaggaaa cggtaaataa tggaggatgc 184260

ttttaagtaga gaaggtgaca ggaccagggc aaagtggggg acaggagaaa aagccacatg 184320

 gaaatcaata ttttataagc tttcttacat tttattatat attataaatg gtaaccttta 184380
 ttcttaagat cctaatagatg aaggettcac gcacacttgg gtcaaaggac atagaaaaat 184440
 caagctggta ttgacctgga agctccctcc ctactgagct gtcacagtga cagaacatgt 184500
 caggcaggct gatgagggag aaaaatcacc aacagtctta cccagctgcc aatactttga 184560
 gctatagtca tgactgacct aacaggattt gcccttgggt gcaatagtag catgaatggt 184620
 atgggagttt ccagcctttc tgattgagcc taaggccac tctccacaga ataggataca 184680
 tgtataatat tgtaaacctg accaagaact gatggctaaa aaggtcacag atactcaagc 184740

 cgaatctatt accatcattt tgtaagggg aggttgaat caaactgcct tctgaattct 184800
 tacctttatt ttcatgatt acgcagctct caaccacat cagagactct tccttttgca 184860
 tgggactgca gtcaataac acactcagaa atgggtcaaag agcagaaaaat acgtgatggc 184920
 ggagtgtca gccgctattg caacacctat attagatctc ttgctctca gattcagcaa 184980
 acatcacaga ggaggtgcta agaagattgt aagagccaga gacataggag gacttatgtg 185040
 aaacggtgtc ttctggacat gaaagggact cacactcaag agctttcagc agttgtgact 185100
 gcctgcataa gacctgcacc acactaggca aaactctact acagatgggg gaggagcttc 185160

 caagctgcca cctttgctgg gtgctattgg cagtccatgg atactggggg tattggaatc 185220
 cttttggaag taigccctct gataggtttc ccatattctg gtgggtctct atgtgcaaga 185280
 atcttcttc atttttctgc actaagtatt tggttttcca ctaaaacgtc tctctgcttt 185340
 tgtgtgtgtg tccccagaa tttcttttat tagtgtttta aaatattgta gggctctttc 185400
 actgcttcag ttagatglat ttctattgat tttattagga ttagttctgt cactgggttt 185460
 ttgtccttc gacatatgct atattgctgg attccattct agtctcctaa ttattatttg 185520
 ggcagggact attatggact tttttatttt gttagtgtat tagtggata tgaatgttg 185580

 cttttgttt attatgtttc ctacaactca ctgaactttt ctgitttagt ttagtcagt 185640
 atctttaggg ctctctgat agaagatctt tctacaaaag aggttgaata tacctcattc 185700
 ctttctagt atgtctttca taaaacttcc tttgactggt ctgactgaga gcagcagatg 185760
 tggacacct catctttca gatctcaaag gaaatgcctt cagctttttc cacttagcac 185820
 atgggcgcag tgtctttatc atatctggaa ctttttgggt gaggtatgtg aggtttgttt 185880
 tcataaagag gtgtttcact ttaatgaatg tttttctgg acccactaat gaaactgttt 185940
 tgatcctctc tgtaatggt gtaatacact atggttttca gttttattc attaatcat 186000

aattaataat ccataacaaa tgggcatggc aaagcaaagc tgcttgctca cctcatgagg 186060
gacaggagca gggtagagaga acaagatacg cctttgaagg acacactgct aaggacctac 186120
ctacttcttc tagctggacc caccactcat atttctacca cctcataata gcactaccaa 186180
ttaaggacac ttiattacat aagctttggg ggaacattca agatctaaat gttaacaatg 186240
tgccTTTTgt tggatcaca ttaaacctg acgtttcttt gctgaatTTT tgtttggatg 186300
acctgtccac ttatgaaagt gggtagctgag atcccctatt gctataatTT ttcaaaaagt 186360
gtctcaagag agaaagactc caggtagacag agctcaagag ttcaagtggg ctttttttct 186420

ttaattatg gggaaaggat cgtaaaagga ggaatgggga gggggagact ggcttccagg 186480
gacaggacca gtgggagaaa ggaaagagag tcagaggcag atgggggggg cagagagaga 186540
gagagagaga gagagagaga gagagagaga ggagagagag ggggtggggg cagggcctt 186600
ttaaaggga acacagttaa tgtgcacagg tgatgctctt agtactgca gctgagggca 186660
tacctgtca gaacccaag gacaggccag tacagatgcc tgaatactga cattcctccc 186720
cttctattta ttataaaaag ataaggtgtt agaaaggggt cgcaggtgag gcaggatga 186780
ggacaccatg ttctgaagc tactcactgc ttacctgagg ggtgtcattc attcatcttt 186840

gggggacctg gaaagtTgg ggtgctTgcc acatcctgga gtttcacttc actgtccagg 186900
ctctgtggaa ccgtcaggtg cctcctggac ctggcaaaat gtcgttcttg gtgaatccaa 186960
atcaactccc tagggcttaa acctctgat ctttcccat ccccacagtg tcaactggact 187020
tgtttggtcg tcatgtttgg tagtcatgtt tggtagtcat gtttggtagt catgtttgag 187080
cggtagtcc tgcaagcctc ctggctatg gccaacagcg ggtagtctg caacagtaac 187140
tgattagaa tggtagtgg gtctccaaag aacatccaa tggaagtaag gatgtataaa 187200
tgatgacaca gctccatga gtgaggctga gaagacccaa gactctacag ttctatcct 187260

ccaagaatt cagagagggt tgattttgac acaggcacag gccaccagt gagtctcac 187320
ataaagggtg acggccgaaa gctcaaatga gcccgagaga gctatggttg cctggcacca 187380
ggacctaaca agaccagaag gcaaaaaaac aactggaga gaggagatga gtctcactc 187440
gtggaaatag tcagagatgg agaaggagga ggggctcttc actcatgcag gttttggatg 187500
gagggacca gtgactgggt tataatgtaga ccagttcca ggggtcccagc atgccacaaa 187560
ctgcctttgg gcaggagaat acaccaggag agccttccca gtcattggaac caatgttgta 187620
atttaaaaa ccaatcaaac aaaaaacgct cactcgagag aaaaaaggca tgtgacagag 187680

ttcaaatgga ggaagtTTTT ttttaatta aattaaagga ccataaaaaat gggaaagggg 187740
gtggggagac tggcctccag agacagcagc aatgggagag aggaaaaaga ggcagagaga 187800
gggaggaggagg gagggagggt tgtcagaaca atgaaaatta cactctgagg gaataaccaa 187860

aggggaggaa aaactattgt tgttttgggg tctatntttc cctttagatc tgacaaggct 187920
 tactttatat aattatagcg tgtgtgtgtg tgtgtgtgtg tgtgtgtgtg tgtgtgtgtg 187980
 tgtgtgtgta tgtgtatatg tgtctctgtg tctgtggtga ctggggaggt gtaacaagc 188040
 acttattcac ccagataggg cataacaaca aaccaaata caattccacc aaagaccaac 188100

 ttagaaaagc catccagttt tacaggctta tatacagagt atgggtaaac ccaagctgag 188160
 tagaccagta gaaaatctca gtgtggatga tgacttttcc atagccgcac agatggagtc 188220
 cccttgtcat tcaactctac acactctgta tacagtcaca gcctctgaga acaggagact 188280
 tcgagcagct ggaacagatg tcagtggtga gagaatggct taggtcacag gtgaatagca 188340
 acagatggtc ttcttactc ttctaagaga atgtcaacag gcccacatct tgagagtatc 188400
 ttgtaggtgg ccaccttga ggtttctgat gaatagtcac gactgctatc cttggaggac 188460
 aaaatcctac ttcagtttat actagttatt tcttcttact caattggtcc ctctctcttt 188520

 ttatagtggc ctttgttgc tectgttagt aggtcttatt tgtcacacaa aattagtatt 188580
 aatcataatg aacattaaaa tctaaattat tctgtggca acaggtacac agttctttaa 188640
 gataaaaagga gggaacagat agaaatgaaa cccagatat tcatgagata atgtcatggc 188700
 ctcaaaaatac acaatgcca aatcttctag gtataaagaa aaaggaacag acctaccatc 188760
 tgattagagg tatttaaaat ttatcatcca aaaatatatg gataaagcat tcatgaata 188820
 aacgcagaaa gaaactgaac agcacaaaata tatatagaac agtaaacata aaaacaatgc 188880
 atagaggaag tggttacaaa gtgctgcca gtcccaacca agaagctatt cacagttagt 188940

 cccctgaca gaagcaaaaa cagctttcat cagcagagta gcactgcctg tatcaaacac 189000
 actccaagac agacctcatg ctccagatct ggccaataca aaatggattc tctatatttg 189060
 ttttgatttt gtgaccattt ttgattgtgt tttggttttt ttccaagaaa gaacgagcat 189120
 gaagtggat gggttgggag gagatcttgg aggtattgga gggggagaaa gaatataatc 189180
 aaaatatatt gtatgaaaat gctacaaaata gccgggcgtt ggtggtgcac gcctttaatc 189240
 ccagcactca ggagaagcaa ccaatagac atttggtaga tgaatagata cattcagata 189300
 aggttgatc ataaaacaga ctaccagtga tatttataaa gaaatgaact attatgctaa 189360

 tacgaagata agagaaaaac ttaagagtgg gataactaac aaaggaactc agcctataaa 189420
 ggctacatag ggcttaatca caaatatata aaatttgtga aagggtaaag ctatggaaac 189480
 taaaaagagc agaggttatg ggaaatgttt tcttgatttt tatttagttt gcattatagt 189540
 gtgcatgaga gagagggaga gagagagagt aagagagaga gagagagaga gagagagaga 189600
 gagagagaga gagagactgc atactgccct gcatatgagg aatcaaagga caacttgtga 189660
 cagttgtttt ctttccacta tgtttcttcc agagatcaaa ctccaggttg cagagttgag 189720

agaaaagtgc ctttatcttc tgagacaaat cactgggtcca ggttgcagga ttctagagta 189780

 atggaatat gctgtatgct gctacaacgg tggttagatg tcatgtgtct gtacaaatct 189840
 atataaggca caatcctgca ctaacgttta ctgtaacat gacctttgga gagtaggggtt 189900
 gtgtttacgt aagttcatca gtagtcactc tggtaggaat actgataatg ggaggggctt 189960
 tgcattgtgca ggaacaaaag ataacacagg gttatcccta ttctccataa cttaatTTTg 190020
 ctatgaacca caagaaaatg aaaaataaag tctgttatta aaaagaattc atatgattta 190080
 gatgatgcta tagagattct ggatggaagc atttcttccc agagggatga agggcgttca 190140
 caagactctg aagttccaaa gcttagaaga actgacaaga atgttacaag actcacaagg 190200

 ccccgctcc agaatacaga agtcaaaaac agttgctggg gagaggagac cttctgtgg 190260
 agctgcctgc aggtcgtctg gggaattaca gtgatgcatc tgtcatgcat gatcacgggc 190320
 ttctagtgat gtgcctacc aagtcacca cgcattgca gggaacccc catctactct 190380
 cctgttgta gcccaaatg aacttggtga ttcaccgaga cagacttgag tggagctatt 190440
 tcctttgtct gtataacctg tctggtgaat agatattgc tctcatctcc gcggtaaaag 190500
 tcatatagca tataatattt taaataatac caatagtgat atcaacagca aatgatagtt 190560
 taaaccaatg tglacaaaat agagactatt ttaaataatt cactggttac aaaataatag 190620

 atatcgtgat gtacacacaa ctgaatgtca taaataggta cacttgaatc ccacaaacca 190680
 ccaaagggac agactaaaga gcgcttagaa atttgtttca ggatctggaa cttcattttt 190740
 atgacagaac tattatag caaatgtct aataagcaga aaaagattca aagatcaata 190800
 ggtttagcaa atgtctaaag tgaagagagt aaacaaatct aagacaaaaa cctggccaaa 190860
 atttgagaaa ttigtacca aatacaatct caccttaagt aaaggattct tcaaagtga 190920
 ttcagtactt acaggacat gttttatgta tactttagtt ttatcaaaca cgtatgtatt 190980
 aagggtttga gtaagcatag taggttacca ggcacagggg tgaattagac acagtttctg 191040

 tttcaaggg cacttagact gctgagagag gtgaacaaga aaaagttcaa ctgttgata 191100
 aattatggaa agtgcagagt tttccagtg tgttatacac ggacacttg aacaagcttg 191160
 aattctagaa taagtgtgaa aatgatgtg ggggtttcct tcctttcacc taactctcac 191220
 aatgtgatca aaattacca gaaattatac tgcctgcaa tatccgaagg aaatttcaa 191280
 gtaattcctc aacttctcac ttgtgttct caagtctgtt caaaggggaa aatgagttaa 191340
 ttctgttcc agccacaagt gaatagaaga attgaaggaa ggcatccctt gccaggtcct 191400
 atgtaaaact aagaatttag aaacagcagt cagggcaggc aatggaatac ggtgcacagt 191460

attatctttt tatttattta ttatcagtct taacagtcag catcccaaat ggaaagagca 191520
 ctcatgggga gtgacatggc attggttact cctgggcttt ctggaggagc acaatcctag 191580
 gtgtctagga gggacagatt gagactgatt agtgagaaca ggagaccagc accatcagct 191640
 gacaagtgca aggcagaggc gactgggaga ctggaaatth ttatttaact attcctagtt 191700
 ttaaaaaaa aactgattaa aatcactcaa gcaggthttc acctgttctg ttttcttcag 191760
 accttgaact tcccattaca cccaaatcag agtgagaaat tataataag gagaggtcta 191820
 gacaccactt taacgagtct caggcactth gctcacaggg gattcttctg gagcattthc 191880

 aattctgaaa gaaaatacat gacacatgga acacagcacc ccagtactat tttgggggag 191940
 cagtctttgc tcccgaagca tctgctgtag tgtgctaaca gctgtttgac tgcaaagggc 192000
 ttctctgtta catgttctgg acagagttgc tagatttctg gaagatgttc ttttttttt 192060
 tttttaagac tgggtttgt gcaactctgg tgcccagtha atcacattta agctttttct 192120
 aactgtgtt ggagtaactt caaggacaaa ccatgctgct ttgagtcact tgttacaat 192180
 tcttcaaat gagctatgc attttgaact cctgtgtgt gcgggcatgt gtgcatatc 192240
 gcatgtgtgt gtatacacga attcctgtac atgttttaga atttgagcac cacaaataat 192300

 aagtctctca gaatatgttt tgcttgttt ccagaacaca gggatattgg ggtttctgta 192360
 atttccatgt caatagctct gcagagtcaa gagcagcagc ctccactggg aagtcctgc 192420
 aggtctctcc aaggactatg aacaaaagaa aaaagcacac agcatagaaa cacaccagaa 192480
 ctctgcaaaa agaaactcag aaatttgcca ctacttctt tggaggaact agctctggtt 192540
 tggtttctct tggcttcaaa catggtcttc tatgtcacct taaagagctc agcttcccca 192600
 atggttaaat aaaaatgataa aggcactctgt tttctggca atgtgattct agattcaact 192660
 tctatagtca gtgtgaaaga acagaaaaag tcaaggcaaa atggactatt taaatattc 192720

 tataatgtaa agcaaaaaat cccctgtacc atagcaaggc catgttaaat gatagatttt 192780
 attctctgac ctaaacagtt ctaagttgtt ctattgctc gaaataaaat tttccagagc 192840
 ggtgtcacia gtggtgccat ggagctgag ctgcatgcta tcagcacata tttctataga 192900
 aatcaattac acgtaatgtc ttttcaaaga accgtttaaa gcaatgcagg gactttcacc 192960
 agtttaact ctgttcttac agggactcag tctagtacca tgagtaagtt attgcgaaat 193020
 agtaagtatt gcagtcagc ccttagcaa agagtgggta taaaggagtt taactgaaaa 193080
 tgctgagtaa gatgatgagt agtgatttat aggttatgga ccatgtcagc attgagggtt 193140

 cttcaccgcg cctgagggtg gttcaattc cacgcatggc caagagaaaa gttgtagagg 193200
 aaaggaaga cctatatgat tataaacggg cagcatagtg gaacataagg aaagaaactg 193260
 tgctgatggc gtcaagccca ataggaagag gtttgctgat gcagttcaca tagctgttag 193320

atgcaggcac aatgaatgcg tgcatttgit gaggcccaat ttgcaagagg acatgtgacg 193380
 ctcccatttg acctttggag ttatagaagc aagagttttg aaacagaccc agttagctgc 193440
 ctgtcacaat gctgggacag atgtatcact tcccgcggcc cgggtttctc atgagaaaag 193500
 cataagatga gtaagtcaaa gggttaagta acataaccga caaatggtta gcacgctgcc 193560

 cagtacacgg tagttaatca taccgtatta actaccttc tttctgttc tgggccatac 193620
 ttctttctca ttgccacat ttgtaccagg ggccagactt tggaaacttt acaatctgga 193680
 taataaaaaa cttcgtaac catggttgca tttttccagc aagttatgca gcacctaaaa 193740
 gagtcaacca attgtcacct ccattgctgt ttgctgctca tgcaactgtt gagatggagt 193800
 cctctctaaa tgitaggtga gtgagctatg gggccctcca tgctactgag ttgtgtaagg 193860
 ttcttgaag taaaagaaca ggggatccag gcatagagcc agtctgtgag ttcagttagg 193920
 ggaagaacaa ttgtgacgcc taaaggcaga ggccgcgcct gctcaaaagc tcagaaagca 193980

 gccttgtgaa gggcaggtag ggttcctcg cacagaaagc ggactaatg ctcttttctt 194040
 gttctttctt ctatcacacc ttctactca gtcccattc cctttgcaat agaatacatta 194100
 agtcttactg aagagggaaa taagccctcc tcatttatta accacttctc agtttcaccg 194160
 ttgagaagtc cgcggtacct caaacctcca actcctgtgc catcttgatt aaggcacaaa 194220
 atgttaaaag caaatactg tgaacaatt cccactaat gtttcagtca tatctgtaaa 194280
 aaatagact taaatatagt tttattaata atacatattt taattaaagc gctggaggtg 194340
 catctagcag gaaaaaatt gaatcttccc gggatttcac atagtggcat gattcatggg 194400

 cagtaaatat gcaaagcttt atgcccataa ggcaatcaga ctccaaagcc gatacgcgtg 194460
 tttttgtctg aaagagtga atccagcagc gtatagtaat aatagtaatc ataacagact 194520
 gccggaatca tcaaatgaat tggctccggc caacagcadc ctctccgtgc aacagaagca 194580
 tcctttcaac cgcaattata tcgtctccaa tattcattat tacttctgct attctcatta 194640
 cacaaaaatc ctgcttatgc ccatgtacct attaaagaac ttcataaata ttgactgtag 194700
 caaacgatca aatgctaggg accacctttg tggactcaga aataaatact ttattgcaaa 194760
 ctgctcgttg ttgctatgac gatgatgatg atggtgatga tgatgacgat gatgacgatg 194820

 atggtggtgg tggtagagaa ggtggtgatt cctgggagca ctctcttca gttcctggtg 194880
 ttgacaattg tctagtgcac cagttaacca gagctgctgt tgcaggcacc aaaggttctg 194940
 aacctcaaca gtgaaacgca ttttctcatg gatttagaag gcagaggctc gagatcaggg 195000
 tgtcaaggag aggttttctc ctgcaactgt agaatgtcac cttctcccac gatcatcatg 195060
 tgatcttcca tctatgtcta tttcccagtt tctctgcat ataaagcaat gagacctatt 195120
 ggttcagcct cactctaagc attgcttgg ctttaattatt caagaacatt ctctctaaat 195180

acaggatcat tctgagatac gaggggatgt gatttcaaca aggggccttt agaatggcac 195240

cagtaatcct ataacacctg gcaactactt tgagcttcag aaattgatac tatccaccac 195300

atgccacggt attttaccaa gaaaaacctg ttaaattgtat aaaaacaaaa cagagcggac 195360

ttaagatctc tataccatca cccctcaaat aaagtttgtg ttaaatagc catatattac 195420

cctacagaca ctgaaaactg cacagaacat tacaattttg gttcagtcac tcacatctat 195480

ttctaagcct aagactgtta cagttatctc ttgtgtgtca tccctactgg tetttcattt 195540

ctagagacgt agaatcattt ccattcagcc taaaacatg tcatttagct tcttttatag 195600

agaaggttaag ctggagacaa accctcttat tttcttacac acacacacac acagagagag 195660

agagagagag atagatagag agagagagag agagagatta tttaacatga aattgtaaaa 195720

gattcatctc caaatttcag gtttttggat taacagctct tcatttcag ttttaaaagg 195780

gttttctgtc atctccatct tccatagatt caggtgagaa gtccataatt taggtcatta 195840

tccacctgtg tgcaagggtg tattctctgt atgtgttact ttccactcaa tctgattttt 195900

tgccagctct gtgatttgc tttcgttgtg tttacttatg gcttgacttc tgtatttttt 195960

gctttttate acatcagggt tcattattat ttccttaaat gttgctgtct caatattcca 196020

ttaggattct attctctctt tttgcatcat ctgactagaa cttgaatttc tgtttgtttg 196080

tgtaaccta ttttgttctc tgttctttgg actcagfatt ttccatcagt attttccatc 196140

aactggtttt caagttcagt gattctcttt gattttgcca tactgttact gaggcctctca 196200

gtgaaaggtt tattacagat gtttagattt caattctaaa ctatccattt gtatcttttt 196260

gatacttaat ttttccetta aggaacaata tcaactttct tttcacteta ttagcttaat 196320

ctttgacaat ttcaaacatg tatgtaattc tttcacaccc tctctactga aatgccaatt 196380

ttctacctca tgggttaggg ctgcaaaagc tttcttaag tctgcttaat agtttagtgt 196440

aactgtcctt tcttctaggg attggtcaca ttttctgtt gtttgtatgt gttttatata 196500

tgcatagtta tgggccacat gttggacctg ttaaattgtg tattccatag atcctgagta 196560

ctattacaat tctttgagaa gtgtttatgt ctctatttta gcaatcaatc catttagata 196620

cagatggcaa gtctttcat ctctctcgtt gagctgcaat tcaaagctca gcttttgtca 196680

tgaggctgtg ccacaatggc tgaggctctaa atcattgggg agttttcaag gtacctgtgt 196740

gttttcacac cagtaaatgg agaatccttt ttccaaaata aatggagaat tctcttcaag 196800

gttttccaa gacagagaga tgtgattgtt gtagatcata accaactctg tcaaatagtt 196860

acactcctga ggctcatccc agaaagaatg ccaagaataa cactccacca attccttttg 196920

ggaataacca aaacctgcct actttgcttt atttcaataa caagtcttta agatgcttta 196980
 gtgtttcadc accaggattt ttataagtt ttctaatttc tagttgcatt cattgaataa 197040
 catagttttg attaagatag ttatgtcadc gtagtgaaat aaaagtcctc tgacttgtct 197100
 gggattctcc ttttagcctc aacaacaaga caaacatgt gaaatcctcc aatgaaacta 197160
 attctgctca acctgtgtca cttagggacc ctagaacctt acctaaaaac agatttgggt 197220
 atggagtaac gtgatgtagt atctgctaga agagggtgcc catccctagt atgtaggtca 197280
 agatcagaag tagctgacag tagagttaat cctaagggcc cagatgtatt cattcacctg 197340

 agtaatttgt gttattagag gtttaaatgc acttctgaaa taaaatatga tttcaaggaa 197400
 atccccccac caagtgaata aagactatga aatgggagca cccaagaaa taactcttta 197460
 ttcgtgcctt taagtaagcc acatacagcc ctagacgagc ttcagaaatg gggtttcat 197520
 ttccataaat ctatttttac tccaaggggg caattataat taatttgtac atggtcacia 197580
 aatgaatadc agcagtgcct gaaagtgcac acattaattc atctagtcaa gaaaagtttt 197640
 tgagcaccta catgtgttgg gcacagtcca atacatcaaa attgtcttaa aggagaactg 197700
 taaactaaca ggttctaaga cctgttacia tctttggaat gagcagtaat tctcttctc 197760

 ctccccaca ttacattact tctgcagttt acctttgat ttattagcat gtttttctg 197820
 atttgattaa tgtgttatat gtgaggctac agtgaatta taaatactct caaagtgtag 197880
 aaagtcatcg atttgaaata agcatgatat ctgagtcac acgtgaagct tcctttaatg 197940
 gtgcatgtg taatggctac tagtaattag aaaaacagtg gccatgcac aaagatagat 198000
 gcaatggagc agagctatta ctgctaccaa aacaaaaag gggggggcaa atgctttgca 198060
 ccacgttctg ccaggaactc ccccccaca accccatta gtaatctggg catgctatac 198120
 ctctccgca gatcaacagg caatctcacc aactcatgcg atgagaccac tctcccctc 198180

 ccagagacta ggettagttt tcaaggtctg taaagggggc atattacca ttgataaaga 198240
 gcagaaagac aggaacagtt attcaaacat caaaagtga caatgtgtgg acagagaaga 198300
 agcttctage caagctgggt agtgtgacct ccatagtcac ctctgacctg acacctttgt 198360
 ccttccca cttttcaag ctctgtttt ctactataac ctactctgt gagagcatgt 198420
 gtgcatgcat gcctctgtgt gtgtgtgtgt gtgtgtgtgt gtgtgtgtg tcaagctatt 198480
 taaaaatagt aacctattc attcagtgtg ctggtttctg cacatttttt aatacactat 198540
 gccaggcact ggactaagta acagagaaac aaagagccca aagttgatgg agatttgcct 198600

 ctgggtcadc cacttctta gtgagacttt gggccatfff atgctttgtt ctctcccta 198660
 aagcctgatg ctgtctctta cctgtatcta ctgccaatcc ctgctctcg tcaccagatt 198720
 ctactgttgt ggcagacctg cgccatctg tcttccccgc caccacctc ctgcctcggg 198780

agttaaagaa tacgtgtgga tcctgggaac gttctttttt gtgtcacatt cataaaaaaa 198840
 aaaaaaagc taaaccaag atttaattcc tactccctca aagcctagag cataacaaag 198900
 ggcttaccct acaaaaatta aaagcacaga agttacaaaa gcacaaagtt tggattttca 198960
 catttcctag atcaatgaaa gtaagacatt ctccctgtgg aaattaatgc aagtttaatt 199020

 ctatttatat tagnnnnnnn nnnnnnnnnn nnnnnnnnnn nnnnnnnnnn nnnnnnnnnn 199080
 nnnnnnnnnn nnnnnnnnnn nnnnnnnnnn nnnnnnnnnn nnnnnnnnnn nnnnnnnnnn 199140
 nnnnnnnnnn nnnnnnnnnn nnnnnnnnnn nnnnnnnnnn nnnnnnnnnn nnnnnnnnnn 199200
 nnnnnnnnnn nnnnnnnnnn nnnnnnnnnn nnnnnnnnnn nnnnnnnnnn nnnnnnnnnn 199260
 nnnnnnnnnn nnnnnnnnnn nnnnnnnnnn nnnnnnnnnn nnnnnnnnnn nnnnnnnnnn 199320
 nnnnnnnnnn nnnnnnnnnn nnnnnnnnnn nnnnnnnnnn nnnnnnnnnn nnnnnnnnnn 199380
 nnnnnnnnnn nnnnnnnnnn nnnnnnnnnn nnnnnnnnnn nnnnnnnnnn nnnnnnnnnn 199440

 nnnnnnnnnn nnnnnnnnnn nnnnnnnnnn nnnnnnnnnn nnnnnnnnnn nnnnnnnnnn 199500
 nnnnnnnnnn nnnnnnnnnn nnnnnnnnnn nnnnnnnnnn nnnnnnnnnn nnnnnnnnnn 199560
 nnnnnnnnnn nnnnnnnnnn nnnnnnnnnn nnnnnnnnnn nnnnnnnnnn nnnnnnnnnn 199620
 nnnnnnnnnn nnnnnnnnnn nnnnnnnnnn nnnnnnnnnn nnnnnnnnnn nnnnnnnnnn 199680
 nnnnnnnnnn nnnnnnnnnn nnnnnnnnnn nnnnnnnnnn nnnnnnnnnn nnnnnnnnnn 199740
 nnnnnnnnnn nnnnnnnnnn nnnnnnnnnn nnnnnnnnnn nnnnnnnnnn nnnnnnnnnn 199800
 nnnnnnnnnn nnnnnnnnnn nnnnnnnnnn nnnnnnnnnn nnnnnnnnnn nnnnnnnnnn 199860

 nnnnnnnnnn nnnnnnnnnn nnnnnnnnnn nnnnnnnnnn nnnnnnnnnn nnnnnnnnnn 199920
 nnnnnnnnnn nnnnnnnnnn nnnnnnnnnn nnnnnnnnnn nnnnnnnnnn nnnnnnnnnn 199980
 nnnnnnnnnn nnnnnnnnnn nnnnnnnnnn nnnnnnnnnn nnnnnnnnnn nnnnnnnnnn 200040
 nnnnnnnnnn nnnnnnnnnn nnnnnnnnnn nnnnnnnnnn nnnnnnnnnn nnnnnnnnnn 200100
 nnnnnnnnnn nnnnnnnnnn nnnnnnnnnn nnnnnnnnnn nnnnnnnnnn nnnnnnnnnn 200160
 nnnnnnnnnn nnnnnnnnnn nnnnnnnnnn nnnnnnnnnn nnnnnnnnnn nnnnnnnnnn 200220
 nnnnnnnnnn nnnnnnnnnn nnnnnnnnnn nnnnnnnnnn nnnnnnnnnn nnnnnnnnnn 200280

 nnnnnnnnnn nnnnnnnnnn nnnnnnnnnn nnnnnnnnnn nnnnnnnnnn nnnnnnnnnn 200340
 nnnnnnnnnn nnnnnnnnnn nnnnnnnnnn nnnnnnnnnn nnnnnnnnnn nnnnnnnnnn 200400
 nnnnnnnnnn nnnnnnnnnn nnnnnnnnnn nnnnnnnnnn nnnnnnnnnn nnnnnnnnnn 200460
 nnnnnnnnnn nnnnnnnnnn nnnnnnnnnn nnnnnnnnnn nnnnnnnnnn nnnnnnnnnn 200520
 nnnnnnnnnn nnnnnnnnnn nnnnnnnnnn nnnnnnnntt ccaggaaaag gggggattaa 200580
 catactggta cttagttggg ttggtaagta caggaaagct tgaattctcc tctaccttag 200640

attgcaggta tgcataatatt tacactttta acattttattt aattttttat gaatttcata 200700

aaggagtact gtatcgatac cattttaaga cacattgcgt ttctcaattt ctgaaggca 200760

agcataaaaag ccaaacaaaag aaatggaatg attgaacaat tcaggttgac caagccagca 200820

tccatgtgat tccccacctt taccagctca gatttctcaag taagcatagc agaagtgtta 200880

aagtaaaaaa caacagtggc catcatttga ccaggacata gataggtatg taagaagttc 200940

atgatctctg tccaggacat actaaaaata agctatgcag tcagctagat aaagtgccac 201000

acacctgtta tcccagcaca cggcaggagg acacaaacag atcatgacat gaagatgatc 201060

ttgggctata cacagaaggt gggaccagcc tgggctacat gaaaccctgc ctcaaacagg 201120

acatactaaa aataagctat gcagtcagct agatagagtg ccacacacct gttatcccag 201180

catatggcag gaggacacaa acagatcatg gcatgaagat gatcttggcc tatacacaga 201240

aggtgggacc agcctgggct acatgaaacc ctgcctcaaa aaaaaaaaaa accactatgc 201300

aaatttatca ccacaattct ctcaaacac acctaataaga gggggaaaag aaagctactt 201360

tcttactcta agttagactg ttgattgccc tcaattcata tgtatgataa atgtaaagct 201420

aatctgattt ggctgttgc aaatacatcc acttcatgct atttgagtgt gagcaggttt 201480

tcctttcttc ctatgactat gtttccttag ttatgaaatg agattaatgc ttaaattgca 201540

ggcaggtgta ggacgtttaa gtggcacaaa atatttgga gacagtgcc aacacatac 201600

aggatcacaga aaaccaatag cactgtcaac tttatctgtt ccatcagtat ctgtaccag 201660

cagcctgcaa tgacagaaag gaagaggga gttggtccac taagtaactt tcatggacac 201720

gcaataactt gaagacctac tcacagcagc cctgaagtgc tgtaaattha aaaaaaaga 201780

aaaagcctat aatattggac tctatcatg cagaattact aactactagt gcagactcca 201840

taaaaatccc attctattta tatgtctata cctgagtac ctgaactaat aaaattgcat 201900

taatggctat ttacataaat tcacaattct aaattagacc ttttaatttct gtaataaaaa 201960

agaaagtggc tctgcaatt tcccattttt attttcctac atggaatacg gtagctctaa 202020

cataatgtac gactttgtga atatttccag ggctgctaat attttatcta atattatatt 202080

ttgtgttttt tgatctctga cccccgttta tactcccaga accctcatga gcaatgttca 202140

ctatgataac ccttggtgaa agaagcaggg ctaaaattga agttaaataca tccatggctt 202200

ggatctctca aggaggcctc tcagggtcag gagtgatattt ttccatgtat atttctctac 202260

tttaagaatg ttctttaaatt atttgattca tcaggactga aatataagcc ctcttttcga 202320

atagatcact ggcaaacact atagagtgtg actatgacct tgagttcttc ttgccttttt 202380

ttttatttca ctttgttcat tataatcaata tatattccta cgtcctctgg ggagcaacaa 202440
 actgaagaaa gaggagcaca ggagaaaatt atgagacaat acagctttta aaagatggca 202500
 aacgtaatth atcgacagaa gaagaaatag aaaaacatta tttttaaaat taaattgaat 202560
 tgggtgcctta atatttacia aaggigtatga gtgtttgaaa ccaaaaaatg gatatacttt 202620
 cctcaaggga agaaaaaaga gttattagaa agaattagga tcaagtgagg accagattat 202680
 gaggaggcat aacacattag gagcaaacac gggagggtta ggatataaat tgtaaatggg 202740
 caggaagga cttaaaccatc aatggtagca agtagaggaa ggcacagggc agccataaaa 202800

 ccacaggga agccgtgaac cagaagaaag agaaactgga tcaactacaa taacacagct 202860
 ttgtgactcc cactcacacc aatcacaga gctactcgaa taatgtgcat ttcccacaca 202920
 ctgaccaaag cactgggggc ctctgcaacc gattcacagc cagtccaaa ggtctccgtc 202980
 cttgtcccat tctctctaca tgggacactt cttttccgtg tctgcattgc ttcccacggc 203040
 ccaattctgg agtttctagc tttaaaagct ttgctgctcc tccatcgct gtaggiacta 203100
 aatccagatt cctgggcaag ggtctccggg atttgctttc atttctgcag tagctgtttg 203160
 ctctccagct tcatggaag tatagccccc aaactgcaa gcatttctct tttttctgc 203220

 ttgcccctcc tctctggaat gttctttcia ctttgacca caacctcccc cggccagaga 203280
 gtctctcac cttgcaacc ccagaatgtt ttttttgc actttttaag cttttagtgc 203340
 caaccaggat gctggcaca cagtcagta aacacacaag taaatgatca cacagaacct 203400
 tccaaagtcc agtaaact ttttcgttcg cttgtttcat tgtcacctcc attcacttg 203460
 ttctgtttt cttcttctct aggactgaga cagacgggca tttgaccgca ccacaggcat 203520
 ttcaggcctg agacagccc aatgcgtgag caatcaaagg actggactgt gaggtgcggg 203580
 agaagaggct caaccttga gctggactgg gctctgtctt gtggaagctc acgctgctt 203640

 ctctctctgt gtgtttctga agacattgtc cctgctctac cgctgactga ttatggccac 203700
 tgagtacct catttgggc atttgtacc cttcagctag ggcagtattc cattatctc 203760
 cccatgatt tggatttga ggggctctag agatcggagc catgggtaac tggtaacatt 203820
 aaaaggtaa gattttgtc ttaatcaaac agtaagacag taatggcact acaaatagaa 203880
 ccacatttt tacattctca tttctccca tggaaatgag catactttc atttgctaat 203940
 gaactacagg aaggtcatag ccgtagtctt attgaaatag acaccatca ggtaatgcgc 204000
 tacagaggtg tttgatctca tctatcaact ggtattacg ttagtgctta ctctgcaaag 204060

 ggcatthtgt acagaggigt ttgtatgtga ggttaact caatctatca actggctatt 204120
 acgttagtgc ctactctgca aaggcattt tctagatta tgtagaagac atgaagaaat 204180
 gtagggcatc ttcccact tccagatccc aaagtatata acaattctc tgaacaaaag 204240

aaacaattct ctttcataat ctgaaaccca aaagatatta aagtggaatt aaccattaaa 204300
 atatgactgc tttctgccag gtgtgatgta tctgtacatt cagtgaatcc gccttacaaa 204360
 agaatttata gggctaaagt gaaatcacga aagatagatc taagatctta aatctgcaag 204420
 cctatgcctg agaacgtagc ttagttagag tgctcgctc gtgtgatgcc ttgagttcag 204480

 agcccagcac catatgaaag atagatctaa gatcttaaat ctgcagccta tgccctgagaa 204540
 cgtagcttag agtgctcgcc tcgtgtgatg ccttgagtcc agagcccagc accatacaaa 204600
 tcaggtgtgg ggatgctcac ctaaaataat accactgggg aggagactac taaagaatta 204660
 aaagtttag gtcatcctca gctacttggg gagttcaagg ctaacctggg ctgcaggaga 204720
 cagtctcaaa aggagagaga gattggtaga aagaaagcag cagaaagcat ctcttcagcc 204780
 cagactgcct cattcacgct cacatttacc cattcgttcg ttcgcctgaa atgtaatggc 204840
 gaaagagaga acagcacgaa ctgggaattc aaagctgcag aggccagaga gagaaagaaa 204900

 ggctgagctg agttccacgg cctcccattg taagtcctca tgactgtcat aaaactcaca 204960
 cattcatgaa atcataaggg aaggagaaaag aatatcaaat gataggacac agagttaacc 205020
 aagatgccag gctgcagtac agacacacag agagaaggga tcctgagtaa atatgggtca 205080
 atgctagaag gatttaaagg gagaccacag atggctgagg tacagtcatg gctaggatat 205140
 ctgtgttatt gttttaaag ggatcctgag taaatatggg tcaatgctag aaggattcaa 205200
 agggagacaa cagatggctg aggtacagtc atggctagga tatctgtgtt attgttttaa 205260
 cctgcttagg ctaccataat aaaatgttgt agactgggtg gcttataaat gacagaaatt 205320

 tcttttttac agctcaagtt gctgccagat ttggagtctg atgaggccct actgattcat 205380
 ggttggtggt ttcagtatct tcatctagaa gataagcatt tcttgggtct cttataaacc 205440
 agccataaca atttgtccca gtgatataat ccttcccc aaaccaact catgatagca 205500
 ccaccttcag ggttgaaatt ccatcacatg atttttgtag gggcaaaagc cttttaaacc 205560
 atggtgatta attatatcca gtattcagca aatgcctact atatgccaga cactgtgctt 205620
 aggtctagaa atacaaggac aaagcactaa ttagaaacag agggaatgga gcaactgggg 205680
 gtggcatgta gactgtgat tgccacacatg atcatgaaag acatagaaca ctctgtggag 205740

 cagatgatat ctcaagagaa caaagtgagg gaccctgaat tgaaactcta atctgacaca 205800
 caggctttgt ggccctggga agttttattc aaatctctca gcctcctgtt tttcatgtgt 205860
 gtaaagggat aggttagatt tcctatgata gtattgcttc tatattactt atctgaagcc 205920
 aaggcttggt acattatcca aacaagaaaa gtcattttat tacacagagt ctgagaataa 205980
 agggagacca tgacataatt gttgcactag aagaagtttg gcatagctgg agaaccaagg 206040
 gttgagaaca acaacaaca attattctca gcaagtttgg actctctgtt atttgacatt 206100

ttcataaagg tgggtcatta cttaaagaaa gggctttcat ggtttcaaaa ctaggagcat 206160

 gcccatgaag ataaagtata catactgtct taggaatact ttagaccttc aacacccagg 206220
 ataaggcaag cggggagagg agtcaaggaa atctatcttc tgatttaagc aggagtact 206280
 gcattgttcc ttgaggtagg caacagtaaa ggaagagcat ctaatattaa tcaaatttca 206340
 ttacaaatcc attctgtaca acatagattt gcacaaaaag aaggaggagg aggagaagaa 206400
 gtacatagtg gaagaaaatg caagtttata tgggaaatta atgatcatat aatggccatt 206460
 tccatttaag gcaaggaaag agttctttgg gtattaatgt taatttggag aagaaaacaa 206520
 cttacagtca gatttatatc atatacaaaa ctagtgtgat gtgaatctaa aatgcaata 206580

 tgaaaggcaa atgtaaaagt aaaacttatg aaattatttg tatgatcttg gaatgtaag 206640
 aagttgctta accaaattag agctcagttg ccatgggta gggacttctg ctattctaga 206700
 attctgttag ttaatggtat catgatcagg gccagcatat ataataaggg aatatttacc 206760
 aatctgttaa aaagaagatg ctgtctgcat ttgttatttg agatgcacaa actatcttga 206820
 cagctcacc taccttcaa tagcttactg cgttctgagt cccatctacc ttcacacagt 206880
 aaaactcaga aagctcattc ttctgtaacc cattgcaaaa ttatctaagt tettectcac 206940
 tgtaactact gtacagactc aagatgacat gttgataagt agaactgagc ctgtatctat 207000

 gagattttc taccacaagc tttctgatag ctctgggtga taaacaagtt tgctgactca 207060
 ctctccaga gtggaaaact gggagatctc aggcaattca ggagtggaag atttggagag 207120
 agcaactgag tcttctagc tgtattgaga caattgctg atgctacaac acccagaacc 207180
 tgaggagca gagctgcatc caggggttgg tgggccattc aggaaagcat agcacagtgc 207240
 agctgaactg tigtgtctc tcttcagtg ccagttagtg tttcgtgtct gtatccactg 207300
 acatttctt ctttgacc ctcaccatt gattcctcca gtcctcaaca tcttttgata 207360
 gattctcaac tgtgcacaac cagtcattc ctattgttac taccatagt gcagggatag 207420

 tctctacaaa ttgaatttaa agaaaaacat ctaacagtcg gttcaaagga aatatagtg 207480
 aggaatcgc ataaagcatt tgtttaaagg taattaaatt acaaccatag gaaccatag 207540
 aaaggatgct tgcctcatg atgtaagaaa gttcaaattt aaacaatgaa ttagacacac 207600
 tatttttact cgttgtattg gcaaaagtta gaaatcgaa tgcataactg atcaaagtgc 207660
 tatgaagaaa aatgtcagta gaatatattag ccacaaactg aacccttatt tectatgtac 207720
 aacacataag actcaggac catcaagaaa tgggaagaca gaaagattct aggggtcaga 207780
 ggaggaaatg taccagagag aaccgttctc ttggacaga tacactcatg aacacacagc 207840

agctgtgact gtctacaaga caccagtgat gggggaagta cttctgcgta tatgtctctc 207900
 ttactggtta atgaataaaa cactgttggc caatcgggaa gcaagatggg caggactagg 207960
 agataaagag gattctggga aatgtagtag ggacctccat gtgccttggga ggagaggaca 208020
 caggagtcta gcattctcgg taagataaga ccttgagaaa aacacacaca cacacacaca 208080
 cacacacaca cacacacaca cacacacata tgtatagta tacgtatatg 208140
 tataatgtata tgtatatgta gtttaagggtt gttacttaag acagagttag ccaacagaag 208200
 ccctagacac tggccaacag tattgtaact aatagagtct ctctgtgtta ttttggggac 208260

 tgaagtggca acaggacceca ggcgggaatc ctgcaacaca ccagtaacat tctagcgtgg 208320
 aatcagaagg ggctcctgat ctgaggagct attgacagtt gatgacttct gggggaagga 208380
 taatcagggt ttggggggag gctgtgcccc tggtagatca accacacccc agtgtatgat 208440
 tccacacaca cgacacccat accttagaaa cacacattg attcagtggg atatcggggt 208500
 gggggcgtaa agaaggaagg agacagtggg gaggtggggt tctggagttt agggggagaa 208560
 gtgcatcaaa ggaagtctc aaagaattaa taaaatatta tatttgaaga aattatcgt 208620
 aacatcttgc aaaggaacca gaaaaaaaaag cagctttgca tgctagtgt caatgtcct 208680

 tcagccttaa agcaatctga aaactgctat aaagctgtat aaatacagct gccctgagc 208740
 taggagccag caactccact ctttagaagc aaagactcta gtacagggga tatgaaaggt 208800
 tgtttgctac agtattgttt gcacccactt tttaaaaag cagttgattg gattttattt 208860
 cattcattat gcaatattat cttgcatatg tgatcaaaat tttatagat ttataccata 208920
 acctattacc atgtttgaat acatgttaca atgcatgaaa ctcaatgatg ttctctgtgc 208980
 actgggaaaa ttgtgagtgg gaatgaagcc aaactcagag gtattgagag agagagcaat 209040
 gttcatgggt aacacgagga agacacggga gaaagtgagg ggaaaaacac aactgtgaag 209100

 tggaaattgc ctgtatgct attacctgat gatgtaagaa tatggagcaa accatgaatg 209160
 acaacctgac ataaaagcac aatactcact cagagcgtt taatcatctg tgtttgtggt 209220
 ttcttctctt atctttagc ttcataaata aaatttggag agaaaaagca agttacagat 209280
 taatctggac ccattgttt tgtttgggta aaaatacata agttctctgt tgttacctca 209340
 gaaaaatgac tggttggtat atgtgactgg gactttatag cttttcttt ctctttgcat 209400
 tgttatgtgt tccacaagaa tcaagtgcta ctttacattt tttactgttg ttgaaaatca 209460
 taggcttaca agaaaaggaa agagittaca actacttca gctaaccctg tcacactcta 209520

 tgtaagtgag gatttcaaaa ctgttgtgtg tatattgtta gtattcagc atctgcctg 209580
 gcctgtcctt gggcttctga caggattcac cctcagctgc agccactaag agcacagcct 209640
 gtgcacattc actatgttcc cttttaaaag ggcctgccc acctccatc cttctctctc 209700

ctttctctcc ctctctctgt ctgtttccct ctctctccct gtctctctct tcccctcttt 209760
tctctctcct ctcccctgct cctgtctcta gaggatgctc ttccccttc cctttccct 209820
ttttatgatt tctttcccaa ataaaaaacc cctctgcttg aacctgtgg catggtgtct 209880
ttctctcagg caccactttt cttaaattac aacatatata ttagaaaatt ttaaacatta 209940

taaaacagga aagcaaatgt ttacttctat atactttgaa ttttgagttt ttttaattga 210000
aagaaattha ggccccacc ctttataaag aaatacagtc agttagttag tgctgaaaga 210060
ggaggaaaca atgggttctc atcaactctt ctctggaca ggtgctgtgg tctgcttgtg 210120
tgtgacctcg gaactcatgc gctgaagcct ccctcgttgc cagggtggtg gtcgtaagac 210180
atggaactg aggcagcatt gatcatatgt ctctccctt gtgggtggaa ttgtcctcct 210240
tataaaggagg caaagagccc ctggggagct tgtatacttt tccacacatg agggcacctt 210300
agaaaccacc acccgtgtgg tctctctccc cagacaatag agctaccgtc tcctgacct 210360

tggcttccc agcctctaga actgtcagaa gacttgctgt ttaaaaatta atcagcctaa 210420
ggtacgtttt atagaaacct gaacagaatg ataaaggctt tccatattca caaaattatt 210480
cttattatga aaaaacacaat tattttgttg ttcaaaaacta ggtccctttt gttatcatct 210540
gagtgaaat acigattatt tgttgaaaat caaatgaggg actagtgaga tggctcagaa 210600
agcaaagcac ttgttaccaa gcttgagagc ctgtttgatc cctggaacce acatggtgga 210660
aggaacaaac caattctctc ataggcacac actttataat aaacaaatta attattttt 210720
aaaatcaaga aggaaataaa atgatgaaag gctaattgaa gcatatggat aagatacaaa 210780

actgggaaat ttttcattta taacattttc agtgaaagga tgcaatgaat gtgtaaaatg 210840
aattaaacaa gatgtaaggg gctcagggag tttaatctaa ggaccagaga gatggttcca 210900
tggaccaagg agcttctctt gaaaaccttg aaacacttga aaaagtgact taacttttcg 210960
acctatggtg gaaaaacca gccagaaaag ctgtctttta agtttgacat tegtgcattc 211020
aaaccacca cataacaata actataaatg acattgtaat tatatgaagg aaattcaatc 211080
taagtcttta gtgtagccat ttaagggtag agtttaggtt gaacaataca gaaagtgggc 211140
agacttcaat gtaatttac cttaaatagc aatgagacce tgagatggga ttaagatgaa 211200

gaatattgat aaccatttgc aaataaaaaa ttagtttttc ccaacagagt ctactggag 211260
atacaatta ttcttaaggg gaaatcctat gccagcagc agatagccaa aacacaacca 211320
actcaaaggc agttttggag gctctttatc tcataatgcc ttgttagggc tttacctcat 211380
acacacacac acacacacac acacacacac acacacacac acacacacac acacacacac 211440
actttaaagg tcttttgtgc atatattatg gtttctgctt ttgtgttttt ataggagttc 211500
tgtgtgtgtg aacatgtata ttctgtatc tatatgtgct tcctagcttt tttctttggc 211560

tatTTTTctt ctgtttgctt gttttgtcta attctggttg tttgttattg ttattgctat 211620

tactattatt gatgccagtt tgtattctaa tgagaaagaa aaagaaaggt gtggatctgg 211680

gtgagtggag aaatgggaag gatctaggaa aactagggg aagggaacc ctaatctgaa 211740

tacattgtgt aaaagaagaa atcaattttc aatttaaaaa aagagaagtt ggagactttt 211800

aaaagctaaa gaatttccat gacttcattg tgcatttaga acagttttcc aaaaatggtt 211860

ccaaagagtt ctacactgaa atacaatcat tcttactgaa gacattttat tttttgcact 211920

aaaatgagct acccataaat aaaacagatt aaaatatacc cgtccctgaa agactgttag 211980

ctttgtgatt gctaataaag taatgacaat aataaacaat aaaaggatct gtcactctaa 212040

aaaaacaata ttttaggacg aagacagcaa atggctcgta agccttagga ccagtgttgc 212100

tgagtctgag ctgccccga agctcatttc tcatgactga agaaagatca caaggctgca 212160

gcttaatgac agtgtggata agtgagagga cagggtgga ccgaacacat cctagctgct 212220

ccatcatgta tgaggaaaca gaacatcca gactagagg gaaggggaa gccagataaa 212280

agtcagccca tcatttaaaa ctgaatcaca cgactcttat ctcatggact tgtgtactag 212340

catctctctc tactgctcag gccatactcc ttgcccacac tgggctaaaa ccagacacgt 212400

atggtacaaa acttccatgt cacattgcct ttatttcacc taatagaac tgagtctgc 212460

tgagattgt ctaccactgt aattaaacac aaaacttaa taacataata aaaatcatca 212520

tgataaggaa gtaaaaggaa tgttgatttt tctacatccc aaaataggat ccaccacctt 212580

aatgcctttt ccccatcaaa gtgcatgatg cttagtcaaa ctgggatgct accatggttg 212640

ctgccttcca actctttggt aagcttttat gggtgccatt tatttatctt agaaataggc 212700

cattactgta gcgttgaga aaatgtcact ttattcctgt gtcacatcca aatagaaca 212760

aaacttaatt tcctttttt tttcttcag attttgtaa catagtatcg ctaaaccaaa 212820

gcagacagca gctgtectct gtctcaagtc acttctctc cgagcaaagt caggatcatgt 212880

gacattcccc actcatttat gttttcccta atgaaaggat gcctctttgt gcctcaatag 212940

atagtttaga ttttttaata ttgttagtgt tgagagataa aactttggt acatattgga 213000

gagtaataaa ttgtgtgaa cattgataaa ctaacgcaat taccagcaag gtcagagagt 213060

cagctaattt agaataatca gtcctaggat ttfgagtgt cccctggaga actgcggcca 213120

ctttattaca gcaggagggt gaggagaaaa tggtgatta ggattgatct ctigtatctaa 213180

ttgtgggact ctgccattcc ttgttgacc aaaaatgctt agttagcaag aggaagcata 213240

gcacaactaa ttgaagacca tccttacac accagacaca ctaaaggaat tctagaaaat 213300

agcagacaaa ctgcacttga ggttattggg aagaggttgt taccattccg gtgcacgttt 213360
 gtatttcttt tgtaacgtgt cttcaacatc atagtcataa ataaaattta acatcttcaa 213420
 ttcatcttgg cagaagtttt cattctcctg ttcattgatct gagctgggtga aattctgagg 213480
 aatgaagtc atcagtacc ccttttttga tagagacata aagttgcttt ctgaaattct 213540
 gaggaatct aatgaagtc atcagtacc ccttttttga tagagacata aagttgcttt 213600
 aggattacct aagcatccga cagatcttca gagctaggaa gcatctcatg gtcctcacac 213660
 atccatcaac actgatttgc ttgcttatgg ataataaag agctgtgcaa acttctatct 213720

 aaacctgttt acttagacta tttaaattga ttccaaaagt gtaaggctaa ttatctgctc 213780
 acatcattat tgttctgata taatttagtt tacatctcgc ccagtcacca tcaggctctc 213840
 gtttctagga ctacactaat ttgaatgatt gtattaaagt caaactgagt aacatcctga 213900
 accttgccc aaaaacaaagt tcaattgaaa tgagattcat gtctggctgc caggcacatc 213960
 acaggcacca tcaaacctgt ttacttggga aaggcatttc aaacgtaacc tcttccaata 214020
 cataatcca tttgacaagg agtttacagg aagtaccaca gtggaaaaca acagaagcct 214080
 atccatgcag catcttggaa aggcattgaga ctgacagggt gacaaaacat cagagcctca 214140

 gactctaate ctggttggta acaaatgcc ttaaaattgt ctctgatag gagcatgcat 214200
 gcaaatatgt aatcacatg caagtagtaa atctagaata aagttggatt atctgaaat 214260
 gtccctctca ggtattatct ctccaaaagc aaaatcactt ccgtagatgg atttttattc 214320
 aatagcctaa aagacaatca ggaaatagaa ctaaaaatag tgatagatt tgctgcagtt 214380
 ctgattctaa atagatcat tttttccata ggcaaggagg ctgacagaaa agggagcact 214440
 cttaggagc cgaggggagg gaaggcatca gagcggagtg atttaagaca atacttcagg 214500
 gtctttgcca agagcccact cagtgaaca ctcttcaca acacacacag acacacacac 214560

 atttccctct gtactctcac ttgctattaa ctatggtaca aggtacttaa agctctctga 214620
 agaatgttga tatttttaga atagggtctt gagactacag ctagaacact cacagttatg 214680
 catggtgagt gcagactgac ctaatgcatt taactaataa ctgatctcaa atagatgcag 214740
 agggaggccc agctgtctgc cctttgtcta cagatttcat tcttaggagc gggctgggct 214800
 aatccctttg tgatgtaac agctccaggg ggttagtcac ttactgca ttattgaaag 214860
 gatgatgaac tggatgagg cccttaacag taagattgta ttaagcagaa tatgaggcca 214920
 aactctgtag ctaggatg tttggagtgt tttgtttgt tttgtttct tataaaaaca 214980

 gttgagacca tttgaaaata agtctaaatt tcctttccag gaaaaggaat ccatatttgg 215040
 cataaagaaa tacagtaact cagaaaaatc agaatatgtt tgtataatac attatatatt 215100
 attaaaatac agatattata ttatttggaa attcacacaa accaatgat ttgtcacaaa 215160

ttatgtccca atttgaatg cccaattcct gcagtttcac aaatttgagg aaaatgactt 215220
 tcagtgttat tttgagcctg gcatcataag atgtgtgtct aacccttacc aacatctca 215280
 ctggctaaga cctatgtgtt catctttcga gggcagtggt gtgtgttctt tggattagtt 215340
 tagcaatcca tgcctctga ctttaggatt cttcaagact gagcacttaa ttttataaa 215400

 aaaacaatct ctcacaaag aagtcaatgt tacttttctt ggtttcaaaa cacagcggcc 215460
 tcaaataaat tggtttaaaa atgcatcaca taggatattg tttcatcag aaagtacttt 215520
 aaattggttt caaaaaactg gtgtataatg ggatgagtgcc ccctgtgttt gccattcag 215580
 acagggttgt aggtcaattt ctcagaatga ccaaccaga ggaattgtcc atctcttgta 215640
 aggacacgtc aagttaaga atttgttata gatgtagga ggggagggaa aagatgaaca 215700
 gggctgactg gctacagaac ttctccttag tgacctagtc aacctgcca atgggtaaga 215760
 tcagagtgac ttcactggc tccaatgct tgagtacttg tccctctagt tgccatattg 215820

 gggcttctct attcagcacc caaaaaacac atttcagat aatattctct ttctcaacc 215880
 aacacctggt atcagattct ttctgaaac tgaaaaagga tgtcatgcta ttgtcacia 215940
 tccatagage agttctaac cagctttca taatcttagc acttatatac ttctagcaat 216000
 tatctataag gaaatcaaag tatcaacttt ttgtttcctt ttgtcttgg gttctgaata 216060
 tatgttatct ttcgagagtt tttttctca aagatattc atggtagtcc taagctctct 216120
 gtgaatgaaa ttgtaagtac agattcccac acaatattca attttctat ttgactaagg 216180
 ttgtctttc cagtttctga aggtcatttt acttccttac aagtttgca gttgtaaca 216240

 aaactactat gtatgtctat gtgtaagttt taatatgagt gtaattcctt aatttatitg 216300
 tgtaataag agtacaact gatgagttgt atggctcaag tatgtttaat gttgtaagag 216360
 agaaaccatt aactctctg caaaggggcc tccatttca tgttttaca gcaaggaatc 216420
 tgttctatt gctctgtgtc ctcatggga gtttcttgt tggttggcca ctatgattgt 216480
 gtgtgtgtgt gtgtgtgtgt gtgtgtgtgt gtcatactgc atctttcag gctttcctg 216540
 gtagtatgtt acctgagta tcttttact cacttgcttg caggcttgt tttcctaat 216600
 cagtgctgt ccatgctgt tgctcatatt ttaaattgag ttcattctga ttttactgct 216660

 gagcaataca agccatgttt tgggtcagtc atgtttcaa catggttttg tagagatttg 216720
 ctgacgtat gcagcttttc tcagtccttt aacattgttt ttcacaagta ggaactttta 216780
 atcataatat cagttatagg tttcatggat tatgactttg gtctgtgttt actagagtgg 216840
 ttgtttctgg gaggggtgca ggctaaggtc aggatgtact atatgagaga agaataaata 216900
 aaaagaagaa agaaaaaaga aaaagaagaa gaaaaaagta ccatacctaa agtcatctag 216960
 cttttgtttt gtttatttca ttttatttt tgaacatcag caaatcctaa tctgtaaac 217020

ctactacagt agigtcttc accttcctaa tgcgtgacc ttttaataata tctcttcacg 217080

tgtgataacg cccaaccata ttttcattgc tacttcataa ctgtaatctt gccactgtta 217140

tgaattgtag tgtaaatatc tgttttctca tagtcttaag tgacccttgt gacagagtca 217200

ttcaagccca aaggggttga gaagcactat gctacgtcat cttttatctt attcagagtt 217260

tttatgtact atacatgttc ccccttccat aaacaactaa gagtaagtta tgataagttc 217320

atgcttcttt cagatgactt caagtctect ccattggcag caggcatttg tgggtggtttg 217380

aatgaggatg acccactcag gctgatataat ttgcatgcta aattcccatt gaagttattg 217440

taaggattag gaggcgtggt cttgttggaa gaggtgtgac actgagggtg ggctttgaga 217500

tttcaaaagg ccatgccagt ctcagtcttt ctctctgtgt ctctccatca ctctctatct 217560

cttcttctct atctctctac ctctctcttt cctcctctc ccactccctt cctctctgac 217620

ttctctgcta accctgctgt tggatcaggt tgcaaaagccc tcagctacta ctccagtctc 217680

atatgtgctc acagccatga taacaaatga actaacctc tgaaactgta agcaagctgc 217740

caattaaatg tcttcttttg caagacttgc ctttctcatg gtatcttttc acagctatag 217800

aacagcaact aagaaaaat taaagaataa aacattatag tggaaatcaa actgttcaca 217860

agatgccatc ctttgttaat ctctatcct gagcatatct tatatagtta ctttagaagt 217920

tagctgttgt gtgttcttga tcacactaca tagtgaacga atggacagca ttccagtga 217980

agatcacatg tccaagagta cttagatata acagattggc cttgagaagt ctttttaag 218040

aaggatctaa ggttgagttg gtagggaaag agggctggat ctgggatgag ctacagagaga 218100

aaagatgaat atcatcaaaa cacgttgtat gaatttagag ggttaatttg atcaaaacat 218160

ggcatatata actctcaaag gataaaciaa ttttttaaaa atgcataaaa caatcctgcc 218220

tacctatagc ttatcatagg aggaaggtgg gctctgccaca caagtgaag aaaaaaagg 218280

tgagcaggaa ataatacttt ataacatgac acttgagaat tgtccaaaac caggaaaaat 218340

aaaatgtatc aaaccactga gtccagaatc tctgagaagc aagaaagata attacaaaag 218400

taaacagaac atacacatat gtctcattaa aatgaagag gaaataatta aatcagtcaa 218460

ggaaaaaaga taacgcatac tggacagtaa cactaataaa gatctgcgga agtggctctc 218520

agctccctaa tgcgtgatc ctttaataca gctgctcag ttatggtgac ccccaacca 218580

taaagtcttt cattgttact tcataactgt aatcttgta ttgttatgaa tcataatata 218640

gatataccat atggaggata tctgatatgt gacccccaaa ggtggagatc tgtgggttta 218700

ctctatagaa ccaactgtct atagggtaaa ctgagtacag tggcatatgt ttgtaatccc 218760

agtgcagggg aggcagagac aggtagagcc ctgagatttg atgacttgac tgcttgcaaa 218820
 gtcccagacc agtgagaaag cctgtctcaa agtgaaagca gacagtgcct aagtaactat 218880
 atcaggcatc caacatcatc ctctgccatc aatatgcaca gggcccaaca tacaaaaaag 218940
 ttaaagtgtg cttttcagaa attctgtgag aagataatga aatgcatggt agttcagaca 219000
 gatgataatg ctctctcctc caatgctctt actgaaatag ctaccatgga tctttaatag 219060
 ctatatgtcg ttggctttgt tttgttttgt tttgttttgt ttatgagatg gggctctcact 219120
 gtgtagccct gtctggcctg taacttgtaa tatatatcaa gctggctctg catttacaga 219180

 gatccaacat acaagtggga ttcaaggat gtgtcaaaag acccaagctg gtagttat 219240
 ataatgtatt nnnnnnnnnn nnnnnnnnnn nnnnnnnnnn nnnnnnnnnn nnnnnnnnnn 219300
 nnnnnnnnnn nnnnnnnnnn nnnnnnnnnn nnnnnnnnnn nnnnnnnnnn nnnnnnnnnn 219360
 nnnnnnnnnn nnnnnnnnnn nnnnnnnnnn nnnnnnnnnn nnnnnnnnnn nnnnnnnnnn 219420
 nnnnnnnnnn nnnnnnnnnn nnnnnnnnnn nnnnnnnnnn nnnnnnnnnn nnnnnnnnnn 219480
 nnnnnnnnnn nnnnnnnnnn nnnnnnnnnn nnnnnnnnnn nnnnnnnnnn nnnnnnnnnn 219540
 nnnnnnnnnn nnnnnnnnnn nnnnnnnnnn nnnnnnnnnn nnnnnnnnnn nnnnnnnnnn 219600

 nnnnnnnnnn nnnnnnnnnn nnnnnnnnnn nnnnnnnnnn nnnnnnnnnn nnnnnnnnnn 219660
 nnnnnnnnnn nnnnnnnnnn nnnnnnnnnn nnnnnnnnnn nnnnnnnnnn nnnnnnnnnn 219720
 nnnnnnnnnn nnnnnnnnnn nnnnnnnnnn nnnnnnnnnn nnnnnnnnnn nnnnnnnnnn 219780
 nnnnnnnnnn nnnnnnnnnn nnnnnnnnnn nnnnnnnnnn nnnnnnnnnn nnnnnnnnnn 219840
 nnnnnnnnnn nnnnnnnnnn nnnnnnnnnn nnnnnnnnnn nnnnnnnnnn nnnnnnnnnn 219900
 nnnnnnnnnn nnnnnnnnnn nnnnnnnnnn nnnnnnnnnn nnnnnnnnnn nnnnnnnnnn 219960
 nnnnnnnnnn nnnnnnnnnn nnnnnnnnnn nnnnnnnnnn nnnnnnnnnn nnnnnnnnnn 220020

 nnnnnnnnnn nnnnnnnnnn nnnnnnnnnn nnnnnnnnnn nnnnnnnnnn nnnnnnnnnn 220080
 nnnnnnnnnn nnnnnnnnnn nnnnnnnnnn nnnnnnnnnn nnnnnnnnnn nnnnnnnnnn 220140
 nnnnnnnnnn nnnnnnnnnn nnnnnnnnnn nnnnnnnnnn nnnnnnnnnn nnnnnnnnnn 220200
 nnnnnnnnnn nnnnnnnnnn nnnnnnnnnn nnnnnnnnnn nnnnnnnnnn nnnnnnnnnn 220260
 nnnnnnnnnn nnnnnnnnnn nnnnnnnnnn nnnnnnnnnn nnnnnnnnnn nnnnnnnnnn 220320
 nnnnnnnnnn nnnnnnnnnn nnnnnnnnnn nnnnnnnnnn nnnnnnnnnn nnnnnnnnnn 220380
 nnnnnnnnnn nnnnnnnnnn nnnnnnnnnn nnnnnnnnnn nnnnnnnnnn nnnnnnnnnn 220440

 nnnnnnnnnn nnnnnnnnnn nnnnnnnnnn nnnnnnnnnn nnnnnnnnnn nnnnnnnnnn 220500
 nnnnnnnnnn nnnnnnnnnn nnnnnnnnnn nnnnnnnnnn nnnnnnnnnn nnnnnnnnnn 220560
 nnnnnnnnnn nnnnnnnnnn nnnnnnnnnn nnnnnnnnnn nnnnnnnnctc tctctctctc 220620

tctctctctc tctctctctc tctctctctc tctctctctg tgtatgtgtg tgtgtgttat 220680
atgtgtgctt gtatacacgt gtacacaggt acatgagagc aagagcaaag gtcaatgtct 220740
tctataactc tttgctgtgt tcttttgttt gtcttttggtt ttgttttagac accgatccct 220800
catcggcctg gagctcgtgg tatagctaga ctggctggac agtgagtccc agggatcccc 220860

ctgactcagt gtcctgcca gctctgcaat tatggttgca ctaccactgg ggatcaaacc 220920
taggtgatca tcttacacag caagcacttg attcactgag acacttccaa cctcaacggg 220980
ggccattagt agcaataaat atactaatcc aatgtaaggt attaatgatg aggaaattgg 221040
agggggaact cttttgtact atcattatgg ttttccata aacctaaatg tctctaaaag 221100
attcttttct aatgcaatta aggtaaaatt ttattaatgt cacaatttat atatcagatt 221160
tatcactaac agaacagaac atcagtacat ctctctgtgt gaaaataaaa tatgagggtt 221220
ggtgatgtag ttcagcatga gtgaggcttc aaattcaacc ttcagcccag caagaacaaa 221280

cagaacaaag acaagatcca cacccatcta aatatcaaag caaaatagaa ttaacacttt 221340
ggttttctct aagaagcttt tgtttaaaaa aaaaaagtgg tgttcaattt ttgagaatac 221400
aaactagcaa aaaaaaatc tcccatctgt aaataatgtc ttgccaaata atgtgctttg 221460
tatcagataa atgaatgta aactctagca tacatttgtg atgtgacaat taggtatgta 221520
attatttggc aggatacatt ttcattgtctg taagcaaaaa attaaatatg caatataatt 221580
ccagggcaaa cagttttcaa cattgcttat gagtagecct tctacttct ccaccctat 221640
aattactaca gatcatcaaa attgaagttt ggcaagtcga agacagtagc tgaaaacgta 221700

agagccccgg gccgactctg caatacttgg cagaaggact gggggtgagg gagaagaaag 221760
caatattctc ccagaagtca gactcaggaa gagtgtctgta ttcattcagg tgacccaaag 221820
tctggagtgt cagataacat aggtcaactt attccaaaga atcaaagatc accaccagag 221880
tctcagaaa agaactcgc atcctgctta catctgtctt tttggcttct ctttgetteg 221940
cacggctttt atcaccactt ggggggcaag ccaaacaggc aagggcgcct tcccaccac 222000
taagtcattc ataaattatg tgttttctga gtcaagaaga cgcttatgat tcaaatgat 222060
tgcttggctt tttcccctaat aaaattcagt catttattat atatttcttc ttcattctca 222120

atacgatttt aaaatataaa ctgatttttg taatccatga acatcgtctt tttgttttat 222180
cttctgtctt cttcttatat gtcaacctgt cagaaaactt ttgtacttac tttgagcata 222240
tttcaactta aaaaaaaga aggttgaagt tgtaaatgca caacacttag tctttaatt 222300
agtaggcaag gtatttgcca agtgcacact attgtgcctt taggttgtat gtccacact 222360
agcagagcac accagacaaa cttttcttcc taaaatgatt tcaaaacaat ttcatttcaa 222420
atgatacaaa aaagcccaaa atattgttta ggaacaaaa ttttttagtt taattgttac 222480

atagatacta tttatacctg gtaattatit tgaacaagtc gtaagtacaa ataaatatga 222540

 atgaaaatga gaaatagigt tttattatgt atatatgtgt atacatatgt atatgtgtat 222600
 acaaatacat attctatatt ttctttctcc attcateccac ttgctcactg gtatacactt 222660
 gtacggcttc catttctggg ctataatgaa tactgctgga ggtagcatag attagcatct 222720
 ctctgaggtg gcaccttcag ttctctgga tgtacactga taagtgggat tactagtta 222780
 tatagtcatt ctttttagga attcaaaggt tccttggtc aaaaggagat tattgttaag 222840
 ctaaattatt tcagccaaat tcttagcaca tgcttctca gtactgtaca ctctgctcat 222900
 tccaaagccc caaaggttaag ggtggaattt gcgactaagt gcttagggag tttatataa 222960

 tctgttagaa cacttttata tattagaact aacaatacta tgcctgggct tctggtttgt 223020
 atgtctttt aaactttcat tcttactgat ttatgttata ttttgcaaaa tattgatata 223080
 taagcttagc attttcaaaa aatattttta atgggtactt cacagaagcc taccactgtc 223140
 tttcctatt ctacgcaaag aaattaaact tgcagtggta aagtaattgc tcagttttca 223200
 accccaaaat tctgtttgtc agtgcctatt cctgacatcc tttctctatt tccagtaaca 223260
 ctgtttgcat ggacactgag tctgcattt cattgcatgg cacgttttgt cttctaggat 223320
 catcaaggaa attatgagtt gtaccaaac accattttcc tttataggca aattatgaac 223380

 tcgctgtccg tggtttcttt tatgcacttt ccttattctc ctgcacatc ttaatctctt 223440
 gtatctacac aataataagt aatgtttgct ttctttccat tatgtataaa tgtaaagcct 223500
 actgtcgcct gacttcacca ctacgcagat cttttgcaca tggtttgata taagatatgg 223560
 aggtttgcct ctctttttt agctttttat tttgaagtag ctttaaatc attataatta 223620
 aacctcaaa aatgtttaca agaaaataat tacaactga ccacaaaaa agcttcacc 223680
 cctttgaaat ggagtatttc tctgcaatgt tctctaagtg taatgtgata aatcagaaa 223740
 taagtagaca gactctcagt tttctcagat aactaaaatt ctagtatgt tttcctggga 223800

 accctgttta aagggtagta tgcaggtata aatgcattca ttgagccaga taaagattga 223860
 aaacaacctg cttgtccttc acatgaaaaa tgtctgttat gtaatagaag aaattcaatg 223920
 tgtgttaagc agcatcatca aggataaagc taacgcaatt caggagaaag aagagggcag 223980
 gagagaggat gagaaaalca ggagggttc tttattatag aagatgggtg gggtttgtta 224040
 taagatatag tgagatatc tcaaggctaa gtagtagacag tgatcaaagg gaccattgtg 224100
 gaaatctaca ttttttaggt tttatttta agtgtgtgtg tgtgtgtgtg tgtgtgtgtg 224160
 tgtgtgtctg tgtgtctgtg tgtctgtgtg tctgtgtctg tgtgtctgtg tgtctgtgcg 224220

tgtgggcatg tgcatctgag tgtaggtgcc cacggtggtc agtgacattg gatccctga 224280
 agcaatgatt gtaagccacc ctgtgtgggt gctgggacca agcttgggggt tttcagatcc 224340
 agacctgaat actctacaag gacacgaaat atgtataact actgagtcatt ttctccaaac 224400
 ccaaccaacc tacataaaag cggttttatg ctttatcttc ttcatacata catattgttt 224460
 ctatttgacc tagattcatt gtacatgggc ctgaatttca taaaaaagt ttatgcaagt 224520
 atacaatgta atttgatggg atttcttccc cctccttcc cttcgttgcg gttcccaggc 224580
 ctgctacatt cttttattca cctagacagg ctcaattata cttccatggt gtggatacct 224640

 atataatfff gtgtgtcaat acaaaatcta gaaccacaa atgagaaaag acatgtatct 224700
 acctgagact gactttcttc cttttacata attatctcta gttttacaca ctttctgta 224760
 aacattatca tttcattctt atttatggct gaaaattatc ccatagttca tattactaca 224820
 tttgctttgc atctgtttgc agggagaaga ggaagccctg agagagtgtg cattgttgac 224880
 tgagacacag ccatgtcaaa gaaccagag cctgaggcca cgaggaatgg aaaagcctcc 224940
 ccaactgggag gctcagaggc atagaaaagg ctttccctgg tccatcttcg gatgctaaca 225000
 gtgtgtgcag aaaaatgcta ccatgactgt ttaccagat cttttggaat gcttaggttt 225060

 ctccatcaga gagcccaata caatctatcc caggctact tctctctctc tctctctctc 225120
 tctctctctc tctctctctc tctctctctc tctctctctc gcgcgcgcgc gcgctctctc 225180
 tgtgtgtgtg tgtgtgtgtg tgtgtgtgtg tgtctgtctg tctgtctgtc tgtctgtctg 225240
 tctgtctgtc tcttttctc attccttcc tggctcagtc agattctagt cctcagaggc 225300
 catgcaggga cttaccacta gtctctgtg gatggacacc tagaatgctt ctgtctcggt 225360
 tattgtaaat agtctccgg taaagatgga tgagcaagtg tctctgtgat gctgacttgg 225420
 agtcctctgg gctccaagga taccaagga tcctaggaga gggatatttt ataaaatcat 225480

 taacatgatg gaggtaaac tttatctttc tgacaccatt taatcttget tctctcccc 225540
 tgccctctctc ttttggtttt tgggacagg gtttctctgt gtaggtttgg agcctatcct 225600
 ggcaactgct ctggagacca ggctggcctc aaactcacag agatccgctt gcctctgcct 225660
 cctgagtgct gggattaaag gcgtgcgctt cagatgctgg gcttaacctt gettatctct 225720
 taaaagctgg tctctaaca ctacattgt ggattagggc tcaatcctat gaacttgag 225780
 agtctccage agaggatttt ctgctgcttt gcctgtggaa tgcttgcctt tttgtagcag 225840
 gagtcaaaag atgagtgaat gccagtgggt tggagcacta tgcatcctct ccgagttggg 225900

 agacacagga agccacttga cgggagacta aggcaggcag aaatcaaaga gcacgtgtcc 225960
 caaagaaaa gaagttttct catgtaaatc agttgttttc cactccagtt cctgatatgg 226020
 aaaattagca ttttaagtct ctattgtcat catagattta taacatattt gctaaaagcc 226080

atcagcaata ttaataatca tgagacgcca ataatcattg ttcctgagtc aaaatTTTT 226140
 cttaacaat attacttttc taatttaact tttgttttcc cttgagaaac aagtgtgctg 226200
 tttctcattt gcctggTTTT attataagtg ccaggTTTT ttagccaagt gctccaatgt 226260
 atttatctaa gatctatgaa gatggTTTT caaataggcaa acaggTgatg tactgttttc 226320

 attctTTTT tttctttga agttcctctt cacatagccc tctgaactac ttggTTTTgt 226380
 tttcctggta ataccaggcc aattaatctg atgattgagg cagttaatca acagacaggt 226440
 agtacataca gcgtgaacac actggacaga gtgacagtcc actttctagg tgagacaggc 226500
 cagaatggta caggagtTca acacattact cagaaaataa gcaattaaaa acttaattgt 226560
 ttatttctgg aaataatatt caccacttac tcttagggac agtacatctg cctgagtTct 226620
 cttgtcatgt gggTcact agaaacactg tctcgctgaa actcaggtat gtgggaaaa 226680
 gtgtggaata tgtgtacact cctcccaatt tgcTgTaaac ttaaaaatgc tttgaaaaaa 226740

 tggTTTTcaaa aaattatcct tgaacataga ataaaggaat acttttaaaa gactgactaa 226800
 aaactTgaac aaaaaaaaa taaatgtaa agtcgggccc tgatgacaca agcctttgat 226860
 cccagcactt agaaggcaga ggcaggTgga tctctgagtt tgaggccccc ctagtctata 226920
 gagTgagTtc caggacagcc acagctacac agggaaactc tgtctcaaaa aaatataaat 226980
 aaatatTTaa atatagtata cagtaataat ttccttaatt tctgatttt tgaaggacac 227040
 atccccaaaa tagataacat attttcagtg tagccaaact acttataaat tgtcacaggc 227100
 aaattTgggc ataggctTga tgtagatatac aatctctgct ttcacagatc gcaggTTTTg 227160

 ctTgatgTca tgetcatgag atgtTgcata taactctcat ttgtTcattg taattgtata 227220
 tggcataata caataactTg aaattctgtt ttTgaagatt ttgtattTgt gtgtaactat 227280
 atatgtatgc atgggtTgt gtgtgtgtgt gtgtgtgtgt gtgtgtgtgt gtgggtTgt 227340
 gtgggtTgac acaggaggcc agaagcgggc ctCagTtacc ctctctatc atttaatcat 227400
 gtattctttt gaggcaaggt ctctttctga agctggagct cgtgtttTgt cacaaagctg 227460
 gaagccagaa agtcccagtg attctcccat atctgctcct ctCagagctg gggatacagg 227520
 catgcaccaa atgctcgact cattacatgg atgctgccat ctgaactcta cgcctttatg 227580

 attgttaagt aagcaccttt aaccactgag ccatttctcc acccctcat aatctcattt 227640
 tttcctaate tatttaatga gtggTTTTat gtggTTTTtt tcatttcccc cattacatca 227700
 acactactgt aaacattcct gtccatgtgt ttctgaggTc tacacaaaa tggTatgtgt 227760
 ataaaaacat ggtgaaactc atccatttta tgctaactaa attttttaat taaattgaaa 227820
 aatctgtgaa gtaagactta ttttctcaat gtgagcagtt agaaaattaa aaatTgcag 227880
 gcgacaatat gggggccttt agagcagaac catctctgat tgactcagag agcaatgctc 227940

tctacactgc tgctctccaa attacagcac aaggaggact cccctgagag tgacttcagg 228000

tgagaataa gactaccggt ggtcacagaa caacatagcc aggtactgca accagcagcc 228060

tgaggagccc ttttaccct caggcaaac cacatcctga actatgca aaaaagaact 228120

ttactactag gcaagtgtc caaaattgat gaagtttatt annnnnnnn nacaaggttt 228180

ttccctgcaa gttaaactgt tagaccaact ctttaggag ttgtgccat ctaacttggg 228240

cactgaagct acactttctt catgcaataa ggagaaagtg tccatctgt aacactcctt 228300

ccctagaaag gaattacctt tttctatgc aactggtaga cttcactctc tgaactatcc 228360

tcttgggaatt cttttaaca ggtacatttt tttcccaat gagagagaat tctcatttct 228420

ctctcttttt attaggataa gtacactctc ctatgtcttc cttagtact cttaatagtc 228480

tattaaaaat cattcattta taagattttg tgtttttgat aaaacatata tcagattctc 228540

tcacactttt aatattctac catatctgag gatgcacat atttctcat tttttttgtt 228600

tttgtttttg ttgtgtttt ttttaatgag actaactttc cattttttta ttattattat 228660

taattcaagt tgaggaacag gcttgtttca catgtaagtc cctctcctt ctccctctcc 228720

ctccctctac ccccatcctt cctctcccac ctccaacta cccccaccc cannnnnnnn 228780

nnnnnnnnnn nnnnnnnnnn nnnnnnnnnn nnnnnnnnnn nnnnnnnnnn nnnnnnnnnn 228840

nnnnnnnnnn nnnnnnnnnn nnnnnnnnnn nnnnnnnnnn nnnnnnnnnn nnnnnnnnnn 228900

nnnnnnnnnn nnnnnnnnnn nnnnnnnnnn nnnnnnnnnn nnnnnnnnnn nnnnnnnnnn 228960

nnnnnnnnnn nnnnnnnnnn nnnnnnnnnn nnnnnnnnnn nnnnnnnnnn nnnnnnnnnn 229020

nnnnnnnnnn nnnnnnnnnn nnnnnnnnnn nnnnnnnnnn nnnnnnnnnn nnnnnnnnnn 229080

nnnnnnnnnn nnnnnnnnnn nnnnnnnnnn nnnnnnnnnn nnnnnnnnnn nnnnnnnnnn 229140

nnnnnnnnnn nnnnnnnnnn nnnnnnnnnn nnnnnnnnnn nnnnnnnnnn nnnnnnnnnn 229200

nnnnnnnnnn nnnnnnnnnn nnnnnnnnnn nnnnnnnnnn nnnnnnnnnn nnnnnnnnnn 229260

nnnnnnnnnn nnnnnnnnnn nnnnnnnnnn nnnnnnnnnn nnnnnnnnnn nnnnnnnnnn 229320

nnnnnnnnnn nnnnnnnnnn nnnnnnnnnn nnnnnnnnnn nnnnnnnnnn nnnnnnnnnn 229380

nnnnnnnnnn nnnnnnnnnn nnnnnnnnnn nnnnnnnnnn nnnnnnnnnn nnnnnnnnnn 229440

nnnnnnnnnn nnnnnnnnnn nnnnnnnnnn nnnnnnnnnn nnnnnnnnnn nnnnnnnnnn 229500

nnnnnnnnnn nnnnnnnnnn nnnnnnnnnn nnnnnnnnnn nnnnnnnnnn nnnnnnnnnn 229560

nnnnnnnnnn nnnnnnnnnn nnnnnnnnnn nnnnnnnnnn nnnnnnnnnn nnnnnnnnnn 229620

nnnnnnnnnn nnnnnnnnnn nnnnnnnnnn nnnnnnnnnn nnnnnnnnnn nnnnnnnnnn 229680

nnnnnnnnnn nnnnnnnnnn nnnnnnnnnn nnnnnnnnnn gtggcagcac cctctcccct 229740
 accctcatgc tctcaattag ctcgggagtt catgccactt cccattcctg gggtccattt 229800
 atcccttaga gtccttcatg tttcctagtt tcttttgtga agaggattat aggctggtaa 229860
 acctttgctc taigtctaaa attcatatat gagtgagtac ataccatgtt tgtctttttg 229920
 taattcatal ttctcattt ttgttgggtc ttttgcccac ttatttcttt gtatagtta 229980
 ctaaacattt taattgttat attgattatt tcaaggaaca aatcttggat gttttattct 230040
 taacacatat attacattta gtttactttt atatggcaaa tgcacgattt ctactttttc 230100

 tactcccctt tacttacatt tgttttcttt ttaccaagtt cttgagataa attctttgtc 230160
 catttatatt caatcttcta tctctattt gatgcatcta gatccataaa gtttcttaag 230220
 tacgggtgtg gctatatccc acaagcttaa tacatgagcc actttctctt ttcatttcta 230280
 aattatttat agctgaaact ttattccatc ttcagagtgt ttttaagattt tgaaaagaac 230340
 tacattttgt tattgctagt atcatttgca ttgtgtaaaa aatatatcca ttatcatctc 230400
 aagtttggaa aaaaattatt ttactttaat ttgttttata atacatggca aatttatgtg 230460
 atgttctatg tattttggaa tcaattgtga tgttgtcadc atttaagtat ctaatatatc 230520

 agtcacaata attattattt gaatattgta ctttcttgtt ttagagtttc ataactatt 230580
 gaggttctga aggcacccct ttttggctct aacattttac tttcttcaat aaaatataag 230640
 tagtgcaga attgcttgtt cactctgagt cccaggttct tcttgttgat tacttgtatt 230700
 atatatatat atatatatct atatatatat atatatatat atatatatta tttcatataa 230760
 gaactgtcca caaataacca caaagctgaa gaaaaaggga agtagatacc agatggggca 230820
 tgatgctatc tactgagaac tcactgaaaa agatctatca gcgttgtcaa caacctttat 230880
 ttgaaaattc atgacttggg tctgaggagg aggcttctgt tgcggtcagg atacaagtga 230940

 ctgttatcca ggcgagaata tagcctgttc atctcacact gacattgaag aactgggca 231000
 ctctactgga gctgatggca ctgtgtcca tttgtaaagc tccatggaat gttgagaaag 231060
 tgttggggaa gcaagccagt acttagggcc agtcaaggcc attacattac cccagtagag 231120
 aaggctcttt cagcacctta aacttctgtg tgtttggaga tatacgggct gtacctctac 231180
 agccaatgga ctgactcatc caagcaagac ctgatggggg atgtctttgt atatatatgt 231240
 ttctcttatt ggttgataaa taaaacactg attggccagt agccaggcag gaagtatagg 231300
 tggggctacc agatgagggtg aatgttggga agaggatgca gagagaagca gccagagaga 231360

 taatatgtag gcagttggga agataggaca cgggtattc tctgtaaga taaggccatg 231420
 tagaaataca cagattagta gttatgagtt aataattaag agagagcaag ccagtaagta 231480
 gcctaagcca ttgaccaaac agtttctaataa taatataagc ctctgtgtgt ttatttgggg 231540

ctgaagctgc tgiaggacca gatgggatag agacaccatt ctacaacac cattccagac 231600
 taagcagttc cttaatgtca aagactttat ctctatcatc atagtcacca gagcccagag 231660
 ttctaaggcc gtgctgagtg aagttaaaga cttcctagaa ttcaatgaga atgaagagac 231720
 aacacaccca cacttatggg atactttgaa agcagtgcta agaggaaagt tcatatcact 231780

 aaatgcccac atgaggaaac tagagaatag tcacactaga aaattgacag cacaactgaa 231840
 agatctacaa caaaaagaag caaactcacc ccgaaggagt agatgccagg acataatcaa 231900
 attgagggtt gaaatcaata aagtagacta ggaaaacaat acaaagaacc aatgtaacaa 231960
 agagttaatt ctttgagaaa atcaacaaga tacacaaacc tttatccaaa cttaccaaac 232020
 agcagagagt gaacatataa attaacaaaa tcaaaaatga aaagggggac ataacaaggg 232080
 acagaaatcc agagaatctt caggtcattc tttgaaaacc tgtactcctc aaaattcaaa 232140
 aatctaaagg aaatggacac caattctcct caaagtattc cacacaatag aagcagaagg 232200

 gtcattgcca aactcttttt aggaggctcc aattaccttg ataccaagc cacacaaaga 232260
 cacaactaag aaagagagct acagaccaat atccctcata aacattgatg caaaaataat 232320
 caataaaata ctggcaaat tgaattcaagg tcacatcaga agagtcaccc accatgatca 232380
 agtaggcttc atcccaggga tgcagggatg gttcaacata tgaaaatcca tcaatttaat 232440
 ccaccatata acaaaactga gaaataaaaa tcacatgata atctcactag gtgctgaaaa 232500
 agcctttgac aaaaactaac actccttcac gataaaaagtc gtggagagat cggggataac 232560
 aggaacatac ctcaacataa taaaagcaat atacagcaaa ccaacagcca acatcaaat 232620

 aaatggagag aaactcaact ggattcctct aaaatcagga acaagaaaaa gttgtccact 232680
 ctctccatgc ctcttcaata ttgtgcttga agttctagct ggagcaataa gacaacaaaa 232740
 ggagatcaag ggcatacaaa ttggaaggc agaagtcaaa ctttactat ttgcagatga 232800
 tatgatagtt tatataagca acccgggaaa aaatctacca ggaactccta cagctgataa 232860
 acaccttcag ctaagtggca ggatacaaga ttaactcaga aaaatcagta gcctaataat 232920
 atacagaaga taaatgggct gagaagaaa tcagaagaac atcaccttt acaattgcca 232980
 caaacaacat aaaatacctt gggatgatgc taatcaaca agacctgtat ggcaagaact 233040

 ttgagtcttt taagaaagaa attaaagaag ataccagaaa atggaaagat ctcccatgct 233100
 cttggatagg taggatcaac atagtaaaaa tggcaatctt gccaaaagca atctacagat 233160
 tcagtgcaat ccccatcaaa atcccagcac aattcttcac aaaccttgaa agaacaaatc 233220
 tcaactttat atggtaaaat aaaagacaca ggatagccaa aaacaacat gtacaataaa 233280
 ggaacttttc aaggcatcac catccctgac ttcaagctct attatagagc tatagctgaa 233340
 aacatcttgg tattggcaca aaaataaaca ggttgaccaa tggaattgaa ttgaaacccc 233400

tgctattaac ccacacatct aagaacacct gatttttgac gaagaagcta aaatcatgga 233460

 aaaaagaaag catattcaac aaatggtgct actataactg gctgtgtca tgtagaagac 233520
 tgcagataga tccgtatcta tcgacaagca caaaacttaa gcccaaatgg atcaaagacc 233580
 tcaacataaa tccagccaca ctgaacctct tatatgagaa agtaaagata aagcacctc 233640
 aaacaattgg tacaggagac cactttctga agataacaca ggtagcacag aactgatat 233700
 tgacaattga taaataggac ctctgaaac tgagaagctt ctgtaagaca aaggagacag 233760
 tcaacaagac aaatggcagc ccacagaatg ggaaaagata tccaccaacc acacatctga 233820
 cagagggatg atctccaaa tatacaaga actcaagaag ctagtcacca agacaccaa 233880

 taatccaatt aaaaagtggg gtatagaact aaatagagaa ttctcgatgg atgaatctaa 233940
 aatggtgaa agacacataa gaactgtctc gacatcctta gccatcgggg aaatgcaaat 234000
 caaaacaact ctgagatacc atcttactcc tgtcaaatg gctaaatca aaaacacaaa 234060
 ggacagttta tgctggagaa gacatggaga aaggggaact ctctccact gctggtggga 234120
 ttgccaactc gtacaaccac tttgaaatc agtatggcgg ttcctcagga aactggaaa 234180
 cagtctaaca caagatccag caattccact cttaggcata aatccaaaga atgcacatgc 234240
 atacaacaag gacatctgtt caactatgtt catagcagca ttattttaa tagccagaac 234300

 ctggaagcaa catagatgcc cctaaactga agaatggatg gagaaaat atgtacattta 234360
 cacaatggag tactactcag cagaaagggg aaaaaaatg gaatctttaa atttgcaggc 234420
 aatggatgg aactagaaga aaccatctg agtgagtaa cccagccaca aaaagacaaa 234480
 aatggtatga actcactcat atacagattt tagacataaa gcaaaggatt accagcctac 234540
 aatctacacc acccgagaag ctaggaaaca aggaggacc taagagagac atacatggtc 234600
 ctccagagaa gggtaaggg acatgatctc ctgagcaaat tgggagcatg ggggaagga 234660
 gaaggagtta gaagaaagag aaggggagaa gagggggta gaggaagaca tgagacagca 234720

 ggaagattga gtcaggggaa aaataaagga aagagatacc atgatagagg gacctttat 234780
 aggtttaag agaaatctag cactagataa ttatccagag acctacaagg ttgaccccaa 234840
 ctaacaatct ttgcaatagt cgagaggcca ccttaaatgc cttcccgat gagactgatg 234900
 actaccttat atgccatct agaacttta tccagtagct gatggaagca gaagcagtca 234960
 cccacagcta aactctgagc tgaactctgg aatccagtg cagagagga ggagtataa 235020
 gcaaaggggt caagaccagg ctggagaaac ccacagaac atctagagt ctgaacaagg 235080
 agaagctcat ggagcctaga ctgattgctg gaaaccaac atggactgtt ccagacctc 235140

tgaacatgga tgcagtttg gaggactggt taatttggg gccctctggt agtggatcag 235200
tatttatccc tagtacaaa atggactttg ggagcccatt ccacacagaa ggatactctc 235260
tcagtctaaa cacagagggg agggctctagg ccctgctcca aatgatatga cagactttga 235320
agatccgcct tagaaggctt caccctccct ggggagcaga aaggggatgg ggagaggtgg 235380
gggacagagg aggaggggag ggagagggaa ttggggtga tatgtaaaac aagggtgttt 235440
ctaattttaa ttaaaaacaa attttacttc acaaaaaaaaa aagagcctgg tttcatttct 235500
aaaccagatg tattttacag ggacagagga cctatcttgc aggggaacct gtagccaggc 235560

atagtcaggg tgacgtagag taagaggttc agggctgctt ttcacttttg ctacgcccc 235620
tgtccatt gttgtcactt aggatagtgt atgtacctag ttagggatag cttcctattg 235680
tttatggttg ggattggaag gaggtgttca ggggtagaca cctctttcag atgactttag 235740
gatttagtta aaatagatag ttaggatgtg acataagcag attgttgtat cttcttata 235800
ttcactttta tgattgttca ttttgatac tttacagtgt taagttttaa tcctctttta 235860
gactaaaagg ggaattgtag gggaacctgt agccacgctt gcttagtggc gtggtcaggg 235920
tgatgtagag taagaggttc agggctgcat ttcactttag tttcccttcc agcttgctgt 235980

acagactgct gccatggcgg ctggctaggt cactctgtaa gtaaggcttt tcctgttaa 236040
atacccttat atttcttggc tccgtattgg taatttccca ctatactatc taattttttt 236100
taatactga actatgaaag ctgaccttat caaaatagaa acaaatattc cattatgatt 236160
acataactgt gtatgtggga ccatggaaaa agctcctagt gtccatgtct ttcagaggtt 236220
tggagcttga aatgccccaa tctaagtgtg gctgacatgt gttgtttatc caggtagatc 236280
aggaagtgac tgagtgggtt ggagctgttg gtatttactg aatgtaaaga agtgttcgt 236340
gcagatctgc ctggttttct tggcctctc tctgtctttt cttgtcttct gatctcacac 236400

ctaaaatgca gattcttttc ccaacacaag tattaaagag gagcatcca ctttgccttt 236460
tgttttggtt ttcaatcttt gctttccaaa agctaaaagc agctttctca tccacacagc 236520
ccagacgtcc tttcagggtc taggacaaac tgatgcaaac aaagccttat ggatagcac 236580
tttggaaagt ctccaagctt tccaatgtc caaccacac aggtccaggg atgtgtgtgt 236640
cctatccata aggatgttgg actttgcata aggcgtgtct tcagaagcaa agcttactct 236700
actctggaaa gcgtatgtag gcacctctgc ttcaccgct gtagtcttat cttcattatc 236760
gggtgcgaaag cccacagagc aacgttttct caataatgtt gaccatgtag ggcctcaaaa 236820

gggtgtcagt gaccctgaga ggttcacaga tcatgcccta cctacaacta agggacttct 236880
agaatgcaat ctaggcacat ctagaacgcc atccaggcag gctgggaatc gtcactgtga 236940
tgaacaggac acctgagtga ggatcactgt ccttgattct gtgtttcctt cctcagtagt 237000

ccatgaaaaa tigtattca ggagagctct tcctctcaaa gggaggatgt ctctgagagt 237060
 tccccacagg gtttgaggct actgtctagg aaagacagga tgcatccaca gtggttcgat 237120
 ctcagaaaca aagaaaaagc aaaacaaaac catggaacca aaagcaaaag aacctggaa 237180
 cactgcagtt tigtctcagt tctcagccct acagaaattc ttagaaccta aaacaacaac 237240

 aacaatttaa agaacttaa actcaatgta acaaatitgg aggtgggtaa gaaaaagaag 237300
 aaaaaaatt taatacaact atttcacttt cagcaaaaaa aaagggaaga aatattagg 237360
 cctttgcttt ctaaatttaa gtgtatattt gggggctctaa gttacttcag gaacaattt 237420
 ctctattaat atgtatgaaa agaaatttat agcagctatc atgaaataca aagcaaccag 237480
 gaataaattc atttaataaa agaaattgag tigtctgtat atatccctag atgttcatt 237540
 taaaatattt caccaactta atctagtac ctagttagta ggcaattaca cactgaagat 237600
 ttagagtcga tacagattta gggttcagtt gtgatcttgg aggcttctca caaacactt 237660

 cttacgggaa agcaagcccc ttggcaacct ttgcatcatt gtgttcaatt aagtgacaat 237720
 ttattctgtt ttgtttgta atggggctcg tcatttactg tcattactgg tccaccagag 237780
 agtattctct ttgcttttct cttcagaata aatctgagcc atcgagagt tactcttctc 237840
 agcagtgaga aagcttgga ctaatgggaa gccagctcca tctagctgtc catcttgtgc 237900
 tattcctctg gccacatcca ccagaggaat atcttgtgtc atcaaagtcc agcttttcta 237960
 aattagtccc ttgccaaatg cagaggtctg tgacttctgt tctgaaaact ttcaaagggg 238020
 ttggtgctca ttcaattatt tctgtgtat tttccccttt tgttctcca acatgaagct 238080

 ggttattcta aggaaagagc ctaacatttt aggcaggtta acaggtaac tgattaagtg 238140
 ttgaaatcgt attatatgtg agattgttta ttgtgtgcat gtgggtcttt atcaaaaaa 238200
 tgctaagcag gtctctgag acttccaaag aagtgtcttc cagtctctct tgetgaaatc 238260
 aatcaaaaa tatttagcat gtggaaatgg tgtgtagcca catgcatctt tattagactg 238320
 tgccaatatt aaagagattt acagaaaaa acaatgcttg ttgcacacat ttctacatt 238380
 gttgttatta aattattctt aaatttghta aattactaag ctctctaate catgcttctg 238440
 agcgagttag gaattgcact gtcaccacag tttatcact aaagagatat getaacatct 238500

 ttataaatc actaaaatca ctttctactt caaagagctc tacatacatt tcaaacatg 238560
 tggtttttaa cacatttca gtgcatttcc atcaatattt cattttgcta tcaccagct 238620
 ttgcctctca tcacaaacag taaagcagcg ggccagtcag gcagttaaac atagcttggg 238680
 ttggggaagc acattacgt atgttcttca ttcaaatagt aaaatagct ctgagggaca 238740
 aaggactate tgtaaacaca aatattggtt tataaacctc tcagactcta aaaaacaggg 238800
 tacatacacc agatgtgatt tctcagattg tgccatgtcc tatctggctc acaatctgc 238860

atttgtactg gtagcaatca tacccatgaa acataaaaac gtcattgttg gagatctcct 238920

 gaagctccct gtcgttacag gttgggcact ggccatgatg cactcattca tccatccact 238980
 caatacaatt ttgcaaatct actgcaaaca catagtctca cagtgagcta tgtccttaga 239040
 cccttaagag aaaacatgtc ctcagatttc ccaccacaa gcattataga gacaatgtaa 239100
 agaatgataa attggcttta cttttctaaa tataatcaat tctctttgtg gttaaagcac 239160
 atgccttttc ttaaaagcca ttgacatcca ccaatactac agcatgattt tgatcatcag 239220
 gaaaactggc agaaagaggt gcactgaaga aagagtcagg gcttctagca atcagaagtg 239280
 agacgcagca ccatacaaca tgaaggacaa cgaggagctt ggagtgagca ctcaacaact 239340

 gcagagagct cgiaccagga gtcgggtgag gcacgtctgc tggctcccag caccaccacc 239400
 actagtgtgt agccatgagc aacacgcagt tgctaacttt cttttgcttc acaggcaaac 239460
 tgaaaatggt aaaaagaaaa ccactaaaat atataaatc tgtaagcttg aggtcttgac 239520
 agtctcaaac ttgcctagga caaggatatg cccaactta gctccaaaac caaatcatat 239580
 tttggtcaaa cacacaaaag gaaagctttc taggccattc tggctgcagg atacattcac 239640
 caaatacaca ccagatatcc cccaattgat ctgaatctct ggctgcttg tcaatctctg 239700
 gtcaaaactg ttcaagatgg gcaggatgcc ccaaaactca tgcttctctt ctttcttttc 239760

 taataacata ctttatgttg ataaatgcag aatgactagc caaacctcca tgtttgaaac 239820
 cttttgctt catctgtttc acaagctccc aaaactggcc agcaccactc tccacagaga 239880
 cacgtatcat aaagcagaaa ctaatcttca cttatatattg tgaagtgagc attttcaaga 239940
 cacgtatgac tgtcaacttt tgtctgtaag ttaaatactt ttgcttttaa ttcgctgtaa 240000
 tcctttacta atccataaac aaagcctcgt taatcatctc taaaattttc ttttatttat 240060
 ttgttataat tccttctat atttgggtga ctctgaggag ataatttatg ggtgatattt 240120
 acttgatatt acagaatggc tttaaccttg caataccaaa agggactctg ctgctcaaat 240180

 acaatcacta gtccagtagg ttgggtggagc atggtaaact taggcttcgt ctcttcctct 240240
 catgcagaac tagattttcc ttagacacta aggatctgat gagatggctc aggatttaag 240300
 ggcagtggtc gctcttcaga agacacggtt cattcccagc gctcggcgt cagcacacaa 240360
 ccacctgtaa ctccagctgc aggagaatcc agtgcctct tctggtgtct gtgggcactg 240420
 tacgtgcata gcgcacagat aaacattcag gcaaagatat aaaatcaaag tgttaaaggt 240480
 gggttgggtt gggttgggta gggaacatgg ggggatggga aggtgagga acgtcgggat 240540
 ggatatgtaa atatgagtaa ttaaaaataa ataaataata aaaaagtcta agcaggcatg 240600

gaggacagct acagctccac cccaggacat ttgtcctgtg taggcagaga tcaataacca 240660
gctgcccatt gccatgagac ccggaacta ggaggacagc tacacagcta caggtcggcc 240720
ccaagtaggg caccattatg gtgagtgagt aaatggtggg ggtggggaca gaaaggttcc 240780
tgtgttgggg agaaggcaga cacgaagcgt caagagtcaa gggcagtgag gaaccggatg 240840
atatgggtgg cctgcttctc acctggggcc aggtttgggc tgttgccaag agccatgtct 240900
gggtctatgg cctactgca ttgatgtcca tggttcctgt taccatcaa gacattgtgg 240960
atagggtgc acagagtgg ttggcccccac ccctcactga cttcagtact aaggagaact 241020

ggccctgctc tacagcaact gtagtactga gaagagcagg ccctggacct tgtctgggca 241080
gcccataaga gctgacccta ttgacagagg ctgagttgat ctggtccatg accatacacg 241140
agatatctag cctcctcatc tgccatatag tggaatgga gagggagaca tgtcctcccc 241200
atccccctgc ctctcaacac ctatggtggg tggttgagtt ggccctgagg tcatgagagt 241260
gggagagctg attctgacc tcactggcct cagtgttcag gagaactagt cctgctcctt 241320
gctgcctgct gcagtgggtg agctagccag ggcaatgctg gagagcttgc ttggtggtgt 241380
caatgatgga aagctggcag gataatcaac ccagcaacca gccaggccca taaccagggg 241440

tatgagtgg cccaccctaa catctatcta cctcacatta tgtataaact tctgggacat 241500
gtgaagggcc tggacctgta gacacagcag gatctccatg acccaaggta acattaggat 241560
atccaaaagg agtcccataa gggeccatta ctgagggtgt agcagaagcc agagaccaat 241620
gactcattgc aatgaacact tacaggtaaa gatacatgga caaagggtat actgtgtgac 241680
tcactgtgta tatccatggc tacagtttcc atgctgagat ttttctttct ctttttcttt 241740
ctttctttct tttttcttt cttcttcttt ttgtatgtt atagtttgtt tttgtttgt 241800
tgtattgtgc tttgggggga gttgtttgt tttaaattt atttatttg gggggggtta 241860

caggggcagt tgggtggat gaagggacag ggagatgaat aggatcagga cacatgatgc 241920
caactccaca aagaatcaat tttaaaaaag cctaagttgg gcatggtggt acacaccttc 241980
aatctcagca cttggaacac agaggcaagt agatttcctt gagtcaagg ctaacctggt 242040
ctacatagtg agttctagga catataggac tgtatagaac aacctctct caaaaaata 242100
ctatTTTTT aagattctaa agcagatggg agactatttg agaaagaggt cagtgcgagc 242160
atcaagggac aaagagtgat gggtaagtga gcataaacia agtgtgttat ctacattatg 242220
aaaatataat aaccaaaagt gctgttttat gcaattaata cacactaatg aaaataaatt 242280

ctcacacagc actcacgctc tgagaagcac tgctctgtgt gacttaggaa cataagtttg 242340
tcatgaagaa actacctttt agaaatataa tgttgaaact tccattatcc cttttgaaag 242400
ataagtaata ttaacaacia caaagtctat cttcagttgc tttgttgaat cgtgaacaga 242460

acagaaaagca aattagcatc gatagcattg gctttcattt agattagaat tacctcttct 242520
 ggtactttta catattcata gcatcgtaac aattgatggt ttttaaattt ctcccaaat 242580
 caatccagat tatgaaactt gaatacttag ttgtcaccaa tttaatacca ctcgtgggaa 242640
 taagggtgca ttttcattac atttctatct tatattgatt tttatctcat ggtgagactc 242700

 agacttgga tggttccaat ctctagggga gatttcctca aagacctatt tacccaatc 242760
 cctccagttt teatccctg tggttctcat acttcacaca aaggcgatgc aatatacagg 242820
 gaacaaaag acaatatcag tatcagagct aactgaaaat atatttgga acaatgcagg 242880
 cattctgtag cctcggagcc agggttctc tcacactctc agaactgagg tgagcctccc 242940
 tgtctagtgc ctctcaggat ctacctactc caaatgcaa agtgctaaag acagcaaggt 243000
 aaagatgcca gacaaaaaa acagtgagga ctccaactca tccggttcct aagctccttg 243060
 aattgagcct taaggaaata gatctgcatg gaagaaggaa gagaggaagg gttggaaga 243120

 tctctgtggt agggcacttg cctgcagtgc ataatcctga ttcagtcctt gnnnnnnnnn 243180
 nnnnnnnnnn nnnnnnnnnn nnnnnnnnnn nnnnnnnnnn nnnnnnnnnn nnnnnnnnnn 243240
 nnnnnnnnnn nnnnnnnnnn nnnnnnnnnn nnnnnnnnnn nnnnnnnnnn nnnnnnnnnn 243300
 nnnnnnnnnn nnnnnnnnnn nnnnnntag agtctttaa atcccatctt ctactgtcta 243360
 gaaaacagge tgtaaacaca gctgccact ctctcaagtg gaacagtctg tgtcaaggcc 243420
 tagcgccttt agctgttatg tttgaaagcc aaagaggaat tttaattdaa taagaatgaa 243480
 gcaccttaa gataacaat gatcctccat ttgagagatt ggatgattg attagcaata 243540

 aataacaaag aaaacaataa gtaagcactg agaacctgaa tattaattac ctgtgttgtt 243600
 cactcttaa aaggaaggaa attctgacac acattacaac gtttgacaa atctccagga 243660
 attacactaa ttgacataag ctatccaca aagacaactg ctgatggttt ctgagctatc 243720
 gtttctatga gtagttagat tcatagaagc agaacacaga tgggccattg ccagaagttg 243780
 gagatgggaa aatgggatgc tgtagagcag gcacagaagt ccagttttac aagatgaaag 243840
 tttcggagag tgggaacacg gcactgtgaa tacactcaac atgactggaa tgaaaagatg 243900
 ggtatgagga agacattata ttcatgttat gtattttagt acaataaaaa atataaaaac 243960

 tactgctttt ttaaccaac cagtaatagc accaatgatt ttcattcatt tgacttccat 244020
 attaaaggaa gtgaaaatga aacattttgg acatagccct agtcaataag tacctcagat 244080
 caactgatca gcttaattt tcacaaaagc cacaaacaat tctcaataac aaacaataga 244140
 gcatccaggt caatataaa tatgctttaa ggttagtctg ggttgagaac tgggaggaaa 244200
 aataacccte tgataccaga gacattgctt ttggccactt ccttaaaact agagagtttt 244260
 tacattcatg cacattttg tcagatttgg ggctgagatt atttttttc ttttgtttg 244320

tttttcaaaa gtgcctggac cccattactt tataacctta ttgtactgaa ataaaaaaaa 244380

 ctgatttggt tgattgtaaa tacttagtag tgaataagaa aatcaacatt tctgctgaca 244440
 attctatcta tactgtttga cccagtggaa atacacatct atgagatagt aaactttgaa 244500
 agaattggta atggaaagac tgacagaatg taagtatagt aagtagtacc atccaatac 244560
 tttagaaca agcaattgtg ctgtgtttgc atatgatcat ttataaataa ctaaatagca 244620
 gaggaactag gggccatagc tcagaataaa gagcatgcat gaggctctgg gtttgatctc 244680
 taaaactgaa aataaataaa taaataaata ataaataaat aaataaataa taaatgataa 244740
 ataaattagt agaagttgaa aaagcatttc tgttcaaagt tattatgggt tatacactgc 244800

 aggcattttc aaagaagcag cggcatttct gtgtcattgg acagagtcca cccacatggg 244860
 agcacctgca atggcattca gggaccact gttactcctg ggactatgat atctggaaac 244920
 gacctctcac gtgaacctca gtggcaacac cttgagtgtg tttggcctct cgtttaagga 244980
 gtgagatggc taatactggc tgtcagtttg acaggatctg gaatccctaa gagacaagca 245040
 ggactgagat gggaagcctg cagcgattgt ggaaagcacc attccaatgg tgagaacccc 245100
 agactgaaaa agaagggggg tgtgaateca gccttagcat tcttctctct cagcttctctg 245160
 actgaagggt ccatgtgcc a ggctacctga agaccatta gccatgactt cccaccacia 245220

 tggaccagcc ccttgcactg tgaggcgcag taaacccttc cttccctcct cgtgctcctt 245280
 tctccaggct acittatcac aacacgaaca gtaactcatg caggaagcat taactgactt 245340
 tgtatTTTTG gaaaattttc tgcatgtcta tgaagaagaa acactcttcc tatatctgag 245400
 gattgacctt gattagattg ttccataatc tcttcttcat gaattcttct tttccccctt 245460
 tcaaacattt tagcaaagca ttccaagtg ccaactctca gtgcctctc agagctgata 245520
 gcttgctctg gtcacaggaa actccataaa agtgcaccaa agacctctcc cctgcctatg 245580
 tccagccgag cacaggttc ttcagggagg atccagetcc acctgcaga gtgagacatc 245640

 agttcctcca gctgtgagtt gaaaatcatc ttaagctgga ctgtgtcaga agaattagac 245700
 aaatactggt ttctgggtga tgctgttctt ctcttgcca atctcagccc tagaatctac 245760
 tcccttgctt gtcttaacca ctttctga tgtttcttcc ccactttggt tgactccacg 245820
 actactgtag gtttagctcc catctagtat ctaggaccac agctctctag aaatcaactt 245880
 gacttttctc catcaaact attatgtaat ctctgacatt ggttccatc aatttttagga 245940
 cctctgatgc accttactgt tctctaaacc ctagtccaaa ctcccaccag ctcttgcaat 246000
 gtccctgtct agaacctgaa ctattatctc cttcccaaat cctcccctc catggttccc 246060

tgcacgacac agtcttttcc atctaccatt cattccacga agccataaat cctttcatga 246120
 attcacgggg gatttgggaa gtgaagtaca aataaatctt ccatgctcag attagtaatt 246180
 caagacccaa aagctgcaaa aacaacacca gattaaagca ttttctttat cattcaaatg 246240
 aattatcaca gcaaaaattat taaagttata tctagaagca gactccaggc tttttcttgc 246300
 ttttctggg aaacttttta tgtgtagtga ctctgatca ttctgtccct taaggcgttc 246360
 ttctgaacc tgtgaactca tcaagataca accaatagaa atgtctacct agaagacaac 246420
 ttggaaagta aaggaagatt ttgtacatgg aaccaagaa agaaaaaat atctcaagaa 246480

 ggcaaagcag ggagaagagg aggaggagga gtaagtcaag ctactccctg ttaacatgta 246540
 atttactcct gttacttatt ttttgtttta ttggaatagt gaaaagctac tgtgtgtcta 246600
 ccatattcta cactactggag ttgtatctca tcaaccaga cagaaagcct tccttcaagg 246660
 ggacaactgt gttgtagggtg ttttagctaat ttttattatt ttttctgttt atcaggagca 246720
 gctgtgaagt ctttttggc ccttacctcc tctgcattaa cttcttcatt atttgatatt 246780
 ctgtctctca tcataccagc atttgtatgc aaaccttta taaccttaa taggcttttc 246840
 caaagtagat tatccattgt gttacatttc agcacatttg tggcttctct ttaactttca 246900

 tacacacata caaagtcaag gtcacgctta agcgattgct ctgtccacaa ttaataataa 246960
 aatgatggag gaaggcttca cggagtttgt aaggtcatct ttcagtagac aaaaaacagt 247020
 ttgccttcaa accaaaccaa cccagtgag aacattttca ggaacagaaa gcagcatgac 247080
 tcttactcag ggggtgcactc ttgagattat tgagttaagt gtctcaagcc acattaacat 247140
 cctttaagcc tgattccttc tctcaactct tacctctccc taggcttagc aagagtcaga 247200
 tgcagactca atttagtact actaccttag atggtccaag gaagctaaga ttgatgaaaa 247260
 atgtgctaaa tatattctca aatcaagcaa aaaagattgt tcagttgggt gtgctaagaa 247320

 gtttgggta cagtcacgcc tctaagttaa aatattttat aaaaataaaa taccttttaa 247380
 ggagatgggg ctggtagat ggctcaacag gtaaagtgtc tgctgcctga gcgcaatccc 247440
 ccaggcccca cacgtggctg gcaatagctt gtttgtgctc taacaaatgc tagaacacat 247500
 gaatcagccc tagcagctgt cctctggcct acaatacat atacacacaa agaaataaaa 247560
 cgtacatata taigtatatg tgtgtgagag agagcgtttg tacacgtatg catatatacc 247620
 attttataaa gaaaagagac ttctctgtgt ttttcccagg tcccaggcaa tagcacattc 247680
 aggtgaatga agatgaggac tgatgtttat ttaaaagctt tagcttcatg agacctttat 247740

 gggccagtg tgccttacc ctttctcaa tcatacctcc tgtctccttt tggcaaaaca 247800
 gaacaactgg aggctgcagg gaagttttct tagaagcaat gggttatgttt tccattttcc 247860
 acttagcatt ttgcatcaca caacttgata gacacaatga ctgaaaaata ccaatgggac 247920

cagatggcct gacattaata tcccaacagg caaataaata atctgcttta ttgctttaat 247980
 tctatttcta tataccatac ccttcatttt ctatacagca aaatgacctt gaactctaaa 248040
 gtttaaactg tagtcggggg atacatacta gaacacgtgc gtacatgatg gcctcaacta 248100
 taatatgttg tgctttggca gaattctggg taactgttca aaattattat ggaaatacat 248160

 actttaatat aagtactcga aataatataa cccaagcacc caatcaatta agagaaaaaa 248220
 gaaaggtgca ttaatcattt agttctttta agatgttgag aaactcaaac acagtagttc 248280
 ttgttaacga tagagtctga aacgtcaagt gggtgcttgg aggtgcagct gctgaataca 248340
 ccaggtcttt ccctatacat cccatttcca agcggaggccc agcaagaaac taacatcgcc 248400
 aagaataaaa cagaacaaaa gctgcgtgag tgtggctctc ctctctctct aactcactgg 248460
 gttgctctca cctgtgttct tgggacgatg agaaataatc ccaacgcttg tgtgatggaa 248520
 caggctgctg ggagaggccc tgcatccaat cttcagatc agaaaaagga atcagtcgctc 248580

 ctgaatgaac ttgaaagctc gtactccagc ctgtgcatta gatttgcacc tgacttttgg 248640
 tagtaacctc cactgttctt gcttgagtgg attgcaggcg gtaaatgctc cgtccagatc 248700
 tgaagaaaac tatggtaggc ttcccggctc cacaactgct ggcaagttag acttctctcc 248760
 tcacacttac ctccctttca ttttctcaca ggcgaggcct gcttccactg agatgacctc 248820
 agcaaaggtt caaggccttg gaattttgtg cctggggcct ttcactgaga aaattgagtg 248880
 tgagaacttg atctccaata gtttccgctt attgtgacat ctctctctgg tctcttcacc 248940
 ccgaaattct tcatttcttt tcagaattta gctgaacagc acttctcttt gctgtttat 249000

 ctccatgtct gtctccctgc tggatattat tgettatcac tgtaagtctt tattgaatgt 249060
 aatctgtttg gggatatagt tggcatgaaa gatgctccac caaacaagt tgtaaagtat 249120
 tatacataaa tacttaattc ctcgatttat ttattatcgt cactacttat ttaccactgt 249180
 acgtaccag gacaccttg aaagaataa atctggtcag ttgctctccc aaatttgatc 249240
 agaatatctt gtaagatata aattatggtg ttatataatt attaataatc ttcatatgac 249300
 tggcatagat tacagtttac aaaaactttt tcacatttaa tcttccagge acccaatatt 249360
 aaaagaacct cagctccatg tttctgggtca ggaaactgag actcagaaag tttgggtgac 249420

 ctagccaagg tcacccaga aagaagcctc acaaatggc acaaaccag gtctccggct 249480
 gcaagttcac agcgcttccc tcttcaaagt ggtctgtggg ctgttagat tccaggaaat 249540
 ccagcaaagg gctcacgaga aacagaatgg ccctgcaacc ccatgtgtcc actctgtgac 249600
 tcttcattga ggtgaagagt taactgtgtg tttatgtttc ctttccagct aacttagccc 249660
 aactttttta tttaatccaa gctcatigga gtctaagttg aatttgagac tgctatacta 249720
 ttttttctg tataactgta gacaagctgg gaaggccacc acagtgatcg ctcatttata 249780

aacaagtaca gtaggttgta ttcaccccaa aatgctagca atagctgggc tacagttgtg 249840

gctttcagag gtaattgtgc aatgtgtagg gttaggatcc tgatcagaag agaatatcaa 249900
taaaatggga caaagatcca tgaagaacaa aggacaataa acaggttaca ggagtgagct 249960
gacgaccttt attactgaca ggctattagg gcacttttaa ataatgaatg tgcgtgtttg 250020
gaagtccaat aggccctaca attaacatca gctgcattca ctcgtctcgt tcttctttac 250080
accaggagta gaggggagga aacacagata aagaatttgc atagctcagt cggcacaata 250140
aaggtccac atccctctgg aaaggcaaaa tcgtttattt tatatacacc attccttcca 250200
gagcaatctt caatagagaa aatcactgtt gcatccaaaa ttttaaagta ttccaaattc 250260

gatcatcctt gggaaaatcc ctacctctca ttcacagact tctacactaa ctctgtcag 250320
tgtttggca gacctgaag ggaatcgact aaacaaactg aaggagagat gctcagaacc 250380
ttcactgggt gccacgaaaa catcttttgc tcatagaaca cttcccagtc tactcgaag 250440
tccgctctgc aaatctgggt accataaagt cattccacac taccctaacc ctaaagagac 250500
gctttgggtgc gaacccaat agctacagac atgcatttcc tcaaaggaa taaattagct 250560
atcgaatctc attccagcag tcaatgaagc acattaagtc cccaaataaa tacactacct 250620
gggaaaattt tattcacttc ataataaaaa cagattaat tgccactttg aactgaaaa 250680

taattactct taaaccaagt ataacagacc agaggcatcc attttgtaa agaaaaaag 250740
ggagataaac agaaaaataa atctctcagc tacatttggg aactatcaag aatgaaatg 250800
aaaaataagg actgtgataa atcatgcatg taggtcagtg gatgaggaa tgtttagcat 250860
gttttctatt tatattctta tttagcttgg taattaaaca taaattaca aacacaggag 250920
tttcaaattg ggiacgaaaa taattaactt tttttgtcaa gtgtgtaaaa attaaagctgt 250980
tccagtggga atatgtcatg ttaatcaata acccactgat gtcattagca atagcttcat 251040
tcaccaaat taattgtatt tccagaagat aagggttaaaa taacatattt tcacctttgt 251100

gccactgtga ccaaatgtg tgccactgtg acaaaaatc taagaaagac ttaaagaatt 251160
actcatgatg tggaaggctc cagagagtgt cagtgtgtct gtcaggcatc agtatgtctg 251220
tcatgctgcc ttcacttcc ggacctgaa tcgaagccca tgggtgcaca catccaatgt 251280
gggtcctctt ttccttagt cttttctgaa gatggaacaa catacacaca cacacacaca 251340
cacacacaca cacacacaca cgatgctta acacacctag atgaatccga atccagtgaa 251400
gacagcaatg aaaattaact atcacaaaga atgaggattt gcagtggttt tcaataaagg 251460
ccattgagac acatttaatg aatgttaaaa gaagaaattc aaactgataa gtagcagaca 251520

aattatacta acggtgaaga atatgatgct gttacagata atcaacaagt ttggcttgag 251580
tctctgttaa acaatgggtg gagaggtttc atttcaatta tctcaaagag ggagcagtct 251640
cctcagggtt acaatgtatt actggacagt aaatcttga ctaacgctca tagagacaat 251700
gtttgtctaa cagagtactc agtagactaa gggtcgtgag tctccaaaag agactttctg 251760
ttactgtcct ttttcagggc acttgtgtta gtaacaaatc ttaaggccag gcttactaca 251820
taatgcaaga tgtatcacac acaataaagg caacatagca catgtattag ctttctgggtg 251880
atccaacttg atcagtccta ggaaaacat gttcttctga cacgcacccc aaggagtgga 251940

tcacagacac acgccacat gcccaactgt catcaagatt tttcacttca ggatggaact 252000
actcattttc agatggagtt agactattct cccaacacct caaacaagta aaactgtatg 252060
aatcaactg ctctgggtg ctttctgctg ctgtgattaa tcactggcta aaaccaactt 252120
gtggaagaaa gggttcattt tgggttacag tcctctacc ttctggagt ctccactgca 252180
accaaagctg cacctttacc aatggcctct cttcaggaaa gcttccgtcc tgccacttag 252240
tgccattgct tagttgttct ccatgacccc ttcatgtagg agactctcac acatcctggg 252300
ccatgttctt cagtcagctt ggtattcagc cttaacacca tactggaata cagcctgtgc 252360

taacctggg aaactattcc gcagtaattt tcatttcaat aatgctattc ttatacaaat 252420
cacaacttat ttttgagctt caactaacca gtatttgggt gatttgaaag aaactgtcaa 252480
aaaaaaaaaga agaaataaat tggecccaaa aaaaactatt aggaggtgtg gagtgtgtgt 252540
ggccttgttg gaagaagtat gtcactgtgg aggcagactt tgtgtgtcac atatgctcaa 252600
gccacacca ggatctcaga ccacttctg ttctctgcaa aatcaaatg tattaactgt 252660
cagtttcttc tgectacatg ctttcatgic ctaccataac aataaggggc taaacttctg 252720
aaactataag ccaccaat aaatattttc ctttataaga gttgccacgg tcagggtgtc 252780

tcttcacgge aacagaaact taagtaaac aagtatctac catgctagga aagcaaatat 252840
tttagttcca cagatctcaa ttcaaaaaca tcatacaaaa agccatggta gaatctaaga 252900
aagattceca aaatttctt taagatgtca caagctacat gggccacat tgectgcatt 252960
tttctcaage ccatttctga gccctaactt gcattctage caaagcteta aatacctca 253020
taattcttca caaataaaa tggtcaggtc catcacagca actctcactc tctgttatca 253080
atctctcttc tagtttgcct tcagctactg tgaaaaata ctgaccaaca ccaactgaaa 253140
aaggagaggt ttacttcagc tcatgggttt cagtccacag tcaaggaaaa tcaggggct 253200

caggacaaag actgctgggtg gggactgggg cacaggatgt gacagagcgc tgctcactgg 253260
cttgcctcac acagcttctc cagcaatctg ttgcagecca ggctaccag cccagggatg 253320
ggaccttctt catcacttag aaattttcaa aaatgccact acagacatgc ccacaggcca 253380

gtctgatgga agtaatccct gaactggtct cctcttccca gacgactcta ctctgacaat 253440
 ttgacaaaa ctaactagag cctttctcct ccacattctg cctcacagca gcaactgccca 253500
 gggcttagag aacgctcagc ttacagtctt ggaattctgc ctggtactcc ttcacttcac 253560
 agaaagaagg cattgcaaaa atatacagaa cacatcattc tgcaattttc tataccacca 253620

 agaagtact gctcaaagta gatagcctct taaaatacag ctgagatctt agaagtaaga 253680
 tagggctctg tgaggacacg tttgttctc aagatgttgt cattcacccc acaaaggact 253740
 gtctatcatt tggatggtg cctaatagaa tatctgctaa cagcagggtg ctgagtattg 253800
 ccagcgttgc atgagactgg ggtaactcca tagcctgctt ccattggaca gagcaaggcc 253860
 aggtgacttc agatgacacc tgtgatttgc tgtttcctct tccttaagtc atttcacct 253920
 caacttcta acattttctg aaaacacttt ctcgataaat cacgtgttat gattaaaact 253980
 accatgtcaa aggctcttct cctgtggaag agcagctttc aactttattt gtatatgaaa 254040

 tagtagaagg ggttgattta aggcaggtgc agtggctcaa atctgtaatt acagcatttg 254100
 agaggctcag gtaggactgt caccatgtgt tggacactac cctgggctac atatcgagtt 254160
 ccaggacagg cgctagcctg cagaatgata cctgtctcc aaaagaacca gaagtaaggg 254220
 gaagaggata acigctggtt taaagtgagg attatittgc cctacctcca gagaagtgca 254280
 ttttacaac acgccataaa gctcaggatt aggcatttaa accagcacta aatatgggtt 254340
 caacagagta gccacgcagc cactctttat gtttactgg cttaaacac cactgcatat 254400
 tatcaacaat ggaaagctga ggactttact gacgtggcaa cattcgaaat caatgcatct 254460

 gagagcaagg gtttctgtag ttactgccag gaccttccca tccccggt tcaactttat 254520
 gttatgactt ccaactctgt catgttcaca gcttcaaat gttaataaaa catgacaagt 254580
 gcaaaagtca aaataaagta gaagaggtga catgtaagta atggactgca cattcttaat 254640
 ttaaatcata tatatttatt cactcactca gtaactgaat cctaaccaaa tgaatttgta 254700
 atatattcca gtctagtttt attaggattt gtgctgtatg ggtaagtgtg aaaacaaaga 254760
 aaatatattg ctacatcaac ttatattatt catgcatata aagttctgtg tatctgcca 254820
 cacaattgag aagatgcatt aggaagtcca ttataataac aagaaaaggt tatttgagtc 254880

 aatcaaac aataaatggg ctagagaaaa aattgtaaaa tatttgttt acattttcct 254940
 ccagtggcac ataaaacatt atctcttct ctaagagatt atgaacattt ctctgtcat 255000
 gtggcacaaa gttgtgattt gtttacagtc atttctgtct ctaaagttac acaagcctcc 255060
 ttgaacttta gagaaagtat attctgcct ccattgctga atattacagt ttttatttct 255120
 aattattccc agatctatat aagtactaaa aggtacttta acaaaaactct aatttgctaa 255180
 cgtattgatt caccacactt ggcactctct cttaaacac acccatattt gttgacaagg 255240

ttcagagtac atgcttggct agtctctcac gaccatccac cttctctcc cgggaggtga 255300

 cacatctctt caagagttag ctgtgaacat tccaattgt gcctctgac cttctttata 255360
 tagtatttga tactgtttaa tgctaaagaa tcatacaaaa ggtggctcta aaataaagag 255420
 atgtttcttt gaaaattaag atgggtgttt caaagaattg ttactttaaa gcatctatta 255480
 aaaattccaa gaaaagaat tttttaaaaa tcctattcaa gtacttttt taaacaactc 255540
 tataaataaa ccaagtaaac aaggaaaaag acattctcag tgaaaacttt cagacactga 255600
 aaacagaaat tgaaaaagac accaataaat ggaacaattt tccatgtgta tcaatttgca 255660
 gtattaatac tgtaaaaaca atgggtacat tgctaaaagc agcccacaga ttgatgatta 255720

 cacttacatt cttcacagag ctagaaaaag aaaacgatcc taaaattcat acaggaacac 255780
 aaaagacacc aaatagtcaa agcaaccca agttaaaca gcaatgcaa aggtattctg 255840
 atatctgac tcaattata ttacagagcc atattaaca aacagcatgg taatgactca 255900
 aaacagattt gtagaacaat tgaatagaat aaaggaacca gaaatgaact catacaacta 255960
 tagccactta atttctgaca agagtgtcaa aaataaacat taaaaatgac tgctcttca 256020
 acaaaatgga aaatggaata tccacagata aaaaagaaaa aatgaaacca gatccaagtc 256080
 tcaaaccatg cacaaaagtt atttctaat aacttactat aagacttgac actctgaaat 256140

 ttctagagga aacccttca agactcaagg actttctcaa aagaattcca atagcatggg 256200
 aaatgattcc aataatcaca aagcttctgc atgggaaagg aaacaatcac cacggtaaag 256260
 agacagtgta taggatafag aaatctctct gttagctata cttcagctat gtaattaaca 256320
 tctagagtac ataaaaaca tattgggttg agattacagt taagtgatag agtgattttc 256380
 tgtacacat aaggtgctgg gttcagtcac caacactatc agaaaaaat gcaagcctag 256440
 agatatggtt caattggaat accgttctat tcttcagga aacctagatt tgaaccctg 256500
 aaccacataa aactaggtat agagacacac ccctcaatgc ctgggaggtg aaagtaggaa 256560

 gatcaggaat tgaaagtcaa tccttagcta tttacaaga tggagactag cctacgctat 256620
 ccatgatagc cagtttatga aagccaaaaa caaatgacaa aaaattaaac atcaaagaaa 256680
 agtaagtgga gtaataaact ctgaagacag ttctcaaca aagaaataca aatggccaat 256740
 aagtactgga aaagtgtca acatgcttag ccttcagagg gatacaaatt gaagcttctt 256800
 tgaaattctc cttcatccca gttagagcag atttcattga aaataacata ttccatgctt 256860
 atgccagggg tgggaaagg gaatccttat tcttactgg ccggaatgta aactaaagct 256920
 tccagtatgg aagtcagtct ggaggttctt cataaaactg aaaacaggac caccatatga 256980

tccagttgtc ccattctgga gtataacaga ttctaagtca gcattccaca tagattcttg 257040
 ggcatacaag tgtattgtcg cattattcac aatagtgaag caatggaacc agcctataca 257100
 tgcattccaca tatatagaga taaataaaat gtggctaata tacgaattgg aacatcgta 257160
 gctttaaata aaagtgatat catgatattt tcaggaaaac gggtgcaaat ggagaccgtt 257220
 atgttaagtg aaataacggc cgactcactc gggaaagaca aatgctggac tgttcctctt 257280
 atgctcagaa ctgagattta aatgtgtgtg agagaaataa ctgcaaggaa aactgaggcc 257340
 atggaacagg aggaaagatc tgaggagca aacaagatgg gacacgtgtg acatgacggc 257400

agacgagatc atctgggggc agaaaaggag ccaaccagcg aggtaggact cacctcacag 257460
 agagagcggg gagaaaggag gaggagcaac aggggtgtgg gacacaatcc acaaaaatgt 257520
 caccgtgaaa ccattactt gtatactaac aaaaaactg ttttaaaac ttgtcccat 257580
 gggcacagct ataaaacact cccatgccta aggctcagag agagagactg taagaccag 257640
 aggagcatgg cgtttactgt gagatgcttt tctcctactg acgtcagaag ctgcaccttt 257700
 aaaagtctcc tcagcacaac cgcctaaaca ggagctgatc aaggacgtga tgaggtggac 257760
 gggggcagcc taggaggata tgtaaccctg tataaaaaac tgtgggaaac tgaagaatgc 257820

caagagtgcg agaatggtc ttctcagtg aagagctcat cagtgggta cccaacatc 257880
 caatggtcag cctgaaaac acacataaaa acaataatat gtgaatatat gcacataacc 257940
 attataaaa atagaacatg aatttgaaga aagcaaggag agatacatga cagagctttt 258000
 agagaggaaa ggggaggaag aaataatgta attataatct caaaaataaa agaaaaatta 258060
 aaatccacaa aaatactctc aaatctttta tatatacatt tatgcatata ttacatacat 258120
 aatacaagga gaaaagcaac gaaggtctaa gagaattcta cacctctca aattgcatcc 258180
 cagggttcta attgctcctt tttaaaaatc cctaattgga aaacatcaag gatccaatgt 258240

tgctgtaatg tacacaataa atgcacaata cacaagectc tctaagaga cccatggata 258300
 gtcccatcat atttactaat taatttatgt tttatgtatt gacatggttt tattaaacc 258360
 ctaaaatfff taataatfff cgaattgtag cttttaaagg caatcgcac aaacagcttt 258420
 accatataatg caaatattcc tttaatgaga cttgcaactga aaagtgccag tttcattctt 258480
 cctcagttat agtcttcaag gcaaagactg agactaccta tgtctttcaa gtgtgtcagc 258540
 catccatcca ttctgactga gtctttgagg agttagggga aaactatcta gactgacagg 258600
 gaaccaaaca agaaaattct gggtcattgt atatggatcat ctttcctttt ataacatact 258660

gccaaattgt tcccaaagg agaagttaa aatctcatgc tcatgcccac gctacaatc 258720
 cactttcttt aaatccttgc caacatttat cattgtcaaa gteaagcctt tgccacacta 258780
 ttgatataa aactttactg ctttaatttg caactcactt agtggagcag ccttttagtc 258840

ataaaacatc aactatttga atctgtttct ccatcaattg cttccttctt cctcaggtga 258900
gctttcctcc tactgacttg tagatgtgtg ttaggtatac taaaaacact ggaaattaca 258960
aagcttactg aactgaaagc agaaatcctt tgtctgtcat ccagtcctga atttttctcc 259020
agagattcaa tcaccttatg gacttttggc tgtttttcat aaaatttatc tcccctattt 259080

tgaataata tgattatag ttgttattat tattgatttc ctatatcgag ggttgagggt 259140
ttagcatcct tacaccatta tctcaccctc ccaataaaat tataactcat tttcttctta 259200
aaatattata atttggaaat ttagattata taaaaatcga ccaatgctta gatcattatt 259260
gccattattg cttttccttt tttaacatta gtttttctcg aaataaataa ttacctcatt 259320
tctctccatg gtttcttca ctgattcttc ctatactcac agttcaattt caacataaca 259380
ctatctaaat tgttttctt ttctttgtga gaaacccttt gtccttctgt tccaacttcg 259440
attgctcatt ctcccaacat agttttctct gggattctga gatctgtttt accctgggaa 259500

tttgtcgctt tctccccag tgaagaggtc tctgtttcct ggataccctc ctctactgct 259560
gtacaaggca acctctgtca atgtgaattg cttttaatca aattagaacc taccatccat 259620
caacctacag attgatact aattcattcc ctttctctat tttgagtttt cettcttttt 259680
gtctattgtc cagtgttct gaagagtttg atgtacttct gactcatttt ccccagactt 259740
aggccgttcc tctctctcc ctacaagatt taagagctt ctgttcatcc ctgtgttctg 259800
aaatctcatg atgtgaagg gaggttgttt tgttgttgtt taggggattg attttggttt 259860
tagttttgcg ttttgggtgt gtctcacat gtgtcctata caaacagaa agatcccaaa 259920

ataaaacaaa agcttctttt ttcataattg ggggtgggaa gactcaagat taaagtctg 259980
ctagatacag tigtgatga ggaccattc acgagtctgt cagtactctt cttctcactg 260040
cgctttccta agcatgagg gcaggaagac aacaaagcaa acattcgagt gaggagctga 260100
gtgcagcatt tgttatgcaa gcctgaacac ctgaattcaa tctctagcac ccatgcaaaa 260160
aggagggtat ggggcatgtg cttgtaatgt aagcctgggg aaagtgagag aggctgattt 260220
ctggggctta caggccagcc acactaggtt actctgtgag ccctgggtcc taatgaaaga 260280
ccttgactca aaaaataaaa taaaaagag acagcttctg agtgtgcaca cctgtatgtt 260340

gcatacctac ctataccac atgagcata tgcacctgc atacacacac aagcacacac 260400
acacacagag agagagagag agagagagag agagagagag agagagagag agagggaggg 260460
aggggagagg tggggcagg ggagagagag agagaggag agggagaggt gggggcagg 260520
ggagagagag ggagatagg aggagaggag atgtcatcta gaaacaaagg atctcatatc 260580
tctttgataa gggcattaat tctactcatg aaggctccat cttcatgacc tectaaagc 260640
accaactcc taacgtggg ttcagcatac aaattctggg tgtacacaaa cattcaacc 260700

atggtgtatt cgggtgtggt ctttttcaca gaatcataat tttgttcaat agaattcaac 260760

ttctctcctg atgetttctt acacagacac ctgctcctct gaactgtgtc attctccatt 260820

tcccccttcc ttctatgtta gagcttttca tgaatgcatg ataaccttg attacacatt 260880

attattaaga ataggttatt agccagccat ttggaagctt tgtgaagaac aagactttat 260940

aactataagg caagattgca gcattgtttt actcagaacc atgagtatcc atgtctctat 261000

tttctttttt actatgtgtt tggggggagt gtgtttcaga gacagaaaag accactgtgg 261060

ttgttaccat tgacttttag cttcacagga tctagaatca ctgaagagat aagattctgg 261120

ctatgccagt gagagtatct aggttaggtt aactgagatt ggcttaactg aagacacagc 261180

tttaatgtgt gtggcatttt aataagaatg gccccatggg ttcatatatt tgaatgctta 261240

ttcatcgggg agtgcattag tcatcaggga gaaggattag gactcatggc cttgttgcag 261300

taagtgtgtc actggagggtg agctttgaca tttcaaaagc ccaagccagg cccagggtct 261360

ctgtcttctt tctgcttctg gatccatatg tagaactctg agttccttct tcagccatt 261420

gtctgcctga attctgccat gctccccacc atgatgacac cggactaaat aaatgtcaga 261480

aagtataage aagcaccaat taaatacttt cttttaaaag aattgctgtg gtctctgttg 261540

cttctcacag cattagaaca ctgactgaga caatgcagat ggtaatatc tgtgggctgg 261600

ggtccttgaa tgcataaaaa ggataaaact agctgagagc cagcattcat gactctgctt 261660

ctgagtatgg atacattgtg acaccagctg cctcacatct gccaccatgt tttcctcgtc 261720

atgatggact gtaaccccc actagaagcc acaataaacc tcctttgctt gcttctcgat 261780

gggcatttga cccaagccac aagaaaagta actaatatgt gcctattaca aaggttttgg 261840

acatcaacca ttaggactgt gatgaagcat ttctctctaa ttagctacta ggatttaatt 261900

tagcactcct gccttcaaca gggagcccaa gtgcactcag aacagcttct ctggagaaga 261960

aaccttgtat ctctgccag agtctgaaga atgagtgtgt gtgatgaagc tgagagcaag 262020

aagcacaagt tcttactct cttttctcaa ctctcttct tctctcctg agaccctgg 262080

ggtatttgag aagaatcagc tctctcccc aggaagcttc tcattagttt cttaggttct 262140

tattttctct tttctctat gtcaaccacc cctcagtcac tggatttcca tcttccacat 262200

gtattgttat ctctcttctc tgtggccatt tctcacgtt atctgtgtgg ctaggagg 262260

agtaatgata attacttggg tctatgcac aggttttaagt caaaattccc ttgcaaata 262320

ctactcctag ttactactcc tatcgttggg tttgatcttc tcctaaaaca ttatcatcac 262380

cataatatcc atccttaaga tattcatgtg aggctcccaa caagatgata cattcaataa 262440

aactttctaa acaatcatta attcaagtcg caaatataga ttctgttaat ctggggaggt 262500
ggggacaaaa ggittgttat cctgtgttac tgtagtgttg gtatgctatg ctgtgatatt 262560
ctgggctata taagaaaaat gatggagcta tttttatgca ttttgggaga cagaagtttg 262620
agtgagtatt ctctgtgaat ccaagaactg gattcttgaa ggtcaaccag atctttgtga 262680
agagactctt ggaggaatca atactgactg aatattttaa tatacagag gtgttgcttt 262740
tcttgcctct tttgaaagga ctgaaaaatt ctggttaatt ttaattaaaa aaatgtcaga 262800
tcactgagct ctcccttcg ataaatgagt ctatctgtta acttagccag accacaaagg 262860

tgtattgtct caaggagttt agattggagg atataatfff tattgcacaa cacaagaggt 262920
agaggctggt tgagcggggt gaagtatttg gtggtgtagc attcaatctt ctctggcagg 262980
tacagaggca atcttctttg cttcaaaaga gcttcagcta cttgcccaag cattttcaca 263040
aagcagatcc tactttgtcc tcaccagaat ccttaaagta tttagactca gtcttatttt 263100
cctgtgtgaa actaagaggg gtcaaaaggc aaggccattt gtcaagtcag atgagagttt 263160
gaatccagat ctccagatgc caaggaaaat atgttattga tcacttcaa gaccagcca 263220
ccagcatctc ttccaaacat gtcactgcaa atatacagag tccaatacca aggtgatgga 263280

acaaagcagg gactctatca gccaaaggaga ctgctggcag atgtctcatg gcatatgcca 263340
gcacattctg tcatccctta gggcaccagg gcatcaggtg accaaaagga catgttgtgc 263400
aaagacctac acicattaca aatggctect ctccctttt gtttcattca ttctgagcat 263460
ctggtacctt tcagtgaagt gtcagaatta tacttaagac atagcacatc attaaaataa 263520
agctctgggc taataattat gtcttgttca tgtgttttat gactaaagat tctgactttc 263580
cctcaaggtt tccaactcac tcttcaaaat tgettcttcc tgaggcattt gttacattgt 263640
ggatgtgtcc ccaacaatta aatagcaatt tagttctcca tctctagata tttctatttg 263700

aagcagtate ccagagetca agctacttct gcttttaaga tggcatttat ggagtcttca 263760
gtcagctcta agltgactg cacacagacg ttcatcagag tggaaagtca gctctcagcc 263820
tccgtgctgc teacacacc cccccccaa tgtagctctt tatcagcaac gagggtaatc 263880
cctctccca cctgccttca tctcaccaaa tatattegac agctattaag atatcttaga 263940
gcctaaattt cacctcagat aggggatagg gcatgtgac cggattatac aagcatgaac 264000
tcttactctc agtattcaaa tttatattgtt aaatgcatcc tgcaaagatt aggtttgggt 264060
ccagagtgct gcittggaga agcagggcct tatggagggt ttgggggtga cagaagtcac 264120

gctactaaag gaaattggag ggccttactc tcttctcttt ttctctgctc cctaaatgac 264180
gaggcagaag acgtggctcg ccacgaactc ccaccataat acactgccc caccagagge 264240
tgaaagtaac agtgccatc tgtctgccc tggaccctcc agaactatga gcaaaataa 264300

tctttttgag tgagttgcct ccaggaactic attataatga tggacagcta gcatgcttag 264360
 ttgttttagg ttttacatta ttattgtgaa aaaccaaac agactgtgag atcgggcatc 264420
 ttttaattatt tggtlaagta taaagaagta gtacttcggg gctggtaata gcattttcat 264480
 acagaatgcc ttgctgaata ctctttggga gctggtgacc ctggtacttt gtgtaatgga 264540

 ccaggatcat tacttttgtt aatgtaatag aaggatgttc cttgttgttt taaagttgaa 264600
 agccttcttc aaccatctcc ttctgtgggt tgatgtctaa catggctctg ccatgtagag 264660
 aaaccaatag cacacactga ggcagcttct ctggcaaaag tagtagatgc atgttaagag 264720
 atttagacac agaataatgc caaatgagcc tttctccaca cattcatggg aagccatctg 264780
 tgtagtattt cacaaattat taatttatgt gttaaactac ttagctttgc tactgtatgg 264840
 gagagtgaga aaagcatttt aaataaaact ttcaatcact ttcctcaca aaaaaactct 264900
 attctgttca tactggctag atattgagac acaaaaagtg gattgctgtg gttgtatggt 264960

 tacagtaaag aataaacatg ccttgttgtt gagatccaaa tttcagaacc cagtacacag 265020
 catttccttt gtcagggtgt ttggactctt cattaattct attagcaaga attttcaact 265080
 ccttttcagg ggaggtgatt ttctgtgagc tgagggttca ggcacaggaa ctgagtcctg 265140
 tgcagccttc atgcagctta aaattattta gtaaagaaac cagtctcttc ataagaaca 265200
 ccccttccca tgccatgcac ttggccttag gtgtctctgg gtctacaaa cttaggtaag 265260
 tttagccaac tggatctaa ctcttacaga actattaataa tatctcatat catcattata 265320
 ttgatgatat atctttgggt gttataattt tagtgaaaac aaggtagact ggaaactcca 265380

 cttaactcacc taagttcctt ttggcagatt gaaaatgttc atgttgatga aatcagcaag 265440
 cctggaaca tacacactgt gaacaactga aaaatcagaa aaaaatgtta gcaaacttt 265500
 aaaatgttag taaatcatat tagccagtat taattaaaga ttaccaatat gacgtgttct 265560
 ctacataggt tatttttcta atgttcatga taacatgact aacatgtgaa gagataaaga 265620
 ttacctcaaa cglagtgaga ggtaagctcc ttatcatgta tgggtctgat acgttcgtaa 265680
 gtgagatctc tgaatatcct tatgcaatat ttatttctg tttgttgagt ttcttttgtt 265740
 gtggttattg ttgtttgttt ttgtttttgt tttttttttt gaggcagggt ttctctgtgt 265800

 aagaacccta gctgtcctgg aactagcttg ttgagtttct actgcatgta agtcacaatg 265860
 ctggcatctg caaaagggag taaaagtgaa gagaactagg ccgccgggtg gtgggtgtgc 265920
 atgactttaa tcccagcact tgggaggcag aagcaggtga atctctgtga gttcgaagcc 265980
 agcctggctc acagagcgag tggcgagtgt taggacaggc tcgaaagcta cacagagaga 266040
 ttaaaaaaaaa aaaaaaaaaa ctccacaggt ggtgagaact ctcatgtaac aagagagcag 266100
 ttcacacctc tgctcaggg ccttctacgt cctgtgtgtt ggctttaaac tctgagcaca 266160

gagctaggct caaagggttg aacacaggac atctgtgtcc tcaaaggccc atagaccatt 266220

gcagatacag gcatccagat ggcttcaaca ccccaaaggt ctgagagcag ggcaaagaca 266280
gggtgtacce ttctaccac agtacccctc ctgtgttcat gaagtaggaa tagaccctct 266340
aaagcctatc cgtgacttta aggaactgct gtttttaagt gggcgaggga tgtgctgtaa 266400
atgatactga ggcggtgagg gcaggaagc tgagggtgaca aacaggagtt tgggctgagg 266460
ggcgtggctt tcggtacaac acttgcccca caagcaccag accttgactc ccgacactgc 266520
aaaaagaaat ttcatgtctg acaagagttt gtattgaggg tgtattgagg tttcagaagg 266580
tcaagggcca gacactaatt attctctaga attgagcact taatttgaa tatatcccta 266640

aacattccca ttccctctgc ttcttttctt aaatgagcct tacaatggtt atgactgctg 266700
tgaatgtcaa aggtcataat gacataaagc tccttttagaa cactgaatgc tacctaaagg 266760
gtagatattt cttatagcca gagacagtig tccttggtca tcatactaac aattaccctc 266820
catcctctcc caaacttaca gtcagaacac ccttagtaaa gatgtttatg actcatttat 266880
aacaaggac aaggagagac agttcataac aacaacaaaa aaaaaaaca tgtgccata 266940
gtcagatgtc gaatccactt attaaatc tcaagtccaa aacacctgt acgagttaag 267000
tcaggtcagc aagcatcgc tcaagaggtt caacagacag taaggcaggt ggggtgcaat 267060

aacttacagg catataaaaa actatccaag aagctcaaga ctgccagaga tctaaaacct 267120
aataataaaa taigaaaagg ttacagtgt attttaggaa tggtaacaaga attcagacag 267180
gggaaggaaa ttcacaaatg caacaaattc aagaaacatg aaaagggtcaa gtgtaagttt 267240
cttgaagaag aaaatatgaa cacatcgtgt ttctaacccc gctatattag gccatgtgcc 267300
ataaccaatg gccacgtgat taatgtctgc tgaagaagg gaaagaggag agaggggcaa 267360
gatggacggg gagnaactta gagtggcagg aatgagaagc aagtctgga gtgagaaggg 267420
aaaaaggaag ggaagagct ctaatcaact caaaccttcc agtccttgag ggttctggat 267480

agcaccgcca atgaagaacc agaaacatct ccttaaatgg gtgggcagga aaattaccag 267540
gggttgggtt gggatcacgg gaaggtagtg ctctattgga agctagagga caattacgat 267600
gcattaatcc aggctcagag cgatgcctct gagagaaagc attctcagtg tgtgctgcaa 267660
catttgtgat gacagagctg gcctccgctg aactcttccc tcgtagatgg gagcatttat 267720
ggggaagcag gacgtgtctt atccagggct ccctagtga gcactggccc tagagatgcc 267780
attgcttctg agtcatggac tgggtagcca catgcagttt ccgagggaac cagagcatta 267840
tcacagcaag ttggctcagg agaggaggaa aatgctgggc acgtttgact atgagtaaga 267900

ctagagagca cagacactcc ccaaggactc caggactact ggaaagaaat cgccacaggc 267960
tatagtcct ccaaatgcac taggagagat tttgaggtga gggaatattg ctttgctgct 268020
gtgtgactgt tacggtgact cctgggattc tgatctgggg aaaaaaatat gagacacaga 268080
aacaagcaa acaaagtct gtcaggcat gtgacctgga gtctgaactt cccttgacct 268140
tgacatcaga gggccccaga ggagtgatgt cccactgct tgctcagct ggcagcaacc 268200
agcatcaaga gtcagccagc cccaaagagt cagaaaacaa gagctgcaat caaacactta 268260
ggggaataca gacatcttcc ttgaggcaaa gcacaaggta ttgtgtaaca gaacacagcg 268320

gccttcatga acccgtctc atttcaaaaa cctcggctgg cagagtctg ctgtgtggac 268380
ctatcagctt gaaaacaaaa atccatactg gaacagcaaa aaggaaaaca aaaggtgtgt 268440
gatatcttat tttcaaac aacatcaaca atacacagtc ctgcaaatgg tactccatgc 268500
taagagcaag cctggaaagt agaatgtgtt ataaaggat aaagggaaaa tacagcaggg 268560
gaatagtatc cctccatagg aaatgggctc ccgaagccca tttgtacct agggataaat 268620
actggttcca ctgatagagg tcctatagac tgcccaggcc tcctaactgg cacccacatt 268680
ctgagggttt ggctcagtc aatgctggat cccagcttt acgactggga tccatgtgct 268740

ctcactaggt caggtcagct ggttctgtag gtttctccag catggtcttg actcctttgt 268800
tcaccttcc tcctctcta caactgcatt ccaggagtgt ggctcagtc ttagctgtgg 268860
gtgcctgctt ctgcttccat cageccactgg ataaaggctc taagatgaca attaaggtag 268920
tcatcaatct tttgagcca ttggccaaag ggatcccata gaccttccc aacatcata 268980
gggtgtttcc attgctattg gttacctcc ataacctggc aataagactt tattgctgaa 269040
tacaccatat acttacatca tcaaacatgg agaaatggag ccagtgccca agcagaagct 269100
tcaccctac tgactgacat ccacagtgt gaagagtgcc atccatgcta caggaggagt 269160

gaccattggt ctacccagg tatgaacctt gtgagctaca acagtgacc gacagcaaaa 269220
tatgccact gglacaatgg aggactaat gttaggaag taagtaacca ctttggatt 269280
aagtttgagg tctgctccat gaactagaat tcgtatctga cattgttaat tagaccaagc 269340
acatgaggct agataggca tgggccttaa gggaaaacct accactttca tectgctaaa 269400
tgagcataac aataaaaatt cctgataaca cgttgctata cacacagatc agctcatcac 269460
ccagccctct ccagagaac ttcttacagt agacgggagt taatacagcg acccacaact 269520
agacaatgtg tagagaataa gagactttgg agtcttcagt cctaactaca ttgtctatgg 269580

caaacctctc cctccaaggc tcagggatca atatggaaag acagaagagt ggtggtggac 269640
ggttccaaga aaatagcatt ttctagacac aacaggagtg atgcaatat aactcacaca 269700
gactgtgaca gcatgcaca cacttgata agctcaggcc agacaaaagt cccagcatgg 269760

agaaggagaa ggggccacaa aggtcccacc cctaaccagg aagcgatttg aaagggatcc 269820
 cttctgggaa agggaaaatt ggggtttttt caatgaata atactgggta tatcaacat 269880
 accccagggc acacccatg ctcagatgta gttggccaac acaagtcaga gtccatctgt 269940
 gtgtttgtgt ggggaggag ggggtgtttt gtttggggtt tgttttcctt tttgttttta 270000

 agaggagag aatatgaagt tggataggaa gggaaggcag aggagactct gacgggattt 270060
 aggaaagaag aaagactatg attaaaacat actgtatgaa ataatacaaaa ataatattc 270120
 attaaaaagc aatacgtcca ggggctggag agatggttca gcaatttaga gtactggctt 270180
 ttcttcgaga ggagccaggt tccattccca gcaccactt ggtcatacca gtccggttcc 270240
 aagggatcat ttggccttca tagtcccag atatgcaggc aaaacactca tatacataaa 270300
 aaataataa atcttttaga gaaagagatc acccacctct atgagtgtag gcataggaaa 270360
 acctgcttta ttaggagaca atgggaatga caacactagc actccttaag acagagttac 270420

 aaaatgaggc atigtgcttt cttgccttg aattatttct ccaggagtaa aactagaaca 270480
 taatctgccg aactatgtaa tgtttacggt tttgtatccc aattgccatt tgtttcaaaa 270540
 ttttatgcat tgaatactgt tttgttggct tttagtctca taagacaaag acttacttat 270600
 tttaaaatag tgattccctt taagtcaccc atgttagtaa ctgtgaggtt caagatggca 270660
 ctattgcatt tcaatgtttt aaaaacctga ctcactttga aacactagta gaatgtacta 270720
 gaaattcaag ttatgtggtt tatctagaag agaaaaagca atctgtttag caggagaaat 270780
 tttgcatgca caaagagtta atgctcaaaa gtgtcatctg ggggtgcagg ctatcctggt 270840

 gtgacccac cgtgcagtct cttctgtcgc tggctgaagc cttttggctg ccaatagacg 270900
 ctatcttctg gagactttga ctcttctct ggctatctc ccagaagat tgatcagctc 270960
 cgcactactg cctgactccc catcagaatg gcgccagggt gatctcaaac ccaactgtca 271020
 tcccagctga gaagactcag catgettagg agggcggaaa ggcagcceta atatecgggt 271080
 actaccctgt tccccctct cctggaggaa agtatgagcc attcgggtag acagcctgtg 271140
 caaggccagc actaacggat ggcactgcaa aactctgcg gtgtagtac tgtactccc 271200
 accccagcgc tgcattcact caacagaagc tgagacttac catttcagg ttcattgcca 271260

 aaatgcaaat agcatgctat tccttgctta ttaattattt gaaaacttta gttgaggctg 271320
 aaggcaggta actaatggct gaactgaaaa actcattcca gctcacttga gaacaaactg 271380
 cttcccctg ttcacttct ccatctgaca gttttaaacc ggtatgtgt ttttttttt 271440
 ttttagtct aagtaafata gtctctctgg gtatcttct tgaggtgata tttcctggat 271500
 tgtgactatt gtgtttcgt gttttactgt ttttacttcc aaaggtctcg gtggctaagt 271560
 ctgttcaatg aggattgctg aagggaaaaa acgcctgagg tcacttggtc agctgcctcc 271620

attgtccat ttcttcatt gttctcgatg ctctctctgc agaataagct ttgtggctct 271680

 aacaatgtct acgaagatat caaaagacc aaagacaagc agctctagac tcagccaaga 271740
 gtctagagct atgccacaa ggaatagcaa ggtcactggc ccagtggcct ccacagcaat 271800
 gctgcttgac ttggcaagtg gccactgctt cctgggcaac tgaggaactc tgccaccagt 271860
 gtctgttggc atgatagaga cctaggagct tccacggtgc tcagctctgg actggaggtc 271920
 cctaagagge cgcctcact tccctgtgct actgcactac agaccttctc atgaaagaga 271980
 cctgatcttc atccggtcgc agctgctaga caaggtgtgt gttccaagc cacctgtgca 272040
 cagatacaca gcatctttac tttaggtcaa agtattttat ttagaaaaca aattgaaaag 272100

 gaactatctg aatgtcccat caaaattata aataagtta tcagccaatg agatatatta 272160
 tcttagtgtt ttattttaat aaaaaatgct ttatgcttag aattattaca gcaggccttt 272220
 cagcttgagt gctttccaag gtggaacact gaagtacatg gttacctaca tgatgacatg 272280
 tagtaagaac tgiacagtc caagtccgta ctgagaaata cctgtcttcc ccctatgctc 272340
 acctgatcac tgctagagg cagcctaaac ccaccaaca ctcaactata gaaagcacca 272400
 cataatctac agctagatgg cagtgatgta ggactttcta ggtcactctt ggacctcaag 272460
 gattagggat gaagcccagc atcacaagaa tttccccat ttcctgacga ggctccaata 272520

 tccaaggagt ttttgaatct tcccacaagc tgccagaggc tctggggag acggagtat 272580
 gcaagtaagt ttccaggctc taaccaatca aaagagacc gttcaactag atgataaaag 272640
 ctattggtac ggccaggcag tgggtggcaca cacctttaag gccagcactt gtaggcaac 272700
 agcaggtaga tctctgtgat ttcgagacca gcctggctca cagagcaagt gccagaacag 272760
 gctccaaagt cacacagagg aactgtctca aaaaactcaa ataagtaaat aaacaagtaa 272820
 atacataaat aaacacaaat ggatatttga ataaataaac ataaataaat atttgaataa 272880
 ataaataaag ccaccagcag gacaagggca ccaccagagg atcaaacagg caagggatag 272940

 gctaagaatg catgaccctc tggggctctt cctagcgtca gaagtactc ccaggacact 273000
 ttattccttt actcttttag gtaaaggagg gttgcttacc caagggtctg tcttaattgt 273060
 acagaactgc tgttcaaact gaattacatt actggttact ttctctagtt cttttttaa 273120
 aaatttcaa ctggatacct tgttttctt ggctcatctc aggtctcct atagaaatga 273180
 actaaacaca tcgataacc tctgaagct tctctattg aatgagactc atcagctcaa 273240
 gtgcctctgg atggcaccac gtgtacatca gaggagctcct ccaagttgtc gctcaggaa 273300
 gctagtctat gtcagagctc cagagggagt ggtgggcagt ggcagcaata gtagacaaag 273360

gaggaagagg ccccatgag attaaatgtg ggaggaaatt gttaagaggt aaggaattgt 273420
gtctacattt cccagtttcc ggcctattga atattaacaa aggcctctctt cgtaattatt 273480
acctgttata agtgggagac tgggcactga gaaaatagca tgaaagtgtt tgcaggcact 273540
gaacataaga attcccaggt acagagtctg caggcctaga catctacagg gattactcta 273600
catattgtgt tagtttttgc tgcaacacaa aagatacctt gcaccaaga gtcttctagg 273660
agtttagaaa cttcagatct tgtgcgtcct gtctctagtg taaaattacc atgcctctgtg 273720
cccagctctt ccctcatgct ctctcactct gatgacaatg tgggaaatgt gtactaatct 273780

gcttggggaa taaggaaacg gcttaggaag aatacaatgt attccctggg aaactatttg 273840
agtttgctaa acagaaaaac atacagactt actctcaatc actctgaagt ggtccatttc 273900
aggtcccttg taaaacacag aaacacaaca ttgaatgtgt gtcccacaa gagctgtcgt 273960
ttgagagctc aggtcaaaca gagccaaacc taccacaaca ctgcctgctg taaatcacag 274020
gtcacaaaac acatctccta tctgccgttg ttctttttca aaagcaaagg caccaccgtg 274080
ctttgcacat gaaacgaaaa tgctatggaa atttacaaga aaagtataac agaaacacat 274140
ggcttttcag aaactcacc tttcccata tctaaatca cctccatcgc cattgtcttc 274200

cccattttct aagctgaaag acctcaaggt tatctctggc tcttctctc caagccccta 274260
ctacctgaac aggttttctg ttgtctctac tcccgtctca cccagctgtc tctttgtctg 274320
cagacatctc tgcagtctt ggctgcatag cacaccgtt agaggcattt attgactccc 274380
agacttacca ttgattctct ctgcactacc tattcttgcc ctgtgaccta acaacacctc 274440
ctgctttggt ggcattccac tactaacagc tatggtggca tcccactgcc aacagctact 274500
catttgcctt cccccttgg gatctgcagg gttttccctt tccaatgttc ctttctccac 274560
ctcggcagac ccaagcagat ggagacatct tgaaatctta cctaaacggc aaattcagtt 274620

catcaaacct tcttagaacc tatctgtgat tatctgcgtc tgaaactgtc acttctcaa 274680
agactgtgat ttctgttcc tctcgccaa tgctcccat tttccgccc caacctcca 274740
tatgtgctg gattccacag cttttgaatt cactcaggac ttagatatca cagtggctcc 274800
atcatcacat taaaggaagg agactctgca cacacaette attctttagc agcatcagtg 274860
gtaaagagct actgcgaact aacagactgg aaaatcattg atcatttttc agatgcaaaa 274920
catttcagtt attttcggtg gtttgaacag tttccccaaa tgccttctga agcctctctg 274980
ttctgcaaat gctggccacc ctgttatctg ttatataacc caccttctcc attggccaga 275040

ctccatgctt tttgctcacc tcaagtagtc tgtgagtcta tctctgtctg acatgtaggg 275100
gagcagtcac gcatatctcc ccctgaatgg cagataattt ttatcactta cettgaactg 275160
ttacattttt tctgtatact tcaataagct gcagatttcc tggagagaag aattgggatt 275220

catctagagg gacactgggt ccagtgatga gtaaattata tgtacatcgt gaatacttca 275280
 aaatatttat tacagacatg cagtgcttta tcaactaata agttatttgg caaaatggag 275340
 tcactgagaa ttacagctca attgctttta tacagagttt acacagaatg gtatatgttt 275400
 ctattaagta tcttatttgg tttttattc tctcctgtca atatactttt tctcaggtaa 275460

 ctggccttgt ctatccaagt atataatcat tgtccatata tacatacata aacatatgtg 275520
 tgtaaacatg tatgtacata tgtgtgtata catattgagg catggtctta cttagctccc 275580
 actagccttg atctcattat atagctgagg ataaccttga gcttatgac atccagcctc 275640
 tactcccaa gtgctaatat tatattataa accaccacgt acacattttt cttttatta 275700
 aatttgttct ttcattgatt ttatacctct ataatgtcca ttctgattac tgtcacgttt 275760
 tactctctgt tatctccttc ccaatcctat ttctagacat gcacgcacgc acgcacgcgc 275820
 acacacacac atccctttct cacatccacg tcttttggga attttgtgat gcaactgagtt 275880

 tagccagaat cctatgagtg accctgggtt tgggaccacc cctcagagca tggaaatgtcc 275940
 acccgagggt acacaaatgg aagagtgttt gccctcctca agaatccagc agtagcccat 276000
 agtacagctg ggatagtagg tccaatctc tgatgaacta ctgacaggcc cattgttaga 276060
 agctacggta gcigtgagac aatggctgct tggcaatgtc atgccataa gatggacaac 276120
 acacagcctt tgtttgtgtt ggttttttgc ttttgcctt acatttttt catcatcct 276180
 ctttagttc ctcctagcg ctttaggaag atggcatgaa tgcctgttc aggaatgaac 276240
 acctggctgt cagttattct cagcatcttg actggacagg taactttgtg tttgctgctc 276300

 ctcatctgta aagaaaatct tctctgattg agactgacag tagaatttgc ctacaggtat 276360
 aaacataagt atttagaagg caacttgatg cacccaggc cttgcgactg ccaggcaatc 276420
 cctccttgc ataaagagc aagctttcta ttttctgcta cttccttctt gcatgaaagt 276480
 tttgtatgcc cttagtgttc tctctcttcc ttacctgagg cctcatacct gttaccacaa 276540
 taatctcctt caatccacag caattactct gtttgggagg atcattgttg gtttttagaa 276600
 cttttaattt cggttacgtc tgtgtgtgtc tctgtgtgag aatgtgaaca tgagtgcagg 276660
 tgctgtggg gaccagaaga ggagctagag tgacaggcag tttgggactg cetaaagtga 276720

 atctcaagag ccaaaactca tagcaatcgt agtttccact cttaaacagt gagccatctt 276780
 tccagcccc taaatcctat tctaataaga actaggtatc actaagatac tggcttctct 276840
 ttcttatec tagaccctta atttatata gtgcaagatt ctcaccatct gcccatattc 276900
 tgtgctactt gctttattt ccaactctcc actaaaagca ttgattgtgc tttttggca 276960
 aatgtctgca aagatgcatt ccccagtaac catgctagta tttagctcct tetaattctt 277020
 cattttcctg gacttggctt gaacctttct ggtttccac aaaccggtgg ccatgtgact 277080

gcaagacttg ggaggtaggg atgtaagaag gctcactgaa gcttaagctt tgatctttca 277140

caagtttctt gctcttctta aatcacctga ttcaattgta gtccaaggca gaacagtctt 277200
tacaagaacc tatgaacata agataaaaat atcttctcat ctttccaaat ggaattccag 277260
gactctgggt tccttactg cacaaagata aatttagttt gtcaacaact gtttcagtga 277320
tactttcata tttcccgcat cccgttatca ttaccacaat catcatcatc acaatcagca 277380
tcagcatcac taacacagat tgtagtctca ctgtatttca ggcaactgtt aagtggtttg 277440
ggaatacca agaaccacac ccttatatag ttttcaaca agtaatcaa ttatatgagg 277500
catattcaaa atactttcca aagaagaggc taacattttc cttctttgtg aagactatga 277560

gagccaaaca gacctacctc aaaaagtgtg tctgcagcag atttacttgg taagtaccag 277620
gggaagccat ctgtcattgc actgctattg gcttccatgg ctcaagtcca cagaattcta 277680
ttaaagcaac ccagtggtta gaaacaaatg agctgctcct ttcaatatta aaaggaagtg 277740
acttcgtgga agatcctggc tgataaaaata cataagaaag tgtagatat gtgaacaaaa 277800
taaaggtggg aatctttaag gaggaaaaat gcctggattt tgcctttcac ctccaaataa 277860
agaataatag atgctcttag caaacagaga gagggaatg ggggtggctg ggcttccaga 277920
ctaacacatc aactatacgc tgtaatttca cttttgcaac accacactct tgactctgtg 277980

gcaccaccag taaaaattca ttttcaggca gcacacctga acaacctgtg ctttgcctta 278040
attcactttc ccigctaaaa gccaacagga gaggtagcct cgcctaagga ggatggacgg 278100
cagagcactc cattggagga ggccacacgc taatataatc atgttccaac tagaatttgc 278160
aattctttga gagatgttca agatggtata aaaaattcag aggtagcagg gaaaggagag 278220
gggctgtgaa gcagaaggca tcagagggca ctttaaatgt gaagggcgca tcacactttc 278280
agcacgtgta caaggcagcc tgtcttacc agaatgtgat aatgaggac tcttctccta 278340
gatacggcat ttgatgggaa ctcccctccc agaccacaca aattgcagat tcaatgctca 278400

tactgcttta gttttatttc tgtttctgtg attaaaacac tgtgacaaa aacaactcta 278460
gagaaaggtt tatttgctt acaattccag gtcacagtct atcattaagg gaagtcaagg 278520
cggaactta aagtagaac ctgaaagcaa gcctgcttgc tattccatgg agcattactt 278580
ctgaccagag aaattattcc acagacaaag aagtgtggca ggcaattgtg aagatgctgt 278640
ttgctgtcag ccaggcagcc ttatgctcag ctagttttct tacacacttc atgatcacag 278700
tctaaggaat ggiaccactc acagtgggct gctcccttcc acgtcaccaa ccgagatgat 278760
ccctactgg tatgccaag tgccaatcta atctaggcaa cccctcaaca gaaagtctca 278820

attttagatt ccattaagtt gacagttaa gtccatgcca gagtttgag agcagaaaca 278880
 taaaggagaa aagatgtaac tatcaattca aaactgtaa atgtatttt tcaaagtta 278940
 accaggacat acgaatatga aattcattta tcatgaatta tcattgatgt gtctatttgc 279000
 aaggataggg tcagtctggg gataagctct ccttaagaga acatagtctg actaagtaaa 279060
 ccagtcttag gagtattgca gtcttctagt ttaaaactcc ttcctgaaa atgctgttac 279120
 aaaaaccact ttctttccca acttctagaa tttcacatt gtaccattgc cttcaccact 279180
 gatcttctc taictgaaag cttccatttg tggctctctc ctgatgcatc atgagttgag 279240

 atcttgggag ggttttcaca gcaaacagat cctctagaat tattcctgta ttttaaaggt 279300
 tgaaagtaaa gcaatggggc caactatgga gttcagcagg tattaatgc acctgccacc 279360
 aagtctaag acctgagttc aacctatagg gcagaaaaat agaactgact cccacaagtt 279420
 gtcttttgc tccacatgga ttccatggga tgtgtaagag catgccaaca tgcattgcacg 279480
 cacatacaca cggatataat aagtgaata atattttaat aagctctctc cttccacttg 279540
 agaaagtgag gctccttgac tgactcctgg gaaatgtgac ttctatatgg aagcctctcc 279600
 taacacaact cccttagag gcacatgaga tctgcccctc aaactcacat tttacctgac 279660

 ttcaagcttc catttagttc ctctactacg ccacactcct caaactttac acaggctggt 279720
 ggccgtcttc ctggcactgt gtccattcca tgaatacctt cccaaggcct aactggtctc 279780
 tagccttcag tccaatgga aacattattg ctcaaaaaga acacatagta tctgtgccct 279840
 gcacttaacc cagtatttct acagttacca cagcaacaca catagcctgc tctgtaacac 279900
 tgaccaccac ttactcaaat tgacgcccac agcagatggg gaaagctact ggggctgtgg 279960
 gtctaatttt ttttttttg ccaatgcaaa cacatagcag gtatttatca catggatgaa 280020
 taaagacaag aatggcattt gattcttcta gctgctagtg tggtagctga aatctaatta 280080

 gcattcagcg aaatactctg gattaatgc aggactaaga acccaagaat gtcagctgaa 280140
 ttcagcagta ccctgagtca gctgggaaaa gtcttctctac cctggttctc gcctgatctc 280200
 tcagtgggct tcttctctc gccttggctc agatgaaagc tagaaaaaaa aaaaggagag 280260
 aaaaaaaca aaaataataa tatgcaatgg aaagcaaac gccacattca aaaacaatat 280320
 tcttctctgt tccttacaat tctaccgtt gaatgccacc cctcccaga ggaaaggatc 280380
 actggaaaa cactcgtaag gaaaaaatc accacatttt tttaaagtgt gctattttaa 280440
 ttctcactca tgaatatgta gctaatttg actaatggga accctaaaag gaagaaaact 280500

 aaggcttttt aaggcaaac cattgaaat aaggtcatct gtaagaaatt tgtttaattt 280560
 tttctgagc cacatccaaa actccagcgg gcacgtttaa taatgaaagt ataaactatt 280620
 gggatttggg gctggttagt atgttggcac agtacataga tccctatgtg atttaaaaaa 280680

aaaaaaact aaaatthttct ctgcttcttt tatctggaag cctccacaat taaaacagtt 280740
 ttcttcatgg agtaatacat gttaaccaaa ttatactcta atathttcat tcaacgactt 280800
 ggaaaagtcat aaaaatgctt gtgtggggag ttgcatgca gaaggagaaa gaaagcacca 280860
 tatcaggagg atthtaaaaa gagagagata aaacaaagag ttccaaggat tgtcacaatc 280920

 tgatctgcat aaataaaaga taatggcttc agtgcgctgg ccaacctttc tgtggagtga 280980
 tccgtctgtg gagagtcatg tctgagaggc tgcaggatcat tatggcagga taaagcctat 281040
 ttctcattta tathaaagca ccttgcctgt taagggttg atthgatct cagacgtaaa 281100
 tgtgcatggg gctacacacc ttgttaagtc aatggctaca tatgcatgct ctccctaata 281160
 cacagataga thcagcatc cacagcccca ccattactcc aactathttt ttcttgactt 281220
 agaaaagata atathtaggt agatcagaag tgcataatg gacaggatta gagcatacat 281280
 thttctcttg acacagaatt thttttctaa thttgcatag aagaacaaaa thttthttcc 281340

 cthaatgag atthgttaca tcaacagaag aaggctaac tgtthccagt tctgtthtac 281400
 atgtthgatt tatctgatta tctggtthca ggcaagatga atthgtthcaa gthtagcattt 281460
 ggagactthg aatgaaaaat atthgacattt aaaaaattca athaaacaaag cccaataaca 281520
 acaaggaagt caaggaaaac tatagcccag tggactcaac ctcttaatg ctacaacct 281580
 thaatacagt tctcatgtt gtggttaacc ccagccataa aatathcttg ctgctacttc 281640
 athactataa thttgtatt atgaaacata thgtaaataa ctgtthtttg thgagatctg 281700
 atathgacc thccaaaggg tcatgacca caggttgaga accctgccc tagccccttg 281760

 aatththttt thaaaaatga thttgthttta thttatgtgc atthggtgttt tgctthacttg 281820
 tgtgcctgtg tgagggtgtc atathctctg cgactggagt tagagatagt tatgaactgc 281880
 catatgggtg ctgggaaatg aaccaggta ctctaggaga athaacagta ctcttaacc 281940
 ctgaaccate tctccaactc cacccattga atththaaag gattgtgaa thaaaactga 282000
 athacttht thgctaagaa tctgagatgg ctgtagthtt aatgaaagct ctacctcaa 282060
 tgctthtggg thaaaaggca catathctt cattcaggca tactthagcc cthaatgatt 282120
 gattggcate agcaatccaa aaaathattc agacactgac thtcagataa aagagcaaca 282180

 gathaactth gactatagta athaatatac ctgatagaag thttthgaac agaagataaa 282240
 gtctctcaat gtagctctc cactaggctg atgagccat thggtthcac tggthcacag 282300
 thttctgcat thcttagtgg atgagtagt aggagthgat ccaacctat gaaaaggtag 282360
 thctatagaa aatggacaa agaaaggaat aggagctaa acagggtgt gctgtgtct 282420
 thaaacaaaa gtctagagaa atcaagaaga gccagactta thaatathgg gthgacttht 282480
 accgaaaagt atcacaggat ggtthtaggg gthctctgga athacagataa agggctcatg 282540

ctgtggagtg ctgtcaaatc tgtgatgtgt gtgtatgaaa gagaacacaa acatattcca 282600

taagaagggg cctgtgtttc aatgaggatg ctactgcccc ttgaaatagg ttttgaaat 282660

tgggtcaate atttattaac ataatggttg ggacattact ggatcatcct agacaagggg 282720

cagggttctc cctgtcttac agtgacaag gaagactaag tctaccccc acttgtcaca 282780

tcatcacaat gatgaacact tgttcattca ccattatcta gttttctctt ataatgcac 282840

atttagcate acttgtctag ttttaatat catggacttc tagagtagca gttataaacc 282900

caatcaaggg catgccatgt gtgtattcag atttttatca agaggattca caatttgaa 282960

taaaaagca tatctctcat gatattgat taaacaatgc aatattaca cagtctttat 283020

ggttggagga tttatagta ttccatata gagtcagatg tctttcaga gaagattcct 283080

ggcctctcct ttataatgaa gttaaggtgc tttttaata tttatattcc agtagtcag 283140

aatgttatat aaaagtagaa ctttggcat ctcttctcc agaacactga tctagggcaa 283200

aatagtctg tatgacaaag gaagaaaata gaagctctca acagactta tgggaagaac 283260

tgtcctttct gagtgtatct caaagtgatg taaattttaa ggaaaggaga aaggcacaca 283320

tgtatggttc ctgagggctt gtgcgtacac agccattccc cactagatg ttaagttaag 283380

gcaaaggcag ggactgtaga gtacatccct cacttggaaa cctgggaaga cactgctttg 283440

ccttgtgtct cacgcagaac accataatac cagcagaata gacatggcag tgtggctcat 283500

acaggcagca agtaaaaatg gtggttctaa gattgcttat gctacagaca gatcacatga 283560

tagaagctag acatatafat gtattcttgg tagaggaact ggatggcacc aggggtagca 283620

agccagaagg ttatctggag ctttcctgt taaagttaag gtgcccctga gtcaggacct 283680

ataggatgga tagtcaaatg ttgtgtttca tttgtttatg ctgcatttgt ttaactgtgt 283740

aaagatgtgt tgcgtttca ccttgctgt ctaaaagcacc tgattactct aataaaaagt 283800

tgaacagcca atagttagac agaggaggga taggtgggcc tggcaggcag agagaaaaag 283860

ggagctggtc agccaggcag gcagacaaag aggaagcagg aaagtagggc atacagaatg 283920

aaagaaggta aaaatcccca aggcacaaaca tacagagaaa caggttaaat taagttataa 283980

gagctaatgg gacaagcaaa agataaggca gagcattcag aattaataat aatctccgt 284040

gtcataattt gggacctagc agtccaagaa cgtctgtctac agtcaaatgc ggttaagatgt 284100

gacagggctc cgtgctatgg ctgagatgta ctacagccc cagggcagca atccctgacc 284160

gctctaagag aagggatcac cacagcagag ccatggacac tgaagcagtt tgaatcaggg 284220

gcatctcaa agtggccagc ttacacacc aagaaactac tgtggtgtcc caaggtctct 284280

ttccataccc agaagccatc ctgcacaaaag aacaagagcc cagacatcag gagagcctga 284340
 gccaggtcca ggagtggcgg aaagccaatt agaagctgag tgactctgga gaggtgtgga 284400
 tactttgcat gaccacgttt aagacttttc acaagggcaa aaactcttcc ctactcagct 284460
 ggataccaac aacaaaatta aaaaaaaaaa atcaaccttt aaaaaaaaaa aacgactcag 284520
 ttcaccaagt tttgtatttg tgtttagcct tccatggatc agaaactggt caagttgatc 284580
 ttgtactaaa ggaactagaa gggcatttca tttatcctga acctaagact ataaaataaa 284640
 aacaagaata agaatgccat ctactggtgt ggaaagtagc aagcctctaa taagtccgca 284700

 gtgagcaaaa gagaatgaaa tgttctgtt attttacaat ggagataaaa gctagagaat 284760
 ggagtcttaa ataactgaag taataaaggc cgtaggcaaa taaacctccc cagctggtag 284820
 atctttcacg gtatctaagt tctgtggtgt tcctaccgt gggttccgct ctgaccaga 284880
 agacaatgtt aaagtggcat aaagcatttc ctttactgac ttgttacaat gtttgaaaac 284940
 aaactaatct cgaacttcat attttagttg ttttgtccag gcagatagat ggaaaggcat 285000
 gtgactgtcc tctgtttgtt ttctggaca ttggcctaata gccagctct tcgcacattt 285060
 ttgcagaaga cacaccaggc atgagtgaac tgtgtgttca gtgctcagt ctggcctctg 285120

 ggcacgtgtt catgtctatg gacatcttca cgtggctgga gatgcatttg tcaccatttc 285180
 aaattgaaat attatgtcta atcacttgtt atttcaaaat ccttttcaa tcatgatatt 285240
 tcattagata tattcattaa aatgtccaca tccccagggc ttatttgatt gagtataaat 285300
 atctcattgt tccagcacca tttacagaaa agataaaatt atccttttcc caactaaca 285360
 gctttggcac atttgcaaaa tactaattga tgaaatgtgt gggcagattc ctgggtttta 285420
 tattctcttc cataatttat ttacctgttc ttcactcttt tgataatgat atctttatac 285480
 taagtcttga atcagccatt gcaaatcgtc taaatagatt cttttcaag aatttttaa 285540

 aatctatfff taggcatttt gcagtcccat ataaacctta aaatcacctt gtaaatttgt 285600
 gcaaaaatga gctgtgggaa tcaattgaga ttgtgtgtg tttctaagtt aattagtggc 285660
 aaattcatca ataattgtga ggttttgtgt attaataggg tatgtcttta caattatgtg 285720
 ggtcctttaa atttttatga agaaattatt tgtaacataa aactcaaat gaatccacag 285780
 actaaataga aagattaaaa ttataagcat tctgaaatag aaaaagaaaa aaaaagactt 285840
 catgatcttg ggtttggcga aggtttcttc aatattataa gaacataaca caaactatga 285900
 gactaaataa taagtaggac ttcatcaaaa tcacagaaga gggggcagag agattttaag 285960

 agccagagge ccaagacatc tgctgctagg aagcttagtg actcctacc accacagaga 286020
 agccacacce aggaaatccc aaggttgcc taaagaagact tgtataatga caacaccagt 286080
 cgccatgcca acatggatgg ggagttttca taagcttctg tgcctagaga aaggactgca 286140

ggcgatcaat gacaactgcg aaaggcccaa tcagttttct cccaggacaa tccccagat 286200
 aggctatcca accctaagt atcagcccta aacacaagta tatataaaca acacagactc 286260
 agtaggtttt acatttaaat acacttcgtg tgtgtgtgtg tgtgtgtgtg tgtgtgtgtg 286320
 tgtgtgtgac aataatagtt tgaaaagaag aggtcatgaa ttaagaact agtgggagag 286380

 aacagagaga taaacagga ggcagacata atgtaaata atgtgctcata catggaattc 286440
 tcaaaacaaa aacaaatcaa ttaaatgaag acttatactc agaaaatgta aatgaaatag 286500
 aatcctatca tattatittg tgagcttgaa atgaattagc ccagatgaaa aaaattaaaa 286560
 tgtaattctt cagaagacac cattagcaaa aatgaaagg caagtccaa actgaaagaa 286620
 aaattttgca aaacataaac tatctacaaa aaagaaactt atctggctgg aaagatgatg 286680
 cagcagttaa gaataattct tgtacaggcc atgccttcca gaaaaccaga tgggctacca 286740
 atagaacttc tctctctct gttcccctag acccaatccc tcagtctctt cactagtctt 286800

 gcaacagacc actagctgta ccctctgcc cccaattccc tgtgggtccc acagactatc 286860
 gcctcctaac ccacctccc caactgtctc tgcattccag tctccaacac cagcaggctt 286920
 tccctgtgaa cacatcagct gaggcaggtca ggaaaacagg caggacatag ccatctcact 286980
 tacagaaaat ccagaggaaa cagaaatcaa ggaacaaaac acctaccat caaagacaaa 287040
 tcagcaccta ggcctataat catcccaaag ccagatgcct agataccagt gtaaaaatac 287100
 aacaaataaa agccagggca atatatittt actagagccc agctatccta tcatagtggc 287160
 cctgaatatg tcaacagagc tgaagaacaa gaaaatgacc ttaatgaaga tgatagaggt 287220

 ccttaaaaat taaatgaaca aatctcttaa acaatacag gaagacacaa acaattggag 287280
 gaaatgaata aatcccttca agaaagccaa gaaaatacac agaaacattt gaagaaaact 287340
 aataaaactg ttcaagacct gaaaatggat atagaagcaa taaaggaaac acaaactgag 287400
 tgaagtctgg agattaaaaa aaagttaaga attgagagag tgcggaggtg aggtgcttca 287460
 ggttctgcct tgggccaac ttctgcctgc ccaccctggc aaatcccacc caagggtctg 287520
 caataggacg actcgacccc tgaggaccaa gcaacccaaa gtctgctgac atctctgtgc 287580
 cagtgtctgt ctccccacc tggagagcga gtgcctcaga cctgcctgct cetaacttga 287640

 gaccatcag agtatcaaag tcaattgcac acacgtgaag agaatgccgg acctatacac 287700
 acctggaag gaagtaacac caactgtacc cactggaaca agagatggga agacaacaat 287760
 ataagaacac atccaacaac aggaaaaaca atatgacacc actagagtct agggactcta 287820
 caccagcaag acataaacct cccaacacag aagcagcaga agagagcaac cttaaaaaca 287880
 acttcatgca gatgatagag aacctaaag aggaaatcag aaaatcctt agagaaatgg 287940
 aagaaaagac aaacaaaaga tgcaagaaat caaggaaagc agaaaaaaaa acaagaaat 288000

acaattaac agctgaagga aacagttcag gacctgaaaa ctgaattaca gacaataaag 288060

aaaacacaaa ctgagggaat gctggacaga caataaagaa acaacaaact gaggaaaagc 288120

tggaagtgga aaagctgagt aaacaatcag gaaccacaga tgcaagcata accaatagaa 288180

tacaagagat ggaagacaga atctcagatg ctgaagacaa actagaggaa ataaactcgt 288240

caactaaaaa tctgaagtct aacaaatccg taacacaaaa tatccaggaa atatgggaca 288300

caatgaaaag accaaaccta agtataatag gtataaaaga aggtgaagaa acccaactca 288360

aaggtgcaga aaacatattc aacaaaatca tagaagaaaa ttttccaac ctaaagaaag 288420

gcatgccaat gagtgtacaa gaagcctgca gaatgccaaa tagagtggac cacaaaagaa 288480

agtcctctca tcacataata attaaaaacc aaacatacag aataaagaaa aaatattaag 288540

agcaacaagg ggaaaagacc aagtntnnnnn nnnnnnnnnn nnnnnnnnnn nnnnnnnnnn 288600

nnnnnnnnnn nnnnnnnnnn nnnnnnnnnn nnnnnnnnnn nnnnnnnnnn nnnnnnnnnn 288660

nnnnnnnnnn nnnnnnnnnn nnnnnnnnnn nnnnnnnnnn nnnnnnnnnn nnnnnnnnnn 288720

nnnnnnnnnn nnnnnnnnnn nnnnnnnnnn nnnnnnnnnn nnnnnnnnnn nnnnnnnnnn 288780

nnnnnnnnnn nnnnnnnnnn nnnnnnnnnn nnnnnnnnnn aattaactac actcgcataa 288840

acataggcaa tagataatcc catgctacaa aaacacaaaa taaaaggcag gataaatcct 288900

catacaatac caataccaac aacaaaccaa aaacaaacaa gaataaacac tcaatggacc 288960

ttaatttccc tcaatattaa tgatcttaac tctctataa aaagacacag gttaacagat 289020

tggatatgaa gacagaatcc atccttctgc tgcatacaag aaacacacct caaatcaaa 289080

ggcagacatt acctcagagt aaagggttgg gataagatac tccaatcaaa tagaccaag 289140

aaatgagctg gggtagctat ccgagtatct aacaagttag acttcaaact aaaatcaatc 289200

aaacaagatg aagaaggcca tttcagattc atcacaggaa aaatccatca ggaagaagtc 289260

tcaattctaa annnnnnnnn nnnnnnnnnn nnnnnnnnnn nnnngtaaaag aaacattatt 289320

aaaactcaaa tgacaaataa gacctcacac agttatagtg ggagacttca ataccgact 289380

ctcaacactg gacaggacca ccagacagaa acttaacaaa gagacaaagg aactaacaga 289440

agttatgacc caattgggat taacagacat ttatagaact ttctatcaa acacaaaaga 289500

atataccttc ttttcagcat cacatgaaac cttctcaaaa atcgaataca ttctcggcaa 289560

catagcaaat ctcaacaggt acaaaaaaaaa ttggaataat ccctgtgtc ttatcagacc 289620

accannnnnn nnnnnnnnnn nnnnnnnnnn nnnnnnnnnn nnnnnnnnnn nnnnnnnnnn 289680

nnnnnnnnnn nnnnnnnnnn nnnnnnnnnn nnnnnnnnnn nnnnnnnnnn nnnnnnnnnn 289740

nnnnnnnnnn nnnnnnnnnn nnnnnnnnnn nnnnnnnnnn nnnnnnnnnn nnnnnnnnnn 289800
 nnnnnnnnnn nnnnnnnnnn nnnnnnnnnn nnnnnnnnnn nnnnnnnnnn nnnnnnnnnn 289860
 nnnnnnnnnn nnnnnnnnnn nnnnnnnnnn nnnnnnnnnn nnnnnnnnnn nnnnnnnnnn 289920
 nnnnnnnnnn nnnnnnnnnn nnnnnnnnnn nnnnnnnnnn nnnnnnnnnn nnnnnnnnnn 289980
 nnnnnnnnnn nnnnnnnnnn nnnnnnnnnn nnnnnnnnnn nnnnnnnnnn nnnnnnnnnn 290040
 nnnnnnnnnn nnnnnncaaat taaccaaaag gcagagagag atcatgcaa ttaaaaaaat 290100
 cagaaatgaa aagggaacc taacaacgac actgaggaaa tccagagaat cctcaggtca 290160

 ttctttgaaa acctgtattc caaaaaattt gaaaatttaa aggaaatgga caattttctg 290220
 gacagttatc acttaccaa attgaatcaa gaacagataa gcaacttaa cagacctata 290280
 acctctaagg aaatagaagc agtcatcaa agcctcccaa ccaaaaaaag cccaggacca 290340
 gatggattca ttgcaaaatt ctaccagaaa ttcaaagaat tgctaatacc aatactctc 290400
 aaattgttc acaaaataga agcagaagg acattgcaa nnnnnnnnnn nnnnnnnnnn 290460
 nnnnnnnnnn nnnnnnnnnn nnnnnnnnnn nnnnnnnnnn nnnnnnnnnn nnnnnnnnnn 290520
 nnnnnnnnnn nnnnnnnnnn nnnnnnnnnn nnaaccata taaacagact gaggaaaaac 290580

 cacatgatca tctcactaga tgtgaaaaa gcctttgaca aaatccaaca cccttcatg 290640
 ataaaggtct tggagaaatc aggataaca ggaacatacc tcaacataac nnnnnnnnnn 290700
 aagctaacag ccaacatcaa attaaatgga gagaaactcg atccaattcc tctaaaattg 290760
 gggacaagac aaggctgtcc actctctcca tacctcttca atatagtcct tgaagtccta 290820
 gctagagcaa taagacaaca aaaatgagat caaggaata caaatctgaa aggaagaagt 290880
 caaactctca ctatttgag atgatatgat agtctacatt agtgacctga aaaactctac 290940
 cagggaactc ctacagctga tannnnnnnn nnnnnnnnnn nnnnnnnnnn nnnnnnnnnn 291000

 nnnnnnnnnn nnnnnnnnnn nnnnnnnnnn nnnnnnnnng atgacacatt ggtggagaaa 291060
 gaaatcagag aagcatcacc ctttacaatt gccacaaaca acataaaata ccttggtaac 291120
 actaaccaaa aaacgtaaaa cacctgtacc ataagaattt ttagtctcta aagaaagaaa 291180
 ttaaagaaga taccagaaaa tggaaagatc tcccatgctc ttggataggc aggatcaaca 291240
 tagtaaaaat ggcaatcttg ccaaaagcaa tctacagatt caatgcaatc cccatcaaaa 291300
 tcccaacaca attcttcaca gaccttgaag gaacaattct caactttata tggagaaaca 291360
 aaagaccag ggcagccaaa acatcccat acaataaagg aacttctgga ggcacatca 291420

 tctctgactt caagctctat tacagagcta tagtctgaa aacagcttgg tattggcaca 291480
 aaaataaaca tatagaccaa tggaaatagag tttaaaacce tgatattaac ccacacacct 291540
 atgaacacnn nnnnnnnnnn nnnnnnnnnn nnnnnnnnnn nnnnnnnnnn nnnnnnnnnn 291600

nnnnnnnnnn nactggatgc tggaatgtag acgccttcag atagatccag atctatcacc 291660
 atgcacaaaa cttaaagtcca aatgaatgaa agatctcaat ataaatccag ctacactgaa 291720
 cctattagaa gacaaactgg gaaataccct tgaattaatc ggtacaggag accgcttctc 291780
 gaacattata ccagtagccc agacactgag gtcaacaatt gataaatggg accctctgaa 291840

 actgagaagc ttctgtaagg caaaggaggc agccagcaag acaaaacggc agctgacata 291900
 ctgggaaaag atattcacca atcccacatc tgacagaggg ctgatctcca aaatatacaa 291960
 agaactcaag aagctattct caaaaacacc aaacaatcca attaaaaat ggggtacann 292020
 nnnnnnnnnn nnnnnnnnnn nnnnnnnnnn nnnnnnnnnn nnnnnnnnnn nnnnnnnnnn 292080
 nnnnnnnnnn nnnnnnnnnn nnnnnnnnnn nnnnnnnnnn nnnnnnnnnn nnnnnnnnnn 292140
 nnnnnnnnnn nnnnnnnnnn nnnnnnnnnn nnnnnnnnnn nnnnnnnnnn nnnnnnnnnn 292200
 nnnnnnnnnn nnnnnnnnnn nnaatggagt actactcagc agaaaaaaaa acaatggaat 292260

 ctgaaatth gcaggaaaat ggatggatct agaagaaacc attctgagtg aggtaacca 292320
 atcacaaaaa gacaaacatg gtatgtactc actcatatgt ggatthtaga catagagtaa 292380
 ggattaccag cctacaatc acactgccaa agaagctaata aaacaaggag gccctaaga 292440
 gagacataca tggthcccta aagaagggga gagggtcaag atctgctgag caaatggga 292500
 gcacgggaag aggggggagc taggagcatg agaaagggag tagaagagg atgcagagga 292560
 catgaggag cagaaaatth gagtcagggg aagaatagat gataacaaga atggaggtat 292620
 cataagagag aaagagagag atthtaggtt tacagagaaa tcagccacta ggaaaaggtc 292680

 tggagatcta caaggatgac accagcaaac aatctaagca acggagaaga ggctacctta 292740
 aatgccctcc cctgataatg agattgatga ctgacttatt tgccatccta tagccttcat 292800
 cgagcagctg gaggaagtag aaacagccac ccacaactaa tcaccgaact gaactggaac 292860
 ccagatgcag agaaggataa gtgaagagca caggggtcca gaccagctg gtgaaacca 292920
 cagaaacagc tgcttgaac aagggggaac tcttgctccc cagactgata gctggaatac 292980
 cagcatggga ctgatccaga ccccaggaac atgggttct gtgaattatt thtcagaaat 293040
 ctacgggcc tctatagaa gthtactact taccctage ataggtgtgg actthgggag 293100

 cccattctgt atagaggaat actccctgag ccaagactca tggagtggg ctaggccct 293160
 atcccaaagg atacaatagt ctctgatgac atcctatgga aggcctcacc atccaggggg 293220
 agccgaaagg atatgtgata ggtagggtht tagthgtga tgctgtagg gcaggactgg 293280
 caagagaagg gaagtgcctg gattgttatg taaaacaaca ctgthtctaa thcaaathh 293340
 aaaaagthg aaaaatatag agcacaaaca cataggaat tccagacat catgthttaa 293400
 agataththt caaaactg aathcttht gtctaaatta ththtthact agggaagact 293460

ttaaaggctc tagctttaa tatagagaat ggatgtcttg tggaatggaa caaacttgaa 293520

 aataaaatat ttttctgaca ataaaaaaaa attaagaagt caaacaggag ctatagagtc 293580
 aagcttcacc aacagaatat aaaagttaga agagagaatc tcaggcattg aatatacaat 293640
 gaaagaaatg gatataatcag ccaaaacata tgttaaatct aatcaaaaa aaattctgat 293700
 gtaaaacatc taggaaatct gagacactat gaaaagacca aatctaagag tggcaggaat 293760
 agagaaaggg gaagagtccc agctcaaaga cccagaaaat atttcaaca aatcataga 293820
 agaaaaatc ctaaaactaa ggacatgcct ataaaggtag aagatgctta tgaccaccaa 293880
 aaagattgta ccagaataga aagtcacctt ggtacataat aatcaaaaca ctaaacatac 293940

 agaagaaaga aagagaatta taagatgcaa gggaaaaata gcaactaacc taaaaagca 294000
 gatctgttag aattacacct gatttctcaa tggagactct aaaagccaga agggcctcaa 294060
 cagatgtgct gcagacgctt agagaacaca gatgccagcc cagactactg tactcagcaa 294120
 aactttcaat cacaataggt ggagaaaaata agatattcca tgataaagtc tatttcaaat 294180
 atttgtcaat aaatccagcc catagaaggt attagaatga aaactccaac taaaggaggt 294240
 cacctacacc catgaaaaca gaaaaagtaa tctcacatca gcaaaacata aagaagagat 294300
 ctctctctct ctctctctct ctctctctct ctctctctct ctctctctatg cacacacata 294360

 cacacacaca caccaccacc accaccacaca acaacaacaa caacaacaac aaccacaaaa 294420
 tcataggaac caacaatcat tggtcattaa taactctcag tatcaatggt ctcaactccc 294480
 tgataaaaag acacagacta acagaatgga tgtaaaaaca ggatccctct tctgctgcat 294540
 ccaagaaaca cacctcaata tcaagggtag acattacctc agggcaaagg attggaataa 294600
 tatgaaacaa agggacccaa gaagcaagct agtgaacaa ttttaatgct taatataata 294660
 gactttaaac caaaactaat caaaagagct gggaaaggac actgcatatt catcaaagga 294720
 aaaatccatc aagaagacat ttcaattctt aatattctcc ccccaaacac aaagacactc 294780

 gagtctgtag aagaacatg actatagctt aaattacata cagatcttct tacactgata 294840
 gtgggagact tcaatcctcc actctacca atggagagge atccagacaa aaacaaaaca 294900
 gagaaatgct ggacttaaca gatattatga accaaatgga cctaccataa ctacagaaca 294960
 tttcagtcaa acacaaaata atatattcat actcatggaa ttttctcaa aactgaccac 295020
 atactcagat acaaagcaag tctcaacagg tacaagaaaa ttgaaataac tccctgaact 295080
 ctatcatacc atcatagatt aaagctggat atcaatggca acagaaagct taaaaattca 295140
 tgaaaactga acaactctct actgaatgaa aaatgggtca agacagaaat aaaaaagaaa 295200

ctaaagactt cctagaattc aataaaaatg aatacacagc atatccaaac atttttaaca 295260
 ctatataggc agttctaaga ggaaagttag tagtactaag tacctacatt taaaaataaa 295320
 atggaaagat ttcatactag aaacttaaca gcacagctga aagctccaga aaagtggttc 295380
 tcaaatttcc taatgctgtt aacctttaat acagtttttc atgtcatggt gtctctcaac 295440
 cataaatta ttttcattgc tacttcataa ctgcaatatt gctactgtta tgaatcctga 295500
 cataaatatc tgatatccag gatgtatgag tatccataac aatattgtgt ttgatatga 295560
 tggccctcag gaaggacccc tacgaaaggg tcatttgacc ccctaagtgg gtagcaacct 295620

 aacaggttga gaaccacttc tctagaacaa aatgaagtaa atacactcaa gaggagtgta 295680
 tagcaagaat taatcaaaact gagaacagag atcaataaaa tagaacaga gaacaataca 295740
 aagagtcaat gaaacagagc tagttcttca agaaaataaa caagatagaa taacccttat 295800
 ccaaatcaac taaaagactg agagagaata ttcaaattca caaaatcaga aatgaaaagg 295860
 gtacacataa caacaaacac caaggaaatc cagagattca taaggacata ctttaaaaac 295920
 ttttactcca ccaaattgga aaatctgaaa gaaaaggata attttcttga tacacaccac 295980
 ttatgaaagt taaatcaaga tcagataaac aatataaata gacctataac acctagttaa 296040

 atagaacaag tcatcaaaag tctccccca cacacactc aaaaaaaaaat atctagggcc 296100
 agatggtttt agttcagaat tctaccaaac tttcaaagaa tagttaaagc caacatccct 296160
 caacatTTTT cacataat ataacataaag aatgcttata ttcctcattt tataagtcca 296220
 cagtagcctg atacctaac aaactgaaag aaaaaataa aaacatgatc atcttattag 296280
 atgccaaaaa agcctttgac aaaatccaac aaccttcat gttaaaagtc ttagagagat 296340
 tagggataca agaaacacaa caaaggcaat aagtaacaag cctatagcca acatcaaatt 296400
 aatggagag atactcaaag caaatccaca aaaatcagga gcaagacaag gctgttact 296460

 atctctatgt ctattcaata tagtacttga agttctaaat gaagcaataa gacaactgaa 296520
 ggacattaag tggattaaaa ttagaaagga agaagtcaaa ccatcattat ttgcagatga 296580
 tatgatagta tatttaagtg attataaaat ttccatcagg gaactcctac agctgataaa 296640
 cactttcagt gaagtgctgg atataagatt tcaaaaacaa aacaaaataa aacaaaaca 296700
 gtagccctct tctatacaaa tggcaaaccg actgagaaag aaatcagga aacaacacct 296760
 ttcaaatag cctcaataa tataaaatac cttggaatga ctctgacca gcaataaaaa 296820
 gacttgatg ataaaaaca tcaagtcttt gaagaaagaa attgaagata tcagaagatg 296880

 gaaatatttc ccatgtacat ggatctgcag gattaacata gtaaaatgg caatcttacc 296940
 aaaagcaatc tacagattca agcaatcccc atcatacttt taacacaatt ctttacagag 297000
 ctgaaatga taattctcaa cttcatatgg aaaaacaaga aaccaagat agctaaaaca 297060

atccagaaca ataaaagtac ttttggatgt tttaccattt ctgatttcaa gttgtactaa 297120
 agaaataata taataaaaaat cacatgctgt tggcataaat acagatatgt tgatcaatga 297180
 aatagaagtg aagaccaga cataaattca taaccattag gacacctgtc ttttgataaa 297240
 gaagccagaa atacacactg gaaaaaaga aagtatcttc aacaaatggt gctgggcaaa 297300

cgctctacatg gagaagagca caaatagatc catatttatt gccctccaca aaactcacat 297360
 ccaagtgcac caaaaacctc aacataaaat ctgagacatt ggacctaata gatgagaaag 297420
 ttgggaatat tctttaactc tttggcatag gaaaagaact tctgaacaga aactgttaa 297480
 cacttagaca ctaagatcaa caattataaa acagaacctt gtgaaactga aaagcttctg 297540
 taciaaggac accatcaatc agataaagtg taagtgcaca gcatggaaaa atattgtttc 297600
 caactccaca tctaatagag ggctaataatc caaaatatgt agaaaacttg agaaactata 297660
 taccaaaaaa gaatctaatt ttaaaatggg gtatagattt gaacagagga ttctgaatag 297720

aggaatctca aatcgctgag aaacacttaa aatgtccaac atttctgat gttagccatc 297780
 aggaaaatgc aatcataat gactctgaga tgccatctta cacctgtcag aatggctaag 297840
 atcagaaca caagctacag ctcatgctgg agaggatgtg gagtaagggg aacactcatc 297900
 cattgctggt aggaatgtaa gccactatgg gaatcaatat ggtggctcct cagaaaattg 297960
 aaaatacatc tacctcaaga cctgctata ccacacttaa agcatacacc caaagtcact 298020
 ccatcctacc acaaggatc ttgctaacc atgttctttt ggctttattc ataatagcca 298080
 gaatgaggaa ataaccaaga tattccttaa aagaagaata gataaacaaa atacgatgca 298140

tttacacaat ggaacattac ttaaatgctt aaaaaacata acatcatgag atttgcacgc 298200
 aatgagtga actagaataa aatcatcctg agtagggtaa gcctgacca caaaggcaaa 298260
 tatgttatgt attcacttat aagaggatat tggatattaa gtaaatgaca accaagccac 298320
 aatttgtaaa cacagagatg ttaggtaaag agtttagttg ggtctccctg ggaaggggaa 298380
 atagaataag tttatttggg agactggggg caggtgtgga caggagcagg aggggtagg 298440
 tgggaaggag atggttggag ggagagagtg ctggaaaaga tggctgaaat tgggaagggtt 298500
 gtggaaacct ggtacagtgg aaacttctg ggatcttcca acattgatcc taatgaggac 298560

tcctagtaat ggtggcgaga gtctcaactg tctatcttc atalccagc aatgtgtcca 298620
 gtagaggaa tggtttgcat tcaactgagt tgttgccaa gggggtccca tgaanaatccc 298680
 caaacaacat aagctgatgc taagacaaa gagttgctct tcccaactg acagtggggt 298740
 cccactgcca aggataacat ccacacaatg cactgaacat ggaaaagtig agctgatgct 298800
 catagaacce tcaccttaca ttctagtctc tttggtgtgg gaagatactc tgcaggctac 298860
 tgaaagagaa atgtggacac caatccagcc aaaaaatctt tgacctacaa tatttcttac 298920

ctataaaata tgctggggca atggtgacac ataacttgtg agagtagcca accaatgtct 298980

gatttgactt aaggcacatt ccaacttaaga aggaacccat atgggacgct gcttgagtaa 299040

ccaagaaccg gagactagac agcccagaga cttagagtaa agccaacat gactaaccta 299100

aaaaaacaat aaaatgattc ataatgatat tctgctatag tcatagatca gtaccttacc 299160

caatcatcat caaagaagat tctccagca gcagatggat gcagatacag aaagccagag 299220

tcagacattc tgggaaaga gagtctaac tagaggcttc cattgggttc ctcccctcgg 299280

agcttaggga atcctatgaa agaggaggca gaaagacttt aagagtcaga ggagacggaa 299340

aatcaagag aacatgacac tctgaaccaa gtaagcaagg cacacatgag ctcaaaagc 299400

cggaagcagc aagcacagca ctgacgtggc tccacagcag ctgctctgca tatatataat 299460

agccgctggt agcttagtat ttttcatgg ctgctgatta tgagaacaag tgggtctctg 299520

gctctcgcgc ctgctcctgg gctctttgct tctgtggggg tttccatgcc aactccaat 299580

gccagagctt tcacttcac ttagtagatt tttgtcgtt tgggtgtttt ctcttagaag 299640

cccgttcttt tctaagaga gattgagaga tggaaaggga ggaaggtgat gaggaactgg 299700

gtggatggag ggagggggag ctagaatcag gatataatt atgagaaaag aactatcttc 299760

agcaaaaaag aaaataatc atataaattc tctgataaag aaaataccac ttgttcttat 299820

agggaacca ggttcaattc ccagcagca catggaaatt cacaactcca tttccagggt 299880

atccactacc ctcttctgga atctatgggt atcaa 299915

<210> 36

<211> 1106488

<212> DNA

<213> *Cricetulus griseus*

<220><221> modified_base

<222> (163)..(2934)

<223> a, c, t, g, unknown or other

<220><221> modified_base

<222> (8456)..(8619)

<223> a, c, t, g, unknown or other

<220><221> modified_base

<222> (15799)..(16086)

<223> a, c, t, g, unknown or other

<220><221> modified_base

<222

> (17737)..(17967)
 <223> a, c, t, g, unknown or other
 <220><221> modified_base
 <222> (20752)..(27272)
 <223> a, c, t, g, unknown or other
 <220><221> modified_base
 <222> (37964)..(37993)
 <223> a, c, t, g, unknown or other
 <220><221> modified_base
 <222> (39955)..(39964)
 <223> a, c, t, g, unknown or other
 <220><221> modified_base
 <222> (45054)..(45065)
 <223> a, c, t, g, unknown or other
 <220><221> modified_base
 <222> (49093)..(49166)
 <223> a, c, t, g, unknown or other
 <220><221>
 modified_base
 <222> (56967)..(58551)
 <223> a, c, t, g, unknown or other
 <220><221> modified_base
 <222> (60598)..(60676)
 <223> a, c, t, g, unknown or other
 <220><221> modified_base
 <222> (63030)..(63997)
 <223> a, c, t, g, unknown or other
 <220><221> modified_base
 <222> (83605)..(83705)
 <223> a, c, t, g, unknown or other
 <220><221> modified_base
 <222> (91044)..(91277)
 <223> a, c, t, g, unknown or other
 <220><221> modified_base
 <222> (91962)..(92175)

<223> a, c, t, g, unknown or other

<220><221> modified_base

<222> (102066)..(102082)

<223> a, c, t, g, unknown or other

<220><221> modified_base

<222> (114085)..(114381)

<223> a, c, t, g, unknown or other

<220><221> modified_base

<222> (125782)..(125791)

<223> a, c, t, g, unknown or other

<220><221> modified_base

<222> (128879)..(128888)

<223> a, c, t, g, unknown or other

<220><221> modified_base

<222> (137854)..(137874)

<223> a, c, t, g, unknown or other

<220><221> modified_base

<222> (151312)..(151323)

<223

> a, c, t, g, unknown or other

<220><221> modified_base

<222> (154767)..(155281)

<223> a, c, t, g, unknown or other

<220><221> modified_base

<222> (155764)..(155776)

<223> a, c, t, g, unknown or other

<220><221> modified_base

<222> (164226)..(164392)

<223> a, c, t, g, unknown or other

<220><221> modified_base

<222> (166478)..(166507)

<223> a, c, t, g, unknown or other

<220><221> modified_base

<222> (168031)..(168330)

<223> a, c, t, g, unknown or other
<220><221> modified_base

<222> (168496)..(168698)
<223> a, c, t, g, unknown or other
<220><221> modified_base

<222> (169262)..(169508)
<223> a, c, t, g, unknown or other
<220><221> modified_base

<222> (170999)..(171107)
<223> a, c, t, g, unknown or other
<220><221> modified_base

<222> (173262)..(173553)
<223> a, c, t, g, unknown or other
<220><221> modified_base

<222> (177094)..(177168)
<223> a, c, t, g, unknown or other
<220><221> modified_base

<222> (203588)..(204814)
<223> a, c, t, g, unknown or other

<220><221> modified_base

<222> (207834)..(207861)
<223> a, c, t, g, unknown or other
<220><221> modified_base

<222> (213726)..(213749)
<223> a, c, t, g, unknown or other
<220><221> modified_base

<222> (224899)..(224915)
<223> a, c, t, g, unknown or other
<220><221> modified_base

<222> (228923)..(229151)
<223> a, c, t, g, unknown or other
<220><221> modified_base

<222> (236770)..(238782)

<223> a, c, t, g, unknown or other
<220><221> modified_base
<222> (239121)..(239607)
<223>
> a, c, t, g, unknown or other
<220><221> modified_base
<222> (256938)..(257035)
<223> a, c, t, g, unknown or other
<220><221> modified_base
<222> (284119)..(284128)
<223> a, c, t, g, unknown or other
<220><221> modified_base
<222> (284653)..(284698)
<223> a, c, t, g, unknown or other
<220><221> modified_base
<222> (285740)..(285769)
<223> a, c, t, g, unknown or other
<220><221> modified_base
<222> (287241)..(287251)
<223> a, c, t, g, unknown or other
<220><221> modified_base

<222> (287405)..(288527)
<223> a, c, t, g, unknown or other
<220><221> modified_base
<222> (298519)..(298620)
<223> a, c, t, g, unknown or other
<220><221> modified_base
<222> (299355)..(299364)
<223> a, c, t, g, unknown or other
<220><221> modified_base
<222> (299654)..(299696)
<223> a, c, t, g, unknown or other
<220><221> modified_base
<222> (306689)..(306712)

<223> a, c, t, g, unknown or other
<220><221> modified_base
<222> (327237)..(327305)
<223> a, c, t, g, unknown or other

<220><221> modified_base
<222> (339484)..(342669)
<223> a, c, t, g, unknown or other
<220><221> modified_base
<222> (346468)..(346737)
<223> a, c, t, g, unknown or other
<220><221> modified_base
<222> (352957)..(355119)
<223> a, c, t, g, unknown or other
<220><221> modified_base
<222> (355338)..(355354)
<223> a, c, t, g, unknown or other
<220><221> modified_base
<222> (357417)..(357713)
<223> a, c, t, g, unknown or other
<220><221> modified_base
<222> (367507)..(367803)
<223>
> a, c, t, g, unknown or other
<220><221> modified_base
<222> (372120)..(372133)
<223> a, c, t, g, unknown or other
<220><221> modified_base
<222> (380820)..(381165)
<223> a, c, t, g, unknown or other
<220><221> modified_base
<222> (386188)..(386311)
<223> a, c, t, g, unknown or other
<220><221> modified_base
<222> (391630)..(392473)

<223> a, c, t, g, unknown or other
<220><221> modified_base
<222> (396265)..(396347)
<223> a, c, t, g, unknown or other
<220><221> modified_base

<222> (405204)..(405213)
<223> a, c, t, g, unknown or other
<220><221> modified_base
<222> (406456)..(406490)
<223> a, c, t, g, unknown or other
<220><221> modified_base
<222> (426332)..(426396)
<223> a, c, t, g, unknown or other
<220><221> modified_base
<222> (429687)..(429853)
<223> a, c, t, g, unknown or other
<220><221> modified_base
<222> (451665)..(451674)
<223> a, c, t, g, unknown or other
<220><221> modified_base
<222> (453243)..(454085)
<223> a, c, t, g, unknown or other

<220><221> modified_base
<222> (463496)..(463579)
<223> a, c, t, g, unknown or other
<220><221> modified_base
<222> (467188)..(467263)
<223> a, c, t, g, unknown or other
<220><221> modified_base
<222> (468482)..(468500)
<223> a, c, t, g, unknown or other
<220><221> modified_base
<222> (471330)..(471358)

<223> a, c, t, g, unknown or other
<220><221> modified_base
<222> (481369)..(481668)
<223> a, c, t, g, unknown or other
<220><221> modified_base
<222> (514369)..(514378)
<223>
> a, c, t, g, unknown or other
<220><221> modified_base
<222> (531263)..(531311)
<223> a, c, t, g, unknown or other
<220><221> modified_base
<222> (532671)..(532680)
<223> a, c, t, g, unknown or other
<220><221> modified_base
<222> (540039)..(540096)
<223> a, c, t, g, unknown or other
<220><221> modified_base
<222> (563363)..(563509)
<223> a, c, t, g, unknown or other
<220><221> modified_base
<222> (570346)..(570449)
<223> a, c, t, g, unknown or other
<220><221> modified_base

<222> (576914)..(576935)
<223> a, c, t, g, unknown or other
<220><221> modified_base
<222> (583216)..(583455)
<223> a, c, t, g, unknown or other
<220><221> modified_base
<222> (587012)..(587064)
<223> a, c, t, g, unknown or other
<220><221> modified_base
<222> (588808)..(588817)

<223> a, c, t, g, unknown or other
<220><221> modified_base
<222> (599898)..(600107)
<223> a, c, t, g, unknown or other
<220><221> modified_base
<222> (601781)..(601794)
<223> a, c, t, g, unknown or other

<220><221> modified_base
<222> (626592)..(626694)
<223> a, c, t, g, unknown or other
<220><221> modified_base
<222> (627375)..(627402)
<223> a, c, t, g, unknown or other
<220><221> modified_base
<222> (630111)..(630386)
<223> a, c, t, g, unknown or other
<220><221> modified_base
<222> (630497)..(630577)
<223> a, c, t, g, unknown or other
<220><221> modified_base
<222> (639423)..(639434)
<223> a, c, t, g, unknown or other
<220><221> modified_base
<222> (640127)..(640178)
<223>
> a, c, t, g, unknown or other
<220><221> modified_base
<222> (648355)..(648600)
<223> a, c, t, g, unknown or other
<220><221> modified_base
<222> (652544)..(652712)
<223> a, c, t, g, unknown or other
<220><221> modified_base
<222> (652832)..(652925)

<223> a, c, t, g, unknown or other
<220><221> modified_base
<222> (657027)..(657090)
<223> a, c, t, g, unknown or other
<220><221> modified_base
<222> (667667)..(667725)
<223> a, c, t, g, unknown or other
<220><221> modified_base

<222> (673937)..(679924)
<223> a, c, t, g, unknown or other
<220><221> modified_base
<222> (680407)..(680434)
<223> a, c, t, g, unknown or other
<220><221> modified_base
<222> (682238)..(682269)
<223> a, c, t, g, unknown or other
<220><221> modified_base
<222> (687994)..(688042)
<223> a, c, t, g, unknown or other
<220><221> modified_base
<222> (688933)..(688947)
<223> a, c, t, g, unknown or other
<220><221> modified_base
<222> (726129)..(732038)
<223> a, c, t, g, unknown or other

<220><221> modified_base
<222> (733080)..(733117)
<223> a, c, t, g, unknown or other
<220><221> modified_base
<222> (741290)..(741344)
<223> a, c, t, g, unknown or other
<220><221> modified_base
<222> (743839)..(743848)

<223> a, c, t, g, unknown or other
<220><221> modified_base
<222> (745514)..(745993)
<223> a, c, t, g, unknown or other
<220><221> modified_base
<222> (746600)..(746715)
<223> a, c, t, g, unknown or other
<220><221> modified_base
<222> (752952)..(753022)
<223
> a, c, t, g, unknown or other
<220><221> modified_base
<222> (753229)..(753544)
<223> a, c, t, g, unknown or other
<220><221> modified_base
<222> (758531)..(758792)
<223> a, c, t, g, unknown or other
<220><221> modified_base
<222> (762510)..(762615)
<223> a, c, t, g, unknown or other
<220><221> modified_base
<222> (766174)..(766183)
<223> a, c, t, g, unknown or other
<220><221> modified_base
<222> (767768)..(767797)
<223> a, c, t, g, unknown or other
<220><221> modified_base

<222> (780681)..(780790)
<223> a, c, t, g, unknown or other
<220><221> modified_base
<222> (784763)..(785306)
<223> a, c, t, g, unknown or other
<220><221> modified_base
<222> (786027)..(787582)

<223> a, c, t, g, unknown or other
<220><221> modified_base
<222> (788669)..(788854)
<223> a, c, t, g, unknown or other
<220><221> modified_base
<222> (795841)..(796531)
<223> a, c, t, g, unknown or other
<220><221> modified_base
<222> (796746)..(796851)
<223> a, c, t, g, unknown or other

<220><221> modified_base
<222> (804219)..(804556)
<223> a, c, t, g, unknown or other
<220><221> modified_base
<222> (807151)..(807255)
<223> a, c, t, g, unknown or other
<220><221> modified_base
<222> (810281)..(810290)
<223> a, c, t, g, unknown or other
<220><221> modified_base
<222> (822028)..(822048)
<223> a, c, t, g, unknown or other
<220><221> modified_base
<222> (826291)..(826491)
<223> a, c, t, g, unknown or other
<220><221> modified_base
<222> (833673)..(833693)
<223>
> a, c, t, g, unknown or other
<220><221> modified_base
<222> (840225)..(841208)
<223> a, c, t, g, unknown or other
<220><221> modified_base
<222> (855872)..(855898)

<223> a, c, t, g, unknown or other
<220><221> modified_base
<222> (858677)..(858686)
<223> a, c, t, g, unknown or other
<220><221> modified_base
<222> (859302)..(859311)
<223> a, c, t, g, unknown or other
<220><221> modified_base
<222> (863211)..(863710)
<223> a, c, t, g, unknown or other
<220><221> modified_base

<222> (863884)..(863905)
<223> a, c, t, g, unknown or other
<220><221> modified_base
<222> (870189)..(870278)
<223> a, c, t, g, unknown or other
<220><221> modified_base
<222> (872829)..(873849)
<223> a, c, t, g, unknown or other
<220><221> modified_base
<222> (874702)..(874712)
<223> a, c, t, g, unknown or other
<220><221> modified_base
<222> (884202)..(884635)
<223> a, c, t, g, unknown or other
<220><221> modified_base
<222> (886013)..(886235)
<223> a, c, t, g, unknown or other

<220><221> modified_base
<222> (886558)..(886567)
<223> a, c, t, g, unknown or other
<220><221> modified_base
<222> (888090)..(888099)

<223> a, c, t, g, unknown or other
<220><221> modified_base
<222> (892953)..(893193)
<223> a, c, t, g, unknown or other
<220><221> modified_base
<222> (895232)..(895241)
<223> a, c, t, g, unknown or other
<220><221> modified_base
<222> (895747)..(895800)
<223> a, c, t, g, unknown or other
<220><221> modified_base
<222> (914130)..(914235)
<223>
> a, c, t, g, unknown or other
<220><221> modified_base
<222> (925901)..(925934)
<223> a, c, t, g, unknown or other
<220><221> modified_base
<222> (942110)..(942909)
<223> a, c, t, g, unknown or other
<220><221> modified_base
<222> (943570)..(948256)
<223> a, c, t, g, unknown or other
<220><221> modified_base
<222> (952040)..(952241)
<223> a, c, t, g, unknown or other
<220><221> modified_base
<222> (954347)..(956856)
<223> a, c, t, g, unknown or other
<220><221> modified_base

<222> (962027)..(964193)
<223> a, c, t, g, unknown or other
<220><221> modified_base
<222> (964736)..(967224)

<223> a, c, t, g, unknown or other

<220><221> modified_base

<222> (967888)..(968702)

<223> a, c, t, g, unknown or other

<220><221> modified_base

<222> (969900)..(972329)

<223> a, c, t, g, unknown or other

<220><221> modified_base

<222> (976998)..(979487)

<223> a, c, t, g, unknown or other

<220><221> modified_base

<222> (982285)..(989211)

<223> a, c, t, g, unknown or other

<220><221> modified_base

<222> (1001164)..(1003286)

<223> a, c, t, g, unknown or other

<220><221> modified_base

<222> (1028002)..(1032268)

<223> a, c, t, g, unknown or other

<220><221> modified_base

<222> (1033965)..(1034830)

<223> a, c, t, g, unknown or other

<220><221> modified_base

<222> (1042537)..(1047439)

<223> a, c, t, g, unknown or other

<220><221> modified_base

<222> (1074169)..(1080307)

<223> a, c, t, g, unknown or other

<220><221> modified_base

<222> (1090242)..(1090530)

<223> a, c, t, g, unknown or other

<400> 36

ctagatttcc tttttaacc ataaaaattt agtaagacct gttctctt gaaggaacca

60

gcttcctttt ggcagccata acagccgaac acgtacttgc cataaatctg ccatggtcac 120

gtagaggatca gatgcctgtc tcgtgacaag gaacccatca gannnnnnnn nnnnnnnnnn 180

nnnnnnnnnn nnnnnnnnnn nnnnnnnnnn nnnnnnnnnn nnnnnnnnnn nnnnnnnnnn 240

nnnnnnnnnn nnnnnnnnnn nnnnnnnnnn nnnnnnnnnn nnnnnnnnnn nnnnnnnnnn 300

nnnnnnnnnn nnnnnnnnnn nnnnnnnnnn nnnnnnnnnn nnnnnnnnnn nnnnnnnnnn 360

nnnnnnnnnn nnnnnnnnnn nnnnnnnnnn nnnnnnnnnn nnnnnnnnnn nnnnnnnnnn 420

nnnnnnnnnn nnnnnnnnnn nnnnnnnnnn nnnnnnnnnn nnnnnnnnnn nnnnnnnnnn 480

nnnnnnnnnn nnnnnnnnnn nnnnnnnnnn nnnnnnnnnn nnnnnnnnnn nnnnnnnnnn 540

nnnnnnnnnn nnnnnnnnnn nnnnnnnnnn nnnnnnnnnn nnnnnnnnnn nnnnnnnnnn 600

nnnnnnnnnn nnnnnnnnnn nnnnnnnnnn nnnnnnnnnn nnnnnnnnnn nnnnnnnnnn 660

nnnnnnnnnn nnnnnnnnnn nnnnnnnnnn nnnnnnnnnn nnnnnnnnnn nnnnnnnnnn 720

nnnnnnnnnn nnnnnnnnnn nnnnnnnnnn nnnnnnnnnn nnnnnnnnnn nnnnnnnnnn 780

nnnnnnnnnn nnnnnnnnnn nnnnnnnnnn nnnnnnnnnn nnnnnnnnnn nnnnnnnnnn 840

nnnnnnnnnn nnnnnnnnnn nnnnnnnnnn nnnnnnnnnn nnnnnnnnnn nnnnnnnnnn 900

nnnnnnnnnn nnnnnnnnnn nnnnnnnnnn nnnnnnnnnn nnnnnnnnnn nnnnnnnnnn 960

nnnnnnnnnn nnnnnnnnnn nnnnnnnnnn nnnnnnnnnn nnnnnnnnnn nnnnnnnnnn 1020

nnnnnnnnnn nnnnnnnnnn nnnnnnnnnn nnnnnnnnnn nnnnnnnnnn nnnnnnnnnn 1080

nnnnnnnnnn nnnnnnnnnn nnnnnnnnnn nnnnnnnnnn nnnnnnnnnn nnnnnnnnnn 1140

nnnnnnnnnn nnnnnnnnnn nnnnnnnnnn nnnnnnnnnn nnnnnnnnnn nnnnnnnnnn 1200

nnnnnnnnnn nnnnnnnnnn nnnnnnnnnn nnnnnnnnnn nnnnnnnnnn nnnnnnnnnn 1260

nnnnnnnnnn nnnnnnnnnn nnnnnnnnnn nnnnnnnnnn nnnnnnnnnn nnnnnnnnnn 1320

nnnnnnnnnn nnnnnnnnnn nnnnnnnnnn nnnnnnnnnn nnnnnnnnnn nnnnnnnnnn 1380

nnnnnnnnnn nnnnnnnnnn nnnnnnnnnn nnnnnnnnnn nnnnnnnnnn nnnnnnnnnn 1440

nnnnnnnnnn nnnnnnnnnn nnnnnnnnnn nnnnnnnnnn nnnnnnnnnn nnnnnnnnnn 1500

nnnnnnnnnn nnnnnnnnnn nnnnnnnnnn nnnnnnnnnn nnnnnnnnnn nnnnnnnnnn 1560

nnnnnnnnnn nnnnnnnnnn nnnnnnnnnn nnnnnnnnnn nnnnnnnnnn nnnnnnnnnn 1620

nnnnnnnnnn nnnnnnnnnn nnnnnnnnnn nnnnnnnnnn nnnnnnnnnn nnnnnnnnnn 1680

nnnnnnnnnn nnnnnnnnnn nnnnnnnnnn nnnnnnnnnn nnnnnnnnnn nnnnnnnnnn 1740

nnnnnnnnnn nnnnnnnnnn nnnnnnnnnn nnnnnnnnnn nnnnnnnnnn nnnnnnnnnn 1800

nnnnnnnnnn nnnnnnnnnn nnnnnnnnnn nnnnnnnnnn nnnnnnnnnn nnnnnnnnnn 1860

nnnnnnnnnn nnnnnnnnnn nnnnnnnnnn nnnnnnnnnn nnnnnnnnnn nnnnnnnnnn 1920

nnnnnnnnnn nnnnnnnnnn nnnnnnnnnn nnnnnnnnnn nnnnnnnnnn nnnnnnnnnn	1980
nnnnnnnnnn nnnnnnnnnn nnnnnnnnnn nnnnnnnnnn nnnnnnnnnn nnnnnnnnnn	2040
nnnnnnnnnn nnnnnnnnnn nnnnnnnnnn nnnnnnnnnn nnnnnnnnnn nnnnnnnnnn	2100
nnnnnnnnnn nnnnnnnnnn nnnnnnnnnn nnnnnnnnnn nnnnnnnnnn nnnnnnnnnn	2160
nnnnnnnnnn nnnnnnnnnn nnnnnnnnnn nnnnnnnnnn nnnnnnnnnn nnnnnnnnnn	2220
nnnnnnnnnn nnnnnnnnnn nnnnnnnnnn nnnnnnnnnn nnnnnnnnnn nnnnnnnnnn	2280
nnnnnnnnnn nnnnnnnnnn nnnnnnnnnn nnnnnnnnnn nnnnnnnnnn nnnnnnnnnn	2340
nnnnnnnnnn nnnnnnnnnn nnnnnnnnnn nnnnnnnnnn nnnnnnnnnn nnnnnnnnnn	2400
nnnnnnnnnn nnnnnnnnnn nnnnnnnnnn nnnnnnnnnn nnnnnnnnnn nnnnnnnnnn	2460
nnnnnnnnnn nnnnnnnnnn nnnnnnnnnn nnnnnnnnnn nnnnnnnnnn nnnnnnnnnn	2520
nnnnnnnnnn nnnnnnnnnn nnnnnnnnnn nnnnnnnnnn nnnnnnnnnn nnnnnnnnnn	2580
nnnnnnnnnn nnnnnnnnnn nnnnnnnnnn nnnnnnnnnn nnnnnnnnnn nnnnnnnnnn	2640
nnnnnnnnnn nnnnnnnnnn nnnnnnnnnn nnnnnnnnnn nnnnnnnnnn nnnnnnnnnn	2700
nnnnnnnnnn nnnnnnnnnn nnnnnnnnnn nnnnnnnnnn nnnnnnnnnn nnnnnnnnnn	2760
nnnnnnnnnn nnnnnnnnnn nnnnnnnnnn nnnnnnnnnn nnnnnnnnnn nnnnnnnnnn	2820
nnnnnnnnnn nnnnnnnnnn nnnnnnnnnn nnnnnnnnnn nnnnnnnnnn nnnnnnnnnn	2880
nnnnnnnnnn nnnnnnnnnn nnnnnnnnnn nnnnnnnnnn nnnnnnnnnn nnnnacctgg	2940
agccgcacgt ttggcgcca cctgccccgg ccctcggggc tccgtaatt cctgagtcca	3000
aggtggatca cgctgcaaa taatgggcaa gaaagaaaga gcgggacca gcagcagaga	3060
aaaaggaagt ggggggaggg atgagttcat tctggtcagg cagggattct gaatctctg	3120
tgtttatctc aggcactaac taaggaaatg ggagagggga taggtgttag ttgcttctca	3180
ggcagatate cggaatctcc tgtgataagc tagactttct ggcatctaac taggtatggg	3240
gtcgccaagg ctggcttctg acaccttaga aagttagtct cctgcagtct tattaggtaa	3300
ggctttccat gcttgaccag cagccactga gatctgtgca tatacagcag ggtcataaag	3360
aatctgctgg cctagaccta cataggctcc cctgccagta agcatttcta agttccttca	3420
aagaaaacca gcagctgigt tgtgctgcac tgtttgatta caaagttctt ggtattcacc	3480
cctccagatc aagtaatctc cccctgatag cgtagctcta cataattgct gccagtcact	3540
gggggtgcaa ttcaaggccg aaaaagattc aaaaatatcc agagtaaaag gggcatgagg	3600
cctgtatgcc acaactgcct cctttagttg ttttatatcc ttaaagtta agcggggcat	3660
gctctctctg actctggcct tggggattaa ttgtctctat aactgggaat atcactccac	3720

ccctctgctc ttcaggaggg gctgaaggaa gacagagaga gctagaatgc tcgggattat 3780

 gagcaggggg acgtggctca agggaacatc tcctaagctt aggctttaat ttgaggatgt 3840
 ccttcttgaa ttgaagtgct tcacctcct tagtctcacc ccctgaagag tagagagaga 3900
 actcagagga agaaacatca gaagcttggg gtgacataac agacagatct ttgtcctgag 3960
 cctctgcaaa agcagctttg gcttctctca cctgctcttt cacctccaca ttatcactaa 4020
 gaagtgcttc cttgacttga cgccacagag aaaaagtaac aattgatatg gcatcttccc 4080
 cttctttttg taatattcctt agtgggtctc ccttcacctg ctccaatca gggatattaa 4140
 agtcacaaa caccaaaaac caagggtgga cctcatgttc agttttcaag aagccttttg 4200

 ctgtcttatg ttgataaccg gtgccctgct tttttaacaa ttggaccagt tggccccca 4260
 taagagagta agaactagca gcaccatac tcaatacacc cactccttac ctttttgaaa 4320
 atgctggcca gcttccatgg gtgattcttc agtgtcttcc cttcttcccc atctcgggtga 4380
 aatctccact tglagtgcct gcactacaac acttccacag tatagggcaa gggacttgag 4440
 gatttaaata aagacaagac agcagatctt tcttgcaggg agagaatgct ctctattcca 4500
 acaagagtgg gggcttatat accagtcagc agggatgggtg gaaaactacc cagataacaa 4560
 gttcagggtc ccaggcccat caggcaatcc tgaatgggtg aacaacagga caacaggaac 4620

 ttgcactcag gccttcaagg aaggaagaaa acaggatgta actgctaggt aagctcctag 4680
 tcacaagctg gtaagcagac ccctatgggg gaagggccca acacccatgg gccgggacaa 4740
 agtgcattgat tttcttcagc aataagttct tactgtctac cagttggggg gagggtagac 4800
 caaggacaat agcaatagcc tataacagcc ttgaccaaca actcaaaaga gaccttctca 4860
 tgcttgggtg tgggattttt attagtcttt ggttctttaga gggaccactg tcagccact 4920
 gggaaaattt catttaatt atatatgtgt gtttatacac agacttacat gttttatagg 4980
 tttgtttggg ttctttttaa atagatagtt aatagtacct tataaaattt tcagacatca 5040

 ttactgttat ttaacctcc tatctcttc tctgtatgt agttcctctg ccctaagtag 5100
 agtccccatt gttaggcttt aagttagccc taaaaatggc agtgcctgctg tcctaagttg 5160
 ggtaaacaga cagattgtta ttggataaac agaaaactag gctcacattc cctgagttc 5220
 ttgtaaggtg ggattctgtt taccaggaag ttcaatacca ccctgatcca cctccaaaag 5280
 ggcatctagt tctgattag accaaaaaag cctgcaacag ttcaatgtct tcatgctaac 5340
 cccaagacta ctatgattca tgagcttctt accactataa ccttcccaac aaaactgaca 5400
 aggcctttcc ctatggctgc tgtctctat tcttggagac cacttggctc tttgttcct 5460

caagaaactt gtcattttac ccacaaacag acagatggtt tgtggtttca ctgaaccttc 5520
atttacagcc attttccaa tgcttgggta aggttactat tgctgtgatg aaacaccatg 5580
accaaaacca aattggggaa gaaaagggtt attttgcctca cagttccatt tatagttcat 5640
catccaaagg agigatagca agaaatcatg cagggcagga gctgatgaac tggccatgga 5700
ggggtgctgc ttactggctt attcatcata gcttactcaa catittgttt ctttttcagt 5760
gctcttaaga tttatttatt gtgtatacag tgctctgtct gaatatatca caggccataa 5820
gagaglacca gatcacatta cagatgttta tgagccacca tgtggtttat gtgaattgaa 5880

ctcaggacct ccagtagagc agccagtgca cttaacctct gagacatctc ttcagtccca 5940
tcctttttta tagaatccag aactactagc ccagggatag caccacctat aatgggctgg 6000
gccctcccc gtcaaact aattaagaaa atgccctaca gacttaccta tagccagatc 6060
ttgtggaggc atttttctaa attgacttaa tgactttagc ttgtatcaac ttgccataaa 6120
actatctagc acaatgttac gataaatctt tctgtcacca gcttgagttc tgcctgccac 6180
atgggtggcc aaaataatac acagagactt atattagta caaatgctgc ttggccaatg 6240
actaggattt ctcacctgct agctcattct taattatcat aaatctatat attttataag 6300

acttatctta ttggacgcca gtggcaagca tcctgtattc ctgggctcat ctgatgactc 6360
tggaggaaga gagaaggggc ccaattcctt ctgccccttg tatttattta tttatttatt 6420
tttggttttt tgagacaggg tttctctgtg tagctttgga gcctatcctg gcactcgctc 6480
tggagaccag gctggcctca aactcacaga gatctgctg cctctgtctc ctgagttctg 6540
ggattaaagg tgtgtgccac taatgccag ctcttgccct tgtttagatg agtctccctg 6600
ctatgtcatt tctgacctgg atcaccactt ctttactaca tttccagaa tctacttga 6660
ctcctagtcc cgctaagt gctgcctcat tggccaaca gtactttatt tatcatcaa 6720

taagacaage acacagatgc actteectca tcatctectc tttctttct aaataaaaag 6780
aaggataact taccttttat aataactgaa gaaaactata atcataacta tctgtcttca 6840
actccatcaa aggccacaga aggatagcat ataaactcta gaattgacag agatatcttg 6900
ctacctggac agtcaccca gatgcacttc cctcatcacc tctcttttc tttctaaata 6960
aaaagaagga taacttacct tttataataa ctgaagaaa ctataatcat aactatctgt 7020
cttcaactcc atcaaaggcc acagaaggat agcatataaa ctctagaatt gacagagata 7080
tcttctacc tggacagtca cccaaagatc ctctataacg ttggggcacc cataggccat 7140

agtgtgtctg gactcttctc cattccaac aggatccctt caggactgct ttgttttgta 7200
agttcagcag tcaactttctt gtgggtcctg catgtccagt ttatacagca acaaacagtc 7260
caggcaagag cagtttcttg cccaatggc taatcttgcc atgttgaaag caaactccat 7320

aacgagtttc ttcgttatcc acccttcttt ctgacgtaat tgggtgctga ggagcaattg 7380
tgtctcactg ccaagaaaac actaaacat ttaaagcca tttttctgt aggtctttga 7440
aaggtttgaa gaaaacctat tcatctcaaa tacatctctg tatactaga aaacctaact 7500
aacctaatta taagttctga ctattatagg taactatata acatgtatit aattatgcat 7560

atcattttaa aagatctgta taaacataat acctaaacaa gaggagacgt atacatatca 7620
caaaattgac cttaacgttg tatcaataaa tgaanaatcca tactccggct ccacaaagta 7680
ttcattctta tatcctatit cccctttttt ttgttttaaa aaagagattg actatgctca 7740
ttaccgttta taaccaacc catttaaatg aaagcaatit ataaacaata ttgggaatt 7800
tgggcgtcat tcattccaaa ctgcttctctg ctgattgggg gcatgtccat accatgggga 7860
tcatgataaa acacagaaat ctgaccaagt ccttgttttt gtagtctgca aggctgcatc 7920
gtctcagctg ttttgaatg aggataagt gggtcactgc ttcaaggggt ctacttgat 7980

caaaccacat ttgtctggaa ggaatccaca gcttttcatt ttctgtggaa acacaagcaa 8040
aaactttttt cccaagtagc ctgtccttag acttaaatit tgaagtcaaa gcatttttaa 8100
aatatataag ttgtattaat ttagcagcac ttataatcaa atgtatitaa gcagcagtaa 8160
ctctttcctt ggcaatcaaa caatttaaag ataacaatag caaatagtat ccaaactctc 8220
tgtgtatitit tcatctttag gtggcttctt gataatacaa aattagctit actgtttata 8280
caattacagg aaacaatcag aaacagaagt aatcctctat acattacaca tgttggatec 8340
catgcaggtc tgccaggcaa actaacacaa ggcaatgata aaatgatca ttgattaait 8400

ggaagtgtgc tagaagcctc agaatttcat aagaaacatc atgtaaatag caaagntttt 8460
nnnnnnnnnn nnnnnnnnnn nnnnnnnnnn nnnnnnnnnn nnnnnnnnnn 8520
nnnnnnnnnn nnnnnnnnnn nnnnnnnnnn nnnnnnnnnn nnnnnnnnnn 8580
nnnnnnnnnn nnnnnnnnnn nnnnnnnnnn nnnnnnnnt cctcttctta gtctcccat 8640
tctgccttat aataaactta tagtcttaag tctcatgtct cagcaatttc tctttcttc 8700
tttttaaca aggccaattc agttattaca cacctgctag aggtgatgac agttatgggt 8760
atatctgcac aaataaaaac tgacaatect ccagcatatg tctccacaaa attggaacag 8820

tttttcaaat attataacat aaagcatgtc actggtatc cacacaatcc tatggggcaa 8880
gcagtgggtg agagatctaa tagaacactt aaggagatgc tccatagtca ggctgggaaa 8940
acaaaccccc aaacacaggt tgcataatgc ttactaaca ctaactttc ttaatgccga 9000
tgagaaaaga caaacagctg cagaaagaca ctggactatg gaaaaactg ctgaactgaa 9060
tcagctagta tacttcaag atgtactaac ctctgtatgg aaaccaggac atgtgttaca 9120
ttggggtcgg ggttttgcat tggtttccac aagagaagaa aaactttgga taccatcaaa 9180

gttgttcaag attcgagttg aaaaggaaaa acctctcgat gaggagaaat gataggtatt 9240

ctactaaggt atatttcata aactaaatag taatctcctt taatgaaaga gaagtgtttt 9300

gtttttatct tcacaggaag actcatctcc agaagtcaaa ggacacttca tggatagata 9360

cataagaaga gaaggtagct ataaccagca acaaaaagga acatgccata cagtaaaactt 9420

tatagctgtc tctcagagaa ctctatttct ctttatttcc tagtcctat tcaattaaat 9480

caatgctgga tttagaggtg aatttggctt tcctcctcta aaatccaagc acattcttta 9540

actaaacttt agagtttctg tattatatca agaataaggg aagaatttgg gaacagtctt 9600

tgtcttttct tggctctttc cttcaaggtg tatacctct cataattatt attttctcat 9660

gattgccttt cciggtatgc atacatatac aagtaaacad ttctctgcta acatttatgt 9720

ttgagtccca cacagccaat gaagaccac ctgacagcaa tccctggatg ctctggaaaa 9780

gaaattgggc catacctcct cgactgcact ggatccaact tactccattt caactgacac 9840

attcattctg ttatattgtt aatatttga cttaaatcaa aagagctaaa atttaagatc 9900

acagccataa gttccatag ttaataaaaa gtttgagctg tttatttctt atactacagt 9960

aagacaatga cccaagtta acaaagggtc taaaataact gctaacccea tgggtctcaa 10020

ttctttagag ttttaaaaac aaaactcctt tataagggtg gcctaggacc acctgtatgt 10080

caaatgttta cattgataac acaaaaaaat tttaaaaact taaaacatca aatttttaa 10140

ggtaaacctg acaatataaa gtcttagttt tataaaagct gataacctgt tacaagatgt 10200

taaaaaata caagttacta gccattctta taaattaaca agtagccaga cttacctagg 10260

cagacttcta atactacaaa gatctgcaga atatggcatt taaaatgta actaaaaagt 10320

ttataatc agacagagaa ttccaattcc agatcctgac agtgacccaa ggtctctaaa 10380

gaagattatg gggctccata gatttgaca atgctgacca ttgagcataa agctcagata 10440

ctatacctac taccaggcag gactgggctc agagtgtgga caggctacag aacactggag 10500

aattgattgc accaccttg cctagacaaa ataaggtcag tcttttccat gtccctcttc 10560

cacagagaga aaaaactctc attttaagga cctggcaaag atttacttct gtcccaaca 10620

ctattgagac ttgagtatgg ctaactttac gtggaccaag ggggggggt tggttttga 10680

gacagggttt ctctgtgtag ctttggagac tatcctgggtg ctcgctccgg agaccaggct 10740

ggcctcaaac tcacagaaat ctgctgctc ctgctcccc agtgtctgaga ttaaaggcgt 10800

gcaccaccaa cgctgtgtg cttctttatt tatacataat tcattaagaa gggatgtatt 10860

catgttgttc taaaatatag atggatcga ttctgatttt ggacatgtgt ttgacttct 10920

cttacatatac ttcagtcac cattgataaa ctgtggcaaa acagtgttat cttttacaat 10980
 cgttttttac tcatcaaccc cataactaaa cttttaagac tctagaggca tatgacagcc 11040
 tattcccagg ctggcaactc ttgaggattc aaggacacta gacagaaaaga aaatctccaa 11100
 gccagcccaa gtagatttcc atgtcctgag caatgtatta ttaactatta atgattagag 11160
 tgtcaatagt cccaagaaaa attctcaggc caaagctgct gcagttacta ttcagtaaca 11220
 actatatttt atacttttat agaattttatt tacatgtcta atcctggcat tcttttgttg 11280
 cttggtcata tgacaccacg ttggctctgc aggagttaag aaactaactt ttcgaagaaa 11340

 gggaggtcct gacacctcat tctttgtttt gttgtgttca aattctgaac ccccaaatca 11400
 ccaagagatc cattctgatg caaaagcaaa agatctttta ttatttaacc agttaactgt 11460
 cttacttgg ttctctcatc tgtccaacac agcagttggg gtgagaagga cccaagggg 11520
 ccaaaggcag ggaatattt ggggagaaca aggggagtgt ctagggttac acaacagtct 11580
 caagactggt gcacttctgg gtttggggga cttctcctat gttgattggt taactggttg 11640
 ttatggccta taggcctcc cagggtggtt gctatgcaca tcactgttat tccacttta 11700
 ctgtaaagca tgtccagagc ctgccagcta acttctgatt ggtttcttgc cacatggagg 11760

 gtatctgacc tcctagtac tagggcagtt ccaacaaggt cagaagggtg gaaatttagc 11820
 aacatgtgct gaatcagagg cctacatgtt gctgggtctt ttctgcagcc tgtcatggct 11880
 gttaaagcag ggggatgggt aagttgtctg gtccttcag cttgtttatt tggttggttt 11940
 gctttgcttt ttgagacagg gtttctctgt agctttggag gctgtcctgg aactcattca 12000
 gtagactaga ctagcctga actcagagat ctgcctgtct ctacctacac agtgttgggt 12060
 tgccaccact acctggcaac acttcattct tttattgtct ttccatacca ttccttgctt 12120
 gtcaatataa ggcctgtgt aggacacagg taacttcac tcatctatct ttgttgctgt 12180

 atatgccaca taattgctg agtgtatagt aggaaaagac ttgtaatctg atctgtagec 12240
 atctctcta gcctagtga tctgttgac ctttttaagt tcactttgct ttgattatct 12300
 tgttctgag taagtgtgt agcagatatt ttaagagtat ctgagagact aataaagaga 12360
 tctttggatg ttttgtgggg agtttgagac aaggatctc tgtgtatctc tggctgtcca 12420
 ggaattcact ctglagacta ggctggcctc aagatttgc tgtctctgcc tccagagtgc 12480
 taggattaaa ggcatcgat atcactggct gactgatctc tggcttcttt atgtgcatca 12540
 caaccttcaa ggcattaagg aagatcttca agtagataag aatatctccc taaaagtgat 12600

 aggggttgtg tgcttaggac tttctgaga aaattaaaag cataatgaac aaatataaaa 12660
 agccctcca gtatgcaacc tgacagaaac aaaatgaaaa gtgaaagaca gtcacagcag 12720
 cgatcgtgtg gctcagcttt tctgggtctt tgcactcag ctgtgctggc tttatgattt 12780

ttgccattcc tataagatat ggctgtatca ccacatcata gattttgatg aaaaaataac 12840
 ataaaccagg cagtggatg gcataccttt aatcccagca cttgggaggt aaaggctggt 12900
 ggatctttgt gattttgagg ccagcctggt ctacaatgca agttccagga cagctagaac 12960
 tgttacacag agaaactctg tctggggttc agaggaggaa cattataaat gaaaatgttc 13020

 tcctccatca agtatgtgag atatgacaca ttagtgacag cccaacagat aaaggtatgc 13080
 tggatcaatga aacatcagac aatggagtcc aggtgtgtgc aaccatttgt aggatgtcca 13140
 atgaattgga accaagcatc cagggagtct cccaatgacc ctgcaagcac tgtgcagacc 13200
 ttggaactgt tctgtcacat tggcaacagt ggcccactgc aatgtggcct gctttatgtg 13260
 gcagctgatg ggtgatggga agaaagtcaa ttccttggca gacagccaaa tccttccaag 13320
 caagtccaag ccaggaagtg ctggccaact tatcagtgtt ggaaggaagg agacagctga 13380
 ggttcactca ctgcagtga ttggagccca tatgactact gtgccaggtg gccacagcaa 13440

 gtgacactac cctgaaaggc tgggacacat ggaatatgaa ccagatatac tgcttagaga 13500
 acatctatgg gcagcttgtg tgttgacctt gacttcaatg ccaacaaaca gtattatctc 13560
 accagctgca gaagtgacta caaagtaaag tcttgggaca catggaatgc cacttagccc 13620
 atgaagacct tataagatca ctcttactgg gtatggagca tctgtctaaa tcctctcat 13680
 gactagctag ctggtcctca ctgacagcag ggtcagcagt gtcttctgt ttaacaaggt 13740
 gtctatttcc tctggtgat aatcatgat tcatacaca cacacacaca cacacacaca 13800
 cacacacaca cacacacaca cgctgagaag tgtaaggaac ccttgcggga caatattatt 13860

 gccacttttg aggcacacga agacagtatg taccctttgg attgggcctc agatgaccta 13920
 aggctgtttt ctccctgag ttgtgacagg aggccaatta tcaacagagt cccaaagcac 13980
 ttaaataatca catactctc tggcggccca tggactgct gattggtact tggcagatc 14040
 tcagaaatct gcagctgtga gataattccc tttgtagaca gatccctcta tgggagaacc 14100
 aacattgctt ccaacaggag ctctagggga aacagctgag ctctaccgg aggctcagct 14160
 gaagttgtca tcaactgtgaa gaatctgcct aactccattt tgaaagcagg agacattatg 14220
 ctgcattgtt aaaaataaat ttctattatt gtaagagttg agttgctctc tgtttccgg 14280

 aacctgactt tacccaaccg atgacctga ctgtcttttg aggatagtct taccctcct 14340
 agacgtctcc aaattgcatg gtgatcatat gattttttta aagatttttt ttgtatttcc 14400
 ttattgtcct atgtctccc atctataaac tactcatgat ttactcctt aaaaggggcc 14460
 caagacatgg atcttagct gctctcttta acccagctta ggaggcaata gttagccaga 14520
 tcttgcatgt accccaataa aaaaaatcaa gcttacctca aatttgactc aaattgtgac 14580
 ggtggcttta ttcttgcctt tggaattagc attttctgga gagccccagt gagattcaaa 14640

ccaccacca aaattctaaa cctggacctt cacctggaa ctccaaaagg ctaggagagc 14700

tacctcagga ggcacatgcc ttaagatggt ccaaggctgc aagactgcct tcagtcttag 14760

taatataggg taaactttca tgctgagaaa tgcagcaagc atcaatggag gcctcctggt 14820

gagttacagt ctggttctgt tttgtgggat tcttacctag gatgtggaat ctccctttct 14880

ctgccagaga tctctataac tggagaagacc agaactcacc tttcagcact agccccaagt 14940

acttagtttc tctaactctg tctttaaaat catttcccta catgagacga cagtcagcag 15000

attctctgta ccctctttgt tgttcttttg tttaaattac attgtgtgat caagatggaa 15060

catgaaccaa gagattcatt aaccatgaag tttattaaag gggggagcaa gaagggagtg 15120

aagatagaga gaaagagggg gacaaaagac gagagaggag ggggcaaaag gagaggaaag 15180

agcagaaaga gaggagagct ggaaagagca gaagcatgta agtgggccgg ggtctgtctt 15240

ttaaaggggt cctttgtacc tgcttgcaga ctagtactca tggaacctg gattgaccag 15300

gctactgcct gagtgcattc tgccaggtga caggggcagg cctgtaagga gccgttacct 15360

atcccccttt tttattaatt aatgataagg cttcttattt ttacaagcaa gtaggtcacc 15420

catacattga gggatagaga cagaggttgt acctccaaa tcatacaata agactgtgta 15480

cgagagtcac cactaggctg ttagcttgac ccaaagcgt ctcgacctat cctccgccgt 15540

ttttctggga aagggaact ggggcaggca accttatgc aggacaacat gccteccaga 15600

gaagcctgca tattaggcaa ctctctgtgc gatgctttgc tcgacatccc tcatgggctg 15660

ctcaagccag acacctfact ctgtgcaatg agcctaggct ccgggtgtcc aagagctgtc 15720

tggccggtgg cctattgctt aagcattgct aaccaaatgt cagtggaagc cccttgttcc 15780

aaggctacaa gcgcttggnn nnnnnnnnnn nnnnnnnnnn nnnnnnnnnn nnnnnnnnnn 15840

nnnnnnnnnn nnnnnnnnnn nnnnnnnnnn nnnnnnnnnn nnnnnnnnnn nnnnnnnnnn 15900

nnnnnnnnnn nnnnnnnnnn nnnnnnnnnn nnnnnnnnnn nnnnnnnnnn nnnnnnnnnn 15960

nnnnnnnnnn nnnnnnnnnn nnnnnnnnnn nnnnnnnnnn nnnnnnnnnn nnnnnnnnnn 16020

nnnnnnnnnn nnnnnnnnnn nnnnnnnnnn nnnnnnnnnn nnnnnnnnnn nnnnnnnnnn 16080

nnnnnngttg gttcattttc cataatatgt ccaattgttt gtttttttgt tttttttttt 16140

ttctgcctc aaagacagga aaagcgaggc acagctttct ttttacctt tctggaagaa 16200

aggaataaga cttcaggcgc gtctcatagg gagggggcgc cgaaggagca acctgtgaga 16260

gggctgtttg aagctgccgt cttcgaagt ttttgctact ttgtatatgg tcatccagat 16320

ggtatctttc tttctcatat ttagcagctt cctcacctag ctcagcttct aagacttcat 16380

ctcctgagct ttcagagtca tcagagctat caagatttaa ggcttcaagc tcatgtacag 16440
gatctgacaa atacactccc ttgtcattag acacactggg aggtcctttt tcatttttta 16500
ttgccgtttt gtttcttgca tacactccct tgtcattaga caccgggga ggtccttttt 16560
ccttttttgt tgccttttct tttcttacct acagccagtc agagagtaac acttccgagg 16620
cggcggttgc cagcctatat aagggatggg tttttgggag ttcagagtct ccaactctgta 16680
agcttatgct ctccctetca agacgcatta aagctttact gcagaaggat cctgaggagt 16740
gtgccgcatac atttttgctg gcgagtcggt tagcgcggga cacaggccag cataatttgc 16800

ctgaattctt acattccac ctttacttat tattaaaaag gtgaagagtc cagcatggca 16860
gattagggat aaggacaccg agttctcaag actacttctt gctgatctgg ggggagtga 16920
ccatcttttg gtgacccaag aaagcatcct gttttctagt cctggattac agccctagcc 16980
atacccact ggcataaaaa acacaagctc ttacacctga ggtttttcca ctatgttgta 17040
agtctgtata taaggatgct ccctccctgc aaaagagaca gaggtccaca cacattctcc 17100
tagcacaac aaccagacat ctctgctttt aactaaatct tcaagcttta cccaatacc 17160
ttggacttgc tcgtggggtg ggcgccacaa gggaggacaa ggttaagttt agagaaaaaa 17220

attcttagat ccggtacttg aaggaggat tgtaagatta gggaggagt cccaggggg 17280
tccaagatg agggaaggga gtcccaggac cagggaagg ttgaataata tctggagtga 17340
atctgacctg ttgggtggg tccaattcag ctccctagaa cttacaagaa tcctttgagt 17400
ttgtgaaaac ataaatttta gacatattag cagtatactc atgtcagaaa tgatttggt 17460
aaaacattaa cacttttaa actgacagat atcttttagaa caatgaaaag caccttaatc 17520
ttgagcttgt agatacagtt atgatggcat aatatggtgt ttagtactct gtcagagttg 17580
gatttagtagc ttatcagaac tgtattttaa gggaccagcc ccccttttcg gcagccatga 17640

tagtaacacg tgetcgetat gacctgect tagtcaactag aggttaggtg cetgcctcgt 17700
gacaaggaac caatcagaag ttagctggtg gtgatannnn nnnnnnnnnn nnnnnnnnnn 17760
nnnnnnnnnn nnnnnnnnnn nnnnnnnnnn nnnnnnnnnn nnnnnnnnnn nnnnnnnnnn 17820
nnnnnnnnnn nnnnnnnnnn nnnnnnnnnn nnnnnnnnnn nnnnnnnnnn nnnnnnnnnn 17880
nnnnnnnnnn nnnnnnnnnn nnnnnnnnnn nnnnnnnnnn nnnnnnnnnn nnnnnnnnnn 17940
nnnnnnnnnn nnnnnnnnnn nnnnnnnggc tctgtgtctc atttgaacca tccaatagaa 18000
atgattctgt atttcgctc atttgaaga ctctgtgttt cacctcattt gaataactct 18060

gtactgcgcc tcatttgaat aacctgtat agcgcctcat ttacattgac caatgggaat 18120
agctctgtac aatgcctcat tagaattatc caatagaatc cctgttctta acttgcgcc 18180
ttttccctat ataaggacc ctttcccttg gctcggcgcg cttggcctca cagaagctaa 18240

gtcgccccggg taccctgata tccaataaag cctcttgagg ttttgcattc aagttcgtgg 18300
 tttcgtgat tcttgggtgt gggctctctt ctacgaaagt acctcttcgg gggcttttca 18360
 cttttcgact ctgggtgtgc tttacggata agcgcacagc aatgacatgc agagcacagc 18420
 aaccacctg ggagggccta tgggccataa caaccaattg accaatcaac acagggcaag 18480

 ccctctaage ctggaggcac accaatcctg agtctgtgca tacctgtaga cacttccct 18540
 tacactgccc tacaagattg ctggcagct ggttcaaggg gtctttgcta gtcattccacc 18600
 acggtgggtg ggtgaaagac ccgagctaac atggggttag ctattaaaa accaataaag 18660
 cctcatgcag tttgcatcaa gctctcgaat ctgcttgggtg attggggtga cctcggctgt 18720
 ggcttgggac cccagatata tgagtttttc cgggggtcta acaattgact aacgttaaga 18780
 ctatgaacaa tagcataaat gagaaaggaa tctgataact tgcatttgta caccttaagt 18840
 aagcttgta taccttaaaa cttttttttt aaaacaaaga aatgataaga agttatactg 18900

 aaaccagcag ccgtcaaaact gcatcagagt tcttgagaag ggtgaaattt tacctgaatt 18960
 aattattaca gaatgagcga gactggctat ctggccacat ggacagccac ctccaaggctc 19020
 ctctatagtt gttgagggca gaggttttaa ggacacctgc cttctgctga tagcatgaga 19080
 cctgtggatt aggagctgta ggaagacttg cctaccattg gccaagcaa ctggagaaag 19140
 taatttacac tgcctcttg gccacagtcc aaagaatcct ttgcagcaat tgaggtgaaa 19200
 ggcaagattg ctgggtggct aacgttacca ctttttggg tggagtttct tcagtgcca 19260
 gtgtttggag gaaatggct gatgccagca gttggcctgt ctcgctgta taaaagctt 19320

 ttaaataaaa ctttttaaat gccatattct ctgatctct gagcatttca gggctgtttg 19380
 tctgtttagt atatctcagc agacaaaatt tgcctttagt tacttgcctt aagcacatag 19440
 atggctaggt aagactttat ccttctaatt aattttgatg gctacagatt agtatggcta 19500
 caatgacatt aggttaggat ctgctggag aactggaatg aagctgagag gctgtggaag 19560
 gatgttttac ttagagccct gtagcctgac tgaactgggt ttaacttag tgggttagat 19620
 ttacacttct aaaagacaaa gaagtagaga aaagtcacct tttgtaatag aagcttaacc 19680
 ttcgtaaaact gtttacagga aggactgggt ggtataaata tttgttaat taaaataga 19740

 cttttataac cttaaatgtt taccatcatt taagatata caacaattta gaaatatttg 19800
 agactgaaag accccaactc aaaccaacc tgatatctac caacatgtat ttgaaaatca 19860
 ccctggccac atatacacag ctctggggaa aaataacaca tgaatggctc agtcatgatg 19920
 accagtctct tgaccctgcc agcaggccag gttattcgcg ggtctcagag gggttgtcac 19980
 ctaaaggggt catgagggcg agagaggagg agaccaagcg gcgcaagaaa ggacaagagt 20040
 ccgtctgtgc aatgtcaagg tctcgtttat tgaaggtaa agcttgctta tatgcagggg 20100

atttttactc agggcgggggt aaggagcag gaggaatgga aaatittcaa gaggaaatag 20160

 aggcgaggta aatcttagcc catggtccca ttgtagcga accgcagcta tttctgagaa 20220
 aagggagaac attttgcaac atgtattgtg cagcttaacc ggaaaaaaca tttgttagtc 20280
 gaagcgattc tggcatccta acaatgatta actcttgatt cagtatgagg ccccttttgg 20340
 ccttcgacat ctcccccttc tgtatacaaa aagggatgat gaatcttatt atcaagagag 20400
 cccctgtctt aggccgcata ggctgcgccc ctggacagge aacgtgcctt gttgagccgg 20460
 tcttgacgac ctctgtacgt tgttgcccc tgtccagga cctatgcata ctcccgcat 20520
 tgagtactcc cttgctgcat caatcttgag ttattaacce tgagtcttg attactgaac 20580

 ctgagctctt gctgcgacce tcgctcctcc cccgggtcag ctgctactaa tttgtggtaa 20640
 tggaccgaaa tacttttagg taagccgaa tcaattgtc ttttaataag ctgggttagc 20700
 cgttgaaggg cccatgggcc aaaagaaaga agcaatagga aaacaattaa gnnnnnnnnn 20760
 nnnnnnnnnn nnnnnnnnnn nnnnnnnnnn nnnnnnnnnn nnnnnnnnnn nnnnnnnnnn 20820
 nnnnnnnnnn nnnnnnnnnn nnnnnnnnnn nnnnnnnnnn nnnnnnnnnn nnnnnnnnnn 20880
 nnnnnnnnnn nnnnnnnnnn nnnnnnnnnn nnnnnnnnnn nnnnnnnnnn nnnnnnnnnn 20940
 nnnnnnnnnn nnnnnnnnnn nnnnnnnnnn nnnnnnnnnn nnnnnnnnnn nnnnnnnnnn 21000

 nnnnnnnnnn nnnnnnnnnn nnnnnnnnnn nnnnnnnnnn nnnnnnnnnn nnnnnnnnnn 21060
 nnnnnnnnnn nnnnnnnnnn nnnnnnnnnn nnnnnnnnnn nnnnnnnnnn nnnnnnnnnn 21120
 nnnnnnnnnn nnnnnnnnnn nnnnnnnnnn nnnnnnnnnn nnnnnnnnnn nnnnnnnnnn 21180
 nnnnnnnnnn nnnnnnnnnn nnnnnnnnnn nnnnnnnnnn nnnnnnnnnn nnnnnnnnnn 21240
 nnnnnnnnnn nnnnnnnnnn nnnnnnnnnn nnnnnnnnnn nnnnnnnnnn nnnnnnnnnn 21300
 nnnnnnnnnn nnnnnnnnnn nnnnnnnnnn nnnnnnnnnn nnnnnnnnnn nnnnnnnnnn 21360
 nnnnnnnnnn nnnnnnnnnn nnnnnnnnnn nnnnnnnnnn nnnnnnnnnn nnnnnnnnnn 21420

 nnnnnnnnnn nnnnnnnnnn nnnnnnnnnn nnnnnnnnnn nnnnnnnnnn nnnnnnnnnn 21480
 nnnnnnnnnn nnnnnnnnnn nnnnnnnnnn nnnnnnnnnn nnnnnnnnnn nnnnnnnnnn 21540
 nnnnnnnnnn nnnnnnnnnn nnnnnnnnnn nnnnnnnnnn nnnnnnnnnn nnnnnnnnnn 21600
 nnnnnnnnnn nnnnnnnnnn nnnnnnnnnn nnnnnnnnnn nnnnnnnnnn nnnnnnnnnn 21660
 nnnnnnnnnn nnnnnnnnnn nnnnnnnnnn nnnnnnnnnn nnnnnnnnnn nnnnnnnnnn 21720
 nnnnnnnnnn nnnnnnnnnn nnnnnnnnnn nnnnnnnnnn nnnnnnnnnn nnnnnnnnnn 21780
 nnnnnnnnnn nnnnnnnnnn nnnnnnnnnn nnnnnnnnnn nnnnnnnnnn nnnnnnnnnn 21840

ccaggttatt cgcgggtctc gagggggttg tcacctaaag gggatcatgag ggcgagagag 27360
 gaggagacca agcggcgcaa gaaaggacaa gattccgtct gtgcaatgtc aaggctctct 27420
 ttattgaaag gtaaagcttg cttatatgca ggggattttt actcagggcg gggttaaggga 27480
 gcaggaggaa tggaaaattt tcaagaggaa atagaggcga ggtaaatctt agcccatggt 27540
 cccattgtta gcgaaccga gctattttctg agaaaaggga gaacattttg caacatgtat 27600
 tgtgcagctt aaccgaaaa aacatcttgt agtcgaagcg attctgttca tctaacaatg 27660
 attaactctt gattcaglat gaggccctt ttggccttcg acagtctctg gaaattgtta 27720

 ttgtcagga gccagccctg gtcagatata aaagtctcct ttacaagagg cctgacgacc 27780
 tccatgctca gctaacacc aattagtcaa gtacctccc tcttaggttc tgggacacct 27840
 gccctggcct gagagcaatt aacaccatt cctccccac ttcctcttctc ttacttctc 27900
 cctttctctt taaaacccc ttgtttataa tcaataaaat tagaccttga caaggacact 27960
 gcttggcttc gattctcttt ctgcccatt tttttcagg ctttgtcccc ctcgaccca 28020
 tgaattacca gaaccccgca ggccccggca gttattatta ctagtcca aggaatgttg 28080
 tagggagccg tcctgtatt ctccattaca agatggcgcc tgcacccgca aggcaccgaa 28140

 tgtaacaag ttattgcga ggcgtgggt aactttctat tccttggctc ctgcctattc 28200
 cgtggcgta tatggcccga tgagctgcag ccaatcatgg ggtgacacgt ccgaggcggc 28260
 ggttgccagc cttattagg ggacgggatt ctggctcgg ggtctccgct ctggtaagct 28320
 tatgctctcc tctcaagac cattaaagct ttactgcaga aggatccgaa tgcctgtgt 28380
 ggttcttgc ggcacgacta tcgcgcggga cagaatgtta ttacctca caactgtctg 28440
 gtttctaaaa attgttatgg gttaccctgc tccagagagt cttactacc catgttttga 28500
 gaataagat aagccactct gttcccggaa aaaaaact agctgtcca tggcttga 28560

 aatgtaaat ccaaaataac attccaacc cctcgtagc aaaattgtaa gttcaatcc 28620
 caaccaatca gtaaatgact cttgtatgt atagccaata aatagtgtgt tgtactctg 28680
 cctagtacc aaaaagatat aaaaactgct tgctttggaa actcggggtc aatctcagag 28740
 aaagaccca atgcattga ataaaactc tttgctttg catcgaact gcactctgtg 28800
 agtgactttg tggggtgtgt ctccaaagt tgaacccac tttggccca acaggactta 28860
 gaacagtga atttaagtgt catatagat tagcttacat ttttgaacag tagctacatg 28920
 tatgcataca catagatgta ttaacagga ctgggtaaaa gtaagaagaa ccagagtatg 28980

 atctctgatt ctcatgttc agcaaacagg cagaacctt aaaggtacag agtagactta 29040
 aaactccag tgacaagaaa gaagatccgc cacagatgga acaggcaagg tttttgtgtg 29100
 aatgtgtcc ctaccaagcc ctggaaagc acgccattcc acaacaagc catgcgcaac 29160

agagccagtg aaagaagaaa ttagagacaa aaataaaagg caaatgaatt atgtctgtca 29220
 gcagggtttg ttggcagaag ctggctagac tgtccctctg cctaggctga gggaaaggag 29280
 taacctatgg agtgggcagg cctacagcta ggccacgtaa tcaagatggc tgcttctata 29340
 aacatgttcc catctgacaa aagtttaact ctcagagtgt cctgagcaaa tgctgcctca 29400

 ggccaggcca ctgtgagccg ctggcatctg tatagaaaag aaacacacta ggtcagccga 29460
 gataggacaa acaggagagt gagagacatt ttgaacagga gcataagagg tctatgaaac 29520
 aggacatttc caggtggaag gaggttcttg cccttagcag tcttagccat gatgggaagt 29580
 ggccagatgc cattgtggca ggcaagagag ttttagtgaa gggaccagcc ccctgttttt 29640
 gcagctatga caggttaaca tgtgtcccc tgccttctg gggcctgtcc tgctcagtag 29700
 gaggtcagat gcctgcctcg tggcaaggaa ccaatcagaa gttagctagc agggctatgc 29760
 tttatggctc tgggtgtgct ttacagacaa gtgcacagca gtgacgcgaa gagcatagca 29820

 actgccctgg gaaggcctat gggccataac aaccagtga ccaatcaaca cagggcaggt 29880
 cgtccaaacc tgaagcaca ccaatcctga gactgtgcat actcctaata accccttacg 29940
 ctgcctata agatctctgt ctcatggttt ctccgggtct tccccagct gtggtggatg 30000
 gatgaaaggc ccaagctcat taaacaactt caataaaaga ctctgtgttt ttgcatagat 30060
 atgggcctct tggtgatttg ggggttcaga atttggacac aacattagca tgctaagaag 30120
 aggagggaaa cagacaagtg aaaaagagca gaggacagac tccaactgt ggatcactgg 30180
 tagaatgaag ggtgccaata agcaggcaca tgatttgata tagggggccc agcttccttg 30240

 agagaggtag agagatccaa agcctataat ctccagcadc ccagagacta agggaggatc 30300
 agatgcaaaa ggcactgact gatthtagagg tccattgagc acaaatcagg ggtcagggct 30360
 cccagagccc aacagataca tgatcatcca gtctctgggat ttttggccgg tccaaaagg 30420
 caagagacca cagtctccat acaagtacaa gtccctaatic ctggttgcat gggcagaggt 30480
 agaaaggaag gggcagccat accagattgg tgaaaccac aaaaacagct gacctgaaca 30540
 agggagagct cttggtcccc agactgatag ctgggaaacc agtatgggac tgatccagac 30600
 cccctgaatg tgggtgtcag tgaggagacc ttggaaatct atgggggcct caggtagtgg 30660

 atcagtactt atcccttgca taggaatgga ctttgggagc ccatcccaca aggagggaca 30720
 ctccctgagc ctagacacaa gggggttggc ctaggcccta tcccaaagaa tatgatagac 30780
 tttgaagacc tcctatgaaa ggcacaccc accgcatgg gataggtagg ttgttagttg 30840
 ggggccaggg gaggaggag ggagggagag ggacctggga ttgacatgta aaataatth 30900
 ctttctaata aaaaagaaa aaaaaagaa aggaaggggc aaacctacca gacatggcag 30960
 tgggtgatag aagaatccag agatccttag ttggaaaagt gaccaagttg aaggttacag 31020

ggttcccaga atatctcaga ctgccacaag caggaacaga tgccaggaaa acctgccgag 31080

 tcacgtgcac caaaatgttg ttcttttgtt taatttacct ggtgcaatca caatggaaca 31140
 tgaaccaaga gattcattaa ccatggagtt tattaaatgg gggtagagcaa gagaggggga 31200
 tggagagaga gacagatgaa gagagagagg gtgtgaaggg gaagagagga gggagtaaaa 31260
 ggaacaagaa agcaaaaaga gcagaaagag agcaagagca cgtaagtggg caggggtcta 31320
 tcttttaaag aggtcctttg cacctgcttg cagactagta ctagtactca tgaaaccttg 31380
 ggctgaccag agtactgcct gagtgtattc tgccaggtga caggggcagg gcagcataat 31440
 gcccaaatct tcaactactga agaaagggaa ccaattctca tgaaagcaac tgaagcaatc 31500

 ctagaatagc ttcaatgctg atgaccagag ggcagagata attgatcatg ctctaccaag 31560
 aaggagactc caatgggact atgacacaga gtgaggtagg aagtcattca gtgaatagca 31620
 ccaggttctg ctagaagggg tgaagcaggc agccccaag cccactaacc tacttaagat 31680
 aacagagatg aaacaggacc cagatgagtc aacttcagct ttcctggagc aaccctgga 31740
 cacatattgg tagctaagaa attaataaca gaaattattc ctaaatttgg cctcccaaaa 31800
 tctttgggat ctgacaatgg cctagctttc acaccaagt tatccaagt gatctctaag 31860
 gctcataaca taaatttgaa acttcttgt aagtatcatt gtcagaagtc aacaaaagta 31920

 gagaggatga atagaactct aaaggggact acaactaaaa atactcaatt gactttggat 31980
 atgactatcc ctcaggtcca gactgattta cctgttgggt acccttacct gatcaccatc 32040
 ccagcctgga gaagttgtat taaaccacca cttcaaaact gaccaggttg aacctatag 32100
 aaaaggccct tacaccgtga ttctccagac cctgactgct gtttaaggaaa tggatattct 32160
 gcctgcatta atcactcaca cttcaagaag acacctgagg aaccacagga agaggatccc 32220
 aattcccaga gatgaaagt gaataaaaaa ggaccattaa aaattaaact ttttaaggttt 32280
 cactgtctaa cataactttg tgttcttget gttgaaattt gcaccaagat gattgtccta 32340

 taactacaat tttgttgttt tgtttcagcc tatgcaaca gaacataaat gcatcttgac 32400
 aggggaaaca aaaggatccc ctaacatagg aaacaccaga tactgtcttg ccatgcaaaa 32460
 aattgacttt gtctaccagg gcccatagtt tggacaaaag gagagtaaat attctttagc 32520
 caaatggatg gaggatactg ggatggaata atctaactga ccaagtcaa tgtaaaaaca 32580
 caggcttcaa catagtcaaa tattctttaa aggattctga taatggaaat tacaggtgtg 32640
 ctaaaataaa aagaggaagg gaggattcat taattacttc aattgaattt aacacacaaa 32700
 atttactta ttcataaaca aatcaatatg agttgcttac aataagact taatgggttg 32760

tagagattac tcagttgctg gtagccatgt cagaggagca acaggtaaaa attgaagttc 32820
gaggtgtcag cctaccagga ggcaaatccc tgttgggtga ttctcagata ggcaaacctt 32880
ctctgcccc acaccagcc ccccagacca cagactccag aatgtctttt gcttccactg 32940
ttcctttata tgtttgctgc tgccatcttt ctctggtatc tggatagggt ggggggcggg 33000
gtagataccc actgcctata atgtagtgtg tttatctcat ggaacatccc attctactgg 33060
gcatttttac ctgtggatta taatgaagag gatttcttcc taagcagtac tgtctaattg 33120
ataaaaataa tgtagttta aatagagttt gatgactaaa aataaataca agaaattgtc 33180

atacaactag ggcctatgag tgtcaccaaa ggagatgcat agagggctat tcaggttcat 33240
gattaaggaa agcaactgag tccccagggt ggctcaaatt cttttcacct taatgttggg 33300
agatgtgctc acaggtttca gagtgtatca tagctgaaac aaagctttta aaataaacta 33360
aggttgggat gagacttttt cttttgttca atagccttga ggtgaaaaac ccaagaagac 33420
aatctaaagt ttagaaagg tacatcatta agtgaggaaa tctttaaggt caggaaacaa 33480
gaacaaagct acccaattat cattagctgg ggtgcctttc ttcttaggat tggttgatga 33540
ccaaagataa tgattaattt cttatactt ataccattt ttgccctcaa tctctgtta 33600

tatatattta taatacctgt tgatgagtgg gtatacacc taaagatttt aaagtagtgc 33660
tgactgtttt tctgtataa aagtctaggt ttatgattcc ttttaagattc cttataaaat 33720
tacctttcaa gataagcaat aaagtgattg gttctttctt tgtaacctg aagcctgcca 33780
ataaaagaat gccttgcttg cctaaactgt taatctataa caagttgctt gggtatgaat 33840
gtgtgtgggt tcttaggata acatgtcttg cacctgtaat acataaaatg tttaatcatg 33900
tacaggtttt ggaaaacaca ctgtttttta ctgcatcca ttgtgattac attatttaaa 33960
aaatagaatg taaccacatt gtaattttta tattgcctga aagatttttg ctgggtata 34020

taagctatca gagaaaaata gaagggagga gaagcaaaaa tatcaagaat gagagaatta 34080
gaaagaaaaa catcaagaaa gacagaaggg acatttatgg atagagataa gaatagagaa 34140
tataaaagaa gaataaaca aaggcctaaa gaagaccatc aagagagtgt gtgtcttttc 34200
cttaaccccc tcagataaaa aagtcttagt attcatggat tccctttggg cctgctgct 34260
ggatgctggt cccccaggca gcagaactca gtgatttaga gcaactggctg ctcttgcaga 34320
ggctcattcc caaattgttt ccagcaccca catgacagct cacaacagtt ccagggtatt 34380
caatgcttct cacttccaag ggctcacaca catatataca cttgggcaca ttgctttttt 34440

tttatttttt aatgcttaag gaaagctcaa caccaacata acattctgag tgacactgaa 34500
aagcacttag ctaccagctc ccaaacccaa atctgtttca ggctgagtat aagcacataa 34560
accattaaag gcagatgaaa atgttgcagg gctttgaagt ttttctgccc ttgacaagaa 34620

gaattcaaac taatttaaca tgacacaaga aagataaagc aagcaaggtt tagtaactaa 34680
cagtacatgt gcaaaggatc taacaacaaa atctgtggtt cggttcagtt tgtttttga 34740
gagagggtct cactatatag atcaggctgg cctggaattc acagagatcc tcttgcctcc 34800
acttccaag taatgggatt taagatgtac actaccacac caggctacac aggcctttta 34860

accagcctg cccactcttt tctacatgat tctctgcatc tcaatgggta ggtttaaat 34920
atctctacc ctctgaggtt ggctcttgaa ctagaagttc cttacttctt tttgaaatag 34980
ctcaagttct tgtggttggt ctcatgactc tctgttgggt agacatctgt tgcttcaagg 35040
taaaattctg atactttaaa attgaagcca gggttttgtg atagctatca gccagtaaaa 35100
atggaatagg gccttagactg tgtttaggc tcttctctca gcttgttttc atatctcact 35160
tctatgtagt aagaaaggca ggagtgacca ggtatatggg tacaggccta aaatcctgac 35220
acttgggaag tacaagcagg aatatttgga gttcaaggtc atcgtcagct ccagagtaag 35280

ttccaaggca gcctaggcta cttcagacc tgttgggaa aaaacaaaca aacaaacaaa 35340
caaacaaca accacagtgg actggcaaga tggcccagaa agtaaaaaac acttagctcc 35400
aagcctgaca atttgagttc aatctctggg accatatgat agaagcagaa aaccagttec 35460
cacaggctgt cctctggcct ccactcacat gattgcatgg gtatatcctc ttttctacc 35520
accaataaa taaatagata aacaggttat taattaatta aaaacaaaag aaaaacattg 35580
ttgttttttt aaaaaattc taaactgggt ggtgggtggtg cacacctta acccagcac 35640
tcaggaggca gaggcagggt gatctccgtg agttcaagac cagagctagt tccaagacaa 35700

cttccaagc caaagagaaa ccctgtctca aaaagaccac acacacacac acacacacac 35760
acacacacac acacacacaa gctagagtca gtgagatggc ttagtgcgaa aaggctctga 35820
tagtcaacce tgaagagctg agttccatac ttgagaacca catagtaata gagaaccaat 35880
gcctgtacat tgtcctctga cctctatgtg cacctttgta cacacaaaa taaaaccaat 35940
caacaaaagc aaaatgggtga catatgttgc aggttacctt actcggacac cccttgggag 36000
agagggtgag aagacaaaagc accaacaact caggcactgg gtgtcagtga gtggcagagc 36060
aggttgcaga ctcatattat tagaaaagttg tgctgcctt tgtaccact actagggtcc 36120

tatttattgg gtaaggcagc tgactgctgt gttatccttt tctcattggt gtctctgggt 36180
cagggtctctc tctgccagcg tctctgggca ttgaggcagg cttggcttgg ctcttagagg 36240
aagtgtcctc tctacatgtg catgtgcatg cagactggcc tgggcacccc gggacaggcg 36300
actccggctt ggctaagctg gctgaagttt ctctacaaa catatcccag tgttctcaa 36360
cctgtgggtc atgaccctc agcaagcctc tgtctccaaa agtatattaca gtgtgattca 36420
taacagtacg aaaattatac ttatgaaata gcaatgaaaa taactttttg actggaggtc 36480

accacaacac caggaactat attaaaaggt ctcagcatta ggaaagtga gaaccactgc 36540

tgtaaccccg tttctggggt tgcagaagta agccaatttc tgtgagtttg aggtcagcct 36600

ggtctcctct aggctacata gagactctgt ctcaaacggc aaaccaaaaa cacacaaaaa 36660

acacaaaact atgataaaa attctgttga ttaggatctt agtctgggtt actgttagca 36720

tccaggcatt atgctggcct ccttgagga cctaggagaa tatgtacca accacaacca 36780

ctccctatgc acatgcactt gctagcatca tgctagcctg cccccagtg tcttcagctg 36840

tagccaggaa gagcatcccc tgcacacatg tgttctcagc attcaggcag atacctgccc 36900

agcccaggat cctacagctg ccatgtcact acgtagtctg catgcatgtg ctatgtcatt 36960

gcgtagtctc tigtgtcatg tgctaagccc ctttaaagc aaactctgcc catttccctt 37020

tccctttcct gctgctcttc tgaagaggta ggcaggcctt tgctcctctc ccttcccacc 37080

ccaataaacc tccaatgtga gagttccttg tacagtgtga ttcactctca ccaactgctac 37140

tacagtaact atttttgtga tgaacacca tgaccaaacg aactgggga ggaaagggtt 37200

tatttgctt acacttccac atcatagtcc ctattgaag aaagtcaggg caggaactca 37260

aacagcacag gaaccaggag gcaggagctg atacagagac catggaggga tgctgcttac 37320

tggtttgctt cttttgactt atgtcaggag acagccctga ttagatataa aagtctcctt 37380

tacaagagge ctggcaacct ccatgcttgg attaccgcca acgtagtcaa acacccccac 37440

cccctccccg aaggttagtg ttctgagata aaccacaaga atgttctggg acacctgcct 37500

aggcctgagg acattaaaca cccattctc cccctcctt acttctctt tctttactt 37560

ctctttctt gtctttaaga actctttgct taagttcaat aaacagactt tgacagccca 37620

atgcttggtc tcgctcttcc tttctcgccc atttatttc aggcttagtc cccctcgaga 37680

gccgcaaatt accagaaccc cgctggatgg ggcagggtgc gcccaactg aggcccaagg 37740

tacggactct tctccaaacg gagaccctcc ccaaggaaac cttcggcagt gcacgccaac 37800

aaggaagtcc tgctcgccga ttgcgatgga cgttggctg ggaacgttat caccactcat 37860

gagcaactga ttcctggta agtccccctc attctattcc ataataatgg gccaaaagtt 37920

gtctaaggag gtcaaatca ttagggattt taagacttcc tttnnnnnnn nnnnnnnnnn 37980

nnnnnnnnn nnnntttttt gtcaagaaca tgcctatggg tcattttaga aagcccagac 38040

attcatcccc taacttggaa aaaggtcgga gaggatctta atagattact caaagaaaag 38100

ggacctgagg cagttccctt acagactttt agttattgga atcttattaa tgatatcctt 38160

accaattccc ctggctctgc ccaccttact tctgcaatta aaaactttct tgagcccctc 38220

tcctgtgctc attctcccac ttctgactgc cccatagaca aacctccatc ctctccctgt 38280
 ccttcagttt ccatctglat gccccctgat gagaccaga cccccacat cttacagaca 38340
 aacctccctt aaaagcccc gtaatcteta tccctcttta cagggcctcg agcctcattc 38400
 ccctaaaaac cttaaaagt accctgtctt tcgttcaaac cccaaacat aaactgatca 38460
 cctaagtcca tcagacgagg aggacctaga agaagcggcg gctgcttttc acaaccccaa 38520
 ctggcctccc ttcgagggt ttacggcccc tacagggtt ccgacttatc ctccgcccc 38580
 ccttctccca tcttccaca acgccttaat tcaagctaaa aaacatctca cccaacaaat 38640

 atcagaactt aaagaggtct tacaattaca acaggagttt tcacagctgt ctctatacct 38700
 cacatccctc cagaccactg ttggccaatc gatcttcgga ctcccactc agcccattac 38760
 agcccctaaa cctcccttc caccaggcaa caggccaaaa atctccaaat cactaagct 38820
 ggcttttct gacttaacc ctcaaggctc caagcataca ccctcctct ctaaccaaga 38880
 cccctcctct acicatacaa ttaggcagga ggatgaggag gaaaactcag agatgaaatt 38940
 aataagaggg ataaaaatga ctctgagtca gataatgagg tccaagataa acagacagaa 39000
 acaaccgaaa acatctttaa aaaattaaaa tttaaagccc ttaaggaact taatcaacg 39060

 gtcgaaaatt acggtcccat tgcactttc acccttggct tactggagc cctctcagga 39120
 gagggatgcc tcacccagc tgaatggcac catgtcacac aggcagtcct tagctcggg 39180
 aaatacttaa ctggaaatc tgaattctat gaccgttgac aaaaccttc taccaagaat 39240
 caacaaaggc cctccactca aaaatggacc cttgataaac tcaactggtca aggaaaattt 39300
 gtctctgaaa ttctccagat taagcttcgc ataggtctct taggacaaac ctctcagact 39360
 tctactggtg ctggcaagc tctctcaggc cgagggtcca tgcttacacc ccttactaag 39420
 atcattcagg gagccaatga acctatataca gaattttag ggagacttac agaggccaca 39480

 gaatgggttt tgggcacaca agaaactgac aataaactcc ttaacaact agcttttgag 39540
 aacgccaaga gtgtttgccg aaatgtctc agaggcacct ttagaaaca gtcccttgag 39600
 gaaattatc gggcctgcaa tgatgttgac tctttttctc aaaaactctc acagagcatt 39660
 tcccaggggg tcaatagtc tattggtgca gctctacaaa caacaggtaa caacagagct 39720
 tgctttaa at gccaccaacc tggacattt gctaaacaat gtccccaaa tattacacc 39780
 agacctcag agggcatcct gacatctega tccccaaatg gcatattgac ctttgccct 39840
 tcaccctgc agaaaactct ctgtcccagg tgcaaaaagg gtaaacattg gctcaggac 39900

 ttagatcca aaactgatg tcaagggat ccctgcctc ctctcaggg aaacnnnnn 39960
 nnnncagcca atccccctt tgccagcatc cgggccaagc ctgcaggcac aatccttcca 40020
 acctgcct ccaagctcta cagagccacc cccggaagca caggactgga cctgtgtgcc 40080

aacaccgact caatattaaa ccctaaggat ggtgtacaga ttctctccac tggattttct 40140
gccccaccgc cccagatac ttgttttctc attcttggtc gagcctctc taccaccagg 40200
gccaggggat cgttagagaga tctcacaaa cactaaaaac atgctattta aactatattc 40260
aggaggagga attctatacc ccactaaagg caatcacaag aacctactca atcatgcatt 40320

gttttgcta aatttctca catatgatgc cacaggaaaa tcagcctcgg atcgctctg 40380
gcatccatca acggctcaaa actatgctca ggccttatgg aaggatcccc taactcataa 40440
atggaataga ccagaccag tcttcatttg gggaaaagga cattcatgta ttttgatac 40500
tcaggccaat aatgccagat ggttgctga atgccctta aaactatata atccaccag 40560
ggaagccctt gagaagtctt ctaattctgc ttaattccag ataaagaatg atgtctttct 40620
ggctacttgt gtgtttctca ctctcaatta tcgttgccgc tgcaatctcc taccagatct 40680
acaactacac caggatgac atcaaccaag ctggtgatgt tgccaatgcc tctacataca 40740

ttggacctca gccctctat tccccctga tagtagctct ttgtgccttg gctatgggag 40800
cccacctct ctgaggaact tgcttttatg caaaaccggg cctcgttgaa gaaagcctaa 40860
aaaagttca ggatagccta gagaaccgta aaaaaacaaa gagaacaagc agaatcatgg 40920
tacaanaatt ggttttccac ctctccatgg ctctccactc tgttacctc catacttgg 40980
cctatggttg ggtttctctt attaatttcc tttgggectt ggccttttca aagattaacc 41040
agattcatta agtctcagat tgacaacctc ctcggaanaac cggtttcggg tcattatcat 41100
caactggagg taggagacc tgagctgcct gaccataatg aaaacccca caatcctct 41160

aaaggcctag attttccagg ccttgaacat cgaacctctg gatttcttg gccttggaga 41220
cgtcaatgac gtcaatgacg ggattatcgt gatgccgag gccagaccg gaccatctc 41280
accagctgta gtgtctca atgacaggat tagcatgcgg ctgtgaccc aggggcccac 41340
tccaagcact ctgagctgc tggccttatg aaacgtcccc tgagtgttg gggcagattc 41400
acctcacgta gcctaagaca gaggtcttac cctcactgt catataaatg acaatatcat 41460
aaacataggg tcttggtgc tgatgccc atgtagcct aagacagatg ctacattcta 41520
ttatacatag aagggggaga tgtcaggagc cagccctggt cggatataaa agtcccctt 41580

acaagaggct ggcgaccatg ctctgggaca cctgccagg cctgaggagc ttaaacacce 41640
attctcccc atcccttact tctcttttcc ttaactctc tttcttttcc ttttagaact 41700
ctttcttaa gtcaataaa cagacctga caaccattg cttggtcttg ctctttctt 41760
ctctccatt tatttccagg cttaatcccc ctcaattccc gcaaattacc agaaccctcc 41820
tggacagggc agacttattc agcctgcttt gtcatagaac ccagaccacc aagcccaggg 41880
ttggcaccac ccacaatggg ctaggccctc ccaataaatc actaagaaaa tgctctaca 41940

gcctgcctac agccaaatct tttttcccc ctgagagaca gggtttctct gtattgcttt 42000

ggcgcctatc ctggcactcg ctctgtagac caggctggcc tcgaactcac agagatccac 42060

cggtttctgc ctcccgaatg cggcattaa aagtgtgcac caatgcccg cttatagcca 42120

gattttatgg aggcattgta tcaattgaga gtccttgtgt taaactgaca taaaaatagc 42180

cagcacagtt ttttaaatg gtttttattt aaattaaaa cagtcttgtt ttacatacca 42240

atcccatttc cctctecctt ccctectecc attcteccca ccaaccctcc ccccatccta 42300

ccccctatcc actctctaga gcggatgagg cctcccttgg cggatcatca aagtctgcca 42360

aatctaagct ctccccaag tatctaggct gagagagtat ccctccttag ggaatgggct 42420

cccaaagccc attcgtgcac tacagataaa tactgggtcc actgccagaa gacccataga 42480

ctgtccagga cccccaactc acacccatga acaggggtgc ctgctttggt cctatgctgg 42540

ttccccagct gtcagaactg ggtcactgtg ctctcactag gtcaggtcag ctgtttctgt 42600

gggtttcccc agcatggctt tgacaccttt gctcatcact cctccctctt tgcaactgga 42660

ttccaggagt tcagctcagt gcttagctgt gaatctctgc ttctgcttcc ataagctcct 42720

gggtgaagtc tctatgatga catttaaggt agtcatcaat ctattatat aggaggggca 42780

tttaaggtag ctctccact atggcttaga ttcttttgtt ttgttttgtt tgtttttgt 42840

ttttcgagac agggctttgg aggctgcctt ttgtagacca ggctagtctt gaactcacag 42900

agttccacc gcctctgect ctcgagtgc gggatcaaag gcgtgccc caaacacca 42960

gctattgctt agattcttag ttggggctcat ccttgtgaat ccctggagat ttccctagt 43020

tcagatttct tagttaaacc cataatggtt ccctctatta aggtttctct tttcttgctc 43080

tccttttcta ttcttcccc aacgtgacct tectgatcct tcattgtctc ctccctgtcc 43140

ccttctactc tctctttct cctacctctc tctccccagt cccccgtgc ttccaatttg 43200

ctcaggagac cttgtccctt tccccttctc caaggggttc atgtatgtct ctcttagggt 43260

cctccttgtt tccagacttc tctgggtttg tggattgtag gctggttata ctttgttcta 43320

tgtcagtgcc attcttgggc tagtggctct ggagtgagag caaattaagc agaaactaat 43380

acttaaaaat ctatctcaat catgggccag ctaacctatt attgataagt aaatttctct 43440

tttcaaagct gactacctct ctgcccata aatagcttgt gaagaactgt tagaggagaa 43500

aaagctcctg gtcacaaaa tagaatctct gacctgggtg gagacctaaa agtccactta 43560

ggctggttca atttctttgg ctaagtacct acccctagga aggcagactc accttaacca 43620

tgctaaagag ataggagtag tatgtagtta tttaaaaaga agccatattt ctcttctc 43680

gaatccccac ttctcgtgta gaagctcatg taggatctta agtctggcag cttttctgaa 43740
 attatgcaca aacgtgtaag ttttccttta ctttggtaca tttgttttct aagcatgctt 43800
 ttattaacac tttgggtccc cccccaatat tttggccttc cttaccgaaa ggttcagact 43860
 ttgacgctga ttggctctac ctttttaaga gacagaccct ccccctgac aacagccgag 43920
 gcacgcacaa gaaaacgtgc tacgtcatca catgtcacc ggacacacatg aggactctgg 43980
 gcatgcgtgg aaccccagtg cacatgcgca gtcttccctt taaaagctcc aactttctctg 44040
 cttcactctc tctctgggtc ctctatttat gctgctctct ctctgctcac tccttctctg 44100

 ctcttctccc acctacgagc tctctctgcc tctctatggc gaccggccat ggcagtcagc 44160
 cattaccctt gttcctcttc tctcttagtc tcctactct gccgggcat ataataaact 44220
 agttaacatg tctaactctg catctttctc ttttccttc ttttaataaa gacataacac 44280
 ttactcttcc tctaaaacc cctcctctgt catgtggctg cttatttatc acgctgtct 44340
 tccacaccag ttiacacagc atggattttc tcttctctcc ttcactctcc tctagccagc 44400
 ttcccaata ctgggattaa aggtgtgcac caccatcacc cgtcgagtaa ttttatatgg 44460
 gattctacat caaggagata aaaattctag tcaaacctga agtggcctca tcaagaatac 44520

 aagatagagg aatgtctgcc ctcttaccct gtcacagtac caaatgaaa aaagaccaag 44580
 gaccaagtct tgaaaaattc ctgtgtttaa tggcaaagga gaaagcttga agacactaga 44640
 acaaccaggg agcaaggaga atgacacat aaaggcaaag agaaaattgt tcacacgagc 44700
 aaaggttttt cacttctgcc aaaggcatgt aagtaactg gaaaacattc tttgtatttg 44760
 agaatgaggg gtttaattgga gacctgagcc tagaaatagc aaagaccatg aataattaat 44820
 ataattctga aaacaaagtt gaaggagttt cacatcatga tttcaacact tactacatcc 44880
 agaagtgtgg tactagggtg taagtgccag ctgatcccat gtcctggggg gccataaagc 44940

 cctcagttct gtttttaaga aaagcataat tctgccaaat ggacaagata accccaggea 45000
 acaactactc aaaaaaaaa aaaaaaaaa aaaaaaaaa aaaaaaaaa aannnnnnn 45060
 nnnntatat ttgctgtata aatctccaat ctgaccaagt gaccagacta gcagtttct 45120
 gtctctgttt aaatgtcggg gcctgctcca acaagacagc tgggttacct gagtaggggc 45180
 atgaggattg agaaatggca gataaagaaa gagtcagaaa cacaggatag attcgggagg 45240
 actgcctggt ccatgccttt cagcacactg gacagccctg agtttatctt tgaacctgct 45300
 tataatataga ctaaaggcaa agcagaacaa agagcagaag cataatcagt taaccagctc 45360

 cctgcaactgc cattgaatcg aggagcagcc tggtcacta tctatcatca ttcgggtcct 45420
 agtaagcagc tgtgttatct agctgtgtgc ctacagcttg ttagttagat aatatgctct 45480
 ttttcatggg cttagtcaga actttctctc ggctctcagg gagactggag caagcaagct 45540

tgaactctaa tgttataagt tagaatagac tccagataga aactgagtca cttgtgggct 45600
cccacactta aaatgttcaa gatgtaacct ggggctggaa actagaagag atttgaggat 45660
ggcagcatat gtaaaataca taagcctatg gtgtatatag gttagtaaag tcttctttta 45720
gagatcaact ctcttttgag cattagccta tgtggtaata tattatttat gatttattaa 45780

agtcagccac aagctataga agccaggcaa tagtagtata tgcctttaat ctaccacta 45840
gggaggtaga ggtagacaat ctctgttagc tcaaggccac actaagctac aagaaatata 45900
tccagtccta aagagaaaca gctcacacaa agatgatctc agcacttggg accacacgcc 45960
tttaatccta ggaccaatga gatgtaaagg gccataggcc caattatgtg acttaaagcc 46020
caacctgtg agcctcctgt aacctgtaat tagatacggg ttggctaagc gggactacta 46080
acgactgctg ttccgagaaa aggccgtggg gccttcctgc ttgctgttc gaagatacca 46140
caagatgttc cagctgatac cacaagaatg ttctagccca agcaaatacc agacattcct 46200

tctgtctatt ctccccgctt gcctcacttc ctattgcag ggctatttaa gcccgtcccc 46260
ttgcttcagt aaatgagacc ttgacattgt acagacggac tcttgtcttt tcttgcgctg 46320
cttggctctc tttctttctc tcgcccataga ctctttcagg cagccccttc ggacctgaa 46380
gaactgaacc ctcaggacag gtcgatgaga gatatttaag acagaaacag ggaggatctc 46440
agagatggca ttattctcc agccacattg aggagaggaa gacattcagt ctcaggaatc 46500
tctagccaca ctggggagaa catagcagtc tgagtgaatc tgaggagcag tgaagtcggg 46560
agcaatttga ggattgtccc tttggtctga gctgaggtag aggtagtagc tggctgcttt 46620

gcttttctga tctctttttt tttttttttt tttgcttttt gagacagggt ttttctctgt 46680
agctttggag ccigtcttag aactcactct gtgagttcga ggctggcctc gaaatcacag 46740
agatctgtct gtctctgctt tccaagtcct gggattaaag gcgtgtgcca ccaatgccca 46800
gctgcttttc tgatcttctc ctggaagctg gaacctctat atctgtctct gggctctttta 46860
tttttcatgc tacaagccta ggctagacaa gcactgttaa agagtttttg tttttgcttt 46920
ttgttttttt tttttgttaa tctctaagtg tgtgaagtga tttttcattg ggaaggcata 46980
ttatttctgt aacactaaga gattatctcg tgatagacag acagacacac agactggcag 47040

acataccaca cacacacaca cacacacaca aactatagga cctatgtaa aataaccttc 47100
aaatttcttc aaatgtttc catacttatt tagtagtatg ctaataaaat ataaagagag 47160
gaattttaac accattaat tatacatggt acacactact atgatttttg ctttattcag 47220
caagtcatag aaatcccttc aagacattat agtaactctc aaaatattga aaaaataata 47280
aataatacat gttaaaacac agttgagact ttgattagga tcatggtagt atatgttgaa 47340
actactgcag taaggtctta cagtggagcc attgggatta aatgcaaaaa catcacgtac 47400

aagtagaat ttagaagtaa gaagttgggt cagggacaga agaaaaagt ccaaacagga 47460

aattgtcagg gatgaaggaa attctggcta aaccaactca acaggccaag ataaccatgt 47520
atcacctgca gctaaaaattc taacctatg aagagggtta gacctcatga ccatggcaac 47580
tcttatgaag taaaacattt aattgggcca gcttacagtt tcagaggttc agtcctttgt 47640
cattatggca agaggcattg tggcttacag gtagacatag tgctggagaa ggagcttggg 47700
acttcaacat tcagctccat aggcagcaga gagagagaca ctgggcctgg cttaaacatt 47760
tgaactcca gagcccatgc ttccttcaag gccacaacta ctccaactga aagaccccca 47820
gaagctcagg cccccaggtt ctcagtccag gaactcaacc atcccaatca ccaggcagag 47880

tcggaagctt gatgcaaaact gcacagggtt ttattatagt tgtttaacag gctaacccca 47940
tgtagctcg ggtctttcat ccaccacca tggcagatgg ctggggaaag acagcttgaa 48000
gcatctgcat agagatatta tagggcagca taaggggagt gtctaggggt aagcacaggc 48060
tcagcattgg tgggctcca ggcttggagg gtttgcctg tgttgattgg tcaactggtt 48120
gttatggccc ataagccctc ccagggtggt tgctatgctc tgtacgtcat tgctgtgcac 48180
ttgtctgtaa agcacaccca gagccgtaaa gcaagcacca ccagctaact tetgattggt 48240
tccttgccac gagacaggcg cctaacctcc tagtgaccaa ggcaaggtca gataagcacg 48300

ttttcggtg ttatggctgc cgaaaggac aggcatctga ccttagtgac caagacaagg 48360
tgaataaaca ggaagccaaa aaggtagtga atcctttgag aaaaggccga agaacttcag 48420
ctctgggaag gacattcagc ccaaagaga tctcacacat tcatcaaat ggctctctac 48480
atitggatgc agtgtcaaag gtctatctc tctataagca gctcaaagta cctcctgtgt 48540
tgtaacctgt cttttcggg cttcagtcag atccagcaga cttgcctgga tctctgtac 48600
ttgagaggga gagtgtggtg tgagaaattg aaaggaccag ctccccattt cggcagccat 48660
aacagcctaa cacttgcttg cctgaccttg ccttggtcac taggaggtca gatgcctgcc 48720

tatttcagca gccataacag tctaactatg gtttgcctga ccttgccttg gtcactagga 48780
ggtcacatgc ccgtctcgtg gcaaggaacc aatcagaagt tagctagtgg ttgaccctc 48840
cagcaggcca ggttattcgc gggctctcag ggggttgtca cctaaagggg tcatgagggc 48900
gagagaggag agagacctg cggcgcaaga aaggacaaga gtccgtctgt gcaatgtcaa 48960
ggctctgtht attgaaaggt aaagcttctc tatatgcagg ggatttttac tcaggcgggg 49020
gtaaggagc aggaggaatg gaaaattttc aagaggaaat agaggcaagg taaatcttag 49080
cccatggtcc cannnnnnnn nnnnnnnnnn nnnnnnnnnn nnnnnnnnnn nnnnnnnnnn 49140

nnnnnnnnnn nnnnnnnnnn nnnnnnaaaa aacatcttgt agtcgcagcg attctggtca 49200
 tctaacaatg attaactctt gactcagtat gaggccctt ttggccctcg acaagtgggtg 49260
 ctatgcttta cggctctggg tgtgcttcat agacaagtgc acagcaaaaa aagatgcgca 49320
 gagcatagca agcaccctgg gagggcctat gggccataac aaccagttga ccaatcaaca 49380
 cagggaagt cctctaagcc tggaggcaca ccaatcctga gcctgtgctt acccctatac 49440
 actcccctta tgetgcctta taatatctct atcctgtggt ttctaggcat ctttcccag 49500
 ccatctgcca tgggtgtggt atgaaaaacc cgagctaaca tggggttagc tcgttaaaca 49560

 actgcaataa agcctcgtgc tgtttgcacc aatcttgctc ctctgcctgg tgataggggt 49620
 ctctgaggtc ctgggctgaa atcctggggg cctgagcctc cgaggggtct tcaaaacat 49680
 caggtaaaga cgctaagaaa aagagacaca ggatagagtc aggaggcat tccagtgaat 49740
 attgaattga atacaccaag tttatacttc atcattctta agcacccca acaaagaggg 49800
 gaacatggta tcgtgtacac aggaataaac aaactttctt ccttaattct ctaagcattt 49860
 ggtaaccaca ccttagactc tatttctgtt tatctggcct tgagggtcaa gagaaaccac 49920
 acctcagacc aagtctgttg ttatttagat aagacatcca aggcggagag caaacatcct 49980

 atagtagcca cgcttatac ctttaggtct tatgacttac taaggacagt ttgtaactct 50040
 ctgactttga gccaaagatga agtggagccg tctttatggg tctgaaaac tctgcaaaa 50100
 aaccagttea tcaggccct ggactggaaa actgcaacce agttgcttat gettgcccac 50160
 aagtataggc cagagacaaa gtaggatgat ggtggtaagt ccttctgtgt atatgttct 50220
 cttattggtt aacgaataaa gcaccatttg gctgattggc cagacaggaa gtgacatagc 50280
 tgggcaagaa aataaaaaca atagatcaac tctatataac ctagttaagc actttctaaa 50340
 tccccctaca caaaaaaga agttttcagg atcagaccaa gaattcatag tataacctct 50400

 ctgattttca tccatcaggt tgtctccttc tctgacacag agatagtgag tettacatga 50460
 caagtgactt ttctattact ctttcagac agtcttgagg aattgaatgc ttccacttgc 50520
 tagaagcatg acaaaaaagg atgaagtctc aaagggtcaa ttccaatttc atcaaaccaa 50580
 agtatattct cttggagatg acattatcag gcaatggaac ctectcatga cttcaccttg 50640
 tcaactacta aaacaaaatt aagggattcc ttgaactcat aagcatcaca gccacaggaa 50700
 gctgacattt tctttactgg gttctccttc atatgaattt aattagtta caaatatgga 50760
 ccctgtcct gaacagactc actactctta ggactccaaa ttatgacaaa gttttatatt 50820

 tgtaatttta aaactcagga caaacaatag agattttaac acagtggaac ccagagagcc 50880
 atggtttatt gtatcttctt gacaatggac tccaaatgta taagaacaag tccggaaaag 50940
 ttcttcagct cagtgaaaat atgtggtatg agacagtggg aacctaggtc attctgacca 51000

gaatgctgtt tctgccaatc cttggcatcc ataacaataa taaataatct ttataaaagc 51060
 cctttccac ccatgtcagt ttgttcctag aacatgtaat acaagtgagc catgacaaat 51120
 cagcaatctc ccctcacac gaatatTTTT gtttatgggt ggggtgtggtg catggcacag 51180
 gacacctgta gagatcagag agcaacttgc agaaatcagt tctctcttc cactgtgtgg 51240

 attctaggaa ttgaattcaa atggttagat ttgacagcaa gcacaagctc tttatgaaaa 51300
 cagcctcaca ggcaccattt tggagcactt attctaaaca actagaagat ggtgccaag 51360
 tggccatcct taccactgtg actacaataa accttttgtt tgcagctggt gtgcttcaac 51420
 ttgcctttta agttgacatt atcattttaa cccttataaaa atgcctcacc cttttgtttg 51480
 ggtgcaatgg caacagccac aagaagccaa ggtctctgcc ctatcacat tcaacctcat 51540
 gttgataatg cactaaaaat gaaaatacca ctgactgac tttcaaaaa acaggagggg 51600
 ggggatccc ctccttttca caaatgtat gcattgcaga aatatgctag accccaccac 51660

 tcacactcct tgacacaaaa ggtccagttg agatctagga cctcttctc attgagaggt 51720
 ccctaactc ctgcctagaa caaaaagaca gttctgaggt agtgctggca aactgtcctg 51780
 tgctatttaa gtcactgag aagctgggtg tggagatggg atctggccaa tttacttcag 51840
 actcaagcat gtttgtctca aaatgtctc caaatcctg tcttgggtca agctggcctc 51900
 ttgactctgt aacaggaaaa agaaaaaca aacagctcag taggtaaaga catggtacca 51960
 taaggacagc taigggcaaa ctattttcac cagaggttac tactattat agagagatgt 52020
 ctatagtaaa aacaactact gtaaaaggat acaaaaagta aagctagtcc ctgactctgt 52080

 gacagggaga aagcacacag tgactgttat aatgctgccg gaactggact ggtaacattc 52140
 cttggggaga ttggggagt tattcactac ctggagacaa acagggtttt gatttcagtt 52200
 tgtttgtttg tttttgtt tttttgtt gtttgtttg ttggttggtt ggttcttgg 52260
 ttttcgagac atggtttctc tgtggtttt gaggctgtcc tggaactatc tetagtagac 52320
 caggctggtc tcgaaatcat agagattcat ttccctgcat gcatgctgct gctgctgctg 52380
 ccaccaccac ctggattgtt ttacttttta aaaaagcacc tttatctctt cctctttccc 52440
 ttgtgtcttc tgcaagtga agaaactaac ctgtgaaact agttagctat ctactgacac 52500

 tgcttccttg agctgagatc acaaaattcc ttctctgtt tttttgctg ttttagcct 52560
 acctgtgtac agcataggtt aactctctc ctatgtccat accaacctaa ctaactgtc 52620
 ttttaaaagg gtataactac atttactggt aaaagactaa aaattaatag aagaagcaaa 52680
 atgaggccgg aatgtagttc agcaactcca ctcttagagg gccaaaaata gtcaaatcc 52740
 aatgtttca gatgaccaca gacctcccag gcagttcatg gagaaacccc acaaaagggt 52800
 cagcaactgc catttactta ggcaagattg attagcacaat cccgaggtct gagggtttta 52860

caaccgggtg gtcaggaggc catctgattc ccagccctcc cctcaagaca aaaggcctcc 52920

taggaacca tgactctcgt actcaacagt cagagggttg cagccctcc ctaagcttgt 52980
gggttttgcc tttaaaaaca cctgtgccctg gagatcaggg cttctcteta gectgcctgc 53040
tgaggaggcc cgtttgtaca aacgttcacc tttcttaaag cctcttgcat gttgtatcaa 53100
ctggactgga tattgagttc ttgggcgact gtccaggttg gagattcctc aatctgagga 53160
tcttttgaag gactttagaa ttaacaaaga aataactaag aagaaaaaca atcctctcac 53220
cctaagaaca gggagacctg acttaaaacc taaccaaggt cacaatgacc caagccctg 53280
gaatttctta gctggcagaa ataactcctt tacaaggcca caagacaacc taactgaata 53340

ccaagaattc ctagagggcc accctgccct agggtcatga agataaaaac agactatccc 53400
actgagccag gagaccatct ggacccaaag ataagagatc tccaaaggat ctgtgactct 53460
ggtcacgtac ccaaaccctt aaaagcctat ggttttttct cctataaaag gaggcctgctt 53520
tagaggaaca gggcttttct ttgtctgtcg gactgggaag cccgtttgcg caaacgtccc 53580
ataataaact tacctcttgt ttttgcatca gctggactgg acattgagtg tttttggggg 53640
gatcgtccga tttgtagaga ctctcggtc cgagggtctt tcactttcac tgggtgagat 53700
ggttgatgcc acacaggctt gttgcctgaa aggaatgggt tcactttgtc acggagctga 53760

actcaccttg agcagaaagc agtcaggtgt tttgcagccg ctttgccctc tttaaagtg 53820
aagcaaccat gtgacttgaa cattatcttt gccaatataa tcatgaaaga ggaaatgtca 53880
tgtgacttta cctccatctt ggttaatgta accacaaggc ataagtcaa acagagacat 53940
ccatttagct tcccagtccc actgaacct caagaggatg acaaacctt tttatattag 54000
actaaggaaa agacatcaa catcaaaagt gttcattttg taattttaat gtttggtttt 54060
gactggactg ttattatag atacagttat tatatgatac agttactgac ttctgttttt 54120
tgaaacaggg tttctctgtg tagcagctcc agctgtcctg aaattagctc tgtagaccag 54180

tctgtcctca aactcacaga gataacctg cctctgcctt ctgaatgctg tgatcaaagg 54240
catgcaccac cactgcctag ccatttactg acttctaaga ggacctggga ctcaaggagt 54300
aaattgctaa gtgctagaca agctgctgcc agcaaggagc tgttccacag ggtctgtctg 54360
aatgcctact atttctgcat ggtatcttca ggctgtttt ctctaactgg taaaatgccc 54420
cccaacctt atgtattcct tacccttact agttttgttg ttctgaggtt gagagacccc 54480
caatcaagac aaccacatag ccagtaacca atgcccacac acagggttta ttgattaaa 54540
ccttgagctt ggagcctcaa ccagattcc aacacagcag gtgaaggaga tcggcccaaa 54600

tgctcagggt aaggagt ttt taaaggaaaa aaagacacaa gtaggcagca catgtgttga 54660
 gggccaaaaa gaatctcaag caagatcttg cacagccacc tgctctgacc tgttctaacc 54720
 acaagatggt ctttttagat aagttgctca aaacatgttt tacaggatgt tcctttactt 54780
 ctcggaatcg gctgcggttg gttggttgca gggacatggg ccaaggccaa ccttatcttc 54840
 acttctctca aaaat tttcc attcctccta cctcctacc ccaaccgag caaaatcccc 54900
 tacatataag caagctttac ctttcaataa acgagacctt gatgcgactc agactaactc 54960
 tatctttctt taigcgcttg gtctcatacc ctctcgcgcc ccattgacce ctaggcgata 55020

 cctcctcgtg accaccaat tacctggcct gctggacggg tcacagatgc tttggcgttt 55080
 caggattggg taaacgtttg tgacctttaa attcattggg tagggtctag ggtctaaaac 55140
 tgttactaac agttgccac aaggaagcct ggggagagtg gatgtagttt atcaaagtta 55200
 gtcattggct gactacctgg gcagggcttc tttggggcag gctacatgtg tggtttttct 55260
 taggactggt tatagctact ttcgctggag ctgaggcagc ccccgccaa gtgtaaaaat 55320
 ggaggtttt tctcaaaatg gagtttgctc tgttcctca atttgacttt gtttctgcct 55380
 gacctcaat atgtttttg tttgtttgtt tgggttttcg agacagggtt tctctgtggc 55440

 tttggaggct gtctggaag tagttcttgt agaccaggct ggtctcgaac tcacagagat 55500
 ccacctgct ctgctctgc ctctgctcc caagttagg gattaaagc gtgtgccacc 55560
 aacacccggc ttgacctta gtaaacctca atctgtttac taaatatctt tgtcaagttt 55620
 ctctttgtc aggtccaaag ggtaccacga ccaataaaag gcaggccac taactgctcc 55680
 gaaattgagt ctgaccag ctcaacctgg actataggag gatttctggt gcttagaagc 55740
 cagcattcct cagtaacttg tgaatccat tgccatctat caaacagaat cacttcctt 55800
 acctctgga aaagagatg atggctctcc aactaacatg tacctgtggc acctatcac 55860

 aatcaaggg ccatgctagc ctgtaggcca gtagttatct accttctaa tgctgcaacc 55920
 ctttaataca gttcctcatg ttgtggggac cccaaccata aaattat ttt tgtttctact 55980
 tcataaatgt aat tttgcta ttgttaagaa cctgtgtgtg tgtgtgtgtg tgtgtgtgtg 56040
 tgtgtgtgtg tgtgtgtgtg tgtgtgtgtg tgtgtgtgtg tgtgtgtgtg tgtgtgtgtg 56100
 tgtgcgcgcg cgcgcgcgta tgtgtgtttt ccgatgatct taggctaact ctgtgaaagg 56160
 gttgtttggc ctacaagggg tctttactgt gtctatcaaa tataactttc acaacaagaa 56220
 tgataaaaat cataatcaga ataagcaaag cattcaaaat cttgttatat taaaatgtat 56280

 cttttatatg attagttata tatagagtat gtagat ttt gtacttagta ccaagttgac 56340
 ttataagtac tcatataaac tacagtttat aacttgacce aacttagttt tgttcacatt 56400
 taaactaaaa ttttaaaaa taaaacagtg atagacaaat atgcatttaa ttaatgtgac 56460

aatatagata aaataagaag agatggtggt taatgatcct aaatctttca ttggacaatg 56520
aacataattg ttacattgt aatttgattt ttgttaaggg ccatgggcc taaactatgg 56580
gtttaagcc catctttgta agttctttta tgacctttaa gttttcgct taaaaccagc 56640
tctgtgagcc tcatataacc tgtaattaga tggtttggtc aaacggaact gctaactgct 56700

tctgttccga gaaagggcct ggggctttcg ctgttccggg gaagaccaca agatgttctg 56760
gctgataaga aactccagc cccagcatac accagatgtt ccttctgtt attccccgc 56820
ttaccaatt tccttggc agggctatat aagcccaatc tgagcccaa taaatagaga 56880
ccttgacaat tgcacagatg gactctggtc ccctctttg cgcgcttggc ctcttcct 56940
tctctgccc atgactctt caggcannnn nnnnnnnnnn nnnnnnnnnn nnnnnnnnnn 57000
nnnnnnnnnn nnnnnnnnnn nnnnnnnnnn nnnnnnnnnn nnnnnnnnnn nnnnnnnnnn 57060
nnnnnnnnnn nnnnnnnnnn nnnnnnnnnn nnnnnnnnnn nnnnnnnnnn nnnnnnnnnn 57120

nnnnnnnnnn nnnnnnnnnn nnnnnnnnnn nnnnnnnnnn nnnnnnnnnn nnnnnnnnnn 57180
nnnnnnnnnn nnnnnnnnnn nnnnnnnnnn nnnnnnnnnn nnnnnnnnnn nnnnnnnnnn 57240
nnnnnnnnnn nnnnnnnnnn nnnnnnnnnn nnnnnnnnnn nnnnnnnnnn nnnnnnnnnn 57300
nnnnnnnnnn nnnnnnnnnn nnnnnnnnnn nnnnnnnnnn nnnnnnnnnn nnnnnnnnnn 57360
nnnnnnnnnn nnnnnnnnnn nnnnnnnnnn nnnnnnnnnn nnnnnnnnnn nnnnnnnnnn 57420
nnnnnnnnnn nnnnnnnnnn nnnnnnnnnn nnnnnnnnnn nnnnnnnnnn nnnnnnnnnn 57480
nnnnnnnnnn nnnnnnnnnn nnnnnnnnnn nnnnnnnnnn nnnnnnnnnn nnnnnnnnnn 57540

nnnnnnnnnn nnnnnnnnnn nnnnnnnnnn nnnnnnnnnn nnnnnnnnnn nnnnnnnnnn 57600
nnnnnnnnnn nnnnnnnnnn nnnnnnnnnn nnnnnnnnnn nnnnnnnnnn nnnnnnnnnn 57660
nnnnnnnnnn nnnnnnnnnn nnnnnnnnnn nnnnnnnnnn nnnnnnnnnn nnnnnnnnnn 57720
nnnnnnnnnn nnnnnnnnnn nnnnnnnnnn nnnnnnnnnn nnnnnnnnnn nnnnnnnnnn 57780
nnnnnnnnnn nnnnnnnnnn nnnnnnnnnn nnnnnnnnnn nnnnnnnnnn nnnnnnnnnn 57840
nnnnnnnnnn nnnnnnnnnn nnnnnnnnnn nnnnnnnnnn nnnnnnnnnn nnnnnnnnnn 57900
nnnnnnnnnn nnnnnnnnnn nnnnnnnnnn nnnnnnnnnn nnnnnnnnnn nnnnnnnnnn 57960

nnnnnnnnnn nnnnnnnnnn nnnnnnnnnn nnnnnnnnnn nnnnnnnnnn nnnnnnnnnn 58020
nnnnnnnnnn nnnnnnnnnn nnnnnnnnnn nnnnnnnnnn nnnnnnnnnn nnnnnnnnnn 58080
nnnnnnnnnn nnnnnnnnnn nnnnnnnnnn nnnnnnnnnn nnnnnnnnnn nnnnnnnnnn 58140
nnnnnnnnnn nnnnnnnnnn nnnnnnnnnn nnnnnnnnnn nnnnnnnnnn nnnnnnnnnn 58200
nnnnnnnnnn nnnnnnnnnn nnnnnnnnnn nnnnnnnnnn nnnnnnnnnn nnnnnnnnnn 58260
nnnnnnnnnn nnnnnnnnnn nnnnnnnnnn nnnnnnnnnn nnnnnnnnnn nnnnnnnnnn 58320

nnnnnnnnnn nnnnnnnnnn nnnnnnnnnn nnnnnnnnnn nnnnnnnnnn nnnnnnnnnn 58380

 nnnnnnnnnn nnnnnnnnnn nnnnnnnnnn nnnnnnnnnn nnnnnnnnnn nnnnnnnnnn 58440
 nnnnnnnnnn nnnnnnnnnn nnnnnnnnnn nnnnnnnnnn nnnnnnnnnn nnnnnnnnnn 58500
 nnnnnnnnnn nnnnnnnnnn nnnnnnnnnn nnnnnnnnnn nnnnnnnnnn ncgatcatctc 58560
 ttgaaactt atccaattc tggttctaca acatggctct tttgcttgag ggtataaatt 58620
 aactttaaga gattatcact cctacttcgg gacacctttg tcctatggta taatagacct 58680
 ccctttagta atactttttt tttttttttg gtttttcgag acagggtttc tctgtgtagc 58740
 tttggagcct atcctggcac tcgatctgga gaccagactg gcctcgaact cacagagatc 58800

 tgctgcctc tgctcccga gtgctgggat taaagtcgtg caccaccaac gcccgctag 58860
 ataataatac ttatatgigt gcttttaaata gttttatgaa taagigaatg tatatataaa 58920
 tataaacatc ttaaagattt ttttcatttt gaagattaca acttctttta aatgatatg 58980
 ttaaaaaatt atatataat tctttttgcg cgcttggctc cttcccatc tctcacccat 59040
 gactctttca ggcagccccc ctccggaacc ctgaatgact gaccaaggt acgggtcaag 59100
 tggcgctga acagggacc gaagtacggt cagctgtcgg acggcggaaa gacagccggg 59160
 gacaaagagg accctgcaga cggacagact ccagccctct ccaggtggag gtaaggtacc 59220

 aatcattgcc gtccaaatgt catgggtact ttcattagta aggagttgca atttataagg 59280
 aaactcaaga caattcaggg agaaaggagt aagagttaa aagaaagata aaaaggagta 59340
 agagttaaaa aggagaagat aaaaagaaat aagagtcaa gtaagagtca aaaagaaaga 59400
 tttagttcat tttttctatt ttattgataa agcttgtcta tggttgattt taacggggcc 59460
 agacatagct cccagacct gggaaaaggt tgggagagtt acttcgcca cagcagagaa 59520
 ctcaaacgc gccacagcg agaaatgctg ctggcagcat tcttagagg cagtcaagct 59580
 tggggctgc aacttacagc cttgggagat gcctaatcaa tgtatagaaa tgctattgat 59640

 acagccagac agaaactggt tttgagactt acaaagaaga aaggcaaca tatttaagct 59700
 tagatttgtt caaattttgg atgctcatat acaacgattg actataagct actgtgttag 59760
 aaatttcaat tagggatttt tctttctac aagctgatca taacctagc aaaaggagaa 59820
 atgtgagac tatgcaagtt atgaatgaac ggtgtgcca cacctggatt cgtgatgtga 59880
 ttgtgaattt acaaatgcaa atgaatgaaa atgtctaaat tgccttggat atgattagag 59940
 atatttatat tgctcggat atagttttaa aaatatcaaa atcactttaa tatggcaaa 60000
 aagagcatcc agtcagtcag tcaatgtctt aacaggagaa attatgattt gagccctagg 60060

agacagtcaa ttaaaaagtt agcaatagcc tatagcattt agcttagaga catgagaaat 60120
 ctatggatga ttctataaaa ttggcagat gagaggataa aggtcttacc aaatttttat 60180
 ggttaaaaaa aggaaatcta gaaaattaaa gttgaaacat gattttaaaa agggtttgta 60240
 agaagcctca ggaaagagcc aacttgtagg attcacagct tggcaggtca gctaacatgc 60300
 aatgaggtc ttatcagctt gtcagcctcg aaggttagat tagaaaaggc tactcaaaaa 60360
 ctctaataa atctagagaa ttgttaaaga catatgttat attctaaaga aattaaggct 60420
 tgatagataa caattggaaa agataattta aaaatcttta aatgagtttt tagaaattgt 60480

 tataaaatat tcattggtta agtacctttt tgggacatct aatgatagcc tacatggtac 60540
 agaaatgtca tatagatttt agaaagtatt ttaggagaaa accaagtatg atacatgnnn 60600
 nnnnnnnnnn nnnnnnnnnn nnnnnnnnnn nnnnnnnnnn nnnnnnnnnn nnnnnnnnnn 60660
 nnnnnnnnnn nnnnnntgtc ttgtctcaat ttccaggaag aattgataat caatttctag 60720
 ttcatggact gttacaattt gcactataca tccttttgta tttctaaatt ataaaaaagc 60780
 agtcctataa aaatatacta tgtaattttt taccaatggt tctattgaga gagtcaactg 60840
 cataggtcat taataaaaag aaatagagca gacagctctg acttcagctc aaataatcaa 60900

 actacaagct gttgcaatgg tcttttaaat cctggtaaat aattcattta atttgatac 60960
 tgacagtcac tatgttttta aggttataa ggtaacagaa acagtcccat gcacaggatc 61020
 tggtaatagc caagtcaaaa tgttatntaa gcaaatcaa aatgttactc acttaagaga 61080
 attatcgtgt ttatgggtca cacggggaac ctattaataa gtcctttccc tgattactgg 61140
 ccaaattgaa tgaattatct gattaacaaa atcagttggt ttgccttaa tagaaaaggc 61200
 tcgacaggct tgtaactttt ctcatcata atagcaagtc taagtaagaa atttggctta 61260
 accagagaga ctgctggta aatcatcaat caatgtagaa taggtccgca atatggctat 61320

 ggctaattta aggattaatc ctcaaggcct gtccecaac catttatggc gaatggatgt 61380
 gactcacatt acagagtttg gcaagttaa aatgtgccac tccacaaca ggagaagcca 61440
 ccaggcatgt tataagtcac tatttaagat gttttgctta catgggagtg ccagaagtta 61500
 taaaaacaga taatgggtct ggatatacta gcaaagcttt ccagcaattt tgtgcttaat 61560
 tcccggagac cggtgctacc ggaacagccc gtatggccta gtcccacca gtgctgctgg 61620
 acctgctgc cgggccccta gtggcgagag ggctgggctt ttgggctttt ggggacgcag 61680
 catgctgctg acttggggga gtgaatcacc tgctccgag cttttatagc ggcagtgaga 61740

 catgaggcga gccacagct cgggcggcgg tgctcctga gccggcggga tgtacaggcc 61800
 aggcagtgtt ggcgcacgcc tttaatccca gcactcagga ggctgagaca ggagatcact 61860
 tgagtccagg aattttgggt tgtagtgcgc tatgctgac ggatgtccgc actaagtctg 61920

gcatcaatat ggtgacctcc agagagccgg cggccaccag gttgcctaag gaggaggagt 61980
 tctatgcat acattgtttg tgttaaattt cctcatgtat gatgctacag aaaaatcagc 62040
 cgcgcatcgc ctctggcatc catcaacggc tcaaaattat gctcaagcct tatggaaga 62100
 tcccctaact tatatatggc acggacccga tccggtcctc atttggggaa aaggacatgc 62160

 atggatTTTA atacagtcca ataatgctag atggttgect aaatgccttt ttaatccacc 62220
 caggggaage cectgagaag ctttetaatt ctgcttaatt ctagataaaa gatgctgtct 62280
 ttctggctac ttggcgcttt atcaccttcg attgctgttg ccgctggaag cccttatcag 62340
 atctacaact acacctggat gatcctcaac cgagccagtg atgctgcca tgcttcacaa 62400
 ctattacctt attctctect taattaacce tactgttcag gccctcctc aagccagcca 62460
 ctcccttatg gaggactgtt gggctctgta gtcttcacc cctccccttt ttcagggaat 62520
 tgcaggcatt tgatccctac cttgectgtt ctaccggatt gactatttac tacaacagg 62580

 actccaaaat ctaaaggact ctttggtttc tctatctgaa atgatgttgc aaaataggag 62640
 gtcttgacct ggtctttctt agacggcctc tatgcagctc ttaaagagga atgctgtttt 62700
 tataaagata aaactgagtt agcaagataa tattaataaa agtaaagaaa aatctagagg 62760
 ataaaaagaa acaagagag caacaagagt cctggataaa aaatggttt caacctccc 62820
 ctggttttct actttgctcc catctctect gggacctctt ataggactat tgctgctgat 62880
 ttcttttggc ctccaaaga atgctcgtt tataaaaagt cagatagatt cacttctccc 62940
 taaagatTTT gtctctgtac agtgacgagc agagcaaaca aggcaacccc ttgggcatc 63000

 aagagaggct taatTTTtct aaactgttan nnnnnnnnnn nnnnnnnnnn nnnnnnnnnn 63060
 nnnnnnnnnn nnnnnnnnnn nnnnnnnnnn nnnnnnnnnn nnnnnnnnnn nnnnnnnnnn 63120
 nnnnnnnnnn nnnnnnnnnn nnnnnnnnnn nnnnnnnnnn nnnnnnnnnn nnnnnnnnnn 63180
 nnnnnnnnnn nnnnnnnnnn nnnnnnnnnn nnnnnnnnnn nnnnnnnnnn nnnnnnnnnn 63240
 nnnnnnnnnn nnnnnnnnnn nnnnnnnnnn nnnnnnnnnn nnnnnnnnnn nnnnnnnnnn 63300
 nnnnnnnnnn nnnnnnnnnn nnnnnnnnnn nnnnnnnnnn nnnnnnnnnn nnnnnnnnnn 63360
 nnnnnnnnnn nnnnnnnnnn nnnnnnnnnn nnnnnnnnnn nnnnnnnnnn nnnnnnnnnn 63420

 nnnnnnnnnn nnnnnnnnnn nnnnnnnnnn nnnnnnnnnn nnnnnnnnnn nnnnnnnnnn 63480
 nnnnnnnnnn nnnnnnnnnn nnnnnnnnnn nnnnnnnnnn nnnnnnnnnn nnnnnnnnnn 63540
 nnnnnnnnnn nnnnnnnnnn nnnnnnnnnn nnnnnnnnnn nnnnnnnnnn nnnnnnnnnn 63600
 nnnnnnnnnn nnnnnnnnnn nnnnnnnnnn nnnnnnnnnn nnnnnnnnnn nnnnnnnnnn 63660
 nnnnnnnnnn nnnnnnnnnn nnnnnnnnnn nnnnnnnnnn nnnnnnnnnn nnnnnnnnnn 63720
 nnnnnnnnnn nnnnnnnnnn nnnnnnnnnn nnnnnnnnnn nnnnnnnnnn nnnnnnnnnn 63780

nnnnnnnnnn nnnnnnnnnn nnnnnnnnnn nnnnnnnnnn nnnnnnnnnn nnnnnnnnnn 63840

 nnnnnnnnnn nnnnnnnnnn nnnnnnnnnn nnnnnnnnnn nnnnnnnnnn nnnnnnnnnn 63900
 nnnnnnnnnn nnnnnnnnnn nnnnnnnnnn nnnnnnnnnn nnnnnnnnnn nnnnnnnnnn 63960
 nnnnnnnnnn nnnnnnnnnn nnnnnnnnnn nnnnnnnntta gggagcagac aaaaaacttc 64020
 aatgacaagg atcttttttt tctgaggtgg gggttttaag acagggtttc tctgtggctt 64080
 tggaggctat actggaacta gctctttag accaggetgg tcttgaactc acagagatec 64140
 tctgctctct gtctcccag tgctgagact aaaggtgtgt gccaccacca cccagtgaca 64200
 agactcttct taatgggctt tttatttcac agatttatgg aataaat ttt gaagcatcaa 64260

 gggagctgag aaactttaaga caggttagga tctgggaagc tcctgggaag caggacaaca 64320
 acctccactg gtatttaca ctttgatact gtaagagaac aaactacag atggaatctt 64380
 ccaccgaaa atcacctctt ctgcttaga aaatcccaca accccttga ccttgaaca 64440
 cagtctctac cactcccca cccatagat ggctgccctt ccttttcta attagaggac 64500
 agtctacctc ttagaggtg agtctctctt cctgcctccc tccctcctc ctctgcctccc 64560
 tctctcattt ttgtttttgt tattcaagac agggtttctc tatatattcc cecatgtcct 64620
 ggaactaacg ctgtagacca ggctggccat gaactcggcc tgctgagtgt tggattaaa 64680

 ggcatgtgct gactaagcct tgcgcctctt tcttctttt tatgttacct tcatcaatcc 64740
 tgatctgtta gtaagctatt tctgttcagg gctgtttttt ctttgtacct tagccagagc 64800
 caaatgaatg gtagctttta aaaattttga cccttttatt ctctgagtga ttagagtaaa 64860
 ttctcactgc ttggcttaat ttggtagaaa caattttgcc atttcattgt agaattagtc 64920
 tttttttttt tttttggttt ttcgaacag ggtttctctg ttagctttg gaggcctatcc 64980
 tggcactcgc tctggagacc aggetggcct cgaactcaca gagatctgcc tgcctctgcc 65040
 tcccagatgc tgggattaaa ggagttagcc accaagtaac tacagtctt acttgataac 65100

 tttttgttat atattttact atgttaatgt taaacccttc tttttat tta cacaggaaag 65160
 aggagatggt gggggaagtc cttctgtgta tatgtttgtc ttattggttg atgaatacag 65220
 cactgttggc caatagggaa gcaagatagg tgggactagg agttgaggag gattctggga 65280
 aatgtagtag aggagtcact atgtgatcca ggaagagagg atgcatgagg ctggcgtcct 65340
 cagtaagata agaccttgag aggaatata atatatatta atatatatat atattaatta 65400
 tgagttaaat atggcagagt tagctaatag aagctgtcat tgaccaacag tattgtaact 65460
 aatatacgtc tctgtgtgtt atttgggggc cctaaagagg tggcagaacc caggcggctg 65520

gtggaacag ttatcgttac aattaatgat taagatacc cccccccac cccaccacag 65580
 acccaggca accaataaca cagtgccatc aggttagggc tgaatgtcac attccacact 65640
 atcaaagact aactaaaca ccaagccagc cacaaacct ttgatttaca atggggtcct 65700
 gcctgaaaga tcacataggg cttgtggcac aaaacttgtg ggagtaatca accaatatct 65760
 gatttgactt aagatccact ccatgagatg gagcccatc ccaacactgc ttgggtgacc 65820
 aagaaccaca gactataata gcatggggac ctagggtgaa cccaagtacc actgttctaa 65880
 aaaaaaaaa aaaaaagtag tgatacaata acttctgatg atacgatata ttctgctgta 65940

 ctcacagaca gggccttctt aatccatcat cagagaagct tectcctgca gcagatggga 66000
 acaaatacag aaatctacat ccaggcatta tgcaaagagt aagagaactt ggaacattct 66060
 gccctaatg ggaattctct atcaaatctc ttcctcagg gttcagagaa cctacagaa 66120
 gaggaagcag aaagagtgtg ggaaccagaa ggggtggagg ccaccaagaa aatcctttaa 66180
 gtcaatacca tcaaagctca tatgaactca cagagactga agcagcaggc acagtgccag 66240
 caggagtctg ctctaggctc tctgcatata tatattgcag ctctagtta atgtttttat 66300
 gggatcaaga gtattcaaac cagtaggtct ctgattcttg tgctctctct tggactcttt 66360

 tccttctttt tgtttgtctt ctccaactcc aatgtgacag cttttatfff atcttactat 66420
 attttattat tattgtgata aagaaattaa aaagactcca actgagcaag aaacctgtga 66480
 tcctatgcta cgaaacagga gcccacaagc agttccaaaa aataaaaggg acatcagcac 66540
 atcaccgact gtaaacgctg gccctagcc cttgtctcta agtaaattag atggcctctt 66600
 tatctgctg tcataaatcc cccagactac agggcatgtt aatcagcccc cacctaatc 66660
 aaacgacagt tatagcttct ttgtcaata cctattatct ttccataacc ttgtacaaaa 66720
 gctttgtaac tttgtatgaa actttgtaac atgagatcat ggatctcatg accctcttcc 66780

 ccttttttga cttccctgtt tgctctttaa aataccttgc atttgtggtt cggggcttca 66840
 tttctcccga cagagtgaag ccccttcttg gttagctggt tttccttgaa ataaacaaac 66900
 cttgtacttg cattgcgatg tggttaaatt ccttgaagcc ttggggttcc tctcttgttg 66960
 ggcacaacaa ttatcgatta gaagtctgtt ctcttttaat gagagaaagg gattggaact 67020
 glatgggagg ggaggtggga aggaattgag aggagaagag ggaggggaac ctataattat 67080
 ataattatat gagtaactaa tctatfffca atacaaggaa aatfffaaaa acaaaaacaa 67140
 aggactgatt ctagacgatg gggatcctgt tgcaggggaa acaggaatga ggctatgtct 67200

 cacattcgga acaaaaacaa taatgctcat ttatagaatc tcaacctgaa ccagtcaact 67260
 caaggggaag aaagctagta ctcccagagc tgatcagata gctagctggc ttgaaagggg 67320
 gttttaggaa gggcatgagg cacatatctt tagtaccagc agaggcaggc tgatctctgt 67380

gagtttgaag ccagctctgg tgcacatgt gagacaaaa tagtaacaat ataccttgca 67440
 ggtaaagggc actgtttgca gtttaagacag ttaaaaaataa gttcctgttt gtctctgttt 67500
 aagtccttgc aagttaagat ttctatattgt gattaagaag aagttcctgt ttcttagatt 67560
 tgatgtaaat tgcaaaacat atttgtcaac ctacactaaa cttataacct cattcacatg 67620

 atgtatgacc ctaccattgg tccttccctt tcattgtatt tttctaaca tgtgtaacag 67680
 ccaactctct cactcttgta aacaatttat ctctcacata aaaggacct caggaggcta 67740
 gcaggggctg ctcttataaa tcctgactta gggagaggca gtcagaatga ccagtcctgg 67800
 gtgcacccaa aatacagctt gctttaattg gataattgtg tatttggctt ttctctcaat 67860
 tttcaggtta acaatagcaa tttccaggta agtcaaggtt gcctattgag gccttctcta 67920
 aaagaaaggt gaggagaggg ggacttgaat tgattcggat acaaagtggg gaaatgtttg 67980
 gtaaatgttc ctaaacaca taattttatt atttgtttat ttgttttct agacaaggtt 68040

 tctctatgta gctttggagc ctgtcctaga acttcctctg tagaccaggc tggcctggaa 68100
 ctacagaga ccttctgcc cctggctccc aaatgctggg attaaagtg tgcaccact 68160
 gccactggc aaccgaaaaa ttttaagga gctttgaaac aaagtccat tetataacc 68220
 aagctgagca taaactggtc ctgtaagtca agttggctct aaactgaac caatcctct 68280
 gcctcagctt cttaaatgct gggattacag acatgtacta ttacatctt cttaagta 68340
 gaatactta tigtcaaa tctgacctt gtacttgatg aactaaaggg ttgacctcat 68400
 catcttgat aaatgtcctg atctcttact ttagtatga gaaatttaa agagaaagct 68460

 ggcacatata tttcttaagc cattcctaaa ttaaatgttg tatctgaagt ctctgtgag 68520
 tccaaactga gcattggata tttccaatac tgcagtcagg gtagggtag agagctgaga 68580
 tagaaggate tcacattca ggcagtgaa atatatagca aggcctgcc tcaaacacac 68640
 caagtctgg acatacaggt cagtggtaga gttcttacct agtatgtaa aggccctgaa 68700
 tttgattctc agcccaaatt aaagaaagaa aaaaaagga gtagaaagaa aaaggagtag 68760
 aaagaaaaag gaaaagaagg atgtggaaaa gggagaaatg atttatgtg ttagatagtc 68820
 aatgaaaggg aaaaattaat aaaagtctaa aaccggact ccaaagcca aatagaaaa 68880

 ctctaagct tctctgagtt cccaaaaggc agctcaacag acaaggttaa acaaaggtcc 68940
 acatgactca aggccttaga cagatatcaa acccttgagc tgtgtagaca ttctccagt 69000
 ccaaagagga tcagataatt atcaattgia gaagtcctta gccaggaaa taattaacat 69060
 actcatttc tctgcagcat cctgcttaat tacacctgc ctgaagcgt caatcattgt 69120
 cccatctgt gtaaacatgg aagttttata atcttgggtc ttccagcct acaatttcc 69180
 cttataaaaa caccctcag tcaaaagtgg ggagtgttc caaacgaatg ggtccttgc 69240

tgcagttcct atcctagagt caataaagaa acctttgtcc ttgcatttgg tgagtcgctc 69300

 tttgttgggtg gtttcttttg ggtttccaca atctgggcac aacaggcaaa ccattttatt 69360
 aactaatctt ctgacctaca taatgttact aaaactaatt gtccctgggta tagtgtctaa 69420
 cacttataat ctctgccag gaggatcggg aattgttatt ctgagctaca tagtgaattg 69480
 aatgatgcc gtgagaaggc ttttattgta gaaataagag agtgaagtca tagataggca 69540
 ttggaagagt ccagagaagg gagagaaagt ttagtggtgta tctcatctgt gaacctgcaa 69600
 caatggtcat gcctttgggg aatggttaca ggtgcagacg tgaccattt aaggtagagg 69660
 agcagggagg aagccccttg ggtctcagag agcatagggg aaacagggtc tgcaccttg 69720

 gagcaggaat gccgattatt gttatctatg taagttcatt cccaacaaac acctatttat 69780
 cattcatctt gggtttgggtg aactaattgt aatcccttgc cttcagaaag taatacaata 69840
 aacatggcca gcaaacfgaa ttgggtcaag aggaccaaga accaggtttt taaaggacag 69900
 agaactgtgg ggagggaaagc aaagcccctg gactggaaag gtttagggta ggaggcaggg 69960
 tggaaagtgc tgaggagccc ggatactggc cagcatagac tgattctgtg aggccagcat 70020
 gcactttgtt ttttaatagc catttattct aagtttcttc agcaccttac attccaagtt 70080
 cagagccagt ctgggctatg taagagtata tttaaaaata aataaataga taaattaata 70140

 aattagataa tttgggccag gcttgggtgt tccatctat aatcctacca ttttaaggat 70200
 cagtataatt tactggaaat gtgccaggaa aagagcaaat ggggcaggga gcaagtgaag 70260
 ttggtaaaag gactgaaggg tgttagcatt tcattatga ttttaagttat taattgtatt 70320
 tttgaaagat ttgtatttgt tcttgtgtgc atgtgtatgt ctgtgtgtgt gtgtgtgtgt 70380
 gtgtgtgtgt gtgtctgaag aagcctaaag agggcatcag atactctgga gcaagagtta 70440
 caggtagttg tgaacttccc aacatgtttg ctagaaccta ggaactgaac tcaggaatc 70500
 tacaagagca ggaagtacta ttaaatgcta agccatctct ccaacttctg tatttacttc 70560

 ttcattgttt tatttatatt tttatgtgta tgggtatfff gccgacttgc atgtctgtac 70620
 accacatgca tgctgttgc ctacagaaac tagaggaggg catcagatct tctgaaactg 70680
 gagttacaat tttgagtcac tgtgtgggtg ctaggaattg aatctgtatt cttcacaaga 70740
 atattcaatg ctcttaactc taagccatct cttgagctgc ctgaggtgag gtctcagcca 70800
 tgctgggtgg gcattgaaact ctttctgtac ctgggaagga tcttgaactc ctggctgtgg 70860
 gtgctgtaat tgcaggcatg taccaccatt tcttttatta ttgttttgag acagagtcc 70920
 actttgtatc cttgataggc ctggaacttg ctatgtagat gaggttggcc tcaaacctcac 70980

agagatcccc ctgctctgat tccccagggc tgagatcaaa ggtatgcacc actatgtcca 71040
 gcctgtaaca ccattccatt ttatgcggtg ataggacttg aacacagggc cctgggcacg 71100
 ctaggcaagt actgtgctaa ctgaagtaca tctccagccc agcatataaa ttttgtaag 71160
 ctttcttggga gaaggagtig gtcaacagat acttttgggt aggagtatac aagattgtta 71220
 tgagggatag gaaggaaggg tggggttggg gcaggaataa gtgtcaaaat ttcttgata 71280
 ggctaagtaa gtattgaaag aaagaaaaaa aagcttgggt tttatcttcc ctgaacacaa 71340
 gggctctgatt agagctcttg ctgaaagaca tctgttttg caaattgtaa gttattttcc 71400

 atttctcaat gctgagagag atgagaagaa attgtattct taaaaaagaa tgggaggtta 71460
 ttttagtaaa aagataagca tccaaaataa acaacaaaaa aatgaaaaaa atataacaa 71520
 ccaaaaatgt tcattgtttt ttgtttgttt tgaatatagg tctcctatgt attcctgact 71580
 ggtttccaac gtacagaaaa cctctctatc ttttggccc agctggacca aatctttctt 71640
 gtctctaaaa gcaggatgct ttcatatgat ggactagtig aaacttgctg aatataagat 71700
 gtcttcaca atgattctat atactctaac ttactataa tgagtccttg tgcttgctaa 71760
 atgacagacc aatgccatga cagttgacaa tagccataat ggcaactgaa aaggagtgaa 71820

 aagaaggggc attgaattc ccatgaaata tcctcttatt ccctactcc ctgaaaaaag 71880
 agaaaagaaa atgtgtgcac actctttcca gtcactatc ctttaatctc ttctatttaa 71940
 gtctataate tcaccacctc cagtgattig agaactgat tcatgagagc attteccata 72000
 tatttctgtt actggccaaa agtaaaaatc tcctttactg aacaattagt actcagtttt 72060
 gttacttttt ctataaatca gaggaaggaa aagggccag gtagaggtca aaacatagca 72120
 taagttcctt gaaatcaggg atcatatatt gttccaattt tgaactttaa aggttctgt 72180
 agttatttct acacagtaaa tattcaatga gctctggata aatgaataat gagagagtga 72240

 aaaatgatct taagattcct tccaattcat gtcaagagca agagccatac taatatagcc 72300
 tagtttacta ttataattgt tctattttat tattattttt atgttgtag ctatttgtgc 72360
 ctaatttata aataaaactt tatcataggt atatattgat aggaacacaa agcaaataga 72420
 ggacacagtg tagttacgaa ggtctgaggc tagaaaggtc taacatggtg gataaatgca 72480
 agttatgaag gtctgagaat ggaaggtata aaggctgtaa aatggaaggt ctaagatggt 72540
 tatgtaaggt gtatgaatta aagttatgaa ggtctgagga taaaaaagc ttaagtgatg 72600
 ataaagtgag ttgagacatt aaaaagaatg aaatatgttc ctgattttctc tttttctcat 72660

 gctactgttc atagtaaagt tctacaatac cactatagga tcataactac aaggtcaaga 72720
 ttaagatgct tttcattgtc ctaaaaaaa tctgtcgatt ttaaaatggt aatgctttca 72780
 gccaaagtgc ttctaataag aatgatgctc taatgtttct aatacttatg tttccacaaa 72840

ttctaaggat tcttghtaagt tccaggggagc tgaattggat ccaaacaaac aggtcagatt 72900
 cactccagtt attcaatctt tccctgggtcc caggactccc ttcctcatg ttgggactct 72960
 tcgggaatgc ctcctcatc ttataatcat cccctcaagt gacaggacct aagaaaaaaa 73020
 tttttttct aaacttaacc ttgtcctcgg ctgccaacat cttacaagt ctaagagacg 73080

 ccagggagtt ccatacagcc tggactgcga tgaacaacc agctaccca tgactggca 73140
 gcacccaac ctctcaggt ccccaaaaga tggtaacgc cacccatgt cagtaggaag 73200
 cagtcttag aattcagtc ccttattcct taacctgcca tgtctaacat ctacccttt 73260
 ttaataataa gtagaggtg gaataaaagg ttcaggcttt aatgctgatc agcaatatct 73320
 cttaagaga cagagccgc cccctgacaa cagttagggc acacacagga aaacatacta 73380
 cgtcattacc atatcaccca ccacgatta cagcctgcat gaggactctg ggcattgatg 73440
 gaacctcagt gcatatgtc agtcttcct ttaaaagttc caacttcct gctgctctct 73500

 ctctactctc tctctctgct tcttactct gctctttgct ctctctacc tacgactct 73560
 ctctctgct ctctgtggca actggccatg gtggtcagcc atttctctc tttctctct 73620
 tctttagct cctactctg ctggccctat aataaactag tcaatatgtc tcatcttgc 73680
 ccttctctt tttctttata tctaattta aaaaaacat aacaactggc atgctgattg 73740
 ggcaacaagt tgttaaattc tttcatcagg ctagagaaat ggctcaatgg atgagagcac 73800
 tagctgctct teaagaggac ctggctttga ttcccagcat atagatgata gctcataaac 73860
 attacaatt ccagttccaa gggaactggt accttctctt ggcctacctt ggcaccaggc 73920

 acatatgtaa agaatatcat gcaagaaaa cattcatata thtagttgtt tgtttgattt 73980
 tttgagacag agtttctctg tttagcagcc tggctgtcct gtatctcatt ctatagatca 74040
 tgctgtcctt gaactcacag agatctcct gcctctgct cccaagtgtc gggattaaag 74100
 gcatgtgcca ccaactgctg gctaaatttt ttgaagtttt aaatcctct atgacaaaaa 74160
 actcctgtcc tcttgaccta gttaccaaaa gcaacttgag gaggaagggt ttagttggct 74220
 tacatttccg tatcattgtt catcatcatg gaggaagta aagacaggaa ctcaaacagg 74280
 gaaggacct ggaggcagga gctgatgtag agactatgga ggcatgctgc ttactagctt 74340

 gttccctgtg gcttgtcag cctgctttct taagaacc aggacaactg actgtgggt 74400
 ccccccatec actatgggtt gggcccttcc ccatcaatca ctaacttgtg cctacagact 74460
 tatctacagc ctgatctttt gaacatattt tctcaaccga ggccaacagc ccagatcaga 74520
 acttgaatcc atccaaact cccatctca ttggcttccg tctcaaaacc tcatctaata 74580
 aaaaaaattg aggcttgagg ctaccctcc ccacttcaa tacttgagtc agtcatgtag 74640
 agctttctag ctctcaaggt cctgagacaa gcagatgcca gctgcatct agaggagga 74700

ggagtgccctc ctgtaactcc agtaaatctt aaacccatct tgggatggtt tgaatgagag 74760

 tgactcccat aggttcatat atttaaatc ttgttcccca gtaatagaac tgttttgggg 74820
 actattagga ggtgtggctt tgttgaagac tataaatgga gttcttaatt ggtctagata 74880
 ataaaaacc agagtcagat atagagagaa atactgagag atcagagaga aggagcaaga 74940
 cacagcatac cttacctct tagcatcagc agataaggga gtaatttctt gtttctcct 75000
 gcttatatct tgtttctgcc caactacctc acttctgtc tatctgtaca gacctcaga 75060
 cctctatggt tagttgggtg caaatctcat tctctgacc ccagacaggc tttatttga 75120
 caagcaagat atcaccacag aagaccactg gaggtaataa gctttgaagt tttaaaagct 75180

 caagtcaagc caagtcttc tctctgccic caacttatgg ataaggatat aagtatttgg 75240
 ttgctgctct aaggccaagt ttgcctgcct actgccatat ttccttccat gatgatcatg 75300
 aactetaacc ctctgaaact gtaataaaac ccccatttaa attatttatt ttggggggag 75360
 ggggttctag acagggtttc tctgtgttc tttggagcct atcttggcac tcctctgta 75420
 gacaaggctg gccttgaact cgcagagatc tgctgtctc tgctctgcc tcccagtgcc 75480
 tgggattaaa ggcagtgcc atcaatgccc ggtaaatctt tcttttata agttgtcttg 75540
 ttcattggtg ctcttcacag caatagaaa ataactaaga catacctcat atagaaaatg 75600

 gatcatagca atctattct tacagcttaa gtttgttcc acagccaaat gctctttaca 75660
 tccccaaac taatgatatt tgtgccctt tgtattacct ttgcacttct tccaattat 75720
 catatttcta agcatcagaa ctcgggccct tctcaaaccg gtagatttga gtgggtgtag 75780
 ataatgtcta ttagatcaa ctcttgcct taatccaagt gtcacttaag ctgcaaagat 75840
 gactcagacc aaacataata ctaagaacat gctttctatc atatggaata ctaaaattac 75900
 ccaaccatcc tccagctctt tattgattc ttatgacctg aggacaggag acgatatagg 75960
 ttccagctct tagaatacca ctgggtgtgg tgacacacag ctgtaatctt agcacatgga 76020

 ggcagaagca ggaggtggaa tactcagact atcatgagcc aaacaagagt cttttattta 76080
 aactagtaac caagagtgag ctcccaacac aaagaactct ttgtcacaaa gcaaagcaat 76140
 acaaggttta gaaaggtaaa accaggtatg ggctaaggga aattcacaag tactcttct 76200
 ctgcaatgaa ggaggaattc tttgttctgt caaacattta acaggcatca tttttcagaa 76260
 ggaaagaggg atcatttgtt tttgttaagg aggaaggagg tatgaagtca attatgggtt 76320
 caggggtagc ctgacttctc ctaggtcatt tcaaaggatt tgtgaacatt taagccaggc 76380
 tggtttatac tacatagctt ttgtaggatt ttcctaggg agatgtgaac aaatgtctat 76440

ccatcccaga tatggcacta gtgactgatic atataaatga ttccatccaa gcctacttaa 76500
 gttgaccaat gagtttattg tagttactta caggaatag ggtgactcaa aggccactgc 76560
 atcaaagacc atcctggctt gcatgggtga ccgttcacia aagctgcctc cctggaattt 76620
 cctgaaaggc ttgtaggag ttgcaccagc tggngaattt cttctttctc ataattgtta 76680
 ctgcttatac aactggggtg tgtgcaacta tatacatacc atggigcaca tgtgcaggtc 76740
 agaggacaac ttataagagt cagtctctc cttctaccat gtgggtccca aggattgaac 76800
 tcaggttgc agacttgata gcaagcacct gttgagtcac cttgctgacc ctggtttcat 76860

 gacttttctg agtcttatgg accttcttcc ttccaaagag aatgtttcaa tttggaggaa 76920
 ggggctatac aacaataagg agaccctgic ttcataaatt aataaatgaa gaaagaattt 76980
 agaatatcat gaaccaaagg tggtcagtta aaaggttaga gggaaaaaat gaggaaaaag 77040
 acaaaagtaa cattctgcc actttgttgg acttgggttt catcagctt ttagagcaga 77100
 tcacaaagct cagggaaaga cctgaattcc atttgttact ttattataaa ggatacatgt 77160
 aaagagatac agagggtaaa ttatactcaa atatatcctt actaacaca ctacctcca 77220
 agaacttcca tgtgttctgc cacttgggtt ttctggaac tccagttgct atgtgttttt 77280

 atgaaaacct tttacatag ataactacta tgaatatct gacaaatgat gattaacagc 77340
 ctctctcttc tttgggaagg ctaagaagtc agaaagattc tgaccatta cctgtttta 77400
 gtctttcttg tgaccagctc atcctgtggc tctgtgggt ctgtcagaca tcageccaat 77460
 gaatagcact gtgtggcta tttttgtacc aggcattcat ttaatatgic ctctgaccta 77520
 aattcctgaa agataagctc ccagaaactg ctccccctc cctagaatag tgtaacagtt 77580
 acgaagtgat taacagctca ctctggtttt tgtaaacctg tctatcactg tggacagtgg 77640
 cagtgagtca atccctcata tagctgtaa cccccagaa atgaaatagt tgtgtttttt 77700

 tttattttaa aatcccttcc ctcaactcct tctgggagta atgccttcaa tttgccataa 77760
 ggctgttgtt ctgctaccag tgttaataaa ttcatctgat tatacgtgga tttatattgg 77820
 tcttttctc aatggcttg aactctgtaa cagcacacag taaaaacata catatcattg 77880
 tgaaaaattg aaagatttgg ggaattacat gtgtggaac agggaagaag gcccaaatat 77940
 atattagaca aaaccacagt agataagtgt cttagtcagt gttctattgc tgtgaagaaa 78000
 caccatgact acagcaactc ttataaaaga aagcacttaa gcgtgtctgg ctcatagttt 78060
 cagaggttta gtccattgcc atcatgtcag ggagcacggc agaatgcaca cagacatggt 78120

 gctgtggaag tagctgagaa ttctatgtcc agatccacag gcagcaggaa gaaagaaaaa 78180
 atgggcttgg cttaggttt ggattcctca aagcccacca ccagtgcgc ttactccaac 78240
 aagaccacac ctacttcaac aaggccacac ctctaatc ctctcaagta gtgccactcc 78300

ctgatgacca aacattcaaa tgtatgattc tatgggacca ttcttattca aaccaccaca 78360
 acatgtgtga gagtctgtgc aaggaagcta tgaacttact atgaactatg gatggggcag 78420
 ggtacaaaat gttcttccca tgaggttcta gaaaaaattg catcaactat gacaattaga 78480
 tgcacttgaa agcaaggaca tgaaagggaa tggccttaca tattcacatt atttctatgg 78540

 gaaaggtgaa gtcttgggag aagtactctt agctctttca catgaccaa gataatatca 78600
 taaggcataa taccagggtg atccctttac tgtgcttgca tttgcttaag ctaactgtaa 78660
 atatcacctc gtgcattgct ttctttaata atataaatga gaattgttct atttgagctt 78720
 cttttgtgtt caaatgcctt aggccactg atacgctact cctgttcaga tcatagactc 78780
 ggtggcaagg gtgggtagac agacacagaa taaaaaaga aggaacaaag agtttagcta 78840
 agggtagggc catatgattt cagtctcaac actcaaaagt gcagaaggat gccacaaatt 78900
 ccagcttagt ctggcctgtt aggtgagacc ctgtcttata tcccactct aacatacac 78960

 agaggaaaa aagggaatg gaagaagcag aaagaaatag agagagaata ttaagtagcc 79020
 taatgttaga agtataaatg aatcaaattg aagaccaga cataaattca gacacctatg 79080
 gacacctgac ttttttttt aataaggaag ccagaaataa acaatggaag aaaaagaaaa 79140
 catctcaac aaatagtact ggtctgactg gatgtctgca tgtagaagaa tgcaaataga 79200
 cccatatata tcacctgta caaaaaactc aagtccaagt ggatcaaaga cttaacata 79260
 gaaccagaca cactgaacct gatagaagag aaatcagggg atagccttga acttattgac 79320
 atgggagaca acttcaaaa tgaaacctg atagtgcagg cactgcaata gacagtaaca 79380

 gggcctcatg agactgaaaa gtttctgtaa ggcagaggac actgtcaata ggacaaaatg 79440
 gcagcttata gaatgggaaa agattttcag ccattctaca tctgccagag ggctaatac 79500
 caaatatata aagaattcaa gaaactagac atcaacaaaa taaatactat ttaaaggga 79560
 ggtacagatc taaacagaga attttcttc tgtgttttt ttttgtttg tttgtttgt 79620
 tttgttttt gtgggttttt tttgttttt tttttggtt ttttttttt ttttttttt 79680
 ttttggtttt tcgagacagg gtttctctgt gtggctttgg agcctatcct ggcactcgt 79740
 ctggagacca ggetggcctc gaactcacag agatccgct gtctctgct cctgagtgt 79800

 gggattaaag gcggagaatt ttctatagag gaatttcaa tgactgagaa acacttaaag 79860
 aaatattcaa caccttagtt attccatctt atatctgcca gatggtataa tgtcacacaa 79920
 gtgacagctc atagttgctg ttctgcagga gctacagctc gttcctgcaa aagccccatt 79980
 tatctcttc caaacctac cctctcagag aatctccatt ggagaagagc tgccaaaaac 80040
 cccagtaccg catcttggtg gctagtagct cctccctga atttgccagc agcccaagac 80100
 accacctaaa agcataaccgt agttggacac aaacctatgt cgtcactcct cgctacagg 80160

atacataagc gacccacggt agatgggcca tgtgattgtc tcctgtatcc atctctgggg 80220

 gttggcagaa tcaccagga gttgctttgc tcaaaatgta cctgttcttt tactttttcc 80280
 attctgcttg atctcactta ctgtattggc tgagaaacct attattgggg cacagaaaac 80340
 ctatcagttc caaaggtatg gagccagggg aacactcctc gatgctgggt ggagtgcaaa 80400
 cttgtatcaa tataacagtt cctcagaaaa ttgagaactg atctacctca agacctagct 80460
 atatcactct tgggcatata ctcaaaagat actccacct acttaggggg tcctgcaag 80520
 tttcatacca ggaagcaaac catgtgaaga gataagaatg agaacctggt acagactgac 80580
 tttgtctacc tggctcaaac tttggagagt ctaataacaa gcggtttatt cccaatgtat 80640

 taagcccagt atgattttag aaaaaacgtt ccctgataaa atgcaatccc tgttgcaaaa 80700
 ggaattataa ttacattgaa attcaactca ggttacacat ctttcttcc aagaagatgg 80760
 ttctagagat aggctatttg tactaactta agggcctaag ggctaagggt tctggcctgg 80820
 tctcagtcac acagataaca tagagatcat ttgggctatt agccacttct ggtcctgggt 80880
 gtgggagctt ggatgagcct ctggccataa ggtcattta gattactagt tacctccagt 80940
 ctgggttata agagttttag atggcctggc ccaatagata acatagatca ctaatcagtc 81000
 aatcatttcc aattctcagc tttctggatg gaagaacagg ttttctatct ttctcattgt 81060

 aaaaacaatc ctgtacgcac aaggaccttt gtgctatgct cccaacaccc taccacaagg 81120
 acacttgctc aaatttacc aaatatgctc atgatggctt tattaacaat agagagaaac 81180
 tagaaataat ttagataatc ctcaacaaa gaatagataa agaaaatgtg gtgcatttta 81240
 cccattggag gattactcca ctattacaaa aaagaaagga agaaagaaag aaagaaagaa 81300
 agaaagaaag aaagaaagaa agaaagattt gcaggcaaat gtatggaact agaaaaaaaa 81360
 atccatcctg agtaaggcaa cccagaaaaa caaacatag tactcactta taagtagaca 81420
 ctagctgtga agtgaaggat aatcatatta caatccataa actaggttcc acagaccag 81480

 ggaggctaat taaccaggag agcttaaaga gggatgcaag tgtctcctg ggaaggagaa 81540
 atagtataga ttttgtgggt agactgggat caggtgggga tgggaacagg agggatcaag 81600
 tgggggatgg agggaggaag ggagiatgga gagagatgat tggaatagg gtaatttagg 81660
 ggtgctatgg aaaaagtaca gtggaactt cttggaacat aattagagta tggactagca 81720
 aggactgctc gtcatggagt ctgtaccagc catcttctgt aaccaggcaa ggcttcatt 81780
 ggtgggacca gccacaaaac ctttgacca caatctgcc tgcccacaag atgtgtagg 81840
 gaaaagggtg ctcagagta gaagaaatgg acaactaata actgatctaa tttgaggccc 81900

aagccacaag ggggagccca tgtctgatcc tgcctgatg gccaggaaca ggagggaaac 81960
tgattagccc agaggcctaa ggtagaacgg aatatgactg aaaaaacaaa cagaaaaaaa 82020
caacaaaaat cagatgtttc ctaatgatat tctgctatat tcatagatga gtgcctagcc 82080
caattgtctt caggaggctt tcctctacca gttgatggga gccgatgtag agaccagagc 82140
ctgttaatcc taaaattttc cagagaaaaa ctaatccac catittgaac cgtattttaa 82200
gcaagtttta ttaaaatatt aaaaattgac caagatggac attggtcagg actactcgct 82260
gtaatttccc agctgagtgg ccctgaaaca tgtgctacag agttacttaa ggaaaaaccc 82320

acatgccatt gtattttccc atgaggcttt cctatttttt ttaagaacta caactcccaa 82380
aatctcagaa gttatctggt ttttggacag gtggggctta caggttaact tgtggtatta 82440
caagccaaac attaggcaga gctcagggaa cccaagaaa ggaaaggagg aagaattgta 82500
ggaatccaag gtgttgagga caccatgaga acacagccag tagaatcaac taagtagggc 82560
tcataggggc tcacagagac ttaagcagat cacagagtct gcatgggttt gtgctaggtc 82620
ctctgtatac ctgttgggt tgtttagctt ttggtttttg gttttgcttt ttttgtgtgt 82680
gggattggga gtgtcagctt tttttgcttg tttgtaggat ctttttctc caactgtgtt 82740

gcctctcca accttgatct cagggtttgt gcctggtctt attgcatctt gttatgttgt 82800
gttcagttga tatcccaggg aggctgtctc ttttctgaag ggaaatgtaa gagcagtgga 82860
tctggggcaa agggaaggtta atgggggagg ctgggaggag tggatggagg ggaggtgta 82920
gttgggatat attaaatgag agaagaataa gtacaaagaa gaaaaagaaa cataagttaa 82980
actattttat gtaaaacct tctgtgttac tcagaataat ttaattcttg caagatacat 83040
taatgaccca gcctcaaggt ggctttgata tgtttgatat gttaatgaac caaccctaag 83100
ttgtgaacct tgatatcaca aaactaacgc cactggaca atacaaaagg caggcactgc 83160

tgggtccca agatattgca tcaaaagcct ctatttgagt tcacacataa ctacctgtea 83220
gcatctgtca gctgcctgat gccctcaaaa accttctaga acttccaaag tgttaggac 83280
caataaate tgttatggaa tgttttgggg ccagcctct agctcctgca aacaggaaca 83340
cctgaaaact ctggcccact attgtattga taaagccagt aagctacta ttgtttacca 83400
tggcctcagg gtaaatgcct cctattttca tctctatagg cctaagcatc tgaataggcc 83460
tgcacctggg ccaaggtgca aggtgtgtga gtgactaggg agtgaccaga agagagagga 83520
gaacaaagag aaaaatggtt ccctcctggt gttggcagga cggttaagaa acagcagaaa 83580

agatggctaa taaagaaatg actcnnnnnn nnnnnnnnnn nnnnnnnnnn nnnnnnnnnn 83640
nnnnnnnnnn nnnnnnnnnn nnnnnnnnnn nnnnnnnnnn nnnnnnnnnn nnnnnnnnnn 83700
nnnnncctg tctcaaaaa ccaaaaaaaa aaaaaaaa aaaaaagac tctagttcta 83760

caacatggaa ctgagagctc tctaaagatg acaagatgtc tgtgtttggt ctttatcgcc 83820
gctgggttgc taggagcttc caggtccaca ccccccaact cagcccgaac ctcatggatt 83880
aaggctgaga cacgctgggt cagcacacca aagaaaactc taattcccca aacttcaaaa 83940
ggcagtgaat atgtccagaa atgacagtct tggcatagct aaagctgcac tgtaggactg 84000

ctaaaagcca acagccagca aaatgggttt ctgcctgcca gagagagacg cttcccttgg 84060
aatttatctg tggttgcata tcaaagctca tgcctggcctc tatgctcctt cagtcctgt 84120
tcgaacatac ttgttacaca ttttgaagt catgctagtc tcctaacct tcttgtctcc 84180
caaaactaa actccacttc tactatgcta ccctaaggtt gttgcagttc acaggttcc 84240
ctcctcccag atacctgctt attctctata taaccactac cacccactc taatatttc 84300
acttcttaca tagatagata gtcctgacca tgtccagtct aatcccccc caatctattg 84360
gactccttc agatacctct ggatattctc tcttttatca acaatcaaaa cttctccaca 84420

aatcttggag ccaccactc catgatttct tctgcaccc tcaactatat tcccagcctg 84480
ccacagatga aggatcttat agtggatgca cattgctccc aaagcatctt caccaaagag 84540
ggttcccccc ggtaaagcct gcagcatttc ctgccattcc ctgctctggt gagatgtctg 84600
ttttgatgag attaccataa actttaggat ggcatggtat tgtaagcaat gttttatgag 84660
aataaaccaa gaatattcag aaggcagaca tcattgtggac atcctagtgg ccaagccct 84720
caaagccac cagctgagct caataaacct aacatatatg aagcccaaag ttgatcctt 84780
ggcaagaacg gtggtgggaa accaagtagc ctagaaataa aaaggcatac tgtcttagtc 84840

actgttctat tgettgcgcc agccagcagg gctgcaacaa gagcccaaac ctcaaaggac 84900
ctggaatgaa taggaacaag agacacaaag aaggcacaac aagacagggt ttctgatcaa 84960
gctgcaaatt tttatttttc tcagagacct tatatagtgg ttgaatcagg aagctttcag 85020
ggcagaaact cggcaggagagg aggccatttg cctgataacc aaaccacaga atgtccctgt 85080
gagtgagtcc ttgaaggcaa gcagagggta cagggtgcta gctgataaga ctagttagt 85140
tggagagtat gtaggaggaa gggttgctaa gtaacctgac cttggaatgt ttcttttcta 85200
ttagctaatt ctgtaaactc aggtgttatt tatcaggaat ttgtggaggg aaggattgat 85260

tgggactaaa ggtagccatt cttttaacat aatgagctac tttcaaaact gctgacaatc 85320
ttcacaagag gtccatata gcaatgatgg ttcttgcat agctattaag agacactatg 85380
accacagcaa ctcttataaa aagaaagcat ttaactgagg cttatgtata gtttcagaag 85440
tttagtccat tatcatcatg gcagagagca tggcacacag gtagagatgg cactggagaa 85500
gcagctgaga gtctacagc cagatccaca gacagcagga agtgatattg gatctgactt 85560
gggcttttga aacttcaaag cccatccca atgacatact tcctccaaca aggccacacc 85620

tcctagtcc tcicaaacca cagtgccca cctgataac aaatcattca gatatatgga 85680

 cctatggggg ttatattagt cagcattctc tagagtcaca gaatttatag aatgaatctc 85740
 tatacacaca cacacacaca cacacacaca cacacacaca cacacacaca cacacacgaa 85800
 tttactggaa tgacctaaag gctatagtcc aacaataacc agctatgaat ggaaaatcca 85860
 agaactctgt agttgctcag tcccatgagg ctgagtctg ttgggatcca gccccacgg 85920
 ggtctctaag agttgtttc cagcataacc ataggtaacct cctgttttcc taacctcacc 85980
 ccactaggat caatatcctg ttgacctggg gttttttaa gtttgtatat aagacttttc 86040
 cacaataaag gtgggagaca ttctctcaga aagtggacca ggcacatcca aatctccagg 86100

 ctttcgccc atacttagac ttagtgggtg ccaagtgtgg ccacagggtg cctcatctgg 86160
 tctactgtat ttgctggaat cctaaaaatg taggctccaa tgccagtga ggaatggatg 86220
 tgctgacaag gtaaggcga gcaggcaaaa aagaacctc ctttcttcca ttgtccttat 86280
 ataaccttc tacagaaaga gtggcccaga tgaagggtg gcctttctgc ctcaagatct 86340
 ggatcacaag tgtgccact atttctggat ttagttcat tccagatata gccaaactga 86400
 caaccaagaa tagccatcac aggggccatt ctattcaaa ctaccacaca taccgaggac 86460
 ctgacagtaa aagatatgag tctgtgtctc ctttgaagtt ttaaattaat tatataattc 86520

 tgtggttctt ctactgaac ttgggtcat agtctacact atggcttccc caagaagcca 86580
 gattatatct ttttttttt ttctggagaa agaaatcaat taaaatagcc aaatcaatag 86640
 aaaaaaaaaa gaatctgaaa aaggagacac tgccgacact gtaagagag acaaagagag 86700
 ctaataagca ctccagtc atcttcaggg cctgaagtg agattaaagt taaatagggg 86760
 cttgggatat gtccatctaa gaagtctgg ttaatgtgt gtccttcca ccatgaacct 86820
 attgaaagac cccagaggc ttagcctccc aggatctcag gatctcagc caggaccgag 86880
 gccaccccaa ccaccaggca gaggcaaaaa ctgatgcaa acagcacgag getttattgt 86940

 agttgttaa caagctaacc ccatgttagc tcaggcctt catccatcca ccatggcaga 87000
 tggtgggaa agatgcctcc aagccatgc atggagatct tataggacag tgtaaggggc 87060
 gtgtctagg gtacacacag gctcaggatt ggtgtgctc caggcttga gggtttacct 87120
 tttgttgatt ggtcaactgg ttgttatggc ccataggccc tcccagggtg gttgctatgc 87180
 tctgcacgtc attgctgtgt acttctccat aaagcacacc cagagccgta aagcatagca 87240
 ctaccagcta acttctaatt ggttcttgc cagaggttag gtatctgacc tcctagtac 87300
 caaggcaagg tcaggcaagc atgtgttagg ctgttaaggc tgccgagcta gacatcgggtg 87360

gcacacacct ttaatcccag cactcaggaa gcagaggcag gcggatctct gtgagttcga 87420
gaccagcctg gtctacaaga cctagttcca ggacagcctc caaagccaca gagaaacct 87480
gcctcgaana taaaataaaa taaaataaaa acaaacaaac aaacaaaagg ctgccgaaat 87540
ggggagctgg tcctttcacc atcagtttct tggcttccat ctctccagga aggtggtctg 87600
acaatTTTT gtgtgtgttt tgtttggtt gtgtgtttgg tttttgaga cagggtttct 87660
ctgtggcttt ggaggctatc ctggfctag ctctttaga ccaggttggc ctggaactca 87720
cagagatcca ctgcctctg cctcccaagc actgggatta aaggcctgcg ccactactgc 87780

ccagctggtc tgacaagttt ttattcttgt atgaaacctt tctgaaagaa aagtttccac 87840
tctgactggc tccatgcttc agcattttcc tctccaagc atgagattct tgggaaaaat 87900
gaggctactg gtgacatata ccccatccat ataatggata caccttaatt aactgtgagg 87960
gacaaaaat taaaattaat caaagtttaa aaacttaggc tctgaaaagg gaatgtctaa 88020
tggaaaaaga aattttaact ccttaaatca ggagtgccat ggctgggtgc tgatccctg 88080
ctctcagaaa aggggaggta actgtccacc actcctgtta acattcctt gctaattgct 88140
ggtcataaag atccccagc ccaagggata actgacagac actgtgactc tgtaacctg 88200

caagcccatg ccctgactta tctcagtcaa atgtatctcc cttaaaatgt ttagttactg 88260
actaactctg tacattgtgt gaccttaagt aaccatggaa actgtaattt gtggccttca 88320
accttatggt ctgccccctt aaaagcttct ctgtttggct ggttggcctc tcatttgcce 88380
accatgcagt agaacctagc tatccagatt gaaataaaaa gaaacctttt gcttttgcac 88440
cagagtgtca actctttgga ttagtgtctg ggatccgaga acctggcaca acaaaatgta 88500
tccatctcc ctccatctc taaatcaaat agcaccacat gttagattgt tgggacctt 88560
ttggggtctg ctgatcatct gtgactaagg gtgaccatt gtgccctgg ggtctgctga 88620

ctgtcttgtg actaggtgtt tactgggggg aggggcaggg catgaactga aagaccccc 88680
tagcagacag agtagggcct agaatatagg tgggttgggt caataactct gttccaggaa 88740
ctggctgacc acaaaagtta tagccggttc agcaactctg ttccaggaat aggctaacca 88800
taaaaagtta ggttagaatc ttgtaaacga tcttaagaaa caggagttt ccccttgtga 88860
tttccccctg ggactttcca ctggtattct tggatTTTT cagtaacacc ctccctacc 88920
ccttgccect ttgggctgtg gtttcttct ttaaatacc cttctcccag ccattcaggg 88980
tcaagctcct ctaccctgc gtgggatatg agtctcggcc ccagcacgct ggttctgtt 89040

aataaacctc gtgagattgc agcaaggact gtctctctg agttcttggg tggctgctac 89100
atcccaagc ttcagtgagg gtctcccttc ttagggggtc tttcagaacc tetgagctga 89160
ataaaattcc actgtggcta ctgtttggtt tggaaatcta gtccccctt aaataaatgg 89220

cattctcctt gcaagaatga ccagctgtct tgcctttatc aaattcttag attccctcgc 89280
ccaaatctgt gagaagtgt agtgtgggca ttacaatatt agattatctt ttaagcagct 89340
atagagaaga gaggacagaa agaaagagaa gcttggctcg acctatgag gaccaagaga 89400
acatcttgtc actcacatgt aaggatgccc taaatatcta cagaggaaga tgggattatg 89460

tcttttactg gagtggaaag tagtctgcaa ggtaagctgg gaagtgtagt cctccagtgg 89520
gaaactatcc agaactacac agagaaacag tttctcattc cccaccccct gagagggggg 89580
ggggacacac cagaaggagg aggaaaactt ggctctcact tcctgcttcc cttttacttt 89640
tttttttttt ttttgggtgtt ttttgggttt ttttgagaca ggatttctc tgtgtagctt 89700
tggagcctat cctggcactg gctctggaga ccaggctggc ctggaactca cagagatcca 89760
cctgcctttg cctcgtgagt gctgggatta aaggcgtgca ccaccaatgc caggcacttt 89820
tttttttttt taatttcctt cttttctcac cccactcaag ggacaggacc tagagacttg 89880

tacctaccag gaaggaagca ctctattata gaattctgtt cccaggtttt ttgttttgtt 89940
caaagtttgt gaaagcatat cactatgtag cttattgatg caaaaaacat agctctcacc 90000
ttaaaaagga ataagggata gtttattctc aaaccatttt tgaatgatca tgattcacia 90060
aattcacaga ttaggttacc ccaaattcca tgttccaatg tggaagcagt tttaaaagt 90120
ttttatagtt gaatggagca aagaaagtca taaatcaagg tatggtgatt cccttgcagg 90180
ctttacagta ggcaggatga gaaaatgac cacagagaga caagaatgaa actcagctca 90240
gtctgatttt attgtagcca gtgctggaca aggacttcta gaatatggcc cagatcactt 90300

tagccatatt taagcacagt acaattttgg aaaaggattt ctgttaacag ttaactcagt 90360
cccaagtaca cagcgattta ccacatgttc acattgagac tccttaciaa gtacatctgg 90420
tttcttttgt aagaatgggt actgttgact cagagatagt gcccaagatt tagggcttag 90480
ggaggttgac tgaagtaaac ataatgccag tgagtgttag gattggcctg gecctaagat 90540
aacatagaag tcaacttagc tgtttaaag tacaagtac ctactcata agagtgtttt 90600
taaaaacaat gttcaagatt tagggaaaag gatctctgat aagttaaac ataaattctg 90660
gaagataagg cagagcttgt ctcatcagac cgcaaagatc accaggatgt aaaacaacat 90720

aattcctaaa gttccagcaa gagcagcttc ctacactcat tcctctgaag aggttgaagg 90780
gacctgctcc cctttcgga gccataacag ctgaacacgt gcttgccata aacttgctt 90840
ggtcacttag aggtcagatg cctgtctcgt gacaaggaac ccatcagaag ttagtcacta 90900
gaaagtca tgcctgcctt gtgacaagga accaatcaga agttagctgg tggcgtctgtg 90960
ctttatgact ctgggtgtgc tttatggaca agtccacagc aatgatgtag agagcatagc 91020
aaccacctg ggagggccta tggnnnnnnn nnnnnnnnnn nnnnnnnnnn nnnnnnnnnn 91080

nnnnnnnnnn nnnnnnnnnn nnnnnnnnnn nnnnnnnnnn nnnnnnnnnn nnnnnnnnnn 91140

 nnnnnnnnnn nnnnnnnnnn nnnnnnnnnn nnnnnnnnnn nnnnnnnnnn nnnnnnnnnn 91200
 nnnnnnnnnn nnnnnnnnnn nnnnnnnnnn nnnnnnnnnn nnnnnnnnnn nnnnnnnnnn 91260
 nnnnnnnnnn nnnnnnnngca gcaagctctc gaatctgcct ggtgattggg gtgaccgaga 91320
 acgtggcctg ggaccccggt tacttgagtt ttccaggggt ctaacaaggt aagctgtgtg 91380
 ttaaactctt ctggcttcca gtgcttttcc atgtgcacaa ggctctttgt tetctacatc 91440
 aatgtaagtt taaaatgaat tggtagggccc ggtgttgggt gcgcaggcct ttaatcccag 91500
 cacttgggag gcagaggcag gaaggtctct ctgagtttgt gaccagcctg gtctccacag 91560

 cgagtgccag gataggttcc aaaactatac agagaaaccc tgtctcaggg gggaaaaaaa 91620
 aatgaatggg tgggtacacc agaaaggcat gtatatcaag atggggggag gtattttata 91680
 ggccaaagaa gctctctgat gatattctta gtgtgatggc taaagaactc cattttatgc 91740
 taagcatcca ttttggfact cattagccat ctgtatttga ttccagtctc gaatagataa 91800
 gttcccagta accctgactc agtgcaccc acccaaaagt atacagctat gactatctat 91860
 ttatgatatt gaagggacta gctcccatt tcggcagcca taacagccaa acacatactc 91920
 gcctgacctt gtcttggta ctaggaggtc agatgcctgc cnnnnnnnnn nnnnnnnnnn 91980

 nnnnnnnnnn nnnnnnnnnn nnnnnnnnnn nnnnnnnnnn nnnnnnnnnn nnnnnnnnnn 92040
 nnnnnnnnnn nnnnnnnnnn nnnnnnnnnn nnnnnnnnnn nnnnnnnnnn nnnnnnnnnn 92100
 nnnnnnnnnn nnnnnnnnnn nnnnnnnnnn nnnnnnnnnn nnnnnnnnnn nnnnnnnnnn 92160
 nnnnnnnnnn nnnnnnggatc tctgtgagtt tgaggccagc ctggtctcca gagtgagtgc 92220
 caggatagtc gccaaagcta cgaagagaaa cctgtctctg aaataaatta aataaataaa 92280
 taaataaata aataaataaa taacctcttg ctgtttgcat caagttttcg cctctgectg 92340
 gaggaagtcc tgggcccga tcttgggggc ctgagcctcc ggggtcttt caattaagct 92400

 agatgcagat tattttggaa aagaaaactc tcttaggata ttggagacat tgccaggata 92460
 cttctaaagt atccttttta cacatgttcc ttattcacc tcacttttt ttctaaagaa 92520
 gaagggtcta atcctaacat aaaactatct acaataagaa caacagccag gtgttgggtg 92580
 cacacaactt tagtcttagc actcaggagg cagaggcaag cagatctctg tgagttagag 92640
 accagcctgg tctgttcca ggacagcctc caaagccaca gagaaacct gctttggaaa 92700
 caaaacaaaa caacaacaa aaaagaacaa ctatcaagta ttgcacagaa gaaagaaaag 92760
 gtaataacat aagcaaaggt gaaactacaa ccagcaagtg tcagaagcca gccttggcga 92820

cctcccatgc ctagctagcc gccagccagt ctagcatccc acccctcagg ttccccggacc 92880
 tggcctgagc cgcaactaac acctattcct tcccccgctt ccttaacaca ggggattccg 92940
 gatacctgcc tgagagcaat taacattcat tcctcccccc acctcccttt tctctgcttt 93000
 ctcttttctc ttiagaaatc cccttgggtt caataaagtt ggccttgaca agaaaacctg 93060
 cttgggccca ctctttcttt cctgcccatt attttcaggt gtgatccacc tcggactcac 93120
 gaattaccag agacactcag gacagggcaa gcaagaacaa catcaaggaa gaaatacatt 93180
 ctaaatgtcc aggccatagg ttactggcaa attacagaga gtattctaata agctcttcta 93240

 tcctggagag tctaagtctt ttaccttaata tgccttggct aaagtgtgag aggattgtaa 93300
 ctgtaactat ctaatthtta aacccttcaa agacctgaaa aggaaaataa tattacctga 93360
 gcaatcagga agtgcaagca agcaatttcc aaaagaagca agaaatgaca gaaatagctg 93420
 gctgcctaga cagtcaccca aagtctgtct gtaaacactgg ggcaaccaac tttggatata 93480
 ggtctagaat atctgacaga ctatthtcag aagcaggaaa attcgaaaga ctctcctacc 93540
 ctatcttggc aaggttcagc agttgttttt ccttgagtcc tgcttatctg gattggacat 93600
 tgtgctactg tcaagagtca agtcaagggc aggtctttgc ccaataggcc agttttgcca 93660

 agaggaaaac aagttcctta tggagtgttt tctgtgcca acatcatctt gggagtagat 93720
 tgggtcttct agaagtggtc atgactcaca catcaacaac tgcaaaaaac tgtttcattt 93780
 actagagaca taigctagag cattgccagt cttaatthgt acaggtattc ccatgatggc 93840
 cataacttct cacaggtgtg taataaaaga atcagccttt ttagaatcaa agcagctgcc 93900
 cagthaaatc ttgaaaatgt atctattgta tgggtgtacat atthtaattt thcaaattct 93960
 tgaaaatgaa acatathcct ttgccaatth tcattthctg gcatacctth agggthactc 94020
 catgtaggca agggagtcta attatataag gaacaagtag ttgactcgct atctctgagt 94080

 caacagtacc cattctthtt tctthctthc thctthtttt thththtaaca atththcttg 94140
 cttgttgcca agtgattgaa aatthactth tcaaacctth ggtgctaata tgatggttht 94200
 ththththtt gaaatthtga ggcctccaga acatthtcta thaaatacat caatthcath 94260
 athaactthgt gctagaggac ctggcagacc tgtatgggat ctgatgtgtg thacatacat 94320
 ctgatgattt ctathctga ctactthctg taatthgata aataatgaag thaatthctga 94380
 ctcatcagga ataagthttag tggthtctat atgthaaata actctgtata thgagcatca 94440
 gthactatath tgagaggtth tataaaatca athtagthaca thgaaatthc atgcaattht 94500

 gactthtthgca cagaatthatg agggctthtga gccactthtgc thagggtthc tgatthgthaa 94560
 cctgctthtt ctgattthatt tgcatcagth taaaacttag gggatccaga gattggtgth 94620
 cccatataa thtgaggaag gatccaactg gthctththta thgaaatthg thctthactth 94680

ttgggataac tgctgttaat gtctcccca aaaaaattac tgtaagctct ttgtcagttt 94740
 tcatttttct acccataaag aggaaatctt ctctttatta aaaggtacta tgatttctgt 94800
 tgggttcatt cctgtcagtt gacaaaagtct taattttcct tttagaatca aatcagaaac 94860
 ccattttcac atatatcttt aatttcttac tctgttggg ttgctaaaaa tatccattcc 94920

 aagacaatat ctccctctg cattaaaatc cctgtagggg aatgcttggg gagctatatg 94980
 tacagaatgc agttaagctt cagatccaca tgatttatgt gggcattctg taatttttct 95040
 ttcaccaaag ccaattttct ctgagcttct gctgataatt tctggagtct atttaagtct 95100
 ttgttaccat ctaaggtatg gaacaaatta tgcagttttt atccattagt ttttatccca 95160
 ttagtgggcc atagtttggg gatgctcct agcaatcttt gaaagtcatt gagagctgc 95220
 aatagatgtc tcctgattta taacttttgg ggtcaaat tttgtaggcat aatttgatat 95280
 tgtaagtaat ataatagaac tcttctttgt attttttagg tgaaatttgt aattcccaat 95340

 gaggcaaact ttcttgttc tttaaacatt tttttcaaaa gtatccattt ttgaatcagc 95400
 taataaggta tcattcatat aatggtaaat aatagatcac agaaactgta caggaattat 95460
 tttgcacaaa atattggcac agagtcgggc tatttaacat tttctgtggg aggaccttcc 95520
 attaatatct cttaactgt ctgaggttg ttataagtag gtaccatgaa gacaaatfff 95580
 tcctatcct ttcttgtaa aggtatagta aagaaacagt cttttaaatc tataactata 95640
 ataagacatc ctttaggtaa cagaaaaggc aaaggaattc caaactgtag agageccatt 95700
 ggctgtatca ccttattaat agctcttaga tctgttacca tctccattt tccagatttc 95760

 tttttaataa caaatacagg attccaaggg ctgggtgatt tttcaagatg ttgagcattt 95820
 agctgctcct gaatcagctg ttctaaggcc tatagtttct ctgatgtcat aggccattac 95880
 ccaacccaaa caggtttacc agctaaccat tttaaagtta cggctgttgg tacctctgga 95940
 agatcaacag ctgttgtgcc ctattagctt gggaggcaga gggaggtgga tcaactgtgag 96000
 tttgaggaca gcgtggctca cagagtgaat tccaggacag ccaaggctat actgagaaac 96060
 cctctcttga aaaacaaaa cgaaggaaag aaaccattta gcagtaagag agttcaactc 96120
 tatcctgagt ctttttagtg cctaaaacat aatttttaggc acagggtgtt ggaactcaac 96180

 atcatgctga cccaccccc tgacaatggg tgggacatgc acagtgcat ggctacgtca 96240
 ttgttgtgct atcattatg gggctgcata aggactcagt atgcatgtgc aaacttcccc 96300
 ttttaagtga gcacctcac gtggtcactc ttcactgtct tctccttct ctcttctct 96360
 acttcttcat atctctctct ctctctctct ctgtctctcc actctttaat aaactggtta 96420
 atgtgtctct tctgttcatg taccatctag ctgcatctta aacaaaagaa caacacaggt 96480
 gcctaaaaaa aaaatcaata aatagatcag gcatggagga gcacacctt aatgccaatt 96540

tccactgact ttggagtaaa aagcagaaga atcacttgag cctagaaatt gtagcccagc 96600

ctggatagca cagcaaggtc ctgttttaaa atgattttta ttgtttaaat ttttaagacaa 96660

ggtctcatac tggccttaaa ctcactatgt agttgagaat gaccttgggc tectgattct 96720

ctagccccc cctctcaaga tcacaggcct gtgccacat cattggctag cattgtctgg 96780

tttttgtttt gttttgtttt tcgagacagg gtttctttgt gtagcttttag agcctatcct 96840

ggcactagct ctggagacca ggctggcctc gaactcacag agatctgcct gcctctgcct 96900

cctgagtgct gggattaaag gcatgtttgt ttttgttttt gttttgtttt ggggggttgg 96960

ttttttcgag tcagcgtttc tctgtggctt tggaggctgt cctggcacta actctttag 97020

atcaggctgg tcttgaactc acagaggctc acctgtgtct gcctcccagag tgttgggatt 97080

aaaggcatgc accaccaccg cctggctgca ttgtctgttt ttaaagacac caaaattggg 97140

cagcatactg tcttagttac ttttctgtta ctgtgacaaa ataccatgac caaaataact 97200

tacaaaagaa agaatttaat ttgagcatal ggttcaaaca gtttgagtct atgatggcag 97260

agtgaaggca tgacaacggg cagctgaatc agaagctgag agtcccctat atccacaagc 97320

agtaggcagg tagagcacac tgggaaatgt gtctttttta aacacaaaac ccatccccgg 97380

tgacacacct ctccaataa gacaacacct cctaattctt accaaacagt tccatcaact 97440

gtatttcaag tatctcaaca taggaacat tcccattcat tccatcacac atgcaagcct 97500

ttcatttctt cctgagaggc ctacaagtca gcggataatt atgcttcaga ctggtgctta 97560

gcaatttagg ctccaaagt ctagttagta cagctgtttt aaggctcaag ctgaagaatc 97620

catgctttgg tgggcatatt gtgtttgtca gctatctgac cacaaaagca aataaagcca 97680

ggaggcaagt caagcctgct taggcctca gttcacattc atttccattc tcagtacttc 97740

actggccaaa gcacaccata ggaccaggtc taagtattac ctgccacag tagaagggga 97800

agaagagtga atatttactg aagaaaaagc aaggcaacac cctaaccttt cattcagcac 97860

tttactatag acagctgatg ttcttgggtgc tgtcattata tgcaatgtta tcaatgcaca 97920

gaaaattata tatatttctt ctataccccc ttttcccaca aaagggtaat attcaattca 97980

aattcctggt ataatgtgtt ggggcccaaa tattggaagt ctattccatc ctgccacaag 98040

ttcagagagc tcaagtcact cctattgtct ttaagatatt agcttgacag ttgcagaatg 98100

tcctggcctc agtatagtga atggctccta tctaaataac aatagacctt ggcccaggag 98160

agtttacact aatcctgaag gctagtgat atgagctgct atggagcacc tgatggtagt 98220

acatgtgtct ttaggattaa gggaagtaac tgctatctgc cctttataca tgataataga 98280

agtcttctgc cattgttccc acctctgggt ggttacttaa gattgaggca tgaataaact 98340
 ggacacattc attattaact gattctgccc tccagatatt atcctatgtc tccatcttcc 98400
 cttaaatgtc tatagctagc cttccctcat ccatactccc ccactcagga acggacctgg 98460
 ggctgtttgg ctggttccaa ttgcagccct gtaaacacca gtacatgaca gtaatgggta 98520
 ttataaactt tgaattatt ccaaatattt acctgattta ctataataag aacctggagt 98580
 gtctctttc tctttgtgag tctgactttt gttttcttgt ttttttctt tcctttttgt 98640
 tttttttttt ttgggggggg gggggttgtt tggttttttt catgctgggg attgaaaacc 98700

 agaaccttgt gaatattaag caagttttta tcacagagct acagcccaa cttctctttt 98760
 tagcaaacctc agtatctgag aactcagggt aaactcacac ttagaaatgc agtgtaaaa 98820
 cttgtcatac ccaatatgtg agctactaac cttaatgggt taggcttgac taacctcatt 98880
 ttgttccta taatttaca cttgttttta cctctgtaat tttatgatc acatgcctta 98940
 aaaattgttt ccattgttct gaaccatccc cagggaaacta actgaccaca accccacaaa 99000
 cctgagcatt tcccaggctt actcaaaata gctaactgcc actttccctc tttgtattgt 99060
 gcttgcatcc aaaaagtcca tatctccaac tcccataaga ttgttaagtc agaacagctg 99120

 taataaacca atttgattg caacttcttg gtgtgttctc atttggttcc aacatcataa 99180
 caaaaaactt caattcaag tgccctgagtt gaatgggcat ttgaagtaca taaacctatg 99240
 taacatctct cttttttgca gagattagca gtgttttcta ggcaaatgt gactattatt 99300
 tttgatttat acttctctg attattcag attttagctt gcacaaacat taattatfff 99360
 ggttattata tctggaccat tagtgtcaca aacagtccca aaagcattgc caaggcagat 99420
 gtggctatta gggggtgga ggctgagaag tgtcaaggca cacacaaaat tgagttagga 99480
 caagatagta ttaccttagt cacttcagt atctacacc agtgatttgc ttctcagaag 99540

 acacttgga cagactgctg cagaccacac cttgttagtt ttctgctaa tctttgatgt 99600
 cttatccagt ccatgccagc acttgcactg ccctaattca acagaacatc atcaggcaga 99660
 gttcttatga aaaaataaat tttaggttga gagcattttt ccatgcatct tcagtgttcc 99720
 aagatccagg accatcttcc taggaatgtt cacacaggca agaaaacaga cagttaggac 99780
 cttccctaga gcaatacat ttgcatttgi ggtggtttga aagaaaatgg ccccaaagg 99840
 gagtggcact attaggatg gtggccttgc tggagaaagt gtggcactgt gggagcgggc 99900
 tttgagattt cttgctcaaa attcctcag tgtgacagtc agcttcttag tacctgcaag 99960

 acatagcact ctgactcca gcacctatg tgctacaca ccacctggt aacctatg 100020
 gtgataatgg actgaacctc tgaactgta aatgaattac cccaattaag agttttcttt 100080
 ataagagttg ctgtggtcgt ggtcatggtg tctcttcaca gcaataataa ccctatgaca 100140

gcattccttg gttaaaaaag aaaagaacca aacaatgact tttctaggag ttgatagtaa 100200
aaccttcaga ggctgatgca ggaggattaa gttgaaggcc cacagctggt cattgaaaga 100260
cttaaaaatt agcaaagaaa tacagcccag aaactgacca agactactac tatgacttag 100320
tgcctggaat ttaccagcca ccaggattac tcctttacaa ggccataaga taactgagta 100380

ccaagaattc ccagatggcc accctccccg aggggctcgt gaaggaaaca gattgcccga 100440
ctggccaatg tgcataaat taagggtccc tgtgaaacaa agagatagct acatatagtt 100500
agcacatcct gaggtctgca ggtcagaaat ctatctgatt cccaggcctc ccctcaagac 100560
aaagggcctc ctaggaacct atgactcatg ggttcaacag acagagagtc gaggcccctc 100620
cctcagctta tgggtgaggg ctttaaaaaa ggctgtgcc tgggggatgg ggctgctctc 100680
tagcctgcat gctgggagag cctgtttgta caaatatcta ctttcatta aaacctcttg 100740
ctgtttgcat caagtttctg cctcctcatg gtggttgggg tggcagcagt ctgggaaaag 100800

attctggagg cctgagcttc cgtggggtct tacagtcagtg gtgacacaca tttggaatcc 100860
aactttggat tccaactttc ttgggtctca taaactctct aggcattgct atgggcattt 100920
tgtgtcagat ttcaaatctc cactgaatga tattgggttt gtaaacactc ttcattgatat 100980
cttttttact ctaatatcc taagtaattt aatgtttggc attgtttgta aggattgtat 101040
agcatgataa ataaaagacc cagagacttc tattggggtt caagcttcaa actgaagatc 101100
agaaaagaaa agcagccagc cactagctct tacctttacc tcagctcaca ctgaaggggc 101160
aatcttcaaa ctgctcctga tttcactgtt cctcagattc actcagactg ctatgttctc 101220

ctcaatgtag ctagagacta atcctaggac tgaatgcctc ttttatacct ctcaaatcct 101280
gggtttaaag gtgtgaactc tgattcactc tcaggttgcc caggatgac ttggactcag 101340
agatccatct gcctttctcc tgagtcctgg gattaaaggt gtatactacc accacctgac 101400
ctctataagt gtcaggetgg ctttgctttc tgaatcgtca ggcaagcttt aataaatcat 101460
aaatatcacc acaggattgt acctggaaag tggtgaaatg tatgtcccc aggaagacac 101520
aaggctgtga gcttaatgca ttaatgccta atgttcacac attgtaattc ccccaaaata 101580
tcaagttca tctagttaaa tctgctaaaa taaaacaaat attatataat gtttgaatct 101640

taaagggtca tatttaactt ttggagaatg agcatggttt gagacaagag tctcattctg 101700
tatctccagg tggcctggaa tttaccatgt agcccagaca agaactgaac tcttctctgtg 101760
tagtccctg agicttggga acacagagtg tgagctacc agaaccat tcttgaatc 101820
ttgggctagt cttgtgactt gctttgacca atacaattaa aacaaagtca tgccaagaac 101880
ccatatatat tcacatcaa gtaacttgtt atagattaac agagtgtgac caaacagggt 101940
atTTTTTTC ccagtcagtt cttttactga caagctgcat attgtggtta caaagaaagg 102000

accaatcact ttattactta tcttgaaaag taaccttata gggaatcttt ttttttttt 102060

 tttttnnnnn nnnnnnnnnn nntgtgtagc tttggagcct atcctggcac tcaggctggc 102120
 ctcaaaactca cagagatctg cctgcctctg cctcctgggt gctgggatta aaggcgtgca 102180
 ccaccacca gcacctgaag tcattttcaa agctttgttt caactataat gactctgaa 102240
 atctgtgaac acatctccca acattaagat taaaagcatt tgcactttct gtgacactgg 102300
 gactcttaat cattaacgta agtcacagtc tatacggtat cccaatagaa actcatgtgt 102360
 tctagctgtg tggcacctcc ttgtcttatt ttttatcctt tgcagcatct gctttatcat 102420
 atgcagaage aacattttat cctaccttta cctatgttaa ttttcctact aaactaacct 102480

 ctatcataat cccttactat atgtattaaa aacctcaat catcaaaatc ctatttaaac 102540
 taacactatt attgtataaa atcattgctt cagttaaaca gtacagctta ggagcatctt 102600
 cataataate cacagctaaa agtgcctcaat agaacaggat atttccaga gaggatccta 102660
 ctgcattaag gacagtggg atctccaaa cccattcaca ccatgccaga taccagagag 102720
 aaatggcagc agcaaacatg cacaaacaca gtagtagcaa gaaacattct gggactgagg 102780
 ctcttggggg accttgctta tctgagattc acccatcaag gttttgttta ctggtgggca 102840
 gatccctga agtccattgc tatctgctct tcctctaata tggccactgg cacatgacct 102900

 ctatacctca ttctccaag atctttttgt tttggttctc ctttaccttt accaccttag 102960
 gatgctccat caggcctact agaaagtgtg actattgtaa aaagagacca atgagaaacc 103020
 aggcaccatt cagagttgga gaagtcattc agtcttacta tgccagcaga ttgaacttga 103080
 gcaaacgcta tgaggagatg ggaactgacc cataatcttt tacattttta ggctaagtag 103140
 tgtcatttct gacttttttt tctgctattg atgagctaca ctttcacctt acatgattga 103200
 ggcccatgct cagaagtttg tcttcaatga gcacgtttac tgatgtagaa acaataaggt 103260
 tagaatggct attgctaattg tctatttcta aagatacgga aggaggtttt tagcctgttc 103320

 agactaatgt atgttttcta gagacaaggg agaaatttta gctgatacag gagtaaacac 103380
 gaagcagaaa ataacacaca ttgttttate tataagtta gtaaaaatgt taactcattc 103440
 tgatcctctt cattatttcc ccttttgttt tgacactctc ccttctcact ctccctccct 103500
 ccctcccttc ctcccttctt ccttctctct ctctctccct cacactctca cactctccta 103560
 cagaatcttt actattaatt attgcaggca ctttgtaga ctcaggagct tactatatag 103620
 gccaggctgg ccttgagctc acagagatct tctgcatct gcctccaag cactgggatt 103680
 aaaggcctgt gctaccatct caggccctta tactttccta aagtatcaat ttctgtgttt 103740

tttaggttga taaactaaca tttgaagttt gatggcctct atatgagaag agggaaccag 103800
 acaggcaaat taaggaatca ggaccaaca ggaatatcat aaaaagcttg agtagagggc 103860
 caattaacag aagtagccag ggtgcctaat tcaaaatctt attccaataa ctccaggaat 103920
 caaatgcata gaggctatca aacttcaatg gaagaccgga gtttatttga gcactagctc 103980
 aagttgggca ctctgctcag aaagctgag ttctccgttc tccaactagt gcttgatgtc 104040
 tctttgttct acttatgat gcaacaaggt ggatgaagag gaagagttct aagtcacat 104100
 cagctatgaa caggttaaag gacagactgg tagagggatt tagaaagctg gctcaagagt 104160

 aagagcactt tcagccgagc gtttgtggtg cacgccttta atcccagcac cctggaggca 104220
 gaggcaggca gatctctgtg agttcgagac cagcctggtc tacaagcgt agttcattcc 104280
 agaacttgag gacgccacag ccgtcacccc ctctctcgg gccggtcagc cgaaacgcgc 104340
 accatgggat ccatctgag tagcggcatc gcgggcgtgg aggacatcga cattcaggcc 104400
 aactccacct accgctatcc ccggaagtgc gggtttctgt gtaataatcc tgctgtcct 104460
 ggaactcact ttgtagacaa gattgacctc aaacgcagag atctacccat ttgcctcct 104520
 gagtgctggg attaaagtg tgcaccacca ccaccaccac caataggcta gaagtggatt 104580

 gattgataat gaactctgaa cctttgaaat cttacaatag cacagagaga gaaggaaatc 104640
 tgaaacactt cacccttttt ttcacacctt aaatcacttc cttagacctt tacaactttc 104700
 atttatacac cttaaacat tttcttagac cttacaact tacataaaac ttcaaacat 104760
 ttcttttcat ccagtcattt accatgagac acttggttga tcacggagag aatagtaaaa 104820
 agttacattg gaaaaaaaa aaaaaagct agttccagga cagcctcaa aagccacaga 104880
 gaaacctgt ctgaaaaac aaaaacaaaa aaaaaacaaa aaaaaaaga gtaagagcac 104940
 tttttcttgc agaggaccgg ggtcctttcc cagtaccag atggtggttc ataaccacc 105000

 atgacaccag ttttggggaa tctaacattc atttctgact gttaagggca ctaggcatgt 105060
 gcatagtcta aataggtaca tatgggcaa aactcatat acataagata aagtaataa 105120
 atctttaaaa acaactttta aaaattaaaa ggagaaagaa aaggggaaaa taacaggat 105180
 agagggaagg agggaagaaa ggggagatag aaggaggac aaaggcagag agagagagg 105240
 aaaggcagag gaaggatga aggaagggca gagatgatga tgcagacctt tagttacca 105300
 tgtgggagcc agaagcaggt gaatctcaga gttcaaagct agctgggttt gcatagcaag 105360
 ttccaggtea tccagatcta cattgtaaga ccctggtctc aaaacatcat catcatcatc 105420

 atcatcatca tcatcatcaa tcatcatcat catcaaaata aagaaatgaa gaaagaaaag 105480
 agaaaggaaa taaacgaaca tctgatgggc cagcacctac atgttttgaa atgtccacat 105540
 ggtgactcac agccatttgt aactctagtt ccaggaagtt caattcttcc ttttgacctc 105600

ctgggttacc aggtgtacag tggctaaac aagaatatct ttttttttt ttttgaggga 105660
 aggctttaat gtatttaagt ttttggtatt gtaacagagc ccccagacct tagtagacce 105720
 ctggacctta gcacaactga ctccatgaca taagtgccat tcaggctgta aaactcagta 105780
 catagacagc accacctgcc aaaaaatgaa aacaaagacc caatccatca aagtccatat 105840

 tatgggaaag tttcttaatg tactaacttt gctttttgac ttctggagta atgcttctgg 105900
 ataactgttc ttgttaactg aagtatgtca tcttgagaat gctaaacatc atgctacact 105960
 gggaacctga acacctagtg tagttgctgg tggagtaata aagactttct attgacttaa 106020
 acctcatgcc agtagtttct tctagtgaat accccacaac acatataacc tagattgata 106080
 gggagggaac atagaagaga aaactgtgtg ctaaaagtgt tgctgactgt tgctcatctg 106140
 gtgaagatac cagagtatga tgtacttttc ttgtatcttt tctctagttt aatgttttgt 106200
 tttgtttttt tcacaccagg caaggtaatg ttgtaagaaa tgttgaataa ttaatctatc 106260

 ctgtaaaaca ctgtttttta tgcttaccct ttctctctta ctgctgaaaa cttacagatt 106320
 cccagatttg tttacttagt tcaatgacca cttctaataga gatthttattt cttctataaa 106380
 acaatagcat gactacttcc ctttactaaa agaaggaatg tttgttttagc cagatgtgac 106440
 catcctgaaa tgattaaact gctctcactt tctccctctt cttcacctc tcctctcct 106500
 ctttaaagcc atttttcata ctagctgac aggtgtagac ggtgagattg aaccttagac 106560
 aataaacgag gaacaagtcc cctctcatta agaataaagg taatgatacc ttggccatgt 106620
 gtgctgctat ttcacttcag tgtcttgc atatthttcat cagtacaatt tgccttgttg 106680

 aaatgcctta atcagggtgg gtgatggctt ctttctctgc aacacagaat atthctagca 106740
 atgtacacct gtaatccaa caataggag gttagaggaag gagiattagg agctcaagac 106800
 catccttgac cacttgata cttggaggct agaatggaat acaggagact ttatcaaaaa 106860
 caaaacaaaa agtatgtaca tgaagattgc atggcttata tcaaatacca cacaatttta 106920
 tgtaaaggac atggacatct atggattctg atatctttgg gatgtcacag caacaggaaa 106980
 cacagcttag tgttactggt ggtataacct gtgaagatct ctcagagact cagaggcctc 107040
 taccgagttg attgcaatgg aattcttgat acaatttcac agaaaagact tccaagacaa 107100

 gtcaaagtga agccaaatca atgaatttat tgattagcgg aaaggatgaa cagatgcact 107160
 tcagagtcag gtgtgggctt tgaaaaagga acaaaccttg gtgctgaagt ggtttggaac 107220
 ttttggaaca atactgttta aaggaacaa tctgtaacta aggttgacag ggcaccacc 107280
 cctccctcca caatatattg ggttctcat ttcatttctg attcattatt tttggtgata 107340
 tatttggatg tatatgattg taaggagcct tgaaccaag caggcaaagg cctggttgg 107400
 ggggcttagg acagaggcta caacagggca ggcaaaggcc tggctggagg aagattaag 107460

gaaagggagc gtaggccac tacgcagccc attgtagata agagtgagga tgtgtggagt 107520

 gggcaaagt gtaattaaca cgatttagcg aactatftaa ggaccagctc agaactggga 107580
 attttagagt gtaccacgac tctatgtect ggagctctcc tccgctaacc taagacaacc 107640
 agtccatcaa ccigagtacc gcctgttctg agctcgattc cagcagactc gccagcctga 107700
 atccagagga gctgaagtcc ggagcctgca ggctgctgca ggagaggtac cccctgctgt 107760
 gaacctattg tctgtggttc ttaggattgt ttgcttatgt ttgtgtgtg ctttgacata 107820
 agtgtgaagt aaaactcata tactcaaac caacttgctg agtttgcac tctcccagg 107880
 tcaaacctgg taacggctta agacaatgat ctaataaaga ttgcctaaag atcagaatac 107940

 aaagctagcc acatccatag aggccaggca atggtactgt ctglatgcct ttaatcccag 108000
 caccagagag gtctataaga ccagagagcc cagggtccca tgtggtattc agactgcaat 108060
 catgtgaag acaggattgc cccagccctg atagaggtac aaactcteta gtggttagct 108120
 gctttgcttt tctgatcttc agcttgaatc tcagtacctg tctctgggtt tttattatc 108180
 gtgcttatat tttctcgctg atgttatttt ttgtttgggt tggtttggtt tggtttttga 108240
 gaaagtgttt ctctgggcaa cagaacttaga tgcctagaa ctggctttgt agaccaggat 108300
 gccttgaat tcacagagat ccacctgcct ctgtctctg agtgcctgaga ttaaagggtg 108360

 gcacatggt tcttaatgtt ttgagccaag gattcactat gaaagattag gctggtctca 108420
 aacttgaag aattctattg cctctgcctc ccaaatgctg cgattatagg tgtgtactga 108480
 aaaggcccaa caatatgaat attaattaa aaatgacttc tcttgggaac tgggaagatg 108540
 gctcaacagt caaaagccca agattctctt ctccatgacc tgtgttcagt tcccagaacc 108600
 tacagatagc ttactacat ctgtaacttc aattctaggg gatctgacat cttctgcct 108660
 cctctagagc caacataatt gaggttcaca gacatacaag taggggcaaa acatccatac 108720
 acgtaaagta aaaataaata aatcttttat gtaggaatta aagttttgt ttgtttgttt 108780

 gttttgagat aaggtctcac tatgtagttc aagctatcct ggaactcact ttgtagacca 108840
 tgctggcctc ctagagcaga actgtacat atctgcaggg aaaccaacc ccaccagaat 108900
 agagctatat aggaattgcc tggcttctga caaccaggat accttttctc ccagagctgt 108960
 aacctcaca actcaatcct ccatgacat acataaacc tagcccctaa atagggatgt 109020
 tggaccccca gattaggata ccaaatagtc ctggcagtea cctgaagaa ccaatatcca 109080
 gtccagtaga tgcaatcagc aagaggaatt ttattgagca ttttcgaaa cgggctcccc 109140
 agtcagacag acaggaagcc ccaagcaatg caagcaggct ccttttaag gcaaaaacca 109200

caaagcctag gggatagagt cgttctctga ttggaggact caggttcgtg ctcaggcat 109260
 ccattgggga ctttccgtgc aggggaacat gtggcggagc tattgttctt tttctgtaag 109320
 ctggctgtaa aaactttccc aacttctctgc cctatctggc tgtaacatct gcctcaactt 109380
 cctgcacctca atgggggagt taggccccga ggatctttca ggaagagcag acagtttctt 109440
 taatttctgg tccatctctg taagaccccc cagaacctta ggcttccggg atctcagccc 109500
 aggaccgggg tcacccaat caccaggcag agtcgaaagc ttgatgcaaa ctgcacaagg 109560
 ctttattata gttgtttaac aagctaacc ccatgtagct caggcctttc atccacctga 109620

 tggtagatgg ctagaaagac agctcgaagt gtctgcatag agatcttata gggcagcata 109680
 aggagagtgt ctaggggtac gcacaggctc aggattgggtg tgcctccagg ctggagggt 109740
 ttgcctgtg ttgattggtc aactggttgt tatgtcccat aggccttcac aggggtggtt 109800
 ctatgctctg cgcgtcattg ctgtgcaactt gtcgtaaaag cacaccaga gccgtaaaagc 109860
 atagcaccac tagctaactt ctgattgggtt ccttgccacg aggcaggcat ctgacttctt 109920
 agtgactaag acaaggtcag acaagcacgc gttcggctgt tatggctgcc aaaatgggga 109980
 gtggtttctt catgtctata gagagaataa atttcttggg ttttgctatc ttggtgtaaa 110040

 tacctaatat aagagtttca gtttccacct aagataagcc accacactgg ttctgattt 110100
 ctttctttcc ttttcttctt tcttctctt cttctattca aggaatggat tgaaaatgag 110160
 acacagacat tgttgggac ctgggagacc accagaaaga tcatctggac tctactgagt 110220
 ttaaatcagc taaattttat ttaagctgca gctgacagag cccttggta gactcaggac 110280
 tgcagccctg tctgggagag ttttttcttg tttttttgtt ttgttttgtt ctttttaggc 110340
 aaaaactaca attatthaat tacttccctt ctgtagacat aagataaaca cacacaaaca 110400
 gttactaagc aagtttacag aagtcataat aagcagttag ctaatcattt tacaactaca 110460

 catcctggga aaggteaaaa gggtcagcat ttctgggggt tccaggagca gaattaactt 110520
 gctagaattg acttcttaga ctcatgacca ggctttttct ttgtttttgt ttgtttggaa 110580
 ttggcattac agacagttgt gagctgcat gtgggcacag ggaattgaac ccaggtactc 110640
 tggaaaagca gtcagtgtct ttaaccactg agctatttct ccagccccct ggacaagttg 110700
 tctttaagac taagtggcag aactctgtga gttcaaggtc agcctggtcc acagagcaag 110760
 ttccaggaca gccagtgtaa gccctgaag gcacacaagt gaccagacc ctccccgag 110820
 gacctcaac tgcagggtc caccaaagga cattccagtt gccctaccag ctggacccta 110880

 cccccacct ataccataca aagcccaagc tctcccccc tcccccccc ccaagaacce 110940
 ctatataacc cctgtcttct gttcagtttt ctgctgtttc ttgctgaaat agaggcagcc 111000
 actatcctgg gttttttct ttccaataa ttctcttgtg tgaggtttgt tgtgtgattc 111060

gactttgtgg cattggctcc caactaccag gatgctttcc catctacata gaaaaactcg 111120
aaaaccccaa agcataccaa aagaaaacaa aacaggattg gccatttcta ggtataagta 111180
ggagcatcaa gaaaccacca aacacaatca aactccatgg aaaaacaagt agcagcttta 111240
ataaataata ataataataa aataataata ataataatac tgccaagcct cctctgacca 111300

tagagaacaa tacaccactg ggaaagttag ttgggttata tagggacaaa tagaagaggg 111360
acacacatct cagatgctga aatagccaag tagttacctt ggggacaatg gagatgcacc 111420
tgttgtgggc agagagtcc agtggccact gtttgggtcc ggagtcatta atataaaca 111480
ttaccatagg atcactctgc cattccctg tcttgagtc ctaacagtgg taaggtccca 111540
tgggtcctta ggagttagac ttgaggcagg tccaatctgt ggcatgtatc ccaggataaa 111600
tattaatgtg gctcaacata ttacagtaa tgtccaaca tctaaaggtt acacaccagc 111660
tggtgagatg gctcagtggg taatagtact ttgcattgtg tctaacaatg agtttgatcc 111720

ctgaaacaca acggtgttag gagagacca agtcccaca gttgtccttt gaagtcaca 111780
cacacacaca ccatgtcaca agagtacaca cacacaataa ctgtaaaaa caaaaaagt 111840
taaaaaataa gattggacat gcctgctaga tgtttgtatc agacttcaca agtcatggac 111900
tgtgtcaaac tctgtcaatt tctgtttgag gggatttcag tgtctttgtc tctacagata 111960
ggctaaaatt gatctttttg tctctacggg tagtatgaag ttggtatfff tcattgtggg 112020
aggcagaaac atctaaaaa aacaagcaga atgaggagga tattttttcc tattttgaat 112080
taaatttttt cttttttttt tctttttctt tttttctaac atgtggtggtt ttacctgaat 112140

gcaatctgtg cctagtgcc aatctgtgcc tagtgcccaa gaggtcagaa aagggtatca 112200
aattccctgg aactggaatt aaagactggt gtactatgt gggttctgag aaccaaattt 112260
gggacctctg gaagagcagt cactgctctt aacctgag ccatcattcc aacatttttt 112320
tcagatffff gagacagggc ctctcactgt aacccttca agctgactag tctgttattg 112380
aggatataat tgaactcca acaacttatc aagtgcagct cgagccagct cagaatgaag 112440
agcaccatta tcaactgcca actgtgacag acctgtgaat gtggcactta ccataacttc 112500
agagcctacc aaggagatgg aatcttttct gaccagcag gagtcccaa tgcacatcc 112560

agagtacact agagaggag aacctctct tagtgagcag gaacagccag ctcgcccttc 112620
tgagctgcca ggtcaaactt cagaacatgc tctggtacat atcaagtgea tctccagca 112680
tcacaaatgt cacagttaac cctccagagc tgattaatga ggttgaaacg tcaatccaac 112740
tggggtttga acctcctaag catctcagct gagaagagct tcccttctgt ttgtatgagt 112800
gtatacactt aaaaaggaca tgctcattct gtataattac aattattata tattttacat 112860
gtctacgtat attattacat tatgaataag ttgcattatt taagaaaagt aatttgttta 112920

tactctataa cciattagaa caataaagta taataaaatt cttttctttt ttattaagag 112980

ttaaaagtta agccaggtgg caatggtgca cgactttgat cccagcactc aggaggcaga 113040

ggcaggtgga tctctgtgag ttccaggcca gcctggttta caaagtaagt tcacaggcta 113100

tatggtgaaga ctctgtttaa actcattcag tcaaacgaag agagttaaa catttttacc 113160

agcacagatt aattataaac catatagttt tgctaataatt ttcataaatg aatataatga 113220

attttgatca ttttcacaac cccaaccctc attatccttt cttgtctcct actcectctg 113280

atgacctttg ttagatcatg tgactttaag atcagatcca ccaccagtt gggctctgcc 113340

cttaaaacca ggaattagc caggcattgg tggcacacgc ctttaatccc agcactcggg 113400

aggcagaggc aggcagatct ctgtgagttc gagaccagcc tggctccag agtgagtgcc 113460

aggataggtt ccaaaactac acagagaaac cctgtctcga taaacaaaa ccaaccaacc 113520

aacaaaacaa acaaaacaaa aagcagcgac tcttctacag cagatccatt aaaagaggat 113580

cctgcttggt ggaagccagg ccccttcacg agactgtctc tggcactatg gcattctaag 113640

tttatgggtt ggtatggagt gttctcatct gaaagctaaa caatttcaat ttagcgagat 113700

tataaggaat atgtatcatt cctgaaatca cataagagtg catgtctcag ctcttgcttt 113760

aggagtactc agtggagatg gctactgcta tccgtaaac gtgcgtttga agtcggtggc 113820

gtccatgtct aaccagtgtc ttgtatcacg gaacccggca tcccactagc aaaagcaatg 113880

agttgccagc agcctttgcc tgaacagtgg tttagggagc caggctggca ggaggagcag 113940

gcaggacggg gcaaccgtgg acagcaagaa ctacaagtcc caggggacgt ttcgcgcagc 114000

tccgcccctg ctccgaatgt ggccaacccc caggccctac tccgtgtgat gtcatttggg 114060

cttccgcgtc ctgcgcgacc ggaannnnnnn nnnnnnnnnn nnnnnnnnnn nnnnnnnnnn 114120

nnnnnnnnnn nnnnnnnnnn nnnnnnnnnn nnnnnnnnnn nnnnnnnnnn nnnnnnnnnn 114180

nnnnnnnnnn nnnnnnnnnn nnnnnnnnnn nnnnnnnnnn nnnnnnnnnn nnnnnnnnnn 114240

nnnnnnnnnn nnnnnnnnnn nnnnnnnnnn nnnnnnnnnn nnnnnnnnnn nnnnnnnnnn 114300

nnnnnnnnnn nnnnnnnnnn nnnnnnnnnn nnnnnnnnnn nnnnnnnnnn nnnnnnnnnn 114360

nnnnnnnnnn nnnnnnnnnn ncgatcccag cctcctggga accgaaacaa gagggtttcc 114420

tcgagttcga ggctagcggg gttatgttgt gagacacagc ccctctaaag caataaata 114480

aaaatttgaa aagctttgcc gggcggttgt ggctcacacc tttaatccca gcattagaga 114540

ggcagaggca ggcagatctt tatgagttcg aggccagcct ggtctgcaga gcgaattcta 114600

ggacagccag gtctgttaca cagagaaacc ctgtctagaa aacaaaacaa aaataaaaaa 114660

tgaagctac aaagacagac tacttgggttc tattgatggc atctaacatt ccatgagcaa 114720
 atgttatttc ttgcctagct tccagtggtt tcttctgaat ttcittgtta ttttttttcc 114780
 tcatgagaca gtcccatgta gtccatgctg gccttgaaca cacttccgct ccctgaatgc 114840
 tgagattaaa ggcatacact actatacacg gtttacctag gcctcctggg tactaaataa 114900
 gcataataac aactcagcta catcccaac ccttttggtt tgaggcaaga tctcatgtag 114960
 gccagatgg tgcagactc acataccagg ctgactttga actcttgagc ctacttctg 115020
 agtaagatta caggcttcag ttattaccac cagcttctcg cttttgcttt tggcttttcg 115080

 agcacaggat ctcatgtagc ccagctggc gttggactca ctacaggca gaggatgacc 115140
 ctgaacttca gatccgtcct gcctgttccct cagagtgttg agtttaccaa tatacattga 115200
 cacacttgac tctgtgggac agaacttaaa aactattta gtggaaagga aataaagtaa 115260
 cagttcagaa aaattattgg aaatttggaa ctaaaacaaa aggatgagta catgatttgt 115320
 attgtcataa ctggattttg ttccttatgt aaaggtccat tttgtcatta ggcctagagt 115380
 ttgcaacct ttgagtgagg aactacagcc tggaaactaac agttggttga gcaagtgtt 115440
 tctgttttgt aacaaagtaa ggatctcatg tcagagttagc attcagctat gccaaaaaca 115500

 ccaaagtcca gcagatggga atgtctattt aagaaacagg gcttgattta catcctgcct 115560
 tctgttccct acctcctccc tgaccagcac cttgattagc acaacctaag agaacccttt 115620
 agatccggca tctagtaatg gtctttgaat agaggcacca aggaaagaga agaatcaagt 115680
 caccatgcct tctgcttata gcctgtataa agggcatgga agaaggaagc tgggtctctg 115740
 cctgcttgca cttgctcttg ctagaagtc tattccttca ctggcattag agccctactt 115800
 cttcgggatt ccagtgtata ctgaagacca gctgagacat ccaccctcat ggactgaaca 115860
 accactgatt cttggattct gttgatagac aaccatcttg ttggtctagc tgaaccatac 115920

 catgtagcca ttctaataaa ttccatgtat atattcttta agttctgttc ctttagagaa 115980
 ccctaactgt aatgggtagg ttttgtttct caacttgaca caagctaaag tcatcagagg 116040
 aaggagcttc agatgaggaa atacctccta taaggcattt tctcatttag tgatcaatga 116100
 gggaggacce agctcatggt ggggtggtgcc atccctgggc tgatgctttg tgttctaaaa 116160
 gaaggtgggt tgagcaaacc atggaaagca agccagtaag cagtacctct ccatacctc 116220
 tccatcagct cctacctcaa gggctttgcc ctgtttgagt tctgtctctg acttttagtga 116280
 tgaacaacaa tgctaaagtg tgatccaaat aaacccttc ctecccaact tgctttctag 116340

 tcatattttg ccacagcaat agaaatccta tgacactgac taatacagat tttggtgccc 116400
 gggagtgggg tatgactgga caggccttgt catgctgttt atttgagaaa tatggaagac 116460
 tttgggactt tggaaacatt aagtggggct tactgggctt actactagta ggaacattga 116520

agacagtgca gttgagtgca gtttgaactc tggggtgccc agaaagaagc ttcagaggag 116580
 aaggatatta gcaagtggct taaagacat tcttaggata ttttggcaa aatgtggcc 116640
 ctgttccaaa acaatctgcc tgaggctaaa ttgaagagtt tttggcagaa gagatttcaa 116700
 gatagcctag cagtattgac tatgttatgg ggttattagt aatcatttta tatgcacatc 116760

 tataatgaaa gatgaccaag ctgaacacag tgttcaagga gacaaaaaaaa aaaaaaagt 116820
 gaaagaaaag cctgggtgcta aatagaataa agagtgtga cctcagggga agaccccacc 116880
 cagctaagca tccaacttat gaaaaggaat taaaggaaag ctaagcagtg aaggaaaaca 116940
 tcaacaacag aaagcccatg caaatgtcat tgaagtagcc atgttctaac cccagcaaga 117000
 agaagaattt ggccgcttca gccacttgc tccagcttta gagtatataa gaaatatata 117060
 tatttcttat atatataagg atataagaaa gagattatgg aatctccctc tgtggctaag 117120
 gcaagccact aatgccaggg gtgtccctct atggaggccc agaaaggaca ttgtgtgaaa 117180

 ctgtgaagat aaagcctgga ttgtcttga gacccaata tattatagca caaataacaa 117240
 atttgtggga tacttgccaa gaaaacctga ataccaagtg tggaaccaac acaagaaact 117300
 gaagtatgtt gcagtcaata aagctgaatt tggggtttgc cctgctagt 117360
 tttgttccac tatttctca ctatgctctc tttcctcct tttggaatgg taatgtatat 117420
 tctgtgttga tggggaatgt actgtgtaca tttatcttat tgattgttaa ataaaact 117480
 atttggccaa tgagacagca agtagacggg actaggagtc aaagaggatt ctgggaaatg 117540
 tagtagagaa gtgtgatcca ggcaggaagt gacatagaaa ggagtcctat atttaagcga 117600

 aggagaaaca ggaagggcct ctcttttccc ctccactcct gctccagtgg cacaatgtga 117660
 tccaccagct aggagggacg ccaatatggc gtctgataag tcttataaaa tatatagatt 117720
 tataataaatt aagactgagc tagcagatga ggaatcctag tcattggcca agcatcattg 117780
 tacctaatac aagtttctgt gtattcattt gggccctaac tggggcgggc agcttgggta 117840
 aagctcacac atggcgctgg ggctcaggca gcttttggcg gaaagattta tcaaaact 117900
 gtgtcattgt tggaagtffc tgatttgcct tttgatttta caggggagtt agagttcaga 117960
 gattgccatg agtctcagaa gagactttga actttgaact tttaaacagt tttgagagtg 118020

 ggataaacta tggggacttg tggagttata ctgaatgcat tttttacatt atgatatagc 118080
 tacaagcctt taggggttgg gagtggagta tgggtgtttg aataagaatg ccccccata 118140
 ggctcataaa tttgagtgtt tggtcagaga aatgaaactc tttgatagga ttagaaggat 118200
 tagaagtgtt ggtcttgttg gaggaagtgt gtcactgaag ggtggacttt gaggttcaa 118260
 aagcccaage cagggecagt gacactctct ctactctac ctatgggtca ggatgtagct 118320
 cccagctagt actccagcaa ctgcctgcat gccatcatga taaatggatt aaacatctaa 118380

aactgtaagc aagcccctat taaatgcttt cttttagaag agttgccttg gctgggcgctt 118440

ggtgcacgcc ttaaatccca cagagtcagg cggatctctg tgagttcgag gcctgcctgg 118500

tctccagaga gagtgccagg aaaggctcca aagctacaca gagaaacct gtcttgaaaa 118560

aaaacaaaa gaggaggagg aggaggtgct ttggttatgg tgtctcttca cagcaataga 118620

atagtgacta agacagtgcc aaaaatacac attagaaaaa aaggcagtct ttttggcagc 118680

tgattctggg aaggcattta gaaaaataaa actatatccc tatcttccca tataaaaatc 118740

aacttagcgt ggatcaaagg ccttaatgcc ttaatgtaag acccaaaacc ctgaaactgc 118800

tagaggaaag cataggcata tgaatggact atctgaaaat gagtgcaata actcagagaa 118860

atagatcgag gaattggcag gtaggattga atgagattaa aaaaagaaaa gcaaaaaagt 118920

acctttgcaa agcaaaggaa atgggaagaa atattttgag gggaaaagat ctttgccagc 118980

tatacatcta atatctagat taatatctag aactcaaaaa atgaaaatat caagggctgg 119040

agagatggct caatggataa agatgcatgt ctccaagtca attcaattcc tgggagccac 119100

acaatgaaac aagagaagtg actctagtag atgggcctcg gatttccacc tgtgtacaat 119160

gactcatata tatattcagc acgacatata cacataaata aatgtgtgtt aaaatTTTTT 119220

gagaatattt taigtattag ctagacaata gtgatgcagg cctttaatca cagcactcag 119280

gaggcagagg caggcagatc tctgagttca agccagcct ggtctacaga gtaagttcca 119340

ggacagactt caaagctaca cagagaaacc cttgtctcgg aaaaaccagt tatcaaggag 119400

gtatattgag aagtaaatat attgggatgc tgttctagga aattatcata cctcctttca 119460

caatatccct tttatatgtc catgtggggt tgtgtataca agcatggaca aagaaagact 119520

gtgcctagg ttaacataag acactaatgg aggttagata acggcagaaa ggggaggatg 119580

gaaatattca aaaggagaaa gaaaaaata aagattgcac taaaaaatg ataacaagta 119640

tacatcatca tttgtgcatt aaaattcgggt atatatagtg gtattttag acagaatttg 119700

taactacttg gcacaggtat gagtttatca gatagttaga atttgaagct gtaagacatg 119760

ttggtcacat tgtaataaag agtctttatt ctttcagaga aatagtcaa gtggaaggct 119820

ttatttagca ctttttggc aaagagcaat gcgtgaagag atagcgggac agaataaact 119880

ctagagctga cagtgagagc tataaggagg ggtgtaaagt ttgtatggcc tttggcaact 119940

acacggccca ggctctagga ttaaggttat ttctggatat ggttcagaga aaggcatcct 120000

gctcaaaggg atttcttctg agtgiaggag aggataggtc agagaccta tttatcctga 120060

aataatcaat gtgccataat gaaatcttgg ttaagttgtc ctcaactgct tcagggtctt 120120

agtggttacc tcacccata attgcatatg caggttactg atttgactc tccatagaat 120180
 ctttgtgatt atactttttt ctctagtcat ttgttgccca tatacagttt ttgaaaattg 120240
 ttttatgtgt atggacagcg tgctctgaat gtatggatgt cagtacacca catacatagc 120300
 tgggtgctat ggctgccaga agagggcata aactgtagt gatacattgt ttattattta 120360
 ataaagcttg cctggggatc agaatgcaaa gctagccata ctagttagct ttagaggcca 120420
 ggcagtgggt gtacccatct ttaatcccag gactcaggag acaaaggcag atgaattttg 120480
 tgagtccaag accaccctgg gctacacaag agtgaaccag tctaaaagag aaacagagct 120540

 catgccttta attccagaac tagagtgcta tataaggaag aaacaaaaag tctcatgtga 120600
 gattcagttc ccagtcatat ggaggacagg attcccattt cagacttggg aggcgtaaga 120660
 gctactggct ggctgctttg cttttctgat cttcactggg tttttattat tcatactaca 120720
 taagatcccc tggaactaga attacagtaa gctgtcatat gcattctggg aatcaaacc 120780
 ctgtcctctg gaaaagcagc cagtgcctttt aatggatgaa caatctttcc agtcctgggt 120840
 ttggttttct gagatggagt ctgatgtagc tcaggtagt ctccaactca ctgatgataa 120900
 ctctgatct cctaccactt cctggtacta gtgttacagt catacactac catgctctcc 120960

 ttaaaatgta ttttagtaaa gtcaagcctg ttatcctaga attctaattg taagccagga 121020
 ggactaggag ttccaggtca tctgtgcta cagaacagtg ggttagagc aagcctcggc 121080
 tacatgagac tcgtttcaa agcaaaattt taaaatacat attgacaaag ggtatacaga 121140
 ggtaaagtgg taagaaaaa tgtcatgtca tatataactt tacatacaca gtgattatga 121200
 atcttgtaa gctaaatttg taacttttat gaaaggacta actgctgaca agcaaattgt 121260
 taagtgaag taaccagtg agacacagtg taatctacta tattgtgttt gtatttcaga 121320
 tgtcttcggt gcctaataat caatatttcc agatatact cagatattaa atattgcct 121380

 cccaacatca aagatagact gattaaaata atgagcacc ggggccggat aacagattcc 121440
 aatataaatg aggtlaagaat gtatacctat acaattatgc ttcgttaaaa gagagtatgt 121500
 agtaagattg ttaattgtct taaaatagga ctctgacttg agaagccagc acccacctc 121560
 ggacgtgtgc tgccttctgc tatectctcc tcctteccc tccccctct cctacactt 121620
 cagtatatat caaaccttt ttattgtggg tgctgctttt gagacagggt ttcactgccc 121680
 tggatggcct tgaactcata gcgatctgcc tgcttagaaa ctgagccatt atttattggc 121740
 ctcaaggaaa tactgaacag tagatcccca aaacaatgga catgtactaa ctactccaaa 121800

 caatgaaaga cagttggaca tggtagatta tgcgtgtaat tctagtactc aggagtcaga 121860
 agcaggagat ttgcatgag tttccagtca gctgggcta catagttagt tctaggccag 121920
 tatgtctctg aaaaaaaga aaaaaaaga gaagaagaag atgaagaaga ggaggaggag 121980

gaggaggaaa aaagaaggga gtggagagat gtctcagcag ctaaaattac ttgctacttt 122040
tctacaggtc cagagttaag taccctcatc cacatcagaa gccttaaac tgctgtaac 122100
tctggttcct agggatccaa tgccaaccaa gcctccttag tcaccacac acacattaaa 122160
aaaaaaaaa aattggagct agagagatgg ctcagaggtt aagaccagtg cttgctcttg 122220

cagagtcct aaattcaatt cccagcaacc acatggtagc ttacaacat ccataatgag 122280
acctgttgc ctctctggc atgcagtcag aacctgtat aaaaaataa atctaaaata 122340
aaaaataaa tctaaaaaa aatcttaaaa agacatggtg aggccaagca tgatggcttt 122400
caccttaat cctagcacgc aggatgcaga ggcaggcata tctctgtgat tttttaggcc 122460
tacctgctct agataatgag ttccagaata accagggata tatagagacc ctgcctcaaa 122520
actacaataa aaaggtatgg tggctttat ctataatcc agcatttgag aggctgaggc 122580
aagaggatca ggagctcaag gccagtctta tctaaatagt gactttgagg ataaaagtta 122640

catgagagtg ttcaggaaa tcaaaaaaga ggctggggtt caatgggaa aacacttgcc 122700
aggcaagcct aatgacctga attcagtcct caaacctag ttgaagaaga gaataactct 122760
ccaaaatga cctctgacct ctatgcatgt actatgacat acaccacaca cacacacaca 122820
cacatacaca caaataatag taataattat ttttaacaa aaaatatttt taacaaaag 122880
actgaaaaca tgttaaaaga agtaatacta ggcccaggta tagtggtaaca ggcccttaat 122940
cccagcatta agaaggcaga ggcagtgagt tcgagatgag caccaggcca gccagggcta 123000
gtaccctaca actaaatacc ttgcctgtaa tatctagtat ctaagagaca aatgctggaa 123060

cacaaaaatg tgttcagtgg ctggagaatg aagaagtggg agctttgctc acaaatgaac 123120
atctccctgc aggacaatg cgagggtaga gggactgata aatgtacttt ctgggaatcg 123180
acaaagatct tccaagaact cgggtgccacc tegtcttatt ccttttatta tctgggactt 123240
ctcttcattg ttgctggtag gcatctttag ccctaagtgg gtctgagaaa agactagaca 123300
actctaggtc aagttaacc tgcatcttc agatgttcat catgtctaca tatagaacta 123360
tgtaagattt aacccaaaga tgaaggcaat aaagagacag acataatcta gagacagatg 123420
tcaagtgttg ctttctatt agctcacceca tcagacattt gttagcagca atacttgtca 123480

agtcctgca ctgtaatctc agttaatgtt aacacaacc ccaggcaggg gtgttatctt 123540
cctcacagct agtgggtgtg tctgctaata attgctcagc tatgtgacct gcaaaattgg 123600
gatttttcac ttaactaaga gctggcaatg ctagaagagt cgtttaggtt tttcagtgac 123660
agtaaaggag agatatgat cctaaaggga ttggttatcc ctgtacctac catcaggcca 123720
tttgactgag aatgtttgaa aggatcttgc ctttttctt ggaaacagta cctgctgatc 123780
agaagcacat aggtccagt gagtgagtca gaaatgccag taggagataa ccaactgt 123840

ggtctccagg gtcccttctc tgcaccagcg acttcagtgt tgaagacttt aagcactgaa 123900

 tgttgcagtt ccagctagaa gctaacttgt ttttgttgtt tgtttgtttg tttgttttcc 123960
 ctgcttcate ttctctgcat ggattaaatc ctacattctt ggctatattt ctcatcaacc 124020
 acctgttacc accaccagat gtggaataca tgcgcttaca gaaaacttaa cttggggcct 124080
 agagagatgg cttagagtgt caaaagtctt ttttctttta ttaatTTTTT tcaaatcat 124140
 gtatttgtta cagggtgttac atcccgaagt ccaaagacta gatctgagga getgtgatat 124200
 ctcagacttg gctctccagc acctgtgtaa atgcagaaaa ctgaaggcac taaatctaaa 124260
 atcctccaga gaacatagaa atagcataac atcagaaggt atgtttatga tcaactgagtc 124320

 catgggcagg cciatacttg gcacctgata caatTTTTga gcaaagaaga aaaaatctct 124380
 tagaggagaa tataaaggta ccaacaaagt ggggagaggg agaagttaga ggagaatag 124440
 agcaaggtag aaaggcatat atgtatgaaa atgttaaaat gaaacattat tttgtatgtt 124500
 aattaaattt tttaaaaaga gagaagagg atatgagcta ggcatataac tgaattcta 124560
 gtactaagag aggcagagaa aagatcattg caaatTTGag gctttacata gcaagtttca 124620
 agctagcctg tgcctacata gcaagagcat ataaagagta tacacacaca cacacatata 124680
 tacatataca tatcagtaaa actaatcaga ctaaaaaaat aaatcagagt aagaagaaaa 124740

 ataattcaaa ttagaattct tgataacat ttaagaaaca tgttaagtac ctgccttata 124800
 ttttaaacad atttgaaata atactacagt attttaaaca ttttgcctgt tatagtataa 124860
 gatatggcca gttgatattt ggttaagggt aaggtctttg ttgttagcca ggtgtgataa 124920
 caaaagcctg tgatctctat atttgggagg tagcagcagg aggatcaaga gtttaaggac 124980
 agccaggtag tggtagcga cgcctttgat ccagcactt gagaggcaga ggcaggcggg 125040
 tctctgtgag tttgagacca gcttggtcta caagagctag ttccaggaca gcctccaaag 125100
 ccacagagaa acctgtctc aaaaaaccaa aaaaaaaaaa aaaaaaagga aaaaagaaaa 125160

 agagttaag gacagcctga gctacgtagc cagtttgagg tcagcctgga atactatgaa 125220
 actgttaca aaagaaagcg aaaactattg ttttggtttt ttgggttagg tcttagtata 125280
 ttgctgttgg ctggcttgg attcactttg tagaccagtt tatcgtggaa ctcttagtaa 125340
 tcctcttgc tcaacctctg gtgtggtcaa ggcactttgc ttgtattta tttgtttatt 125400
 gtttgttag ataggatctc actacatccc tggctggcct caaactcata gagatcctct 125460
 tgcaatctgc ctctgggtg ctggaataa aggcctttac cactactttt ttgatgcagt 125520
 attagaaca atcatcagat taagatgggt ggggtggctc ttattttaa acccaacact 125580

tgaagggtga aggcagatag atcaagagat caggggcatt ctcagccagc tatatattga 125640
atthtagact tggtagatca caagatactc tatctcaaaa ggccaagata aatcagataa 125700
acgaggcaat ctttataaaa ctgtctaaaa ctaaaaccag aaaatttaag gaaggttgtg 125760
gctaagagga tgacttagaa gnnnnnnnnn ncagtttaaga gcacttgctg ctctttaga 125820
ggaaccaagt tgacccgaat ggctgcttac agcaccaca ttgctgtaac atcagttcca 125880
tagaatccaa taccttcttc tcaactcttt gggcaccaca tacacatgcc acacagatat 125940
acattcagga acaacatcta tacatataaa ataaaaattt aaaaatgact atgattggga 126000

acagaatcta acacagtata tttatatcta aacggtatat ttattatgaa gggatactca 126060
cacaagaagc cgataaccag attggcactc cgagcagccc agtctcagat gcactccgag 126120
acctggcttg aaccccaaaa gagggcaaga gcctcctctt tccttagttc ttttatccca 126180
tccttctgt gtacctgtga ccacctgtga ttgggcatgg tgggattctc cctacatgac 126240
tatgcagtac atgttttata tccagactat tttctcagag taattacatg aatagtgga 126300
tttttatatt tggttaagtt ttttggggtt ttcatttttt ttctagtata gatcattttt 126360
cagttcagga tttgaacttt attctttttc agtacaataa agaagtactt agctggatat 126420

aggtagcata cacctgtaat cccaacactc agaagtctga ggcagaagga cctgaagttt 126480
caggctgctt gggctctgtt atgagactgt ctcaaagaaa aggaaggaag gcagggagga 126540
aggaagaaag gaattacttg cataagtagg tttctggata atcgtttgac tagttgactg 126600
tattcccaa tcattttggt tatccacttg ggatactcat aatactttaa acaaatgtgt 126660
ttttaaatgg ttacaagaaa aataactcac taaaaaaga gccctggaaa aaagtacagc 126720
cattctgata gtaaataagt atatttctct atacaaagca attatcttac tctccatata 126780
ccagctgggt ggittttgca ttttaattt atttctggc tgtgatgtc cctgtagagg 126840

tcagaggaca gcttggggga gttggttctt tgttcccacc atgtggattc cagggatttt 126900
gcagcaagaa cctttgctta ctgagccatc ttgccagccc cagttgtatt tcttactatt 126960
taattaaggt ctgtcattat ctacttggag ttagaatcac atgccacagc taaatctgca 127020
ttgcaagact gtctccagtt catatgccag tcccaagac ctgacctca gtaggtactt 127080
ctgactaatc agctatacag aatttctgca acttattcct tgtgacaggg caaaggttcc 127140
tccatgttgt cccagctgga accatctttg gtctaactga ctccaccctt tectaaacct 127200
gcagtgaaaa gtcccatggg aaagtaacca accctgttct agaaaaatca aatcaaaat 127260

ccccagctaa ctgcatgatt tttgcttctg ttgaactgct tgcttgcctt acttcccct 127320
gcaactgcca attagagttt ggtttttctg tgttgttttt attttttatt ttattttatt 127380
ttattttttc ctttaaaagc tccctgtaa atgcattcga ggctgctctg ctctgcagga 127440

ctgtttctct ccagctaaat aaagactcct aaattcacac tttggtgggt ctgagtggtc 127500
 tctgggtcac aaccctgcaa cactcctcag gatttaataa cttgtcattg tggtcacia 127560
 aactcaggaa tacacttggt ctttgttata atccatgtga gaaagttata gaccatcact 127620
 aatataagac caaataagag tcctttatit aagccagagc aggctcttgt cacaaagaat 127680

 tcccagccag aagttcagag atgcagcatt tataaagata aaaaacacia cagtatcatt 127740
 gttaggtgta ggttagggaa ccttgaaca ttcgttttga cagaacacag tagttgtttt 127800
 ggttatccat ttagtagtca ttttggtaa acatctgggc tatggttagg gtcgtggaaa 127860
 tgtactgcca agatagatat agtcattcaa ggggtgggtt ttcagttgaa agaatacctc 127920
 aacagacaca aaatggggtc aaggttaaggt caggacagga tgggtttacc ttagtcactt 127980
 gagtggatgt ttactagttg attgcaaatg gtatttataa aagacacaga tgaatagcca 128040
 cacaaagaga acattgggga gggcttagaa ggatccccag gacaggagct tttgcccaca 128100

 cagatatgga attttaagtc aatagcccag ctctggcagc cctagaaacc tagactgtgt 128160
 cacccatacc aaattaccag tgaaggaaat gagtaatgat gaaaaccaga gaaaggagat 128220
 ttaatcagtg tacattggaa gagcagataa agaggtccag ggatccaag ttcactttta 128280
 ggggttctga cacaagcttt aggcctaaat agagaaagat ttagggcagg atagcaagac 128340
 agatgcctaa ttaagtatta gtctgggtca agataaggtt ccacctatca ctgaccaatt 128400
 ctgctctggt accacaaggt attggaatgg ttaactctgc tataacctaa gggaaccaat 128460
 ctgtttccta catatggtac ttttactaca gagtgaagcc tcaccttcat gtagtaattct 128520

 cctattctca aatagtttgc cctctgagat ttggctcttt aaatcaagga tggctgtagg 128580
 ttttaagacag ttatttatca ctgtacttta agtcagtggt acaagtaggt cagagccaaa 128640
 tgtttctaga ttcttggcgt cttattcaaa gaactaaaag ctgggggggg cctcacagat 128700
 ttgcaaagga ggtatgataa ttttattcag aatgaagtca aagtacggat tatagaaaga 128760
 tatactctca agattgacta tggatcactc aggaatattt aaggaacca agctacagct 128820
 ttggttttct ttttttagag ttgtaaggga cagtttagaa aaggtcacac cttgcattnn 128880
 nnnnnnnntt aactgattag aacttcagtg agtgtgcaaa gttggaatgt tgtatgtcca 128940

 gagtcaaatt acagttactt ttagctctct taatagacat ttgttgcctt cctctgtgtg 129000
 tcatctaaag ataatcctt tggaaataa aaacaaactc cttatttcca ccaatccaaa 129060
 aactgagcat gccaacagat agcatctgag gtataatttc cttttcccc cctataacce 129120
 acctaaataa tgtgccatc aatgcatttt aaaagtgcc taattcagcc gggcattggt 129180
 ggtgcacgcc tttaatccca gcaactcggga ggcagaggca ggcagatctc tgtgagttcg 129240
 aggccagcct ggtctccaga gcgagtcca ggataggctc caaagctaca cagagaaacc 129300

ctgtctcgaa aaacccaaaa caagggccct aattcaggat tattttagtt ttgttacgat 129360

aaaaaatacc atgaaactgc taacttggga tgtggaattg ggaataacct gactagtgtt 129420

cagggccatg gtcattcata tcaggctcta gaataaacta tctctaatcc ctttcaggta 129480

agaatagtgt ttttgcata gttaaatcta aagaaggct gacgactaaa ggcatagtt 129540

taggtggttt tctattttga ttgctagatt agatcatata ttaatttttc ctattgtgca 129600

tgtcccttc cataattccc ctccctgcc caattatgca taggcacaaa atggatgaata 129660

ggggattctc ccgaaagt tactaacaga cacaattttg ccttatgggtg atatagccca 129720

aactagtgca tctgaatta actcttctat tctttgtacc tggatatact agaaatactt 129780

ttgttctcgg ggicttggag agggctctgta ctattttca gaagtagcct gatggaggtg 129840

ggaggcttaa agagtctga gattgctaga catatttggt catagaatgc acagataaag 129900

gagctgggct gccacgtgca ttattataag aggaaggagt gtttacaatc aaaaccaaag 129960

agagtctctg gctgaactat atctcctatg ttgcctgcct caaaagtaaa agttacagac 130020

ataaaacaag gaaagatgt caggcttata tctactttt agtcaccttg tcagtctgag 130080

tgaataggca gtctttttt aacaaaagca gttttaacaa aagcctatit caatatcact 130140

aaaaaattag tglatctca tgggggtag ggtatgtcct ttggtatgct gtggatgttt 130200

cttttattgg ttgatgaata aagctgtttt ggccaatgga caggcaggat gtagccaggc 130260

aggaaatata ggcagggtta ccagactaca agtattctgg gaagaggaac acagagtgag 130320

tctcgaggaa gacacatgt agcttctgag acagagcaac aggcctggct atcaccggtg 130380

gtaagccaaa accatgtgga gatacacaga ttaatagaaa tgggttaata attgagagag 130440

agctagccat taagaagtct gagccattgg ccaaacagtt aatatcaata taagtccatg 130500

tgagtttatt tgggactaaa cagctgcagg accaggtggg acagaaactt cagtttacia 130560

taggtatcta acaggacttt tcttttgat ttgcctctg cttcttttcc cttttgctta 130620

tccattctc ttagcctttt gttgaaaata tgttaattgc caaatctttc tgaagagcca 130680

tggaaccag aatatctagc ctttatagtg cccttctta gtttttaaca tgcagaatat 130740

gtctaagaca ggaagcaagc catggtgact cacatatgta attccagcac tctagaagct 130800

gagacagggt gattgttgtg agttcaaggc cagcctggac taccagtga ctccctgcct 130860

gaaaagaaag aagagggggg ggtggatgaa tglataaata aaagaaagag ctacagaagg 130920

tctatgtcca ttgtgatgtt ctgaccagag aaaaagagag gaaccaggga tgatgatga 130980

tggcaaacct ctcacctc ccctagccct tgccaccaa gaaaagccc taaattatgc 131040

tttcttgaga atctacact ctgtgtagta gaacttctc ctgatttctt acttggtctc 131100
 tgagtctttt gccagtgaca ggaacttga aatacctggt agaaaactta atttgggctt 131160
 tttttggggg ggtggttcga gacagggttt ctctgtgtag ttttgagacc tatcctggca 131220
 ctcgctcttg agaccaggct ggccttgaat tcagagatct gcctgcctct gcctctgcct 131280
 cccaagtgct gggattaag gagtgcacca ccaacgcca gcttaatctg ggctttttac 131340
 ctctaagaat tccccacta gccctcacta ccaacaaaac tgctacctcc ataaatctac 131400
 tttccttgcc tctaccctt gtcctggata tactttgect gttgtgggat ggactacttc 131460

 gaaaatgact aacatacagt tggagattgc taaaaatgaa aatctgcatg cctttaatcc 131520
 cagcgctcgg gaggcaaagg cagacagatc tctgagtta aggccgcctt ggtgaacaga 131580
 gctagttcca gaaagctag agctgttaca cagagaaacc ctgtctcaa aaaaggaaat 131640
 ctgtcttagt cacatttctt acatatacgc gcatgctcac gcacatacac acacacacac 131700
 atacacacac tacagctcag tgatagagca ttgccaatt ttataatgat gcaagataat 131760
 gacctcactt gaaggaggta agaaattatt tattctgaat atgggtaacc taggatactg 131820
 gtccaattt ctcagaaaa aactaatgac tttaaaatac aatagtacta gaaaacattg 131880

 catccagcga ctacatttgg tgggcataaa tcatatcact agtttgaggt aaagcaagga 131940
 aactctgacc attggactta gatagcatct tactgcattc ctagtgtggt aattactata 132000
 gtcaagtctg gagtctatct tttgtcaagt taggtatgct taacatgcat ccgcagaggt 132060
 taccttgtcc aactgatgct tgaagaaatt ctattctgat aattttgatg gcattctaaa 132120
 ttctgcaata tacatttatg accataaagt tcaactgattg taattgtgtt tccccctagg 132180
 aataaaagct gtagcttcat cctgttccga cctacatgaa atttcttga aaggatgctg 132240
 caatgtcact gatgaaggag tccttgcctt tgcaactcaat tgccagctgc taaagatcat 132300

 tgacctgggt ggetgcttaa gtattactga taagtctta caggcattag gaaaaactg 132360
 cccgtttttg cagtgtgttg attttcaac tactcaggta aatgagtcac aaacttgatg 132420
 caaattatgt gctgcctcaa ttgtcatcca tgactaatca gaatcacaca gttggttctt 132480
 ttgttattat tgaattgtt gaccatttct tggatataggt ggatgagaa tgatttttct 132540
 ggaatgcctc gtgtagcttg ccttcagaaa tagaacattt gcccaacctt gtaaccagct 132600
 tcatcatata ctttgagatc atttaaagct atacactgtg tattcagctt gtttaactat 132660
 aacttacctt taagaaaaac aacatgatct tctataactt tgtatcccc atgtaaatca 132720

 aactctaaaa gctaaggiga acacatagct ttgatctcaa cctacattcc ttatttctta 132780
 ctcataacta ctctacgcca tgacttggaa taaggatac atccccctg taatccttcc 132840
 atgtcactaa ctcaaaaca tgtgtgaatg tgtataaagt atgataacat gtttttgggt 132900

ttttcttgcg gtictaggac tatggggtca gagaaattac ttcttcccat gtgaaactcc 132960
 tgtaaaagat caaacaaaac tcactcctat atcatggctg atgtgctttt cagtaaacag 133020
 aaagtgtggg cctctgttat gaaacatcaa gctcacttgg ttaaacaact ccaggagtca 133080
 atttctttca tgctacactg ccacagggig gttaataatt gtactagaat ttacatattt 133140

 ctattcacta ttttaagtaa caaagatgga atatatgact acaatgcacg tttgctgaat 133200
 gggaggcaat cattcttcat ggtaaatgca ctttagaagt tctcttgtct ccatcacaag 133260
 tatttatfff ctcttttgcg cagggtgtctg acagtgggtg ggttgcactt gttagtggac 133320
 catgtgcca acaattagag gtaatffffa aatgtctatg aaaatattaa actttatfff 133380
 atcctcaaga aaaaaatcat gattattggg aaggcagggg actttgtaca tttggttctc 133440
 tccttcacc tttacattag ttctgaagaa ttcagttctt caggttcaag tggcaggcct 133500
 ctgtctgttg agacatcttt tcctctggc ccttttatct ttttagaggtt ttttatttgt 133560

 ttgtttgaat ttttgttttt gctttatatt ttgagcccag actggcctag aatttgcagc 133620
 agtctcaatc tcccatagt tagaatcaca gtgatttga ttccataccc agattttcat 133680
 actatfffft ttctttttta aaaaaatatt tgtgttctgg ggctggagag atggctcagt 133740
 ggctaggagc attggttgcg cttccagaga acccaggttc aattcccagc acctacatgg 133800
 cagctcacat cgtctgtaat tcaagttcca gtggatcaaa ctttgcacag acatacagcg 133860
 ggccaaaac caaatgtaca ttttttttaa tgtgtttgtt gtggctcatg tgttttaatc 133920
 ccagcactgg gaggcagagg caggcagatc tctgtgagtt cagggccggc cgggtctata 133980

 caataaatc taggccagcc agagttacct gatgagatcc tgtaaaaca caaacaaact 134040
 tatttttatt taatgcaatt ggggtgttttg cctgcatatg tatctgcact acatgcatga 134100
 ctgatgcgtg aggaagccag aagaggatat cagatcactt ggaactagag ttaaagagag 134160
 ttataagcag ttatfffft ttatfffft cataaacata agttatfffft gttatacat 134220
 ttggatcatg gtcagagtc tgaatgtgtt gccaaaggca acatggctat tgggtgggta 134280
 aggggctgag aagtatctat gcagacacaa agtggactca ggaaaagatg gagttagtta 134340
 ccttagttct ttatataaat ttttttccaa acttttttgt gctgttatta tagatctagt 134400

 ttaaattfff ttatttcatt ttgttttcta cataggagat taacatggga tattgtataa 134460
 atctaactga taaggctgta gaagctgttc tgactgctg tectcagata tgtatacttc 134520
 tttttcacgg ctgtccccta ataacaggic agtgtgacag gttacttcta tttaaatctt 134580
 gacttcactt tttaccaact tgcatataca acatattata aaatttatct ctgctaattt 134640
 taccttaaat attgttctgg ataccatccg gaaataatca aactggattt tectcttcta 134700
 tttttaatag aaaccaaact aggaaaaaa tttacacagt caatagaaaa atgattctta 134760

gacaaaagct taatatttat ttatttataat gtatatgtgt tcacatgccca tggtaggcat 134820

gtaaagtcgg aaggtaactt gctggagtca gttctctctt tctacatag gagttttggg 134880
atcaaaactct gcctgtctca gtgacaagca aatttactca ctcatggaac catctcactg 134940
gccccaaaca gcttaataa ataccataga aagtagagaa gtatccaatt atgtgacaac 135000
ctttgtgtaa ttaaaatfff gtttaatgct ttaaaaatga aataaatacc ataacactta 135060
aggataatga aatffffaaa aaatatacta cccaagggat atgggagggtg gtgtgcatat 135120
ggaggcaaaa aaaaaggaac taccfcccc aaaaaatgag tttagaggca aaaaagtacc 135180
agcccccatt ttgtgaagct gtggaagtta agcctggatt acattggaga tgccagagcc 135240

caagacatct gcaaaggaga gctgcagaca gggagtgaac cagccctaaa gagaactaag 135300
ttctaggcag caatgctaga gaaatggagc catctaagcc ctgacatctg tcatggagct 135360
acaacatttg gagtgtgtcc ctatfftagtc tegtattfccc tcactatgcc cccattcctc 135420
ccttgttaga atggtaaagta tattctgtgc cactataagt tggaagtata taataagctt 135480
ttttatffta caaggcttac aattaagaga gtgcactggg tgtacacacc tffaattctg 135540
aaacttcagg gacagaagca ggcagtttga atffaagggc agcctggctct ctataggaag 135600
ttcaaagact gccagggcta tgtagagagg ccctgaaggg ggtagggtgg ggggattgct 135660

ttgaatcttc caattgactc tgaactffga actfftaaaa agtgttgaga ctgaaaaact 135720
gtgaagactt ttgaagttgg accaaatgca tfftgcatfa tgatatggac acaagcctff 135780
gggggccagg gtttgaatga gactgatact catatgttca tgttcatgff tgatgfftga 135840
agacgtgata tccagttggt gaaactgff gggaaatgact aggaggtgtg gcctffctgg 135900
aggaggtgtg tcactaaggg caggctffga gggffffftg tffftcaaga cagggtffct 135960
ctgtgtaaca gctctggctg tcttggaaact tgcfffttag accaggctgg cctcaaacfc 136020
agatctgtct gcctctgcca agtgccagga cfaaagatgt gcaccacctc cacccagffa 136080

gactffftgag tffaaaagac acaattcaca ggtffftctct gctffctac tffatgggtca 136140
ataagtgagc tctcagccgt tcatgctacc atffctffftgc tcatggatag atagactcfa 136200
accctctgaa cccataagca caatfaaaca cffftctffta taagffgctt tggfcagggt 136260
atffcatcac accaatagaa acattagctfa ffacacatca ataaaggaca aaaaatcatcc 136320
aaacagaaca accactffgag aaaaatctag cacacacata ctccatffcc tgataagagg 136380
catctgffaa aagccaggtt aacagctffca cctacagaga aactcaatct caaagaccaa 136440
aaaaataaac aaaaaataat caaaaaacaa acaaaatffcc ccagfftaaca ctgtgatgga 136500

cccgtagaaa ctgttattgc cgaaaagcac tgactcctcc gttgggcctg tacttatgaa 136560
 aagcagaata aactctggat ctcagccttc attttacatt tgtacatttt acattccttt 136620
 acttcgggtt catcacctgt ttaatgcggc agagttaagt gtttgaacgc ctacctgaaa 136680
 tctgaggctc tctgtggagg ttgaaagaa aatggcccca aaagggatcg gcactattag 136740
 aaggtgtggt cttgttagag gaagtgtatc actgtggagg cagtctcata tatgctcaag 136800
 atactgagca gtctctcaga ccactttctg tcacctgtga gtcaagatgt aagaatgctc 136860
 cagcttctc tctagacca tgtctgtctg catgccgect tgcttctgc cctgataatg 136920

 gactaaacct ctgaaacaga aagcaggcca ccacaattaa atgttttctc tcataagagt 136980
 tgctgtggcc cticatagca atagaaccc taactaagac cctaacagag gtgagagtaa 137040
 ctgagacacc atctgtcagc ttgtatcata ttctattttg ttcttcacct gaaagtggcc 137100
 aattattgtc ccaaacctcc agtcatcttg gattccagga acagatctct aaagtgaaa 137160
 gaattctcag tgaattctcc ttagagcctc caaaaagaag ttcagacagg ccaaacccca 137220
 attttagtcc aatcagatcc attttagtat tctgcccttt aaaactgtac agtaataaat 137280
 tggtagctgt ttaaacct gaattagggtg cttgttacag cagcattgga aaactaatac 137340

 aaggtaaata cattgagttt cccatgtaa aaccaagca atcgtaatac cattttgcag 137400
 ttgctattgc aggttttgtt aaggattttt gaacctatat tcataagagg tcttgatttg 137460
 tttttgtttt tttttttct tttctttaa ctctcttct tttgtggat ctttgactat 137520
 atttgatgtc aagacagtag tggccttcaa cagaatgaac tgagaagtgc ttcccttct 137580
 tctacagagt ctctccagct ttgaacagaa gttctcagtg tgttgtatct ttgtccattt 137640
 cactactttt aacatgtgat tttgtttatt ggggtgctgg agttataacc aggaccttgc 137700
 acatgcttag caagcactgt gccactaact tacacccta atctgactgt atttttttc 137760

 tttttaattt acttttaaaa aaaatgttgt atgttctat gtgtgaggtg tgtgtgtgtg 137820
 tgtgtgtgtg tgtgtgtgtg tgtgtgtgtg tgnnnnnnn nnnnnnnnn nnnngtgggg 137880
 agatatgtag atgcttgtgt gcctatgaaa gccagagata accttacttg tccttcagga 137940
 gtcacccact gagaccata ccagcactag aattacaagt gtgcaatac ttattttct 138000
 gtttttctt ttttttttt ttttttttt ttttttttt tttttgagtc aggtctctc 138060
 aatgtgtaga tcagcagagc tacatggaaa gacctatct caaaagaaa aagtaactac 138120
 attttgggt gtgctaaac taatgatagt gaagagtaac attaattatt aatgacttat 138180

 tcagttgtat actgtgcttt ggattttaa agtacctta ttaccagg ctggcaatct 138240
 agctcaggtc ttccagagga cccaggttca attaccaata cctccatgat gctgtgaact 138300
 ccagttccag ggaatctgat attctcttct ggcctctatg agcaccaggc acacaagtga 138360

taagcacata aaatntaaaa gtaaatcaac attgtttttc aaaacagagt ttttctgtgt 138420
 agccctagct ttctgaaat tegtctgta gaccaggctg gccttgaact catggagatg 138480
 cacctgcctc tgcctctcaa gtgctgggat taaaggcgca caccaccatg tccagcaaaa 138540
 taaataatnt tttaatgtgc tttaaaaat acatttgttt gtgtgtagag gggtgcatgt 138600

 gtcactagt gtgtgtag agatcagact attcattcac cagccccatt gtgtttata 138660
 tttcatgttt ttaatcctc caataagcat gtaatagctg tcatcacacc tagatntat 138720
 tttttgttta tgctaagaca gcatcttatg aactggatct gccttaaatt cctgactctc 138780
 ctacctatac ttccaagta ctaatattaa aggcatgcat tatcacacc atcttacatc 138840
 cagnttatat atgaaacatt aaatatctnt tattattata aattaatata ttgtntct 138900
 cttntataga tcatctcga gaagtcttg agcaattagt aggatcaaga aaacttaaac 138960
 aagtgacttg gtctgtntat tgatctttac tgaggctgat ctcaagaacc tgtccaggat 139020

 atgctctata aataactgt tttcactta aactaattt attatntgt cttagttaag 139080
 ctgtaactcc cagagaatca gttcaactt atnttaaatg tttgtctnt taagttaacc 139140
 agcctcagca tttggcact tctattatcc cctgttggtt tgatgagca tetatntat 139200
 ttaatggtga tcttggatg tgtgaactgt acttgatgga gaggaggctg ggtntgtntc 139260
 tttataaca aaagtcaaa tgactatnt tccctctata gtcctntctc tggtaggt 139320
 atntgagctg ttgtaaaaga catttggggt agaattctaa ataaagatgc tnttaaaagc 139380
 gtaattactt tctagttga cttctggctt ttacctacat gaaatgtca tccaaaagca 139440

 atgtggaaca tatggcctgt tactcttca cagaaagaga tatactntt tcaactgaaat 139500
 cagtagtaat aatntgcccc ttaaaatgag acattcagct gcaaaagtgg ctcagtggtta 139560
 tagcacttgc ctactntag tgatgctagg gntggatnt caacaccaa aaaatntaaa 139620
 tttacaaaa gaggggtggg cagccattca acatattcga agtactgagg cttntactca 139680
 ctcatntcat tgatctntc cctgctcagt tctaggctt gatctcagg cctcatatat 139740
 accaggcaga catgctacca ctgagctata tccaaggca atntcattgg gntntatggc 139800
 tgctctntc aagtacatnt tnttcatctg tgagctntt ccttggcaaa actggattca 139860

 tagtntgtgg gntnttacta ggtatntaac ataggntcc atgcatgcta gtaggtgct 139920
 gtaccattag actatctca atntcagaag tntgtaaaaa ttaaatatga aatgctatta 139980
 tagagnttg tntggtggtt acacattct a gctctcagga ggcagaggca gaagcaggca 140040
 gatatctgtg cgtntgaggc cagcgtntc tagccagct agagctaca agtaagaacc 140100
 tntctcaaaa aaaaaaaaa gaaaaaggat cattatagag atntagntta ctgaagctct 140160
 actatntcac agcaagtca tntctagcag tcaataacca gatcatcctt ntgtntataa 140220

ccagttacag tagtaatctg taataactgc ccaagacttg tattgaaagc tagtcccca 140280

 tgcagtaatg tccataagtg gatcacgaga tctctgacct cactaatggg ttagttcatt 140340
 aatggattca taactgaatg gacttttggg aagatggggt tcatgagaac agctgtgagc 140400
 caatttttca tacctctttt atagggcaaa actgcagggt ggggattttg caagcaagca 140460
 cagttacaga agcaagacga ggcaattaag gaaatcttcc tagaactctg ttgttcctag 140520
 aacattctgt ggttatgctg ggagggggca gcccaagtct gataaacaca aacttaagtt 140580
 ttacagtaga cagaattggt ttctgatta caaaatggag ttgggctgat ttctcatcg 140640
 atgggaaacc taggaggtgg gactttgttg gaagaaaag tcagtccagt taggtccttg 140700

 gagggtttat gtiattcctg gtccttggct ctctctgctt cctggccacc ataatgtgag 140760
 aagccacttc tactgcacac tgttattacc acaatatccc acattgcctc cacacaaaac 140820
 aacagaccca acagagcaag gatcaaagcc tcagaaaactg agccaaaata aaccacccat 140880
 ttaagttgat ttatcagct attttgttac agtaacagaa aggtaacacc ccagttcctt 140940
 atctttccag agatatttta ttaatactgc agcaaattgt atatattata tccatacata 141000
 tagatatact ttctacataa ccagttgtat atgatacata ttattccat tttgttttag 141060
 agtacagtgt ttgctgtta taaaatcctg ataacctagt atatgaaatg ggaacaaacc 141120

 attactaact ttagtaagcc atatagagtc atccaagggt ttaaagcaaa ggaagaagga 141180
 attttttctc tcctctctc ttttttttg agacagggtc tcaactgcata gctctggctg 141240
 tcctagaact cactgtacac caggcgccgc tcaactccc agagatccac ctgcctctgc 141300
 ctccaagta ctgggattaa aagtatgcac cactatgcag gactgtacag agaaaatttc 141360
 aaataacttt ctccatgaga taggtctca ctatgtagtt ctggctgtcc aggaactaac 141420
 tgtagaccg tctggcttca gactcacaga gatcagccta cctcagcctc ccaagtggtg 141480
 gtattcaage ctcaagtcac cacaccccaa tgaattgcat tccttaaact gtacctccag 141540

 cagaggaaat aagagttcaa tacaacaga actgaacttg aaagcactct gacaaatcag 141600
 ggatgaaat ccacactgc gcttgggtc agtccactat tatcctgctg agttggctct 141660
 ggaagagtgt attcttctaa tttgtgtagc tgatgccgaa tactgtgtcc actgaactgg 141720
 ggctcccag ggtcaccaat caatactcgg gttctgtagg tccaaaagta gttctccagc 141780
 cacagatgca gactgtctgc aaggcttca tcataaaaca tatctccaag aacaatgaga 141840
 tcaacttac ctgtttggg actcaaatg tttttggtta aaacaggaaa aggattcagt 141900
 ccatttaatt tgcaatttag tgtaatgcc attcctgcaa cttacaaaac atgataaatc 141960

agtctacaag aattatatca gtaggctatt tttaatcttct tattaagggtg tttaaaaaca 142020
 ccttttttcc cacatgaact ctatatctca ttttctcttt cagcccaagc tttctcaaaa 142080
 cataagtatt tatcaacaat gattaatatg aattctacat aaggagtctt ttaacatata 142140
 aacaatttta ttctctttga gtaagatgaa aaatttaaca gacaatatgc ctctttctct 142200
 actcctcaga aaatagtatt tagaattttt tccaatttag taattgtaa tgtattatta 142260
 aaaattcaca aaaacatcct gtaactccat gacatataag ccttgtgtat atagtctgta 142320
 tcatttgcta ttiagacctc ttaaccaaga tcttaatact gatgaggaag taatttgta 142380

 cctttttggg aaagagaatg cctgtcataat catgcattta aaccttgcat aaatatttgt 142440
 ctctctagaa actgccattt ttacaaattg caaaagtcag tgggggatag tctgagtctc 142500
 tgtggttaaa cacctttttt aatctaatag aggccagtga gatggctttg caggtaaga 142560
 tgcttgacac taaatctaac aggagttaa cacctgaagg ccaggcgtgg tggcacacaa 142620
 ctcaatcca agcactcagg agacagtgc aggcagatct ctgtgaattt gaggctagcc 142680
 tggctctatat agagagtctt aggacagaca gctaggacta cacagaaaga acctgtctca 142740
 acaaaccaaa caacaaacaa agagttaaat gcctaaaaca cacatggttag gaagaggaaa 142800

 ccagatcgca caagctgtcc catctccca tgggatgtgc actatggcac acacacacac 142860
 acacacacag atgaataaat aattgtaaaa aaataacctt attaatactt atctcctttg 142920
 ttaaaagga tttgtttgtt gaatttaatt taactttatt tgcaatggtg ttttatctgc 142980
 attaactgt gtgtgaggtt atcggatccc ctggaactgt agttacagaa agtagtgagc 143040
 tgccacattg gtgctgggaa ttgaacctgg gtcctcagga atagcagcct gtgctcttca 143100
 ccactaaacc acttctccag cccctgttgt ttttttttt ttttaggca aagaagtca 143160
 aagtttatgt cagtacaac tatatactgg ctgggcatga tgatacatc ctgtcgtctc 143220

 aagactagat agtatacaac aggaagattc ctgcaagtat tagccaacct ggggtacaaa 143280
 gagaaatacc aggccatgta ggtctacagc ctaagacct gtctcaaaa acaaaacaaa 143340
 gaggcttggc atggtgttgc atgcctataa tcccagcact tgggagatgg aataggaag 143400
 aatccaagg tcatccttag ctctcatagct agctgaggcc atcctgggct atgtaaaact 143460
 ctgtctcaaa aaaaaagaaa aaagaaaaga aaagaaagaa ggaggaggga aggaaaaag 143520
 gagggaaagg gggagagga ggggagaaga gaggaagga agaggaattg gtctaggaga 143580
 gaacaggtta tcctactcc atacccttct cccagaacta cacctgctt gacagaacag 143640

 tttctcctt ctcaaaaag atgcttgtaa aatgtttaa agactagtgt tcctccttcc 143700
 ttggtgggaa atgacccctc gtttaagta aaaactgcac tagcatgcac ctgatatgat 143760
 ttaattgtgg tctttatct ttataaattc tgtggtgttt aatctagggg ctgagagttc 143820

actgtgacaa aagccttctc tcaatctctia gcttaaataa agcactctta tttggcctta 143880
 tagtcatggt ggtctataac caaagaagga cctttttaa aagctatatt gaatatagaa 143940
 gagcaacagt gggatTTTTA ggaccatttt ctgggtcttt ttgtatgttt gtttactgca 144000
 gacagaaaaa caattgttgg gcttgattaa gttacaagtg aaacctctta ataaaaaag 144060

 acccctggag ggccttacc taaatgaagg taggatcaga aaaaaaatc agatgaactc 144120
 tgtagtctac ttgactcagc ctccctgggt gctggaatta aaggatggg ctgcctgcca 144180
 taccacaatac aacttgggtc ttttttttt ttttaagatt tttttatTTA ttatatatac 144240
 agtatcttgc ctgcatgcat gcctgcaggc cagaagaggg cacaatatct cattacagat 144300
 ggttttgagc taccatggg ttgctgggaa ttgaactcag gtcctctgga agagcagtca 144360
 gtgctcttaa cctctgagcc atctctccag cccccacaat ttgggtctta atgcagtaaa 144420
 aatatccact aaagacacaa agttatctct acttggactt tgtgtcatat aaacattact 144480

 gacacattcc agggaattct caaccagaa gctaacatgc atgcccag tttgtatccc 144540
 tctggaatat ctgacaaata aatccaatcc tcttggggga atgcactgtc agttcaggcc 144600
 ccagataatg tccactgaa cacacctega agtatcagat taaaaacaa ggcaatcagt 144660
 gatcacaatg tatcctgaaa gggggacagt gagctttaaa tgttttaaaa tatgcagtcc 144720
 ttactgggggt ctatgtcatt ggccaagatc tttgatgcac cactcatctt agcagcaatt 144780
 gctgttgctc cacatccgct cccaagatcc aagacagact ttcctctaac aacatcaggg 144840
 ttatccaaaa gatacctaaa ttagaaagaa aacagaaaat acctgagtat gggaaaagac 144900

 agtaagaaaa ataataaat aaataaataa aaaataaacc aaaacaagca agatggttca 144960
 gcagataaag gtgcttggctg ccaagtctga tgaccaagt tcaacatagt ggaaggaaag 145020
 aattaataca taaaagctgt cctctgacct tccatgcac accatggcat acctgtgcta 145080
 catacacaaa cacacaaagc aattaatggt aatTTTTccc ccatggtata gaacctacct 145140
 gacctagacc atcgtaaca tactactcct ggggaacagg aatacctttt gtttgacaac 145200
 tatataacct taagacataa ccagatgaac tcatgaacaa cactagagca aagagtagat 145260
 ggacatgcta aaagtactta ccctatgcca ggcagtggtg gtgcacacct ttaaccccag 145320

 cactcaggag gcagaggag gtagattctt gagttcaagg ccagcctggt ctacagagct 145380
 agtcccaggg cagccaggga tatacaaga aacctgtct tgaaaaacaa aatcaataa 145440
 aaaagtattt gcttttgttt tagctactat ttcttaacaa aaagaatagt tgcagctata 145500
 tgaaaaaaac aagatggaca ggaaggagct taaaaatgca taatcatggc actggagaaa 145560
 tggatcagag gttaaagaca ctggetacac tcccagatgt cctgagttca attctcagca 145620
 accacatggt ggctcacaac catctgtagt gagattggat gctctcttct agtgtgcaag 145680

catacatgca gatagagcac tcacataatt aaataaataa ataatctta aaaaaattt 145740

 taaatgcaga ttcaagtcaa atgcagggtc cacctaagat gtcttgaac tgccacaaaa 145800
 cagaaaaatcc caaatgacca ctcatattc ctgtgtgctg aaaaggcagt cctaggagag 145860
 ggtggaattt acagtattag aagcaagatc attggagggt tgggtcttta agatccatct 145920
 aggaactctg tactgactgt tgatttggcc atgaacttga acacaaagta agacatatgg 145980
 atcttttatg accatgtagg ttcttttagca gttgacatta gagtttcttg tggggtagaa 146040
 gctttattha tggatattca ttaaaaatct tgtgtaaggt ggtgaaacta tgcaatgaaa 146100
 caccaaagggt aggatcaaac tactatcaaa acaagacttt ggggataagg agtgatgta 146160

 caaaagttag tatgagggtt ggaaagttag ctgagcgggt aagagcactt gctgctcttg 146220
 tagaagatcc aggatcaagt cctggaactc acatgacagc tcacagctgt aactccagtt 146280
 ccagaggatc tgatgacttc ttccagtctt cacgggcacc aggcacatat gaggtataca 146340
 aacatacatt caggcaaac actcatacac aaaatagata aatccaaaag aaagtttcaa 146400
 agaaaaagt gcttagtggc acatgccttt aatccaaca ctagaaggca gaggcaggtg 146460
 gatctcttag atccaggta gcctggctca cagagtgagt tccaggacag acagagctac 146520
 aataggaggt ccctgacaag aaacttttaa gggaggatgt gtttactttg aaggaacaat 146580

 ttggagatat aaactaatct atcacggaat gtctggcagt agggggctgt ggcagtagac 146640
 atatgagatt gtttctcac atcagtaaaa attatgaaga aaagaattct aggactcagc 146700
 tagctttctt cttttttgct atccacattc aaggtgggcc ttcctcagt taagctaac 146760
 tggaaatgct ctatcttggc tagcgtttgg tttttttgtt tagttttgtt tttgtagact 146820
 tgacaaatgc ctccaccaga ctggcctggt agcaagccta tgggacattt tcttgtttaa 146880
 tgatttgctg gagtcaacta acaccagggt ccaggtccca aagaggaggt atggagttag 146940
 tgaggtaaag gaggagacag gatctgaggg tgaatctggt atggctgcta ctttactgta 147000

 gctgcacaga agattaaatg ggaggaggag ggcatgtgag cttggctgtg gcttgctcac 147060
 atcagggact aaggaagtta gaattggcct taacgagtta atagtcacca cagtcatatg 147120
 ttaatgaaag ggccacaagt tcctcttggc agagataaaa atgactcact ttttaacaag 147180
 aagggacttt cttcaggccc ctgagggat aggggctgtc ttaagagttt ttattgctgt 147240
 gaagaaacac catagctgtg ggggactaaa gtatttccgc tatagaatat tttgagatcc 147300
 agcctttggt ctactaac atggagcacc gaaagctccg gccactatt gtattgttaa 147360
 tgccagtagg gctactattg tttagcgtgg cctcaaggta atgtcctct tatttgcac 147420

tctgtgggcc taagcatctg aacagccct cacctggatg gaggggctag aggtatatga 147480
gtaacttgtg aggatggaag gttaagagt aggggcgagt ggccagagca gagaggggac 147540
aaagagagaa atggttccct cgtggtattg gcaggatggt taagaaacac cagaaaagat 147600
ggctaataaa gaaatgactc tagttccaca acacggaact gagagctctc tgaagatgac 147660
aagatgcctg tgtttgatct ttatcgccat tgggttgctg ggagcttcca ggttgggcgc 147720
ttccaggtec acacaccccc actcaggcgg aacctcatgg ctgtcgtggg ttaaagctga 147780
ggcaagccgg gtcacgacac atagccatgg caacccttat aaggaagaca tctaattggg 147840

gtggcttgct tatagttcag aggttcagtc cattatcatc atggtgggaa gcacagcagc 147900
atgcaggcag acatggtggt ggagaggtag ttgagatttc ctacatatca caggcaacag 147960
gaagtcaact gagcatagga aacctcaaac accaccccc acggtgacac acttcctcca 148020
acaaagccac actcactcca acaaagccac acctcctaat aatgccactc cctataagat 148080
gggggccaat tacattcaaa ctaccacatt caaactacca cattctactc cctggccct 148140
gtaagcgtgt agccattatc aggatgcaaa atgcatttag tccaactcca aaagtccct 148200
tggctatca cagtctcaac agtctcttct gaaaatcatg ccatctctta tctgtaatca 148260

cctataaaag tcaaaaataa gcagatcaca tactgggatg aagaccccag gccttgccc 148320
agaccctgc ctggtcacc cctagacatg acaggctgca gaaaatacaa agcaggatac 148380
agcaggatgt gctgtacacc tgacattgia cagtgcccc tgacctgtc ctattgcta 148440
aaaagaaacc gaaatatccc atatatggtg aggaaccaat taggagctaa cagactctga 148500
atgtgcttcc ccataaaagt ggaatgtagt aaccacaaca atcacccaag agatagcaat 148560
ctccctgcag ctacaactaa ccaattaacc acagtcaggt gtccccagct cagaggtata 148620
ccaatcctct tagtctgttc ctaggcagtc tatatccct aacccccct tgctttacc 148680

tcaatatata cctacceca ctgctactct gggtctctcc tactccacca ctgtgacgga 148740
cagacacgtg accaggtgcc aactcacaat taaaattctt tgcttttga tcagatttg 148800
tctctaggtg gtctttggg tccagatctg ggcataagaa ggatatacat taccattctg 148860
aaattaagga agggcgaata gtggggaat accagacca agcaaggcca aaaccagct 148920
gggtaaacac caaattctgc atttccatgt ctgatgacaa atcactcttc aggtcccaa 148980
atcctttcag ctacttttt tctcttgggc tggttccact cctttagcag ctctctcag 149040
cagatatccc atggatgigg catctccaat attttggtc tctaaaacag tcagaattca 149100

ccttcacage ttcacacaat ggcctctcta ggcctctatt cagtacacc tctgacacat 149160
gcctggacte agagacttcc cttagtctca gggacaaatt ccatagcccc ttattctat 149220
ccctaactcc agaagctgcc aagtctgcc gcttactggg gctggacatg gcctcttgt 149280

tagttacatc ttcatcaatt ttctgtcctt cactgcctaa gcttggctgt cctgaaactg 149340
gatctctaga ccagacctca aactcacgag atctgcaggc ctcagctccc taagtactga 149400
gattaaaggt gtgcaccacc acacttggct ctccagcttct ctttaatgcc ttgacacagg 149460
ttggaagatg agatgggcgg ggtcttgccc tgaggctcact actcccttta ttttatgtaa 149520

tatcccgtc ttctctaate tgctgatctc cctgaatata ggatttagct ctattccact 149580
tcctgggtgcc cttttctcc ttgaactgta cttttgtat ttctccttgc tcagcttgcct 149640
ccttttcatt ataatcttc atcagagtta aactaataa ccatacaaca gacaactagg 149700
ctgttttgag attccctcta ccaaaagaat taatccaaaa ctcttcactt tagcctcagg 149760
cagactcttc agacaaggac aaaaagcagc cacattcttc accaaaatat cacacggaca 149820
aattctagga aacgtactaa aatgcttcta ggaaatatct tgatctagcc atggacaatt 149880
taaatcatta tcagcaccat tgtcttccat gctccatgct taaagcattc ctaaccctaaa 149940

cgaccaaagt ccaaatcccc acaacaaac catggtcagg cctatcacia caatacttca 150000
gtccctggta ccaacttctg tcttagttaa ggtttctatt gctgtgaaga gacacatga 150060
ccatggcaac tcttataaag gataacattt aattgaagta gcagcttcca gttcagagat 150120
tcagctccatc atcatttctg gggagcatgg tgggtgagcag gcaacatggt gttggctaca 150180
tcttaaacag aaggcaacag gaagtagact ctgacactga gcaaagctta agcaaatgaa 150240
acctcaaage cggccccac agagacatac ctcttcaac aaggccatac cctccaaca 150300
aagccacacc cactaacagt gccactcct atgagattat gggggccaat tacattccaa 150360

ctaccacaag gtcttttctc taaatgctg accttgggaa aaggacttcc ttgggggact 150420
agacactcca ttacagatta cagtttttta tatagctttt atagttacag aatattggat 150480
atatagtttt atatatcaa ataggtaaag cttaaagtaa gcaaagacia agctagacia 150540
atattactgt gaaccttagg aatttatata tcttatcaaa tatactttat ttatcaagca 150600
tattatctaa attttctagc agcttagtat taacttgtgt gggagtaggc agaattatca 150660
cactataggt ttccacagtg gcagagattt tttttcaaaa gaatcattt gttaaagag 150720
gctgtcattt tatgcattt catcttcaa agccataca aaatttcca aagggaagg 150780

cagaagggaa ctctcataac acatagttag aatcattaaa aatgaaagt aaagggtgct 150840
ggagaattgt gatccacaaa gtgcaaatgc tggaacttgg tcaaagcagc aatgatcctt 150900
gtggttcaca ccaatgattg atgtgggagg gccagctca ctggggcaat gcaactgagca 150960
ggtgatcccg tatggtatta gaaagcaagc tgagcaagcc atgaagagca agccagtaag 151020
caggatcct gcatggcctc ggcttcaatt cctgcctcca agtcttgagt tectgcctg 151080
atttccaga tgaatgggac atgactgaa agtataaaat gaaataaacc ctttcttccc 151140

caagttgctt ttggttgctc tttttttttt ttttttatta cagcaatgga aactctaaca 151200

aaagcatacc ctcataatca tgcccagagg tgtgtcttgt aggttaattcc aagtccaact 151260

gagttgacaa caaaggttac ccatgacagg tgtgaagaga acaactttgt tnnnnnnnnn 151320

nncccccaa cccccaacct cacccatggc aactgtgaaa atcaagaatg taaatacaca 151380

gagactaaat tttttaaga aaccattggt atatatcaca gggcagcttc aaactcctaa 151440

ccctcctgga tcagcttcca aatgetagaa gtacaagtga agggaccagc getgctcccc 151500

acttttgga gccatgacaa gctaacgcat gcttgcctga ccttgctggg aatgccttgg 151560

tcactaggag gccagatgcc tcgtggcaag gaatcaatca gaagttagct aacaggacca 151620

cgctttattg ctctgaatgt gctttacgga caagtgcaca acaatgacat gcagagcata 151680

gcaaccgccc tggaagacc tatgggcat aacaaccaat tgaccaatca acacagggca 151740

agctgtccaa gctggaagc acagcaatcc tgagactgtg cgtaccteta gacactcccc 151800

taactctgcc cttttaagat ccctgcctca tggtttctag gggcttttc tctaaccatc 151860

tgctgcagag gatagatgaa agggccgagc taatggggtt agctgtttaa acaactgcaa 151920

taaaagactg cttttgcat gaaatgggccc tcttggatgat ttttgggttc agaatttggg 151980

cacaacacaa ggatgtacac atcatcacga ataactacat aggaggcctt tttggagatg 152040

actatatctt cccataggac aaatcctctt ctacgagagg attctacaaa tacaatctt 152100

ctacaaatcc ttiacgagaa ggaaagcaac ccataccata tacaagttgg aacatgtgag 152160

ccccagtac ttcttgttt tgctgttatg ctaagggacc agaaagaagg gaatggaggt 152220

gggggtgggt gctgagagaa tgactcttca atagccatca gccgtaaaga ttcacatttc 152280

agtgagacat acctagacag ggccctggcca cctggccagt agattgcca gtagggatca 152340

ctgtaggccc acagctcagc cctttccac cagaacttgc acctgggggt caaaagccgt 152400

aactggattt caggggtaag gctaccactg ctggtgactt cagtattctc ctccaggtag 152460

gctttcatct cagggccaac acagctcctt gctgtcctcc aggaaatcag agggaacca 152520

ctgctcacag cctgcaggaa actccaatgg ctcttgaag tttccaacc cagtctgaaa 152580

gccattagta ctctccaaa tctcaggctg tcagtgttgc cattaaaagg attgttcccc 152640

aagcagatac aatgagggtc tgccctcca cttagttgac actggaattt tggatctcta 152700

caacaacaaa acaacaata ctgaaaatc ttagtccata tccttcaaca taacaagaaa 152760

ataagcaagt gtatgttcta acaactcaca agtacaagtt catttcagag gacagctttg 152820

gcttatcaat ttgggtaag aaatccagtt gctttttttt tactgtgtaa tccttttagt 152880

aattcactat gacaaaaata cacagacatt ttatfffaca acaatcttca agaaaatgaa 152940
ataaagtata cctffffggc fffffffffff ttttaggata gacttgtgtg gtgatatt 153000
gtttatgatt tattaaagcc actggagatc aaaatagcaa agcagccaca ctctttacct 153060
atagaagcta ggcagtggg gtacacacct ttaatcccag gactcagaat taagaggtag 153120
acagatatct gttagttaa gatcacactg aactacacga aattaacca gtctaaaag 153180
atacagctca cacaaaggtg atctcagcac ctgggatcac acgtctttaa tcccagcaca 153240
atgggtggag acaggagtga tatgactggg cagagaaagg aatataagga agaggagaga 153300

gaaattgaga gcctffffg tctgagggtt tgtggagaca ggattgcat ttcagctggg 153360
taaaggftaa gatctactgg ctggctgct ttgcttctct gattttcagc ttgaagcttt 153420
aactccaatg tctgtctctg gatcttttat tttccttgc tttggggcta aagatatagc 153480
taaccagtta gagcacctga tgctcttga gaggaccag gttcagttct tagcaccac 153540
atagcatatc acaaacataa ctccagttcc aagggatctg gtgcctctc ctggctttgt 153600
tgggcaccag acacagacag tcaagtacac aggcagacag acaagcaggc aggcaggcag 153660
gcaggcagac agacagacag acagacagac agacagacac acacacacac acacacacac 153720

acacaaggca catgcacacc cacatggtac atttatacat atgcaggcaa aacactcata 153780
cccatcaaat atagacctgt actgtagcct aggcggcatt ggaattcact atgtagacca 153840
acctgacatc aagcttgcag ttacctctt gcttctgtct cttgaatgct gagactacag 153900
gcatacgcca tcataccag catggatttc attgtaaaag gaccacagct tctaagtcc 153960
catcaatact gacttgactt taccaaacct aaacttaaaa tattataac ccaaagtaca 154020
ccttggttag gaggaatgag gaataccttt tttgtttgt ttgtttctg gcacaaggtc 154080
tattatgtag ctctggctgt cctagaactc atgcattgaa ctcacagata tgtgccacta 154140

tgctgcctt gttgctgtt taaagattg ctttattat gcgtctgtgt gtatgtgact 154200
gtctgcaaag gccagaggca ccagctccc ttataggcag ttgtgagctg caggacatgg 154260
gtactgagaa ctgacctgg tctctgcaa gacagcaag cgtcttaac cctgagctat 154320
ctctccaact cttgtttgt ttcagatggt ctcatggctc agattggctt ccatctctct 154380
aagcagagaa ggatggtctt gaatttctgg ttctcaaca tcacaagtgt tctggtgcca 154440
ctactccaga gttacttgtg cttggggtca aacacaaggc ttcacagtg ctgggcaagc 154500
actctacaa ttgacctta acaccacagc attacggaat tactctgtat ttggacaaca 154560

tgtcttcca gcactgacag tttgcttatg aagaagtat aatcaaagta tgttataaga 154620
aagctagcag gctgggcatg gtatgacaca ccttgccttt aatcccagaa cttgggtggc 154680
agaggcaggc agatctccat gaaagaaaga agcagggatt taaaaaaaa aaaaaaaaa 154740

aaaaaaaaa aaaaaaaaa aaggggnnnn nnnnnnnnnn nnnnnnnnnn nnnnnnnnnn 154800
 nnnnnnnnnn nnnnnnnnnn nnnnnnnnnn nnnnnnnnnn nnnnnnnnnn nnnnnnnnnn 154860
 nnnnnnnnnn nnnnnnnnnn nnnnnnnnnn nnnnnnnnnn nnnnnnnnnn nnnnnnnnnn 154920
 nnnnnnnnnn nnnnnnnnnn nnnnnnnnnn nnnnnnnnnn nnnnnnnnnn nnnnnnnnnn 154980

 nnnnnnnnnn nnnnnnnnnn nnnnnnnnnn nnnnnnnnnn nnnnnnnnnn nnnnnnnnnn 155040
 nnnnnnnnnn nnnnnnnnnn nnnnnnnnnn nnnnnnnnnn nnnnnnnnnn nnnnnnnnnn 155100
 nnnnnnnnnn nnnnnnnnnn nnnnnnnnnn nnnnnnnnnn nnnnnnnnnn nnnnnnnnnn 155160
 nnnnnnnnnn nnnnnnnnnn nnnnnnnnnn nnnnnnnnnn nnnnnnnnnn nnnnnnnnnn 155220
 nnnnnnnnnn nnnnnnnnnn nnnnnnnnnn nnnnnnnnnn nnnnnnnnnn nnnnnnnnnn 155280
 ncaaaccgcc tggagagacg gtgtgggcag taagagagct tgcttctctt cttcaggacc 155340
 agggtttggg tcccagtgcc aatgtcccga agtgtgtact tgtaacttta gcttctggtg 155400

 acacacattc ccgtctccac agacattcac atacacacac acattcacac actcacacag 155460
 acaccaagc gcgcgcgcac gcacgcatac acagataagt aaacaaaca ataaataaaa 155520
 aggttaaatt ccaaacagtg cttgtgagct cgttactttc ctcagaaaaa aagaaaaaag 155580
 aaaaagaag aaaaaaaaa gacaggacta tactttttaa aggggtagtg cggttcttgt 155640
 ggcttacct gatthtctg gagtctctcg cgcaaacgaa aaaaaagaa aaaaatgtac 155700
 acagagtctt ctttctcggg agaggaagac agctggaaaa acacagagcc gccgccgaa 155760
 cttnnnnnnn nnnnncccc cccccccgc caggacacac cagctccgcc tttcttcta 155820

 gctgtgcttt gtctggggc tcgctggcta cccaaggcag ctgggaaagt gaaagccctt 155880
 ctgtaacctt gagacttta gaatggggaa agtggcccca ggtcagtccc tgtagacctg 155940
 gagcgcaact gcacagcttg tgtacgccgt gcttgcgcaa tcctgattta taaaacctcc 156000
 tgcagaattg tatgcagccc cactgcgtgc caagcacttt taagagtaag tgcctggata 156060
 ggtgggtaaa cttttatga cacattcaat tgctataaat cataatatgc ggctccacta 156120
 ttgtaaagtc acagcctaag gctatthtctc agcctgtggg gctcaggttc tgaatctctt 156180
 aatccacct ttctagttag tttagatttc cactggccc cteaactcac gactcaaaa 156240

 ttaaccatc tactttcat taatgaaat atgctatgat gtacaagaaa gaaaaaatac 156300
 cccaaactaa aaaaaaaaa aaaaaaaaa aaggattaaa aaaaaatctg ggacaggcgt 156360
 tgggtgtgga tcctgtgag tttgagacca gcctggctca caagagctag ttccaggata 156420
 gcctccaaag ccacagagaa accctgtctt gaaaataaat aaataaaaag aatctgagtg 156480
 gtgatggtac ttgccttaa ttccagcact caggggtcaa aggcagatag atctctgtga 156540
 gttcaaggcc tgctgtgtct atagagttag ttacaggaca gccaggacta cacagagaaa 156600

ccctgtcttg taaaaattaa ttaattaatt aattaaata aaataaaaaa ttttaaaagt 156660

 ctgtatattgt ggcttgcctt ctgtcctaag catgcttgtc taactgcttg ctaagcatgc 156720
 agttgtactg ttatggggtc ttttgcttgg atctcaaata gctcaaaca caagtcaatg 156780
 aaaaaaaggt tattataatc aattctgcta actgatcaat aaggaacaca gaacagaaca 156840
 gacttgggag ccaaactgtc acccgaacc agaatactac agagatttta acacaaaaac 156900
 cacaaataag gttttacca attaggattc agggattggg gactttccta gggacattac 156960
 tttatggttc acttctgttc tcactggttg gtttgttcac ctatggctat gtggctaac 157020
 ccacatttat gtctcaactt accaaacagg ttgtcagtta cccagggagg tcttgggaat 157080

 ttaaaactta ttigaccctt actcaaaatg gaagttttac tttaaatggc ttacattgcc 157140
 cccttgtctt tacattattc aaatcttga ttatctgttt tagagtataa gggattgtat 157200
 tgggttctta ggaccatgag cttaacttag ttaactctag acagaacaaa ttttaactaag 157260
 acattgagga tacaacgcc tatgagaagc agaagagaag gaggaccagt ggtcttgcta 157320
 aggtggtgag caaggtggtt ggccaagggg aacaatcaa gagattctgg aaccagttac 157380
 tggactgtct cctttgttc tcctattca tcagttttgt tttacttttg ctacggtgtc 157440
 ttggacgagc ccagaatgct tggcataaaa acaacaagtt tcccacaatg ccatacagag 157500

 acctctgtcc ttaagaaacg atagatccag tcctctctg tttttagagg ctacttctgc 157560
 cagggagtct gtttttctaa ctgtcacatg gagaagtaaa ggtggcttag gtctctgtct 157620
 gcctgtctgc ttaggagtgt gaggtttttg ttttggtttg ctttggtttt ttccaaccac 157680
 caggaaggct attccccaaa ctgttgagcc agcaatgcca gttcctaca gcaaaggtag 157740
 gagctgaatg agatgggctc ttcagaaatg agtggctcca atgaggatta taccagctca 157800
 acctgtctga ccattgaagt atagaacctg agggatgatg taaacaagaa tacggagttc 157860
 agatttgtct gagaaatggg ttagagctac acagtgggta ataccagaca tgcagacaaa 157920

 acaaatgata ggigaactca tgagaatgct agccagtttc cttcaggctc catcttttgc 157980
 catggatgga gtatgtatag ttatcattac aatatgtccc ataagagat ttggtcaaag 158040
 aaaaagctgt caatctcaag caagtctcta tgcctggat atcccctaat gtaatagaca 158100
 catgaataga ccaaaggcat ttatcatctg cctggcctaa ggttatctgt gtgatagatg 158160
 agtctttccc tgggtgtggg atacttgcaa tcctacatt gtggtgatat tattcatgat 158220
 ttattaaagc tagcctgagg attcagaaag tgaatcagc cagaagccat agaagccagg 158280
 cacacatctt tcatcccagc agccaaaagc taggaggtga tggtaaacac cttaaatcct 158340

agaactcagg attaagagat agatggatct ctgtgagtcc aaggccacac aggatacaag 158400
 agattgaatc agtctaaaag aaaaaggaat cacatgcctt taatcccagc actagagggg 158460
 tataaaagat agaagcagag tatgagttat tcattctcca cccacactga agatagcagc 158520
 attcattctc cagccaaact gaggagaggc agcaatttga gacttgggtga agagctcatg 158580
 cattgatcag ccctttcagc ctaagataga agtgagagct agtgaccagc tgctttgctt 158640
 ccctgacctt cagcttgaac cccaaaatct gtctcttggg catttattaa ttcattgttat 158700
 ataacataat aaaggagcct aggggtctaaa cacagtcaat actaccagag ctaaactttt 158760

 agtccaagac tttctgcttt ccttttaatg gttttccaac tatctataac taggagcctc 158820
 caggaagaat aacaccatta taccaagtaa cagccccaaa tatattatca tttgcctcag 158880
 atgaatggta tgittattcc tactaatagg acccacacc taaaattcca gaatagtctt 158940
 agataccttc tatagtaacc aatagctttt aatggcctat attaattatt tatgagtagt 159000
 tggtagtata atgacatata catgigtatg ctggtatact tgtcaaagat ttagagtagt 159060
 aggggttgtc agactcaatc agttgtcttc tttaatccct tctataactt attgtttcag 159120
 attgtttttt tttctatga acttggagct ccctgctgca gctagactgc tggccagcaa 159180

 gccctagaat ccacctctct tctctgctc ccctctctg cccttcccct tcataactga 159240
 aattctagca cctggttatg tgtctgagc aagggtagaa ggaatgctgg agtttgaggt 159300
 tagccagtct gaactatata atgattatca ggccagccag gactatgaag caaggccctt 159360
 tagcagatac ccctacctac ctatccccat gcacagaagt ctgaaagctg gagctgggga 159420
 gtagtagaga acatgcctac cataagtaag aacctggttc cattcatcct gaccaccatt 159480
 taaaaaacia acagccaggc agtgggtggc cactccttta atcccaacac tcgggaggca 159540
 gaggcaggca gatctctgtg agttcgggac cagcctggtt tacaagagca agttccagga 159600

 cagcctccaa agccacagag aaacctgtc tggaaaacia aacaatacaa aacaaaacia 159660
 acttagcttc ccctgattat atccaataga aatatcattt agcaatgtca ttgcatttc 159720
 tctacacagc ctctcatgag gcagaccatc ttaagccttt tctacttttt ggcacaatat 159780
 agaaagtgtc agaaattcta ttaagcaaaa gttaagagca ggtatatgta tagttagcca 159840
 acattaccag gctaattgct ttctgttcc tgtgacaata tataatgaaa aacaacttat 159900
 agaagaagat tgtggggttt tttattatta tattttctgg cttatggttc ctgagccaga 159960
 atggcagggg aggcattgata gaagatgtcc agagcaaaaa ggtgaatgat cacattttca 160020

 atagcaagga aaaagtaaaa agagctaaat glaagtgagg ctaggatact gtcttagttg 160080
 gagttctgtt gtgaagagat gctgtaacca tggcaactct tataaaaagg ctgggcagtg 160140
 gtggcccatg cctttaatcc cagcactggg aggcagagag agacagatct ctgtgagttc 160200

cagatcagcc tggcttacia gagggagttc caggacaacc tccaaagccc caaagaaacc 160260
 ctgtcttaaa aaaaaaaaaa caaacaaaaa ctatttaatt gaggctggct tacaatttca 160320
 gaagtttaat ccattgtctt catggcagct catttattct gagccaaatg tgaaggacca 160380
 tggaatgggt tattctttgt gacacatttc accatgaaca tgattacatg aatgttcaca 160440

 gtcacagatc aagacgaagt aaagcatttt ccacatacat tgggtgggcat atcaggtaga 160500
 cagagttata gcaaagtgag aaatctgttc tgtagtttca gatgctgtct tatatacatt 160560
 tttagctttt aggggtgggg aagctaagtc actacaaagt tcatcacat tcattctgaa 160620
 atcatatata gaccacactg gcatactgat gtggattatc cttatctcct tcaaccagca 160680
 atgtctgatt atgtttccat gcacttacca gatgtcttaa ttagggcttc tattgctgca 160740
 atgaaacacc atgacctgtc caaaaaaaaa aaaaaaagtt atttaaaat aaataaaaaa 160800
 gccgggagtt ggtggcgag gcctttaatc ccagcactcg ggaggcagag gcaggcggat 160860

 ctctgtgagc tcgaggccag cctggtctcc agagcaagtg ccaggatagg ctccaaagct 160920
 acacagagaa accctgtctt gaaaaacaaa acaaaaagaa aaaaataaat aaagtaaaat 160980
 taaaaaaaaa aagaatatgc cttgagataa ggatattggg ggattgacta taactcagtc 161040
 aaggacttca gggataagga gaaaatttat cttacctgt cattcttgct gttaatctag 161100
 gtgtccctgt gtctcttttg tcctcctga gacctctgct ctgggacaga gcatggcttg 161160
 atgcttcaga ctatgaattc tagtattaaa aggacagacc gtgacctaac agcacatgtc 161220
 tgctgttac accagcaag tacactaaa ataggaactt ttatcccttt tattcagttt 161280

 ggggatgaat aattcagtaa attggttctg aaggttactt gcctgagaaa ctcccatcat 161340
 gtcttctga ttctttacc tttctctgg agtcacctag attccatgat tgataaacat 161400
 ctttataage tgggtctcaa actacccca agtaacatga gcttcaggg cctgctatat 161460
 ccagatgggg acaaatatcc atgattgtga ggccttacc tagagcagaa gcagtcatct 161520
 gaggagaacc agactgttcc ctgaggagat gacagagata acttctcag gaccaaactt 161580
 gagacaataa gtaacagaac acaccttcac tggcaatgct gagtgtcttg aaagcgtgt 161640
 ttgacgaagt tccagtgtt ggacaacttt gagtgaaccc tacacaactt ttgcttgctt 161700

 tgctcagaa acatggaact atcatggaca ggaaaagatt ttgattatga aactaatgac 161760
 aagttgtgt gccagactc tgaactcca aaaccaccaa gagactagat ctgatgcaat 161820
 tgaattcaa cgiattgaa tcaatacaag cctagacagg gacctcatcc aaaaacgccc 161880
 taagactcaa ttgcaggggg tttataaagg caaagatcaa agaataagat taggggtacc 161940
 ggttcaaage tgattggctg cagagtccag ggttttatct cttgtacat ttgtgtccgt 162000
 aaaagttgtt tcagcttttc agattgggtg ctccctgggg ttagggccat ttgtctcccc 162060

ttccagcctg ttggggccat tcgaaggttt cttcccttc agtttgtag cttttccaga 162120

 gggggtgggt atggtgtaag ccatcttcac aggtcatggg gtcaggttct cacatcctgc 162180
 cgtttttgac cctttttctt tagaatggtt ctgggatggc cttcaaagc ctggtgccct 162240
 tctgaaggca aagcaagctg ttttaggaatc ttaatgttct tctccccitt gcaggattgc 162300
 aataaagaga ggggtcctat tgaacaaaag gtttatgaca aagtcacaaa aggaaatag 162360
 gtggctcagt gacttttcat gtcaggactt ttctgatatt gtggaaaaaa taaagagcag 162420
 aggacaacac ttcaaaaacc aaagggaagg atggtgggct tacatcagat ataaaagaaa 162480
 aagaaaacaa aattaacaaa ggcactgagg gattaagtcc ccaagaaaag atcagatatt 162540

 cattatagta gattaatcaa ataatacaag gtaagtttga tataacaggt gtaggaaat 162600
 aacttctgat ctgtttactt agtcaaacct agagacatcc tgtctagaat gtctgtagct 162660
 ggaagggttt atggcactga ttttaaggaa aaagacattg agttaaaga attgatttta 162720
 tcagaatgtt agattttagg tctcatgaaa tttgctgttt actcattttg cttcttttac 162780
 tttgatacgt ttatctaate aaggaagact ttagaaaaag taatgtacca tgaaaaggct 162840
 ttgtaataca tgattacagt ctatgaggaa ctgattttgt gtgtataaat aaagtctgtg 162900
 agagttgcag gcgtcagag taggtcagac catactaaga tgtgtccct ctctatcctt 162960

 ctcccataaa agaactaaaa atgtccacgt ctgtggctgc tcttggccac taagtctgag 163020
 tattgggcaa aagcctggag atttggatga accacaagac tcctggctct tttctgagag 163080
 aatgtctccc acctttcttg tggagcagcc ttatatacaa acttacaaaa atcccaggct 163140
 aaagggttca caacagaata ttgatcccag tggggtgagg tcaggaaaac aagaggtacc 163200
 tgtggttatg ctggaaaaca actcttagag accccatggg ggctgggttc caacatctcc 163260
 ccttcttta tatatacaa aatagttatc aagtaagaac tataagattt taaccattct 163320
 atcttagtgt gttactataa ctatcttcaa ctccatcaaa gaacatagaa ggataatata 163380

 taaactctag aactgacaga gagacatctt gcttctaga cagtcaccga aagtttcttg 163440
 gtaacgttgg ggcattccatc ttttgcttac aggcaacaat gtatctggca gacttctcag 163500
 caaagcagga aattctaacc tgtccacctg cattggcagt ttgtctgaca tctttttct 163560
 gtgtctgtag aatgtctggc agactcttc atgaagcagg gaattctaaa ctgtcctgca 163620
 ttgacagttt gtaactccca tgaagcagga accctttagg cttttctctg tgggtcctgc 163680
 atgtccagtt tataaagcaa cagttaaaag agtagcttct tgcccaaatg gctggcttgg 163740
 ccatacaaa gtcaaacctc ataacaagt tcttggatgc ccatcttct ctcagatgta 163800

attggtgtgc caggagcagt tgtgtctcac tgtcaagaaa aacctaaac catttaaatg 163860
 ccatattttc ttaggtctt tgaatggtat gaagaatatc tataatatcta gaaaacctaa 163920
 ctggtatcaa caaatgagga tccattccaa tacaaaatat catttctata tcatattcct 163980
 cttttttcct tttaaaagtg attgactgtg accactacca tttctaactg accaaattta 164040
 aatgaaaaat attcagatca cctgggccta ataccatacc agcccttcac cctccatgga 164100
 aataaaagca gaaatttccc tcccaagtaa cctgtacttt cccaagtaac ctgtgcttta 164160
 acaactgttt ctcttcccc agcaattaac gatttaaaga caacacaata gcattctttt 164220

 gttaannnnn nnnnnnnnnn nnnnnnnnnn nnnnnnnnnn nnnnnnnnnn nnnnnnnnnn 164280
 nnnnnnnnnn nnnnnnnnnn nnnnnnnnnn nnnnnnnnnn nnnnnnnnnn nnnnnnnnnn 164340
 nnnnnnnnnn nnnnnnnnnn nnnnnnnnnn nnnnnnnnnn nnnnnnnnnn nnttcctgta 164400
 tggctttttg tagggcctgg gtcttttctt tatccacttg gacatatttt cttttctcat 164460
 ccgatcgcac agatgatgtg gatggcttgc gatgagggtc ctgggagacc ggctgaaagt 164520
 ccagggtcat gtaattcaca ttgccagtac tctttttgga gctaggttgt tagtgccact 164580
 gggtacaggg gatgaagact ttgggttctg catagaaact tagttctcct cactgtctct 164640

 ggagtctgtg ctggtgatgc ttttgtgga gatggaacgg cagtactgag agaaacagga 164700
 gttaaaggtg tggttgactg agaaccaata ctggtgaca ggtgacttga aaggaagccc 164760
 attgatgaca gtgtgttttc tcaggtcaag ggttattggt gcaagtgttg atactcctga 164820
 ggttcactga tagacatggc aggcctggatg tggcttgaca cagggggctg gctagagtgt 164880
 gaaggagata aggactttct tgctcggagc aggtgctgac tggagctgct gaactcagct 164940
 ggagaagagc agagactatg actgaccgaa gaaaggtttc tctgggtgtc agtgctctct 165000
 ttagtctgac tgaagccaca gatctggcag atgctctgga cccacctatt aatgtcagcc 165060

 tctgtctcag ccacaagata gaaggtgagc tcattggact tgatatectg cgggggtttc 165120
 ttggagtgtt cattcttgta gtagtcagaa catctgggtc accattcatt tgacctctcc 165180
 gcagaataaa ccagcatttc ttccaagcat agtgccccaa ctttttctca ggaggtgatt 165240
 tctccagcca gcgcacaaca catcattgcc ggctgactgg agtcctcaac aggctcaagt 165300
 ggacaagagc atgggctgct gggctcagctg gcagctggtg cacagctcaa gagggagggga 165360
 ttctcagtg aaggatttcc cgtatttctt taataatfff cttagcatta ttacttaate 165420
 caaagttaaa atgaaatctt accagtacct tgtctcttta aactttctct gtgtgattga 165480

 ctgtgatctc tattccaate caactctctt aagagctgag gcaccctttt tccagctttt 165540
 tgccaatcca actccctcag gagttgaggt acctattttc tagtaccttt tgcaatccac 165600
 cctcacaact cttacttgc tttccagcct tctgcggtg atctctcagg gtcccctttc 165660

tttcccgatc tcagtgaaac ctccatctgt ggctgctctt ggccactaag tctgagtatt 165720
 gggcaaaagc ctggagatct ggatgaacca caagactcct tcctggctct tttctgagag 165780
 aatgtctccc acctttcttg tagagcagcc ttatatacaa acttacaaaa accccaggctc 165840
 aaagggttca caacaggata ttgatcccag tggggtgagg tcaggaaaac aggaggtacc 165900

 tgtggttatg ctggaaaaca actcttagag accccatggg ggctgggttc caacatgtgt 165960
 ctgatttcac cctcttgaa cccacccctgc cctgtgttcc cctggagctg gactatggca 166020
 cttcatcatg aatgcttaat tgtgcatgcc tcaattatct ctctacaaa accatgtctc 166080
 cattggtatc taacttgctc cccaagtcag gtctagtat ccatccgaag taagccaact 166140
 agaagagcca aattaaaata gaagcagaga acggagatct attcaatttg actacattcc 166200
 aaagaagaac aaagagatcc agtgaactcc cctcagagtc cttcttcagg gtgctggaag 166260
 tgagactggt caaagaagga tgtcatttga acatcattat ctggggtttt gtctcatcct 166320

 gtaaaatggt ctggcaagtc attacaactt tccagactgg gcattggtgg cacacacctt 166380
 tagtcctagc acttgggagg cagaggcagg tggatctctg tgagtttgag gccagcctgg 166440
 tctacagaga aaccctgtct tgaaaaacca acaaaaannn nnnnnnnnnn nnnnnnnnnn 166500
 nnnnnnccc tctctgactg ggaatcttct gtctccaaa agacattggt atgccagga 166560
 cttgggacct ttgctaaaa ggtagcttat gctttaggca tatccagaat agtagtgaat 166620
 tgccatcgag cacctccttt aaaggtcact gtgtggtgtt gagnaagcca gctggaacac 166680
 ctccaagca ttgagacgt cattaaggt tgattacacc agcgggagga attttcctt 166740

 cattagtaag gcttgtgtgc catcttttct tttgttgcatt ggaatgggac ggaagagggg 166800
 ggataatctc tcaattgttc ttccagctcc tgtgtcctga gtaactgctg gcctcctgag 166860
 aatgccaatg cctgatctgt ctgaatcccc tcctagctc ccatggtagt ggaagacat 166920
 cataccggg aagaataat cttgtatcag accagaagag atttcgggat caccgctgct 166980
 gttgttgccg ctattgcat atttcggaca ttgccattgc tcagtctgct tccaacgaag 167040
 aaactgttaa taaccttctt ggcagagtc ggcagagcct ggccatgcag aataccctaa 167100
 attccatat tcagtttgat ttctgtaaaa aatgtttcta tgggagtgtc cagattgaat 167160

 gcatatttgg ctggaccctg gaatgattct tttgtaaagt ttacctatgt tttggctcat 167220
 cagattgtag aaattaataa gatgaggggt gttccactct caggcgagtg gtgggggaat 167280
 gccatgacc agttaggggg ctgggtgcag tgatggggag gcactatgct ctttaccatt 167340
 atgggagtac tctgctctg tctggggtta tttgactat gcaaagtcca gtggaccttc 167400
 caacagaagg aacagatata tagacaagtc ctacttagcc tcacccatgg ttctcctgat 167460
 agccatgaga ttggctaca gatgctcact caacaagaga tctgaagggg tctccacgac 167520

aggcaacca tgggacactg cccacaccta aacaggagat caggccctcc aatgacgggt 167580

aaggggcagg aaagcctatg tgacctaaaga cggggacccc tcatataaaa caaaaaaggg 167640

ggaattgtgg gaacaaagtg gccctggcag aaaccaaca accacctccc cccaatgcgg 167700

ttgcaaaaca tgtttactgg agcagaatgt tatttcctt ctgggaaatc tctggcctaa 167760

tctgttccga gaacaccatg tccatgccct gaaccaggc ttgtgactag ccgcttcttc 167820

ctaagtccc cctccctctt ctggtgctag ggtataaac caccagga gaaaaaata 167880

aagggccttc ttaccacaa gccagctccc tgtgtgtta atcccgacat gctccgcaga 167940

tcagattct cagtcccagg ccatccggcg cggcaacttc cctcagttgt tttttatttc 168000

cccactatat agtaataaaa agaccataa nnnnnnnnnn nnnnnnnnnn nnnnnnnnnn 168060

nnnnnnnnnn nnnnnnnnnn nnnnnnnnnn nnnnnnnnnn nnnnnnnnnn nnnnnnnnnn 168120

nnnnnnnnnn nnnnnnnnnn nnnnnnnnnn nnnnnnnnnn nnnnnnnnnn nnnnnnnnnn 168180

nnnnnnnnnn nnnnnnnnnn nnnnnnnnnn nnnnnnnnnn nnnnnnnnnn nnnnnnnnnn 168240

nnnnnnnnnn nnnnnnnnnn nnnnnnnnnn nnnnnnnnnn nnnnnnnnnn nnnnnnnnnn 168300

nnnnnnnnnn nnnnnnnnnn nnnnnnnnnn tggagagtg gatcttacta ccaggtagag 168360

ctggagatag atatggatga actcttggac atggaaagtg ataataccg ggcttctaga 168420

gtcaaagagc ccttagttga ctgttcaaaa cccactgagg ccttcatctc tggcctgcta 168480

gacaaagtcc ggggcnnnnn nnnnnnnnnn nnnnnnnnnn nnnnnnnnnn nnnnnnnnnn 168540

nnnnnnnnnn nnnnnnnnnn nnnnnnnnnn nnnnnnnnnn nnnnnnnnnn nnnnnnnnnn 168600

nnnnnnnnnn nnnnnnnnnn nnnnnnnnnn nnnnnnnnnn nnnnnnnnnn nnnnnnnnnn 168660

nnnnnnnnnn nnnnnnnnnn nnnnnnnnnn nnnnnnnntt aaaaaaaaa aaaaaagacc 168720

catacaatt ttcagttta agttttacag aagcaaaggc agcagttaac acctcacagt 168780

ccatcatctt attcttatct cacttgcagg agactaggag ctccatgta ttccagagca 168840

aaaggtcaac agcccttaag ggatgatgcc tagctccata ttaagtttct gtagtcatca 168900

ccagagacct aatgactgag atagattggt tcatttctgg tcaggcaaaa acatggtgcc 168960

attgggttag ggctggctgt cacatcctca taatattaa gagacaaaac ctgcaaattt 169020

tggccattta gacacatggg caattgtcac agttatcttg aaacagagca agccaggcca 169080

gctgttaacc tgggcatgc tgccctgctg gcagaattat gctgtttctg atgagagaga 169140

gcacaggctc taatgagcag ctgttagcct ggcttcttc ccagaactgc caggcagaaa 169200

catggtcctt ttgatgcga agcagtcctg gtcaacagac ttaacaaaa acatcctcag 169260

tnnnnnnnnn nnnnnnnnnn nnnnnnnnnn nnnnnnnnnn nnnnnnnnnn nnnnnnnnnn 169320
 nnnnnnnnnn nnnnnnnnnn nnnnnnnnnn nnnnnnnnnn nnnnnnnnnn nnnnnnnnnn 169380
 nnnnnnnnnn nnnnnnnnnn nnnnnnnnnn nnnnnnnnnn nnnnnnnnnn nnnnnnnnnn 169440
 nnnnnnnnnn nnnnnnnnnn nnnnnnnnnn nnnnnnnnnn nnnnnnnnnn nnnnnnnnnn 169500
 nnnnnnnncc ggttcaaac aacttttaa ccaaaagcaa tgcttgggtg tttgctatct 169560
 tggctaata tcaagccagg aacatcctgt ctttgggat agacataggc acccattccc 169620
 aagaacaaca atatcgttca aaattcaaca aagcatattt atagaaataa gggtagattg 169680

 acataaactg tttgcataca gttagcttag ttaccactca ataaagctga ctcaattcct 169740
 catggccaga ggtaatttat taccattat ttccataaca agaaaggaca accctgggct 169800
 ggagagatgg ctgagaggtt aagagcacag gcagctcttc cagaggtcct gattttgatt 169860
 cccagcaacc acatggtggc tcacaacat ctgtaatgag atttgtgccc tcttctgacc 169920
 tgcaggaata tatacaggca gaacactgta tacataataa ataataaat aaatcttgaa 169980
 agaaagaaag aaggaaagaa agaaagaaag aaagaaagaa agaaagagag aaacaacat 170040
 gatttacagc tggccattag gctcatccct gtgtcaaaga acacacctct aataggettg 170100

 gagaggggcc tgggtgtgta tggggagggc aggcacatcc aagattaagt cctagtctgc 170160
 cactaagttc ctgtgctttt accaagaaaa gcatataatt ctgtcaagta ggcaagatga 170220
 acctgggtaa caactatgtg aaaagaacaa tctggggta cttagaagt aattctggca 170280
 tcatcctttg ctgtgtaaat ctcccctctg cccaagtagc cagacttgta gtctctattt 170340
 aaattgttca aagtgtaac tggggttggg tctgaaaga gatttaagga tggcagtgta 170400
 ttagaaaagt atacactgat aacattttgt atttaagact ggttccttta ttagccagaa 170460
 ccagtcaagg gctattatta aagaacgttt tgttagacc cggaaaact caggcctccg 170520

 gggctcagc ccaggacctt ggtcacceca atcaccaggc ggattcgaaa gettgetgca 170580
 aactgcatga ggctttattg ttgtttaacg agttagcccc atgtagctg gtttctttca 170640
 gccccgcc atggtggatg gctagcaaag acagctcgaa ggggctgcat agagatcttg 170700
 tagggcagtg taaggggagt gtctaggagt acgcacaggc tcaggaatgg tgtgcctcca 170760
 ggcatggagg gcttgcctg tgttgattgg ccaattggtt gttatgacct atagacctc 170820
 ccagggtggt tgctatgctc tgagcgtcat tgctgtgcac ttgtgtgtaa agcacacca 170880
 gagccgtaaa gcatagtgcc accagctaac ttctgattgg ttccttgcca cgaggcaggc 170940

 atctgacctc ttagtgacca aggcaaggtc atagcgagca cgtgttactg tcatggctnn 171000
 nnnnnnnnnn nnnnnnnnnn nnnnnnnnnn nnnnnnnnnn nnnnnnnnnn nnnnnnnnnn 171060
 nnnnnnnnnn nnnnnnnnnn nnnnnnnnnn nnnnnnnnnn nnnnnnngaa atagttggtc 171120

atgatgacca gtctctggag attgttatta ttaatagttt ccaaggaata ttattatctt 171180
 caacaactgt ctggtttcta aaaattgtta tgggttacc tgctccagag caccaggtt 171240
 ttaaaaaata gtcaagtcac tctgttcct gaaaaaccac tagctattcc atggccttgc 171300
 aggtgtaaaa accaaaaata cattccaaac ccctcatggg caaaattgta agttcagttc 171360

 ccaaccaatc agtaaatgac tcatgtatgt tataaccaat caatatgttg tcacactcct 171420
 gcctagtgac caaaaagata taaaaactgc ctgctttaga aactcggggt cgatctcttc 171480
 tcagagaaaa gagtcattct cttctcagag aaagaccca acacattgga ataaaatcct 171540
 tttgcttttg catcgaactt gtgtctctgt agtgactctt gggctgtgac tcccaaagtt 171600
 ggtccccctt ttgggcccac caccaccagt gccagcaaca gtgaccgaag aaccagacca 171660
 ggtgagagtc tgggattaa gaaggacaca actcaggtca ttccatagaa acgaaagcca 171720
 tcagtttatt gcagccagca gtttatataa caagaggaga tggataaata ccacttgcta 171780

 gcagaacgca ttcccatgcc ccatcataag gaaaccacaa cccccacca ctgcaacaa 171840
 agcaaaaagg ggatgggggc aaggcaatgt ttcaataaca agaaaggttc ataacaggat 171900
 gttagtgggc gaggcttaga aaaacaggag gtgcctgtgg ttatgctgga aaacaactca 171960
 cagagatccc atgggggctg ggtccaata agctggggca tttgcctac cttctccac 172020
 cccaccctt tttggggggg cactgtaata ttacttataa gttgaacatt tggtaaatgc 172080
 tcataattgt agaaatgaat agtttagtaa ctatcttctt aataaataac tcagttcagt 172140
 cttacaactc aagagttcag atgcaagcaa tggataaatt aaattatc tgtaagttt 172200

 caaaactgag tcaaacctg aagtgcctgc atctgtactc tccagccca aggctgggct 172260
 gtcttctc cagaggctct tccctataa atccagacat ttgggttacc cttcttttt 172320
 agactattgg tctgctgga gctgtacctg gttctctct ttgctcctt cacctccct 172380
 tctctgcaca tggtcacgt cagcctagt gtgtccact tggactctc cagatgtccc 172440
 tggccctgg tcccttatta gccagaacca gtcaagggtc attgttaaag aacctttcc 172500
 ttgttaatct ctaaatgtc ttttatctac aataaacttt ctctccacc atacctaga 172560
 gtagtcatgt tcttctctt ccttttctt tttccagta cccaagcaag tgtgattgcc 172620

 tgtgcaatcc aagaataacc tccacacaa ctctgcagg aagtttgatt tactagatct 172680
 taattcttgc agcttctctc tccaatgaat tgccttatga taaatcgcta gcatgagctt 172740
 tgtgggtatc tggaaattc ctgtttgtt cctggctctg taacagcaca ggctcacacc 172800
 ggtaaacat tactgtagaa agagctgaac cccaccaat ctttagctaa ctgatgggtg 172860
 ggtaccacct agtggtaacc taatttaag agcacaagc cctacctaa aaaagatctt 172920
 taaaagacaa aacagaaata atgaaacagt ctgatgtgta aagaacaaag attctagcag 172980

gcaaaggTgc gTgtttcttt aattgtaaga tatggcagaa atacttatta ctgataagta 173040

gatatgcctt aaagtTtaag agcaattttg tatcatctat aacacattgt tttttccctc 173100
tccctcttgt aagcaccact tcactgattt aatacagttg tccctaacc cttcagtttc 173160
cacccttctt cctttgctct ttcctctaca gaaaaaccac aacaaccccc tttcagaagc 173220
cagccttgge gacccccat gcctagctag cgcaccagca gnnnnnnnnn nnnnnnnnnn 173280
nnnnnnnnnn nnnnnnnnnn nnnnnnnnnn nnnnnnnnnn nnnnnnnnnn nnnnnnnnnn 173340
nnnnnnnnnn nnnnnnnnnn nnnnnnnnnn nnnnnnnnnn nnnnnnnnnn nnnnnnnnnn 173400
nnnnnnnnnn nnnnnnnnnn nnnnnnnnnn nnnnnnnnnn nnnnnnnnnn nnnnnnnnnn 173460

nnnnnnnnnn nnnnnnnnnn nnnnnnnnnn nnnnnnnnnn nnnnnnnnnn nnnnnnnnnn 173520
nnnnnnnnnn nnnnnnnnnn nnnnnnnnnn nnnngacagg gccaccccc cccccaaaa 173580
aaaagtagag cccagcaaat ggaaggacag gctcaaggat ggagacttga agagtgtcc 173640
tggaacata gcaatgaaag gccaaaccag agccatccta gaaaaaagg gccaaaaaca 173700
gcactatgtg aaaacctgac cccatgacct gtgcagatgg cttacacccc cccccaaaaa 173760
aaaccacca ccaccaccac cggaaaaget gacaggcagg aaggggagat aactacaac 173820
aggcgggaag gggagacaaa tggcctgac cccagggggc aaccaacctg aaaaactgag 173880

aagcaacttt tctggacaca aatgggtaca agagataaac ctatgaaaag tcccaattc 173940
cccaggactc tgcagccaat cagcttcaaa cctgtacccc taacctatt ctgtgatctt 174000
tgcctttate aaccctcac ttatgagact tgagacctcc tcctgcagct gctgtgccag 174060
tctgtggaac gaggtccctt ctggaagggt ctaacatgga ggataaatgc aagttatgaa 174120
ggtctgagaa tgaaggat aaagatctga aaatggaagg tctaagatgg taattaaggt 174180
gcatgaatta aagttatgaa ggtctgagga taaaaagact caagtatga taaagtgagt 174240
tgagacatta aaaagaatga aatatgatcc tgatttctct atttctcatg ctactgttea 174300

tagtcagtaa agttctaca taccactaga ggttcataac tacaaggta agattgaaag 174360
gttcaggcat tatgtctggc tgcacctgtt acctggttga acaggcagta ccctggtcag 174420
ccaaggttc catgggaact aagtctgcac gcagggttag aggacctt taaaagatag 174480
gccccgccc atttacgctc tctgttctc tgtctctctg tttctctgtt cccgctctct 174540
ctgtttccc ctctgtctct ctatggcgac cagctatggc agtcagccat ttaccctgt 174600
tcctctctt ggictccca ttctgccggg ccttataata aacttatagt cttatgtctc 174660
atgtctcage atttctctt tcttctttt aaacaaaaca ataacaaaga ttaagatgct 174720

ttttattatc ctaaaaaaat ctgtcaattt taaaatgta atgctttcag ccaagttgct 174780
 tctaacaaaa tatgctgcta atatgtctaa tactttatggt tccacaaact ctaaggatta 174840
 ttgtaagttc cagggagccg aattggatcc aaacaaacag gggagattca ctccagttat 174900
 tcaatcttcc ccigtgccca ggactccctt cccttatctt gggacacctc gggaaccctt 174960
 ccctcatctt acaatcttcc ctcaaatacc aggacctaag aaaaaaaaaat ttctaaattc 175020
 aaccttgtec tctgctctgc caacatcttt ccaggcctaa gaggetccag ggagtccat 175080
 acatcccga ctgcaatgaa acaaccatct accccaggac gtggcagcac cccaaccttc 175140

 tcagatcccc caaagatggt caacgccccca ggtcagcagg aatcagcctt gagatttctt 175200
 catecctact tcctaacct gccacgcccc attcaccaac ttttataata aaccacagcc 175260
 gggattgtaa gaacaatata tttggatgac cccaccccc taacgacagg tggggcacgc 175320
 acaggaaac gtgctacgtc atcaccaggt caccacaat gcattatggc ctgcatgaga 175380
 actctgcgca tgcatgaaac ctcagtgcgc atgtgcagcc ttccccctt tctccctctt 175440
 tgactcctct tgggttggt gacaaccaa ctccatctc cccctcttct ggtaataaaa 175500
 ctccccatgg gttgtccatc cttagcttcc tttctttaca actacagctg cagcttaaaa 175560

 gaaaaacacc ttcgtaggct tgaattaaaa caaaacaaat ctttgtgcac ttgcatttgg 175620
 taagtggct ccttagtgat ctctcttggg gtcttgtgga ctaggcataa acaagcaaaa 175680
 tccccatca aaataaaatt ttaaaattta tctcaaaact taaaaaaaaa aaattgtcat 175740
 tgttaggtca caaagtaggc ccagaaatgg ctgtgctgta gacagtgtcc taagatgaca 175800
 gcctgggtcc agcccaggcc agattcttat ttcataaata gaaacctaac taaactcagc 175860
 attccagggc tggagagatg gctcggccgt taagagcact gactgctctt ccagaggtcc 175920
 cgagttcaat tcccagcaac cacatgatgg ctcaaca tttatagtgg gatctgatgc 175980

 cctcctctgg cataaagtgt tacatgcata tatacagctc tggatatgta tatattgaga 176040
 aagagagggg gggggagtgt gtgtgtgtgt gtgtgtgtgt gtgtgtggg ttgtttgtca 176100
 ggaaagccac tacttcttt ctctgctcag catctagttc ctgattaacc caaacaacct 176160
 gcagcagctc taggacttcc ccattateac ttaaattcca cttgttttcc cactgagcag 176220
 gtgctctctt ttcccagagc tcagcagttt gtcaccagc atatatttta cctacagaat 176280
 ggtctagttc agtggtttgt cccctttctc agaagtccac atgacttaa taggaagaaa 176340
 ccagagacat taaggtacag tagggataac tagtgtttgg taagctagtc gggatgacat 176400

 tgacattgca ttgaatgcaa ctctctccat ctccctctc cctcccttc tgccttctca 176460
 actctaact gctctctctt tcttgacaag atctcaagtc tttaaactca ctatcacacc 176520
 ccctgcccc ctaggattat gaggttacag gtatgtgtca tgatgccaa ttcaagtatg 176580

ctagagattg agcctcagag cctgtaagca ccaggcaagg actctaccaa acgagctgca 176640
tctccaacac ctatctatct tctctctccc agcctctccc tctcctctc tctttctgac 176700
atTTTTTTaa aaataaggtc tctctctgtg tgtcttagct actctgctat tgctgtgaga 176760
agatgctatg atgaaggcaa cttataaaaa gaagcatttg cgggctggag agatggctca 176820

gaggTTaaga gcactgactg ctcttccaga ggtcctgagt tcagttcca gcaaccacat 176880
caccatgctc acaacctct gttataagat ctgggtgcct cttctgggtg gcagatgtac 176940
atggaagcag aatacataat aaataaaatc ttaaaaaaaa aaaaagcatt tgccagggtg 177000
tggtggcaca cacctttaat cccagcactc aggaggcctc accatgctca caacctctg 177060
ttataagatc tggtgcctc tctctgggtg cagnnnnnnn nnnnnnnnn nnnnnnnnn 177120
nnnnnnnnn nnnnnnnnn nnnnnnnnn nnnnnnnnn nnnnnnncc tttaatcca 177180
gcactcagga ggcagaggca gtcggatctc tgtgagttcg aggccagcct ggtctacaga 177240

tctgtcagga gacagccctg gttagatata aaagtctcct ttacaagagg cttggggacc 177300
tccatctaaa ccaccaatth agtcaagcac cccaccctt aggttagtgt tctgagataa 177360
accacaggaa tgttcccga cacctgceca ggcctgaggg cattaaaaca cccactctc 177420
ccccttctt acttctctt tctttactt ctcctttctc tttaaaact ccttgcttaa 177480
gttcaataaa cagacctgg caaccattg cttggctttg ctctttctt ctctccatt 177540
tagtgttctg agataaacca caggaatgtt cccggacacc tgcccaggcc tgagggcatt 177600
aaaacacca ctctcccc tccctactt cctctttctt tacttctcc tttctctta 177660

aaaactcctt gcttaagttt aataaacagt ccttgacaac cattgcttgg tctcctctt 177720
tctttctcac ccatttatth tcaggcttag tccccctga gactcacgaa ttaccagaac 177780
cccgaggcgc ggggcacaga tcgagtcca ggataggctc caaaacaata cagagaaacc 177840
ctgtgttgaa agaagcattt aattgggtac ttgtttacag ttttagagga ttattccatg 177900
attgtcatgg tgggaagcag acaggcttgi cactggagca atagttagga gctttacatc 177960
ctgatgtaca gacagcaggc agaaagacac acagtgggcc tggaatgggc ttttggaaacc 178020
acaaagttag gctggagaga tggctcagag gttaaagca ctggcttctc ttccagaggt 178080

cctgagttca gttgccaaca acatgggtgt tcacaatcat ctgtaatgag atctggtgcc 178140
ctcttatggc atgcaggcat acatatagge agaatactgt atatataata aataaatctt 178200
aaaaaaaaa aagaaagaaa ccacaaagcc aacccccaat gtcatactc ctccaacaaa 178260
gccacacctc ttaatcttc tcaaacaaac agctccacta actggagacc aagcatgcaa 178320
atacattage ccatgggagc cattctcatt caaaacacca cagtctcaa getcacagca 178380
attctgcctc agtcccctaa atgctggaat taccagccta caccactaca tgacctaaa 178440

gtttcatttc cattctaata tctgtaattc tagagaaaac agagagtcac ccatcacct 178500

cttccttggg ttcttttct gaatgagttc ctgcacagat caaagtagaa actgtatata 178560

aaggacagag tataccgttt caggatgatcc cagggtgtggg catcttact attaacagtg 178620

gcaaatgata acctttgacc tctgtgtctg tctgcaggag acacagaaag ttggtgagca 178680

tggcaggtta cttctcctc tttccacaag gcatcattgc aacagagtag cttgagcttg 178740

ttgacaagaa ggetttcttc tcaccttcaa cagcaccaca tattttgtat actttattat 178800

tagagccatt ggttgcctgac agttactcag ctgctatctt catttagctc ccttggttgt 178860

gcacctacca tgactctcaa ttaaaattcc taacagaatc caagtctgaa accagctggc 178920

ctcacctat ccatttcatt tcatctccca ttgcttggcc cccagaaaagc tccactccag 178980

ccaggctgag ctctttatcc ataggaacc tatgcattcc tgtgttagac tgtgtgctgg 179040

aaatagctct ctctttctca tcactgagtt taaatccagt aatgggatat gacttgcctg 179100

ttaagtgcct tgctcttgaa caagtgttct gtttgagatg ggacccact atgttgaact 179160

tgtccttgaa ctcttagatt caagcaatca tccatacggg agtcccagta gtagctgtgc 179220

tatcatttct agtttactgc aaattaacat caggcaaatt acttgatctc aatctctggt 179280

tgtcagggtg ggtggaaagt gcctttcacc tctgagccat ctttccatct tatttatctt 179340

gaaaattggc atttgaaaa aaaaaaaca ggttgggttt taaatggatt atgatgaatt 179400

ttacaggatga aatgacaaat ctgggaactt gaaaggttgt ggaggttgat actcctcaac 179460

cttctaagt actacaaaac ttttaataaag ttctcatat tgtggtgatc ccctcccacc 179520

aggccatgaa attttcattt gtacttcata actgaaatct tgctactgtt atgaattgta 179580

atataataat ttiggagaca gaggtttgtc aaaggggtca caaccacag gttgagaacc 179640

tatgatctag ggttcttgtt gctttatctt ggttttataa agtctctgtt cgttcaacat 179700

cttgtgtgac tttttttttt gttctgcccc cccccagcca tcaactagaaa tagtttagta 179760

tctatgaatg aaattgtaag agaaatagaa gaaggcaaaa aaaaaaaaaag atatatatta 179820

tttaaaagga tgtgtaggac tggggaatgt aggctatgg catagcactt gcttagcaat 179880

tgcaaggcct aaaattcaaa ccccagcaca gcaatggcag tttaaatgaa aatgtcccct 179940

ataggctgag atgtttgaat agtttggttt tagttggtgg tgatctttgt gtagctttag 180000

gaagtgtgtc cttgctgag aaagtgtgtc attgagaatg gccttttagaa gccgggcagt 180060

ggtgatgcac gcctttaate ccagcactcc ggagacagag gcaggcagat ctctgttggc 180120

tgtctctgct tagtgcctga agttccaggt gtgagccctc agcttctgc tctgcccacc 180180

ctgtcttcac tctgccatca tggactctaa ctcttggaaa ccataagcca aaagaaactc 180240
 ttttttttct ttctttatct ctttcaagtt ctttctttta agctgtgttt aaagggtgtc 180300
 accaccacca ctcagcaaga aactcttcta taagttgcct tggccatggt attttatcgg 180360
 tgacagaaaa gtaactaata caatagcaaa ataaaacaaa ttttcaatat atataacat 180420
 gtaggagaaa caacatccta aattggaatt aatgaagatt tatggcataa ggattagtgg 180480
 gctgtagtag tatggtataa ttccaactac taggaaagct gaggcagaag gactaccttg 180540
 agttcaagtc caacctaggt tacagagtga attccaggcc tgctggggct acagagtgag 180600

 acagggcctt actcccacac ctgtgtgtgt gtgtattcta caaacagaat acaaaagatc 180660
 atcaaagtag tacatttagg tcttaggtgg atgttcacca aaaaatgtta ggtagatgtg 180720
 gtaaaacatg cctataatc taccacgtgg gaggcagaag cagagaatca ctgcaaggtc 180780
 aagccagttt gatctactta tcaagttcca ggccagtcag agcggctagt aagactgttt 180840
 ttgttcttgg ttttattttt ttaaggcaaa aaaaggagag aaaggtctca ggtgtagttc 180900
 aagcctgtgg cctgatgctc cggaagcagg ggcaggatga ttgctacaag tatgaggcca 180960
 acctagccta cataaggaat ccaggcagat ctggcagttt tgttagaaac aaataaaaca 181020

 gttaaaacaa aaattggcat ctgggtgtctc attgctgtga tctcagtgct ctgggattga 181080
 aacaagaggg atcacctaga gatcaatcca tatcactgtc cataccagga gtttcagaat 181140
 ggctgaact aggaattttc tctttttttt ttcaagacag ggtttctctg tgtagccctg 181200
 gctgtcttgg aacatgcctt gaagatcagg ctggctccaa actcagagat ccaactgtct 181260
 ttgcctccca agtgcttggg ttataggtgt gtgctaccac atttggctac ttgaactgaa 181320
 gtaaaattaa aaacaaacac ccagccaggc tatggtggca cacacctta atcccagtac 181380
 tcagaggcag gaggatctct gtgagttcaa ggctagcctg gtctaccgag tgagttccag 181440

 gacactgaga gggctgttac acagagaaac tgtgtctcaa aaaaaaaaaa aaaaaaaaaa 181500
 aaaaaatcaa aaccagccag gcagtggtgg cccacgcctt taatcccagc actcaggagg 181560
 cagaggcagg cagatctctg tgagttcgag gccagcctgg tctacaaagc aggtttcagg 181620
 acaggctcca aaactataca gagaaacct gtctcagaaa acaacaaac aaaaatcaaa 181680
 gcatactctc aaatcaatc atgtctagct tatgaataaa atttccact ttacatttt 181740
 cagaaatgct atgcatacat gtaaaggggt agtccacaca agtgagctcc aactggggc 181800
 agatgacatg ttgatcactc cttgetcata tctgcctgcc aaggaacatg tcggcaggga 181860

 gagttacatt aagcagctca caaccaactg tgactcccat tccaggagat ctgacatctt 181920
 ctctggacta taaggttacc tgcactcata cacacacaca cacacacaca cacacacaca 181980
 caccacacac cacacaccac acaccacaca ccacacacac acacacacac acacacacac 182040

acacacacac acacacggta cataatftaa aaaccttttag aataaataaa taacagttaa 182100
 ttgtgatggt gcacatcttt aatctcaaca ctctagaggc tctatatac aaattccagg 182160
 ccaactaagg ctccatgcag agacactgtc tftaaataca gaacatatca aagcctggag 182220
 cacaaagtaa gacccaagtc aaaagaaaga gggggaataa aaggaagagg aggaaaatga 182280

 agaggacaat ctgctgttta gttgtttgcc aactaacagt ctactagaga ttaagaatgt 182340
 cctttgtctt ttgctgcct ccctaacaca ccttctcaaa tgtttttaa tgtagtctca 182400
 ggtcagttaa ctcacttcac tctttcaaga gcctgcagaa ttattccagt cagtgtctgcc 182460
 ctggaagctt ttacctgtg gacaggtga ttcaccctt tgaaatctgg gacaccagat 182520
 ctagaaacct gtcttaaca gttttgttt gtgtccttc ttccttctt ccttccttc 182580
 ttccttctt ccttcttc ttccttctt ccctctccc tctctccctc ctctctctc 182640
 ccttctccc attcttctc tttcttctt tcttcttctc tttcttctt tcttcttctc 182700

 tataattgca aatgtttaat atacactgta ctgtgtaaca cgaataaaag acccagagac 182760
 agatattagg gttcaagctt caagttgagt atcagaaaag caaagcaacc tgccgccagc 182820
 tctcacctct agctcaggct gatccatgca caactatcaa actgtctgct cccctcagtg 182880
 tgtctggaga ataatgctt ctctgagacc ttgcttctgt cttatatacg tcctaattgt 182940
 tgagattaaa ggtgtgagca ataattcct tttagactga ttcactcttg ttagatctg 183000
 ggtggccttg gactcacaga gatctattta tctcttaate ctgagtccta ggattaaagg 183060
 tgtgtaccac caccacctcc tagcttctgg ttgctggaac taaaggtgtg tgcttgctt 183120

 ctacagcttt tgctgactt tgttttctga atcctcaagc aagctttaat aaatcataaa 183180
 taatatctac tacaactactg agcttcacat ggccattttt taaaattaca tgtatttatt 183240
 tcgtgtgtgt gtgtgtgtgt gtgtgtgtgt gtgtgtgtgg gtgtgtgtgt gtgtgggtgt 183300
 gtgtgtgtgt ggggtgtgtgt gtgtgtgtgt gtgtgtgtgt tgggagaggt gttcacaggt 183360
 ttcagagtgt atcattgctg aaacaaagct ttgaaaataa caaggtctaa gatgtttttg 183420
 tcaaatagct ttaaggtaaa aaaaccaag aagtggcata gctgagtgat agattcatta 183480
 ggttaggaaa agaacaaagc agcccagtta tcattagctg gcataccttc tttactaggg 183540

 ttggctgttg atcaaagatg atgattaatt ctttgtacc atttctgcac tcaatatcct 183600
 gctattaaaa aaaaaaaaaa tgttgatgag tgggtatgcc ccctaaagat ttaaggtaga 183660
 gctatttttc atatgtaaag gtttatgttt gtgattcttt taagattcat tataagatta 183720
 cctttcaaga taagcaataa agtgatgggt ccttctttgt aactgcaata tgaagcttgc 183780
 cagtaagaga actggacaag aaaaatactc tgettgetca cactccccta gtctataaca 183840
 agttgcttgg atgtgaatat atgtaggctt ctgggatgac gttgtttaat catgtaaggg 183900

aaatgggaaa caagttcttt tgtttgtttg tttgtttaac ctgtattcat tacaatcatt 183960

 cacttgaaaa atagaatata atcgcattgt aatttttata ttgcttgaaa gatttactt 184020
 gggatatata gttgaaaagg taaaaaaaaat aaagtgagtt tgaagagaaa catcaagaac 184080
 aatcaagga aatcaccagg aaagatgtag aggaaaaata agaagaataa agaaaaagtc 184140
 agaagaaaac aatcaagagg gaatgtatgt cttttccctt actccttcag ataaaaaaaa 184200
 aaaaaaaaaa aaaaaaaaaa aaaaaagttt tagtttgcag actccatgga accctgagtt 184260
 gctggaggct gggccccaca gcagcagtggt gtatgcaacc tggaatcaag cttgggtttt 184320
 gcagagcaag caccacccca gtgaaccaac tcacttgacc actttcttag attgtataaa 184380

 attttaccaa cagggaaaaa taaaagttct atgtccttgt aaaatcatca aaaccatttt 184440
 aacctgtgta agtattttaa tctatataaa attccctgtc aggggatata gctcagtgg 184500
 agaatatittg cctagcatgc acatttacac aagaccctag gtttgattcc tagtaacaca 184560
 cacacacaca cacacacaca cacacacaca caggcacaca ggcacacagg cccttctggt 184620
 ctacagaatg agtttagctc aacgaaggct acttagtgag atcctaccta aagaaagaac 184680
 ggtggaaaag ccaggcgttg gtggcacatg cttttaatcc cagcactcgg gaggcagagg 184740
 caggcggatc tctgtgagtt tgagaccagc ctggtctaca agagctagtt ccaggacagc 184800

 ctccaaagcc acagagaaac cctgtctcga aaaaacaaaa aaagaaaaaa aagaagaaga 184860
 acggtggagg cagcaagggt tgggggggag ggggtggaggg tacagagggg gagaagtact 184920
 ggtggaatac tcttgaata ctctaggaat aatgaacatt ccttaacttt gaagaatatt 184980
 gtcactgtag aagtctctcc acagactgaa gaactctggc tcttccccct accttagac 185040
 ttcagattat gtcataatta gtacctaca ctatttatag gctgtacttt tccaaggttg 185100
 taaaacttta atcttccat atgccacaga gagcattaaa ctataatggt gttttcaaat 185160
 tgctgtatga tattagtctt ctgttgtttt ctttgttttt ttttgggggg gttgtttgtt 185220

 tgtttttcaa gacagggttt ctctatgcac ctttggagcc tgtcctggca ctccctctgt 185280
 agaccagget ggcctcgaag tcatagagat ccacctgcct ctgcctcccg aatgctggaa 185340
 ctaaagtgtg gtgccaccac ctttagttat tgttctcttt gttgagaggg ggtttcacta 185400
 tgtagtccag gctatccttg agctctcatc aatctttctg cctggttcag attgagaaat 185460
 cagaatttgt caaaatctc agcgattaca gaaccgaaa actcatttta agatactaca 185520
 aaaattcttc ctctcttta tttglatgig tatctagagt aaatttacta tcaagtttat 185580
 gcttataatc ccagtaggaa gctgaagcaa gagaaccttg aataccagc tggccttggg 185640

tatatagcaa gatgcaagag gaaaatgaga aaaggtagtt gcagcttcca aggcgttaag 185700
 tgcctgtaat tccagcactg gggagggtgga gacaggaaca ccaggagttt aaggttgtcc 185760
 tctgctacat agctgattca ttgccaacct ggcttaaggg atcttttctc aaaaaaaaaa 185820
 aaaaaaaaaa gtataaggag gggaaagaaa agtaaaagga ataggaggag gaagaaaagt 185880
 actatgaaca aagaggcaag cacttccagg acaaccagcc attcagagtt tctgttattt 185940
 cctggfacat ccagcagtg gagggaagga gaaacaacct gtgttgaagg ttgccggccc 186000
 aaaatgttca cagctatagt caataaggtt tagccctcac tntagcaaag ctgagatggt 186060

tgtaattaga gtcaagtta tgctagatga ctgaaggaaa gtttgttgct ttgggtgctg 186120
 acagaaagtg ggggccttct ggtggttggg tatcctttta aaagtttgtt tgtttgtttg 186180
 tttgtgttat atgtgtttgt agggggtaat gagtttccta tgaatgtag aagaaaactt 186240
 gtgggagtca gttctctct tccactctgg agttccctgg tgggacaggt ttgttctgtt 186300
 ttagtggtaa ccacttttct ctaccgaacc tccaacttgc tatgtagcca agagtgagct 186360
 tgaacttctg atcttgtctc agctgcctga gtgcgggtat ttcaggccag caccatcatg 186420
 cccctgtgat gctaggattc taaaatacct atggtagagt ttagatctaa ccaaaccatc 186480

aacaaagcag ctgcaatgct cacaatagcc agaagagggg ggtgtttact catttctgta 186540
 attcactctg tggttttctt tctttctctt cegtcttcc ttccttctt ccttcttcc 186600
 ttcctttctt tttttcttct tttcttctt tctttcttct tttctttttt tcttctttt 186660
 tttgtgattc caagcaggtc ttaattttt ttattttatt attctcactc tggagcagtg 186720
 gcagagtgga ctatcagcct ccgaagtgc atcagttcca cgagatgagt tatgttcagc 186780
 agcggacatg tgatttctt gttatcacct acctagatcc tacctgaaca gttccttttt 186840
 catgtcttc ttgtctgtaa tgataccatc accaaataaa caccaggaa ggtccctcag 186900

tgaggaatga agggatataag tgaagcaaga tgattaattt cttcttttct tcttttttt 186960
 ttgtttttgt tttgttttt gtttgtttgt tttggtttgt tttggttttg gtattggttt 187020
 ggtttggttt ttggttttc cagacacggg ttctctgtaa cagccctgga tgcctggaa 187080
 ctgcctcttg tagaccaggc tggctctgaa ctcacagaga tctctctgct tetgtctccc 187140
 gagtgctggg attaaaggct tgcgccacca ccaccagcc cggcaattaa tttcttattt 187200
 tggctattgt cacaaaaaca tcttcttca cactccaatg ccaagaggag attcaaccag 187260
 tctccagtgt ggttatctgc agtcaggatc tgaataaag agtaatgaag atgttttcca 187320

acattgaacc aattgtgacc ttagactggt ccaaatgtc atccaactct aacattcact 187380
 ggctgttaga gaatgttttg aattagteca ggcctcagtt tccacaccta ctgtagaaca 187440
 actgaaaaat ggiacttacc ttttgtgaa gttaggggaa ctaaatggaa taacataaa 187500

gacggtagaa acagcatata ggccatagtc agtgtttaac gtgactgtct gcctttgtca 187560
tttgtcagag ttatTTTTTT tttcttggca agccattggt cccattagaa atccaccag 187620
ggggtgaaga ggccagtgat taataatttg tgcactagat ggcaactcaa agaggagctg 187680
attgttttgt acttctgggt ctttgaactt aaaaaccag acttagtaaa aggagactgt 187740

catctaaaaa tactatTTAA agattgggga gccctgcag aagaagagg tagctgtttc 187800
aacagagaat actgtgatct tttgtcaaca agcactttgt ggtttaagca ggttttctgt 187860
ggtacggaag agcaaacagg gccaggataa ctaggatatg ggaagggtgt ggggggtgat 187920
ctgagaatga cccagaggcc agcctaggaa cacttgcga ctcaaactta gtgaggcca 187980
aggtccaggg gcctgggaag gaaaagagat agaccgaagt ttgactaaca agcactttgc 188040
tcttggcgat cagtgagagc aagcatctga gctaactcatt tatcgtttat caagcaaaga 188100
attgtgagac cttgtgtctg tccttatcct aagcaaaca gaaggcttgt taaagtccta 188160

caggaagggt gggTTTTGTA ggaagctctt ttccagaaca cagattgtgg atgatttttt 188220
ttaaactggt ttcaagaat cacaaggact gagtaaaatt ggacactgac agtagcaact 188280
tttatatttc ttgtttagtg tattgtattt cagataaagg atgaaatgca ggtgtttgct 188340
ggacctaggg agttaggat atttacacac agagatcctg cttctctggc aaactgcctt 188400
gtttggaaca ctctttgctt ggcggtgtgg cttttattat aatttcttc tgacccaaaa 188460
ttaggtaaaa gtcaataaa actttctttt tgagtcaggg tctcaagat ctgagctgt 188520
cctcaaattt attgtacca aagatggact tgaatttata ttccttctc cattttcctt 188580

gtgctgatta taggaatgca gtaacacacc tggtttaaga agtgtcagaa ataaatccag 188640
ggctttgttc ttgttagaaa agcactcaac caactgggct atctccccag catcagacaa 188700
aacttaaaat gagaacatc agcacaaatg ctgaaacttc agtttagtct caaatcaagc 188760
caggtgtag tgccgatgc ctttaatecc agcagaggca gagacagggt gatctctgag 188820
agtttaggc cagcttggtc tataagagct agtttcagga cagttagagt tacactgaga 188880
aactctgtct caaccccc ccccaaaaa gaccactgag ccatctctcc agccccaaa 188940
attaatgttt taaaagacct acaaaccaaa aatagtcttt gattttattt tatattttgt 189000

gtagcactgg gaattgaatg ccaggtcctt ggtatgttaa ataagtgtct tgtccagtgt 189060
tctgtcactg tgaagagaca ccatgaccac acaactctt agaaaataaa gcatgtaatt 189120
ggggctggct tacagtttca gaggtttagt ccatatgcc atggcaggag gcatgctggc 189180
atgcaggcag aaatggtctg aggttaactga gagttctaca tctggatcca taggcaacca 189240
gaggagaaag agaaaggcag aggtctctggc ttggcctctt gaaacgttaa agcccatccc 189300
cactgttaca cccctcca caagtcacac cacctaattt ctcccaaca gtgcatgcc 189360

cagataatca agcattcaaa tatatgatcc tatggggcca ttctcttgca ccacaacaag 189420

 agatctatca ctaagacaca ccattagcct ctgaaagtgg atttcaaata agctaaaatg 189480
 gagggataaa ataatgaatc aaccatacat tgagacatac agacatatca caatagacac 189540
 ttgaaggctt attagtctat tatttgagtg tgtttggaaa tttctgtctc aaaaagcaag 189600
 aatgtgttca gtatcttctc agtttttggg gatctgtgga tgatgtttga aacagacata 189660
 caagataaaa gcttgtaaac cgtttcctat ttaatttggt ttggaatggt ttttcttgaa 189720
 aaaaaatgtg tcaaattgta catttaaaaga tggatataaa aagtagtatg tatttaacca 189780
 taacctcatt tatctagatt ctggaattca taaacactcc caaccatagc aaggagagta 189840

 aataatacc cctaatttgg cctcaacaca actgctgtca tactaattgg tactttgtgt 189900
 agctactgcc agctttagc caatgattac attgtaaaac attacaagaa caatatTTTT 189960
 aatgtcttaa attcacatat acatttagca atattcccat attttagtaa cattttgagc 190020
 caaatgttt aaaaattgac tgggttcttt aatccagcca agccatatgt tgctttagag 190080
 gagtgccaa agtcactttg actcaactgt gttgataagg taattgcaca tatttttagg 190140
 tttctagctg taaattgta agtgtgtatc cctaagataa taccaattct ttctacgggt 190200
 aataattgta gctactttat aaatagctct aatgggccag cataatggct cagcagacag 190260

 atgcacttgc tgccaagact aatgatctga gtttgagccc cagatccac atggcaaaaa 190320
 gagaaaactc ccagggttgt cctctgactt tcacatatgt attgtttcac atgttcatcc 190380
 acacacgtag acacacacta aataataaat gtggagctgg agagatggct caatggttaa 190440
 gaatgtttac tgctcttgca gagtattcaa gtttactttc cagtaccctg ttgggtagtt 190500
 cacaaccacc cacaactcca gctccagggg atccaacacc ctcttctgac ctctagaac 190560
 ggacaccctt acacctgigc aagtgcacac tttgtacaa acatactaat aatTTTTga 190620
 aaacctcata aaaaatcaatg ttaaaattta taaaataaaa aataaatagt tectatgtgt 190680

 ttatggaagg aacattgcta aaagggttta aatgggcatt ttaagcatga attatatttc 190740
 ctctTTTTTT aattagattt atttatttta ttttgtgtgt gtgagtattt ggctacatgc 190800
 attatgtgat gacctgttgt ctggigccca gagagaacaa aagaaggtat catatcccaa 190860
 gaactggagt tgctggttgt tataagccac taaatgggtg ctgggaactg agcctgggtt 190920
 ctttgcatga gcaacagagc aacaggtgct cttaaccaca gatccatctc tccaccctg 190980
 aattgtgtat ttttttctc ctgagacagc gtttctctgt agctttggag cctgtcctgg 191040
 aactagtct gtagaccagg ctcatctcaa actcacaag atccacctgt ctctacctc 191100

aggaattaaa gtcatgtgct gctgccgcca ccaccagct tctcagtatc ctcataaagt 191160
 agataccaga cataaaggaa agtataacaa gcctacaatc cacaaccccg gagaagctag 191220
 aaccctcttc cagaaacaga tggaagcaga tgcagagatc tacaactatc cattgggctg 191280
 agctcctgga gtacaatcaa agtgatggag gagcgatag agcaaaggag tcaagaccca 191340
 aatggggaaa cttacagaat cagctgacct gaactagtaa gagatcattg actccacact 191400
 gacaactgag aaaccagcat aggactgaac taggcctcct gaatactggt ggcaatgctg 191460
 tggcttgggc tctatagaga gataccttgc tcagcctaga cacaggggta tgggggtgtg 191520

 ttaaggaggt aaggggggtg gggggcttgt cttgatactg cctcaacaag ttggtgggac 191580
 agacttagtt gacttcctag ggggaagcctt accctctctg agaagtggat gggggggggg 191640
 atggggcaag aaggagaatg ctaggattaa aggtttgtgc cagctgctgg ctttatTTTT 191700
 atTTTTaatt cttatgtttg tttcttgaga aagtctcatg tagccagtg taagctcaca 191760
 ctagctttat agcccagggt ggccgtgaat tctgatcct cctgaatctt tgcaagtgcc 191820
 agggttataa aaggcagcac gacacttggf ttaaagcttc tcttctttc actgttgttc 191880
 taggaactgg accagggctt tctgctacgc aagcaatgta ctgctgactg aaaaccagac 191940

 atttgatggt gttttctaaa gctgagaaga taaggcaagc atgtaaagca tgcttaactt 192000
 ttcagtcctt agggaatgaa tgtctgtaat ccagctactc aggaggcaga gacaggggga 192060
 tctctgagtt tgaggccagc ctggcttaca gagtaatttc caggacagcc aggactacac 192120
 agagcaacc tgcctgaaa atccaaaaga caagattcct tgcaatgaa agacaaggaa 192180
 ggtaattgca ggcagataaa tcttgaggag atggcaatgt gtcctgaaa tggttggctc 192240
 atgcccctgc cactagatgc tgttgttctt tcccaacctt ggttaatgac atgagcttc 192300
 aagaatcaagc ctttcatggt gccctgggtt ctgttacttt aaatagccac ctaccagatt 192360

 atagtTTTTa tttgtttgaa gattgtcaga gtctaattt aattTTTTt cettaacaaa 192420
 ataacaatga acaagctaga agaatagcta ttgaaggtag tacaattaac ttggcttttc 192480
 tcccagcgtg tttctggcag ctgtTTTTt tttTTTTt tttTTTTt tttTTTTt 192540
 ttaaaaaaat ctcttaaga aagaaagggt ttattttcca aaggataga gttcatcttc 192600
 agcggagaag gtatggcata gtgtctggag caagaaacta gctgaacaca tttcatcca 192660
 catataagaa gcagagagct ctttctggtt atttttactt attgtctgaa gctgaagtta 192720
 aaggaagtaa tcatggggat aatttttggf ctttaaaggg ggaatttctt tctttctttt 192780

 ttaaatgtgt atgtgcaggt acccttagaa gccaaaggag ggtgttagat cccctggacc 192840
 tggaaatgca ggttattatg ggtcacttga gtgagtgcta ggaatcaagc tctgggcctc 192900
 tgtccagaac tagacagaac agggctgtca agaactctac attgctgagc cacctctgta 192960

gacacagttt tttaaaaatt tagctgactg aacatagagg tatacacctt taatccaag 193020
acttgggagg gagagacagg caaatctctg tgtgttcagg gcagcctggt ctacatagt 193080
ggttacagga tagctaaggc tgcattggtga gaaccaagtc tcaaaaattt tttttcatta 193140
aagaattaat taattaaaaa ttatgagtat ggggtgttttg accacagggtg tgtctgtacc 193200

tcacatgcat gcagtgccca caaaggccag aagagtgcgt gggatcttct gggacaggaa 193260
ttacagaaga tcatgaattg ctgtgtgggt gctgggaact gaacctgagt ctctggaaaa 193320
gcacccagtg cttttaacca ttgaaccatt tcaccaacc ttctaggccc tgtccaccaa 193380
aaaaaaaaa aaaaaaaaa tcactttgtg gccagggtg gcccaaatct cactgcaatc 193440
ttcctgactg ggctcccag gtatcccagg tactattaca ggcataagcc atgggtcttg 193500
gctaggagag atatagaagc aaagacagag tttatatatt tcaattaaaa aaaaatgaga 193560
ccctttctaa aatgcattca ttccataaac tatcattaaa ctaaaattac tccttagaaa 193620

tggagccaaa ggatgggctg attaacacag aggttaaaga ctgctcagaa gcaggctgag 193680
ataaattaac accctgaaaa ttctaataat tcaagcctaa ttcaataaag ggacggtagc 193740
taagttgcta aacttaaaat aattgcctca tgaatagtca tattgaattg attatgaccg 193800
aagagcatga agatttgtgt tttatattt gtctagatgt atgctcttca ctaaggaagc 193860
tgaggataaa tttagtgaat tgattatctg aaaaagttaa ctgtgggcac gaggagagac 193920
aagttcttag ccctcgaaa tgcaaagttt agaagaaaaa ctgtcttttg cttttgtggc 193980
aggggcttat gtattacaga cttttttttt ttttttgctt gtttgctttt ggttttattt 194040

gtttgagaca tgatctcact atgcaatact gtccaactat aaatatatag atcaggctgg 194100
ccttgaactt gtgctcatta taatgtctct gtttcccaga ctcagggatt actggtaggg 194160
tacataccag ccctagttaa tgtagtgttg gcaatcaaag gactttgtat gtgctaaagg 194220
aacactctac caggtagacc atattcccat ctccctgggg ggaaaactta aaggttatga 194280
tccttactgg gtggttttgt gtgtcagctt gacacaagct ggagtattca caggaagga 194340
gtctcagctg aggaaatgct tccttgagat ccagctgtaa gacattttgt catttagtga 194400
tcaatgggga agggcccagc ccagggtggg tggtgccatc cctgggctgc tggctctggg 194460

ttctataaga agatggttga acaagcaatg ggaagcaagc caggaagcag ctccccctcc 194520
atggcctctg ggtcagctcc tgtttccagg atcctgcctt gtttgaattc ctgtttcgac 194580
ttccttcagt gatgaacagc gatgctgaag tgtaagccaa ataaccctt tcttcctaa 194640
cttctttttt aaatcatatt ttgccacagc aatagaaacc ctgcctaaga gatggtctga 194700
atgattatgt cctcttgaag ttcttacatt gaagcctgcc cctcaagggtg atcatactga 194760
ggaagtgagg ccttaggga gtaattttt ggagggatgg tctctgtagc caaggatgat 194820

catgagcacc tgacctcct ctteccactt cctaaatggt ataatcacag aagaatgaca 194880

 ctatgccccg ccaaggtgga ttcttcctga atggaatgag tgctcttaca acagattatc 194940
 agctatctct tttttttttt aatttttttt ttatttatta tgtatacagt gttctgtcgg 195000
 catgtttgcc tgcaagcaag caagaagggg ccaccagatc tcattacaga tggttgtgag 195060
 ccaccatgtg gttgctggga attgaaactca ggacctctgg aagagcagac agtgctctta 195120
 acatctgagc cccatcagc tatctcttaa cccatgtgag aacacacca aaagccacgg 195180
 tataggaaca ggaacagcc cttaccagac agaaactccc aggatctaga tctcagacat 195240
 cctatcacct tgagctgggc acccacagt caaatcactg ttagcatcac tgtcttctat 195300

 taattcccta ttaaagggtt gagagagaaa taaattctgt tgtttataag ccataaagtt 195360
 tatggaacag aataacagtt aataaacctg aaataataat atactactaa atggggtgac 195420
 taattacaga tgtctctgaa ttcagagtgg gagacaacag ataagtgttc tgtgatttta 195480
 aagaaatcgt taaagagcc aggcagtggg ggcacacacc ttaatccca gcactcacia 195540
 ggcaaaggca gtctgatcct gtgagcgaag gcctggtcta cagagtgagt tccaggacag 195600
 gctccaaage tacacagaga aacctgttt caaaaagcaa aacagagggc atagtggctc 195660
 atacctgtaa acctagcact tggcagggtt aggcaggagg attgcttctt aggctacata 195720

 gtgaaacact gtttcaaca caacaggcag gggagtgata atgcaaactt gttgtttcag 195780
 caacatggga ggctgatgaa ggaggatggc ttgaacacag gctttccagg ctagcttctt 195840
 ggacaacata gtaatacacc catctcaaaa cgtcaaagtc aagggtggtta caaggttgtt 195900
 acctgctgga ggaggcccca cgctcaagc caggccgagt tctctctctt cctgtgcgtt 195960
 cagctgtaga tagaacctc agctgcctct ccaacacat gctctgcagt ttactgcat 196020
 gcttcccaga catgatgata atggactaaa ctctgaact gtaagtcagc cctaattaaa 196080
 cattttcctt cataagaatt accatgaaca tgatgtgtct tcacagcaat agaagattga 196140

 ctaagataga tggtagcagg agggaggtat tgtgataggc ctggccatgc ttttgtttgg 196200
 aggattgtaa gctttgagat ttgtaattag aaaggtagtt gaacccttta ataggaatt 196260
 aatagaaaac agigatgcta acagtgattt gaactgtagg tgcccagctc aagagatttc 196320
 agaggaaatt attagtaagt ggcctagaga taattctgat attttggta agaattgga 196380
 tgtttctgc cttgtccaa aaaaaatctt tgtaaagcta aattggagag ttttggatta 196440
 acagttttgg caggggagat ttcaacagtc tagcatttat gcagatctat aatgaaaagt 196500
 aacaagctga ttaaggaag aatacaaat gtacagtttg aagagaaaag gcacaccagg 196560

aatagagcta agtggcatgg accaggtgac cattgctgct tgacgaagtt ccctcctgat 196620
tacaccaaga acaagaaagt tagagattta ctgacacac ctaatccca g gatgaaatg 196680
cctacaattc agatccagag cctgaggcca ttaaggggaa gaattcagtt aatgaataca 196740
gagaaaccag aatggtacag tataatggga agagagtaag gcatcaggat ttcacctttt 196800
gagagagtta tgaagggggg acaggcccat agaataagac taggagattg tagtacagtg 196860
tctgctcccc agaagtcctt gtccaagggt tctccatcct ttggtggggg aggggggct 196920
gaggaaagtt cctgattgat aaagcagaca ttctccttat ctctggcaga atgaatttaa 196980

ggcccttcat taacatatga atggtgcta ttgtcaaggt caatgcaaga ttctcaatc 197040
cctgatctca agccactccc catctcacat gctccttgcc tcccatctcc ttttaatact 197100
atgtgaagct atagagtata aaaactgtag tcttcttttc aattaaacgc tgctagcaac 197160
catctgatt caccttccaa tggagtccat ctctctctct ctctctcccc acctactgca 197220
cacatcccca aaggggacct gaaacattac ctccccccc cccaaccct actaaagcag 197280
gtctttggca gctaagcttt gtgctcaaag agataaatgg ctggaagaag agcctgatgt 197340
taaatgaaat aataggagtg atgacctcag agaaaaacce cacttctca gccccacc 197400

atatatacag ctaagcctcc aacttgtgaa aaggatttaa agaaaaactt aaactgggtg 197460
tgggtgctca gacctttaat cctaacactt cagaggcaaa ggcaggcaga tctctgcttt 197520
tgaggccagc ctagtataca gacttgagtt ctagaacagc taagcttaa cagtgaaga 197580
aaccgtgaa aacagaaagc tggtgaaaat gtgtttgaat gagagggtca tgtttcagcc 197640
cccaaagca gcaaaatttg gcagctttgg ttatgtggtt ctggctttgg agtcaaggat 197700
acaagaaagg ggtttagaga tctccctcca tggctaaaga aagctgctga gtccaggcat 197760
gcatgtgtca ggggtgtccc ttcattggagg acgagagagg ccattgagtg aagcttgaa 197820

gttgaagcct ggattgcatt ggagaccca agatgttggg gatgccagag ttgtgggata 197880
cccgctaagg agaactgcta ttaggtaca taaccagtcc gagagagaag tgtgttgctg 197940
tcaacaaagc tgaagagaga tggagatctg aagaacgctc tgccattgtt gtgcccatt 198000
tctgaacccc caaatcaca agaagcccat ttctatgcaa aagcaaagag tettttattg 198060
cagttgttta aagagctaac ccattagct tggcctttca tctatcatct gcagcggata 198120
gttgagaaa agaccccag aaaccatgag gcaggaatct tataggcag ttttagggga 198180
gtgtctaggg gtacacaggc tcaggattgg tgtgcctcca ggcttgagg gcttgetctg 198240

tgttgattgg tcaactggtt gttatgacce acaggccctc ccagggtggt tgctatgctc 198300
tgcattgcaac tgttgctaac ttgttcataa agtacacca gagccttaa gcaaagcgc 198360
accagctaac ttctgattgg tcttggccac gaggagggca tctgacctg tattgtgcag 198420

ggcaggccca gcaaggtcag gtaagcacat gttagccttt catggctgcc aaaacggaag 198480
 ccggacacac acacacacac acacacacac acacacacac acacacagga cacggggact 198540
 ggtcccttca acatcagaca tagagatgca gtttggagtt tacacagctg cttttcagtc 198600
 tagcttttgg ccagtatttc ctactgtgc tccttttct ccgttttaga atgaaaatta 198660

 tattctgaat gttggaagta tgtgatctgc cttttgatat tacatgggat acagataaga 198720
 gattgtcagg actctcagag gagactttga acttttaaac agtgttgaga atgttataga 198780
 ctatggggac tgccttaggg tttttattgc tgtgaagaga caccatgacc atggtaacgc 198840
 tcataagtga aaacatttaa ttgggggtgc tcacttacag tttcagaggt tcagtccatt 198900
 atcatcaagg cagagagcat ggtggcatgc aggcagatat ggtgctgctg aaatagctga 198960
 gagttctata ccacccccca cccccagccc agacagggtt tctctgcttt ggaggttgtc 199020
 ctggaattag ctctttaga tcaggctggt ctcaaactca cagagaaccg ctttctctg 199080

 cctccaagt actgggacta aagacatgca ctaccactgc caggctgaga gtcctatata 199140
 ttgcaggcaa caagaagtca actgagacac tgagtggat cctgagcata ggaaacctca 199200
 aagcccatcc acacagtgc acacttctc taacaaggcc atacctactc caacaaagcc 199260
 acacctctg agagtgccac tcctataat atcatgggga ccaattacat tcaaactacc 199320
 acagggactt ttgaagtgg accgaatgca tttctgcatt atgatatggc taagtagaat 199380
 tgggtggttt gaataagaat gggccccata ggttcataga tttgattgct tagaaaccag 199440
 ggagtgcac tattaggagg tgtggcctta ttgaaggaaa tatgtcactg ggatactcaa 199500

 gccaggccca gtgtcctctc tcttctgta gatccagatg tagaattctt agctatccgt 199560
 ccagcaccat gtctgcctgc atgccacat gcttccaac tgtagtaatt tgaatataat 199620
 tggccccat aagcacaag aaagtggcac tattaggagt tgtggctttt ttggagtagg 199680
 tatggctttg ttagaggaca tgtgtactg tggaggcaga ctctgaagtc tcatatatgc 199740
 tcataccaca cctagtgtct cagactactt cctgttacct gcaagtcagg atgtaggact 199800
 ctcagctcct tctccagtat catgtcttcc tgcattgtgc catgtcgac catgacgata 199860
 atgtactaag cttaaaaata taagccacc caactaaacg tcttttctt ttataagagt 199920

 tgccatggtc acggtggigt ctcttcacag caatagaac cctatgacac cagccatgat 199980
 gataatgaac caaacctctg aagtataagc cagaccaat taaatgtttt cttttgtaag 200040
 agttgcatg gttgtggat ctcttcacag caatagaaaa tggactaaga cagctaccaa 200100
 acatcaagt atacaggaag aaaccagatg ccaggcatta gacgaattat ttttctaac 200160
 ctccagcagg taacaacctt acaggtagat ctctgtgttc aaggtcagca tggatatacat 200220
 agcaagtctt agggatccag gactacatag agaaaaccgt ctcaaagaa aagttgtatt 200280

gtagctagct cagtggttgt gtgcacttgt tgctcttgca gaggacctag cttgattctt 200340

 agcatccaca tcagacatct cgcaactccc catagctcca gttccagggtg atctgatgcc 200400
 ttcttccagg cagtgcacac acatgatata catacagaca aacatgtagt gatgcattat 200460
 ctatgattta ttaaagcttg cctgagaaag tcagccacaa gccatagaag ccaggcacac 200520
 acctttaatt ccagcagcca gaaattagga ggtgggtgta cacaccttta atcctaggac 200580
 tcaggaagag agatctctct gagttcaaag ccaccagggtg atacataata ttgagtcagt 200640
 ctaaaaagag taacagggtca cacacctttt atctcagtac tagaggggta taaaagatag 200700
 aagcaaggtc tcagagaggc attcattctc cagccacact gaggagaggc agcagtttga 200760

 gacttgaaga acicatgtgt ggatcagccc tttcagcctg agctagaggt aagagctagt 200820
 ggccagctgc cttgcttttc taatattcag cttgaagctt gaatcccaat atctgtctct 200880
 gggtcattgt gtgtgtgtat gttacacaag caggaatata catatacaca tgataaataa 200940
 aaacacaatt tttttgtgt tttgtttttg gttttcgaga caggttttct ctgtggcttt 201000
 ggaggtctgc ctggcacttg ctctttaga ccaggctggt cttgaactca cagagatccc 201060
 cctgcctctt cctccctagt gctgggatta aaggatgtg ccacaatggt ccagctaaaa 201120
 acatgatttt aattgtatta gttagcagga aagacagctc agtgaatact ggcactcgtc 201180

 aagcttgagg gcccaggtta gatcctcaga aaccacatag aaggagagca ctgactgact 201240
 cctgataaatt gtccagtgcc ttccctgtgc tcagtctcca gtgcagcaat agtttgtttt 201300
 gatattgttg agttgtatga gttctttaat aaaagtcata tataatata tatatatatc 201360
 aagcatttta acacctcttc agctgaggat acttgataat agtaaatcta taaaacctat 201420
 ataaggttta tatagaaaac gatttaaaca aaatttaaat cagctgttat tggcataaat 201480
 tgaccctttt ctaaaaacta taatggggac tggtaaatgg cttatcaggt aaagacacct 201540
 gctgccaagt ctgactattt tattcattcc ctaagatcta caatggtaga aggaaaaaac 201600

 tgactcatac aaattttact ctgatctcca caagcatgcc tatacacaca cacacacaca 201660
 cacacacaca cacacacaca cacacactaa taataataac aatgaaatac cagagaattc 201720
 acaaaacaaa gatgtaataa aaatgtaaaa aactgaacta atgagggata cagttactgg 201780
 tttcccaaat agcctttgtt gtgataagat ttttctaaaa gccaaaatct tggcattgga 201840
 aaatgtcact ccagatttcc ttgtggaaac tggaaatgtg acagcttggc atgtttttaa 201900
 gctaattaga ggtaaagct gagattactg actcccctgc aggtttgtcc attcaggcag 201960
 caattgcaca agggacccta atagaaagga agtattctaa catggccctg gccgtcctgg 202020

aatgcactat atgaaccagg ctggcatcaa actcaggaag atccacctgc ctctgcctct 202080
tgagtctgg gattagaggt gtgccaacc acacctggcc tttgagagaa cttttcttca 202140
gtggtgagtc actgacaaag tgcacatgct cctgtagaca accgctcacc cgttgttctt 202200
aagcagctct aatgaaatgc acagatcaga aaagtggatc agcaggcaag gagacactgc 202260
caccaagcct gactacctga gtttgatccc taggaccac atcatggaag gagagaacca 202320
acgcctgaaa cecatcctc tacctctgca aatgcgagcg tgtgtgaaca cacacacaca 202380
cacacacaca cacactaa atgtcattta aaaaaatctt ttaaattaaa cacaaaggaa 202440

ctaattggct caccaaaaga gttaaagaca tgaaagcaga agaaggaagg ggatcagagg 202500
gaatgggagg gggaaaagg agggaaatag aaggatatga ttacaatctg tacatgaagc 202560
tggcagtgg ggcacatgcc ttttagccca gactctcgg gaggcaaagg cagacagatc 202620
tctgtgagtt cgagacctg ctggtctaca aagtgagttg caggacagcc agggctgtaa 202680
aacagagaaa cctgacttg aaacacaaaa gcaaaacaac aacaaaagta catgtatggt 202740
tataggatta taagcattaa tgacttagat tttttgttt attagtatat tatatataat 202800
accgaattta tgacatttcc acacatgtgg tttgtttctt ggctagcaca cacaataatt 202860

ttctgctgta ttgcttgac tagtttagaa tctaacattc tacaagaagc caccaacaaa 202920
aataggagcg cacatccagt aaaatacttt ttgtgcatac ctcgttataa cagaagcaat 202980
aattgataa tagaaaactg tcgtaacat tacagatatac aaagtttatt attttccag 203040
taacaccaac ctgctactac cgagattatt aacattcttt cattcaaaaa tgacaggcaa 203100
agtgaggcca tagtctgta gatactgga tgataataag ccaagatgca taactaacca 203160
catccccac cccaagtaca acccagctaa gaaggtaaga gaagcttta caagggttct 203220
agaggattgt tgaagagtaa gatagaagct aagggtcaat taccagctt gtaatttgc 203280

cctaccgag agcctctccc cctcctctc tctcccctc tttctttccc tetgtgtttg 203340
tgtgtctgtc tggctcttt ctccagatcc tctgcctca gcctcaagag tgcagggatg 203400
atagacggga gttaccacgc cccgccagg actagatct taaaatgttt taagcatctg 203460
catgtcggtt taagaagatg gttcagacgt tgtgggaaat gacctcagcg tgctgtctgc 203520
cttctccaaa gctacgttat tgtttaggtt gggttgggct acatcccctc ggaagacag 203580
gattccgnnn nnnnnnnnnn nnnnnnnnnn nnnnnnnnnn nnnnnnnnnn nnnnnnnnnn 203640
nnnnnnnnnn nnnnnnnnnn nnnnnnnnnn nnnnnnnnnn nnnnnnnnnn nnnnnnnnnn 203700

nnnnnnnnnn nnnnnnnnnn nnnnnnnnnn nnnnnnnnnn nnnnnnnnnn nnnnnnnnnn 203760
nnnnnnnnnn nnnnnnnnnn nnnnnnnnnn nnnnnnnnnn nnnnnnnnnn nnnnnnnnnn 203820
nnnnnnnnnn nnnnnnnnnn nnnnnnnnnn nnnnnnnnnn nnnnnnnnnn nnnnnnnnnn 203880

nnnnnnnnnn nnnnnnnnnn nnnnnnnnnn nnnnnnnnnn nnnnnnnnnn nnnnnnnnnn 203940
 nnnnnnnnnn nnnnnnnnnn nnnnnnnnnn nnnnnnnnnn nnnnnnnnnn nnnnnnnnnn 204000
 nnnnnnnnnn nnnnnnnnnn nnnnnnnnnn nnnnnnnnnn nnnnnnnnnn nnnnnnnnnn 204060
 nnnnnnnnnn nnnnnnnnnn nnnnnnnnnn nnnnnnnnnn nnnnnnnnnn nnnnnnnnnn 204120

 nnnnnnnnnn nnnnnnnnnn nnnnnnnnnn nnnnnnnnnn nnnnnnnnnn nnnnnnnnnn 204180
 nnnnnnnnnn nnnnnnnnnn nnnnnnnnnn nnnnnnnnnn nnnnnnnnnn nnnnnnnnnn 204240
 nnnnnnnnnn nnnnnnnnnn nnnnnnnnnn nnnnnnnnnn nnnnnnnnnn nnnnnnnnnn 204300
 nnnnnnnnnn nnnnnnnnnn nnnnnnnnnn nnnnnnnnnn nnnnnnnnnn nnnnnnnnnn 204360
 nnnnnnnnnn nnnnnnnnnn nnnnnnnnnn nnnnnnnnnn nnnnnnnnnn nnnnnnnnnn 204420
 nnnnnnnnnn nnnnnnnnnn nnnnnnnnnn nnnnnnnnnn nnnnnnnnnn nnnnnnnnnn 204480
 nnnnnnnnnn nnnnnnnnnn nnnnnnnnnn nnnnnnnnnn nnnnnnnnnn nnnnnnnnnn 204540

 nnnnnnnnnn nnnnnnnnnn nnnnnnnnnn nnnnnnnnnn nnnnnnnnnn nnnnnnnnnn 204600
 nnnnnnnnnn nnnnnnnnnn nnnnnnnnnn nnnnnnnnnn nnnnnnnnnn nnnnnnnnnn 204660
 nnnnnnnnnn nnnnnnnnnn nnnnnnnnnn nnnnnnnnnn nnnnnnnnnn nnnnnnnnnn 204720
 nnnnnnnnnn nnnnnnnnnn nnnnnnnnnn nnnnnnnnnn nnnnnnnnnn nnnnnnnnnn 204780
 nnnnnnnnnn nnnnnnnnnn nnnnnnnnnn nnnntttttt ttttgcgtaa gggtagagaca 204840
 cgtgacacct accacctgaa ctttatctgt gtcagtgtc aaccttagg tcatagcctt 204900
 tcagagcatc ttctttggat catagcatgc ttcattgatt gcaccagtat agattttttt 204960

 ctctctccca ttgaggagag gattgggaag actgtattaa ataatagatg atagtaaaca 205020
 aaactgctca gcttttaaaa atacagtccc acgttttagc tgagcatctt tttattaaga 205080
 cagcttcaca gcaagacgta tagttttatt tatcgaaaag aggaataata gactaccagc 205140
 ccccccatg tgtaattatg taatatgcta tctcttcagg taagatttca tgtatgtgtt 205200
 aagaatggca ttgttaaggg atgtgaagtt ggggtgggga atgatcagca gagttgtttt 205260
 ggagaaagat ttctcctgtg ttggtaaaaag aattctcttt cttggaggcc ttctatgcca 205320
 agtgactgat gaaagaaaaa agcctgttat ttgtccttct ctcattgtct actaacacce 205380

 aaacaacaac aacaacacct tttaaaaaaa gtgtgtcctg ggactctcca gatgtaatgc 205440
 aatagcata gaacatttta acataattta aattttctct cttccttact ttttttctt 205500
 tttgtaacag caggatgtgg tagctcatgc ctgtagtgtc aatactttcc aggctgaggc 205560
 aagaggagtg gtgtgggttt gaggccaggt gggactacag ggtgagatac cctgtttcaa 205620
 aaacaacaaa gggcagggga ggtcggagaa acagcgactg gggtaaaagc tataccaagg 205680
 aagaaatggc tataaacatt cgagaaatgg caaacgtag gcgccagcgc gtgtgcacac 205740

acacacacac acaggcacia agaattttgt catttttatt tattactttg tgtgtatgcc 205800

 ttgtgtgtgt gtgtgtgtgt gtgtgtgtgt gtggttgtgt gtgtgtgtgg gtgggtggga 205860
 catggtgcat gtgccacaat atacatatgg aggactgagg ataactttgt agaaccaatt 205920
 cttgcattcc acctttatgt gtgttccagc aattgaactc gggctcttag acttgtgcaa 205980
 gtgctcttac aactcagcc atcttgggaa ctctttaatg tgctttcaaa agatggatag 206040
 atagatagat agatagatag atagatatac atatgtgtga gtgcacactt acatgtaccc 206100
 atgcagaggt gtaggtgtca gcagaggcca gaagagcaca ttagatctcc cagagctata 206160
 gttacagggg cttgtgagga actgatgtta gttctgggaa ctgaactcat gtcctctgga 206220

 agatcagcaa gtgctcttag cttctgaggc atctcttcat cccctttga cgtgcatttt 206280
 ttaaaaaatt atatttatat gtgtatgggt gcattgctgt tttctgtggc atgaacatgg 206340
 agatcaaaaa cctttaagag tcatttctct ccttccaata tgtagagccc agggattgaa 206400
 ctcaggtcat caaatttggg ggcgggtgcc tttgcctgtt gagccttctc attggctttt 206460
 attataaatt ctttaggacg acacagctgg gcattggtgg cacacactt taatccaac 206520
 actctgaagg cagaggcagg cagatctctg tgagtttaag accagcctga ggtctacaag 206580
 agctagtctt agttccagga tagcctcaa agccacagag aagaactaa aaaaaataaa 206640

 aaaaataaaa agtctttggg acacaagttg tgttttctt ttttgggta aacatgtaat 206700
 tgacctttct gctcacagta tttggagtgc tcaaattatg atgtaatttt gcctggtttt 206760
 gattattcaa tcgttcaaca aatggatttt taagagcttg gtgtagattg tcaagaagca 206820
 caggggggaa atctgtaaag aaaataaagt cctttcata ttggagctta catactagtg 206880
 taaaaaata gtgacataga tgtcccttt ttatttttta ctccccccc cttctgtact 206940
 ggatattgat aatagggcct catacattct aggcaactgaa ctacataca cccacctct 207000
 ttaaaaattt tctgtttttt agtcagggac tcattaagtt acccatattg gectgaaacc 207060

 tgcatgtat ccagaaaagg ccttgaacat gggctcctcc tcctcagcc cttccccagt 207120
 agctgagatt gtagctttc cataacaggt ccagtttcta tgtccaaatt agtaaagatg 207180
 tataagaaaa aaatggagca ggaaaatgic atcagaattg ctgttatttt atgttattgg 207240
 tgggtccca ccttggaaat gcataggcat gtgctctcat cattgggata cctcagcctt 207300
 tgattttaa tagggggaca gcctcacaga gaaagtgata tttgaacaca gccttgaaga 207360
 aggtgaaaa agcaagtga atggactgic cagggcagtg gttctcaaca agtgaccccc 207420
 ggggtgcaaa ggtccctttc taaggggtca caaaagacc atctgcatat cagataactt 207480

gcattatgat tcataacagt ttcaaaatta gttatgaagt agtgatgaaa ataattttat 207540
 ggtgggggtc gccacaacac gaggaactgc gttaagaggt cacaacatta ggaaggttga 207600
 gaactactag tctaggggaa gagcgtata ggcagaacaa acagcgagat agcttgaagc 207660
 agaacagcga ttagtttatg tagataactg taccaggctt tgtcttttga gccaccaacc 207720
 agctcccaaa tcgtgacatg gaaacttctt attagttatg aatgcttggc ctacacctagg 207780
 cttttatcta ccttttgect caggctcttt acctttcttt ctatatgttg tacnnnnnnn 207840
 nnnnnnnnnn nnnnnnnnnn nctgcctggt ttctggctcc aggcactctct ctctttttct 207900

ccctccttct ctgccctctt ctctctggtt attagatctc tctgccttag ctattgccca 207960
 ttcagctttt ttattagacc aatcaagtgc attagggaga caaggtgga cagcaacact 208020
 ccttttcata attaaacaaa tgccgcataa acaaatgtaa tacatcctta aatagttaa 208080
 tgcagcagaa gcaaatgtaa cacgcttta cacagttaa gtaatagtcc acaacaggaa 208140
 atagctagga ggccaatgtg agtggagtgg ccaagatcat agagacagat tacgagaaat 208200
 attacagggc ctcaaagaca ttgcttttta ctctgagttg ggaaggcact gatTTTTTTT 208260
 ttttaacaga ataattgat catctgacac accttctaaa agaactactg tctgccagtg 208320

agacagctca gglagaagtg gtacttgatg caaagctgac aacccgagtt ctatccctga 208380
 gactcacata gtaggacaga acagattttt acacgttgtc ttctaatttc cacaggtgtg 208440
 tgctgcccc ccagcagatg accacacaca cacacacaca cacacacaca cacacacaca 208500
 cacacacaca aatgtaatag gattacaatt gttttaaata aaattattat tagttatag 208560
 taccactgtt ttgctgcat gtatatcagt acaccacatg tgcttggtac ccaaggaaac 208620
 ccaagtgggt attggatccc ctggaactgg gcttatagat ggttgtgagc tgccatgtag 208680
 gtgctgggaa ttgaacctgg gacctttgga agagagccgc tgcittaaac cactaagcca 208740

tctctcagcc ccaataaacc aaaacattaa aaaaaataaa atagatcact gtggctgcca 208800
 ggttacatag gtgtgaagga aaacagtaga agcaggaaac ttgttgcattg tttcattatt 208860
 tggcgtaaaa atggtttggg gaattgggtg taatgagtca ggtgtgtgtg tgtgtgtgtg 208920
 tgtgtgtgtg tgtgtgtgtg tgtgtgtgtg agagagagag agagagcgag catgcatgca 208980
 tgtgtgtata tglacatgag caccatcaga ggttattaat gaattgtatg attgtggctg 209040
 atttctgttt tcttttaaga tggttatact atgtagcctg gaagacctg aatatgaggc 209100
 agtcctcgtg ccicatgagc ttataagagt gtgtgtgtgt gtgcgcgct gcgtaccaca 209160

gccacttatt atgatggagt tctattgatt tagtagtcag atgaggaaca tgatcggtta 209220
 tgactgaaag atttttggcc tgaacaattg taagtttctc tgtggaagga agactaatgg 209280
 agaatcagac tcagctttag ctacagttca ttttagacat gttaaggttg aagtgccat 209340

ttaactttaa tggagatgct aaataaataa gatatgtctc aggggaaaag tccagactag 209400
 atataaattt aaagccatga agccacttgt gtgttgagtt aatagaaaag agggggaaac 209460
 ttgatgattg agtcctaggg agggggataa tccaacaggc acaggtggag agagtgagaa 209520
 aatacccaaa gagattaaat aatagtattg acaggaggtg ggtgggtaaa ggcagtatca 209580

 tattttcagt taacagtatt ttccctagag ctacatttgg agaccaggaa gctgtgtatt 209640
 aattagtttt ctgttgctgt aacaaaaatg ccttaggcta ggtatgttgg taaaatatga 209700
 agttttatta gcttatattc ttggaagagg aaagtccaag atccaggtga tcatatggca 209760
 aaggcctcat aatagcatgg caatggtgga tgagtttaca ggagagaaca catgattaga 209820
 gaagccagac attcaggttg gttagacctg ctctttttta aataataact gactctctca 209880
 gcaattaacc attgtaaggg gtctttctca tcagacttta aactgccaac cccaagtaa 209940
 cgactcggag acttcttatt aattatgaaa gctttacctt agcttaggct tgttcacaac 210000

 tggctctttt aatttaaatt aacctgtttc tgtaaatcta cattctgcca cgtggctttt 210060
 taccctccg ccgttgftct gtacatctga ctccctctgt gtctccccta gctaattcca 210120
 cacatctaga ttateccct gagttcctct cactgcccag aagtctctgc taacctaac 210180
 tttactgctt agctattggc tgttcagctc ttattaacc aatcaggtgc cttaggtagg 210240
 tgaggcaaaa catggacaca tattcataca gtgtaaacaa atatcctgca acaccattcc 210300
 ttggataact gaattaatct tttctgaggg caacacctca atatcctaata tacctgccaa 210360
 gaggtctcca tcaagattt catccattct aacattgac aactaaaga ctaagcttcc 210420

 agctagagaa actttttttt gggggggggt gtttgtttgt ttgaggcagg gtctctctgta 210480
 gccaggctg ccctctactt cagtgtgtag ctcagaatga tctgggaact tcagatctc 210540
 ctgcctttgc ctccaaagt ccagggttat aggtgtgaac caccatccga ggttatattg 210600
 gctttattga ttattcagat tctaatacatg gcaggctttt agagaggcct tetgaagctt 210660
 tactttctc cacacttttt tttgttttgt tttgtttttt gaaacaaggt ttccctgtgt 210720
 agctttggag cttttctgg aatttgctct gtagaccatg ctggcttcga actcagagat 210780
 ccgcctgtct ctgtctctg agtgggtggga ttaaaggcat gcatcatcac cgcctggctc 210840

 ctggcttaat aaccagctt catttgcac agcatttaga aggttaattt ttaaagatat 210900
 ttttaaatat attttttaca ttccagctt atttccccct cctctctctc ctcccattca 210960
 cctcttttc ctcccactgc aactcctatc tgctccttgg agagggtaag agtgccccta 211020
 ggaagtccac taagtctatc ccatcatctc cttgaggcag gatcaaggag atcctgtgtc 211080
 taggtgagc aaggtatctc tccatttaga atgggctcca ctaaactcagt ttttgcctta 211140
 gtgttagatc ttggaccac tgccagtggc ctcatatatt gtcccagtgc caccgttgtc 211200

acctatatta agagtctagt tcggctcttat gcaggttccc catttgtcag acctgagtca 211260

 gfgatctgtc actagctcag gtcagctgat tttgtgtgtt tccccatcat ggtcttgact 211320
 cctttgttca tactatctct tttccctcac tttgattgta ctccaggagt tcageccaat 211380
 ggttagttgt agatttctgc atctgcttcc atctgtttct ggaatagtgt tctggcttct 211440
 ctgggcttgt ggattatagg ctggatatct tttgctttat gtctggtatc cacttatgag 211500
 agagtacata ttaaatttgt ctttctgggt ctgggttacc tcacttaggt tggtttttcc 211560
 tagtttggtc tgtttgagag gctaatttta aaaaaagtgt acattagttt tgtggaaaga 211620
 attatcttac taatttatca gcctgttctt ttcttcctga aatatcatat gataaagtta 211680

 agcgtgtgtg tigtgtgtg tigtgtgtg tigtgtgtg tgtattttga gacagggtct 211740
 ctctatgtag gcttgactgg cctggaactc acagtgtaga ccaagctgac ctggaagat 211800
 ggctgaagg gccaaaagtc catgtagca ctggctgtcc tggaaactcac tgtgtagtct 211860
 aggttagacct cgaactcaca gggatcctcc tgccctccta gtgctgggat caaaggcgtg 211920
 cccccccac cgcccggtga aattggagca taatgattta tgtttctagt atctctttaa 211980
 ttacttagga ctagaagagc aaaagatgat ttcatctgga aaaccaagac gtgaatcaga 212040
 attttgaagg gtgggagtgg ggatcaagta ggtatcacac agtgtgtgtt tgtgtgtgtt 212100

 gctgaggctg gaaaagaaag cattatacat tgtgagccat taagtgtctt ttgaactctt 212160
 gtacaacgcc cccccccat catgtgaaag ttcccttgtt gtaattggac tagcatatta 212220
 tttgtaattc cacgagaatg aaatctgact tccatcagag gagtctgagc actgggaatt 212280
 tacagattta agacttagga gtcaatttag cttttggtga gtgttttatt ttactaaact 212340
 aattgctctt ctctttaagt ttaacttaac ctttaaggaa atttaaatg aaaaaaatg 212400
 tttctgcct ctatcttgt gtattctttt tcttttctt tctttttttt ttttaagattt 212460
 tatttattat gtgtacaaca ttctgcttcc atgtatatct gtacaccaga acacgcacc 212520

 agatctcata atggatggtt gcgagccacc atgtggttgc tgggaattga acttaggacc 212580
 tctggaagag cagtcagtc tcttaacctc tgagccatct ctccagcccc caagtgtatt 212640
 cttttctta ataaatacac tttcatctgt gtttcggtat tccagattac ctccgggaaa 212700
 atgtatttgg cctaactttt ttatgtattt gttcacaaga acaatgtctg tgatttcata 212760
 gtttataaaa catagacagt ggtaccctt gggattatgc cttttgctt ggttctcact 212820
 tttgtcagta ctactcctt catgacagcc ttgtctcaa ccttgaaagc tatgtgtgcc 212880
 ggaatgaaaa atcttattta ttgtgactca tttgtaaacc atcttatctt gttcctggtg 212940

gaaggacaa gtaggacaca gtgaaagggg agcatatagt tagaaattgg tagaagatga 213000
 atttaatac cacttgttat tccacagttc tcttttgctc ttattggtaa ctctcttca 213060
 tcttgctata caacatttc agttagagga caacacatgg tacagaaatg cctagacaaa 213120
 ctccctagtc ctgagatttc ttgtaacccc tcttatTTTT tttttttta tttactagga 213180
 ttttaaatc aatttttgtt gtttctgtct gaaaggcatt tgtgtgggta tccacagaga 213240
 ccacaagaag gcattaggtt ctccgaggtc gaattacagg cagtgtggg atgccagtg 213300
 tgagtgtgg gaaccaagct tgggcctcc aggagagcag cgtgtgctcc tgcctgctaa 213360

 gctgtctctc caagtcaaac atttactgat aaatcataaa taattttatt tgaaaactaa 213420
 ctctttggta cacatacaat tttaccatct accaagaatg aaaatacatt tgtgtgtact 213480
 ttattgtttt gtaaagaatt aaattttggc agaataattg atattgcaag agacagcatc 213540
 atcactgttt ttctgagttg attactattt tgattttata attgttagtg ctgagaatat 213600
 gctctattct cagtatgaca gaagaatggtt attaagagtc attcagaaa ctgtaaattt 213660
 tgccttaatt ttaatcaaaa attctttttt tttttttttt tttttttttt tttttttttt 213720
 tttttnnnnn nnnnnnnnnn nnnnnnnnng ctttggagcc tgcctggta ctcaactctg 213780

 agaccaggcc ttgaactcac agagatccac ctgtctttgc ctctcagtg ctgggattaa 213840
 agttgtaaac caccaccgtc cagctcatgt ttttttttag agccagagtc tcattttgta 213900
 gatcaggctg gtttggaaact ctaagaagcc tctgcttccc aagtgtggg attaaaaggg 213960
 tttttgtttg tctgtttttt ttctttgggt tttcaagaca gggtttctct gtagcttag 214020
 agcctgtcct ggaacttgtt ctgtagacca gactggcctg aaactcacag agatctgcct 214080
 gcctctgctt cccgagtgtt gggattaaag acatatggga ttaaagtttt gggtcatact 214140
 gggcttgctg gtttatgctt ttactctcat cactcaggag gtgtaagcag ctggatctct 214200

 gaattccagg ccagctagca ttacatagtg agaccctgtc tcagaaaatt aaaagaaaaa 214260
 aaaggagggg aaaggatgg ggggacttgg gctgcctgt ccatgttatg attttctaaa 214320
 atggagtta aaccagcaac tcaagcagca gctttttaaa aaaaagacct atattttatg 214380
 tgtaagaatg tttgcctgca tgtatgaata tatatatgta ctgtatacct gactgatggc 214440
 tgtcatttgt tttctttttt ttggacatgg tctcatataa cccagggtgg ccttgaactt 214500
 ggtttgtagg accttgagct ccaggttctc ctgcctctat atcccaggtt ttaagattgc 214560
 aagactgcag gtctatatca ccaaacacat cttttttttt gtttttaaat actttattta 214620

 atgtgcattg gtgtaaggat accaggtccc ctggaactaa ctggagttac agataggtgt 214680
 aagctgcat gtgggtgctg ggaatagaac ctgtgtctc tgggaagatg gccactgctc 214740
 ttaaccactg agccatctct ccagcccca ccaaacatat cttaatcctc tctttcttcc 214800

ttctttcagt actgggaact gagcccacag tctcctgtgt actgggcact aagctacatt 214860
 tccaaccct ttttagttta acttaatgtt atgtatatga gtgttttgca tgcttgcatg 214920
 tctatgtact gcatgtgaac cctggtgccc aaggaggttg gaagatggca ttggataccc 214980
 tgaaactgga gctgcctggg tccctcgggaa gaacagtgtc agtgcctctt aactgttgag 215040

 tcatctctcc agccccactc cactcgtttt gtgagacagg gtctctgtat gtagcctgac 215100
 tgtcctggga ctactgtgt agattagget gggctcgaac tcagagttct gcctctgcca 215160
 tcaaaggcct tcaccacat gcctggtttc aactccccat ttttaatttt cagttttgag 215220
 acaggttctc acaagttgac cagagtgggc tgcaactaac ttggtaaccc agttaggcct 215280
 tgaatttgtg atcctcctgc cccagctagc tgaattacaa gtctgtatca ccaggttcag 215340
 atccattatc tttctataag agcagaaaac tggggctgga gagatggctc agaggttaag 215400
 agcacctagc tgttcttcca ggtcctgagt tcagttccca gcaaccacat tgcggtcac 215460

 aacctctat aatgacatct agtaccatct tctggctctgc tggcaggcat gcagtcagaa 215520
 cactgtatac ataataaata aatacatctt tttttaaag gagcaaaaaa ctttatatgc 215580
 ccagtaaaaa ccatcataat tcatatatac agtagtcttg actgtgagtg aagttgtttg 215640
 agataatgtt tattgggtgc ttgtggcaag acatcttgca cattgcaaaa atgtacttgt 215700
 attcagaaca aaggctacaa tgaaattgta taatagagcc aataacactt ggattcctta 215760
 tgcatttgat ttttaatgaa ttttagttc ttgcctgttg ataactctt tagtgtttag 215820
 ttaccattt tctgtgatcc tcccacttc tgttaagtga cttctgaaag tttatgact 215880

 taaaacttaa gtagcagagc ctagagtaac aaaagtgtga attgattgct agaggaggca 215940
 gtagtcagttg tacagactga gtcaagagac tgcacagtca gccaggcatt ggtgacgcac 216000
 accttaate ccagcactag ggaggcagaa gcaggaggat ctctgtgagt tcgaggccag 216060
 cctggtctcc agagtgagtg ccaggatagg ctccaaagct acaccgagaa accctgtctc 216120
 gaaaaaaca acaaaaaaa aaaaaagaga gagagagaga gagagactgc acagtttctt 216180
 gtacagttac tcagtctgtt tactgaaagt ttaacaaaat tatgttttct cttgaacata 216240
 aatgtaatte aagcaggaat aaaaaattgg catcttctga atgtggacat ggctgttaaa 216300

 tagacatgcc ttgttgaatc attaggagac gaaggccttg aatgacata tctcttgata 216360
 tgtatatgta cataagtatt tatttttgtg ctttttggaa gagatgacaa ctttttctg 216420
 aaagcctttg aggaacaact gaggctctag tgtgtgtttg agagattatt caagtacagg 216480
 tgaaaagtaa ttttaatttc cttgctctta ataagtcttt aatattaaag ctgcattgag 216540
 acttaaahta caaatgattg tattgctttt gtaaatccaa ctgcatagcc tttaatgcca 216600
 glaaaataat gagatggctc actctcaagt gtgggaacta ctctgcacgc cattcccctg 216660

tcccctgacc ttgacctttt aaccctgttg ctttgtaatg agattatggg cctttaaggc 216720

tgtctccagt ttgctcaggt ttccttgcac aacataaagt tttaggcttc cttgaaaagc 216780

tgttttttaga attgaagaaa caacttagat ttaagtgtgg ctatgacttt tgtaaacagt 216840

ttttctttta agaagttttc ttccttaatg tccaaaatat catatttcta atagtgactt 216900

tagtttgttt ttgttagtgt atgacttaat atgccctctc cctttattta ataaaatggt 216960

cttggaaagt ttcataaaat aaaattgctt atttagacag aagctaaaat tgagctttct 217020

ggggcacgga gctcagaaga aaccctgcac agcttattcc catagtgtgc cctgtaggca 217080

gggggagtta gcatggatca aaaggggatc acacatgact agcaattgct tatggtcaaa 217140

gaaaaccact gctttaatct ttctataata agcaagtgt actttatcag ttgttgaaaa 217200

taaaggaaga gaaaaagaga taacttgta gtaatagagt gctacttgtt acttgttatt 217260

aataagtgc ttttggggga aagggtaaag ttagtgacaa aagagtttgg ggccgatgcc 217320

tcatgaccta agtcccgtcc cctggttga agatgaaagg tgagaaccaa ctctacagag 217380

ttgtcctcta gcctccacag gtacctcatc atgcacacac aacaacagta ataatagtaa 217440

taaaagggtt tcagctcagc aggtgaagcc cttgcttcca ggctaatga cctgagttea 217500

atccaagac ctatatggta ggaggaact gaagcaaatc ctgaaagtg tcctctgacc 217560

tccacaagtg ccttggcatt gatatccctc ccccatcaat aatgtaata aatagaaaat 217620

taaaaagcag taagagtttg aggattctct gtgttttggt cttttgtatc ctatcttggg 217680

gttattttaga aaactgaaca tgtgtttgtt tcagctatct gcttcccttt ctttgttgtt 217740

gttggagagg gtctcttaca tgtagcccat gctggcctca gatagctaag gagatgactg 217800

aactcctggt ctgcttgctt ggattacaag agtgtgccac catgtccagt atgttccagt 217860

aattttaaca gtactttctg aggagtgtct gttttaaata ccactgaca gaaaatgaag 217920

ctgttagacg ttggttctca tggcactttc ttattctgcc aagagaaaag ataaataaaa 217980

tgattggttt gagataacaa agggcagtaa gtgctttttt tttattttta aagaattgtg 218040

gatttttact agtaacagga acaacacact caagtttaaa actaaagtgt gtacaagaat 218100

gccttcggga aataactgcc acctgttatt ccacagagac agaatgtgac ataaaaatag 218160

aacttctcat ttccggtttt taactagaag ccagagtgac tagtttattg ttaagtaagc 218220

tgggcattaa tcaggaaaa ctagtaagat tttaaaaatt attttagaag attttatacc 218280

tgcatatatt atatgttaag catagtcctg ctgagttccc tctgtcctct ccctattttg 218340

tcctgttctt tactattagg cccctttgtc cctcagatga tttacttctc ttttcttttt 218400

ctttttttgg ccgagggggg tttggtttgg tttggtttgg atttttgaga tatggctctt 218460
 ctgtgtagcc ctggctgttg tggaaacttgc tatatacttg gcagacctgg gactcacaga 218520
 gatccccctg ctgttctctc tagggtgtga gagttaaagg catgtaccac cataacctggc 218580
 ccttccttct gttttcatgt gagataaata tattgtttta tgtatctata ttaaaatcta 218640
 ggaatgacaa atgagagaaa atacaatgtc tgtctttttt aaattggcct aggtcattta 218700
 attataataa tttctagtig catcagcaaa agattttgtt caaattatta ctatttaatt 218760
 tggcatatga cttttgtaaa gaactcaata tglagtgtt gactcagaga atatggagt 218820

 ctcggttgtt tactttggga gaaatcaaaa ccttggcact tgcgacacat ttttttttc 218880
 ctgttagaat tctccatac catcagtaat taaaatacag ggggaaaagg aagaacaact 218940
 ttgagtctca ggagttaat actaaaataa tctactcttt agttttttt ttttttctg 219000
 taatggaaag gagaaaggaa aacactaatg ataaatataa tgggaagaca gaaaagctta 219060
 ctaagcagaa tglagtaata ttttgttgt aatttaacaa ataaagcttg cctgaatatac 219120
 aaagtgcaga gctaagctac tagttagcca tagaggtcag gcagtggtgg ccacacctt 219180
 aatcccagca ctcaggagac agaggcaggg ccacctggg ctacatgaga gtgaatcagt 219240

 ctaaaaaaga aatggagctc atacctgtga tctcagcgt agagaggaat ataaggcagg 219300
 atctcagtgc agtctcattg tagtctgagg tttgggtggag aacattgcag tctgtagtca 219360
 caacaaggac aggatcggcc cccaaccccc ccattagaga tgactgagcc ttggtagagg 219420
 tgagaactct ccagtggttg gctgctttgc ttttctgata ttcagcttga acccaatat 219480
 ctgtctctgg ctttttatta tttgtgtac agcagaagag gcaattaagt gtgaagattt 219540
 atttgtgtc acacaacaca accataatgt atttaaatgt tataagaaac ttctgaggaa 219600
 tgcttgactg tctcctgtc tacaggttgc ttttagacaa tggtaggga ggctggatca 219660

 tctggcaact gctgcaaatc tgtcataget tcatcctaac tcacaagatg ggattatata 219720
 aacattcaca atcagtgttg ggcactaact ctagaatgaa gagaatgtct gcagtttccc 219780
 tttacgtgta gcaggaataa gatcagagac gatgttttgc ctttttttt tttggctgtt 219840
 ggtgatttta aaattctcag atcatattgt tataaggaag ttctgatttt tgateccttc 219900
 tgtgatatga gtttcagatg aaaaaaagc aaaacaaagc catacaattt tgtatgctaa 219960
 cctagaaatt taatttaaag acattcagaa ctaatctaga gtttacaag gttcatttgt 220020
 catacgtagt aaacttaagc aaaggtagat gtttatcatt ttccataaac ctgtcagttc 220080

 agtttactga aaattaatgg aatttaaaaa aacttaatc tgtttaatga gtgtgggtat 220140
 tttgcctgca tgtgtgtctg cataccactt gcatgcctga accctggaac tggagttaga 220200
 gatgactgtg acctgccatg tgtgtgcgga gactccagcc tggatcctct ggaagagtag 220260

ccaatgcgca caaccactga gccatctctc cagctctgga ggactttttt gaaggcaggg 220320
 acctactttg tagccctggt tagcctgga ctcattatgt agacctgact attctcaaac 220380
 tcatagagat ttgcctgcct ctgccttcag agtgaagga ttcagtatgt acaccatcac 220440
 acctggttct gaatatgatt tgaattagtg tagcaatgcc tactagggtt tgtcagttta 220500

 cttatttatt ttgagtaaat gaagcagaac tcctggaatt aaaaagtaca ttaataacga 220560
 gggggatgca caaactgact tagtggagcc cattctatat ggagagatac tetgcccagc 220620
 ctagacacaa ggggtggcctg gagaggggccc ttggtcctgc ctcaaccaga tgggtgcaca 220680
 gacttagtag acttcttagg ggagccctca cctctccaa ggagtagatg ggatgtggtg 220740
 gggaaattggg aagagggaga agaggggggg ggaactggga ttggaattta aataataata 220800
 ataaaaaag aaaacattta aaagcaaaaa aaaaaaacc aaccacaagc cacaccaaac 220860
 aaacaacaa acaacaacaa aaagaacaaa ggggagctgg acataataa tctcaggcct 220920

 tggcgggttt gagtaggaa gctcaagagg tcaaaaccag ctctatcaca taatgatttt 220980
 ggagccagac tgcttatgtg agacactgtc tcagaagaaa taaattggag agagagggga 221040
 agggaaagag aaaaatgaaca aacacagagt ggttagcttc taattagaga gtaaatattt 221100
 gcattttttt ttttctgag agtaactcca catgagagat tttgggttcc agctgatata 221160
 gacacagtgg tttgtgtaag gaaggaacac aaataagtta gtttcagatg gtgcatattg 221220
 aagtcaattt tggttttcg atagtacgc tggtagtaat aacagacacc ttttaagttt 221280
 tttttccct ctttaatat ttttctccc ttcgtaacag tgagaattag ggtcattttc 221340

 tccacatttg tctgatagt attgtagac ctagaatttg atttttaag atgtatttat 221400
 ttattttatg tgcacatgtg gttttgcctg catgtatgta tatgtacat gtttgtgttg 221460
 tgtttggtgc ccaaggaggc tagaaaagag cactgggccc cctggatctg gggttacaga 221520
 tggttgttaa aatgtcacat ggggtctgag aacggaacat gatgtttcac aagagcatec 221580
 attcagtctt ctttaactg agtcatctct ccagacccta gagttttatt ttaattaa 221640
 acttgttgtt ttttgagac agtcttactg ttagccctg gctggcctga aactcaatgt 221700
 agaccagtct ggccttgaac tcacagaaac gtgctttcat ctgcttcct agcacttaga 221760

 ttaaagacaa gcaccaccag gcctgggaa aatttgattt taaagttcag accagataa 221820
 tttctagtgg tttttccctt ttgtcacacc tacctatag cattttaaat ttttcttcc 221880
 tcttctctt tccttcttt tttgtaagg aaacacagaa tatatacata ctcatattatg 221940
 tctgctttga agatggagca taaagataac aacttaaat tatgttagta caggctgaga 222000
 ctacttttt gagttaaaga aaagcatatt aattattaat tagtaaatat ttgtctgttt 222060
 tgttttcaa agcttcagtt tgcagttaga gtgcacagct gtttttatgg cagaccttaa 222120

aatagtttgt tgtttggaat acatctgtgt tctgggtcca taagtcaggg aacccatga 222180

tttttaatgg tgagtttata taacataccc gtctataact agttcaaaca gtgtcagatg 222240
cttgcaactga catttctaata gcctagatct egggaactac tctaggaaaa tgtctaccag 222300
ttatctgagt ggaagaatgt gattaaatac ttgctgttgg ttgtaaatgc aggaatagtg 222360
tttagtatgg agttgagtag gatataattc ctcataaaaa gctatatgtt ctgggaactc 222420
ttgtgtagac atccagaagt aagttcctaa ggttgtgacc actttactga cagcttttgt 222480
gtgtgtgtgt gtgtgtgtgt gtgtgtgtgt gtgtgtgcag tgtgattgtg ttcaagtgtt 222540
gaagtcaaag gataactttc tggagtcagt cctttctttc taccatataa gtgagggatt 222600

gaactctggc tgttttacta ggcagcccag gcatgatgaa atatgacat aatcaaagca 222660
ctcagaagac gaaggctgta ggattttgag ttctaggcta gcctgggcta ctcgtaact 222720
tcaaagcaaa acaaatctca tatctgcctc tggccattta cttatttctc tcagaagtag 222780
ttaatcacat ttttgtttat tgtttatatt gccatgggta ttttttttc cagacaggg 222840
ttctcaatat agctttggag cctatctggc acttgcctctg tcgaccagc tggcctcgaa 222900
ctcacagaga tccgctgcc tctgctccc gactgctggg attaaagtg tgcgccaaa 222960
acacccgcc tgccatgagt atttttatat actgtgacat attattaatc ttaaatgtat 223020

ctccctagcc aaaactcaaa agttttgttt tcagaaagag ttttttatt ttttgtttct 223080
ttcttctttt tttttttttt tttttttttt tttttttttt caaggcaggg ttctcggta 223140
ggtttggaga ctgtactgga actctctttg aagaccagc tggcctcgaa ctcacagaga 223200
tccgctgcc tctgtctccc gaatgctggg attacaggtg tgcaccacca ctgcccggct 223260
cagaaagagt ttttatttct aaaatctctc acaactttt agtgaatggc tataataacc 223320
tccacatttt tactaggttt tctgtggccc gtagggtctg gccatcagca gactagggca 223380
gagaggtaca ctagggtagc tctgcttgc tctggtgct ggtgacaact tgcttcagtt 223440

tatttcatct acagtgatct tgtcctccag gtcccagatc ttgatactgg agcctgtggc 223500
aggacagagc cagtagcagt tgagctaaa agcacaagc aacagcgtat gtagcctggc 223560
ctcctcccct ccaaaagcac agaaggatct gtctggacag accatgtgaa cttttttta 223620
aagtaagtct catacggccc aggagcagtc aaggagcctt agttttatgc agtactggct 223680
ggtggatctg agtctttgtg caatgctagg cagtttatct accagcttcg atagtccca 223740
gcctgtttt taaggcttct agagttaggt taattatgta gatgtgaga aaccaaccag 223800
ttactgaaag tggattattc cgtttttttt ttaaaatcta gaaatcagct ggggtggtgt 223860

ggcgcacgcc ttiagtccca gcacttggga ggagaggca ggtggatctc tgtgagtttg 223920
 agaccagcct ggtctacaag agctagttcc aggacaggct caaaaataaa ataaaataaa 223980
 cacaaaaaa acaaaacaac aaacaacaa aaactactca ataaaatcta gaaatcttag 224040
 gatgttcttt cttttaacat ctgtactata aataaacttg ccatctggat gcactggtgt 224100
 atgcctgtca ttgaagtact ctgaggatga cggatccctc tgagttcaca gccagcctgg 224160
 gtcacagagt aagacattct ctgaaaagaa aaaaaaggc aaaacaaaa caaaaaaaa 224220
 aaaaacaaaa acccttaaac ttgtcagtag ggctgctttc ttttattagc ttattacctt 224280

 gtcagattac tccagaattt aacactctcc aatgtatgct gtagatagat atagttgagt 224340
 ggtacaacgt gtgcctagca tgaatgaagt gtggggttca ttctgagcg tcagaccagc 224400
 ccacctgcaa aatcttttct gtttccctt cccaggggac ccctgcatcc cccacttga 224460
 cctagttagg ctctcatgt ccacttttgc ttctgtaaag acatctggag tctcaagttc 224520
 taaaaagcaa ttaggcgtga ggtttttgtt tgattttata gtttatgatg atcttgaaag 224580
 aaaagtgatg gtagttttgg tctttaaaa taaaaggag aaagattagg atagtgtgca 224640
 gggggagggg gagacactgg aaagtgcttg atgaattatg taaggaaagc atttggcttt 224700

 ggtcagaagt ttagttgagc tgggctgcaa gtgaacccat ctggcactact tttcattat 224760
 tctctgaaa tattcatggg ctcccacagt cctgccttg tttcatttg attcatacac 224820
 actctcatct tccaagact gctgtgggtt tgcagtaggt tgtcctcgtt ttgtttccat 224880
 gttgttttgg atataatcnn nnnnnnnnnn mnnnaggaa aagtttagat gcctatgggc 224940
 gtggaacaaa gtaaaactaca tgtattttga gaatgggaaa caatgaccaa agtaatcacc 225000
 atagtttatt atactttaag gtatgtgtaa tacttagata tctctagatg aatctcttct 225060
 gaccattaaa tagcactcct tttcactggt agtccctagc actacaagaa aagaatatat 225120

 aaataataat aaatctggcc cttagttagt aaatctgtgg tttaaaaat acatactttt 225180
 tatctgtgga caattagcca tttatatttg tcacttaggc ttctggcaat aaggaagtag 225240
 ggctgtccag gtgtattaat ttatttcttt tcttttcctt tttttttttt tttttttttt 225300
 tttttttttt aaaagggtt tttttttttt ttttttgggt tttcaagaca gggtttctct 225360
 gtggcttttg aagctgtcct agaactagct cttgtagatc aggcaggttt tgaactcaga 225420
 gatccgctg actctgcctc ccgagtctta ggactaaagg tgtgtttcat caccgctgg 225480
 caatttattt ctaaatactt taaaataatt ttatttatgt gtctctgtgt gggatatatg 225540

 acataggtgc aagcattcac agaggtcaga agtgggtgtc agatcctctg gaactgaagt 225600
 tacaataat tcagagccaa actcagatcc tetggaaaag taatacagga tettaaccac 225660
 tgagccatct cttcagcct ctgtgtttct accttctaaa cctgaaacca tctaaaataa 225720

acagtttagc ataatagtig taaacttggg ttctgggttt ggcatggtca aaatagatct 225780
 gagaaccaag tcttgtagt gagtggaatt ttctacttca ggtcatgctt atactgatac 225840
 agggaaagca tcaggcaacc tagagaccaa gcataaggtc tgtgactatg gactcacctt 225900
 tacctaaaag tggaatacag acaatactct tgggacagaa gtctcttggg agaataagtt 225960

 ggcggaaggg ttaaaactga ctcttgatac catatttga ccaaatacag gaaagaagag 226020
 cgggaaatta aaggcctcat ttagacggga ttgttttagt ctcggcagta atgttgatat 226080
 agatTTTTCT ggaccgacca tctatggctg ggctgtgttg gcctttgaag gttggcttgc 226140
 tggctgtcag aagagttttg acacagccaa atccaaactg tctcagaata attttgcctt 226200
 tggttacaag gctgaagact tccaactgca tactcatgtg aatgacggta ctggatttgg 226260
 agactcaatc taccaaaaag ttaatgagaa gactgaaaca tcaataaacc tggcatggac 226320
 agctggcagc agcaaacctc tgTTTTGGCA tcgatgctaa atataagctg gattgtaaaa 226380

 ctctgctctc tgccaaagta aacaatgcca gtttaattgg acggggttat atactcctct 226440
 gaccaggagt caaattgacc ctgtcagctt taatagatgg aaagaacttc aatgcaggag 226500
 gtcacaaggt tggattggga tttgaactgg aagcttaatg tgcttttgag aagaacatca 226560
 tttgccctg gaagtgaaga aaaatgaacc cactgtgttt tggccttaa atctctgtaa 226620
 atttcaaagc tgtgaacttt tattcttcca aagaattgta atccttcca cactgaagtc 226680
 tagagattgc aaatccatcc taagagaggt ccttgaaggt atgcctgcag attgtcatgt 226740
 ttgtgccaca tttcagttga gttctgcagt gttagttaa acatgttctc cagtaacaag 226800

 gtagtgccat attaaggaag atgatctgac accccggttt gaacatcacg tctgcatgt 226860
 cacactccac tttccatga ccttttgtaa taccagtttc tgctgtagtg aaatctttgg 226920
 ttttgcatca gagtgaagaa aaccgtcac atttgtaaca taaacaaca caaaaaagac 226980
 cctttcggtt gtaaacttga gggaaacttg gcctgatat aggtgccagt tttctctct 227040
 taatctagga gtagctgcag gtggaactgg taatggattt ggcactttgt aaatctgtat 227100
 tgaatcaaca gacttctgg gcattgaacc ttgatttctt gactcagaac tgctaaaaac 227160
 tgtggcttga tgatgtagac agaccatata ggaaaagact tttaaaaata gettttcatg 227220

 ccttattccc accccagcca tctttacctg ttacaccaa agtagcctat ggggtgtgat 227280
 agctacttct tttgtcattg tcatgtcgtt tgggtagag aggatggatc tgaggaagcc 227340
 agtaattcaa gtcttaattc ctcttgttat ttgtaggttt ctgttattt cactgcacca 227400
 aagtatgaaa tagctttctg gaactccgga catgagcaag gcagagtttt tgtcattgtg 227460
 tcacctggta acaacattag agatgtaaac tggacttctg ttgcatttgt cagcaactgtt 227520
 tattttttaa tagtctcata ggtacatttt agagtttctg ttttgtgtgg aattacatct 227580

tttccttcaa acgctgttat caacatcacg taaaaaaact tgaataaaat attgagacct 227640

 aaaaagatga gatcagtaga ggaaaaaaca tgaggttgct atctgacctc cacatacata 227700
 cacctgtgca tacagctaat acacacacac acacacacac acacacacac acacacacac 227760
 agacacacac tcacacacag agcacagaat atttgcataa aattggatac taatttttac 227820
 aaataaatta tttctacagt aaatcccaa gtagtatgtg aaaaagattg gacagaaaaa 227880
 aaaaagctta ttcaaaatag ttaattttgt tatagttgtt tttttgtttt agttatccta 227940
 ttagccttg gctgtcctgg aactagctct gtagaccagg ctggtctcga actcacagag 228000
 atccacctgc ctctgcctcc cgagtgtggt gactaaaggt gtgtaccacc accactggct 228060

 attccttat ctttatagag tgtgcaaagg tccacaagtc atgggtgtga agtgaagtc 228120
 agaggacagc ttgtgcaagt ctgttctagt cttccatggt ttttcatgg agtatcttgt 228180
 tttctccatc tataatgatt gaaagctttg ctgggtatag taatctgggt tggcatcttt 228240
 ggtcccttag tattaataga atatatatcc aggtccttct ggtttttaga atttccacgg 228300
 agtggtgagg tgtaattctg atagggatgc cttcacatgt tacttagccc ttttctttgc 228360
 tgctcttaat attctttctt tattctgtat gttttttgtt tttattttta tgtggtgggc 228420
 ctagccagcc agcaggacgt aagtagaaaa tgggggttca catgtgtgtc cctcactctt 228480

 aaaccttctt cacttcaccc tgaccacccc caattggtca tggccaggca catatgtaac 228540
 cagcccctag gcaggcatgg ttaggggtgc cctacaatt ccccttttag tctaaagagg 228600
 attaaaactt aacagtgtta aatatccata attaaaaatc acgaggataa aatacaggaa 228660
 gatataataa tctgcttatg ccacatccta actatgtcta ttctatttca actaaacctt 228720
 aaagtcatgt gaaagtggta tccaagcctg aacacctcct ttctatacca accataaaca 228780
 atagaaaact agccctaact acgtgtacag caccagatct tgtaacatat ggttgtgagc 228840
 caccatgtgg ttgctgggaa ttgaactcag gacctctgga agagcagtcg gtgctcttaa 228900

 tctctgagcc atctctccag ctnnnnnnnn nnnnnnnnnn nnnnnnnnnn nnnnnnnnnn 228960
 nnnnnnnnnn nnnnnnnnnn nnnnnnnnnn nnnnnnnnnn nnnnnnnnnn nnnnnnnnnn 229020
 nnnnnnnnnn nnnnnnnnnn nnnnnnnnnn nnnnnnnnnn nnnnnnnnnn nnnnnnnnnn 229080
 nnnnnnnnnn nnnnnnnnnn nnnnnnnnnn nnnnnnnnnn nnnnnnnnnn nnnnnnnnnn 229140
 nnnnnnnnnn ngtgggtgca tattgggttt tctgttgttg aatgtgcttt taccttgtec 229200
 tcttctcatc ctttcttcta gtggatgtag caagtgtttt ttgttatcct ggtgggtgtg 229260
 ggaccaaggt tccttctga tgtcggctct cttctcgtag atggaggtgt cactgtttcc 229320

cgggtgtcag cagtgccggg tcccctgag gtagttggag gcagagctgt cacccggcct 229380
 cagggtgtcg gatcccctg ccgaactctg tctggcatgc gggtcgcttg cctcagatga 229440
 ctctgagcag cgacaatgaa caggagccgg aaacagcccc tggcctccct gggccagtgg 229500
 atggaagcca ggctacctct ggggtgttcag tgttcggaac ccaccgctgc cgaacacggt 229560
 ccggcacttg cctcagatca ctctcctttt acagaatctt aatggcctag aagttactaa 229620
 tgatggatat taagtaata gcattgaaag attgacttat tttattctca ttcaaaatgt 229680
 gtcataaaga gctgggcgtt ggtggcacac gcctttatta atcccagcac ttgggaggca 229740

 gccacaggcg ggatctgtgt gagttcgaga ccagcctggt ctacaagagc tagttccagg 229800
 acagcctcca aagccacaga gaaaccctgt cttgaaaaac aaaaaacaaa aacaaaacaa 229860
 aacaaaaat atgtcataaa gtgattgtaa tatactggca gttacaggct gaactcagca 229920
 tgtgagtaag gggaacaaaa cctcacaaaa tacttgataa tttgattttg aggaattttg 229980
 ttgtcaacag agggtttggg gtcttttttg ttttgtttgt tttttgaaat agggctttgc 230040
 catggatccc agactggcct cagaaacatc acccttctgc ctcagcctcc taggtgtaat 230100
 acttgtgtgg ttctttaaca tactttgtag acagagtgc ttgtgttcat ctactttgga 230160

 tcttatggag tttgtcttct gtgtctggtg cttcagagtc atcccataga aaagctgtac 230220
 tgtttgaact gaaggatggc cagtaaagcg tgcagtgttt ttaacttcag acagtagctc 230280
 ggtagttatg catgtagatt tattactatt tctttccctt gtgctacctt cagaagttag 230340
 taacacgtcc tgaccagtcc cctgtattca gaaagaagca caatacattt ggtgtatcta 230400
 ttttctccta ctaaccttct gacacgggtt taatgctgat tagtcccaa agaattctag 230460
 atccaggctc catggcagga taaagaataa tcgttggttt gcacacgggc cagacgcagg 230520
 tgttagtcc agaatatgtc acatgaagat catattttgt ttaccaagat gaggttaaat 230580

 tagcatagca tgaactggag agaagaaagg gtagagtgag gtagagagga gcaggctata 230640
 ccagtcaatt aggatgcaa agtatctaag ggcatgaaa ggttgactga ataccttatt 230700
 caggtgagct ttaagtcact ttgcattggg aagataatat atagtcctaa aggctcaatt 230760
 aaaagtcaca tgaagatgt gcttgctaata aattatggta aaaatgatgt ttgaataata 230820
 cttcgaact cagagatgcc attttagata ctctcttgt atgtgcctct cactcagttc 230880
 tgggtctgac ataggtgtaa ggtgggcatt taatggagta gaactctgac tttgggtttc 230940
 tggaagtttc atccaaacca tacttgaaga cccaggctcc taactcctac acacaaggct 231000

 gagttgaggg atgggaacct tgtttggatt ttcttagttt ttgagtgaag ttgtgttag 231060
 aggatcaaat tgcctattt tgcatthaat ggtcacatgt ttcaaagctc ctcttgacta 231120
 tggatatttc tcaggctttg ttgtctctgg tagttttttt aggcctgctta ccagatatat 231180

gagccctttt ggaatgtgat attttgcctca tgagagtaga gttctggggt tgtgtgtcaa 231240
 aagcatgttt gatcttacta aactgtcttt cacactgtca gttctgagag ttcttggcat 231300
 ttggcatcct tagcattttg ggatactaac tttagggccca caccatttcc agttggtcag 231360
 gatacaattc ttacaagtca tttagtttta tcatcatttt gtttcctttg tctgagtatt 231420

 cctcttgaaa ttagtcttaa gatgatgtg ctttcctct atacttgtaa gtgttcgaga 231480
 tgtctaagta gtagttatta tgttaaaatc acttatgttc tttgcttga aactacatgt 231540
 cactgaagtt aagctgtggg tctgacctga atgtttcaaa ttaattgct tttgtttaat 231600
 tttttgtctt cattttccat tctcagat catTTTTgtt tttgtttgt ttttgccttg 231660
 ttcataaaga tttttgttc tattacatta ttagtTTTTg taccaatggc tagaagcaga 231720
 tCGTcatggc aagagccaag atactgcaa tacgacttca ggtaaaatag tttaaaatg 231780
 aatgggggat tagaaatcac aattttaatt caccccacgt cccattgtga atgcttctta 231840

 aatttgccta gacaaaatta taggtgatag ttgttttttg ttctctcctc tgcattctaa 231900
 ttttcataaa gacctcactt tgctttaagc ctfgaaaaaa atatatttac tagtctaagc 231960
 tgtcttggca tgtatttctt atttcttag gaggaaaggc ttagttaaag tttaaattta 232020
 gtagatcatt tggcaatatt gtttgaat agtctgtat atagtttata agagacaata 232080
 ttaacattgt agctatcttt tggcaatggg aaaaaattta acataggttc cttacaagta 232140
 tataaatact tgaagaaatt tgcattcctt atttattca agactatatt aaaaaggtaa 232200
 attttaattt aaggatgttt atatacagtt tctatttcat ttgaatcaa aatctcaagc 232260

 ccagtcattt tttcctatga actttttct tctcccactg atgttagtaa gactagaata 232320
 actacattta ttattcctg aatccttacc agtgatatca gactcttcc ctaatttctt 232380
 tcaaaataat atttgccaag acagctgtac atatagcagt gatctttctt gttgctcttc 232440
 tttctttctt tctttttct tttttaacag tataagagaa attggtgctg gtgctgctag 232500
 tagctgtggt ggtgatagtt acgggtggtg gaggtgttaa taaacggtgc aagtatcggg 232560
 ggcagtggtg gtggcgtggg tgggtggtgt gaaaggagga gaaggaagag gagggggaga 232620
 atacgtgtga ctgtttatgt gctttgtatt tttttttta attctttatg gggcataaat 232680

 tggttgtgac ttcagattgt tgggtgttcc acaggcaaca gaacaattat attaaaata 232740
 aaactgttgg ccaggtgtgg tggcgcacgc ctttaatccc agcacttggg aggcagaggc 232800
 aggcgatct ctgcgtttga ggccagcctg gtctatgaga gccagagctg ttacagacag 232860
 gaacctgtc tcgaacaaga aaaaaagaa agaaactgtt atgacttctc ctatttatct 232920
 tctgtccat ttataacttg atatctgaat gaagatgtta ctattttaac catgcacagg 232980
 caggaattca ttaaaggta agtattaca gtagttatat catgggttat attctgtttc 233040

tgttttttg gttcttggg tattttctta cagttatgga taaaaatagg catttcaggg 233100

 tcttagattg tgggccaag agagggttc tatagcttg cattatctca tgataaactt 233160
 ttgctgtga caatagetgt cagtaacata ggggtttttg tttgtttgtt tgtttttga 233220
 aacagggtct ctctatttag ccctggctat cctcaagctg gttctgtaga ccaggttggc 233280
 cttgaggtca cagagatcca cctgctctg ccttcccagt gctgggatta aagggtggca 233340
 ctagcttgct cagctgagta gtatagattt ttagaccaga ggaccttttt cctggctacc 233400
 tatttatta tagacaaaa gtgaagtga aactagtctt tttcaacca agaaaatata 233460
 aaatatcttg atgttcaca acaacaact agtacagctt aagaacatca tttatccaga 233520

 agtcaacaat ttigaactct gaattctgig ttctcagtc gtactgactc atggttaaca 233580
 tttatctcct caaccttag tcattaggca atctaggagc aaggtttaa aattggtgaa 233640
 tttactaaga aagcatttat ttatttaaaa atttatttaa tatgtatacc gtgttctgcc 233700
 tgcataatg tctataggct agaagaggc aacagatctc atcacagatg gttgtgagcc 233760
 accatgtggt tcttgggaat tgaactcagg tcctctggaa aagcagacag tacttttaac 233820
 tgctgagaca tcctccagc tcccagagag catttattta tttgtctgic tatttattga 233880
 gaaagaactc aactgtagcc caggctggcc tggaaatcac tatgtagccc aagttgcct 233940

 agtattcaca gtgatctca tgctctgcc tctcaacggc tggaaattata gacatgagaa 234000
 accacatcta gttttgggt gcctttgaca gtttctctcc tggaaagtaga agctctcaac 234060
 tcttagactg tgatgtatta tttatgactt attaaagctt gactgaagat ttagacaagc 234120
 aaagttagcc tgaagttgta gagatcaggc agtggtaatg cacacctta atcccatcag 234180
 gcagaagcta ggaggttgtg gtacacacct ttaatcctgg gagctggtac atggagcagc 234240
 ctttcaacc tgaatttga accctgtat cagtctctgg gtcatttatt tttgtgttac 234300
 actacataca tacataaac ttgactaata aaaaaaaaa agagactcca aaggaaatg 234360

 accatttgtt aaggacttca gttagaagcc gtagtttagt tgttttcagc aaatacattt 234420
 aaattatgtg ctttattcat aaaagttcct gtatatttaa cattgtcgtt tccaataaga 234480
 tatcagtgta taacatttcc cttgigtgat ttttttttt tttttactca cacaactcaa 234540
 agctgtttta gtatcttacc ttttcatatt tttatcccaa gtggacactg agtcatgtct 234600
 agcaaggtag cagtgccact tctaagtcg attgatttgt gattctttaa ttgtacaaat 234660
 actagtaaat tacatttata tctttccata actgtagttt gtacttaatt agaactaaaa 234720
 agtagaagge atccattctt taatcccagc attcaggagg caaagatagg tgaatctcta 234780

tgagctccag gacagccaga actgataata gtctcaaaag gaccaaagaa aagaaaagga 234840
 aagaaaagaa aagaaaacaa caggaataa tgaattcct ttgaggtctt ctaattcctg 234900
 aataactaact tttttacatt gactgtttaa gatccatcta aatcaagcta ttttatgaaa 234960
 ctaagctatt tggggaata gtcttatgga aattaatttg gtcaaggaaa taacaaatc 235020
 tgattaccct atgatttttt tcatggggga tgggtgttcg agacagggtt tctctatgta 235080
 gccttggcaa tccaggaact tactctgtag accaggctgg ccttgaactc agagattcat 235140
 ctgcctctgc ctctcagga ctggaattaa aggtgtgtgc cacctctgtc tacagttacc 235200

 tttctagaaa tttgataggt gttgacttgg gtatagaata cttatttctt taaaaggtta 235260
 acgtgtttag tgiattttac ccattgtttc tgattttgtt gattcaatca ctgaaaacct 235320
 gtctgtcaga cacttttgtg gcaacttaa caaaattgca tgcctgact gcagcattgg 235380
 gtttgggga aaatttcagt atcataacct tcagcttaa tcaagggtt tcttcggtga 235440
 aacgtttcta tataacttat cactgtatgt tgaatgagt ataataatta catgcaccaa 235500
 tgatatttgt gtattttgac ttttagtgtt aaatacagct gtgattttaa aattcagatt 235560
 ctaatgtttt taagtacaga cttctttctt ttttttttg actgttttc tttcttttt 235620

 cttctttct tttttcctt ttagttttt gagacagggt ttctctgtgt agctttggag 235680
 cctgtcctgg aactcactct gtagaccagg ttggcctcaa attcacagag agccacctgc 235740
 ctctgcctcc tgactgcaga ctttttaatt gatagtctc cagttggtaa gtattttca 235800
 aataagtttg agaaatataa tcagtaaatg ttttttaag atatacctgt atattatcca 235860
 ggtgtgggtc catacacctt tgatcccagc actcaggagg cagaggcagg cagatttctg 235920
 agtttgagga cagtctgttc tatagagcaa gttccaggac cgtcagagct acacagagaa 235980
 attctgtctt gaaaataata atagtatat agagtagata ttttaatta ttatatctt 236040

 ttcaattcca ggtattcatt gattattaat tatttgtgt aggtgaaat ttgaccaga 236100
 gtccittgag aagaacgttc aaatctaaag ttctggcaca ctaccctcag aacatagaac 236160
 tcaacccttt tgatcaagat gcagtgaaca tggatatatat ttttccttt ctgtcctgtt 236220
 tcttcagcat ttcttttatt aggatataaa tgataaatgt ctattattta atacaactaa 236280
 tcctttaaat tctatgagaa atagtattt taaggtttca tttttaaat gtctgtatcc 236340
 atcttttga tgatacatgt gtatgagtgc ctacagaagc cagaacaggg catcagtgtt 236400
 attgtttgt ttaaaaagaa gaaaagagga attgctgaga aagacatatt gactataagt 236460

 ttattataag ggccggcaga atggggagac taagaagagg aacagagtaa tggctgaccg 236520
 ccctggccgg gcgcataga gagacagagc ggggaaacag agagacggga gagcacacac 236580
 agagagagag agacggggga gagagagaga gcgtaaaggg gaagggcct atcttttaa 236640

ggggtcctct gcatggaacc ttgggctgac cagggtattg cctgagtgga ttccaccagg 236700

taacaggggc aggccagcat aatgcctgaa cctttcattc ccacctctac ttattattaa 236760

aaaaaggtgn nnnnnnnnnn nnnnnnnnnn nnnnnnnnnn nnnnnnnnnn nnnnnnnnnn 236820

nnnnnnnnnn nnnnnnnnnn nnnnnnnnnn nnnnnnnnnn nnnnnnnnnn nnnnnnnnnn 236880

nnnnnnnnnn nnnnnnnnnn nnnnnnnnnn nnnnnnnnnn nnnnnnnnnn nnnnnnnnnn 236940

nnnnnnnnnn nnnnnnnnnn nnnnnnnnnn nnnnnnnnnn nnnnnnnnnn nnnnnnnnnn 237000

nnnnnnnnnn nnnnnnnnnn nnnnnnnnnn nnnnnnnnnn nnnnnnnnnn nnnnnnnnnn 237060

nnnnnnnnnn nnnnnnnnnn nnnnnnnnnn nnnnnnnnnn nnnnnnnnnn nnnnnnnnnn 237120

nnnnnnnnnn nnnnnnnnnn nnnnnnnnnn nnnnnnnnnn nnnnnnnnnn nnnnnnnnnn 237180

nnnnnnnnnn nnnnnnnnnn nnnnnnnnnn nnnnnnnnnn nnnnnnnnnn nnnnnnnnnn 237240

nnnnnnnnnn nnnnnnnnnn nnnnnnnnnn nnnnnnnnnn nnnnnnnnnn nnnnnnnnnn 237300

nnnnnnnnnn nnnnnnnnnn nnnnnnnnnn nnnnnnnnnn nnnnnnnnnn nnnnnnnnnn 237360

nnnnnnnnnn nnnnnnnnnn nnnnnnnnnn nnnnnnnnnn nnnnnnnnnn nnnnnnnnnn 237420

nnnnnnnnnn nnnnnnnnnn nnnnnnnnnn nnnnnnnnnn nnnnnnnnnn nnnnnnnnnn 237480

nnnnnnnnnn nnnnnnnnnn nnnnnnnnnn nnnnnnnnnn nnnnnnnnnn nnnnnnnnnn 237540

nnnnnnnnnn nnnnnnnnnn nnnnnnnnnn nnnnnnnnnn nnnnnnnnnn nnnnnnnnnn 237600

nnnnnnnnnn nnnnnnnnnn nnnnnnnnnn nnnnnnnnnn nnnnnnnnnn nnnnnnnnnn 237660

nnnnnnnnnn nnnnnnnnnn nnnnnnnnnn nnnnnnnnnn nnnnnnnnnn nnnnnnnnnn 237720

nnnnnnnnnn nnnnnnnnnn nnnnnnnnnn nnnnnnnnnn nnnnnnnnnn nnnnnnnnnn 237780

nnnnnnnnnn nnnnnnnnnn nnnnnnnnnn nnnnnnnnnn nnnnnnnnnn nnnnnnnnnn 237840

nnnnnnnnnn nnnnnnnnnn nnnnnnnnnn nnnnnnnnnn nnnnnnnnnn nnnnnnnnnn 237900

nnnnnnnnnn nnnnnnnnnn nnnnnnnnnn nnnnnnnnnn nnnnnnnnnn nnnnnnnnnn 237960

nnnnnnnnnn nnnnnnnnnn nnnnnnnnnn nnnnnnnnnn nnnnnnnnnn nnnnnnnnnn 238020

nnnnnnnnnn nnnnnnnnnn nnnnnnnnnn nnnnnnnnnn nnnnnnnnnn nnnnnnnnnn 238080

nnnnnnnnnn nnnnnnnnnn nnnnnnnnnn nnnnnnnnnn nnnnnnnnnn nnnnnnnnnn 238140

nnnnnnnnnn nnnnnnnnnn nnnnnnnnnn nnnnnnnnnn nnnnnnnnnn nnnnnnnnnn 238200

nnnnnnnnnn nnnnnnnnnn nnnnnnnnnn nnnnnnnnnn nnnnnnnnnn nnnnnnnnnn 238260

nnnnnnnnnn nnnnnnnnnn nnnnnnnnnn nnnnnnnnnn nnnnnnnnnn nnnnnnnnnn 238320

nnnnnnnnnn nnnnnnnnnn nnnnnnnnnn nnnnnnnnnn nnnnnnnnnn nnnnnnnnnn 238380

nnnnnnnnnn nnnnnnnnnn nnnnnnnnnn nnnnnnnnnn nnnnnnnnnn nnnnnnnnnn 238440

nnnnnnnnnn nnnnnnnnnn nnnnnnnnnn nnnnnnnnnn nnnnnnnnnn nnnnnnnnnn 238500

nnnnnnnnnn nnnnnnnnnn nnnnnnnnnn nnnnnnnnnn nnnnnnnnnn nnnnnnnnnn 238560

 nnnnnnnnnn nnnnnnnnnn nnnnnnnnnn nnnnnnnnnn nnnnnnnnnn nnnnnnnnnn 238620
 nnnnnnnnnn nnnnnnnnnn nnnnnnnnnn nnnnnnnnnn nnnnnnnnnn nnnnnnnnnn 238680
 nnnnnnnnnn nnnnnnnnnn nnnnnnnnnn nnnnnnnnnn nnnnnnnnnn nnnnnnnnnn 238740
 nnnnnnnnnn nnnnnnnnnn nnnnnnnnnn nnnnnnnnnn nngcaaacag acattgccaa 238800
 ccaagaagaa acagtcataa atagaacaaa cagaacaatg agggacattc ccagggtgaaa 238860
 gaaagttccc attgggaggc agaactccgc taatttacct attcactgcc agtaacctca 238920
 ctgccagtaa ccgaaagatc ccgtaaaaat gtatttcccg tgggcaaggc caaaaaatgt 238980

 acagattgcc ctgtctgaga gcaccggcc cgaaacgaa aaatggacc agagtgaaca 239040
 gttctgggtc tgcccatag gaacgttttt tggtatctta ccgattgta gcgaatagc 239100
 agatcagtga gttccagaaa nnnnnnnnnn nnnnnnnnnn nnnnnnnnnn nnnnnnnnnn 239160
 nnnnnnnnnn nnnnnnnnnn nnnnnnnnnn nnnnnnnnnn nnnnnnnnnn nnnnnnnnnn 239220
 nnnnnnnnnn nnnnnnnnnn nnnnnnnnnn nnnnnnnnnn nnnnnnnnnn nnnnnnnnnn 239280
 nnnnnnnnnn nnnnnnnnnn nnnnnnnnnn nnnnnnnnnn nnnnnnnnnn nnnnnnnnnn 239340
 nnnnnnnnnn nnnnnnnnnn nnnnnnnnnn nnnnnnnnnn nnnnnnnnnn nnnnnnnnnn 239400

 nnnnnnnnnn nnnnnnnnnn nnnnnnnnnn nnnnnnnnnn nnnnnnnnnn nnnnnnnnnn 239460
 nnnnnnnnnn nnnnnnnnnn nnnnnnnnnn nnnnnnnnnn nnnnnnnnnn nnnnnnnnnn 239520
 nnnnnnnnnn nnnnnnnnnn nnnnnnnnnn nnnnnnnnnn nnnnnnnnnn nnnnnnnnnn 239580
 nnnnnnnnnn nnnnnnnnnn nnnnnnnngac ggggggggga gggagagaga gagagagaga 239640
 gagagagaga gtgagtaaag gggggggggc gtatctttta aagggtcct ctgcacctgc 239700
 gtgcagactt ctttcccatg gaaccttggg ctgaccaggg tattgcctga gtggattcca 239760
 ccaggtaaaca ggggcaggcc agcataatgc ctgaaccttt caatcagatc cectgcacct 239820

 ggagttgaa ggtcaattcg ggtcttctgg aagaatagtc tcttaactc aaagccatct 239880
 ctccacacat cctggaaac acaatattgt ctatttttac agatgggaa actgagtctt 239940
 ggagaagata gtttctcaga tttccacag caattatcac atcgtattac ttgtagtaa 240000
 tatacaacag aacctcaagt ccattttatt tctactgtt aatctgtgtt tgggtttgta 240060
 ttaatacatg atacttgta aacagtggag ctttctgttc cagctgttcc cacggctttt 240120
 gagccccaa ataaacaaa agacgtatt ttagttgtaa atctgttggc caatggctag 240180
 ggcttcttat tgctagctc cgtcttaatt attaactcat ttctattact ctacatattt 240240

ccacatggtc ttggcttacc ggagaatgcc tggacctgtt actcctttgg cagcctacgt 240300
 ggtgactgtt ctggcaggct ttctctgcct acctctccca gaatcttctt ctctcttagt 240360
 cccgcctgtc ttcccttcctt attggccaat agtgttttat tcatcaacca ataagagaaa 240420
 catgtataca gaaggacaac tcccatcagt ggtaaaccac ttctgtttgc ttgagggag 240480
 gaacatgatg tatttcata tatcaatgag tagtgtataa ttggtttgta ttttgcatt 240540
 tttcagacat catgaagatg gaaaggaact ctaaaactat tttatctatc ttatgtatgt 240600
 atgtatgtat gtatgtatgt atgtatgtat gtatgtatgt atatggactc agcccttcca 240660

 cagcatgcat atggagatca caggacaagt tttctctttc tgccgtgtat gtccctggga 240720
 tcaaaactcag ttggtcagggt ttggtcataa gtatcttttc acccactgag ctatcttacc 240780
 aacatgtttt tctttaatag acaggatttc actctagcca gactggcctt gcctttttgg 240840
 ctgtctttct acaccagcct ctcatgtgct atggatccac cacacctaga ctgtagagga 240900
 gcttaaatag gctatttaaa cgtcgcctagg aattgtttat gaagcatttg aatccaggca 240960
 atacgtcacc caggagtgat tataaatttc tttggttgcc cgttgggtgt ggcgcacgcc 241020
 tttaatccca aactcagga ggacagaggca ggacagatctc tgtgagttcg aggccagcct 241080

 ggtctccaga gcgagtgcc ggataggctc caaagctaca cagagaaacc ttgtctcaaa 241140
 aaaccagaaa agaaaaaaga tttattttatt taatgtgtga gtggtctatt atctgcatgt 241200
 atgcctttgt ggtaaaagaa ggcatcagat cccactagag atggttgtga gtcacatgt 241260
 ggtcatgtag ttgttaggac ttgaactcag gacctctgga agagtagcca gtgcttttaa 241320
 ctctctgtcc atcttgaata agaatgacca ggctcacctc gaactcagag aaattcacct 241380
 gcttctgcct ctcaagtgt gagatcaaag acatgcacca ccaccacca gtccttttt 241440
 ttaatagttc caaatttatt tagaatgtga gtttacttaa cattaacaat tacattttgt 241500

 tatgagtgtc cttacttct taatttttaa ttggaaataa attcttctcc catgtaatac 241560
 atccaaccac agtttccct cctcctctc actactctg gtttccctc cctctccat 241620
 ttcccttcag taaagggcag tcttccatga gacaacatcc aaacatggca aaataagaca 241680
 aagcaaaaac ttcatatcga ggctggacaa ggcaactcaa tagaaggaaa agagtccaag 241740
 agcaggcaaa agagttcgac acaccactc aactgttag tctcattta agggctagag 241800
 atggcatage agttaagagc acttgaacta tcttacctc ttccgtatac attcagggtg 241860
 ctgcttctct gggttccat acatctatct tggctcagga ccatcaggag ctcttacttt 241920

 cctttattaa tcaactgtctg atcagcttct cctgtctatt ctgttcttcc tctaccttct 241980
 gcttattctg ctacttctct tggcttgagt ctcttccca caatgaatta ttttttaata 242040
 gtttattttt attttatatg cattggatgt ttgcctgcat gtatgtatgg ctgtgtgagg 242100

gtctcaggtg ccctggaact ggggttacag acagttgtga gctgctatgt aggtactggg 242160
 aaatgaacce agttcctctg gaatagcagt cagtggcttt aactgatgag ccatctctcc 242220
 aggccccggt gaattatatt tacttattat ttatTTTTTg gTTTTtcgag acagggtttc 242280
 tctgtggttt ttggaggttg tcctggaact agctcttgta gaccaggctg ttctcgaact 242340

 cacagagatt ggctgcctc tgccctcccta gtgctgggat taaaggcttg gcctcactca 242400
 aaacctgggtg gcactttgaa ttatTTTTTt aaatggattt attttagggt cagtgaata 242460
 gctcagcaga tgaaggcatt tcctccaaa cctactaact tcagttcaac cccagaacc 242520
 cgactgtag aaggatagag tcaattccca aaagtatcc cctgatctct acacacacac 242580
 catagcatcg gtgtgtccac gacatgtaca tacatacatg ttttaaaatt atttattaat 242640
 gtcatatTTt gtatgggtat gtcagtgcca gtgcctgtgt agaccagaga tacaggatcc 242700
 tctggaactt gaggttacagg caattgtgag ctctttgata tgggtactgg gaactgaact 242760

 ctggtccgct gcagaaacag tattaatgac ttaatgagta agctgtttct ccagcaccca 242820
 tggtaaattc ttattgattc ttaagatttc attttaata gaatgttcat agagaaaatg 242880
 tcactttcca ctgtgtcact catggaagca ttgtccagta tttggttgta agacacatct 242940
 tatTTtcagt tgcTTTTgt tagttgaaga ggatgttgtt agtaagtatt gtgggttagc 243000
 aagagactta gagccatggt gagcaaatTA tgatttatgt ctcaagtttc ctgagagact 243060
 taatgtcttt gttcctggta atttatacaa ttctgacttt gaaaaagtca tcatgttttc 243120
 caattcagag ttcccagaat ttagaataca aatTTTgcct ttttaatttg tggaaaagag 243180

 tttaaagaaa attcttcat ctgttatcta tggaagcttt tcttcacttg aatataactt 243240
 ttggcaagct tttcctgtaa atgtttgaat gtgtgctcaa gaaagctaca aacccttaac 243300
 tgaactgagt atttggccac ttttcaaaaa cattgtgagc tttttggttc tctggtttag 243360
 atggtaaaga agcctgtcaa taaaattaag tcttagtctg cctagtgaca taatcttagc 243420
 acttggaga cagaggcagt aggctcagga attcagcttc attcttggct gtctacatag 243480
 agagttcatg accagagtgg aatatatgag accctatcaa caaaacaaaa acaaaaaaca 243540
 acaataaaat cagcaaaaaag catgaaatca aaaaaactta aatttgactt tetgcatgtc 243600

 actacatttc catattgtct acctgatata aaaagagaag ccttggggag ctaaagacat 243660
 gtcccagcac ttaagagcac ttgtgctct tgcgaagac cgggttttag ttcccagcaa 243720
 acacgtagca gtcacaact gtctgtaact ccagttccag ggaacctggc actctcttca 243780
 ggctttcctg ggtaccaggc ggggtcgtgg tgtacatcca cacatagaag caaaacattt 243840
 gtgcacatac aataaaaaata attcctTTTT aaaaaatgta gagagccaga catggtagca 243900
 ggcctttagt tctagcactt ggggcggtag aaacaggagg attagaaagt caagaccatc 243960

ttcggccacg caacaagcct gatcacatag attatgtttt aaagacagta aataaataaa 244020

 taagcaagat aattggccca gaaatctgtg atttgagtag gcttaacaga ttctacttca 244080
 tggatgatta gaatggttta cagactaaag agggatatca gctgaagact ggtactcaca 244140
 ggtccatttt cctatgtgag gctatagctt ggacatgtgt cattgtgctg tctcttcac 244200
 tggatcttgc catgtagcat gacagcttca agtcagccat ttttcctttt cctttcctgt 244260
 ttaatcaatg aaaaacattt attcagtttc aaattaaaat tataaaaacc tatcatctta 244320
 gcttatttag aaaaaggag acacatgcct aaatttttca aaaggaataa aaattttacc 244380
 tcctctcaac cctttatgag gatattaaca atcttttttag tttttaacce caagtttcaa 244440

 gaacacttac aaaaaaatt gttttgggta tgcctcaaca aaaaagcctc tttttgtata 244500
 tagtgtcaat aagctgacta gtacagaaaa ttatatatac tgtattttta gcaatgggca 244560
 ggctgctacc gtatcttggg agagctcaag tgggtgctggg gaaaaggagt ttgctttctt 244620
 tccatggctg tggcatgaa acaagcagga agatatgaag ttactccagc ttgtatcagc 244680
 tggctttca gacagctgaa gatcatgtaa tgagtcttga agatttgag tatttgagct 244740
 cagtgaaggg tttgtgttcc ccagttggga actcccgttt gctgggctcc cattatcctt 244800
 caaatacag aaattttttt tttttttttt tttttggttt ttcgagacag ggtttctctg 244860

 tgtagctttg gagcctatcc tggcactgcc ctggagacca ggctggcctt gaactcacag 244920
 agatccgcct gcctctgcct cccaagtgcct gggattaaag gcctacgcca ccaacgcctg 244980
 gccagaatac agtatatttc tagttgtcca tgtagttagc tttccataac cttacacagc 245040
 agtcatctga agatgccagt actgttctctg ttgtgttaca acttaccgc cagacctgag 245100
 aattatgggt accccactga gccacagcac agattcagat tttgttgaat ccccagaagt 245160
 aagttcttcc ctcacaagtt ttaatgtgaa aattcttagg tctttggctg ttattgccag 245220
 gatgtagaaa gatcttccca aatttgagc aaatgcaata tcatgaacag gatccagtga 245280

 ccatcataag agtttcagct ttgcattatt catggtatct tcaactgtaat aaaaaccttg 245340
 agctggggcg tgggtgtgct ggcttgaat cctggcactt gggagacaga ggcaggtgga 245400
 tctcttcgag gccagcctgg tctacaaggc gactgccaga gctgttacac agagaaacct 245460
 tgtctcgaa aaaacaaca aacaacaaa caacaacaa aaaaaacca aatcaaaaa 245520
 cagaatcctc cgaacctcgg ccattgcatg gactagactc ctcttattac ttctcacagc 245580
 tatagtggaa gactgagtg gggcaagagc tggaggtgct ccaagaaata cagctacagc 245640
 tcagcttaca tgaggtctca ctctgcagag acccctggga gagagcagac atctggtgcc 245700

tcacatattc ttactataacc atctgctgag caggttgcta acatgagacc catatgcaca 245760
 gagcaaatTT cacattcgtg atgggtgctc tgcTgtctcc tggagttacc cctttacca 245820
 ttgactttgt cctggaaggt catcgtttga ttctcccgTt tcttcccata ctgaagctgt 245880
 ccagtcaaaa gaacaggaag cctaagcctg tccacattca ggacaagcct gcatcccga 245940
 gatccactgt gtgtcttcca gccagcggTg taatgccagt ctccattttc actttctgtc 246000
 cctgagatgg ggaccgcctc tccctgaggg cactggcatt tgttcagtac tgttaaact 246060
 tgacggctctg gtctgttTgt ggagcaaatg gccgtctggc acttTgtgaa gacaaaagac 246120

 acatcataga tgatgtccct gtggTccact gtgatgccac ctgtcacaaa atagccagcg 246180
 ccaccagttt tctttatttg ttgcttcaag acttccaaga tgtgtgacca gtgagaggtg 246240
 gagctgcctt tttttttgTc tttgacagct atgtcattat gtgtcatttg ttactgctgt 246300
 tgaatttcat tataggggtg atctacattt cccctgtac aaatccatct aactttttct 246360
 tctttttaat ataataaaaa attttaactg cttattctta ttcagtcatg ttagaacaca 246420
 gccatcccaa gcctataTgt gtttcacact gtagggtaga gttgaatcac attcagatag 246480
 ttatctgact ctgtaagaag tttgctactc tgtggTatag gcattctgag cagcctggct 246540

 glattcagga gaggggtaga ctcgacttct tcttcttctt cttcttcttc ttcttctct 246600
 tcttcttctt ttaaagattt tatttattta ttatgtatac aacattctgc ttccatgtat 246660
 atctgcacac cagaagaggg catcagatct cataatggat ggtttgTgagc caccatgtgg 246720
 ttgccgggaa ttgaacttag gtctctgga agagcagccg gtgctcttaa cctctgagcc 246780
 atctctccag ccctataatt taaaatatct tgttatatac ctttctattt tagtaaataa 246840
 aaaggTttca tttttaagt ttatttttct aggatcaagc atgattgttc aaaatagcaa 246900
 aagtgatgtc agcatctgca gggTccatca tttttcaga gatttctact cacaaaaacc 246960

 taggatcctt gcgaaactgg gcaccctgca cgtgggtgTc agttaggagg tetgggcagt 247020
 ctatggcacc tctggcagtg tatcagaatt tatccctagt gtacaaatgg actgtggaag 247080
 cccattccac aaagagggat gctctctcag cctagacaca cggggatgTc ctaggccctg 247140
 ccccaagtga tTgacagac tctgaagatc cccctggaa ggcctcacc tttctatgga 247200
 acagaagagg gatgggatgg ggattagtgg gggacatggg agaatgggag atagagggac 247260
 ctgagattga tatataaat aagattgttt ctaattttaa tttaaaaaa agaaaaaaa 247320
 aaccctagga tcttTgattt tTctcttagt aaaagattt catgattggc ctctgtattg 247380

 ttgttgggtt ttttttttt ttctttttt tcttaaacc ttttTctctt ttggggggcc 247440
 ccaccatcca gctccatgtc tggctgtgta gctgggtggc tagcccttc ttttcttTct 247500
 cctctctct tctatctttt tctctctctg tttattctct ctgctgcca gccctctTg 247560

tcctttttcc tgctttgctg tgggctgttc agctctttat tagaccaatc ggggtgtttta 247620
 ggccaggcaca gtaacacagc ttcacagagt taacacaaatg caacataaaa gaatgaaaca 247680
 catctctgca tcagtaaaca aatgttccac agcataaaca aatgtaacac atcttaaaat 247740
 attccacaac acccgtgtga agcagagttg taatacatta ggggatTTTT aacatagaga 247800

tgctcaggaa aagggtaaaa ttaccccaag tgagcatagc gacttttcaa tggagagtca 247860
 cacttaaata tctttaaggt agccaaatgt gcctgggtgt gatgatgtgc tcccctaate 247920
 ccagcattca gtaacaaaag gcagagccaa gcagatctct gtgacctctt tgaggccaac 247980
 ccggactaca tattaaattc taggacagcc agaggtacat agtgagactc ttgtcttaaa 248040
 aaaataaaat acagccaaat gtacgttttt tggatatctg tgaagttgta tctcaaaggg 248100
 ttgtcaatga acttaaaaat gaggtcatag ggtgatagct gtgacaggct tgggtagcat 248160
 tacagcttga taaaaaagcc actctaggtc acaaggactg cagaggaaga ggattttcaa 248220

attatTTTT gtgcacgggt gttttgccta catgtatgac tatgctctgc atgcatgcct 248280
 ggtaccaaga tcacctggaa ctggagtgga cagatggttg gaagctgtca tgtggttaat 248340
 ggaaatcgaa tcttggctct ctggaagagc aaccctgtgc tcttaaatat tgagccatta 248400
 ctccagcccc atatggtgga attcttgatt ttaccaccagc agaaacctca gtcagactct 248460
 gggaatatgg ggacaccttt cttttctcat gtctccttaa ttttctgtct ttctgtcctg 248520
 cttagggtaa ctttttattt ttgttaactt ctttttcaact aataaaaaga gccttcatgt 248580
 ccccccccc ccataaacac tgtcataatc cctttaacaa tagtacttaa ggctgcgagt 248640

ggtggcacac atctttaatc ccagcattcc tgaggcagag ggcggtgtat ctctatgagt 248700
 tcaaggccag ccaggtctat atagggagtt ccatgccagg gctctatata gaccctgtct 248760
 caaaaaagta ttgttaaagt gtcccagcat ggtttgtcat caagtcttgt tcaagattga 248820
 ggattttttt tttttttttt agttgttgag ccctaatacca agacctcatt ctcttaaaag 248880
 ttttaaggtgc tagagagatg gatcagtgtt taagagcact ggttgctctt ccagtgttcc 248940
 tgagttcagt tcccagcaac cacacggtgg ctcaaatca tctctaatga gatggtgccc 249000
 tcttctgaca agtgtataca taataaacia ataaatttaa aataaaaata ttttcatgt 249060

athtagtgtt gggttttatg tgtgtgtatg tfgtgtgtg tgcatgtgc tgtctgtct 249120
 taccactgtg tftggaagtc aggagacagc tttcttctc caccatgtgg gttccagtga 249180
 tgaactgag gcttaacagc aatccctttt cctgctgagt gatctctctg actccagtct 249240
 tctcattctt aataaaaata cccgcacagt caatattttt ttccatgtat gtgttcatct 249300
 attttttaag tacatttact tactgtttgt gcgtgtgcac ctgtgtggag gtaagaggac 249360
 agctttagg agttagattt ctctttttac tftgtggccc ccaggaactg aaccaggct 249420

gtgaggctga cagttggagg taagcacctt tgtagaccc ccgaaaact caggtatccg 249480

gggtcccagg ccacgactgc ggtcaccca atcaccagac agattcgaga gcttgatgaa 249540

aactgcacga ggctttttgt aatttaacga gttaaccca tgtagcttg ggtctttcac 249600

ccaccgcca tggcggatgg ctagcaaaag acggctctta gggcctcca agagatctta 249660

taggacagcg taaggggagt gtctaggggt atgtacaggc tcacgattgg tgtgcctcca 249720

ggcttggagg gcttgccttg tgttgattgg tcaactggtt gttatggccc ataggcctc 249780

ccagggtggt tgctatactt tgtgtgtcat tgctgtgctc ttgtctgtaa agcacacca 249840

gggtcgtaaa gcatagcgc accagctaac ttctgattgg ttccttgtca cgaggcaggc 249900

atctgacttt ctagtgtcta ggacaagaga agcacgtgtt cagccgttat ggctgcaaaa 249960

atggaagctg gtcctttcac cttaactgct gagccaaatc ggccccacat ctatttctct 250020

tgagaatggt ttatctacat gtaagtgaag aacttatggt gtatttctga tttaaagcta 250080

ctgctgaaat taaatctgga taaaacttac cctttggatc ctgctaaaaa agaaagtcat 250140

tccccctct ccttttttt tctggtttga atttatgcat attccgatt ctgatgcttc 250200

ccccctctc ceatgtctcc acagctgtgc atgccgaaag ggctgtcttt cagaacgcaa 250260

gccgacaata aagaacctca gttccactca ttataatca cccgggaaga tggtctctgc 250320

acctatggct ttgtttcac tttttatgaa gaagttacga gtaagcagat ctgcacagca 250380

atgcagactc tgiaccagat gcataacgct gagcagtaca gcagcgtgta cgcttcatcc 250440

tcttgcacta tggactcctt ggccagtagc attgatgagg gagatgcaac ctctcttttg 250500

aaactccage gatacaactc ctacgacatc aacagagaca cttatacgt ttcaaaaagt 250560

atatgctga tcacgcctct gcctttcatg caagcctgca agaaattcct cctccagctt 250620

cacaaggcgg ttacctctca gcagccacca ccttgcgc tgagagcta catcataat 250680

attctctatg aagtaccct tccactcgc gggaggctac tgaaatttta cgggtttat 250740

gaacctgtca tctgccagag gcctgggccc aatgaactcc ctctttctga ctaccctt 250800

cgagaggcct ttgactcctt gggattagag aacctcgttc aagtgtttac ctgtgttctt 250860

ttagagatgc agatcctgct gtactcgcaa ggtagggtgc ctttgattt cctgttctaa 250920

aaacaagcac ttcagcctg aactgctttg tttccttaca gaatcaatca ctgatcttgt 250980

ctcttctgca taaaaagaat aggtttggat gagatgaaat actagaggtt ttttctgtt 251040

gaagtacag tggctgcaga gataaacagg aaggagtga aagtgttgtt ttgaccaatt 251100

tggttatatt tattttttaa cgaaaacaac tctttatcca caacattaat cattgatttg 251160

tgttgaacc tgttactggt actaatggac tctctttcat tacaaactgg caaagtttta 251220
 catgaaaatt caggtgacac ttgaaagtaa taaatgtaat gtttactctg caacttcctg 251280
 aggccgacaa ctttggacat ttgcctgtag gggcatttca tgggtgacaa agagaagaca 251340
 tgcaggcgag aaacagatac aactgcccta gacctagcag cagatctgct agagtgtgt 251400
 gtagttgtct ttttagcctc caagtcacag aaggtgttac ctttattgta tcttttattc 251460
 aaagtctcc caacacagat ttagttaaga tactagcagg ttgaattttg tttcactatt 251520
 atatttttga tgattgglat tgagcctagc ctggatatct gttcccatct gaatattaat 251580

 ttacagaaga aatagagatg ctgtgtcata aatagatatt ggattgtagg agattgtaaa 251640
 ccagctgtgt gcaactgttaa aactttggaa aatatggcac agatacttgg attggcattt 251700
 tgctagtttg tatttaggct ggcagaattg tggaacagtc tccctactgt ttgctgctat 251760
 gtttattttt tcaactttct tttttatttt tctattttta attgtaagt aaactgagcc 251820
 aagcaggcta tatttatgct tccccatctt gtgtgtgtgt gttgacactt tttgtgtgtt 251880
 gacagccctt catgaggttt ctcagtttat cctacacaat agtttttgat aatgtgttca 251940
 gtattgcgct ttgtgtcag agagttctct aatggctgtc tgagtccttt atgttccttc 252000

 tgctctcatt ttctcagtc tcaictatca ttacctgttt attgtctgct tgaggctcgg 252060
 tagaattggg gaggttgatg atgtcagctc tcagtgtcag attccagact gtttcagatt 252120
 ttgggattag aaatgtttaa gtagggcaga gaaatggtgc aggggttaag agcatttact 252180
 ctccatggtc tttcagatg acttgggttt ggttcccagt tccaggagat cttgaccttc 252240
 ttttgacctc caaggacact aggaacacgc acagacacac attcgagcaa agcctcatac 252300
 acataaaaca aaataaatgt ttaaccggta ttggtttttag aagtcataaa tgccttagtc 252360
 tcaaacctct gctctgtccc ttattaacta taagtgtgt acgtgactga cttaatttc 252420

 acaagtgttg tttctegccc ccatgtctct gggatgtttt tgccaccac ccaccctga 252480
 ttaattgtga aagttaaatg agaagacctt tctagaattt ttagactatg tgcgatgttc 252540
 cttatatcca ggggaaatt ggggaacagg agagataagt aaccatagca caactaacta 252600
 ttgtgtaat tcaaaaatg aggccttagat cagcctctct ccagatgact aaacctggt 252660
 ggtaactgta ctggatccac acatgatctc tccttacctg tctcagtact catttttaa 252720
 ttatttactc attcttcggg catatgatca atgtgctata ctaaatttt atagagtata 252780
 aaatgaaaac tttgtgtaa tgcaacgtga acagagtttt aaaggagtca tttgtcagt 252840

 ttgcactctg gtgcccttg tgattctgtg tgagggttt taaggatatt tgctacttca 252900
 tttgttacat attgataaat gtgtgctgta aaatttaaag gtgcttcag agccaaacaa 252960
 ttacatgaa aatccaaagt gaatctaagt agatggattt caatgatgaa agtgttcatt 253020

gaactgattt gaaatctcag tccacaattt atgtagacag attgagtcta ttgtctagag 253080
 agtaattccg tcacggcttt ttttttttc agtgagaatt caccaggaa gccaggctc 253140
 tttcctggca ccttatgtca gaagacataa ggcgtaacce tgaaggttac atgaagccag 253200
 acatcgtaag atgggagtat ggccctcttt tcaaaagaat agcggaaata taaacgatgg 253260

 ggaattttaa aactagtgt ctgacttttg gtaccaataa ttaaagcctc tagaacactt 253320
 ttggggcttg attacttacc tcctttcggc cttcacagag gaaataagca gttactgcca 253380
 cctacaccaa cccttatcc tgttcccatg tgccctctga ggccttctct gccattccat 253440
 cgctgtgagg aaagtaaaag ctctcggag ttttctttaa aacattgaaa gtcttttcat 253500
 tacatgctgc tagtcatgac aaagtagacc ttgtttgttg gttgtagttt atcaatcata 253560
 aaaaggaaac ctaatatct gatagaaaga aacgatgctt ccatgacctt gacccaaaaa 253620
 gcagtacaat ttaaccagtt ttgattaata ttttagtatt actagatttg ggggtaagg 253680

 ggcgtgaagt tgccttgaac atgttaggca aatgttctac cagtgagcac atctcccta 253740
 ctattagacc tattttatgt taagcataac cttattgtca ttaaattgt ttgtctttt 253800
 ttgtttttcc agacaggatt tctttatgta acagccctag ctgtgctgaa actaactcta 253860
 tagaccaggc tggccttga cctcagaga tttgcctacc tctgtcccc atgcacctgg 253920
 gattaaaggc gtgcaccatc accgcctggc atttgcctt ttttttttt ttttttttt 253980
 ttaaaaaaca tagggtctca tgtggccctg gctggctttg agctcactct gtatctgagg 254040
 ataactttga actggcttac aaacatatgt tgcctgtct agctctactt gtgttgttt 254100

 taaagcagta aggaagattt tattcaggcc aattgtgata gatatatggg actatcctgt 254160
 gcaagctgcc ttaaatagtc tgattttaca ttgccatct atctgacct atgactatca 254220
 taagttagaa aagattcaga tgaagggtc tttaccattg tgcttctct tttatcactg 254280
 ctagagaaac agtgtatggt ttagecagtc cattaagctg atttgtttt ggcttctca 254340
 gttgttct taaaacaaga catgcttggg ctggagagat ggctcagagg ttaagagcac 254400
 tgactgttct tcagaggctc ctgagttcaa ttcccagcaa ccacatgata gctcacaacc 254460
 atctgtaatg agacctggtg ccctctctg gctgcaggg acacatgcag acagaacact 254520

 atatacataa taaataaatc ttaaaagaaa aaaaaaaaaag aaaaaaaca agacatgctc 254580
 atttgctttg gagctgccat ccataaatca cgtcacctt tttggcctt tgagaggcgc 254640
 atgtccaaat gacagtggaa cttgcagatt cccatataat tccaaccagt cctaaagga 254700
 agagatgctc tgcatttatg tatctctttg cactcagtgt tagcaagatc cgtataaact 254760
 atttacattt cttcatgcca ctttcctgc agagagtttt tctgacctta caagatacta 254820
 tgagtacttc agatttcaag agtatttgat gtacttcagt catgggatct gttttgttta 254880

ctatacaatt gcaagctcat agttgctcct caaatggaaa ttctgtagtt cattgccct 254940

gcagtggta ctaggaaata aagatattta acatagtctt catagctgtt tcattgagga 255000

tttgtcagta tcagcttctg gtttacattg ttgtctcagg aagacctatt cattccatt 255060

tagtgtgtct aatagatg acttgaaaag tgagtttatt taatttctgt cctatagcaa 255120

tacatactac atagaaaaag tgttccata aaacatgcat gtaaaccctg cttaaatatt 255180

ctaattcatt ttagacttct accttaattc cataacccta actttttatt tgtttagttt 255240

ttcaagacag ggtttctccg tatagtcctt tctgtcctgg aactcactat gtagaccagg 255300

ctggccttga actcaaagat ccacctgctt ttgccttctg agtgctagga ttaaagggtg 255360

gccccagaac taccagcat aaccctaaca ctttaatatc ctatcact aattatagct 255420

tggtatatga ggcactctg taaagttgtt ccagaaacct ttttctacc ctgaccactt 255480

atatgaacct gtacattagg tcttaggctt ctgtgaagga gttgtgctaa gggacactag 255540

tcctttgtc tatcctgaat gtggattatg gcccaaacag gctttagttt atattttat 255600

tattttttta gtttatgtgt atgggtgtt tctgtgtata tacatgcacc ctttgaact 255660

ggagttacag gcagtataag ccaccatgtg gatggtagga atcaagtcca attgctctag 255720

aagagtagcc tigtctctta accacagagc tgtctttcta gcccacagt tgatattct 255780

tttctttttt ggggggtggg gggaacatca gattccctag aactggggtt agacagtct 255840

gaactgcctt gtgggtactg ggaatcgaac ccaggtctc gacaagagca gccagtctc 255900

ttaaccactg agccatcctt ttagtccca gtctaagta tcttgatctt atccactccc 255960

aactcattcc ttttctata agattccctt cccatgttta tattttctc ctttccct 256020

cccttccct ctgttctctc ctccctccc tttctctctc ctccctctt tccttcttc 256080

ctcactctct ctttctccct ctgaccggcc cccatctct gtaactgagt gatttcagtt 256140

aatgcttctt gctggaactg tgactgatct tgtttaggta aaatagctgc agtgagttea 256200

tgagtttaca tgctaggag acagcatctc acagacttct tgttctttc tcctctctt 256260

ccgtgacatc cgtgagctt tgtggaagt ttagagatg tcccgtttat gaccgagcac 256320

tcagtgtca cttattctta gtacttagac cacttaggag tttctgact aatgcttccc 256380

actgcagaaa gaaacttctc tggtaagac tgagacagtg ctaaccggtc atcatgtcct 256440

ttttgttca cccattgtgc tataagtctc catattgtg agatgagtgc ctgactctc 256500

ctcccacttc atatcctttt aaaaatgctt ttttctttg tgtggtgtgt gtgtgtgtgt 256560

gtgtgtgtgt gtgtgtgtgt taggggccag tgggactgtc ctgctgatgt gagctcagtt 256620

cttagaaccc acagtggaag aagaggactg actcctgaaa gttgaaattt ttttttagct 256680
 gcatgcacat agtaaataag tagacaaaaa taataaattg ttttaaaatt gttagacccc 256740
 cccccagaaa actcaggcct ctggggcttc agcccaggac ctcagtcacc ccaatcacca 256800
 ggcagattca aaagcttgct gcaaaactgca tgaggcttta ttgttgttta acgagctaac 256860
 cccatgtaag ctcaggtcct tccccaccc gccatggtgg atggctagca aagacagatc 256920
 gaaggggctg caaagagann nnnnnnnnnn nnnnnnnnnn nnnnnnnnnn nnnnnnnnnn 256980
 nnnnnnnnnn nnnnnnnnnn nnnnnnnnnn nnnnnnnnnn nnnnnnnnnn nnnnnctcc 257040

 cagggtggtt gctatgctct gcgagtcatt gctgtgcact tttctgcaa gcacaccag 257100
 agccgtaaag catagcgtgg ccagctaaac tttctgattgg ttccttgca tgaggcaagc 257160
 atctgacttc tagtgactag gacaaggtca tggcaagcac gtgttactgt tgtggctgcc 257220
 gaaaggggca ggcatctgac cttagtact aagacaaggt cagacaaata cgtgttcggc 257280
 tgttatggct gccaaaatgg ggagctggtc cttcaaaat aaaagagaga gggaaactat 257340
 tcagaagtc gttctctct ccaccaatg cagaaagtc tcttgttct gctagctgcc 257400
 cagtgagttt ctaagcgatt ttctcgtecc cttgtcatt tccccatagg gacaccgagg 257460

 ttacacacat ctggcttttt acacaggttc taaggctcca actcagatct tgcggcggct 257520
 tgtgtggtgt tgatgttcta gtttcatttc tattgctctg accgatttag gggagaaagg 257580
 gtttatttgg ttigtattc cagatcatag tccatcacta caggaagct actgcatcag 257640
 gagcttaaag cagctggca catcatgtct gtagtcaagc agagagaaat ggatataggt 257700
 atacccttg cttgcttacc tgtgttagac ccccggaaaa actcaggtat cggagtccc 257760
 aggccatgac tgcggtcacc ccaatcacca ggcagatttg agagcttgat gcaaactgca 257820
 tgaggcttta ttgtttttaa cgagctaacc ccatgttagc tcaggtcttt caccactcg 257880

 ccatggcgga tgctgcaaa gacacctega accggctgct gagagatctt gtaggcagc 257940
 glaaggggag tgtctagggg tacacacagg ctcaggattg gtgtgcctcc aggcttggag 258000
 ggcttgcct gtgttgattg gccaatggt tgttatggcc cataggcct cccagggtgg 258060
 ttgctatgct ctgcgctca ttgctgtgca cttgtgtgta aagcacacce agagecgtaa 258120
 agcatagcac caccagctga cttctgattg gttccttgc acaaggcagg cacctaacct 258180
 ctagtacta aggcaaggtc atagtgagca cctgttactg tcatggctgc cgaatgggg 258240
 ggctgtccc ttcacctgtg ttcagttaga tttcctcttt cagagcacat ggtaagaact 258300

 ttaccctgt ttaccgggat ggttgcctc ttgagtgtat ctgaatcata cgccttggtt 258360
 tcacagtggg atatggtcc tgtatcaatt gaatcttgtt ctattctgaa acatctaaaa 258420
 atttaaaaa gccaattttg atggcacatg cttgtgacct gaacacttga gaggcaaaga 258480

catgagggtc tctgcaagtt tatagcctac ctagtacaca cagttggcat acaggtcagc 258540
 taggactaca cagcaaaatc tgtctcagaa aaaaaaaaaa aaagtgagaa ataaagtcac 258600
 catcctagag tagacaccat gataaagatt cttttggaaa ctgatgttcc cccagatgag 258660
 gatcttcaca ttatattcct gtagcttctt ggttttgctc ctctcctaca tgagctaagg 258720

 tcttagaagt gccctgttgt ttccatataa tttcacccct tggagagggg agattgaacc 258780
 tagtggccaa gctcagacca actgaaatct gagctttttc cagcatcaag ctctaacata 258840
 acactctcct ctaatttcat tttagttctt taaaaaaaaa aggaaaaaaaa aaagatgttt 258900
 atttattaca tacagtgtcc tgtttgcatg tctgcctgca ggacagaaga gggcaccaga 258960
 tctcattaga gatggttgtg agctacatg tggttgctag gaattgaact caggacctct 259020
 ggaagagcag cctctgagcc atctctccag ccctcattt tagctccaaa ataaccaggg 259080
 gagtttataat ttcattatit tattatttggg ttgcattcct ttaagtgtct gtaaaactgcc 259140

 tcccaagaat tggatccatt cctgcattcc attggaatg gatgattgat cccagtggat 259200
 cttactccct tccatgggga ctatgtgacc acccggagcc aaaggatctc tacacctgat 259260
 tttctttttt attgagtcca gggtttgaaa tgaagtetca ctctgtagcc ccagatgaca 259320
 tcatgacact ctgcttccat atccccacac ctggcacagc tcttcccttt catctctcca 259380
 cacactgcgt gtttccaaa ctcccagcca ttctagcaag tctaattgtt tctgaaacta 259440
 acaaataaga ggctttttc attctttctt tctttttttt cccgagacag ggtttctctg 259500
 tggctttgga ggctgtcctg gaactagccc ttgcagacca ggctggcctt gaactcacag 259560

 agatccacct gcctctgect cctgagtget ggggttaaag gtgtgcgcca ccaatgcccc 259620
 gcttgagacc tttttcttct agcctccagt tctgatgctt actaggtgat aaacggttca 259680
 gttcagttct gacattacc agagtaaca acaaaactaca gatttaaagc ttcaagccta 259740
 ctagaatctc acttttgatt ctagtcataa atggaatccc taggctacce acctttcttt 259800
 ctggctgact ataaattcag ttttctgat agtctcacc tttgtttttt gtttttaata 259860
 ttgttttggg gttttgttgt tgtttttgt tggtttttga gataaggttt ctctatatag 259920
 cccacatagg ccttgaactc atgatcctc tgcctcagct tctgaatac taggatttca 259980

 gatttgtgcc accaagcctg gctccttggg ttgataatc tggtagaaca attcaccaa 260040
 gtaataagaa gcactttata tacttacaat cagctattat gaagaataca gcttggaaag 260100
 gccaaatgaa agtgggtgtag agcaggaagg tgcaggggag gggcttgcac gtcctcttta 260160
 aggataatc ttagccacc tcagatgtt cctagcctg gaagcctccc tgtctctggt 260220
 gttcttttta atttggaata ataaagttta aacttgtgtt gcacaaatc taattgtttt 260280
 taataataaa aactcaggct ggggtggttca gttaatcca gaactggggt ggcagaggca 260340

ggtggatctc tgtgagctgg aggccagcct ggtctacaga gaaaccctgt cttgaaaaaa 260400

 aaaaaaaaaa aggtgggtgg gggcacttaa ctacagagaga gctgttggga tgaaagtga 260460
 agaattagag aagcaaagtg gccagccact agagttctca cctctaccag tgttcagacc 260520
 aaaagggaga tcctgtcctc agactgtctc ctacagactgc ctagattgct tcagactgtt 260580
 tcagactgaa tgccttgagc tcctgtctcc tctgtccatc cagccatc acttctctgc 260640
 tccacctctt taatgctggg attaaagggt ttgggatccc aaatgctggg gtcacatttg 260700
 tgtgagcttt gtttctcttt tagacagatt cactctcatg tagcccaggg tggccttgaa 260760
 ctaacagaga cccatctgcc tctgtctccc aagtgtctggg agtaaagggt tgtgccacca 260820

 ctgcctggcc ttiatggta actagtgtga cactgggat taaagggtg tatcaccact 260880
 gcctagcctg tatctgacta gtgtggctag ctttgactc tgatctcag gcaagcttta 260940
 tttgttacat tataaacaata ataccaccac aaatttgtgt gtgtgtacac atgttcagc 261000
 acgattgtgg aggtcagagg acaactttta ggagtcagtt ccacctcca ctttgctgag 261060
 gtaggtctc tatcattct gcggtgcaa tatgtactct gggttagctg gccacaatg 261120
 agactggttt gagtctctaa tcctctgcc tccatctccc aagtgttagg ctttactct 261180
 gtttgggat aagtctcact aggtcatcca ggctggcttg gaattatita ctgatcttc 261240

 tgtgtcagcc tccaagtatt tggtaataca ggeccataca tacacctaac atttttgac 261300
 ataagcactt aacctgatac tattcagcat ctttaattca gataactgat ctgggtcgta 261360
 gctcaataat agaacatttg cctagaatat gtaaggcccg gacgagcatt aaaaaaaaaa 261420
 aaaaaaaaaa aaaaagtfff tctttgctgt tgttgttttt ttcttttcaa tgatgggtct 261480
 cacatctggt gctggccttg agtttgctat tttattttta tcagggatga ctttgaactt 261540
 cttattgttt cacatccacc tccaagtgc tggggtcaca gacatgtgcc cgtgcctagt 261600
 ttatatggtg ctaaggagtg aacctgtgac ttcacatgat ttaggcaggt attctgcca 261660

 ccgagctatg tgcccagggt taggagtata ggcgagcga gtaccaccac attcagcctt 261720
 tctcatttgc gttctaagca taaaacttaa tattaggtct acatgtcatt cacttccgat 261780
 tctggccaa ctacactgcc caagttttgt ttaggattta tggagcaagg aggaggagg 261840
 aaggagagag aagagtgcac gaatgagttt gaatacctt ttgtgtggg aaggcatttg 261900
 tgtgccactg tatgtgtgtt gaggtcagag gacaactttg aggtgttagt cttgtctgt 261960
 ccactttgag gcaggatctt ttctctgctg tacatgcca gttagctggc cttcaattc 262020
 ccactgtact cctatctcag tcacctgtct ccaggaggg acagtgggat gagatgctgt 262080

actacatcgt acigttagg ccaattaatt ttatgttaac cttttcttt gacagctttg 262140
 tacatgatg taatacattg ttttaagat tttttttgtt tattgttaga gaaatatat 262200
 atgacacagt gtaagtgtag aggtaagagg acagtttttg ggagtcactc gtctctactg 262260
 atcctaggag ttgaactcgg gtcattaggc agtagcactc ttacacatct gagctacatc 262320
 tcgttgattc tgtaatgcat tctagtaact ctaatctttc acaccttctc tcctctccct 262380
 tcccacctcc acaaaccacc ttctcccta caagtctcag gtgcatgcat tttgttttg 262440
 tttgtgact cactaagttt aagtagggcc atgtccctgg gcatgtccat tggagcctgg 262500

tggatattct aggcaaattt ttgaaaatat gttttactat gtaacatagc caagcataat 262560
 tttgtcggta ttcaaagta tatttcattt tacattcctt agttgttaat atacacattt 262620
 attggccaat tacaatgtag taaaccctgg attctattct gaaaattctg agattagaaa 262680
 tatatggtc aacttttgtt ggtagtataa gcctttaatt ccagcattgg ctggctggct 262740
 ggctggctgg ctggcagaaa caggcagatc tctgaattga ggccaacctg gtctaataag 262800
 tgatttccag atcgccagg gatacatatt acgacctat ctcaaaataa atatagccat 262860
 cacttggggc tggtagatg gatggctcag tttttgggat tttcttggga gttagttttg 262920

gggttttatg catgtgttg tctggaagt tctccttgtt tttgtttcac tttaaataca 262980
 aacatttgtc aggtgtgata gtagactttg aactcagga agttgagaca gagggatcag 263040
 tttagcctag tagtatggga ccagctggg aacacagcaa gactacatct cttttataag 263100
 aaaaagtgat gcaggagggt gctcagcagt taaatttctt tttcattatg tctaacttga 263160
 gtgtaatccc tggaccaca tgggtggccag agagaaatga ctctttcaag tcattttcta 263220
 acctccacag gtgacacaca tctatcttgc acctcctcc attctcctt ccactaaatg 263280
 gatgtgtaat ttttaaaagt gtgtgtgtgt gtgtgtgtgt gtgtgtgcag agacagagac 263340

aagtatacaa aggaagatag taaataggg aacagaggca tatcaataat tataatagaa 263400
 ttataatagt ttagacaaga tagataatta atgttgtaaa agaaataaga aatcctagca 263460
 cttagagggc agaggcagg agatctgtgt gagtttgaga ccagcctgat ctacaaataa 263520
 gtcccagac agccagggt acacagagaa acctgtctc aaaaaacaaa aaacaaacag 263580
 taaataaaaa attaagcgag taaataaatg tgcttgggt acttgaata aatgactcc 263640
 cttgggttca tatatataa tgcttaggta gtggcactat gtgaaagact taggaggtat 263700
 gaccttctct gggtaggtg tggccttgit ggaggaagct tgtgggggt gggatcaag 263760

gagtagcatg agttctaac ggttttaata ataaaaacct ggagtcagtt attggcatta 263820
 atactgaaga tcagagaaac aaagtggcca gccactagat agttcctttt ttttttccc 263880
 aagatgtatt tacttattat gtatacattg gtctacctgc atgtatgcct acagtaggcc 263940

agaagagggt accatattctt actgaagatg gctataagtc accatgtggt tgctggaaat 264000
 tgaactcagg acctctagaa gaggagccag tgctcttaat ctctgagcca tctctccagc 264060
 tccactggag agttcttacc tctaccagtg ctgagaccaa aggggtgatc ctgtcctcat 264120
 actgcattct cagactgctt agactgctcc tcagactgct ctgtctctct cttttgtttc 264180

 ctcttgcectt acagtcttct cactgtatct cactccagcc ataacacttc tgtctgcacc 264240
 accctagtgc tggcattaaa ggtgtgtgat cccaagtctt gggatcactt tagtgtgagc 264300
 tctatttctc ttttagacag attgaatctc aagtagccca gggtagcctt gcctctgtct 264360
 cccaagtgct gggattaaag gtgtgtgcca cactgctg acctctgtgg ctaactaatg 264420
 tggctagctt tgcactctga tctccaggca aactttatct gttaggtcat aaatgaagta 264480
 tcaccacatc gggcttttag gtcttttaga tagaacagta agatgggtgct gaatgggaag 264540
 acggctcagt cagtgcctgc caggtaagtg tgagtacctg agttgaaatc cctattacta 264600

 cataaaagcc agctgcagtg gtacacacct gcaacttgag ctctgaggag aggagtgggtg 264660
 aaaacaggtc tctggaggcc agtagccagg cagtatagcc aaattggtga actccagtgt 264720
 ctcataaaat aaaggtggaa agcaattaag gaagacatat tacatcaacc tctggcatgc 264780
 atatatataa acacaggcaa aagaatactt aaagaagcat tttgttcttt tcttttttgc 264840
 tgtgctagtg attgaataga ggctttgtgc atgctagaca ggcatcctgc cactacttta 264900
 ttaccagctc ctgctgttta tttcttgact gagttaaag ggatgctcta cctctgtgaa 264960
 gcagtctcat tgctaaaaag tgtatgatgt atccaccagt catatagaga atccaaacct 265020

 aaaaagatta gacatagaac atttacaagt gggaaaacgg tagtaaagga aaaacaaaca 265080
 gcgtccctga aagtccagaa tagagaaaaa tgtgtaatta attttactt cccatggtgt 265140
 tttttctata aataaagcaa gaagataaca cacagtaca accatcatta ctgaagaaa 265200
 gtgtatttcc caggagaccg catatttctc cagtcacaag taaactagct accttgttag 265260
 gaatttagtt tgcaccagatc ccttttcttt tcagtttagg ttcaccagg agacagaaat 265320
 cataaagtag tttaggatga ggaatgtaat atgaattggt ttggaaaata agctgtaaag 265380
 tgataaaactc tgaagggtac tcagtgaagc acaaacattt aagtgggaac ccagacccca 265440

 aagctgtaat ggattcctct tgaagaaatt ctgttcataa ggtgtggaga aggccagtgg 265500
 attgcttgtc agtatgttcc ctggaccaga gctgatcctt ggccactgat ctaacagaag 265560
 acaaagtcca aacccatgt tgtctgtgac tgggtgaaca gaccacagg acctgtttga 265620
 atgtcactgt ggtatgagat ctgagattgc agggtagtag agaaccatata gaggaagtag 265680
 ccaactgactg ctgactcttg gcatgtggca tagcagtgtg cccctgata ccttcacaca 265740
 cccacactgc tggctctcca agcagcaaga gcaagacata ttgcatactg acaccaggaa 265800

actgtgtgtc tccatcgccc tctactggca aagtataata ttgtattcat tgtcaaaatg 265860

ggtagaggcc aatcagttat aagaactgga tgaatttggg gctgagagcc atttaatgaa 265920

taattggcac ataatttgc taaagctcca agctagecct ccacattatc tggcatatga 265980

tggagaaaga aataataaaa tcagacacta atgtcttaga actgatagcc cttgctgtgt 266040

ctatggactg atgtgatcct catgtctaag ccgtgctttt ctgtaggact taaacaacc 266100

caaaagaata acaagcaatg ttattatgtg ctccacaaaa tacacacact ctctctttct 266160

ctctctctct ctctctctct ctctctctcc acacacacac acacacacac agaaccaggg 266220

tctctctggt acataaccagg caaatgctct accactatcc tacattcctt acactttata 266280

ctcatcatag atcaaattha ctgagatact gcactttgat tttcttgtcg gactttcttt 266340

ggactgccag ccccaata atgacacaga gacttattat taattgtgaa agcttggcct 266400

ttagcttaat cttgttcaaa actagctctt ataacttaaa ttaacctgct tctattcacc 266460

tatgttctgc catgtaactt tttacccttc tctgttctgt atgtctggct tctgtgtctc 266520

actggagtct gtggcagcct cagattctga ccttgggttc ctctctctgt ctggaagtcc 266580

cgctattct cctgcatagc tattggccac tcagctcttt attaaaccaa tcaggtgcct 266640

taggcaggcg aggtaaaaca tagacatc ctgacacagt ttgctcaagt atccctcaac 266700

aagataacta cctggtcaca gactacttca ttttgacagc ttccaatcca aagcaagtct 266760

ctgttttctt aatgcccaca attatctgc aaaatccca atactatact agtctttctt 266820

cactaagatg ttccacagtt cctgaagagt gttcatatta tttctctgca aaataaacc 266880

agctttgtct gttgttttt tttaaacagg gtttctctgt gtagtcttag ctatctaga 266940

actcactctg tagaccaggc tggcctttaa ctgagatc cacctgcttc tgcttccca 267000

gtgctgggat taaagatgtg gtgcaccatc gcctagccaa accagttha ttaagtaca 267060

agctaattcc tggggtggtt ttttttttt gttgtttggt ttaactgact gaagggtcat 267120

agtaaaagaa ttaatttttt tgtttttaa tttttataat tgtctttaa gtattatgat 267180

gaacactttg cacataaacc tttaaaaata actctagaac tggatctaatt ttgccagtgc 267240

gatactggat aagggtctct gctaccaagg ctggtgacta gaggttcaacc ccctcagatc 267300

cacacactgg aaggagagaa ctactccca cagttagcct ctaacctcca gaggtttacc 267360

ataacacaca caaataaata tgaagaagac aattgtgatt tttgaaatta gttttaagta 267420

ggtctctgag ctctacatct gtgtatgcat agctagaatg agtcatttgc taatagtct 267480

ccacaggtgg atgctaacca tggcctagt attatatagg gtatttggat ttcttatta 267540

tgtacttagg catacgttaa ttctgttata taccagtagt tgtactaagt aaaaaggtta 267600
 caataaaaaa ttaaatccct ggttgaaatc tacagtatag aatccaagga catttttctc 267660
 tggatttgtt cttttggagg tgacggggag agggtagcag tgttaaaact gggtttttagc 267720
 taataaacc agactggcct ctgtctcgtg attcacctgc ctacaccttc taggtagctg 267780
 ggactacagg caagtggctg taacacggaa gaaaaaaaaat aataaaaaac agagacagat 267840
 attggccttc aacctgaaga tcaggaagc aaagcagcct gccactagct tcttacctct 267900
 acctcagaat gaaagggtg atcctgtgtc cagcagctct caccaagcct caggctgttt 267960

 cctcagcgtg gctggagaat cctaagactg aatgtctcct gtectccttg atacaaagcc 268020
 ttctgtgca gctggagaat caatgcctcc tactcaatac tgaagatgct gcttccattt 268080
 tctatattct tctagtgtcg ggattaaagg cgtgtgatct gttactcttt tagactgatt 268140
 caatctcatg tatccctgtg tggccttgaa ctcacagaga tccatctacc ccttaatcct 268200
 gagtcctaga attaaagtt tgtaccatca cctcctagct tctagctgct aggatgaaag 268260
 gtgtgttctt ggctccaca ttttaagagc atccagggt gtgtgtgat aatggcatat 268320
 gcctttgatc acagcaactgg aaatacagag cagaaacaag ctggctcttc agaactcgg 268380

 ctgcatagga agatgctgga gagagaggca ggtggggaag agagagagag gatgcaaatt 268440
 gctcaccact gcttccaaga agagtgtga tgcgttttct gtacgttctg caagctattc 268500
 aggtgaaata atttaactct gtaattacaa tgagctagaa ctgacctact ttctccatgg 268560
 tcatgacaaa atacttttta aattttttaa aaggtttatt tatttgttgg gcagtagtga 268620
 tgaatgcctt tagttcctgc aaagcaggt ggatctctgt gaggttcaagg ccagcctggt 268680
 ctaagagtga gttccaggat aggtctctaaa actgcaaaga aacagtgtct ttaaaaaaaa 268740
 aaaaaaaaag atgtatttat gtgcatgact attttgtatg cattcatatg tgtgcacca 268800

 tgcacctggt agcctcaggt cagcagaggg gctcagatcc tctggagctg gatgactgat 268860
 gtttatttagg tatcgtgggt gctgggcac aaaccaggt cctctgcaag agcagtaagt 268920
 tctctaaacc actgagccat ctttccagtt caaaaacatt taacacaatt tttttctga 268980
 tgttttaggt ttgctgcagc acctgtttc acttggattc ttecccttta tttttctgt 269040
 cctgtacaga ttatcagcgc ctgatgaccg tagcagaagg catcaccaca ctcttgttcc 269100
 catttcagt gcagcaagac tatgtgcca tccacctgc ctctctgctc cattttcttg 269160
 atgcccctgt cccttatctg atgggtcttc aatcaaaaga aggaactgac cggctctaaat 269220

 tagaacttcc acaagaggta aagctggtca ttcagtagga agcagctat ttgttgactt 269280
 aggtcatggt tgcactaag taacattgtc tttgtgcagt tgttacctt gaatctccca 269340
 gatactgttg gttaggcct gagccctagc ctgcaaacctg tttcttctaa tacttgatat 269400

agcacaacta ttagttaaact acacctcaaa gaaggacagt aacaaatfff tacaacttat 269460
 acatttctga aggtgggtca ataatagttt tttttaaga ttttattat ttactatgca 269520
 tacaacattc tgcttccatg tataatctgca caccagaaga gggcaccaga tctcataagg 269580
 gatggttgtg agccaccatg tggttgctgg gaattgaact taggacgac ttaacctctg 269640

 agccatctct ccagccctca ataatagttt gatattacca ttttattact ctaaaagcat 269700
 tgaacttttt tccatcctcg tgctataaat tttgttttaa agtgtattag tcagagtact 269760
 ctagagtaac agaattcata tataggataa atacatacat acatgtatgt gtatgtgtac 269820
 atacacacac acacacacac acatatatat acatatacat atatgtatat atggctctct 269880
 gccagtgaag gaacagactt gccagcagga tgagagcaaa caggaaaaga aaggggcttc 269940
 cttcttccgt gtccttctgt gggcttccag cagaaggcaa ggcccagatt ggaggttatt 270000
 ttttacctcc attgaatgga gagtgcctctc tttcagcaaa cgagataatg gaaacagcaa 270060

 acactttact gcttgccatc tttagctgta gccagttagt agcctattct caatgttacc 270120
 ttgacatggt ctgtaagaca aagaccccct aacttcttgg cactttaatc ttgttttcaa 270180
 atatttagga ataaagtaat caagagtctt tgaatcatt ttatatgtaa tttttagctc 270240
 tgttaatgcc actcaaattt gggatgtaa gctttaaaat gaaatattga agaggatgcc 270300
 atggcctatt aaaagcataa aacggttaat ggcattatta gctatttaat taccaccttt 270360
 cttataaaaa atcactttag cttgttctta tttctcatag ggattctcat tctaataagt 270420
 gaatataagg gctggcctgt ggtagtgcac gcctttaatc ccatcactcg ggaggcaaag 270480

 gcagacaaat ctctgagttc aaagcctggc tgatctacag attgagctcc agggcagcca 270540
 gggcaagaaa tcaaagtaaa taaataatta aaaaaaaaaa taaagcagtc tttttaaaga 270600
 gatttaaatg tgtacactag tgatgctccc tctctttcc tctgaaaact ctgagagaaa 270660
 atctagcaag aaagtttcta aagaaagatg ccacttaca aattattaat ttaggaaagt 270720
 attattttag ttgttaggtg gctaataata ctgcctagac ttataattaa ccacactctc 270780
 cctttgctca tgattccaaa atgatagatg ttagtagcca tttgttatag tatcttttag 270840
 ggagtatatg gggaaggtgg aaaaatggag cactaagtat tgattactaa gtcttgtacc 270900

 tcacctcag ccattcttaa aagaatcaga ggctgggatt aaaggcatgc accaccacat 270960
 ggcagctcag aactgtctgt aactttagtc ccagggatct aacacctca cacagacata 271020
 catgcagaca aaacaccaat gtacatgaaa taaaaataag tctttaaaaa taaatcttaa 271080
 aaaaatgaaa aaggaaagga aataaattct agtgggaatt ggagaaagaa ccatcatgta 271140
 ctgctgatgg gaatgtaaat tgatatagcc aatatgaaag tcaactgtgga cattcctaaa 271200
 aaaaataaaa acagaactac catatgacct agctataaca ttcctggata tacacactca 271260

atggaatcta aatcccaaca ccatagagac ccctagatat ccatgtttat tgatgcacta 271320

ttcaaatgg ccaagatagg gaatcattat agctatgtat caacaatat aataatacga 271380

aaaaatgtga ttgcatgca cagtggaatt tcattcagcc ataaaataga aagttttgtc 271440

at ttgttaga aaatggatga actagagatc atgttaagga cataaacctg gccaggtggt 271500

ggtagcacag gctgttaatc ccagtgttga ggaggcaggg gcaggagaat ctgagttcct 271560

ggacaaccag ggctttacac agagaaacc tgccttgcaa aaaaacataa aaaataaata 271620

aataaacctg ctcaaaaaga gaaatattgt attttttct tataatggaaa ctagattttt 271680

taataacata catatataca tacatacata cacacacaca tacacacaca cacacacaca 271740

cacatctctc tctctctctc tctctctctc tctctctctc tctctcaatg aaagtagaag 271800

tgtggctatg taaggtgagg aagggcctaa tgggaaggtt gagagggtaa ctgagaggaa 271860

gacaaagtct cacacaggat ctaagtttaa catttgggag gtggaggcaa gaggatcata 271920

agttcaaagt catctcagtt gcctaggtag ttgaggcca gactgggata ccaggggtgg 271980

aggcagaggc aggcagatct ctgagttctga ggctagcctg gcctacatag tgagtttcag 272040

gacagcccag gctacataga gaaaaacctg tctcgaaaat cccaaataaa tagataaata 272100

aaattagaaa tgcattatta tctggggaatt gtgaaccctc ttgcaaatcc ttaactctca 272160

ttgataaac aagacaactc agaaagtagc aaagacaatt agagctgtgg gcatgatgga 272220

aatcagttgc tgggaagatt cacatagata agaaagttac ttgttttgag ttacaaagca 272280

ggcaaacctca gcaatggaat cttctagcac ccaaacctggg agtcagagtc ttcagaaata 272340

tcataaggat gccagagga aagtgactta gaattttggc tggatctga caagataaat 272400

aaaaagaga agaaaacaaa ccatactttc ctaaaaagaa caaaagcttg gcattgagaa 272460

tatataaaca gtgcattgca ggagggtttc tggcattaaa gggataatta tttctccat 272520

cttcttgaga tgcctttaag tataatggac aactttctctg agggatgggt agtttctat 272580

ctaggtgatt gtattaatca gaggttcacta gaggagcaga attgggggtt atctatttat 272640

ttatatgtat tgttacaatt atatataata tttttatata taattataac aattatatgg 272700

catataacaa atatattaca attatataat acacattttt cttatttata ggtaggtta 272760

gtggaatgcc ttgtaggctg tggctcagct agttcaacaa tggctgtcta ccaacacaag 272820

gttcaagaac ccactagtgt ctcagttctac aaggctggat gtcttagctg gcttttagta 272880

tatgccagaa tctgaagaag taggctctaa tgccagtga gtaatggact tgccagcaag 272940

agcaagatca aataggcaaa aaaagtaaac ttctttctcc tgtcttcttt gtatagggtg 273000

ccagccacag gtatacatct catttaaggt ggacttccca cctcaaagat gtagatttga 273060
 ataagaaaaa aaatccctca cagggtgcc cagtctttgg ggggttttag ttaattctag 273120
 atgtagttag gttacaaca gtggfcagt atcagtatgc caatttggat taacttaaag 273180
 gttcacaag aatagctcca tctttgagaa atttagaata ccatgtctct acatcgagcc 273240
 agaggtatag aactcagaaa gtattcttgt gcaaaaatca tatagaaaaa aacttttttg 273300
 gttttggttt tttagagaaa ggtgtctctg tgaacagct ctggctgtct gattgtcctg 273360
 gaattcgctc ttagaccag gctggcctca gatttacaga gattattggc ctgtgtctgc 273420

 ctctgagtg ctgggattaa agacgtaatc atgtaaccac ctgacaaaa atcatgtaac 273480
 aagtaaatta aagaatatta aagaaaaata aataatctgt ataaaatagc tatactttac 273540
 catgaggaaa taactgttcc cttaatgagt tttagcagtc ttgctacctc cacctttctg 273600
 cctttcatat attttaaate ttttctttaa cttttattga ttctttgtgg gtttcacatc 273660
 atgcattcac tcatctcccc atcccctcac ctccaccctc tgccttcca acccccacia 273720
 acagaaccaa atttaaaaga aacataaaa agaactcttt aattaatttt tatttaaatt 273780
 tttaaaate ttattttgca taccatccc agtccccct cctccatcc ttttatttc 273840

 cttatcatct ccctatccca cccctcatcc actcctcagg gaggtgagg cctccgatgg 273900
 gggatcatga aagtctgtca cactatttga gagagtatcc ctccacaggg aataggctcc 273960
 aaaagccat tectgacta gggataaata ctggttccac tgccagaggc cccgtagact 274020
 gcccaagtcc tccaattgac acccattc agggggcctg gttcggcttt atgcatattc 274080
 ctcatatgct agactggagt cctgatctc ccactgttc aggtcagctg tttctgtggg 274140
 tttccccage ctggttttga cctctttgct catcactctt cctctctgg attccaggag 274200
 tttggggaga gagaagaatc tggtagtga agttgtaggg tagcccgttg agtcacacag 274260

 tttactcttt acttgaagt gttcattgcc acgaatcatt ggatttgtct gactcaaggt 274320
 ctctgattta tactatgaca cagctaatgg gcactcattg ggtctcctct tggatatcct 274380
 gttgtctgt gtcttgcca gctgctggt ttggatctca agactggtgt attaccaagg 274440
 atataggagg taacatctag acctagtat ggaaggagga tctatttaa tgatctccat 274500
 gcctgataac atcctattag ctacctaaca tcatgagggg ggggggcagt atttagtga 274560
 tgaagggga aatagagtta gaaataggga agataataac tcaataaaat ggaagacaaa 274620
 tacgaagtat atacaaagta taaatgtatg aaaatgcat aatgagaggg ctagagagat 274680

 ggcccagaag ttaagagcac tggctctgag ttcaattccc agcaaccaca tagcagctca 274740
 caaccatctc taatggtatc tgataccctc ttatgtctgt tgggcataca tgcagacaga 274800
 aactgtaga cataataata aataaatctt taaaaaaaag aaagaaagaa tgccataatg 274860

gaacaagttc ttttatatgc tagaaaaaca tttaatgaat gaaagattct gttgataaag 274920
 gtctgggta caattcctat catctcttca tacataaaat tctgagcctt gaaagggttg 274980
 acttaagagg tgggtgtgctg aaatggagcc caaggatcca gtctcaattt ccaaacactgc 275040
 atataaccag cagtaaatgc agtghtaaaga aatgattttt gagccaggcg tgggatgcat 275100

 gcctgaaagc ttaaggcacg agaggtggaa gcagaaggag ctggagacga gtggcatgct 275160
 catctcatct gtatagcaag ttcaaggcta gcctgggtct tctattttta agatggtcta 275220
 aaaatagtat aatttgtttc tgtttataat agaataatctt agaacattga cttcttttac 275280
 tccaagtgtg caccataaaa acacagtctc caccttaaag ggagatggtt tattctggag 275340
 acaagaatga gtgacctta ccagagagca cagatttaaa tgaccctaat accatattct 275400
 aacatggcaa tggtttcatg aatttttcaa atgtgttggg gggaaaatta ggtaagcagg 275460
 ttacagcaaa gcagggacat ctctcctata ggcctcaagt gttacttgat aacattcttt 275520

 gtgatgaggg tttttgtttt tgtttttgt tttgtttgt tttgtttgt accaccagtt 275580
 cccaataat gacatggaaa tttatgatta attatgaata ctgagccata gcttaggctt 275640
 gctctaaact attcttataa cataaatcag cctgtctttt ttaatctacg ttctgccacg 275700
 tggcttgggt ttctctgttc tgtatcatat gcctgacttc ttcggagtct ctggtggaat 275760
 ccatgtgect agctagattc cttttcttct ctctctctct ccctggaaat cctgcctagc 275820
 ctctctttcc caggtattgg ccattttgca gataaaccaa ttagaagggt ccatggcaaa 275880
 gactcatcac agtgtacaaa tattcttcaa caattcttac tttaggttgg tgttagctaa 275940

 aggtctggg tggtaaatc ctcacttaca aagggttag gccaatcaca ggtgggcaag 276000
 aaaatgcat ttatgaggct aaaaatagcc cgaggactt tggctctgaa tctacaattg 276060
 gaacccttg aagtcattta agttttaata gtcagccttg tacaagttct gaaatctcta 276120
 tgtttttggc cccccccc catttcaggc taattttgtc ttcgtggata ttgacaacca 276180
 ttttattgaa ttgcctgaag agttcccaca gttcccctaat aaagtagatt ttatccaaga 276240
 actatctgaa gttcttctcc aatttgggat tctctctgag ggcagcctac attgtagcga 276300
 gagtgccacc aaactgaaga atatggtttt gaaagatttg gttaacgacg agaagaatgg 276360

 caaactccc accaataaca tcagcgtgta tgagttcatg aagggcaatg aaacatagc 276420
 ccgctccag gctctcgtg ataggactgg cgtgactgtg ggaaaaattg acctctcagc 276480
 ctctctgaat gaaaaagaaa aggatttcaa attacagtgt gaagaggcag aattgaggga 276540
 ctaccagctc aacgtacaac tacgagaagt ctttgcctgc cgctttatc agatgtttgc 276600
 tgactatgaa gcgttttga ttccagactgc ccaggacatg gagtctggc tgaccaaccg 276660
 ggaacagatg cagaacttg acaaagtaa aagaaccata gtttctctct ttatgcttac 276720

taatggccca catttccagt ctttttaac ttttaaaca gtttacttat ttttagtgca 276780

 tttgtgtttt gcctgcacgc atgtctgtct gagggtgtca gatcttgag ttacagacag 276840
 ttgtgagcag ccatgtgggt tctgggaatt gaacctgggt cttctggaag agcagccagc 276900
 tagtgctctt aaccactgag ccatctctcc agcccctagt ctttttaact ttttaagcac 276960
 aggtttttat atttcccttt ttacatccta ttaagtatnt tatgctagat aaatagtntc 277020
 acacaaaaac aaattcttgg gaggtagaag caggagggcc aggaatgcaa ggccatcctc 277080
 tgctatgtgg taagtttgag gccagcctgg gatacctgag acgggtctca aaaaaactg 277140
 gcctttgaat tgtgtattaa attggtgtgt gtgtgtgtgt gtgtgtgtgt gtgtgtgtgt 277200

 gtttgatttt cagcagtcta ctgctcttgt aagagtttta tttactcttg tgaccaagtc 277260
 tagaaaaatt aagcctgttc cttttctaag agatgctcac tgacagtta gcctccccc 277320
 aatgatgtaa cacccaattt gttcatgtaa aggtaacagt tcaatttcat aagcctaatt 277380
 ttatatcttt tgiatcttaa aagagaacag atgagtaaat ttggtttcga gactgttagt 277440
 ataagattat gttccagagt ttttagaaaa ggagactagg agatgtagta gctctttact 277500
 gcttactgt ctactggagc ttcttgctcg ggttctctgt gttctgtcca aggccctca 277560
 tgtacccag ctctctcaa cagacaaaag cactagagat gtatgtgaag tcatttaggt 277620

 caccgggatg cagttcagtc ctctacctct gttagtgaac aagcataatg ctgctgttag 277680
 aatgtgtcat aaaagacctc ccccaaaaga gctattacac tccaagatgc taagtgttta 277740
 attttggagc atctggcaaa cagatattaa ctaaatgctt tgtgtagtat caaagaatat 277800
 tttctgattt calcatattt tttcttatgg aggataatat gccatgtgca tcagaaattg 277860
 ctggtgtact ttatgcctga ttaaacgtct ttaatattaa gaaaccactt tcaaatata 277920
 tttccgccct gggacctgtt atcatatttg cttagttttc attatgcttt ctctccagtt 277980
 tgagaactaa tcttacetat tcatgateta tctttggggc atgaattcat atttaaattt 278040

 aaattcatat cctcctagta ccttgttctt tcttactctc tatgtagctt cattctagaa 278100
 gtgggatcct tctgtataa cccctaagaa aatgaaattt acatgtcaga ttccagaaag 278160
 ctagagtcac cttatntttc actaaagaag tatgcagggc atagtcactt tgaagtcaa 278220
 gttctggttg attttaaatc ttacagagca catgaatcta aacatcaaaa gctagatgtt 278280
 tgcccgattt tctaaggggg ggggctgttt ctttctata caaagtaggt ttgatgttta 278340
 tctatgaagt aacattaagg agatggattg atttctggag actgctatga gtctgtctgg 278400
 atatttgtac ttacataagt acatttaaac tafggaagca cttaaatcaa aaagtggact 278460

ctgtaaaaaa tcttttatta aaagtaccct gaaataataa aatgggaaaa ttaaatatgc 278520
 taggaaaaaa cttgataaat actaaaaata ataaccttat gttggaagtg tccttccatc 278580
 tttctccttt tggctctgac acaactgcac taactttgaa gagtgaaaga atgaaaagaa 278640
 aaaaaaaaaa aaaccaaccg agtaactgga ctaggaattc actcacaagt ttcagctcat 278700
 cttaaccaag atgagacttc ctacatatac cgtacatgag ctgaagagag caacaacaac 278760
 aaaaaaatg tgaacacttc agattagaag ccaggtataa tttatgcat caagcaaact 278820
 ggcaagaggg aagggtagct tgttcatttt tgaagatcat ttgtatgttt tttttttgtt 278880

 gttgttgttt ttttgttttt ttttttttaa ggcaatgttt ctctaagtct cagatagttg 278940
 tgtcaacaca gatatggaaa gagtttaac ttgagttaac aagaagagtg aacctagaca 279000
 aacatctgct tgaagaccaa aacgattttg cccataggca caaattccat gttattattt 279060
 taaaggattt atttttattt atttttttat tctgcataca gtattctgcc tgcattctctg 279120
 tcttcaagcc agaagagggc accagatctc attacagata gttgtgagcc accgtatggt 279180
 tgctaggaat tgaactcaga acctctggaa gagcagtcag tgctcttaac cactgagcca 279240
 tctctccagc ccccgtgttg ttattattaa gttcgttaatt gaacatatgc aaactattgt 279300

 gcatataaat gtgtgtgtac atatataata tataagcagt tgctcatctt cagccttttg 279360
 gttagaggtt catttcctag gctaggaaca gagaacatga gagatgactc actgggaaga 279420
 agaatcagaa tgtaatgga agtcacgtcg atggttgaca gtgcatccaa tagcaactta 279480
 tcggccatca gtcattattg atgtcctctc tcttgggcag tggctccttg gataactaata 279540
 taaatcagtt ttgaaaggta agatcaagct agcatcctca gtgacaaaa actctacaaa 279600
 cttagaggaa aggggaaaaa aatggactgg caagatctta agtgtcaagc atcgattgta 279660
 tgtgttataa gtttaaaaag taataacctt aacaaactgt tcatgttcat cttacataat 279720

 attaagacga cctcattaaa gtaataattt gctaattatc tccttacagg cetctttcct 279780
 ctcggaccag cctgagcctt acctgccatt tctttcacgc tcattgaaa cacagatgtt 279840
 tgccaccttc attgataata aatcatgtc tcagtgggaa gaaaaagacc ctctgcttcg 279900
 ggtctttgac tctcggattg agaagatacg actgtacaat gtcagggcgc ctacgccac 279960
 ccttcggaca tctgtgtatc agaagtgcag cagtttaaaa gaagcaggtg tgtttgcat 280020
 ggcttagagg aaaataatcc atgatcattt ctttttatag attgttgact tatataaac 280080
 aaaattaatt ttctcctttt ttgggggggg gtttgagaca gggtttctct atatagccct 280140

 ggccatccta gaactcactc tgtaaaccag gctgggcctc aaactcaaga gatctgctg 280200
 tctctgtctc ccaagtatca ggattaaagg tgtgtgctc cactgtcctg ctaaagttaa 280260
 ctttcatttt aggacatcag gactaacctt ggtattatca agaagtattt ttatactttt 280320

tcttcagatt tcigtgaatc actatctctg ttgacattca aaagatgcag atttttgcta 280380
 ttttctgtg ttagaaaaa aatgtaacc tctatctttg gtgtatcaa cttaaagtag 280440
 ttaacccaaa actgggcatg gtggfacgta cgtgcctaag tcctagcact caggaagcca 280500
 aattcaggaa gcctggcacc aggcatntaa agccagcctg ggtaatgtag caagatnttg 280560

 tctaaaataa aaacaaagca aaaaggaaat ttagttatgt aaaatgctgt ctactttaca 280620
 taacttcaac agtacatatt tgctttgtgg tacagttagt cttgaaatta aatccttgga 280680
 tttttcatt caaattaag tttccccaa ccctaacacc aatttccttc aaagaatgat 280740
 gaatnttct tgtctgattg tgaatatgc tctgttaaat aaataacccc actaatagcc 280800
 aacatttgag cctttctac atgccagtta tgccagtgtt tgtttgata tgccnttta 280860
 catgtacct taatgacagg ggtatataca caggtatntt tgctgttgct ttattactat 280920
 tattctatgg gtgaggaaac tgaggggnta aagaatntgg ctgtgnttct tctntttggt 280980

 tttnttttt tttnttttt tttnttttt tttnttttt tttnttttt tttnttttt 281040
 tgtnttntt ttcgagacag ggtnttctctg ttagagatc tgctgcctc tgctcccaa 281100
 gtgctgggat taaaggcgtg taccaccaat gccagcttg gctgtgntc tataactagt 281160
 tctcagtgga gccaccagt ggatccagat ttgactgact tccagtacct aacatcttat 281220
 cctnttattg gtaggcttat tcattaacaa atatgtaaaa cgtaccaatt catgggntt 281280
 tgacatnta tgctagttc ccaacccatt ctttgcgaa tagaaacata tatcctnta 281340
 tttctntca ttaaatntaa agtggcactt ttgctaggca gagtgcaca tgctntagt 281400

 ccaccacata ctgggntca gaggcaggca gatctctgtg agnttcaggc tagcctgtct 281460
 acagagcgag ttccaggaca tccaggccta cataaagaaa ctctgtcagg gacgggggcc 281520
 gtgggggggg cgagagntg gtgtgtgata tttnttatt gagaccnaat gntctactgt 281580
 ataagaggac acaatgntg gtagctntt tgcctgctt ctgttgntg cttagtctt 281640
 cctntccatc tclattntaa cagntcagtc atggaagtaa taacnttgct ttagcatttc 281700
 caaggnaaga agtagtaaat aataactntt atgcagctt caaggccat gntgtatntc 281760
 ctatgtataa gngtgatntc ttggagcccc ttcaggaagt ggcaagntc tetgtnttc 281820

 tagaagctga ggagatagaa taaatnaagt tnttgagaga attatgactt ttagtctnt 281880
 taatgntat gtaaatacct tgggnaatc tcatcctct cttcctggca gaatntnta 281940
 aatgaagtac ccagagntc ttagctntac ctgtgtctgg gaaatctac caatntaat 282000
 ggatnttctc tntgcccctt ggagcctgat aatctcactc tcatctcaga aactgtntga 282060
 gntgctnttg aanaatntac cattatagac ttagcatgcc tgnaaanaag attagnttat 282120
 ggcatagnt gccaggaat tntgnaaagt naagagac gntntctat gntccccca 282180

ttcagcacag ataataaatt ggtgtgtgtg agggagggaa ggaggaggga gagagagaga 282240
 gagagagaga gagagagagt gttcagtgtc aggaatttaa tgcagggcct tgccttgggc 282300
 atgacagaga agcacacgac tactttttat atttctttgt tttgagacat tcccagtcat 282360
 tgcataaggaa agctttgaac cctcaattct acttccttgg cttcctaact agctaggggt 282420
 tacagggcctg taccaccagg cctggctccg ttcattcttt acaggtgaac ctgtgaggcg 282480
 cagactgtct actgttgaca ctggetccag agccttgtga ttacagaaaa accagaaatg 282540
 gatagtaata tgattttctt tctcctcacc aatcaccaca aatcaatatt gatacaaacc 282600
 cttgaaactt ttaacaatag acccagcctc tgacctcaca aagcaggcat ttgctaattt 282660
 ctgaatattc agiattcctt ggcagtataa gtactaaaaa gttacattgc tgtgtgctcc 282720
 ctatggatgg atactgttaa tattccaat atttacttaa agctaatttt tctacattca 282780
 tatttctgat tcccagagac ctgtgtgaaa agctttttca gggtaaagg atgacttgag 282840
 gtttctgtag gtgcatgaat gtatgataca acattgattt ttagaaacaa aatgcctcta 282900
 atttattgta aatttaattt atagcccagt caattgagca aagactgatg aaaatggacc 282960
 aactgctat taccacat ctacttgata tgaaaattgg tcaaggcaaa tacgagcaag 283020
 ggttcttccc gaagttacag tcagatgtct tggccacagg accagccaat aacaagtaag 283080
 cattcgtttt acctgagtga tgagttaat gaaagaagg aattgttctc cagtgttagc 283140
 caggcagtgt gtgaacatta aatatcttac ctattacgtc tttaaattta attattcctt 283200
 tgaaagcact tgacttttaa ttgttatgtt aaaaaaaaa tctaagacc agggattttt 283260
 tttcacagaa gtattaatag acacatttct ttcttgtatt cttttttta atttgtgtt 283320
 ttgttactgg tattgacaga gtctcaataa ttaaacaga ctaactaga attcagtata 283380
 taatgaagg ctggcatcaa atatatggtc ttgctcagca tcctttcctt tttctttctt 283440
 tccttctttt ccccatcct atcccagtat tgcagaactga acccatgget ctgtaacct 283500
 atgcctgtt ttttttttt tttttatcct tgaagtgcta gaatcaaacc caagtacaca 283560
 gttaaatggc tacattaaag cagtctgggg tttgggtttt ttgtttgttt gtttgtttgt 283620
 ttgtttgggt tttttgggat tttttgggg ggaggttcaa aacagggttt ctctglatag 283680
 ctttgaagcc tgcctggaa cttgctttgt agaccagact accctcaaac tcagagagat 283740
 aatgcctgct tctgtctccc aagtctggg attaaaggca tttgccaccg cccagctttt 283800
 ttttttttt ttttttttt tttttttta ggggggtttt tttttttgtg ttttttttc 283860
 tcgcctttt aacagctctg gctgtcttgg aactagctcg gtagaccagg ctggcctcaa 283920

actcagagat ccacctgcct ctgcctccca aatgctgggg ttaaatatgt gtacctccac 283980
 cgcttgcaa aacctgtct taactaat caggggtggt gactttgcca gtaacctga 284040
 tagttgaaag ggagacctag aaaaaattt gaatttaagg acagcttgaa caacatagca 284100
 agtttgaaga tagttagann nnnnnnnnac cctgtgcat aaagcaaaca gataaacact 284160
 gaacttgaaa ctttgctaaa aatgttggg gattatgggg ctgagtgtat tcaactttta 284220
 aaagatttat gtgtattggg attttgcta catatatgtt atatacaca tgtgcatgcc 284280
 tggtagcagt ggtagctaga agagggcatc agatcccta gaactggagt taacagatgc 284340

 ttgtgagcca ctatgggtgc taggagccaa atccagtct tctgtgaggt cagtaagagt 284400
 aactctgagg tttatgttg gttttgttt gtttgttga gacatgacct ggtattcctg 284460
 gactagcccc agactttcag ttcagattgc tctgaacttc ttttcatat attttctatt 284520
 tattcttga gaattttata cacatataca atatgtttg atcatatgca ccccttctt 284580
 gttctccagc aatccccca gtgctcctga ttctctctct ctctctctct ctctctctct 284640
 ctctctctct ctnnnnnnnn nnnnnnnnn nnnnnnnnn nnnnnnnnn nnnnnnnca 284700
 gccaatgcc aattgctctc caggtagaaa tggggcttca tgaaccctt ctccatccgt 284760

 gctgaaattc tgaccatctg gctctgtgc aggagccac accactgtg agttcatttg 284820
 tgtgatggcc ctgtcctgga tggaaatcag tttcacaacc attctctca cctctgtct 284880
 cctgcaatct ttcattccc tcttttgeaa cgatcccag cctctcaggg gcggggtgca 284940
 gacaccatt tagagctgag gacagctctc atcctcaca ctctgtttct atctagagtg 285000
 ctagattgca gatgttggg acagcatctg acttacaatga tgctggaggt gaaataaag 285060
 gtgttgtgca tgctaggtga gaactctacc aactgagcta catctgtctc ccagggtcga 285120
 agttttctt tcaattact ataaaatact ctaactgtt gaattgctt gatataaatg 285180

 agtacactgt tggcctaaca gttttgttt cctttgata acattatggt tttcgtctgt 285240
 ttggtaaagta ttggttgtgc cattggtata taggattatc ctggctaaag attgaacagt 285300
 gaatccagct tgggtgtaca tacttgtaat cttagcattt gggtactga gaaaattca 285360
 aagccaatct gggtacata gaaagactgt ttcagggata aaagaattta gcagtgaaat 285420
 gaacataaca gcaacaata aaaaacattt tcaagcaca gaaaacaat caggctggag 285480
 agagaactca gaggttaaga gcaactggctg ctctttcaga ggttctgagt tcaattccca 285540
 gcaaccacat cgtggctcac agccatctgt aatgagatct ggtgccctct tctgatgtgc 285600

 aggcagaaca ctgtatacat aataaataa tctttttaa aaaagaaaa gaagcttctc 285660
 agtttcagga ggtccattt attaatgtg gatctcagtg tctgagctac tgggtttatg 285720
 ttcaggaagt ggtctcctgn nnnnnnnnn nnnnnnnnn nnnnnnnng ggtatttctc 285780

attttctctt ctaataagtt cagtgtggct gggtttatgt tgaggctctt gatccatttg 285840
 gacttaagtt ttgagcatgt cgatagacat ggatctatct gcagctctct acatgccagc 285900
 atccagttat gtcagcacca ttttttgagg atgctttctt tattccattg tatagctttg 285960
 gcttctttgt ccaaaattag gcgttcatag gtgtgcagtt taatatcagg gttttcaact 286020

 cgatttcatt ggtctacctg tctatTTTTg tgccaatacc aagctgtttt caggactata 286080
 gcgctaatag agcttgaat ccaggatggt gatgcctctg gaagtctctt tattgtacag 286140
 gcttgTTTTg gctatcctgg gtcttttgtt tttccatata aagttagga gtggcactat 286200
 taggaggtgt ggcttgttg gtagtagcat ggctttgtta gaagaggtat ctctctatgg 286260
 ggtgggtttt gaggtctcat atgctcaagc tacactcagt gtgtcccaca tttgcttctg 286320
 ctatgggcaa ggaagctctc gcagcagtggt tgtccatgat tgcagactca taactgagga 286380
 tgggagacat tgaagcaact tctctcccac cagcaactgcc cccccccaa aaaaaagaga 286440

 cagttaagac agtgagctgt tgaaaagagt tctttaaagt ttggtaaaga tctgaagtg 286500
 tagctcttca cagttgatgg cttatggtgg aggggtggga aaggactcga ttttctttaa 286560
 gggactggcc actgttagtt tgactagct ccagtgacta tataggcaac acaaattgaa 286620
 cttggtgttt ttgttttgt tttttgggg ggagggcagc gggctcagat catagacatc 286680
 aacatagttt ctggcagcag cacagatcat gggcatcagc gttgcctcca gtggcatcat 286740
 ggacatgga agtcttcaa ggagacttga tccagaaaag gaaccattct tcatctggg 286800
 tatcttggtg ctcaagatca gggatgatgt gaagttgggc agcattaccg gggacaagac 286860

 ctgtgctggc tgcaggettg tgtaactccc cccgcectgg taccagctc cccccggta 286920
 cccagggcat gagcatcgtg tttccagcct gtggatacta tggcctctg ctctccttgt 286980
 gtcaagtgta gcagccattc catgctgcag gtggcaccag cctagcagac agcaatgagg 287040
 caatgtagac aggtgggtgg cctgagcctc gcagaggccc aaacaccagt cctacatggc 287100
 agcaatgtgc tcctttgtct gctctagga cagactctca ttcctgttgc tgccattgca 287160
 tctcaaacc tgcttctctc agtcatctt ctgtctctcc actgcacatt catttactaa 287220
 agtgacattt caatctgccg nnnnnnnnn ngttactttg cccaacagc tttacatgca 287280

 gacacttaat gcattgagtc attgaactgg ttcaagttt ctgaggcacc ataaactg 287340
 gaatattggt gagactcatc cctggtatcc tgtgtcaag agtcaggag attgtacagc 287400
 tgggnnnnnn nnnnnnnnnn nnnnnnnnnn nnnnnnnnnn nnnnnnnnnn nnnnnnnnnn 287460
 nnnnnnnnnn nnnnnnnnnn nnnnnnnnnn nnnnnnnnnn nnnnnnnnnn nnnnnnnnnn 287520
 nnnnnnnnnn nnnnnnnnnn nnnnnnnnnn nnnnnnnnnn nnnnnnnnnn nnnnnnnnnn 287580
 nnnnnnnnnn nnnnnnnnnn nnnnnnnnnn nnnnnnnnnn nnnnnnnnnn nnnnnnnnnn 287640

nnnnnnnnnn nnnnnnnnnn nnnnnnnnnn nnnnnnnnnn nnnnnnnnnn nnnnnnnnnn 287700

 nnnnnnnnnn nnnnnnnnnn nnnnnnnnnn nnnnnnnnnn nnnnnnnnnn nnnnnnnnnn 287760
 nnnnnnnnnn nnnnnnnnnn nnnnnnnnnn nnnnnnnnnn nnnnnnnnnn nnnnnnnnnn 287820
 nnnnnnnnnn nnnnnnnnnn nnnnnnnnnn nnnnnnnnnn nnnnnnnnnn nnnnnnnnnn 287880
 nnnnnnnnnn nnnnnnnnnn nnnnnnnnnn nnnnnnnnnn nnnnnnnnnn nnnnnnnnnn 287940
 nnnnnnnnnn nnnnnnnnnn nnnnnnnnnn nnnnnnnnnn nnnnnnnnnn nnnnnnnnnn 288000
 nnnnnnnnnn nnnnnnnnnn nnnnnnnnnn nnnnnnnnnn nnnnnnnnnn nnnnnnnnnn 288060
 nnnnnnnnnn nnnnnnnnnn nnnnnnnnnn nnnnnnnnnn nnnnnnnnnn nnnnnnnnnn 288120

 nnnnnnnnnn nnnnnnnnnn nnnnnnnnnn nnnnnnnnnn nnnnnnnnnn nnnnnnnnnn 288180
 nnnnnnnnnn nnnnnnnnnn nnnnnnnnnn nnnnnnnnnn nnnnnnnnnn nnnnnnnnnn 288240
 nnnnnnnnnn nnnnnnnnnn nnnnnnnnnn nnnnnnnnnn nnnnnnnnnn nnnnnnnnnn 288300
 nnnnnnnnnn nnnnnnnnnn nnnnnnnnnn nnnnnnnnnn nnnnnnnnnn nnnnnnnnnn 288360
 nnnnnnnnnn nnnnnnnnnn nnnnnnnnnn nnnnnnnnnn nnnnnnnnnn nnnnnnnnnn 288420
 nnnnnnnnnn nnnnnnnnnn nnnnnnnnnn nnnnnnnnnn nnnnnnnnnn nnnnnnnnnn 288480
 nnnnnnnnnn nnnnnnnnnn nnnnnnnnnn nnnnnnnnnn nnnnnnnntga aaacataatt 288540

 aaataggata tttttgcccc cacatagcat atttatattt tttcatataa ttagtgttta 288600
 tttgtaccac ccigccattt aaccctaatt tgttttggga tgaggagtgc agacttttgg 288660
 ttggttggtc agttggttgg ttggtgggtt gcttggatga tttagtttgg ggtttattga 288720
 gaccaagtct taccaaggag ctcaggatgg cctacaatac actgtcccc ttgtctctac 288780
 ctccaagag ttggggctat aaacatgtac ctccatgctc agatgaacc gaatttgtca 288840
 gtccctgtga aatttgtct aactatcttt atggcagtac cgttttcag ttttaaatta 288900
 cattatttgg gggttttcac acatgccatg gtgcacatca gaaaccagag ggcagcgttt 288960

 gggactcagc ctctcactt cagcaggctt ggaggcaagc tcctttccc acgcactatt 289020
 ttcaaggtct ctgtgccaaa gatctacct tgggtctttt tacattttc tctgttaatt 289080
 taagtctcat ctattgtaag ctatttgtgc catgtagttt ttatgagaat aagctgtaga 289140
 aattacattt tgtgttgat tgagcagtta agcggtagca cttgagagta aagtctgttg 289200
 agagctgata aaggcatat ggaggtattc gtgtcctaaa ggaagcagg tcctggtgtg 289260
 gtgtgaaacc aaggagtcaa ggacagtttt cccaggattt ggggctctgc tcagcaaggt 289320
 tgaaggaag agaattgtta aaagaaaagg acatcacttc tggagtactt tgtatgattt 289380

tcttgggtct tgggccagaa ttgaaagaaa aaggagcaca aaaggtatgg aagagctaat 289440
gtaacaggag atagacattc acacattaga tggaaatggt tcagatttct gaggtccagg 289500
actagagaga tggctcagct gttaaagca ctggctgccc ttccagagga cctgggttta 289560
gttcccagca tcctcatggc agcttiacagt tglctgtaac tccagttcca gaggtccag 289620
tacctcaca cagacatata tgcaggcaga acacggatgc acataaaaga aaaatttcta 289680
aaacaaaca gtttttcat aaaacatctt ataggccacc atttcataga aacacaatca 289740
tataatttta gagcccagaa taatcatatc ctacctcct gacacaaaag agccttaagt 289800

ttagaaagac ctcccttaa aaacgtaaca atcaagcatg gagagatggt ttagtgatta 289860
agagcacata ttattgcttt tgcagaggac ccagcgtggt cctgacctc agtttttaa 289920
aagtattaat tgggggatg gttgtgacta tccaaaatcc attagattga ctgctttgat 289980
gggtaatta aatgtcatct aaaattataa cttaagcat atttgaaaa gaattggttg 290040
aaagaactga gtgtggtggc acgggtgatt tcaaggccag accagagagc aggagactga 290100
agaagaaca aggaaggag agaggaaaac ggctactgct agccatttgt gcagaacgat 290160
tcactcttc tggttccttg tttcgttttg ctttgccttt tgcgttgtt ttggagaagg 290220

ttggtgtttt gggggggttt tgtttgtttg tttgtttgtt ttgtgattgg gtttttctat 290280
atagccctgg ctgttctgga actcactctg tagaacaggc tggcctcaa ctcacagatc 290340
ctctgcctc ttgtctggg attacaggcg tgtccacca acaccagac cattcttct 290400
gttttctct tttatttggc tgattttctt aatctatatt gtctccatat atttatttgc 290460
cagtcgctgg gtgagtcgaa gtgccacagc acagcgccgg aaagagcgc ttcgccagca 290520
ttctgaacac attggactgg acaatgacat acgggaggta tgtggtcgga ctgcctggga 290580
tgccacaatg cagagatcag aaaactcacc caggaggtgt taggatcttt caaggtcttt 290640

taaaaacagt tcctcttatt ttaaaatact atttttatac taaaatgtag cagaaagcat 290700
ttttccagtc ttgtcctttt attcatctac aatagggtt tatgtctgtg tattaatct 290760
aatagatgct ttatttaggg taaacatttt gttgttgttg gggttttgtt gttgttgttt 290820
tttgagacag ggtttctctg tgtggctttg gagcctgtcc tggcactcac tetgtggacc 290880
aagctggcct ccgaactcag agagaccac ctgcctctgc ctcccagtg ctgggattaa 290940
aggcatgctt tatttaggtt aaacttttgg tcagtaggtc tctgaaggt agaaacattg 291000
agatacacat atatctaagt ttcacataat atttaagata aagtaacaca ttctttggct 291060

tttggctttt ggcttttggg ttgctgatgc catttttttag aggcaccaga gctgtttttt 291120
agactaaaat ctatatgctt tatttgtatt cattgaaaat aaaattcaaa ttacgtttta 291180
glaattatat tttatttctt gtgataaaaa gaaaagtgg aacaaaaatc ttcataactg 291240

ttttgtaaac tcagatgggt agaaatacaa tagaaaacac cattccagac cgaagccttt 291300
 cttcttggtc attgtctttc cttcactccc ctccccatgc tgtggtccta tcatgtcat 291360
 gcaggttttg cttctctttc ttttttcccc ccttgtttac ttctctgtca ttgaaatgtc 291420
 gtcacatctc tagccttccg ggggactttt ggtctgtcag aactccatgg cattctggga 291480

 gtgggatcag ggcccaactc ctcccgcacg gcttcctaaa aagtccttct ctgagtgtctg 291540
 cctggtatgt ccttggcctt gaaagtgtt cacaagatat tctgaaatct tgctacttgg 291600
 tgtttcttga atggcccaca cctatgagtg catgtagcat gttttgctct ttgtttgctg 291660
 cctgtttgtg ctggcatgtg cttgcataag taattttatg ctgttgacag taaaactgac 291720
 attcaagtcc tgagtcattg aggggtatgt gtgtatgtat acatgtgtat atatgtatgt 291780
 atatatgtat gaagaacctc gataacaaat tacttttctt ttaaatggga gagaaatgta 291840
 tgataaatcc tttatatfff aaggatttct tttcacaagt gcagaagtag ctgaatatca 291900

 gcttttatta gatattgtc ttcataccat ttaatttac ttttctggt ctacattttg 291960
 tttcagaaaa ctcactcadc atcatagaat actagtgcta agaggaggaa cctttgaggt 292020
 tgtcttgtct agcttgacat tttagctgac aagcaagaaa tttgccaca gttaaatgga 292080
 catacacagc agagctgagc ctgtagcaca ggactcctaa tgtccaggct caagtgtctt 292140
 cccactaatc atgctgtaac cactgctcac ctgaggacac aaatagtcta ggactctggc 292200
 ttaacttttt ctctgttatg tcattagttt acatttacag cagtcttctt ttccagtgag 292260
 ttagcaccaa ctaaaaggtc agaataaat ataatatata ttattatgta atataataa 292320

 taataagcta ttacaaaatt gtggggaagg ctatattaaa gagcaattat ttctaaaaat 292380
 cagtgtttat tgaacaagat tgcaatttaa tacatatttc ctagtggctt attgcttctt 292440
 tttttcggtg gggggcggtt tctgggtttg tgtacttgtt ttgtttttat tttgagacag 292500
 ggtatcaacc atgtaactct ggctagcctg gaactcacag agattggtat gecctgccc 292560
 cccaagatct gggattaaag gtgtgcacca ctacaccaa ctgttttatt gtttttctg 292620
 tgtgtatggg tgttcacatc tgctgtctg tctgtctgag gatgtgaatg ccacctgagt 292680
 ataatgccct cagagtacat tgcatctctt gtagctagag ttacagttgc ttgtgaaccg 292740

 cctgaagtgg gtgctaggaa ccaaattcag gtctctcca agagtaataa cctccgtttg 292800
 cttttgtatt gagacagggt ccgtgtatcc tagcctgaca taaactggca tgtatttaag 292860
 gctgatcttg aacttctgat cctccttttc cacccccaaa gtactgggat taaagacagc 292920
 atcactatac ccagtttggg ttgtttttaa taataataat aataataata ataataattgt 292980
 taattgcagt ggtgggtggt ttatgaggca ggtctcact atggacatgt gaccatcttg 293040
 aagctccctg tglagaccag gcaggcctcc aatttaacag aatcagctt accttgcct 293100

ccctagtgc tgggattaaag gtgtatacca cctcacctgg cctttatatt tcttttaaat 293160

 tatgttcatg tgtgtggggc tatgtgtact taagtacagg tgccctgtga agccagagac 293220
 atcacatact cctagagctg gagttaactg agctccctga tgtgggtgct ggaaaccgaa 293280
 ctcaagtccc ctgcaaaatc agcacacact cgattcctct gagcatctgt ccaaccccac 293340
 cacaccagc gtttataatg tgcctgggaat taaaccaggg ttttgtatat gatagtcagg 293400
 cactctacag ttgaactata tccccagtgg gaaagctctt tcaacattaa aaatttattt 293460
 tcacccatct ttatatctag cttttaattc tgcctccaaa taacaataga aaatgaaat 293520
 gtaatccca tatcgatgct gccttgtagc tcagattgat ttttctaaaa gtgcttttat 293580

 ttccacatt tacttatttg aaaattgact ttgacaggt ggtgtagcat gcctttaatc 293640
 ccaatgctca ggaggcagag gcaggtctct gtgagttcta ggccagccta ttctcagaaa 293700
 gtctcaggac aggtcccaa gctacacaga gaaacactgt cttgaaaaca aaaaaagaac 293760
 gggttcctgt gccactgct acatttaatg tcctgtctga taatagtttt ctcatctca 293820
 gtttttcatt tttattttc ctttgaatac tttttatta aagtggaaac atacatgtaa 293880
 gtgctgaagt aactgttaca tggagaactc atttgcgtgt tcagtggttc cttaaaatta 293940
 ttagactgaa aaaaattatt agaccgagaa caagccatat catcttgta atgttacctt 294000

 ttgtcatgaa cattgagaga aactaatcac ttggtcgtta atcagtggaa cttttggcag 294060
 ctttagtggg tctattttct tccaaagggg aaacagattc tcttacattt aaagagttca 294120
 aaggatttta cacatcttat tttatagat caaattctcc ccttaagata ataagaatag 294180
 atttacacct atgccctga atgtgtcaat tcaactagcac gcagctctcc tcaacaaaat 294240
 gctagttttg ctgtacgatt tagagcagtt cttcaaatg tagtcttaag acacacatct 294300
 tttggagatt ctgccttgta atcttcatgc caagcacttg atgaggttct tcaggcagtg 294360
 gagaagcaca gagaacatag ttctgtgctg atgaggtgtg tgggggcctc ttttgagatg 294420

 tgctcttgag taacctagcc tgacctcaa cttttctatg tgacctgaa aactgtctct 294480
 ctctctctct ctctctctct ctctgtgtgt gtgtgtgtgt gtgtgtgtgt gtgtgtgtgt 294540
 gtgtgtgtgt gtgtgtgtgt gtttgttacc acaaagtcag cagaggactc tgggcataaa 294600
 agtaaggatt gtagaacaag gaaaggaagg aagggttttt tgttttgttt ttcatttttt 294660
 ggtgcaaggg aaggttttgt gtgaacatct cagtagagtc atccagctc ccatacctgg 294720
 agcccatcat gattttcagt cttttctgtg aactgtatag catggacat acagtgacat 294780
 gcagcaacat tagacattcg atgatacga cattagctac aacacaattt tggactatt 294840

taaagttaat tagagccaag gatttggctg gagagcagtg ccccagatga ttgacagact 294900
 tgaagtctct gttgagagaa gtagaacaga ggaagccagt gacctgagaa cactctgtt 294960
 tctgtggaac ctgagactag actagacacc taatTTTTTT ttgctcttat ctgatccca 295020
 actaatcata aggttggggg ccccaactaaa aagactaaac tcaatgaaac tctgatttt 295080
 gaatgaattt caacttaatg cttctgtcac agcccttttc acaagagtta actggtttgg 295140
 ggaggaatac acgtgttctc tgccttctat caatcaccga aatcttaatt gctgttgccc 295200
 acgtacactt acggcctttt gtacaacctg cctgttgtat ttattcatat aagttttaag 295260

 tagaaaataa tatgtgatgt ttatacattt aaaatactcc tgatttttag aaatacatgc 295320
 aagaggcacg aagcttagga aaaaacatga gacaaccaa actgtcagat ctctcacctg 295380
 ctgtgattgc acagaccaac tggaaatttg tagaaggctt attgaaagaa tgcagaatga 295440
 aggtatgtat cctgccccca gacagtgtgc attcgtatgt ataccctgtg tggatctaag 295500
 acgaggttaag tcaactccca tttgtccctg taacttctct gaaaaaaaaa aaagttcatt 295560
 atttcatttt tttatgagta tgggtgtttt gcctgtatcc atgtctgtgt gccacatgtg 295620
 ggcagtgtccc atgaaggcca aaagaggaca tcagatctc tgggattggc attacagatg 295680

 gttatgagct accgtgtggg tgttgggaat caaacccagg tcttctgcag gaccagccag 295740
 tgctgttaac cctgagtc aactctcaag ctcaaaaaga aacatttttt gtaacataga 295800
 cctgataatg ctcttactg aagtcatgaa cctccatgaa gtctcacagc ccacagcatc 295860
 aatgacatgg gagcattgca tagtttttca tttttttta actattgtat gatgtatggt 295920
 gtgtgtgtgt aggcacacat gtgcaagtca gaggacagct tagcaaagtc agttcttacc 295980
 atctacctcc ttttaggcag cgtttttttt gtttttcggt tgtttgtttt tttgtttgtt 296040
 tgtttgttgc catcactatg gctgtttgaa aatggcaggc ccatgaactt catctcaaat 296100

 ctacacatag agcgttgaga ttgggggcat gtgccgectt acccagcttt tacatggttc 296160
 ccgggatctg aactcaggtg gtcaggcttg tacagcaagc acttttactt acaaactatc 296220
 tcctagccc ttagctggag tcttctcttt cagtatgatg tgaagccatt catgagttat 296280
 ataaagaatg ttgctctctt atgtgaaaag cagtgtgtat acctgtgtaa agccttgctt 296340
 gtgccatac atgttatcac atgtgccca gggaaaggat cttactatg gtataggtca 296400
 gtgagtatta aatatcttc tctctcaca gaactgcctt tatacagggt agccatatga 296460
 atgaaaaacc tcagtaactt gtgagcatat tcaataaaag tactgttttc agtgtcagtg 296520

 tgtacaggta attagacaag gtactaccta gaggagctgt agctttctca ctttgctgt 296580
 gcaagactag ctaaggtaga tgtgaattaa tttacctgaa actggttttc attttctgat 296640
 acatccttgt gagcaagtaa gaaaaaaaa ggggagatgg tgagaaccct agttcactca 296700

caaactagga agttctcaaa aaaaaaaaaa aaaaaaaggg aagaaagaaa accatagagc 296760
 tactcatttc tattgtggct ttgggttaag tacagaaagc tttagtgtgt caagatgcca 296820
 gagtcbgtaa aggtcagctt gtagtgacgg aatgaggttc ttgtgtcaga agatgccttt 296880
 tctaaattca agacaattcc agaagcttta ggacaattat actgttacag aagtcaatag 296940

 attatgggtt ttttttttt tcaacattac catgccttac aaatactatt gtttcattag 297000
 tgcctaaca tttctctgaa gtaatagtaa aatatagaag atattactcc aaccagctga 297060
 ccaccagatt aagatatttt ctccatgggtg cctgaaatct gttatcagaa ttgtaatgaa 297120
 gggaagcaga tctccctaaa ctagtaattg atttccttgg ttttgagttt ccttgctgtg 297180
 gtaacttatg accggtcata ttgttttcag acaaaacgca tgttggtaga aaagatgggg 297240
 catgaagcag tagaactggg ccatggagaa gccaacatca ctggcttgga agagaacacc 297300
 ttgatcgcca gcctctgtga cctactggag aggatatgga gccatggctt acaggtcaag 297360

 caggtaacca actcaagagg caccgggtggc acggctgatt caagggtta ttcattgcca 297420
 gggactggac tgttcaggtt ggcaactcggg aagcaaagca ggtggatctc tgtgactttg 297480
 aggctagcct ggctctacaga gtgagacctt atcctaaaat aaggaaagaa ggccaggtgg 297540
 cggcggcggc gcacaccttt aatctcagca ctcgggaggc agagacaggc aacctggtct 297600
 acagagctag ctccatgata gccagggtta catagagacc ttgtctcaa gaaaaaagg 297660
 gaaggaagga aagaagcaaa gatgaaggat gaggctggca agactgctca gcaccaagcc 297720
 tgacaatatg agtttgatct ctggaacca cctcatagaa gggaaagaga cattcacacg 297780

 aatgagaaat gtgacaagaa aaagacccca caagataatg aaatatatat cacagactgt 297840
 ttggttccag caaaagaaac aatctgggct agatgtggta gcacacacct ttaatctcag 297900
 tgcttgggag gcagagagaa aggtggtttt gatgagaata ttttgtgata aatgtttctt 297960
 taaagtgaac gttttgtgtt tcttgtgctt tcaggggaag tctgccttgt ggtcacattt 298020
 aattcagttt caggaccgag aggagaagca agagcacctc acagattcac caggtaaaga 298080
 ggcgttggag taagatagat tgcttcaagt ctctgtatc ctgggctaac cctgtactct 298140
 tgatctttct gccttcacct ccgaagtgtt aggattatag gcatggacca ccaacctagc 298200

 ttgagataga ttggtttgat agagtgggca gtataggca aaaagaagaa tcagttagg 298260
 tgggtacatc tcaatctaaa atttaccac gttgccaata aggataaagc agaaggagca 298320
 ataatacaag atattaatct aaggaagctc acttgaccct atcttctgtc ctctcactgt 298380
 aagacagaga aaatgatagt agctatccag agtgatcacg ttgatataaa ggaacaaca 298440
 caattaattg tgaagaacat tacaggtata tggatatac tgttgttatt gttattttat 298500
 cattattggt attgaaaann nnnnnnnnnn nnnnnnnnnn nnnnnnnnnn nnnnnnnnnn 298560

nnnnnnnnnn nnnnnnnnnn nnnnnnnnnn nnnnnnnnnn nnnnnnnnnn nnnnnnnnnn 298620

 aaaaaacaaa gaaaaccct gcctcgaaaa aaaaaaaaaa aaaaaaaaaa gaaaagttt 298680
 tgtgaccttc aataatactt tttttttttt aattggtttt tcatgacagg gattctctgt 298740
 gtagtctctgt ctgtcctgga gctcacgctg tagaccaggc tggccacgaa ctgagagatc 298800
 tgccagcctc ttctcccaa gtgctaggat taaaggcatg tgccgccacc acctgcaat 298860
 aatcttaata tcttctaata catcttattt aattttttta atgtgggcat gtgcatgtgg 298920
 aggtcaaatg acagcttgca ggtgtcattt gtctccttcc actttgtggg aactgagaat 298980
 ttggttctgg ttgctctcgt gtttgggtgt gggcgccttt atcactgctc tcaactatcct 299040

 tcctttcttt ctttctttct ttctttcttt ctttctttct ttctttcttt ctttctttca 299100
 taatgtcagg atcaaatcct gggccttgta ttataaata aactttcagg aaaaattaca 299160
 tattcatctc caagactatt taagagtcag agtctttggc ttggtctcctt tccttctttt 299220
 tgagataggg atcttacttg gatgctcagg ctgacctcaa actttgtgtg gattccacct 299280
 tagctccacc ttagctggg actacaggcg tgtatcacca cactcaactt aggagacaga 299340
 ttcttcagtt tatannnnnn nnnnggcata attctctctgc taatcagaat tatacaggat 299400
 tccttatgtc aaataataca actattacat tatttttttt acctcaaaga gtttgtttgt 299460

 tttttttatt ggcagtgtg agggfcagac ccagggcacg agccactgag tcatgtccac 299520
 agcccagagc ttggttttct ttatgtaaga taacctcta tttcataaaa tataaaatta 299580
 acagtaggaa gttaacagaa ataaaatgtt tgggtgggat agggcagagc ttggtctgtaa 299640
 tctcagtact cagnnnnnnn nnnnnnnnnn nnnnnnnnnn nnnnnnnnnn nnnnnnctta 299700
 tcccccaaa aaaaacctg aaagggaata atgcaagatt ttatactgaa ttagccattt 299760
 aggaaccact ttttaaatta taaattcttt aaaaaattca aaaataaaag attttttttt 299820
 aaaaaaaaaat gtttttgaga catgatctca ctgtgtagct ctggctgacc tggaaaccac 299880

 catgtagacc aagctggcct tgacctcaca gagatcccc tgctctgcc ttcagaatgc 299940
 tgggatcaaa gacattggcc actatactca gctgtaagag tctgtggtat ggctcagaga 300000
 gcaaagattc ctctgccaac tctgaaaacc tgggcttgat ccccagagtt catatggtag 300060
 gagaaaatgc cataaaatta ctttttgacc tccacctgga gaccatagaa cgtacgtgtg 300120
 tgtgtgtgtg tgtgtgtgtg tgtgtgtgtg tgtgtgtgtg tgtgtgtgtt attcacataa 300180
 actaaccacc aacttaataa gtaaaactaa gtaaaacata gccggttaag gatgtatctc 300240
 agtgaagaa tactcactag caagtgtgaa acctgagtt caatccccag tactgaaaaa 300300

tagatagata gatagataga tagatagata gatagataga tagatagaac aatgaaaga 300360
 agggataccc ttgtattcat ctccaattcc ttttctatc cctaccaag gtagcattat 300420
 cctacagagt ttacttgtaa aaaaaaaaa atcattttca atgtatctta taagataaca 300480
 ggaatatgga ttigatacta cattgccctg gaactcctca atagcttgtc ggtgtcctaa 300540
 gccctttgcc ataactatat ttatactaag ttagatttag gtctctaata cccacctctt 300600
 ctccatttt tgctatatag aaagtaaaag tacattggtc tatgtcctgt atctaacagg 300660
 aattgtagcc attggaatg aaaaccacgt aagaaagata gcttatctaa atttcatttg 300720

attataacta gaaggccagt aagtggtag agaaagcaga gttgagagta gtggtcacc 300780
 caacctatg gtaagggtca agagttgcag gccatccctg gtatgtgat tagacctgt 300840
 ctcaaaagag aataagttct taagaagtag ctattcatgg ggtaaaatgt tggaaagcca 300900
 agttcaatta agatgggaca gatgcattca actctgatgc ccagaaaggc acatgagaat 300960
 gttcagctgc tgttgggcaa cacacgcagc tcttgtggtt ttcactggcc aaaagttgag 301020
 tggttcagtt agaaatcaaa ctctgactg tcttcagtgg cctccagcaa attctaaagt 301080
 gcaagataaa tgaagtggtg tcgaagatct atacagttac agtctctgcc aactgtcaa 301140

atcgatgaag ggctaagat gtaagagcaa acagtatctt agtgttctca gtaagattaa 301200
 tgacagccat gtaacttttt tctttttcag agtctcatta taaggctctt gtctggcctg 301260
 gaactccta tgiagatctg gctgtcttca accttacaga gatctgataa cctctgcttc 301320
 cccaagtgat gggattaaag gcaggcacca gcacttgccc agcataacta atttttttt 301380
 taattatatg attgtatgtg tgtaaatgtc tttggaggcc agaagagggc atcatgactc 301440
 ctaaacatat agctacaggt ggatatgggc tgcccaacat gagtgatggg accaaatttg 301500
 gtagcctttg caagggcaat acatactgat aaagctgagc catctcacca gcctaagcc 301560

gtagagaatt tgaagtctgt gtttattggt tcaatggaaa ggaggcagag gcaggcgaat 301620
 cttggtgagt ttgaggtcag cctggtctac aaattgagtt ccaggacggc caggaccatt 301680
 acacagaaaa acctgtcttg aaaaacaaaa acaaaagttt taaacttaa aatgcatggc 301740
 agagtaacat cacctacttc agggetgccg gggaacagag gtaggacaaa ctataccatt 301800
 ccattgcatg ctgtctgtga cctgcttgat cctgttaggc ccaagacaga gtacaccctt 301860
 aaagggcaca cacactcagt gacctacttg atcaatgtgg gcccagatt ctcatctctg 301920
 ccacctccca atgccgtcag actgtaagtc catcagtga tctttgtact gattaggcta 301980

gagtccagat gattcagtca cctcccaaat gttgtgccac gtgtgaacat tatattagga 302040
 accaaatcgt aaacacagtt ttgggaggtg catttcccat ccacattaac agtccctttc 302100
 cctataagac actgttggtg aagctgcagc tgtactaaag actctatctt cattgcttaa 302160

tttattgggt ttggtagag gggttgtacc caggcctcac gagcactgta tcgctgagct 302220
 gtacctctag gccacctgct gactatgggc atctcctctg gctccttggt tcctctaga 302280
 caacttgctg actgtagtgt caactctttt cctctgcttc atagttttct cccgcttctc 302340
 agggttttgt ttigaggta ttattctctt cagttttggt tgttgaggca gaatttccca 302400

 tcgacaaaga tgaccttgaa ctctgatcc tgcctcctcc actttgcaa tgctggaata 302460
 caggttggtt gccactatat tccttactat ttgtgtgggt gcatttatgt tgccatgtgg 302520
 aatgaagagt cattctcga gccatttgac tttccacccc cgaagaatgg cacacttta 302580
 taacacactt aaactaagat ggtcttgata ggaagataaa catatttctt gcaggtgtct 302640
 aagacaattt cctcactgtg cattacttcc ctgagtatcc aaaagagatt agtctttaa 302700
 gtcccagttt gaaaattacc ttcctaagc cagatgttgt ggcacactca cttaatcca 302760
 gcacttgga ggaagaagca ggtggatcca tgtgagtca aggggtgcct ggtctacaga 302820

 gcgagtctta ggatagtcag gctatgtaga gagaccctgt ctgagaggaa gaaaatgaaa 302880
 aaagtccct ccctaactctg cctcctgacc gccatctaga gcctccgtgt cagtccata 302940
 agtgatcatt tatatctact agacacgagt ccagcttttt caccaaacac caaaaacata 303000
 aagatcta atctctgagat tttcactgac cttccttgg cagcatgggc aggagagaag 303060
 catcttccag tatcacacc ttgcttgtca acatcagtgg atctaaaacc tgagaaaaaa 303120
 atagctatga tataaagcaa aatccacttt ctaagttcca tcagtatatt tgctaaaggt 303180
 ggtgcttcag ttcagtttcc atttacagaa gagaaaatgg aaatgaagaa ggggtgcaaa 303240

 atgccatcgc atctaccaa aagtgagacc aaacatctgt ctccacttca tagccagtgg 303300
 ctgtgtgctc gatgcttctt gtaagagtca tttccttct tttataaaca ttagctgtgg 303360
 aactggagag agagctcagt ggttcagagc agttgttct cttgtagagg acctggattt 303420
 gatttccagg atccacctga tggttcccag ccatccttat ctccagtgcc aggggacttg 303480
 ataccctctt ctctgtcca tggaccaaac acatgcaaaa catgcttctg gtatttaaac 303540
 gttaatgtga aataaacatg gcatttaatt tattaaaaat tactcaccga gcatgattgt 303600
 acatactttt aatcttagca tttgagaggc cagtagatcc atgtgaattg agccatccta 303660

 gactacatag tgagttccag aacagtcaag tacagggtgc aaacctgtct caaaattaaa 303720
 aagaaaaaag aagaaaagga aagaaaacca ttcattgtatc ttatgctttt gaaagccaat 303780
 ttaaataact cactttgcat gatgtgcata atgtagttag gattctgaac tttgaaggag 303840
 gaatttacca gcctaaagag ccagagcagt tatattaat gcaaaataat aataaaattt 303900
 aataaaagaa aaaagctggg catggtggca cacccttttaaacctaaccc ttggaaggca 303960
 gaggcaggcc tggctctaaa agcaagttcc agaacagcca gggccattac acagagaaac 304020

cttatctcaa aaaaaaaaaa aaaaagaaaa gacaaaaaag ccttccaaag tttaaacatt 304080

 aaatgttttt ctgtgccaat gatgttctgg gtccaatccc cagaatcaca tgaacagggt 304140
 gtagtatcac atgcatgtta tcctagcatt caggataaga aaacagcagt gggtagatga 304200
 ggcaaaaagc cataaatagg tttccagttc ataaatctga agatgaaggc tcacatacct 304260
 catagcttaa ctctcaaca ttgcccttga gtaattacc agcacgatga gaacaaatga 304320
 atagctaaat ggctggccct catggccata tttacatat attgcattat ttagaagatg 304380
 tactttcata aaatacttgt tttaaatttc caaatatagc cacagcttgt ttagaaagaa 304440
 catacctgtt tactgtatta ataaattatt gataactaat ggtcagccct aaagacatac 304500

 acacaagtaa cagtgtgcag acagagcagg ttgtcttatg tgtttagaaa tatatatata 304560
 tacacatatt caatgacaaa gaaaaggaga ccatgtgggg aatggagggt acatatggga 304620
 gggcttaggg ggaggaaagg gaagagggaa atgatatatt attattataa tctcagaaat 304680
 tcttttttgg ggttttttga gacaggattt ctctgtatgt agcattgtct gcctggaac 304740
 ttgtctgta gaccaggctg gcctcgaact ctggagatc ctctgtctc tgctcccaa 304800
 gttctgggat taaagggtg caccaccatc accaccaga aatctcagaa tttttaaaaa 304860
 aattatttta agaatgtatc aataggccaa acatggtgat acacccttc aatccaaca 304920

 ttggggaggc agaggcagtg gagctctgtg agttcaaggc cagccagggt tacacagaaa 304980
 gacctgtttt gaaaaaaaaa tttttaagta taaattttta ctgttatttt cctaatactt 305040
 tgctaataat tttctacata gttgccttg gaccagaaag aagaaaatct gactcaggag 305100
 ttatgttacc aacctcagg gtctccctta ttcaagacat gaggtatttg ttacacgtta 305160
 acgaatgtcg gtaactatga ggtgtagctt tcacctgagt tgctcaagtg attataacca 305220
 taccttttgt ttacataatc tgaagaaagt attttcataa ttataaatat gggtttttta 305280
 atttatttta ttttagttta tattatgagt attagtgttg gacctacatt tacacataca 305340

 caaacatat gcgtgcctgg tgcccacaga gttcagagga gagggaacta gatctcttga 305400
 aaccagatt agggatgggt gcaagctacc atctgggcac tgaaaactga gcctgagtga 305460
 agagcaataa gtgtttttta ctgcacagcc atctctccag cctacatttt aattgcttac 305520
 tattgtgctg tttgttgtt ggcttttttt ttttttttt ttacattaaa tagaaagggg 305580
 cagttgggga agagctttct ataaaacagc tataaactgt aatttctctt tgatgcatct 305640
 cttaaagca tgctatctat agatatgcag acaaaaaata tagatgacaa caggtggctt 305700
 agcagaaaa atgctctcag aatgatacaa ttttctttt tatgtttatt tgtttgtttt 305760

tccagacagg gtttctttgt ggaaccctgg ctgtcctgag actcactcta tagatcaggt 305820
 tggcctccaa ctacagatc aacctgccaa gttctgggac taaaggtgtg tgtgccacca 305880
 ctgcctaata agatacagct ttaaaaatac aaatattaaa attaacattt cttgccaggg 305940
 agtgggtggca catgccttta atcccagcac ctgggaggca gaggcaagtg gaaggtagag 306000
 gaggcaggca ggtaggctc tgtgagttca aggccaacca tggctgttac aatacagagg 306060
 aactctgtct caaagcaaaa caaacaaaaa agaatgaatg gaaaaggta cacttttttc 306120
 ttataaacat ttaagcaca atatttagtc actatttaag atatcagagt tcaaatgtg 306180

tgtacataaa atataaaata actgtaacac ttatgacttt ttgttccggg gctagggaga 306240
 tggctcagca gttaaagaca ttggctggta ttctagaatt gagcccagat tcaattccca 306300
 gaactcagat ggcagctcac aactatctat aactgtagtt ctaagggatc ctcacacaga 306360
 catacatgct tgcaaaacac caatgcacat aaaaataaat ttgaaaaaa gaaaaagaaa 306420
 agaaggggaa aaaaagactt gtgtcttttg tggtagcgtg agtctttgac ctcaacactt 306480
 ggaagcagaa gcagaggatc tctgtgagtt tgagaccagc ctggcttata taatgagttc 306540
 caggatagcc aaggctgaat taaagagact ctgtcttaaa acagacaatt acaactttcc 306600

tttaaatgtg tattttgttg gtatagtttg tatgtgtgtt catatatgtg tgagctcgtg 306660
 cgtgcgtgcg tgcgtgctg cgtgcaggnn nnnnnnnnnn nnnnnnnnnn nnccaaagga 306720
 caacttatgt cttttcttaa gtgctgtcca cattggtttt tgatacaagt tctttcattg 306780
 ccatagactt ggccaattgg gctagttagg ctagttagaa agctcctcct atctctgtct 306840
 cccaagcaca agaattataa gcacctcatt ttatgttttg tgtggtgtgt gtgtgtgtgt 306900
 gtgtgtgtgt gtgtgtgtgt gtgtgtgtgt gtgtgtgtgt gtatatggat gtttctctcc 306960
 ctcccaccag ttccaagtac ccaattacc acacagaac atattactta taataactca 307020

actgatagct caggcttatt actcactaac tcttacactt aaattaacce ataactctta 307080
 tcaatgttta gccatgtggc ttggtaacct ttctcaatat ggcaattctta tcttgtttct 307140
 ctgcatttgc cagtgtactt cttgactctg cccctectca tcttagtctg gctctcacac 307200
 tcaacctctt cctgcccagc tateaaccaa tcagctttta ttttaataata agtataatec 307260
 acggtgtgtg tigtgtgtgt tgtgtgtgtg tgtgtgtgtt gtaatgagtc aactaacia 307320
 agacttttca ctagagttag tttttactat ttacctgtc ttctttttct gatcttcct 307380
 ttctctgctg ggaggaaaaat tgcttaagaa aataaattat tcatttctcc tggatccagc 307440

agtgacttct atatagaatt ctaatttata catatatatt gcattcactt gctattggtc 307500
 acacaatfff ctaagtcctt ttccacattt taagacttat caccactttg ccaggtgtgg 307560
 tgccacagca gcaggtgaat ttctatgagt tctaggctag tctgatctgc atagcaagta 307620

ctaagacagc caggactaca taaacagacc ctgtctccca aacacagaca aataaatcaa 307680
 catagtactg cttatctcct ctaatactgt ataaagtaac taaagcagtt acttcaata 307740
 aaccaggcat tgggtggtgca cgcccttaac cccagcactc tggaagtaga ggcaggcaga 307800
 tctcttgagt tagaggccca cctgggtctac aaagagttcc aggacaggca aggctataca 307860

 gagaaacctt ttctcaaaaa acaaaacaag acaaacaaaa aaatatatca cccaagccag 307920
 tcgtggtgca atatgcattt aatcccagct cttaggaggc aaatggatca gtgtgttggga 307980
 ggccaacctg gtctgtatga tgagttccag gccagccatg gctacatagc aagactctgt 308040
 ctcaaaaact aaacaacaac tacaaccaa agaaaaaaa aaaaaagagg gctgaagaga 308100
 tggctcagag gttaaagaca ctgactgctc ttccagaggt cctgagttca attcccagca 308160
 accacatggt ggctcacaac catccattat gagatctgat gccctcttct ggtgtgaaga 308220
 tatacatgga agcagaatgt tgtatacata ataaataaaa tcttaaaaa aaaaaaagg 308280

 acattgtgta ttaccattt cttcatctaa atacaaaac ttttcttggg ccagcattgt 308340
 taatactttt taagctcttt tccagcttaa agttatcctt aaaaacctct cctagtctac 308400
 tgtgactggg gcgaagagc aaactaagca catccttggc aatttcaata gttaccagtt 308460
 ttgttttggg ttttttga aaacatgaat ctagatggcg tgggtgctct cttagactac 308520
 tgttgagatg gcgtgattct ataagtact ttctttaagg ataatttagg aatgggaaaa 308580
 tgtaacaaa ttggaaagt atttttgatc tgcaccttc accatgactt getattgctt 308640
 gtcacatg caacaccagg acttaggaca aagaggacta agctgggtgg tgatggcacc 308700

 atgcctttat ttccatcatt tgggaggcag aagcaggttg atctctctga gttcacaggc 308760
 cagcctggtc tacagagtga gttccaggac agccagggct acagagaaac catgtatcaa 308820
 accacactta tctctccac aaaaaaaaa aaaaaagaca aaggggactg atgtcatttt 308880
 gagtttttat ttgactgtg atttatttga atcagatgta ttattttaag ggaaaaaaaa 308940
 catttcatat aggttgtcta aaaacaagat gtattttaat gcaaaaaaaaa tttcttctt 309000
 gttggtactg atttttaggc atattcagaa catgagtgag atcaagactg atgttgccg 309060
 agccccggca tggataagat tgtctctaga aaagaagctt ttatcacagc acctcaagca 309120

 gctgctctct aaccaactgc tcaccaagta agactcttgt ctctcacgat atttgttctt 309180
 gtgatctgtg cttacaaagg aaattaagta agctgatgaa ctagcacctt catcatgaat 309240
 cctgattaat gagcacatac atttttgtat aacaggtgtg cttcagaaaa taacctttgt 309300
 gaggctggac tcagaggcac tggctgagtt cagttcccag caaccacgtg gtggctcaca 309360
 accatctcta ctgggatctg gggccctctt ctggtatgca accagaacct tgtatacatt 309420
 aataaatctt caaaaaagaa agaaagaaag acctttgtag aatatttgat catttctgag 309480

agggcacacc agatttaata gctaagacca gattactgtt ctgtaatcag aaaaataaat 309540

 gctcactagt ccacacaagc tgacactagg ttgaacttac attagcttca ttgcataaaa 309600
 ctccagcaaga agttgctgca gagcactaag aggcaggtgg atctctgtga gtttgagggc 309660
 agcctagtcc tcaaagcgag ttccatgaca gatgggtcta caccgaggaa ctctgtaaga 309720
 aaaggaaaaa agaaaagaaa agaaaaaagt tggtgcaaga tatttgatca cactgtgaac 309780
 actgagattg tgtattttac tggaaaacc tgtttctgcc tgtagcatgc acctttaatc 309840
 caagagcttt ctgcttgaat attgtaagca ggattaaaca gaatcaacct tatgtcaaga 309900
 ggtggagcaa gcaaccagtg gacaggaaag aaccatagag aatgaggag ttggaaggat 309960

 ggggagagat gtgcaggaag tagaaaggag ggacatccca ttggaggagt ttattttttg 310020
 ttttgtttta ggtagtgtaa gagaagctg tctttctggg acagcagtgg aggaggaagg 310080
 ccagctgggt gctttctctg cttttctgag ctgacagagt ttcaccccag catgtggctc 310140
 ctgacttttt attgctgaaa tggacaata gaaatttagt ttaaacaag tagactaggg 310200
 ctggagagat ggctcagtgt ttaagagcac tgctgctcg tccaagatc ctgagttcaa 310260
 ttcccagcaa ccacatggtg gctcacaacc atctgtaatg aatctggtg cectctctg 310320
 gcctgcagac aaacatgcag gcagaacact gtgtacataa taagtaata aatgtttaa 310380

 aacacaaaac aaaacaagta gattagaaga acagaaagat ggagtcttc taatagactt 310440
 ttaatagttt agattcaggg aaccagttgc ttacaagtca gttaattgtt acccagtcag 310500
 atagtttctg tccttaccca aaagaacaa aaaacaaaa gcatttattt ttttattctg 310560
 gagctacata aagtctcact atgtagtctt agctgcctg aatctcacta tntagaccaa 310620
 gctggcctca aactcatgga gatttacctg cttctgcctc ctgagtgatg ggattaaaga 310680
 tgtgtgcctc caagcctggc aagaaatcct tctaaatgat aggacattag aacttacttg 310740
 aaagctaage agttagaatt ctcaagagta aagggtggt agcacctta atcccagctt 310800

 ggcgtagtgt gtctcaggag tggatgaatcc ccagagctca tttgacctgc cattctagct 310860
 gaaccaatga actccagtc tgatgagaaa cgctttcaag aatgaatgaa tgagccgtac 310920
 ctgggtggct cacacctta atcccagcac tcgggaggca gaggcagatg gatctctgta 310980
 agtttgagac cagcctggtc tacaagagct agttccaaga cagcctcaa agccacagag 311040
 aaacctgtc tcgaaaaacc aaaaaccaa aacaacaaca acaacaaca caagaatgaa 311100
 tgaatgaatg aatgaatgaa tgaatgaatg aggtagaagg ggctggagg atggctcagc 311160
 acttaagagt actgggtgct cttccagcat acctgagtta tattcctggc acccacttga 311220

ttaaatgata gtgtgtttg tttgtttgtt tgtttgacat gtatgggtgt tttatctgta 311280
 tacgtgatg tcccacaagt gtacagtgcc ataagagagc gccagtcctc ctaggactgg 311340
 aattacagtt atgaaatacc gtgtttgtgc tagggaatca aatctatgtc ttctgggaaa 311400
 gcagccagtg ctgttaatca ctgtgtgctc tctctctagc ccatgtttga ggggattttt 311460
 tgtttgattg attgatcttt agttttgtgg gagggggttt gttttggggg gttttgtgta 311520
 tttttttttt cttttgctca aatgcatggt tacaagagcc accatgaatg tcagtgtgtg 311580
 gaaatcaaag gacaacctgt ggggtgttgc agatgttaca ttctccttcc ccacatgggt 311640

 ctccgggatt tactcatggt ggtggtgaga gttggcagca agtgccttta ctccctgagc 311700
 ggggtgcattg acicagaggg tattaatttt aagtcatgat tcttaagaat gagaactgtg 311760
 actgctgttt tgtgcctgtg ttaacctttc tcaggaagct gtacaagcgt tacgcttttc 311820
 tgcgctgtga agaagaaaga gagcagttcc tctacatct gctctcactc aatgccgtgg 311880
 actatttctg ctttaccagt gtgttcacca ctattagtaa gtgtggagag ttgactttta 311940
 agtgaacaat ctccaggtga gcaggcatgg gtggccaata gctgtaatcc caacgacact 312000
 cagaaagctg aaagaagaaa attgccagtt cagaaccagt gagtgtgggc tatgcatctt 312060

 taccctttct caaaaaaga gaaagaaaag actagctttg aggtggggag attctcaagt 312120
 cactcatgga ataaaagtat tcatttttcc aaaagtgaga tctgtcacag cacaaggagg 312180
 aactgacga ccctcgatt tccattagga atgtagaaca ctccctagcc ctctgatgcc 312240
 agcctgtgca aaggtagtgg tagcacacac cattaatccc agcactaggg aggcagaggc 312300
 aggcatct ctctaagctc caagacagcc aggactacac agagaaacce tgtctttaa 312360
 aaaaaaaaaa aaggtctaaa gactgggcat gtagctacta taatccctcc tgaggcaaga 312420
 agatcaaaaa ttcaaggctg gggcaggggc tagatagatg gctcagaagt taaaagcact 312480

 gactgetctt ccagaggctc tgagttcaat tcccagctc cacatggaga tttccaacca 312540
 actataataa ggtctggtgc cctcttctgg cctgcagga cacatgcagg cagaacacta 312600
 tacataataa ataagtaaat gaataataa atctttttta aaaattcaag gctggcctag 312660
 cctacacagg aaagttgat ctcaaaagaa agggagatcc agctagatag ctcagtgagt 312720
 aagggcgttt gccccagagc ctgacaacct gggttcagct cccatggtag aacgagaacc 312780
 gattcccaaa agttgcctc tgagctctat atgtgcacca aggtgacaag tacaggtata 312840
 caccacacac acacacacac acacactctc tctctctctc tctctctctc tctctctctc 312900

 tctctctcac acacacacac acacatgttc actcacacac acaaacacac ccaaagtgtt 312960
 tgtttgtttt tttttaagat attaaaagaa aagaaagatc acttaagatg gctaaaaaca 313020
 tggtcattct cagctgtttt caaggccaga atgggatgca taaatcaat ctcaaaaca 313080

aaaacaaaca aaaggactag aaagatatct cagcagaaga aggcaccttg catacaatcc 313140
 cagtgacttg aatttgatcc ctggagccca tggaaagatg gaaagaaaac cagttgtgaa 313200
 tgagccatgg cactcgtgta ccaacgctca cgtaggcatg atacacgata cacatgatac 313260
 atgatacaca tcatacacga taataagatg cctaagaacc tctaaaaaat attcttgtat 313320

 ctgtaggttt ctctttttct gagaagcttt caatttgagg cattggaata tattaagaa 313380
 atattctggt atcctagctc actccctttg ccatgacaaa taccatgacc tgaaaacaaa 313440
 ctaaggaaag aacaagtta ttccagctta gtggttacia tctatcactg aagtaagtca 313500
 gggcaagaaa ctcaaacagg taagtctta aagcagaaag gagccttaga tgcattctga 313560
 actgggcttg tctaccaagc agtgagcaac ctaagttaac tttactgga aactgtacac 313620
 aagctaagaa ggggtctcag tccaggaatt acccagctca aattagcctg taggcacgtc 313680
 tgtgagtggg gtttttttc ttcttttct ttttttttc ctgattata aattggtatc 313740

 agaggccca gctcatttg ggtggcactg ttcctgtac aggtcctggg ctgtataaga 313800
 aagctagcta agtaatgagc ttgtgagagt aagccaacag tcatcagtgt tcttgcattg 313860
 tttctgcat tccaaatfff cctgggcttt tatatttagc caaggtccat ggcaagatgg 313920
 tgacatctag tggtagagcc ttgaaaagg gtccatatag atccgtgcac atctggctct 313980
 cccagattcc tggtagcat gagtcacttc aataacctga tccaggcatt ctgtaggagt 314040
 tggttctctc ctccaccat gagggttcca ggggtggaact caggttgtca ggcttgcaa 314100
 taagtaacct taaccactga gccatctcac tggctctcat gattatgtct taataattga 314160

 tcataaaaag cccaatafca ggggctagag agatagactc agttgctaag aacacttgtt 314220
 cttgctgagg acctgggttc agttcccagc acccacatgg tggttcatca ctctagtacc 314280
 ctaactccag ttccaggagg tctgactcca ttcttttgac ctctggggtc actagacaca 314340
 gatgtatgca tatataacat gcaggcaaaa cattgctaca cataaaaaga aacaaaataa 314400
 cttcataagc aaaatgtatc ttaaagcat ctagtcttag ataattgtgg gttgtttat 314460
 ttgtttgttt taattcactt ctgtgttttc ttccagtcat tcttataga tcagtatca 314520
 ttccaattaa aaagctgagc aatgcgatca ttacatcaaa cccgtggatc tgtgtttcag 314580

 gagagctagg agacactgga gtaatgcaga ttccaaaaa cctgcttgag atgacttttg 314640
 aggtaggtta gccaatacct ttttaattct acagaagaaa tctggttttg cttttcatt 314700
 ttttcttg aacaaatgaa ataaaggaac atgcagtat gtaggatcat tttgttattg 314760
 tagccttata catgtctgaa gcaacttaca ctagttagct ttttattttt atttctagac 314820
 cctatttttc tactttagt aggccttacc aggtcttgtt ccttgattcc cagcgcctaa 314880
 cacagaacat gacaaacaga aatgttaag taaaagcttt ccctaaagtg gtttctcttc 314940

aggacgagag agctgatgtc catgcttatg gcttttgaag taaaaagtga catacataca 315000

ttagtatgct ttttgtttg ttttttcttt tctttttttg gtttttttca agacagggtt 315060

tctctgtage tttggaggct gtccctggaac aagtcttgaa ctcacataga tccacctgcc 315120

tctgcctcct gatttctgga attaaaggctg tgcgccacca acaccagac attattttgt 315180

tttttcaaga tagagtttct ctgtgtaaca gccctgaatg tccaggaact cactctgtag 315240

aacagggtag ccttgaactc ggagatctgc ctgcctctgg ctcccaggta ctgggattaa 315300

atgtgtgtgc caccaccgag cagttcctat aaatatgact ttttatattg tcagttttgg 315360

acaatataaa agatctgcct gcctctgcct cctgagtct gggattaaag gtgtgcgcca 315420

ccaacacccg gcaggaatag tcattttcat ttggaatcat aatccaagc ccaacagtag 315480

tccatttggc cttatgtatg gggcagactc acatctattt gtatgtaaaa gttaaaaacc 315540

accaggtggt ggtggcacat gcctttaatc ccagcacttg ggaggcaaaa gcatgcagaa 315600

tttctattac cattgctgta ttttgtgctt gtcccaaaa ggccagcaag gacattaata 315660

actacagttc attcgtaatg tcactttcta cagttgtggt acctgctgtt catttgtggtc 315720

caaaaacata aagtggaaaa ttccaaaagc aaaaattcat agaagctgag catgatgtat 315780

tcctataacc ttggcacttg agaagcagag acagggtcag agaagttaa ggcatcatca 315840

gctccatagc aggtttgaga tcagcctggg ttgcatgagt tcatgtctct aagagcaaaa 315900

caataaaaat aagaagccag gcatggtggt acatgcctgg attccggcac tcgggataga 315960

agcagaagaa tgcigcaagt tcaaagcctt cctgggctgc ctaatgaaac tatctcaaaa 316020

acaaaacaaa aattaaaaat tatgagtgtg cctggcgggtg gtggcacacg cttttaatec 316080

cagcactcag gaggcagagg caggtggatc tatgtgagtt caagaccagc ctgatctaca 316140

agagctggta tttcaattgt acaacatggt aaattgcaca atgaaacctg tgctgtttct 316200

gtgtcagcca tgaattctgt ctttttctaa cgtgtttgtg tgtgtgctac cetcccattt 316260

aggttatcag attgcagtgg cttgtgtcta tgtaaccttt atttactta ttagtggccc 316320

tacagcataa gagtaatggt tcagagaagg atccaggcca taaaacatgg aacaactctg 316380

gtatatgtag caacatcccc atgcgtatag gaaagataca gtattttag gtttggattt 316440

gggaagtctc acacacctac tgggagctct agagtatct actttaggt aagatgattt 316500

ttacaaatag cttcttaaac ttctctagta gatcagagcc ttgaacatgc tagacaagca 316560

ctctaccact gaactatacc ctagtcctt gttaaaaaat ataaaacct atcagttagt 316620

gattttttt taaaaattg gctgtttgct ctaagtcaat ctaaataaga tccttccca 316680

cttactgaaa tcctttttac ccttaagctg aggcataaat cattattagt gattctgttt 316740
 ctggattccc caaatagaaa taaatgttac ttctccagca ctctctaac acttgcttac 316800
 atttctggtc cagcacacca agcactccgt cccatttggg agtcagtgtc catctcctgt 316860
 ctcgttgtat gaaggtccct gagcgcaaag actattaat ttatgccatt aaacttagca 316920
 cactgtgaag gtaggtctc tgtgctaat ggagccaaag ttgaaagga atagaaaaga 316980
 actgagtaca gaataatttg tggctctgtc tctacagtgc cagaacctgg gaaagctcac 317040
 tacagttcag attgccacg ataactccgg actgttagct aaatggctag tggattgtgt 317100

 catggtcaga aatgaaatca caggacatac atataggtga gtaaatggac ttaggaggag 317160
 cagaattctt taictcaaaa ctcttttagt aacaaaatgt ttttaatttt cctaaagcct 317220
 tccctctatc tcccaacta gtttttgagg ggatgtatta tttgttcta tttatagaac 317280
 acaaaatgg ccaggtatga ttgtctagac cttaagtccc agaattcaag agatagagac 317340
 aggcatatct ctgagttga ggccaccctg gtctataaag cagccaaggc tacttagaat 317400
 gatgatgatg atgatgatga tgatgatgat gatgatgatg atgatgatga tgatgataaa 317460
 tagttgctaa cagttctttt taaacaaca gattggggct gacaagatgg ctgagcaata 317520

 agagcactta tactctatcc aagttcagat ctgagcacc acccaggta gcttacaact 317580
 gcctgcaact ccagccctag gatatccagt gcctttgctg gcctctatgg gtatcacatg 317640
 catctgcaca tigtgtgaca caagcacaca caaatgcata catacacaga catgaataag 317700
 aaaaaatat ttaatctttg gtaaacaga ttgtggaagc tagagaaata gcttggtggg 317760
 taagagggct tgatgcttc agttcccagc acctacatgg cagatcacag tcgtctgtag 317820
 ctccaattcc agagatccag tactcactct ggctctgca ggacacaggca tacacatggc 317880
 acacagacat acatacagac acacactcat agatataaaa taataaaatc ttaatttagt 317940

 gtgtctgtat tctctctctc tgtgtagcac tgggttagac aacctatctt ggaattcaca 318000
 gagctctgct tccaagtgc tagatttaa ggcatatatt accacaccta gctgttctct 318060
 actgttctat gtttttgaaa tttctcatgg tgaacgaac acttctcaga tattagcatc 318120
 atggacttta cctacaacgc cattttaaaa tctttaatta aaactctagg aagccaagcg 318180
 tgatgtcact caggtctata atcccagtac tccagaaact gaagcagaag attgcctgga 318240
 gttagagacc agcctgatag ccttcgaata ataaattcta ggatagcctt agcagcagag 318300
 tgagaacca tcicaaatg aaaacaagac aaaatcctag ttttaaaaat gtagattcat 318360

 gggatctctg gagaccagag taagttcaca acaacaaca aagtagattc aaaagatttt 318420
 aatcaaaag aattttttt tttctgccc tgcagattc ccatgtgggc ggtggctggg 318480
 gaaaggcatc gatgatgaa gcctggaaag aattcttatt ggagaattga tgacatcagc 318540

ttcagatgaa gacctgggaa agcagtgctg gactccacca cagcagaaat ctcccacgac 318600
 aaccaggaga ctaagtatca cgtcactaac aggaaagacc tccagtgagt tgttttctag 318660
 tgtaccgct cgggtattgc aggccttctgt ggcccatc cagaaaagca gttgtgttaa 318720
 tgaattatgg tgaggagatt tacaagaatg gactggggaa tgactcagaa gatacagtgc 318780

 gctcttccct cgcataagc tgggagttac attcccagca ccctccagcc gggttccaag 318840
 cattcaata gatgagcctg tgggggtaat tctcattcaa actgccactg tgatttcagg 318900
 tcccatgctg gcagcctacc aagccaccta gaaagaggcg cagatgacca gtgctcacag 318960
 ggggaatgga gcgaggagg taccagtca ggaaggaag aaaagaaagc ctgacttctg 319020
 gccagcgcac cgcgtggcat ctgctagct tcttccctta aaccacaaca gcagaatttc 319080
 acgtaggta ctgagagcct cgatgcctta gcaaatacct gcaagattct tggctgggaa 319140
 cctctgagca atgatgaagg gaaccttct cacttcattc cccacatcgg gagagtgttg 319200

 cactttgtga tgggaacccc gccacgtgat tgcactgact atcttgttct gttttctcag 319260
 tgaggagcgt ttgttggtt gggtttgtt tgtttgttc ttgttctgtt gtggtttggt 319320
 tttttgttt tttgtttgt ttttaagatt tttttatata ttactataa attgttctgc 319380
 ctgcatgtat ccctgcgctc cagatcacat tacggatggt tgtgagccac catgtggttg 319440
 ctgggaattg aacacaggac ctctggaaga tcagccagtg ctcttaacct ctgagccatc 319500
 tctccagccc ttggtttgt ttttcaacta ttttcagttg agaaaagcca gaggaaatta 319560
 aacatgtggc ttgtgtgtg gttcgaaggt agtgtggctg agattgagt ctcggtctc 319620

 ttgggttctt cagacttggc cattttatcc agtagcaaac tggaaaagcg agcttgctca 319680
 aatgaagttt ttctgcagg gacttaacag tcgaataccc catagtattt ttgttcattt 319740
 atttcttaca agaatgtaga cgctattaat taattattt gcagaacca atgctggaca 319800
 gatccaggaa ggaattggag aagctgtgaa caatatgta aagcacttc acaaacctga 319860
 gaaggaggta ttatgggca ggaagctgt gtgtatagt gggcttttt ttaatttatt 319920
 tttttgaga cagggttct ctgtgtagcg ctgtcctgga acttgcctca tagaccagct 319980
 ggctcaaaa tcacctgcc tctgctcat gggattaaag tcatgcacca tcccacctg 320040

 gctaccctca gctcttgtt ctctagtatg gtgttattt ggggtgctg ggggttact 320100
 ttatttcatt tgtataagt ttttcttgc atgtatgtct gtgtaccaca tgtgtgctg 320160
 gtgcctgcaa agctagaagc tagcattggt tcccctgaa ctgtagttaa ggatggttgt 320220
 gagccacagt gtgggtgctg ggaactgaac ccaggtcctt tgaaagaaca gccagtctc 320280
 tttgtcactg agccatctct acagccctc tagtgttggg tggttttgct tttgtttttg 320340
 tttgttttaa gcgtagaagc agcagaattc ccttgttact gtgttaacat tatggtttac 320400

agagaggaag ccttacagtg ctgctgtgcg gagaaaatgg cctggttgct gcaactggaac 320460

 aggtttttcca tcacgggttc aaatctgccc gcatctttca caagaatgtc ttcactctggg 320520
 acttcgtagg taaattaagt agatgtatgt tactataaag acaactgaagt gtttctttaa 320580
 aaaccctgca agctggggct ggagagatgg ctgagaggtt aaaagcactg actgctcttt 320640
 cagaggtcct aagtccaatt cccagcaacc acatgggtggc tcacaacaat ctgtaatgag 320700
 atctggtgcc ctcttctccc ctgcagggat acatgcagac aggtcactat ataaaataaa 320760
 taagtatata agtaaattha aaagaataaa gtaaaactca ccaggcgttg gtggcgcagg 320820
 cctttaatcc cagcactcgg gagacagagg cagacggatc tctgtgagtt tttaggccag 320880

 cctggctctct agggcgagtg ccaggatagg ctccaaagct acatagagaa accctgtctc 320940
 aaaaaactaa ataataact aaataaaact caaaaagcca atttttttt tatttattaa 321000
 ttcaagttag ggaacaagct tgtttcacat gtaagtcct tctccgtccc ctccccct 321060
 ttctttatc tglatatctt tcttattcca tggctggctg tgtgacagag tttctggctc 321120
 ctgggtgcat cctctcttc tcttttctt gctctcctc cctcttctct ccaggagacc 321180
 tagatttctc ctcttatcta ttctctctgc ccagcagccc tgcctagcta ctggccattc 321240
 atctctttat tagaccaatc aggtgcttta ggcaggcaag gtatcttcat tccacctct 321300

 cttaaaaagc caaaatttha aatgaataga aattagtaat acaactagtat gtttgggggc 321360
 taatgagggt tcaacaagta gaggccctga gtttgatccc aggcacctac cagggtgaaa 321420
 gagagaactg actcccaca gttgccccca cacatacaca cacagtgttc actaaaataa 321480
 aagagggggc tggagagata actcagcagt taggagcgtt tgctgttctt ccagaggcct 321540
 gggaactcaa ccacatggtg gctcacagct ctcttacct ataattccag gggatctgat 321600
 gccctttgct ggcttctgaa ggtactgtac tcccatagta cacacaggca tacaggcagg 321660
 cagaactccc atacatgtaa aataaggata aacaagtctt ttaaaaagtg tectaagtct 321720

 tttttgtttt gtttttcgag acagggtttc tctatgtagc tttggagcct atcctggcac 321780
 tcactctgga gaccaggtg gcctcgaact cacagagatc gcctgcctc tgctcccga 321840
 gtgctgggat taaagggtg tgccaccaac gcccgctt ctttttttt ttttttttt 321900
 tttttggtg gtgtgtgtg gtgtgtcctg agtcttga ttttcttcc cctttaggta 321960
 tataggattc taaacctct agtttcttha aagggtcagt gagccattt tgtgtttgtg 322020
 acgttggcct acatgaactt tcgggcaaag aaagggaat tggccatgca cctaagagtg 322080
 atttgttcc cctctcttc tagaaagctt agaattttac tgctcctgce tctaagtct 322140

gcagctctct cagattaagt cagtactcca caaggcccat ttaggtccat ttaataatct 322200
 tactgatggt agccattcta gaagagggca ccacaccatc ttaatggtca aatggctact 322260
 gtgttgattc atggaagggt tcactcttag gagataattc ctttcatttc gtggttcctt 322320
 ctctctctcc tcctctctcc tctctctctc tctctctctc tctttaatgc ttttgTTTT 322380
 ttaatgcat tttctgtttc atgaagacat tttaaaagaa taaactttcc agccctctgg 322440
 aatgtggtct tgaanaataa ttactagaca ggtggggggg gggggggctc gcctttaatc 322500
 ccagcaccag gaatcatact gctttggcat gaacttctta agctctctgt gattcattct 322560

gaaatcagtg ataaactaat gatttggagt aggggactgt gaagccaagc cccagtagag 322620
 tttccagaat aaattagatg gcatttctgc atacaactgt ttagtgtgtg tgtgattctg 322680
 cttgtcttcc tcagagaaag cagtggctta ttttgaacc actgaccaga ttttagacia 322740
 tgaagatgat gtactcattc agaaatcacc ttgcaagacc ttctgccact atgtgaatgc 322800
 tattaatact gcaccagga gcattgggaa ggatggcaaa ttccagattc tagtttgcct 322860
 tggacaaggt tacagagtca aagttacgct ttcttattt ttgttacgtg gtaagaaaa 322920
 gttatatgcc aggttatggc tatttctctt gtgtttcttc tttccaactt ttattatgag 322980

actactgtct cccgggcacc tttctgttac agtagaaact gatttaccca tttcttaaga 323040
 aggtttctgt gttttatfff gtatatgaat ggtggtttgc ctgcttgggt gtggaggctc 323100
 acaactataa tctagcact caggaacag acttgaagat ctttagctc aagccagcc 323160
 tggtttacia atcaagtcc agtactacag agagaaatcc tgttactaaa agccaaaaat 323220
 aaatagataa atgtatgttc ttttgcctgc atgtgtgtat gcgctaatta tctggtgcct 323280
 gcagcaacca gaagaggggt ctggagttaa agacagtgt gagcaatgtt tgggcccctgg 323340
 aaattggacc tagatcctc gcaaaagcag aaaatgctat ttaactga gccatctctc 323400

cagccccc atacctatff tataagttag aaaataggaa ttagatagcc ccaatacat 323460
 tagcaacta tccaaaaatc gcatagtag aaaatagcca ttccttatgg cactggtctg 323520
 taataccagc cttcaggaa gcaaaagcag acaaatcaca aggttaggca ttgccttggc 323580
 cacagagcaa gttcaggacc tgactaggaa gttagttagt gagacactgt ctcaaaatat 323640
 gaaaagaggg cgggggtggg gcttagaggt agaggcctta accagtatgc acaaggacct 323700
 aggttaaatc tacaccactg agcaggggag ggagtataa ataaatgttt agtgaanaatc 323760
 gagataatff taitgttttt gtttgttggf tttgcttttt gttttttgag acagggtttc 323820

tctgtggaac ttcctttgta gaccaggctg acctgaaact caaagaaata tgtctgtctc 323880
 tgcttccaa gtgcctagcc agcccttacc caggaggagt ttcgagaggg acaactgagat 323940
 ggattaccgg ggaatactgg gtttaattagc aaagttgtta actgaacaaa gaaatgaaat 324000

aaaaggatgt tgacattact actcctaaag tatggagaac atttttactg tagatacaag 324060
 gagaaagcag gcagagagaa gaatgcaggc tgatcatggc cagaaaatta aactggacca 324120
 tgagagaaga gaaggggaga gagagcaaga gaggagccac taaccaagag aggtggcttg 324180
 gaccaagacc caaaatggct gagttatgag ggatcaggct aggggaagag aagccaagcc 324240

 cctgaggtgg agtagtttag ggtaagggtg ccgggtgaga agtgcaagag ggcccatggg 324300
 tgtgctgaga gagatttacc ctgggtttgc aaccaacatc tacatagtgg acagacaaag 324360
 gggccactag gagagtggtc tgcaacctaa catctacata gtggacagac agaaggggccc 324420
 actaggagag aggcctacgc agacagcatg gtaggggctc tgaagagggg agccacagcc 324480
 cacacaatgg aaataatatt ctattcttac ttctttctga gaatgggaaa gtttttacct 324540
 tacaagcctg tagctaggct ctcgattccc agagaggcag gagggggggg aacaggatgt 324600
 gtggccaata cttcctttga tgtaaaacta cttccaaagt gtgctacat taacatagaa 324660

 tttggctggg ttgggcacca tccaactcct actctcccta gtgtgtgtac attgtgtatt 324720
 gttcatgcct gacctgtggg tcacagcttg tgccacaagc caggctcagc tacctgtcct 324780
 ggttaagcaa agtaaaatg ccaaattaat agtgaaaagca ggggctagag agatggctca 324840
 gcagttaaga gcactccctg ctattccaga ggaccctggg tcagttcca gcaccacat 324900
 caagcagcaa ataaccacct ttaactctga ctccaggggg tgtggtcacc acttctgacc 324960
 tccatagcca ttgtacacac atggcacaaa catatatata tattttccta gtccaacata 325020
 gggctgggac ttgaggaaaa ggattgtgaa aagtttctat accctgataa gcaagcctct 325080

 ctgccgatgt agcagtctgt aagacccccg gaggctcagg cccccaggat ctggccaga 325140
 accgaggcca cccaatcac caggtgaagg caaaaacctg atgcaaacag cacgaggctt 325200
 tattgcagt gttaacagc ctaacccat gttaaacttg gcctttcatc catccacat 325260
 ggcagatggc taggaaagat gctgagaagc cacgcatag agatcttaa ggggagtgtc 325320
 taggggatg cacaggctca ggattggtgt gcctccaggc ttggaggact tgccctgtgt 325380
 tgattggtca agtggttttt atgtccata ggccctcca gggtgattgc tatgctctgt 325440
 gcatcattgc tgtgacttg tctgtaaagc atagcatcac cagctaactt ctgagccagg 325500

 catctgacct catagtgacc aaggtcaggc aagcacgtat tagactgtta tggctgctga 325560
 aatgggggga gctggtccct tcagtcctaaa tcagacaaa tcaaatcaa ttagaaaaag 325620
 cccatgttta atggatacat cgctcaaagc tcctgtatgg cctcccagcc ccctagagag 325680
 gagacaggaa agacagcccc ggaaaaccac aggtctattt tctgggggat ggtttaata 325740
 ccctgtggga gtggtcttga gcattcagg ggggctttct gagatgcaac agggtttggg 325800
 gggagatagt ggaatggggc ttgggtggag cttctgtccc accaaagtaa atccacccat 325860

tattttctaa gtcccatata tctcctacaa ggtcacctga caagttcttc ctcagictgc 325920

accaaagact taagccttct cccaggagac gattccttgg gggaactttt attttacttt 325980

gagacagggt ttactatgt agctctgact agcctagaac tcggtatata gacaaagctg 326040

acctcaaact taagagatct gccggcatct gctttccaag tgcttggacg aacaggtgt 326100

gtgccaccac agatgctcct aggagaacc cttttttttt tggggggggg gttccaggca 326160

gtgtttctct gtggccttgg aagctgtcct ggaactagct cttgtagacc aggctggtct 326220

cgatagtgtc gggattaaag gaggttggca ccccatacc cattccact cccacccca 326280

tcccagctt aatgtattgt agtattattg tttcaatagg ctgataatta aggggaaaga 326340

cacaaggag gtcctttac aatgiaccc ttagagctca gacactgttt ctgtttgggt 326400

ctgtaggat cacctgctcc cacagtggat tcattgcta gcagaatgtc ctgcatcac 326460

ccgaatgtat gaagagagcg cactctccg agaccacatg actgtcaact cccttatccg 326520

aattctcgag accatttagg atttccatc agtcttggaa gggctctca tcaaaggagt 326580

agatgtgtaa accagctgac agaaactctt catcctggcc ctggctccg aacctcccc 326640

aactgtggga cctcatttgc actggtctga caatagtgag cactgcctgg gcagtgcacc 326700

catgggaagc ccagtatgaa cagtcgccac tctgcacaca aggcaaagtg ctgtattgta 326760

gttcatttga acctgaaatt tagtataaaa cagagtattt tcatgtgtta gatgtgtgta 326820

aatatgctat ctttaagaaa ttatattact ctaataagat acttttctta gattgaatat 326880

tcctgtgact taaaattagt agcctaaaaa aaaaagtgg ggggggggag agtgggtgta 326940

gtcaggaaga agccagtcaa tgtgtaaatt gcgcgccag tagggcttct ttttccctcc 327000

tggtatcttg aaggaacca gaatgcattg ttctgaagca gccatccttc ctggagtcc 327060

atcctgtgtg tggigaatgt acacagcttt acatactgta cagcagtatg tacctttaag 327120

ttataacca ttaatacgt ttgaattatg agtcacttct ccagtttggg gaaaattttt 327180

tcaattggta caagtaaaag atataattaa agtattttta aattttaaat accaggnnnn 327240

nnnnnnnnnn nnnnnnnnnn nnnnnnnnnn nnnnnnnnnn nnnnnnnnnn 327300

nnnnntttga aaaaaaaca caagaagccc tgagaagtgt gttcaagtgt gggattacag 327360

cttctttaat ttgaaagat tagcctgaag tagcttcatt cttggaattt ttgtgactgt 327420

gttttgaaa taccttggag ataataaatt tcagcattaa tcgtatagtc ataataactg 327480

caaaagaaaa ccagtgtgac tctgtgcttt tcacttggcc acctaaactc taaccagagt 327540

tagactacca acctgcctt tgttaggttc cagccacccc ctctgccagg gcccacccc 327600

ccctcaggaa atggaaggaa tgtgggagaa ggaggaggtc tctgtgtgat tggaatgctt 327660
 ttgtgaaagt atttgttgac catgataatg caaataacag gggcagagag aaagaatgaa 327720
 gcctttctgg gtgtttcagg gcaatgtgag gcaattggca tgaagaagtt aagagccact 327780
 ggggcagact gagaagtgaa attgagacaa caatttagaa agacctgaag ttagaacttt 327840
 ctagttagat agtctatatt ttaagctaaa taaatatggt agcagttgca taggtcttta 327900
 tcttctggtg agtaaatcg tagaactcta attaggcact gataacctgt tagcagaaaa 327960
 attgtctcct caaagctcca ggtttattcc ccattgcagc tgaaaaacag agctatgggc 328020

 tccgaggagc cttgcgcaat ataagggtcc tgggctcttg ccaacagtgt tgttttcctc 328080
 atttactata ggaagaaact gatagaccag gggcctcact ccctgaatca gagactgact 328140
 gttcagccaa ggaacagctc ctgggaatgt gaatagaaag gggctccaga tgacctgggt 328200
 aaaccagaca tttgtttacc taaaataaaa gtgtgtctaa agtattcgac tattgtagag 328260
 acacaaacct gctatgggaa acatccataa gctatcaatg gtccattcca ggatgttact 328320
 gttctctttt cccatagggc catcatcctg aactgagca ctggatagat ttaagtaag 328380
 tatgccacaa ttgagtcaac tagtgcagct tcttcatatt atacatggaa cagagtcaag 328440

 gaggtaatta atagtcttgc cccccccac cttgacaaca caggatttgg agtttatgct 328500
 ttttaccaca ccagatgcat gaaaccaacc ttcaaggcat tcttacttaa tagtatttct 328560
 tctgttgagt cticattcac ctgtagagat gtgaagcaat attcctgtaa tacttagtaa 328620
 ggactgatac ttaagttaaa ttgttttgc gtgtgtgtgc gtgtaaaaca agatctctct 328680
 gtgtatggct ctgaccagcc ttggaactcc attttagac atgctggcct gaaactcaca 328740
 gagatttacc tgctctgcc tctgaaatga ggggaatatt caagtgagtg cctgcccac 328800
 caaactgttc ttaactcttt gttgtgttt tgttttgttt tttccagaca cagtttctct 328860

 gtacagcttt ggggcctgtc ctggcactta ctctgtagac caggatggtg tcgaaactcat 328920
 ggagatcctc ctgtctctgc ctcccagtg ctgggactaa agttgtgtgc caccactgcc 328980
 cagcttgctt ttaccttctt agacattaca tctgttgtaa aaactgcatt acagcttgtg 329040
 tttaaaactg ttacttaaaa cgtaatacca aaaaaaaaaa aattacctat aaaagtgtcc 329100
 atgtggtatc atttggatga actagtgaaa tggttgatta aaactatcat acatcctctc 329160
 aaagactggc cttaccctt ggtggtaatc tttgccatat ggaatagatg taatatgtag 329220
 aaatactata aagaccttag gagaatgctc ccactgagtt tggggttacc aattacaaat 329280

 gataaagaag taagacttac catgtggctt ataacaacct gaatcagtat gagacatatt 329340
 tacattacca caaaagcaga ttctcagaa ctaatgcaca taaccataag gattcaggea 329400
 ttattctggc ctgcccctgt cacctggcag gatgcactca ggcagtgccc tggtcagccc 329460

aggggtcccat gattgcatgg atgcctgtgc agaggacccc cgcccactta tgctcctttc 329520
 ccgctgtttc ctgggggcag aaaggactct tctgtcttc ctcttctctt gtgtcctctc 329580
 tgtgtgtctc tgtgtcctt cacctctgtt ctcttccctt ccccttctc ccttccctc 329640
 cctctctaa tacaacttca cacataagct ctgcctgcca ggcatgtttg tccccacct 329700

 gggtcaccct cgctgcctt ggaatccgcc aaggtcccc aaacgcttta tcataataac 329760
 catccaagga ccatacgaca ggcacctttc ttgctgtgca tttttgttta aactagtatc 329820
 atgctttgga atcacctcaa agtaaatgaa aatcaaaact gcttcttttg tgtatatgat 329880
 tgtccaaatc actttaaagc aaatatctgg gaccataatt aatattccac atagtaactt 329940
 ggaagtactt tttttggggg ggaagggttt gagacagggt ttttctgtgg ctttgagggc 330000
 tgtcctggaa ctagcttttg aggacaggct ggcttgaac tcacagagat ccatctgcct 330060
 ctgcctccc agtgctggga ttaaaggcat gtgccaccac caccocgcta gaggtaactt 330120

 gttttaagt taaatctgca aggctgaagt gatgcctaag cagttaaag cactgcctac 330180
 tcttgacag gaccaggtt cagtcccag cacctacatg gtaacttaca accacttgtt 330240
 actatagttg caggagatcc atgccttctt ctgatctctt taggcacca gtatggtgag 330300
 catatataca tagaagcaa acactcataa aataaaaaac attcataaaa taaaaatta 330360
 ttaaatttgc catgtctggg gatgtagttc agtgggtggag tatttatgta ctatgtacaa 330420
 aacctgggtt tctgtctca acagtcaaaa ataaaattgc caaaatctca actccttcaa 330480
 aagcttattt gccaaagtatt tttcttgagt actaaaatct ctaaccacaa cttcatgtc 330540

 acctttatgg tagctttata atagtttcca ttttatgtgt gaaaagtttt ctatgctacg 330600
 ggaagcaggg tgcctcagc gccttagcat ggctgagact gtcctctgta gcgggaaaag 330660
 cagggttacc aagaacaagc ggagctgccc aacctgacct tgtttccac tgggaaacct 330720
 aaaatttga aaggtggaat ttcatctaaa attcatttta aatgtttgta ctactgtac 330780
 cttttctagc tctgtgggtt ttattttaac atgacttttt aagaaattat tttaatgaac 330840
 ttctataaca ctatgagtta gttacactac accaagtcgc ttctactttt cggacagtga 330900
 gttcacatat atgtaaatgt agtgaaaaat acattaagac tatgcatagt acctcatgtg 330960

 tagcaggtgt taatctctt aaaatatttt aaaagatgag gcagtacaca aggagggtcc 331020
 ccaggaat atttgacagc attgggaata gagctcttca ttcataatgt gaaatatgtt 331080
 ctaagaatag tggctttcca agagattttt ttgtttgtt ttaggaaatt gtattttctc 331140
 tgaggtctac agaggctagt ctactctttt catggtgttg aaaggcact ctgaactcta 331200
 cttacatatg tcagcattaa cacactttta ttgattgaca tcagaactct ctctcttctc 331260
 gataagagta aatactactt ccaggcctct ctttctgtc tggttagttg gtttgttttg 331320

gttttgattt ttgttggtt tggttttggt tttagttttg gttttcgaga cagggtttct 331380

ctgtgtaaca gccttggcca tcttgaact cactccatag accaggttgg tctctgaact 331440

cacaaagatc cgcttgctc tgcctcctaa gtgctgggat caaaaatgtg cgccagcaca 331500

cctggcaagc atctatgttt ttagaaatat ttgtttccta tataactatt tattgcatta 331560

tcatttagca taacaaagag aaagatgtcc tttttttcca ttaaataca tatgcaaatc 331620

ttctagatca aaccgaattt tgagattctt gaagagattt gcttttacag tatgatgaaa 331680

ggaagccaag gaggggctgg actggagctc agtcaacttg tgtgcttagc atacacaagg 331740

ccctgggctc tcagcaccct aacaaaagag aacaataaat ccaaggatga tcatacctc 331800

ccaaatggga tgcctctttt aaggataagg tcaaaattca gaaagacaca ctgaggtatt 331860

tatattata tcagactgaa aaataaatta cccaattcct gcttttagaa agggttctgc 331920

tatatcctta gttatttagg aaggagccag ctgatccag ttaactgtgg attggatcca 331980

atgtgtattt taacaaatt ttgatgtaga agggaatagt aaggccaat gatgatgtaa 332040

aacagaaaaa aaaatctgct gcacttgaac cacatgtaa ggtatcttgt gttgtttgt 332100

ttgcttttaa ttaatatctc tccatttaa ttattgttcc cctttgtatt attaacaatg 332160

tgtgtctgaa ctggaatttt ctccccttc ccaatctgaa cataatatga aatctgaaga 332220

gtattgtgat attaagcact ttaacatatc gaacaaactg acttgattt ttcaggtttt 332280

ggagtagatt taatatgac ttttcatgct ttgttcttta caaataaac tggggttgat 332340

actttgtttt gtttcattat tgggtcttac taaaagtctc acaagataag atacttaaaa 332400

agcagagata aactaaaaat cattatacag cactcaggag gcagaggcag gtgaatctct 332460

gtgagttcga gttcagcctg gtctacagaa tgagttccag gacagcctcc aaagccacag 332520

agaaacctg tctcaaaaa acaaaaacaa acaaaacaaa aactaaaaat cattatatag 332580

aaaagtaagt aaaaacctgc tgaacatggg attattcagt gtggtagttt gaatggatgt 332640

ggccccatag acccatgtgt ttaaatgctt ggcttatagg aagtggcact attaggaggt 332700

gtagtcttgt tggaggaagt atgtcactat tagggcaggc tttgaggtct catatgctca 332760

agctgcacc agcatgggac acagttcact tccattgcc ttcagatcaa gatgtagaac 332820

tctcagctac catgtctgcc agcacaccgc cataatgcta atggactaaa cctctgttat 332880

tgtaaacca cctcaaatgt tttcatttac aaaagtcatg gttgctgggt ggtggtgtaagc 332940

acatgccttt aatcccagca cttgggaggc agacaggtgg atctctatga attcaaggcc 333000

agcctggtct acagagctag ttccaggaca gctgaacttt gccaagacag tcctttttga 333060

aggacagtcc ttcaaaaatt cctgcttcac agaaaagtct gtcagatctt ttaggtccat 333120
agactgaaga tggatgcccc aatgttgcgg aagaatTTTg ggtgactgtc caggaatcca 333180
gatgtctctg ttgtctctat atTTTTggaa gttgTTTgca atgcactTTg tttgtacagg 333240
taatattata tccttctgag gtcTTTcatg gaattgaaga ctagatagtt atatTTTTcc 333300
ttagtcatga tagaaggtaa attaggtaca aaacattgga ttcaccaaca gagaataaat 333360
aatggactat tttctTTaaa attgccaaat ataagtgcac tggacatTTt aactgtaatt 333420
cttacctgat aatgttctt attgtataca gTTTTtattt agaagaaagg gaaatattac 333480

aagatatttg attacactga gtaaaaatat atcactgtga ctgggtggtg gtggcataca 333540
cctTTaatcc cagcactTgg gaggcagagg caggcggatc tctgtgagtt tgaggccagc 333600
ctggTcttca aagagagTtc caggacagTc tccaaaacat acagagaaac cctgtcttga 333660
aaaaccaaac acatTTTcag ggcagagagg atactgagaa gaaaaagggt gaagtacag 333720
ggagccacca ggagaaacaa agggagcaag acatgctgga ggacaggtaa agtcatgagc 333780
catgtggcaa tacacagatt aatagaaatg ggttaactta aagtgaaga gctaattagt 333840
aatcccagca ctcgagaggc agaggcaggc ggatctctgt gagtTcgagg ccaggTctcc 333900

agagcgagtg ccaggatagg ctccaaagct acacagagaa accctgtctg gaaaaaaaa 333960
aaaaaaaaag ctaattagta ataagcctaa gttatggcca agctTTTatt attaatcacc 334020
agtctccatg tcattaatgg ggagccagca atcctgagga aaaggtccaa ctatagagca 334080
gagctcttcc gtggccactg catcagctcc tgctccaag tcttTgctct gTTTgagTtc 334140
ttgtcctgac ttcttcaag gatgaagagt gacgtggaat ggtaagataa ataaacccat 334200
tcctcctcaa gttgctTTTg gtcatggTgt tttatcacag caatagtaac cctaactaaa 334260
acagggattg gggaggggtt tcctTTTgga cctgaaagtc cacaagcata catgtgggca 334320

aaacagtcat aacataaaaa tTTTTTaaa agaatgtaag ctcatacagc cattatggaa 334380
ataagtaaag ctgaaaatTT ataggggtTg gcaagattgt ttagcaaagg tactTgctgc 334440
caagctTgac aatctgggtt cgggccccag gatccacatg gtggaagtac agaattaact 334500
tctgcaatTT gtctctgac ctctacagac acatctTgat atgccctac catgtagcag 334560
tgtctTgct gtgaacctgt aacggtggcc acaccctTT gggtgtggct tcaggcagac 334620
agaagcagaa agagggaaTt ggaagtatga ggcatggctt ctctTgtgtg cagtctTTct 334680
ttTgagTcag ccgatccaat aggaagggca gagaaacact cccgaggttc tttattatca 334740

tctgtgtaag gttccccaa taaacacca ttatcattta tctTggTct agtgaaatct 334800
ttgtatcctt gTTTcacca ccatacacat aaacaatTTg agaaaatTTg tTTTctcaaa 334860
taaaatTTga gaaaaatTT taagctgaaa ataaaactac tatgtgaccc aactctccta 334920

atcctggatg tgiacctaaa agattctaag agatacctac acccccatgt tttcactgct 334980
 atatatccac agtagccaga aaacaaagcc agcctagctg ttcattaaca aatgagtata 335040
 taaagaaact gtggtacaga cacaatggaa tttttaacga tttatatttt tttattatgt 335100
 atgtgttaca tatatgtgtg tgagcatgag tgtgccatgg catacctgtg ggagtaagag 335160

 ggtaactcgg gagttaagtt ctcttctct catgtagggt tcagagatca aacacaata 335220
 agtcatcagg gctggtgaca agtgccttta cctgttaagc aaatatatgt aaagtaaaat 335280
 agaaaaactt tcttaattgg gtgtggtgtg tgtgatgaaa ctagaacgg gatcatgagt 335340
 gaaaaggaag aaatgttacg tgaggaaaag ataaggtaat agggatatacc tgataagagg 335400
 atagtaaggt aggttatctg ggggcaagaa atgagacaag cttgatcagg gccttggctc 335460
 aggggtaaga tgacatcata aaacccatca ttttgaagc taatctaat ttttaattga 335520
 aaaaaatcca taaacccaaa tgtggcatcg aaactgcctt tcctagaaga taagcccaaa 335580

 tatgtgaggg ggiactgtga ggatagagta ggtaaagtta cagacagcaa gttgaacat 335640
 aggttaaaaag ggtaatgaag gtgtacacaa atacacctga aatgttagca taagaaccac 335700
 cacaaagaat gaaaacaggc tctcgggccc atgctttgtc tagaagcctc tttttcataa 335760
 cagccttttt tttttcttg aagaatactt atttttgcc agcttttacc tgtttgaaaa 335820
 tgtttatgac catggaagaa taaacaactt cctcagctcc gtaaactctt ccaaacttgt 335880
 aggacagcaa aaatactaga tggctgtgct tgtactttga aaaagaatag ttgatctagg 335940
 ctgtggaag ggattaaaga gaccagggca ggaatgtggt tgaacagaac tgatgataca 336000

 tgcagtgtaa agacctttct tacctgtgga accattttag acgctgtttc tccaatagta 336060
 actttataac aacaaaaagc ctgtgtgtgt gtgtgtgtgt gtgtgtgtgt gtgtgtgtgt 336120
 gtggagagag agggaaagag atagagagag agagcgaggg gggggatatg agctgggctc 336180
 attgcttttc ctcaacaat cctgtatatt aaacatcatg ggctgcaaaa gtagctctgt 336240
 tggtagagtg ctigcctaac aagctggaag cctgactggt ttagtctgca accctgcata 336300
 tactgggtgt ggtgtcaaat gcctataatt ccaacactaa agacggggag gcaggaggat 336360
 caggagtcca agatcagcct tgggcatata ttaaataaga agctaccttg tgccaggcag 336420

 cgggtggcaca cacctttaat cccagcactc acaaggcaga gaaaagtgga tctctgtgag 336480
 tttgagacta gcctggtcta cagagcaagt tccaggacag actccaaagc cgcagagaaa 336540
 ctctgcctcg aaacgaacce ccctccaaa aaaaaaaga aagaagaaa agagaaaaaa 336600
 agaagctaac ttgcagtata tgaggcccta tctcaaaaat aactaccagc agtgggtggcg 336660
 cacgccttta atcccagcac tggggaggca gaggcaggca gatctaacac catagcccat 336720
 agcccttgtt attggctaag tgaaaaagaa aaaaaaaaa aataggaaac tgaagttgat 336780

gttgctggcc tcagcaagca aaatccctga ccttctgctc tcctttcacc tgtttctttc 336840

cccccaacce caaggcaggt cttagaaatg gttatctcct ccgttggccc tttgaccggt 336900

agggactaag acctgcctca cagagggccc agccccagac atagaggaga aatgctgaag 336960

aatcccgaca gacaggcctt gctgggtttc ctacctgaca gctgtccgtc agtgcttgac 337020

taagatgac ttttggcca gtcccattgc agcatcgtg tgcattatit ggtcacgct 337080

accagtga gtttccatag agaccactgg acatggttca gggagcttgt tttggccgag 337140

cacatgacag ttgagactgg ggcttgtctg gcaaggccag ggatgctctg aatggtgcca 337200

cacacatgc ccagtgcac tcctctctg tctcttccac aatcttgcac gacgaaaatg 337260

tttctctgaa gtctgagagc cattcaagca aatgtgtga aactgagaca ttctgaaaat 337320

actgactggt ggaataattg ttaaaacaat ctagggcagg tggttatctc catacgatac 337380

aagggtggac agtggcagat ctactggga aagataaact tgccatcagg cagaacttaa 337440

tgggaaggaa gttttattgg gaggggagat agagaaaggg ggacaggggg agacagaaca 337500

gacagggatc ttctgtctgc ctctcagag agatggtggg ggcagattgc ctcttaaggg 337560

gccagagtaa gtacacctgc catgtataga gggctgaaag gggggccag gtttgcctag 337620

attacaaca cagtgatgaa catccacat tgggatctga catgatctcc aacagacagt 337680

tgcagccctt ggtaaatata gggaaaggaa ctgggcatga tggttaatgt ctgtattccc 337740

agcactcagt tggctgacac tggaggactt tcacaagttc caggccagca tatggataga 337800

tagatagata gatagataga tagatagata gatagataga tagatagata gattttaatg 337860

cgattaaaga tctgtctcag tggttaaaag tacttcttct tacagaggac cagtgttcag 337920

ttcccagcat ttacaaagtg actcacaacc atctgtaact ctattcctag ggtccaaca 337980

ccttcttctg acccccacag acaccaggca cacacatgct acatataat acatgcagga 338040

aaaacaacca cacagataaa ataaataagt ataaaaaac atttttttaa agacaacaaa 338100

accctaag aaatgataga atttattgac tgtccagaaa cagggaacaa caagaaaaga 338160

aggttcaagg ttttggagct tagaagcagt ggtttccagc tattcatttt cattgttgct 338220

cagtcttggc ctigaagact gtgtgtatgt ctaatatctg gctggttaca gatgcagtgg 338280

ttggccgagt ggcaaaattc cacatgtcga tggctgatga gcagtgacc ccagctgcct 338340

gggtgccatg ctgggggtac agtccatccc catggacata agctcctggc tgctatagga 338400

agagccctat gttacctaac aatgaataag cacacaggag gagatgagta gggaatgaga 338460

gaggacattt tcagaactgt gagaccgcc agctttctct gggcagtggc aggctggcca 338520

gagaatgcag ttgctttaat cagtaggaat ttaagtaatt agtataatgc tgagcacagg 338580
 tttacaagat ttctccttg gacatgaaat ttatttatct gggctgctgt tttcctcagt 338640
 ttcatccta cttttaggct tgaggttttt gttttttggt tttttgggtt tttttgtttt 338700
 gttttgtttt ttctaaatgg catgtgggia tggcttgtaa atgataagct tggcacgtta 338760
 gcagctaaag cctgaagcag ggagatgaaa cactgcatg accgcctgtg ctgtaaattg 338820
 agtctggata tacttcactt actcaggaag ctggttaact gttgccaaca gaaacctaaa 338880
 gaaacacttt ctgcaattaa tatgttaact atcattaatg gctttgtttt ctgcagacca 338940

 gccaacagct tcttggctct gataaacagg ttctgaacat atgagctcag ggagaacagg 339000
 accagcaagg atcccgtgt gaaatgctac ccgcttccca ggatgaatca aaacctggaa 339060
 cttaggact tcatctcatg tgtcaggaat ggttgggtgac atatgtttta cagctgccag 339120
 tcccaggctt tactaaacat acacatcttt tcctacaacc tggagggcag tgtgcctctc 339180
 taacatactc ccagctcccc agttctcaaa cctcacttct tacactcctt gttattcttt 339240
 tgtttaaaag aagaaaagag aaatattgag atggacatat tgactataag ttattataa 339300
 ggcagaatgg gtagactaag aagaggaaca gggcaatggc tgaccgcat ggccggtcgc 339360

 catagagaga cagagcgggg aaacagagag gggacagaga gcaggaacgg ggagagagag 339420
 agagagagcg cgagcgtaaa ggggcagaga gagagcgggg aggggcaggg gaaccctgtg 339480
 aacnnnnnnn nnnnnnnnnn nnnnnnnnnn nnnnnnnnnn nnnnnnnnnn nnnnnnnnnn 339540
 nnnnnnnnnn nnnnnnnnnn nnnnnnnnnn nnnnnnnnnn nnnnnnnnnn nnnnnnnnnn 339600
 nnnnnnnnnn nnnnnnnnnn nnnnnnnnnn nnnnnnnnnn nnnnnnnnnn nnnnnnnnnn 339660
 nnnnnnnnnn nnnnnnnnnn nnnnnnnnnn nnnnnnnnnn nnnnnnnnnn nnnnnnnnnn 339720
 nnnnnnnnnn nnnnnnnnnn nnnnnnnnnn nnnnnnnnnn nnnnnnnnnn nnnnnnnnnn 339780

 nnnnnnnnnn nnnnnnnnnn nnnnnnnnnn nnnnnnnnnn nnnnnnnnnn nnnnnnnnnn 339840
 nnnnnnnnnn nnnnnnnnnn nnnnnnnnnn nnnnnnnnnn nnnnnnnnnn nnnnnnnnnn 339900
 nnnnnnnnnn nnnnnnnnnn nnnnnnnnnn nnnnnnnnnn nnnnnnnnnn nnnnnnnnnn 339960
 nnnnnnnnnn nnnnnnnnnn nnnnnnnnnn nnnnnnnnnn nnnnnnnnnn nnnnnnnnnn 340020
 nnnnnnnnnn nnnnnnnnnn nnnnnnnnnn nnnnnnnnnn nnnnnnnnnn nnnnnnnnnn 340080
 nnnnnnnnnn nnnnnnnnnn nnnnnnnnnn nnnnnnnnnn nnnnnnnnnn nnnnnnnnnn 340140
 nnnnnnnnnn nnnnnnnnnn nnnnnnnnnn nnnnnnnnnn nnnnnnnnnn nnnnnnnnnn 340200

 nnnnnnnnnn nnnnnnnnnn nnnnnnnnnn nnnnnnnnnn nnnnnnnnnn nnnnnnnnnn 340260
 nnnnnnnnnn nnnnnnnnnn nnnnnnnnnn nnnnnnnnnn nnnnnnnnnn nnnnnnnnnn 340320
 nnnnnnnnnn nnnnnnnnnn nnnnnnnnnn nnnnnnnnnn nnnnnnnnnn nnnnnnnnnn 340380

nnnnnnnnnn nnnnnnnnnn nnnnnnnnnn nnnnnnnnnn nnnnnnnnnn nnnnnnnnnn 342300

 nnnnnnnnnn nnnnnnnnnn nnnnnnnnnn nnnnnnnnnn nnnnnnnnnn nnnnnnnnnn 342360
 nnnnnnnnnn nnnnnnnnnn nnnnnnnnnn nnnnnnnnnn nnnnnnnnnn nnnnnnnnnn 342420
 nnnnnnnnnn nnnnnnnnnn nnnnnnnnnn nnnnnnnnnn nnnnnnnnnn nnnnnnnnnn 342480
 nnnnnnnnnn nnnnnnnnnn nnnnnnnnnn nnnnnnnnnn nnnnnnnnnn nnnnnnnnnn 342540
 nnnnnnnnnn nnnnnnnnnn nnnnnnnnnn nnnnnnnnnn nnnnnnnnnn nnnnnnnnnn 342600
 nnnnnnnnnn nnnnnnnnnn nnnnnnnnnn nnnnnnnnnn nnnnnnnnnn nnnnnnnnnn 342660
 nnnnnnnnnc tccttagaac ctggagacag gagctcaagg ccaggcttgg ctgcatgaaa 342720

 tcctgtctcc aaaaacacaa agaaggaaag aaggcaggga gtgggaaaac aaaacaaaac 342780
 aaacaacaa acaaacaaac aaaaaccctt ctggattcct cgagctttct tggaggtatc 342840
 tcagaccac agctgaggca gaccaggaa acaggaattg atgctgactt ggggcctga 342900
 taacaaaac acagggccag ttagcaactt gatctcttta gggcacacct tcctgggtg 342960
 ctaagcatct gatctttatg cgtggttcat ttatccctt cacagaagc actgttctca 343020
 tggctaata gcatagaatc agtcttgtca ctggtctttt taatttttta cgtgtgtaaa 343080
 tgtgtgtgtg tacatacaca aacagagatc acaggacaag ttgcaggagt tggctctctt 343140

 cttccactac gtgggcccga gtaatggaat gcctattaac agacttgaca gcaagtgcct 343200
 ttacactactg agcaatctca cctaccagct gctagtaatt tttgattttt taaaacatcc 343260
 taggcttaat tcagctgctt tcatgccaac attttgctg cagcttatta cgaagttcac 343320
 tgagagacag tataacgtca ctgtggtgga cacctcgagg cccaacatg gttcccttgg 343380
 tacagacaga atcaccttgg acttctgaac tgctctaatg gcatccaaag gacacaaagg 343440
 agattttttt ctttctttct ttctttcttt ctttctttct tcctttcttc ctttctttctg 343500
 ggggagtgga atggaggatg gtggtgagac agtctcactc agtctgacct atgatccct 343560

 acacaggcca ggctggcttt gcattcacag aaatcctcct acctctgtga ccaagtacta 343620
 gaattacagc tgtgccacc caccacaga gctccaccgc acctccactt tcagtctgtg 343680
 tgagaaaaga cggggtcaca ctgctctctt acatccatga tgtcacccaa acttcagaca 343740
 cacttctctg aacacaaagg taggaaaagc tcatttgtgt ggtgagaaag gagaccaaag 343800
 ctaaagtctg ctagtaacaa caagaatgca gagtaactga ggaggggaacc agaatgcctt 343860
 cctgttactg ggacttctaa gacagagggt gaagtacaag aagcaagggt gacctggtga 343920
 ttttaacaa ctcacacaca atcaccttc catgctgaac aggactataa tgtaatccca 343980

gcactcagca agcagattca gggttgtcac aaatttgagg ctagecctgat ataatactca 344040
 ggtgggttct gggccaacaa gggcaactta gtgagacccc atctcaaata agcatccctt 344100
 tctttctttt cttcgttctt tcttcccttc ccagtcctca tttgactttt attttgacac 344160
 atagtgaagt catctaggct ggttttgaac tttctcttct gactcaacct ctgaagtagc 344220
 tgggactaca aacctgctcc acagagccca gcaaatTTTT acatttcttt tcccagcttc 344280
 actttttaga gactcctggc tgatgggtgc agaaagtctc tgtgattacc tctgaatgac 344340
 cgcttcaagt gccatgactc cgtgtggaag gatccacctg gagcctttcc tgacatttgg 344400

gtttctgtta cccagaatct gccattgcac tgacatgtga cctcaciaac cctggacatt 344460
 ttccagctca gcittatttc tataaagaga caacaagtat tgtataaaag gagaatctat 344520
 tttcaataaa aaagatttat ttatatatgt atattatgta tacacacata tttaaataaa 344580
 gagataatga aacatacttc acaggattac cgtgaagatt aaatgaagta atatctgtgg 344640
 cattaagatg cttattaat gtaactccta tacttaaagt taattattat tagctcttat 344700
 taaatgacac ttgaggaag ataaatttta ctaggttatt ggagtcacac atgagcaatt 344760
 gtttacagag tacagttgtt ctgttgagge aagagacttc tcaccagtat agtataacta 344820

aaataatcag aaatgatcct taaggaacta aactatagct ggttatggca gtgcatgccg 344880
 ggagtctcca taccaggag gctttggcag gagtattgac ggaagtttga ggtcaacctg 344940
 ggctacatag caagactcaa aaataaaaat aaaagaaaat agacctcgcc tatgttttcc 345000
 cttactttc cttcagaata ttactacaa atttataaca ttaatattat ttaatttgta 345060
 tatacattta cttaaaatat ttctccaaa ccaggatgg tggcccatc cttaataacc 345120
 agcactcagg aggagagge aggaggatct ctgtgagttt gaagccagcc ttgtctacag 345180
 tgagttccag gacaaccagg gctgttacac agagaaacaa atgtcttgaa aaaccaata 345240

taggactgga gagatggctc agagtttaag agcactggct gctcttccag aggtcctgag 345300
 ttcaattccc agcaaccaca tgggtgctca taaccacaa taatgagact ctgagggctg 345360
 tgctctcctg gtagagctga gtcttgaggt agattgattc ccagttttct gaggaacggc 345420
 catattgatt tccatagtg cgtgacaagt ttgcactcca acttgctgic agacctttct 345480
 gtcaggactg ctggctccca aataatgaca ctgagattat tttattaatt ataaaagacc 345540
 agcctatage ttagcttagg cttgttacta gccagctctt acagattaaa ttaacctgt 345600
 ttttaataca tctacttttc atcttggtgc tttattacct ttactctgta ctgcccacgc 345660

tgcttctct acatctagct ggagaatctc ccttctctt tccctgtgtg cctgaagatc 345720
 ctagecactg gacatttagt ttttcattaa gcaaatcaga acaacacatc ttcacagtgt 345780
 actaaaagtt tattccacag caccaccag caacggaggt gtgtctcctt tgcttccat 345840

cctttgcctg tcaactgtct tattgatcct agccattctg acagatgaga tagaatctca 345900
 aagttgtctt catttgcatt accctgatgg ataaggatac tgcacatttc tttaggtgtt 345960
 tctcagccac ttgagattcc tctctgtgta acaactttgga tgtggaatgt ccttctgaaa 346020
 gacccccgaa gatgtacttt cgtagaagga gacccgcacc caggaatcag cgagaccaca 346080

 gacttggatg caaaaccgca agaggtttta ttagagacgc gggtagccgg ggcaacttag 346140
 ctctctgtgt gctaagcgca ccgagccaag ggaagggggt ccttatatag ggaaaaaggc 346200
 gcaagctaga agcagggatt ctattggata attctaataa ggcatgttac agagctattc 346260
 ccattgttca atgtaaatga ggcgctatac agggttattc aatgaggcgc aagtatagag 346320
 tcattcaaat gaggtgaaac acagagtctt tcaaatgagg cgaataacag aatcatttct 346380
 attggatggt tcaaatgaga cacagagcca ttctagatca gcatattctc aaggtctggt 346440
 gtctggtaca acagactcaa ttccccnnn nnnnnnnnnn nnnnnnnnnn nnnnnnnnnn 346500

 nnnnnnnnnn nnnnnnnnnn nnnnnnnnnn nnnnnnnnnn nnnnnnnnnn nnnnnnnnnn 346560
 nnnnnnnnnn nnnnnnnnnn nnnnnnnnnn nnnnnnnnnn nnnnnnnnnn nnnnnnnnnn 346620
 nnnnnnnnnn nnnnnnnnnn nnnnnnnnnn nnnnnnnnnn nnnnnnnnnn nnnnnnnnnn 346680
 nnnnnnnnnn nnnnnnnnnn nnnnnnnnnn nnnnnnnnnn nnnnnnnnggg 346740
 aagacagagg ggcagggggc atgcagaagc attccgagcg ggtctttcac ttctgtgtgc 346800
 tgcaaatgtg atccacctgc ccctgcctat gccaccactg actgactttt ttttttttt 346860
 aatgattcta ttacttttt ttaaatgcac attagtcttt tgcctgcatg tatgtctgtg 346920

 tgaggatgtc agatcccctt ggattgaagt tatagacatt tgtgagtttt cctgtgggtt 346980
 ttgggaattg aacctgaatc ctctgaaaga acagccaatg ctcttaacca ggtatctcaa 347040
 actgacctgg aacttactat gcagcccagg aagacattca gtttctggtc ctccagattt 347100
 taggtgtact atatctagtt tactctgtgt tatgttatag attgagccca gaccctcttg 347160
 tgtgcaagac attctgcaa ctgagccaca ttcccagtcc ctcaagtata catgtttgga 347220
 tccttttctg atcatgttta aggtctggca gctaaacact gtcaggtaat aaacatggct 347280
 gatctgaaaa acaaacatac aaacaacac agaacaacaa aactggaatc aatgtttcaa 347340

 gacggagttt cttccagcc aggtctgca cctaccaatt ctaactgaa taatatatac 347400
 actcaaatgt gtttagccta cgaacacagg tttgttgact tggaaacgga atggtgctgt 347460
 tatgtcagct gagtgtggtc caagaatctg ccgacaatga cgggaggac ttagtatatc 347520
 accattatac ttctgtgcc tctggatctt ccatggacac ttccatctgt ggcaggacca 347580
 tagagcaaag ttgtcgcgat ctgactacag ataggagaaa tacctcactc acctcctgag 347640
 agtcaggggc aggttcggac acatctgttc tcttggcacc agagcagctg gtttacagca 347700

ataaccccaa gatagcaggc ctgagagtca ggctgaaaaa ccaacaaaac agggctacag 347760

 cagagcactg gcctaacagg aacaaggctc tgggtttgac catctgtacc aaaacaaca 347820
 aaagctattg gaaaaattta aaaacaataa aacaaaagtc gtgaagtgtg gtggtgtgct 347880
 gttagaccaa tattcacaag gataaggcaa gagtgtgaag cccacaccag gctacataag 347940
 gaatttcagg gtaacctaga ctatatagca agaccctgtc tcagaaaata aaaccaacca 348000
 acaaaacaaa catgagtccc ttaatgacat tacattcaac cttttcccag tacaccaaaa 348060
 cccaaaacat gtcacctgt catctagatg gcagaatctt ttttttttt ttttctttt 348120
 tccccgagat aaggtttctc tgtggctttg gaggctgtcc tggaactagc tctttagac 348180

 caggctggtc ttgaactcac agagatccgt ctgcctctgc ctctgagtg ctgggactaa 348240
 aggcttgcgc caccaccgcc cagcagcaga atcttttaa gtctagtagt ttactggcct 348300
 gaaggccccc agtattggaa aataaaaaac aaacccaaa gcttcttttg tcttaacat 348360
 ggccaatgaa aaaatattag gggctggaga tatggctcag gaattaagaa cactgcctgt 348420
 tcttccaaag gtctgagtt caattcccag caaacacatg gtgactcaca accatctgta 348480
 atgagttttg gtattgaaca ctgtacacat aataaataaa taaatctta aaaaatatta 348540
 ggattgttaa gtcctttta aaatacccaa gaatttgc atcttgctat gttgtacctg 348600

 tggtttaatt ttgttttga acaaccttgg aaaatagctt cctagccacc ccagagaatg 348660
 aaagatggtc aggtcaggtc atgttgaag tgacaaaact ggaattcagg agaattcttt 348720
 ccctccaacc cactcccttt tgtaaaaatt cagccatgag tgagtagtac agtctataca 348780
 cacacctca gagcatcaga catcatagga gtgcgaggag taccaggat acctgggtgc 348840
 aaacagtaca ggcagactgc ttttctgtcc tctacttgt ctctagagct cagggaccac 348900
 tgcattccag gccagcagga cccttgaca gataggccag gccaagccta ggggtccctt 348960
 gggcccttag tgtgtgtggc aggggtgggg gtggtggccc tgctatgcaa gttccagaaa 349020

 gtgaaagctg caagaagaca cagacacgag gctccacttt tcagtttcac ttttgcaggg 349080
 accacatgca cagggactga gcatcctga accacctgg aaggtgcct ctccccactc 349140
 cattcagaaa atcggagtgc gccccagta agtggctgtc cgagtgcctg ttgacattaa 349200
 gtgaatccat gtgtctcaga acaaggatta agaggcctgg ggagaatcgt gccacttcc 349260
 ttcttctcac tacaagtgcc acaatctaga ggcttcgtta tggactggac actggtcatt 349320
 tatagaaaag accacagcta gagatggaag atccagacat tgccagcctt agaactcagg 349380
 acagtgaatc aggtgtggag gcaggcacgg gttccgtaac agcactggat gtctattact 349440

gagtaattaa ctttccaaac actctagttt aggacatcag atttgcttgg ttgggctctg 349500
cctggctgat ctttctgaa gtagcagcga tgctgcctgc tgggatgcc cttagtagag 349560
aaagatccca ttccaggccc actcacagga atggtactgg gattcctttt tctgagtgt 349620
gcaagaattc ctccactgct cacaggcaaa ggctatgtgg agcaaggag aacagcaaga 349680
gaaaacaaaa acaaacccaa aaaaactaca gtcccagat aaccagcct tcgagttcac 349740
atcccattac tattttgta ttcttttatt cagaattgca ccaagaaaca gtgccctgga 349800
gggaagagga ttatgcagga gctgggatgc caggagacat cacagggcc acagaaatca 349860

cttgggagac tgaaggttgt ctggggagtg acaggactaa ttaagtctga agaaagagca 349920
ggaactaaga atggctaggg cagtgaacac aggcatagtt caggatggtt gagtggagag 349980
gtacctgcag gtagagatgg gggatgtag agcggagcca cgcagcgcca gagcttttag 350040
agaaggagag cttcatcctg gtggctacgt ggaataactg gctattaaaa tattaactg 350100
gggtgggcat ggigaagcat gcctaaaatc ccagcagcac tggacagact gcagaagcag 350160
gggatctct gggagttaa agccagcctg gtctacaag caagtttcag gacagccagg 350220
aactgttgtt acacagagaa acactgtctt gaaggcaaaa taaagcaaac aaacaaaaca 350280

ttatactgct ttggagagga tagattgaag ggagtaaaat aaaagagaaa gccagctggc 350340
tttgctggca catgcctttt atccgggcac aaaaacagcc tgcccctcaa aacaaacaac 350400
aaagacaaaa cagagacaga gagagcacca ataagtcacc ctaaatcaag gtagtgatta 350460
aagaggcaga gtgcaatagg gatcaattt agggccgcat atgtttcag caagcactct 350520
accaactctc cagccctgtt ctgagattgg gattingtat actggccaag ctggtcacc 350580
ctacactcga ggactcctcc tctgactctt taatgctggg attgtgagta ctgcaccatg 350640
ctcagatgaa ggaattaaag gctttctggt ttggggaact aggcaaaggc attttctgag 350700

atgaagtcca tggcmetaag tagtctatgt tgagaggtag atgaatggga tagaagtcta 350760
ggcactcctc agaggaatgg ggagagaggc agactagagc atcagaagta tcacaatgcc 350820
aattgcgggt aatgaaatat acaaggagg ctgggcatgg tggcacacac ctttagttcc 350880
agcattcagg ctggatttat gaggttcggg caagcagatt tctatgagtt caagtgagtt 350940
ccaggacagc cagggtaca tagagggacc ctgcctttaa aagcaaagta aaacaacaca 351000
tacacacaga catagacaca ttaaataaca aacgtataaa tctaaaaaag atatcatctt 351060
taaaaacaga agaaagtctt aaatctgtca ggaaactcag taatgatggt gatgccagaa 351120

gagaaccaga cgggtgtgtg taacagcact atgaactgt gagagctaaa atacctgaaa 351180
atgaaagccc atggagaatg tagagagaga agaaaagcaa tgtcttagaa atgtaaagca 351240
ttactaata ccttagaatt tataaatata atttccaaac ctcatmetaa caacaagcca 351300

ggaatcaggt atgatgacaa gtcctttaat accagcatcc aggagtcaat ggcaggaata 351360
 tctctgtgac ttcaaggcta gcatggtcta catagcaagt tcaggccagc cagcagtaca 351420
 cagaccctct ctcaaaaaca aaaaaagca agctgaaaac aagt caggag ctggagaaat 351480
 ggctcagcag ccaagatcat ctgttctctc gcagacggtc tcggtctctg ttccgtcccc 351540

 cacatgtag ctcaaatg tccaggactt tagttccagg gaatctgat ctttctctc 351600
 atctccttag gcaccagact tgctcgtggt acacatgcat acttgcaagc tgaatgaaaa 351660
 caaggaccac tccaaggcat ggttagggga agggtttttt ttttgtttt ttgtttttt 351720
 ggttggtttt ttgtttttg ttttcgagac agggtttctc tgtgtagctt tggaggttgt 351780
 cctggaacaa ctccaggct tagctcttgt agaccaggct ggtctcaaac tcacagagat 351840
 ccgctgcct ctgcctcctg agtgctggga ttaaaggcgt gtgccaccac cgccccgctt 351900
 ggttactgaa ctttttaaaa aaccgagttt tgaactgtgt tctgggagtt ggctattgaa 351960

 ttaaagaagc acttcgaaag tatttctttg aatctgtaat gttggttggc cctacagcaa 352020
 aagcagtaaa agcagcaatg atgacgtttc gcagtgattt ttcactttgc aacaaggac 352080
 caaacatcaa gttcttgaaa acaataaac aaacaaacaa aaaaacaaa accatccttt 352140
 tctccttctt ctccccatca tgctccaaga atcattcaac catttgttat gggttgctgg 352200
 gctaaaggag tcatatccgg atcgttcttt catttctac ttttccattt gaaaaagata 352260
 ctccaggate attctctccc ccccttcatt ctttggaaacc tcccttttgt ttctctaga 352320
 ttacgtcctt ctagaattgt ctctctcttt ttattttctt tagaaacatt taggtgttag 352380

 gttaccatgt attccgcaag gaacactgta tttttgcttc cactttctgt ctcccccaag 352440
 tggcttttct tgggcgagggt gctctccgig tcttttcaga aagtgacc atccccgag 352500
 tacttaccac catgcagttc gcagagactg gaatacttag gtccaagcga gcaagaaaaa 352560
 caaccagct ggggttggga tcacgtctgg gaaggcaat ggacagtgc aagatgggac 352620
 tttattaac gactcattaa aactacaaga aggaaacctt tgctggagag ctgacgtttt 352680
 tttttgtgt gtgtgcatgt ggaagtgaat ttgcagaagt cggttctcga ctccagatgt 352740
 ttttcgaagt actccgccag aaaatattta aaagacaaaa tggaaagctc accttcaaac 352800

 agatthtagg catggtgagg aggacaagta caaactaagt gcgtgcttcc aaaaagcctt 352860
 ttctgtcacc tcaagctaga aactgtgcag aggtgcgcag gatgatgcaa aagcaccttc 352920
 cagaactttc tgcgcacaaa agagtcctaa aggggtnnnn nnnnnnnnnn nnnnnnnnnn 352980
 nnnnnnnnnn nnnnnnnnnn nnnnnnnnnn nnnnnnnnnn nnnnnnnnnn nnnnnnnnnn 353040
 nnnnnnnnnn nnnnnnnnnn nnnnnnnnnn nnnnnnnnnn nnnnnnnnnn nnnnnnnnnn 353100
 nnnnnnnnnn nnnnnnnnnn nnnnnnnnnn nnnnnnnnnn nnnnnnnnnn nnnnnnnnnn 353160

nnnnnnnnnn nnnnnnnnnn nnnnnnnnnn nnnnnnnnnn nnnnnnnnnn nnnnnnnnnn 354960
 nnnnnnnnnn nnnnnnnnnn nnnnnnnnnn nnnnnnnnnn nnnnnnnnnn nnnnnnnnnn 355020
 nnnnnnnnnn nnnnnnnnnn nnnnnnnnnn nnnnnnnnnn nnnnnnnnnn nnnnnnnnnn 355080
 nnnnnnnnnn nnnnnnnnnn nnnnnnnnnn nnnnnnnnng tctcttcccc ctctcatgtt 355140
 ttcttaaaaa gatcgaggca acttttgctt gcttttagta agaagaagtc gacgtgaaac 355200
 ttgtcattag cagggtactg aaagcacctg cttttgaact gaagtttgcc agacttgaga 355260
 ataattttta gtgatcgggtg ctgcagaact gaacacgttt aaattgccca ctctaaatga 355320

 aggtctggga ttcgcttnnn nnnnnnnnnn nnnntaaaaa aaaaaaacct gtaaaaatat 355380
 gcagaggatg atttcggagg atttgtgtgt gtgtgtgtgt gtgtgtgtgt gtgtgtgtgt 355440
 gtgtgtgtgt gtgttttgac acagataagt cttagggatg accttgagga ctctggaatt 355500
 ggggagtagg gtctttcaga gatagtaaaa agactctggg agaagttgct ggagtatgac 355560
 aatgctaggg attccttgct agcttcacaa ttactgggaa ctgggttgac cttcgagtta 355620
 cccctcttag acttttttca agctaaagt ttttttgta tgtggctcca ggcatagctc 355680
 aaaaattatg ctgggttgac acatggatgc ttctttgta tttggggttt gcctgcagtc 355740

 tagacatcca accagcagca cagtatctgt tgcttttttc ctgatttctc ctgtgtgtta 355800
 gtttgttagc atctaggtgt gtcgtggaac tgggaaataa tgccttgccc tcttgactg 355860
 caaatggaa tcagttttta cctgtttatg ttattagga aacattcaag ttttggttta 355920
 ccaagtagc aacctgtaa gacttgagta tcctaggaaa gtccttaaca ccatgtagaa 355980
 ctaaagtgtt ctgttcttaa aatcaataa tgcttgcaaa agagacttta acgagtaag 356040
 agaaaaatga aggcaatgct ttaactccct tctcgtgttg ttttttggg gtggttgggg 356100
 gttttaaaga gcatttgtgt atttgtatct gcatacgtga ggccaaagaa ctactggag 356160

 gagttgggta tctctacat actggttttag gaattaaatt aatatagggt gtcagttttt 356220
 attggctgag tcatctaact agccctgttt taaccccccc ccaacttgc tatcctgtg 356280
 ttctcaacce caggtatagg tacatgtag gtaagtattg taccactgcc tccacaacta 356340
 taaaataate ccccctccc cccagcgttt ctctgtgtcc tgggaagtctg tagaccaggt 356400
 tggcctcaaa ttcagatctg cctgtcttct acctcctcag tgctgggatt aaaggcatgt 356460
 gcaaccacca ccaccactg actgacataa acttttaaat ggggaataaac tatattttta 356520
 tgtgcattgg catttctgct gcatgtatgt ctgtgagggt gccagatcgc ctggaactgg 356580

 agttgcagac ctttgtgacc ttccatgtgg gtgctgggaa ttaaaccag gtctgttgtt 356640
 aaccgtgag ccactctccc agtctcagtg gggggggaaa aatcttaagc cagcttcata 356700
 aggctgcttt gagaacaatt agcttgacat gccaaagcca tagctattct ctttagaaat 356760

atgtcctctg gtccctggag ttggtttccc ctcttctcta actgaaggcc tgaattggta 356820
 tcccagcacc catgccaggt ggccctgcaa tcacctgtgt aaaggaagct ttgagagacc 356880
 cagtgtcttc tectggcagc ctctttgggc accctcacat ttgtgcacac accccacatt 356940
 gacaaacaca taataacaag tcttttaaaa agtcatcctt cacccacagc ctctccccc 357000

 gcccccatg gtaacactaa ctgggaagaa aggtagcaaa cacatttctt gaagtacttg 357060
 cttactgtt cagaagtgtc tggggttaaa aaccgactta ggatgggggc ggaatgctgt 357120
 gtggcacctt taigtcttca atctcagcac ctagcagagg caggcaggca ggttatctga 357180
 gtttgagccc aggctggtct cactatccag ttccaggaca gccagggggc tacacagaga 357240
 gacctgtct caaacaaaa agaggaatgg gtacaatggg aagctgcagt gcttgggttc 357300
 agtttgtcca gttttttcac ctgtgatcat ggcaagcata cctatttcac agggttgaaa 357360
 gtgacctaa gtggggcagt aagtggctgc tgtgtcttc gggggttttg ggtagnnnn 357420

 nnnnnnnnnn nnnnnnnnnn nnnnnnnnnn nnnnnnnnnn nnnnnnnnnn nnnnnnnnnn 357480
 nnnnnnnnnn nnnnnnnnnn nnnnnnnnnn nnnnnnnnnn nnnnnnnnnn nnnnnnnnnn 357540
 nnnnnnnnnn nnnnnnnnnn nnnnnnnnnn nnnnnnnnnn nnnnnnnnnn nnnnnnnnnn 357600
 nnnnnnnnnn nnnnnnnnnn nnnnnnnnnn nnnnnnnnnn nnnnnnnnnn nnnnnnnnnn 357660
 nnnnnnnnnn nnnnnnnnnn nnnnnnnnnn nnnnnnnnnn nnnnnnnnnn nngtgcgaaa 357720
 aagaaaggca ttigtcttca aggtgagaat tctctcttc tccactagga atacaaaggt 357780
 cacagatact tgctattaca gatatttctt tccagtacaa aagctgaaac cttacctaaa 357840

 ataatttatt ttctagtgt gtattttgtt tcagtctatt acaagtttga ttgaagtagt 357900
 tctaactgta agactcattt ctctagtgt ccccccttt ttttttttt ttttttttt 357960
 tctcaagaca gggtttctct gttttgcttt ggaggttgtc ctggaactcg ctcaagtagc 358020
 cagactggcc cctcgaaaag ttgctccctt cttgacataa gaatgaaatg cttttctacc 358080
 atttgtaatg taaattgttt accattaata atctaagcaa tttatttttg gtttacattt 358140
 tctggaate ttttagaat taaatattc aggaaaaact actttgaaa actttaaaaa 358200
 aaattgttca cttacgttct taaatgtttt tcatgtgtta atgtacatgt accaggtggg 358260

 tgccctggtgt ctgcagagat cagaagagag ggtccctaga actggagcta atagatgttt 358320
 gtgagctgct gcaacatggg tgttaggaat tgaactaggg tcccactgga agagcagcca 358380
 gtgctgggaa gtgctgagcc atgtctgcag tcttttctt ttaattatta ttttctctat 358440
 agtggtcatt tcttccgtct ctgccctta tgttcatctt tgctatccta ctttctttgg 358500
 tagtaagcag gtgccatgt gtagagttag tacttgggta taatgcacaa cgagcttctt 358560
 tgtcctgagg caataacgaa gtgaataggt aatgaaatc ttgattgata ggtaacagct 358620

ggatgttgtg gctcaggctc gtaatcttag cacctgggag atgtaaatgg gagaatcaag 358680

 agtttgaggt catcttcagt tgtgtattga gttcatccta ggcacgtgac tgcttcaaaa 358740
 caacaaaatt gggctgagca gtgggtggtat tcacctttaa tcccagtgtc tggtaggcag 358800
 aggcaatgcc agccagggct acagagcaaa ttccaggaca gccagggctg ttaaacagag 358860
 aaaccctctc caaaaaaaaa aaaaaaaaaat caaagcaata ttgaaattga agggctggag 358920
 agatggctta aaagtaagt gcacttgaga ttccagagga cctgagttca gatctcagcc 358980
 tacatgtcac aacttccat aactccagct cctccatgtg gatccaataa tactcccttc 359040
 tggcctccac tggctcccac acatgatgta ggtacacata aatacaaatt aaatacattt 359100

 taaaagaata aagacataga aaagtttgt aaataaactt ccctgagtga gggatggaaa 359160
 aggaagccat ctacagacaga aacgcccgcc tgagctctgg agtggcttgt tatcaaagct 359220
 gatttggccc tectggaata ccagatttac aagttgtgag cagctggtag gcagggctag 359280
 atcccgaaaa gctttgaatt ccttgccaag gagttcagag cttagcctgc agccagagtt 359340
 ggtaccctgg aaggatgatt aatatttgaa ctgtaggaag ataaccatgt tcgagaagtt 359400
 agtccaaca aagacagгаа caagacagag aggtaaggaa agcagcataa gggcctttat 359460
 gagattagat gggagggcct tggagagagt ggtgagtaag agatcagttg actttgggac 359520

 ttttgtctgg ctgtggatca taaccaagga agctgacact gaacaacaga ttaggagggg 359580
 caatagtatc atcagtttgg ggcattaaag gttagaatgg tttggtagtc acttggttgt 359640
 attgctcttc atagcaaaa gaagaagttag gatcaggtcg ggatgttaga atttccagag 359700
 agtggactaa tggcaaaatg aagtgtagag gtttcgtgga agaagcgaga agagctggta 359760
 tttaaaacac aattgtcagt caggggtggt gcttactgaa tgaacgcagt cctggttcca 359820
 gcctgattac cacaaaaaac aatgctgaat tctgtccga tgtgttgggt tgtaatatc 359880
 aagaattggg atttagcctt gttttaagat ggcatcaaag ttttaagtaat gtttatgaag 359940

 tttgagttag gtatgtttgt catcctgact tcacattttg ttagagtgga ttgcttacga 360000
 ttttctctc atacctcca ctcccaggt tttactttc ctgcagaaaa cactcagttg 360060
 aactcctagg atgtattctg gaactggtaa agtttgttc agtataatgt gcagatctta 360120
 acaaattgaa gaaaaaaaa tgtatcttgg tattttcata cacttggcaa gaagtgagat 360180
 ttcaacttta tattgcaaaa gggccagtag aatcagaaac aatttttgggt ttttttcaag 360240
 gcagaatttc tctgtgtagc cctggccatc ttggaactta agttagacc aggctgacct 360300
 cgaactcgga tctgcttgcc tctgccttc cagtgttggg attaaaggtg tgtgccacca 360360

tactcagcta gaagcaaatt ttgctctcaa aaagatttat ttttatttat gtctaagcgt 360420
 gttcatacat ttgtacttaa gtgcagatac ctgaggaagt cttcctctgg aagagcagca 360480
 agtactccta accactgaga catttctcca gctccctaaa agcaatttct taattgtgaa 360540
 aaagtggtag ataccccttc accatttact gtatggttac attctgtaac taataattgt 360600
 aataattgcc tcttaaaagc ttacaaattc cccaaacct cccacatcac tcttaatcta 360660
 gaattgggtg ggacagtttt ttttttctt tatgttgc aaatgggcag actttttttt 360720
 tttaaatacc atctaaattc cagaggcctg ggtttgtgat ttaattttta acctgtgctg 360780

tcctagtgga agacatgttt atgagtttgg acccctttct tgtaaagtgc gttttagtag 360840
 gctctgccaa attcaaccac agttaaaaat gcttaggcat atagatagct tctcagagac 360900
 agagtacatg ttggaggtc ttggcaaaca agtgggtct acaacctcat acttgcttc 360960
 taggcaaatt aaagtccatc actttaaaag tgttgagta aatttgaag cttaaatgca 361020
 ggtatctaga aagaaggagg aggaacaat attactctt ctctccagct tccctaggc 361080
 actgatgtgg tgttcattg ttggacaatt ctgcagccaa gtggcctagc aatgggggaa 361140
 gaaacaaagc acttctctg ttgaccctt gagtgaagag tgttctcca gttctgtgtg 361200

aacacagggt taaagagca cacagttgat taaaatgcca gcattaccag ttgcagcaac 361260
 ttggggatcc ccatacctg tggttttcat gttgagttc ccatctttgg attttcttg 361320
 gtccatttg tttgtccat acttgcctt tctgcttta caagggttat actgttctt 361380
 gttctgtagt atctgcagt gagtggattg tataacaggc cagtgtctt acatctgtt 361440
 ttgtttttta aaaatttca agatagtgt tctcgtgat agctctggct gtcttggac 361500
 tctttagac caggctggct tcccagtgt gggattgaag gcatggcca ccacagtctg 361560
 gctccatctc ttttgcctt aagacattta ttaagctct ctgctcttc gattgttct 361620

tcaggatgaat gaaggtgcaa tataataaca tctgggttgt ggtgctctg gttaggaatg 361680
 gatagcttgt agaagagaat aaagcaaaag tcacctcat gtttgcatt cctagaggac 361740
 atcaatattt tcagctcccc ccccccata gggtttctct atgtagctt ggaggctgtc 361800
 caggaactta tttttagac caggetggcc tcaaaactcac agagatccac ctgcctttgt 361860
 ctgccaagt ctgggattaa aggcgtgtgc cactactgcc cagcgttaatt tattatttac 361920
 ttattttttg acttttaaaa acaaaaatgt attaagatg ataacaggct ccagcataac 361980
 actttattat agctatagac agagaatcca tatatttaaa tagtgaaga ggctcacct 362040

aggtacaagg aacagcctac attttactgt atttcttaatt ttaaccctc tatggctgga 362100
 ggggtgaag ggtgctaacc tgaggccttg gctttatctc ctcttgctt gtttcagggg 362160
 ctgcttcttg ccatctttgt gactggacgt gaggcctgtg gtcctttccc cagaccctga 362220

tcatcctctg ttgtattatc tgagacacca aagaaggtga acataaaaga tgctttgcct 362280
 cattttttt attgttttat gtgtatgat gtacacatgc acgtgctgcc ttcattgtgtg 362340
 tctatgtacc acatatgtgt ctgggtgccta aagaggccaa gaaaaagta tttgattgtc 362400
 tggagctaga gttaaataatg agccactgtg tatgtgctag gaattgaacc tgggtcttct 362460

 taactgctga gccatctctc ctgttctctt tttcttattt tgcataggct ctcatgtagc 362520
 ccagctatc ctggaactcc ctttgtatag taatatttat tgatcttgac tacagtcttt 362580
 ctgccacca ttctgggtta caggcatgtt gcacacactt agcctttaat tatatgtgtg 362640
 tggggagtth tagatccctt ggagcagaag ttccaggttg tgagcccacc ctcttgagtg 362700
 ctgagaatga gagattctga accatcactc cagttcagcc cttccctttc ataggggagg 362760
 ttaactcact ttgggtgggg ttgtttgatt tttgtttatt gagcatagta tttatagcca 362820
 ctcatcctgt gatthttatc agctattttac tttgcaacaa aatgtgttaa gaggatattt 362880

 atacaagaaa gtggaggaa ggagtctatg ttgaatgat acattattat atattaactg 362940
 tttattgtgg aataaactga gaaattatag cttgtggttt ctggcattta tgactttcag 363000
 atacaatttg tcataaaatt tgtttgtgta aatatataat acagtggcta ggtttgttgt 363060
 catcaccacc actgtctata actttagaaa ataagtgaca atttaaagtc ctttctaagt 363120
 ttaatthttc cctgtccctc agacacacac ttacattaca gatgagatca tgtggtgttt 363180
 gtttactgt gtgtcagct ggacttacc tcagtcagga agcaggtgat tgcttgtggt 363240
 gcagaatggt ggggtgagaa tgctctccag gacagacaag atgcatagct gaccaagctg 363300

 tttgagcaag tgaggcagtt ccagaggaac cacaactca caaatgtggg acttgaaaag 363360
 aagtgaaaaa cagctaccag gttgctttaa ataccagaaa tctcaaaatc acaaccgaac 363420
 tgtgccagac ccaccacca ctttctcaga tataaagctg atgggggggg gggctgtgct 363480
 gttttctggt ttactacag agactggata gatgtttttg gttttgaaca taagtgactc 363540
 cataggthtt gtgaaaataa tttcagttta ttccccagac ctcagaatgg ttaaatataa 363600
 accaccactt aatggggctg ctataaacia aggttagagt gaacaccct gtgaatttgc 363660
 tgcagattcc caggttgccc cttaaggaca tggagagct cagaaggac taatagagtt 363720

 aagtgatcat ccagtaagag acgacctggg tgcccttca ggtgttagga tcttgcttca 363780
 tttctcacag tatggacct gggthttctc gctcccgcc tacccttgtt caagtaaaag 363840
 ctagtccaca ggaatgtggc ggactgtcaa agactcatgt taaaagtctt gatgggctgg 363900
 tgggttgctt ttgtgtctat cctaccaag aaaatgactg cttggcctca ctgttgagca 363960
 tggccatag catttctca tagcttgtca ggtttgtgtg aaatggacca aactggcttc 364020
 taaggcagcg agcctcacag ctagaggcag tctggatgcc ctgtagthtt ggcattggtg 364080

tttcctgccg ggaagggagg ggactgtgag ggtagagtta gtagaggctg gcatggagca 364140

 ttgtgtgtac ttcctttgtc cttgctcatg aagaggctga agtttcctag ctctattgat 364200
 gattgtaagg ggaactgtgg ccttttgacc ttgatgacca gagtgtttag agcagacaca 364260
 ggaatataca tgctacttt gatactgttt tggctaaagt gacatggcca ttgcttggg 364320
 aggacttttt cctctgaatt cagttaaaaa gaaaaagtct catcttgtgt ctcatctgc 364380
 agattttttt ctttttgat tatgtagagt acttttccca cttctaataa tccagctact 364440
 tttttctgt cttaatggtt tttacacagg tagctattag tntagactta acacaggcag 364500
 aggcaggcag gtctctgagt tcaaggccac cctggactgc agagtgagtt ccaggataac 364560

 cagggctaca cagagaaacc ctgtctcaaa aaaaagatat acatgcctct ggatattttt 364620
 ggttacgtgt gaacctgttt gtgccttgct gtggtccact gaatcacagt gggctcagge 364680
 aagagatgac atagtggcag atgggaagtt tcattgctca tataattact tctaaaataa 364740
 tataaggatg gttttgtgt tataattcca gcactatag tgcaaagga attgtacttt 364800
 tttctttctt gcctgatat ttttggta attggttaatt ggggtgatgc atcctgtgat 364860
 tggcccattg gggtttaagt ttccatgttt attttccctc cacttgtcag atcaggctta 364920
 ccttgaactc agagcagtc tgccctcagtc tccttagtgc tgggactaca tgcattgtgtg 364980

 accaaactta gcatttcttt gtctttttat gcctcctaat cgagatctgg taaagttgac 365040
 cttagatatg gactctcact ggcctctaac ctaaagatag tttttacctt ccttagtatt 365100
 gggattttga ccagggtagt taatttcagt catcatttct aaactctaag gttgtcatat 365160
 ctgtgatfff cataccttcc taaagtgac tgfatagaac ttcagttatc aaagaacaca 365220
 cccccactt ccacagagca cagccgatat gtggagcctc ttgtgtcctg ggaacagagt 365280
 ggtcatagt atgcacact actttcccag cagggtttt aaagttttag gtacattctt 365340
 aatggcatgt gtgtatgggg gtgggcacag tagtaaagaa agtgccaaca tgactgactg 365400

 ctccatgatg tggttaaggt ttttattaga tgaacagcag ccagcaaact gggcatggcc 365460
 aggttctgt ctcttgagta ttgtggtata gttagtctct atgttgtgtg atataagaaa 365520
 caaaggaggt agiggatgcc tcctagctcc aggtattttc gaatgttttg tatactggcc 365580
 ctatggagta gtagatctgg ggaattcttg tagtttgttt gacttggcta taaaattgta 365640
 tgtgctggag gtaggggtgga acagagaaaa gtcccttgc atgtttctgt catttccctt 365700
 aacaaagctg tgccaattcc tttgtcttta caggatttgc tcagaagaaa agatgtttgg 365760
 ttttcacaag ccaaagatgt accgaagtat agagggtgc tgtatctgca gagccaagtc 365820

ctccagctct cggttcacgg acagtaaacg ttatgaaaag gacttccaga gctgttttgg 365880
gtaagattag ttatgggtccc tccccaccc cattaccct cactctccac cgaggcaggg 365940
tttctctgta gcttaagagc ttgtcctgga actggctctg tagaccaggt tagcctcaaa 366000
ctcacagaga tcctcatgag tgctgggact aaaggcatgc accaccacca cccacctgta 366060
ttccattctt agagggaaaa ataatcagga ttgtgtgaa atgtttccat gcaaagcaat 366120
ggaacaatg tgctaatatt taaaactact agttttctat ttttgggtt agggaggatt 366180
catattcttt ttggtttttc gagacagggt ttctctgtgg ctttggaggc tgtcttgaa 366240

ctagctcctg taggccaggc tggctctgaa ctcacagaga tccaagtgtc ggggagaatt 366300
catattctta aaatgaatct aattagctgt gaagcccttt atggttacag ttgggcaaac 366360
ccctttgtcc ttaactgtag gatgtacaag tagattttca aaatgtatcc ttactctctt 366420
accagtagta gtctccagt gttgtcttca cattgtgttt gtctccacat tgagttacat 366480
tttaatttgc ggaggataat agtttgcct ggaactaac cccagggtat gtttaacttc 366540
caacagatac ttgggtgaaa taaaatattt aatgttgaa catttctat agtatgcttg 366600
aggaagagag agtgcataata tatgcatttg catgaggttg attttgattg attaaatggt 366660

cactttgttt ttaagacagg gtttttctgt gtagccctgg ctgtcctgga acttgctttg 366720
cagaccagge tgacctcaac tcagagattc tctgcctcct gagtgtctgag attgtaggca 366780
tgaatcacta cagctctgac tttgtacact ggggctggag aaatggctca gcagttaaga 366840
acactcgtg ctcttctagg aacctgga ccttgggtca gtctccagca cctgttgga 366900
actcaactgt ctgtaattcc agtttgagga ttgaggagat ctctttttt tttttggtt 366960
ttcgagacag ggitttctgt tggctttgga ggctgtcctg gaactagctc ttgttatact 367020
aggttggctt caactcaaca gagatccgcc tgcttctgcc tccggagtgc tgggattaaa 367080

ggcactcgcc accaacaccc agcgttttga ggagatetta cttcttctga tetctatgta 367140
gcaccagtca calacatagt acacactgat acacaaataa ataaatctga cttggttgat 367200
tttatttatt tttttgatt tgtttattta ttttggtagg ctctcactgt gtagttttgc 367260
ttgtcccga tggaactcac tatgtctata tgccaggcag gctttgaact cacagagatc 367320
cacatgtcct gcgtcccagg tgctgggatt aaaggcgagc accactacac ttggctttaa 367380
aaagattttt aaatggaatg tgttggcatg attgataggt ctctagaagt taataatfff 367440
taattgaaaa tticatatgc gtgtgtgttt tgatcaaatc tacccttctc tttccttccc 367500

accactnnnn nnnnnnnnnn nnnnnnnnnn nnnnnnnnnn nnnnnnnnnn 367560
nnnnnnnnnn nnnnnnnnnn nnnnnnnnnn nnnnnnnnnn nnnnnnnnnn 367620
nnnnnnnnnn nnnnnnnnnn nnnnnnnnnn nnnnnnnnnn nnnnnnnnnn 367680

nnnnnnnnnn nnnnnnnnnn nnnnnnnnnn nnnnnnnnnn nnnnnnnnnn nnnnnnnnnn 367740
 nnnnnnnnnn nnnnnnnnnn nnnnnnnnnn nnnnnnnnnn nnnnnnnnnn nnnnnnnnnn 367800
 nnnatcacct ctatgaatca taagtggatg tatttcccca agagaagtat ccacacagga 367860
 atcctcatga gggaaaagca tgataactaa cattctgttt tcttttcagg ttgcacgaga 367920

 ctcgctcagg agatatctgc aatgcctgtg tgctgcttgt gaaaagatgg aagaagttgc 367980
 cagcaggatc aaaaaaaaaac tggaatcatg taagttcacc tctctctctc tctctttctg 368040
 agacagggtt tctctgtgta gctttggagc ctatcctggc actcactctg tagaccaggc 368100
 tggcctcaaa ctcaaaaaga tccacctgcc tctgcctccc gagtgtctggg attaaaggtg 368160
 tgtgccacca acgcccggct tgtgttact ctttttatgt cgtgtaacag ttaaaggtac 368220
 acacgagccc tcagacactc ttgaggataa aactgattct taagtaagca tgggcctaag 368280
 tgggtttaa tttcagat tttcttcag gtgtcacact caagggcagg acccagtcta 368340

 aagacaacat tgaacccaaa gaaagtgaac actctatctg gaaacaggat gaaaagcaac 368400
 cagatcagta aactgcagaa ggagtttaa cgccacagtg agtttctgt tgagtactag 368460
 tgctgtttca gtatcttaat tttgactggg gctggtttac agtctgtgtg aatccatttc 368520
 ttacttactg tctactaagt tctgaggtgg tgccttctt tttaggagtc ttagcctttg 368580
 gaaggcactg ttattgactt tgggaatatg ttcttattc tgtgaaatat aactctgatt 368640
 tggatctta aagtaactaa aggggcttgg gatttctctg agtagataaa tagcttctg 368700
 caaaaaacat gaggacttga gtcagaccct aacaccaca taaaagctga gtagagcttg 368760

 caagggagct tatctgaaa ggcggttct gcccaggcct gactctatga ccagtgtgtt 368820
 aagagagaac cagctccac aagtgtcct ctgacttcta cagtgcacca taacatgttt 368880
 atgcctgtat acatacaca atcaatgcat caacaaaaag ctgggctaac acgcttgctt 368940
 gtgatcacag cactcaagat tcagagatta gggttccctg ggacagggtg tctggcagtg 369000
 agcactgggt tcagtgagag accctgcttc agaagccagt ctggctttca tatatcatgg 369060
 gtgaacatgt acacggacaa aaacaacatt catagtctct gtctctgtct ctctctctct 369120
 ctctctgatg gcagtgtagt gtcatttgta ctgactttgt agactgtcag aggaggttgt 369180

 ggttatatat tcagcttaga ctttgaaaag ggaagccccc tcttattact acctgtttaa 369240
 ctctcaggac tcaaggcaaa actgtctgat taaacacatg agtatctcat aataagaatg 369300
 tagttgtttg cagtagaaaag aattgctggg ttgttatctt tttattcatt tagtgtgagt 369360
 cactactaca ataaagataa atgtttggag gttctgattc aaagagcttt gctcatgctc 369420
 tcttgttctg gcctaaacta tccttacctt acaatttcag ttttacctg tatgtagttg 369480
 ttatatatct tgggtgtcca aagtcttaga ttaaacctaa ggatgttgca gcttttaaat 369540

gtaaaaatgg tataactga aatttcaaat agtttcaaaa accctgagca ttacagtga 369600

 tcctccctca tgtagaaact gttgatgta ttgtgaggtt taaatcct gctagatcac 369660
 tcctttcagg taggattctc ttgaaaattt tttcttcagg aagtgaata ccatttatta 369720
 aagtgaatta gcatattaat aacacatgat acgttataac aatactttat tttagatggt 369780
 taattttaca gtatctatgt aagcatgctt taagaggaac ttgtaagaac cttgtgattg 369840
 taagcttatt tttccttgta atggtagagc tcacaccag agctttgtgc caggaaagca 369900
 cttcactact gaactgcacc ccctgccctt gtgagcccg cagaaaaat gttttagtga 369960
 ggtcggagtg atggctcagc gtgctactct tgcagaggag cttggtgccc atcaagcacc 370020

 cttaatgtgc tagctcataa ctacttctga ctccagctcc agggcattag ataacctctg 370080
 gtcactgagg ttgatgcac atatgtgac atgcaaaatt agactaaagc tttggtgttt 370140
 aataaatatc taataattgt ttctctgagt tagaggactg ttctatccat ttcctagata 370200
 gatgggaagt ttaaatggtg gtcgtgatct cctcagact acagcacagt gactgtcaac 370260
 caaaaggttc atttctggc atttatttat tcattctctg gccaccctgg aaatcacaat 370320
 gttgactagg ctatcctcg actcagatat tgaaccaca gatatggtgt gtaccacatg 370380
 ccctgattta tttcctggct tctaaatgca tgggtggaa ataatgctgg ttagcttta 370440

 ggctagtaaa tcacctctgt tcctgagtt attttcccgt atagagaagt cagcagcacc 370500
 tggactttgc acgtgatgac actagaaatg tcttctgtgt ttaatgcaga ctctgatgct 370560
 cacagtacca cctcaagtc ctcgccagcc cagtctcct gctacagtaa ccagtcagat 370620
 gatggctcag acacagagat ggcttccagc tctaacagaa ctccagtttt ttccttctta 370680
 gatcttacct actggaaaag gtaaaaacat ctgttcagag tcaccacttc atctcaacca 370740
 ctagctgcag tgttctatgt gttatacaca gttgaaaata tttgacaaat aactggtggt 370800
 acaggtagga agttggattt agtgggcttt gatgagactg gatgtaagac atacatcaag 370860

 gttcttaaat ttatgttgat ggggtaaac tagctattct gacagctcta aaaagttatc 370920
 ttataggtgt cttgttttcg tttctgcttg ctgtgataaa acacatgtgt ttttttgtt 370980
 tgtttgtttg gtttggatgt tttgtttgtt tgttttttcg agacagggtt ttttctctgt 371040
 gtagctttgg agcctatcct ggcactcgct ctggagacca gactggtctc gaactcacag 371100
 agatccgctt gcctctgect cccgagtgtc gggattaaag gcgtgcgcca ccgatgctg 371160
 gttaaaacac ctgtgttaaa gggtttattt tagctccagg ttgtggtgcc tgtcacctg 371220
 gagaactgtc cacatcactg tgaagagcag agaggatgtc atttgtgctt gtgctcagcc 371280

agcatttctct acitcttcaact tctaggatca atgccacca ttaatggaca agttttccga 371340
 cttcagttct agattgtgcc aggttggcag ttaaaactgt catggtgaca ggggacaccc 371400
 aggccatgta aaatgtagat atgtggccag ataccaaaaa gagacaaaat aattagaaaa 371460
 gagaaagtat tticaaagaa aaagtaggat ccctaggaca cagaaaacat agataagaca 371520
 ttttacctgt agacatgtct agagctacaa aatatgaagg acagtctagg actttacgga 371580
 gaaaatatac tgctttcaca ggaacaccca agatgcaaag gtgaattctt tgaacattc 371640
 ataaaacaat ccagaaacca gtatattaat gtcttcagac ggctaggaga tagctctgat 371700

 cgagggtggg tggcttttaa tcttagcact agtgatatag aggcaggtgg atctctgatt 371760
 tcaacataag agccaagaaa attacattag ataaaacaaa ataatagaaa ccaaccata 371820
 taaatgaaaa tgaagataa gtgctacttg cagcactgaa aggaacgtta actgtgttag 371880
 cttgaggttg atctttggtc tcagcactgg ggaggcagag acaggatccc agggctttgc 371940
 tagtgaatta ttctagccag ggtggtgagc ttcagttgag gtattacctc aaagtaaagg 372000
 tgaggagcca ctgaggaaga catcccatcc tgaaatctag ttacacaca cacacacaca 372060
 cacacacaca cacacacaca cacactctct ctctctctct ctctccacat caagatgtan 372120

 nnnnnnnnnn nncgtatgt caagaaaata gaagctgtgg tgttgaaag atggcttgg 372180
 ggacaaaggt ggctcctgtt gaacttgagt tctaaaaatc tgtgctgtta acatatcttc 372240
 tcctttatctt cagacagaaa atatgttggt ggatcatcta taagggccgt tttggggaag 372300
 tcctcatcga cacgcatctc ttcaagcctt gctgcagcag taagaaggca gctcctgaga 372360
 agcctgagga acagggacca ggcctctgc ccatctctac tcaggagtgg tgactgaggt 372420
 tcatgcagaa gggaaacaaag agcaatttaa actttgaaa gaccacaaag caacagactg 372480
 accctctat ttttaacttg gatactgct attctgcaa aagacatttt ctagaatagt 372540

 ttttaatggg ttacceatcc ccccatcaa caaactcgga agccagttct agcttactgc 372600
 aagaagagag tglacataat atttaatatg ctgagtattt cataggaagg ctgaatgctg 372660
 ctgtaaagtg ctctttaagt ctttttttt ttttaatccc ctctaatgaa tgagattagg 372720
 ggggtttcag gggacagaga tgggatttgt tgtgtgataa accatatgta gtttagtctt 372780
 tctgtggaga ggcagtgggt ggggcatttt aaatggctgg ctacacttgt tttcccctca 372840
 tggaatttg tcataactca gtagcacgac ctgccctag aagtagttaa agatttttaa 372900
 atgctaaggc gttgccaagg ttctgatgat tcagacctgt actactgatt attaagcagg 372960

 acagactgag ctttctgcaa atagctttaa ggaggaagca atatctgaac acacaggtag 373020
 cactgtgttg gctcccctca tggtaatatt tgataaacgt cgttatgtga gtcttataaa 373080
 acagaaccac cggggctcct tctggggaag gcaagcctgt aggatgggca aggtcctata 373140

gggatagtac caaagcatca ccattcggca gagaacgcgt ggttgtaaac tacttaacag 373200
 attgtgtgag tcctggggat gcgcggggca cagttgatgc tgcttggggc acatttctta 373260
 gagggcttgc attgtgtaaa taattgacat tgggtgttaca caactgtctg ggattcactg 373320
 aaatccacac gattcagttc tagctctgga ttacctcagt tgacctttgt ggaggtttta 373380

 tctatagagt agttctttgc cttgtcataa ctttattagg gttttaggtt ttgttgtttt 373440
 attgttttgg gtttttttct ctcccactat ttaaagtga ttagaaggaa aaagagtgtt 373500
 gtgttagggc tgagttaggt gggttggcct cttggagttg ggcttctgaa catcaagatg 373560
 gctgaataga gctcctcaca ttgagatctc agcaagggcc tctcagtaga tagagagagc 373620
 cctgtggaag ttgtctgatg gccgattctc aaagttcagg aaaaacaata gtgccatttc 373680
 agacctctcc tagagggagg ggggtatgtg gctgccttag tattcctcac tcatgattat 373740
 tttaaaaact ggatttttaa agtctgttag ttttcacaac agggagggcc gcagtttgtg 373800

 gcatcctata gtgtgtagt ttttacattg tgtgtctctt ccttttggg aaaaacctac 373860
 ctagtacaag ccaccacatg cacagacggc ccagtgagtg ggtttgtttt ccacagcctt 373920
 ggtgtgttac agagtcacgc cattaccatt ctctgcgctt actttgacat gggattgttt 373980
 ttgtacattt tggctgcagt attggtggta gaataactt ttgatggatc atctctactt 374040
 ctgtatttat ttatttatta ctagacctca accacagtct tctccctcc actctctgcc 374100
 ttagagatgt actgtacgta gtcatgcaact ttgtattaat atattagaaa tctacagatc 374160
 tgttttgtac tttttact gttggatact tataatcaaa acttttactc tagggtattg 374220

 aataaattta gtcttattag aaaataaaag tagctgtttt gtgatttttg ttttgaaggt 374280
 ctctggtagc aatgtttttt aggactcggg gagatctcag tttgttaaaa gcactgactg 374340
 ctcttgcata agaccacgt tgggttctca gcaccatata gacagttcaa aaacatctgt 374400
 agttcagatt ccagggcctc tgatgcagtc tggctctctt gaggacaagg ccgacacatg 374460
 gtgcacagtt agaggcagac agaaacacct agctccaca atttcctct gacttgaca 374520
 catatgctct gtcacactca ggccatttcc ctgtccttag tgtgccaagg ttcagagtgc 374580
 ctttctatac agaatgtact tctcagacta tactacagct taagaaatag cacattcctt 374640

 tttctttgag ctggaaagtt tgtgtggact gtttacttct tataatcaag aagtaaacac 374700
 acttcttagt gtgttaggga tcagaatgtc cacttagaaa cccaaatcag gcaggaactg 374760
 aagcaggcac cgiagaggaa gactgcttac tgttttcttt acaaccagt accacctgct 374820
 caggagtggc actgtccca gtgggctggg cctccaaca tcaatcattc attaatcagg 374880
 aaaaatgtcc cactgacttg tctatagggc actcttatta aggetgcctt agttattgtc 374940
 tgttgctgtg aagagacacc acgaacaagg cagctgtcac aaaagaaagc atttaactgg 375000

gagcttgctt acagtctggt aatggtggca cacaagcagg catggtgctt ccaaagtaac 375060

tgagagcttt acatacttag cagtagacag tgggcagaaa gagacacgac cttagcctagg 375120
gttttgaaac ttgaaggccc tccatcttca acaaagecac atctgctgac cettacctta 375180
gcaggccgaa ctgggaacca agcattcaaa gatatgaacc tatggcacca tttttattta 375240
ttgtcaccac agaggcaata agattcactt cccaaatagt tctaggtctg tgaatgggc 375300
aaacaaacca actaggacaa attgtgatcg aacatacatg aatcatcadc atttttaaga 375360
tgaagctcta agtttagagt gggctcttta atttgtgtag caaataggaa agtagatctg 375420
ctatgaaaca cctatgagcc ctgtaacttt aaacatggat aaaacatcct gtgtagtgt 375480

cttagttact ttctgttgt gaagcgatac atgatcagag caacttgtaa gcatttaatt 375540
gggggcttgc ttacagtttt agaaggttga gtccatgacc actgtggttag ggagcatggc 375600
ctcaggtagg tgtgagctg gagttgtagc tgagaagctt acatgttgag acaacatga 375660
actggagtag agagacttaa ccaagaggag gggaaaggat gtgtggggtt ttgaagactc 375720
aaagcccage ttcagtgaca cacctccaac caagaccaca cctaactca tactctgctg 375780
ccgcacaage attcaaatat atgagccgct ggggacattc tcattcaaat caccacaaaa 375840
attaatataa aacaacacag ggctggagag atggctcagg ggttcagagc actggctgtt 375900

cttccagagt acccaggttc agttcccage acccacatgg cagctcacta ttgtaactcc 375960
agttccaagg gatctggcac cctcagacat gaatacaggc aaaataccaa tgcatacaaa 376020
attaaataa accttataaa aaaagcaaag ctcttgacgc tgagtagaag ttcaaagaag 376080
agtatactct gcttttatga tttgtatttg ctttttttct ttctctcttt aaaatggttt 376140
ctctgtagct ctggtagtc tggaactcac tccataccag gcaggttgtc ttcaaaactca 376200
gaactacct gctctgctc cccagtgcta ggattaaatc atgccagca gtatttgctc 376260
tctttctttt taaataattt gtgtgtaact agaacecca ggtccctcc tgcctcaacc 376320

tcccagcact gggattatag ctgtgccgca ctgtgactgt ggggactgtt tgtgaatact 376380
agggatctaa actcgagacc tgcagccgga gtccatagatt tgtttgtgtt tgtttgagac 376440
agagtttctt tgiataactt tgaagcctgt cctgggtgctc tgtagaccag gctggcctg 376500
atcttacaga gatccatctg cctctgctc tgctgagtg ctaggattaa aagtgtgtgc 376560
tgttactgcc tggccctagt ttcatTTTTT aatctgatct tggaaaagta ttgtaaagct 376620
tcctggtggt atacacctat aatcccagca cttggagggt gagacaggca gatcacgatt 376680
aattcaagac cacctgaggt aactgaacg agggccacaa tggacagcct caatatgtag 376740

ccagaactta atgcctgctg tgtaatgtag ggctgaagct ctccaaggac cctcttagaa 376800
 cagtgacca ggaagggtca atgaactggg actggaagg gaggagacag ccaaattgga 376860
 tcaaaggtag gtaatttcac aggctcattt gtgaaagaaa ggtaccagag gatcctcttg 376920
 gtgattatc tagctgtgga gtttggttac tcatagtgg tatcatgttc cctacacct 376980
 gagtaaaggc tacttatgt agtatgtga gtctagaggc cttagacaag cccattcatt 377040
 tgggtagaaa gtgactaaaa ttggagctgc cctttgtct ccatgtctgc aaaggggaa 377100
 atggttctgt ttiagaatgt ctatactcat atagcttacc tacacttaac ttcaggtgtg 377160

 ggaaagatgg ggtttatgct tgtgtttatg attcagctc aataatagct cagcagcctc 377220
 aagttgttta gcaggtgtgt tagaaaagga atcaatggtg ctgttgtttt aaggaacacc 377280
 gtatgttctt ggtcgtgagc tgctttcaca aactccctgt tgattgtccc caccactcaa 377340
 ggtccctgct gactttgctg tgggaaatgg cattacaatc acctctctgc aggtgacctc 377400
 aaagggcccc tgagctttaa caacaatta caaactcagc ttaattagc gcagagtctg 377460
 cctggcctca gactcacaaa cttggctggg ggcacaggat gtaatccca aattcaataa 377520
 caaaaccatc tcatagattg caaatgggct aaattactga gaaggctatt ggggaagagc 377580

 ctgctactgc tgcataaaa ctcagtggat tttcttcccg tgcagtaaga tagatacгаа 377640
 tgcccaccag gtggcgttag tcatgaaacc cgaagaggac attgtaggca tcttttttaa 377700
 agacaaggcc tctgtgaagc tattggaaga tgagggaacc tttaggagc agaaccaagc 377760
 aggagaaagg taggtcattg gtggagctcc ctagaaggag acacggatcc tgaaaatcct 377820
 atcacatcag ggcctcctc cccccctct ttcctctctg ttcctcatct tcttcccctt 377880
 tttccatttc cctagcttct gtgttgaaca acctcatatc cctgcagttc tgcctcttgc 377940
 aaggccccca aaagcagtat atgggttga accaaaatat acttttctt ttaataaact 378000

 gacacttttc aaggatattt gtcacagaat gcttacatac ctttaagaaa taagtaatag 378060
 ctacctcaa aactccttct tgataagtac aagtgcaga ccaatataac attttgataa 378120
 taaatcattt ttattttaag acagggtctc aaccaggttg gtggtggctc atgcctttaa 378180
 tcccagcatt caggaggcag agggicaaat tccagtacag ccagaaatgt tacaagaga 378240
 aaccctgtct caaaaaacca gagagagagg aggggttggg gatgggaatt aaggaaacac 378300
 tttcttaaaa aataaaaatc tttattgcct ttattttaga taaactcact gaatgtcac 378360
 ctctgtgttt taggacaaaa gtgtaatctg ttgcttcacc catagttaa ttattccagc 378420

 ccaaagttaa actttaaaaa tgattttgtt ttgggctcg agagatggct tagaggttaa 378480
 gagcactage tagtcttcca gaggtcctga gttcaattcc cagcaaccac aaggtggctc 378540
 acaactatct acaatgagat ctcatacct cttctggcat gcatgtatgt ataataaata 378600

aatcatttaa aaaatgtaaa aaagttaa aaaatgattt tgtttccttt ttattgtgtt 378660
tttatatatg ggtgtttgcc tatatgcata tgccttgac tccttgagc taaagtgtt 378720
ggctgccatg tgggtcttgg gaatagaatc tgggtccctt gaagaataag ccacactcct 378780
aaactgctga acaaaccctc ctgcctacc ctccccttg cctccaacag gatctcactc 378840

tagcccaggc tggcctcaaa cttgaggcaa attcaggaa tcctgcatgt cctagccact 378900
tggctgttgg gattacagca taaaccacca tactcagttt acaatgtgtt ccatttgtct 378960
ggccaggata atgtaggttc ttactatgaa ataggacagt gacagttacg gctaatacct 379020
atagcccctg aacttgagaa tcagggcag taaactcata gcttcaacca tgacctctt 379080
aaaatTTTTT acaaatTTTt ttcaatgtta ggtgcatgag tgtttgcct gtatatTTgt 379140
gtactgtacg cattcctggt accttctgaa gttggaagag gtgttgacc cactggaact 379200
ggagatacag agagatcgtt agctgccaga tggatactgg gaactgaact caggacctct 379260

gcaagaacag ccagtgttcc taactgctga gccatctctc cagcccctct ttcttaaaaa 379320
gttattgcac ttacttattt ataaggtaga ggtgtatgcc tggtgcaatc tgcaatcaca 379380
gtgatacact ttaaattatt tttaaagaga ttcatatTTT tgtgtttaat tatgtgtctg 379440
tcgtggggtg tigtacaca ttgagtggg gtgccacag ggaccagaag aggggtlaca 379500
caccctccc agacagacac ataaacacat aatagacac aaaaataaga atcttttaa 379560
aaaataactt gaagtacacc actgtgattg cagattgtgc tgagaatact gaactggata 379620
tattatcgtc tatatcaggc tttccaggct gctgtgattc ttttattatt tttattatta 379680

tgattttaag acagggttcc atgtagccca gctggactt aaactcacta tatgtagtga 379740
caaagagttt tgaacttctg atattcccgt ttctgcctct caaatgctgg gattataggc 379800
atgctctgcc aaagctggtc aataccttgt tacctttaa aaaatgaata ttttaaaca 379860
tttattttgt gtgtttatgt gtggttacac acatgtggag gtcaaaaaac tgccccggag 379920
tcagtTTTTT tggttgtttt tttgagacag ggttttctct gtgtaacagc tctgactgtc 379980
ctggaactag ctttatagac caggtggcc cacaactcac agagatccct ctacctgtc 380040
ctccttgagt gctgggaita aaggcatgcc ctgccactgt ctggtgggag tcaggTTTT 380100

gtttgtgtt tttatttta tttatttatt tttgagatg gtttctctat gtagccctgg 380160
ctcaggatcc atatgttct ccagcttca tcatcaaatc cagaggtgtg aggtctgctt 380220
tggagaaga gaagactgta ccctgaagia gttgtaggcc ttgactaacc tgtgtcctcg 380280
ggaactgcag tatacgtata gggttggatc ccagggaaag ggaacagaat ttaaaatgga 380340
aaaggagag tttcaggata cagcatgat gcactggctg ggtgtccagg agatggcgt 380400
catacactgt aaagttgtc cttacaagia ttgatcact gacgtgagg accttgaag 380460

ctctgctcga gcaataaat agacaaataa gtgcagtgac cgactatgcc gcaatgcatg 380520

gattagggct gtgttcagta cacagttacc ggggaggttg gagtaggagg accatgagtt 380580

gaagaccage ctaggtaatt tagtaagacc ttcaaaataa aagcataaga agaggagaag 380640

aaaggaagg gggctaggaa ggtaggaagg tggagtctg ggttagcatg tgagaggccc 380700

cttggtttga tctcaagtgc ctcacattgt acaggctata aaaccaccca tcaactcatgt 380760

agaatgggag actcaggata ttgcgcgcac acacacacac acacacacac agcacacagn 380820

nnnnnnnnnn nnnnnnnnnn nnnnnnnnnn nnnnnnnnnn nnnnnnnnnn nnnnnnnnnn 380880

nnnnnnnnnn nnnnnnnnnn nnnnnnnnnn nnnnnnnnnn nnnnnnnnnn nnnnnnnnnn 380940

nnnnnnnnnn nnnnnnnnnn nnnnnnnnnn nnnnnnnnnn nnnnnnnnnn nnnnnnnnnn 381000

nnnnnnnnnn nnnnnnnnnn nnnnnnnnnn nnnnnnnnnn nnnnnnnnnn nnnnnnnnnn 381060

nnnnnnnnnn nnnnnnnnnn nnnnnnnnnn nnnnnnnnnn nnnnnnnnnn nnnnnnnnnn 381120

nnnnnnnnnn nnnnnnnnnn nnnnnnnnnn nnnnnnnnnn nnnntgggg gagttaggt 381180

ggtagtggga tataatatca ctagtgttac tgggtatgtg gctcctggaa caccagagge 381240

ctgtcaagag caggatagag cttcagatga acagacaaaa gcaacttgcc atggacatag 381300

aagtcaggat gggatcggtc aggaggtata gctccactat cagcccataa aactcagtg 381360

aggccaagcc ttcccactg aggtagattt gttgttttag acaggatctc attctgtagc 381420

ccagggcac ctaacattag gccaaaatgg cctcaattta tagagctctt cttgtctcaa 381480

cttctccagt gctgggatta taggtatatg ccaccacacc attgatagct gctcttagat 381540

gtccctgcca tcttttcta taggtcaaac taaacctatg ctgtccaaac tctgggcttc 381600

tcatatcatt atttagccaa tgttaccgac catatttcag aaactactgc tgttgtttaa 381660

tccatccctg tgtaccaaca tttcattatg gcccatgcag ttaacctgat gtaagatcgt 381720

tgcttatgta aatgctaag catttccctt gcttgtctct gcttcacct tgacttacia 381780

tttttattc aactgcagc caaaggtct tatacaagaa ctaagactca gattaaaca 381840

tgagatcacc taataatgct gtttaatgct ctctcttcat ttccatcac actttgaata 381900

aaaaaccaag cccttccat caccctcaag acctgaatg acctgacct acctctctgt 381960

tctattttct tttcttttt attttttatt ttattttct tctggcttga agctcgactc 382020

acattctctc tctgtctcat aaaaaatac tcaagcttaa ctccacctac tctctaaagt 382080

gttcttactg agatgcacat ggagcctggt ctatttagaa gaagggttga aaaggataat 382140

taaatgtttt tcttggatgg tggtttcatt caccagagtg tgagtactgg ggggagagga 382200

aggaggaact taagaattgt gtcactagct gacatttata gggtgcttgg tgctgttagc 382260
ctatgtcgca taagaaatga accctagatt tagtgtttag tagcttaata aaaccttatt 382320
gttattatta ttattattat ttttaagaca gggtttcact tatgtagctg agtctggcct 382380
ggaagtcaca aagctcctct tgcctgtgcc tcttgagtac tggatcaaaa agcatatacc 382440
accatggctg gcttaacaca gcttttatta gttcaatttc tgtggatcag ggatctgttt 382500
gtaggttggc taggtttcta gaggcagtta aaacaccacc aggaaggatc agctgcctac 382560
tcaagactgt taagtgggcg aggttccttg caagttgttc tattgcgctc tcattttctc 382620

atagcctggg ggctaaaggc ttggcccagc tcctcaccac acaagactca caagactcac 382680
tggagggaga tgagattatt agcaatagaa ggagggagta aagggaataa aggaaaaagg 382740
gggtgggtgg gaaggagagg aaaaggaagc agtatcagtg tgtaagctga tgacctagga 382800
aaaccattgg tagagtttcc ttctggctaa cgaaggcct gaggatgagg aagcacatgt 382860
cagtgggcaa aactgatgaa agtgactgtc ctagctccag cagagtaaat acattctttg 382920
ttctgactgt gttctcagtg gcgtgggtga tgcccactgc agagatgagt gtacttttct 382980
tcactcagtc catagttcaa atgctaactt ttctggaaa caccttcaca gacatagaca 383040

gatgtaacat ttttttcca gctatcttcg catctcttag cccagttttt attgatataa 383100
aaaaaaatcc accatcactt ttgttatatt ccatgtttca aaaggaagtc attatgttca 383160
cacttaaggg aaggtgtcac acagatctga atgaagactc agagaccagg gggaaactgtg 383220
tccgaagctg ctaaacatag aacttgaact tgccatcctt cttagcttcc tgagtgcgga 383280
ggcgcctggg gtctactgac tcagcacctg cattctcagt gaggtggctg gaatgtgaag 383340
taaaaactgg attgcttgag agaacagtgg gttggcagga aaaccggaag aagtgattcc 383400
ctagcattga gagaagagtc taagtaacc cttaggtagc tcctgggtgcc aagaatagtt 383460

attcacgtgt tccttctgta aataataaga cagatatggt gctgcatacc ggcacttggg 383520
agagtgaggc aagaggatca caggcctaag gttggcctga gctatatctc aaaatacgac 383580
caccaccaa agattcaaat attttgctca tegtcaaata gttgctggaa gagtactatt 383640
ctgggcactg tatagttctc tggctttaaa gatgaaatat aaattggaaa ttttgaataa 383700
cttctcaaa tcatttgctt aactgtcatt tattaaaatt cgaatcctct cactatataa 383760
tgtagcacta tggagtgtct tgatgttaga atataagcaa tttgtaaatt gtttgcacat 383820
attttaacta ttctttctac tttgctttc tctattatct acttagcaat caaagtgtct 383880

cctccactta acatacaaag ttagaaatac tttcacagta tttgcagtta aggtcctttt 383940
cctattactg ttgcttttcc tgcaatcaag tgcagaatga caaaattctg ttttctattt 384000
tatcaatata tctgctgtgt tctttcgttt ggcttactga taactcacta tgatttaatt 384060

tcagagatgt caaattcaat actattctac aagctataca ataatcaact tctccaaatg 384120
 aaccataagt taaaaccaa ttttaagccgg gtgttggtgg cacatgcctt taattccagc 384180
 gctcgggagg cagaggctgg aagatctctg tgagtctgag accagcctgg tctacaagag 384240
 ctagtccag gacagcctcc aaagccacag agaaacctg tctcaaaaa caaaacaaaa 384300

 caaaaaaca aaaaaacaaa caaacaaaa aaaacaagct taaactactt ttttcttcat 384360
 ttgtctaca caaaccaag ctcggtagt ctttttagta agtacagtgg gcagaattca 384420
 ggagtttatt ggtlaagaagt cttacgtaga gcacagagaa gacaaaagaa atcacctatt 384480
 tatctaattt ataatttata tttggagagt ataattgaaa ggcagcctgg tttcttttta 384540
 acaaaatact taaagtggaa gaacaatggt gttctgcatt tagtatttat taaataacaa 384600
 tgaagagaaa taggttgtaa gaacctacat ataaagtatc gaacatctgt gatcctaata 384660
 ctcagtaggc agaggcatga ggatctccac gtgttcaagt ttagcatgga ctacatattg 384720

 actgggtggg ggtacatagt gagacccac cttttaaaaa aagctaaaac aaactggtgc 384780
 atgcctttag ttccagctcc tggaactaaa gaggcctgcc tctgcctcct gagggctagg 384840
 actaaagggtg tgcgctatca ctgattggct agtataatca gtttctaagg aataaatttg 384900
 acatgttgat gatttctcca tttattagc caattttata aattttcatg ttgtagctat 384960
 ggtaacactc tgatgattta tatggctatg ccagagcctt cttatttgtc tattagaatt 385020
 gttaagacct tectttacaa aaagtgctcg ttatcctcca aagaacatta gcatcagga 385080
 ttaactttaa agaattaat atgcaagaga gttcacattt gaatcctgaa aatgctctgt 385140

 gggcctaaat gagtccagct ggcaaagctt tagtagcctt gaaaccatta ctgtgtgact 385200
 caggttcagc ttctaaact ggattacagg ctaaggctgg tttttttct tcccttctt 385260
 tcctttatca tacttctac cccaccttc cagatagggc ttctctgtgt agcttgactg 385320
 ggcttgcctc aaaattgtgg cagccttct gcctcaatct cccaagcctt gggattatag 385380
 gcatgacta actcttagtg tatttctggg tacttgagtc tgtgaaacat catatccgct 385440
 gaacaccaca atgtaacttg gaggttgcc aggagacaga tccttgagc cacactttgg 385500
 agaatctaac tgggctctgg catagacctt tgtgggtttt gtttgtttgt ttttgatttt 385560

 tttgagacag gtttctctg tgtagcccag tctggcctgg aactcagaga tccagttgcc 385620
 tctgccagtg ttgttttac taaatctcaa tcattcgatt ttgccaataa atgctcggcc 385680
 agtaggtcag gcttgttact agctaactct acaaaaaat taaccactc actttaatct 385740
 acattttgcc atgigggtgtt acctctcttt catcttgcatt ttcctatttc tttttgtgt 385800
 ctctctgatg acttctactc tgccttcttc ccagtgtcct tagtctggtt ctcccaccta 385860
 accttatcct gtccagctat tggccagcca gattctttat taactgaatc tcagcaacat 385920

atagtccac agtgtaaagg aatattccac agccttttcc aaaaccatt gagctgttct 385980

 cactggccct ctgatctcta aattttgttt aaacatcaaa caaacgtac ataggctgct 386040
 gtgaagaaac ggtggcctt aactagaaaa gatactttgt aactgagaac attatagttt 386100
 gagtatacaa tgacctcaaa ggctcatgtg ttggaggttt ggccctcagc tgggtgtgct 386160
 actgagaagt gatttggtta tgaggatnnn nnnnnnnnnn nnnnnnnnnn nnnnnnnnnn 386220
 nnnnnnnnnn nnnnnnnnnn nnnnnnnnnn nnnnnnnnnn nnnnnnnnnn nnnnnnnnnn 386280
 nnnnnnnnnn nnnnnnnnnn nnnnnnnnnn naatttctgg tgttaccatc atagcgaacc 386340
 gaataacaat ccaagggatg taggaaggta gttcagttca acaggactaa gtagctggtg 386400

 ttggttcaaa cttttggagt ctgaccccaa gtagttcatt tgaatcacat ttaagcacag 386460
 cacaagttgg taaaaacttt gctggggata attaactcaa tcctatgtgt ataataaagt 386520
 acaaaataaa gattgcatgt gactacatcg agagtctttg aacagtacat gtgaaacctt 386580
 ccataaagat gagacgtata gatttggttac atggggaact tttcataaag atgggttcaa 386640
 ttagctggac agtgatggcg catgccacag aggcaggcag atctctgtga gttcaagacc 386700
 agcctggtct acaagagcta gttccaaagc cacagagaaa ccctttctca aaaaaaacia 386760
 aaaaacaaaa aaacataaaa aacaaaaaaa agatggattc agtggattga ctgataaaaa 386820

 caagttcacg ataagggttt gggagaagtt ctactttctg ggtagataac aggttatgga 386880
 tcacttctg tgiagcaaca accctatgtg tttaacattc caggccccc tagtgcttat 386940
 ctgtgagccc aaggacctcc atgcctctga catctgggat ccttttgctt ctgtctctgg 387000
 agtgctgaga tgataggtgc atgtcagctc actggcttcc atggttggag ctgtccttg 387060
 tccttgtctc tcctctcgg gatggatttc ttgactgcca tgaggtaaga agctccctgc 387120
 accgaaatcc ccacaagtc agcagacca gcaacagagc cactggtctg tgggaaggaa 387180
 cctctgaaat tgtgagccaa aacaaatatt caatccttct agttgctcat caggcatttt 387240

 gtcatacgca cttaaagtca ctaaagtac acttaagtag gtggggcac caaaagcagt 387300
 tgtcctggag aaggctctac tccagcctgg agtctgtgt gttcctact gcagcaaac 387360
 ctgttctgtc tccttggatg tctgiagaga agcctgggca tctccagcgg catgaagcat 387420
 gtaagtggag atctgtactc ttctaagatg ggggggtgtc ttaataactt ttctgttct 387480
 gtgaagagac catgaccgag cgagagagaa actctgtctt gaaaaaccaa aaaaaaaaa 387540
 aaaaaagaga gagagagaga gaccatgacc aaggcaactt accatcattt tgggaagcaa 387600
 ggcatggtac tacatcagtg gctgagaact tacttacctc tttttgttt tgttttgtgt 387660

ttgtttttt gagactgggt ctctttacat agctgaagct gtcctagaac tcactatgta 387720
 gatcccacct gacaagagct tacatTTTTT ccacaggaag caggcagaga ctaggtagag 387780
 gtgggatggg cttttgaaac ctcaaagccc acccaccct agtgacgtac atcctcagtc 387840
 aaggccatat ctctaagtc ttcccaaaga accaatTTTg ccattgaagt ttgagattt 387900
 cacttgggta tatgttagca tggatctttt cacactTTTT tcctggaaat ctattgaata 387960
 gatTTTTcag ttgaaaatc caagactttc ctctttgggt gccttcaaga accttcacc 388020
 ggttgatata ttttctattt catatgaaaa tcagcatgtt agtttccttt tattttccat 388080

 gtccgtagg ttgctaacct gtaggaagaa tatcattctc tcaggattcc tgctgagatt 388140
 acaggaaata ttattcaaat aattcactga atttattctg gtacagacag tcacttcaaa 388200
 gctttaatga gtgtggcatg atttaaaaga ggctaatttc caaaagttaa aaataatatt 388260
 atgatggatg acgcaaatgg agagccattt atatcaaaga gtcaaaagct cacttggcac 388320
 aggggatata gaacttgitt ttgcaccttc ttctagctaa ttttttcat tgtgatctgt 388380
 agtgtgtgta cacattcctt cgtgtgtgtg tgtgtgtgtg tgtgaagaca gagatcaatg 388440
 ctgggtgttt cctcatgttg tggaaataatc attttact gtgaagatgt gfactcagat 388500

 tggtttaata aaaagctgag gggctggaga gatggctcag aggttaagaa cactgactgc 388560
 tcttcagag gtccagatt caattcccag caccacaggg tggctcaca acatctaaa 388620
 agagatctgg tgcctcttc cgccctgcag gcaacatgca ggcaaacat tgtatacata 388680
 gtaaataaaa tctttataaa aataaaggta catgccttta atcccagcac ttgggaggca 388740
 gaggcagaga caggtggatc tgtgtgaatt aaaggccagc ctgatcaaca gagcaagtgc 388800
 caggagaggg tcaaagctac acagagaaac cctgtctcaa aaacaaaaac caaccaacta 388860
 accaaacata acaaaacaaa acaaaaaaca aaaaaagaag ctgggcattg gtggtgcacg 388920

 cctttaatcc cagcactcgg gaggcagagg caggtggatc tctctctgtg agttcgagac 388980
 cagcctggtc tacaagagct agttccagga cagcctcaa aagccagaga aacctgtct 389040
 caaaaacaaa caaacaaaca aacaaaaagc tgaacagccc aaagctaggt aggattttcg 389100
 gggcacagag gatgctagga aaaagggeca agttgctagc tggacacaga ggaagtagga 389160
 tgttcaggag gagagccatg agccacatgg caagacacag attaataгаа atgggttaat 389220
 ttaaattata agaactaggg caggtggaga gatggctcag aggttaagag cattgactac 389280
 tcttcagag gaactgagtt caattcccag caacctcatg atggtcaca accatctgta 389340

 atgagatctg gtgccctctt ctggcctgca ggcataaag cagacagaac actgtatata 389400
 ataaataaag aaacctaaaa aaaaaaaaaa aaaagttata tgaactagtt aggaaacaag 389460
 cctaagctat actctgaact tttataatta ataataagtc tctgtgtgtg gatttgggag 389520

ctggatggca ggacagagag actacacttt cagttgtcct ctatcttatt ttttgaaca 389580
 gagtttcttg ctgaaactgg aactcctcac tacttcagct agagcggctg gcctgcaagc 389640
 cccaaagctc ctgtctctgc ctctctattg tttagtttac agacacatgc tcagatcttc 389700
 atgcttgtat ggcatgcaact tattggctga gccattttcc taggttgttt ttatgagaga 389760

 ggttcttact ttgtagacta ggttggctc caacttgcaa agattttcct acccaatctc 389820
 ctagatgctg ggattagaga cccatgccac aactggctgc ttgataataa tcacaaaag 389880
 aattcaaaga acttcaaat gggcaggtga aaggtgatac tagaaagaga acaaggcaag 389940
 tggcagccag ggactactcg ctgctctcct gagggacttc aagggtgctg aatgggaaag 390000
 cataatgtat tcattccagt cctacaaaata gcatacataa agctactgaa atttgattat 390060
 aatttgaagg aaaatatcag cccctcagac attaacttta gctgggtgta gtggcacatg 390120
 cctttacccc cagaattcaa aatggatctc catgagttcc agaccagcct ggtctccata 390180

 gcaagttcta gaccagacag aattcaaat ggatctccat gagtccaga ccagcctggt 390240
 ctccatagca agttctagc ctcatattga ttaaggtaat tagtgtctta ttgatagatt 390300
 tattaataat tcttctattg aatagttagg gttatagtta gatataatgg cccaaatgat 390360
 aattatgata attctggaaa tcttttgttt taggaggggg aatcagtctc cctctgtagt 390420
 ccaggctgta ctgaaacttg ggatcttctc acctcacctc ttgagttctg ggaggtgtgt 390480
 gcctgtaaag gtatgtgcct aaaaagggtgt gtgccacat ccctggttgg aaatactatt 390540
 gttaggttca ttattagcat aggataaaca aggcataaat acgaatataa taggtctgct 390600

 aaattttccc aagatgtgct catcacagge ttcatgtcca ttctgtgtgg caaagctgag 390660
 agtgtattag tttttctcat ctcatctcac cagcatgttc tttatcaggt tatgaacaag 390720
 gaagaaacag acaacttaat gttcgtctaa tgtccaagtt acatacgggg ttcagaaatt 390780
 caagctacaa cacaaaatta aggtacataa caggaaaggg aggagagatg gctcagtgg 390840
 ttagagcact ggctgctttt ccagttacat ctgtctgtaa ctccagttc agaggacca 390900
 atgccctttt ctggcacgag gcaccatat gatacgcaa catatatgca ggcaaaacat 390960
 catcggta caataaaaa tagaatgaag caaaacaaa agaggtatac aataccacca 391020

 ggatgaactc aaatggtaag tggcaggata tagaatcaag gaatgcaaa gccaaagtga 391080
 ctttttattt tattttattt gcggccttga ctggacttta aactggctgg gcctttgctt 391140
 acttacttga tttttctttt gacggtcctg ttctgaataa ttattattc ctcatggata 391200
 ggacttaaaa tctcttgtgt ttggtaaaat acttgtgggc aagtcattat tctacattta 391260
 ttagttctat tattttgttt atttagtttc tgaggtagcg ttttttttg ttttgetcag 391320
 gcctgtccct gcctgcctag gattagttag taagccacc ccacaaaact tcatttgata 391380

caggaagccc taccagtcca gaagctaacc cacttcgtct tttccactaa ctttatgcaa 391440

 ctcaataagt aatttcacca gctgtttcag tgccagtgta atgaactggt gcatagcaac 391500
 acatagcctt gccgcacacc ctcctateac aatcgctgca gteatctggt ctgcttttgt 391560
 ggtagtgtg tcccagggga gaggacatgg tgatcttctt cattccacga tgaaaaaac 391620
 aatcatctgn nnnnnnnnnn nnnnnnnnnn nnnnnnnnnn nnnnnnnnnn nnnnnnnnnn 391680
 nnnnnnnnnn nnnnnnnnnn nnnnnnnnnn nnnnnnnnnn nnnnnnnnnn nnnnnnnnnn 391740
 nnnnnnnnnn nnnnnnnnnn nnnnnnnnnn nnnnnnnnnn nnnnnnnnnn nnnnnnnnnn 391800
 nnnnnnnnnn nnnnnnnnnn nnnnnnnnnn nnnnnnnnnn nnnnnnnnnn nnnnnnnnnn 391860

 nnnnnnnnnn nnnnnnnnnn nnnnnnnnnn nnnnnnnnnn nnnnnnnnnn nnnnnnnnnn 391920
 nnnnnnnnnn nnnnnnnnnn nnnnnnnnnn nnnnnnnnnn nnnnnnnnnn nnnnnnnnnn 391980
 nnnnnnnnnn nnnnnnnnnn nnnnnnnnnn nnnnnnnnnn nnnnnnnnnn nnnnnnnnnn 392040
 nnnnnnnnnn nnnnnnnnnn nnnnnnnnnn nnnnnnnnnn nnnnnnnnnn nnnnnnnnnn 392100
 nnnnnnnnnn nnnnnnnnnn nnnnnnnnnn nnnnnnnnnn nnnnnnnnnn nnnnnnnnnn 392160
 nnnnnnnnnn nnnnnnnnnn nnnnnnnnnn nnnnnnnnnn nnnnnnnnnn nnnnnnnnnn 392220
 nnnnnnnnnn nnnnnnnnnn nnnnnnnnnn nnnnnnnnnn nnnnnnnnnn nnnnnnnnnn 392280

 nnnnnnnnnn nnnnnnnnnn nnnnnnnnnn nnnnnnnnnn nnnnnnnnnn nnnnnnnnnn 392340
 nnnnnnnnnn nnnnnnnnnn nnnnnnnnnn nnnnnnnnnn nnnnnnnnnn nnnnnnnnnn 392400
 nnnnnnnnnn nnnnnnnnnn nnnnnnnnnn nnnnnnnnnn nnnnnnnnnn nnnnnnnnnn 392460
 nnnnnnnnnn nngtgggcg gtggtgagtt agtgacata caaccggaag ccacctcggc 392520
 aatgcagtct gtgagaaggc ttggtggct accgtgacca ggggtgatgc acttggttag 392580
 tcctgggca gccaaagaga cgtaaacatg ctgttcaag aaacttgctt cacctagcct 392640
 ttgagtaga ttgaagttgg gggctaaagt aaaggttcag gtaaagaggt getaatgtgg 392700

 caaagtggtc gtactccct ccccccttg ggtgatgacc atagaaattg ttcagaagga 392760
 gaaagtcaga agccttttgc ttgcttgga gttcttctcc gtgtgggaaa ttgaactaat 392820
 ggaaacgttc ctatagtga cttttgcct gcgagtagtc tgtctttatt ggccattgct 392880
 ttcagcgcc agttgatgca agaacgctga atgaagcacc attgtgtttt gatttcattt 392940
 ttgtggaaga acattttaa ggaaggtttt ccagagatga taaaggttgc tgctatgcac 393000
 ctttagttta cgtttatact taactctccc ccaccccaa atcttaagcg tcatctgttt 393060
 cagtgtgca actctctca ctctctcat ttctttcgg ttaccagtca cttcaggcc 393120

attcagtgga gggacaagtg ggaaatatga agtcagccaa gcccctatgtg acccacagt c 393180
 agcacgggga atgcctgcag gccctgagcc ctctgcagtc tactctcagt tctgttcat 393240
 ctcttccca ggcgtatgaa acgtatatcg ataatggact catatgcctt aaacacaaaa 393300
 ttagaaaacat cgagaaaaag aaggtaactt ttacccecca ccaagccctg aatgtgcatg 393360
 accttaagcc agggttaagg agctgacata ttctttatca tcagagaaca taggtcttcc 393420
 aaaagattta actgacctg agatttcttt gcctgggaat aattaagcat ctaggctaaa 393480
 tgcttgcttc atttgccaac atagccgaat aacaatattc ttcacagtaa atttgttaca 393540

 catactgctt ttgaaaagt tgcgttttta ggtctgatta atttcttgag atatattatt 393600
 gtttcttate ctagtccctt gtgactgcat caagtgatat ggcactacag cctctgcagt 393660
 cattgggagc atttgtcat gagccaggaa atgctttaac attttttcc acagctagat 393720
 actggtttaa gattggttca ggaaagtgtg gtagacagct ttgtaagag actttggatc 393780
 cttaccagtc ctaacattac agtaaatgtt atggtaaaga tccagataat ttctcatttc 393840
 ctcaagcagt ccctagggat gcaactgtgt gtcgtgtgtg gttctcattt acttttgaca 393900
 ggtaaggctg aataagttct acattctttt aaaactgcag cacaagatct agtaaaacaa 393960

 gaggaaagt ttttgtttgt tttgtacagg gatatgtaga gatttttgat ttttattgac 394020
 tgtatcttcc ctgtgttgg gaggtagcac agaagggcta atggttttta tcttttccat 394080
 gcattttttt ttttccctt cgagacaggg tttctctgtg attttgagg ctgtcctgga 394140
 actagctctt gtaaacagg ctggtctcga actcacagag atctgcctgc ctctgcctcc 394200
 gagtggtgga ttaaaggcat gcaccacat gcttccatgc attttttgaa tgcattgatt 394260
 tagttactag tgtgactaga tgattgtgcc tgggtcagca caggttcctt aacgctgaga 394320
 actagctcat gcaggtctg ttagtgaga gtcttttagt acattcctag tggacatgtt 394380

 gagtatgtgt tttcctgtgt tatccagcta aactgtaatt acttctttaa ttctggatgt 394440
 ctgtttgcta ttgacagtgt ctttgcttcc agcttctagg taagtatttt aagacctaaa 394500
 accaatatag gaggagcctg caaaatgctt atgtcatgat tatggggcta atagatgaaa 394560
 tttagttttt atgtattttc ttaaatacca aaatttecta tgacaggtaa catcatatct 394620
 tgggtcttct gtagaaaagt taactattat gaaaatgcta cacagttaa caggtaacag 394680
 tcagtagaat aagtaagcat gaactacaaa gtatgcagaa ctagtacgcc atgatgctat 394740
 tgatgctttg tgctagatca gtgcttctca accttctta atgctgtgac cctttaatac 394800

 agttcctcat gcggtgatga cctcaacca taaaattatt ttgttgctac ttcgtaactg 394860
 tcattttgct actgttatgg atgtgataa ataactgaaa tgtgaccccc accccaaaga 394920
 ggttttgacc cacaagtga gaaccactgt gctggataat tccttgtag aggctgcctt 394980

gaacagtgtg ggatatctgt cagcagtcctt ggcatctgcc taaaagatgc cagaagcact 395040
 gttaacctcc tccagactct gcaaattgtg ataatctcat atatctctgg gaataaattg 395100
 gcctggctga gcacctctag gtaggggtat atggttgact ttagacccta tttaaagtaga 395160
 ctgattataa atagaagcca ttaagagggt aaaaaaata aaatcaggct gttgagatgg 395220

 cttagctggg aaagctgctt gctgtacaaa cccgatgacc tgagtaataa ccccaggatt 395280
 ttgcagtgga aggagatcat cagctcccaa aagtcctcag acctctatac atgcactaat 395340
 aattttaaaa agattcgggg ctggagagat ggctaaagg taaagtatg tacagaaagc 395400
 tgggcatggg ggctcatgcc tttaatccct atacttagga gcaaaggcaa gcacatctct 395460
 gagttcaagg ccagccaggg ctatgtagaa agaccctgtc tcaagaacaa taacagcaaa 395520
 gagtacttac agttctttta gagaacctgg acttgattcc cagctccac atcagacatt 395580
 ttataaacc tccatttggg ggtgctgatg gtggaggagt actgtctagt gatgactctg 395640

 acctcctggg gcacctgcac ttatttgcac ataccctcgc acagatacac ataattaaaa 395700
 taagtcgggc ttggtggctc atgcctttaa tgctaccact aatgaggcag aggcaggcag 395760
 atctctgagt tcaaggccag cctggtctac aaagcaagtt ccaggacagc cagggctaca 395820
 cggagggatc ctgtttcaaa aaattcaaaa accaccccca ccccagaaaa aaagaattca 395880
 atcactacac tgatatacta gttcatctta gcatgctgac agctctgtgt atcatggtag 395940
 tttgccacat acttttctat aaaaaatttc ttcactcagt ctgatattt catattctaa 396000
 ttaggtaact ccaatgtaat cctttaaata accccttatt ataccacaca cattaaaaa 396060

 cccaagtaca ctgacctgct gcttttgtgc ctcatcttgg gaaacttcag gttcaacaat 396120
 gtgtttaa atacagtgagaa gcttactttt taaaaaattt tttgagatt gggtttctct 396180
 gtgtagctct ggatgtcttg gaactcactt ttagaccag gctagccttg aaatagaaga 396240
 agtcagcctc tgccttctga gttcnnnnnn nnnnnnnnnn nnnnnnnnnn nnnnnnnnnn 396300
 nnnnnnnnnn nnnnnnnnnn nnnnnnnnnn nnnnnnnnnn nnnnnnnaac agtgctaata 396360
 aagttcttct ctcaaatga gccttaactg ttgaatgatt ttttactggg ataccagatt 396420
 tctaggaatt ccatttttta catagaaagt tattcatgtg aggcctcttg agttaatgca 396480

 tggtgaaaac tcaacctct aacctgattt ttagaaata aatftaaata gtatatatct 396540
 aagttgaaag actagttctt atctcagaat tgtgaatatt aaatgaatgg ggaatgaagc 396600
 atctgtcaca ctgccctgtc accacaagca ctactccct gctttaactg ccgtgcagg 396660
 ttaccttctg atgcatgact attccatctc ttagaggct ttttctggt ttcaagagta 396720
 gggagataat taagatagtt gaaataccag catcaatgca tccaactac agtggtttat 396780
 acctgtagtg ttcagctatt cttagagcag cctcagctct taagcttcag ctgcattttt 396840

gagatgcaga caagtcttg gagcataagg caaacctgg ttgggtagaa gttatTTTT 396900

tccgttggtc aagtgcctga aatagctact aaattgtagt aagtttagct gtaatctgct 396960

gggatgagta cgtgggacaa agctgactga tactgctctg tgtTTTTTT tttTTTTTc 397020

ccaactgagt tggaacacaa ataccgttgc tatctgctg tatgaaattg tagtctggca 397080

taccagcata ttcaagaat ctcatTTTgct tcagatTTTT ttctatcaga ttatgccata 397140

aaatacatat ttctTTTTg tagctcaaac tggaagatta taaagatcgc ctaaaaaacg 397200

gagagcagct taaccagac cagtTggtaa gtgcttgag attatTTgtt agataactg 397260

gtctgctTtc tttctTTTT ttgtttattt ttTgaggcaa cgtTtctctg tgtagccctg 397320

gctgccctga aactcactgt gtagaccaga ctggctTtga acttacagag atctgccctg 397380

cccgtgcata ctattagatg atattggcta gatatgggtt aaatagaaca agttagatta 397440

gataaggtag catgtacatt gaacttaatt cgtggtagga agactgagta tactcaagtt 397500

ttcaactctt cactggTtta atataaactt gacatctTtc tattctaaaa tctgtTTTTg 397560

tagctTtTgc atgattctga ctTgctctct tTtaattTct tTtatactTg agttatgtac 397620

ttagcctTtt aaacattaac ttcactataa atattgacta taattTtTct tattTtgaac 397680

tcatagtTgt actTctgcat Tgccctatga aattctggca ttgcaggcca cacaaggcac 397740

catgcccagc tacaattTtt tttTtcatg ttTgccctgt tcatgatata cctgttaatt 397800

ccaaatatta ctagtTtTg aaggagaaca tTtacaatat ggactaaaaa attctTtatg 397860

gttatTtTgat gTtTtggcct gatcacattt cctgccTttt aagaaggTgac aaagtTgTcc 397920

taaagtTatt taagattTat tTtTtTaaat gtatgtTat gcatgtatat cTtTgtTgTg 397980

gtatgtgcat gTtagTtcaa gtgcatgtTg aggccagaag aggtattTgga tcccctgaag 398040

atgtagtTac aggcagTtct gaactgctca atgtgggtga taggaaccaa attcacatcc 398100

ttgggaagag caagtTctTt tTaaactgcca agcagccctc ccagacctga agttattTga 398160

tctggctcat gagcctgtta acattTcct cctTgctTgT ttgtcatctt ctctgaccta 398220

gaagtctcat ggtTtagTaa ttatgattct attgaggctt agctTtgaat tatgtgagct 398280

ctgagcacc tctacatagt gaagggactt ggctaactcag ccatcattta tTtccTtTgt 398340

ttTgtTtTca TgctctTgTc actaactTaa aatgtTgaag cTtctctgta agaatcccag 398400

aagTtctTgtT agaatcTgat cattgaggcT cTtTtTgatT gaactTgTtT aaagtTctTg 398460

ctgcataaga atgagatcct gagTtcagTc ctggagTcca Tgtaaaaaag ttgggtTgtTg 398520

TgggtTgtTg TgtgatTgTg Tggtgcactc tTtTtaagat ctattTattt atttattTat 398580

ttatttattt atttatttat ttattatgtg tacagcattc tgcctgcatg tgtgcctgta 398640
 ggccagaaga gggcaccaga tctcattaca gatggttgtg agctacccta tggttgctgg 398700
 gaattgaact caggacctct ggaaagctgt cagtgtcttt aatctctgag ccatctctcc 398760
 agccccacac tcttgaatc ataaccctgg agtggaggag acagatcctt ggggcttgct 398820
 gtctagttag gtaaacctat ttggcaagt ccagcgagt gagagaacct atttcaaaaa 398880
 acaaaataaa aaaagcccca aaaccaaaaa acaagcaac aaaatgaaaa caaaccaaaa 398940
 acagtggaga actgtagaga ttgggtctta agaactctta ttactcttct agagaacctg 399000

 agttcagttc tcaacactca tgtcactcag ctcaaacctg tctgtaactc cagctccagg 399060
 gaatctgata cttttgcatc cttggttacc agtatttata tgcacatgcc aatacacaca 399120
 cacatattta tcattaaaa taaatgttag gggctggagg gatggctcaa cagttcagag 399180
 cacttactgc tttactagaa gaccaggttt aatcacatgg tggctcacia tcatctgtaa 399240
 ccagttccag ggiatgtgat gccatcttct ggcctcagtg gccaccaggt acacaagtg 399300
 tacacagaca tacatatagg caaacacca atacacatta aattaaaata aaaaaaaaaa 399360
 tccccaaaa caccaatgac ctaggcttgg tggcacatat ccttaatccc agtgctgagg 399420

 agacagaggc aggcagatct ccgagtctc tgaagagca cacagggttt ataactgcca 399480
 agctatctct tcagtaccat gaataatctt tttatgtata ttgacatata catttatgta 399540
 gaaatgtttt gttttgagta atgttttcta ggagtagaat aatacactat ctgtatatgt 399600
 gtgtgtgtat ttttaataa tatatttact tactttgtgg atgtgtgaag gtcagagaac 399660
 aacttatagt agtccttct tttctctgtg tggattctag gaattgaacc caggttgtea 399720
 gtatggcag caatcatatt caccaccaa gcaatctgtt gataactacta cactatctga 399780
 attattgaga ctccaatata gttttaactg ctggaataag ttcctaact tgttctgtcc 399840

 caagtggacc tttttctca ttttaagtta aaaagggtct gggcatggtg acacaaacca 399900
 ttaatcctag aattcaagag gcagaggcat gtgtagatct ctgagtttga agccaccatg 399960
 gtctaataag tgagttcctg gagtgtcaga tctttatagt aaaacaaca caacaacaac 400020
 aacaacaaca aaacaaagca gaacaacaa aaaaagcaaa attacattta tttattggtta 400080
 tgagtgttgt ggggaggta gaggatagt tgtgggagtt agttctttc ttccaccgtg 400140
 taattctgt ggatcaaagt tggtagtcag gttttgcagc aagtgccttt acccactgag 400200
 ccatctcacc atctggctcc aaactgactt ttgtcttct ccacaaaaag ttaagacaaa 400260

 ctcatctctt ctgattacca gttgagtag aaatcttta tttatttatt tttagtcact 400320
 ttatgtgtat gaatacatat gtttgtgtcc tgcatagttt tgtgtcctgc atgtgtgtgc 400380
 ttggtgcctg tagaggtaga aggaagtgat ggatctccta gaaccggagt tacagatggt 400440

gtgagtcatg acatggttac tgtgaaccaa acccagggtcc tttgcaagag caacaattgc 400500
cttttacctt aagccatttt tccaggccct gtaatatgaa atccttgttt ttgttttttg 400560
agacagggtt tctttgtata gcctttgctg tgctggaact cactctgtag atcaggctgc 400620
ctcaaaactca tagagatctg cctgcttctg cctcctgggt gctgggaata aagggtctctg 400680

ccaccacagc ctggcatggt atgaaatctt aaaagaagtt acttctttaa tttcagtagg 400740
atagtgcttg ttataaact tatgatctt attacaagca attatttaca cattgtttct 400800
gccatttttt agatgtttca cagttgctct tcttctgtgt gatatttatt attcctatag 400860
tacgtttgag tgggtgaatga tgttgactga ggaatcttaa tggcttagtg ttctcaaaac 400920
ccatagagat ctctaactta aatgittaga taggatagaa ttaggactct gattttttta 400980
ttttgttaca tigtgtgatg tgtatgtggg gggccagatg gcaacttgct gaagtgggtt 401040
ttctcctacc atgtggatcc ttgggattga attaagctct tcaggtttgg cagcaagaac 401100

ttttaccac tgaacctct caatggcca gggctctgat ttctaataa aaaattagag 401160
gtttagcttg gtagtgtatc taaagatatg cttgagggat tgaggcatgg gaatcgt aag 401220
tttgtgtcta gctagaata cgtacgagtt ttatgccaac ctgagatcca gtgagaacct 401280
gtctttaaac aaacaaaagt agaggcaggt ggatctctgt gagtttgaga ccagcctggt 401340
ctacaagagc tagttccagg acagcctcca aagcctcaga gaaacctgt ctcaaaaaa 401400
aaccaaaaa ataagtaaaa aataaaaaaa ataaaataag caaacaaaag ttctagcatt 401460
aaaatagact tttatatta ctttaccttg tagatacctt tctttcagt aagtactttt 401520

ctaacttaca aagtccatc tcctttatca attaaaaatg atttatgttt atttgtatgt 401580
gtctgtttgt gtatgggaat gtatatccag gtgtccagaa gaggggtgtca catctgttag 401640
tgctggaatt atggtgactg cctgatatgg ttgctgggaa ctctgatcct ctggaagagc 401700
agcatgtact cttaacctct aggccatctc tctagcctt tagccattta gggaaactt 401760
atatttctg agcttaccac ggatttgctg gggttttttt cctgtctggt aggaagctgt 401820
ggagaagtat gaagaagtac tacataattt ggaatttgcc aaggagcttc agaaaacctt 401880
ttctacactg agccaagatg tgagtatgtt tcattgctt tctttgagc cactttagct 401940

gctgacgttg aagaatafgc cactaccta aaattgtgtt tgcttatcag tcatctgaaa 402000
ccatgtggat agtatactga ggaagtctca ctaagactcc taggaagtcc ttgaactcaa 402060
tatgtagccc agacaagcct ggaaattgig attctcctgc ctgagccact tgagtgtctg 402120
ggattatagg tgtgcacagt tgtgcctggc tctagactat ttttaatttt ctgctaaatt 402180
tatttaggct tggattctt gactttgaag agatttttgt ttgttttttt gagacagggt 402240
ttctctgtaa ctttggatcc tgtcctggaa ctactctgc agattttgaa ctcacagaga 402300

tctgcctgtc tctgcctcct gagtgctggg actaaaggcg tgtgctatca ctgccctgtg 402360

tgttcttttt cttagggcac tcatatatgt tcttccacca tgggtctcta gagatgtcac 402420

ctacttttggc aagctatgct gtgtagtttg actttccttt tgggctgaca gcccccacac 402480

aatgacattg agacttaata attatgaaat cttgaccttt agcttaggct tgttcccaac 402540

tagttcttat aacttaaat aatcagtttc tgtcaacta tgttctatca tgtggctttt 402600

tacctctttt ccattcagta tgtctgactt tctcagtttt tcactggcat ctctgcaca 402660

ccaaggttct aaccctctaa gttcctttct ctgcctggaa gtcccaccaa cctctcctgt 402720

ctagctattg gctggtcaga tttttattaa accaatcaca tcgacacatc ttcacacagt 402780

gtaaaaaaat atcccacaac aatgctgatt ccatgaaagc agtttctttt tttggtgctt 402840

tttttttaaa aaaataatth tttaatggtc attggtgctt tgcttgcata catatctgtg 402900

tgagcacgctc agatgccctt ggaactggag ttgcagacag ttgtgagctg ccatgtggat 402960

gctgagaatt gaaccaggat cctctggaag agcattcaat gctcttaacc gctgagcctt 403020

ctcttcagcc cccatgaaag cattttcact tgttgcccat gctttatac ttttctctcc 403080

tccctcctc ctctctacc tcacccttga gacaggttct cactatthtag cactagctgg 403140

tctggaactc actctataga ccaggctggc ctagaactca gagatctgcc tgctctgct 403200

ttccaagtg ctaggattaa aggtgttcat taccatgcct gggcactgct tcagatttct 403260

ttctctcat aatgtgacag taggtctaga gcttgctaca accccatctc atcccatttg 403320

aagtatthtt agattaactt actttacatg tgtgtthtga ttgcatctat gtgtccatgt 403380

gcataccttg tgtttgagga ggtttgcaga tagttacaaa ccacatag ggtgctggaa 403440

actaatagac ctagggtcct ctacaagagg tctattagct gagccatctc tccagcctg 403500

agcttgtctt cttagtcaaa gccctcaagg tgtttgtcat taccttcta ttcctthttc 403560

tcgtagthtt tgggctgctt taaactthttg ttgtcacgctc aatagattgt ggaacatctt 403620

gttctthttat cctcagtcta actacattct tcttagthttc ttgagatgat tctgttctt 403680

agccaaaatc cattatacta agtaatggtt tggaaaataa actthttgttc agtattgctg 403740

attggattgt tcatgtgtht tctthttcaa actgatcaac aaagaagaaa aagggtgaag 403800

atthttcttag thttacata ggtaaagaca agaaagctgt tagtggtthtt catgagatct 403860

gatcatgagc taggagacag tgtagthtagt tgacttgatt tathhtaacag gtatthtgagt 403920

tcttgttaca taitcagctc tgtgccaggc agtgatgtat ggatgaataa ccaaaatata 403980

gtctctgtca thatgaatgc agaaaataa aagtgacaac tagggactgg aggtgtagtt 404040

cattaggtaa agcactagct tagcgtctgc atggccctag gtttgattcc cagcactgcc 404100
 aaaaagcaat aaatagataa atgaattata cacatgacta tttgatgtga caaagacttt 404160
 gctggaggac tttcaggttg gcataaaccc atagaacatc taatctagt tttgggaata 404220
 ggctaaagag aaatatgaag taatgaagtg gtatgtatgt gtttatttct gtgtgttgtg 404280
 tgtatgtatt catgtgtata tgtgcctgtg tftggagacc caatattgac tttggatttc 404340
 ttttttgatt attctctact ttattgagat agtgtctcac ttgaatccag aggttgccca 404400
 tcagctagtc tagtagccag tttcatgagg gatcccatca ctgcctcctg agtgcttagt 404460

 gttacaggca gcaccatgcc tgccctggctt ttaagtggat cctggggatc tgaattcttt 404520
 tttttttttt ttggtttttc cagacaggat ttctctgtgt agctttggag cctatcctgg 404580
 cactcactct tgagtccagg ctggcctcga atcacagaca tcttctgcc tctgcctccc 404640
 gagtactggg attaaagggt tgcgccacca acgcttggcg ggggatctga attctaata 404700
 tcacactttc ccttgggcaa gcccttaat cactgaaccg tctccccagc tctatgatgt 404760
 gtatgtggtt gtgaagacat tttggttaat tagagtcaa agctaaccac actagccata 404820
 gagtccaggc agtgggtgaca cacaccttta ttaccagcac ttgggagaca gaggcagaca 404880

 gatgtctgtt agttcaaggc cactctgggc tacacgagat tgaatctgtc taaaagagaa 404940
 acagagctca cacaagggtg atcccagcac ttcgaatccc ccgctttta tcttagcact 405000
 aaggagtgga gacaggaagt gatacagctg ggtggagagg aatataaggt gggagaagac 405060
 aggagctcaa tgcagtctga gtctgaggaa cagtgcactc aagcagtctg aggatttgct 405120
 tctctgatat ttagcattaa cccaatatac tgacttggcg gttttttttt tttttttttt 405180
 tttttttttt tttttttttt tttnnnnnnn nntctctgt gtagtctctg aactcatttt 405240
 gtagaccagc ctggccatga actcactgag atcctcctgc ctctgtctcc caagtgtctg 405300

 gattaaaggt gtgcaccacc accacctgac cctgactctg agcttttatt attaaaacct 405360
 aagagaactt gtattacaga ccacagcaac tcttataaag gaaacattta attgtggtgg 405420
 ctcacagttt cagagattca tccattatca tcatgtcagg gagtatgaca acatgcaggc 405480
 agacgtggtg ctggagtga cagtccttac attttgactc agaggcaaca agaagttgac 405540
 tgactgtcac cctgaggagg gcttgagaaa aagatactc acagtctgcc caacagtgac 405600
 aacttctc caacaaggcc acgcttcta atagtccac tccctttggg ggtcattttc 405660
 tttcaaaaca caacacctt taaaatttc tttttgttt gcttctttc tttatacttt 405720

 tcccttattt tctcttccc tttctttgc ctgtctgtgt agatggctta tttggaactc 405780
 atcttgagc ttgctgtgct caaatttggg aatcctagg catgcattac tgtgcctggt 405840
 tagatatac tttatagac ttaagattg tatcaataac ccatttattg gaaaaaatc 405900

ttgagtcctt ttctttcttt gctgttttgt taagaaataa ccagtggtat agaaacataa 405960
 tcataaaagc tatgtgggaa aactatattt tcttagtgga aacaggtaca ttattatctt 406020
 taaaaaatta ggcttatttt gttttatgta tttgagtgtt ttacttgcat gtatgtatgt 406080
 gtacatgtg tgtgcctggg gctcaactag ttcacaagag ggcatcaaat ttcaaactgg 406140

 agtaacagga agtaatgacc cccatgtaga gttgggactg aactgagccc tctggaagaa 406200
 caagcgtctt taaccactga accatctccc cagcccacaa ttattatctt tttttcagat 406260
 agggttttac ttgatagccc aggttttctt gtgttcctta tggataccag gctggccttg 406320
 aactcacaaa catctatctt cctatgcctc ctgagttctg ggattcaagg catgtgtcac 406380
 tgtgcctagc aataagctct ttatttaaag ggtatgtcac cttgtttaca taacatgtta 406440
 agcttcaaga taaagnnnnn nnnnnnnnnn nnnnnnnnnn nnnnnnnnnn atctctgagt 406500
 ttgagccag cctggctctac agagtgtgtt ctaggacagc cagggtcca cagagaaact 406560

 ctgtctcaaa aaaaggttaa aaaaaggttg gtatgttgtg ggtgggtggg tggatggggt 406620
 gagctagagg gaatgggtat gactaagggt catgttatat tatacattaa tggaaatttc 406680
 aaaaaataga aattgaagct gagcgttggg ggtgcacacc tttaatccca gcacttggga 406740
 ggcagaggca ggcggatctc tgtgagtttg aggccagcct ggtctacaga gcgagtcca 406800
 ggatagctc caaagctaca cagagaaacc ctgtctcaaa acccccccc aaaaaaaaaa 406860
 aaattgaaaa caagaacctt cattctcat tcaattaaaa actttaatga tggaaagtggt 406920
 ggacacattt tctgtgggta ttttaagaa aagggtgagt ttttgttcc agatccctgt 406980

 ggtagaagt gtttggttt tggataaatt aattatacac ataaaaggga ctatcttagg 407040
 gatgagactt aattctagat atgaaattca cttacattta acatagccta agggtaattt 407100
 tatatactac ttttagtatg cttctatatt taattttata tttattttgc atgtgtatgt 407160
 tgtgtgggtg tgggtgtgta atgccacagc acacatgtga agatcagagg gccacttgtg 407220
 cttctattat atggagtcta agattgaact caggtagtgg ggcttggag caactgcctt 407280
 taacctctga gccatctctt taactcagtg ttactgcatg ggtatcaaga ttcaactggac 407340
 tcagtacagg ttaagtgaag tttattcaga gagattgtgc ttacacaaga ggctggtgac 407400

 catctcgggt tccagctcca aggatcctcc caggctgttc cctgtgactc aatcggaagt 407460
 aagagagatc tgggtgatct ccagggcccc agatctagtc agtctctcc accatcttgt 407520
 cctcacctgt gaccacacc atttggctat aggtgtgggc tgggtggata tctcactaca 407580
 cagtgtcctt acatttttga ctgtgacca tcacatggag ttgatgtgg aattttcttt 407640
 acatttgtat tttcacattg gtactcaatt taagattttg actttttttt tttgaatttt 407700
 tttcctttct tcttctctc cttctctctt tttctttttt ctttcttttt tttttctttt 407760

ttttttggg tattttaga gcaggctgg ctcaaactca cagtgatctg actatgcctc 407820

 ccaagtgcgg caaaagtgt gcaccaccac cccagcctc tgttcagttt ttcagttgca 407880
 aagtgtatca tctaggetgg gtgttggttt tgtgcgcctt aaatcccagc acttgggagg 407940
 cagaggcagg gggatctttg tgagttggag gccagcctgg tctacagagc cagtgccagg 408000
 acaggctcca aagccacaga gaaaccttgt ctgaaaaac caagaaaaaa aacttaccat 408060
 ctaatcccag ctaacatggg taattgagat atgtgaacct gcatttgttt taacagctac 408120
 tgaaagctca gaaaaaggcc cagagaaggg agcacatgct aaaacttgag gctgagaaga 408180
 aaaaacttcg aactatactt caagttcagt atgtattaca gaattgaca caagaacatg 408240

 tacaaaaaga cttaaaaggg ggcttgaatg gtgcaatgta tttgccttcc aaagaacttg 408300
 actacctcat taaattctca aaactgacct gcctgaaag aaatgaaaag ctgaggttaag 408360
 tcagtgaagt gattttctg atatagaact tgtgcactt ttagcttttc tgttataggt 408420
 agttagggat taactaagaa aaactttaat ttattcaat atgggaaact tagatatgtt 408480
 tgatagatca ttcaggaatt cagaaaagt tgaatgtttt cattaaccct gtctgtagta 408540
 tagcctgat tttgaaaata atgtttggtc aggtgtggtg agaccgtctc tcaagcaaaa 408600
 caaacacgct tgatcattgt cttcaccta tgcagatatt cactgtgata ctagttataa 408660

 atgaactgat gatttaaac tgtaaaattg aggctaccta atatttcctt ccccagttag 408720
 ctactatfff ttgtattgga tatacagct aacagacaga tgtttatgct ttttctttgt 408780
 taaacatgga ttgtccagc tctttgttag ctgtgaaagc agagcttaga agagttcagc 408840
 tgttactaaa gatcagcttg gtgtagggaa gaagctccat acaactcagc ttactctgga 408900
 agctgcatgc ctactcctt gctgggttgc tgttcattgt ctctatctgt tgtttgttgg 408960
 ttgctgcctt cccactggag ttggttcagg gaatggggct ttctcatgtt gaaaagtaag 409020
 ccactctcag gctggagaga tggctcaggg gttaagagca ctgcccgttc ttccagaggt 409080

 cctgagttca attcccagca accacatggt ggctccaac catctgtaat ttagtctggt 409140
 gcctcttct ggactgcagg tatacatgca ggcagagcac tgtatatata ataaataagt 409200
 aaatcttttt ttttttttaa agaaaaagta agccactctc tacaaagtaa agtcaaatgg 409260
 agctttgagt gtttccattt cacttttatt cctgaggcac atttgataac taatgatact 409320
 gcactggcag ctggaattct tggctatcc ctggtagtt gcattggtaa aatctttttt 409380
 attcatttta aggaagacat ttagttttga taagtatgta gaaaattcag tattttgctt 409440
 ccaaataata aaagggtaaa attagcatal ttacatatct tgactgttga tgggttatat 409500

tttatatgta cattgtactg ctcttcatgt gtagcgtat gtctaaagcc actctgttct 409560
 gctgctgctt ttccttgta gtgttgaaga ccagatggag cagtcacctt tgtacttttg 409620
 gaaccttttg gaaggtagtg agaaagcagt ggtaggaacg acatgtgagt tttccctact 409680
 ctggacttag gtagtaaata gtaaacctttt tgccctaaagg tttagtagta tattgagggt 409740
 ctaaactgta ttgtccacc agaattgata tgctgacaa tgggtattc attggaagaa 409800
 tggccctttt atttatgta aaaggagcta tcgtatattc ctatttactg aaaggaact 409860
 aacagatttc aagtgacaac caatatgatt tggaaacaaa agctaagtac tagttctggt 409920

 ttaatactag cttaatcatt ttggagtcca gtttctatt ctgaatagtg gtacatgttc 409980
 tagttgagaa ctttaaatcc ctacctgtt aatataaggc ttatttagta ggtcattcta 410040
 agaaatgaca aatggtttgc ctagtctgtt ggacggtcag atgaccacat tcaaattgcc 410100
 agacatgaaa tataaagtac acagcttagg atcttgaaaa ctccctataa agtaataaat 410160
 atttcataa tagttaattt ctctctcttt agaaaatc tgctgggtgt tgggtgtgca 410220
 caccttaat ccagcactt gggaggcaga ggcagcagat ctctttgagt ttgaggccat 410280
 cctgggtgac agagcgagtg tcaggatagg ctccaaagct acacagagaa accctatctt 410340

 gaaaaaaca aaaacaaaa agaaaaacgt aaagaaaata tccaagtcta gggcctgggg 410400
 tatggcttag taaagtgcta tgtaatcatg aaacctgagt tttatccct tacctgtgtt 410460
 aaaaaaaaaac aaaacaaca caacaacaac aaacatttca gcatgcaatg gctgaaatcc 410520
 catcactgag gagatgaaga aaggagaatc cctggggctt gttgctggct agtctagctg 410580
 aatcagcaaa ctccagattg aaggagggag ggaggggaaga agagagagag ggagagagag 410640
 agagagagag agagagagag agagagagag agagagaaag aaaatgcttg aagaagactc 410700
 ctaatactga ccaatagcct ccctaggcat gtgcacgtgc aaccacacac aagtacatat 410760

 accttcagaa aagtaagccc atttatgtgt aactatcaag gtttataact ctgtttaaga 410820
 cttaaatat aagtgaaaat ttatatTTTT gatccaggca tggtagaatg tactctggtc 410880
 ccagttagtc agaaggtagt ttgagcacia gaattcaagg ccagcctgaa catcgtggca 410940
 aacctgtct tgaagaaaac aaaaaagaca aaggaaaaaa tggtttgaa aagagtttg 411000
 cacttctct tttattttat atacttacta tactatatat actaagtata ctatatatac 411060
 ttaccatata gccaaatagt tacatgtcca gaaccgaaca gaaatgaaaa caagtctca 411120
 cttaagtaca atgcttatac tctgttcata gtagttctct gttagagtca gtgtaaatgc 411180

 acagcagtaa attgatafac aaaataggat attttcattg agtagatttt tagcaattaa 411240
 gtaacctctg ggtctggtgt ctcatgcctg taattttttt cttaggagac acacacagga 411300
 ggatcattac cagtttgagg tcggactgat ctacacagtt ctaagccagc tagagctaca 411360

tagtgagagc ttattacaga acaaacaaaa accaaaatcc caaacaaaac agcaaaaaca 411420
acaaaaaaca ttaatacatg caagagcata gatgaatctc aaagtaatta tacttagtaa 411480
aagaagccag acaagacatg aatatatata ttgtatgact tcatTTatat agaattctag 411540
aaaaggtcac taagttgcta gggaagggga ccaattcaga aggtccttga gggatttgg 411600

ggatgctaaa aatgctttaa aattgtggtt ctgttgggtg tagcgtgttt ttgtagctgt 411660
taaagctatg aatgtgaagt aggtgaaaaa ttttgtttat aagtaataac tcaaagatga 411720
ctaaaatata gctgtgggtg tacataacctg tagtcctaga attcaggagg ctgaggcagg 411780
agaattgcta tgagtttgag gctagcttgg gctacaaagt aagatgttta aaacaaaaca 411840
aaacaaaaaa ccaaggctga ttaaaaagag aatcaggcca ggtgatggtg aagcatatcat 411900
ttaatctcag ccctcaggag ggctcagatc tctgagtttg tggccaacct ggtctacaga 411960
gtaagttcca ggacagccag gaccacagag aaacctgtc tagaaaaaca aaaacaaaaa 412020

caaaaaaaca aaaaagagag aacaaatcaa tgttataata cgcaatgaat aataggcaca 412080
tactatggat gttctgcctg gtttggaaft gggttttatt ggacatgtaa aataaaatat 412140
atgcaacttt gacattactt ttataattaa aaaaaacttt ctagtctag tttgttagaa 412200
gtgacatgag tgaatctta ctgaaggagt tttacaattt aaaaatatta agccagtct 412260
tgtggctcaa gcctgtaatc ccagcccta ggagatgtgg gatggctaag gcaggagaat 412320
aaccagtttt tagactgctt gggtcaatag ttattgagac ttggtttcca catagccaac 412380
caaaaagaac aaggacaaca aaaccaggag tgtctgagat aagatttctt attggatatg 412440

atggatgaat taccttttat ttctatatat ccttaactaa taggtcaaca tagagcagtg 412500
gctagttgaa tatcttgaa gcatatggaa aaaatgtctc agctcaggga atttgtgctt 412560
tgtcatactt tttgattagg ttctttcttt gatttttagt catttttcaa atggtaaaaa 412620
tagagaacce gagaaactca agtaatttgt taaatatata gtctcatgtt tactgtttgt 412680
atTTgtcaa catgaagtgt aaagataaat cactcttta ttttctggc acagacaatt 412740
ccaagtgtcc tctgcccc atccactctt gtgatgtta actataagca ggataacatt 412800
gagattctta ttctcataa ttgtcaatga actcttaggt tgtatgctaa gtcttcatca 412860

ctctttctta gacaaacatg tgaagatct gctgtctaag ctgctcaact caggttattt 412920
tgaaaatgtc tcagttctca aaaattctaa ggaaaaagag gaagaaatgc taatgcaatc 412980
aggaaagaag aaacaattac tgaagactga atctatcaaa gagtcagggtt tgttgcgatc 413040
tttgaagggtt tttgttttg tttgttttg tttgttttg tttgtttga gacagggttt 413100
ctctgtgtag ctttggagcc tgtctggat ctattctat tggccagggt gacctgaac 413160
tcacagagat ccgcctgctt ctgcctcct agtgctggga ttaaaggcat gcaccaccag 413220

cgcttgcca tctttgaagt tctttagttt gctatTTTT taactttatt tttaatattt 413280

 attttattta tttattttga ggcagggcat aaactatgta gccgggttgg ctggacttac 413340
 tatgttagt aggctggct tgaacttga tgattgtcct tcttctgcct tetgagtgt 413400
 gaaattaata ggtttact aggactcctg tttgttttg ttttaaaaa tttgcttagc 413460
 atacaagaa atgggttata ctatgacatt ttcattttca aacatacaat gcttttgttc 413520
 ctaataatte ttgcatgtg atgaaagtcc caccttgccc acttagccc aaaataaatg 413580
 cacagagaca atatattaat tataaactgt tgcttgggg cttcttattg gctagctgtg 413640
 tcttaattat taaccattt ctattaatct gtgtatttcc acatggctct ggcttacagg 413700

 agagcacctg gcacagcctc ttttctggg cctacagtc ttcctatgtt tcccagaatt 413760
 ctcttgtct cctagtcctg cctatcttc tgccttattg ccaacactgt tttattcacc 413820
 aaccaataag agaacaat atacagaagg atttcccat cacttgcat ctctgatgg 413880
 agtgccctta tctttcatg acatgtattc cattatagag gttgcttct taatgcattt 413940
 tagaacctc atttgaaat gatttagttt gttggattct atatgaatgg agattttat 414000
 ttgttgaat ttaagcctg gtttagaaaa cagattacta gggattggag ggattgctca 414060
 gtggttgagt atgtactgct cctacagaag attcaagttt gattaccagc agccaattg 414120

 gagagcttac aactttttg gcctctttgg gaattgcatt ttgtgtatag acccaccctt 414180
 agacacaagt atacacaaaa attaaaaaaa aaatgttaa aaagagagaa aacagtgtt 414240
 tgacttacag ttagctttt tttttttt ttaaaaagat tttattatgt atacagcatt 414300
 ctgcttccat gtatctgc acaccagaag agggcaccat gtggttctg ggaattgaat 414360
 tcaggacccc tgaagaaca gccagtattc ttaacctctg agccatgtct ccagccccag 414420
 tttagcttct tttgtttg ttgagacaag atttctgta gtaaggctg gcctgggttc 414480
 ttgttctatg tctccaagt gctgagatta aaggcttctg ccaactaaact gatttcaaga 414540

 ttgaacctta atagaaacat tagtttacct tttgtttga gagaaaatatt ttggttaaaa 414600
 ctaggcattt gtgaaacctg aataaacctc tttgctaac tataatagga taattccatt 414660
 tatagtatag cttaaatata agccatagtg gaaaacagta tttgtagaa aatgtgagt 414720
 ttgggatcag ttattgatg aagggaag aaaaaaaaa tagaaatga gggattgggg 414780
 atttagctca gtagtagagc tgggctgggt ttgaggact ttaatccaag cactttgtag 414840
 gcagatgcag gctcatctct gagatcgagg ccacctggg ccacaaaaca aatttcagga 414900
 cagccagggc tacaagaga aactgtgtct caaaacaac aaacaagggg gaaggggagg 414960

gagagggaga agggattggc acctgaagca agcttgttcc taatttgaac taataaaata 415020
aaataaaaa acaagaagaa aatgaatat atttttgatt agccatttat ttccttcttt 415080
ccctttttaa aattaaaaaa atgtttttat ttgtcaggt ctcattgtagc ccacgtggc 415140
cttaaattha ctatgtaatt taggatgacc ttgaaccttt gatcctcatg cctctacctc 415200
tccagttcta agattaaaag ttgtactcc tctgactagt ttatgttgta ttcagaatcg 415260
tatctaggaa ctatgctagg caaagacaac cagctaagct acatccctgg tcttacttca 415320
ccttaatact aagttcagtg cttctgtgtc tcctctctt acctctctg accatagtat 415380

ggtttggcag aggcctctgtt tcaagttgag tttactgatt tgtccttgta aactttaact 415440
gtaattgcag ttttaataag gctatttgta ggtattttac ttaggaataa aatcttaaaa 415500
ccaggttgtg ttggtacaca cctttaattc tagcactcag gaggcagggg caggcagatc 415560
tcttgagagt ttgaggccag cctggactac aaagtaattt cctggacagc cagggttata 415620
cagagaaacc ctgcctcaaa taaacaaaa agaaacttca gtaaatatct catgaaatac 415680
cagcttcaat gacaattttc cttaggacc attctctttt tgtcctttcc tttttgtgct 415740
ggggatcaaa cctcaggccc tgtgcatgct gtgcaagtgc gttctaccac tgagctaaa 415800

accctaggcc ttccacgtgc tctgaccaa taacaatag ctggagtagt cctgctatga 415860
atatatttaa ttgcattaat tattctgagc cctttgacat tctttactgg aatgaattat 415920
ggctatagcc agactaaaaa cctagaattt gtacttattt ataattcttt tatcttctca 415980
gaatctcctg tggaaactgt gcagcctgag atacaaccac aggaggtgag aatgtgatca 416040
atcaggtcct ttgctgaagt tgttttaagt tttcatttgt tactgtggat tagagtctga 416100
ggcttgggca gacaaactga acttgaatgc tgccttgcaa cttattgggt tagtgtctgg 416160
ctggattggt gtctctatct aggtagtga gctgggatc atatctgggt tgactgaggg 416220

ccaaatgggc tagtctgatg catagtaact tctttagaat tacttattgc tgttttaaac 416280
ccttatgttt gactttaagg atgtatagaa ttttgttacc aggtttacaa tggtagcaga 416340
agagagtgtt tactcttttt aagtgcattt gaaatttgtg gaagctgaaa agaactggag 416400
aaacagatgc acaatacaat agatatgtgg aggaaattga gaaaaacctg ggaaccgagg 416460
agacatacag ctaaacaata taactttctg taattgaact atcctagcag tgacttttaa 416520
aggaggtgta caggtgtgtg gaaagacct cagtctggca aagacaaaat tgctttggca 416580
aagggactat ttaaagtgat tgtagtcca taatatgtag tttcttctaa tcttatatgg 416640

gtcacagatt tctaccttg aagtgtcaaa gtttacattt ctgttaattg aggagaaaga 416700
gtagatacag aagtcacca gtttcttcaa ataggataag gataagagtt tcattcagag 416760
ctgggtgttg gtggtgcacg cctttaatcc cagcacttgg gaggcaaagg caggtggatt 416820

tctgtgagtt caagccagc ctggctctaca gatccagtgc caggataggc ttcgaagcta 416880
cacagagaaa ctctgtcttg gtggggaggc tttcatgtca ggtagtttct tgtgagattg 416940
acagaaatag gaataactaat agagttgaac attccattga aagtctatgc attttaagct 417000
tgaagcacat tgittatttc tctggcttag tttcttaaca gacgtatat gacagaagta 417060

aattattcaa gaaaacaaga aagtgaggaa cgatcttggg aagcagatta tgtgagaaaa 417120
ccaaatctcc tcaaatgctg gaatatgctt cctgaaccag atggtcaaca gaagaagcag 417180
aagtcctcca agtcttggga gtcttctgtc aggtcccagg aggtaccaa gcctgtggtt 417240
tccttagatc aggggaatcc taggtcaaca ttgtaggaaa agcagaggca gcagatttct 417300
atgacacctg tcagccaatg gaagccacaa acccctaagt ccaaagtggg cagccctcaa 417360
gaagagctga gcatacagga gacaccaaag ccatgggtag ttaagccaca gaaagaacaa 417420
gatccacaga agctacctcc tggatcctgg acagtctctg tgcaaggtga acagaggac 417480

aggagctcct ggaccactcc tatgtgcaga gaacaggatt caatgaagcc tgggactcca 417540
gtgtcctggg aaaacaatgc tgagaaccag aaacactcct tagcaccacg tcacagattt 417600
tttttaaagt cctggggagc agcttcagca ggctgttac caaatgacca getcctgccc 417660
aggaagttaa atgtagattc caaagatgtg agtagatttc taagtctgcc tcatcctggt 417720
gctgataaat aaatctttct ctcaggatgt gaggtttgta aggaatgatc cttggataat 417780
ctcgctagt attgcttgtt cttaaattat aaattaacttc atattgctta tgaaagcaaa 417840
catgtacca cttgtttgc taacaggtta acttcaagg ctctccacc cactaagta 417900

gttgtccttt aaccactgc ttttttagcc aggagcttcc tgatcaaac tttggagagg 417960
tcaaaacatt gcattttata aataaacaaa ctacctctca atgctgcctt ccagaaagag 418020
aattttagag ttattcatct ttttttttt tcttttcttt cttgcaacag ggtttctctg 418080
tgtaacagcc ttggctgttc tggaaactgc tttgtagacc tggetggcct ggaacttaca 418140
gagatccacc tgctccaga gcactgggat caaaggtgtg caccaccaca cctgaattat 418200
ttttgagaca agatcttatt atgcagctct ggtgggcttg gaactcatta tgtagactag 418260
tctggcttta aaacttttag aagtcacct gcttctgcct cctaagtgtc ggcattggag 418320

gcacgggcct ggctttttcc tttttcttt ccttgttttt ctctctcac gagctaatat 418380
ttttttttc tcttcttttc tcttcaagtg ctgatatttt tatcttattc ctgccttgt 418440
agaagattga cagctgcact tcatttaattt acaacatcta gtagtaattg tatggttgct 418500
gtttttgata tgcatattaa acccatttt aatatcccaa taaagcagta agagacaaca 418560
gaactttaat ttgagaattt gaggccaacc tgatctacac atagtaagtt ccatgccagt 418620
tagtgctaca tagagagcct gtctttaaac aaacaaacag aaaacaaaa aaaccacaa 418680

attccccgta ggggccgaat cactaggat ttgaacctt accatactag aatattgatc 418740

 ttatgctatt tgttgaatga tattgaaaa cagggatggt tagttacaaa ggtccaaca 418800
 ttgaatttgc ttttatgggc accattatgt tgaagtttta ggctctttca gtaagtaaga 418860
 gggcacttac atctctatga atagctgatc tcagctataa aaatatggct taaggcagga 418920
 gagatggttc agtggttaag agcactcact ggctgttctt tcagaggag actgtggttt 418980
 gattcctage tccttatgg caattataac acctgtaatt ccagtctgc ctatctgaat 419040
 cttctagct ctgcaggtag caagcacata catggtattc acgcaggcac gactcgaac 419100
 agagataaaa caaccatata cataaagatt aaaaagaaga agaaaagaag caagaactgt 419160

 aaatgttaga gcaaattcaa gatgctacc aattaattta tcatgagagc ttctaacag 419220
 cagcagcttc caagagtata cttttaaatt aaatataatt gtgtgtatat tgcatatgga 419280
 tataatattt ttataaatat tttaatgact ctgaaatcac atgtatcttt aaaatgggat 419340
 gcatatttaa tglagtgata gtaatTTTT ccttgaatag aaacactgct atgtgtcata 419400
 gtcagtggct tctgtcaca gagaacaaat agtagtaact gtataatgga acacttttat 419460
 ttttattgtt attatTTTT ccagtTTTT gagacagggt ttctctgtga aatagtcctg 419520
 gctgtcctgg cactcactct gtagaccaag cttgctcca actcgagatc cttctgcctc 419580

 tgactcccaa gtgctggaa ttaaaggcat gggccaccac tgctggcaa tgaatcactt 419640
 ttaaagaatg gtcttaatt ctgggtcctt ttagaaagaa atgcttcata tttttaaag 419700
 attttcttta aagtgtttt gaaaggggaa agccaattaa ttggaaaatg gatttatgta 419760
 aaaatcttac tglgataagt ctaaaaaata gtatctccat tgatttctga ggatgtaatc 419820
 gtaatgtaag ctgtgtgact gagactcact tacacatggc gggtttgtct tgtaggtgtg 419880
 tgtatccatg cttcagccta tggactcttc ctccccctt ccaaaggatc ctctattgag 419940
 gaaagaaaaa ctgcaggacc tcatgacceca gattcaagga acttgtaact ttatgcaagt 420000

 atgagctggt ttgttttatt ttgatcttag gatattttt attctttgac aacttcttac 420060
 atgtatagt tctcttgatc atgtccagtt caaattcccc cttccattg tcttttatag 420120
 ccccaatac ttccagttc caccttcata ttctcatgaa tatgagaata tgaacaaaac 420180
 cacagcattt cgttagtgct gccagtatgt gtatgagtgt gggaccattt acccatttat 420240
 cagagaaaaa gcaatctagc agccacaaga aaaatgatga gctcccatca cctccagcag 420300
 ctatcaattg ttgttagctc ttcagctaga tgtaagctc ataaatccct tatctcatcc 420360
 tcctgggat attgactagc ttggatttct gtaggtcgcc atagctcca tgagttcagg 420420

aacacaagag ctttggcatg tccagaagag tgtttcacgg tactcctccc aatcttctgt 420480
gcttgctgt gggataatcc ttgagctttg aaggagtga tgcgtgtgc ccacttagag 420540
ctgagtgagc atttaacagt cattctaaac actttggcca gttatgagtc tctgactga 420600
cttatgccca tggcaaaagg cttctctctg accaaggttt aaaatagtac taagctgggc 420660
agtggtgga cacacctga atctcagcac ttgataggtg gatctcagtg agtttgaggc 420720
cagtctgac tgcagactga gttccaggac agccagagct gttacacaga gaagtctcaa 420780
aaacaaaaca aaaaaagcat aatgtattta ggagtcaggg ctgctgtggg ccattggtaa 420840

ttacctaag actgacagtc tgtttgctac ttggtctttc aggtcccact aaaaaattat 420900
gagacactca tcatctgect tcaaagctgt agaagattgg aaacttgtgt taaatcaata 420960
gttaaatgat aaattgtga aaagactttt ttactttaa aatagggtct gactgttag 421020
tcttgctagc ctggactca cagttagat cagactggca ttgaattcat agagatcagc 421080
ttgcttctgc ctcccaggtg ctgggattaa aggcctatgc caccaatcca tcatgaaaga 421140
ctatgttaa ttaaatagtg tgacatagac tcttagagaa tatcagagca gcagtatatt 421200
attgaggcct gactactcaa gtaaacaaag taaatgtaa taaaggatct ttgagctttg 421260

gatttaaca ccgggtgta aacaccaatc ctatctttg cctcataact ccagtcaatt 421320
tctttaattt ccagccctag tctgcaaagt gagagataat ttgaagataa atgaaagagc 421380
taggatgctt ccacaaatt ttctagctct gggaggtttt cttgagagaa ccctgataca 421440
cagatatgag aagagaatgt ttatcagat gaaccagtag gtgattgaga taaaaataaa 421500
taggccttct cattagttag gtataataaa atccaattc aaacagacta aggccaacat 421560
tttatgctta agactcatat caggagtgca tgcctaagtt gggctttaga atcatgttct 421620
agtttaatac ttgaccaat gttgaggttt gacagtaacc ttgggttta gttttgactc 421680

tttaatttct tgtttaagaa taatttgta acatcacaag gaagagccag gaaatggtgg 421740
cacatacttc taatcccaa actctggagg cagatgcagg tggatctctg tgagtttgag 421800
tccaacatgg tctacagaga gagtccagg acagctaggg ctgttacaca gagaaacct 421860
gtctcaaaaa accaaaacaa acaaaaaacc aaaaccacaa ggtaggaatt agctagatgt 421920
ctgcaccttt agtaaaagt gtgatcaata cagttagcta cttactact ttaaatgaat 421980
catctgtgtt tcttctact atttaaatc ttatctttag gaatctgttc tagatttga 422040
caaacctca agtgcaattc catctcaca gtcgcctca gcttctccag gtaaccagat 422100

aggagaataa taattctaaa gacttaaac acacagcttt atagttaaca actatttctt 422160
ttacgaatca ttactccat atagcttaag tgtttattaa tttattctaa ttatatccat 422220
cagtcagtag agttgcatag ggacaaatta tcattaggac ataagtatac tttgtaaca 422280

tgtttatatt tgtagagaa aaatcctcag atgggcaagt agaaatgctt aatagctgct 422340
 ttatcaattt tccatgttct ttctggagtg atttctgact agaacctgct tgaccttga 422400
 actgtaaadc tagtgtggag gcttttgagt actgatattt agaacagtga ataccatggt 422460
 aactgatgat ggaaccttaa tctaaaactg gtgtgatgcc tcaaagctga ggcctctggc 422520

 tccctgctaa tttctctcag gtaaggaatg acatgatcaa gctatagtcc aacctgata 422580
 agcattgaac acctgctaaa gacttatgct gtagtgctgg gcgaagcaaa cgagtagtga 422640
 ctggttaatg agagaaacca aactaaaagc tatgtaattg tagaaagtat attattatgt 422700
 gtaaccacag gggaaaaaat ctaaacaac agatgaccag ctaagactta ctattaagat 422760
 tatgtgtatc agttagtac aactcatatg gcttagtctt tgtcttcag attattatcc 422820
 ccagtaattt ttttaaagtc atagtcttt tttttggaa gctttaatgc ttttgccat 422880
 ataaccttaa aacatcagca tgggggctga agaggtggct cagtggtaa gaacatgat 422940

 tgtccttgca gaagaccaga gttcaattcc cagcaccac atcaggcagc ttacaactgc 423000
 tagtaactcc agctccaggg gatggtccta acatcaggta catgtccata tacagacata 423060
 cacacatgtg tigtgaaata aataataata aaaatgttaa agacaaaaac aagaacaaaa 423120
 aactgcgtta ccatatacca cagatggaat tagtgtttct aactagtatc caatctactc 423180
 tcttcaaggt tgcagtagga acctgttctt ccagctgata ctttgtgaag agtaaaactt 423240
 gctttgtcaa gttgacatgc attactcccc ttaattgttt gatttattt agtttctaca 423300
 gtatctgcag aacaaaactt gcccaatcaa aatgattttc ttcaagagcc attacaagta 423360

 acttctagat taatttgtct tatactcttc tttgcttcaa gggggaagac ttcttacttt 423420
 gtcaagaata atcataaagt ttttctgtgc gtgcgtgcgt gctactatta ttggagacaa 423480
 agtctcttaa tatagcccag gctggccttg aactcactct gtagcatata ctggtttaga 423540
 acttgtgate ctcttgctt aggagtgtg gaatgtgtc ctgtgctagc attctttag 423600
 catttatgct ttaataacc tctctatgtg agtctgcata cctacactta gaaccctag 423660
 tctcaaacac catgtttact caccagtatg taaagtact tctggctact caaagtata 423720
 atttagagge aagagtgatt gcacctata aatgaatact aatagtaaag attttgtgt 423780

 taagtaaac ttcatttgcc cagtgtggg ctagacattg aatgaatcta gctaggcaaa 423840
 tgctctgcca ctgagctaca tctgcaacce catcaaatga agctttaaat aaaatttgac 423900
 attttgttg ttattttgag ccagggtttg ctttgtagtc tagtgtggc ttgtgatctt 423960
 cctgtttcat tcttctaacc ctgggtaata ggtgcattcc atggtactgg gtttcaactg 424020
 atgtttagtt taactattga atggacaaag gaagattagt ttagtatctg ggttttttc 424080
 cccctgtac ataagtatag ctcaacagaa gccagtctca tttatgatgg gttgacttat 424140

tattttaatt caaagtactg aaaaaagcat agtttcagaa caagctcata aacctaatat 424200

ttttgttaga tctaaataat gtgtgttttag tatataaaat gttctaaagt attacaaaaa 424260

attttccta aactctcttt ggaggtgggtg gtggaagaca ggatctgtct gtgtagccct 424320

ggttggccta tcaaactctt tctctttctg atgtgaaagt gaaagtgtgt gtgtgtgtgt 424380

gtgtgtgtgt gtgtgtgtct gtctgtctgt ctgtctgtct gtatgcatgt gcacatacct 424440

gtgtctgttt ttttttttg ttttttttg aaacaaagtc ttatgcaaca gtattcaggt 424500

ggacttggag ttactatgt agttgaagag gatgaccttg aactcttgat cctcctgact 424560

ctaccaccta gtgcttggag caggttatag aaacataact actctgatgt tcagttaaca 424620

tgcattgatt tctgtgatgc acctgtgatg ttatgcacct atgatgttac tggagcttct 424680

aagaaccacg aggaagtatt gggatgcagc attgatgcg caagcactta gctaccactc 424740

ctgctagatt gttttctga ggcttctctt ggattctaat acctttttgt atcataggtt 424800

tctaccaaa ctgctcttgg tgttttattg ttaagttgtc acggccttca ttccttttgt 424860

gcttgtttct agtttttatt atttattat tgggttttt gagacagggt ttctctgtgg 424920

ctatctgga actagctctt gtagaccagg ctagtcttga actcacagag agctacctgc 424980

ctctagctcc cgagttggga ttgaaggcgt gcgccaccac tgcctggctt ctagttttta 425040

ttttataact gcttctaact cataatttc ctagaacttt gatactgctt tgatcttctg 425100

ggagcttgtc catcgTTTT tatacttctg cctgcctctg tagggcatga aaagtcttta 425160

gactggaagc atgattagcc ctgtacctag ctgttcagca tgcactgtga agtgtcagcc 425220

acattgcaga tctgacacca gattttcatg gtcagcaagg ctgtagtga actgggacac 425280

agtcttggaa aggcagtgtg taaatctaag tgttctgcta ttgaacttta ttctaatttt 425340

gggcagatta gtttactttt ctttgttgc tttcttttgg ttgttgttgt tttcaaaata 425400

gggtttcttt gtgtagctct ggctgacctg gaactcattc tgtagaccag getggcctct 425460

aactaagatt cagagatcag tctgtgcct cctgagtgtt gggattatag gcatgcatca 425520

ccactgccc actatcttct tcttgatgcc actaaaataa ggataatagt gcttactaca 425580

cggatttctt agaattaagt gaattaataa atgtaatgca cttaacatac tgcctggtac 425640

caactgagtc tagtaaaagt gacatatcag ggagtccagc acccaggaaa tttgaagtga 425700

acacagaatg tgttgacaat gctttctgtc tttctgtgtc taggtgacat cctcagttac 425760

ttgtagctca aatgcttctt tggttactac tgatcaggct tcttcggaaa ctgaaacaga 425820

acttatgacc tcagagacct ctgaggtaat gagaccttaa ttactttgct gtctcaaaga 425880

atggcagaat gagcttatga attactggca tgattggaat tatgatgttt gtatttgta 425940
atgcattatt ttctgtagat gtgtgatccc agaacataca caggtcacta ttttagcttt 426000
gccatgatg tagatthaat agtgcctatc ttacctgatg tagtaaatgt attttagaa 426060
ttatcatttt taagtttttt aaagatttat taatttttta tgcatgtata tatgtgcacc 426120
acatggtgct tggtagccga agaaggcgga aaaggacatt agatccctgt aactggagtt 426180
aaagatggtt gtgaactact gtgtaggtgc taggaatga accaaggttc tctgcaagaa 426240
caacagtgc tcttaactga taagccctct ctccagcctc cctattactt ttttttttt 426300

tttttttttt tttttttttt tttttttttt tnnnnnnnnn nnnnnnnnnn nnnnnnnnnn 426360
nnnnnnnnnn nnnnnnnnnn nnnnnnnnnn nnnnnncccc ctgcctctgc ctccaaggg 426420
ctgggattaa aggcatgcac caccaatgcc cagcctatta cttttttttt ttttaattta 426480
tttattactt tttttaaaaa attttattta tttattatgt atacagtgtt ctgcctgcat 426540
atgtgcaggc aggccagaag agggcaccag atttcataac ggatggttat gagccaccct 426600
gtggttgctg ggaattgaac tcaggtcctc tggaaagca gtcactgctc ttaacctctg 426660
aacatctct ccagccccct attttttgtt ttgatctct gtagctcagg ctgatcttga 426720

attcctgac catttcaagt gttgggatta caggaaagta tcactcagct tagttactac 426780
tttattaatt aattttaata agtagcatcc agggctgcag agatggttgg tttagtgatt 426840
aagaacatgt actgagggac gggctggaga gatggctcag cggttaagaa cactggctgc 426900
cctccacag gaccaggtt caattcttgt acccacatgg cagctcacag ctgtctgtag 426960
ctctagtcc agggtatctg acaccttcac cccaatgcac ataaaataaa gttaaattat 427020
taaaaaaaaa aaaagaacat gtagtgattt tggaaagaat ctgcatcttg attccctgca 427080
ctcacatcag gaagctcact actaccctg actgtagcca cagagaatct gaggcatttg 427140

gcttccatgg aacttatac tcacatgcac aaaaatagat atattcacac acatacatac 427200
ttaaaaaca agtagatctt taaaataaca aagaattaag tttcttattg aaattttaat 427260
ttaaaaaaga gaaaagcaaa aacagagaga gagagagaga gaaaagaga agctttaggt 427320
aggattagga ttagggaaaa tatattcatt taactgaaga tttgtttttt tatagtgtta 427380
ttagcactga gttagaatga gttacagtct cctgactca tcttatcaa agcattttaa 427440
caagccagaa gtggtgacaa ccccccccc catttaatcc cagcactcag gaggcagttg 427500
ggtctctgag tttagacca gcctggtcta ggaaggaggt tgaaggctgt caagggttac 427560

agagagaaac tccaagaaca aacaacaaa aaatgcagaa tcttgacagt atgaggtttg 427620
tgtgtgtagt tctaaatttc agctttgctg tttgagcaaa tccttgagct agatagacac 427680
agatgggata aattttgggg aaattcagta actgtaggt tagagttttg aggtgaacta 427740

ataaaggaga attcattata gactataaga aagcatagat agtttagttgt tatagtactc 427800
 atttggctcta aattaagata gataacttct ttatgacacg aaaaaaagtg acttttacta 427860
 agtgacctgt agtgatctcc tttataatct tgtagggatt gggttttatg tcataactaat 427920
 ttggctttat aggtaaagat tacttaaaatt atatgagttg tgtttttttt ttttgttttt 427980

 ttttttgttt tttttggcag aggacttagg aattcattaa tcttttaaat agagaactaa 428040
 cactaaggaa ctccccaagt ttttcttaaa ctccagctctt gcttatattc agagtaatat 428100
 tagattatta gtiggaaaat agcaattcag agctttagg gagcttgggtg gtggaggaag 428160
 ttgtgagccc cttgtgtgat acacactttg tcagcacctc atcaaaaagc aaatgctagt 428220
 gtgcatcctc agcagacgag atttaaaaat tgaagcaaa cgctgctctc tgcattcctg 428280
 tgttcccatg tcatcctaaa gaacttgctg acttgtgcca gcttggggct tagtgtaaat 428340
 taacctcctg tcatatgtat ggcaagtgtg gctgatgctg catttctcct ccacagatgg 428400

 ccgtttccac aagtaagcca gcatctgcac ttacttctcc aaatccccc ttgtcaaagg 428460
 gcttcagtt acctcctgca agtggaaatct cagcatccat tagcacagca ccctttcaag 428520
 ccttgagac agtgagtatg taagggtctac tgaatagccg tggctctctc cacactcatc 428580
 tttggcattg gatgaaaatt ttgccttcat gttgctctta tttgggttgc tgggttttac 428640
 atttgtccac tggaaaaaat gatgttgtga cagagtatta tatctacaac ctccagaatt 428700
 ttcaagaagt atttttttt cttttattga aaatagacgg gctggagagg tggttcagtg 428760
 gttaagagta ttcactgctc ttccaaaggt cctgagttca cttccagcat ccacatggca 428820

 gctcacaact gtctgacgcc ttcttctggt atgcagatgt acatgttaga caaagtatct 428880
 atatacatca aataaataat aaaataaaga aaataggctt tttcataca atatatattg 428940
 attatagttt ccctttcttt tcttttcctt gttcctctcc agctcccctc ctatccatat 429000
 cccctcctat ctttagaaaa caaacttgca tctaagaaat aataataaag taaaattaaa 429060
 taccataaaa aatcagaata tgaaaaaat caaacaagaa aaagaaccaa agaaaaagca 429120
 caagaatcac atatatatag atgcagcaac acacatgttt gaacacacag gaatcccata 429180
 aaatcccaa aactggaagc catagtatat gttcaaagga cctgtaaggt agaaaaaagg 429240

 ttttaacatg agacagagaa cctccaagga tgctgttgag tttgttttat gttggccatc 429300
 tactgtctggg catggggcct acccttaaga tttgttcaag gagatTTTTT ttatcagagc 429360
 cttgtttcct ctctgaaaaat taatagacaa agcttaggac ccatgtaaga atgtgtgtgg 429420
 ttgatccctt gtactcctc ctcaaaaag gaatatgtgg gtggtaaaca ttgttttgat 429480
 aacagctaat gttaatcgtc accagtctg tattactgag ggtcctagca tcagtaacct 429540
 gaacaaaaag gatacatata tatgttagtt ctcttattcc tgaaacattc ttttaatttt 429600

attttagtct ctttttgttt tatagaagtt ttggtttgtt caggtgtgag tgtgtgtgtg 429660

 tgtgtgtgtg tgtgtgttgg tgtgttnnnn nnnnnnnnnn nnnnnnnnnn nnnnnnnnnn 429720
 nnnnnnnnnn nnnnnnnnnn nnnnnnnnnn nnnnnnnnnn nnnnnnnnnn nnnnnnnnnn 429780
 nnnnnnnnnn nnnnnnnnnn nnnnnnnnnn nnnnnnnnnn nnnnnnnnnn nnnnnnnnnn 429840
 nnnnnnnnnn nncttagatt tgtataattt ttcaggggga gaaaaccttt caatatagca 429900
 gtacatgcct ttctgttgg tgtttcatct gggaccttgg ggatagtgtt agtgggtgag 429960
 cagtatagag caggcccaga ccagggtctc tgaactcagt agcatgtatt tatggacctt 430020
 cctattccgg ctgcacagtt tgagggtctt tttcttgcct ttcttcttcc ctgggcagcc 430080

 tcataatatt gtcgcacaaa tttagttttt cttttcccaa ttaaagcag acagtggttc 430140
 atcacatgat gaaatagaat cctttacctg aactgttgaa gtccctgcta acctgtcaga 430200
 ctactctact gggcttctct tgtgttgttt tgcagagtc cctctttgtt gatggttttc 430260
 ttcactctgt ctgcctcttt gaagctgcc tagttcaagc aggttctcat tcattttatt 430320
 tagcaggagg taaggcccta tctattttta aagatttatt tttgctattt ttaattatgt 430380
 gtatgtgtct gtgtatgggt atgtacatag gagtgcaggt gccttcagag gccacagcca 430440
 ttagatcctc ctgtactgta gcccttctca caagagcagt agcatctcct aaaagctgag 430500

 tcttctctca agctctttta aaagcacata tcaggttttt tgttttttgt tttgttttag 430560
 agacaggtct cactctgtga tctggatgtt ctggaactca ctatgtagac taggctgacc 430620
 ttgaactcac agagattcag cttagcactgt tttttgtttt tttttgtttt tttattagtt 430680
 caaattagga acaagcttgc ttcacatgtc aatcccttct cctctcctct ccccgtagcc 430740
 actgtttttt gtttgttttg agacgggttt ttatttttgt tttggagata agttctcact 430800
 atgtaatgct agctagcctg gaacttgcct ttagaccag actgtccttg aattcaaac 430860
 tatatgcctg cctctgcctc ttaaagtctg tgattgaagg tatactctat catgctagct 430920

 caggaattct tttattcac cagaggtaca gaaatgaaga acaaaacaaa ccactaaagc 430980
 tattctggaa gctggctttt taccatggaa gggagagaat tagagagatg agagacagtt 431040
 actcaatact caagtgtact gcacacaaaa atcgtcagag tagggaagcc aaaggagac 431100
 acgtgttagc tcatgacttg tgcttaggtg tctggaagac tcctgcatgg tggaaattta 431160
 acaactgctt tcttcttctg ggagattgaa ccaagggtct tgcatataca ctaggcagga 431220
 gttctgcctt tgaagttttt aaagcttttt aaaaatttat tcttgggctg gagagatggc 431280
 tcagaggtta agagcactaa ttgctcttcc ccgaggtcct gatttcaatt cccagcaacc 431340

acatggtggc tcacaacat ctgttatgag atctggtgcc ctcttctgat gtgcagatat 431400
 acatggaagc agaatgtgt atacataata aataaataaa atctttaaaa aattatctt 431460
 tgaaaaactt atacatttat atgatctgtt ctgatcataat ctatctacca ttacttcata 431520
 gccatttact actactccac ccccagcttc ctctaagacc cccatctttg tctatctcct 431580
 ttctaagtgc atggctattg tcagtaataa ccttgagtcc acttaagtgt acctgtatgt 431640
 gcatggatgt gagaccattc attgggaagc gagtcatgta ctaggggtca catccccaaa 431700
 gaatggtgac tgccccctcc tccgcagtca ttgactaccg tagttccctc tatcgagggt 431760

 gtctggggac ctttcttca tccatgctga aattaagact gggttgaact cgtgtaggtt 431820
 ttatgaaggt gaccatacct actgtgagtt gaagtgtgca accaccatgt tatgttcaaa 431880
 agtcatcatt tctcagctcc tgttctcacc taccagctct caaattctgt ctaccccatc 431940
 ttccaccatg ttctctgtgc cttggatgag gtgtggttgt taaaaatgat ttatctacat 432000
 ctaagtgtc acttatactc agctagtgtc tgcattgacc atcaccact gcaaaaagaa 432060
 gcttctctga tcagagttca aagcaacata aatctatggg tataaacaga aatattaga 432120
 aagctgcttg acagaataaa tataatcataa aacactaaca gtagctttcg accaggttta 432180

 cagtaccagg cgigaaacc tgtggtacag gcctcatatc cagtcagga gcagcatgtt 432240
 acttaataa ccattatgcc actatcgeat cagttgctc atttcaccag gttggtattg 432300
 tgacacgcag gatccattgc aaggtagac ttgatgcctt tttctctcc agtaactccc 432360
 atagcacctt ctggctctat gtaacaaga cagaaggcag agactttcct agacaggtga 432420
 attgctctat gtcctcacc caaatgagg ggtgtctgca gcaatagggt cctaccattt 432480
 aataggcaac caagagcaat ggcaataacc ggtgtttgtt tggagcctta ctgaccagga 432540
 actcagagcg aggtatccct tggtttgca cttatTTTTT ttttttttt ttttttttt 432600

 tttttgttctc tgtttaatta tttgagacag ggtttcactt tgtagccta getggcctgg 432660
 aacttaggcc tagctggctt tgaattcaga gatacacata tctctgcctc tcaagtctg 432720
 aggtcaaagg catgcaatac atgcctagcc tggttagttt tattgttacg ttgacgtgtc 432780
 tgttggggca ttgtcttgat tgctaactga tgaagaggg cccagccctg tgtgtgtgtg 432840
 tgtgtgtgtg tgtgtgtgtg tgtgtgtgtt ccttaggcag gcagctttaa gctgtataag 432900
 aaaactaggt tagcaagagc ctagaatgat cctgagaatg agacatcaag cagcattcct 432960
 ctgtggttctc taccatactt ccttgtctgt gattgagctc ctctgtgaga ggtggaatag 433020

 caagcatgga atagcaagga ggcctacttt caagtaactt ggaagtgtaa gccatataaa 433080
 tcctttataa ataaaacact ggtcagagtg ttttatcatg gcaacagaaa gcaaaccaga 433140
 acactcatta gattgtaatt cccagtgttt cccccctcc tgcacctcta ttctacttgt 433200

gtctctatga agttacttat tctagctaga aatgaaacta tttttcaaaa tttcctttat 433260
 tagcagggtc agagcaggca catactaca cacaagtgga ggtcagagga caatcttatg 433320
 gagttggttc tctccttcca gcttgtttca cttagcatag tgtttttgga taggcggtat 433380
 agatcatatt ttcacttttt ttatggctga aactatattg aagtttgtgt ctctgttttac 433440

 tcaggaataa tgttactaag gtcatatcat atttgctcaa gtctttgact tcttttgggt 433500
 ggatacctag acatgaaact ggtgggtttg tatttacctt tataagaagc cattatctgt 433560
 tttccacat gcttgtccca tttttacctt tcccaccagt aacgagggtc aagtttcttc 433620
 tccttgctta gtcttgtttt tcatattttg acagtcagtg gtggtcctag tggatctgaa 433680
 gtgctatctc atagtggttt tggtttgcatt tcccgatga ctaatgatga tcaggttttc 433740
 actgctttat tagttgtttg ttgccttaga atggtagagc tgtacaggtt ttattgaggc 433800
 atttcctctg agccataccc agtgggtttg tgtgctctct ctctctcttt tttaaaggtg 433860

 tttaatatta acgcacctct cctccactg aaagaacaag aaatgaaaga atccccttgt 433920
 tcgcctggct acaatcaaaa ttttacttca acaagtacac agacaataac ccaatgccaa 433980
 ctcccagcta tacacataga acagacagcc caacctecag agaccggtat ttaaaccag 434040
 cactcgggag gcagaggcag gtggatctct gtgagttcga gaccagcctg gtctacaaga 434100
 gctagtcca ggacagcctc caaaagccac agagaaacc tgtcttgaaa aaccaaata 434160
 ataataataa taataataa aataataa ataataataa taaatatata tttttaagtt 434220
 tatgaatgtt ttgcttgcaa gtcctgatac tttcagaagt cagaaaaggc atcagattcc 434280

 ctggagctgg agttaatgga tgatttgagc caacacatga atgctgaaa tggaaaccag 434340
 agcctctatg agagaaacta gtgctcgtaa ctgttcagct atctctccag tatcttgaac 434400
 tgttatttta aagatctgtt tttatttata tgtgtttgta taccacatgt ttatggagc 434460
 cagaagagag cattggatct ctttgggctg agattccagg cagttgtgag ctgcctgatg 434520
 taggtcctgg ggtcctctga aagaacagca agtgttgtta actgctgaag catctctct 434580
 gtcccctgat ttgaatttg aagagatgta acgtcagtg ctgctttaga tttgttggtt 434640
 ctatttttga atttggtac cctggctacc tgggtgtgagt tggcatcata tacttgttct 434700

 agttgtaact tagttcattt attgtagcac ctggaaggct cattcact gtgacatgtg 434760
 ccaggtttc ttcctcata acttgagtaa tattctgtt ctgatatgtg tttttaaagg 434820
 gagaaaatat aggttagggg tgtgcatgtt acatatatat caatatatat ttgatatat 434880
 gttgcagggt accatctga tggaaactgt caagtaagca atggcaacct tgcttttac 434940
 ccagcaccca cgagtatgtt tcccagacct gctcagccgg tagtcaggca tctgtgagag 435000
 gatgtacacg tggagggagg ttactaatga atccgtatcg gtctcctggt ggctacaag 435060

gtagtgtttg aatcgagtg actgagttat tgtatatact ttcctgcctc aaactggatt 435120

 caatittgac ttgttctgt catttccatt tataattgtc tattagtagg taatagagtg 435180
 ctttagaaaa ctttactta tgttttattt attactgttt ttcctgaata taagtgcagt 435240
 gcttgagat gccagaagat gttgtcagat ctctgtgtac tagtctcaga tagtttgggtg 435300
 ctgggtctg aacctggtc ttctgcaaga gcaaccgta ctcttaagca ttgagttatc 435360
 tctctggccc tccagtaict ctaatataac tgttttctgc aacagaccta acttgctgtc 435420
 tgcaaagcat attgaagaag gggggttgat cagcttgggt ttcaaggggg attttgattt 435480
 ttatatttga atgatatctt ttaactgattg atttaacttt tttttaaatt tttttttaa 435540

 gatTTTTatt tatttattat gtatacagtc tctgcctgc atgccagcag agggcaccag 435600
 atctcattca aggtggttgt gagccacat gtggttgcg ggaattgaac tcaggacctc 435660
 tggaagagca gtcagtctc ttaaccactg agccatctct ccagcccatg agccatctct 435720
 ccagcccgat ttaactttta aaatgtgaca taatcagaca aggctcattt tcaagttact 435780
 ttcaaagtat ctgacagata agaacaagag aatttgagtt cacataatgg attcttgaga 435840
 tttagttatg gtttcaagta ttgtgatgac agcttgatat tagcaaaagg acttgatact 435900
 gaggttttaa gtacctaatt atgttagcct cgtcctcacc caaacccaac ttgtatattt 435960

 taacagcatt ccaagtcac agaaaatgtt gggcatgggt gtacatgctt tttaaccca 436020
 tcacttggga gacagaggca ggtgaatttc tgagtttgag gccagcgtgg tctgccgagg 436080
 gaggttctgt acagccagg ctacacaggg aaactctct ctcaaaaaa acaaaataaa 436140
 taataaatt gccagcagaa gtatggtatt taaaaaatt atttattatg tatgtagtgt 436200
 tttgcctgca tgtttgcttg cacaccagaa caggacacca gatctcatta cagatggttg 436260
 tgagccatca tgtggttagt tactgggaat tgacctcagg acctctggga aaacagccag 436320
 tgctctaac ctctgagcca tctctccagc ccccggttta tggatatttg ctgtagaac 436380

 attttagtat attttagtt atagaagaca cagatctctt tcactctggc ccatggcccc 436440
 aacaagtggt gctaaaatg tagcctcctt acaccagtct ctgacaaaagc cagaagtgg 436500
 atgacaaaca atacaagaaa gcccgcgtgg gcaaagccct agagtctaat ccttttgag 436560
 gtgtttctca tgcaaagaga attgtgctgg aaaaattagg ggttgaagtc aaacagacaa 436620
 attctctac caggaagttt gtcagagtat ggcttatcaa aatgccaag actatcatag 436680
 catttggtt cattgatgtt tgcttgaact tcatcgagga aatgatcaa gttctggttg 436740
 ctggatttg tcaaaaagat catgctggct gggatagat ggcacatgcc cttaatcca 436800

gcacacagga tgcagaggca ggcagatctc tgtgagttca aggacagcct ggtctacaaa 436860
gcaaggacag acagggctac acagagaaac tcttgaaaaa caaaaacaaa caacaagaa 436920
aaatcaacca agcaaaaaaa aaaaaaaaaa aaaaaaaaaac ccaaacaaaa caatctcccc 436980
ccaaacaaaa cccttaaaaa gcaaaaacca aacaacaaca aagaacctgc caaataaaag 437040
ttattgcttt aggtattatt cttagagtct gctttaaggt tgtaaatgta gccagtgttt 437100
ctctattggc aagaagggaa ggccaaccaa gtccataaat tttgacagtg ggaacatagt 437160
aataaaatth catattctat aaaaacaaaa aagaagacat atatctaag atgacattgt 437220

aagatctgtc caactttttc cctttagttt aacttttaga gccagagttt agtgagcttc 437280
gtttccatt atttatgta tgctgtttgt ttatatatta ggttttgata gttatagagg 437340
acctcttca gcttccaatg ggaattacaa tcagctgcag ctgcaagcta gagaatatcc 437400
tggaacct tacactcaga gggtaagtag ttattgctac tgaactgtgg aacagtgtg 437460
gatgtcagac aggtaaacat tttccctatc atcaaggga gaaggaatth aaaagtgtga 437520
agtactgtac atgttccat aagctatth ctcttccact gtataggaaa aggtccagag 437580
ggtaaatth ttgtttgtag ttcacagcaa gtaaatggga taaaaattac attgcaaatg 437640

atthaaaaa aattgtgtca ctaaattacc ttcaagtth cttactttth atataata 437700
gtagagtth tctthataag thtaactgtt ttgtatattc tgatttgatg actcagcaaa 437760
ttttcttatt tttgtatct gacaaaactg atthagatat tccatthtag taagecttct 437820
aaactttctg tcatggtht atthgggth caccagtatt tttctttth thtaagatt 437880
ttattttth atthtgtata catcattctg ctccatgta tatctgcaca ccagaagaag 437940
gcaccaggtc tcataaggga tggttgtgag ccaccatgtg gttgctggaa attgaactca 438000
ggacctctgg aatagcacc agtgttctth acctctgagc catctctca gccccagtat 438060

ttttctthta aaactthatt thatttactt atthctgtgt tttgtatgtg tgtgtatgtg 438120
taccatggta caggtataga ggtcagagga taatthtagg aattgattat catgtgggtt 438180
ctaaagatth aactcaggtc actthggctt ggtgacagtg tcttatccat taagacttct 438240
tgatgacct agtctthaca thtgatthaa aaactgggtc atattgaata atthtatgtc 438300
tcttctgtct tgctthacta tgctctthta tattaagatg attgacagag gccatctatg 438360
cttctgaatt tccatcatta ctgagcaccg tgtthttthac atgggttthcc ctaaatgcca 438420
attaatctgt actthtggtg ccaagtthaa tttcatgta thcatthtag gataatthcc 438480

agcaatgtth taaaagatca gggacatctg gtggtctthca ggccaattcc aaaggttaagg 438540
gtaattacct gtatagatth gccc aaagca tgetthgatt tcaactgtatc ctctgtcaat 438600
ttctctthaa agcacattgc thtcagcatt tatccattga agthcatthtt gthtaactth 438660

aattctaaag tattgaatga ggcagtagac taccaagaag gatatgaaaa ctgtcaattt 438720
aattgtgtat gtttcttaaa aaatgttctt ttctttacat gagcacaatt taacctttga 438780
tacaatgcca catgctaact ttaggttgag tctgatggtt caaaaatgat gagttttttc 438840
tttttttag atttattcat tgtgtgtgtg tgtgtgtgtg tgtatgtgtg tgtgtgtgtg 438900

tgtgttgccct gcatgtatat ttgtacacca tgtgcatgct tggcgccttt gaagtccaa 438960
ataaggaate tgattccata gaactggggc tacagatggt tgtggacaac cacatgggtg 439020
ctgagaactg aatgatggct ccaaaaatta ttattggtat gatttatacc attgatatat 439080
ggagcaatga tagatttgaa taagcagcag ttaaacaca gggtagtgtg cttaatcata 439140
cttgtaaatg agaagagacc attaaatgat ttagtgaat tgaaaaagaa ttgcttaaaa 439200
aaaaagatta ctaaagagac atttttcttt ctttctttct ttcctttctt ctttctttct 439260
ttcttttttt tttttttttt tttttttttt tttttttgag acacggtttc actgtgtagc 439320

tctggctgtc ctgtaactcc cttttagat caggctggcc tcaactcaa agagatttgc 439380
ctgcttctgc ctcccagtg ctgacattac aggcgtgcac caccaccacc tggcaaagag 439440
acatttttca aagcaaagca gtcttctat tttgaggaaa tgatcatatt gagcagtttt 439500
tcatacagca caaaaaacat tattatttca ggctgggga gatggctgtg ttgggtaaaa 439560
tgcttaccat gcaagcatga agacctgagt tgagattcct agctttcatg taaaaagcta 439620
gattctgtgg cagtaaatat caacctagt ggtagtgggc aggtctctga ggcttgccag 439680
gacattctgt ctagttcttg gtgagctcca gggtcagtgg gagactctgc ctcaaaaat 439740

aaggtggaga gggactgagg aagctatctg atgtcaacct cttggcttcc tatacatgta 439800
caggggtacc tacacctaaa tgttcacaca cacacacaca cacacacaca cacacacaca 439860
cacacacaca cacacacag attttaaaat attataacat taacttgaa atgagaacca 439920
agcatttacc ttgggaacta gtcttctgt cagaacatct ctgaatggct tagttgttgg 439980
tagttctaaa agctgatgtc tcttttctaa tcttaaatga tcttgagctc ttttgtatta 440040
tctactttga gtagaagatt tgtcactgaa aaattaactg aatgagagtt atagaagaaa 440100
ggtaagtaaa aagtgcccca atctggtctt agtctttgtc attgagtttt ggtaaattac 440160

tcaatttggg gaggaaggca ccacatttc ttgacctta aaaaacagaa agcagtcaac 440220
tccagatttc ccaggacctt ctggtatata ttattgctt ttgttttggga atcttgtgtt 440280
ttcactagct gactaatgtt aaatgacctg tgaaaccttc cagtacacgt ctatccctg 440340
cctcagcaaa tgcgagtgc cttctcagct gccagaacat ccaatctggc tcttggaaact 440400
ttagaccaac ctattgtatt tgatcttctc ctgaacaatt tgggtgagac ctttgcattt 440460
cagcttggta gattcaattg cccagtgaat ggcacgatg tattcatttt ccacatgcta 440520

aagctggccg tgaatgtacc actgtatgic aatctcatga agaatgagga ggtcttgggtg 440580

tcagcctatg ccaatgatgg tgctccagac catgagacag ctagcaacca tgccattctc 440640
cagctcctcc agggagacca gatatggttg cgcttacaca ggggagcgat ttatggaagt 440700
agctggaaat aciccacatt ttccggctat cttctttatc aagattgaaa ttcagttcgg 440760
agtaaaagaa tgaagtctc actagtgaat ctaaggaaaa gtaatccttg ccctggtgat 440820
tgattgactg gttggggaaa atattttgtt cctagaggaa gaaagagatc cttacttttt 440880
tgttttctc tttatgtgaa aactttggag cagaatgaca attagcacta atctggcact 440940
ttataaattg tgatgtagcc ttgctagtta cacagtgaat atgtattgtt tgcacttaac 441000

cctcaactgt gttaatggtc cacttactga actgactgcc tcaacttcag acaagttaca 441060
atgccttgtt gtgcctcaat taaaaaaaa aatcttagac tgcacctcca gttgtttctg 441120
tttgcataaa tgtttgatta agagatgagc attaatcact ggtcgattca taagttcatg 441180
ggttatttta aaagaagacc ttacatgtac taggtctttc tgggggttcc ttttctctga 441240
tacatatcta tctcatttat taaaagatga atgtttttca ctggccaaac tgcacatttt 441300
ccttgtacct gtttttactt ccttgcataa gtgtctecct tcttttagtt acattttggt 441360
gtctgctttg tatattaaaa taaggcacag taagaaatat acatgtatgc tctgctctta 441420

gtaagatgct gggtttaatt tgcatagaca aagtgtgag taatcaaaaa gtttaagctt 441480
tgtgtgttta tatcctgtct ctgcaactcc taattaacct tgggctagca attttacctc 441540
taggattgag ctctcttttc ttcccttctt cctccttgt ttttaaagag tttcttcca 441600
tatataactg gatccatgta ataggatagt tgcaaaattc tactaaggac atatctaaac 441660
atgtaacaca ttgtcttagt tttctctcc cccccatt ctgaaaacta gggttttgtg 441720
gctatgtgtt cactgtctta aacagttcag cagccactgt acttttgca ttcattggag 441780
aattttctca tatttcttag cttaaactta aatttcttaa ttgtcactaa atatcttatt 441840

tgtcagttaa tataaggagt tatttcaga agtactttgt taacaatatt caggaatata 441900
tgaaggatta aagaaggaca tttttagcta tcaactgatg caactcatct gccaaggcag 441960
aaagttattt tgattcttga ctttcatgic cagaacacaa agcacataga gaaacactga 442020
taccattaaa tgactgaggg caggacagtg tcagaagca gctagtatc agtctctttc 442080
tcaagtctct gagtctttag cttagtcttt attattgcta cacaatcaat gcctttacaa 442140
tattgttggc aactctgtcc tctcatgtta agtctataa caatagattt gctaattagg 442200
ttgtcccgtg gctgtcttga atttctagcc tggcctggaa cttaaagaga gagatctgtc 442260

tatctttgcc tcccaaacac ttgaattaca ggggttcacc accatactg gctattctgc 442320
cttttaaac atactgtgtg tgtgtgtgtg tatgtgagag agagagagag agagagagag 442380
agagagagac agagagacag agagagagac agagacagag acaccgagag acagacgtgt 442440
attggagcgc caggtcagaa gagagctttg gataccctga aactgggtgt tacaggtgtt 442500
tgtgagccac tgtgttagtg ctgggaacta ctgagaatcc ctctaccatt cccccacca 442560
ccccTTTTT tttgagacag ggcatitgggg atttgatttg aactgaggtt ctcatgactg 442620
agcagcaagc actttacca ttgagccatc tctctagccc agatcaggga ctaaatgcct 442680

tctttagcca gaaactctga acattctttt ggcaaaggct gctcagggtc tctggttact 442740
catgatattt taacggctat tatcactgac attaatatag tactaaaatt cttaaattta 442800
caaactgtat gcatatitaa tcactagata ctgtgatgaa gagccctgcc aagataggct 442860
cttttagatg gaggcgctca agcataagct aaataacact aacagaagga tatgatatta 442920
cctgagtaaa caggaagtgc attgcaaaga acatccaaaa ctctagaaat gacaaagaca 442980
tctggctgct tgggcagtca cccaaaattc ctctgcaagg ttgaggcatt catctttggc 443040
ctacaggcct agagtatctg gcagactctt ctatgaagca ggcatititga aggactgtca 443100

tgccittgat tgacaaagt t cagcaatcac ttttttgtgt gtcctgaaga atgtctggca 443160
ggcttctata tgaagcagga attctgaagg gcagtcctac cttatcttgg caaagttaag 443220
caatcacttt ccigtgtatc ttgcaagtcc agtttatata gcatactgtc agcagttaag 443280
gcaaagctgt ttcttccaa atggctagcc ttgccacatt gagagaaaac tatatggagt 443340
tttttaaatg cccatcattt tttaaagatt ttatttattt attatgtata caacattctg 443400
cttccatgta tatctgcaca ccagaagagg gcaccagatc tcataacgga tagttgtgag 443460
ccgttaaagg ctaggctcac aacaaaaat ataaataaat atcccacagc ataaatggat 443520

gtaacacatc ttaaaactaa tattecacia caggctgcca cttaacattt agttttggtt 443580
ccattagtgg ttgaagagac atccgtaaat catgcattat ccaaatgctg tgaccattct 443640
gttggccag actctgcaat ggtgactctt ttgtgggagc agtttaggga tggggattat 443700
agacaactga gctatitca cagttcagga agacacagaa cctttgcta ccacactctg 443760
gtcactaagg aattcagata ggtaccaatt cactgtaat accttcctc ccatggataa 443820
gcctgtgaag gtctgtatc aaacagacc aacccatcat ggtaaagtgt gctcttatga 443880
ccatagggca tttggcaatg actgagtata agtttcttca tgccttgtaa aatgtacaaa 443940

tttgttttc aaaagagaga atatttattc tccatatatg gaaagcattt gcaatggaag 444000
tcaacaggca aatattggtg gacttctttt tactttaaga agagtctca gttgtcaatt 444060
caccaataat acaaagttag ggtatcatct agctcaatat tggctcgggt tgtgtgaacc 444120

aagaacttat tggcaattgc aaaagctgca atttgttcct gtgtccattg gaaattagcc 444180
gcttttctag taaccctaac tatgatgtgt gattcgtatc tgagttttgt ccttgggtga 444240
tgggattaaa ggcgtgtacc atcaccactt tgttcaactg actctagaat tcagaaaaca 444300
actaatttat agagatctgc ctgtctctgc tggaaatgat ggaatgggct accaccaacc 444360

tgctcaata ttttgcctg actccaaatc attcccactc ttagagattt agaaaacaac 444420
tttgaacttt agcaaccttt gaatttactt aaaacatfff aaatctctta actatgtttt 444480
caatactaaa caataaaaat atttaagaag aaaactcaaa agctgatgtc caagatgggtg 444540
tgggctactt gggcaatcta cagtctaaca ttttaacctg taattaggac acatggctta 444600
agaaaactca gttttcattt atatcagtaa ggttaagtatg tttttggtaa tttaccattc 444660
aaatftttat atfttttact tttatftttc atgcctgatc aaatftaaagg cattttgttag 444720
tctttataag ttagtttggga ctaaataacc aagttatctg atgaactatt gcctctcttt 444780

attgtggagg tctctcctgt tcaaatctaa tctttatcaa tcttgatggt acctatagct 444840
tttcttctcc catggaaaca aggcaaaacc tcccagcaac ataacatatac agatttggaa 444900
attctgagge ttctagtga tttctatta acagctgatc aatttcatca ttagtttgtg 444960
ctagagggcc tgatagacc atatgggatc tgatatgtgt tgtatacaat ggatgatttc 445020
tgtttctgat tacttgttgt agttgaataa aaagcgaagt taatfttgaa tcatctgtaa 445080
taagtccagt ggtttcaaca tgtaaaaaaa aaacacacaa aaaacaaacc cttccgcata 445140
ttgagaatca gtaactacat taagagattc aggaaaatcc aatcacacca taagagtggc 445200

atacagctct tattfttttg taactgaacc ataagggtctt tgagccactt tacttatttt 445260
ttctgacct gcctttcctt atftatttgc atccgtagag aatgttgggg ctccagaaat 445320
tgggtggcct tttactatat gaggaagaat ccaattagtt cttttataa actgaagtct 445380
cttgcftttg ggatatttgt tgcttatttc tccaaaatat tactgcaata tcccagtgtt 445440
cattttctgc ccacaatgag acaacttcag gattagtaaa agagatctca atfttctctg 445500
ggtttattec tctaattga taaagtatca ttttctctt cagaatcaat tcagacaact 445560
tctctacaca gatcttcaat ttttaactct tgtgtactaa aaggttccat tetaagatat 445620

tattftcttt ctgcattaga attcctgtgg gagaatgagt agaaggtaaa ataactaaaa 445680
cataatcaag ctctggatcc aagttatcca catgcatcct gtaatftcta ccaaagacaa 445740
ctctctttga ggctcagctc atatftttct tggactattt aaatccttac caccttctaa 445800
ggtttgaaat aaattagtaa gttctttagt tgtcaatcca gttgagtagt catagtcagt 445860
tactftccce cagcaatftt tgaaaaatcat taagagtttg taattggctg agtgttgggtg 445920
gcacatgcct ttaatcccag cactcgggag gcagaggcag gcggatctct gtgagttcga 445980

ggccagcctg gttccagag cgagtgccag gataggctcc aaagctacat agataaacc 446040

tgctttgaaa aacgaaaaaa aaaaagttag caattgatct ctctgatatt gtattttctg 446100

tgattgaatt ttctgttaac ctaattgaca gaatttctc tttgtatttt ttttcaggag 446160

ctatttgtaa tccccagcaa ggcaaaattc tctccatcaa acatttttcc cctaagtta 446220

ctacatctgt gtcagccagt aagatatcat ccatataatg gtaattttta gattgaggaa 446280

actggaatg agttatttct agttgctgtt gttcaaaata ttgacacaag gttgtgctgt 446340

ttaacattcc ttgtggaaga actttccact gataactttt tcccttttcc ttttctttcc 446400

tttcttttcc tttcttttcc tttcttttcc tttcttttcc tttcttttcc tttcttttcc 446460

tttcttttcc tttcttttcc tttcttttcc tttcttttcc tttcttttcc tttcttttcc 446520

gatacctttt aacagttgac attattataa gtaggaactg ggaaggcaaa gtttctgcta 446580

ccctgttctt gtaaaggtat agttaaaaaa aaaaagtagt cttttaaatc actgtaaatg 446640

actataactt aggtaataaa gaaggcaagg gaattccagg ctgtaaatgat cccattggct 446700

aaatcacctt atttatggtt cttaaatctg ttaacatcct ccattttcca gacttctttt 446760

tttaaaagat tttatttttt tatttattat gtatacaata ttctgtttcc atgtatatct 446820

gcacaccaga agagggcacc agatctcata atggatggtt gtgagccacc atgtggttgc 446880

tggaattga actcaggacc tctggaagag cagttggccc tcttaacctc tgagccatct 446940

ctctagcccc tccccagact tctttttatg acaaacgtag gagaattccc aggactggtc 447000

agttcttcaac tatgttgagc atttagctga ttctgtacca gctgttctag ttctgtaat 447060

ttttctgatg tcaatggccg tttttctacc catacaggtt tgtcagtcaa ctgttttaaa 447120

ggtcaggttg ttgtactttt tgaaagacca acagctgtta cgtcctcttt atgtacaacc 447180

tgaacagtct gtgactgttt gtgataatat cttttaaatt ttttctcaga agcgttcttc 447240

attttatatt gtttctgaga ttgaaggaat gttaaatatgt gtttttcatt getgtaacaa 447300

atcacgtccc tgtaaattca tagctatatt agccacatat ggttttagtt ttctatttg 447360

tccttctggc tctatacatt tgacacatct tgcagtttgt tttatctgag ataaagtcc 447420

agtccttaga agctgaatat ttacctcctg aagagtccaa tctggaggcc aagattttgg 447480

tgaaattatt gttccatctt cccctgtgac taccaaacct tttattttaa tgcatttat 447540

atatagtttt aactttggtc tctgatcatt tattgcagct tgccaaaata ctctcttct 447600

ggactcttct gatttttttt tttttttttt tttttttcca tttttaaga aatgacttgg 447660

aagtcaaaag atgagggigt ttggtgccct gaactagact tacaggtggt tgaaggctat 447720

catgtgggtg ttgggaactg tttgttcctc taacattata ccaacagcag ccacagtgga 447780
 aatttactca ggtaacagtc catgtcccca agccccctgg cagtgggtgg atacatttgc 447840
 atacttgcac acaggcctga gcagaaggag ggaagtgaac acctaagcc taaacttgag 447900
 gcagagagag agaacaccaa gggcacctta ggtcacccag cagggtctca acaggaagcc 447960
 tagtcatgag gcgggacagc caacccaag ggcactgtag gtcaccagc agggcctcaa 448020
 cagaagctgt tctgtccttt gttacattca gagcagtgtt gtatagcagg actttctttg 448080
 gagcaccagc tccaagtaa agacatggag atttctgatt aattatgaaa acttgacctt 448140

 agtttagggt tgttccaac tagttcttaa aattacatca acccctgttt atatttatat 448200
 gctactatct acgtagtacc acatggttca ttaccttcc tcagtacagt aggtacaact 448260
 ttctccacgt ctggctggag actacctcac ctctgagatt ccttcctaga gctttcatct 448320
 ctctctggaa gtctcctca tgcctcctg ccaaggtgtt tgcgtttctg ttctttatta 448380
 aaccaatcag aagggtgcctt atgctgatga gataaacag agatacatct tccaagtgtg 448440
 taaaaagatt atcccacaat ggtgttattt ttaacaacag acattaactc ttcaattact 448500
 ctgtggatga gtttctgact ggaaatgatt gaatcaaatt tgatatcagg gcctatatga 448560

 ggccccctgg gtcttttcc aatggcaaag ggttatctta cctgttcctc actgaactgc 448620
 actgattagt cctttgctag tctttgccac accttctgca tgcctcagaa ggcttggact 448680
 ttctctttgg attatctcta aaacaaaaat tgtttctagg aaggctttac ctacaatccc 448740
 ttttcaaatg accttgctta ccacaattaa aacatctgac attttgattt ttttagaaat 448800
 tacttctatc agagtatcat aaatgtgaga tgcaggatca gcttccaata ttgctgctgc 448860
 caaatcttta tagtcttcta gtcttttgit cttagttgcc catgaattta atttctactt 448920
 cctatagggt gaatgcatac aatgtgaaaa tgaccacttc cttaaatctc aaatctaata 448980

 tttctatgga ttccgtttaa ctctttttgg gggggggcaa ggtttctctg tgtagccttg 449040
 gttgtcctgg agctcactct gtagaccagg ttgtccggga actcattttt taactgcctc 449100
 tgctcctga gtgctaggaa taaagggtg caccaccacc acctggcacc atttaacttg 449160
 ataaccttgc aggtgcctat catctgctgg tagttcttgt atagtaacca gataaactaa 449220
 agttggtttc ctiggaacct tggctacatt ccaccatctc aaacctcaaa gttaatgtct 449280
 ctcccttcta ctgctgtgc atctctctat ccactctcag acttctctt actttctatg 449340
 gttttcttg tteacttct gtccactggt tgettgttc aactcttgac ctatggttga 449400

 ctttattgaa tctgtttat aataagcaga aagctcttgg cttaaggtg tatgttgagg 449460
 ctgaacaaca tcacaactag aaaatagggt tgttttggaa taatcttttt gtgcactgtg 449520
 aagctgtgcc actctgatgg ttaataaaaa agctgaatgg ctaatagcta ggcagggttt 449580

ccaggcacag agaacagtag gaagaagaag ggcagaaatg ccaggagaca cagaggaagc 449640
 agtatgggca atacagagta aagttcacca ggccacttaa aagaaagtag gttaaaagat 449700
 atgtgttaat ttaagttata agagctagtt acaagcaagc ctaagttatg gccaaagcttt 449760
 cataattaat aagtctctgt gtcacatta ttggggagcc gatgagcctg atgaaagagt 449820

 cttgactaca aatggtgcct aaattggggc ttgaacccta gaccctgaga ttaagagtct 449880
 tatgctctac cacctgagct agctggggtt aagatataaa agctagtggg acaagcctaa 449940
 gctataggcc aagctttcat aattaataat gttctgtgtc atttttttt ttttttggg 450000
 gagctgtag accaaagaaa aatccatcta cacagttttt ttttttctag taaataatgc 450060
 aatctttagg tttacagtgt gatcaaatat cctgccacac agaggaactg atgttttctt 450120
 ctggcttctc tgggcactgt gtgcacagac atacattcag gcaaaacatg tgaaataata 450180
 aaataattaa taaacagaat aaaatcacgc tccaaccagg gagagacagt ttcatatgag 450240

 gaattaaaa aaaaaagtc tactgcattt ggtccctata gggaccagtg ctgatcttta 450300
 cttgtcagtt ccaagagaag caaggctaga aagtgtgaga acagcttgaa tggatgaatgg 450360
 aaagaaagaa gtagcaaatg aagcgcgtc ttgccacaa aatctggaaa agaattaaga 450420
 atcagcagta cttaaagttt ttaagttttt ctttaaaat tttttctttt aaagatatta 450480
 tttatttatt atgtatacag gttctgctg gcaagtatcc cttgcaggac agaagagggg 450540
 accagatctc atcacagatg gttgtgagca tcatgtggtt gctgggaatt gaactcaggt 450600
 cctctggaag agcagtcagt actctaacc tctgaacat ctccagacga aagatgattt 450660

 ttgttttgtt ttgttttctt ttgtattgag atagtcctgg ctgtcctgga acttactttg 450720
 tagaccaggc tggcctcaaa ctcacaggca tcagcctgcc tctgcttctt gaattctggg 450780
 attaaaggcg tgcgccacca tcacctttt ttttttttt tagacagcat gtagctttgt 450840
 tgttcaggct ggtgatcctt tcacccagt ctctacca gctagacagg ttgttttaga 450900
 ctgaaattha gctagtaggg agaacaaggc tggacatcta ggaaaaaac ttacaaattg 450960
 ttagcaaaga acatgtaata aataccccag atttatatta tttttgtag gattttttt 451020
 tagatttgtt ttacacatct tagtgttttg tttgcatgta taactcattt cagcagccat 451080

 aacagcctaa cacgtgcttg cctgacctg ccttggtcac taggaggtca gatgcctgcc 451140
 tcatggcaag gaaccaatca gcagttagct ggtgttgcta tgctttacgg ctctgggtgt 451200
 gctttacaga caagtgcaca gcaatgatgt gcagagcata gcaattgctc tgggagggcc 451260
 tataggccat aacaaccagt tgaccaatca aactgggca agtcctcaa gcctggagge 451320
 acaccaatcc tgagcctgtg tgtacccta gacactcccc ttatgctgcc caataaagat 451380
 ctctggcttc ttgggttctt ttctagcca tccactaatg gggtaggtc gttactgca 451440

ataaaacctc ttgctgtttg catcaagttt ttgcctctgc ctagtgattg attggggctcc 451500

ccgaaggcct agactgagat cctggggacc tgagcctctg ggggtctttc attaccatgt 451560

acatgccttg ttctgaaga ggtcagaaga gggcattgga ttctctggaa cctgcgtcat 451620

tgatggttgt gagccaactt gtgggggctg agaatggact ctggnnnnnn nnnntcataa 451680

gcaaagtct cctaactctg gactcattcc cctccccccc ccatttattt aatgaaacat 451740

tatgcaaaat agagccatgg tctggagaat atgggagagg tcctgttcag gatgtaggga 451800

atgaggttca gaggtaggta cacagtgatg aatttgggga tgggtgaata ctgctgtcag 451860

gggctttgct cttttggta gggctctgta agatggagtg gggctacctgc taacattgtt 451920

gaggtccaga acaggcagag ctggttaaag acaagggaca ggattgatcg atggatgtga 451980

agaaaaagca gcaactgaaa caggtgttct ttctctcgga cacatcatgg tgtcgaatgaa 452040

cacagtagtt gaattgggag acaaaaaaac aaacaaaaaa acagaaaaga atgtgtagtc 452100

tgggaaaatt gctcaagagc taaggaataa gtgagttaga gaacaggtgt agcattgtta 452160

agggaaagac agaattggta gaaaggacta cattgaagtg aggctctgta ctggaatagc 452220

aagcagcatt tgaaaaactg aagccacaat ttctagacca gcctaggcta taaaaagaga 452280

tcttgtatca aaacacaggg aggagcgtct cttagagtta agatttcaca agtaaaggaa 452340

attggtggtg ggggcagaaa aggcacgatt tccaactgaa aatgcatttt ttataactt 452400

tgatggctgc atgcataaag gactgaaatg ggcaatgctg gaggcaacgc gtcacagcac 452460

acgttctgtc tcattttgta actttttttt tcaagacagg gtttctttgt ggagccttgg 452520

ctgttctgga actcactctg tagatcagga tgacctcaaa ctacagaca cccgctgcc 452580

tctgtctccc gatagctgga attaatggcg tgcgccaccg tggcctgttc tcccccttt 452640

cctttgtatc ttcttaaac ccagttaact gaaccaatat attgcatca tatgctcctg 452700

gcagaatcac aagccttcag cagcatttgc ccacatcacc tttacggtgt gtgtttagaa 452760

ccctcttttg ggttcaccag aggaaaattt tgctgatatt tctatgcatt gcagttgtgg 452820

aaaggcaagt tccttcttgc ctttcacgat gaaagtctgg acatttttgg cactcttaga 452880

catatagttt ttcttaccac tgtgctttta caccctaaga atatatacat atacttgatt 452940

gtctttctat taactatgag cttttctgta caaacttga ttgaatttca tcttgttata 453000

agatacctaa aaattatagt cttctgtttg gaaaacacat tttaaaaaca tgttccaaga 453060

gtgaatggca agataaaggg tggctctcat aactgaagg aatccccttc ttaggctac 453120

acgatttcaa ggttcagca agtttctctc gaaaaagctc aattgtttgt cccagaggtc 453180

ttgaacaaaa ggiaccactc cgtttagcta cgcctcattt gcagcaactg taagtagatg 453240
 ccnnnnnnnn nnnnnnnnnn nnnnnnnnnn nnnnnnnnnn nnnnnnnnnn nnnnnnnnnn 453300
 nnnnnnnnnn nnnnnnnnnn nnnnnnnnnn nnnnnnnnnn nnnnnnnnnn nnnnnnnnnn 453360
 nnnnnnnnnn nnnnnnnnnn nnnnnnnnnn nnnnnnnnnn nnnnnnnnnn nnnnnnnnnn 453420
 nnnnnnnnnn nnnnnnnnnn nnnnnnnnnn nnnnnnnnnn nnnnnnnnnn nnnnnnnnnn 453480
 nnnnnnnnnn nnnnnnnnnn nnnnnnnnnn nnnnnnnnnn nnnnnnnnnn nnnnnnnnnn 453540
 nnnnnnnnnn nnnnnnnnnn nnnnnnnnnn nnnnnnnnnn nnnnnnnnnn nnnnnnnnnn 453600

 nnnnnnnnnn nnnnnnnnnn nnnnnnnnnn nnnnnnnnnn nnnnnnnnnn nnnnnnnnnn 453660
 nnnnnnnnnn nnnnnnnnnn nnnnnnnnnn nnnnnnnnnn nnnnnnnnnn nnnnnnnnnn 453720
 nnnnnnnnnn nnnnnnnnnn nnnnnnnnnn nnnnnnnnnn nnnnnnnnnn nnnnnnnnnn 453780
 nnnnnnnnnn nnnnnnnnnn nnnnnnnnnn nnnnnnnnnn nnnnnnnnnn nnnnnnnnnn 453840
 nnnnnnnnnn nnnnnnnnnn nnnnnnnnnn nnnnnnnnnn nnnnnnnnnn nnnnnnnnnn 453900
 nnnnnnnnnn nnnnnnnnnn nnnnnnnnnn nnnnnnnnnn nnnnnnnnnn nnnnnnnnnn 453960
 nnnnnnnnnn nnnnnnnnnn nnnnnnnnnn nnnnnnnnnn nnnnnnnnnn nnnnnnnnnn 454020

 nnnnnnnnnn nnnnnnnnnn nnnnnnnnnn nnnnnnnnnn nnnnnnnnnn nnnnnnnnnn 454080
 nnnnncctt accctcactc tattctteta agcagtctcg acattgttcc agtgttactt 454140
 tcaatatttc ctatcttttt tttttttgtc cctactette tctctctctc tcctctctc 454200
 tttttttttt tatttttctt ttctgagaca gggctctcact atgcagttgt ggctagcctg 454260
 gaactcagaa atccgcctgc tgcctctgcc tttctgctc tagacttctg ggattaaaag 454320
 tgtgtgctgc caatctggtc caacatttga agattgtaat aatcataagc tctgcttctg 454380
 cacatgtaaa gagggaccag gggcccctta ctaaaagta cacattaat taaaatctcc 454440

 tcgcatggct tagcaattgt ttggaagttg ctacaagtgt gaaggattat tacttaatta 454500
 gtggatctta aggggttgcc aggaccagtc tctgctactc tgagaactat tgggcatggg 454560
 gattatgggg ctccatccct gatgtaaaga atctgaaaag ctcggagtgg gaacaagttt 454620
 gtaatttaac tgcttccca aggcgattct gtacctecta caatataagg gtgcttcttg 454680
 gccagtgtgt ctctcctggg tgagttttta aaagccgggtg ggttttgaat ctgaaagag 454740
 ataatactaa ccgaaaatat gtgtggagtt tgaggatatt gtgaatccc ggtcccacag 454800
 agataaagga gagttagac tcctgttacg gtctatttgg ctcttctgtg ggagtgttca 454860

 accaagaatt ctgaggccc tatttgattt ccagccctgc tcaagcctgt aatcctaaca 454920
 cacacaaagt tgtgttgaat gaaaggccaa aaaggatgct ttgatgttc agaaacaggc 454980
 tgtcacctca gtagaagaga cacttagagt cagtgcctgt cccagacttt gtagagtact 455040

atctggatta acagtcatta ggatttagtt agtaagaatg ccacagggt tggacttgca 455100
 acctgctggt gtgtacagtt tgacttccag tttgacactg ctctcaccac gttgcaagat 455160
 gtccctttga tagtgataat tgggaacaga actttgatgc catgttacac tttctgctca 455220
 tagtcaaacc ttgcttactt ctgatttggc atcatgtaag tgcagtttat atttgggaagc 455280

 agaaaaggct tggagcctgc agaaccagga gaggttcaat tccatgctct ctcatagtg 455340
 ttttaatcca aattctgctt ttactcttcc ctgctcccat ctattcatct caccagagac 455400
 cattttcttg gttacttacg ttttacagtg tgaggcccta ggctcatgcc tgacaccaca 455460
 aaaatcaatc caaagcaaca aggtaacatt gctgtgtcat tcattcagca ggtgcatctt 455520
 gttcagtgtt ttgattgta ttatgccttc aataagtttt tgtacttgaa gtagaaaaat 455580
 tagatatgat gttattttat cattaatgag gtgcatgttt ggtattgggt tttgcatgct 455640
 tgtcccttag caccctgtg ctatctgtc tggctgcatg aatgaaaaag catctactgt 455700

 gaggaattag agcttagagc tcttttacag tccccctcc aagggtctca ttagagccag 455760
 gctgtctcac cttactgtgt ctccaactct tgagtgtgc atcactgtgt atggttggtg 455820
 tgggtgctgac tctggagctt ggggttctgt gcatgctagg caaggtctct getaactgag 455880
 ctaccccc cactctttt ttttttttt ttttttttt ttttttttt tttttgttc 455940
 tttcgtattt tttctgttc tccccctc ctcttccctc ctccatctct ttgacatagt 456000
 gcttgccat ggagcctgct cctctgect cagcctctg tgtgctagaa ttatagatgt 456060
 atactgctg gctttttat ttctttggtg gtataggggt tttgctcatg ctaggccaac 456120

 agtttactct tattctcagc cttaaaacat ttactttcat taccaagttc tggaaattct 456180
 gctttttttt gatttttcaa gacagggttt ttctgtgtag ttttggagcc tgcctggca 456240
 ctgctctgt agatcaggt ggcttgaac tcacagaaat ccgctgctct ctgctccca 456300
 agtgctggga ttaaaggcgt gtgccacaa caccgggcta tgccttatgt tttttatctt 456360
 tttgtggtgg tgcttatgg ttgggccag tatcacacat gggaggcata caccaagcta 456420
 ctacatcctt agccatccat catcatcttt gctgttagga atgatgagtt atttgctgat 456480
 ttgtgttcta ggcattggtg tgaccacatg ttagttgggg gagacaggtt atgagttgtg 456540

 cagagagcag cctacaagtg tgttgaata aatagatggg attgtcattt tctaaggaga 456600
 cccggatgtt gaaacaagaa aggcaggtca ggttcagggc aggagcaaag agaacaagtc 456660
 caggaaggct tcatcccacc caccagctgg ggaactacag ggattggtgg gtcagagacc 456720
 aggaatctca agtcttgcca ttgtatgagt tttataaaa catagaattt aagtaagaaa 456780
 cacacagttt tattttcaga aagcttcaca gatacaaagc aatatatccc acgaagtcat 456840
 tgagaaatga gtcactttt tgttagacac ttgaagcca aagaggaaca acgatggggt 456900

attattgtga ggggagtggc ctggaaatgc atctgcattt gccctgaatg ttttagcttg 456960

ccaagttaac ataggccaaa tcaccaaaga agtcaaaagt ttcaacagtt ccttaaaatg 457020

gccaacagtt gcaaacacagg agttccgaaa tgtgtccaat ggcagcaaca gttttaataa 457080

gtagcattag tctaaagtga caggttattt tgtgtctata taagagtttt taagaactga 457140

agtcagtttt tatgattata ataaactgag gatgtttatt tttgatttac gagacctttc 457200

actattcaaa aagctataaa cctaaattat ttttataatg cgtatgttga agttgtagaa 457260

gactgagtta aatcaatatt aatattttcc ccataaaaac tgctattaag ctggacattg 457320

gtggcacatg ctcttaatcc caacaggagg cagaggtggg ctgatctctg tgagtttgag 457380

accagcctag tctacagagc aagtccagg acagctgagg ctgcacagag ataccctgtc 457440

atgaaaaata aaaacaaaac aaaacaaaac aaaaaacct aaacaaaca actgttgttc 457500

aacacacatt tttttttttt tttttttttt ttaagacttg tttttgtttt tgaaaccagg 457560

tctcactgtg tagctctggc tggctctgaa attgatatgt aatcatatt ggacttaag 457620

agatccacct gcctctgcct ctaagtgtc agattaaagg cctgtgctgc cataaccagc 457680

aaaaagattt attcttaatt atattcatat aattaataat tcatataatg cattttaatt 457740

tgtgtatfff tttttaaagt ctgtatgtat atgggtatat gcaggtgtct ttggaatcca 457800

gagtcactag aacctatgga attggaatta caggcacctg tgagcagctt gacttagtgc 457860

tgggaactga atttgcaccc tctggaagag ctgcagatgt tctctcctaa gccctgctt 457920

tgttttgttt tgttgttttt tttttttttt ttttggctgg ggtttcactg ttagctttg 457980

gagcctatcc ttgaactagt tagctcttgt agaccaggct ggtctcaaac tcacagagat 458040

ccgcctgcct ctgcctcctg agtgcctggga ttaaaatata taccaccaca cccagttgga 458100

gaagtctttt taaaagttt cctggggcct ggagagatag attagcaatt aagagctgtt 458160

gcaggatatt tgatcacact gtgaacactg agattgttaa ttaatgggaa aacctgtttc 458220

tagctgtggt gtggcttagc cctagcacac accttagtc caagagcttt ctgcttgaat 458280

aaaatcaacc ataggtcaag aggagcaagc aaccagttga caggaagtga atgtaggatt 458340

aagggaaaaa aaaaaaaaaac agtaagaggg agtcaggagg atagataggg agacgaacag 458400

gaagtagaag ggaggacct tcagtttaa gaattatfff gagatggtat aggagaaggg 458460

agagttttct gggatatcgg atgaggagga aggtcagttg ggtgctctct ctgagctagc 458520

aggctttcac ctcagtatct ggctcctgag tctttattgg tgaattgaa tttttgtta 458580

atatttccat tggatgctct tccagaggtc ctgagttcaa ttccagcac ccacatggtg 458640

gctcacaacc atctgtaact ccagttccag ggaatctgac tcctcttctg acttctgtgg 458700
agaccagaca cgcaagtggg gccaggcat acatgcaaac aaagcactct tacacatgag 458760
aatagattta aaaattgagt ggtttggcaa gatgacttag tgggtaaagg ttcttggcct 458820
tcctagcctg atgaccagag ctctcatctag aacacatata aagatggaag gagagagtag 458880
actccacaaa ttgtcttctg acctacacac acacacacac acacacacac acacacacac 458940
acacacacac acagacacac aagaatTTTT tttttttttt ttgaggaaaa attgagtggg 459000
ttactaactt agctgtgtct caaagggcta catggcccat atgggcttta gaagatgtca 459060

agctgaatgg accctacgca gtgttcaagg tctggtttct ctcttgaga atatcttggg 459120
acttctggta gtatcagtg gcaggtaag cggagctcca gggatgtgca gggctgtggg 459180
atatctgtgc aaatatggtc agggagaacg gggttctgtg ctgtttgtgc ccatggccag 459240
tctcaggaac agatcagagt aaacagccag tggatgaaat ggtccaggca tcaggetgaa 459300
caggaagtgg ttatcgtgga ctctcgagac atcgtgacat tgagaagaat gtgcctagcg 459360
acgcccgcc actgctgtcc atgctgtca gtcccactca ggaccagcct ctctctagca 459420
catggaatt tttggTTTT ttgggcattt ttgtttgtt tttatTTTT tgagacaggg 459480

tttctctatg tagctttgga gcctatcctg gcactcgctc tggagaccag gctggcctcg 459540
aactcacaga gattctctg cctctgcctt ccgagtgtg ggattaaagg tgtgtgccac 459600
cactgcccg ctaacacatg gactTTTT ttttaattt catctcttt ttacattgt 459660
tttgtgattt ttttttaaa gatcttattt atttagtata cagtgttctg cctgcacggc 459720
agaagagggc accagatctc attacagatg gttgtgagcc accatgtggg tgctgggaat 459780
tgaactcagg atctccgaa gagcagtcg ctgagccatc tctccagccc aacacatgga 459840
atTTTT aaaa acatattgta ttcgtTTTT gttgtcaaa aaaaaaaaaa ttcacatcaa 459900

gaaaattaaa gccagataa tctgggagga aacgtttgtc ctgagtaggt tatgttagtg 459960
gcttttctt ttctagtaac aaatacccga taaaagcaat ttaagagagg aagggttac 460020
tgagagtgta gtccaccatg gtggttaaag catggcatta ggagctttaa acagctggc 460080
accttgcagt ccacagtaag gaagcagaga cagctaaatg ctggtgtctg ctggcttgtt 460140
tcttttctt cagtggggga ccctggccca tgggctgatt cagcccatgt gtaatgagtg 460200
tcttctgta tcaattaact ccaactacaga tttcttcag aatgtctag aggcttgact 460260
gagagttgaa tglagatccc gtcactgtga caatcaatat tgactaccac agaggtcaaa 460320

taaaaggctg agatcataaa tccattagta gctcttagag ttgattaata aaaaatgaaa 460380
tatcccctct caaaggataa agggttttat aagacatttg tagaagaaat gaatgtcaa 460440
caaaaaggcc cttagtaac agaggaagta tcatttaaga tagtaataag attttgaagt 460500

ttcaaaagtc ctigtggtag gtgaactccc gtcagggct agagagctac ctactttgag 460560
 ctacaatfff ttttttttt ttggtttttt tttttgagac agggttttct gtatagcttt 460620
 ggagcctatc ctggcacttg ctctggagac caggctggcc tcaaaactcac agagatccgc 460680
 ctgcctctgc ctctgagtg ctgggattaa aggcccgcg agctactact ttgagcagag 460740

 cattttggga atatatgcca aacatcataa aagtactcat atttttatc attagttata 460800
 agaatttttt ccaacttaaaa gtattttcat aatcttcatt ttacctcagg atttctttaa 460860
 ttgtttatgg tttttctttc atttggacag taatgtattc tgtaatggtg tgtgtagcta 460920
 ttcagaatgc cctgttttta caaagcattt ctttgtaatt tcagtcctac aagattatta 460980
 attttgcccc cagcttgctt cggatcatag tctccgacca ggtggagttc ccagttcgtc 461040
 aggcaggtaa gtcgcctttt caagttaatg agagttctgc cttaaatcta aatagttata 461100
 atgcactgta ccagacctgt tcaacgaaaa atttaataat taaaaaaca cttgtacaag 461160

 atcatgacaa ttaaaattcc agcatagatc caggaatgac ccctaaagcc cgcacctat 461220
 gggcaagttt gatggcagtt gatggttgc ggaggagaga gtcactctcc tttggggata 461280
 tgtggttgc tcagtgaatg gccacacacc catgttcata gggcatcacc aatgtgactc 461340
 agggctacta acatagcaa cagaaaataa cgaggcaatg acaatgggaa gaagatgtca 461400
 tctcagtcac taggggagtt gaggaaggt aatggtggat ggatagacc agtattcatt 461460
 atccataate ggattttttt ccgtcaggga ccatccgctc ccctgtaacg acatggagcc 461520
 ttactactaa ttatgaaagc tcaactgata gcttaggctt gacttaaat aaccctatc 461580

 ttttaactcg tgttctttta tgtgcttgg ttacctttat gctgaactgc ctattatgct 461640
 tcctctctgc ctggctggtg actccacct tcttccagt gtcctccgtg cccggaaatc 461700
 ggtcattcac ctttttatta gaccaatcaa agtggcaca cttcacagtg tacaaaaaga 461760
 ttattccaca acatttcccc cttttgtcta aataaaaagg aaaggtttta actcttacac 461820
 agtaacacta talacaataa gaacaattat caggtaagaa ttacatttgt aatatctagt 461880
 gcatttgtat ttggcagatt cagagagagt actgtattaa ttatctaat gtatggaaca 461940
 ttcaagtaat aaaaaataat taaaaataa aaatcttttg aaaaatttgg aagaaacact 462000

 tctaagacat aaaaatattt tcttctggg cagtgggtggc gctgccttta gtcccagcac 462060
 ttgggaggca gaggcaggtg gatctctgtg agtttgaggc catcctggtc tacagagtga 462120
 gtttcaggac agccagagct atatagagaa accctgtctc gaaaaaacca aaaaaatfff 462180
 tttttctttt ctcttgaaa gttagcagta gatactgagt tctcacattt accctaggtg 462240
 attttttttt gttgttgtg ttattttaat ctctttgctg ccatccgtca gttccttggc 462300
 tctgtaacat tgctgtttta catttaatt tccaatfff agtaatttat gatcccttca 462360

tattacctta ggicacctat attaagactg cagatttatt tatctgaatt ctagcagcaa 462420

tagtgtcaag tcacatagag acttcttatt aattatgaaa gtgtggctga tagctcaggc 462480

ttgtttctaa ctagtctta taacttaatc tgtatcttta agtctatgtt tatttattta 462540

tttatttatt tatttattat gtatacaaaa tcttgcttcc atgtatatat gcacaccagg 462600

agagggcacc agatctcata acggatggtt gtgagccacc atgtggttcc tgggaattga 462660

actcaggacc tctggaagag cagacagtgc tcttaacctc tgagccatct ctccaacct 462720

ggtctatgtt tctttatgtg acttggttac ctttaatgcc atgtggcttg ctctgtgtcc 462780

ctggcctctt ttcacaacte ctcccttttt ctccaccaga tctctgtgtc ctggaaatcc 462840

tgccatagcta ttggctatcc agctttttat taaaccaata cgagtgcacac attttcacag 462900

tgcacagtaa gattattcca caacaattcc tcgaagtcgc cgtgtttgtg ctcagctga 462960

agacatatat atggtttcca ggtcatttct gtgtcattta ggatgtctcc cagcttggtg 463020

taatgtcctt gctttgactc ccacgagaca ctcttgagct ctctgcattt ccctttccca 463080

agttggccct ttgtacctct aagggttttc atccctgttg ggcgtggcat cccacatgga 463140

aggctgttca gtctttgtgc tccgtgtgat tgagttgacg tgatcttctt gattccagca 463200

tatctgttct tctcttaaac tcagctgcca tctacctgaa gaatatggtg acacagtact 463260

ggccagacag ggagcctcca ccaggagaag cgatatttcc atttaataatc catgagaatg 463320

accgacagca aattcgtgac agcattgtgg aggggataat tcgatctccg gatctggtga 463380

ggtagcccat gccctgtcta tgtgatttga ggaggcagct ggccttgact gggactgaca 463440

atgggtgta atcttcagct ttgtgtgtgt gtgtgtgtgt gtgtgtgtgt gtgtgnnnnn 463500

nnnnnnnnnn nnnnnnnnnn nnnnnnnnnn nnnnnnnnnn nnnnnnnnnn nnnnnnnnnn 463560

nnnnnnnnnn nnnnnnnnng tgtgtgagtg tgagtgtgtg agagagtgtg tgagtgtgtg 463620

tgtgtgagtg tggtgtgtgag tggtgtgtgt cgagtgtgtg agtgtgtgtg tggtgtgtg 463680

tgtgtgagtg tggtgtgtgag tggtgtgtgt cgagtgtgtg agtgtgtgtg tggtgtgtg 463740

tgtgtgagtg tggtgtgtgag tggtgtgtgt cgagtgtgtg agtgtgtgtg tggtgtgtg 463800

tgtgtgagtg tggtgtgtgag tggtgtgtgt cgagtgtgtg agtgtgtgtg tggtgtgtg 463860

tgtgtgtgtg tggtgtgtgag agtgtgtgtg tggtgtgtgt tggtgtgtgt tggtgtgtgt 463920

acttttttga ggcaggtctc ttgtatccca ggcctgtctc aagtgtactg tgtgaccag 463980

tgatggcctt gaacttctag tctccagtc ttcttctcaa gtgctgggat tacaggtgta 464040

taccactatg atagctgtgt gtagagttgg agcttaaac cattgtgggc aactttacca 464100

gctgagctat gtctccagcc caggaataa gtttctagct ccatgaattg gacagcatag 464160
ctgtggagtc aagcattttg cagtcttaa atagaaacaa atttacttca acatatgac 464220
tagtaatgaa gttttctttg caaatggagg ggaagcacia cagatgaaac agtgttggtg 464280
ggtgagatta ttaaccaga tattaagtgc agttatgatg aaaacaggag aagaaaggag 464340
atltgagga gacagcaaca ggaagaataa gcgttgaatt gctgtgtagt ttttttctt 464400
agctaggaga acacagggtg gctcaactgca gaacagcacc cttattctca ttggttgacc 464460
acatgctaac cgtgttcccg gagcctcgca gaacatagc atgttaatct gtgaagatgc 464520

ttgtccctga ccgcctcacc tcccagtggg tcttagcaac acgggagtag cttctcctgt 464580
cagtcttgcct ctggcctgg agtgagaaat ggaccatgag gcccatctca agatgaaac 464640
ttaaagatg aaatlttagc tatactttct gccagtgttg ttaaaggaa cagctgctgg 464700
cattgaagg ggttccctgt ttattctgag acagccctct gtggctttgg tctccccatg 464760
tcctaaataa agccgcctga agactcttct ttttattgcc tgattttgtc taaaagtatt 464820
gcagagaaac ttgatttggg tccataagga aggttcaata tgctgcttac cttttccag 464880
ttttgtgga tctaagttat tggatattca actgaacact agtttattgt ttattttttt 464940

acagtttga atcctgggac tgaggatgta gctcagttgg tacagcgctt ttctagcatg 465000
agagcttgtg ttcattccca gcaactgcata cagtgggtgc atgtagtgtg gcatagtgg 465060
tcttgtgtgg atctcaggac tccggatgta ggaccaggag gataagaagt ttaggatcat 465120
cttcagctac atattgcaact ggagatcagc ctgggatgca gtaaaccttc tcacaattaa 465180
acagcccacc aaaaactgca atttgggtcc tagttttgtc aggttaattt tctaagcaaa 465240
taaccttatg tagacatact tggtaatttg tagaaggagc atttttgttt ccctttattt 465300
tctttttaat cttaatcaca gcgagatccc actcgtgatt aagaagtgat gcctgcacca 465360

agtgttgtgg gataatatct tgcatctttc tgctaaagtg ggaggtacce ctctccttct 465420
gttttatctc ttgggttgc ttttttttt tttttttaac ttatttcttt gaccttgggt 465480
cctagatttc tcttttcag aaattcccta gcaaatccat atttgtttta ttcaaagtac 465540
aaaaattagt gtgtactttt actggtacag tatgccatac tgtctcttaa cgaatgagaa 465600
ctatgttttt ccatttgata gatgtgtgtg tatgtatata tgtatacctt acactttgag 465660
aggtgctcta ccagccctag ggctcactcc agccctaggc ttgccattt ggtagatata 465720
tgtgtctctg tctaaatgtg cttgtctgtc tgtctgtctg tctgtctgtc tgtctatcta 465780

tctatctate tatctatctc atgtatctat catctgtgtg tttatctcta tatatttatg 465840
tgtgtactgt tgtattattt atttatctat gagtgtgtat acataaccaa tgtctatttt 465900
attatccctt ctcttttgtg gtctgtctct gtgtctgtct ttgtggatgt gctgtagatc 465960

aaacctagga ccctgtacat gctgctcctt ctggatatga agaccagat ataaaataag 466020
 taacgatttt tatagagttg aggcagattt gctgaacacc tggaaatttt tttacagtct 466080
 ttttgaattt atttatttat tctttaaaaa aaataattta tgctttatga atactctgca 466140
 tgtatacctg catgccagaa gagggcatca gatctcatta caaatggttg tgagccacca 466200

 tgtggttgct ggaattgaa ctcaggacct ctggaagagc agcagctaat gcccttaacc 466260
 actgagctat cttccagcc ctggattta tttttaaat accttaggc tgggcggtgg 466320
 tggggcacac ctttaatccc aacattcagg aggcagatgc aggtgaatct ctgtgagttc 466380
 aaggccaact tgggtgatgg agcaagttcc aggacatcta gggctgctac acaaagaaaa 466440
 cctgtgttga acictgctc ccccccccc caaaaaaaaa aacacctta ggataagatg 466500
 aaggtatata ttgaggagt tccccattc tgtttatfff cagtagattg agtcactgag 466560
 gtttttaata tgatcacttt tcttcacacc cctcatgtat acagcttttt gctgcagagg 466620

 ttaacaatgt atacagtgg atcccatgtg attfacatcc ccttagatgc aactagatgg 466680
 acatcttagg ttataaaggt atactctggt attcacacat ttctcaatgt tatctgtgct 466740
 cagtgggtcc tgaactgtgg tgtaaaagga gttagagaac ttttaagaa tacccatagt 466800
 tcttttggg ataatactct taactgcttg catctgggca ttttttccc cccatgttac 466860
 agagtccagt taacaatgtg tctccgagtc atcatcaaac atgattttcc tggtcactgg 466920
 cctgcagtg tegacaagat agactattac ttgcagtcac caaacagtg gagctggctt 466980
 ggcagtttg tatgcttgta tcagctggtg aagacctatg agtaagttcg tttctactgg 467040

 cagaagagag ccagtgtcct gtggaatcag gcccatgag cctgagtgt gagattaca 467100
 cccaggtcgt ttcccttctt taagacgata gttcagatag ttttatggaa tttctattta 467160
 gtaaatgttt taggttgcca gcaccgannn nnnnnnnnnn nnnnnnnnnn nnnnnnnnnn 467220
 nnnnnnnnnn nnnnnnnnnn nnnnnnnnnn nnnnnnnnnn nncagcttt cattttacag 467280
 aatgaattaa tatgtgatg gagttaactt aaacttaga aaacttccta tataaatta 467340
 ctatagatgc ttggacctt ctttttttc ttccttttc tttctttctt cctcccctta 467400
 ttttttttc cctcccctc tcccctctc ccttctctc tcttctctc tttcttttt 467460

 gttgagaaa tatcttaag aactgggatt gcaggtcttc agttttggac tcttaacta 467520
 gtcccaacct ttaagaaa gtttctgtc tgeccaaacc aagactttat tctctcaaag 467580
 ttccttcaa cttattct tccaactgca tagaacattt aagctgcatt ttgcatgttt 467640
 ctggcttcac gtggttaac tttgcttcta tctcattgag aaggagagaa gccatcacct 467700
 tctttattct ctgtctcatg cagatataag aaagcagagg aaagagagcc tctcctgcca 467760
 gccatgcaga tatttctgcc tgaattcag cagcaaatcc tgcagttact tccgatgcc 467820

tcccattact ctgtgttgct acagaaacag attctgaaaa tcttctatgc tcttgtccag 467880

gtcagttcta cttcagaata caaccatggg gcctcatatt tgttgttcta ccctgtagaa 467940

atgtcattat ttagaatcac atatitttaa gatattttt tattttatgt gcattaatgt 468000

tttgcctcat gtatgtctgt ctgagggtgc cagatcccct ggaactgaag tcatagataa 468060

ttgtgagctg ctgtgtgggt gttgggaatt gagcctgggt cctctggaaa agcagccagt 468120

gctcttaacc actaagtcac ctcttcagcc cctagaatca tatgttttta ccttaggaga 468180

atcaggctca caaaagttaa ctcagtcagc catgagcact gggtatgcaa ggttcagttt 468240

gggtgtctgtg gctgttttct cagtctcaag tcccaactca tgaagagccc atgcgttggt 468300

tgagcttaga ttcaagggtc cctgtctgca ggtcggctgt gattggagga ggagaggaag 468360

gaaacacaga gtccttttct atgggaagtc acattgatgg ccttttctct tcttctgcca 468420

acttcaagcc aacacggatt tagtggctcc ccccggtttt tttggggggg gggctggggg 468480

gnnnnnnnnn nnnnnnnnnn catggtcagg gaagaatgat tttgtaacc agtgctgggc 468540

caagacttct tagagtccgg cccagatcac tttagccata ttttaagcatg gcatgatttt 468600

gaaaaaagta ctcagataaa tgactatgac aaagcttaag acatgtttac attgaagttc 468660

ttagcaaagt acatacagct tcatctgtaa gatggtttct tgtcttagaa acattgttca 468720

ggataagggc ctctaaggta aacttaatgc ctgtaggagt cagtattggc ctggccctga 468780

gataacacag acatcactta gtctgttgta aagtgcagggt gacatctctc acaaggagga 468840

gtctcatggc ctagaagtaa agctcaaggt tttaggggga aagtctggga taagcaagca 468900

caatattctg ggggatctgg gcagatcctg gccaacagg tagcaaagca ttaccaggtt 468960

gtaaaactaa tttccccag cgttccagga gaaacagcta aatatcttct ccctttggag 469020

aaatgagcta tatgtttaa tttccctggc tctgcagtg ctcatccgtg tgcacaaggc 469080

ctttttgctc tctatgtatt ttctgtgatt taagccgac cccttttctt atgtgaaact 469140

ataaaggata ctagtatggt agttaaaaa ataatgggaa gatagagttg gaatgtttct 469200

aaatttgaga atatttaaca ctgaatcctt gaaaaacctg agtaaatgct ttcagcctgg 469260

gaagaactgg ggtcagcctg aaagtgatgt cggattaaaa ctgttttggt tgctttctca 469320

acaattccct gtgacgtgag ggtggtttag ttgagctggg gtgacaggcg agttgggagt 469380

tgttcttggt ttattcaact tgggcgcctt tggactattt tagggttata ataaagtctc 469440

ctctcataag ctttttggtt ttatittttg agacaagggt tctctgtgta gccctggctg 469500

tcctggaact cgctctgtag gcctggctgg ctttgaattc acagagatcc gcctgcctct 469560

gcctcctgag tgctagtatt aaaagtgtgg ccacctcacc tggcctcata attgtttaat 469620
 aaagtcagtt gcaagcaggt tttgttttct tttttctttt ttttttttcc aggataaaaag 469680
 gaagtaagga gatctcacia gagcgaagaa agtagaatat cagggaataa catctttcca 469740
 cattttctga agtatttggg aagaaagctg caggcctttc ttgtagagtt agtattagag 469800
 atctcctcag taggcttact ttatgctgga cattgtaaca acaataatag cccatgtata 469860
 tggggctgga ctagcctttc ttcttgata aacagagccc aggtgctggt tggtaacatg 469920
 aaggctccgg gcatgaggtt tctgtggttt ctttatctac ttggctcact aacagggaaa 469980

aaaatatttt aaacataata aaaacaaaaa acccccaaac aaaagatgaa ctgctttgac 470040
 atctgacatc ttaaactgtt ttggcaatct gttatatata aatacagtaa tgtgctcctt 470100
 tggaggcata attgaaaaaa aaaaagcag agaagcaaaa ctgcaatgat ggagtaagaa 470160
 ttgcctgtct ggggcacaga aggtcctgat gagctgttcc taaatgtcta attcaatgag 470220
 attgattatg ttgtcttaag tagcatttgt ctgtgtagag gtacatatgc cgggagtcac 470280
 cacttttggc ctaaccctcct gcctgccctt cttctggacc ttagtttgag cccaaatgcc 470340
 tcctcccat atggcactga gaggaaagta tggccattct catttttttt tttttttttt 470400

tttttttttt tttttttttt ggagacagag tcccactgtg ttttttgcc ggggggacct 470460
 caaactcaca gcaggcttcc tgtctcagcc ttctgagtga tgggatttca tgtgtgagcc 470520
 accatgtctg gcttataggt gtgaatttag catccatage tgectgtctc tectecttca 470580
 atgtttgtcc ttctgtctt tgaacttggg atttcagct gaagtgtgag cttggtgaga 470640
 cagagtgatg tctctttag ggttatgcca ttagctcata gctaggaaca gtagagcaat 470700
 gggcatggag gcagctcctt gcagctcatg catggtatag cagggttgat ggaagcctgt 470760
 gtaatagtca tggtaggtac tgggccacac actagaggat aggaatcaga aagaatttca 470820

tgtgtgttca tgaggtgaag attttcatca gactgcttat aagtaatagt ttgatacacg 470880
 aagaggcaag ttgtaaaata acccaaatg tatggaataa atggaacatt attgatatta 470940
 aatctctctt tgtaaagta gacaatggaa acaattaatg acatatatat tctttaaatt 471000
 taaaagtctc atatataaaa gccaggtgta ggttgtacat gtctgtaagc ctcattgttt 471060
 cagagttagag gtgggaagat taagattgta aggctatctt tggctctata gcatatttga 471120
 agcctgcttg gcttacaag agacctgtt taaaaacaca tccaaccaat aaacctgaaa 471180
 aacagagagg ctggggagta gcccaggtgt tagagtctt acctaggtgt atgaaacca 471240

ggggtcagtc ccccgtaact agtaaaacta gtcgaggtgg tgactgtaat ttcagtatgc 471300
 aggaggtggg ggcagcaggg tcaggggtcn nnnnnnnnnn nnnnnnnnnn nnnnnnnngt 471360
 gtgttagcct aggatatgtg aggccttgtt tcctcacaca cccaagagt atggattttt 471420

taaagttaat ttgaggttga atcacgagtt gccgtttcct gctccaattt atctattttg 471480
 tgtattttca ccttgtgata taaagtgcg acttgtatgg acaggagggt gactgtgtat 471540
 tgttgctctg tttcctagta cgcgctgcct ctccagctgg tcaatcacca gaccatgacg 471600
 acgtggatgg agatctttcg gaccatcatt gacaggatgg tccctccggt atgtcagggc 471660

 tctgaggaaa tctgcaaat gttgactcac tgtccagtct gtcacctgga aaacaaaaca 471720
 ccactatcat agtaaccagt aaaaaagtgt aatacatgat tagtaacgtt tacagaaagt 471780
 cagatcagca agaataatgaa agcagtaact atgtttgact taagctgggtg aaacatttta 471840
 aaccttgcta catatctctc tagtcttttt ttcttggatg tgtatttaga attttacttc 471900
 tcaaaatagt acatgtagct gtaccttcat atttttcac caaaaatgaa acatgaatat 471960
 tattaatact ttctgggta taactttttt ttttaaatt agtttttatt ttacatttaa 472020
 attttttagt gagtgtgtat gtgtgtaggt ggtatatgt atgggagtac ccatggtgca 472080

 tgtatagagg tccgaggacc ctttgggttc tttctttcca ccatgtggat cttggggatc 472140
 aggctgaggt cattcaggtt ggtagtaggt acctttacct actgaacat cttgcctgcc 472200
 cttgactggt ttttttttt ttcaagatgg ggtttctctg tgtggcttgg gaccctatec 472260
 tggcactcgc tctggagacc aggctggcct caaactcaca gagatcctcc tgcctctgcc 472320
 tctgagtgc tgggattaaa ggcgtgcgcc accaacgccc ggctcgattg tttttatact 472380
 gtcgttttaa taggggtgctt cattgctaga ttttgggta gttttcatgt ttaagctatt 472440
 atctataaga atgtgattta gtgccttggg ggggtgaact ctgtggcaga gtggttgctt 472500

 ctgaaaaag tgttgggctt tcaacagacc ttgcaaagcc gaaacaatgc tcaagcatgt 472560
 actttagtaa accatggccg agagtgtttg ctgcaagtgc aactgattc taaactacct 472620
 gttttatagg taaaagtatc aaagtgtggc tgtggtagca acaatagtgc tacgtttcac 472680
 ctgtcaaatt aacctttgta ttttaaaaac ttgagttggc ctgaaatgc cactattctt 472740
 tttgtgtcca ttctttttat ttacttacct atttaggttg agcccaagga ctctcacatg 472800
 ctaatcatag tgacatatct tctccattgt tcatacatga aacaaattat ttcaagtttt 472860
 aatgtgtcca cagttcagtg atttttgcca acagtcttgt ttgtgttgac tacatcaaaa 472920

 ctcagaactt ttctatcct ctgaggttc tgtttctgcc tacttgcttc cttgaagat 472980
 aagtacaaa accgactcag caaggaaaga tttgcttaac ttactgaatt cttttttttt 473040
 ttttttatt aactaactta cttcttaatt agctacctgc aaagtagagt gtatattcac 473100
 atagcaagtc tcaactcgaa tagctatggc ttaatctata ccaaaattta tgccattttt 473160
 gtcaaccage ctaggaaaaa aaaatctgat ctggatgttt tteccgtctt aggagactct 473220
 tcaaatgat gaggatgacc gaccagagct ggtgtggtgg aagtgaaga agtgggctct 473280

gcacattgct gcccgctctt ttgagcggta ttactcctct tactgtgtta atggcgttac 473340

agttggatc ttggtattgg gtatactaga agtgagtggc tccctgatgt tctacagagt 473400

acgatttttg ttttgttttg tctttaaacg catagagagc agctgggctg ggcctaagtg 473460

acataacgt ctattctaag ctgtagggaa gtggagggag gaggtcatg gatcgaagt 473520

cattctcage tactcccaac agtgagttgg aggccagggt gagctatagg agaccctgtc 473580

tcatacaact gaaaaccaga ccaaaccaaa ccaaaaacac ccacaggtgg caaagcttta 473640

ccagctgttc aaagtaggct tgtgccact gcctagaaa tcataacaaa gtgggtaacc 473700

atctctgcct cttttctact ctgtgcaaaa aacatggaga actttttatt tttttccca 473760

ccagctatat acagaaagta tgtaaggtgg cgcacatgga tactcggctc cataagaaag 473820

tcaaatttaa ttttaaaagc ttttattgaa aaacatgtca ggcataatat ttttattcct 473880

cctaggagtt aattggttta gaaattagaa atttctgttc aaaatgttaa ctgtgctgca 473940

gacctatgaa ttctcctga ttcatattgt atcttgtgga gaaagagaac atgctagttt 474000

tctgggccag tggaagacat cttttaatat ctgtgtttaa actagcaagg atgctgtgct 474060

tttaaacctc acagtactta gatgtttctt tttcttgaat ttttaaggat ggaagcccg 474120

gaaatgtcac aaaagaatac ttcgaatttt ctgaattttt tttgaaaacc tatgcagtag 474180

gaaatccagca ggtaataaac ttaatgcttt taaaatagag ggatggttgt tattgagtgc 474240

tgcttctacc tgttgcttgc ttacatggia atctgtcgca cactcacaga tggggaaatg 474300

gcagctgtgg gaaatcgaca cagggcaacc agcttgagaa cccaggggcc tctatgacce 474360

ctagacttgt gaggacacct cagatgatgg tftagacctc tccgtgttct taccagtttc 474420

cagtttctct gagctttccc ttgtctattt gaagattat gcagtgtaa taatctatcc 474480

caacagcagt ctagcttaga tatcaatgaa gactctcagg taagaacatc cacaagtctt 474540

tggaggttgg agtateccagt ccacataagg aaaatgtgga actcaggaga ctgttgatgt 474600

taatatttaa aaactttaa aattgcaaag gacagtgaac tctgattggt ccatcaata 474660

ttgccaactg agccgtgata tgtttgctat ttatattttt aaaatgagag ttagtaatta 474720

gtaattagct gtgccagggc ctgtataggg aagctaggac tgcttaatca gacataatcc 474780

aaggcttcag tgatgcagaa ggtatttata ggcttttcat aaatcagtaa tttgaaatta 474840

agtacttaag taagatgtaa caatttctga aaagtacttt gatatggtac ccatgagata 474900

ctctgtaggg gaagttaata aataataagt gaaattatct gtccagatat tcagtgtct 474960

ctctgactct gttctgccgc tgttaaacct caagaagtgt cttaacattg atgcctcttg 475020

aaagtgtgtt tagaattttc tagtatcatt tacacatgca tgtgtatact tgtattaaaa 475080
 aacacatgct gtgtccatgt gtttttgcca gaaatgttac ccaagacata tactcttgat 475140
 attgaaaatt agtttctcgg ccagagatgt catctgctgc tgtcttcagt ctctcttatt 475200
 gctgtgggta ggaccagcct gcatcggctc agggatagag tggcatccaa tggggtcagc 475260
 ggactaatac ctcaacttga cttttctatc tgagggagta aaacttaact ctctggggct 475320
 ggcaaaaaag agaaacacac acacatgcac gcacgcacat acatacatac acagacacac 475380
 gtcttaaaca tgcaggatc tcacataggg tgctgatgaa tggcaagcct tcagcaggtc 475440

 agagaaactg aagaggagat gcagagtaga gtggacagac aaacagacac acaggacttt 475500
 tctaggccaa agtttcttca ttttatcatt cttactgttg tttgttctac tctattcctt 475560
 ttctgttctg tttttccacc ctgatgtttt cttctctct tgaagtcttc cttctagctt 475620
 ttcttttaca tctttctcgg tgttttctt ctctcgtgtt tttatttttc cctcttagag 475680
 cttatataca taccacagta gaatctttca agcaatgtaa aaggtacaat gtggttacat 475740
 actgtttttc aagtgagtga ttacagtaca agtaaaaaac agcatgtttt tttatatccc 475800
 ttacatgttt aaacaattta cgtaccacag gtgaaaaaac aagtcacccc aagaaactgc 475860

 atactttcat gtccaagcaa ctgtttatag attaacagag tgtactcaag caagggttc 475920
 ttctcagcca gttgtttttg ctggcaggct tcattttgtg gtttcaaaga aaggaccagt 475980
 tattttatta ttgtttcag aaggcaatct tataagaaac atcttaaagg aatcacaact 476040
 ctaaaacttt atatatgata aacagtcagt tctactttaa atccccaggg tgcacacca 476100
 cttaccagta gtttttatat caggaagctg agggcagaaa tgggtatagc aagaaaggta 476160
 catgagccag caatagccag gctgtctttg ttctttgttc ctgacctcaa cgagtcctc 476220
 gctcagctat taaaaataat gcctttaaat tgttttccgc caggcgttgg tggcgcacac 476280

 ctttaatccc agcactcggg aggcagagc aggcagatct ctgtgagttc gagaccagcc 476340
 tggtttaca gagctatttc caggacagcc tccaaacca cagagaaacc ctgtcttgaa 476400
 aaaacaaaa acaaaaaaac aaaacaaaac aaagaaaatg tttccaagg gtttttttt 476460
 tttttttta acctcaaagc cattaacaaa aacatcttag tttaacctta cgttatttt 476520
 aaagttttgt ttatcgatga tgcacactga aacctgtgaa cacatctccc aacattaaga 476580
 tttaaagaac ttgagttagc ctagtttctg ggacgcagtt gttttctta atcattaacc 476640
 taagccacag tciatacggc tcctcaagaa aaactagctg tgtgacattt ccatgttcta 476700

 attttctgtc cttgtagtc cctgctttat caggacagc ggcaaggaca gcacaatate 476760
 ttgtttttta cctgtattag ttttccact aagctaacct ttatcataat cccttactat 476820
 atttgttaa gacctcaat catcaaatc ttatttaaat taactattt attatatata 476880

atcattgctt caattaagca gtacagctta agaggaaacc atcttcataa taatacacag 476940
 gtaaaaatgc ccagtagaat gggatagtcc catgagataa tcccactaca ttaaggcag 477000
 tgaagatctc cccagaccca ttcaaaccat gccagatacc agagaaaaat ggcagtgga 477060
 agagacacag cagtagcaag agacattctg ggactgagtc tctcaggtcc tagcctaccc 477120

 aagattcacc catcagtgcc ttgcatgctg gtgggttgat cccctgaagt tagttgccac 477180
 ctgctgctcc tctgacttgg ccaccatact tgtttgaacc ccagtagtgt caggacagcc 477240
 ctgggcaata tcatcctctc agctgccact gcgagagttt ctaggtgta gctggacttc 477300
 agaccaatth tattaaccta gattttaggt aagttggata aaattcatat tctaatttat 477360
 aaatthtga tahtthtga aagatttagc aactcactth aagcttgaca caatgaagt 477420
 atggggacca agaatggga ggcatgtgc tgtctctaaa ggcccttgag tcagtcacag 477480
 ccactthtca aggtthtthc ttataaaca gaatgtaaat cagccataa gaaaagtcca 477540

 atthtgtctt atgttacaga ggtthtcttc ggctgacat tataaaatc acatthccta 477600
 caththtctc taggaactcc atactgtta agtathtctc thtctggagt thaththgt 477660
 gtgaaggta gthggggtc tagthtaatt atthcataga ataathgtt atthcagc 477720
 thaththata ataaththt thtctgatt aaggtctaa gthtggct gctggthct 477780
 thtgaactg thgtgctgtg thattatata gaaththtga aaththtatt thctcagth 477840
 gathctgtht ththattgaa ataggagaag thgtctgtc thgtcaaagt thththtth 477900
 thgaaggca athgacct ggcaactct ataaaggaaa gaththttht ggcaggtct 477960

 acagthcaga ggtthtctc aththctca thgcaggaag thgttgga thcagcaga 478020
 catagthctg gagaagthc thgagthctc athctggat thgtaggcag caggaagaga 478080
 thgtgacct ggcctgctc thgagctctg aaactcaga gccacccc actthctct 478140
 atctthtthc thcaacaag gccacacta thcaacaag gccacactc thththtgc 478200
 cacaccgtg agctggggg gggggaagg ggcatthtca thcaaccag cacaccg 478260
 atggactaga accatagact ththctgagt agcatatagg thagaagaac aathgctaa 478320
 aagthcaga gaththctc thgtcagth aaacacacag accatthaa agathaa 478380

 thgtctgcat gactthtctc agctctccc ccaathctg thgtgtagat thctctct 478440
 acagcttht atgctgctc thagactc ththctctc thththtga thththctat 478500
 gththctctc ccaathctc thththctc thgthtacta ththththt thgththt 478560
 cagacggaaa gaathatag cccctgtht ththcagca gaththctc thththct 478620
 agggthtgc cagctgtht ththggaagca gthgagcca cactacag thcagctth 478680
 thccgctct thccacctg thctgthtga thggththt thgthgagag cagththt 478740

tcctctctat gtcttctact gaatctctgt tcccactaa caatagttac taacaagtgc 478800

 tgtcttatga tgaagggtctt ccaactgttg aacatttgag aagagagaga ttgtgagttg 478860
 ggaggtctgg agtcaggtgt cagtcatttt atttagcctc agtgtctgtt ctgctaaggc 478920
 agatcatgat gttttcttga cccttgtgtg aaaacatttt gaaagctgcc agcagtactt 478980
 tacaaggga gtgttatfff gcagaggatg aagtctgatc gacgacgact tttcttttgt 479040
 ggataigtgc cagaaggcca gtctgcctcc ctgcctcctt cctccctct ctctccctct 479100
 ctgtctctct ctgtctctct ctctctcttt ctggattca gttcttttagc ataagtggaa 479160
 gttttgttta tttttttaa aaaactttat ttattatgta tacagttatc tgcattgatg 479220

 ctgacacacc aggtctcatt acagatgggt gtgagccacc atgtggttgc tgggaattga 479280
 actcgggtcc tctggaagag cagtcagttt aagtgtcttt aacctctgag ccatctctcc 479340
 agccccctg agttttgttt tattaanaac agctttatft ttattatftt ttaanaagt 479400
 ctatnaaac ttatcaatgg ctgttttta tgccaacttt tttgtttgtt gtttanaag 479460
 acagaattgt tattgtcat aatnaagag caaatcagaa tgganaatga tggaccaata 479520
 atgtacacat tttatftga cataaatatc tgggtaactt aaagacattt agaactgacc 479580
 ctccacttg aatnaactgt gagttcttgg cgtcaactt ttttttttt ttccttttga 479640

 gacaagacca ggtctgcttt gaactcagag agatctacct gttctgcca cctgagtgt 479700
 gggatgaact catgggccac caagccaggt ttataatatt ttttttttt ttggtctttt 479760
 gagacagtag cccagactga cattgaactt cctgtgtgtt gggcagatga cttgagcttc 479820
 tggctctctt gctctatct cctaaggtt gagactgcag gcatgcacct ctgcccctgc 479880
 ctgtctggtt tatgggtga tgaggattga actaaggtt tgggaacct catgcatgct 479940
 aggcaagtgc tccgtcaaac taagctacat tctagcccc ttgtctttaa atcctgtaag 480000
 ttggtatgtg acaagaaaa tcagttgctt tacctttcat ggtatctatg atagattta 480060

 ggtagtatta cttttttta aacagtgtct tgctgtatcg tttggccttg accctacca 480120
 tttttctct tccactttct gaatgctaga attatattta ctgccacct cagctttggt 480180
 tagcattatc tgaacacaag tcttacacat ataagacttt ctaaaaaata atttaacttt 480240
 attatgtgca ttgattagta tgagagtgtc agatcacctg gaacaggagt tgcagacagt 480300
 tgtgagctga tacgtaggtt ctgggaattg aaccaggtc ctctggaaga gcagccagtg 480360
 ttcttgaacc actgagccat ctctccagct ctgtgcatta gcttttaaat ttgtgaatta 480420
 tggattcttt ataactgttt tctactatg accaaaaagt ggtaatttct ttgcaattag 480480

taaagatfff gttttcattt tatttacttt gtacctgtaa atgtaaggct gacatgaaat 480540
 actaaatagc atctttccct ttggccttac ttttttattt aaattcttta attactactc 480600
 atttacatat ccatctcccc cattcccttg ccctcccata ctcccatggt cccccaccaac 480660
 cctcccacca gggaacttca aagtctgtca tatcatttgg gggagggcct aagccctcct 480720
 tgctgtatct gggtgcaat agtatccctc catagagaat gggctcccaa agtccatttg 480780
 tgctctaggg ttaaagactg gctctactgt tggaggctcc atagactgtc ttggcctcct 480840
 agctggcacc cacattcaga aggcttgggt tggccaatg ctgtttcccc agctttatga 480900

 ctagggtctc catgctctca ctaggtcagg tcaactgttt ctgagggttt ctgcagcacc 480960
 gtcttggctt ctttgcctat ctctctccc tctccacaat tgaatccag gagtatgatt 481020
 cagtgttag ctataggttc ctgtttctgc ttccaacagc tactggatga aggctctagg 481080
 aatggtaacc aaggtacata tcaatctcat aggggaaggg catcaatggc atctctcca 481140
 ccactgcctg gattcttagt tggggtcctc cctgtgtctc cctctatcaa ggcactcct 481200
 ttcttgcct cctctagctc tcccctgtct caggcctctt gatctctcc cttctcccc 481260
 ttctcccctt ccatctcct tcttcccc cccctcctc ccacttctt cagggtttt 481320

 tgtccccctc cccttcttg agggactatg caatctctc ttggggtcnn nnnnnnnnnn 481380
 nnnnnnnnnn nnnnnnnnnn nnnnnnnnnn nnnnnnnnnn nnnnnnnnnn nnnnnnnnnn 481440
 nnnnnnnnnn nnnnnnnnnn nnnnnnnnnn nnnnnnnnnn nnnnnnnnnn nnnnnnnnnn 481500
 nnnnnnnnnn nnnnnnnnnn nnnnnnnnnn nnnnnnnnnn nnnnnnnnnn nnnnnnnnnn 481560
 nnnnnnnnnn nnnnnnnnnn nnnnnnnnnn nnnnnnnnnn nnnnnnnnnn nnnnnnnnnn 481620
 nnnnnnnnnn nnnnnnnnnn nnnnnnnnnn nnnnnnnnnn nnnnnnnntc cttctccac 481680
 atctctcca ccatagactg tcaattgtgt tttgatttta gccgttctga taggagtaag 481740

 atggtatctc agagtgttt tgagetgcat tccctgatg gctaaggatg ttgagccact 481800
 ttctcaagtg tcttcagcc attttagatt cctcagtga gaattctcta tttagtctg 481860
 tactccactt ttaattgga ttatttgggg ttttgggtgc tatctcttg agttcattat 481920
 atatttgggt gatcagccgt ctgtcagatg tggggttgtt gaatatcttt tccattctg 481980
 tggactgggt ttttgtctg ctgactgttg tctttatttt tagttttttt atttttata 482040
 tatttgaatt acaacaaga ttgaattaca tgacaatccc agttccaag gtgaggtcag 482100
 gatgactcgg gatgggctct taagggcct tgagcacatg ggaggccct tctctctggc 482160

 ctccctgcct tgcgtcctg gtacgtctg gcttgcgttt ggctgatgtt tatctgaata 482220
 aagataactt aaacctacag gttcttgcct tattggtttt tctgttctg aacgtggtct 482280
 tattctgtca tattcccata cttcttcca gtgggtgcac gtgggtctc tccccctc 482340

agaaggcagg aggagggcag agggcggagg gttgataagg ttgagatgtg tttggactca 482400
 ggggtggcct tcctgtctgg gcaggtccac tcttgtccgg gggaggctca ggaagaatca 482460
 agcagggagt gatgggatag gttgggggcc ctttggcctt atttttacat agcttttgca 482520
 taaaaacttt caggaaaata ctgacattta ggccgaagtt caactaagtg ataagaaatg 482580

 gtccccccc ctttttttt taaagatttg ttttcatttt gcatgtatgg gtgttatgcc 482640
 gcatgcttgt ctgtgaactg tgtgcatgcc tggtgcccaa agaggccaga aagtctttgg 482700
 atgccttaga actggagtta gatggttaag agcttccatg tgggtgttgg gaatagaacc 482760
 caggctctct ggaatatcgc cgagccatcc ccttagcccc ggtcctattt ttatgcgaga 482820
 gttaccagaa cacacagggc ctgcttttagc ttagctgctg ttcagaggct gcttaggaaa 482880
 cttcctgtct gaaacacaca gctgtggagt agagtactgg tgttttgaat atggaagcag 482940
 agaagacaca aatattgttg atgttttgat gctttggacc aacatggaca catgaaatat 483000

 tttcaacatg agaactataa tagtaaataa aatcctggtg gcatttttct tcacaagata 483060
 tcacggtgtg tttaaagttg acctgtcagt gaagttctgt ctgttgttcc tgcctcact 483120
 tcaggagcgc tcaactctct gcttctagcc tccaactcct aagtgttcag tcagttcgag 483180
 tctcagctat tgcctctct ggatgtgaat gcaggctgag aaggttccact gtaactctgg 483240
 ggaaaactaa tatcgggagt cttgtcggga tggcctgtcc ccaactcttt tgtttgttc 483300
 tcaccttaga acatctctga agatgtgatt ttctctgtga tgtgttaca agataggat 483360
 gaagagctgt ggcaagaaga tccatagaa tacataagga tgaagtttgg taattgaatt 483420

 ttccctcage actttctgga tatataaata cgactaattt gctctgtctg gtgaactcag 483480
 aaattcagaa aagtctcatg ttattttgca ccaagggtct tgatgccctg ggggtccaga 483540
 gacacaagaa gccttatcca tctcttgcgg cagagctaag gcccttgcg aatggtttgg 483600
 gtccctgccc atgtcagaag cacctcaggc ttgatttgc tctccttcc ttgggccaag 483660
 cattccacca gggatagtat ttccctcacc aactaatagt tcttttttgg tggctttttc 483720
 cagacaggtt tcctctgtga aactgtcctg gttgtcctgg aacttgcttt gtagaccagg 483780
 ctggcctgga actcactgag atccacctgt ctctgcctcc tgagtgtctg gatcaaagtc 483840

 gtgcaccacc accatctggt ttaattctgg catctttacg ttataataca ataataaca 483900
 aaaccctttc gtgtttgtct tcagcttgtt tgetatagtg actatttaca aacttcatca 483960
 actggggctg gagagatggc tagcaattaa gagaactggc tgctctcca gagaatccag 484020
 atttgtttc cagcaccac aaggtggctc agataacctga gctatattgc ttttctttaa 484080
 tcttaccact tgaaggttg agcacatggt gtttgctaaa cattaaatca taaattagat 484140
 tgtgcatgaa aactctggga ccatgacatc tttattgtgt aatccactgg ccaggtttaa 484200

agtttgata ataaagagtt tttttttat taataagatt tttttgaca ttttagatat 484260

 ttttgaagat tatgcttctc ccaccactgc agcccaagcc cttttgtaca cagctgcgaa 484320
 gaagaggaaa gaggtacca gtggatggaa atgaaaagta gctaagtgtg ctttgacgtt 484380
 ctgatatgcc ctcaagtatt aacagttcat atcattacct atagcctatc actttaaata 484440
 ggtttttttt ttttttttt ttacaagtaa aaggtcgaag tatctttgac acctttctca 484500
 tcttgagctc atagttagtg aataaagcac agtaaaatgg ctttaatttt gaaaattaaa 484560
 tttgaaaatg tigtcatat ttaactgggt gttgacaaga tggagactgg tgcggactga 484620
 aatggattct tctgtttctt taggtgttgc caaaaatgat ggcgttctgt taccagatac 484680

 taacagacc gaactttgac cctaggaaga aagatggagc cctgcatgtg attggttctt 484740
 tggctgagat tttgttgaag gttaagactt atcaatctcc ttttttttc atatgttaga 484800
 gggatattgt gtagttagtg tgtgtagtg tgtgtgttca tgtgtatata cacacatggt 484860
 ttagaggcca gagtaagctg tctgtatgta tggctctcca ctattcattt ttgtattttt 484920
 actttatatg tatgatgggt atttgtctgc atgtgtctct gtgtactgtg tactgtgtac 484980
 tctgtgtaca gtgcatgctt ggtgcctgaa gaagcgaggg gaagatgtca gattcgtctg 485040
 aggttatgag gtaccaaag agtagtggga ctgaacctgg gtcctttgga agagtagcca 485100

 gtgctcttaa ctgctgagct atctctctag ctgctatgta tttgttctca ttagcttggga 485160
 acttaccaag tactagactg tggccattga gctttgggga tctgcctgtt gctgcctcc 485220
 ccatcacccc cacgcttggga tcacagatat gcaactgtac accattactc ctggccccgc 485280
 ttgggaatct cagctcaggg cctcatgctt gtgtggcgga catgtcgcca aatgagccgt 485340
 tttcccagct cagatgatca agacttgact ttaagctgtg aattggctca agccaaccaa 485400
 agcttgaaaa ttcttgggta ctaattctaa ttgattggct ttaatgtaa tatcctttcc 485460
 tttataacct acatacgttt tttaaaaata tacatttctt attttatgtt tgggttttaa 485520

 aagtatcttt attatctttt tttccaatgt aacattttta ttgattattt gggaatttca 485580
 cgtcatgtac cccaatcaca ctcacttccc agtctctcca agtctactcc ccacctttt 485640
 gacctctctc ccccaacag aagaaggaaa agctttcact actatatttt attcacttac 485700
 tttgagtgtg tgtgcatgtc cttttgcgtg tftgccccac cacacagga tggagtctcg 485760
 aggacaacct gtggggttgg gagtcaattc tctctgtct cctgtgcat cctggggatc 485820
 aaaatcaggt gattagcttg gtggcagcat ctttatttgc tgagccatct caccagctct 485880
 gtcacttact ttcttagcta aaaagaaaat ttacttttgc cagtttacca gtttgaact 485940

atagctctgt aagaaagatc tgaatgatt ttagtataat tccttctatc tacaaaaacc 486000
 aactaatata aaaattgttc taagatacta ttcttgagta agatactatt ttaacgatgt 486060
 gatgtgtgga tcaacaacac ttacaaaatt gggtatgaaa tgcaagtcac cataagcaca 486120
 ctttttggga agtggctctc ccatatgggtg gcatcattgg ccgctaaaaat tggctttctg 486180
 ttctttctta acagaagagt ttattcaagg accaaattga actctttcta cagaatcatg 486240
 tgtttccatt attattgtct aacctgggat atcttcgagc tagagtaagt tttccttacc 486300
 tctgttacgc atcttaagat ctcacctgia gggtagtttc tgaagtgaat gtgatgattt 486360

 ggtaaaaaac tttccatgtg tgacattgtc acagggtgct gtcataccat ggttgctcct 486420
 tgacactcac agaccgctct tctcccagtc actgtcccct gacactgtca cacagcactg 486480
 ccatcccagt cactgtcccc tgacactgtc acacagcact gccatcccag tcaactgtccc 486540
 ctgacactgt cacacagcac tgccatccca gtcactgtcc cctgacactg tcacacagca 486600
 ctgccatccc agtcactgtc ccctgacact gtcacacagc actgccatcc cacagtcacc 486660
 gtcccttgac actcacacag cactgtcatc ccagtcaccg tcccctgaca ctgtcacaca 486720
 gcactgtcat cacagtcacc gtccttgac actcacacag cactgtcatc ccagtcaccg 486780

 tcccctgaca ctgtcacaca gcactgccat cccagtcact gtcccctgac actgtcacac 486840
 atcactgtca tcagtcactg tcccctgaca ctgtcacaca gcactgtcat cagtcactac 486900
 atctcagtea ccgtcccctg acactgtcac acagcactgt catcccagtc accgtcccct 486960
 gacactgtca caccacactg acatcacagt cactgtcccc tgacactgtc acaccacact 487020
 gacatcacag tcaactgtccc ctgacactgt cacaccacac tgacatcaca gtcactgtcc 487080
 cctgacactg tcacaccaca ctgacatcac agtcactgtc ccctgacact gtcacaccac 487140
 actgacatca cagtcactgt cccctgacac gtcacacag cactgtcatc ccagtcaccg 487200

 tcccctgaca ctgtcacaca gcattgtcat cacagtcact gtecccatct ctcatgacag 487260
 tctgtctggg tgctgcatgc atttagttcc ctgaaatttc ataacgagct caacctcaga 487320
 aatgcagttg aattagcgaa gaaaagcctg attgaagacg aggagatgcc cgtcaaggtg 487380
 gaagctgccc tggcgtgca gtcactgatc tctaaccaga ctcaaggtga ttcccatggg 487440
 tcttactttt tttttcaat aaatggccta aaataatctc atccacttcc ttcttaaaag 487500
 gaggagattt ctagtcccaa gggcccagag tttagattcc ttgcctgctt ctgaattttg 487560
 taggcacttt ctttgcctat ttagcagctc tgttgtggtt tccagttaat aattgctggg 487620

 tactgagctg ggccttaaga cacctggacc agctttgggtg ctctctgact ggccacatga 487680
 agcaggaaaag gcatccagtt tctgtctga agcttataaaa gctgacgagg ctctgacct 487740
 gtcagccttc atttctctct gcctcagttc aaggagtaag attgggcagc accaagattc 487800

cactccaggg tctctgtggt tctaccagt t cagaaagtag tgagtggat ttccagtggg 487860
 cagtgcaca ggtgttttgt ttgtttgttc aagatccaaa cagcctctgc aagtaaattc 487920
 agctttacga gaacatgagc ttgtgtcctg tcttgttggg aagattggat gaggtgtaaa 487980
 catgtgctgg ggttgggttg ggtagagggt ggtagagggt ggtagagacg ggcaggacag 488040

 gggcaggggg gggcggccgt gggcaggagt tctcacactg gtcattggga cccacagtca 488100
 ggctgcagac acgttttgtt aattggaatt tctcagggtg aggatacaga gctgttggcc 488160
 tttgggtag gacagctctt cccacacctg atgctgtgtg gcctcaggag gtctttactc 488220
 aatacagctt tgggacttgc tcagcacagc acagcacagc agcatctaga accttatcta 488280
 ggagtgcagag tgtgtgagtt cccaactctt gctgtgtcat ttatctgcct gcattagcca 488340
 aggagcacat gagaccacat gtgaggccca tcatgcagga gctgctgcac attgtcaggg 488400
 agacggagaa tgatgatgtc accaacgtcg tccagaagat gatatgtgag tacagtccag 488460

 aggtgcctc catcgctgtc gacacaacc agcacttggg aagtgttga ggacttccac 488520
 tggggaggct gaacaagcct ctgttcactc caaatagggc actggtgaca gactaaagaa 488580
 atgatcctat tcaaatctag ctgtgtgaac cagtgcctt attggggtga ctcacaggag 488640
 agtgtcactc acaaggcaac tgcatccctg aaaagcctgt tcgtacatgg gcaactatga 488700
 aaactgcatc cctgaagcct cctgcgtaa cttttaggca actcactctc tccccagcac 488760
 ttgtgtctt tataatttgg agaggagcct tgtgaatctt aagaacttcc tgaattccct 488820
 ttgtgaacct tcttaagttt tgtttgcttc ctgagtctta taaaccttcc tcttccttc 488880

 cactctctt acgaagaaat atttgcaaag caacagtaag aatgacctaa gtgtgtacta 488940
 gttttgtaaa gaaccacat gccagctcac aactgtctgt aattccagtt ccagtggatc 489000
 tcatacttc ttctgacctc caggecatca gccatgtgtg tggatataag acatataatgc 489060
 aagcaaaaca cctacacaca tttaaaaaca aaacaaaaca aaaaaacagc cccaaggaat 489120
 ctaaataatg ccctcccc aataaattaa acttcagaat ttggaattga gttttattta 489180
 tttataaaca atcttaatat gaaagtattt gccttagtga ttaagatgtt cctgaggttg 489240
 ggttgattag ccttaaatca acccattca agacagtccc tttcacctgt aaaatcctga 489300

 aatgccataa taacactctt gatgtgagct accttaactc ttccttttgc acttgggaatt 489360
 ggaatttcaa tccccctctt tggaaaattt aaaagtattt tctattgttt atgtacatgg 489420
 tgttgtgtgt gtgatgcaga atgtggaggt tagaggaaaa ctctgtagag ttggttttct 489480
 ccttccactt ttatgtgtgt tctgaggatt gaactcctgt caccaacctg gtgtaacaag 489540
 tgccttttcc caaataacca tcttccaggt ccaggagaat gttttttgct gcctctttga 489600
 taaaaatggt cctattgtct tctccccctc tctgtacttc ttaatgcaga caatcagact 489660

ggaactgagt cccactctca tgccttttct cctctttttg tctgtgtctt tgtttaatct 489720

 ctgagtgatc tttgatttca tcttctaaat gttctgtcac atcttttctt ttagacatac 489780
 tggttttcag tgtttctaga tttcgatttc gtctaaagat aactagaagt taagtaata 489840
 ttagtccatg gttataatag ctactatgtg tctcatgtca gtgactaaa tgagtgcaga 489900
 gggatgttca tataagtgtt gacatgatct gtcattgcaa gaaaaaggc gattcagtca 489960
 ccaaagtgtt agaacttagt gtctgagaaa cattagcadc tgggtgtaca aactgcccc 490020
 tccacatgg tgcaatggta ccagccagtg agtgttctaa tgtcattttt acaggctgag 490080
 atatttgga aagtcttca aagtgatgag tatgaagaag tcgaagacaa aactgtcatg 490140

 gctatggaa tttacatac tatcgacacc atcttaacag ttgtggaaga tcacatgag 490200
 gtgggattcc ttgtgtttta ttatatggtt atattaaccg aaatttatat gaccagtgg 490260
 tatgaattct agtcttttta gtttgggggt gtgtatgtgc gctagccatg gcatgtgtgc 490320
 ggaagtcaga ggacagctct taggagtctg tttgcaaatg ttttttgcc ctttattttt 490380
 taaatttatg tatttgtgtt gtttatattg actgtatgtg cacatgtgtg ggggtgcat 490440
 tagagccag aagaggacat tggatttctt ggagttggag ttataggcag ttgtgggcca 490500
 cctgacctgg gtgctgggat acaaaccag gtctctgaa agagcagcaa gcaccctaa 490560

 ccaatgagct atctctccag cactgtgacc cgtgatctca cctccttacc tgtatcacca 490620
 tctcaagat ttggtattaa agatttatgt ttagttatat tggtaaattt taaaaattgt 490680
 tctcacttca gcatttatgc aggaagattt caagtccgtg gccagcctgg gctaggtagt 490740
 gaaatccttt ctccaaacac acagacaaat aaattgaatt tctctcaaac tttaaagtea 490800
 tgtgttaaga tgatcgagga ggggagtttc acatttatgt aaagtaatcg atataagcct 490860
 ttgtattgat ctgagtcagc gtctctgtat ctactgtgtg ccaggctggg tttctgtgac 490920
 ttccagatag aatagaataa gggacttggc ttctagaaac ccaccgtcta atcttagtgg 490980

 ggaagtgca gtaagaatgg agaggtaac aagaactga catcctaatc cttaggaac 491040
 accgagtgat agaattaact gtttgagaca ggggtgtcatg tcaccaggc tgacccaaa 491100
 ctactctgt agccttcaac tcttgatcct cctgtcctac ctttcccctt atgttgggac 491160
 aaaacaggta tatatcatca gatgcttttt atgcagtgtt ggggatgga acccaggtct 491220
 tttctgctgc caggcaatca ctccaactga gtcagtcaaa tcaaaggccc aggggtaaga 491280
 gtttgactt tctgttcagt gctcaccct tagctggcgg aagaatgccg ataggtaatg 491340
 gagtctcctt tgcagagaca gaaatgttta gggttattgt acctggtcac aataaccagt 491400

tataactagt tataacgtat aactagtttt aggtctagat ttgtcactgg gccactcttg 491460
 tcacacattg gcttttccaa cccacagtcc ccttgggttc tcctttccaa ggggaacatg 491520
 gcctttcctt agtgaagatt agcagtgtgt ttgttgcac tgtgaacaca ggctgcttgt 491580
 gttggcaatg acgtcagatc tgctcagtca gcgagggttt ggaagcaggt accagctctt 491640
 ttacagtgtg ctgttagcca tgtgactaca ggttcatccg tttgtaaggc aatcaaggga 491700
 tattgcagtg ttactctgag tagggcaaca ttactccact ggaccctcct gcgacttagg 491760
 gctttatgtg agcttcaact tccatattcg ttttattttt gtgtttccat gttgactctg 491820

gtcttcttgg taacagcgag tatagtccaa attaacttag aatagctata cttaagcta 491880
 actatacttc tttcaccttg tattttcaat ttcattgagac ctgagaaatc actaaattca 491940
 gtttcccaa gtatgggtat ggtgaggaga gcaactgca gggttatttt gaaacaatg 492000
 gcattttgcc ttttgcftaa tcttttttga tcttgatag aattgttttg aacttcaact 492060
 aatgttgagc attcagagtt aaccataatt atcaaaggag acatgagtta aagttgagac 492120
 aactaagaa aatcacatct ggcttctgt ctagagatga aaatgtaaaa ccttcagcac 492180
 aattagaggc aaacctgcct gagatctggc acacctggct gccatctggc ctctgggtca 492240

cctgttctta cttagctctt ttgaagctta taatatataa tcacaccatt tctctcttcc 492300
 ctctctccc tccaaacct cccacaaacc cccattttta ctcttttca catttatggc 492360
 ctctttcttc ctgtttacat aaatatatgt gtatttttagt tacagatgtg tgcgtgtgtc 492420
 tacatgtggg tatgtgcaca tgttcatgga tgcccctgga aggtgcattg tctaccagg 492480
 agctggagtt actacaggtg gttgtgcact gcttgacatc tgtgctgtga actgaactag 492540
 ttataacctg taactagtta caggctaga tcttgtcaca catgagattt tccaaccac 492600
 tcttaactgc tgagatatct ctctgcccc attcattaac ttgtaacttc actcagtga 492660

agtgaactct ggaagccata ctctttcag agaaaaacat accaatggtt acttagaaag 492720
 ggcaaaattg gaaatctgaa aataggtact caagcaggtt catttttacc tgatgtttta 492780
 aggatatcaa tagagtctag cttttggatc atttgaactt caaaataata gttaacatt 492840
 tatcaagtta tcaaacgtg cctacaaatg attatttcag ttaaataaga aatgtccaaa 492900
 ataaaattaa aattgcatat tagaatatgt tctaagggtg aattatactt tgacacgaaa 492960
 gtgtatctca ctactgactt taaattttat tcatttataa aacacctgat acaaaagcca 493020
 ggaatactgt tgiacaactt taattccagc acttgggagg cagaggcagg cagatctcta 493080

tgagttcaag gccagtctgg tctacagagt gaggttctagg aacagccaga gatgcatagt 493140
 gagacctgt ctggggcaa aaaagaacct gatacggcag ttagtctctg aagaaaaggc 493200
 aggaagggtg atctctgaat ttgaggctag cctggctctac tatagtagat ctctgtgta 493260

gatagtgagt tctaggctcag ccaggctata caatgagact gtctgcatgt attgaatatt 493320
gaataattga aatcatgaag atatacttaa ttaaactcac tgtttattgg gttcttcagt 493380
taaccagtt ctcttccag agtggtagtt ttcacaggt gtatttattt atttatttat 493440
ttatttattt atttatttat ttgtttttgc cacactagta aaaagtgagt gcacgtatat 493500

gtctttcatg aagatgatca tgaggatfff gctaaaattc cttccctggg ggaggagtgt 493560
gaaccacatc cacctccctc aatctaaggt ccctttgaca aaccagagtt tgtaccggg 493620
agaatcattt agtttattgg gcttacaatg catgttgac ttttacctg tgtataaaga 493680
tgtgtcattg tgactgggta atggccagta gctcggcagg aagaggttag gtggaacttc 493740
tggggacaga gaggactcta ggaagaagaa aggtggagat gccaggaaat gcagcataag 493800
caggatgtgc agggggagaa gtaacagcca tgaccacgt gtcagaacgt ggattaatgt 493860
aaatgggtta atttaagttt aaagaaatag aaacaacccc aagctatagg ccaaactttc 493920

atagttaata agaagtctct tgtgacttta ttggggagct ggcaagacag agaaaaaag 493980
acatgttaca atgtgggtg agcctcaagt agctgcactg ggatgtcttc acagcatgga 494040
tgtttgcttc ctcaaaaaca gaggtcctct gcagttacce ctecccctac ttcagcctat 494100
atactttagc ccctcccaa gtcccaaag ccatatgat ttagggcaga attgaatatt 494160
tatgactgga aggattctca agtttgggtc cagtgattct cgtcataccc tccttgtatg 494220
aggaatgtca gtagttgaca ggccttctcc tgatggactc ttgactcttg taggcagtea 494280
cggctgacct gatgacgatg gcataacaac attatactgt tgttttaact gacaaatfff 494340

acttaatgta tctgtgatt ctccgtatc agtcagtaag catatagttt taaaaatatt 494400
ctcttgtatg tatatcacat ttacagccag tctgcagtga gtagacaccg tcatttgggt 494460
gttacagtca cagatactgt tgcactgaat ggccttatcc atgtcctgta gctggagtga 494520
ggagtgtctg tgggtgaatt ccttggaggag atattgttgg ctgagattac attctggtgt 494580
gtaatccca gatgagagct cccgtcttc tacctcact tctgacacaa cctcagtgtc 494640
atatccagtc atgtgtgaca gtgaccatct ctttatgacc ctgagacact tttgtttgtt 494700
tgtttgttaa gtaggtttag ctgtttttct gtcagatfff tctgttagat ttcaagtata 494760

aggggaatff ggtgttgttt gtgataccac ttgacaatat tccagtcctat ttgcatctg 494820
tcttgatctg ttctgcctt gtacacaaag ttcttgatag ttttgcagtc aggtggtttc 494880
ttattttggt tggactttc tttacttctt tatggttaca tagggattct tttacttttt 494940
ctggtatfff tgtgttatag ttttattaca tagaaatcat tgatccatta gaaattcatt 495000
tagttagaa tatgaggtaa ggaagtatct aattctaatt ttccatggat ttaactcccc 495060
ttcctatcat tggctcctt tcagaatfff cttgtatfff tgcatatffa atttcacat 495120

gaagattaca gcttctcctc tcagaaatag ctgtagatat ttcactggga taatattaat 495180

 ttgtatgata accttagaat actcacagtg aattttagac tctataaaat ttgtctttag 495240
 atcatacage agttggagaa catctgtctg agaatcatcg atcttgtttt acagaagcgt 495300
 gtcattggta agttcagatc aaaggtaaac tgagatttct ttttccattt gatgaattca 495360
 aaagtacatt tttgtagctc tttaaactta gtgaggtaca cagttttgag agaggagagc 495420
 ttgctttcct taaatttgag gctcagcttt ctgatattag ctaggtatat tttcattcag 495480
 tggngaactc ttaatgtgtc cagagaagaa tttttggttt aaggaaattt aaagaatgga 495540
 gaatgtaata cctacatctc aagcagagct gggccgagag gtcagttggt ggagggcttg 495600

 cctggcaggc aggaagcctt gggatttgtt cccagcacca acatacactg acatggtgac 495660
 tgttgctga attctcagca cttctcaggt ggaggaagga agatcagaag gtgactttga 495720
 ggccagcctg ggctatttga gatccgagtg tggagcgctg gagaagaaaa agtggcagag 495780
 ggagagaggg agaaggaag agggggagga tggggagaag tagggagggg tgaagttat 495840
 ctgggacttg taaagtgcac aaaactagac aaatgtttta gtatgaatta gcagaaaagc 495900
 tttgagtttc caaggtatgt actagctgct ttcattgagaa aaggcagagc ttagaagtta 495960
 gatgtctttg ctcagagata agagctatgt gttttctggt gggatattta gatatggttt 496020

 cctccctccc cccctcctc ctctttcttt ctttctttct ttcatttttt tgagactccc 496080
 gagtgctggg attaaaagtg tgatccacca ccacctggca gatatggttt tcttttgact 496140
 gagagtatgt aatgtgtgta tgaatacaga acatttcttt gggcctcttt acttatagt 496200
 gtataaagta ttgtaaagta aactaaagaa tactgctcaa actataagct ctataacttg 496260
 aagaaaatgt tatatctttt atagtgtttg gtaaaactat aagtgagata gtaatacata 496320
 ttatctctgt atcattaagc tatctagaga tattactaat ggtttataca ttttgaatct 496380
 acatgataga agtatgctaa tatagtctc ctacacattt acaatataaa gttatagata 496440

 gaaattttat tttctgttat aaaatagaaa tttgattttt ttgtgtgtgt ttgtttgttt 496500
 ttttgagtcc ggatctcact atatagtgtc gactgtcctg gaactcactc tntagaccag 496560
 gctggcctcc agagatccac ctgcctctgc ctctgcctcc tgagtgtgta gattaaaggt 496620
 gtataccact atgcctggct gaaatttgat ttttttttc cctctacaag atttcacat 496680
 gctgccttgg cttttcctgg aacttgccac gtataccagg ctageccttga gcttagagat 496740
 ctgctcgctg ctgcctccag aatgctggaa ttaaaggcca gtgccctgc acatggccta 496800
 aaatagaaac ttaagtttt tttttcttc agtactatga gaagaccatt gccttgtgtt 496860

gttgagcaga gggttgatct tagttaagag ctgaaggcag cctctctggc tgatgccacc 496920
 gaggaaggtg ttcaggaat cccgtggcac atgggagga tgtgcttag tcctctatgt 496980
 gatcccttta atctttctgt tcctcacat tctaactaaa gtgtttttcc ttctagaatt 497040
 ctatgaagaa atcctttccc tggccttcat cttaacctgc catgccatct ccccgcagat 497100
 gtggcatctc ctgggcattt tatatgaaat ttccagcag gttttctctg agtacttcac 497160
 aggcattgca tgatcatact acagtttttc tttctttcta gacacctca gtactaatca 497220
 gatgttttaa tttactgtc caggaaatgg ggacagtgat tataccagtg tctcagccct 497280

 taggatagge aaaggaagt ttgtttgtct cttttcttat gttagtttgc aaccagagca 497340
 tntagccatt tgtaattga gtaaatattt tctgagcaca gccatgtcct aagcactgtt 497400
 cttagcccag caatccagca ggggacagct tcagcccttt gctagttttc atcctgggtg 497460
 ggggtgataa caaaggtgca ctaaagccag ccaatgagag ccttggcagt gtgtcaggca 497520
 ctaaaaccag ccaatgagag ccttggcagt gtgtcgggca ctaaagccag ccaatgagag 497580
 ccttggctgt gtgtcaggta caaaaccag ccaatgagag ccttggcagt gtgtcaggta 497640
 ctaaagctaa tcaatgagag ccttggctgt gtgtcaggta taaaaccag ccaatgagag 497700

 ccttggcagt gtgtcaggta ctaaagctaa tcaatgagag ccttggctgt gtgtcaggta 497760
 taaaaccag ccaatgagag ccttggcagt gtgtcaggta ctaaagctaa ccaatgagag 497820
 ccttggctgt gtgccaggta gtgctgagtg cagtgagaga gaggaaaggt cagaagtact 497880
 ctgataaaca gtgagcattt taaccttcca catctgcatt cccttagtc ataaatagag 497940
 tgggtatatg tagggagaca ctgtaaccac gcctcctaag ggctggctac agatgtgcct 498000
 gaccacgcct atcaaggcgt agtcaagatg aggtcagagt gaccacggca tgggctctta 498060
 agcaacctca agcacaatgga acagtttctt cccttcggc tgccccttct ccttggcctc 498120

 cctgccttgc tgcccctgag caccctctgg cttgcctttg gctggtattt atctgaataa 498180
 aggtatcttg aatctacaag catttccctt caggatatc gtgtcctttt tagtttttgg 498240
 ctgctaaggg agacagtatt tgagtcttag agaagtgtgg ttccaatggg aatcattcat 498300
 ttctgtcctt gttgcacgag tctcagttag attctggatc tttccaaga catgatgccc 498360
 ctctgcata attatgtgac agtagacacc aacgcgttgc tgtcaaatcc aaagcactta 498420
 gaagtcttgt tcaatgtgag caggaaggta agtgcacct gtcagttgtc atgtgattct 498480
 ccgtaatgtt tgggtgttta gtttatatta ctttatctga atagattat cagcttcatt 498540

 ttaaaagtga gtttgtgatt gttgtaattt taaagtttca cagtatgtgt tgtacttatg 498600
 tcaactcaat atctatgtac tttgaaattt tttaaaaaga tataattatt atgcatgcat 498660
 glatgtctgc agccagaag aggggaccag atctcattac agatggttgt gagccacat 498720

gtagtttctg ggaattgaac tcaggacctc tggagagca gccagtgtc tcaacctctg 498780
 agccatctct acagcccat acttactttg aaattttaag taaatacagc tatttgtctg 498840
 tatccatgga gacccttcca ggaccctat ggatatcaga ccccatgaat cctcctgtct 498900
 cataactaac aagtatggtc tttgcgata gccagcatac atctcacat gaaccaacc 498960

 cacttttata ataacatcca gtacaatata gtgttatata aatagttgtt aaaccgtgtg 499020
 ggtcagaggt agagacaaga aaaagaatct gcacacattt agtatagatc caagttttaa 499080
 gaaaacatct gacttatggt tgggtggaatc tgtggacaga gaacctgtgc atatggaggg 499140
 tcagctcgtc acttttcttt ccatTTTTTT tttcctttca aaaataaaaa cttaatggta 499200
 gctggagagg tggctcagtg gctaagagca ctcaggttca gttctcagct cccatatggt 499260
 ggctcacaac catctgactc caggccagg gaatttggat acccttttct gcctctgta 499320
 ggcaccagac atgtacttga tacacatata taaatggaag caagaccctt acacaaatac 499380

 aattaaag aaaatttaa aacataaact tgttataatt aaagtgtgg gaaaactaac 499440
 catacagttt gtcagtctgt gacagaatgg tatctgtctt tttactttta attgattgtg 499500
 tattggaagc tacctatgtg cctagatata ggtaatttta acataagcaa cataaaacia 499560
 tggtaagagt tacagaagca atacittgtt cagtatgtga tgatttatg ttgcatttat 499620
 gcagacatga tttccatta tgttatctta atcctctatt ggttatatct taagaatgtt 499680
 ttgatgacta ggicagtta cctacttcag gtaagtgtgt gtgtgtgtgt gtgtgtgtgt 499740
 gtgtgtgtgt gtatgtgtat gtgtgtttgt gtatgtcgta tgtgtgttcg tgtatgtgtg 499800

 tgtgtttgtg tttgtatgtg tgttttcgtg tgatattatg tgtgtgtgtg tgtgttttg 499860
 tgtgtgtgtg ctigtttgca tgcgtgtgag tgtttgagtg tttgtgtata tgtttgcgtg 499920
 tgtgtgtatg tgtgtgtct tgtatttgtg tgtttatgtg tatgtatctt tgtatatgtg 499980
 tttgtgtgtt tatatttgtg tttgtatgtg tttgtgtata tgtgtgtttg tgtgtatgtg 500040
 tttgtatgtg tatgtttgtg tatgtgtgtg tgtttgtatt tgtgtgtgtg tttgtgtgtg 500100
 tgtgtttgtg tatgtgtatg tgtgtatgtg tatgtgtgta tgtgtatgtg tgtatgtttg 500160
 tgtgtttgta tgtgtttgtg tgattgtgta tgtgtgtgtt tatgtgtgtt tgtatgtgtg 500220

 tgtttgggtg tttgtatgtg tgattgtata tgtatgtgtg tgtttatgtg tatgtgtttg 500280
 tatgtgtgtg agtgtattgc tcaaggagge cagaagaaag tgtcagatcc tctggagctg 500340
 gtgttacagg tagttatgag cccacagtg tgggtgctgg gaaacaaatt ctggcctct 500400
 gccagtgtc ttaactactg agacatctct ctggctcctt cccatccca atattctgtt 500460
 tgagacaggg tttcactgtg aagctctggc tggcctggaa ctcacttttt tttaccagge 500520
 tagtttagaa ctaacagaga tccagttgcc tctgcctctt atttctatgg ctgaaatga 500580

aggggtttcc ttctctggc attcatgctg agctaacttg tcactctagg tactgtatgg 500640

 agaggcagga gaggacgctg agtgcttcgc cgccaaactc ctggaagtca tcattcttca 500700
 gtgcaaagga aggggaattg atcaggtgat atacactaaa aaagcctctt cetggacact 500760
 tacataacaa atgtccatgc ctgattgata ttctacttat atttgatgga aaagtaaaaa 500820
 ggccagccata gtatgtgctt gctgtgtccaa atcctgtttg aatgatagga aaaaaaatga 500880
 ctcaaaaca ttcatggcaa tggtaacagt aacagaatac aaactgaagc atgtgcagtg 500940
 gagatcctat gtggcctgta aagtaaaaat catgtttgct agatcctgtt caaagaacct 501000
 ttgagcagag aaacaaccaa atcaaaggtc ttggctgctg agcgtgctac cagttttctg 501060

 cagaagagca aggaggctgt ggctgggtgga ggtgtgagaa aagcagtagg aaggaaggaa 501120
 caggttttat agcaggagat tgcgtaggaa gcatcagaaa acagaaggcg ttagaggaga 501180
 gagccgggaa agggcaagaa cctaggtttg cctgcggaac cttccctgag taaggagccc 501240
 attgggcagc agagtcatgt cacccacact tacagcctac aggtggttat agatgttcat 501300
 aaaagaaaa tttttctagg gtcaaatcta ggggaaaatg ggccaaacaa aagtcaactg 501360
 ttgtgtgact atttgagtg tgtctaggaa ggtataatca tattgttttc cgagttaaat 501420
 atggaatggt tttgctttgt aaaccccaga gccatataga tggctttgaa tgggctatth 501480

 agataatgca gtgacgtgtc ttgagataga gggaaatgta aaattgttgt ctgatgactt 501540
 tataatcatca tcaacttagg agagttgtat gaagtgggaa aaggtgacag cttcagtttg 501600
 gagggatgtg ctaagtagga agtatttga tcagtgcctt catctgcagt gaccctgtgt 501660
 gtcagtaaag agtcagtggt gtgatgcagt gagcttgttt tagacttggg ttccagagga 501720
 ttggaagctc agagctgagc actgtaggig atggaatggt agtgtggaca ccacatagca 501780
 ccctcaggtg tagcatgggc atgatgcttc tctgccttc ctgtcagcta gaggaatagg 501840
 gtttgccttt ttagtcaaga atacttcaga ggtccctgtg agttatttct gccaggaggg 501900

 ctggtagaaa tatgtcagtg ctattggtgg tgatcattta tttatttatt tatttattta 501960
 tttatttctt attgaataaa acatttctat gaatatattt tectaagtca tcagtattgc 502020
 tttaatthaa cagaaatgga taattgctat attaattthaa aaacttaagg atttcctthaa 502080
 ctcttggtgg ctttactatg acagthaaata tttgtthaaac tttagtthttg aaacatgtca 502140
 gaggthttttt atttatttat ttgtthttttt atthttttggg tgggtgctggt tcttgagaca 502200
 gaggthttctt gtgthaacct ggctgtcctha aaactthttc tgtagaccag gctggcctca 502260
 actcagagat ccacctgctt ctgcttctg agtgctgggga thaaaggcgt gthccaccac 502320

agatggctca aagttaatct ttccttgtga tttttactga ttcttaacta attattgcac 502380
 catggctggt gatttttttt tttttttttt ttttttgggg ggggggggtt ttgggggggg 502440
 gagttttgag gcagggtatc tctgtggctt tggaggctgt cctggaacta gctctttag 502500
 accaggctgg tcttgaactc agagatccgc ctgtgtctgc ctcccagatg ctgggattaa 502560
 aggcgtgagg caccaacacc cggcagctgg tatattttaa tgtaaatgat accagacatg 502620
 tatgatccaa tccagtccta tccaatccaa ggacactaaa tatctaaatg agaaataatg 502680
 cttgagttag cattgtagtc agaggacttg agaccacag ttgttttgtt ttctccagca 502740

 tttttgagct ctcatgtgta gcagtaggat tttgtttttc aagagacaaa tgggtcactt 502800
 catagtccta ttcattaatt tccagatgga tatcagttct gtctttgtca tttactttaa 502860
 acatggaagt ggctgagtga gcgaacacct tttcaatctc ctgctggctt cagcgtggac 502920
 ataaaagga atgagacttc ttagactacc actgtttgcc tacttagtct gttggtctct 502980
 ctgagtttga tgggaacata ggtctttaaa cgtctctac acacagttga aataagcaaa 503040
 cactttactg tcacaaagat gcatttatta aagatacagc cagcatcagc cttcaggaag 503100
 tctcttggct gcagtggtg ggtgactctt gcttctctcc catctccag tgtatcccgc 503160

 tgtttgttca actgtcttg gagagattga cccgtggggg caagaccagc gagctgcgca 503220
 caatgtgtct tcaggtggcg atcgcgctc tttactacaa ccctgagctg ctgctgcaca 503280
 ccctggagca ggtccagctg ccacacaacc caggacctgt cacctcgcag ttcataaacc 503340
 agtggatgaa tgacaccgat tacttcttgg ggtatgtgcc tttttggttt gatatggcat 503400
 cgatgtttca ggaagtttag tttttgtttt ttgctttttt ttttttgttt tgtttttgt 503460
 ttttttgctt ttttgtttt tcaggacagg gtttctctgt ggctttggag actgtcctgg 503520
 aactcgtct gtagagcagg ctggcctcaa actcacagag attcgcctgc ctctgcctcc 503580

 cgagtctgg aattaaaggt gtgcgctacc accacceggc tggaagtta gttttcatac 503640
 agtgatgtgt tgagagataa tctttatc ttggggacta tttctcgtgt atttttattt 503700
 ataaatttt gaagtgtatg tatgtgggca cagttgtatc atggcatgtg tatagaggaa 503760
 tgtctgagga cagctgtcag gagtcagttc tgttcttaaa cctttaccta ctgagccatc 503820
 actttaatcc agaaaattag gaatatgttt tgaagtatca cctgatggaa agatacattg 503880
 tatagtcat agtataat tagttgtttt taattttatt tgttttcaag acatattgca 503940
 tgtgcctagg ctggccttaa ataattgatc ctctgcctc taccttctaa gtacaaggtt 504000

 ttaggaatta tttttattca tgtgtatgtg tgtatgcatg tttgggtacc ctgaggggcc 504060
 agaagaagtc ttggctctcc cagagctggt gttgtagggt gttatgagcc actcgtgggt 504120
 actgggaatc aatctcaagt cctctagaag aactggtatt cttaacactg agtttctttt 504180

cccctagctt ttgtcttttt aatttttgaa gtattttaac aaaggaaata tttcatagaa 504240
aagtatgtga ccaatcattt ttcctttgta attaaaatct ccttattctg ttagcagagg 504300
ctgatggtag atgtgtgtag gcaaccaggt caatatgcta ggtgctgact tcttgaagta 504360
tttttggcac ctggggttgg tgtggatgga ccatactctgc caagaaagct tgaggaccag 504420

gccaagagag caagtctaca gaattatfff tcccagtgtg taggaatctt acgctgccaa 504480
gtagacattt cagctctaac aaacctcatt gtgttaacgt tcagatacag ctcttttatt 504540
aattgtaagt ggtgttattg caaaattcaa aatgctaatt gtagactcct gtaagccttg 504600
tcctctgtcc cgtaaccaag tcttatctta cagcccaggc tggccctgaa attgctctat 504660
agtccaggtt taccttgaat ttatagtacc cctgcctcag tgtcttcaga gatgtggttg 504720
tagggatgag acaccacacc tgacctcct cacaggtctt tgtgataaga gttggttgg 504780
tggttggttg gttggttgg tttgtagaatt tggtttacgc agggtttcac ttgctttagt 504840

ttttctagag cagtggttct caacctatgg gtctcgaccg ctttgactaa cctctgtctc 504900
caaaaataat ttccataatg attaacagtt aggaaaattg cataaaatag tttatgtctt 504960
ggagcacaat tgaagtgagg gaggatcaaa aatatgaaca aggagtcaag accatgatgg 505020
ggaaacccat agaatcagct gatccaagct agtgagaggt cactgactca ggtctgacaa 505080
atggggaacc tgcataagac caaactagac tcccttaata taggtggcaa tgggtgggct 505140
gggacaatat atgaggccac tgacagtggg tccaagatct aactctaag cacaaactga 505200
cttagtggag cccattctat atggagagat acctttcca gcctagacac agagggtg 505260

ggggtggaga ggggccttgg tctgcctca acgagatgat gggacagact tagtagactt 505320
gggagtagac taigggaggc ctcacctct ccatggagca gatgggagga ggggggagtg 505380
caaggtgtgc gaggaagga gggaggggga actggggttc tattgtaaaa attaaattaa 505440
tgaaaaaga gaaaaaata aactagtaat acaaaaaag aaaaagaaaa tagtttatgg 505500
ttgggggatc accacaacat gaaggagtgt attaaagggt cacagcatta ggaagagttt 505560
gtcctttgtg accacatctg catatttcc aacatctgca gacaccacga ccggaagagg 505620
tgtatcatag gactgagcat cctcttggaa ctgcagcacc gacctcctgc tgtggacgca 505680

gtggctgcac agatcctgcc ttccattctc ttctgttcc ttggcctgaa gcaggtctgt 505740
gctaccctgt aactggtaaa ccgcgagat cctcaaaag cagagaaagc cgacatggag 505800
gaaaatggtg aagcctgcta cttatgattc actctatagt ccattttgct ttttaaatc 505860
agtttatcat taatttgata ttataaaaat taattatta tttttgtgc atgagtgttt 505920
gccagcatgc atgtttgtg gccatatgtg tgctgttcc ctgtacagac cagaagaagg 505980
tgttcagtct cctagaacta gaattcagat tgttgtgaaa cccatggtt tggcttgaga 506040

accaaaccct ggcctctgc aagagcaacc atggctctta accactgagc tatctctcca 506100

 gccccagatt ttgctttaa aacttaaagt tatacttggt tgtgtgtgca tgtgtgtgga 506160
 agtcagagga caacttgag gagttgggtc tttgctatca catgggtcct ggggattgaa 506220
 ctgagatctt caggcttggg ggcaagtgcc taactcactg agccatctca ctggcctgtg 506280
 cttttttggt ttttgagaca ggtcttgcct tgtagctcag actagtttta aattcatgat 506340
 tccccctgat tcagtctcct gtgtcctggg accatgtgca tgcactatca tttctgacct 506400
 ggagtttgat ttgagcacac attttctta cattttagcc tgtttgatgt cattggagtt 506460
 tctgttcage ctagtctgc agcccttcag ttccaataa acacactgag gcttgtatta 506520

 attagaaact gtttgccaa tggctcgggc ttcttattgg atagctttct ctttaattatt 506580
 aatccatttc tagtaacta agtatttcca catggcttta tcttaccaga gaaagctccg 506640
 aacctgttac tecttctca accacatggc atctcccag ttgacctctc tetgccttac 506700
 ctttccaga attcctctgg tcttgaacc ccacctatac ttcctgcctg gctactggcc 506760
 agtcaagcaa taatataac agaaggaaat ctccccatc agtttggaaat cattaacag 506820
 actgactttc cttgacctgc gacacattta aactggggct gtgtcccttg atacaaaac 506880
 cctcagtgc ttctaagtg agctcagtcg atgtggtttt gccttgagaa gcataaatgt 506940

 aagagaatca gatggtctg actatgaatt agcaactta gacttaactt ttttgtttat 507000
 actaacaagc tcagtgcag tagctacat taactaaatg actccctaga ttaggtatac 507060
 actgtcagta caagattgtt acacagatgg atgtttttt aaagtgggtc ttgggttaatt 507120
 tgtctcaaa aagtacaatt tcaagatact taaggtttag acaaacttta tcaacaaact 507180
 aggattctgt ggigtgttca catttccaga ttatttcata atccttgttt ttcattcttt 507240
 tacacaatta atgggctcac agaggagatt tccagtgagg aggaggagga gacaagtgtt 507300
 actgctcaag ctatgcagtc acacaatggc agagttgaag aggaagaaga ggacgactgg 507360

 gatgaagaag tgctggagga gacagccctc gagggcttca gcacccact ggacctgac 507420
 aacagtgtgg atgagtacca gttttttaca caagctctac tgagtatgtc ttcacctccc 507480
 cccacctcca ttccccaac ctgaagattg ttttttaaca tttttaattt cttcctgtta 507540
 gaagtgttt tgggatctgc tcccatactg gtatagattc tctgagattt tgtcttttgc 507600
 ttttagaaaa tatccaaca tactttaa at gcaaaagggt agcatcatga cacactcaa 507660
 aagcaatcct agactcccat tgctgtagta gcagcatcag gatgggcttg ccagccatct 507720
 ttacagatgt catgttcagc acaagtgtca gaatggctgt tttctcttc acaaatgaga 507780

tgttagtggg tgaggagcag agaacacaga catttcaatt cctaatacat gcaccaatc 507840
 tccgaagagt catacgttgt gtccacgtac ccatggagag ccatgtgctg tttctccttg 507900
 aacttgttcc agtgattctc cagcctcaca ggtgtcaagc tctccctaag acctcatgta 507960
 acaactcagat gtttacaatc ctccatccca ctgaccacaca gttttctgcc acagccatt 508020
 ataatcacag ttgttaggaa aacagatggc catgaccaga gacgttacag ttctgacagg 508080
 gcaagggcaa gggcaaggac cgaggaatat atataatata tataatattct actagaaaca 508140
 caagaccaga cataactgaa aatactctag acacaaatgc agaaccaaga ctccaaagt 508200

 accgcttcgt atgctttgca ttgtaggatg taaaaccatc cccctctaac agaattgtgt 508260
 agtgccccc gagacagtca cagcctctcc tgattcaggg tctgctatt ttctggttgt 508320
 tccaaaaaa ataaggaacc agcaaatgat ttaacctctt aaaatattgt ttacacataa 508380
 aaagaatagg ataagatatg atttcccca ctttttaaaa acgtttctag agctgctaaa 508440
 aaaacttgaa ttacaaata gttgatagaa aatatccctc tgtattgcac aagatgggag 508500
 gcaggggcca atgacagaca tgacgggtgg ggctttttt ggcttctgt gcacttgggt 508560
 ggatgggctc ggctgacagc cttgcgaggt agccttgacag agtggtgctt gggctcctcc 508620

 accttggcca ctctcttga gctgacctc cacttgggtg tcatggtgga cccgggggtg 508680
 ggagacatac atgatgcaa ctcagccaca gagctgcact gcctgtccac cactgtacga 508740
 actcacaatg gccactttta caattgcggg taaagtggtc caggcatgca gtgctcaacc 508800
 actgtggctg tgagcctgtt aattattccc aagtccttat gggaagacac agaggacaag 508860
 acccaatgaa gggatgcttt tctacattga ctctactgac tttgtgcaga gagtaacact 508920
 tgtaagtat aggattcctt aaagccacat gtgttcaaag gccttgccaa atgagtaaga 508980
 gcagtagaca tgaacacaag agggagatgt ggatggaac cttagagata atgccactgc 509040

 aagggaatga agagtaacac tgagaaaact gggattcaga tgggttgggc tttctagtta 509100
 agaagctgca gtacccttga agctcagtga gtttggtata cacagttgaa caggggggtg 509160
 ggttattata gacaactgta aatgttgggt ggcaggagtt gggacgagcc aggatggaca 509220
 ttttctgcac aactgtcaa tatttgaca tggatccaag gaaagcttg cgtactctg 509280
 agcctcctcc agagaagctt tgctgctccc atggggctga ggctctggtg tccttgacat 509340
 agcgggtgctc atgtcaaca cacacattca actcattcac tcgttccta caataaaaa 509400
 tagagaataa gccagtgaaa tacttagaaa attattaacc tataacttgt acttaaaaa 509460

 acccttaact aatgtctgtt atttgcttta tggtaaata gtagttctgt gtgttatcat 509520
 ttatttctac tattagatgt ttaatattct caggcgcgcc tactactttt gccactagg 509580
 caatgccagc ataacacacc gccattattt agttctgaca caagtatagg agtgcttga 509640

aagccagctg tggagatagg gataggaagg tatgctccag gatggtcatc tgtagacaca 509700
gcatgcaccc tgaccaccac aggagctctt gggctctcaag tgcagcctga acatgcacaa 509760
cagtttagaa ggtcccctgc tggggttgca tggctgtctg ttgacaagcg tgggcaggag 509820
ttcctgggga ggatggcata gaactgaggg tgactgcctt gaataaaggc ttccttttgc 509880

ccagcacaga gtgggtgga tcttcaggat cccaagcaac gtgagattgt tagaccagg 509940
tgcacagtgt ggactctggt gggaagagtg ttaggtaga ggacgttaag agacaggcag 510000
agtttgatgt gggctgggca tggctacaga taggaagggt ttagagctgt gataaaaatg 510060
ggagagtga agcatttaga aagatgttga acttggtttc agtcttgta agtttgaagc 510120
atthagttgg aaaagtccag gaataaaggg gaaggatfff gcctaagggt gcagacttgg 510180
gccctcagt tagaaacaga gctggtacga agatactagg aagattccag gaggacggt 510240
acaggtgagc ccaggtgttt cccagtgtca ggcattctgg gatatatata tatatatata 510300

tatctgggaa aacttgcaga aaaagaagat agaaaggaca gaattagga aatcacacat 510360
ttgtaacggg gacattcctt gtggatctc tcggttgggt gaggggccc tcagaagtga 510420
ttgtctgttg ggatcgggat cagttttatt atcccgtgc ttaactaact cattgagatc 510480
tgatcgtgcc acttactttt cctgagataa taatggctgc tggctgtctc cctttcctt 510540
ctccaaacce ccccgaaacc ccatagctgt gcagaatcgg gatgccgct ggtatcagct 510600
gctggtgga ccaactcagt aggaccagaa gagaaagctt caggaggtgt acacagtggc 510660
agagcatcga cggacaatgg caggtcagtc ccccggtggc tgccatgtgc cacactaat 510720

taaaatggct gaagagcagc ccttcgtgaa aatgagcaat cccattgttt tgtttttaag 510780
acaggatctt gciatgttcc tgagctggcc tgagtgtgta atcctctat tttcatctgt 510840
gtgtctaga gttactagtc tgtgttactt ctctgggct tgtttttct ctcttttga 510900
gatgctggag ttgaaactca gagcttcgta catgctgggc aaataatgta ccagtgagct 510960
atgatcctag tcctccacc tcccagctt tctctctctg tctctgtctc cgtcgagatt 511020
gggttttact tttagcctg gaactcattg catagtcaa gctaactca aactcactat 511080
ctctctgct caacctcat taaggtgat gccacatgc ctactgtttt ttgttgtgt 511140

tgttgtttt tggtttttg agacagggtt tttctgtggc tttggaggct gtcttgaac 511200
tagctctgt agaccagggt aatctcaaac tcacagagct ccgctgct ctgctccc 511260
agtgtgga ttaaaggcga gcaccaccac cgcccagctt tttcctttct tttaaaatga 511320
gatgttctg tctagctca aatttataat ctttgactt gtgatctcc tgctcaacc 511380
ttctgagtag ctggattata ggcagtccc tgtaccacta ggeccagttt gatggttctt 511440
tttaatcata atattgtatc tctctcaaca tcatttctgg gtaggggtta ttagtgttc 511500

cccaactcac atcctcctca tgttttggag aagtaagggt tgggacaagt ctttctgaga 511560

 aagactttgt cagcccagta tccacctaac atctacaaca gatggaccaa aaagcacct 511620
 gtggatctta gaaagagctt gtattcttga aaatgaaatg ccacgttget caggttatca 511680
 ctgatgttac ttggtacctt aggagatcaa cttaaagga gaaggtttta ttttgactct 511740
 tggttcagtc ctttgatfff gagcctctgg tgaggctcgtg tctcctggga ggagtgtgag 511800
 gtggaggaaa tgggctggtt tccagggatc tcagcagcag cagcagagag aatgggactg 511860
 gactccaagt atccccitta aatcacacc ctgtgtggct caagaggggg ctgagcaatt 511920
 aagagcactt gctactcttg tagaggacce agattaggtt cccagtactc acatctggcc 511980

 tcttggacac ctgcacacat attgcataca ctcgcaaat gtgtttacat gcacactgac 512040
 tctctctctc tctctctctc tctctctctc tctctctctc tctctctctc acacacacac 512100
 acacacacac acacacacag aaacctcact tctcccaca aggctctcc tcttcaagge 512160
 tctgctacct ccigtatgic cagagtctgg gaaccagtg ttcacgtgt ggacttggga 512220
 catttatgac caaaaatgga gcaagttctc atttatattt gttggcaact tgtcaatttt 512280
 cagcttttat gaagagaaaa ttgtttaatg ttgggatttt gagctcactc ctgggtcatt 512340
 agtgggaaag attttgtggt tacaactat ttcagtggga gatgggagtt ttagttgagg 512400

 actgttcttc agtgtcactg tttgggtag ggagcaatgc atgttttgc agcatctgat 512460
 gctgagtgga acctgcagcc cttggctccc agcttcagaa ctgtttacat ttcacttact 512520
 ttagcaaaaa gttttccag ggtaaacata actgcttctc agtatggttt tgttaaagge 512580
 tggcattcat ttagatggca ccactaatac gaggaaatgc attcattta agtcgtaaat 512640
 ccatagaaaa gaggcaggca tggcaacaag gtggggaggg gaattggtgt atataatccc 512700
 agcacttggg gtgcagagcc agggggatca ggagttcaag gccatctca gtcacatagt 512760
 gagttagctg ctaactctgg ctacatgaga gcctgtctgg aaacaaaact aaaaccagtc 512820

 cacttcatga aagtctggca cttgaaggtt tcttctatac tctcacctta aacatccttt 512880
 tatgtcttcc ctcccctctc tgttcagtag caggaggct tcacatttga ggacaaggge 512940
 atcttctctg cctttacctt tgggctcgcg cccagcaaca accgaaagge gcatccaacc 513000
 gttcaccgac catcatcacc gttgctgcat attcacggg atgcgagagg gccgagagag 513060
 agggaagcaa ggggctgtgt catcgcatc aggcagccgt ggactcgtc gcccttccct 513120
 tgttctctct aacctggaat acgtatffff caacagctac tgtaatgtac gaagttaag 513180
 aaaagcagaa tcattgatca gaaaggacaa agcgtctgct cggaaggagc aacgtgagg 513240

ggtttagagt taggtacggc gcatgcgtct caggtttttg ccatgcagaa tcagtggatt 513300
 tatgcggata acagtgcctt ctgttgata tgaattatca gaaaaaaaaa ttttttgag 513360
 tgcgttgcaa tttttttaa tcatgaaacg ttttctaga taccctgtaa ccttggttat 513420
 gtgtcatttt attctgcttt ttactctgia ctgactgaca ggacgttagt gcaagictca 513480
 ctctggtttc agaaacgacc ctgccccctt tggccaccct gcgccagag gatttttctt 513540
 caaaggttgg agcttaggca gtggcttttg ttttccaaa gtcactgca gctttcctga 513600
 gcactgttgt atattccctt ttccatcaca ttttccctct tgaacagggt gatgtttctt 513660

 ttaggatcac aaatgtgtg attacattgt aacctgctaa gttcagggtt taccgcttc 513720
 ttggcagccg gcagcagaga gtggttagtt actgttgca gtcactgggc ttagcagctg 513780
 agcaagaccg aagtcttag gaatcatgtg ttaattatg ctgcaggggt tgggggcatc 513840
 caaatagaa ggcacattga agttctaagc agacagtgat ttctgtgtgg ggacttggtc 513900
 ggtagtaact taccattcat tctagccatg taggacaggg cccaatgcat tttacaattt 513960
 ttttttttt tctccttcca gccctcttct ttttgagata gactcttgct ctgtatgcaa 514020
 ctgagcagg cctcaaagt acagtcctct tgactcaacc tctgactgcc attaacacac 514080

 ccagctgatt ttaacttct tttgaagtca gggtcttgct acccagttct ggctggactg 514140
 gaactctctt tgcagcccag tctggcctca gacttgtggc agtcttcag catcagcctc 514200
 ccaggggttg gaggtagc cactacagag gatttccatt tagtaaaaag acctaacaga 514260
 tctagcagct tgcttttca cagtctgaaa ttctccagc ctgatttagg ttgtctttta 514320
 ttggggctca gtttttttt ttttttttt ttttttttt ttttccann nnnnnnnca 514380
 gctgggtgta taggtgagtg atgtcagtat tgcagatgaa ttttctcaa ctgttcaaat 514440
 gcagaacatg aaccacagt ctttcattg gcaaatgga aatatgcat atatgcatc 514500

 aggacttgac gttatttctg gatgtgatac acattgtttt tccctgaaat atctgcagtt 514560
 aaaatttcca tcagcaactg gcagaatttt ctagggtgctt cctgaattac caacccttac 514620
 tctttgtaa aaatttaggt tatttaattt tccccccca gaagtatctt gagaagccat 514680
 acatttcaa gtgagatgac cctgtatttt tcatgeccc ttttttttt tcagggcacc 514740
 aaagctgcat gtccccaac agttagaagg gaaagattgc attgttgggg gattttagat 514800
 ctttgaata gtttggtttc tctcatgtct catacggttt aattataata taggtaataa 514860
 tgccacaca ctggatcttg ggcgtgggtt ttggagatat tactttgttt tgtggtgaat 514920

 tgtcatctgc agtattaaag ggaagacata gtctgcacg ccaccacacc ttgtttttga 514980
 agccagagtc attgtatgat tttattacca gaagtgctaa cgggatgtg atctggttac 515040
 cttgaaatgc aggaacttac atgaatgtac tgtatatgta taataaatg tgggctaat 515100

cccagaaatg gaactgtgct gtatggaatg ttttctggga tgttgaagtg ataactcatt 515160
 ggcatgtttt tccgacttcc aggaatctga acacaagagg gctattggta ttgagaggac 515220
 agcaggagat gtcagagcca gcaggtctca tcatgaacag tgagagcagg ggaatacttc 515280
 tgcaggccat ggiagtgtat cctggtagac aaatgataaa gaggatgaga cagggggctc 515340

 actggtttga ggccagccta cactatactt ttagagcagg gcacggtgac acattcatgt 515400
 aattccagca cttgctagca ggcaggagga tcagttcaag gccatcctca tcatcaagct 515460
 gagttagagg ccagcctggg ggggtgtatg actgtctcaa aattaaatgt ataagaattt 515520
 aaaatactaa aaagtgaatt gaatagcatt tcagaaaagg attatacact gtagtcatat 515580
 gaaatttatc ctaagggatt tgagaatgitt ttgacacatg aattaacaca cctgtgagac 515640
 aaaaccacca tcatttcaat aaacatggta aaagtagttg ataaaattta acatcctcca 515700
 ataataaaaa cttgaaaaag tttagcaaga atttgcctca acttagtttc atatgtagta 515760

 aattcaggta gcgcatatt aaatgggaaa aattgaaagc atttcttctg agaactaact 515820
 ttggctgttt ttattgttcc agaaggctta gcctgagaaa ttaggcaaga gaaagaaatg 515880
 ggggcaccca aatcagaaaag aggacctttt tttaaaaaaa aatatctttt aaactttctt 515940
 tttatttatt ctttgtgact ttcacatctt gcactcfaat cctaccatt tctgcctc 516000
 tgctttgca cccccctccc ccccataaaa tagaataaca tttagagaa agaaaaagaa 516060
 aaatctcate atggaagctg tcgtgtggca cagcgagtcc cacagtaaac cgttttatec 516120
 atgtatcttt atgtgcaagt gttcattgca aagtgttatt ggtcaggttc taataacta 516180

 ttgatgctgg tcctecat ggacgactcc tggctatcct gttgttgccc tgtgtcatgg 516240
 aggtcctgca gctttgggtc tgcaggattg gcccttcag gtgctccagc agatcacaga 516300
 tgggtgggca caactcatag ccttggttct gggtctaaat aattgctggc ttggtcagca 516360
 tgctggctct tccccatcc tcacctcag gttgagtctt ccagcattgc cctggctagt 516420
 tcatcccttg gagcaatgag caaggggagg agccagtctt cttgctttca tgcctcagg 516480
 gttggttctt cccacaccta taccatcagg gcagctctac tgtgttgccc aggtgaggtg 516540
 taggggcat tctctgtagt gctgcagggtg gtgaggggca ggattaactc tectgatctt 516600

 ataacctcag ggccagctct cccacctgcc acaggcagtg agggggagga gggcatctct 516660
 tcctgccc cgccatcaca tggcagatga ggggtgggat cgccatgct catgttctca 516720
 cccgaacctc tgicaatagg gtcagcttta ctgtgctgcc cgggagaggt gttgggtcta 516780
 cagaaagagg actctatttc tgtttgcaa tagcatgaat ttaaattttt atttttaaat 516840
 tttacagttt ttttctgaca attttttaaa atgtagtata ttctggttat gcctttcccc 516900
 ctctccaat tctccaaga tctcccat cacatgtgca tatttgggtc ctgtcataaa 516960

ggttctagaa tcaaattcgg ttcttaaggc ttgacagcaa tcaccttacc tagtgagcta 517020

 tcttgggggc ctagcatgat cttacacaaa gaaaaatcta aagacacagc taaaaacctg 517080
 ttaggactga aaagaagttc agttaagttg cagaatgtaa gattgactta tcaaattagc 517140
 aagcatatct ctacatgagt aataaacaag tagaaaaatc aagagaataa taagagttac 517200
 aaaaataaat ataaccctaa aacctataat aaaattgaca agggaaacaa actataatga 517260
 agataaacta ttgatgaaag aactgaaga cactgaaggg aaaggtactc catgttcaca 517320
 gattggaaga ttattatgtg tgtgtatgtg catgtacaca tgtgtgatg cgtgtggaag 517380
 ccagaggcta acattgtata tctttaattg attcctactt tttttttga gacattttct 517440

 ctgctaaat ctacagtcca tcaattggct agattggctg gccagtgagc tctgaggatc 517500
 cgcttgttcc cgcctagtt accaccaata ctagggttac agatatgtac tgtctactga 517560
 atgatgttcc ttgattccaa gatggcttct atgagtccac aatgacctc atgacttcaa 517620
 gattgcccct gatgcaagat ggatcccagt ggttctaaaa tggatcccat gccttttaag 517680
 attgctgcca gtgatcttgt ccagttgtct tctatatctc ttctgtaatg atatggcaaa 517740
 caggagacca agaaccctaa attatatgat ggataaagaa agcattttca acaaatggtg 517800
 ctggcataac tggatgtcaa catgaagagg aatgcaaata gatccattat ctgtctccat 517860

 gcccaaaact caagtccaaa aggatcaaag acctcaacat aaatccagtt acacaacctg 517920
 atggaagaga aagtgggaag tagccttgaa cacagaggca taggagacca ctttctaaat 517980
 ataactccag tagcacagac actgaatggg acccctgaa acccagaagc ttctataagg 518040
 caaagggcat gtttaataag acaaaacagc agcctacaga atgggaaatt atcttcacca 518100
 accccacatc tgacagaggg ctgatctcca aaatctataa agaactcgag aaactagaca 518160
 tcaaaatacc aaataatcca attaaaaatc ggggtacaag atctaacat aatcctcaac 518220
 agaagaatct caaatggccg aaagacattc aaggattgct caacacctt agccatcagg 518280

 gaaatgcaaa tcaaaacgac tctgagattc catcttatac ctgtcagaat ggctaataac 518340
 aaaaacagct catgctgcag aggatgtgga gtaaggggaa cactccttca ctgctggtgg 518400
 gagtgcaaac ttgtatagcc actttgaaa tctgtttggt agtttctcag aaaactggga 518460
 atcagtctac ctcaagacct agcaatacca ttcttgggca aataccatac cacaagaata 518520
 cttgctcaat catgttcata gcagcattat ctatagtagt cagaacctgg aaacaatcta 518580
 gatgcccctc aactgaagaa tggataaaga aaatgtggtc cattataca acggagtatt 518640
 actcagaggt aaaaaacaat aacatcataa aatttgcagg caaatggatg gaactagaaa 518700

aaaaatcadc ctgagtgagg taacacagac cttgagagac acattgtgta ctcacttaca 518760
 agtggatatt agatgtaaag caaagataat caggctataa tcctcagccc tagagaagcc 518820
 aggtactaac aagaatccta agagggagga atgaaccaca ctgggaaggg gaaatatatg 518880
 agatttcctg ggtaaactgg ggatggggct aaaggggagg ggatggctgg gttgggggag 518940
 gtacagagag gcagagcaat gaaagagtat cttaatagag ggagccatta tggggttagg 519000
 gaaaaacctg tgcagggaa atccccagga aaccacaaag atgaccccag ttaagactct 519060
 tatcagcagt ggagacggtg cctgaactga tctgtaatca gattggtgat accttaattg 519120

 ttatcataaa accttcaccc agtaactgat ggaagcagat tcagagatcc acagctaagt 519180
 actgggcaga gctcagatcc aatggaagag agggaggaag gactatatga gcaagggggg 519240
 tcaagatcat gatgggggaa atccagagac agctgacctg agcttgtggg agctcagggg 519300
 ctctagattg atttatagct agggagcctg cagtagacca acctaggccc ttgcatgtgg 519360
 gcgacagtgg tgiagtgggt ctgtttgtgg ggttcctagc agtgggacta ggatctgtcc 519420
 ctagtacatg agctggcttt ttggagtcca ttcctatgg tgggatacct ggctcagcct 519480
 tgatgcatgg ggggaagagc ttggtcctgt ctcaactga tatgcatgc tttgttgact 519540

 cccatgggag gccttacct tctgaggag ggggggcata gaaaaaggt ggtgggagag 519600
 aatgggagga gaagagtaag gggaaactgg ctagtatgta aaatattta taataagaaa 519660
 gaattttgat gacatccaat taatcaattg acttttaaaa gcttatgata agttttttc 519720
 ccaaaaggac actatttggg gctggcagct ttgcttcca ctgaggccct attcccgaat 519780
 atttcaggat gtgatctcat tgagatggga attcacagag ggtcaagttt gaaattaggt 519840
 tatgggaata cattctaate ctaatggctg taccctacat aaaagggaaa ttgagggca 519900
 aatagaaaga atgctaagta aacaaatgta gagattggag ggggtgctga tctttacagg 519960

 ccacaaattt ccaatttct gtcagagttc tagaagagga gagatgcatg gaccagaag 520020
 gcctaccag ccigtatcta gatctggaag cttacctcc agaagcaca aatgaattac 520080
 tgttagaact ttcatttggc gtatacatag cgtactcagt aacagcttg cccacaagc 520140
 atgaggactt gggttcaatc cccagaacc atgtggaaga gatgggtttg tcatgtgctt 520200
 ataatctcaa tgctgaggag gcagaggcag gtggatccct gaggttcag gccagccag 520260
 cctaccctca tcagtgaact ccaggccaag atgagatgtc gtctcaaagg aggtggattt 520320
 taccctgaa aatgacacc ggtgatagat tacaataaa ccaaaaaaa caaataccag 520380

 cacacagctg ctcttgaatg aacatgcaca cccacacgga ctaaataaaa gattcacttt 520440
 gtgagctttt attaccacag tcctagcaat ggtcactaag tcatgaaat gtcttttctt 520500
 ttttaaga aatttgagc aatcttatga aagagtctt gagttcagaa tatttcagta 520560

tgtcctaaag aagccagaat ttgctgtag tgctaagtgt tttattggaa tgaagatccc 520620
 gccttgtctc cggtaaagcag cgtgatttca tctttgaagg ttcagaagta cagttttggt 520680
 ggccaggaagc tgcagtttgc tcagctatca ttctgttccct gttgaggaaa tgctttactt 520740
 cttcattggt agatagacct caaacagaag gttttggaat gaagggggga gtagtgaact 520800

 gtgctttag taataagtgg aggcaagaag tcttgatta gatttcagca gaggctgagc 520860
 tgtgtctctt ccgtgtttaa tgtcatcttc agctctactg gtctgccgga aaccacagcg 520920
 gctttggaaa ttcaaataga caaggggact catggtatcc tcagtctcgt cacgatagat 520980
 aggaaccctt aagatggaat ctgatactaa gggaatctgt ataactactt ctgtgattct 521040
 catgcattct tacgacagtc ttgaggataa gtcacctgctg ggatgctaac tctgaattac 521100
 aagcattcta gccagggtgtg acagcttctg tgttagctct tgggagccag aggcaagaga 521160
 attgagaaga gtttgaggcc aacctgggat agatgacaga aagtcagat aagatgctag 521220

 ggaaagagaa acagttttta atataccatc ttgcagaaag ggatgacaac cttagaggatg 521280
 gttttaaagt cctgatcac gagaaattcc tatctattcc tcccaccct cccccccct 521340
 ttttttttaa aatttggat tgtgtaaaa tacacataaa gacaggggct ggagaggtgg 521400
 ctgagtgtgg ttaagagcac tggctactct tccagtggat ccagggtttg atttccagca 521460
 gtgcgatggc agctcacaac catctgttaa cgccagtcc gggagatctg acacctctt 521520
 tgtattagtt agggttctct aaagaacag aattggtagg atgaattgtg tatattaaaa 521580
 ggggatttat tagagaggct tacaggctgt ggtatggcta gtccaacggt ggctgtctc 521640

 ccaatgaaaa ggctaagaat ctggctactg ttcagtccea aggccaggta tctcagctgg 521700
 tcttcagtct gtgttggat cctgaagaag taggttctaa caccagcaaa ggaatgcccc 521760
 agcagtaggg aagaacagca agaagaggg taaacaggta aatgcagaa gcttctctct 521820
 tctgtgtcct tttatgtaag ctgccaccag aagggtgtgt ccagatttaa ggcgggtctt 521880
 cctgatcact gtgaatggtc aggacccttc aaatgacca atcaagagta atctctcaca 521940
 ggtgtgtcca cctgattcca tatgtgtca acttgataac caagatcagc catccccaca 522000
 ggtaccagtt atgcataagg tacaetgata tacatgcagg ccaaacacat acaaccccc 522060

 ttctcccc ataccacac ttggtgtgaa ccatcctatt cctaagtgcc ccctcttaca 522120
 tttaaatcta tgttaaaatc tttcacaat aaaattgctt ttaaaattac aatttaccat 522180
 ttgtgatggt ttgaatgaga tgcctccat taccgtatgc ctgtgtgtat gcacaggtgt 522240
 gtgtgctgac atgagcaggc acacacacac actttaggt gatgacagtg agcatggctc 522300
 caggaaacte acagagatca tttctgcttt taataaaca gatgactgaa gatgttagag 522360
 ccagactgtg agccacagag ctgaaaggat ttatgtttgc agcacacagt ataaattctg 522420

aattgggctg atggctaggg gttcttactg gctagctctc tgttaattat taaaccataa 522480

ctactaatct atgcatttct acatagcctt atcttaccag agaatgcctg gtgtgtccta 522540
tcttcccaga ctctacatgg catctccagg tggcctctct tctccttctc ctcagtagcc 522600
ctgcctatac ttctgtctg gccaataggg tttattcat caaccaataa gagaaacata 522660
tatacagaag gacatcccc atcagcttct ggttctcttt ttgagaaaa acataatfff 522720
gcctgatggt taagacgacc ccaggtagca actattccga aagaacaaca ctgttgatat 522780
ttttgctgtg taatatctcc catctgacca agtggccaga actacagttt cctgtctctg 522840
tttaaattgt tcagagtga acctgggact gggacccaaa agaaatttaa cgatgacagc 522900

atatgtaaat tgcataagcc tgagggtgaa cagtgtctaca gatcccactt aactgtggaa 522960
catggatcta gaattaaaga gcagtgtgat ggtttccaag ggacggctctg tgagggcaag 523020
atgttcgcca aaaggcacaa attttctactt acccaggatg aatagtctg gagactttag 523080
catggtggtc ctagttaaca tactgcattc ttgaaactaa gactagatct ccagtattct 523140
cactacaaaa accagaacaa ataaaaacac tggtagttat tggaggtaac tgacatgta 523200
atataggttg gttaaagccg tcacttgaca atgtaataaa gacctcatgc aacacacatt 523260
aaatattacg tigtgtgtg tgtgtgtgtg tgtgtgtgtg agattatggg ggcactcaag 523320

ttcgtgaaaa ttatgggtaa ggcatfffgt atcttcctta ctgtgcaaca tttccacagc 523380
ccaatgccgg tagcacacta aaatctctct tcttgaatg gtcaacctgc attccccac 523440
ccgaaacct gctctgagca ggacacaggt cccaatgga tccatctgag tggcatcact 523500
gtccccactg tgcactccat ccagtattgt tacttttagc ttatgtgaca ggtgttgatg 523560
taccttctc caggaagtgc tgaaccgtct aggtcagaga atgggcacaa ataattatgc 523620
tatggttagt ctggcttga aggtgaatca acatfffaaa atcagttgca aactffaaca 523680
ttttgcatgg aactagcttt ctgatgcctt ttgaaaagct ggaaaattct gcattccagg 523740

actcaacagt tigtgagctgg gctgactatg ttagatgaag caatggtctt tagctcagtt 523800
aattagcagc ctggaggcac tcacacgtga agctggggaa ctcaccaggc tttgttctga 523860
accacataac agcaaagtaa gcttgtcttc ttgcttataa acggtatgc agttcagagc 523920
acctatctgc tccagcctaa aaggtcacag gacagcattc aatctcttct cattcaact 523980
tggaccctca cacattaagc agagaacttc acccaccact aacctatcct tggttatgac 524040
tctgtgggtt tcaagagtga cctatgctca tattcctfff aatcatagtc tcaggagtgt 524100
gctaacaaac ctgctgatta attcactfff aagtggtttt cctfffcttt cctctfff 524160

ttggggggtg gggtagggta gggttttcia tgaattatth tctcattgct gcaaacaat 524220
 acctgcaag aagctcttaa tggaggagg gtgtgttctg gctcggggtt tgacagaca 524280
 tagttatta tgttaggaa ggcaaagtgg ctgggctcc ctgacagcag gatcatgagg 524340
 ttgagtcctc ataggttggt agaacaggaa gtggacaatg tcagtgtca cccttttctc 524400
 tcttttttcc gtgaaggacc atatctatg gaatgatgcc acccatgtta ggttgggtct 524460
 tccttctca gttaaatctc tctggaatta cctcacaaa cacgccaga gatgtgtctc 524520
 ctaggtgatt ccaaatccag tcaagttggc aacgattcgc cgtggcaaga ttgaaccag 524580

 ggcctttctc atgattaact tgcttttttag aggaactttc gagtttattt aatgaagcct 524640
 tctgggtagc ttgatttag gtgggttccct ttaatttcat ccatactgct ttggtctgtg 524700
 ttttcatcca ctctgaggaa ggacagtgtg ccccatgag aggcccaact agggccagaa 524760
 aaagtcaaag atccatgtg caagtcacct gagaccactt ggcctctgtt acccagacca 524820
 gtgtgaaacc aggcctcttg gtaagggtc ctttaattat tattcatta tgctctatag 524880
 aaaaggaaca tggacacagt agccatacc agtatccacc agtcaggcag tctgtgcaaa 524940
 cacaatagtg gtgtaagcct gtagatttca caccacacat tttataagaa gatcctctgt 525000

 cagatttgtt tttactttta catttggtg gtggtggtgg ggggaaggga actagtaatt 525060
 gttaaactac tgaggttcca tcttggtta gcacttccac tacttccaag gtcaagtcca 525120
 agccatcgag gccagcataa tteccagca atgttttctt caatatgctc tgagaattht 525180
 tcattaccac tgacagcttg ctactatgga gtattcaacc agaaaaatga aaagggaatg 525240
 aagagtgaat attaaattaa cacgttcca gagataacac ctttagctca tgaataaaga 525300
 ggtgttagaa aattcacatt aggtgtgtc aagatctaaa tgtcaggata ccttctgcat 525360
 ctgttaccac cgataccacc cccttcaaaa cagagcttaa aaataacctg aaaagacctg 525420

 ggttttcagg agcacagttt atacaaaca ctgagattgg aatthtttct tctgaaaag 525480
 atacattaat accacacctt caagaagtaa aatattgagc aaagaagtag tgaagctatc 525540
 aagtttaatt tcttttccc agatatgtaa aaaaaattc tttttgaga cagggtcctt 525600
 ctatgaatgt agctctggct gtcttgaag ttacatcaac gaggtgagat ttgaactcac 525660
 atagatctac ttgccgctgc ctctttgaat gatgggatta aaggtgagc acacatcata 525720
 tgttttaaac taaatgtht tgttccactt atggaaatct gggatagtht tcaacttht 525780
 ggacccaaaa aagtaacaa actthtcaa gtaacctgc atthttagga ataaataatc 525840

 thtcaatgg ctthcaattc aagaatgac ataaaatgt gggcaggca caagtthtgc 525900
 cggcagctga cthtctctc thtctactga tgaacctga gtgagtaaag tgctacttht 525960
 aggatctatg aaggtgccag gtgtatggct gaggcaggag gattgctatg agthtaagaa 526020

cagtgtgta gtttatgtt ttgtgataaa atatcacgac gaaaagaaac ttaaggaaga 526080
 gtaattttt gtttacagtt ccaaaggggg caagcatagc ataggggcat gggcaggggc 526140
 aggggcaggg gcagggagta gcagagtgat gacatttcat ccctgtacag gaagctggga 526200
 gagggagaga gagagagaga gagagagaga gagagagaga gaaagagaca gagatacaca 526260

 gagacacaga gaaagagaga gggagagagg gaaggagaga aaaaagaaag acgagagaga 526320
 gcagagagga gggacagaga cagagagaga aagagacaga tacagagaga gacagacaga 526380
 gacacagaga aagagggagg gaggaaagga gagaaaaagg acaagagaga gacagagga 526440
 gggacagaga gacagagaga tggagacaga gagggagga gagagagaca agaaacagag 526500
 acagaaaggg agggaagggc tagagagagg gagagagaca gagacagaga ggaaggggag 526560
 agagagaggg agggtgagaa tgaatgaatg aatgaatgag taggaaatgg gttgaagcta 526620
 tattcaaac ctatttcctc tagcaaggct ttctctgaaa gcttcctcaa acagtatcac 526680

 cagctgtgcc tagagatggg gtattgttat aggcctgacc atgtgttgat caggggaaat 526740
 ccggactttt ggagtttggg ttaggaaagc agtggactgc actgagcatg gcataatagg 526800
 ccatgccaac aagcatggaa gacagtgggt ctgagagtga tttgaacagt gggggttggc 526860
 tcaagaggtt tcagaggaga agaatttttt ttttttttt aataatttat tttatttgca 526920
 ttggtgcttt gcctgcatgt atgtctgctt gagggtatca gatctttgga gttacagaca 526980
 gttgttagct gctatgtggg tgctgggagt tgaaccggg tcctctagaa gaagtcggtg 527040
 ctcttaacaa ctgagccatc tctccagccc ccagaggaga agaattttaa tatgttgact 527100

 tgagatcatt tttgtgatat tttggtgaag aaagtggctg cttttgccc ttgtctgaag 527160
 agtctgcatg aggctaagt gaagagattt ggattaaaac aacatattgc agactctatt 527220
 gttgtggtat tattggtcac tcatattgaa agaccctga agaggtactt tcgtagaagg 527280
 agaccgcac ccattatgtg ggtcattact acattcaatg ggggtcaggg attgtagcct 527340
 ccaaaggcag tggcactatt aggggtgtgt gctctgttgg agtagttgtg accttgttgg 527400
 aggaaatgtg tcaactgtgag aatgggcttt gaggtctcct atactcccgt gactcccaga 527460
 caacttcttg ttgtctgtct caagtcaaaa ttaggaatc tcagctctat caccagcacc 527520

 atgtctgcct gcacaacaca atgtcacatc atgaagatag tggactaac ctctgaaat 527580
 gtaagatacc ccaattaatt tttctttat aatagttgtt gtggcatca tgtctcttca 527640
 tagcaataga aaccctaact aagacagaag ttggtaccag gagggggta gtactgtgat 527700
 agactgaacc atgtttctgt ttggaataat atggattttg ggagtttggg ttaggaaagc 527760
 agtggaatgc ttcatgtgct gcttaatgga caatactagt aggagaatgg aagaccatgg 527820
 tgctgagtgt gatttgaact gtggggagtt gactcaagag gtttcagaaa agaattttaa 527880

tgtgttgccct agagattatt cttttatata tttggtgaag aatgaggctg ctttttgct 527940

 ttgtttgaag agctgcctg aagctaaaat gaatagatta ggattaatac cttttgtaga 528000
 agaaatcccc aaacaacctc ttatagactc tgtcatgtag ttattagggg caaatctagg 528060
 aagatttata atgaaaagga gcaagaaaat gtaaaatttg aaaaaaggaa gatcaggaag 528120
 tagaatggag ctaaatcctg tgttcaagga gatgaacaga ttaagaaatg gaataaaggg 528180
 agtggtgacc tcagggctaa tateccacc agttaaagtt tccatcttgt ggaaaggaat 528240
 gaaagaaagc ctagagctgt gtgtgggtgt gcataccttt ttttttttga gacaggtttc 528300
 tctgtggctt tggaggctgt cctggaactc gctctttag acctggctgg tctcgaactc 528360

 accgagatct gcctgcctct gtctcccag tgctgggatt aaggcgtgt gccaccaaca 528420
 cccggctggt ggtgcatacc tttaatcca tcacttcaga ggcagaggca ggtgatcat 528480
 gagtttgagg ccagcctggt ctaaggagtt caaggacaac aaagcttact cagtgaaggt 528540
 aaccactgaa accaaaagct ggtgaagatg taattgaaca aggggccatg ttccagcccc 528600
 agcaagcagc agaacttggc agctttggcc atgtggtttt ggagttaagg acagaagaaa 528660
 caggttatga aatttgcctt catgactaag gaaagccact gaggccagc atgagtcagg 528720
 ggtgtccctg aatggagact tagaggggcc atttccctgaa gctgtgaagt tgaagcctga 528780

 attgcctgag agacccaag atgttggaga tgccagagct gtgggaaagc tgctgaggaa 528840
 gctgctaaga gggagtggaa ccagcccag agaaagaagg tgcagtcaac aaagttgaaa 528900
 ggggttagag atctgaagag cgtttttttt gtttgtttgt ttgttttttt acttaaacag 528960
 tctttaatgg aagctgtgta tgaggggctc ctactcctgc atcttctcaa ttgtttcttc 529020
 cttgtatttg cccttctctt ttctacttg tcgagacttg gctttccttt ccagatctt 529080
 ctttcggtct ttgtccagct ttagcctggt gataaccacc ttgctggggt ggatgccac 529140
 atggaccgtt gtgccattag ctttttctcg ctgcactcgt tcaatgtagg tgacgtattt 529200

 cttcctgtac acctggacca ctttgcaat ctgctgacct ttgtagtgc ctcgacaac 529260
 cgaacttcat catcctttcg aatgggcata gatcaaacac tgtacttctg tctcagctct 529320
 ttgaaagag gggaagacat gatcttctc cggatgtgag aaggtgcatt gaaatgcat 529380
 ttgcagtctt tgcttcggtc agaagtcacc aaggattga acttcatttt ggcggctgcg 529440
 atccaacaat ggccgcctga agagcgtttt gacgttagac ctggagatac agagtttgg 529500
 gtttgcccag ctggtttttg gtcttgcctt ggtccactat ttcctcagta tgctcccttc 529560
 cctgtgtttt ggaatggtag tgtatatcct gtatcattaa atgttgaaag tatataatct 529620

gctttttgac ttagatttta taagggatta cacttaagag attgcatgat tttagaagag 529680
actttgaact ttagacgctt aaataagttt gagattgtta tagactttga ggacttttga 529740
agttaggctg aatgcatttt tgcattttga tatagctaca agcttttggg ggccagggag 529800
tgagtgtaat gtggtggttt gaaagaaagt ggcccaaag ggagtgggtg tattaggagg 529860
tgtggctttt ttggagtagg tatggccttg ttggaggtaa gtgtgtcact atgaaggtgg 529920
gctttgaggt ctcatatag ctcaggccac acccagtgtc tcagaccact tcttattgcc 529980
cttgagtcaa gatgtaggaa tctcagctcc ttctctagca ccatgtctgc ctgcactctg 530040

ctatgttga ccataaagat aatggacaaa gtcctgaaa ttgtaagctc ctttaattaaa 530100
tgctctcttt tataagggtt gctgtggtca tgggtgtctt ttacagcaat agaaactcta 530160
actaagacac ccttttttt gtatttttat atttgtattc ttttccctt tttaaaattt 530220
aaattagaca caagcttgtt ttacatgtca atcccagttc cctctccctc cctctctccc 530280
ctctctccc caactcccta tcccattccc tttctgtac ccaggaagg tgaggccttc 530340
tatgggaggt cttcaaagtc tgtcatgtca ttggagcag agcctaggcc ctccccatg 530400
tatgtagact gagagagtat actctatgtg gaatgggctc ccaaagtcca ttcgtatact 530460

agggataaat acigatccac tactagaggt ccatagactg cccaggcctc ctaactgaca 530520
accacattca gggggtctgg ttcagtcta tgcgttttc ccagctatca gctgtgggtc 530580
catgagctcc acctcgttca ggtcagctgt tctgtgggt tttccagcct ggtcttgacc 530640
cctttgctca tcacttctc cctctctgca actggattcc agagttcagc tcagtgttta 530700
gctgtgggtg tctgctctg cttccatcag ctactggatg aggactctag gatggcatat 530760
aagatagtca tcaatctcat tatcagagaa gggaatttaa ggaagcctct cctattgctt 530820
agattcttag taggtgtcat cttatagat cctggacat ttcctagtg ccagatttat 530880

ctttaaacat ataatgctc cctctattat gtcactctt ttctttttt cttttcttt 530940
tttggttttt tgagacaggg tttctctgtg tagcattgga gcctatctg gcaactgctc 531000
tggagaccag gctggcctcg aactcacaga gatctgctg cctctgcctc ctgagtctg 531060
ggattaaagg cgtgcacttt ctttccct catgtcttc tctcccctcc tcttctctc 531120
ttctctttc ctaactccc tctcccctcc cccatgctcc caatttgctc aggagatctt 531180
cttctccagg ggaccatgta tgtctccttg ttacctagct tctctggagg tatggattgt 531240
aggetggtaa tcctttgctc tannnnnnnn nnnnnnnnnn nnnnnnnnnn nnnnnnnnnn 531300

nnnnnnnnnn ntttttttc tgagtgtac tccattgtgt aatgtacca cattttctct 531360
atccattctt cagttgaggg gcacttaggt tcttccagg ttctggctat tacaataat 531420
gctgctatga acatggtga acagatgtcc ttgttatatg aatgtgcttc tttggggtgt 531480

atgcctaaga gtggaattgc tggatcttga ggtagactaa ttcccatttt cctgaggaag 531540
 taccatcctg aattccaag tggccacaca agttctcacc cccaccagca atggagaagc 531600
 gtcccccttt ctccacatcc tctccagcac aaactgtcat tgggtgttttt gatttagcca 531660
 ttctgacagg tgtaagatgg tatctcagag ttgttttgat ttgtatttcc ctgatgactt 531720

 aaggatgttg agtaatttcc aaggctgaaa ttatgtctct cagaacatga catgattgga 531780
 ctgaggtgtt attccaaact tgctaaggag ctggattttc aatatttctt attctcactt 531840
 caaatggaac tctgtaagtc tctatttcaa gtctcataga gtaacttgct cttataggtc 531900
 agcaaattta gatactcaga gtccctcata aacaccaaag tctggaacta tgctctaaag 531960
 gaaacttgaa aggagctaga gagatggcctt ggtgggtaag accacttgct gctcttctag 532020
 aggactcagg ttigtattcc agaaccaca cagtggccca cactgtctgt aactccagtt 532080
 caggggatct ggtgccctct tctgatctat gtgggcacca gatactcact tgatacacag 532140

 acacatatgt agataaaatg actatataaa cagaaaataa atgaataatt aaacctcaca 532200
 aaaccttgag tgatgtcatc ttctggccc aaagaggag ggacctctt gaatatttg 532260
 ttttcatagg gcatattaaa agttgccatg tgtttaagtg tgagatttct gaacttcga 532320
 tgccaggata accttgcttt gaaagggaga gttgtttggg gattttcttt caattcttag 532380
 atttattcaa ttattttata tgagactgtt ttgctgtgt aagactgtat gtctgtgcat 532440
 aaggtgcatg catggtgcct aagaggtcag aagaaggagt tagattcccc agaactggag 532500
 ttaacagatg atttcaacc acctatggg agcaggaac ccaacctgag tcctctgcaa 532560

 aagcaacagg tgetctaac tgccgaacaa tcttctcat cctgttttgg gattttaaat 532620
 tccagaagtt ttttttttt ttttttttt ttttttttt ttttttttt nnnnnnnnn 532680
 tgaagctctg gctgtctgg aactctctgt gtggaccagg ctggccttta actcacatag 532740
 atccacctcc ctctgctca tgaggtacat gctaccacac ctggtcaatc ctagtgttct 532800
 tgaagaaagg ctctgtagt tccttgggtc agtgactctc aggcgatgac tagtgtctct 532860
 aatggaggat cctaaggctt ttttttttcc ctttttagata ttggatttcc ctgaagcact 532920
 taaaaagaat tcacaacca ggttacatct aatacactt tagtgttcaa ggcaagttec 532980

 aggtctcaag atgtccaaaa taacctata ttatctttt tcatagctaa attcggacgc 533040
 cacttcaagt ggetggacaa ctttccctta caggggtgtt gtgtacatgt atgcacgaat 533100
 atgtgtgtgt cttgtgtgt gtgtacttat gtgtacaagt atgtgacat gtatgtggag 533160
 ggtaacctgg attgtcttc cttagacatc ataatcatac ctgttttttt ttttttttt 533220
 ttaagacaag tctcttatgg gcctggaact tgccaactag gctagactga ttggctagca 533280
 agcccaag atgaacat tctgtctcc ctagggttg gattacaact gatgtcacta 533340

agtctggcct ttttaaaacc atggatcctg gggtttgaac tcagttcccc catgcttgca 533400

 aatcaaacac tttactatct tcccagcccc acaagatgct ttgaaaaaga atttaagaaa 533460
 cactgtcttt agtaggagga ttttaagacc actgattaca gaatcaaag gatctcacia 533520
 accacttggg ggcagtcagc tctcggatc tcagcaaag atctgaactg gaagactttt 533580
 tttttttttt tttttttttt ttttcttttt tctttttaag aggctgttt tcttttgtgg 533640
 ctccattgat catcctgaat aaacattggt cagagataag gaagtttcgc cctgacaca 533700
 ctcagaatgt cacaatcgag tgcaaaaata tcatcggttc tatagaagcg tcttttgact 533760
 ttttttaaaa atttttttca tcaaatgctt ttctcacctt ctgtttattt aaaggacccg 533820

 tgatatacct acacatacat ttatttattt agtgtgtgtg catttgtgat ggaggaagt 533880
 gtagctggag gtcagaggac aactggcaac actcagttct cttcacgaac catgtggttc 533940
 ctgggggtgg aattcaggtt gtcagccctg gccgcaggtg tctttcccca ctgaccatc 534000
 ttgctggtcc ctaaaatata atttcatact aattgtaagt ggctagatta ggtactggaa 534060
 ttatttcage cgaaaatttg actttggtgg ctaagaatcc aataggctca ttatgttgta 534120
 agtgaatcta gtgctaacga cagccctggt gacagtgaca gttactggtt atttacaaca 534180
 tgcaagtcca gccagagat tgtcaccaac tggctataaa agctgaattc ggccacacaa 534240

 actccctgag ctgtgatctc tcatttgaag aggattagac caggcagata tatcataggg 534300
 tctttctttc ttttaacaaa ctataaatgt aaactaataa cttttctaag tatatccctg 534360
 ggaaataacc cagacatgta acttctagtg caggggtttc tttagaacag gtgtggtcga 534420
 tcagacacca tgtatcagaa ttctctgaag gttgtatacc tgtaccacgt gttggtggtg 534480
 aaaggaactt tagtctgttc tgaaatcaga aaggaagcca tcatgtcttc tttgtcttga 534540
 gaatcaagct tcaggccatt gctgggacc tgtgatgcag cctggaggct cattttactg 534600
 ctgagtatgt cactcttccc tatggacat gcctccatgt aaggagacgc aaacaaggag 534660

 atgacctcat gcagcggctg gcggaattt cactctcaac cctgcatca attgctttga 534720
 attctctcca acttgctaag tctttgagge agttgcttgt tgtgcatggg tggccttcag 534780
 aggatgccag ggagttttgt gtgactacac ttgggaatgt tcgtccaag ctacaagcag 534840
 ctaattactc aggaggaaga gacaattcat tcagtgtgt aactgttaga gtgccatgc 534900
 atctgcaaat ctctgaccca tgacctacga accactctaa ttaaacctgc tgagtcaaaa 534960
 gcacatatac acaaagacat gaaagtagaa ggcagaatag ttgagaagaa taattatcat 535020
 tgtggcagga ggacaagga caataatggg gtaaatatga tcgaaatgca ttgtatatgt 535080

gtggaatgt aataacatca ttaaacatta ttttaaaga ttatgtgat taatgcttg 535140
 cctgcatgta tctgtgtcgc ctacgtgcat acctggtacc tgtagaggtc ataggggtgt 535200
 tggatgcccc agaactaaag gtacagatgg ttgtgagcta ccatgtggat gctgagtgag 535260
 acctctgtaa gagtatccag aggcacctct ctaactccac tatgttcaat ttatataagt 535320
 tcacacaaca ttaataatgt ctgttaatct tgataccaga gcatcctatg attgggtgga 535380
 aagtgttgaa aatgacactc ctgcacattg acagaaaatc tgtgactaaa atgagccttc 535440
 atggttacta caatccaagc ctttgcattt cctccaaatc cagaagccga aacccctgg 535500

 gggagggact aggaggtcag acccttaagt gattaggtct tcaggaaagg gatttcatga 535560
 atgagattag catccttata aaagaagttc aggagagttt gttttccctt tctacactgt 535620
 gaagacttaa caagaaagag tcatctataa acaagaaagc actggaactg aatctgtctt 535680
 ggcatcggtc ttcccacact ttagagctat gagaaaataa gttgtttata atttactttt 535740
 atattttgac agtaatctga atcaactaag aaaatggtca aaagactaac actgggaaca 535800
 aggcaaggac atttataatt tctactgcaa ctttaactg cactggaggt cccagacagt 535860
 atgataggac aagaaaaaaaa acaattaaag ctatgcacac tgacaagcag aagtgaagtt 535920

 ttccttatcc acagatggct tcaaaatata caaagaatcc tgaacattgt ataaaaata 535980
 taataaagca agactcaact gcaaatagcc aatttaacta ggtttccaag tgaaaggtea 536040
 atataccatg atcattaatg gaccataaag ataaagtga acacttcaa aggtttgcaa 536100
 gaaaacacac taaaccttc cctgtctggg attaggtgaa gaattcttac aggtgacatc 536160
 aaagatgcaa gaagaaagtg aaagtatgg aaaactggat ttcacagaaa tttaaatttt 536220
 catgtttaa ggtcctcatc aagaaatcga aaagacagcc cacaaaatat ttgtttcagg 536280
 agaaaatgac cacaaatcag gcatttgaca aaagccttac ctccaaaatc caggaaggat 536340

 ttttccaatg caacagagaa agataaataa accagttaag cggggaacaa aagatgtgag 536400
 tgagaactta aggagaaaag aaacatggag gtcaaatgat cctgggcaga cgccattag 536460
 tcaaattcca cgagagccac agtgacacca aggccctta ggccagccat agtgaatga 536520
 tggacaacga gccgtacagt tcgtgtccgt tagcaatgga acattatttg gtcagtcagg 536580
 aatgaagtac tgacatgtag atgaacctag aaattctgct gagcagagga aaccaaacac 536640
 aactgtata tatttcagta taaaaatgt tcagaacaga ccaaacctg gggacagaag 536700
 gggggattac tgggaatggc tataatccag tgcaagtgc tttatgcaac aagtacccat 536760

 cacaaatag gaaccagcat acagatattg cttgacaaat ggtatgtttg caatactgag 536820
 tgcttcaggg tcagttaggg tcagttggta aataatttaa tttcctggaa aatctgtttg 536880
 atgtgggata atgctctgt acacagtaa gatttgcac gtgtattgat ttaataaaat 536940

gcttattggc cagtagccag gcaggaagta taggtggggc tgccagacca ggagaattct 537000
 gggaggagga aggcacgagc aggaagcaag atgagaatgc cttactgaga aaaggtacca 537060
 aacctgtga ctaaaaatag ataagaatta tggtttaatt taagttgtaa gagcttgga 537120
 gtaataagcc tgggcaatag gccaaacagt ttataattaa tataagcctc tgtgtttatt 537180

 tgggactaaa ggacttcagg actgggtggg acagaaactt ccatccattc tgttgaagat 537240
 ttctgtaaac catcacttaa acacatttcc cacgtaatgc ttttctgtgc cgtccaacaa 537300
 atacagagca aagctgttag ggatagcatt caacatgctc gaagagggac agtcagacat 537360
 caggcagga tagatagatg cacaacagat agactacaga caagctacag acagatggaa 537420
 gacacagga gagaagtga gaattcaaac ccaagaagct gtgatgaact ttcctaacg 537480
 ctccatgaca cgatgcattt tggcctct gaaggtatct ttaacatttt aaccaatgta 537540
 ttttgggtgcc tcatgtgagg aatctctaata acatttaata gatgcatatc aagacacctt 537600

 agagaggtct taaaaattaa agggaccctg ctatctgtga cagtgtcact taaggaagtt 537660
 ggagcccaca taaatggact acgctgaagc ttgaaaacgg taaagtccc attacttaa 537720
 aacctgatga gaacttgta gaactetaaga tgettctcca ttaggaaaga ggcactctggg 537780
 tgagctggat gtgtactcac cccagtgacc tgcacagagc tatcttcttt tgaagagact 537840
 gagagactag gtacttttct ggtcaccatg gagatcaagc cagaggccag ctctctccat 537900
 cctggctcat ggatgaacct gctgctgagc agagatttac agaggaacca ttgaaacta 537960
 tgacatctgc acagccctga aacctggcaa gctacaagct ggactccagt tctgttcaat 538020

 aatgtagca cgagttctaa taggtctcca taataaaaac accggagtca gatatggggg 538080
 tgaaagcgt aaggtcagag aagcagagca ccagagctct tacctctatg aatcctcag 538140
 actgagtaga gagtaaatca gggagcacaat ggttgaggca catttcaag gacctctga 538200
 caagcccat ggagattgac catgtctcat tcacaggctg tgatgacccc agttaccgat 538260
 atgattgctt ctgacaactc gacactagat tctgcatctc ctgcacattt gcgacctaa 538320
 tcagccttgc ttagcaaatg ttaaaagatg ctttttaag cttggagtgg cagagcacc 538380
 ctgtaaggct agggatgaga aagagtagcc tgggttacat ggcagaatcc catcacaac 538440

 aacacccca actaaacca accaaccaac caaacaggcc acctaactag agcaactgac 538500
 ccagttgtga gtaggggaa cgatcatctc tacagcactc acatgtcttt ccctgtgact 538560
 cattcattag aaacaggagg atgagaggca gtaagaacct tttctcacct ctccactct 538620
 ctccactct ctcttgaat caggtcacia aaccaggaat aggactctct gatatccct 538680
 gaagacttct ctgtgatgga tatctgctt acatgtggag gaaggaggaa gctgtgtgag 538740
 aaaaatcaaa gcttcgggcc ttactaggca ttctactct tgttatcatt aatcatcat 538800

ttgtcctat agtgtaggt tctaacta tatccccga gagctatgca taaaagtaga 538860

 gatttcttc tcatgggtct tcaattcctt atgatgctcc caaattcaca gaacccaat 538920
 gtctgtgagc tgatgaataa agcatggtat atccatacaa cagaatatta tttactgtg 538980
 aagaaggatg aggtattgag gcatgctaca aggagagggg atctttgtgt gtgtgtgtgt 539040
 gtgtgtgtgt gtgtgtgtaa tattacttta tttgttttt tgagataggg tttctctgtg 539100
 tagttttgta gaccaggccg gccttgaact cacaggetgc ctctgcctcc cactcccgat 539160
 taaaggcatg caccaccact gactggcaaa gaagagggaa tcttgaaaac aactaagca 539220
 aaagaagtca gctccatgca acagtatttc ctatattcta tttagatgaa tttctaagaa 539280

 taggcaaatc tatagacaga agatagtta gtgataaact tatgttatat ggggttgagg 539340
 gtaaatagga tgattagtg ctagtgtggg atcttttggg gaggtaaatt tgtgttttg 539400
 gactagacac agaagtagtt gcagagtctt gggactgctt gaacagtcat tgctttctag 539460
 acttcaattg gtgaactgtg taacatgtga acaataccac aataaagcta tagaaataa 539520
 aaggaggagt cagtaggatg gtcactgtca caaaacaaat gtgaaaccag tgatgaccta 539580
 agaccctaat gatgagaaa taacaagttc tgtctgggag ggataagaga aatttaatta 539640
 gaagtctggg tgggatgtga aatggtcact aaggaagatg gtatggtgt tcttcaaat 539700

 ttagaagtag aatcatcaaa gtagggatct gaaaaatgct ttacacctat gctcatagta 539760
 ttattattgg ctttggccaa agcagcccag gcttccgatg ccaaatgaat ggataaagag 539820
 aatgtgtgtg tgcataagtg agatagtatg tagccttaa aaggaaggga attccaatgt 539880
 atactgcagt gtggttgaac cttgagggca ctgtgaaaag taaaacaagc tgtcaccaaa 539940
 gggatgataa atacatgcaa caccctttat atgtatgcat ttgattttac tacacacaca 540000
 cacacacaca cacacacaaa aaaaaaaaaa aaaaaaaann nnnnnnnnnn nnnnnnnnnn 540060
 nnnnnnnnnn nnnnnnnnnn nnnnnnnnnn nnnnnntttt tttttacaaa cacacaaaca 540120

 ccacaaaaca aaaaaaaaaa aaaaaaaaaa aacccttaa aggcttgcac ttggagtta 540180
 cattggagaa caaacttggg atctgggagg tcagtgtctt gggttttatc ttaggggctc 540240
 tgtggccatg ggcaggatcat acaagccttc tgttgctgtg tctttattat taccaggaca 540300
 tgggtgtttt gtacctcaca gggttgcaat cagagcactt gaaataaatg tcagggtgact 540360
 attgatgtct gtcagggtgt gtgtcttttag aggtggagcc aagagtatag atgtgaactt 540420
 ggggatacc tgccagctca gtgtcagtga aacaagacaa gtttcatgaa taagcataag 540480
 acagaccca cccatgaaag ttatgttaac tatgtaaaga cgtgttatat ttgcttatgc 540540

tgtgggatgt tactctgtaa aggtgtaagc ttcgtttatt tctgctgcat ttgtttaatt 540600
 atgtaaagat gtgttgcat tgtttcacct tgctgccta aggcacctga ttggtctcat 540660
 aaagagctga ctggccaata gcaaggcagg agaaaggata ggtgggactg cggggcagag 540720
 acaataaata ggagaataat ctatgacaga aggagagacg gaaggatatg cctggggcag 540780
 gctgggcagt caccagcctg acaaacatga gaagcaataa aagtaagata tacagaagaa 540840
 aagaaaggta aaaaatctga ggcaaaagg t agataaagag aaacagg tta atttaagtta 540900
 aaagatgtag cctaaagctag tccgagcatt cataactagt aagtctctgt gtcattgattt 540960

 gggagctggg ttgtggccca aaagaaaaag cctgggtacag ttatgattta cccaatttat 541020
 ttaatttcta aaaagatttt ctgaaaatgt tcttaaaatg gaggcttccc agtaggatat 541080
 tatttatttc aaaagtittta atttgtttaa ccatcaggct atggtccagc tctggaacct 541140
 tcttggcatt ctgtgagctg gcaaaccttg gccggatctt agcagccaag tcccctcttt 541200
 cgaaagcccc agggggcctt ggcctcctga actgggttct ggtggtgctc aactgcctt 541260
 cctggctggc tggagtcat gtttcatctg catatgcttc cctttgttgt caccaggtg 541320
 aacttctgag ctatgtaaag aacacccaat ctgttctga tcaggacacc cattgcctcc 541380

 ccatgcagcc tacactgtgg cttccaggtc atcccctct gccacatgg tcccctaga 541440
 catcagcatg gcacatggca tctctttccc tgccttacc caggaggaca cctccacct 541500
 tccctgaaca catgcaactg ctttagaac ccctccagg atagtcacca ttgcatgaca 541560
 tcatatcaca aaacaatcaa ctttagaaaa ggcagatcat gcagcatgca ctagaatttc 541620
 agatcaacct tctcaaactt cacaaagctt ggctagatgg cgatggtgca cagctgtgat 541680
 cctagcaaca agggagctga ggctggggag gattgagagt tgaatgctag cctgggatat 541740
 gtgatgaaat cctgtgtcaa aagtgaggg gaagaagaag gaagaggaag aaaggggaga 541800

 ggaggaagag aaggaggcag agggaagaaa agggaggagg aggagggtga ggaggaataa 541860
 ggagaaagag gaagaagagg aagagggtga ggaaggggga agggaagaga gaaggggaag 541920
 gaggaagaga agaagtatag gaagaacat gaaaggagg cacaagtgtt gtcaagtaaa 541980
 gattttaatg attattttat ttaatcttaa ttttgtcatg taaggatgcc aatgaataaa 542040
 gcaactata tcgtttacct ttattatcat tcataagcg aaaggacggc actagtagca 542100
 ctaaattgaa acagacaca tttcataatt tagaaactgc ataaattagc tttatgaaga 542160
 attcatgaca ttgtctgcta attttcattt ggatacagat gagcagaacc ctgtcaaaga 542220

 ccaacagtcc acagccatcc attccttcaa acaacattcg ggcagatca gagtgtggca 542280
 gtaggcaaaa tccaattat tccaagg t aaccagccag attggcattc tttgggccac 542340
 ttttgctaaa ttaggtttct gatcacatgg caaccaccc tgctgatgtt aaccttgca 542400

aaaactatgt tccttcttaa ttcccttttt ttctacaact cccagacagc agaggccaac 542460
 acaaagatac agaatggacc ccacatgcca gttgtgacat ttctcatgcc tcatctcaag 542520
 aaagaaacac cagagctgcc tcttcatgga ggtccctatc catacttttt cattttatgt 542580
 taataaatat ctttagaaag tttaatcttc aacagaaaac cacaaagaat tacttaaaaa 542640

 aaactcccat gtttcaagtc tctgcacttt tggagaccca ttataagct ggtgactata 542700
 tttagtgttt cttttcttc taaatattta tgacaactct ctgtctgcgt tetgttagtc 542760
 taaattctgt tccaagtcgt gacatctgtt ttcgaaaatt tgactttctc cctgttccaa 542820
 cctacacatg ttcttattag tttagaattt tcttctctc tctttttaa gatctatfff 542880
 attttaact atgtgtatat gtgcaggctc ctgtgtggag tggcagaaga tgagaggcat 542940
 gggattccct gaacctggag ttgttagctt cccattgga gccatctctc caagagtctt 543000
 gaagtttctc tttaatgctg aagtgagtga attgttttat aacctgtggg tgtttaatca 543060

 gaatctatta cttatctgat gtttcttgc tttccactt tttcaacat aagacacttt 543120
 agtcacttga catatagcta aatcctgagg aaaagatctg aaatfffft tctccctaaa 543180
 ttaaaattag ggccccagt tgtggagtga acatgccata tgtctgcctg ttcacaaagg 543240
 acacctgcaa aatggctctt gtcaacagac agatattctt catttttttg ccaataaaag 543300
 tcttgacctt gggacctac agagagatct tggatcattt tctgtggcta taacagaata 543360
 caacagattg agtaatatat aatgtgaaca tcttctcaca gttctggagg ccccaaagac 543420
 agatacaatg gggccagcat cttgttgccc cttttgctgt tccataatat ggcagcagtg 543480

 gtctttagct tgcctctgtt cttgtctgg caaagttaca gatttcaeta tgacttcata 543540
 aaaaactaat tactttgcaa acacctgcc ccagagtttg accaatctgt gaatfffggg 543600
 ctgaatffff ggagctatga atctggagcc ccagcccatg gaggggccac acacttctgt 543660
 tgtctctgca aacctccata ggggtctgtc tcttaggcca ttctaaatct tgttaccttg 543720
 acaataaaga ttagacgtca cagcagccag gagatgatgg cttactctgc actcactctt 543780
 atctataatc tctgaccca ctcatggacc agagcctcta aaaccacaga agtgaggfcc 543840
 cacctggggg ccttagctc attagtaaaa gaatffaaga aactcacgg gccagagaga 543900

 agactcagca gttaaagca cttgctgacc ttccagaaca gggttcagtt ctcagcacc 543960
 acattggagg ctcaactg cctgtaacce cagctctagg gcactagca cttctggcc 544020
 tcttgggaac acacacacac acacacacac acacacacac acacacactt ctacagtga 544080
 attctaagga acacacacag ttacataca catacatgtt cacatacca tacatagaga 544140
 cacacatcat tttcttttaa aaggactcag aagttcatgg acaatfffgc cagagtttaa 544200
 aagaatccct atctgaaca aaccaagctg taaattacag caactgtgtg gaggacttaa 544260

ggagaaggcc atgctttctg aactatagac acatggcttt taagcagctg tatggcaggg 544320

 agggagggag gcttagaaca gaggacggaa gcctagagta tcagaggaag catacctagg 544380
 tcctggccag cacccaaaag aacaagacag aaaacagaaa atggaaatgt tatgcatttc 544440
 tgactcaggc ttcagaaagg tggacaaacc tagcagagcc ttcttggtgg tttgtaggga 544500
 ctgtgctgga ttggggagga gcatgggatt ctgggaaggg aagtacagaa gaataatttc 544560
 tcctttctcc tcctcttca gcatagccaa ggtaagccct aagggatgtg tgctccccc 544620
 cccatcccca cattgatctg gcccaactgg actgttaggt ctctagtctc attttcttga 544680
 ccagaaggat ttatTTTTct tgcTTgggct tttactgcta ttctTTaaac tgaccaaat 544740

 ggccatggg catatctgtg gggatTTTTct tgataattga tataggacag cccagctcac 544800
 tgtggacaac accattccct ggacaggtgg tgctgggctg tgtaagaaat ctagctgagc 544860
 atgaacctgt gtcaagcca gcaaagattt ttctccatg gtttctgctt gagcttctgc 544920
 ctcagttcct gcctgactt cccttagtga tggacctga ccttataagc tgaataaac 544980
 cctttgtccc ctaaattgct tttgaactga atgtttatc atagcagcag agatgaaact 545040
 agaagcagaa ggatgatagt atcttcccca tggcctgaat gctgggcttg aatttccctt 545100
 tttggcttgg gaggtttag aaaagcattc tcaggagcac ctttctctc agcactcttg 545160

 ctacagtctc caagtgacc aagtgtgagc cacagatgtg gctaaatagt tcataggaga 545220
 acattggccc ttctcagcct acaaattatc acagattagt cacccagact ggggtgctctg 545280
 gaggtcctt tatctgtctt cctcatagtt cagcttccaa agcttggcaa acagccaggg 545340
 aagcaaagat agatgcagat taacaggcag atgcaaatgt ataaactgga agaccagac 545400
 tgtcatgcag agacacagat taaagattaa taatctagga tgctagatta tcatgacac 545460
 agctaaatgc ttgtgcctc tggcgagacc caggtttaga tccacacagg tgagcacaag 545520
 ccacaccctg ctcaaatgca gagacaggga gggagccaca gcttctctg tagtccaaa 545580

 gtgactggac aaagctgagt tggaggaaat gatggcttgg aagtttccat agcagggtgc 545640
 catgcctggg gctcattacc tgatttagct ccaagcttta ttgacaaaat ttaaatgaga 545700
 aagtagtagt agaccctga aagccaaaaa taaacctgta cactccaggt tattttagac 545760
 aattccaaat aacgcttttc tgagtccaaa ctttctttt ctctgagaga ttgcaatgaa 545820
 ggcaaatga aatcagatta cttacatttg caaacacacc tcatttttcc tatcattatt 545880
 gactaacaca tagaaaacag gctatTTTgc tttgcaatct gaaataaata aggaaaaact 545940
 actccacaga ccatagtttg cttacttgac aaaggtctaa atactTTaa aactggattt 546000

cccaaaggca gccaggatt taccacagtc atacaaatct tttccaacaa taagggtgcta 546060
 attcttggct tacttcaagc cacatgaaag aacagtaaa cccagaaagt tgccatttta 546120
 atggttaaaa gaggagataa agacatattt gtgtaacggc ttctgggaaa ggtactttca 546180
 tgggtggactt gattcctgcc atccaactgt attcatgcaa aacaaatcaa aacatgctgt 546240
 atctctttgg gcaaagccca gtgtcttact attgagatgc atggggataa aggtataata 546300
 gattatitita catctgaaga agtgtctaag aagctccttg taggggctgg agaggtagtt 546360
 cagctgacag tgcttgccca gcctgcagaa agttcagggc tcaattcca gtctgccta 546420

 agatgggcat ggtgggagg taagaagttc aaggtcattt ctcggtaca aaggagttg 546480
 aagccagccc agactacaaa acctgtgtaa ataaataaag caagctacta tcataggttg 546540
 acacttaaaa gaacaactca cttctgcca agtaagcatg catggggaca gcttatctct 546600
 acacttaaga gggatcataa ctgatccata acttgtggca acacagaaat aaaaccacac 546660
 atggcatcag aggcatagaa gatgccccag aaagagactt ctatgaataa gcatctaatt 546720
 ttctggaaaa cttatititt tgaggatgt gtctatgtct gtatccatct aggttatatg 546780
 cacatgaata cagttggcca cagagaccag aggaggtttg ttagaaagag ttctggatgg 546840

 gcttaagtga tggcttagtg gttaaagaaa tttgttgcta ttgaagaaga cccaggatca 546900
 attcccagta cccacatggt ggctctcaac catctgtaac ttcagttcca gggcatctga 546960
 tgcttcttc tgatctccat ggggtaccagt ctcatgggca ggctaaacat ttatacacac 547020
 aaaggaaaat acaaatctt aaaaaatact ttgaaaatcc tttacttaaa aaaagaaaaa 547080
 gaaagagtat ctgtagctac agacaactgt gagccacctg atgtgggtgc tgggaactga 547140
 cctggaccct ttgtaaaagc agcaagtgt cttagccact gagccatgct gccaggaaac 547200
 tttacatgat cgatatgaag cttcaagaca tgataaagag gcaatgagaa ctgaatacat 547260

 tgtgagggtt ttttcataga aaattccttc aagatggtag aaacaagat gettgactaa 547320
 aagcaaaggc aaagaataaa actaacactt ggaaggcact gagctattaa acacacacac 547380
 acacacacac acacacacac acacacacac gagagagaga gacagagaga gagaaaaaga 547440
 aacaatgaat ttcccctccc tgtcaataa ggttcatagt tttctttgta taatgtctgt 547500
 atatagatga ttagagtcaa ctgagtaaat ttaacagtgt caaaagtaat ttagtagat 547560
 ttgaaagaga agagttttc cagtggctct ggaaggctga tttacaaaac agtcctgtca 547620
 ttgggtcatt tcaattcca aatactggag tctgtatit aggaattcac tctgcccagc 547680

 ctggctgctt tagatgcgtg accttcacaa aactgctgg tcagtggtgt ttggaggcag 547740
 atgggctgca acatggaat caagacttga ataaaaatgc agttggaagt acaaatatit 547800
 attagcaaac aagtaaaaag tgaggcttgc accatctgtt cttgcaagct cagagagccc 547860

ctgctctgtc taatggctgt cctccccgc cttgcataga aggctgcctg agcaagagta 547920
 tgcagctccg gggaggaatg attcctcttt cagccacact gggcttacag cctttgggag 547980
 gtgtggaaac cagggtaggg ttcagatcag cacagtgagg ctggtgagct aatgggctga 548040
 ccagcctcag ctctcttccg tccaaggatg atggtattcg cacaaccttt tgagataact 548100

 cccagcttg gctactacca aattaactgg agtaaaatta cctcctgaca ttctcacc 548160
 tgaataaacc tccagtacca gtattttgac agcagtttgg aaatactgtg gcagcccttg 548220
 agggcatgga ctccaggtaa gctatgttta taaaaatcaa ctggctctag atgtgatttc 548280
 aattcaacac acatggttgt aactcagtgt tagcgtgat aagttttaa tggtcacgca 548340
 gaccatatag attagtctg tggtttttgt cctttcctat ttacttttgt gcctcgtgtt 548400
 ttctttctga gccatctgtc aaattatgtg gcttcattc tgcaaagatt cacagtgaa 548460
 cttgaaaact taggagagaa acagaaaact gattgcata tgatgtcacc ttggttttat 548520

 gtgggaagga acigtactg aacatgtgat gaataagctc ttgcaggga aataccatct 548580
 ctgcataccc ctctttgtgt ctactttgtg ttactctat gtcaagatgt attttatgga 548640
 gacaaagcca aacatgcaca gtcctaatca cagcctttgc tgtcaggact ggcaagtgat 548700
 gtttctgcc tcigaaact ggaatgtaga agaaaaacta caggaatctc aggctctcat 548760
 cttactgttg ccttgacgag ttctccataa cttaacaaa aacttccaaa ggaatcctta 548820
 ttaagtgat gttgttaagg acacaattct gtgtagattc cttgttacc aaattcttt 548880
 tatctttaa ggtttatttt attttatgtg tgtgtgcttt cttgactata tgtgactgt 548940

 gtgagtgcag tgcctcaga ggccagaaga ggggtttcta tccctcagaa ctggagtac 549000
 cactcactgt ggatgctagg aatgaatgtc agtctctgt aagagcagca agtgctcaga 549060
 tctgcagaac ctctctcca gctctggatg ttgttattct tgaaggcagg aaggaggaaa 549120
 agtagacata ataattagt tctggaggga cccattactg tgtctacact ttctgctca 549180
 cgtttgtcta agcccacact tcccagaggg cctgaagtg catctgatga caaaattccc 549240
 gttctgtgta aacaactctc cagggtggtt aatgtgattt atggactcag ttgtatagag 549300
 agacacctgg gatcttagcg agtcacactt cttgggtatg cagacggtga cagctctgac 549360

 ccaaggaatc tattaacagt tttgaataga cgattgaaa gtgggtgaa ctggatagag 549420
 gaagtatgtc attgggggtg gacctttgag gttatagctt cccacagtcc ctctctatca 549480
 cggctctact ctgcttctg acctttctc tacactttgc aactgctgtg atgcttctgc 549540
 ctgctcacag gcccaaatca acagaacaa gcaacctga accaaactg tgaaaccgca 549600
 agccaaagaa aatccctgct gctttaagat gcttccatcg ggcttctgtc acagtaatgt 549660
 acaaacagta acacactccc atgtgctat tacaaggctg gaacatactt tgagaaatgc 549720

cggtaaagaa tgatTTtagt gTaaatgagg cttgaaagaa aagtttatgt ctgtggaaat 549780

 gctcgtttgg tgaagtgctg gtcttgcaag cacaggggtg ggggatcccc agcatccatg 549840
 taaaaaaca aaacaaaaca aaacccccca aaaatcaggc acaatggttc tataatccca 549900
 ggtggaggcc ctggagctta ctggccaggc agtctgactg aaccaaagag ctctaggttt 549960
 tgtgggagag caaatgaaga gacactgggt gctttacttt catagttgt agtgagatat 550020
 ccacccgcc cgcactgat gcactgacca cgctcattta ggctgtgtca gtgcatctga 550080
 tgcactgacc acgctcattt aggcgtggc acaggtgggg atgtgatgag ggaaggctag 550140
 gtctggggtc ctggatctca gcttgctctc ttgtttctg ttgggtgtcg gagagcagcc 550200

 tgggtgtgga tccttgagc tggaacttgc aggtcatcag tttcttatgt aagtgacttc 550260
 tccccgaata aaattaacca cgatttaacc aagtcctta atcttaact gtgccactac 550320
 agtaggtgct ttaggtcttg tcattaggcc tacagagaag cactaaggac tagtcatgtc 550380
 catgtctagt aagTacattg cgtactgagc tgctagttt tataTcatgt cagcttgaca 550440
 caagctagtg ttatctgaga agagggagcc acagttgagg aaatgcctcc gtaagactag 550500
 cctgtgggca tgctgtggg atattgtctt gattaatgat tgatgtggga gggcccatec 550560
 tacagtgggc atggccaatc caggcaggtg gtctgagtt gtatcagaaa acaggctgag 550620

 caagtCagta agcagcagct cgtctccag gtctctgctc ttgagttcct gccatgactt 550680
 cctcagcaat gggctggtaa ctggaagtag aagatgaaat taacccttc cttccaagt 550740
 ttcttttggT cgtggttttt atcacagtgg cagaaacct aaagaagaca gaaattggta 550800
 caagTcata gaatatgtct gtgacagctc cggccatgta ttttatttc caaggttat 550860
 ggtggcattt gaagtttggg ctggaaaaaa gctgttgaat gttttgagtt cagtgttcag 550920
 agcttagggg gccattctgt ggatgcacag aagataaaag gcttgagaga atttctcatg 550980
 atcaagatct gactgtcaa gtttcaaagg gaagttagag aaacctgaa agactatcca 551040

 tggcgtgaat atttgagaa ttaagaattt gtgattctgg tcagctggtg ctgaagcatc 551100
 agctgtgatt aacaggagat caaatccact gggacagtta actgatgccg gtcagcggga 551160
 tctgagaaat tagcagggat tagcaagaga ccttcgtcaa ggagtgaaa tcttctgggg 551220
 agcgttgccT tggagtcagc acacagtagt tgcatlagag gcggtgagg ctgctcctta 551280
 ttgtagcagt tgataatgtg caagagattc ccaggtggta ctagtTTTaa aggaataaag 551340
 ggatcatgga aagcagctgg ggtgtggtat ggtgagaagg ttaaatagc catggtgaga 551400
 gagactgagg ctTggcacca catggcaggg tgccttggga gaagTccag gaagaagctg 551460

tcggtgaagg tgcaacctag gtacagtgaa caccagcat tttggagaat ccagtgtcat 551520
 ctcatggcca ccaaggacag ctgcagctgt ggtgtggagc tgatctaagc ctatgagaca 551580
 agctgtctgt gctgtgaatg gcagaaccag atatgtgcag atgtccaaac cctttggagc 551640
 tcagaaaatc aacagtggat cccagacatc aaacaccaat ggagttcaca ttgctggatg 551700
 tggttttgtg ttgacttgac tgtgagtgcc ctgaatcgtc ttctggcaca agaaggtatg 551760
 tgacttattt ctgattttta atgggagacc acagttgaga gagactggtg ttttggagag 551820
 actttatata ttttagagct gttttggata ctttggagag ggtttgaaat tggagaaact 551880

 aagtgtctta aagagatgac attttttaaa ggggtagaag ttttaagac tgcactacag 551940
 ccaggcttga tggtagctgt ctataatccc agcactcagg aggcagaggc aggtggatct 552000
 ctgagtttga ggccagcctg gactacagaa cgagtcccag tacagcttgg gttacacaga 552060
 gaaacctgt ctcaacaaa acaagcaaac aaaaaagac tgggactttt aaaagttgga 552120
 atgttttata atgtggtatt aatattaact tgccatcttg gggacaaatg agaaaggaaa 552180
 tgttctagtt gaataatgat gtgtttgtgt gtcaaattga caaggtgtca attgtgctgg 552240
 ttagttttat gtcaatttga cacaaataga gttacctgaa aatcgggagc cacaactgag 552300

 aaatattggg ctgtaggcaa gtctgtgggg tctcttgatt aatgattgat gtgggagggc 552360
 ccatcccaca gtggtggtcc cgagtagtgt aagaaagcag attaagtagt gtggagcagg 552420
 tcagtaagcc attccttcat ggtttctgtt ttagttctctg cctccaggtt catgctatgt 552480
 tttgagttcc tgccaacact cccttctgca aggaactgtt aactgaactg ttaacctgaa 552540
 gtgtaagata aaataaactt ccccagtcaa ggactatttt gaggttgctt tctctatcta 552600
 agcttggtag agcagaacag ctcttggctg ctgttacaga tactcaaggt tttcttgg 552660
 ttttcacctt taagcatcct tcctcatcc ccctttact tgggtcactt ctgatttggg 552720

 cagttataat ctgaattaag cctagtggtc ttttctggg gggatcatgac tccataaac 552780
 tttcttact aaaatttcag ctctaataag atggtttgat gtcattctgc ctttctgtta 552840
 catttgtaaa tattatttca actaattaaa cataagcaac acaattggaa gtatgtcgtt 552900
 agtattgtgt ttagaaaagg aatttgtgtc atgggatcca aactgagga ggggagggca 552960
 gtgggctcat ttcaccatc atgtatata ttggatcata tctggatctt gaaattcatg 553020
 gttgggcttc cttccttctt gctttctga cacttgtaaa gatgtgtcc tggagttgat 553080
 ttgtgtgtct ttgaggatga tgtgacctg aaaacgatca tgaccagatt ctgtgaacaa 553140

 ctggtgtata tacagtgtc tccaacata ctgtgagggc tactgtgttg ccaccatccc 553200
 aaggcatgac ataccttct ctggcctcac agcatggtac agaaaggctg gggagtacac 553260
 acagctggcc agttgcagag cctggcctct gttcagatct aggcgtgttt cttcactcct 553320

agcctcccct ccttccagtg tgaggacatc tgacctagat cttgcattga ggcagttctt 553380
 tcctatgta caccaggtct caccaaagag tgagctggtg taatcgatct atctggggac 553440
 actggtagat gaagtctgtt tctgcagacc tagaagggtc cttggccctc gatccagttc 553500
 ctttactctg taaccaagga aactcgaatc cccagaaacc atacatacac tgttgggaag 553560

 agagaaatca gggctacaga agattggcat tcagaggac tcaaggaaca ggaaggaacc 553620
 atgtgggtga atggatatgg ctgtctgttc ttgggatgtg atgtgactag ccacctgag 553680
 tccttgccct gacttccctt taacaatgaa ctatataacc cagaatatga gtggaaatga 553740
 gctttttctt ccctaacttg ctttttgtca ggatatttta tcacagcaac agaattgaaa 553800
 gctaggactg tagccagaga ggggctccgc agggaatcag ttgtaaatg acatactgga 553860
 ttgtgaattg gggaggggac gtttctagaa ctttcttagg aacgcgtgtc tccttccttt 553920
 ctgaagcaaa agaagaaagg cagcagcagg catgctaagc attcagaggt agtatctgga 553980

 aagtgtgaat ggaaaaccac cccacagtcc ctaagccgaa gactgcagca gtggctctga 554040
 ggtgatgtgt acagtgtgtc tgccagtaaa tcaccgaaa gaaggaacga gtgttgagaa 554100
 aagatgttat ctctgggca tggggagtta ttgagcatct gagt caggga gcagggtttt 554160
 gtgggaaggc aatttcctgg gtccctctcc aaggacaatg aatcacagct gagacctgcc 554220
 acactagga ggaaggccag aggggtgacgt gtccagaaaa ctggaagtga ctgccaagca 554280
 ct caggcaag actgtgtgga cactttctgg agccccgtca gtgtccact cagcaccaag 554340
 tgtgagatgg ccctgcttgc tcttagggac tcaaactagt tgggtgtttt ttctccccac 554400

 attctcatct aactccagtc ctattctgcc ccttgggaat gccccacat aggccttctt 554460
 ctaaatacata cccacctatc actgaggagt agaagccgaa gaggtgggta gttagtgtta 554520
 attaaaagca gatcaaaact tttttgagac agggcttttc tgtgcagctt tatggccttg 554580
 agttgatgag agctccctct gtcttggcct tgaagtgtg agatgacagg tgtgagcatg 554640
 gtatctagct gtgggtgtta attttaagtc tcctctgtga aggctcagca gccagtgaca 554700
 agtgggaaga catcctcaac agggattgtg tcaactgcagc ctggttactg caggctgcct 554760
 tgtgcagggg tcagggtctg gagtccagga gagctgagac atggttgggg caattccgga 554820

 ccctttctcg cccgttttcc tcagtggatg gttactgcat ggggtaaca gggaggtgtg 554880
 ggcatgggag tgtgcagatg gtctgtctta gcacttccca cattcccagt gaaagagaaa 554940
 gccaagccat catctgagag tgacagggaa acgggagctt gagatgaaag acaatagtgt 555000
 gacacagctg tctatagagg ggggggctgc agcagtggca ggggtcccc tgaagcagge 555060
 ggctgtgggt ttaaggaggg atcccacata gaagagaagt agaagctggt ttcgatgtgt 555120
 tgctgtgata aataccatga ccagaggcag caactcgggg aggaaaatgc tgatgtttcc 555180

gggtcacagt caactgttgc aatcagggca ggaactcaag gcagcactgc ttgctgttcc 555240

 atgcagatca cctccaactg tggaaactcac agctgaggaa gtagagcagg aacctaggag 555300
 gatgctgatt gtaggctggt gcatgcttat ctagctttct taagtagccc aggaccacct 555360
 cctaccaggg aatgtgtgg cccacaatgg gctaggctct cttacatcaa ttaataatca 555420
 atataacccc cgtagacagg cccacaggcc aacttggctc aggcaattac tcaactgaag 555480
 ctctccttt tgaatgact cttggctgtg ccacactgat aactaaggtc aaccacaaca 555540
 gtcattctct ttaaatatga tccattttaa ggcaaaccta attttacac atacactgtc 555600
 aatctacca gaaagcttat tttcaaggtc tttgatgta tacagaaatc ccacgttttg 555660

 agaatgacgt aagtaccaac cttagtcata gttattgaac tgggaatatg acaaaagcaa 555720
 gttgttgggt aaagttcca ccctggcagc ctggctccac aaccgcttca accccaata 555780
 aatacacaga tgctatatt aattataaac tatattaat tataaattat aaaattaatt 555840
 ataagaagcc cagtagctag ggcttcttat tgctagctc tgtcttgatt gttaactcat 555900
 tttgtgttct tatcttactg gagaagggtc cggtgcatcc taccttcag ttctcatttg 555960
 gtggctgctg tctgctaca ctteccagaa ttctctcat ctectagtcc tgcctatttc 556020
 cctgcctcta ttggtcacag tattcatcaa tcaataagag aaacatatac acaggacaac 556080

 ccgaatcagc aagtggtagt aaattactcc tggtatgtgt gtgtgtgtgg tgggggagga 556140
 tgggtagcag atagaagagc cagcgaagc caagagcagt attaggaggc ctacctgggc 556200
 tggtcagtc ccagaacagc agtctcccag aagatgtgga tgggtgcaga gaggctatgg 556260
 cagtgccaa ggcagcagtg gctgaggatg ggcagaccat ggtaacacac agcatgattg 556320
 ccaagttcat gatgtggaac aagttcctga tgtggaacac gctggtatag gtagcaagtg 556380
 accaaaatga aggtccttct tatggactga gttcaggaag gggaggagag catggagtgg 556440
 gtggggcgtg ggaagggaac caccaccag aaggagtgct cagtggccag ctggtgttca 556500

 tgacactctt cactctctga gtgcaacctg attttctact ctgtatatta aaacatggtg 556560
 cctattccat taggctttga gactgatatg tctggattgc aataaattca gctgcttctt 556620
 cacttcctg tccatgctct tgcaggccag cggctctgct tgttagacta tttacctgta 556680
 atactttctg gatcaagatg agaaattaat acaataaatc atcctcttgc agcagtgggt 556740
 ggatagactc ttaggtgatt cccatggccc ctgctccca ttgtcctat ctttgtgtaa 556800
 tttccttctt agggattagc tgctggtgaa agttccagct catcatatct gtggttccac 556860
 acactgtgtg aattttctc ttgctggtgg gctgtggact gctatgaggg gttgcctttg 556920

gagaagcctg ctgccatggt gaaaaagagc ttgtgaataa ggaactggga gaaggctgtc 556980
 actgatgaga atgaccttag catagcacta gtaagaagtt ggggcctcag ttgcagcaa 557040
 ggatatgaat gataccagga gctaaatgaa gtttagacat cccagtcaag ccttcagacc 557100
 aacactaagc ctigcagagg acccgactaa ccatgcctgg actcctaacc cacagaggtt 557160
 gtaggtaata attgtgtact cttttcacc actaaggttt ttcatttatt aaacaatata 557220
 tagagtaata gtactctata tttgcttttc attctctctt taagatgtgt ttgggtcatg 557280
 gaagaaatac ctgtctgatg acctttgtca gagagctgta gacctcttaa gcaggctgat 557340

 gaaggagatg agtgtgagtg atgctaggtg ttgaataaga gccagggcag gagtataaag 557400
 agtttgagac cagccttctc tgcatagtga gttcttgtct tagaaaataa aacaaaataa 557460
 tagaacaaca tctcaacca agatggggca agcctgcctc tatgtctggg aagaggccac 557520
 acctcatata taaactctgc attttcacca ctctctcaca gctggctact aactgggtca 557580
 ggcagcagtt acctcctgt gtaccagacc atcagtatgt tctaggtacc gagctatgtt 557640
 ttatggctca tattggttat gaggcatctg gtgttgaga aggcctgtgc atggatgggt 557700
 ggggtggaagg ggcaaaaggt cacttctagg gcatgtgaaa gccttcaagt caccctgcca 557760

 aggatattcc aatgttcata tccatgccta gacatctcta attgagtcac aattagacaa 557820
 gtctatctt ctctcaaag gatctatcc aagactctac atttgcagc atgccccatc 557880
 tcaagatagc cagtgaacat gtgagagaaa gcctcctcca aacacatcgc tcatcaataa 557940
 catccagtgt ttcggcttct ggtggttcag gggagctaca ttagagagta caagaggcag 558000
 gggaactata aaaaatagaa gcaacggcat taattctcaa acaatcaaag ctgggccagc 558060
 tattttcctg atttatgita ccttttattg caaagctgca tgccttgtcc agcttaaatc 558120
 tgaaagagcc acaagggaaa ctcaagtgca tctccagcct gtgccctcc tgggtataaa 558180

 cgaactgcac acaagaaaat agagtaagcg gcctcgtctg cttaaatact gtttatttct 558240
 accgtgctta cttacattcc aggggggtga ttattctaata cacaagcatt gagagcaaat 558300
 tagttcatct taaaattcat tattgacaat ggacttggtt caaactgaa tttctaaca 558360
 catctccata tecaataaag ttgaatctgg ccctgtgtg tgcagagaat gaacggagtg 558420
 ggagtggagg taggtgggtg agtgatgggg aggccacaca ggttaggagc agcctccgtc 558480
 tctttaaaaa tgtttcattg attttaagt tggcatacag tgtaaataggt tttatgacgg 558540
 cattttcata tatatgcat tacaactcgt tcttactgga gcaccacacc cccaaccca 558600

 ctaagttccc ttcttttcc aaaaatctct tgtgttccc ttcttccc tgetaagtcc 558660
 ccatatactt ceattgtctt ctctttctc ttctttaga cctcttctc cctctcatg 558720
 cctttttc tcctctctc tctctctc tctttctc tctctctc tctctctc 558780

tctctctctc tctctctctc tcacacacac acacacacac acacacacac acacgcatgc 558840
 aggcagcaga cagacaaaca cacatacaga catacaggca gacacacaga catgcaggca 558900
 ggcagacaga cacagacaca cagagacagg cacacaggca gatacacaca cacacacgca 558960
 cacacagtca cactcacaca cagtcacact cactccctga tgtcacacce acctatggct 559020

 cactctccac cagctgtgcc aatctctttg ctcttctgga atgttctcca gaactcaggg 559080
 ccttattctg gaatgttctc cagaactcag ggccttgggt actttctctg tagttggaat 559140
 acatcctaca agtaccaca tgactcgttc cttcacttaa tgtctctgtc taaacttctg 559200
 tctaattctc agaacctcac tctgtttcat gcaaaaatgg gaagacagtt ataagttaa 559260
 gagtccattt cagggtctta gcactctgga gaaaacacca gaggtgtgag agagtgagca 559320
 gtgtgtttcc atgtaaaata aaatactttg gtatattaac tacttttttg ttgttgtgt 559380
 tgctgctgtt accagtttct gacaaaagca agttaagaaa ggaagacagc ttggatgcag 559440

 gacagcacag cagcagcgtg gtgggtgggt tgggtgggt ggtggtggag gggtttctgg 559500
 ggatgggtgg gcgggaagcc tgggtgggtgg gggattcctg gctatgggtg ggcaggaagc 559560
 ctgggggtgg tgggattcct ggctatgggt gggcaggaag cctgggggtg gggggattcc 559620
 tggctatggt ggggcaggaa gcctgggtgt ggtgggattc ctggctatgg cggcaggatc 559680
 atgaggcttg ttcattgtgt ggtggggctc ggtggcttg gcagaaagat taatggttac 559740
 ataatggtgt caggacgtgg ttttatgaac ttccacataa aagcttcaca aaagcttaaa 559800
 aaggggattt tagaagcaaa agaacagaga caaacacaac ttcttggtag cagcattttc 559860

 tcagggtggtc tgttttgcag agacaagcag aggctggagg ctcttttaag agaggcttcc 559920
 tgactcagca taagtggcaa aaactgcaag gctctttaga ggtcttgcta acaattcagt 559980
 ggtgtgtaca agcagctggc catggcagtg accacatctc caagccggca gcatgctgct 560040
 tgattgcage gtagaccaag gcagtgagca cagctctcac tgtggcagt aaacgtatgc 560100
 cctccatctt ggaaagacaa tgggtaaaaa atccactgct ttaattttag cagtgttgtt 560160
 tagcagataa aagactgtgt ggccagaaaa aggtaaagat ttacagtaa gcagattcag 560220
 atgaagaaaa acctccctct aaaggttaac agtgtattta aaaatatatg tagacttgtg 560280

 agagaaaaga aacaggataa agtaattaa gaaaagccgg tgggtgggtt ggcacatggt 560340
 ggtaggattt gctgaaggaa gcagaggcaa gcagatctct gtgacttcaa ggccagcctg 560400
 gtgtacagag tgaattcaag ggccccaat gttacacaga gaaaccctgt ctcataaaag 560460
 gaaaacttaa aagtaaaaga aatagagtaa tgaaaaagcc acgtaaggat ggaaaatcca 560520
 cagtctggat actatatgcc ataattgttg tctttaaatt gtttgattgc cgaggaaaga 560580
 gctacagctg ctaaaagata tttggttacc aatgctgcta aattaatcca acctatcat 560640

tttaaaaatg ctttgacttc aaaatttaag tctaaggaca ggctacttgg gaaaagaatt 560700

 tctgcttttg ttacacagg aatgaaaag ctgtggattc cttccagact aatatggttt 560760
 gatcaagcaa gacccccctga agcaatggcc caactgattc tacatccaaa acagctgaga 560820
 tgatgcagtc agaatccatt atagaaggat tctgtgtttt tatcatgac cccatggtat 560880
 ggacatgcc ccccccccc caaccaccag gaaccagaga atgaatgaca cccaaattca 560940
 caaatactgt ttataaatgt ttgttttcat ttaaatgggg ttgggctctc tttctctccc 561000
 tccctctgtg gccccagccc tctgctgct acccgtggat caggatataa agctctcatc 561060
 tacttcttta gcaccatgcc tgectgcta ccgcatggt cccaccatga taatgatgga 561120

 ctaactttct gaagctgtaa gcaagcccc aaacaaatgc tttcttaggg tcagactcc 561180
 gagcatctaa tctcagctgc cctctgagac ctgaccggaa ctcagggaga gcaagactgt 561240
 ctgtcctccc agaccaaaa cccacacggc caaacaggca tggtcagcgc cacaggtagc 561300
 ctcccaggaa atcagcatgg gcccatctat gaccaaggca gaaagccaac aggtagt aag 561360
 caaagcaaca atgtgaacag atgtggagcc ctcagatcta ctacctacc aggttgtgtg 561420
 tgtgtcttca ttttgagtcg gagcacaggg gagtcatgg caatgctctc ctggactttg 561480
 aaagagagat gtacatatgc actgattttc ttatccttct ttccttttgt tggctgctagc 561540

 aattaaacc agggccttgt gcataccagc caaacgctct accagctgag ctgcattact 561600
 tctattctta ggaatggtct gattgctctc tctggacagt taggaggaga tgatagccaa 561660
 ggaaaggtgc ctcttctgct agttgacctc ctgtccttat gaagcagga gggatactga 561720
 tctcatttct ctgacttcat ggttgcagat gacggcagag aatcaagtc tgtactaaag 561780
 acagtagtat gattgattca ttggatgcaa ttgtcctta taccatttct aatttgttat 561840
 tggctcttag actactaaag acagcttact ggagagtta cagttcagtt tcctcatttc 561900
 atatatgaga aagaaatcta gaatcaccca taaggagact agagagatgg gtcagtgggt 561960

 aaagtgtttg tgccacatat atgaagacct gagttcaacc cccagcacc atgtaaaaag 562020
 ccaagctcag tagtaaagac ttgtaatctc tgtgctagag agatggagat ggacttctgg 562080
 attctagctg aaccagcaag ttccatgagt tcctctccca aaaatctatg ggagaatgac 562140
 taacaagac accagacatc aactgccttc ttatttatat gtgtacaca atttaaaga 562200
 catggtttcc agtttactt ctttggctt tctactgaa atgactggat ttgttttaat 562260
 tttgtgttg ttgtttggtt ggttggttgg cttttactta gctttctggc tcttttagt 562320
 gtaatttca agttgttca agaacagaaa atattaccag tattgtacc agtatactca 562380

gaaagagtta tgactaagtg ataaaggcat caagttaaaa aacaaaaaac aaaaaacaaa 562440
 aaaaaataaa tggggttggg tataaatggg gatgatcaca gtcaatctct ttttaaagga 562500
 aaaaagggga ataggatata gaaaggaata ctttgcatg gtatggattt tcatttattg 562560
 atacaacttt aaggtcaatt ttgtgatatg tatatgtctc ctcttgttta ggtattgtgt 562620
 ttatacagat cttttaaata gcaatgcata attaaataga gattgtatat agtcaggtct 562680
 aatagtcaaa acttacagtt atgttagtta ggttttctag atatacagag atgtatttga 562740
 aatggataga tattctccaa acctttcaaa gacctacaga atatatggca tttaaatggg 562800

 ttagggtttt tcatgacagt gagacacaac tgctcctggc ataccaatta catcagaaag 562860
 aaggatgggc agtgaagaaa ctcaatatgg agtttgcctt caacatggca agattagcca 562920
 tttgggcaaa aaaactgctc ttgcctggac tgtttgataa actggacatg aaggatccac 562980
 aggaaagtga ctgctgaact tgcaaaatga gacagtctg aagggttctt gcttcatgga 563040
 gaagtctgcc agatacactg tgacctatag gctgaatatg gatgccccaa cgttacagag 563100
 aaactttggg tgactgtcca ggtagtgaga tgtctctgtc agatgtagag tttatattat 563160
 ccttctgtgg tctttgatgg agttgaagac agacagtttt ctttagttat tataaaaaga 563220

 taagctacat ataagacctt agactcaca agataaaata gatgatagaa tattttcttt 563280
 aaatcttgct aaatgttagt gaactaaata tcataactat agttcttact tgataactgt 563340
 ttgtttatat attttactat gtntntntntnt nntntntntnt nntntntntnt nntntntntnt 563400
 nntntntntnt nntntntntnt nntntntntnt nntntntntnt nntntntntnt nntntntntnt 563460
 nntntntntnt nntntntntnt nntntntntnt nntntntntnt nntntntntnt nggaaatgtag 563520
 taaaaagaag tcttgtgatc caggtaggaa gtgacatagc aggcagactc agaataaag 563580
 cagggacaag caggaaatcc ctctcttctt ctctctccta ctctcttctc tgggctgtca 563640

 ccctgtgagc cttacaagag aggatgcatg ccaccggcac cctggatctg ataagtcttt 563700
 ataaatacat agtttaatga ttatggttga taattaagac taactagcag ataagaaatc 563760
 ctagtcatg gccagcagca ttgtaattaa tataagactc tgtgtgttat tttgggtgcc 563820
 catgtggtgg cggggcttgg acggettggc agaaagattt attgttacag gcaagcatgg 563880
 tgggtggtgt ggggattcct ggctatggtg gggcaggcaa gcatggcagt ggggggattc 563940
 ctggctatgg tgacaggatc atgaggctt ttcacatctg cgcaggtcag gaagagagag 564000
 aaatgagctc acatgccaat ggcagtctca tttgccacce cctttatcc agtcctgaac 564060

 tctaacctag gcatttctta gttcaatcaa ctfgacaatc gaaattaatc atcatgaatc 564120
 catcatgaat gtattcaaac atgtctcadc aatctacaat tgaaatgaaa attttgaggg 564180
 aagataccac agatttctaa aacaaaagca taaaagcaaa gcctggggca ggggcaagca 564240

aagaaaacca acggccagag ccccatagct tctcttttct ctgaaggaat tcagatacta 564300
ggctacaaac aggtcacact cttgtagaca catgtccaat ttccaaatgg gtttaaatt 564360
taagaaaaaa atttgtattt cctaaaaaaa ataataatgc tttaaataac ttttaattatc 564420
tactgtcttt gcctatgagt gggccatatt ttttctaag gtgtggtatc cacaggcata 564480

aaatatatth tcahtagaa agatttcacc atcattatgt acaggaagaa aatggtgtga 564540
ggtgatgtcc agcccatagc acaagcagat ccctatcaga tgtatgggac ttaaactgct 564600
gcaaggaggg tcctcaggag ggtgggctct ttgcagatga gctttgcaat ttagagatga 564660
acaatgaagg cagggtatta atgagttcac cagacacaag ataaatgata aatgggtgtt 564720
ttatcggggg acaacttaca cagataatag taaagaacca tcacagagt cctgctccag 564780
aagaagcagt ctctgccctt ccaatgctct cggcacaacc caactgatag tgcccagacc 564840
tgcttctcta cttcaggca gtcatgggtg tacctgaaac cacacccaaa agggtgtggc 564900

cgctactgca attttactg gcaaggctac atgccactac aaaacgacat tccccttca 564960
gtaaagctaa cagtttatg ttggcgtctg cttctgtcat ccatccattc ctgcaacaa 565020
ctgaactgge ctactacct tctgacacac tatgccatgt ccagtctgca ctgctttgct 565080
ggggtctgtg tccaggcctg tgaggaggat gcagccatcc cttagtccc caggcttttg 565140
gatcctggtg cctgacagtc aatctatagc tagtctttt ctgtggtcag aggaaccact 565200
ttctggttga caataaagc aacctcacac ctcatgtttg tcaataactg agcctcaaat 565260
ctccttggca tgagctactt gaattcccag gagatggcta gcagatttag aagtatatgg 565320

cacacattht acaggagagg aagcccctta agagatthtgc gcagagtgc gaaactgtcc 565380
aagaaaggac ccccaaaggg atagaggga gagaggctgc caagcacggc tgggaataaa 565440
gcctgtctcc agcagccaga ctggaaaaag actcataagt cccagagatt gggataagtg 565500
ttcaggagag atttcaaaag tgaaaaatta attgcatggc ctgggcacca tttcagaatg 565560
cccaactact tttccgggtc ctaaaagacc tagaaacagc taactaacc aattacttaa 565620
ctacatagta gaatggagcc caggcagtt tgaagaatc caaacattc catcatcaa 565680
caagataact ttcagaaagt ctgtctggac tctaatcaga ggcaatgtgc aggccaagaa 565740

agaaaactta accctcaatc cagaaaaggg ctggctagtt acaaccagct tagaactggc 565800
cccagtgcta gaattagcat cagcttgaat taaaactggt gaggaatctc caaccaggga 565860
tttatggga ataatacaca tgaggttga ctatagttct cacatacaga ccaggctgt 565920
ctcctgtgtc tacagacaga gggaaaggag ttagggcct atatcatgct caaggacgat 565980
ccgtagtccg taaggctaag atttctttat tcagataaac accagccaaa cgcaagccag 566040
agcgtgccca gaggcagcaa gctagctagg ccagagacaa ggggtctcca cgtgtctgag 566100

gcccttaag aattgccct gcatcatctt cgacctccc tggccacgcc ttcattggcac 566160

 acctgtaggg gcttctagga ggcggggcta caatctttcc ctacaggggc caaagagttt 566220
 atgggatgaa ctgttgcctg ctgggtctta tatagctaga gttctgattg gcaaatgtta 566280
 attgtgggta ggcaggattt gaaattgaat tctaatagaga accctgtagt ttcagaatgg 566340
 ggggtgcagga gtcaagcacc ctttgttctt ttttgggtcac ccactgactc tgtttcaatt 566400
 ggatgtcaca ctttgtgtta ttagtttttg aagtgcagg gagacactga aagtctgtcc 566460
 cagcaacatt gtcaccctag ctgaacctta aaaacagcat gttcatacag atgggaaaac 566520
 agacttttaa aaagaaaag agattctcag gctggagaga accctcagt gtaagagcac 566580

 tggctgctct ttcccaggat ctggattcca ttcccaacac ccacatggaa accacctgta 566640
 attctagtcc ctgggattc gaccacctt tctggcctcc acagacactg catacatag 566700
 gtgcatagaa gttcatgcag gcaaagcagc tatatgcata aataaaaata agtaaatctt 566760
 aaaaaacaca aattctctaa tgtgaagcag tgctaaggaa tattaaactc ttacagtgga 566820
 cgataagagg cagaatatta aaaagcacgt taccaccatc atagtggtc attacagttag 566880
 ttccaagact tgacaggaat tgccatgact ttgaggetaa actgggcttc aaagtgagat 566940
 cctgtttcaa aataatagca aagccaaaca acaccatcca attgcagttg aatcctcaa 567000

 acaggtaaaa ttcattagtgt ttaagtctgg ttgtttctgg agtatgggat cacagaggta 567060
 aagactaaa gagggcattg gggaaggta gggattctct gtatcgaaa gttgcaggcg 567120
 tgtttgcagt tataacagtg gattgcactg tccagtttgt ggaataggaa ttctcattag 567180
 cattccaaga agccaatagg aaaatcacac ttcattgtaga agcagatcca atggcaatgt 567240
 tgagcagatg aaaacatgtt cagtatcatt aggattctta gtaacaagca gaatcacagc 567300
 cagaaaatat tttatactg ccaaactgt gatattttaa aactttaagg tatttttgac 567360
 acctcttate atgctgtgtt gatgcaagat aatataataga gtgatcatgt taggaaatat 567420

 tatggcttat ctgtgccatt aaatactcct tccatgagtg tttccgtaa aatgacttg 567480
 attattagag acgtggaatt tatggaacta tagacaaatg gtagagtcaa gtatgcatgg 567540
 ggtacaacta tcagaagtg aattgatga agctacataa aaacataggt aatctcagg 567600
 gtgtaacgct gactgggaaa agctggtctc caaagactac ctgcagaatg agttggtatc 567660
 tactaccta cctatctgcc atctatcaat ctaccatcta tttggcaaca tacaaaactg 567720
 tatgaagttt acaggcttaa acatggtaac aataagaaa agtggaaaca atgaacagaa 567780
 ttaaatcatg gaactagaga ataatgcaa gatgtttgt tctttattc ttcctcctt 567840

ctcttctctg acctcttttt cttcttcccc tctgctttga tgatagggtc tgagacaagc 567900
 agcccagata ggcttggctc tgcaatcttc ctgcatcagt cttcctaagc ttatatgct 567960
 actctttaca ccttatatat tctctgcaga aattctttct tttcccctta gtgtttcata 568020
 tgagattaag tgaagagtg aaaaaataat ataggagagt caaccaaagc ttataaagta 568080
 aatatatata tatatatata tagcttgcca gtgacaactt aaaaaccttc atgaaactca 568140
 atttaaacct gcctattttt aatagtgaaa tgcctcatt tagattgata agattatgct 568200
 gtctaagggt agagctgaaa gacacaaatg atgctattaa tgaataatg catgaggtaa 568260

 attcgaggag ttatgaacat gttgctcatt cccagatcat aattaactga ttacatgtgg 568320
 aggtgaggag cttgagtga aagacttctg ccatttctct agagatgctc atttggcctt 568380
 ctttacacag cagttcacta cacgcagtgg aactcatctc ccttgctgga catttcaagt 568440
 catcagaggg acggagggg tagctttggg tgggtgggg acccaacaca gaatcctgct 568500
 tccgagaacc caatatgtaa gttgaaattt tattccatgt cttctgaaga ctgatgtccc 568560
 cctggtacat ttgtgtccta catgccagtg gtttctggaa gaaacaacct gaatctgaag 568620
 gatttattgc ctataaaagg agggaaattc cattctgaat ttttggcttt ttgcaagacc 568680

 acagtggca tggacagatc tatttagact taggagtctg cctctgactg agtggctgag 568740
 tctcagctca taagcaatgg agagaaaaaa acagacacta ttctgggttg tctaaaactg 568800
 cttccaaaat tacacaatgc aagtctgagg atgtggctca gctgatagac agcttgctca 568860
 gtatgcttga ggcctggtt ccagtcattg gtacatgaat tgggcttggc agcacaacg 568920
 tataatccta gtagttagag gcaacaggga gatatgagtt caagccacc ttggctacat 568980
 aaaaagtta aggtcagcct gggatacatg agaccttgtt ttcaggaata gaggaagaaa 569040
 ggaaaggaag aaaggaagga aggaagaaa aaagaacaag ctctctctcc aaggagctat 569100

 gagcagttaa tggtttatgg gaggagtaga gtcacagtcc ttagtgtgta tccactgtga 569160
 agctgccctt ccacctatgt ttatttaagt gactttaatg aaatgcagag ggtcacaaaa 569220
 ggcatgaaat ggggggcctg tggggtaaag agaggggtac agtgtgagtg ggaggggaac 569280
 aagaggataa tgggtttggg atatcaaagt gtattattat ttttaaaaat atttattat 569340
 ttttatttta tttgtgtcct ggcctgcagg acgtcaacct ggggcaagag agtcagggat 569400
 agggaatggg gacaagagac acagaaagaa cgaccacaag acaggattct gatcaagtgg 569460
 caaactttac ttttctcagg ctageattata tagttagcag agcaggatat ggggaggggc 569520

 agaatgggtt gtttgtgtac caggtgttag tataggcagg atattaggaa gccacaaaga 569580
 ggatgtttgg cagggtaaag agttcatgag taagaggtcc aggaagggtt gcctaggtga 569640
 ctgggcctgt ggggtggagga ctggatcaag ttgtttcttt tcttgagctg aggttctaag 569700

gagctgcaat gtaaaggtta atatacaact atgtggccag ccaagcatga cctaggatct 569760
catgccaagt cctgagatct ggctccaac atatttgcac tggatcttg tctgtatgta 569820
tgtctgtgtg agagtgtcag atcttggagt tacagacagt tgtgagctgc catgtgggtg 569880
ctggggattg aaccagagac ctttggaaaa gcagtcagtg ctcttaactg ctgagccatc 569940

tctccagccc cccaaagtgt attattatat gtatgtctct ctgtatatgg atggattatg 570000
aaggaacagt aaagattatg agtgttctga ttatagaaac caaatatctt cttgtggaaa 570060
ttacagcaag attaggaat tagaaaagag catctcttaa atgtcagact tgtttattgt 570120
ctctatccag ctacccccag gatcaggaag caggagatgg ggaggtaggt tctgccttag 570180
gctggggaag aaacaattat aatagaagag gttctgagag tccaggatgg ggagtgggtg 570240
tgggtgggtg gggtgtgtgt gtgtgtgtgt gtgtgtgtgt atgggggggc agatgttgaa 570300
aatcttgtgt cagcctcctt cactgctcat tcaatgcagc cttctnnnnn nnnnnnnnnn 570360

nnnnnnnnnn nnnnnnnnnn nnnnnnnnnn nnnnnnnnnn nnnnnnnnnn nnnnnnnnnn 570420
nnnnnnnnnn nnnnnnnnnn nnnnnnnnnc tgtttgtgtg tgtgtgtgtg tgtgtgtgtg 570480
tgtgtgtgtg tgtgtgtgtg tgtgtgtgtg taaacactct atgaaaaatg tctccagtaa 570540
tccaatctg aacttttttt tttagttttc cccatttttc tcttttcttt gatttcaacc 570600
tgtatgcttt ctctgtatct gtttactgat aattatctta gtgtacttgc cactaaagaa 570660
atgggggtga gagaagagga aaagggagga aatgagcccg cactagtgga gttcacatct 570720
ggaccagat tagtgtttgc ctaggtcagc atttatttat cttttcacta aacttttcta 570780

tccaatcata agctaaaagt gctttccagg caagtggaca taagatgacc agcgacactg 570840
atggagttac agaaggtaac cagaagatgg gacactggcc atgtaggagg tcattccttt 570900
gacaaaatgg aaaaatctata ttcttttttg gtgtgtgtgt gtgtgtgtgt gtgtgtgtgt 570960
gtgtgtgtgc atgcctgtgt gtacatccaa ctgtgcatgt gccatagtgt ggagctcaga 571020
agtcaacttc aggaatttgt tctgtcctac cacatgggtc ctagggatca cactcaagcc 571080
cttaagcttg gcggcagatg gatgcctta ccttgcaaag ccatctggct ggctcaagac 571140
agcattccca gaacaatggc tgcagatctt atgagacact gtggtagtaa caagaggcat 571200

atttaattca tagtaagtcc agttgttcat tgagtaaact taaaggcaca atattgaacc 571260
ttgcggtcct gaaaattcac acaggaagtg gctgtgaagc ttttccactg gtcagtaatt 571320
acacagagca cagtgttgac cctttactcg agaaccacc cctacatata tattctgact 571380
ggcttaaaaa tttctgtagg taaaaaatta tagttaaag ctgtcacatt tttcaggaag 571440
aatatggaca agctaaaggc tttcttaatg atgtcttgca tagagctgtg tccatgaaga 571500
tgggtttcct gtgagcaagc catacaaatc tttaatatgt tttgtatttg cactaacaat 571560

catggaatt tataaataag ttaggaaatg gatatcagtt aaaaaaatc acctaagca 571620

 gaaatttcta caaagaaact taccctagga gatagctcac atctataaac caacatttgt 571680
 ctgaggcaag atcagagacc agcttgggtg atgagggatg tccttctgta tatatgtttc 571740
 tcttattggt tgatgaataa aaacatttgt tggccagtag aggcaggaag ataggiggga 571800
 ctaggagatg aggagaattc tgggaaaggt aggcaggaga gctgccaggg agacgccatg 571860
 tagagaccag gaaaatagga tgcaccaggc attctccggt aagccaagac cacatggaaa 571920
 tacatagatt tatagaaatg ggttaataat taagatagag ctagctaata agaagtctta 571980
 gttaataac taatacagtg tctgtgtgct ttttgggcc tgaagtggca acgggacctg 572040

 gtgggacaaa agaaaactcc agcaacacct gggctccatg ctgagttgga ggccatctgt 572100
 gcctatagaa tgaactgtg tctaacaaa caaacagcta ttttcttga tactgcactg 572160
 actggttaaa tggccatttc ttgaagattt gaggaattct gaactctgaa aaccttacta 572220
 aatgaacct ctgacatctt ataatttga aatattagct cttttattaa ttcacaattt 572280
 tgttatgtcc ctttcattt gtaaatatt gattcactta gttatgcaa ttcctgaat 572340
 gataaatcat ttcattacat aataggagaa attatgttca ttagcactca atctatgttg 572400
 ccaaaaaagt ttttaggatt gggaaattct tagtacagga gcagattcca tgattctaat 572460

 tttcggttga aaggacaaat tttgccttg gcaatgaata ctatcagttg ttttcttcta 572520
 agtgaaaact cccttcagtc atcttcttag aaaacattac cagatctaaa acagcctggt 572580
 ccacatagta aattccaggt gagctagtga ggctgttact caaaacaaaa caaaacaaaa 572640
 aacaaaaaca aacagacaaa caaaaaaca acctaacccc aactaatagt gtctgactaa 572700
 aatcaacatg caacgatag ctgactgcc agctaagctt tcaagcaaca gaggttcctg 572760
 gaaaaaaagg tgcaggatct gagctatccc agaatcccag gagtacttct ctgagagatg 572820
 ccacctggct tgtgaaacag caacacaagt gctgtatgca cacatttaat tetaccgct 572880

 gaaggttaaa agaaactact ctgaggttag agatttaata aaaccaacc cctgcaggct 572940
 ctttttttc cttccattta ttatgtatat agtgttctgc ctgcatagat gcacacactc 573000
 cagcagaggg caccagatct cttacaggt ggccgtgagc caccaggtgg ttgctgggaa 573060
 ttgaactcag gacatctgta agagcagcca ttgtacccc tgcaagtctc tgacagtaaa 573120
 gacacatagt ggttgttgtt gacttggttt gggccaagag cagttttctc cactattgct 573180
 ttttctcagt catttcaggc tcagcacagt gacaaaggca gatagcaccg tagacttttc 573240
 attccgagaa cccatttgtg atggtgattt tgactgtcag cttgatttgt ctcagacatg 573300

cctgggacac agtgagggtc acctctgctt tcagagaggg ctcatgaaat ggtgatgtgt 573360
ggatggcacc catcatgaat gtggctgcg atcctggatt taataagga aatggacaa 573420
agccacctga acacaattct tgttttaatg ttttcctggt ctgttgagat gtgagcaagc 573480
agccttctgc tgcaggcagg ggctagtctt gcctccttgc catcactgat gtggtggact 573540
gtaaacctg aactgtgaat catccctcaa gttgcttctt gttacatagg tggctgcagc 573600
cataagaaaa gacactcatg tagcattgaa aagctcttgt ggacccccag tccccaggt 573660
ctgaaggacc aactctaga accgacgact gttttagaag ggacagggat gccactaat 573720

tgagatttgt gtgggggact gaggttgct aagcagcagt tccaattaa ggccatcga 573780
agtgatccaa ggacatcagt ggccaactac tgcataaa ttaacaggaa tttgtgtctt 573840
agcatgtgat ttatctggaa gaggctttta gtctgagtt ctggaagaag ccaagaaga 573900
ttttattacg gtgatctatt ttaatttga gctcagttca gccatcaaag ccattttcaa 573960
taagctttca ggaaacacac ggatgtctct tctctttagt catgggctct ggggctgctt 574020
cagaaaggaa ataatcctc tgctaatgt taggaactaa cgatgatgac ttcagcctcc 574080
ctaaaacttc tctcaagctt tgtagccttg acaaggaaca gctctctggg aaagctctgc 574140

atgtttcgag gcttatttta aagcaaacta agattcagac tggggcaaat caattaacat 574200
gcagaatctt agcatcaggg gaactttgta ggatgcaatc ctgttttcta ttggttctta 574260
caaacaaagg taaagaaggc aggaaggcca cactaataca aaccatgtat actagtttgc 574320
aatactcctt gacatttctg tatcttctat gacaaaataa gagaatttgg atccctctag 574380
ccagtaagat attcccatca ttcacctctt tctgcaactgt ctcagcatac actaggcttg 574440
tcgacacccc aggacaccaa agtctggcag aagccatctt cattccattc tgctgaacag 574500
gtgtgttttt gtaaacgttg caaaaacatt ggggtgtgtt ggaactgaag atctggaaag 574560

ggcctgagga aataggaagt atattcagat ggtggaactg tgtgtggaac aacacaaact 574620
tgttttggg caatgataac ggttggtttg atgctaaca ttgcttgaa gttgctgctt 574680
cttcaggtct ccacatctc actttgctgc caccaaagga ccaagtttca gtagctgtag 574740
ccacatgag gtctacatga aaggetggag tcatcgtaga acacaggaaa aggaagaatt 574800
ctacatattc ttaacaaag agcattcata cgagaaagga ataaaagagt tgaggataaa 574860
agaagaggaa ctttgcaaaa ataaaaaaaa agatagtgtg gtctaaggaa agctgtaaaa 574920
agatgaggtc cagttcagtg gttaaagctt tacttagcct gattgaagct taatctttta 574980

cacagctaca aacaaaataa tcagtaaata attggtggc cctccctct ttagtccttc 575040
ttccctttga catctattca tttattaggt ttaattttca tcaaggtatt gaaaatgggt 575100
gggtgtggag atattggaac atggctgtag attcttggat gcaccttcat ggagaagccc 575160

ggggtctgtc tacttccttt aaactcccat gagcttgtgg ctgcctaagt cagtgtagta 575220
 cggctgtagt gatggagtga taactaagac agcagtggcc actgcaactgt ctcagaacat 575280
 ttgcttctga gaactgaggc actgtggaag aagcctgcac agcctacagc accatgttag 575340
 agataccata agtagccatt ctgcttcaca gtccagatgt ggcttcacac cggcatccta 575400

 gccccagcga aggatatggg agtgaccccc cacccataac cagtcaactgt agccctccac 575460
 aacacagcca tagtagatgg ggttcagtca gacagtgagg ctgagaggat gettccttgg 575520
 ggtacctctt cggagtctct cacctccacc ccacccaga aactatgagc acagcatggt 575580
 ggttgttggc taaccccact gagatgggtg attacttgtg atggaaaacc cactgattt 575640
 atgagatggt tgattacttg tgacggaagg taggggtgag tagctggttc tcagttagac 575700
 aaacacaagc ctacaacatc agatacttcc tgtatctgat ggttctgtca cctggtttgt 575760
 acagtcggtt catcaaaggt catggacacg tgagactgag atggtccagg accagccatg 575820

 ggggaaagca ggcgaaaatt caccgatttc ctctcaacac tacctcgtga ctgacgtcag 575880
 taactttgtc agcctcaggt accacatttg ccttgaaaac tcagagctca tcttggatgt 575940
 taaagcatga caagcagat cttgtggaga ttttttcaa ggtaaggctc gtgaaaacgc 576000
 aacattaaaa tgatccctaa aaagactacc taagcattct acggtaaagg tcacagtatt 576060
 tataggcctg cttcagtctc ctgaatttta aatccctgt ggttttaatt taataaccag 576120
 catgaagctg ttctctgctc tctaacctct cttaatgtct tgatttactt gactatgtaa 576180
 aggtaattat aagagacttt ttagagtcac caagtgagaa cccacttctc atcccatgg 576240

 gaagagaaat ttaaccaaat tgatggcgtt ttctatctaa cttctgagag ctgagctttg 576300
 ttctgtgggc tgttctagcc gccagcacct agcatggtga ttggcatgtc ataactatgc 576360
 aagaagtgtt tgttgatgaa acagaactga cactactgag tgggctactg aagaaaagag 576420
 aagtatccac aaactcttag agttcattct ttgagtaaag aattattttc tataaatgg 576480
 catggtgtcc calactggtg ataccagcac taagaaagct gaggcaggag gattgcctag 576540
 tagtttgaag taactttggg ctatgtagtg aattccaggg tggcttgaac tacagagtga 576600
 gatcctgtcc taagaaaaca aaataaaaca aatgaaaaa catttacttt ttgcatattt 576660

 tggccactgc ccagtgaag taaagtcagt cagaagaaag tataatgtaat atacatgtca 576720
 ataggctggt ggtattacc tgcacactt ctgtaacccc gttatcatca aggagggcag 576780
 aggcaggagg atagaaagtt ttggcacaat cagcctggat tatgtagcaa gactgtctaa 576840
 gatttcttgt tgaattaact gagctttcaa atgtaggagg gaaagctgtg gccatgagct 576900
 tagcattttg gcgnnnnnnn nnnnnnnnnn nnnnnaaat ggccacaaa ggggtggcac 576960
 tattaggagg tgtgaccctg ttggaggaag tgtgtcactg tgcaggcgga cttttaggtc 577020

tcatatatgc ttatgatacc acccagagtt ttaaaccaca tcctgttgcc tacaaagcca 577080

 agatgtagga ctctcagctc cttctccagc accatgtctg cctgcatgct gccatgtccc 577140
 accatgatga taatggactg aacctctgaa ctgtaattga gccacctcag tttaatgttt 577200
 tcctttataa gagttgctgt ggtcatggig tctcttcata gcaatagaaa ctctaagaca 577260
 acagaaacaa cggcacagca caatacagtg aaaaaacaaa attgattgaa gttttattca 577320
 tattctatat ctgtgtatct aatatttcca tcacttagaa aggcctttat catttaacac 577380
 aaaaaccaag ttgcctataa tctctaacta aaggaatgga actcagttga aaccctttc 577440
 cttgtctggg gatgtgtgca aacatttgat ttgtctcatt cccaatacaa gtgtttacaa 577500

 ggggctcccc atcacagta gatcccgtag ttcaacaata gcacaatcct ttcacaaacc 577560
 ttttcccage ctgcaggatg ccatctattg ttacagagc acctgggaac acagcagcat 577620
 gtccctggcc ctggtgaaac agacacaatg atgctgctgg cttctgtggt actcaagtec 577680
 tgccactgct cttttggfcc tcatgccaac catgtaggga tgggtttata cttgccatca 577740
 ctattatcca tatcctggag aagaggacac taagtgtta acttttgcca agtaacttgc 577800
 ccatgtttta gtcactgttg tgctactgtg accaaacgcc tgaaagaaca atttaaagga 577860
 gggaagataa atctggctca tcatttcaga ggtgtcaggc tgttatggtg gggatggagt 577920

 gttggagaag agcagcttgc accatgcagc caggaagcag aaagaggaaa tagggaaggc 577980
 cagcaccag gaacacatcc agagggacct acttcccca acatggttcc aacacctatc 578040
 ttttatcact tccaataat gctatgatat tatcattcag gggatcaata tattgactag 578100
 gttagagctt tcacaatcca ctaatctgca tgatTTTTtag ttcaatcatg ttagcaatta 578160
 aaaaaccatc atactactca atttcaaaca tggataata gccaagattc aaaccctacc 578220
 ccctgactt cagattcagg gttctcatct tggactgtat tacttcttag acactttggt 578280
 attcatgacc ggtttatgct ctccaaaagc atcaaaacag gctatagtaa taattttata 578340

 ttagttcctt tatccactaa aaataatagc ttggggctag ggagtctgca gtttaagagt 578400
 acttgttget cttgcagaag acctgtttac agttcccage accacatggt agctcacaac 578460
 cttttgtaac tccagttcca ggggacctga catcctcttc tggccttggg gggcatcagg 578520
 catgcatgtg gtacacafac atacatgcag gcgaaacact catacagatt aacattttta 578580
 aaagaaaaga cagcttgctg tctttttttt tttagatttt ttttggattt tcacatcatg 578640
 aaccccagtc ccattcatct ctcagtcct ctatatgagc ctttcacct tgtagcgtct 578700
 ctctcaaaa gacaataaaa aataagaata ttaataaaaa taaaataaaa aaacaaacca 578760

accaaacaaa caaaaaacca ctttgttctc tcgtctttcc tacctttgca tcttgccttc 578820
 attcattcat ttagtggaac ctgggagctg cgggtgtgtca cacagtatac cttttgttca 578880
 aacagcttta cttgcaattc ttctttgtaa tgagttgttg gtctggttca tgcctctggc 578940
 ttctggtata caccatcaac tggaacctca ccatgactcc tctcggatat cctgctgttg 579000
 ccctgagtca tagagatccc gtggctatgg ttccacagga ccagtcctt catgtgctcc 579060
 agcaggtcat agatgggta aatgctgggg agggccaact caaacctgg atgtgggtct 579120
 ggatggtagc ttgggctggc cattcctggc ctctgacatc ttgcatttca aatagagaaa 579180

 gcttccttcc ttgtaaatgt aacttgaaat atctctgacc catttttagc aaagctttgg 579240
 catgctgttt tcattattca aactagccca ggggttatgg atcatcttc aaacctgccg 579300
 tgaatccaca tgiattagag aagtaacccc atggaagtac atgaagaact ttggggaaat 579360
 gtttcttttt gtggacacag aagtgatctc caagtaactt cctgtgtctg agcattaata 579420
 aggagaccag tcacatgtac atagtgtgca aaggcctgt ccactctgtg gagccccaac 579480
 tggaggcaat gatggggctg atggggaaca gttgtggatt tgggagtgag atagtgtgc 579540
 ccagtctga ctttgccact tataaatcag ctcttatgtg gaaggtacta atgagcccc 579600

 agactctcag gtgctttcag atacaatggc cactgtagaa tatctacctc caagtagatc 579660
 tgccagtatt agtgataaaa aatataggtt acctccctaa atttgaattc cagataaaca 579720
 cagtatttaa agaaaatagg agtgccttca atgttgcatg tggcacaac taaagtatt 579780
 gcatgagata caagaaaac ttccattatc tgaattgaa gtttattggg catcctgtgt 579840
 tgtaggaagc acctctacc gaaagggtg gtgtgatggc tgaagaaag aagtaacagg 579900
 tacciaagtct agcccacttc ctgcgcatga gagagagaca acatgtcgtt ctttctccta 579960
 tagaagaacc ttgtgtacc aagggtctc tcttggctg gacttgcac ctctctctt 580020

 aagagtttcc tctcctatga ctgagaaaat gttccttatg caccgaattt aacataaagt 580080
 attaaaattg ggtatttctg acagctagca ttaatttct ccctagtctt ttgcaaattt 580140
 atcaagtgag gtgataatgt gtttatgatg aacaaataaa gcttccccga aggtcagagt 580200
 acaaaattag ccacactagt taaccataga ggccagacag tggatgata aactttaatc 580260
 ccagcactcg ggagacacag gcagatggat ctctgtgagt tcaaggccac cctgggctcc 580320
 acgagattga atcttctaaa agagaacag agctcacaca aaggtgatcc cagcacttgg 580380
 gateccatgc gtttaatecc agcactagga aggaatataa ggcaggagct cagcgcagt 580440

 tgaagagcag ttgagtcagg agcagtgtgg gttttgtgg attgcccctt cggctctgagc 580500
 attagtagag gtgaggctc tctagtagcc ggtgctttg cttttctgat attcagcttg 580560
 aacccaata tctgtttctt gtttttatt attcgtgcta caatagagta ttttcatgt 580620

agctccaatg tgiatttatt cttgcaacac ttcccgtgc ctgccacagt gctgggaagt 580680
 ggagcacaga agtgagtgtt ccctggggct ggagagacgg ctgagctgtt gaggacacac 580740
 actgctcttg cagaggacct gagttcattt cccagcaccc atatctcaca acctcaggag 580800
 atccagcacc tcgtctgggc actcatacat ctgcctggca tacattctct ctgtctctat 580860

 ctctgtctct ctctctctct cacacacaca aagaaaaatt ttaaaaatta taaagacatg 580920
 ggacagtgcct gaaggaatct tgcccttggg gttagtattc aggcgtctgt actggcgtec 580980
 ttggggact gacaggatac gcccttagct gccgccactt agagcaccgc ctgtgcacat 581040
 tcactacgtt cccctttaaagg ggccttgc ccacttccca tcttctctc tctctttctc 581100
 ttctctctg actgttctcc tctcccttgg tctctcccc tcttctctt ctctctctt 581160
 ctgctactcc tctctccaga ggcagctctc tctcccttt atgatccctt tcctaataa 581220
 taataataa aaaatccctc tgcttgagcc ttgtttcatg gcgtctttct catgcatgcc 581280

 gcttttctac aacatttga gtcaccacct ccggcaggca gcattctgct gacgtcgctg 581340
 tattcacgtg tgttacttgt gtgaccaaga ccaatacaa accagtgtaa ggggagaaga 581400
 gtgtacagge tgccatggtg ggaaggcata gcagcaggaa tgtgaggcta ctgggtctca 581460
 tgttagctga ctacgaagt gggaaagaac agcaagtgga actggcctat aaaaaacttc 581520
 cttcagtaag gttctgcctc ttaatgacca cacagccttc gggaacagcg ccacctgctg 581580
 gacaccaagt attcacacat aagcctgtgg ggaatagttc atattaaca agcatctggc 581640
 tactgatgcc tctccccgta cccaccctt ctggggaact acataaatcc tcttctattt 581700

 cttgcaaatc ttgtgccttc ttgagaattc atctgcactt aagtcatttc agcaaattec 581760
 tctctagtct tttctctct atacagtcaa gcctcacacc caggaatgtt gcaatttttt 581820
 ctctccccca ttctatccat tggtagataa ttttactct ataaagaac ggcaccctta 581880
 agcttcatt gtccttctt tcccacaaca caggacctt ccttctcat tagtagcata 581940
 gccacctgct gccagcttcc ttgattcaaa caaccgtga ttattgtaat aaaatgatac 582000
 ttatttagtg tgctgttgg tgtgtgactg tggaggtcag aggacaactg gctggggtcg 582060
 cttctctct tccacctgt gggteccagg gattgaactc aagttgtcag gettggcagc 582120

 gagcaccccc atggaacctt ttattgatct ttgattggac ttttaaaaa agcacattta 582180
 ctcatcactc caatatgtaa aacccccaaa ttaacaaac ccaagacttc tcattccact 582240
 cagaaaaaaaa cttcactgg ctttcaagac tcttcttct cccatccctc gaccggtca 582300
 ctgccctcaa atttagagcc ctttggcaga gacgtgcagg accgactgcc cactcacagg 582360
 gtgggggtgt tgctgagggc tttacctgct gaagtccacc cagctggacc atcctctttt 582420
 ctgccacctc ccattccaca ctccatcatt gtctttctca ttgggaaagg gagccacgtc 582480

ttgtctccat gggtcaccag gatgtgtctg gtctagaac agtgcctggg gagtcatgga 582540

 cattcattgt ctatttctg agctggagt agtgtggatg gttgcacagg cagacagaga 582600
 atgtgagcaa gaccagaaa agagagcatt tctgggact gaacagaagg tgagaattga 582660
 aatatccatg gtatgaacag tttctgtgtt tattggaata ttaacttgcc tatgactgta 582720
 cacctgagat ttacaggatg ctgctgaact cgggagtcaa agaaagcaaa aaacattaca 582780
 aaagccttg aaaaaccatc tccttctgt tctgtccct gggtccttc tcatactat 582840
 gccataataa attcatatac caaacacaaa gaacaggag ggagcgcctc ttcctcccc 582900
 acaaaactaa gcacctgtc tctatgcca gctgggctc ttccatcagg gaagcaggag 582960

 cacatttgtt gtcttattga ggcttcaaga gtgtagctca gcaactctga gccagatgag 583020
 ggcttccagc agtgttctg gcttctagct acttattttt ttttttaaa ttgatctta 583080
 gatgttcag aaatggagcg acagaaaaa taggaagaga agtgcctata gtcacaaaga 583140
 actggctcag ggcttctctt ttccaggtgt ggaggacaca cacacacaca cacacacaca 583200
 cacacacaca cacacnnnnn nnnnnnnnnn nnnnnnnnnn nnnnnnnnnn nnnnnnnnnn 583260
 nnnnnnnnnn nnnnnnnnnn nnnnnnnnnn nnnnnnnnnn nnnnnnnnnn nnnnnnnnnn 583320
 nnnnnnnnnn nnnnnnnnnn nnnnnnnnnn nnnnnnnnnn nnnnnnnnnn nnnnnnnnnn 583380

 nnnnnnnnnn nnnnnnnnnn nnnnnnnnnn nnnnnnnnnn nnnnnnnnnn nnnnnnnnnn 583440
 nnnnnnnnnn nnnnctcac acacactcac acacacacac actcacacac acacactcac 583500
 actcacacac acactcactc acactcacac tcacacacac gtgtgcacac tcacatactc 583560
 acacacacac actcacacac acacacacac acacacacac cccacatgca tgtatgcaca 583620
 tgattcatcc ccacacctca ttagggccac attgagatg ggacatgggg aaaccataac 583680
 catggttctc attataaaaa agggaggggg tatcttgct tttttttttt ttctttctag 583740
 tggaggagca tgtactgca tgcattgtt catgtgtgtg gacacaagtg ttgcaagtac 583800

 acatggaggc ctggattgac agcagaaatc ttctggatt gtggctgcc tgcaccatct 583860
 gagtatcagg caaaagcctg gagatttga tgaacgaaa aacatccagt ctttttttga 583920
 gagaatgtct ctacacctta ttgtggagca gccttatata caaacttaca aaaccccagg 583980
 tcaaagggtt cacaacagga tattgatccc agtgggtga ggtcaggaaa acaggaggtta 584040
 cctgtggtta tctggaaaa caactcttag agacccctg gggactgagt cccaactctg 584100
 gatcacttat tctttgagc agagtgtgtc agtcaaactc agagctcact gatttggtta 584160
 gtcttgctag ctgctagct ttgggacccc tgggtatga tttattaac aatttataca 584220

tttttactta ttggggacat ggtaattgtg atgatttgag taagaatcat cccattggc 584280
 tcatatattt gaatacttgg tcctagtgtg gtagaactgt ttggaaggga ttaggaggtg 584340
 tggctttgtt ggaggtagtg tgttctgtga gttttcttcc catccaggtc ctgctgcctt 584400
 tcagcccaaa ataaacacac agatgctata tcaattatga aattgttggc caatggccag 584460
 ggcttcttat tggctagctc tctctaaatt attaacccat atctgttaat gtaagtattg 584520
 tcaccaggca gaggttatac tgcaatcctg catgttactc ctttggcagc atggtatctc 584580
 tactgagcct ctcagatttt ttttaaagat ttttttatta tgtatacaac attctgcttc 584640

 catgtatatac tgcacaccag aaaagggcac cagatctcat aatggatggt tgtgagccac 584700
 cgtgtggttg ctgggaattg aactcaggac ctctggaaga acagtcagtg ctcttaacct 584760
 ctgagccatc tctccagccc gagcctctca gattttattt attaaccaat aagagaacaa 584820
 tatgtacaga acaacatccc ccatcagagg tgtgtcactg gggatgggct ttaaggtctc 584880
 caaagactcc catcatttcc agtgtgctgt ctgcctcctg ctacacagaga ggcactctca 584940
 gttgttcttg attccatcat aaactctcac cctctgaacc catacacca attaacacc 585000
 ttcttttata agttgccttg gtcatagtgg tctctttttt ttcttcttag ggtctcactg 585060

 tatagctctg gatggcctgg aacttgctat gtagaccagg ctggcatctg cctgtttctg 585120
 cctctcaagt gctggaatga aagacatgga ccaactgcatc cagataatca tacttttatac 585180
 acagcaacag aaagtaacta atagagtaat aatgttgatc cctagtttga aaataagtca 585240
 aaccatactg ctctttattt gtgtctttat ttacatggga tagggatgga aaaggacaaa 585300
 ttccagagtga tggtgactta taagagaagg gctggaacag tgagtgggaa aagagatttc 585360
 aaatatacat aattttttaa taaggtgagt gtgtcaagat tattgaggac tagtggcaca 585420
 tatttataga cttagcactt gggaggctga ggcagaaggg cccagagttc taggtcagct 585480

 tgggctacac attaacacac catctaaaaa agatttgatg agtgtttggt ggaaacagtg 585540
 gaaatggata taatcatttc tttattctgt taggttctat caaagctata ttttcaaag 585600
 tagaagagaa ggatggagtt ggataaaaca gatttcatgc cattcttgca gcctgagtta 585660
 aatctagaga gatttaattg ctccatgtg gaaaagcatt tggcattttt ctttgatgtt 585720
 gttatatttt gctatagctt gaattatgaa actaaagatg tttgagatgt tccagggttc 585780
 agatttgcca tagggaaatg gtctctttca ctgtagtgt actttctcgt tgggactgcc 585840
 agcctgcaaa taatgataga atgatttatt atcaattata aaagcttggc cttagcttag 585900

 gcttgttctt caccagtttt tataacttaa attaatccat atttttaaatt ctatgttctt 585960
 atgtgaggct cattacctca tctccatatt gcccttecta gagttctctc acagactgga 586020
 agtctcgcct agctattggc cattcagctt ttattacac ggatcacagc aaagcatctt 586080

cacacagcgt ataaatacce cacagcatct ctacatttct ctctctctct ctctttctct 586140
ctctctctct ctctcccttt ccctctctcc gtgcgtgcgt gcgtgtgtgt gtgtgtgtgt 586200
gtgtgtgtgt gtgtgtgtgt gtgtgtgtgg tgtgtgtgtg tgtgtgtgtg tgtgtttgtg 586260
tgtatgtatg catgggtaca ttgcttccat cacatcccca aacatcatct gtgtaagaaa 586320

ccacccccta atatgttaga acaaaatgcc aagcatttcc ctgggttctc agcgttgaat 586380
gaggaattcc agcagggcac atgggtgacc tgagtcttca ctgggctgag agggacctca 586440
gctgggatga tgctcactgc tgctcatgtt tgccttattt ggtggatgat ttatatcttt 586500
aattttcttc cttgctgcgc tggtagcctg agtaaccaag ggggttgtcc tgctcaggtg 586560
gctgtgatca ttaagacaac ctggatatct ttccttatta gcccagcttc tccaactggc 586620
tgacttgagc ttccttctg tctcaggatc attggatttc ttcctggca tttatttccc 586680
ctcaaagaaa gtgttccaga aggcggagag tgcaaatcgc tggctccatc agacttgggc 586740

ctggaactac cagtgaaact tttcatcatg tctctttagt tggctggatc agagagaggg 586800
gcagcccaga taactactct tacaggtctg cctacaaggg gagtctctac aggtttgtag 586860
ccatcttgc tgcattttcc aaggacatgt gattcctcaa acaccaacac cctttgatgt 586920
ggtaggagca ttgcatggta agctaagcag cccaatcttt gcagtctctc ttcattggcct 586980
tgtgttctt ggatgggagc caggtgtgcc tnnnnnnnnn nnnnnnnnnn nnnnnnnnnn 587040
nnnnnnnnnn nnnnnnnnnn nnnntgagag ccacacagaa ccaggtccag attctgacce 587100
cattcctcat tacaggtgct accttaggtt ggtctttct ttttattaat taaaattat 587160

ttgatatttt atacagtat ttgcagtat tctgaacata tctacccttc tcaacttctc 587220
tggctcttcc ctacaccttc ccatttctt cctacttca tctctcttt ttttttttt 587280
ttttttttt aatgttgtga ccgagtttat ccattatgtg cacgagtgtg gggccaatcc 587340
actggagcat gggcaacctc ccagtggctg tgttctcgaa gaaaatgaaa tggacttttc 587400
atctcttagc agccaacagc tgcccaaac tcccagata ggggtggggt ctggtaagcc 587460
ctactccatc catgcaggtg tgttaagtgc ttgcttgtgt gaaggcaacc acagctgtta 587520
taagtttatg gcttgataa tttaatTTTA aagattaaac aaatatttta aatggtgtgt 587580

gtgtgtgtgt gtgtgtgtgt gtgtgtgtgt gtgtgtgtgc gtgtgacatg agctcaggtg 587640
tcctcagaag ccagtagagg atgtcaaacc ccttgaatt ggagtgatat gaactgtctg 587700
gtgtgggagc tgggaaatga actgggtcc tctggaagaa caatgcttgt tttgaacagc 587760
tggctatct ctccagctc ctggctggtt attcttgatg ccccagttc ctctttgtga 587820
gatggaaata gacgcagccc ctgtttggct ggtgtgtgt aaggttagac tggcatgtgg 587880
ccagattca gtaatcacgg tctgccttc gccagctctc ttgtcatctg tgtctggcat 587940

tagatgacat cttgtgtgaa cgcttccata agcagtgcca tggttgtaac cagttactac 588000

tgtgatgtgt ctacctgctc tgtctgacta ggatgtgttt acaggtagga atcgtgcctg 588060

tcctgttctt gggtttgctt gtccetaacg tctgcagag tgctaggtac agactacaca 588120

ctgaaagaga ataatgagt taatgaatga atgcatgaat atcccatat gtgaagctgt 588180

agggcatgag agcaaacagt tttgaaaggc ataggattgg gtgctgggaa ttatgtttt 588240

tcttagctat aggacagcag ctttgttctt ttacagaaat tctgctagct tattaggaag 588300

gtcaggaag ggtattcaga gaacaaaaga gccaatatc ctcttgaga aaagcatggc 588360

tcagcagtga caggatgaag aggagagaat ctgctggagg agtcctgaga ccagagggag 588420

atgagctgca ggacagctct gactgcactg tgtgcaggat gtgccaacac ttaggctctt 588480

tgggtgtcag tgaggtgaag caggaatgag gtggcataag aagcaagcta gaagaaagag 588540

gggtctccag gcttttccc aaagctgagg cagctttgtg ataactcaa tgggccagga 588600

ctttgtgccc tcctaatttt gggacactaa tccagtcttg gcagtgacac ccacactga 588660

catgaacacg tggaagtgcc aaagctcct tgcacacatc catggggagc tgcagagcc 588720

ccagctatg aagaatatcc aaggatcacc tgccaggcag gaagatgttc agaatgtctt 588780

gtccgggctt gttgtcactc agtagtannn mnnnnnagt acacttgtca tcttcatatc 588840

aagaaccata aagacataga acattttaaa aaaaagctct cagttttttt ttaaaaggtg 588900

aattttttca tcigtcaagg cagagagtaa atttatcaca gaaagaacga gttttaaaaa 588960

aagacggtac cgtataatg ctgccattaa gaacttcagt ccgcttgtca aatatctgat 589020

atztatgagt ttgatagggg aagaaaatct ccatgtgtgt ttaaacttct ccacgtctca 589080

gttattattc tccatgaagt acctccaggt acaactgaat atgcagaggg ttaatttttt 589140

tcatgaaat gggttgcaaa acttaaaact tctttaattt gaagctccta agtgactaaa 589200

aattctagtc agcgtaatca ttcatctaa taggcttgat gactgctgtc tttgacactg 589260

gcgtgtgtgc ctctcagtc cttctggtca catggccctc ctgccttgga gtccacacta 589320

agggggaagc agagactgaa caggcaaaga gcaatggctt ctctgctgag aaggttctgc 589380

atgggcagtg aggaaaacat tctgggatcc tctcatcatt acaaaaacct tatcagtgtg 589440

attatgaaa acacaagat aatttaccat tacgtttctt gcaaaataca tctcttctc 589500

ccgattagaa atgtgaactg aggtcttatt gattgagata gggtggcatg cttgtgcat 589560

aggatgatg cagactccag gggacaactt ttgggaggcc gtttggccct tccaccttgt 589620

tttgaggcag tgtctctctt gttttacca ttctgcatag ttcaggctga tctataggat 589680

tccaggtgac tciccttctc gtcctttcat ctcatgtagg catgctggga atacaggtac 589740
 attcccacac atctaccttt tttttgttg ttgttcatct aatcttattt tatttttatt 589800
 atgtaaatgc ttatttgtac tcttttttct atttttaatt taaattagaa acaagattgt 589860
 ttacatgtc aatcccagtt ccctctctct ccctctctcc cctgcccccc actaacaccc 589920
 tgccatccc ataaccttc tgttccccag ggagggtgag gccttcttcc atgggggatc 589980
 ttcagagtct gtcatatcct ttgggatagg gtctaggctc tccccatgt gtctaggctc 590040
 agggagtatc ccctatgta ggatgggatc ccaaagtcca ttcctatgct agggataagt 590100

accgaccac taccagagc cccatagatt tcggaggcct cttcattgac attcatacca 590160
 cattcagggg taacacagtc tatgctgatt tcccagtcct atgcatggtc tggggacat 590220
 gagtcccca atgttcaggc cagctgtttc tgtgggtttc accagcctgg aaacatacat 590280
 tcttcaaat ttgaaaatct aaaggaaatg cacaattttc agtagagatt acaattacca 590340
 aaattaaatc aagaacagat aagcaactta aaaaaacata taaccacctc atgaaattga 590400
 tgcagtcac agaagtcctc caacaaaaa aagcccagga ccagatggct tcatttcaga 590460
 ggacatttaa ggtagccttt ccactgggac taggatctga cgatgaggct ttatataggg 590520

acaggcctta ccgatgaac catcttggtg gctcccctgc tagatactta aaataagtct 590580
 gtgtctttat tttatctttt tctctttttg cagtatttgg atggagttag gacccctca 590640
 ccctctcatt tcaaaatgta gttagtttta ctttgactct tteccacttt ctgagctctg 590700
 tgcagctgca aatgacttct gtcacatccc gcctgagaaa gttattgcag gcagactcct 590760
 ttgctactgt taccttgctg cactgagttc ctgtcaacca gcagctgagc ccgatggaaa 590820
 attttctggt catgttaca acagaacctt cttttctggt gggatccagc ctgaaactctg 590880
 tcatgggtga tcaactctcc agaggctacc tgcagcctga agctcccatg ctgtctctca 590940

gggcattgaa gtgagatggc tacceatgtc ctcttcatg tttggttttt ttttgttgtt 591000
 gttgcttgtg ttttgaatg tctgtctctc tctgggtttt tttttttttt tttttttttt 591060
 tttttttttt ttttggtaac aactgtctcc aagctgcagt aagcatgaat ttccaactgg 591120
 agaactggag ttaacaatgt atgtatctc ttcacttttt agatcaaatt ggcagcataa 591180
 ttttaaaaag aagtgtttta cattcatcat atataccgat attttaaggt aagatgtcac 591240
 tgtctctgct ttaattgtac tgcactctct tcatcctcat ttatatgcac atcaagagc 591300
 ttgctcttct ttttaaaaga attacttctt ttccatgtat gtgtgtgggt ctgtgcacat 591360

gactgtgatt gtccaaggag gccagaaaagc agcattggat accctagagc tttgtgtgtg 591420
 tgtgtgtgta cccccacat aatacaata ttctttcttt ttttcttctt tecttcttct 591480
 cttcttctt tecttcttct cttcttctt tcttttcttt cctagaaaagc cccggcgact 591540

ctcctgtttt taiccttcca cccccgttgc tggggtaatg cacacacata gctgcacctg 591600
gctttcatgt gggggctggg gatctgaact taggcatcgt gcacagcaat gctgaatgtt 591660
tacaatgatt cttaacctga gaaggattct cttctcttcc tctctcttct ctctctctct 591720
cttctctccc tctttcttct ctccctctct tctctctctc tctctctctc tctctctctc 591780

tctctctctc tctctctctc tctttccatc ccaactcagc atcttgcaat tgctaggcaa 591840
gaactctacc actgagctaa atctccaacc cccagaagct acttcttaat atctaggata 591900
ttttaccttc ttttcccctg aaacaagtat tctgttccag tttccctcac agcatttcag 591960
ctcactgtga ataagactta aaaactctta ttaatggctc tgtttccaaa cattataaat 592020
atgtatataa acttgagaat tctaatttct catagctata aggctttaa tgtcaaaaaa 592080
ttcaattaag actatcatgt cctgcattat taacagagtt catgaaacca ctcatacaca 592140
tacaatgata cacacactaa acaggttttg ataattagat attaaatgtc gacaggcacc 592200

ttggaggttg ctgcttatgt ctgaatagct cttaccatt gcaagtgaca ttctgtttcc 592260
tctttataga tttttcacac ttaaaagga agaattatga cacagtgaag actccttttg 592320
gtatgccaga actcctagtg atttatcacc agaattatc ttcagttctg tgtccctgac 592380
tgctcaatta ctttggtag aacaacagc tggaactcac ctgatacaaa atgatttacc 592440
accccagtt atggattata tacagatttt ttaaagattt ttatttttgt tttaaagtgt 592500
gtgtgtgtgt gtgtgtgtgt gtatgtgtgt caagtgcacc tgagtgcaat tgggtggaagt 592560
ggccagaaga ggggtgtcata tccccgggat ctgaaatgac aggcagttat ttggaagcca 592620

cttggcacag tgctaggact gacctcagc cctttgcaag gggactctta attgcatctc 592680
tcttaacca tgggttagac ctccatgtc tctaaatgt gatgtgttga ggtttggtcc 592740
ccactgtggg ggactgtccc tcaaggag cagctggact ccaaaactta ctttctttt 592800
ctcattaggg aagcagcctt attccacct ccaataatga ggccaactga cagggtgaca 592860
cctctgaaac tgggagccaa agtaaatctt tctactttt agttgacttt ttttttttt 592920
ttttttgctc attcatcaca atgatagaaa ctaagacatt gtaccagtgt tatttctct 592980
ccaagtttt ggaaaacata tagacagget ttgtctcacc taaggacttt tcgctgatgg 593040

gctgcactct tttaaaggta ttttgcttaa tccaagaatt tagaatcagc tattaatggg 593100
aatatcatgg tttatttgc aagtactact ttagatactt tagaacgaaa tggttgtggt 593160
atatatttgc acataataca aatatttgtt ttaagtatta agatgtccag gtttaactta 593220
ctcattttat gaatgatacc tgccatttga cgtatttgac ccaaatcagt cttctttatg 593280
aaataacaga ttagacttac ttaatgtgat ttcatatttt taattcaaat aaggctatga 593340
aacgtattcc tctgagaact gtctcattca tagattcagg gcagtcagac actagggaaa 593400

ataccatag ccctatttcc tttccacat cgtgtgcttt gcatgtgtaa gcctgtgtgc 593460

 atgatttgca tgtgtaagcc tgtgtgtgtg tgtgtgattt gcacatgtaa gcctgtgtgt 593520
 gtgtgtgtgt gatttgcaaa tgtaagcctc tgtgtgtgtg tgtgtgtgtg atttgacat 593580
 gtaagcctat gtgtgtgtgt atgtgatttg caaatgtaag cctctgtgtg tgtgtgtgtg 593640
 tgtgatttgc acatgtaagc ctatgtgtgt gtgtatgtga tttgcaaatg taagcctctg 593700
 tgtgtgtgtg tgtgtgtgat ttgcacatgt aagcctgtgt gtgtgtgtgt gtgtgtgtgt 593760
 gtgtatgtga tttgcacatg taagcctgtg tgtgcgtgtg cgtgtgcgtg tgcgtgtgcg 593820
 tgtgtgtgtg tgtgtgtgtg tgtgtgtgtg tgtgatttgc acatgtaagc ctgtgtgtgt 593880

 gtgtgtgtgt gatttgcaaa tgtaagcctc tgtgtgtatg tgtgtgattt gcacatctga 593940
 gcctgtgtgt gtgtgtgtgt gtgtgtgtgt gtgtgtgtgt gtgtgtgtgt gtgatacaga 594000
 gaggcagaca tgtggaggtt caattttgat ggcgagaatc atccttgatg actgcatgtt 594060
 attcatcaag tcagggcttc taaatcaaac atagacctca tccatattgc gtctcttctg 594120
 agggagtttg ctgtgctgcc ttctgaggct ggaatcacag ctggaccacc atgccaacat 594180
 ggcatttatg tgggttccag ggatttgaac tccaatctc acctttgtgg ggtaagcact 594240
 ttaaccactg agcaatctc ccagccctt ctttcttct tcttcttct ctttcttct 594300

 ttcttcttct ctttcttct ttcttcttct ctttcttct ttgttgctg ttcttcgaga 594360
 cttgttttca tgiagccaag actcatctca agcttgctat gcagttgagg gtgaacttga 594420
 aattccccga tcttctgtt tccacctcc aagtgtctgg attgcaggca tcaaaccatc 594480
 ataaacgtcc ttctacacag cctcagtaaa attctgcatg ggaattatga ctgtgtttg 594540
 taaagaatcc tagagagaaa gaactgtgtt catgggtgtg ttgacgaca gactatttta 594600
 gaaagggcag gtgtgaatta aaaataaagg gcctgagttc ttaaaaacca ttgtgccatg 594660
 tgctccttgg ggaatcttgg ttgcacctga gggatgtggg tcccactac agctggcttg 594720

 ggttgcttac agtactgat gggacacttc tgtccagtgc atcaccagaa gggggcttta 594780
 gagccagaga gcatctgcat tataagagaa caccaatatt tttttctac aattgactgg 594840
 gcttcatagg caataatgtg gagtatattt gtgggtcacc ttgttactca tctgatgtg 594900
 aagaatacca ggctaacttt catagctctc tatctacga gctctacatt gtaaagacta 594960
 tgaataaaaa gcgggatgag agatggtaag aaacgatttg cagcaggaat aatgtgtaga 595020
 cacacagatg ctatactgtg cttgccgctt tgagcacctt ggggcatcag ctttcttcag 595080
 tgaagacta cagctcttca cagttccgat aataacgat ttaataact tcaaaaacat 595140

gttcatcctg aatgctcaat ggcagcaact gttatcactc acccagggag attgtcaagc 595200
 aaacacacag tttattattt ataaaagata aacaaaatat tttagcagct ttttaattct 595260
 tgttcaccag ctgttgttgg attcaaggag agagagagag agagagagag agagagagag 595320
 agagagagag agagagagag agagaattga ttttaattgt gcttatttct gagttcctca 595380
 gtgtgaacag gatgggaaaa aaccccagta cagaacaaca ttttcaagct catcatggtg 595440
 gtacactcct ctaatcccag cactcatgag gtagaggcag gaggatcagg agttcaatgc 595500
 cagcttcact atgttgtgac tttgaggcca gcgaatgcca catgagactc tgtatcatta 595560

ccaccaccac taccacat aaagaagaaa gacgctataa aagcaagttc atgatatctg 595620
 aggacagctt tgccacaggt gtacacgagc tcaaaagaca gtaggacaca gaggatcata 595680
 ttgatggcat aaaattagag atgattcttg cttgtcaaaa acatttagtt ttcattgcaaa 595740
 caaactgtca aaataactga gtctgcacta gatatatata gagattgtaa atataattag 595800
 aataccacaa gggaagctgt gcaaaaatcc attgggtata gatcagttac tcaatgaatt 595860
 agtaaaaagt gattccaac atccagttag tctataattt gagggtct gattctggtt 595920
 tattcctcag ttttgagaaa atcactgcaa atacagttca attgtagtcc aggaagtttt 595980

gatgttctgg aaaaagtcag gagacctca cacctcaaag ttttcagata aaggggctac 596040
 acgttggcag taaattatca ccatgctcac cctttgcat gaatcctaca aacagctcct 596100
 tggactcat ccaccaaac ctctctgct cctctgctgt accattagtc atccaatcaa 596160
 ggactagtgt cctcagccca ttgaccaaga acgtgtgaca catcagtaaa aatcacaagg 596220
 aatgtattta tcacagaact atcaaattag gagatcttta aaatcccaga aggttcttct 596280
 atccataatc agatttgagc taattttgac acagacatgc ttgtgcttta tctttaaatt 596340
 agacaggatt tggagaacct catgaagctc tagattcctt aggaaggaaa attgtaccaa 596400

cattgttgc tggttggaac taagtcttcc gtgctaagcc ttgtgaactg ccctttgacc 596460
 tagaaccaa gaaaaggata aagactataa tggccaatt agtagaaat aactcatttt 596520
 tcttcaatcc tgcttftaa aactccaatg gaatgaactg cagatttct tctgatctga 596580
 ggctaccaac aggataatta gaaattgtgt caagtgatga caaatgcaag taaaatctcc 596640
 ttttttgat gagggtaat gattcttaag ttatgcaaat ttaatatttt aatgagcaga 596700
 actttctgac ttagctttaa tatagtaatg tcagtggcaa aggaaaagca tggaggtagg 596760
 aatattttta ttattgtcag ttttttggg aaatatacca aggaagtgt tttgctaaat 596820

cttttaattt caaaatftaa ttctcagtaa aaatgtaaga ctttaaaaag gatagagaac 596880
 taaagtctt ctacactggg acccaggtgt tgtgtggggt ctcttgttgc agttatctga 596940
 ctctttatgg gtttcatct ttctctgctt tcagctgtg ctaaaattcc acaatttga 597000

gaataagtaa ttctcatcca cagaggttcc aatgaattat gtccagtaga ggtatgaaaa 597060
 actattactg tgcttatatt tgtgttattg agatttgtgt attcatttta ccattcataa 597120
 ttacttgtac atgaaggat ctgtcttcag attctccctt gaataatttg ttggctgggg 597180
 aaataaaagt gtggatagat tctcataaat tactcttaag actatittga gctgggaata 597240

 ttattcagtg gtaatgcact tgcctagcat aaataaggcc ctaggttcaa tttttgcatt 597300
 gcagtgtgtg tatgtgagag catgtatttg tgcatgagca cgagcatgtg tgtgtgtgtg 597360
 tgtgtgtgtg tgtgtgtgtg tgtgtgtgag tgagtgcgtg ttaataatct gttttctgtg 597420
 gttagaagc tggttctagt gtttaagcat gaagattttt gtggttgtgg atacttgaga 597480
 ctctcatcat gttagaacac aattgttaa attctcttgt tggctcaaag ggaagtcagc 597540
 tctactcaac aatcattta ttcatttcct cagtggttgg ctagtacctt aacattttcc 597600
 atctaagtat caaaaaggta gtgttagttg gatgtggtag tgtacacttg tcagcccagc 597660

 acttagaagg tgggcagga ggactgcccc aagtttgagg gaagcttggg ctgcagtgtg 597720
 agttctaagt catctagggc cgcagagtga gactttgtct caaacaaca aacaacaaa 597780
 caacaacaa caacaacaaa acaagagcaa ggaacacaaat aaaatgggcc agtgtcactg 597840
 agtctgtaaa ccaaagggg ctatgatgta agaattatga atgtaaccct aatgaacctg 597900
 taatgggta tgggaggact agtgaagagg tatctttcca ataacgtccc caagtgtct 597960
 ctcttgattc agtagatctg gaacattcat gcttcattgg ccagatcctc tggggaagtg 598020
 actcctgggt gaattagctt catacatgtt agtttaatgt ctgtcagaaa gttcatctaa 598080

 tagttcacia gataaaatga ttttccaaca tggaaacata ctttagaagc caaatcagca 598140
 tggtaggat gtgaactctg agaaccgagg aagaggctc cttccgcaca gattttccag 598200
 gttccccta gcttactctt tctcacagtc tcattggttc atgatttcaa taatccatcc 598260
 acaatagaaa gatgtgtgga ttataaaaca cctcataaat attagctatt aattttagaa 598320
 atttctatg tgaagattc ctttacgtgc ctgaactact ttgattttct attgctgtaa 598380
 taacacat tttatcccc aaaacaactt gggataaaaa ggggtttatt tgacttatga 598440
 ggtacaaggg acgtcagggc atgaactcaa agcaggaacc caaagacagg aactaaggca 598500

 gagactatgg aggaatgctg cttactggct ttcgccacc tcctaagga tagccctgct 598560
 ccagtgggct gggccctccc acatcgtag taattgagaa aatgttccac agacatgcc 598620
 ataggccaat ctcccaggt ttttttttt tttgtatcaa gttacaacaa attgatcagt 598680
 atagcacatc attcaccatt tagaaaaacc ttgactttct tcggtgggta tctgtgtggg 598740
 cctttgtaa gagctgggaa aattttaacc tggctgctgt caactgtggt agctactgta 598800
 gcttgaattc ccagaact tttctcct gtttgaacct gtcttgacct ataaaagcat 598860

cagcttccta ctgttcacga tgacaatgac acagcaggca caatctatac tgcctcagtt 598920

 tatttttggga aaagactatc agcattttca ataactttgt atctcatcga gaagaatate 598980
 ttccacaagg caagaatatt taatecccat tcataggccc ctgtgcctta atctgetcaa 599040
 attcaggaag ggatcttgat acattttgaa gcccagtga gtgatgact cctgtgtcct 599100
 agcacttggg aggtagaagc aggagaagca gaaattcaag ccagcctggg ttacacagtg 599160
 aatttgagge cagcctgggc tacacaagat cctgcctcaa tgaacaaacc aatccttctg 599220
 ccctctaagg ataccatttc tgtagcaaga gtttgatttc tctcatctgg tagtttttga 599280
 tcctgatcat atatgtccta caacaactaa aacattctcg gaaacttctg aaagtctgat 599340

 ttttattaaa aatcattata atttaaaaaa tcttggggct ggagagatgg ctcagcggtt 599400
 aagagcactg cctgctcttc caaaggctct gagttcaatt cccagaaacc acatggtggc 599460
 tcacaacat ctgtaatgag atttgggtgcc gaacactgta cacataataa ataaatcttt 599520
 aaaaaataa aaaaatcttt tctgagggcc tggagagatg gctcataggt taagaccact 599580
 ggggtgctctt ccagaggctt tgagttcaat ttccagcaac cacatgatgg ctcaacaacca 599640
 tctgtaatga gatctgggtg cctcttctgg cctgcagggga tacatgcaga cagaatactg 599700
 tatacataat aaataaataa ataaataaat aaataaatct tttctgagtg agaataaaac 599760

 ataaaattct ttaagtgtgt agatgatcaa ctcaaaactt tccagcaatg tgacatata 599820
 cttcaaaata atatcaagtt gccctttaa aagatactc tctctctctc tctctctctc 599880
 tctctctctc tctctctnnn nnnnnnnnnn nnnnnnnnnn nnnnnnnnnn nnnnnnnnnn 599940
 nnnnnnnnnn nnnnnnnnnn nnnnnnnnnn nnnnnnnnnn nnnnnnnnnn nnnnnnnnnn 600000
 nnnnnnnnnn nnnnnnnnnn nnnnnnnnnn nnnnnnnnnn nnnnnnnnnn nnnnnnnnnn 600060
 nnnnnnnnnn nnnnnnnnnn nnnnnnnnnn nnnnnnnnnn nnnnnnnntaa tacattttct 600120
 ctaggttttt gttcataatg ttttcttget atgttctttg atgaaatcta aagtgttggg 600180

 tcactttcca aggagcagtc taatgccccca cccccatg taggttcaca agcactgtgt 600240
 ccatgtgcat caggaggaca gaggtcaatg tcaagtacct ccacttaagt ttctgagaca 600300
 ggttctctca ttgaccctgg agctcactga tttagcaagg ctgagtatcc agcaagctcc 600360
 caggaatcca ctgatcattg cttccaagc actgggacga tagacacgtt tgttcacatc 600420
 cagcttttta tgtgggtgct gggaatcagg tceccacatt tgtacagcaa gcaactttacc 600480
 ctgagccacc tcttctgccc tgaacagttt actttttaac tttgacttt agaattttca 600540
 tgggcatttt atagctgctg tgtaagagac acctgaagta atctagatga agctattctc 600600

tctgctttgt aatggaaaat ctcatcaga aaaacaacag gctgttatct gttaaagcatt 600660
 tgtaaaacaa aataaaaata ctacagataa ttgaacttaa aaggagccag tcaggctact 600720
 actgtggaat attcctgttt acttttcagc taggctgtca atgttgcttt ctaggtgatg 600780
 catatgattc agacgttagg tgagaactag taagaagatg attgatttat ttatgtgttt 600840
 attgttttgt ggtactggag atcaaaactca gggactggg tgtgctagcc aggcattggac 600900
 atgctacaca ccatggacgg agaggaaata tgtgacagcc tactactgca gccaaagactg 600960
 cagtgatcct ggatctacag acctcaatct ccacagagac aacagctcat cagaaaagct 601020

 tcactgctc cttccaattc tgtcttggc tccccttggc gcatttgaat gcatgggcac 601080
 acgcatgtgt acacacacac acacacacac acacacacac acacacacac acacactatc 601140
 gatttccaga aagtccctt acaacagtgt tcttttggct ggagcagggg tgaacaggaa 601200
 ggctgttccc tctggcccg aagactggta ttgctggga tctgtcatt agcatccca 601260
 ctgtactgag tggccccagt cttgcagggg tttccacct gtgacttgat gggtagcttg 601320
 acaggacttt ccaggcctgg gctgctaaaa cctgagctca ggtcctggaa acaataaaag 601380
 tgcattttcc caagacattt acctgcagaa gagccgggaa cataaaagcc cattctgtta 601440

 tctactctg agccttctc tcttagtctc tggtagaggt ggggctgtat cctgtcctgt 601500
 taattaaggg tgacatagaa tgtcatctca gcagctgctg ggctgctgca agtgccggac 601560
 aagaatccag tgacatctga caaggacac tgatttctag caggagggaa ccaggagaac 601620
 cttttctgca gtgagtcctt gagactggcc cagaccctac acagtcctgt gccgcccagt 601680
 gctgtgatca gtgaggggcc cctgaaatgg ggtcttttgg aatcacaag caggaaggga 601740
 gcatgtcttt gacccaagct cctcagagag tctgagggaa nnnnnnnnnn nnnnactcc 601800
 aggattatct tggctccta gttggtgtgg agtggccatc tgtgagcctc atcttagcca 601860

 cagcgtgctg gaccctgtct cacttaacag gcatgggatt gteacttgtg cettcccttg 601920
 ccatttctc ttggctgtca cagtaatctt gtaatcattc actcctgggt tcatcctgct 601980
 gtttgcaact ctctgtatc cccacacct tgcctcttt ggatgctgc aatcaaccac 602040
 aaaggcatgt attgagtaa tgtttcactt tgacagagta gatctacat ttgtcagctg 602100
 aaggtttaa aatcacaagc cctagacctt ggtaaatgta catggctacc tggctgatga 602160
 cttagtggg gaagtctcag tgggggatgg gggcatctg acaactgaga ctcccaatg 602220
 tcttatctgg gggtgataat tttgttctc cataggggtt ggaggaggac cettgctgtg 602280

 gggcaaggtt agagcatttt tcccacctga tgcataaag tgaacgggga gagcatccag 602340
 ctaccccca cccgcaaat cttaggtgtt ggctgggtgga gacctgtcca ttattatcac 602400
 aggaggtatg ggactcactc agacagaagg ttctctgaat atctgggca tggaaactac 602460

agtactatgg ctatgagcag gatccatggc catgccagcc catacagtcc cagaagcatc 602520
 agctatctgg actgcaaata tccatgacat ctatcattaa gatgggacag aacttgagca 602580
 tcaggttatt ctctaggtgg ttgtgacaaa ctcaagccaa gagtgcctct gtcaactttt 602640
 tcagattgaa taaatctttc aagtttcatg gaaatgaaaa catcaacat cttccaatg 602700

 tacatggatt ttacttgatt tggaaatatt tagaattgta atgagttttt ttttttttt 602760
 ttttccctc cgagacaggg tttctctatg tagctttgga ggctgtcctg gaactcgctc 602820
 tgtggagcag actggccttg aacttacaga gatttgctg cctctgcctc tcaaatgctg 602880
 ggactaaagg tatgtgccac taccactgag caattcttgc ttacctatat ggagggctga 602940
 ttttacatat attaatagga gccactgttt tttttccca tagcttcctt actctgtagt 603000
 taaagtgatt gctattaatg aataagcagc caatcactga agacactcat gggagcagtc 603060
 atcaataagg aaggtaatga gaggaaatca gcatagggtt atgcaggaat agtgtccaag 603120

 cacaaatfff attcagatff atcaggactt gcctgttaat ccacagaagt gatccataca 603180
 gcaaacaaca aaccaaccac catctacttc ctgaaaatgc tagaaagaaa gtagtffaag 603240
 cacatccctc accacagtaa gcctggaagc aggtggaggt tagagagtcc aggtctatec 603300
 aggaatactc aaactctagc cccaagcctg gatttcactc cctggctttg acctcattac 603360
 tgcccaaaag catcacagtg ttaaacacta tctatttcta ggtttcgagc aacctagaa 603420
 gccacatca aggtggctac ctccctggc cagacatgca gcatctgggc tggteaccag 603480
 acaaggcaga actgatgaa ggtattgtgt cccgaccttc aggacatcaa cctggggcaa 603540

 gagagtcagg gacagggaaat ggggacaaga gatgcagaaa gaacgaccac aagacaggat 603600
 tctgatcaag tggcaaactt tacttttctc aggctagctt atatagtcag cagagcagga 603660
 tatggggagg ggcagaatgg gttgtttgtg caccaggtgt tagtatagcc aggatattag 603720
 gaagccacaa agaggatgtt tggcagggta aagagttcat gagtaagagg tccagggagg 603780
 gttgcctagg tgactgctcc tgtgggtgga gaactggatc aaatgtttc ttttcttgag 603840
 ctgaggttct aaggagctgc tatgtaaagg ttaactatgt ggccagccaa gcatgaccta 603900
 ggatctcatg ccaagccctg agatttggct cccaacagta ctggtcagga gccatgtgag 603960

 catctgctga acatcatggt tcttttcaa ggagaacctc tgatcacagg gtgcagattc 604020
 tgtctctttt agccactggc tggctcttac aggcattggg gttttctgga tacactgctc 604080
 ccatgaaatg agtttcatat ggtgcctttt ggcttaatta gatgagtgaa catttcctg 604140
 agctgcacct tggtttaata acaccttctt gcagccaacc caccattctc ctttgcttct 604200
 gaatttctact aatgagctat tcactccatt ttccagatca ttagtgagac tgtcagaatt 604260
 ctaactgggc cagtaccagc acctatgggt gatgctgttg ctctggcagc ccacagtcaa 604320

attattgtcc attcccattc aaactccctc atatcacagg cagttttatt ctctctctct 604380

ctctctctct ctctctctct ctctctctct tctcttatgt ctatcatcta tctacctate 604440

tatcatctat ctacctatct atatttatca atcatttate tatctatcag teatctgtta 604500

aatatctacc tatctatcat ctatctttta tcgcatagta tatttcagta gagtcgcaat 604560

aacctaggct gacttcaaac ttgctatgta attgaggaag gccttgaact tttgatctta 604620

ttgcctccac ttccaaggg taaggattac aggcatgtgt tatcacacat ggcttatgtg 604680

gtgctgggta ttgccagggc tttgtgaatg ctagtcaaga actctatcaa ccaaattaca 604740

tcctcatcca gtctatgtac tttacatgct accccccat tttttaaag aagtaatata 604800

tgactgtatg ttgcataata cgtglatgcc cttgaacgcc agcctttcct gaatgctgac 604860

agcaggttca tttagtattc attttgtct attgaagatt agaaggatga ttatatgctt 604920

catctaaatg ccatctcttc tttagccac actcttgact actggtatac ctttttact 604980

tggtacaagc ttaagcttc agcctctctc cttggccagc tcccagactg ttttatgaat 605040

attagcaggt cactgggtgg ctaagaattt catataaatg gttcatatct agcattggaa 605100

aatctgaaag tttcatggag aaaattgaga actatttgct ttgctctgct gattccctc 605160

actcacaaga taaatacac attaattcgg tggcttaaat gaaataatcc attaggtgag 605220

gctgttttat tattttagt ttaaaattac taggttttta gccatgccac tgtgaacata 605280

ctatattatg taccataatt gtgcatgact ttatttatga gataaataaa tgaatggaaa 605340

aaaattactc agtttcagg caacactaac ttaaggaact accagctatg catctctaca 605400

atgcaagccc tttgatgtga ccatgaaaca ttctttttac agtctatgga aatatacttt 605460

tcaacaacac aggaataatg taagctgaat gcaaaattat atctgttacc attttgccat 605520

gcaaaaatat gaacttgac actaactgaa agaaaaacag aagcctgact tcttgaaaag 605580

taactttgtt aaagtattct taatcttaga ttaatttctc ctgacacat aaagcattta 605640

tgacgtttac ttataagttc tggatataga cttctaaaat tatgatacag agagaaaact 605700

ctgagcatca gtatcgttta atgtgccctt ggggaaggct ctcttctgc tatatgctaa 605760

gtgctgtggc ttttctag caaaccaata atcttttcca tacaacaggc tctctagact 605820

acctgcagaa gcaccaagag ctgaggttca tftagttaaa tgttatcggg gccagtgag 605880

cccttcaga atgctgttca tctctctgt gactacatgg tgtaatgagt ctttctctgt 605940

cccacgaggc agctcccaa caatgacatg gagacttact attacttatg aaagcttggc 606000

agtagcttag gcttgtttt agctagccct tatgacttaa atcagctcat ttatattaat 606060

ctatgttctg ccatgcagta ttacctcctg tttcctccgt gtctggctgg agactccacc 606120
 tttcttttcc tcagagtctt ttcttccctg gaagtccagt ctagtctctt cttgcctagc 606180
 tattggttac tcagctcttt attaaaccaa tcagaagggtg ccttggcaaa gaaacaattt 606240
 catagtgtaa acaaatattc tgcagcaatg tgggccacgt gttcctttgc aactgatgc 606300
 tcagggacgt ctccccatgg cacaggaggt ggtgccgtgg ctgtgggatg tggaggaga 606360
 tgttgcccca cagtgtgcc ttgtgtagag tgggatggca cccggtatag aatggtgaga 606420
 actgcaatga tgiectgtaga gtggagcggg taggacatgg aatcacaggt cctgccatt 606480

 ctgtgaggac aactttgaat gtatgatcta tgtccccaag agtcagtttc atcatgggaa 606540
 acatgagtac tcaaagtctg ttttgtgagc taatgattaa gcagagagga ccatgcatac 606600
 atgagctagg agtaagatat aacagtcaca ctactcctca cacactttct tcatgcatgt 606660
 cactgaacce taaagtccca actttaactg agatgcacca tggaaagcat ccaaagagca 606720
 ttgctggctg tgattctgga gtagttgatt tctgcctctt aaaatagtta atctttactg 606780
 gccacttgat taaagaatca ccaggaagat acatctttgg aagtcctat gagaatgttt 606840
 ccagaaatat ttaattgaac tggggttcca tgccaaatgt gggccacatc attcctggc 606900

 caggagtctt ggactgaaaa aaaggagaaa gtgagttaag caccagtgtt cacctctcgg 606960
 ctcttgaca gtaaatgcag caatggccag ctctctcaca ctctctctgc catgccttct 607020
 ccacatgac gactgtattc tctaaaactg taacctaaact tttcttaaat tgcttcttgt 607080
 cagacatctt atcacagtaa taaagcaagt gtagtgtaag ccttttaaga gtagaattta 607140
 agtggagtcc tacttgggtg cttagtcaat gaggtggat accctaaaag tctgggacta 607200
 aataggatct cctaggttat acctggtccc agtctggtgc taaagaccta gaaggttcac 607260
 aacctgaaa aatgcatgtt ttactcaag atgagcatag cttccatgaa aacaaggcta 607320

 catctactgt ctaacactag aagcattggc agcttcaggg atcttggag ctttttctc 607380
 ttagctagag caatttctgt agcttgaggt atactgttaa ctactgatca ggttgctttc 607440
 tttctttctt ttttttttc ttttttttt tttggttttt caagacaggg tttctctgtg 607500
 gctttggagg ctgtcctaga actagctctt gtagaccagg ctggtcttga actcacagag 607560
 atctgctgc ctctgcctcc cgagtgctgg gattaaaggc gtgtgccacc accgcccagc 607620
 tctgatcaag tttcttgagt taaaaagtta aatgaaaatt ggacaacaca caggtaagtg 607680
 gatttcaaac agcattagca tttgcaagct atcagagggt tttgtaccac tacgctgaaa 607740

 atttgtacct ctttggtttg aggactgaga tttctctagt gcctaactag agcactgtgt 607800
 tctaaggccc actgccaacc ccactgtggg gaagaaaagg agtggcagac agtgtacat 607860
 gtccaagtgt catggttttg atttgaaatg tcctgaagc acatgtcagg gacttgtctc 607920

agttgtgaga tgatgggttt ctgggaaatg attcggtcac gagggttttg atttatcaag 607980
 gcatgaactt attgagggat ttgtaactcg atggcacatt tggtagaccg gtgggaaagt 608040
 gtatcttgtc ctttgttctt tctctctctt ttctgtttcc tggctgctac aaatggagca 608100
 acctcttttt atcatgggtt ctccctatg ttctgctttg catcaggtcc aaagcaatgg 608160

 aaaaagctga ctgtggactg aaacctgga aacctgagc caaagcaaac cttttctatt 608220
 ttaagatgat tttccctggg gttttgtcat aattgactaa cagatcaagt gttaaatgtt 608280
 tcttggaggc agagaggggc tgctcagcca atctaagtct gagccaggct cagaactacc 608340
 atggagggct gttgatttgg atggtgagat ggagttttaa tattgctcac tcaggaaagc 608400
 cagtgatctt tgttgactca gagaacaaca ttccagtggc tcaccaagag aatcctgagg 608460
 ggtgatgtct agtgttttat tagatctatc atgtacatgg tcaactaagg tcaaacataa 608520
 agtccattta tgtgtgacag tcattttaca gatccattta ttattggaat tacagttaac 608580

 attgtaccct aaggaaaact gtttgttagt caaggacatg cccttattag gcagaattcc 608640
 aaggtgtaca cagtgagagg actgttctgc cgtgatgctg tctttagcta gaaagagttc 608700
 aatttgcaat gttatgagtt gggtaattat cagagacaat attttatttt caaaagttaa 608760
 tagttacat acigtgtgca aaatccaaga agttgattat aaaagcagtt agtgataaat 608820
 atctttatgt ttaagggca acatttgcac tgagaatcac atctctgttt tgcatttata 608880
 gtaagtgaat aaatctgcta ttgcaaattt tccagacaat cgtagggaga ccaagacgag 608940
 ttcagtcgtt aatcacatcg tgaactaca cacagccaaa aaggaattaa aaccagcaa 609000

 accaaaataa cacaactgga aagcatgaaa cctgtccagt caattattgg atcctagtgg 609060
 tgtttgtctt tctgacctcc attttctgta ggggtcagaa ggacaagtgg aaagaacaa 609120
 tgaaagaaac agaactctat tcttagaaaa aaatgtatta agaatggaga aagtatattt 609180
 tatgtgttga aattgttttg aaaattaaga caaaattatc attcacttag tntaggaaca 609240
 gcattctgtt attaaaaaa gacaaagaat tgggtttttg acttaatgaa agcaaaaatt 609300
 tttactccta agaatatgag aaatacaaca ataaaatgct aggtcggca taatttatca 609360
 aagtaacatt gggtaattgg ctgtttttca aagagtgcct gtcaccagag agctccagcg 609420

 tgatagaaac acattctttc tgttgttggg aagaatctgc agtgacacat ttgggactta 609480
 gaaacacaga gatagaggag cccattgaca tcagagtgtg gttgctgcat ctctaattcc 609540
 tttgaatccc agacgtttgg ggctctagag gaataacccc agaagacctt tctgctttca 609600
 ttcttgattt ctttttttt gctttcattc ctaatcttcc tggtaggagc cgcaggacca 609660
 cactgctctt tacagcttc agtgectgta aatattttgg tgcaatgtct ggtacatggt 609720
 aaggactcaa cacaagctgt gtgttactgc tgcatttttc ttggtcacac ttggagtacac 609780

cagtctgggt gtgggttgc attcctgtaa gtccagcact agtgaggatg acctggaagt 609840

 gttacaagtt ggagtccagc ttgggctgca taccgagacc ttgtttaata aaaagagaac 609900
 aaggatcatt aagtctcaag aggaggcaga gttcttcata gctgtcccgt caccctatca 609960
 ttacagata taggaatgtt gttggcatag gcatggggca ggtaggttca gaactggaac 610020
 ctagattccc caactccaag gtctgcagtg tctctttgtt ctagaccaca gacctttccc 610080
 cactctgttt caacttgagg atgtgggggt cctctgtgga gaactcagcg ctcagcagca 610140
 agcctcactc caagtgcctg ccaccactga ggccacatgg atgcctcatg ttacagatga 610200
 gggcaattta tgtgctaaaa tcttttcagt tattaccac tctctaattg gagagattaa 610260

 agcaacttaa atgagctata ttttatntaa taccatctc accaggcatg tttttctaac 610320
 catgatttat tatcccagtc ctgacttact ctgtggaggt agtgagatct ctgggctgctc 610380
 agtaagatgg ttagaatgct tgtgagtgga ctgggagacg tatttggatg tttcctgttt 610440
 ccatttactg agccctgaaa gaaaatccat gaattatcta ctcaataatc acagcccat 610500
 tagatgcagc ttcccattta caaggagaca ctaatcttgt tttctctcc ttttttttt 610560
 tttttttgag gtgatatctc acactgtaga actcagtatg tagccaagga tagtcttgat 610620
 cttgtgacaa tctccagcc tcagcttccc ataagtgtga gtgtgtaatc ctgataagat 610680

 gaggaagaag gggagggaga gtgggggaaa ggaaaagaga ggataagaag tcggaaggaa 610740
 tgtaggaaga tatggggaat ctgggagaag aaaacaaaga gggacacaga ggaagaggga 610800
 gaggaatgga acgagacaga ggggagagag aatgggaggt ctctctgtgt taaagtaatc 610860
 ttacgtgata cgtgttttgt ttcatctaaa ctcagggttc ctccaagag gcatacttgg 610920
 aataggaggc tgttcatggg tgtgcttggc agtggtaggt tggttttgat ttattctggg 610980
 ttccatcacg ttaagtaatg gtcagacctc taacagggaa atgaattcat tcacagtgc 611040
 catcttggaa agtgtgtaga gcttgggttg tcataaaaac ttgaaggtgt tttctgtgtt 611100

 ggctttttct tgctcccctg attccatttc tcattgtctg ttttagttc attcttcctt 611160
 cactttttct cacctcattt ttaacagtaa acttcgatgt taaaactctc tgaattgtcc 611220
 cccaacaat acagcaatca cgactgtctc gttgtggtta ccacaggtga aactacaaac 611280
 ctcatntta tagaatgaca gagcttagaa ctggagggga tttagacca tggcagacag 611340
 tttgccatct gaacaccctc tgcgtgaagt ggaactgaaa tcttctctct catgtgggca 611400
 gaatcacagc cccaaggtgc ccgagagctg taatgttccc ttatttggaa acggagtgtt 611460
 acggtagtga tgagctaaag atgtagcatt aggaagatgg tcctgggttg tctagttag 611520

ctctgaatgc agicacatctgt tctgttcgta tgtgtgtacg tattttagg tgtacacgta 611580
 cacatatgtg tggggtacat gtgcacactt gtaaccagg atgtagaggt gagaatgtt 611640
 atgtcattcc tcaggctctg ttcacctctg atatatattt tttttacaag tgtgtgtgtg 611700
 tgtgtgtgtg tgtgtgtgtg tgtgcatgta agtaagtgtg tatgtgggga catgcactat 611760
 aataggcaca tggaaagtcag aagaaaattt caggaggtt ggttctctcc atcctagaag 611820
 gataactctgt tgcattggaac tgggttgta gactcagtgg caagtgtctt aacctgttga 611880
 gccattccct tctgacagac tctctctcac tggcctggag ctcaaaaaga aagctatgct 611940

 ggctggccag caaacccag gtatcagctg tcttaccttc ttagtactga accatatcag 612000
 gaaaattttc tttttctttt ctttttttga tctattacat cttttaaaaa ttatttcttt 612060
 tatttttaac attataatca catcatttcc ctttcccttt cctcttccaa gcctccctt 612120
 ccttgccttc tttaaaatcc atggcctctt ttttcgttaa ttgctgttat atgcatgtat 612180
 acacctatgt tcctaaatat aacacgctca gttgggttag tgtaacttgt atatatgttt 612240
 tctggcagtt tttatgtagt ttctaggac tgaactgagg tcctcatgtt tacaaggcaa 612300
 gtcttttact gactgagcca tctctacagc cccgtgtgcg tttgtctaag agagggggag 612360

 agagggagtc tccacatgga aagaatagaa ggtgccatgg ccacagcagat ggaggcagac 612420
 caatatggaa ggccatcaag ggattccacc atcttccaaa agctgagaga tgctaggact 612480
 ggctctaccg aagtccctgg aagggttgat gccgggtcaa tgcctaacc cagtttttgg 612540
 catcttttca gacttcttgt ctccagctgt gtgagagaag aagcaagtct gctacacagc 612600
 tccaggtgtg tgggagtttg tcacagcagc tctaggaact gactacactc tgaaccgag 612660
 ttgtcttctt ttagttagtt taaagtagtt ttatatttt tggacacagg gtctctgtag 612720
 gagacataaa ttaacatat ctacttcat ttagcacctg tgatggtag cttaaatgtt 612780

 aatttgacac aacctagaat ttctcaggaa gactgtctca gtgacggatt gtttaccatg 612840
 ggtgggtgtg tgggcatatt ttcggggatt atcttaataa gttactaat gtgggaagac 612900
 cttgtcagct gtgggtggca ttatccctta ggcagatct aggggttctt gaactgcata 612960
 agagtagaga actgcataag tgttcattcc ctttctgctc ttgactatgt gtgtatgacc 613020
 aagtgtctca agccccctgac actgtgactt cctacaatg atagactggc acctggaatt 613080
 gtgagataaa ataagccctt tctcccttaa gtcactgttt gtcattggcat tttatcacag 613140
 caacagaaaa gaaacttga cagtgtttt cttttacca atggtgtctt ttcattgaaca 613200

 attactcttg acatagtga atccaatgtg ttagactttt ctttcttgt tggcctatt 613260
 tagaataact ttaaaaacct attcttagat ctaaaatcca tgcacaactg atttctatgt 613320
 gtagagtga acttggggtc tatggttcac tgatcatcta tttaaaatgt agtctttccc 613380

ctcctatgct gtaattatat ctttgttatg aaccaagtga ttctgagaat cttttggggg 613440
atgtctagga agtagatgct aagctggaat tcagggtaca agattcatcg tgggaagaaa 613500
ggtatacggg aaaaagtaca gataaagcag gagctgttat atttgttccc tgtgaacaga 613560
ggaggctctg tgatagaagg cgctcagaca cagtagagct gagacgattg tggccagttc 613620

agtgaagagc tccggggcaa agacaccagt tgggatagtc ctgagctaga gaagcagcca 613680
gaccccagat gccatttggt gtgtccatgg ttggcacggt caggaagagg gtgccctggg 613740
caatgctgta gagaccttga agttgccatt actcagactc ctacaggtag tctagggaga 613800
cctgagtga aaagtaaca ctatggcttc catggttcag ccttacattg ctttctgtac 613860
agccaaacac cacagtcccc acaggcttcc ccagagggtg ctacaggtga atgttgggag 613920
gctgaacaag gatctttatt ttgtgactct ttgcaatgct gtgacctata ctcaaggtca 613980
ttactcttcc attattcctt cttaattgtc acctctgcag gtatgggggg cttgcctggc 614040

attatgacce aaaaccttag tgagtcttag gagccaccac attcctccag cagggaatgc 614100
ttcaattagg agaaaatagc tacatgacag caatgtaggt ggtatttagc acataaaaca 614160
cattagcttt tagttgccat attcttctca gaccagggtt tttgtgcata tccacttatg 614220
gttacattga gcaagataag caagtgggag tccagtgagt cactcagtgc acaaagtgtt 614280
ccacttgctt tattgcatag gacacactgt ctattctga tgatcaggcc gattggccaa 614340
gaggcttctt ceattttca agggacagtt ccttaactat ggcagtggtt attggccagt 614400
gaatcctatg ctttgttctt ggtctgtaga tggaaacctt taagtgatgg gggatgtcct 614460

tctgtatata tgtttctctt attggttaat gaataaaaca ctgaccaata ggggcaggaa 614520
gatagctgtg gctaggagat gaggagaaat aggcagagag ggactgcaa gagctgttat 614580
gtagctggca agggagtaac aagtctgggc attctccagt aagccaagac cacatgaaaa 614640
tacatagatt catagaaatg ggttaataat tatgacagag ctagccagta agaagccta 614700
gtcattggcc aacagtttaa tagttaatat agcatctgtg tgtttatttg gggccgagaa 614760
gggtggcggg acctggtggg acaaagaaac tccagtaaca ttaagcatg cagggttat 614820
ggtttggggg acaggggcta taaaattatc caagaggggg tgaaggatta ttgaagtggg 614880

actgcttatg cttccactca ttgtttctg agtgtctgtg ctcttccctt taggaattac 614940
tgcagtgtct tgagctctct ggagaagagc tcttctacc tctgaggcta atgggtggac 615000
acaactgtag ctgaaagctt ctatgcattc cacttagtct ttagtactat tataagataa 615060
tcactctgag cttaacatta tttataattg ttggccaat ggctcaggca tattactaaa 615120
taactctcac atttaatta acccatttta attaatctgt gtatcaacac atggctgtgg 615180
cttactggta atcctctggc atcttacttc tccagcgat acctggcatc tctctgactc 615240

tgctttcctt ctctccatat ctctgtttgg atttctgac tggttctatt ctacctggct 615300

 actgtccaga tcagcttctt tgtaaccaa tgtaacaaa acacattcac agagagagag 615360
 gcatcccaca ttacacaatg cttactgaac caaatgettt ggcatggcat gccaggatgc 615420
 cagcatgccc cciggtcatt gtctaccctg gctttgaaga gggccatgga taaattctgt 615480
 gctgtgtgga attggatag taggaaacct ctgcacagtg atgttgctga gtttctgtgt 615540
 tcatcaaaag ccaacagaga gcaggaacca cagcctggcc tcacccatag tcaatttctg 615600
 ctataggcct ttccaagctg tcagcctgtg gcatcctggt ttggggctgg agcagtgcc 615660
 ccacaacaac caggagagct ccaccaggcc ccagcctctt tatatggaag atgcaggatg 615720

 gagccatttt ttcacctta ttttttgat gcatatttct cttattcaga ggaaggcatg 615780
 tgttacagag gccttcagac tggtcagagg gggaaggaaa aacaattct gagaggtgca 615840
 taagtgcct tttagaagat ggttgctctc ttggtgtctt ttgctttggt tcaggtttg 615900
 actgtacccc aaaggcact gagatcttc agattgcttc acaggaggac cacgtagtct 615960
 ctggtcttaa atggggtgga gtggcatcta gtttgaaat cttttcagg ttgggggcag 616020
 cttcaaggat gggaagaaca agacaccagc aggttctca tcatggacag cctgaccatt 616080
 tgtgaagatg tacatcaagg cttgacagtc accttgggtga cacatgatcc gtggctatat 616140

 agtgagtcc aggccagcct gaggtagaga gtgacctgt ctaaaagcag acaaatataa 616200
 cccttaaaat atgcaaaatt gcagaaggca gagatgagga accttcatgg cttccaacc 616260
 caaatgagtt ataacacact tgctgaaggg acagcagccc actggagcaa gtggctctgg 616320
 cagcctttac tcttccccc cattccctct gccttgetaa aaaccgttag attacattcc 616380
 taaagctagc aaccaaggtc tagtccttag gctgacttct aaagtctgtc tcccttctat 616440
 ttagaggcaa tctctgtcc cttctggaca aatactctg ccccttttc cttgtccct 616500
 tcccttcttc cttacccecc catctccttt accactgcat cccagccat tcaaacgcag 616560

 acatccccct ttctctct taaaaccaca cccgaaggt catittgctg ctgttttcta 616620
 cctgagccag caagcagtca ctgtaacttt tcttccctgc ttaataaaga atctctctgt 616680
 ggaaacaggt gtttggatgt gatttgtgcc taatctgggg tctaggaggg agaccccaca 616740
 ctctgctggg gtccccctca tttgcagtgg aaggagctgg gccagcatct gcttagggct 616800
 gttcacagca aaatattctt cagaacagca ctgtaactgcc tttgctgtgg ctgctcacag 616860
 gtagttcagg ataaagggtt gtttactcag atacatggag caacagatgc tgggacaatg 616920
 gctaggttat taattgcata gtttgtcttt acaacaaaag atgttcttag ctctgttgg 616980

ggtgttttgg gcaactggtg acttcaagga tcacatgttc tgtttttagc taatgtgttt 617040
 tgtgtgctaa ataccatcta cattgctgtt gtgtagccat tctctcccag tggaagcatt 617100
 ccctgctgga gggaggatga ggctcttaag actcaggaag ctcatgaaac ttataagact 617160
 caggtatagt gcagagctca caaagtcaca agcctgtccc cgctccccca atcaatgtta 617220
 taaaagctcc tagtaaacag tggctaaaaa aaaaggctag taaagtatca cccatgagga 617280
 ggtgggcttt ttagggatgt agctgttttt gatcactcat actcttgtaa gtaaccccaa 617340
 taagctctca ggttcatcaa gctggacttg agtggaatgt ttcitttggtt tgttgttgg 617400

 gccttatctg agttaaagag gaaaaacat acaacagtgg cctagtaact cttgagcaag 617460
 tatatgcctg tgatgaaact ggtttgaaga ccttgcacct actgttggct cagtgttgtc 617520
 tgtgcctagt tctgttcaca cattggagca atgaatgtga ttagaatgtg gaataatggg 617580
 ccagacacac tgtaaaagct aactgatcct ttgttttctt tcaaaattga atgtcctact 617640
 ttaattgaaa ttgtattaaa tgatcaggaa aatccccca acccaaggta ctttttaaat 617700
 ccttgtaaat aattagtgg atctgtgtaa cagcttcctt ttattattat tcaagactgc 617760
 ctttatgtga tgtctaggac ccactctttt ctaattaact gctattatct ttataagtaa 617820

 gaataaaagc cglagctttt actctaagat tacaagacc tacatggttt aagaagtaag 617880
 cacactttct cttacctatc atgttgttct aaatttgcac tttcctcact cctcctttat 617940
 attgtcagtg ttttggatgt agaattcttt gatgggtaac aaagaaagt agtattatat 618000
 tcttcaaacc agaagacag agtgatgtga cctgcacgtt atatttagag ctattgaaat 618060
 ccaagcacag ctatgctgtg ggcagagtta ttgtcacia gtaagtgtgg atgttttggc 618120
 tgtgtgacct gccttggatc atgtgccaag gcagtggtag gaagccaatg tcacactcag 618180
 gatacctgca gataactaac gctgagccag ctgggtacag agaggcttta caaggacatg 618240

 tgggcttggc atttgtgaag aacatatttt caaatcttta acctccattt tectacaact 618300
 gcttgtgcat gtacctgtga ttgtaaactt gtctgtgttc ctgttttctt ttctcccacg 618360
 gtcaactttc tttcaattta taagcaagag acacacctct cattaaaagt attgaactat 618420
 aagtgtgaga actgtggagg cccttcagca ctggttctga aatataggag tcaggacacc 618480
 cccttgcacc aagacagcag ccacttagca cagctcagcg gccctgccc atgcttactt 618540
 ctgcacaagg gaaggctcag gagtaggact ttcaaccgga atcatcttca gtagtaatgg 618600
 attatattag agagttactt gttgtaggga ttcttagaga taaaagttaa ttcaggatgg 618660

 atggctcagg cttgtcacag caattatttt ggagacagaa caggaagagt ccaaattcaa 618720
 ggtcaacttg ggtcacagag caagttcaag ccaacctgtg gcagcatagt gagatcctgt 618780
 ctcaaaaata acacgaagag agcttggaat gtagtacagt ggtagagtcc ttgcctatca 618840

tgtgcatgat gctgtcgag aagtgaaccg tacccggaat aagggtatag ttggttattt 618900
 attaaaagag ggaatcactt acatgagaaa ccgataacca gatagcactc cgtgaatcca 618960
 gtctcagcag cactctgaga cccaactgga accccgaaga gagcagggag ctcttctct 619020
 cagcccttta ttcagccacc tgtgcacacc tgtggccaca ccccaaatgg gcgtggttat 619080

 cggcacaggt gcgcagatct ctccctacat gatgctgggt ttgatctcca gtaaacaca 619140
 cacacacccc tacctatcat ctatecatcc atccatccat ccatccatcc atccatccat 619200
 ccatccgtct ttctttcttt tctccaacg agaaagcagt cttgtttgac tacaactaca 619260
 aagtctaagg acatttatca gttaagtcca tggtagctat tgcccgtaaa tcaggtgagt 619320
 taatttacag ctccaagact ttggttaaaa cacaaagaat tttagctggg agacagtttc 619380
 tgtgactatc tcatggtatc tatagctcaa gttttttga ataaagtca ggagaggttc 619440
 agagacatac ctcccttccc tgaattgttc atagggtaaa cagcttttag ccaaaggatg 619500

 agagaaataa gcaccaggat ttagttagat ctcaacaagc ccctgggtga cttcaggagt 619560
 ggagaaggtg actaacctca agaatagggt agcaggttac ttagcaagtg ggggtgattc 619620
 tagctatgta ctttcaaca aatggacaga ttgttgagct gttggcctat gtgtcaaca 619680
 atgcacactt ggatataggt caccgtgcag tactgggagg tatgtgagat ggagagagtt 619740
 taaagactta ctatagtccc ttcttttatt ctcatlgtt cacgaaagca accaataaag 619800
 aaaaaaatt agagtaggtg cttcatgatt tctttttgta gcaacaagta aaaataacct 619860
 gggatacaat aataagtact tcataccgc ttctgcaaa caagctctca aatggtcaga 619920

 acagcctgtt acagtctgaa cattcaatct tgaaaaatga gtgtgtcaaa accaaacttc 619980
 tgaagtttac ttggcgttgg tgggtgggga ggtcttgggg aaagtgagtc ttgaggttgg 620040
 agcttatttg tggttaaaa aaagcttaaa aaagcttctg gagctgcaat ggcttagcag 620100
 ttaagagcac ttgcttttgc agagaacctg tgttcagttc cctgcacaca cagaacatct 620160
 cacaactatc tataactcca gatccaggga atataatgcc ttctttgaa ttcttggat 620220
 accgggcaca tacatggtgc aaatggatac aggcatcac ataaaaaagg ctataaagg 620280
 ttgtgaagac acaatgagaa gatgttatcc atgagaaagt agatcccacc acacactaaa 620340

 tctgatggga tcttgactat ggacttctaa gactccagaa ttttaagaaa taactactgt 620400
 catgtgtaag ttgactaatc tatggcattt tattatagca atgcaaatgg atgaagataa 620460
 caatccacaa ccatcttatt aagaggtata attttatatt taacaaaaat cataatgtat 620520
 ttatatatca cttgtaafga caaccttaat ctgtgataat ttttaacac tttatagcct 620580
 tttccataaa gaaaactcaa cttgtgtgtg tactttgatg tagagaaatg aaataataaa 620640
 aaaatggatt tcaagcatgg aaaggactta tactaaaata gagtgatgtt gagggacgtt 620700

ggttatgtgg taicttagtt agggttacta ctgctgtgat aaagccaaaa caacttgggg 620760

 aggaaagggt ttgtctggtt tacacttcca tatcattata tacatcatcg aaggaagtca 620820
 aaccccaaac tgggcaggaa cctggaatca ggacctgatg cagaggccat ggaggaatgc 620880
 ttactggctt gttttccatg ccttgctcag cctgatttct tatagacccc aggactagca 620940
 gcccacaatg gctgggcccc acacatcaat cactaataa gaaaatgttc tacaagcact 621000
 ttctcaactg agactccctc ctctcagatg actttagcat gtgtcaagt gacaaaaaac 621060
 tgtccagcaa taiggattct aggaaaagag agaataaag atgaagtgt ttacattcat 621120
 ataaatagaa gagcaagggc ttgtgtggtt actctgttta gacaccactg tgtgtgcttg 621180

 ttaacagtag tcttttagt agtagtagaa gtagtagtag gaggagtctt gagtagcctt 621240
 tactaaaata attttaaaa ctgcgccata aatggaaaag cagaaagggt tttatttaa 621300
 gagatagcat gagacaggca agagtgtagc aggttacttt gaccagagt cccaagagta 621360
 ctggctactg ttgaggctt tctttttttt gggctcctcaaa gaagaagaag gggttggttg 621420
 ctaagtgc atggttatct gttttgattg ataaccttgg gtcattgtaag cctcccttac 621480
 aatgatccca attttaaaa tttgaatgcc caatcatgta taggcataag gtgattaaaa 621540
 ggagatttct ctaaaaagt cactcagcaa acacagtgtt ccttactctc ctgcatccca 621600

 aactggttca ggatgggtta gccctgcct ctggttccag atatatcaac tggatatttc 621660
 tgaatggaaa gtggagggat atgtacacag ctatgggcag gggaggagcc cagtgcacatg 621720
 gaggggttgt atagctgaag acaggaagg attttatgtt gggaaaggga ctgggtaac 621780
 ttaagccaag tctcaggta ccaatctaca ctatgcttac ccatctcacc taaaaagagt 621840
 tataccactg tticatgtt ttataccagc acctacagtc cctacagcac ttacagtgg 621900
 gcctttcaa tgaattgaat ctaggatgaa aactttttt aaacttttat ttatttacga 621960
 tgtatacagt gtctgcctg cataccagga gagggcacca gatatacatta tagatggttg 622020

 tgagccacca tgggtttct tgggaattga actcaggacc tctagtagag cagccagtgc 622080
 tcttaaccac tgggcatct ctccagcctc taagatgaaa gctttaaat accaatttta 622140
 aaaagcaaaa tctagcaaac agttaaaca ttttgggaaa tacatgagga gaaagttaa 622200
 agaagtggg ggggtgagt ctaaattga taaagtgtcc agaggaatct gtgccaaga 622260
 aaagaaaacc ctcaatatg gattttatta gcaccctagg actgctataa tgaacatca 622320
 catactgagt taccaaaaa aaattgctaa gtatatcaaa ctgcagattt gaaggctaga 622380
 agtaagcaaa caaataaaa aacatcactg tttatggaac catattcct ctgaaggta 622440

cagagaggca aatgtactat gcctggttcc tcagctgcaa acaggcaggc aggcaactcct 622500
 tggcttttag atttgatact tcaatcatgt agccacatct ctgtgtcttt catcatctta 622560
 tctctgtgaa catctgtatc tagattttgt aaaggcacta tcattaaacc agagcccaat 622620
 ttaaccatcc ttagtttaac ttaattaagc ctttaatgga cccaatttaa aatattgtaa 622680
 tagtttgaga tgcttagtgt tagaacttca ccatgtatct tgagggggac taacagttcg 622740
 ccctagaact ttgattctaa gttttccaaa caaatcgtca atgaaaccaa ccacatggag 622800
 aatataaaat gctcagcatc taagcaaaag taggaaatta atatatggaa aacagcagtc 622860

 actgtggaga tctgccattc accccagatg gaatgttagc aaaataaaac tttgtgggga 622920
 gtaaaagaaa aaaaagaaag aaaatttgtg ctaatagtga ggacaataac tgggagaaag 622980
 aaactggtct ggcgaccagt ttccttaggc caaactatga agagggcaag catgaaacca 623040
 tagtaagctg ggtaatatga tcacagactg agaatttaga cggctctatgc catggagact 623100
 gttctattac taaaatggcc tttcatgacg cttccagcat tcttgggcac taactgagaa 623160
 ggatccatgg aaacacaatc aaagggcaag gaggtgtgag agttggagtc tgactcagct 623220
 aagcatgtta gagaagacct ttgtaggagg gtgggagagg agaagaaagg aggtgaggca 623280

 atgtgtccag gaaattgaat tacaccatta agtgagaaac aggaagactc tttagagtag 623340
 acctgatca aatttctgag gaggcagatg tgaatatgca catcaacgta gcatgttgta 623400
 ggtgaccaag caatggaagc atgaaattaa actattatct ttggtcttta gagacagggc 623460
 cttgtactgc agccagatct ctctagagct aacagtattc gttctgcctt agcctcctag 623520
 tgctaggata attaagtcaa ctgtaatgta tttatccaca gatttattag ataatacaaca 623580
 taaacctga atagcacttg tttaaacctt cagttaatca gatggtatctt acaagccaca 623640
 caaggacatt catgctttg ggctccgtat ccttggtttg aaagatacca acatactctg 623700

 tgatttttat aagtggttcc atttaatacc atgattaatg agatttttaa aatattttac 623760
 agacaataaa gacaagtagg tcaactgtaga ataaccataa attcttctct taccacaaag 623820
 aagtgatgtt tttattttcc tagactttat gtttctgcca gtctgtgccc ttttctgtcc 623880
 tgcagaatc agtagaggtg aaaatgggct agagggttag cgctgtggtg gagtgetcac 623940
 ttttctgtg caagaccctg tgttcagttt tcagcacctg ggggaagaaa gaaaagaaaa 624000
 ataaggatgg gacaagaatc tttctacacc tcttctctc tttgatccct ggcagctcca 624060
 catgaacaag ctcagatctc ctgctagagg atgagaagat aaaggccaca tgaagcaaag 624120

 atggatggcc ctccatgagt cctcagacct gtgaagaagc tagttgaagt cagcaattag 624180
 tgatcttgca gcagcccaaa gatgcaccag tgaccagga tgagatggaa gagccagcca 624240
 cacagcagaa cacagccgca gctgctgagc catgaaatgc tgtgttagga atatccttta 624300

tctttagttt tagagctatc aagccgtgag taaaagctca caggctccatg aggctcagga 624360
 taaaatcttg ttcacagcca cacagctaac tggtagcaga agcttatgaa gacaaacatg 624420
 gtaggagact acctccctaa ctttactcat actcaagatg ctcagtttta caagagctga 624480
 tatggggagt ttagaatfff aaaaatacat aggttatagt ctgacattta tggtagctt 624540

 atgttggtg acaaaacttt tcttggggag atgcaacaaa cacgtctact aaccccagat 624600
 aggaaacctc ggcagaccaa agtatggata acaccaatgt acaacttgat gaacatgga 624660
 ttttattggg gttatttaca ggaatgtggg taggcttac ttataggaga agaaatgact 624720
 caaagacagc tgcatacca cagccaacc cagcacagac agcagctcac aaagagggga 624780
 acctggagca cagtgcacag cctgcaggca gctcaacagt ttggagagtg tcctttccag 624840
 gtgcctcagc tggcttaact ctctttcagg cagctcatct ggtttctact tcttcagga 624900
 gctggtctgg tctcagctc ctttacatct tggcatggat gagagggact ctcaaccttt 624960

 atgtttacc ctggcagga gggcctggt gaatctggtc agtttcagga attcctgaag 625020
 ctatfttgag ttgtttacct tcttcttaa ggagcttccc tgtaggatgg atgtttcaa 625080
 ttttgagga aactattaca caagttataa aagcttagat tatccagagg aaaacataag 625140
 agactttct gattcagcag cacataaatt cttcagttg ttttcttact accatttttt 625200
 ttttatgtag tccatgtctg cttcaagttg tgatcctgct gcctgagagc ctgggattat 625260
 aggttttac atttttcaa ccattggag ccagtaggat gatatatgtc tgtaactcta 625320
 gcattaggag gcagaggtag caggattaca agtttgaagt atcattaaaa acaaggggaa 625380

 aaaagccggg cagtgggtgc gcatgccttt aatccctgca ctggggaggc agaggcaggc 625440
 agatctctgt gaggttgaga ccagcctggt ctacaagagc tagttccagg acagcctcca 625500
 aagccacaga gaaactctgt cttgaaactc cccgccccaa aaaaaaaaaa aaaaaaaaaa 625560
 aaaaaaaaac caagaaaaaa tagaaattct aaatcataac ttaataaaaa gttacttata 625620
 tctaatttgg cctccttaga ttactatgt agtccaggct aacctgaaac ttatcaactt 625680
 atcttctgc ttttttttt ttttacctcc tgggtgtttt gggtagacac atgcatcacc 625740
 actcttggtc aggttttaat ctttcaagag taggtaagtt aggactagt aagaatttct 625800

 tgttgctttc agagtftaat gcaattagaa atcctatftt atttagagt ggagatttca 625860
 gctaagagat gaagctgggg ttggaggctg gctgcacac cttcaggaac tgggctgag 625920
 acagggtca gtgatctcc atcccgaac ctttctctgc tacaggctgc tgcctttgca 625980
 agtgtcgtg aaagaggtga tgaccggagg tgcaccaca gatgcctttg ccctctcttg 626040
 atgcatgga caggaaagt ttgatgacag gctttttggg gggagcttta gcatcaagcg 626100
 gccagcaga tggtaattg aacactcagt tgtgactgt ttaaattgtc tgtgacctcg 626160

gggctctggca ttaagcaaat aacaatgaaa tcagatggtt gagcgaggct gtcctcatag 626220

 gigatagggc ccttgggtat ttggagagca gctcggtcag ccaagctggt cttgccatct 626280
 ttcagagcaa ttgcaacaga tttgggcaat tggccatttg caaatcattg gccgcacttt 626340
 tgacacctat ttctgacca taagttaatt tggagagcaa agctggaaca tttctcagac 626400
 acagagagac agcagtaaat gatccagtgg ttagcactga ccacaaaaac caacctgatc 626460
 atggctgatg ggtttatctg agttaatgct atgttttatt tactttcaat atgagtttta 626520
 aaatctctct ctctctctct ctctctctct ctctctctct ctgtgtgtgt gtgtgtgtgt 626580
 gtgtgtggtg tnnnnnnnnn nnnnnnnnnn nnnnnnnnnn nnnnnnnnnn nnnnnnnnnn 626640

 nnnnnnnnnn nnnnnnnnnn nnnnnnnnnn nnnnnnnnnn nnnnnnnnnn nnnnctgacc 626700
 cattcactgg ccttgttttt atttattttt agaacatag atagccaatg tgatacagga 626760
 caatagcagg aagaggagga gagggtttgg tcttaggttag cttctcattt ttgatagtac 626820
 agtaacattt tatattcatg ccccaaacac tttttgactt ttcagttaaa aaacaaaaca 626880
 aaacaaaata ccccaccaca atctggagtt agaaccacat agcagatttt aaattgtaat 626940
 agtataaaaa actagatcat actagattaa tatgaggagt agaagaattt ggggcatgac 627000
 tatttagata acattaatca tagcattaca tgctattgtg atttgaatgt gaagtgtccc 627060

 cacagactta tgtgtttgag cacatggtcc cccgctgggt gcgctgttta ggaagtgtgt 627120
 atctatcttg aagcagcttc aggggtacagc ctgcttactg aggaaagctg cctgttatct 627180
 gtaggggaga acctccctag ttcttccagc aagaatgggg gagggtcatt tccagaaaag 627240
 gaggggtggg ccacttctgt accatccaca gtgttctgga aactctgata aatgggttca 627300
 aaatacaggg ggcacttact cagtgttttc tcctactca tgtgtggtgt tggcttgtgg 627360
 acttggcttg gaggnnnnnn nnnnnnnnnn nnnnnnnnnn nngcagctcc attcgtctc 627420
 tgcagagagt gaagcctctg tgagggatca agcattcctt gtctctcaca tctcagtgac 627480

 gaacatcttg gccatgagtg ctcacatccc tacttccaca gcagtgctg tcaaagcaac 627540
 aaccgccaa tctatcatc ctgtgtgatg gttaatcttc attgccaact tgataaaact 627600
 tggaaatcacc taggagacac actttgaggg tgctgtggg gatatttcta gagaggttta 627660
 gataaagaga gaagaccctg aacgactgtg aactatccc ataggttagg attctgggat 627720
 gaataaaaaa aagtaagggt taagttaggc gttggtggcg catgccttta atccctgcac 627780
 tccggaggca gaggcagcgg gatctctatg agtttgagcc cagcatggtc tccagagtga 627840
 gtgccaggat aggctccaaa gctttacaga gaaatcctgt tttgaaaaac caaaaaaaaa 627900

aaaaaagaaa gaaagaaaga agaagaagaa gaagaagaag aagaagaaga agaagtaagg 627960
 tgaacaccag cactcacctc tctctgtttc ctgactgtgg gtgcaatgtg acaccaggag 628020
 cctcatgctt cccccatcat gaaatgagtt ataccctcaa actgtgaacc aaaataagcc 628080
 cctctttcct taggttgctt tggttatgia ttttctcaca gaaatgagac atgtaactaa 628140
 cacacttagt gactaataca cttagtgact tgcctttcct ctgcatattg tagaaacca 628200
 ctaatgcatt ccttttact atgtaccatc ctatatgacc cctgcagaaa gctttcaaaa 628260
 ttaggctcca caaggctttc tgagatggct tcattttacc aaactttgtg gtttggatcc 628320

 tcaacaggag aatctaaaat ggaatttttc ttgtctggtg cttttgaaag aatacccttg 628380
 agatgaaggc ctttatgcac cccattgac agctattgac tgttggctgc tctaggaaag 628440
 ggcaaccttg aactatggt ccttcagttg aagccatctg tcaaactct gccagcaatc 628500
 tggatgatg cggagtggg accacagtga tggttcagca gcactgtact gaacagccct 628560
 tcgctattct tcctaagttg cggctcccat gtgtggtagg tgaatgggga actgtattcc 628620
 agtgtacca acagcctttt ggaacaggat aagaatagag caagagagaa attgtcttgg 628680
 ttaatttttt ttgatagct tgacataagt tagagttatc acagttgaga aactgcatcc 628740

 atcagatcgc ctgtaggcaa gtctgtagtg tattgtcttg attaatgatt gatgtaggag 628800
 gatccagttc actgtaagta gctccacct gtgggctgga ggtcctgggt tgtataagaa 628860
 ggcaggctga gcaagtcaaa gggagaaacc agtaagcagt gttcctccat ggcttctgct 628920
 ttggttctg cttaaatgtt cttgccttgg gtataaggcc ctgacttccc ccagtaatgg 628980
 actatgggct atatgagaga tataaagtaa aataaacctt ttctccctc aagtagcctt 629040
 tggatcaggt gticcattag agcaatagag acaaagctaa aacagagaaa gaggatgtgg 629100
 aagagaaaaa cagagctact ccactgacta aaacaatgat ctcaggccat ttgaagtaag 629160

 gagagetgtc cccaccacca gttecccaca gtagatactg cctgaagtc tgtttctatg 629220
 acaactagga tgaagacctc aaaagagaca acttgaggcc aactgcact ggggttatta 629280
 atgagatggg gaaacgattg tgtttgtcat gtctcatgat cacacagagg taatttacag 629340
 ttttaagtctc agtgaanaat tgctatacct agagtaactag cttctggctc ataatgttat 629400
 gtgcctacag tccatgaat ctccagagac tgtgcacatg attccaagg ctttcttaga 629460
 gtccccatgc cattccagtg tggagctcca tttgcacaac tacctgaagt tcaattaatg 629520
 tatgcaagcg gggccatcca catcaaagg cactccttgc cttggaacct ttttgggtac 629580

 ctgagtggtg ttgcagaata ctgccccat tggagacttg gtcagtgaag ctccacagat 629640
 gttgtgtttg aactccaag gcaaatgtt atgttatttt aatacataca attaaaatga 629700
 aagcacaact ctagtagtcc ctttaactga agaaggtata aattgtaggc attttaatgt 629760

gtgacgcgtc gtcaagaatg tcatgacgaa gcagataaga agctaaaaca tcagctgaga 629820
atctctttcc cactacatc cataaatagt aaccatttga catggagaat cgaagtcagt 629880
cattatcggg aaaaattact tctgatcttt ttctttgcat ggctgattta ttctctacc 629940
ctgtcaaggg aagactttta cctcaaaaat attccccctt ttaaatttcc cacttcttta 630000

tcccccttga caggaggatg gcagcagctc tatcgaatgg caacaagctg ggatatgttg 630060
ttaaatttta atcatectcc tgcccgtgag gctgataatt gggcatggtt nnnnnnnnnn 630120
nnnnnnnnnn nnnnnnnnnn nnnnnnnnnn nnnnnnnnnn nnnnnnnnnn nnnnnnnnnn 630180
nnnnnnnnnn nnnnnnnnnn nnnnnnnnnn nnnnnnnnnn nnnnnnnnnn nnnnnnnnnn 630240
nnnnnnnnnn nnnnnnnnnn nnnnnnnnnn nnnnnnnnnn nnnnnnnnnn nnnnnnnnnn 630300
nnnnnnnnnn nnnnnnnnnn nnnnnnnnnn nnnnnnnnnn nnnnnnnnnn nnnnnnnnnn 630360
nnnnnnnnnn nnnnnnnnnn nnnnnntect ccttctctc cttctcttc tectctect 630420

tctctctc ctctctcc ttctttatt tgttttgtt tgttttgtt tgtttttgg 630480
tttttgaga cagggtnnnn nnnnnnnnnn nnnnnnnnnn nnnnnnnnnn nnnnnnnnnn 630540
nnnnnnnnnn nnnnnnnnnn nnnnnnnnnn nnnnnnnccg cctgcctctg cctctgctc 630600
tgccctgcc tcgcccctc cagtctggg attaaaggca tgcgccacca ccagctggcc 630660
aggccaatct tctttatcag aggcatctct cctctctct ctgccttgtt ctgtctggta 630720
aagaccctt ctttgtgct ctaaaaagct aggtgtaggg aacaaggaag aggtcaatgg 630780
aaactcagt ccgtgatcag ctttctgtg catctgaaa tgcctttta aaaaatcaag 630840

tctgttaatt tgataaaaac tgtctctcaa tctcttcta ctttctcac tcacaaatgg 630900
atgatagcaa gtgttctctc tgctggcca gccctgcaca tttgaggtt ccctatgagt 630960
tagtgtctc tgtggcttg gactcactgg tccagtacg ctcttttaa ctttttgtt 631020
gaattagtgt cctctgtgc taaagactgc ctggaatg tcacctacat ggtttctgt 631080
tttcatccca tctctgtaga attttcttt tgcttcatt tttgactct gtcttaaca 631140
acttctataa tagtgacagg aattgcactg ctggaacagg tcttacaac atcaaaactc 631200
agtttccaat tctttacttt taaaagaaaa cttcgtaac agggtaatca agagcattgg 631260

gaacggctgg taatgtcatt ggtcaatgg acctactgg ccaaaaactc caaaagaggc 631320
accattctt ggcattggac tttttgttt ttagcctatg gtgcttagca gtggcattat 631380
tattgtgta cagggttaact tcactacac tttctgtctg tctgtctgc taatgatta 631440
tatgttatag aaagcttctg cagcagtagg ctcaaatatg acttcatgaa aaagtgtgtg 631500
tgtgtgtgtg tgtgtgtgtg gcgcgcgcg cttgagtgtg catatgtgca tgcattgaca 631560
ccgtggtgct tglatggatg tcaaaggaga atgttctgga atcagtgtcc tctttcact 631620

atggattctg gtggttgaac ctaggtcatt tatggcttgg cagtgatcat gttttctcac 631680

tgagtcattt tgatggccag tgttatcttc atgtctattc tttgtttgtt tgtttgtttg 631740

tttgtttcag acatggtttc tctgtgaaac agtctctggct gtccctaggac tcaactctaga 631800

atctcactat atagcccat ctggccttga gcttgcagca gtccactcac ctttgccct 631860

tgagtacggg gattacaagc atgaaccca tacctgatg atttcctttt tttcttcata 631920

tgtatgtgta ttcacatttt gatgatcaac accataggac tcattgaaac agctcttggc 631980

tcagcaaatt cciggctgtt gttattcttt tttttagga gcctgcttta caggctcttt 632040

cagactccct cttttaacag tgtttactga gtgcctgtta tgtgccatgt gccatccttt 632100

atggggagaa taatcctgta ttcataaatg agtctgtctt tcctgtacgg atgacactgg 632160

atgaaacaca cccagtggat ctcaagaagtc cctgtttctg tgccataca agtcaggtag 632220

accaagtccct gggtcagggc taggttgaga aaggtttcat gtatggcgtg gaagtgaaat 632280

cttaaggact ggagaattaa ggaatgtcct gctttattgt caggggtctt gtgctttgtt 632340

gttttcccc aaagaggata tcctatagct taactttcaa attgtttaat ctcttaaage 632400

aatgaagat ctttgccta tgcaaaagt tggaggcta agagtacttc ggatggaagt 632460

tgggtgcctg caggacaca gggacactaa cttggtgagc taattcttta agattagcac 632520

atagaagaaa gctctgacta aatcacctag tgcataaag gcgtgacatt ctctgctaag 632580

gaaatcactc acttgtcctt gctctttccc gtttcaaatc cctcctgtat actggactca 632640

catggatagt cctgggcatc attaagctgc tctctgtcaa caaggtgtga agttgatgaa 632700

taagtctcca tgttaaactg atgtttgcca actcccttca ctttaatac tectcatgag 632760

agttcaggcc taattcaca aagactcttt gcataaggtc tagacatggt cttgaccatg 632820

ggtgccatga cagtggtgtt aattgtatg ttttctggaa atattgtgcc ccaactcctc 632880

ctcccttctc tgtgttctca acagtcactt ctccatctt tteacgtctt tgtttaaaga 632940

tgtgagactt agattgcat gaatatttta gtttcctttt gagttagaag ttctcctgcc 633000

tagttgtagg ccttatgatg ctgatgctaa gcctactgtc acaacatggt gattcaggaa 633060

agcaatgatg atggatgctc aggagagagt aatttgtatc tgtatttgg tccatgggag 633120

gcagaaagca gctcaactga caaaacctc tagcttattt tctatcagta tatctaaact 633180

ctgcaacttg atgaatacat acaaaagctt cctatgttcc ttgtatgaac gatcccttta 633240

tcattatgga aatccttatt tgtggttcca cctgtcatag ttacctacag tcaactgcca 633300

tctgggaatg ctgacatttg tcttgacttt ttcaagagag agactatagt cctttttatt 633360

acagttaatt gttacaattc ttcaaatttt actattggtt ttaaaaatta actgtcaaaa 633420
 cttaagtgt tattttatca ttggtagta tacaggcctt tgcacccagt aggtactgtc 633480
 ctctctggtt tcaggatcc actggaggct tgtgctgtat ctccagtaaa gaggaggggg 633540
 actatggtag gtttctagaa gttattttc ctttatgata aattttgtgt aatttaacca 633600
 gcattcatca ttttctgctt cctactgca ggtgcaatgt aaccagctgc ctcaatttct 633660
 cttacctccc aaccccagat gctagtaatc accattctac tcttgggtgc tatgagttaa 633720
 atattagatt acatatacaa gtgaaatcag tttgtctttt catgtatacc ttatttcatt 633780

 taacatagtg tctctactt tcatccagga tgaataaat cacaggattt tctttcctga 633840
 ggctaaatag taicccacta taaacacaga caccatattt tctttatctt tatgtagaga 633900
 gctgcagaaa accgcaccca aaagatggcg ctggtttccg ccttccgcca gcccgacggc 633960
 gagcgtctc tgtggtaac aactccaaat atggtagagg tcatgtatcc tcttaattct 634020
 gcttggagac aacctatctt ggccgcccac gtagggtag gtgattggtg gatgtagact 634080
 atatcaggcc ccgtctcctt cggcctgggg ccgccctc cattatacat tgtacaaagc 634140
 aaagaggttc ccgattaaac tgtgtttgaa gaagattcct cgggtggcg tctttcttgc 634200

 tggcaaggg tggacgccg atctttatcc atttaggtt gttccacatt atggctgtt 634260
 tgaagtattt gcacataatt ggctaggata taggttagta tggtcattat gaaacacaat 634320
 atggaaaata ataattcatt aaaaatggaa agaaaaccta caatgtggtc caatgatgat 634380
 cctactgtgt ggtatatac agttaggtt gattttcatc gtttagctgg gaagatttaa 634440
 aatcaccata gaaagatcta tgggcatgtc tgagagtgtc tccagagagt tcaattgaaa 634500
 gaggaagacc cacctatac atgggccaca ccatctcatg gtgtagggtt ccaggctgaa 634560
 tataaaggag aaagcaagct gagtccact attcatcact ttctatttcc tgattatagg 634620

 tgcagtgtga aatgctacct tgggtttgtg ccaccatgcc tcccctggca tgatgatgac 634680
 attctctcaa actgaaccaa aaataaacct gtcccttacc aggttgcttc ttgtcaggta 634740
 ttttagttat agaacaaga gaagaaacta gcatagtatt caaaggagac aaaatcaata 634800
 ttctggtgag tatctgtgct ctatgcttta ctgtagtgca tgagatgact gcagcatcta 634860
 cctcacttaa ctctgattct gtagctgttt gaactcctca gtgcttcatt agctatctaa 634920
 aggcaagtgc cccagtgtt tgtggtgtt ctagtgtga tatggtgtt atgagtgtc 634980
 attagtgatt actgaatcaa catggctgcc atggctacag gaaatcag caacatggcc 635040

 tccctgggct gcagaaaagg gatcatcctt tctttatata gtgtgcaaat agatgtgtgg 635100
 ttccacctgg taaatataaa acacaggtca ggagggtgtg tacttgtgca acattatag 635160
 tatggtcagc aaaggagaaa ggggaggcac ttgtttatgt accaagagta ttgtaacaac 635220

ataaaccaa atagataat gactaatgic tccgttcatt cgctaaagat cagctactta 635280
 gtaattattg tatctccagt attctaactt cataaaacac ctgggatatt tctatgatct 635340
 catttcacag atagggaaa taaaatatag gaagtctagt gatcagcctg tgatcacatg 635400
 acttctaagt ggiagagctg aaatttgaac acacatagtc tggtcacaag ttcccaagtg 635460

 cttttaactg ctacgtgctg gctttctcaa gatgacatca gttaactgag tttaaatctc 635520
 tgagttttaa atactcttag tataatatga taataataat aataataat aaataataaa 635580
 taataaaaag aggaagcact taaatgcagt aggtctttct tgggatcaat acctactgga 635640
 taacaactg tgtaatacta catttgttaa atgtactgtg tttctttgic cattctttag 635700
 ttgagacatc taggttattt ccagcttctg gctgttatga ataaggctgc tatggacata 635760
 cttaaagcaag tgccttggg gtaggatgga gcgtctttgg ggtatatacc caagagtgg 635820
 atagctggac ctgaagtag atcaattcca aattctctga ggaaccactt ctctaaagga 635880

 actgagggaa tactgatttc catagtggtt ggataagttt gcactccac cagtcattgga 635940
 ggagtgttcc cttgctcca catctctcc agcatgagtt gtcacttgtg atattgttct 636000
 taccattctt gacaggtgta agatggaatc tcaaagtagt ttttatttgc atttccctga 636060
 ggactaagga tgttgagcat ttcttcaagt gtttctcagc catttgagaa tcctctattg 636120
 agaattcttt gtttagatct gtgctccatt tttaaaattg gattatttgg tttgttgatg 636180
 tctagtttct atatattca gatattagct ctctaccage tgtggagtgg tgaaaaacct 636240
 tttccatcct gtaggcagct atttatcct gttgacaatg cctttgctt tacagtttca 636300

 tgagatcaca ttactaatt gttgatctta cagcctgtgc tactgctgtt ctgttttagga 636360
 agttgtatcc tggccaatg ctttcaaggc tattccctat tttctcttct gctctgttca 636420
 gtatatctgg ttttatgtg agatctttgg tccatttga cttgagtttt gttcagggtt 636480
 ataaatacag atctatttgc cttcttctac atgctaacat ccagttagac tagcaccatt 636540
 gttgaagatg ctatcttttt gccattgtgc ctttctggcc tctttgtcaa aaatcaggtg 636600
 tccataggta tggacataga tttgatttca ttgatcaatg tgtctgtttt tatgccaata 636660
 ccatgagatt ttttttatt actatagcat tgtgtacca ttgtgggagc tegattcctt 636720

 tacaattagg aatgatgata cctctagaag ttcttttttg ttcagtattg ttttagctat 636780
 tttgggtttt ttgtttttt ctatattaaa ttgagtattg tcctttcaa gctataaag 636840
 aattgtgttg gaattttgat ggggattgca ttgagtctgt agattgcttt tggttggatg 636900
 gccattttta ttatgtaatt gtactgactc atgaccgatc tccatgggag atctttctac 636960
 tgtctgatat ctcttcaat ttctttcttc aaagacttga agttcttgc atactagtct 637020
 ttaactttct tggttagggt taccceaagg tattttatat tgtttgtgac cattgtgaat 637080

ggttttgttt ccctgatttc tttctcagcc cttttgtaga taggagggct actgagttaa 637140

 tcttgatcc agtcacttta ctgaagatgt ttattatctg tagaagggtc gcttatgtat 637200
 tctatcctat catcttcaaa taatgatact ttgacttctt cttttccagt ttgaaccccc 637260
 ttgatctcct ttagttgtct tactgttctg gctagaactt caaglaccat attgaataga 637320
 catggagaga gtggacaacc ttgtcttgtt tctgattttg atgtaatgt tttgagtttt 637380
 tctccattta atttgatatt ggctgtaaac ttgctgaaat tgccttatt atgcttaggc 637440
 atatctacta tatctctaac ccctccaaga cttttatcat gaagggatgt tggattttgt 637500
 caaaggcctt ttcagcattt aatgagacta tcatatttct tttcctttca gtttgcttat 637560

 atggtagatt acattgactg attttcctat gttgaacat ccctgtatct ctgagataaa 637620
 gcctacttga tcatggtaga taatctattt tgatgtcttc ttggatttgg tttgcaagta 637680
 ttttgtttag tatttttga tctatgttcc tatggctctgg gcattagggt aattatgatt 637740
 tcataaaata aatttggcaa tattccttct gtttcattt tgtggaataa ttaaggagt 637800
 attgtgtgct agtttgaatg tgattggccc ccatgagctc ataggagtg gcactattgg 637860
 agttgtggtc ttgttgaagt ggggtgtgtcc ttattgaacg aactgtgtca ctgtggggca 637920
 ggctttaaag tctcttctgc ttaagtttcc ctcagtgtca gagtccattt cctaagctt 637980

 tctgatcaag atgttgccag caccatgtct gctgcacac tgtcacactc cccaccatga 638040
 tgataaagga ctgaacctct gaactgtaag ctgccacctc aattaaatgt tttccttttg 638100
 aagagtgtct gtggccatgg tgtctcttca cagcaataga aaccctaaca aagacatatt 638160
 agtattaggt ctcttttga agtctggtag aattctgagc tacaactgtc tgggcctttt 638220
 ttcttttttc tttcttctact tttttttttt ttggctcag agacttttaa tgactgtctc 638280
 tatttacta gggattatag gtctatttaa attggtgatc tgatctttat ttaacttcag 638340
 taagtatttc caaccccaca ttgggtgtca aaatattgtt tgccttctc ttttggctct 638400

 ttgctctttg ggttttttgt cttttgaggg cctgacacc agctcccaa taaatcacac 638460
 acagtgagge tttagcctct tttctttctt ataaatgccc ggcttagct tggcttcttt 638520
 ctgcccagct tttcttaacc taaattatcc catctacctt ttgcctctgg actttttcct 638580
 tttcttactt ctgtatgctt tactttcact cttactccat ggctgggtgg gtagctaggt 638640
 agctggcccc tgacaccate gtctcttgtt tttatcttgt tectcttct tctctttgtt 638700
 ctctctattc tctctgctg ccagcccaca ctaacctttt tttgcctca ctattggcca 638760
 ttcagtctt tattagacca tcacacattt taacaggca aagaatcaca gcttcacaga 638820

gttaaacaaa tgcaacataa ataaatgcaa cacatcttta cattgctaaa caaacactcc 638880
 agagcataaa caagtataac ataccactg caacaaagcc ataccaccta atagtgccac 638940
 tcctctgtaa cttaacagca ccaattacat tcaaaactacc acaaataccc ttctcatggc 639000
 cacatcttac ttgtattttc tactaaattg ttggaacaca attatcatgg ttattttaca 639060
 gttcctgtct gactgatagg tctaacagca aaataaacta tgggtctagc tgtgttgct 639120
 actttgctat ttaaatatac ccttttgttt tgtgtgtgtg tgtgtgtgtg tgtgtgtgtg 639180
 tgtgtgtgta tgtgtgtgtg tgtgtgtatg ccaaattac ccttgaatat tggaaacttt 639240

 atgtaaateg taaagccatt ccaaagacca ttatactctg tgctgtggct ggggtgtgttt 639300
 gtgctctttc aggtccacta agattgaagg ttagccacc atggtggcat tgcagggatg 639360
 cgatggactt gtaggggcag ggcctcacgg ggaggtcctt ggaggggggg ggatatgcct 639420
 ttnnnnnnnn nnnngggata tgcctttgga atgcaattct cagtggaggt ctagagtctg 639480
 gaggtttttt tgcctgatg gagatgtaat ccctgggctg ctctgttcc tggttcctga 639540
 tatttgccat gttgatggg gatgtcctc tatgtatag tgttttctt attggtgat 639600
 gaataaaaca ctgtttggcc aatagaggca ggaagataag tgggactagg agacgaggag 639660

 aattctggga aagtaggca gaaagggagg ctgtgaagag atgcatgta gagactggga 639720
 ggataggacg tgcaggcat tctctggcaa gataacacca ttagaaaata catagattta 639780
 tagaaatggg ttaataatta agacagagct agctaataag aagccctagc tattggccaa 639840
 caattttata attaatatag tgtccatgtg ttgggatgg aagtcgtggg acagaaacac 639900
 cagcaatacc acttcttatt ctctgaaagc cctggggtga ggcagttaag gacagacctc 639960
 ttcaagtctg ccctgtgtgt ttggactttg agcctcatag accatgagct acattttttt 640020
 tttttattgc aaaagtact agtaccagg atcttgttga ttacaagat ctgtttggaa 640080

 tgttcacagg gctcttgggt aggccatcag tggctaagca tggetannnn nnnnnnnnnn 640140
 nnnnnnnnnn nnnnnnnnnn nnnnnnnnnn nnnnnnnnct tggcgtgg catgtgcct 640200
 gtgttctcac aaggctcttg acagacccc aggtcttctg gcctgaggca tgtctatttc 640260
 tcttgacctt attcctttct agcagtgtca ctgcagatga gcctacgat aaggcctctg 640320
 agtttagagt aggctgtggg gaggtcctct gaatttcttg aaagaaatac tcaatgagga 640380
 atggaatctg gctgacctgc ctgattgtag gagaagcagg aatgatggga tccataaagg 640440
 actggcattg ctcaatttct taaggatgia ctacttctt ttgaggattg tctttaggga 640500

 atagaggctc accggcttgt gtcagagagt tctgcttggg tgctctttga gtggttgggt 640560
 ggctaagcaa gctcctaaa ttccctcata gtgactgggt tagatagatc ctatctatct 640620
 atctatctat ctatctatct atctatctat ctattctact tatctatctg tttatttaac 640680

atctatctgt ccatctatct gtcactatc atatacctat ttatatectg tcatcatctg 640740
 tctatcatct atcatcatct gcctatctat tatctatcta tctatcttct atctatctat 640800
 ctatctatct atctatcttc atcatcatca tcttcatcat ttgcctatct atcatctatc 640860
 atctatctat ttgtcatcta tctatctatc tatctatcta tctatctatc tatccatcta 640920

 tccatccatc cataatctat tatctctgtg tatataaaag actgtagtta ttcccttttag 640980
 ttgaatcccc agtgtgtata gtaaagcacg gattcttttg atgtgttcag ctgaatgctt 641040
 gtttgaaact gggctgttgc ttagacagaa ctgagcactg aaatgcctca tttcaataaa 641100
 ctgcttcttg gcttcattta gaaattatca ctaaaaagctc ttccaataaa atcacatgtg 641160
 aaggagataa aattccctta actcatgagt agcatctggg agaggttctg gctactgttt 641220
 ccttggtca ttttgcttc atgtggattg gatgaggctt ggcaattttt catcactcat 641280
 gtgagtttcc gtcaatggaa aataaacctt ttcccttctc agttgtaact aatcaacttt 641340

 aggcactctgc ttctaatat atcaccagga acatgtattg aaagatatcc tgtggggtat 641400
 agctgcttct ggttttgctg taagtgtgcc atgctgtgt atgtgtgtgc atgtgcatgt 641460
 ttcccttctt gttttcagta gattacaatt ctaaaaagta tcgattattt ttatattgag 641520
 aaaacacagg agacacatag tttcttccat aagaacataa ctttaagcca agtagtaaat 641580
 ctttgagtt tcaagaatt tagaagccac atttttttc aacagaaaaga aataggact 641640
 gtagataaa gataatctca aaatataaat attactttat aatccatcaa tatteaccac 641700
 gactcataaa catcaaccta gtgatcagca tagtagtttt tgtagatgat tcaggctagc 641760

 ttgttatagt caagatgatg gtaaccattt tgcattgat tttttcttat aaaagcctga 641820
 agtagacaat attcagagta gctatgagca tggatgaatt tatcctgagc aggctgagtt 641880
 cttgtctctg aatgttactt accaggtaga tactattgag tgaattgatg aagctctctg 641940
 tgcctcaatt tcttcacata tgcaaaggca gacacaactac tacctgtact ttagaactac 642000
 tgtgaggaat aagtgatgta acataagaaa accatagaga tgacctggta tagaggcaca 642060
 agggctgctg taagggttcg ggtttgaggt tctgtcttc atcctatggc agttgaggaa 642120
 ctattgctga gaggtagttt ctttttacag ctttctctgt tcttttaggt taaggaaaat 642180

 ggtaaagtct cagcttgaca tgtctatgat ataaattatt tgcgttcttg ttatgggatc 642240
 ctagattca agaggaaaca aaaacagctt gaagaataaa aaggaatgct gtagcaggaa 642300
 aacataaagc ccagtgtgtt ttggaatcag atgctgtgtc aacatcggat cctcccagaa 642360
 ggggtgattt atctaafaga tgaagatgga ttgaaaacat ttgctgtgct tattcttttt 642420
 ctatgatcaa caccctaaa catattgctt ccttcatccc tctccttcc tecttctct 642480
 cttcagtctc tgcttatata gttggccttc tattaatata acaaatatct ggagtgatca 642540

caaaggttta ttgtggctca aagtcttaga gacagagtta caggcttcat agtgacatta 642600

 tcactcatga ccagctccat cgttttgggc ctcaagtggca catttgggggt ggggtgttta 642660
 tggagtaaaa ccattttcct catggcagaa aattgagcaa gagagagaag aaagagcagg 642720
 acctctccat ccccgagggg cacgtacca gtgctagaag aacctgtac tagatcctgt 642780
 ctcttggagt ttctaccaca ttccagaaac actaagtagg ggaccaatc tttagtgtgt 642840
 ggggctttgg gggacattcc agatccatgt cataaatcac tttgtttatt aaaaagccca 642900
 aaccacacat ttactaatt ttaaaattat cattattgtt attgtatatt attgtttgat 642960
 gtgtgtgtgt gtgtgtgtgg ggggtgtgtg tggaggggca ggtggccata gcatgtgtgt 643020

 ggaggtcaga ggicaacttt gtagagttta gttctctcct tctacctta catggcttct 643080
 gggggttgaa ctgggttgt caggcctgca ggataaatgc ctttaccac tcagccattt 643140
 cactcccttc atattttact aatttttaga tagataaaca ttattttaat acaggaagtt 643200
 tttttgaggt aagttttgca atgtcttatg catgccacat accacagcct ttgttattta 643260
 tatacaagtt gggaaatgca cgtagatttt gaagtcaccc tcagcatcag tttctactgt 643320
 gagattttaa agatttaacc tccaaagtat tggtgaaata tttaaagaac acataaatcc 643380
 agacttctag ggggaaggaga caattaaatt tatcgtaatt tgaaaaaaaa taaaaccaa 643440

 cagccatgtg tgttgatgta atggcctggg gccccagctg agcccaatca attatcaata 643500
 tgcttttagct gttgatagaa ctttgtgtaa ctttaatctt tatcagagat tttcttctta 643560
 tcttttagct ttaagcaatt ttttttttt ttttacttag aagtgtaaa agaattgtaa 643620
 tctggggttt agttgtgaca atcatgtaca ttttagttta tatgattgtc tgattttttt 643680
 taatgtagaa tttatctcc actatagttt gcctcactcc aacaattctt tgctaagtca 643740
 cccaatttat aactttgaaa aaaatgaatg aacagcagag aaacattgag accaagagtc 643800
 acccttatte ttgaaaccaa gagctttaca gtgtcgtgtaag gacctctctt ctgactgac 643860

 ttcacaacca ctcttagaa acttcaggac gtaggatgac tcatggcctg ttcttttgaa 643920
 agccagcacc ctagttagg tatttcctta tttatgttga gttaaaagta tatgagatgt 643980
 tttaggtcgg ggaagaagag ggcatgtctg ttaggacctg actgtgactg ttagcctca 644040
 ggccagtggg tctagttttt catcttgaag atgacagcaa tgaaaggcca tttctgttta 644100
 agccaccacc actgttctct ctggcattcc tataaatttt tttataaagc tgcagagatg 644160
 cagttctttg aaacattgct gttcttccca cagcaggtga gaactctgag gctctacttg 644220
 gigttaggat ctgggagga atctttctcc aacctagaat gttaaaagac agtcattgat 644280

cattcagtga aaacctatct agttatcact tccttctgt gtattagtgc cttgcaagaa 644340
actaaaattc tttcaaaatt ggcaagcaaa aactggagac tcactggaag gatacaggag 644400
atcttacaga gcctgaatgt ggggtgtgggg tactagtttg tagacagAAC aagtggaaaa 644460
gtctaactga ttcattgctat gcctcctctca ggccctgaga attctttttg tcttttgtct 644520
aggtggtttt catttccttt ttttttttc aaagaccagc tttctattt tgtgagagtg 644580
gagtggcctc taaccagct ttgcatggct tctctgagaa atgaagtaca ggggctgggc 644640
tgatgcctca gttgttctag actactccaa ggagccattt ctgtcacca tgaacatgaa 644700

cacacacaag agactgattg cctggcatgg gtttagatggc tgcttacaca atagtgggaa 644760
agagatccta atacaaagta caaagataaa aagtgtgtgc acagtgctgt gaggcacagc 644820
ccacaggatc tcatcaatg ggggaagctt agctggagca gatcctaata gtcaactaaa 644880
ggctccagga agaaagtga ccataactct cagcaggatg gatgatttcc agatgagtga 644940
gtgtggcagt ggccactcag gctgagtcac ggggaggtgc acaggtgccg agtggaggag 645000
ggggctgaag gcagtgtcaa acctgatagt agatataaca ggtcttattt tggccaccaa 645060
ccagctccca aatcatgaca tggatactta tcattagtta tgaattcttg accttatctt 645120

atgcttgcc cactagctct taaaacttaa atcaacctgt ttcctttcat ctatgtttg 645180
cttcagggtc ttttacctt ctttaactg tatgtctac tctgtgtctg tctgtctgtc 645240
tgtctgtctg tctgtctgtc tgtctgtcag ctgcctggct ggctggccct ggacatctct 645300
gtcttattct tttttctac tctttcttt ctacctctat ttattctctt tgtctaccaa 645360
ccctgcatac ccttctctg cagctattgg ctattcagct ttttattaga ctaatcacgt 645420
gccttaggca ggcgaggga accagcaaca ccctttaca tagttataaa gtgatatccc 645480
acacagttaa agtaatatc cagaacaagt ggaggagct ggaggcagta tcaaaagaac 645540

tcttgcctt ggcaacagtt gtggttgcct ttggcttcta tteccatgtt tttaaaaaag 645600
agttgtatct gtgttagaaa gaatgtgata tttaaaaca gagattcaa atattcaagc 645660
cttttcatgc taatgataat actttttaga aaaaccataa gagttttgag atttttaaa 645720
tcacatttga gtctgcatg tttgtttgct gttgatagtc tcaagtgagt tectttatat 645780
ctatttgtat ctigaaggaa tttaatattt aagaaatggc atcaggagcc tttgtggtat 645840
gattgatttt atgtctgtg ggatggagaa actgtgctat tactcatacc tcgtaattga 645900
tttaaggttt gaaaccttaa ttttctctg aagaacatga agattaatgg aaactttct 645960

tataatcatt tctgaacatc tacagctgga tgcatttggc tgaaggagc actgaccagt 646020
gaggtttgag acccgagttc taaggacat ttgccctttc aacgtggata attagaaaca 646080
aatgaacac acagctatga tgtcttatgc tctgtctctc atacaggtat taaacacaca 646140

ttgctggttt ccaaaatcta tctttcttta tcttgataat ttttaagattg aaatagcagc 646200
 ttatttatga tgataaagat gcatctggat tcctttgcct gggggaagca aacagggcat 646260
 gtgtttcatt ggttcttctg gggaagatta gaacaaggac catttattga tcatgcaccc 646320
 acctgcatcc ttcacatcat tcttgagtac ctggctgac tgtaacgctt agctaattgc 646380

 atgggtgtggg atttaactcc tgccgtttgc atccaggcag ctggcaaatg ttgtgctaga 646440
 acaggtgatt aagtgattgc atgttcttgg ccaagaaaat aagcagaagc aacacaaata 646500
 cttttctttt ccgcttgctc cttcggaagt tctgaaactc agtatctatg ttttaagtca 646560
 tgtggcaagc acagtgcagc attgggttgc atatactgtc caccatgaaa taggttatgt 646620
 cagtgtcata caataatctt tgtggagttg actagttttt ctggaattgg aggtcaccga 646680
 gaagcttcat gtctagtaaa tgtgtgacat catctttcaa ctcaaaattt ttgggtaac 646740
 tttttcatct ctttatcatt gttgggaaga aatatgctaa ggagcattta tattaagact 646800

 gaaaagtaat gcctctagct ggcacacacc ctgaaagcca cacttgccta ggatatgcag 646860
 agctcagga tattatatga tttgcttggc atcacactga gaaagtaggg tgcttaggta 646920
 tttgaactta gaccagatt tcacaatgtt gtcagccta tatttggtag attgaaccct 646980
 tgacagctgg gatgttcagt agttgcaatg ggtaatctc ctccatattg acaggcctta 647040
 gagccactgt ggaagcaca ctcatcagt tgatgggtt tccagaaaagg ttaacttaa 647100
 gaagaaagac ccacctgaa cgtgggtggc acctttctac tggttggaag aaggaagacc 647160
 tgccttgggt gtgggcagca ccgtcctatt gtttgaaga ggaagaagga agaactggg 647220

 tggcaccatc ctattggttg gaagaaggaa gacctgcct catgtggcg gcaccatcct 647280
 attggtttga gctctggatg gactaaaaag ggcaaagcct gctgagcacc agtgttcgtc 647340
 ttgctgtggt tcacgattgt ggctacagct acttctggct attatgcttt cccacaggg 647400
 atgagtagtc tctgacaaat tgcaagacaa aagaageccc tcttctta ggttttttgg 647460
 tcaaatgttt ttttgttta gtaataggaa aagtgtctaa caaggcaacc atggagagca 647520
 ttgtttgggt ctattttct cctcatcctg tgggtcctgg gtggatttgg cctctatccg 647580
 acactcatta gtcgctgata atttgctata gtctcaect catcatcatt gggttggaga 647640

 acagtgagag tccacagtc agggccttgg gcttagcaat ttccagaagc tccattaac 647700
 tccggagcaa aatgggaact tcatcgact cctccttccc tgtaaagtgc taactcactg 647760
 aggaattaaa tctgggtcct aatagcttat ggattttttt tttaaagatc attctgttcc 647820
 tctgggggag aaaaattacg tacaactttt gtgaggctg gatctttttt ttaagttat 647880
 aattacttta caggcttttg gccaggattt taaagtaaat gcatgtctga acaagcattc 647940
 agtgtgggta aagtgttta acagcagagt taaggtgggt aactggtatg tcgtgcgtta 648000

agctttcttt aaaaaacaac aacaacaaca aaaacaacaa ggcaggtaat tcaagtgaga 648060

 gtaaagggtg aatatggcct ggtatgcctc ctgtttgaaa tgaaatgtcc tgagatccta 648120
 tttttatatt tatatgtttc ttttaaatit tttaccettag aacactatgt tectttttaa 648180
 accatatttt aaaataattc ttccattggt caaattacc atcaaaaaag aggggaaaaa 648240
 gcacataata atgacacaag tattctcat gcctcgaaag aatgatttta gacacttgca 648300
 gtttctcttc ctgtccccgc aggaagacag tgtgggtatc tgtctctgtg aactnnnnnn 648360
 nnnnnnnnnn nnnnnnnnnn nnnnnnnnnn nnnnnnnnnn nnnnnnnnnn nnnnnnnnnn 648420
 nnnnnnnnnn nnnnnnnnnn nnnnnnnnnn nnnnnnnnnn nnnnnnnnnn nnnnnnnnnn 648480

 nnnnnnnnnn nnnnnnnnnn nnnnnnnnnn nnnnnnnnnn nnnnnnnnnn nnnnnnnnnn 648540
 nnnnnnnnnn nnnnnnnnnn nnnnnnnnnn nnnnnnnnnn nnnnnnnnnn nnnnnnnnnn 648600
 tcagtccctt tttttaetat gtctacaatc tctttcttgc tgccttcccc cagtcttttg 648660
 ctttgcatgt catctataag gtattgtttc tgaaatttat ctctacctc catcttcttt 648720
 tactctgtga gataaatgta tttattccac agtatgatgg ttcacttta ttgtcagctt 648780
 gacttgatca cctgggagac gcacctctgg gtctgcctct ggcgtttgcg gagatgttta 648840
 actgaagagg gaagacgagc tctgaatgtt ggggtgggacc atcacatgga ctggggtatt 648900

 ggactgagtg aaaaggaaaa agtgagctta atcctggcat ccataacctc ctgcttcttg 648960
 atggcagatg tcatgtgggc tgcctcacgt catgactttc ctaccacgat aggcctctacc 649020
 accaaccgac aaaccaaaaa acgaacctc cttaagtgc tttgtcagc catttcgtca 649080
 cagtcatgcg aaagtcacac acccaacatc cctttaaaca tgttatcttg tgagaatit 649140
 cttagtgtgc ttgatatit tggggtaaat tcatccacat ttaaaaacat tgtcatctca 649200
 ctgtagataa ttgtaacttt taggtgtct tataataatg aaaatgcacg aaacatttca 649260
 ttattgcaaa tgcatttcac ttggttgtgg ttattcaagg agttacagtt ctcatitit 649320

 gtgttctcat ttttaacatt ggattcattg ttagtctgga tccatattgt gaagaagttc 649380
 tttaaatgtc tatgctttcc gtcggcggtt ggtggtgcac gcctttaatc ccagcactcg 649440
 ggaggcagag gcaggcggat ctctgtgagt tcgaggccag cctggtctcc agagcgagtg 649500
 ccaggatagg ttccaaagct aaatagagaa acctgtctc aaaaaaccaa aaaaaaaaaa 649560
 cacaaacaaa caaacaaaaa aaacaagtct atgctttcac cttcaaaagg agtaaatcag 649620
 tgtttgtcac agcaaccaga cccctcagta gacgtgtcaa cctctgttag ttcaaattc 649680
 atcttttcta aaggacactt gcctttatag tactagccca tgagtatagc tttgtgcatt 649740

aactgcaccg ataattctgt gtataatttg gggtagtttc tttttttcc ccagctttat 649800
gagctgggac aatctctcct acattagcat tggagggggt gaatactgct cttctgtca 649860
tactgtcatg tggtcaccct gccagtggtg actttcagca tctagctcac tttgtgagac 649920
atgcattcga gciatctgtg atttagcgct ctttactaa catcatattt ttgcccagga 649980
tgttttatga aacttgaaca tttctgtcag ttgaatcaca aatatttatt tgacactgat 650040
acaatactga atttcaatga gaaaaatctc ctagggfact ggctggaaat ggaagcagta 650100
ggacacacac aagcactctc cccaccccat atttgcaccc ccaagttatg aacacatact 650160

atgtgtatgg gtgcatattg tcttgatacc cagattccat acttggtaac cegtttactc 650220
cctatcatgc tttttataaa ttttggatta ataattgtgg agttttcagg ctactcttgg 650280
gtagagcaga gaaaaacttg agttgcctga cccaaatgtt cccagaggag gttggacatg 650340
gctatagtcc agttcacctt tgtgacttat ttaattatgt atctatttat ttttggagca 650400
gatttactgt gtagcttaag gtggccttga attttataat tcttcatctc agattccttg 650460
ctgatatgat tataggcatg ccaccacacc tatctgtcga ctctgatttc ttctttcaac 650520
tctcacactt acaagtcctt tttttctata tatatgcaca cacacacaca cacacacaca 650580

cacacacgtg tgtgtgtgtg tgtgtgtgtg tgtgtgtgtg tatgtatgta tgtgtgtatt 650640
gtgttttagt gtaattttta tgttttttct catttttaaa gtgttttgtt ttaattttta 650700
atatttactc tctatagtggt attgaaagcc ttgggctaag ttcctctgg tgttctttaa 650760
cctgtgtctg tgttgggctt tctgggtcag tccatgggtt agggagccat cattaggaat 650820
aataatgagt caataatgca tctcctctca ctggaggaag aagaaattac tgttccatac 650880
aggaaaccac caggaaagtc aaaacaaaac aaaacaaaa caataacaac aacaacaaca 650940
acaaaaaac aacatctgta agttttgatg tggataagga aatatttta aatctagctg 651000

aatttgtgaa tacctgaaat aataatggat aaaagtatta tagacagcat tgcttcaagg 651060
ataaaagcaa agacacttca acttcagcca tgtgaccag ggtctgtcaa gtgcttagcc 651120
cctgggccag cactggctga ctcacacatc ccccaaagct gtgccatatg atatgtgtga 651180
cacaggcatg caaggaagat tattcaaatc agaaatctgc agaaaatttc caaaggcagc 651240
tgccaaggtg acgaagaagg gtttcatgga ggagtagttt ttcagactgt gagagtatct 651300
tgtgttatga cgccatggag cacaaatgtc ccccaaagcc tctggtttta aatcattcaa 651360
aggctgtgaa acagattatt tgtaataagt ctatcttttt gggtagacaga aacatactta 651420

aaacaaggtt atgcattgaa aagctgataa aagtgggtgtg atcagagaat tgcaaaagct 651480
gagcctcata cctcctagag gagcaatgac cctgaattca ctaaagtagt gtatgtgggt 651540
aacttttgaa gcttaaatc agcatctacc aagagctgat ttatttttta aaaggtttat 651600

ttttattatt ttgaaattat atgtgcatgt gtgtctgtgt gggcagcaggt atctctggaa 651660
 gccagaggca ccagaccccc ctggagttag agttgcaagt atttgaagc tacttgacat 651720
 gcatgttggg aaccacactc tggctcctctg aaagaacatc atacactctt aaccctgaa 651780
 ccatctctcc agccctaaga gacaacttct tgtcaaagtc ttgaagggtt tttttttta 651840

 taattgtgca tcctaataag attatagttc acagcctgta gggaaaggag ctggctggga 651900
 actcttgtct gggcacaggg aatagtcttc aggcaaacat gttttcttct gaggggaaaa 651960
 cctcaggttt gttcctaagg tgtttcaaca gagtgaatga ggctcacctt gattatcaag 652020
 aataattttt cctgagacct ccagggttct tgatcctgtg ttaataatct cagaacatga 652080
 ctgttggaat ctgttttgtg gagtttgggt tctcagatgt atctggttca attcacagca 652140
 ctagcttatt tagggctagt taaaacgtg catttgtccc tttgtatac acatcctgga 652200
 cagggttaga attctcacca gcagaacatt ctattctagg tgttcagagc tacatcaggg 652260

 ccttgtgcct ttttgccaca gcatgattct tcagtacat atagctgtga cttgtgtttc 652320
 tccaaggacc aacaaaaccg aatactgttt tcaaatactt aatggacaag gaatatgtct 652380
 actgtagctg aatgtcatga catgtacctg ggaaggetga agcaggagaa tcccaaattt 652440
 gagccctttc tggactgtat atagtctctg cttcaaaatc ccaaagagac aaatacacat 652500
 ttattattat tattattatt attattatta ttattattat tatnnnnnnn nnnnnnnnnn 652560
 nnnnnnnnnn nnnnnnnnnn nnnnnnnnnn nnnnnnnnnn nnnnnnnnnn nnnnnnnnnn 652620
 nnnnnnnnnn nnnnnnnnnn nnnnnnnnnn nnnnnnnnnn nnnnnnnnnn nnnnnnnnnn 652680

 nnnnnnnnnn nnnnnnnnnn nnnnnnnnnn nncacatttt tttttaaac tagccctaaa 652740
 taagctaag ttgggacatg aaccaaagtc atctgagaaa ccaagctcac acaaacagat 652800
 tcaccaaatt atgttctgag attgtaaca tnnnnnnnnn nnnnnnnnnn nnnnnnnnnn 652860
 nnnnnnnnnn nnnnnnnnnn nnnnnnnnnn nnnnnnnnnn nnnnnnnnnn nnnnnnnnnn 652920
 nnnnnnggat tgattgaaag aaacagctat tctaacggtc tcagtggtag acagcagaac 652980
 aagagaaaac agtaatgcaa attgtcctg aaaccaaagc aaaataaatt taatagaaa 653040
 tcataaaaat ccccaaca gcagtcatt atgaatgtca tggggagcgt gtcacagttg 653100

 aaaagattaa ttattcaatt cttttgaat tcagctggta attgttagt tagaatctga 653160
 agtgttctgc aaagatgcat gcattgaatg aaggcttggc ctggagcctt ggggtgaggt 653220
 gttcctggga ggggtggacc ttgaagagaa taccagaact ctggcacttc cttcttctgc 653280
 ttgttatttc ctggctgctg ggaggtacct aggcaggttt cctctgctcc tcacacctga 653340
 catgatatgg tgetttgcca caagcccaaa ggcagcaggg ccatgccact gtggactgga 653400
 acctctgcca ccatgagcag aaatattttc ctcttcagg ctgatttgtc tcactttgta 653460

ctgttgatgg aaagctaaca catggtttgg aatgtcttgc ttagtttgta atttatggtt 653520

ttctcataat ttatggatgc aggccaccg tctgctgact gacacaactc cggtaggtgg 653580

gaaagctaga accagaaagg acagttatct gggctcagag tctgtgacct tgatacctec 653640

tccttagtcc tgccttcctt gggcagctgt agacaggtag tctctggta ctgtcactcc 653700

ccatctcctg ctctggcct ggtaggcaa tttgttctct ctctctgtct ctatctgtct 653760

gtctctctgt ctctgtctcc ccctcccaca cactgccag cgcacctgtg ctttctaact 653820

ggtgcaattt ccacccatct ctatcttcc tcattcataa tttgtttga cacaaagcag 653880

tacatttget gctgtttctt ataccact cccatgactc gttgtaactt tcttgacaat 653940

ccatatcagt tacagtttgc ttgtttatca atataacttg gtaatttgta ttcttcatt 654000

atcaagctcc cggagtggg gtggtagtgc ttctttctt ctttctctc cctctcctc 654060

ttcttctct cctctctc cttctcttc cagcaattct tattctgcac atgttaaact 654120

tgataaatac caattagtgc actaatttca taaaagaatt acttgccaag aaagataatc 654180

ttagaacctg aaacaacaca cttgtaaaaa ctttcatgcg tgttgtgtag ttgaaagcca 654240

agccatagct tgggatggg agggtagcag gtctccatcc tctgaataat ttcagtggaa 654300

agaagacaaa tgaatgcagg ttttatggcc aaggaaaaag gtataaaga ccaaagcaa 654360

tgggtggaat gttctggagc cctgttggaa atgagcatac ttgtttggaa ggcataggtt 654420

agctgttgc atccttaaag ccccaagta cacagccaag gcaacagaaa aacctgtgct 654480

atgcacactg atcactatc tgtttctct ttaaatagcc tttgtaataa cccaaactc 654540

tataaatcat gatattactt tattacctga ctttattca gtaaatgaaa ataatttagc 654600

cataaaattg gtattagatt tagagaattt ctttgttcc cttccagtaa ttggagcaca 654660

aggaacaaat actcaaacat tctatgcagc catgtaggtt taaatagttg cctagtttca 654720

ttttatctt ttttaattt taagaactta attttctt aatgtttaac atcatgtctg 654780

aggatgcatt tccttcgtgt gtgtgtgtgt gtgtgtgtgt gtgtgtgtgt gtgtgtaggc 654840

atztatatga gtgtgtgttt gccagcttcc ctttcttca acaaacacct gggatagtta 654900

agtttaaaga gtaagaattt tggttcatta tttcagcggg gtctctacaa ttgattgacc 654960

tatcatttta agcctgtggg aaggcaacc atcgcgggtg aagccatgt aaagtagaac 655020

catcttctc atgagatgga agcaagagag aaattaagag gaagaggcca gagtgtcatg 655080

atcctacagg gatgtgatcc cggatgatgt gtctcggac ctcccaccag gctctacctc 655140

ccaatagtgc ccacctagag atcaagctat gaacacatgg gcctttgggg gaaacattat 655200

ataaattaga gatcagatca ctgtatgtac ctgaacttaa ctccagctcc aggagatctg 655260
tcactctctt ctggcttcgg tgggtactgg aacacacaca cacatacaca cacacacaca 655320
cacacacaca cacacagata aaattctaag ggaagagttt gtcttggctt tcagtttgag 655380
ggtacagtcc atcctgggtg gggagggata gtgttaggtg gctggagcag gaagtcaaga 655440
gatcttatca caactactca actacacaca caaagcagag agtgaaaact ttaagtgggg 655500
tgaggtctta aactctaaaa gtctaccccc agtaaggcca ctattcctaa aggtccaca 655560
acttctgaa acgtcaccac aaactgggga ccaactgttt aaatataca gcccatctgg 655620

gacattgctt aaaccaccac acttttcctt gttacaatgg actgtgttta ttcaaaccat 655680
gaacaaaag aaacgtttcc ttccctctag ccaggcaggt atttggcat agccatgaga 655740
aaaacaaggc gcacacatct ttccattgct tgcagagtc ccacattgaa actgaactgc 655800
tgtcaacagg ggatgtgtgt ggttaggctg tagagtacag ggtttgcgat aggaaacacc 655860
tgaagagaa acagaagaca cccagaaaat ccagagctgg cgtccttccc atacatggtc 655920
ctatcttaca gggaggtggg gtaacagaca tttctccagg ctccacatgg aaagagtga 655980
tgtggggtgc cacaagctt taaacacaga cactgccgca gaggaagagg agccagaggg 656040

atztatggca ggcattcctg actttgaaga aagtgttttg cctgatgaga aaattaggtc 656100
cggacagctc agtttgggtg gagcaattc acagaagagc agcttagat aatgttgatg 656160
gattcagctc tgatggagcc ggtaaacac catgagctct gtgatcacac atgtgggtac 656220
agacggaaca agaacttct catagcatca agtcagctcc catggtcttc catcctggcc 656280
aagaagact gctatgactc cttgtccaga agctgctggc tgggccttgt cccactctc 656340
agaagtccg ccatggcaac attggctcct gtgccttctc ttccaatgc caactccaac 656400
cctgggagca aacttttaat attggacaca ggcgccagg gtttccttgt gtgagtctc 656460

cttttagtgaagaagttagt gctcctggta ggtttcaaat gttgcctggg gacactgggt 656520
aaaatgaaag ggggctgttg gctgatgggg tataagaaag caggtcaact aggagaaatg 656580
gggtttattt gcaacagttc agtgttggg gctaagagta ttaaataccg taaacatatac 656640
tcctgcatgt gatttaaatg aattttctt tttatttat ttcttttta tttttcgaga 656700
caaagcttta tagaccaggc tggcctcga ctcacagaga tccgcctgcc tctgcctcct 656760
gagtattggg attaaagggt tgtgccacca ccgcttagcc ttgaatttta cttttctaa 656820
gcttgataa ttaattaagt aaaaggaaag cataaaataa aaattatata ttaaaagatt 656880

atattatgaa ataacccaa aagttaacca tctgtgaaag ttaaatagc tatatctaga 656940
ttatttttg tttgtaaaat taaaactggt ttatggatat gtatttctaa tttttgtgac 657000
gggtggaatt gtggcttgt taaaaannn nnnnnnnnn nnnnnnnnn nnnnnnnnn 657060

nnnnnnnnnn nnnnnnnnnn nnnnnnnnnn ttggcactgt ggtgaacaat gaaacttaag 657120
 ggaagcaggg gcatgacagt ggtggggtct ttatacaga gcagaaagat tctctttgtt 657180
 ctgtcaagtt tcagggaat catttaacca agtcccaaaa gctgagcata atttattatt 657240
 atttaagcag aagtctatcc atgatgaagc ttatctttgg catcttactt tttaaatccc 657300

 cttaagcat cacagctaaa agaaaccgag ataataattg tgaaaattta cagagttcac 657360
 tctatggaag ccaccagggc aagtgcttca tggtttgctt catcccaaag ggacctgaag 657420
 acgcaggtgt ttctgaaggt ttgacagggc ctgagagttt tgagaatttt cttagggcca 657480
 tcctgctagg aattggaaga ttgagaactg gtgttgctgg cttggcataa ttggaacttg 657540
 tgtgggacag agctttacag tctatgatgg gcactctca gcatgggtgt tacaacagca 657600
 gtccctgtgt cctggtagg tagctagata gggattgtag cctcagaggg cttttaggat 657660
 ggacacctcc ctaatgaagt ctacttctgg ccttgggtgg acatgtgatg ttctgatctg 657720

 ctccaaaat gagaacatta catcctatta tctcctcct tcagagtcaa ccagctggg 657780
 cctgtcaatc acctaccagg agtccatgcc agggaagtta gctgatttac ttaaagccat 657840
 gctaaggaga ggggaggaat gattatctcc ttaatgagat aatgtactta tecttcccag 657900
 aaacctcctc ctggggcag ttgcctgctg agcttccatc ttgtagaact gcatgctgcc 657960
 cacccatttc ctgagttacc cagaaaggca taacttttgc tttccaatc tttaatatct 658020
 tttctttct gactggagc aaagcctgaa ctgctttcc ctgactctga ggtgtctcat 658080
 tcttttttc tgaagctccc tcccttctgc caagcagcta ccatgcttat tgatcaccag 658140

 cactgaacct gectgcttc ttaagggcct cctttgact cttcctcttc tctctctct 658200
 tgaccattgc caagacttac agctggctg ctctgggtgt tgtctcccag actctaacia 658260
 aattgttctt gacattccta ccaactctgt tttaaaatc ttttgtaaat gagactgacg 658320
 ctccctcaa aggaactctg ttttccctt ataacatag cacccaattt gggggttccc 658380
 agaaatttta gaagcattct gagatgctct taaagtctgc tttctgcca actgtggctg 658440
 tactgctctg tgtggagga aaaaatgcc agggtttag aagagagtc agtccagcct 658500
 cagaggagga aactccat atgtagtgtta cacaataat aaaaagacc agagacagat 658560

 attggggata aagcttcaag atgaagataa gaaaagcaa gcagccacta ctagctctca 658620
 cctctcagct cagaccaatg ggtgatctg aaaactgctc ccaatgtcac tattctcag 658680
 attcactcag acttctatgc tctcttaat gtggctagaa actaattctc agactgaatg 658740
 cctctacct ttatacctc caaatcctgg gactaaaggt gtgagctttg attcattctc 658800
 cagtagccta ggggtgctt ggactcaaga gatccatctg cctttctctc gactcctgga 658860
 attaaaggtg tigtccacca ccacctgatc tctatagctt gaggcgggtt ttgcttactg 658920

aatcctcagg caagctttaa tgaatcataa ataatatata accacatctg agtgcacagt 658980

tagtgccatc acttctttca tgtcggatc aagcagttaa cagtgtttag gaccctctt 659040
aacctgcaaa cactttgcc tctgtcctta ctgcaagttt tcttcacag gattgtcccg 659100
gaggttccag ggaggggagc tgcctgttc agccttttca tccccacatg ctaggctcag 659160
aggcccacc tgaacctgt gactgacagg gtcaccacg taccagtgc ttcctttcag 659220
gtctcaggca ttccaatgt ctggtattgt ttcttctgtc ctttgattct catgcctgt 659280
cacagctgag taggtcacgg ggtctagaag cagagccgga tgctcatggt gacacaggat 659340
gccatttact ttatgacttg gaattccac ccccaaatat aatactgcta tgaagatccc 659400

tgaacattt taacaaatcc cccgtcttc tcttaaaggg cttctatgat tgaataaga 659460
aacccatgcc atatgtctgg tcaattctga aaattcccaa ttctctaatt gctctgttaa 659520
tagttgtcta taaatagaaa gcgatgaacc ctcttatgtc taatcctccc aaagcttcat 659580
tctgatgggt cctgtttacg ataaatcttt ctgcaaaaag cggcccgagc cctaccccc 659640
acatgtgcag tctccaccag ctgcccaggt tctgcccgcc acgtggatgg acaaaataat 659700
acagagacat attaggtaca aagctgcttg gccaatgact aggatttctc atctgctagc 659760
tcagtcttaa ttatcataaa tctatataat ttataagact tatcttattg gactccttat 659820

tggcgtccct cctagctggt ggatcacatt gctccggtgg aggaagagta gaggggaaaa 659880
gggacacttt cggtttcttt tgtttaaata tgagtctcct tgctatgtca cttcctgcct 659940
ggatcaccac ttcttacta catttcccag aatcctcttt gactcctagt cctgtctaac 660000
ttgctgtctc atgggcaaaa caatatitaa ttcaataatc aataagataa acatacaaaag 660060
aagcacattc cccatcagtt ccctgagctc ctaagcattt aaagctccat ttctgcagca 660120
catgggtctg tatccaccat ggaacacagg ttgcatgtg aagatcagtc taggtgggca 660180
atgatgggtc ttctgtctc ggttcccttt tgettcaatt atgctgcta taaataagta 660240

atgcaacaca ttcttgcatg gtctagcttc catagcatgg tgtgccagga tttccttgc 660300
gtgttttgac attttttgaa acttaattga atttgacaaa gttcagcatt gcaatgttac 660360
accctactg gccacagaga gcctcctaga agactgtagt aaagaggct tgaggctctg 660420
taccgtgttt atgagcggga ttggctctta acaatactga agcctagtgt tgagtcatga 660480
agatatcgg atgtggtaat cttttagttt ccaagtagaa acaatagctc ctattttcat 660540
catgattttt gtactgggac tttagatgcc ctggcttctt ttctgttctt gcttttatca 660600
caagctatta acacttcatg atggtcctgg tgaagttaa ggctagtgtg ctggatactt 660660

gacctggaat gaaacttttag gattgttaag gatttgaagt acaatgtatc aaagattgtt 660720
aaagctgggt aggggtgtta aaagggattc aaaaaacct ggtggggaac tgttgtgaa 660780
taatcttttt tgtacactct gaagctggct cactcggatt ggtttaataa aaagctgaat 660840
ggccaatagc taggcaggat tgtttttgaa ttatgtcaga acccagtgtc tactgaacag 660900
acagaagcaa gaagagcaat ctgggggat ttaacaagat tggttatttc ttccccctc 660960
agccccacct tctctgttc cacccatcta tcctggttag ccctaggaca ggcaatggca 661020
attctaggct tgtgagtttg agtggtatct cctgatacca cacaatgtgc tcttctgtag 661080

tagggttggg caaacacagt gtttgggctt cctcctcct ttgggccagc acctgacagc 661140
ttggtcaggc tgtgggattc tgagctgggg ctgggaagtg ttggttcttg tcaatggtgt 661200
gggttatagt gggacttgtg tctttctgct ggacagcctg ttgittgcat tcagatctca 661260
ttcttggaa tgtcctttgc acatttaa atacaagaatga attttgaact gactattttt 661320
aaaaaaaaattg ggcccatata tttgaccttc caaaatctgt cttggttcat ttctgaaaac 661380
tttgaatgc taagcaagaa gaggcagaat aactgtctgt acaatctttt cattataaaa 661440
aatcaaatta gtatctttca aaaagattga tcatattttt aattattaat atgtatatgc 661500

aatgtccat ggaagccaag gtgtcagacc ccctggagct ggaattacag gtgactctga 661560
gttgtctgaa gtgggtgctg ggaaccaaac ttagttgttt ttgagagcag tacagcctct 661620
ttaaactctg agccctctct ccaaccagct gactgttate taaacaaata tgaacttgg 661680
gctatagatt tggctcaggg gtagggcctt tgcatagtat gtacaaggct ttttgagttt 661740
gcatcctggc attgaaacca tatacatcca cttttcatag aaaagtcaa taattaagat 661800
tttgggggaa agicatcatt ttatagcatc ccaacactca tccccatgaa gtgtttttat 661860
gaaatagcta cttaccaggg gcccttcagt tatgcttttc acgtacacag atcttatgag 661920

tttaaatgag aacttgacag agctacagct ggctagaatt ttagagtcac ttctgatagt 661980
cttgccctagc atttgtatct gatgtgttca acttccactg tgtatttttag ttgttttaag 662040
tgtttgatgt agtttataaa caaatgataa gaaaacccat gataaatttt acagggtttg 662100
gaatggattc agcaaatacc tctagtgtgt attccacca ctacttctgt ttcttctga 662160
gaagtacat tatcttagat tttatattta gttttccttt ttatttatga ttttaacaca 662220
tatgtttatg tccttaagaa tatattgtat gtttttgaaa taagtatttg gtttatttta 662280
tttttaatca tatgcatgtg tgtgtctgtg aggggggtat acacacatga aatggtacc 662340

cgtggagtgc tcttaaccac tgagccaact ctccagtcct gtattgtatg tttttgaatg 662400
ctttgaaatg taaatcagct gaagcacat tctgtagatt cttttgagtt gcctttttac 662460
tcactttctg gttctgataa tcatctgtgg cttttggttt gtccataagt ccccccccc 662520

aaggccgttt ccacctaag atcacacatt acacatatgc tgtgctataa tcatggggta 662580
gacagctgtt tttccactgg tctgttacag gtagtccttc tgagaacttc tctgtgccta 662640
ttgatggagg tgtgcaaagc ttgctagtta ctagtccctag gatagacgtt tctggatcat 662700
aggtcaaggg caccattaac aatattagat gaccttggca tcatgtgtac tttgttttgt 662760

tttgttttgt tttgtttgat ttttcgagac agggtttctc tgtgtagctt tggagcctat 662820
cctggcactc gctctggaga ccatgctggc ctcaaaactca cagagatctg cctgcctcgg 662880
cctcccagat tcagggatta aaggcgtttg ccaccaatgc ctggctcaa gtgtactttg 662940
taaaacacca gaacagtatt atatcattg aatgatctct atatatttgt caatgcttga 663000
tactgtcaga ctcaaaaatt ctggccaact gaggggcatg ggatgggtgt acatcactgt 663060
gggtttggtt gtttttcccta tgaattctaa agagatgtag catgttttca tggatactt 663120
ttggacactc agatggcttc ttcagtgcag ttcatgtttt aattttttgc tcattttttt 663180

ttttattagt gggttgctca tatttctgtg tgtatctcct gggctgttcc tgtctacaca 663240
gaactcctg ggttattact gtctctctct gttttatcaa cgtatattg tattctgctc 663300
tttctttttg ggaggcagaa aaaatactca atttattttc ggataggcag cattagcaag 663360
taaaaccaca ctgtggctca cacattcatt cacagggtat gagaaagcca tagctggtgt 663420
gtcctctgtg tgcaaacagg cgaacagtca aaccggtgaa tgctttctta cggggttcac 663480
ttctaatecc agaagaaaaa gcatccccag gcaaaaaacce gaaacaataa aattttggtg 663540
caacaactaa gaggggaaag tttggttcac aggccttcac cacattctct ggagaaatga 663600

gtctcttctt cattaacat cagagcacgg ttacaacagc tgtttaaagt cctgacatat 663660
acacaaatgt aataaaaaat aaacaaacc c atgaaactag ccatgaagac atcttgaaca 663720
tccagactg ctaccagta ctttgactcc tgaaatgaa gacctggaaa tatttgtttt 663780
tcacaaaage aaagtgtca ctacctcct cctcctccc ctecccccc cccctcccc 663840
ctctctctcg ggtaaggaaa ctgaacaac aacagaaaga atgtggagct gtgacgggag 663900
gaactggccc tctgggagt ttctctctta agaagaaaca tgcatcacc cctcgcctcc 663960
atgcagcagg catgaaaca acatatcaa tcaactgagg tgtctgctct gatgcctgtc 664020

cactccaggg tctgggaaga aggtcggttg ttacgataaa tctttccgc aaaagctgcc 664080
tgagcccacc cggcacgtgt gagctttaca ccagccgcca gcctgagtta ggataaaatg 664140
aatacagaga aacttgtatt aggtacaatg ctgcttggcc aatgactagg acttctcatc 664200
tgcgagctca gtcttaatta ccataaatct atatatttta taagtcttat ctatcagac 664260
gccttattgg cgtccctcct tgttgggtga tcacatcgtg tcgctggagt aggagcggag 664320
gggaaaacag ggccttctt gtttttcccta cacttaata tgagtctcct tgctatgtca 664380

ctctctgcct ggatcaccac ttctctacta catttcccag aatcctcttt gactcctagt 664440

 cccatctact tgctgtctca ttggccaaac agtattttat ttaacaatca ataagataaa 664500
 catacacagt acattcccac ttagtcgttt gtgggagggtg tggggagcag gtggaattct 664560
 tgggcacca aactgtttaa taagcagcag gaataagtcc taggggcca ggtcagtttt 664620
 cagagggcat cctaccaagg gctccaaggt taaaggaat ggattaatft tttttgtttg 664680
 ttttagcttt ttgaggtttc tttttattcc tttctgcta aagtacatta aaactaaaac 664740
 aaccacaaga tgaatacagc atagaacca gttcttctca cacaggtgtt catttacctg 664800
 cacatagtca ccatggaagt acacagtaca ctggcaacc caccctacat cggggttaagt 664860

 agttgtccct tccactgtgg tccattgagt cctaactatt tttctctgaa acaggigaca 664920
 gtctttggaa aaaactatga ggccatacac aacttctagt acatgatttt tcccaagcaa 664980
 caaaactatt ttcaaaacc tgcttcttcc aaaattaa caaacaaaca aaaaatttcg 665040
 tctgttttag taatttttg ttttgtttt ttctattttc ctaatttttt tttcattttt 665100
 tggaaagcac catagcagca atcatgattg taggattgcc gaaggctgtg ttcacaagca 665160
 taatatcat ttgcataca agaagagaaa aaaaaacca ggaggaaatg gattaagaaa 665220
 aaaaatggaa aactgaaaaa taaagcagaa attctggaat ctgcccctga ctgaagtctt 665280

 gttttctttc agaaattggg ggaactggta ttgaccaca gggtcgggaa cattaggctc 665340
 ctccacattc tggtcatgc cactagcttg gaaagtgtag cattgcttac ggcagagatg 665400
 acccccaggg tctccttggc cttcatggct aaaccatgc tgtggacaat gatgcaccgg 665460
 ttccacacac agcagggggc acgtcacag aagtctcttg gaaaacatgc ctctctccct 665520
 tcacatctgg cacagtacg gggttctctc tggtaggtt tctgtcctgg caggcttatt 665580
 gttgttccaa tatgtgattt agtggacctt caggttgtgt ttggtgggga gggctccacc 665640
 acatgtgtgg cagacaaggc ttttctctgg tgtgcgtctg ctcacggatc tgaaggccgc 665700

 tggtagatga gttcttccca caccctgtca ctgtggctct actgctagca aagggtcat 665760
 ggaggagggt taatgtggga aaataccaat acagagccag gtaaaagagg caggcggatc 665820
 tctgtgagtt cgagaccagc ctggctctaca agaactagtt ccaggacagc ctccaaagcc 665880
 acagggaaac cctgtctcga aaaacaaaca aaacaaaac aaacaaata caaaggtatt 665940
 taataggaaa aaagccttac ttacagagtg acctagccag ccggtggggc agcagtctgg 666000
 acaccaagca gaaagtgaaa ctgaaataaa aaccggccac ctgaacgccc ctcaactac 666060
 atcacctga ccagccctc gcagcgtgg tcaggcacac ctgtagccag ccaactaagca 666120

ggcgtggcta cagcatcccc tacagagggt cccacaaagg tgccgtaaac ttcaacttgg 666180
 acatagtggt gcttacttgg atatattttc aggagtacaa cacttttgtt ttagaggat 666240
 gaccttgtcc ttgtccttga catacaaagt caaggcagag atatttagga gcttcccttt 666300
 tcttttctca gatgagttga gttccacagt agagagagga ccccaaaaga gcatatagcc 666360
 tgggtcttga gtagcagca tgcttgggag gccagacatg aatttgggga aacacaagt 666420
 cccatcacac ttcaagctga tgggcgtaag agacaaggac agtgagctgg ctgtggagga 666480
 aacactggcc tgaagcagct tggtatgtag agacagacta ggcttgcgac tttccggcag 666540

 agccactgca ttggcatct tataggacta aggtcgcccg agtgtccaca ttggccactc 666600
 cacagtagag cgcatgggca atcctagact tggacttttt ccgtgagctg gatcatttgg 666660
 agctgtgct gtagacacag gatctgctct aggacccatg ggatgctgtg ggcagcttgc 666720
 acagaccctg atccgtgctc cactggttca ctgccatctt ggcacctcag agcacctgca 666780
 gagtcacacc agtgggacc actttgcatt tgggtaaatg gcttatgtcc tgggtaagg 666840
 gtgtcagggc agcctctgtc ttaagtaaa ggttgaactc tgtgcccagc ttttcttgg 666900
 agttccctga gatgctaact gctctcctga ttgactgatg actgttctta atgcttgggt 666960

 tggctgactg gtagctcggg atggctctgc cgaagtcac ggaaggcact ggcttctcac 667020
 tgatattcat gatgaagaca ggaggatttt ttagtgcaac attgttgtt tccatgaacc 667080
 tagagagact gaagaaccga gcacaacact tctgcagat gtgagtcttc tgctgagcca 667140
 ctttctgtga gcagtgtctt ctgtcacttc atcacttcat cacttcatca cctctctccc 667200
 tggggagttc actggagcac ccggtaccct gtggttgcct gccctgacac tccttcaagt 667260
 gctagggctt tgctgcata tgccctgcaca tggtgacac atcagggtgc tggggagagc 667320
 cctggtgact ttgccccttt ccatcaccag ttcttagggt tgggaaattt taccctctt 667380

 tgggtgatg tgcgtgtctc aataataacc tcttttetat tccttatctt ataggtcatt 667440
 cttatgacct gaattgtgta ctctgtgaa gacaacattt atacattgaa actcaacccc 667500
 agcatgtgcc tgtgtttgga gacagccttg ttaaatctt catttattac tatatgctag 667560
 taatatatca tttatttcat tgtgatactt tcatgtatgt atataatgta tgtatataat 667620
 tttggttgta gtcactcctc atttaccct ctcttattct gttaatnnnn nnnnnnnnnn 667680
 nnnnnnnnnn nnnnnnnnnn nnnnnnnnnn nnnnnnnnnn nnnnngcttc tgtctcctct 667740
 tctctcctct cccttctctc ctctctctct ttctctcttt tttcttctc ctcttctac 667800

 cccctcttct tcattcttct cttctccct tctcttctct ctctctctcc cccttcttct 667860
 tcttctcaa acaattttct gtacagaagc atgggtgaga ggcaagttac aggatcctga 667920
 gtcctttaca gtgcctatgc ctttgaagaa aatgaggttg ccttttaag aggcaattgg 667980

acctaaaatg aagccagtag agtgggtcct tgcccaatat aaaacagtct ttatatacac 668040
 agaggagatg aggacatggg gagatgagca cctgaaagtc atggagaacc atttataaga 668100
 atttaattct gcaaagacct tgatcttggga cttttggctc cctactgtgg aaacatgatt 668160
 tcctattttt taaaagtgat tcatctgtgc ctgatgggtgc tttgttttgg cactttgaac 668220

 aggctaagt agttgtcatt ttaactaatt cctagaactg ggaagaatgt ctaagtcagt 668280
 acagtgcttg ctttgaagc atgagggcct gagtccaatc cctaggacce aacctgtgca 668340
 cagttgtaat ccagagctg aggagtcagt taggactcat tggccagcca gcctagccaa 668400
 cttcttgact tccaagatca tgagagacc tgtctcaaga aacatgctag acatcctctg 668460
 aggaacaata tctgtggttg tcctctggcc tccacatgca tggtaaactt gtgcacacat 668520
 gtgaattgcc aggtatggta ttcagtcttt cttcaggttc agagctatca gagtcccttg 668580
 atgcttttgg ggtggacaac taggctgctg aagttaacat gagcacctgg ggggaatgct 668640

 tcattttagt gacttagtag actagttgct tgctccaaag tcaatctcaa aagacatgct 668700
 ctggattttt ataaggtgtt ttaagatcac ctttgccctg tcttttagga attctgcatg 668760
 ctttgactca tagttaaaa gtcaacactc acaaatetta agaatttaca tgtaatgcag 668820
 aatgatttct tcacagttaa atttggttgt ttttttttt ttttgaataa gatacatatc 668880
 ccattgagtc tggatttttt ttgaattgtt gaattgtaag atttctttct tttctcagat 668940
 atgccatgta tatttgtgt ctagcttttt gatggaacat gtacacaggt aagatagtct 669000
 cctctttcct gagcagaaaa attatcatac atggtttaaa cctagggtctg gtaagatgct 669060

 tcagtgggtg agatatggcg ccaagtctga cccacactgt ggaaggagag aaataactcc 669120
 tataacttgg tctctgacct ccacacatgt gccgtggcat gaacacacat gtgtccctac 669180
 acacacataa ataatgtaa aaaaacccta gtttttcatt aaaaattgaa atctaacaaa 669240
 aattttgggt atatgtgat atatgtgtcc atgtgtatgt tggtagacat gtgtgtgcat 669300
 gcatgtggaa gccagaagac aagcttgggt gtcattctc tagtatgtca ctacctgatt 669360
 tttgagacag ggtctcccat tcaactttag cttgctcatt aggtgaagct ggctttccag 669420
 aaagctccag ggatctacct gtctcttccc caaacactgg gattacaggt gcatgccacc 669480

 atgcttttct attttgtgtg ggctctggga acccaaatca gatccctgta tcagtgaaga 669540
 aagtgtata ctgaaagaac tatttcccca gctctaaaac cttaatatg gaaagttaat 669600
 tctatttgtc aagactaatt aaattcaaat gctaataaaa cagtagaaca tctttgtac 669660
 agtgacatgc tgtttcttg gtttttaagt cataggttca catgaacatt gttgttcatg 669720
 cttagcatca gcagctggca tcctctgact atttagtcc aaggcaatta gcatgttaca 669780
 tgtgcatctc atttggttct tgcaatgact atattaggca gtcactcag gcttgagcca 669840

tgggggtata gtccttaca tcttgagtc tgagtgcagg atgtccacgt ggccaggttt 669900

 cacacacaca cacacacaca cacacacaca cacacacaca cggtaggggg agagagaggg 669960
 aaggagagga gagacagaga gacactgact ccttgctatc ttttctaata aaggtacgaa 670020
 ttcttcagcc ttcccagtag ctggaatcgt aagcacatgt atggcagctt gaatgtggtt 670080
 ggccccata atctcatagg gagtgggtct attaggatat gtgggtttgt tgggtgggta 670140
 tggccttggt gtaggaagtg tgtcactgtg ggggcaggct ttgatgttc ctatgctcag 670200
 cataccacc agtgtgtcag tgcacttctt gttgcctgca agatgtagca ccgcatctgc 670260
 catgctctgt ggcatgatga tcatgaactg aacctctgaa ataatatgtg agccacccca 670320

 attaaatgat tccttttata agagtgtctg tggatcatagg gcctcttcac agcaataaaa 670380
 accctaagac accatgccac agcatccata tataataaac aaattttatt ggccatcata 670440
 tttctttaca atgcaaagt atagtacat gttcaaattt taaactatga tcacaaggt 670500
 glaaatgcta acatgttttg ggtttatgaa ctccaactaa atatgtatga taaatgcata 670560
 aatgtaggga aatatggcca aaaattctag acagattttg tagtctgtct agatttgaaa 670620
 tccagattgt cccagttttg tcacctgca cagtgttctt aacctctctg tatatccagc 670680
 cacctaacag gaatatctag ctctcagagt ttagctcata gagtcatctg ttttaaaaat 670740

 ttatattatt ttcagttgtg tgtgtatgtt tgtctgtatt aggcaaatgt acttgagtgt 670800
 ggggccaag gaagccagaa gcacagctcc acctggagct ggagttacag gccattgtga 670860
 tctgtttgat gtgggtgctg ggaactgaac ttgggtcttc gggaagagca gcaaattctc 670920
 ttaattgctg actcatttct ccatccctct taagagaatt tgcagagca aaatatgttc 670980
 gggagttaag gccacagta agagccatgt ttgctctgt tcttgtgttg atgcttatac 671040
 acagactgta aacttttgtt gaaattatc agttactaga aagagtcagg aagagagcca 671100
 cccaatttt ccatgttaac ctgcacgagc ttatgcagge ttgtatctct tctgtgtgt 671160

 gtatataata taagaagatc acctaatag gttacatac taatgactca attttcagtt 671220
 ttacattttc attttgata ctcttctct gcattacctg acttaatttt atcgaccacc 671280
 tgacatcctt gcigtactt tctctgaac cacacagatt tatggattat ctgtttactt 671340
 ggcacctcag gaggttttta cactgtaagg tggatgatct ttgtgatgtt ctagaagaag 671400
 gaaaaattga cttttcttt gtaaactggt agaaatagct tctgggaaag aaaccacaag 671460
 gttcgtggac ctctggcttt ctgagattga ttaaccactg acatcatgtc tgtgagcgag 671520
 tccatgggtg gcctctggag aactgactgt gtggtccctg tcactgtgcc agcatctgct 671580

gccctgaagt ctctattcct tttcccgcct agagtgggtc tattaacaaa ctggaacaga 671640
 caaggctgga aacaaatgct atgatgggtg gacatgtact gtaggttaa tttgtctct 671700
 agggatcaac ctgtccaaca tacaacaacc ttacagcata aggttgttcc cttatgctgt 671760
 aaaatgaacg atggctttgt tcttaggatt ctcaacatg tagcttttat gctttgtttt 671820
 gtgttctgtt tcatagaag gctgtgacaa atttcagcag atccaagaag agtcccagaa 671880
 acagcatttt gtagagtggg ggcccttagag caccttgttg agcaccagg agttcaggct 671940
 gcaggtgctc cccaccaca cgggctccag agagattttt agcctctttt ttttttttt 672000

 taatttcttc tttatctct gctctgctcc atcataagat atactgtcat tgtcatggtt 672060
 ttagcttgag ttaagaaaac atccaacaaa caacaacaac aacaaccacc caacaacca 672120
 ctactaata tcttaggatg gtgcattaaa aattaggcat tagaattcac aggataatgc 672180
 caaaatacct cagtgggttt gaagatctga aaaccaagat ctgtctactg tcttctcttt 672240
 atcatctaaa gcaaccaca aacctaatcc cccagtgaac actttccttt ctttgiaggc 672300
 tatttacctt tcatgtcttc tgggctgaca ataatctctt aagggttcag ctaggttatg 672360
 ccaaggacat ttgaagtcca ggctggtaac aaacctggg ttcagccatc ccttggcttt 672420

 aggagaattg acaactgctg ttcttatggc cagggcctta gaaaagaac tgcttcaggc 672480
 taattggcaa gcagcagga gtgcatcaa gtccaagtg gcttacaagg gccaccacct 672540
 gcccctgta tcatgcaga ctaaaacttt cctgcagatg cagcatgggt gtgcaggctg 672600
 gatttggagt agccagcctg agaaccttat ctttgtgaca gttgctggtt gaatcaagga 672660
 aacagaactt gactctaaag tctgctgtg tctcttcaga gatgggagtg tgtgttcccc 672720
 tgctggaac cagatagcc cctgagatat tggcacaaca gcctctttt aatagaataa 672780
 ccatcaggct aatggctctt ctcttgagca aatgagccac tttgtagtg ttcaaggtag 672840

 ctgccaatc gccagtgaag ggaccatctt cccattttgg cagccgtaac agcctagcat 672900
 gtgattgcct gaccttgctt tggctactag gaggtcagat gcctgccttg tggcaaggaa 672960
 ccaatcagaa gttagctggt gatgctatgt tttacggctc tgggtgtgct ttaaggacaa 673020
 gtgcacagca atgatgaca gagcatagca atcgccctgg gagggcctat gggccataac 673080
 aaccagtga ccaatcacag ggcaagtctt ccaagcctgg aagcacacca gtctgagcc 673140
 tgtgcatacc cctagacact ccccttatgc tgcctataa gatctctat ctgtggcttt 673200
 gaagctctt tctagccat cctccatagt ggatggatga aaggcccgag ctaatgggtt 673260

 tagctcatta aacaactaca ataaagcctc gtgctgtttg catcaagctt ttgactccac 673320
 ctggtgattg gggctcatcac agtctctggc gagatcctgg gggcttgaac catcggaggt 673380
 ctttcaccag gagcatctca ctttcttggc agacgttttc ataggatggc aaggcagtca 673440

atagcagcct ttgcctttct tcgtgtttta tgcattgtac atatcataga gatccatfff 673500
 acaggcagca taataaacac cgagctgtta tttttgtgtg tgtttacatg tgtgcaggta 673560
 catgtgcatg tgggtgtccac cttgtctttt gaaacagggt tttcttcttt ccttgggttg 673620
 agctagctgg ccagtgggcc ctagggatca tcctgtttct acctccctgg tgctgggatc 673680

 acaagcttgc accaccgttt atgttttttt aaaaaaatcc atattttatc tgggtgctga 673740
 actctgggtg gttagggtta ggctttaggg ttagggtag ttttaaatf aaaggaaaag 673800
 tttgggaagc aggtaaaaga atgtagggat gttatccct catgcctgaa aaaggtaga 673860
 tatagtaaga aattaccaat acagagtcag gtagaaatat aagggtatf aatagggaaa 673920
 agccttactt acagagnnnn nnnnnnnnnn nnnnnnnnnn nnnnnnnnnn nnnnnnnnnn 673980
 nnnnnnnnnn nnnnnnnnnn nnnnnnnnnn nnnnnnnnnn nnnnnnnnnn nnnnnnnnnn 674040
 nnnnnnnnnn nnnnnnnnnn nnnnnnnnnn nnnnnnnnnn nnnnnnnnnn nnnnnnnnnn 674100

 nnnnnnnnnn nnnnnnnnnn nnnnnnnnnn nnnnnnnnnn nnnnnnnnnn nnnnnnnnnn 674160
 nnnnnnnnnn nnnnnnnnnn nnnnnnnnnn nnnnnnnnnn nnnnnnnnnn nnnnnnnnnn 674220
 nnnnnnnnnn nnnnnnnnnn nnnnnnnnnn nnnnnnnnnn nnnnnnnnnn nnnnnnnnnn 674280
 nnnnnnnnnn nnnnnnnnnn nnnnnnnnnn nnnnnnnnnn nnnnnnnnnn nnnnnnnnnn 674340
 nnnnnnnnnn nnnnnnnnnn nnnnnnnnnn nnnnnnnnnn nnnnnnnnnn nnnnnnnnnn 674400
 nnnnnnnnnn nnnnnnnnnn nnnnnnnnnn nnnnnnnnnn nnnnnnnnnn nnnnnnnnnn 674460
 nnnnnnnnnn nnnnnnnnnn nnnnnnnnnn nnnnnnnnnn nnnnnnnnnn nnnnnnnnnn 674520

 nnnnnnnnnn nnnnnnnnnn nnnnnnnnnn nnnnnnnnnn nnnnnnnnnn nnnnnnnnnn 674580
 nnnnnnnnnn nnnnnnnnnn nnnnnnnnnn nnnnnnnnnn nnnnnnnnnn nnnnnnnnnn 674640
 nnnnnnnnnn nnnnnnnnnn nnnnnnnnnn nnnnnnnnnn nnnnnnnnnn nnnnnnnnnn 674700
 nnnnnnnnnn nnnnnnnnnn nnnnnnnnnn nnnnnnnnnn nnnnnnnnnn nnnnnnnnnn 674760
 nnnnnnnnnn nnnnnnnnnn nnnnnnnnnn nnnnnnnnnn nnnnnnnnnn nnnnnnnnnn 674820
 nnnnnnnnnn nnnnnnnnnn nnnnnnnnnn nnnnnnnnnn nnnnnnnnnn nnnnnnnnnn 674880
 nnnnnnnnnn nnnnnnnnnn nnnnnnnnnn nnnnnnnnnn nnnnnnnnnn nnnnnnnnnn 674940

 nnnnnnnnnn nnnnnnnnnn nnnnnnnnnn nnnnnnnnnn nnnnnnnnnn nnnnnnnnnn 675000
 nnnnnnnnnn nnnnnnnnnn nnnnnnnnnn nnnnnnnnnn nnnnnnnnnn nnnnnnnnnn 675060
 nnnnnnnnnn nnnnnnnnnn nnnnnnnnnn nnnnnnnnnn nnnnnnnnnn nnnnnnnnnn 675120
 nnnnnnnnnn nnnnnnnnnn nnnnnnnnnn nnnnnnnnnn nnnnnnnnnn nnnnnnnnnn 675180
 nnnnnnnnnn nnnnnnnnnn nnnnnnnnnn nnnnnnnnnn nnnnnnnnnn nnnnnnnnnn 675240
 nnnnnnnnnn nnnnnnnnnn nnnnnnnnnn nnnnnnnnnn nnnnnnnnnn nnnnnnnnnn 675300

nnnnnnnnnn nnnnnnnnnn nnnnnnnnnn nnnnnnnnnn nnnnnnnnnn nnnnnnnnnn 678960
 nnnnnnnnnn nnnnnnnnnn nnnnnnnnnn nnnnnnnnnn nnnnnnnnnn nnnnnnnnnn 679020
 nnnnnnnnnn nnnnnnnnnn nnnnnnnnnn nnnnnnnnnn nnnnnnnnnn nnnnnnnnnn 679080
 nnnnnnnnnn nnnnnnnnnn nnnnnnnnnn nnnnnnnnnn nnnnnnnnnn nnnnnnnnnn 679140

 nnnnnnnnnn nnnnnnnnnn nnnnnnnnnn nnnnnnnnnn nnnnnnnnnn nnnnnnnnnn 679200
 nnnnnnnnnn nnnnnnnnnn nnnnnnnnnn nnnnnnnnnn nnnnnnnnnn nnnnnnnnnn 679260
 nnnnnnnnnn nnnnnnnnnn nnnnnnnnnn nnnnnnnnnn nnnnnnnnnn nnnnnnnnnn 679320
 nnnnnnnnnn nnnnnnnnnn nnnnnnnnnn nnnnnnnnnn nnnnnnnnnn nnnnnnnnnn 679380
 nnnnnnnnnn nnnnnnnnnn nnnnnnnnnn nnnnnnnnnn nnnnnnnnnn nnnnnnnnnn 679440
 nnnnnnnnnn nnnnnnnnnn nnnnnnnnnn nnnnnnnnnn nnnnnnnnnn nnnnnnnnnn 679500
 nnnnnnnnnn nnnnnnnnnn nnnnnnnnnn nnnnnnnnnn nnnnnnnnnn nnnnnnnnnn 679560

 nnnnnnnnnn nnnnnnnnnn nnnnnnnnnn nnnnnnnnnn nnnnnnnnnn nnnnnnnnnn 679620
 nnnnnnnnnn nnnnnnnnnn nnnnnnnnnn nnnnnnnnnn nnnnnnnnnn nnnnnnnnnn 679680
 nnnnnnnnnn nnnnnnnnnn nnnnnnnnnn nnnnnnnnnn nnnnnnnnnn nnnnnnnnnn 679740
 nnnnnnnnnn nnnnnnnnnn nnnnnnnnnn nnnnnnnnnn nnnnnnnnnn nnnnnnnnnn 679800
 nnnnnnnnnn nnnnnnnnnn nnnnnnnnnn nnnnnnnnnn nnnnnnnnnn nnnnnnnnnn 679860
 nnnnnnnnnn nnnnnnnnnn nnnnnnnnnn nnnnnnnnnn nnnnnnnnnn nnnnnnnnnn 679920
 nnnnacccga gccccccccc ctccccccgc ccccccccc ccccggtggg gaggagcacc 679980

 caggtagcca gccccaaga aggcggggct acagcttccc ctacaggtag aggatggaca 680040
 gtctcagccc agggatgag caattttcat cgcttttcta ttttgcctt cttttgaaca 680100
 tctgtgaaat cctcccccc cagtttctta cctgtcacca ccatcagtct ccagctctgc 680160
 ctctctcccc agtgtaaaca ctgcttcagt ttctctctt cctctctctc cagctcatat 680220
 atgtttagt ggcgtccctg ccccaggcca tggggctagg gtggtgtttg ggtgtggggc 680280
 ctgggcagca cctaccggtt ttcttttaa aataaaatct ctctctctct ctctctctct 680340
 ctctctctct ctctctctct gtgtgtgtct gtgtgtgtgt gtgtatctgt gtgtctgtgt 680400

 gtgtgtnnnn nnnnnnnnnn nnnnnnnnnn nnnntgcact tgccagactc agtcggtcag 680460
 gcttgccagc aagcacctct ccatttaagt ctcttttgc gtctgctttt ttcccccat 680520
 aatgtgccca atattattct aaatgtttta cacagattat cttgtttact gttcacacaa 680580
 ccctatggca tcagtatgac tgttctgact cctattttac agaaccacaaa ggggctatca 680640
 ggtacagcca cagctctctct tttgctggc tggaggagat cctggcactt gtatctaagc 680700
 aatcttctc agaccactct atgacaggc ttcgaagaac tctgaccctt atctttgggt 680760

gtaagacttc aaagacttca tacttgact tctttttaa atagatttaa taaaattga 680820

 tagttttagt tatgctctc accacagttc tgtacctgc cagcattctt ttctgccact 680880
 tttcttcttt gctttagact cgtttgaag aatgaactct tggcagaaac atcactttat 680940
 tttattccct cattaactga acgaaactgc ccacttgatt ctaagaacgc taaagctcca 681000
 ctgtgctttg accttgcat cgaaatatct tagatacatc ttagaatat cttagatacc 681060
 tctttttagt ttcccatgct tgtaaaacaa gtagagaaaa atatgctcta gatttatgcc 681120
 agattcttag gtatctgtgt ttccaaggaa aatcttctct ttaaaaattc actaggcaaa 681180
 taaaaatttg ctatttggag tgtgccatgg ctctgactgg aaagctcaac ctctgagtg 681240

 aggagactat aaagaaaaac ccaatcatac ccgctccagg atagtttcat cactctttga 681300
 aagtatctca caggctggac tggaaactgt gggaggctgg ggtccccact gtgtagagca 681360
 tactgtctgt ctcatcacc cccctctgaa tgggtgtgct gagtgaatac atcactgtac 681420
 cccctcagaa ccgcccgtca gaggtccttg ggttatcttt cctaagtaat cagcatggac 681480
 tcaagtctg tgggggatcg atgacagaac acaataaca catcatcca accctccgga 681540
 agcttcacgc tctgcagaag gctcaaaccc ctaactecct agtgcagccc tgtgaataat 681600
 ggaggggagt ggggaggcaa caggaaggga agacttttta tggaggtggg actttgtggg 681660

 aggagcacc ctggagaaaa catttcaagg tagtctgaag aacaagacca acaaaggagt 681720
 agaaccacag gtgcaagggc cagtccaaag agagtgagag ggccggggcc ttactcaggg 681780
 actagccaag agagggatag agggctgagg tcttactcgg ggaccagcca agtgaaggcg 681840
 agaggtcgg ggcctttttt tttttggggg ggggttcgag acagggtttc ctctgtgct 681900
 ttggaggctg tcttggaaact agctcttgta gaccaggatg gtctcgaact cacagagatc 681960
 ctctgcctc tgcctccaa gtgctgggat taaagcatg caccaccaac gcccgcgag 682020
 ggttggggct ctacttggg gaccagtcca gagagagcaa gaaggttagg gacttagccc 682080

 tcctatgat tctcccactg gccctcctt ggttgctaaa atcataggtt ttattgatcc 682140
 tagaaggact ggggctaggg ctgacgggg ggaggcaagg actggtgaa atttggagga 682200
 aggtatttc agcaagcatt aatgacagca aagcctcnnn nnnnnnnnnn nnnnnnnnnn 682260
 nnnnnnnng ccgacaaagg gaaggaatag cttacatatt acatcatagt aggtaagcaa 682320
 acctgttct agaaggaggc aggatactg agggccactc agtgcctgtg ttcccatggg 682380
 cttcatgaa aactgaattt agcccaggca agagcagagg aaggaaggag tgagtctaga 682440
 gagttgctta gacctttagt gctggggcga ggtgcacaca tggctgacat cccaaggcat 682500

cccaagatac cctaaaccca cttgatacat atgttggagc gattagcagg acttaacttg 682560
 ctctggctct cacaggatgt ctgccccaga agccccacag gcctcactac aacggttacc 682620
 ttaccctctt gagacagggg gcaggggatg atgcttcttc taccacttca gttccaggat 682680
 ttccacagat atcaaatcca ctgttttctt ttgatgctgt tcttgctatg ccgcaaaatt 682740
 tgcccattag ttttgttccc ccactacttt attctttttc tgtggggagg gaggtcacia 682800
 tttacagaca aacagcaaga acaagacgga tagcagcaac aaagccaggc atgaggaaac 682860
 aggaggcgca gagatgggag gggctcttca gtgtgagaaa gcacagcggg gtactgatgc 682920

 ttgctgaaaa tctccccgga gtctccggtg gtgtcaatac aattctggga actcggaaac 682980
 tggttctcac agaaatcatt attggtaggg atggcagttt ccaagtgtgg cgttttcaga 683040
 gtcactgctt ttagagcctt ctgaagcact ccagcgtct cagtcacctc cccacactgc 683100
 tgcaagagact gcgggactgc ctctggaggt aattacttca gactgagctt cacgctaata 683160
 gtgctacctc attagcaaca cggcttggag cgagcgggcg gctactttca atgggttttg 683220
 aatggagatg aaattaaagt ggaattgttg ggtagagaac tgttttacga atgtcctcac 683280
 acaaagggaa cagtaaggat gttgtgcccc ctcccatctt gtcttctcta agcctggctt 683340

 tctcttatta cagggccagg gtaagtttca gccctctct gtggttgggt tctccctaa 683400
 ctccagatgt gcctgtctct agctgttggc ggtgttttgg tcataattct gttttgtatt 683460
 tcaagttaca attctgtttt gcacagttaa gccacacaca aacagcctta atggaaaagt 683520
 ttgatttcta ggatgtaggg ggagaggatg taagtgtgtg tgtgtgtgtg tgtgtgtgtg 683580
 tgtgtgtgtg tgagagagag agagagagag agagagagag agagagagag agagaggtct 683640
 agtttccatc aacaattggc cttttgaggg attattgtac agtgtattat gatgtgaatt 683700
 caccagactt tccaggatcc cagccacaaa tgggatcctt gtaaatatca tgttaacaag 683760

 agaatatcta aaaaggtgtg gaagacatac gcttgctcac tcatacatga gcaaactttg 683820
 tatgctgctg gaaggcttga ggccacagga ttgaaaaatg ccatgaagga atgctgtgta 683880
 tgggtgatcc ctaccctgct agatgtaggg agacagaaaa catgttagaa ccagattgca 683940
 aggattgcca tgggagctgt tgatatttac tatggattct ctggatgagt attgttatec 684000
 aagaaactaa tgagaatgat atatggtcct ggaagacctt tctggaagca tgattggaga 684060
 caatagtgtg tctagaatg tagcagggca aattaggact taagacagta aatgagagcc 684120
 ctttgagaca gggacagccc ccactgattt gagagcaggg gctatttctg gctgaatagc 684180

 ataccagttt aaattttctt tctctctcat ttgccctgaa gttgaattaa aacaaccaag 684240
 gacatgttgg cttttgaaga taaattaacc ttgaaactaa gattttgatt gaaatttcat 684300
 ttttttaaga ttagatttgt ctcatattgt caattaaaca tgaggcctct acaaatgaag 684360

ttgaaagacg ttcattggaa acattttatg ctttaataga gccctttcct cccattcgag 684420
 attttgctta ttaataagat tcatagaaat tcaataaaag tttctttcat cattactctg 684480
 tactctctca agagttgaaa taccatttta aaaataaaag atgagtaaaa agcaactcag 684540
 gaactcaaat gaaagcaata aaatcttgta aggatgtgta tggggaagt tcatgtgagc 684600

 agagattcat tagtgaacag aggagagaaa ttcattggact ttggctgca gctgtgacct 684660
 gacttttgaa ttgttagaa tggttcctta gtccacaacc agttcctcca tcttctacta 684720
 cctgtgttta gaacaaatag acgctttcta ggttgagcat tgtggggagg aggggtcata 684780
 gttaaagaat ccatttgtct acacaagtgc aggcttcatg ggagaactat aatgttgtct 684840
 atcaaaaagt aaagacttga tttctgtat ttgatccact aaggctgcag gggtttctg 684900
 aaaggaatgt tcctggatgt gttttagtg agatattatt tatgatttat taaagttga 684960
 ggattcagaa agcagagtca gccacaagcc atagaaacca ggcacacacc tttactcca 685020

 gcagccagaa gctagaaggt ggtgttacac acctttgatc ctaggactca ggattaagag 685080
 gtagactgat ctctgtgagt tcaaggccac ccagatctag acaaaattga atcagtctaa 685140
 aagagaatta tagctcacac ttttaatecc aggactcatt ggaggtatata tgaagatcc 685200
 ccagaaggct cagtccccca ggatctcggg ccaggaacgc agccacctca atcaccatgc 685260
 agaggtggaa acttgatgca aacagcaaga ggctttattg tagttgttta acgagctaac 685320
 cccatgttag ctcaggcctt tcatctacc accatggcgg atggctagaa agatggctcg 685380
 aagcgtctgc atagagatct tatagggcag cgtaagggga gtgtctaggg gtatgcacag 685440

 gctcaggatt ggtgtgcctc cagctttga gggtttgcc tgtgttgatt ggccaactgg 685500
 ttgttatgct ccataggccc tcccagggtg gttgctatgc tctgtgcgctc attgctgtgc 685560
 acttgcctt aaagcacacc cagagccata aagcatagcg ccaccagcta actcaaactg 685620
 gggagctggt cttttcaata taagacagga aggagcaaga gtcagaacca ggcaatcagt 685680
 ctccagccac tctgaggaga gcttgagggt cagcccttc agcctgaaag ggtaagaatt 685740
 agtggctggc tcttttgatt ttctgacctt cagcttgaag tttgaacccc agtatctgctc 685800
 tctgggtctt ttattaattt gtgttacacc tgtgttcag tgctgaagag tacagggttg 685860

 gttcacgctt gaaattttaa ccctctgctt ccctagatgt ttggctgtgc aaatcctcag 685920
 gctctgagca tccatgaaga gatgctcctc cctacagtct ggggaagactg tgagatgcag 685980
 tctttgcctg gatgctgtta acactgtttc agtgtcttga gtccagaatg cctgtgtgga 686040
 agtghtaagtt ttttttttc tttttctttt ggagggggta tggtaacca aatgacataa 686100
 caaatataaa aagaagatatt tttctgggtt tttttttttt tttttttttt ggtttttcga 686160
 gacagggttt ctctgtgtag ctttggagcc taccctggca cttgctctgg agaccagggt 686220

gggctcgaac tcacagagat ctgcctgccg agtgctggta ttaaagatat gcgccaccaa 686280

 gcctggctct tttctggttt ttgtaaggag taaatcatta gtgtttatgt atgagtctg 686340
 gggccctggc ttgtatcagt cccatgctac agatgtaate tatatgggac tgatgtcttc 686400
 ggggctgcc tggagccag ccaaatggct atgggtccat ccctgagtgg gggagtgatg 686460
 gacagggaaa ctcttagcta cctaattgtg ataaattcca gacacaggca tcttgtcatt 686520
 tcaggagagc tcttagtcaa tgctggaaaa ccagagactc tggtttattc aagcatcctc 686580
 ctaaatagct tttcaacggg ggtggggggg ctgaccgcag aagacatcta ctatcatata 686640
 ttgaagggac ccgctccca tttcggcagc cttgacagta acacatgctt gccaaaacct 686700

 tgccctggtc acttagaggt cagacgcctg cctcgtgaca aggaaccaat cagaagttag 686760
 ctggtggcgc tatgctttac gaccctgggt gtactttacg gacaagcaca cagcattgac 686820
 gcagaggaga gcaaccacc tgggagggc tataggccat aacaaccaat tggccaacca 686880
 acacaggga agccctcaa gcctggaggc acaccaatcc tgagaatgtg catatcccta 686940
 gacactccc ttacgatgcc ctataaagat ctatatgcag tgggttcgag gtgtcttttg 687000
 cgagccatcc gccatggtg gtgggtaaaa gatctgagct aacatggggt tagctcgtta 687060
 aattacaata aagcctcatg cactttgcag caaggtgtcg aatctgcctg gtgattgggg 687120

 tgacccggt cgtggcctgg gaccccgat acccgagttt tttggggctc taacaatata 687180
 aagctatata aaaaaattgt tttagcttta gcagcacacc taaacagtcc ctaggtgcat 687240
 aaataaggcc tcagaacagg tgcaggcaca agggccctag gtctgttgtt atgcaacta 687300
 gtggactttc tccttgagg ccaagccatc aagcgataat ttagccagca tctgaaagac 687360
 aatgagagat tctggctcct ggaaatggag tggaaattg gaccccaaaa ctttataatc 687420
 ctttttggg ccccgaaata ttaggtatgt tcagagctca tctatgaatc acaggtatgc 687480
 aggacacact agaacaattg ttgccaagc tctctaatec cccctcccc attcaaatat 687540

 atgagaccaa tagggttgtg actcacaact taagaagctg atgtcacctc attataaata 687600
 ctggctggct tgttttgagg cagagagatg gctcaaaaca cactgctctt gtagaggacc 687660
 taagtttgg tccctagcacc cacattaggt ggctcacaac cctctgtaac tccaagtcca 687720
 gaggttctga accctctcat ggactctgtg ggtgctgcc ctgcaaacat ccacactcag 687780
 acacaaatat ttaaaaataa aaataagtaa gaatgtattg ggggaattca aaagacctca 687840
 aatacaaac acaaaaaat taaagagaag aaaaagctgg tacctgtgtt ttgtgtctgt 687900
 tagacccccg aaaactcaag tatccggggt ctcaggccag gttcgcggtc accccaatca 687960

ccaggcagat tcgagagctt gctgcaaact gcannnnnnn nnnnnnnnnn nnnnnnnnnn 688020
 nnnnnnnnnn nnnnnnnnnn nnaggcttac gcacaggctc atgattggtg tgcctccagg 688080
 cttagggggc ttgccctgtg ttgattggtc aactggttgt tatggctcat aggccctccc 688140
 aggggtggtt ctatgctttt tacgicattg tcgtgcgctt gtccataaag cacaccaga 688200
 gccataaagc atagcggccac cagctaactt ctgattggtt ccttgtcaca agacaggcat 688260
 ctgatctcta cgtgaccaag gcaggtttat ggcaagcatg tgtttggctg ttatggctgc 688320
 caaaagggaa acccgttctt tcatgtcgtt tcaaaggtga ctacacaatg actaatggga 688380

 agttgctatg gtccattgca gatctatagc acacagtggg agatataatt tgacaattgg 688440
 tatacaaagt gaagtcatga gaccagtgia gatttgacaa tggatcattc ggtgagaatt 688500
 ggataccttt tgagagagag aaaatagttc tcaatccctt ccttcatacc ctattcagaa 688560
 attaatcccc aaatggatag acatctgat catgtctggg taagaaagat tgctatacaa 688620
 attagtacat gtaaaaaaac ccaaccaacc aaccaacaa acaacaaat tagtatatgc 688680
 acttgacat aggtgtgttc acacacaggc acacacacag gcacacacac acacacacac 688740
 acacacacaa gccttgccat gaggccatgc tcagcaagaa aaagctgcaa atgatagaca 688800

 tacaacagca ttgatgaaga tgaaaaatgg tgcaagcaaa aaaaagccaa agcccaaaca 688860
 tgtactgcat ggaattctac aacattgaga caatgtatag tgactaaaag aagcagtttc 688920
 ctcaactac ttntnnnnnnn nnnnnnnnata aaggacatga gggagcttct gaaagtgatg 688980
 aaaatgcatt gactcctaag atgtatttga acacttaca tgatgcatt ttattaagtg 689040
 tgactctcac tcataaaaac aattccaagc caggtattgg tgacatcaac cttaaatccc 689100
 agtgcttagg aggcagaggc agatggatct ctgtgagttc aagaccagcc tggtttacia 689160
 gagctagttc caggacaggt ttcaaagcta cacagagaaa ccctgtctca aaagacaaca 689220

 ataacaacaa caaaaaaatt ccaagagcaa aaaccattac atacgcatat attttatagt 689280
 tttattttat ctctttaaat agatagaact aaagcttata ggtagccctg tgcctatata 689340
 aattatagt taataggata atttccagc cagcattgta tgctgtagct gaattcaatt 689400
 tctaaagtgt ggacctccag ggctggagat gcagctctgt agtgcagctt gccaaagctca 689460
 tactagcctt gaagtcatt tcacccttcc aaagaaacgt ggctgtcagt atctggtggg 689520
 attgcacagt gcagagtaag acttttgaga tctattagac tgtacacact tgtttattct 689580
 gaacagctgt agaagttatt aaacacatct cctcttttct ttctctgctt gtaacttta 689640

 tagaatgtaa gtgtaaaaaa tgttatgttg gttgatttca atctgatgaa agaattcgat 689700
 tgctataaag ggcagatgag aaaacgttag ttctattttc agaatgaacg agctgaaacc 689760
 agttaatggt tattttccac gggagaaatg cttgcttttg attaaacttc tttatacaca 689820

gtggctgagt gatgattcc aggatgtgtt ctgggagaga tggagcatgg cttgctttct 689880
 ttgagtcttt gttaagttc tcatcggctt attatttcgt gtgactgac tcattggaag 689940
 accatgtttt taaacttcta gaatgtggga tggaaatgtt tcagaagagt ttgatttagg 690000
 tctgatttca aactttatat atattttaga cagggtcttg ctacgtagct caggctagcc 690060

ttgaactcat ggtggttctc ctgcttcagc ctcccctata ctgggatgag agtacatgct 690120
 gcctgtcctt gccgtatctt tagaccatta gtaacagtaa gaccttgta ttagatcttt 690180
 agaagacagt gtglagatgg ttcttttctt ccataaatct tagtgttgaa ttaaatgctg 690240
 aacttgttac ttgttgtgtg cagattcttg agatgcattt gttttggctc acagtttgaa 690300
 ggtgtcttca tggcagcagg atagtgaggc agcatggtcg tgtcacatcc atagtaggaa 690360
 gcagagagtg acgactgctg ctgctctgct tgttttctcc ttattcagtg tctgtcagcc 690420
 cccccccca tcccccatg actcaagaag cccaggcagt ggacattttc tggagcttgc 690480

ttggctcaag gttaaagaac acatgtctga aaagttaagg tggtaaatgg gaacctttcc 690540
 aggcattgtc aatttcttcc ttgaaaactt ttgttgaac acaaggaagg ggaaatttga 690600
 aggtgtatcc atataaaggc ttgctcctaa ggacacccac ttctctatc tgctaaccat 690660
 tccagcctcc agaggaaaa aatcacaga aaggaagtgt agggagagat cctggatacc 690720
 tgtaccactg accaggccca aacgggtgtg gttgcaggta cttagaggga tagaataaag 690780
 agagaggaca ggaggtgctc ctctctctt ggggtacaag ccagggggtg gtggctcatg 690840
 gcacgccttt aatcgagcac tccggaggta gaggcaggcg gatctttgtg agttcgagac 690900

cacctggtc tacaagagct agttccagga cagcctccaa agccacagag aaacctggg 690960
 cgtggtcagt ggiacaggta tccagagtct ctcccacaa tgaaggcca tcctgctct 691020
 tctacacatt ctctgtgta aaattctccg ttgagggga cagggttgtc aggaatagaa 691080
 tgttattgat ttttctgct tgggacctg gtgaaattgg ctttaaggctt cagcgaggec 691140
 cctactttcc acttgcctat tagaagcata caactgggag aaacagaaag agtaagcaga 691200
 gtgtgggctc aggaccagac tgccctgttt ctttctcagc cctgctagtt attgcaactc 691260
 caaacccggg gacgttggtt gactgtgtgt gcctgtgtct ttcacttta aatctcggtt 691320

taccattgac caaggagcac ttagctttct atggtggctg taaagagcag cagggttact 691380
 gcatgtgttt cgtcatgag gcctcagtgt gtattcacta cttctgggct attgttttgt 691440
 aagtacccat agigtgcac tttcaagcac tctgggggtg tcttcttcag agtctgccac 691500
 aggactgggt gcagggccat tgcccaatgt ttaccttca ggtggagcac tgacatagaa 691560
 ttgttcatga tagcagtga atcagagcca cctttttgtt tcttccagt tgagtggtaa 691620
 ttccccacta tctgagttg ttctagcata ttgtcagtag attcttattt ctgagagaag 691680

tgttggaaac tcaggcatat tcctgctagg gcgaagtctg agattttggt gccctcaca 691740

 agaggggcag caggcatct ttgagtgaga attctgggtt gaggtgacc tattgaaac 691800
 tgactctcct acacagcttc tagctgtaca accctgagca agttactacc atttagtgc 691860
 ccaggttagc ctctataatg tctcaataat aacagcatgt gtgtcgtgaa gttttactga 691920
 ggatttattg tagatgggtt ttctgtcctg cctggctctg ctgcccttca gtcccaata 691980
 aacatataga tgcttatatt agctataaac tgtttggcca gtagctcagg cttcttattg 692040
 gctggcactc tcttaactat taaccattt ctattaatct aagtattcc acgtggtttt 692100
 ggcttactgg agaattgtcc agcatgttat tccttcggct gttacatggc gtctccctg 692160

 ccactcactc tcigcactct ctctcagac ttctcctcgt ctgttagccc tgcctaaatt 692220
 tcctgcctgt ctattggcca atcagtggtt tattcatcaa caaataagag aaccaaata 692280
 acagaaggat accaccatc aatttatata tcaatataag tagatcaatt agggaatgcc 692340
 cctgctcaac atcaatggtt attgttattt gttattgctg tcatgggtgc actaggatct 692400
 tgctctggac tccttactc tctccagtcc tgtggcctct gttgaaaaac ccacacaatg 692460
 tacacagagt atagtgtggg ttataggttg gttttattac agagtgaagt agaaagctct 692520
 caagggatga gagtcaacaa tggccacagg gattgctgga gattgaagta ctctgaaggg 692580

 ccagagagtg gacaatgacc agagggccca ttgtcctgat ctgaagtttt gacagacttg 692640
 atctccaaag tcigtataac aggcagcatt ttcttaagta ggtaattgac aggtccattg 692700
 gaattgagtc ttacaaaggc ttccatgtag acagcgatct ttttaaggctt agatatttat 692760
 ctgttcatta ccttctgatg ttttaagatgt cttttctta accacggcca gagataaggc 692820
 tctaattcca ttctatgcat cagtcattha agcaccagag tttcagtgtc ggccatgcaa 692880
 gctgtctgatt atgagggaga agtacattcc cagggtcttc taagcctggt aatgtcttac 692940
 tagctactta ctaattatat ggtagtataa cctccatttt tcaagatagt ctcagtgtca 693000

 aatattctgc ctacagcat tattagacta ttatttattt gatcctcatg ccaattagga 693060
 actcataaaa catgactaca aaaaccttgg ctgtttttaa actttgtact aagtttacat 693120
 acacactgtt atttgcattg attccttaga atttagaaga tggaaataga agtttaggaa 693180
 gatggaata aaggagaaaa tgtaaggaat atgtttattg cagagaccaa atcctggttc 693240
 ctcattttct gcctatggcg acctcacttc cccatccttc tctgggcttg caggctcatc 693300
 ccttcagga atgtgaatga gtcatactct cactgtaata catcggtagt ctgtcactga 693360
 aggttaaaaa gcaactgagag gatgcctggc ttccagctca tattgtctca acgtctgaca 693420

ttctgcttcc ctcatcccta tccaccacca aggagatttc acttcttgcc tctaggtctc 693480
 ctcaataatt ctaaagttc cccatctgct actcagatgt tctcccaaaa gtccctcacc 693540
 cattgcttgt cctggctcct gtaactgatg ctgtcaccta gttgggtggag ttatccctat 693600
 acatcttact ctgcattgtg ggggtgctcc taccatggcc ctggaatggt accttataaa 693660
 tgttactgtc tggggacgct gttctgctag gaatccgatc ctgctgacctg cctgcctcaa 693720
 caccctttct tggtcccta tcatcttcaa aaggaaagtc agtctcccaa cctgtcttcc 693780
 ttaggatcac cattgctgtg atgaaacacc atgaccaaag caacttgagg aggaaaagat 693840

 ttgttttgc cacaattcca taccacagtt catcattaaa agcagtgggt gtaggaactc 693900
 atgcagggca ggaacctgga ggcaggagct ggtacggagg ccatggagca tgtgcacggg 693960
 ggtgggtggt aggtgggtgt agaggatgct gcttactgac ttgctcctca cgctctgct 694020
 caacctgctt tcttatagaa tccaggacca ctatccctgg ggttgacca cctaccatgg 694080
 gctgggcctt tcccatcaa ttactaatta agaaaaatgc cttagttgaa gtttctcagt 694140
 tgaagtccc tccatttaga tcattctagc ttgcatcaag ttgacataga actagtcagg 694200
 acacctgctt tttcatgttt tcccatgagg tgccagcttg ggtctccat ctcgagcctc 694260

 atttctttaa tatcgacct cagtcctct cttctctctg agttgttttc aggttgcctt 694320
 gtgggcccctt tatctatcgt cctctgtgtc taagctccag ggtctgacctg tcttctgtt 694380
 cacacatccg aaccccatct ttctgtccgg gtcttctttg ttcaggatct gagcttgctc 694440
 ttgtcttacc ttactcctga tgctcaactc tgacctgcag cgtgaagcaa tagtcagcag 694500
 ctgcagctgc ccagccaatg tctctagctg cttctttatc ttcttccac aagctcttta 694560
 cttttgtcag cctcccagct gtggcttctc aggcctcttt gaaaccacta gctgctttag 694620
 tcatatttgt agccatcttg cagcctacat gtataccag gtatagatga tacagccata 694680

 tagatattta ctgtgtgatg tgtaattcgt agtttgagat tggaaacgaa gggcaggaga 694740
 gatgaccag ccattacaag gtctggctgc cttcttagaa gacctgggtt caattccaag 694800
 ctcccacatg gtggctcaca aaccctgac ctgtaactcc ggttctgggg gatctgatgc 694860
 cctcttctgg tgctcaggca cacatgcaag gctgacaaac aaacacaaca cataaaataa 694920
 aactcacttt ctctggcagg atgctcacac cccttagttg gagtgaattt cttctttgcc 694980
 tggacttttc acaccatttg ccatctgtta tctcttctg tatggctggc actatgtctc 695040
 tgaatgtgtg tatacatgga gtcctttctc tgcatttgtt tgtttgttca tcaactttt 695100

 tgggttttga agacagagtc tcatgtagtc tggatgact ttgaactcct gttttccctc 695160
 acatgtgccca gggttacagg cctttccacc tcatccggct gctgtatggc ggaacctggg 695220
 gcttccagca caacagatga gccacacccc cagcacagaa actggagttt tagcatgctg 695280

ggacacagct tgiatcagtc ccactctaca gaggctatct atatgggact gatgtctctt 695340
 gggctgagat cagagccagc cacatggccc tgcgtccatc cctgagttgg ggagtctctg 695400
 acagggaaac tctagctac ccaacagcaa taaagaccag acacaggtat ctgttcattt 695460
 ttgggagggc ttcagtcaca tgctggaaaa ctggagtctt tggtttattc aagcatcctc 695520

 ctgaatagct ttccaacagt gggggtggcc tcagaaggca tctactgtca cgtatatagt 695580
 tgatagcaag taattctttt aattcaagag tcacctaaat agtccttagg catgtagaca 695640
 aaacctcag gacaggtgcg agcacacca gggcataggt ctgttggtat gcaagctagg 695700
 agacattctc cactgaggcc aagccatctg ggggtaattt agctggtatc taaaagacaa 695760
 tgggagattc aggcctcctg aaagtggagt ggaggtttgg accccaatac ttataattg 695820
 ataatttttg ggcctgaca ttagcacagt ggatattttg ctgaggtgac tggaaagaca 695880
 tagggcaggg cctggtgtga gagctcttga tcttaacttc ccctggtgt ctacatata 695940

 cctttggtac aatcagcccc ttagtactga aaatgcattt attcttctct tcaaatgtc 696000
 ttgagcctcc aaaagaccaa aatggtgttt tgattcattt gaccagaag gtgagtgtg 696060
 tgtgtctgac gcaactgtaag ataagcagtt aagcatttac taaaatgaat ttgtaatagc 696120
 ttcatttctg ccccaatgt aacattttct tccaccct gctatctctc tcatcctca 696180
 tctttctttt cttaccacc aggaataaat cagggagaag ggctataatg tccacagtga 696240
 gagagagcaa gagggcagag aaaactgtgg aaggaattat ttctctacat tttttaacc 696300
 acaggcactg gcatatgctt ggtcaatgct tccacactga gctglagcaa tagcctgatt 696360

 tctccacct taattcctgg ctttttgaac aaaaacattc cattagagtc ttgagttctt 696420
 cattgactaa ataaatactt gatcattttt gcttaaatgt tgattctgga aactcatact 696480
 ttggtgtgtt gtgcccaaac tctgaatccc caaatcacca agagaccaa tccgatgcaa 696540
 aagcaaagag tctttaattt tacaagttaa ctgggtgtt acccccttcc cctccatct 696600
 gacacagcag gtgaagcagg cagggacctc aagcagtagt gggcagggaa tatactgggg 696660
 tagagcaagg ggagtgtctg ggaggtctgc tagttgcata gcaacagcct caggattggt 696720
 gcacctatgg gcttgggcaa cctgtccagt attgattggt cagctgcagc tacaataagg 696780

 ttgctatgct ctgcattcca ccattatcag taaagcacat ctatagccca acaactaact 696840
 tctgattggt tcttgcctc atggagggtta tctggcttcc tagtgtttag agcaaggtca 696900
 ggcaaggtca gaggctcagc acatgttctg gagtcagagg cctacatctt gctgggtatt 696960
 ttctgcagcc tgtcatggct gccaaaacag ggggctgagt gaataccat acattcacag 697020
 aatgcccata tattgcaaag agctttataa aaagttttcc taaagcatta ataatacaa 697080
 cagttttcct tattctttta gtcaggaaag agaatacga atcatgtact ctaacaaaaa 697140

aagaatttga attcatagtt acttaataa aaataaaaaa caaaagtcct gaaattcttt 697200

ttccttttga agagtaggaa aaaacaaaga aacaaacaaa caaaaaaat ccaaaacaaa 697260
aacccaataa gaacccaaac aaaaacaaa cctctcctct actggctgaa gaagcagaga 697320
cacagccac gtcatgacag attacagctt aatggtacaa agaggttttg ggtctgggtc 697380
ccctggatgg aagaaagaaa catgctatgg aaaacttact cctacagaag agccccacag 697440
cccttgacag ctgtgtttct ttgatattca aaggcagttt ctgaagtttc taaccagaga 697500
aggcaccaca gagatctctc caccaggct ctgactagcc ttcaatctct tgtttcacag 697560
ccagctctta tcccagcatg ataacttaca aaaaagtfff gtgcaggaga atgtgtctcc 697620

tgttatcaca gcagggatgt gtgaggcacc tgggaatagc agcagtttcg ttctggaagc 697680
cagtttgaaa gtcacagaag gaatggcagc cagactccgg gtgtatctgt tataattagc 697740
agaaacacaa gcattcttgc agctttatgt atgagaaaat gaggccagag atacttaact 697800
gacttacata aagtcacacg tggtcattta tgtcaaagtg tcaacaataa aatccagatt 697860
aggctctttc tggigaattc agaagtttcc cagtctacca tactagtaat ttagtcagag 697920
aaactgatt attaatctct gcatectcta aacttaatag gtttagccag gtttgttgcc 697980
atgggtctcc tcgttattaa caatgtcaag gaagttgtaa cttagagca agccctggca 698040

tgtagtgagt ttcagttttt atgtggatca tattttacct catctaatct agttcctgta 698100
gcagccctta gcaggggtgt tgtacctcat ctctgccta agtctgcct aacctctcct 698160
gcctagctat tggccattca actctttatt aagccaatca gaaggtgcct tagacaggca 698220
aggaagaaca gcaacacatc ttcacactgt gtgaccaa atcccacaac agctttccac 698280
actcctttaa gatacctgta ctagaatttg ttatcttgac tgtccataaa gttatcttta 698340
atattatccc taggtaggag ttgtgctttg ctfgattata tgtcctctgg tgcattctag 698400
tctattatte ctgtttctt caccctccc tggtagattt ttctctttgt caccagctct 698460

gtgctttagc tctgtctcc ttgttttggc atcataggct cctcgtttta gaagtcagtt 698520
ttgtttctct ggtgctttag ttcttttgaa gggtttataa attctgtgcc ccattttgtt 698580
ttgtgttttc attgacatga tgtaattgca catatgtatg ggtgcagtgt gatgttctaa 698640
tacatgtaaa cattatgcag cagtcagatc agggtaactg acatatccat cacctcaaat 698700
gtcagtcatt tctttgtgtt gggaataatg aaagtcatct ctactagcta tttttagata 698760
catagttaat ggttgtcagt tatagctact ggagacttta gaagttatta ttcttttcga 698820
gtgtcctcct aaaccgata accatgccct agcaccaact actgctttac acttccaaga 698880

gagcatcttc ccctatgtac aagtgagagc ccattgcagt attgtctttt tgtgcttgac 698940
 ttcttcatca aacacagcgt cttctagttc cacccatgtc actacaaatg gcagtgctcc 699000
 aatctttcat ggctaaatth tatarattaca tatatatata ttaggaatgt attatatgta 699060
 aattatata ttttgttttt ataaatthaa attaggaaca atcttatttt acatatcaaa 699120
 cccagttccc tctcccctcc attctcccat gccccacca ccccatccc attctcttc 699180
 tgctaaattg aaaggatgaa gccttctatg ggggatcadc agagtctgtc acgtcatttg 699240
 gggcagggcc aagggcctcc cccgtgtgtc taggctgaga gagiataatt ttctthaaaa 699300

 tttttattc cattttatgc atatggatgt tttgcctgca cctatgtctg ttagcacat 699360
 gccctcagtg gccagaagat gtcagatccc ctggaactgg agctacagat ggttgaagc 699420
 tgccatgtgg gtgctaggaa tcaaacaaac gtccctcagaa gagcagccag tgctctaac 699480
 tgccaagcca tctcccacc aacatatcat aatthtaaaa gactctthca acagtcaccg 699540
 tggctgatgc catgttttgg ctgttgacta cttatttctt tgctthttaa tataaatctt 699600
 tttgcctctg gcttgaaga ggatgtgca caaacagaa gcacataccc tgcttagaaa 699660
 gagctgcagc acagccaacc ttgggtggct thtaaaactt gacttctcag ttctgatcac 699720

 gagggagcca ttagtagctg ggggtagtta cctgggtgtc gccctcgtc agaatcattt 699780
 agtctctcac attctctatt ttatctcag tagtcagtat ttccatggcc gatcaataac 699840
 tttthcaacc tggagtgtg agaatgtgct aatcaatgga atggcatgac ataggattgt 699900
 aatgtgtct gctthcaagc tgcgtagaaa gctgtaatta aaagttaaag gatagaggag 699960
 tcattgtgct ttgattagag tgaggaaaaa tgaaggcgg cttatgaact ggaagcctgt 700020
 gaaggcacia acttccacct gcagacacc cggggctca tgggtgtca tggtagctt 700080
 ctgctgtcaa ctgacacia agctagagtc atctggttag agggaacctt gactgaaac 700140

 ttgcctcagt cagattggcc tatggccatg tctgtgagac atthtaaaa atcattaatt 700200
 catgttagag ggtccaggtc tctgttgggt ataccattcc taggcaagtg gccctgggtt 700260
 gtataaaaaa aagcaacctg aacaagccag taggcagcat ttctccatgg thtctactcc 700320
 tagttcttgc ctggacttht cttcatgata gattattgac tgggaagcat aagatgaaat 700380
 aaaacctct thcccccaa gttgcttht gtagtggctt ttataacaga aagtaacta 700440
 gaacaactgg catatgacct gtccaggtt gaatagtgg cagtcatgct actacattgt 700500
 ctcttcatt tgcctctgt caagcttga gttctaacat taaggttgga tgactgctt 700560

 tggcaaggca ccgttgtgat cttggaccgg acctactga tccgtctct aatcttgaca 700620
 cctcccttgc tctctcttht aataatagg gccgtccatc ctaaatgccc ccagttccct 700680
 accaagctca gtttgtcca aggcattthc aggtgttct tccactthac ctctctctc 700740

gtgacagctg tttctccgtt actcctaggg cttcttgccct gaaagtctta gttgtgccag 700800
atgctctgga aacctggatt ttcttctgtc tcattgcctt ggatgttatt tgtctgccag 700860
tcacttactc ccccttgcca tgagggcttg aggtctgcgt cattcctccg tctgtgtccc 700920
tagcggagga agacccgcgg caagtgcgta tcaaatgaat gatttcacgt gtgtaaaatc 700980

cggacatfff ccacttcag tgtccacac ccctatcctt ccttcacca gctggaaaat 701040
cccgatcaat gtaattggcc ttttacctct tgaagaaaat ggcatgattc catatattat 701100
gtttctatta aaatcttcaa ttgcaaaaaa aaaaaaaaaa aaaaaaatt gataaaagca 701160
aagggaaaca tccttttctt gcaaaaggctt ggaacataat ggcaaaaatc atttttataa 701220
tgactaaagt gccaggctct agtgaacacc atgcaaagcc ttttaattta aattttgttc 701280
cttgctgact gtgtttctaa cacaaatgct ctgtgatgtg atcatctggt ggcattacta 701340
tcaggggtcc cagactctgt aaacatctgt ccactcactt cagtcacgtg gaggctcaga 701400

gtcacctgag gcgaaccaac aatccagtct agagaggggc ttcttgaggt caataccaag 701460
ctcagcacat ttttgtgtct atccccttat ggtcaccgag ccgaaatgat gctagggagg 701520
gcagtgaggt gggcacaga tgtcagagcc tcacagatgc ctgcatgtgc taggcgtgac 701580
ctcttaggct gtctcccacc ctatggaact gatgaagttt tgtcgggtgc tgactcgtct 701640
catctgaaat tctgaagtg gttagagtgc tcattagaag acagacttct tgtctcaaag 701700
tctggaagcc tgtgcctgat acaaagtata atcaatgtgt gattgtttgc aaaaactggg 701760
aggaaggtta gagaaaggaa cagtattggt ttaaagtcca agtglagcac agagcttgg 701820

aatagtaag aatgatttt ttttaacaa gtgctcatca tgtttctcc ctgcttagat 701880
gtctagaaac ttactgttgt atcttatgac tctatatttg atcctaaggt actaactact 701940
gatgctgat cattttaat ttactatata tttatctggg gtaagaaaag tcatcctta 702000
agccatatta atattcagt taacttcttt tatacatttg cacttctgtg gettgcagaa 702060
gggactgcat tctcacgagc tgatctcact gggtgctaag gaggttacctt aagggtgtag 702120
tcccagctaa gtaccagacg actggaatgt gcaggcacag aaagtgaaa attcttacac 702180
cagcaagaag cacaggtgtg aattatttcc atggtttaaa gtgtttaata taaggtggt 702240

tattaaacc ccttgattc gaggtcattt atttaagaa ctgggtgcag ggaaatgatt 702300
gtacagaagc ctgggcttgc tgggtgggtgg tggcgcacgc ctttaatccc agcactcggg 702360
aggctgaggc aggcagatct ctgtgagttc gaggttagcc tggctcaccag agcgagtgcc 702420
aggataggct ccaagctaca cagagaaacc ctgtctcgaa aaaccaaata aataaataaa 702480
taaataaata aataaataaa taataagcc tgggctctgc ctctggccgc tectgtttta 702540
gtgagaggac agagcaggca cagggagttg tgctaaagcc ttggtgctgt ggtcttccag 702600

cctggcctgg ggagagggtg ggacaaggga ggcttattag aggaagtgac atttacacag 702660

 gacatgaagg atgggaggag ttggagttac tgacctgtgg aagttgattc taggagatgg 702720
 agttagccag gtgctactct tggggatgga agacctaaag gatgaggcaa ctggatgtga 702780
 cgtgaccaat gtgtaagaca agggcaaagg agaggctggc agcagttcag agacagtgct 702840
 ccagtgtcaa ctggaacaag tgacagagag aagctgaagt aggtgggtgt aaaggaggcc 702900
 tgtggcccag gcacgggctg tcttcatctc cagcaggtgg tggtcacaca gtctcattec 702960
 tgagatgctt ggtgttacta ctatttcatg gcctttgtgt ctgtgaactc tgtatcctca 703020
 aaccaaccta atctttgctt gaattagact gaatgagttt ccattgcctt ctgagtcaga 703080

 gatcttggat tticcaggca ctggagcagt gttctccttt tcttgatggt gacttctatt 703140
 ctgttcctta gttcctaaga cttttctgtg ccttcttcag ggatagatta tgtacaagca 703200
 acaccttttg tcttttcagt tgatttcttt atgtattcaa atgggcctca gtcagctcaa 703260
 ccttgggttt gttctacttt ccttaacaag gatttattat tctttttct tccagcactt 703320
 tccaggcacc aaggtctgaa cccctgattt tgatgcctgc caagccattg ttgggatctt 703380
 ctgtgactcc acatgaattt ggtttagctt ttgtcagtgg ataatgctgg tgttctatag 703440
 ctgcatcacc atttggccct tgtgaagtta ctgggagaca gaatctgagt aatgaacact 703500

 atttccttgg atactcagtt gctgaagcca ttagagtaaa tgccccatg tacgtagtgt 703560
 gctactttgt gttgtgtgtt ttccttctga gtgtaaaatt gaacaaaggt gatagacact 703620
 ggcccttca ccatgtafgc tgggtgtctgt tgactcatg gttgttatgg gtagaggcca 703680
 tgctagttag cacaaggaca ccagagttag gctgatagaa actcccagag gatcaagagt 703740
 gagactgaat ccigtgtctc gaagaagggt tctaccaga tgaagttcag atgtcatggt 703800
 ctatgtttgc cagagcttag atcccagacc tgatacctag ccaagatgtg accctggcct 703860
 gttttccttc taaagtgact caaactccca agctaactcag gaaaaaaccc acttctataa 703920

 gtttacctga agttcaagag ttggacacta tgctgggtct caccctgtca ctatctggag 703980
 aaatattcct agcatgacat catgagcagc aagcttcctt ttccgtgacc ccaaattcag 704040
 cctgccaaca agcaagctca ctgtcttccc aagaatttga attccctttt catgagctat 704100
 gttctgtcaa tgtctacca gtttctagtc ctgtaagtga gaaacaggtt gtttctgaca 704160
 agctctttct ttgtgtctg ttagtgcaga acctggtttt tgatttgttt ctttgaagtt 704220
 atctttctgc ttctttctt tctgttgcca tggctctctcc cagcaccaga agaccacat 704280
 catcttgtgt gttattttca ccacgtcagt gttttagct cactgactta tttttggag 704340

tcgtctcttt tgtttgaaat tacagaaaac cttggaaca agttttatta tacctcttgg 704400
 ggtttaaggc tctcttcggc ttgctataaa tggccacctc tccagccgtg tttccaatt 704460
 atttctcttt cctaatacac agtctcagct gtaattttat tgttctcaa aatactattt 704520
 tttaaatagt tttatttcac tgttcttgc cagctgggca cctctcttcc tttcaatctt 704580
 tcccagttct gccttcttac tgggtgatgt ccccataggc actgctgtgc ccttcattat 704640
 ctctcatttc ttgagttcta ctgacacttg atgttgataa catataaacc atccaatctc 704700
 tctctctctc tctctctctc tctctctctc tctctctctt tctctctctc ccttttcct 704760

aatgagtcta agatttgtgg gcagaatctc cttctacgt ggatattgct tatgaagaga 704820
 agtgctgatg gcacccctct ttgcagtgat gagagatcgc catgttgagt ttgtctataa 704880
 ggtgacactg tcgttgatct gctgtaggca gtgctaggtg agatctggag gctctatgaa 704940
 gcatctctgc tgggtctgga gtgactggag taaagtgggt gccacctaga taaacgatct 705000
 gactgtcaca gctgggtggac agaacagaga ttgtgggat gggtagaca acaaatgcat 705060
 gccggggtat atgtgtacac gtatgcatgt gcacaaatgt ttgcatatgt tcaggtgcat 705120
 gtgaggccag aggccaatct cagatgtcac tacttaggag ccatttggcc agtggcctta 705180

gaaattatgt ctatttctgc cttccaatca ctttaattac aacatgtgtc accatgcttt 705240
 gcatacatat gtatatgtat atgtatatgt atatgtatat gtatatgtat atgtgcgtgt 705300
 atatatatat atatattata gagtatgggt gttttgccta catgtatgcc agcataccac 705360
 atgcatgctt agtgcctgca gagcccaaag agggcactgg gttctgtgga actggagtta 705420
 cagatggttg tgagctgcca tgtgggttct aggaataaaa tcaggtcctt tggagagca 705480
 accagtgtct ttaactgtg ggccatcttt ctaagcccgg gactggccat ttttttttc 705540
 atgaggctct ggggatgaaa ttggggtctt tgtacttgca aagcaagtgc tttacctgag 705600

ctgtttatcc agcctgaaat gctggccaga aagcaatcct atattgagtc tggatgtttg 705660
 acaaagtgca caatactttt cccaaaaagg aaacacctga ctaaagtgtg atttagcaca 705720
 tcttttaaaa tggagcatt tttttgaact ttgggagccc tctccacata gagggatact 705780
 ctctcagcct ggatacactg aggagggtct aggccctgct ccaaatgatg tcacaggctc 705840
 tgagggtccc ccatggaagg cctcacctc cctggggagc agaaaggggt tgggataggg 705900
 gcgtaggtgg ggaggagggg agggagaggg aactgagatt gacatgtaa agaagattgt 705960
 ttctaattta aatgaaaaag aaaagaaaat ggaagcattt ttaatactat tacaaccca 706020

taaggtcatt tacttcatca gatctcagga tgccatagaa tcaggagag ccttgattca 706080
 tatcagtage actctgtgtt cagcaggcag ctgctgctg cattctgttt gtgttttgtg 706140
 ctcagcatgg gcatcacaga cttggtcttg tgacaaggaa acatttcagg ctcccattat 706200

ttcttcacca aagttttctc aaaggcaaaa ctacagaacc ccaatttccc atttgaactt 706260
 aatgcattct ggaattttaa ggaatcttgg tctcttgatt aaaagatgat ttaaatttaa 706320
 agggccagac aatttaatta agtgccagtt gatgaatgct ggctgctctg tgctctcatc 706380
 ttccctttct tttcatgag tctttgttac aagtctcttt tctttggcta accagtggga 706440

 atgcatgacc caactcctta agcttaattt ttggcttggt tttgctgtat agtctgtttt 706500
 gtgtacaaga tattttaatg actttcttcc catgagcaag atttatacta gataattgct 706560
 atttgagggg gggagggaga gagagagaga gagagagaga gagagagaga gagagagaga 706620
 gagagaaaga acaagcgaac aaatgctagc agggcagaaa ttttaagctg atcacctcat 706680
 ttctaaaatt ttagcagaaa taagcaagat gattagtttg aaatgtaatt catagtcaat 706740
 ggttaaaca aaatacttga gttgctgatt acagctcaga tagatcctaa gcatgcaatg 706800
 agcttctgga gtgattccaa gtgtcttttg cattcaagag tgctctatgg agataaaaga 706860

 atcactaaga tgagtgtgtg tgtgtgtgtg tgtgtgtgct tgcgcatgag catccctgta 706920
 tataaatgtg tatgtgtgcg tgcagtatat atacatggag agggaaacat aagagtgagg 706980
 gaaagatgaa gagaggtagg taagagggaa gggaggggga caggagagag agatagagag 707040
 agagagagag agagaagatt tattgtgggg acctcttcac atatttctgg aggctgagaa 707100
 gtcttcaat atgctgcctg taggtttag aacaggagca ccagggtgt aatttagtcc 707160
 tagcctgaga acatacaagg gtagggagga aggaagatgc tgtggaaagc ccccttcccc 707220
 agatgtcaaa acaaagtga acaggagcat ggctgtctgg aggcagcaga tatgaggcat 707280

 gtcccaactc tgagaaggag cttagatttg cctccctctg ctcttttgtt ctgcctgtgc 707340
 tctcagtggg catcatgccc actcatgat gtgggtaga ttataaccaa cttagtttct 707400
 ggtctgaaag gtaccagtta atttctcat tgttgtgacc agatgcctga caagagcaac 707460
 ttcaggaaga aagggttgt tatggctcac agtttgaggg tatagtccat catattgagg 707520
 aagtcatggt ggcaggaaca agaggtagct cctcacattg catccacagg caggaaacta 707580
 ggggaaaaca ggaagtgaag cctggctata aaacccaag gaccgaccc agtgateccac 707640
 ttcttccagt aagggtccac cccttaaaat ttccaggacc ttccaagcag tgccccagc 707700

 tagggaccaa atgaccaaac acatgagcct acagggaaca tttaacatct aaaccatact 707760
 gtgtcttgtc agacagaaga aaagaggaat gctgcatct atccagcttt ctgttttgt 707820
 tccttttcat cagtctggtc cccaggctgt gtgtgatggt tccattcaca tccaggcgt 707880
 gtcttatttc tcagttaatc ttctcaggaa aaagtctca tgtatgcca gagttgagtc 707940
 ttctaagtga tccaaatct agtcacactg accatgaagc tcaccgtca gagcccatgt 708000
 ctttgagagc acccccagaa agacctagag ataataattc cctgggtggt agtttgaata 708060

aaagtggccc acataggctc atagagtggc aatatcaaga ggttgccttg ttggaggaag 708120

 tgtgtcacta ggggcaggct ttgcggtctc aaatgctcaa gccaagtcta gggtgacatt 708180
 catgactgct gcctgcagat caccgtttaa ctctcagcta cctctccagc accatttgtg 708240
 cctgccttgc ttctaccat aatgataatg gactaaactt ctgaactgta agccaggccc 708300
 aattaatgt ttttctttat aagtgttgct gcagtcatgg aaacctaaag acatcctggg 708360
 tatgtgggta taccttacc aaccaaactg acacaaaact atcacatttt ttccccctgc 708420
 ttaattcatt cttttaaag ctgtggatg gcaacacaaa ctgtcttgaa gaatttaaga 708480
 cttttggacc aataagcatt caaagaagaa gggaaaacta cctggaaaaa aattaccaag 708540

 aaaagaata atctgaccta atgtgatctt tgaagtctcc aaaaagaaga ttgaatccaa 708600
 gctgggtgga ggtcacacac gcctttaatc ctaccactca ggaggcagaa gcaggcagat 708660
 ttcaaagtga gtttgaggca aggctgatct acaaaagtgg tttcaggaca gtcaggacta 708720
 ttaaacctgt gaagccagag aaacctgtc tgagagagag agagagagag agagagagag 708780
 agagagcgag agagagagag agcgagagag agaagagaag atggagcctc acaatgacaa 708840
 tttttccagg attatgacaa cactattaag ctgaacacct tcaactaaag atcggttttg 708900
 gactacaaac tgctcagaat gatttcgtgg aggtcaaccg agatgatcca atctcacaaa 708960

 cactgctcag aacaatttgg aggtggctat cagagatgat ctagcctcac agacactgct 709020
 cagaacaatt tcaaggagc tagctgagat gatccagctt cacagactac tctagccagg 709080
 acttaagaca agccctgcac tttcccatta tgcagagact ggataaaaat gatgcagctt 709140
 gacagctaac caaaagtctt cttttcaggc tctcttaaag gtgtcattgt tgccccaga 709200
 cagcaggaag taactttaag aacatgatgc ccacattctc caagaggtgg ggtgggtgtt 709260
 tttttgttt tttgtttttg tcatcattg ggttatggat atttgtcatt gtttaggat 709320
 actggttata aaatgttgtt tgttatggtc aggaagtaag ttgaacaaag gggattagat 709380

 tcaagatfff tgittccaaa aaaaggatac agacatgata cgataaaaag attgctgaat 709440
 ctactcttga aaagaaaaaa ggaaggctat agatataata taaaaaggca ggttgttgaa 709500
 tctacttcta aaaagtatag gtttgaagag attaaaagggt aaattattga atttactttt 709560
 aaaaagcaac tactagtttt aaatgtttta cattggaatt gaacttctgt atattgtata 709620
 tgaatattgt atattgacat aaatttgaga ttaatttgtt aagacatatt ttacatatgt 709680
 ttctatttat caatgcaatg taaatttcta gttcttgaaa gttattatta ccaactatat 709740
 aaaacaataa ggaatgtag gtgagtaatt agtcacctc tataatttga acttghtaatc 709800

atgttaggta ttttttcaat gtcaaacata ttttcagaa agacaggcca tcttcaaaca 709860
cctacagaat atggcattta aaagttttaa taacataggt tatittttat gacattgaga 709920
catgtctgct cctggcagcc ccaatataat tcagagaaga tgcggggcat cgaagaaact 709980
cacatagagt ttictttctt tgtggcaaag gtaagacact gggcaataaa agtgccttg 710040
tctctactgc tgacagtatg ctgtctaaaa tgaacaaaca ggacacaaaa aagagtcact 710100
gcaaaccttg ccaagagaag gcagtcact ccttcagaaa atcctgcttc acagaaatgt 710160
ctgtgagaga tgctaggcct ataggccaaa gatggatgtc tcaatgctgc agaggaaact 710220

tgggtgactg tccagacagc cagctgtttc tgtcatttct cacagttttt gggagtcact 710280
tgatcacact tctgtttac tcagttaata ttatttcctt ctcaggcttc tgagggagtt 710340
gaagactgga tagtatagtt atagttttca ttgtttacca gatttagaaa aaaaattcac 710400
taaagatgtg taaattgcaa atggtttgag agacattaaa agataatttg aaaatgcaaa 710460
ttagaatagg aaataagaac aacagtagac aatgaggtat tttctctgaa cgtgtcaaat 710520
gcaaatagac tatatatttt ttctgaatgt atcaaatgta aatggactaa gcattgttga 710580
tgaacttatt tactgtatat attatatata attattgtac ttattgtata tagtttttct 710640

tctattagtt gtagccttct tttgtatta gacaaaaaag gggaattgta gtgatatt 710700
atztatgatt tattaaagct tgcttgagga ttcagaaaagc aaagtcagcc acaagccgta 710760
gaagccaggt acacaccttt aatccagca gccagaagct aggaggtggt ggtacacacc 710820
tttaactcta ggactcagaa taaagagata gactgatctc tgtgagttca aggccacca 710880
gatctacaca agagtgaatt agtctaaaag agaattatag ctcacacctt taatccaac 710940
attaaggaag tatataagac agaagcaagg gctcaggag gcattcactc tccagccaca 711000
ctgaggagag gcagcagttt gaggcttggg gaaaaacttg tgtgtgggtc agtcctttca 711060

gcctgatctt gaggtgagag ctagtgtccg gctgctttgt tttctgata ttcagcttga 711120
aacttgaacc ccagtatcgg cctctgggtc taatatctgt gtctgggcca tttatttatt 711180
cgtgttacat ggtgatgttt ctggtagcat tgaaacactt tgttggtcgt gttgacttct 711240
agggtactac gtggcagcag catcttgagt ttttaggtac agtatataca gattaaagag 711300
aaaaactg tgggctacaa tggctctgtc tcttctgat gcatttgctt tgtactttct 711360
catctcetta atgcattttt tttcttttga aaaataatta ttatgaataa tttcattcac 711420
tcacagcaga gcagagagca gcttagtcac ctctatgcac ccaacactga tacttgccaa 711480

cccgttttc ttccatctgc atccctctg ctttgtcttt tcccctacac aggattattt 711540
ttgaggcaaa ttcccagat tcaagtgtct tcatatgtaa atagctctgt gcaacatccc 711600
tggctgacct ggaactcgtt ttgtagaccg ggctggcctc aaagtcatag agatccacct 711660

gcctatgcct ctcaagtgct gggattaaag gcgtgcgcca ccaccatcca gcagcctcc 711720
 caaattctaa tgaatcacat ctgtagcatc ttctacttag acatggctgc tttttgccta 711780
 ggagccccag ttctgcatgc ctctgtcatg tgtgttaaat atggatcctc atgattctgg 711840
 gagacgcaca gaaaagcttt cctctcctgc gagcttttgt tcacccgagg aatgaatgga 711900

aattcccact gcagggtgga agggttttct tttggtggaa acgtaaaaga atctccaatg 711960
 tattatgaaa agggagggga aaaaatgtgg tgattgagat tgtcggacca gcctttgtgg 712020
 tacttggtat ttcatcctca aacacggatg tgagcatgct ctaatgcttg gaggtgatgc 712080
 atactctaca tctttatctt gcagaggggg gtggcagagg tgggggcctt taccacgtct 712140
 gcttgctgcc tggcctctct ttcatacact ggaatggga tgggaatcag ggcttgaaag 712200
 ttgggcactc tgctagtcaa ccaccttta ggttatttcc cagcccagtc ttttttttt 712260
 tatttctagg aactctattt ttcaaagtgg tggtttttcc caaggcaatg actttaagga 712320

ccctggacgt cgtccagcag tgcaactca caggaaacag gtttggctga tgttctgtgc 712380
 tgtgagagtg aggcactcga gaatatcaac accagagctg gaaatccttc cagtcagag 712440
 agtcagatta aactcgttct gtatcaccca tgcctgttt taaggagaga ggaagtctgt 712500
 taccagaaag agtgccttgg gtagaaagct catgtccaga acaccaagga ccaggccaaa 712560
 catttccatc attgttaatc ctactggaag caagaatagc ttttcatgcc cggatcttcc 712620
 ttcatgacga ggtgtttgtt gatggcctgc tatggactgg caacctaaca ctcatctagt 712680
 gttttgttac agctgtgagc agaacaaagc cttggagact tggatgtcaa tagagaataa 712740

ttggtgtgca aactctatgt gtacctcaga attaagtgt gataagaaaa aatgttgaa 712800
 cagatattaa attggggctg tcaagtaaga agaagacgct tgtccaagt ccagaatgtg 712860
 gtgaggaagt agactcctgg gatatttctg ggaagaacat tccagacaca gggaaggaag 712920
 gctgcagaag ccaagaagga gcctggctga catgattgaa gagcaacatg gaagaaaaag 712980
 gctgaagcag ggctgggtag atagtaaca gaaacacagg gatgcaggaa ggcactgcaa 713040
 agcgtgggtc agaatccctt attgttttctg tttaggaatt taatgtgaag ttgattacc 713100
 cccctacccc caaacaata tgaggtttag catgggtagg acatatagaa gaaatgtttg 713160

aaatttataa gatactctcc ctgatcagta gaactttggg ttagaaataa ttgcagattg 713220
 agtgtgagcc atttctctat ggtgtcagct atagggactc aagtttagca tccccctttg 713280
 gacaaagagc tcatgtaatg cttggcagga ttgtggcctt gaggggagcc tggagaaagc 713340
 ttatgcttgt agctatagag taatttagga attagcattg gattgaaacc tttgttgca 713400
 ataaatttta aatgagcta atttgctatt gaccattgtg attagaataa tcgccccatt 713460
 ggaatatgtg tataataggg ataaagggaa ttatagctct gaaggctgat gcatccattt 713520

cctcctatga atagttaatg ctcttgtccc aggaggacag tctctgcaca cacgctagaa 713580

 tctgcagatt taagctggac taggcatgct ggtttgcaat aaatagtgac ataaatcagg 713640
 caaagagcca gcacagtttt gattgggaga attaaagtcg ttgggtctac tttttacagg 713700
 cagattgttc ctatgattcc taatgtgtgt tcctgtgcg ccaagaggaa acttcattga 713760
 attttattta tgagtaactt atttggtatt gggttttcat tacattctca cagcctgtct 713820
 tgtggtttgg gggtcttttt attatgcatt ttatgattat gaggtgtact tgcaaaaaag 713880
 aaccttgggc aggagtaaga gagaagatgt aatctgcaa acaatgaccc aaaccgatat 713940
 atcctttgct gatggcgtga atctgtggag tcctgtttgg aaagtgatt caaataaatt 714000

 tttcctccta gagggaaaag tgaccatctg tcctaataca atcacctca cccatctcac 714060
 ccattcacc acaactccac tagccccccta cccatccatt cttctagcca tctattcate 714120
 tactctgtea acccaccat ccatctacc acccacctac ctattcatcc attttctcat 714180
 ccatccatcc gtctatcacc ttctcctcc ctactctat tcctctcata gccaatatca 714240
 atcataggct gtagttctgg gacctgaaa gcaaaccaaa tttccaggca cacatggaaa 714300
 tgaatccaca gcgcatggat ggagetaatc accaatgaga acttagaaat ggaaggatga 714360
 cagagagact aacatttctt tacctagggt gggggagcat attcatctca gggacctccc 714420

 ttcatgccta tgcacagacc tatttttaat tttttccatg atcacctgtt ttatgtctct 714480
 aatcaatttc ataataaaga cattagacat tttttcctgg aaatcaaaga ttgtctaate 714540
 attctctcaa tacacatgtg tggacatata cacaggcaca gggaatacca tgaatcatt 714600
 tatacctgta ggttattgcc aaatggactt ggagaagatt agaaaaatat cctcagaaaa 714660
 atagaatgac tgttttggg ccagagtcaa gaagaggaaa ctggcttttc ttgggtttgt 714720
 caaatggate tgcctgggta aagccttacc aattttcatg gcagataggt tactctggaa 714780
 tgcctttgat ttccagaaga atgtattgtg gaatgtcaca ccatgtcata aggtttaaaa 714840

 gaaatgtctt acttagatac aggatatcta aagtaatggt atagtaatag ttctagcaat 714900
 gcctgtttt ctggcctaca tgccctcagg ctgtcttact atgctagacc taacttttat 714960
 tctgtgatac taagaaacac atttccacac tatcaaagtc atagcttaca tagcccatac 715020
 tgctgtgttc tgacatgaga cccctgtgtt ctgtggctag ttgtgttggga ttcatccatg 715080
 gccaccactg gtgggcattg tcactgtccc tatgtgtcca gatttggctct tgataggccc 715140
 tctcagctta tacttagaaa ctatatacct cctggctccag actcagttaa tgttccatt 715200
 tggcacctta ttgtttatgt agcaacttc ctctatttat tgatattta ctatttgata 715260

tctatagcat tcttcaattc tgagattatt ttaaaccatt ttccccttag agctatttga 715320
 ctccatgaac acagacttac accatgtctt aaaagaagac atgtgaagat ttaactccat 715380
 taccccaacc ccaataatgt ttaggtcatt cattgctttg ctgctgtctg caattttcac 715440
 tcacctctgg taaagatcac ttcccttagc atctcacttt aaatccagtg atcatggagt 715500
 tcatgtgggc tcttggact gccatgatat ctggcttcac aacctggtc cgttcagtct 715560
 cccaattct tttataaaaa ataagattta tttttaatat tttaaaatta tgtatacatg 715620
 agcatgtctg tatgtgagta tgtgattga gagcaagtgc cctcagaggc cagtaggggg 715680

tattagatcc ttggagctg gagttatagg tggttttgag cagcttcca agaagggtgc 715740
 tgataatcaa acttggattc tctgcaagag caatactcac tctttactac tgtgtcatct 715800
 ctccagtccc aggttcctta ttctttcacg atattcatac cttttctgtc ataactcca 715860
 acacacatth tgccttcttt tttcaataaa agcataaaga attagaatag agttttctta 715920
 ttctcagcgc catgtcttcc acctacctgt tttttttttt aatgctgcag agttcactgc 715980
 ctctcactta tgccaaagtc acatgtcatc tctccatgtt catttaaaga tgaatcattg 716040
 caaatgtgtt gtgatgtttt tccctgataa aacgtcaacc gcccatctcc tttaaactac 716100

catgtaatgt ctagttctag aggaaacctt agcccagtga ctcaaatga tctactcgg 716160
 tcttgaact cctcatttct ttttcttgaa tttctctggg aatctctaca aaagtagctt 716220
 agctgagatg actgcccac tctctcgcga gccagggtc tgattctctg gcctacctta 716280
 ctctcagca tgtttgattt ggtccactgg tctctccttc gttgtgttga ttctgtccaa 716340
 tcttcccatt gtcactgtta actctggtgt ttctttgcct cacaggacat ctgtcaccag 716400
 aaatgtcctc atttttctac ttctaaatag ttcagttacct cagagcatgt cacagactgc 716460
 tagcttgtat ggttttatgg ctttaaatgt tacctgttgg gtttttagcc caacatttat 716520

gcctaagtat ggaattctcc cacaagctcc tcacagetga ctgtccacat cacattttct 716580
 tttggctccc tcaaatatta catgtccaga actaaactga tcccagctt ttgctgtcta 716640
 gccttatagt aaccacaagc ccatagttac aatttatcag acctaaatt ttagcttgtc 716700
 ctagaatctt gttgcattta tttaacccac tgcaagccct tctggctctt tectgaagat 716760
 ggaggtttct atctgcctg gtctgtagc caattctct caaataaaca cacaaagact 716820
 tatattaatt tacaattgt tggccagtgg ctagggttc ttactgacta gctctgtctt 716880
 aattattaac agatttctat taatctatgt attccacaa gcctgtggtt taccataat 716940

ctggcatgtt actccttggga tatcaggatg tttctttgcc atctatcttt gccttctct 717000
 cccagccat cttgtcaggt agctccactt atgctttctg ccaggctatt ggccaatcag 717060
 tgttttattc ttaaccaat aagagaaaca tatatacaga aggacatccc ccaccacttt 717120

tcttaaattt caictactct ttcaatctct actaaagtca ttttcttgta atgaacaatt 717180
 ttctaaaag gctgattcat ttacatttc cacagcattt aggaagtttt ctctaaatct 717240
 tagccaatat ttgcttttat gagacattta aaaagcttaa actaacattg tgcctatgaa 717300
 gagctgtctt agigttaatct taatttactg aattcattta atttattact gaatgggtgtt 717360

 gatcaggttg gccatcaagt ttaattgcta tccattctat ttctagcttt gtaaacactat 717420
 tttctaatat aatgcaaaaat ttacttattg catttacttg ctggttatth ggctccctga 717480
 aaatctttta cccagtagaa tgtcatcagg gagttttctc tgctatgctt gctgctgttt 717540
 acttaaagtc catattcttt agcaacatca agatccttct caacctgata ccagacatct 717600
 cctcactgtt agttaatttc tccccatcat ttgtctaate tttcagcaac taggaacaaa 717660
 gctccagagt attggatctt tccatgacag acttttcata gatggttttt ttaagtcaaa 717720
 actaaaaatg taaagaaggc agggagaaca gactcaatgt taccaccaca gttcttgctg 717780

 gtgccctctg tgaacagcac aggagaggcc aggaggcgag aggagtaaac ttggctttct 717840
 cttactttct gtcctgagg gacctagtgg tgtaaacatc ttggtgtggc agataggagt 717900
 ctgtttaaag acatgcattt tgtatgcagc ctagtctctg agaagaatgc caactgcttg 717960
 atatggtatg agccatctgt cccagatctg tttggcaagc atctttagag acagcataca 718020
 cttctccacc acacagactt tgtaaaggag tttcaaggct gacttttaac ctgtgtgatt 718080
 gtgcttcatt ttctgacttt tgaaccagc ttacacagca ggatcacact gtcactctgt 718140
 agcaccaagg tactgtcaca acctgtttcc aggggggtata tctaacatat atgtctaatt 718200

 cagaaaggca aatgctctat gaatgaatgt ctttgtatgt ggaatatgaa gaggttgatc 718260
 ttagaaacaa cattataaaa ggagtgaaga gatggatc gaaaggaag aaagatatca 718320
 aatactgcca agcttactt tgctaaggtc taaagagatt cttttgtgat ctgttacatt 718380
 ggatagtgc cacagttaat tatatgctgc atatctttaa attattaaaa taagctgtat 718440
 gtatttcata ggctttagt ctgagctatc tgaggggcca aggcaggagg attgaatatt 718500
 caaaaatagc tcgagctaga caataagctc aaggctagcc tgggcaacta tgtcagtctg 718560
 agttctcaag aggaggaata ttgattgatt taatacatat taaaagtga tttattaggt 718620

 tggcttacat gacacacaca cactaggtaa cccaatacat gttgtgggtg accttgcttg 718680
 gacacctctt ggggaagggg gtgagacaat gcagcaccia ggactcagc cctgggagtc 718740
 agtcagtagc aaagcatgct gcagacttgt ttactaagga agttagacct gcccttatac 718800
 acctcccaa ggtcctattg gctcatgtgg ctgactctgc tgcattgtct tttcctattg 718860
 gtgtctttct gtcagcagtc tctgggaaga ggcaggttg gctcaggag gaggtagctg 718920
 ccaggcatgc tcatgcaggc tggcctggac acctgagtgg gacactgtg gcttgggtag 718980

gctggccggc agtttctcct acaaaacaagg gctatcttca cactcacgag tctgagaaac 719040

tggtagggtc ccagcccaaa aggctggaag ctttagcagt cctaacttag tgttgagggt 719100
ctagagggtt cctgagagct gctggccttc agtccatgat agaagttgga agaattgtggg 719160
ctctgatatc agcaaaggaa taaacacatc agtgggtgta acagcagcag cagacaggat 719220
agataaactt gccagagaga gacaaaggca atgaggcaaa aaaccagagc ttccccctta 719280
gacttccttt atctggcttc caccagaatg tgccaccac acttagggaa ggttttccca 719340
ctgctggaaa attctccata gatgtgccat ctgttagttg gttccagatc caatcaaatt 719400
gacagccacc attaatcgtc acagcaactt aggtcttgtc ttaaaacaaa gggttaaaaa 719460

tgtgctgagc tataacctcag ttcacaggtc agttaccaa catgctcaat gccctaggtt 719520
ctattctggg actgcccana taaatagata actaagtcaa agttttaaaa gggaagggga 719580
aagtagatga tttcaagtct tgtgagcaaa ggtagtggtta cttagggaaa aggaagcttg 719640
gtcagcgctt ggctcctgtg ggaagtcggt agacggaatt gctaattgatt gatgggggaa 719700
gtccttctgt gtatacgttt gtcttactgg ttgataaata aagcactggt ggccaatagg 719760
gaagcaagat aggtggggct aggagtggag gaggattctg ggaaatgtag taaagaagaa 719820
ggttaccatg tgaccctggg aagagaggac acacatgtct gacgcctca gtaagataag 719880

ttcttataaa aatatataga tttatagtta tggctctatat tcaagacaga gctagcaaat 719940
aagaaattct agtcattggc cagctctgtc caatataaga ctctgtgtgt tatttggggc 720000
cctaaagctg tggcagaacc caggcagcgg gcagaaagag ttatcgttac aaatgatggt 720060
ctccagggga tcagtggttc ctctcatctca gggagcaaaa catggagatg ggatattgtg 720120
gagaatgaag caccggctga tttatcttgg gtgcaggaaa gattttccat ttgccagaca 720180
acttctagaa aggagttatg ggtcaccgac ttggggaact ctcaacctta ttctctctgg 720240
aacagtgtgt gccaacatit tctaacaatg ttctagtgtt atggactgct aaaggaggtt 720300

tctcaaaata aaagctctgt tatcaaatgc ttctcagagc caccattta accatgctct 720360
gagagtttcc atagcaaaagg tctacatggg gcatgcccac atgttatgct ttgtgagttc 720420
ccagtggaac aggatctgaa aagggaaaag agttctaac tatattttat cacctaacct 720480
agttttaaaa gaggattctt ttaggattgg tgtattgtat ggctttttgt ttgtttttgt 720540
tttttgagac tggatcttgc tacatagtct tggctggcct ggttgctcca gatttttaag 720600
atggacaaga gggcagataa atctgtggat attgatgcca tattctaaaa ttttcttgca 720660
tgttaagact ttgtgaatat aaccacacga aattcaaat ctggcttaag atttctttag 720720

aaccacttat ttaacagttt tataaaaatg ttctcctgag agctgcccta gactgacaac 720780
aaggctgtca atcctcctcc tggtttctga acacatgcct tgaacagcaa cagcagagct 720840
gcggtgagaa gcctctcagt gggcttttgc tgtgaagcat atggctcttt ctgaatgttc 720900
ccaatgaaac aagagacagc tccaaggcca ctcaggaggt gctgtgacct gggaggtgtg 720960
tgttacctag aatagttcac tcagtacct gaaggcttct ctgaaagccc taagagtcac 721020
gtagctcttt acatacgtgc tgtgacacat ggagattatt gactgaaggc ttgggagcca 721080
cagtaactta actggaatgg tccatcagag aggaggcatg tctacatgic cttacctcgt 721140

actttgaaat gaggccaaaa aaagtgggga ggagtgagaa gggccatgct gggagccaaa 721200
cagtgtagaa tggtgccgtg acaaccattt aacatatgtg agagtaagtt tatatcaatc 721260
tagaccctag aggtatctgg tcagcagcca aaacaccaag tcctaacttt gtctcctct 721320
gggaaaggca tcaaatcagc gtgctgcaga aggatactg tgtacgtgaa cccatgaggg 721380
attcactatg cacacagct gtttctcagt gactgcgggc tgggtgtaac acagaagggt 721440
tgatcttcag tgactatggg gctggtgtga acatgaagg gttgatcctc agtgtctgtg 721500
ggatggtgtg aacatgaagg ggttggctct cagtgttttg ggggtggtgt gaacatgaag 721560

ggctgtccct cagtgtctgg ggcatgctc tagtgttatg caattctccc tcttttcta 721620
agctattagt ttcaaaacct tccttgaata ctaaatccac agatgttaca gttccttgta 721680
taaaaccate cacttctata tttgtgtata aataatacce atactctgt atattcaac 721740
tcatttttg atcacttcca ataactataa caatgtttat gttttgtgta gttgttataa 721800
attattgttt aaggaagaat cacaagaagt caatatgtgt tcaatacaaa cacaatcttt 721860
ttcaaatatt ctgatccac ctttggtaaa attcatggag gcagagccca tgggaatgga 721920
gggcagatga atatatgata gggagaaaaga aagagactgg gaaggaactg gttcatctca 721980

ctgtacaact gaaagtttg cagtcaatag agcagattgg aaaatgagaa gggaaaggtt 722040
tttctgtgt agtttttggc agaattactg cttcctaagg aaaccagtc tttcctggca 722100
agttacagga tgatggtaac cttcttcatt taaagtctca tgaatatagt ttatgttcag 722160
gaatgacttc acatcaacat ctagacagat gcttgacaaa actcttgggc tccttagctt 722220
agcctagtgt acatctgtca ttaatcacat ggacaagctc ttacaatggt gctgtcaaat 722280
ctgtgacaga ggtttgctct gtcttaaaca aggtgagttt tctaaggatc ttctgtcttg 722340
agataagtgg tggtaaaacc acatggttgg ggagagagag caaagatctc tgtccttaca 722400

aaggtccaac tccagaaagc ctcatgactc aagtctctgta ttgttgggac ccagcaggaa 722460
aggttatcaa ctgacctgat tcagggtgag ctgtggattt tagctgctct atccagagca 722520
ttgatttacc tcctcaaat gatctgttac acagggttct tgcaagagat ggtgagaaca 722580

aagtagggac tcccagagct tagaagagca ggggcacagg acaccttttg tctaacttgc 722640
cagtagatgt ttgcattcca gcataggttt gcaaaggcat actttcatca tcatatattt 722700
ttcttttttg ggtgtatggt ggtggtgctg gtggtggtgc tgctgctgct ggtggtggtg 722760
gtggtggtgt gtgtgtgtgt gtgtgtgtgt gtgtgtgctt atgtttggag gctagaggtc 722820

aacataggtg tctttattgc tctccacctt attttctgaa acaaagtctt tcaactgaact 722880
tggaaactcaa ggattcagct agtctggctg aaccatcctg taccctagct gaaattacag 722940
tgggttaccac ctacgtccag ggttttacct ggggtgctgga tttaccagg tctgatgaac 723000
acttaccctc tgagctgctt cctccacctc tcaactgtgt acctatcat gttcttattg 723060
ccaagagctg caggcttcac agactctggc ctttgttaca tggccaaacc atcttgcttc 723120
agttcatagc aggagtatag aattctctgt tataaagcca ttgctgggtg tgtgggttgg 723180
gtcaggggag cctgggatct cctctagtca gttgactgtc atccttttga tttgaggact 723240

taggttagtc ttttggacac tgtagattta ggtccttgtc ataggttgct gaatgctgga 723300
actattgctt ttaacaactg tgccctctcc atctgacctt gtagttgaac gttttcctct 723360
gtgtcactgg tctccttaga ctggctccct ccccccccc cccgcttgag ggttcccata 723420
gctgcttata aaataatcac tcaaaggcta aaattaata tcatgtttg gccagtgggt 723480
ctggcttatt accggctagc tctctctctt ataaattaac ccatttttga taatctgtgt 723540
atccatctgt ggttgtggct tactggcagt tttctggcat cttacctttt tgggtactac 723600
atggcatctc catcttcttc ctctctctat ctctgtttgg acttcccacc tagctgtatt 723660

ctgccctgtc ataggccaaa acagctttat caataatcaa taaaagcaac acatatttgc 723720
agcacacaga aggacatccc acatcatggc cccaacccat ctaaatcttt aaaactctta 723780
aaggcatttt ctaggaagaa aaagctttca tttagtgggt aatgttagat tttcacatga 723840
ctcctttctg gaattgtaac gttcatataa attttgcaaa gttttcaatg acttgtgttc 723900
ccttaagaga cagtgttgat attttgaag gaaagattgt ttttgtttat tttgagacag 723960
agtttcatta ttagccctt cctccatgtg cctctggagt gctggaatca aagacatgtg 724020
ccaccacacc tgtacgaaag cagtcttttt gaagaaaaca ttttccatgc tatcaaagag 724080

tgtacatagg tgtacaaatg tctgaattaa gaaaaataaa gataatggaac caatttttga 724140
gtttttacta gcacatatta attacacata atgagtttca ctctgacatt tccaagtatg 724200
taatatgttt tgatcatatt catctgcac accctctctt tctcctctg cctatcgctt 724260
tcctcttccc agctgcccc tttactttt gtgttgtttt atgactagat gaatttcaact 724320
aagggtggctt gtaagaaaga gcatgagaac ctctctagtgg ctacactact gatgaaaaca 724380
tttctccctc ccccagcaac cgtggcgctt ataggtatta gaatatttag aaacacaaaa 724440

cctttgctag attttgtttt tagcttagta acattttcct ttgaggctgt gtaagcaggt 724500

 gcctgtgcaa gtcaaagta agaaggctaa gtgagtttcc tctgaaaaca gctcttcagc 724560
 cacccecctaa gaagctaagt aatccatcat actttatcac cttgtactca gaagtaggaa 724620
 agtggatcct gtccagagag atacattagg ttttgattta tgagatattt tgcttttggg 724680
 tgaatatgct gattgacttg gaataggagc tacctgtact gttaacaaca gctctcccaa 724740
 atcacgcatt ctaagatgat gcttgctagt tctaaggttc ctttttatat aatgtggact 724800
 tgaagtaagc taagatcctt ctgttacatt ggtctgatgg attgtgggga attcttatct 724860
 gcctgtagga gacttggccc tcagctgctc ctatcttcac tttccaaact ctttcttctt 724920

 gttgactttt agatgacagg acaaaagtgc catttgctaa tgtagagaca tgaatgaaaa 724980
 agaatcctca aattaggggtg cccagaaatt ttgataacaa gtgttttctt aaaataggac 725040
 tgagcaagga cagaagccta ctctggagca aagctgttaa tgcatgcacc ccagatgtgt 725100
 gccagccggg tcttcattgc ctcaactcc ggtttctctg cctcactaga gctcaccccc 725160
 taaggtgtct cttgcagatt taagtgttct ccacctggta caacattgtc tgattttttt 725220
 ctggggattt aattactttc catctttttt tttgtgatca aacagctgac aaaaaaactt 725280
 aagttgggaa gggttttattt tgacttaaag gtcagggtta cagttcatca tggagaggaa 725340

 ggcatgccag cctgggtgta ggtggctggg cacactgcac acagtcagaa agcaaaggta 725400
 gaacagaaaa tgaaacctgg ctgtgaaata tcacttccca accacagtga cttacttccc 725460
 tcagtgagge accacctctt agaaccttc aaaatagcac cagcagctgg gaatcaagta 725520
 ttaaaacaca aaccggtagg gccatttcac atttaacctg catcacatgc tgatatgcct 725580
 gtcactctggc tctgcaactg tatgtaaatt cttggacttg ctctgttgat gtattcctgg 725640
 tgacatcatg gggggactcg aattaccaga tgctgggaaa tatttattga atgaacagaa 725700
 aaggagtgag cattctatat tatgtagga taacaaacce aggacttgtg agttaatgga 725760

 cctaaaattt gagcagtcag aaccagtat cacactttaa acagtgtag tgaaaaatac 725820
 aatactctaa aaaataaatt gccactttga gagatcatga caagattatg ttacttgggg 725880
 ctggggttgt agctcagttg gtagagtgct tgccatagcat ggaaaagcca tgggttttac 725940
 cccacataa aactgattga gcgtggtggc acatgcttaa tccaatact tgaaagggtg 726000
 agttcaaagt catccttagc cacacagtgg gtttgggct ggcagaggat atatgatacc 726060
 ttgccacaaa taaaattaaa aactggtgct actgggaagt tggtaaaaga atgtaatgta 726120
 gatttcgcn nnnnnnnnnn nnnnnnnnnn nnnnnnnnnn nnnnnnnnnn nnnnnnnnnn 726180

nnnnnnnnnn nnnnnnnnnn nnnnnnnnnn nnnnnnnnnn nnnnnnnnnn nnnnnnnnnn 731700
 nnnnnnnnnn nnnnnnnnnn nnnnnnnnnn nnnnnnnnnn nnnnnnnnnn nnnnnnnnnn 731760
 nnnnnnnnnn nnnnnnnnnn nnnnnnnnnn nnnnnnnnnn nnnnnnnnnn nnnnnnnnnn 731820
 nnnnnnnnnn nnnnnnnnnn nnnnnnnnnn nnnnnnnnnn nnnnnnnnnn nnnnnnnnnn 731880
 nnnnnnnnnn nnnnnnnnnn nnnnnnnnnn nnnnnnnnnn nnnnnnnnnn nnnnnnnnnn 731940
 nnnnnnnnnn nnnnnnnnnn nnnnnnnnnn nnnnnnnnnn nnnnnnnnnn nnnnnnnnnn 732000
 nnnnnnnnnn nnnnnnnnnn nnnnnnnnnn nnnnnnnnac tatccctgga gtacatgcac 732060

 acgtctgccc ttttaatgct cctgcagcac acttgggtgt tcacgttaa ttaagggaca 732120
 cactgattga caaggctcac agtcagcagc tgtgtcttgt catgtcagag tgtggcctga 732180
 atgtcagcaa ctccgagtt ccatacaga ggatggcggg gtctatgctt aactggagag 732240
 tgactgggtg gtgtcatgt tagagacca cagctcctga aactctgtgg ctgtctgacc 732300
 ttctgtcac tigtcacct ctgttggcag agggatattc agccaactgt gagtcaaaca 732360
 atggaggtgc tgacatggcc ttccatatct gagaatggcc tcagggtcca gagctacagg 732420
 aactatggga ggaagataga ttgtcaaatg tcagcttaga actagcggtc cctctcactg 732480

 ttaagtgaa ctgactaaa tcactaatg tctttgagcc atgtttttt ttttttttt 732540
 tcatctggaa agtaggagtc attgtaagt taccagaaag gcttatgggg cacactgttg 732600
 ggggatagat acctatact ataaagtatc catcttataa tactatataa tctacataat 732660
 atataactac ctatactgt ctaccagttt cagcttagtt attagctct ttttttctt 732720
 tatttattgt tttgttcggg tcttcacct tggcatgtct aagtcttacc ctgatagcac 732780
 acatggaatc taicattga aagggaactt atggttcatc tgtttaaaac tctgctacca 732840
 ttcttttcta aaattcttat tcttgccggg tgttgggtgt gcatgccttt aatcccagca 732900

 ctcgaggagt agaggcaggc agatctctgt gatttcgagg ccagcctggt ctccagagcg 732960
 agtgccagga taggcttcaa agctaaacag agaaacctg tctcgaaaaa accaaaaaa 733020
 aatttcttat tcttaaaaga cacacacaca cacacacaca cacacacaca cacacacacn 733080
 nnnnnnnnnn nnnnnnnnnn nnnnnnnnnn nnnnnnnnaaa aaaagaaaa gcagagagag 733140
 agagagggag agagagagga agggagggag gagggagggg gatacacaca gagacaagtg 733200
 caagcacaaa cataaataaa catgtacaaa gacacacaaa accatattgt tttctacccc 733260
 cateccatt tctggttga accaaagaac aatgacaaag aaactttcat tactgaatac 733320

 tccttgatt gtcataagc cctgtgatgt ttcacattta taattgacca aagcctcctc 733380
 agtcagtac tttgccaaa tgctcagggg tggcaatgaa cccaaggctc tgaggagget 733440
 tgctaggtcg ttacattatt tgtagctgac taatattttc aactcaaat ggtttcatca 733500

aggcataagac actactgtaa ggcaagggac acctgtaagt ttatatttct aagcaggact 733560
 gctgttttgc ttatttggat taataataaa aagaaaacat tgttggaca gcaataacct 733620
 actctagtta actcaggta gtactttttt aaaaattgct ctagtaaaat aaggaattat 733680
 tttttgaagt gttatatacc aataaaatat attcatcccg acaacagtgt tgcgcaaatg 733740

 gtggagaaga aacctcggg tcttcccag gacctggac agcggcgggt gctggaccgg 733800
 gcagcccggc agcgacggat caatcgacag ctcgaggctt tagaaaatga caatttccag 733860
 gatgaccccc acgcaggcct cccccagctg ggcaagaggc taccgcagtt tgatgatgat 733920
 gcagacacag gaaaaaaaa gaagaaaact cgaggtgacc atttcaaact tgcgttccgg 733980
 aaaaacttcc aggccttctt agaggagcag aacctgagtg tatccgaggg cccaactac 734040
 ttgacagcct gtgctgggcc cccatcccga cccagcgtc ccttctgtgc tgtgtgtggc 734100
 tttccatccc catatacctg tgtaagctgc ggtgccaggt actgcacagt gcgctgcctg 734160

 ggcacccacc aggagaccag gtgtctgaag tggactgtgt aaacctggca tcaggagag 734220
 gaagtcctg caaccattaa ttaccccaga ccatcccaa aggacagaga gaggagctgt 734280
 ccaactcacc agcaaaattg tccccactgt tgtggggttg ttcagcccac agagcctgt 734340
 gataataaat ggctctgta aaggaaaaaa aaatattcat cattgttttc ataagagat 734400
 agtttaact cacaacctgg tttgaatgaa gttcaagaga actggttaaa acaaagcca 734460
 gaagcttagg agattgcttc gtgggtatca tgcctgtgtc acaagcaca agacctgagg 734520
 cattcccaga gcacacatat aaaagacagg agtgggtgat acccctgtat taccaggga 734580

 gggttaagga ggagtaagga ggattatccg aggcctctctg accaacagcc tagctcaaat 734640
 gatgagttcc tggttcattg agagacacta tctcaaaaa gtgaatgcct gatgcagact 734700
 tctgaataac tgatgacat ggatgcatac acacaaaaaa ctcaagattg atacagagag 734760
 atcaagtttt ggttctccac aaagcagacc ttcaaaaggc cagttaaga acaccatgga 734820
 tgctatctgc cttaattct ctaatcatca ttgtgtgtgt ggtggtgcct ctacagaag 734880
 aaatttggcc tctggaaaag gggggcagat tatgtaagat tacaaggct aattgcaaga 734940
 taatttgagt caccattgat agaattagcg agggtaaaga tgatggcttc agagtccac 735000

 aattgttaa tgaacctggc cctgtgactc aattccaacc cctcctggt tcattttctg 735060
 tggacagcag cagaggcact gctgtgcgga tcaaatggga atttgctta gggcctggaa 735120
 gaaatttaga ttgctgtgtt ctgtgattca tgcggcaagt aacttaactc ataatgtct 735180
 tatctgaggg ctcaacctta cctcatacaa ttggaagtct gaacagtttt ctcataaatg 735240
 tcaagaaagg gtggcacaat caggtgacag atggtgggtt tccagtgatt aaaatactta 735300
 gcattcttta atagcttttt ccaataatga aaacaagaaa tgaagtctta acatgttgac 735360

tcccctgagc aaataaatca ttatactcat gatagaataa gtagtaacaa gcagaggatg 735420

ttaggtaga atatcagact aaaaccctg tatcctcatt aaaaagccac caccaccacc 735480

accacctcca ccaccaacac aaaaccattc cctacaagtg tcagttctgc caaactatec 735540

tgagtattca aactatcttc agtattcaaa atctaagaat tagcttctta agcccatggt 735600

gccatgtgtc accagtatca gaagtagaaa ataacctcag ggaaaggtct cataaaaacc 735660

tacaccaggg ctccaatc acacagtcct agtcactaac tttcttctta acccttcaca 735720

tttctattga tgiacctatg tgttctcatg gtaagaaatt ttaatataga gtacattgtg 735780

aagtgttatg gaaaacaata ataacaatga caaaccaggt aaccaactgt caaccaacta 735840

actaactaac taaccaaca agcaaccaac caatcaaca aggaaccaac tgtccaccaa 735900

ctaactaact aaccaatcaa acaaccaacc aaccaatcaa acaaggaacc aactaatcac 735960

ctgaataage aactaactaa ccaatcaacc cccaatccaa acaagcaagc aaataaataa 736020

ccaaccaggt aaccatctga acaaacatag actctaacca gctaaccaga tgggaacag 736080

tgagttaagg gtgacaatag aagtgtgggt tgctggacat acctagagga ggtccatggt 736140

ggagatgtag ttgtgtggag agactccaca agattccttg aagaaaagaa agtgagcctt 736200

caagggtgag taggaggtct gaaatccctg tgactcattt gctcaaagtc actgactctc 736260

ccgctgcagc aagcacacgt gcgcagaggt gtcaggtggc tgtgcacata gctctgtctc 736320

tgagaggttc tgagaggaag gaagcagtggt ctgaggagag gtgggacaga caaaaactga 736380

ggggagagca aatcctgaac tgcaaatctg gctatgcctt gggcttttgc ctcatgcctg 736440

ttgggcagcc ctttcttaat gatgatgtct gacataaggg aagggtcata catctccaga 736500

aggttggggc ttigaggaat tctaggaagt gtagattcat tcaactgttg ccattgtcag 736560

cttggcgtct tcatctagcg aggaaggggg agacttatg tcaacacttt cccttagatt 736620

gataaattgg agacagacag ctagagctta gagctgceaa ataaatcttt aggattgaaa 736680

tataactgca ctctgcatca aactaggagg aatgacagcg taccctaact gcactggcat 736740

tgcttttggg gttgaaacag tgagtgatgc cagaagctta tttttatct ttgtgggaag 736800

gcagcaatct acagtgggtg gagtctgcat cataggggag aggccctcct tggtgcccat 736860

tcacctcatt gatggccact cattgcctat gctcggcgtg catgtgtccc tggatgtcca 736920

tattggtctt gtctatacat ggctggaggg atatgtgtat aagaatcact atgtttctgt 736980

gtataggtgt gagcacatat ccatgtgttg taatgtagtt gtatgatgtt tatactaca 737040

agtgtacctt gttgtctatg tctcatgtgt ttgtgtatat accttttgtg tgtcttgta 737100

cattcatgaa tatattgcat atctgtgagt ctgtaagttt tattgtctgc atacctttgt 737160
gtgatgtgt gtgtggtgt gtgtgggtg tgtatgatg tgactgctta acaacctgtg 737220
tatatttga tgtacatgta tgcatttgtg tgtatgtctg tatatgtgtg tgcaggtatg 737280
tgtatgtgtg tgggtcctg tatgtatgtg acttcctgtg tttgtatgta catgtgggta 737340
tctgtgcgtg tgtattatgt atttgtaa atctgtatgc atatatatgg agtatatatg 737400
agaggagcat atgtgtatgt atgtatatgt gttctgggca tgtctgtgtc tgtctctatg 737460
tgtttgattg cctgactact ctctctctct gtatacacat ctgtgctggc tagttttatg 737520

tcagcagaga caatgtaggg tcatgtgtga aggactctta atcaataaaa tgttttcatt 737580
ggcatgtata ggcaagtctg tggggcattt tctttattga tgattgatgt gggagggcc 737640
agcccatgta aagcagtgcc acccttgggc aggtggcctt gggtttatga gaaaacaacc 737700
tgagcaggtc aggaggagaa agccagtaag cagcactcct ccatggcatc tgtttcagtt 737760
cccaactcca gattcttggc ctgcttgag ttcattgctct gacattatcc ttcagtatg 737820
gactgaaacc tgagagtct aagtcagtaa cagaaacttt aactaagaca ctctctatg 737880
tgtcttagtt atttgtgtgg agggattgtg tgtatgtgtg tgtgtgcgcg cgcgtgtgtg 737940

tctctgtgtg tigtctgtg tgtgtttctg tctctgtgcc ctagaagttg agctcataga 738000
ccctgaactg tattttccct atagtcattt acagcgtgaa gaagattcct acctgatcag 738060
ctgctgggtc agatgtgatg ctgctgagt ggcatctgct tggttctctt ggtttaaatc 738120
tggtcagtgg gaagagtcaa acaggggcat tgagataaga tatttatagc cctgccactc 738180
aagaacccca ccccaaacca gaaaagcagt tcatgttgaa caatccttgc catggcattg 738240
tgtagtgta cacccttgac tttcataggc tctgaggta ggctcagcca gcaactgatca 738300
ccttttaaaa tagctaggca ctggattgct gtatagaac aaatgtcca tagtcagagg 738360

cagaaatact gtggcagttt tggatgtgcc attagcttgt tgattctgtt gtctcttccc 738420
ttcctagtgt gattaggaac atgctcatca gcctcttttc tcagccacaa atactctgtg 738480
tttatcttgg aaaaatgctt tttttctctg ggctctcaca ttgtgtttaa attctgtctg 738540
aathtagttg gatgaaataa gctataattt ttagacagt tttgtcaaat aagccataaa 738600
aatgtttagc caattttga tccccagttt cagagctggg ctctctcca gtccctcata 738660
ccccaggaag tgcagacgga gctcagtggc atattttgc ctgctttct aactttctc 738720
ttggcagatg tigtgtcaat ctcaagaagc agcatcataa atatttaaat ccaacttggc 738780

taattgggga ggaagaaggg aaaacacgag aaaggtagaa tctgatacca gggaagcatt 738840
tgactatctc tcgttttcaa aattgttctt gtggagcttg ggcattttgt gatggcctct 738900
aatttaatgc ttagaaaca aagggaagtg cagatcagcc ccctgtctct gtaggcaggg 738960

gcctgaaagg ggagagctgt tgattccata gctcacagct cacactgtga aatggctctg 739020
ccatcccttg tcctatgagc aatgtgactc gttctcatgg gctttcagaa aactgctcc 739080
ctgcattcac tcagcccat agaaacctgg gtctcctcag gccctaaaga gaggaagagc 739140
taatggctat gagctcagct ctggatccac tgectgcccc tctgtccatg acttctacca 739200

gcactttctc aggatcctag gcagaaggcc gctccatagc aggggtgtagc aataactctt 739260
tctgccagct gectggggtc tgctgccact ttagggcccc aaataacaca cagagactta 739320
atattgttac aaggctgctg gccaatgact aggatttctt atttctagc tctgtcttaa 739380
gtatcaacca taaccattaa tctatatatt ttataaagac ttacctgtc gaggatgcca 739440
gcggcatgcg tctctcttc cctgggatca catgggtgact ctcttacta catttccag 739500
aattctctt gactcctagt cccccatatt tgcttccta ttggccaaca gtgctttatt 739560
taacaaccaa taagataaac gtatacacag aaggacttct cccatcatca ggctacaact 739620

gatccttctt ggctcctct cctgccgctt tccttggtg ctcagcattt gaagagcatc 739680
aatggcatt catattaatg actttcctga gggtgcaaa aaaataccta gcaaaaacaa 739740
cacaaggaag ggaaggatta tcttgactca atgtttgagg atatagtcag tcacagcaga 739800
agtgtgggtt ggttggctac agcccatctg ccatcagaaa cagagacatg aatgctgtcc 739860
tcagatcact ttgccctgtt cattccagga acccagccca tgagatggtg ctgccacat 739920
ttaggtagg tcttagattc ttggctacac atctctggag acgccatcgt agacatgcc 739980
aggggtatgt ctcttaggtg actcctaaatc ttatcaaagt gaccagcaga attaatcatc 740040

attgctctca ggtgttccat ggtggcgttt ccatattcct gttggtgtct tcagcctaga 740100
atgctatgtg ctatataatc agtgtgggtt ggaggtaagt ctgttttcac tttataaca 740160
aattgagaaa cccgtgttcc gaggccagca tgaatcagtg atgggtgggag ctctctccag 740220
ctttcagaat tccaacttct tacatcttca catcataaaa gagagcgaga gaggtttctc 740280
acttctcact aaactcatcc caagcgttcc cccccagga ccaaacaga ccccaaaggc 740340
tctgcctttt aataaccacca gaagggtggt taggacttca gcattgtgaa tccagatgca 740400
gagggatcag tcataacagg tattgcgtaa tccaggagac aatctgtaat ctgtaagatc 740460

gagatatctt tattgagata aataccagct aaacgcaagc cagagcagcg aggccagagg 740520
gacggggaag gagaagaaga aggggttcc ttgacaggcg cagttaggca cacctgcagc 740580
cagcctctaa caggcgtggc ttactgttcc ctacaaacag ggattaacat ctgagcccca 740640
gcaggttcca cgatcagcat ctaaaatgcc agcatcagtg acttgttctt tcacactcag 740700
cctgtcttct gctgctaaca catctcagaa cacaacctaa ataactgaaag cctctggagt 740760
gtgactgggc ttctaacccg ctttctgtct aggaggaagt aggtaccttg gagacagaca 740820

ctgacagga caggaagaaa gcagggtctc ctttgctaca ttccttgctt aggccagatg 740880

 caactgtaca aactcagttg atgtagaaat aaaacatgtg agtggtgaga agagtcagga 740940
 actcaccag ggcctctctgt taageccagg actcttatca agggattcca tttgtctaat 741000
 ttgcctttca ttcagtaaga attttcaaac tgccagagat gggtaaaaat caacatagag 741060
 gaactaagt gaaattaatt tgccttcat gatcatacct tcaaaaagac gacatgtgct 741120
 ccccacttag ctggtgctga gcaggaaacc acagagtggg ttgcatggat ggcaacattt 741180
 gctttgtgtg tgggtctgcc acttgggttg gatagggtgg gggcagctct tctctgctgt 741240
 acatgcactt ggcttgaca caaggtaggc tggaaatggc agctctcggn nnnnnnnnnn 741300

 nnnnnnnnnn nnnnnnnnnn nnnnnnnnnn nnnnnnnnnn nnnnctctgc aggcttctgc 741360
 ttctcatcg acagacaacc aagcccaggg tggcatgct gagagaatgg tcgggagacc 741420
 ctcttaaga cctagtgtag gaaattatgc acagtgaatt ctgcacatc cattctctg 741480
 ggcgtacagc cccatgcata tttcagaagg aacactggag accagaaata ctgtaggct 741540
 gtttatagaa actacagtct gctctgttg aatgagaagt catttcaatt gacttattgt 741600
 tccccatgtt ccttccatc ctagggagca gactcctca ggtgtgttct gtggtgggca 741660
 agagaattct ttatgttctg gggtaattac cacacacaac ttcctcccta atgaatcctg 741720

 ccttctctc ctaacctcta tttatcctac aggaagaact cttacacata tgaaaactag 741780
 acccatgtgg atttgagatt ttattacaac agcctcgggg atagatagcc ccacagacta 741840
 ttgggtaagg ttaaatttag acctgttcat cgtggctcat aatagttgt acacaactgt 741900
 aagatgtaca agaatggga gaggttgatt taggctcaca caagctcaca gcagtaacca 741960
 agctcacaaa gtctcacc aaacatctac atattctact aaagaagctg cctagaatgt 742020
 attgattgtg atatattaac tcagttgta cccaattaag tagcattgtt ttagcaaacc 742080
 tatctctctc tctctctctc tctctctctc tctctctctc tctctctctc cccctctg 742140

 ccccatgat ggatgtgcac atatgtgtgc agtgcccatg tctgtggaca ccttgatgcc 742200
 atgggaggac atggagtgtc ctgctataa ctctgactt gttcacttgc aacagtctct 742260
 gactggacct gaagctaggc cagtggcag caagcccag gccacctct gctctgtctc 742320
 cccacagcac tgggtcacag gcactcacag ctgcacctga ctttatatgg atgctgggga 742380
 tctaaatca ggtccctgtg attttaagc aagcactct tctgcttat tccaagctc 742440
 ttctctttaa aaaaaattt aaatgaggaa aacctcat gaattcgca ttagaaaaa 742500
 atactaaggt gctttcaat tatacaagag tataattgag aaggtagaga ttataaata 742560

atgacactaa gtatttggat atttgcagtg ttcccaaggg ttcctttctt gttatctgac 742620
ccactgcaat ctcccagga attctttctc ttcacatgac tggaaaatcc ccaactgaaa 742680
agatagggtc ttggttccac cactagtcag ctgcacagtc gtaagcaaga cacaccactt 742740
ctttataggc cttttttaa atgggtcatt tgaccagccc atctccaata tttctctaca 742800
gatgatatac aagaatgaca tttactaata gggggtgttg taaactgaaa cagggaaaac 742860
aataagaaga aagaaggttt tcttttgatg ttgaattaca aatgatcaaa gccatatata 742920
gaaatggcat gtgtgtgtgt gtgtgtgtgt gtgtgtgtgt gtgtgtgggt gtgtgtgtgt 742980

acacacaaat atgtatgtgt atgtgtgcac atatatacat atatatatat atttctcaat 743040
aagttgttat tcaaactctc tgaagacatt tcaatacaga gtttgaagaa atggatttag 743100
gatgtggttg gccatccttt caccacctat ataacctcat tataattgga gaagcaaaat 743160
taaatattat ttcataaagg caaaaaatagg agagtgtttt tttttttttt tcaactgtgag 743220
tgggtcttag gaatccttgc aatgtcaaaa gctgccacac tgccttgcca ggtgagaaga 743280
ggcagagctt tgcctgcac ccaatgttaa ctccaaggcc acctttgga gatttggta 743340
ttctattagg tctaattggg gcactttttc attaaattta catttataga atgcctcctg 743400

tattttggca gagtcttgtt ctgtagtctg gctggcctgg aactcacaga aatcttgctg 743460
cctcagcctc ttgaggactg agattatagg cacgagccac catggctgac tcacaccacc 743520
tcctctgaag taggtctcca gtatttgaat ctctacttcc aaaaacaaat gtcattaaga 743580
gaattacagt taccagagtc aatgcttagc cagagcacct agtaaactct aacagcatac 743640
ccatccttct atttaccaaa cactctttgg ctgtgaaaac aagatgttag cacaccttga 743700
ctgagtcagg gggcttttat atgtcagctc cagtcctatg agttaagtaa tcatgacctt 743760
gtacacttcc cacgttagtg acatttctca gtgcaacttt gtagccacag gtaggttctg 743820

gattccaatt ccagcttann nnnnnnnct tcagccttca ttgtgtttaa atattttcaa 743880
gggtaagtga gtcaataata tgaataact atgtgtggga taggaaacat taggtacacg 743940
ttgattcttc agtaacaatt attttactg ttggcttgac cctgtggacg atacagaaag 744000
ggctggcttt gaactgttaa gtaacttgc ctgtacaca cattgtaaca gaattggaaa 744060
gtttattgta ctgaatatca aatgtctca cttctaactt ttgtattgt tcaattgtac 744120
atttaacaca gagagataat attattttg ttgtgattag gctgaagttg gtttctataa 744180
acatttcttt aaactttttt taacattatt gttatgggtg aagctccacc ccageccctg 744240

gcgtccatat acccaaagag tctggaatgt tatggtgcaa gttctatcca agcctcctc 744300
ccctctctct ccaaacctg ctctcatctca gaaagccgc caaatgatga ccctcccc 744360
agaggtgctc aagaccactc ccccagggtc tctaaactgt accccagaga acagattcat 744420

ggttttccgg tciccccttt ctgtttcccc ttgggggggt gctggaaggc catctgggag 744480
 cgttgatctc attaaatgtg ggcgttttct aatttggttt gatttggatg gctgcatcag 744540
 cagagaggct tadcaggga tagaaacttt tcaatggtat ttttattgat tatttgggaa 744600
 tttttagaaa tgiatcttga tcacactcac ttccaattct tccaaagtct accttcccac 744660

 ccttggtctc ccccccaaa agaagaaaac aatacatacc aagtccaatg tgtgtagccc 744720
 atgtactcat tggagcgtgg tcaaacttcc agtggccagg accttaaaga taactgagtt 744780
 acctacccc taccaccagt agtcatcaac agtgaggagc tatacatcaa catctttacc 744840
 acaatttata aggactctca atggttttct gtcttgagtg tttcatttgg ggaggggggt 744900
 gtgtcatcg aagccttcag tgatattata aacctaggaa aatctttcgt tctttaaaaa 744960
 ttctgtcaaa tgaggaaatg ttgatcattc ttattctaa gaaggtccgt gatatttccc 745020
 ctctctcttt gtggcaaaga cttacaaaga aaagcccagc ttctgatgt agagctgtgt 745080

 agatctttct agaacctgga aaaagagcaa acaaaaacag cagtggttgt gagtcttttg 745140
 taacagtca ggaatctgtg gcttgggcta ctccctcaga atggtctgtc tcttattctt 745200
 attcgaagt gacacattct tgtttttatc ttttacaac cttcacttgc aaaggtctag 745260
 gattttttt ttttttttt tttttttta aaaaaacaga aaacctgtta agaaagtgct 745320
 cgaaagaagt ctcagaaatg cagtcagtca tttatcaca accagatgat taatttatta 745380
 ggggacagag aacgcattcc caggecacc caggaaagca caagagagaa aactgagcaa 745440
 caaagagaaa agccaccaca gcacaatagg acaggttggg tcaaaagcca cagggatgga 745500

 caccgagtaa tgcnnnnnnn nnnnnnnnnn nnnnnnnnnn nnnnnnnnnn nnnnnnnnnn 745560
 nnnnnnnnnn nnnnnnnnnn nnnnnnnnnn nnnnnnnnnn nnnnnnnnnn nnnnnnnnnn 745620
 nnnnnnnnnn nnnnnnnnnn nnnnnnnnnn nnnnnnnnnn nnnnnnnnnn nnnnnnnnnn 745680
 nnnnnnnnnn nnnnnnnnnn nnnnnnnnnn nnnnnnnnnn nnnnnnnnnn nnnnnnnnnn 745740
 nnnnnnnnnn nnnnnnnnnn nnnnnnnnnn nnnnnnnnnn nnnnnnnnnn nnnnnnnnnn 745800
 nnnnnnnnnn nnnnnnnnnn nnnnnnnnnn nnnnnnnnnn nnnnnnnnnn nnnnnnnnnn 745860
 nnnnnnnnnn nnnnnnnnnn nnnnnnnnnn nnnnnnnnnn nnnnnnnnnn nnnnnnnnnn 745920

 nnnnnnnnnn nnnnnnnnnn nnnnnnnnnn nnnnnnnnnn nnnnnnnnnn nnnnnnnnnn 745980
 nnnnnnnnnn nntctgtgg ggggagaagg gctccttgac actgtagggc agtgatggga 746040
 ctctgcttc ctgectagg ctacgctaac actttgtaag tgtctgcttg ctattcctct 746100
 atagtcgctc agataccatg aggagggtat aaggattcag gcattatgtt gaccccgccc 746160
 caggcaact ggcaaggtac gggcataacc gcattcaggc agatacttaa gcagctcaag 746220
 gggccctgtg ttgtgtgtct atgtcaagtg ttatgtggct gcgtaaggac tctatgcatg 746280

tgcaatcttc ccgttttaag caagcacctc ccatctgttc atcccttctt cctctctcc 746340

 tcccccttct tccaccttg taccctccc ctttccctc catctctgta ggacagcgt 746400
 aggggagggt ctagggttac gcacaggctc aggattggg tgccctctagg cttggagggc 746460
 ttgccctgtg ttgattggtc aactggttgt tatggcccat aggcctccc aggggtggtg 746520
 ctatgctctg tgcgtcattg ctgtgtgcaa tgtccgtaa gtacatccag ggtcgtaaag 746580
 catagcgcca ccagctaacn nnnnnnnnnn nnnnnnnnnn nnnnnnnnnn nnnnnnnnnn 746640
 nnnnnnnnnn nnnnnnnnnn nnnnnnnnnn nnnnnnnnnn nnnnnnnnnn nnnnnnnnnn 746700
 nnnnnnnnnn nnnnnaaagg tttcagctct caatgtgatc ttcactgcca gaacccag 746760

 ggctgagtat atgcccttct ctggctttt aattaagaaa tcaagctttt actaggcaaa 746820
 taaaaaaca aactagtcca acaaccaacc aaaccaataa acagccccc caccctattg 746880
 gtagctctgg attgctgctt cctttggctc taaatcagg gtgtgtgtgt gtgtgtgtgt 746940
 atgtgtgtgt gttcacacat atatgaaact cactactgtg tcatttccta tcctgcccc 747000
 atctcaccac ctctcagatt cttctgaggt ttattttct tacagtgtcc aggggttttc 747060
 attacagttt attgttgta tagttcagtt tccccagaat cggaagcctg ttatcaatgt 747120
 ttacattaa atcacttcc agttccatca ttgccgtgtc tgcttactca cgcacatgct 747180

 cataaaccag attaagtgt ggccactctc aacctcagt cattaagtcc cagaaagctc 747240
 acagactggt gcctggagaa ggggccccag gaaggagggg gatgcatgc ctctccttt 747300
 ccagactcct tctctctagc tctgccact gctggtgttg acctagcca ggctctcca 747360
 gccttagctg ggatgaagca ggattacacg ctgaggcaaa tattaatat ttattgtag 747420
 acacatagtt aagcatggga atacctaaa gaattttctg ggggagaagt tctagatttc 747480
 agggagtga ctgtcaac caaccactcc agccactgtt ggtgggaggg ttttgggct 747540
 tccttgtgga gtgatcagtc agcagccaat agagctaagg ttttctttat ttagacaaac 747600

 aggtcaagtg caggccaaag cgagaggag ggagctgtaa ccagcgcagg tagctgggga 747660
 agcagaagag accaggcacc cttctgctga ccccttaaga agcctttcta catcagccta 747720
 agacttctc ttaccccgc ctcacggcg tttcaggca cacctgtccg ggtacctggg 747780
 gcgggactag agtctccat atgttttct cgatgccgt ggaaccttct actgtgtcct 747840
 atctctctc tttgcaacag catagcgcca tgcatagcag ttctctctca gcatgggagc 747900
 tggactgaa tcaatacta tacacatacg ttcttttcc tctcttccg tttggaacag 747960
 tttctgacta tgactttta aaaaaaac aacaaatga taacacagt actgtttat 748020

atcattaacg ttatcttag gcgctcagca gattgtgagc taaatcacat gcaaaaaagg 748080
tagaaatcca gtactctgta gtagaaaaag gcattttgta gttgcgtgta attaaattaa 748140
aaaggaaga tacagaaaaa ccatagaaac ataaagactc taccccaaat tagaaaactg 748200
attatggaaa ttagaacagg aagtattggt cgttcacac ttacaagctt caggagtgat 748260
taatgaaggc acatttggc atttcacaca gtaattaaat acttgccgtg ctctgaagtg 748320
ataggattta aagcttagct aagaaaattt gttttattca aacttaaca aatattgcta 748380
atgtgctgt ccagccatac agcatgacac agtatcttta ttaagtcca atgaaatcat 748440

gttcaaaatt aggtacagac atactgtttg cctgcactat cacctttatg agtcagggat 748500
gaaccacctc ctccccgag gttgcagtct ggtgtctcag gcatcactgg aatggagtgg 748560
gccttctgtg ggatgggtg ggaaaaacat ttggcagttg gatttgcctt gtggtccttg 748620
caggttagca gttccttctt gggctgtgta agaagtattt gtttcagaat cttagagtct 748680
tcttcacacc cagctccatc tttcttgagg ctactgacag tgcaaacat tcttacctca 748740
aaggggataa aggatagttt attctggaac acagattaaa gctaccccaa agcccatgctc 748800
ccagtgtggt aacagtttgc tgaagtttca tagtagcaga acaaaatata aatcaagatg 748860

ttttaaaca cattgatgga gacatcgggt agatggttac cagaacagca aggaaatctc 748920
ttttgggtgt caggtgctct agtgacaacc ctagcttttg gattggtggg atctaggtgt 748980
ttgctaagaa cacatcccta agtttttgggt cgtcacagga tgaatggctt tcaaagcaaa 749040
taaatagtcc aagatgatct ggctctggtg ttaacattt tagctctccg tcatcccaa 749100
atccagccat ttggcctttt agaattttta atgcaagcgt gacttcttc cccttggac 749160
ttcagttcac atgaaaaaac atgcaattcc ttggaatgac ttctcctggg agatttgaac 749220
agacatctac ttaccaaga ggcacccagc cttgcttgtt gtactagtga gcttaaccag 749280

cattacttat gggtgactca atgtagctat cacaaggaa aaaaaatgac cactgaga 749340
gctcactctg cccaacctgc aggcagctac agcacgcaag agtatctcac ccctgatac 749400
tgtttactgc tcatgtaacc tctgagaggg gccttgtgac atgagcctct atccttccat 749460
tcaccagga taccacagta actgaaactt ccatttacag gaggaatccc tgccctgctc 749520
ctagagaggg aaaaaggtaa tctcaatgc cctgggccga tgagatctgg aaaaatcaga 749580
caatgacaga tcattacact ggaaacacat ctggaatatt tattgtggga acttaaaaa 749640
catgacaaga tcacgtgtag aaactcctgc ctgggtgccag tactgcctaa gtgctagtga 749700

cctgaaagta aagaggccag gattcctgtc cccaagagc agtcagtctt ctataggaaa 749760
tacagtgatg attgagatgc agacactttg cctggcatta agatgggagt gacagtaatg 749820
gtttgtggag gcaacactgg ggacaggagt atcctgggca tggcagactg aaggtttgat 749880

ccccaggaaa aggcgagcaa gactgtataa ttgaggtgg ctgtaaatgt atagcagcct 749940
 ccctcatcat atgaccaagg aagaaggaat gggaaatgat ggagtaaaat gcttgcctg 750000
 gcttgaggaa ggcttgaga agtggctctt tactctgaaa gagcttcacc cccacctccc 750060
 tcctgtggca tctgagtac tcaagttgat ctttctaata accagaggca tggatgatat 750120

 agtccatcag atccagattc aaacaccagt ttttcgtttg ctgaacggcc ttgggtaagc 750180
 cactaaacct gtccgaggaa gccttccttt cctaaacatg cagcccaagg ggcagccatt 750240
 cctgaattca taigagtctt gaacctggca gtagtaattg ttagattgtc taggtgggga 750300
 aactggccct ctaggaata ggttcattcc aaacaaaaa acctctaggt ggcaagaact 750360
 ccaagcagga caagtaagt accatcaatc acatcacata ctaactggtc ctattggtct 750420
 tcagaggcc ccatgccagg gatgcccttg agaccttca aacacctgcc tcagccagaa 750480
 atataagaaa acatagtctg ttagtttacc ttggtgtgag ccaaacttgg atgatggggg 750540

 atgcccttct gtatataatg ttctcttatt ggttgatgag taaaacactg tttggccaac 750600
 gaggcaggaa gataggcagg actagaagac taggagaatt ctgggaaagg taggcagaga 750660
 aaacctgcca gagatcgtc atgtaggctg ccaaaggaga aataggtccg gaccttctc 750720
 tggtaagata agaccacgtg gaaactta gattgataga aatgggttaa taattaagac 750780
 agagatagcc aataggcctt agtcatcggc caacagattt ataactaata tagagtctgt 750840
 gtgtttattt ggggccaacg gctgcaggaa gctccagcaa tacttggatc cattacctta 750900
 tgggtgaaca cctctccctc cttactcctt ttacagggga ccttaaaaga aaggctctac 750960

 tctccctcag caggcctgaa gcatcttact ttagaccctt gatgccatgt gctgtgtgct 751020
 gtgtgccc tttccagggc agcgttaatc aagctgttgc ctgatgattt gactgtctct 751080
 tgaaacctcc ctctctctac agaaccctaa aacctaaca cagtaatgac agcaggagca 751140
 acctccaag cagacgtact gacagtctgt agaatgtgag ctgtgtgctg tggctcgcac 751200
 aggtttggat ttgatggctt agaaatattg ggatgctgag ttcaatatca cagatttctt 751260
 tctgtgcaga gacgagctct gatgtgtgag aagtcagag atactggaat gcctgcgtgg 751320
 cactccctat ctgtgtcccc tgggaaagca actgccctg tgtttttaa gtccctagt 751380

 ttgatgtgct ccaggcaggc agaggagaac atagttttca gctctttgtc tagtctacc 751440
 ctgccaagtc ctttcaggac agactcctcc aggggcagta gcagaactgc tttagggtc 751500
 ctggagtctc tctaggcagg actgcatggc cctatgacc tatggcccaa tcttgetcca 751560
 tttgcatatt tccaccctg aacacatccc attttatagt tatggagcac agcctctccc 751620
 tgctgtgatt cttatgaaca acttgtatgt cttcgagca acagtctgt gccaatcaat 751680
 gttcttgtgt gttgtgcatg ttcagcttat tgaagaattc agggagagtt ttggagtac 751740

agtaagtcac tgagcaacac tcttatctaa agcaaaatga agaggcctca aactttgggg 751800

 tgtcgtgata tttatccaca cggcattcac caacaatatt tgggtggcca gaagaagtag 751860
 gaggctgggc tgtttctgag ctatgcactg gtcaggtagg agacagagaa gaccaatcaa 751920
 gaggagcctt ttttgtggtg tgactacgat tggtgactgg gccctccca catggctcta 751980
 gacaaaactt tctatattga tctgtgtaa tgtatatgat aatagatggt aaaacctgga 752040
 actgattaaa ataataaagg gagttactgt ggttaagtcc aagatggatt ggtacagaga 752100
 gtaaataaat tagtcaacat gtataaaata gtgttagta cataggaagc attcaacata 752160
 ggatctggta tctcaacatg gttagtacag tcccaaattt gcaccttctt atctgttacc 752220

 agtttttctt ggictgtctc cataggaaag gccataacct atcatttctg ttacagaaga 752280
 gtgagcaate ttctttccca aatatgtcac aactcattag tatgatatgg gttacatttt 752340
 tgttccactg tctatggcca aaccaatgtc atttgcctcat tagcgttgat tgtttcaact 752400
 gagacaatta tcatggcaag agagatgaat ttcacagagg ttgtcgagag gaacagaact 752460
 agacactctt ctgggtcctt tcatgagggt cagacaatga cagtttgctt tggttcactg 752520
 agatagtaga agttcttcag tgcactgtgt gtgatggttc tggatcatct ctgttcttcc 752580
 tacactgggtg aaatctgcc tgtgtagtcc ctgtctctcc tgataactgt tgtactttgt 752640

 actcacttgt ttgtctgtct gcctttcttt ttatttttct ttttgttgggt ttgagacat 752700
 catctcatgt agcccaggct ggcccctgac ttgctctgta gctgaggatg agcttcagct 752760
 tctgatcctc ctgccgtcgc ctctcaagtg ctggggtcat ctgtgtgcac cattggacgg 752820
 cacagctgtc ttccaagtg atgggtatgt gatgtcgttc gtctctttcc catcatccgg 752880
 tgactcttgg ttgcttcaaa atgaacaccc aaatctcaga tatgaccac aagacctat 752940
 caggcctgga tnnnnnnnnn nnnnnnnnnn nnnnnnnnnn nnnnnnnnnn nnnnnnnnnn 753000
 nnnnnnnnnn nnnnnnnnnn nngcctatg tgaggagag ggctctctcc caccctctc 753060

 tttctcttc ttacacctc cttttacag gtttgtttct acctagtctt acagtctcag 753120
 cttagctgtt ctttctctg gatgtcttcc ctggttggga atctgcaaag atatgagaat 753180
 ccatggatac tctatatttt ttaagattt atttattat tatgtattnn nnnnnnnnnn 753240
 nnnnnnnnnn nnnnnnnnnn nnnnnnnnnn nnnnnnnnnn nnnnnnnnnn nnnnnnnnnn 753300
 nnnnnnnnnn nnnnnnnnnn nnnnnnnnnn nnnnnnnnnn nnnnnnnnnn nnnnnnnnnn 753360
 nnnnnnnnnn nnnnnnnnnn nnnnnnnnnn nnnnnnnnnn nnnnnnnnnn nnnnnnnnnn 753420
 nnnnnnnnnn nnnnnnnnnn nnnnnnnnnn nnnnnnnnnn nnnnnnnnnn nnnnnnnnnn 753480

nnnnnnnnnn nnnnnnnnnn nnnnnnnnnn nnnnnnnnnn nnnnnnnnnn nnnnnnnnnn 753540
 nnnncctatt tccttcctg gaagacagt ttgcaaaaat tggcatgat gcctgtggc 753600
 tcaaaaggct atggttgaat ttttttctaa gaagctctta tttgcataca ttctgcaacg 753660
 agtgtcttat ggctttactg gggaaatgtca ttttaagctg agagaagaca gaggagatgt 753720
 tggttaattt gcatttagca actatagatg ccgttatcta gtgaaggaac agaacgaact 753780
 aggtttgtct gagaacaaca ggctggatgg tttcttctca ttctgtgttt cctcttgggtg 753840
 caaatgaaaa aataagaagt ccttaaagcc aacttcacag taaggacgaa acacgagcag 753900

 aagtcactgg cgcttaattg tcgaaggag ctggctctgg tactacttcc agcttttccc 753960
 tcctgagtt acaaaaataa acctgtttt atcaactgtg cttctggaaa gaagtgtgtc 754020
 tcttgagaaa tgaggaaaa aattaagctc taataatact acgcagtgat ttgaaatat 754080
 tttatcttct tatgccagac tgaaaacacg tttctgttga aaatacagtt ttcttatgaa 754140
 gaagacctca tgatgcaaac attcaaatgg tcttggttat tttgaaataa attgttactt 754200
 tttgtatgca gtttgagaa aagctgactg gcacaattat tcaccaatth agtggctgtt 754260
 tacgcaggtc actgcagggt ggcttttctt ttgaccattg ctggtgtttg tagacgttcc 754320

 tgaaggagat accatcttct ccttgcctgt ctactctctg agagtctgta aagtctcca 754380
 tcctgcagat agggaggaaa ataattgggg agctatagcc caagtgata gcaccaatag 754440
 tcagtctca gtgtctatgg ccactgcaag aattattgat tacaagaca gttgtctctc 754500
 agacttctac tggttcatag tgatagccaa cctgcctttt tacaattcgt attttcaatt 754560
 agtgcataat aactacatct tcacagccac acaaaactct cagcttttta ttttctcagt 754620
 tattgaagac caacagccct tctcctttta gcaaagcatg ttttatttct atgctgtgag 754680
 caaactctct ggatgtgctg cttctaactg tatagattta atttagagcc tgagtggag 754740

 gaaaaggtea gaatcctttt cttaaagctc cagcacgtgc acacagcaag gccggatctc 754800
 ctttcatcgg ggacagtctt ccctgttaca gattgtggtt atatattta gcaaatgcag 754860
 ggtcaaggct tcgtagccag ccagttgat gacagtttct ctctgttgc tgggaaactg 754920
 tcctcaaaa gcaaaggcat aaaataataa tcaccactc tttggtcaaa attatgccac 754980
 agggcagagc tctcctagtc agcttgtctc tgcctgagg tgttagctgg actcatttgt 755040
 atgcctatac cattcaagc ggatgcactt ctaagtgggg atgtggttcg gttggtacat 755100
 ccctagcact caagaagctt tggcttgggt ccccagcaca gcataaacta ggcatggtga 755160

 tgcctgctg cgatcccagc actccagagg tagacttagg aggttcagaa gttcaaggctc 755220
 atccttggct aactgagtg tttgaggeca gctgggata tataagacc tgtctttaa 755280
 aaacaacaa acaacaac aaacaacaa acaacaacaa acaacgaaa acaacaac 755340

aaaaaacaac gaagtagaag tgatctggag aatataaact cttaagacga taaacaatta 755400
 caaagcacca ctttttctt tgtaaagagt ttgcattatt ttggcctcat attctcttgc 755460
 atgtcaaac aagtttcatt ggcatittgt tatgtgcaca gtcttcagat tgctaaagtg 755520
 gagtcagcgg tagcagtaac tctgtgagaa acagctatgt ggtgttgctt agtcacagtg 755580

 gcacttgtaa gctgtcttag ctgctacaat caggatctgt ccttcttcag gagtctgctc 755640
 aacacattcc tgataatfff tgteccactgt ctgcttgccc ccacctctgt cgtctacacc 755700
 attgattttc cagggcagtt tcagcattcc tgggcctcag gttcagtttc cattctccct 755760
 ttacagccat gcacaggcca tacccttcc cgtgtcagct cagagctatt cctggctcat 755820
 ccctgcctc ctcagctctg cccagggatc ctcactgctc ctgaaacaca gtgacaggca 755880
 tagccctgcc tctgcgcttc tgtcatgctg ttcccaaggt tgttctcac ttactctgg 755940
 cctttgtaat gtcacagata cagatttctc cagcaagaaa tctgtttcc tgtctgtgtt 756000

 gcaggcccca ttttgcact tccagaatct attctgtgga tttttggtg aagttaaaaa 756060
 taacaactga atctctgtta tattttatag catataatta ttgtacaaaa tgatatggtt 756120
 agtatattgt tgetggaggt tcttgtctgc caggtcctgc caccttctc agccccaat 756180
 aagcacacag atgttatatt aactattaaa ctgttgcca atagctaggg cttcttattg 756240
 gctagctctg tcttaattat taaccatta ctactaatct ttgtatttct acgtggcctt 756300
 atcttaccgg agaacacccg gtgcgtccaa tctcccgat cctccctgg cctctctctg 756360
 gtggtctctc cctgcctacc tttcccagaa ttctctcat ctccctagcct cgctatatac 756420

 cctgcctcta ttggccaaac agtttttact gatcaaccaa taagagaaac atatatacag 756480
 aaggacatcc cccatcatct cctcttttct gtctaaataa aatgagggtt ttttaacttta 756540
 acataataaa actgcgtata acaacaatt atcaagtaag aactataatt aacaatattt 756600
 agtccactaa catttgcaa aatttaaaga aaatattcta tcatctatcc catctttgtg 756660
 agtctaaagt cttaaatgta acttatcttt taccataact aaggaaaacc atagacataa 756720
 ctattcgtct tcaactccat caaagaccac agaaggatgc cacatataag aggaaactta 756780
 tgatacttgt ctttctgggt ctgaattact tcatttttcc aaaatactca ggaaactaaa 756840

 ttctacaaat ttctaaacac cctctccag cccaacacgc tttctatgtt gctatacttt 756900
 tcagggtat agtaatgata taatatggca agaacaat tttctactta caaatgaaat 756960
 cttggacccc tggtttctg aaaattgaat ttatgtgact tatgtctttg agaattggtt 757020
 tctaacagta gaataaatta gccaaaaaag aagcaattat tccaggggaa gaggtaatta 757080
 atgctgtaca cttgcatct ccttagttga ctgttgcct ctaaaactta attgtgttgt 757140
 ctttttgaa actcaaagat ttctcaaga tatttgctcc ctggtatfff atgtatatca 757200

cttctttttt aaaaaaacia tcacttagat ttattttatt ttgtgtgtgt gtgtgtgtgt 757260

gtgtgtgtgt gtgttttccc tataatgatg tatgctcacc atactgtgtgc ctctgccca 757320

gggaggtcaa aagaaggcac agatatcctg ggactggaga ctccagccct caacatcact 757380

tcttaataac atgattaaca tagtaattat gtaaatcaaa attttattgg catatagtca 757440

ctgtacatag gcctgggtac aagtatcatg gggacatfff cgcacaagga tgtaacatcc 757500

tttgtgatg tectgcccc attgetccat gcctgtaact ctcttttgat ccctttgaca 757560

gtttagaatc tgttttcatg cttcatttgi atttataatt ttatataatc atataaaatc 757620

tgggattcac aagtgagaaa aaaacgtgaa ctattttctg agtctgactt aacttactta 757680

ctatgatgcc ctctgttga atccattgac catactctct ttatccattc ctccgccgat 757740

agatgcttag gtcattagtt gtcgtgaaca gtgcagcaat acaatatctc ccatatgttt 757800

agactctttt aggagaataa cagggtggtat aactggggct gttcattttt taaggaaact 757860

agtgtggatt tctgccaagg ctgtattagt ttacataccc accaatgatg tctaaggact 757920

cccttctggt cacatctca ccaccatttg ctgttatttt tttcaaattt cagtgcagtt 757980

ttttctttt ttaaaatttg aattagaaac aagattgttt tacatgtcaa tcccagttcc 758040

aactcctcc cctctccac tatcacacc tcctaacta aaatcctacc tatcacatat 758100

cttttctgct cccctggat ggtgaggcct tccatagggt gtcataagag tctatcatat 758160

cttttgggat aggtcctagg cccacccccg tgtgtcttgc ttcaggagat attcctccat 758220

gtggattggg ctcccaaagt ccacaactat gctagggata agtactgagc tactacagga 758280

ggtcctgtag atttccgagg tttctcaat aaaatccatg ttcctggggt ctggatcagt 758340

cacatgctgg tgiiccagct atcagtctgg ggaccaagag ctccctgatg ttcaggtcag 758400

ctgtttctgt gggtttcacc atcctggctc ggacccttt gccatcact catccttctc 758460

tgcactgga ttccagttca gttcagtgat tagtttggg tgtctgcttc tacttccacc 758520

agctgctgga nnnnnnnnnn nnnnnnnnnn nnnnnnnnnn nnnnnnnnnn nnnnnnnnnn 758580

nnnnnnnnnn nnnnnnnnnn nnnnnnnnnn nnnnnnnnnn nnnnnnnnnn nnnnnnnnnn 758640

nnnnnnnnnn nnnnnnnnnn nnnnnnnnnn nnnnnnnnnn nnnnnnnnnn nnnnnnnnnn 758700

nnnnnnnnnn nnnnnnnnnn nnnnnnnnnn nnnnnnnnnn nnnnnnnnnn nnnnnnnnnn 758760

nnnnnnnnnn nnnnnnnnnn nnnnnnnnnn nntttttttt tctgctgagt agtactccat 758820

tgtgtaaatg taccacattt tctctatcca ttcttcggta gaggggcatc taggctgctt 758880

ccagtttctg gcgattacag atagtgtca gtgcagtttt aacctgcatt tctctgatag 758940

ttgatgatgc taaacacatt tcatgtgtct attggacatc tgtactttgt cttattgata 759000
 taatthttcat ttttaaggca gttttaatta tgtgtatggt gtgtctatgt gggactatgt 759060
 aaacatgagt ataggtgtcc tcagagacca aagggtgttg actcttagag ctggagtgc 759120
 aggccattgt gatctactct acatggattc tggaactgga actcaggact gtaagggctc 759180
 ttaagttgct gaactgtctc tccagccttg atacatthttt ttattatthttt atthttatthtt 759240
 tttgggtgttt cagcacaggg tttctctgtg tagctthtggg gcctatcttg gcattcgctc 759300
 ttagaccag gctggcctcg aactcacaga gatccactg cctctgtctc ccgctgtctg 759360

 ggattaaagg catgtgccac caacccccg ctgatacatt tthtaaatga ttgatttctt 759420
 tcagccatga thtccctaac tgtaaggtag aagcagtagt catcttactt taaagactaa 759480
 tgaagatggt atgatctaag gagtgggaaa aactthtaaaa actataaaa ataacacatg 759540
 ctagaaattc tagtggcaca gctthtttaa actthtttac tttgtgtctc atthtttctt 759600
 cagacacaca cthtctctca aagatagtg cctagttaca atgatcaatg tggagtggag 759660
 taactacatt thcaccact ggaaatgat gtagatataa gccatgagcc cthtaaatga 759720
 tcaaatagct gtgtthatta agaatttaca thttcaatgt thaaactgaga agactaaaa 759780

 cccagggat tagacattgt thtcttgatt gctaatttat tctattcctg atcaacatag 759840
 taacacctat gtctthgttt thcaaatgaa aatagtctgt cthtatggga actthctaagg 759900
 tcatcgaatg cagtatctta taatgtgtga atthttthta aattcaatt tacaaaaaaa 759960
 cccagcaat cacaagaggc atgaagagat agagactgaa caggactgtg agaagggaaa 760020
 ctggagagcc attcagatgg tcgtcaagta gattcactat cccatagag cthtctacc 760080
 ctgggaatct gagtthattg thttcagagg aatagagat taactactaa caggatttht 760140
 tatgacatac ctgtagaagt caaaatcaaa atgagcttaa attagttctg acagacagct 760200

 ctggaattat tcatcattc aatagaaaat acacccccac tccctacccc thaaccccc 760260
 ccccctaaa attacagttg thcaaatata tgtgtaaaag acaaatatac agagtatgta 760320
 ttgctthctc atgcatatag agtacactt caaagtgc atgtthaaag aacatagtht 760380
 acagcaaaa caaaataaaa agtgattaaa aaaaaaaca aacacctgat tgttgaagaa 760440
 tcccttaagg aagtgcaatg ctagcattaa ttggttgaac cctaaggact thtcacctaa 760500
 ttagggagag tggatattg thccaggcac thcacattc cagaacaaa acaaaacaaa 760560
 aaaagacctt cattgtcgat ggggaggctg catgtgtgtg cccaatcagt gcattthctg 760620

 agacactggc caccctgtc catgagacgt aaggcgctg tcaaggccag gcctcactct 760680
 ggctgagggc ctctccagat ctctccctga agthttggga ctacagcagct gtgtgcactg 760740
 ctctctgtc acaggggtca tggctthta tgtgatgaag gatagaaagg cccagggtac 760800

acatctcatg aaggagatgg cctgtgtggg agccacttca ctgtcctcac tggacacccc 760860
 tcagatcgga gagggtgtcag gaagccgagc ttagcataag caaagtgtaa ataatgact 760920
 caaacttggg atttcagcct cgctataaca aactcttaga gcaggaacca gagcacggct 760980
 tcagtgggtg gccgtgtctg tgacttccac tgactgtctc tctgagatgg catctggagt 761040

 ttactggccc ttgactgctg cctactgtgt ggtagagggg tatggagtcc ctggagttag 761100
 ctgtcttgac tatggaaggt tcccagagtg aagcagagga tcttattgag getcaggatg 761160
 atttctgtca ggctgctgtg tcctaagct cttatgtggc ttgtgagcta atgcagcttg 761220
 cgttttcaat agaaattccg tctgtcctca gaaggaatta aactgatggg gcagaatgga 761280
 gtaggagtgg ggggagaatg acatttaac accctgaac ttgacaagcg ctgatcctgt 761340
 ttttattact tgggagtat cgtggctttt ctacattaaa agccatcccc attgtcttat 761400
 ttttagaaca ttgggtgaca gagatggaaa gtgcctatta aatagcaaac atgcctaacc 761460

 caaaggaagc agacacagct aagctagacg gtggccgtcc agtggcatct ttagctttt 761520
 cagtgagaat gtaacattaa ttctccacc cctcggttgt gtatctgtgg aagtcaggc 761580
 tattggatct cctctgcatc tgcttctgtc actgagaagg gctgtgcatt tggaggtttc 761640
 cttgtatcgt ggcaaatgc ttaagtgttc tgccagggtt ttagtcctaa aatataagcc 761700
 tggaaaggct gggaaaatgg ctccataaat aaagtgttg ctatagatgc atgaagacct 761760
 gggtttagat cctcagcgt caccaagaa gcagggcatt gagtgaggag ccagcttcta 761820
 attcaagcac tggagagatg gagccaggat gatcccagac cctggccagc cagtttggct 761880

 gaatccatga gctgtaggtt cagaggagag agactgggga agatgcctta cgttgtcctc 761940
 tggcctcgac cacacacatg ttcacacaca aatccacaca atgaagtcag gcaggagaaa 762000
 cctagaataa gaataatgtt tcagaaatct tgcattttta ctttctcttt aaggcagtct 762060
 ttccctgat aggacactgt gcaatgagga ggccagcagc ccagcaggtc tgagccaaaa 762120
 gggacattct tcigttaagga atcgcagtgt gtgtactgtt gtcacctttg cctggtagtg 762180
 tgttttacca ggtggttatt tattttcatg ctctgtggag attattttct gactgaggca 762240
 aatccacca gtgttttatt ttgagagtgg aatcatcatg agagatggaa gagcaggcca 762300

 ccctgtgcct agcttgggtt tctatgtaca acaaatggtg tagtatctct cttctttccg 762360
 ccattcaage actctgtgct gtgattccag caggggcagg gtgggtgtga cctagagtat 762420
 tgttcagtta gatcacagct ctgctggtcc aggcagaatc ctggaaatgc cttaagagt 762480
 gttgagtgtg aagggtttg caatcacacn nnnnnnnnnn nnnnnnnnnn nnnnnnnnnn 762540
 nnnnnnnnnn nnnnnnnnnn nnnnnnnnnn nnnnnnnnnn nnnnnnnnnn nnnnnnnnnn 762600
 nnnnnnnnnn nnnnntaac agtatctctc caaatgtctt tctgaagatg ctattccata 762660

gctgttccta attgacaaaa acaggtgtgt ggggcatttg ccgctcagat aggcttggaa 762720

aatgatgggt ttagcacaga cacagactct ctctccctct cccaccctca ttcttttctt 762780
atacattaca tectgaetac agttttccct ccttggactc cactcagtct tcctcccca 762840
acctccctc tctctgggc ccacttctgc tccaatttc ttcaaaaaa aaaaaaaaa 762900
aaaaaaaaa aaaaaaaaa aaaaaaagaa aaaaaagaac aggctccca tggatatcaa 762960
ctgaacatag cataacaagc tataacaaga ccaataagac taggcacaaa tccttatatc 763020
aaggttggac aacgaaacc agtaggagga aaaatgtcct aagcacagc aagagtca 763080
agcactccca ttccattgt taggcatccc aaaagaacac caagcctctc aaccagaaca 763140

tataatcaga ggacctagct cagaccata cagggcctgt gattgttgct tcagtttcca 763200
ttaacttcta agagccatgc ttggttgatt ctgtggctg tgttctcatg gtgttcttga 763260
ctcctctctg gctcctaca tccttcttct ccttgttctg caaggtttcc ctggcactgc 763320
ctagtgtttg gctatgagtc tcagcatctg ttccatcag tttctgggtg atacttctct 763380
gatgacaact gggctaggca ctgatctatg agtatagcaa actatcacta gtaatcattg 763440
aactttttc caattgtctt tggttctgtt ctgtatctct gggtgtcca gectctggtt 763500
cctagtcac caggtatgct cagtatctct ctctcatggc atggcctcc agttggacca 763560

gtcattggtt ggccactccc acaagctctg ageccaccatt gccctagcac attttccagg 763620
caggacagat tgiaggttga aggttttgta gctgggttag tatcccagtc cttccactgg 763680
aagtcttgcc tggttataga aaacagccag tcaggctct gtaacctcca ttattaggag 763740
tctccactag ggtcactctt gtagattaca gggagtctt attgcactta cgtttccaca 763800
ctgccatgca aatgccacc aattctctc cagtactctc tccctctacc catccccac 763860
cctgtctgat ccttttatt cccatccaca cccacccca gtccactac aaatctattg 763920
tacttctctt ccaggaaga tccatgtgtc cactcttaac cccccctgt tacttagcct 763980

ctctgggtca atgaattgta gcctggttat cctttactta acagctaatg tctacttata 764040
agtgcataca gactatgctt gactttttgg gtttgggtta ccttactcag aatgattttt 764100
ttctggttcc atctatttgc ctataaactt cacgatgtca ttgtttttaa cagctgagta 764160
acactgcatt atgtaaatgt aacacattt ctttatccat tcttcagttg aggtagcac 764220
agatagacat ttactgtag tgcctctca aaagtattat ttttttagc atatgtatgt 764280
gtgtgctgtg catgtatatg tactcatatg tgtgtgtgtg tgctcatgga tataaaggcc 764340
caaggttaac atctgatatc ttcattgatt gcctctctac ctcatgtact gaggcaaggt 764400

ctctcattga atctagagct cattggtttg gctagcttga ctaactgatt gactgactga 764460
 gcttgctctg gaggtctcct gtctcttcca ctcctatgt tctaggattg cagcatcctt 764520
 tcatatccga atgtgctctg tgaatcttta agaagaaaat atgaattcag cattgaccaa 764580
 ggaatgactt ttcttaggga aacatttctt aagaccaaca ttccaaagca tataatctgg 764640
 ggatgaacac acaggtata gaacttgggt ataatgcca gtttgcctc ctggtaagaa 764700
 acagtacact ggtgttagaa ttggtaatgg acattcttag gagtggcatg tgctatttgt 764760
 ttgttccat gctaggcccg atcgtgtaat tggactgttg aagatgggat ttggagtttg 764820

 ggatcttgtg tatttattca cacaatgatg atttcagaag tgataaact cagaatgaag 764880
 gctacagtca caaagcaaac actgaaaaag ttaggaatca agagcagtta ggaaactgtt 764940
 atctatgtct ttaaggaga cgagtattta ttcaagtaga gaaatggaga aataggacca 765000
 ggaatatttt catccagttt tgtgtctctt ctgtgtctta tctgggccac atgtttgcta 765060
 gaaaatgaaa gaccaccctt cactgaatta tcacaacaca ttgcatctcc tgctgttgct 765120
 gtgccatgct tatcaacaaa ggtgaaaatt agcaataaaa tttacctag cagtatttgt 765180
 gtttagaact ttggaaacca gaaaactccc acaagatfff ctcttaaagt tagttatttg 765240

 attaatttta aggtggcaat gagacttgtt tttactttca gctcaatgct ttggggctat 765300
 tagagtaagt gaggattcgg aaacttttgg ttattcatat tattagcaca gatggtctta 765360
 cctggggcct ttictatgaa gtcacageca ccaagctgaa catgcataga caatgattga 765420
 caagactgct agttttcatt gatgcattga caaagacttt ttttctgggt catcctaaa 765480
 attagtgggt tgtttttgtg atggttaatt ttgtcaactt gaaatgatct ataatcacc 765540
 aggagacaag acictagat tcccacaggg actatccagg ttagattaac tgaggtgga 765600
 aaatctacc taagtgtgag tagcaccatc caacagcca aagtcctgga ctaagaagag 765660

 gaaaggaagc agaacacagg tatcttctc tgtgttacga ctgcacacat gtgaccagea 765720
 gtctctgat ccagtcacca taccttccc gccatgatga aaggtattgc tgaatatga 765780
 agtcaaaatt agtccccagg gatgtggctt ttgtcaggta tgttatcaca ggtacaagac 765840
 aaggagaaaa tatgagtttg ctctectact ctccacaata gagctgatgg atcatatagt 765900
 ataatgggcc ctctgtttt cctgattaca ctgcaccag gactatattc actgattatg 765960
 tggatggatg tctgtatgtg tgcttgtgat ttcttcagtc tcattaagca gaatattggt 766020
 taactatgga gccacttttg tatagttagt acttataatg gtgtgaagta aactttacac 766080

 taaaaaatag cctcagctct catgatagaa cataatatga agaggttgaa atcatacaca 766140
 cacacacaca cacacacaca cacacacaca cacnnnnnnn nnnatattac cctactgttg 766200
 aggtatatt gatltagat cactttcttt ttttaagaa aaaaagttaa aagtaaaatc 766260

tggatactgg gtactttgag atagaaacta aggaggaagg taacttctga agcagaaatt 766320
 ccatctcact accaggaaga tccccatgaa aacaaagga gtcaaagata caggaaactg 766380
 gagaatagtt attgtggtct ttatttagat tacaggactc cagagtgtct ggtattttat 766440
 tctattgcta ttggttttat ggtttcgcct tccttctagg gactcatttg ttaaagtac 766500

 tgctgcttct cagcagtcta cttgcagcct taaagacaga aaggttggaa aaatgggttc 766560
 tgatgctttt gggggatgga ccaaatcaaa acctgatttc gactcccagg gagacctgtg 766620
 gaagtttttc ctctgcttct tcccaggaaa gttagtcttc agggcttggc tatgcagaca 766680
 actcattctc aggaaagagg tctcaacact tcaatgcaac acgcattggg tcagcagaaa 766740
 ctcttctaaa ccatttttac taaaatccaa gaaaggtatc tgtactacca tcttctttt 766800
 ttcaagtcac aagtttctaa taaccttctt attattgtat ttgaatctaa cttcaagatg 766860
 tgggtgtgtg gtgggtatg tgtatgtgtt tgtgggtgtg gtgggtgtg tgtgggtgtg 766920

 gtgggtgtg gtgtgtgtg gtgtgtgtg gtgtgtgtg gtgtatgtg tattgtgggtg 766980
 tgtgtggat gtgtgtgtg tgtatgtgtt atatgtgtg ggtgtgtgtg gtgtatgtg 767040
 tataatgtg tgggtgtgtt gtggatgtg tgtgggtgtg gtgtggatg tgtgtgggtg 767100
 gtgtgtggtg tgtgtgtgtg gtgtgtgtg tgtgtgtgcg gtgtgtgtg ggtgtgtgtg 767160
 gtgtgtgtg gtgtgtgtg tgtgtgtgtg gtgtgtgtt atatgtgtat gtagtgtatg 767220
 tgtatggat gtgtgtatgg tgtgtttgag tgaactgtat gtgtgtcgtg tgtgtgtatg 767280
 glaagtttct agtgtatgta tgtgtgtgtt ttgtttgggtg gtgatgtgtg tgggtgtgtg 767340

 ggtgtgtgcg gtgtgtgtt ggtgtgtgtg tgggtgtgtg ggtgtgtgcg gtgtgtgcag 767400
 tgtgtgtgtg gtgtgtgtg tgtgtgtgtg gtgtgtgtg tgtgtgtgt atgtgtgtgt 767460
 gtgtgtgtg tgcgtgtgtg tgcgtgtgtg tgtgtgtgtg tgtgtgtgtg tatgtgtgtg 767520
 atgtgtgtg tgtgtgtat gtgtgtgtg tgtgtgtgtg gtatgtgtgt gtgtgtgtg 767580
 tgtgtgcgtg gtgtgtgtg tgcgtgtgtg tgtgtgtgtg tgtgtgtgtg tgtgggtttt 767640
 ttgggtgtg tatatgtgtg tgtgggtgtg gtgtgtgcgg tgtgtgtgtg gtgtgtgtg 767700
 tatgtgtgtg tgggtgtgtg gtttgtgtg tgtgtgtgtg gtgtgtgtg tgtgtgtgtg 767760

 gtgtgtgnnn nnnnnnnnnn nnnnnnnnn nnnnnntgg gtgtgtgtg gtgtgtgtg 767820
 tgggagtat tgtgcgcacg tgtgtgaagg tgaaggca ataaaaaaa gtcaagtaaa 767880
 accaggatt cttttccctg atgctgcac actgaagtgt ctggaaggtt cttttgtaaa 767940
 agctatgct tccacaacac tattcagggt ggtttcaaat gaggcaaaag ctggggctat 768000
 agcttagtg tacagtgtt gcctggcatg acaaaagctc tgggttcaat ccctggtgtt 768060
 glaataaaca cataaataa caaaatgcag gtgtgtgtt tattttatga gcacctcaag 768120

gtccaggaag tggatcagag taaagagaag ctcatctctg agggcctaga ttctcatcct 768180

ggtctgcagt tgcattgctg tttgttgttt ttgcatttgc aagcaggatg actgaatctc 768240

agtgtagaca attcagaata gtagattatg gaaatcgtaa cagttaatac aggtatggaa 768300

gtctgttttc cagacggctc ttgtgccctc caccttactt gatttcagag tgatgattgt 768360

cagggcagct attgtcacct cggctttcct tcccagactc tgacaaagct ggatgacctc 768420

atgtgttcca aggttgaatc ccagctcgga gatcctcacc ctggtcagtt tectttactt 768480

cccacagtgc ttgccacccc aaatttgttt aggtttccat tttaccattt catttctctt 768540

ttggaggaat gcttctctct cactgtgtct caagaaaaat attgaatttt gtttgattc 768600

cctgagtta gcatctctga tccagaagag gtgaccaga aagcagcaga actaatccac 768660

atthagatag ctttgggttt tatttctact ttccataagc tatttatact tctccaagtc 768720

cagcctcaaa gaccaaaatt tcaaatgat tttttttttt ttttacttga tttgtttttc 768780

tctgttttg tctctctgcc tcacagtaga attcggcttt tgtttcagtg tttgctttac 768840

aaatatggac cttaaaaagc aagaatttaa tcttcatggt tcttctaaaa actagtctca 768900

gctcttttgg aagatcaaac tgaattagat ttgagcagcc cttacaaagt ggggcaatgt 768960

caatatcgtt attttctaag gaaagtcgaa tcttggaata gacctcaaca tagtgcccag 769020

atcacctcat cccgagctct gcttcagcct tcaactcccc gggggtcacc tcaaagcagg 769080

gagtcacagg agtctctccc gagtcttcaa tggatgctgt tagccaaaaa aagcatgcag 769140

ggttgatcag tctagaatat gaagacagac ttggtggcta aattgtgtag tacatgaatt 769200

atattcfaat aaagttaatt ttttagaaat aaaagagaaa ataaaaacag aagccattag 769260

aaattttggg gagacaggca agcttcttag tttccctagg agctaattaa atatatcgac 769320

atcttataaa acattcagga agttccagac aaatatcatt caatttctta ataatataga 769380

tgacctatt tactgtgaaa acataggtca cctgagata gcagccaata acattgaaat 769440

ttcctgatgt gttaacttt gtaatgaata attaagcagc aaagccagaa cactgattat 769500

tttgattat attgatatat ctagacattc ctttatactt gttcaaagaa atacattaag 769560

agctggtgag atggctctgt ctgtaaagtg cttatgctgc aagcctttaa gaacaagtta 769620

gatctgcttg atcccatgtg gaaacaacaa cagctgggtg tggcagtggt gcctgtaat 769680

cccagcctg gggaggtgga gacagaatga cctctgcctt tcattggtca gccagcctag 769740

ccaaatcaga aagttaacg attagccctg tctcaaaata aggtggagag tgattgaaga 769800

agacacccaa cagtgacctt tggcctctac atatacatat gtgtgtgaac caccctcacc 769860

cacatgcatg tatacacatg aacacataaa aagcgatgat tgaataaaaa atggttgaat 769920
aagcttgaaa atgtcgtacc acttcagggc ctactatccc gaattagcca caggctcaca 769980
ttgacgcaaa gtgaaggaca gagttctctg actccctgat gctgtcccat tgtcactgga 770040
tggaaatcaag gtctttcggg atggcacaga tctccatcaa tgtgagcagc ctgaggctgt 770100
gtgccccgtt ccatggttct ggattctttc ctttgcaatg ggagttttag agctgtggct 770160
cccacaaagg tgcagtttcc agtgagcaat tctgatggg tctcttggg agtgaaaaac 770220
atgcagggtt atgtaaagtt accatccctg tttgggtgac atgggctcca acagagatgc 770280

tatataggag gtcaatcttg tgataaaaa caagccattt aaacagttag accttttttt 770340
tattttactt atttggactt ttgtttgttt gtttgttttg aaacagggtt tctctgtgg 770400
tttggagcct gtcttggaac tagctcttgt agaccaggct gatcttgaac tcacagagat 770460
ccgctgcct ctgcctcccg agtgtctggg ttaaaggcgt gtggcactaa caccggcct 770520
tatttagact ttttactat tatcatgtgt gtgggtatac atgtgcctca gcatgcagat 770580
ggaggtcaga gggcaacttt gtggagttag tttgtctggg accaacatac aagttggttt 770640
ccaggattga actcgggttg gcaggcttat gtggtgaggg cctttgtcca ccgagccatc 770700

tcatcaacgc ccatcagtc acacttcagt taacatttct tttactcttc tgactttgga 770760
aagcatacag gtaaggggt ctgcttctta aattcacttt tgcttgaaag agatttccag 770820
ggaagatgtt gggaagagt tttaaaagcc ttaactgaa gtagcaccat cagccataaa 770880
acccaagaaa aaatgccag tagttagata gcagcaacaa aaaacttcat ttaaaaatgt 770940
gtgccggagg aagtactct ggggagtgt gtgatctgag agtggattgt gtgtcatcct 771000
gaaagactca cagcgtctat atgtatgcta aatgagtgtg aagtgagtga gtggcttctt 771060
gggaaggcag cccggaggta caacttgatg acaagctggc agccagagca agcaaagggc 771120

tgactctcag aggggcagag cagagggacg gcctcctcct tgggaaagct ccaagactac 771180
aagtcacatg tgctgacac atgtgaatag acagtgagtg tgctgtcatt tgtaaccca 771240
gcacttggga gggaaactga ggcacaggga tgggtttggg agggaaactg aggcacaggg 771300
atgggttttt ggagggaggc tgaggcacag gcatgggttt ggggtggagg ctgaggtaca 771360
attcaaggcc ggtatgggca atatagctag acttctctgt aaaacaaaac aaatggggaa 771420
aaaggcaagg ctaagaattt gctaaactga aaaattaaaa ggtgtagaa gggcagttaa 771480
acacattttt gaggtctgtc gtagcaaaact gccacggagg caaaaatggc ctgggaatga 771540

gcagccttgg gcatacgatc atgaaaatgc ataatgtcaa aatgagggat ttccctacce 771600
cagggagcct ccaggtgggc tgcaggtgct gtttcagctg cttttgctgt ttcccacagc 771660
agctctgttg aagccaggag tctgacagtg agcctgggtg tggcccagc ccaggtggtg 771720

ttgggatggc aataaggttc cagggaaga ggtggattga aggacaggca ggtacaagag 771780
 tattttgtgag ttgtactcag tgcctgtga gagccatta cccactata ctgagctgag 771840
 ctcaactctgc atcctgggag aaaagcgggt gataacaaca ctatgcta atgcacctga 771900
 aaacagcctg tgggagttcc ccagtggtt aacacagagg tcagaggcat gcttcatacc 771960

 tagtcaacaa gcagtttga gagcctctac acccctcttc gtctgtatcc aaggactgtg 772020
 tagaccacta aggggctgga gcaacattgc taactcagge acagcagtag ttaggcttct 772080
 gtgttatggc cacagacata atggtcaggt ggtggcctga tgggtcccgt ggtatcagtg 772140
 acagaatctt tactgacaaa ggggtcccagg gccctccaa gccagctgtg aagagcaacc 772200
 agcccttcca ataagaccac agtgtagaa tagccagctt tctttgctac taaagttgca 772260
 tgtgccccac agcttgatac attgtgtttg aaattgttc atattgaata gagagccaag 772320
 cctggcctg gtaggcctc ctctccgtg cacactctgc agtgggatga cccagtcca 772380

 gggctcctgt catcctccag aactttgtgg aacagctctg gagatgttgg tatcgccta 772440
 gaaaatgttc tgctaaaggt ggggtaagg tattgtgagc agttgtatcc tgctgagcaa 772500
 aattcccag tagcttctga ggagaactgg agtacctgag caactccaag ccttagcatc 772560
 ctttctgctg agggccaga ggcaggaaat cttcggctac cttgacaaag tctcgtttag 772620
 ttggctctga gtgaaaaatt cacagtaaat catgcagtca ctgcaaaaac taataatatt 772680
 gaggtccacc aataagcttt taggcaaac gtcattaact ctctaagtct caggagaggt 772740
 taagaagagg tttactcca tgaaacacaa cccaagttc ataggctgga gtttaagtca 772800

 tctgtcaage aggtcctcat ttccacttaa tcttatgcaa cactcttaa ttaaattaa 772860
 ttaaaactac caatttacc aaatacaatt taaaaatat ataaattaag atagtcagtt 772920
 tgtaatgtat gagtttagaa acagatttt caggtaacag ctttgatgtg taatttcaag 772980
 attgacactg atctctatga cggttttctt ttgtgaaaaa gaaaagcctg ggctctgaca 773040
 caaatactta ccattctata gcagggaggt tttaggttag ggtcatccac tcaggtaggg 773100
 cattctctat caccttctgt tgagtatgat tttaaaaata gatggggaaa gagagataat 773160
 tattgccac teattgctat tacttaaaat gtatgatatt tctagagaag ataattagtg 773220

 tatcttataa ctctctatt ttttgccat agacaactaa cctgtagtat aagatcattt 773280
 actgtacagc aggttagatga atgcccgtgg catctgtgaa aatgtttca ccgctgtgcc 773340
 ttatgggtgcc accatctgcc caagaacag tgtttgctaa gaagtgaac tacagctttt 773400
 ctgctgttat gtgaaacatt tgttttactt taggggtttt gttgtagttt tccatgctg 773460
 ctttctctct teattgggtg ccactcaaac attgttctgt ttgaaagaga tgccatgagg 773520
 gctgtctctg gtataacagt gctggctctg tcatgctgtc ttttaattcc cctgatgtgg 773580

actctcccgt ggtgtaaagt ttgtttgtcc attgtgtccc agcatcccct cagtatggtc 773640

tccctgattc catcttagtg actacacacc acatagtaga tacttttgat ggtcgatctt 773700

gtcagctttc tgggatttag agttacctaa gagacctgct tctgggtgta tetaggagga 773760

tattttcagc aaggtttaat ggaagtagaa aatcccagag tagatgtagg cagcattatt 773820

tcatagtctg aataaaaaag agaaagtgaa aagagcacag tcattttaa aaggagtctt 773880

taattggctt agataataaa aagctggagt cagatataga gagaaggaat aaacctgc 773940

tacaccttgc ctcttagtg tctcagcaga caaggagtg atttactatt tctccctgct 774000

tatatctga gccagctac atcacttctt gtctgtctgt acagaccacc agatctctat 774060

ggttagttaa tggcacactc taccctctga cccccagaca ggctttattt gtacaagcaa 774120

ggtattacca cagtcctctt ctctgtttc ttgactatag atcagtcact ggtctacaaa 774180

gtgaccaact ggcccacacc tggccacact gggcatactc tcaaatttg gaccaaata 774240

accgtttcct aagtgtttt tggcaggat tttgtcacga tgagaaaagt accctagtac 774300

agtgtcctcgt taaacttaca ggatgagtga ctatagattt ttaaaaaatg tatttcatcc 774360

atttccactt tattcttga ttaaggctac tgcctcatca gagtctctgg gcaggaaggg 774420

gaaagagctc aggcattcac agcactgatt ttagcaagggt gttctctgtg cgacactctt 774480

gcctacacag aggaacgtta taggaaagag ccgtgtgaat cactcactgt ggcttcaggt 774540

ttggagaagg gtcaaggcca ccagcaggca ctctactagg gaacattttc atatacatc 774600

cagggcaaaa tttctcctt ggcttacaca tctgatcagt taaatatctt tggttgtgt 774660

atgtgtatcc tggatgaatag ctcatcact gtgttttact gttggctggc ctgcattta 774720

ctctgactt gttccctct cagtggttga ctctatgaa cttaataagc atgtagtgc 774780

tttactgta aatgaaaatt atagctcca cgcactctgg tgaacacatt gcagatgta 774840

gcgccatttc cagatgtcc tccatttatt tcttccgtgt aataccctct ctgctgtgcc 774900

tttcttctaa actctagggt tccccagat ataaaccagt gtccccctc cccaagacc 774960

tgtctcccac ttctgtcttt gcccatcagt catgtatctt cacttctgt ttcaagatga 775020

ctgagctgtg atttaaatct cattaatttt tcagcttggc aggcttatct cctgagcaaa 775080

actgcccact tctacaagag aaacacaatg cctttgatt tttccatagc tccccagaaa 775140

agtctagaat tatgactgca tggaaacctt tgtgagtgg aagcaccggg aaaaactggg 775200

gtctctgag aaatatggtg atatattatt tatgattat taaagcttga ctggggattc 775260

agaaagcagt catctacaag acgtagaagc cagacactca cctttaatcc cagcagcaag 775320

aagctaggag gtggtggtac acacctttaa tcctagtact caggattaag aggtagatgg 775380
atctctgtga gtccaaggcc acccagatct acacaacagt gatccagtcc taaagagtaa 775440
tagctcacac acagatgac ttagcacctg ggatcataca cctttaatcc aagaataagg 775500
aaggtatata aaataggagc aagatgtcag taticagcat tcattctcca gccaccttga 775560
gaataggaac accccagcct tttagaggta agagctctct gggtagcttg gctgctttgc 775620
ttccctgatt ttcagcttga accccaatat ctgtctctgg ttcttttatt tatcttgta 775680
caaagaaaag gtgtgaacgg ctagaccaga ctcatgtag gtcactgtat cagtccaatt 775740

tctcctgatt ttgtcagtc tctcagtggt tcacagagca aggggagtg aacaatagtt 775800
ctgggttcta agttcagccc caggaactag gtatgtgagc tttagaaaga tgctgatctc 775860
tcaggatccc ttacaaatc taaagaggtg tgtgtgtgtg tgtgtgtgtg tgtgtgtgtg 775920
tgtgtgtgtg tgtgtttatg tgtctgtatg taggggtca gggagctggc tgtggtggca 775980
aacaccttc acctcagcac ttgggagaca gaggcaggca aatcactgtg agtatgaggc 776040
caacctgac tacataatga attccagaag agccaaggct atatattgag acctgcctc 776100
aaaaacaaaa taaaataagt aaacaacatt atctctactc ttctaattat aaaatttat 776160

gagttcctta tgttatccct tttgtaaca ctcaactgta accaacgtta taatggatag 776220
aacagattcc agctatgatt aatgctatca tctcaatgct ataatatatt catatntaaa 776280
acagcaatcg tctttcaat aacaccaat ttccaattt atttattat ttatttatt 776340
atttattat ttattatag agactcctct atctcaggct cctggaactc ttagctcag 776400
aatggcctca aattcacagt gatcctcctg cctcagtgtc aggaggattt aacatgagct 776460
attatgaacc atgtgcaat tacagcatat ggcaattgat aattcagatg tcaaccacc 776520
agaggagtga ctctgaggaa ggctaactct gtccagacaa ggcctgcagg acattgactc 776580

tggaaactgc tgetcacatc tgetgaagca gcgtggtgac tteccaatac ctgcacggca 776640
gtgtatgac tcatgcatg tgtatatgta atctcatgat tgtatctaga tgtcatgggc 776700
acatatattt gtgggtggtc aggaagatga cttcattta gctatataga atatgtctg 776760
ggacatgctt cataactaca tctatttgtc ccacgagact gtagaccctt aaaagcctec 776820
tttgttttt ttgctcagac taatatcaga aaataacaaa tttcttctca gtctaagaca 776880
aactgcacag aattagctca cttttacctc agagcaagtt caaactaaag gctttttgta 776940
aacagatcat acattcaaaa ctttacagct atgcacaagg tcagagtcac aggggtctta 777000

ccaaggttac tacacaaagc accctaagta aagtatgcca attcttctct tgacagcctg 777060
ctaacaatag acctgtgtgt tatgataaat ctttccgcca aaagccacct gactctact 777120
gccacgtggg tggtttccac cagcagcctg agttctgccc ggcaattag ggcccaatt 777180

aatgcacaga gacttatatt aggtacaaat gctgcttggc taatgactaa gatttatatt 777240
ttataagact tatcttccat tggcatcctc ccttgccggt gaattacatg gcaactctgg 777300
aggaagagag ggcccacttc cttcttccat tgtttatgta tggctctcac tgctaagtca 777360
cttctgcct ggatcatcac tctttacta catttccag aatcctcttt gactcctagt 777420

cctgtctaac ttgatgcctc attggccaaa cagtacttta ttcaataatc aataagatga 777480
acatacacag aagtacattc cccatcatct atgtctcaaa gttgtcact ggtcactgtg 777540
ttcctccttc tcccctcaat ctggcatga tcttactcct ggaaccttgg aaccttgtgt 777600
tgccaagaca atgacttggc accttactgt ttaccctag gaatgtgctt ttgaccaatg 777660
agaggtaact ctigtatatt tttaaaatct cttcaaggct cctgtgaaaa acagagtatt 777720
tagactagag gagaagctag gaggaattag aattaggaca ggggaattag aacagaaaca 777780
gcaaaataaa gagacttgtt tgcaatagca cagtgtgtga aagtgcattg tcacctcag 777840

atactctaag aagaaaaaag ttccttttac ttgctgttgc attgcctttg aacctgaag 777900
agagtcttgg tgttggacc ctaagactc ttgttacctc agctttttga gagctgggat 777960
atgcttgtac catcgtgctt ggctgtgaac tttttaaatt tcagcacaaa gttaaaattt 778020
accttttgag taattctgat tgaaaagcta ttatttaaaa atatttaaga tgatcactgg 778080
ccctgaagcc aatgtcgtg tctttccact catctttgct attgaccatt ctcatagaag 778140
atagtgtttt tctctatgt ttaaaaaggt gacaggcacc ccatctttaga atcaatagtt 778200
aaaatttaat ttgagtgaac ctcgagggtt tcttgatag aaattgttc atttcagata 778260

tttgaaactg taagcagttt taaagaaaa gtattagcga gattctggtt ttgctctat 778320
ctagaggttg catcccttgc cagtatttct tacattaaac acaactctaa gatgctatga 778380
gacttgagaa ataaattgga agtttgaaag attagtctt gagcttttgg ggcaattgat 778440
tttggcatgg aaggaaagag ttgatagtga gcacaactat gtcgggaatg cctgtctctt 778500
tgattttcat attttaatt ctagtggtaa ctagagaata ttcctgtggt ggtgactttg 778560
agtgtatctc cccaagagg ctcatgcatt gaagacctag cctcagtgc aagccgcctt 778620
cagaggtggg gtacggggg aatcacgagg gctctgggat taatctgtt atggagatac 778680

tatttgaatg gactgttggg aggtgtggcc tggttggagg aagtgggtca ctggggtgtg 778740
tcttgagggg ggtggatgtc ctccctgtg ccttcttatt gtgaactctt tgcttctctg 778800
atcctctgaa gtaaatagcc caccattctg tcttctctac ttgtggttac acctatcac 778860
aactcaggtc cacagtagca gagccagcct gcttccaact aaatcctgtg acacctgagc 778920
caaaataatg gtttctccc ttgagctatt tattgacct atcttgtcat agcacaattc 778980
ccatttccat tcagaacca gagaatttgt tcatgggttc agaacctgtg gctcaatggt 779040

cttgcagcaa acgacaccac tttgttatgc caatcccctg agctgtgtga ggtccacttt 779100

tataaacctt catcggttgg tcacaacttg tgaaaccta tgccaacccc atcttttctc 779160

agtgcacacat ctatgcacat ggcagcccat gtttattgca gaggtacaca cctgggtgaag 779220

ggcaggtaca atgattctaa agacagcagc tattatcttg ctttcttcaa ctcaaccgcc 779280

tacagatgta ggcatccaga ggaaaatc cagtacctga ttgaacacat tcttttggtg 779340

agcaattgaa tgactaggaa gtacttccct gtaccacga aactgaaatt tgtctcctgc 779400

caagctgaac tcaattggcc ctgccctcct tccaccgag agcctgttta gaacagggcc 779460

acaggcatca catcccatcc tctgtgttcc atttccatat ggttgtcttt tgggtaacca 779520

tgctttgcct agcctgcaga tctaatact ccccatggga tctggaggag aaactgcatt 779580

ttgaaatgga ctcttaagt gcaagaagaa agaacacttc cttgcctgtg gctgggatga 779640

tctttggcat ccagaacagc cccttgaaca aatacatcat tcccaacaca aacctctctg 779700

tttcttggtg aaggtagtct gtgtataaca aaaccacaa agcacactgt caagtagcag 779760

ttgtttcctt gtgatcacag gtgtgatagg cagctgtcac ccatatcaca gcctagtgtg 779820

gtggtttaaa tgacaatggc gactaggctc atatatgtga ataactcagtc tccagtgggt 779880

ggaattgttt aggaaggatt aggaggtgtg gtcttgttgg agaaggtatg tcactagggg 779940

tcagctttga ggtttcaaaa gttattgcca ttctgatgc ttgtggatca aatgttttaa 780000

actctctcag ttactgctct agttccatga ctgcctgcct gctgccttgc ttctgccat 780060

gatggtcatg gattctaacc tttggaactt tgatccacaa atgaaacact tttttataa 780120

gttgccttga tcatgggtgt ttgacacagc aattgaaaag tagctaagac atctggtgtc 780180

acaggaatgt attgcatatc acactagccc tagaaaagat caaaattcta aatacagttt 780240

tgaagaata caaattgctt ttgtgacatc tttgcatgtg ttctcatcca tgtgtgagca 780300

gctgagagtg cagatagggtg agcatgtatg tgtgtgetca tgtacatgga gtcagaggtc 780360

aactttgggt tttgttcctt aggcaccatt tatattgtat ttttgagaca ggtctctca 780420

ttggccaagt aggctaggct cactgttcag tgagaccag agatccgctt gctctgctt 780480

ccacattctt tggatggtaa attccgtggc tggtttgttc tgtgagttct ggggaatcaa 780540

actcaataag gcatagggtc cttattgtaa ggcatgcact ttactaagtc accccaacce 780600

tgttctgtgt gatctgtgtg acagagagac cattgtttga ggctgtccc attcctgaa 780660

acagagaccg tttgcttcta nnnnnnnnnn nnnnnnnnnn nnnnnnnnnn nnnnnnnnnn 780720

nnnnnnnnnn nnnnnnnnnn nnnnnnnnnn nnnnnnnnnn nnnnnnnnnn nnnnnnnnnn 780780

nnnnnnnnnn agggggtggg tggggggggg ggggggtctc tagaatcttt tcttcaagct 780840
 gagctcagtt ttaatccaga gacaactaac tftgggcttc cctttattac cacctcacag 780900
 ttcttctgtc tatggtgata cttgacattt ttgtgtggca cctgactgaa accatttccc 780960
 aggtctaagt taatgaggct gtaaaaatat gactaatttg gaataattat cttagtgacc 781020
 aaaaaagcag aagttgcca ctttcttct actactgacc atttatgtct atatagcatc 781080
 tctgtccatt ttcacttctg ttatttgttt ttgggtgtgtg tgtgtgtgtg tgtgtgtgtg 781140
 tgtgtgtgtg tgacctglat ggatttctta tglaccatgg atgttaattc atcatcagtt 781200

 gtgtatccca gtgtatTTTT ttggaagcac aggctgaatt ctcatTTTT tggttgttct 781260
 ctctactgtt cacatctgaa ctgaatcttg cacagagagt ccagtcctcc tgtatgggga 781320
 ttgataggtt agtagatttt ttttaagggtg gtctctgtaa gatccctatg cctggttata 781380
 caagtgaaca ctaatctaat tactgcttct atgaaggctt ttgcagggtg aattaaagtc 781440
 ccaaaccaat tcaccttaaa ctatagaggt tgctggggtg aacttgggta catcttgaga 781500
 gagctttaac caggcagaag agaaaggagt agtctgaagg agacaacagg tgaaaatgag 781560
 tctgttgggt tgaagacagc ggaatgataa ggaatgtgga gagtctacag ggggaacgct 781620

 cccatctatt attaacaagg acgtgaggac attgtccctc accaaccca agttagaaaa 781680
 tgctgtcca gcactttgac ttttgtcttg tgagacacta ccaagaaaat ccactgtagc 781740
 ctcagaatc tgaccacag aactgtacct ggataaatga atgttgtttt gaggcactag 781800
 ttatggtaat tagttacagt gtggataaaa atgatatctc agtcacatgc tcatgtcaga 781860
 tgcttacacg tgtctatcct ctctgttta attgctatct tagaaaatgt tgcacacact 781920
 tctatgttac ttiagcgtct ttgtgcatgc catcttaaga gctaactagt aggtctgaaa 781980
 tgggtgggtt agaggttatt tagtaatac ccattgtgta tcatttgggt cctttctggt 782040

 ttgaatactt tatttctgtt ttatttgtgt gtgtgtgtgt gtgtgtgtgt gtgtgtgtgt 782100
 gttagtgtac acgtgtgtat gggccaacc gaaaccagaa gagatcatca aatccttggg 782160
 gctcagagct gcaggcagtc atgagctacc tgatgtgctg ggaagtgaac tctggctctc 782220
 tggagaaca gcaactgctc ttaaccaatg agtggctctt ctaggtattt ttctctattt 782280
 tatgagaaaa agaatactt tgtgtatctg acttcctaag gatagactgt ggtggtagtc 782340
 aagacggatt cagaaggtag aaatgcacaa ggtattcatg gtcacgtggt ccattctgtg 782400
 atttccaac tggatgtagc ctctctgga gacattcagg cctatatagt tactacgtct 782460

 ggagatggag atcaaatgga gtgaaggcac aagtctgcag aagtgggaag ctgcaaaaa 782520
 atgcaaaaata cagcaagtgt ttgtttttat ttatcccct ttccatattt cctgacaatg 782580
 ctgttctccc ttgggtgtag gctcacacca tttttcttt ctttggctgt tatttaatga 782640

tattgggcat ttcttctttg aaatgatatt tctctgtttg tcacagtttg gtattgatga 782700
 caccatcctt gctgctaaga aaacatgagg ttataaaga gacatttgct aagtaggggg 782760
 acatcagagt gccagatcat cttctgtata caaaagatga atcaggagtg taaatgagtg 782820
 agtgagtctc tttaaagtgc tatgcagctc ggagagagag agagagagag agagagagag 782880

agagagagag agagtgattc tgtggtgcaa gcatagagga taaagtttc acaactgtta 782940
 cagcttttga attagtgagt cttgaataac atgtatctta aagagataac cggaacagat 783000
 ctaaactctc cttagtattt ttatacaaga tacttttctc tgggttatgg gcaaatatct 783060
 gacaatagc agctacaggg aggagggttt atttgggctc acagtctctg gaaggtgcca 783120
 tctgtcatgg tgggaagtgt gtgaggcagc ttctgacttt gcactcagtc aataaacaga 783180
 gtgtggggga tgggcagtct aacctcaagg cacacttcag tgaccacag cctacagcaa 783240
 ggctctacct tctgaaggca gacagccttc ccacacaaca cctccagggg agccaagtgt 783300

tcacagacat tagctttgag gacagttcac acacattagc ctgtggggcc aagtattcac 783360
 acacattagc ttggagtc aattcatattc aaaccaccca gtcctcctt agtttttttt 783420
 ggtatgatg gtaacttaga aaaacaggga ttattttgt tacctcagga ggccaacaat 783480
 cagatatata gagctggcag agcatattct ctgtggatag aacattcaa actcatccag 783540
 cttctggtag atctggtgtt gctggttcc cttttgtaac aaattcactc tagtctgctt 783600
 tcatctctac cctgcttctc ctctgagcct ttctgttctt tctctgttt gataaagaca 783660
 ttggatgtat aacaggatga cctcgccatg aattctttaa ccaattatat ctgcacagat 783720

ccttgttcca aataaggcat atattcaaag acccagggga cttaaaagta gacacaactt 783780
 tgtgggtcta aaacatcagt ttgctatagt ccttaattta ctataagtct cctactggta 783840
 attgttcata aggtataatt tatgactcat tatcaactag ttgaaaata tttttagagt 783900
 gtggctaage acatgattat gatagacagc agctttgctt gatggtacaa gagtccagct 783960
 ccctctcctt catctacatg ggtgtggaat gccacagtca ccctctgtgc agtgcaataa 784020
 acatatattg gagattgccc actccaaaaa acacaagcac agacatgtgg tatatcattt 784080
 gtacatttcc atacatacct ctgtaggatt atagtctctt tattcaaaaa gacaccaagg 784140

caagatacag gccagagcta ggttatagaa ccagcaagc gcgccagaa caaaaggggg 784200
 ccagggtcca cacgtgcagc cccttaagaa gctcccttac gtcaccccg ctttcttca 784260
 ccacgccctt atgggcgagt cccgggtcca cctggtacct gtcccaggac tattgggcgg 784320
 ggctagggtg tcttctata tactctctc aatatggctg cccatgtgta tctctctg 784380
 catggtacac ttacacctca ccactgatac aaatttggag gacatgactg ttgcatccag 784440
 caaacttcta cccagggagg aacaatacct cctcaaaacc attcctatg tcaactgcat 784500

tttattttac tgcagatfff tttatttggf ttagaacaa gagtgfffa catgacaatc 784560

 ccagffccct fctccffca gfcffctct fcccccctgc ccccaactaa aaccctacct 784620
 atcacatate cffftctgctc cccctggatg gfgaggecct ccatagggtg tcatcagagt 784680
 ctatcatatc cffftgggaaa ggggctaggc ccacccctg tgtcttggtt cagggagtat 784740
 fcctctatgt ggaatgggct cccccccccn nccccccccn nccccccccn nccccccccn 784800
 nccccccccn nccccccccn nccccccccn nccccccccn nccccccccn nccccccccn 784860
 nccccccccn nccccccccn nccccccccn nccccccccn nccccccccn nccccccccn 784920
 nccccccccn nccccccccn nccccccccn nccccccccn nccccccccn nccccccccn 784980

 nccccccccn nccccccccn nccccccccn nccccccccn nccccccccn nccccccccn 785040
 nccccccccn nccccccccn nccccccccn nccccccccn nccccccccn nccccccccn 785100
 nccccccccn nccccccccn nccccccccn nccccccccn nccccccccn nccccccccn 785160
 nccccccccn nccccccccn nccccccccn nccccccccn nccccccccn nccccccccn 785220
 nccccccccn nccccccccn nccccccccn nccccccccn nccccccccn nccccccccn 785280
 nccccccccn nccccccccn nccccccccn nccccccccn nccccccccn nccccccccn 785340
 ggttggtgaa tatctffftcc cagctctgtg gctcctgfff tgtcttgctg actgtgcct 785400

 ttgccttata gaagcttctc agtttcagga ggtcccatff atcaattgff gatctcagtg 785460
 fctgtgctac tggfghtaat ffcaagaa c ggtctcctgt accaattaat tcaagggtat 785520
 fffccacctf fctcttcaat aggttcagtg tgcttgatt tatgffgagg fctffgatcc 785580
 atfftgactf aagffffgfg catggcaata ggcffggatc tacctgcagf cgtctacatg 785640
 fctgcatcca gffatgccag caccatffgt tgaagatgff cfcfftgffc catcgtataa 785700
 aatffgatt gfffgtcaaa aatcaggtgt ffftaggtgt gagagffaat atcagggtff 785760
 fcaactctat fccgffggfc tacctgctc ffffftgfcc aatffcaagc tgtfffcagg 785820

 cctataggfc tgaatagtg cffgaaatca gagatggfga gctctccaga agffccfffa 785880
 ffgtacaggg ffgffffggc fatctggggt fffffgfff fccacatgaa gffgagfaff 785940
 atffctffca ggcfcfgtaa gaatffgff ggaatfffga fgggaatfgc atffgaatctg 786000
 tagatffctf ffgcaagat fgctatnnnn nccccccccn nccccccccn nccccccccn 786060
 nccccccccn nccccccccn nccccccccn nccccccccn nccccccccn nccccccccn 786120
 nccccccccn nccccccccn nccccccccn nccccccccn nccccccccn nccccccccn 786180
 nccccccccn nccccccccn nccccccccn nccccccccn nccccccccn nccccccccn 786240

nnnnnnnnnn nnnnnnnnnn nnnnnnnnnn nnnnnnnnnn nnnnnnnnnn nnnnnnnnnn 786300
 nnnnnnnnnn nnnnnnnnnn nnnnnnnnnn nnnnnnnnnn nnnnnnnnnn nnnnnnnnnn 786360
 nnnnnnnnnn nnnnnnnnnn nnnnnnnnnn nnnnnnnnnn nnnnnnnnnn nnnnnnnnnn 786420
 nnnnnnnnnn nnnnnnnnnn nnnnnnnnnn nnnnnnnnnn nnnnnnnnnn nnnnnnnnnn 786480
 nnnnnnnnnn nnnnnnnnnn nnnnnnnnnn nnnnnnnnnn nnnnnnnnnn nnnnnnnnnn 786540
 nnnnnnnnnn nnnnnnnnnn nnnnnnnnnn nnnnnnnnnn nnnnnnnnnn nnnnnnnnnn 786600
 nnnnnnnnnn nnnnnnnnnn nnnnnnnnnn nnnnnnnnnn nnnnnnnnnn nnnnnnnnnn 786660

 nnnnnnnnnn nnnnnnnnnn nnnnnnnnnn nnnnnnnnnn nnnnnnnnnn nnnnnnnnnn 786720
 nnnnnnnnnn nnnnnnnnnn nnnnnnnnnn nnnnnnnnnn nnnnnnnnnn nnnnnnnnnn 786780
 nnnnnnnnnn nnnnnnnnnn nnnnnnnnnn nnnnnnnnnn nnnnnnnnnn nnnnnnnnnn 786840
 nnnnnnnnnn nnnnnnnnnn nnnnnnnnnn nnnnnnnnnn nnnnnnnnnn nnnnnnnnnn 786900
 nnnnnnnnnn nnnnnnnnnn nnnnnnnnnn nnnnnnnnnn nnnnnnnnnn nnnnnnnnnn 786960
 nnnnnnnnnn nnnnnnnnnn nnnnnnnnnn nnnnnnnnnn nnnnnnnnnn nnnnnnnnnn 787020
 nnnnnnnnnn nnnnnnnnnn nnnnnnnnnn nnnnnnnnnn nnnnnnnnnn nnnnnnnnnn 787080

 nnnnnnnnnn nnnnnnnnnn nnnnnnnnnn nnnnnnnnnn nnnnnnnnnn nnnnnnnnnn 787140
 nnnnnnnnnn nnnnnnnnnn nnnnnnnnnn nnnnnnnnnn nnnnnnnnnn nnnnnnnnnn 787200
 nnnnnnnnnn nnnnnnnnnn nnnnnnnnnn nnnnnnnnnn nnnnnnnnnn nnnnnnnnnn 787260
 nnnnnnnnnn nnnnnnnnnn nnnnnnnnnn nnnnnnnnnn nnnnnnnnnn nnnnnnnnnn 787320
 nnnnnnnnnn nnnnnnnnnn nnnnnnnnnn nnnnnnnnnn nnnnnnnnnn nnnnnnnnnn 787380
 nnnnnnnnnn nnnnnnnnnn nnnnnnnnnn nnnnnnnnnn nnnnnnnnnn nnnnnnnnnn 787440
 nnnnnnnnnn nnnnnnnnnn nnnnnnnnnn nnnnnnnnnn nnnnnnnnnn nnnnnnnnnn 787500

 nnnnnnnnnn nnnnnnnnnn nnnnnnnnnn nnnnnnnnnn nnnnnnnnnn nnnnnnnnnn 787560
 nnnnnnnnnn nnnnnnnnnn nngaattgtg caattgggtg ttacttaatt tccatgagtt 787620
 tgtaggtttt gtgtaattca tgttgttgaa ttctaacttt aaagcatggt ggtctgataa 787680
 gatacagggg gttatttcaa ttttttttgt atctgttgag gtttgctatg ttgccaagta 787740
 tgtggtcgat ttagagaag gttccatgtg gcactgagaa gaaggtaaat tgatttgtat 787800
 ttggatggaa tgttctatag atatctgtga agtccaattg caccataact ttgattagtt 787860
 cctttgttcc tttgttacgt ttctgtctgg tattcctgtc cagtgggtgag agtgggggtgt 787920

 tgaaatccc cactataagt gtgtgcgggt ttatgtgtga tttgagtttt agtaatgttt 787980
 cttttacaaa tgttgatgcc tttgtatttg ggtcataaat gttcagaatt tagacctcat 788040
 cctgatggat ttctcctgtg atgagtagga agtgaccttc ttcactcttc ttggttcatt 788100

ttagtttaaa gaccaatttg ttggatatta ggattgctac ccctgcttgt ttcttgggtc 788160
 catttgattg gaaaatcttt tccaacat taattcttgg gtatcttctg tctttgagat 788220
 tgaggtgtgt ttcttgtatg cagcagaaaag atggattctg tcttcttatac cattctgcta 788280
 atcttgtctt ttiatagtcg agttaagacc attaatgctg agggatatta atgaccattg 788340

 attgttcatt ctgttttgtt ttgatttgg tgatggatgat gaaattatat gtaggattct 788400
 ctcccttttt ccttttggct gttggtaaag tgggattatc tattgcctat ggttatagtt 788460
 aacttccctg ggttgcagtt ttccitccag aactttctct atggctggat tggatgatat 788520
 gattgtttga atctggtttt gtcatggaat atcttghtaat ctataatgat tgaaaacttt 788580
 gctgggtata gtagtctggg ttggcattta tggctcttta gtctaggtag aatatctatc 788640
 caggaccttc tggctttcag agtttccann nnnnnnnnnn nnnnnnnnnn nnnnnnnnnn 788700
 nnnnnnnnnn nnnnnnnnnn nnnnnnnnnn nnnnnnnnnn nnnnnnnnnn nnnnnnnnnn 788760

 nnnnnnnnnn nnnnnnnnnn nnnnnnnnnn nnnnnnnnnn nnnnnnnnnn nnnnnnnnnn 788820
 nnnnnnnnnn nnnnnnnnnn nnnnnnnnnn nnnngtatgt ctttctttag gttgtgaaag 788880
 ttttcttcta tgattttgtt gaatatgttt tctgcgectt tgagtggat ttcttcacct 788940
 tcttctatac ctattattcg taggttttat ctttccagta tcccatattt cctggatatt 789000
 ttgtgctagg gattttgttg gaccatattt tctttggttg atgagtctat ttctctagtt 789060
 gtatcttcaa ctctgaaat tctctcttcc atctcttcta ttttttgggt tactcttgea 789120
 tctgtatttc ctgaccttt acccagcttt tctatttcca gcattccctc agtttgtttt 789180

 ttctttattg tctctatttc agttttcatg tcttgaatgt tttccttcat tgtttgatta 789240
 tttttttctt ggctgtcctt gctttcttta agagatttgt tgattccttg catttttgggt 789300
 gtaattttct tacacttctt taaggggttt tcttatatcc tatttgagag cctctatcat 789360
 tttcatgaag ttgtttttaa ggtcattttc tctgcttca tctgtgttat tctgttcagt 789420
 ttgtgctggg atagagcctc tagactctgg ttgtctcata ttggttttac tgttgttggg 789480
 tatgttttta tattgtcttc ttccggtttc gtctttgggt ggctgtagaa ggactctccc 789540
 ttctggtagt tgcaaacagg tccaatactc ttatgtctct cctcttctg tgaatacact 789600

 gttaccaggg ccttggcagt gtcggggtct gttggatcct gctgccaagt tcggatctgt 789660
 tgagcagacc cttggcatca gatgtttcct gtcacttga ttttaataa ggtaaagtgc 789720
 atggatttga tattttcctt gggaatccat aaagtctgtg gagaccacaa atgcagtcca 789780
 aagacatcca acttactaaa tcaaatggaa gagtaagtaa ctgcacgaaa ttaacttca 789840
 gtgccccgct cctacatc gatgatctag gcagtttttt agttgtgtct caggcttctt 789900
 aattatctct tctctgaaac ttatgtagga ccatgtgctc aaaactgtaa agctgaaat 789960

cccacatccc agactctcca caatcttggga caaattggga cccaggactt tggtttcccc 790020

 agagactgat ggggctctgg tagaaagata tagcaagacc atacctgcag ccctaaagaa 790080
 ttcacattct ctgagatggc ttatgcctat cctatgtgaa tttattcatg ttcccagctt 790140
 catcttacca ccatctcaga agcttgtggc tcttgaccca ggtgagccca tgctctggcc 790200
 tattcttcta agcagctgca cctggagttg gctggttggc tcatgatttc aggtatccaa 790260
 tgcaccaag aaaacatcta atttgcagtt ttcccagatg ttattttttt tttcactgta 790320
 agaatgagag cctggcctc ttacctcaat acatcttcca tctgaaacaa gaagtgtcgc 790380
 taagcatttt aatatccaca actgaaacaa ataatgtgg gtaggagtgg taggtctgtc 790440

 tgcattgttg atcgtgacat gggcatccag cacatttagt gcatcaatgt ctggcataca 790500
 gatgagtgtg tgittggaca ttcatgggat ctgctagcag tgtttgcaat gtgatcaggt 790560
 atgtatttgg tactctgagg tactggggac agaatgaaca ctgggatggg agaaggagct 790620
 gcttggtag gggccaggtg gcacataacc agggcaaatg catgactcca catctcctgg 790680
 attttagata tgcacctga cttgcctgga aagtctgagc cacccttctc tgggggtggg 790740
 aagctataac tgcagggtg gcttcatttc tcaatgagtt aaggtaata atcaggcttg 790800
 ggtagtaca ccattgacac cattgtgtgt attctataca cctgccact aagcacagga 790860

 atgagcccat tgcgatact tcagccagat cctgtgatac tagtcagctt tctttctgcc 790920
 ttaacttcca acttctggag tcactttgtg ctgttaaaaa acaaaacaag gtctggggtg 790980
 tagctcattg taaagcctcc aaggacaaag ggttcaacc cagcactgaa agcacacaaa 791040
 tgaaaaacag gcatggtggc tcacacctgt aatgccagca cttacaagcc tggggcagaa 791100
 ggattgcat gagtctaag ccatgggact acatagttag gtgcaggcca gcctgagcca 791160
 tagtatgaaa ctctgtctaa aaacaaaaca acaaaaaaaa cctacaaaga ctacagagaa 791220
 agaaaaggca ggataaacc ttgtgtttct tcacacacaa gatagaaaca aaaagacct 791280

 ttttaataaa gcttttgcaa tatactgtt taatagaatc aaaactaagt ttgcaaatga 791340
 aaattagtag tttatttgc tttatatata tttatgtagt aaaatctaag ctttttggca 791400
 tgtttatgga ataatcttc tgataattga tattatttac ttctctaaat gagccattaa 791460
 aaaaaccctt taatttggga tttacagtgt tctaccttt gctcaaacca gctgctcttt 791520
 ttcttgcct cccctacca gtcacctg aaggacctct gctacacctg aacctctgcc 791580
 tgagaggatg tgacattgcc aaatccatac acagagatgt ggttggagt cccacaccaa 791640
 ttcttctctc caaaagagag aactattag gaggtatggt tgtgttgag gaagtaggtc 791700

attgtggaga caggctttga ggtagcatgt atgctaaagt catgcccagt gtctcagatt 791760
 acttctgtg gcctgtgagt caagatgtaa gaactctcag ctcttctctt ggcactgtgt 791820
 ctgcctgtgt gccaccatgc cacaccatga aaataatgga ctaagcctct gaaactgtaa 791880
 gccaccacaa ttaaatgtta tcctttgtag gagtagccat ggtcattctg tctcttcaca 791940
 gcaatagaaa ccctaactag aacaaaagt ggtaccaggg actagggcac tgttgtgata 792000
 gacctgacca ttttgtttta aagaaatag gaccttgggg ctgttgatta gaaaagccgt 792060
 caaacatttc aagagctgct taatgggcca tactagtagg aacatggaag acagtgggtgc 792120

 tgagtgcgat ttgaactgtg ggggtgccta gctcaaaaat tttcacagaa gaatttttaa 792180
 catgttgcta tagatcattc ttgtttatt ttgatgaaga aggtggctgt atttttgctc 792240
 ttgtccaaaa tgctgcttg agaagagatt taggttaatc ccatggcaa aggaaatctc 792300
 aaaacagcct agtatatata tactttgtca tgtggctatt agtggttaact ctaatgaaga 792360
 ttcataatga caggagaaaa gaaaatgcaa aacttgagga gaaaaggaaa atcaggaagt 792420
 ggaatggaat taacgtctgt gttcagggat ataaacatta agaaatgga taaagggggg 792480
 tgggtgcctc agggcaagat cccaccagc caagttcca attttgaaa aggaactaaa 792540

 taaaagctta gagctgtagt gtgtgggtgc acacacctta atcccagaac tctagaggca 792600
 aatctctgag ttcgaggcca gcctggctca cacagcaagt tccagaacag ccaagtttag 792660
 gcagtgaagg ttatcattga aaacagaaaag ctggtgaaga tgtaattaaa caaggggggt 792720
 gggatgttcc cagcaccccc aagcagcaga acttggcagc tttggccatg tggttctgta 792780
 tttaaagtta agtacagaat aaagaggtta gggaatattt ctccgcagct agggaaaagc 792840
 actgaagaaa gacatgtgtc aggggtgtcc ctgaatagag gccttctaga gaggccattg 792900
 cctgaagctg tgaagttgaa gcctggattg ccttgagac tccaagatgt tagagatgcc 792960

 agagtctgg gatgcctgtg aggagagctg ctaacaggga gtagaaccag cccaagagag 793020
 ggaagtgtgt tgcaatcacc aggagctggg gaatctgaag agcacttgat gtcagacatg 793080
 gagacacagt gtggagtttg cccagctggt ttacagctt gctttgttcc agtattccct 793140
 cactatgctc ctttccctat gttttggaat ggtaatgtat atcctgtgcc attatatgct 793200
 ggcagtatgt gatctacttt ttgagatttt gattttacag aggattacag ttaagagagt 793260
 tagagaatct caaaagagac tttcaatttt agacttttag atacgtttga gactgttata 793320
 gactatgggg acttttgaag ttagaaagaa tgcatttttg cattatgata tggctacaac 793380

 aagcctttgg gggccaggga gtggaatgtg gtggtttgaa agaaatgcc cccaaaggag 793440
 tgtcacaact aggaggtgtg gctttgttgg agtaggtgtg cccttgttgg aggaagtgtg 793500
 tcactgtgga ggtgggcttt gaggtctcat atgtgctcaa gccacacca gtgacacaga 793560

ccaattcctg ttgcctgtga gtcaatatgt aagaactctt agttccctcc ccagtgtcat 793620
 gtctgctgc atgctgccat ttttctcact atgaagataa tggactaac ctctgaacta 793680
 taaacctgct caattaaatg tttttcttta taagagtgc catggccatg gtgtctcttc 793740
 ccagcaatag aaaccctaaa taaggcaaca accttcattt ctcagtgtct cctgatctca 793800

atgtgaccac ccacataaga ttcccattgt cacctcttcc tgtcaattgc atgctcaact 793860
 aaccctttct tcgctcatgg cagctatctg gtcataacag caaatcctga tatgtgcagt 793920
 cacagatgtt taaatggcat gtgtattatg ctagtatttt tgagtataaa ggaaaatc 793980
 tgtgagagga ttcttagaag tgaagtgtc ctgctcaagc tggggacaag tcacccaat 794040
 tttctgaaat tggacagtgt thtagacatt gacggttctt tattcactgc atggactttc 794100
 acaagtcatt cctattttgg tgatgggtgt ctagagtgga ggaagatttc aggctatgac 794160
 cagcctaca gagacactcc tgatgcttcc tcccccaaa ccataagtcc taacaaacc 794220

tctttcctta aactgatttt gtaacagcaa caagaaaatg aatcagcaga aacacccttt 794280
 gtatgggtag gaaactgac gtgttgctat atacatttgt ctaaacaaaa atgttctagg 794340
 gttcatagge agttggtagt tgggtgggga gaggggagta tgttcttcgt tggtaggcaa 794400
 ggcactggct agttgtcttc cctctataa acccttactc ctgtaagaaa caacacagaa 794460
 ttcatggtc acacaagcat gcacacagac acagacagac agacacagac acagacagac 794520
 agacacagac acacacacac acacacacac acacacacac acaccacaca taccccacac 794580
 tacactacac gagacacgaa agtaaaagga gacctgacta gttgggagta aaggcaagca 794640

agcatagcca tacacattat atacatgtgc aaaaactct cagtgaacc cattgtcctg 794700
 tataattaat atatgctaata aaaaacattg aaaatattct agtaattaaa actcttgcca 794760
 gtgaagtcag ctccctttgg gcatgaagag ccttgatctg ctcatagatt tgtataaaaa 794820
 ggttgaatca cagggtcagc agtattgcca aagcctgtct gcattgagaa ttgaactgga 794880
 ggaggcagct gcttgaagac tccatggtaa taagaaattt ttattacaaa cccatttat 794940
 gctgaaaacc acagttttct tataggtcaa caccagtggg gaatgatgca cggtaataga 795000
 aaatacctgg attccctgca ggcatcttca gcctcttttc ttcctcgagg ttggtctgctg 795060

agggaaatta cacctttctc ttccttccac tttggatcag gtgtgaacaa gatttcagaa 795120
 aataacagga aggggtcacc tgggctggtc ctgcgtggtt ccctggggat gagtgtggct 795180
 tactccatcc aagccttatg tgtaaggaaa gtgccttccc tgttggtag ttctatgaca 795240
 ccgagataaa tatggtagtc tgcagagcag ttgtggaggt aggctgcgaa gaagcaccac 795300
 tctgcgtggg cgactccagc acacggtagg ttgggaagac gatattgcta tacagctgta 795360
 gctttccaag ctattcttgt gtctttcttc tccccagggc tcaaatagct gtgggttatt 795420

tgtcctttga gatatatgaa gatgaaaacg agatgcataa aatgtgaatc aggccttgtg 795480

 ggggtggcgc acgcctttaa tcccagtact caggaggcag aggcaggccg atctctgtga 795540
 gtttgagatc agcttggctc acaagagcta gatccaggac agcctccaaa gccacagaga 795600
 aacctacat tgaaaaacaa aataaaacaa aacaaacaaa caaaaaaaaa gtgaaccagt 795660
 gttgtctaca ctctgtgtgc aacagcatgg atctactttt ctggcttttt tgtttgtttg 795720
 tttgttttgc agatttttta aattgaatta gaaacaagat tgttttacct gacaatccca 795780
 gtcccttctt ccctccagtc cttccctcac ccctccact caattaaac cctacctatc 795840
 nnnnnnnnnn nnnnnnnnnn nnnnnnnnnn nnnnnnnnnn nnnnnnnnnn nnnnnnnnnn 795900

 nnnnnnnnnn nnnnnnnnnn nnnnnnnnnn nnnnnnnnnn nnnnnnnnnn nnnnnnnnnn 795960
 nnnnnnnnnn nnnnnnnnnn nnnnnnnnnn nnnnnnnnnn nnnnnnnnnn nnnnnnnnnn 796020
 nnnnnnnnnn nnnnnnnnnn nnnnnnnnnn nnnnnnnnnn nnnnnnnnnn nnnnnnnnnn 796080
 nnnnnnnnnn nnnnnnnnnn nnnnnnnnnn nnnnnnnnnn nnnnnnnnnn nnnnnnnnnn 796140
 nnnnnnnnnn nnnnnnnnnn nnnnnnnnnn nnnnnnnnnn nnnnnnnnnn nnnnnnnnnn 796200
 nnnnnnnnnn nnnnnnnnnn nnnnnnnnnn nnnnnnnnnn nnnnnnnnnn nnnnnnnnnn 796260
 nnnnnnnnnn nnnnnnnnnn nnnnnnnnnn nnnnnnnnnn nnnnnnnnnn nnnnnnnnnn 796320

 nnnnnnnnnn nnnnnnnnnn nnnnnnnnnn nnnnnnnnnn nnnnnnnnnn nnnnnnnnnn 796380
 nnnnnnnnnn nnnnnnnnnn nnnnnnnnnn nnnnnnnnnn nnnnnnnnnn nnnnnnnnnn 796440
 nnnnnnnnnn nnnnnnnnnn nnnnnnnnnn nnnnnnnnnn nnnnnnnnnn nnnnnnnnnn 796500
 nnnnnnnnnn nnnnnnnnnn nnnnnnnnnn nagttgtttt gatttgcatt tccctgttgg 796560
 ctaaggatgt tgaacacttt cttacgtgtc tttcagccat tttagattcc tttattgaga 796620
 acgtctattt agttctgcac cccacttttt ttattggatt gtttgggtgtt ttggagacta 796680
 gcttcttgag ttctttgat attttggaga tcagccctct gtcagatgtg gggttgggtga 796740

 atatcnnnnn nnnnnnnnnn nnnnnnnnnn nnnnnnnnnn nnnnnnnnnn nnnnnnnnnn 796800
 nnnnnnnnnn nnnnnnnnnn nnnnnnnnnn nnnnnnnnnn nnnnnnnnnn ntcaaaatcc 796860
 caaccaatt cttcacagac ctggaagaa taatttcaa ctctatatgg agaaacaaaa 796920
 gaccaggat agtcacaaca accctgtaca ataaaggaac ttctggaggc gtcaccatcc 796980
 ctgatttcaa gctctattac agacctaaag gctgaaaac agcttggat tggcacaaaa 797040
 atagacaggt agaccaatgg aatacagttg aaaaccctga tattaacctg acacttatga 797100
 atgcctgatt tttgtcaac aatccaaatt tatacagatg aacaagaga acatcttcaa 797160

caaatggtgc tggcataact ggttgcagac atgtagaaga ctgcagatag acagcctatc 797220
 gccatgcaca aaatttaagt caaaatggat caaagacctc aacataaatc cagccacact 797280
 gaacctatta gaagaaaaag tgggaaatcc ctttgaatta tctggctttg ttcttaaagt 797340
 ttgtgtaaat cagctgtgct cttaaagaga gccatacatg cttatggaaa gtgtcctttg 797400
 acattgattt agaacccttt tctgtgaact aagatcctgt ccgagcatgg gttctcatat 797460
 gaggttgtgt cacacagga acattagtgc cccttgggtgc ctgataaaca gcataggtca 797520
 cacctagttc attgtttatg gatctgtgtt tcactctcag agactccaaa gatggatgat 797580

 ggattttcag aaagctgtca cagatttaac acacacagct aactagtgt gtacctgtga 797640
 aatcacctg gtaatccctc agccctgtgc atcatactg gaacttagaa tggtagttta 797700
 ttaggtcagg ggattgccag gaaggggaca aggccacacc tccccctta cgccaagata 797760
 tcaggaggga aaatgcttc cgagtcacag cacagtaagc atgagactgc tgtctgctct 797820
 tttactaaa aatagttgca gtttcattta agaagtcaca ctgctattag gcttggttat 797880
 caacttaatt atcaaagtc atctctgagt gtttgtgat gtgttttga ggattaacta 797940
 aacaggaaga cctctctgaa tatgggcaca acaccacag gttggggacc cagacagaat 798000

 gctgacacca ggaacaggtg ggctttgctc ctagacagat gagcagcctc agatgtgtga 798060
 tggctctgtg tgetcacagc tgggggttag atgaggtcaa agcatttctt cctctgcaca 798120
 gttgtgggga gcattttgtt aagtttacca ggcttgaaga agtcagagtc aggccattgt 798180
 ctatctctg gagtacatta ttgattgcag aggctgccta tctgacagtt ttgagacatg 798240
 cacctggagc ttttgaatg ctttgcata aaacaaacac tttattagat tttactccat 798300
 aggtcccagc agctgtcatg taagctgagc cactcactgg ggctctggag attagggat 798360
 ttgtgtaagc tcatacaaat ggccactgga gagaattcca caagtttctt tttccagcca 798420

 tctcagagca tacaggacac gggaagccaa gcttacaggg ctcaatga ctgtcctgga 798480
 ataccagagc tgttgcttca aagtgaatgt gccagttgct gattgtgatc tcagggaggg 798540
 aggagtggga ctggggaccg acagccgttc acaatctact gaagtcacag cgtcattcct 798600
 atggtgcagg tgcagctctc tggccatggc atcaatggac ctggagaata ggagccctag 798660
 attaggaagg aaaactttct cagcaccccc aacccaatt cttggtatat gattccatag 798720
 taaatgaggg tctaaatgct gtctattttg ttgttgtgt tgggtttttt ttttttttt 798780
 gcctcttctt gctgttcttc actattttta aatggtecat ctttaagggtt cctagtcaat 798840

 gttcagagc tgcgttgtt catagtatct catgagattc agacaattc agtgttgttc 798900
 gatgtacttt tctcatcact ggcccacat ttgaggtcct tcatggcaga ggaggtcatg 798960
 cgggtgggaat ggaaggtacc tggtcacatg gcatctgcaa gcaggaagca aagaggtgaa 799020

tgggctgctc agcttactcc tactgtcccc cttttatcag tctgggatcc catgggatgg 799080
 tgccagccac attcaggta gcctcttaag ctgggtgtgg cccctaagtg attctaagtc 799140
 cattcaggca aactatgtag aagaacaacg ataaacattt cattcaggaa ctgttgagaca 799200
 tggagtgagc tggaggaat atggaggagc tgttgatact acgcacatag tgggtcagat 799260

 tattttcttt tgcaatatgt gattgtagca aacatccttt ggaagagaga ataggtgaag 799320
 aatgataaat tigtctctcg tgtatggctg gagtgctttt cccctcact cctttcgggt 799380
 gatttaggaa cgcagtacca aagtttgttt gcgtgacctt acctccctc taatgccact 799440
 aacaaagcct cctctgcaat ttgtaataca aataaagaca tgcagatgac ataggtctat 799500
 tctttggacc accagctccg aaataacgac acatagactt tttattaatt atggaagcct 799560
 ggccttaact tcttaggctt gttcccagct agctctttaa acataagtta acctgctgac 799620
 attaactac attctgccac atggttcgtt acctctctc agtactgtag gtccaactta 799680

 ctgagagtct ggctggcgaa tctgccacct cagattcttt cctgagttc ctatctctcc 799740
 ctggaagtcc tgcctatcct ctctgccta gctattggcc atccagctct ttattaaacc 799800
 aatcagaagg ttccccatgc aggtgaggta aatggagac atgttcacac agtgtgatea 799860
 aatatccac aacatgcaga ccttgagctg ggctaaaaga acagacatca actcccctcc 799920
 cttataaga tctcagaga ggaagagtca gcaacaacac atgtgtgagg aataggtat 799980
 gaataaagt ctctccagag ctctctctt tccataatcc caacagaagt tgaactgaa 800040
 gaggaaggtg acaattaat cttttaaact gatgttacct actttaaac tattatgctt 800100

 aaaaatggtt atgataggaa cctgctaagc cagaccagg tttgaatctg ttgggtgctt 800160
 gatctcaggt actcccacac ctttttgggt ttgcattttt attataaaa actttctaca 800220
 agtaagaagc caggacaaa ttttaggtt gcatttataat ggccacggag ctctatctgg 800280
 gactccaggt gactcctctt ttcacagttc atatactatt tgtagtttgt cttttccaca 800340
 gtgctcattt gtagtaggaa atgtatttgt ttttactta gtgggccatc tcttctacca 800400
 tgcgacggcc cttgtcagtt acaagagtgt atgaacacag agcaaagaca tgcctcaat 800460
 aggtcaggtt gatatgtgtg gcaactgcaga gctgttcttc tgacttgagt ctctgctctt 800520

 ggggtgtact ttcaatacct catgtttata cagaactta aatctcaggt acagcaatgc 800580
 ctgggtttga aacagacat gatgtatgaa tataagacct ggattactct catagcatgg 800640
 taacattggt ttcagttctt cagggtcctt gttaatctat cagtgttatt tagtgaccta 800700
 gtaattttat ttctcatat agagaacct ttaattaaaa caatagactg tgctttcagt 800760
 tagactccat ataacttgt ggatcaacag ctggactgct gagagaatgc tataaaatac 800820
 ttttatagcc gggcattggt ggcacacgcc tttaatcca gcaactcagga ggcagaggca 800880

gaggcagggtg gatctctgtg agtttgaggc cagtttggtc tacagagcga gtgccaggat 800940

 aggttcctaaa gctacacaga gaaacctgt ctcaaaaaac cctttgggaa gagatggtga 801000
 cagaaggcca gagaggaagc tgagagatca tttctcaacc acacacagga aacagaaatc 801060
 aaacaggaag tggggcatgg ctctaaacc ttggaactac cccagtgttg tacttccttc 801120
 aacaaggctg aaccttctaa aggttacata acctcccaaa atagcaccag gaagaagtta 801180
 tagcaggaac tcaagcaggg cagtaacctg gaggcaggag ctgttcgaga acctgtggag 801240
 ggatgccact tactggcttg ttctcacagc ttgttcggtc ttccttctta cagtaccag 801300
 gaccaccagc ccagggttgc caccatttat aatgaatggg ttggatcctc ccatattaat 801360

 taagaaaatg ccctacagct ctgtctacag cccagtcttc atggaagcat tttctcattt 801420
 gggcttcttt cctctcagat gactcttalc ctatgtcaag ttgacataaa attaaccagc 801480
 acacatggga agatattgtg agtgaatgta cctttgttta gctataaact ttgaagcttt 801540
 taacaatgaa caaaacct agatttagaa cctgcagtg gcatcttgcc ttgtcaatga 801600
 actttagta gtggccacac ctttgggtgt ggtttcaggt gtaacgtgac cccttcaagg 801660
 gagaggagtg gcagtgggg gcacttgcct tcttgggtca ccgagagcat tgggaaggca 801720
 gactgcatct tctgaagcag acaaaacacg gcagttattt gctgttatct gtgtaagttc 801780

 tcccctaata aaacacctat ttatcattta tctgggtct ggtgaactca ttttaagcccc 801840
 accttcagag ccccatcatt gaagaagaat ttacaaaagt tactaagaat ctggatattg 801900
 tcttagccaa tactgcattc tgctctctcc ccttgagtat tgtagctgag ttgaaaaggg 801960
 ctctaaagct cagcttccag ggacctcttt atggtattct caccaatcca ggggtggggga 802020
 gacaggtttc ttgtctgtag aatcttaaag tatttttatt gggaggtatt tccagattct 802080
 taggaagact tctgatgggc ctactaactt ctgttactgc ttgttaataa gcagaatgag 802140
 gagacaagat attgtgcgag ctcttagcac tggctcagag tacactgtga gcaactcgtg 802200

 ctctcagat ttctcacatg agttttggat gcatctttc ttcaactttt cattgttttg 802260
 acttgagact cactgttgcc acagattcat aatagtacc ttaagctttg gagacagaaa 802320
 tctgatctat tctgaatatt tgtactttac aggtaaaaca aagacagacc aatgggtcaa 802380
 agtcagagtg gattcaagca tatgttaaca tgttggta ggtttacat cactgtgcag 802440
 ataccacaga tgaacaaca tgaagagg aaagccttat tttagctcac agttttggag 802500
 atttcagtga ctggttgttt gctccattg tcttggcctt gatgggagca agtgaagaa 802560
 acagaaagag acaggaagga atgatgtccc aatgtctctc tcaggacac atcccaatg 802620

acctaacttc ttttcattgg gacttcctcc tagaagtcct gccaaacttc attagcataa 802680
 gagtgaacca agcctttcaa cacacgggtc ttttaaggaac atttaaagtt caaaccataa 802740
 tacgagacac taggaaaacc acaacttaga tttaaattgc tttttaaatt gatgttttaa 802800
 tgtcaatcat agictaaatt gtttctaaag ccccataggg ttggagcttt aaaatcatac 802860
 agtgtgtata atcacatctg atgggttagg taggcattag aatgtggtac tgataatgga 802920
 aattaaattg tgaacgggcc tgtaagatgc tatagctaca tataatagat actagtgtct 802980
 gtccaattc ccaaagtcac cctcagtcca gcatttgata tggagctggg cacatggtct 803040

 aggagtttg atgttacttg ctgatttccc agtcttcaac tctgtttcct gcttttctat 803100
 ttctcattag ttcagaccac agccaagagt ttgatgatcc ctattcccaa aaggcatagc 803160
 taactataat tatcattata ttttaatgat taatgttaac tatttcagat gatggaaca 803220
 ttttgggga acaaaagtga agagcatagg tctggaagat ggctctcccc tacatttcat 803280
 tcaactgatac aactggagag gggagcttga aaagtccga acttagcca gatttgttga 803340
 aaagcaatga atgatacagt tgccataaac taatttaaaa aaaacaaaca aacctgagtt 803400
 gaaaagtaag aatgaagagt aagcttttag taatcatgct acaaaactta ctgccttgg 803460

 ttgtgagaca aagtctgct acatagccca ggctagcctc aagtctgtgg tattccctg 803520
 cctctgccat ccaagtattg aattgcaggc atcaaccact tcaccagcc aaattttgtt 803580
 ctgttttgt ttgttctgtg attagctttt gagaatgagt ctctgtaac ccagcttcc 803640
 ttcaacttg ctggggagcc aaggacaacc caccacctca cacattctgg gattataggt 803700
 tgcaactgcca cagttagctc taagtttctg cattttaatg cagagaacta agctctttta 803760
 cgcaactagac tggactccag atgtcatttg caaaaggagc tggctcctat atatggagac 803820
 ttgaataatg gatttgaat gaccttccct gccttgacta ttctctactt ccactattca 803880

 acattttctt atatgtctta cacttattga ccctaatac attctaatta aatggatcat 803940
 gatgccaag ccagaaaata aaaattggtg caaaaatcat ctccctgtct ttgtacaaga 804000
 agtgcagttt gtacaaggaa tggtttcaca ataatgctg gtgacatcct actaagtcag 804060
 tctggtttgc tgtattttga cattggaaaa ttctctgatt cggtgaaag tgtttctctt 804120
 tttccagcat tccaatgact gacagtttct attataact ggttttatct cccacagaa 804180
 gcagtaagat gttctcagtt agaaggttat caaaggagnn nnnnnnnnnn nnnnnnnnnn 804240
 nnnnnnnnnn nnnnnnnnnn nnnnnnnnnn nnnnnnnnnn nnnnnnnnnn nnnnnnnnnn 804300

 nnnnnnnnnn nnnnnnnnnn nnnnnnnnnn nnnnnnnnnn nnnnnnnnnn nnnnnnnnnn 804360
 nnnnnnnnnn nnnnnnnnnn nnnnnnnnnn nnnnnnnnnn nnnnnnnnnn nnnnnnnnnn 804420
 nnnnnnnnnn nnnnnnnnnn nnnnnnnnnn nnnnnnnnnn nnnnnnnnnn nnnnnnnnnn 804480

nnnnnnnnnn nnnnnnnnnn nnnnnnnnnn nnnnnnnnnn nnnnnnnnnn nnnnnnnnnn 804540
 nnnnnnnnnn nnnnnncttt gtatatgcta ggtaagcatt ccatcaacca agctacacce 804600
 tcagtcccat aattttttaa aaaaaatgta tttttaaatc ttctttggca atttttcctc 804660
 aaaactttca tttgtgatg tctatacttt gctgttcttt cccacgtatc agaatgcatt 804720

 gtggttaaat atgacagagt ttcttaaaag tttaaagtta ttatcatatt gttctgaaca 804780
 gtcttcttga aagaggttac acgtagggac aaagaggtgg tggcacatac cttaatccc 804840
 agcacttggg aggcagaggc gggatctctg tgagtctgag accagcctgg ttctacaaag 804900
 agaaactctg tctcagaaaa ccaaactgga aaaaagaggg ggggtaggg ggagtgtta 804960
 gggctagagt tgcatgtcta gtgtttgca gttattttat cccatgaaac attccttgt 805020
 aggtgatgag agaagctcct aagtgttagg aagcaaatga aacacacaag gccagaaag 805080
 taaccaatc ttacaaggct gacaatgctt ctgaaactta caagggtcac aaggcccctt 805140

 ctgggggta gagaagcagt aacagtcct gagcagtga tagctgagca gccaactgcc 805200
 taaaaccagt tcagcaagct ccagggatgc aattttctg agtggccag gaagtctgag 805260
 gtgtttaagt taaattagc atgtctctcc tcaaacatt taaagttga gtacttggtt 805320
 cccagctggt ggaactgta gggaaggatt aggggtgtg gccttgtggg tggaggtgtg 805380
 tcactgggga ctgattcacc ctttcccag tgtctctct ctgcctctg ctgtggttag 805440
 agattgagc actcagctgt tcttgacacc aggccatctc tcccctca tggactctaa 805500
 ccctctgaaa ctgtaagccc agctaatac tttctttgt aagtgcctt ggttgtggtg 805560

 ttttctgaa gcaatagaaa actaatggag acagggtcac acagtgcca gtgggcagct 805620
 gcagagctga cctcctcttt agcctgatgg aggacagtta attttaata tgaccctggg 805680
 ttcacagcc ttctagtct acctctagtc cccagttgc tttgtacca tcaaggagcg 805740
 gggtttgcca catggggcca tctccatag gtcagttgt gacatagcc aactcagacc 805800
 cacctctccc actcagtatt ttcaataaca ccttccctg cccattcacc taactctgc 805860
 ttgcactagc tctttccct ataaagtgat ctactcctt acaagggagc aattttctga 805920
 tttctgagat tcagcccctt ggtggtgctt tgcagttccc ataggtaaag agcaggcaga 805980

 gtaggcttct ctttctctg gatccatcac aaacagggtc tgtacctttt aaaacatggt 806040
 ctgtgtggtt tccaagaagg gctgaggcag gttgaagaat taaactggca tcaaatttgt 806100
 gcagtcctgc cgcggcgtct tcgtattttc ttctcaacct gttccaatc ttcaaagga 806160
 aaggtgtgac aaacgcagtt ggcctgggat ctgagacaga tgtttccaca gggtagtgt 806220
 catctctggt aattgtttcc tttagggtt gggaccagaa gagttagcg ggaatttagt 806280
 gtgaatgtcg aatgctctca ctaggccaac cgtgggtcac agttgactta acctccctat 806340

gagtttcctc agttaatcgt ggcaaagaag ttgaaagggc agagaaatct aaggagggat 806400

 tcaactgggct tttgccattt tgcctgtgaa aaaggaatag gaggtgcca ggagactaac 806460
 atccgagcct acttgagacc agaaatttaa aattactccc tctgccaaga aaagcaatta 806520
 catgaaagt gggtcagata tagtttcaa gctgcataat ttgaaaaaa aattcacaat 806580
 tttggaagct aagcacaat cagatcgaga atgataagaa atgttaatgt aaagaggcac 806640
 gctgttacc agggccaagt gaaatgcagt ggcgcttga ttttagctgg tatctctgtt 806700
 ttaaaaaat tatatgagat ggaaaaggca taactacct gatcatggat tcatggcttc 806760
 tctggttacc tgtgtttagc tgaattgcca tatgtctggt agacgtggca agccctgtct 806820

 tgaagaatca gcacatctcc ttggcagcag aactgtcagc aagctggga aaacctatg 806880
 atgcagaagc ccatatccac cgtgcactta gacaagagtc tctttctgaa atccctcaag 806940
 tgcttcgata gctaagtgat gtttacattc tacaactaat tatggacccc atttaacct 807000
 aacaccctg gccgggact ttattaatgc attgccatt ctgccagggt ggggtgcacac 807060
 gccacaggag ctgggtgctg tggagctggg tctgccagc ctgggtcca gctctctttg 807120
 cagacatggt ggcaactggc tttatcacag nnnnnnnnnn nnnnnnnnnn nnnnnnnnnn 807180
 nnnnnnnnnn nnnnnnnnnn nnnnnnnnnn nnnnnnnnnn nnnnnnnnnn nnnnnnnnnn 807240

 nnnnnnnnnn nnnnngtata gtggagaggg tteccacct gggcctcagc tactttaatt 807300
 gctgtattta gaggttggt gttgagccgc taatccctct tgatggcagt gatatttaatt 807360
 tggatagaat tacattcaat tattgtaagt gtagtaagga gtgctatctg cctgtactca 807420
 ttaattttta aattttttaa aatttctgag atactcaggc tggagagatg gctcagagg 807480
 taagagcacc gactgctctt tcagaggctc tagttcaat tcccagcaac cacatggtgg 807540
 ctcaacaacca tccattatga gatctggtgt tatgtagtat acataacaaa taataaaaat 807600
 cttaaaaatt ctgagatact cgaacttcaa ggtgtggacc agatgatttt tgtgcttct 807660

 catgctaatt taaaatatca taaataaac gacactctgt ggaggcgact agtagctgtt 807720
 tctgaaactt gttttttgt ttttcttt caggaacatt tgtcatggct gttttttgtt 807780
 tgtttgtttg tttgtttgag acatggtctc ttatagccca gcctgcccta ggatggtcta 807840
 ggtagctgaa gatgaccctt aaactcttg tctctctgtc taagccacca gatttctggg 807900
 atgacagata tgcgccacca taccctgaca tttgtcacgt cttaacatac ctttatgtgt 807960
 aactgcttt tctgctgtgc cataataact ttaaaaggca caaatattgt cctgctatta 808020
 agtagaatct aaatcaacac accgagtatc gaagcagaaa gacaaaaaaa tgtgaaaaaa 808080

tgagcaaac aattctttct aggaaggtaa aaataccgaa cacaggcttt gggcgcctgg 808140
 gaaaacagag caatgcattg gcttttgta aagcatggca cagcagacac tcagggtgtc 808200
 tgactgccgc tgggctagtc ttgacttcac taagaaatgt gagggaggga gaaggcatag 808260
 cacacgcaag tcacatctgt ggagtcaca caaccagct gctctggtca ctactaacta 808320
 actgggggat gtaactaaa ccaaggcttt taaaactttt cccacttggc ggcccccttc 808380
 cactcagtac cctctttgca ggtatattag ggtatttact gataatagtg ataataaaa 808440
 atatctatag ataataaatc acaagggagt ttattataaa acagttcctt ggtgtaaatg 808500

 taattaattt tatactttat tggagagaaa agcaaatttg catactataa tgaatgaat 808560
 attcaggctt gtatagcaca gtacaataca ctaatttgat acttataaac caaggaacag 808620
 tggtaagaaa atactagagc tttatctttc tgggattaaa ccattacgtc tctgtaagag 808680
 cagaaggttt ttgtgtgctc agtacaact ttgctcttca taacatgagc caagtgtttg 808740
 cattgcttgg cgttgcgtgt catgttggaa tgtgtagtgg gaagtcctca cattgtgtgt 808800
 ccagaatcaa ggctacagtg aagtcatgga tggaaatttc acatgcttta ctttggcat 808860
 tgtgaattcc gaaagctttt tggcaacatt tttatgatcc ccacattcag ctgcttgatc 808920

 ccatatgggg ttgctacca ctcttgagac acttccgtct aaaccagtgg tgatacaag 808980
 agaggccgaa actctccagt tttgatcaga ctctctcca gagaggaact ccatagagag 809040
 tggagacatc ccagctctgt cagatgacct agctttaga agagctagaa ttacaggag 809100
 ccaaagatga ctcagagcct gtgagacatc tgccttctcc aagaagctgg ctgtctagcc 809160
 aggtgctgaa gtgtaagtgt tacaggcaca aaaagtgaca gtgttacaag gacacagaga 809220
 gctgtgtgac ccagcagagc tctgaatcac agaccgtatc attaaggcaa cctgggactc 809280
 cctggctttg catgtcacac aaccatcttg tgaatcagag tccagactcc tgtgtcggtc 809340

 tgatgttcca tcttccctcc caggtcagag accgtggagg aagcagaaag ggcaactatg 809400
 tctggatgta gctcggcggg gccactcttc tgaaggtggg tgcaagcctg gactttgccc 809460
 cagccaagca cacaacaag ataagcatga caaaaccaga caatcttcag tggcccaaaa 809520
 aggttctgct tctagctctg cttcttacca gcttgtgtca actcgacaca agctagagtc 809580
 gtttggggga atgggaacct caactgagaa aatgcacacc caagagtgtc ctgtaggcaa 809640
 gcctgtgggg tgcagctcac tgtgagtagt gccaccacgc ctggggaggt gatcctgggt 809700
 tgtataggaa agcagactga gcaattcatg aggagcaagc cagtaagcag tgctcctcta 809760

 tggcttctgc ttcagttcct gcctccaggt tctgccttg attgagttcc tgaccgact 809820
 tccccagtg attgactgtc acttgggaatt tcaataaaat aaaatcttcc ctccctaggc 809880
 tgcttttggg catggtgttt tatcacagca atagaaactt taataagaca gctaacagct 809940

acagtcaaat ctaagttcag attccttatt tctgaatagc catatcctgt gtattgctag 810000
 tcctaaacag ctctcacc aaacaagttc atatgatgaa caatttagta actgtgtaga 810060
 ctgttacctt ttcacccct aaccacactg cagggtgtct caatgctgca atggattcct 810120
 atcccctgca ctgttacagg aagaatgtac cggttgtgct atgtgggagc tatgctataa 810180

 atataattca caccagacat ttggggatat gtaacgttca aaatgggggc atcggagaag 810240
 aaagcaaac ttcctcctgg tttcttaaag tggcagtgtc nnnnnnnnn cactcagtec 810300
 tttccctcag ctctggcct tccccaggca ccctctctc cttcccttc ccagactaag 810360
 cccccaaac ttcacacca ccacatttct ccaccctcc cagagccagt tcaatcatct 810420
 cttgtctctg tgggagaaac ttctagtac tggcactac catatgaggc tagaaggatg 810480
 gctcaggggt aatggttctt gtcactcaag ctgggggatc tgagttccat ctgcaaacca 810540
 cacacacaca cacacacaca cacacacaca cacacacaca gactgtcctg aaactcactc 810600

 tgtagaacag gctggcctca aactcacaga gatccgactg cctgtcttaa cctctttgct 810660
 catcactctc ttttgactct ttggggacct gccaaagcaac tcccaataa aacatggaga 810720
 ctattatta attatgaatg cccagcctta gcttaggctt gttccattag ctcttttaac 810780
 ttaatttcac ctgtttatag tcatctatgg tttgcctcag ggccttttac ctttgttcca 810840
 tttgtatgtc gtactttcct gtttctcca tgtctgtctg tctggcccct ggcactttt 810900
 tctttcttc tggagcctaa attctctc ctacttactc tccctgacag gaagtctgc 810960
 ctaaacctcc tcccttgcta ttggccttca gtttttttt aactagatca atcaggcccc 811020

 cttagacaga caagtaaaa cagaacacat ctcatatag ttaacaaat gcaacatctc 811080
 tttctgtagt taatattct ggagcagagg ggagggaat aaaagggtgt gaagacttac 811140
 ttggcagatg tggcactggg aaccactcac ccattctgt ctttttcca cacagagcaa 811200
 taggatgaga aagaggcaag ttgaaaatgt atatttattc ttactgggat cagggtgtt 811260
 ataactgagc cacactgcc catgcttgca aatgataagc ctgcagagtg ttggggaaag 811320
 catagaaagt tctgtgggtg tttgaaggag cctgtatcgg ggctccatc acaaagctgt 811380
 ctggaagaaga aacatggaac caggcctct ctggaccaca ctgattgtag gtatctttaa 811440

 ggaagggtgc atgataaagt ttacaatgga agagaaggac ctggctcatg ctgggcagtt 811500
 ggatagaaaa caaagtgatt tgatggagaa aaaaaatcc atttaagttt ggcacctgct 811560
 cctctacaat ctgatgggta gagaatgia aatTTTTTTG gaccgggaac tgctgaacta 811620
 tcattttctt ttttcagtt tatattaatt ttgagtttct tcataggtag agctggacta 811680
 gaaacattct gaattaagga agaaaactgt aagtaggcaa agctgtgggc ttaccattca 811740
 acatattcaa gccaaagtga tttagataga atttgtgcaa tagtactca atttccaggg 811800

ctgtaggaga tactaaaata cttatttata aattagagaa caacacctct caacaaagcc 811860

ctaagagaca gatttagagt attaaaatat ataaggaaca taaaatgaca aagctagata 811920

aatatttggg gatgtgtaaa tgaatggaca agctataaag tagattactc ttgctgttct 811980

caaagccatc ctttgtggaa tttgttgta ttgtatttct gaaatgggtt tgggagttca 812040

gagaataaat tctgactttt ttaaaattta aaaggttttt gttacgtgca tgtttgtgta 812100

tctatgtgtg tcatatccac tggacaaga gttacagttg gtggtgact gtccctgcg 812160

ggttctggga tctgaacttt ggtcctctgc gacctctctt aactgctgag ccatctctct 812220

agccccaag actgagttct gttgtgggat gggatgttac ttgaagatat gttatatttg 812280

tttatgttat ggaatatttg tttaatgata caaagatgtg ttgcactctt ttatgttgcg 812340

tttgttcaac tctgtaaagc cgtgttactt tctctgcta aaactccca ttgctctact 812400

aaagagctga atggccaata gctaggcagg aaaaaagata gatgggtctg ccaggcagag 812460

agattaaata agaggagaaa tctaggcttg gcagaagacg agaagaggaa gaatgagagg 812520

agaggaggac gccaggggcc agccaccag ccatacaacc aacctggag taggaaggaa 812580

ataaaggtat atagaataga gaaaggtaaa agcccagagg caaaaggtag ataggataat 812640

ttaagaaaag ctggctagaa acaagccaag ctaaggccag gcattcataa gtaagaataa 812700

gtctccatgt atttatttgg gagaggagtg gtgggcccc aaacagaaca aaagacaaaa 812760

caaaacaaaa aaccaaaaaa aaaaacaaaa accatccaac tttagttctg tttagctcga 812820

agcttcatac cagttaaaaa ttaagtcttg gttgtttgac ctgaatccag gggcttgta 812880

cttatagctt tatgactagg gcaacttaat ttagccctc atctaccctt cagttttcct 812940

actgaaaatg gggatgatgac aagcaccaac ccaccgcac tgctaagaac acttgggttt 813000

tttgagagac cctcttcttt ggaggaactg cagcctcacc cagacaattt gcttttcatt 813060

tcttagaact caggctcaga tgccttccag tcatcagaga cttgagcact gtgctcagag 813120

tcctccctg cctatgtatc tatttcacac tgagttctga ggcagtgctt ggcctcttgg 813180

tctcttgggc actcctactc tattgacctg ctccccgc ccattctctc tgtcaaaact 813240

ttcatgactt tagtcttcac atccttttat ctgcagtctg agcatctctc tagatgccct 813300

ggacccttta ctcttcaca agtttatttt tctctgagtg gaccacagta tcttttct 813360

tcattttcac ctactcagtc actgfacttc acagttcagg tctttcttc atattgtaca 813420

tactattgac atatcatggc ctgggattcc agagagtaac aacacctata ttcaattact 813480

ctagcagga aaaatatcaa taataaacta tcaggacaat ttccatgaat gatttatgcc 813540

atggtatggt gtcaggaata tggtagacac tcagagagct agtagctagc catgtacgag 813600
atgtggggag gattccagat tgtgagacca gcaaatataa aggttatgaa ggggaatctc 813660
ttgaagggtt ccagaaatag aaccaagcaa gataaagatt ggacttgggg atggaaagag 813720
agacaagagg gacaatatga gcctgtttct atctgggggt tcattttcac ctggtctttc 813780
ttcccacat tgcctgact cttttatca catgccagc atttcttagt gtgtctgcca 813840
tgctatacct tgggtcattt tgtccaattg aaggcgtca tcactgtca cccaaactct 813900
cctagaattc ccaattgtct ttaatacaaa tactcaacta atccaaaatg gaagattaat 813960

tatctacta tataatatat aattctctac aggatgcaaa acccggcttc ccatcatgat 814020
agaatgtttt gtatagtctg gtggtagcat ctgctaacat tgcaaaacaa agcacatgag 814080
gatcctctca actcccaagg cctttgttaa gtcatgcat ctcatggact ctatttttc 814140
ctgataactg ctagaagaaa gttttatact tccatacagt tataaacaga ttccaagatg 814200
gtccacggtt ctccagctt tttactctca acattatgtg acccactctt catcgtctgc 814260
aaggcctgtc ctgtttcta gtcaaaagaa catggtaaaa ccaaagggtt gtgtttctt 814320
ccacaactat ttaattggtt taccactatt tctgggagac ttctttctgc ttgctttgaa 814380

aaggcagct gctgtgggg gggaaccaag aagatgccag gaacaagcaa aactccagtc 814440
aggaacctca ggatctcagt tgaatagcga caaccaagta aattgtgcta attaatactg 814500
tcaacctgac aggatctaga ttcaactaca atcccaattg ctaagcaagc ctgtgaagga 814560
ttacctatca ctaggcaagc atgtaagat tatctaccac gaattgagga tcactacca 814620
ctattgagcc tgtaaaggat catctggact gtgttaataa agttgggaag acccactta 814680
cctgtgagtg gtgctattcc attgagtggg gtctgggct ggaaagtga agtgagtga 814740
gcaccagcat ccatctttct ctgtttcca gctgcagatg cgatgctgat cagctgcctc 814800

atggtactgc tgccatgact tcctctctac gctggctgca cttctggga gtcagaataa 814860
gccctcttc cttacgttgt ctcttgctag gtattttgtc atcacaagaa gaaaaataat 814920
tggcacacag atgttgcaac caacatgtgc atagagacat gtgctcagct gccccagtg 814980
agatcacage cccagccaat acttegactg aagctatgaa agactctaaa actgaggttc 815040
tgagtaagct gtgcttcaaa tcttcaggca tcttagcatc attttcagt cttttcca 815100
tctttgttat ttagatata gtctcattta gtccaagtta gccttgaact cactatgcca 815160
ccgaaaatga ctttgactc ttactcttc tctctctgcc tcccagtga gggaggacag 815220

gigtgcacce caatgtctat ctctttctgc agccctaaag caccaggtca tgcagccac 815280
atgccattat ttctgatgga catggtctgc cctggctcac acatcctca aagatggaat 815340
tctcctctc cctcctccc cgttgctccc cacacctgag tcagacatgt ttccctgttc 815400

ttttcttagc agaacatcga ttcctcccag cagacaccac ctccttggaa agatggagga 815460
 gtcagaggtc acactttata cacttaatta atgtttttca ttgactgggt catatttaca 815520
 tccttcctta gtacctatat agtttaattt catttcctaa aaatatttaa gtaggatttt 815580
 cccataaaac ccccagatag tgtttttggg atgagagctc ttaacatgtg taaagagtac 815640

 taatttctct gctttctgat gagtcctttt aatctttttt gtcactttt tcattcacia 815700
 atgtatggtc atctttccaa actcccaca attataaaga gtcaaagaat catgcaagat 815760
 gttggggaaa gagcccagtc atgaccaaag caattgactg gccctgtagt ctctctctct 815820
 ctctctctct ctctctctct ctctctctct ctctcacaca cacacacaca cacacacaca 815880
 cacactcaca ttcaggacat ttgaggccca cttttacagt aattctgtct ctctgtctgt 815940
 ctgtctctct gtctctctct ctctctctgt gtgtgtgtgt gtgtgtctgt ctgtctctct 816000
 gtctgtctgt ctctctgtct ctctctctct ctctgtgtgt gtgtgtgtcc ctgttcttg 816060

 aattagtac acactttgtc cctgcaccc caaatatctc cctaagtta tcttttatct 816120
 ctccagtctc caacttcccc tggggaaact tgttgagaaa gaagctaatt ttctctaatt 816180
 gagatatgca atttgaaatt ctaattctcg atgatagctt tatttcttct atagcatgtt 816240
 ggcagttgat agttatgagc agagtctctc ttttgggtca ttggtgggaa aaattcagct 816300
 ccactaagct caactttgca catctaaatc taggcacaac agtaattggg agctcctgtg 816360
 tgtaactcac aatgtttgca ggagcttggg aataagactt gcaaatgagg ccgtgagcgg 816420
 gtgcaccagt cggctgcaga ctgctgggta caagcctgag atagctattc tgattttttg 816480

 ctgcatttta cttttggct tgaatgtggc agcgtttttc ttcttagatg ctctcatttc 816540
 ccaggtcctt ttgccatcag ctgtgcagtt gtaatagact tctctgtaga tgtggcatgg 816600
 ccatcaacta gggaaaagaa aaaaaaaaaa ctctcatttg gaaaattgct ctttacatag 816660
 aataaatage ccccaaatgt ctgttatecc cagagctctg atgagtttaa aagcaaaaca 816720
 ccatgcccc gtagcttaat aatgaatgct atcatctta acaatggtaa tgaaatgat 816780
 gtcttaagta gcaactctct aattccgcaa gcatttgca atgtgtgact gtattacatg 816840
 actaccgaa tgttgtgctt tgggtcatga tgaattcct ctcttaggat aggggctcgg 816900

 agggcacttc atgttcttat gagcagcacc agcagcggag ccgcaaagag tctttgtgtt 816960
 ttccacacca gcttacgtct cttttcagca gtgcattttc tctatctagt cataaataac 817020
 cttggttcag gtgactctta agattccaag tagggagcaa ttttactgct ctgggttccc 817080
 accacacaga cacctctgtc agtcagtcgg ccattttttc accaggaac aaatcttcgc 817140
 ggcttcagat tttctggaga tgggtgaaaa gtgcttcatt tcattttcca tctcagacac 817200
 aacatccttg tggttgagtt gtagggttgc ttcccctct cacttagtga tattgtccg 817260

tcatcctcgg ccttacattg ctcttgtgtt tatcttttcc tttaaatagt gtgtgtgtgt 817320

 gtgtgctgt gtgtgtgtgt gtgtgtgtgt gtgtacatgt gtgtacatac tcgtggagac 817380
 cagatgtgga catcaggat ttttctcaat ggctctecat cttatTTTTg agacagagtt 817440
 cctcattgaa cctagagttc attgaaatcag ctggactggc tggcccatgc attccaggga 817500
 cccacctgtc tctgcttct agccctagga ttttagaact tcagacctca tgcaagcact 817560
 tccccatgc cegatacttg atgatattta tagccacttt ttttcaaaa tcttttctta 817620
 tcaaccctat catctattgg ggatctagt ccatgatag cttgataga tttcttttt 817680
 ggctatagge catatttacc actttttgtg tttctaacca gtttaacat tttttattgt 817740

 atatggaag tacttttggg aggactattt gaatttggtt atttattttt attatgttga 817800
 attcactttg gcaactttga aggttcatga cctaaggga atcttggaga ctgtttctg 817860
 tattttactg atgcaacact catctagtat gtcttttact tctgggttag ttttgattg 817920
 ttattattaa aataactctt cttagcctgg ttgtctcaaa tattctgcca gtaacaaatc 817980
 agaaatctag gacttaacag ccccaggaac ttgagacttg cttggctttt agttgctttt 818040
 aacctctgat cttaccat tttgtccat tcatgtattg atataaata atgactgttt 818100
 caaaggaaat aagaaaatag ttcattttga aggtcaacaa aatggcttag gtgtaaggc 818160

 actcactagc gtgccagtg accctgtcaa tctccagaac ccacttggca gaaagagaaa 818220
 actgactccc acaagttgac tgtcatagat gtacagtggc ttgaatgcat tcacatgac 818280
 acacacacac tgataagtaa ataaaaatg atgaaagaaa atagtttatt ttgagccaaa 818340
 tgtgagtaac tacagaacca ggaacatgga ctcacattac tgtgaatgaa tgccctacca 818400
 tcaaagaggt gacatgaact ttattgttgc agaataaaag aaagccagaa atcaatgac 818460
 caaatgcgtt gatggagaat aagaaagtga agctattgca aagtggtaa attgatgaga 818520
 ttctgtatc atattaaaac actcttagct ccagtgttgc tggagggtgg aagtctacga 818580

 agtttagcta caccttcaag aattctcct gagtcacaag aatgtcagat cagatacaga 818640
 ggttaaaata aatagcattt taaggagca agatggcctg agatggcctt ggtgggaaat 818700
 ctcagcttcc caacccccag aagcatgatg ctctgagtca cacagtcttt ggggttttaa 818760
 cagagatgca ccaataccag tcaatattta ttgtccaatc atatggacc agaactatgt 818820
 tcattatcat actcatagca tgggttgaat attccttata ctcaaatgct ccaaactgga 818880
 agtttcaaat gttcacagat gttacaatat ttatatattc ataataataa ttttatttta 818940
 ttacagtatt tatgtttcat gtataccttt atacacatgg cctaaaagtt aaagataatt 819000

ttacacagta ttttttacc caccttggct tcaattaaat ccaaccact aagtcagagg 819060
 tggaaat ttc cgctcatggg gtcgtgttaa tgctaaggag tttcaggttt tagatgggg 819120
 ttagatctga gatgtttgac cagtatttta aattagcaca aagatgcctt tcagagtaga 819180
 ggatagaaag tctagtgatt ggcctatggg caaatggcctt ctaagtggaa aagctgagga 819240
 tctgaggtgt gtgtgtgtgt gtgtgtgtgt gtgtgtgtgt gtgtgtctgt ctgtctgtct 819300
 gtctgtctgt ctgtgtctat gtctgtgcct gtgcctgtgc ctgtgtctgt gtctgtgtct 819360
 gtgtctgtgg tattggctat ggaacctaa accttgtaca ttttaggcaa gttctaactg 819420

 ctgagcccaa gcccaagact gaaatctgaa cacatatagt ctgattacaa gtccccatgt 819480
 cctatgttaa ctgtgataac tctagctttc ccaagacctt ttttgattgt tcttgggtgct 819540
 ctgttcaatt taatgatcac aatcaagaaa atgtcataaa caatgatttt gcctcgataa 819600
 gtggatattt aaataatcag aatctgaatc attctgtttt caaaaggccc taagagctgg 819660
 gcactgtcgt tgcttcacag tcaagggggg tgaagcacac tgttgtgtgg taacttcttc 819720
 aaggtcacac aggaaggggg caacaagaa aaagctgac tctgttgctc aggtccagag 819780
 gccctgacct taccctgctc catggctctc acagaaaagg ctcacattgc aatgttaggg 819840

 ttctctgcc ctctgcctca gcctcctata cctcctgagc ttgggtctta tctactctgt 819900
 ccccccttct tagactgtgt ctccagttgt tttcctaacc tagtggttga tgctagctga 819960
 tgacctagag taatgctaaa gaaatgaggg tgggggtgggc caggaggagg gttgctttgc 820020
 aatgctatta aaggagagccc tgtttcttct taagactgat taactgcagg tttgcatttc 820080
 caaatgtaat tgtctttgaa catggctgga atctggaagg gatgggtctc tcattaggct 820140
 ggcagttgtg cacagattac ttgagtttaa tgtatttata gaaggtctgt gtgtcacaca 820200
 gcccttgggg aatacttga ctatttaaaa tataaattag aaaaatagc tgatgtaatt 820260

 gtctgcctg aggaattttc ccctcaccac actgccttca tgccaatgtg aaaactccta 820320
 cttggccagt ctcccaggc agattggagt atgcaatgca agttagttag aatgcttgg 820380
 tctgaacaca aatgctttgt agtctagggc tcttcatgga atttatcacc tctgtcttct 820440
 ctctacctg ggaacatctc ttatctccta cctgctgggtg tcagtggctt tatgtgatag 820500
 tctctgcttg gacatcttca atgtttgctt gtctctaact gcaaagctct ataagtggtc 820560
 ttaacttctt tcttcttca cgtgaaaaaa gggaaggaaa aaaaagaaa agctacaaca 820620
 tctggtttga agtggatgat caataattat tttgaaatac aggggtgtgt gtgacagaaa 820680

 agactatgat taaagggaaa tcaatcctaa actgtttttt tttttaaag ggtctcacac 820740
 atgccatgtg gtgggtgctc atgcttttaa tccatctctc tacgaggcag aggaaggtgg 820800
 atctcaaatg tggtaaatga ctgatatgaa atccataaaa ttaaggtaac ttttaataga 820860

taaacgccag ccaacagcaa gccagagcgt gccaaagcag caaggcgaga cagcacccat 820920
 gtgccttgtc tgcctttaa aaacctctcc cacatcagct tgaccacacc ctgatgggcg 820980
 tggtcgggca cacctgtagt cactcctttg gaggcagatgat tatgggtgtct ccctacagat 821040
 ctttgtgagt ttgagaccag cctgggtctac agagcaagtc ctaggacagc caaggctacg 821100

 aaggagata aaccctgtcc cccaaaacaa aacaaagcaa acaaacaaac aaaaagatgg 821160
 gtcttatatg gtccaagctg actttgaatc actatgtatc actaaaaatg accttgaact 821220
 tcacatatgt gccactgccc ctagtatatg aggtgttaga gagccaaccc aggaattcat 821280
 acattctggg caaacactct accaactgag ccacatttcc agctcaagtt aggttctgga 821340
 gaaattttc tagactctgt agttttcttt ttggggagtc tggagtctga tggcaggcta 821400
 gtgattttca aaataatggc agtgggaacc tgttgagatg caagtcaaac catgattaag 821460
 tttaaacccc agaaattgcc ggtgacttca catccatttg gtgatgccta tgtagecctca 821520

 tgcccaaac caagctcadc caaaaccca tcctctcaa cttcacctcc tgctgtcaca 821580
 ctcttctca gtctgccaa ccacctggc tttctccatg ctcttcacc aagcaaggcc 821640
 tacttctgcc tcagggcctc tgcacttctt gttgttggtc tggaacagtg gttcgcaacc 821700
 ttctaatagc ttgaccctt taatacagtt cctcatgttg tggtgccca accataaaat 821760
 tattttagtt tctacttcat aactgtaatt ttctactgtt atgaatcata atgtaaatat 821820
 ctgatatgtg acctgtgaa atcattcgac cccaaagagt tgaaatctac ttttgagaac 821880
 cactgattta gaatatcgtt taagatatgt atatacttct tccccctttt attcaatgtt 821940

 accttctcaa tgatgcattt tctagctatc ttacttcaaa ctacacacac acacacacac 822000
 acacacacac acacacacac acacacannn nnnnnnnnnn nnnnnnnngg ttttatcccc 822060
 ctcaaccata ttctttctcc taaaaccatt attacttttc cataacttac gaattttctc 822120
 tactttttct tcaaagctc tttaatggcc atgttttctt tttccatctt attctctatt 822180
 gtatcccttg cctagaccag tgcttggcat gcagtcagtc agccatatta tacatttatt 822240
 gtactgatga atgaaagcca ccagttgggtg acatgccagc ctctctcgge tctctgaagg 822300
 aacatccctt geatttatgg ccttctcttt ggctgtggta gtctctcagt cacattctct 822360

 aatgagccaa gcttgactg catttaata aatgcttttt cttgtttttt gtgtctaagt 822420
 attgttacc aattttatg ttacaataat aatgtctgaa atagtgatag aaaaaaatca 822480
 ctaacatctt ggaagtggca aaaataaaca aattcaaaga aggccttaca ggcataaagc 822540
 aaaattatgt ttattctatt aaaactacaa cattaattat ttaaaatgta attcctggga 822600
 agcccacca cctaccatt atgctccagg ctcaattcta agagctggag tcacatgat 822660
 gaattagtcc ctgtcttctt agagctatgt tgttgataa ttaacaaca aacacatggt 822720

ccaggctgag ataagctgaa agttaactca gtgtgttaca cagagatgca aagtggggcc 822780

aataaaaatg gctttgcttc atcctgattt aaggtcagag agttcaaac tatttttact 822840

cttccaaggt taaagtcata agacctaaag gtctaagggt tagcttctat aggatatttg 822900

gtcttagtgc tggatatctt acctaactaa caagagactt ggtctgaggt atggttactc 822960

ttatatTTTT ggttgtgagc ctagecctta acagctgagc catctctcca gccgaggtag 823020

agttactctt aacctgcaag gccagataat gagagattta gtctaagacg tggttaccaa 823080

atgtttggag aattaaggaa gaaagtctgt ttcttcctta tatcttgata aagaagtctt 823140

ttgccatTTT cccctTTTTg gttgggggtat gtaagaatgt tgaagaataa acttggcact 823200

ttcaatattt gctggattgc cctcctgact ttatcctgtg tctctgactc ttcttagtat 823260

ctttacctgt ggtttctcaa tccacacctc cccctctcag gtacaaacca ggcaaatcgg 823320

ctagattcaa ctggagcccc tcatagatgg gttactgcat gtaaccata aatgggaaa 823380

atattttaag tattatgac aggaagaat gtgttagtca ggctttccat cagtgtgaaa 823440

aatacttgaa gaaagcatgt taaagggagg gaatttatct ttccactcac agtttaacag 823500

atctcagccc attgtctttg gtgagcctat ggtgaaacag agtgtcatag tgcaggagc 823560

aagtgggtga agccgctcac cctgcagaag aaaggaaaat atagagaaag gagtctggg 823620

ccaggtacaa cttccaagg catgctcagc caacacctc cccaatatg tccttccttt 823680

cccaaaatag ttccaacagc ttgggacctt gcatacagaa gctcctgagt gacatctcaa 823740

aattaaaact ataggagaga gagtaggaag cattttagag aagtgtcca aactaagaaa 823800

gtcacataac tacaatgacc cccccctt tttttttta aaggatcagt aagtataatg 823860

tccttgagat ctgaaagtct ggtgcaatac caactcctt cattctgggt tactactgat 823920

tgtgtgaagt cagcacaaaa gttcaagcag atctcatccat cttcagtgt gaagcaagga 823980

acagctgtgg aaatttgaat ctctgtcta ccaaacagat gagtttggtg ctttcgaat 824040

gcagtctaga acttgcttca gaatcacctg ggagcttct gaaatgcaa ttcttggccc 824100

tcacttcaga actcctgagt cagatatttt caggacagac ctcaaaattt gcatttaaac 824160

agctttccaa gaggtccca tgcaaagatg gttgaggtgt gtgctgaatg gttttatgtc 824220

aagttgatac gagctaaaat catgagagga gggagtctgt ttcttcaatt aagaaatacc 824280

tcctatggacc ctgagaaaaa catgtatttc tgggaagggg aaacagataa aatttcctga 824340

gttaaaaaaa aaaaagattt cctgagtaaa ttgggagggg gaaggaaggg taaaggggag 824400

aagtcagggg aacatgagga aacggttag ttgggacaga gagggagatc aaggaaagag 824460

ataatctagg tagagggagc cattataggg ttagagagaa acctggtgcc agggaaactc 824520
 ctaggaactc acaagatga cccagctaa gactccaagc aatagcagag aaggtgcctg 824580
 aactggcctt ccctgtaat cactggtgac taccttaatt gtcatcatag aaccttcacc 824640
 cagtaactga tggaagcaga tgcagagtgc cacagctaag cactgggcag agctctggga 824700
 gtccagtgga agagagggag gagggattac atgagcaagg gaggtcaaaa tcatgatgag 824760
 gaaaccagag acagctgacc caagctagtg ggagctcatg gtctctggac tgacatctgg 824820
 ggaacctgca taggacaaa ctaggccctc tgaatgtggg tgacagttct gtgacttggg 824880

 cagtctgtag ggccttggc agtgaacca ggatttatcc ctggagcata actggctttt 824940
 tggaacccat tcctatgga gggatacctt gctcaacttc catacagggg gtgggagggg 825000
 ctgtgtctg ccctaactg atataccaga ctttgtgat tccccatggg aggccttacc 825060
 cttttgagg tgtggatagg gcactgggtg ggggaagata gagaggggag gggatgggag 825120
 gaggggaggg aggggaaact gtggttggta tgtaaattga aaaaaatctt taaaagaaaa 825180
 gcctacataa gactgggctg caggcaagcc ttagagcat tttcttaact agtgattgat 825240
 gtgggagggg ccaacctatt gtgggtggta ctatccctgg gctgatggtc ctaggttcta 825300

 taagaaagca ggttaggga gccagttagc agctctctc cgggcctctg catcagctcc 825360
 tgtctctagg ttctacttt gtatgagttc ctgtccttgc tgttaataa aagctgtgag 825420
 tgaaataaac ctttctcc ccaagtgtc cttggtcatg gtgtttcacc acagtaacct 825480
 taactaagac aaaagtgtg gaataaggga tctcagtatt ggggttgcct gtgctaggat 825540
 ggcaaagaag gaattctgaa gtacagagat tcaaggctgg tttagcaggg cccctcttc 825600
 cacttaagat actgctttc ttttgttct tcttttagaa atgtctgaaa tgcacaaatc 825660
 atgcaatac ctgtaccac ttagacagt aaaaaattaa aagaattaa gagattgatg 825720

 atatctgtgg gattagctgg cctataggat gacccaagc gcacactttt gcactcaca 825780
 ccacagaatg ttttgtgt taatttgggt cctttgtcat tctggaacat gataaactcc 825840
 taacaatata tggaacttg tttacattt tttcagaag agaggggcag taattttcat 825900
 aaagtattca gaagagtca agaagttta gaaccataat aaaaaaagg tggtagcta 825960
 actctgatca aatgttaac acattttgaa agccaggga attggctttc ttaccctta 826020
 gcctccccac atccaaatc tgactcagaa ttagctttgt gggtagcatt tttctttgta 826080
 tatagagtgt acicatttat gtcatagaac ctcataaata gcaattttat cctgtcagg 826140

 attgttttga cttaaatgag gtggtaggg ttacaaatc ccctggtctc cctcctcctg 826200
 acctgttate tctgaggtg acagetaacc tttgattctc cagtaccac acacacacac 826260
 acacacacac acacacacac acacacacac nnnnnnnnnn nnnnnnnnnn nnnnnnnnnn 826320

nnnnnnnnnn nnnnnnnnnn nnnnnnnnnn nnnnnnnnnn nnnnnnnnnn nnnnnnnnnn 826380
 nnnnnnnnnn nnnnnnnnnn nnnnnnnnnn nnnnnnnnnn nnnnnnnnnn nnnnnnnnnn 826440
 nnnnnnnnnn nnnnnnnnnn nnnnnnnnnn nnnnnnnnnn nnnnnnnnnn nacaaatccc 826500
 tcctttgctg tctccccatt tcacctggca tacagccaac cctgctatgg ccaaagtcta 826560

 tgaccacagg ggctctggat catctattcc ctctcttcc cctctctgt catcccttca 826620
 gctctcctct tacctaata ccatctccca cagaaccttg gtgtgggat ggctcacaac 826680
 taccatgac tctagctcca gggaatgtga tgcttcttc tgacctctgt gggtattcag 826740
 atattcacac acacacacac acacacacac acacacacac acacaccagc aacaagccat 826800
 caattctttg tgatttaaaa aattagtcat atttttcttt tgcttgagac attaattatt 826860
 tttctgttaa aacttagaga gttcccgtgc accccaaatg ttcaaatgta tgctttgaac 826920
 acatcactgg caaaaatgat gtctcttag actgcacatt ctgtatccat tctttattct 826980

 ttgctaagga aatgggcgat atctcactat gtgagcagtg gccacttacc tgaaggcagc 827040
 tgttattgcc ctgtggctt cccttgcat gattaacagt ccctacttcc ttaactttt 827100
 tcatgccatg ttgttttaag aaatcttcc ttgctggact agaaagatgg atcagaagtt 827160
 aaaggcactt gccatcaagt ctaaaaatcc gagtgtgatc cttggcactc acatagtgga 827220
 aggagagagc cggccccctc cggttgtcct ctgacctcca catgtgtcaa gggccctcac 827280
 ccccaaatat agtcacagac tgtaagtaaa tgaaaatata acagaaatct ttcctttggt 827340
 tttttgtttg tttgtatggt tgtttgtttt cattgatact gtcccaaat cgaaaccaa 827400

 tggcacactc tgaggggat ttggaagaat aaagaaagca gaattagtga tggagatgta 827460
 gctagagcat ttgactgctt agtatgtatg aggatctggg ttcaatcacc aatgctgaca 827520
 ttttacacac acataaacac acacacacac cacacacaca cacacacaca cacacacaca 827580
 cacacacgtg catgcacgcg cgcgcgcgcg cgcacacaca cacacacaca agagacagag 827640
 agagacagaa agacaggag agagagagag agagagagag agagagagag agagaagcat 827700
 tatcagctct gctctttaag atgttaatac actagccagg tggtctggtt gtacaacttt 827760
 aatcccagca ctcgaggagc agaggcaggc agatctctgg aagtccagg ccagcctggt 827820

 ctacagagta agttctagag aaacctgtc tcaataaaaa agatattaat aacttgaaa 827880
 gtaaaaaatac aagtttgacc ttacattaac taaatccca gaatcttagc cagtagggcc 827940
 actgtgaaag tcatatcaca ctacctact ggatgattga cacttgacc aaattgtcca 828000
 agtcaggcac caggccttgc atctgccact gccttttaca gctttgtgtc agctctaggt 828060
 ttcataact gtcccttctt ttaccact tttctgtcac ctgagcattc caaggcagag 828120
 gggcctatgt gtctctgagc agatggtgac aatcactggc acttccactc tgggtaaca 828180

tccaaagccc cgtgttctcc aagagctaga gagtcttgat ttccttcct gaatccagtt 828240

ccacttccag gaattcttcc ctcacctcac ctgcttctgt ttggcatca tctttctgta 828300

gtacataaca ttttctctc tggggggagg ggggaaagac ccagaacca gtgtaagcc 828360

atgagatgtt cacaccagct caccagacc ccagtgtct ctgatggtgc tctgcctcc 828420

cctgagccct aagaacacc tccatgttta gtaatctctc tccccctgga gacacagagg 828480

gcactctgct ttcggtatgc ctggtacaat tctgcccct tcatgaatag cactcaaagt 828540

aaagctttgt tatctatggt gtcacacagc tgactgacc tacagtacc acaccatgtc 828600

ttctggagcc aaagaggatg ctagaagac agaactgtct ggagaatgca tctttcttgc 828660

atggtgctct ccgctagtgt tgttacttgc aatcaaagaa tcttggcac cgcagacaac 828720

caccaaccaa ggaagagga ccagttctgt catcctccag cacagaactc tgaacatcca 828780

agctcttctt ttctctgga gtcaggatga agcagctgaa tctctcttg gactaattct 828840

cacccttct ctcacatgt tacagctctg gcctcagcag ggaaaggata atttgaaat 828900

tacttggatg tgcattgaac tgaatttatg agacaaaatt acacagtgc atctttgagg 828960

tttagttca cattgacatg tgactcttgt gattaaaaca cacacacaca cacacacaca 829020

cacacacaca cacacacag tctccgtgag aggtctgctg aagacatggc agaagccagc 829080

tgtaaggaag accgtagtgt cagccctcag ccatcacagg gacagccaga ctgaggagat 829140

gaggggtatc ccactttctc ttgtgttaca accagatgtt gtttctgttt ataattatgt 829200

ttttatttct gaccttatta gcactgcaa aaacaatcac gggactccac actgatcaag 829260

ttgtatcctt caactgtggt aggtcccagt tgcctttcaa gtttactct gcactgaaag 829320

ggtatctgtt tgatcagtg atatccacat ggcatgcca attctcaagt taattaaatgt 829380

ctgttggctt catccacca acaatcatal aaagacagaa accatggact agtgagaaaa 829440

ataggcagge atggatgtaa gactggggcg ggggggggg agcagtgtat gtttgtatgt 829500

ttacctatga gttcttaggg gctggctaca gcttcccta cacatgagga aactcagaca 829560

aatcatttgc ttccttttca gaaaacagaa aataatgacc tcattgcaa acatgttact 829620

gtgtcaatcc catgtcttta gttgcatttt cacaatgtct acttatgaac aacattagga 829680

acatagcaag catcttctat tcaacacatt ttgactagt atgtggctgg gactgagact 829740

ggttctgggg atacaacct ggaagtagca gcctgtggtc agcccagatc ctccattgtc 829800

aaggctgcct gttgctttag atgtatatta cacagccttt ccactagaac aagtagaagc 829860

caggtgtgat ggtgcatgtc tgtacttctg aagcagtggg aatgtccaaa gttttaggta 829920

gatcttgggt aactgaaca ttccaggcta gccaccacca caacaaaaga actgaaattt 829980
gtcctccatg gtgagattca agacaccaag aaggatggag cgaacctgag taaggtgcc 830040
acctgattgc aatcaactgc agaattttgt actgtaaggt tctcattcta gacctgagac 830100
ataccaggac cgatccttac attacagggt tcagttggta aactggtcg tattgcttag 830160
cactgatgga ctgattagaa ctttgtgact atggagagtt agagtgtcac agtttcagcc 830220
aaactttggt tatctttcat ctccitaata gccatccatt gcccacctct gtgtctgacc 830280
taacatcttg tgaatctcag gtaaacctt ctgggacata tgaacttaga agaccattag 830340

catttataac accgatccct gtgggcctat aaggccattt gcattcaaac caccagacta 830400
ggatatctggc ttaagggtt cttggcctta cagattgaat aaggaacacc agggaacctt 830460
agcaatctat aggcgatgaa ggaaacata attaacaagt tttgggattg actccctaac 830520
tgtaaagggc ttttaaagcc cagctttcta ttccttatta gaagtttcag gagcaacaga 830580
gaggctacct taagtgtctc ctccgataa tgagattgat gactaattca tattacatcg 830640
tatagccttc atccaacagc tgggtggaagt agaagcagac acccacagct aaacctgaa 830700
ctgaactgga atccagttgc agagaaggag gactgatgag caaaggggtc cacaccaggc 830760

tggagaacc cacagaaaca gctgacctga acaagggaca gctcttggtc cccagagtga 830820
tagctgggaa accaacaatgg gactgatcca gacccctga atgtgggtgt cagtgaggag 830880
accttggaaa tctatgggac ctctttagt ggatccatac ttatccctag cataggaatg 830940
gactttggga gccattcca catggaggga tactccctga gcctagacac aagggggttg 831000
gcctaggccc tatcccaag aataagacag actttgaaga cacctcctat ggaaggcctc 831060
accctccctt gggagcagaa agggatggg ataggtaagg tgttagttag gggggtcagg 831120
ggaggaggag agaaaaggga cttaggattg acatgtaaaa taattttctt tctaattaaa 831180

atataaaaag aagtttcagg aaaacaaact ttaaaggaat ctcaataggt aatattgtaa 831240
caacatttat gaaagcagtc agatgaaata tgataagagt aggtctatct catgaacaaa 831300
ttggggttta ttgtgatttt tttttagtag aatgaaggt gtagcaagtc cttctgtgga 831360
cctgctatac agctacagct gggcctattg tagaacaatc ttttgtaca ttgtgaatat 831420
gtgttctgt cattggtttt aaaaagagct aaataaatgg tcaatatcta ggtagaaaag 831480
gttaggtggg actttcgga atgaagagt tggggatgaa gaaggtggag tcaccaggag 831540
actggggatg gagggatggg agggagccag atccagaaca agttgaacac acaaaatgtg 831600

atagaggtaa tcaagccatg aaacagaaca caaattaata gaaagggta aatttgagtt 831660
ataagagcta gttagaacaa agcctatgct attggctgag cttttataat taataagaag 831720
tcttcatgtg gttatatttg ggaggtggtt ggtgggatag aaaagtctgc ctacatggac 831780

ccgtgttacc acigaaggca tggggatgcc catggtccgt gctgctacct gaagccatgt 831840
 tgatgtctgt gggccaggct gcctccagt atcatgttgg tgtccatggt ccatactgcc 831900
 actgaaaacc atgctgatat tcatggcatg tgttgacatc aaaggccagg tggatgtcca 831960
 tggatccatgc tgcaccaga tactatgtag aagtcgatga tctgagctct tgccaactgt 832020

 aaaagacaca gaagcttctg tgggtgtcagt aattacagac tatcagctga gaaagagga 832080
 catagaagge ttctatggca acccctggc ctccccacc ccaaaaaagt aataccctag 832140
 acaggaagcc agtgaagaga actcttaaaa ctgtgcataa ggatcctgga gtgtagctct 832200
 ccataacaga ggttactggt gaggggtgggg tggaaaagaat tcacttttct ttaaggagct 832260
 ggacacaagg agttgacca tgctccagtt acaatacaaa ttgaactctt ttttttaatc 832320
 ttttttttgg ggggggtaga aggccacaag ggggtggggg aagcagacct gggaggactg 832380
 gaaagtaagg gtgaacaggg tgcattttgt gaaattccca aacaatcaat aaaaatatta 832440

 tgatgataat aaaataataa atcttaagat aaatttatac aaagaaagag aatgaaggt 832500
 ggctgttaag tagaaagcat cagtctgtgg aataccctt gtcagattct aaccacagc 832560
 tctacataaa gtcttcctc caaaggctta tgacatgggt gacttgataa gaacttctga 832620
 ggactacagt tagtccact gttgagcggc ccattcaggg tgttcacttc aggtgctgca 832680
 aacagacatt cagattgcga tgtaggaaaa cagcaagctc agacctagaa acctcgacta 832740
 accttccct ggacttgaga gtgagcttct agtgtgttc tgtgtagtaa tctttgttt 832800
 tctcctggtt atctcacaa gctcatctat tgctgctcat gactaagcca taccctcaat 832860

 attttggttt tgcctcag aaagtcattg ttaaaatctt ccttgtgtga tgtatttate 832920
 tcagtattct tccaagtgtg ttatcagtcc ttatctactt ctaggtggtc ttattatgac 832980
 taacgtggca accggaagat cattaacaca ggaatcttt cttcaaggag ctccatcagc 833040
 atcgtgagtt gcaagcccat gatgagacag actgacceaa ggttcaatta gtctatcatt 833100
 aataaaaaac atgttggta ttaataaag aaaattgctt caaacaac aactggagtg 833160
 actgaaccag gcccctgaa catggatgtc aggagtctg ggcagtctat gggacctctg 833220
 gcagtggac cagtatttat cccgagtgca caaatggact ttgggagccc attccacata 833280

 gggagatact ctctcagct agatacatgg tggaggcct ctgtccttcc ccaaatgatg 833340
 tgacagactt tgatgatacc ccaagggagg cctcacctc catagggaga ggatggggag 833400
 tgggatgggg gattgggtgg gagttgggtgg ggggcatggg aggacagaag ggagagagaa 833460
 ctgggattgg ctgttaaaat aagtttgttt ttaatttaa taataattta taataataat 833520
 ttttaaaata gagtaaatga ctgaattgct gaaatgcttg tcatgctaga atgaccacct 833580
 gagttcatcc tcagcacca tgtgacaaag tcactagga ggcagagaca aaaggacccc 833640

tgagactctg gctagctagt cttgttctat gtnnnnnnnn nnnnnnnnnn nnnacctgat 833700

 gtcaacacac acacacacac acacacacac acacacacac acacacacac acacggaatt 833760
 aaaaaggcat ttatitttcc aagatggcct aagtgttttg tttcttttta agcaaagtgg 833820
 cctcaaatgt aaacagtgag aagaacctg agcttaagta agaagcagac agtcattcac 833880
 tcaccagga ctgtatctcc aaccacaccc acacaggcaa ctctcactg ggtccagaac 833940
 ggtgaattat tcaccgacat ccaatcacag cctaataataa gcccacagtt cacacttcag 834000
 agaggacat cttttccag tgttcatgct tcttatccag agttgtcctc tgcgcagata 834060
 aactctgctt agttttctga aacttttcat cttagtagct gtaactgcat tgcaagtacc 834120

 aataaagaca caccagcaag ggcctcctgt aacagaagag gggacggatt ttaattggtc 834180
 ctccaaggtt attcaagtaa gactggatgg agtgaggaag aggggaagga tgacagaaag 834240
 tataccatgt gtgttggtgt gaaatgggtg agaaagtgat cagagtgtga aggaaccttc 834300
 ctgaaccttg agagcctgtg ggtaaataag gcagggagtt attgcctttg gcagaggact 834360
 atagaacctt ggaacctggc aggcaagttc attattcatg tgacagtga cgggaagcat 834420
 agaaggtcct tgaacaaggg aggagctgaa gattagcagt tgtggtggtg agggggattg 834480
 gcctgaaat ttctgcttga gaagtgggca gtggagccca gagatgagc ctaagaca 834540

 taacaaaag ccaactgtctc acgatgattg attaaagaca ttctatcatt tcagcaagga 834600
 gaaatttga aataacctca aggtttctat aataacagtg ctacaattga ggtataatta 834660
 gacaggaggg aatggagcca ttaagatgta acctgaagtc ttctttgtta atagctacac 834720
 cacggggata caactgagga ttagggaatg gagccaggtt ggctcaggca agtgtgagga 834780
 gccagcttca tgttggcatg ttgaattttc ctagggtcca tgtcagagtg gaaatactgt 834840
 ttttaatttt agctgaaata taaatcaca attacatctt catttcttag aaagatctga 834900
 actggtcaat acaaggatatt attgtccttg cccttagcca ctccagttgg gagtactcga 834960

 caagaaaaca cattactgag gcactaatca gcctgtaaca tgttagtgat tcttggcatc 835020
 ttcacgtg aaagtgggag tctgcactac agatgacact agaaagcatt catagaaata 835080
 atggacagga aaatttgtg tcattcatcg ccatgccaac caagcttggg gaaacaggcg 835140
 ttggtgactt tctgaacttg tgcattttga agaacccea cagcatctta gacttgccat 835200
 tatcttttgc atcatagaac taagggtgtt tttttctgta gtaaagacca ctatcatata 835260
 tgtaactaaa tattctatgt gtatcgtctt attttccgga acaaagtaga aagcaaatct 835320
 ccagggtgtg aacaagattc agagtccttg gagagccttt ctttctctc tcatttcaa 835380

gctgctctga gaccctttcc cctcccagga aatgttcttg actatagggc tgtaccggac 835440
ccttaaagag ctacagcct ggtggggaaa tacatcaaaa agtcagctat gctgcagcct 835500
tattctcggt ttacaggaca tcaagctata cgaataaaaa ttccaggaac ctagttagca 835560
gagggagcca tatcgaagaa gtgatctttg aaccctgact tgaaagacaa ggttacaagc 835620
tcagccaaag gaagacagag catcccttgc aaataaatga caaacatggc ttgaagactg 835680
taagcgagac agataagtaa ggaaagctgt gtggttgatt ggtggtgttg gaggaggtgt 835740
ggggcagctc agccaagtca tccagccaag ataggactta agcctgctgg gcgccagtgc 835800

ctgctcttgg cctcgtcca aggctgttg gagcttghaa aagaattcac attaatgtgc 835860
cttttttagg taicttghaa atcagtaaca aatagatttc tcattttatg atggcagtgc 835920
ggccctactg tgcaaggggg cagctttgha tggcaaggag tctttgaagt tagctcagcc 835980
ggagaagaaa tggatttttc tcaagaagcc ataccttgag aagctataca atagaaaaac 836040
aaaacaggac aaaaacaggt gtaacatcac actgatgtac taaaacacaa gaaggaatt 836100
ccagtgtgtt gtaaggggac ccagatagaa aatgccagct gtttccaaag ttgattatgt 836160
gaacaagtaa cttttgattt tcactgtgta agtcagcttc taaaatttgg ggtttacttt 836220

gtgtttttac ttctccagca gaatggctat catttcagta gtagcttctg tgaaaatgac 836280
aactgtcttg tcagtaagac catgacttga agccattttg gcatctttaa tctacaggea 836340
ggatttattt gaaatattaa tctgatgttt tcacaagcaa cattttcaca tcaccacccc 836400
ttctttctct tactgagagt tgctttgaac tcactatgta gcccgggatt gccttgaact 836460
cacagaaata ctcttttct gtctcacct cctgaatgct gggattacag gcacaccac 836520
catgccagac ttctctctct ctctctctct ctctctctct ctctctctct ctcttctgt 836580
gtgtgtgtga attcacatgt atgaatacat gaaactaagc atctctctta tccaaaggaa 836640

acaaaaccaa catctgggtc atgaggacc ttataatgct agcacttgcg aggcagaagc 836700
cagaggagtc cagtgttgag gctagcctga actacatgat gagaatctat ctcaaacaaa 836760
acaaaatcag aagaatccta ttcttcacaa caatatgtat gaatgaattt ctaaaatagt 836820
atgcttagga aatagaaaga caaatactga aaaatcttac atatagaatc taaattatgt 836880
gaaataaaaa ctglagaagc agaaatttca aggagctggg gagcaaggag ggatcttagt 836940
taaagggtgc aagctcccag gtgtgaggta tgtgggttgt gtggcccctg acagcacggt 837000
gactacagct aagctgcaga tgtgatacaa tctggaagtg ggtagacctt caagtctca 837060

ccctgtgtgc ccatgtgagg catccggggg caagcgttgc agctaactca gaaatcacca 837120
tacaatgtgt acacgtatca aataatttca acattatctt cagtttatac agcttcatta 837180
gttgccatc tagaagctaa gtgagaaatc ttttgaagtg aaaatttaag agccaagctt 837240

ccttttcggg caacttgatt ggaatcttga gatgtttgct ttcccactga tcctaataca 837300
 gaagctgtcc ttgccagat cagttacaca ggactggcag gcagggctgg aagctttaga 837360
 agtctcttta agcagaaaaa ctcatctgta gtgtcacagg ccagagccat ctacgtgact 837420
 tctaagctta accgtgtctt ttcciacacc attggtcttt ctattttccc tttctcaatt 837480

 ttttaactttg ttctttatta tttcttaaaa aacgagtttg tgtgtgtagc ttatggtctt 837540
 gccacctgaa aagtttgttt taaccaagt ttgtccctcaa aactttgttt tagatctttt 837600
 gactgcaatt ctttcattta gtgatagaac gaggtattag attttttttc aaaggatttg 837660
 ccgaggttca aggttttcac acaggcatga attcacagtt ctgcagctgt ccaagcaatg 837720
 ctgcatagga gttaaactca cagggtcagc tgtgtgcatt cttggtagct acgaaaacct 837780
 tttgtatttc atttcttcat ggttagtatg agtttgatgt gaaaaataaa ttaataaatc 837840
 catgtgtagc ccttgggata atcatgtact gttttgttgt catttctaata gcgcctttca 837900

 cagaagcaaa ggtttgtcaa gcatcacagc tgcttttgac ttctgaatgt tccactttgc 837960
 catggagaga gggggaggga agaggagaga gagagagaga gagagagaga gagagagaga 838020
 gagagagagg ggtgttctcc ccacatgtgt gtgatattcc ccatcaaggg caggggaggg 838080
 agtctcacia attgcagtc cttttcaag cagcattcaa aaagttgctg aactccagct 838140
 tggcctccat aacaacttgg ctttgtgtct ctttgatag tatgaaccag attttcaaaa 838200
 atttctctct tgiagtcttg cttaggatga gtccacaagga agatggcaga tggaatgatc 838260
 tgccattcaa gaattggcag acatagtac tgatctgctg atgtgccttg ttggccagag 838320

 acagcagctg gacctaaaga cactctatgt cctccagaca gagatgtgtg catgtggctc 838380
 caggccaaat ggcaggctt ctggaggaca cattaccac caagaatgca cataggtttc 838440
 actccaacia ttcatgtgaa atccctatat atgattctgt gtgtgtgtgt gtgtgtgtgt 838500
 gtgtgtgtgt gtgtgagtgt gtgtgactca cctatgtgag tatatataga tatcaaaagt 838560
 catcttctgc tgccttatat gtgggtgcta aactcaggtc ctcatgcttg caaggctagc 838620
 aaccgactca ctgtgccatc tcaccagccc acgtcatgca ttttcaatga ccataaagtt 838680
 tcttttagtc atgtaccatg tttaaatcaa gaacctaaag agagcaatca cettgctttt 838740

 agtgatggca cagcagcaaa cacttttatg catcggctct tccagggttc tctgattatt 838800
 ctcttaagac aggtcccag aagagagact gtttaatcaa atgctaagca caattacatt 838860
 tccgttccact ttatcagaat agttgctctc atttactctt ttactggcta aggatgaaaa 838920
 gacctgattc ctcaagaact ccttgaagtt ttaaaccagg gcatctcca ctggacttca 838980
 gctttgatga actgagttgg gattttgttt ctcaagatct gttatagcca aagggcgtct 839040
 cttaaagccag ggggctgctt tgcttcaact aatcttagtc acacacatct caactctttg 839100

ggccaggaat gaaagttcca atttcctgc ttcctccag gtgtctctct tgggaatc 839160

tctgagactt caaaaaagg gtcaaggta ggaagtccta gaagcagctg agaaaacgtg 839220

ctgaaccage ttgcttgagg aacctgctga agccttcacc ttgcgctcaa ctccagagcg 839280

cctgtagatc tctgtcagca agctcctctc tgctgagaa aggataggct tcacaagttc 839340

tctacgcgtc cacagcctc acgtgaact catgagtca cttgaaacac ctttcatagg 839400

gagctaaaga aaaagctggg gtgtgtgggg ggggcgtgag ttagcggctc agctgatcca 839460

cacacattta tattttcatc ctgtttaaa gggttctctc actatgcagg ctttgagggg 839520

gtcccagtat gacaaagtc atttcaatta cagatcgaata ataaccatta aatcatatc 839580

cctgccaagc ttcattttc taatgtaaat cactccct cttttaaaa gacagctggg 839640

aaactcatct tctccaagg agagcaggta aaatggcttc agtccacagc caatgactcc 839700

gtctacccta ggttcttggc tcagtaagg agactacctc cttttataa caggatattc 839760

acatacatgg gaacctcatg tgggcggcaa ccaaactca tttctctact acatttcca 839820

gaatcctctt tgactcctag tctgtctaa ctgctgtct cattggcaa acaatatttt 839880

atttaacaat caataagata aacatacaca gtacattccc catcacatgt gettcaggag 839940

tctttgtaaa tgaagtttat ctcaaaggtt tgtaagtgt ttggctctga gtgggttttg 840000

aacggtaggt gactgcctaa ttaatgaacg aattgtgtat ctaacagtgt ggttcggatg 840060

tgtgatggca tgggtgaaac tgtgtgacag tgggttggg gtgtgttctg gtgtgtggtt 840120

gggtgtgtga tggcctggtt ggggtgtgtc tgatgtggat ggggtgtgtc tgggtgtgct 840180

gggtgtgtt ctggtgtggt tgggtgtgt tctggtgtgg ttggnnnnnn nnnnnnnnn 840240

nnnnnnnnnn nnnnnnnnnn nnnnnnnnnn nnnnnnnnnn nnnnnnnnnn nnnnnnnnnn 840300

nnnnnnnnnn nnnnnnnnnn nnnnnnnnnn nnnnnnnnnn nnnnnnnnnn nnnnnnnnnn 840360

nnnnnnnnnn nnnnnnnnnn nnnnnnnnnn nnnnnnnnnn nnnnnnnnnn nnnnnnnnnn 840420

nnnnnnnnnn nnnnnnnnnn nnnnnnnnnn nnnnnnnnnn nnnnnnnnnn nnnnnnnnnn 840480

nnnnnnnnnn nnnnnnnnnn nnnnnnnnnn nnnnnnnnnn nnnnnnnnnn nnnnnnnnnn 840540

nnnnnnnnnn nnnnnnnnnn nnnnnnnnnn nnnnnnnnnn nnnnnnnnnn nnnnnnnnnn 840600

nnnnnnnnnn nnnnnnnnnn nnnnnnnnnn nnnnnnnnnn nnnnnnnnnn nnnnnnnnnn 840660

nnnnnnnnnn nnnnnnnnnn nnnnnnnnnn nnnnnnnnnn nnnnnnnnnn nnnnnnnnnn 840720

nnnnnnnnnn nnnnnnnnnn nnnnnnnnnn nnnnnnnnnn nnnnnnnnnn nnnnnnnnnn 840780

nnnnnnnnnn nnnnnnnnnn nnnnnnnnnn nnnnnnnnnn nnnnnnnnnn nnnnnnnnnn 840840

nnnnnnnnnn nnnnnnnnnn nnnnnnnnnn nnnnnnnnnn nnnnnnnnnn nnnnnnnnnn 840900
 nnnnnnnnnn nnnnnnnnnn nnnnnnnnnn nnnnnnnnnn nnnnnnnnnn nnnnnnnnnn 840960
 nnnnnnnnnn nnnnnnnnnn nnnnnnnnnn nnnnnnnnnn nnnnnnnnnn nnnnnnnnnn 841020
 nnnnnnnnnn nnnnnnnnnn nnnnnnnnnn nnnnnnnnnn nnnnnnnnnn nnnnnnnnnn 841080
 nnnnnnnnnn nnnnnnnnnn nnnnnnnnnn nnnnnnnnnn nnnnnnnnnn nnnnnnnnnn 841140
 nnnnnnnnnn nnnnnnnnnn nnnnnnnnnn nnnnnnnnnn nnnnnnnnnn nnnnnnnnnn 841200
 nnnnnnnngt gtgtggggtg tgttctgggtg tggttgggtg gttctgggtg ggttggggtg 841260

 tgttctgggtg tggctggagt gtgttctgggt gtggctaggg tatgtgggtg tgtggctggg 841320
 tgagtctgg tgggttggg tgtgttctgg tgggttggg gtgtgttctg gtgtggttgg 841380
 gtgtgttctg gttagatgg gtgtgttctg gtgtggttgg ggtgtgttct ggtgtggttgg 841440
 ggggtgttct tgggtgggtg ggggtgtgtg gtggcatggc tggggtgtat gaaaagtacc 841500
 tcttctact aacaaggaag cctctttctc cttagcatca cttgaaacac ttttacagtt 841560
 ttgttacaaa tttctgaggc ctagaacccc agttacctgg aagtctgtt tcttactaat 841620
 agctttctta cccagcaggc agagctgcta taagctatgg caggctgagg agagagggat 841680

 tctgttttca taaggaaga ggctctttcc tttcaggta tgggtgaca agcagctctg 841740
 gagataaagt cacatctctg tcacactgcc cttctgtcct ggatgttaac ctgtattacg 841800
 gtttgtgtcc aaggcttgtt gctcagagtt gtggggagggt ggtggcactt ttaagaggtg 841860
 agccttgtat ggtcatctgg actggaacat tcccattaga gggcatctg gactggaaca 841920
 ttcccattag agggctagtg tagcctaac ctactctgt tttcattcat gtctgtcca 841980
 tggagtgact gacttgcttc actagtgttt catgaagtgc tgcctcacta cagccccaaa 842040
 agcagtgggg caaataaatg actatggact gagacctcca acgctgtgag tcctttccac 842100

 ttgcaagtt gacttatctc aggcatttgt gatagtaaca gaaagctgac taactcaaaa 842160
 gataacaatt agtgaactt ttggggtctg gggcaggtaa cgttttaag ggaggtgtgg 842220
 tgagaagaaa atgggctaaa ggctttcgtt tcatatactt tgtgtcttag gcttagtctc 842280
 aggagagcag ttcacaatga ctagtcaata ttacttggta ctaattatat tagacacatt 842340
 tcagaaggca gcctgcttga agcctatcat tttattagca aggaaagtcc gaactctgac 842400
 atgtctctca tctgtatctt tgccagatct attcactaaa tttatctgca catactcacc 842460
 ccacatacac atagtcatc acataattaa aagtaaagta ggtcttctaa aatgcaaat 842520

 gatthtggta gagagthtgg atatcctacc tctgaaatgt ctgggaccag aagtthttha 842580
 gatctggaa catttgatg tgaactgttt gggggatggg acccccagtc tacacacaaa 842640
 acccacttat gcttcatgaa gattgtctga aggtaatttc ttttaattatt ttttggtagg 842700

tctatggtct gactgtgacc tagttagatg aggtaaactc tggaaatttc cacttagggt 842760
atcatatcag cactcagaaa gatttgaat ttggaacatt ttagatttca gatttttga 842820
ttagtgacac tcaacttctt ttaaccttga tcccatgact ttggtaatth tacttattgt 842880
aaattgttta gaaagtctta aaacatttgt gttacctgta aaaatcttca ttgctccttt 842940

actgatttaa aattttcttt ttatthtatt ttattgccac agccaagatg tccagtccaa 843000
tacaacactg aaggtaagtg acagtgagtg tagccacacag ggcatagtgc aggctctgca 843060
cgccaagat cacatactct taaggaacag caggctttga ctagctgggtg caggatcag 843120
ttgaaactac aagtgttaga gaaatgtaa actgatttac ctactctgca agagagaact 843180
gtcatagtth aggggaggat gcatccctaa gatgatgccc agggacaaaa caccaggtgg 843240
gaagcccaga gggagaagaa gaagaagcaa tcctctccc tcctcggctt ccattctcc 843300
tttagcaatg gggcttatga caggatcact ctatagagga gagatgtggt ttgcaaatca 843360

tagaccagc atcacaaaac tgaatacaga ggataaattc agtccagggg cgcagatta 843420
ataacgatcg ctccagaagt tcacatatca acgtcagaga ccatggcatg accctgagca 843480
actccaaaa agtccacaga acttcacctc tgetttgttt tactttcatg gcatgggaaa 843540
gaccatcaag ctcagggtaa cacaggttca ctctgctctg agctctgccc cacattgagg 843600
ccctgggaac tcagctctgg ggaagcctct tgacagtgc acttctacca tcttatgcca 843660
tcatagcctt tgccttatt tctccacat tctccgaatt gctgtcactt tctecacaa 843720
aagtacttta ctcttgatcc tgagagaact ccattcttag caccctgt ttaggagtc 843780

tgcttccttc cagggtacca tgagcatggt gacctacct ctctctcct cttaaacgt 843840
catgcacaca ttacaaaaca cacaggcaag tgtgcacaga cctggcaacc tcagctcaga 843900
aaccaggac ggaagcagag ttagatcca acttttctc ttgctgattc tgaagtctt 843960
gttctttgtg tctgacctga aactacaat tctttagtct tcaaacactaa gaatcaaaaa 844020
ctccacctta tatcccttca ttttaattt gcttttaaat atctgtctgt atgtgacaat 844080
caaatctctg tttaaaatgt aggatggttt atattatth ctgtatgtta taagaggaaa 844140
ctttggctca gatcctttcc taacagagag gaaagcaagt ccaaaggaaa cacagatggt 844200

tgatgaacce acctctgth cagtgtgth tccatctgag ctactthaa acattthgag 844260
attaacteta taccceaac tcccacgtc tctttctt cctctgctg gaagccatcg 844320
ggcactgth gtcttttag agatggctgg ctthcttaga agthagtthc tagthctgg 844380
aatattacc agcacattg cctctattc caattthtc ctgctththt ththtgagtg 844440
ctatgctctg agtactthg tccctcaaa accaatatgt tgagagatga ccaggtcatg 844500
aagcctgtac tccatgggc tggagtacag gcttatgaag gaggattgaa ggagcctgtt 844560

acctcaccac caccttgta gtgctcctgt agaaggtgag tgttcctgta gaaggtgagt 844620

gctcctgtag aagtgagtg ttcctataga agtgagtgc tcctgtagaa ggtgagtgct 844680

cctgtagaag gtgagtgtc ctctagaagg tgagtgtcc tatagaaggt gagtgtcct 844740

gtagcagggt ccttttgta gcacagagca agcccttca cacattgact cagctgtgcc 844800

tccatcctgg tcctctcagc ctccagaact gtgagcaata cactttagt ttttacaag 844860

caaccacact atattgtgta ttgatatecc acatgagcca aggtatgtgg caatctcttg 844920

aacatctacc tttttgttc gatgtggtga gagagacaaa catcaaaagg cctgcgctta 844980

cttactgtg tgagccttag ttgacagagc caggagaacg tagctatttg tctacagatt 845040

tcataggtgc tgcacagtgc ctgcaagcgt ttgtagctcc atgicctcc agatgcacct 845100

ctggggagtg aagtatttaa tctgctgggc cactatatct caagcttga agtagaattg 845160

gcatcaacat cagaactcct tagctagatt caattgatcc tttcttggtc cctttgttat 845220

tattggtttt caagaggagg tctctgacc agacattcct cagactcact atgtagacca 845280

agtcagcctt gaactcctga tcctctgcc tccatctccc aagtccatc attttagaca 845340

cgcaatca tgactggctc atatgtgcca gtgaaagcta gaggccaatc tagatcgat 845400

tcaccttgtt ttagagggtg agtctttcac caaaccaga gttcactgat taggctggac 845460

tgactggcca gagagcttag ggatccacct gttctttctt gccagcact ggggctagag 845520

gtgtgcccc catcaggcag acaggaaagg caagtcaata cgcaaacaga tgctggagac 845580

acagcaagca tggaattcca gcagagcaat gctatcctc cattttcca ttgacaaaa 845640

tgggtgagaa agcctgggtg atgatggcac agtcggtaaa gtctttctat gtgagtgtaa 845700

ggactccggt tgagattctc aagcataaag gcttggagtg gtggtgtgca cttgtaatac 845760

cagcactagg gaggcagaga aaggaggata ccttggatta ctggacagtc tagccaaatc 845820

agaagcgtcc tgtctcaaaa attaaaggct ggagtgatta aagaagacac ttaacattga 845880

catctgacct ccacatacac acataccccg tatattgtac acacacacac caaagggtgg 845940

gtgagattgc attattttct catcagagge tgtgattaca tgacttcata ggctatgctg 846000

catcttgtgg ctttctgttc tggttctatg agcatcagga gttccagggg aatgtattga 846060

taacaaagtc cttagaaatg tctctggcaa aataattcaa aattgacttg ggatgatgaa 846120

ggcatatgtg tagcaagctt tcttgttga ctatcttga cttgctagcc cccaaataac 846180

aacatggaga cttattaatt atgaaagctt agcctttagc ttaggcttgt cccaactagc 846240

tcttacactt taaattaacc tgcttttatt aatttatgtt ctgtcacgtg gctttgttat 846300

ctccactcca ataccatata tctgtgtctc cctagcataa actgtgtacc tagattcctt 846360
 ttctcttcc tctctctccc cagaaactct acccatctc ttctattggc cattcaacce 846420
 tttatataat caatcagaag gtgccttggc caagacatat cttcacagtg tacacagtgc 846480
 cccaggagag cgggtgctgg gtctggccag aacctgacat ctctatgatg atctggaaga 846540
 gggagccaat ggctcgttaa tagagtctga aaatgaggta aaatgattga tgggttctg 846600
 ggaaacaaag ggattagtaa agctagaggc aacttatgga aatgctcact catccttggg 846660
 tcagaaagtc accatctgaa gtcgtttaat ggaagtgatc agtccagaaa gcaccttggg 846720

taccagcaaa tgcttgaga caatgccagg aagagatggg gagctgagcc agcacaattg 846780
 gaatttctct ctggaaggat ctggcaacat ctggccaggg ttcatgagtt ttctcagct 846840
 cttgatacac atccaggac cctgaagtcc attctgttct gcctgattgc cagcttggcc 846900
 tcacacttct tgetggctga gaaagatgcc ccagatgggt ttctcatcat ttcaaaccag 846960
 tcaagtaggt gcgtttaat actttgtccc ctggaggcca ataacaaggc caaggctaaa 847020
 gacatgggtc tctctccat gcagaatgct ggagaatggt ccagctttaa ttggaagtgg 847080
 ttatgtgtaa ggataagtct ttctgccaag ccaccaagc cggctgcca cgtgggcgcc 847140

agaaacaaca cacagagtct gatattaatt acaatgctgc tggccaatga ctagggtttc 847200
 ttatctgata tctaagtctt aagtatcaac cataattggt aatctatata tttataaag 847260
 acttatctga tcaaggatgc tgggtggcatt catcctctct tgtggggatc acatggcagc 847320
 tcccagagaa gagaggagga gggagaggaa gagcatgatt tcctgcttgt tctgcttat 847380
 attctgagtc gcctgctatg tcaattctg cctgaatcac aagacttctt tttactacat 847440
 ttcccagaat ccttctcagc tcctagtccc acttatcttg cttccctatt ggccaacagt 847500
 actttgttta acaaccaata agacaaggac ttctctatc agttaagtct ttggcttcta 847560

ctgtcatcct aaccaggtg tgctctatit ttagtcttgt accaagggtg atactgcttg 847620
 ccaactacaga gtttagccgc caggcttgcg ggatggatc agtacctga gtgtttccc 847680
 tggcatctgc atgcctcct tccagtacc tttatctcc tgaagcattg ggaaagactg 847740
 aagaatttaa ggtatttaag tgtcaactag aatccagccc tgacttcaga aggccagggt 847800
 caaacatag tttctccaga cttaggagtc taactgtccc ctgaaggtg agacaaattc 847860
 cttctctct tttctctccc catatttttg ttgtttgtgt ctttctctct gttgttttaa 847920
 gatgaggctt caggtagctc agactggctt ctaaatcatt atgtaactga agctggtctt 847980

gaactcctaa cttctctgtt tttctctccc tctgagatta caggcatttg ctattttctt 848040
 ccctgtcttg actgttagct taatcaaacc ttgtaacttc tgagaggag acagaaatcg 848100
 tcttttggg tgacagtctt acctgcaatc aggaagtcac ggccagcttc tcaactgtagc 848160

atagcatcat gtatattaca ttaaaatttt taaccagaa aaagcacaat tgcttcttat 848220
 gagagcctgg agtcgactca gcaatgctat ctaactctac tgtcttgggc tattaataaa 848280
 gttgaattta tgctgattca gcatttggaa gaattatgga taacaggatg aacttgcaag 848340
 taaatggttg catgattact agattaacgg agaagaagga aagggtgggt aggatatgcc 848400

 aatgacagt gtccagcaca cgatggatag gattcactct tcagactggg gttcactggt 848460
 gtctgcgcca cactagcttg gaaagccaag aactggaga cccccacac cettttcttt 848520
 aagctccatg tacacttggg acaagataca cttccttctt gctctgtaat atggaaatat 848580
 ccactttcag tagcagtctt ctgagagcca tgcttggcca tgcccagaat ggactgtagc 848640
 ttctgacctg aactcagga atcatggaaa agattctgta gattctcaga ccttggtcag 848700
 atctgtccct tgcagacgt caactggatg cttgctcagc attcaacagc aaacagctga 848760
 cagttctgaa cctgtatcc ttcagctctg cccttcccaa cgtgcagcct ccactgctc 848820

 actggttctt tglagccaat gcatcagtgg ctgctacgat tacatttcat gtcacctca 848880
 attaacctga caggatacag cctccttac ccctccaga cactaagagg agagaagagg 848940
 cttaaagtag aaaaacagaaa gaacttttat gttcttggct cttctgcagg taaatctctc 849000
 agaaaattgc acattttatc tttccaggct ctgagctcac actgcagcag ccagatctg 849060
 gaagtacctg tcaatttacc catcagcttt cacagggtgg aaaccctgt gagactgggg 849120
 ccactcgcca tactgggat gctaatagaca gggtcacagc aaacgctgt ctttgtcct 849180
 ggtgggtacc tccatttca tcttcagat aaaaatagca cagaacttga ttgtagaaga 849240

 aataaaaagt gtgtgtgtgt gtgtgtgtgt gtgtgtgtgt gtgtgtgtgt gtgttgtgtc 849300
 tccacaggat agtgtcagag ccaaatgcct gtgaaatttt ccaaggaaag tgaacacata 849360
 gttgtgtca acctcttca gggaatccat tttcccctc tctgaaattg gactgaatac 849420
 aatgcagagg cattgcagtc tgtaccaaag ctgtggetgt tggatatttc tccatatgca 849480
 aatggagctt atgacatagt tactcacatt atctataca cacacaagca gcatttatta 849540
 cccagaaagc aacattgaca attaaactga aagttgggga agaaacctag ctactactt 849600
 aatctctttt caatgctgga atatgccaag tatattttat taaaattaat ggattatagg 849660

 ctattatttc actgttatat caatcattga aggccaaga tatacactg acaaattagc 849720
 aaatacaaat gcaccagtgt ttctgtggta tacaccitta attccagggt tcaggaagca 849780
 gaggaagggt gatctctaag ttagaggcca gcctggtcta cagagtgagt tccaggccaa 849840
 tgggagctac atagtgagac cctatctcaa agaacaaca caacacaaca aagagggaca 849900
 cccaatgtgg caattagctt tagttaccaa cttgactctg atgagtagac gtgctgacac 849960
 ttcccctagg cagggagtc tgaactatat ggaagtagag agagcaagtc aatgagcgt 850020

gcgttcatca ttcctgctt tcgactgtgg atatgataag actaattggt tgacatttct 850080

tccttgactt ccacagaatt atatctgaaa taaaccatt tcttacctag attccttttt 850140

gtcagggtat tttatcatca gagaagcaaa aaatggetct aggacaacca gttaatattg 850200

atthtcagat aaacagcaca tattgcttgg actataatta taccaaatat tactaaattt 850260

taaatthtgc tggctatata gttttattgg caatthtaca aaaacaccta ctttcaagct 850320

aggtacagtg ggetatacct gtaatcctcg tttcttggga ggctgaagtg gtaggattec 850380

ttgagcccgg gagtttgggc tcaataacat agtaataagc cattcatcag ctcaaaaaa 850440

aagaaggaga aggaggagaa gaaaagagaa attaagaaaa aaaaagaaaa gtaagaatac 850500

caagatatct acicaagaga agcatgaggg tggagagatc tgttttggtt cagtgtcaga 850560

agggtcagtc agtcttgaa tggctctaga cacatgcaca gaacctgtac accagagaag 850620

attcttcate gtttggtagc caggaacag agagccagaa agagactggg gaccaggaat 850680

tacctgcaaa gtcatctctc aggtgacctt cttccaacta aacctatctc ctaaagattc 850740

tagaacctcc caatagcacc accagctggg acccaaacct tccacatttg aacctgtgag 850800

gaacaggtca cattcaagc agaaatgctc caaatgtgta ttccttcagt cctcatctc 850860

attatggttt ccttgtttat aacctatggc tctgtagtt gatgtcacca ccctaatgtc 850920

tgccaaagtg catgttagga aaactctgag gaagccggga agtgatttgc tgcagctggt 850980

cttctgattg tcgaagtctt gggcttact gtgtctgtga tcagtatacc cctgatgttt 851040

gcttccgggt cttctttgcc acactcattt cttcatcatt ttgaagtata aatacgaaca 851100

cagggtgga ctatacaaac aattggagaa gatactggag tccgagaaag tgtggaggag 851160

ggagataggg aagtatggct gttaatattc catggcatga gtatctctag cacagt caca 851220

cccgtggtt gccacaatta gttgactgtt tcaaagtagc tggtagggag ggtttgaatg 851280

ttccaacac aacagcttga tgaatgtgc ggatgattat tttttatgac ctgatcactc 851340

tatttgtgta tigttagaca gaccacactg aaccctttg agctgtataa ttaccaggtg 851400

ccaattcaaa gaaagctgc ataaaattc catgagaagg aaaataagaa cctcaaggtg 851460

atatttaag ttiacaatat tactctggct gctttgcttt tagcaagcta gttccaggca 851520

agcgatgctc tatttaagc aggggtgagt gagcatctg aatgggaatt ttaaagggtt 851580

gtctcacctt tgttgagaaa ctttctgaaa cagagctgg aagtacatgc ctgaaatccc 851640

agcactcaag agccagagga aagagaatgc taggctgtga gttcagtgtt agcctgggct 851700

acgtaatgtg ttccagatct gccagggcta catagcaaaa aaacagcaaa acattttcta 851760

aggaatctca ttgtaagaaa ttaatatattt tagctttcca ctaacaagaa aaggaaaaat 851820
 agatTTTTga ctagtaaaag ttttatcttt ttttgatgcg gcattgctgt gtttactaag 851880
 taaccaagac aatatagaac agattcttta gattcaagtt ggccttgaga tggccaagta 851940
 ggatgatggg acatcatagc aagagcaatg ccttccagat gatgtcagga ggactggaaa 852000
 catccaggtc ctggatgaaa gggctcagtg gcttccggag tggcccctgc tccttgggtg 852060
 gctacctctg gactgtgaac cttgctgctt gctctctccc tccagtctct gtgtcactgc 852120
 ctcttgtcaa gtgctcatga tggcacagga gccttccacc tgataccac tgcttcttt 852180

 tcccatgacc aagttagctt tcatgacaca ttgaaatgc cccagagggg acagctgtta 852240
 gagtctacac attgcctgtt gctgttaggt tggtaactca cagagggctc attcagacac 852300
 accatactgt gggaaaatgc ctcaagtaagt aaagcactct tggccatggc cttcggaata 852360
 cttttcagcc agatccaatt ttaagtataa gtccatgtac gctgtgtctt cttgtcacta 852420
 ggtcaagagc tgacattcat ttgttcattt gcctcatcgt tcctagttaa ttttcatgtt 852480
 ccctcaccca ttggaaaaag cgtattgagt cacaatggca atatgcaatt ctattattat 852540
 ttctggggtc acatttgaga ttcaagacct tggagtcatt atctgctttt tttccttttc 852600

 actgggaagt ttctctcca gaaagtttta tcataTTTT taactatctt caaaaattgg 852660
 ctcaaagtgc tggtcgcat aaaaaaata ttctgtggga aatagggata gactacagct 852720
 tttgattaca gttgactgaa agtcaagaga cctggattt tgtaataaaa ttatcaccca 852780
 gagattcttt tctcctgggt taaaattgtc taccacagat agtgtccctg tagcaatagc 852840
 ttataagggg aagaactgca aggggtggtc tctatgggct ttgcattctg aggcaagggt 852900
 tccttgggtt gaaaacttcc ataactcagt ccagtaaaaa tgtctctttc ctcacttagg 852960
 aagtattagg tgaattatt gacaaactc atgtttttat aggtgaaaac tagcaaaata 853020

 tcttccattt tccactggcc aagtgattgt ttttcagtta catattttca atgcacgcat 853080
 ctgtgcatgt gcaccgtgtg tgtgcgcgcg atgggtaaac ctaaggttaa ccttggatgg 853140
 gtgtctttcc tccaaatcca tcttccacct tggatgactt ttttttttt ttacaaagtc 853200
 tctcattggt gttctggggc tgacatacca ggttatgctg gctgaccact gaggccagga 853260
 agctccatcc tctgcctcct gagcacgggt gttacaaggg tgcatgcct tgctttgctt 853320
 tttacacagg tggtagagga tcaaaactcac acccatatat gtagcagcaa gccttttctg 853380
 cctgacctat ctcccact caaatgtgcc catcttaata gcacagtttc gtgtgtgtgt 853440

 gtgtgtgtgt gtgtgtgtgt gtgtgtgtaa gcatgtaaaa aagacgacaa cacacataca 853500
 cacacacata cacacacaca cacacacacg tatgtacca cacatgatg taccagtga 853560
 gacacaaatg taatcttctg acaaaacttta gtttctcaga caaccagcta ctgtagacca 853620

attgtgtctt ctctaaaatt cagtgttaact tgtgtgatgg agtatataac cttgggtgtct 853680
 ggcttctcac ccagaaaggc ctgtttcttc atccacagca tggcagtcag cagcttgtct 853740
 tactgttaca gcttataact gtcagtttct ttaccacta acctattggg agatatttgc 853800
 actgtttcca ctggggctg attatgaaac tgccttggat aaatatttgc attcagatct 853860

 gtttgtgatg tattcatttc acatggatga atagggatgg agtgttggac cacatctaac 853920
 ttactaagaa gctgctatct ccctatatgt ttatttctat gctattctgt tcccctggca 853980
 tataatatta actttgtggg taaaaatta gaaaccattt atgatgttct gaatttaagt 854040
 atcagaagtc ttgtagcttt gccacttttt tctggctttt gtgctcttca taactctaga 854100
 atgaggggct ggagaaggag gcttagcagt tagtagtgc tggtaaagga agtgatttgg 854160
 ttcttagcac ctgtgttagc ctcttcatgg ccacctataa ctccagctcc aggggagcca 854220
 acgccctctt ggacctctgt gaggacctgc actcgtatgc atatgccac caactgcaaa 854280

 taaaatagat ctttgaata catacataat taattttaat atattttact tgcaacagtt 854340
 aggactatgt gcatgttatt ggtctgtttc ttttagtaa aatgtctttg atgggtaat 854400
 agcccaatte tgtactttac agagaaaagt gcatcttctt tttcagtttt ctgaaggagt 854460
 ttctactgtt gccactaaga ctccataaa tatttgatgg cattcattat gagaatctgc 854520
 tgtgactgga gttctctttg tagggatttt ttaattatt tcactacctt aatctattca 854580
 atttattca atctactca ttgattttta actctacctt tcatttcttt ccatctcccc 854640
 aaccagggct taatttactt gtggatttgc tgggaagggt ctgaaggaa gctgacagaa 854700

 acagtgtgat cctcactgtg gtgatttctt aagggtaggg tcaatgcagg taagagtagc 854760
 atggtacccc aagactagaa ctatacaatg gatggagggt gcgtctcaga ggtccccttc 854820
 tgcccattct ttgcctttca gaaatgttga ctacaaaagc aatcttacct cagatctata 854880
 ctctgttac acctactaga taatttcac atctcagata agaacctgga gacagcattg 854940
 aagctggctt tgctgtgct ctgcccacac agtgactgat gagagtgcta aatctctgct 855000
 gtgtccacac ttggcaagta cagctggcat gaagactaga aacaggagga tgggaagggtg 855060
 ttaggatgct tecaaccac atccccagct aaggteccca atcaagaaca tetctaccag 855120

 agtctacggg agagatgigg agattcagac accacctctt ttggcttact taaggtgatc 855180
 cttaaagtgt agcaatggcg tggactgcct tggtcagctt gtaggagttt aaaacttccc 855240
 aatcatctgg tgctactggg ttagttgtgc aggtagctcc tgcaactttg gtcaaattaa 855300
 atggtatgtt tctgactgct ttgccaattt catcatcccc acagcatcca taaaaactag 855360
 gtacagcttc cgatgattgt tctgttcaca ttggtagttc ctgtacatgt aacagtgaag 855420
 cgtgggtcac agagaacgta ggaatttgag gttcccacca ttacccata gttataagtc 855480

agctttctat gtaaccagca agtgaaggct tggatatccat gtggcaaaca gtgtcctgag 855540

 ggtctagttg cagctgaaga caaagggtgc atctatgcca ttttcattg tctatcaatc 855600
 acctgagaag ggacagattc ttggatgatg tgaanaatctt tatgaagaaa aggagtgtag 855660
 aaagaacagt actaatatct gctatcgctc atgttgtaat cactagcact gaagggcagc 855720
 actgtaatta ctgtagatgt agtttgggtg tttgtgtgtg acttaggctt cacatgaaag 855780
 gaggagttag gctaacaat gacgggggtg ctgagggtg ttagagctgc ctattctttg 855840
 agtctaggca ggiggatgaa gcagcagagt tnnnnnnnnn nnnnnnnnnn nnnnnnnnag 855900
 agagagagag agagagagag agagagagag agagagagag agaattgtgtg tgttttctca 855960

 cagtaactaa tggatgattc ttgtgtttgt tttcgttttt tgtttgagat agggtttctc 856020
 tgttagccc tgctgtcct ggaactcact ctgtagaccg tctggccttg aactgcctgt 856080
 ctctgcttct caagtgtga cattatagat ttgtaccacc actgcctggc ttactaatgg 856140
 tgattcttat aatataaaa gaaaaagta aaagttacat attttaatt tgcaaagcta 856200
 ttaactttct ttcctttat tctaaagcta tctcaaaata tctgtgtatg agggaagttt 856260
 ccaccaatc tagccctggc ttagaaacca gatcttctgt ttctagcttc agttcatgca 856320
 aaaatagaca gatlgggaac aatggcctat gggtttcca gaggttgtca caaaggattg 856380

 aaaagtggt tttcaattct ccatcttcta ttgccaactg gactcatgcc aagttctaga 856440
 aacacaagcc taccccagta aataacctgt gtcgtgctgt atgtttctg ttgtcctgtt 856500
 ctactcaaat tagtcaaagg cagatccttc cttgtgctca acattgtgga gccatacttt 856560
 ggcatccgag gagcctgtta ctatgtatgg tcaggttgac tgaggtcaaa gagactaaa 856620
 tgttagttc ccagttggta gcaatctaaa ttcttgggga atgctagtct tttctctcag 856680
 ggtgagggta aattctctg cttaaaagct tctcttctt tcttagatg acttacattt 856740
 gtaaaaacat gttcttagca gagggccaca gggctagaga atctgtcaga tgagcgatct 856800

 gaggagaaag gaagagggtc ttggaaaaaa ctcaaagcag aggaactggc atctagcagg 856860
 aagaacatac tcaaaagaga attaggctaa cagctaaaaa tgacaaaggt tcagtgaatc 856920
 acaaaaaggt cacaagtttt tcttctttt ccaatagctt tgggaaaaaa aaatacctt 856980
 taatgaaact atttggatgt cagaatttgg gttagacatt tcttcttgtt aattaaana 857040
 aggtaggata tccaataact agaaattatc atgattcttc actccaaatt atctataaaa 857100
 tgaacaatgt aagttacatc gagcgttcaa cagaacggcc actagcattc caaattatct 857160
 tgggtgaact tgtataactt tgtaagatat gcataagaac tcaaatcaga tgaagatc 857220

tgacaaggag ccattgataa agtctgaggc agcctttgag aacttacaaa gatctgatac 857280
 aaatgtctat tgtaaagcta caagccctcc aagcagaatc cagtcattgc tgacaacaga 857340
 acttataaat aattggcctt tagtcaatga aaattttgga aacctatcag agagaaaaag 857400
 gaaaaaata gaacataata tatttctaga tggctactga ggcacaattt atctgttggg 857460
 agatattagt ctgacaaggt cttaaaattt tcagttacca gggcctagat tgaaagtatt 857520
 ggctgttgtt cacaacatta attcatgtcc agcctaacca ggtgtgtcta tcctatggcc 857580
 cacgggttac atgcatccca gggtagtgat gtgtttgtag atgacaattt catgttgcag 857640

 tgtcaaaaag ttggctaccc caaaccaaag agttttgtta gagtcccat gtggttttcc 857700
 agtgatgtct gcatccatgt aagctgtgtc tgaggataag gctagaggta ctgagactgt 857760
 ggtctacaca ccctataag ctgttatctg agggtaaggc tgtacatcat gtaaacggg 857820
 tctgaacatt ggactggaag tgctaagcct atgaatttgt tacactctgt tctacacagc 857880
 attgcacgtg acttccattt gtagatacta ttggttaaaa agtgatgtgt gtgtgtgtga 857940
 gagagagaga gagacagaca gacagacaca cacagagaga gagagagaga gagaaagaga 858000
 gagaggggaga gagagagaga gggagagaga gagagagagt ctctcttaag caccttgcag 858060

 gaactaccta agtttgttct cacgtcacac acttaccaag gccatccagg taggaaaggc 858120
 aacctgaat tcagtcccgg cagttgatgg gcttcacctc tgtcttcag acagtggaag 858180
 tttcaagggt tigtaggggc tgggtggctgt gagtgtacac tgcatggcgg ttgttaaagc 858240
 accaaaatac ttcgtaaac tgaccaacgt gagcatcgat tctatctccc taaagataaa 858300
 gagttaatgc caactccagc tggaaacttc tagaaaccaa gtcaagaacc aaatgttgca 858360
 cctctgtcca tgggtccttg gtgtgggatt tccccgagg atttctgggg catgcatcct 858420
 ggggtgtggtt ttattcactt tcatccagaa acctagaaga ttctataaat gtaatacttc 858480

 ctactttttt aagctctgaa gagaagtgtg gtatatatat atatattcta ataggattaa 858540
 atagtgaatt tcacttctg cctccaggag atgctacaca gcttttctga aaccttgcct 858600
 tctatacatc tgtgaatata cccaacatg aattcatacc gtcaattaac aattaacctg 858660
 gcttgctagt ggatgcnnnn nnnnnngtgg ggcacatgga aataaactg gtggtttaag 858720
 cttatatata tataaacag cttaccacag ctatcaagtt taaaagcaga aagctacctg 858780
 caaagctgta gttccgacta taaatcagct gtatttggtta aaagttaaca tttttattgt 858840
 cttatgagac ttgtatttag catgttttac caagctcatt catagttgct tcatgattgc 858900

 ctttcattca tcattggagg taaaagacca ggtcttatct tcaaaatgcc ttcactgttt 858960
 tattagggag ttctttttaa aaggcacgtc aagaaaaatg gggcttttgt ggggtgtcagt 859020
 taaccctttt ggctcatgtg tctttcattc ttaaaaaaaa aaaataggga gggatatttg 859080

agaaacagat gacatctctg cataatgtat gtatagccca acaactaatt cccaagtgtg 859140
 tctctcccta gatattgtca aaacaaaaga caaaattaaa aggtctttat tttgtgactc 859200
 cagaatggaa accacttcag tccataaaaag gtagtatfff atgggccgag caagagagat 859260
 ggtttcacaa agaaacagaa aaataaaagc agactgacct tnnnnnnnnn ntgggaagtt 859320

 tagttatttc tcttaaccaa tttcatgaaa gattgtgtga cagctcaggg tttgtgaccg 859380
 gagctttggc accaatgact ctagtttgac ttttgtctgg tcattaggtc actgggagtg 859440
 tgcctaaga gagcactgtg gaaccttggf tgattcctta ttctctcctt gcttctcaga 859500
 acacagtaag gaggttttct ttaccatatg ttcttgcctat gatgtacat cgctcatctca 859560
 aacatggctc atcaacatct gactcagttc tctaaaactg agagccaaga tgaacctctg 859620
 attcataagc gatcattata gacagtttta ttttttacag taatacaaag atggtttaag 859680
 ttaccacaaa tgcacaaggt aaatcacagg tcagtgactt ctctttgagg aatgtcctgg 859740

 gctggccatg ctiggctcac tctcatcgat cccaatacaa aagagaccac aaacatgggg 859800
 cctgtgtcac cctctctgt cctagcattt ctctatcatt aacctaaagt tgcaaggcaa 859860
 acgtccttgt cattgttcag tttggttttc tactattttc ataggaaggg ttggtctggt 859920
 ttatctagac ctgttttga aagagaaaac ctctcttga tttggttttg cccagggcat 859980
 tttcattttc ttcaagggtt agtacaaga gccttagtct gctgtttctt ccaaccattg 860040
 agttaataca gatgtggcca aagaaagtca gctgtgaatt tgaattgca aaggaaaata 860100
 aataaataga aagctccagg ctggagagat ggctcagtg gtaagagcag ttgctgttct 860160

 ctgagaggac ctgggttcag ttcccagcgc ctctaagatg gctcacaagc agccttaacg 860220
 ccagttccta ggatccaatg ccctcttctg gccactatgg ctattgcata tacaaggatga 860280
 gtaaacatac acgtataaag caaattttaa gttttgggtt ttttttttag caagcaccia 860340
 gttttttttg ttttgtttg tttttgtttt ttgtttttt taagctcaca ggaaaaatgc 860400
 tggcattggt aatgattcct tctatttta tgctagctta ttttagcat acactcagct 860460
 ttagatffff aaaaattaag cagaaaaaaa atggagtaaa ggttagagat aaaatagcca 860520
 aggttattgc cagtgtgata taaaacatgc tggttttata gggaaaacat acctctgaag 860580

 tgaaaatttg aaatttaagc catgaaggta aatattaata tgttggaaag gaaaaaagg 860640
 gggagataat gcattgactt caaaattggg gtaaaagcag ggaagcctag tgactcatgg 860700
 gagctaaggc aggcgggcag ccatgctgic attcaaaaat agctaaatgt tctgggattg 860760
 ggaagcagac acctcagga tgcttggtaa taggttctcc attttacaat aatggggagg 860820
 gaaggaaggg aggaggcagg ggaggaggga gggagacaga gaggcattga gaagaagagg 860880
 tgaactgctt cgccatcagg ataataatcc cccgtcaaaa cttgcttttc tgagcaccta 860940

gctgtgtgcc aggccatcct caaagctcct ggctttggtc aattctctcg ctcattgcccc 861000

cacctccacc ctctagccag cccagcctc tcttatagat ccgagtgctg gagcgcagtc 861060

tggcagctat ctggccagga ggccttgctc tctgtacagc ttgccccgaa aacattggaa 861120

acagaagaga gcaattagct cctgtgcagg tgtgagactt ggaggaccaa aaattttact 861180

gcaataaggg aacagagaca aaatagaatc catatttacc tgtatgaaca cattttttta 861240

attgtgggga agacaaaagg agtcacccgt taggagcatt tatttgtgca gaaatggctt 861300

tagaaatagc tcttagtggg atttttttat ggagttttct cactttccaa gtataccgtt 861360

cacagaataa tcctaatatg gcagcttaat tctgtaaaac ttattataga aattgccttt 861420

aaaatacaga attaagatct gtcttcttac tctgttttaa aattttatta gaaatacttt 861480

tattctaattg acaccaataa catctgaagc ttgacgtgaa gtagagacag acgcagacag 861540

tacataggtg ggagagcttt atctcaggtg ctaacttttag tttgtatttg tgaagggtgt 861600

gtggattggg ctgggacgat gcctctggag ctagctaggt gttttatggg catagggaa 861660

aggacatttc tggcatgggt ttacatcact ccagatgcag ccattctgta gttgttatct 861720

gaaatctggg cagaatgtaa gcaggaaaaa taactaggtg cttccatag cacagggcat 861780

cagcagttag agtgcagcct tatcttact ttcttagagg caaatgctca tccttttaa 861840

caagtttatt tagttggcta aatccctcca tgattcattc cctcagacaa ccaaccagga 861900

aataaaatca tagcaacaca gaaaaggaaa gaatagaatt cgtgagacca accacgaggc 861960

aggactcaga aaagacacaa tattctgctc tcacttgaga taggtaaagt ttaaaatcat 862020

tttaaaaaac taccataaaa agaagtaaag aaaaaagta aatgttcaa agatcaatct 862080

aaaagacatt ttttttaatt tctttatggg ggatctgaaa ggtcacttct atctctttta 862140

attcattcac atgtggaaaa atagccaag aagtaaatg agcaacacag tgaagaaga 862200

tggcagacag ttatttccca aggggagagg ttatcttca gatataacct tcatttctca 862260

gcagcgataa actcctgiga tgggctctcc atctcttta ataacagtgt ggaaagtgg 862320

acactgagtt atggtaggaa ctgtattggg tcctttgttc cccaagccca ttaattctgg 862380

cttccccaag actgagttgg gaaattctgt gcggagagct ccctctgaag caggcctagc 862440

ctttaggtg tacaatctgg aatctttttg ctctgtggac tcagtctca gcagccttc 862500

actgttgggt gttggttgaa tgccctgcat tgaactggc taagacttgg gcatactgg 862560

atgtaattcc ttgggtctcc tatcaggaga accctccagg cccatcacag acaactcaca 862620

gaagccaggt tctctgtgca atgacacat atggtaaaat tctctctc attcaccag 862680

taaggagctt ccctcccaca ctctctacaa actcctgtca acaaactggg aaggagatt 862740
 ggagcccata ggcagacca ctctgacagg tgagctgtga tgtcaagctg caagaccag 862800
 ggatggcata gtgtggagag tgctcacctc aggcattggg gcatatccat gaggatcagt 862860
 cactcaaggt catcctagct acatattagc actgaagcca gccttaccca ttgcataga 862920
 gttactgctt tctttgcata tttggcaggc aggggtctct tgctcagttat tatggtcaca 862980
 gaagtaactc attaaccttg aaacaaggga tccgttattt taatctaaca caggaccac 863040
 aatgatgctc tctgaaactg ctaaagggtg atgttgggcc atgggaccct ctctctctct 863100

 ctgtgtgtgg ggtcattcct taattagatt atttttgtaa ttaataaaa tgtaaagtgg 863160
 tggcattaaa ttaatacatt aaagcaaagc ctgacagagt gggatacaac nnnnnnnnnn 863220
 nnnnnnnnnn nnnnnnnnnn nnnnnnnnnn nnnnnnnnnn nnnnnnnnnn nnnnnnnnnn 863280
 nnnnnnnnnn nnnnnnnnnn nnnnnnnnnn nnnnnnnnnn nnnnnnnnnn nnnnnnnnnn 863340
 nnnnnnnnnn nnnnnnnnnn nnnnnnnnnn nnnnnnnnnn nnnnnnnnnn nnnnnnnnnn 863400
 nnnnnnnnnn nnnnnnnnnn nnnnnnnnnn nnnnnnnnnn nnnnnnnnnn nnnnnnnnnn 863460
 nnnnnnnnnn nnnnnnnnnn nnnnnnnnnn nnnnnnnnnn nnnnnnnnnn nnnnnnnnnn 863520

 nnnnnnnnnn nnnnnnnnnn nnnnnnnnnn nnnnnnnnnn nnnnnnnnnn nnnnnnnnnn 863580
 nnnnnnnnnn nnnnnnnnnn nnnnnnnnnn nnnnnnnnnn nnnnnnnnnn nnnnnnnnnn 863640
 nnnnnnnnnn nnnnnnnnnn nnnnnnnnnn nnnnnnnnnn nnnnnnnnnn nnnnnnnnnn 863700
 nnnnnnnnnn gggctcagga gccagccaga gtaggcagat tggtagcagt gagaacagtc 863760
 tcagtaaca aattgtgcaa tgctgagga atgactgcta aagtcctcct gtgaccttac 863820
 atgcttatgc tcataacccc cccatacac acacacacac acacacacac acacacacac 863880
 acannnnnnn nnnnnnnnnn nnnngctgt gggatatattg tgcactgtga aatatattg 863940

 ctgtgatattg gtttaataaa gaactgaacg accaatagct aggcaggagg tataggaagg 864000
 acttctctggc agagagagaa ttgagaagaa gaagaatcta ggcgtgcaga agatgccagt 864060
 gagacactga agaggtcgga catatgggac agagtcacat ggtagaatgt agattaataa 864120
 aagcaggtta atttaagtta taagagctag tggacaagcc taatctaag gccaagcttt 864180
 cacaattaat aagaaatctc catatcgta tttttgggct ggtggttcag aaaaagtact 864240
 attacacaca cacacacaca cacacacaca cacacacaca tttttaaat catgctccat 864300
 ttgttgtttg ctagaagtgc ccacagaatc actggaaaca ttatattcct agccatggat 864360

 gattatggga aaagacacag atgaaggtca gccaatagaa gaagcacact ggggtgtgtc 864420
 aggaagagat ggacacacac aggtccctg tctccccca cagagccagg acttctctct 864480
 ctttctgtcc ctgcccactc tctatgtgac agtgtgcagg aatcattcct acccaggagg 864540

ctttggtgtc acatactctg tgtgtggctg accttcacac tctggcattc cagactggag 864600
cttacacctg caggaagag tttcttcccc tgcctcctg ggttcattgt ctgagcattt 864660
tgcaaatata atgacagaaa gactaattaa taggagaaat agcagattta attacatata 864720
ttggcatggg agtttccaaa gaaccaatgc accaaaaggc agttaaactt agcccctatg 864780

agcaacttta ttttaaggt tgtttatatt attttatatg tatgggtgct tggcctgcat 864840
glatgcatg cctgtgtacc gtgtgtgctt ggtgcccatg gaggccagaa gaggggtgtg 864900
gattgctga atctggagtt acagttggtt gtgagccacc atgtggagc tagaacttaa 864960
gcccaggctc ttaactgctg agcgacctct cctctccttg ctaagatact actttaaaac 865020
agagaaaaag aagaggctct ttgcttctgg ggaagaggga tgaggctctg gaaggaaacg 865080
tggcaagtag ggattgttta gtaaggccta ttgtgactat aacagtcctt agtctttggg 865140
gtagctcctt cttggtttgt tagaggtagc tctctttaga aatggacatg gatgccgcgc 865200

tatcagacag aaaggaggcc agagagctca ttgctttgaa cctcaaaaa tctgatggtt 865260
agagaggtgt atttgagct tctatctatg gatctccagc acatttggtg tctctagctt 865320
ctgcagaggt cagaactgat acactgtgtg tcaccttaat ccatgctaga tgtccagcat 865380
caaaactgcca gaaagagac tctgtgagc cagagcattc taggtcctct gcagggccca 865440
aggtcaaagg ccagtcttgt ctatggagaa ctctattttt ttaaaaaaat atgataatct 865500
tccaatattt accattcaat tcaaagttac aaaactatta acaccaatca cagcccatca 865560
gtaccattct ctcggatagt ggaatagaga gtcaactgag gagtttcacg agccagttac 865620

caaacatgga cataatcaaa agttaagttt taaaaataaa gttaataaaa ttaggatgga 865680
aagacaggaa attaaggaga catgggggtga gttaggttgc agcagctcac cagctgagag 865740
tcaataatc agtacagtta acagcatttg ctgtggaggt gcctgacgaa gacacaacac 865800
tccttttatg tggagatatt ttcaacaag aatgttaaa atagcaggga gccatgttta 865860
aggcttgcat gccatgacc ttgaagtatg ctcttaactc ctttcaaagc tghtaatctg 865920
caatctctg ggaatttcat gaacaaagct attaaactta tttgtagtgt tttaaaaaag 865980
tggcttaatt gcctgtaca ccctctgtga gctgcaactt taccttgaca actgtaatac 866040

tatctggagt acctcaggaa ccaccctaac tctcatttac ccaaatgaag gcaggagag 866100
agggagagag ggagagattg tgggggaggg aagagagagg tgcagaaata ctttgaacaa 866160
tghtaactca gatgtcacct acatggcctc tcgtgtgtgt gtgtgtgtgt gtgtgtgtgt 866220
gtgtgtgtgt gtgtgtgtgt gtattacgtt ttctgagtg cctcttattt tghtaatgcc 866280
cgtgtggaat gtctatgcca aaatctctta acaaaactca gctctgcttc atactgacce 866340
atcctgagat tcttttccat gttggagaat ccactttgc ccagtagact tctctgaaaa 866400

gatctcttca agctacatct gtgtctcagc ttccctctta ccctgctgct aacaacaaat 866460

gtttgaagtt ttataatfff ttaaagtcac cttattattc gtcagctcct ggtcttattt 866520
acagacggtt tctgacctgt gagcaccttg tagagtacca ccacgaggcg ctctctgtgt 866580
agggttgcca ccctcttagc acacgatgga cccgagtgag cacagtatga tcagtactat 866640
gaccaggaat ttttttcate tttgactttg agatacttct ttctgctggt caagtggta 866700
caagaactgt tgagaacatg ttacaggccg tgacaacact gggccaaatg tetgataaat 866760
tacctcaaaa tacaagttt gtatagagct catgaaccg acccaagagt ttacctaaag 866820
gatctcactc tcatacaac cttgttctgt gtgactctgg atttaatfff aagtgtaaat 866880

ttatacaatg gcatttcagt gcttctgaca ttttgtgtaa attgtggagg atgtatgaga 866940
aactaaaact agcattttga tttataagtg taagatataa atgtatgcat gtaacacttg 867000
cctcttgtga aaacagtgtt cttttctgtt gtgcataatg atttcagtgt gaggttctaag 867060
acaggggatg ttiacttcta tgtggcagca gtttcaaatg cagagactcc agtccttccc 867120
attgctggta tggggctcag ggtgttctgt cccaggtatg gttccttggg aactggaca 867180
aaaagagcct cctgactttg cctgaagctg gtcacaagac tactctagtc agagacattc 867240
aactttaagg aggaaggttt attttatctc atatfffacc aggttgcagc ttccgttcag 867300

tggatcccag ggctttggat cagtcacagt gggaagtgtg tggagggaca aaaacctca 867360
cctaattgaa gaaacaaaag agaacagaga ctaggggccg ctctctctta agggaatgcc 867420
cccatgact tcacgctct cctctagacc tgacctccta aaggctcctt cccctccaga 867480
tacagccaca cactggggaa ctaatctcac agcacagaac cgtgcagaac tgtcactgaa 867540
catggcagtg aagcaacag ccagcattta agaggtggca ggggtgtcag tctccaaatg 867600
tggagacact aaaaatgaact tgactggatt agtgtgggga gcaggggaag ccctgtatat 867660
gtgagtgagg agtgtgtatg tgtaggtgag tgtgtatggt ttgacatggg cacctcatgt 867720

taagggtccc aaagcctcag acctagggga aatgggaaag ctttccctcc ctatcggaat 867780
gtgaatggtt acacgctgtg cagaaaatga ccagcatagc tttcttcccc ccagatattt 867840
gtgggctgca ggttgcctcc cctcagagtc tgctcctaca gagattagct aaacctgtct 867900
ccttgttcag cagtatafaa tcacccaac tcttgtcagg ttgcatgcaa taacctgcc 867960
tccttgtgca acgatacccc tctctttctt tctatctatc taatctgtat ctgtctgtct 868020
atctattgca ctgagctfff atgggtcagt gttttctcca tcagagagct ctccccacct 868080
gatcccagct tttctgtgtg tcctgtgtc tgcctttttt tcattccctc actgccccat 868140

caggacaagt tcttggagct ctgccaggat gtggcagatc agccttgcca agtttccccg 868200
 gttactgcca ttaactcagc ccatctatcc tatcatgatc ctagcccagg atcttctatt 868260
 ctccagcaaa ctgaataaca caaacaacc caaacaaaa gccaccagg tgggacatat 868320
 aagagagggt cacaggtaa gactactcac tggctgctct tccaaggacc agagtttgg 868380
 ttccagcacc acatagcagc tcacaactgc ctgtaacca ggttccagg gatctgacgc 868440
 cctctctgg catttgtgg cactgtatgc atgtgatgca cagacattca cgaaggcaaa 868500
 acacatctat tcacgtaaaa tataatgaaa aaaaatacca ggttaccag tctttgggac 868560

 ttcatttctg taatctcctg ggtcttttaa gtcatacatt aatcagttt atagcctttt 868620
 cttgttaate tgccatcgac tatgtggacc cagataagag ccaaaaagt caggaggaaa 868680
 aagatatttc ctttcttcta acatgccatg gtgcagtgc cacacatgtg cttttgtcct 868740
 gtaggtgcag ggtgacagt tttgtctct aagcgatgga atattaatga taagagatgt 868800
 ttttgagact tattcctgtt tgctttgtga agctgtcgtt gcacagtctc aggaatggaa 868860
 agggaagtca gttacctcc acgtaaagtc cgtgtcatct cctgcctgca gcctctgcag 868920
 ccaccagtct aagaccagg aagaccacag ctactactgc agacatgtga catcacagac 868980

 tgttctcact tgctggcta ggtattgggc aagtccggga gcacaggtg cctgttgctg 869040
 acaggattgt ctgaagaag agataatatt caagttacta gatattaaga atagatattt 869100
 taaagtatag ttgtcagca ttttctaaa tttctgcctt tgtaacattg tactcaatct 869160
 cctgtacata acctatctga ttagggagta ttgttaggat ggaaaaatca cagtggactg 869220
 tgttcaagga aaaacaaatt attggatgat acttgttaa acacagtcag actgacttta 869280
 ttcaggataa tgggtggcagg catagaacca tggcaacaag atcttgctgt ggggaaaggg 869340
 atcaagctca acctgaata cagccaggag tcaagcagga attggcattc aggagctgtg 869400

 tgtgtgtgtg tgtgtgtgtg tgtgtgtgtg tgtgtagtgt cattggatga ggtattgcta 869460
 aaatactata tcagagtaa gaaggtgctg ttctctgaat gcaaatgta ccccatgtt 869520
 ttgaatggtg gtgctcttcc tgcagattgt gaatcctcta ggaggtggag ccatactgga 869580
 ggacgtgagc cagtgtgggg ggttggacct tctgtttgc tatcccactt ctgtttcctg 869640
 ctcatcttgg atacgaacag gatctcgaca ctttctttc acctccctca ttttctctgc 869700
 catgatgggc tgcgtctccc cacgtgtga gccattcaa gcccttctc cttttgtgg 869760
 cgtctccaca gtgttctgc acagtatcaa gaaaagtaat gtaagacccc ccccccaaa 869820

 gctcaggcct ccagggtctc agcccaggac ctcagccacc ccaatcccta ttcggagtca 869880
 aaagcttgat gcaaacgca cgaggcttta ttatagtgt ttaacgagct aacccatgt 869940
 tagctctggt ctttcacca cccgcatgg cagatggcta gcaaagacgg ctggaagcag 870000

ctgcatagag atcttatagg gcagcataag gggagagtct aggggtatgc acaggctcag 870060
gattggtgtg cccccaggct cggagggtct gcctgtgtt gattgggcaa ctggttgtta 870120
tgccccatag gccctcccag ggtggttct atgctctgca tgtcattgct gtgcacttgt 870180
ctgtaaagnn nnnnnnnnnn nnnnnnnnnn nnnnnnnnnn nnnnnnnnnn 870240

nnnnnnnnnn nnnnnnnnnn nnnnnnnnnn nnnnnnnncg aaagggggag ctggtccctt 870300
cggtaacagt tataagaagt ttctgactga actgatacac caggataaat ctgtagttgg 870360
gtagtcaggc attgctaagt gcatggtgaa tacaacctg atcaaatatt caggatcatc 870420
aaactaaag ctggatttag actggatttt gtagggctgt gcatttcac cagggtccta 870480
ggctaagctt atgaggcttc aataaggttt ggtaaagcaa agaactttg cagttaattt 870540
gaattcagtt tttatgaaa tattgacttg cctttgattt atttctagt ttcaggaatc 870600
ctgttcctaa gaagtgtgtg aatgactctg cctgagcctc agaggcactt ctggaattat 870660

ttgttttaca ccggctctgg gtggacacag atctctgaga aggtagtatt cctgcaatta 870720
ccaagatctt aacaataatt ggatactaag tagcaagata ttaaacttaa tttccttttg 870780
ggcctctctg ttagctgagt gttttgtaca cagagagagg agcggccacc ttgatggcgg 870840
ctgctctctg ataccagcac tctatggcat ggagcaggat tgggtcagga aatgaagagg 870900
ctccaggaga atcttctgc ggggtcccct gggctcacia tacatattgt gaacaatgtg 870960
ttgggactg gagtgtcat acatcgaaac acacttatta cttccaacct gtggaacttc 871020
aagttaatct gaacaccaca gtgtcagtgg cacttctgg agcttcagga ataccaacc 871080

caacctcag agtgtgtttt ctgtgcagta gatggcctc acaccattgc caaactggaa 871140
ggctccaggc tgaacctgt aagtcaggga tcatcttgat tctgaatgaa ctccaatca 871200
tccttttgaa gtaagatag tgaaaatgtc actgaacca ggggtgtagt tgtgcttccc 871260
gaatgtttct ccctctttg gagtctcagc tcaggctact ctccagcaag atcataatec 871320
ctgacagctg attttgctc gcctggaaac ccaaactgcc aagataggc aggagtgcgt 871380
agaggaagtg aattgccgta gagtccattc tcggagtctc tctcttggtt ttaggtatt 871440
gtgcctagat agctcttgtt cgteacacac aactcacct atcaccagt accatttcca 871500

cagggcactg ttactgtttg gctgttctag agagccagt atggtcggga aatgtccctc 871560
ttgtattgtt taccactccc aacacacata gtcaatctgt ctctcacaca cagactctac 871620
cacacacacc agtcagtttc tctcacacac acagtctctc acataataca catactgtct 871680
cttatacaca gatacaagtc agtctgtctc acacatggc tctctctctc tctctctctc 871740
tctctctctc tctctctctc tctctctctc tctctctctc tctctctctc 871800
tctctctctc tcagacacac atgcgagcac gcgcgcgcg gcgcgcgcg gcgcacacac 871860

acacacacac acacacacac acacagaatg cttgagtagc tttatgcctc ttccttctct 871920

 tagcacagtg tgtaccaggt aaatccattt tttaaaaatt actatggagg aagcaaaaga 871980
 cacaagtgtg tggggtctgg ctagggcaga cattgaggtt tagatgttct gggaaagctg 872040
 tcaccaggac tcaggatttc aactttgctt ctctctcatg aattttaatt caccaagaaa 872100
 acaaataata aataaaacat caaaagaggc aaaatgggtc aggtcttgga ctgtcttctc 872160
 gttaatctgg gaactgctga attaagtgtc cagggtgtaa aaattaagga gccattggga 872220
 agcaciaaga acaaattctc ctttatgttt caaatttctt ttcctaagtt tcttattggt 872280
 tgttgttgtt cggtttgttt taatggtgac tttattttgg tctggatgta taaaatctcc 872340

 gctaacttca gcaataaagt cacgtcaatt cacaagtgtc ctgagagaat taacaggctt 872400
 ttcaatacta ggaattcag tgttactccg gaatacctca tttatttaca tattgtgatt 872460
 gccattcaaa agtagaacag tttcgggaaa gaacaggaag tttctgagtc agaggcaatg 872520
 ccaggcgggt cagctgtttt aatttgtatt gacagagcca gggcagcctc gcatgcacta 872580
 cccaggagac aacagtcaca ctcaagagat ccagtaagac acaggtacaa gtagctagct 872640
 gggccaagga ggctgaggca ggaggatttc catgaggaca gcctggcttc catagccatt 872700
 gccgggcctg ctgggagcag agagtaaggc agtgtctcaa aacccaaacc aaaagaaagc 872760

 cagaagtgat gtgttcggcg cctctctcat tgcttaagag tttaaaggaa aaaacaaaag 872820
 gaaaagtcnn nnnnnnnnnn nnnnnnnnnn nnnnnnnnnn nnnnnnnnnn nnnnnnnnnn 872880
 nnnnnnnnnn nnnnnnnnnn nnnnnnnnnn nnnnnnnnnn nnnnnnnnnn nnnnnnnnnn 872940
 nnnnnnnnnn nnnnnnnnnn nnnnnnnnnn nnnnnnnnnn nnnnnnnnnn nnnnnnnnnn 873000
 nnnnnnnnnn nnnnnnnnnn nnnnnnnnnn nnnnnnnnnn nnnnnnnnnn nnnnnnnnnn 873060
 nnnnnnnnnn nnnnnnnnnn nnnnnnnnnn nnnnnnnnnn nnnnnnnnnn nnnnnnnnnn 873120
 nnnnnnnnnn nnnnnnnnnn nnnnnnnnnn nnnnnnnnnn nnnnnnnnnn nnnnnnnnnn 873180

 nnnnnnnnnn nnnnnnnnnn nnnnnnnnnn nnnnnnnnnn nnnnnnnnnn nnnnnnnnnn 873240
 nnnnnnnnnn nnnnnnnnnn nnnnnnnnnn nnnnnnnnnn nnnnnnnnnn nnnnnnnnnn 873300
 nnnnnnnnnn nnnnnnnnnn nnnnnnnnnn nnnnnnnnnn nnnnnnnnnn nnnnnnnnnn 873360
 nnnnnnnnnn nnnnnnnnnn nnnnnnnnnn nnnnnnnnnn nnnnnnnnnn nnnnnnnnnn 873420
 nnnnnnnnnn nnnnnnnnnn nnnnnnnnnn nnnnnnnnnn nnnnnnnnnn nnnnnnnnnn 873480
 nnnnnnnnnn nnnnnnnnnn nnnnnnnnnn nnnnnnnnnn nnnnnnnnnn nnnnnnnnnn 873540
 nnnnnnnnnn nnnnnnnnnn nnnnnnnnnn nnnnnnnnnn nnnnnnnnnn nnnnnnnnnn 873600

nnnnnnnnnn nnnnnnnnnn nnnnnnnnnn nnnnnnnnnn nnnnnnnnnn nnnnnnnnnn 873660
 nnnnnnnnnn nnnnnnnnnn nnnnnnnnnn nnnnnnnnnn nnnnnnnnnn nnnnnnnnnn 873720
 nnnnnnnnnn nnnnnnnnnn nnnnnnnnnn nnnnnnnnnn nnnnnnnnnn nnnnnnnnnn 873780
 nnnnnnnnnn nnnnnnnnnn nnnnnnnnnn nnnnnnnnnn nnnnnnnnnn nnnnnnnnnn 873840
 nnnnnnnnnt cctcgtgttc tccctgctca gctcgtcct ctagggtcta cgtttgctcc 873900
 tccctgctca gctcgtttct cctggctctg ccccatgtcc cctgggctct gtgcttggtg 873960
 tccctggttc tgccttcagt accttctact tggctctggg tcctcccggc tctgactaat 874020

 gttccgtcag cgaagccccg gcttctctct gacagaggtt ctcggcaatc tgccccagga 874080
 cctctcttcc cctccgtctg gatcctcccg gttctggccc tgatcctgtt gcgccaagct 874140
 ctgtccggag tctcctggc tctgcctctg gttctttgcc agggttctca acctgtacc 874200
 gttttcttct ggctctgtct tgggttctct ccgcgctact cagggacctc cccgctctgc 874260
 ctggctctc ccagctaagc ctaggttctc ccgcgcttcc tggcccctag ggctcgggct 874320
 gcggagttag gaccagttt cccagagtc tgggctctcc ctgctaggat cctgggggtt 874380
 tagggctggg ggccttccc tatecttccc ggtctactca tggagaccgg cgggttccag 874440

 agggcagcga tgctccaagc tattgcttct cccgggagcg ggggtgttgg actgttgggc 874500
 agatgaggag tggagggaac aggatcgggt ggcctagaat atccctggag ctgccaggct 874560
 atgagtgttc caggcggag ctggggagag gggttaggta ccctagtctg agtaccaggc 874620
 tttgtgact gggccgctga tagcctcct aaccgaaca tctcaatcc cagcctccac 874680
 atcctgaaac tccgaaccc cnnnnnnnnn nccccagcc tctgagtcca ccgtgtggga 874740
 ttcacactga gaacgcgcaa agtgggtggg gacctgctg gggcacaga gaaacctttg 874800
 cctagctccg gaatcatgac tcggcgtttc tgggtgaag tagtggatcc ggacgcgttt 874860

 gtaggatggg gtgtccgctt ggatttagaa ttctggggaa aggacgagtt ggagtctaa 874920
 gaggtgaacg ccattcagtg taacttgact ccgctttga gctggtgtga gtgagttagca 874980
 cagaacagct cacagggtat tagtcccata ttaacctgct ttccaattct tgtcatccga 875040
 accatagtte gtggcactaa tctctgggaa cagttggcaa agtgaacag tcagcgtggg 875100
 ccttcaggcc cagggtttg gagaggtggc cccatgactt agaaaaagaa gcctggcagt 875160
 tggcttttca cgtagttttt tcaataaac taatgtttta aagacggcaa gaaaataaca 875220
 catctgactc ccaaggggat gtattataaa catttatctt tggaatgttg tgttggtttt 875280

 caaccaagg atagccttag ctgcagtttc tccacctttt taattttcca agtgtgtgtg 875340
 ttttttaat cttaaaaata ggaatgcttc cttttacact tgggtgggctt tcatggaatg 875400
 ggtgaggctg ttgattaatt tgaaggtgtg taagctcaca aactgcaga ctttttacag 875460

ctttgatccc tggctggagc agtttccatt taaagggcca gggttggatg cctgctggag 875520
 gatgggtgta agtgcaaggt gctggctgtc caagtgtttt taatagtcc taataggagt 875580
 tctgccttgg cagaggagga aggagggaga actgtgtagc aactccacct tgatatcact 875640
 agcttgactt cacacacaca cacacacaca cacacactct gtgggagggtg ttagtgaaga 875700

 aggggaaatt ggctgctttg ataggcaggg gtggcagagt agggaaagga ggaatataca 875760
 aagtctttgg ggtattcatt gtttatgcac agcagtttga agtcaaagac attgctcttt 875820
 gatgtgggtt gctttaagag tgctggctag gtttgtttgt ttgttttgtt tttgtttgta 875880
 tgtttttttt tatcaacttg acacaagcta gagtcatcta ggaagacggg ggaagctcaa 875940
 ttgagaaaat gatgccccca tcagattggt ctaagcctgt gtggacattt ccctggttaa 876000
 cgattgatgt gggagggcct ggcccactgt gggtagggcc tcttctgggc aggtggtcat 876060
 aggttgtaaa aggaagcagg ctgagcaagc cagtagtcag tgttcatcca tgtctttgca 876120

 tgttctgccc ttgacttccc taaatgatgg agctgtggtt cagacgtgta agacaataa 876180
 acccctttct ccctaggttg ttctaggttg tgggttttat cacagcaata aaaagcaagt 876240
 agaaatacag cgagtectct tttttttttt ttttttaatg gaccaattga gttgtgagtc 876300
 tagagatcga ctaggtgta ctcggaataa gttacctat ctgtaagaga aagcagacca 876360
 gtccgttcc acatggtcag tttcaatcag agtagctacc tcttcagtag tcagtgaggt 876420
 gcccccccc ceatattcta gtacagtcac atgaactgaa ggcccttgaa tcttcagaca 876480
 cttttaatag ttttcatccc tttcccattc ctctgtttt tgttttgttt gttttgcttt 876540

 cctttgtttg tttcgtgaaa caggetttcc ctccatatcc tgggctagct tgggattcac 876600
 tatgtagccc aggatagtcc tttactcatg gtaggtcttg tgccttgcc tcccagtggt 876660
 tgagattaca gattcagta gctgccgtgt ctagttaggt ctgtattact tgagcctgca 876720
 agaagggatg gaaaactact ttgatcattt ggtatgactc aagcattggc ctagtgtcct 876780
 gactgttttt tigtcaact tggaacgagc tagagtcac tatgaggaga gaacttcaat 876840
 tgagaaaatg cttccgaat atggggctgt aggcaagcca gaaaggcatt ttcttaatta 876900
 gtgattgatt gatacaggag taccagecc attgtgggtg ttgccacctc cgggctagtg 876960

 gtccctgggta ctaggaaata aactgatat aatgtgtggg acccctctcc ccctagatt 877020
 taaccagctt tttcataact attttattta tcttgggtgc tatttagttc tctgcagttt 877080
 tatgccaggt gtcaatttct gagattctac ttagttaca aagcctagga cacattcatc 877140
 acgtggactc tacacttctt gctcatgata gcaaccacc aagctctagc gtctaacca 877200
 caaactccca cctgacat gacaaccaet aagtctecat ctctataatt ttatcatttt 877260
 gatgttatgt aaccagaatt gctcagcata cactttattg agattttttt tttatcttag 877320

catttctctg gagcttcatt cagggtcttg tgtgcaacga agagttcatt ccctttcgct 877380

 tctgagcgac catctattct ataaaccacc caaagtttat tcgatcatag actccaagt 877440
 caaaatataa acccttttct ttctttttgt ttagaaagt tatattcttg atatattaaa 877500
 tgtatgtcac atactgagat agaaactgtc ttcagaacag cataaccaat ttatacataa 877560
 ttcttttgtt gggcaaatgc ttgtgtataa agaataacag ccacgctgtt attaataaag 877620
 agcctttcat gcttctcaca taaaaagaaa ggtgaagtig gctgaggaaa aggttaccag 877680
 atcatattag ctgtagagtc tacagccgtg aaacaagggtg tgacaggatt gtctactcta 877740
 tcactttage tctcttghtaa ctgtttctag aaccctttc ccagggtgtg ttgcagaggt 877800

 ttctttgtcc agccaggfcc cgtcacttca gcctcaaatg aacacacaga gacactgtat 877860
 taattataaa ctgttggcca atagctaggg cttcttattg gctatctctg tcttaattat 877920
 taaccataa ctactaatct atgtatttct acatggcctt atcttattgg agaacaactg 877980
 gtgtgtccaa tctctccagt tctccatgt tgtctcttct gcctaccctt ccagaattc 878040
 tctctgtctc ctagtctgc ccagcttct gcctctactg gctattggcc aagcagtgtt 878100
 ttattcatca gccataaaga gagacatatt tacagaagga catacctcat caagggtggc 878160
 tctgcattag ggctgacccc aggagacatt tctgagaggt ttgaaaggta gagatgaagc 878220

 agctgtgatc aggctgagaa gatttgtgta ggttttgggg gctgtggaat cctatgcaga 878280
 ttcagcagga agttttggct gttcatggig acagcagtag ctgaggtcac acacaggcct 878340
 ccagctctcc ctgagctctt cctcagttgc cagggtgtct gcacagctgt gagaaactgg 878400
 agtggaagag tgggctctc tacaggttca ccttgtcaag gtggagagac agtgtactgt 878460
 agcatagtgt gtctctgggt ctaactcatt ctgtcttcc ctacttctt tttcactgac 878520
 ctctcttccc cactggctgt tttgttggct tccaaacca aacatcacac ttgcgtagat 878580
 gaggtaatgg tgacctgtca catgactata gtaaagtgtt ttttttttt tttccagatt 878640

 actcctgggg gtctgccta agtgttgcaa acagtcacct ctgccccttg aattgctcag 878700
 tcttgtctta ggctcgtgaa caaggacagg caggaatatt tttattaaat atatttaatg 878760
 ggggaggggg acattacaca gtttccactg gcttgtgtcc tgtaccttca gigtattcac 878820
 cccatacctt tcctttctt ctggctgccc ctcccccttg tcccttactg gcttctccag 878880
 atagtgtcac tctacctgc atgttatatg tgtgagtggtg tgcgtgctgc catgtgtata 878940
 ttatatatat ggttttatgt ctatataaaa gatatacaag aggaacatc tggatattgc 879000
 cttttctggt ctccagttgc ctccatttta ctgtgaagga cacagtgtca ctctctccc 879060

tggatcatggc ctctgaaatc aggaggaatt gcattaaact tctctgtaga cactgaactg 879120
 aacagaacc gaaggctaca gtgcccga cacccccttg aaaaactgcc ttgattgatt 879180
 taagaggtagc ttagtgTTTT cattttactc ctttcccctt tctcttggg gagaggttcc 879240
 tgtggaaatt tccattcagc cagttagtgg agcctgattc aacaatgaac caaccctggg 879300
 tcttctgcgc taaagatggg gaagctgagg ctgattacag gaccttaac tcacggtttt 879360
 tctttccatg tttaggctat tagatcattg tttgctataa agttttactg aatgcctctg 879420
 aagctaacat aatcataag agtgacgtgg gtggctttaa tgtcagagct aaaaaataga 879480

 aatgttaat ctgtgtggct gtggggacct gtgatgcttt aatgtttgtt aatgagagat 879540
 tttaccagtt ctcatctttt agtcagagcc tctgccagc tctgagattg tgcaagcatt 879600
 ggcttccatg gcttatacct gagagccctg aatgttcat ttgggtctgc ctctgctgat 879660
 ctgacttctt tgaggcctct gtctctctgg actgctttct atatactcta gaacagttag 879720
 taaagatggc ctgggatact tggttaaagt gccagacat tctatgatgg tcacacaggc 879780
 aagggaaaaa aagatttgaa gggagtaaag tctctatggg aaaaataatt tttttaaaaa 879840
 tgaaatttct gtattaaact aagagatccc tggaggtaga gattgtgatt gtggtctcat 879900

 aggttagtct agacctcagt ctggttgtat aggaagagta ggaaaggaga gaaaccagtt 879960
 tttggattgt agggtttttc tccaaatttc tccctgaagg aatcatagg attttctcaa 880020
 aaagcagttc gttttatca acaaatgtct tctatatttc cttgcagcca cacacttatt 880080
 tttttccaga ctttgagtct agcccttgct ctttatgagg actgaggaat gtttggctcat 880140
 gccaaaggaa tggtaatgtg tctcttccca ttgataagac atggtggctt ctgcctgcaa 880200
 agttctggac tctgcctcc cacgccgatg tctaggctct catttccacc cagtaccctg 880260
 gagacctggc ttcttcacag gtcagatttg ctgctgctga gggcctctgc gctgggcagt 880320

 ctcttttggg aaagcccttc cctaagctgc acagggetgg ctttctctgt accttcagta 880380
 tttgctgaga cattactttg tcatgggggc ctgccagga ctctgtctg aaccttctca 880440
 acgtttcacc tttactttct tactctgacg ttttagtgcg ttttccagca ctgtgacaga 880500
 atacctgaga gtagcttaca gaaggaaagt cttattttat ctcacagttc tagtctatgg 880560
 ttggctggct ctgtggtttc tggggctatg gtgaagtaca gcagaaggct tgacagagcc 880620
 gagctgctac ctcatcttag aggaagctga gactgagata gagaggagcc caggaccaga 880680
 tggaaactgcc aagaacceca tgcccgggtga tcaacttctc cagctaggct caacctctct 880740

 ataacactat cgaattacta gtccaacacc agaaaatcca tgcttaggtc agagccctca 880800
 tgatacaaac acctcccagt ggtttggctc accatctagg gaccaaacac tcaacacaag 880860
 aaccttttga gaggtctgtc tcatccaaac cctctataac ccccactgct atctgatatc 880920

attctgttgt tgttgttgtt ggtttcagtg tctgccact gctctgtgag ctgtctataa 880980
 catgtagcgc tttacttggg ttgcaaagta ggacttagaa ttagacatgg aatcctcttt 881040
 gcgtaggaga tctgcttggg tctgtcttta tttaaaggct tttgttttaa gtgtgtgtgt 881100
 gtatgtttat atgtgtatgt gtgtgcatct gtgtgtctct gtgtttatgt gtgtctcagt 881160

 gtgtgtatat ctgtgtgat ttgtgtgtct gtgtatgtgt gtgtttgtgt ttgtgtgtct 881220
 ctgtgtatgt gtatgtatgt gtgtgtgtgt ttgtgtctgt gtgtgttttt ctgtgtgat 881280
 gtgtatgat ggatatgtgt ctgtgtttgt atctgggtgt acatgtgtgt gtctgtgtct 881340
 atgtgtgtgt gtctgtgtct ttagtgtgtgt atgtatatgt ctctgtgtgt gtttatatct 881400
 gtgtgtgtct ctgagtatct ctgagtgtgt gtatgtctct gtgtgtctct gtctgtgtgt 881460
 gtgtatttgt gtgtctgtgt gtgtgtttgt gtctgtatgt ctctgtatgt gtgtgtgcct 881520
 gtgtgtcttg tctgtttggg gtgtgtgtgt atgtgtttgt gtgtgtgcat atatgtgtct 881580

 gtgtatgtat gtatgtctgt gtacatatgc actggggcac agcacctgta gagatcataa 881640
 caggtagcca gatctccctg cagtgataga ttgtgaactg cctaattggg aaccaactc 881700
 aggttctcca gaaaagcagc caagtactct tagccactga gccatctctc cagcccagtt 881760
 ttctgtctta atttacctt ctccctctc tctcaaagag aaaagtggaa gcagaagggg 881820
 gatttccttg gacattgcag aggatctctg agggctctgt gtactgaagg tcaagggcag 881880
 ccttgactat agaaggatga ttgtggctca cagttataat gttgagagaa tgacaatctt 881940
 tagtctggca ccatctcccc cccacacccc aggatgccac tgaagcacag atagttgcag 882000

 aaagcatgtt gcaagtcca gacaggagc aggaggctgg ggcaaagccc agaagggggt 882060
 tctctcccc tctcccttt gggggcttaa gatccattca taacaccacc ttgctttcta 882120
 taatcaaatg gagcacaagg aactagccta tccagcgatc tagatttcat ctggtgtttg 882180
 ctttgtgttc cttcagagaa accttcttc taaactcttg ggatttctca atgtaaggaa 882240
 tttcatatgc ttcagggagg actcatggtt caccatgctt gaggagcaag tgacgaaaaa 882300
 aagaccggtt atgattaaag ggatgggctt tgagctgtgt gatatttctc ctaccctccc 882360
 atttgaagag ggagatggga ttgaagtcct gtgtcaatca agtgggcaa ataatgaagc 882420

 cccaaatcat aaagcccca taaaactctg gagctcagag tttgctcaca cttccagtag 882480
 gtctctgcc acctgatgc tctgagctgg gtgcatcttg aggcttgca aatgtgtgtg 882540
 tttaggattc tccaggcacc cttccaggcg tgctagctc cccttggcc tgagttttgt 882600
 tcttaataca tgactgtagt acagcagttt ccttggttct ggaaggcctt ctaaagcact 882660
 ggagaaccag agagaaatga ggaaacactg gttttatagt aaccggtcag aagcacagat 882720
 gctttgggga tatttggagt caggagtctc agaaggactc tgcttggcct aggctatttc 882780

ctgtaacttt gggtagtccc tgacagaact gcaatgtgcc caggtatgct agggaacaca 882840

cccttctcaa agaaagcaaa tgcaaaatta acagtgtagt tactactgcc actaagatat 882900

gtgacattgg gctcttctag ttatttgcgt attctctctt tctgtgttg tcaccagtgt 882960

tcttgcccaa tgcctctccc tttagtgtcc ttccttttag tatgttatta ctcagaatgc 883020

caaaaagaca gtaatggtgg ttggaatctc tcttggggag tagctttctc ctgctgagtg 883080

aggatgggag gcccgagctc cagtcagaac tggattttct ccacgctgtg gtaccggtca 883140

gttgacagat ttgtttcttc agatggatga ggtgatgatg atttgttgat ttgtctagaa 883200

ctagaaggat ggaagaagag agccagaatg atcgagcatc tatgggaatc gcctgaaagg 883260

gaaaacaagc tgagccagat gttatttatt ggttgattga gctaagatga acgtggaaac 883320

cattccaag cttgacaact gcagaacggc tagaggtggc tatagggaaa caacagaaga 883380

tgggcatggt ctgtgtgttg tactgggctg tggacacca ggaaaaaaat accataaatg 883440

gtgatagagt tgggtaata gctcagaagg taaaatgctt gcctcgcaag catgaagacc 883500

ccgagttcaa tctccaagaa cccccctt tttttaaga aaggagaaaa gagaaggaaa 883560

aggccaggta tgettattag cccagtactg gaaagacaga gacagttaga tctctggggc 883620

tactggctg gcaagcttag cctacgaggc gatctgtctc aaaaacaagg tggatagcac 883680

ctgaggaatg acaactgggg ttgttcaaat gcacacgcat ccatactct ctgcatacat 883740

gtacacatgc aaaaagaaa caatgataaa ggggttacac ttacccccgc ccccttctg 883800

attgctgttt tgttttttg tttttgatc ttaaagaatg cttgtctgat agcacactga 883860

gttttctgtt gaacctgtta cccccctgt gccttcgact gagetttgag acccatgtct 883920

cgtagccctg ctagtccct tcttgggtgc agatctcagg cttcatctct atctgctcta 883980

tcttgatgat ggatgggagc tgaagttgc aaaaagaagc tcggtgacca ctggtaacce 884040

caggaggcct ctgtttaggg agatgaaagt gtcacattgt ctttagttca ttgtaattca 884100

tattccaggc atctgcagct gcctgtactg gtatcttctg ttccaataca gtctgtctcc 884160

ccaccccacc accaccccc ccagaggagg ggggcaagag gnnnnnnnnn nnnnnnnnnn 884220

nnnnnnnnnn nnnnnnnnnn nnnnnnnnnn nnnnnnnnnn nnnnnnnnnn nnnnnnnnnn 884280

nnnnnnnnnn nnnnnnnnnn nnnnnnnnnn nnnnnnnnnn nnnnnnnnnn nnnnnnnnnn 884340

nnnnnnnnnn nnnnnnnnnn nnnnnnnnnn nnnnnnnnnn nnnnnnnnnn nnnnnnnnnn 884400

nnnnnnnnnn nnnnnnnnnn nnnnnnnnnn nnnnnnnnnn nnnnnnnnnn nnnnnnnnnn 884460

nnnnnnnnnn nnnnnnnnnn nnnnnnnnnn nnnnnnnnnn nnnnnnnnnn nnnnnnnnnn 884520

nnnnnnnnnn nnnnnnnnnn nnnnnnnnnn nnnnnnnnnn nnnnnnnnnn nnnnnnnnnn 884580
 nnnnnnnnnn nnnnnnnnnn nnnnnnnnnn nnnnnnnnnn nnnnnnnnnn nnnnnaaatt 884640
 acttcaagct cctgactgtg agagggagga ggcaaggagc taatgccctt ttgacctta 884700
 ttctcctttg gtgtcagatt attggacgct gggacctttc ttgggacctg atgtggcagt 884760
 cctggagaac agccagctctg agtgctttga gctcatgccc ccttctcctg gtcagctgtg 884820
 taggaagaca gctggctgaa aagaggaagg ggagtctatt aaactgagag gcttacagac 884880
 ggtcagagat tcctgttaag attatttcag aaaaaaaaa atggcctac tgcttgacct 884940

 agttctaaat gagaataaa gactaagcca aataaaatga gagactctta gagctgaaaa 885000
 ggaaagatgg gattttctga ctcccagtat aatttagatt catttgttta ctcaacagat 885060
 ttcgtttaga gtctattatg tgctgaatgc aatggatttc agtgatgaag agatgttagc 885120
 ttctgaaatc tctgaaaaag tgctcataac tcctgaagac agttgttaat gagtgcctca 885180
 tggaggcact gtgggtgac ctggaacctg agacactatt ctggttagat ggtgttcttg 885240
 gccccatgct ggatgccacc tgtagttggt ttctcatcct accctccagt tcccaaataa 885300
 ccattctgag gctcaatatt aattagaatt gtagtttttt aatgtttgc aagctacatt 885360

 ggggttttct agaagcactg aactcatagg atgtatgcat agtatttaa agagtgttg 885420
 ggttgggtta tgtgggagag gctaggtagc aaggaccacc tccttgggtg agaagctgag 885480
 aacactgtag ctgcacagtc cctgaagctc gatgccttgg cagtccaat gtgatgaggc 885540
 ctggaagtc cctgcagagc tgctgaggct gaatcctcat tggaaggctg aagaagctac 885600
 gatgtcagcc aaggactcac tcaggtagaa gcagaggctg actagtgtg ctttctcctt 885660
 ggatctcttt gtgtcttga gtctcttttg aaaagtgatg cccacctga ggatgagtgt 885720
 ctcccctcgg ccctttcagg aaacagtgcc atggacaggc cccgagttat tccccttcg 885780

 tgactetaag tcccatcaag ttgatgacag tccagacagg cttctgtgct getgctttct 885840
 cttagctgaa gacttcatgg ttcttttct ctcaaggttg gaacctcagc tgctgaaggt 885900
 gtcagctgac ccagtcactg agggcgaggag cttcggttct ttggtatata cagtacctca 885960
 cgtttagct ccatgagttg taaaaatgaa aatcggaaaa aagagagaaa gannnnnnnn 886020
 nnnnnnnnnn nnnnnnnnnn nnnnnnnnnn nnnnnnnnnn nnnnnnnnnn nnnnnnnnnn 886080
 nnnnnnnnnn nnnnnnnnnn nnnnnnnnnn nnnnnnnnnn nnnnnnnnnn nnnnnnnnnn 886140
 nnnnnnnnnn nnnnnnnnnn nnnnnnnnnn nnnnnnnnnn nnnnnnnnnn nnnnnnnnnn 886200

 nnnnnnnnnn nnnnnnnnnn nnnnnnnnnn nnnnnagaga gagatgggag gtgggcaggg 886260
 cccttttaaa agggaacgta gtgaatgtgg gcaggcgggtg ctcttgggtg ctgcagctaa 886320
 gggcgtatcc tgtcaggacc ccaaggacag gccagtagc atgcctgaat actagacca 886380

tggtcatacc tccttttcta ggaatatact ttgtttactt taaacaatag acattctgac 886440
 tatctcttta tctcctgtgc catggaatt gagcggctct cactagaagc acattagaga 886500
 gcatggctaa ttgtgaacat ttgccctaata gaaacaggca ccctataccc ccatgtannn 886560
 nnnnnntgt caagtcctct aatattttga gataaattag aaatgcttat atgtagacat 886620

 cttaaagaat attggttgac taaaagatta aaagagaaaa tagatataaa gatgaaaaga 886680
 aactatttac tggggtgggg gggtgaaacc tgacctgggg ggtttgttc taatgtaatt 886740
 agatcttgc tcccaccttg ggtagacttg gaataagcaa ttgcattgct tcaatgtttc 886800
 attcctccat ccatcatcta cttcagtatt tactgtgtga cagccatgag tgacacttgc 886860
 tctgagacac tggagagcga cgctgtaagc tccataagca tcacatccct tgcacactga 886920
 tcacattttt tttttacca tctctctagt ttgagcatcc cccatgtccc caaacctacc 886980
 ttctgagac tccattttag agggccctca ccatcctgga gctccctcgt gcaggggacc 887040

 ccagtgtcta agatgctctc tcagccctgc tgctccacct tgggtaccat tgccttgcc 887100
 tctcttttc acttggagaa tgttttctt gttgaaagct gtgacttga aggtccttcc 887160
 attgtggag ctctgccact gttagtgatc tgagcatgct cgttccttgc teccactact 887220
 ctctgaacc ttaagagta gacaccatat cttctctttg catctctggg cctgacctcg 887280
 tgtggtttag acctagaaaa atcttgttga ataaactgaa atgataaact gttgagttct 887340
 tggctcctt gtctctctgt tggtgatttg tactctttag tgtcaggaga acatcaactt 887400
 tttcaggtga aggtaacaac ctgctctggg ccatagtata tgtacagttc taatctggat 887460

 gcaagtattt tglaccgggt gagttttggc tcccactgta gtgttgacat gaacacttgt 887520
 ggccatgtgg ccctgaatc tcagggagtc ttccagtga cccttcccct taaagtaag 887580
 acggtgtgta atcttttag tgtggattct gggctgttgg tcatggcatt gggcagatca 887640
 gagataatac gaggatactg tgacaggcac tggaggctc agtcctggag gacgttgatg 887700
 tattagtctc cactctgtgt tggctgcaaa tccatcctgg gctgtcatgt atgcagtagg 887760
 cagacttcaa gatattttga tgaatgtctg tgttaagaca tagatgcaga gcacgatca 887820
 cagtcctct cctattaat taccaaat taaacagttaa cctttcttc tgtgcgctg 887880

 tattggcttc cagaaccaga aactattctc tgcttacaga caggcactgt ttgaaaattt 887940
 tgctagcatt ttgaccgaaa cttatgcac tctatcttt cacactttct agatctatat 888000
 tttataaata acattatgag gtgtgtgtgt gtgtgtgtgt gtgtgtgtgt gtgtgtgtgt 888060
 gtgtgtgtgt atatgtgtgg gggagggcan nnnnnnnna aaatcactca tccttagttc 888120
 attctctac attattaaga ccctgtctca gtcaaaccta gacaccaagg cgtgcaactgc 888180
 tccagtccea gaacctgat gatgagcagt gaggtaacaa agaaaggaca aatatacaaa 888240

tgtgggaaca ggaaagctgg gaacagatgg ggggtgtgttc actggatgga agccaccct 888300

 ggccatccag aacctctgta tgcttattag gtacagcacc tgagtttgat cctcaggccc 888360
 acatggtaga aagagagaac tttattctct cttcgggaaa ggagggtcc cetaagaagt 888420
 ctctataggt gaacatcact tgggtaaggc ttgtccattc ccatgggaca gaggtattgg 888480
 agtccttggc attgctgtgc ccatgtcaac aataaacaac cactcagga ttccctgct 888540
 tcctacactc agagcttacc aaagcagcta gtcttggat cccatctcta cttgctcaag 888600
 ggagaaagag tttatttgg cttacagttc cagagagata cagtctacag tggtagggga 888660
 agtatggcaa caagatgact ggagtgggaa caggaacatt ttcattctcg tataggaagc 888720

 aaagtaggag aacaggaagt aaggagagt ataaatccct caaatcctc tttcaggtag 888780
 gtacttctc tagcaaagct acgctccta accataactt cctcaaatag tgccacctac 888840
 tggggactag gtgtttaa atcatgacct atggcagtga ttttctcaa accaatgcaa 888900
 ccagtgactg tgggtgttag attcatgtgt ccaaatgaag cttgggatgc ttagagcttt 888960
 gaaggtcaa gccgtgtgtg aatcaagcta gctgtttaga atccgatta aggtgacttg 889020
 tacattctcg gttggtgtt taggaaaaga gggtagttt gtaatagggg caggtcagga 889080
 gccctaggat aaagacctat tgttctgtt ttgtttgatg gactggagag aagacagcta 889140

 tagaccatca aactacttac tgtgtgcaca ccgctgctaa ggcacctgg ataagagcat 889200
 tttctgtttg tttttgggt aaaggcttt actctgtagc ccacaatggt ctcaaatca 889260
 caccagctct tttcccacg ccattttagt gctgggatta ccagttttg ccaccatgcc 889320
 tagtaagagg tttgttgag aaacatttt tttctctat aattaattcc tcatcagatc 889380
 ttaacctgta ggiagtgacc catttgggtg aatggcactt tcatagggtc acccaagacc 889440
 atgagaaca cggttcttta cattacaatt ctgaacagta tcaaaattac agttctgaca 889500
 ggaggaacat tatcaagggg tcgaaacatt aagaaggcac tgatctatag acttagttgg 889560

 ggacattaca tcctgttacc aaagtgacc tttagatgta tctactctgt gttttggtgc 889620
 catgaagatg ttttaatag tggtgagcac ctgatttccc ttctgtttgt agttctcttt 889680
 tagttggctt atcatagtg taacagttag attctcagat cagtgggaga ttgtgttaa 889740
 aaaacaacc ctgtccatcc agatggctta gaggatgaag gcttgctgcc aagcctgatg 889800
 acctgagttt gatcctcagg cccacatggt agaagagag aactttatc tctctcggg 889860
 aaaggagggc tccctaagt tgtcctctca cctccatgtg tgcacagtgg catacatgtg 889920
 tgagcacatg tgctaccg ctctattcct ctccccaga catgcacaca aaacaaatag 889980

tgtgagcaat gctgagacc caaggtgagc ttgctctttg tgttgtctca gcattcctaa 890040
 cgagccctgt gtgggtggc aacgagactc acttccagat ggagaatctg gaaacatggt 890100
 tcctgggtgt accatggctg agagcatatg ttcattgctg gttcgtcctg gctgagacac 890160
 agttgcagtc tcctggtttc tgttcatctc cagtgcactg gactttgaca ccagtacttg 890220
 ggactctccc tctggctaga agtaaacaca agaatagtag gaaaggagcg ctttccaag 890280
 tcatgggatg cctgtctgtc tgccttctgt gaggggtcca agttcccgga atagcaatgt 890340
 gctgtctctg cattgatttc tgcagatgag ccagttctga gataggaaaa agctggacca 890400

 tccacaagcg taaagtgtg agagttactg gaagctatta tcaaatagct tgtcttctta 890460
 aatgatggat ggatctcttg tgcttttata ttgtgagcat gacttgaca gacttctcta 890520
 tttttaattt ttgctttttt acaggctaaa catatttctg gctggcatga atcctttcta 890580
 cttccatgcg gtgaatgtca ttctacactg cctggtgacc ctcgtgctga tgtatacctg 890640
 tgataaaaca gtcttcaaga atcgcggact ggcttttgtc acagccctgc tctttgcggt 890700
 gcacccggtt cacaccgagg cggtagtat agtggacact gtgaataat ggcacctaac 890760
 agcctaactg ctatctgcat atatcagcta aaccaaccct cccctttca aaactgtga 890820

 attgaaaggc ccacaccacc atcagcctca cctctgtgcc ccagtgtgc tttgataatg 890880
 ttcacatggg ctctgccag gattcaattg catctttgca caggggctgt ggttattata 890940
 agggtaaagg agactcmeta tttttattt gcaaaaataa atttaaatcc catgtgcttt 891000
 cagccagcag gggacattgt gagaccccc acacacacac cttgatgtca ccatccctgc 891060
 tctgcttcat gcctgtgttt acattatgaa gctgcaggtg ctgggggaag gaccaagaaa 891120
 gctagactga tgacattctg ccagttacaa agatggactt gggttaattta gaaattgctt 891180
 tctgagttac tgaatgagaa gttcaatgat tttgtgtgag gaagactctg ttcagaaact 891240

 attgctagtt tggatctgtg gccctttaaa aaaggtttgg tctatcttgc acctgacggg 891300
 atagtgtcat gaaaccactg tgtcatataa cggtcctga ttccttttat atgtgttgc 891360
 acagggaggt gaaagctttc tgacagggcc acaaacacca agattttcag ggaatgggtg 891420
 atggttccca aagagagaat ggcttgctaa gcctctgctg gcacctggac actttcttga 891480
 aaatctacc aagagcacac ttttggtaaa gacacaacat tgatctgttt tggagtttgt 891540
 tctctctcat ttggatgagg catgctcatg cattgtgacc tgattgtgtc cctgtaatcc 891600
 acacctctga gaccctgca aaaggacagt ttgacgtgtt ggtgttgca tgcctctgtc 891660

 aattaaggca tcatagttct agagaaggct tcctggcctg tgttctattt ccatgaagaa 891720
 tacaacttgg cagtagaaat actgggtggt actctgtgtt aaagtcttga gtcagaagtg 891780
 aaatagtgtc cagagggatt catagaatgt ttatttgaac tggcatggga attctgattc 891840

agttaactga taicacagtg agtcttgtca atttggctctg tgatggctgt gtttctgtga 891900
 acagaattcc ccatctctga gcctgatgtt tgacatatat gtgtggctctc tcatgtatat 891960
 cattcacagg ggggtgtgtgt aaatatatgt gtatgtgtat tagtatatat gcatgggcat 892020
 ctgatgtaca cacacatcca tatataatta tatatgggga aagtacacaga taaaatatac 892080

 cttataaact attacatcat ttggatagtt ttcctaactc tttctgagta tgttagactg 892140
 ggcaaagtcc ctgtaagtgg aagagtttga cgtgtaagtg acagtcctcc agtgtgtctt 892200
 ggtaaaagctg attactatac ttctgtaaaa tagttacagt gagaggagac tctgaagggc 892260
 aggttgctat cacgactgtc caaattaaag tcaaacccgg ctgattagtc agattatgga 892320
 tcacaaaact tcacatgaaa tggtagattc cctacgtggg agttgcctct gactttggag 892380
 ttagaagcgc taagccatac ctgtaacacg aatccttacg ttcctatgca cggaacagt 892440
 ctaaagggta gaggccagac ttagaattgt gcggcacact atcttactct tctaagagaa 892500

 ggtggaccag acacagcact taatgacacg cacaccttca tgtgtagtgc ttaacatttt 892560
 cctgctttca tcatgatgtg aattataacc agaacactaa tacataatta aaattataat 892620
 atgtagagat ttatggttgc cccgggaaat ttaaaaagta attaagggcc atagatacag 892680
 ctctgtggta gagtgatcgc ccagtgtgtg tgaggccctg agttccatgt ctgacgacac 892740
 acacacacca aaagaatcca tatgtttttt cattatcgtg aggtaatgtg ataagtaaag 892800
 ttcattttaa cattagtatg cattaaataa aatacattta atgttagtat gcaatgcatc 892860
 aagagaaaat gctgaagggg agtagctctg aagaaaatca caggaagaga gcactccaga 892920

 ggtctccatg gaaaggggaa atctccctag cannnnnnnn nnnnnnnnnn nnnnnnnnnn 892980
 nnnnnnnnnn nnnnnnnnnn nnnnnnnnnn nnnnnnnnnn nnnnnnnnnn nnnnnnnnnn 893040
 nnnnnnnnnn nnnnnnnnnn nnnnnnnnnn nnnnnnnnnn nnnnnnnnnn nnnnnnnnnn 893100
 nnnnnnnnnn nnnnnnnnnn nnnnnnnnnn nnnnnnnnnn nnnnnnnnnn nnnnnnnnnn 893160
 nnnnnnnnnn nnnnnnnnnn nnnnnnnnnn nnntatgaag aaaaatagcc aaagatttct 893220
 gctctccaag gccaggggtga cattatgttt ttgacaaatt tgtagattac agttgcaggg 893280
 ctgtgctgta cttggggaca gctactgcaa gaaagaccaa ctgattgtgt ggccacagtt 893340

 ttaattcaat ggctgaggag agaagagtac atatgccagg caaccttgag cagtgtgatc 893400
 aagacctgat agaggatata ttttagttct atataaaaa gaaaacaaaa ggcaaacctt 893460
 attagcaaaa tgaccttag aaaggggttt ccggggcttt tgtactaata aaaaatccat 893520
 agtaacacaa ttgaagaggc gtaggttttg aagagcttgg tcattatttg gagatggata 893580
 ctgggaagat acttgctttt gcaagatgaa ggatctgtgg ggacaagagg tgaacagatc 893640
 tgaccagca caccattac actgtaaagc agagtggaat ctgctattta attatagatt 893700

gaagctcaag ttcttagga ggaggacaga gagacagaag aagcaatgta cttcatagac 893760

 aattagtgat aaattattaa gcatgcacag taagacatag gggcttggg aaatcactca 893820
 tctttgtttt taaaaaaga ctgaaaattc gaccatatgt tatgttattc caggaaggat 893880
 ggagaattta aatttggggg tggaaatttg tttagatccg tagatatgat tgcgtgtcag 893940
 cacgctgatg tggctggctt tataagtgag gcagttagca aatagcctag ctacaagcta 894000
 ggcatatagg taccagaaa tcatagggat ggggcgcagg gtgcctcccc cagtttgtac 894060
 acaagctcac agaaagctgg agactagaca cacaatcga tgtaagagaa acaggagaga 894120
 aaagttaatt cacatttaag catgcaggga cacattgatt aatctgcctt tcaggaagca 894180

 tttgaatgca tgcatttggg aacagtgggg tagtgtcctg cagggcaggg actgaagagg 894240
 accagactgc ctcatthaag ccctggagat tcttgggcag gcttcccact gttgtgttcc 894300
 tttgaaagt tctgttttc tgaattctca atcatgaaga aaaaaaatt gggaaaattt 894360
 aaacttggtc atcacagaga ccatlgtttt gcagaagtga aagcaaac aagcacaaag 894420
 agtttgaaga tgaagccaa catttctaga atcagaacag gagggctcag gagagaattg 894480
 gctctgatct aatcagttgg tctggctcct ggtgtttgtc acatgtttca tttgcgttcc 894540
 tggctctgtc tgatgctaag ggagctcatt cttgcaggta aaataaatat ttgtaactct 894600

 atacagagcc tacttgatac aaacctgtc agtagcattt ctcaaatat cgcattataa 894660
 cttggcggca aatggagtcc taatgggcat ttcccactg tgatttgtt ttcctggctg 894720
 acaggctcac acatccatta cagctcagac acccctaacc taaaattctc aaattccaaa 894780
 ctctccaaag cctgacctc ctgaatgttg acatgttaca agtgggaaat ccctctgatt 894840
 tctgacctc aaggtacagg tcatgtttaa atatggcaac actaaaaca ctgtataagt 894900
 tcacctcag accgtgtgta taaagtagaa agaaatatag gtgagttttg tgtttagcct 894960
 taggtcccat ccctaaaaca tctcattgct tgtacctgca tgaagatagt ctaatctgag 895020

 gcatttctgg tgctaagcat ttgggatag agagactcat ctgttttaa ttctatctag 895080
 ccacattcac tagcacttc cagtgtgta acagagctct aacacaacag cccttagtga 895140
 tgaaggcctg cagcttggg ctgagagatg tgcatatatt cctgcgcacc gtgagctgct 895200
 ttgctgcctt gctatgctg aacctggcg gnnnnnnnn nctgcagcat caccagcgtg 895260
 ttaaccttct gctctgctg ccgtggctc ggcgttctcc ctattgacag tactatcact 895320
 tctgcctccc ctccagaac tgccccggg tctcctaccg tccaagagga aggcacgata 895380
 gtgccttcc tggtcacggt tctcatgtg cccttgta aactcctgaa gtcttcttg 895440

actcttttac tcttgggtca cagagctggc ccttctgtga agcttcttcc caggtcctgt 895500
agcgggaatg agtcctttct cttttctgcc aacaattttt ctttgtgac tatgtggtct 895560
tgtctctgaa tgtaaaaaat aaataaataa ataaaaagga aaggaaagga catgactggt 895620
aggtgtgggt gaggaagatt gttgtggata tccaggagag tccagggtgg acatgaccag 895680
gctgagctgg gttccatagg gaggggggga gggagaaagg gaaaccaggt gcagtagaca 895740
gggggcnnnn nnnnnnnnnn nnnnnnnnnn nnnnnnnnnn nnnnnnnnnn 895800
gggggagggg cggcccagcc ccagagctgg aagagagttt agggtaaagg gcagggtatg 895860

ccagccatac cctgtaatag gtggaactg agggatgctg ggagaacctg gcagccaggt 895920
cggctttggt atgttaagta ggcacctcag ccccttgctt ggggtttaaa acttgacagt 895980
gtcctattta atactctctt ctgactccag cagatgttaa agtccttgag gcaggcttat 896040
agtacctgct tggaaagtgc tcgatcactg gaacaagccc acagtgaaga ctgatagca 896100
tggactgaca gtcacaggaa atggcagctg tagccaagca tttgataggg atggttactt 896160
tgttatagag gtccaacact ttgcccaaga cctcagctca acaggggtac acggtaggca 896220
tttaatgtgg cacgctggaa agttgtgggt cagcctctcg aggagcctgc tagcatgggc 896280

actagcgctg tcacaccatc tctgaacttc tgctagtggg attctacatt atgatgttat 896340
tgttagggtg agggcttact atgtaacca ggctggcttt gaactcgtga ctttctgcc 896400
tcaaccttcc agtgcctgga agacagatat gagttagcat gccagctag tatattcttt 896460
tttttttttt tttttttttt ttttggtttg gaggttctcc tggcactcgc tctgtagacc 896520
aggctggtct caaactcaca gagatcagcc tgcctctgcc tcccaaatgc tggaaataaa 896580
ggtgtgtgcc attaccgctt ggctattctt tatgtcttgg tgcattcaac tggcatagtc 896640
gtctgcgctt tccagattgg ctcagagtga ggagcagggc ttcaagacac ttggcgggtt 896700

ctggttatte ttgcatagct tttgattgct gtactccgcc ttgctatatt cagagtcaac 896760
ttgcaagtct tgctgttggc tgtggtgata tcttgtttgt acaataaag cttgcctgaa 896820
gatcagaggg ttgagctagc cactagctaa ccatagagat ctggaggtct gtacagacag 896880
acaggaagtg agatggctgg gcagagagag gaattataaa ggtgggagga gacaagaact 896940
cagttttttt ttccccctg gaaagttgag taggtaaggt ggctgtgggt ttgctccttc 897000
gtctctctgg tatctcagca tttccccta ttatctgact cctggcttcc attattaaga 897060
cctattagaa ctctgtttac agttggccac atcgtttgtt ccaggatgag catccctcta 897120

ggctttgcct caggatgca tggcaggcta ggtgggctg tcttctaac ttgagttcat 897180
gctgagttaa atgttccaag acagcagtggt ccaactgagcc tatctgagcc ccaactgtga 897240
cttctgcatg gtcgttgctt agcctgaact gggagcttgt accttgtgt acaactcac 897300

tgccctgcctc ccctggagcca ggcagcttct ccgatgtgac tctcaagctc cttatagatc 897360
 agccaattaa tgaacactcc gtgtggcca agccatacag gaagtgtat gttggagtta 897420
 agagtttctc ccttctccaa aacatacaca atgtagcacc ttcgatgtc acctcattgg 897480
 caacagcagt ctgggtgtaa cacctgagat gataaactgg ggtctcagaa gtcaggggct 897540

 ctctctcacc aacaccatgg cctctctgac tgtacagtgt gtcataaca cagtatgtca 897600
 gtggttcaaa ttcctgaac attatttct ctttatgttg gttgattcgg cagtgcacat 897660
 ggacctgggt tcttctctga cttgggtgat gtttgctgtg cctcagaggt cagccttact 897720
 catctccat gtaacaact cctggccatg atggggaaat ggtcttctgg atatgtttat 897780
 cttactggtt gatgaataaa acactgtggc caatggggca gcaagatagg caggtctagg 897840
 agatgaggag gattctggga ggtgtaggca gaaagcagtc accatgtagg atgccagagg 897900
 agtaacaggt ccctgggctt ttctacagta agataagagc atgtggaaat acgtagatta 897960

 atagagatag gttagtaatt aagacagagc tagccaataa gaagccctag tcattggcct 898020
 acagcattat aattaatata agtgttctt tggggctgac acagctgtgg gaccaggctg 898080
 atgggaaagg gtgtttgtaa catggcccag ctcttctga gatgttgtt tgtttagttt 898140
 ttgtcaact gatatgagct ggagtcactt gagaagaggg aacctccgtc acaaatgcc 898200
 ctctagtct ggcctgaaag caagccattt tttttgattg atgattgatt cggaagggcc 898260
 cggcacagtg agggcatggt gccatccttg ggcagatggt cctgggtagt ataagaaaca 898320
 gatatgtata agaacaagcc ttggaaaaca agccagaaag caatgtttcc ctatggcctc 898380

 tatttcagtt tctgcctcca ggttctctt tgagttctgc tgtgacacga aataaactct 898440
 ccctctcgg gtttctttg gccatggcac tttgtcagag caataggaag caaactggaa 898500
 cagaaatact taaaaaaaaa tatatgttcc tgtttacagt cttatagctt gtattaaaag 898560
 gagagagaga gagagagaga gagagagaga gagagagaga gagatgatct tcagtgtgag 898620
 ttttatgcta gcacagcaaa tgccattcc agcttctcaa acagcactta cttctaaaga 898680
 aacttcaage ttctgtctca cactggctct atgttcttta tcaaggcca ctgattttta 898740
 acttttgctg gttttgtct gttattctc tcttctccc tctctatgaa aatattgttt 898800

 gttttctgaa gcagttacag agggctacat aattcatgct ccttcacaca tcaataatc 898860
 agttgtgtat ttctaacac ggagagaatt attcattggt ttggtttcat ctcttttagt 898920
 cctgaacact gtctttctat catataatac ataaattca ataggttca gagtttacct 898980
 taaaatgcat gtagtataaa ctgtttttga tgtatttggt tgcaacttat taatgttata 899040
 taaatagtga caatataatg cataacacaa atacttatta gaggcatagt atattaaaat 899100
 atataccttg aagataaaaa ataatatagg ttgtgtttaa ataaatagaa tgcattttaa 899160

atgtacaaaa ttaatatca ttatcagtat atatacacat atatatacac tagacctata 899220

agtttatgat tttatattat tacaagttaa aagtagtaac ataattagga atcaagatta 899280

ataaaaaaac aatatacaat gcaataaaaa atacaaaaca caataaaaat aaatgtaata 899340

atatcttaat gtagattaat aggctataat ttaaaatag tgtttatggt taataacata 899400

tttacatcct ctttcttatg gatttgtctc ctcttgaaa ttgtctgatt tttctcatgc 899460

acgtgattag gtgtatacat ccttggctag aacaggcctg catggtgtct ctgtcttate 899520

tttgaagata gtttcatatt tgatttcttg gtgaacatgg tgtgctgtct taagatgtcc 899580

tctccatagt gtcttactc tttcattttt ctaaaaatta agttggtgag caaccgttg 899640

aagttgtgta gatacctgc atctcaata aattacatat tctagagtta cegtctgttc 899700

attttattgg tgctgaggat tgaaccagg gccttgggct tgctggaca gtgctttact 899760

attgagttac cctcctagct tgactgatat tctggettc ttgttctatc caaaccttac 899820

tcttctagaa gccaatgta tttccagct ttgccctttt atccacaac atcgatggct 899880

tttttagcca gcagagtctc cccgtgtta ttattcatt cattcgccgt ttgcatttag 899940

gcacttttaa ccttcatcac ccgtgtgtca tgcattgga ttgtagattt ttgtgtcttc 900000

aatggtttat aatatacat gttccttata tttaaatcaa gtttttcaa gtttgctcag 900060

caggagcccc ttttcttgg atcctttccc cttgactaa cattctgagt gcttctgtac 900120

tccgacatga gatgatgata cttgctactc ttgagtttcc ccaagcctcg gccctagaat 900180

cagacttttc caggagacca gtgtgtttt ctgagggtgg gcagigaatt atggatcatt 900240

gacagacca tgaagccaca cagacacaca tctgtgtgca cacatgca cacacaaaca 900300

tattctttt agcagccagc agtccccctc attttataaa atcctgattt ctctccttg 900360

tttccctcc actctgtaa ttctctgtgg cccatcactg cccactctc caacgatgag 900420

tacaatgctt gacactcatg ttgatgata gtttctttg agactcacac ccaggcatt 900480

gtacagtcta gccaagcagc ctaccttta gctatgcca caaccctaa agtgtatatt 900540

aataactcaa taactgaaca aaattttatg ctgagaattt atcctctgtg gaagagaacc 900600

tagaaataag gttaaaaaa attctgtcac ttgtttctc cttctctctt tctctaatg 900660

tactgtggaa catatgtaat aatcagaggt gactggaggt ttggttcata gattgccatc 900720

tgtaaaact atgctttctg ctgtgctgtt catatgtcta gaatcagatg ctttctgca 900780

agataccgtg acaataattt tccagatttt acattttttt ccgttgtgtt atactttcta 900840

ggtggctggc atcgtggca gagctgatgt gttagcatgt ctgctgttcc tgctggcctt 900900

cctttcctac cataggtgag tgggattgag caaactcttc tgtggttttg gtcacatact 900960
 gccatatata cactaaaccc ctgtttgacc agagagagggc tgtggctgta acatgctcag 901020
 tgggtaccag ggagagaaac gctcttttta cccagtgttc acctgttatt ttccaacccc 901080
 attctgaagt attcactgtg tgtgtgtgtg tgtgtgtgtg tgtgtgtgtg tgtgtgtgtt 901140
 tgtgtgtctg tgtgcatgta gtgtttatac atgcatgtac atgttccat ggagacaaga 901200
 ggtcaatgct ggttgttttt ctcaattctc ctccacctta ccttttgag cagggctctc 901260
 cacagagcct gatgggaatc tgtgtatctc tgtgtataac cactccccta cccaatgcta 901320

 tgattgcaga catgggtggct aacacttttt ttctgttta atgtatgcca gggatcaaac 901380
 tcatgcctca tgcttatgca gcaggcactt cgcccactga ggctcttcc atccctcagc 901440
 tttaaaagac tgccatcccc acgctgggaa tccaaactct tgtttctttt gcttgttgat 901500
 ccctggctga ggatagaact ttagctgtga acaaaaaata gatgtgctct gttctgtttg 901560
 cctttgattt gtttaattta tcttcatttc attcatgttt tacctgttc tattattctt 901620
 acaatagcca ctcacagtta cataacgagg ttgactggga agtattgttt cttactaga 901680
 gttttgcact tcagaatctt tttttttttt gtcaaaatac aagaaacctc tttctattcc 901740

 attgtgcctt tatcccaaaa gtgaaggcat ttttaactga cttgtaacat atctacatgt 901800
 agagcagaac aagttaggaa aatgagagtt tgaacagagt gctcagggtg tctccctaaa 901860
 gatgccaggt cagctatacc aactgacttc gtagagagac gctagctggg aattggtaaa 901920
 ctggccttt gagttagatt tctgtgtag ctattggtag agaaaaagga agttacgaat 901980
 gaacaacca tgcggagttt attgacaagg ggggtggggga tggagttgga ttgtcagcca 902040
 acccaaggag aggcagagtg agagagaagg ggggaggctg gaccctttaa agggaagacc 902100
 atgcatgcgc agtgaggctt cacgcatgca cagaatctc atgcaggcca taatgcatgg 902160

 tgggtgatgt gatgacatag catgttttcc tgtgcgtgcc gcccatcgtt aggggggag 902220
 ggtcagccag gtgcacatcc caacactttg gatcaatttg atgaactgta acttacaag 902280
 cccagtgatt cacttttaag aatattgttc taaacctaca atattgaatt agcaaaaatt 902340
 tcccttcttc ctctagggta gtagttcctt tggcatacct atgacccaaa tatctgagag 902400
 aacagcctaa aggaaggatt atttatttgg gctcaatgtt ttagtcaaaa cttggttctt 902460
 ccgtcttcca gtactctctc tattcagact tggagcccat taatgtatta aatcactcat 902520
 taggccagag cccttgtgac atcagtcacc tcagggttca cactgagccc ctgtgacatc 902580

 agtcacctca ggtgtcacac tgggcccctg tgacatcagt cacctcaggt gtcacactgg 902640
 gcctctgtga catcagtcac ctcagggtgc acagtagcgc ttgtgacatc agtcacctca 902700
 ggtatctctc tagcccttgt gacatcagtc acctcaggtg tcacactggg ccctgtgac 902760

atcagtcacc tcaggtgtca cactgggccc ctgtgacatc agtcacctca ggtgtcacac 902820
tgggccctg tgacatcagt cacctcaggt gtcacactgg gccctgtga catcagtcac 902880
ctcaggtgtc aactgggcc cctgtgacat cagtcacctc aggtgtcaca ctgggccct 902940
gtgacatcag tcacctcagg tgtcacactg ggcccctgtg acatcagtca cctcaggtgt 903000

cacactgggc cctgtgaca tcagtcacct caggtgtcac actgggcccc tgtgacatca 903060
gtcacctcag gtgtcacact ggacaagtga cactggcatg tagtagatag agagtaaaaa 903120
tggcccctga cagatgtcct gcagtataa ggacagacct cacaacaagg aatttcttg 903180
cagggaaata ccaatatgac cgaggatgca ggtaccgtcc agtggaggcc ttaggtctgg 903240
agtgagatgc atgaaggctc aggaggaaga ggtggagcc agactagtgt tcatctccag 903300
gcccactgcc tactgcctac tgcatttcta attgtgcaa cactgttagg aaatctgaaa 903360
acttaaggtt ggatttaata ctttctattg ggccagaatc aatctattga tttaattdaa 903420

aattttccat ttggttgatg tatctgagaa ggtgatgagc tttgcatttg ccctgtctg 903480
tgtgggtgtg agctggatca tcacaggtga ttgattgtat atgcctgtct cacctttgga 903540
aatttaagtt ctagatcaac cccatggaga atgcacattt gccatctatt ttgcatgtaa 903600
ttttgtataa ttgtccaag gtgcaataca tagaagaaac tgtcacaata tagacagagt 903660
gttggccctc acttcaaagg agaggagct agtgtctgtg tgcctatatg aggaaatagt 903720
ggtacttctt agggctagtt ttatttataa ttgggaaat aacttgagg acatcataaa 903780
aattcctgta ggaattgtg ataaaaata aagatgacag ggcttgggag atggcagagg 903840

accctaatgg ttccagcac ccatactggg tggttcccaa ctgcctgtaa gtctctctc 903900
agggatctaa tggcctcttg tggcctccat tgcaactgca ttcacaagtg tgcataacca 903960
cacacacaca cacacacaca cacacacaca cacacacaca cacacacaa tttaaaaatt 904020
accctataca tgtacttga aaataaattc aaatgatcag agtagtcaa agaaaggaaa 904080
aatgcttaaa gcctgccttt ccatcataga gagaagtct atttacttgt ctccccctg 904140
tgagtgcata tacgtgtgta gaaacacttt gatcaatcat ggtgatggac acttgacatc 904200
tgtcacttat ccagtccttg ctaacatgct aattctccc tttctgctg atggtatccc 904260

atgtgtaac tgtacatctg tggttgtac caggaatct ggcttctcaa tccatgcata 904320
tttgctagta atgtgtgtca tttgctttaa atattccat aaacatcttt ctatctacta 904380
agtctatcct taigttagtg ttttaaatga ctttttagt gttcattcat tacaacat 904440
actgcatcat aatttgata ccgtaattta gttctaagtt gatattttt ggactttctt 904500
ccatttaaac aacattttaa gagattttaa aaactgtgtg tgtgtgttg tgtgtatgtg 904560
tgtgtgtgtg tgttctcaag gaggccaaa gaagggttag gatctcctga agctgcagtg 904620

acagggggtt ctgagctgcc tgatgtgac tagactccct tcctttggca gagctgcaag 904680

agctcttagt catctcttca gccccacca ttttaacagt ttaaaatagt tgcattgcaa 904740

atgctctggg agaaatcttt gcttactgcc ttgttctaca cgagatacat ctctaaaaga 904800

tactgactgt ttcatagcaa cccatgtgtt gataaggaaa tgccaactt gctttgcagg 904860

agtctggac agggctgtgc cgggcagtgc tttccccga cagcttctcc ctcttctctg 904920

ctgctcagtc tgtttctggg gacctgtgcc atgctggtga aggagacggg tgtcacggtg 904980

tttgagtggt gcttggttta tgacctcttc tccccctccc acaagcagga caagttgtaa 905040

gtcatttcca acctgtgttg ttgtattggt tacttttctt gttatgatga acctataaa 905100

gtaacttggg ggaggaaggt tttttcttt tttctgattc atggtttcta aaactgtcac 905160

atctggaatt gaaaggagct gttttgacta ccagtcttca ctcttggttt gtttgggttg 905220

tgctctgctg agggaatcct gattcacaaa gaaatcgtg tcatgaatgg taacattag 905280

ctgcttgtgt tgagcccca atttctgatg gctgttacc acgagtgagc tccatgaact 905340

tgaaacctgt ctgcttgctc tagctgtgca atctaacagc attaggaggt tggttggaga 905400

cattcttggg tattcatgtg ctcacagttg tgtgattttt ccagtgaag aggaaactta 905460

tgaagcacc tattttcttc taaactgta aaggccatt tgtttcttgt tggatttcg 905520

atgctaagag tgactgggga tattagaagt tcaagcatgt acaattttct ttcctcatca 905580

agcccacagt ccctggcagt tttacatgtg tcattaagaa aacaaatgac aaatgttgat 905640

aagcttgtgg agacaagaga atacttacac actgctgggtg ggattgcaa ctaatgcagt 905700

cactgtggaa ataagtatgg aggtcacgac aaacaacaac aacaaaaagt ctatctatca 905760

tatgaccag ctgtagcatg tctggatatt taccagaaag actccaaatc agcataccac 905820

agagacatgc acatgaatct ttattgcaac cagctgggtt caaaattgac ctagggtttt 905880

atcaacagag aactctataa agttagtgtg gtatttatat acaatggaat tcagccatag 905940

agaagaaaga aatggtatca tttgtaggaa aatgggtgta tctggaggtc atcacacatg 906000

gtgaattaag tcagaaagac aattatcttg tttttcttc tcatttgtgg gttatatcat 906060

tgtgtgtgtg tigtgtgtgta tgtgtagaat tcacttggga ctgtcttggg aatgaaggga 906120

aatgaattta gaagaaagga aggtcagaga gaatggtggg gggtatggtt aaagaggctc 906180

atatacttac atgcaaatat cctcatgaaa cctagctgct cgcacagaga atatgtgcca 906240

ggaaagacaa aactgaataa gaaaaatcga caatgcaatt atgcatttga aagtagatag 906300

ttgcaaatag cagaaacagg agacttggag acttgaagtc acatccttct agcagctca 906360

gctaggggaag caaggggtag ctgcttttct gtcacaagcc ttgtcatttt gtctgacttg 906420
ctttttcctt aattctgtga actattagga gcaatggggt gatctgtcag cacagcttac 906480
agcagccagg gaacccccag tctctctctc agcatggcca cccccaccgt gagagcagaa 906540
aacacgcctt cccacacaaa gacacttggg gaggctgcca tcaaccgctg ccaccggagc 906600
ccaagagcag cggattccct gtgtccccag gagcagtgtg gtccttgatg aggtaggtac 906660
tgggctgggt tctccaccgt attcctttct tttgttga ttgcccaggg ttgcagccca 906720
tgggtgctgc agagctgaag tactgagtca actctctggg atggccttcc tcccccaagg 906780

gtcttgactg tataggttgg ggactttcat ggtgggctgg gaaattagtc cggaggactg 906840
tgaatacctt gaggggtggac actttctctg tgttgacggc agttgactcc aagttgttca 906900
tgcagctctt ggctaatagt tatttaaatg tttgtgagag taaagaaatt aagtagacca 906960
taagaatgga ttggaatcaa ccataagaaa aaaaggtttc agtagaacta gcaatggtgt 907020
aatgcggggg aagatgttag atagaagaat gtaagacttt tgtttgcatt tttattttaa 907080
gtttcacatg tggggtttag gcccatatgg gtgcagatga actatgcaga ggagagacga 907140
gagataccag agcagaaaagt gtaaaggtga aaatccacaa gggtggcatg ctcacgtcct 907200

ctgttacta actgactct ctgaaagggg agccaggttt atgcccactc atttccatgt 907260
aaatgtccct acctcagctg atgccaagct gtggtgtgac atcactggcc tgtcagctct 907320
cagtttctac cagacagaag acatcagcaa aatctcaaga accaagtttg ctatgtagtc 907380
taagtaggaa atgcccagag tggatgcgta acactctttt gatgtacttt gtttaagctt 907440
atctaacttg atctttggtg atagctggct ttaataagta gcttgcaaga ttcctaaaca 907500
attagtcagt gcctattcct gaacatcaat gaagcaggtc cactgtgaaa gctgaaacaa 907560
acttcttacc tctgttccac ccacctactg tttactgggt aggggagaca ctgacacac 907620

aagtcacac cgtgtctgtg gccacactca aagttagcaa gtgtgggagg ctgggctgga 907680
actgggctgg gtcacttagt cctatgcttt cctaccact tgtcaggctt ggagtgcagg 907740
atcctggtga gcacttactg gaggttcca cttggaccag tttgtgtctt ctggtctcct 907800
tcattactgc tctgggtttg gaaagattca tgcagtcate tgtaggtcca cacatgggaa 907860
gtgggtgaga gtttggtaac attgtatgtt aactctgtt tttcatcca ggacaccatg 907920
ttctagaagt aggccacatt ctcacctggt cagcatgatt gtatggaaag atcattttcc 907980
ctcctgggga aggaaggetg ccgtatgtca tctatttgag cgtaaatcta ttactaaaat 908040

tggtaagaa aactctgctt attttttgt cagatgtgtg attgggtaa gccactgagt 908100
ttggagagge aatggcatcc tgccttttaa gatctctggc tcagtggaca ggacattaag 908160
ccacaactcc ttcagatgct ctctgttacc ctaaaagtaa catgccagat tggctgccag 908220

gaccaagagt actgaacatc aacaacaagg aaactggtgc cttgcagccc gtgtttctct 908280
gatatgccac agaccctgc atccttactg ttagctctta cccttgctcg ctttaactgc 908340
tgacttgata cagtctagag tcaacccaag atggaagatt cagttgagga attgatgact 908400
ttggcctgta ggcgtgtgca caggaattg tcttaactat taattggtgt aggaggacgt 908460

agccctgtgg gagtgggacc attccctacc ctctgattct gagctgggta agaaagggtg 908520
tgcaagcctc tgagagagcc tgtgttcagc agagtccac cacggtctgc tetaagtct 908580
ggccctgact tgatgtgtaa gccaaacaat ccatttctcc ccccgagctg cttttagtca 908640
gaatgtttta tcacagcaac aaaaggagcc tcgcacagtt ctgctgtgtc acgattgatc 908700
gggtctctga acaccaggt gcaatgtgag tggtagcct gtccatggg gcaggaagag 908760
agattgtgtg ggggttttct gttttggtt atctttagg atatatatct caagcttctg 908820
taagtggctg acaaaggctc aatcgagaat tgtcatatga agtgtgttt tcagaagttt 908880

cataattcag gggaaaatcc aaaccagta ggaaaaccta ctgcaaggca ttgatttagt 908940
ggcttgtctt tgtgtgat ggtcttaggg gtaaaaagta tagcgggaga tgggaaagcc 909000
aaggcgcac gccctggagt cagatcacag ttggctagta aaaccattta tggaccact 909060
gtatgtgaaa tgctttgat gacggcaaac ccccgcatc ttaaagacat gaaatacaca 909120
catgctcaca cacactcgag tatgtgtgca cagaggcaca cctcccctt catgttagga 909180
agctcggaga gtgctaaaag aagtcacatt tttgttctc atgatacac gcagtcaatt 909240
ccatagacag gccacagtgg ccacaattgg caccaaacac agtggtttct tgtactcaat 909300

cctctgcaca tgccttttc tcttgacacc cagtggaagt cattctctct catgacatgc 909360
cctgctctc ttgtgatgt ttagacattg ttttagtgct gagaacatag agttaataat 909420
gacagtgacc aatcgtatg cataattaaa attacttcta ttaaagtata tatttattta 909480
atcctagcac tcaggaggca gaggcaggcg gactctgtga gttcaggac agcctggtct 909540
tcaagagcta gttccaggac agcctctaaa gccacaatat atatattat tcatttagt 909600
ttgagtgtgt gtgcgcgcgc gcgtgcgtgc gtgcgtgcgt gcgtgcgtgc gtgcgtgtgt 909660
gtgtgtgtgt gtgtgtgtgt gtgtgtacaa tttagtgtag agattagagg acaactgtg 909720

ggagtctgtt ctctcttcc accgtgtggg tcctgtggat tgaactcagg ttgtcaggtg 909780
tgtaacaag tgccttaacc agatacacca cctcatagcc cctgaattca tttactatca 909840
aatggcttta aacctgttta tatctaggat ggtatcactt gggctcagaa ttatctaata 909900
cccttttctg atcttagtcc cataggcccc cagtgtcttc acggcttttt ttttttttt 909960
tttttttgt cttagtgtag cgtattgctt ggacttttct gggcccttac actggtgctt 910020
gggcctcagg caagctgata aattctagt tgcaggagg aagtagatta ttattgcagg 910080

catctgtcct catgtgaaga cggacatgat ttgttgggaa ggttgtgaag gaaatgctga 910140

 aacatttacg tctttattaa caatTTTTgt cattgtttga gagggtttct ccttataggg 910200
 caagggctgg caggagactt acatcatagc ccaggctgtc cttggacttg aggtcctcat 910260
 gaagtggcag gtiactctga actcctcttc cctccagag ccacaacctg catgacagac 910320
 aaaaatcagt ttctccttc ttgagagac aatgcttgta aaatgttcaa cagatcaaag 910380
 ggttccttct tecttgctgg ggaatgatct gttgtaaaaa tgttttgggg ctgagagttc 910440
 tttgtgaaa gtgcctaaac tcagtcacca gtttaagtaa aggacccttt ttgtcctcct 910500
 atgtatgggtg gtctgtaatt tcttttagtt cactaagaca ctctgcctt ggcctcctga 910560

 atgctgctat tacagccatg cccaccacc aaggaatttg gcataaaata acttttaaaa 910620
 aagtaataa gaatcttatt taaaaatac cctgatggta tcatggttac aaggctcatt 910680
 taacatgaac tgtgtgtttg cagacagtgt ggattttaaag tttttatcga ctctaaagta 910740
 atttctctca aatatggaat ataccagaaa aaaataaaac tttcttctgt agatggagag 910800
 gaagaacaca aggtggatgt ggattttttt tccctctgaa ctatttctg tctgtgaact 910860
 cagagtgggtg aggaatggca agcaggccca atgtgggatg caacagaaag tgcctggaca 910920
 cattccccca gagctgggtg acttctgtt ccgtcttggg ctaagctcaa tgcagcactg 910980

 ggtggcttta acagagtctc ggctggcttt gtaagactca gcaccgaaag ctctcccc 911040
 caacaccaca cactcaggag gcagagctcc ttttaattat gggagcagtt ggcgcttttg 911100
 aggggctggc attccccgt tcaattctgca gtccatgat tggcttctgc ttttctgagt 911160
 cgcagtcata ggetgatcag ttcttccet tctcagcata gagccatcaa getaggtgtc 911220
 tgattccaag tggagacaca gggacatatg ttgaaggaga gccactcggg tgcaggcatt 911280
 tctggttggc actcaaacc gtcacatca caggaagctc ctggaagagg tctcagattg 911340
 tctgcttttc caggagccca acagacacca tctggagtat ccagcgtctg gettctgtgg 911400

 ttcagagtgt ggcagctgtg acttcaaggc caccaaccag ctctctctc cagttctgct 911460
 gagcttggag agagatctca ggggtgtggct ggcaatttgc tgataatttg ctcttctagt 911520
 caatttcttt ctatgcagc tgatttttcc ttctttctct tttgcagtgt agcccatggc 911580
 acgatggtaa taaaaggcag tatttgttca ttgtaacaat atgaatactc agggcgtgtg 911640
 tcagtgttct tccgtgagat attattctgt gccaggfcat aagtattgt ggcttcagac 911700
 atttctttgg gatttgcagt atgctacttt tcacagtgc ctaacgtgtt ttttgatcag 911760
 gtacatgta ttacgtgata ccatcaatgt gaccaaatct taaaatgaca caccgcttga 911820

aaggaacaaa tcttcaggaa gtgtgttgaa gattagtttg tctaattggga gtaaagcaga 911880
attgtggaaa tgcaaatgat ttggaaccc tcttataatg ggagtgatcg atgagaccac 911940
gattccatca tggatcaatat tgcaggcata tggtagtact tatgtgtggc tagcatctat 912000
atgacaggca ttaaataaag cttggagtig taatccttac caaagcctgt gagggagaca 912060
atggcctccc aaagaagigt cctgggtttg gggtacttag tctgccagtt gtgtgactag 912120
ctacagatca cttcgtctct ggttacttct gtgtcaaaga ctctggccct ggtacttgcc 912180
tcctggagtc agggtgagaa gcaaatgagt taatatgaaa tgagcgtaga gtaactttta 912240

attgagattt tcacaggtgt taaaatcctg tacacattat tttatgttaa gactggtgtg 912300
aagcaaaggg tgtttggaac cttttttctt tattgttgtt gctcataacc atcacitttt 912360
ctttgctgta tttataaggg gagtgtttta gtcttggttt gacttattta tagtgtctgg 912420
caacattctt tttatgcaat tacaatgtgc tagaaggaaa cagaatacta aagacaaaca 912480
ttccatagtc atgggtggac attgtccatg tttacagggg agtagatgic tgcgattgta 912540
tttcattaac tgatagagc tgcctcttt agagtttcaa acattcttgt tattcttaga 912600
ttctgaaatt attgacttaa aaaaattaca cagctagcct tgagctcctg atcctcttgc 912660

ctctgcctct tgagtgtctgg gggcactgg cattgtgatg tccagcttag ttgaaatgt 912720
tgatgcattt agggctatgg ctgaataaaa tgtgggtgga aatccagtaa caaagacttg 912780
atagtgagtc ttttaaaaca gatgcctcaa taaccttagg aaaatgtgct tcatggtatg 912840
gatttatgaa tttttcatgt tttcacatca ctcaatccac agtctatatt ctcttataa 912900
gctgaggatg catattgatt tcaaaatcac cccaaggtac tgaattcaca agaggcccaa 912960
gcattacaga tttgccttta atgatttagc ctgctcaact agtgctaaaa tgtttaaaag 913020
aatgtgagta ttgactttta ggggataaag gcaattaata cagcataatt gaaaaaatt 913080

aaaacaaaat cagccagagc tcagtggaag agagaactaa tgtttgtgtt ttgtgttaga 913140
gttcagcatg tccagatata ttgtagtaac tggatcttg gttcttgagt ggtgtggagc 913200
atgttctcac caacagttaa atcttataat atatattttt tccgttctgt gtattcagtt 913260
ccaagtgagt tctctttgtg gtggaatgta gctttggaaa gaatgagat ctacaatatg 913320
caatgatgaa aagctttgat tggaaaaatg accttacttg gacagagcca gcaaagactg 913380
gagcttcccc agtagctgcc tctcagttc tctgcagctg tcaaggacag gtaactgat 913440
gaggcatttg taiccaggcg ctcaattatg gttatagttg gtggctcaga acagaacgtc 913500

ttgagcgaga aactcatta ttgcattgcc cgaattgttt atgaaaagtc aacaacaatg 913560
tggactgtga agagtgtttg gattttgttt tgttttgcct tttgttcttg ggagaacaag 913620
ttgtttctag atcttcctgg agctgcagat aaagaaagga gaggtggtgt gttttccccg 913680

ctggcttcca atgtgcagca tgtctgttgg gtcagttgct gacctctctg gatctcagtc 913740
 tgatctcctt cctttccttc ctccctccct cattctcct cgctatcctc tctttccccc 913800
 actctcttgt taatctttcc ctttctcttc ttcacttttc cctccctcc ccttccctct 913860
 cttctcttcc ctccaactca ttcatttatt catttatfff tgagacagaa tctcactgtg 913920

tagaccaggc tggtttcaaa ctcagttttt ttgtttgttt gtttgttttt tgccagagat 913980
 gtctgagtga tgcattaca agcgtgagat accacacctg gtttcatact tgtgtttcat 914040
 ttacttagtt atttgtacct gtgtgtgtgt gtgtgtgtgt gtgtgtgtgt gtgtgtgtgt 914100
 gtgtatgtgt gggatgtttt ttttgctgn nnnnnnnnnn nnnnnnnnnn nnnnnnnnnn 914160
 nnnnnnnnnn nnnnnnnnnn nnnnnnnnnn nnnnnnnnnn nnnnnnnnnn nnnnnnnnnn 914220
 nnnnnnnnnn nnnnnctact gtgttcaatt tgcatttcc cctcatttc cttttctatt 914280
 ctagacttct atactgcctg ggtctttgaa acttaggtca aatgtattga tggaaaatgt 914340

caacattaaa aagattaact tctaaagatt aaataccctg cctccagccc tcatagtgt 914400
 ccttacacgc ttggtcagat cactgattct ttggaataat gcacatttat tataactca 914460
 cagcaagccc gggctttaag gatcatttac agaaggatt cgtgcggatt tttatattga 914520
 gcttggtttc tggacacaat ggccattggg tcggtgtgca tacttatttg cttttgcctt 914580
 tcaagaactt gctggcatct cgtttgatta tttaaatgcg tggttttact tctcactttt 914640
 agtacattta ttatfffatg tgtatgca tttgggtgca caccatggca cccactcacg 914700
 tgaggtcgga ctacagcttg tgggatactg ttctcttctt ctaccatgta tggagatgga 914760

actcatgta tcaagcttgg cagcaacgct ctgtaactca ccgaagtctt gccatctgtc 914820
 cttcctttca aagactgctg ttatttgagt attgcaatct aactcattc tgcctttcta 914880
 tatccctctc agttcaattt tatgtacaag atgagctgtg accactatgt cctgattcat 914940
 tctcaataaa gaaagtagtt ggcccagcct ggactagctt ctatggaggt aggaaatcat 915000
 gcaataaaag ggtgagaac acaaggtag aattagaaag aacaccaaag aggtcacctt 915060
 agcaacctga gaagtcggc tctagctgag tctgttatga cgagacagtg agctgggagg 915120
 tgggtgggct cctccaggct gaaagcacag tttgggcagt tcaggacaga gatggaagaa 915180

gtttccagga ggaagctagc actcaggcac ctcaaccctt cttagaccga gctgtgtgct 915240
 gtgtgggctt gtctgattta gatttgtctc cagtagagcc tgagcacaag acttttagtt 915300
 ttcagaatgt cctaaacaata gttctagagt ttttgaagca atgactgaat tttgtgtagc 915360
 tgtggaagct taatatttcc ttttaagggt gtatcaagta tataatgtga ttatatttac 915420
 ataaaagcat catttatttg ttgacatagg gccttaccat gtagctaagg ctagtcttaa 915480
 actcactaat tagcttagac tagcatcaaa attgaagtga ttctcctgcc ctggctgtga 915540

aatatggatt cacttgttct cagagttttg tactttttgc agaatgttca cgtttaagag 915600

aagttatcag gatccttggg agagaaaatt tttcctggtc ctacagtaaga gactactgtg 915660
gttagtttta aaagtcacct tgtgacaacc taaaatcacc tgagaagaga ggtacttgcc 915720
tagatcaaat tggcctctgt gcatgtcttt agggggttgt cttgattggt aattgaagta 915780
agaagactca gtcaccctg gtggcaccaat tccctaggca agaagcccta aatggtgcca 915840
gacagagaa atctagatgc aggcagttag caggcagtat ggggtattc gtctcccgt 915900
gcttttcagt gtggctgtag ctgcttctag tcctgcctt gatttcctc agtgaggtag 915960
tgtgattgta agccctatag tccttctct tctgtatgtt gctttttgtc agactgtcag 916020

tcatagcaac agaaactata acagggacag agtatcattt attccacctg ttcattgagt 916080
taaaccctct caattcatgg ctgtcttcca aagagcatgg tcgccagaac ccaataggct 916140
gctaaccctt tctgttatt cattcagtat atttaactta taattttgat tcttggttc 916200
cacttaaacg ccttattttc tcttatgat cgttatgcct cggcagctgt tgtatttcat 916260
tctggaacag ataattactt tccaaagtgg cagaaaagtg agtggttggt tttttctggc 916320
ttgattgate aggagctctg tgatgcaata ttgactgggt tttccacagt gacagaggaa 916380
gggcaccaat gtccagtggc agctgtctacc tgctggtagc ttcctgtggc caagacaaat 916440

ctgactgagt ctttgtgtca gattctggct ttcagaactc aaggttgaag cagttaaag 916500
gcatgtaag gaaaatagta tgctgtcctg aaggaccca cagatgcaat tttgttttc 916560
aaagtctct ctggaatfff cttctctggct cacatgtaat catggagtgc cacagcaagc 916620
tcagtggctc atggagccca gagtcacgag gaagtgattt aaaggagatt tctcatttag 916680
cagcagtaga agtttattag ctgatttcta gatttcttca agggaatgac tgggtgtggc 916740
tattatagat ggcatgctac ctgctcctta tatgaagata ctcagtctct tccacaattg 916800
gagctggcag aggatggatt gcattcattg ttaataacce cggctttac ttttcaatgt 916860

cttgggggtt tggaattggt atccatcatc tctgtcatt ttaggtaaaa aggaaccagt 916920
ggggaatgt cttttacgtg gcttgaccc tccccgact ctatcaccaa acccttggga 916980
catatgtcct cagtcctcaa atgaaagaca gactctcatg ctgactctt cacgtggttg 917040
tgtcatttac aaaatctctg cctagtattt ctactttga tagatcagca accagatgat 917100
tccagtggtt tgaggctact gaatctcaga cttaatctct agtatgactc cggattcat 917160
cactgttaca tgiacaaca gaaggtccca gggcccagag actgtgtaac ttgcacaaca 917220
gigaacagct ggaagtggga cagtcttggg tttgaattca tactgtttg ttcacctgcc 917280

caggcttctt cagactgcca aagttagcag ttttttctg caaacattta tgaacaactt 917340
 cgagaaagac ctaacatggg ggaagggggt actcattgtg ggtattgatc tactgccaat 917400
 gtttggtgc atagggaact aaacggcagc cctctgagtg gcagctctgt tttcctcatt 917460
 agtgtcaagg tagctgagga ggtgagactt gtctattcac cataaagcaa agttttgggc 917520
 gggacacttc acgtttttaa aagctctcca gggcagtgtt cactggccac tcaggaacag 917580
 atgaagccca gcctgctctt ccttctgagc ttggtgccag aaggfcattt tgcccttctg 917640
 tggaatctca ggagtggcat tttctagtga tggatggtag ggctcagggc tgtctctctg 917700

 tgcacataga agtattccat gtgggcacaa accatgcttc ttgtcaccaat gttacacat 917760
 tcgtttgtaa agcaagatga cgaaaatgag aaaggctgtc gttctgtcac tgagaaattt 917820
 aaaatattaa gaatatgaga aatagtatca tagattttcc tgttgctatt taatcacttt 917880
 ctccagtctc tctctctctc tctctctctc tctctctctt ctctccctct ctccctctct 917940
 ctctcgctct ctctctctct ctatggaatc aagtagtaga ggacagaaag gatctgcctc 918000
 accactgcat tattctaggt cccttctcag ctccctaggg ttggggaccg agtggggttt 918060
 ccataagaag atgctcgact gggtcgctc ctcccgfcat caaagcttca gtctctggta 918120

 aatctggtcc tgcagtgaat ctccagtaag aaatggatca gaggtgtgtg tggcccaggg 918180
 gaaagtgtgt tctcagttct tgtctggtcc ttcaggctgt catggacctc acagacatct 918240
 tcctttgaat ctttaataac cttagagagac ctaatttccg gcaactgtaa atgacacaaa 918300
 gctgactcag attfacctc atctctctta cttccagtca cctaagcacc tgctgtacag 918360
 tggctgcaaa gtgttgctct ccttgctctc taatgtcaaa gccacaggag ccagcagtga 918420
 ctctcagcag gactcacctt gccctatcag agttctctctg acacatgcag tcagccgtct 918480
 ccaagtctgc cgatgtggtt cctatactt cactggcatt cagtcaacac catctgggtg 918540

 atgaggtcat agttttctta gtggatatga tatggaaatc taaaatagag tcctcctag 918600
 acgatgtgga gtgcgtgtgc gcatgcgtgc acacaaatgc acaaacgcat gcgtgcacac 918660
 aaacacacac acacacacac acacacacac acacacacaa tgaggcacag ccacaggcca 918720
 aggtttttat attcctcttt agtttctgta atgtggagct tttgttttct tgttttgctt 918780
 tgtagaacag aagtgtgac aggaaacccg ttctctgtga tgaaaggag cctggggggc 918840
 tctgaggctg tgcaggctcc ttgtaaacac aacctgtgga tcttttgaat aagatcactc 918900
 ttgttattgc tgttctttgt ttctgttttg agtttgcttt ctgacagtgt ttgacttcca 918960

 ttataaggac cagcttcttc caggctaaaa atatctaaag gtttcagaca ccgagtcata 919020
 ttccaacat gtttccattc agccccagag tgaagggtcc tgcgtcaggg aagcagagac 919080
 ccagcccagg acaccactc agaaggtgca tccttgact gatgaggggt gctttgggaa 919140

gctgtgacat ttcccagaag aattcgctta gcacacatgt gcacgcatta ttaccatatt 919200
ctgtgtgcat gtgcgtgtat tagcacatgt gcagaggcca gaggtcaacc ctggtgtcac 919260
tgaatgactg aatctctcac tggcctggaa ctcatctatt aggctaggtt ggcgggctgg 919320
agagcccccag ggatcctcct gtctctgccc cctcagtcgg gggattgtat gtctgtacc 919380

atgcctggct tttttacat aggttctgga gtttgaactc aggtcctcct atttgcata 919440
caagtacttt acctattgaa ctgtctccct ggccagatag ttctgttcgg cctgtagaac 919500
tgtcagtgtg acctgtgacc actgggttat ttgcacctgt ctgcatgcta cagcagctca 919560
gagggtatga caagtgtcag aaatacagga aggaggatgg cttggggctca aaggcagagg 919620
tcagggtcat ccatatggga atgcttgcac ctcccagggc ccatcagagc acgcagctgt 919680
tcttcaaggc agatgttcca aaagaataa actgtctctg tgggcatcac atttgtgctt 919740
ttttgcaggt taagagaaat acagaaatta caaagacaaa agcactatta cgttaaggaa 919800

aggactggag ttigtatgtt agcgtcacat gcttacatgt atacagcctg cacattttca 919860
tgtgtgtggg ggtgctaatac agtgtacatg tgtgcatgtg gagggcagag gtcaacctca 919920
gctgttcttt ctcagggtgt gtccatcttg gttttctttt gagacagtct ctctctgacc 919980
tgggtcttgc caagaaggct cagctatctg gcagtgagct ccatggatcc tcctatctcc 920040
accttcccag ttctgggatt aaaagcacag aatgtggttg gttttataga gaagctgaac 920100
tctctcaage cctaaggcct gaacagcaag cactttactg actgagccat ctccaaccc 920160
tcaggctcac tgtttaatgg aggacctttt tgtgagcctc tcaagaaagc agatgtgca 920220

acatggtttt cgggacactc tgttctggag cagaatgaaa ggacacagga tagcagtgt 920280
gtggaagggg cagagtctca tgcatcaga gcagaagcaa agccattttc cccagcaagt 920340
gttaggtgtg agtcttcaaa ggaaaataag taaacaactc cagtgcatta ctgtgtacg 920400
gaaactgtca tgaaaaaaaa aattgccttg gtttgtcaaa atacaggaac agaaagttec 920460
cacatagaac aacagagcaa gcagaacagt gttgaaaaca ggtaacatga gagtgtggca 920520
cgctgagtgt ggaattattg atggcacaga aactgagagg gacaaagaag aatcaagaag 920580
aggctcttga gaaattcaag ctcacaggga ggcgtagagc tagccagatc ataatgtgt 920640

ctagttccat ctagatgaca ggggaggtgg gatatactca gaatatggaa actcagaaga 920700
gttgattcgg ggagaagagg agacatgctg tgtggagaag cagggacctt ggctggacac 920760
tgtggcctgc ccatgccatg ggaatagctg gcttgatttg tgccaagctt cgtggtgagc 920820
atttccccgc ttaatgctta aaggttcca tttgagatgg attcgggtca cgtcaagaga 920880
ggaagccgtg aaggccacag ttagggcagc attgaatctt gttcagataga acctgcgttt 920940
gggtgtctata ggtggtttgg tttcaggccc agctttcatc cttgtgagcc catgtcttcc 921000

tactgtgaga gtttgcctca gttcagtgac tagccactga aatgtgccta tattcctgat 921060

gtccccgtttt ttcctttctc atctgccttg gtaccaccac cttagccacg ttcaacgac 921120

cttatgtggg cactccttta aacecgccca ccccatcctt ggcattagaa atgaacctca 921180

gagatgtgcc tggcaagctc cctaggcaaa ctctttgcca ctgagccaca gccagccct 921240

ctgaagaccg tctgtgtaat gtgtttggct aagcaactgg cttgttcagt ttcctctcct 921300

cctaagatga accaaattat tatgggcccc tgcctgcctt gtattttag ctgtaatat 921360

gtgtttcctt ttaggaagg aatttaacat ctctgccgtg catccaaca gtgcttaatg 921420

ccacattgta cacaccgttt acacttttca tactcaattg gctgacctca agaagggat 921480

attctaatec aaagatgtaa tcacaacca catcccagtt tatggaaatt ggagtaaagt 921540

tgccacatt tgtaatagag aaagagaaag gatcacgagg aaataatac taaggaaaat 921600

ggtatagtaa gagaaagaat attctggaac caaagagctg tgagcactct ggaagaattg 921660

gatcacttgt gtgtcagaaa tctttaacc tgtaacagag gtggtlaacta tagcaacatg 921720

ctttagagta ggctgtacct caatgtaggt gtagagtggg ctgtatctca gtgtgggtgt 921780

agagcagggg gtacctcagt gtgggtgtag ggcagcattc ttttcccttc ttagctaattg 921840

tgcgcatatt ctttacaac tgatacttgt ttagctagct ctttaagta attgagaggg 921900

aaaaataaca ttaaattcag ggacgtttct atgttttggt atttgtagt atttgcagaa 921960

gcaggagctg ccctacaca ttttattatt ttacttagtt ttatttcaag agcacagcat 922020

ttactgagta ctgcttttgt tttatcggtt taaagtctc tttgttttaa gacctttatt 922080

cctccattcc ccacctttt ttttttctgt gttaatgtct ataactagtaa gaaccagatc 922140

acacagagag aaaatcgctg cccaaaatag tttgttfaat atattacaac taattgggca 922200

aaaccctcc aaattccaat ctgtgggtgt ccacaaaaat atgtggtatt cgagctggag 922260

taatggtgca gcggttaaga gtactggctg ctttcccaga ggacccaaat ttggttcgac 922320

tcactatcac tctgttcca ggggatctga tgcttcttc tggcctcaa gggcacagca 922380

caatgtggg acacaaacat atccatagc aaacactgat atgtgtaaaa taagaatag 922440

tttttaaaaa catggtgttt gacctgttta gcgttgacag atggcctct ctaaaatcag 922500

gggctaaga gaccctgct cagcaccac aaactaac agggaggtca gcatcctgag 922560

gcccgtctc ctgcttgaac aggaagtaa tggaacttcc gactgtggtc cctcccctt 922620

tttgtactca aagtggattt agtactaagt taactactaa catttctgga atctgagaaa 922680

gattattagt tactgggttt actgactttt attctcatca caaagagtga gcggatgtgg 922740

atccctttat tgacacaggg aaagaattaa gttttcttat tgctaatacc actgtctcta 922800
gtacacagag agcatttctt gtgggtgcc ttctcagggg tgattatgaa ggtacaatct 922860
ttgcatgctt gtaggaaatc tgactggggg cagagcaaga gtgcaagaaa aatagaattg 922920
tctgtcttca agccataggt aatacttaga tgacatgta gattttcttc atctcaagca 922980
gaagtggaag actgacttca caaagctgca agccggcagt cttaagagac tcataaatgc 923040
ccctgcctca atccatctgc ctctaatga gtgggctggt ttccataaaa tagatttttt 923100
ttggggggtg gttttgagac agggtttctc ttcggtttg gaggttgtcc tggaaactcac 923160

tctttagac caggctggtc tcgaactcgc agagtctgcc tctgcctccc aagtgtggt 923220
attaaaggca tacaccacca ctgcccggca aaatagattt attttaagg ataaaaaatt 923280
agctcgagcc aggatgggta tgtggatgcg tgagtgtacg tgtgcgccgg tgagcatgtg 923340
tgtgtgagca tgtgtacgtg tgtgtgcatg tgtgtgtgca tgtgtgatag ttctgtgtaa 923400
gcacacagtg gtctgtctt gatagaaaag ctgcaaaact taccctttg tgtttatccc 923460
aaatcttact ttcccaggta aaatctttc aaaattctta ttatttttt tttttttaga 923520
ccagagtgag tcaattcaca ttgttggat ccacattgtg cttatctcag ctgtgtcctt 923580

ctccaggcc aggagtcata tgggtggctc atccctttc cctcctcct tgtcagcctg 923640
tcagtggac acacaccagc tggttcttag tgactgagg caagctctct ggacgtagga 923700
ttaaagcata atttgttga gaaaaataaa ttgtatttag ataccagag ggactggggt 923760
ctgtgccagg cactttaagt ctaggatatg aatttcacat tgcaggtgct cctcatttc 923820
cagtgcctcc cacttcttga gtgtatgaag agcatcctt aggggatgac gcttagtgga 923880
taaatgatgg cacatgggtg gtcatgggac aattatgtca ctttcaaatt aggacacttg 923940
cagaggatag ttgtgaacac actattcaca gggacgagtc ctcaggccat taaaatggca 924000

ggcctgacat tatccaccac ggggaggaaa aagtctgtg ggtagccat cttgagaagt 924060
ctttggtcca cacttgcc aggctaggaa gggtttgggc attaggttcc ttggtctccc 924120
gcctcatag cctctgctct gtggccaggg tccccatca ggaatgaaac tgtaagtagg 924180
aggtggggag ggactgata gacaccacac aggacagtat ctgataacag ggtgggaaac 924240
acctctgggt ggccagtgag aagatcatga ctatacagat gggcttctca gccaccaag 924300
gatctcccac ttgtatgggg acgagggcat gacagacat tttcatgcc ttaaacgata 924360
actgaaaatt attgaggcag agcatgggtg gttatgccta gactaccaac acttgggggg 924420

ctgaggcaag aggcgttctg agtttcatta tgagaccatg gttctccaat gctcccaaaa 924480
ccaacagcaa tagctgtgtc agcccaaatg aacacacaga cgctatatta attatataac 924540
tgttggccaa tgacttgggc ttcttattgg ctagctctgc ttaattatt aaccataac 924600

tactaatctg tgiatttcta cgtggcttta tcttaccgaa gaacgcctga cttgcatcct 924660
ctcttcccgg gctcacatcg atactcctcc tctgcctacc tctcccagaa ttctctcat 924720
ctcctagccc cgcctatctt cctgcttagc caattagtgt tttattcgtc aactgataag 924780
agaaacatat acagtataac atctcccatc agtccccctc ctcccatgt tctaagcttg 924840

gatgcccacc ctaaggccta tgaccagcag tgtggccagt gctgccagct gcttctttct 924900
aggtcccagg cattgtttct tttgtccctt gattctcatg cctgtcatg getgagtagg 924960
tcactgggtc caaaaactga gccacgggct cacaatgaca tgtggtagtg tcatttactt 925020
tacactttgg aatttcaagc ccaaacgtaa tactattatg aagacctctg acacctcaac 925080
aaagtttttt tcicttaaag acctcctaca gttagcagga gcagtagcag gaggctgaca 925140
ttagctgcaa cagcaactat agaaggaaaa ctaaacaac aaaaaccctt cttactaac 925200
atltgaaca gacatgggca tctgctgcc atgttcccaa acatcctacc tatgatctgg 925260

ggctccttag ccatatgcaa aacctcagca cctctcagaa aagcagtcaa gggcattacc 925320
aatcctttct tcctttgctt gaaccgcaca gcctctgtca atcactggct aaatctttct 925380
ttgcacgca ctegtgtcca ttatgacca tgtgacggtc tctatgctgt getttgacag 925440
gggggttaat ggcaactgaa cagctctctg tctaatacaga acctgcagg ggctctacc 925500
cctgctgtgc ccagcacatc ctctgcaag gttgtggaga aggttgcctga ctgtcttgtt 925560
accagtttg tagaattcat tatecctaa ctgcatccat gctatacaga agtcacacgg 925620
accaagtatt tggaaaggat gatcttttcc cagtacattg accttgtgtg tggcatgtgt 925680

atgtacaagt atgtgtgcat gtgtgtgct atatatgtgg agggtagtgg ttggagtcaa 925740
gtaccttctt cattgatttc catcttaact tttagagaca atctctcatt ggaacttact 925800
tagacaacaa gcctcagga cctactgtc ttccccctc caggctatgc ccagttttt 925860
acacgagtac tggaaattgaa ctcagggtgt tgtgcttgac nnnnnnnnnn nnnnnnnnnn 925920
nnnnnnnnn nnnntctcca tctaacaag tcaggatgac tgtgctaagg gtgtgtctt 925980
tctgatttgt ctgctctgtt tataggagtg ttttctctac ccacgggcta ttcttcccga 926040
ggctcacaag cgccatgtgg catgeccagg atttaacctg ggggtggaat cctgaggtcc 926100

ttacgggata ggtgagcagt gctgtcaggt ttggttatga ggttggatgat gagtgtggga 926160
gaagacagga aaaattccag aaacagcagg atggagtctg tgcctgattg cccctggag 926220
gggcaaggct tgiaggtaac tctgcttatt gtgtttgtct tggctttgtg ccttacttat 926280
ttcttgggga atgagaactc tttatataaa aatctaagga gacattgggc ctgtgttaca 926340
gctgagatgg agtgaatcca ttactaacag tacacactat gagtcaatgt cccaagtatt 926400
cttaagggtg gcttataaat taattgtttt tgtattaaaa atttcaagtc cagctattgc 926460

gggagatcta gggtgctttc cagaactctg cttccttccc cacctgggtt ctctacagct 926520

 ctggctcaaa ggcctcccaa gggcaggctc aggtctctgg gggggagggc agggaggttg 926580
 gggatgggtg gtgtcccta cacctgcatt gttttcagag gccagttgga tgctcccaga 926640
 acgcctgta tttttaaata tctgctcaga ctgagaactt ggcagcatgt tcaactgaac 926700
 tgtgaacttc tggacttagg tgggtccctg taaagtttta tgtcttaaaa aactacaaa 926760
 aagccaggat ggaactttcc ttccagtggg cagcctgtcc tgggagtcag aggccctttt 926820
 ctgatgtgtg tcccagaagg caaagccaaa gttttgagtt tgaataatag acttaatagt 926880
 cttaggtttt aaatgacatt gttttctcac tggaaagtcgg tcccataatg actttcagat 926940

 ctatTTTTGG aatcctgagt cctgtggctg atgacagatg gctgtggagt agccaacaca 927000
 gccactatct ttctgaaat gataaaggct ttattgctga agcatcttgt ctctatagat 927060
 gtataattaa ttatgaaca gaaataaatt gtatagctcg tggcatatTT atttggTaca 927120
 gcattttata aacacgatta ttcactggTg tttctcagtt ctgcctttat tacatgatga 927180
 tctgataatt caggatgaga aatagctgca ttaaggactt ggcagagagt ttattacaa 927240
 attttagatt attttgaat aaaatagtac cagtgatgtg gcactttagc tcacaatcat 927300
 agtttcacac acacacacac acacacacac acacacacag tgtttttcca taaaagtTgg 927360

 atttcagta ggaatTTTaa atgtTTaaat tgtttagttt tttttttTgt ttgtttgttt 927420
 tttttTgaga cagggtttct ctgcattact ttggaggctg tcctggaact tgctcagtag 927480
 accaggtTgg cctcgaactc acagagatcc acctgcctct gcctcctgag tgctgggatt 927540
 aaaggcgtgc accaccaaca cctggctTaa attatTTTTT aaaataatgt attaaatgtc 927600
 ctccatggc acctcctcc tagaattgca gaggTgtag tgataccaca tgctctccca 927660
 gctgtgtgat actctgTata aggccatata gactggagag cacatctgtc actgtacagt 927720
 ccagggtttt gctgtcaca ggagcatttt tgcagccttc ctttcatgt ttgtttgtgtg 927780

 tgcacacaga ctaggatatg tactTTTTc gTatgTaaT gAgTggtgtg tgtgcagagg 927840
 ccagaggagg aactgggTata tctcttactc tactttcttc ctttTgagaca gggTctctca 927900
 ctgaaccctg agctaggctg ccagccagaa ggtcccagca atgttctgtc tctgctttac 927960
 cgtctgcagc catgcctgac ttgttatgtg ggtcctggga tctgagttTg agtcctcatg 928020
 atgcaaggat agcactccac tgaactgagc atccttccag cctctgactg actccttttc 928080
 aaaggTctcg ttttggTTTT tcacctttgt acatgttctt caaaggTgag atgtgtgtag 928140
 attcTTTTg tttgtTgtgc ttggggTgTata tcatgaaTt gaggaatttc ccatctggaa 928200

attcaataca gttatgcttt ggtgtttcct ctgaggcttc tttttttttt tttctggttt 928260
 ttcttttggt ggctcctgt taaatttgcct aaactttctt actattccct tatttctact 928320
 tctcctgctc tcacatctaa tctttttgtc tgtttttatt ttattctggg tgatagaagc 928380
 atgcctgatt ccacttaate acttctctca tctttctttg tctagtccat aaatctgccc 928440
 cgtggagttt tatgcttcag tggcataccc cttatcttta ttgtttatta tttttagaag 928500
 ccttcattgt tttattcaga tctacttaga ctttttatat gatttttctt ttcattgcttt 928560
 ttgtgtgtgt ggcaattctt taaacactat agagggagaa gatgtgaatt atagaaaagc 928620

 acgcacgctg acctgtctgg caccatgtta actggggaaa cacacacaca caaaaacccc 928680
 aagagtcctg ttgtcctagc ttctgggagg ggaggggggt caggaagaac ccaagtcca 928740
 ggccatcctg aaaaacttag ggagcccttg cctcaagata aagtaataga aaacaacaac 928800
 ttccaatgtg gcctgtggat tatagtctag gatcctgcat aactttgttt ttgaaagaca 928860
 gggtttcaact atgttccttg gctagcctgg aactcataac gatcctcctg cctctgcctc 928920
 cacacctggg ttttgcataa cttttaaagg catgaggaga cagtgtgtaa accaagctgt 928980
 ggaaagtta agctgtgaag ctggagtaat acagtttccc agcaggatcg gcacatgggt 929040

 ccaaacattg cagcagtggt gtatatatgt ccacacttca cgcttcatgt ctcactcatc 929100
 atctgggttc catctctccc atgttgtgtg tatgtatggc ttcagtgtctg ccaaggtgct 929160
 ttgcatctgc atagtggact ctggatgttt attagacagc tcagacaatt ctggcttccc 929220
 tgccccgtgg attcctctag gcccttttct gtggcttttt gtgcaactgc agatgtgatg 929280
 gtgtgttaca taggcttccc atcacaata ctggaggaca cagtctgtgag cagggaaacc 929340
 tgtttgtgct catggtctca gaggcctcag ctgtggccag ccggctccac tatttttagg 929400
 cctatggcaa gagataaaca ttacagagaa agggcatggc agaggaaact gtgtggtatc 929460

 aggaagcaaa gaggagtaac aacatccggc agaagataca cacttcacag gtgcctgcag 929520
 gtaccacctt ccgcaccgac tcagttctgt tcagacctca agtacattac tagataaacc 929580
 tcacatcaca tctagtctgt tctggaaatg gcacgtggga gggcaaggca aaagactgg 929640
 tgcaggttca aggccaggct gagctacaca gtgaggettg tcttaaaaaa aataaaatct 929700
 gcaagtaagt tagcacgctt ttcaaattgc cactcgagcc atagtgagaa cctgatgggg 929760
 ttgttaggag gttgtgtgtg tgacacactg aggagagttg ccctgtaaca aatactttgt 929820
 ggatttttat tattactcta gccatgctta ttgaaagtga acagtcattg atgtgttttc 929880

 ttatgaggtg aatgcataat aaaaatcaac ctatgtgtca gtggigaata ttatttgttg 929940
 ttgggatgaa tctgggtcca ggcacgggct acgtggetgt gttgaggett ctctcacaaa 930000
 ggggacagat agggagacac tgatagtagc atttttcttg tggctgtgct gccctgtct 930060

cccaggctac tctagggctcg ggaaacacat tccatgggcc accagtcac actgtttcct 930120
gcttgctagg cctgcctgcc cacactgcct ggcaggccac cctctatttg ctgtcttcac 930180
cccaggcctc agaaggacta tctagcctct gcttctaagt aatggttcct aaggcaatga 930240
ccttcatttc ctgagtttgg ggggatgccca ataggcaact tgggtgtggt aagctgtaac 930300

aggcttaggc agcttcatct aaggccccgc tgcacacagg gacatggctg agccctccgt 930360
ggctctccca tacaggggct ggtgagtgcc gggctctata ccatagtctg agtgeccatc 930420
ctgaaccac tagaggctct ctggaacctt ctaaagtct tgcgatcaga attgggggtt 930480
tgcagaaagg acccttttgg agtcacatgt cagccttctg aagcttatct cccagcagcc 930540
cggctggcac ttctactca catgagctcc ttagaaacag ctggcagtc cggggccact 930600
ggggtgggt ggaggttctg aagcagcctt cctgtgtgc ctgggtacc agcaggcagg 930660
cctggcccaa gaatacatct aataggcaa taaaaacaaa attaatgtaa aatcacctag 930720

gaaaaatggg ttigtctgtg agcatgactg ttggagatta tttctgtag actattgagg 930780
cagatggctc cactccctag gcaggagatc ctggcttctg taaaatggag aatgaatgg 930840
atattgagtt ggtgtgtatc ttttctgac tgtggatgac atgtgaccag cgtgttcaag 930900
ctccagccac tigtgcttcc actgtgatga actgtaacct gtagcgggta gctaatcccc 930960
caaagcagaa gcctccatt taaagtttcc gctgacacag tattttatca cagaaagaca 931020
gcaatgctgt ctgtgtagt cataagccga actggttaca ctttcagca ttgttctgt 931080
tagacgtgtc agaaaaacgg tcttgtgtgg ctatgatata atgccacagg ctgggtagtt 931140

tatgaagcac agcagggtgt tctccctact gaaaaatggaa gcattcacag gttaggtctc 931200
tgtttctgtt tctacctggc acctcgaaca cagctgtctg gagaggaact gtggtacacc 931260
cttctatate cagagagcaa cacagagaga gccaggccat ccatgaagcg tccatcctat 931320
gcttcaataa acccccactc acccacactc cttaacactg cagcatgagt gcctaagtct 931380
gaagcttgtg acttccagg aggggggag caaagtcaag ctgtaccaat gtggatggat 931440
attcatgate ggcattttct ctaagtgagc aatgcagttg gcagtcgtag gaagacagct 931500
tacagtgttg tigtgtgtgt tgaggctcag aattccaac aagaaaagtg ggcttttgg 931560

aactgtccag ctgtatatac tggcaatgaa aagtaggacc ctgggtaaat gggaagagag 931620
ggagaagccg gagaggaaga caggcgggtg taggggaagt ccactcataa tttgtggggc 931680
tggcaagttt ggagtgatcc ctgcctgagg attgggcagt ggggcagggt ttttcttga 931740
gaggcaagat tccttttga gtggccaag ttttctcta aggccttaat tgctagataa 931800
ggcccacat tcgccagtga ccctaagtgt ttagtcagat attgaaagtc cttggttttg 931860
gcattggaac atgaaaggtg gtgcctcca tactggtgca atcagagagt atggtaccga 931920

gttagaactt agtagagatg tgtttgcttt aataaacctt tttttacttt cagaagataa 931980

 ccccccttt taaaaaactt tttacaata gtaacttttc tatttcctta aaaacaacct 932040
 acatagggct cagggaggtt agactaaaaa tgtctgaggt cacagtggtt ggtgatagac 932100
 gctgatctct gtacgttcgg gtttctgtct catagtccct gagagacccc tgaatagga 932160
 gcctagtttg gtgactgcag agaaaaatca gccacagact gattggtgca aactgattgg 932220
 caggcagagg gagtccagg agccaggac ttacaaggga ctgctgtgtc cttgcaggcc 932280
 tggagggttc ctgctgacct tggcaatgtg gtgcaggctc tggggttaag gacattcagt 932340
 tcgaagccat ctggctttgt gtcggcttct ggttacaag tggtagtgga aataaggga 932400

 cacagaggaa catgacagac cctgaattcc atgcattgga gacctgtctg ctagcaaggt 932460
 cataaagtgc attgctgigg acgccttctc tgtggcatct ttccttttg tcatttaacc 932520
 ctttcctgg gggcagtcct tcgacacgac ttttcttctc tgtgatgagg agaggggagt 932580
 ttggccacag aggaaggaa gtgtttggcc ggtgttggtt cacggtctga gacacagta 932640
 ggtcatagca ggaagtac tgcagccaga gcgtgaggca gctggtcagt ctgtggaagt 932700
 gaccagttag gaagcagaga gacagatgaa tctggcact gagcccact tttccttttt 932760
 tttattcagc caggaaacct agcctatgga tggtgccacc cacatccagg ggtggttttt 932820

 ctctccttg taaaacttt tgggaaactc cctcccagac ctgcccagag ctgtctccta 932880
 agtgattcta aatccagtca agttgacaat gattattaat gaaccagtct tacaggttag 932940
 cagaacaagt caggcaaagt cagtcttttag tagaatttgt gtagtgcaa ggcgttgtga 933000
 aggcaggag ctctgggac actctgcatt tgcacatcca gaaaagtgtc ttccagctga 933060
 gtggtcacag cactgtgtgc acccaattcc tgcaatgaag agatgggagg agacaaaaa 933120
 gctctgggac aatggggatt tatacttttt tttctgtcg agttttgtt ccctttcttt 933180
 tgaataactg ttagaaaatt ctgtctcatt ttttttttt taaatctgag cagcaacttg 933240

 tatgtacct tcttctagc tctgtggga gtgggacagg ggagtagga agaatacaag 933300
 ttccagtcca gctggacag attagggagc ccttgtttca agataaagaa gtagaaaaca 933360
 agaaccaagt attgcttggg agcagagcac ttgcaaagca tgtgtgaggc cctatactca 933420
 ctcttcatta ttatcattgt tagttttggg gcagacctt gaaccgagt cctgcacct 933480
 tctcagcagg caaacctct atcaatgagc cccatccca ggccctgaat gctacaaat 933540
 ttcaatttat ttatttaag gaaatgtatt tttatacttt tgttttgtt tgttttgtt 933600
 agacagggtt tctctgtggc ttgattctg acctggaact agctcttgca gaccagactg 933660

gtctcaaac cacagagatc gcctgcctc tgctcccggt gtgctgggct aaaaggcgtg 933720
 gccaccact gcctagctta tttctttct tttttgtgc ttggtgtgag agtctttct 933780
 tgctttgtt tctttccac cctcctgact atattattha tttcaaatc caaggcccca 933840
 gatattgctg gaaagttgtt tacatgctct atcatgacct gggtgtggtg gtttatgcct 933900
 gcaatacaaa tacctgggaa gctgaagcaa gaggatctcc tgggctacag agtgagacce 933960
 cattctcaac atgtttatcc tcctaagaa taaaaataaa aaataaaact cataggctat 934020
 tacactcaca cacacacaca cacacacaca cacacacaca cacacacaca cgtccttgaa 934080

 atatttctac aaaaaaatg aggctaagaa gatgaatgtc tggtaatcg aagtcagagt 934140
 tggcagcatc attatgtgaa ttttaagtatt aggactaagg caccaggtc ctcaaagcta 934200
 ctctgccag ttgtctcca ccattgaaac atctctacca tactttctc atgtttgcat 934260
 tatgtcatg cgtgtgtgtg tgtgtgtgtg tgtgtgtgtg tgtgtgtgtg tgtgtgtgtg 934320
 tgaagccact gtgagggagc ccctaggcca gtacttctcg atcatcctaa agctgcaatc 934380
 ctgaaacaca gttcctcatg ttgtggagac cccacccaa cataaaaatt atttttgta 934440
 cttcataact gtaattttgt tactgctatg aaacatatta taaatactat tgaagaaaga 934500

 ggtttgtcaa aggggtcgca acccacaagt gagaaccact gccctggggt tgaaaaacta 934560
 gctacaagct cactggatcg gccatgaagc tcatggtgac caccctcacc gttgaataa 934620
 ttgatgtgct teacataca tatgtctccc tggctcccag aaagtattga agagccagct 934680
 gccaccact ccaggaatgg agactccaga gccaaaggggt taccctggcc tgtattcttt 934740
 gatgactggt gtcttttgg cctttaagta accttgcct taccacggtc caggtgtctt 934800
 gttgggttac atttatata ggaagcatct gggattcaag aaagtgtgat gcctaagcc 934860
 agtcactgt gtgccagta ttctttccac acagacctgg agagcgtgc tctattctct 934920

 ggattcagga agcaaggatc agagagtga aggacctagg ccacggcaca caggaactgt 934980
 ggtgtgctta tgactttttt tactctgggg ctattggcca ggttccagtg aaacacttcc 935040
 atagtaagaa taggtggcgc cgagtatcca gtgagcagga cagggtgca gaacagtttg 935100
 gggaaggctc ttctactct gtagcatgtg ggaggcctc cactggcca ggtcttactc 935160
 tctgctttct ggttctgcaa cataaagcca gtgagtcaga acccaagtga tgggggttgt 935220
 ccttctgtac atatgtttct cttattggtt aatgaataaa aactgattg gctgattggc 935280
 caggcaggaa gtataggcag agctaaaaga tgaggagaat tctgggaaac ataggcagat 935340

 ggagtgtca tgcagagcct gggaagagag gacgctcaag gtgttccca gtaagccaag 935400
 gccactgtga aatataataga ttaatagaaa ttggttaata attaaggcag agccagccaa 935460
 taagaagccc tagtcatcgg ctagcagttt cataattaat atagtatgtg tgtgtttact 935520

tggggctcaa gagctgtggg accaaccggg acagaaagct cacattacac ccaagggcct 935580
 gcagagggtc ttcttttcag tgataagaaa gacaagattt ggccaaagt gctgggcat 935640
 gagtcaaggt ggggtgtgaaa acattgtctg acagaaagag ctctactgg gcccttctgg 935700
 acagggcagg ggctgttgag gcccccgact gttactttgc ctcttctgc ccagcagctg 935760

 ctctgtagag agtggagggg acacacggga gctcaacagg gcctctctat gtgattcttt 935820
 ctcccaagtg tgggggtggc tgcaaagcag agagctccag gtagaaacag ccaaagcctg 935880
 aaggggtggg atccctgagc gatggaagat gaagcagagt aaggataggg catgaagtgg 935940
 agactatcca cccctgagc gcagcggatg ctgacttcca ggaggcagag tccaggacag 936000
 caagaggatg agtggagacg tgattgaaaa gatagagaga tggattaagt gggttctgag 936060
 ccgtttttcc ctattggac gcacttgctc atatgcaaat tgcgaagttc agagtgaag 936120
 aaagcaggaa tcgtaattg agacgctaaa aagctaagct ctgagctcct gccattgtat 936180

 tagggtattt ttattgtgt ttttctgaca gaatacctgc caggaacagc ttgggggtgg 936240
 gggattaggt ttactgtggg ctcatggttt cagagtgtat cggttcatgg cgggtggcaa 936300
 agcgtggcag ccagagtgac tccgtccagc gtggcgggag tggtagcaca gcaactgtcat 936360
 accctgatgg gttgggatgc aaagttcagg ctagaagcag atgcaatcaa agcccacagg 936420
 aagccccgag gcttctggga aagggtgtga gagagagaaa cagtttccat atcaaggtca 936480
 caaagcttca tttttcttc ctcttttct cgcagacgt ttgtatcct ctgtacctat 936540
 ttggagatgt cctttaagtt cccatccctg gtgacagcct gggaaacaca aaagctctaa 936600

 ttaaagactg tectgagcca cactttctgg aggagcggg ccaagcagtg gcccataac 936660
 ctgcaccaag acctttttt cgggtcctcc aggggtgctc tcaggctggg gcttaagccc 936720
 tgatctcttt ttcgtggggg agagcattgt tcatcccagg cctgattaac gtctcaagcc 936780
 gcgttttcaa ctttgcctgg ggttaagagg tagacggacc cgcttaccac aaggaagaca 936840
 atacaggcac aactgcatct catgaaccac actcatgtgc cacacagaga tatccagagc 936900
 agagacctag acgtgtctcc aacgggctgg ttgccccag ctgccccgag acagctacct 936960
 gctccttagt ctctgggatc tgctcagaac taggcagggt cctctctgcc accctcccgt 937020

 caacacagag ggcccagcaa aggggggaga tgatgaacat aagaaagaga actctcaagt 937080
 ggctcacttt ctctctctc ctctctctcc tcacatcctt tgtcttgaac tactcaagca 937140
 ccggggtgcc cactgcctgg ttctccaagc acatggctct gggattctcg gacaacttac 937200
 gcaagctcat caagtacag ccctgcacct gtacacgctg catcagccag ggcaaggtct 937260
 catactgggt cgaccagcgt ttcaacaaga ccatgcagcc gctgctgaca gccacaacg 937320
 ctctgatgga agaggacacg taccagtgtt ggctgggtgag cagagtaggg gctggcaagg 937380

gtgagaggag gcaaatgcta ggtctggggg gacccaaggg cccaccaatc atctggcagc 937440

atccagggtg tcatttcttt cagtcagcaa ctgtttattg agcaactatt atgtgtaagt 937500

cagagaaaaa cctactgct ttccctcctg tggctcccat gacaaatcac cacctggtgg 937560

gtaagacat cagaagggat cacatggcac agtcctggag gccaagggat tttaccccc 937620

atggcttttt cctactgctg cagctgacca ttgtgtgtac ccacatctgc aggatccaac 937680

ctctgctccc atgttgcatg gttttcctgt gtctttgggtg tcctctcctg ggaagggcgc 937740

gtggccttgg ctctagggtg cactctgagt ctatgttcat ctgccctgcc accagtagca 937800

aaactagatc ttagcagggtg ttgggaatga gaaatgcagt cattattgct gtctgggtg 937860

tctagggatt ggccttcta actgaaggtc agctaaagcc ctagtctcgt acacagtagg 937920

taccagaga gtacctgtag aatggataca tgagctttct ccctgtctcc tgtcttgggg 937980

tgggggtggc tatcactaac cgcctgtgcc ttactgtta gtagctgggt ttggtagcat 938040

cggagccaag ctgaccacc atcccctctg tcctccgcc cagaggctcc aacgggagag 938100

gaaacctaac aacttgagt acaccatcaa ggaactgtt cgcgtgggtc ccgggagggt 938160

gggcctgggt ctgggcaagc ggttgggtgg ttgccgacgc tgtgcagtgc tgggaaactc 938220

tgggaacctg aaggactcct cgtatgggcc tgagattgac agccacgact tcgtggtgag 938280

gtgagactg gaccctaac ccaagcctag ggatcctcag aggtgcgtga aacaccttg 938340

ctcagctcag aaggacacgg ttccagggcc ccaggagtga ctgacctctg ggtctcagtt 938400

ccccatcat gcaatgagaa agccttggct gggcgggaat ttccaatggg ctggtgactt 938460

agtacctaa gcgtagctat tgggtgggca aactgattt gaagcctgtg ctctctgtggc 938520

tcaaatctac cccaccct accccacc cggatggatgg atggatggat ggatggatgg 938580

atggatggat ggatggatgg atggatggat ggatggatgg atggatggat ggatggatgg 938640

atggatggat ggatggatgg atggatggat ggatggatgg atggatggat ggatggatgg 938700

atggatggat ggatggatgg atggatggat ggatggatgg atggatggat ggatggatgg 938760

atggatggat ggatggatgg atggataaat ggatggataa atggatggat gggtagatga 938820

tggatggatg gcttcatgtc catagacccc ttccctggct ctcagtatac ctagtatcag 938880

tgggaatgcc cacaatgaga ggccaagtca tgttgggtc aggcctgactt cagttcaaag 938940

gtgtatcttg gtagacagct catctgggtt ctggatcata aaaaagggtc acctggtagg 939000

tgcaatcaca cagggtgtca gttactagag ggcaagacc accccactt gcatttattt 939060

aaaaaaciaa aataaaaaca aaaccagggg ctggagagtt aatgaagcaa ttaagagcac 939120

tggctgctct tccagagggc ctgagttcaa ttcccagaaa ccacagggtg gctcacaacc 939180
 gtccgtaatg agatctgggt ccctctctgg cagcaggcgt acatgcaggc cgaacactat 939240
 atataataaa taactaaatc tttttaaag gccacaacaac aaaatagcct tggtagcctc 939300
 tgttttgctg aactagggat agaacttggg ttcgtgcatg ctaggcaagc tgtctccct 939360
 tgagtttctc aggctggact tgaatttggc atcctcctgg ctcaacctca gtacgggggt 939420
 tttcagacct gctctactgt gcttgtgtgg cctgtgtcta gagtgtcccc attgttcaca 939480
 tggggaact gaggcctagg gaacgaagag gctcacctgt ggttatcatt cagtggactc 939540

 cagctgcagc attcttacca agtgcctctgt tttcctctcc tcccaggatg aacagggcac 939600
 ccacggtagg ctttaggca gatgttggga gcaagaccac ccaccatctt gtgtatcccg 939660
 agagcttccg ggagctggga gataatgtca gcatggtctt atcttattga gaatgccaga 939720
 ctcatgtatc ctctgttat tttttttgt tttttttgt tgcctgtttg cctgtttgtt 939780
 ttctaagag agagaaagtg tgtgtgtgtg gagttggatg gatgaggaag tgaggaggag 939840
 ttggggagg agaaagtga atcagaatat attgtaaaaa ttttaattga aaaactattt 939900
 tcagttaagg aagaaggaa ggagggaggg agggaggag ggaggaaga aggaaggaag 939960

 aaaggaagga aggaaggaag gaaggaagga aggaaggaag gaaggaagg ggaaacctag 940020
 caaggggata gcaacaggag ggcagggtgt accagggcaa gtgagattct gagttgattg 940080
 ctgccctct ggagagttaa tggecctect tttcctgggt cacagaggga gacacacttg 940140
 taaatggaga tttctttgtg gatgcatggt ttcccttaca gaagggttat ttctctctg 940200
 ttttcaaagc tttttctgtg tctgcagttt ctcagaatag ctactcaaa ataaacctta 940260
 tcctaggaag catatttgg ggtaacatat gctagtctaa gaatactagc aatagataac 940320
 tagaaaaaa agcaacctat tctgagcttg ctcaagaata ggcctagacc cttggggttt 940380

 gagggggccc ggggaggaac ggggcaaaca ctcccacag cagcctgtca gcaatgctgc 940440
 cctgcgtct cctccctggg gtggacagtt cctaagctag caatacttgt cttgccctga 940500
 cctttctct accagcaggc ttcatttact aaagaacttc ttttccaaa caatcaatca 940560
 ccttcagttt ggttagcctt tccttgcaca gaatagtgt cagtcttatt attttgcata 940620
 aaaccatcac tctcccttg tgggtggctt tctgctcatg tagcctagt atctgcctt 940680
 caagagcaga aactgtattg ttagaaaagt ttcccattg cagaggacat gagggagaag 940740
 aaaggttag tcaggggaag aatagaagat aacaagaatg gagctgggtg gtggtggcgc 940800

 atgcctttaa tcccagcaca cgagaggcag aggcagggtg atctctgtga gttcaagccg 940860
 gtgacttctt ttccaagatg tgggtgtgtg atggtggcac agagctacac agagtacca 940920
 gtccctggca cttgtgaagc ctactgata aggacagtc ctcaaagtgg gtctccagaa 940980

cagccccacc acctgggaac ttgccacagg tgtgactctt caggagtacc caaacctgct 941040
 acagctggcc cagggtagac cagctctcac aagcccctga agggtagggc atgtgtaggc 941100
 tgcagttttg ttttgtttgt tttgatttga actattcctg ggagcttccc aaagccatac 941160
 tcacctcttt ctctccacac ctctgtcctt gataccataa tagagggaga cacttttgg 941220

 ttacagagaa atcaggcact agggaaatgt ctgtagatct acaaagatga caccagctaa 941280
 caatctaage aacagaggag aggccttcctt atatgcctc ccctgataat gagattgatg 941340
 actgacttat atgccacccg atagccctca tccagcagct ggtggaagta gaagcagaca 941400
 cccacaacta atcactgaac tgaactggaa tccagttaca gagaaggacg agtgaagagc 941460
 aaaagggtcc agaccaagat ggtgaaacc acaggaacag ttgacctgaa catcggggag 941520
 ctcttctcc ccagactgat agctggaata ccagcatggg actgatccag accccaggaa 941580
 catggctttc agtgaggaaa cctcagaaat ctacaggacc tcctatagta gttcagtact 941640

 tatccctagc ataggtgtgg actttgggag cccaatccac atagaggaat actccctgag 941700
 ccaagacaca tgggggtggg cctaggccct atcccaatgg ataccataga ctctgatgac 941760
 accctatgga aggcctcacc ctccaggag aagcataaag gatatgtgat aggtagggtt 941820
 ttagatgtgg ggtgggggat ggtagaggag gaggggaggg agaggggaact gggattgttg 941880
 tgcaaaacaa tcttgtttct aattcaaat aaaaaagaga gagagagaga aaagaaaagt 941940
 ttcccaaat ctgcaaaagg gacgccagct cttaggagct gttcttcacc catactctgt 942000
 catatcgag agttgttcat gacatcttta accttcttat tcttctgttt ttaccceca 942060

 gatagggttt ctctgtgtaa cagecctggc tgtcctagaa ctcaactctgn nnnnnnnnnn 942120
 nnnnnnnnnn nnnnnnnnnn nnnnnnnnnn nnnnnnnnnn nnnnnnnnnn nnnnnnnnnn 942180
 nnnnnnnnnn nnnnnnnnnn nnnnnnnnnn nnnnnnnnnn nnnnnnnnnn nnnnnnnnnn 942240
 nnnnnnnnnn nnnnnnnnnn nnnnnnnnnn nnnnnnnnnn nnnnnnnnnn nnnnnnnnnn 942300
 nnnnnnnnnn nnnnnnnnnn nnnnnnnnnn nnnnnnnnnn nnnnnnnnnn nnnnnnnnnn 942360
 nnnnnnnnnn nnnnnnnnnn nnnnnnnnnn nnnnnnnnnn nnnnnnnnnn nnnnnnnnnn 942420
 nnnnnnnnnn nnnnnnnnnn nnnnnnnnnn nnnnnnnnnn nnnnnnnnnn nnnnnnnnnn 942480

 nnnnnnnnnn nnnnnnnnnn nnnnnnnnnn nnnnnnnnnn nnnnnnnnnn nnnnnnnnnn 942540
 nnnnnnnnnn nnnnnnnnnn nnnnnnnnnn nnnnnnnnnn nnnnnnnnnn nnnnnnnnnn 942600
 nnnnnnnnnn nnnnnnnnnn nnnnnnnnnn nnnnnnnnnn nnnnnnnnnn nnnnnnnnnn 942660
 nnnnnnnnnn nnnnnnnnnn nnnnnnnnnn nnnnnnnnnn nnnnnnnnnn nnnnnnnnnn 942720
 nnnnnnnnnn nnnnnnnnnn nnnnnnnnnn nnnnnnnnnn nnnnnnnnnn nnnnnnnnnn 942780
 nnnnnnnnnn nnnnnnnnnn nnnnnnnnnn nnnnnnnnnn nnnnnnnnnn nnnnnnnnnn 942840

nnnnnnnnnn nnnnnnnnnn nnnnnnnnnn nnnnnnnnnn nnnnnnnnnn nnnnnnnnnn 942900

 nnnnnnnnna aaaaaaaaaa aaaaaaaaaa aaaaaaaaaa aaaaaaaaaa aaatctctcc 942960
 ctccaggag gcaaaccgga gcattggcag tccagtcttc ggectgtac tetgcctgc 943020
 agagaaaca ttatcaacat cctcagtcac atgaccgaaa tccttacaat ttagtcactt 943080
 ctgtgcatat gcatgctgtg tgccctctc ttctctggag gactctggct gatacatagg 943140
 tcatttatta aggtttttac tttagatact gaggttggag ttgggcttca cacatggtat 943200
 gtgtaacata aactttagaa actaaaagca tgtgttgatt attctgtgct gcgtgcacgc 943260
 aaagatgac cgtagtcctg aaggctaaga tttctttatt cagataaaca ccagcccaaa 943320

 cgcaagccag agcgtgccca gagctcccaa gctagagtgg ccagagagga gaggctatcc 943380
 acttttgtgc tgcctctga cctcctctga tcacgccct gagggcgtgg ccagcatac 943440
 ctgtaggggc tactaggagg ccgggctact aggaggcggg gctacagtgt ctccctaaa 943500
 gcatggcctg ataaagcact aataagcttt cattttaaa tacttctgtc agaaatcaaa 943560
 accagaaaa nnnnnnnnnn nnnnnnnnnn nnnnnnnnnn nnnnnnnnnn nnnnnnnnnn 943620
 nnnnnnnnnn nnnnnnnnnn nnnnnnnnnn nnnnnnnnnn nnnnnnnnnn nnnnnnnnnn 943680
 nnnnnnnnnn nnnnnnnnnn nnnnnnnnnn nnnnnnnnnn nnnnnnnnnn nnnnnnnnnn 943740

 nnnnnnnnnn nnnnnnnnnn nnnnnnnnnn nnnnnnnnnn nnnnnnnnnn nnnnnnnnnn 943800
 nnnnnnnnnn nnnnnnnnnn nnnnnnnnnn nnnnnnnnnn nnnnnnnnnn nnnnnnnnnn 943860
 nnnnnnnnnn nnnnnnnnnn nnnnnnnnnn nnnnnnnnnn nnnnnnnnnn nnnnnnnnnn 943920
 nnnnnnnnnn nnnnnnnnnn nnnnnnnnnn nnnnnnnnnn nnnnnnnnnn nnnnnnnnnn 943980
 nnnnnnnnnn nnnnnnnnnn nnnnnnnnnn nnnnnnnnnn nnnnnnnnnn nnnnnnnnnn 944040
 nnnnnnnnnn nnnnnnnnnn nnnnnnnnnn nnnnnnnnnn nnnnnnnnnn nnnnnnnnnn 944100
 nnnnnnnnnn nnnnnnnnnn nnnnnnnnnn nnnnnnnnnn nnnnnnnnnn nnnnnnnnnn 944160

 nnnnnnnnnn nnnnnnnnnn nnnnnnnnnn nnnnnnnnnn nnnnnnnnnn nnnnnnnnnn 944220
 nnnnnnnnnn nnnnnnnnnn nnnnnnnnnn nnnnnnnnnn nnnnnnnnnn nnnnnnnnnn 944280
 nnnnnnnnnn nnnnnnnnnn nnnnnnnnnn nnnnnnnnnn nnnnnnnnnn nnnnnnnnnn 944340
 nnnnnnnnnn nnnnnnnnnn nnnnnnnnnn nnnnnnnnnn nnnnnnnnnn nnnnnnnnnn 944400
 nnnnnnnnnn nnnnnnnnnn nnnnnnnnnn nnnnnnnnnn nnnnnnnnnn nnnnnnnnnn 944460
 nnnnnnnnnn nnnnnnnnnn nnnnnnnnnn nnnnnnnnnn nnnnnnnnnn nnnnnnnnnn 944520
 nnnnnnnnnn nnnnnnnnnn nnnnnnnnnn nnnnnnnnnn nnnnnnnnnn nnnnnnnnnn 944580

aagcaccttg aggatgaatt ggtttctggt gttgttgttt ttgtttgttt tacaatgata 948360

gtagactga aagggttgg cactttcaaa tgctacttag gatttcattc ctgtcactga 948420
ctggaacatc caaatcgggt cagcagagac aagcagaggt gtggactaga tgctgagggt 948480
gaggatgtgc tcaataaat acagggttgg gttaccatt cgggtttcca cccataatc 948540
aatatgttat gaacacagtg cggatgagcc gtttagcatc cacacagcat aatcccactc 948600
cccacagtgg atgagcaaa agtctagagc gtgggttccc tgcagacatc aggacacaga 948660
agaggccacg caattctaga aggctcagca agtctagaag gtaaccgtta ttcatttccc 948720
agtgtccctg caaccatcct gacaaagggg ggagcctggc ccaggaggtg gctcagtgat 948780

ggcagagctg tgcgagcatt gggacaggag ttcagatccc gaggaccac ttgcaggctg 948840
ggtgtgcttg gcggttttct gtaattccag cctcgggaag ctgatacctg atcctcagag 948900
caaacgggct gaaaggcta gccggtcgg cgagctctgg gtttactga gtggccctg 948960
ccttgatgaa gattgggtaa ttccagactc caaccgagg cttccacgcg catgcgaca 949020
agcgtgctaa catttgacg gaaaccaaac caaaccaaaa ccccaagct gtacacacat 949080
gcatacctag aagagaaaa ataaaagcct gtgattctca gtctcctggt ccgtgcagtt 949140
tctgaagctt tgaagttcac gcctttgacc tctgtggctg aagcagcgga atggaatctc 949200

cgctttgac ctctcgggag gctgaagcag ggggatctcc gagttagacg cggccagcc 949260
tggctctgac agcggaccct ccctcgggac cattcggagc ccagagccac gctctgtgtg 949320
cgtcgttga gaagagatc cctcaggacc caggctggag tgcggaataa ctgttctcta 949380
atttaattga agcttgactg tccctgttct gggacagaca gacagacgac agacagctcc 949440
acgtttgttt accgccagtt ttggggactg cctgctaatac agtccctggt atcccgttag 949500
ggttctttct agtgcgccag agcccagaaa gatcatcctc ctacagatga atgaagtaca 949560
tttacacaag cactttaagt gcattttaat tgtaaaaata aagatgtgca tgagatggga 949620

tgtttccatt ctacgtgct gttttggttt gtttgttttt tcaatgcggg cagttgaacc 949680
taggatcttg cccgtgctag gcgggtgctc taagaaatgg acctacatgt tcagtcccta 949740
ctaattctaa agigtcatctt ataagctaga gatgtggctg tgttggtaac atgcttgtct 949800
agagtggggg aagcccaggg ttcaatctc agtaccacac aaacctggct tgaataaagc 949860
tcattctagc actgaggaca cgagacaagc agttcggggc tatctttggc tgcacagaaa 949920
atttaaaacc ttccgggact agagatcgtc ctgtgattaa gagaacact gctctttgcc 949980
ggagattgtt ctacgactc agtcagatcc ggtagctcac ctctgcttat aacccaact 950040

tgagggtct ccacctctgt ggaacttcca acctctgtgg gcaactgctcc cacacagatt 950100
 tataaaactt ctcatctttg gatgtgtgtg gcaaaactgt cctggaaatg ttgtttgagc 950160
 aggcaaatg gcaaaattgg agaactatit aacttttctg gctcactggc attgaagtac 950220
 tgggaaataa attattttca ttttacctct aagctgcggt tatgaagaca accgagtctt 950280
 cttataatta gtttctttg aagccttgct tcagtgttag tttccttggt ttagatttgc 950340
 tgtttccgta aacttgggtt tttctaaaag agaaaattat agccgcactt ggttttaag 950400
 aaacacccctg gcaatagaaa gcttgactta gtgctcatgt cataatacac ttggccacag 950460

 gttcctaagt taggggtgac atttcagtat attctctaaa ttatttcctt tgggggttag 950520
 aataacattc ccattttttt gtttttggtt gtctgttttt gttttccgag acagggtttc 950580
 tctatgtgta gtcttgcca aataatcca tttttatacc ttgttaactt tccgagtctt 950640
 tttatttccc gattctttgg ggaggagatg actgacgtct aaagtttcta ctgattttta 950700
 tcgacctctg gtcattcagt cccaatcctg gaatactaaa ggaataacga aacaacattg 950760
 gttcagttgt cagcaagggt aaccaaaccc tgcttacc catcttttc aaaatgaggt 950820
 gaccatacat cagggtggtt ccctgcactc ccctatgac gaggcatttc ggcaaggggg 950880

 ggggggggaa accaaaccac agacaaccag aatgaagttt gcttcctttt ttttttttt 950940
 ttttaattca catgctttct aaaactggaa ggataaagga atacaggtgg gccagaatga 951000
 agctggcttc ctcttttaa actcaacatt gctgtcctaa agtaaaactc caagtagaaa 951060
 cgaatacaaa cggcctctcc cccccacg ccccatgtcc ctcccgctcc gcttcacccg 951120
 ctctgcttgg ccgccagct cttgtctctc tcttcggcga tggtcaggcg gatccccttc 951180
 ccccggcga gcgagatcca cggttgttg cccttgccga tcacgaagat gttggagagg 951240
 cgggtggcga agccgttccc gttggcgtcc ttcacgtgga ccacgtcga ggagccgggg 951300

 tggcgtccc ggttggatg gacgccgatg cgcgccaggt tggcgcctcc ggtcaccatg 951360
 cagaggttgc cgggtgcga cttgatggcg tcggtgatct tgcccgtgtc cagcgagatc 951420
 tgcacggtgt cgttgacctt gatgagcggg tcgggtagc ggatggtgcg cgcgtctgctc 951480
 gtcaccaggt ggggatgcc cttggtgccc acgaagacct tccgcacctt gcagagcttg 951540
 tacttggcct cctcggcgt gatgcggtgc acggcgaagc ggcccttggg gtcgtacacc 951600
 aggcggaagt tctccccgt cttgtcgatg ctgatgacgt ccatgaagcc cgcgggtag 951660
 gccacgtcgg tccgcacctt gccgtcaacc ttgatgaggc gctgcatgca gatcttcttc 951720

 acctcgtcgc ccgtcagcgc gtacttgagg cggttgcgca ggaagatgac gagcgcagg 951780
 cactcccga ggcggtgagg gcccgaggac ggccggggcg cgaacacgcc cgtcagtttg 951840
 tccagcatcc agtgacgagg ggcggccaca cgcttcaggt gcttcttcgg accgcgggcc 951900

atggcggggc ggcggcagcg agggcgagcg agaggcgag caggcgggag caggcccttc 951960
 tcctaacca gagcacaagt cgaatgagcg gggcggctgc gcgcgcagtg gctggaacc 952020
 ccgccatct gggctctttt nnnnnnnnnn nnnnnnnnnn nnnnnnnnnn nnnnnnnnnn 952080
 nnnnnnnnnn nnnnnnnnnn nnnnnnnnnn nnnnnnnnnn nnnnnnnnnn nnnnnnnnnn 952140

 nnnnnnnnnn nnnnnnnnnn nnnnnnnnnn nnnnnnnnnn nnnnnnnnnn nnnnnnnnnn 952200
 nnnnnnnnnn nnnnnnnnnn nnnnnnnnnn nnnnnnnnnn ngcgggaaaa taccaagata 952260
 agtatcgcat aagctatctt ccttctggaa gagtgcagcc tgcatcagc ggaaaagtaa 952320
 gatcaacaaa acttgcttgg atactttttg tttgtttgtt ttttgtttt ccagacaggg 952380
 tttctctgta gcctgactg ttctgcagct ctgtagtcca ggctggcctc ctcgaactca 952440
 cagagatcct cctgcctctg cctcccagct gctgggatta aaggcctgcg ccacgattcc 952500
 caggccttga atacgtatct tgtactattc tttatattct ttttattttt ttattttttg 952560

 agtctgttag tigttaaact agaggatggc ttttttcccc caccatgtga ggcccagaaa 952620
 ttgcacgtaa actcctgggc catcagcatc aggtacatga ggatcagagg gtgagtttat 952680
 tgtctaacce gctgcagctt ctgaatgggt acagtgetca ggtaacacca ggcaaggact 952740
 atacaggcct agggaggcaag aaacttccag gcaagttcac cttgcctcaa aggatgctga 952800
 gcaaaatgga gccggcatca acaccatca tgcattgtat ttcactttta ggtcttgaac 952860
 ctccatcttg geactcttac attctgattt taggctttagc tttgagacac tttcaggagt 952920
 gtaccagtg ctgtctagca gagagccagc agggagcttg ctgttgctca tctcagacc 952980

 tgaactgttg tccaggcact tctcttggcc cctcactgtc cacactctta cgttttcagt 953040
 gtctctccgg cctcaccgtc cacactctta cgttttcagt atctctccag cctttggcca 953100
 agcatgctt ctcctttgta gtttctttc ctttcccag tcatgtcaac accttctctg 953160
 atctgtagcc ctcatcttt tgttgccttc ctggggcagg gtggagagga gccagtgcac 953220
 agactcacat ccgattctg ctgatgactg gttcactttt taatgccttg gtttccttag 953280
 taccacttga ttctaatta catgaaggta gaaaaagagt tgaagtgtt ggagcagttt 953340
 ctggcccctg ctgtgcctc agcaaacatg agctgttatt taaatgtag attatgcatt 953400

 tattcctttc atgtaact tctagggcct ggctctgttc ctggaacttt tctgtcaaa 953460
 ttgaatatcg ttatgtgagt aacttgtcac tttcatagc ggtgaagttag tagtaggtg 953520
 tctctcatt tccgaattg atcagttgt gttgggaagc cctgagcttg aatctgtctc 953580
 agcatgtgtc cctgatctgt ttgtgatca gaggatgat ctcaacttca gactcttag 953640
 ggatatggag acggctttgc tgacagtgat tggagaggag aaaaatgtgt gcattgaagg 953700
 cacagacttg ttttctacct cccatctctt acttctgtc agacctagg acaaagtacg 953760

gggccattaa tgccacaatt tcccctcttg caaaaggga atattaatag tgtccatgta 953820

gigggcacgt gatcagggtc acgtgtaaca gcctaggata cacagtaggc agtcactaaa 953880

tggtaaccta aagttaccac ccactgtata ctgggacccg gggcctcttc aagaccaaaa 953940

catgctctta attactgttg ggtgtctgca ggcccaaaca aaaggtccat gctttttagt 954000

aagaacagcc cctgatcctg tcacagcaag gggaacatgg agagaacatg ggagcacaca 954060

gtacagtgac tgacacctgt caagtgcact tgtggggctg tgactgaaag acaagctga 954120

catcaccagc atgacatcat tcctttaga aataattaa aaccagggtg gctgactaaa 954180

ttaattgtgg agggaaagta aaatggttcc tctgactaaa ttaatgaagc ctgatttcat 954240

tgacttttga catagaagga ccatgacttt ctccaagtca gtttacgttt ctggcacac 954300

gtgtgtgtgt gtgtgtgtgt gtgtgtgtgt gtgtgtgtgt gtgtgtnnnn nnnnnnnnnn 954360

nnnnnnnnnn nnnnnnnnnn nnnnnnnnnn nnnnnnnnnn nnnnnnnnnn nnnnnnnnnn 954420

nnnnnnnnnn nnnnnnnnnn nnnnnnnnnn nnnnnnnnnn nnnnnnnnnn nnnnnnnnnn 954480

nnnnnnnnnn nnnnnnnnnn nnnnnnnnnn nnnnnnnnnn nnnnnnnnnn nnnnnnnnnn 954540

nnnnnnnnnn nnnnnnnnnn nnnnnnnnnn nnnnnnnnnn nnnnnnnnnn nnnnnnnnnn 954600

nnnnnnnnnn nnnnnnnnnn nnnnnnnnnn nnnnnnnnnn nnnnnnnnnn nnnnnnnnnn 954660

nnnnnnnnnn nnnnnnnnnn nnnnnnnnnn nnnnnnnnnn nnnnnnnnnn nnnnnnnnnn 954720

nnnnnnnnnn nnnnnnnnnn nnnnnnnnnn nnnnnnnnnn nnnnnnnnnn nnnnnnnnnn 954780

nnnnnnnnnn nnnnnnnnnn nnnnnnnnnn nnnnnnnnnn nnnnnnnnnn nnnnnnnnnn 954840

nnnnnnnnnn nnnnnnnnnn nnnnnnnnnn nnnnnnnnnn nnnnnnnnnn nnnnnnnnnn 954900

nnnnnnnnnn nnnnnnnnnn nnnnnnnnnn nnnnnnnnnn nnnnnnnnnn nnnnnnnnnn 954960

nnnnnnnnnn nnnnnnnnnn nnnnnnnnnn nnnnnnnnnn nnnnnnnnnn nnnnnnnnnn 955020

nnnnnnnnnn nnnnnnnnnn nnnnnnnnnn nnnnnnnnnn nnnnnnnnnn nnnnnnnnnn 955080

nnnnnnnnnn nnnnnnnnnn nnnnnnnnnn nnnnnnnnnn nnnnnnnnnn nnnnnnnnnn 955140

nnnnnnnnnn nnnnnnnnnn nnnnnnnnnn nnnnnnnnnn nnnnnnnnnn nnnnnnnnnn 955200

nnnnnnnnnn nnnnnnnnnn nnnnnnnnnn nnnnnnnnnn nnnnnnnnnn nnnnnnnnnn 955260

nnnnnnnnnn nnnnnnnnnn nnnnnnnnnn nnnnnnnnnn nnnnnnnnnn nnnnnnnnnn 955320

nnnnnnnnnn nnnnnnnnnn nnnnnnnnnn nnnnnnnnnn nnnnnnnnnn nnnnnnnnnn 955380

nnnnnnnnnn nnnnnnnnnn nnnnnnnnnn nnnnnnnnnn nnnnnnnnnn nnnnnnnnnn 955440

nnnnnnnnnn nnnnnnnnnn nnnnnnnnnn nnnnnnnnnn nnnnnnnnnn nnnnnnnnnn 955500

nnnnnnnnnn nnnnnnnnnn nnnnnnnnnn nnnnnnnnnn nnnnnnnnnn nnnnnnnnnn 955560
 nnnnnnnnnn nnnnnnnnnn nnnnnnnnnn nnnnnnnnnn nnnnnnnnnn nnnnnnnnnn 955620
 nnnnnnnnnn nnnnnnnnnn nnnnnnnnnn nnnnnnnnnn nnnnnnnnnn nnnnnnnnnn 955680
 nnnnnnnnnn nnnnnnnnnn nnnnnnnnnn nnnnnnnnnn nnnnnnnnnn nnnnnnnnnn 955740
 nnnnnnnnnn nnnnnnnnnn nnnnnnnnnn nnnnnnnnnn nnnnnnnnnn nnnnnnnnnn 955800
 nnnnnnnnnn nnnnnnnnnn nnnnnnnnnn nnnnnnnnnn nnnnnnnnnn nnnnnnnnnn 955860
 nnnnnnnnnn nnnnnnnnnn nnnnnnnnnn nnnnnnnnnn nnnnnnnnnn nnnnnnnnnn 955920

 nnnnnnnnnn nnnnnnnnnn nnnnnnnnnn nnnnnnnnnn nnnnnnnnnn nnnnnnnnnn 955980
 nnnnnnnnnn nnnnnnnnnn nnnnnnnnnn nnnnnnnnnn nnnnnnnnnn nnnnnnnnnn 956040
 nnnnnnnnnn nnnnnnnnnn nnnnnnnnnn nnnnnnnnnn nnnnnnnnnn nnnnnnnnnn 956100
 nnnnnnnnnn nnnnnnnnnn nnnnnnnnnn nnnnnnnnnn nnnnnnnnnn nnnnnnnnnn 956160
 nnnnnnnnnn nnnnnnnnnn nnnnnnnnnn nnnnnnnnnn nnnnnnnnnn nnnnnnnnnn 956220
 nnnnnnnnnn nnnnnnnnnn nnnnnnnnnn nnnnnnnnnn nnnnnnnnnn nnnnnnnnnn 956280
 nnnnnnnnnn nnnnnnnnnn nnnnnnnnnn nnnnnnnnnn nnnnnnnnnn nnnnnnnnnn 956340

 nnnnnnnnnn nnnnnnnnnn nnnnnnnnnn nnnnnnnnnn nnnnnnnnnn nnnnnnnnnn 956400
 nnnnnnnnnn nnnnnnnnnn nnnnnnnnnn nnnnnnnnnn nnnnnnnnnn nnnnnnnnnn 956460
 nnnnnnnnnn nnnnnnnnnn nnnnnnnnnn nnnnnnnnnn nnnnnnnnnn nnnnnnnnnn 956520
 nnnnnnnnnn nnnnnnnnnn nnnnnnnnnn nnnnnnnnnn nnnnnnnnnn nnnnnnnnnn 956580
 nnnnnnnnnn nnnnnnnnnn nnnnnnnnnn nnnnnnnnnn nnnnnnnnnn nnnnnnnnnn 956640
 nnnnnnnnnn nnnnnnnnnn nnnnnnnnnn nnnnnnnnnn nnnnnnnnnn nnnnnnnnnn 956700
 nnnnnnnnnn nnnnnnnnnn nnnnnnnnnn nnnnnnnnnn nnnnnnnnnn nnnnnnnnnn 956760

 nnnnnnnnnn nnnnnnnnnn nnnnnnnnnn nnnnnnnnnn nnnnnnnnnn nnnnnnnnnn 956820
 nnnnnnnnnn nnnnnnnnnn nnnnnnnnnn nnnnnnnnaca aaaaaaaca cgaacgcaca 956880
 cgcgcgcaca cccacacac acacacacac acacacacac acacacacac acacacacct 956940
 gtaccctcc agactctcta aageccattc agggacagcc actgtgcacc ctgctatggc 957000
 agctgcagtg accctggcct ggcctcatgc caaacactct gctgtggttt cagaagggaa 957060
 gaaaggacac agagaagctc tggaaatgg acctaccag aacttgtag cagcaagctt 957120
 tattttctct aattagccag ttctgagcat ggaccacttc cagagattct tatgagccag 957180

 aaagaggacg agacctgctt ttgagtaaag ctgtcgcttc tctgcagttc caaagcactt 957240
 cctacactac aggggectca cacctccagt gggcagactc aaggtggacc tatctctgcc 957300
 ggacactagc cactcaagt ttactgaaga ggcactgtct ggaccaaagt ttctctccag 957360

tgaaaagccc tcattcagtg gcagatctta agagagaaat tctttgaggg aagaaacaga 957420
 tgaaggagg tgaagagct aatgaaaag ggttagggaa aataaggagg aggggaatgc 957480
 ccagggatta tgtgattca gttcaacttc ttttctccgc tttgactgaa gtgtgcaagc 957540
 cttcatggag gataaatatg accctctatg ttgacacagg gggcctgtca acctcagctc 957600

 ttgcttctag gtcacagaag ccagccagtc ccattcaca agctgcaact cctcctactt 957660
 tgaaccagtg gcaacgatgg tggatgcagg gtccccatta atctctgaca cctgcccccc 957720
 cccaagctga cattcttgca ctctgatttg tttcctaggg cagaggacag taagcaaggg 957780
 acaaaattct tcaggtgta tgggaagtct tcgatccacc ccagaagcac agtgtatctt 957840
 acttcacata atcttgcat ccttgttctt caaggacaag gcaattgtga gatcttctgt 957900
 ggatcgaagg cattgtgcc ctcaaattat ataaagtggg taaatgtaa ttcattgtac 957960
 cagtgttaca ggtcaatcag gggcaaatgg taacatttat ggttaacagt gctaggtcct 958020

 gtttcattta ttatctcctt cattccttac actgttccca caaagtagat attattgcct 958080
 tttaaatgag caaagcagat gtgcagagaa atgaagaac ctgttccac ttcccaagtc 958140
 acaagtggca gaaatggagt gttgaagccc acattctcgg gctccaaagc caggctcctg 958200
 gtgtcttctc agagctcagc gtctttacag cgaggaacat tgtgtctgtag atggttgttc 958260
 ttatattta tctttctcc cctgtttcag gtgtctgaca ggaagcagca acggcaattt 958320
 cctgcttacc ctgagacctt ttttaaacg ggccattttg gtcgtcagtt atgtaagtat 958380
 ataatgtata ctttgaatat agctagtaag ggtgttttca cttagtctca actcggagac 958440

 atgttccaga ttactgaata agctcactat caacatcacc tcatcaggaa ggtttgcagg 958500
 tggcaaatgt tgctcttgcg caaacgtgtg tgggaaacca cacacaggaa tctgaggcgc 958560
 tagtgtgaac cacacagggt taaagtccc tttcaaagt tttcaaagt gacctggatg 958620
 tgtcagttct ctactgetgg acacagcacc cagtccctgt acccgaggt gtagacacag 958680
 ctacctgctg tigtccagg cggctttagt tcggaagctc agccaatga tttccgttt 958740
 cctatgtcat gattggggcc agggttatcc aggcaggctt atctctcagc tgtaagagga 958800
 ggagacagct cctccacttc ttgatggagg atcagaacac atgtacagag atggaagaca 958860

 tacatgtagg tggacatttc atcaggtctt ctattcctt caagtgact gtcattttgt 958920
 atttccgctt gtggataatg ggaggaacaa tgeccctctt ctccgagcag gacaatccag 958980
 cttegttttc gccttacatc cttacaaggt cagtggacgt ccatcatgca aactttattt 959040
 ggtatttggg agttttgtg aacattttta ttgctgtaa atcatttcta caaaataata 959100
 ggtctcactg cactgagatc atacattctg gatcctgtcc aataatatta aaccacaggc 959160
 cagctatgca tttcaggaa atattgatca tggactagcc atgtacgagg ataggaaggg 959220

aagcacaata cttatgtttg caattctttt caacccatgt gagcatctgg acagggttgt 959280

ggctatgatt ctactggta cataattgtt tttcaacaa gtatatttatt agatgcttat 959340
tgtctgtagt gtctattgag tgacttttaa aacaagcatt acaaagcaga gcacagagat 959400
gtgggcagag attggttaga caacaccacc taaatccag gagtctcaga acaacgaata 959460
gaaaggaaca atatttgcaa agatagtgtc aatggttcct tacatgtcct cagacgttcc 959520
agagatgctg agttaggaag tgatgttgat gaatgttcct gtgcactggg aagatgtttg 959580
acttcttacc agctgcgttg tactgttaga gctttaagat aatcacatt tccaatttta 959640
aaagcttcag accaatttct gttttataat gtctaagttt agaacagaac atcacctgaa 959700

ctgtagtggg ttgagtggat ggaggcagaa accccattt ttggtctcat cacttctgtg 959760
gttatntaaa caaggttgg gctgtgctac tatattcctg ttcaataatg atggaggttt 959820
atctgttttc ttcaattgtt aaatgttcct tgccactaaa ggtcgggtgtt aagtacaatg 959880
ttctgaatat atttggttac aaatcatata tttatnttct tattgaagag ttggctcagt 959940
ggttgatact ggtgctaata atgcagcttc tcagttgctg ttgcaagtta cagctgccga 960000
tggaagact cagtaagcca gcaaagacct taagaatcgg gatttattac atttatattt 960060
ggcagaagga cctaataaaa ctgtgaaata cttttntaa agaaagcttc agattatact 960120

ctccatagtg tnttaaacat gaagatgtca tgfacaacta tnttcatagt catatatgct 960180
ataaatatct tataatgtta tatcattnta atgataaatt tatggtagta atctntacta 960240
ttttgggtga tatatnttg aaatgtatta taaaacatgg taaaacagta ttcaggacca 960300
tgaacacaaa caggtgtcaa agtctgacgt tagcttcct cttntcaaaa tgttntcag 960360
tcttaagctc aacatctgaa actcagctct cgggcaatag cctgtcctnt ttagatctcg 960420
ctcatgaca tgcagctccc aggtcctnt cttgctatnt ttagatgtga cagttcatgg 960480
atgaacagtt ctggtctgtg gctntntcaa cagctactnt ccacntntaa gaggaaacag 960540

gacatcaagt cctgnttctc cttggtgaac ccactatctt cattagagtt attggcataa 960600
aaagacacca tgaccacagc aactctnta aaggaaaaca tntaattggg gctntcttac 960660
aggntcagag gnttagtcat tgtaggaaac atggtggcat gcaggcagac atggtgctgg 960720
agagnttgc atntggaagg gccacagca ggaagtgaga gtgagccact gggcctagtt 960780
tgagcttctg aaacctcaaa gccacctcc agtgacaagg ccacacctcc taatagtgcc 960840
actcctggc gattaagtgt tgaatctat gtctcagggg tccatntnta tntaaaccac 960900
tataccatc tntcagntc aggatcatgt cntntaactt tggaatgntt tccntcagc 960960

tttagtgtgg tgttgtttgt ctttgggggtg atttcctact gagctttctg tctatgaatt 961020
 gaggcagcta ctctcagctt ctcaagtaga tgtagcatac tccatgaatt aagccaggat 961080
 gaggaaatga aaccaataa tccttcctgc tttttgtctt ttctctgatt tctttaaggg 961140
 agcttttcat ttctcttta agggcctcta tcacttcat aaagtattt ttaaggtcat 961200
 tttcttgtgc ttcagctaca tggaaatgtt caggtcttga tgtcatgtcg taggatctct 961260
 gggttctggg agtgtcatat tgccctttct gttactgtgt tgttgttgtt gttgttgttg 961320
 tttccaact ttttaaattt gaattagaaa caggattttt tttttacat gacaatccca 961380

 gttcccttct cccaccatcc tcccctacca ctccccacc actaaaacce tatctatcac 961440
 atatcctttc tgctcccctt ggatggtag gctttccata ggggtctatc agagtctatc 961500
 atatcctttg ggacagggcc taggcccac cctgtgtgtc ttggctcagg gagtattcct 961560
 ctatatggaa tgggctccca aagtccacac acatgctagg gataagtact gaacttctac 961620
 aggaggtcct gtagatttct gaggtttcct cacagaaacc catgttcctg gggttggatc 961680
 agtcccatgc tggatttcca gctatcagtc tggggagcaa gagtttctgg atgttcaggt 961740
 cagctgttta tgtgggttcc accagcctgg tgtggacccc tgtgctcttc actagtcctt 961800

 ctctgcatct gggttccagt tcagtttggg gattagtgtt ggggtctctc ttctacttct 961860
 accagctgct ggatgtaggc tataggatgg catataagtc agtcatcaat ctattataca 961920
 ggggagggca ttaaggttag cctctcctct gttgcttaga ttgttagctg gtgcatctt 961980
 tgtagatctc cagacatttc cctagtgcct gatttctctg taaaccnnnn nnnnnnnnnn 962040
 nnnnnnnnnn nnnnnnnnnn nnnnnnnnnn nnnnnnnnnn nnnnnnnnnn nnnnnnnnnn 962100
 nnnnnnnnnn nnnnnnnnnn nnnnnnnnnn nnnnnnnnnn nnnnnnnnnn nnnnnnnnnn 962160
 nnnnnnnnnn nnnnnnnnnn nnnnnnnnnn nnnnnnnnnn nnnnnnnnnn nnnnnnnnnn 962220

 nnnnnnnnnn nnnnnnnnnn nnnnnnnnnn nnnnnnnnnn nnnnnnnnnn nnnnnnnnnn 962280
 nnnnnnnnnn nnnnnnnnnn nnnnnnnnnn nnnnnnnnnn nnnnnnnnnn nnnnnnnnnn 962340
 nnnnnnnnnn nnnnnnnnnn nnnnnnnnnn nnnnnnnnnn nnnnnnnnnn nnnnnnnnnn 962400
 nnnnnnnnnn nnnnnnnnnn nnnnnnnnnn nnnnnnnnnn nnnnnnnnnn nnnnnnnnnn 962460
 nnnnnnnnnn nnnnnnnnnn nnnnnnnnnn nnnnnnnnnn nnnnnnnnnn nnnnnnnnnn 962520
 nnnnnnnnnn nnnnnnnnnn nnnnnnnnnn nnnnnnnnnn nnnnnnnnnn nnnnnnnnnn 962580
 nnnnnnnnnn nnnnnnnnnn nnnnnnnnnn nnnnnnnnnn nnnnnnnnnn nnnnnnnnnn 962640

 nnnnnnnnnn nnnnnnnnnn nnnnnnnnnn nnnnnnnnnn nnnnnnnnnn nnnnnnnnnn 962700
 nnnnnnnnnn nnnnnnnnnn nnnnnnnnnn nnnnnnnnnn nnnnnnnnnn nnnnnnnnnn 962760
 nnnnnnnnnn nnnnnnnnnn nnnnnnnnnn nnnnnnnnnn nnnnnnnnnn nnnnnnnnnn 962820

nnnnnnnnnn nnnnnnnnnn nnnnnnnnnn nnnnnnnnnn nnnnnnnnnn nnnnnnnnnn 962880
 nnnnnnnnnn nnnnnnnnnn nnnnnnnnnn nnnnnnnnnn nnnnnnnnnn nnnnnnnnnn 962940
 nnnnnnnnnn nnnnnnnnnn nnnnnnnnnn nnnnnnnnnn nnnnnnnnnn nnnnnnnnnn 963000
 nnnnnnnnnn nnnnnnnnnn nnnnnnnnnn nnnnnnnnnn nnnnnnnnnn nnnnnnnnnn 963060

 nnnnnnnnnn nnnnnnnnnn nnnnnnnnnn nnnnnnnnnn nnnnnnnnnn nnnnnnnnnn 963120
 nnnnnnnnnn nnnnnnnnnn nnnnnnnnnn nnnnnnnnnn nnnnnnnnnn nnnnnnnnnn 963180
 nnnnnnnnnn nnnnnnnnnn nnnnnnnnnn nnnnnnnnnn nnnnnnnnnn nnnnnnnnnn 963240
 nnnnnnnnnn nnnnnnnnnn nnnnnnnnnn nnnnnnnnnn nnnnnnnnnn nnnnnnnnnn 963300
 nnnnnnnnnn nnnnnnnnnn nnnnnnnnnn nnnnnnnnnn nnnnnnnnnn nnnnnnnnnn 963360
 nnnnnnnnnn nnnnnnnnnn nnnnnnnnnn nnnnnnnnnn nnnnnnnnnn nnnnnnnnnn 963420
 nnnnnnnnnn nnnnnnnnnn nnnnnnnnnn nnnnnnnnnn nnnnnnnnnn nnnnnnnnnn 963480

 nnnnnnnnnn nnnnnnnnnn nnnnnnnnnn nnnnnnnnnn nnnnnnnnnn nnnnnnnnnn 963540
 nnnnnnnnnn nnnnnnnnnn nnnnnnnnnn nnnnnnnnnn nnnnnnnnnn nnnnnnnnnn 963600
 nnnnnnnnnn nnnnnnnnnn nnnnnnnnnn nnnnnnnnnn nnnnnnnnnn nnnnnnnnnn 963660
 nnnnnnnnnn nnnnnnnnnn nnnnnnnnnn nnnnnnnnnn nnnnnnnnnn nnnnnnnnnn 963720
 nnnnnnnnnn nnnnnnnnnn nnnnnnnnnn nnnnnnnnnn nnnnnnnnnn nnnnnnnnnn 963780
 nnnnnnnnnn nnnnnnnnnn nnnnnnnnnn nnnnnnnnnn nnnnnnnnnn nnnnnnnnnn 963840
 nnnnnnnnnn nnnnnnnnnn nnnnnnnnnn nnnnnnnnnn nnnnnnnnnn nnnnnnnnnn 963900

 nnnnnnnnnn nnnnnnnnnn nnnnnnnnnn nnnnnnnnnn nnnnnnnnnn nnnnnnnnnn 963960
 nnnnnnnnnn nnnnnnnnnn nnnnnnnnnn nnnnnnnnnn nnnnnnnnnn nnnnnnnnnn 964020
 nnnnnnnnnn nnnnnnnnnn nnnnnnnnnn nnnnnnnnnn nnnnnnnnnn nnnnnnnnnn 964080
 nnnnnnnnnn nnnnnnnnnn nnnnnnnnnn nnnnnnnnnn nnnnnnnnnn nnnnnnnnnn 964140
 nnnnnnnnnn nnnnnnnnnn nnnnnnnnnn nnnnnnnnnn nnnnnnnnnn nnnnagcacac 964200
 actttgttcc tgttcacacc tccatcatac ctctctgggag cacatacttt gctcctgttc 964260
 acacctccat cacacctcct gggagcacac actttgetga tgcttcteta gcaaacaccc 964320

 ttggtttgtt tctgtctttt gctaagctag ctctgatca cctgacttag ctgtgatgtg 964380
 gctgcctctg tgaagtctgt ctctctgggc tccagattta tcattggctt tgtctgtctg 964440
 ccttagtgaa aaattcttct gcatttgtct gctaggactg acatgagccc tcctagtact 964500
 tcaggccaca agtcccaaat caacatgctg tcagagtgg tgtgtggtga gatgtctgtt 964560
 tctgtgtggc aaacaaccac ttactctcgt gcgtgcgtgc gtgcgtgcgt gcgtgcgtgc 964620
 gtgcgtgtgt gtttgcgcat gttgtgtgta tggatgtgt ttgtgtgtgt gtgtgtgtgt 964680

nnnnnnnnnn nnnnnnnnnn nnnnnnnnnn nnnnnnnnnn nnnnnnnnnn nnnnnnnnnn 966480
 nnnnnnnnnn nnnnnnnnnn nnnnnnnnnn nnnnnnnnnn nnnnnnnnnn nnnnnnnnnn 966540
 nnnnnnnnnn nnnnnnnnnn nnnnnnnnnn nnnnnnnnnn nnnnnnnnnn nnnnnnnnnn 966600
 nnnnnnnnnn nnnnnnnnnn nnnnnnnnnn nnnnnnnnnn nnnnnnnnnn nnnnnnnnnn 966660
 nnnnnnnnnn nnnnnnnnnn nnnnnnnnnn nnnnnnnnnn nnnnnnnnnn nnnnnnnnnn 966720
 nnnnnnnnnn nnnnnnnnnn nnnnnnnnnn nnnnnnnnnn nnnnnnnnnn nnnnnnnnnn 966780
 nnnnnnnnnn nnnnnnnnnn nnnnnnnnnn nnnnnnnnnn nnnnnnnnnn nnnnnnnnnn 966840

 nnnnnnnnnn nnnnnnnnnn nnnnnnnnnn nnnnnnnnnn nnnnnnnnnn nnnnnnnnnn 966900
 nnnnnnnnnn nnnnnnnnnn nnnnnnnnnn nnnnnnnnnn nnnnnnnnnn nnnnnnnnnn 966960
 nnnnnnnnnn nnnnnnnnnn nnnnnnnnnn nnnnnnnnnn nnnnnnnnnn nnnnnnnnnn 967020
 nnnnnnnnnn nnnnnnnnnn nnnnnnnnnn nnnnnnnnnn nnnnnnnnnn nnnnnnnnnn 967080
 nnnnnnnnnn nnnnnnnnnn nnnnnnnnnn nnnnnnnnnn nnnnnnnnnn nnnnnnnnnn 967140
 nnnnnnnnnn nnnnnnnnnn nnnnnnnnnn nnnnnnnnnn nnnnnnnnnn nnnnnnnnnn 967200
 nnnnnnnnnn nnnnnnnnnn nnnnaaaaaa aaaaaacaaa aaaaaaaaaa aatgaagag 967260

 ttggttccc agagccacca cacagtttca gtagggacag ttggttagct gctcttcctc 967320
 aggaagctta ccctttctgt gtatttctgt aatgatatct tcctgtcatt atgtattttt 967380
 gacagggcct ctactctag tgctggctag cctggtgcta acagtgggct gggctctggt 967440
 acaccaatca gcactcaaga caatccctca cggttatgct cacggaccaa cctgatctag 967500
 gcagtcctc agttgaaact tctccttttc agtgactct aggctgtatc aagttggcag 967560
 tagtgcagge tgacctcaaa gttgcagtga tcttctgcc tcagcttccc gaggttctggg 967620
 gttataagca tgagcagcca cttctggcta tgaactcta cttcagtcac cctgggttc 967680

 tcaatttaa aaaatgaatc attaaatfff ttacatecaa tttccagttc tetgagttgt 967740
 atattctatt tggttggcaa gacatttttt cggtttcccc ccattaatag gatttatagt 967800
 agaaagctgg taaataatff tctttctggt ctgacagaga gagagagaga gagagagaga 967860
 gagagagaga gagagagaga gagagagann nnnnnnnnnn nnnnnnnnnn nnnnnnnnnn 967920
 nnnnnnnnnn nnnnnnnnnn nnnnnnnnnn nnnnnnnnnn nnnnnnnnnn nnnnnnnnnn 967980
 nnnnnnnnnn nnnnnnnnnn nnnnnnnnnn nnnnnnnnnn nnnnnnnnnn nnnnnnnnnn 968040
 nnnnnnnnnn nnnnnnnnnn nnnnnnnnnn nnnnnnnnnn nnnnnnnnnn nnnnnnnnnn 968100

 nnnnnnnnnn nnnnnnnnnn nnnnnnnnnn nnnnnnnnnn nnnnnnnnnn nnnnnnnnnn 968160
 nnnnnnnnnn nnnnnnnnnn nnnnnnnnnn nnnnnnnnnn nnnnnnnnnn nnnnnnnnnn 968220
 nnnnnnnnnn nnnnnnnnnn nnnnnnnnnn nnnnnnnnnn nnnnnnnnnn nnnnnnnnnn 968280

nnnnnnnnnn nnnnnnnnnn nnnnnnnnnn nnnnnnnnnn nnnnnnnnnn nnnnnnnnnn 968340
 nnnnnnnnnn nnnnnnnnnn nnnnnnnnnn nnnnnnnnnn nnnnnnnnnn nnnnnnnnnn 968400
 nnnnnnnnnn nnnnnnnnnn nnnnnnnnnn nnnnnnnnnn nnnnnnnnnn nnnnnnnnnn 968460
 nnnnnnnnnn nnnnnnnnnn nnnnnnnnnn nnnnnnnnnn nnnnnnnnnn nnnnnnnnnn 968520

 nnnnnnnnnn nnnnnnnnnn nnnnnnnnnn nnnnnnnnnn nnnnnnnnnn nnnnnnnnnn 968580
 nnnnnnnnnn nnnnnnnnnn nnnnnnnnnn nnnnnnnnnn nnnnnnnnnn nnnnnnnnnn 968640
 nnnnnnnnnn nnnnnnnnnn nnnnnnnnnn nnnnnnnnnn nnnnnnnnnn nnnnnnnnnn 968700
 nnagccagcc tggctccag agcgagttcc atgacagcca tggcatgtta cacagagaaa 968760
 ctgtgtctca acaacaacaac aaacaacaaca aaaacaactt aatgatgagt ctctgtatcc 968820
 agctctatctt attatccact aatatagttt tttttccaac tataataaa aagcttgggt 968880
 taatagctgg tttctctgac ttagcctctt tctcagttac ttttcctagt gctgtgttaa 968940

 aattcccca caaaagcaac ttaagggaga aagagtttat ttcggctcag tgttccagct 969000
 gtgcagtcgg ttatagttag gaagcagcaa tgggggagc ttgaggacca ggaagtggcc 969060
 agagagctgt gactgactga ctgggaccag ggagcagaga gagagctgtg actgctcagc 969120
 ttaagtctc cttttcgttt ggtccagtct gaggcagagg gaacaacgct ggtactcgt 969180
 attagaatgg gtcttccac tttggtttac ctcatcagga tagtctcata gggcacacca 969240
 aggggctage ctagtctaat aattctcagc agatatgcct ggaggctggt cttttaggt 969300
 tttttatgct ttgtcaaatt gacaatcagc acttaccact aagctatata aatagattct 969360

 gtctctgggt gtgtctctca ggccattctt aacttatgca tgtcccccatt taccatatgc 969420
 ttaagaaact agctccttgg tgcagtggtt tctccacac cctgggact gtgtctccaa 969480
 tttgtcatga aatgtgtct gatggttctt cegtgtatcc catattagca gttggtctta 969540
 gaactggttt aaattcaagg ttttgtctct gttgtttttt ttttttaaac aagattattt 969600
 catcataggt ctgtttaagc tttctttctc tctttatgac attaaaatga attagttagc 969660
 tctatgtacc taaatgtttt gtttgtgtt tgagacaggg tctcactcag tagacctcta 969720
 gcctggcctc tgactcatgg ctatccttct gcctcagcct cttgagtgt ggggctgtag 969780

 gcacctgatt ctccatcac attagcgagt gcgttatctg ccactaacct aatatgttta 969840
 gcagtcatta tatataatta atatatatat atatatatat atatatatan 969900
 nnnnnnnnnn nnnnnnnnnn nnnnnnnnnn nnnnnnnnnn nnnnnnnnnn nnnnnnnnnn 969960
 nnnnnnnnnn nnnnnnnnnn nnnnnnnnnn nnnnnnnnnn nnnnnnnnnn nnnnnnnnnn 970020
 nnnnnnnnnn nnnnnnnnnn nnnnnnnnnn nnnnnnnnnn nnnnnnnnnn nnnnnnnnnn 970080
 nnnnnnnnnn nnnnnnnnnn nnnnnnnnnn nnnnnnnnnn nnnnnnnnnn nnnnnnnnnn 970140

nnnnnnnnnn nnnnnnnnnn nnnnnnnnnn nnnnnnnnnn nnnnnnnnnn nnnnnnnnnn 971940
 nnnnnnnnnn nnnnnnnnnn nnnnnnnnnn nnnnnnnnnn nnnnnnnnnn nnnnnnnnnn 972000
 nnnnnnnnnn nnnnnnnnnn nnnnnnnnnn nnnnnnnnnn nnnnnnnnnn nnnnnnnnnn 972060
 nnnnnnnnnn nnnnnnnnnn nnnnnnnnnn nnnnnnnnnn nnnnnnnnnn nnnnnnnnnn 972120
 nnnnnnnnnn nnnnnnnnnn nnnnnnnnnn nnnnnnnnnn nnnnnnnnnn nnnnnnnnnn 972180
 nnnnnnnnnn nnnnnnnnnn nnnnnnnnnn nnnnnnnnnn nnnnnnnnnn nnnnnnnnnn 972240
 nnnnnnnnnn nnnnnnnnnn nnnnnnnnnn nnnnnnnnnn nnnnnnnnnn nnnnnnnnnn 972300

 nnnnnnnnnn nnnnnnnnnn nnnnnnnnnt caatttaaat atcttccttg ggaactgtgt 972360
 cttttttttt ttttttcttt ctgttgaggt cagcacccaa cacagtggct aggaactgag 972420
 agataagttc ccaggtgadc agtttaatat atagtttgat gtccttcctc atcttcctct 972480
 aactgaaacg atgacagaac agacatactg tttcctagaa ctgtgtaag caagtgtttg 972540
 ccaaagtggg gaatgtatat ttcacaactg ttctcttcat aggttcctga cctattccta 972600
 cctccttgcc ttcaatgtgt ggcttctgct ggcacctatc acctgtgct acgactggca 972660
 agtgggcagt atccctctgg tggagacat atgggatgtg aggaaccttg ctaccatcct 972720

 tctggcgggtg gtgatggcct tactgagtct aactgcatg gcagccttca aggtaatctc 972780
 taagagcaaa tagattctca tatcgaagac atatgtctct cttactactg ctccctttcg 972840
 taatggggtc tgggtcaaaa tcacatgtta ctgacttaca aaagtttgaa aattaatfff 972900
 tcctaataga taatataat ttaaagtct ttagcaggtc tcatagacca tgccttctt 972960
 aatfffatcc tgtctttatt taaaagattt atfffatatt atgcatatat gcgtgtgtct 973020
 ctatgtgggc atgccacatg tgtatagatg cctgtggtgg ctagagaaag gtgtctgatc 973080
 ccctggagct ggagttacag gtggttgtga gctggctgac tgggtgctgg aagccagact 973140

 ccactcctct ggcagaagag caattgttct tagccaactga gccatctctc cagctgtgtg 973200
 taatfffctt gatcatgtcc agatgttttg taagaataaa aatffctcc tggatagtt 973260
 ggctaataat tgaaggaatt taattgatac aatgtcataa aaaatgaaa tacacttaca 973320
 aatatttaag gtctgattga gactccatat ccacttaatg atattaaatt tgatggtttc 973380
 tttccagtc agaaaaaat atgaaactga acaaaattat taagttcaat catttaaaaa 973440
 tgatcaaagg tagaagaac tagaaaatac tgattgatgg gaaattgaca gacattgatg 973500
 aaatgcctct cactgggct aaacatgcc tggagctfff ctttatgact ttgatacaaa 973560

 ctttacagcg ttagaaaagc acctgtctg aacatggtgt gtttaggagg cttctttcca 973620
 ctgggctcc tcttaataga ttcttctcta tggcctgtcc tctaaaatag cctcactgag 973680
 cgacaggaaa tgctgccag tgggtttcgg aagcaatgtg tttgatatgt gttccttatg 973740

tcattctcac aggatttctt gagatthtaa agagcattca atgactthta tagccttgca 973800
 gcatcctgta aaaggaaaac tggataaaca gaggaggaga agaaggagga ggaggaggag 973860
 gagaaggagg aggaggaaga ggaggaggag gaaacatggt cacctagctt ggcttggtg 973920
 actgcctcac agtgacagag atctthctg gcagaggcca taggtctgtg cctatctgtg 973980

 tctthagctc agtctctaa tgatctctc gagatcagga ccaaacacag gctgagctct 974040
 gagacctgga aaacaaacct agtctctgga tccttaggaa gatgaagtg tagctggagc 974100
 actthtggtt ggggtaact gcaatgaggg cttagaggag cctctattgt gggaaggaag 974160
 cctctgaage cccttacctg aagacctga tgcattcatt cctgggactt ccgttagtgt 974220
 cagttcttag ccttgctttc cccctthaaa gtccacatca cgattctcat cthctctc 974280
 cctggagagt aggcacctgg ggtgaagaga ctccatcta gtgtctctga gtaagatccc 974340
 atattctcaa caaggaggca ggctagagta agagcaactg ttggaaagta gttgtctgcg 974400

 tgtggatac ccaacctgt taagaacaga thtagagcag ttgagtggac aacccacac 974460
 tcccctagcc cccccccc ccccacaca cagacagacc aaagaaggca caccttctg 974520
 ttgctaagga agaaagtatt agaagctthg ctgccatgt gatctgtcac aactthatec 974580
 ttgaagcaca aatagccaa ccaacctac agccaaaat tgttctacca tagaccata 974640
 caattgaact agacacgatt ccagattgct agaaattatt thtgacttht gctcattcaa 974700
 ataataggtt atcatgttat tgtgacacat thctagaatg tccctthaaa aacctgatga 974760
 aataaacatg tgtththta cacagtgaat atcaaatg gtagaacct ggaggatgaa 974820

 gacagactth aatagcgagt ggtctththt ctccctthc cctgccttggt gctatthtag 974880
 thccctthct thgcaccag cactthcca thcacgthc ctcaattcat agaaattctc 974940
 ctctcaggaa aatagggact cagtctthct agccataac agccctctg gatgggttht 975000
 atthggcccc thgatagthg aggtccaaa atgtgtctcc aaggtccat gthtgaggtc 975060
 agctggthgg ggtgtthctt ctgtgtatat gthctctta thgthgatg aataaacac 975120
 thththggcca atagagthg gaagatagc atggthgga gactggagaa thctgggaaa 975180
 gggagatgga gagagacct gaggagatgc catggagaga ccgggaagat aggatgcgcc 975240

 aggcattctc ccgtaagata agccatata gaaatacata gattagtagt tatggthta 975300
 taattaagac agagctagcc agtaaaagaa gcctagcca ccagccaata gthtaataat 975360
 taatatagcc thgtgtgct ththgggct tgagaaggac agctggatct ggcgggacaa 975420
 gaaaccacca gcaactgaca gctcgaagt aggtctagtc caggcagctt tccagcgtg 975480
 thctctccgg atctctctc thactthctt acctatagcc acctgatcg cgggccat 975540
 ththctacct cagthgctat ctactthca thgthgctt thgacctac aatagaatg 975600

gaatgcac tgiaaccctt ttctgagggt agtttgaag taaactttac cctttaccct 975660

 catatggtaa agaggtatgt tatgggagag acaagctttg ccctggaact tactcagaga 975720
 ccctctgctg ctctccctcg ggcgtgcat atcattgtgt tgcctatgt gataaagaga 975780
 cggcttcctt tcigcggttc taactttgta tggattcac actttaaatg catgccacac 975840
 cacctcaagt gaagcctggc ccctctgtac aggaggtgta agaggagagc cacccaagt 975900
 cctaggagga gggaggccag agtgggtaat gatagcttca ctgctcctca cctgtgtctg 975960
 ttcccctccc acagactccc ctcccctcct gcaccatgct gcgaggctcag accagggcac 976020
 ttggtgcctt ctgacacagc accatgatag ccctcacaga ggaacaatga agacattcca 976080

 actgtttgca gagtctggtc attgtcaggg tcacgatcat cccaaaagcg tggcagctca 976140
 actccaggag gacaaaaggg ctctctgtgta taaatagcag agtgaatgca aagaaagcca 976200
 ctgactgctt cctttgtctc tgtagtcaag acccgtgctt gctcaacagt cacagtgtat 976260
 atgaagttat tgtattttat gaatgtcaac cctctacctc atccttaccg tgctcccttc 976320
 atccccagtg gcaggaaca tctttaaatt ctttagaaca gctgctttct ggacttgaat 976380
 gtacctggg tttcttttct catcacactg acaaatgaa gggaggaaaa gcttctttgg 976440
 cccacagct tggatactca gccattatg gccagcctt ggtggcaagg cgagggtctg 976500

 ctgctcacat ctggacagat ctggggacag agaaggggca ggacgattag ccaagccct 976560
 ccaccagca acccacttcc tttagtggga ctccacctc tgaagtctca gcctcccaga 976620
 atagctgggt tcaaacattc gaacctgtgg ctgatgtcc caactcagat catataaaa 976680
 aactacatc agaagtgtgc agtctctgtg ttcagatgac acagaaggac aggagtgaaa 976740
 tcaactagtt aactgtatgt gaggggcaca cacagtaaag aaagtgccta cctgaccatt 976800
 ccatggtatg attaaggaa aggtttttta ttgtgcataa gagagaaaa atccatagc 976860
 atctggaaga gccagagca gcagagagaa aagaaaacag actggacatg gcctgggcta 976920

 tattagagag aaatggaaga atagcagaag aaagtgagtg tgtgtgtgtg tgtgtgtgtg 976980
 tgtgtgtgtg tgtgtggnnn nnnnnnnnnn nnnnnnnnnn nnnnnnnnnn nnnnnnnnnn 977040
 nnnnnnnnnn nnnnnnnnnn nnnnnnnnnn nnnnnnnnnn nnnnnnnnnn nnnnnnnnnn 977100
 nnnnnnnnnn nnnnnnnnnn nnnnnnnnnn nnnnnnnnnn nnnnnnnnnn nnnnnnnnnn 977160
 nnnnnnnnnn nnnnnnnnnn nnnnnnnnnn nnnnnnnnnn nnnnnnnnnn nnnnnnnnnn 977220
 nnnnnnnnnn nnnnnnnnnn nnnnnnnnnn nnnnnnnnnn nnnnnnnnnn nnnnnnnnnn 977280
 nnnnnnnnnn nnnnnnnnnn nnnnnnnnnn nnnnnnnnnn nnnnnnnnnn nnnnnnnnnn 977340

nnnnnnnnnn nnnnnnnnnn nnnnnnnnnn nnnnnnnnnn nnnnnnnnnn nnnnnnnnnn 979260
 nnnnnnnnnn nnnnnnnnnn nnnnnnnnnn nnnnnnnnnn nnnnnnnnnn nnnnnnnnnn 979320
 nnnnnnnnnn nnnnnnnnnn nnnnnnnnnn nnnnnnnnnn nnnnnnnnnn nnnnnnnnnn 979380
 nnnnnnnnnn nnnnnnnnnn nnnnnnnnnn nnnnnnnnnn nnnnnnnnnn nnnnnnnnnn 979440

 nnnnnnnnnn nnnnnnnnnn nnnnnnnnnn nnnnnnnnnn nnnnnnnnttc ctgttgggag 979500
 catttttctc ttagaacctc acaagcatac cccaggaaaa acacgacccc acctcacaaa 979560
 tatgggtcag ttttcttctt tgatgtcaca cctcactttt ttgtaaattc actaaacact 979620
 tgagtgtttg atggaagcag gccctttgat gggcctctct tcattgcctt gaaacaata 979680
 aatggatgtg ttggtatgta catgctgga cttggaagat tacaggtgtt tgaaccataa 979740
 agcataaaga gccttgcttt tccatcctct gctgcatgcc attaaaccag taaatttaag 979800
 tgggtgtaaa ctgaacccat agtgaaaaat gagggaagaa tcccagacc agtgatttgt 979860

 gaagagagcc cttaactgc ctcttgtgag aacagaatta tccattagc tctccccatc 979920
 acacacctca gaagcagaaa agtgggacat gttccttgat tggctacaca ttgtggtaga 979980
 ttctggatga ggacattgac tgggaacaga gcccaaatct acctgatgac acctggatct 980040
 tgttgcctt tttctcagtg cttaggaaag agggttcctg gtcttgtcac ccatgcacag 980100
 agtgacctga agtaaggcag acccagacct gccatttgtc tgataaagca gggtagctg 980160
 ttgctaagag atgctcctgt aagccagtta gtcttacta ggggaacaca accacgtgtc 980220
 cctcgtgtct ctcattaat cccagagtat agaacaagtg ttcacctct cagacagttc 980280

 catgtgggta ggtgaaccac agctctctct gcaataaga caaggaaagg ctcttgtctc 980340
 tttcatggca gatagatgtt gatggcatcc tgcactgggg gaggggggtg cctgcttagt 980400
 agatgtcccc gcacaagtat ggtaagtaag aaaacattc tgctggccac acacatccgc 980460
 aggacaaagt gacttaggga acacttctgg ttcttgetct gcctgcttcc tegaccccag 980520
 gagaggaaga cccaggggac actctactgt atttaaatca atccatgatc ctaccaagt 980580
 cccttctga gacactcttg tgaagttaag tttattgacc ttggattttg tggttgcatg 980640
 agtttggatc tggaatgttc tccaaaggcg atgtattaaa agcatgatcc ctagectgaa 980700

 gttgtaaaa gtcattgtca ttctacaaa caagcctagg cataatgtgac ccatttctg 980760
 aagcctaggt gtcccgtaa gtgatactgt acacctcaa gcttctctc attctgaat 980820
 cccttctgtc tgagtgaacc ctgagtgtca ctcacattgc attcccagaa gagtcaagct 980880
 caaatttgta aagtaagtg gtgtgtgtgt gtgtgtgtgt gtgtgtgtgt gtgtgtgtgt 980940
 gctgtcaagt gcttgtgcac gtgtgtgcac gtgcataagt gcgcacatgt gggcatgcat 981000
 gtgcgtggaa gtcagaagcc aactttagg agttagtgtt ctctgctac cacatggatc 981060

tcagttatca aactcccatc accaggcttg gtggaggcac cttgactctc tgagccatct 981120

cattggcggc ttcatatgta tatgaagtat gtatatactt cacatacagg cggagtatgt 981180

atatgetatg tgttatatgc tatgcgtctg gtcttggacg ttgggtttca ggagagtaac 981240

gaccatctca aaccattcct tgattccctg aagcagaaca tgtgagaagg agcagtgctg 981300

tgtagagtac tgggcttgtt tctcctgatg ccctctgtta gacgctgtaa ggggcgagat 981360

ttccttgacc atacagcacc tcgtgtgget tcctccacac tgcaacatct gactccttgc 981420

cctggcattt ccacctacac ttgattttgg atatagaaga ggacaaactt tggagtgggt 981480

caggtctcgg gtgttttgtt tttttgttct gttttgtttt tgttctgtag ttaggaggag 981540

tctttcagac tagaaagatg acttgggggg caaagtactt atgaagacct gaatttagac 981600

tcccacaatc cacataaaag tccagcctgg tgggtgtgtc tggtaacttt attgttggga 981660

ggcagagcga ggtgagetca ttggatagcc agcataacce aagcgttgag cttcaagttc 981720

cctgaaaaac tttctcaaaa atgaactgta gagacagata cccagtgtga cctctgcctt 981780

ccatgtaaga cgttacttgt gagcacacac attctcacat acacacatat gcaccacaca 981840

cctgcaatac atatacacca catacctgct tgccacacaca cacacacaca cacacacaga 981900

gagagagaga gagagagaga gagagagaga gagaggagg gagggagaga gagagagaga 981960

gtgtgtcact gtgtagccca ggttggactt gacttctcaa tcctctgtt tgaacttccc 982020

aagtgtcggg atggcaagtg tacatgccat gcctggcttt tagcccttag tttgaaactt 982080

tcacttccca ctattggag tgacagctaa gtgccagaag ccacacctg aagttaatg 982140

gtggccttcc ccagcatgt tcctatctcc tctgttctt gcctccttct gtcttgcact 982200

aacctcagga tactaacccc tcagcataac tgaccctgag gctcacagag ggatttgtac 982260

attgaataga cccttagagg agganntttt nnnnnnnnnn nnnnnnnnnn nnnnnnnnnn 982320

nnnnnnnnnn nnnnnnnnnn nnnnnnnnnn nnnnnnnnnn nnnnnnnnnn nnnnnnnnnn 982380

nnnnnnnnnn nnnnnnnnnn nnnnnnnnnn nnnnnnnnnn nnnnnnnnnn nnnnnnnnnn 982440

nnnnnnnnnn nnnnnnnnnn nnnnnnnnnn nnnnnnnnnn nnnnnnnnnn nnnnnnnnnn 982500

nnnnnnnnnn nnnnnnnnnn nnnnnnnnnn nnnnnnnnnn nnnnnnnnnn nnnnnnnnnn 982560

nnnnnnnnnn nnnnnnnnnn nnnnnnnnnn nnnnnnnnnn nnnnnnnnnn nnnnnnnnnn 982620

nnnnnnnnnn nnnnnnnnnn nnnnnnnnnn nnnnnnnnnn nnnnnnnnnn nnnnnnnnnn 982680

nnnnnnnnnn nnnnnnnnnn nnnnnnnnnn nnnnnnnnnn nnnnnnnnnn nnnnnnnnnn 982740

nnnnnnnnnn nnnnnnnnnn nnnnnnnnnn nnnnnnnnnn nnnnnnnnnn nnnnnnnnnn 982800

nnnnnnnnnn nnnnnnnnnn nnnnnnnnnn nnnnnnnnnn nnnnnnnnnn nnnnnnnnnn 988320
 nnnnnnnnnn nnnnnnnnnn nnnnnnnnnn nnnnnnnnnn nnnnnnnnnn nnnnnnnnnn 988380
 nnnnnnnnnn nnnnnnnnnn nnnnnnnnnn nnnnnnnnnn nnnnnnnnnn nnnnnnnnnn 988440
 nnnnnnnnnn nnnnnnnnnn nnnnnnnnnn nnnnnnnnnn nnnnnnnnnn nnnnnnnnnn 988500
 nnnnnnnnnn nnnnnnnnnn nnnnnnnnnn nnnnnnnnnn nnnnnnnnnn nnnnnnnnnn 988560
 nnnnnnnnnn nnnnnnnnnn nnnnnnnnnn nnnnnnnnnn nnnnnnnnnn nnnnnnnnnn 988620
 nnnnnnnnnn nnnnnnnnnn nnnnnnnnnn nnnnnnnnnn nnnnnnnnnn nnnnnnnnnn 988680

 nnnnnnnnnn nnnnnnnnnn nnnnnnnnnn nnnnnnnnnn nnnnnnnnnn nnnnnnnnnn 988740
 nnnnnnnnnn nnnnnnnnnn nnnnnnnnnn nnnnnnnnnn nnnnnnnnnn nnnnnnnnnn 988800
 nnnnnnnnnn nnnnnnnnnn nnnnnnnnnn nnnnnnnnnn nnnnnnnnnn nnnnnnnnnn 988860
 nnnnnnnnnn nnnnnnnnnn nnnnnnnnnn nnnnnnnnnn nnnnnnnnnn nnnnnnnnnn 988920
 nnnnnnnnnn nnnnnnnnnn nnnnnnnnnn nnnnnnnnnn nnnnnnnnnn nnnnnnnnnn 988980
 nnnnnnnnnn nnnnnnnnnn nnnnnnnnnn nnnnnnnnnn nnnnnnnnnn nnnnnnnnnn 989040
 nnnnnnnnnn nnnnnnnnnn nnnnnnnnnn nnnnnnnnnn nnnnnnnnnn nnnnnnnnnn 989100

 nnnnnnnnnn nnnnnnnnnn nnnnnnnnnn nnnnnnnnnn nnnnnnnnnn nnnnnnnnnn 989160
 nnnnnnnnnn nnnnnnnnnn nnnnnnnnnn nnnnnnnnnn nnnnnnnnnn nagagaacc 989220
 ccacatggta gaaggagaga acctaccccc acaagttggt gtatgacctc acatgtacac 989280
 tgtcacaggt acatacacac acagacacac ccactcagtc actcactatc tatcgtctgt 989340
 ctgtctgtca tctatctatc tacctaccag tctatctatc tatctatctc cttaagaca 989400
 aaagaaaggg aggaagaag gaaggagaa aatgaatcct agtgatgact agagtctttc 989460
 accgatggct ctgtaggttt gaaaaatact tccgaatttg agctgttggc ttatgtctct 989520

 acaggttcag acttggccca ggggtggttt gtaaggctc ctgtgtgctc tgtatggaaa 989580
 tctctggttg gcagcacagg ggtcccttaa ccagagtaac cagagcaagc aagactcagg 989640
 ttccatctcc tggagaaaaa gcatgtagtt tctcatttgc ttggttttcc actttctctg 989700
 tggcctcate ttgcctccag tgatagaacg tgtttctggt gcccgctact gggagctgca 989760
 ctaaaacaaa tgttggagga tgaagtttca aaatagagga gtgtgtcact cactgtaatg 989820
 tctgtatctg aaagaatgta atggttccca agaaattgca aacctagcag agattacttt 989880
 ctatggctta atatttctga agccatgtgt caattcaagg actttggagg aaaaacaatt 989940

 tatcatgtta ttgatacaa aaattgatgt caaatggtaa ggagagattc tccttcaccc 990000
 tcacagagca ggggccagcg aactgtgagg cacatgagtc aggtctggcc ctcttcacag 990060
 acatgcctat tcacttacgt ggtggatgct tactctcaca cagacaggtt gaaggagagc 990120

tgacagaggc attgtggcct ctgtagagat gaaggaactt accctctgcc ctccaatgt 990180
 ctggatattt atgtccaatt agaggaattg acaataaaga gattgacagg agtaaaggca 990240
 aacaaatgtg ttcatggaca gcacatcaac tcagaagctc agagaaggca aaagcatctg 990300
 tactctctcc ccttagggaa gaggccagtg ggacacataa catgggtgga tctataaagg 990360

 atatgagagg cctgaagaac cagagtgagg ttgacacagt gctctgggtg tagacagtgg 990420
 gctgacacag tgctctgggt gtagacagtg ggctgacaca gtgctctggg tatagacagc 990480
 tgacacagtg ctctgggtgt agacagtgag ctgaccagtg gctctgggtg tagacagtgg 990540
 gctgacacag tgctctgggt atagacagct gacacagtgc tctgggtgta gacagtgagc 990600
 tgaccagtg ctctgggtgt agacagtggg ctgacacagt gctctgggtg tagacagtgg 990660
 gctgacacag tgctctgggt gtagacagtg ggctgacaca gtgctctggg ttagacagt 990720
 gggctgacac agtgctctgg gtgtagacag tgggctgaca cagtgctctg ggtgtagaca 990780

 gtgggctgac acagtgctct ggggttagac agtgggctga cacagtgctc tgggttaga 990840
 cagtgggctg acacagtct ctgggtgtag acagtgggct gacacagtgc tctgggtgta 990900
 gacagtgagc tgaccagtg ctctgggtgt agacagtggg ctgacacagt gctctgggtg 990960
 tagacagtgg gctgacacag tgctctgggt gtggacagct gaccagtgct tctgggtata 991020
 gacagtgggc tgacacagtg ctctgggtat agacagtggg ctgacacagt gttagagtgt 991080
 ggtgattgtt ttcagctctc ttctctctgt gtgggagttt aatcttctc ggttaatgtc 991140
 gtttcctaa gcagcttaca ggcagttgta tcccccttg attgatccag tctctaggtg 991200

 ggtatgggaa cttcacgaaa gccctcacat gtgtttctgt gaaaatagga ttgagagaca 991260
 ggaagaaggg agactgggat agggaaggct agagaggcct taaagacgct gtttcagtag 991320
 caggtaaatt cagggtctct gggggataat gttttgtgag cccaatata gaaaacatct 991380
 gccctgttta ctgcccactt ttttagagga ggagtttgta atcctcagct ttagcatttt 991440
 gtcagattct gcatatctgg ctgtgtgagt gttagcattg gggctgtagg cgagttcttc 991500
 aatttgtctc ggtttttcgt ttcttctctg aggacatgga taacaatgag aatttgtggt 991560
 tcaagtcaga aaacataatgc aaaatacaac cccttgcct gcaaatgctg ttgagatctc 991620

 aatgacact cttagcactg tgccctggcac agaggacgtg tctgtgaaca cccagacaca 991680
 caciaactga tggtttcagt cactgtcttc atcatcttg tctgccaaca ctttagtgca 991740
 ccactgtgca tctgccaggg ttccacaccc cccccctcc agctgttctg tcacagggca 991800
 gctgtggttc ctgcaaccag tgtggtctca cgaatacaga gctaacactt agtagtgac 991860
 atagtgggtg ggataggatc cagcctgtca tatcaaaaac catatagcag ggcagcatgt 991920
 ggggtcaagg tgctgggtct gaattcctgg gctagtctcg ctgtccctct gttctctaga 991980

tatctgactt aattcaacat ccttcaccct cttcaccagc gtcttcttgg attaagagcc 992040

cctggcatcc atagctttgt gggaagccat ggtgctgccc acacaagatg atagccccta 992100

accttagcaa tcttcatgtg gaggtgagta gggagagagg aagcctggga atgcaaatgt 992160

ctgcatggcg tgttctccat gcatttcagg ctttcatgcg tgtgtctgca ggttcttaca 992220

tgaccatcca tgttgaaata cccgtcttcc tactgcttga cttcctcatg cagcaaagta 992280

taacacacat gcctctgact taatctaccg tttcctccccc catgttccag aattgtgatt 992340

acagtcttgt ttattcacta ataagttctt ggtgcccgta atactcttat ctacatagta 992400

gtcagtaaat tataacgaat gagggttggc cgtcaagtg agcttgatcc ccagcatcca 992460

tggaatgtg ggaggagaga atcaactcca cagagttgtc ctcagaccgc cacacaagcg 992520

gtactctcac acaatagtaa tgaaaaatta aaattatfff taaaaacaaa ttataacata 992580

ggaaggaatg gactccagag gaccttcttg tgggccacaca agcatcctga ctagcttggga 992640

ggatggggga acctggctgg ggctagaaga gcagggcagca aggaacctca tgcacttgag 992700

tagccattat ggtcaggcat tgcagtaaca ttagcacaaat cagtcttaca gaaacagtag 992760

atgttagag gagcctcaca tctttaaggt caaatatgga cattgtaatg tgagaagact 992820

ttttttttt ttgtattgga gaatgttttg ctgtgtataa ggtaccgaag gacctgtgtc 992880

aactgaattc agtacttggg gtcatatctg ggaaccacc tacgtaggta gatggggact 992940

ccctttagca aactttatgt tctcttgagt ctgttctgcc agtagcaagc tcctctgcat 993000

gtgcatgagt ggtgggaaga acctatgctt tcagagatg tgatgctagg ccaaagcctg 993060

ggaaagccgg gcagagccag tgaagaaacc tcattagtcc agctcaggag gcagcctgca 993120

ggtggatttg gaaaatggga ggaccttagc cgatgcactg ggaggccttg taggtggcgt 993180

atctctggtc ctcctgact actgtctagc ccagatgac ctcaggctg ctgggtcaga 993240

cctacaggct ctgaattcag gcataccttg tgatggaggc atgaggaaac ctgggccaga 993300

gaatccctc aggtcccatg taagactttc catgcctgag gctttgagcc tatggctttg 993360

cagcaatgct ggagagctag tgagccatcc tgtgagagct agtgcctcag acagcccacc 993420

cctgtctgtg acaggagaat tcatatgtgt ccctctagaa cagagcaggt ctgtttgtcc 993480

taatagcacc cataatgagc cccaaccac agtgaccgtc ttagtcactg gtctgttgtc 993540

gtggtgattt attattgac atttactaaa gcttgccctga ggattcagaa agcaaagaca 993600

ggcacaagct atagaggta ggcagcggig atacacacct ttaatcccac cagccacact 993660

agatagccat agaagctagg aggtgatggt gtacacctt aatcccagta ctagcgagga 993720

atataaaata ggagctcaga ttctagtctt agtttgatt cagactacac tcacacactg 993780
aggataggat ctccccagcc ttagtagagg taaaactct ttagtggctg gctgcttga 993840
tattcatctt gaacccaat atctgtctct gagatttat tattcatgct acaactggc 993900
tctagtgaaa atgtgtaaaa acattagatt agtacatctt tctatacctt ttaattattg 993960
tatgttgtgt ttatagaag ataattgcag atatagagtt caactagata tctcaatata 994020
tctagatata taaaccacag cagcatgttt ctaagcagaa tctcaaata aagacattgt 994080
tgctacctgt cataccactt gctcatgatt cagagtcttg aactgagca gcatgtagcc 994140

acttctagat cagctgcctc tactggcatg ttcagacaag gaggagagtc ttccattagt 994200
aagtgaacgt acttgagttt tgtaccacag aagaccatat gtaatacttg atgtggctat 994260
ttttcagaaa gaaaacaggt tattatntaa agggggacat agatgttgta tagtttaaaa 994320
ctggagatag tcaatatgca ggtcattttc ccatggccta taaactctgt cattagctgt 994380
caaagacatt taagataaat gattacaggt atcagtacac aaatataatag aaggaataag 994440
ttgtgggtgt ccacatcacc ttgggggtgac tgcagagttc aaaataatcc cttgttatta 994500
tatgaagatg taggaaacag gagctcaaag gttcctacat aaagacataa tgagcaggaa 994560

atgctaatta cccatttgat cagtgcatc ttaggcata tgttgaaata ttgcaacccg 994620
tatctcaate tctctctctc tctctctctc tctctctttt cctgggtggtt ttgtttgttt 994680
gtttgttttt ctctgtgatg aaatnttttt ctgaatacaa gcgtgttgct gggttggtat 994740
taacagctct ggggtagagc acttaccagg caccctggat tagatcccta gtatcaccca 994800
tattgggtgtg catatgtata tttattatgt gtatatgtac atatatgtga attgtgtaca 994860
tatttacaata tatgtgaaca catcttata atataacat aaacacatgg atatgcatta 994920
tgtgcatata ttcatatatg tgtttatatg tatgccagg tacatgtgtg catatatgtg 994980

tgtacatatt tacacagaca tacatatctt tgtgtgttca tctatagctt tcagcctttc 995040
ccaaagtatg aatattggaa ttagttggaa ttagtagtga agaagtgaat gaatgcaaga 995100
atgaatgaaa aaataaggta gatgttctact gggctctgct atgttttgaa aataatata 995160
ctgagactgg gtgtgggtgt gtatatcttt aatcccagca cttgggaggc ggaggcagag 995220
gcagaggcag aggcaggcag atctctgtga gtttgaggtc agcctggtct atagagagtt 995280
ctggggcagc catggctgca cagttagacc ctgactcaaa aaaaaaaaaa aaaaaaaaaa 995340
aggaaaaaaaa aaaaaaaaaa atgtgttgat cttaaagcatt aatgtaatta acttagtgta 995400

caagtctggg tgcattttaa cagcatagtg tcatcacagc cctgcttagc acagagtaac 995460
tgctgtaaga agataagcct ttctgtttat cagaaattat aatgggtttc atgttgacac 995520
tctctgcatg aatacaaggg atttgacca cattcattct ccattcagtc ttttgcctcc 995580

tgtccactga tcgecttctt ttgaactaat atcctgactg ctttcatttc tttgtttaac 995640
 aagttttaag atttttattt tatttcattt tatttttttt tatgtgtatg agtatcctgt 995700
 ctgcaggat gcctgtacac catttatgtg tctggtgccc acagaagcca gaagaaggca 995760
 tcagatctct gggaactaga gttatagaca gttgtgagcc atcatgtggg tgctgggagt 995820

 caaacacagg cctctgtaa gggcagccat gctctgaacc cctgagtctc tccaggcccc 995880
 ctccctttg tgagttccat tagggctgtt aacaggtttg tttataggat cataaatact 995940
 tcaccaagg ctacaccact gaagacagag tctcttcta ccaccaaag ttttgcttct 996000
 gcttttttag tgccttcaca gacctgataa agaactctgg ggctttgccc tagccttctc 996060
 cactcaccga ggttctcaca gaacacaggg gcctctccct cctcatgcct tagtctaggg 996120
 gcgttgaagt tcagacttcc tcttggctc ttggtttaat ctttctctca ctttgagcag 996180
 ctgacttttt atggaagact tccaacat tctgctattg tattgagcat tttccctggc 996240

 taaagccaca cactgggaat ggcatcttct atgatgttta ctgcttaac aaaacaactt 996300
 agtggaggag gtggaggca gtgtttgctc caaggataat aagctagagt tcaaaccctc 996360
 ttagactaat acccatagtt aaaaaataag taaaacagc aacaacaata aaactggaac 996420
 acacactgac ttgcatccca aaccttctgt cccttctgat agaagtatgt tggaatcaa 996480
 tagctggtta ctacaataca accattgcac agctgtgctg gcagggactg tggcctggga 996540
 ggctgaagat ggagtttct gtccaccag gtctgcccgc ctttggccc caaataaaca 996600
 cactgaggct atgttagtta taaaactttt ggccaatggc tggggcttct tactggctag 996660

 ctctctctta attactaacc catttctgct aatctttgta ttgccacaag gctgtggttt 996720
 acctgtaac tggcatgta ctcttctcagc agcatggcgt ctctccccac atctcctgcc 996780
 caatcagtgt tttattcacc aaccaataag agaacatat atacagaagg acattccca 996840
 tcatcaggcc ttgaagatg gggtgatttt gtgtgtgtgt gtgtgtgtgt gtgtgtgtgt 996900
 gtgtgtgtgt gtgtgttca atcaaaataa ctgatacttt aaatacaact ttgactctaa 996960
 gtcgtgggga aagctggagg cttgtagaat ctttttctc ttttaaggcta gatgtgcaca 997020
 tcttcatctg tgagaaaaca tgctaatec acttggacac ttcacctca gcctctgagg 997080

 tagggcaggg tgaacgagt actgaaggca acatctggag ttggacttcc taactgcatg 997140
 ctaattgctt gctctcgggc caatctctta aagttcattg aaaacatgga gaataacagt 997200
 gtttattatc taaggtataa tgtaagaata gaacaacaca tgagaaatc ccccgacaat 997260
 gtttgagatg gggtaagcgc tgtgtaaagt tctcagatta taactgtgtt ctggcatcat 997320
 agatgagaaa gatacagggg tgacagggag aaaggaagga aaccaggaga ggaggactcc 997380
 ctggaggacc tggaagctag cttagagcag atgttactgg tatcatctct ctcagcgtca 997440

tatactaact agttttagga atgaacttga tgttggcttt ggttgaaatt ctgccc aaat 997500

acttaccagg actctggcct cttcatctat gttacaggat acagtagcta gcatctgccg 997560

tacagtgtgg tgatgacatg tggtaggtgg gcacttggcc cgggttttgg ttgaagatgg 997620

gtggtagaca agcatcgcca tctgttatgg cagtatgaaa ccttgggcca aagtcggact 997680

caaaaccagg gcgatatagc tttcctcctt tcctttctct gatgctctgg ctgccatcaa 997740

tgatgttttt gttcatttta ttgttcataat taatgttttt tttattagat tggatattaa 997800

aaataacggt catcaatgat gttttaatgt ttaatctcca gctagcaact ggagacgggt 997860

ccaccaacct tctgttcagt aatgtgaaca aaataagtgg ctgttctaaa ccctgggaga 997920

gacatgtgat gaagatggct gtttctgttt tgttttttac tatttcttct atgtctcaag 997980

tcatctacaa ataagagggt tgaaggagat gtgtgaaatg caagtgttga aatgctgagt 998040

ggtaaaagct ggggagatgg ctcagcagtt aagaacactg gctgcttttc catagggcct 998100

ttgatctctg acaccctgat gacagctcac aaccatctgt aactccagtc caaagggatt 998160

agatgcctc ttctagcctc tgaggacact tcacagacaa catgaaggca aaacacacac 998220

acacacacac acacaacaca cacacacaca cgcacacgca cacgcacag cacacgcaca 998280

cgctttaaaa aaacaaaaca aaacaaaat tctgagtgtt ggcatactgc agt gatctca 998340

gcacttagga ggtgtgcaca cccacactac tttattttta gtgaacttta tggttcctca 998400

agtctttcgt tgacaggata aaaataaaca agattacagt gttttaatga agggatcca 998460

gagtaaaact taggatcacc ccacctaact tggtttgcac ctttttatgg aacctgagt 998520

ttatttctcc ctctctactt tctgttacca ctttctgct ctctgctccc gtgggtttga 998580

attcttagaa acacagcact tttcctatgt gtggcttttg taatgtcttc caggcctact 998640

catgtgtcaa acattgcacg atctctctt gtaaagctga ctatattcca ttggacagat 998700

aagtcacagt ttctcttttg ttgttgttgt tcatctgttc atgggcctta tgttagtgta 998760

ttatgattat ggigaataag ggggaaagat gttgggcgtg gtcaggcagg cctgtagcca 998820

gcccctatgc aggtgtggct acaggttccc ctaaagcccc tggcaatgat ttcttagatg 998880

tcacaatgaa gggtaagcac aggccaataa aagcagaaat gaagaaatag ggaactgtta 998940

ccaaactgta accttggigt aacattcttg ggatcattag caggattata aatcaacagc 999000

ttagaaaatg gagtcttgc agactctagg tgggactgga atccagctta ctcatcctta 999060

gaaacagaag ttttgcaaag ggttaaaaat agagtcaccg tgttgttggg tgatgtgtcc 999120

ctgtataagt ccacaagaat tgagactaat actcagagtg tctgtactcc agcaacaggg 999180

tgtaaatatg tcttcaactg tgtctagatg acccatccct ttgggacagt ttttagcttc 999240
 ctgtggccct accaagcctt gctacagtgg cttgagtttc agtcaggggg ctttgagtga 999300
 aaaaataaaa gaggctgtta tttcagcaaa attgttccta atgtatttcc ccagtgggtt 999360
 ttatatgatg tgggatttcc ctactaatat taccctcatg ttaaaaaatt aaatgaaaat 999420
 ttcacatgat agaggtagtc cagtacagtt cagttgcca taaagcaggt tctcatcaac 999480
 tgttcccctt tctctttcag tcaaaaataaa tcccaggagt tttctctcca aatagtcctc 999540
 tgtcctgtgc actttgctgt taagagtgtc ctgccaccac ttccttttag gcaaaggaac 999600

 aggctccaga cccaaacacc atgtgctega gtcccctccc tgctgtctga tcttcttcag 999660
 atgcacagga caagctgacc ctctctggc cccacccttc tcttattgtc ccctgtagg 999720
 ggacccccta ggtctatgat ctgagccctg tgatggggaa tgcagccttg gtgtttagcc 999780
 acggggcact gggagctacc acccacagtc actgttgatt gataatcatt atgtactgtg 999840
 gttgagagca aagacagtgg gattttaatg ggctgagtc cccaacttaa attcatcgta 999900
 cagttgtact ctgtttggag ttggagtttg ggagggaaat gctaataaat gaagtcatta 999960
 agatggggcc ctggccaag gtctgttgcc aatacaggaa gaggacatga gaacttattc 1000020

 actgggcaca ctgacaaaga gaggccatgg gaggacacag ctaaagagta gatgtccaca 1000080
 ggccaggagc agggcctgcc caacagtga ctgaccagat tagatgctaa tcaacagaat 1000140
 tgagagaaag aaatttcttg ttaagccac ttaagctgtg atgtttcatt atgtctggct 1000200
 gaacagaata tcaactgctt tgtttgtgt ttgggtgtg tgtgtgtgtg tgtgtgtaag 1000260
 acagagtttc ttctatagc tctggttgc ctgtaacttg cttttaggc cattctggcc 1000320
 ttgaactcac agagatccac ctgcctctgc ctctgcctcc tgagcgtgt gattaaaggc 1000380
 gtgcaccacc actgcctggc ttatcatttg cttaagcaag gttttgatg cttccaaat 1000440

 cttcatttgc ttaattatag aataattatt cctacgataa tttagtttag ttagacttg 1000500
 atatggcaat attaatcca ataatcttg tcaatagga tgtcagccta cattcatctc 1000560
 tctggtaatg attcattttt gtaactcaat tcaaatfact ggaagaaaaga aaacaaaag 1000620
 aagggttagc tgaatgaagg aaggaaaaac acaacaaaac aaaaacggag tggcctgtag 1000680
 gtgcaagttt tctctgatgg aatccgtcac agattgtgcc acctcccct cctggccaca 1000740
 cccaccctct actccctctc tcttcccac cctccttct ctctcagtt cctcagaagg 1000800
 cctcctacc tgcagtcatt ttgcacaaag tacgcttttag gatccttga gaacactcaa 1000860

 tgggtggcat catttctct cttaaagccc tgcctgatt cccccactgc tttgcaaatg 1000920
 aagcccagag ttttctgtct gatcaccagg ctattggtct cctcattctc agtctggtct 1000980
 ctctgtgctc aggcacctct tactctcttt tggtccctc ccccaccgtt ttctgctctc 1001040

atctccctgc atcttctagg ttgcttgttg cccgatgaga ggcaacttac gggtagggagg 1001100

atattatttg ggagataaaa accatcatgc ccaggaacc atggcagcag gagctagggt 1001160

tgtnnnnnnn nnnnnnnnnn nnnnnnnnnn nnnnnnnnnn nnnnnnnnnn nnnnnnnnnn 1001220

nnnnnnnnnn nnnnnnnnnn nnnnnnnnnn nnnnnnnnnn nnnnnnnnnn nnnnnnnnnn 1001280

nnnnnnnnnn nnnnnnnnnn nnnnnnnnnn nnnnnnnnnn nnnnnnnnnn nnnnnnnnnn 1001340

nnnnnnnnnn nnnnnnnnnn nnnnnnnnnn nnnnnnnnnn nnnnnnnnnn nnnnnnnnnn 1001400

nnnnnnnnnn nnnnnnnnnn nnnnnnnnnn nnnnnnnnnn nnnnnnnnnn nnnnnnnnnn 1001460

nnnnnnnnnn nnnnnnnnnn nnnnnnnnnn nnnnnnnnnn nnnnnnnnnn nnnnnnnnnn 1001520

nnnnnnnnnn nnnnnnnnnn nnnnnnnnnn nnnnnnnnnn nnnnnnnnnn nnnnnnnnnn 1001580

nnnnnnnnnn nnnnnnnnnn nnnnnnnnnn nnnnnnnnnn nnnnnnnnnn nnnnnnnnnn 1001640

nnnnnnnnnn nnnnnnnnnn nnnnnnnnnn nnnnnnnnnn nnnnnnnnnn nnnnnnnnnn 1001700

nnnnnnnnnn nnnnnnnnnn nnnnnnnnnn nnnnnnnnnn nnnnnnnnnn nnnnnnnnnn 1001760

nnnnnnnnnn nnnnnnnnnn nnnnnnnnnn nnnnnnnnnn nnnnnnnnnn nnnnnnnnnn 1001820

nnnnnnnnnn nnnnnnnnnn nnnnnnnnnn nnnnnnnnnn nnnnnnnnnn nnnnnnnnnn 1001880

nnnnnnnnnn nnnnnnnnnn nnnnnnnnnn nnnnnnnnnn nnnnnnnnnn nnnnnnnnnn 1001940

nnnnnnnnnn nnnnnnnnnn nnnnnnnnnn nnnnnnnnnn nnnnnnnnnn nnnnnnnnnn 1002000

nnnnnnnnnn nnnnnnnnnn nnnnnnnnnn nnnnnnnnnn nnnnnnnnnn nnnnnnnnnn 1002060

nnnnnnnnnn nnnnnnnnnn nnnnnnnnnn nnnnnnnnnn nnnnnnnnnn nnnnnnnnnn 1002120

nnnnnnnnnn nnnnnnnnnn nnnnnnnnnn nnnnnnnnnn nnnnnnnnnn nnnnnnnnnn 1002180

nnnnnnnnnn nnnnnnnnnn nnnnnnnnnn nnnnnnnnnn nnnnnnnnnn nnnnnnnnnn 1002240

nnnnnnnnnn nnnnnnnnnn nnnnnnnnnn nnnnnnnnnn nnnnnnnnnn nnnnnnnnnn 1002300

nnnnnnnnnn nnnnnnnnnn nnnnnnnnnn nnnnnnnnnn nnnnnnnnnn nnnnnnnnnn 1002360

nnnnnnnnnn nnnnnnnnnn nnnnnnnnnn nnnnnnnnnn nnnnnnnnnn nnnnnnnnnn 1002420

nnnnnnnnnn nnnnnnnnnn nnnnnnnnnn nnnnnnnnnn nnnnnnnnnn nnnnnnnnnn 1002480

nnnnnnnnnn nnnnnnnnnn nnnnnnnnnn nnnnnnnnnn nnnnnnnnnn nnnnnnnnnn 1002540

nnnnnnnnnn nnnnnnnnnn nnnnnnnnnn nnnnnnnnnn nnnnnnnnnn nnnnnnnnnn 1002600

nnnnnnnnnn nnnnnnnnnn nnnnnnnnnn nnnnnnnnnn nnnnnnnnnn nnnnnnnnnn 1002660

nnnnnnnnnn nnnnnnnnnn nnnnnnnnnn nnnnnnnnnn nnnnnnnnnn nnnnnnnnnn 1002720

nnnnnnnnnn nnnnnnnnnn nnnnnnnnnn nnnnnnnnnn nnnnnnnnnn nnnnnnnnnn 1002780

nnnnnnnnnn nnnnnnnnnn nnnnnnnnnn nnnnnnnnnn nnnnnnnnnn nnnnnnnnnn 1002840

nnnnnnnnnn nnnnnnnnnn nnnnnnnnnn nnnnnnnnnn nnnnnnnnnn nnnnnnnnnn 1002900

nnnnnnnnnn nnnnnnnnnn nnnnnnnnnn nnnnnnnnnn nnnnnnnnnn nnnnnnnnnn 1002960

 nnnnnnnnnn nnnnnnnnnn nnnnnnnnnn nnnnnnnnnn nnnnnnnnnn nnnnnnnnnn 1003020
 nnnnnnnnnn nnnnnnnnnn nnnnnnnnnn nnnnnnnnnn nnnnnnnnnn nnnnnnnnnn 1003080
 nnnnnnnnnn nnnnnnnnnn nnnnnnnnnn nnnnnnnnnn nnnnnnnnnn nnnnnnnnnn 1003140
 nnnnnnnnnn nnnnnnnnnn nnnnnnnnnn nnnnnnnnnn nnnnnnnnnn nnnnnnnnnn 1003200
 nnnnnnnnnn nnnnnnnnnn nnnnnnnnnn nnnnnnnnnn nnnnnnnnnn nnnnnnnnnn 1003260
 nnnnnnnnnn nnnnnnnnnn nnnnnnagaa gaaaaccca ggaccattca tcattgtgac 1003320
 aattgtttct ccctggatgat tggatagact gcctgtactt cagtagtact gtttcttgg 1003380

 gggaattgct gagaggata catctcctac ccaatgggtt ttctccttga accctgggtg 1003440
 atctcacgtc ctccatattt accacagcaa ggaagagagt gactggggaa atgaccaggt 1003500
 agacctccc tcacaggaag tggtatattt ctgttgcgtt ggtggggagc agagggcaga 1003560
 ggggaagcag agcctggctg tgaacaaaa agcaccaggt gacctacttc ctccagtgag 1003620
 gactcctgaa gagtctacaa gttgcaacag cacctccagc tgaggacgag tgttcaaatg 1003680
 cacgggtctg tggggccttt tcatgcacac accacctcag aaacctgccc ttaaactctc 1003740
 agcaaatgct gagcatgtgt tagctttgtg ttgccgtgag gggcagcttt cctgttcaca 1003800

 cttaatctcg gcaactaaagc ctgggatttt catatgagag agtcaggatt ttcatatgag 1003860
 agagtgggtg taictgctgt ctgtctccag agctttctaa gtatcttgaa tttgcaattc 1003920
 tcctgcttca gcctcccga tagctgggat ttaggcctg catctcagcc agccttatga 1003980
 acacttctca gtatatttatt ttaccttgaa atttcaaatg tacattcatt caccaacctt 1004040
 ctagtaacaa aataaataaa taaataaata aataaataaa taaataaaag tccttaagag 1004100
 cctgcggatt agactttgca atgtcagtgc ccactacagg tttgttattt tagagtagaa 1004160
 taaaagttaa aggtgcttgc agtcatttgc atagacaggt tgaatttctg cttattttcc 1004220

 tccaatcctt tacggttctg tcacatctaa atcagtggca attttttgg acaacctct 1004280
 cgttttacta tttctaattt acctacttct cttagaaata caacttctta ttcccact 1004340
 tatattttac ctgtttgtaa agtatttcaa agcaatgaat actgcaagtg aaaaaaaaa 1004400
 aaaaacttca ttagacacag ctgagtttta gtagtcctgg tttagctcat gggagcagga 1004460
 aggctgagtc tttgagttgc aaacatccca atatatttac ctggttttaga ggctgtctgg 1004520
 aaatctgttg gcacaattaa caggctcttt gaagagcagt cttactacag gtgatagtta 1004580
 taagatctgc ttctgataa ctgtttaaac ccccatag ttaaattcag attgttaaac 1004640

tgtgttggtt aagtaccagc acctggaaca gagactaaag cttgcctttg tccaggtgga 1004700
 tcagaaagat ttctgtctga gcaaggtgat gcaggcttga aatcccagca tgtgagaggc 1004760
 aatggcgtga atgccactgg gaactcaaag ccagccgggt ctgcatagtg agttctaggc 1004820
 ctgccagagc tatatgatga agaattgcct gaattctcat tcccatcccc aaagaaagaa 1004880
 agaaaatggg gtgaggggaag gaggggggag gggggagtaa ggaatccagg aagaaaggaa 1004940
 gggggaggaa ggagtggagg gagggagata aacctctctc ctctcagggt aagttccatg 1005000
 gaaccttcat tcaactgcat gtgtcacccc ctgacacata ttctatgtgc aggatgctat 1005060

 gctgataaag gggcgggtgac cccctctgtc attcagccaa ctctctttac aaggatggct 1005120
 ccatcttaaa ctcacagtta aagtttggcc accacaacc caacagtaca gtcaggtgat 1005180
 tcgatgccca ctctgaagtc actcaggtgg acatttcagc caggtttata gcctcaagca 1005240
 tgaattccct cctgtgcaag aaaccttaag gtcaatccaa aatgactgat tgcacccaaa 1005300
 acctacatgc cactattgca ccagagagca catcccgcct ggcaggtcag tcagtattgt 1005360
 tgtatgcaga gttcatcaca gggtaagtcc actgatgggg ttttcttcc ctaacagcct 1005420
 atacagcatt tctgccactt tgaagctag cctgcaggga agaagtttc agatgggttc 1005480

 caacttgatc tcctctgttc ctacaaccaa agtatgtcgt atcttcagca atagggaag 1005540
 ggaccagctc cccatttcgg cagccatgac agtaacatgt gcttttctga cttgtctta 1005600
 gtcactagag gttaggtgcc tgcctctgtg gcaaggaacc aatcagaagt tagctggtgg 1005660
 tagtatgctt tacagctctg ggtgtgcttt acggacaagc actcagcagt gacacgcaga 1005720
 gcatagcaac aacctggga gggcctatgg gccataacaa ccagttggcc aatcaacaca 1005780
 gggcaagccc tcaaagcctg aaggcacacc aatcctgagc ctgtgtgtac ccctagacac 1005840
 tccccttacg ctgccctaca agatctctat gcagcccctt cgagctgtct ttgctagcca 1005900

 tccaccatgg cgggtaggtg aaagaccega gctaacttgg ggtagcttg ttaaataaca 1005960
 ataaagcctc gtgcagtttg catcaagctt tcgaatctgc ctggtgattg gggtagcggc 1006020
 ggtcctgggc tgggaccccg gaggcctgag ttttccgggg gtctaacata ggctcttacc 1006080
 atctagttaa ggggggcaac caatagcagt ggcaatagcc tatttccggg gggagggtta 1006140
 tttggggttt ccigaccaac aactcatagg gagatgtctt agttactttt ctatggctgt 1006200
 gctaggatac aatagccaag gcaacttata caagaaacag ttttgggta cttacagttt 1006260
 cagagaggga gtccatgacc atcattcaca gagcatggca gcaggcaggt gggccggacc 1006320

 ctgaggccat agctgagagc tgacaccttg atctgcaaac acgaggcaga gaaaaacta 1006380
 actgggaatg aatgggctct tgaaacctgg aagcccaccc cagtgactta catccttcaa 1006440
 taatgcaca cctccaacc cttcccttac caactaggta ccaagcaatg gaatacatga 1006500

gcctatgggg ccattctcac tgagacacca caggatgtgg atcccacagt ggaccagtct 1006560
cttttctatc ggataactaa aatttctctt gtgcaaaaga cgtatccagt gtaatggttg 1006620
atttccatcg ttgacgactg gttaagaaac acccaggcca ttgatgagcc gtgccactga 1006680
gtgtacctgt gaggggtgtt ccaaggaggg aagatctact ctgcaagtag ctagcaccac 1006740

tctgcaagct tgggtcttca actgagttaa aagggaaaag ggggtggctgg acaccagcat 1006800
tattaccgtt tgggtagct acgagtaagc agcctccttt ccccatgctt tcccatggt 1006860
ttatcacagg tacaagaaag agaactaata catccatcca ctatttgatt ggctgacgca 1006920
tggggaagaa ttgaactaaa atctattgca gtttgctcag cctatagact tgtcagaaga 1006980
acaaagccca ttgatgtagt tctttgtgtt tcctcctacg cgggatgact gaaattctac 1007040
agggaaatcc cattagattg agataagagt ctgtgggaaa atgaactaat agaggaagga 1007100
gtgtcgaaga agcacagtgt tcattagaca ctgaggaaac ctgggatgtc taattaacca 1007160

ctgctcttga tgctccagt ctgtcagcat tatctccttg taattccttt aaaatgctgt 1007220
ttataagctg ctttagtttg gtcttataaa ctcaggcgtc agtgagtgtt tctagaactt 1007280
cctttacagt ctgtgctgag ggaacatttc agatgtcttc ctcatggcca cgacaccatc 1007340
taccttgctc ctctgggaaa aaaaattaaa atcccagtat tattagccag gtttagccag 1007400
gaggatatgg tttctttggc tgctgtggta tttttatcag tgaaattcta aagacatttc 1007460
caatatcgta agtaggaatt tgaaattatt ttgttttttt tttctgttg atgaaccaag 1007520
aggaaattat atctttaacc tacatataca tacacaaaca tgcacatgca tacacacaca 1007580

tatatcaaat acacacatgc atattatgca catatgtaca catctgtatg tgttttttat 1007640
tatgtctcat attcacaaag ttttaaggaac taatattact ttatttggga aaatactgaa 1007700
tttttagttaa attgtggcca acttatcaac tcagtttcaa aatgaaagt ttactattta 1007760
tcttcaggaa agttatgtat tctccggctg tcttttttcc tctccatgic tcaacttctc 1007820
ttaattcgct tagctgaggc ttcccaggat gtagactcca gggcagaggt tttcaggcag 1007880
gaaaccctc cagttcactc tcataaacac aggaaggaag gaagcagaaa gcaggatgga 1007940
caggggtgtg gggatgcggt gaactgcacc aggctcactg acgctgagta cttctgcagc 1008000

aggctgacc gttcagagct gccatgaggg gacatcagta tagatgtacc ctcatcagct 1008060
gggcactaca ccccaggcat ctggfggaga ggcggcgggc ctgctagca ccatgtctg 1008120
acacctgaa atgagtgcct gcaaaactgaa ggcacataca caacaacaga cactgattct 1008180
tcacaggagc ggtaaccctt gcccaaatg tafgggatct gagtgtttag agttcacagc 1008240
attcatcaga gtagagtttt gactttatgt taatgaggat ggtgctgcca cctcttcaa 1008300
atagatgcca gattccattg ttattcctgt agccagctaa aagtcatgic caaatcactc 1008360

atcagatagc attcagaaac aaagtctaac catagtcacc atcctactg tcccactgt 1008420

 cacctagacc ttgcagcaca ggctggcctt gaacatggaa caattcttct gcttagccgt 1008480
 gaaattatag ctgccttagt tatggttcgt ttgctataaa gggacacatt gaccaaggga 1008540
 atttttataa aagaaagcat tttattggga atttgcttaa aatttcaaag cattagtcca 1008600
 ttatcatcac agtggggagc atgggtggcat gctggtcctg gagctgaggg ctttatgtcc 1008660
 tgatctacag gcagcaggga gggagggagg gagggaggga ggaagagaaa gactgggcct 1008720
 ggcatgggtg ttigaaacct caaagtccac cccatggagg atacacctcc tccagcaagg 1008780
 ccacacctcc taatctact aagcattcaa atacttgagc ttgtagagga ttcttattca 1008840

 aaccaccaca ttcattctc ataggctggt acctatatca atcataacce aaaatgcatt 1008900
 tggccaact tcaaaagtc ccgtagtcta tgacagtctt aacattgttc agaagtcca 1008960
 agtctcttct gagacctgag gcactctctt aactgtaacc ctgtaagatc aaaatgaaaa 1009020
 cacagatcac atactgccag catacaatga cacagaatat acattacat tccaaaaggg 1009080
 agggaaggga acatagtgag ggaatactga accaaaacaa gacaaaaaat ccagcagggc 1009140
 aaactccata ctgttttcca tgtctgatgt caaagcttcc ttcagatctt caactccttt 1009200
 cagctttggt gactacaaca cacttctctc tcttaggctg gttctaacc tagtctgaag 1009260

 ctctccttgg caggtgtccc aggattctgg cacccccagc atcttagggt ctccaaggca 1009320
 atccaggctt catcttcaca gcttcacaca atggcctgtc caggcctcca ttcagggaca 1009380
 ctctgacac atgtctgcc gaagtactg tccttagcca tggcagcaaa ctccgcaacc 1009440
 tctttcttgt atccatgact aaagccagaa ctgtgtggct aaagctgcca agttctgtctg 1009500
 ctttctgggc tggaacgtga cccctcatt caattacatc tgcatcagat tctgtttccc 1009560
 tcaactctt tctttaattc ctttttaciaa gttggaagct tagctgggta gggctctgtg 1009620
 ccaaggtcac cactcectct attccatcta gcgtcaggcc tttctttaaa ctctgtgtgt 1009680

 ccttgaacac taaacttggt tccaacatca catttccatg tgctcctttt ctcttcaaac 1009740
 tgtacacttt gtgtttttcc ttgtcccttt tcttattgtg gatctgcata agacttaaca 1009800
 ctaataacag gacagtcaat actagactat ctttaaatct cctctgtcaa agcccttaat 1009860
 ccaaaactct tcaatttagc ttggaagatt tttagggcta gaaaaaaaag caccgtatc 1009920
 tttgccaaaa tatcaccaga gtggfcttta ggccacttta atatttttgc cctctgaagc 1009980
 ctccagagct gggcccctac attccatag gcctctctca ccaactgtctt ceatgcttct 1010040
 tctaaaatag cccagtaagc cccactcaaa gtgcataact ggttttctct tccacactct 1010100

gccagtgagc aggattataa ggcatgtgac agcaatgccc tagtccctgg taccaactgc 1010160
 tgtttgggtc attgttctct tactgtgaag agacactatc accaaggcaa ttcttataaa 1010220
 ggaaagtgtt aagtctggcc tcgcttacag tttcatagta ttagtccatt atcaccttag 1010280
 tggggagcat gatgggcttt tgaaactgca aagcacgtcc ctgtcaaggc catgccttc 1010340
 atccagtagg gccaaagcata catcctgacg tacttcccac atacatatcc caccttccac 1010400
 ctatgtgtga tcaagtacat cctgtgcagt tggggcaacc aaccttattt acagaagtga 1010460
 aaatatgtgg ctigtatcc tacacgtgca acagcccca gcattaccac aagttgtctg 1010520

 tccttgggca agtggggctt acaggttaga tgaatthtgg ttttagatc tctcaagcat 1010580
 agtgattaaa acttaaaata taaaatccac aacatcttc tttctctccc tgctcttgc 1010640
 ccttcatcag gaccagtcc caccatcact gtcctcctt gtaagtctc agttagaac 1010700
 accttagga acaaggagcc cccggtcgta tgtgtttac atgctcctg cagctcactg 1010760
 tttccacttc cgctgtccat ttctactgc ctggaagcaa gggcaggta taggcctctg 1010820
 acagaggacc tggcccactg tagagaagaa gcctgtgtga tgacagcagc agcgtgtaac 1010880
 atctcaggca cagaacactt agtgagtgtt aactggtagg tgggtattct cagagagcta 1010940

 tgggcaatga gggcagaata gctcatccag tactgggatc taggtattgc cagatactcc 1011000
 acagcctacc tacttccaag tgcattgccag cgacgatccc cagtgggtcaa gactgacgtt 1011060
 tggaaatgtgc gccttccc cctccatgct ctctccgct aagagttgtt gattaggaat 1011120
 gcgggcgtat ctctctgcc actgttatct ctaggtaac tcaacagcca gtatgtgtc 1011180
 atgccaagaa atgcatgac aacagagacc caggagcaca caaatctgtc actcaaaagg 1011240
 cacacaggac ttggaatgac ctctaacct tggcatggc tttaaaattg gtctagcatt 1011300
 gtgtttggtg cagaggaat gggagaaacc ttggtttcta ggctgctatg ctccatagg 1011360

 ctcccatgc tgetaggccc gtgaggatca attctecta ctgtgaagaa ttgacagttc 1011420
 cccaagatgg aaatggctcc ttagccttgg taccaagaag gcacagcaca ggaagaatgg 1011480
 gcagatagga gctggtttaa gtgtttgttc actgggctgg tgatgggaa agaataggtg 1011540
 ttgtttgac tgatggaagc aatggaagca attcaaagc ccctagagc caggaagaag 1011600
 gtgagcgggtg tgtgtgtgtg tgtgtgtgtg tgtgtgtgtg tgtgtgtgtg tgtgtatgtg 1011660
 tgttcacggg tgcaggtgca ttctctccc ctgtttttt caagacagtc tctccctgaa 1011720
 tatagaggca acccactgta tcaattagc agccagtaag ctttaggaac ccacctgtt 1011780

 ctgctccca aagaccgagt ttacagacat acacaacct gtccagcctt tgcattgagta 1011840
 ttggggagt cccaactcat actagcatgg catgcttcta tgacaggac tttgccaact 1011900
 atctcccag tccaagatg atgtttctgg agagccctag cctgacatgt gatcaccaga 1011960

gttctgcatc tgaactcaaa gtacagtgtg gatgatgtct tcatgccctt atctcattca 1012020
 catggaaagt ttataaaagc agctaacaca cacacacaca cacacacaca cacacacaca 1012080
 cacacacaca cacacacaca cacacaccgc atcacaccta gcatcatgca actggcatct 1012140
 gtccccagta ttttcccat ggaccagttt cctgtccacc actctgccac tcaatccaaa 1012200

gttcatcacc ctgcaaactt ttcctattga aaagagcagg gaattgttag tttagtagat 1012260
 tttcccaaac ccaagaagtg aaatctctgg agtcaggaca atacagccat tacaagtgac 1012320
 tcacttccgg agggcttcaa gaaaatgttt ttactctgtg gagccttggc caaattcctg 1012380
 ggtggagtcc ctctaccaca gcaactgaggt cactgaggtg aaagggtgag aggtcatgtt 1012440
 taatccctaa tgctttctc cagagatcag gaaccagggg aaaaaaaaa aaaaaaacgg 1012500
 agaaggaaca gagcaggta agtgctagca atcacttcag atgatcaaag acgtaacca 1012560
 gtaagatcgc cagtgttacc cagggccagt tagtgacagg atgattgaac tcatggcaca 1012620

gaaggaacca agcattttaa gtatccgaa tcagcagtct atcaactct gaagagaagt 1012680
 tagttctgag tatacttcag tccaggghaa ctgagcttca attacagaga gatatttttc 1012740
 ctagtcatat ttgcctttgt gatttttttc tcaacaggaa atagaaaata aacaacttta 1012800
 gagtagttaa cctcaataa attaatgtgt ggcatgaaaa tcagacactt gattataggt 1012860
 gtgtgtgctc tgggaggag ctgcaacta taaccataaa tcaatgttat ttgaacaata 1012920
 aaattactgg taaggtactg aaaggttaa aacataagge atccttaact tttcaatfff 1012980
 aaaagacatg aatgaaaca aatataagcc caaacttcag ttccaaacag ctaaatctgt 1013040

gggccttcac agacacaggt ggaaagatgg cacagtgggc aagagctctt gatgacctag 1013100
 catgatgacc tgagttcaga tcttggcacc cacattagaa gccaagtgtg gctgcttgtg 1013160
 cctgtaacce agcctgtgc cagtggagac tggatcagtg gggcttctg gctgccagcc 1013220
 tagctcgggt tttgatgaaa gacctgect caaagaaata agacagagac tgatagagca 1013280
 ggacactaag catccagaca catgcacaca catacgtgta cacacacaca cacacacaca 1013340
 cacacacaca cacacacaca ccttacaac agtgactaca agcaggagct cacttcttac 1013400
 aggctactga gtgtaatga ctccagctag ttccataca atgtgtgctt ctcaaagagg 1013460

taattgtata aactaaggac atgaccactc caaggtatgg ttgaaggaa ggtttttatt 1013520
 ataaatatga aggagataac tatagccatc tggaagtatc tagagcagga agaagtagcc 1013580
 aatggaacat ggccagcaga atgaacttgg tcatgcagag agagagaaag gaagagcaag 1013640
 agaggaagac aaagagaacg agggcaaagg agaccaagga agagcggggc taagccaaaa 1013700
 tagccaggtt ataaggagat cagaagctag ggaagggaag cccatgagtt agagaggtgt 1013760
 aggttaggga gtaagaagag ccagggtgtg ccagtccac cagtcaagaa gaatacacta 1013820

ccataattta aagccaagtt tgaagcaagc ttttattaaa tactggtcag atccatggac 1013880

 tttctgacca ggtctctatc tctgggtttc cagaaaatgg cccaagcca tggttcgcag 1013940
 gggcttaaaa aggtaaaacc cataattggc catatttccc atggggtcca ctgagggtta 1014000
 agagtccacc ctgatgaatt tctgcctgt gaactcggcc ccacatgtga tccagcacat 1014060
 tgggtgcaga tgggtcaaac aaacttgttt aggggagtga agcgtggttt gtttgttacc 1014120
 tcataaaca acagctccca gcatttcagg aagtacatgt ccatgagaag aggcttgcag 1014180
 gtcagaggtt ttcttgtttc atggatctct taggcacagt aattaaact taaaatgtaa 1014240
 ctttggttct cacagatgcc agtgtggact catgttgttt taatctaagt tattatattt 1014300

 accataaaga ctgaggatc agatattggg gtgaaaagct actagatcag agaagtcaag 1014360
 gagcaaccaa ctctatggct aattctgtc aactagtccc tggctccacc cccaatccaa 1014420
 cattaatfff attagctaag tctcagagtg tcacagtggg gacaaatc ccacaacaga 1014480
 ctgagtaaca gatataacag ttgtgatact gggagagctt ggtggctagt agtagcacag 1014540
 atagccattt gtgtgaagtt tctttgtac ctgacagtaa atgatgattt taagacagcg 1014600
 ggtgatactt ggaagtaaat aagtatctgt gaagccaaca tttttacatg ttgcatagat 1014660
 ttcactctgc cctctgagaa ctgggtcata ttaggtcaca atttaagtga actgctcata 1014720

 agaagtaata aaaatattct aaatagaagt ttcaattcct agcaattcat ttatttgctg 1014780
 aggtgaagct tgagtgactc atgtattatt tgggaaaacc aatgattgac aggaataatt 1014840
 tgccttctta acacctaaga ggacaagtat ttctgggatg gtgcttgtgt gagcatgtgt 1014900
 gggggggtga gggaggagg gagggaggga gggagagaga gagagagaga gagagagaga 1014960
 gagagagaag gagagagaga cagagagaga gagagagaga gagagaagga gagagagaca 1015020
 gagacagctg ctttagttca ttttcccag cctccttttc cttgatggta aaactactaca 1015080
 ctgggaattt ttaaataggg tgatgtatga gaaaaagctt caaatgcca tttgcattag 1015140

 cacatactgg agtgagctct gtcttggctt ttgtgatta aaggccagct ctatggataa 1015200
 gtagcaggta gagcaagact tctagcctgc taaggatgac cactccagat tggtagagaaa 1015260
 gagctgactg tgggtggtt ctaccatatt gaatgaaaga ctgaattgac tctcctctcc 1015320
 cttcatgtgg ataataatag ttgctgatac atatccacc tgctttttat ttcttttgaa 1015380
 ttttaggaag gctgacttat acttcatcac atgctaattt ttgtgtctga actgttttaa 1015440
 gttcttaaca ttttaagaac tgtatcaaac gtagtgaag gaaagtgagg gagatgggga 1015500
 aagagggtga agagcaagtg tttccttca ttaggagaca ggagacttcc acccttctct 1015560

ggctggggca gtcttatcag gttctgatcc agagatattt gaaaagatcc catataaaca 1015620
 gaggcctttt ctgtgtcctg cccagccctg tagctgctta caaaataatc actcagaggc 1015680
 ttaatattaa ttataattgt ttggetgatg gctcaggctt attactaacc agctcttaca 1015740
 cagaaattaa cctattttat taatctatgt attgcatgc agctgtgacc ttatgicatt 1015800
 ttctacatgt cttgcttctt cagtggctgg ctagcatctc ctcaaccccg tcttctttca 1015860
 cgcatagctt ggetttccca cctaactata ttctgcccctg ccataggcca aagtagcttt 1015920
 attcatcaac caataaaagc aacacatatt cacagcatac agaaagacat cccacatcaa 1015980

 tccttctctg aggggacccc acacgggtag taagcactga acaggaact gtagctgtg 1016040
 tgacctgcac agaaagtcc catccagggc agggaagatt cttggcaga gggactaaaa 1016100
 tgtgtttact cttacagatt tacattttct tactcttgca gtgttggggt ttatttctt 1016160
 acacctctga gtctaaaggt tttgctttct gctatattta tttgcatgcc ttcagctgca 1016220
 aaagcactta tgacacagac atcccattac aaggaaaagt tcagggtccg ttggggctgc 1016280
 gacatgcttg gagtgccagt ttagaagtcc acgtttaaca ctttgatttt ccaggctgta 1016340
 cccacgccac gcaagtgcac tgaacaacct cgggacactg acaaaggaca cggcagaggc 1016400

 aaagctgtac taccagaggg cgctgcaact ccatcctcag cacaaccgtg cgcttttcaa 1016460
 cctggggaat ctctgaagt aagtggggtg gctcctgcgg gctgggtggc ctggagagtt 1016520
 cccgagacce aggtttcagg gtgctactga tgccctctag cgatgaatag ttttcacacc 1016580
 tccgtcatag tcattaactc tgtatttctt aggtgtcttt ctgggaccag tccattgatt 1016640
 gtccccggga actgagaagg atgacatagc caagaaaact taggatgtgc tgtgttacia 1016700
 aaagagtgag gctacaaaga gctttcctat gcctcgagtt tcttgtgaat ctttctgaag 1016760
 aactccttag ggtacagcca ttccaatgct aacagtctgt agtatacttc caagaaagtg 1016820

 gtgttgttct ctgagggtaa aatgaagggc ctgaacagga atcattttca gettgaatta 1016880
 agagggaaaa aaagccaggc ttgtttggag ttagaataat tctcaggaag ggatgcaaag 1016940
 atggctcagt ggttaagagc aagtactgct cttgcagagg tctgagttc agttcccage 1017000
 tcccactttg ggcagttcat aactgtctgt aaccccaggt ccaggaatct gatgcctct 1017060
 tctggactcc acaggcacc acacatgtgt gaacatactc acacagacac atgcacaaaa 1017120
 ataaaaataa atcttaaaag ataaaatagg agcagatcaa aaggcatgag aagggtgagt 1017180
 tctagttact gagacagctg gctagctgca ggcatacctt ttacttact ttagaaactt 1017240

 tgtgaacct gtgtctttgt gtgacgttgt aaggactcag gtctgaacgt cactagagta 1017300
 tccatgtgtg ctttgtttat ggctcagatg agtgggtaga aaatcccaca gatatctct 1017360
 tagataattg gtttctatag cacgagtttc agagatcttt ttttcttct ttttttattt 1017420

gaattacaaa caagattgaa ttacatgaga atcccagttc cttttccct cccttctcc 1017480
 cctacagacc ccccaaaact aaaacctac ctatcacata tctttcttg taatctacac 1017540
 ctgactcaac ctttctgctc cctcatgacc tctgcatctt tcttttctt cccttctcat 1017600
 tctcatagct ccctccccc tcttccatg ttctcacttt gctcagggga tggtagacct 1017660

 ttccccttct ccaggggaca acgttcgtct cttttaggat cctcctagtt tactagtctc 1017720
 tctatcagta tggattgtag gctggtaatc ccttactcta tgtctaaaat ccgcatatga 1017780
 gtgagtacat accatgttgg tctttttgtg attgggttac ctggctcaga atggtttctt 1017840
 cgagttccat ccattttctt gcgaatttca agattccatt gtttttttct gctgagtagt 1017900
 actccattgt gcaaatgtac cacattttct ccatccattc ttcagttgag gggcatctag 1017960
 gctgcttcca gtttctggct attacaaata gtgctgctat gaacatcgtt gaacagatgt 1018020
 ctttgtgtg tgaatgtgct tcttttgggt atatgcctaa gagtggaatt gctggatctt 1018080

 ggggtagact gattccatt ttctgagga atcgccatac tgatttcaa agtggctgta 1018140
 caagtggca ctcccaccag cagtggagaa gtgttccct ttctccacac cctctccaac 1018200
 ataaactgct attggtgttt tttattttag ccattctgac aggagtaaga tggtagctca 1018260
 gagttatatt gatttgcatc tccctgggtg ctaaggatgt tgaacacttt cttatgttga 1018320
 ggtctttggc ccattttgac ttaagttttg tgcaaggtga aggcttgggt ctatctgtag 1018380
 tcttctacat gtttgcacc agttatgcca acaccattg ttaaagatat tctatcccca 1018440
 tcaaaatccc aacacaattc ttcactgacc ttgaaggaat aattctcaac tttatatgga 1018500

 gaaacaaaag acctaggata gccaaaacaa cctgtacaa tagaggaact tctggagtca 1018560
 tcacatccc tgacttcaag ttctattaca gagctatagt ccagagatct tttcaataag 1018620
 tatattttct ttttctaaga agccaagctc aagggtggc tgcagagtga gactcctggt 1018680
 caggaatgct gctcggagt ctgtgctcag attgtatagc atgactctgt ggcaggggtt 1018740
 ctgtttctct gttcccttc ctcttctgg ggaccaagct gacaatgta acccagctcc 1018800
 ttcttccate catcagtctg tctccactga cttcttcaat ggtcacattt gagttaatac 1018860
 ttaggaaag aatgcttag aacacagtgt gatgactgct tttcagtggg agaggetact 1018920

 gacttactgg cataagactt tctcctgctt gggaaaatca gttatcactc agatccatag 1018980
 tacagcttta ggtctgcata agactggcac ctttctggg gactggtggg agatgtcctt 1019040
 ctgtaaataat gtttctctta ctggttgatg aataaaacat tgtttggcca atagatgcag 1019100
 gaagataggc gggacgagga gatgaggaga aggctgtgga gagaggagag agaggcagag 1019160
 gagactccat gtagagactg ggaagatagg atgtgctagg tgttctctgg taagataaga 1019220
 ccatatagaa acacatagat tagtagttac ggattaataa ttaagagaga gctagccagt 1019280

aagaagccct agccattggc caacagtttt ataattaata tagcatccat gtgtttattt 1019340

ggggccaatc tgcttcggga ccaggcagga cagaaaccgc catcttcagg gggcttttca 1019400
tttttcatgg tgctcttcca gtcagacttc agtghtaagtg gggaagagga gcaggggtcc 1019460
tcagacatgc catgcatagg gagaagcagt catgtctcaa tgtgagtccc agaatccagt 1019520
gggtgaaatc atgctaatag ctagtatttt tgtagtactt tctaactgac aagtcatata 1019580
cacagtattc ttgtaacata tgtttgcatg tgtatagctg catagaagaa ttctgaaaac 1019640
aacctgtact gggagggtgtt actatcttca cctcctttca caggtaagct cctccaagaa 1019700
ctatgtgacc ctgacctagg cttgtgactg acccagatca aactctctgc cttttgactg 1019760

cttgtcttgt ttactttaca ttctgtttg tcctaaatag ttccccagcc ccaaggttac 1019820
ataacattaa gttgtataag agcttgcctt ggccttgtgt agacttccta atagtcttcc 1019880
tgaaggaaac agtacagtgt attttcatta agcagagggtt gcttgctaag tgacagagga 1019940
aagcgatgca gaaagctgca gagctattct gcattcagat ggatcagac taacctctgc 1020000
ttcccctaat gggcttcagg gccagtagtg atgagtagaa atcaagaaaa ggttaagaat 1020060
gttgtaaatg tggggagaag tgtgagatct actgtttctt catccatgcc ctagtgtctt 1020120
ctccagtctg ctctgagtt gttggagttt gctttataaa accatgcctc cttctgtaga 1020180

gtagaatgta atgctcactc tttgtgatg agaagctcag gtctgacat tcctaagagg 1020240
cagccactca ctgttctat ttaataaacg aggatactag agtttgact agagaaacct 1020300
cagtcctttt aactcagcag acctaacac tgcctcctag tgaccacat ggaaagtgcc 1020360
agccagctgt gaaatggcca ccagctgcct ggtaggagct gtgtatgcaa tgtcaggaag 1020420
tccttttaaa acatataaaa atgaacttia atcatalctt taattaaca ctaactctgc 1020480
taaattatta ttttagctca cgattaatat ttacaatgg tttaaatttt tagcataaaa 1020540
catcaaagat atgaatgaga cgacttgcct tcttacacta aatctcttaa atctaagca 1020600

tatttgatgc tcacagccag tctcagagca gctatacttc acatgtgtga ggatggttcc 1020660
tctcttggcc agcactgtct tttactaata accttgactt tgaaggaatc gcaggtcctt 1020720
tgtccaggcc caaaagtcta aaaatgagat gtttctctgt cagagagtac cagccagctc 1020780
attgtaagtt gcttggattc ttggaattat atggttctctg cttcaacagt agactctaag 1020840
ggtaaccac atgtgtgtgg tctcattcaa gccatcctt gaggttttga agcttctctg 1020900
ctgtgagtct ctacggcaca ttgtgggtgga agactgagaa ggagcagccc ccaattcata 1020960
ttgatcaata acggcttctc ttgggactta aaatatcaaa aaaggagaaa ggaaaaagaa 1021020

aagaaaaaaa gagaaaagaa aagagcaaga aaagcttgtg atttttatgg gcaaagatta 1021080
cagaagtccc cagtgtgtca caaggtacaa cagagtgttt aaaatcaggg tatggggaaa 1021140
ccatttatgt gaatgcatga ttgaaataga tgggtggcttt tgttactaaa atgaaaaatg 1021200
aagaaatgtc agggttcatg tcataccctt gccatttgc gcagcagcct tccactcctg 1021260
ttagagagtg tgggtgtcca aagtatttct atgaatctgg tgaggacggt gacagaacat 1021320
accagaatgt ccagcaacga aactgtgtga taaactgaat agccatgtgt gttttatfff 1021380
ctttagttgg ctcttcaga atgaagacct tctaaggatt gtgaagacat ggaaactaat 1021440

tattataata aatttaaatg tttggtgcat acttctcat agcgtcttca ttggccacac 1021500
agtgttttta tgaaggaca tccgtatgtg cacaaagctg gtagatctct gcttctcaac 1021560
tttgttctct ttgagacag agtttcactc ttagcttag gttgacctg aactcatggc 1021620
agtctcctg tttcagccc caccagtaa tgaactcag cgtctatgtc agctcctgg 1021680
gttctgttca tcttctgtc caagggcgcc cactcctgc actgggtcc atccttctcc 1021740
ccaaggctgt ccatctgac tgtgcttggg tactttcaa catggctgtg ccaccaactt 1021800
cctacatgtg cagacatttt cattctatag gtctggatt ctgacctttg acttttggcc 1021860

tctgacctct gatggctcac ttttctttc tccattttc ttcactcctg ctgaccttga 1021920
tgaattgtca tctttagacc cttctttgtg tctcttctct gtagttttct tttcagacct 1021980
cctgtgatga gcacagctct ccacttatac caccttctgc tgcctgttc ataactttgt 1022040
tagatttctct ctattaaata tgtctgatga cattatttta ctctttatc caatacctag 1022100
tcttcttcat cctctctatg gacttgggag ttaatgcct ttgcattatc acagagtgca 1022160
aacgtctcag cattcaggtt ttcctgccc tcatcactca tatccattct tctgtcttca 1022220
ggaaaccag acccagctaa tactgacct tgcagtggtg tgagagtttc cttccagact 1022280

gcattgactg aggccctcag cgaggcttaa ggataaaact gttctggtgc actgaaaatg 1022340
tcccatttcc cctcttctct tttcagtgct tgcccaactt cccagactta cctgggaagt 1022400
gagagcatgt gctgtgacc cacaactgag gacatagcag accattacag tacttctgtg 1022460
agcattgccc cacaattgtg ctcacacaca ccacaattcc tgccggtctt aagtcacag 1022520
tggagtctc tgctgtgata acacagtgca ggccagagca gagtccaca ggaagcattc 1022580
ttaaaggagc ctggggcttt gtttacattc tctggaagga ttgtcatcca ctttccctga 1022640
gcagatatct ccaggaaaag ttaatgctcc agccagact gccttgtcaa gtacaagagt 1022700

ttcaagaate tcaggccgct actctcctgg gtgcctttgt agttgagctg tcttaagacc 1022760
cagagggaga tggcttaagg caggaacctt ccagttaaag gctaatgata acatgccagt 1022820
cactgggaac ttcaattaca gacactgtca tacgttagac aaccaact tcatcctgta 1022880

tcttgagtca gtccagcagg ttttcacttt gtctcaaagg tcaacttggg atttgggttg 1022940
 ttggaggatc tcaaaagctt tcaagttaa agatgctctt tgtacaccag gcagagaagc 1023000
 aagaagaaca gaagaacatt tgttctgtgt tctcatacct gtttccggcc tgcaggctcc 1023060
 aaccaggca gcacttgggg agtgaatctt ggcttaagaa ggccgccctt tctcagggac 1023120

 ttgtcaattc tgccgcttcc ttctctctct gctttccaca gaatgcagtc tccccagcca 1023180
 gtctgctgga tagcacatgg gctttctgct ctccaccctc ctgttacctt cttctgattg 1023240
 acaggaatga tggttgattc acacctttct tatgactctg tccactggga gcagtggggt 1023300
 accaatccat aatctctctc tcagacagag aactgactag gacaggatcg tgtaaagaga 1023360
 ggttctttgt cctgtcttgt ggcccttaag cctcaaataa gcaatcagat gctatattag 1023420
 ttataaactg ttgtctgggt gcttcttatt ggctagctct gtcttaatta ttaaccatt 1023480
 tttatcagtc tatgtattgc cagaggctg tggcttacc agtaatccct ggcatgttgt 1023540

 tactctcca gcagcatctc gactctttct gtctggccca ctctccctgc ctttcccaga 1023600
 attgtcctga tctcctagtc ctgcctatct tcttcccaa ttgaccgaat agtgttttat 1023660
 tcatcagcca ataagagaag catatataca gaaggactat cgggggagca aggaaaattc 1023720
 cattagggaa tttctggagg tccaaacctc cggagctcct gtctgcattg aatctctaca 1023780
 gaactaagca tttgaatagg cctgcaccag gtcggagggc aaggtatgta agtaaccagt 1023840
 ggggacggag agaatcagga ggtagcaggc agagggtttg actggaggag agagaaatgg 1023900
 actcatggcc agggaagcat ggttaggaaa caggaagatg ccaaataaag aagagagtcc 1023960

 agttttgcag catggaactg agaactctct aaagatgaca agatgcctgt gtttggcttt 1024020
 tagcgccatt gggttgctag gagtttcaa gtccaccctc cccactcag gccgaactga 1024080
 acctcacgce tgccctggct tgggctgtag acatgctggg ccacgacaaa ggacatcccc 1024140
 catcaggate acatgccaat caacttcaga gagggccttg acatccttct tccagtgaca 1024200
 tcaacatgt cttttcttag aataggcagc tattaccatg tgctgatctc tgattatcac 1024260
 gtcaattcag gaaaacagtt tcagctggct gtggcttcac ctgttcatgt ataaagtaga 1024320
 aatagtctta gaaactgaac atctcttaag tactaaatgt aatgtattaa gaacttaata 1024380

 caggaccag cacacaataa ggatgaacta gttatttagg tgttactgta acctaaaaac 1024440
 atagtatctc ccatccaate tgaagctcag ctctctgggtg taactgtaat aagggatgag 1024500
 aagtgggcag ccattctcta cccatgccac tagttaaaca tcctatgatg acagtcaact 1024560
 gctgggagac ccgatctct ctacttaagt agaagaaaga gcctctcatt gtctctggac 1024620
 ttgccaata ggctagceta gccagccagt gagctccaaa gtecacctgt ctccatctcc 1024680
 caagtctgg gaatacgttt gttattagtc acacgtacct gctagggatc aaactcaggc 1024740

cctcttgttc atacggcagg ccctttacca atggagccat ctccccagcc cagcagtgtg 1024800

 atttgaattg tccgcttttc cagtcttcac tgcctatgtaa atcaagcaga acaataagtg 1024860
 tgaactacag teacacttat tttttacaca ctgctttgga cacaatgcac tcagaaatec 1024920
 cgtgctaaag cgatgcagag caaccaggag tccttcccat cccgtgtggg aagcagagcc 1024980
 ccaggaagcc cacaattaca aagcccatct cctgagatgt ctgtccttag cttgaatttc 1025040
 acacggcaag ctggtaatgt ctctgcccgt aaaagcagaa ataaaaatct tctttgttta 1025100
 cgggaaacat gattttcgac ccagttacag caaagagcag cactgcaata acagaagccc 1025160
 cgtggcgcag aggacctgct attcctgcct tcacccttca ctcttttctt ctcatgttcc 1025220

 ctctcctctt gtcgcaaacc tatccagtct agtttatatt agccagctgc cactatggga 1025280
 agggctgccc tggactgtgg ttctgtatcc ggtgtcacgc cattgaagaa aactgactgt 1025340
 cctctccag cagcattcaa attccaatag ctctcagct aggggcaaga atttgtgccc 1025400
 actcctccca ccaccacaaa ccccgctgtg agatttttgt ctgacttgag cttgtgcgtg 1025460
 ctgacacagt catcgtgagt tcacatatac atctatcctg ttgtgtttgg gaaacactcc 1025520
 tcccttaaac teatctacca ccctctgttt cttaacaatct gtecaccctc tcattaacat 1025580
 agagacctga gcaccaaggg gaagaggggtg atggaaacat cccatttacg gtggagtact 1025640

 ctgaagtttc ttattctctg tacattgacc agttatgagt ctctgtgtta aaaaccattg 1025700
 tgtagtttca aagaaaatgg cccccaagg gagtggcact atttaggaag catggccttg 1025760
 ttggaatagg tgtaaccctg ttggaggaag tgtgtcacta tagaggtgga gtttgaggtc 1025820
 ttctttgctc aagctatacc cagtaagtca gaccactccc ttttgccctc ggggcaagat 1025880
 gtaggaatct caactcttcc tacagcacca tgtctgctg cacaccacca ggcttcccgc 1025940
 catgatgata atgaactaaa cctctgaact gtaagccacc caattaaatg cttttccttt 1026000
 ataagagttg ccatgctcat ggtgtctctt cacagcaata gaaatcctaa ctaagacagc 1026060

 cacctactga tggccactgc tgcttgcaag tcaccagtcc tgtgtctgct actgacactt 1026120
 ccaaagtcca tcccatgtat caattcttcc ttaaagcaat caactacttc tgttgagatg 1026180
 actgtgggac tattggcaga aatccagagg tttgtacag tagcaaaactt aacctatctc 1026240
 taattactgg aagaaaatgt ggcatatcct caatgcattc gctaagtacc tatcattgag 1026300
 atggcccgaag aaagtgagcc tccgagaatg tttttacttg acgccacaga ggaaaacaca 1026360
 accacagggga agttccaag aatcacaaa cactgagctg caaaatttcc acattctgag 1026420
 caaaatctaa tttctactcg atgtcttctt tatgaaatcc attctgagat attactggtt 1026480

tcaggaaccc attctgatga acttttttgg aaattcctgg ggcaggagtc atttaagaga 1026540
 gatgagtcct gctacagagt tgtaaaaggt ttgtatttgt gcttgattct tacatggata 1026600
 atatggtgct atgtacctgt gattcatggt tgagggcact ctagtagagc tcctgtagag 1026660
 aacgctacct ctacagtggc aatgtctctt tgcattcct tctactccat ccatcactgg 1026720
 ggatggcttc gaagtcttac tataatgcaga tcgtgagatt atcttagact gagtgttcag 1026780
 ttgctggaaa gagacacat gaacttagca actcttaaaa aaaaaggaaa atatttaacg 1026840
 ggggctgact tacagtgcac agggttctgt tgctgagttg ttttctgtc ccaccaggtc 1026900

 ccaactgccac ttcagcccca aataagcaca tacagatggt atattagtta taaaactggt 1026960
 ggccgatgac tggggcttct tactggctaa ctctgtctta attgttaacc cacttctatt 1027020
 aatctgtgta ttccatgag gtgttgactt accagagaat gtctggacct tctacttctt 1027080
 tgtcactac atggggactg tctttggcag gctctcccca cctatcttc ccagaattct 1027140
 cctcatctcc tagtctgcc tgtcttctta cctcattggc cagacagtgt ttatacagaa 1027200
 ggacatccc catcaggctt tatcattat cgtccatggt gggaagcatg gaggcacgca 1027260
 gacagatagg atgcaggaga ggtaactgag aaggctacat atggaccaga agacagcatg 1027320

 gggaaaaaga ggatactgag cctggcttga gcacttgaaa cctcagagcc caccctcagt 1027380
 tacacactcc ctcccacaag gtcacacctc ctaaagggtc cacgccctgg tgaccaagcg 1027440
 ttcaaattga tgagcctcgg ggtccattct tattcaaate accacaaaga tccaaagccc 1027500
 actctcaggg gagtttaca ttagcaaag gtcacagagc acacactctg ggtgttagga 1027560
 tccccgtgag gtgggtgttt ttctcaagg gatttactga tacactgttt cccagagttc 1027620
 cctgggagaa gcctgatgg ctatttact gtgtcactca gatggacatt aacagagttc 1027680
 tcaaggactt gcattaaca gctgtgttaa gtggtattta atctctctag gttcatctct 1027740

 gaaaggtcca agtttcatt ctagetgaca tgagttatta caaatgaaag ccactaacc 1027800
 attactaaa aattattgta ggttttccc cctttttgc tgattttgaa ggattcccag 1027860
 ttaaatagtg tcctgtagca actaattttc tgccttaatt ctgtaagtcc atatctccc 1027920
 ttggattcaa gcagcatttc taaatgtact tggtaagac tctttggaat tetaactgta 1027980
 aaatctcagt ggtaataaa cnnnnnnnnn nnnnnnnnnn nnnnnnnnnn nnnnnnnnnn 1028040
 nnnnnnnnnn nnnnnnnnnn nnnnnnnnnn nnnnnnnnnn nnnnnnnnnn nnnnnnnnnn 1028100
 nnnnnnnnnn nnnnnnnnnn nnnnnnnnnn nnnnnnnnnn nnnnnnnnnn nnnnnnnnnn 1028160

 nnnnnnnnnn nnnnnnnnnn nnnnnnnnnn nnnnnnnnnn nnnnnnnnnn nnnnnnnnnn 1028220
 nnnnnnnnnn nnnnnnnnnn nnnnnnnnnn nnnnnnnnnn nnnnnnnnnn nnnnnnnnnn 1028280
 nnnnnnnnnn nnnnnnnnnn nnnnnnnnnn nnnnnnnnnn nnnnnnnnnn nnnnnnnnnn 1028340

1030260

1030320

1030380

1030440

1030500

1030560

1030620

1030680

1030740

1030800

1030860

1030920

1030980

1031040

1031100

1031160

1031220

1031280

1031340

1031400

1031460

1031520

1031580

1031640

1031700

1031760

1031820

1031880

1031940

nnnnnnnnnn nnnnnnnnnn nnnnnnnnnn nnnnnnnnnn nnnnnnnnnn nnnnnnnnnn 1032000
 nnnnnnnnnn nnnnnnnnnn nnnnnnnnnn nnnnnnnnnn nnnnnnnnnn nnnnnnnnnn 1032060
 nnnnnnnnnn nnnnnnnnnn nnnnnnnnnn nnnnnnnnnn nnnnnnnnnn nnnnnnnnnn 1032120
 nnnnnnnnnn nnnnnnnnnn nnnnnnnnnn nnnnnnnnnn nnnnnnnnnn nnnnnnnnnn 1032180
 nnnnnnnnnn nnnnnnnnnn nnnnnnnnnn nnnnnnnnnn nnnnnnnnnn nnnnnnnnnn 1032240
 nnnnnnnnnn nnnnnnnnnn nnnnnnnnag tacatacagt gtttttctt tgtgtgtgtg 1032300
 tgtgtgtgtg tgtgtgtgtg tgtgtgtgtg tgtgtacttg gttcagaata gaatatcaa 1032360

 tgccttctc tgttgcctc tgccttgaga tagggtctct cattgcacct gaagtttact 1032420
 cttttggcca cacttggcgg ccagtgttct cctaggatca tctacctgtt ttaactgag 1032480
 tcaactgaggc cataaacaca tgtgtgtact agggactcaa actcaaacc ataagcttat 1032540
 acccagtagc cctctccct gtcccttttc tgagtgtttg atctaattgc cattgacct 1032600
 gcagatagag ggggttgct gtgttctctg aacagcacag aagggtgga gacagaaagt 1032660
 ctatccgggg tagatgaatt tcttgaatgt tgacatatag cgttttaaat taaggcaatc 1032720
 ctccagtctt tgacagcctt tagcttatgt taatgaagac actggagggt tttctagata 1032780

 aaagattgcc tgcacccctc agtgtcaata cttctcactt caccctggct cttcatctt 1032840
 ccagaaacac ataccctacc tccccgctg cgacctagca tgccaaacac cctcactggg 1032900
 caggcatttc cctcaaccac cacacatctc caccaacacg gatccatttc cttcttcttg 1032960
 ccatgccagt ttctgccac acaatatctt gaggtcttcc cttgtgacct ttttggcaca 1033020
 acttccatca cttgtcctg tgtttcccat tctttacaaa cttataccat ctaacatagc 1033080
 tttctgtatt aatggtcttt cacacaccic cagaatgtct gagttttaa ggacagtat 1033140
 tgaattcatt gcaatatccc cacacgtgcc aggctgtacg cagttagtag attccagatt 1033200

 ggtgagtaac taaatcaact tgaaaaagaa ttctgggttg tgctcctgca ttacaggggg 1033260
 ctggacttgg ggtcactctg ctgtcatcga atcatgcttc agtgtgatgg cccgcctgc 1033320
 cctgaggact agactgagaa gcagtcattg ggcactattc atagtgacct caggctgtca 1033380
 tcctgaggct gttgcatgg tccctcacat ctttatgagg cctgagggt gagagatcta 1033440
 tgtttcagtg ttggaaagcc tataatctat tctccgaaat ttagtttttc tttcttttc 1033500
 aacctggtgc attgagattt ttttttgtt ttctgaaag gteaattctg tctccacttt 1033560
 cgttctctct caactgacag ccatctggaa tgtattagct gcttcttccc agtgcgttcc 1033620

 ttacttctac atttgtttgg ttttttccc ccttaattc gtattcagct catgttctg 1033680
 ccttaatttc attatgcaac aatgagggtg gactgaagat cgaaatactt cccagctcag 1033740
 atcttttctc ccagctccct aggcaggtag cagacactga actgcttgct ctctgggggg 1033800

gaaaaacaca atgttaaaca ctgttacatt ggcatctaca agcgataacc aagtgccttg 1033860
ggagtatccg atggacagat ttctctttac atagtctctt tttctcagga ccatatttct 1033920
ttctaagtcc cttcttgtgc ttccggaaca attcagtttc cagtnnnnnn nnnnnnnnnn 1033980
nnnnnnnnnn nnnnnnnnnn nnnnnnnnnn nnnnnnnnnn nnnnnnnnnn nnnnnnnnnn 1034040

nnnnnnnnnn nnnnnnnnnn nnnnnnnnnn nnnnnnnnnn nnnnnnnnnn nnnnnnnnnn 1034100
nnnnnnnnnn nnnnnnnnnn nnnnnnnnnn nnnnnnnnnn nnnnnnnnnn nnnnnnnnnn 1034160
nnnnnnnnnn nnnnnnnnnn nnnnnnnnnn nnnnnnnnnn nnnnnnnnnn nnnnnnnnnn 1034220
nnnnnnnnnn nnnnnnnnnn nnnnnnnnnn nnnnnnnnnn nnnnnnnnnn nnnnnnnnnn 1034280
nnnnnnnnnn nnnnnnnnnn nnnnnnnnnn nnnnnnnnnn nnnnnnnnnn nnnnnnnnnn 1034340
nnnnnnnnnn nnnnnnnnnn nnnnnnnnnn nnnnnnnnnn nnnnnnnnnn nnnnnnnnnn 1034400
nnnnnnnnnn nnnnnnnnnn nnnnnnnnnn nnnnnnnnnn nnnnnnnnnn nnnnnnnnnn 1034460

nnnnnnnnnn nnnnnnnnnn nnnnnnnnnn nnnnnnnnnn nnnnnnnnnn nnnnnnnnnn 1034520
nnnnnnnnnn nnnnnnnnnn nnnnnnnnnn nnnnnnnnnn nnnnnnnnnn nnnnnnnnnn 1034580
nnnnnnnnnn nnnnnnnnnn nnnnnnnnnn nnnnnnnnnn nnnnnnnnnn nnnnnnnnnn 1034640
nnnnnnnnnn nnnnnnnnnn nnnnnnnnnn nnnnnnnnnn nnnnnnnnnn nnnnnnnnnn 1034700
nnnnnnnnnn nnnnnnnnnn nnnnnnnnnn nnnnnnnnnn nnnnnnnnnn nnnnnnnnnn 1034760
nnnnnnnnnn nnnnnnnnnn nnnnnnnnnn nnnnnnnnnn nnnnnnnnnn nnnnnnnnnn 1034820
nnnnnnnnnn cccccccca acaaattcat ctgagagagg aggaggggtt tattccgcc 1034880

acagtttggg ggtgcagtct gtcacggaga gaaaggcatg gcagggagtg gttctgacta 1034940
ctacttgttc acatctcagt ggtccaggaa gcagacagga agtgggccca gctataagtc 1035000
tcaagacgtg ctttcagtc ctcacttctt ctacctagag atgctgttag agaaccagca 1035060
gcaccagctg ggaaccgcat agcctataaa ggatgtttca tccaagagcc atgacatcag 1035120
cataaaact catcatttat tttatttctc gggttagtat cctgagatga tgtttaaacc 1035180
atgtgggcca gggagatggc tgcctttgca aagtacttgc tgtgaaagca agaagtctgg 1035240
agatcctcag actctccata aaaagtgaag caagcacttg ggaagcacag agaggggagc 1035300

cccaggctgg gatcaccaga gaaaacctgc ctcaatacag aaagtgagc acgatggagg 1035360
aagacacata aagtcaactt caagctcca catgcatgca ctcacacaaa tgtgtacaca 1035420
catgcactca tgagagcaca ccacaaatgc atgcactctc acacacatca agtgtgaaca 1035480
cacacacaca cacacacaca cacacacaca cacacacaca cacactacat cacatttaa 1035540
aaacaaaaac aaaaaacaat tgatttttga tgtttcaggc ttatcttctt ccgaccacag 1035600
gtttctctgg aatatcgtgg tcttagatat aactctaatt agtatcattg tttatacaca 1035660

aataaaacat taatgtgtg agactgtgaa aattaatggg ccttagtggg tatcccaaag 1035720

tttcagctgt attcccttcc taaactgatg aactctgagc tcagttaaag aactgtgtt 1035780
agggtcggag agatgacttg gcagttaaga gcactggatg ttcttccaaa aggcccgggt 1035840
ttgattctca gcaccacac agcagctcac aaatgcctct aactccagtt ctaggagatc 1035900
tggaacctt gcacagacaa tacatacagg caaaacactt gatgcatata aaaataaata 1035960
aatcttttaa aaagaagata ctacttagag tgattaggat gtttaaggac cttgacattt 1036020
gtactggctc acccaggaca gtcacatgac tgttacagta gacagaccct ataccaggcg 1036080
gcagtttgtt gtttgcttgg ttttttaatg aaataaagac attttccagg caaaaaaatt 1036140

taaaagaata acatatactt tttccttagc tgaagtcaa ggggtcaga tgggatattt 1036200
gaaatgattt cctgattatt tcccgtggga atatgggaag ctgaagcaaa aagcttccaa 1036260
attccacaca atgggagctc aatagtgtg gcgagaaaca gactatgcag gagacctcca 1036320
tcttttctga cagacagaaa ccacatcctt tgaaggagac ctccgtcttt ctgacagaca 1036380
catcttttgg cttttttcc cactctggag ggggtcgtt ggggtatgtg aaatgctttg 1036440
ggatctgaga atctcactga aaaatctgaa gggtccttct accctgaggg caattggttt 1036500
taacttgaaa gggacaagac agctgttagg cagaactcag ggcccctccc ttctccaagt 1036560

ctacacatct taccttaatt tctggaattc ttttgagaag acacagggtt tctgatacac 1036620
actgatgaa ccggcggccg tcagaaatcc agacctgatg ttcttcaagc tgcccccttt 1036680
cctggtagca cccctctaac agcatcctag cttttaaacc accgaaaat atggaagcaa 1036740
tattcttaaa gcgcagttag tcagcatgca cacacatgtg gtaccttccc ctctctctga 1036800
gcagagttac catctgccac acacacacac acacacacac acacacacac acacacacag 1036860
acagacacag acagacacac atagacagag agagagaggc catgcccatg cccatgctaa 1036920
catccattgg atgtggacca atgtcatgct aaaagaaata ataactgaat aaaatctccc 1036980

atgtgcaggc aagattccag aagctgtgtg aaagaattca cattatcta tatttaattt 1037040
caagtttga gagagcacga cctatggagc tatgaggcac ttggcaatta gaatgtccat 1037100
acaagattgt ctttcaata tgcatggttt actcacacaa acattactta tgctactgtg 1037160
ctcatataaa aactaaacag atatttgacc aagcaggga cagttgattg gacagaaaat 1037220
gttggggaat ctctctgtt aaggacactt tggaaacttg caggctctac ccacgtctgc 1037280
agggaagtcc ttcagctgtg gcaggctggg tggatggcag tgggaaggt ccaagaatcc 1037340
cctgagagca tagaccagca gctgggactg acgagtgggc ctgtgtgtgc ctgagataa 1037400

tccagaagtt cggtaggttac caagacgagg ctgggcacag agttttacag cttcttgctg 1037460
 gtgggtaaca acacagagac tagagaagcc atctttccag agaaagccag cgccatcctt 1037520
 gaggccatth ctaaagttgc tgtttttatt atttactggt gcagtagctt tggctatcag 1037580
 ggctcacagc ttggggttgg ttcagtagca taccagcgtc tccttggggg tcaacttggtt 1037640
 agtgtaccaa ggcatgtcct gggctaaggg cttatgtgag ttgcttgggg ctgccactga 1037700
 ggcttagctc ctgacagagc tgcctggtga caagcttggg cattgtatth caagtcacac 1037760
 acacacaaaa aatggcttht taagtcacac aaaatagcgt gttcctaagt tctttgtctt 1037820

 ggctgaact tctgattct ttaggactth ctagtctgt cttttctgcc atttagatac 1037880
 ttaccctthc caggtagcta tttcagtgag aaatttggga acagtaactt tgaattatth 1037940
 ggttatgtct ttaaaaagaa aaactthtg gccatgggga tagtggctca aacctgtgat 1038000
 ccaactatth ggaagaagaa gcctgagagt ctgagaatac agaaccccag cagggcccct 1038060
 ccaggacagg gacacagaac cccagcaggg ccctccagg agaaatcact cccagtcact 1038120
 tttagccttg gagaagccag agaaaagcat actccggcag aaaatgagat cagccctthc 1038180
 tttctcttat cacacaagaa tgggtgtgat gtgttaaaaa tcagagaagt gacatgtgtc 1038240

 ctttactccg tglagtatct agaaacaatg ccatcttgtt tcattcaggt tcttatatgc 1038300
 gtttgtgtha aacttaggt ctatgtgtgg cctgagtgag tcttcccc tgccactcac 1038360
 ttatgaatac caatgtgat cattttgtgc atgtgtatgg atacacacat atgacaccac 1038420
 atgtgtcatg gcatgttht ggaggtcaga cgacaacct agggagtctg tctctccat 1038480
 ccatctcatg gctcagcagc aggtctcttc acctgctgag acacctcacg gtaccccaca 1038540
 aatatcattt tgatgccagc tttctagtta aaaataatgt gttgtagttc acatacaaaa 1038600
 gcaccagctt tggattctcc tctctctct ccttctctcc tctctctct ccttctctcc 1038660

 tctctctct cegtctctc tcttctctc cctctctccc cctctctcc tctctctct 1038720
 cctctctthc cctaaacag catacttht ctttctggta gctttgtaaa ttacaacaa 1038780
 tattttgagc taggtgtgat agcccaacct ttgtaatcac atggaactgt taaatgaaaa 1038840
 tcccacatgt acaggatggg tgggtggaca cctgagatag gaaagtgact ttggactgca 1038900
 aacaaatgaa aacatattat gagcaggtga tctctcagag tgagcagtaa agaacagtat 1038960
 tgtgggagtg gggaggatct tagggtagg agaatagttc agtcagtcca aagcttgttg 1039020
 aacatgatg aggaccagag tctggtgtga tgggtgtgat ggattacgt tataatccca 1039080

 gcactgggga ggtggaacaa ggaggattcc tgggcttac tggccagcca gcctagacct 1039140
 tgagacctca ggtgcagag agaggacaga acctgagggg aaaaactgga cgtttacttc 1039200
 tgaggtgtha ctgcaactgg agaaagtga cgcagctctg ggtaccacac agcagaagag 1039260

gagagictta gggaggcagt agcctgactt ccgcttggtt ttccccagat ctctgtcagc 1039320
 atgcagaggt agacactgag cttctcagac agggcttcga gttcttgagc ccataggaac 1039380
 ttgtaaccac ctactcttg tcacagaaca aagcttgga ttacattagc agcaaagaag 1039440
 atgaaattaa catttcttag aatcctgacc actgtaaatt atcactagcc tcgggtttat 1039500

 agtctattga gaagctcaat taatatgaag aggtttataa gatattttcc ttttgtgtat 1039560
 ctggggatgt gactttatit aataccagag tgtgaggtgg cttagaggtt aagagcactg 1039620
 ggtgctcttc cagaggtcct gagttcatct cccgacaacc acatgttggc tcacaacat 1039680
 ctataatgag atctggtgcc ctctcttggt gtgcaggagc acatgcagac agaacactgt 1039740
 atacataata aataaataaa tctttacaaa aaaaatacca gagtgaaca tgcctttaat 1039800
 cccaggactc ggcaggcaga ggcagggtga tctctgtgag tgagttccag gacaggttcc 1039860
 aaagcaatac aaagaaaccc tgtcttcaaa aaaacaaaaa caaaaaacag agtgaaagaa 1039920

 gactgagacc taacgtgagt tcataagagg acgggctccg ttcctctcct tctacagtgc 1039980
 tgtcatgaat tgggtcagtc aactcaaca ctcacagcta ggtcaacttg gagtgaacce 1040040
 taatgtaaga atgtattgat ttaatccttt agctcatggt ggctgagatc gcaaatccca 1040100
 gcaaagatcc atcaagtggc aagtctgtg tcttgccctc ctgggagcta gtcccaggac 1040160
 cagggacttt gaagcagggc atgagaacac ctgcagcaag tgtgaacagc actctgcacc 1040220
 aaggaggatg tcatggagac ttgagcttat gtggctgggg tgtggcaggc gccataagct 1040280
 aatggaggaa gctgaggagg aaaacctctc tggccaggag tagacggtgt gaatcttaca 1040340

 tctgccagag tagaggacgg agcaaatga taggaaaatc tgggagtcac acacgggggt 1040400
 ctctctttc ctggtccac gtcatgcctg tagagggtca ctcttgcgtt ctttcttctt 1040460
 gagtactaca tttatctgag aagtccacac atgtgtacag tgtaatgtga ccacactcct 1040520
 cctttctgct tcttctcct gccaccattt ccctaactc acacctctgt cecatittea 1040580
 tatcttctc tctttcttt aaataacca ttttgccca ctttgttcac ttagcatcat 1040640
 cactggcgt gtggacaatc tcctaaaag aacgattctc cctccccctg gagctgccag 1040700
 ctgccagctg tcctcagtt aggggtgggg ctatcagcta acgctcaggg aagtatctec 1040760

 tgatttttac ttagttttg tgggagctgc gttgtccact tgttcatggt acttatgttt 1040820
 taactcttc ttgcctacta gtgcgtttcc gtgaggttt ctcacaacct tacttttgggt 1040880
 taagccattc ctccccctc ccttcccca tcccattcc ccttgcctcc gtccagcttg 1040940
 acactttaat ccttgcctc tcctctctc tgtgtcagac atattattgt atatccctc 1041000
 ccaatggcca tctctccca ttgtctctc actgctctgg ccttctctc tgaagtgact 1041060
 gtttctctta cgccccctt gtcacacaca cacaggctc aactccgct gggagacaaa 1041120

gacatgcagc atcagaagat gccagaattt cctcaggag gaagaacacc aagctcgtcg 1041180

gtccgattca gttggatgct aaggaaaacg aggcacaaa tattgataga atgctccca 1041240

gaaatgtcct gtgatcgctt gaagetgac gttcactgtt ctgtaaagaa aacaacagtg 1041300

gtgagagtga ggaggcagag ccctcggggt gtcttcatct ttggagctgc agtgtcttga 1041360

gtagtcttct agcaaagtca gcaggaggtg acagagccac agactgtcag acttgtcaga 1041420

ccccagcttc ccagggatgt cacatccctg agtctccagg tctccacttt cctcaggctg 1041480

ccagacttgt cagtccccag ctccccagag tgcacaaatcc atgagtcctc agcttcccag 1041540

tgctgtcaca gacatacatc cccggtccc cagggtgta ctagtgaaca gtcactgtgt 1041600

gactgcctgc ttcatgggtt agaaggaaca ctttctgca taggtccag acctgtggct 1041660

gtgtcaggga gcttttcta atgttagagg aaccactgt atacgtcctg tacattaaat 1041720

acgtctggct gctgtggacc gtctctaaag tcacaaact ccagtagtgt cgagggagcc 1041780

aagccccac agggttcaca atggctctg cagtttctt acaaatatga aaaagtaact 1041840

tgtctttcac tctcattctt ttgtgaattt gcagtagttt tcggtggca tatgatatag 1041900

ccacaattca gaaacgctg ttaaaatgat agttccctt tccaccttc atcccgctag 1041960

gtcacagttt cttcatgctt gaactacaa taacaggaaa cacttaaaa cacaccgtca 1042020

caaaagcagg tgtgagaagc caggatctt ctactagtc aaacattaa gagatgggta 1042080

aatggagcca ggagacagct cagtaactag catgtgtgtg gctcttaatt ctgtcctcag 1042140

aatgccata accaaaataa tctagtaagt atctcaatta atactactgt cgtatcttct 1042200

tttgctttgg aaggctttt tatatagaca cattgtttat gttagagctt attgtcaatt 1042260

ctctccttct atgaaagttc gggagattga actcaggttg tcaggcttgg cagctgacac 1042320

cttaacctac ggagcctctc tcacaggtcc caggagcag caattcttga tggacgtgcc 1042380

ctacttecta tagcagetgc aactgtcgtg gcaccctgga taaatgaaca aatgcctct 1042440

aatactttct agatgttggg tggaaatctga ttagtatac attcttctg tcctttaaca 1042500

cacacacaca cacacacaca cacacacaca cacacannnn nnnnnnnnnn nnnnnnnnnn 1042560

nnnnnnnnnn nnnnnnnnnn nnnnnnnnnn nnnnnnnnnn nnnnnnnnnn nnnnnnnnnn 1042620

nnnnnnnnnn nnnnnnnnnn nnnnnnnnnn nnnnnnnnnn nnnnnnnnnn nnnnnnnnnn 1042680

nnnnnnnnnn nnnnnnnnnn nnnnnnnnnn nnnnnnnnnn nnnnnnnnnn nnnnnnnnnn 1042740

nnnnnnnnnn nnnnnnnnnn nnnnnnnnnn nnnnnnnnnn nnnnnnnnnn nnnnnnnnnn 1042800

nnnnnnnnnn nnnnnnnnnn nnnnnnnnnn nnnnnnnnnn nnnnnnnnnn nnnnnnnnnn 1042860

nnnnnnnnnn nnnnnnnnnn nnnnnnnnnn nnnnnnnnnn nnnnnnnnnn nnnnnnnnnn 1046640

 nnnnnnnnnn nnnnnnnnnn nnnnnnnnnn nnnnnnnnnn nnnnnnnnnn nnnnnnnnnn 1046700
 nnnnnnnnnn nnnnnnnnnn nnnnnnnnnn nnnnnnnnnn nnnnnnnnnn nnnnnnnnnn 1046760
 nnnnnnnnnn nnnnnnnnnn nnnnnnnnnn nnnnnnnnnn nnnnnnnnnn nnnnnnnnnn 1046820
 nnnnnnnnnn nnnnnnnnnn nnnnnnnnnn nnnnnnnnnn nnnnnnnnnn nnnnnnnnnn 1046880
 nnnnnnnnnn nnnnnnnnnn nnnnnnnnnn nnnnnnnnnn nnnnnnnnnn nnnnnnnnnn 1046940
 nnnnnnnnnn nnnnnnnnnn nnnnnnnnnn nnnnnnnnnn nnnnnnnnnn nnnnnnnnnn 1047000
 nnnnnnnnnn nnnnnnnnnn nnnnnnnnnn nnnnnnnnnn nnnnnnnnnn nnnnnnnnnn 1047060

 nnnnnnnnnn nnnnnnnnnn nnnnnnnnnn nnnnnnnnnn nnnnnnnnnn nnnnnnnnnn 1047120
 nnnnnnnnnn nnnnnnnnnn nnnnnnnnnn nnnnnnnnnn nnnnnnnnnn nnnnnnnnnn 1047180
 nnnnnnnnnn nnnnnnnnnn nnnnnnnnnn nnnnnnnnnn nnnnnnnnnn nnnnnnnnnn 1047240
 nnnnnnnnnn nnnnnnnnnn nnnnnnnnnn nnnnnnnnnn nnnnnnnnnn nnnnnnnnnn 1047300
 nnnnnnnnnn nnnnnnnnnn nnnnnnnnnn nnnnnnnnnn nnnnnnnnnn nnnnnnnnnn 1047360
 nnnnnnnnnn nnnnnnnnnn nnnnnnnnnn nnnnnnnnnn nnnnnnnnnn nnnnnnnnnn 1047420
 nnnnnnnnnn nnnnnnnnnng agcgcctctct ctctctctct ctctctctct ctctctctct 1047480

 ctctctctct ctctctctct ctctcccagg ctctcagcca ccagagcaag tgggaatgcc 1047540
 aagatgaggt agaaaagggc tctcaaagcc ctgtgagggt tacacagaaa acaatagtga 1047600
 gcatcacatg tccttctgaa actatgttct caattccacg gattcttgag atcattgatc 1047660
 cggacattct acccacaggg agcttttctc agaagecctc ttacctceca acacatcttg 1047720
 aaacaacaca cccttgctc ctcttggtt ttcaaatcca tcatatcggt attacagttt 1047780
 gtttcagct aaccagcccc tgcacgcca gcccccctgc atttcagcc tctgcatgcc 1047840
 cagcccctgc atgccctctg actctcaagt tttaatgttt gatgtaatcc tcaggacagc 1047900

 cctgggaggc agagctgtca gaactattac tcttcatctg catgttgaaa aaaatcacat 1047960
 aactgttaac cgtaattca tgaacctact caagaaaata tttgttaaat gcctgcaaag 1048020
 tgtcggacac taiggtagac tccaggcaca aggaaggatg ggaaaaagat gtggccctgg 1048080
 tcttaagga gctgagagag agagagagac agagagagag agagagagag agagagtgg 1048140
 caagaggggc acaagcatcc cattgagaat gaggggaggg tgaggagagg aagaggtcag 1048200
 cgagcaaaat gggcagccga ggaccagcac acagaccctg tgacggcaga gtcgggtgtg 1048260
 cctgaggcac agaggctgg gaaggaggtg gggcacacag ttcaggatga aaacatgact 1048320

agagtcccc ccccacacac acacacctat ggaaaggcca ggggttttat tcttgattta 1048380
 ggataaactc tggagtttta acagaaaggc agaattgtgc ttctaagcgg tgtctatgtg 1048440
 caaaggcggg gcaggcacca ggggccagca gtccagatgg acacatgacc atgcaaacc 1048500
 cactcactgc agctgcgtca cctacttgta aagcaatgga gacgtttgat tcttgctcgt 1048560
 ctatggatgg ggaacctgag ccatgaggaa atgctccttc tggggccttt ggttcccagt 1048620
 gagttagaa agtacattct gtgtgccaca gggtcacact agctgacgga ggtgtaatgc 1048680
 cactctcagt taggtttctc gaatttcccg atactgcagg cactcgaggc catcgacaag 1048740

 gctcttcagc tgaagcccag ggacccaaaa gtcgtatctg aactcttctt cacaaaagga 1048800
 aaccagctga gagagcagaa ccttctggac aaagcttttg aggtaaggcc aactaacag 1048860
 tcattaagtt tacaggttta aatgaatac acagccaatg agggagtcta ggtgtaact 1048920
 ccagtcattg gtggtctgta gcatgaatgt tgtgattaat tgacagtgct acagactcgc 1048980
 ttcccttggc ctctggtttt tgatcacaca cacacacaca cacacacaca cacacacaca 1049040
 cacacacaca cgcacacgca cagcacaca taacacaca catacataca cacatacaca 1049100
 cacactcacc acacacacac atacacacgc acacacacat acacacacac acacacacac 1049160

 tcacactcac cacacacgca cgcacacatg cacgcacaca cattcgcata tacacacaca 1049220
 cacaccaccg cctctgtgtt atctcttaaa agtatggtag atggggaagc attcaaagct 1049280
 cccaaattct ggaattctga agagacacct aactgtgtg gtgatctctt gcttgtacia 1049340
 ataaagcctg tctgggggtc agagaatgga gcttgtcact agctaaccat agaggctcggg 1049400
 aggtctgtac agacagacag gaagtgaggt agctgggaga aacaggatcg atctctgctc 1049460
 tgctgagacg ctgaggaggt aaggtgtggc tgtggcttga tatctcaaca tttccctcta 1049520
 tgtctgactt caggtttttg ttatctagac caagtatgag ctccatgtac aacaccgtct 1049580

 gttttgtctt caagaagctc ggtcacagct ggactggagc ccaagtagct ttgggcactt 1049640
 acatgtctgt gacacctgcc atcactcta gacttcctct tatcccagg gctctgtctt 1049700
 tcctgggaag accctcaga ccatcattc ctgcagtac tttgttcta aagcttaata 1049760
 aatatcacat catgggtggc tcagtgggcc aaggcacttg cctccaagc tgaccaccta 1049820
 gaacctgctt ggcggaagga gactactgac tctccaagt tggcctctac ctccacatgt 1049880
 gtgcagtgac atgcatgtac ctacacacac acatactaaa atgtttaaa acattcctat 1049940
 gttagcagga tatagagata taactggaga cagagaaaat aggatgacag gttcaagccc 1050000

 agtgagttcc agggtaacaa ggctgtaatg agagactctg tctcaaaaa aaaaaaaaa 1050060
 aaaaaagaaa gaaagaaaa aagaaagaga aatgaagaaa aaattaaca ctccatcatt 1050120
 aaggtatcaa gtcatttggc cccaagcagc taaaattaca gaagtgtgcc accacatctc 1050180

agctttgaag agcttccaaa aggcagaaga aagagggtgtt gtgaccacctaa taaagcaatg 1050240
 tgagcgtgtt gctttcttta gatgtttagc aacaggttgg aggttgaagg gcctgggcta 1050300
 tggttaagct gttagaagag caccttgggt tctatggttt cctttgtctt ttctttctct 1050360
 tctttctctt ctctctcttc ttctttctct tctttctctt ctctctcttc ttctttctct 1050420

 tctttctctt ctctgtcttc ttctttcttc tctctctctt cctctctctc ctctctctcc 1050480
 tctctctctt ctctctctc ctctctctc tctctctctt cctctctctc atccttattg 1050540
 agagctgggg ataaagccca gggcctcaca tggactgagc ttgtgctctg cactgagcta 1050600
 ctctccttag attctgtaat gctgacagca gtgctctca tcagctcatt tatggtaggg 1050660
 aaggctaata agcacagctt tctgcagag ccagagaaac gagctgtttc agaagtcctt 1050720
 gggccccac cagcaggcca gagatctgct gtactgaag cccctggggt ctctccactt 1050780
 cagaaccatc aactctaaaa ggatagcaga ctaaacctgc caccgcctaa gtggccgtta 1050840

 gcgaccaggg cctccacaca ggcaggggtt tgcacagttc cagggcacct tagacactgt 1050900
 gtctcatgtc ctaacatgaa actttccttc tctgctagag ctacgaagct gctgtgacce 1050960
 tggatcccga ccaggcacia gcatggatga acatgggtgg tatccgacac atccaggtag 1051020
 gggtagcact cactgtgttc ccatcctaac cctggctcag aagccactgt ttgtagttag 1051080
 agtttctctc ccacctggtc cacaactgtc tagccccaag tgagacatag agaattttat 1051140
 tagttagaaa ctgtttggcc gatggttagg gcttcttact ggctagctct ctcttaatta 1051200
 tgaaccatt actgtaaatc tatgtattgc cacaaggctg tggcttacca gtaacctggg 1051260

 atgttactcc ttcgtcagca tgggtgtctt ctccaggctt ctctgggttg ggtagccctg 1051320
 cctatgcttt ctgctggctt tctggccaat cagtgtttta ttcatcaacc aataagagaa 1051380
 acatatacag aaggacattc ccatcaactg ttcatcatct ctcttaaatc atttcaatac 1051440
 ttaaacagg cattttgaaa gtaaaattca gaagagctat gttttctgaa tagtgaatat 1051500
 cacgggcctg tttaaatgtt tataaactca actccacgat actgtggatc gtaaggaaat 1051560
 cacatgtgtg agaagaaggg ttaccagaca atggctcagg tctgagtgcc ctaacctgtg 1051620
 aagcctgcca acgccccagc aataccagac tgttaatcta aataccctt tactatttct 1051680

 tattttttat tatatgtgaa tgtggttgtg ggtttatagc tatgagtgcg atgccttcag 1051740
 aggtcagaag aggggtgtctt tgggtccctt agcctgggag ttaggggccc ttgtaagatg 1051800
 ccagcacag gtgctgagaa ctgaacgtgg gtctctgta tttaatgtta ggaagctcta 1051860
 cccagcccca ctctctcat tccagacctt ggccttgaga aagcctgcta tcagtggctc 1051920
 ctccccctgg gatgctcaag accacacctc caggctgttt aagattgggt cctcacctgc 1051980
 cacctggttc tccttgggg tttctccctt tcccctggga gcaccggga atgctttgct 1052040

cagattaaac ctgattttac ctatttggcc taatctgatt tagtgcac ca gcagagaaac 1052100

 acttttcatt tataactttc tcaggtggaa tataccagaa attaaagttc ggttgtaaat 1052160
 ttgaagtaga aaggatatac ctgagagcat tcaaaagagt aaatagtgt aattattctg 1052220
 tatttaaact cagagctgta tgttggtaaa acagagctct ggagattgaa gcaatatctg 1052280
 ctgggataaa tgttttcaaa ttttaattgac attcatttaa aagaaccagc ctttgtcact 1052340
 gcagacatca tggattagct tgagcaatag gaaactcccc catccacagt gaacaattc 1052400
 aatgggtaaa ttgaataat gtgatctgat ataaatgtgt gtagtgggca catagcttgg 1052460
 cagtggatcat tctgacacca ccataaaagt ctaggattat cactgaaggc acacaggaac 1052520

 aatcctgaac ttctgtgtc ttttcaaga gtgttcatca ctggagaggt ggctcagcgg 1052580
 taaagagcat cagctactct tccccaggct ctgagttcaa ttcccagcaa ccacataatg 1052640
 gctcacaacc atctataatg agatctgggt cctttttctg gcttgcaggc ataaatgcag 1052700
 gcagaacact gcatgataa taaataaata atagtgttca tcacaacgct acccatcctg 1052760
 gtcttagccc ctgccctgtg cctgggggtat agagctctga gggatatgga ggtgaagaat 1052820
 tgaaataagg ctttgagagg aggttagcaca ggaatagggg aaagacagtg aaggttgtgg 1052880
 ctgccccagg aaggaagggg catagtcaca caatgtgtct aaggtcagtg ctgtgacctg 1052940

 aagtgcctca gatgtggaca gtcaagtcta actgcagccc ctgctgctaa ttgtatgggg 1053000
 tatttttagt gtgtctgcat ttggatggta ggccattcca tgaggtccat tacagaagcc 1053060
 tctcttgatg gtatcttgc tgttcagaaa gtgtcaggct ttgaacaatc tgcattttgg 1053120
 gggttagggg tgcctactct ctgatagctt ccatgaactt ttatgtgagg tgaagtagat 1053180
 gggctggaat ttcaagctgc aatgggagtc tgcacatccat gccatattc aaatactgtt 1053240
 tcagcttggc ttgatgacga ctttcagaaa tgggtgtgtc taaaagaact ctcggtctga 1053300
 tgagggtgtc ccatgtcttc actgtccaag gagcagtgac tggccatggc aacggggcac 1053360

 aggaaatgtg tctggatga ctgatggttt ttagtcttaa ttaattaa ttcagttcta 1053420
 gaaatcagat aattctagtt cctacatagc atagaattag agtcattgac ttaagggata 1053480
 tgatttcttt ttccaaaata aataaataa taaacaggat ttacagtttc atcaagaaaa 1053540
 gagaactttg aagtagagag gggaaactgg attttgtgta aaaaaaaaaag aaaccagtg 1053600
 atctgaaaca atgccaaagt taaggatgag gcctaaattc agggtagcct ccagggacag 1053660
 tttgagggcc tgctgcgtgg agaacttgc catcgagccc ttggatccac agcctgcagg 1053720
 tgcccaaacg tacattaagc ttaacagaaa ccagaggctt ggaggaggag ttaacaaaac 1053780

aacaatgcag cagaagtgtg ctccctgttc caagtcatag gcataaattg tcagatataa 1053840
ctgtctactg cacaaccagg tgcaggcttc tcagtgtgca attccttttt ctcttggttt 1053900
ttggaggttg attttgtttg ttgttgttgt tgttgttgtt gttgttgttg ttgttttccg 1053960
gcatttccac gccgtcttac agcagctgca cgcataaaca aacagcatga gaactagaaa 1054020
gtgagtcag gagactgaac agtctactca gtggagactg aacagtctac tcagtgatgg 1054080
ggggtagctc gagcacctg ttgaggctc actgtatc aggccgggtc taagctcttg 1054140
atacacacga acacatgtgg gaagatgctt ccgcctaggt aggcattagc cgctggtttg 1054200

gggagtgct gtttgaatt gtggtgaagt ttaaaacatc gctgcgtcca cccacgtggg 1054260
agccgcagct gaggatgatg taaaagtcga tgtgttgttt tagagtggga agaaattggg 1054320
cagctccccg gggaaaggct aaagccccag ataggagaga cggaggaaag agtcctagct 1054380
cagtcaccgc tggatgatc atgagttcct attttagtct caggagtgtg tgtgtgtgac 1054440
tccaagggtg taaggtagaa gcttcacctc agtcgctggc atccatata acccaaagag 1054500
tctgaaatgt tatggtggaa gctccacca ggtccccctc cccgatctcc ctccaaacce 1054560
tgctgcatct cagaaagccc tgcagagatg ggcaacacca ctcccacagg gtgtttaaac 1054620

tgctcccaca gaaaccagac ttgtggtttt tccagtctcc ctttccatc tctgtgggg 1054680
ggaagagggg cgtggcctgg aaggccattc gggagcactg catcattaa acgtgggctt 1054740
tttctaattc ggctgatgt gggtggctgc atcgacggag aggcctgctt atcgggggtgc 1054800
agaaactttt cagaaagcac cagcatcacc gagagcccat ctgagctgtg tctccagagc 1054860
tgctgcccga gtctcagcca cctggagtcc cctccctcaa cttgcagcca ctgttgactg 1054920
cttatgtgac ctgagagagg ggccccagaa gtctgcaag tctcatgagc ttcccgcgcc 1054980
ttgcttgctg aggaaacagc agacactgta acagagagtc ttgggctctg caggactcag 1055040

aacggcaagg ctgcactgga ggaggagat gagcgttagg ccgtagagag gggagcagga 1055100
gaagctactg gcctgacca gctgggcca ggacacaca agttattaaa cagatgaatg 1055160
ctgacaagaa gtggggcggt gtgtgctcag caggtcagag gtccattcc ttcttcctc 1055220
cctcctgcag caagtgtcta gctggtactt ttcaaccaca tacctggct aggagataaa 1055280
cctgtgtcca tcttaaggg gtttgggttt ttttttttt taagatttat ttctttata 1055340
tgtgtgagat ttgctgttt gtatgcatgt atgtacgtgc accgtgtgct gccgtgctca 1055400
cagaggtcag aagagggtgt tggatcccct gaactggagt tacagacggt tgtgagccat 1055460

catgtgtgca tgtgtgtgct gtgaatagca ctgaccccaa gggcccccta gaagaacaag 1055520
tgctcttaac catcctccca tctctccagc cccaagtcca cctttaaatc aagcctcaaa 1055580
ttgtgtaaaa ctgcattagg caaaggctga tattgtgttt caagtgaag attagaacaa 1055640

acttagaaaa taaaatagat gtctgtttaa ttattgctct ccctccctcc ctccccacc 1055700
 ccctaccca agcctatttg cttaccgaga acagcagacc agtgctaacc tccaagaat 1055760
 actacaaaa gaccgcctcc tccttccct tactaggaaa gctgaaaaat gtgtttctgc 1055820
 catttaactt atgggtgtagc agctatcaga ctccacgttc tccagctggg ctggttcgtt 1055880

 ctctcttct tcttcttct ctttcttct ttcttcttct ctttcttct ttcttctgtt 1055940
 ttgttttttg agacagggtc tctctgtgta gctttggagc catcctggag tccagcttg 1056000
 gattaaaggc atgtgccatc aatggccccg gcatggtctg gttcttaaaa caaatggatt 1056060
 ccccaaaagc acccaagag ataaggatta aaatattcac agataagggt tcctttgggg 1056120
 aacctgaact ggaagggcaa agggcgggga gagagagaga gagagagaga gagagagaga 1056180
 gagagagaga gtgtgtgtgt gtgtgtgtgt gtgtgtgtgt atgtgtgtgt gtgtggggtc 1056240
 ctctctctca tctcagagg gttatgctaa gcaatcttc tcttgttcta cccccacc 1056300

 ccaggaagc tatgtgtctg caaggggcta ttatgagaga gccctgagc tggttccaga 1056360
 cagcaagctg ctgaaggaga atctagccaa gctggatcgc ctggagagaa gttacaaga 1056420
 agtcagagaa agggatcaaa catagacca aggacaaagt cagtgggact cagcaggctg 1056480
 gatgagaaca gaaggaggcc taacacacag tgggcccgc agccaggcag tcccctctg 1056540
 gtggcacagt agtctgaaa gagtgtttc ctgaaggga caaacagcaa agaggagcaa 1056600
 acagtctgaa ggaaggaa atagcatgtg tcttacagg ctctcccgt gtcactcca 1056660
 gtccccagga tacagaactc cattctact gtagccaga aacacagaag ctgaagttc 1056720

 ttagaggag acagctattg gtaaggaagg ctgtatctg tgaagtcagc cttggggaa 1056780
 atctactcgt agaagttagt taattctcaa gaatccagag tgggtggtga agagcattgg 1056840
 tagaggcttt gtgaaggctc tgggcagag cacttgatcg gcaggcttg tctaataatcc 1056900
 cccaagagta tcaactgagga ctttggaga agtacattaa attccactct gatagacgtt 1056960
 ttttccagt gcctaaaaca cgaggggacc gtctagaatc atactgggt atcattatct 1057020
 ctacaggaga aagcttctg agcagttaaa aacaaaagtt cagattttgc ttgattagtt 1057080
 atgggaatat ttttaagtgt ttgaattgta ttccagacgt tgctagagtt gtgtctccac 1057140

 tctgaaactt cccagtgtg tagccaaaag atgtctgcca cttgaaata tgctgctgt 1057200
 gtgtggagcg gtgggtgca ggggtgactc tgctggaag tgtagagag ccagtccaga 1057260
 gaggtgctct ctttattct cttaaggtca agacatcatg agatttatta ttttgaaag 1057320
 atatatata gcatcaagga acctttacat tgtgttcag aattcctcca ggactgagtt 1057380
 gaggggaaga gagctctatt tattgaattt tgaggttag tgggaattgt attcttaaaa 1057440
 gacaaagtga ctctctgctt ggcaagttt cagactccac agagaatgct ctgaaactct 1057500

tgggtaaaat ctaaattcat aatTTTTTaa aaatatatTT atatTTaaaa atgaggaagg 1057560

 caaagctgaa atcataatTT gacattatTT tagtgTTatt tattgtataa cttataaaat 1057620
 atttaatatata tatatatatc cacatgtctg atTTTTTTTc ctctgtacat agcagctgcc 1057680
 aaaaccaatc atatgaaaac tgtaaaacag gaaagctTTa acaatctccc ctgaattata 1057740
 ctggttatta atTTccactt atggaaagct aatggaatta ggggtcagct cagtgtTTgg 1057800
 gtatcagtga aggagctgga gcacctgctt ttaactgggt actaaccact gaaaacagaa 1057860
 accctcaggt aatgcaggtc ccgaagctga gccagctgtc acacaacat gacaaggTTg 1057920
 tctcacctgt acagccaggc cagagggaga gccctctgct tcttgcaacc cagcattggg 1057980

 atgcagtgcc tcctctgtgtt atTTTTTTTT ctggcaggta agTTgaaata aatggctgaa 1058040
 aacttatttg aaaaggcattg gtgaagccag ggagtggTgg tgcatacctt taatcccagc 1058100
 actcgggagg cagaggcagg cggatctcag tgagTTcaag gccagcctga tctccagagt 1058160
 gactgccagg acagccaggg ctacacagag aaaccctgtc ttgaccctg cccccctccc 1058220
 caaagggggT ttgactcagt gcacacctac gctTTggagc tagtatctgt cactatcacc 1058280
 tgattatgta attgtctgtc agtTTtacct atcataaatt gatccggaat ctcaattTct 1058340
 tccatctaag acataacatc tttagtacca aggtcaaaag tatgtactac agcgtTTatt 1058400

 ataaagcagt tccaagcccc ctaatTTTga aagcaggggg tactTggcaa catcttagta 1058460
 ctactTTTTa gaatagcgtt tgaccaaaat gggTgcatgg aaaaccaatg ggacagattg 1058520
 aactgcagag tttgacataa cTTTccctTg tGtaaagtgc tacagaaggt ctcagtgtaa 1058580
 actTgttaga ataattaaaa aggcaattac aacataaaca tTTctgagga gaaaaagcca 1058640
 cacattgtct aggagattgc cgccatcagg cctctctcct tTctcctTg tctgccatt 1058700
 ttggcacctc ctgagcagt aaaaacaagc actgctTaaa aagaaaaaac gaaatctgct 1058760
 tgctTTgttg gctcggatat taaataagcc aatgagatag tTTTcatagt agaaatgttg 1058820

 cctgggagaa gaaaatcagt tgtgaagtgt tTctcaaagc tgtTgagtgt gtctTgtaac 1058880
 atgctatTTg gccctggTga tgtggaataa tacctggggag tcattacagt agaaagagag 1058940
 agcctggctt gtctTgaaaa tgcatctgat ttgccattgg caggcgtTg ctccatgagt 1059000
 gactggagag ctgtTTctga aacctaggag tggagtTggc tTTgtgact caagtactct 1059060
 gctggcaaca ctagcattgt cctTgtcttc atcactggta ctgagaattg aaccaggac 1059120
 cttgtacata ccaggaagca ctccccactg agctcgtgtt tTTgctTTTT tTtaaaca 1059180
 gggTccagcc ctgtgtctca gaattctgta accctgggtt acagaattct gtaacataac 1059240

cctgggtatg ttacaggagg ccacaaagag tgaatcagga gttgatttgc cttggttgat 1059300
 cctccagtat agtggctcct ggaggtcttt cctcccttac acattgagcc attcacatct 1059360
 gtgtaacccc tccccaccg ttccatgtca ggctgtcaa tcatcccacc tagaccagct 1059420
 ccttgtcatg aaatccatcc agtggcagga tattcacttg ccctttgaca cagaaactat 1059480
 aggaatggct ttgttgctt attttaatt tagggattat tcagtcagga tttttcaaag 1059540
 tgattcaaat gtttcaggtt attaaccctt ttataaaatc tgttttggtg gtgtaactca 1059600
 ggtgaatgaa ccaaaaatgc agaaaccata gggaaataag tactttgggg gtgctgggtg 1059660

 ccttgtttgg ggtgctgggt gtttgtttgt gtggttctgg ggctagaact ccatgcacac 1059720
 caggcaagct gtctgtcact ggctaccagt gtcactcag ccctggactt gtttatttgg 1059780
 aaggttatga caaagcaaag aggtttctgg tctttatcag tatgcaggtt ctctctgaa 1059840
 gtctgcagca gagttttcca caggcctttt tcagttttca ggcaagacta aataaaaaat 1059900
 tccacaccac accgcagaag cccacctgag gtgactgaac caaggagaaa aagaaagcaa 1059960
 gtgtccatt tctgttagc aaatggtcta catccttggg attacagagc agcatggact 1060020
 tgtaggagge ctcccctct gcacagggcc tctcagcaact gtctgccttg agagaacagc 1060080

 taggattctt ccaaactccc taagaccag ctctctgttg ccagcaaggt cctacagagc 1060140
 tgactactct aacgaggttt atgatttcta ccaaggagct gtgaataata tegtgaatt 1060200
 tttatttcta gctactgggc taaaatgagc caaagaattc taaaggatga gtcattgctc 1060260
 tgtgggttgg tcaaggctat tattcctaga ctgactggca ggtagctgag taggggtgtc 1060320
 ttatgctgtg gcaactgaac tataatttgt ccttctattt agaaaattct tgggtgtcaa 1060380
 atggagagge accaccattg ccagttgcac aactaggtt gtgtgaggtt gccaaagaga 1060440
 aaaaaatgaa caaaaaacct gatgtctttt ttactctta gaaaatgtcc atggcacaga 1060500

 gattgtctct tectgcctgg cacacagaca ctagggtttt gttatttagt tectgattgt 1060560
 actcactaaa acctgttttt ggtgtcctga gtgtgggtggc acacatcctt agtcctagca 1060620
 cttgggaagc agaggcagge agatctctga gttcaaggcc agcctggtct acagatcaag 1060680
 tttcaggaca gccagggcaa tatagagaga cttgtctctg aaaaaccaa ccaacaaac 1060740
 aaacaaaacc accttataaa aaagatcat aggcaaaaat gtctgctctt gtctgtggtg 1060800
 gatccatcca ggggaatgat aaaccttcat gagattggtg atgacaccga aagcatgagg 1060860
 ctatggtaga agtaggctgt ttcgttttct tgttttcaaa aatcacactt taactgtaca 1060920

 taggcatcac cctaattgcag caaaaccaa gtctctaat gccaccattt tacattgagc 1060980
 agcaaaaacc aagtctctaa atgccaccgt ttacattga aaaagtgtaa tgtcgttcaa 1061040
 acattccttt cagactgtag ctgtataagc taagacttta gactaccaag aaccaatatt 1061100

tggaaacatt ataattcttg ccattattct cagtttccaa tgaaaacatg ttatatagtt 1061160
 atgaaaacac ttctaagtgt ttgattctg tgagttcttt gttccaagag aggagataaa 1061220
 gtaatctgag tacaaaatgt gggttcgtat tagagaggaa caacaagatg gataaaatac 1061280
 ctggtgcagt caattggttc atattaaaat agtccatfff caccaccagg gctctttggg 1061340

 ttaaagccat tggaacaac tttaaaaaca acaaaacaaa taaacagcac ctcaacaatac 1061400
 actgtcctgg tccaagtgt aatacaggtc accaggaaat gcctgcaagc agaggfccag 1061460
 gatatctcct cctgtcagg ggcatatggt atgtattagt agtgagcctg gaagtcttg 1061520
 ctgtgcatac cttttggggg ttatttagcg gctagcccat ggtggaggcc cactagtcca 1061580
 ggattcttca ttctggggtc attcactcia aggagtccac ttaccagggc aggttatcc 1061640
 atgtcacagt aaagttgtc acctatgaag cactcactgt cctgtccagt ggttcccggg 1061700
 ataccacgag cctctgaaat gcactaaaaa gcactatgta tctgtggaga taatgattta 1061760

 agtcctgact gttcttghaa caaccacaac aagggaagac taggctgccc aagtgtgta 1061820
 cttcacaata gtaactctta ctttacagtt gtgcttaaaa gctcttatgg tgaccctgtc 1061880
 actttcctgg gggagtagat aacatcttct ccttgggaac tgaggtgctt gtagaagaca 1061940
 gtgcttgttt tgacatgtgg aagtcactgt gtttgggtc aggaccttgg tctttcttc 1062000
 tgctactcaa gtttctgtt ttggttgggt gtatataaat gtacatccgt gttatTTTTg 1062060
 ctgtgctgct taaaatattt ctccgtttaa gctgactgt atactttgcc taagtctttc 1062120
 aaaaataaaa tttatgtaaa tgtctatfff atataaaaca tgctaaaaat aagaattctg 1062180

 tctggcctca gtctctcaag ttctgtgget agaateccacc agtagccttt ttgctggtgg 1062240
 atctgagctt caaaagcaaa ggtggcctct ctctgtcatc tttcaggaca cacagtgact 1062300
 gcttcccacc cacaccaac tctacctca ggccaaaacta cctgctgcta gcttggtagg 1062360
 tgcagatggg agttagaaaag caagggtctct ctggcaacat cctgtactcc atccacaggc 1062420
 gtacctggac ccaaccctat cttaccgca actttgtcct ctccattaac gtcttttact 1062480
 ggtactgtct taaagctgcc taatgggtgg ggacacattc attcgatcac tagcacaaaa 1062540
 aggggagaaa acaccgaaat ctccacaaa acccaggaaa agtcctctct ttagtcctcc 1062600

 attttghaa taactgctag gttcttttc accacaatca tgctttttcc ctagtacct 1062660
 gccatgtttg ctcaggactg ttgtcacac cacaggaaaa aaatgctct cctgtcccc 1062720
 agcaaccatt acctgccttt atatctcag ggagagagg catcacagac actgcttggg 1062780
 tcttgtgctg atcaccaaac tgctgagagt acaagaaaga gtacagccac actttctgaa 1062840
 taggaaattg ctactgacca actctaggga agatgtgtcc aaaccaaagg caagatattc 1062900
 cgtgtgccac aagttcactc agggcagccc agaccctcc ctgcgactaa tgttcttttc 1062960

ttttacttat ccccatgttg tgttatTTTA aatatcatcg cactgtttct ctactactgt 1063020
 agacagtTTC tacttgccat tcattatctt tgcataatc caggcaaacc tgaccccgtc 1063080
 tctcaagcac ctgagcatgg catggcaggt gtctgtaacc tggccctTTA aaagaaaaac 1063140
 cccaccact tcctcccctc ccccctgttc cttacagccc cccctctctc ctttcttttc 1063200
 tctcaccct tttccctcc ctctctaatg aaacttccca ctctgcctgg catttttgtc 1063260
 cctcaccgc catggaacc accaaggtcc cccatgtatt ttgttctaa cggctctatt 1063320
 agtgggcctg aagtTatcta gccacctgcc agtctgcatc ataattcata ccgatgggct 1063380
 cttttcccat ggatggaag gctttgttag ggtgaacctt tgtggatgaa ttctctacat 1063440
 taggataggg tctccatta gacagagggc tttcaactct ggtaacaaca atcatgacca 1063500
 gaactggatc atggcgcccc tgcagttact aagcaacaca gctgcccagc tgcggatgat 1063560
 agctttactc caaagcttt tgggtgggtt ttatattacc tcttactgaa aaagaatgtt 1063620
 tagactgtgt tcgactctga gtgtcattgg aaaacaatgt tcacctgggg taaatgagag 1063680
 ctcggtggag tgggtgggtg ggtggggtgt gcaatcctca tggcactggg gaaagaaagc 1063740
 agaactctgg gaggaataag ttageccagc actagccagc cagctcacag tgggatgctt 1063800
 ccaggagggg acacaagct ggaaggtgaa tattgtacca cctctgcccc aagcccactg 1063860
 cctcatttct gtggacttgg atcatgaaa tcaagtaaca ctctttgggt gcctgcacct 1063920
 gaacttgcca tttttagtct actgcttcca tgtgtctgcc ctcccaactt caagagacag 1063980
 tgaagccctg ggcggagggg cccaggattg ttgatatatg caatgtcctt tcaggcttgc 1064040
 cctttgagtc tgatcaaata taactcaact aatagtctgg cttttattcc tttcccatec 1064100
 tcagcgtaac ttattacat acagtattga tggagaaaat actgacatga taccctacta 1064160
 atgaattatt atactacct taaacaacag atcacacagc attggctcag gctgttgaag 1064220
 tggatggtag aactacaac ccaggaaagt agtgagtgtg aacattcttg aggagcaaga 1064280
 gcttgacag gcttcttaga ggccaacag cagttaagcc ttgaatctcc tgttttgaga 1064340
 agtgctcact tgcactagc gtggattccc gggttcagtg ccaccgtctc tgcactctac 1064400
 ttagtctgc agatttcagg ggtctaatat ttcaatccca ataaccacct cgttctca 1064460
 gatctgttgc aaatcccatg ggggatttgg ggcttactgc tacggagcct cctccttaga 1064520
 gcctgtgtgt cctggcatct ttggTgcaga ctcagctctc taaccttgac acacaggagg 1064580
 ggacctttag ccatggggac acctctcccg gggccagggt ggggcaggag gcactaggaa 1064640
 accagaatg accaggttga cagtgaagag aatgatcatg agagacacct gaaccggag 1064700

gtgtgacagg tgcagccccg tgttgccctg agaggaatta aacagtcatt tgagctcact 1064760
 tcctcacttg gtatcagcag tctgtgggtc aggagggtgc agagctctca tggagcctct 1064820
 gtctgtgaat ggactgctgc tggcgacctg taacccccag aacctagtag gtgagtgaag 1064880
 gcccttgat ctgccaccag gtgaggctca ctctccatgg cttgctcgct ctggatttcc 1064940
 tatggttga gtcactatgg gcccataaat tcccaaagga aggctgtct tggtagaatg 1065000
 ctctcatctg gggatttggg gcttttctact acggagcctc ctcttagag agcctggtgg 1065060
 tcctggcatc ttgggtgcag actcagctct ctaaccaaat ctagtccag aggtagggt 1065120

 gtttctctcc tgtcctgggc cttgtcttgt tagggcagcg tggggccagt ggcagggtc 1065180
 tgagcaacct gagctgctg tggggtgttc ctcaagaat cccaaggaag ttaaggagg 1065240
 gggggctgt gaaagctgag tgacttcaga gtgtctgtgc caggcctggg aatctgactg 1065300
 aaatcttgac aaagtggatc tgtaagcaca ggctctgtgt gccagatata gccacctgtg 1065360
 tgtcttctg cggcgtgag gtgagaagca cacacatgca tgcaagtacc cagaggtgcc 1065420
 agaagagggc atcagagctc ctccaactgg agttaggcac ttgagagctg ccatgagggt 1065480
 gctggaact gaacctgat cctctggaag tgcagccaat gctcttgact cctgaaccgt 1065540

 ctctccagct tcccaaaaag tacttaagac atttccagg accctgtctt catgatgtgt 1065600
 taaccttag taaccaattt atcttttgc tcttttctaa ttgctcacc agtgaagact 1065660
 gccagctgc tcccataga tctcatcccc gctcccatgg ctgcctcaca cttcaaaaat 1065720
 gctgttcata atgttctgc tgctgtcttt ttttgggggg ggggatgttg ttgttgttt 1065780
 gaaacaaggt ctctctgggt agcctctggc tgtcctggaa ctactctgt agaccaggct 1065840
 ggctcgaac tcagagatcc acctgcctct gctcccagg tactgggacc aaaggtgtgc 1065900
 tccaccacac ccaggtctg ctacagtcat tttattttg cttgtcagac aaagtcaaga 1065960

 caggtgacct tgetacataa agggaaagag aggggctgga gagatggctc agctgttaa 1066020
 ggctaggctc ataacaaaa atataagggt aagagagtga gcaggagact gaaacctcc 1066080
 tgtgtttaa actgtaatgc tttataaagt taaaccaaga gccaacatgc agaggtaag 1066140
 tgtcacgac agtctcacac agtcatttct ggaggctgac acacagtagc tgaagtaaat 1066200
 cctactgagt ggtgtgctgt ggatgtgctg agcgaacaga tctgcgctct gtggcacaga 1066260
 tatactgat gggaacagca aaagtcctaa ggccagcaca gcttcttgac aaagatcctg 1066320
 caaagctgag ccacgtgatg gctgcatgc cacctttggt tttctctcca cctgctgcat 1066380

 acttggggtg ggggctttta gtatttgc attttgggga tattggattc atggagaatt 1066440
 atgaaccatt tatgccttct cccaggagta ctgcttctaa gctccccagg acagtctga 1066500
 atgtaccacc cctccccctt ttagggagat atccttatct actttaggt cttccttatg 1066560

ccttggaatt tgtgagacgc ataaagaaac cagaagtctc tttgagacta cgaaatagtc 1066620
 ttgaaacatc tgtctctgta cttacttggg aacaagatac tcaaaacaaa ggtcaacaag 1066680
 atttggtggg ctagaggagt tggccacagt tcagattgca agcctcttcc cagtatacat 1066740
 tcaggcaatt acatggcata tacagcaaca aagttagatt agatgaagtt gcctcagccc 1066800

 cacaaagact tatattgatg agcaaagtgg agagtgaaga catgatagaa gaataagatg 1066860
 tcaggacctc ctttcttag aaaagttagc aatgcagagc cacagtggtg tcatctgacc 1066920
 agggaacaaa agaatgccag gattggattt ataacaaat tttataaaga tacaaaaata 1066980
 taacattgtt attatgtcag aaattgaata ataactgcag cagctttggc ctgaggattt 1067040
 ttcttggcgc tctgaccatt aagagttaat aacacactac ttgggacatg gccgtctgcc 1067100
 tgggctgact tgagattttg ttttggctca gcactttga agacacaaaa gcctgagaac 1067160
 aggctgtcaa atgctttag attcttaaaa acagggttat gagttaatga gtaaaaatgg 1067220

 ttataaaagg tatctgttta tcaatgatgt caaaacttga ggggaaatgg gtataaaaga 1067280
 taattgttta tcaacaatga ctaaagaga tccaagagga agtaaacac atgtccaaaa 1067340
 gcaaaaaatga tatgatctat gtcttgggac aacatgaatc tatctctgct tactgaattc 1067400
 tgtataaata aatagcact ctgtctgtta gtcagtcagg ctgcaaggtt ctcaggacca 1067460
 tcatgcctgg ctactcttt cctttgcaga ctctctctg ggacttgtca agcccttggg 1067520
 ttgtcccctg aaaacttgg ccaccagcaa tagtaactgt gtggaggaca gttaatcatt 1067580
 ttcacatgaa cacatgtgtc caaacacact atatgcttca aatatgaaca gttttaatca 1067640

 cctccgagct cacagatgac tttatittcc taataaaga actttacaaa acattatitt 1067700
 ataaaataat tgggtttccc ttttgggtaa acatttacia agaaactgaa aagggccaca 1067760
 actgcttgtt aactgaaaa ggggtgaattt cttttctaaa aagtccttta tgtcatccat 1067820
 tcacacttac aatctcagtt cgctaaaatt ggcttgaat tgtgttagcc cttaagtea 1067880
 catgtccact cgtctgggta ggtcagttgg gaatgtttcg gttctctctg cagcatcaga 1067940
 aggctgcate acaagaagca gagcctccct tctgggatgg tgggcatgt agtaccgttg 1068000
 atgcttctgc caccagatgt aaccgaccac gttgtgtgtc gcctccctca tgggaccaga 1068060

 aagctgctag gtacctagcg tacggctaag taccagcat ataacagcct ggcagcgagc 1068120
 ttgcgctctg cttttcttc cctctggctg gtgctttggg gaactactgc ttccccagtt 1068180
 ctttcccctc cticcattcc gtgtggcttc catggagaac gttagcttgc tctgagagag 1068240
 aatgttaatt atgaatagt ttctgcctgc atgtaccct gaacgccagg aatggcate 1068300
 agatctcact acagatggtt gtgagccacc atgtggctgc tgggaattga actcccact 1068360
 ctgtaagagc aaccagtgt caagatcaga agaaagtgtc atgtctcctg gaactggagc 1068420

tatacagatg gttgtgagtc accacgagga tgcctgggacc tgaacatctc tctctattaa 1068480

gcaagtgttt taccacacat tgatttatac tgttttttgc acatgccatt gtaccatact 1068540

tttttagttgt gggaaatgtc ttcacgtctc ctttttaaac ttttcatcat ttgcttcagt 1068600

cagggaatga agtctttgaa tcagggagtt agtcttggaa agctaaccct tgaggcaggt 1068660

ggatctttta ttatatcaca ttctgtcttt gtgggaactc tgggtgctcat tattattcca 1068720

ctctgcttca gtgttatcaa cctttaggtt ttccagggtc gcacttcaca tgtgaaaggg 1068780

gacggttgcc atgggagata agacagattg ggaagccgtc agagtccctt tccactgagg 1068840

gtcaccatgc cagactagct gacattgtcg ggggcggggg gggggggggg ccccaaaaac 1068900

agaagacca cctcctgcaa ggctctgaac tctcgccatg ctctgaactc tcgccatgac 1068960

caacacagac cttgactctg gggactccc gattcagctt ccaagcagct gggattacag 1069020

gtttgatggg gatgtccttc tctgtatatg tttctcttat tggttgatga ataaaacact 1069080

gtggccagta gagaggtagg gagatagatg ggactaggag acaaagagaa ttctgggaaa 1069140

ggtagccgga gagaagtgc catgtgagcc gccaaagggtg gtaagataac accacatgga 1069200

aatacttaga attacagaaa tgggttaata attaagacag agccaataag aagccaagc 1069260

taccgccaac cagttttata actaatatag tgtctgtgtg tctttggggg tgaacatct 1069320

gggagaagct ccgcaacaca ggtttatacc ttcaagccta tttgggtatc actttacata 1069380

aagaagaatt gagccaggca tggtagaaca catctataat cccagtagca ctcggaacc 1069440

tgaggcagaa caattgcaag ttcaaggctc acctgaccta cctacagatc aagaagaacc 1069500

tgtcttcatt ttttttaag aaaaagaata acttaagaac taagtttctt tactacaaa 1069560

cagtaattta aagggtgact ttgaaaaata aaattgaatc ttcctattag agtgcaaaca 1069620

gataacggcc gtgataatgg cctctgttat gaagacatta acatctgca ggcggtcagt 1069680

aactggtgct gcagctctaa ataaagggca tctcgaaacc cttgactgag ttggtgtcat 1069740

catgcgagaa atggaaatga gggtagttac ggccagaacc aagatccccg cctgtgtgca 1069800

ggaacctgct ttgaataaag cagaaaaata acttcagtga ctttctgaag taacagtct 1069860

gaagtatgtg aggccttagtc tacaacaga agtgcctagcg tatgcttggc tgctgatgga 1069920

ttcggtcctt aggtacttca tttggaggct ttggtgtggc aaattcatag atatcgattc 1069980

tttccctttt tcaagattt atttgttat tttgtgtata tgagtattct gcctccatgt 1070040

atgtttgaaa aaaaaaaaaac atgtttactt gatatctcag aaggtcagaa gaaggcatca 1070100

gatctcctgg aactggagtt ggagttgtga gctgccatgt gggtgcctgg aattgaaacc 1070160

agatcctttt gagtgcagca agtgccttta accgctgtga cattctccag attcaagttt 1070220
 ttgacatcac ttaaatgcta caagaagcat taaaccctt aagtttatag gtggagtaat 1070280
 tttcacaag tggataacca tgtaactgac agctggatca agaatggaag tgcctaaca 1070340
 agaatagcct ctgcctgccc ctgctacttg tactccctt agaagtagcc aagtgcctg 1070400
 gatcctaata ccatgggtga gtttgcctg gaactaaga ctcttaacc tgtttctgga 1070460
 ttcttaggag ttttaaaat gtggcctctt gagatgcagc cctgtcagat accgtcttga 1070520
 gactgggtag taacaaacct agaccacaag ctgtctcatc ttcaatgcgt tttttcctt 1070580

 acatgttctt aatattcttg tcaataaagc cttatatatt cccttctcta tctgaaaaca 1070640
 gccagtgat ataaataagg actccaaga cttttacag ctgaaaggaa tggatacaac 1070700
 agtccaggag tggagattgt tagcccttga gaaaaaggca cagagtgtga catgaagata 1070760
 cggccccat gcctctctc cacacaacat ggagcatccc tgggtaactt cctgggcac 1070820
 tggagttcc caaagtttgt atcccctgag aaaggacct ggaaagacat cagctggtat 1070880
 ttctcccaga tgtcggagtt ggtgaaaaca tggcatggg acgaaatgct ttcttccatg 1070940
 gtccacatct caagtcacc ctgatatgcc ctgctagaat cagaactaac ctttagaata 1071000

 aagaaaactt gattgattta aaattcttag cccaacatat atgaatgat ctcagaactt 1071060
 gtgagcattg atgtttcca ttttaacaca gactggatct tgtataaaaa tttcataagg 1071120
 tttgttttct tggtttatg agggttttaa gcagcttttg aatgagagt cttctttttt 1071180
 ttagttgtca cctcccctaa cttctacat ttggtcttgt tctttctct tggcattgtg 1071240
 tggaaattag ggcggctctc gaaagtcat ctgtttaagt ggctgtagaa tctagatcca 1071300
 gaatatgtgt ggatgtcgta actcagttct gcagctctcc agctctggct ccaggagccc 1071360
 aggcctgcat cctcagaca gtggctgcag taactcaggc ctgcagctt cagacactgg 1071420

 ctgcagtage ccaggcctgc agctctcaag acagtggctg cagtaatccg tgtctgcagc 1071480
 tctcagacag tggctgcagt aacctgtgc tgacgctctc agacagtggc tgcagtaacc 1071540
 catgtctgca tccctcagac agtggctgca gtgcccagg cctgcatccc tcagacagtg 1071600
 gctgcagtaa cccatgtctg catecctcag acagtggctg cagtaacca tgtctgcac 1071660
 cctcagacag tggctgcagt aacctatgc tgcatccctc agacagtggc tgcagttagc 1071720
 caggcctgca tccctcagac agtggctgca gtaacctgt ctgcagctct cagacagtgg 1071780
 ctgcagtaac cctgtctgca agctctcaga cactggctgc agtaacctgt gtctgcagct 1071840

 ctcagacact ggcctgcagta gctaccggcc tgcatgctct tggatagagg ctgctttcct 1071900
 gctaactgca cattgtcctc gggcttcatg gtatttttaa taatcctcca accaaacaca 1071960
 gatcctgcct aacatgagac caagaataga agcaaaacaa cagttgctgc cactttgcag 1072020

ataactactg ttcaggtagc ccaaaactcat ctagaaaatg ttcaggaaag aacattcaag 1072080
 gtctggggtt agtaattttc tttgcaaatc ttaaactgtg aatttcttct ggctggtaga 1072140
 cgctagagaa gcagagagtc tttgtagcca tctagcaatg gtttccagtc cacaggcata 1072200
 gcttttgtat gcaaaaaatct tgcactatg aatagggtgcc tggttgtcag agaaggttac 1072260

 agaatttttt aaacttctac cggagtactg agcatcggct ttctgggtat cttatggatt 1072320
 aagattctgg ttatgaaaca acaaagacag ccatcagaat taactcggct cttaatctc 1072380
 ctccagtagc tattgtcttt gctcatagga ttttggattt tagtatcgaa tggaggggtt 1072440
 aggtgtctgt aataaacttt gtaggaaaat ggaagtctg tagttcatca cccttgtttc 1072500
 acaaatgctt gtctttttcc ttttccccc ccctgcctc tccctaacct acacaagcac 1072560
 tcaactctgg atgatgactg ggagttagtag aagaaaattg aaaaagtctg ctgggtgtgg 1072620
 tgccacatga tgtaatccct aacttgggtg gtagatgcag gaggatcact gcaagttcaa 1072680

 ggccagccag agatagagag accctgtctc aaaacaaaga aaaccaaaga gtatgcaaaa 1072740
 caggaaggt agacttgtag gcacaccttg agtagcgaag gggctggga ctgagcactg 1072800
 aaggttgggt gtgttaggag caaagagaag ttcattcatg gggttcgaca gaggcaggtg 1072860
 aggtgagat tccagcactt gtggaatccc actctggatt gccatcttct cagaagataa 1072920
 agagcttgtt aaagagatct tgacaatttt aagagaaaac agagaaacca tgaacattt 1072980
 ctctatgaca tagtgcccag gatcggaaga cagaggacag ggagatcatt gagcagggtg 1073040
 gctaaggtga atgactgtga atttacaaag aacagttcc cacttcactt agctgtctgc 1073100

 tttccacggg catacggagg ctcatgcaga ccaggagaaa gtggatttac tcacagtttt 1073160
 tccaagtag gtgtagtggg gtggagtcca gagaatatgg gaagaggtca ctaaagtaat 1073220
 atatcattgc ggtgtaagat ggcaaaggag tgaagtaagc atgagagatg gaagggggga 1073280
 aaggaggag aggatgggga cagagggaca caaactataa atctgacaga tgaagcccat 1073340
 aaaacttgat ttctgtgacc aaaggtaat taattatfff tattttgttt tttgggtttt 1073400
 tcttgacagt gtgtgactct ctgacacagg ctggccagtg agtaaatgat tttgagtccc 1073460
 tgtttaatca ttcaggtagc taagtggcag tgataactgt cagtgtatcc tttgagttac 1073520

 cccttcaagt tgctaaaagt tagtgttag aatggcaaat aagacgtttc tgtgctgtat 1073580
 atgttcacaa attctttacc atggcaaaga actttgactg gtttatctat acaagcatgt 1073640
 tgtttggctt agtgctacga gatattagga ctgtgccatc ttgacacca gccactccct 1073700
 ctttctgct tgtgtagaag aagtgacaaa tctgggcatt tgaggttgtt atccccatta 1073760
 gaatccatac tgtgceat ttttggcaga tttcccatgg cagatccatg ttgagaaaga 1073820
 glaaaatcat tglacaaaa cctccgacag atcatgcaag attcactgtg ctggttgttt 1073880

tgagtggaga aggaccataa ctgttttact ttgttatcca tgtccaaact agaggacaag 1073940

 gtacaatact gttagaccaa aacagaccaa ggaatatcta cttaggtgac aataacccaaa 1074000
 taaaaagacc ccttctgaag tgacagccag aggcactgga gtagaaccca gaatacctgc 1074060
 agctcttctc ctccttggg cctactgtca cctgtctgtt taggaaagtc tgtttgcatg 1074120
 cagtcgtccc cccacccccc actcccacc cccaccggcc ggctggatnn nnnnnnnnnn 1074180
 nnnnnnnnnn nnnnnnnnnn nnnnnnnnnn nnnnnnnnnn nnnnnnnnnn nnnnnnnnnn 1074240
 nnnnnnnnnn nnnnnnnnnn nnnnnnnnnn nnnnnnnnnn nnnnnnnnnn nnnnnnnnnn 1074300
 nnnnnnnnnn nnnnnnnnnn nnnnnnnnnn nnnnnnnnnn nnnnnnnnnn nnnnnnnnnn 1074360

 nnnnnnnnnn nnnnnnnnnn nnnnnnnnnn nnnnnnnnnn nnnnnnnnnn nnnnnnnnnn 1074420
 nnnnnnnnnn nnnnnnnnnn nnnnnnnnnn nnnnnnnnnn nnnnnnnnnn nnnnnnnnnn 1074480
 nnnnnnnnnn nnnnnnnnnn nnnnnnnnnn nnnnnnnnnn nnnnnnnnnn nnnnnnnnnn 1074540
 nnnnnnnnnn nnnnnnnnnn nnnnnnnnnn nnnnnnnnnn nnnnnnnnnn nnnnnnnnnn 1074600
 nnnnnnnnnn nnnnnnnnnn nnnnnnnnnn nnnnnnnnnn nnnnnnnnnn nnnnnnnnnn 1074660
 nnnnnnnnnn nnnnnnnnnn nnnnnnnnnn nnnnnnnnnn nnnnnnnnnn nnnnnnnnnn 1074720
 nnnnnnnnnn nnnnnnnnnn nnnnnnnnnn nnnnnnnnnn nnnnnnnnnn nnnnnnnnnn 1074780

 nnnnnnnnnn nnnnnnnnnn nnnnnnnnnn nnnnnnnnnn nnnnnnnnnn nnnnnnnnnn 1074840
 nnnnnnnnnn nnnnnnnnnn nnnnnnnnnn nnnnnnnnnn nnnnnnnnnn nnnnnnnnnn 1074900
 nnnnnnnnnn nnnnnnnnnn nnnnnnnnnn nnnnnnnnnn nnnnnnnnnn nnnnnnnnnn 1074960
 nnnnnnnnnn nnnnnnnnnn nnnnnnnnnn nnnnnnnnnn nnnnnnnnnn nnnnnnnnnn 1075020
 nnnnnnnnnn nnnnnnnnnn nnnnnnnnnn nnnnnnnnnn nnnnnnnnnn nnnnnnnnnn 1075080
 nnnnnnnnnn nnnnnnnnnn nnnnnnnnnn nnnnnnnnnn nnnnnnnnnn nnnnnnnnnn 1075140
 nnnnnnnnnn nnnnnnnnnn nnnnnnnnnn nnnnnnnnnn nnnnnnnnnn nnnnnnnnnn 1075200

 nnnnnnnnnn nnnnnnnnnn nnnnnnnnnn nnnnnnnnnn nnnnnnnnnn nnnnnnnnnn 1075260
 nnnnnnnnnn nnnnnnnnnn nnnnnnnnnn nnnnnnnnnn nnnnnnnnnn nnnnnnnnnn 1075320
 nnnnnnnnnn nnnnnnnnnn nnnnnnnnnn nnnnnnnnnn nnnnnnnnnn nnnnnnnnnn 1075380
 nnnnnnnnnn nnnnnnnnnn nnnnnnnnnn nnnnnnnnnn nnnnnnnnnn nnnnnnnnnn 1075440
 nnnnnnnnnn nnnnnnnnnn nnnnnnnnnn nnnnnnnnnn nnnnnnnnnn nnnnnnnnnn 1075500
 nnnnnnnnnn nnnnnnnnnn nnnnnnnnnn nnnnnnnnnn nnnnnnnnnn nnnnnnnnnn 1075560
 nnnnnnnnnn nnnnnnnnnn nnnnnnnnnn nnnnnnnnnn nnnnnnnnnn nnnnnnnnnn 1075620

nnnnnnnnnn nnnnnnnnnn nnnnnnnnnn nnnnnnnnnn nnnnnnnnnn nnnnnnnnnn 1079400

 nnnnnnnnnn nnnnnnnnnn nnnnnnnnnn nnnnnnnnnn nnnnnnnnnn nnnnnnnnnn 1079460
 nnnnnnnnnn nnnnnnnnnn nnnnnnnnnn nnnnnnnnnn nnnnnnnnnn nnnnnnnnnn 1079520
 nnnnnnnnnn nnnnnnnnnn nnnnnnnnnn nnnnnnnnnn nnnnnnnnnn nnnnnnnnnn 1079580
 nnnnnnnnnn nnnnnnnnnn nnnnnnnnnn nnnnnnnnnn nnnnnnnnnn nnnnnnnnnn 1079640
 nnnnnnnnnn nnnnnnnnnn nnnnnnnnnn nnnnnnnnnn nnnnnnnnnn nnnnnnnnnn 1079700
 nnnnnnnnnn nnnnnnnnnn nnnnnnnnnn nnnnnnnnnn nnnnnnnnnn nnnnnnnnnn 1079760
 nnnnnnnnnn nnnnnnnnnn nnnnnnnnnn nnnnnnnnnn nnnnnnnnnn nnnnnnnnnn 1079820

 nnnnnnnnnn nnnnnnnnnn nnnnnnnnnn nnnnnnnnnn nnnnnnnnnn nnnnnnnnnn 1079880
 nnnnnnnnnn nnnnnnnnnn nnnnnnnnnn nnnnnnnnnn nnnnnnnnnn nnnnnnnnnn 1079940
 nnnnnnnnnn nnnnnnnnnn nnnnnnnnnn nnnnnnnnnn nnnnnnnnnn nnnnnnnnnn 1080000
 nnnnnnnnnn nnnnnnnnnn nnnnnnnnnn nnnnnnnnnn nnnnnnnnnn nnnnnnnnnn 1080060
 nnnnnnnnnn nnnnnnnnnn nnnnnnnnnn nnnnnnnnnn nnnnnnnnnn nnnnnnnnnn 1080120
 nnnnnnnnnn nnnnnnnnnn nnnnnnnnnn nnnnnnnnnn nnnnnnnnnn nnnnnnnnnn 1080180
 nnnnnnnnnn nnnnnnnnnn nnnnnnnnnn nnnnnnnnnn nnnnnnnnnn nnnnnnnnnn 1080240

 nnnnnnnnnn nnnnnnnnnn nnnnnnnnnn nnnnnnnnnn nnnnnnnnnn nnnnnnnnnn 1080300
 nnnnnnnncaat gagctgaaca tgctcatgaa cgagctaacc ctgcattcga agaggaggag 1080360
 cccttctgt gagggatgag atgcgtctgc atgcaaaaca gtaaaggagg ctatcctat 1080420
 agttaaagg ggtgaagtgc tccatcagaa aactctcaat tctgataaat gcttttagaa 1080480
 aagtagcagt tacaagtca atacacggaa tcagtggctt tctgcctaca tactacttac 1080540
 aaacatgcca agaggagatc agaacaatcc tattcacaac agcattagaa aaaaaaac 1080600
 aacaataaca caaacctca gaataaaca acaaggaaaa tattttaaca agaaaacagc 1080660

 ctgagatggt gattatacta gtctggtatt tgtttgttg ttgtgtgtg tattgtttt 1080720
 tgtggaatc tagaatgct taaaataag ttggtaaat gtaagaagg ccagtgtta 1080780
 tcagtatatt cticatgaga ttgagataaa acagttgggt tacatattt aatgtaatg 1080840
 gaaacatgag cctacatatt cttggttact caactcctat ctataaagaa cagtgaattg 1080900
 gggctctagc atgtgtttat accgattctt ggcatatgat caagcagttc aagattggtc 1080960
 ttcattaaca agcaagatca ctaagtggta acattctaaa taactttt aattctgtat 1081020
 acaaagaaca gagattgtt ccaaatgctg attcaagtgg atgataagga aagaatcaat 1081080

aagcagaaag aaagccacga agaaggttgt aagtaccata ctttggatga ggaaggacca 1081140
cgtgctaaag ggaccacgtg ctaaaggag acttttgtct ggaagtagaa tgaccaaag 1081200
acagggaac actgaatgtt catcaaggtg aaggtacttc tgagagctgc cttcatgccc 1081260
ctcatgcttc tagtatccag agcttctgag tgtgggtcta gaatctcacc ttcctcaacc 1081320
atggaatgg ctttgaagtg gttcaagagc agggatgtgg ctgctctgga aatgaaaaa 1081380
aatgaggtgc ccccttgggt gtcacccttt agcacatcc aggtaactgt gatgaggaaa 1081440
gaaaaagaga ctatcatagg tgagtgtccc aaggccctag catgaggtcc cccagtcac 1081500

agcagcaaca ctgaaaagg aattctccaa gtccccagga tggggaggga gcaggtatat 1081560
atgacttcta acagtttctt ctgtagaaaa tgaagattga cagccaaagg tctgtctggt 1081620
tcactttaac acagtcctga ttttttcca agaagtctt tttgatata ctaaagagaa 1081680
agatgggatt tttactcaat actggagcca catactctgt gttcactgtt aaaaaggat 1081740
cctatgcagg tigtgtgtg ggagacttat ggttcccca gccactgatg caggctgaga 1081800
ggtttcagaa cactcacttc tgggtttctg aatgccctag tccactagca ggaagaaacc 1081860
tattagagaa accatgagcg actgtaactt tccagtggga tagtgaggaa actttgctaa 1081920

ccgtcgtcat ttattcctg ggacaaaata cctgagatga acaggaaaga aggaaaaaga 1081980
attgattttg actctcggtt ttagaggtct cagttcaggg tcatattggg cgtgtggtgg 1082040
atccttgcac gagggcaaaag tggcaggacc aacctctcat ttcttctgta aggttcacc 1082100
tcctaaatgg tcccaccatc tctgtgtgc ccaagcatgc gtgcatgtgt gtggtgtgtg 1082160
tgtggtgtgt gtgtgtgtgt gtgtgtgtgt gtgtgtgtgt gctgtgatta ggaggagtg 1082220
tcccaggcgg aggccttctt gttgcacttg aacgtgctgg tccctgagat atccccaaat 1082280
gtaggaaca cgactgtatg gtttgtgata gtggaagtg ggggctgcac tagagtctc 1082340

cccttaaaaa ataaaaata atcttaaaag aaaaaaaga cattccctcc aggttaacat 1082400
tttttatatg gcttcttaat cagttgatag ttaatggact tccatacaa ttatctactt 1082460
actatttct ctctgtcac acaggcatca cgagacatta agtgtttcac tcaagtcgga 1082520
attcattaac gttatctgtt tcccctagc cacctcataa ttaaacttc taaaaatgaa 1082580
attaggttaa ttaaatgtgg catgtaagg atcttgtgct ggctgtcac gaccactgag 1082640
ttcttctggt accagaaac catctgcta aactttgctc ttacattttg ctttaagttta 1082700
cttttatcta acacctactt atgatccatt gtaaacatca gttggtttaa tccactttga 1082760

gtattatatt acattataat ctcaaaaaca ttatgtaaaa ttatgtaaag gaaatccaag 1082820
gcagaggagg ttcaggaatg tgcccaagc cacagatttt gaaaagtggc agagattatg 1082880
aatcatggtt ggctcagcag agtggtgag tcaaccaca gactgctttg cactgtaggg 1082940

gaagggtgct ctgcccatag gaacagggac agtggggacc tggccctctg agaccagcct 1083000
 acagcacact gatgaaagt aagtaagac ctgaggttct gacaccactg gggaaccatg 1083060
 gaagagctgt caaggtgtg acacagctgg ctgttttttg actgttcccc tagatacaca 1083120
 caaaatggca aaaactgaca aatggaatta tacaaaactg gctggagggt tctcatcccg 1083180

 ctgcccagtt cccattaac caattaatta tcattgtttg gccattggtt caggcatatt 1083240
 actaactage ttcacaact aaattaacce cttcctaata tctgtatatt taccatgagg 1083300
 ctcggtcttt gttacctcac atcttgcttc cctggcggct acatggagtc tcctgactt 1083360
 tgcttcttt ctctctgtat ctttgtttgg atttctgcc tggctttatt ctgcttgccc 1083420
 attggccaaa tcagctttat tcatcaacca gtaaaagcaa cacatattcg caccatacag 1083480
 aaggatcccc catattaca aactaatgtt aaaaaacct tatgtacaac aaagaaaata 1083540
 atcaacagag caaaaagatg gcataatgaa agagaatgtc tgttgatatt acctgatgaa 1083600

 aagttaatct gtagaataca taattccaaa taaactgtaa aaataaaaaa aatccaagt 1083660
 gaaacaatga aatggatca atggccagggt gtggtgttac aaaccacac taccactttg 1083720
 aaaacagaat cagaaagatt gtcatgactt tgagggcagc ctgtactaca cagcaagttc 1083780
 caatctacc aggtaccctt ttcagactaa atataacact ttaccatatt ttttctggt 1083840
 atcaagtcta gacttggttt gtaaattctg cactgtttta aagattcacc caaagagctt 1083900
 atgggatttt gtgttctctg ttgtggagta ttttgtatgt gttctctgtg gttctgtaat 1083960
 gggatattac aatcacagat tctcagctct agtgggtcat gattaatca ttttcttta 1084020

 tcatgtttgc atcttagaat tacataaggg ctttaaataat gccccagata tttacaccta 1084080
 atcacagcca ttcagaaac aatgcttttag tatatgcca gaaaaatagt tgagtctaag 1084140
 tactctgatg tcttcagttc tctgaggctg acttaccac agcagggaac cctaatacaca 1084200
 gcttctcage agcaatgtgc acagctcctt tttctctata ttctttgctt tcaatctttt 1084260
 gctaatttag agactataaa atggtagttt gcactctgtat tctattttgt tggctagctt 1084320
 ttcttctctt cagccaaacc actctatcaa ttcattttat attttctgt ttaaatcctt 1084380
 ctactttate tttgcctttt taatgttttag aatatttcat tcgaatatgt tattacacac 1084440

 atacacacac acacacacac acacacacac acaccacggc tttctgtgta gcacttcttt 1084500
 ctctctgggg atggggtagg atcccttctg aatgggcat cttatgagtt actaacagga 1084560
 aaggttgggt gaagaattac actgtagtgt gctcccatca gaaagggtgc agaccatcag 1084620
 tttctgtgac ttaccttga gaatatatat atatatatat atatatctaa aatttgatta 1084680
 cacagctaca attttgetaa aaccattatg cctgcttac aatgggtttg ttttagaggt 1084740
 atgaaatfff aatcaaat ttgaacagt tatggagctt ttattagcag atttttttt 1084800

tctggacgag aagaatctac ctactatagc tctgatattt ccaggcaata aaattttcac 1084860

aatagaactg ttatgtctag gaagcaaact gctttttggt acttcgttaa attggtttgg 1084920

atatattaag cagcgcctgtt caagaattca ggacatctga ttgctcagtt ctcattgtctc 1084980

caattctttt attctttctca aagttccac aaaggattag tggcagagaa ggagggtggc 1085040

tgatacagtg ttggacagca gttctcttac caaactaagg acatcaggtc agcgtgcaca 1085100

gtaactgtgc ttagtgacac agatgagcag gcagctggat aaggtgggaa gaagttgcca 1085160

tgttgccctt ctccaggccc cacacagcct cccacagaga tacctttcac ttaagggagc 1085220

aagacagact tgggttcaga tttctaacag tgagaccaga gatacggaga gctctgtggt 1085280

cctgcgtctt aggccactcc agcagactga gttggttaac tacttttggga agatgctttt 1085340

ggttccccca cttctgaaa cctctgccgg caaagcaggg ctcaaacctc tagcagtggc 1085400

acacggaaca cagaaaactgg tgcagggatt taccttggag cccatgccac agggagcctg 1085460

ggcccctggg aggaacagga gaccgggtgt gcaggtcaga gctcccagat ggagcctgta 1085520

gcctggctct gacgtcaggc agaggcctgt gtgctggttc agctttgggg tagagcggac 1085580

acacacttct cttctggaac aggaccagtc ctgggactgt aagacctgg tgcctccctt 1085640

ccgggtgggt tcctcaaag ccagtctcct aactcaggta gcacagttat caacagtgtt 1085700

tatgcttcag gctttcaaac ttctctgtcg tcagacctg tcccagttag acagacttgt 1085760

tttggccaca gccagctgtg gtgcgacccc agtgcgtccc taagattaag caggtactta 1085820

tggcagttag actcaggaat gaccagctt aaccctagca taggtggcta aggggtctt 1085880

cagtgtctgt gtccccact tggatagaac agtatcatgt gaggccgtt tgttggtgtt 1085940

ggggcaaggt tgcaagcatg agactttgcc ttgtaactta gtgctgtgtt gataaatggg 1086000

aagacctgg agacaccccc aacccccaga tctgtctacc aataaggcct ctggaacagc 1086060

agcagactca gggagggcag cccccacc cagtctgttg gactaccagg ccagctactt 1086120

cagcctgtgt ctatttacca tggccacggc ccacaaatcc tccttagcag agtctgctac 1086180

tacagcagta tagtaacttg gtcttaactc aaccattgta ctgctctgt caggctgtgg 1086240

gctcagtgga tcacacagct ggggtggaata ggtggttaca tatgtgacac aggagtcaga 1086300

ggtgggtcta cccatggiga gcctgccag aggaggcag agttcagcag cctatccgca 1086360

ggccagtgtc tgtggaagag gcatctaacc ctaaccgggt accagggaga atcctgcatc 1086420

atccctagga ggcaggctat ttctagatct ccaatttctt tttcattaac actccaagac 1086480

tgattggaac aaacgtgggc ttagatttcc atctaaaact tccaaaacga gacccccaaa 1086540

gcacagcccc agcaaatctg cagcaagctc aaaggaaacc agcctcactg gggacagtca 1086600
 ggctcagtgg aaatcagact agagtaaaca ccttaccctt ggggtctcac atgtcacact 1086660
 agcttgcacc aagggtttc aggggacttt agggaactct gagctcatgt aggactcagg 1086720
 cagtaacctg cacaggggtc ttagtgagaa gttgaaatta ccattttagg aagatttgat 1086780
 gagcttaagg gaacagaaac tcctaacaga ggaactcatc aagctgaaag caaattaaaa 1086840
 agttcccaag gtaaaaaata ttctctgtga aattgagact ctcacagaag gcatcaaaag 1086900
 taggtgaatt gaatagcatc agtgagcttc aagatgagct tcttaaaatg cactgttga 1086960

 gataaaagaa atgagaaagg gaaaaagct tatgggaaaa ttacgaacta ctgaaggaac 1087020
 aagtatgcta ttggggtgca agaaggaccg gtgaatgcca aagaagaaga aagcctattc 1087080
 ccagaaatag taacgggaaa gttcacaac caggagaaca gaaaaatcct ggtatacгаа 1087140
 aggcaagagt caccagtcaa gcttaaatca acaaaagtcta cctcacaatg gtataatcaa 1087200
 gcaaaactctc acagctgaaa gaagagcccc aaggctataa gaaacaagaa agaacacagg 1087260
 ggagacaaaa ttctcctaac agtgacttc tcagcagaga cataatgggct gggagtgttg 1087320
 tgaggttttc atggtaatgg agagaaagag aatacctgtc agcgggtcccc aaccaagcta 1087380

 ttctgtaaaa aacgaacaga taatgacatt cccagattaa agctgagtgt ctgtctagac 1087440
 ctgctgtaga agtaatgcta aaggaagttc taagaaagca caggacagct atactcctag 1087500
 caccagagg atggaagcag catcagtgtc aggagttcaa ggttacacag agcaagtcca 1087560
 acgccagcat ggctacaag aatcatgtc aaagaggaca gagaatcggg gagataaagg 1087620
 agggagagga agaggaagaa aaggagaaaa aacactagtt tgtaaaatag ggtgagagtg 1087680
 aactatgaaa cacactcagg acactatagt attgtaagca tggagcagac aacattcaaa 1087740
 tttttagtat aaacaacaac agaaaacaa aaccccaac aaacagatga tgggacctag 1087800

 ctggacaatg tactcatata aattcagatt ttcaagetcc aaagtaatgg agcacatgga 1087860
 aaaaggatga agtgcataat ctacaatgtt tgaaaatgta taggcagcta agtatggtgg 1087920
 ctcacatctg taaccagcag acttggggagg ctgagacaga acaacttccc caagttcagg 1087980
 gtcagcccag gatataggtc aagtctgtct tagcaagcaa aagctagctg gtacaaaatt 1088040
 tgagtagaaa atttgaatc atctatactt gaagcacata atgaggacga ctctggtgga 1088100
 tagcctagaa gctgggcagg atttcatgaa caaattgact gcgggcattg gcaactaggg 1088160
 agagaaagga aacacagact aattcaatca aatttgaggc tgggtggtgat tatttttcta 1088220

 tatcgagaga aggaatagat ttggggtagg aataaaacat aaaatccact tgagatatat 1088280
 gggggccttt gtatagtaaa aaaaaaaatc agtttccctt acttttgta ttacttgcct 1088340
 aaagttcata cccaaccac agaagtaaaa agatgccctg aaaatataca tttccacggg 1088400

atacgggttc ttttgaacca gctgttcatac ccacactaaa actagtgtcc aataagtga 1088460
 acataatggg atgaattttc tcaaaagcag attttttttt ttccagatac agcaccatca 1088520
 gttgtatgga aattaaccta taaaatcagg cagtgtacct cagtgcagct taacttgtat 1088580
 caggcccaaa gtttcatccc aagtaccaa cacaacaaaa caagcaagaa aactgattga 1088640

 ttaacaagtt tcaactcttg gggaaaatta actttaatgt ccatgtgagc tttgagaatt 1088700
 gtggctttct aaaaatagta ggatcaaatt agttagtitt gctatattgt gaaagctaac 1088760
 tctcagggga cagttattac ccgaaaagaa acttactctg gagacgaagg atcaggtgtg 1088820
 taactatgtg aacaacagcc cagcctctgt ccaagtaaga gtctgtacaa gacctggggt 1088880
 tagggaaaag ggicaaggga tatgtctacc catgtcttta tggctaagat tatagctaag 1088940
 atagaggtgc acagcagaca tgtattgact caaggcgggt ttaggacat ttcacagcgg 1089000
 agggaaagga ggtacaaaga aacgaatac gctccaagtc acacgctgtc acaagacgtc 1089060

 agacgggatt ttcaggctg ggaaaccctg gctttcagag actgtgctta cacccgttca 1089120
 actctgctcc ttcaacaagt cagccgggga ctttcaatt aactggagtg atcttcaaag 1089180
 tctggaaaaa tttaaagtgg ccgccagagg gcatggatct gcccttggtt ccggggcgct 1089240
 aggagatttc ctttccagc taaaggcgtc cacagagtaa agacactggt gatgtgagcg 1089300
 gttggagata caggcgtca cagagtaaag aactggtga tgtgagcggg tggagataca 1089360
 ggcgctcaca gagtaaagac actggtgatg tgagcgggtg gtgtgtacat tttgtactgc 1089420
 ggtcgagggt tccccgctg cttcgtttt ggtagctctt aactgctcct taccgctc 1089480

 ttgaaactaa aacccttac ctactgagca agagaaccac gggtcattat tattattatt 1089540
 attttgaac agccgtgtga ggatccagcg cgaaaggacg agcgtttggg gcggcgcgcc 1089600
 ccgggcacac gcgcgtctc acagacaggc cgtggcggac ggggtggcga gcgtcgcgat 1089660
 gggagctggc gtggcaggg acaggaggag acgaagcgtc tcgtttcccg tacggccac 1089720
 catttaggga aaaccgcca ccacacggca ccggctgctt aacccccgaa ccgaacccc 1089780
 ggccccgccc ggccagggc ggctgagcgc tcggcgacga aagcccaac cactactcgg 1089840
 ccgtgtgaac gaaccacagt gcggccgggg cctggcgggg accgtggtct cctcccgcg 1089900

 tcggacgaa ggcgaaacaa acgtctcct cttcccggg aaaacggacg agcctctcgg 1089960
 gggcgtccc cgcggccggg gcagccgggc cccccctc cgccgttga tggcgtcaca 1090020
 caccaccgac gcgggaagca tcgcgaggc tccggccccg cccctccct ctggaatcag 1090080
 ctgtgagtgt gagagcgcg tgtgtgtgcg cgtgtgcgcg cgcgcgcgcg cgtgtgtgtc 1090140
 gcctctgttc tcgcatatt cccgtggacg ccgggctcgg gcgccccagg ggcttctggg 1090200
 aaacatggcg gtcggctggg accgtagcac taggtaggac tnnnnnnnn nnnnnnnnn 1090260

nnnnnnnnnn nnnnnnnnnn nnnnnnnnnn nnnnnnnnnn nnnnnnnnnn nnnnnnnnnn 1090320

 nnnnnnnnnn nnnnnnnnnn nnnnnnnnnn nnnnnnnnnn nnnnnnnnnn nnnnnnnnnn 1090380
 nnnnnnnnnn nnnnnnnnnn nnnnnnnnnn nnnnnnnnnn nnnnnnnnnn nnnnnnnnnn 1090440
 nnnnnnnnnn nnnnnnnnnn nnnnnnnnnn nnnnnnnnnn nnnnnnnnnn nnnnnnnnnn 1090500
 nnnnnnnnnn nnnnnnnnnn nnnnnnnnnn gcgcgaacgg ttccgctgct gctcggccac 1090560
 cccgtgtgcg tccgtggacg ggcgtccgtc tcctcccggg gacctggcgt gcgtgcgtgc 1090620
 gtgcgtgtgg gaggcgatcg gtgtgcgcgc gggccggtaa cagctgcccc ggtgtagcgg 1090680
 ggagcgatga aaggccgtgt aattttaaag attacaaat gaggctttgt tcacgggctg 1090740

 gcagcagccg tggtgccgaa tttgggctcc ttcccgcctc tcccggcgtg gtttcctgca 1090800
 gaaacgggtc ggcctggttg cccacctgtg ctgtcagtcg cctcaagttg ttactcgggc 1090860
 cccactcggg ggaggaagac cccggccagt agaagaagc cccgtgtttg tttttgttt 1090920
 tttttgggtt tttttggagt gagggttggg aggtttctct ctgatagtaa acccaccac 1090980
 gtacatgaac agagtatgta tgtcggggtc caccttcag aagccaggca agcatggcaa 1091040
 ggtaagaaga gaggtctctc tgaaaggaag tcattgcagt ttactgcaag agcgacggag 1091100
 acttaggaaa aaaaaataag tttatcttca cgggggttag tcgtttcaat gataattcat 1091160

 taaaaaaaa aagttggttt ttagacttgg tgtgttacia atttactta atagtctgtc 1091220
 tggagtttag ttctgtttta acgccaaga gcttatcctt ggacttcggc gccttagttg 1091280
 cctcaccagt aaaaatgaaa tgataagggt gtaacttacct catagaaggt tgggaagagt 1091340
 acatgtttca gatgccecaa gtgtttagaa cagtgcctgc catactgcgc ttcgtctgac 1091400
 tgtgtttgga ctctgaagt ttcgtgcggc ttggctactt aggcactgaa gagatcgttt 1091460
 aaaaattagt ttctaaccct tcaaatgat taaacacttg aaggctatgg ttagtaggaa 1091520
 cgtttgtctt tctgcttctc catgcagtct tgtttatate agtaatgctc cccacacttc 1091580

 tctgttagct cctgtcttg catgtgcact tcacctttc tgtttgtat ctcttattt 1091640
 tcatctaaag aacttcgttt gagtagctgc tgtgtcctt acttcccgtt gctggaaagc 1091700
 acttccagac tctgtttgga atgacacttg ttgggtgtct cttcctttta actatcagtt 1091760
 tgtggtatta tccactaact cgggtacacc caaacttct cacaacctga ttagaaatac 1091820
 atctatcttt tctgaaaatt acatttatta aatagctcac tttattttga ttggtaacaa 1091880
 gggtagccct catggaagga attctgagaa gttgatgac ttaaaatttg taacaactag 1091940
 taagtcca gaagagagtt tggttgtgt ggttgcttgg ttggtctgtt gtttgtttct 1092000

cagatcacia aacttgta gcatattatc ttcccagtga actttttatt cctaagaaat 1092060
 ttatggaatt aaatctgttt accataaacc aggaagctta aaacagtgga aattgactgt 1092120
 tttcagtttt caagactcaa atgaagatgt gggaagggtc tagcttcatc tgaagtttg 1092180
 gaatggaatt cgtccttgct gtcctggcct ctgaacaatc cctgtaaaca catcactcta 1092240
 cactctgaca cccctcctc tctgtgggga ctcaattctc catgtggtct tgagagggcg 1092300
 tcagtctttg ttttagttca ccctaateca ctatgttttc agctaagtgt ttttccattt 1092360
 acaagtaacc aggccatagga cttcagcacc tctctttgaa aacaaagttc attccacaat 1092420

 gcagtggat gctaactact tagctatttc tcattgagaa gtgcacatta taaatagcag 1092480
 gagactgagt aacattgata atagaagata aattcttgtt gccagtgagg tagctcatct 1092540
 gacacggggc ctgatgcttg ccaggacca caccatagat ggagaggact ggtcctacag 1092600
 attactttct aacgtctaca ttgttccatg acacagttcc cctttgtaa tgaatgtaat 1092660
 tacacaggag gtttcatttc aaactaaatt cttgttttac atacgtaata aacttaattg 1092720
 atcaggctgt atagtttctt gagtctata ttttattcta atattaatat ggatacaatg 1092780
 atgaagtagg ctatacatg ctgtcaggag tgttgggtgc tatttcagca tgaagagttt 1092840

 tgttgtttct ttagcagttg ttcaagtatt gtcttagttg ctatcaccat atccttgagg 1092900
 tttaatTTTT gtttctttgt ttaaaggaca atttagggga gacatcaaag aaacatag 1092960
 tggattaga gatctctaaa gtgtacacac atgtgtctacc agtgaacaga aacatcgtgc 1093020
 agagattccc aagtctttag acttttgtaa acgataagaa atataacag gagtaatgct 1093080
 agtgaaggct gggttttag atgcaaatag ataaaagtca cagtgttaat tttactaaat 1093140
 aaggataacc tatgtgatgg gaatgtcttt tgtacatacg cttctctggt tgatgaatta 1093200
 aacactgatt ggccaggcag gatgtaggt gacgctagga gactaagaga atgctggaaa 1093260

 ccataggcag agggggtagt catgtgagcc caggaagagg ggactggagt caggcgttct 1093320
 ccagttagat aagactttgt agaaatagag attagtagtt acgggttaat aagacagggc 1093380
 tagccaataa gaagccctcg tctttggcca gcagtttcat aattaatata gtgtctgtgt 1093440
 ttatttgggg caagcggct atgggattag gctaggggga aagagtgctc ataacacctg 1093500
 tgttatttat tgatctttt attttattt tatgtgatg ggtgtttagc ctccatgcat 1093560
 gcatattcca catcagatga tgggtggagtg gggggagaca agtattgact gatccagga 1093620
 cagaagccac gggaaagtta tgaatgcact tagatgtcca tagatgttg ctacaagccc 1093680

 tgaagtcagg ggcgctggaa tttggaacag actttggaga caggctgctt gagactaaac 1093740
 ccctgttcta catagtacac ttgcatcttc tgggaaata aatataagaa ataaaagtgg 1093800
 catctgtggt atagaagaat aagttaatat gttaagtga ttgaatagta tctagcatga 1093860

aagttgttct gtatgtctta actgctatta ttaggggaag atagacttca aagagaagag 1093920
attcagagca tgactttttt accctttgag tgttaggaat gaagtattgc atgagagtaa 1093980
caacaccagg aagtaggatt tcataaagtt caggttgatt tttttatttt ttaaacaatt 1094040
ggataacttg tgcatgtccc aacggtggct gtacagtggc atgtgttggga atggatttct 1094100

tgggagtagt tagtgagctt gcaggaatgg gacagaagta gagtgggtggc ctgcttcctt 1094160
ctaaaatggt aatcttagaa aacagtctcg gacagggcct gagactggta ggcaggtgga 1094220
cttcactgtc tggctccagg aggggaaatg cataggttgt atttgttctt tgtgtttgtg 1094280
agaccaacag ctacttgctg tagatccatt gaataaaaga aactataaag cttactatga 1094340
aaatgtactt aagttttgca agtggactcc ctgtttattt ttccagtaaa attttttaca 1094400
caactactgt ttagagctgg taattctctc tagtgaacaa aatcattccc catggatagt 1094460
gtttttaagt gttcctttac ccatacatga cagtttgggt ttgcagtgct actgagggtg 1094520

tttctcttc ttccttaat acttacttac ctgctgctg tgccaggcat tgggtctaca 1094580
aaggtgaact cagacatggt tccttccttg actgtcctga ggagaaaata gaatctgcaa 1094640
tcagtggcta gaaacagttg taggcacaca aggccagaa gagt cagtgg agtcagtcac 1094700
atgaaagctt gggggaggac aaggaaactt ttgtgcagag agagcacggt tttcagtgtt 1094760
gctggaactc agactgtaag acggtgggtt tgggtgactt ggtttgtgaa ggattctgaa 1094820
gccatcttag gatagtctaa atactatggt acgggaagtg acttgggctt tgagagagat 1094880
aatatgcaat atgatggtcg ttaataattg gttaatggcc ggaagggaaat cgagttgaag 1094940

cagtccagca gcaaatcgta gccattgaga ctaaggctct agtaaggac ttctctgccc 1095000
ccaggaagaa agcaactaga gaaacttagg aagggttaa gtctgaaggt gtaacttatg 1095060
tttctggctt gtacagtttg ctgtgtactg ttaatcatta agacatgaaa gtggaaggaa 1095120
accaggggtg aagtatttca gtgttgacc tctgggaaag aaatgcatat agtagaagtc 1095180
aaggagatat tcttctgagg catcacagct gaaaacaaag attgggagga atccaagtct 1095240
agatgaaaa tgagaccgg gaatcattg ggaatgag catcatgtcc actttcaaaa 1095300
tcttgggttt tgaagcagtt tggcttttcg gcttttgatt ttgagattg ggtacttgc 1095360

gagtttctta ggtcaaggca agagactgtt tgataaggaa gaccttttt tttttacaca 1095420
tgcgtgcatg cacacataca cacacacaca cacacacaca cacacacaca cacacacaca 1095480
cgcacgcacg cacgcacggg tgaggaatga gaatttgaat ataatacat tctagacaaa 1095540
gctacagaat gaagttttc tcttgactt agtaccacag aagagacaac cttgagccag 1095600
ttcggtgagg agatgggaag ggatgagatg aagggttggg ctgtaggtgt gctatcagaa 1095660
atctgtactt aagacttggga ctgagtttaa agagacgtga acattttaa tatttaataa 1095720

gaggcctatc aagatggctc agtcaagtgc ttgctgcaca aacctgaaga gtttagatcc 1095780

ttagtgccca tgacaaaagc tatgtgtggt ggcattgcagc tctaaccctg cagtgaggag 1095840

gcagatgagg ggggtgtctgg ggcttcttgg tcatccagtc tatctggatt gattagcccc 1095900

aggttcagtg ggaggagacc tgtctcagga agtggagagg ttgaggacag tgcttagcat 1095960

tgacctctga ctcccgtgca catgtgcata tgcactagca tgggcggatg cacgcatgca 1096020

ctccatccac acacaggcac ataacgtctc agtcacacaa gggactgaca ggtcagtctc 1096080

aggtttctgc ttaggttttg gaagtggctc agaggtgatt taaaagtgat gtgctgggat 1096140

cattgcaagt ctccatctta ggaaatggct tgagcactgt gtattttctt gctgtctgtg 1096200

taaccaagac gctgagaagc acctgtgttg tgaacttat taatatatga gaacttagtc 1096260

acagcttatg ttgccttata acttttttcc atatatatgt ataatttgtc aacttaatac 1096320

aaagtaaaat ttttaactttt taagtgttaa aaatgtgaca gtttctcact tttgattttc 1096380

tatttaacgt gtgtttgtat attgcctttc attcttgatt ttttctgagt gggaacagat 1096440

taaagagtaa aatgggcttt ttttttttg gtcaacaaga gatgggaatg ctaatttctg 1096500

agaaaactgg tcatatattc atttatctgt ttgtccetta gcatgactat atgaaggag 1096560

aggaaggttt ctctgaagat gaggcgactg aatcggaaaa aaaccttaag tttggtgaaa 1096620

gagttagacg cctttcccaa ggttctgac agctatgtgg agacatcagc cagtggggga 1096680

acagtgagc ttgcttcaga ctgccttagg catcatgcac gacacatggg cgctggccat 1096740

gaggatgagc tcatgctgga tcttagagtg gctttgtaac tgctcatcct gtgccaatt 1096800

gctctgcttt tattatcttt attctctgta gcctttggca gtgcctctgt gccactagca 1096860

gtatttatta aatcttaatg agcaagtagt acagtttaca ccgtgggtgtt attgtgcata 1096920

taatattata caatatgttg tataattata tataatgctg acacagctct gttcctatc 1096980

tgggttggat agcaagtaaa gacttgctat gataaagtcc tcagaatgga gtgagagcta 1097040

gctcagtttc atctgcctta gttcttctgt gaaatgagga tgtagcatt tatgtggcta 1097100

gagttaatgt attaatgatg taacttttct gtaagtgttt agagcaacac ttggtacaaa 1097160

tactttactt tgtaagtaa agtaagtgat agaatatgta aaagaaatct gaacctataa 1097220

tgatgcttcc taatattttt ccctatggt gaattagcaa gtaaccctt catacgttt 1097280

tgcaacgtca ttggattaaa aaaaaaaaa atgtgtaata catacaacc agttgttact 1097340

gctggcctag cacgtgtgga gccaggctt tgaatccagc atcacgtaa ctgggcaggg 1097400

tgacacatgc ctgcaatccc aacactgggg aggtggatgc aggagggtct caactttag 1097460

atcactcttg gttacgtagc cagttatagg ctagcctgaa ctacttgaga ctctgacgca 1097520
 aaacaaaaca aagcaaaaaca aaacaacccc tagtgaataa agtgcataa aatggcttgc 1097580
 tgctcccaac ccctgagagt gaagagagtg ccgattcttg ttgcacagcc tgccgtgtat 1097640
 cttgtattat ttagtaaatt cttttgactg ggattctatt taatatgcta tgtagtaata 1097700
 tattcaggat attgcaaagt acatgaaaat attttagggg cttggagagc ttttgatfff 1097760
 ctggctcaca gatatttggg catctcagga cctcttttgt ttgttttaag ttgcattata 1097820
 agcatatgtg tatttcttaa taaagagggg agtgttttta aattgggtgt gtcaacatgc 1097880

 ttatffffat tagttatcct atctgtgcct gatgtgtagc aatacaaac tgtctgtctg 1097940
 gcgatagaca ctgttgaaac tgaagacgag tcgttctttc tcagtatgtg gatgtttgtg 1098000
 ctcggttgtc atttctgaac tgtttccaaa catctgtaac attttaaggg aatcatttat 1098060
 gctgcttatt tacataatgt tcatgttggg cacttctttt ttttctcat ttttaattctg 1098120
 cttaaaggtaa ctgtttgctt ttttattgtt ttaattctgt ttttctctt ttgattctc 1098180
 agtttcttta atagcattta ccactatggc tttattaaca ataatggaat tctcagtga 1098240
 tcaagatacc tggatgaagt atgaatatga agtagacaag gatttttcta ggtaactaac 1098300

 ttttcttgt ttaaaggcca tgtacagtca gctgtggtgg tatacatcat tactcccagc 1098360
 agtctggagg cagaaacaaa tgaatctctg tgaactccag gccagcctga gctacgcagt 1098420
 gagagcctgt cttagagagg aagggtctg atgccatag catccgatgc tttcctggtg 1098480
 gtctgtctc ctttgtctg acccaggcct ggctctaagg ctggctgtct tctgttggg 1098540
 catgtgtgcc aggcacgtat gctcctctga gcaactaatac ttgaaccagg agcatccact 1098600
 tgataattcc atccgtagt aaagaaacga cattgagggg cacccaacgt aatgtgtgat 1098660
 gtatagtttt tatgataagt ggaagaaata acttgggaatt cctgcttctt gattcaggtt 1098720

 ttatgtcctt aaaggactgt tttatctgaa gtttcagtag gccaacctta gtttcttggg 1098780
 attattggct gtaaagttac tattaagaaa gatgactgtt aagcatggag aagcagaaat 1098840
 ggttttttaa tagtactta agtgaactt ttaggaggcc agagggatgg gtggctcagt 1098900
 ggtaagagt teacattgct tttgcagatg gtcagagtte agtccccta cccacctcag 1098960
 ggggttcaca caaaagagaa tttttaaag tttctgttct cattgtaaag actgcacatt 1099020
 aagtcctaac ttgactctg ctgtctgaag tccacatfff tcatgggtgg gttggttttc 1099080
 atttctggtg ttttctgat tgactgatga ctgatgactg tctcttctc ttttagcaag 1099140

 ttgagaatta acattgacat caccgtgcc atgaagtgcc agtgtgagta caccctcagc 1099200
 accgcccggc tgcagctca ctgcttttc tgaacatgac tatagtgtaa agaaaacat 1099260
 atcaaggttt ctgcagtccg agttgtgatt tggatagcct gtctgtcttg tagagagcca 1099320

ggctttgtac cccactcca caaggcattg tttcacctga tccaccttta ccacaccttt 1099380
 actctgcagt gtaaatlaca ggtgcagtgt tctgttagg tgaagagtga taagtctcct 1099440
 cttctgcccc aaccctgacc gtgcttactg tactgataaa agtggaaatg tactgatcga 1099500
 tatctggtgg attatgcttg aatcagcgat gatgctctgt atggaagtca tcctctaagt 1099560

 cactgcttgg aaagtggaaa ccagtaagac attacttcag gcaacgcttc agtaatgaag 1099620
 aagttttacc ttgttaaagg gatcggttct aggggatttc atcacaaaac aacagagtct 1099680
 ctttttcag tctcagtttt ctttatgtta gtggttgtga gatatatgga aatacattat 1099740
 aactaaattt ttgagtttagc actgatcctg aatctatgcc atatttgaat atttaaatac 1099800
 cattaaaatt ttagcttttc agagtaaaat ttctattct ttacttttta aaatctcagt 1099860
 agataacacc ttataatttc tttgaatcct taaaatattt cttgtgatta atattatggt 1099920
 cagcattttt agtacttaga gctatttaat tttggcaagc tagtcagtca gttaacctta 1099980

 gcttctttac tatgtgcat ctttctcaga gcaagaagga gaaaaataaa atcattttca 1100040
 aatttcagaa tactatccac aaaagctacg taatgctact gttttaactt ttgaacaaat 1100100
 gaaaagtacc tcaggttttt tgtttttata tagcagatgg tagttttgat tgaagttcat 1100160
 agtgtaaaaa ctttgtttta atgcagatgt tggagcagat gttctggatt tagcagagac 1100220
 catggttga tctgcagatg gtctatctta tgaaccagta agtttgattt atgtgatgga 1100280
 gaaaagtat acctaatac aaaaacttga gattggaaca cagctggcat ttccgatagg 1100340
 ctttcta at gtcggttaca gttcaagtca ctgctttcta tcgggtcacc tttctctttt 1100400

 gtatttgcca taagaatgga agtttgtact tcgtagttgt ctcaggactt tgacctgtgc 1100460
 ctaaactttt aaaaacattt accctgtagc tttcttatca ttggcattta cccttcccag 1100520
 tgctgatttc tcttaattag ttctaaagta caagctgtcc ataacatagc tgactcacca 1100580
 catagcgcat tacaggacta gcatgtacga ttgaccagga ctagctctaa aacagcttca 1100640
 gaaaaagcgt gtggccact ggcctcatgg tatgtagttt acatcggct cactttaaaa 1100700
 ttcattttct tgtgactaag caaacttga gaataatgac tacagagga ggaagagtag 1100760
 aattcattgg ctgggttga acaagaaaaa ccctggact agttctgatt getgaattaa 1100820

 cataagtta cagcaagaaa atacatgttt gtctttgata tgcacttgtt ttcattactt 1100880
 ttaagtcact gacaatatcc ctgtcagaga caacttgagg gaggagctgt tcattgattg 1100940
 ttacagattc agagggttca ggctatggtt ccttgacctc ttatagttgg gccaaacatt 1101000
 atggatgctg gaatgtgiga cagaggagct tttgtcccgt ggttgacagg tgacagacag 1101060
 gaaaaggcta agagaagaca cctgatgtca aaaccagccc agtgacttct tcagttgtac 1101120
 catcagctgg ggtctgggtt ttacttagaa acctgaggca aatagatcat attgagacca 1101180

taaagcactc ctaaagtaga aatgtaata gaaaagtaat ttattgttgc tctgatcccc 1101240

 tcttctgatac tattttcca ctaacaaagt tcatagtaat ttacatggag taagtaaatg 1101300
 taatttgctt tataaattta gatactatta taacgtatta gagtgtgac tccagactgg 1101360
 gatccaaatg gttaccagta gacactgaga tgtttgcatt ttatactgtt tttagaacat 1101420
 tcagtatcag agcttttccg tagctttag tagtgttactc atttacacac gtgtatgcat 1101480
 attgagactt gaggttagcc tctggtgtca ttgggaaagg tgttgcac catgtttttt 1101540
 ggcataagga tctttttcac tgcctggaa cttaaacttt aggctaggct ggctagccag 1101600
 ccagctgctc tcagggacc accgtgtgt gtatgtgca cacacgttac atgtttggct 1101660

 gttttgcgtg ggatcagatt cagtcttca tgcttgcaag gcaagcgtt tgccagccca 1101720
 gagttctgcc ttgccctgtg acctttgtt tctactatt ctttaattctg ttgtttgtt 1101780
 tctcatttta tgggggagg ttttgaggtt cttttttgg cacaggtgtg tggcttgggt 1101840
 ttgtgacaat ttctaccag gaggaagagc tgcagatgct tgagttcca cttactgt 1101900
 gtctgtctg tcacctgct cctacccc atcctcagt ttatccttt cgttttagtt 1101960
 cgtagcatg agtttagtg tgttaagtcc taaaatagcc atttcctat aattgtcagt 1102020
 gactgtacac aggaaaatag ttatcattag taaagttct ctatgctatc tttgaacaca 1102080

 acatcacaga ttaatcatg aatatttctt attagtacca taattttatg tttctgttc 1102140
 atagaaaaac atttaactt gtgatacatg accgcatgg gatttattg ccagtgcagg 1102200
 ttttttctt tttcagcca gtattgacc tttcaccca tcagagagag tggcagaggt 1102260
 aaagtgtgaa cagtgtcac accagagaaa cctagaccac tttgtttgc tggaaatctat 1102320
 gcatatttta aagtatttta gtacataaac aatccttatg acctcaaag ctatcagatc 1102380
 ttaggaaagt cacacataat ctttctgta gtatatttg aatcataat aaatttagt 1102440
 ttttattta aattttaatt aattaaatt ttttttaat catgaaagta tatgaacatt 1102500

 gtttagaatt tggtttgag cctggtgtga tgatgcttac ctacaatccc agcatttggg 1102560
 aggctctgc caggaggatc gtaagttcac ctcttctg ggctaagtag tgagttcag 1102620
 gacatgggtt aaatacagag actatctcag aaacaaaagg ttcactttc agctttttca 1102680
 ttctgggaat tgccaaacct tgagtatga gagccatgtg tgactccta ggaactttgt 1102740
 gttaagaaa aagtgtttc cccatccat tttggttcgc aagatggtt atatttaagg 1102800
 ttttctaatt tcagattatt accagaaatg tacttaaacg tctgttttt gtttttgtt 1102860
 tttttttaa gacaggttc tctgtgtaac agccctagct gtcctagaac ttgtaaactc 1102920

acagagatcc acctgcctct gcctcctgag taccgggggt taaagatgtg cactaccact 1102980
 gccagcctgt ttttttgtt tgtttgtttt gttttgtttt ttttgtttg ttttttcctt 1103040
 cagacagttt gttttctaata tctctgtaca cttgaggact ctttttcttt aattaccaat 1103100
 ttctctgggtt ggaagaatct tactattgaa attgaatata gttgaataaa agcagtgaat 1103160
 cttaggcctt tctgggtatc tagcacttta attagagaac tctctctaaa gaggaatgt 1103220
 tacttttate cagaaatatt gaagtgtggt gcatacttgt aatcccagta attaagaggc 1103280
 tggggcgggg aactgaacct agtactgga gagcagagag cacttttaac ccttgagtct 1103340

 tctcttctga cccaagctga ctctttttat ctagaattct attaggtatt gcagaggagt 1103400
 aatgattggg ggcagagacc ttattaagga agaggggttt ctcatcgtgc ttgggctttc 1103460
 tgcattgcctt catacggagt tcatacttgg ttgtttggtt gttccaagc agaagtctca 1103520
 cacagtttc tcaaactgct gccatccatt aagcttaact tgaacttttg tagacttaga 1103580
 aaagatggaa agctctcagg ttctgggctt agctccaaag tttatgtctt tagatatata 1103640
 atctgctttc tagatctttc ttaattatta tgttatgctt ctaaattgat attgtagtgt 1103700
 agtgggaaaa tctacaaggc ctgtcacttc ctaataaggt acatactaga atgttcttta 1103760

 cctttggaat ttgctctctt ggctggtgtt ttgccctaaa taggatcaca atatttttaa 1103820
 aagacaattt caaacctgg acacagcctt ttgggatatc tgctttctct ttctatattt 1103880
 aaggtttatt tcaaactaag tttattgtgt aaattcgatt tttaatgtta acaaacagg 1103940
 cctgttaate cagtattcta gatggatagt gcataaatat ttttctcatt tctgtgttta 1104000
 tacgataatt ttactattgc gatgaggat ggtatattat gagataaata gttgtgtttt 1104060
 tttaaagatca tatgtttaca tatgtttaca tgtaagggtcc cccccacccc cctactttta 1104120
 agttcactat tagttagttt taagttcaca gagaagggtga gtggaaagtg cagagttcac 1104180

 atgtctcagt ctcttttate agcatcaggc accagaatgg cttacttgtc atgtcaatga 1104240
 gactgcatgg acccagccca acattactga tggctctgtag ttcacttggg agctcccttt 1104300
 tggaggtctc tctcttgagt ggacagttgg gtaatgatat atatccacca ttgtaccate 1104360
 aagagcagtt teacgactct gaaagtctc gctgtcaccg ctcatttctc cccagtggtg 1104420
 gtagtttgtt tgcttgctat gctgtgactt gaggtgttac ttatttaagg tcatgatgaa 1104480
 agagacgaat ctaagcattg ttttatgttt ttttaagattt atttttactg tgtatgtttg 1104540
 aacatttaaa aaattttagt tttttagatt tattttatgt gtgtaagtgt tctgcttgaa 1104600

 tctatgtctg tgtgctgtgt gcacctgga actggagtta tgggcagttg tgaatatacc 1104660
 atgtgggtgc taggaatcaa acctaggacc tctgctggaa caccaagtgt tcataatcat 1104720
 ttctctagcc ctccgtgtgt gtgtgtgtgt gtgtgtgtgt gtgtgtgtgt gtgtgtgtgt 1104780

gtgtgtgtgt gtgtgtgtgt gtgtgtgtgt gtgtgtgtgt tgttacctga atgtgtcttg 1104840
 ctttacaggg aagatgattt gttactgact ccagatgcgt gcagaatcca cggatcatcta 1104900
 tatgtcaata aagtagcagg gaattttcac ataactgtgg gcaagtatgt tcttttctact 1104960
 tcctgaagtt ctttaggtgg ggttggagct tgattaaaat tactcctttt cctagtiacac 1105020

 aaccaccaca aagggcactt taaagtgttg tctgtgagta aataggaatt aaaacctctt 1105080
 aatggtaact ttttagcca gagagcctga ccctagatgt tccatcagtg tetttcattha 1105140
 ttgatagtag gtttttgttt tgttagccct ttggtagttc tcataaaaag gacttcctt 1105200
 agtaattcta gaaaaactca aaagtacta atgtgtagta tgaagtaatt taggcaaaaa 1105260
 cttagaaaa ctgccactat cctcctgaat ataatccagc atcacaaaaa actcttggtta 1105320
 gatctacca tgggtgaaca tctgtcccc agcttcctct ttccaggag acctgatgag 1105380
 ctcttactg tctcagccat tgctgaata cctgatgtgt gcagagtact agtatagggg 1105440

 aacctgtagc cagcccctaa gcgggcgtgg ctacagttc ccctacattc tagcctggag 1105500
 actcagggtc aaacagtga aagaggaagc ctttactctc ctgctgtctg aagtcataca 1105560
 agaataattca aactttgacc agtaactaca ttagctgtta ctttaattata gttgtattga 1105620
 ggctgtagag gagatatata gccgataaga aaaattttga cattgtctac aagtcagcag 1105680
 agcttcatg aggaaacttt ggagttgtat ggggagttag gaggtcacat cgaacagaga 1105740
 gcatgtcaca gaagagaact tggcttcaag ggtggctttg gttttttgt ttatagaaag 1105800
 agaacattag atttttatat atattttttg ttggttattt ttgtttgttt gggttttgg 1105860

 tttttagaga cagggtttct ttgtggcttt ggaggctgtc ctggaactag ctcttgtgga 1105920
 ccaggatggt ctigaactca cagagatcca cctgcctctg cctcccagat gctgggatta 1105980
 aaggcgtgtg ccaccactgc ctggcacata catgtttttt ttaatcagga aagtccttat 1106040
 tgcttataat aatcagatca aaatttagtt tttctttgct gtgcttttct cctgcaaatt 1106100
 cagattttgt cgtttgcca ctgttgagtg ttcatttacc aaatgcagat ggtcctaggg 1106160
 actttgaagc cttggtacct atagaggcag ctcatgatgg agaaggcttc ttcagcttct 1106220
 ctgcaaaca gtgccctagt ccaagaggaa gcacagtgtg agcttctata tatggcctat 1106280

 attttatttt tgctgtttt tctcccctaat ttcatacctt tcagcagatg gtaacatata 1106340
 tacatacata catacatata tcaatcagac cccaaaggaa aagcttttgt tgtgtctctc 1106400
 aaactccagt ggacttacct tttctttctt tttcttttct ttattttttt gtgtgtgtgt 1106460
 gtgtgtgtgt gtgtgtgtgt gtgtgtgt 1106488

<210> 37

<211> 631989

<212> DNA
 <213> Cricetulus griseus
 <220><221> modified_base
 <222> (27435)..(27483)
 <223> a, c, t, g, unknown or other
 <220><221> modified_base
 <222> (115988)..(116163)

 <223> a, c, t, g, unknown or other
 <220><221> modified_base
 <222> (178045)..(178291)
 <223> a, c, t, g, unknown or other
 <220><221> modified_base
 <222> (210690)..(210717)
 <223> a, c, t, g, unknown or other
 <220><221> modified_base
 <222> (231990)..(231999)
 <223> a, c, t, g, unknown or other
 <220><221> modified_base
 <222> (257630)..(261324)
 <223> a, c, t, g, unknown or other
 <220><221> modified_base
 <222> (264590)..(264614)
 <223> a, c, t, g, unknown or other
 <220><221> modified_base

 <222> (271207)..(271462)
 <223> a, c, t, g, unknown or other
 <220><221> modified_base
 <222> (309069)..(309169)
 <223> a, c, t, g, unknown or other
 <220><221> modified_base
 <222> (322641)..(324219)
 <223> a, c, t, g, unknown or other
 <220><221> modified_base

<222> (334465)..(334495)
<223> a, c, t, g, unknown or other
<220><221> modified_base
<222> (350232)..(350241)
<223> a, c, t, g, unknown or other
<220><221> modified_base
<222> (356267)..(356374)
<223> a, c, t, g, unknown or other

<220><221> modified_base
<222> (364325)..(365335)
<223> a, c, t, g, unknown or other
<220><221> modified_base
<222> (388535)..(389136)
<223> a, c, t, g, unknown or other
<220><221> modified_base
<222> (431575)..(431707)
<223> a, c, t, g, unknown or other
<220><221> modified_base
<222> (465258)..(465288)
<223> a, c, t, g, unknown or other
<220><221> modified_base
<222> (465497)..(465701)
<223> a, c, t, g, unknown or other
<220><221> modified_base
<222> (540074)..(540237)
<223>
> a, c, t, g, unknown or other
<220><221> modified_base
<222> (543149)..(543265)
<223> a, c, t, g, unknown or other
<220><221> modified_base
<222> (585616)..(585695)
<223> a, c, t, g, unknown or other
<220><221> modified_base

<222> (615469)..(616634)

<223> a, c, t, g, unknown or other

<220><221> modified_base

<222> (617073)..(617179)

<223> a, c, t, g, unknown or other

<220><221> modified_base

<222> (617512)..(617652)

<223> a, c, t, g, unknown or other

<220><221> modified_base

<222> (618244)..(618267)

<223> a, c, t, g, unknown or other

<220><221> modified_base

<222> (618400)..(618438)

<223> a, c, t, g, unknown or other

<220><221> modified_base

<222> (618684)..(619156)

<223> a, c, t, g, unknown or other

<400> 37

tgtatgattt cttgctggcg agaaatacag agcgcgcggg acactccaca aaacctggca	60
actatcctcc atcatgcatt ggcaatagta ttcaattcta gtacacctga aaagtactat	120
gtgaactcca ataatgtta tcaataaaag atctgcgcct tggtagcagtt tctttcacat	180
tttattctta cagatgtcac ttgtttctca agctatttag tcccctttaa tgagtttgtt	240
tcagggactg ggaaagtaat tcagttcata gaatatgcta ggaagcatga aggcctgggt	300
gtgaccttca gtaccaaata aaacatcatg gtagcataat ccccatagtc ctagccagca	360
cttggaaggt aaaggcagga aggttagaaa ttcaaggcca tcttggaacta cactagcaag	420
tttgaagctt tgctacatga gaccctgttt aactaacat acttacaata agtttgtttc	480
atacatttta gtgtagttaa attgttttgg tgacactctg cattccatcc tgggctctcc	540
tgctgtggta atttgaataa gaatggteac cataaactca tagatttcaa tgtttggtea	600
ccaggaaca gcacttttag gagggtgggc cttgttggga tataatgtgtc cttgttggag	660
gaagtgtgtc actagagggtg ggctttgagg attcaaatga tcaagccagg cccagtgtct	720
ctctcttctt gctgcctgag gatccactac ttcccacat tacaacaatg aattaaacct	780
ctgaacctgc acgccagccc catttaaatg ttttcctttc taagagttgc catggtcatg	840

gtgtctcttc acagcaatag aaacccctaag atgcccatca ttgatatttt ttgtttatat 900
 taaggtttac ttaatgtgct ataaacttct atggcttttg acaaccccaa gctgtcatgt 960
 atcatcaact aacaaatcat aaatgacatt ttcacatga taaacacaca gacacacaaa 1020
 catgaggata taaaaaggtt gcagaagcca actaagacag ctaatactaa agctaaattc 1080

 ctaatgcttt gacaacaaaa tattgttaga ttatttctca aagtgaaaag cagtgtcttt 1140
 gtcttcataa agatactagt aaatgaccaa acaacaata gaggaatata aatcttccgt 1200
 gtaaaagaat tccaatttat gtagctctc taccaccag gaagcatgca ggcaaccct 1260
 gctccttaac tgttgactaa acatcttgcc ttccttccaa agactacagt atagaaaaag 1320
 gatgaggaaa gataacttca caggaagaa agtgaccaac acagctacag ctaggagatg 1380
 aatgtcaaca tcagcagagt gtaataaagt tgataggata aacccttgt atcatgtgat 1440
 ggagtggcac ttcacctgtg taatcttctc aacactgtaa ctttaatgat ggggaaaaca 1500

 tttaaattcc atctatggga catctacaaa actcctgacc agtacttctc aaaactgtca 1560
 acatcatcaa aaccagcaaa gtgcaaaaaca ctctcgaggc caagaagtta aggaaaacat 1620
 ggtgaatgag cataatcagg tatcacagat gagaagctag aacagactag gtagcaaagt 1680
 aaaggggaa aglatataaa ttcaaaactt tccaaaaaat aagctttact attaaaagat 1740
 aagagtggca gccaaactgt cataatctgt gtccagtaaa tagggaactg atactgttaa 1800
 aggatgtgca cacccttgc cagacagggt cccatgcagg gaaggtcatt catctcagtc 1860
 cagccagctg ggatgtcacc ggcaaataga tctcagtaac cacglagacc ctctagccc 1920

 attcacctt ttcttctcaa tttctacaca cattcaattt cacttttatt ctgtttgtgt 1980
 tattatttct tttaatttat gactgttgat ctctttatat ttcagacaca aaacttcttc 2040
 agtaataact tcttattctc aggggtgtaa acataaattc tgttgatttt ctgcccaca 2100
 actgaaaaaa ggagccctgt gctgtaagac tatcttcccg attccacaca ctggaagttg 2160
 caacatattg ttctaataa ttgctagcat ttgtactgtt cggcatggaa actctaattt 2220
 cctgaagccc tggatccaag agatgaacca ctggatggtt aaatgaagga agcaaggcgg 2280
 caggcaggta agaaagtagg aagataggaa agaaggaaga aacagggagg gaaccaagg 2340

 ttgaattccc ataagcacat tcactatgat caagccagct gccaaggagc tctcagtaag 2400
 aaaatgcttt aaaattgctg ggacactaga gtacttccca cctgaagaag tgggacaaaa 2460
 tctctgggtg tcaactggaac cctacataaa acatgttata ataccactcc aagacatagt 2520
 ccatttttct ctgtgttttg tgtttatga gttagtgtga ttttcttga ctagtgttag 2580
 acatgtttga aatttgtaaa ttaatcattt aaacatcaaa atcaaagctt ctttgtgggt 2640
 agaaccttgg agtttcctta ttactaagc ttgtttcact ccagaatcct ggagttaagg 2700

gttttgtttc agagaaggaa aactttatag agttcagagg aagtattgtc acagtttctc 2760

 ctgctttcag ttacatttca gaaacataat ttgttgggaa ggtgaaagaa aacagcaatt 2820
 tagagtatac ttaagataga gctggtgcct attactgggc atccctgtaa tgtttttatg 2880
 actttggtgt caacatgcac ccctcccacc atcccacccc acaatccaat aatgcctac 2940
 tctgagttga cccatgatct aatggcccat ggtagccatt tgatccttct tagtgtttaa 3000
 cataattttt tcaggtttta ttateccaact caagtatttc agaagtttcc aatcctcttt 3060
 ctctgaaagg ccttcacatt ttctgtagac tctcacatgg aggtgatgac tgttgggggc 3120
 ctgcaaagct aatatgagca ggcttccact cattcctttc ttggtcactg gagataaaag 3180

 tacaactcca ttctcagcg gcaaaggtag tgaatccag gaaggttgtc actgatctca 3240
 acatcacggg gctttgaaa ggactggagc tgtggctttc agctgtggct ccacctaaga 3300
 acaacctgga accctttgca aactcttcat gtccatgttc cttctagaat gatcaatcca 3360
 ggcttctgaa ccttagggcc agcgtcagaa ttctacagt tctcattctg atgtgtaaac 3420
 taaatttaga ataatacagc aacaagtga ttagtaacta accttgagtg gttttcatgc 3480
 cattcttttt atttctttt ttgtettaca tctttgaaca aacaatatga agtatgttag 3540
 gcccatcaca atagcagcca gcatctacc acttaacaat ttcacaggac ttttcattgg 3600

 aagaaaatat cacaaaatag attacatacc tccagcaaag ctgcagtttc tttttgcttt 3660
 ctaagcctcc agaatacagt ttatattaac ctaaatcccc caaatagtct ttcctttgat 3720
 ttatgggatg aatgtttgtc aacaacact ccagtaatct cacttaaaga aaactgtggg 3780
 tttttttcca cattctcaa gaagactttt acccaaaca ggaagccaca aacacaaaga 3840
 ggcagaactc agcaagggat tcacactgac cttataataa acatgcagcc aatgcctag 3900
 gccagcaact tttttctac cagaagctat ttttaaaaca tcaacaacca ccaccaaact 3960
 tcactgcaat gaacaaaagg gattaaaagc tgectgaatt ttatgcaaat aactttgtat 4020

 ttgcaatacc ctctttggaa gacttctctg tccccaggct ctttacttca tggatgagat 4080
 tattttgttg tagagcaatg ccaccacat ccacccaaa actgaaatgt aaaaagaaaa 4140
 gagaagcact cacaggagta tctgttttat agcccaggcc atgatgagat ctgtcaaaaa 4200
 ttaggctcaa aactgatatt ctagaagtcc aagagccttg aagatctctt tcccccttct 4260
 ttccttcat atttcataca gcagttccaa ggccttcatg gagattgtgc agagtgaaat 4320
 agcagtgggt tgtgtgtgtg tgtgtgtgtg tgtgtgtgtg tctttctgcg tgtgtgggtg 4380
 atgtgtgtgt gtgtgtgtgt gtgtgtgtgt gtgtgtcttt ccacttagaa gatcccctga 4440

tgttttcatt ctcccccca tgggtgatta aaatgagcag ttttatgagc atttgtagct 4500
 cagtaactac ttccaaacat ttacattact ataagtagat atgggaagcc acttaactaa 4560
 ttctaattat tagttgttgg ggatgggggg gcagtactac tgatggcatt ctctgtgtca 4620
 ccacgagaac caagaccaac atctttacca gacatccgca acagagtctt tgacagcata 4680
 ttccaccta taccttcaat ttctgcttgc tttaggggag ctgttccatc gggatcatcg 4740
 ttttctccca ctccctctg ctgatatttc cactaaacgt ttcaagaggg gcttggtagg 4800
 tctgcgtctt gcaggttgag aaatcccagc ctcagaactc cctgcttgcc tctgattctg 4860

 ctgcttccc ttccagaatg gtcttgctat tctgtttagt tacaagttt ggtctttgac 4920
 tacaaccagc ttcagttcat ctgttcccc ttgtgtcttc cctctctgtc ccaatatcca 4980
 ccaaaagttt tccattactc atattatatg taataaaca taattgaaat gaaatgactc 5040
 agaattatgg ccagttagct gcagggttta atcccagcac ttgggaggtg gagacagaaa 5100
 aatcaagagt cccagttatc ctgagctatt tggtagttt gaggccagcc tggactacat 5160
 gacccctat gtgaaaaagt acaacaaca taaaaatgac ccaaaggcaa tggatgatcaa 5220
 tagcactgt ataatgfat ggaatgttca atgaataaaa ctattattta aattattttt 5280

 ttaaaaaat agggaccaga gacaatagct tagccatcaa aaactgac tgctctcca 5340
 gatgatctga atttgattct cagcacccat atcaggtcac aactgtctgt cattccaatt 5400
 ccaaggagc gatagcctt tttggcctct gagggcacca ggacacata tggagactgc 5460
 atacattcac tacatagttc aaagacatat aagcaggcaa aatacacata cacatacaat 5520
 aaatatttta aggcaaaaa catgaaaact ataaaaatg aaaaatataa ctcaaaaatt 5580
 ttaataata gcaatttgag ccctggcgcg agctggccat gtactcata acatctaaa 5640
 tgcattgcca ttttctttt cttcttgaag aagcattcat gctctttgtg gaaaatata 5700

 acagagcctc ttaagttgct ttcttataga gaagttactt acgggattta atgaataatg 5760
 aaggatgaaa ttacattgct tttctgatct caactctgtt aaaaagcca gggagtagat 5820
 acatccaaat tcagtaggaa ccatcttttc attttttcc acgagtattg atatcttctc 5880
 tagctgtaga agactagttt tctccaaaag tttttaaagt tttattttt taaacttata 5940
 tgcataaatg ttgtgcttgt atgcacatac gtgaacctg caatgaatgc atgcagtgtc 6000
 caaagaggcc agaagagggc accagaacc cggaaactga ttactgcagg tgctgggact 6060
 caaacttctg gactgcacaa aagcagcaag tcttaaccac tgagccatct ccccgtccc 6120

 tagccaaagt cttatttacc aaaatgctgt taaaatctc tgcactttgc caatcccact 6180
 ctctgccage cagatctgca gcagcagata agagacagct tcatgccaga cttcacgata 6240
 ttcaagtttc ccaagatgaa tgccaaccga ttccattcac cacccaccc ccacccatg 6300

atgctttcca tcctttacca ccaccatcac caccccaggg aaagttaaga catgctcccg 6360
 tggccttggc ttgccagctc aatttcacca gtcctcgtc tttttccat gctaattggct 6420
 acatgacaca tacatatfff gactccagtg attgtccaca tgggttccta ccatctttgg 6480
 tccaatgaag agcatgggtg acaaattatt gcaggaatt tagcttcagt gagagtcca 6540

 tgtgttggg gatattgat cactctgtga atcccagtt tctttaatt aaataaaat 6600
 caacctgtt tcaaggggca gaaccagcaa ctagttcacc agaattagcc atgaggagcc 6660
 agaaatatgg atagagagac acacaggaag gagtaggaag gggacttggg gttttgcagt 6720
 cttttttgtt tgggacgaat agagagatgc atcttttga gggctctctgg ccaaaaagaa 6780
 ggtcagctgg ttgcttcttg gcctcgtga tctagcaggt ttgcacccc acatctgact 6840
 tctgagtctt tgttggtaa tagagtgata gaatgacagt gacttagtta aaaactgcat 6900
 ttggtagccc tggccaagct ggggctgtgg gacagaagtc cttccaggcc gaagcctgag 6960

 tggcagtag aatgctgact gctgggctgt gaggcctcag acagtaatta aaataccagt 7020
 agatttatgt gcagccacta aactgacaga aaaacatcag tcaggatata aagtgtgtgt 7080
 ggtccatgca acctcctca tactetaga ctttctctgt agacagggca gaagcttttg 7140
 tgtttcagct aagacattgg gactgtggat tcaaagagga acttaacttc agctagaatt 7200
 cttaatfctc aaacaaagtc accacagtg aacattfctc gcaggagttt gacaaacagc 7260
 aactgatgaa gcagcctgct tctgtggctgg tctgcgtgg cttgtgtatc cttgtggcca 7320
 ggattccatg actctcact tcccactgca ggtcccacag attgaaccct caccagcag 7380

 acgttccctc ctacctccc tgccatagtg ctgctgccc gcttgacccc agctctactt 7440
 gaaggtttga ccttgtttct gcttctcact tagtcctttg gactcaacc aatggatcca 7500
 tctttgcatc tactccagc actgaacatc tagctctat tcttccactg cctgcttctt 7560
 ccagtgtgt tctactgtga aggaatccca ctgtcttcta gtggtggcta taggatcaga 7620
 tcccagccct ttgacagatg agtaaacctt attcctatag tttctccaga cagcagctctg 7680
 aggataacta agaatgcagt ccaacatgaa accagaagct tactcaaac acagaaactt 7740
 ttttcataac tcaattgtgt gatagatgac aaggttgggc atgtttgcta atcatccaca 7800

 gagaacaagg ccattatacc tggacttact atcaatgtca ccacctcaac agtgatgtca 7860
 actactcatt ctggcaggtc tgggtgactg gcctggatga gcttaccagc tattttatac 7920
 cattataatt cctacaatta cagccattgc tagaatataa actaacagcc aacatgatcc 7980
 tgatgacta aggggggtca tgaggaactt actgaagcct gacctgtaca atagaataaa 8040
 atcaaatgaa actaagcctg cacctctata aggattcagg cattatgctg gectgcccct 8100
 gccactggca ggatgactc aggcagtacc ctggctagcc caggggtcca tgaatactag 8160

tctccgcaag caggtgcaaa ggaccctttt aaaagacaga ccctgcccac ttatgatctc 8220

tttttctctt ctctttcttc tcttctctct ttctgtcttc ctctctttct gctcctgtct 8280

ccctcttctc ttctgtcttc tgtctctgtg tctctttacc tcttttctct ttccttcccc 8340

ctccctcccc ttcttaataa aatttctcac tcaagctctg tctgcctggc gtgtttgtcc 8400

cctcacctca gtcaccctcg ctgatacagt ttacaagtca aactacatt taccacagaa 8460

cttaaaataa tecaatacag caaagactaa cccttctatc ccacagcctt catccgcact 8520

tcctaagagt ctggacagag taccagcaca cacaaaagac tttgttttga agtgacctct 8580

gttttgaagt ttcccatccc tgctctgac ttctatcggc ctgttgctcg ctattgctgc 8640

cctcttctct cagtggttct ttggtttggg ttggtttggg ttggtttttt tcagtttttt 8700

gagacagggt ttctctgtag gtttggagac tgcctgcaa tgccttttga agaccaggct 8760

ggcctccaac tcacagagat ccacctgctt ctgcctctcg aatgctggga ttaaaggcac 8820

tcgccaccac caccagttc ttaaagtttc ttcttatttc tttcataaaa ccaggagggc 8880

tttccccctt aattaattca aaagtcaaa taaacaacaa agcaaatgtg agagtcagaa 8940

aggcatatcc acagcccttt tcataaatgg ctggatgtct tacttgcttc tctctctctc 9000

tctctctctc tctctctctc ttaaatgttc ctcttcagat gtaatggtat cactaaccaa 9060

gcattcaagc aaggctaccg cagttctact gcagtttaca aagtgaaaat ctctcacc 9120

aacaagtaca ccagtaggag atggggacaa tttttagagc cccaaattaa aaaataatcc 9180

cactatttaa tacttttgac agccaacctt tctccacca gcaatttctc tgagtaacaa 9240

ttcttcgaag ctgacatttc ccaggggtgt gatgcaatcc atagaggaga catcctgtgt 9300

gcgtgaataa cagccgtgct ccagctctg tggcccataa cagtcacca ttttgiatg 9360

tttgtttttt tttttctct tctcttctct ctgttctgag ctctagaagt aaattacat 9420

tctcacagat gtgtgccag tgtacaacta agctgctgtt ccaagtttag cagcacctca 9480

ggcagggaca tcagcaaac cgccactggc taaggcccaa gccagagct caaccaacac 9540

tcagagcgtt tctctctggc ctctcttagg ctatgggatt tcccaactgt tgtaacagct 9600

ctgacacgtg tctatcaggg atgccaaaca caaccagaac ctccaggaac ccctcatgat 9660

gcctccggaa gtaattgcc tttgtctctc aatgactct caactctcat tagcctgggc 9720

actggectca gcctaactc cctcatccca gggccagctc caagtggct ctgctcttgt 9780

gtgctctccg ggigtgctag gtatccactg cactgcacct gaagaaggct catgcacatc 9840

ccaggcacta ggcacccgtt ggcagcctgg ccacgtctt tctaccccaa caacttcaat 9900

ctactccact tgcctctaatt tccagtgaca tglctgtgac acaaactaac cttgaagaag 9960
tagaaactac ctggagtgga gactgtggga ggagcccagg aaatggagaa taggacatct 10020
gggagtagat aagaatatct atgtccatgg aaagaacat tttatcccct cccacttaag 10080
gggcccacac ctccaccaca gcatctggtc ttctcctgga cctgggagtt gggggtagaa 10140
catataggct catctgtgta ggaacacact gacgagcact gtgaacacagg cagaatatac 10200
cccaagtcta gtcccttact tccattccac gggctcaggg gtgccctga aatgaagccc 10260
ccccacacc gtgccacta cattgagata atgaggtaac tatgacaact accataccaa 10320

agtttgtcag agggaaactc ctcagccaac attttgagtt cttcctgtgt gttttagatt 10380
gcaaatggat gttgtggigt gatgactgaa acattaaaaa aaaattgacc taggtaggtt 10440
gaaagaagta agcgaggttc ccagggagga atatttcata ctaaaatgtg ttttctttt 10500
attgccatg tatctggccc acagtacct cggcccttc cctctctggc tgcagaaatt 10560
ggagcatttt ggaacatacc taaatctagg tggctcctgt cttcgtgttc gttcagtcca 10620
tccagctggc ttttggcaca ctgaaaaagg cacaggagag gcagttcatt gaattccatc 10680
ttaccacact aatgtttatt tcttgtgagt tgagatgacg ctcttgaaa acatcaataa 10740

aaccacatca ctacatcac aacacacaaa caggaaattc atctgtgttc ataattagca 10800
ctgagagcta aaaataagta aaggatgtgt gtccagctaa aacacacctg aaagctgccc 10860
atgggtaaag cagtaccagc aaacagccat gaatgagaca atgccaggac cgtatgttct 10920
ggaggatact gtcaaacagt gacaacttgg aaagatgttg aggtttggtc ataaaagtg 10980
agccattgc aatcctaata aaataaattg gatttggggc acactcctgc ttactttag 11040
atTTTTatga acactggctc aattgtcatg tctgctttaa cacacaagga agacaacat 11100
catcccttac ctttccattg tctcctcag gtggaggtct gccagactcc aaattcttaa 11160

tctctgcaaa agatataatt cttgttagaa ctgctaaca gagcgttagt ttaaaaaat 11220
aggaaaacaa tgaagcaga tgacaagtt taagcaaggc attagctagg tttttagatt 11280
agactactta acagttgacc ctaccagaga ataatgtatt ggtcacctga ccgaacacac 11340
actggtatta tttgtgtaca ctaagatgta aacaggcagg gagctgtcac tggaaatctt 11400
ggagccacag ggctggggag gacattaaat acatcagtgc cttcacaac aaaggaaaga 11460
tgctcatccc caaagctta gcatagatgc tgaagatgca actggtgccc acctgagcaa 11520
atcccactcg tccttcccc tggattccac agatggcaaa gggagaaaga aaaaatgact 11580

aattcattct caaagagacc cagctgtccc ttctgaagca ctgtaagggg agcacgccac 11640
acagccctca gcaccgacct caactggcca ggtggtetaa gccgtgactg gccccacatt 11700
tcccctcaca gaaagctct tcttgaagc aatgttcagg atgttctgtg atgaacatga 11760

aaatccaggt gaggccgect ttttctctgt tccttggctg attggttctc ttcccaaata 11820
 ctcagtttc cagaacaag ctttaagact atggaaatag ttacagtgtg caggtttaac 11880
 cctagggaaa gtaagtgtg atatccctag caggggcaaa tagctgaaag tggctctgtc 11940
 gaatttaaag aaatatacaa ctttctgggc cttgggatct ttgctggaat ctcagcttcc 12000

 cggaccctaa gtaccttttt gatatggctc cagagaaaag ccagaaatth ccccagaaag 12060
 ttcataaact ggacattccc tacccttttg tctctctgc taatttcagt tgcctaccac 12120
 ctcaaaactc caagtggact tattcaagct cttcactc tatgtggtac agtctatatt 12180
 tctgcacaga aaatgtactg ggcttattt atatggctct ccatgacaaa ccagacaata 12240
 agggatag atcgcaaga tgggacagga agtaatgggg caaggacgaa gcagccacaa 12300
 ccccacttgt caaacttttt aaaaatactt ctatthttgg ttgtgagcct agcatttagc 12360
 agatgagcca tctctccagc cthtttttaa tacttaagaa taactgaatc tgggctaggg 12420

 ggatggctca catgccaaga gcacttgcig ctcttacaga gaacacaagt tcagttccca 12480
 gcgccacag atgtgctaa cttcagctcc agggcaccta cacccttttc tggcctctac 12540
 tagcacctc acatgatgt gtgcataccc acacacatca cacaaacata cacataagta 12600
 aaaaataatt tathttttta aaagaactac tgaatttgc tcatatcaac caagcaattc 12660
 tacagtgtca ctggacaact gtttatcgac catgaactca taatgcttat tatgtttcat 12720
 gataaaaatg aaaaacataa aacctcaatt ttatgctgtt gtgtcaactc tactcaacag 12780
 agaatagaca caaggtactg aagtctgcc tggtagctta tacaggtagc atcaatgcca 12840

 gcttttacat gcacatcaca atctggcctc ggggtggcgg aagagtaaca tttgcgtaaa 12900
 gaacagccat atatgtgaaa acagccagct tttgcctttg agagtgaatc ccgtttcagt 12960
 gccaaaagtc caagcaaac aaagcaaat ttccagtcca cttcatatgc acagaactgg 13020
 tgtgaatcac ctactatgat gtttgcatt taggtgtgc tgaaaaatcc ctttgaaac 13080
 tcatacctac aagataaac ttcaagtaga gaagatagct acaatgggtc caaagagaat 13140
 aaccagaacc aagatcagga acacatccgc accagagagg aaggagacca tgcaattcca 13200
 tctgtctggtc tacagctat gcccataaca cactacaga ccacggtatt cetaaagcat 13260

 tccatacatg caggcattta ttctgaagag cgtcctggaa aacaggatat ggctgttat 13320
 ccattggctt tcttctcag cccaaccccc aatgacct gatcttgga catttccatc 13380
 cccacatttt ccccttaaag tctctgtga ttttttttt tathttttta cttttaaact 13440
 aactgctgta gaaaatagga caaaaggagg taatcatatt aagtgaaaga agccagtctc 13500
 agaaagacaa atattatcaa tttcttccat ttgtgctcc tagatthtat aaacatgcat 13560
 aaaatcatgt atgtatacat gcatgtgtgt atgtaatgga agaagtaaaa ctaggggcaa 13620

agtagactaa taagactgaa ggaagggatga ggaagaaag ggtaacggca tgggaataga 13680

 ctcaacataa tatctacttg gtaaaaaacg tcaaagacaa aaaaaatttc aaatatTTTT 13740
 aaaatctgca ctgcctgtaa cttatctgca ttgtaattac ttttaacttt aaaactaact 13800
 ttcaaatata taaaaatcat caccctaaaa ttacttaatt ttgtgaaaat gtgaagcctc 13860
 tgattcataa ctcatctttc attaacttag aggcaactaac cagaatgaca tctcagggtt 13920
 tctcagaaaa tatgggtgctc attctactgg ggtttaatta aattgctcca ggagcatttc 13980
 tgctaaatta gtaggctcct tttactactag cccagagtac caccaattgc acagtgcaat 14040
 caaaccactc gttgttatag caacctttgg ttgataatag taccagtaac tctagctatt 14100

 ctgttttaag ggctgttaa cattgtcttc aaggctcacc cacaaggaag gattacatct 14160
 ctaaatacaca cttaccaaac tcgataaaca tgtttttttt tttaatattg ccaaactata 14220
 ataaaatgag ataatactcta gtacttatgt tcactaatga cacagcacca acaaacaggg 14280
 atttttacc cagggataag tagctgtaa gttaatatct gtttcattaa gatttcctcg 14340
 gagaaaagct catctctgtg tataagcttt attacctctg cttgccaaat ggagccagag 14400
 tctaggttta agcaacaaaa agtgagtcag aactctctca acagccctat ggctaaacac 14460
 aaggaaggag caggagaaaa agctctcacc agagctaggc tgcccaggag tacagccttc 14520

 tactatccca ttctacaatt gatggccgca cctaactgag accagcagag atgtcctgca 14580
 catagctggc aagctgggtg cgataacat gtgctctgcc tccctaataa ataaaatagc 14640
 accctagtga tgctcatct caccctacaa ccctatagc tataactaa ttcatacata 14700
 attcaatgct ctcttgagtg tgtgacacaa gcctgtaacc ccagcactgg ggaggetgag 14760
 gcagagggtc acatagtaag ttccagaaca gcctgaacta cacaaaatga tatcctgtct 14820
 caaaaaacaa aaccaaatac accactcttt gaatgggtcc ttgtctctc atgggtactg 14880
 aatgcattct ggaacggac tttgggttgg aaccaaattg gtctgtgaac ccatgattgt 14940

 atcccctgcc tgitacatgc aagggtggga atcaacaaat cccccacca cctacatttg 15000
 ttgtccaaaa tccatccatc tgatgagata tagtgggtgt tgggccagct ctgggtgggg 15060
 agagagaagg aaagtgtctt gctttattga attgcaaatt cgaacacttg cagtcccagc 15120
 actatttcat tactacagtt ctggccacca gactgactgg acagaccagg gttctgcccc 15180
 ctgctcttc ccacacatgt agccttgcca cctctcttgt tgtgcacaa gatttactg 15240
 ttgacttatt tacttccttc tatggcacac aacatgcaac tctcgggtcc agacagctaa 15300
 cgtggcaaaa gagacactct aaattcacia actattataa cacttgaact tcggttaaat 15360

tcctcccctt ttcccacaat aggaatatta atgagaacac tcatgttgct ggcccagcac 15420
 agtataacgt gggggaaca atgaagcagt tatccacaaa agtcccaatg agtcttttcc 15480
 tccaagtgct caaatattac aggcaatctc acaagctcaa atcattccaa tgaagctaca 15540
 gcagcagaga taccaatgca aagatggaat ctggccctca agtaccctcc tcccttgtgc 15600
 tggctccggg tcattttatt tttatatctg ggattattcg gaatgaaaaa ggcactttct 15660
 ggaaatattt ttatctaaat tattcttaat acttttttct aagctacaac agtaattggt 15720
 taagaaaact tgaaaaataa atatcaatat aaccactatt aaaggagaat atagcaaatt 15780

 ttaatgtatg ttatgcttat ctagectagc tggagtgtaa tgcatacacc aactactca 15840
 tttgtttaag gcacacgcac aatttgttta gctttaatat ggtcaagatg tgcaactatt 15900
 acccaccatt agtttagaa cattttccta ttgtcaacat gaaacccac agccatgagc 15960
 aatcactctc catagttctt cagctgctct ctgacctct tccacagcc cagccctggc 16020
 aaccactacc ttaatttctc tcagtggttt gcctgcttaa ggtattttat acaggctgag 16080
 tcatgtgctc ttttgaatt ggctttataa acatagcagc atgtcttcag gtactctatc 16140
 agtacttctt tagtttttaa tgattaaaat ctttagtggg gggtggaaag atggttcagt 16200

 gatgaaaaat acttgctgat cttccagagt accagagtta ggttccaag acccatgtca 16260
 agtagctcac aacaacctat aactccagtt ttattaaatg gaaaaaaca agcaagcaag 16320
 caagcaaca aacataaac caaaactcaa ctacagaatt attattagta tagatgctcc 16380
 aaattttctg tgcttaagtg aagtaaaaca ggatttgcca cacaaaataa ggctacatgt 16440
 gaaatatgga agaactgaaa ccagcaagca taaatgcaac ccatatctgc attttaaag 16500
 tattaacat ggggctggag agatggctca gagagatggc ttaatttagt caacagctta 16560
 actaagataa agtagtcacc tttcaagag ataaagtgtg actttaggat tgctttatc 16620

 ccttgggact tcaactagag tttacttcaa gaaaggggtt ctttgactac atgcttaaga 16680
 taagctatcc aaatctattt ctccctagct gagttttact cttgtccca gctgataat 16740
 ttgaccctc tggaagaaag aatctaat t aagagtgaaa caaatttatt gccttgaggt 16800
 gcactatgtg gagccctgg cctgtgagcc tcataagggt gttcaatcag atggctctga 16860
 aaactagctc cagctgaagc catcatcctt caatttttt tgatacagtg gaaggagaga 16920
 agactttttg ttcatgtatg gggaaaagct agtagtattg ttctgacagt gtgcaagtgg 16980
 gcctgctctc agcttgacag cctgtcttca tccttgacc tttactgatg aaagtaattt 17040

 ccttttagga gaaacaagac tggcaaac t aatctctaga gaaaatttgg agaaggatgt 17100
 gcttgccagt agagtgaaag aagtaactac aaaccactt aaaggaacat tcaactgctgt 17160
 cttttgtaa ttttaaaaa tgtattttt gttcttgagg gaaccactgc acctattcc 17220

atattggctg caccctctta atcactacca gaatagtgtg tgggagaaca tacataagac 17280
ttgtgtaaac ccacaccaga caaaatcca gtgtggaggg tgggggggat ggggtgcaca 17340
atccctccct agctatgtag ctattgacaa ctgctagatg cttggagggg gagagacagt 17400
attctctaag aciatggccc ctggtaagtt ggccacattc caatggaaga ccacaagtcc 17460

aagaataaat gggcagcaga aattagtctt gaaggattaa aatttagaac acaaagttag 17520
aagggtaggg aatgggggtg ttgaatctga gaagcattgg ggaggggta aatatgatca 17580
aaacaagtta tatgaaactt tcaaagaact acaaaaattt ttttaattg atgcaggctt 17640
agatatattt acatgtacac aatgtatcag agaaatctgc atttctacca tgtctttgat 17700
ttcagagcct ataaattcct ctttctagtt cttaaaatat ctaaggtgtt ataaatcaca 17760
gtcacctgc tigtctatgg agcaatatgt tccttttaca tgacagtatg ctggcatctg 17820
tcatccaaat tcccataat atttctccc tctccctgat tcccacctt ctccagcctct 17880

agtaaccact tcccacttt ttctgggac atcaactctt gtgactacca ctgatggctg 17940
agagcataca ctatttgctt ttctgtgcc ttccatttaa aattactaaa aatgcccaaa 18000
ttctctgtt ttctctcct cctctcctt ctgtttttt gagacaaggt ttctctgtg 18060
aaacctgag tgcctggaa ccctcctct aaaccaggct ggccttaac tcacaagat 18120
ctgcctgct ctgcctctg aatgcaggga ttaaaggcat gtgccaccac ccaccactgt 18180
ccagcttct ctacttctta gggaatggta ctgatcagg cttagatact ccaaactaga 18240
ggaggagggt gttgtatctt caactaagtc atcatcttag aaaacagttt cctcaatgat 18300

acacggaatc cccaacacct cagttcccag ctgccctggc ttaaagaact tttatcttca 18360
tgaagcactt gtaccacatg caaatattct aaaaagcctt gagtgtcagt atttaaatg 18420
aaacatctca gaaaggaac tttttgtgga taacagcctt cttactctcc caatactgtc 18480
tcatgggaaa tatgcaaata tggagcacca gtcaactatt cctccacaaa ccacatgaac 18540
aattcaagca aagaatctgc tcacttccag tcacataaca tacttctacc actacctaca 18600
ctccagtata ggctggagtt acttaactta cactcagagc caggcaacag gcacaaggcc 18660
accactacac aagagactga gcaagtgcct caccttgggt attaatgac accgcacctc 18720

tactccctc caccctctc tgccatctcc acacaagcac acaggcctga gtagctttca 18780
taatgctgaa aagctagtta gttcaagtcc acagcagagc tgagttatga gctgtctgct 18840
tgctgtctag cagcatgtgt catcgagaca agtctgagca tgcggggccac aaatttctca 18900
gigacaaaag cttgagatta gcatttctag gcaatgattc tgatgttaca ctttttccat 18960
cacacaaaca ccagcgaaca ttcgagacca gcagtgtgaa cattcaataa atagattctc 19020
tagtctggga gtggttgggc tattggagtg cagtgtagat aaccagctga cttctcactg 19080

cctagacaag acatgctact taagaaaatc tcttctgcgc tactcctcat gaagagtagt 19140

taattcctaa ttctcagaaa tgccccttcc ccatgaccac tagtgtgtgt gctccatgag 19200

tacctagage ttcttgggt tcatacagac tcagtgcctg ggacagggcc tggcatacaa 19260

caagtgctca aaaatactgg aggaaattac taagagtaga gttgagagca gggatcttgt 19320

agcttgcttt tgtttgctgc tgattctgca ggcctacaat agtgtccaat acaaagtagg 19380

cacaaaatac attgttatat atggtgatat attattcatg atttattgat aaagcttgcc 19440

tgaggatcca gaaaacaaag tcagcctcaa gctacagaga tcaggaagtg gtggtacata 19500

cctttaatcc caaaactcag gagacaaagg cagatggatc tctctgagtt caaggccatc 19560

cagggctaca cgagattgaa tcagtctaaa agagtaacgc tttaatcccc tcaccagaca 19620

ggtataaaat ataggagctt gggctctcag agtcagtctc aggattctcc agccacgttg 19680

aggagagtat agaagtctgg gattgcagtc tgagggtgtg tggagccagg atcgctttc 19740

agtctgaggt aagacctaac tgactgtttt gcttttccga tcttcagctt gaagcttgaa 19800

cctcaatate agtctctggg tcttttattt aattgtgtta cagttataga ccatgcaagg 19860

agagaaccta caggactcca gctacctgcc caggctgtgt cttgtgggtga gttcttggcc 19920

tttctcatca gatccataca ggtaaacagc tgggacagcc cagtcccaa ggaaacagct 19980

ttacctgtt ggaactcatg ttccaatccc ctttctctgt ttcttgtta atgaagctat 20040

ggagggcaat attacgggaa ggagctattt taataaagtc acagaccaat gacacagaag 20100

tgagacagca caccatacag atgttttgtt ccatctacaa aaacaatttt taatgaatta 20160

atatgatcaa actatattgt ttacatagac cataatcaaa tccactcatt tgcatagtta 20220

atataatgga ataaaaataa atactaaaa aatgaaaaag aacctggatt tacacagtgg 20280

tacctgggct gtaatagttc tcagcttgca ctatgaccaa taatttcaa gcaagcaagg 20340

cctcttatac accaaaaact gtgaaaacca ggtgcagtgg ttcacaattt aatcacagca 20400

ttcaagaggt agagagggtga agtggcctca tatacaggaa ggcctgggtc tcaaaagcac 20460

aaaaatatac agggaatttt agcagggcat tgggaggtgc agatggcctc acccaaacia 20520

gaccacctg agtggtttca tattcacctc cctagaccgg tagcagagaa tgctactgta 20580

ctgagagatg ctgaaaatca aggtggcagt ggaaaaggga atgcagtgtg cgaaagggtc 20640

gggggagatg ttacttgcca tcaacctcca gactacctc ctcagaccac ctctaagga 20700

tgtttcattg accatctgag ttgaaggagg ctacacaagt tcctaattct tgactcacta 20760

gaatctgtga tgcagcaaat gcattccaag tctctcagtt aggtctcaca gagagcattt 20820

tctatgtatt tggaggaa gtccttactt ttcagaacat cttctagctc agtgtattgc 20880
 ttgcaaac attctaggtg ataaagtaga cacggtggtg cacacctgta atctcagagc 20940
 ttgggaggtg aggaccggaa gataataaaa ttaaagtcac ccttggctac ataacaatt 21000
 taaggccagc ctggtctaca tgagaccctt tcacaaggaa ttggggaaat aaaacaaaag 21060
 aaaatcctag agtaaaggga ctgttaagaa taagactaaa aaggctggag ggagaatgga 21120
 gcttatttct tttcaaatgg tctatggcgg tctgaatgag agtgggtcat gtatttgaat 21180
 gtttagtcac cagggaatgg aactcttcga aaggattaga aggactagga agtgtgtcct 21240

tgatgaaaaa ggggtgtcac aggggggtca ttgagatgtc aaagcccata ccagtcccaa 21300
 tcattccctc caccaccac ccttcctct ctctacaga ccagcatgta gctctcagct 21360
 attgctccag caccatgggc actgccatgt tccacacat aatggactaa acttctggaa 21420
 ctataatcta gcccctaatt aaatatttct tttataaaa gagtggctt gggcatggtg 21480
 tctcttcaca gctaaagaac agtgactaga cagagccatt taattgttc agaataactt 21540
 cccattattc ttcaagtaca attgcaatca tgaattata aaccataatt agttcacaat 21600
 aataataata ataataata taataataat aataataata aatcattta tcacactcac 21660

aaagacagca aagtaatat ccaggctaaa gttattacag ttctctactc tatgacagca 21720
 gacacaagtt cccagcggga ctcatcacca cagcaggag aggggtgcaa tctatctaat 21780
 caccaatgca cctcaaagag acaggttagt gtcatgaaga aataaaaaag gacacttta 21840
 tcttaggatg ctgtttgagt cttgtgtagg catcgaaag gaagaaacct aagtgtcttc 21900
 actttaggga aactgccct ctaactggaag gtataaacag cttctatcat tccttcgatg 21960
 cattctaggt ctacaaaatg tgcctgtcag ttatgtggac ctatggact tgggtttctt 22020
 gccaaattct ttcagtttgg tgcctgcagt cctgttcacc tgtcccttag acaaatcaaa 22080

ctcaatctgt ctaaaattga gtacattatg tgacatagac ctgccttcaa geccaccag 22140
 aaacacacc caggcacaga actctcttc ctctccaca cactcatctc actcccaca 22200
 acattcatct atcccacct catctaagac aacattcatc tagcctcacc ttgccaaaag 22260
 atggcattca tctagcccca cctcagccct ggccttactt tgccatggtg tagccttct 22320
 aatgacttt ctaaagccct gtagctttcc ttgccttcca tttagacttt caactggaat 22380
 ctccattctc ccagagtac ctttccaaac agctgtttaa aacagctccc agaattctca 22440
 gggagaagct ccagcccctt gagtctttcg gaagccctgt caatctggct gctctcaagc 22500

ctgtgttctt ggtatttcta ccaccacaca tgggtgtgca ggtggaaaaa tgacctgaat 22560
 cctcccatt catctccact atctagaatc cttttctca ctaacatct aactccaggg 22620
 acaaatcttc catgacagct gcattgatca tgcactgtt acaagctaca acatgcttga 22680

agcaatgagt catttgaana tgactcatag agcacttccc atactctgct tggagagctt 22740
 gttttctgt ccagccacaa ctgcaaaccc cacacctccg cctcagctca agaactccag 22800
 cacttattta gacttccttt tattctgaat tagtttaaaag gtggagaata agggaagaaa 22860
 gaggcacatgag ctaacctttc taaaataaaa aaaaaaatca gaagttgact tttaaagggg 22920

 ccagaggtgc tgtaaagata caggaagcac tctgaactgg caagttagaa acttatcacc 22980
 aagtaigtgtt atcagccgag taagaaacct gaccagctac agttacagca gtagaagtgg 23040
 actaggagct taggggacgc cagcagtgcg gacacaacac caggaagaag tgtctcacat 23100
 aatcttcaag aagaaaacat aacattatct agaccacatc ctgggcaggc agaacagccg 23160
 gcagtagccc tcccagagca gaacctatgc aattcctcct accccaagcc cacgaggctc 23220
 agtcaaggtt cagtcacttg ttcaaccag cagcaggtgc agtgtgtatg gataccacca 23280
 gagcccagca agtctttaca tgctttctcc aaggcttctt ttcagctgac agagaggcaa 23340

 agaacctaag gttacactat ctgtcaataa ctcagaatga aactgctctg tgctgctaac 23400
 taatacagc atcaaaact aaccagctat taacactcac ggtagagaaa cagggatctg 23460
 gccacgtctg tccctgactc cagcatctgg aactgtgatt ctcagtgcc aacagactgt 23520
 attcctttgc attctttgat atttcatgga gtctcattgc tatccaata ttaagttgat 23580
 aattaattct gttccacata tgaataatct tttatgtaca catttcaaaa taaagaacc 23640
 agtghtaata ctaactaaa atatgaatat aacacctgg ctaaaatag cagcaaaaga 23700
 aactgataat atgatcattt gtatttcagc attaacaatg ttttctgtg ctgtagcagc 23760

 cgccatcaaa gagcaacagc catggccctg agttaccccg tggetgcccgg ctcaacaaaa 23820
 gtcacaaggt gatcgacaac atcaggacca tcagtacaaa tataaggtga caaaaaatca 23880
 tcagcaagcc caggctcagg tggggagggg gagaggaggg gtcaccaatg acaacaagtt 23940
 cgtgtgggac acgaccagg aggatgtgtg gctttgtgcc ctacgagcag catgccacgc 24000
 agctgctcaa ggtgtccaag gacaagggca tgcccagggt catcagaaga ggttgactc 24060
 gcacaggtgc actaaaagga agtgggaggc actgagcaac gagacggtgg ccacaggaa 24120
 gaccagggtc aagaaggatc ggtaccctg ccacacctc ccaatagat gtttatgctg 24180

 aagacagaca aacaacaaca aacaaaacac aatgtttcct atgtaccag tggttaagact 24240
 tgcgtaattc ctagattga agatttgtgt aattcctaga tttgaagatt tgtgtaattc 24300
 ctagatttga agggaaatta gaattttttt ttcaagacag ggtttctctg tggagctttg 24360
 gagcctatcc tggcactcgc tctggagacc aggctggcct cgaactcaca gagatccgcc 24420
 tgcttctgcc tcccagcac taggatataa ggcgtgcgcc accaaagccc tgctcgaat 24480
 taagatttta ttccacagca gaaacataat aatatgcaaa gaagtaaaaa tgcttctat 24540

aaaaactatg cctagtatta aatctactat cagattatTT gtatagagaa aatctgtgaa 24600

 ctacagtaag gctTTTTTat atgcaccccc ccccccgaa aaaaacctgc cacattgaac 24660
 agaatgagaa gcaatgacat tcctaattggc aaaaacaagg gtgtctgagt gacccttgt 24720
 gccttgatgt ggaataataa cattagtaga actgcattca aacttggtag tggctctata 24780
 ggaccagctc ctgggttttc aggactattc tgcacctga caaacacccc tggtaacctca 24840
 tctctagatg acatcagtc tgcacctcc tcatgccaac aaacatactt tectgctttt 24900
 gaagcatccc cataaagatc caccagtcca gccagagga gcagttatcc aaagcttgaa 24960
 tgagcaaagt aggaggcaaa ctgaatcagt ccctgaagat ccagggaccc tgactctgct 25020

 gaggtcgctg ggctactctg cccccaggca gtgcagagtg cagagtgcag aatgcagaaa 25080
 gtacagaggt gagctgcttc ggccccctgcc ttgggcccac cttccacctg cccactctgg 25140
 gaaatccac cctgggtct acaggcaaaag tgaatcagtc cctgaggacc caggaacca 25200
 gactctgatg agattgctgg gctattcggc cccaggcag tgcagagtgc agagtgcaga 25260
 atgcagaaag tacagaggtg agctgctttg gccctgact tgggcacaac tttcacctgc 25320
 ccacactggg aactcctgcc caggggtctg caggcaagta gactcggccc ctgaggacca 25380
 agcaaccag agtctgctga catctctgtg ccaggcctgc tcttgcccac ctggagagcg 25440

 agcctcggac ctgctgcac ccacctgag acccatcaga gtattgaagc caattgcaac 25500
 cacctgaaga gaacccaga cccatcacaca ccaggaaagg aagtgcaccc acctgcaccc 25560
 attggaagaa gagatgggaa gaccacaata taagaacaca tccaacaaca gggaaaccaa 25620
 tatgacacca ccagagtcta gggactctac accagcaaga catgaacatc ccaacacaga 25680
 ggaagcagaa gagagtaacc ttaaaaaca cttcatgcag atgatagaga tcctaggaga 25740
 ggaaatcaga aaatcctca gaaaaatgga agaaaagacg aacaaaagat gtaagaaatc 25800
 aaggaaagcc aagaaagcca agaaaataca atcaaacaga tgaaggagac agttcaggac 25860

 ctgaaaactg aaatagagac aataaagaaa acacaaactg atggaatgct ggaagtagaa 25920
 aagctgagta aacaatcagg aaccgcagat gcaagcataa gcaacagaat acaagagatg 25980
 gaaaacagaa tctcagacac tgaagataca ctgaggaaa taaattcatc aagcaaagaa 26040
 actcttaagg ccaacaatc ttaacaaaa aatattcagg aaatattgga cactgtgaaa 26100
 agaccaaac taaggatact aggtatagaa gaaggtgaag aaacccaact caaaggtgca 26160
 gaaaacaaca aaatcataa agaaaacttt cccaacctaa agaaaaaat gccaatgaaa 26220
 gtacaagaag catacagaac gccaaataga gtgggccaca aaagaaagt cccctgtcac 26280

ttaataatta aaacaccaaa cgtacagaat aaagaaagaa tattaagagc agcaaaggaa 26340
 aaaggccaag taacacataa aggcaaacct atcagaatta caccagactt ctccatgaaa 26400
 actctgaaag ccagaaggac cagaatagat attctaccaa ctctgagaaa acacggatgc 26460
 cagcccagac tactataccc agcaaaagctt tcaatcatca taaatggaga aaataagata 26520
 ttccacaaca aaaccagatt taacaataat gtaaccacta attcagccct acagaaagta 26580
 ctggaaggaa aactccaacc taaggaaatt aactacactc acaaaaacat aggcaataga 26640
 taatcccact ttacgaaaac ccaaaagaaa aaaacagggt aaatccacaa tacaatacca 26700

 ctaccaacaa caaattaaaa acaacaaga ataaacattc aatggtcaca ctcagccagg 26760
 caatgggtggc gaacaccttt aatcccagca cttgggaggc agaggcaggt ggatctctgt 26820
 gagttcgagt ccagcctggc ctccagagcg agtgccagca tacgtttcaa agctacacag 26880
 agaaagcctg tctcaaaaa caaaacaaca aaacaacaac aacaacaaaa agaataaaca 26940
 ctcaatggac cttaatttcc cccaatatta atggtcttaa cttgcctata aaaagacaca 27000
 ggctaacaga ttggatatga agacagaatc catccttctg ctgcatacaa gaacacacc 27060
 tcaaattcaa agacagacat tacctcagag taaagggttg gtataagata ttccaatcaa 27120

 atggacccaa gaaacgaact ggggtagcta tcctagtatc taacatgta gacttcaaac 27180
 taaaatcaat caaaagagat gaagaaggtc atttcatatt catcacagga aaaatccatc 27240
 aggaagaagt ctcaattcta aacatctatg ctccaaatac aaaggcaaca acattcgtaa 27300
 ttgaaacatt attaaaactc aatcacaaa taaagcctca cacagatata gtgggagact 27360
 tcaacacccc actctcacca ctggacagga ccaccagaca gaaacttaac aaagagacaa 27420
 aggaactaac agaannnnnn nnnnnnnnnn nnnnnnnnnn nnnnnnnnnn 27480
 nnttctttt cagcatcaca tggaaacctc tcaaaaatcg accacatagc aaacctcagc 27540

 aggtacaaaa gagtgggaat aatcccgtgt ctatcagac caccagctt taaagttaga 27600
 attcaaaaac aacacaaatt gcagaaaacc tacaactca tggaaattga acaacaggaa 27660
 attgcacat tcatgggtca aggaagaaat aaagaaatta aagacttgct agaattcaat 27720
 gaaactgtag acacaacata cccacactta cgggacactt tgaaagcagt actaagagga 27780
 aagttcatag ctctaagtgc tcacacgaaa aagctagaga atagccacac cagagagctg 27840
 acatcacagc tgaagctgt agaaaaaat ggaagcatat tcaccacaga ggagcagaca 27900
 ccaggaaaaa atcaaaccga gggcagaaat caataaagtt gaaaaaaga aaacacttca 27960

 aagaatcaat ataacaaga gttggttctt caaaaaatca actagataga ctatccaaac 28020
 taaccaaagg cagagagaga acatgcaaat taacaaaatc agaaatggaa agggaacata 28080
 acaatagaca ctgaggaat ccagagaatc ttcaagttat actttgaaaa cctgtactcc 28140

acaaaatttg aaaattttaa ggaaatggac aactttgtgg acagttatca gttaccataa 28200
 ttgagctaca attacattgg tactcaagac acaactaaga aagagaacta cagaccaata 28260
 tccctcatga acatagatgc aaaaatactc aataaaatac tggcaaaacta aatccaagac 28320
 cataccagaa aaatcatcca ctatgatcaa gtaggcttca tccctgggtt ggttcaacat 28380

 tccaaaatct atcaatgtaa tccaccatat aaaccaactg aagaagaaaa accacatgat 28440
 catctcacta gatgctgaaa aagcctttga caaaatccaa catcccttca tgataaaggt 28500
 cctggaaaga tcaggaataa caggaacaca cctgaacaat atatatagta agccaacagc 28560
 caacatcaaa ctaaatggag agaaactcaa agtgtttcct ctaaaatctg gaacaggaca 28620
 aggctgtcta ctctcccat atctcttcaa tttgtccgtg aagtcttggc tagagcaata 28680
 aggcaacaaa aggagattaa ggggatacaa attggaatgg aagaagtcaa gctttcactg 28740
 tttgcagatg atatgatagt ttacataagt gacctgaaaa actctaccag ggacctccta 28800

 cagctaataa acaccttcag caaagtgtca ggatacaaga ttaactcaa aaaaaaatc 28860
 agaagcccta caatatacag atgataaatg tgctgagaaa gaaatcagag aaacatcacc 28920
 cattacaatt gccacaaaca acataaaata ccttggggta aactaacct aaaaagtgaa 28980
 agatctgtat cataagaatt ttgagtcatt aaagaagata ccagaaaatg gaaggatctt 29040
 ccatgttctt ggataggtag gatcaacata gtaaaaatgg caatcttgcc aaaagcaatc 29100
 tacagattca atgcaattaa catcaaaatc ccaacacaat tcttcacaga acttgaaaaa 29160
 acaattctca acitttatatg gaaaaaccaa agaccagga taggcaaac aaccctgtac 29220

 aataaaagaa ttttcggagg caacaccaac atccctgatt tcaagcteta ttatagagct 29280
 atagtctga aaacagcttg gttttggcac aaaaatagac aggtagatca atggaatcaa 29340
 attgaaaacc ctgacattaa cccatacacc tgatttttga caaaaaagcc aaagctatac 29400
 aatggaataa agaaagcatc ttcaacaaat ggtgctggca tagctggatg ctggcctata 29460
 gacgactgca gglagaacca agtctatcgc tatgcacaaa acttaagccc aatggatca 29520
 aagacctcaa cataaaccca gccacactga acttattaga agagaaagta ggaaatacce 29580
 ttgaacggta caggagaccg ctctctgaac ctaacaccag tagcacagac actgagatec 29640

 acaactaata aatgggacct cctgaaactg agaagcttct gtaaggcaga ggacacagtc 29700
 aacaagacia aatgacagcc cacggattgg gaaaaatac tcaccaaccc cctatccgac 29760
 agagagctga tctccaaaat atacaagaac tcaagaagct agtctcgaac acaccaata 29820
 atccaattaa aaagtgggtt acagaactaa atagagaatt ctcaacacag gaatctaaaa 29880
 tggctgaaag acacataaga aagtgttcaa catccttagc caacagggaa atgcaaatca 29940
 aaacaactct gagataccat cttacacctc tcagaatggc taaaatcaaa aataccaatg 30000

gccgtttatg ctggagagga tgtggagaaa ggggaacact cctcccctgc tggtagagat 30060

 accaactcat acagccactt tggaaatctg tatggcgatt cctcagaaa atgggaatca 30120
 gtctaccaca agatccagca attccactcc taggcatata cccaaaagaa gcacattcat 30180
 acaacaagga catctgttca actatgttca tagcagcatt atttgaaca gccagaacct 30240
 ggaagcaacc tagatgcccc tcaactgaag aatggataga aaaatatgtg gtacatttac 30300
 acaatggagt acttacttgt tggaaaaaaaa ggcaatgggg acttgaatt cacaggcaaa 30360
 tggatggaac tagaataaac cattctgatt gaggtaacct agtcacaaa agacaggcat 30420
 tgtatgtact cactcatatg tggatTTTTG acatagagga aaggattgtc agcctgcagc 30480

 ccaggctgcc agagaggcgg gaaacaagg aggaccctaa cagagacata cagggtcccc 30540
 caggaaaggg ggaagggaca agatctcctg agcaagtgg gagtatggga ggaggggaga 30600
 gggactagg agaatgagaa ggggagaaga ggagaggtga ggaagacata atgggacagg 30660
 gaggttagt tgggggaaga acagaagaga gcaagataag agataatata aatagagga 30720
 gacattatag gtttaaagcg aaatcaggta ctagggaat gtcaggagag ctacaaagat 30780
 gacaccaact aacaatttaa gcaacagagg agaggctacc ttaaatgcct tctcctgata 30840
 atgaaattga tgactaattc atatgccttc gtatagcctt taaccagcag ctggtggaag 30900

 tagaagcaga cacccacagc taaaccttga actgaactga aatccagatg cagagaagga 30960
 ggactgatga gcaaaggggt ccataccagg ctggtgaaac ccacagaaac agctgacctg 31020
 aacaagggga aactcttggc cccagactg atagctggga aaccagcatg gaactgatcc 31080
 agaccacctg aatgtgggtg tcagtgagga gaccttggaa atctatggga cctctttag 31140
 tggctcagta cttattgcta ccatagaaat ggactttagg agccatcct acatggaggg 31200
 atactcctg agcctagaca caagggggtt ggcctagggc ctatccaaa gaatatgaca 31260
 gactttgaag acactccat ggaaggcctt acccttctg gagagcagaa aggatatggt 31320

 tataggatga atagggcatt agttggggga aggcggggaa ggaggggagg gagaggaacc 31380
 tgggattgac atgtaaaata attttcttc aaataaaaa aataataaaa aatgttaaaa 31440
 aataaaaaaa aatgagcaaa gtagcaaatg cttaactgag gaaggaaaga atgaacaaag 31500
 ccaactttgg aaggaagaaa ctaggacatg gggatacacc ccccccaaa aaaaaaggc 31560
 tgagatgaag ctctgaagat ctggaccaca aggacctggt ttaggattag caaatgggta 31620
 aatgggtaaa ttagcaaatg ggtaaatTTG caaatgggta aatttgagta agaggcaaac 31680
 aaaaTGGTgt actgtacatg aacctagggg tgtattgtac cccacaacc tatatcttgc 31740

ctctacacc cttatttctt gctatgcttt aatgtgcaact tcaacagact ggctagcaag 31800
 ccctgcattt tccaggttcc caacatggag caggggcagg catacctcct tcagtttcta 31860
 cagctccaga aggcattggtt ggtctctctt ctgtcttcca ttcttgttca agagcctaca 31920
 agataaaggg gggaagggtg gtaaatcact gaaaactatt ttgggcccca tatgcaaaag 31980
 aggtaaaaat caccatcaca gagctgggaa agctgtcaag gacagtatgt attagcgcaa 32040
 gaggtaaact ctgatagagg aacacacagc cagtatccaa ggatgatgac aagaaaagtc 32100
 ggatgaaacc caggggcaag ggtaaaaacc ctgtcacaaa ttctcacttt ttctgctggt 32160

 cataaccca agtttctcag gcatgctgtg tatgaaccac agaaaggacc ttgacacaaa 32220
 aagggagaac tgagtgttgc tacacctacc ctactggagt gtccataacc cacatctac 32280
 acaggtgatg aaaagaggag ctgatgagga ggtaggacca cagtcagggt atatccagag 32340
 tgaccaccag tcaaaaagta tgcaggctgg cacagattgt tcttggctgg atccaagttg 32400
 cagagccatc tcaaggtcag ggcaaaaaga tgcctcttgg tgatcataat tgcttttgag 32460
 attctcttgg cccatgaaaa tatgaagaaa cataaaatta cattaatgaa ctgaacagtt 32520
 aagcagccca agatggtgtc aataggttct acaataaatc ttcagcctca ttgggtggaa 32580

 aaagtataca actaacatag ttggtgaatc ctaccacaca attaagctgg tagattgagt 32640
 gagtgcctca ttcactcaga acatcctaag atcaggatat gtatccaaag taccaaacta 32700
 caaaggggaa gtgggcaata aggggtaagg catacatggt gggctacctc tgccatgtcc 32760
 cctataagaa gtgcttttct ctcttttggg ccccatgaga ttaggaaagg actagaccac 32820
 atctacaatg gatgctacca aggaagtatg atctagttag cttttattgt caacttgata 32880
 cagcctggag tcacctggga agaggggcatc tcagttgaat aattctcttg atcagttggc 32940
 ctatggacat gtatacaaga gactatcttg attgatgatt gataattgat gactgataat 33000

 tgatgtagaa cgccaagcc cactgtaggc agtaccatcc ctgggcaggt tagatggaca 33060
 tcagtcaaga gcattcgtg ctcttccaga tgacctgggt tcaattcca gcacctgat 33120
 ggtggcttac aaccacctgt aactcccact tccaaggatc tgatcatatt ttctgacctc 33180
 tgcaggtatc agaatgcac atagtataca tacacaggca aaacactcat acacataaag 33240
 aaccctaata atctttttta aaaagtattt ttggcacac gccittaatc ccagcactcg 33300
 ggaagcagag gcaggtggat ctctgtgaat tcgagaccag cctggtctac aagagctagt 33360
 tccaggacag cctccaaagc caaagggaaa ccctgtctcg aaaaacaaaa aaaataaaaa 33420

 taataaaaa taaaaataaa aaaacaagaa agaaagaaag aaagaaagaa agaaagaaag 33480
 atagatagat agatagatag atagatagat agatagatag aaagcggagt gtgagtcagt 33540
 aagcagcatt cctcatggtt actgcctcca ggcttctgcc ttgagttctt atcctaacat 33600

tccctaataga tagactgaca tggaagtgtt agccaaataa accccttctt cccacgttga 33660
 tttggggagc agtgtttatc agagcatcag agaacaact ggagcaggtg gcacctagta 33720
 taaggagtga tgcttggag aggagtcttc atacaagctc aaggcctgag ttaaccatct 33780
 gtccactgtt taccagga caaccttgac cttgaacca tcttccatta aagggttgg 33840

 ccaagcctgt gtgagaagag ggcatcagac aacactagtt tctgattaca aaactaatg 33900
 tgaaataaaa cacctaactt tttcatgtaa atgagaggca taaaaattt ttattcttat 33960
 ggccgttttg gaatacatct ttaaacactt aaatttcca gttgacatat tcattatagg 34020
 tcagtctag gaccacattt atcagcacac tgactaacac aaacaggctt tgttaaaaag 34080
 agatcattta aaaaacatta gaaggtacag gcaagctctc acctacaca ggtcaggctg 34140
 catatgtgga aggctctgag ttcaatccc aacacaacac aataaaata acaaaaata 34200
 tatacttagc tatatttaga attctataca catatgtagc atgagactgt atttttcaat 34260

 tctttaaatc cttcactaag tttatttatt tacttatttt gtgtattgtg taattatgtg 34320
 tgtcgcagc atgtgctgat gtgtgtgtgt agcagaggac aactcacagg agttgatgtt 34380
 ttccttccac tgtgtgtgct ccaggaaatt aaactcaggt catcaggttt ggctgcaagt 34440
 gctattacct tccaagctac ttcgtcgtcc caaatttctt aacatttggc actacagttt 34500
 ggatagttag caacagtttg acttttagta ctgtgggtgt ttgaaggaga atggcccat 34560
 aggctcatat gtttgaatg ttggtcctta gtagtgaac tgtttgggaa aggattagga 34620
 ggtgtggcct tgttggagtg tcatacctat gccaggccca atctgtctct gtgctctgta 34680

 tctgggtctc tctgtatctg tgattctctc tgtgtctctc tctgtctctt gcttatggat 34740
 cagatgtaag ttcttagcta atgttcccaa gccatgctct ccacatgat ggtcatggac 34800
 tcaccctcag aaactgtaag caagcccaca attaaatgct tcttttata agctgccttg 34860
 ttcatggtgt ctctcacag taacagaaca atgagtaaga caagtattta ttacaaattg 34920
 tcaaggcatt atcatcatca actacaagac agagtggaaa acataaacat taacagctct 34980
 gaccaagcgt ggcttttgaa agtgatgaga agcagagttc tggatcatga gaaggcaagc 35040
 aaggacttgt caaggtctta tgattaagt ctacagagct gtaggtaaca acaacattec 35100

 cagaccactt aaaatgagca tgtctccttg aaggacgga gtatggctgt ggcccatgt 35160
 acacagagca gccactcaga tcatgatcat acagaaaaaa aaaaaaaaaa aaaaaaaaaa 35220
 aaaaaaaaac agatttcagt acatatcaga ttcaataaag cttgaattat ttttctttc 35280
 cctcccctct ctttctctt ttcttcttg tgtttgaaa caggctctca tatgtagccc 35340
 aactggcct aaaacttga atcttctgt cttagccccc agagtactgg aattatagaa 35400
 atatgaatgt tatgtatgtc accactcctg ggttagcatg aatatactgt atgaatctc 35460

catatgtatt ctattaata tttattgttc acaattgtca aagtgtagta tagacatgcc 35520

 aaataagaat tgcctttggg ggctagagaa ataactcatt gttaagagc cctttctgct 35580
 atgacagata attactgttc agtteccaga caccacatgg caattcacia ccaccactaa 35640
 gtctagtcc agggaatcca acatcctctt ctgattccat gggcaccagg aacacacagg 35700
 tgcacacaca tacatgcaag caaacatgc atacacataa agtaaaaata aatggtgat 35760
 aaaaataate tgccttttgt ttatacttac agtaacatct aacctatgaa gatatagcat 35820
 gaccaattat aaatttaaga acgtacagaa gcatttgtca tggcagttgg cgtgattggc 35880
 tttggatggc aagaggaatg ctgaccttct ccctaccttc ccagacttct tgtttacttc 35940

 ccaagcaatg ggattacagg agcaagccac cacacctagt tcttaactgg ttctcttatt 36000
 tttttcatga aacgaaacct cagaaacttg tcattcaact ctctgcat tgttatgta 36060
 gagcccacta caataaaatg atgtggcatc tcattttatt aatcccatac ctttctcaaa 36120
 gtcagtttct caaatgtgtg aaatatcaac aaatccagct gaaggattct gtaatgatac 36180
 aaattcccag tgtgttggt gcacacagaa catgtcctgt tctttctact tgagtcacca 36240
 catgtgcac tctctctga acagactcag cagggccatg catgttgcca ggctctatec 36300
 ctatggggct tctggggcca gactcctctt gagaatattg tgcagcgtag cccagcatct 36360

 cctggcaggg actcatcacc attcggact tcaagtgagaa gccacaggaa tggtttagta 36420
 tcattaaatg acaagtgtt gaagctcagc cctcgcttgt atatactaaa ttgaattgta 36480
 catttcagaa aatgacacat aaaatttctt aaaaccaat ggggggggtc agactctgaa 36540
 gaacatattt cattttaatt atgccaataa aattctacat gggatatgac aataatattt 36600
 atttgctatg taatatattt aactgcattt gtagtttaat tatataacat aaacacagaa 36660
 gccaaactat gatggtttct gtttctctcg gttaatgttt taatctggtt gaaaacctgt 36720
 tcagctgagg aaaacctct tagaagtaga tgtgcttgac acatgggaaa ccacttgatc 36780

 tagacagga ctctgagggc ccctgagcac tgtccactag actgaaccag attgtattca 36840
 aaacaagttt gcttactaaa agtgaaaaat ttaagtattc tttatattg accagaggcc 36900
 ctcaaatccg gtgtcattgc catgatagga aggagtaaat ctctttataa aaggactctg 36960
 ttctcacctg tctgtttta aatacaaca ggacagaaga aatcatcgaa gtcataagat 37020
 gctgtaaact gttttagata agaattagag ccagacgttg gtggcgcag cttttaatcc 37080
 agcactcagg aggcagaggc aggcggatct ctgtgagttc gaggccagcc tggctccag 37140
 agtgactgcc aggagaggct ccaaagctac acagagaagc cctgtctcgg aaaaacctaa 37200

atcaatcaat caatcaatca ataaataaat aaataaataa ataagaactg ccaatgagta 37260
 caaagaaaac atatcatatt agaatttag aattcagttg tgggagcctg gtatggaggc 37320
 acacatttgc agttcaagta caaagatgta aagatcccaa gtgcaaggat agcttgggct 37380
 acacagcaag accctgtctt agaaaacaaa accaacaaca aaagaaatgc aagcaaaaca 37440
 acaatggact gctacttcca tgccacctaa agctgtgctg gcctccattc cacttatcca 37500
 caggagctct gacttccat catcaagttt tcattaggaa aaaaaaatgt tagctaccaa 37560
 gcaccattcc aaaccagtac acagatccca cacacactaa ggagcatgca ccatcgagcg 37620

 agtactgcag tacaacctt gacaagaaag gtcctgtccc aaaagtactt cctgaagagt 37680
 ttgatatctg cctccaacaa atgctcagca gtgtgattaa cagtcagagt caatgtttct 37740
 gatgagtgaa cgaactgcag acaggcatct tcgttgagat acagtcggga gaagcctgga 37800
 gaacggctac cctgaaaact gaaccgtcac aagtcaatcc acgcagcttc acagatgcta 37860
 tcccgcattc tgcccagaga ttaaaaatcc aaatggaaaa tgatccttaa aagtcactta 37920
 cacaccaat tacacaatcg tgtgtaaca gatgcggtc aagccatctt tgttttcca 37980
 ctgagtggtg gtttttaaaa ccctatacat ttttaaggtt cctataaata acaaaacagt 38040

 cctgattttt aagcatagaa atgtacctca ctatttcct ctccttttag tcagaaaaga 38100
 tatttctccc tttaatggag ctcatgtaga acaaatagc tggcaaccaa tagtttgta 38160
 ggtgattata atggaaaaca gataggatct ccaggagta tggggaggtt tgaatgtgac 38220
 aaacaactgt taagattcct aacacactgg taccactgta ttaatcact tcctcatgca 38280
 aattagacga tgcataaatc tgattaggtc atagtctga acacgttcat taacaatgaa 38340
 acaatatacc caaactaaat tcttgaatat aaccttattt tctcatctgt cttggctggc 38400
 taagaacaac tigtgtgta gttatacagc tgttagttat acagcttctt gatggctgaa 38460

 attacagcac taaatcagca tagcttataa gatcatgtaa tagtaacagt aaatatgcat 38520
 caggtgaaaa atattgatgt tcatcatgtg gtcacatgcc aacagactgt ccccagatcc 38580
 ctggctttac agaaccagct ctgcccctt cttcttctgg catgatctca tttgttaat 38640
 gtttcttta cagaaataaa agagcctgta acttatgatg gcttgatttc taacttgta 38700
 atgctacaat gctgtaggag atatgtgaat tcactagaaa tattacttcc tggcttgaa 38760
 ttttgatttt acccagactg gaggatgata catacatagt gtattactct ctccagctgt 38820
 tggacagtgg aaaaaagcct cateccacag tcaccatac agccataagg ctacaaatct 38880

 gatctcccac agtggaccat gttgccagc gttgtataga aggctaagta caataaatgt 38940
 attggcaact tgggctattt tcaacctaa ataggctcac aggacatacc tecttttaaa 39000
 attgaggagt ctgaggtgac ttatctctc agatggagtg acaaaaagag atctataaag 39060

agcagctcta ctagaaaaca cagtcttcac actgactcca gaatcttcta taaagcaagc 39120
 ccttatgcc acaagccatt gaaaagaaag gatcataagc ctgagcaata gtagagctgt 39180
 tgttaattta gaacacggac actccgtcaa tgatcatatg atcacataat ctgttagcca 39240
 gaattgagtc tacttttaat tccacctatg agtggatctg ttaaacacat aaacttttaa 39300

 aacataccgt atcttctggt gctagaaaca ggaataaggt acaaagcacc cagcagataa 39360
 aggagtctac ctccaggagg gaacactgca ccagccacca taactcagtt aaaggacatg 39420
 ttcttggctc agtctttgta gccaaagaaa tagggttgtg ttcataacca aaggaaagga 39480
 caattccctt tggagaggtt tgtcccttgg ttaatgactg tttgatcaaa taaggcaggg 39540
 gatgagaaag agaaagtctt ggtttctgcc taatggctac ttaggcatca aattaccatt 39600
 aattaattgc atcaaattaa ttacattgag ttatatgacc caaacaagaa aaaacatccc 39660
 actaagacac accatgtaat aatactccaa caatatttaa aatatttgtt gtaattttca 39720

 atgtactggt caatttataa tttgtatttt accatgcat atcaaggcaa ttactatata 39780
 tggctccttc cttcataagt tagaacaata attcatctga accaaaataa tccactggtc 39840
 actcactaga ggtaatgaga acattaccga cacagacaac ttcatagtta ccagattatg 39900
 tctcttgca tagctcaata aattctagt actactccta taggggttgc ctgttagtct 39960
 tacagtgaaa attatggcat aggcatgga ctagaaatag tccaataagt agaccagaaa 40020
 tgttcccate ttcacatga ttcagaagat agccaaaaaa gtaaatggtc atgtctgtat 40080
 aattataaat tgtggttatt actaaaatta atcataatca taaaagaata taacttggaa 40140

 gcctttgctg aggaaatgat gttaaagctg aagcctgaaa gatagtgtag cccactgctt 40200
 ggcaatcctt tttcattat ctccctgtg tctcccttac aaaatactcc caacaaaggt 40260
 atccacttat gctagctaa catatacttg tactacatgc aagaaggcta gctgaaaaaa 40320
 aaataagtca acattagcag atggetttagt tattctcatt ctcccataat gettgtcagg 40380
 ctttatagac atggttaaga aaggcctat caagcaatg aactcacttt gtgatgtctt 40440
 ccaccagtgt ggagtgtcca ccttgcaaag ctaagtctaa cgggtgctg ccctcttcat 40500
 taggtagctc caagccttg actccccag ggagacacaa gagaaagtgg aaaagcttag 40560

 gcaggcccca tctcacagcc aggtgcagaa gagactctct gtgtagagat actgaagaaa 40620
 agggaaaacg taatgttagt tctccattc ataaactttg tttgtatat tttattatat 40680
 actggatata acagaagcct caggctgga aggaatcaaa agcacctcat cttgacctca 40740
 tgctctatga atgatgagag gtcctgggat atttctggag gtcagggagc caaagggtac 40800
 cgggtctatg atactcatga ctggactgg cttttccat ccactacact acatcctgct 40860
 gccacctagg atgcaggaag gaacatcacc agaggataca gattctcagg aaagatcatt 40920

ctttagaaac acactcatca gcttccaagg tatccactaa gaagatcctg ccacacaggc 40980

aaggcaggct atcaagacca caggcacaaa gaaacctctg tttccacat tcatcctcag 41040

agcctgtcct tcatgagagg ctgtgacaga aagcagttcc ttaagtgcag agcacttgtg 41100

accacagtct gtccccaacc tcacagtgtc gtgtgtgccc agcaattaga tccttgggaa 41160

catctccaca ctgccagagg caccctggtg ctatgccttt gcagatggcc ctgaacaggg 41220

gtccttggca gcctcatgct agtttccact gtgggtgtta ctgttgtgcg ttatgctcat 41280

ttcctgactt tcaactgatg ggctgccagg cccttgaaga ttttcttct taacagtagc 41340

tagtaatgca taaagccatt aaaatacttg cagagcttaa aaataattag ctattaaagt 41400

ctcaattgtg tigtatatt tacttcatct gtaatttga gagagtttgt acttgtctct 41460

ctactgtaat agcccagtac ctaagacaca ggtgattcat gacacaaact gtattgcaaa 41520

tatgcaaaat ataaaaacat tttcttacct tataaaagct agaccagac tggctgtggg 41580

ggcactttcc tggaaacca gcactcagga ctgtgaggca ggaggatcac ttatgtccag 41640

aagtttgaca ctaatctggg caacacagca agatacagac tacatacata catacataca 41700

tacatacata catacataca tacatacata cagggtcctt aaactttata tgcattgtca 41760

cactttaag acaccttctc ctaacagcct aaattcgaag agctgatcac tacagctctg 41820

tggcgataag cagagcagca cacagtaggg gtctagtaag taataaact gaccatatacc 41880

ataaccaag agagctagac aatgaatgaa agaccaaca gggtaggac cttgtcttct 41940

gccctgtggg atcctcaaag catcacagca cctgacacac ttgctaagca ttacagatt 42000

acaggaaatt acacacaaat agcaaaccce tgtggaagct ggcttttcat ctttactgt 42060

gctactgtac acaacacca tcaactcttg ttttgtctcg gataggtctt aatgaagtc 42120

tcacaacaga cactgtggac tcccacttgg tactcccaca tacaactagg gcattaagga 42180

caaaaatgcc agcttcccac acagctcact gtccacaaaa ccatgatctt attgttccac 42240

tgtcttcatt aacataactt cactattgcc agactcttgc ccaggcaaat cagtgactgt 42300

ttactgcaga aatttcccag cagactcacc aacctctcgg caggaatcac caatggagag 42360

tgcagagaag ccctaatac aattttaagc tatcatgac cttgccaact cctaaggagg 42420

tccccatcta aacctgcat tccccctcac tafgactaac cctactacca caatgaaaa 42480

tctttattaa accaagcttc aatttcttag tgaatttctg tcttgccatc cccagtcct 42540

gaagccacta aaggtttga acagtgtcac ctgacttaat atgacagcca caggcacagc 42600

tttgttatat gagggtaagg aatatttgtg gagggagcat ggaacaaaat cccaacacaa 42660

cagaaataaa tacccactg tgcattgata caaaataaaa ctgcttcttt tacattttca 42720
 cagatctatc cagatttctc aaaatccaca tcaaagacta cagggcttta gatttcaaat 42780
 acattaggac cgataccaga gtccctatca cagtaaagta ccatcgagtg ccctgtatgc 42840
 tctatcattt gtcatgtgac atatagcaca taccctcta tagtgaaaca gcagcccaaa 42900
 taccaaaaca tctgaaaaca gaccacagc cctggctgca tgcagttacc atgcatccgt 42960
 ttaatatgct tcaactcacc tctatgaaaa ccacaagact cgtgttgctt tttcctctcc 43020
 aggtgctgga aactcaacc aatgcctcat ggacactagg caggaaaggt ctttcttgta 43080

 tccttgaagt tattaccatt gcacttattt aaacatcatg gctatcattc ttagcaggtt 43140
 ccctgcagga caagtctgac aacatttgta cttatttttc ctattttaaa taataaccag 43200
 gaagagactt gttaggatca gataacaaaa caagcacaca cctgcacatg catgcacaca 43260
 tacactgacc agcagaggag ggccgatcat catgagatac tgagcagcca gccacactaa 43320
 atggaatfff tacaccacag atcccttctg aatattgtga gaaatgtccc atgtttgcac 43380
 aggtcgaat ttttccaag aaaaatacaa ctgagaaca aacaatatct gtctaaagca 43440
 gtggagtcca aacagtagca tttggtaaag gcaagcatgg tttcagtatg tgaacagtat 43500

 tccttagtgt ctgctgcaat gttctaaaac tgggtactgt tgactatatt cagctgacta 43560
 agaagagtga gtgtggggcc ttgtttctc cagtagcaga aacttccagg cctgtctggc 43620
 tagtcccagg catctactgt gttttatgag gggcagaggg ggtccatcct cacatatcaa 43680
 atgaaagaga actgtaacaa tcatgcagct cactggctct tcccctagc ctcagaagtc 43740
 cttcttctgg aagaggaagg aggatggaag gcagggaaag aaggctctc tgatggtcaa 43800
 agaaagcagc gaataaaatt accagtgtta aagagagagt actctcattc agtataaagt 43860
 ccagcatgga gaagaaggca aacagcttga aataggaagc atcgtgacat atataataa 43920

 ttctgcttgt tagaaggttc agatttctta acagcagcca aaaaaaaaaa aaaaaaaaaa 43980
 aaaaaaaaaa aaaaaaaaaa aatgaaatgt gagaagacac taaaatgggg aaaggggtta 44040
 tacagtttgg cagaggtagg gctatttaat taaaatgaaa aaaaaaaaaa aaccaataa 44100
 atgcctcttc ctgttggttt agctagtagc aggagtgtc tgaagttact gaaacagaat 44160
 tactaataat tgctctgatg gcacacatta aaaggtctga cttctaacat cctgggaaca 44220
 caatcatccc gacagagaga aactgaacag gctgtgactt tcaattaacc actcctgttt 44280
 tggaacgggg agggcctatc tgccctaac aggaacaaa gcttgattct tacatacttc 44340

 actctgtgca gcatcagttt cttttcttat aaaatgagtc tgacatacac aaaaaaggag 44400
 ccagtaaate ccggctcatt gccatgacca aatattccgac aagaagcaac tcatgggagg 44460
 aaaggttgat ttggcgctt ggtttgagaa ggcacagtcc tttttgaca ggagagtgaa 44520

atggttgctc acacagtgtt cacagtcagg aatcagaagg aggccaccga tgctcagttg 44580
gctctccctt tccccagccc ataagaagga agagacctgc attcagggca ggtcttgtct 44640
ccttggttaa tctcttttgg acacacccaa agacttgctt tactaatgcc cagtgtttct 44700
taaccaatg gagttagata ttgaaatgaa acaccctaag tccactcctt ctcaacttga 44760

taccxaaaca agtcactttt aaacacaaac attccaactg cccttaaagg ttcattggcca 44820
tcttataatt taaaatatit ttaatccatc ttttaagttt accagttcca ccattgttca 44880
aaagacccaa gtccaaaatc tcacctgaaa ctgaaaaatc tcttaactgt gacccgtgaaa 44940
taaaccctct aaaaatitit ttaagttaa tttttcagt atacagtggc acagaagtaa 45000
aaatcccat tccaaaatgg aggaatgggg gcatagtaaa gaaatatcag atggaagtaa 45060
gatgggaacc cagtaaagca aatgccacaa cctgcaggct cctgcccagc atctgggact 45120
tataacacca taggaactcc aacaggttta catagccctg ctctccaga tctgttctta 45180

gggcacatgt ggcctttctt taagacttct gtactttctt ttatactgca gctttacact 45240
gtagatgtcc aatattitit gcatgccc aaatctgaga actccattgc aaatttggt 45300
cctctttctc agctttacac acccttgcag gtaacctgca ccaccacacc atgcctggt 45360
ttagatgtat tctggaacct tggcaaaagc ctacatgaca ccctcactct caacattgtg 45420
ctaggagctt aagatgtagc ctggccctcc tgcccaaagt tgcctcagct tctaaggggc 45480
tgatctctgt gtgtcttaa agtcaatecc aggaatata ttgcatagcc aatcctggac 45540
ttcttcctt attgtcctgg aggcactttt cctatcattc cagtacaaag tccagggctt 45600

ctcattaatg gtgctaact ctaacatcaa agccactttg tcccaaccaa gctcctttcc 45660
tctcaacaa actgtacatt tttcatctt ctgcatgttc tcttcatc tctctcctc 45720
ccccactct ctctcattt aatcttggc aatgtgagt agtaacctg tcacatcctg 45780
aatgttacgc cgtcttcac caaaaaatgc agttcactgt ttttaactc agcctcactc 45840
aaattttcag gacatgggta agacagggtt tcaatttag tcattaatcc tctctggaaa 45900
tgccctcata ggcacactca aagtgtgcc tcattaactc ctgagatgat ttttaacta 45960
ctcgagttag caatcagaat taactgtcac agttccaaag agaagtcagt ccagtctga 46020

ctttatagt agcaagaagt acaaaaaaca gcataactg aggggactta cagatcatct 46080
aaggcaaaag agaagaaca gaagatgttt taagaaagt gttttacttt gcagtcagtc 46140
tgcatgtgga accagtagta taactataca tacctttcaa ttagcataat attcagcatg 46200
gaagatttaa aacttaatt gccaatgtag gctcatcaat tataacaact gtggagagta 46260
gaagaagtta caaatgtgta aaaataaaag gcatttagaa aattgctggg ctggtgagat 46320
ggctcggtag ctacagcat ttgctgacaa gcccaaggat ctgagtttga ttcctaggg 46380

catacatggt ggaaggagag catctacccc tctgatgtcc acacatgtac tgtggcatat 46440

gcatgcattg acacacaagt aaataataaa agataaaaat aactaactaa ataaggttcc 46500

ctaaaagtaa aattcaagga ttttctatg agatgcctct atatccatgt ttattgacac 46560

actactcaca ataatcaaga tacagaatca gtctaggtgc ccattaacaa atgaatagaa 46620

aaagaaactg tcataagtac acacacacac acacacacac acacacacac acacacacac 46680

tgatacccct aatattcaag taccagcaac ctagaacact cgtattatga ttagagatac 46740

atatctagaa gattcaatct tgaagaagtc agatgcattc tccaaagcca gagaactatg 46800

aattgaaatca gttttcaaga agactagaaa cactaattaa aggcgtataa tatatattac 46860

ttgattttaa tatagttgca ttttattaat aatatttcag tatcattcat ttgtacatac 46920

tttgttggtc tttgtagaag gctttttata tggccaaaag aagaattaa tcatgttctt 46980

tgaagtaaat gggcaggaca agaaatcttc atgttaacag aaataagcaa gtctcacaca 47040

gacaattatt gttttctcac atatgtggaa tgtatgggaa catgttaaaa ggacatgaaa 47100

ataaaagagg gactattagg atgtggaaat gaattggggt gaaggggaag gagggctaag 47160

aaaggaatg aggagataaa tatagtcaat acttctgaaa atagccaatg ctgggccatg 47220

gtggcacatg tccttaatct cagcactagg gaagtagagg aaggcatctc tctgtgactt 47280

tgaggccagc ctggaatgag ttccagggca gccagggcta cacagagaaa cctgttttg 47340

aaaaaccaga tagaaagaaa gaaagaaaga aagaaagaaa gaaagaaaga aagaaagcga 47400

gcataaaaaa tgtctgaaca ctcaagaagg ccctccccag aacaataaa taaggatc 47460

tgaagggaga tgagcaccca tgtttcctag agactctaac actaaccag agttagggtt 47520

ctgccttta aagccagtaa ttgttaggca aaatacatcc ctaaggtttg ccttctagag 47580

cactgttttc ccaatctgcc ctgaagaact gtcattctct aaaaagaata ttaccaaagg 47640

acaaaaactg gctacagttt tctgtgagtt taacaagttc tttgccacce aaggcctaa 47700

ctgctaagcc aggaaatagg cttaaactct tagcaaaata ttataattaa tacacaatgg 47760

ggatgaaat ctagaagtaa atgatatttt caaaacacta ataaattcag aagctagagt 47820

tcagaatgtg ctataactcc tgagggaagc cataggaata tattcagcat aataaggttt 47880

tgaagaccaa tgggctttca ttcacataaa tctaattcat taaaacaagt tctattctta 47940

tttccaatac tgcacaatg tacaggctc aacttgctt cccaagtcac tcagcaaaaca 48000

aatattaaat aatcgaattt ctatgtgcca aaccaagtg tagatgaaca tagttcctcc 48060

tggatgaacag caaacagcca tttgtgttca gaataaaata aaaggctgac ctatagaatt 48120

gttgtctagt aaactagaat tctaaggcct agacataaag agtgtatgag gaaataagaa 48180
 gactattcag ctgacaagga aatgtatcta catgtccaac atacgaggta tcatgacaca 48240
 gaagtttaca gatgtttata aagtccaac tatggagagc aaaatttgag gaaactatta 48300
 accaacattt acatagaaag taaaaagaag atttggcatg gacatacaca ggctctgaga 48360
 tatttcaag gttgtcagt aaagtaagaa aaggggccag gttgtacagc attttctgcc 48420
 catgcagtct gttcaggct cggtagcgg gtatacagcc agccttcagt accaaagatg 48480
 ggaggctggt gaatctaaag tagaaatcac aactataaat atgcttattt gaaaaaaag 48540

 atacagagca tcaaaaagaa cagatgacca acatggcagc cataggctga tcataaggcc 48600
 agaaagaagg catggagagg cattagcaca gtggcaggcc atgcttgctt caagctgctt 48660
 ttctgtacct aatgcattca cattgcaacc acgctaata atctctggaa acatccatca 48720
 catgccatca ttctgaaaa tctacattgt ctgtttacaa cttagatggg tttggcatct 48780
 cactgaggat ggctgtattt tggcttctgg aactataact aaatagttga aacactaaaa 48840
 agtctattag agctccaaga tgaaaacctc attttgctt tcacatctag atacattcca 48900
 aacagaaaca cacaatgtgg gcaatagtat caggttgtaa gaaccagac acaccttcaa 48960

 tagtgtaaag ggggatggat gaaaggggtc agggcctgga gttgagcatt tacagagttc 49020
 caactctggg gaaattgctt tgtctgtaa agggaaaata atatcaagcc agcttactat 49080
 ctcaaaaata cagaataac atataggtca gggttccca gaactacaca tgatctttt 49140
 taatacgaga aatcacagt tactgtcact aaatagatat gtggcgtgtt tggaaacagt 49200
 ttttctctgg ttatcattta aaaacataat tgaaggaac tagtctccgg cttaggatgc 49260
 actgtaattg catcagtact gtgctccaga tgagcatta agacaaatg cctgtaatcc 49320
 cctgactggg gctgcaggca gtcattaggt gtgataagca ccaattattc cagaccttct 49380

 ttccagacta tgcaatccat ttttctctc actggctaata gtttcttcaa gttcaccatc 49440
 tattcatggt gaatttgctc aaagtttctg tgctccctc acacaacagg tgagtggaat 49500
 tctcagatgt gtgccctgat gaccttcag gaacctgct ctttttagga gcaaatgaa 49560
 aatgtaatgc agttttcact gttttactaa taagaaggaa gtgtgggttt atcttgcaac 49620
 tgcctttcc aaggctgcag cagttgtttc aattcaagta caaccaggaa attagccaat 49680
 gaactacagc tgggcagact gtactcattg ccttggtact agatactga gccttaggac 49740
 cctgttccca ggtaagaca tgtaaacctt ttttttttt ttttttttg gttttttgag 49800

 acagagtttc tctgtgtagc tttggagcct atcctagcac tcgctctgga gaccaggctg 49860
 gcctcgaact cacagagttc tgctgcctc tgctctga gtgctgggat taaagctgtg 49920
 cgccaccaac gcccgccca tgtaaacctt ttgaggtatg aactgtacca tcattgagcg 49980

atttttatcc acctcattca gtgtctgaga cactgggaag ggagagaaaag aaggggagta 50040
 gaatccacca agcaggaagt cagtagcaaa gtgtctgtat aatcagggtg aggctgggga 50100
 cgttgggaag acatttcaaa ataaatttag acatcgtacc ctaagcagaa cagggggtgg 50160
 aaagataaga gcccagatg gtgggtgact acaatgaagt agtgcagctg cacatatgaa 50220

 caatgtagct gtgagagcat tcaccaggcc tacacacaac aactcaaga cagagaaaac 50280
 cctgatatgg aattggggaa atccgcagga agtcccatct ctagctgaat gtagtggttt 50340
 ggaagaaaat ggccccaaa ggcaagtggca ctattaggag gtatggcctt gttgtagtgg 50400
 gtgtggtctt gttggaggaa gtgtgtcacc gtggaggcga gctttgaggt ctcatgtatg 50460
 cttaggcat gcctgtgag acagttcact tctgtatgcc ttgggtcaaa atgaagaatt 50520
 cctcagtatc atgtctgcca tactcccagc tgccatgctg ccttccatga taatggacta 50580
 aacctctgaa ctgtcagcca ccacctcaac taaatgtttt cttttataag agttgctgtg 50640

 gtcgatgtgt ctcttcacag caatagaaac cctaactaag acaatgaaga tctactgaca 50700
 actgctagct aatgagagac tttttttttt ttttaaggat atgacctcct gttaaatcaa 50760
 ccatattcca ggagaggacc acacacacag gaatatattag atagcacaaa ttggacatga 50820
 aatagggtag gatggatagg gaggtaggag gggaaggagt tggggagggt ggatatgac 50880
 aaaaatgcatt gtataaaatt cccaaggaat taataaaaat gttgtttaaa caaaaaaat 50940
 ccctaagaag gaaatggaaa cttgccggaa ctcataaaag tatgtataaa tggctaagtt 51000
 ttataaaatg taaaatattt ctcaacagaa tttttatttt atttttaaaa aggagccatc 51060

 acagacacgt ttatttcatg cttatgaggt ctctgtgatg tcagtgttaa tagttctgac 51120
 atgttcccaa ttattcaagg tcaactcagga atcaagaaga gcatcaagaa ttgagacccc 51180
 ctttcttctt ccaaagcttt agctagtctc tagccattat tcctcccaga aggcaaagge 51240
 ttgaagtggc ctcaactgca gtgtacttat gaagggaat ggattaaagc caacaataag 51300
 aagataataa aggttaactg ttgaagagaa acagatttat acaaaatgat taaaactcca 51360
 ttagtaaaga atcaggaatg gatttattta atactgttta tgcttatatc tcctactata 51420
 aattacagat ggaaaagtga gaattacgga ggggaaaaaa aatctgcaaa acaataaaaa 51480

 gccaaaaata gacattttaa aagagaacac aaaaaggtag accccatagg aaaccaacaa 51540
 attgaaggtg gaaggaggat ataagcagaa gtaaatgagc tatacaagct ctaaggactc 51600
 aggctgatac ctagtctcag gctttcaaca cacacacaca cacacacaca cacacacaca 51660
 cacacacggc aaattaaagc agctgtaatt acaagagtgg gcaggagca cagatatgta 51720
 gaaatacagg gtaagattac aaaagacttt tagctttatt ttttaaaact ttttaaaaga 51780
 tttgttttat tttatatata gggatgtttg acctgtatgg atgtctgtgc agcactgtgt 51840

gttcctagtg tccattaagg ccagaagagg gtgttgatt cccttagact ggagttgtgg 51900

cagttgcaag ctgccaatatt ggtgctggga atcaagtcta gtcctctgga aaagcagcca 51960

gtgctctaaa ccaactaaaca tctctccgga cctctccttt aggtttgtag catacagctt 52020

ggtatgggtt calatccata ccaaggctcc tatttgagtg aacaaaaggc tattaaaagt 52080

cactggggtc aagtaaaggg aacttgagca gagcacacag ctagctagct catgtcactg 52140

ccagagtctg ctccaccac tctcagctct ctcccattca ctttctacaa ccaactgtgct 52200

tttgaccatc aaagcctggt agttttacaa ctcatatgcc acttttttt taaaataaag 52260

cagcacaaga acagtcacca tcatccaaat cctattaaga aatgcaaaaa gtatcagaag 52320

ttttcacctt tttccccctt aaaaaataac tataaaatga ttccttggt gctgtcgttt 52380

tcaagttcaa ttctaattcc atgtgtgcag tcaaaagctg ccatgaacat cctgtgtatt 52440

tgggtgagtc caagagcaac gggggtggag atgggcctgg ctagcagagg cgaacttcag 52500

aggctcccag ggtttgggtt cctgagggaa acaccagggt agggcattca aaaataagat 52560

tcctcttta tactctctct ttttctgaa aattataatt gggagagaca gtgacccaaa 52620

tacaccctta cgttctatit cccagatggg agaataaccag tgggattctc tactccaagt 52680

ctaaggtcca ttgttgccag acagaagcaa agtttcttaa atacttcatt actttatag 52740

tatgagtgtt ggcctgaatg tatgcatgtg caccatttgt gtgcctggtg cctgtggagg 52800

tcagaagagg gtgtcagata ccctggaatt ttacagacgg ctgtgagcca ccatgtgggt 52860

gctgggaate aaaccaaggt cttctgcaag aagagccagt gctcttaacc cctgagccat 52920

gtctcccate aggagacatt ttttaagaa gagtttatga tgtgtcttct tcttgaagga 52980

accattttta aaaaagagaa tgggcccaag aagagccacc aacttaagct gcaaaaacaaa 53040

tcxaaactat ctgaagggga caacagttct tttcctgaag gacttcaggt ctgcactgta 53100

ttcttactgc caggaactct attccttgaa aacctaaaat ggacttgaa gacaatgaaa 53160

acatttttaa attaaggatt taaatcttc taaaggatac ctacacacaa acctaagcag 53220

tgcgaaataa ttgtatcagt tagacataga aattcgccat aggcacaatt ccaaagaaca 53280

ctgtcccaca tcattagtat tcacctgag ggttacctta gcaaccaaag ggatagaata 53340

ccagtttagt gtgtcagaaa agaattgtgt gaaatgattg acccatagaa aataccagaa 53400

gcaacagaag gctagaaagc aatactgaat atatacaaaa ttactttaaa aaacaaaaac 53460

aaaaacctat ccaaaagaaa cacacaagcc accaggacca ggtgtttccc agttttccac 53520

aatgcactaa tttcaaaact cagaaagaaa ataagcagag gaatttgtat gttggactaa 53580

atcttgcttg taicggtttc ctaccactg gtgtttcagc tcgtgccatt gaaacttggt 53640
ggctgttaca aagctttggg tagaatgaca aaacagacag gccccatgat ctgcaggcca 53700
ataagcaagc ctcatgctcc agcactcaga tagggacctc agtgaagta gcccaggga 53760
gggcaactgc aciggagctt cactctcctt cctcctagt aactagtta ctaggatgaa 53820
gggggcgcag ctccatccca aactcatccc aatgtggctt cctgcaggtt acaaggtct 53880
ttccatgcaa ataaaaaca aatttcctct gcaaacgctg ctgaccatac atcccccttc 53940
tctggctgcc tagaagaaag gggatcggig catgtgacat ggagcattat gtccatgtgt 54000

gaatgctgat ggtaagaca gattcacagc tgctgaagaa cccttaatct taaaaacttt 54060
cctctgaagc cctgtggct ttgcatgctc tctcattagc tgcaaagcac ggagaaccga 54120
gaattcttca gaggatgta atgcatgaag acctattta gcagagcata gtcatgctaa 54180
ctgccatct ccattgtgat agcactgtgt tactttccct gcaactggca tggcatgtgt 54240
gcttcatgac aacgttcagt ttttccttta agttcatgct gcaaccattt tttattcaaa 54300
caagacactg ctcaaactg ccctcaagaa catgtacttt gtgactgta aatcatacct 54360
ttaatctcta gatttgcat taagtctagg atgttgaat cagttacaga acagattctt 54420

aatccaatct tgcattaag aattaagaga taccatgctc taacctatct ccaactggctc 54480
ctgccaggac taccaaccag cctctttga tgatggatct ctacacagca aataaccaca 54540
gcctctaga tacttggct gtgtttaaag ccaacactgc cctgaagaaa cattgaaagg 54600
accaattggc ttatctctg aattccctct gtaggtagaa taaaacagg aagacagttg 54660
gcctctttaa acttcataaa gcaacttcat aaagatcaa ctttgtttg ttggaaattt 54720
actatcttc cctgcagatt caacaccatg ttgaatgat tgggtggtt taacagaacc 54780
catgtactcc atcaggaaca gaagaacatc tgcccagaag acctgaagt aagtggccat 54840

gtccatctac agttttcac aataataatt tacccttatg ggctggagag tttttgtgtt 54900
aatctgacag aagccagggt tatctgaaag gaaggaaact aactgagagg gggaaatcag 54960
tcataagat ccagctgtca gggagggcc agccatggc aggtagtacc atgcctagge 55020
tgggttctg ggttctataa gaaagcaggc tgatcaagcc ctgggaaatg agtcagtaag 55080
cagcacacac tattctatgg cctctgcatc agctcctgac tccaggttcc tagcctgttt 55140
gagttctgt ctaaacctcc ttcaatgaag aactacaatg tggaaagtga agccaaataa 55200
acactttctt cccaacttt cttttggtca tagtgtttca tcaactgcaat agaaaccta 55260

actaggacac cttacaaagc aaaatcttca atctgccaat taatgtgat gtattaatat 55320
atgtgaaaa tactatttat gtgtcctttt taaaagaagg agtccccca cacacacaca 55380
cactgcaaga gcttaatta gaaggcaagc tgtatctctc agtaggctgg caaagaagta 55440

actatgttca caaagccagt gtcattagaa ttgaggtggc cacatggcag ctcctcctg 55500
 gtgaagcctg gcttaccagc catccctgtc gggcttctgg gaacacaaat gcaggaagc 55560
 catttggtg agcaggaagg gaagcttcaa ctcaaagtgt atctgagcac caatcagtga 55620
 gacattagaa aattttatcc cagttaacct aattgtctac attataccaa tctctgcaaa 55680

 aacatttctg tcaaacaca aacaggcaag aaacccaaaa caaagcagat aaactgtgac 55740
 atcttcttgg gtaattctat tacttcactc agcatcttac tgcaaacaaag gagttcaggg 55800
 gccctgcaag agcttctatc ataaaagcta gctcacataa gaaatgggtt taatcttatg 55860
 aatagaagc acagtttgat agaaggcctg aagttaaata aaacctgggg cacttcttc 55920
 tattgtatgt ataataaggt tgtactatga ctgatgatat gtaagatagg gaccaagatg 55980
 agaccctgct ttcttaaggg gtgccacgct tctctacca tctctcctg acaaccatca 56040
 aaagtaaat gtgagaattt accacaaaag acagaggaat gcagtaatgt ctcatgatag 56100

 gtcttgggtc ggattattha tacaacaaag ctattatcaa agttaactaa cactcctctg 56160
 ctaaaataat gtttacact aaagaaatca ttaaaaatgg ataaaaattt tgaaggataa 56220
 atacagaaaa ttttagatgt ttctgatggg tactaaaata gataattgct gaatggtttg 56280
 cagggccctt taaaaact aaagagaaca acaatgtgat ccagtgattc cattgctgta 56340
 tatgcaaagg caataaaatc agacagctag agaagcatct acattctcat actcatgaca 56400
 gccccactca taagagctaa aaagtaagca acaagtgatg aatgaaggga gaaaacatgg 56460
 tcatattcaa aacggagtac tatccatcca taaaaatga aacctgtca cctatggcaa 56520

 ctggaactgg atggaactgg agaccattga gttacagaaa ataagccaga cacaagcaga 56580
 ccagtaccac ctgatctcac ctatatgtgg atctcacaga gaactgtcat agaaactgaa 56640
 tcagatggtc accagagctt aggggtggtg gggaaatgtt gatcagaagg tgttacatta 56700
 cagctagact ggagcaaagg gttcttgtgt aacagcaact gtacatttca aaagctaca 56760
 agaaaggatt ttaaaaagtt ttaaacacaa agaaatgatg actgcttgag gttaagtata 56820
 ttaaccaat ttaaacatta cacaatgtac acgctatca aaacagtact cggatgatagg 56880
 tatattttta tgcctatcaa aacagtactc agtaaaggta tatttttatg tttcttcatt 56940

 taaaaaagtg aattgaaaac acaatgacta ggaaggaac tggattctgc ttatgactga 57000
 tgtecccacc aggaatacaa tccgaattct catgggceca accctcagcc tagtcttac 57060
 gtcacgcta tactggcaaa ggtcaagaga ccaagaaggg gattctgaga ggagaaaaca 57120
 aatcaagtt ggggttgaga aggaagacaa agaagaaaga gggcaatagg atacatgta 57180
 catagaaaca gtggtcactg ggggtgaagg agaccaatac tgtgggcaga gggctcggaa 57240
 aggctagtgg ggtcagagaa taacaagaac aaagcactgc aaaaccctc aatgaacac 57300

atttactggt tgiaccagtt ttgaaaataa taatatataa ataaaatag attcatctgt 57360

 gaaatcccaa attaaatata aagtgatctg cacagatccc acaggcagga gtcccaaggt 57420
 tcccaggata agtatatcac cagacttgaa ggtacttttg tcaactatgg cattaggaac 57480
 tatttttcca gatggtacaa tgtcttacta tcaaaaggaa aggaattgtc ttcctttttc 57540
 tcttatccaa aaatggatct cttagacagtc ttgaaaacag cagcaggaca acagtggca 57600
 gctacagttc tctgaacctt atttattatg tatatctacc agaaatacac acccaacatt 57660
 gggaaatcat acacacgcac tactgtaaat tcccagggga accatgcaca catactatta 57720
 caaatccaca gatgtagaaa accttaaat ctgaattttg atgtggaaaa ctaaaagcag 57780

 caagtatgca atacaaatth ctcttcggag gctcacggct taagcttggt catgtgcagg 57840
 ctcatgcta gttgatactc atggattcct cttatccaag gtctttaaaa aaatcagagc 57900
 caggcactgg tgggtgcacgc ctttaatecc agcactcagg aggcaaaggc aggtggatct 57960
 ccgtgagttt tggccagcct gatctccaga gcgactgcca ggataggctc caaagctaca 58020
 cagagaaacc ctgtctcaaa aaaacaaaac aaaacaaaaa aaaacaaaaa aacagaaaca 58080
 aaaacaaaaa caaaacaaaa atcagagaca ttcagaagtg cctgggaagg tttgtaataa 58140
 ttctgatgta atggagaaat gaatatcatg tctggttata gataatggcc tcagtacct 58200

 gcttataaaa accatagcca tcacttacag tggtagagta cactcaatct cacccacgat 58260
 caaatttaag ccaattgtaa gtcacacca ggagtaatca gggatcaaat tctttgaagc 58320
 agcatcatcc aaccacaag ctgaagtcag gagaggaaag cagcacattg acaacgtgcc 58380
 atgtcaagaa aacaacatct ctggatthtc aacaaaatta catcatttgt aatcacctta 58440
 agaaacagct actgggtggc tggtagatg gctcactggg taaaagtgtt tgctgtcaac 58500
 ctggthttaa tctgtgggat ccagatggca gaaggagaga aatgactctt gaaagtgtc 58560
 ctctgacctc cacatgtgca caaagccaac ccccaaaaca caatctaat gaataaatga 58620

 aagcaactth ttaaaaagga acatctatta agcagthttc cttcacacc aagtgggtth 58680
 atatatgact cccatagctc tacatatatc atagcactgg agaacaagaa ttcattcacc 58740
 cttagtaatt ctaaaagtta gtgcaaatgt aacacaaagg aattacacat atctgaggaa 58800
 gtggaactaa taattgctgt agthtggcca acatgcatth ttcacatgta tataatgatc 58860
 gcagtgtacc ctgtagataa ttacaatgctg tctcaactga aaaacactth tgggacaggg 58920
 tctctgtacc thattctagc tcacctggag ctcaatgt agagaccaga ctggcttcag 58980
 actggcaag acctgaatcc actctcagth taaagthttt thaaatctat aatgcctg 59040

agggaaactg actttgtatg tatgtgctaa tgttcccact tgcaagtcca tgtgagtgtg 59100
 catgagtttg tgtgtgtgca tcagtgtata tgcagtcata catttgtgcc tcgtgtgtgc 59160
 atggagaggc cagagtgttg cttttcataa gtcacatgc attgattttt ttttaagacag 59220
 tgtctccagt tagagctaga actcaccaat tcagctagac tggctggcca gggagcccag 59280
 agattttcct gtctccatct taccagtgtg gcgttacaaa tgccccctt ttttaaatgt 59340
 gggcactaga gacggaactt aggtcttcaa gcttgcctcat caagcacttt ccaactcagcc 59400
 atctcatctt ccccggtctg actcttatgt tgcagtcggt gtttgttgtt catcagttac 59460

 ctttctttca ggatgcatct cttccaacca ttacaaagag cttttttat ctttctctat 59520
 ttggataatg gcaacaatgt ctcttctca tggcatgaaa ctggccaaag gaattagagc 59580
 cacagtcaa agccacaggc tcaagagcca gccataaaga aacaatatca ccaccaccac 59640
 agacaaagcc cttaaatggt acctctcag acctctggg acccagaagc atcagccagc 59700
 cagccgagag atgaatggct gaagacttca gagaaccag ccacataaga gctaatggtt 59760
 tagctaaaag gtgggaagaa aatctacc agagaaacag atggtaaact gtaaagtaca 59820
 ttcttgactt gaaacagaaa gcacacaccg cacatctgag tttctgaca gacctacctt 59880

 caagtgagga attccccagg actgtccagc ccaaaggcag ttccagtgg ctcagagcca 59940
 gcaccagttc ttcaccaag gcaggcagcg ctctgcccgt caggcacaat ggggttagca 60000
 gcatctgggt actacagcc gtgagtcggt cagcctgagt gaccagtaga cgagccagtc 60060
 ggcaggccat attgtccaca taggtcactg agccagagcc catggtcact ggagagtacc 60120
 ctccgagca gagacacaca gacaccatca ccgtctctg aagccagtgg cctagatgac 60180
 aggatgacaa aacttttagc tcatgtctga aggagacaca cagtaccct gggtaggcaa 60240
 cactctccag ggtcaagta gaaagtaagg tgcactctct aataccacg atcctggggt 60300

 cactccagag atgatatctt ttttttgggt gatgggtttt aatgatcct ttggaacttc 60360
 agagtctctt ccaccaacc accgtccttt gccacacttc ctttcccttc tacctaagcc 60420
 ctggattcca gtctgccatc tgaaggtct tcatatttc tgtctgcta taaacagggt 60480
 cacacattct tagccattta ttgaggtaac agatttttta aaactgtatc agaaatatat 60540
 acaagtgcac ctaattcta cagagcggct ttgaaagtgg ggtgaagacc ccttaactag 60600
 actctgtgtg catgaacaca ttcaacaaaa agcaggagtt tcccagggcc ccctccagaa 60660
 agggcccctg tgcctgtct tctcactact tccagtgtgg ctgctcacc tgctcctgc 60720

 tctccttaca ctctctttg tcttctttc ccattctgct aaggttggcg aactgctgcc 60780
 cagctatgtg ttttttctt ttggtagaat ttccaagaag tcaatagctt ccaaccctg 60840
 ggaccatag atggctggac tgagaagagt ccctgaactt cccctgagca caatgcctt 60900

gtactcacta gcaagtgatc ataggtctgc atcctcctgc ctgcctgacc ctccaagctt 60960
 tcccacaaag gctatgtctg cggaattcca aagaccaaga gcatcagggt tactagacaa 61020
 gattcgttgg catcctcata atgactctca aaagatgcca acccacagac agtacctatt 61080
 gagtatagat tgcaggacat actttccatc acttggtaga tgaccctggt gaagctaacc 61140

 attcctaata ctcaagggtt gcctcactga atctataatc agataagttt aaggtaaca 61200
 aataaactgt cactcaccca caggaacct gacaaaatga agacaagggc tggccctcac 61260
 ttttaagtggg ccattaaata aggagagata gcttttagcac atcagagggc aatgaggttg 61320
 gtccctccag gtaacaaga aagaacaaa acaaaaagtt ttctatcaca agggacattt 61380
 ttgttatttt taitcttttt ctataggttg ctattaaaa gggaaaacat aaggaacctg 61440
 gaatagaaag gatgtcaatg tattggccca gagtaaaagg gtagcaggga agggaccaac 61500
 agcagaatga caagggccat taacaatac agcagtatga ttgattgatt gattgattga 61560

 ttgactgact gactgactga ctgactgatt gattgattga ttgattgatt tttgagacag 61620
 ggtttctctg ttagtctctg gctgtcctgg gactcgtctt gtagaccagg ctggcctcaa 61680
 actcagagat tcacctgat ctgcctcctg agtgcaagga ttaaagttgc atacaccacc 61740
 acctggcatt tgggtttctt ttgttatata tgaattcctg gggctgccag gctgaccaca 61800
 gaggaatgag gaaggagaat gaagacatgg tctgtcatgt caccttgtcc agagccaact 61860
 caggcatcag gctgggacta aggaggtgac acccaaggca tatcctccat tggctgcaca 61920
 ctagaccttg agagctgtgg gcggcccgtt ggctaagctt gctgggacta agtcaaggta 61980

 gacactattg gcgggcccc aggagttagt ggcaaagagc aagtgtcttc cetaacagca 62040
 tgcacataca cccacatgaa ctctgacct tggctagtgt ttcttctttt ccctcgtgat 62100
 tctcctctgg cacatgcctt ggagggaga catagatgtg caccctccat cactcagagg 62160
 cctcctcacc tggaatgctg gattggagaa cattatectc ggtgcgctca gcaatcacta 62220
 catgtctctg ctgcgaccca tcataaataa agtaaaactc ggcatcttca ggaagataaa 62280
 catttttggc aaactttgca tagaccgtcc tctgtccctg aaaaacgagt aagtctgggc 62340
 atcagtacac ttcttgttc tggctctgag aaaccacagg ggaagggcac aggcccacaa 62400

 cattgacact tgtcatafgc acttcatgtg agtgagctca aatgtcacag agcctccgac 62460
 caacaatgac cttttccag gaacacctta ctgatgtgct tagtatggga gtaagagctg 62520
 gcctacactt tctgaaagtc aaagaagatc aaggaatagg aaggaatcat tcttttaatt 62580
 tgctagatat gtgactgiga ttttttccag taccttgaat tctactccc caaacatcac 62640
 tgtgcataat aatgttatcc catatgtgaa ataccactgg cctactagaa tgcfaatagt 62700
 tattcttagc ttaggcctta gcatgtgcta gaccactgta caatacatta aacataaata 62760

ctcacagaca tttttcatat aaacaagagt ttttactcac atgctgtacc aactgccttg 62820

accccgctctt ctctgagtga ccccatgtcc tctgagtgat gtctaagccc tttttatcat 62880

ctgggttggc ctctcttttt gtcttaagag tttctggcta atacaaagcc ttacaaagtg 62940

tcctggttcc cagaagaagc attcctcaa aggaatgaca acagagtigt ggtcttggtg 63000

caggaggcct tgcaggggc tagctgacag tcaagcctgc caggatcatcc caggatcctg 63060

caggcctcag aggattcagg atgctccctg cctggagtac acaaaggcag cctagagcag 63120

gtctccaggg agagaggatg cattctgccc agcccagggg agtgacaggg agatgaaagc 63180

caggagaata gatattact ctagagactt gcacagctta ctgatatgg agaaggctct 63240

gggtgtctgt gtagctgect aaccaaata aacctgttc tcatcctggg aaaggagaa 63300

gaagccaaga agagtcagaa taaggctgct ggacatgagt gtcagtcca cagtcccta 63360

cagcatgaca ctgcaggatg ctaacagtta agttaaggag gagcaaaaca ccagccaaa 63420

tgggctcct gcgccagtg accatatcat ttttgatct aaaaaatgt tttgaaata 63480

aaaaatgctg tctttcata ctcttgcaat ctactctca gaaaggcctc taaaattatg 63540

aattaaaagt gctttgggaa acacactggt gttcagttcc aaattttcct gtctttgcat 63600

gtaagcgtgt gtgtgtgat gtgtgtgtgt gtgtgtgtgt gtgtgtgtgt gtgtgtcaca 63660

caaaggaatt gatagaaagt gatgtgcaa ggaaaatcta ccatacaata gcttcagaaa 63720

gggaacagga aggagagctg aaaagcaaag gacaaaaaca ataacacaca ttgacagga 63780

ccgaaagagg aaactcagac gactttccat ttctataaa atgaagaaca gattgcttta 63840

gtcgtgttcc tggttgctaa agggetgcaa actctccata gatagaccct gcaactggcct 63900

actagtggtt ttcttaaca cagaacagat tgtataaata gatcaaagat ttccacagat 63960

cacaaagata cctgcatcgg ctccaacaa tggtcagatt agtctctcgt ttggcaaggt 64020

caacaaggac tatcacttag gcaagagctt cactacaacc tttccaggtc catccttccc 64080

tgactgcata gtcttgatgc atagtgttc cctctcgaga ccacaccacg cttcacgatg 64140

gtaaagacag acaacaggat acctcggata cctcgagaga ggtgacctag ttgtctcagc 64200

aacaatgatg aactcagaa taaaagagat ctcccactta gtgacacaa ggatatcaga 64260

aataaatcaa ggattctggc taggaaaaga gatgatgcag aaagtcaacg gaaggagctg 64320

aggagggaga ggcagggcagg tgctagagga cagcagagaa aggaaatctg atggtaggag 64380

agtaaaaata gtggtgtca ggaaaaggaa caggaggctc aaacaaaagc tgagctgagc 64440

tgtgtaggag atccctgggc agtgactact gaaaagaaag ggctgagcgt gtgaatacag 64500

ataatcagct gcagggacag ccctaggctg agactgagct ctctctggcc tcagaggcca 64560
 ctgaaagtct gccactctct tatgaagcca ctcaattccc acatggtaaa gacagactcc 64620
 gcttacaaaa ctgccacata caaacctcac tcatgcccc agttgaactc aagggcaggc 64680
 tttgcttttg acaactgaaa acaataacct gtccaaaaaa aaaaaaaaaa gctggatcaa 64740
 cgccagaatc acaactgcag atgggtgtgt tagcaccttt cggtaattc actgggcccc 64800
 acataaaaa ttcaaaactc tcattagaaa tatagttcat tgaggggcta gagagatggc 64860
 tgagctgtta agagcactgg ctgctctccc agatggccag ggttcaattc ccagcatcca 64920

 catggcagct cacaactgtc tgtaactcca attccagga atcttacatt gccaccagc 64980
 tatacatgca ggcaaaacaa caatacacag aaaaaataaa aataataat cattaaaaag 65040
 aatagttcct taaaacttct ggaaacaatg agagacgtat aaggcaagat tatctccca 65100
 aattaatcta caaatthaac atattccact caaaaccaa actgaatatg ttcaaggaaa 65160
 attgaacaaa attattcaag agtccatttg aaagactaaa taagaataaa gatttggaca 65220
 ggaaataata tttgagtgga ggggagaggg aaaagctctt attattgcaa agcaaaataa 65280
 agaataaaac caagatcttg taaacagtgt gacagtggca aagagacaga acccaaagta 65340

 gagaccagag accaacacga ggacacatgg aaattacata agaaagatgg tgggtgtctca 65400
 gataagtagg gaagaaatgg tttctgcttc ttcaagggtt catgtacca cctgcatgtc 65460
 ctaaggactt tttccttagt ctgtctctct agggtgacta tattagcca atttctggga 65520
 tttctcatgc taatgttctc atccaccatg caggacacat atgtatagct atactctgtc 65580
 aatgagaata ttatttgcta ggcaatcttt actttttagt ttctaaacta tctaactgtc 65640
 ttggacaata agcaaagtac tttcaaatca gataatgaga acagaatggt gcatctgttt 65700
 atggtggact tctgcaattt agggccatag aaagagtta tacgtggatt tcaggtagtc 65760

 tcagtacatg taaaagtcat taaaagact gtttctgtgt atatggatcc atttattgag 65820
 agaagggtta ttatagccat cataatcatt tcaaaggtcc actgatTTTT cacaggctta 65880
 tgggtgttagc ttttgaaga acaagcaaaa tgaagctca acacattttt tatggctctt 65940
 taatggtaat tgcacttt tataagatga tcaacatggt ctgttatttt ccaaaacatt 66000
 caaatattat acacagcctc tgtgtgagag ggcttttagg acaagagcat gagaaaggtt 66060
 aatgtgaact gatacagtaa ttttaactatg aaagttaact aatatatgcc ataaaaacca 66120
 ttattctctt acatgatagt gtaagtgaac tgccaaactt tgatattttt tatatttgaa 66180

 atatctttat tataacaatt ctgtacaaaa ccttcctgt agagcaaaaa tctttgacaa 66240
 gttttaaaac acaaaaaacc caggataact ttgccttttt ataggaaagt taacacact 66300
 gcaggaacca atgagtcttg aggactgag agttagacac acagcattgt gtatcttgat 66360

ttctgccaca catccaagcc aattcacttc ctcacaaattc atcacccaca gtgtcttcag 66420
 gtgattctaa agaaagtgat gagggcagaa agtatttcac atcaaatttc tgtgtgtaac 66480
 taaagaatct cattaaaacg ctgggcactg gggagacagc ccgtgcacaa taatgaggac 66540
 ctacattgaa aaaaaaaaaa aaaagcaciaa tggtaaacac ttgtaatccc agtacttgtc 66600

 aggtagacac agatggatcc ttgaagttca ctgtccagcc agtctagcct acttgacaag 66660
 ctccaagcca gtgagagact ccacccaac atccaaactt aacagcatcc taagacacca 66720
 tatgttgata tctggctctcc atgcacacac acacactata gttagaaagt gtttccttat 66780
 tattttctca cattattcta tgagaacccc tatgaggtac tactgtgacc cttatttcta 66840
 aaggagaaca ctgaaaagat caggctctct ggccaacttg gagcttctctg tgccagcctc 66900
 agcacctttt tctctgtttc acatttctgc acatcagcaa ataccagct gcttggtaac 66960
 ttccctcaag ttttccattt ggtccccttg ataaggggtg tccaatctta aactcctagg 67020

 tacagtcaac tcaacatgta tttgagacac ttaacacaaa gctgctcttc ctaaaacca 67080
 taggtgggag tgccatccct tcatctccct gaagatatgt gtgacagga catttaccta 67140
 tagataatte tctctggtaa gagactctta gaggacaaca caaggtacat atgatccaaa 67200
 ctagttaaga accactgaat taaagcctgt ttaaccaac ttgtttttta tagtgtaaaa 67260
 tatcagggtt actctaacct aacaccaac aaaattaatg tcaacacaaa ttggttaaaa 67320
 tggaggagaa atatcagaat atcttttttt ttaaggaaa gcttatttcc ttataggtca 67380
 aaagactcac aaaacatctc tttagcagtt gcctttgggg aaggaatggc ttctacgtcc 67440

 agataagatg aaacaaacaa caaaattcaa catttatcag gtagagacta gggagagaga 67500
 caaattaaaa ggtccttctt cttcaggaca tcagagtagg atagaaacta tgaagaccgc 67560
 agtgacagat gtcatgagac agtagaaca gtttaagggg atgattgaag ctcacacttt 67620
 actgaaattt taatgaaatt tatttatcaa cacaaacaat aactgtaaat taaaggtgta 67680
 tgttaatggt caggaagtgg tccattatcc aaatttatgc attaaactca gaaattcaaa 67740
 aagtataaac atacaaacca aaaaggtcat tgtgacctc atacaggatg gactgagttg 67800
 ccactctggg attgaaatga cttttgtttc tctaacagca aaatcgagtg aaaaataatt 67860

 caaggctgag attccctaca agaacagagc agactctgcc cttcacctct cccaggatcc 67920
 aaccaaggc cgcgatgaaag ctagataaat aaatgtctg ctgagccaca gcactagcct 67980
 cacaagtagg cttttttttt aaagtgttct catagattaa tttccaaatt ataacttaca 68040
 gattacatga tactgaatac aaatacctga catgcttccc gcatggcagt gggaagcatg 68100
 ttgggtgggg gggctgagac agtagaaatt atcatttcca tactagggag gctggggcag 68160
 gaggattgca gtgttttgag gctagcctgt gctgcatagt gaatttgagg ttagtctggg 68220

atacatagaa agatactatc tcaaaaatca aaacaaaaac aaacaacaa acctgcattc 68280

 tcacaatatt cagttggctc caaaataatc tgcacaaca ataaaatgct gtttaacaac 68340
 tgcacacagg gtgggatttt agtttagtaac tagttaccat gaatcagtct tgacagacat 68400
 gaaatgcaa tcctaccctg tccagaaatg gagaaaccta gtaattcctc taggaatgaa 68460
 aatagacaca cttaggccac agaatgcttc agtctaaaaa cagacaaaac tggctacatg 68520
 tttagaggaa agtgacaaaag atgccaaga gatgcaaaag gcatgttctc acaggaagaa 68580
 caattgaagg aactggagct gttttgtcac acaagagcag actcctgggt aacagtcac 68640
 actgcaata tctgaggctc tgccatgcca acgacaaggg attagatgtg tgctgggggt 68700

 ccctggggag atcccagaac aatggaggga aggctaggga cagagtccag ctccctgaga 68760
 gcattgtgag gaccagagaa gtacagagct gtcaggcttc aacatagggg aatgaacact 68820
 accctgagac agggcacttt tgtggctact gttgtatttc tgttttgctt ttctgtgtgc 68880
 tctacaagac aacagtgcta aaccataccc agccctgtga gccagagcc cacaccacct 68940
 gctacagaat tacagatgaa ttgcttact gaataactga gtacatttca ttctatcca 69000
 ttctccctg tgetttgctc ttgggcaaac acttaactca gttatgttta gtctgtgtg 69060
 atttcaaac aaaacaacag aacccatag ttctagtga aggatattgg aattcacacc 69120

 attcaaattt catttgggaa atgcatttct tcttctttt agaattaaat cttaaaagac 69180
 tgctatttgc ttiagtggat tattaaccaa ttttaagacc ccagagaggc tccaaaccac 69240
 caggctcagt tgagttgaaa caagtaatga atttaaaatt aaagaataaa atcgtaatag 69300
 tagattctgt taaagtttat attttgaagt tcctataat gctctgggga aaatatttct 69360
 cctacaaaag tticcgtatc acttcttttg ggttttttgg cccctctatt ccctaacaga 69420
 agacaacact ctatcagtca ccagaccac caatggtcta agaaaatatt tcccatacce 69480
 attttataat ttatgactcg aacagcttgg tagttaccac accataaaag actgtgaggt 69540

 cccaccaaca ctttggaatc ttgctgaact ggcacagaca gcaaccacat gtgcttgta 69600
 tttaacattt gaggactgtg ggtttatgtc aaaccaaag ctatctgatg gtcagcgtag 69660
 tttggctgac agctttaaac atgccaacc taaacaaaa cacacaacac aaagacctt 69720
 aagtctctgt aaattgatct gtcctgggca aagaatagtg ttataacat caaaagtctc 69780
 cctgcagggg cagaccaagg agaccctgtg ctccacagga aggcctctct aggaggtgta 69840
 agagcaagga acagtgcttt ttgccctct cttctgggca gcagctgagc acacgtgca 69900
 ccacatatac acataccaca gagcaggtta tcctaagag cactgaagac cctgccaagg 69960

aacaccaagc acaagataaa gaacctagtc atcctcagca agagattccg aaattataaa 70020
caaagttcat ttagatccaa gtccttagtt tataagtaaa gatacagaag acccaaagag 70080
cccatgtcat ggctctccat tatgttgctt caagctccca gaagagcgcc aacctctgac 70140
ccccaaaacg agccccacc actgggaagg acttttattg aaaaagtcag aaataaaatc 70200
aataaccttc taccaagccc cacttcataa tggccctctc ccctaaaatg tctcctgtca 70260
cctggactaa aagcaaggca gtactattct cctccatctc ccccttccaa gtcacagctt 70320
aagcaggtaa aatcctgaac cttccccttt cacagcatgg aaaacaggaa gcctaactga 70380

ctgagctggg agaaacgtgg aggcactctgg gaagggcctc gagagggcg tcagccccac 70440
ccttcacacg gtcaggga gccaagaaga cctctgctggg gcagatggaa agtaaaaata 70500
aacagcagca gacagataac aatgtcgagg ggaggaagag ctggaaaagg cagcccaaag 70560
gaatgggctc aaaaatcgga gctggagaat gcatcgattc acggaataa aggagagagc 70620
gcagtctgcc agggacaaca gcttgaaaag cttaggaagg aacaaggagg tagaccaggg 70680
agaaaatggg cctctgcttg gaagccaaca aaccaggaac tgagggtaaa agaggcgctt 70740
tgcaatgta tcttttctg gtagtggcaa gtaaggtac ttttcaaag cccttcttc 70800

caactaacca cacagcatca agttgctaag tctgtctctc agtgaactag accacaggtg 70860
ggcggagtgg tggcactctt ggaaagaccg gccccacca aagagcttgt cttattctcc 70920
atcccgttca ggcagagagt tggctggctt ggtcattaaa aagcagcttt tgccagccct 70980
gtcttttctt gcccttgtt aattcattct cttttgtgtt ctacttttg cactctgat 71040
ctacctctc cttctcttt cteccccgcc ctgctcaagt caacggttg ggactctaaa 71100
ccagaagaaa acagacctgc tatagatag ccaaatcttt gctccccag aggtgctatc 71160
tgaccaaagt aaattaggtt ccaccttcc tctatacttc agccagcaca aggtccagaa 71220

gtgtgagagt agcaactata gccatagacg cagagagtta aaggagaaga gectgagagt 71280
gaagttaatc ttgttaagaa taatccttcc tcagtgatgc tgtgcaccct agagacacca 71340
caggtaaagta attggctcag gattctctg gacagcagca ctaaatgtcc tcatttatcc 71400
atitgtatc aagatacata cagagaatac actagggtgt tggctaaaa taataacct 71460
gccctcatca aactcttcta gtgggagaca cagacactaa ataataatt ctgcatctga 71520
taaggtcata agtcagagg aaggtaatgc tgggtaagga gaacaaagcg tcaagagcct 71580
ctgatacaat gtiacttta tagagacctt aataaagtaa ggcacaaagc tgtgtggaca 71640

gggaagagca tatgaggcaa aggccctgta gtaacaagaa ctggagtgtg taaaaagcag 71700
ggaagaaact tgctaatata tcacaggggt ggaggaggca aggtcagaga caagcagagg 71760
ccatccaagg gacttggcta gtgagcccaa tctggagtag aaaagtaacg aaatcgggtg 71820

ttcaaaggat cattctgggt gttttgttga caataaacca taataggaca tgtttaaatg 71880
 tgagggaagcc agtccatcaa cccaggcaag gctcgagcgg acatcctgac agagcagtgt 71940
 ctgtgtatca ctgaagcatt actgggattc tgtcggccga gaagggtga tgcagttgtt 72000
 tttgagacta cattggcatc tagctctgct tctcccagat cacagcagct ccagcaacca 72060

 ccacagcaga aagcaacact ttctagaagc caaacaggta actgcagtga tctgatgcta 72120
 ggggtgggctt agaacttggg gccatttttg ccattcttaa agggaaatga atgagtagac 72180
 caacgagaga gtaatccctc tgggtggcttt taccagcaat tacttacagc atacaataat 72240
 taaatggcca tatgggtcag gtagcatttt ttaactaac atggaagtgc ctttgagcat 72300
 cctctaactc cagctgcaac tattgggatt aacaagattc agagttttct aatttcaact 72360
 atgacaaaaa acaggccatc tcaacctgag atggtttaca gaccattcca tggcaggtgc 72420
 ctactgaaga caacacctaa acattgtcag ggtccctgcc atacaggcat tactatagac 72480

 attgtttcaa tatcaaatat ggaaaacgtg gaacctcaat gtgaaaacag tgtgttgata 72540
 atttgaagtt gcttaaggat aaaaatcgcc accacaggag tcctcgatac ctttaaaaac 72600
 tacatctgta tgettcaaat atatggcatt ctggaaaaga tagaactatg gaaatggagg 72660
 aggggagatt agtggctccc agggatagat gacgagagaa actgtgaata agcaggtcat 72720
 tgtattagtt atcgtttgtt ggtatgcaa aatgccaac aaaaaagaaa aaagaaaact 72780
 tcagcaagaa agggtttatt tgggcagctt ctgagattag agtgcacat ggaaggaaag 72840
 gcatggtagc agaagcttga aacagacagg aagcagagag agaggtgcat gctggaactc 72900

 aggccccctt ctcttttga ttcagtccat gggatggcac caccaacaag aaagaagggc 72960
 ctccctctt cagttaagcc tcactgggaa atgcattccc tggaacatgc agagaagtgt 73020
 gctctgcaag tgatttcaa tccagttaag ccaacagtga acatcagcca tcaactgtgt 73080
 ttgtagagca atggtggaga ggtgtcattg ctctttagtt taagctcaga agatgcgcag 73140
 caccaagaga gagccctaaa gtgcctggtg gacttcaggt gattgtctat gcagctcttc 73200
 aagtgtaa caatgtgccac cctggtgaag tgtgttgta atgggaaag ccacatgtgt 73260
 gaaggagag aacatatgga aatctcggtg ccttctgctc agttttactg taaatctaaa 73320

 aatagctttt gaagtaatta gaattaggcc ccagtgatca agagccacat tcagttgggt 73380
 aagtcatagg aagcctcag agtcaggcat gaaagctgag atcagaatgg caaggtgtgt 73440
 gtgggtttat tcaggagga aagtaataag aatggcatga aagggaagga aataaaaatg 73500
 gatagtgaag aaggaaaacc aattggaaca tcaaaggccc aaacacaaaa caaaatggaa 73560
 ggagttaaggt actccttgaa ctcactgaca gtgagatcag caagaaggtg acacagttgc 73620
 tctttataga gatcccagaa agctgttgggt atcacaataa caccacatct aacagtccca 73680

cagaaat ttt gtttgaataa ctgctccaag tagtgggtcca ggtcccaggt tectgcatc 73740
 ttgcgactgt aagtcccaa tttgccttat ccatttcaac cagctgagg aggaaatca 73800
 tagaaaaccg tagattttca ggtctgtgca tggtagccat ctctagcacc aagatgtggc 73860
 tggagggtat tttataggca agtgtccagg aaaaggaagg aatggctga ttatgggctc 73920
 catgtctacc ataagctctc attgaatggg tgaagccac agaacatcta aggaagagaa 73980
 ggcatggcaa tgggagctaa tcacaccaca agccaaggtc aatcaaaagt gaagaataca 74040
 ctttaaaaca aaacacacac acacaagaaa aaaaaaaaa acatgagaag agagaaaaaa 74100
 aaacaaaaaa ctggagactc atgactcata ttggaagttc tggttaagta ctattttcct 74160
 gccagaaag cttttcaaaa gcacattccc ctctcccct tccagaattc tactccaag 74220
 tatatttacc ccaatacag catcaaaggc tgtactgcca taagaatccc ttaattcggg 74280
 agagaagga actgagagaa gcaacctcat caataaaaa attgtttata tcataaagga 74340
 aagccacat tcctctggag aagagctatt tctgtgacca aagactaagt tatggctgtc 74400
 tgcttgatt agctgtttct gtcatccac aactaaatac cttgcagttc caaaggatac 74460
 agttaatcgt ggaggggag ctatgctagt aagaactgaa agtagctgct cacattgcat 74520
 ccacagtcag gaagcagaga gcaatgaatg ctccaacca tgggatgggtc ttgcaggata 74580
 attgtacact gtgtaaagac gtgccattgt gattgtttaa taagaagctg aatggccaat 74640
 agctaggcag gaggaattag gtgggacttc taggcagaga aaggaactct agggatgaat 74700
 ctaggcatga agatttcaat agcatgacat ggtacaagtc agatgcacgg tactgaagag 74760
 aggtaagag ccacatgaaa aaatgtagat tagtaggaat ggattaattt aagttataag 74820
 agctagttag aaacaagcct aagctaaagg taagctttca taataatgct tccatgtcat 74880
 tatttgggt ctggtggctc aaacaaagt tgataagaaa acttgctaca gacaggatga 74940
 tgccacatat ggggtgggtc ttcccacctc aatcaactta gtgtggaaaa tectcacaga 75000
 cacaccagg gattcattcc catagtgggt ataatcctg aggcgctgac catcaagatt 75060
 aacctcact ccaacctgta cctttgaag tcaccaaag tccagcaca gtagagtaag 75120
 tttttaaag gcctaaggct ttataactta cctatcagaa agtaagacaa atctcattcc 75180
 atatgcccc tatttttca aaactgacta tttaaatagc aacctgctga tcatacgtg 75240
 gcagtaacct tgagtttctt cttaaagtct cctattgagt atgagtgttc tgaggtccc 75300
 aactgtttcc ttaaatgtaa atgatctcaa gatattacac aagaccctc cttttgaaaa 75360
 catccttcca caactaagcc tacacacatc tcaaaaacat gctgcttggg tctgaaagat 75420

ctgcttgaag agggctctcc accactgtga accctgaagt cctttccaaa cagatggata 75480
 cacactcaca ttgcagaac cagttataca ctccctccag actgcgaatc ccaaccctct 75540
 gccacataa ggaaggcaca cataacttct ttgagtcaat gtaaacacat tcccaataat 75600
 tatagaaatt aaagcattcc tcttgaacc taatatgcta aattttgttg aacacacagt 75660
 tgctaaaatg gagtctcctt gtcaggtttt aaatgtttct ggataagaga ttgggtgggt 75720
 tttgttttat taataccaaa agcagagaaa gaggaaaaaa atcaaagcag attgtatgggt 75780
 catcataaaa tacacgagtt caggccgctg agatgtgtgt tttcaatgggt ttgattaag 75840

 actcaaaaca aatgttagaa aaagaactgt aaaagattta aacaagtgat gaatttaaga 75900
 aatttcaaga atttttcttt ttaaatctaa actgttaaat tctaaacaaa tcaaatttag 75960
 agtccgttgc cctgtgtcag gcagctgtta ccgagttggc tgtattttgc atctgttacc 76020
 tatcagtgga ttctgtggat tactctgccc ttcatcttgc ctcaaaggca gcttcagaca 76080
 aacagtagct gtgcaatcca gcaagcgggg ctgcaggcct ctatctcctc acctccttc 76140
 ctatctagcc aacagtcaac ctgccagtca ttctccagg cttctagatc atttctaac 76200
 aaggtgacag gcattttagt tcaactagca ctctgtgtaa agtagacaca gacacgtctg 76260

 cccgggacag aatagtatgt agcagaaatc tgggtttgag gccagattga gactccacta 76320
 aatttcaact taaaacctta caaacagagg ctgcaaagac ggcccagttg gttaaagaca 76380
 ctctgtgctc ttgcagagaa cttaggttct attcccagca cccacacatt ggcaagcaac 76440
 catctataac tccagttcca gggaatctaa ctcttcttc ttacctctgt gggcaccagg 76500
 catacatgtg agacacaaga atcaataact catatacact aaataaatac ataaatattt 76560
 ttaacttaca aattaaaacc tataaataga accataagcc acaagcaata aactacaaat 76620
 aatatggata ttagtgcttt gtgtttgtcc ctgagccaaa gcaaatgat gtacaaccaa 76680

 accaagatta agttatgaat tcattggata gcaactgggca cctctgtcgg gaacacacgc 76740
 catcctcaca gcacttcacc atatttctta ttatccctac ttttaaaagc aggaaagtga 76800
 gactctatgt aaattaggtc acagctggga tttaaattca gacctgtctc cactcactgc 76860
 ttactcctat ttcaagatta aaactattgt tagaatgtgt gtcaatagct caaggatatt 76920
 taagatccc cccacaaaa tttttttga aaggccctga aactctgttc tctcaggctg 76980
 acaaaaatag tctggataat ttggggcagg ggtgactact tactataatc tggacttctt 77040
 gtcagggaaa agaagtactt gcctctataa catcaagaaa cagcagcctc acctcagaa 77100

 catggtcggc acttaataa gaaactaac acatctcag cactgaaata agaggtgaca 77160
 acataatgaa gaaaaggagt atcatTTTTT agaacaaga aacctctaga tttctacaga 77220
 atgggaattt ctcaatcttc atttagcatt tacttaaacg caaggccag ccagcacagg 77280

tgagcattgc agcctggcag cttcctgtgg aggtaagaca gacttccttc agtccagggg 77340
 acatggtctt gaagacaag tccagcactgt ccacagatag catcttcatg agcagggccag 77400
 tgcagatcac cacttcctgg ctggccacag cccactaac ctgctctcag cttgacccca 77460
 ccccgatcct ctgaggcaga tgtctgttat aatctctgtt tgacaaataa ggaagcagaa 77520

 gtagacatcg ctaagacaat ttgtccaagg cactgcagct tgtcaggagg ctgagccagg 77580
 gagtctctgc ccaggtcctt agagagactc agctatgcaa attagtgatc tcacatactc 77640
 ttcaaatccc tggaaagtcaa cagaggactt actctacaca tagtgacagt cacaaggctc 77700
 atcacagtct ctaggatatc taacattacc tgacttctgc tcacttttat tctccatate 77760
 cttactgtg tcatgagcta ccaaaacaac aaaaaaaca aaacaaaaca aaacacaaaa 77820
 cctctcgtat caaatgccg gcaccacatg ttcctccat cttggggacg agtttacata 77880
 cctgtagccg actatcccac atcatcactg ttcttttttg aacacatgg agatggcaga 77940

 aagaatagcc atggaaagta gcaggacaga gacatgctca agccagggtt atctggctgt 78000
 gccaccatca gatgacctg ccagggttcc ccagggggaa ccttctcact tagtatgcc 78060
 actgctatgc tcagtaagga gtgctgttca gttctctgtg gctgaaagca ttccttagca 78120
 tcttgcctat tagcctctca tactggcttc actgtaaatg caaagaggcc tttattatat 78180
 tctattctgt attattccca acaattcaaa tatcttttta aatggtttat tagcctcata 78240
 aagtctagge tagtctcaa ttcactgeac agttgaggct gccctgtact tetgatcctt 78300
 tggccgctcc tcccaaatgc taggataata ggactgtgtc acccaccggg ttttatggtt 78360

 ttatgccatg ttggaaatca aaccctaac cttgagaagg aaagcaagca ctccaccaag 78420
 ctgcatccac agttccttaa gttattgtta acaagtagtt ttgataatag acttaatctc 78480
 agtactatca acgggcagaa ggattactgc taaggctata tagtgagact gtgtctcaa 78540
 aaagaaatga aggagggagg gaaggaggga gggagagaag gatgaaggag gaggaagtaa 78600
 aagagggagg aaattatcta gttatctcct gacttgaaag aaaagttaa tttcaattt 78660
 tcaaatccac aaagtgtctc tgaattttgt ctaggcactg caaagaaaag ccatcaattg 78720
 agaggactga ttaaatcaac cactagccta ttccttatt atactgtgat aaaacaaga 78780

 gataattatc ttaggaatga aaaaccttc aagcaacaag tggggctctg tgctgtgctc 78840
 agtgttgccc atggcctcag tgaaggccca gatgagctta tcaaatgtgc caatggcaga 78900
 aacaagggtg ggaggatcag ttaaggaagt cagctgggtc aacctgaga tgaacctcac 78960
 tatcagttag agttctgtgc tgggatcacg acacctcagt agcatgaaag aggccggaag 79020
 tgtccagtgt ccagctagac actgctactt cggaaaagga cctggagatt ctaatcgggg 79080
 gagccaaggc tggctacca aacatgatgc agctgcccag attcagctat gtccctgcaa 79140

gacagcctca gatcaggga ggtgacaatg gcctttctc ctacattaag cagaatcact 79200

gcagcgttct gctctattag ggacaccaca tgctaacaat tttcgggct caattattag 79260
gacaatatgc atggtaacaa ccctcaacc aactgtgaa ggtggggtcc ctgctggcgt 79320
gagacacttg tgggaggatg tgaagtgtc ttcaagctt ttgaggatg cttccaggac 79380
agagcagagt tactacaca tgtcttggg gtccagaactg gaaccaaag agagaattgt 79440
tgtgggtgg ttgaagcaat taaaattatt agtatctgt tcagtttct tctcttctg 79500
gtaacaaaca ccatgaccaa aagcaacttg gggaagaagg gatttatgt actttcactt 79560
ccatgtcaca atccatcatt gtcttggagg caagccagga acccaaatag aaaccacgga 79620

gggatgctgc ttatggtgtt gctccctgga tcccatttag ctagtcttct tatacagccc 79680
aggctcaccg acctacagat ggtgctgcca cagtgggatg gcccttctc atcagcttc 79740
aatcaggaca tggccacagg ccaatctgat tgggcaatt cttcaatgga agttccctt 79800
tcccaggtag ctcagggtg tgtcatctg acaacaaaa ctaaataact aacaattaa 79860
aattgtttg taataactac aactggccaa tcatggactg ttcctccacc attagccaca 79920
cttaaggaga gtaaccagca tcttttctgt tatcagagag tgttctata cacaacagtc 79980
catgatgaag acaatgctgt cctatgctaa acaagaacac cttctgttc ttgctgatat 80040

ttggggactc ctgaaagatc ccagaaaaag tgatcacaac agatctttc acagctccc 80100
ctaattctaa ccagggatac aaatcaccca tatagatcac tactctattt ttttcttta 80160
ttttgtctc caaaaagaga ttttctatc tctatagatc tggctttgg gggggagcat 80220
tgtttgaaca gtctaataca gtttctctt cctagctata ccaatccacg tggttactct 80280
tctgttcttg tatcaaacac caagaccaa acaacttat agaagaaaga attttatagt 80340
aagaaaccga aaccgaaac gcagtcccc tactactct gaccagccc tcacaagccc 80400
tcaggtaact ttgtagccag ccctaagaa ggcgtggcta cagcttccc tacagaattt 80460

atthtggctt atggttccag agagataaga gtccatcatg gtgagaaacc atggcaccat 80520
cctggtgagg aacctggaa ccatcatggt aggaacat gccagtgaac agcaggggta 80580
gaggcaggag caggaaactg aaagcacaaa gcttcaaatg tcccagtgat gtacatcctg 80640
caacaaggct gcacaaccta agcctcccag cagtaaccag ctcaaaaaca agattcaaat 80700
gtccaagact atgggagaga tttctcttc aaactaccac taccaaaca gcctctgtaa 80760
taattttgca aggaaactat attaatgga gaattttaaa caatgagcat agactactct 80820
tccagaggac ccagggttca attcccagca ccacatgga accatccatt ccacagttct 80880

aagggatctg acactctctt ctggcctctg caggtaccag gcacacatat aacacacagt 80940
cagacatgta gacaaaacac ccatacataa aaaacaattt taaaaattaa aaaataatg 81000
aaaccacat caaactctaa taaactgggt tgttgttttg ttagattttc aaaacagtta 81060
ttttgttgt ttatatatta gaacttagaa accatgaatc tcccaaatct ctacaggcca 81120
aatgtcttc aggacactta gaccattag gagactctcc gcatacttc actttgaatg 81180
caagcagtga ctcttctac aagagctctg ctttcatttt cagaccaga tgctctccat 81240
gcagagagaa caaggcaggg acttaatgtg ttagattaa atcacccaaa actgagggca 81300

aacaacagtg ggctacaggc atccaggaca gctttaaaag gctggtgaca ttacttgggtg 81360
ttttgtttt tggggtcttt tttctagttt acttaaaaag taccaaaaact acagcttcaa 81420
taacacacgt ctttctctca tttctttaga aactggaaaa actactgaaa tacagtgtgc 81480
ttaagacaca cttagcatag aattcttgct ggcctattc ctagcaacct ccaactgagct 81540
tggtaaactg atcacacact gtgctgctac acatccacac caaactaatc tgccagtgag 81600
tgagcagatc agtttcatt aaccctctc attccaagt gagctggacg gcatgttcca 81660
gagtctcttt aaatgcttc ccaacagaag actgaaaacc agggactaga gagatggctc 81720

aactgtgaag agcgtggct gctcttcag aggttcagtt ctgacaccc acatagtgg 81780
ttgcatctgt aatgcagttc tagcggatct gacaccctct tctggtctct gcagagacac 81840
caagtacaca catgataac agtcagacat gtaggcagac taccaataca cataaaataa 81900
ttaaagtatt taaaattaa aaaaacatc aagtctaat taactccatt gttaagtttt 81960
tagatttaaa aaaaaaatg tgtatgtggg caggtggaag ggcttgtgca tgtaactgca 82020
ggttcccatg gaggccagaa aaggacatca aattccctga agcagcatca tgggtgattg 82080
tgagcctccc tgaccctctg accctaacat gctgagatct gaattctgtc attgcttgg 82140

tttaggtaat gtgtccatag ggaagatagc aaactagtat ctatataagt tgaaaactac 82200
ataaatctat atgaaaagtt ggctaactcat acctggtgga gaggaattc agagtctaga 82260
acatccaaag aacttcaagt tttccctaga ggaaacacat cacaccacac acacacacac 82320
acacacacac acacacacac acaaacacac acacacactt tttgcatgag tetggtcttt 82380
acaaacacac tcggtcctga tgggaggaaa agcacacatt gggaggggct ttattttaa 82440
tgctttcttg tgtgtatgtt gcttgaagt taagaactgg aagaagaaag agttccaag 82500
catccagaac agcagcagag tctgtgttct ctgagatcct tgctctgctc ttccttgcct 82560

cgccaaatct tttcaggcat tctttacaga atcataaaaa catacctcat gtgcaaccac 82620
tttaaaccag gcatgtgaac aaacacactt cacaccaag aacatctagt tttccagata 82680
gctacaaact gtctatttca atagaacca ccctgaatt agcaatgcag gagattattt 82740

ataacaatct ctaaccttaa tttcattaaa aaaacaatgg attctcttat acagatatag 82800
 gacaatgttt atattcacca tataaagaac tgtaagagc tattgtgttt atacaaggag 82860
 gaaaaataa tgcccagtg attaacattc tattattacc catgggctca caactgaagc 82920
 atatttctca caagacaatg ggacatatta accctaactg gccctaaaga tcttcacaga 82980

 acagagtgtt gttctgtgaa gagctaccac caaggaacac taatctctgt acagaaacat 83040
 ctcatccttg tgacctggcc ttatgagttt cctatcatta agtttaagt tagatattat 83100
 gaagacattg aaaattatta tatctaata gaagaacaa cacttgcattg gtgaaaaaca 83160
 taacaaaaaa taggtaagta gcaagtattt tgttatagta ggatgtaatg aatgaaaat 83220
 aaaaaataca catgattggt ttcttaagc agtggttctc aacctatggc tcacaactcc 83280
 tttgggggtt gaatgacttt ttcacagggg tcacctaaga ctataggaaa acacagatat 83340
 tttttacatt acaagtcata aaagtagcaa aattacagtt atgaagtaca aatgaaaata 83400

 attttatggt tggggcgat cacaacatga ggagttgtat taaaggcca cagcattagg 83460
 aaggttgaga accactgcag gtttcttggg aattttctgt gttttctag ttttctagac 83520
 tgtccatgca tcacattat aattagaaac taaagctaca aaaatctaaa agagacctac 83580
 agttgtcctt ttaaaattg gttttattt gtgtgtgagt gcttggcctg cttgtatgta 83640
 tgtgcatcac ttgcacacct gctggataag gaggccagaa gagggtgtct gatctcctgg 83700
 aactggagtt atggatggt ttgagtcacc aagtgagatc gaatctgagt tccttgcaag 83760
 agtggcaaat attcttaact actaaacat cctctgtagc cctaacagtt gactttcagt 83820

 aactatgaac ttgtcttaca atccagcaca ccacacctac aggcatctt ttaggtatag 83880
 agcatggtgt gatcttagat tagcacacaa cctgtgagtg atcacagcag ctctcacat 83940
 gaccaccagt gatcacagca gctctacca tgatcaccag tgatcacagc agctctcacc 84000
 atgaccatca gcaaacgcaa aaateccttg cagtctecag tgagtaacag aactctgcc 84060
 cagtgtcatg ctaccagaa tccacagggg cagagaacta aaatgtaca caacctcatg 84120
 attctccaac aactgcact gttaaaatga aattttaatg accatataac atgattctgc 84180
 tgatatgaca tctgagaaga ttacagatta ccagttatgg gggcagggct tgagaggag 84240

 tggcctgac tctgaagat gatgtatata gtctacatct gatgtagtg ttgatcatgg 84300
 gacagtaagc atttgtcaaa taacaaaact atatactaaa ggagtaaat gtgttatatt 84360
 aagttgcaca ctgataaata tgccttttac aaacaatcac ccttagaaa taaaggtata 84420
 taccattca gattatacca aggtctatga aatgctttc caaaatttc ctatggaaaa 84480
 gatctgtggg tcatTTTTT aaggttatat gaattttaca tagtaggcac aggattgtga 84540
 aggaatggga cacagatatg aggagttttt gttgtttct tgtttttgc tttcaagacg 84600

gggtttctct gtgtaacagt cctagctggt ctggaactca ctctgtagac caggctggcc 84660

tcaaactcac agagatccac ctgcctctgc atcccaagtg ctggaattaa aggtgtgtgc 84720

tggcctgata tgaggttttt aaatataggt gtgtacatta cacaaaactt ggtatcaaac 84780

ctcggtagac caccggttgc caggagggga tcttacagga ctagagagga ggttcggaag 84840

atgaggacca ctgactgaaa atgttgactg tcagccccc aagtagaagct ccagggtccc 84900

cacaggagcc atgactctgg ccatectagc attgccaat tctctgcct ctaccaaagc 84960

atctctgtat caagtcagc acgactgagt ggtcaccagg ctgctttggt ccatctcatt 85020

ccagacttaa gctgctctct atgcctttat ggtattataa aagtgtgtct gccagatgat 85080

ggagatgtaa acagcttctc ctcccaatca gtgattttca ccatcctagt gctgcaaccg 85140

tttatacagt tcccctggt gtggtgacc ctaaccataa ggctattttc attgctactt 85200

cataactgta attttctac tgtttgtaat cacaatgtaa atatctgtgt tttctgatgg 85260

tcttagttga ccctgtgaa agggctattt gacccccaa aggggtttgt atccacagat 85320

tgagaactac tgcctaaat gaatttggga gcaaggagcc ttttctggac ccaaacgggg 85380

gacatggttc tttcagtttc tttttttca tttcaaagtt catttaaaaa ggccacaatt 85440

taatccttgt cagaattata aagtcataat gagaacacaa atatgaaaag tagtttgtat 85500

agagcaagaa agtgtttttc taaagaaaca ttctttctac caatggaaag ttgagacat 85560

gttttctatg gagagcattc gagagcagcc cagacaagtg caggtataat tactgagcag 85620

caaatgaaca atgaacaacc ttctgtctgt gcacacctta aaagaattgt ccagcatctg 85680

gatcagcadc tggatctaca gatatacaca aacagaagaa aggetgccca gaaaaccaat 85740

actcttgaaa gagaacaaga ctgccaatta agatattaaa ttatttttaa ggctttaatc 85800

agactattta cacttcagct gggcatagtg tcacacacc atagtctcag tattggaagg 85860

tagaagcagg tagaacagag ctgaaaggag ttgaaggcta gccttgcta agcacaagt 85920

tcaaggctag atggtgctat ttacacct gcctcaaca ccaaagtcaa accaaagaaa 85980

acaataaata aacaacaaa caagttaagt gagaaggagc tgaggaacaa atggaggag 86040

ggaggaagga ggaacggagg gagggaggga gggagagaga gagggaggga gggggaggaa 86100

cggaggagg gagggaggcc catgtttaa agtggggaat aggtgtccta ctctaattta 86160

cttattaaac catgttacct gagcctgggg gaggggtagc tccattggtta cagtgttgt 86220

tgagaaagct tgttcaggac ctgagttcag atactcagac ccatataaaa tctgggtgt 86280

catggtgtct gtaatccag aactaggag gtggagatgg gcagatctgt ggggttct 86340

agccagccag cctgctgaac cgggtggtctc tgggttcagg gagagacttt gtctcagaaa 86400
 ataaggctga tcctggatga tgaagacacc tatcatcaac ttctagcctc catgtggatg 86460
 cctgtgcaact cacacaaagt aaaaaataaa gtttaaacaa aaacaaccag atcaccaagg 86520
 aatggctact ctaaaagtta gccttattta ctaatattha tgaataagat atacctggc 86580
 cccacacat gtgcacatat tgtatatctt cttttctcat gaaatttaa taacgatcta 86640
 tcaaaaactg gacatctgtc tccttgcttc tcaacagggt tttctaaatg tcaaaactagt 86700
 aagtttacag caataaccaa atgccaaca ataatagga gtaaggcaat tfacagcagt 86760

 tattttcatg ttctacctca aagcaaagat ggtcaccta aaagatagtg tgtgtgtgtg 86820
 tgtgtgtgtg tgtgtgtgtg tgtgtgtgaa gaaagagatg tgttaagggt gagactcatt 86880
 tgaactaaa accaaaagca ccggggcact tccttctatg ctattcacac catcctttat 86940
 ttgttctat actcccaag ttatcactta agcaactgtt gactttacac aagccattca 87000
 tactttctgt gtaccttaaa gttgttcaag accagaggca gccactgagc aaactggaag 87060
 ccagcctggg ctatatgaca catgccattt ataatatatc tctgagcctt aacgaggaaa 87120
 aatcacaca tcctgagtaa gtcaagaatt agataaacgg tttatataca aacagccaac 87180

 aagatatcag ggtgcagtgc agaaattcaa gaacactctt tagctctttt cctctttcct 87240
 ttcttctag agagtttttg ttatgtagtt gcatgaatc atttctgcaa tctcctaaaa 87300
 gaagagtta gctagagaca agctttgatg tccttgagge catatggaca gttatgcaca 87360
 tgacctacta atgaataact tgtcaattag tagtgaacag caacaaaaga cattatctga 87420
 cgggctccca gatacaatta tgtgatatca tctgtatgc tttggcttgc agagaatttt 87480
 ccaagttaag acagttccag ctccagggtc atgacaggaa ccacagctaa gcctctgtat 87540
 accaaggcat ctctggcaga aagagactgg tgagaacaca attcataaac agttccaag 87600

 caaaggacac aagttttaa tgaaatcaat ctcttctttt gtttgtttgt ttttatatat 87660
 ttgaattaca aacaagactg aattacatga tgatcccagt tcccttctcc ctcccttctt 87720
 cctctctac ccccccactc aaatctacc tgcataatgt cttttcttct attctacacc 87780
 tgactcaaaa tttctgcttc ctcatgacct ctgcatectt cttttcttc cttttgaaac 87840
 caatctttaa gtgaagtgat tctaactaa aactaaaagt aagatgatgt caagtagtgc 87900
 tatgaaacgc taccttctgg tttgacatgg ctacagcact cacaaactcc caacgggcta 87960
 gggctcatata tacaatgca atccagcaaa aactccagac acagggggag gaggtgcctt 88020

 tcaggcccca tccttaatt cagagctatt ggttaattgac aggtactggg ggagaaataa 88080
 tcatgtttgt ttgtttgttt gatgtgtggc cactggtaga tttccaagt tccaaggat 88140
 aatcccacac tcatatacac ataggagaaa ataattggat ttagtagtta tcaaaaatcc 88200

atcaccagaa aacaagaaca aaggacatta agtcaggaga aggccatggt gcaggaatt 88260
 caggagcct tggagaggag acactggagg aggatatggt tatgtatag gaataacat 88320
 atatgtttat gtatatgaca tacatgtata gaattctcaa gaataaaca aattaatatt 88380
 ttttaactag cctgccaac aagccaaact caagctcatc ttaacaaag gcctcacggt 88440

 gttcaatgta gaagcagttc tggaaagaaa tgagttctaa agtcacaggc cagtagaaca 88500
 aatccagggt ctgtggagtc caggctgcc cccagcccct tgcacattca atgggatctg 88560
 tagagtgcac ctcttgagt agccagggtt tctccagccc acaggagatc caatatataa 88620
 gcagtggctc agaaaaaca tagaagtac atggccaaca tgtgtccaca gaggcctggc 88680
 atgaacatgc agttccatg gacaccagag cagggaaacc atagaaggca gccctgaggc 88740
 ttgacggatc cctcaagtcc aacaggaaaa aatgaaggta aaagttaaga ttcagcaacc 88800
 gcctgatctc cagattccca gaatgcacta gagtgggaat tatgggatg aaacttctca 88860

 tttcagttta caaaggaatg acaaatggaa caaagctgag cctctcccag tatgaagaaa 88920
 tcttcgaata ggcccagtc agatgaaggt gctgctctga cagaaattgt tctggttccc 88980
 ccaaaggctc ttcagagcct acagcgcac taaaatggca acacacaggc gccactggca 89040
 ctgtgatggc tatgcattcc atgttgtgtt ttgttgacat caactttgag acatacttac 89100
 acacaagtgt ttgccttttg tgagaagcag tcagttagtg ggaagaagtc taaacaatgg 89160
 atatctgact ctgggttctt ggtccaagt ccataagccc tctttgttta tttctcaag 89220
 tctcaaaggg agccattccc ttccagttcc atccatgtcc tcagtctctg tcaggtgaga 89280

 cgctcaaacc ccagttcac ttctcactt ccacatccct gtctaacgca ccccatcctt 89340
 gcaaaattat ctccaaaac tcatgacact cttataaaag ggcatctgtg ttgagataat 89400
 cattttgtac actgtgtaaa gctatgtctc tgccttctt cactgccta aagcacctc 89460
 tgataggctt aataaagagc tgaatggcca atagctaggt aggacttcca tntagagata 89520
 ggaactatgg gaagaatctg gtgtggatga tttcacctgt aagacatgag gaaatcagat 89580
 gtatagtact taggagtgg aaagagccat gtgacagaat gtagattaat ataatgggt 89640
 taatttaagt ttaagagct agttgggaac aagcctaagc tttcataat aataaaaagt 89700

 ctccatgca ttatttgaga gctgtgggtc caaagaaagt ccaactacac atctgtgagg 89760
 gttatTTTT ttaagtctc atacctctga tttcttaggg ccactgcat attccaagtc 89820
 attacatcta gattaacctt tatgtatatt taaacacat tttcattcta accatttttc 89880
 tgtgagacaa ctgataggct aaagacagaa ctgataatgg gaactgtacc gccactggt 89940
 gagcctgtgt ctttcccag tacacagtat tctgtggctt tactatttaa taagtctttg 90000
 ttatgcattt agaattttag aatataatcc ccagataaat gagagtagat atgtccaag 90060

tcccagtggg ccttttctgg gtccaagcag ccaacatggg caggttggtc agagcagcag 90120

agagcaatcc aggagtgaga cagatttga tgctataata tggggaagct gttctggaac 90180

cattccagga ggtggcagag catattacac acatggaggc agaatagcct ggggaggaga 90240

gcagacagct ttcccaacc agccacagaa aaagcccacc agaaaaaag accagcagtg 90300

catcaacaaa tagcgggtcc cactaatga gcaggtggcc ctgaggactg caggggttat 90360

agggatgacc accagaccac agatgacagg aagaactgca ggggttacag ggatgaccac 90420

cagaccacac atgagaggaa ggcatgatag cacttgtgca gggttcaga aaaatgtccc 90480

caggaactga gaagtataag caaagtcagc tcagacagca accatactct gacatggctg 90540

aaagaaagtg aattttacia cccaactaga gcaaggatgg aggaactcat tgggggtaa 90600

catgaaacca gagattccca accctatacc tgccttcccc atacatgcag aactgtcct 90660

ggaaaggagc ccaggaggaa ggcaaatata ggagaggcta agtgttttat taactgaatg 90720

aatatacaaa acctgaagga actgtttcta ccctgtatc agaccacaa tatcagaatg 90780

gactcctttt gttatcatca gctaccaat gctcacagca atcaggagcc tcaaatcttg 90840

cttagaaaaa aaaaaatgaa gaaattacat ggcttcttgc tcgaaagaaa cattaggaga 90900

tctataatcc cactaattag taaacagaag acaagtcca tttcataaa gactatttc 90960

agtgttgta ttatttccat gactgatggc aacagcctt caccattct cattgtcaac 91020

aagaataagc tcacatacca gactcttaa ggcttacaac tcaaatcgtg gcttctcttc 91080

cccacttctg gtccaggaaa cgctgaactc tcttctctct gtatttctcc catctatag 91140

gcagtcaata aaatggtaag gagtaatggg cagtcaacaa aaatggaaca caacaggttc 91200

tcccatgtca ttagagtaca caatgctggg ctatggcatc attctagtat ttcccaaata 91260

ttatgttgat gtgctctaat gagattagtc agaatgaact acaaggaaga gtaaggagag 91320

caaccacaac atcaagaggg gaaaaataag agagtataac aaaccaagca atataacca 91380

ttcaggaggt ggaaaggaa aaagaaggac aaagtggctt caggcaagac ttacacaatg 91440

acagcaaagc aaacacacac aacaatttt gtcaatgcag cagaagcccc acagtgacaa 91500

gttgactatc actaggagct gtaattatgg agttatacag tctacagagc taattgccaa 91560

atctgagcac tcaccaaggt ggaggatfff tcaaatcta cctatctcc tctgtttcaa 91620

ttctttaage tcaccgacta ctcaagtaag gaatgtgttc tttgttaagt gtgcaaatag 91680

gtcatgcagc aacagcaata tcttcttcc ttgttttct tttccagtg ttgggcataa 91740

aaccaggggt actatgcaca ctaagcaagc acagagtcac caagttatgt cccagccct 91800

gtattatctt cacagtgaga aacaaatgga aatgatgaac acaggaagaa tagaggcctt 91860
tagtcacaaa attcacagcc taaacatgaa ctcctaaga ctcaactc acaaatttc 91920
tacttagtat ttagcttaac taagcacttc taagccaaaa tcaataaact gaagcaata 91980
tgtcccaag tactcctca aaggacctta atctctgagc accagtatgt gtatagacaa 92040
cctagaaaa catacactaa aaagtctgaa gaatgtcact aagagctgtg gcatctgggt 92100
tggccccata agagagacgt ggtgtttcca taacaaagca aacagcaaca aacacaagct 92160
gttctgctgg ccacatgagg atctcgctgg ggccacagtg ctgccagaa aacacagctt 92220

gagcaggact ctactgcttg gagtaggaga cctggttaca gcagcaatgg gccttctctg 92280
catctagata tgcttaaggc aaaatgacaa acgtaatcaa agccccacca aaacagctgt 92340
gcagtatgtg taaaatccta cacacaagac taatagtga aaggggactc ggactcaaat 92400
tcaggctcct gcattggcaa aatggtcagg tctccacatg ttccagctca aatctatag 92460
attcaataaa ccagggttga aaaatactca gcaagaaact gggttgcaac aaacatggat 92520
agactttctt ctgttggtta ttccttaaaa aaatatagta actatttatg tagcatgcat 92580
attgtattag gtattacaag tagatgatat aaagcatatg gtgggtggtg ggtgtgtggt 92640

gcatccttac attccatcag ggaagcagaa ggcacgcagg attgtaagtt ccagaccagc 92700
ttcacttaca aagtgagtc aggccagttt aggtacaaa gcaagacttt gtctccaaat 92760
acagagggtt agaggtatag ctcatggtac tgtgcttgcc tagcatgcac aaaacatgg 92820
actcatgac taacatgaca acatacacac aatgattatg aaaactatgc agataccaca 92880
cattgttgtg taatagact gaaacattca cagatttgggt atctgagagg ttgctagacc 92940
aatcttgggc taatgaggaa gaaccttgc aattcttaca caaagtaaga attctcagat 93000
aatacattat tacttttaga atgaaatgaa ttattaggat taatttagga aataaaggta 93060

tttgggtgggt ggtagcttat caattaaaga gggaaaaaca tcactcceta aggagttttt 93120
aatttctgtg gtagtctgca tgtgaatgac cccatggact catatttttg actacttgggt 93180
gccccattaa tggaactttt tgagaaggat taagagatgt ggccttgttg gaggaggtgt 93240
gtcactgggg gtgggctttg tggtttcaaa ggacattttt tgagtgggtt ctctctgcct 93300
cttacctgca gatcaagatg tatgctctcg gatgctcatg ccaccatcac cttttccag 93360
ccaactgtgg actccacccc tctgaaactg taagcccaat taaaggcttt ctcttataaa 93420
ttgtctcctt ggicatgcat cacagcaata caaaagtaat taagacaatg tcttaagggc 93480

acatggatca aattcaggtt actcctcatt ctgaaagaac atacagttta aaggagacac 93540
aattctcctc cttaaaatga agctgaaaat gtcccgtatt ataggggagc ctactattct 93600
tcaggaaggg acatcactca agtgcatggt aaagaactct gattggttca tcacctca 93660

gtcacaggac aagtaaattt ctttgaatg ccagcataaa ctttgtgaga ttcaacatac 93720
tctaaaaaac tgtctttgaa aatgcaaagc cacactacag ggctaattgt taaaggctcc 93780
acgaatggcc tggatccaa agaacagctt actgtgacca ctgcacttgg gatctgctat 93840
ccgacacaca acagtgttag aatgtgccct gatccttagt caaaatccac ctttacaata 93900

agggatagtt tctgaccatc attgatagta gtaaaataac aataataaga gaaagctgac 93960
tgtgttgagc gcctttgcct tgggagtctt tgttttgttt ctttttgtct gaaaggcatc 94020
caaactgcct tcctatttga ggcaactcacc catttgttga gtcctgggtg caggagagac 94080
cctacctcac aatggacatt tccttccctg gtccttggaa gtcattgtaac ccaggctcag 94140
ctcctatccc cticcaggca cacaagagg cagagtctt agagactagt cacagagctt 94200
caggaagcca caatgggagg gagtcaata agcgcctcag tccttgtgcc agctctggag 94260
ccacacttac cctggctgct gcagactctc ctatgttctt aaggcagggc cttgtatcac 94320

tcttgccttt gtctcagcc tgggcttcca gcctcttct gtctgtatta tttctgcct 94380
aacgtgcct aactcagact tctattgctt gcagtaaagg atgtgactt ccccagggga 94440
gtagtgattt ccatctgagc cataaagagt taataaacca ctgggagcag ccaacttgta 94500
cacaggacaa taatgaagtc ctcaagaaag gccacatagt ctgagaaatt ctactttctc 94560
aacactagct tgtttagaaa gaaaaatatt caggtcaaat atttattcta tgaattaat 94620
ctctaagat ggaaatcga actaatgttt actttggggg agtagaagga atgggagggga 94680
ctgtaaaaga gcctgaggat gctggaggag ttctgaattt tcatcagggc agtagtggaa 94740

tggacatgca catttgtaaa aaacactatg tgcagatgta tgcatatggc tacatataat 94800
ttacctaat gaacacacag acacatggag tcataaacag aaacacataa agaaacaggc 94860
ccagctgatg atgtccacat gatgtcatgg atgatcaggc ccttagcaat ctttatttat 94920
gcacatagtc tcctttgacc ttggaccttc ccaggcattc taatctgatg atagacaagt 94980
ccacagtgga cacatttcaa tgctcagcac cttttaaag taaggattca ggcattatgc 95040
tggcctgccc cgtcacctgg cagaacgcac acaagcagta ccctggatcat cccatggttg 95100
tgtagtctgc acacaggtgc aaaggaaacc tttaaaagaa agacaccccc ccccgccca 95160

cttatgctct ctcttttctg ctgttttccc ggggcagaca ggacttttcc tgtctcctc 95220
ttctctgtc ctctgtctct gtgtgtctgt gtctctctac ctcttttctc tttcttcat 95280
cccccttcc ctttctaata aaacttctca ctaagctctg tctgcttggc atctttgtcc 95340
cctgcctcgg tcacctcac ctgcatgga atctaccaag gttcctcag agctttatca 95400
taacactttg gacttgggca tatgatcagt tttggtgtca ccgcttttt tcaacctec 95460
aactttggat caaacttggg ggcccaaca tagataagt atatctgcca tctccatggc 95520

accattgacc aatgtttcaa atgcaaactg atttctctgc cttcaaatac cttttctaca 95580

caaatggcct tgaccatctc cctaactgat ccccaaaata attaaactat gagccattg 95640

ctgacacaag cacttgatgt ggccagctac taaccaactgt cctctttatc cacaggagga 95700

aactaagata cttagaagcc aaacagctta acccttgaag acagcttgac ctgaagctcc 95760

ccagtcaacc ctctatatta cagctaaaat ccaagaccag tacatcctct cctcttcctt 95820

cattctcctt gacagtgaag caatgaacta atgatttctg tttaaagata tccattaact 95880

tttttattgc ccccttcctt ccttccttgt attccaataa aacatggctc atgacaaata 95940

agcaaggaaa gctgcttcca tctagaaggt ctatattaat ccagattccc tccttcaga 96000

caatagaaaa tatttaactc acgatgaaaa ttcatgggtg actttatacg caatacatac 96060

ttagaatgac caatcctggc tgacccccag aatgacactc tccattcttc acacttctaa 96120

gtggtaagct tcacaaacac ctcatgacca catctcaagt agctctacta gaaatttcta 96180

cttgtccaga cccaaccaa caatctggag tgatgctggg aacctgttt cctctgcttg 96240

tgttcagtgt ctaccactct ctgtacctgc agagtgcaca ctttaaaact cccaaaagac 96300

aaagttaact tgtgtcagta agaacattgt gtccactggg atctaacact ttgttctgga 96360

tcctcagaag gcagaaaaaa atgagaggaa agaagggagg ttggaagtga gagaggaag 96420

gagggatata aggaaacgaa ggataattga aatgctgac ataaaaaca gccagagaac 96480

gcagctgtca cagaagaatg gctggctatg tctctgtggc tagaactgac ctgtttgttt 96540

gcttgggcaa tgagtctggc ctctaacaaa accttggtag gaaggttgtt tttttcaca 96600

attagaatga tagcaatatt atcaaatgtt tccatataca aacctctac acagtaatat 96660

tatttgattc ccttagtggtt attacattc ctccattgc aaatgagtta aaaggtata 96720

taattatag tggggatact attacaatg gttataaag aatccctct ttaaccaatg 96780

ttcattgcat ttatatttac ataattgttt ccaactgac aatacacaaa gtaatgatct 96840

ccaagctcaa tacaaagtta cagtgtata caactcactg attgccttct gcctcctctt 96900

gacagtgagg caaagaaagt cagcccatga gctgggttat cagcctggaa tgcgagtgg 96960

ggaagcatgc ctctacceta ggagctagat gaggcctctt ctgtgtacaa agcatgctaa 97020

gaactcgagg gaaagttca ctgagtttgt cttcaacaac ttctcactgg tcaacaagc 97080

agagctctat gcaagctggg gcaagtttgc aggaaacttc agacctgcc ctttgcagaa 97140

gtcaggcaag cattagcagg acctccata gtccctagtat tataggtacc aagcactca 97200

aggagaagaa aaaatccaaa aatctatgc caagaggcaa agaaaggtga atagcaataa 97260

agatactac acttgtaact cagtatgaga aaaaaaaagt gacttgtgtc caacagtact 97320
 attcatcatt ctctcccctc acatcccaca agccactgtg ctcccaggtt cttagagaga 97380
 atccatTTTT taaataaaaa acagaaccag ggtcaaggca agtaaggttg gttgttatgt 97440
 tgtgcacgta aagacatggt aggcaaacag gctgagtaca cagcacagca gctttaagtg 97500
 acctcagggt atattattaa ctctgactgt gaaatccagc aaaagtcca gtctctttga 97560
 atgtaggtaa cttttttata ataatacatt gcaacagaag ttcaacagag gaaaaatgat 97620
 cctctcaaca gaaggatgat gaacaatgga tcacatatat tcaaaagacg gtttgtacat 97680

 acctcatggt aaacaaaatt taactccatg gcatcatgga tttcaatgtg catacaagac 97740
 tggagggctt tgTTTTgttt ttgtTTTTTT ttttagaaga aaacaaggag aaaatctgca 97800
 ggagtccatg ttggcaaaa agtatttaga tatagcacca aagacaggac ctataaaagg 97860
 aaaatttagg gccagcaact cagccagtaa tggcgcctgt tgctaagcct ggcggcacia 97920
 gtcaaaacc tgiaccaag aggtgaagga gaaaactgaa tcctgagagc tgtactctga 97980
 cctccacct cacattgtag caactgtaac agttacagac acacaaaata cttgtaattt 98040
 aaaaataaac tcagaaaact agagtcactt taaaaaaaa ctgaagaacc atggtgaatg 98100

 ttttghaaat aataagtcac aggtcaagaa aaaaatactt gtaaatcata aacctghaaa 98160
 gaaacttgta tccaaaatat gtaaagactt ttgcaaatcc cgtghaaaaca agcaagccac 98220
 tgtaaaatgg gggaaaggga aacacatctc cacagacatc taatcaaaaa aagcacaggt 98280
 ggcagggatg cccatggcag tgcttgctac cactgataag agaagcacat ttgggcacaa 98340
 ggaagctgca gcccactg tcaggatgcc aatacagaga cccctcaagc aggggttgag 98400
 ccaggcctca agtcacaaaag aaaagaaatc acataataaa atacctgggc tttcaacaga 98460
 ggaatattta aactgtggtg tacatataag ggttacatat atacaattag aaacaagatt 98520

 gctttacatg tcaateccag ttccctctcc ctcccctcct cccctactac cectcccaca 98580
 ctaaaacct acctatcaca tatcctttct gctcccagg gaggtgagg tcttccatag 98640
 ggggtcttca gagtctgca tatcttttgg gatagagcct aggtccacce ccgtgtgtct 98700
 tggctcaggg agtatecctc tatgtggaat gggctcccaa agtccacacc tatgctaggg 98760
 ataacttaca agaggtcctg gagatttctg aggtctcttc actghaaacc acattcttgg 98820
 ggtctcgatc ctggatacca tgttggatc ccagctatca gtctggggac caagagctcc 98880
 tcgtggttca ggtcagctgt ttctgtgggt ttaccagcc tagtctggac cctttgctc 98940

 atcactcgtc ctctctcgg actggattcc agttcagttc agtgattagt tgtgggtgtc 99000
 tgcttctact tccaccgct gctggatgaa ggtataaga tggcatataa gtcagtgcag 99060
 aattctacca gaaattcaag gaacagctaa taccaactct cctcaaagta ttccacacia 99120

tagaagcaga agagtcattg ccaaactctt tttatgaggc ttcaataacc ttgataccca 99180
agccacacaa agacacaact aagaaagaga actacagacc atatccctca tgaacattga 99240
tgcaaaaata ctcaataaaa tactggcaaa tcgaatccaa gaacacatca gagaaatcat 99300
ccacatgat caagtaggct ttatccaggg atgcagggat ggttcaacat atgaaaatcc 99360

atcaatgtaa tccacaatat aaacagactg agggaaaaaa accacatgat catctcacta 99420
gatgccgaaa aagcctttga caaaatccaa cacccttca tgataaaggt cttggagaga 99480
tcagggataa caggaacata cctcaacata atagaagcaa aatacagcaa gccgacagcc 99540
aacatcaaat taaatggaga gaaactcaat gcaattctc taaaatcagg gacaagacaa 99600
ggccgtacac tctctctata tctctccaat attgtccttg aagtcttagc tagagcaata 99660
agacaacaaa aggagatgaa gggaatacaa atcggaaagg aagaagtcaa actttcacta 99720
tttgcatgag atgatgatg ctacatgagt gaccacaag aagtgttact cttaaagtgac 99780

ataaaccaac agcgtctct ctctctctc tctctctc tctctctc tctctctc 99840
gtgtgtgtgt gtgtgtgtgt gtgtgtgtgt gtgtgtcttg tgggcgctg cacgtgaatg 99900
ggcacacgca cactaacctc aaatacattt tgacaagtgt aagaagccat actcataaag 99960
gctacatatt atatgacttg gcacataata cagtctttaa aaatgaagac tatggaaaga 100020
aaaacaggca gtggtggcac atgccttcaa tcccagcact tggaagacag gggcaagtga 100080
atctctaagt teaaggacag cctggtctac agagtgagtt cctggaaagc caagggtac 100140
acaaagaaac cctgtcttga aaacaaaaa taaagaaat aatgaaaaa gaagaaaaa 100200

gaaaaacaga atagcacttc ttgggcattg gagacaggaa aagggtttga ctgcaataga 100260
ctagtacaag aaaaccagag agcagatgga atcacttggg gcgaggctgt ttttgccaaa 100320
tcctacagaa ctctagaata cagaaagctt attttagtgt atataattaa aatgaaacca 100380
tcaggactg tgggagaacc cagggtttaa cacagacagt agcactgaag ccaactgtat 100440
ttcaaatgta tgtcatgagc acttggaag aagtgtagaa gaaggagct gacctcagcc 100500
actgtgttct gactgaaaag cagagaagtg ctgggtgtgc attgtgatct aatagtaaag 100560
tctacattcc cacgggggtc caggtcagca atactataaa ctacttaaca agcaaaagtgc 100620

tgggaaaaa tgatcaaatg cactgtagat aatgacagcc cagagtttca ctgtcagaga 100680
aaatatttta aagaataaat accagaaggg actctgcagg actggagtta ggaaaacatt 100740
cctaccaatg gctaaacgat gtatcaccaa ctgctatttc ccagagatat accgattggt 100800
tttgtttcca gaaagaggaa ggaaaaaaa cctctttgtt tttgtttatt tcattattca 100860
attgacgtgg tatatgattg gggcggggtt agggaaagt attctccaa gaaaataaaa 100920
catgctttat gtcaaaacca actttatag gccagacata gagttaatat atacctgaag 100980

tcccagccac ttgtgccatt gaggcaggag gctggcttga actgtcaggg gtctagcata 101040

aactgcccaa gacagcaaaa ccccatctca aaaatcaaaa acaaaatcta tcatttttca 101100

aataaaaaaa ttataaaatc catgagccag cctcaccatt ctagtccagg gtggctaaac 101160

tgaggatgaac atatgagctc gctgagcaaa catgacaaag tttatatatg ctatgggaat 101220

tccccgattt ctgctcagag tcagttctaa gggcacctga tagaactcca caggcagccc 101280

aaggtccage ctctttctat tccacgctac gaatgccact tctggaaag aggcagaccg 101340

aatatcctca ccaaaatctc aagtggccaa accacagtca cctgctaate tctgcccact 101400

gtttctttat acggttgaca gatgtacacc cacactatag ccacagagca aaagcgcct 101460

ccacatcgca gacttctcca tctgctgcct ctccactctg gtctagtcat agaaagctat 101520

aatacaagat gagactaacc aggaaggaca aggccccaga aagctatcac cttcaaagtc 101580

cagctccage caagggctta tgtagagtga agcatgaatg ttgccctggg agggacaaca 101640

gggaaatcca gacatcccca gcagaggacc caggccaaca gggagtgcc gttctcataa 101700

aacagggctt caagatacca ggccaggatc ctaactcagg caccaatttg catagaggag 101760

aggactgtga accccagaat aaacttacct ttgaggecct cacaggacac acaccctat 101820

tcactcaagt caaggttccc acccacacat cacttatgag catgccaca aattcttatt 101880

tgctgtagc aggcagaagc agcaaagaga ggaaaagtga cagagaggag aagaggggaa 101940

actataggat gtgtgtgca ccacagcatc ttgactctc ttcattgtca cttctagact 102000

caccagggac acacgtgaga gggaactctt cagacttttt aacggatcta gaccttctgt 102060

gaaagctgca aacctaaagc taaatgttac cttctgaag gtgattctta tccaaggcct 102120

cagttgcttt cccacctact cattctccc ctgctccag taaccactgt ctggctccct 102180

acttctttga gttgacttt gagacatcac aaggccatga aaccttatag tttcatctc 102240

tctgctggt ttgtgtgct tgcttgctt tcttttttt tctttcttc tttctttctt 102300

tctttcttt ttttttttt tgatttttaa ggcttaatgg tttctatc cacattttta 102360

aatccactta tctattgatg ggcaacttgc tctttctta tctttctgt gtaagcagtg 102420

tagcaatgaa caaggcagcc ggcatcccct ctcccagca tactgatttt tcagcccta 102480

actcagtggg attgcacaca cacaataaa caataaata tatgtctgt tagttattta 102540

tttatatag tcatcttta ggtagtcca gaagattcat tggtaataa gtagatctc 102600

caagccttta ccatcataag aaccacatag aagcatttac ttatctacc tgggagtaac 102660

acagtcttc tcaacctacc agcctacca aactatgat cttagatgac tcccaacctg 102720

caattacacc ccaacacact cacattgtag catggttttg ttgtttgtag aaagtaattc 102780
 agtgtgattt gaagagggtg ggagtttaat gtcctctata aatggtcagt agtcatctcc 102840
 cagagaaagg gagagagggg gagactagct cactgacttc tgggagagga caaaattcta 102900
 aagactgaaa ttcatgaaat aaatattaga agcaaaagag gactgtgact tgaaggtggc 102960
 agatgacact atggacatag attaaattag tgcctctgc agtcaccttc cctctctcc 103020
 cctccacagg gactcctggg gctggaagct ccaggatctg tgagctgcat ttccttccca 103080
 caggaaactg ctaaattttc tctgtggca aaggcctttt gggactgcaa gattcctctc 103140

 taaacatcta agacagatcc taaggggagg atcagagaac tctgaatcca ataaataaat 103200
 aaataaataa ataaataaac aaataaataa ataatctctg ggtagattt tcaaggcact 103260
 gtaaacctg gttttctctt catcaggcaa ttgactaaa tgccacaaac ttagccataa 103320
 aatgagcagt ctgccctgcc tgctcaagct tccctgaga tgtttctga agggtgactg 103380
 ggtttacaac agccatcagc tctgcaaagc tctgctctgt acaccagctt cccagatgga 103440
 ctcaaatgac aataaatgta tatgttgatg tacacacaga tacacagtgg attcaacctg 103500
 aagaacggta catcccatcc aacctggctc agagtgcag tagctgactg cactcaccat 103560

 ataattctgg tatcccaaat cattatctaa atctacacag tgatgataaa agactctcca 103620
 ccgtatcaca ggaataaccg tgtaacacta acatcacctt gaggtagtgc aaactcaggt 103680
 catgatgtga gtagtttgag aacttcattc ctgccctctg gacaagatca gtgtacaag 103740
 cttaagggag ctttagtgag aatgccccat gctaaggatg cccatctgca atagggtcat 103800
 caaaatccac accacaacac ttctcaccca tcaggacatc ttcattcaga acaaaataca 103860
 aacataaaac tgggtttggg gggacatgga gaaaatagga ttcctttgta ctgccagtgg 103920
 agtgtgaacc cacacagctg ctgtggggaa caatctggcg agtcttcaa cagctaagca 103980

 ttgagtttcc acgtgaatga gcaattctac ttctaggtat ctgctcaaaa cactgaaagc 104040
 aaggactgga acaaatcttc gtacatcagt ggcttttagag taaccaagta cacagggatt 104100
 aaaaagtaga atggtcgctc ccatgggctg ggggggactt tacgaatgtt gttggtgctt 104160
 aatggatgag gagtccaga cggagaagag gagaaagtct cagagatgga tggatgcaca 104220
 accatgtgaa tgcacttacg gccactaac tatgctcaaa tgggctcaaa tggggcccat 104280
 ggggatggcc taattggtaa agtgttgggc acacaagaat aaggaccaa gttcagattc 104340
 ctagcatcca tgiagaaaag ataggtatat ctatataatc ccagaagaag gattataggc 104400

 atacacagga ggcaacagag agatttgggg gaggagtgtt gctggctgtt gaatctagca 104460
 gaaacagcaa gcccaaggta cagaaagaga aggagactct gtctcaaaaa acataatgaa 104520
 atgtgacaga aaataacacc gatgtcagcc tccagcctcc tctacacata catgtgtata 104580

cataccatgc acacacacaa acatgtacac atgcatacat ctcacacata acacaaatgg 104640
 ctaaaatggt gtttgactac agaagatcca tcagaataac aaagcaaata tttttgggtt 104700
 tttttagact ctattctatc ttcacaagga tgcagagaaa tgggatctct caaatacaca 104760
 ctgctgacaa gaagcaaaat gctaagaccc gtccccctgg aaaatatctg gccatgcctt 104820

 taagagagta agcatatggt cacacaaacc agcaaacata ctctgcaga tagatgacag 104880
 agttgcaggt tacatctgag caaaagtga tataaagcca accattgcag ctttatgtat 104940
 aatacccaaa acctgcaagc aaccaaatgt cgtgatgata caaacttatt ccacaaaact 105000
 ctatttagca aaaagaaaa aaaaaagtgt ggctacctcc atcacattgg ctacctctg 105060
 tgagcatcat attagatgag aaagaagtct caaaagatca catgttgtat gattccatgc 105120
 tataataaat tctcaagcag ggcaggttgg cttgcacctt taatctcagc acttgggaag 105180
 cagagacagg cagatctcta tgagtctgag gccagtctga acacattgtg agtttccaga 105240

 ccagccatgg aaaccctgtc tcaaacgaa ttctcagaac aaggaaatta cagccatgaa 105300
 gatgactgct agcatttatg aatggtggaa gaaaagtagg gagatacca aatatatcat 105360
 agtttatcta ctcatgatg aaagatactg acaactgtcc tccatcaaaa gtttccaaat 105420
 cccacattcc cattcattaa cacaggacca catctgtca cttcagcctc cactggaaac 105480
 acaaagagac tcccacaaac ctgtcacttt caatcccaaa ctgacatgga agtgatgggg 105540
 aatgtaccgt atatgttcat cttatcgatt attgaataaa atactgtttg gccaatgaga 105600
 cagcaagtta ggcaggacta ggagccaaag aggattctgg gaaatgtatt agaaaagtgg 105660

 tgatccagge cggaagagac atagcaagga gactcatatt tagcaaggaa aaacaggaac 105720
 tgtccctttt cccttttgcc tctccagca gcaggatgtg agccaccagc aaggaggagc 105780
 gccataaagg ctccgataa gttaaactca ataaaatata tagatttatg ataattaaga 105840
 ctgagetaac agatgagaag tcttagtcat tggccaagca gcattgtacc taatacaagt 105900
 ctctctgtgc attaattggg gccttaattc gggtaggtgg ctggcataaa gcgcacatgt 105960
 ggcggtgggg ctcgggcggc ttttgggtga aagatttatc gtaacatgga agtaattctc 106020
 ggagaagata acatcagctt ttgacatggt gtacatatcc aactggttct acattctct 106080

 gccttaccta ctccaacaa aaaagtcatt cttaaaactc ctttcccat tcgttctct 106140
 gctcttctc ctctcctc ctctctctct agtctctc ctgcccctct tctctctc 106200
 tctctctc tctctctc tctctctc tctctcact ccctctct ctctattct 106260
 ccacccttc tctactccc tgtactctt tttctgtcc tacttctct cctctctcc 106320
 ctctctct ggaaaagaaa ttgtggctgc ctagtaagtc taagaattg aagaatacag 106380
 cacatcacag aacttgctac aggaggacc aggatagta ggtacaggag gaccaggta 106440

cagtaagtac aggagaccta tttcatcatt actccaccc tggacagcag gaggcataat 106500

 ggattatttc atctaagatc cttgcttccc tacagtctc tggcccagtc aacacatata 106560
 cctcctca gectcacat ctccttgaa attttctctg aggttcaacta gttactaaa 106620
 gccagccta tacaagctcc tctgagaggc acccctaata cttgctgttg tttcagaagc 106680
 aaattcagta tgtgtctatc cagccctttg tcacagtgat catcactaac attctcagta 106740
 atgaatccct aattgttaag tctctatgga aggaccctt tttcccttcc tetgtaaagc 106800
 tagaatccca aaggacagc caccaaactg caggaatgaa gtcttgggga tctggtctgt 106860
 aattccaaac gctggggagg aacctgcaca aagtatctac aactgtcatt tttcttggtc 106920

 tgcaacaata agcagcttcc agaatagaac cacaattgac ctgcacaagg ctggggttgc 106980
 caccagatgc catcagaaga caacacgtga tggtaggaaa ttagcttgtt acctgttatt 107040
 tgttcagagt gttcagtgag aattacatta caggaaaaat ttaaattatt ctctgaggtg 107100
 gttcgggtgg tgggggcagg gtaggagttg acatttcaac tgcaattagt aatgtttgct 107160
 tccttccat gcacttccct tcagacactc ccttctctgc tgagtggccc tggaaatgct 107220
 gagggcatgt caatacctag gccagaagca actgaattag gacttttaac ctatggaatt 107280
 tgccagcctt cataatttct aatttctcac tataattact cactttttat ctagtcttgt 107340

 atttataatt tcatttctct ttctgaaaga gcccttcaag aggtccagc tcataatctg 107400
 tccccaccta taattcacta agtacctggc acacagaatc tatccagtga attaatggaa 107460
 gcaccaatgt caagtcaaat cacttagcat cactgacaat aatgagtcac ctgagattct 107520
 agagaaatag ttaacaagaa aacatattgt aagataccac acaatacct aaaccggcaa 107580
 agcagcagct ctttttttt ttttttttt tgcaggctg tgcaccagaa tggctatgaa 107640
 tactgggaga tattactgaa gaacattaga agctgttgtt atttgaagt cacatggggg 107700
 ctcaacagaa ggetcagcag ttaatgtctc eggtcttct tgaatccaca atgagctgct 107760

 tatagctgcc tgaactcca gcccagagg atctgacacc ctcttctgac cctgcaggt 107820
 gcctacatac atgtgatgta tgtacatagg cacacgctg cacacacaca cattttaaaa 107880
 aatctttctt tcaagtgcac gtggcatggt tcatggagac tcttcttga gtccgggat 107940
 tctgaagaa tccttaggt taggggagat cccgggctg caacttcaac aggacattct 108000
 ctgtcatgaa acagtctca acaaggctct gtcgacctca cataatgtat gcacacaatg 108060
 gccagatgta gtcaagtctc aaatctgggc catgtttctc ccaaccatca ggtttgctga 108120
 cacttatgat tacagcccc tcttaactga ctccccaac tcttctgtg taccagaat 108180

acaaaagtaa ataaagacaa tgactgcctt gtcccaaaca atgatgctct catacctact 108240
 acgggaagcc agaaagagag agaaagatgc aagaataaca atgcaatagt gctctagagc 108300
 cccagtcagg gctctgtggg tgaggatact tccccaaaagg ctgaatttaa tccccagacc 108360
 ccaggaggta gaaagagaga actgacccca gcaagagttc ctttggcctc cacacatgct 108420
 gtggctcaag cacatacaaa taaataagca agtaaatgtt gaaaacactt aagcatactc 108480
 taggactagc ctcggtcact atatatggat ggaatgggct aaacttaaat catttattac 108540
 ttaagtactg agcactgaat tagtactgag aaatctgggt accaaatcat tfaaattctg 108600

 ccgtttggat gctttcccat ttagcagata agaaattaaa tgaaatgata acagcaaact 108660
 ccttcaaac gtaaagctac tttatgtctc gaggacttcg ctgaagatat gacattttag 108720
 ctgaaacatt catggaataa acttagctac acaaaaggac agaagcagga gtatgcccg 108780
 aaaggaagca ggcacacaga ggtcctaaga ttgaaagaaa cagcatttga gagaaactga 108840
 gaaaacactg tatggctaga gcttctaata tgtgggcttt ctaccatccc acctgtatga 108900
 tcaaaagcca tttgaatcag cagcagctat tgaaccaact ggacccccac ccagggacac 108960
 cagcatccct caaatggcct tatagaaagt cagggggcat gcttgcttct ctccatcaa 109020

 cattcacaga gagactacat tgaataccac atcaggatat gttgaaggga aatggagga 109080
 cttggataaa gccctgggaa caagagaatg gagacagaat gaagccagcc tcggacaggc 109140
 taagagagga ctigtctaac cagaacagag agagattttg aatgcagcag gagaggtgaa 109200
 cacaggccaa gagcctgtgt tctggggatg gggatgaaata gagtcatcac aaaatagaag 109260
 aaaatggaaa ctctgcaggg gccaaagcaa caatccaaa gtgaattagg atcactgtca 109320
 ggacagaaag aggcagtccc agtagcagga ggccataagg atgtgtcaac tgcaggacat 109380
 aagaagactc agaaaaaaaa aaaagtgggt ttcgctggg atgcttgaga gactggtgct 109440

 cagcaatgaa aatcaggaag ctgtaagggg gctgcttttag agaaacttga aaagtcttt 109500
 aaaaaatc accatctggg ttttaagtca aggatggata actaagcgat aatggcaaac 109560
 agactgtgtg gaaaaagaag aggcggccac agcagagggc agggcaagaa ggccacatgt 109620
 ggggtgattc aaggagaagt cacaatagaa taggagcaga tgagctggcc tagaagaaga 109680
 gagaggactt tggagaaagc catgcagctg gagcaggaaa cacagctgat gcacagccct 109740
 gggacactgg caaggagtg gcaggaggtc agggacccca acgggtccac ttttcagtat 109800
 aaatcagaac acacaaatcc tctgtggagc ccacactctc actttctgta ttactcaca 109860

 actccagtta ctcttgacct ggccccgcc acctgtcacc tgctttctcc cacacaaagt 109920
 gccaccact agccccctca atataggaag ttctgcact ctctgggagc gggcctttgt 109980
 gccatctgac cccccatta ggacactctc gtcacacacc tatgtgtacg tgtatgtaca 110040

catgcagaga cacacacat tcatctcca acacagcaac acgctgctct agcacagcct 110100
 tgagctgctc taacacatat catgacttga attctcactt ttgtttgtct gcattccccc 110160
 attttctaaa aagaccagag gaaggttaagg gtctgggacc tctttctctc atctctgata 110220
 ttacagtgca tggagccaaa tgaagactta agaggaagga gaaaaagcag cttaaagaaa 110280

 agaaaaaatg tgtgacctt ctaagattgg ctttgatcca acaagatgcc taaagccgga 110340
 ctgcaaaaag ttgtggagaa gaagccttaa gacaaaaact tctctaaatc acacacacct 110400
 gggggctaag gagacacata ggtgcaccgg tgtgacctat ccctccagaa aagctgattt 110460
 ttctagaata cctaataaa acactttgac caggtcacat ttcagttctt ctaccaaggt 110520
 tctcactgtg gagactcaaa ccctcaggcc tgaatatcc ccttagatgg ggtttatgtt 110580
 tacaatgaa atgtaaaagc caaatggcta ggccagcaag atggcccatc gggtacaggc 110640
 atctgccatc aagcctgatg acctgagttc caccttggaa acccacatag tggaaagtagg 110700

 tagccaactc ctgcaagttg tactctgact tgcatatgtg cacatggcat gtgccctcat 110760
 ccccatgtat gtacacagga atgcacatac atataaaaa aggtaatcaa atgtaacaaa 110820
 aaaatcaagt cagttaactt ggaatttttt attgaaaaca caaaggtgta cattacccaa 110880
 acttgtgaga gggctactga aataagggaa acagagtggg gcagacttga gaacactagg 110940
 tatttataga ccccaaagct tttcaggcat ggcagggatg ggcagggtgg ctgctggcca 111000
 ggcaaggtaa atagtcccc tgctgtgtgc ctacaacatg caaagcaagc aatgaaaag 111060
 ggaaagagaa ttttataaaa gtaggccaaa cagagagagt gggggaaagc tcagttaagc 111120

 tgagaacaag agctcctcac agcaggccag cttcagcaag cctggcttaa acaaacctgg 111180
 cagagacttc cagcagctgg caatgggtgg gaggatgctg gaggcctgt gtctaagtca 111240
 agatacagca tcacagacac attgcagaga acaaaagtgc acaaagcaaa cctgtggccc 111300
 agaagttgac tctaggagag acccttctct attcactct ctaagccatt tgaagagaca 111360
 ccatggccca tacacctga ccctacata ctcccttc aggctttccc cagaagccag 111420
 tgaggacagt gaagagaagt gccagaagt gacactgtgt tcagagccct gtttatttta 111480
 gaatttgat agaggtgaag ctaatggagg ggctctatca ggtttctaag tcaaagcttt 111540

 tgctagagtt tgccagtgga tctctattaa actatgcttc tgggatatca gatcacagtt 111600
 aatgcatgtg ggtttttgtg agcaaaggaa ctctcaaagg tcaggacttg cctggatgta 111660
 gttaccacta cccttgagag aaaataaaag agagagagag actttttttg tttggttgg 111720
 tttttgttt gttgtttgt ttgtttgtt ttcaagacag gttttctct gtgtagcttt 111780
 ggagcctate ctggcactcg aactcacaga gatctgectg cctctgcctc ccgagtctg 111840
 ggattaaagg tgtgcgccac caacgccag caaagtgag acattttaat gaccaaaaa 111900

atgctgatat tttcatactg tgaggttcaa ggaagacagc agagcaggaa tggcccaaac 111960

agcacccttt agtggccaag aaattggagt tctagtact gagcaatggg cacagtcact 112020

gtaatttate aaccactaag gtggggaaac cccaaattca ttgagggatc tgccattaac 112080

aagtactaag caaatatata ctgtggtttt taacgcagaa tctgtgaagg caatgcacag 112140

agacaaaatg gcagagtcaa catggcaaag caaatcactc agtgtaggag cttaattcg 112200

tcatcagcaa agtgacagag actggtcaaa aacttccaag gtgtccttac aaacactacc 112260

ccatgatgtg gtcaagcaag accagtcagg agtcgggggt gttaagggtc atgagaggct 112320

agtcatgggg catgcagagc tacagacaga gaaagagcag gcctcaggac aggatttctc 112380

ttagcaggaa ccagaagttg gtgggcctct gtgggagtcc ggaaggagat gtctgtctgg 112440

tgataccaga acaaagccac caagtcactt actgcctcaa taggaagcat ctcccagag 112500

ctaggaaatg gccttggaa ccaaacagtc caaccagaca acctgggacc tgtcctcaga 112560

cccccaacag aaggcaaaga cccagggagt gtgttcagtc aaataaata tacatgacat 112620

ccataagcta gaagatccag actgtcagaa agactgatgg aggaggattt agctcgggtca 112680

cctaaagcat ggattataga ttacaacttc atttaggaca ctgaatgatc ccagaacaac 112740

cagcatccct cagtaggata ctgaatgcc ataaaataat aatataaata taacatgcaa 112800

taggaataga agattaacag atcgaattga caatgagcta ctgaaaaaac tccactgtcc 112860

aaccaaccag ctgtatgca cctgcagccc tagagagaaa tgatggcatc cttctcagca 112920

aagtccacca gtacaaaatg tcagaaaggg agctggcagc atgagtccac aagcaaaaat 112980

tcacaagtgc acctctggag atgctgcaaa aaaaaatctc cgtgcattgg ccagagctag 113040

agaaagggca gaattgaagt tttgtcttct tataaatgtg aggttaattt tttttaacat 113100

actgctttga aaaaatgact tcatctcct cctactggtc tcctactata aaaatggaac 113160

tattgaatag tcaatcagtg ccactctaga catataccag aaggtaaatt agcacacagc 113220

aaagacacct gccaccatg tttatgtggc agtatcaca cagtcaagaa acagtaccag 113280

cttaggttcc aagtaacatg gatacatttt ttaaatgtgg taggcattaa aatggagcaa 113340

tattcagcca tgaagaagaa caaaattaca tcttttgcag aataaaactg gaagtcaata 113400

tattaggtaa agtacactag actcggaaaa acagatattc atattttctc tcttgtactg 113460

agattagtat ttaaagagtt aaaggagtct tcagccagaa aataaatact gtaggttggc 113520

tgccaggctt ctctaattt atatctttcc aagcttacac attcctgaga ctcacctctg 113580

ctagcttgaa acccaccaca ccacaatacc cactgatgat tcaagatgaa catgactaca 113640

gcagagaaca aagagcctgg ctttcagac ctgtggcttg gggccagac ccatggatga 113700
atgaagctgc tccaagactg caaaggat gcaatgtcga cttccaaca ctgagcaaat 113760
cagttattgg agatgctcac cccactgcc a gtcttgccat catgctgctc ctcagacctg 113820
accatggtct gttttatit tctcacaata ggggttcagt ggaccatcct gctttactgc 113880
atataaac tagaatgagt ccatggttaa gcttaggaat atcctgacat ccctaagagt 113940
agggcaaagc cttcttcta aagataagca aacagaaaca acccccaaag tctgtaacaa 114000
acaacacaac agcatccata ttcccttctg aaattgattc ctagtagaac aagaaaacaa 114060

ttctacgtcc tttctttgtg cttaaaagaa aatacaaaag attacctctt tagagttgtg 114120
gacacaagga ggccagcata acatgaaaat gctacataga aactaaaaat aatagaagct 114180
aaaattatgc tggcacgaag taaaaaaga gaaactagac acaacaaaa cataattaag 114240
ttgaaaacat gcttccaat ttcagctccc atctcccaa aagacaaaac aaaagacaaa 114300
tctagtcctt agattgtttc ataataaaaa ggaaaaaaca aaaataaac caaaaaacc 114360
aatagtggaa gacacaaaag aagaaagtct taaaaataa aataaaaaaa gttttcttca 114420
tggatccaaa caaagtaatg gggaatttca agtataatatt tataatccaca gataatctgt 114480

agttataaaa aaaaattctc taccatcttt agaaagagtt ctccatagtg atacaaaat 114540
agaaacaccg gggcatttta accataagga catcataaga actcattcaa acaactcca 114600
ggcaaaggaa tcagaaattc cttgtaagac ccacttggat gagatgcttc tttctctgag 114660
ttccaagtag aggtggggaa atagttcca ccaacatttt gccctctgga attattaat 114720
tatccagatg atctaattct cttggaggta aatctcataa attagtttat ttttaaaaag 114780
actcttgtag tgactaaaag ttaattttt attttaaaaa tactaatgcc tgtaaaaaag 114840
ggaattagaa aaaaaaaca ggctttagga aaataaaaat tataataat tatttgttca 114900

cttaagacaa tatcctgac tgttatgagt tcttcacaat tcatgaagtt taccagggtt 114960
atattccaaa agaaccaatt aaaacaacag agaatgtcaa aactcatta aagcatcaa 115020
atacatagat aggatgcctc acagtcaaca gaccaacact acaacactga aataagtgct 115080
gaaagaacte gtgatcagat tcaacacaga tacagatgga cccctggaag aacacacatc 115140
aaactgtcag cgaggcttag aactcatgat gagattaac accaggcttc caatttgttt 115200
ggcttactct agttctaatt gtgcagtgtg tgtacaaaac acaacacatg tgaattaaaa 115260
aatattaagg gtttgatata caaaatacag tgaactgtaa gaaaccagac atgaagacat 115320

tcacccttg acatccatgg tgcacagggt tcaggaccaa ttgtagatgc caaatccac 115380
agatgctcaa ctactttaca taaaatggca tagcatttga gcatttgcatt attaccceca 115440
tattatcctc ctgggtactg tcaatcatct ctgattttt ttaataacta atttaacaca 115500

aacactatgg acatagtggc tatgctttat ttgacagga agaaaggcaa gagaaagctc 115560
tgcataagta caaacagat acaatttttc ctataaatat ttatgataac tgtatttaca 115620
aacatataat gaaagaccag tgatgagatg atataattatt tatgatttat taaagcttgc 115680
ctgaggattc agaaagcaaa gtcagccact agctatagag atcaggcaat ggttgtgcac 115740

acctttaate ccaggaccaa ggtaaatagt cccctgctg tgtgcctaca acatgcaaag 115800
caagcaaatg aaaagggaaa gagaattttt aaaaagtagg ccaaacagag agagtggggg 115860
aaagctcagt taagctgaga acaagagctc ctacacagcag gccagcttca gcaagcctgg 115920
cttaaacac actggcagag acttcagca gatggcaatt gctgggagga ggctggggga 115980
cacgtggnnn nnnnnnnnnn nnnnnnnnnn nnnnnnnnnn nnnnnnnnnn nnnnnnnnnn 116040
nnnnnnnnnn nnnnnnnnnn nnnnnnnnnn nnnnnnnnnn nnnnnnnnnn nnnnnnnnnn 116100
nnnnnnnnnn nnnnnnnnnn nnnnnnnnnn nnnnnnnnnn nnnnnnnnnn nnnnnnnnnn 116160

nnnagtgagg acagtgaaga gaagtgccca gaagtgcac tgtgttcaga gcctgttta 116220
ttttagaatt tgtatagagg tgaagctaat ggaggggctc taccagttt ctaagtcaaa 116280
gcttttgcta gaggtttcca gtggatctct attaaactat gcttctggga taccagatca 116340
cagttaatgc atgtgggttt ttgtgagcaa aggaactctc aaaggtcagg acttgctctg 116400
atgtagtac cactaccctt gagagaaaat aaaagagaga gagagacttt tttgttttg 116460
ttggtttttt tttgttttg tttgtttgt ttgttttcaa gacaggtttt tctctgtgta 116520
gctttggagc ctaccctggc actcgaactc acagagatct gcctgcctct gcctcccag 116580

tgctgggatt aaaggtgtgc gccaccaacg cccagcaaaa gtgagacatt ttaatgacca 116640
aaaaaatgct gatattttca tactgtgagg ttcaaggaag acagcagagc agaatggcc 116700
caaacagcac ccttttagtg ccaagaaatt ggagttctag tgactgagca atgggcacag 116760
tactgtaat ttatcaacca ctaaggtggg gaaaccccaa attcattgag ggatctgcca 116820
ttaacaagta ctaagcaat atatactgtg gtttttaac cagaatctgt gaaggcaatg 116880
cacagagaca aaatggcaga gtcaacatgg caaagcaat cactcagtgt aggagcttta 116940
attcgtcacc agcaaagtga cagagactgg tcaaaaactt ccaaggtgtc cttacaaca 117000

ctaccccatg atgtggtcaa gcaagaccag tcaggagtgc ggggtgttaa ggtcatgag 117060
aggctagtca tggggcatgc agagctacag acagagaaag agcaggcctc aggacaggat 117120
ttccttcagc aggaaccaga agttggtggg cctctgtggg agtccggaag gagatgtctg 117180
tctggtgata ccagaacaaa gccaccaagt cacttactgc ctcaatagga agcatcttc 117240
cagagctagg aaatggccct ggaactcaaa cagtccaacc agacaacctg ggacctgtcc 117300
tcagaccccc aacagaaggc aaagaccag ggagtgtgtt cagtcaaata taatatcat 117360

gacatccata agctagaaga tccagactgt cagaaagact gatggaggag gatttagctc 117420

ggtcacctaa agcatggatt atagattaca acttcattta ggacactgaa tgatcccaga 117480
acaaccagca tcctcagta ggatactgaa tgcccataaa ataataatat aatatataca 117540
tgcaatagga atagaagatt aacagatcga attgacaatg agctactgaa aaaactccac 117600
tgtccaacca accagctgta tgcgacctgc agccctagag agaaatgatg gcatccttct 117660
cagcaaagtc caccagtaca aaatgtcaga aaggagctg gcagcatgag tccacaagca 117720
aaaattcaca agtgcacctc tggagatgct gcaaaaaaaaa atctccgtgc attggccaga 117780
gctagagaaa gggcagaatt gaagttttgt cttcttataa atgtgaggtt aatttttttt 117840

aacatactgc ttgaaaaat gtacttcac ctcctcctac tggctccta ctataaaat 117900
ggaactattg aatagtcaat cagtgccact ctagacatat accagaaggt aaattagcac 117960
acagcaaaga cacctgccca ccatgtttat tggcagtat cacaacagtc aagaaacagt 118020
accagcttag gttccaagta acatggatac atttttttaa tgtggtaggc attaaaatgg 118080
agcaatattc agccatgaag aagaacaaaa ttacatcttt tgcagaataa aactggaagt 118140
caatatatta ggtaaagtac actagactcg gaaaaacaga tattcatatt ttctctcttg 118200
tactgagatt agtattttaa gagttaaagg agtcttcagc cagaaaataa atactgtagg 118260

ttggctgcca ggcttcttct aatttatac tttccaagct tacacattcc tgagactcac 118320
ctctgctagc ttgaaaccca ccacaccaca ataccactg atgattcaag atgaacatga 118380
ctacagcaga gaacaaagag cctggctttg cagacctgtg gcttggggtc cagacctatg 118440
gatgaatgaa gctgctcaa gactgcaaag aggatgcaat gtcgacttcc caaactgag 118500
caaatcagtt atiggagatg ctacccccac tgccagcttt gccatcatgc tgctcctcag 118560
acctgacat ggctgtttt tattttctca caataggggt tcagtgacc atcctgcttt 118620
actgcattta aaaactagaa tgagtccatg gttaaagetta ggaatatcct gacatcccta 118680

agagtagggc aaagccttct tcctaaagat aagcaaacag aaacaacccc caaagtctgt 118740
aacaacaac acaacagcat ccatattccc ttctgaaatt gattcctagt agaacaagaa 118800
aacaattcta cgtcctttct ttgtgcttaa aagaaaatac aaaagattac ctctttagag 118860
ttgtggacac aaggaggcca gcataacatg aaaatgctac atagaaacta aaaataatag 118920
aagctaaaat tatgctggca cgaagtaaaa aaagagaac tagacacaac aaaaacataa 118980
ttaagttgaa aacatgcttc caaatctcag ctccatctc cccaaaagac aaaacaaaag 119040
acaaatctag tccttagatt gtttcataat gaaaaggaaa aaacaaaaat aaaacaaaaa 119100

aacc caatag tgg aagacac aaaagaagaa agtcttaaaa ataaaaataa aaaaagt ttt 119160
cttcatggat ccaaacaaag taatggggaa tttcaagtat atatttatat ccacagataa 119220
tctgtagtta taaaaaaaaa ttctctacca tctttagaaa gagttctcca tagtgatacc 119280
aaaatagaaa caccggggca ttttaacat aaggacatca taagaactca ttcaaacac 119340
tcccaggcaa aggaatcaga aattccttgt aagaccact tggatgagat gcttctttct 119400
ctgagttcca agtagaggtg gggaaatagt ttccaccaac attttgcct ctggaattat 119460
taaattatcc agatgatcta attctcttgg aggtaaatct cataaattag tttattttta 119520

aaaagactct tgcagtgact aaaagttaa tttttat tttt aaaaatacta atgcctgtaa 119580
aaaagggaat tagaaaaaaaa aaacaggcct taggaaaata aaaattatat aatattattg 119640
tgtcacttaa gacaatatcc tgatctgtta tgagttcttc acaattcatg aagtttacca 119700
gggttat tttt ccaaaagaac caatlaaac aacagagaat gtcaaaactc cattaagca 119760
tcaaaataca tagatagat gcctcacagt caacagacca aactacaac actgaaataa 119820
gtgctgaaag aactcgtgat cagattcaac acagatacag atggaccct ggaagaacac 119880
acatcaaac gtcagcgagg cttagaactc atgatgagat taaacaccag gcttccaatt 119940

tgtttggcct acctagttc taattgtgca gtgtgtgtac aaaacacaac acatgtgaat 120000
taaaaaatat taagggtttg tataccaaaa tacagtgaac tgtaagaaac cagacatgaa 120060
gacattcacc ccttgacatc catggtgcac aggtttcagg accaattgta gatgcaaaaa 120120
tccacagatg ctcaactact ttacataaaa tggcatagca tttgagcatt tgcattatc 120180
ccccatatta tctctctggg tactgtcaat catctctaga tttttttaat aactaattta 120240
acacaaaac tatggacata gtggctatgc tttattttgc aggggaagaaa ggcaagagaa 120300
agctctgcat aagtacaaa cagatacaat ttttctata aatatttatg ataactgtat 120360

ttacaaacat ataatgaaag accagtgatg agatgatata ttatttatga tttattaaag 120420
cttgctgag gattcagaaa gcaaagt cag ccactagcta tagagatcag gcaatggttg 120480
tgcacacctt taatcccagg actcaggatt aaaaggtaaa tagatctctg ttagtcaag 120540
gccacatgg cctacacaaa agtgaagagt aacagagctc ataccttga tectagcacc 120600
tgggatcaca cactttta tcccagcatta tagaggtata taagacagga gcaaggtctc 120660
agagctgta ttcagctca ggattctcca gccacattga ggacagaata gcaatctgag 120720
attacagtac gaggtttggt ggagccagga tcacctttg gtctgaggca ggggtaagag 120780

ctagtgttt tctgatctta tgcttgaagc ttgaaccca ataacgtct ctgaggttt 120840
tatttatcat gttatacaa gacgtcccc aaaatacaga acaaacggtg gcacaggttc 120900
ttgtctgta cccatgcatt ttgtgcattt gctgggactt ggttaagag tggtttccat 120960

tgtaacatat gctactgact ttttattggc agaggccaag tagccacatt ggcttaagtc 121020
 agtctgcaat aatttgacat acaatattaa gtgaaaatgg caagacacat catagatatg 121080
 tagttataga cagagatatg aagagtcatc catattaaat atatttaacg cttttcacct 121140
 aatctaggac accatcagtt acaatataca ttttatattc tactatgaat gccatgtttt 121200

 attacatgga actacatagt cattaatga gtccttcaaa aactaattta tgcacagatt 121260
 ttaacatgta teacagatat ctttccatgt ctttctgtgt acacaacagc tttgtcttct 121320
 aatgccagtt cttttttaa tcaattattc catgcagtat aactgaaat gacaataata 121380
 tgaaccactg tgaccaagat gacagataca caggataga atctgccaag acagagttaa 121440
 ggccaggata tggtttcaga aataaaggta gggagaaatt ataccttaga attaatgaca 121500
 tagcaatatt tcaataaaa aactatctga ggtgaggttg tgacttattt tcttaatact 121560
 atgtggcatt tgcttgatt ctgataagta tatgtttaa aattagaagg gttttcatat 121620

 gtgaatgctt acttgggtca tttaacacc ttgtccctta tacaagtga tcagttcttc 121680
 tcctgctctg tcctggccag tatgtctgtg tgcataatag ctacggcagg agggtgacaa 121740
 gtacaagatt ctgtgactct acaacatgac tgagtgtgga gatgtgtctg tttgggggag 121800
 gggagcaggg tgagatcagt gcaaggaaga agctgagtg acagcaacaa tgaggctggg 121860
 gagttttca cagtttagtc ttgggcccac ctttttttt taaactaatt gtggcaggac 121920
 ccagaggaca ttaataaac tgtagacat gatctgaaa gcaaactaca gacctgagt 121980
 aactcagaag gcagcatttt ctattattca gaaatccatt tttttatta ttctgtcttc 122040

 ttccagtga tacagtggc tatgcgatgt gtgcagaagg gagagagaaa ccagagaaga 122100
 tggtaggggt tgctagctga gtaatgaggt gtgggtggta gacgaatag ttaatatatt 122160
 tattaattga ggtttctgac taaatttgt ctggcccctt aatattttgc tgtaaaccac 122220
 ggtttcacce acgcacacat ccataacctc tgcccaggcc catctctgag gaaggaggca 122280
 gagaggatac tggatgcat tttgttagta agaagacaat tggcttagat tgtatgggaa 122340
 ctagtctcag aaataagctg gaggcatatg gaaaacatct gtcccctgcc tgccacttcc 122400
 acacacaact tacagttgta ctctaaattc ccatttcatg ttcaaagcta aaaccattat 122460

 cggcaaggca cacctccaaa attacaaaa aaaaaaaaa aaaaaaaaa aaacgcatac 122520
 ctccaaggca cacaagaaaa acacgttttg ctattatcaa gaaattacca caaaataaaa 122580
 tgtatgaaaa ttcttatga aagtaacca gatgagttgc aaatcacata gcttttcaaa 122640
 aagtactgaa tgaagataa ttaaagtta gattttggga aaagaagcca ggacgttcta 122700
 aaaggccata cagaacacc tgatttagag agtaaatattc catgtggttt ttaaaggcct 122760
 ccaactcata gtaagtaaaa cattctccc ccacttcagt cacaagttt caagttagga 122820

aagggccact gggacctaag gccagtgct tagggactta cataaagagg cacgtcattg 122880

cagctcaact ccatgactcc tgcatctgta atggaaacaa cacaagcatt atggtgggaa 122940
gcctatcacc agccctcaga gtccctctgtg gcccacattc agtgtcaaca ttatggagga 123000
aggagtacaa taattaagaa aactacagag atattaata cacacacaca cacacacaca 123060
cacacacaca cacacaagga ctagggtcac agatcaatgg tggcatgctt gcctagccta 123120
caccaaggcc tggagtccat tcccaagacc ccttcaaaaa tgaatggaa aagagacatt 123180
ctcttacata aaattattct cccaagaaa acacaatggc atcccttcaa aactaaaca 123240
catgatcagt aatttgacat ctgagtatat acacaaaaga actgaaaatg ggctaagcag 123300

tgccaaagtg aggacagtag cctgtccatg ggcaatcaaa atgcagtaga catatgcaat 123360
ggaacaatat tcttcaaagt gctacaatgt gaatgagaca gaaagattaa aaaaataaat 123420
aagtcaatca cgaagaaaaa aaatactgtt gccattccac ttacatgaga tacctaaata 123480
ggtaaatca tagagacaga aagcagaata taaattacca agatccgaa ttactgctca 123540
atagagacac aacttttatt tgagaagata aaaacacagt cctaaagatg ggtgatggtg 123600
atactacaca gtacaaatgt gcttaatgca gctgaatcac ataactcaaaa tgatccaaat 123660
gatagatcct atcttattat aacaaggca tagaaaggta tatacagtat gtacctaaagg 123720

cgaaataagt agctggaat aaatattcaa atcatgtgtg taataacata tacatgatgt 123780
acatacatgc ctacatacat gtatagactc atctttattc tttcagatta gtttcacaa 123840
ataaggaaat cccatcacta atgactatcc cagaatttgg aatatttcta aaagccacag 123900
aggggcaaca taaacattag gaaagcttga acccctgga gtgggctccg gaatgacaat 123960
ctatttctag caaaagtaac ttcagagct ggacctgagg cttccagagt ctgagaaaga 124020
catctcatga aagataaac taacaagaat ataacagaat agtcttagca tggattgctt 124080
agtatgaacc gaactgttcg tcggttctg tcagaaaatg aaaacaatgt gcaactcaag 124140

agccctgaca aatggagggc tgccaaactc cttgttatct tttgtctttt cttttcttt 124200
gttttgttt gttttgttt gttttgttt ctgagaccag gtttctctgt gtagccctgg 124260
ctgtcattgc ccgtagacc aggctggcct cgaactcaga gattattta cctctgctc 124320
ccaagtgtg taattaaagg ttggtgccac cacagtcagc caaactcaa attatcaaga 124380
cagcacttta aaagtttagt tcaactgccg ggtattggtg gcacatgcct ttaatcccag 124440
cacttgggag gcagaggcag gcggatctct gtgacttca ggccagcctg gtctccagag 124500
cgagtgccag gacagccagg gctacacaga gggaccctga ctcaaaacaa aacaaaacaa 124560

aacaaaaacac aagtaacagt atacagactg agcaggttgt atttgtgtgc ttgggagtgt 124620
atatgtatgc tacataagtt aatggaaaaa aggccattat tttgaatgag agcaagagga 124680
gtatatggga cagtttttga gggaggaagg ggaaggggga aatggtgtaa ttataatatic 124740
aaaaactgaa agaaatattt ttttaagaaa tagacatttt ctgaaactct gcttatattt 124800
tctagacatt ttttaaaaa ggatcaaaact caaggctttg gtattctaga caagcactct 124860
gacacagaac tatattccag tccttggctct ttaaaacaga gtcttagtta taagcccagg 124920
ctggccttga acicactctc ttgactcagt ctccctaagtg ctttgattac aggtgtacat 124980

cacagcatct ggctagaatt tgtttgttca ttaaatacaa caaaaaaaga agtgggtccaa 125040
ggggaatggg aagagatgag agtggatgta attatgacca atattcaaat tgcattatac 125100
acatatataa aaatgtcaaa gaatactgca tgtgcatgca cacacagggc gtgtgtgtgt 125160
gtgtgtgtgt gtgtgtgtgt gtgtgtgtgt gtgtgtgtgc gcgtgcgcgt gcgtgcgcgc 125220
ggcgctctca accattatgc caagcagagt gttaatccgc tatcctgttc aacatgactc 125280
agtagctggt gttggttcaa acttcgagta tctgaactga aatagtttat ttaggcata 125340
tttaaacaca gcacaatttg gtgagaaatt ttttctgggt gataattaac tcaagtctat 125400

gtgcccaata aagcttaaga catgactaca tcgagaatct ttgcaaagta catggggcat 125460
cttcataaa gatgggttct atagatggac taagaaaacc aagctcatga taagggtctt 125520
ggtgaggaag gtcaccaggc cacatccact ctgagccttc taggcggaaa acatctcttt 125580
cccttgaag aaacaacct gcatatttaa cattcctggt cccctagta cttatctgtg 125640
tgtgcaagac cctctgtgcc tctcacagaa taccttttta aatatgtttt aaaatccaaa 125700
agaatgaaaa aaaaaaacat ttggggtgag aatgtgaaga tatattctga aagcaaatta 125760
ttttattaac aaaaataaat taagataaaa taacatga ataagacagt ggctccgaca 125820

aagatgtttg ttttggctct gggggcctgg gaaggtatgc gcatgtatgt gcaggttcac 125880
aatggtcaga gggagacttc cagtgtcagc ttatcccttt aagacagtct ctttactgaa 125940
ctggaagctt gtctttcggc tggccagaga gctcccaggg tctgtctgta ccaacttcca 126000
atgttgggtt tacaggcaca ggtggccata cctagctctt tatgggagca ctcgggattc 126060
taactcaggt cctaagcat gcacagcaac tcttaacaaa tgagccatcc tcacaaccaa 126120
atgagtcate ttcactgcc cgatgaagct ttaaaagtgt cacacctgag atccattcac 126180
tttgtcattt gtgaacaaaa tgctataaca aagaacttga agccaaaagc acacagaggt 126240

ttacaaacct gtagcctgta agaatggatc atttcacaga agtatttcaa cgcactcaga 126300
tcattacaaa ttctacagga agtagtcata aaggccttta ccacattggg gaaaacaggt 126360
tatatggtgg cagtgtactt tttaaagtg tcaacaaaac atgcactgcc tatttttttc 126420

cttataaata cagaagtact ccaaacttcc tgggattcct aaggtgggaa gtctctagtt 126480
 atattagaga tttggggggg gcactcaaat gacctgttct ttccagaaag aagtagtgct 126540
 ataataagtg gaaaaagaaa atgcattcca aaggtttag acagttgtca cagtgaggat 126600
 gttttggaaa gaattagtig ggcttcctcc tcctctaggg tctagcctag taaatggatg 126660

 gaactagaaa tgatcctact gatcgagggtg gccagaccc agaaagacaa atgtcacgtg 126720
 ttctctctca tcagaagctc ctagetccaa atcttcaggt gtgggaacat atcctagagt 126780
 tacagaaagt aggaaattaa aaaggacag ttccatggt agggatgtgg gggaccaata 126840
 gagagaagaa tagcaggta caagagatct gattagggga atgagggaaa agggaaaatt 126900
 ctaaccaggg aatagcaagg gagataaata tagaaggagg atgatggggg ggaaacaata 126960
 gtaagaatgt ctgaaaaagt cataggaat catactatta gctatttacc taaaaaaat 127020
 atatatatat atatatattt tatattatat atatatatat atatgtatat atgtataaat 127080

 atatacatat atatgaaca agctaggcga ttctccctcc ctgagccaaa gatccctgga 127140
 ggacctacct ctgcctccca tgccaccata gctgtccaat actatgattc tttatagtaa 127200
 tagtgtcgaa tattgttag aacatgcaaa agacttagga caccacctga ttaatctttt 127260
 tctgtggagt gggaaaccca caccacacat caaacatgag aagccctttt ttgagtgtt 127320
 gaccagggct gtctaagaca ctccaaaaac atactgcta ttgctgttgc cttttggtta 127380
 ccccaagag gtggaaggta agtgactatt gctgaagaca ccatgtactt cccgaacagg 127440
 gctcagagg tctcagtggg aactgacttg aacgcttaca ctctaggac taactcatg 127500

 atagcagaag gaaggacaca accaacaact ggtctaccta gccatagcac catgaactac 127560
 aacaactaac atggtacaat aactctgagg gttagtgtga agtcatggat cttggaggag 127620
 aaactaaaa gcaccacttt actaaaccag cactatctct aattcattct aaatatgtt 127680
 ccttatacce acagacaagt gtagtcctcc ccctttgtc aatgaaatgt ccctttgcaa 127740
 tagacagact atcacagaga gccacaacca atcaaacac agagttgtgg agcccagtcc 127800
 cagaggatac atctacaag caactcctac agttcaggaa acattgcaa agagcgggtg 127860
 aaagattaaa acagccagag ggtcaggag tttgctgagt ttgctgagtc tccaagaatg 127920

 tcagaagtta cactcatata gttccacaa catgactgcc taaacatgag ctaaacaagg 127980
 acaacagcaa tagacatcca tgggtggacag gggcaagatc aaaaggctc aaccatacac 128040
 aaagaactac gggcaactaa agaacgctga gaatgggaga gatagtcttc ttcaggaag 128100
 agcacaccaa ttggttatct aataccaaat gtttagcct gaaaacatat gtacagataa 128160
 caatatacag aactagtagg ttgtatgtag ggataaatg tatgtaacaa caattaatga 128220
 aaaagacact atgaattga aaaagacaa gaggtatatg agaggcctg gagggaggaa 128280

aggagagga gaaatgggtg ggttatatta taacttgtat gttatattac aatttgtatg 128340

cttgtgtgca taccacaggt ttggagcatt tgatacaaag tttgcaatta cagtagccct 128400

cacatctgta ctctgtaaat ttggggaaa tctttttttt aaagcttcca agaggagcat 128460

ttcctatctt tcccgtttca ttgtttgat ttatacaaca cctcctgggtg agtttgcaga 128520

aggacagaca gctgtcaggg atgggtgagca tttctttact gacacagaga aggggggctt 128580

ggactggaat ctaagtcctt cagtctgat cagggcagtg agcagagaaa ggctttgccc 128640

aactctgtac catagggaac tattttctcg tcctcaaaaa ctccaaacct atttcaaagt 128700

agatagcaat gagaacaaa gactccaagc acccagctgc tgtttcacat tgatgatgtt 128760

tagggaataa acaaggaagg ttaacacaga aactttacta ccatgtttaa tccttatagc 128820

tttctccatt tttacatagg ctataccaag tgcaccattg tgttagtgta gtgtataagt 128880

aaacacatac atacattaat tatgatacat gataaccctt ttttttctta atagagtaca 128940

tactagcatt ttgaaaatct gcttctaaaa aaccaggccc ttcccattg gtcaggactt 129000

cctatcagtc ttcttttact tagtccagggt gggaatggct gatgggggta aggggtcaact 129060

ctaaggtgca attctccagt gcatgtgacc tgcaccagg gtgaggtggt gagtgtgatc 129120

tgcaccagg gttaggtgca ccttcacctg gcaccatgaa ggacttgttt tctccatata 129180

tcactcatca gtccacataa ggctaaggga gacagagctg tctcggcttt ggtctcaaca 129240

gaaacatcca agcccagata ccacctgtta ctggttttgt accttctgtt tagtaactta 129300

ttaaataate ttatttcttc cagctcaacc tcttgggtatt tagtatagca acttaaaaac 129360

cactttgatt aatattaatt acattttcca gaataacccc tttgactcct tacgcaaaat 129420

aatcttaaac taaaatatgt gacattagtt ttgaaaaac tgggtttcct tgaaggtttt 129480

aatattctgt aaatgtatta gcttaaatgt ctggctcttg ttactgtgga ccttaaaactg 129540

ttctgttttt agctttgtgt gtatgtgggtg tgtgattgta agaacatttg tgtgtgtgaa 129600

taagttcaca catacacacc atgatgcaca tacagaggtc agaggacaac ttcagatgct 129660

ggcccccatc ttctgccttg attaggcagg gtctcttctg tgtgtgtgtg tgtgtgtgtg 129720

tgtgtgtgtg tigtgtgtg tgtgtgtttt cactgacagg tgggtttctg gggactttct 129780

tgtatcgtcc catctccta aaggatctct aggattatgt gggatctggg tattcaaac 129840

catgttctta tgcattggga gcaagtgtt cacacactga accatctccc taatctgaa 129900

actgatttaa aggcatttct attctgataa aagtaataga gtccccaatt tcatccaag 129960

tccttctaaa attcctactg acatttctta aatgagttac agagaaagta tttagggaaa 130020

aaaaaaaaaa agatccacc caattcaact gtcaacttc aaactggata ttatttttaa 130080
 agtttattcc cctttgggtt ttctcacat gaactcctct ttgtccatgg gaaggggttc 130140
 tgagtctgc tgtcccctcg ctaaactatg ctgggtctcc ttctacactg gtggttctca 130200
 cccctcctaa tgctgcgac ctttaataca tttctcatg ctgtggtgag catagcatga 130260
 ggaaccatcc aaccataaaa ttactactgt tafgaattgt aatgtaaata tctgtgtttt 130320
 ccattggctc caagtgacc ttgtgaaaga atcgctggac cctcaaaggg gtcacaacc 130380
 acaggttgag aacaactctt ctacaccaa ttagtaatc aagtaagttt gtattttgcc 130440

 aggccaattg tagctgcact tggcctttag catctccctg tataaatgtc atgttcagc 130500
 ttctgctgtg ttccaaggc ctgactccct cctataactt ctaaatggtt atgttcaaat 130560
 ccttaaata ataatacaa taagaccaca ttttctaaaa acattttggg aaaataaatg 130620
 ccaaaatatt tcaaaaaac tcacagaaac caaaggatgg tttggactat agtcataac 130680
 atttttctta tgittgtctc caaaaaggta aacaaatgtt actaatgaga tactaaaata 130740
 ggcttatatt acatatcaa atatcaaaaa aatctttgat tgctggttaa ctctaaagaa 130800
 aaatattaga ccattttgag caagctaaat ttgtaaagtt aggaagaaaa gcaaatggag 130860

 cactcaattt gcaagaaaa aattcatgcc ctcacttaa gaaattccgg gtttctaact 130920
 cttgtacctc acctccaat gaaatattca tggatgtaa gccatgactt cattgtttga 130980
 gtgtggggat ttcttgggtt tgttcatttg tttgtccatt tggagacagg gtttccat 131040
 ttagcctgcc tggagttcac tatatagacc agactgactc aaactcaaca agatccacc 131100
 cacctctacc tcaagctgc taggaaggcc tacaacacca caccctcag agctaggtct 131160
 ttaattttgc ctttgaatat gataataatc aatgtcttac attcctttta taaaccata 131220
 gcaatgtgc actataata ttagtaacta aactcagaaa gctaacgata tagcacacc 131280

 catgccaat atttacaaa catgacagc tgaagaagag tgtggaaaac aaaatcttga 131340
 acatgaaaac attctacacc taactcaca aattatgtgc ccagtaagt cctccccac 131400
 tcctccactg cctctccct ccactcagct attacacttc tgcagagcaa caggcttttg 131460
 gtagtctctg tgtttttgt ctcaactgtga tttgcaaatg gtgtaataaa atataaatta 131520
 gtttaaaact caaaaggctt taaggcatta atttttata aagttgagaa aaacatcatt 131580
 gtttaagttt tatatatgaa gcaatttacc aataagactg aggtagcaag aaacacagaa 131640
 aaaatcctaa gacagccgct ccaaacatat taactttaat gcaaaagaaa tgaaaagtg 131700

 gtctaataca atggcagcat aacaatgctt tgaataata aattgtgat tgcaatcact 131760
 ttggcagaa atatgctgc accatcctca atcctacaca gacagacaga cagacagaca 131820
 gacagacaga cagacagaca gacacacaca cacacacaca cacacacaca cacacagatt 131880

cattctttga tcaactgtctg ggtagcaca aagttaaag tgaaaaatgg cagcctgcat 131940
aagatcccac agcaaatggc agagctggta cccaaatcaa ctgtgacgct aatggagaag 132000
ggaaggacag tacactctgg ctgtgaggcc aagtctccga gacagccttt gatgccagca 132060
caatggaaat gcgtaaggaa aaagcattta ggcatgaagc tactattgaa tagacaatgc 132120

tgactatata aacctgtctc agactagaat gatctatctg tcatgcaagt ctcaaaagct 132180
gtaagaggaa tattaaacta tttcataatc accgaggacg tctctgaaga ttagaaagga 132240
aacaacaaca cagtaactct tcaataggat ctcatatag caaactaatg ggggtggggg 132300
ggcagggagg aataaggaga gccagtctga aatagtgcag cctaaattag aggttgttta 132360
taaagtacaa agaggagcat gagttggccg ctaacagaat gttccgcaa gcctgtcaca 132420
ctcatttcta tttctcaaga tatattgca cagagacaca gtgattaagc cttttaaag 132480
cttttccaa atctactgaa cttttgctga ttctgtgagt ctccgtggac tgtttacagt 132540

caacacaaag ctccataacc atccaagcat cctgaggaag atgacgactt tcaacacctc 132600
aattccctcc ttagcaagaa atctccaaag ttctcttga atgctcagag tcaactcacc 132660
gtggactgtg tgtaaagcat gctgtaggct gtcttgggag ggacactaaa acatagaaga 132720
cattatgcct gtcacggctc tcacagcctg gtccacatga taggcaggaa gatatcagaa 132780
atggcactgg tgactggcag aaggatgatg tgggaagcca gcataaattg acaaggagat 132840
ccttggacag aagggggttc aatatgaaga caggcttcat gcagacacag agttcaagag 132900
gatgaagcca gagagaacaa cagtgcctc ctacatctat acagaatcca tcctacaag 132960

agacatcctg taactacaca gaaggcatcc ctaagtcaact cactgtgtct tgacagacag 133020
aatggagcta taggggctga ggagatggat cattcagtaa agtgcttacc acacaagcat 133080
gagtacctga gtatggatcc ccagcaataa aaccaggagc agcagtgtgt gcctgcaacc 133140
cctgtgctga gtgtaggaa tggagtagg aggatcctc tggtttctg getagataat 133200
ctagcagaat caaagagaga ccctgtctca aaaaagtcag tagagtgata gggaaagatt 133260
cccatgtcat caatcactgg cctccatat gcttgacac atgcacacac acacacacac 133320
acacacacac acacacacac acacacacac acacactact tacatagaaa tgaagggat 133380

gaaaggggga agggttcttt gacaggtct gatggggaat gtccttctgt gtatgtttat 133440
cctattggtt gttgaataaa gtaactgttg cactgaaga agcaaattag gtgggattag 133500
gagtcaagga ggattctggg agatgtacta aaaggaagtc ttgtgaaaca ggcaggaagt 133560
gacatagcag gcagacatat atataagcaa gagcaggagg aagaagggtc ctgccaataa 133620
tactcctgt tatatgttac cttttgccc aataacatgt atcccagttt cctctgcttt 133680
cccctcatgg cacagagat gccttattaa ggtcatggga aggctgacc ctgacagctc 133740

caaatTTgac acaggactca tcttgaacat ctcatTTcca tTTtgcttat gctcaattcc 133800

 atcttagaaa atcagagcaa agacacaccg ggtgagggtc taggcctgc tccaaatgat 133860
 atgacagact tttagattc ccccatggaa ggccgaacce cccctgggga gcaaaaagag 133920
 gttgggatag ggggtgcagt gtcagggggg tgacaaggga ggaggggagg aagaggaac 133980
 tgggattgac atgcaaaaga agcttgtttc taacttaaaa ttggtctaata tacaattata 134040
 aaaataataa taataataaa aagaaaatca aagcaagaga acaagcaaac cacacaaagc 134100
 ccggctgcta aaactaagct ggcaggtagg gccaccccaa gttcattcat tttcgatgt 134160
 catgagaaaag gttgttttat ttattgtagc tattctgtct ataaaatgca aagcagcaac 134220

 ctggacaaaag agaagacaaa tgacacatgc ctgagagagg gaacatgaag ttttaagtca 134280
 acacaaagcc ttactaggca acttgctttg gctcactctc attttacaag ctaaagaacc 134340
 tccccTTTT aatttggtaa aagggaaggt gactTTTTct gggacctaat gtggaatttc 134400
 tagaaattaa tatgttaact aagccatgag cttgtaatgc atggtctatg aatgcacttt 134460
 atagagacat gaactccatg aaattaatgt atgattttat ttatatgtat ttttctggca 134520
 agagtttaaa gcttacattg ggttctcagt ggaccattaa aacttgaaaa aaagacaaaa 134580
 atataccta caaaattaa tttcttgctt tgtgaaagct catgtagga gactgaatgg 134640

 atgtagtatg ggctagggga aaatatttgc caaacataga cccgacaagg aactttcaaa 134700
 caacctcact ggcaaataca cagaggacag agactaacgt ttactgcag agagtacaca 134760
 gatggcaata aacacatggc aagacactca gcatcattag ccactagga catgccaatt 134820
 caaacacag tgagatcagc acctgtcact caacatgaaa gacaaacaaa aagggtgcat 134880
 gcctggaga gaatgggaa acaagaccac actgctggtg ggataggaaa gggtacaggt 134940
 actatggaaa acatcagggg attcctaaaa tctaagcaca gatgtgcat cagcaggtgc 135000
 actaacggag aaataagaac ccccgttaca caaggcecca gatactttca tggcagccct 135060

 atttatgca gcctcaacac tagatgatcc cagaagtctc tcagcagcat gacagttcag 135120
 cttcagaaca gagcgacata tgcacagcag aaacatgtgg tggcctcct cattcttggg 135180
 ttctgcattc ctgcacceta ccaaacacac actgaatatg cacttgggct tattatggtt 135240
 gcataaaac taaacttgta cagatTTTT tctcatcat tcttccccca acaataaagc 135300
 attacttgcc taatgatgat aggaattata agtaatctag aggcgagtta aatatatggg 135360
 aggagtcaca tgggttatat gctaacacaa tgccatctct ataccactg aacatcctcc 135420
 aatttaggaa tccatgtgaa gtcctaggcc aatacctacc catgcaaagg aacagccaca 135480

ccatttacca acacaaagga ggaaagtggg ggcatggaaa aaacttcagg aagtgagact 135540
 agagaaatgg ctaacaac gagagcattt gctctaacag agagcctgga ttcaatttcc 135600
 agcattttgt caggcagctc acagttgcct ctaactccag ctccaggagg acctgatgcc 135660
 tcttgctcc ataattgctt gcacttgtgt gtgtcacaat caataataat gtaaataaga 135720
 ctttaaaagt ttcaggaagg tatagtaagc aataaaagcc aacccccaaa actggtaggt 135780
 aatacaatcc tataacaac atttgtgaaa gaaaaatgtc aatcagatgg gaacagtttg 135840
 ggagttaaaa aacagcagtt gagtaaagat gtaggaagct aattatgatt atagaagggg 135900

 aaaacacagt tgagtttca taaccattca atgtcttaca tgatagtaga catacaaatt 135960
 tacacagggt acaaatgaca cagcacagac attgaaaact catgctgact catggaagaa 136020
 aagtggaaag ctigaataag gttgataaga tgtatcaatg ccctccatgc ttgaggtttt 136080
 tttttcttaa tttcactatt taatatttat tttatcttgt gagtgtatat atcctgcatg 136140
 tataatgtg caccatagtg gtacctagtg cctgaagagg ccagaagaga gtgtaagaat 136200
 cctggaactg gagttataga cgttgtgggc caccatgtgg atgctgggaa gcaaacctgg 136260
 gtctctgga agagcaaccg gtgctcttaa ccacagagtc atctccccag tccctagaga 136320

 ggtgtgtgtg tgtgtgtgtg tgtgtgtgtg agagagagag agagagagag agagagagag 136380
 aaagagagag agagagggag agagagagag agacagacag agacagagac agacagagag 136440
 acagagacag agatgggggg gggctgagtg cagcaattcc tgtggaggcc aggaaagagc 136500
 atcagattcc ctgaagctg gaggtacagg tggttgtgag ccatctaaca cgggtgctgg 136560
 gaactgaaca atgtggataa ctacttaggt agaaggaaga attgccaaga agactgtgaa 136620
 agggagatac cacaggcaaa agcaatagac agaaccacta gaaagcataa aggaagatat 136680
 tcattgagct acaagatct ccagagcccc caagaaatat gtgtataagg caaatcgaag 136740

 aaagactttg tcaaaacccc aaaataatgt cacataacaa gcataaatat caagcttgta 136800
 gggggtgggg ttaaggtgac agatgtgata ggaattgttt ttaaagaaa actattgtgg 136860
 gtggtgccag atggatttga agcaaagaaa ggccaaagac aggaaaacca gaaagggat 136920
 actgctgtcc ctccaggaga gatgctgctg ccctcaggg agagatactg ctatecttca 136980
 gggagacact gctgtccctc agggagagac actgctgtcc ttcagtgaga cactgctgtc 137040
 cttcagttag aactgctgt ccttcagga gacactgctg tcttcaggg agacactact 137100
 gtcttcagg gagacactgc tgtccctcaa agatgccact gtcctcaga gaggcactgc 137160

 tgtccctcag ggagacactg ctgtccttca gtgaatgacc tgaatgctga atgaaagcaa 137220
 tgccatagaa ataactctag agaccttcaa gaaagaaaat ggacagcctt gttaccaagt 137280
 taattggaga gcctgggggt ttctaagggt actcttgggg tcccagaatc agaaaccggg 137340

tgtgtggtat gctactgacc aggattcggga tgcagagagg aggagaggca gacatcaaga 137400
 cagataccaa ttactaacca tgggttccca gaaccacag gaaaacggtt tcataccgta 137460
 acaatgaatt ttagaattta agattaaaac aacaacaaag agtttccctt ttccattgac 137520
 tactataagt gtcaatgacg ttagttgaaa gaaaatttca actaacaat aggctttttt 137580

 ttttcaacct gaaggctgg gtatgtagtg cagtgggtaa gtggtgagtg tgcacaggcc 137640
 ctagaactga tctgtagcac tgaataataa tctgaactc ctgaacatta gaaatggtgt 137700
 aggtaacat cagacccac cttgagata attagagaca aactcagtca cacatatagt 137760
 taacaacaat ctcaagctaa ttctgacatt ccagaaaata cacagtactg tgtaataatc 137820
 cccttgggtg attctctaga gaagtagtac ttagtttctt gttttcaaaa atgatctact 137880
 agataaaact catattctac tttcccttgc tattactaac tcgttttaag tcaaatagaa 137940
 aagcaacatt attcttactg gacacttcaa aattattggt taaaaatgtt caacctgcat 138000

 ggattccatt aggatgaatg gctttattgt atgtcacggg agcactttgt tggtagtcca 138060
 caccaagga aaccaaataa aaaggctttg tctttccggc cgtcttgctg tggacaagtg 138120
 ggtgagcctt aacattgaat actctccaaa gcataactg cttgtagtga ggcaggtgaa 138180
 ctcggtctt ttccttctc atggcatcaa ctcatactgt gcccttgac ccaaatgcc 138240
 ctctcagct cgtgttact acgattttaa tgtcactatg ctgtctcaga caaactgag 138300
 ttcttaagt gagtccccag tgtggggacg aagaggagg ggtggaagg ggcaggggag 138360
 aaggaacagg aacaggaaca aagtgttatg ctctacagag cctaagggga cagacatcaa 138420

 gtcaaggtag atttcatat gccatgaact gaaccaacac tgtgttccag aacacacaac 138480
 ctcaaaaatt aatagggtgt gaagatccat gcacagcaga ccaatagtca gaattgatc 138540
 ggtgttctc atcacaatat tagcctgtt gattttcacc tcagtcctct tcccagaaac 138600
 catctatatg tatacacatt gtattggagt caccagagga aggagactca getgaggaga 138660
 ctctccatg ggatctagct atgaggcatt ttctcaatta gtgatcaatg aggaagggcc 138720
 tggcctaga ctggaggtcc tgggttctat aagaagacag gttgatgaac tgaactggaa 138780
 tccagatgca gagaaggacg aatgaagagc aaaggggtcc agaccaggct ggtgaaacce 138840

 acagacacag ctgacctgaa catcaggga ctcttactcc ccagactgat agctgggata 138900
 ccagcatggg actgatccag accccaggaa catgggttac agtgaggaaa cttggaaat 138960
 ctacgggatc tctgtagta gatcagtagt tatccctagc ataggtgtgg actttgggat 139020
 cccattccac atagagggat actccctgag ccaagacaca ctggggtgga cctaggacce 139080
 atcccaaagg atatgataga ctctgggtgac acctatgga aggcctcacc atccaggggg 139140
 agcagaaagg atatgtgata ggtagggttt tagttggggg ttgggggttg gtagaggagg 139200

acgggagaga gaagggaaact gggaatgtca tgtaaaacaa tcttgtttct aattcaaata 139260

aaaaaaaaatca gaaaaaaaaa aagctcacc tgagaaaaat tttaggctac ccagtgtagt 139320

tgctggtggg ttcattgat acttaattct tcaagtactt acttcataac attaaataaa 139380

atgccattta ctgattaaaa aaaaaagaag aagacaggtt gagcaagcca tgaggagcaa 139440

ccagtaagca gcacccctcc atggcctctg catcaactcc tgcctctggg atcctgcct 139500

gtttgagtte ctgtcctgat ttccttcagt aatgaacagc aatgctggag tgtaagccaa 139560

ataaacctc accccaactt gccttttggf catggtatth catcacagca atagaaatcc 139620

taaccaagac acacataaac acaaaccttt tcctatctgg tctcttatta tctttatth 139680

atgtatatga gtgtttgect gtgtgtatgt atgtgagcca tgtgtgtgcc tgggtccagc 139740

aaaaccagaa gaggatccag gtcagatcac catggaacca gaggtaacaga cagttgtcag 139800

cctccatgtg ggtgagagga actgaatcca ggcctctgtg aaaagcagta agttctcata 139860

accactgagc aatctcgcca cccatttagt tcccacttht tgctaaatga ttgttaactg 139920

agtgtcatga ttaaaattaa tatgataata gatcctgttg ggtaaaaatc ttagtttate 139980

tctatcagta taccagact caaaaaagg aaccagaaa aaaagcaaca tgcacagttt 140040

gagatgcagc ttattcaaga agcaatcca caatcagacc tcttgactaa attacagaaa 140100

acatgtaatt tctgaggat ttacacacat gtgtatgtgg ggcagttagg gtgacctaac 140160

tcacatgcca caaactgtc tactaatgtg ttctataaat ttagactaca cgctgtggga 140220

gaaatgtcat tatagatgaa agctcattta acactctgta aaacatagat gtgaccggca 140280

cttcacagag tgtctagtg aattccggcc aagtgagcaa tttattgatc gacaagcata 140340

gcaccagtte cagacaccag ccattatctt ctctctgtt gtgaggccag gccacactct 140400

gcccataaa ttaccttta cttttgaac tatattaaga gaataaacat tacattaaa 140460

ttttaaaaca gtaattccat ctgtatgatg ctaccacact ttggacagaa aatcatttt 140520

ctgctgtgaa agaaactcct tcatcaactg ctgagagatt aggcctttgg gtggcttgct 140580

tcctttttat ctctgcacc caaacccac cccaccatc tatcaactat cggttttccc 140640

atgggggttc catttgttcc tagttgctgg aaggtaactc ctctttctct ggtacatcca 140700

accctcctt cctcctcag catgctcagc taaaaacct aaggtagagg aaacaaggtg 140760

attccaggaa gccaagttc tatgggaaga gatccataat agctaaggct atggcttcaa 140820

gaacattaaa aagaggcgag gcttgctagc agagaacca gaggagat atcgattaagat 140880

gccagaaagt aactgaaaac acacacaaa atgaaactgg agcttacca gcaggtgaag 140940

ctgttaggat gacctgagag gaacttgtcc attgaatfff tacagctctc ctttctgcta 141000
 tattactgct ttaataacct cagggcctta ctggtcagaa ccctagctaa actatttcag 141060
 gaattactfff aaatgagtaa tagaactctt caaattataa ggaggttctc caaaagccat 141120
 aaatactgtc ataaatttat gactaagaat cttcccctga ggccttgtga ggggtttcaa 141180
 gagcccagaa gatccacttc taacaggctc tgaggaagga gacaaaatct tgactcatgt 141240
 gtgacgggga agaaaagctg aaagtcctac atggggcaag acacacagag tgacacctff 141300
 agtcaataa taattaacaa taatactaga aaaaatatgg caacaagcta aagggaaga 141360

 aagaaacat tttccaagcc taagctctaa gtctgaaagg ggggagggtc ccctcagata 141420
 ctctaactga aaaattaaca tggaaaatag ttccacacta caagcacgtg taggctaact 141480
 cagaattcca ggattcccac agttatcatc tcattggaca cagactctca acagcataaa 141540
 aactcagca aaactctcca tctccaaaga caacataaaa agtaaaaatc tgtcctttcc 141600
 aaaggfcaaa taataggfita accaatcagc ctataagtca atagatttaa ataaagatgt 141660
 tttgaaaacc agtgaaaaca ttttaaaaaa tgaacaggg tatcatccag aaggatgatg 141720
 tcaagatgac taagacgcaa aaaggacttc ataaaaaaag acacagfita aatgttcatt 141780

 gaattagtta aatagaatag tgaaaagtca actagtacac actggattff gaatcttaag 141840
 aaatgagfcc ccacaccaag agagagagaa aaaaacagag aaagtgaaaa agataaagat 141900
 ccattaggaa aaaaacaaat atagaataag cccaacatac tttatatagg agttccagac 141960
 tgaagagatg ggcaatgcac cagaagaaat cacaagtgtt cttttataat ttctttgaat 142020
 tgacaaaaga gaatttctca gattctgcaa ctatattagc accacaaatc catcaaagca 142080
 aacaaatctt aggcaatttg cagagfgatg tfgatttca ctttaataat attttgatg 142140
 gtgaccagca aaatacagaa gtggatgtgg tgcactccc ctctggfccc tgaactggg 142200

 aggcagaaat tggacaactg ggagfittga ccagcctggg ctacattff agatcaaaac 142260
 agtaaggaaa gaaatagaga aatgtcaaaa ccatcaatgc tgctctcca caatgtggac 142320
 ttgtgggga ggacacaagc atttacatgc ctttaaaaa cacctctact ctctgattg 142380
 tgctgaccac atactttatc tghtaaatff tatttgtatt tttgtttaa gatttatgta 142440
 ttaattatgc atacagcatt ctgcctgcat atatgtctga aggccagaag agggcaccag 142500
 atctcattac agatggfifat gagccacat gtggttctg ggaattgaac tcaggacctt 142560
 tagaagaaca gcaagtgtc ttaacctctg agccatctct ccagaccctg taaattatt 142620

 tatttattta tttattfatt tatttattta ttatgtatac agtgttctgc ctatatgtat 142680
 acccacagge caaagagggc accagatctat attacaaatg gttgtgagcc accataggt 142740
 tgctgggaat tgaactcagg gcctctgcaa gacaggcag tgctcttatc ctctgagcca 142800

tctctccaac ccctgtaaa ttcttaaaag caagttaatt ataacaatt tctaatttca 142860
 aatttaaatt gcaaagtga gaataatgta actatatatt taatatgtag ttatattta 142920
 agttgtatth aataagtctt aaaatthta ttcttaagtc cttcaatctt ttaatthtt 142980
 aaaaaacta aaccaccaca aaaaggaaag taaattacca aactctactg cactttgcga 143040

 cccttatct gaaaaaaag catctgtttt tcaaagctgt gtcaaagaca ccatctgcag 143100
 tactcagtct ttactatagg cagagtctc ctccttggt ctcacacact gtcctctgaa 143160
 attactgcca ccatttatg cttttgtc aaagcctgtc agcactatac tcatccccct 143220
 ctgccccctg gtgtttctt ttctgtggga gaaaacagtt ctttgatta tttccccctc 143280
 acatcacttg atcagatcca aactggctc cttttccaa ggctcctact attatcaaat 143340
 gtactaacag gctaggtag agtgcttgc taaaggtact gggcctctga ggctcctaat 143400
 cctagccac tgetgaatgc cttctctcac ctccccaca cccattcatt caccaagtgg 143460

 tggcaatgc tgttccatc tcccctgtt actactcat cttattgtc aatctggcag 143520
 ccataacct tcaccaccac cacctcaag tctatgctaa gagcctgta agccatcac 143580
 aaggcatcc atctgggaa ctatgtccag gtttagcagt cagaagtcaa agtcaactgtt 143640
 tccacccttt attcctctaa tgggaaaatg gccctggtc accatttgc acgtaaaccc 143700
 tcccttagcc aagactagct ttccatgtgt ccccatccat gctctacaga gttcaatcag 143760
 ctccaaccta tcaccccat gagttcctt ttgcttagtc taatattgtg tggatgtgt 143820
 cattagaggt tgaatgttg ttaagcatcc actcattcta tgacttcatg tttcctgacc 143880

 tgtttcttag ttcatgtgc aaggatcaaa tggaaaccag gaggaaagac acctggagaa 143940
 gtactgacac tcigaatgta cttggcaaat cacagggacc attctttctc tctttgtctt 144000
 cccaataatg gtatcttcat ttatctgaa atttagccaa cagctgacac agctctgttt 144060
 gctaattgtt catctcatc tccaattaca atcttctct aggatcctt tetattctct 144120
 gtacctagca aaactgactt aagtgagtaa gttcgttgt tagactctt gagaaaggcc 144180
 agaggacaat ggcaattgt tagaaaacat caagagttt ctataatatt tgggtatctg 144240
 ctgggtatca agatatttha tgttaaatat catatcattg agcaagagaa gcaaaactct 144300

 cagcatttc gaggtttgca atttattgat aggcaataag tagtgtctaa aaagcaatg 144360
 ttatagcact ttagaaggt ttaggaaaga ataaaaggca gaagagattg gcaagggtgt 144420
 gctgcagatt attgtthaa ctatgtaaag atgtattgct gttttacctt gctgcctaa 144480
 ggcacatacg tgattgatc aataaaaagt taaaaggcca atagggaagg aagagtata 144540
 ggtgggactt ccaggcagag agattaata gaaaggagaa ttcaggcttg agagaagaaa 144600
 gaaaaagaga caccagggtc cagacagaca gacatggagg aagcaggaaa gtaggacata 144660

caaaatgaaa ggcaaaaagg cccaaggcaa aacatagatg aatagaaaca ggttaaatta 144720

agttaaaaga gcttgtggga caagccaaag ctgaggctga gcattcataa ttaataataa 144780

gtctccgtgt ctttatttgg gacctgttg gtgatccaaa gaaaatcca actataaggg 144840

tgtagtagg tgcaccttta aatacagctg ttgaggatg ccaacagga aaagttagc 144900

aatgtgagg gctgagctct agaagcctgg ctatgccata agcatgtgta gtgagctgca 144960

agggggccaa atacctgaag cagcgggaac agaaagagag caatgaaaga tgaggacaga 145020

gaagagtgca aggtaaacc ataaggcctc agagatcacc ctgaagcccc ggcttccat 145080

cagaagctga gaagccgtct atggttctga gttgaggaat gacatgaggt aacatagata 145140

tactgacagg cgtgcatact aactatttg cagcaggcag gctgagagca gtcaaaggca 145200

agagcagggg acttgtctga ggctactgct gtgactcact acaaagagga taatagctga 145260

gacagagacg tgcacaagaa taaaatggtg agaagtagtc ggatttggaa tatatgctgc 145320

agacagctgg taaaatgtcc tgacaaatag gaaaagaatt tgagagagga gtgacatcta 145380

tcctccaag cttgaagtct aaggaaagca taaagcacc accagcagac atgggatgg 145440

agtgggtgt acggagctgg gtgagggaac caggagttag gtaacagatg ttatcagtct 145500

gatgcataca tgaagagctg tcccagaggc atgagacaca cactctgcat catacccaca 145560

aattcctctt gtggctgagt ctttatgatt agagctctag caggaggtg aacaagccta 145620

acagagaaac agaattctgg ctggccctag agctcaaggt caagcagggg aagaggaaag 145680

aagtccacag ccaaaggcag cgggaacatc caaagcaggg ctttagaaa caaaaacacc 145740

gccacattct gactacagca gacaagatac gtggaaagaa cacaaggaag ggaaaccacc 145800

tggccatttc acaagaaacc tcctctcaca gctcagttct ctagttagaa tttggctcat 145860

ggggctattt tccttggaaa tcatggttat ttacaaaga aaaatgaatt tgaattttct 145920

agcagtcgag aatgagtagc taactataaa cgaagcagct caagtcaacc ctagctcctg 145980

gtgacctctg cctccaact ttgtttctca gtgtgcaagt actgtcttgg gagtgtctgt 146040

ttcccctacc tacacacagg ctttctggaa atcaatgggt acctgcataat taagccat 146100

gagctactca aataaaggga cagtgaaact gaatctgtaa gattctgaag tctagacaca 146160

tcagttctat tttctataa acccactga aattgggtg ctaacacaga cctgtaatcc 146220

cagcattctt gagacaggat gatgatgagt cacaggctag cctggacttg atagaaaggc 146280

cctgtcttca aatttttaga aatgicaggg gcatgattct gtggcgtat gcttgtctgg 146340

tgtccacagg ccttgggtc gatccccagc actgaaaaag acagataact gaagcaaaag 146400

ttattttgta ctgacctgtg gatacaaaat gagatggcat gggacactct tttgaagtac 146460
 aattatgaaa tgacctcttg agataaaaaa tgcaatatta atcaagtcaa aatcattaa 146520
 aagtcactaa aaataagcta aaagctgttg ctctacagga agctcctccc tggggttaaa 146580
 tatgctgacc tggagccat agttaggcca aaccctgtc gtacaagctg gaagcacgac 146640
 aaaacctga gagaaaacac agacctttgt ccaagagctg tagaatcagg cgcattgtaa 146700
 gggccatcca tgaagagagc cctgttgaag gcgttttctc ccttatttc cacgtgctgt 146760
 ccaactccat tcaagtgcg acaattagca ttgaagtga taggccactg tatagatact 146820

 gttcgtgatt cacagagatg ggaatggacg tcagtattca agcaacctg cattttaatt 146880
 aattcctgca tcagagcatg ccaaggacca gaagaacaca cagctctgtc aaagcaaggg 146940
 tgcgctggca ttactgtgca tggagggggg gggccttttt cacacctaca ctttttctct 147000
 caggaacaaa aagcacatga tagtcagaaa agtatcaggc acatagaaag cagaagccag 147060
 ccagcagctg gacagaatgc tgaggttggc ctgagctctgg gtagatgaga atgagttcat 147120
 ttcaacagca ttttacgttg tggccaact atggacacct gagacaagag tccacacatc 147180
 cccaaggtea gggagtccag atctctcacc tactaattct ggatttccat ttctgtgttt 147240

 actgcccact gacactaatc tctactggt ctccccatgt ctatcccagt tcaacttagt 147300
 cttgtagcc catgactaaa attcacacct gaaaattctg cctatgctac cgtctagccc 147360
 cattcccttc taaatecttc agtggctccc aacagcccag aatgcaaagg tgtccttgtc 147420
 tctccgtgaa tgagacagcc ccttcagggc ctgagtcagc atgctctttt tcttcagagc 147480
 agacatttgt gggatgttgg ttaccgggcc tctttccttt ttctttgtta gcacctggat 147540
 ctccctctg ggaatcctc cactgagtat aacttcgaaa ggaagtagaa ttccataacc 147600
 cttacagaag ccatgggatt tttctcagcc ctatccctgc cccagcagag ccaagagctg 147660

 gtacacggct agcatgetta agcaaggtcc tctcttaaac agttaattaa attatcaaag 147720
 tccatttata tcattcacag gcaaaaacaa tggctaagtc actctgcaac ttacaacttc 147780
 aataagcaag ccagccattc cacttatggg gaccaattcc atataccca gacaccacat 147840
 atacactgct acccctgtga catcttctctg gaaaatagag gcaagacagg agggcctgaa 147900
 gagatgagcc tgagtcagaa atgccagtcc tagctcagag gctgggtatg agtagtgggg 147960
 cagcccagaa gagactggac aggatgttga gtccagacag acagatataa gtcagccata 148020
 ctaaagggaa gggcagaggt ggaccaggag ggcagaaata tccatcata tacactgagg 148080

 gagagagcat gactgtgggt aggatttaag ctccctccca tgtagctgtg tacaaaatat 148140
 aagatgaaga gataaggagc tagagatgaa agcaaggtcc actcaggggg caccttgcac 148200
 agtgaagaca cctgaagtta cagagaagcc ctgaagaaat ttaacatctg agtcctcaca 148260

tcatgaggca tcicaatctg attcccataa ttaactttgt gaaattccta tatccagtct 148320
 taactcattc ttaatagtta cataccttca taaaataaga caaaattcat gtttcagtaa 148380
 acccggcca aaagagctta atctgtagac atggcacccc caaaatctat tccagagcag 148440
 ggagtagaaa aggctggagt ttatctaagt gaagagtctt aaaaacaaca agctcaagga 148500

 aatcataacc ctgaaatgaa ggctcccagg tcttatctcc aataaggtat gtatctgtgg 148560
 acaagttaaa ctcatgaagc cttagtttcc ttctctataa aagtgaagga tggcaatagc 148620
 tacaacctg ggtgcacagt gaatcaaaag tatggcaagc ctctggggtg tgctgcctgg 148680
 atgttgacac tactctatcc ccagctctc taggctggaa gacatgcctt tacaccctga 148740
 ggcatcacct caggcctgat gacttgagaa ctcagtttcc cacctgtaa gtggggccac 148800
 aggaggtgca gtgtggcctg atctaagctt taatggattc tagatgcata caaacattat 148860
 tacciaagtgc ttatgtactt atgaatggcc ttctcagaga cagacttcca acaccacctt 148920

 tgaatttcca gtccaaccac tttctcctg tccttcataa acccacaag actctttatt 148980
 gcttactatg cctctaaaat ccaattgcct tccactttt tattgtggcc ccaactctgcc 149040
 cagcaatgtg atgctgttcc ctctgtacc caaatgtaca gcactctgt cccatctcat 149100
 tctcatagtc cattctccc tttctctcc ctccctcctt cctctctcc actgtctctc 149160
 cctgtcctgt ctctgtctgt ctctgtctct ctctccaca gcagatccac ttctctcct 149220
 gcaggagac ctctcccca atggcccag gcataatcat tctctctgaa tggaggactc 149280
 cagagttctc agccaaactt ccagggtgaga tatctgactt ggctggctaa catctctact 149340

 tccttcctc tactgttacc tcaagtaggt aataagctgc caaagggaga agattgtatc 149400
 aggcatttat agccctgccc ccctgtcagt tgagaatagt tcagacaaca cagaagagca 149460
 ctggggacct cacacctc tgcagcctca aaactttat ctcaactcac ctccaaaacc 149520
 ttcaacaage acttaatgcc aatgggagcc tcgatgatga gagcaagtcc tcaggtctat 149580
 agtccagaga gacaaaacag ctgctgcagc aagagtaaga ggagctccag gtggttatgg 149640
 cattaatgt ggactcagat ttcaatctcc aatcacagtt agagaatgaa gttgcctttc 149700
 ccctgtagg aactgaacca caaactcaga tacagatgca cgtcacagat tataaaaca 149760

 gaaaaaatgt taggaaaagg ttagaagtcc ctcagtgagc atagtaatag ataaagtat 149820
 gaaatcactg aaaaccatca gttttgaaaa gatgtttaag ggcataaagc ccaactggct 149880
 acaagtttg taigcatagg ttctatatgt tcatatctta taaagcaaca acaataaggg 149940
 tagcttggga gagaactttt aacatcccc atcatctctg ccagcccct ccccaaaat 150000
 gcaatctaaa caacagcaca atctgcagag ccttatggtg acaccagagc tecttcccgt 150060
 acaactgctt tcctcattc atgctcttcg agacctggaa tcgctctaa aagtgtgta 150120

accatttact ctgcacagta atctacagca tgcagatatt ccccttttaa tgacagaact 150180

gtgagtccta agctacaaa tgaaccgggg tccggctcag aatttaatcc agcctatcac 150240

ttcagagctc acgactaggc tatgccacca agagcagggt tcatgcccac aaaaactgtt 150300

aaatcagact attaaaagct ctgtgtatgt caacagatca gtgctgaatg aacccttatg 150360

aaatttgacc caattcattt tcaattgcct acacatctca gtttggcctt caaagctact 150420

tggtccttte taaacagtgt aatttctgcc attggttctg cagatcacta atttccatca 150480

ccacgccttt ccacagacaa gttttccatg gggtagatgc ataggaatat cacaccacca 150540

gaacacagct ctctaatagc ttctgcaagt gaactgtctg cagttctaaa gcaatcctgc 150600

acgctttggg agagttgact acaagacca tttagctcac aacctcagtc agggctctctc 150660

ccaccacaa tggttagcca cattcctcag gagaacgagg ggttccatgt tgggattcaa 150720

gaaagtgcct ctccagcagc ctgctgggag ctttacacac ataacttctct ccatgcccac 150780

agccatggga ccaggatact caaatcaaag tgagtaatgg gacccttgta gaatagggaa 150840

ccattcatca atatctctct ctctctctct ctctctctct ctctctctct ctctctctct 150900

ctcccctgcc accactgtgt cagccagctc ttctgtgacc cccttgagtg acaaagggaac 150960

agctctgttc caatttctcc atttcctgc tattactctt caaacaagca cagactcctt 151020

tctggtattt tccaggttct ttatctgtta gcaacaagta gaaacattta atagaaataa 151080

caagcaaggg ttctttacag aaccttaaaa ggtcaaaactg aaatagtgtg actaaataaa 151140

attaaacttg gaaccagaga aggttggatg aagcacacgg ctgacttcat ttactcatt 151200

aggaacatgt ctttgggcaa ataattttct attcctgagc ttttgagatg tctggttttc 151260

atgtgtctga gtccaataaa ataagaggggt tgaactacat tttggctata gcttcctgggt 151320

cctaaagggc atcacagtga acactctcct aacactttaa atatatgtga gtctgagatt 151380

tctgggggttc ttgctaccct gcagagtata gtggaacctt tctgtcatcc cagagggatt 151440

gtgagtttga ggccacatgg ggttataggg agagactgac tctgaacatc aaaagaggag 151500

gggaggggaga gagaaaaagg gaggttgtct ttattcccat ccacatgtcc cactcagtga 151560

ccctctccat ttctttccca actctgccac acacacacac acacacacac acacacacac 151620

acacacacac ttacacaaaa tacccttgag caggaccaca taatggctaa aagctggaga 151680

tttagcccca cacatagatg ctaatccaat ttaacaactg attatcttgt gactaagcaa 151740

gcaatttaac ataagcctgt ttcaacacat gtaaagtggg gaatcaacat catacctatt 151800

gcataaggta gttgtagga caggtgaata gcattgacca agcccttagc aagagctgg 151860

cacgtgtgtg ctcaaacgc cttatcatg ggaatgatac aggtgatgaa tgctcttgtt 151920
atgttactct cctgaagtcg ctacatgggc tgagacacat cccaagagtc acttgtggga 151980
aggaagagag aagcttctgt ttgcagaagg gactggaagg gggtgagagg gagaagtaaa 152040
ccattgctgg aagattgagt aggtgggtgca gtcttgcccc ctactccct cctgcctatt 152100
ctgtagccat cacatcacag gaaagctatt atttcagcta cctgaccgtg agagacacgg 152160
gacagggatg agagagtgga acagtctgtg gcttctgaaa ctgaacctgt ttggggaaca 152220
gtcagccttc catctaata gatgagaagc tgtgtgcagg ttgcattgca ttccaggagt 152280

catggataac tttggctcat cttctggcaa tactgtgttt cagatataaa atattatcca 152340
ctctatgaca taatagatat ataatattc caggaaagca tttcccaaaa aacactgaac 152400
cagaactctc aacacaaggg tcccatgcaa acagtcacat cctgctcttt cacagttcac 152460
aggcagctgc cgggaaaagca agattcaaaa tcccagggaa acatggatgt tctaggcaca 152520
ggtcattata cttttcaaaa catcatctgt agaagcaggg gcctttccat tagatcagaa 152580
tatgaatgtc acctaaatgt gtggaatgt cacctgaatg tgtgtaaca gcaagtttaa 152640
caaggagagc agaggaccac caccceccac acacacacct agaaacatca tgactcatga 152700

caagcatgga ggaggggct gtagcatgtg tctagaataa tgaaaacagg tgagctattt 152760
tgttatttgt ttgaaatctc cattcaatta ctctattcat tcaactaatt ataaaaaat 152820
ttaaacaatg gaaaataaaa gagagagggtg tctcagtcct tttggtctta agatgttcaa 152880
cccaatgaga ataacagccc acgtcagata actgtatgta caaagtgtca catgaaacgc 152940
caagcattga attaaatag gacaggtggg agcagagact ggtcagagga gagacaacag 153000
tggtccagg cttaccctgt tattaattcc cacctttatt ttagtggcag aatacttcca 153060
ttttagctgg gttcatggtc atcccactaa agtctcactg tccagtatgg tgtccacagt 153120

cacaaagact actgagctta gaatacggcc agtcttacct gctaacataa tactacctta 153180
gctacattgt cccaaatag ctcatgatt tactttcacc ttttattttt ataatgtcat 153240
tattgaaaa tttcagactg tagggggttt gtttactctt tttttgaaat gaggtctcac 153300
tgtgtgtcac agctgggtctc aaactcatga attcaagtca tcttgctca gectgctgaa 153360
gagctgagat gacatatgcc ccctcacctg aaaatctgag attacataca tgtctctcat 153420
tatatttgtt tagacggcac ggagctaaag actacatcac accgccttcc gtgatgttgt 153480
ctgtgaggat gatgcagtca cggtagtca gacgtgacta ggaatagtgt gcccaactgtc 153540

taatgcagge aacatctcc taactcctt cctgttctg gctggatgga tgcaaatgtc 153600
tagcgtgac ccaactgcaa ccatcaagta agccacatcg gtgaccagg gataatggaa 153660
taatctgttg cctggataat cccaggagtg atccaccggg ttcccagaa ttctgtaaga 153720

ttagatagct aggcaagaga agattttatac taagtctctc tagagaaacc taaactgtaa 153780
 tccagttaat gcaagggggc atgccaggaa agttccaaaa ggggccaatc attttaagga 153840
 catcttaaag aacaggagct agccagagta agagcccaga gtgttgccac aaggggcaac 153900
 aagaagaggg atcacttgag gcagaggaga caacagagaa ggaagaaagt tcaaaacat 153960

 cagggactat ggtgagccct caaatggagg ctacagaggt gagtacgtg ctggagagcc 154020
 ttggagggtg gaaagctaata gagtgactgc ccgaggaggg ggcaatcagt tetgccttac 154080
 atggagctat ccagtgtccg tgcagagtcc catctgtggc tacagccgta tgaacagaag 154140
 gtggcagagg tggtaatgta tacctgtaac ccagtattca ggaggtggag gctgaaggat 154200
 tagaaattha aggtcatcct tggctacatg gaaagtatga ggctagcctg agcttgagac 154260
 tgcctttaa aaaaattatt aaaacattca aaaagcaaaa tcatcctggg gtaggaagag 154320
 ggaggccaag gaggtggctc agcaggtaaa agtacttgcc acacaagcat gatgactaga 154380

 gttccattcc ccctcctcat tacaggaatg agacacgaat ctgtaatccc aacattccta 154440
 tgacaaaatg agaggcaaac acaggcaaat cagccagaag cttgctagcc catctagcct 154500
 aaagtacatg atccagtaga gaaacaagaa ggacttctcc tctctctctc tctctctctc 154560
 tctctctctc tctctctctc tctctctcca cacacacaca cacacactta ccctctgggt 154620
 aagtaataa ttacaggag caataagaac agagaacaga ctagactggt ggggggcggg 154680
 ggtcccagct tagagaaaga tgtccacagc caagaccaga tccagagcta ttcaagtaga 154740
 cacagagaaa ggactggttt catttcggca gagtctagcc tgttgttcgt gccacatcat 154800

 atcataagca gctttccct acagacacac acaccaatgc ttaaaaacag caccagaatg 154860
 ggatcaagga tgcagacttc aagagggcat tcaggagaa acccaatgat aacaggtgtc 154920
 aacatctaaa ccagtggctg tatgtacctg agggaaggag aagagggggt aaagacagga 154980
 aaagcataa tccacatccc aggagcccaa aattctctg acctctct gtttctcagg 155040
 gggaaaaag gtagagaac aaaaacaaat atgacattgg tagtaagggt ctccgactg 155100
 tcaggagact tcaagtttct gctcagagta gctctttact aaccccagca ttattttta 155160
 gtaataacag catcccaaat tgcttaatgc atctcaecte tctatgtct gtactatgtt 155220

 ttcagaggaa ttaccacaca tgtcaaaata caattcatt aaagtttgg tcaaaattaa 155280
 aatcagtaaa gatgaggttg aagttcacag aagttttgtt ttttgtgtt gttttgttt 155340
 gtttgtttg ccaggcaaaa ctactagaat atgctaactt tacagaaatt gcagattcat 155400
 gtcactgtt ttctttctga tcagtaact aacccttct ctttctttt acttatttat 155460
 tattactgtg tttatgatgc acgtgtgtgt gtgtgtgtt gcacgtgcca cagatgtgtg 155520
 tgtgtgtgtg tgtgtgtgtg tgtgtgtgtg tgtgtgtagg caaagggaca gctctgtggg 155580

tcaggctctt cctccttgc tttactcaggc tccagggacc caactcaggt taccaggctt 155640

gtggggtgag agctgctgag tcatgtcaac cagcccacat acttactga cttctcgtga 155700

aatagcatga gaagaaatct ctcctttctc aatctaaaac aactatgaat aattaggaac 155760

cttcatgac taattattat acaagtgtct tttaaaaaca tgaccagtg agttccagtc 155820

tccatcattt ttttaattga caataaaaag tttgactcac tttgataaaa attctacccc 155880

ctaggaacc tgggattaag atgttaataa ggctctcaga gtgttaactg taaatggata 155940

gactattttc ttacacagag gaactctaca cagtggctaa aatgactttc ttgtatagag 156000

aagcaagcta attgacagag ggaaagcaac agaacaact gtggttttct tttctttcct 156060

tttcttctct atgttttaga caggttctca cttttagct caggctggcc tggaaactca 156120

tgtgtaccgg gctgggtgcc acggagattc acctgcacct gcctctccag tgctgggatt 156180

caaggcatgc accaccatgc tcagcccact gtgccttttt cattaaactg ttcctgggca 156240

aaaaaaaaa aaaaaaaaaa aaaaaaaaaa aaaaaaaaaa aaaaaagacc tactccatta 156300

gggcttaagg caaattgcca ggctcacct ggctagagat tctaattcat ggcttggtg 156360

accatggttt atacttcaa agcctccttg ggtggctcag agaccagctg gtttgggatc 156420

cacttctcta aagccagaaa atgcatctt tgatcacagg gcctagtaca cacagtatca 156480

cagatagctg aactctgtgc tgttgattca agcatacagc acgggtgaaa agagcccagt 156540

ttgcacaagt gtctgagtta ggtgtgggag cccagcatct agtgggtgag aaacaaggcg 156600

acacatacca gtgatatgac accatacaat aagtgtcact gtggaagctg attcacacac 156660

ttactccagc aaaagggaca gatggcgggt gactggctca ggctccaggt gtccctggaga 156720

gcaggagctg cggggaagag ggagt agagg cgagaaggaa ggcaaaaagg agaatggagt 156780

gcaaatgcag acagcctggg tgtgctctga gtggctctga gatctatttg gcagggtgca 156840

ggccagacag aagcacacac cgcaaagatc catgaaggcc tggcaagctc aaggagccca 156900

tgacacattc taggtagaca gctggcatgc cctgccatgt attttagagt catcacctg 156960

aaagcagcag agatgggctt gcaggaacct ggaatgggg gctgtaatga ggaagccatt 157020

atagcagccc agagaaatgg tgatatctga actatgggga acacagctaa agtcacagga 157080

agagactggc aaaaatgata ataaaaaca ctttaggtt tttatgttaa atttcaatgt 157140

gaacagtagt attcaaaagt cagaagaatt aatgctcgt taggaagcaa ggttaggaaa 157200

catatcacac ctcttactgc tttagtctt tgcattttaa atacaaaaat ccccaatgg 157260

ccacacagag tggcacattt aaactaattc agctttgtct atggcacta ctgtcattac 157320

ctatttcaca gcaaatgttt gaacacacag ttaaactgtg ctcccgaat cacacaagtg 157380
 catccatggt gagcctatgc aatgccaac ctccctgaat tcaactctgaa acaaacaca 157440
 tataacgtgc agggctcaag cacgtaactg ggagtgacca cgcttaaat ccacgtcaat 157500
 cacaatgtgt attaaggagc ccactttaaa atgggctaat tagaagcttc catagatatic 157560
 aacatgaaat agtgactgtc tgcaatggct gaggccttaa agcagaaaga atattgcttt 157620
 ttaatagcag taattctaga agccagagac ggcatlggat cctgactaaa tagactagta 157680
 ttggctttta aaatgtttct aaattctcca cagaaaatac atatcctgtt gtctgcaccc 157740

 tggaggtcag ggaaggagc aatgcagttg tccttgggaa tgacatggga aactgaagga 157800
 cccaagggga cagaatcgag gtcaaaaatg agcatgtaca cagtggaca aaggtgaaca 157860
 gggtaaacc atgagaggag ctgaatgaga agtcttgctc aagtctaaag catttaccag 157920
 gcaaacagc tctgggatg tgtaaaagag ctgggaatac aggtgcagag tggtcagaat 157980
 gtgggatcta caggattacg cctaatacaga agctcttccc tctaaaaatt catcttgaac 158040
 ttgaaaagt cataaatgac caactggatg acgatttgc taggggtga aaaacttttt 158100
 ttgaaacttg ttcatttttt tctaggaaga attaataaaa ctacgtaagt cagatcatta 158160

 aacatagacg gtaatttctg tccaggaggg cagcattaca aagatgaaga gacatctttc 158220
 cctttgaaga caaacagaa aatggagcct cagtggaaat ttccaggacc atttgactag 158280
 agcaggtcct cgggtctct tgaacatgag gacaagtga atcctgacca agccttccac 158340
 agaaccatgg gcggaaggg aagaagggtg caagaacccc acagatgggt caggagtcaa 158400
 gctgctgacc tggagcatgt ttctaatct ctccactcca taggttcct cgtgtgaaac 158460
 acgttgaca gtaaggatc ctgtgggaatt aaagctaaca taccgatatg agttaagggt 158520
 gacatacaat aaaagctctg ccattttctt gcacgtcact gaatgcagaa gtgctagatt 158580

 aaggttcaga gtgaacaag gagaaactgc caacaaatga tcagtactat ggttaagaat 158640
 atcaactcc agaactcctg tccttaggat gggaccttca gccattgctg aatgcatgat 158700
 taaccacat gagctgtgtt tctgcattc cattttcaca gatgttcgct accatccaa 158760
 cataaggtea tcatgtttca ccagaagata cagaggaagg aaggcctttt atttggttgg 158820
 gttttactt ctttgggttt tttggagggg ttgttttatt ttgtttttt tatatgttac 158880
 agaagttagg ccttgctagg gaggaacag aaatttatga ctctagaaaa atcaaagtat 158940
 aattgactct aaaaatttct aacataaata gaaaaaaaa gtaaatgtac catttctgca 159000

 actgatgtga ttctaaattc aactgagatg agcaaaaaca tggttttctt tccttacct 159060
 tttttatagg ttactaactc aatagaaggc atcttttaat aatcaagttt gaattaaaag 159120
 agaccaatgc tgagagcagt aaaccaattt gtgtgtgtgt gtgtgtgtgt gtgtgtgtgt 159180

gtgcatgaat gtttgcttgt gtgcatgctt gtatatgtct gtgtccatgt ttgtgtttgc 159240
 atatatattgt gtatgtgcat gtttgcat acatgtgttt gtagtgtgca tgtttgtgct 159300
 caaatgtgtt tgcattgtgt tgtgcatgca tgcttgtgtt gcatgtgtgt acacatatgt 159360
 atatggttgc ttctagggtg gagtgcaggc atacacatac tgtgatgtac tcttggaggt 159420

 gagaggatta ccttgggtgt cagccctctc ctccccctt gtttgagaca gtctcttgtt 159480
 cacatacact aggctagctg gccttcaagc ttccagaatt ctectacctc tgttctcat 159540
 ctcatcacag gagcactggg attacagacg aacactacca agtatggctt tacatgggtt 159600
 cttggaatct gaactcagtt cctcatatgt atgtggcaag cactttacc aataagccat 159660
 ctccccagac cccaaaatct ttaatgaaaa aggaggttaag cacaggccaa ctgcttaact 159720
 gtatccatcc caccctctc ctaaacagga cagacatgct cataccaat gtctttgaca 159780
 gtaagtattt tccctaaca aaatacttcc gtaactaagt ggccttatac tgtatctaag 159840

 tagtgaaga aaatacgaac accatctttg tgaccttcaa tacagaacca gacagccgta 159900
 gaatacagtc actcattagc tctgatcctt acacaacagg cctctttcaa actctctctc 159960
 cctaatttga attggctctg cagttttctc gcacgtcact gaatgcagaa gtgttatatt 160020
 aacaaagcaa ctcaggatct ggcatggaac caacagctc tgttctctca cacccatag 160080
 tacagcgata gtaaatctat gccttaaaaa actgactgca gagtaagtta tagcttttct 160140
 ttgtatatgc atatgtcatt taaactttgc acagtttcca tctatctctt ggcttgatea 160200
 gaaaattatc atttttagct aaggagctgg tggtttctc tttcataggt caggggacaa 160260

 agaatacaaa acaattatct aaaattacac taagccggcc atggtggtag cacaggcctg 160320
 taatcccaga acctgagagg tagaggcaaa aggatcaaga gtttaagtcc agcctcagct 160380
 acataataag ttctcaactg tgctgtgcta tatgagacc taccctgcc cctcccacaa 160440
 aagaaaaaac taaagttaaca ctcagtttgc acccctaact tcccatttaa ttttgagaga 160500
 ccaactgcat ttaaacaaa tgcaacacat taataggtat ttgtcact gacttctaga 160560
 ggagaaatct gtaactggct ggctgacaca gtaaatcctg agctgctcgc tttatagaga 160620
 gaatagtctc atcttttctt ctggaacttt ttaaatggct gctaatatga gtgatgcaaa 160680

 ggagagcttt gcttaaacag aatgtatgct tfgtgateag tgcacaccta caacgctcag 160740
 taagctagag caggaagatt ccaaatctca ggccagtcaa ggctgcagaa caagagctgt 160800
 ctgagacaga cagaataatt atcactaac agccatttgt ttggcaatag aatatccaa 160860
 accttagtgt gaacatagaa cacattttct tttttgaga cagccctggc taccctgaaa 160920
 ctcactttgt agacctggct ggcatcgaac tcacagagat tcacctgct ctacctctg 160980
 agtgctggga ttaaaggagt gggccccac acccgccac gttacacacc tttagtacca 161040

gcactcagga gagataccta gacagataatc tatgagctctg aggccagcct attactccaa 161100

tggcattctg atgcaataca ataaatatac taaacagggc tagattatag actttgcaca 161160

tcatacatac aaattgcttg tattcattgc tcctagaatc acagaaggta acagataagg 161220

aaactgagac taagggtgca cagctaggga ggtagtcttg tggctaggta tctgcctggt 161280

tcctgcattg gaaatagaga agaatcccag gaagagaatt ctggaacaaa gggatcatgc 161340

ccaggcaagt gcagcccctt ctctcatctc tgaatcatgc cttataata ctaatacctc 161400

cagcttgcca tttcaagaa tgctagctgt ttccatgtgt gcttctcagc ttaagcaagt 161460

tctagtttag acagtgacat cagttacaaa agcaatatgc tccagaaagg atccttcaact 161520

ataacattga cattaagcaa actgttgact tggctctttt ttacatatat tttgttataat 161580

ctagatagga aaatgttcaa atgtgaaaaa tatattatag aaagctagtt attaaggaca 161640

gcctaaagtt tttactgata tgctatgggtg gtttgaatgg ccccaaaagg ggatggcacg 161700

attaggaggt atggctctgt tggaggaagt gtgtcactgt ggggacagc tttgggtctc 161760

ttgtgctcaa tcttccctca gtgtgacagt cagttgattt cctgctgcct gaaagatgta 161820

acactctcag ctccagcacc aggtctgcct gcctgcccgc atgctgcctg ccatgatgat 161880

gatggactga acctctgaaa ctgtaagtga gccaccccaa ttacatgttt tctttataag 161940

agttgccgtg gtcattggtg ctcttcacag caattaaaac cctaactaac acatatgcat 162000

tgcaaagcta cctctaattg caaagatgct acctcctcct cttaaaaatg tagtcttttag 162060

tgttagatgg gctacctaaa actcccattc ctctaagtgt taagcaacag agagctcaca 162120

atccgcagca tgtaaccaga catcacaaaa agagaatgct cctgagagtt gaaaaatcct 162180

gttttttttt ttttcattag aagttacctg ttgtatgctt gccctcacia tgtataactc 162240

actgcagatg tggcccagtg gcaaagcact tgacgcacia acccataagt acaatcctta 162300

gacacacaca cacacacaca cacacacaca cacacacaaa atactgttaa agaagagcaa 162360

ttaagtctat attgagtaaa gaagtaaagg gcatttgggg actgtggcaa tatgtcttac 162420

tactcaagtg taaggacctg agtgagatca ccagaaaata tatacataca tacatacata 162480

catacataca tacatacata catgcataca tatatacata catacataaa gccaagtaca 162540

gcgacatgtg cccacagtc cagctctgga gaggcataga caagaggatc cctgtatctt 162600

gttggccagg cagactagcc aaatcagtga gcagagattc aaaacagaat aaagtagaga 162660

gtaactgaag aaaacaccca acatcaaaact ctggtctcca cagtcagca cacatgcatg 162720

catgcatgca tacacccta tacacaggca cacacatgta cacacaaaaa aagaaagaac 162780

aaagaaatgc aggaaatata aaccaaaaat tatatactgg caggaagaa aagtatttgg 162840
 taatcacca cctttaaate aaacacttat aaagtcaata gaatttaca actatcttta 162900
 ttatcatgaa atttacttaa ttttacagat atatatgtac ttttttctct ggtcagcaaa 162960
 catatgatat tcccaccaac tgcacacggt gctgaattaa tgacaaaacg catctttgca 163020
 tgtgtccatg taatttctta acttagagaa agatggtttc ttgattcttt ccaagtctgt 163080
 gtctaaagca tgtgaaaaga gggagctggt gcctcctccc tgatgactaa gctatcaaag 163140
 aatctgaagg tgctatgcag gctgccagga gagaaaaata actaacagtc ttacatatgt 163200

 aaagcttaca aaccatagca atgaccatta cagcaagaca tttccaaggg tgcaatagtg 163260
 gcacttatat cttaggggta accaacaatt acctaattta acttccactt atcagtaggg 163320
 aactcacact tgggactgta aacctagcca acaacctgtg gttgataagg ccatggaacc 163380
 tagaaaagga ccctttatgg ccactttcct aaaccagtgt agttctaaat atctaaaaac 163440
 ataaatacac aggtatgcat agctctcact gttcattaca caagcttctt ttgfaatcaa 163500
 cagagacat tacaggaatc cacaacttgt taaaatacag agaacaactg accatgagat 163560
 gctcagctcc aactgataca tctacaacac aatccctatc ctgaggttca agcagcatag 163620

 cagaagaaga ggtgaaaga ctgtaagatc agaatgtctg cagagagatg tgacttcta 163680
 tatatgacag ggagctgaac ccatgaaatc tgaaaaatat ggtgatctaa ataagacctg 163740
 catggtgaaa acaccagctg atattccaat gtggatggag gaattctagc aaggctccac 163800
 ccctagatgg agagctacag gcaattaatg gctgcacatt ctgagagaga gagagagaga 163860
 gagagagaga gagagagaga gagatagtct tctccagggt ctagtccct aataggctat 163920
 ccagtcccaa gtggtcagcc taaacataat aggttgattt tgtttgttg ttgtttgtgt 163980
 tgttttttg gttttggtt tggtttttcg aaacagggtt tctctgtgta gctatggagt 164040

 ctatcctgce actcgtctg gaagccagge tggcctcaaa ctcaaaaaga tetgcctgce 164100
 tctgcctccc aagtgtggg attaaaggcg tgagccacca atgcctggca ataggttgta 164160
 tttgtataca tgtgtatgta cacatgtgtg tgtgcatgtg tgactgtgta tgtgtgtgtt 164220
 gcatgcagca atataaaita aagaagagat catgagtttg agagtgagtg agggggtgac 164280
 ttggagaaat tggggcggt agaaatgaca tgaatatagt attgatata gaaactctca 164340
 aaaaaatcaa caaataaat gtaaaagtag aaaaggtag cttctgattt gtttcaattc 164400
 aaagtatgce aggecccttg taaaagtaat tattgcttag ttacatatgg atacacacac 164460

 acaataatag aaaaacaaa gccctcccta atctctccac agatgactgt gggaacaatg 164520
 tatcatgtaa atgcaacctt agctataatc tgtctaaagc catgtttgca aatccctttg 164580
 gaaaatccta cgtgctgggt ccataaagat ccactctcca gacaaaggca tctgactgg 164640

acatgttcaa aatagctctc aaagacaaac aaacaaaagt cactgtgcac cagccacacc 164700
 aaagaaggga gaagaggaac cgtgaaaggc taccagactg gggaaccga ccacatattt 164760
 ggaattctac agaaaaagt agcaacaaga agaaaacagg cacctggcag gaaaaaatgc 164820
 aaaggaattt attgagacgt gatacacttc ctgtcaaac aacacacgag gtggtgattc 164880

 attccaatag catcttctag aatttgtgca actttaaatg tgccataaat tcaacctatg 164940
 ttactgtggt gtagaaggat tttgtgtttt tgctttaaat actaatctaa tcatgtcaca 165000
 ctgtgcccaa aatgcatgg aaagcagaat gtactcctg tatccatagc catgcccctt 165060
 actgccacca agacaagata gcacagtgcc aatgaccttc ccttgtttac ttctgacttg 165120
 agctgtggcc tttggtgctg ttcaatctaa tggagtgctt agctctagac tggagagctg 165180
 ccccttgga acaaaaatat aataatcagc tactgttga cacaccaaga gagtccaccg 165240
 gatctttatc agatgcttcc agaactgtc aaaatgatag cattcttaag tatttgaggt 165300

 cagaaaaata caaaactaga tgtttccata tattctcacc catccccca cctaccgcg 165360
 tcctgctgaa ccatctcacc agccttcca ataaattcaa gatgtaaac cattataaat 165420
 aagcagattg tcaaaaatag cttaaatag tgggtctct gtttgactt tcatttgtgt 165480
 gtttatgtgt gtgatgctag tgcatggacc caggcagggt ctgctgtgtt caaagcacc 165540
 actctaccac tgggtacaa caatcctaa attgctatac ataattctgt ttgataatac 165600
 ccaactttt cccccctca aatagtact ataaccattt attccaacc ccagcttga 165660
 aagttttaa gtatgggcaa tgaggaacca tgtgtgaatg tcttaaggaa aaacaagaca 165720

 aacaatggtt tgtgttgaa tactaaaatc tgagattcct ccagcttcat ttatgagcta 165780
 aatgaagtg ctgtgatttt cactacattt ctactact gtactcttt atgtttattt 165840
 taaagtttta tttatttat atgtatgtat gtgtgctggt gcctgcagag gctggaatg 165900
 ggtgtgagat ccttggata gagttaaagg taggtagtgt tgaggacct gatatgggtg 165960
 ctgggaacag aactccagtt ctctgcaaaa gcagaaacag ctcataacca ttgagacatc 166020
 tgtccagccc tacactctt cttattttcc tattgtcacc aaagcgacag ccacatgttt 166080
 acaatacaga ctacatttac aacacatga ttgagaggaa aaaagcaagc aagcaatatg 166140

 tggttaacta tactatcagg catgcttcc agaaaaaaaa aaaaaacta aaggtgactt 166200
 cactcaggtt gctgaaagca gccagtacat accatctctg catcactgtc taccaaatgg 166260
 cagacaatgg ctaattcagc agcactaaga accttttatt gctggtctcc cagaaccag 166320
 catatgtctc cctctatgta ataatcagcc aaattcagtg aaggctcaa agtcagataa 166380
 gccccacat aactacaca cacacacaca cacacacaca cacacacaca cacacacaca 166440
 caaaaaaaaa aaaaaaaca cacttccctg gagaagaaa tctttagaaa gaactctaga 166500

ttatttgaaa gttttgaagt cctactccaa gccacgcgat tcaaatccca aacagaacaa 166560

 tgccaggttc ctgccccagt gtctaaagca gccatgatgc agaatatctt gagcttgaga 166620
 tatcctagaa ggtaaacaga tgtcatgctt ttaaacacgg ctccctatga atataatttg 166680
 gcatagatca tattaatcat caggaaccac atgataaact gggttttaga aattcattat 166740
 gccaggcatg gtggcacaca cctttaatct cagcactcgg gagacagagg caagaagatc 166800
 tctatgagtt caagccagc ctggcttata tagtgagcag ccaagaatac acagtaagaa 166860
 cctgaataaa aagaaaggtc acatattttt agaggaaaat tgggatggag gtggtaaaga 166920
 gaaagaagaa agaaggaaga gagtgaactg ttatgaatgt tcttacttta gttgaaaact 166980

 gctatttadc aaaaatgcc aacatttcag ggcatgtttt caaccaaggg gagcagggta 167040
 cattaagtcc cactgctaaa atgaaattaa tatctatctc tggatcatctt cgaattcaat 167100
 taaaataatt cctagattat tactggctca ttctgcctgg ctgttcagga agggctctga 167160
 cgacaacaac aacgtcatga gctgctgtga cagggtcacc cccaagtcct tctccctgt 167220
 gaagatacaa cactagacta ccatcttcaa acccaccttc ctgaacatct gcatgtagcc 167280
 agccaagggt ctggcacct cgggaatcag ggcccacgct agatggtaac ccatgaggt 167340
 taaggcacca tcctccctcc acaaaacttc aaaaatggag ccaggcctgg tggcatggac 167400

 ttatgatccc agctgctcta gagcctgaga caagaagatt gcaagttcaa ggctgctcg 167460
 gctgcaaagt gagcttgagg tcagcttagg cagctaagtg agtcctgac tcaagataaa 167520
 aacaaagtaa aaggggggac tagaaatgta gccagggtgg aatgcgccta gcacaatgcc 167580
 ttaaattcaa ctgccattgt ctatccttca actactgggtg gtagttggga gggggcagta 167640
 ggacctgaga gatagaatgc acagtgggat gggacggccc caaaccttg gatttcaatg 167700
 acatcatagg gggccatcg agaattcaat ccaaatcca gttctagtcc agcctgtggt 167760
 atgctcagcc tagaaacctt cctcctgtag ataattcagt tgccagcagt caaacccaac 167820

 tcacaataac aggactgttt taaaattcat ttagtccaga tagcttaccg acttctatt 167880
 tctcctgctt catatacact tctgtagaat gatagctaat aaaaataaag actcctgcca 167940
 ggaatgcaga aggaaaaaga aaacctggat cttcaggtca aagagattgt tcagtgcgta 168000
 aaagcactca ctgacaagcc tgatgacctg agttcaaac ccaggatcca catagtggaa 168060
 ggacagacta actcctgcaa gctgtcgtct tggcctccac atgtacaaca tgggtgctcac 168120
 ctgtacacac acacacacac acacacacac acacacacac acacatacat 168180
 tcatgcatac atataaaca acacaatat acatacatat cccacctat tattctctta 168240

ctgttgtag tttttgaga cagggttct ctgtgtagcc ttggctgtct tgaactagc 168300
 tctgtagacc agactacct caaactcaca aaaatccacc tgcctcagcc tctgagtg 168360
 tgggattaaa ggggtgcatc accaccacct agctccaaaa tagcattctt ttttaagttt 168420
 aaaactctcc tctaggggct gaagagagat ctcttgtagc ggacctggtt ctattctcag 168480
 cacctgcact ccagctcaca gcagcctaac tccagctcca gcaagtcca tgcctcttc 168540
 tggcctctc aggcaccaag cacacacatg gtgcacatac atacatgcag gcaaaact 168600
 catacacatc taataattaa caagaacaaa acctgtctt aataaagcaa tctcaaaga 168660

 gcacttagta ttctaccaag tcaaggctc cttaaactgg tcatgggaag ctgagtttc 168720
 tctagctcag cccatgtctg ttaatctaga aatttctgaa gatcaggcat attcagggt 168780
 gtatagccat gataatccag tgtttcgaa tgttcaatgc tattgtaag caaccaccg 168840
 tccagcatcg tcaaacatt ataagattt aacacattta gataagaagg ctaaaagga 168900
 aaggatgta agcctttctt tgtctcataa tgaacaaatt cttgtccaaa ttctaactt 168960
 tgaataaac atcaaaaaat gccttcacac tgttgcctt ccaatgagca aacttggat 169020
 ttactggtgg tcccacaagc tttgaattta ttggtatgac aagaaacaca ctgctgagag 169080

 aaatacttct acttccagtg gtaggagca cttgctataa gcaagaagac ctgagttca 169140
 atcttcata tccatataga gcaccaataa acccagtgct tgtggaggat gaaacagg 169200
 ggatcactgg ggcttgctac ttgccacccc agactcagct tcagtgaaag gctctgtct 169260
 gcagagaatg gacagggcac ctagcatctt cctctggcct ctgcatgtgt gcaggattg 169320
 atacatatcc acacacaaaa aaaaaaact aaataataa aaactaatt ttggggctaa 169380
 agctcagtaa tagaacctt actctgtgtg cagaaggccc tgggttcgat ccacagcaa 169440
 cacacacaca tacacacaca catacacaca cacacacaca cacacacaca caccacaca 169500

 cacacacaca cacacacaca cacacacaca cagaggaaac ctgttcagcc cctggggact 169560
 gtgataactg atacaaaaga aacttccaaa cctccatccc tgagaacttt ggaccagctc 169620
 tgaatattt ggcagctctg aaaagcagca tttgagagct aagttgagtt gcacatgaga 169680
 gtgactttct gaagtgcaag gcaccagtct gcactctgcc accggcataa atctgaacct 169740
 tagttttcac caactcacac catctgaatt cacctccacc aaactttact cacaattaa 169800
 tcacacctaa aacattctcc cagggtgcaa gcagaaaggt caggagttca aggtcatctt 169860
 tagcttcate tactgagatc aaggacaatt tgggctactg gagatcttgt ctcaaaagga 169920

 actaataagg aatcacaatt cataaaaaat gaccacagac catcattgc aaaggagatt 169980
 gatgctaagg aagcctgaga gggattaca ctcaatgagc tcaactagagc caggcctcct 170040
 gacccaagc ttactgttca caccaataaa gagttgggac agtgacaatg gccttcaatt 170100

gctgcactca ggaggcagag gcagatggat ctctgtgagt tcaaggccag tctggictac 170160
acagaggact ccaggacagc cagagataaa taaagagacc ttgtttaaaa caaacaata 170220
aaaacaaaa caaaggatga ctttattttt cctgctccta acccactttc aagaacaaaa 170280
atgaggggagc catgttccca agagtgggt cgagcagatg gaagcccaaa taacgctgaa 170340

ttttccaac aaaatttcat cttaacttag ttataagcg aggtgtcaa aggcagagag 170400
cttcatgcag atgacagagt atagaagaat gccaaagatg ggagaagaat tetgtccact 170460
tggagttcag aaagaggtgg tcagaaagga gagaaagggg tgggactata actcactgcc 170520
atgcagaaca cttgcctagc atatgtgaga ccctaggagt tggaaaactt gtaactataa 170580
tctatgggaa ccgtggagaa tagcagcaga gtcagaccaa gaggtaaagca ttgtcattac 170640
catctccaaa ggcagaacct atagatccta ggcagaaggc attccaagtt gctcctcaat 170700
aaggttctgg agatcatgta ggaggatgct atgcaagagc ttcaaagaga aaggcttgag 170760

gccaatgggg ctctcaacag taagtactt gagaatgggc ccatattcct agatggaggc 170820
aaaatagata cagtgtacat cttgtgaca agaaggaaga ttaacagtga ggtgctgaca 170880
caaacggtgg tcattagatc cctctacctg atgctgetta ctatctatct gaagaagtct 170940
gtggagacac ccatttctact ccacctagac cttagcctaa atagcagggg tttgtatcct 171000
acagaatgca gtggaggtg taataaatgt atcaatgcgt taaccaatth gcaatgggtg 171060
gaacagccat aggcaaggaa ataaatctaa gagagataaa tattgctcag aggactaaaa 171120
aaggaaactg caagtctatg aacgaggtgt ggctcagccg ccacacacat taaaaggagg 171180

tttgaatta caagatggtt gtaaaactca aaaagcaact gcaccactca caagcaccgc 171240
agctgtaatg ccattgtttc cagagttgtg tgtgaaagaa gcccttatca caggcagatc 171300
caggtggagg ctaaccgttt ggggtgacttg aacggcctgg ccctatgact gaactgcagc 171360
tgattgtccc catgagctgg ggagctgagg gagcagtggt cctgctgcgc tccatcagat 171420
gcaagaactg cattctgaga aggaggtagc agattggaat agtcagcaca gcaagagaat 171480
tcaaaaccac atatgttacc aattttttaa aatgtcatta caagagcaat tgttcagact 171540
ggcctgcatg ctgcagaatt gtggtaaagc tggctgaaag aaacaccaat ggagcatcat 171600

tcggcttccc acagactaga ctatctttac tgcttagcag tcctttatca ctgtatcggg 171660
acagctgctt agccatttgg gagtatgcta tgtgggtgat gtgtgactg ccagagacca 171720
gacagaagtt tccaggtgtc tgtcaatcca cagattcaga ttccatcaag aatttcactt 171780
gtttctcctg gcagaaagaa actacttctt tagagaagtt cacagagtgg ccctgataca 171840
tcaggaagge cagccaccta cttgcttctt gggaacctt gaccttgcac ccttccatcc 171900
cgggtggtttc caatgcaatc catacacaat acacaggagc acaccactgc taatctttat 171960

agagatgctg ggiactagaa ggactttgga taattattag caaataatt aatcaataa 172020

 cacatgtgca ctgcacttta agtccctgca aagtagccta aatcgggatc cctgccacca 172080
 ctggtcgtat agacagcctg aaacactgac actcacacag aaacacacag taggcccagt 172140
 gcctggtgtt gtgggaattc atttcacaa cagcctggtg gcaagtgatc aatgagaagg 172200
 gccagcaata gagagacaag ggctcaggta caaaggcggc tctcaggcta ctaagttaat 172260
 caaaggcttc caaaaagact gtgcttgagc tgggcatcaa ggattataat aggtggtatc 172320
 tcagtagaag aggccctcca tgaataaagt caagctagaa attgaatcaa ctctcagtat 172380
 caaaggcctg ctggttcctt aaccttcaca gatcctaaaa tccaagatg ttcaaggctc 172440

 ctatatacca gttagtatt tgaatggaat ctgtgcactt cttgcattct agataatttc 172500
 taataaccaa tgcaatgata atgctatgtg catacttgtg atccaggttt atacaggtgt 172560
 taacagccag gaaataatct gtacatttta gacacaggat taactttcaa cccacagctc 172620
 actgaacca aggaagccca actgtgaata cagctggcca actgtataca gtagtcatta 172680
 ggcatggctg atggatgcaa agtgttcaca aaaagagaca acaagaggat gactgacatg 172740
 tcagcagcat ggaaggaaca ccaagggaat tgataggagc tgctccttct gtagacactg 172800
 taggataaag gatgccagaa acagctagaa aagtggctta tgttggagtg acctcttttt 172860

 caaatgatgt cagatctacc tggaaatggtc ccagtgaata gtataccgg gtttggaatc 172920
 ctgcaggagg ggctcagaat aaatgccca ctgtttcacc aatcagaggg aaccctggac 172980
 attctgagac cctagatatt ggataaacag caaacatgc agttggtgga gcaagaaaag 173040
 ggggaacagt agacaaaaga ccaggtggca atgcacaggc aataagtcag agggcttacg 173100
 gcgaaggcag acaactgtaa ccaaggctca ttttcctgga ccacaaagcc cagcaaaaat 173160
 gtcttagaag tctcaatga gacttctttt gccccagaat ttatctgcag catgaaatca 173220
 aagaaataat cagcttgatt accattcctt ttcagtcca cactatttca caaggagacc 173280

 aggtagccag ctgaccacg cacgtgggat ccagacttcc ttgtcagcaa tctcttggga 173340
 ctaagtcag aaagataacc taagtcttcc ggtgtgctga ctgtaaggc tatgtccact 173400
 gctgcagcca aagtgtcac ctggagacca cacatgcca gtcttgtgga ttgcagccag 173460
 aaaagttgaa tagactgaga ctctggttac ctgtaaacct caacactgca cagaatgtcc 173520
 caactgagag ggccatgaat ctcatccttt ctggatgaag aaagaccaga aatgactcgt 173580
 acttgccaa ggcacaca cagatgagca gttatgaaga ggtctatgtc tgccttagac 173640
 tcccagcaa gggcagttg ccctggatca tactgacatt tcaccactt tgctgctgga 173700

aagaaagccc actaaagcca ggcatgcagg cagctgctgg ggaacaaagc caggcctcac 173760
atgctgagct ttgtgttga tctaccactg agctccactc taaccagtac cactctttat 173820
aaatgcttca tttctatctg ttgtcaacat aattaccacc actgtgtcac tccataactt 173880
atctcatctt caaccaatga tgccagttac tgttatcctg gtttcacttt tttttttttt 173940
aaccgggtac tggatattaa cccagggctc tafgcatgct gggcaaggta ttctattgcc 174000
atggattatg tectgccctt gtcttttcca ttttaacaaa tggaaaacct gaggtagaga 174060
gaggtcacat agccagaaca aaagtaggtc tttctaactc actgtagctt cacagtcac 174120

acttgaaac acctcattag actttatgac atacaaattc attaaattat aaaatgagga 174180
aaagagagta agcataaaca ccaggggaac aattaccaat gatgtacaat aaatttaaaa 174240
gctaactgtt tttaaagtat attccatggg ctgactagat ggctaggtgg gctaaagtgc 174300
ttattcccaa acctcatgag ctcaattcag ttctaagaac tcacttggtga gaaggaaaga 174360
attgatcact ataagctgcc cgctggcctc cacatgtgtg cacacacaaa aataataata 174420
actatatttt tttaaatctc ttgatcatgt atttgagttt aaaattttta ttacatgtat 174480
ttgtttgtgt gtgcttctat cccttggctc aggtgttgag gtcagaggac aactttcacc 174540

catatggatt tggttctctc tttcaccca tatggattct gaggatcaaa ctcaagttgt 174600
ctggctcage agcaagagcc tttgcctct gagccagctt gccagccctc aattacctat 174660
ctgtaagga aatgtctgga tacgtgtttg atgggcagta gaaagcatgc tagcatttct 174720
agaatacagc tttccatgc tcagtgggtca caaaaagctt gtccttggc agagatagga 174780
tgtgactcac ctggtggctt ggaagggctc tttctgggta agcttcagtt actacctgct 174840
ttggtgcctc tcccacaaca cacacacaca cacacacaca cacacacaca cacacaaaca 174900
cacatacacc cctctgctct tcaagaaaca tcatttttat gttaactcta ctaaaaccaa 174960

acctcaaatt attactaagt ggactgaaac cagagactga acctctaaag attaataaaa 175020
tgtattttga ttagcatatt caaaaccagc atcactagaa taaataacaa acattcaatt 175080
atctattttt cacttgtcct cttattaaag aatgatgctc aatctcatt accttgctta 175140
ctcaggagaa gaaatccagg agcaataaca tctcaaataa gcaaattaca actgtatcta 175200
agatcaaatt tcgggaggaa aatgggagtg cattaagaag atgtactgcc acacagactc 175260
atctccctag ccagatgtct tgatgggtga gcaagcaaaa agccatcctg caaataggat 175320
gaatcctaaa acacaagagc cataggagtg tgactctgtg cctgaattca accaccagg 175380

gaatgaagge aaagagcagt aacaggcaca cgtcgatccc tcaaatttgc tgagagaatg 175440
aaaactgaag aaagttttca cagaacatga gggaactggt agaaattttc agaacatcca 175500
agcaacaatg ttttgagtgt tgacaacatc tttcaatgcc attataacaa cagtggaacc 175560

agctaccaag gactggatga aatgacagac tataatctgc tccaggaaaa aacaacaac 175620
 aaacaaaaa cacctctcct atgcatgcct gatctgcacg tggtaagcaa gaaaaacatc 175680
 tctaagctca gctttgccta agcaagaggt tcagacccaa acctacgggt ggtataatgt 175740
 ttccagtaca acicctaacat ggcaaaattt cctgagtttc tgcacttcaa atagaccact 175800

 gtttttgttt tagcacctc tgtagaagt gtccagaatg acccaactct tcataacaga 175860
 tctcacctaa ggtcacaggg gaacaacctc tgagctactc tgtcccactg aaagtaagac 175920
 aagtagcatt tcaatgaaac caaatctaca cccccagag ctgtcctatc tcccaggaca 175980
 ttaaagcaaa ataaaattac agccagttca gattttgaga ataatttggg ctatttagca 176040
 ccctcctaac catttactgt cagaaaaggg gttccaaca ttacaatac gaattttct 176100
 tcttgggaat caagacttga tctcaactc agagagaact cagtgggagc ctaaggacca 176160
 attttataca aaaacactta atcttaaagt aatagtatat cccgccactt aataccact 176220

 taggttttgt ttttgtttg ttttttctc acatggcata ctaaaggaaa ggaagccaca 176280
 agtatcaaag cacatctgaa atgcctttcc aggagaagtc ttagccaca gaatagtctc 176340
 ttctgagaac acaataagaa aatacttcag aattttccaa agtaccacca tggttaaaaa 176400
 aaaaaaaaa gcagtgaac cctagcaggg taatgagatt tcacagacc tccattacgc 176460
 actgatttcc tctgtacctt taaacattc ttaactgctt agagggcaga cagtacttca 176520
 gaggaagtc ccgtaacaca cctgtagag aacctgtca ccgctggcct ggctgtacag 176580
 ccttgataag agagaaaaca gtcactgca tggcaaacac tgattgtctg ctctccagtc 176640

 tcatgtcgaa ttagacaca cattcccaga agtcccatac ccaagaacta gttgtgctc 176700
 agtgtccta accactaagt atcaggtgtg gtactataca agttctatag tcaaaataat 176760
 tacacataat cacctataaa gtccacatcg gaatattact ttgagatgct gtcagagtac 176820
 aacttccaaa ggettatgca atattctctt ccttcaaca gtccaataga cttagctcaa 176880
 ctattcatcg agataagaca aacacctatt tggtttaaca gcattgacat aaaagttaa 176940
 gagagaggta ctgaaacctt cccaggaag gttatcagag cttggattat cgtgtccaaa 177000
 gtagatccca tagaacctaa ctaggtaag cctttgattt cgtttactga gacagcttca 177060

 gggctgagga acagaagagg acaaaacaca gaaaagcagt ggatccattc ttataacta 177120
 tttcttgact acttgggtaca gaaccagtgg tcaatctcca caatttggcg tgtgtagaga 177180
 ctggaactcc agcaggggtc gggagccaga agctggcaaa cacagatgtt gccctccac 177240
 caggcccacc cagatgtaac caatagacag ggcgctgtgg actcctaaag aagtctcct 177300
 tagaaacctg actgggtgtc gggaaaccag agcgggttcc ctgggtggtc tgaacacca 177360
 gtgtccacag ggctcacaac aagggagaat gccttctccg cccgtgacct ctaccacca 177420

cactccagta ttccagcgaa acccttaaaa caagtgcattg gattcccacg gaatctaaag 177480

 gccctccca aacaagataa tcatagatgc ttttgtaaac tcagcaaagc ttttcacaag 177540
 aaataaatgt cctgagcttg agactgacca gcagtctggg gteccccaag cgcctgaacc 177600
 tcggccagaa gcacagatgg gaagaggggg accctggctc tcatgcgctc cttctccac 177660
 ctcccgatg ccaactgactt ccaccgctcg cgaagagctg aggttgaact ccctcacct 177720
 ccgcaccggt gcctgagacg gtgaggggca gctgctgcct cctccccggt gagctcgcaa 177780
 ctgccgctc agaccccgca ccgcatgca tgcacttgtt gccatcccc agagaccagg 177840
 aggcggcgcc catccctccg gctgcccagc cggcagggtg caacctctcg ccgctctgc 177900

 agaccctgc gtctcggag accctggaga aactttgtcc cctgcgaact cagtgggcaa 177960
 acttcaccg gggctcgga ggacaccaga gggatggctc ccgcggtcag ctttacctg 178020
 gagctgtggc ccgggagcgc ccggnnnnnn nnnnnnnnnn nnnnnnnnnn nnnnnnnnnn 178080
 nnnnnnnnnn nnnnnnnnnn nnnnnnnnnn nnnnnnnnnn nnnnnnnnnn nnnnnnnnnn 178140
 nnnnnnnnnn nnnnnnnnnn nnnnnnnnnn nnnnnnnnnn nnnnnnnnnn nnnnnnnnnn 178200
 nnnnnnnnnn nnnnnnnnnn nnnnnnnnnn nnnnnnnnnn nnnnnnnnnn nnnnnnnnnn 178260
 nnnnnnnnnn nnnnnnnnnn nnnnnnnnnn nccccggcgg cggcgcccgcc tcgccccggg 178320

 ggctccacg ccctagtggc gccggaggaa ggagctggcc tgtcagctcc taaggggagc 178380
 agtgccaggc cctatggagg ctgaggttgt cccagccca aagccaccac acccgggaca 178440
 taatagcacc ggggtctgtt acaataggaa gtactatttt aaaagaaact accctcttaa 178500
 ttcattggga tgatgaatgt tactctggtc cacagctcg attgcctagg cttttatgca 178560
 cacagtgcc taaatgacat tataaataaa taaataaaat tcagggtttt gttttttttt 178620
 tttttttttt tttttttttt tgagaaagc atagccactt acacaatgct cagcaatgtg 178680
 aagggacccc ctgatcttgc tgcaactaat tactgagcac tgactcaacc ccaaggtaaa 178740

 aattccctcc attgtacagc tcaccataaa ataggtttta gacggtcatt acagctttaa 178800
 agataaaatt atgcatctgc ttttctgaaa ttacctgaa tattggcttt gtttttctca 178860
 agaagatgtc tacatcaaca tgagaggtgt ggtggcccca agaacttggg ccaccaattc 178920
 tccaaatcag aagcaggacc cctctctaat catgccacc aaatgcctg gaccaccctc 178980
 ctaatgttc ttgtttcaac agagcccagg gaatgatggg ataccaagaa aagatgccca 179040
 ggtcctgtcc cagcgaaac gctgctcttc tttcccac caggacctga cattggcctt 179100
 gcactattga aactgcact cacatcaact gatctcacac cgcagagcca taggcccaca 179160

agagaaccct ctccactgaa gaacttcaag gtctgaaga taaaaataa aagcaataat 179220
 attattttca aacatcaata ttttcaattt gaaaatgtca actggagatt agctgagtca 179280
 acacaccgga caaaaacagt tttcaagctg gttaggagaa aagtgagtaa aagaagcctt 179340
 cattgttgac ccctttgttg ctgttgcct cttatttctt tgtttttttt tctttttcgt 179400
 tgattctgtc atattgccag aaaaaaagc aaggaattgt gggaagagga acaagtattg 179460
 taagacgtta tgccaacat ctccacact aaaaagaagc agacaggaaa actgtcacta 179520
 aaactctcag caggattgta gatgaggaca tgtaatcca ctactgcag ttgccttgcc 179580

 ctccctcaag cactgggctt gatcaatatt taataagta cttggctttc aactgttctg 179640
 ggttcaaaact ctaagcgcatt gctctggcaa cttgaaaaga agcaggtgac tgcctgaggc 179700
 aggaagatat ccctgtgtaa ataactctt gcatctgatt gatttcgctc ctgcagacac 179760
 aggtcactca ggacatggat agcactgagc tgggctggaa ctgcaggtgt ttagaattca 179820
 gacaaaagcct gctatttca ggccacagac aaggagtgtc cagccagaaa gaaagcaggt 179880
 gggcaattct gctggcattg cccagcttc ccaggagtc ctctgcagta tcccagctgg 179940
 tctgtcttgt ctaacagtc agcctccatt catcctaac ctttatgcta cccagacctc 180000

 ctccgtaagt cccttctcca ttgtctgct ttcttccatc ctctgacctt tgacaaagag 180060
 tcgtagtctt atcacacgga agagcacttg cctatacttg ctgtcatggg caggactatt 180120
 aaaattctct gatgactagc ttgtgtcaag ttgacataaa cctagacagc acagaagcca 180180
 atcctaactt tctttctaat gctgtggcga ataccataac caaaagcaag taggggagga 180240
 aacctttat ttggtttcct gatcacagtc cataaagtta aggcagtacc ctgggggtgg 180300
 gaactgaagt agaggtcaca gagggatgct gcttactggc ttgctttttc atataacca 180360
 agacacttgc ccagatatag tagggcacag tagactggac cctcccaat cagttattaa 180420

 aaattgaaaa caattctccc atattctcta caggccaatt tgatgtaagc attttctcag 180480
 ttgaggttcc cttttcccag gtggctctag tgtgtgtcca gttgggggaa gaaaacaac 180540
 taacagcaca gagcccaaca tactcaaac caggggaaag tctcaagtgg aacctgtcc 180600
 atgcacaaaa taatgtttac ctccagcaaa tcctagggg cctgaaactc taacattaat 180660
 gatttgttcc gcctctattg ccactatttt taaaataat gttttcaat gaacttttta 180720
 atgtaagtat accaagtaat gggtttcatt gtatatggaa gggactgttt atattcaaca 180780
 cagttctctc ttctggctac atattatcac cccagggccc cacactagac cataatctcc 180840

 aggggatagg acccaggttt gtaacttccc caggggattc caaagtctag accaagttgc 180900
 aatcagatga aagggaactga gtttgtcacc agtgcaggag atgaacatca acctttaatg 180960
 acacaaggtt aagtgcata gccctcctt ctgtttctcc tgtgttgac aatctgctca 181020

gaacttgagg tggctctgc ttcaggaag tggcacatg aatcatgttg ggattgtaga 181080
 aaggcaaatc ctgtttta atgagctgaa ggctgcaatg ctgcatttct gatgaacttc 181140
 agaaagtgcc cacctgcctg gtctccagac caacctccag gtgtgtagt tcatgcctat 181200
 aatccagcaa ttgggaggtt gaagcaagag gatcaccatg agttcaaggc agcctgagct 181260

 atgtagtaag ttccaggcca acctagacta ttttagaga gagcctgtct ttcaaaaagt 181320
 catgatagag caagatgaca gtgggcacac ttttaacct agcactcagg aggcagaggc 181380
 aagtggatct ctgtgagttc aaggccatcc tggcttagaa atgagttcca ggacaaccaa 181440
 ggctacacat agatacctt tctcggaaaa aaaaaaaaaat ccatgctaaa cacctgtaac 181500
 cccacactt gaaaggcaga agcaccagtc taggttggat tagccacctg ctttctatac 181560
 ccagaattgt tctgggat atttgaatag aagctgtcca caaaagaaga gttctcaatg 181620
 gctgttatga aaggaaaagc ttattccatt gttctatgtg ggatgtgtgt gcagctcatc 181680

 gcaggtgagg gtctagcct tcaaggtaca ttgctaggca aggatatgtg tacatgcagg 181740
 agagagtgtg ggctccaag tgcatatag aagagggatg tgtgaaccaa aagttcaaga 181800
 ccaccagtc tacacagcac aattctgtct caaaatacaa caatgcaaaa acaataaga 181860
 acagaagttc aaaatagaca taagggaca gcagagaaaa agtcaatatt tgctacaaa 181920
 gaagtcacta cctcagaata ttttagtca aataatagta actgctaact acccacaaa 181980
 tgcataatgtt acaatcttg tataaaagag atcataatgtt gccagttta aatataaaat 182040
 ctttctgaca gggaaaactt ctattaggca aaacctgtt taaacaaagt tactttcaa 182100

 ggctacaaa aatgtttta ttttcttga acttggagt aaaacatgaa cttttaggtc 182160
 aagaaaaaa atgtctacc atataatatt atctttatt gcagtaata aatatttctt 182220
 attttaattt ttcaggagga ggaggcctac gaagctgaag tgacacagac ccacagaaat 182280
 ctcaatgac acaagttctc aaagtccatg ttctgcccag gtagttagaa aagcctgtag 182340
 accttctat catggctgat atttgcatc agctgcttac atgagtgga ggaagatatt 182400
 agggaaatta taaatacacc tcttgagtag aaccaacct ataaatatac aggatttgac 182460
 agttcccaca catgcaattt gtgaaacact gtccatgac aaaaattgt ttattcgtct 182520

 aatccatagg gtcttaaac tctaacatta aagatttgtt ccacctctat tgctacctt 182580
 ttttagctgt gactggtgtt cctatctgga cccagctctt ccaggttctt tttgtctcag 182640
 ttaaagaatt aaaatacaga tgacacaga ttacagagtg agaaggaagc ttcattcaga 182700
 ggcaaagcaa tattacatc ccaatattcg gtcaaagagc agaggccaac tgagtgaaag 182760
 agcattcagg ggcagaggca ttgtttgggg cttcattttg tgggctctag gaggaggatg 182820
 ggcttggatg acaggggct tgggagtgtg gttctctgtt ttggctgaca gatttgatta 182880

tgtaagattt ttttttcccc tctgagtggt ctttcccaca atgcatccac accatactgg 182940

 acactctgct cttttttcaa gttcccacaaa agactgcctg gaagtgccca gatcaaacag 183000
 gacttaaaact tgaagtaatt tttctgactg gctcgacagt gccaggatta caaacatgtg 183060
 ccaccaaacc tgggccttga aacaccaatt tcgattttct gtctctcacc ctttgagagc 183120
 tctggatcat tctgacttgt gaaaagctat caaatcctac cagagatcca tccaaggaac 183180
 cactgagggt tgcaaagaag tctactctaa ggccgggcat tgggtggcaca cgcctttaat 183240
 cccagaactc gggggaggta gaggcagacg gatctctgag ttcaaggcca gctgtgtcta 183300
 cagagcaagt gccaggatag gctccaatgc tacacagaga aacctgtct cgaaaaacca 183360

 aaaaaaaaa agtctactct agaacagact ttatctcaga atatgattgt ttgctacact 183420
 gatgtgatg cttgtgtgtg tgtgtgtgtg tgtgtgtgtg tgtgtgtgtg tgtgtgtttt 183480
 ctgtctaaaa tggctacagg taacttctct ttatatctta cttcttaaat attaagctaa 183540
 tgtaagacc cttttttgat ctccaggcat aactccacaa gacagtcca agagatactc 183600
 ttaaaagcac gctgtgtcta tgtatcttc atcagtcac agatgttcca gagtgtcca 183660
 atgtgggtgt gtaagagaga actacatgta ccctaacacc tgtccaacac tgataggaac 183720
 atgttaaatc tcagcctgaa gcaagctttc acggttatat aataaaagcc ctttttaag 183780

 agttgataat tgagacacta acaccatttt aattagggtg gcacaactag tcaactgatta 183840
 tactgtggg aaataatggg tacgaaaatg tcacatgggc tgtaattata ttgaaagctt 183900
 ctggtgactg gtgacatgac agatgtgaga atgaggcctt gctgctctgc tcatgacgtc 183960
 atctgaacac tgcataatgc atgtgtggct ctgggtgctc ttaactcatca cagacaatcc 184020
 agttcctggt ttctattta caaagggcag gcagaggaag ggaccagaga ggaaactcca 184080
 taacaaaaat aaggatgaat ctgtttccct ccacaagaa gttatataaa gtattttcac 184140
 taagcttttc agacttcatt tgaatacatc tgaagcttc taacatagaa tetaaattga 184200

 aatcagatcc tgccataaac ggatctcaga acttttgtct aaccacctt aactaacctg 184260
 caatttctaa agctaattta aaggacctag agtcagggtt aaaggcaatg caccacagct 184320
 gccttgtttc tgttttcaag tctggaagat ctgtgcctgt tcaacttgta tagcttcac 184380
 tctaactc aaagaaggca ggcagggcaa gtgagtttac agaggcattc acacttcaac 184440
 ccaacaaaac caacttaaca attatagta atatgcagaa aaaactacac acttcagtaa 184500
 gcactcacat tgicaagaga ggagagagag agttcaaatg aataacataa tgatatacc 184560
 caacggttta gaaaaacatg caaaagccaa tccaatgac tgcaagaaat aacaaataa 184620

aaagtattct aatcaataag tagactaatg aattaaatag acagttctca aaagaaaaaa 184680
accaagaaac caataaatat ttttttaaag tgtccaatat ctcagacatc agggagatgc 184740
aaattagaat ctctgagagg ccatctttcg ccaaatcaga atagtaaaca tcaagaaaac 184800
aaatactagt gaggatatgg aaaaataaaa ccattactcc ttgctgttgg gagtataaag 184860
cagcacagct agtatggtat tcagtgtgga ggttcttcaa aaaaattaa aatagaacta 184920
ccctataggc cagctctatc actcttggga atatactcgg gggagtctaa gtcttactag 184980
agaaatgctt gtacatccag tttatacctg cagtaggcac aatagttaag aagaagccta 185040

ggccaccaat agttgaacag ataaagaaaa tgtggtatat attcacagtg gaattttatt 185100
cagccaaaaa gaagaaaaac aaaatcatga cttttgtaag aaaaatatgg aaactcghaa 185160
acattttgct aaagaaagca agcatggctt agaagagaaa ataccacatt tgtgtgtgtg 185220
tgtatgtgtg tggttcctac attttgattt ttatatattg ggggggcatg agccatgaaa 185280
ctagaaaagga gaccatgaga ggggaaaaga gacctggggg cagaaagaga gaaaaagaag 185340
gcaattgaat tcatgtcaca agaaagcata agggagctac tggagagagg aagggggagt 185400
gtgggagggga gaagagggca agagagggaa gtaggagggg aatcttgagg gaacctatgg 185460

gccagtagaa tagtgaagaa aagataagag aaggagctag aggaggaagg acaaagtgg 185520
gcagcaggct ttcttggact gccagcctcc aatcacaaat tattaattgt gaatgctcgg 185580
ccttagctta ggtatgtttc tagctaacct tttcttttaa cttatatcaa tccatttctg 185640
tcaacctatg tgctgctcca aagcttgttt acctcatcta agtactgtcc atcctgcttc 185700
cctgcttctt ccatgtctgt ctgtctgtct gtctggcccc tggctaactg gctccccttt 185760
gtctctgccc caccaccccc acctatccct tctctgecta actattggcc attcagcttt 185820
tcattagacc agtcagggtc cttagccag caaggtgaaa cagcaacaca tctttacata 185880

gttaaaacaa aaacagcata aacaaaagca atacctcttt acatagttaa acaaatattc 185940
tattctacaa caaaatgggc ttagaaatgc cataatgaaa cccattatit tgtatgctaa 186000
ttttgaaaat taaaaagaaa agaaaactat ggtatttagc ttcaggatga agctaagcca 186060
tgaaaaatga aaaccaaata ctgtgtgaga ttaaaaaaaa attcttatta gtatattgtg 186120
gagatgcaca agaaaactat gtatctataa aacaaaaaca agtcactgtg aaaaaggagt 186180
catcagagga caagaaatta aaaataggaa atagtaaatt ttaaaagttt aacacagggt 186240
tgatgataaa gtcatagaaa tgtcccagaa agttgtgttg tgactatttt taagacaaat 186300

gcacaggact gaggatggct tcccatttgi gtttctctct ctctctctct ctctctctct 186360
ctctctctct ctccacacac acacacacac agagagaaaa tatgaaataa tttttaataa 186420
atattaatct cacctaact cccactaaaa gaaattctaa gtgaagaaag aaagggggaa 186480

tgaagaaat gattaaagaa catttttaag ctcaaaattc aggaaaatgt gtatgtcttt 186540
 gttaaggtta ctattgattg ctgcaatgaa aacacatga cccaagcaac tagggaaggg 186600
 caaggtttct ttggcttaca cttcaatatac actgttcatac actaaaggaa gtcaggacag 186660
 gaactcgaac agttcaggaa cctggaagca ggagctgatg cagaggttat ggagggttgc 186720

 ttgctatggt ttgctatggc ttgctctgcc tgctttctta tagagcccag gatggcacca 186780
 ctcaaatgg gctgagccct gccacatcag tcaactaagaa aatgccttac agccagatct 186840
 gatgaaggca tttctcaacc aaggttcctt cctttcagat aactctagct tgtatcaagt 186900
 tgacataaaa gtagccagtt tacttctaatac agatcctcaa gacctgttaa gagtgttaag 186960
 gtacacagac aagactgttt gctctataca aacttttga aacagcaaaa ttgcaaaaa 187020
 atgtgattgt tcatatggtt gtttggtag gtaactata gaaccttctg catgcagttg 187080
 ttttaaaata ctaatgtgag gctggcgtgg cccagggtga gagcacttgc tgctctacca 187140

 gagaaccac gttttatccc cagtaccct gtaagactat tcacaactgc tgtaactcc 187200
 agttccaaat gatcctccac ctctagcctc tatgagtacc tgtactcaca cacaaataca 187260
 cacatatgca cataaataaa aaagaaagca aatcttttta aaacgcacaa taaatacata 187320
 acaaggaat agaggcaag atccatggtc aagccccag tgttcagag tgaataataa 187380
 aacgagaaca gggcagttt tataggtgtc tgtgtttgca gatgtgctgt agcgggccta 187440
 gaatgtcact gagaatgtat caacacagtg acctcagaag agaaacagga ctcaggatta 187500
 gtgaacaacc ttaaacagta gacacgaatg aatgaatgaa tgaataaatg aatgaatgaa 187560

 tggatgaate tgatgattta tcctattcta ttaatecact gccaacctac tatagtactc 187620
 ttttaaaaa ttttttatt tatttaattt ttcatattt tgtttgaaaa gtatgtacat 187680
 gcatgccaca tgaatgtgtg gatgtcagag aacaactgt tctatcatgt aggtcctgag 187740
 aatcgaacte aggtcatcag gctagacagc agatgccttg gcctgctgaa ccatctcacc 187800
 aaccctctca acagttctct agagaagtgt gttacccttc agctctgtcc tctttatcta 187860
 cagggtagtg cagacttctg gtctttgtgt gctgatagaa ttggcttttc atccatgtgt 187920
 caacagcctt gaagacattg ctataacaac aactttcaca ctatgcttta gttggttgc 187980

 tgctattttg cagatgcagt ggttgagtaa agggcagtg gcactctgcc attggacata 188040
 attgacattc tcttctctg tcttttaac aatgactgt aactcactaa gttgacttt 188100
 cctcacctt aacatgaaaa ccctcatagg agacttagca tcttttagaa ctgtgatgaa 188160
 gactggagcc tggcactcag ccagaatgct ggacaaggcg gccctatta ttattgcttt 188220
 gtccttgctg gacaacagtt aggtaagagc aaggtcggct tcgttgtctt catatgattc 188280
 cctagtgtct atacaatatt gatgccatt ttagaaacct gaatgtcacc tggcaatcct 188340

ttagaaaagc tctgaaaaac tggcatgaaa gccagagtat gggtcagtga acaccagccc 188400

 caccgtgatg tccatgagtc aggtgggaag ctataggaat gataccactc ctgggatag 188460
 gtggaattgc aggattctcc ctgtgggta ttcaagggtc tagggttata gacatcattg 188520
 ctgcttcttt tctgtgttaa tatgttgag cttaatatgc attattcata ttagcaatgg 188580
 ttcttcagg tgaactctgg tcagagggtt tgtgtagga ggtttctga taaaactcct 188640
 atgagatggt ccattttagt tgcaaatgtg gagttgcatg cctgcctggc cagtaccatt 188700
 atgtgtccat taagtgtgt aggcatcaa ctatacacag taatgaggct ctgtgtcttc 188760
 tgtaactgct gcaaaagttc ctaggactat cacttgcctt gccaagcaa catctgaagc 188820

 atggggcata gcctaccta agtatttggg gggcacctct ctgtgctcct cctagcctgt 188880
 catcatttgc ctctccctac atcctggcat ataccactg cagcactcaa ttgcaaagtg 188940
 caaaagaact catttctttt ctgatactct gcatgagccc atccacaagt tccccctcc 189000
 ccatccagct gctacctgat gttaagcaga gctatctgga gagctgggat ctggacagac 189060
 acatcgctca gaggtgatt cagcagttct ggtgactcc aggaaattcc tctagggtg 189120
 atctatctgc taggtgtctc tccaattctg tcttgagaa acaccaatgt gaacctcct 189180
 ccttctctaa tagcaacct taccagcacc ttctggagag atactgtcct tgggcacat 189240

 tttcagtcac ctagtctgc tgagaagatg ttattgacca cagccttggg cacgatcctg 189300
 gaattccata gtcagccatg gtgtatacct ggcacttaac cctccaccac accaggagat 189360
 gccagtagtg gcttaagtga gggaagcacc aatgactaac aaagcctaga gctacacca 189420
 gcctatccct tctccaaaac cctgtgtggc ctcatgtggg gactttttaga aaaatcgcta 189480
 gagtcatttt ctctgaagc tctaactaat acaagctcct gtgcagacca ctgctaccct 189540
 gatccatctg gcttcaccac caactccagc tccccacct cttctgtctt gccaacaaa 189600
 gttctgaaaa caacattgct gagctcaatg tctttctgcc aatcatgtca gectccttc 189660

 agcagaggct cctcaacctg ctcatccatg cccatctggg gtagatgtca ctagtgcac 189720
 acccctact ctgtgcttcc tttggccttt gggtttactg gccagcatcc ctggaactgt 189780
 ctctgactcg gtctacctca gcagagcagg ccctaagggtg atcctggctg gttgttctct 189840
 tctgtaattg tccactgaat aaacaatgta ggtctcaacc acccttctga ccctcaccta 189900
 atagaaaagg cttatgcttt gtctctggtg tctggggaaa gaaggaacgt ctgtaatgg 189960
 gccaatgtc tcaaaaacct tcagactcat cctttgcatt gcttgctacg ttctgagag 190020
 acttgatctc tttttctca actgaggagc caggatacaa cggcttctct taacacggaa 190080

aagatgtctt cccaatcaga ctccgagggtg agcatgtctg agaagagtgg gaaggcattg 190140
tataaaacc ttggctgcag aatgcctttc acctttgctg ccaactgcat ggcaaagtgt 190200
acagatcata agcaaacagc acgccacaag atgaaagccc caagtgggaa agcaccattg 190260
ctcacgcca aagcatatgt gcttttctgt tggcaatgga gtgcctgcca ttgtttctcc 190320
aggagttaa tgtgtcgtgt ggtacaatgc catccaatc tgcaccccg cagcaggaaa 190380
gggggacggg atgacacttg tccactgtgt gggcacgttt ctctaaaatg aaggcttggc 190440
ttgtgtgtgt ggcagggagg actggaggct gacctcctct gtaaaggctg ctacacttag 190500

catctcatgt tggaggcaac aaaaaggaag tgtctacagt aagggttcag tgaaggaaaa 190560
gaaggcagct cacaaagcca tgtgagagtc ttaagaatgc ccaaattggg cgggagagcc 190620
aactcagagg tcaaaagcac ttgttgctct ttcagaggac ccaggtgcaa gtcccagcac 190680
ccacattaca gttcacaact gtctgtaact gcagttccaa ggggtccaac actctctccg 190740
ggcctcgatg ggcaccaggc gcacatgtgg tacacatata tacatgccga caaaactc 190800
atacacatta ggtaaaacta aataattaa aaaccaata acagggagct ggagagatgg 190860
ctcagtggtt aagagcactt cctactcttc caaaggfcc aagttcaatt cccagcaaca 190920

acatggtgac tcacaacat ttgtaatgag atccagtgcc ctcttctgac ctgcaggcat 190980
acatgcagac agaatactgt atgcataaat aatctttaa aaaaaaaaa agacttcaaa 191040
aaaaaaaaa aaaagccagg cgatgggtgc acccgcttt aatcccagca ctggggaagc 191100
agagacaggt gaatctgagt ttgaggccag cctgggtctcc aaagccagga gaggttccaa 191160
agctacacag agaaacctg tctcaaaaa ccaaaaaaac gaaacaaaac aaaacaaaa 191220
aaaaaaaaa aaccaataa cacctattc ccctccaaa tcccagagaa catctcagaa 191280
gaggagacag agagctgtaa gagctaaaga gtgagggaaa gtgccatgaa cctcttgaat 191340

atcctttggg attatectct cctctattat taattcattc agtagtact gagggaatct 191400
tactgatgat aatattctcc tatgtccaag cacagtact gctactggta ttgcaggaac 191460
actcggagaa gcttgcatc tagtgagtaa gagcagatag taagcaaata aatcaactca 191520
ataaggagac atacaggatg tcaggtgagt agggaaaaa agggggaagt gctaagggca 191580
ggcagttgag tcacaagctt gagtgggttg ggaagagaag tcctcttaca aatgaaaaag 191640
tgacggacat ttgaagagac cagagcatgc atgcttctga taccagatg tggagggagg 191700
gtgtcccaga gcatgaatag caagggcaa ggccaccagg taggagcatg cctagaaag 191760

cgtgtgggca atgcttagca cagtgagctc cctaaggta ttcctagcc caacaggaac 191820
cacagggaga aactaactt catgctaagc accccttgtt catatgtggt ctgcaactggg 191880
gatctgggca agcctcctgg gaacatcaag cttaatttat gcaatattag acatctatag 191940

ataaacctcc ttgtttctcc aaatacatag aggatttagt tgcttagcaa caaacatac 192000
 acctaaaata caaatcaata gagctttgat tatattaaaa cttcagaggg gattattttg 192060
 gcatcattgc ctctcttata aatgttttct tagaggcagt cataaaattg gcatttgagg 192120
 gaaggcattt ccgtgtgtgt gtgtgtgtgt gtgtgtgtgt gtgtgtgtgt gtgtgtttct 192180

 ttactaaaca ttcagagctt tgaaggggga gatztatcat gacatagaat ttttcatttc 192240
 aagtctctga ctigaataa aaaaaggaaa tttgataaat gtaggtacat taaaagcagc 192300
 agtgtcgtac agcaaaatac catgaagaaa attaaaaagg aaattgaaa attagaataa 192360
 aatattttaa acagagaaaa agactagtat atgccatag caaaatcagt tggcaaaatc 192420
 attgccacat gagcatgaga acctgaattc aatgccaga acctatgtaa aaagccaagt 192480
 gtagtggcag gtgcttccac ctccagtgtc gccacaatgg ggactggcag atccccagg 192540
 ctactggtc agcctgcctg gcacaaacag agagcccagg ccagtgaaaa acctgggca 192600

 acaaaacaag gtaaacagtg cctgaagagg tcagggcctc tgccctgcac acacacacac 192660
 acacacacac acacacacac acacacacgt gcacaaacat gtatgtgcag atgcacatat 192720
 atgaccagaa catgaacaca tccatcctca tacacacaaa aaaaagaact tttgagaagc 192780
 aaaggacaga atgactacta gaaaaatgga gacaaataca cagacagttc gtataaaga 192840
 tacgaaaatg tcccacatac gtatgaaaaa tgtataaaca actacctta gaaaacttca 192900
 gtgctagaat gtcagttctc acctatcaga ttgggaaaaa attaagagca tagcatctca 192960
 tgggtgcggg gaggcctgga ggtcattctc ttgactcact actgggagtg cagatggcac 193020

 gatgcttctt gggaaaatca ggcagtttct cagaaactca aacaggacce atccatgtea 193080
 cttctagaaa cccgccctca agccacagca ccaaaagcac agacatatct ttttaacatt 193140
 ttatttgttg tgtgtatgta tagcattact gaaatccatc tcaataaaca tgctcatagc 193200
 agtagctaaa taaacgatga tatgccatt cactgaatta aatagatgac agtatatccg 193260
 tcaactgaatt acttagcagc gtaagaacta aggactgtag tctagaaaat ggtattattc 193320
 tggggctaaa tgagaaaagg gaattgcaaa aaaaaaaaa aaaaaaagt tttataatat 193380
 gctaactttt gtgtaagaaa gaagcagata tgaataaca cctgcatctg aaaatctatg 193440

 aaataaaaaa tgcagaaatt aaagaagctg tctgtctcca aggatgagta gaaaggggta 193500
 aaaggatggg ggggtggagta gtaagaataa gctgggagct ttcattctta aatcatagt 193560
 aatggtatgt gttttccaa aagtaacaa tacttaacta aatacaacca ggatgtggag 193620
 agaacctgaa atgaaatcca aacagtaaca gatgagatca atcttacaag taaatgatag 193680
 agttacagtg ggggagatgc gggatgtgga gtcagtccag gaactaggaa acgtcact 193740
 ctctgaaagc aactagacaa atagtacact gttgttggtt gtttttactc tttagtcttt 193800

tgttctcttc tgaggggect gccacccagt ttccaaataa ataccgggtg ttttagacag 193860

 gcaaagtaac aaagcttcac agaggtaaac aaatgcaacc taaaggaatg caacaaatct 193920
 ttgcatcatt aaacaaatgt tcctccgcat aaacaaatgt aacacatctt taactaatat 193980
 tctgcaacag taacctattc tagtaaatct acttctcatt ggaggatgaa ttgataatgc 194040
 tgtaacttct taaaatatgc ctggtaggga ccagggtgtgg tagctcacac cttaaatccc 194100
 aacattcagg caggcagatc tctgtgagtt caaggctagc ctagtctca tagtgagctc 194160
 caggacagcc aacctacat aatgaaacac tggtagacat gtagtgtggt atgtgtgtgt 194220
 gtgtgtgtgt gtgtgtgtgt gtgtgtgtgt gtacaatatt tgtagtgtac tctgtcccaa 194280

 gggcagagag agaagctgta aatatgttat gaaatatcac ttggacttgg aggagtggaa 194340
 ggaagccaca gagcttcgga tacatagggt tccacatgag cagaatgaac agaaatgaac 194400
 aggtgaaaac atagatatct gtgctagaat gcatttctca cttcagtcca ttagaagagc 194460
 tttagagcaa tgatcctctt agaggccgta cgtattttca gggctcccat cctgaggtca 194520
 aacatcactc tttaacacaa agagaattct ttggttctag gactgaagta ggaaaaacgc 194580
 aaattgggcc aggagcatag tatgatacca gcaagagaag aggggctttt tttaaaaaat 194640
 gaaggaagga aggaggggaag gaaggaagga aggaaaacat gggcaacatt atggtgatac 194700

 agactgtaac cttcagaata aagaaaatat cttaagtccg tacttaggga tgaacagagg 194760
 agagacaact tcicccata aagaattcca acaatgaaga aatggaaatt ttcactgaa 194820
 ctccactaca atcattgctg ttggcaagat cagaacgtgc taaaattagt gggtgaaaat 194880
 atagtcatca acatgatatt cctgccaaaa acacatactc ggaatctagt ggagagaaaa 194940
 catcagaaa acccaactg acagacatgc taaaaataa ttgaccagta gtcataaaaa 195000
 gtcacaagtt cctgggaagc cacacattc aggggtgcta agaaaacatg acagctaaat 195060
 ataatgaagg atgctggact agatcctaga gccgagaaag gacagggcag aatggactgg 195120

 aaaaaccagt atgtctgagt gaacagcatt agaccaaagt tgattgctgg ttccaggcat 195180
 ccgctgtgg ctatgaaagt tgttaacctg aggacaggct gtccgaaacc tctctattct 195240
 tggcaatgtt tgcctcag tcaaaaatgg cttcaaaata aaactacatt ggagtgaag 195300
 actctaaagc catctgtgt tgaagctccc acttgtatct agttctccac acagcagaga 195360
 cgtgtctcct tgcagtgtg gacagagcaa gtgctgcct ctgccattgc tgctagtccc 195420
 aatcagata tttgccctc agaatccaac tttcaagagc aaacatttat tctggctgag 195480
 tgttgactc tggacatgag gctcctgtgg accctgtcac catgtatcta tgtccactat 195540

accctccct ttccctttc tccagctttt catgggtaga tccagataac ccatacccta 195600
 atctcttaga ctaatcataa agaaatccat aggtaactac cccatgttac tattataaag 195660
 ggatattggg gatgctgaaa attaaattca tatcctttgt ctatcaagt gccttcatgt 195720
 cctatttgat aagagaaatt tgaatcaata atgtggccta ttacatgaa gggacagtgt 195780
 tttagctatg agtacagct actactattg gggattcctg tggagagtt tagattcacc 195840
 ttgtgacaaa ccggaaatca tctcatcaac ataaattaaa gggcagggag agtgggcat 195900
 ggggacagct cagtgggaaa gtgttttctg tgcaagcatg aggacctgag ttcaaatccc 195960

 cagcattcat ataaaaagcc acatgttatg attcatgcct gtaatcaaag ctctgggagc 196020
 tggagctcca caggaggtta gggggaacag ttcactggac agacttctgt gagctccagg 196080
 ttcagtaaga aactgtctca aaatataagg tggaaatcag tggagaggt caccaacatt 196140
 gaaattgtgt ctccaagcac acactcaaga tacacacata cacatataca cactcacaca 196200
 cacaataaag taictttgct aggaacctg ggcagtgatt cagaatgttt taacaaaaca 196260
 agaaaatc ttaaagtaga acttcacgtg agcgtggtga tggaggtgta agtcagagtt 196320
 cccagctaag cacttcaatt gcgctctgtt atgttgtaaa taagtaatgc cctgaagacc 196380

 cggacactga aggcgtggtc cccagctggc gtatccaggg atcacaccac aagagctcta 196440
 acatgaccag tgcagtgatt gatggatggc atcataatct gatggcatta ttagaaggcg 196500
 gtagattctg gatgtggggc ccagttgcag gaagtagatc actgggatac atcactgaag 196560
 gatatttggg ccaggaggtc cctacctctc tttctcttc tctttgtcc accatgaagt 196620
 gagtcacttt gcaccaacac atgcttctg ccaaggatat tctgcccctc catgaatagt 196680
 cccagaagca atggaaccga gtgactgtgc gttgtgagcc gtgttaaatt tttctcctt 196740
 aaagtctctc tcatgttctt gccacagtca tgaagaagtc aactaatatt ctctccttgt 196800

 aaaaacagtg gtgataccca tttcttttac ctctttggca gctgtttaa tagcatcaaa 196860
 ttctgtaact tccatttatt agagtctca ctccatctc cagcactaag acttggtttt 196920
 ccatatttga tagcataaag ctattaaatc cttagctctt tttttcttt gataagtttt 196980
 tgtatgtttt ttttttagat gttctcactt tgtagccag gctgctcttg aacttgtgat 197040
 cctctgcct cagcctgctg agtttagctc tttttgata tattgacaca atggactgaa 197100
 gggagatca aatcactta cttcaciaac tactaaatgc tacctttaga ggaatacgac 197160
 atcctagcat gggataggtg gcacataaag tcagtgtgct catttgagtc attggtggga 197220

 agcctaattg cccatttagg ggaactgagt ctttctaaa aatccatag gaggggctg 197280
 gagagaagge tcagaggta agagctttgg tagctcttcc agaggctgag ttcaattccc 197340
 agcaccaca tggcagctca caacttcttg taactctacc ttcaggaat ctgacacct 197400

cctacaggca tacatgcaga caataaataa acgcacaata aataaaaata aataaattat 197460
 tttttaaat ccatatagaa ccaaaagcta cagtagagag ggactgaaga ttaagggact 197520
 gtgtagacta aatacctgat gacttgggat gacttccttc tactcttagc cctaagacaa 197580
 tgttgcttag caccacat aataccacgc agcttcagaa atgccatctc ccctcctgaa 197640

 actgactaaa atgactaggg agaaacaatc ctgctaaaga aacctgacac cacaaactaa 197700
 actaatttct tccaacaga atgaagtctg gggacattga tgaaaacaac caaaaactga 197760
 ctcacagaaa atgtgcttcc caactcattc agccacctca gtacattga ttcagacacc 197820
 aaagccaaaa gaggcctcac agcaatacta ttactcagtc ccccttctga ctgtaaatgt 197880
 taaaatcctt ggttgaattc cagcaaaaaca aatctgtgta aagcattata tactgtgacc 197940
 aagaggaact tatcccagga atgcaaggac ggcccacat gaaatgcaag gacagtccac 198000
 catgaaattg aaggatgtat ggtccacat gaaaggacca atcaactcta catcactaaa 198060

 ataaaggaga aaggccacac tgtcatctca actgaatgag gaaaagcacc cgacagaacc 198120
 taatgctctt tatattcact aggagcagaa ggaaacactc ccaactcagg aaagactatg 198180
 tatggaace ccaaagctag agtcatagtt aacaataaaa acctgaagtc tetttccttc 198240
 atgtcaggaa cagaatgaga tgtctgttct tgcccttct agttaatact gcctggggg 198300
 ttctggccag agcggttaca tcaggaaaga aagccaaagg catctgtatt ataaagtaa 198360
 aagaaaaact ctctaattcc aatgacatgc ttttgtaaat agaaaattct aggtaatcaa 198420
 ctaaaaaact ctttgaatta gcaagcaatt ttaacaaaac tgccgtttat aagcgcaata 198480

 taaaagttag ttacatttcc atatactaga aaacttata tcttgggata aagcccattc 198540
 ttgtccagat taagatcagt aagaaaggt caatgagaca acccagacaa taaagatgct 198600
 tcctggctgg tgacctgaat tcaatccctg aaaccacat ggcagaagg agctgactcc 198660
 tataaactgt cctctacct ccacatacac atgatgacgt gattgtgagt gcgtgtgcgc 198720
 aaatacacac acacacacac acacacacac acacacacac acaccaac ttctagtagg 198780
 cgattagagc aaggtttctg tgtacacact tagccatca aggagcagtt agaatttat 198840
 atcacaaaat aaaatgctta tgcacaaatg aaccaatac ctataagatc aatacagaga 198900

 aagctacaaa actctgatga aagaaaccaa agaataaat gagactgttt cctagatata 198960
 ggaaaattca gcaaatacca tgttatgggg gctggaaaga ttgctcaagg ttatgaacat 199020
 gtgctgctca ggcagaggtt ccaagttcag ttcccagcac ccacagagg caggtcacia 199080
 ctgctgtca ctccaactcc agaggacca atacactctt ctggactcca ccagcaccaa 199140
 cactcacaca tgcatatgcc cacaaacaga aacatacaca cgtacacata attaaaaaga 199200
 aaagaaattc ttaaaaataa atcttatgca tactgacaag tgtattcaa acttcatttg 199260

tcaaagcaaa gaaccaata tggttgaagg agtaaaaaa agccaaggaa ccatcactac 199320

ccaaattcaa aactcatggt aatggagcag agtagaaaac ccaggaataa acccaaatag 199380

acaggatgat ctgaacatta gttacgaggc aaaggcaatt ccatggaaca aacaacaaca 199440

acaacaaca aagctatttc agcaaatggg ctgctgaaat aaatagaatg tgaatgagta 199500

tttcacaatg tggacacaga tttgatccct ttcagaaaga gtcaactaaa agatgaaatca 199560

tagacacaac tttaaacatc atacatagaa aacagcatgg gagaaattct aggtgttgtg 199620

agcttgacca tcaactgttta gatggaacat taaaaacaca gcccatgaaa ggagaactga 199680

tgttgggctt cattcaattt aaaaagctgt gtttgtgaat ttaaaaaaa gtaataaaa 199740

agaaaagcca caggcttggga gaagatcttt ccaaaacca tatccaatga aaaactggta 199800

ccaagacaa agaaccata agaatgtatc cctaggtctg gagaaatggc tccatgcttt 199860

agagcactgg ctgctttccc agaggacctg gattcgatcc ccagcacca catctataac 199920

tccagttcta agggacctga tgcctctgc acacactgcc tctgccttc tggcctctgc 199980

acacactgca cccatgtggt acacagacac acatgcaagc taaacctcca tgcataaac 200040

ataataaaat taaaaattaa taaaaatgaa cttaacata aaaactcag gtattattg 200100

taggaatgcg aagtgataca accactctga acagcagttg cccattttct tatagaatta 200160

aatacacatt tactatctct tagttgaata agtaccagg aagtgtgatt gtaactgcta 200220

aaacttgcaa ttaaccagaa tttccttcaa taggtgaaaa attaaactgt aatgcattca 200280

tgcaatgaaa tattattcag caaatTTTTG aaaatgggct agtaagccat caaaagatac 200340

atagaaaacc tgattaaata catctgttga ctgaaaggaa acagcctgca aaaggcatgt 200400

atatactgcc agcaattctc agatgagggt acgtatggct cacttctcc aagtgtttgg 200460

ggacactgct agactaaata gctttaagga acatttatag cttaaaacat ggttgttgat 200520

tttttaata ttttctggat ttctgagtgt tgetattatt ttgctttgag tatttttagt 200580

ctagcttccc agataccaca aggggtgtga ctttgctaca ccatgatgca cccagggcaa 200640

tcagacaaag caatcatgga ccaaaacttc tgaatcatg agtcattaac tttgcattaa 200700

tctttctct tctatatgg ttttcttgg gaatctgata tagccatgga agtttaccag 200760

cacaaattct caaaatttta gtagagtatc aaaggtttaa ttcattgctta tatgttcac 200820

atggatctga cgtctctccc tgteccatgc cacctcccct atgaaatgag atgatttttg 200880

ttttatTTTT attttgaga cagaatttct ctgtgtgtaa cagccctagc ttcctggaa 200940

ctagtctgt aagttaggct ggccttgaac tcacagagat ccactgcct ctgcctctgc 201000

ctcctgagtg cgggattaaa ggcatgcaca atcaccaccc aacccttttt ttttttttaa 201060
 gaaatttatac tagcaagtgg ctttgcctcat ggcagtgatg aaaaacttga ttttacactt 201120
 tttttttttt tggtttgggt ggcttgccata catatacatc tgtgcacat gggcatgcct 201180
 agtactggag ggagccagaa gatgagttaa gatttcatgg aattggagtt acagatggtt 201240
 gtgaaccaat atgtgggttc taggaatcaa acctgggtca cctggaagag caaaaagtgg 201300
 tcttaacctc tgagtagtca tctctctgtc tccaagaact tgctatcaag catctgctta 201360
 tatttgcattg gcattcacttc tgctctgatt ccatgaaata agtcaaatca cacctcctga 201420

cctcaaccaa gtggagatat gtgatcctcc caaacgggaa gacacaaggc ccaaggccaa 201480
 ttcaaatccg ataaggtaga gatctggaat agacacaaca ggatctaaa atgcatggaa 201540
 atagtgtgac ctatgaatga agacatttgt caggcttctc tttatttggc tgactttaga 201600
 aactactgcc agacatttcc tcccttaagt tctagatcta ttttagatgg atttggcttg 201660
 aaacagttaa ataattcatt agcgcacaac tcaaatctag ggcaggcaag atggcacttg 201720
 ccatccaagc aagacaacct gagcttaatc ctgagaatcc acatagaatc tagtggtttg 201780
 tattcaaat ttagccgagt atgtgagact aatgagatgg ctaagtggta aagtacttgc 201840

cactccggca agaaaactgg agtttcaatt ccataaatg acaagaatgc tggatgagtg 201900
 gggcagccca cctataattc cagttcctga gacaggggat gggattcccc gtgtaaatta 201960
 gccagtgaat cttagcctat gggcgaattc tgggtttaac tgatagacca ggcctcaatg 202020
 aataaagtag aagagctgtg aaggaaagat tcctgtatc atcttcaagc cttcacatga 202080
 attcacatac aaatgcaccc gcacacacat gtacccatgc gcattgcaac acaccacaca 202140
 cacacatgca caagaaaagc atccctgggt ccagtttctg agattcattt ccataaagtt 202200
 ccacatattc ttataaactg cttaattctc ctctggatat agttatgtct tgcattcaat 202260

ttttattaac cagtacagca cagcacacat gcttgtgcaa cctgggatgg ttgtgaggtt 202320
 agtcatatga ccttctgtg gcgttttttg tgaagatcaa acaggaata tatgactgg 202380
 tgagagtage tcttatcca gctcactatt agtgtttgac tctctctta tatcgtctat 202440
 aatcttccag atttgttctt gttcatttat tggtttgtct ttaagacag tttctctgtg 202500
 caacctagac ggtcctagta ctctctccat agatcgggct ggcctcgaac tcaaagacct 202560
 acctgcttct gcctcccaag gcattgtgca ccaccatctg actcagattt gttcattttt 202620
 tacactttat cttagggcag aattatatac attcttctct aagagctggc catggagttt 202680

taatggtgac tgacttctcc tgtgccaatg acctgtact acaatggtaa gtttaagtaaa 202740
 tagaatcact gggatctgtt caagggtgat gaccttacca tacaagcat gtgtaaatgc 202800
 aatgtctctg ggtaaacatt aataaggaaa ttaacatttg ctattataat ttcacagcac 202860

aatatctatg ttgttctttc cccaatTTTT tcatgacaaa tttattcct tctgcatcta 202920
cttccaccaa aagataaaaa tgatgatgca gggaagccat aaagtctctc ttaacctggc 202980
cacaggaaga ggaaaaaaat ctggccattg attccccctt gtttcctatg aggaaaccgc 203040
ttttagctca ttaacttctc atttttgtat gactttgtca agtttatatc tcttatggta 203100

taggtcacia agctagaat ggggctatgt aaagaaagga agagtcttaa gggaggtagg 203160
agaaagaggg taatggaata taagaaaata gaagtgggga ttaacttggg aagccagaca 203220
gaggcagaga ggggaacgga ggagaacaaa gtataccagt atatataca agatgccatg 203280
atgagacccg ttacaatgta tgataatcca aaactgat ttagaaaaga taatgcctta 203340
tagtaatgtt tataggaat taccaaactc attaattagc atagcttata tttttaaac 203400
tttagtcaat aaagctgtca catatccaag ataatatgt taatttgaag tggaaagtct 203460
tattaataaa tatgtttgaa gaagacaaca gtgtcattat gatttatctg aaacatcccc 203520

cagaggctca tigtttctga cacttggctc ccagctgctg gcatccctt atgaggttat 203580
tgaactttt atagggggc tctagctgct ggaagtgggt cactgggtga gccttgaagg 203640
ctatggctcc cgttccaggc tcatggctc tgtgtcctag gcagctatga tatgagggt 203700
ctccacttta cactctgctg ctaccagatc tgctgtggct ctatgcctt tccacatggt 203760
aaagtgtgcc ctctaaaacc atgacccaaa taaacctccc tgctgttctt aaattcctc 203820
tcttgggtca gagcattgag gaaaagcaac agagacaagt gcatcaaat ttctaccag 203880
agcatcaata acctagttag aactacctc ttgctttctt cttctctgtt cagactgcca 203940

accataccgt gtacttcaa aattcttgtt aattcggta atcttaaat aggtatatgc 204000
tttttttct tttgtttac ctattcgtt cagaaaatat tcacaagagc tgggtaagtg 204060
actcagtgtc agatgctgc cttagacata tgagacctg aattcaatc acacacacac 204120
acacacacac acacacacac acacacattt ataataatat aaaagaaaac ttgaatttaa 204180
ctcttaccba agagaaccag ataatgttag taataagata agctaagaaa aagatcagac 204240
aaaaaaaaag tgaagttttc tgtgtgtcac cacacctc cttaaatcta ctgtgtcagc 204300
atagcaatta gaaaaaagct tgcgtccctt ctgaaggagc tgtcattact cctgagaac 204360

ctaagttctg agaagggaca gaagagggga ctgttctca cggtttcta aataaactg 204420
ccccctgtg gtctaatctg gagttgtggt accgtttcaa tttctcatga tcaacaggca 204480
gtaagaatta acttccaaa aggctttctg tttgagttgg atctttaga gcaagaaag 204540
ctatctccat gttatcttac gcattctaaa taaaatattt ttctacaaat cagcccaat 204600
gacaattcat tcaattctc acttggtaac tacgtagtta ccaagcagga gacatattgt 204660
gcaaaagtta ctatgagagt gaataagaac attctgtgtt tatagaacat gagatgttat 204720

tccttcactg cttgaaaaca cacactttta aagctgtggt tgagctcaat ccaaatttgc 204780

cactaattgt gtgactttgg acatgtcacc taaattgtca cccaggtgtc tttgtgtgca 204840

gaactggata tcagcattgc ctgcttcata tagatactta gtgctctgtg aatattaag 204900

aggtttcata gaaactgata ttttctcaga tgaagaagcc ttggggaaga ggggttacca 204960

ggcacagttt ttgtgggtgg agaaaagacg cattctccag gatccatgtt gataatgttc 205020

gctcctcaaa aatcaccaaa gcttaggtaa aacattgcta gatgcgtaac tgctttgaca 205080

tataaaaacc tgaagccag gtgtatattt gcctgtagat acaaaactct gaaagctgtc 205140

agaatgcca tctatggcaa tcaactatac tgattgtgct acatctgtac agtgatgtcg 205200

ggaagccagc ctaagaaagg atgaagcaga gctgtatgca ttgggatggc tcagcctcgg 205260

tgcaacataa acagaaaact ggaatgcaca accacaagct gtgtgctctc atttgtttaa 205320

aggtagctca acacatgcaa ctgtattcaa aggcgtgccg actactgggc agagaatatt 205380

gtacttatca gtgtcctgac cgccttagga tgctagaatg tcgtcagaac ttaggggctg 205440

gacatttaaa gcctttgcaa atattgcca gatgaaaact gggcttctag aggagatgga 205500

tgtgacagtt aatcacatat gtgggttggg aatcacctag atggcgacct ctgcatgtea 205560

tgtctctgtg tttaaagagg ttgacggag gagagaagac ccacctgaa ctcagtgga 205620

ccatcccatg ggcgtgtagt caggactaca ttacaaaagg ggtggggcag ttgagaacca 205680

glatgcatct ctctgattcc tgactatgga ccagtgtgag cagctgcctc acactcctgc 205740

caccacagct agagacactc ctgtcacctt gcctttcttg ccctgatgga cctacacat 205800

tgactaaaat aaaccttcc ttaagttgcc tgtgtcaggt aatttgtcat gagaaaacta 205860

atacatcata ctaatacatg atctggaaag caggggtgag gaaaagccag ctttctgctt 205920

gttattgtcc tcaaatcagg agacagaagc agagaggtga cagtgggtgaa gtcactagge 205980

caccaggat ctattctcta tcttcagat ggaagaagtc atggactttg ctttctgtgg 206040

ctgtattctt aagcagtggc tccattcaa ccctttgatg tcacaaagac ctggttcct 206100

aaattaaatc ttatctgcat tcgcttctag cactggacag ttagatactt agaaaacaag 206160

tatttctct gtgtgggtta atatgaactg ccgacctcat ttgaaagc agcccagata 206220

gctggtaaaa cattaccatg ggtgtgtctg caaggtgttc tccgaacaca ttagcatttc 206280

aatcagctga cctagttagg aaagctgcc ctcagtgatg tgggtgttcc ttgaaggccc 206340

agaaagaaaa ggiaaagaaa aggcaacttc ccattcttcc aagacactaa agctacagge 206400

tctccaacct ccaaatttgg agacaaagac tggaatcccc tctatcacgt acctcttcc 206460

agattcagcc tggagccac actttcccta gttctccatg atgctagcag cagcagatca 206520
 tggatattct gagccttggc agtctcatat aaaatatgac ccgtgggttc tgtttctcca 206580
 agggaaccta agacaagtct ctacctggaa gagaggtttt ccttttcctc atgaacctta 206640
 gtatgttata agaaaatgtg tgcgatgaat atattttata aaaggtagct ctatgagtac 206700
 tgatctgaaa tcacagctgt gtcattaaac ttttaacaa tgacaactgt gttatatatc 206760
 ttattttctca ggcacatggg gaaaatccat atatagacgc tacatatagt ttggaacata 206820
 tccaggcaca cagaaactg cacaacaaaa tacttgtttg taaatgtttt ctgagagcct 206880

 ccagatagct ggatgaaggg attagagtca tcaccagacc ctgtgaacct tagtatcttg 206940
 ggccctgtac atgaactgcc tgaaaaataa aaaaaataaa aaataaaaaa aacaacctct 207000
 agtaagtttg aaaaagaata atttgcttta gccaaaggcac tggatcttg tagctgataa 207060
 atgggatgta agctgggtga gttgattgtt ttactctttt gttcttttagg ggccctcac 207120
 ccagctccca aataaataca catgiagttt ttattattac ttataagtgc ttgactttag 207180
 cttggcttgt ttctagccaa cttttcttaa attatcccat cttacttttc tctattctat 207240
 ttactttgct ttaccttta ctctgagact ggctgtgtag ctaggttgct agccctgggt 207300

 gtccctgtttt tacttctcct ccactctctc tcccagagtt ttccttctat ttattctctc 207360
 tgctgccag cctgcctat ctttctcct gccttgccat tggtcattca gctctttatt 207420
 agaccaatca gatgttttg gcaggcaaag taacacagct tcacagagtt aaacaaatgc 207480
 aacatgaaag aatggaacac aagccgggca gtggtggtgc atgcctttaa tcccagcact 207540
 ccggaggcag gggcaggtgg atctctgtga gtttgagacc cgcctagtcg gcaagagcta 207600
 gtccaggac agcctccaaa gccacagaga aaccctgtct taaaaaaaaac aaacaagggg 207660
 ctggagagat ggctcagaag ttgggagagc gctgattgct cttccagagg tctgagttc 207720

 aattcccage aaccacatgg tggctcacia ccacctgcca tgagatctgg tgccctcttc 207780
 tgggtgacag gcatgcatgg gggcagaatg ttgtatacat agtaataaa taaatcttaa 207840
 aaaaaaaaaa ctggaacaca tctttgcac attaaacaaa tgttccacag cataaacaaa 207900
 tgtaacacat cttaaaatga taatccacia caggctgggt cttaggcagc acaatctagg 207960
 agaaaagggc aactgggat tttgaaactg aaaggaaacc tgagtttct actccatttg 208020
 tttttgttta gaaatcttc actttcaggt ctagagagat ggctcagggg ttgagaacat 208080
 tggctactct tctggaggac ctgggttctia gtgccagtac ccacatggca gcttgaacc 208140

 aactgtgacc ctagtccag ggaagccaaa gccttttct ggctctca gtcactgcac 208200
 acaagtggga cacatacagg caagacaact atacaaataa agttttaaaa ataattttaa 208260
 aaaattttaa gatcattcat cttcaaggcc actcagctga gcaatagat actttcccat 208320

tagctttact ataagcaaca cctctagcca ggtgtggtgg tgcacatctt tggcctcccg 208380
catatatgtg acatttgtgt agcttggctct tcttgtggaa ctccaacag tgggagcagg 208440
ggctgtctct cattcagtta cctgctttgg ggactctttc ctctgactgg gttccctcat 208500
ctggtcttaa taggagagga agtgcctagt cttactgaaa cttgatatgc catggttgg 208560

tgacatccat gggaggcctg tccttttctg aagagaaatg gaggaggaat ggatgtgggg 208620
ttgggagaaa gacggagtgt gggggaagag actaggagga gaggaggag aggaaactgc 208680
agttgggaca taagaacaat aatattatc tctgtcatgt tttatgttct ttttatctgc 208740
tgttttgttt atatttatac ttgtctatga agaaaggcta tgattggcaa taaaaattaa 208800
ttaattcagc taaattttta aaaaaccctc tgaagtgttg atcatgatgc taacagtgc 208860
ctagtattgt atgaaggcca ttttctgaa accatcaact cttcacttgg atctatacag 208920
atgtcatctt ttgatatcag aaagccaaaa tacaaccctc aaaaatgtgg aatacacctt 208980

tttgtatatt gtgaagatgt gtcactctga ttggcttaat aaagagctga acggccaata 209040
gctaagcagg atttctgtgc agagaggatg ctgggaagaa gaaactggag atgccaggag 209100
accagagca agcagaatag gcaaaaaggga aatgaggtaa taaagccaca aggcagaaag 209160
tagattaaga gaaatgggtt aacttagaag aactagtcag aaacaagcct aagctaaggt 209220
tgaattttca taattaataa gtctctgcca tgtcattact ggggagccgt ggggtcccag 209280
gaaaaagtct gactgcactc aaatcacact aatgcagcca ttttgtggac atgtgtctta 209340
tgaaaagaca tgatctagge atgagccaca tttcatgcca gtattcagga agctgaggaa 209400

gttggatctt catgagtcca aggccagcct ggtctagagg gcaagttcca gtctaactag 209460
ggctacatag taaggccctc tatggaagga aaaaaccctg ctggtcactc tagccaggga 209520
agcagaagca ggtagactaa ctgcagatct tcacctctcc ctctctctc ccaaacccea 209580
ccccccagtc tcacctcagc tctgtagtag actaagacac tgtggcctct cctcactctc 209640
tgtccccatt ctcagaagac tcagtagatc ctggtgaaac actgcttttt tttctctctg 209700
tgatcttctc cagccaccac caccctttc gagcccatct gagtcttaag agctccaaat 209760
acctagaaac ccattctacc tggaaacccc tgtggccaca cctaacagaa tetgaagaat 209820

tccttaccag gcaacacaca gccaccacac tctaagaacc agacggcaac agaggacaag 209880
gaacaaaaca cccaccacc aaaaaacaga ccatatatta gcacctagaa ttacaatctt 209940
ctcaaaccta gatgtctaga tgctaccgta aaaatacaat caataacagc caatataata 210000
tgtctccact ggagcacaga aacctacca cagcgggccc tgggaaatgc agcagagctg 210060
aagcaacgac agagacatta acacagccct catgaataac atagaggtcc ctccctccct 210120
ctcattttgt tgiaccctc ttccaagtca gggtttctct gtataacagc cctggctgtc 210180

ctggaattca ccctgtagac cagtctggcc tcaaactcat ggagatccac ttgcctctgc 210240

cttcccacc ccagcgtga gattaaaggc atgtgccacc ctttctgat atgttataaa 210300

tgagcaaatg agcaggcttc tgcatctgta tctgtttctt gtgccttttc ttgtgctctt 210360

ttccttctgt ttigtccaat tccaatgtat tttttcttt tctctatta tagtttatct 210420

cttttatccc tgttttctaa tgagatatgg atgggaggac agtgggaagg agctggaagg 210480

aattgagaat tgagggaggg gaaaaacaat caggatcact atatgaaaa aaaactcaat 210540

tttcagtaaa agaggggagc atgggggttc attgtgcatg tgccaaccac tgattacacc 210600

tgtgccaat ctaacttttc ctatgccaca gacaagcctg ttcttttctt ttcttctctc 210660

tctctctctc tctctctctc tctctctctn nnnnnnnnnn nnnnnnnnnn nnnnnntat 210720

gcatctagt aaagaaaca agtggtgaga gcatttaggt tgtcttcaac ataagaaacc 210780

tcaagtgaac agagccttc taatgttcta atgtaataac cagtgttgcc acaaccccag 210840

gacctcaggc catcagcttg tagtgaataa acagaatgct catgtgtaca cttgagctac 210900

catgtagaca gctggagaaa cattagctct aagcatatcg ggcaggacaa ttccagaaga 210960

aactagaatt tgaatctgta aggaagaact cagccatgga gataggtgtc atccagtgg 211020

ctcaaggcta gaaagaaga gggacagaaa aatgaattcc ccctcccat ccctgtcagc 211080

tgaaacactc ttctcttgcc cttggatgtc agaaaggggc cttcaatctc agaatgaaaa 211140

ttattctgtt gactttggac ttggttccaa gtccctttga cttggaccga gcccactac 211200

caagtgtgtc cccattatct ggcttcttag acaagcctat gtcagacata gcctccatga 211260

ttgcatgagc caatctcatg atagetatca tcaatcattt ttgtgtgaac ctccacatgc 211320

ttcttttctt aattattctg gaccatctgg cagccttcaa tgccaactac cctagctgct 211380

ctctcttctg gtgataaat actgtccaaa actgatttgg gcaggaaaga gtctatttgg 211440

tgtacaggtt acaagcctac tatttatgga aataagagac catggaggaa cactgacttg 211500

ttctcaaact caagttcaac taccaatctt atataccta ggctcaactg cctactaatg 211560

gcactgccc cagtgggctg gaccttcta cattagtaat caagaaaatt cgacacagat 211620

aaaccacag gccagacaat tctcagttga gattctctct tcctccgtgt gtcaagctga 211680

aaacagaagc taattatgac accagctgga aacatttcag tctatccac atcttgactg 211740

ttcaccacat cactcaacat catctgatac acaattacgt taccaaaact ttccctcaac 211800

tacgatgta gctaaaatag accattgtcc attttgtca ttttgataac tgctggatct 211860

caatgtctca aattgtgggg aacaaaata tttccgctat ggaatatttt tgagatccag 211920

cctttggtct cactaaacat ggagcaccat tattgtattg ttaatgccag taaggctact 211980
 attgttcaca tggcctcagg gtaatatgcc tcctaatttg catctctatg ctctaagca 212040
 tctgaatagg ccctcacctg ggccggagggtg ctagagggtg gtgagtaact tgtgaggatg 212100
 gaaggtagg agtgagggaa caaagagaga aatggttccc tcgtggtatt gacaggatgg 212160
 ttaagataaa ccagaaaaga tggctaataa agaaatgact ctagtctac aacgtggaac 212220
 tgaaagctct ctaaagatga caagatgcct gtgtttgatc tttatcgccg ttgggtggct 212280
 aggagcttcc agatccacac tcccactcag gtagaacctc atggttgtcg tgggttaaag 212340

 atgagacatg ccgggtcacg acatcaaatc aagaagtctt cagtcattca atattaaat 212400
 ccactcagtc aataagtaag aaaaatata tttattgagag ttccaaaaga acttcatgga 212460
 ggaggaagaa gtacaggcaa gataccgggg agggaaagcc agcaggaatg aagacaggtt 212520
 ttctggctag tgaggtaggg cagtcgttgg ctttattttt tcctcatata agatgcattc 212580
 tggaaactgc tttctctgtt gaagaccaca acatagcatt cccagcctcc cacatctccc 212640
 tagagaagtg gctctcaacc ttctcatgt tgcaacctt taatacagtt cctcatgttg 212700
 tatgacccca agcataaaat tattttatta ctaatccata actgtaattt tgctactggt 212760

 ccgaatggta atglaaatat ttttgagat agagatttgc caaagggtgt gcggcccaca 212820
 ggttgagaac cagatTTTTT tttgacttag aagaacaatt tcactataaa tctggacttg 212880
 tagacagcct gagtaaggta taccacccct ggtccaggca actgtggcca aaggaataga 212940
 taacatcadc tgccagcaaa tggttttcag tttctcaggg atactttgtt caaaggcaaa 213000
 actatccatg gtcagacgtg gttagaaatg gtcaaacctt tcttaattt ttaacttggga 213060
 agtatgccac tgagaaaatg actccaatca cattcaaggg agtctttaat taatgtttgg 213120
 tagaattcat ttgagttcaa tcagtggagt tcctaacct cccatttgac atcaattcct 213180

 taagcaattt aatagcacag gcatttgaga aatttgacta gaaacagaca gaccttccca 213240
 tatgtttaag ttgagttaa cataataaat taacataaa tgactaagtt ccagcaacat 213300
 ttcattattt ttgcatccat ggtaaaatat caaatattt ccaactaaga agaacaagtc 213360
 taagaattca ttaagcattt gactectaag gccaacatta catattgaaa tatgtcaatt 213420
 atgttaaac acttcacata aaaagttaat agtttcaatg aatacaaaaa caacttctga 213480
 gttgggtgtg gtggcacaca ctttaaatcc cagcactctg gaggctgaga catggatctc 213540
 tgtgagtctg aggctagcct ggtctacata gtgagttcca ggacagccag ggccacacag 213600

 agaaatcctg tctcaaaaa caaaacaaag aaaaactcct taacataatt gcatggagga 213660
 ctgtgagaaa gtctcctaat cctttcaagg gtctgtaatt actataaatt ttacacagga 213720
 gctgcaacac tcttagtttg tcaaagggag tgagtagtta ggtccagca ggcgagagca 213780

atgcagggat gataaggaac tcaagcctgg ggaattgagc aactttaatt taacgttagt 213840
tacaagagaa tgactgacac tcaactcgggt aggtgtgaga agtaaatgaa gtaatggcca 213900
ggaaatgctc cagagttgct cgggggacag cagcaacagc tttaaatca caattgcccg 213960
aacaactct gcatacttag gaagatttac ttcaatagct gtatttaact aagtcaacct 214020

tctcaacctt aaagcacagg ctctcatttg tgactaatgt tgtaactact caaaaaagc 214080
aagctccagg gtctcaciaa gacacagtat catatcacag aactgtttca getcactaaa 214140
gagaactata ctctatcgtt gagcttgtgt ccacaccaga acattctaga catatcccta 214200
ctcttctgct ttaaggaat ctaaattcac aaaactgaat cattacaaaa tctttcccca 214260
aggactcctt tagctcagga tgccgtctcc agatacattg ctaacctaag gacggtaact 214320
gaaggaaggt agggcagtaa aggctgtgga tcagtatgtt gtcacaagt cactgactgt 214380
catcaggaat tgagacacct cagaaagcca agaagacgaa aagaatctct ttataaaaa 214440

tatagtttac aatgaacttt caaaaacaca atttttcaaa gcaaactgct cctgtttgag 214500
gttcagacce acacaatgaa gaacagagaa aaagaagcgg aagtacagga aagagaactg 214560
ttatctgctc cgaacacaca cacaggctaa aaggccattg ccgtaaggga aaggacagcc 214620
cttctcacag acctgaggaa ggtgaggatg gaaggaaggc agcagacat gaggagggga 214680
tctggttcag tcaggtctct ctggactttg tctgcaaag aagcagagac aggcaagact 214740
aaagaaaaca cgggtggaga gtagtttga ggtaaaagac tcatcacacc ctaaatacga 214800
ttctaggagc accagtctgt gatctgccac acttgggaaga cagtcccaca aacagctggt 214860

gagaatgtgt gaccaggact tcgaagacac cagtaaggag tgaaagtct caggggcaact 214920
gagtacaaag aaagaagttt tgcgttgctg ctgttcttgg tatttcccag gctagaagta 214980
gaaaacaaaa gaaaaccaa ggttctgttc acttggcagg gctccacttg ggacctctc 215040
cagctggcca cataaggccc cacagcaact gagggtttgg ctacattaaa atcagtatea 215100
actcatcaa ggtcgacaga cactgtgcc gagacaacta agttcttcta gtggaagaca 215160
tcaaaagata aatcaaatta atacatgga aacctgtct tgaacaggt acttatttcc 215220
caattataat taatccagtc tcttcataa aactcctgta aattatctta ttgaatgtct 215280

tgaagatgct tccttctcag taattaagag ttaggagttc ttgtctgtgt caccgggttg 215340
acatggtgat tctgtctct ctgggagttc agcaggcaca ttctctgaca gagagacact 215400
gtcatttctt gacatggtgg cgaacagcat gtccatcatc cccaaggttt ccaggagttc 215460
cctttggtaa tcaatttctt tttctacgag tccttgaagt actataaact ttttatcaac 215520
tactggtgac tggccaatca caggagata tatatctaca aaggcagaa aatacattaa 215580
ctagaaacat ttctgtagg tgaattgat acaaacagta tggcactaaa atataaaggc 215640

actgaatacc agtattttta ataattaatt tgttatttac aggaagcata acaatctatc 215700

tgactaaata cttttgaaa agaaataatt acacaatata tacagcatgg ggtcttattt 215760

tcattttcat gttaaaaact agatgactgg gggctgagga gatggctatg ggtaggagtg 215820

cttgctttgc aagcagttaa gatctgtatt tgattcccag aaccattaa aaaaaaaaaa 215880

agaaagaaaa gaaaaagaaa ctggccacct ggcatacaac tgcaatgcag ccctggggag 215940

gtagagacag gtagcccagg gcttgctagg caccagctga gctctatgaa cttcattcag 216000

gttcaatgag acagcctgcc tcagaaaaac agatggagag tgatggggaa agaccagga 216060

agctgcctg tggcaaacat gaaacaatgt gtcaggtacg gggctgcagg aagagatgta 216120

gcacaggaaa ggcattggggg tgcaacagta agtctcaggc aggaccaagt gagatccaga 216180

aacactgaac tttagatgca taaatgaaac aaaggacct aacataagga ctcagaagta 216240

gacagggtga atccccctca ctgtggcttc aggaagagag aaaaggacca ctttggttgg 216300

ttgccgttac actaccgggc tctctaaaaa tctagaaaaa gagctgagac tcacgcagca 216360

aacatgactc agtttgttca tgcttgtcac ggtgaggaat caccttatgt tactaatctc 216420

ttgtggaggg gggatggggg gacaacaaac aacacaacac agggggacac ggggtgacagg 216480

gcacatatata tgacaaagga tctctgtat tttcttattt ccaagcccca aaggcctctc 216540

tactctactg gataagaaaag tgtgcatcac aaaagtccat gtggacttgg gaaatggttg 216600

tgacttggac actacatcag atataaggat taaatgatag aaagctagaa gcaccctcta 216660

ctttttactg cagttgagaa ctgccaagtg gaagaacaaa agaccaactg catgggaatt 216720

caaggaggga aggggtgtgg cagagactgg cctggccaga gcacttagga tcaactcagtg 216780

gtagcttagt tgcctcagc gtggatcccg ttgggcctaa ctgctttcta cattctaagc 216840

cccagagact ttaagagaa atgcaaccac tacttgggtg ttcccacgc cccaccggga 216900

ctggtagaat acctccataa taaagcagca cctgcctgg tggcctctg getcatgaga 216960

gcagcctgag ggtggatgct acatgacct cactactgag gttgcacaca gacatgcagg 217020

actcaggcca gcaacctcc atctctcag caggaagtaa tacactgtcc ccgccccac 217080

tgttttgtat tacacttct caagtctcc ttctcacact ttcatcctaa atactcttt 217140

ctctatctt gcctcttctc ttctcttca ctaatctcca ttgtattta taatatttt 217200

accttactg agttttaaat tctagctaa cctatcact ccctcgggtg ggccttactc 217260

ttcttctta ctgggtata gctgttctca ggtggtttgc tatatgtaa tatgggtttg 217320

gctcagccat ttactgcagc ctgctttctt tctgtgtgt agcagacata gatatcaagc 217380

aaaggtctcc atacagactc agcagagata tccatcccaa gggatgtgga aatcacaatg 217440
 gagaatggga gaaaagcaga gcagcaggac tcttcacag gacgctaact cttcaactgc 217500
 tggacctgca gacaccgatg gagctgaaat acctaacaaa cacaatgacc tcaaagacgc 217560
 aacctgaaa tagatgaagg aagtaaaaag tcagaccaa tgcaaacctt ggatatgaat 217620
 ttggattaag tcaagcagga gaaggtggga gctcttaggc tgaggaatta tcacatccat 217680
 taatacttgt caacaaccaa agcaaataca ctcacagatt tcaaggactc tagggcacga 217740
 caaaggaaaa acaaaaaatc taagtatctt caatgtagaa gcatacaaaa tctaggcaat 217800

 gaaactggag cagaaaatct caaaatccag ggaaagatac agacatccaa atacaggagg 217860
 cactcaaac ctaaacacat atgtccagaa aagaacctc ctacattgtc caatactag 217920
 catggaacaa aacaccaagt tactcacaca gatgagtca tcactaggac actaggcctg 217980
 tcagcaaacg aagggaataa ggaagtgcg tcaagccta agaggaataa ccaccaacca 218040
 agagaattcc atccactgaa gtcttccttt aaaactgatg gagggaatag attgaagcca 218100
 tgaccactaa accagtgtaa ggacagcgac acggaaggaa agtcaacaca caggtaaaga 218160
 agtcacaatc acacaggaaa ttgagaaaat aagtaataag agaaaataga tgagtaaaag 218220

 aaaattagga aagaatcaga tgtttccaat tcaataaacc agcaaatctc taagatgaat 218280
 agacaaggaa gaaaagaaca gatcaactgg gggaaacaag gatcttatag gaattagcac 218340
 acacctctca attctaacc caaatataaa cggcctcact tcttcaatta agcatgcaga 218400
 catggctgtg catagcgaca catgcctata atgccagcag ggggcctgtg ctcacacaca 218460
 ttcataataa ccatataagc atgaagaaat acacacacac aataaataa taaattaatt 218520
 aaaaaaaga aagatgacca ttatagatgt ttatgggaa aactttctta aattatactt 218580
 atcctagtct cgtcaattca aatctgctac tgtaacattt tactacattt taattgcacc 218640

 tgttctctca ggtttcctgt ttcaggttct ttcactgttt tccaatgctg aggcgcaagt 218700
 gcaggagccg ggacaggctg acacattctg ccgctgagct ctccagtcca aggcctcagc 218760
 tctcacagca tgttggaaag cttatgtttt acgacttacc aattactatt tcagcagcat 218820
 taatcagaac aggggcaaat ctccgctgag acagattcct acaagcaaa acttctgttt 218880
 aataatcttg caaggcctat ccctggcact taagctggca tttgggaatc tattcccat 218940
 gctgagtgc ctcgccagc cttgatgcag cgggaggagc tgtgtcctgc ctcaacttga 219000
 tgagccatgc tttgttgatg cccatgggag gctgcccct tctgaatgg agatggagga 219060

 ggagtgaagg gggaggataa agggagaagg catgggagga aaggaagggg gaaaaactgt 219120
 ggttgggata taaaatatat aaaaagttaa attaataact taaaaataa ataaataaaa 219180
 tcctaaaac aaacattgtt acaccagttc tctgtaaaga gcaactaaa agtagatgct 219240

tctcaccgag tgataatgga ggacttaagc cacaaagcca agtcaagcat accttatcaa 219300
 aaagttcaga acccgggtaa tctccttctc atccccacct gcaagagcat tggctaggac 219360
 tcctctccga ttcaattcct ttatgatgga aactgtaacc tcgggcgtct ttattacaca 219420
 attaggctag aaaaatgttc agagtcagta cagccaaaag gacggacaag aaaaagatca 219480

 ctacctgca ctaaactgcc aagcttatct ccacaatccc aagtcatagt aaatcataaa 219540
 ccatcatcaa gatggttccc cacatgtect ttcacttttt ttggacaggg tctcacttta 219600
 caagccttag caggccaact ttattatata gccaggttg accttactcc agagactatt 219660
 ttgtttttt tcttttttgg gggggggagg tgtgggggga cagggtttct ctgtgtagcc 219720
 ctggctgtcc tggaactcac tctgtagacc aggctgcct tgaactcaca gagatccgcc 219780
 tgccctgcc tccaagtgc taggattaaa gatatgtct accgggctgg agagaaggct 219840
 cagaggttaa gagcattgac tgctcttcca gaggtcctga gttcaattcc cagcaaccac 219900

 atggtggctc acaaccatcc gttatgagat ctgatgcct cttctggtgt gcagacatac 219960
 atggaagcag aatgttgat acaaaatgaa taataaaat ctttaaaaaa aaaaaaaaaa 220020
 aaggatagt gctaccacta ccaggttaga ataattctt aaatactctt cactagctaa 220080
 gcatggcagc tctcaatgct gggaggcaaa aacaagagga tcctggcagc tcaactggcaa 220140
 cctggtgagc tccccgtctt agacagtta tcacctgaca caagcaagag tcaactgtga 220200
 agagagaaca tcagttgaaa aatgtctcca ttgtactggc ctgtggacaa gtctatgtgg 220260
 tattcactgt ggtggtgcca ctctggcag gtggtctggg ttgtacaaga aaaacaggct 220320

 gagcaaaacca tggggagcaa accagtaagc agtgttctt tatggtttct aattcagttc 220380
 ctgcttcag atttctgct tgggatcctg acctgacttc caatttcag gtattataaa 220440
 ctgtaagatg aaacgcctt cctctccaag ttgctttggt catggtcttt acattgcaac 220500
 aaaaagcaaa ctaagacaga tatgatctca agaagatgga atgatctctg gccttcccat 220560
 atgcatgtaa atgtacceta tcacacaaa aaaaattaaa aaatagtgtg aaaagacaat 220620
 tattctcact cacctcaagg actctgcaa gtgcctttga gatccgaaaa cttttcaggt 220680
 ccttgcata ccattctagg tgtttctttg ctggcctatt gatcatgata tcatectgaa 220740

 tgaaaaagta aatttataga agaagaaagt tagtatctat atagttccat taaaaataaa 220800
 tgtttccag tagagctggc cctggcgata tgagtaaggg agacctggat gtgagggccc 220860
 aagagcagaa ctigtacag ctcttgctg taggctgcat tgggtgagct agccaaggca 220920
 gtgctaaaga gctcatccag gttgtgaaga tgagggaag ctagtatct gaccaacca 220980
 gccaccacc aggcccaga gttggcccac cccagccacc aaatctatga actgttgaag 221040
 catgtgaaag ggatgaacct acagttcaa aacagtatga catgggataa caacaagatg 221100

tccaagagga gccccagtga gagcccatta acattagtgt agcataaacc agaggcctct 221160

gatcagacca atgactcctg gtaatgaata cttacaagta aacatgaaca gactaaaggg 221220

taaactgtgt gtctcaactg gtcacactac agcttccatg acaggattct ttttttgttt 221280

tttctttggt tggtttttct tttaaatttg gttttgtttt gggggttgca agggcagaga 221340

gcaattcaag gggatgggga gataagtggg gtcaaatgc atgatgtgaa atccataaat 221400

aatcaacaaa agaaaaata aatatttaag taggtatggt ttcacaataa agtgatacat 221460

gttaaagtta ggatgctttt acaccacaca acaataatg tttctatggt cataatcaa 221520

gtgatacatt ttgcatgctc aatgtgctct tatgtttttt agcttactca aaaaaaaaaa 221580

aaaaaaaaa aaaaaaaaaa aaagcagtat gaccacatat aaaaagaagt aaaaaacaaa 221640

ccagagacta caatgtaatc gtcacacctc tgatgagctc ctgggtcatt agaactttac 221700

atctcagtc tctccaacac caggagagaca ttacaggcac acgctgttca gaggacccaaa 221760

tcagagagtg ggtgacagac actattttga agacggtaaa gcactgtatt atttcatgat 221820

tcagggtact aagtaagtag tcctgttcc ccattattct tcaataatgt actacagcag 221880

tctggaacca actttgatgg agtgagaaga aaataatgta catgtatgtg aatcacactt 221940

tcagtaaat tccaggaatg ggtggaattg actcttccaa gaaatatcat actttcaaaa 222000

ggataagaaa cacataatca cccgttgctt catgtaaatt tttcctttaa caaaggttcg 222060

glatgcaggc ctctccttc ttgagagaga ttcttctttt gcttcagatt tccgggtgtt 222120

aacgctcagt atcccattag tcattcccac aactatcgtc tcacttcat gctaaggtta 222180

atcagaaaaa ccattctact ttaaccaaca tcttacagta cctttgactt gaaacagcat 222240

ttgcatcacg tctgctatct atcttactgc ccacagttcg agtcaataca gacagtgatc 222300

tacccaaaat gttacagcaa attcactttt cctccagggt atcactatcg ggacagccct 222360

tcttatgctt gtacagfact gccagtgaag tgtatgtaat gagaatgatg atgttggtctg 222420

atcatgctaa taagatgcta atggcatctt gacaagtffc aaaataattt tctatgctct 222480

ctgaatagaa aaaggattac acaatggcat gacttttgta agctggctcc ccacaacagc 222540

tgctcttgac tcttcttctc taggttgaaa ttccatata acatattcag gtatcttctg 222600

gccaaatgtg gctcctcatg aaaccgaca gtgaacactc cagaaagcac attgctcact 222660

cagctgctcc taccctctcc acttttctgg ggccaactcg ccattctcga gctttgtaac 222720

acccttgggc ttgttgaagg gagagttaac aacatcctaa tccagttacc atgatagcag 222780

tcagtgccac caagtgggaa ttcatgtggt taacaggaaa catcacatcc tagcaactgt 222840

ctttgttagt atttgtttag tatttagaca ttgtactgg cctgtccttg gggttctgac 222900
 aggatatgcc cttagctgct gccactaaga gcaacacctg tgcctattca ctgtgttccc 222960
 tttaaaaagg gccctgccct cctccatctc tctctctctc tctctctctc tctctctctc 223020
 tctctctctc tctctctgtg tgtgtgtgtg tgtgtgtata cctgtctttt tctctctcct 223080
 gctgttcttg tccttgagg cttagctctc ttcttccctt ccccttagc attcttttcc 223140
 cctaataaaa aacctctcca ctggaactct gttgcatatc tttctcagcc actttttaaa 223200
 aattacaaca gtcttgactc aaacatcgaa tgtacctat ttgaatccaa agataacccc 223260

 caaagattac actttacttt tacataatgg cataatgtgt aacaacttga gaagaactga 223320
 aagtacatac agacagtgcc agactcaaga tggagctgc atagtcaaaa ctgtggacta 223380
 ctttgaaga agttgtgctg tagaccttga ctttctggt gagaaagaga gccatcaagt 223440
 caccttagaa tgagtgaaaa taacaagttt ctgttttttag cacactatat gaatatgaaa 223500
 atttacacag tcaaacggg tgcttgccct taatcccagc actcgggagg tagaggcagt 223560
 cagatctctg tgaattctag gccaggctag tctacacaac tagttccagg gccgagggct 223620
 aaacagagaa acctgactt gaaaaataaa taataataa agtaaaattt gcacagtcca 223680

 gaaaaacact gatgtaatat taattacaaa gtacttcacc actgagttcc ttgaaaacta 223740
 actgtatttc agcactaacc aagtttgaat aaagactgac taggaattta taaaagaaac 223800
 caaaagacag accatacacc aaggctatca gaagataaaa caaaggacct atgaaaatgc 223860
 acagtaagcc acaaggtagg gtttccaagc ccaataaggc cctctgttgg ggacagtagc 223920
 agcatctctg gccatgtctt ttctaatag caggaagaa gtacaacctg gagacaaaat 223980
 gaccatcaga aaaaaaagg aaatctaca gcctgtcagt actacccatg tgtgactact 224040
 gaaccttga catgtagcta cagaaaagga ggtaagtta aaaaccattg aacatttat 224100

 aaagtattat agcataccat ctattttaga gacaaaattc atttctagca tttttctaag 224160
 taaactgatt acatgttgaa atgacagttc atacgagttt tacttttatg ttagataatg 224220
 aactacagtg aaataaatat gttactaaaa gcaatTTTTT gttttgcttt gtttttctag 224280
 acagggttct tctgtgtaat agtctctggg gcctagaact ctctttgtag accagctgg 224340
 ccttgaactc acagagatcc acctgcctct gactccaag tgctgggatt aatcacacct 224400
 agcttttttt ttttttaac atcttttaat atggctacta aagcatttaa aattacatat 224460
 gcaacctgca ttgtgagttt gtttgacaac acttttaaat catcgaaagt agaacttctc 224520

 aattgactat ttaaatgact tcagtgtctg ggatagaatg gccttgcaaa tactgggtaa 224580
 gtgctctage cactgaacta tgcctttagt gctctagaaa ttactttaa gtcatagtac 224640
 ttgcaccaca ttaatgcaca gaaatattca tatgaagttt gaaatcttgt ttgtttttt 224700

tgaggcagag tctctctgta gccctagctg tcttggaaact cactatgtag accaagctgg 224760
 ccttgaactt agagaccacc ctgcctttgc ctcccaaatg ctaggattaa aggcatgggc 224820
 tactactccc ggttgaagtt ttatatttta aagaatttaa cctaaaataa aatatacct 224880
 cagaataaaa ttttcaaaat acatatgtat atataaaatg gctttaaaag aaactatggg 224940

 aaaatagact atttcaaaag atcagtgttc aagtatgtaa gttaaagtaa taaataatta 225000
 tttctgggga aatataagta gttatatgaa aattaaagggt caaactattt tcaagtcaat 225060
 agattttatcc tctataaaaa ccattagaac ctttttaaat cacaaatact gctaaaataa 225120
 ctcaattttc caagcagtaa atgctaataa caacgcacaa gaaaactaga atgctaccta 225180
 tccagtgagc cggagagtaa tctctgtcca gagctgctca gacacaagca tgtcacagtc 225240
 ttatgatgat ttttcaaga cacaagcaac tgcctcctt ttaacatgct ccagacttta 225300
 acataacgac ctctgtgga aagaaataac cacttgtgtg agattctgca tatgctcaga 225360

 atgctggaga tctgagaagc actcctcact ggagctaagt gaagcctcca gaactagacc 225420
 tgagcttaaa gaagcctcca gagccagacc ctacctgctg gccacacaca ccttgagagt 225480
 ccctaccaac agaaatgta acatgactaa gttattgctt attttaggta cagcaaaaca 225540
 aatagggagc tgaaaatatt tcaagtaaag tataataaat ttgctgagag aaatactggg 225600
 tctgcaagat ggctcagtag gtaaagacac ttcccagcaa gcctgaagac ctgagctga 225660
 tccttgggga tgaccggta gaagataggt ggctccggaa agttgtctta gctggaataa 225720
 cagaaggta tagagtagac ttctgaggtc agatgggaca catacataat ctactaagtt 225780

 ctcacggtct gggactttag acctgccact caccatgttg ccttggacaa actagctgat 225840
 gctttcatta tttccttaat tgtaaaacag aatgccaact acctgggaga actgtctagc 225900
 attagaatg acatgaaaac agcagcacag tgccagtgtg ggccagacac agtgagtac 225960
 aactactage ccacccact taccaactga acaataactt agatgtgaaa ttcaagaaca 226020
 ccaacaatct acaaatggca aaaggaaaat ctaatctctc tgagaccaat agtggcaaaa 226080
 gctcttttga aaagcaatac ctgaagacac caggagacct cccgagggga aaagcaggac 226140
 actctccaca ggetgcccac gctccacaca gagaacattc ttatttgtcc gggcgtcaaa 226200

 catcttcaca gtgtgatcat atgatcctga aatgtcaatg ttggtattat gtgaattttg 226260
 ctctttaaag caataaaaaa tttgtttatc catacattaa aattagaagg agaaaaagat 226320
 tacatgaaat tttttgaaca tacacacatg attcataaag tcggtacttc tgatactact 226380
 gttcctaaag cactatgtaa tactacatag aatcttactg gctctgacct tcagactcct 226440
 atctccatgt cattccctga gaatctgttc agacacctac acaaactgag ctccacctac 226500
 agtgctatgg ctgctggggc tctatgacaa ctagagtacc atgagccact gaaacctgat 226560

atctatgata ctgtcaagca gctaaatata ttcccctccc cccaaataca tttagaagaa 226620

acaaaaccca ctatcaagag aagaaaaaga aatcaaaaaa taattgactt taatgaagac 226680

cacacacata cacatthttat ggtgctgaga attgaaccca gggctctcaa caaattaggc 226740

aagtgtcca ccaactgacc tcatctctag taatgaaaat gtaagcccct ccacccaaa 226800

agaaccata gcaataaagt ggagagagcc caccaacctg ttacaaagag atcagggttc 226860

agcttgctgg cacagccaca cctcacataa tcggaatgtt ctctgaatgt ctgaatttct 226920

ttggagtttg gaatatccca taatttaact gtataatcat cagctccgga gaccacatga 226980

tacttgtcag ctgtaaaatc tactgtatga actgctctga aagatcaaaa gtcaacagat 227040

tacaaaaatg gggaaaactc atgcttgatg atagctctca tccagcagct ggtgcaagta 227100

gaagcagaca cccacagcta atcactgaac tgaactggaa tccagatgca gagaaggacg 227160

agtgatgagc aaagggatca aggccagct ggggaaaacc acagaaatag ctgacctgaa 227220

catcagagaa ctcttgctcc ccagactgat agctgagata ccagcatggg actgatccag 227280

accccaggaa catgggtttc agtcaggaaa cctcggaat ctacaggact tgctgtaggt 227340

cagtatttat cctggcata ggtgtggact ttgggagccc attccacata gaggaatact 227400

ctctgagcca acacacacgg ggtgggccta ggtcctaacc caaaggatat gatagactct 227460

gaagaccccc ccccatggaa ggctcacca tccaggggga gcagaaagga tatgtgatag 227520

gtagggtttt agttgtgggg tgggtgtagg gaaggatggg agggagaagg gaactgggcc 227580

tgtcaagtaa aacaaccttg tttctaatc aaataataaa aaaaaactgc aagaaaaaaa 227640

gataaaaaaa aaaaaagggg aaaactctac cgccttcac ttctaacata aaatgttct 227700

tcctagattc aaaaacaac aaacaacaa acaaaagccc cctcaggttc aagccagcaa 227760

gacagctcac tgggtaaagg tgcttgctgc caagcctgat ggccggagtt ccatctggga 227820

cccccatga tgaatggaga gaaccaactc eggagtgtg ccctctgacc tccacatgca 227880

tgccaccaga tatgcacacc tgaacacaca cagtaagtaa acaattctca acttcagaaa 227940

atagaaaaca tttatggaag aaaaaataga aaagggaaaa cttttaaac aggtgtttgt 228000

atgtaaatgt aatactatgt accgaagtgt aatactatgt tactattagg tcaacaagaa 228060

tattaagtaa cagatgcaat aattagttaa agttaagttc taaatgttgc aacagaggta 228120

atthtttaagt gtttatttat ttatttactt atthttatgtg tatagtatth tatctacatg 228180

tgtgtctgtg cactctatgc atgcctagga ctgggcttat agacagtctc gagccagcat 228240

gtgggtgctg ggatccaac ctcttcaga acagcaagtg ctcttagcca ctaagccatc 228300

tctccggctc tgcaaaggta catttcttta aaaacataac aaagagttct ttcaaaagat 228360
gagaaagact tgccacagag cagaatcccg ttaaaagaat ttgttttgag tgttttagtg 228420
atgggtacaa acaccctgac agtttgcaat ttaaaaaaag aaaaaaagaa acactttgat 228480
atttaaatca acagcagagt tcagcaatga ctttagtgat cctgaaacag aagtcagaaa 228540
accaaattta tcaagaaaa gaaagtagc cagatttcag tgtgagaggg tacagccagc 228600
cggacctaca gcatcaccag agctgtaaga ctgccgttag accagtgggt cacattttca 228660
actggtcaga gagcccactg aacctcctaa ataattagac acatacaact ttagagcagt 228720

cacaagctct aggaactgga tggtaagtt cttgtctga gaacaacagg aaataactat 228780
acatacaggt atactcttca cacaaccaac atgtgtttat caaaagcatg gaagcagagc 228840
tctcaacaga aaaacaaatt aaaaaccata tcaagctggc tcttactttg tatggccttc 228900
aaactgcctg aggggagccc tcccacttat atcaaaaagt tgaaccacac catcttcact 228960
gccagcaaca agcagttggc catcctgtcg aaaagtagca cagtatgctg tgccttaaa 229020
acgggaaaag gtttttatag gttcttgaga gtatcgcca taaatgtgga tctgtaagat 229080
aaaaagcagt atttactag atggcccaag cccagtagta aatcctataa caagaacaaa 229140

gatgatcact acigtactta ctcttgaaga agctgtgact gcatagttat acggaggctg 229200
aggagaaaag tctactttgg acacggcacc aaactcctta atctgaacag gagtcttaat 229260
gaaaaacaaa agagtattgg cagagttaa aaggcgagcc atacttaagc atcacgctat 229320
tttctatgga tcatttcctt ttgatcttag taccaattag taggttgat tcacagagaa 229380
atatgaggaa aagaggaaga ggaaagacat aagaaaggt gaagcaaaaa cactctatt 229440
gtccaacccc cagactatc ctttgacatt acagaagtaa acacagttag agagtcacat 229500
cccatgtct cagcagctaa ctttactcca atgccacca agaaaaagaa gagctaagcc 229560

tacatcaate aactatgatt ctaagttaat aaaaagatga acagaccatg taacagacc 229620
tacatctttt ttgcaccac taaccattt tagcaatctc tgcatataag caataaattt 229680
gccatccatt ttataaaga tacaccatcc accaacccat gtctaatgga catattttc 229740
aagaattcca atattacatt acatatgtta ataaacattt tacatatctt aataaacgtt 229800
tgaaagcatg ctaggcttca agctatgagt acaaagcaaa aatgatgttt ttataaaatc 229860
ctaacagtta ttgtcaatc ctttctcaa ttttcttct catttatgcc aatatgacag 229920
aaaaaaaaag taictaaact gttatcttat ttggttttat gttctgtttt tttcatctta 229980

tttatttgta ctcatgtgta tgtgtgtatc tgcttgccca aaaatgcaca tgtgtgaaac 230040
acatgctgaa ggtagaaaa gatactagag ccctggaac tggagttaa ggctgcccac 230100
tgtgctggga actaaacca ggtcctatga aagagcagca aatgctcttg atttcaagta 230160

gctaagacta ccctcagcct ccctgagtaa caaagaatga ctctgaactt accatctggc 230220
ctccacctct caagggctga gattacaggc atgtgccacc aaagaggttt gtgcaaggct 230280
ggagactgaa ctcaaggctt cgggcatgcc agacaagcat tctaccaact gagcgactcc 230340
atthtagttt gtgagtaaca tttttattat ctgattatat ttcattttcc acaaacaacc 230400

taattgcaaa cgttttctag ttttctaggt tctcaattta aaaaaaaaaa aattgcaagc 230460
cttactagaa ggtacagaga agctaatttc agagtaagaa aaagcaagaa agtcttctctg 230520
catataagat tcaagtttta cagtttcact tgcattgca cacatgttct gcattaaaca 230580
tctgcatggt taaattaagt ggtatggact tttacatgaa gctctaagaa aaaactgata 230640
acaaattatc cacctgaact attagtttta gctaacagtt ctgctagcat aagatggaga 230700
attaagataa atggataaag aaatgtccaa attctttctt ccctcatttc ctcttgtact 230760
ttaccttata attgttccag tacagagtgt ctgggtgat tttttacca agtacaggat 230820

atgtctgaat cgctacaggt ttataaccag ccatgatttc atatagttac actgctgtcc 230880
cagggccaat aatctggaac tgatgtcagg gaactgcagt gactctgcct tatacctaaa 230940
aaataaaaaa gaaaagaaaa gaaaaaagca catattatgt atacacttcc acatacaagt 231000
atgattttca ttctacttcc tttcaaaagg ctgtgtggaa cttcaccgat tagtgaccaa 231060
caaaccattt cattggaacc ctagaagaaa cactggaaga atacagcatc tgcagcatct 231120
gtacatacta gctgtatatg tatgttctca aatctccaag accagtctgt aacacttgaa 231180
aataaacatg atcagcctc ccaacagtcc aactagaaaa gcatgcaggc ctagaatgct 231240

tgttttcttg acaaaggaat taacatagaa ctcaaaatat caagttatct ctacatattt 231300
ggcttcttaa agaaaaagat accaagaaga aaggaaaaca aagctaatat tttagtgtag 231360
aagcttatga tgaattaga gataatgttc tgacataaga caaaaggttt aaaaatttaa 231420
ctgtataate atcagctccg gagaccacat gatacttgtc agctgtaaaa tetactgtat 231480
gaactgctct gaaagatcaa aagtcaacag attacaaaaa tggggaaaac tcatgcttga 231540
tgatagctct catccagcag ctgggtgcaag tagaagcaga caccacagc taactactga 231600
actgaactgg aatccagatg cagagaagga cgagtgatga gcaaagggat caaggccagg 231660

ctggggaaac ccacagaaat agctgacctg aacatcagag aactcttgct ccccagactg 231720
atagctgaga taccagcatg ggactgatcc agaccccagg aacatgggtt tcagtaagga 231780
aacctcgaa atctacagga cctcctgtag ttcagtattt atccctggca taggtgtgga 231840
ctttgggagc ccattccaca tagaggaata ctctctgagc caacacacac ggggtgggccc 231900
taggtcctaa cccaaggat atgatagact ctgaagaccc cccccatgg aaggcctcac 231960
catccagggg gagcagaaaag gatatgggan nnnnnnnng cagaaaggat atgtgatagg 232020

tagggtttta gttgtggggt ggtggtaggg aaggatggga gggagaaggg aactgggcct 232080

gtcaagtaaa acaaccttgt ttctaattca ataataaaaa aaaaactgca agaaaaaag 232140
ataaaaaaaaa aaaaagggga aaactctacc gccttcatct tctaacataa aatgttcctt 232200
cctagattca aaaacaaaca aacaacaaa caaaagcccc ctgaggttca agccagcaag 232260
acagctcact gggtaaaggt gcttctgcc aagcctgatg gccggagttc catctgggac 232320
ccccatgat gaatggagag aaccaactcc ggagtgttgc cctctgacct ccacatgcat 232380
gccaccagat atgcacacct gaacacacac agtaagtaaa caattctcaa cttcagaaaa 232440
tagaaaacat ttatggaaga aaaaatagaa aagggaaac ctttaaaaca ggtgtttgta 232500

tgtaaatgta atactatgta ccgaagtgia atactatggt actattaggt caacaagaat 232560
attaagtaac agatgcaata attagtgaaa gttaagtctt aaatgttgca acagaggtaa 232620
tttttaagtg tttatttatt tatttactta ttttatgtgt atagtatttt atctacatgt 232680
gtgtctgtgc acctatgca tgcctaggac tgggcttata gacagtcctg agccagcatg 232740
tgggtgctgg gatcccaacc tcttcagaa cagcaagtgc tcttagccac taagccatct 232800
ctccgctct gcaaaggtac atttctttaa aaacataaca aagagttctt tcaaaagatg 232860
agaaagactt gccacagagc agaatcccgt taaaagaatt tgttttgagt gttttagtga 232920

tgggtacaaa caccctgaca gtttgcaatt taaaaaaga aaaaagaaa cactttgata 232980
tttaaatcaa cagcagagtt cagcaatgac tttagtgatc ctgaaacaga agtcagaaaa 233040
ccaaatttat caaagaaaag aaaggtagcc agatttcagt gtgagagggt acagccagcc 233100
ggacctacag catcaccaga gctgtaagac tgccttaga ccagtgggtc acattttcaa 233160
ctggtcagag agcccactga acctcctaaa taattagaca catacaactt tagagcagtc 233220
acaagctcta ggaactggat ggttaagttc tttgtctgag aacaacagga aataactata 233280
catacaggta tactcttcac acaaccaaca tgtgtttatc aaaagcatgg aagcagagct 233340

ctcaacagaa aaacaaatta aaaaccatat caagctggct ctactttgt atggccttca 233400
aactgectga ggggagccct cccacttata tcaaaaagtt gaaccacacc atcttactg 233460
ccagcaacaa gcagttggcc atcctgtcga aaagtagcac agtatgctgt gtccttaaaa 233520
cgggaaaagg tttttatagg ttcttgagag tatcgccat aaatgtggat ctgtaagata 233580
aaaagcagta tttcactaga tggcccaagc ccagtagtaa atcctataac aagaacaaag 233640
atgatcacta ctgtacttac tcttgaagaa gctgtgactg catagttata cggaggctga 233700
ggagaaaagt ctactttgga caggcacca aactccttaa tctgaacagg agtcttaatg 233760

aaaaacaaaa gagtattggc agagttaaaa aggcgagcca tacttaagca tcacgctatt 233820
 ttctatggat catttccttt tgatcttagt accaattagt aggttgatt cacagagaaa 233880
 tatgaggaaa agaggaagag gaaagacata agaaagggtg aagcaaaaac cactctattg 233940
 tccaaccccc agactattcc cttgacattt cagaagtaaa cacagttaga gagtacatc 234000
 ccattgtctc agcagctaac ttactccaa tgcccaccaa gaaaaagaag agctaagcct 234060
 acatcaatca actatgattc taagttaata aaaagatgaa cagacatgt aacagacct 234120
 acatcttttt tgcacccact aaccatttt agcaatctct gcatataagc aataaatttg 234180

 ccatccattt ttataaagat acaccatcca ccaacccatg tctaattggac atattttcca 234240
 agaattccaa tattacatta catatgttaa taaacatttt acatatctta ataaacgttt 234300
 gaaagcatgc taggcttcaa gctatgagta caaagcaaaa atgatgtttt tataaaatcc 234360
 taacagttat tgtcaattcc ctttctcaat tttctttctc atttatgcca atatgacaga 234420
 aaaaaaaagt atctaaactg ttatcttatt tggttttatg ttctgttttt ttcattttat 234480
 ttatttgtac tcatgtgat gtgtgatct gcttgcccaa aaatgcacat gtgtgaaca 234540
 catgctgaag gtagaaaaag atactagagc cctggaact ggagttcaag gctgccact 234600

 gtgctgggaa ctaaacccag gtcctatgaa agagcagcaa atgctcttga tttcaagtag 234660
 ctaagactac cctcagcctc cctgagtaac aaagaatgac tctgaactta ccatctggcc 234720
 tccacctc aagggtgag attacaggca tgtgccacca aagaggttg tgcaaggctg 234780
 gagactgaac tcagggttc gggcatgcca gacaagcatt ctaccaactg agcgactcca 234840
 ttttagtttg tgagtaacat ttttattatc tgattatatt tcattttcca caaacaacct 234900
 aattgcaaac gttttctagt tttctagggt ctcaatttaa aaaaaaaaa attgcaagcc 234960
 ttactagaag gtacagagaa gctaatttca gagtaagaaa aagcaagaaa gtcttctgc 235020

 atataagatt caagttttac agtttcactt gtcattgcac acatgttctg cattaaacat 235080
 ctgcatggtt aaattaagtg gtatggactt ttacatgaag ctctaagaaa aaactgataa 235140
 caaattatcc acctgaacta ttagttttag ctaacagttc tgctagcata agatggagaa 235200
 ttaagataaa tggataaaga aatgtccaaa ttctttctc cctcatttcc tctgtactt 235260
 taccttataa ttgttccagt acagagtgtc ttgggtgatt tttcaccaa gtacaggata 235320
 tgtctgaatc gctacaggtt tataaccagc catgatttca tatagttaca ctgctgtccc 235380
 aggttcaata atctggaact gatgtcaggg aactgcagtg actctgcctt atacctaaaa 235440

 aataaaaaag aaaagaaaag aaaaaagcac atattatgta tacactttca catacaagta 235500
 tgattttcat tctactttct ttcaaaaggc tgtgtggaac ttcaccgatt agtgaccaac 235560
 aaaccatttc attggaacct tagaagaaac actggaagaa tacagcatct gcagcatctg 235620

tacatactag ctgtatatgt atgtttctcaa atctccaaga ccagtcctgta acacttgaaa 235680
 ataaacatga ctcacctcc caacagtcca actagaaaag catgcaggcc tagaatgctt 235740
 gttttcttga caaaggaat aacatagaac tcaaaatc aagtatctc tacatatttg 235800
 gcttcctaaa gaaaaagata ccaagaagaa aggaaaacaa agctaataatt ttagttaga 235860

 agcttatgat gaaattagag ataatgttct gacataagac aaaaggttta aactgtaggc 235920
 tagaaaacca aaatagagca aacttaaaat ggcagaataa gatttaaaaa atgtggggga 235980
 gaaggaatgg gggtagaggg agggagaggg agaggggaat tacatgtgaa acaagcctgt 236040
 tccttaactt gtattaataa taataataat aataataata ataataataa taataagaga 236100
 aaaaaagat ttaaaaaatg aattaaagct cttaacatgc aatgaaacca acatcttcgg 236160
 agaagcattc aactgaagac agtctatttt atggatgaat ggttccagtg atacaactct 236220
 ccatccattt gagagggctg caaagatgac atcagtaaca ccggaacaaa tagcatgcca 236280

 tgttctgact aacgcaaagc aaaccaagat tcaagagaga aacttttcta ttcagtcaaa 236340
 cacctccaat gtgcaagata gtattcaagg cactgggaat ccaaggacaa taaacagaca 236400
 tgatctatac ctccaatgat tgggectatt aggaatctag acttagcttc atcctcattc 236460
 ctaaaactct gaagaagat cacgtatcac tgcctctga tagagacact agcaatcaag 236520
 atttcaactc tcaagattt ctttgtgtgc aaaagtgtgt gtataaagcc agagagtctt 236580
 tctctatagt gctgcacctt atttctgaga caggatgata tctctcattg aacataaaac 236640
 tcaccaactg acaacactgc ctaattagca agcctgacta acaagcctgg gggaatcttc 236700

 ctgtccctgc caccagcac tgggatttta ggcatactcc aagetctctt ttttacctag 236760
 gtgctcagga ttigaccca ctatattcac taagacatct cccagccct taatctctca 236820
 aatatttcta aacctcaat ttacttaacc ctagtccaat tgcactaact tttgtctttt 236880
 tgacaactga aataaaagca acaccattca aaagtctcct ggactcccga atccatcttc 236940
 caaatagtag tgggctaca aaactgaata ctgccagaa aatgaagccc tagatcctta 237000
 gcatgtaagg ttccctttgc tctgccctt taagcttcac ctcttgctgt tactgtttac 237060
 agttcactaa actcagcaca ctattcatt cttgcttcaa catgtgctct ctaccaggaa 237120

 ggtcctttat ctgtttaagg tcattgcagg aaatcagact gtccttcaga aatccctctc 237180
 tgcttctga gactgggtgc tctctctat gatccaattt gtctctattt ctgtaagtgt 237240
 gcataatctc gctgcattgt agtgaccttt ttccagttaa atagaacaac atattggaag 237300
 tatttgtttg taaaaatgct caaacaatga tctttttaa agggggagca tcatgaaaat 237360
 tcctattgga aaaacataaa atcaaaagca ttagtggttt ataataagaa caatgctata 237420
 cagcagggtg tcaatcaagg gccagccaga tggtaaatgt tttaggcttg gccaaacaac 237480

aggcaaaata ggagatattc tataattaat gacataggaa aaattcacia tttttacagg 237540

aggcttcctt aacaatcata aacacaatct ttgtttgtgt ttgtgaaaga gagtagaatt 237600

ctctgaggte aagggtfact tcacttaatt ccaagccaat cactgtacat ataagacagt 237660

atgtttatct gttaaaaaaa aaaacttagc tcattaata taaaaaaca gacatcagaa 237720

tagattcaag gatgggtagc tcctaaatct atttttcaag aaataaaacc atttggagga 237780

aagaagtga tagtagctgt gacaaaatga agataggcat tgggtgccg tatgagggaa 237840

gacagtgcaa atagcgagtt gctatgaaaa cgaatgaaag aaaactggac caaagtacgg 237900

gccaagaaa ctggggttta ctgaataaca ggcattacta caaggtgtga tcaataaac 237960

tctgtagtta gactactgag aacatgcaag aggaagatgt ttaattctac ctggaaaagg 238020

ttttccattt catcagcgtc tgtgagcatg acatgacacg atgagcacia aaggagtaaa 238080

cgcagagtga gacgaatacc cggccattct caaatcacca ggacagaaat ctgtccttgg 238140

ctttggagaa aagcaggtta ctctggggac tgacatcggg ggctaggaga gcgactacag 238200

aggagcaaag cctgggtcga attaaatcgc aaggatcctc agaggcaggt aagtccaatg 238260

atctgcggag cctgggaagg gccagagcag catgtccagc atgtcagaga tcagagttag 238320

gcctgagcag agcctgggcc gccaccggga gccaccatcg cctacctctg cggggccccg 238380

agggtccgcc gaggcacccc gatccccagg acgactcccc agacttcgcc agctcgtctac 238440

agcaaatgtc tcagaagcac ttgctcaaac tcacgaggac actccaggag ccggaatgc 238500

agaggcggcc gagcggggc cggacggatg acgtaatggc gcatgtgcag aagcaaccaa 238560

gaactacaag cgagccccgg tgggtggagc agtcggggag gggtcggcc tttctctggt 238620

gatccggaac cgaggtgacc cttagtctc tgagagcatg ggctgaggac cgcgagggga 238680

accagagaaa atccctggaa gtcgtctcgc ctctcgtgaa tgctctgggc tttttcaga 238740

ggaggaaaaa tataggaagt gacgtctggg tccgaagcag gccgggcttg aggacttga 238800

gcatccgca gctggccctg gccgggcccg agcctcccct gcggtctggg ttgtcgagtc 238860

accgctgga cggctcccctg tcccggggtc cgctcggcgc tcgagagcga gttcagcctg 238920

cggcgggaac gcccgccggg acacctgtcg cttgtgagac gttttcttt ctttcttct 238980

tctttcttc ctttcttca tttttcttt ctctcttct tgtcttctt ttttctttt 239040

tctttttta ataacactt tttcgtctc taggacaatt tcaagagttt ggaagaacgg 239100

gatgcctctg atatttgctt cccctgggtc ggtgtccact gccgcattt aagactctat 239160

ctaaccttgc ctgagctctg gcaagtgagc ctacctactg tctatgttaa ccctttctga 239220

tcacctgtta ttcattcatt ttttttcctc tctgcacat caccttttgg caaatgtaca 239280
 tctttgcttc tccttggagc ctacataagg gttccttcca tatttctga tctcccttca 239340
 aagactggca attccgtata ttgaaacctt gacttgttct ataggagctg caaagaacat 239400
 tagagatgac tatttctaca tcattttata aacgattgag tctcgggaaa tgtatacaat 239460
 ttgtgtgac aacacaaatt ctattgttga gaatggaaaa ccacatcaa ctaaaaaatg 239520
 tgagaaacaa aatgttaaaa attgttga ttaaggtcag aaaatatcta tggagcacca 239580
 gataggtttt gtgtgttgtg actccctga gtagtttag ccagggtgtg tggcgcacgc 239640

 cttaaatccc ttaatcccg gcaactcctga ggcagaggca ggtttcacac agtgtttccc 239700
 taggccagcc agctctacat aatagtgagc ttgactataa agtcagacct tgtctcaaaa 239760
 aataaaaata aaaaagtggc ctctatctgc cagttttccc cttaatggg agtttgaaag 239820
 gaagctgtca agagaatacc aagtgttaaa agaaacacat gacatcccc caggagccg 239880
 gagttgctct cagccactg accctagaaa aaaatggtac ttcattgctg gctttttaa 239940
 agaccagtc ttctctcac gcctccatct tcattgagt ctctgaacta actttctgtt 240000
 ctgttgctt tctgacaaaa tgtagcgact ttgctatggg ataacttttc tgactatagt 240060

 ctgtcttcat ctctccccgg aagttttgga ctctttctat tgctgtttac ttactgacca 240120
 cagtgataga gttgtagag caaggtgtgt ctaccgggaa tcaggagctt tttcttgagt 240180
 tgaaaaaat tacctgcctg ttctactgag aagattgtaa taaggatcaa ttttttttg 240240
 tgttttggtt ttttcgagac aaggttttc tgtattgctt tggaggtgt cctagaacta 240300
 gaacttgctc ttagaccag gctggccttg aactcacaaa gatctgcctg cctctgcctc 240360
 ccgagtgtg ggattaaagg cttgagccac caatgcccaa cgggctcata tcaatcttt 240420
 ttttaaggat ttttttttg ggggggagg taggttcagg acatggtttc tctttgtatc 240480

 ccttgctgt cctagaactc aatctataga ccaggctggc cttgaactca gagatccacc 240540
 tgccctgccc tccttcaact atctgactta ttttctctt ttaaggatt ttaggtctc 240600
 tcgattatgt agctctgact gtcctagaac ttccatgta gaccaggctg gcttcgaact 240660
 caagagatte acctacctt gcctccaag tctgagatt aaaggtgtg gtcacacac 240720
 ctggcttgtg taaggtttc gtatgatgt tttcaggct gttctaccta ttacataacc 240780
 agtaggtatt ctctctctg gggaagactg tttctctgc tgtatagtag tgctccacc 240840
 atgccagcg ggatcaatct tttgaaatga ttttaaaatt aaaacactga acagtgtta 240900

 tgtgtcaat tcattttcc cttgattcca agtcattctg atcattgcac acttagtacc 240960
 ctttcagaat gtccaaggta cagtatctg tcacatgaca aaaattaatt ggatgttcat 241020
 ttcttccat ttaagggat tatgtattg ggactgtcat atatcctgtg ataccgatcc 241080

ataatctcca tattttatnt ttcattaaaa cttacatcca gcccggcatt ggtggcacac 241140
 gcctttaatc ccagcactcg ggaggcagag gcaggcagat ctctgtgagt tcagggccag 241200
 cctggctca gagtgagtgc caggatagc tccaaagcta cgtagagaaa ccctgtctcg 241260
 aaaaaacaaa caaaacaaaa caaaacaaaa caaaaaacct tacatccagc caggcagtgg 241320

 tggctcaaga cttaatccc aacactcggg aggcagagc aggtggatct attagagtta 241380
 aaggccagcc tggctatag agcgagtgc aggacagcct ccaaagccac agagaaactc 241440
 tgtctgaaa aacaaaaaaaa aaaaaaaaaac aaccttacat ccagttgttt atgcttactc 241500
 tgaacaaaag atgacagata tactttcgat tcttcaacag tagatttgt aggtgcagag 241560
 agatgactca atgggtaaag gcacttctg ccaaagctga tgacttgagt tcagtcctg 241620
 agacattcat gaaggaagg agaaccact cctgaaatgt gtcctctgac acatgatatg 241680
 cctgctgtgg cccatgtgtt cccacacaca tgcaaacaaa atgcaaagta ataactactt 241740

 tttaaaataa gttttgcaa gtgcttact gtctcaatcg tgtattatag agaatagtgc 241800
 taatcaactt ggctacaagt tggttatct tcagttcaaa ctgggagccc acttacagga 241860
 acagcatntt taaaaaatg atctcaaat atagcttact gtttaatat gaggctggtc 241920
 cttaaacatt tgccaatagt cagatatcg aaagagtaga aactaactaa aatgtgttga 241980
 aacatagtga tggagggtga ctgtatttcc ttcactctt tccaggatga tgggtgtatc 242040
 tctttttaca aatgatactc aaggctatta actcatgcac atcacatagc taataaatga 242100
 gaaagcttga gttcatgggc aggttaccta cctctgagta ttgtgtatct cctattatgg 242160

 acagaatctt acaagagcac tgtttggatt tgtggttga agtaattgtg tgtatacatt 242220
 tacataagtt ataatatgct gctttaaatt ttccaaatct ttcctttcag atactttaat 242280
 atcccaatc caagcataca ctggaaaaca cccttgcaaa accaagagga aaccgtgaag 242340
 aatgtttta attattgaaa ccatggctac atcagcaaat ctggacattg gggcccagct 242400
 gattgtgga gagtgcctca gcagctatag tctctctgac atgccagaca tcaaataga 242460
 gcaccagctg gaccctaaact cagaagaagg gtcagcgcag ggtgttgcca tgggaatgaa 242520
 attcatattg ccaaacgat ttgatatgaa cgtatgttct cggtttgtga agtccttaa 242580

 tgaagaggat agtaaaaaa ttcaagatca agttaactct gacctggagg tggcatctgt 242640
 ctattttaa ggttgaaagt tatggtataa ctcctacaa ttgctttcat ttgcctatt 242700
 tcattctgtt ttctctgcc atgaaatcag agttgaggaa aagcatgaag ttcttttagg 242760
 aagatnttc taggatctca cagaagccaa cattaaatt ctattaatt tgaaaaatat 242820
 tcctttctaa gctgggtgag tgatgcatgc ctttagttaa tcccagcact tgataggcaa 242880
 aggcaggtga gttgagagcc agcctaact gctctcacta gttcagtcca tccagggata 242940

catagtgaga ccctgtccaa caaataaaat ccttgccata tctttattta caatttcctt 243000

 aatttggta ttcttagtg tattttgttt tgtttttgtt tttttgagac agggtttctc 243060
 tgtgaacccc tgggtgcctt agaactagct ctatagacta ggctggcctc aaacagagat 243120
 ccacctgcct ctgcctccca aattcttcaa ttaaaggctt gcaccacat cgctggcct 243180
 agttacatct ttttaataa tagaaaaata ttcctttttc aaaattagtt taatattttc 243240
 tatttcatga ctaatttaca tcttaattta cattttaate cagtgatctg tcagcatgct 243300
 ttaaagttac ttigtactt attaatatta aaactagtca ataaaatttt tcaaaattaa 243360
 tagttttctt tgtagaactt atactgtagt agtatagact catacagaat tactatcaac 243420

 tgatgaacac ttgaattgaa actgtaagc ctacacatt ttttcatgt gaacattgac 243480
 acttttatta gaatgcttg tctttaaact actattttta tttgttttat ttagctgagt 243540
 gcaatatcca tacatctctt tctctggga ttcaagtaag gcatgtctac acccctcta 243600
 caacaaaaca tttctcccc ataaaacagt caactacttt aaccaacaag cacaggggaa 243660
 atgaggtctc taccacact ctgttagcaa atgtaagta tgcgctaaga atgtactgaa 243720
 acattactac tagtgaatt aactaatgca attacaaatt aggaattggg ctttgaata 243780
 ttagtatccc taataaaca ttccagtttg gaaagctta gtgatatt taccactta 243840

 ataaattgaa actttttcat gtgtttttat gtttaccgt ttctgttat atctctctga 243900
 gaacaaatac agtttaaat attattaaaa cttttatagt ttaccataa aaaagtgagt 243960
 tactgtgaat tatttgcaa ttaagatac aatgtttttg tgttcttggg agttttgtat 244020
 ttagtggata tgggcacata tttattgtaa atatgtcctt atgtattatt tcactaagaa 244080
 atagtttgta ctaaaagcta aataattttt actgaaatgt ttcattagca tataaatata 244140
 atgacttgga atgtaaagtc attatatagg atataaagtt tctctaagct aaccgatatt 244200
 gggtagggca tgagtatttg aatgagagaa aaccagcta acagctagat gataataact 244260

 acatttggta ccataatgtg agtgtgtctg tattctggtg agtatcttga tctttacttt 244320
 ggaaatctta aatccctcca gatgtcacag ttgcatacta tagcagttga gccaggaaga 244380
 atcttttagc attctaattc cacctatggg ccatttctag tttaggtaaa tgtgtgtatg 244440
 cttcacagtt gcttttctgt attgagacta ccagtcata tcactaaagg cagtattatt 244500
 taaagtgct tctcaaac accatgttac aatattctaa ctgtagaact tcttactga 244560
 aaaaaataa ataaaaagct aaagactgtc cccctggca tgaataaaa attataatca 244620
 gttagttaga attaacatgc taactagcct caattaaacc tctactcata aatttacttt 244680

caccaacat gggtgtcaca cctataatcc caaaactcat gagactgagg taggacaatc 244740
 agaagtttaa agctatccag gctacataat gagactgtct ttaaaattaa acttaccccc 244800
 tcaaaaaaaaa aaaaatctcac acagctagtt ttctacttat gaactcattc ctaattttaa 244860
 gaaaacccat ccaattccaa aataaaaaata ttcaggaggc tgaagagatg gctgagcagt 244920
 taagagcact gactgctctt tcaggggtca taggttagat tgccaccact tacttggtctg 244980
 tcaaccccca gtaactccag atgectcaat gggcactgca ggccaatac ccacttgcac 245040
 aaatttataa atacatgtac ctaattagca tttaaaaggc tgggaatggt gatataatcc 245100

 tgtggtttca cctgtttaga aggttgaggt aggaggattg tttgagccta catgctcagc 245160
 ttgggctcag cagcatgggt agaccctctc tcgggaaaag aagttagctc ttcagtggaa 245220
 tcactaagaa aactaaaagg aatgtctttt tggccttctc cgtaagtttg gatacagaag 245280
 tagcatgtta aacattaagt acataaatca ctcttttagga taaattttgc cccaaaaaat 245340
 gataatttgc agatgtcata ttaccatatg agtcagttct cagagaacac tatctgagga 245400
 taccaggata ctcccttca ttaggcttac atgatgagtt ggtgggtttt gttttggaaa 245460
 agaaactggc ttcacctga gacaatagct gtgtacctac aagatgact tgaagaattt 245520

 taacattata ttgtttcagc tttgtctgtt caccagttgg cagctcaagg agaaatgctc 245580
 tacttgcta ctctattga acaaggtaat agcctagttt taagtactat attttaata 245640
 ttcatttgaa tttattaggt ttgttatctg ttttatttc atataggaga ctataaagac 245700
 aaaataagtt gtataatctt gccaaagcaca taagccaatg gatagcaaaa agggaaattt 245760
 taagtaacaa agtataaaat ttgggacttt aggggtggctc tgagattaag agcactagct 245820
 ctcttccag aggtcccatg tttagttccc agcacccata tggcagctca ctaccatctg 245880
 taacgccagg tgtagggtat ttgatgccct ctttctagcc tccaaggta ccaggtacat 245940

 atgtagtata catatafaca tacaaggcac aacaaccata caaataaaat cacttgattt 246000
 taaaaagaag ttttagcttc cttttccca aaacaaacat tgtaagtttt ttgtatttct 246060
 agaaatcatt tccatttatg gttacatttg agaatatgta tgtgcttttg ttaggtatac 246120
 aagcaagaaa atgttacata tactgcaaca tgcctttttt catttaatat tggaaattgtt 246180
 ctactaattg gagagtgttc tactaaactt ttttttaat gtgtgtgtgt gttttgcctg 246240
 tatgtgtata tgtaaacctt gcatgcctgg gacctgtgag gttaaaagag gatccctaag 246300
 aactggagtt aggatgggtc cagccatcct gtgcgttctg ggaacctggg tectctgcaa 246360

 gaacattgaa gtgctcttaa ctgccgagcc atttctccag ccataagatc tttttcttga 246420
 gaaagagtct cactatgttg cccaggttga cctcaatctc acagtcctcc agtctccgcc 246480
 ttctgagttc tgggatcaca aacatgtatc tctacacca gccattttat cctgttttac 246540

tataatgtgt atgtattact atgattttta tttgttcttt taacaattca cctggctgat 246600
tacaaatgtt tgctggcaat cctagcataa attctttata aatatataca ttgagtaaat 246660
tttcatacat agtatgccag gtcataaact aaatgatfff tgctgtgccg tgggttgaat 246720
cagctcttca catgggctag aacagtgtct tgcgccagag ccacacctct gactctgcct 246780

ccgccttctt gttgttacat tttactgga tgtttgtcct cacattagcc ttagagttgc 246840
agtttcccca aactgtcaca tatgaagtga gacttcagtt ctttaataatc tttggggaaa 246900
agtgggtgctt cacaggaatt ccactgatac atttaggtta taatgccttt gagtttcttt 246960
ttgtctgaac tacctacgtt atatttgtat atttgtatcg tataaacttc aaagtggaag 247020
aaactgactt ctgttgtttt gtgcatatag ttttcccaa tttgtccatt ttgtatgacc 247080
tcttcagatt ttaattgta aatttttctt ctttttgact ttggaagtgc gtggcctact 247140
ttgaagattc cccactctag gattataaag aaaccactga tttttacgct ggaacttgtc 247200

tggtttctt tttatcacc tttgatgtat aagaaaactg ccaggtgggtg gtgggtggcag 247260
acacctttaa tcccagcact tgggaggcag agaggcaggc ggatctctgt gaattcaagg 247320
ccagcttggg ctccagagtg agtgccagga cagccatggc tatgtagaga aaccctctgt 247380
ctggaaaaac catcattgtt gattacaggg agcatgatcc aagaatttta ttttcataag 247440
acttagatgt atttctgttt ataacttaact atcgggggct ggagggatga ttccaaacct 247500
aagagctggg actgtcttgc agaggacctc agttccattt ccagcaccca catcaagtgg 247560
tttactga cctgtaactc caggagatc tgaagctgct ggttttcaca agcacctgta 247620

ctcacatgca cccacacccc acccccacac ttacatagtt aaaaaataaa aataaatatt 247680
taaaagtaga aatttcatgt tcaaaaaaat ctgaaaaaaa atttcatgtt caacctacta 247740
aagtgtacag gaaagctgt gcagtttata actattagc tacattcagg gaataaatga 247800
ggttaaaggt gaaataatgt gttacactaa agatgatcga atctccatat tatgctggca 247860
actgtacgga tgaaggaaaa tcacaggcag caaggctagc tagagtggaa ggtagctttc 247920
gaaagctgtt gaagttttaa gtatacattt agttaatgct aagggtatc atgtatcatt 247980
ttattgtgat ctcccaggt atgtgtttag ataagcaagc tattaatctg tgttttagcag 248040

aaattaagtc acttgcccag aaccaaacca ctgaaaaatg aaagagccag gattctatct 248100
tgggtttcct gtccctgaga ccaaagttga caatcttga cctaacacga tactatactg 248160
tgtgtgtag ttiatacttt acagagtgtg ttccatgaac ccagcttttt tatattgagg 248220
cacattttca catgtccata ctgaaaatca caacacattc agatttcaat aatcaaaagt 248280
catctcattg aacttcattg agtttttaca atgccggtgg tttcaaagt atattaatat 248340
gtggttttaa attagatcac aaaaattgct tttcttttaa atagaaaatg ttatcaatca 248400

cacggatgaa gaaggattta ctcccctgat gtgggctgcg gcacatgggc aaatagctgt 248460

 ggtagagttc ctacttcaga atgtaagaaa aatgctcaga aaatagtat gtgtagtttc 248520
 tggagctcag ttaagtcttt agtgcagtat ttatatctgc agccaagcag acataaaggt 248580
 ggagggtaca ctgccttggg tcttgtggaa cctgggtcta gctgggaaag cagtggtagc 248640
 catatatgaa acagtgagaa gaaactgaatg tctagcccct ctgagtagag caggaacaga 248700
 agtgctgttc acaggtcctg gagggaaagg ctctgggggt gggggtcggg gggtaggct 248760
 tttcagaggg aaggagacta agtaatgagg cagctggaga gagggaggca aggagcagg 248820
 catccaggca gtttgggta caagcaccat ctatcacttt tctgttattt cctcattaat 248880

 cctagaatgt ggcccagcct cagtgttaa cgttagtctg attgacaaag acaagtgttc 248940
 ttgtttaaat taattggaag tctctgtgtg tcaactcca tgacagggtg cagatcccca 249000
 gcttttagga aaaggtcag aaagtgcgct gtcttagcc tgtagtaaag gctacacgga 249060
 tattgtcaaa atgctgcttg actgtggagt tgatgtaaat gagtatgact gggtagttc 249120
 acacgttgaa ttgaaaactg ctgtaacaag cctgtacctc cattgttaa gtgccagctt 249180
 agcacgaag ggcccagt tcaaaccta gagataggaa gataaagatt atctttgct 249240
 ggcttcatgg ctatttcaa gccacaggac tacttgaac cttgcctcaa aaataataa 249300

 ataaaataa ttattgtaat atttttgga ttgaattgat ttcagggaga cataagcttt 249360
 attaaggact tggaagaaaa aatgactta cttaatga gcaactaat gtcataaatt 249420
 caattattgc ttgtgactta tattttcac aaagtattaa tattattta aactacttct 249480
 acatgccag tgccattgca gcatttgatt gactgttct cagtgagaaa tgctgatgac 249540
 ctttctctc tgcagaacgg agggacacct ttgctttatg ccgtccatgg gaatcacgtg 249600
 aagtgtgtaa agatgctgct aggtaagcag gtgaatacag tcattattca gaagccctgg 249660
 gagcatttta tttgcaatgt ccctgttcgg acaagcttac ctagtctcg gatgtattac 249720

 cctgcggcgt ttgctcctgg gtttcttta ccacgggct gccctgagag aggcagctcc 249780
 atcatactgc aactgcact tgaagatttt gcccttctg ctcacatctg gggteacctt 249840
 tgactccagt ctggtgttct ccatgcacag tttctttgag tataagttgt ttatgactt 249900
 caactactct agagacgttt aggtaccttc tccagccacc agatgaactc tgtatccat 249960
 gcgctcagga ctttgtatga gcatgttga aatagcctcc gcattggctg aaatctgttc 250020
 aaccatttgc atatgagcca cgaatagaca gacatttga tttcatctt atttatatag 250080
 attttctgt tttgatacag aaaacggagc tgaccaaca attgaaacag attctggata 250140

caattctatg gatttagctg tagctttggg ctatagaagt ggtgagtatt ttagagctct 250200
caggtttcat ttaggaaga ctttatatat agtaattgcc agtgatccaa acctttttca 250260
tcacttcatg ggtaaaacat tatattatcc taactctggc catatgcttt aacggagtgc 250320
aaagtaaaca gatgtctata gagttaagaa atgaattaac ttattgttct ttttcataag 250380
ctgaaataat agttactgga ggaaaagtgg gcagtatattg caaggttttc aaaaatggta 250440
ctttggagtc ttcactttta aaaaaaaaaa aaaaagtggt aaaacctcag tagagaaaac 250500
acagaagctc aggcagctgc tgaattagga actacataac agtcctactt agaaatagca 250560

gaaatagctt ctttttacia aataaccagg ctaagttgaa tttatagagc agcagccttt 250620
tgtttgcttg accttgcttt gtttctgtgc tgtgaccttg gtggcctgic tttgcagttc 250680
aacaggtcat tgagtcacat ctctgaagc tgcttcaaaa catcaaggag tgatgcaacc 250740
cttagaaaat gccagctgcc ctctcttca ctctttggtc cttataaatg ataattctgt 250800
ttacgtgtaa atttttacct cagttgcaat atttgctggt ttttagtgag ttttaataaa 250860
tattcctctg aataattcac tggtttataa taaagttaat cctgattttt attttaaat 250920
aatttttaaa caaatgtgtt tactatatat ttaaagtat aaattaatgt tttatggcat 250980

gtaaattttt atggtacagg tggttatgtg tctttgtatt aagtacaaa atttgacact 251040
ttgagaaatt ccacctgtt tatcttcaact ctgtattaa ctctctgact ttgcacaggg 251100
cttactgtaa gtctatggga gaaaaaaaaa atgttcttgt tgaattaaaa agtatacagt 251160
atgatggttt acaaatcat gtttaataa aatacttctg ctgtctgtgc attctagctc 251220
tttgattatg tttagcaaga ttttcagttt atcatttatg ttctacaaat caatcaacaa 251280
agtaccttta gaacattgtt ctcttataaa ttggtttgag aaggaaaagt cattatgaaa 251340
tacattatga aataatgtat atgaaattaa tcaatacat tatgaaagag atgtgaggat 251400

gctctttaac cctactggag gaaaaccatt aacttgcctt ttactaaaat ctagaagagg 251460
gagccacgaa ctgtaaagtg atttgactga ctgtgagact tgattgagtt aaatcccttc 251520
ctctgcaaag tagatattat atcagttgta acccacatga attgatctgt atagtataaa 251580
caaaagagag ctaagtggga ctgaaaagat gccttggcag ttaaaagcac tggtcacttt 251640
tgcagaggac tgggatttgg ttcccagcac ctacatggca gctcacaat cgttaactcc 251700
agtttcaggg ggatccagca ctctatgtgt ataaccattg catgcatgtg gtgccatac 251760
aaatatgcag gcaaatattc attcacataa aattttttaa agttatgtta caggtaatat 251820

taggtacaat tgctgagtta tatgcaaatc ttgtccatat acttacactt tggggcgggg 251880
gggtctctgc agtcactctg gccagcagac caacagctcg caagaggtgt gaaagttcag 251940
ttcaacatga ctaagtagcc actgttgggt caaactgaga gtctgacacc aagtagacta 252000

ttttagggac attgaagcat agcacaatit gttctggata agtacacaga actgaagttc 252060
 cctttgtcct ttcacgggg cctctgagaa agtcttcgat tggcttggt cccacttaa 252120
 aagcctcgtg ttttcccaca gatccagagc tttccatgac ttaagaatga aggtcaaaat 252180
 gagtttctgc tcagcagctt ttggaacaaa ctgcagggt tctgaagcct gaattattgt 252240

 tcttctgttc taggttaggg ccctaagccc aagaagtct tcccacatct taccaccata 252300
 tcagctaate agcgtaaatt cctcttttct ttaaggctcg cacaatgtgc taagagatct 252360
 ctgccttctt ttctttttat tttatttatt tggaaagata ggagcatgtg ctcaacaaga 252420
 tgcacatata ccatggcaca cattgaaagg tcaggggaca atttacagga gccagtctc 252480
 tcctcccacc atgtgagttc caggattgaa ctcaggttgc tgggcttgac agcaaacact 252540
 attacctgct atggagtgtg acagctgttc aagagatgat gtccaggagt ctgtcactga 252600
 taccatcagt gatgggatct gggacaccct tctacagggc tttctataag gctctgcaag 252660

 ttagaggttc tgggattaaa agaaccttca ggtgtgcttc cagtaaaggc agaacaatct 252720
 aagacaggac agttaaagc cagttttgta gcactctgtg gttatttcat gagcaatttg 252780
 ccagtgccctc ttctgagggt aagaacctat ttcaggtagc aagggtgtta atgaaacttg 252840
 gaggattttt ccacaaaaat gcatgctatc tggaaatgtt acactcacag catttactg 252900
 ttgggaagge taagcatcac ttctaagcag ttattctctc catttccact acaagccagt 252960
 cagaatcatg ttcttttaat atcagagaca ttataatcag atgtgttgc atgttttaga 253020
 gttaagaaat acitttact tcagtgacag ataaagacat gtctcagttc cagacataga 253080

 tgcacagaga gccatatgga agaaagcaaa caaaacaaaa caaaacaaaa aacccaaaga 253140
 actctctatc tcctctctc tcttctgct tatttattta tttatttgtt agggatggaa 253200
 cgcagggtct tgcctagcct ttttgagcat ttttttttc aaattgttct cttttgtttt 253260
 aaataaaatt gtgtttcatg tcacaacac ttggccctag ccctgggtta cataacacta 253320
 ggctaattgt ggaagaaagt gaacagtggc ttcaggcaaa cggaattaga atcaactaca 253380
 caagagacaa agacagtgat ttttgacaca gtgtgtggga ttctttatct ttcctctctt 253440
 tttctctaga gcatgggatt cttgactgac ttgaggetac atatagacaa acagacacaaa 253500

 ccagactaca caaaacaaa gtcactagta agtgggattt ctgtcacctg ctactgagga 253560
 cagatgttat acacagcttc tgttatgcta tgtataacag atgtatatct ctgttataca 253620
 tcagcagggt atcaccaaca gcagaccaca aaggctaacc cccaggctgg agagatggct 253680
 cagggattaa cagtttatga gaactggcat tcagagtca aagactggca tccatgcaac 253740
 aagcctataa tccagctag aaaggaggcc gagactggag aatgactggg gcttctggc 253800
 ttccagccta gccagacaa cagagccca aggttcaggg agattcccct gcctcagcca 253860

gacagaagat gagaaaggag gacacctggc actctcttta ggcctccatg caagcacaca 253920

ggcatggaca gtcctctccc acacctcata aatgtgtaca tatactcaca cagatacaaa 253980
catacatgaa taaactaata ataaaaata atttctaaaa agctaataat ccccttcact 254040
tagccatcaa tagataatat ttccataaat gtgtgcaaag ttgaaagaaa acaaataca 254100
taaactctga agatggtagc aagacctgga atcagaaaag ctaaatttct gttgctccct 254160
ggactatcct tcaaggtcaa gggaacctgt gcaagtaagt aagcccatgt ggccccaaca 254220
ttaatactt tcaaacacca gcaagtgacc tttaaactgt tcccagatca ttttcaaag 254280
actacaaaga caggacacct tcatacaact aagcctgtga caaatacttt aatcttttca 254340

tgaataacgg aagaagtcag ggagaagctt aactagctga acattatgac atacccttt 254400
agttctatca ctcaggaggc agaagcagat cgctgagtct gaggccagcc tcgtctacac 254460
agtgagtcc aggaaagcca gggctacaca gagagatcct ttctcaaaaa aaaaaaaaaa 254520
aagttaaac tggccctgac tccatataag atgctgggga actgggctga ccttgagata 254580
agattgctgg tcatatataa acctagctaa tgagcaacag gaacctacac tgcctcgaat 254640
ggctcattcc cacagtctag aacttgtttt gttttacaga taaaaatctc caaagtgggg 254700
caggagagac agcttttctg attctcagta cccacacagt ggctggtaac catctgcact 254760

ccagctccag ggcattctac gccttcttcc agectccaat agcaccaggc atgcaaatgc 254820
tacacagata acatgcagca aaacccccat acatgtaaga gttcttaaca atttaaaacc 254880
tatgaagcaa cctgtaattt cactcagtct gtggccttta acaaacagtg actatttaat 254940
cagattctgt ttctccagat aatcctctgg gggactttgt cccatgatgac attgaaagaa 255000
catgtcacca tgacctgta agacttcagg gaaagcatgg ctggggttaa ggaaatcacc 255060
ctggtgatta atctcccttc ttctcatcagc tgatggtaaa cgaatacagg tgcctgaag 255120
tgttggtgac aacgcttgc ttacatcacc ctgcttatat gagacggcat agtgggtcca 255180

ggagtacct cagggaaaga agtgaaaac tggagatctg caggaaaaaa ggttaaggtt 255240
ttaatatgct tgatcattat aaaaataaat gcctgggcgt ttaaggaaaa tagtagtgga 255300
tggattttct gaggtttca ctctgaaatt ttctttggaa tgtcagcctc ctgtatgggt 255360
aagattttat tgcaatactt ttaacactt ttaattctgt tcttagcaca aagtgtcat 255420
atattcttat actattgata gatgatagat agatagatag atagatgata gatagatgat 255480
aggtgataca cacatacatg cataagatag atgctttgtc aggttatacc atttaccatt 255540
tataatccag ttggggcaag gaatctactc ttagatctta aaagatttgc tgtgtgaaaa 255600

ctaaaatggt tgcaaatctg atagcttgaa agaattgcta cacaaactct ggctattgta 255660
 aacccataag tattcttttt catctttttt ttttttgtgt gtgtgtgtat gtgtgtgtgg 255720
 caagactcct caaattactt gcctaatagac agtctcataa gtttgcttc tcactcgtaa 255780
 aattccaat tgiagctata ccttcttgta tttttaaaaa taatttattt atttttattt 255840
 tatgttcttt ggtgttttgc ctacatatgt gtctgtggga gggggtcaa tcccctagaa 255900
 ctggagtac agacagctgt gaactgtcat gtgggtgctg ggaattgaac ctgggtcctc 255960
 tagaagaaca gtcagtgcac ttaacactga gccatctttc cagccccaac attttttata 256020

 ttttgttct aataaatttt taaaatgtat gtgtatttgt ttcataacag aaagtaacaa 256080
 tagccaggtc tgiaacctca actccttgga aggttgaggc aggaaaattg caagtataag 256140
 ccttctctgg ctgcagtatg aattcaagac cagtcagaca acttagtgag attctgtccc 256200
 aaaagagaga gaaaaatag actgtgttta tagctaggtg gtgggatcct tgtctggcat 256260
 atgtaaggcc tciacatgca ctagcatgtc catggtgcac atacatacat gcaaggcaca 256320
 tataatgta taaaataaa agtaaaattt aaggaataac tttttgaaa aataacatag 256380
 gaggtggag agatggctca gcagttaaga gcactagctg ttcttcaga ggtcatgagt 256440

 ttaattccca gcaaccacat ggtggttcac agccactaca gtgggatctg atgctctcac 256500
 ttggtatgca gtcatacatg aagacagagc atgcataaaa taaataaata aatctttaa 256560
 aaacataata caggcactag agagagaact cagaggtaa gaccaattgt tgctctgaca 256620
 gaagacctgg gttccattcc cagaaccac atggtggctc acaatggtct ataaatccag 256680
 tcccagggga gcaaatgcct tctgcctcc aagggcacca ggcacgtatg tgaggcacac 256740
 atatatgtgc agacaaaaca ctatacaca taaaataata agagaagata aatctaaaaa 256800
 attactaac attatcatg ttattgaatc cataacagaa atcaagaaat gttttctac 256860

 ctaggcagtg gttgagtaca ctttaaatcc cagcacttgg gaggcagagg cagaggcaga 256920
 gaggtctctg tgagtctgag gccagcctgg tctacaaagt gagtccagg acaaccagag 256980
 ctattaccta gagaaccct gtctcgaaag aaagaaagaa agaaagaaag aaagaaagaa 257040
 agaaagaaag aaagaaatgc ttactattg gtctttctat ggtcttttga tttgagaggg 257100
 tcagaagtgt gactattact ctgggaacag ttacaattca tttctgctg aattctctca 257160
 ataaaatgag acctctatac atacaggtct ggattcacag atgcattga ctactagaaa 257220
 taacccaaat aaccaagatt gcctctgtat tgaacatctg cagacttttt cgcattctcat 257280

 tattccctgt gaaggaaccg gcttccttt tggcagccat aacagccgaa catgtgcttg 257340
 ccataacct gccttggca ctttagaggtc agatgcctgt ctctgacaa ggaaccttag 257400
 tcacttagag gtcagatgcc tgtctctgta caaggaacct tagtcactta gaggtcagat 257460

gcctgtctcg tgacaaggaa ccttagtcac ttagaggtca gatgcctgtc tcgtgacaag 257520
 gaaccttagt cacttagagg tcagatgcct gtctcgtgac aaggaaacctt agtcacttag 257580
 aggtcagatg cctgtcttgt gacaaggaac caatcagaag ttagctggtt nnnnnnnnnn 257640
 nnnnnnnnnn nnnnnnnnnn nnnnnnnnnn nnnnnnnnnn nnnnnnnnnn nnnnnnnnnn 257700

nnnnnnnnnn nnnnnnnnnn nnnnnnnnnn nnnnnnnnnn nnnnnnnnnn nnnnnnnnnn 257760
 nnnnnnnnnn nnnnnnnnnn nnnnnnnnnn nnnnnnnnnn nnnnnnnnnn nnnnnnnnnn 257820
 nnnnnnnnnn nnnnnnnnnn nnnnnnnnnn nnnnnnnnnn nnnnnnnnnn nnnnnnnnnn 257880
 nnnnnnnnnn nnnnnnnnnn nnnnnnnnnn nnnnnnnnnn nnnnnnnnnn nnnnnnnnnn 257940
 nnnnnnnnnn nnnnnnnnnn nnnnnnnnnn nnnnnnnnnn nnnnnnnnnn nnnnnnnnnn 258000
 nnnnnnnnnn nnnnnnnnnn nnnnnnnnnn nnnnnnnnnn nnnnnnnnnn nnnnnnnnnn 258060
 nnnnnnnnnn nnnnnnnnnn nnnnnnnnnn nnnnnnnnnn nnnnnnnnnn nnnnnnnnnn 258120

nnnnnnnnnn nnnnnnnnnn nnnnnnnnnn nnnnnnnnnn nnnnnnnnnn nnnnnnnnnn 258180
 nnnnnnnnnn nnnnnnnnnn nnnnnnnnnn nnnnnnnnnn nnnnnnnnnn nnnnnnnnnn 258240
 nnnnnnnnnn nnnnnnnnnn nnnnnnnnnn nnnnnnnnnn nnnnnnnnnn nnnnnnnnnn 258300
 nnnnnnnnnn nnnnnnnnnn nnnnnnnnnn nnnnnnnnnn nnnnnnnnnn nnnnnnnnnn 258360
 nnnnnnnnnn nnnnnnnnnn nnnnnnnnnn nnnnnnnnnn nnnnnnnnnn nnnnnnnnnn 258420
 nnnnnnnnnn nnnnnnnnnn nnnnnnnnnn nnnnnnnnnn nnnnnnnnnn nnnnnnnnnn 258480
 nnnnnnnnnn nnnnnnnnnn nnnnnnnnnn nnnnnnnnnn nnnnnnnnnn nnnnnnnnnn 258540

nnnnnnnnnn nnnnnnnnnn nnnnnnnnnn nnnnnnnnnn nnnnnnnnnn nnnnnnnnnn 258600
 nnnnnnnnnn nnnnnnnnnn nnnnnnnnnn nnnnnnnnnn nnnnnnnnnn nnnnnnnnnn 258660
 nnnnnnnnnn nnnnnnnnnn nnnnnnnnnn nnnnnnnnnn nnnnnnnnnn nnnnnnnnnn 258720
 nnnnnnnnnn nnnnnnnnnn nnnnnnnnnn nnnnnnnnnn nnnnnnnnnn nnnnnnnnnn 258780
 nnnnnnnnnn nnnnnnnnnn nnnnnnnnnn nnnnnnnnnn nnnnnnnnnn nnnnnnnnnn 258840
 nnnnnnnnnn nnnnnnnnnn nnnnnnnnnn nnnnnnnnnn nnnnnnnnnn nnnnnnnnnn 258900
 nnnnnnnnnn nnnnnnnnnn nnnnnnnnnn nnnnnnnnnn nnnnnnnnnn nnnnnnnnnn 258960

nnnnnnnnnn nnnnnnnnnn nnnnnnnnnn nnnnnnnnnn nnnnnnnnnn nnnnnnnnnn 259020
 nnnnnnnnnn nnnnnnnnnn nnnnnnnnnn nnnnnnnnnn nnnnnnnnnn nnnnnnnnnn 259080
 nnnnnnnnnn nnnnnnnnnn nnnnnnnnnn nnnnnnnnnn nnnnnnnnnn nnnnnnnnnn 259140
 nnnnnnnnnn nnnnnnnnnn nnnnnnnnnn nnnnnnnnnn nnnnnnnnnn nnnnnnnnnn 259200
 nnnnnnnnnn nnnnnnnnnn nnnnnnnnnn nnnnnnnnnn nnnnnnnnnn nnnnnnnnnn 259260
 nnnnnnnnnn nnnnnnnnnn nnnnnnnnnn nnnnnnnnnn nnnnnnnnnn nnnnnnnnnn 259320

nnnnnnnnnn nnnnnnnnnn nnnnnnnnnn nnnnnnnnnn nnnnnnnnnn nnnnnnnnnn 261120
 nnnnnnnnnn nnnnnnnnnn nnnnnnnnnn nnnnnnnnnn nnnnnnnnnn nnnnnnnnnn 261180
 nnnnnnnnnn nnnnnnnnnn nnnnnnnnnn nnnnnnnnnn nnnnnnnnnn nnnnnnnnnn 261240
 nnnnnnnnnn nnnnnnnnnn nnnnnnnnnn nnnnnnnnnn nnnnnnnnnn nnnnnnnnnn 261300
 nnnnnnnnnn nnnnnnnnnn nnnnagacc gagctaacat ggggttagtt cgttaaatta 261360
 caataaagcc tcgtgcagtt tgcagcaagc tctcgaatcc gcctggtgat tggggtgacc 261420
 gcgaacctgg ccigagacc cggatacttg agttttcggg ggtctaacac ctgcaagcaa 261480

 ctacttaacc atccttcaca ctgcattatc tagagatgac gaagtagatg agaagacgtg 261540
 gataaattgt acatataac tggcacacat tactttatgg acttgagcat ctgtccattt 261600
 gggcgtcaac ttaggaatt actgggtcca gtcccctgtg gatgcacagg gaggagtatg 261660
 catgaaaca catggtatgt ttagtctcca aatggcaga ttcacttgag ttactttatg 261720
 ggcacatagt atctgaaaca attagttatt ttgatattt ccccccaca agccagtggg 261780
 gacaggttct agcaagatat gttacatctc ccagaatcca cttgtgaaaa acctcataat 261840
 tatctttgtg gtgttcagtc cagctgttca tcatctcttc cccataaagt attaggagat 261900

 tactctaaat gtcattaatt cttcagcatg aattaccca tgctacagtt accaatacaa 261960
 ctccctctcc ctgggacctc catgattcca tctcccaggt gatctctct gaaccatgca 262020
 tcctaaaaca teatgtaat cgatgtcagg ttccctcagat accagtttgt accaaggaaa 262080
 gctaatagagc ttccttctg ttttctgctc tagaggttcc tataacagag gagcggcttt 262140
 cactgaggca ctggccttcg ggattcatgg cggctcacag ggttcacca caaagccagg 262200
 taactctcc aaggtgcaact cccattacga aatctcttcc tgggatgttc tggggtttcc 262260
 ttgccacaga gatgggcagt ggtaataaag ccaattgctg gtgatcttgg cttagtgaga 262320

 acccagcttc tgagccctc agatgtttga gaaatggttg ttaagaattt aacagccac 262380
 ctacctggcc aagtcagagt ttagcatcct ggcttttcc agagaacaag cactctctc 262440
 tgccgttcca ggtcctggac cacaacactt gtattcatga caatccaaa tagaaacaac 262500
 ccaattagtt ttcaagattg tattttattt taattatgtg tctatctgtg taagagtgtg 262560
 tgcattgtaa tgcagatttc tgaggagacc agaagaggtc acacgatccc ctgaaactag 262620
 agctacagge aacagtgagc cactcgatgt ggttactggg aaccaattg caatcatcag 262680
 caaaagcagc atgtgccctt accactgaac catgtctcca gccctgagga ccaccactg 262740

 gttacctctc aggtctccag cctgaggac ccccccca ttgtacctc tcatgtctc 262800
 tgccgtgaca accactatg gttacctcta ttggaggaat gggagtcaca caggaacatg 262860
 agggcacct caatcttgcc ttgggtagtg attacatgga aatgtgttca aggtcaatca 262920

cactgtgcac atcacattct tatgctttcc tatagacatt taagataaaa atcttaaagt 262980
 atatgtaagg agtcatcccc atcacaacta aactcagatg gctgatgtac ttttgttga 263040
 gaggttgcttc tctgtggata gttctttctg gtgtgctaca gtggagtaag agctggaaag 263100
 tattaacag ttgatgatac tacctgtgtc aaaggcaagg aaatggccgg gcagcctcac 263160

 tgtaaagtcc acgtgttcca gcctattctg tagcccgtat gtgtataatg gctgtcactg 263220
 tgtgaaggct teatctctct ttcagggtgac aggaatctct tttcttcac ctgctggaga 263280
 tgtaccttca gatcagcatc ataaaagagg tgatgtttct accttaaaa aaaaaaaaaac 263340
 aaaaacaaaa aactaggatc ctctacaaga gcaaccctgc tgagccatct tcccagcctc 263400
 taatgccagc ctatataat attttacttt gttgaaatct cagctttcat atattctttt 263460
 tacttcacag aattctttct ttagttgggt ttagtgtttt gaggcaggct ctactagat 263520
 agctcaggct ggccttgaac tcatggctct ctgtctctgc ctctgagtg ctagggccat 263580

 agacatgtgc tacctcgtcg acttgttttc taagaatgct ctttgtgtgt gtggtgtctt 263640
 cccgtctcct cccacacat catcatctgt ccccagggga gtgtttagtg attagttatt 263700
 tcacatttta cctgccacc tgaattaact ttctcaggt catcctcaa agcatccatg 263760
 tggactggag atagagccca gtcacagacc acggtgatag aatgcaggca gcctcagtt 263820
 tgattcctgg gactgcatgt actgtacatg gtggcacatg cttgaaacc cagcacttgg 263880
 gagacaggca gttcaaggcc atcctcgaag acctgacta cacagtgaat ttgagatcag 263940
 cctgggctac atgagacct gtctgggaaa gcaagtacac tgcatctgtg tgatggttta 264000

 agtgagatat ccatctccca gagattcaga tgtttcaata cttggttccc agttggtgac 264060
 actgtttagc ggggttttagg aggtatggag gtgtgtcact ggggggtgaa cattgaggtt 264120
 tctaagccat acaccaatcc cagttttctc tctgtggttt acgatgggag ctctcagctt 264180
 gcttcagcca ccaggectgt cttctgccac acttccctgg catgaccata atggaccggg 264240
 aactcttgcc ttcgtcatga cactttatca cagcaatgaa aaagtaacta atactttctg 264300
 tctgtttggg gcctccgtct gttaaagcat gcagaactta ttctctagtg aagggttat 264360
 tcatctgac cagaggaca gacgtggagt tggcttttga gagccccggg tagcgtgcac 264420

 ttaagcttgt tttctacttt ctgcctcact ctacctgcag catgcctgct gcctctaac 264480
 ccatagctcc tftgctctct agaaatcaag cctgaagatt cagttgcccc gctgcctaga 264540
 gagagacagg acccaaattc cagctgttct ccagacagac tccaaagtgn nnnnnnnnnn 264600
 nnnnnnnnnn nnnnccccca cccctgccc tgcccctgct tccatgcttc tctcatcct 264660
 tgatgctttc tgagagtaga gaggaacagt tatctggctc tteatcacac tgtcataaag 264720
 atcttagcc atcaccaaac taaactcttt gaggtcattg tcgctccttc tactttcaat 264780

caccaagtgc catagctgag acgggtgtgc agccattttt tttacacagg aatcactctg 264840

 cctttttctt cacttgtcct agatcacatg tgaagaaag tgagcagaaa tacctttgtc 264900
 ctgtcttctt aggaaccata tccattcget ttcccaaagc caattgccag aactgtttg 264960
 ttctctgtaa caacaagca tggaaactcc taacatatt tgctgttacc tgagctatca 265020
 cacatcagca ctctagaac ttttcacagt ctgatgtgta cctagaaact cacaaaaata 265080
 tacttggcac tgggcagaaa gagatttctt tttctccat gtcagccatc tatcggctctg 265140
 ttctcactgc atagtttata agcacacaag tcagtataat tgaaggtccc tgaaaagcca 265200
 gccagtcttc agagaagtta ataagacttg acccattcca tggagacaaa aagaggtaat 265260

 ggttcaaaag cagctgaaat gtcaacagga cttgcaaaag gccaatcagc aaccccagaa 265320
 taaaaacgct gagttggigg taatcttggg cagctgaaga cagaagtgtt ttacaaagaa 265380
 ttcaagacaa agttctgggtg ctgaaaagct tagctttgat gatctggaga ggcaagagaa 265440
 atagtctga gctatttccc actttagaaa gattttgttt atccttttct gctagagttg 265500
 gagccaaatt tgagttagtt cttaatatc ctggccactc gagcactcaa gtcaatggtg 265560
 catttctggg aacagcctgt caccacagac tacaggetga gacagaaaga gcctgtccat 265620
 gtgacaagct ttctcctttt catcactttg accaacgact ctaggacact ggtacagtgc 265680

 actgtgttct tcccaggagc tccgagtctt cagctatgca ttgtttcttt acctgccttg 265740
 ctgtgagagg caagaccctt agagttgagt gaccattctt aataaacatt ccagtcacat 265800
 taacacgaag gcagacagaa aaacaagctg atggcacaca cctctaacc cagtgtctggg 265860
 aagtagagge agacaaatct ttgagacttt aagaacagcc tgatccacc aacagagcta 265920
 gtttcagga ctacataatg agttctctgct ccaatacata aataaacac agaattagat 265980
 gattcttgag aacaagact gagtctttc atttggaac ccattttagt ccatctgtga 266040
 atctactcat tcatcttata agtgattcca tttacaatct ctataagatt tgccacacag 266100

 tgaaaaggca tgaagcttta aaaatcaaat gctctggatcc aactcctgat gtcattggtg 266160
 ttttaaagtc ctcggttttc tttctctgac aataaagcta aggacttgtc ttggcaagat 266220
 tgttttgagg gtttgaata atgtacctaa agttactggc gtataataag cactcgatga 266280
 aagagagtgg cgctgtgac tgtcatacat tattatgtcg ctctgttgag ccagacagge 266340
 ctatccagct tccatatcca cctaaggagg ctgttttate cctaaagact cattctcact 266400
 accttgtgac tgactcatcc aaactgaaag aggtctcagt ccctgacaaa gactttctct 266460
 ttaaaccaca gttacctgac tctgtaagta ggctcactcg cttgacctct gcctgtctgc 266520

ttagttgctg ttctattgct gtgaagagac accatggcca aggcaacttt tagtaggcag 266580
 gcatggcact ggacatgtag cctaaagcag agagagagct aactgggaat ggcagggact 266640
 tcagaaactt caaagcccac cccagtagct cacctcctcc aacaaggcca caccctaat 266700
 tcttcccaaa cagttccacc aactggagcc caagcttcaa acagatgagc catttggggc 266760
 cattctcacc caaaccacca cacctgctac gctcaatfff ggcacaaaaa tcttacatca 266820
 ccgactaatg tcagatgtca ttttgccctg tcatattgcc tggcctca tctgcatgc 266880
 tggctataca atgctcagtt ctctctgtaa tatgtagagt tgagatctgc ctgttttgcc 266940

 tactgcaact atttggatg aagttttttt ttttctaaa agagttcact cttatctcc 267000
 atgtgtctgt ttcttactgg acaatgcaca tgaacttaac ctctgatatg gtttggatgt 267060
 catttgtcac caaatattca cacactggga ccttgtttcc tgttggta gagctgagag 267120
 ctggggaagc cttttagaaa tcaggcaaac tatgaagttc ttaatacact catggctgat 267180
 ccatgagaag ggctaagaga actcccatgg gtccctccgag ctctgatgag agcaggttgc 267240
 tatagaaca agctccatcc ctgagtgact ctggctttct ggttcaatat gggatctccc 267300
 cctcacatgc actcccactg ttgggacatt gctgccatg ccatgaggtc ctactagag 267360

 ctacagcaat actgctgcca tgccttgaa cccagagtt aaatagacct gttttctcta 267420
 taaagttagt ctgcttcgag tactttatta tagtaatata aaatgtatta atagagtctt 267480
 cccatgccag gacatgccac cctgagagtc cacttggttt ctctgaagct gagctactgc 267540
 cagttggtat accgagctgg acaaatgcct ttctgatgat ggaaggggca gagctggctc 267600
 cgcagatgca gttgctcca ttgtaggctc agatctctc tacacacctg cctcagctc 267660
 aggaaacttc tctgctctc tttgccacct cagtgcctcc aaggcattgt cccctgtaa 267720
 acctccacac atccttttag tatactacat tactgagtct tcctatgatg aaacaggcc 267780

 tatcttgttt tcccaggctc ttgagcctgg gtgagtgact cactaatctt ctgacagct 267840
 tctcttagt gtgaatggca ggaactcctg gatcagcttc tcacacttat gtgtgcagtc 267900
 aatcaggagt ttatgctgac catgaatfff ggagcctgcc catctgatcc tgttttctg 267960
 gtgacaaca tacctgggac atttgtaaa tacaattac ctggccttgc ctctagatgc 268020
 tccaactttg ggttaggct ctagaacgg aagctttgca aatacttacc agggatgtcg 268080
 gggaagtgtt cctgcagccc cagatatgtt agggaaaggg gagtgtatg aaaggaagaa 268140
 gggtagctgg cgtagccatt gctgggggtc acccagcttt tccttggcag gtgcaagtcc 268200

 agcatcagge gtgccctgtc cagcatagct tagttatgga aacctgcctg ggctgatgaa 268260
 ggaatggaca acggtcaaat acatgtacag aaaagctggg atctgataga ggggcaccaa 268320
 cgaggagaca attcagaact acctactacg tacagtagca cagcgggagg ggttagatgg 268380

tctcagttgg aggtccctat atgtccctat agggaaacag tcttggcttc aggagggaga 268440
tactgccaac ataggccacg gaccagagga aggcctttgtc tgacctgagc ctgacctaaag 268500
gatggttttg ccagctccca tgagctgca gcattgggtcc ttgtcaacaa tacacgttca 268560
ctcagggcc ctagctcc ccacatcgc gtatcccatg cttggggaac gggaggctcc 268620

gatcctaaca atcttgggtc ctcatggcc tatgggaacg cttcatgagg aatcatccct 268680
ccagccatgc cctacagtt tggcttcca tgtttgaaac aggatgatgg cagccctgcg 268740
agaaacatac agctttcccg aactcttggf gtgggatttg tgtctcca atgagcttca 268800
atcgtaccat aactttacc atttgatccc cgggcccttc atgtgtaaaa taaggtttat 268860
tccactacat tgaagccaaa gcttttttc aaaagaagct gccaaactga gctgaaagt 268920
gggttgcag cagtaaggga agagctggag tttatgttac tggagagaag tgccggtact 268980
cattaatgag gtgccctcta gtgggaaagg caagcaagga ccctgtttcc tcaaaccac 269040

ttaaccggtt acttgtact tctgggaaat taccctaatt gccaccaagt tgccctcatt 269100
tttaattttg ttatgttatt ttaatgcacg aaatcgtaaa tgagccggcg gtggtggcgc 269160
atgcctttaa tcccagcacc cggcagtcag aggcagcgg atctctgaat tgaagccag 269220
ccaggcctac agagcttgtt ccagaacagc tagggctaaa cagagaaacc ctgtctcaaa 269280
aaaacaaaac aaaacaaaa aaaacaaaa aaaaaaaaaag aaaacaaaac caaaaatcat 269340
acatgatgtg aagtgtcatg ctttagatac ttcggttagt ctgtccagc tgccttaaca 269400
aagtacagcg gactggatat tttctaacag aagtctata gtctggaaa gccaaagacc 269460

cggtaccagc agattcaggg tctggtgagg aactcttct gcttcagcc tctcagttag 269520
agtgtatgct gaatcatcgc gtttctgaag tcttgatttt tttttttta atgaacactg 269580
ttctgttca tgaggatgga cctgacctc tagagcagtg gttctcaatc tgtgggtcac 269640
aaccccttgg gtgtgagtg accctttcac gggggtcacc tatcagatat gcaatatcag 269700
atatttata taccattcat aacagtagca aaattacagt tatgaagtag caatgaaaat 269760
aattttatgg ttggaggtca ccacagcatg aggaattata aaaagggtca cagcattagg 269820
aaggttggga atcatggccc tagaggctcc ttcgaaaatg taaacacttt ttcacgtaca 269880

agttttggag gtacacaac tttcaacca tagcatttga tataaatta taggacaagg 269940
ttaaatacca attccacaaa gctggtaaac tagaaattg taatgcttgt ttaacgttga 270000
tgggtaagtg gatgacactg ttctgcagaa actgcatggc caccttaggg ttagttaatt 270060
agtcatgtct gatgtataa tttagcttgt tttataacg tgagcttcaa actacaatcc 270120
acagtatctg tgtgcacaag aaaagacatc ccagccttgt tcatggttca gcagaagcaa 270180
agcttctcct cgtggttctg tcagggagga atgctggtat cagtctgtgc cagggtacta 270240

tcatagtga aaacaaatct gtaaaaattt ggaggttttg ttttgaaga tagggtttct 270300

ctgttagctc tggetgtctc cgaacttgat ctatagacca actgacctca aacccggaga 270360

ttccctgce tctgcttccc aagtgcaggg attaaaggcg tgagccacca cggctgggct 270420

tgatttgtaa ttcttgtaaa gaagctccag gcctttgaac aactgtccag agatgctgtg 270480

tagttgagca tacaaggaac gctacctctc ttccctttt ttgacattcg gctccaagtc 270540

caattctgtc acaaaactaag tgttaaaggc tggggcaagt ttcacagctc tgcgtctgtt 270600

cctcccacca atgctgcatc tcacaggctc ctgttgaaag tgaggtaggg tatttgaaca 270660

catctacacc tctagcctgg ttaccaaagg gaaaacaccg tggtcacaaa ggcagaagca 270720

agcggctgga aatttacatc taaagacttt aaaggtgcta acctgtcatc agcagtagta 270780

tattatgtgt ttccgggtac gccagctctt tgcctgtga gacgcctaa catgcacaaa 270840

gtgctggctg gttcgcagga agctgacceca attgctcact gctgcctct ttagtgcata 270900

acttggattg catgggatgc tgcctagcct gcaaatgagg aaaagccctg caggccaag 270960

acaaacgctt gtggctctt cagctggaca ctaacagtc atgctgtctg ttagtgcatg 271020

cgcactctgt tctgcegaac gattgaagag ggaattggca cttcccacce ttgceatctg 271080

ccagtccag tccttcagg cctgcacaaa caaatcattt ggaatgaagc ctatctaact 271140

ctctctctct ctctcttct ctctctctc tctctctctt ctctctctcc ctctctctc 271200

tctctcnnnn nnnnnnnnnn nnnnnnnnnn nnnnnnnnnn nnnnnnnnnn 271260

nnnnnnnnnn nnnnnnnnnn nnnnnnnnnn nnnnnnnnnn nnnnnnnnnn 271320

nnnnnnnnnn nnnnnnnnnn nnnnnnnnnn nnnnnnnnnn nnnnnnnnnn 271380

nnnnnnnnnn nnnnnnnnnn nnnnnnnnnn nnnnnnnnnn nnnnnnnnnn 271440

nnnnnnnnnn nnnnnnnnnn nnttgaatca aattctttc taacttggcg ctcataaatg 271500

cagcatttaa aagaaagtaa tttcaactga gaagcatggg tgagaagacc cagcagggtt 271560

aagaagacta cattagaaca tctgtttttg cacgatgttt aatcctatcc ttgaatttct 271620

atthtgcacg atggtttaat atatatatat aatatatata tatattatat atattataaa 271680

tatccataag tctgaagga atgctaatg catttcattt agttattttg ctgatgaaag 271740

aacagacaat cataaaacct taagaagat tctagaagag tatattagtc tttagagtaa 271800

caatttttcc ctttagaata atttttttgc agattttatt tgaattagaa acataattgt 271860

tttacatgac aatcccagtt tctctctctt ccttctctcc cctaccagcc tcccacaact 271920

aaaaccctac ctatcacata acctttctgc tcccctgga tggtagggcc ttccataggg 271980

tgtatcaga gtctatcgta tctatccttt ggtagagtaa caatttatag aatgaatcac 272040
 tataatata gaaaggggat tcataaaaat gatatacagg ttacagtcca gctagtccaa 272100
 caatgatgga aggtccaaaa atccagcagt cattcagtcc acaaggctgg atgtctcagc 272160
 tggctctcag taigtgccta aatcccaaag taggctctaa tgccagtaaa ggaatgaagt 272220
 tcccagtggt gtgagagtaa gcagccaaag agcaaagtgt ttccttcttc catgtccttg 272280
 tatagactgc cagcagaagg tgtggcccag attaaagggt gatcttccca actcaaagat 272340
 ccagattaga agtgggtctt ctggcttcca atgattgaat taagaaaaga ccaactctta 272400

 aaagctgttc tctgactcac atgctcacta aggagtgtgt aagtattcgc attatgctgg 272460
 ccttcccctg tcacctggca gaatgcactc aggcagtacc ctggtcagcc cagggttcca 272520
 tgagtattag tctgcacgaa ggtgcaaatg accctttaa agacagactc ccaccacta 272580
 atgctctctt tctgctatct cctttctttt tccagctctg ctctcctctc tegtctctgc 272640
 tccctctgtc tctgtttctc ttaectctt ttctcttcc tccctttct cectctcttt 272700
 tctaataaaa ctcttactc aagctctgtc tgctgtacc ccacctggg tgcaatggc 272760
 ccccacgcag gatccccttc cagctttatg ccatcatctt aaacaaaaga acaacaatgt 272820

 gagcatgcag gcacacacac acacacacac acacacacac acacagattg tacagccctg 272880
 actatatac cgttttataa attcatgcac ttaatctcta gcgattgctc cctgccttta 272940
 ggaagcagat gctgggggtg ggtgtagcac taccaaacac ttaggtttcc tgtgatcaat 273000
 tacactctgt agaaagtctt tgtacctaaa gctttcttct gtgtatcaga taatacgtta 273060
 ggacagagtg tcaacagtga gatgtcaaag cccactatct cacaggggcc tctactctgt 273120
 aatgacttgc tctctttcat gtctctctgt gttgctgtga caggtcacag ctgccttccc 273180
 accagaaaat gtcttgtgac ttctgtgtg gcatttcttg tacttggagt tgtcgtcaca 273240

 gtgattgctg ttgggatcac ctttgggaag cctgcaagta tgtgtcacca cacacatgta 273300
 ttactactgc ggatgttcca aagtgggtga acctactgat ggggagtggt tggcatgtgc 273360
 tatgtccag ccatcagcca ttttgacat ctcttctgt cctcaactcc gggaatgtgc 273420
 ctattatggg cagtatgaa ggacactcag ggagaaagac agcttgcctt ggatcatgta 273480
 actgtgaagt aaacaagaaa gcgttctgac tcaggtcagc ccaattctta agtatacaca 273540
 ggatacggtc tctacctta aggaatttcc actgtaaatt gggcaatggg tggcggaata 273600
 ccgtataatt agaaattaga gagaactcag caagcaccag tgatgaaggg acatggaaat 273660

 gaaagaattg aaactggaac tgagccttgt agggaccctt gagtttagac tgtttcgggg 273720
 gcacaaagga cacggacttt gtcttgcac aaacctgagg tacgtgagga agagatatga 273780
 aaaatagtgt taagaatcca gttcaggtgt agggggaggg gcaggtgggt cacaagctca 273840

agtcagcctg gactacatag caagattatc tcaagaccaa ccaaccaacc acaaacaaaac 273900
 aaaaagtggc ctcagtggat gaggtcacac ttgctgccaa gcctgatgac ctgtgtcatt 273960
 cagccccaca tggcagaagg agaaaaataa ctcttgcaaa tggttcttag aactccacgt 274020
 gagcactgtg gctggcatgt gcacacatgc acacaaataa ataataaat gtaaaggaat 274080

 taaaaacaaa acctcatagt gagaaatggg tattgtctaa aaagtaaac cattgcaatt 274140
 atacacatac acacgtgtat aacctagctc cctcccctac cttgcctctg ctgtgatgtg 274200
 cttttcttcc attgctcatt tgggtaactc ctaagggtaa aagaccaaac tcagatgtcc 274260
 ccaggatctc tctatactag acagtcccag ccactagact ctggatccat cactctgctt 274320
 tcccaacagc ctagttaagg tcagtactgc agagacactg gagccagccc atgctgtagg 274380
 atgtgggcag tgcttcagtg aggaactttg cacacagacc tcattaaat ctgtcctgcc 274440
 gtggacatta gactttcttc agggtttaat gttccccacc tgtgcttgac tctgcccttc 274500

 tccttcatag gcattgcccc aggtactaac ttcccaccag agtcacatct cattccatcc 274560
 tagtatcaat ttttcagagg gtccaaactg atatcaattc cttcagatga ccagaactaa 274620
 ggattcttgt ttctgaaacc acaatgcctt taccaattgg atctgttttt atctgcctct 274680
 taattgttca agttgaaaat gcaccatcat caagtaaact ccaagccaag tacctcagat 274740
 atgccccca ctgtgtaccc ctttgcacag ctgaaagggg ttatggggga agacacaact 274800
 atgctgagat acaagtgtca ccagtgttgt ggaatattat tttagctagg caaagatgtc 274860
 ccacttgttt atgtactga acattacttt taactgtgta aaagtgtatt acatatgttt 274920

 atgctgcatt tgtttaatta tgtaacaaag tgttgcatth gtttcacttt gcctgcctaa 274980
 gacacctgat cagtctaata aagagctgaa tggccaatag ctaggcagag aaaagaaata 275040
 aataggagaa ttctaggctt gagagaataa aaggaataaa gaaagagaac agggagaaaa 275100
 agaggagaa gcctggaaca gaagccagc agctgctaga aagacacaaa gacagcagga 275160
 aagtaagaat gaaaggtaaa aagcccaag gcaaaaagta gataaagaga aacaggttgg 275220
 ttaaagttaa aagagctagc cagaacaag cctaagctag gcctagcatt cataactaat 275280
 aagcctgata cacaccagta tttctataac ttccatcagt ttggtttttt tcccctagc 275340

 acttgagatt tttaaaaaga cttttccctt tcaaataggt agattccgtt atattttaaa 275400
 atactatcat gtgggggctg aggggtgtagc ccagtggtaa aatacttgcc tagaatatag 275460
 gaagtcctag gttttatccc agctctacaa acttgtggag gcctgggtgc acaaacttgt 275520
 gatcacagta ctccagaggt agaggctgga ggatcatggt caatgtcagt gattcgaaaa 275580
 tcaatctgag ctaagacatg ttgtctcacc attggctcacc atcatcttaa tcagaggcga 275640
 ggttgaact tgctggtaga tccctttccc agtattcgta agaacctaaag ttcaatctcc 275700

aggacctcca aaacaaaaat cttaatTTaa ttttactcac aatacgacca tgaggttgac 275760

atagcaagtt acctcagcta agaaaaataa tagacaggac tgtaatatcc aatccgttac 275820

agagtcata cgggggacca ggcctgttga cctctcagct gcctgccatt acctcttget 275880

gggactgagt ctacacttgt ttgccagatg ccaatggttt tgagggaaaa ggaagaacca 275940

tcaagttaag aaggcctatc tctggagagt ttgggagtat ggggtgggaaa gaaagaaggg 276000

ggaagaaata ttggggacag tggcacaaag cagggtgagga tacctggcat tcttgcatct 276060

ttcagatcag ctgtctcacc aatgcagaac agcttcacag caaccaggct tctgtgtga 276120

ggaccacacc acttgcttgc tgcctctct gctttgtgat ggcaagatgg actgtggaga 276180

tggtggagat gaatctgcca cctactgtgg tgaggtggac tgaagttggt tgTTTTtagt 276240

ctcttattct tactcttTga ggacctgcca ccagctccc aaataaatac acagaggctt 276300

attgtttctt atgaatgctt gcattagctt ggcttatttc tagccagctt ttcttaaat 276360

atcccgtcta aattttgctt ctgggctttt accttcctct atcctatata cctattttta 276420

ctttttacta catgacttgc tgtgtagctg ggtggctggc tcctgctgc atttctcctt 276480

cttctccccc ccccatctc tctccccaaga tttctctcc catttattct ttctgctga 276540

cagccctgcc tatttctctc tgctgcctag ctattggcca ttcagctctt tattaacca 276600

atcaggtatt ttaggcaggc aaagtaacac agggTTTTta attaatgttt gfacttaagg 276660

agcttcaatt tagaattatt tTtaagcaaa tgagttaaat aaatgaacc taaaagaatg 276720

caacacatct ttgcatcatt aaacaatat tccacagcat aaatgaacag aacctcaag 276780

ttaagaagge ctatgccacc aggcagtggg ggcacacacc tTtaatcca gcacttggga 276840

ggcagaggca ggtggatctt tgtgaatttg aggccagggc agaggcaggt ggatctctgt 276900

caatttgagg ccagcctggt ctacagagtt agttccagga cagccaggac tgttacacag 276960

agaaaccctg tctcagaaat aagttTaaac aaagcagcta aaatatgtac atgtagctac 277020

tatttaagaa ctataaggta accctatgca gtctTaaatt cagctgtgct aagtttcaga 277080

cagtcaagcc tacacaggaa aacctgtct ggggggtggg gaggagggga gcctatgcct 277140

ggagagtttt ggagcatggg taggaaagaa aaaaaaagaa gaaataatgg ggacagtggc 277200

acaaagcagg tgatatccag cattcttgca gctttcagat tggatgtatc accaattcag 277260

aacagcccta tgatggatta ggtatacagt cctgtctatt atttctTaa actaatatc 277320

tacaacagta gacaaagTaa agaacaatag ccagggtgg gcaatgtggc ccatgtgttt 277380

aatccagca ctTgggagge agaggcaggt gggctctctga gttcacggct aggtctacac 277440

agtaagacc tgictttaa gcagtagggt agtagtagta gtagtagtaa gataaacttc 277500
 agaactacca ttaaacatt ttcataaata atttttccac tataaataat ttatttatac 277560
 aatataggtc aaatgcccaa cagtctccca ccaaacttga ttttcaagt tcccaaccag 277620
 aagacatgga tatatgtgga cagggtgtgt gacacaaaga atgactgctg tgactgctca 277680
 gatgagtcag gtaaaaacga aaattccata gttgatcttt ttaatgggtt ctgggagtg 277740
 ctgcccttac acttcaatta cacaaattag ccctaactta gaaaccttct acaggggatt 277800
 tacacacaca gactaagaaa ttctatcatt ccctaggccg cagggaatgc caaggtagag 277860

 agcaggctta ggcaggctga ggatcctggc ttccattcct agccccacca ccaaaaacaa 277920
 ataggaagga gatagacagg gagagaagaa aggaagatag caggaggaaa caagagggga 277980
 aggaggaaga gggaggggaac tatattattt cattagtcca tgtctatttc aagtaacaa 278040
 gttctctagc aaggaagtta acaaagtcag ttttgcaaga aatgttaac agaaagctct 278100
 catctattat caactttcac ttgggtttct ctggcaattc ttcaagatat acaaaagttt 278160
 tgttcagtgt tttagctctc aaaaaactag ttgttaacct ggtcatttct tcctcacttt 278220
 catcctgtgc ccccatcatg tteccaacat ggcttaacac tgagctgcaa agatccctac 278280

 ttcacaagca ggcaagacc caaccgtag gcagtccagt gcatgatggc tccaactgat 278340
 aactggaag cggcatcaga aacacacaga tctgctcttt gccagtggg gagggtagaa 278400
 tgaaaacaca tttttgtagt taggaaggag agggatggat gtgtgaagag gcctttgct 278460
 tctggctagc tgacaattag caaaggcctg ttcccctgct gactgattgc cccaactcaa 278520
 ggggacctt cctgtttac tcaccatgct agtatgttta gtttgggctg atgggtagag 278580
 gcagtttctg ctctggcttt tcaaacatg ttagaatct tcagcaatca tctgctgatt 278640
 ttcccatgat agtttactg atttttttt ttaaacctaa agggttattt cttgtccaat 278700

 agtatTTTT tcccagtga cattttaagt tatgctttta aaaataaata caattgtcta 278760
 gtttcacaga gccagcgtg ctgaggctgg agatgtgata ctgttttctt cgctgactgt 278820
 gcctgcatc ccagaagtcg ctgcagaaac ggcattcaag actgtactga ctggagtgat 278880
 gaaaacctgt gtgattaggt ttataatcga ggtttcagaa aagctgaaaa atgcttcttg 278940
 ccctaagact tcctcaaag tatcgcgctg tctgtcttcc atatttacct tcttggaatg 279000
 tagggaagga agaacctgtg cctcgtaac caagaaaact ggcagaaatc agatgcaact 279060
 ttaggtccct gtictaaatt tgtttgcaaa taaccacagg gttatgtggg aagcacacac 279120

 atgtactctt gtttaacca gtatgaaaac agttacccta agaactttta gatggagatg 279180
 cctagttcac tagtgtttaa tagccctggc ccagatccta gcagaaaatt aaatttttaa 279240
 atgtttttaa attagtagat aaagtattag aagtcattat ggcatttttc aaagtgtgtt 279300

ttaagtagat agcctccatg ctctttttaa ctccccctgt agtctccttc ccatgtgtcc 279360
 tttttgtctc catctcctcc ttcccaaca tctctttacc ctctcttggt ctcttctagc 279420
 ttttgaaggc tttatgttaa tattgtgttc aggtatatat tacaagctag gatctgcata 279480
 ttagagaatg tagtttttat ctgagtttgg gaccattttt cctggaattt ttatctttct 279540

 tcacagtgga ataaaattcc attgaacatc tataaccacia ttttcattat ccatgtgtgg 279600
 atgatcatct agcctggctc catttccgtg ctactgtgaa cataggagta atgaacctga 279660
 atgtacaagt atcttggtag gatacacaat tctgagtaca tatagccagg aatagtatag 279720
 ctgggtcaca tggtagttat tttgggggaa acacccttac tgatttccat aatggctgtc 279780
 atcattggca ctccctgcaa tataattaag ggttccctct tcctacatcc ttgccagaat 279840
 ttgatgtcag gtttcttgaa ggtggctgtt ctgactgggc caggtgcaac ctctaagtag 279900
 ttcaatttgc atttccctga aggctaggga gaaaaccagc cftaacagtc aagaaatcat 279960

 cagcagacca gaacagtctc cttcaacctt caaggttcta acgtgattgt gctgtccttc 280020
 accagtagta accagaaact gtagacaaag aaaactgcaa ggatattgta gattgtgcta 280080
 ctgttactaa cactactcta aacaacctta tgaccacccc agtgacagtg ctgtcctctg 280140
 gctgatgtag tctgtggtat tatgtgcata acttccgagc ctaagtttgg ggagccagct 280200
 ggtgatatgc caccttttct atcacaagge tggcaaggtt ctaattaaac gctgtcctctg 280260
 caataaagta gaacagaagc aaacaaggca tcaaatgtga cgagcctttg gagctttttt 280320
 ctgataatag agattatgaa ggaaaatgtt tccttattaa tccacagcta ccaacacact 280380

 atcactcaat gaaaaaccag caaaaacact tgcagaggct gaggaatcaa ctctggttag 280440
 tgacagacc agctggaaac ctttctaca gacctaaatc acagccagtc agcagccgtc 280500
 tctacaaact gaaggaatgt cactgtcacc ttaagagttg acatcctgag acaaactgag 280560
 aatgtttcta gctcccactc acaacactcc agctcagcca ttccatctgt ttggattcta 280620
 aaaatgagtt ttcccagta acagatttat cctatttct atgccccatc attgggcaag 280680
 ctgtgtttac aaccaacctg accacaaaat gtctgggtga ctaggatttt tagctgttga 280740
 gacctcagga ccttgttac cactgtagca gtcgaccttg agggatgact gcataattct 280800

 gcacattcct cccaacttca catttgatac aactaattct gcacagtaac tctggaatgc 280860
 agctgfaca caccttaaaa ggggagcttc gaaccacagt atatatttaa aacctctca 280920
 atagtaaagg caattttcag ctctcttggt gttcgatgaa gggacaaggg gacttctctg 280980
 gaatggtgga actggtcaat attctgatta tggcagcttc agtgtaaca tagagccttg 281040
 gaaattagta actgaaagta tcaggttata catacaaat ggagatacta attcatacct 281100
 cataaagtta gaataaacg ttaaaactga gatacagggc ttagagatg gctcagcagt 281160

taagagcact gtctgctctt ccagagaaca caggttccat tcccagcaca tacatacata 281220

 cattcttact tatatacatg gaggtcaca accatctata agcccagttc cagggatcct 281280
 atactctctt ctgacctctg cataaagata ccatacactt acaataaata ataccaagag 281340
 aaaaagcatc ctggtttacc cacagaatac tgttctcata gcacatccac cacacagagc 281400
 atgaaagccc ctagggttgg tggagaagca aactctcaa tacactttca tttatcacca 281460
 aatgctatca ttacaaccac acaccatgat caactttcta taaactgctt tctctgtata 281520
 gatgagtgtc gtcaacaag ccatatacta ggcaaagaat tttattaacc cctttccaaa 281580
 ctttattccc aggcttcttc agcttaattt gctgcaaaga atgaattgtg ttttaagcaa 281640

 aactgaaaag agctgcagtg tccagggggc ttgggcttaa aaatattaag agatctagat 281700
 tttatcagat ccataaaca aagaatttta aaaagcagtc atgatataaa atagcagctc 281760
 ctgtgacttc tgcaagtgtc accttcttca gaagtgcct caattcaatt tgcctcgttc 281820
 ttagaagcct catcaaaatt ctccaccaga tctagaaaag aatcaaaaca gacatctga 281880
 aaaaaatcca gctcaaaaa acgtacaagt atttatggaa acaatctcaa atttaaacac 281940
 ttgccaccte caatgagact attttggcac agtaagtgtg gtctggcata getactggag 282000
 tgaacatcat gcttaaaaa atctatttta tctcaattt aagaactaaa tacaacacac 282060

 agattaatat aacaggacta aagactacca tgacatgac tgagtcttc ttgggtttca 282120
 gggacatttg tagaaactag aaaatgtatg catttttaaa aaattcctcc acaggacata 282180
 aactcaatgt aatttagtgg gacatgatgt catttctctg taatcccagc actggagagg 282240
 ttgagtcaga agattctcaa atttgagcta catattgaaa caatgtttca agtaaaactaa 282300
 aaaagaaaa cattgcccg cgttgggtggc ccacgcttta atcccaggac ccaggaggcg 282360
 gaggcagtgg cagcggcagg cggatctctg tgagtttgag gctagcctgg tctccagagc 282420
 aagtgccagg aaaaacattg ctaaccaagt tacttagctt tagaattatc acaccaagat 282480

 atttaaacct ctccatacc atttcataaa ccagtgtgtt tcaaagtagc atcagtcct 282540
 attccttga attctctggc ttttaacttat taccaccatc accatcctgg aactttttct 282600
 gtaaaagatt catttttctc ccttgccaaa gtgattctta cctgggacct catcatcatc 282660
 atcctctcca gtagcaagtg gtgctttccc atccacagct gagaagaaa catgaaaatg 282720
 taaccaacce attttctcta gatcaataaa catcaaccac aagaacatat gaaacaccaa 282780
 gtcacaactc acatttga tggaagtgtg attgaatttt cacctatagt cccattaaca 282840
 agaaattgtg atgggcacaa actactgaaa cacaggtaac agtaactctg aatacattga 282900

gaacagtgat tagggagcgc tcaaagatga aaccacacac caaattatag tcaggcttat 282960
 tttgggaggc aaatgaggaa gccagccatt tcctaataa ttctgtgcat ggcacaaagc 283020
 ccaatgaata ttgaaataaa aacttaagcc aaatgtggtg actcacacct atcaaccacc 283080
 gaacttccga atgcaaaggc aagactataa gcgaactcca taacagtcca gcctacatgg 283140
 ggagacctac ctacctcaa agccaagaag gggaggaaca aacaaaaagg acaaatttaa 283200
 agtatcttcc aactgttaac taaccactgt tactcttttc cttccccttt cctgaaatat 283260
 taggaactga attcagggcc atgaacatgc tagcaagaac tctgccactg agcttcacta 283320

 accagcctat ttttaataaa tacattttaa agacagttaa atttgccag tctttcaaca 283380
 cataaaagtt ccatcagtac aagtttcaa agctggcttc aaagatcaag atgacctaaa 283440
 acatcttgat gctcctcctt taacaataaa agcataaaat gagttagcat ctaacaaca 283500
 gctgaggaaa tagcaagcct tagagtaagc ctcttgactt gcttctgcat tcataattctt 283560
 aattttaag ccaaaacatc aagcataaag ctgccacacc acctaggatg actaatcttg 283620
 gtaatttga caccagggg gaaggacct aaatgcctcc atcagatcag cctagtgaca 283680
 tgtatgtgct gcattttctt aattgataat tgatgtagga gagaccagcc cattgtagac 283740

 tagtgccatt ggigggcaac ttggcctgga ataagaaagg ctgtccaggg ccagatggtc 283800
 agtcctgaaa acatacatgt aagtaacatt atacacacca aagaggttat atttaggaat 283860
 gtgtgggtat acatacacc atacaataac aatgaaaaaa ggttatgaat ttaaaagaga 283920
 acaggaagg ttatatggta gggatggggg tgtgtgatta taatctcaa aataaaaagc 283980
 agttgattgt gagcctggga gtgagccaat aagcaacagt cctccatggg ttgcctcaag 284040
 ctcccgcctt ggcttccttt gatgaactgt aaagtgcaat gaaataaacc cctttctcct 284100
 caagttgctt ttggtcatgg catttattac aacagaaatc aaagagaaca cagcttgttg 284160

 tacatgtagg ttacagtctg ccctaacaaa aaaccttacc aaactataat ctgaaacacc 284220
 aaaatattta ttggtacctt tcatctatgt caacaataat ttattatgtg tttataagta 284280
 attaagacc ccaaagata ccaaacacaa agactgtaaa taaggatatg gaatgttagt 284340
 attattcttg ttttttctt agacagcatg tttgtagccc aagctggctt ggaatcctgt 284400
 aattctcctt agttcagcct ctcaaagtgt taccaagtgt gagtacatg gccagcctg 284460
 tcaattctaa tcttaaaacc tagcaaaact aagattaaca gtttttttc atttctaact 284520
 aaagttaagt ttttagtgat tcaaacctag caagttggta agaacaagc atccaactaa 284580

 tcaagtataa tgatcacaga aaaagtagac acatcactgt aaacgagaat gagtaaaagc 284640
 agttagttaa aggggtgatt attcttttag gcattctgtg tctaaggaca ttcttagcaa 284700
 ttctgagcct gagatgacac aaatgtaact ctgaggatag tcacattggt tgggcaaagc 284760

ttcagccagt ctccctaac tagtcagact gtctgcccga agctggttta ggatgctggg 284820
 aagcatttct gtcagctgct ttgtctcagc gtggcctgta atggtgaaag tgtttgctgc 284880
 cagagacgcc tgaactttag ggttgttaaa atggatcact gttccttggg ttgtaaacat 284940
 gttcacctat aagaaaatac aattattata agtaatgctc accaacaatt cctttaaaat 285000

 cagtttttat aaaactataa tatgtctgag ttttcccct ttgaagcaca ggtgacaatt 285060
 tcccaggaat gtgtaatcaa ataactgtct ggcttcccaa tctctcagat actcaaacat 285120
 ctaatggagc accgactaca ttgctaacag cagaggcaag acaattactt aatataatgat 285180
 cattaanaact ttccagtttc gtgggtgctt gacactcacc tcttcaatac cagagatggt 285240
 gttcacccct aacttcttta aggagaactg cagtttttta tcatctgctg tggctgttct 285300
 gtgaaccacc ttcttcttc tgcgagcagt tccttagtgg gagaaggga gacagcacat 285360
 ttacacgaca gcagctctac ctaattcttt tcagaccttt gcttctgtac aagttagtta 285420

 accagataga acatggggg gacctgttc ctttagtccc agcactcaag aggagcaga 285480
 ggcaggtgga tctctgtttt gaggccagcc tggccacat agtgagtccc aggcaaacca 285540
 cgagctagg ttcaataaa aaacaaaaca aaaaccata gaattttaaa aatagtcacc 285600
 aaaccacaa accatgaagt taaaaggca ggttacaacg gaagtatggg aaaggaatgc 285660
 ttatgaattt ttataagca ctagtttgta agatgcaaat ggtcccttac aagtctaac 285720
 atttaagtct tttaaaagt gatcagagat ggcatgtgac aacttaaag aaacttcatt 285780
 tatacctttt gtttcaaag aaaaaccaag gccttaatta atactcacag agggaatagt 285840

 aaacaaagta accaatgaat ctgtatacag atgtctacta cagcagagag gacaaaggta 285900
 aagttcttaa ccaaccaga tctttctaac tgaagatcct ctttgatgtt ccttaaagga 285960
 gaacaggcta gtgccctagt gcatctctga atgctatccc tcttccctgt actgttcage 286020
 ttctcccta gagtacattt ctcttcacc caactagga catccacaag catcagtctt 286080
 gcctaattta cttaagta ttctactca ttttcaaaa tgctgttcaa gctattattc 286140
 catctgtctt caaagccca actctgcatt aactgtatgg catgctaage cactccaaa 286200
 tgtatactat gaaaagactt ctataacact aagtacacca ccaccaggaa aagattagat 286260

 tctaccacct atagattca cacattcac aaatgtagaa ttactacac ttactcaaag 286320
 aattgtcage atttcatta gacaccgaaa ggggtcttga ataatttca cctgaaagca 286380
 tgcaaatcta atactgcttt tctcactcac actataaggt ttctttaaag gtacagaaag 286440
 atgtcccat attatggctg gaaacatttt gtcttagctt aacaatact agatacaaag 286500
 tctactgtat aagattaact tggaaggctt tcttttccc ttagagatgc cctcaaagt 286560
 taaaagccat tagaggaacc acctgcaca tctctcaaa aactatactg aaagaactg 286620

tcaccactgc cccaacccca gcacccgaag ggtactatgt taagataaag gataagaaac 286680

atccaatggt agtgtcgtga atggaaactg aagattacaa ttgtcagcaa aggcaaatca 286740

ggtgtggatg ttaactgttg atcaagtcag ctaactaagc aaagctgtgt cttatttaag 286800

ctatacgcaa gatctgggta tctcacagaa aactctcctg aaggtaaatg tttaaagtta 286860

ggacaattta atagtaata aactggtaga atggaagctc cacaagtttt accaagtaaa 286920

gacatgctct gattcaacca gcagacacca caccttggtc aaaacttcgg aatgtgctaa 286980

cacaatacat gaaactaagg agatctccat caggaactga cttcagatta gcaaaccaaa 287040

caccagattc aataaagaat cttcattaag cttagtaacc accaggagta accaattagc 287100

caacacattt ttctccac tgtaggataa ttacaaagac agaacaaaaa aagaaatcta 287160

acaccgacta ttcattgaatt ccaaaaatat cccgttgagt atttagttca gaaagcattg 287220

ctgaaaagggt ctttaattaac gaaaataaat gtctactttt ctaagcatta agtagaacia 287280

caacaaaaaa aacaccccaa aacattcggg ggggggagcg caatgaagta catgcctagc 287340

atgaactaga acctgtgtct gatctccagc acagcttaaa ataaagaaaa aataattcac 287400

caattttgta caactcaagg gtagagggtg acaatgattt ggacagagagg accttctccc 287460

ccattaataa aattaaatat actttctgtt tatatgttgt aatcttagaa acacgcaaat 287520

tatgtttaag tgttattttc ttcttacta aattacttgc taccaccccc cccaatatac 287580

agcttccacg ttctttgtg tgtctcatct cttttggatt ggcaggcttt tccaatttcc 287640

cctgccaagc aaagtgacaa aacagcgtga gaaatgcaaa gggaatttta aaaagtaaaa 287700

acaagaacia caaacttact ttcccacga tgcgcaactg tgctgcagc ttggccagtt 287760

tttctgggtt catgatcgtt tctttcatct ggaaaagaga ggaaatcctc agcaaagaac 287820

ggtcgggctc actccagcat tccagctcg ttatttccca agacaccgc aggagaacgg 287880

cctccgagg ctgaggcctg gatecccaaa ttcacctac gaaactgcga agtcggctec 287940

cagcgagccc ggtgagcaca agcactctcg ccaactcccc ccccccttc caggcccaga 288000

ctcgggctca cccccacagc attccccca cccgcggccc tggccggcct cggcctcccc 288060

agggcctgcc cggccccgcc actctccgca gcctcgcgg tacctgaggc tctgtcctc 288120

gggttccgcc gagaagtgga ggaagagac gcgtgcctc gccccgggg cagccgcccc 288180

tggctgcgcc tcgccccga gactcagcct gagcgggagc gcctgtccgt cgcactcgtt 288240

tctctcctc agccctgtcc ctccctgtct cgtccagcc gggaactgcc ccccccgct 288300

ccctcctcc tcccacgcc gcgtccacag cttttttgta cttgtcgga gtggaaatgg 288360

ggccgcgagg gggactaggg ttcgcgctca ggggtctcgg gcagaccagc tgagataagg 288420
 cgcacacacg cggggacgca agatggcagc tagagggtgg ccggaagtga cgcacgcca 288480
 ctctctccgg aactcagggg actcggcgtc tctgcgcacg cgcggccggg gcccccgggc 288540
 gaggggtcgg gticgggtgg ctcccagttc tttccttgtg tcccgcggcg tgccgagagc 288600
 agcaccggag agctgtgagg cgcggacact ggcgctcgtc ctgggaaagg ctccccgtgg 288660
 agctgtggtt aagtgggtct gccctgtgtc tccccccca ggacgtcccg ctctgtccag 288720
 tagacagcag tgictgtctca atgccgggtg taaatgaaga aaaggtatca aaatcagga 288780

 agctaattgc tttccagaat taggtggctt gactgatgtt gaaaatcgca attcagaatt 288840
 tctagaaagc gtgttccgaa ttcacccggg tacccaccc ctcagagcaa ttccatccat 288900
 tcaaggttga aacacagtaa cagatttcta atccccttaa ccctccacac cacggcggtc 288960
 gcgtacttaa ttaaatctct agtaggcaaa cggttgactt ctcgatatcg attttgcgtg 289020
 gatttgacca tgaatcattc acaatggagc aaatcttacg gttagtaatt gaatcagaga 289080
 cgaactgggg cctgatgtgc ttggagaaaa aagcgcggct gtgagttaa gtttgcgtaa 289140
 ctccagtaca aattgtgttt tgtagtgttt gcgttttttg ttgtgtggcg tgatggttgt 289200

 ttgaaaagt gtaggtagtc ctggctagtc agaaatagct atcctccaac ctgggtttc 289260
 ccgtccggtg ctgggattac aatcctgcag caccatcccc aaacaagttt taagacaacc 289320
 ttaaaaaata tctttgtggg gggaaaaata taaatcttag tgaaaattct gtgtagtcag 289380
 ccttcttga aatttagttt tgggatgctt ttgaatattc aaaagttaa gtgtgataga 289440
 aatttgagag aaaataaat ttatctgaaa aacctgtgta agtgcatacc cctctagcta 289500
 aaatcagttt ttttcttga aaactttttt acaagaaagt ttacaacagt gatgtgtcat 289560
 tatgaaaatt ggggggataa ctagttgct ttgtaaagtg attgtaacag ttttttgtt 289620

 ttttctttt tgtttttgaa acaatgtttc ttttatecag ccggtaaatt tatctcccag 289680
 aaaaccgtgc ttgttctcta ggctatgtag ttaccggcc tagccataaa gatccaata 289740
 actgccagc ggtggtggca catgccttta atcccaatac tcgggaggca gaggcaggtg 289800
 gatctcagtg agttggaggc cagcctggtc tacaagtaa gttctggggc agttacgact 289860
 gtattcaga gaaaccttat tttgaaaaa gaaaaaaaa atccaaaaac tgaggtaggg 289920
 caacattatt tagtctaca agaaaatcta taaaatata aactgttaca tgtgatttat 289980
 aaaactcaga actagtcctt tataaagaaa tttatgtcta taaaatatta tacccttgg 290040

 attatactga gggcatgiga aactttttt tgtttttgt ttttcgagac agggtttctc 290100
 tgtggctttg gaggctgttc tggtagtagt tctttagac caggctggtc tetaactcac 290160
 agagaccgc ctacctctgc ctcccagggg ctgggattaa aggcattgta caccagctg 290220

agggcatggt aaacttctta tccatgatgt ttcttaaatt ttactttaa accttacata 290280
 tgcaactgac acctgtttct tcttttatac caatattcaa gaaatgtgat ttattttatt 290340
 ttcccttggt cctacagtca agtgtacaca aaccttgtct caaaacaac caacaaaaga 290400
 actgaagagc ttigtgttg tttttctctt cccccagtag ttactacttt gtagtcttcc 290460

 cacatgttcc caatgtctcc agcaaatgtc aaaggttgac tccccatcat ttactgttca 290520
 tataaaacag tgcaagaagt gcttatttag catttgagat ggtctctgtc aacagcatgt 290580
 gagagaaggg aaacatgttt gctcttcttg atttatagcc tatgtctaata caaaaccag 290640
 aaattgtttt catctctgac ctgaacttga gttggcttca gcaaagcca gatatttact 290700
 tgacattatg cttaatcctt ttactaaatt aaaaaaaaaat gtgtgtattg gtgggtttct 290760
 cccaagccat ctcacagtcc atgttctgt gcttttagat gcttgggaac cactaaaatt 290820
 cccttacatc ctcttccag catcactgtc tctgccaagt taatatctat aactggctc 290880

 tccgagtctc aggaaacctt gctcagatac cttacctac actagtttac atctctttgc 290940
 cacagaaatc ttgtttttct tgtagtcacc cggccccaa attgtctgtg tgatgtcagg 291000
 tagtgcctta acttgtatac acagtatata tattccacgg agaatgtagc cctgggggca 291060
 catggagcat tagtgaggtg attgatacaa accttggccg gatgcagaga acagtcatg 291120
 gccttgaac atggtttgtt cttttgctc ctcatccagt tcagagaaaa aaataaattt 291180
 tccattggta gaaccacaa ggtcttggaa ggtagatcta actggtcaat attataaaat 291240
 acatttaaga aaaactctcc cagacctct gacagcagtg taagtactgg ctggcccagt 291300

 ggccctgacct ctgtatctag atagggaaag gatgaccag gaaggatggc atcgggtggac 291360
 gtttatgatg gggcagagga agatctttct tcatccctgc ttgctgcaag gaagtttctg 291420
 agtgggtgaa agctgtgac aaattgtctg ctaaaaccaa gtatggggtt caatgcaatg 291480
 aacaagtca tttggggccc atgttcacac aggggcaaga aaacacaaga aacgtctgtt 291540
 taaccctca gatggagaca ttgacctac aagatgacct gtaacaatcg tctcacctca 291600
 aaccacagac cttcattgct gctgaggttg gtaacacata actccactct tctcttccag 291660
 acaaaccta gctcatcaac aacctgtgg cagattcctt actgagaggc agaacaatct 291720

 gctgccaaga aggcagctat tgaaggtgtt caggagcata tgactgagtc agagtcacaa 291780
 ctgccagttt cacacatctt ctgttgggcc ccacaggcaa gcacagcagg gttgtcttcc 291840
 tgcttgaac tctggctcag accttggctc tgttttatcc agtgaaaatc cttcagtatt 291900
 cctatcatgt ccaaaaatca aggggtggaa gtatgggagg caccattcac tattgacaga 291960
 gcttgtctgt tctctctgca atgtaatgct ctcttgctt agaggcctta gttccagaaa 292020
 gggaggccgc ttcaccagaa gagatagtag tgatctcact gagctgaaaa ttctatggtc 292080

acctggacac tctgggttcc ttgtgccact gagtcaacag aagaaggaag ctgagggttt 292140

 tttgtggggt actaactacc aaagagaagc tgggctacta ctactccaca gggaggaaag 292200
 gaagagtgat tcttgaatcc agaggtccct aatgaagggt taggtcactc cattgggtaa 292260
 agggccatac cagctgaagt tgccaaaggc aacaggaata tgggtatag tagaaaatta 292320
 taattaccag ctgtaaccac atggcaagtt atagaaatga ggatattata tcattactat 292380
 ggcttctttt tatgaaaaaa aaaatgtgta tttgattgta cactactgtg ctggctagtt 292440
 ttatgtcaac ttgatacaag ctaaagtcac ctaagagaag ggaacctcta taaagaaat 292500
 gcctccataa gattcagctg tgggcaagcc tgtaaagtat tttcttaaag taatgaatgg 292560

 tggggtaggg cccagtcacat tgtgggtggt gccaccctg gactgggtgt cctgggttct 292620
 ataagaaaaa aggctaagca agctttgagg atcaagccag taagcagcac ccctccatgg 292680
 cctctgcate agctcctgtc tccaggttcc tgcctcact gcttttgata tagaactgtg 292740
 gatgaaataa accctttcct cccaaagtcg ctttgggcca tgggttttc atcacagcag 292800
 tggtaaacct aagactatta cttactggtt ctttttctgg aggaccttg tgaacacaag 292860
 ggacaccaca ttctaccagg aactgcacag taggaaagaa tccctggga tetgaagggc 292920
 tggagttagct gagaatagaa cacttcagac caacagtaag aatgaagcat aaagcaatta 292980

 agaaggctag aaggggcctg gcctgcccc aacctgttgt gccagactat gttaaactct 293040
 cataggagac cttaccagtg aggaagagtg cactgagtgt gggctggggg gaaggigaga 293100
 gggttgggag gaagcagggg gatgggaggg agaactgtgg ttggaatata aatgaaata 293160
 aaaaaatfta aaaaatafaa aaaaaccac aaatftaagt gggacaaaca aaataaaagg 293220
 gggaaaaaaa ggctagagca gtgctttctg aagcctagga ctttaatcac atttttggtg 293280
 gttcccagtt acatgaggca ttatgcatg atacaattat acttgaaggg ctctagcagg 293340
 ccggagtggc aaacatggca ccaacaggtt ttgccctttt cccctttctc tectccccct 293400

 tgctgaaaac tgtagatta cattcctaaa gctagcccc agggcttagt tccttatttg 293460
 gccacagatt cattcctcag actgaacacc aaggtccagc aatcaaagtt cattattcgg 293520
 ctaacatgtc caatcagaac ttaccaactc accctagcac agactcctcc ttttctccct 293580
 aaaaaccac tctgcaaac acaactgctc tcttgctgct tgctgtctgc ccttgcccaa 293640
 tccagaggca gctccccacc cctgcttgc cctccgggct aataatctcc tttgtgctga 293700
 gatgttgggtg tttggggatg tctgtacct attgagagtg ggggcaccaa ccctccctt 293760
 actatactca ttttagttct ttcttaaac ctctgtatg gagaaaatgt tctttggcaa 293820

caagtaacac acattgtaac atttggtaac ctattaaagg gagagcccat ctacacttag 293880
 cactctctgt agccacatta cctagatagg attaacaat atttccttt cctttatggt 293940
 gattgaaact aatttactgt tttcagttgt gatagttttc ttttcagggg ctggaaaaat 294000
 gactccttgg ttaagataat ttgttgttct tgcagaggat ggaagtttga gtccaaacac 294060
 ccacatgaca gctctgctg taactccagt tatatgcct ttttgacttc cagggcacta 294120
 ggcacacaca tgcggtacac aggcatacat gcagttttaa aaacaaaact ttaaaattca 294180
 agcacttaa ataatgttta aaatattaa aagaatagct ttggttgtct aaaactaggc 294240

 ctatttgtga aatcaacaac caacacagt tttaaaacat gagagagaaa agttttcaaa 294300
 gttacttate taggtgatat taaattgggt gatactcggg catcttagaa ggtatgagac 294360
 agtgtgtagt tggctaaatt ttcaaagcta tgcattgcaa gaaatggcaa aggatgagac 294420
 tactaagata aagaagcagt tatgagggta ctggaagaca tgctaagaac cgggagttta 294480
 accataaagt gaataaagga ttcttggaaa ttgtgagctg caaaagatgt ctgttgacac 294540
 accccatgac caaagatctg agtggggaca aaacagggga ctccaggctt ctgagatcaa 294600
 caggagtaca agcaaagcac ttgtcatttt tataattaaa acaagcaaat gaagtgacat 294660

 ttacagttag cttaagcaaa tacaggtaga gcaagggat gcacctggtg ttccctcttt 294720
 ggtcatgtgt acagagccaa gaacattcct cccaggcctt tgcctttcca catggaagct 294780
 gcttgagggg aaggtagagt gatttcacaa ataggcctag ttttagacaa ccaaagctat 294840
 tctttttaat attttaaca ttattttaag tgcttgagag ttttagcatct atgtattgca 294900
 ccatgtgac acatggtgtt ggaggaggtc agaagagggc acccattccc tgagacagga 294960
 gttacagaca gttgcaaacc accatacaga gtccctctga agaggaacaa ggactcttaa 295020
 tgaatgagcc aactctccag ccctcaaagc tctttttgat gacttggctt atccccttaa 295080

 gtcagtggaa gcctctgaag tacatacatt agatcctttt aagagcttcc aaccaatgt 295140
 agctggttga tgcagtttag ccatgaacaa aatagctacc ttagagatat aaagtatggc 295200
 tcctctagat gtattagcta tgccatgcta aaattttata ggaattttaga atataatatt 295260
 actaatagga taataggtat caaaatatga gcattggaag tcagaataaa acgatgtcct 295320
 catcttccat gtgactcagg taaagtactt cacatcccat gtcccgtccc cctagatctg 295380
 gatgtacaac ttgtggcaag atgctgcttc ccacagactg gccaggtgt gattgccagc 295440
 tgctcaggag cagtggccac actcagttgt aggaccagat gctagacatc tgtctctat 295500

 taaccaggat caaataaag ccctgctcaa gagctgacaa tgtggaacat gtaacccaaa 295560
 caaagatggc cctgttgcct gtttagcaaa gcacttacca caggaacttc gatcttctca 295620
 acagctggag aatcaagcc ctttcaatgt ggccttttgc tcctttgtct ttttctctga 295680

agctagactg ccgttatttt ttcaactctc cttttaagtc atttctgct ttagcctccc 295740
 aaacagctgg gactatgatt atgcaccact actctcaaca acgatcccc tttaaaatta 295800
 ctatatgttt ttttgtatgt gtatgggttt ttgcttgcac ataagtctgt gtacatgtg 295860
 caagcctggt acccacagag gttaaaaaag ggcattgtga gctacatgt ggtactggga 295920

 atggaacctt ggtctttatt attattatta ttattattat tattattatt attattatta 295980
 ttattatfff atttggtttt tcaagacaag gtttctcttt gtaacatccc tgactgtcca 296040
 ggaactctct tttagacca ggctggcctg gaactcacag agatatgtct gcctctgcct 296100
 cctaagtctt gggattaaag gcatgtgcca ccacactcag cttagaacct ttgttcttta 296160
 gaagatcagc cagtgtcttt aacctctgag ccactctctc agtctctgac ccaattttgt 296220
 tcatcagtta ctaaggctga tagaatgaaa cacaacaggc tgtgacttca cctcctgtgg 296280
 tggccaacat tacataatct agaactctct gggaggcagg ccttcagaaa cacctgaaga 296340

 tagctcctga gatatctatg ggagacagtc ttgattgtct ttttgttttt tgagttttgg 296400
 ggttttgggt ttttgtttgt ttgtttgtgt tgtttgttt gttttgtat tttagacag 296460
 tgtctctctg tcttggaaact cactctgtag accaggetag acttgaactc acagagattc 296520
 acctgcctct gccttgatga tcttaattga tgcaggaaga cccatttgaa ctgtggggag 296580
 aaccattcct tgcttaggga gcttgtgctg tataaagtga aaaaagtgag ctgaaatatt 296640
 attcatttac tgggtgtgga cttaagtcta ctagctgttt tgtgtgctcc ttgcctttaa 296700
 tttcccacca tgatggattt ctcacagtgc cttcaaccgt gagctaaaat aatccactc 296760

 ttcttgaagt tggatattta ttactgcaat ggtagaagga acatcctccc aatggetgat 296820
 gcagttcaat agaaagggtg ttactgttaa ctgattatgc accaagagaa cagagtggct 296880
 catcttttag ttctgtgtc tctgtctttt agattttagt tgttttagca ggaaaaaat 296940
 tgagtaatga aaactactgg ggtaactact gtcttagtta agctttctat tgctgtgatg 297000
 aaacatcatg accaaaagca agttggagag gaaagggttt attttctta catttccca 297060
 tcactattca tcatcaaagg aagttagggt aggagcctgg aggcaggagc tcatgcagag 297120
 gccatggctg ctgcttattg acttgcctcag tcagtctgct ttcttataga atccaggatt 297180

 accagtccat ggatggcacc acccacacca ggctgggccc tcccacatca atctttaatt 297240
 aaaatgcctc cataggcaag cttgtaagge attttcttaa ttgagagtcc ctcttctcag 297300
 atgactatag ctatgcca gctaacataa aaccagcagg cacaactaca gtcaacaaaa 297360
 acctattgtg tattttataa gtaaatagaa ggagaggagt tggaaggctc caaaccaaag 297420
 taataaggaa atgggaatgg caattagtct gttttgataa gtacacattg tatacaagta 297480
 ttgaaaatca atgtactcca ttcttatttt taaacttcaa cagagagtca gttaccctgg 297540

taattcagca acaacaagca ctttctgtc aaacacctaa atatctctaa tcataactt 297600

 ctcagaatgc aacacttgag atgaaaccct ccagtcacag ccatctatcc acctagettt 297660
 gagactgagc attcacacac tttgtgtatc gctgtgtcgc gtgctgttca catggaactt 297720
 taaaaagttc atcaagaaga ttttaagcact aataaataaa gttttcgccg ggtgttgggtg 297780
 gcgcacagct ttaatcccag cactcggcag gcagaggcag gcgatctct gtgagtttga 297840
 ggccagcctg gtctccagag tgagtgccag gataggetcc aaagctacat agagaaaccc 297900
 tgtcttgaaa aaccaaataa ataacaaat aaacaaataa ataataaat ataaggtttc 297960
 cactaggtag ggatgcagta tggagaatca tagatgatgg caatgtctac aatgttttcc 298020

 caccctcadc cccagaatca atttcttgat tgattgcccc aatgaagaat atgtgttctg 298080
 acagcatcaa cagtagctct gaggaaggac tccttaact ggctccagac agtctcaatt 298140
 tcatcccaca gattctctag tatttggaac taactacatc ctttcaatca ctagtaccct 298200
 ccctcagctc tcctacaga tctctgtaac tggagtctt gtgactcagt cccacgtta 298260
 ggagtcctaa tgtggaaggc actgttttgg tccccaggct tgtcttaatt gctttccaat 298320
 tgctgtgaaa ggcaacttat aaaagagttt attagggctt acgattccag gggtgagtec 298380
 atgaccatca tggtagaaaag cacggcagca ggtactttaa gtgctggagt aatagctggg 298440

 agcttatacc tgatctacaa ataggaggaa gggggggggc atgaactggg aatggtatga 298500
 gcttttgaaa cctcaaagca caccctagt gacacacctc ctgcaaaagg ccacacctct 298560
 taatctttcc caaacaatcc caccatctgg ggaccaggct ttcaaatata tgaccctatg 298620
 ggtgtcattc tcatcaaaact ctacaaaatg gttatcattt ttgcatccct gcaatttgtt 298680
 gttaaaatga ggcacctgca cacgtgtata taatagtctg aacttagta aagaaaggat 298740
 ctctcttccc ctgtttgta aatgtatcta gtgacacagt ccaagataga gcctgaagg 298800
 aggcggcctg actggcttcc tgaagctacc aagcactgaa ctgaactccc ggagccttcc 298860

 ttcacgtgtc cagctctgag gttggaccct tcttctccc cagtgtttt ctgagacca 298920
 tatgagattt gtagtcacac cattcccact tcattctgcc agcctctcac tgctcttcca 298980
 acatgttgag atatttgaaa attccgactc tatcatccag tgttgttgtt cctttatctt 299040
 ttcttttctt aagaaatctt catgcgggct ggagagatgg ctgagcgatt gagagcactg 299100
 gctgcccctc cagagctcct gagttcagtt ctgtgcaacc acatggtaac tcacaactat 299160
 ctgtaatgag atctgggtcc ctcttctggt gttcaagcat acacgataa gtaagtaaat 299220
 cttaaaaaag aaaaaaaaaag tcttcatgca agtcagagaa gaaagaaaat gtttgaggaa 299280

aaggaagtaa aataatcagt tcctggtttg ggcatatgct gagatgcctg cacaaggaag 299340
gcttagtggtg tctaagcttg tcttaaaagg cagcatcata tagtctccgt gtctctccac 299400
ttcaggcaga gaagggatgg agataggccc tctcaggact accttcaactg aggtttcaaa 299460
gtaagatgtg ctigacatct gtggtttaat catacagtat gtgtcagtgt gcattacact 299520
gcaaacattg ctggaacaat agaatgataa aaaattcaaa gcttgctcta tttcaggtgc 299580
ttaactacct gagccatggg ctatittgac cacattaaca attaagtgga ccaacagcac 299640
acttttggaa agaaagattt tgcttcaatg ctgcatgggt tttgggatga gacatctact 299700

caccaatggc aggttaaaag agatgatttc ccaaactcta ccttaagtgt accaatgagg 299760
ggctggagag atggctcaga ggtaagagc actggctggt cttccagagg tcctgagttc 299820
aattcccaga aaccacatgg tggctcacia ccactataa tgagatctgg tgcctcttc 299880
tggtgtcgag atatacatgg aagcagaatg ttgtgtacta aataaataa atcttaaaaa 299940
aaaaaaaaagt gtaccaatga gtttaaatga caactttcag gagcataggt aatttacagg 300000
cagctactcc ccggaagaag tctccctca gcaatgctaa ccatacattt atccacagag 300060
agggaggagg cttgctgtgg agcattcatt taggatgtgt tacatttgtt tatgctgtgg 300120

aacatttgtt taatgattca aagatgtact gtattctttt aggttgtatt tgtttatctg 300180
tgaagctgtg ttactgtgcc tgtctaaaac acctgattgg tctaacaag agctgaatgg 300240
caaataacca ggtaggagaa aggataggcg aggctggcag gcagagagaa taaataggag 300300
aaatctgaga agagaaaatt gggaagaaaa gaagaaggag aggagcacat caggggccaa 300360
ccaccagct acacagccag ccctggagta agaagaaagg taaataaaat agagaaagat 300420
aaaatcccag aggcaaaagg tagtcaggat aatttaagct aagaaaagct ggctagaaat 300480
aaaccaagct aaggacaggc attcataagt aagaataagc ctccctgtat ttatttggga 300540

gctgggtaga aggcccccta aaaagcaaaa aagagtaaga gtaaaaaaac aatcaactct 300600
agggcctaac aaactttgtg gctttccctt ctgtgaggag gtgttagcta gcccaatctt 300660
atgagaaatc acagctgctt tgcttttgag acagccatat cgtgctcgga agacagctcc 300720
acagcactgc tgggtgctgc tctgatgagg gtcaaagggg agtgtggact tgaattattt 300780
agacatctgg cctaactctt cattcagtga gaaagacca gctcatgaca gtaattcat 300840
gctacttggg gtccaaaaca gttataaagc tacttcgaaa tgtcctcaac tatgcctaag 300900
agacctgttt ttgacagatg tgctcatgia gtccagtcaa tcggcatatg gaattttat 300960

gtacaagtgc ctgcacaagt ttcaccatgt aacttttatt agcgtccca ctagcatggg 301020
gagacagatg gcatacacat tacaactcaga agtatgcttt gcaattggcc ttcctggctt 301080
gactgctgag tgctcattgt gcatgtgttc acatgcgtgt gtgtgtgtgt gtgtgtgtgt 301140

gtgtgtgtgt gtgtgtgtat gtgcgtgtga gagagagaga gagagagaga gagagacaga 301200
gacagagaca gagagagga gacagaaaag agagagatca acagacacca gtccacatgt 301260
aggtgtgagg tttctaaagt ccaatctagc cgccttagtg tccactgtgg agccttcctt 301320
tccttgctga gatctcctc cctacttctt tgccttttct ttgattttcc acctctggct 301380

ttccatctct tgcacttagg ccaaggctag gtaggtttag acccagcaa gtgtgtctaa 301440
cccttgattt gtgagccaca tgcagccaaa gatagctccc agtgtggccc aacacaaaca 301500
ggtaggttta cttagagcat tgtgacatta ggtgtacaat tttccttttt atgacttcac 301560
tgtaaggttc ccagtcatga actttgtaga caacaacaat cctgttgctt ctccaaaagg 301620
ttgactcac aagcgggaga taagcaaggg aagaacctt ccagaagggt ttctcttcat 301680
ctctctagct ctgtctctct ccctgccctt ctctgacag tctgagttag cactgccttt 301740
ccttgttctt ggactgtgct acagtctgaa catagttggt ccctccctaa cccatgttgg 301800

agtttaatcc ccattgtgag atatggagag aatttagcta tgggttagg ggttgccctt 301860
ttgagaggag tgcatagatc tggaaagtca gcagatggag cctctccac tgaatattga 301920
tggctttgca agaacaaga gctacataga gaaaccagaa agaatagtca ccagaaggat 301980
gggcctagat ggtttagaag actaagttga ggaattgagc ttcgataaaa ttattttgaa 302040
gttaatttgg aagaagaaat attcaatggt agtcaaaata tttggaatat atatatatat 302100
attctgagac agggtttctc tgtgtagecc tggctgtcct ggaactcact ctgtagacca 302160
ggttggtctc aaactcagag atccccctgc ctctgcctct caagtgtgg gattaaaggc 302220

atgagccacc acctccaaga aaaacatttg aaaatctttt ttcttttttt tttttttggt 302280
ttttctaac aaagaaggat tgaattaaat ctaacaagtg tcaattacag aaattaggtc 302340
agattacaga aattaaacca gtgctagata gattaaatgg aaaggctatg acttttacia 302400
agaaactaaa gtgaatgaga agactgaacg tataataaag gcaacacttt acatttgagg 302460
aagagatctc attcagtaaa tggcattgat caggcatgga agttcatgcc tgaacccca 302520
gggcataggg gagaagacag caggctacct agggcttctt ggccagacaa tctagccaaa 302580
atggtgagcc ttaaattcag tgagagacc tgcctcaaag aaatgattga agaaagacat 302640

tctctacag gggcacctgc aaacacacct gcacaaaagt caatatacta cacacaaaac 302700
tcaaaaaata gcaagcggat tttagaacaa ctaccaccta actgaaggag aaaattgact 302760
ttctgtaaag cctagcatgg ggaggtgtgt ctcataatga cgtaagaaca agatcatctc 302820
tttgacaaa taaaactgaa aactcctgtg ttacacaaac aaggaaatca aaaggcgatt 302880
tgggacaag tattggtatt tatatgacaa cacattctgg caaagaaatc cgcctccatc 302940
aaaagaaggt aggttgagaa ggtgagtgga caattcaca agaaaaaat atatatgat 303000

tcaaacctcaa catcagttaa ggagttaatt attaattaat gttaataatt cattaccgct 303060

agttaattaa aacttgactt ttgtttttcc tatcacaaca caagtacttt aacaggatat 303120

agtgtacaac attggcaagg atgtagaaga ccatggatta cgaggcagag gtagataggt 303180

tgggacagag tccattgctc ctgaagctat tggacatctg tcagtcttgg tcaatccagc 303240

tggagtctt gacagcatag gaagacagac agcaggaaag caaggagaa agatttggga 303300

agatgctcag aacacacgta gtttctgatg ccatgcatct aacatctact ttctaattcc 303360

tcctcattcg tgtttttgat atttattggg tacccaagga tcaactctaa gaactcagtg 303420

accattaatt ctggtttctt ttaaaaagca ttttacttt tagtgtttag agcaggaaac 303480

agtgtagtca ttiaaatgag ctgaggcatc tacttatgta caatgtgctt ggcaaagact 303540

cctgctggtg gccaggtcg ggaaacagga gtgcatgggt ctgagttcac tagctatggg 303600

gttttggaaa gttgtttaat agttttcagt ttgtttgcta tacatttcta ttactgtaac 303660

taggcacaat cacctttagt gtgattgtga ggattaagta aaaatgtgta cgtaggccc 303720

catgacttgg tacacacttc ttaaaagcag gtttcttcc ttctaggag aactagctgt 303780

gtggtaagtt atctcacctc ctgtatctcc gtatcactgt gtttcccagc aggtcctggg 303840

tttcaaatc caaagcctg ataatctctg atgaagggtt cttggcaata ataataata 303900

taattttcat ttttaaatga gctgtttcct atttctgtgt gtctccagc tgagagagaa 303960

gctctggctt ctggtggaat actgatgtct aatccagaat ggccctgtc cagctcccca 304020

gctgtgtagg ataatgtgtt atggctgcat aaaaatggaa gagtatgtga cccatctgg 304080

tgaggaaact gagaacaaaa gatgggcaaa caggaaccag caagacactg gtctaaaggg 304140

ctactaaatg ctcatggctg tcagaatttg gggattacct gtagtcacca cattaagac 304200

aggacaattg ggtaaaaagt acacatacag aaaggggctt ggtggagact tcaactgtcc 304260

atctgacact ggtlaagccac gttlaagtcac acagcttctg acacggctgc tgctgtgctg 304320

catttcctt taagaggtaa aatagaaagg ttacttaaaa tgaagagatg cttccgaaat 304380

tggaggtgga aagtggagat cactgctgcc caacttcaat cttcctggca ggtgcattag 304440

aagtacctgc ggagtttgtt aaatacagag accagagcct gatgcctttt gccatgtgg 304500

gtcactgtga caaagtacta tgggcaggct ggcttatcaa cagcaggaat ctccaaagtt 304560

ctgaagttag ggcaccagca tctgggttct ggtgaggact tcagattgct atcctctcac 304620

tgtattccca tgtggtggga aggggtctag agggctcct ggaggagtcc ctttttaag 304680

ggcactgctc ccattcaiga gtgcttccc cttattatct aatcatgccc ctgtgtcca 304740

ccttctaate ttgttacatt tacactagat gtcttccttt ttaaaaatac ttttattatc 304800
agctgggcat tgggtggctca cgcctttaat cccagtactc gagaggcaga gacagacgga 304860
tctcttgtga gttcgaggcc agcctgatct acagagcgag ttccaggtca gcctccaaag 304920
caattcagag aaacctgtc tcgaaaaaca aaaaaaaca aaacaacaa acaaacaaaa 304980
aacaacaaaa aaaccaacca aacaaaaaac ttttattatc atttattat atgtatgtgc 305040
atatgtctgc atatgaggag gccagagggg tgcagatcc cctggagctg gagttacggt 305100
tctaagctgc ctgatatgga tgctgggaat caaacttggg tcctgggcaa gagcagtatg 305160

ggctctaac cactaagccg tttctcctgc atccactagg atttcaacat gtgaatttgg 305220
ggatggcacg cagccagcct gttgtccagg agcaggacca gagactttca gaaaaactcc 305280
ttggtgctgc ggtgcagggc tgggacagcc aagagtgcta tcttgtgtaa tttccagatg 305340
gctggggaac gaagcctgaa gactgattag ttctcaagag tatgcagacc aggtttcttt 305400
agttttcaga acatgaaagt aattatccca atctctcttg tcttagctaa ggctggagca 305460
gacacaactt actataatag ggggtcagat aacagtactg tatactggtg aaacattagg 305520
gaaatctagg aaacaggaag gaaggaaacc caggctttac actccatatt cttttgtgat 305580

gatgatgatg atggtgtgtg tgtgtgtgtg tgtgtgtgtg tgtgtgtatg catagtgtag 305640
gggagcatgt gccattgtag tcatgtcagg gtatgagtgt agaggtcaga ggataaattt 305700
attgagtcag ttctctcctt cctcttttcc ggggctctgt ggttggatcc cagtctgcta 305760
ggattatgta acaatagcct ttccacacag agccttctca cctgctcttt gccagatgt 305820
tctgaggtaa ttggtttggg gtggtctggg aacaagatta agttttcaa gccagtaac 305880
ttgctaccag agttgagaac ggcttcatta gctcattatt gtcaattttg gctacacata 305940
ggaagcactt ggagagcttt ttgtttgttt gtttgttttg ttttgggtt ttttgtttgt 306000

ttgtttgttt gtttgtttgt ttgagacagg gtttctctgt attgttttgg agcctgtcct 306060
tgaccaggct ggctttgaac tcacagagat ccactctcct ctgcctccc agtgctggga 306120
ctaaaggcat gcacccccaa tgccctggccc tgttagaaag cttttaaaa aggatgctgt 306180
cttagggttt ctattgctct gaagagacac catgacagca actctcataa aggaaaacat 306240
ttaattgggg ctigcttaca cttcagaggt ttagtccatt atttagtita ttagaagcgt 306300
ggtggctgca ggcagacatg gtgctggaga gatagttgag agctctacat ctggatccct 306360
aggcagcagg cagagagaga ggccctgggc ctggctttgg catttgaaat cccaaagccc 306420

acctccagtt acaaccttc tccaacaaga ctacacctcc taatgttacc cactcagcac 306480
tcatacagga gtctctgggg gtcattctta ttcaaatac cacagatgct ctgatcccac 306540
cccagagttc aatttaatca taatgggata cagcttggac atccagagtt aagtatccat 306600

ggtgattttg atatgtctag tatataaaca aatttgagaa caattgttga ggccagagaa 306660
 gtagctaggt tcccctctta attatctacc ccaaattccc tgggctagca tcagtatcac 306720
 cgagaaatct ttaagaaaag cagttctctg cttgtggtgg tgggtgctcac ctttaatccc 306780
 agcactcggg aggcagagac agctggaact ctgagttcga ggatagccta gttacagagg 306840

 gagttccagg acagcagagc tacacagaga aaccctgtct tgaacacccc cttaccctcc 306900
 cccccaaaaa agaagaaatg cagttctctg gatgcacaca agatccagtg cagcagcaca 306960
 caccctgggc tatccaaggc ctccagagcc cctgatctcc ctgtggttag tagtagattt 307020
 cacttccac agttgttcat ggtccagctt gtctctccc agagcctagc cagttcaaga 307080
 atcaagaacc acaggcccct ggacattgga caatgtcaaa tctcccagat gaggggccaa 307140
 ctttcttagt gtgtctgaat ttttttaat tagttcaaat tagaaacaag cttgtttcac 307200
 atgtcaacce cttctcttcc tccctcttcc ttcctctcct tcagcccca cccccagtct 307260

 cccacctcat ccccctctgc ttcccaggga gggtaaggcc ctccatgggg gtttctcaaa 307320
 gtccgtatca tcttggggag ggcctaggcc ctcccctatgt gtccaggctg agcagacatc 307380
 cctccgtgtg ggatgggctc tcaaagtecc ttcttactcc aggaataaat actgatccac 307440
 taccaggggc ccatagaat gccgaggcct cctcattgac atccacttca ggggtctgga 307500
 tcagtccctg gctggcctcc cagacatcag tctggggctc atgtgtctga aattttatat 307560
 aaccgagaa gatattttgt tgtctgaaa ctgctggtgt caaactggac gagtctgcta 307620
 ggggatagca gctgcatttc tgctcaaca aaccaaatga ggaaggagg gcaaaggcag 307680

 gggaggcacc actcagagca aacctgtcc ttggctgtct aggatgtaa actaacatga 307740
 agtatgggga gaacggagca aaggcacgtg tacacagctg cagaggccag agagggtgtt 307800
 gtttggggtg ggtttttgga tatgggtgcc ttcagttttg tcacacagat caaacgcate 307860
 tttcaagaa aatcctgttt gttgtttttg agaccaaatc tcaactctagc tcagactatc 307920
 ctccaatttc tagcaatcct actgcttcag cctccctagt gtttggattg tagatcttag 307980
 tcaccaacct agtccaggac tgcgtgatgt aaaataataa tagtaattgc agagggtgtgt 308040
 gtgtgtgtgt gtgtgtgtgt gtgtgtgtgt gtgtgtgtgt ggatgtcaga gtaaacct 308100

 agcatatggg tcttggggat gtcagggtta gcagcaaatg tctttccct ttgagccatc 308160
 tccccgctt tcttgataag aaaacaaca caagtgtgta ctgtattaaa ccttgaaga 308220
 aaatctgcat ggacacttta aggctcaaca gtagtaaaaa acacacattg gtggatcaa 308280
 gtcacttaca caaaaaaga cccgcaggac cgttacttt catatatga gttatttta 308340
 attagtcca gcccttctg aggatgcca aggtgtagat ggcatgaaac ttgatgtcaa 308400
 gtaggtcact ttctagcagg gagagagggt agcaagtgt tttctgttct atgtgtgat 308460

ttccttgtaa gcagattcca ggagagttac agagggtgag ggtgatgtca tcagtggagg 308520

 ctggccctgg gcctggtttt gcagaggaag gaaaggcgtt ttgcatttgc atcaatccat 308580
 ttctgttgc tgtaacagaa tacatggaac aggtaagcag taaagaagt tgttgactg 308640
 gagagatgac ttagtggtta agagcattgg ctgttctaga ggacctgggc tcaactcca 308700
 gtaccacat ggtagctcac agctgtcttt aactctagtt ccaggggatc cgatactca 308760
 tgcacataaa ataaagttaa acaattttta aaaagaagtg tatttagtcc agttttcaca 308820
 gaaagccaga agttgtcac cacggttcat gatagaagag cagaggtgaa ggtggcaggg 308880
 acgaatcagg ctggccttgt tctgtgacaa ccctcttgg gagaaaggca ttaagctgtc 308940

 tgtgagggca gcatcccat gacctaatia cccttcaaaa gccatgccac agctgagtgc 309000
 tgccacactg gggactcatt ttctattgat ctggaaggag acaagcctac acagaaacca 309060
 tagcactann nnnnnnnnnn nnnnnnnnnn nnnnnnnnnn nnnnnnnnnn nnnnnnnnnn 309120
 nnnnnnnnnn nnnnnnnnnn nnnnnnnnnn nnnnnnnnnn nnnnnnnnnc aacactgtgg 309180
 gcttctggct gctcagtgtt gctaattggg taatcatgga gctggaagca gcaatctctg 309240
 taatgagatt acagagtggg tggagatgag gggcccttct atatgcagct aagcaacttg 309300
 aacttagca tacttatctg tcatggccaa acctagggat cgccaaaatt agctgtctggc 309360

 atctctaaaa taataaagca atatcaagtc ccaggactca tcttagaagc actaattcag 309420
 tggtttggg tggccagag ggggaaagga aaatagaaca gaggccagga aatctaaagt 309480
 aattcagctg gtcccctgaa gcagctagag cttagtgcaa tggactatgg gatggctagg 309540
 tccctccatt tcaacattaa aaactcattt aagctttatt tagagaaggc aatgaggggt 309600
 ggcccttggg cagactatcg gtggttcatg ttggaggtgg tttgctgata tacattggac 309660
 tgtgagatt accaatgctt tctggggttt gattgggact ccacccatgt gtaaagtca 309720
 tcttgtgctg taacattcat cccaagtagt gacaagattg gaaacaaatg aagtctgtgc 309780

 atacttactg ctatactaag tacttgtatg ggttgctctt agaatttgct aatgataaat 309840
 gtttaaaatg tactttgtac agaaaactaa caggcagaga tttgtctgag tgaagacaag 309900
 attggcaag gctggatggc agtcactaat agtggatgtc tactacaaat aagcaaatca 309960
 gcaaaggggt ataaagtaga ccaaatcctt gagccagaaa aaataattct caggaagttc 310020
 tgctaggaag cgctggcgtt agacacatgg cctttcattg ccttgggaag gagtcaacca 310080
 tagattttct gtctgtcttg cttgggacca tatagttggt atttagctc ttggcccaca 310140
 tcaaacatag gaaacctata aaagctgggt tttctcaaaa gtatatgttt tatgttgaga 310200

gctgagagat atgaaatgaa taatataagc tatcatagag tctcatcact caacttttta 310260
tgtcatgatg ttgaagactg ttttccaaaa ctgtcagtaa aatgtctccc acaagcggtt 310320
tttacctcat tcttttgata ctctcctct tgagagttag gtctccttta caggttaaat 310380
catgttttcc aggaatttct atgtggaagc agtaactcac agtacttcgg tgtgtgatct 310440
tagtaggaaa ataggatcat ttttgtttgt tttgttacac agggtttctc ttcacagccc 310500
tggctgtcct ggaactcact ctggccagtc tcaccagact ggctcaaac tctcagagat 310560
ccacctgctt ctgcctccaa agtactggga tttagaggct gcgcatcac acctggctgg 310620

aggagaggat cttaaagagg atttttatgg aggtaatgca gttggagagt cctgataaat 310680
agtggaggct tgaacacaga caaaaacaga gggaagatga tgttccaga cacagagagg 310740
aaacaatcac ttatgaacca aggagagggg cctgaaacag aagcttcct cacaccccag 310800
gaggagccag ctctgcctat gccagtctc gagacatcac atttctgttg tttagcttcc 310860
tagtttgtgt tagtttttac aacagcccta actctctac agttctggaa tctttgaaa 310920
attgtggaag tgacactgtg tgtcttctg ggctaggcca taaaaggcaa cagagctacc 310980
acggattgta ttgagagacc aggttccag gaagctcaag ccacttgcaa aggtcacatt 311040

ttggtgccct gccagcatcc caggggattg gaagaatcaa ctgctagagc tgtgaaccaa 311100
gacagctaca gatgattcct gctcctgtgt gggtcagctt agcctgacct gaacctgct 311160
acggtctaat tagttattaa aaagataaga gacagttttg agtctttaa gtgtgctcat 311220
ttttaaagta gtgttcttat tttttagga ttacttttat tgcagttcta ctgatcatat 311280
gaggctggag agctagccca gtgtttaaga gtctgttct ctcacagagc actcatattg 311340
ggtagctcac aactgtctgt cactccagct ttcggggatc tgacacctct tttgacttct 311400
acaggcactc acatgcatgt gtgcctatgt ggtgcatgca cacacatgaa taaaaattaa 311460

aaacataaaa gtctatttta taactatttc aataaaaaca ctactgatca taacttctec 311520
tttataaatt ctgtgtagca aagccttttc ttattgttct tgatgaattt ttccattctc 311580
tgaaaagtaa agatcttcta tattccaaga tttagtaagt agttcctttg gtatttgaat 311640
gcagagtgtc cccatagct ttgggcattt ggacacttga tccccagta atggcactgt 311700
tcaggagggt ttaggtggtg aggccttgct ggaggaagta tatcagaggg ggtgggtttg 311760
agaattaaaa agccccatct gtttcatttg ctctaccaaa ttaacagttg gccactcaag 311820
acttgagctc ttggcttct gttctgcca ccatgcctga ggcttgttc catacttgc 311880

ggacaccatc atggactctt atctttctgg agccaaaata aattctcttg gtcttagaat 311940
tttaccataa cagaaaggct accagtgtag ctctatata tttttcatt ataaagggt 312000
glatcattga atatatactt tcaactaaag tattgcagcc agacatgaaa agaggaaaag 312060

gttctcaaat tttaaaaatt cttcccgtgg tagtttgagt aagactgtcc cccatagata 312120
tatttatttg aatgcttggg ccaaagtgg tggaactttt tgggaagtat taggaggtgt 312180
ggccttggtt aaggcgtgtc tctggagatg ggccattggg attttgccat gggatattggg 312240
tcttgtggga tatttgtttt gtacactgtg tgaggatata ttgctgtgat tgggtgaata 312300

aaaagctgaa cagccaatag ctaggcagga ggtataagcg ggatttctgg gaaagaaag 312360
aaagaggagg agaatctag gcatgcagga gaagcaagga gaagaaacag gaggtacaag 312420
ataggagaga ggtaacacca cacaataaaa catagattaa tacaatgtg ttaatttaag 312480
agctagttag gatcaagctg gaactgtagg ctaagctttc ataattacta aggcggcctt 312540
ctgttattat ttggaaactg gcaggacaga aaaaaaactc attacagatt cccttgaac 312600
tggagtaca gatagttgtg agctgccatg tgggtgctgg gaatcgaacc cgggtcctct 312660
ggaagggcaa tcagtgttct tatccagtga gccacctctc cagctgcccc catcacttct 312720

aaaggatcat tagtttagta catctgggat ttattttggc atatgggcta aacatttcat 312780
ttttgtacct cataaaagca gatcaactgt tctgtaccag ctgctgaata attcctaact 312840
tttgttctaa tctgtgagcc actatgaagt catacactga gttgtccatc atcaciaaagc 312900
aaggccatt tctggacttt acagtttga cttgacttta gttttagatg gggcttccca 312960
taatatctga taaaggagt ccacactctg tcattctttt tggaaacttt catagttgtc 313020
ctcacacact tattttccac acaaacattg aatacagctt tttaaagctat cataattgct 313080
attccaatag cataaactca ggaatgtagc taagaaatat ctatgcctgt taatagtat 313140

cattgttgtt tgcaagtgtc attcatatat ctgtgtttgt ttcataccag caaagcctta 313200
gacgcagcat gccaggaat atactcactt cataatcctt tattaattgt tgggtgatac 313260
agagatggtt aatatafatc ttccacaaac aggtcacctt tattctgcat caaaacatca 313320
ttgggaatta gatgcagata aaagcgagag taattttaaa ggcacacagt ttggtaagtt 313380
ctgtgtatgc accatgaca ttctcatggg tcttggatgat aaacataacc ctcagtccca 313440
aatttccac gtgtcccat acattctagc attccattct cctgtactac catttccagg 313500
caactggtaa cctacttcca ctctagtttg ctttttctgg aaatttaaca tggatttttt 313560

aaaaatagaa tgtactgtct tgtttaattt tctcttctg tgaagagata ccatgagcaa 313620
agtaatttat agaagagttt atggatgggg acttacggtt tattgggatt agagtccatg 313680
atccatgc tgggaagcat ggcagcagcc aggcaggcat ggcactggag cagtagctga 313740
gagcttgcac ctttaagtca aataggagc acacagagaa tcaggaatgt catgggcttt 313800
tgaaatctca aagccaacc cccagagaca cacctctcc agcaaagcca cacctctat 313860
tcattccaag ggtcttagcc caaccacaga aggctgagct ggggtcccagg aagggttaagt 313920

gctgctcacc cattccccag cctcccagga tactggagtc aatcagacac agcagggagt 313980

 ctagtcaagc aggaactcat ttattgctcc acagcaagca tcttttaag caaaacaac 314040
 acagagtggg aaaacagcta gccaatggtt ttaaaggcca gcctatcagc tgcctagaca 314100
 tcctatgctt tacctagtga acatgagcag ttcacacagt gacctcattt ggtttgatct 314160
 tggtaacca tcaccgtttt ttgtaacat ctccagattc actctctga cttcccctca 314220
 tcaccatggt taactggctc ttgtgccctt caccttecca aacagtttta ccaaatggat 314280
 ccaagcattc aaatataga gcctgtaggg gtccattatta ttcaaacca cacattctac 314340
 tcctgcccc cccataggct tgtagccata tcataatgca aaatatactt aggacaattc 314400

 aaaagtcccc ataggctttc acagtctcaa cactgtttca cagtccagtt tttctgaga 314460
 ctcaaagaaa tctccaatt gtaaaccct gtaaaagcaa aaatcacact gcatacttc 314520
 atatacatta gcattttaga aagagcatac atagcataaa agaaagaaaa ggggcatagt 314580
 gaggaatac tggacttctc cttccctgat atacatcatt aatttaactt ttgcttttaa 314640
 aagctgggaa cagtaccctt tctccacc cttatacctt tactttgtca caattattat 314700
 ctttaacaaa ttatatcatt catgtcattt atttcttcta gtgtcctgag aagactccca 314760
 cttttttct gatgtatccc aagtgtccag aacctgcctc gaggtacaca atacatctgt 314820

 tgagtgaatg ggaagacct tcctctagc aaacaccaag tcatttaact gcatcatggt 314880
 gctagctcca gatcagtttc tcaagctagc aaagaaacat ttgaaaatgt tacgttgtat 314940
 tggttctct ctggaagggt cacaacacgt taacaaatcc agcagctcca aaggctgcag 315000
 tcaccctgc tttctccatt tacttaagac ttcccagctt ttctggcca aggaacattg 315060
 aatacacaac agigtggtag agttcttacc agtattgcat gacacctggg gatattttct 315120
 attccattct actctttttt atgtattcta ttttctctgt cccattcagt tctctttcaa 315180
 tattgaccaa acccaatatt tcatgagggt ggattttgtc catgactggt gttttgggga 315240

 gagtccttca gactaccatc aaactcaacc catctattat ggtacttate ccattgtttc 315300
 caatttagtt cttttaaaaa aaaatcagtg caattaacct tcaagaatcc agttgctaat 315360
 cattctggta atttatgaca aaattctaga ataaatggtt caaaggaaat agatgctaag 315420
 atccaacctc tgcattgcta aattattttc taaaaggttt gcaccctgt ctacctacac 315480
 agacaaatgg aattctcca acatactcat ctctctatgt aaagtctac ttgctagagt 315540
 tttcttttcc ccctattttt catgattcta atattgttc tgactttttt tgtaaatttt 315600
 gcatccaggt cttttccag ctcttttctg ctctggaaga gagccagcta aggggctctg 315660

tatacttgta gtggaaggta ttgtgatcct ttctgaggac agttcatggt tgtacttgac 315720
 tgcaaccaac agcctctagc tttgtgaggg aacatagaat aaagtgaagt gctgtctgga 315780
 gggtaaacag agggtagaga gaggctagaa gatgggttgt ttatcttctc tttttttttg 315840
 aatcttttat ttgaattaga aacaagattg tcttacatga caatcccagt tccctctccc 315900
 tcccctcctc ccctaccacc cccctcccca actaaaacc tacctatcat atacctttc 315960
 tgcttgaaga tgggcttttt aaaaatcctc tatgatcta tatacatat ctatctacca 316020
 tctatcaatc tatcatatgt atcatctatc tctatctctc atctatctct atcgtctatc 316080

atctatctat catctatctt tgtctatcat ctatatatca tttatctatc aatataatcat 316140
 ctacctacct atctatatct aatcttatga aaggctttat tatgacctca taagcatcct 316200
 tttcactttc agtatgtctt gtagacaaat gaaactccta aatcacttta aaaagccttg 316260
 cctttcctaa ggagaacaat ttctcttcac agcccctggg tgaactatac atggaaaata 316320
 aataaatcca ctctttctag acatagtaca ggccgagtat tctaaatcca gaaatacaaa 316380
 gtctgaaatg ctcaaaccat tgaaccacat tgaaccactc acttgccaca gcaatggaaa 316440
 attccacacc tgacctcttg tggcaggtca cagtcaaaac acaagcaaat cagaaatact 316500

gtgtgagtcc accttccagc tgcatagggt catgtgaaat acagatgggt tttgtgttta 316560
 agctggctcc tagcctcaag atgttttctc taacatatgt aaatattcta aaatgtgaaa 316620
 aatagaaata ttaaaaactt ctggctccaa ggagttttta gaaaaaagt actcagcctg 316680
 caacctaaaa aaattatttg ttattattat gtgtgcatac acatgttcag gtgccctgag 316740
 gtcagaggac aactatataa agccaacctg taatctaate tctcaattct ttctatgtaa 316800
 gaactaaata tactcagctc gcttccagga aactgagata ccacatcaga acagagctgc 316860
 agctctgttt tctagagggg gttgtcttaa aagcagcctc cagactttgg agctatgctc 316920

atgatgaaaa tagcatgtga tgcagagaaa aagggttcag tgggtaaagg cacctgcacc 316980
 gagactgaag acctgagttc attcccaag acctacaaa tgaaaggaaa gaagtgacta 317040
 ctgaaagtgt tcttctgacc ttcacatgga agccattgca tgcccatgcc ctcaaatgc 317100
 acatatgtct gcaataaaaa tgcaactaaa ctatctttta taataaaata agtaacactt 317160
 gaacatctga gttaggggca caaaatgca atgtgtgtca cttggaacca ccaagcatgc 317220
 ctgagtggtg cccttaggag ctagggttag tccgacttaa ttgtgtagt gaaaattcct 317280
 gactcaggtg aaataatttc actgttataa aacagattta gacctttgtt gatattctgg 317340

gttctgagg atttctgagt ctggctcatg ctagttaaaa aagctcttat gcaagcaaga 317400
 cctagcgggt gaggtctgga ggctactaag acagtctttg caaagaaagc tcaccttctc 317460
 ccagcacacc aaaaagacc accattagaa accagtgtag aacattgtgt ccgtggaatt 317520

ttccaggtta aaattcacct gtgcacgggt gataacctacc acttcaccag tggaaacttgg 317580
 ccttgcccttg aacataTTTT cagattcttt gcagccctga agaaacagtt ggggggtgggt 317640
 ctggcattcc tgttaccgag agctagcagt tcccagacac catttgctca gtcatacacag 317700
 ggaggttgcc atggcttggga attagcttag tgttaagtgt tacattgtaa cactattaca 317760

 ctgtagagaa tgaggaagag ggatgtcaga agctgtgttc tctcaggtaac aaacctcgaa 317820
 gggctgggct gctcggatgg atggetctgg ctgcaacccc aggaatacag cttccaacag 317880
 agggaggcca cagatgacca ggaagaaaag ttagggcat ctgatcccct gagaaataga 317940
 gcaggcaaga aggtgtaaaa tgggatgtag tgaggatgtt ctcagatttc ctgaaaaaga 318000
 atctggaggg attgtaaacg tatcttttac tgaagatgct tcaaagagtc taagcctcca 318060
 ggtctcaaaa ctgaaagctg agctttcaga tccgcaaagg tgagtattca ggagtatata 318120
 aagtagaaac cagcttcttg cactgtcagc acagtgggggt tcctttgaga atttcaggaa 318180

 tggaggatgc gagggaatgc atatgtcaca atgtttactg gatgtctgtg acatgaagag 318240
 tgctacaaaa agcagagggga aggttagaga catggacaga gaaataggaa acaactctaa 318300
 tagccatcac agatgaacta ataaacagca taggaagtat atgtgcacag tagattacca 318360
 atctgccttt aaaaagtctt catctatgct accacatctc tcatggatga acctcaaaga 318420
 aattaagctg aacgcagtaa gtcagacaca aaagatgac atgtataatc tcacttatgt 318480
 gatatatctg gaatatccaa atccacacag aaagtaacag tggttgtcaa gggctagtgc 318540
 ctgtacctgt gcgtgtgaag tgtgaatgtg tgtgtgtgtg tgtgtgtgcg tgcgtgcgtg 318600

 cgtgcgtgcg tgtgtgtgtg tgtaagtgtg tgcgtgcact cacgtgcatg cgggtgagta 318660
 gggggaatgg agagttatTT tttcatgggc acatatttaa gtttgccacg atgaaaacat 318720
 tctgaaagtg gtttgggata atggtgtctt agcaacacaa actctaagtc ccctggaaca 318780
 gtactttgaa aacaggacag taaactcttc gtgtatttca accctctca agaccacaac 318840
 aagcaataa caaatgagag ggccaagat ttgacatcag aaatagagga atgaagatca 318900
 tgcagccaca ggaagggcag tccaagatga gaaaccgggg tgcactgcag caggctcagg 318960
 tgctctcca tcagtttgg ctaccagaag gagaaagcct tccatttagg aatagtgtt 319020

 tcttattact tggtactta ggcacaaagc agtaccttg ttgtgtttg aggcaggagg 319080
 cagggtttct ctgtgcagac ctggetgtcc tgggtgtcatg tagccattg agtaggctc 319140
 aaaatcataa agacttgctt gactccacct cccagtgct gggattaaag gccaccataa 319200
 ccaaagcact aacttaatgc ttgactacag aatgactctt ggaaggaggg aactgcccc 319260
 agaggtccca gagttaaga aatgatcaca tctggttca gagacaaacc aaggagtctt 319320
 ttgtttgtct ttgggtttct gttgtgtca taaacatga gacaagacca aaagcaactt 319380

aggaaaagaga gggtttattt ctgcgtagag ttccacatct cagtctatcc ttgaagcaag 319440

tcaggggagg aattcaaggc aggaaaccag ggcaggaact gaagcagaag ccatggagga 319500

gtgctgctta ctggcttgct cctcatggct tgetttagcct gattgcttat ggcacccagg 319560

acctccagcc caggtgtggc accaccaca gagggctgtg ccctccata tcagtcaagt 319620

aggaaaacac agtacaggct gtgtctacag gccaatctgg taggggcatt ttctcagttg 319680

aggtcccctc tgccaaaatg actctagctt gcgtcaagtt gacataaaac tagccagcac 319740

atattgattc ttaccttctg agtttacata gccaaagtcc acctcaaaag aatcttcag 319800

gcctgtgtca aaggcaaaga gttgaggcag ggcctccttc ctgaaggtgg tgccaaattt 319860

gttacctcag ctctagggtt caggccatgg acccaaacag cctgtagcga tgaaactgat 319920

aaacctaaag cccaaggaaa caactgtgtg cgggcgcagt ccctgccct cagaggatag 319980

tttgagaaag actcatagat ctgaggcctg attcactctg caccttctgc tcccaggatt 320040

tctggccacc aaggtggcct caggtgccca ggccaaccg agggacagct gggtccaca 320100

ccgccccag ggggcagctc cgccgcctc ccacatagcc agcaacttcc ttggtacctg 320160

cgtatggtgg aggggggagt cacagttgat accgagtgac agtctctgct gcctctggt 320220

aaaatttctg cccaccccc agtactagct tgagggggga tgagatagag atttaccagt 320280

cctggaaaaa gccagggtc caggagacc agagctgggg aacagggagg cagaaagagg 320340

atgcgcgagc acggattggg tttccatgct gggaaatcgc aggacgagaa acagctaaag 320400

gactcagagt aacaggtact ttaactaaag caaacaacac aggtggagcg cccaaaggtg 320460

gagctttggt gaagcttacc caaatctctg ttaacgtatt tcgtatttcg tccctacagc 320520

gatcctagtg ggttaggct ctctgacaaa tccccagtt ttcccgagtg gcctgaaagt 320580

ccaggaata gcccttaat taaactttg gggacagact tggggcgat tttaacaaca 320640

gaacgcaaac tctcatttcc cataccttc cagaacagac aagttgaaga cgctgcaaat 320700

cttgagtaga aagatggctg taattgatcc tctaacttta ttaatagctt gcgaacaatt 320760

cttctgtat tcatcgtca aatgcattgc cacacagca cactcagcgc tcgaaaaacc 320820

atggtgttta ttggatata cgccgagtac tcacacaact taaacgttcg atgtaaaagt 320880

ggacatcttg gtaaggactc ttgtctgcat caacaagca ctcgctgcct gattaacggt 320940

gttgattaat gttggcgcag gttattacaa taattagatg gtccagccat acatcaaacg 321000

gagaggcaat gaaaaataac gcgttcagac catgaggcat tctcgtagct ctttcaaga 321060

tcactaatag actttacggg ccatttacia gtggaactgg tggtagcca ttggagggaa 321120

ccaaacctga ttigaaaaga agtcttggat ggggcaagag ttcatttttt agactctgtg 321180
 atgaatacca gttggaacaa gtcgtttcag aaagtaggaa agtacttggg tgataaaatg 321240
 acatacaaaa gagtccttga gattgttctt caagatagcc attgaatttt tactcagttc 321300
 ttggcaaatg acctttttta ccagaaagt 3aaacttcta aggcagcggt tcccctttga 321360
 aatagaacat ctgagcaaat gcaaacattt agaaagccag gctatgagaa tgaattcgag 321420
 ttacacaatt attcggatgt tccaccagtc aaaacaatta gtttagctgg tgatgagcac 321480
 gggatcctt aaaacagaat tatacttgca ttattcctat tagcttgtca cctggaagaa 321540

 aaatgaactg agtggagtgt attcccatat ttatgttaaa aaattcggtt cttttctcta 321600
 agagggtaaa aaaatttaat gtattttcca aaacaatata aaaagttgac ctcaaagtaa 321660
 tctttgcttt gtcttttcca gcaccgatcc tgctgagca gcatgtgtga tatgttataa 321720
 taattccagt atagagagtt ccatgaaacc ccaccagagc agatctttta ctgaaaaaca 321780
 tagcgcctt ttttctaaca tggcaacagt tttttgatgc tcttagatac aatctctctc 321840
 tctctcctc tctctctctc tctctctctc tctctctctc tctctctctg tgtgtgtgtg 321900
 tgtgtgtgtg tgtgtgtgtg agttttcact aaaattttct atttcttttc ctcatcaac 321960

 cattgctcta ttcccatgga atttgcgaga tcctctcatt agagtggctt agtttagctg 322020
 tcaagtctct agggcattca attgcagata aatgactaaa acgccagcct aaccgcattt 322080
 ttattaacag atggcggaaa acaaacgtct ttggagaaga accgaaggaa aagggttaaa 322140
 gggtaataa acaattatta ccgtgcttaa aacgggggag atttctcctc agattccaca 322200
 ggcagaggct ggcccagtc aggggagctg ggacacccca ccagactccc ccgctcagta 322260
 ttccagggac caccacacac agagtaagtt gtcccacagc gcttctgatg ttagggttga 322320
 ggactaaatc cggagaagct ggctggggac tcgaactcgt gcaaccttcg gatgcgaatt 322380

 ggtgctggct agggcgtgat acaagatata cgagaccttg gcaagaaata gcaatagcgg 322440
 ggtccagtgt ccaactcttg ctgccacccc tctgctgggt gaactttctc tcctgtacg 322500
 ttgattccct tgcctttctt tcccttcccc agcccgctct ctgacgtgca caccatgtga 322560
 caggccccct tctgctataa gctcagacaa ggtccgcctt cttctggact cagccctggc 322620
 ctgcccagc tcggttctta nnnnnnnnnn nnnnnnnnnn nnnnnnnnnn nnnnnnnnnn 322680
 nnnnnnnnnn nnnnnnnnnn nnnnnnnnnn nnnnnnnnnn nnnnnnnnnn nnnnnnnnnn 322740
 nnnnnnnnnn nnnnnnnnnn nnnnnnnnnn nnnnnnnnnn nnnnnnnnnn nnnnnnnnnn 322800

 nnnnnnnnnn nnnnnnnnnn nnnnnnnnnn nnnnnnnnnn nnnnnnnnnn nnnnnnnnnn 322860
 nnnnnnnnnn nnnnnnnnnn nnnnnnnnnn nnnnnnnnnn nnnnnnnnnn nnnnnnnnnn 322920
 nnnnnnnnnn nnnnnnnnnn nnnnnnnnnn nnnnnnnnnn nnnnnnnnnn nnnnnnnnnn 322980

nnnnnnnnnn nnnnnnnnnn nnnnnnnnnn nnnnnnnnnn nnnnnnnnnn nnnnnnnnnn 323040
 nnnnnnnnnn nnnnnnnnnn nnnnnnnnnn nnnnnnnnnn nnnnnnnnnn nnnnnnnnnn 323100
 nnnnnnnnnn nnnnnnnnnn nnnnnnnnnn nnnnnnnnnn nnnnnnnnnn nnnnnnnnnn 323160
 nnnnnnnnnn nnnnnnnnnn nnnnnnnnnn nnnnnnnnnn nnnnnnnnnn nnnnnnnnnn 323220

 nnnnnnnnnn nnnnnnnnnn nnnnnnnnnn nnnnnnnnnn nnnnnnnnnn nnnnnnnnnn 323280
 nnnnnnnnnn nnnnnnnnnn nnnnnnnnnn nnnnnnnnnn nnnnnnnnnn nnnnnnnnnn 323340
 nnnnnnnnnn nnnnnnnnnn nnnnnnnnnn nnnnnnnnnn nnnnnnnnnn nnnnnnnnnn 323400
 nnnnnnnnnn nnnnnnnnnn nnnnnnnnnn nnnnnnnnnn nnnnnnnnnn nnnnnnnnnn 323460
 nnnnnnnnnn nnnnnnnnnn nnnnnnnnnn nnnnnnnnnn nnnnnnnnnn nnnnnnnnnn 323520
 nnnnnnnnnn nnnnnnnnnn nnnnnnnnnn nnnnnnnnnn nnnnnnnnnn nnnnnnnnnn 323580
 nnnnnnnnnn nnnnnnnnnn nnnnnnnnnn nnnnnnnnnn nnnnnnnnnn nnnnnnnnnn 323640

 nnnnnnnnnn nnnnnnnnnn nnnnnnnnnn nnnnnnnnnn nnnnnnnnnn nnnnnnnnnn 323700
 nnnnnnnnnn nnnnnnnnnn nnnnnnnnnn nnnnnnnnnn nnnnnnnnnn nnnnnnnnnn 323760
 nnnnnnnnnn nnnnnnnnnn nnnnnnnnnn nnnnnnnnnn nnnnnnnnnn nnnnnnnnnn 323820
 nnnnnnnnnn nnnnnnnnnn nnnnnnnnnn nnnnnnnnnn nnnnnnnnnn nnnnnnnnnn 323880
 nnnnnnnnnn nnnnnnnnnn nnnnnnnnnn nnnnnnnnnn nnnnnnnnnn nnnnnnnnnn 323940
 nnnnnnnnnn nnnnnnnnnn nnnnnnnnnn nnnnnnnnnn nnnnnnnnnn nnnnnnnnnn 324000
 nnnnnnnnnn nnnnnnnnnn nnnnnnnnnn nnnnnnnnnn nnnnnnnnnn nnnnnnnnnn 324060

 nnnnnnnnnn nnnnnnnnnn nnnnnnnnnn nnnnnnnnnn nnnnnnnnnn nnnnnnnnnn 324120
 nnnnnnnnnn nnnnnnnnnn nnnnnnnnnn nnnnnnnnnn nnnnnnnnnn nnnnnnnnnn 324180
 nnnnnnnnnn nnnnnnnnnn nnnnnnnnnn nnnnnnnnnnc ttactgcta ggatttccaa 324240
 ttgtagaaa cgccgttagc ggcgctgaaa aagcgaaggt aggactcccg getcttttct 324300
 gcggatgggt ggttggtttt gttcggccct cccggccctc ggcgacctcg cgcgccatt 324360
 ttcggcgctt cggattcttg gaccggactg tgttgggcac cagctggggc acagcgtat 324420
 tgctattgga ggtccctcta tttatgcaa ctcgcctgt gctgcaacce agacttgggg 324480

 tgggaaggaa ggggttgta ggagaatcgc cctgttttg cactagggct tcttcgactt 324540
 ttgacaaatt gagaaaaaca aaacaaaaca aaacaaaaca accaaaacca tcaatactaa 324600
 gcctttttga ggiatagaga ttctcaggic caggagtittt ttttttttt taagtcaata 324660
 atgtttatat aaagctcata caaaaccagt aaagggtcc aaaaatgcct ttatttgctc 324720
 aactagttt ggcgtacttt ttcatggaaa ggaaaaaat tgattaacgt gtttacaaa 324780
 gaacaagtc aaaatttatt atttcttatt ttaacctgtg tttgtatca taatggacat 324840

gcggaatfff tttttgtac ttactgcata ttctttacaa ggagtattgt aaatfffact 324900

ggcgattatt attgtactat tctaagttaa gatfffata cttfffccag aaataaaatt 324960

cttaatfff c aaagaaaagc taactaagta attggctgaa ttgtccttgt cttagtfff 325020

ttfffctg ctaaggaaaa aaaaacttat agattataag tccaaactca gaacaaaatc 325080

tacttaata ttacttccaa agaaagctta acataaccac gatggcacia tgtcataaat 325140

ttgtttaaa ctttccaaat cagaacctag gcataatcaga acttattfff cagtgactgc 325200

aaatgaaagt attactttgc tagatgtttc caaggttaag ctttctccat cttaaagatc 325260

aatgagacat ttttaaagtt gaagttgcag tcaccctaag gtgatttaat aggaatgtat 325320

gatttaatff ttaactctc cagttaatff ctgcttactt tccagcacia tgatgcacac 325380

aaaatagct caaacgtggt gttaaactgt aatgaaagta acacaggcag aggccgtttc 325440

tagtttaaaa ttttaacagc aaaaagagat gcgtagatta tctatftaaa gtgttcaaag 325500

tcccagataa gcaaatatff gcacttacia catgaattgt atgtgaaagt tctagcattf 325560

aagataaaaag tgagtccagg aatgcacia atgagttttg aatccaaagg caaatgtact 325620

gaaatfttag ctgacatgaa taacctaaga ctaagaaaaac ttgtcatctt tagcagagta 325680

tatagttcaa aagatftaaa ggtgagagct cttgggtgt ttattgaact aaataagcaa 325740

tttgggtat cctfffcaa agtttaagtc tttccttgc t gattacatcc agcatctaat 325800

tccttggggg aagccaaggc taatcttgac tactgtgagc cctgctftta gctgatacat 325860

ctgtaacatg taatftgaat gcttcttcgg gtgagcaggt tgcagtggac actgaatctg 325920

tttattcagt tctfttaaaa tgtgggtaag tftacacact atggtatctc aagaccaca 325980

gatttaacct gtccagftta tgacgcgtgc taatattata ggctagtact gtgtttgtct 326040

ggtcacactt aatgactttg ctctcagagg catctgagga aggaaaagac tcaaatacce 326100

aagatgaaag ttccgftfff gttfttgtft tctctctaag agatgtgcga aggaaagcaa 326160

agaagftaga gtaaaaacat tcacagtgaa acgtatcact aaatataaa ctaattgtta 326220

atgaagatct cacatggaaa gtcttctggt actctagtat agctfttagaa gaaagcagac 326280

ctcgcgtccc agaccttctg catctgaga gtccctftac agggcattca caggcaggac 326340

ccaaaggcac acacagatgc agcgtttcgc ctgtagactt gatcacgcac agaatggact 326400

ttfttagatft gaaagftatt gcagaagata gcccaaaacca aaacctgtg atftftgtft 326460

tctftcagga tgagtgtgta gatgtctcca aagcaggga tcacagctac gtctfttctt 326520

aagctftaaa aatgccaaga ggagctctgc ctccctggct gtcagtgcac aagcctcggg 326580

ggcaaccctg tcttggcctt gtcgtccctg ggctaggttc ccacgtcacc atctaggcca 326640
 gcagactgca aacttgcctt tgatcaggca gactgcagtg agggcctcct gcttgtctgt 326700
 tgcattccgc caggttcggg gtcctttccg agatttgggg gtgtgtgggt ggctttactt 326760
 acttaggaga cctgcagggg acagtaagag gctttaaggt gtagcctcac agtgggtcgg 326820
 ggcagaggct aggtataggc cgagaactgg accgtgggcc ttggacgggt gagccaggag 326880
 tgtggggcgc caggctgtgc tggcaagcag gtgctggaac aaaggaagcc gggctacca 326940
 ggcctttgat gggcaaggat gtctcctcct ggggctcctc attcgcctgc aaatccagcg 327000

 ctggccctt tttctttgaa ggcaaacaga aggatgtttg tgtgtttgta ggcaagaagg 327060
 cttctcgaac aagccttctt caataggctg ggtctcgaac aataaaccag ttggacaaac 327120
 attggccacc agctctcctc ctcccacta caaagtgtgg atttctaca actcattaac 327180
 ccgacgctt tctctctttt tcttgtttc ttactcacc aaacgcccc gtagagcctg 327240
 gagacaaatg accgaagcgc agtcgggagg gaattgcagt taatggggag agggatatat 327300
 tggggctaag ggttcaggca gctcccagg aaggaccaca caaaaaggag cctctccatt 327360
 caaggctctg ttgtgctgcg gggatttaat ctgcagctag atttagccaa atgttatcta 327420

 ttgcgggggt aatgaagccc ttatgggttg aattgctcct tgtaccacac atgggtgcat 327480
 gacctcagac tgcttcttgg ttgatttctt tctctatcgg gtaattattt tatttctttt 327540
 aaataaaaag ctagtgtctt tgctggacaa cgggtttcct ctccattccc accccacaca 327600
 ttaagaggc acttgctttc ctattttaag aaagaaagaa agaaagagag aaagaaagga 327660
 agaaacaagt aaccgaggaa gtgaagggga ggctgtgggg gagctttccc catcttttac 327720
 ttactgaagc atctttatat gcaccatct ctgcttctct gttctctacc cagcaaactc 327780
 tcttgtgtcc aaactttctg cagacttgag ctggaattcg ggatgtgcat cccactcca 327840

 agttcttaca gtgagcgtga acctcaggaa aaggcttcta tccctgaag attttctttt 327900
 tcataaacc ccatgttttc ctgtagcctg ctgactggga gaactggggc agtgctcatt 327960
 ctgatggaag gtgattattt tgatggaata cggccccctg tcgtttatta aaggctgtct 328020
 gaggccactg gttgaggctg tgctgtttt gtttttctct ctctgacct gatgactctg 328080
 ctttctttgc ttgaggagg accaagccta gacgagctaa aggtgtttt acaaccgct 328140
 gctgatgggt aaggatctga ccctactacc cacagctaag aatcaaggac cctagatcat 328200
 gatatttaaa ttctctgcta gccatacatt ctgttcacca gagcaaagtc acacgggggc 328260

 aactaaaagg gatgttatca ctgtcgaact caacccaaaa tcagaaattt tcccaggttc 328320
 tcatttggct tcttcagggg gacttccctg tgcatttagt tggaaatcca agagttccca 328380
 cacaccata tacaccat cccttagaac tgaaccagag atggacctag ggagcagctt 328440

tatcctcact caagtctctg cctgggtgcag ctgagtcacg catacacaca ggcgtgcatg 328500
ctcatggccc ggcagctgcc tctttcccct atgattttgc aattaggcat atgttttttg 328560
ttggtaaacg tgtttgatgt catggccagt gaaatgtggt gtgtttatag ggccacgaat 328620
gtaaatgtgt aaatatgttt agtgtaaaat ctagcccttc gacttttagca ataaataggc 328680

tgccaacttg gatcccccta catttgacag ggagatggag tccctgatcc tggccagctg 328740
ctagggctgc cacgcttgt actttcgcaa ctgaattcac ttttgctaa tttctttaca 328800
catcgcacct ctctgatcac atcttgctct cgctgtgacc agcttgggct gcttttact 328860
gctgaccctt ctggagtct agaagcttcc aggtttttcc ctcaagcttc ttaacaacaa 328920
aattcctcta gtcatcatca agaaaaacct agaataaac agatgacaac tagtgaacct 328980
ttccaagcg ctttgccttt aggcatgaca ggatatagga gctgatttgg tggttatgtg 329040
ctgaccoccta gccattaccg ccattactac caacatccta actgtaaaaa gtgctttgat 329100

ctagaatgtg gaggctgggg cagaatttga ggggatctga gctacaaaac caaggcatgt 329160
cacctattt caaaacaaa ccacacgaat ttgagctac tctaactttt aagagtgtaa 329220
tagagataca ggagagctca gaagtaactg agtaactttc cacctaact gaggacactg 329280
ggtagctcat cccagatcaa gaagctgttt tatcagctgg gcgttgggtg cacacgcctt 329340
taatcccage acttgggggg cagaggcagg cggatctctg tgagttcgag accacctggt 329400
cttcaagage tagttccagg atagctcca aagccacaga gaaatcctgc ctcaaaacaa 329460
aacaacaaa aaagctgttt tatgggtaca ttaggcttcc ctttcttatt ccagccagta 329520

ctctcagtaa acattagcgc cccggccccc agggttttctc tgtgtaacag tectggcagg 329580
ccttggactc actgagatcc ctttaaacct taaaggcatg caccaccatc acccagcaaa 329640
cattagatth ttaaggaagg attttacta atatttcaga aagaatctct taaatthta 329700
atthttatth gtttcaatg ctgatgttg agcccagggc ctcatgtatg ctgggcaagt 329760
gcactaccac tgagctacac cccccaggcc tccagcagtc tttttgaaag aagcctgata 329820
gattgactg tgaatatgct aggaaaagaa tcaactgtga ctctgcttha ccaatcagat 329880
agcaaagctt aaaagagggt aaataaatga cttgcccaag atcatagcta ttgtgacttc 329940

actactgaaa tcccacttha tttacaagac ctgtttgtca cttttttct tattattatt 330000
atcattggga tttgttaagt cctatagggg taggaatag accagaagtc atagagtaag 330060
tgcagttctt tcctttttgt atgtccccca tactctctcc cctatcattt ccataggaag 330120
cctattgttc tagctgtatt taaaatcaac agctaattgt ttgagactth ctccatgtag 330180
ttctacatgg tactctccta gcateccctt tccattcct cctctctctc ctctcttttt 330240
tccttggcat cagcaatccc ttaaaaaagt atcctgtctg attacatcca caaacaggtc 330300

atgttgact ccictttacc tgtatcttc acttctcttg tagattgaaa caaattatct 330360

tatgtgcac catgttttc catgtaagca tgtgtgcac cacatgcatg ccttttgccc 330420

atggatgcca gaagaaggca ttggaccttc tgttattgaa ccaaaccatc ttatgggtgc 330480

tgggaatcaa acttgggcaa caagtgctat aaaccactga gccatctctc cagccttttg 330540

taggttttta aatgtcaag tttggcaatt gagaacattt ttctaaactg ctaagcagat 330600

cgcacaaatg ccttaaggct acatectaca tcttttctt tttcgagaca gagtttctct 330660

gtgtaacaac cccgtgtaaa gcctggaact ggtttttag accaggctga cctctaactc 330720

atagagatcc acttgcctct gcctcccaa tgcctgggatt aaaggcatga gccacttctg 330780

gccggcaagg ctacattctt tctgttttga aaaggaaaga gcatgtaagg agtgagactg 330840

attcaataat taaatgagaa aacagttctt ttttttctt tttgagaaca tgtgctctct 330900

tctttccata cactcttttg aagactttgc tctttttgca cagctaagt taggtaatgt 330960

gctgtagcca gtgattttaa tccctgcaga ttaaatctac agcacaggag cctctgtagc 331020

cgatgatcta tcagtagctc ctatctgcct tggatgaact ctcccacagt tgaagcactg 331080

gtggatgaat tccggaactc ctaccagttc acccttgcce actactatcc agaaaagggc 331140

agctttctca ggcaggggct ggggttactg ttttgatact ccatccagag ctagggtctg 331200

aactcagtgg tagagcactt gctgtgcagg cacaaggctt gataaactat gagctgcaga 331260

atacaatcaa gaacttatga cagtcttttc aaggaacagt gattaatgca aaaaaaaaa 331320

aggttctttt taaacaccag aaacaacaaa aataattaat ggcacacctt gaaagatagc 331380

actgccccca taaaacagt tcacaacat tagcatgctt atttaaatgt tttggaaatc 331440

tgaatatgaa attaggaat gaggtggaag ggtatttct acttttaaga aagatatttt 331500

caaagatagg gtatttctt gtgtgtagac tactactgat gggagatata tagtcttgta 331560

aggcaagtac aagctatgat tgtggcttag acccagctga ttaggcagc agcagcagca 331620

aacagttgga gcatgaatat ggggtctcag aaccttgctt ggatcttact gcaccagagg 331680

gtgccaggca cacgaattgc tcttacttgt aacttcatca gtaaaggatt ggcaaacaaa 331740

aagaggggag gacagagatg gattcctaca ttgcgagttt tagcaatact tgtgaaaaca 331800

gaaaaatatt ttcagtaata aagggaagt acagatcac tgaaaagtct acaaggaagg 331860

acttttgta ggaaaaacta cttgattctc ttttttcat atttttaat gcagagcttt 331920

atgtgtgta aaatagctac aagattctat tgttaataa ttgatgacat gcagagagag 331980

agaaaaatcat caaccaatct ctaaagtctg tagaacgaag acttcataga aatgaactgt 332040

taggtcgggt tccactcttg tgtatagctt gcttccttac tctttcctta tctcttcctt 332100
cttttccttt tctcagaaga tggcatgtga cagcaaaata gttatgtggc aatgctctgg 332160
aaaatataga agatattaat gtaaacaatt atgatctgtg gggcttcttc ctacacctta 332220
ttcattcagg caaaaaagg ggggggggag aaaaaatccc caaactttgg gatataacta 332280
aatccttgaa ttgtaaatgt ctacatgctt actttcatcc catcttecta tctctctctg 332340
aaaccagtta ttgcttaatc ctttctagaa gtaatgaaga taaaagagat gacgtttccc 332400
cttacttcag tcagaattgt atttggactg ataactttct agcctcttct aaaataaaca 332460

aatggataat gttttaaacg cattcttctg gcctcttget gtttcttccc tctgctcget 332520
catccaccga tcactcttaa ccctcaagct tggaaaagta ggatcagttt gcaactgtttg 332580
tggagcacct gctatactgc aaatcccttt agatatagga acaaatgaa agaattcctg 332640
acaccaagct gctcattacc taagcacaaa cattgagcag gagagaaggc tttttttttt 332700
tttttttttt ttttcagga acagtggggc agaggggaagg ctgggcaggt aattctttta 332760
ttttccatta gaacacttct ttttattact agaaatttct atagtacata aatgacatga 332820
tgatgtgtgc ttgatgataa tatctttggc acatagccac tttactcaca gfatcaaact 332880

ccttcatcca gagagctggg catctgagtt tcctccgttt tggaaggctt cttctgaagt 332940
tcccagttct ctgagaataa atgaaaggac ggctgttata aggctccctg tactgtgaac 333000
caagactgtg acctgcacaa attgagggtta catccacacg ggtctccgaa gaattatgca 333060
cggagacagt tigtaaaacc aagagcacat ttcccccttc ccacttttga acattttatt 333120
acagataaaa agaaatttta aaacaaagta aagtattttc ttacgttatt ttaataactt 333180
ttcaaataaa aagaaacccc acttgagaaa tttcaatatt caatttgcaa aactgtcag 333240
agagttcggg tttgatccg ctgagggtgc acagcccgcc aagaatttcc ccccttttc 333300

ttttgaaata caattcaaac atttacctca cttttaaagt tgtcatcget gaggagcttg 333360
gtccaagtca tccagtttgg attttgtctt cttctcaaaa agcaaccagg aggacacagg 333420
gtaaagcacc acggaggact cgggtctgtg tttgtctatt tcaggaattt aataatttgc 333480
cttctectc tttccctgga ccccccteca gctgcacaca tagcagggtt ccagaaaaac 333540
cagctcccac acagctttag aattatgtga gatgggacct cttattctgg ggagctggtg 333600
ggtgagggtc gttattgtaa ctctattctg taactaaagc tctggcgtgt aataaatctc 333660
tccccaaaga cttttggatc tttgatttga aaaatcggat tccttttagt gaaacacttg 333720

acaggaacct aaaaggatta gttgcattcc gtacaggata atttttactg gcaacatttt 333780
gaaacgattt gattccttc agaccttaaa caatgtccag aaaaatgatc taacgagaat 333840
cgtattgttt tcctttgtat gtcaatctgt ctgccctcc cgccaacatc tccttggggt 333900

tttttgaggg ccctgctccc gagccgtgca ccgaattact tctcggatcg ttctttctat 333960
 caggttatct tttcctgcca ggggacggtt tgcgcctcct gggcctaccc cgggacagag 334020
 ggacctcact cctagctccg caagggtctgc tgcaggctgt gcaaaggcct ggcaggaggt 334080
 cgccagcagc ttggcgggcc ccagtcctta tggcccaaca ttcctcgcag cggaaagcag 334140

 agagggatgg gtgaggacaa gcaagagcaa ggaatttgcg gctctctttc gccccgcggc 334200
 tcagcgggagc cctgaggggcg agcagcctcc tagcgcacag cgcacggctc ctccccgctg 334260
 gctctcggct gtttattcgg ttgtcagcgg actttggaga tgtttttggc tagaggttct 334320
 gaccccccc ggcgctgtgg ccgctcggct cggactctcc cggctgtttt tacacctgca 334380
 cagactcccc cgcactctc ggctgattt attgcctaat taaaggttca gtgctctgcg 334440
 cgccaccggc gctcccttcc cgccnnnnnn nnnnnnnnnn nnnnnnnnnn nnnntggac 334500
 ctctcccga gggcccctcg aggatgcggg ctgggacgcg acggccgtgg ccccgagacg 334560

 ccgagctccc atagcggacc atggctgtgg gcgggaggca cgggggtcac agaccgcca 334620
 gccccggcc cagcctagc tccaacctcc tccttgccgg ccttttctt cggagagaa 334680
 taaacgtcaa gccagcggag attggcagca ttgagcatct tcctaaacca getctgtctt 334740
 ctttccatct atcaatccac ctttctaatt agactaatta ggagcgttt gcagtgtcgc 334800
 taggcccagg gactgaaccg cttgggggtt gtgaaaagag ccctgaatgg ccacgtggg 334860
 ggccaggcgg gggcctttgc gactcattca ccacagagta acagtggcta catttatccc 334920
 tagccattga aaggaggctc gattaaaacg tttgggaact aatgccacct tgctccct 334980

 ctaattagag gaaccgggga gatggcggga gttcggggac cctgcagaca ccttctctgt 335040
 gcaccactgc ttccgcccct ttcctttcag gagacaaaag tccccccct tcccactgt 335100
 tgccccgcc ctgctttccc atcctttcag agctccagtc cctgccccaa gcagaaggcc 335160
 cagccaactg ctctaggacg cccagcaagc caggatgctg gggggggcg ggggggcatc 335220
 cgagcggaaa gccaggcgtc tcagaagtat ctttcggac accgctcttt ctggagatag 335280
 ccacccccct catttctccc attctacata ggtagtcccc tctccaccc accccacaaa 335340
 atttgagag aaagcatttg tgaatgaccg gaagtgggtt agatgccct ctgtccgctc 335400

 tcctgtctc ctgtcgtct gacaaagttt ctactagta gaaataatt gtgcattttg 335460
 tcaactagtc gtctgtctt ccttctctc ctcctctct ctctttctcc ctccctccct 335520
 cctcctctc tctttgaaa aatgcttta agcacctact atgtccctag agactcttaa 335580
 cagcccccc ccccccca tcttctttg ctcttagcct accttaatt acatctaac 335640
 taaaaccgga cttgattctc ccggcaaget attgagctc tttctatagc tgtaatgta 335700
 acatattct ctttatctt ctcttgctt aataggaaga atcccagaca caagctatta 335760

gggacgtaaa agacaaatga gaaacagaag tcgtttgcta atacagattt ttgtgtggaa 335820

 ggaaagtgc ttggttcatt ttgttgacga gatgatggg tctagtattt ttacaaaaat 335880
 gtgaaacact ttgccctaaa acaatggtga ccaagaaagt ttgattcttc getttcttec 335940
 tctttttact ttaaccccc ccccccttc ttggaaaaga gccagatgta caaagaaata 336000
 tcatcaggtc actgttcttg atcatgttaa tttagaaaat ggaaccttgg tagaagatgc 336060
 tattaactaa atgtcaacce acagegtgca gaattccttg gatccaaact tcaaaaacaa 336120
 aatgaaaga tgtcatgta gtgaaaggaa ttgtggaaat tttttttaa aggcctaac 336180
 tgatcttaat agagttttat tgcttcaca ccctacctca caatattta atttaacagt 336240

 tacagcatgc atgccattgg aacataagtc cagcctctta agaagctggg aggagcaaag 336300
 aagaggaagg acttttttt ttttaactgg ctcatcttga ttggagaaaa tgacaatttg 336360
 caaacatttc aagtctctgg aaaccttga atagaaaacc ctaatctata ccgtctgtga 336420
 tttttatcac aaaacctctc atttttccat ttcagctgtt gatttgaatt ttaatgaaga 336480
 ttaacataca ttgggtcaag ggtgcatccc cataagtatg cagagggtgg atacaaacct 336540
 atataatagt acttagatca agattaaaaa gaaaaacaag acggaagagt cccctccagc 336600
 tgcttcataa taacaccac ctccatccac ccactagtct tgtttttata ccctcagatg 336660

 ggtcttatac tttcgtgaat tttatataaa tgggatcatt cgatgtgcat tttttgggtg 336720
 tcttttcttc accatgtttg caagattcat tcacttgaat ccataccagt aagtcaatgt 336780
 aggtgcaaa taatttatac aggtacaaat gaaaatcaa cagtgagaa agcttttagtt 336840
 tagacaacct gcccataaa acaccacat tccattatca tccagaaaga taatcctaag 336900
 tgaataaata aaattagttt atccatacat agtaactgtg ggttacatca ttttcaagat 336960
 gcaattgtgg gtagctgcaa gaagagcaga agccacaggc tgcttttga atttgattct 337020
 atttctact tgccattca tcccetaaga ctagtagtaa gtactttggg cctcttcaca 337080

 aagaatggca tgaactttag agggaaagtaa attgcatcca gttgttctg tctcagacgt 337140
 gtaagtcctt gatgcgacag cctgtcaagt gtgttttgaa ttctgtttga aagtaaagtg 337200
 ttcaatttgc aactaacaca gttaccctgt ttgtaggtca ccacacagac cagttaactt 337260
 cagagaaaag cacagcaaac ctgtagaatt gtaattgtcc tctcaatgc cccttcctc 337320
 agaaatctgc ccacaaaacc aacctttgcc taaatttatg ttgccgatga tcaagcagag 337380
 acaccagga agaccgtcat caccagtctt ctcttcctc aatggaaaca ggagcatgca 337440
 gactgagggc ctttcctca ggaagggtag tgtctaggaa taggtctatg tgtgcaatag 337500

gagagatgag agcatttga aacatgtttt tggttgatta tattggactt ttgtaaattc 337560
aaagtggga acattctgtt ttataatctt aagtctaaaa attaagttaa acctataata 337620
aagcacagag ttcactccaa ggaaggcagt atggggttaa taataagata actccactga 337680
gttatcataa taicagacaa ataaattgaa ttactttattt aaaaatatag caagggccag 337740
taagattgcc cagtttactt ttatttttct aataatttat ttttattttt gagcattgat 337800
tgggtttttg ccttcttgtt tgtctatatg aggggtgttg atcccctgga actgccatgt 337860
gggtgctggg aattgaacc cagtctctg gaagagcaac caatgttttt aactgctgag 337920

ttatctctcc agccccaag attgctcagt ttttaaagat gcttgctatc aagtctgatg 337980
atgcagttag atccccagga cccatatagt ggaaggaaag aacacacaca cacacacaca 338040
cacacacaca cacacacgcc atactgtaa aaagagacaa ctatataaaa taaaatagc 338100
aatactacc aaatactatg gatgttgaga cactgatctc ttgcatatta cctagtgtga 338160
gtgtaaagtc accctgaaag atattactta taaaactaaa aatgacttac caccctatcc 338220
agcaattaca ctctagacta gggcctctat accagagaaa tgagaattta tgttcataga 338280
aaaacatgta tgcaaatgtt catagaagat tcatttgtga aataaagaaa ggggaaagga 338340

aagagaaagg aaagaaaaa tcatattcat gagccatctc tccagcctga tttaaatga 338400
ttacagagac aaggacagat tagttatgcc aagaatcagg gaagaggaga tgtatgagtg 338460
caaaagggtg gaaagggggg ttacctgggtg atggagaagt ctgcacctta atttgggggc 338520
tgctgcatga atatatatat gggattaagt tgcataaagt gaaacacaca cacatacaca 338580
cactgctatg gcctgatgtg tccccaaaca cattgaaaac atcacccca atgcagaatg 338640
ttaggaggta gagcttagta gagagccctg actaggttca ctggaaaaa aaaaagaaga 338700
agggaaaagg gctggtagt gtgacagggt cacgtgagaa cagaggcttg cccttctctg 338760

cctttctctc accatgtgag aatgtagcaa gaaagcctca ctcatgcctt cetgtgctct 338820
catcttagga cctgggatgt tgaggcagaa agactgttgt aagttcaaag ccagcttggg 338880
ctacagaatt atggtcactg tctcaaaaca cccaaaagag gaggaggagg gggaaaagaa 338940
ggaagaggag ggctattacc atattttgca tctcctggca cctagtactt ggacttctta 339000
gtctctagaa ctgtgaaaaa ctgctcttta taagtagccc agtcgcaacc aatctgctgt 339060
agccgtgtag aactaactcc ctcatatgaa tgcacataaa atggagccag ttatataagg 339120
tacttaatag tgctgcacaa acatcaatgt cctgggtttg tggttgact gcagctatat 339180

actaagtcac cactggggag tgggtggctga agggcagatg gaacactgtg ggctcttttt 339240
gcaacttctt gggaatccag cgttatttca aaagaaaaa gatccttcaa tcagtgtctc 339300
attataagac ttctgctga tgacaagagc tgccttaggt agattttcat aattaataag 339360

gcaatataca ttttcataag caatgttcat aatggtttta ttaatattat atacgataat 339420
tgcccactgt gtttcatgtg gagagctcca atattgaaaa tgaaaagggt ttggaacatc 339480
aaaaatattg ttcattcatt tgaaagtcct cgttctttgg gggtagattt aactgtgaat 339540
tgtcaatatc gccaaagagtc aactatggta aattaggtag atgaccaaat tgaataagac 339600

ttttttttt taattgaagg cttatagaag atctctcaca catgtattct aggaaccggt 339660
taciaaggga aaggtttttg tttttgtatt tgttgtttgt ttttcaaga cagggtttct 339720
ctgtgtaaca gtctggctg tcatggaact tgctgtgtag accagaatgg tctggaattc 339780
acggagatcc atctgcctct tctctcaag tgctgggatt aaaggcatgc gccaccactg 339840
ccctgctaaa gggagagttc ttaaaatgcc cctgaaagac tttgacatta gtctttgtcc 339900
agggccacac ttagagggga aaccatttg catgcttgaa ttctggtatt tgtcacattt 339960
ctagagtcac actggaaaaa tggttcttgg aaatttgatg cttattttaa agatgctgtc 340020

ataattacca tatgacaaag tgtcttttta tatggcaca actgcctgg aacttattat 340080
gcaaccctgt ctggtatcca acttgttacc ctctgtctc agcctctga gtgctaggat 340140
ttccatgtgc accaccatca ggtgtttaag gcagtggttc tcaaccagtg ggtcatgacc 340200
ccaaaatgtc aaatgacctt ttcacagggg ttacgtaaag ccatcagaaa acatagattt 340260
ttacattctg atccataata gtagcaaaat tacagttatg aagcagcagc aaaaataatt 340320
ttgtggttgg ggttaccata acatgaggaa ctgtataaaa gggctctcagc attaggaaag 340380
ttgagaagca ctgatttaag gggtagcatt tattagtctt cttttttttt ctaagacaag 340440

gcagtacaca cttctttact tggtttataa agtcttccat gtgaaaattt tatgacctct 340500
aatcactgtt tcaactttca taatccctcc acgaaagaat gactcaaca gaattagtta 340560
atcaggtgaa aattgcctt tattatgaat tcagtaggtg cacaattatg gcacactttt 340620
catttggate cttcctttaa gatctggcct gtctgcctgc ctgtaagtgg atcacggcat 340680
ataagcagtc tgcactccta ctgaaagcag cccaaattac aaatgacttg gtgtcagaca 340740
gattttaaac ttgggtgcca gtagtgtttt aactatgggg cttgttcttt tctttgactg 340800
ttgtattatt ttattccac taggaattgt ggagttctaa atattattag tggtttacca 340860

cttttgaca catgtgtcct attaattttg gagacatggg aggaaagtga caggcctctt 340920
ttctcecccc cattcatcta cctgtctaca cagacaggcc cctgtctgtt tagagttcag 340980
aaggaccac acagacgcta agaaacttga gcacaagaac tggatcatgg gtatctgggg 341040
gcgggggtgg agggatacaa aaaccttag taactagatt gttttggttt ttagttcttg 341100
atltgcttga aacagctcat gtaaaaatta aggcaactta caatgtacgg cttagctctg 341160
taaagccttt aaagaaattt tagagaaaac agaactttt tacttaaaaa aaaagccgct 341220

aaaactacat aaaaaattaa tagtagacta agcccattca ttctgaaatg ctgtaaggag 341280

 taacaaactt ggaatttgt gaccttagtc ttatgtctac acaacatgat acacacaaaa 341340
 tagcataaga atagaaaaaa aactacaaat aaagatcaca ttaaacacagg tacacttaa 341400
 gcaaaacaaa ttaagggaga tcaaagacct gcctttagtt tcctattcat tctcactgag 341460
 tcatcttctg tgcacttagt gagcacctat agtatgctga gcataatggg cgttgctgtg 341520
 gatacaaaaca aagacaggac atctggctgg aggagggaga gaggagacac acatgctaat 341580
 taaaatatta cacagagtac gtcaatataa atatgaactg attggtaaaa gatcgcagca 341640
 aaagaagctg ctatctggga ggcccaaggc aggcttctcg gaggacacga cgttggagct 341700

 gaatthttgga aagcaataga acttccatat ggaacaaaa ctctgagtga gcagggtgct 341760
 tccagcatga agaggaaggg tgatgctggg gtctcatgat acagacgagc agtagactat 341820
 tctagtctga tacagtccag agtttctgta gcggagcaga gaattggctt gcatgtgagc 341880
 aatggggaca gggtagactg gggcctgtca gtcaagcatg tggttaactg ttgagtatat 341940
 ttagthttcc aaacacatcc ctgtcatgtt gactcctaag tgggaaagtc ctatgagaaa 342000
 cacaagtgtt cgaatgagag gagaaggtc acttccctca atccctatcc ccaatttgtc 342060
 agccttggct gacctggaat gctctattta gatcaggctg gcttcaaact tagagatctg 342120

 cccctgcctc tcgatgacca ggatatcttt cctgatagag cagagtaatg gaaagataca 342180
 ggatacagag ggttgaaaa gcctggggcc aggagagtgg aaaggacag actgggcttg 342240
 ttagaaggag aacagattgt aatgactcac atgatgctag aatgatgcc cccacagtct 342300
 agcgtccagt ctctcttact cgggtgacce aggtttcaga cttaacgtct ctaaacctctg 342360
 ctatctctgg tcccagattc agctgcctgc tagatattcc ataacattcc caaggtaaagc 342420
 acctctccat aatgattcc ctctctggct aatactccat ttccttagta actcagcctt 342480
 aacatthtca gagtcttgat ttctccctcc atcacgetga ctctgagaac caattcttc 342540

 ccagtcttg taagthttgc agaaacttgc ctcatctct ttcttctcca ctcttgatgc 342600
 tgggagcctg taccactaag ctgctttcag cthttctagt ctgctcattg accaacacgt 342660
 gttacaaatt aactthtcaa taccctctgt ttgtthttggg agacagggtc tcatcattta 342720
 gccagagctg accttagctc ctggtcctcc tgctccacc actagttagt atgctcccat 342780
 gcctgtcctc cagaaaggct cctgtcttga cacactctt tctgttcaag aactgaaagt 342840
 gactthtctag ttgtataaaa ctgtccagtt ctaatctggt cctthtatagt tgggtcaaat 342900
 ttactgtcta agggggccct gcaattgttc tgcgtthtac actattgatg tcacagtcca 342960

tacctggaga gtctccctct tctccccgia gtcgtcgtca ttacataaga actggctgag 343020
 atttctacct tttcttggaa atactgttgc cttatgatta tctactgca tgagttaatg 343080
 tgtatggaat acttccaggg aggctgcatt tgaattaggt tagaagaatc atgtcatgtg 343140
 actttccggc attctaccag gcacacctgc ttttccttat caagtaagtg gacgagctaa 343200
 catggaggat ccaggcttag gtggtcttac ttgagaacct aggcctcatc attctcatct 343260
 gtccccagtg aaaacatgta cccccattct cgacggttta ttttctatcc catttatttg 343320
 acattattct attaaagact cttgtgaaca ccatctttat tgtgtttgct atgaatttcc 343380

 tgccatattt caatctactt aaatgtaagg ccacatcttt tttattttta tttaaattct 343440
 ttaattacca ctcatattta catatccatc cccccattcc tcccccttc catcctccca 343500
 tgttccccac catctcccc ctaccaccc cctaactct ccccaggac agagaggccc 343560
 tccaccaggc accttcaag tctgtcatat catctggggg agggcccagg ctctccttgc 343620
 tgtatctggg ctgcaaaagt atccctccat agggaatggg ctcccaaagt ccatttgtgc 343680
 tctagggttg aagactggct ccaactgttag aggtccata gacggcctg gactcctagc 343740
 tggcaccac attcagaggg ctcattttgg tccaaagctt taagactagg gctccatgc 343800

 tctcactagg tcaggccac tgtttctgca tgtctctcca gccctgtctt ggctcctttg 343860
 gtcacccctc ctctctctt acaactgaat tccagtagta tggttctgtg cttagctgtg 343920
 gatgcctgtt tctgcttcaa acagctactg gatgaaggct ctaggaatgg taaccaaggt 343980
 agacaccaat ctcatatag gggaagggca tcaatgaagg ccacatctta taattatttt 344040
 ttttgcata ccctattgat attacaacat tttctgcgga ctggaaagat gactcagtgg 344100
 ctaagagcat ttgttctct tgcattgggt gtgggtttgg ttcttagcac tcaatagcag 344160
 tttacagcca tccaataact tctgttccag gggatctgat gccctcttct gaccagatac 344220

 caggcatgca catgatacat atacatacat gcaggcaaaa cactcacaca tataaaataa 344280
 agtaagtaat ctataaaact attttctgac tactgaatac gttgaccaat ctggcagatg 344340
 aatgatgtgg gtaaaacaat ttgcagaaaa ttgtctttgt ctatgtatcc aaaggtaaaa 344400
 ccctgaaaat aagaaactgt tctaaccaac catctcagcc taatgaatct ggagtccaac 344460
 tagcacagtg aggggttagt agcttacatt tgcatttcta tgaatgacat ttacaatgct 344520
 ctgctaactg ttggttggcc tgattgtagt tcatagaata atgcctgtta tcttcaataa 344580
 taatggaata agagaagaca tctgcttata attcataggt accataccta aaaggtcttt 344640

 ccattcaaaa taatacactt tcttcatact ttcatttact tgccttgcct aaaacttgat 344700
 ttgtattttg taagcaaaag ctacacatac tcaataatta ataattaaaa gacaaccatt 344760
 ccgcagctgg agagtgtgtt cagcagttaa gaccaccaga ggaccagggt ttgatttcca 344820

gcacccacac agtacttaat cattggtaac tataggggat ttgatgcct ctttcctcct 344880
ccatacacac tgcattgcgcg tgatacacia tatacaaca gacctaacac ccacacataa 344940
aataaaaaat gaaaacaaaa caaacagaca gaaatcaca ccatccata ttgacttgt 345000
gggggagatc acatttaaag tgatggacca caaatgata tggccccagt agatgaagcc 345060

acttagtcat gagtcatgac tgtcttagtt ttcataccta caatacactt atgctgatac 345120
aaagacaaaa tcaccagca acaatacagt tctcaaatg cattcctttt attaaattat 345180
atatgattgt acttataaaa gcaagaaat ggtacaaaa gatcttttta aaaattacag 345240
tgcattatta aactgaacca ggggattatg tctctttgaa ctgttgactt tggcatgatg 345300
ctttccaga agcaaccagc atgaagttag ttcataaggag agttgcaaca gctgttatga 345360
aggatcttgc ctctcattga tcacagagtt gccaaaggca agcgactaaa ctctctattg 345420
gctataccaa cagaaagtgt agaaagagtt aatttcaaca atgcaatatt tcttattttc 345480

atcatatgtg tcaaaggac agttgaggtc tccacagtt ctaatagata tattaatfff 345540
tttatagtac tgagggtgta acatcaataa tacagttgta ttatctgctc agatcaaaag 345600
ctaatgcatc ctatgaacaa cacgaatgaa tctccctaat gagatttgag aatagttcat 345660
acaccctctg catgaactac taactagaaa gttgtttcat tgagtgtagg tccactatc 345720
tgctcctga aatgtccagc tagtcaaagg gtacatccct agacttttgc aagctctaac 345780
acttttggat ggctaagat gtacaggacg acatgccaag ccctagggga gtataaacia 345840
aaggaagggt gaaataacat ttatttagca gctactgtgt ggtaagaact tttatatcac 345900

attgctttta attfacatgt caaatctagg agatatgtgt ttggtctgtc tccaaaatag 345960
aaacagactt tcaaagggt taaataaata aattcaggct acatggcttc taccagagtt 346020
gagatttgaa cccaagctt ccttcccaa actctattct tttctacaat aacatagaaa 346080
cttttgaaga tatgaccatg aatttgaag tatggtaaag agagtaatac aagtctgaaa 346140
tcccctgtat acatgaggct gaggctagag ggctgaaagt tcaaggcaaa cctgggctgc 346200
ataggagat tttctcaaaa accaaccaac caaccaacca accaaccaac caaccaacca 346260
accaaccaac caaccaatc ctaaataaat aatgcaaaga aaggagagg gaactggatg 346320

ggacacaacc aggaaggttt cagatfffft attgtaacta ttgtatatca tgggtgtgat 346380
gttaactatc tctagaagga cctagcacac aaattagcta tttttagtca ctatgcctt 346440
tgggaacaca actgtgacaa ataacatfff aaaaattatt attattatta ttcctttfff 346500
ttatttctgt gcatgtgiga ctctgtttat gtgtgccacc tgagcccagg agcttggagt 346560
ccagaagaga gtgttggcgc ctctggaact agagttacag gctgttatgg gttgccttgt 346620
ggatgccatt aaccgaatc ggatcccctg gcaagagcag taagaagagt tcttagctgc 346680

taacgtccca attacaatTT atTTTTtgag tttcaatact ggggatcaaa tctagagcct 346740

 cctgaaactg gacaggggca tggttgacaa aatttcatct agacatgcca tatgaggTac 346800
 tattatatga agtaagccct tctcagTcat cagtTgcaagg gaggcggctc ctagaatagc 346860
 ttctctgagc cacacttctc agtagTcaca acttttTgtc aatttcttc ctttccgagt 346920
 acgatccgga tttagtgaat tacttccatc aaagacaatt cagcaaatgt ggtgggggag 346980
 catatggcga ttctagctgt tttgagggcc ctccgTaacg atttccaaag tttctggata 347040
 aatttacatc ccccagcagt ggtggctaac cccccattct cactagcatg ctctttcact 347100
 tgttttcttg aggacagcca ttttgactag ggtgagatgg tgtagtTTta atttgaatTT 347160

 cctcgatggt taaggatgTT gaacattttc atacatttat tggctattta tacctcatct 347220
 gttcatttca ttgggtcact aattggTtgg attgattctt ttcttttctt tttttttttt 347280
 ttttaagatt tagtttttat gtatataggt gctttgtttg catatatgcc tgcagaccag 347340
 aagagggcat cagattTgta actgccatgt ggatgctggg aattgaactc aggacctttg 347400
 gaagagcagc cagtTctctg aactgctgag tcactctctc acccctactt ttttcttggt 347460
 atatTggctt tctagatcac ctctctctct ctctctctct ctctctctct ctctctctct 347520
 cctctctctc tctctctcat acacacacac acacacacac acacacacac acacacacac 347580

 acacacacag tatgtaaggc atgaaagtag aagcagggta ggaccagagg aattaaagac 347640
 attggTgggg cagaggagga gaaaatggaa atatggTcaa agtccatgat gtgcttTgat 347700
 gaaactatTT ctacgaaaca aaaaacaaaa aaacaaaaaa cccccaaaac accaagccat 347760
 cactatgtac aatgaatgta tgtcaattag aaaaaaatag tattgggatg tgactagctg 347820
 gtgagtgacc atcctgtcct ctcgctgtgt ggcactgatg cagtTgatgc aggctacgct 347880
 ctgtttagag acccacatgg ggagaaactg aggtcagacc agcagccaac agccctggaa 347940
 gaactcatgt ctcagtccat tggccactga ggaactgaat ccttccagca aacatgTaaa 348000

 tgagctgggg agtTaattca tccttTcag actttgggag acctttTgta cacttagacc 348060
 tacattaggg gatctagtca aactgcactc tgaatcctga cccacaaaaa acttcaagga 348120
 agtaagtgtt gcTctgaatt cctgtttggg ttaattTgtt acatagcaaa gatagctggt 348180
 aaaaacacgc ttctctctg tcaggcacta tctggtctg ggataatagg gaatggaggg 348240
 ctgtTctga gtgtgagTac tgaaaacctc cactcagggg gctgtgcggg ctactactgt 348300
 acagccgtct caagtcttTc ttattccagt tttacattgt ttattttTg cttagaatac 348360
 caccgtttgT tgtaaaatga ttttatttct ttattttTaa gtctctctct ctctctctct 348420

ctctgtgtgt gtgtgtgtgt gtgtgtgcat tcatgaatgc atacatgtgt acatatacat 348480
 ttgtgtcat ggggtgtgac acagacgcct atggcgttta gaagagaatg tggagcagga 348540
 gttataaata gggattgaga gatgccaaat gtgggtgctg ggaaccaaac tctggtcctc 348600
 tgctagagca gcatgtactc ttagccacta agtcatgtct ccaacccttg tggattacc 348660
 ttaaataagag atttttaaaa gtaatttatt tcattttatt ttatgtgcat tcgtgtgaga 348720
 gtttcagatc ccttggaaact ggagttacag acagtgatga gctgccacat ggggtgctggg 348780
 aattgaacc aggtcctctg gaagggcagc cagtaccctt aaccccaag ctacctctc 348840

 agcccctaaa tgaagatggt tattcagata gccatctata gctactactc agaagtcctc 348900
 actctacacc caagaatagc tataggcaaa acaaaatcta gatagaataa acccaagttc 348960
 cattttgagt cgttttgta gtaagaaata ctcttctggc aaatgactgt tatcccagaa 349020
 ctggagagac tggagccagc ctgggctcat agagtgacc tgtcccagaa caagcaaca 349080
 aagccaagct atcaaagat ctacagtatt aattttatga tactttgtat ctcttagaag 349140
 ttgataccta aaggcagata agaactaaag gaggtctctc taggcaacag caaacatata 349200
 aatgacccaa aaagatggtt cagatttaca agactgagaa tcatgctgta tcgttttcag 349260

 agaggtttct ttttatagta gagaaaaaga ccataggaaa tacctaagt tttgtgttca 349320
 gtcaacacat cttgaaacgg atatatctct atggcagtaa tagaattcta tcataaaaga 349380
 caatagatgg taggtcttta ttttttccc aaagactaca cgactttggt ggataaaaat 349440
 tagggtgacc taaatacgaa cagattaatt tatatggagg aaaagttaca aatcattcac 349500
 ttaaaagctg gctccatgcc cacattctag cagtacactt gggaggcttg tcgtgtaca 349560
 gctaattgtct acatggagcg gatttctgaa cataattat gtagatgaag tgtgcagaat 349620
 gtttttattt gttctacatc tcaactgtct acctctgcat gaacttccc aggccagatc 349680

 tactccaaat agtctcactc cccttcteca cacttccctc caactgttt gccttggcaa 349740
 ctttcacgtt cttacaaca gttctccca ggaatcaat cactcttgca cccaagaga 349800
 aatactgcgc actcagtgcg atgactaaat gaaacatggt tgaggcaaac catgtgttcc 349860
 cgcgtgtccc ggattacgt gtttcteca ggaacatggt cctaatgtgt ttggcttctg 349920
 ttacccttg tgattgcaac tttcactgtc ttttgaatt tatgattca gaagcaactt 349980
 cttggactca ttaacaaga catttttaga gtgtgaagcc tgggggactc attgggcctc 350040
 gtcattctgg tcctcttct agactagtct ggcccaagca agggcacctg ctgtttgagg 350100

 aattgtgggg aggttgatct tctcttccat ctggaacacc agacagaagg cttatctaaa 350160
 tgacatgtgt ctattgtct ttgaaagcta tttggttcat caggcacatt atttgagat 350220
 atatatatat annnnnnnnn nagagaaatt tggaagtca aatacaaaga aatgataaat 350280

attaagaaga tggaaatccc agcatttggg aggcagaggt aagaggactc acgtttgagg 350340
 cccagttgtg ctatcattga gagtttctag tcagactggg ctgcacagca ggactctgcc 350400
 tcaaaaaata aaataaaaag agagaaaaaa gaagggggag atgaggggtg cccctattta 350460
 atcattatac aacaattaca tgtttcaaat tttatgtttc atggctggca agatggctca 350520

 gtggggaacg gcaccagccc taatactgag gacctgagtg gtccccagca ctcacacagt 350580
 gggaagaagt gccccttgg cattcgcatc catacacagc acacaagtgc tccccacaa 350640
 taacaaata atacataaca agaaatcacc ctgtaacta ctgccaaatt attatcctgg 350700
 aagtatgttc acttatgtgt caataaaggg gggggagaag aaggaagagg agatggagta 350760
 aagaaagaaa gagaaaagaa agacggaaaag gaaggaagaa agaaagagag aaaggcattc 350820
 tctttgagct gcctccctgg aggccctcaa ggtaccaacc atactcacat tgtttactaa 350880
 acattgcagc tgcaagacta ccaattctat ctcatgctgg ggccaccaa ttaacaaaa 350940

 tgtcccacca gtcacctc ctttgggtgc tctttcctta cccaaggatc atcatagga 351000
 gaagtcaggg tcattagcac tttgaatfff tgtgctttct tctctgaaac tcttcagagg 351060
 tcccaggttc cccctccttt tttttttttt tttttttttt ttttaatteta ctttctgtg 351120
 gagcctgaga aactgagttt tgtgtaagtc taaggtggtt ttgttgctgc tgtatgatg 351180
 tatgatgta tgtatgatg tatgatgtg tttaatgtca ccttaggggc tggagaaatg 351240
 gttcagtggt taacaacact tactgttctt gcagagtgg gttcccagca cccacatggt 351300
 ggttcataac ctgtaactcc agttccaggg tttctgaacc ctcttctggc ctctgtgggt 351360

 attgcatgaa cacggtgaaa tataaggatg gtggtggtgg tgggtggaac attcatacaa 351420
 acaacatgaa agaaaccac actattttcc ttttacattt aacttaatta aaaaactttt 351480
 aatatttgtt tactcaattt tgtggtgctg agagttgaac tgaggtcttt atgtttggca 351540
 agtccctgc cattgagctt tacteccagc tcagtttttag attattttaga gccacaaatg 351600
 gaacaagtac ttttcctag tgtgtgggtt gaatgagaac aatcccata ggctcatata 351660
 tttgaatgct tagtctccag ttgggtgggac tgtttgggaa ggattaggag gtgtggcctt 351720
 gttggagaag gtgtgtcact gggggtgggc tttgaggttt taaaagcca ctttattccc 351780

 agttacctct ctgtctctgc cttatgctta tggatcagga tgtaattct caactacaaa 351840
 tccagcaaca tgetggcctg cctgtccta gtccaatgg ccatagactc caactctctg 351900
 aaactgtaa tcctaataaa ctcttccttc ttttaagtgc cttggctatg atatctgcac 351960
 agtgatgaa aagtaacaa gacatctagc ctggagtctc atgcattgaa aactaagtat 352020
 gtgaaaagga atcaatcact ttttttctct ttcagcaatg ggaatgaaac tggcttggaa 352080
 g gatcacaac agaactaag cagaaggac aaaaagagac ctggatttaa aagatggggg 352140

tggaaatgggg ggggcaggcc tataatccta ggctgaagca ggaggattgc aaattcagag 352200

 tttgcctggg ctctaagag agttaaagc tagcctggaa aaactagcaa aaccctatct 352260
 caaaagataa ctaagtaaag agagagctgg ggatgctgcc tggagttaga gcatttacct 352320
 agcatataaa atggagaaag gaaaggaggg taggaggagg gaaaaagga gagaggaagg 352380
 gagggaaaag aaaagaaag ggatattaga actgacatat tcaagagacc tgggaaatat 352440
 acttctatgt agtaagaaac atgttcataa ccaaacacta aggtttctat taggaaactg 352500
 ttgactccag ggcagtghaa tgaactttt aactgtcat catcctcaga cactggggag 352560
 ggagctcttg gtgcttaaaa gggatcttat gacactccat tgtttaagat cacaagcttg 352620

 ggagcacaaa cagaggacaa tggctgcca ctagttaacc tggcaaagaa attattaac 352680
 ttccttaagt cttagtattc tcagttgtaa actgggcaaa aatatctacc tcaaagatgt 352740
 attttgacag ctatataaca ctgtggacat aaatagtggc acatgacaca ggtgaaatca 352800
 gtattaattg ttatcaacat catcttatta tcaccactgc cagtgatttg aagggtgcc 352860
 tcttaaata agcacaggag tctttttta tttctttct attttaaagt tttcttcatt 352920
 ttaattatg tagataagca ttttgactgc atatacatca atacaccaca tatatgccga 352980
 gggctcacia aggacttaag aggggtcct agtccctgaa aatggagtta caggtgtttg 353040

 tgagttacca ttaggtgct gggaaccag gtcttctgca agagcaaca aggctcttat 353100
 cactgacca tctgtcagt accaagaact ggattcttag taccagtgca aacaacattg 353160
 agaggtgat ccttaatggg aggtgttttag gttatgatga ccctgccttc ccatacacia 353220
 taaagctgca atagctggag ttggacttgg tgcaggga gtaggcgct tacaggtgga 353280
 cagatttcag ctccatttg cctctttctc atgcatgtga tgccattacc agatgccctg 353340
 gctgtccagt gctttgctt ttgacttccc agactctaga actgtgggga gacaaattc 353400
 tgttctcaca aattgcccac tcttactgt tctgttacag cagcaaagag taacctaata 353460

 cacaccattg ttgacatacc actttagaag ttaggaaggc aaagtagaaa tactcatgag 353520
 gattaagggg ccttaagaaa ggaagacaaa gttttaaat ggagaccagc ttttgactt 353580
 tgagccttg agatgggatg ggatttgtca tccagtatcc tttgtctcca gttctaagac 353640
 tgtatcacac tgacacagga gtgccctct cttatagatg gaatgtttgt gtcttccta 353700
 tttttttt ttcaagacag agtttctctg tatatcctg gctgtctca aacttgetct 353760
 gtagaccaag caggctggcc ttgaactcag agatccacct gcctctgcct cctgagtgt 353820
 gggattaaaa gtgtgacca ccgtcactgc tgtgcaacca ccactggct ggctcatttc 353880

cccattctt atattttatg tattgtcatc ccgaccctta gtgtgatgaa atttggaggc 353940
 taggactttg gaaggtagta aggtttagag gaactcatgt gggcagggcc caatgatggg 354000
 atcagtacct ttctaagaag aggaactggt tcgagcttgc ttgctctgtt ggggtggggac 354060
 acagcaaaaa ggttactttt gcaaggcaga agagaattct cactaggcac ccaatctttc 354120
 catccttgac tttgatttc tggacttgag agttgtagaa gtgagcacca gaggtttaca 354180
 ctaccagcc tgttttgta ttgtattgta gactcctgtg ctgaatagga tgctcttgca 354240
 ggagatggag ccttgggtccc agcctgcaaa gacgctgccc ttcaagcagg cacatgcaca 354300

 ggtcctctgg acaccagaca ctgctgatgt cttcttttg agtggcaggc ccagaggttg 354360
 ctgactcatg gaaatccgag tttgaaatat cagaactatt ctcttggttg attctgaaga 354420
 cattacattc cacagttatg atttttgggc tggctgaaa gttttgcttt ccttagttcc 354480
 tttatctctg ccaaccattt cccaaataac agaaaggcag gccgttttc cgggggtctt 354540
 tcctttcctg ttataaactc aaggccatgg atatctctga gggaaagaag ccacaaacc 354600
 ccttcacgtt tctcagagtc atagacaatt tagttttgag ttgggggcat gtatggtcct 354660
 tcttgacatc agccagggtg caactgtcac atggctgatg caatcacgat tagcataaat 354720

 caggcaattg aagggtatat ccaatggggg agagacctag ttcagatgtc ttcacttgtg 354780
 gcttcccage ataacaccc tctgacagag gatgaggag acacggattc atggtttcta 354840
 attgttcatt tagctttcat ttctcaact ctgcctgctc ttggaggcta ccacatggca 354900
 tttcccagt atcactagct taggatccct gtgactgcag atgcgtgttt cctgtgcat 354960
 ttgaagtgat ccatccgtct taccctgcac ttgggaagtc ttctcactag ggtaaattca 355020
 ctgtttcctt gatcagatcc aattcgataa tttcaatgct ggctcattga catttctga 355080
 aggcgctttc tgggtgtgag ctaccaagc cagcacagct caacctcatt atttctccta 355140

 agattgcacc acgggaaagc tcacttcagt agacatagct gaggatgtca gaggatgaca 355200
 gagggggaac tactgcccc acccacagct gtacattaa aacctctctc tctctctctc 355260
 tctctctctc tctctctctc tctctctctc tctctctgtg tgtgtgtgtg tgtgtgtgtg 355320
 taacacatac tacagtgcac atgtggaggc caaaggacaa cttgttaggg acttggttct 355380
 ctctaccac gtgggtccca ggattgaatt taggttgaga ggttaggtgg ctaaggactt 355440
 tccccttga gccatcac caacttgggt ccattttctt aataatgcca tctactagcca 355500
 ggatattttc atctgttct cagttactag ccagcacaga gctatggcct agtgatcccc 355560

 aggcagcttt acagatcaag actgtatact ctgaacctc atttgcctat tgtcagacct 355620
 gaagcttctc cggttttct agacagtggc cagtggcttt gcaatgactc agtgcaacag 355680
 ctgtttaatc gcttttggag caaactcaac aactttactg gagcaacgtt gaaatgaagc 355740

tttcttgggt gagttttgag agaggaaagg caagaggaag gaagagtta aagggaccaa 355800
 ggtgtctgtg gaggggtgtg gcctgtgga acccagtgt gctcgtgctt acacgtggg 355860
 acctcttgcc ttggccccct ttcttaagac agatactcct ttctttcttc tcttttgttg 355920
 acttggatag gaaagggcgt gcgatctttt cattcagctc aaacataata caagaagtct 355980

 cccgcacttt ggggacatgt ggttgtgttc taaggacat ctgcaggaag atggtcttgg 356040
 gaaaaagctc ctctccaga acacagaaac atctccggag tgagtgatct cegtgcgcac 356100
 agattcaata agcccaacca cacttggctg gggcacaac ctaatacggc agcccatatt 356160
 gttgctcggg aggtctccag ccaaaccgac ttcttgtaaa aataaatact catcagcaaa 356220
 tattttgatt agtataaaat gttcgagatg gctaggccct cgctccnnnn nnnnnnnnnn 356280
 nnnnnnnnnn nnnnnnnnnn nnnnnnnnnn nnnnnnnnnn nnnnnnnnnn nnnnnnnnnn 356340
 nnnnnnnnnn nnnnnnnnnn nnnnnnnnnn nnnnctgctg ctgccctgcc tctgtgccc 356400

 cgggtgtctg gctcctcctg gtggcgcaca tgctaacag attaacatgc cttggctgac 356460
 ccacgcttcg caaccgcgg atagggtttc tgcagctcca tgtggaaatt aacctatctg 356520
 taccctgggt cagctgcgcc cggtctctcc cgtcttggcc gggcaataca aacaaacca 356580
 ggccgctggc cccctcctc cgtgactctt ggctctctc cctttcctg gccaaatatt 356640
 tattgaaaa gaggttcttc tctttggccg aaggtagggc acatttctga gatttctta 356700
 tttgtaaat atttttggc agggccaggc acccttacga gggaggtggt agggaaactca 356760
 ttcattggtg ggagctctc acccctttgc aggcaggag ctatttgtgt ttgttcagag 356820

 cacactagtc cggcatgaa aaacactcag gctgtctgta gattgctttt gcaacagctc 356880
 ctctgtttaa caggatgttc tgctttgttc tagggcaaat tccccctgct ccatctctgc 356940
 ctacgattgg tactcactga gtacggtgaa ggaatttttc tagattttct tcccactta 357000
 gatgaattga aaaaaggcaa ctacagaggt gatgggtacc agcctgagcc caagactta 357060
 tcacagctgc ctctacctc cgaccaccac tgctctctcc agcaaccag gtaatggag 357120
 ggattattaa tgggtctcca gttcacttgc taagcgtttt ccgtctgtat cccattatc 357180
 aaccgataat aacatgtagg cagctcgctt tttcactaga tagaggctgg agggaaactg 357240

 tgcgggttgg acaggctgc tgtagtacc actgccagg agatggatgg agcttttcag 357300
 attccttacc aagacctca tctgaaaat gceccattg tttgggaacc agggatggct 357360
 cttttctgag ataaccacta ttctcgactt aagcatggtc accttacctc actactcaaa 357420
 gtgagcccag gccatccgaa gttcttgccc agcccgtcat tctccttgg tttctggcag 357480
 cctgtcatca agttgggggt ggtttgggtg tgtctccagt gctgtttctc aaggcctgtg 357540
 gcagctatcc atctgctgg catttacttt ccagtgcct ctgctgcctt ggcattagtg 357600

aactgcgtga gacctgcagg tggcacccat caagctgtat gatgggtgtg atggcagcac 357660

ccaagaggca gaccacagt aggccacagt caggcacaac tgtccacgaa tagaacctg 357720
tgtctcagcc agccgagtgt caggetggct ctgttggttt atttggcccg ttctttccag 357780
ctgtgtatTT ctTggatgga tggcatgttc ctgagctaga aaaggTtttc agagtgcaaa 357840
cttccagaaa aataatcaga aaccaactgg cagcatatTT tagctggTgg cagtgtgatt 357900
ctgaagggtc gaactagcac tggcgtgggt aatataTgca tagttaagaa ctgcatcaaa 357960
atgaagatat aaatagatgt gctgaggagg aagaaaaaaa agcattgctc ccccaaata 358020
tgcactgcca tgagaaatct agatTTTTct gctaaggcaa gagaaaccac tgggcctgaa 358080

aagaaaaag aaaaaaatt gaggcacaag gctcaaagaa gcacaaaggc ctgagccagc 358140
ccaaagctgg acttctTgt tacctctggt atggataaca cctcggaaTT cattccagct 358200
caggatggTg gggTctaate agaggctccc aggagagcat gctccacatt ttcatccagg 358260
cagctggcac ctaactTct ggggagcctt tttctTcate agcacctcca gtcgatgtTg 358320
tccatatagga Tgcacgtgtg ggaacacaca ttgcagcaac tttTgtcttt Tgtcgtgaag 358380
ggctgacagg gcaataaaca ctcacaggt cctcctcca ggaattcctc ctctcctctg 358440
Tgtggctcta gcctgtgga taatatcatt acaggactaa acaataagc agtcgatccg 358500

aatcaagcag gaggcactgg ggactgcgca gTtctctct gcaaagatga gacacgTaaa 358560
tttacctcg aagctTggaa gccctccagc agccatgaat agctgtTcag ttctgtcagg 358620
cggggaggag ctgggtTct cggctgacc cagctccagc tttgtctcca tcaatgtgag 358680
ctttcaaggt tctgtttTcc ttaccatcga caactgagat caacaagggc cagtaaacT 358740
ttttatgaac ctTgggtcTca aagaagctaa gctgactaca gagTtagcat attaaacca 358800
gtgacatgga ggaaaactta acacactcct gTtagctgct tcccctcca atgtgactcc 358860
catgtTcagg ttgtcactgc tcccatgcta cagataccag agTtacctct gccacaagcg 358920

cattccacag gcacgtTgtt tctttctTct tcagcaagag aacatggact atagTaaagg 358980
atgcagcaga cagtcaaatt ctgaccaaca gactactTaa tatatgtTac ctTtctate 359040
aagTtcatac attgagatgc catactcttt accatgtatg aataatTTT tttattcata 359100
aaatTTcttt actgaaaga gTtctTatca caataaaatg agcactacat gcaattacta 359160
gtttTaaag ggaagctTtc tttgTtcta atgataTaa tatgtcacgt gTaaacagTtc 359220
aaaaccaga gactatTca cagTtatgga gaacaatTTT ctTatTTTat TgtatgtTtc 359280
ctTTTtcaa atacatggca gTtctgggct Tgaaaatctg gTttTcttt ctTtctTcc 359340

tgaacaatt tcataaaaga cattcttgct gagctccaac taggacacag actgctatTT 359400
 gccttttgtc gactgttttt tgcttccttt tagtagcaaa atctattagc tgagcttaag 359460
 gctaccoccta cagactacat ttcccagggt cctttgcagg tagatTTggc caattggaaa 359520
 taagtggaaa tgctatactt acatagaagc tgccgctctt ggctctcttt ttcttgCagc 359580
 ttggttcaag ggtacatagt ggtgaggGca acgtttgtaag gatgacagag cagcacaatg 359640
 ggaggaaact ctgacctact cttatgtatc tttccataa gagatgcacc tattttatTT 359700
 cagatactat cattgatctt tgTtaaaact gcaactgctg tttccagcat ggctccgggg 359760

 ttggacctga cttgggtggt gagagaatga agaaaagcaa acacacatag acaggcagac 359820
 agaaaagctg ggctgagtg aactgcgatt ccttacagag gagccacaca tcccagaagc 359880
 tcagcatgct tattatacac aagagaacag agaggcaggg tgctgaagac agctgaatca 359940
 aggaggcagt gtttatggta tatgggtgag tcaagatTTa cctctgtaag agagcagact 360000
 tcaggctgta aaCTaaggg gatggagaag gctgcggtgg acatTTtctg cacacacaca 360060
 acactcgtgc taagaccagg agggaagatt ttgcattTTt cctgagctga gactgagaaa 360120
 ggTTTTgcta ttttctggt gggTTtgagg ctttggggtta cctgacatgg ccatgttcat 360180

 gTtaacaat gcacactcac tcagaacttt actcattcct tacaataatc caatagtcca 360240
 acaaatgcaa caaatgttct gagtttattg tctcatataa aagagtggga ctttatggat 360300
 cataaagaac aattttaagt cataatTTg aatacaaaaca ttaataaata tgcattgctta 360360
 ttccagtgtc tgttgaataa aagaaaacct ttttttttc tgaagtatgc cTTaaggaaa 360420
 ggggatagca caatatagat gacaaggcaa tagggaatgg gggtactaga tgtgaaaatg 360480
 tttgagaggg atggggtgga cagatgggaa gggaggagg ggcaacccaa acaaagggtta 360540
 tatgaaaagt catatgaggg actagagaga tgctcagtg gTtaagagca ctggctgttc 360600

 tttcagagga cctgggttca gttctcagca cccacacagc agctcacaac tatctgtaac 360660
 tcCagttcta ggggatctga tctctcaa cagatgtaca tgcaggcaaa aactaatgc 360720
 acataagata aaaaataaatt taaaagaaa aatccatag gaaatctatt ctataaacca 360780
 attaaaagag gttagctaaaa caattagtta gaagatagac atcctgccag getagacaat 360840
 gctgttcta aaatccgtga gttattgaac aaaaatcca gttggtgagg tcccagaagc 360900
 ccctaaaaca ataaggctaa gccaccatgc accatggtta caaggtatag agaaacccaa 360960
 ccgtagcttc ctccacctt cactttcat cgcattggagg gtgctggtta gacttctgg 361020

 ggagccttac ccagtcatta accttcaaaa ctacaatgcc aacctgcag acaagatgc 361080
 ctgtttgcta cagtagtggc ataactgtca caggatagc caacaggtcc atgattgtat 361140
 ttgaagccca atccacaaga aaaaattcat gtctgacact ataaactgg tcaaaacttg 361200

tgaccgtgga ggictaaata ctaggaaaga atacattact gttgttttagc taaattgaca 361260
 ttggtgctaa actggttcct aaatacttat atttatagcc atagatgaat gctattctca 361320
 gccttaatca gagaagtffc tctttgtagt tataaggtga atacagactc tcatactctgc 361380
 tcatggtgct gagaataaat ggtagttgag tgctcagccc caacagaaca tttataccac 361440

 ctctctaaag tctcaggaag catcatggaa gaggaggcag agagaatgta aaagctagaa 361500
 gacagggaga aaggctgtga aatactgtct tctaagcatg acacagtcat tgtgattttc 361560
 atctcatagc agccatggct gcctacactg ggctgtcaa gactcaatca tgtatctggg 361620
 aggggttctc agggteccat cctttccac ggaactatgg gcaactatgt gcacatacat 361680
 gcacaagcca taggccagtc tggggtcttg ttctcagtg taccggatgg ttttgtatgt 361740
 caactcaacc aagctagagt caccgaaag gaaagagact catttgagga aacgcctcca 361800
 taagatccag ctgtaaggca ctttctctat tagtgatcaa tgtgggaagg tccagcccat 361860

 ggtgggtggt gccatccctg ggcttctggt cctgagtct atgacaaagt atgctgagca 361920
 agccatggga agcaagtcag aaagcaactc cctccatgg cttctgtgtc agctcctgct 361980
 tccagaatcc tgctgtttg agttctctgc ctgacttct tcaacagtga acagtaatat 362040
 ggaagtataa gcaaaaaaaaa aaaaaaaaaa aaaaaacaaa aaccaaccc accccacccc 362100
 cccccaccgc cccgcaaaaa aaacaacat tttctctcta gcttgccttt tgctcttggc 362160
 atttgttgc agcaatagaa accataacta agacaagagg aatgttattt atctcatttt 362220
 tggagacaca gtctctcact aagaccaat gctcacctgg ctagtctgac aggtcagctg 362280

 atgggggggg gatgtccttc tgtatataatg tttctcttat tggttgatga ataaaacact 362340
 gcttgcccaa taaaggcagg aagataggca ggcttaggag acaaggagaa tgctggggag 362400
 agaggcagag acacaccagg gaagagacac catgtagccg agaaaggagt aggaggtccg 362460
 gacccttctc tgtaagcaa agaccactg gaaatacatt gacttacaga aacgggttaa 362520
 taattaagac agagctagtc aataagaagc cctagccatc agttaacaat ttaataatta 362580
 atataagcct ttatgtgttt atttggagct gaagcgacag agggaccagg caggacaaga 362640
 aaactccagt aacagtcagc aaccccaggg atcctcctgt ttcacctcc ccagcctgg 362700

 aattacaaca tgtgccact tgcttagttt tctttctttt ttttaagattt attctggggc 362760
 tggagagatg gctcagaggt taagagcact gactgctctt ccagacgtcc taagttcaat 362820
 tcccagaaac cacatggtgg ctcaacaaca tctgttatgt gatctggtgc cctcttctgg 362880
 tgtgcagata tacatggaag cagaatgttg aatacataat taatacataa aatcttttaa 362940
 aatgatitta ttctatatig tgtgtttggg tgtttcacct gcctgtatat ctgtgcacca 363000
 catgtgtgca gtgcctgtgg aggccagaag aagggtgttg attttctgca agtagagtta 363060

cagaaagatg tgagctacca tgtgggtgct ggaattgaa cccaagtcct ttacaacagc 363120

 aaagactgct cftaactgct gagccatctc ttcggccccc atgccagacc ttttgtgtga 363180
 gtccaaggga atgaactcag gtcttcatgt ttgtacttca ctgacagagc tttctcccca 363240
 gactcctagt ttgttttttg tttttttgtt tttttttgta ttttatttat tttttgtttt 363300
 caatgcaccg tgatcagttt cccgtccctc cactcttccc agtccccgat acctctcttc 363360
 tcctgaagat ccaactcctc tctgttccc ttcagaaaaa gcagggatg ccattgagga 363420
 tgacataaca aattacaata agaccaggca caaacctca ttattattaa ggctgggcga 363480
 gacaaccag taggaggaaa aggggcccaa gagcagatga aagagtcaga gacaccccca 363540

 ctcccatttt taggagtccc acaaaagcac cagggtaaaa accataacat atgtatgcat 363600
 gcatgcatgt atgtatgat gcatgcttgi atgtaatgta tgtatgtatg tatgtatgca 363660
 tgtatgtatg catacatgta tgtatgcatg cagatccggc acagacccat gcaagctctg 363720
 tgattgctgc ttcagtctct gtgagccaga ctcttaattc ttaacaataa tgtttgaagt 363780
 tctgctcata atgggtatca gattaatgac tctgtcttg aataaactat cagaatactg 363840
 atcttcctca gtctgatttt aagaggcac actcagtaaa accaccagt tatctctaga 363900
 atggaaacta cagtatgtga gtgactcctt gcaaactagg agtgtttgtt tccttattag 363960

 aaaagcatgc tggcactagc cctggtgact cagtgcgtgt gtctgttget ttctcttgca 364020
 tttgcacatg aagtggcttc cttgaatcat ttttctttgc ttgatttttc tagatctaaa 364080
 caggatttcc tatctccatc ctttccatc tcattaaagc cctccccagt ctaggaaatc 364140
 tctcattcac agtacetgtt ataactggtt gtatttatta tggttacttc tgtgataaga 364200
 ctgtgagcac tcaaaagata ctgacaggca tgtgtgatga ctgcatgttc acatgtgagc 364260
 gaccagcatg acattctatt gaggagagag agagagagag agagagagag agagagagag 364320
 agagnnnnnn nnnnnnnnnn nnnnnnnnnn nnnnnnnnnn nnnnnnnnnn nnnnnnnnnn 364380

 nnnnnnnnnn nnnnnnnnnn nnnnnnnnnn nnnnnnnnnn nnnnnnnnnn nnnnnnnnnn 364440
 nnnnnnnnnn nnnnnnnnnn nnnnnnnnnn nnnnnnnnnn nnnnnnnnnn nnnnnnnnnn 364500
 nnnnnnnnnn nnnnnnnnnn nnnnnnnnnn nnnnnnnnnn nnnnnnnnnn nnnnnnnnnn 364560
 nnnnnnnnnn nnnnnnnnnn nnnnnnnnnn nnnnnnnnnn nnnnnnnnnn nnnnnnnnnn 364620
 nnnnnnnnnn nnnnnnnnnn nnnnnnnnnn nnnnnnnnnn nnnnnnnnnn nnnnnnnnnn 364680
 nnnnnnnnnn nnnnnnnnnn nnnnnnnnnn nnnnnnnnnn nnnnnnnnnn nnnnnnnnnn 364740
 nnnnnnnnnn nnnnnnnnnn nnnnnnnnnn nnnnnnnnnn nnnnnnnnnn nnnnnnnnnn 364800

nnnnnnnnnn nnnnnnnnnn nnnnnnnnnn nnnnnnnnnn nnnnnnnnnn nnnnnnnnnn 364860
 nnnnnnnnnn nnnnnnnnnn nnnnnnnnnn nnnnnnnnnn nnnnnnnnnn nnnnnnnnnn 364920
 nnnnnnnnnn nnnnnnnnnn nnnnnnnnnn nnnnnnnnnn nnnnnnnnnn nnnnnnnnnn 364980
 nnnnnnnnnn nnnnnnnnnn nnnnnnnnnn nnnnnnnnnn nnnnnnnnnn nnnnnnnnnn 365040
 nnnnnnnnnn nnnnnnnnnn nnnnnnnnnn nnnnnnnnnn nnnnnnnnnn nnnnnnnnnn 365100
 nnnnnnnnnn nnnnnnnnnn nnnnnnnnnn nnnnnnnnnn nnnnnnnnnn nnnnnnnnnn 365160
 nnnnnnnnnn nnnnnnnnnn nnnnnnnnnn nnnnnnnnnn nnnnnnnnnn nnnnnnnnnn 365220

 nnnnnnnnnn nnnnnnnnnn nnnnnnnnnn nnnnnnnnnn nnnnnnnnnn nnnnnnnnnn 365280
 nnnnnnnnnn nnnnnnnnnn nnnnnnnnnn nnnnnnnnnn nnnnnnnnnn nnnnnnctat 365340
 gcttagcagt tctgaccag tgcctctgga gtctagccca gaagcccca ttttaataa 365400
 gccttctctc tccaaggtga atggagggtga tgggttcgta gagcccttt gagtgccttt 365460
 taagtaaatg gttgaatgga ttggatccta acaggattta ccaagccctt tacctctgga 365520
 tcacctcatt gctttcattc tatttctctt taccatagga gaactcatca tgtggtgggg 365580
 gtatgtacta ggtaaatcc ataccctttg aattcatacc ctctaattc atatecttc 365640

 cagaaacttt atttaatttt ttggttttc gagacagggt ttctctgtgt agctttggag 365700
 cctattctgg cacttgctct gtagaccagg ctgacctca attcacagag atcctcctgc 365760
 ctggctctc agagtgtgg aggtgctcca gaccaccact gcctggtgaa actttatttt 365820
 ttaaaaaat aatttattta aatttatgtg cttttgtgtg aagggtgcag atcccctgga 365880
 actggagtta cagacagtgt tgaactgcta tgtgtgggct ggaaaccaa tccagtctct 365940
 ctggaagagc cgccagagct cttaaccctt gagctgtctc ttcagccctc agaaatttta 366000
 taatatgatg taattttaa ataggtcatt ggggatacac tttgtgttc agaactttc 366060

 ccagatgata tgaacaaatg cctctttgcc ccagacatgg caccaatggt agaccaaaga 366120
 aaagatttca agtccagatg gtgaaccaat gagtttgttg atcttattta tagacacata 366180
 ggtgaagggc tacttattta caggaggtgt gggagaccct caaagagatt ccttgctgga 366240
 aaaccccage ccagcctgtg tggtgacatg tccaaagctg ttagataga gtgccctatt 366300
 cattcagtgg accttaacc tattaggtac ttagtgctc ccttaggtca catgtggttg 366360
 gggcaggacc atatacaact ggaagaagc aggaggaac aaacactgg attctcaggt 366420
 aagggtttga tgcccttatt cccattgttt ccatcaagga atacagtagg cttagtcttg 366480

 ggagggttct gcacaggtat gcatagctgc ttgggtttca agatggcagc aggtcatgac 366540
 atgcttggag gatgccattc cacagcact agttaagatg aagccatact ggagcaggat 366600
 ggttctactg agatggctgg agaggcagag ggagaaggcc atgtgacaat tgaggctgag 366660

atgggagtgc tgcattatg agccaaggat tgcctggggc catagcaagc tatgaagtgg 366720
gaaggaaggt tctctcctcg agcattcgag cattcggaga ggctgatagc ctgatgaca 366780
gcttgatttg agacttacag cttccagagc cgtgagagaa tgcattgtctc tcatttgaca 366840
caaccagtt taiggtgctc tgttatggcg ccgtaacata ggaaactaat tcatggctct 366900

cactgtgac ctgccaacat gcagagaagt ggctaagctc tcaatgtcag catctatctt 366960
atatactgt ttgattactt ttaaagagtg tgggcattca actattctca attgtcctaa 367020
actagataag tggcttatta gcattataa caaccttttc ttaaatgcc cctaaatag 367080
tgggaggaga ggacctcagg gtatagtacc tgcctaatgt gggtgaggtg ctaggatcca 367140
ctcttatata gaatataacc aaacatgtgt gttcttccat attcagtcg gtaggactt 367200
tactatctat gagattataa aagtaaac ttatttttaa taagaaacag aacctcca 367260
atctttgtaa ctgaacatac atttgttttg tgattatgtt gtttaattgtg aattcatttg 367320

cagttactct ttctcttac taaaattcaa atagtttcaa gaataaatct gatttttcac 367380
tggtttgaag tgatggagat tttttgtac aggacgtttg tctattaaa ttagacctgg 367440
atgaaaaaat tcatagatga aattcttta agccaaactc ttatttttcg gggtattgct 367500
ttgtaattgc taaggtatga ctaataaaga tctgttttaa ttgttcactt ttagagaac 367560
ctcttcagtc tctgcctcg taggtgggtg acgtagaact ccatgacaca acagagtcag 367620
ggcaatgtgt tgcacgcaca ttattttttt tttttttaat gctactaaaa cactcaactg 367680
agtcatcttc tctgaccgtt cttccaatgt ggaaagaacc taaatcaaag accatgactg 367740

cttttattgg caaacagtag ataaatcagg gatgtaaaaa gggaaacagg attcggcaca 367800
aatgagtctc ggaatggact ctctgggtga aaggtttatt ctgccggttt tctcttgag 367860
acacttaggt ttaaggaat gtttgcctg ctctagagaa atagtaggtt gtatgtttt 367920
cctttgtgtt tggatcactc tggaaagtaat tcttagggc acagtatct aacataggc 367980
aatgtagaaa gagcccgaag caaaggtcat ttggatgttt cagacaggaa cgaagaacat 368040
ccatctaat acgactcagg aagggtgaag gcgcagcctg tggtcagagg gccggcgaaa 368100
gggaaggggt gcaagtccac acagaaaaca aaactgtggt ttttgccttt acttttgttt 368160

gigtgtgatt ttacatgaga actggttgtg tftggggggg aggaaatctg ttggtgatag 368220
acaaggagtg aatcagatca tcatgccacc tgfactgtg acctgatag ctgagcaaag 368280
cactgaactc agiattccca caccggaacc tattgttctg gtcttaaac tcttaccatt 368340
ttcttttact aagccttatt gttgtagctg gtcgtgggtc tgcaaattac tcgacagttc 368400
tgcaaccatg gtctattcta aactttgttc ttttagatga ggaaaataag gtcctagaag 368460
agaaacgacg gtctgcaaa agcagaccca agaacagatg agtctggctt ctctaggtca 368520

aaactgcagc tgagatcaag tttaaagggt ctaagcaagg agaaatgcct tcccacacac 368580

 actgaaaaga aacttagaca gcatcacaaa tgagccaaat acagcatttg gaagtgagtt 368640
 ctgaaggaca taactggatt tgaagcagac ctcatactga tttttttta taggacatgt 368700
 ctaaaaacca taggctctca tattgagttt cctcaggtct ggggtctggg gatgctggca 368760
 ttgcccate gtcgtctcac ccaaagaacc ctgtggtcag gatctctaag cagaggagca 368820
 agttgaatgg ttctgctagt atctcagaca gccaactgtc ctactctgtt cctgaccact 368880
 gctgtcccaa tgaaaatggg ttaatcttga taatggtgta tgttcttctt gcaaagctgg 368940
 aaagaaaact aagaccagcc ctgtatcagc tatgcaacaa gtggtattac atgctggaac 369000

 tgaaccttgt ggctgcctat ggtttccaaa tgatcccaag gttcattctc agtacattgt 369060
 gtcttaggc acagtactgt caggactcaa agtcttggtg gattatacat gaggcaaggc 369120
 atattgaata gttgctttta cgtttttagat gggagtagaa ggtctgattt tagccactat 369180
 gtctcagctt actctccata actctctgat aataaacaac atttaaaaa atctattaat 369240
 aagcaagttc gtaactccac acacacacac agcaaaactga aactctgaag gaccagaaaa 369300
 atccagggaa tttttcagat gcatttcttc ctatgagaaa tctttaactt tcagttccct 369360
 ttgtgtaaat tagatgacta tctaggttgc tattagatga ttcaggaaga aaaggatatt 369420

 tgaatatagac aaacacacat accaccacac tcaaggagac tgaaaagcat cgcattttt 369480
 cctgatgtcc tgcacaccca gtttcgtttg aggaggtggg aaggatctcc ttggcaagaa 369540
 gagacactct tctgtaaaag agatagtcgg gaatttctta catacctggt gagggtgtag 369600
 aagggtgagg catcagatat ttgccatgtg agggctcaagt agagagtgga aataatacaa 369660
 ggaagttctc ctgagacatt tgtcttggca gcattcggta tcacagcatg ccggagctga 369720
 atacactaat ctttcacatg ttgtttttgt tttggaatca ctgtgtagtt agcctcatct 369780
 tgaacttaag gtctctctgc ctcagctttc caaggctctc ctgcctcagc tttccaagta 369840

 ctgggtttgt aggcgtgtgc caccacatgc agctaaagtt tatagatgaa gaaaccaagg 369900
 gctaagcagt ctgtgggggt tgttggccag ttgtaagcaa aagtgggcca ctagcctcta 369960
 agtatatttc tttcacggaa tgtggtgtct gggaaaacgc tcaactggga ggacttctgt 370020
 gaatacaaat cagtttgtgt taaacatttg aggcacagtg accttgacc aggacattag 370080
 cttttcaagg cgcaatgtct ttaagtggc ttgggttttg gctgtgtgta aaataacaga 370140
 ggactcatcc ctagtacaca tctcaaatgc tctacacctt ggtcacaagg acaaagatga 370200
 aggaggggca gagctgatga ctttgagcca ctcagagagg ctaggtcttc atagtcacag 370260

acacaacagc agcctaagag agcacaacca aggcccagcc ttattcttca gcgttctgct 370320
 tctgcagctg aacttcctat tgacctatgg aacctcaagt tccttaatat gcttctattt 370380
 ggcatgaaac acagctgaag aggccgagca aggagcatca ggaaacagct ctgatggact 370440
 tcagcttctt taaggtatg gcttgagaag aattcaggaa gacagagaac gctgcccact 370500
 tacacaaagc tagccatcac tgctgtgttt ctgaggctg catgttcttc aagttgactt 370560
 cagaatgaaa acaatgacac tagttacaaa aatattgcta tgccaggcat ggtggcacac 370620
 acctttaact ccagcactgt ggaggcagag gcaggcagat ttctacatag caagttccag 370680

 gtcaatccaa ggctacatag taaaagcctg tctcaaaaat aaaacaaaac accattgtct 370740
 ctggacatag ctagttagtc tatctatgca catatatatc aaagtgat atgtatagat 370800
 ctatttaaat atatatcttt gaaatagttc ttaattgatg tatgcctgta atcctagcat 370860
 ctgggtggtt gaagtaggat atccgtgggt tgtggggcag cctgggctac acagtgagat 370920
 cctatcttca aaaccccaaa ttttaaaaat gaaattaagc tacacatggt aacttgaaga 370980
 agttaactgg acaaagagag ttcatctac ttattatcaa ataatgttca gacctagaa 371040
 agctgcttat aaaatacttt ctagctatgt gtatgggtgt ttacctactc ctaaggttga 371100

 gctgaagtat caattgagcc caggaacttg ggaccagcct ataggcaaca tagcaagatc 371160
 ctatctcaaa gaaaaatata attaatacat gttaataaaa atgttcttca aggcatatgt 371220
 cttaggattt tcatgtctgt gaagagacac catgagcatg acaactctta taaaggaaaa 371280
 catttaattg gagctggctt acagttcagg ggtttagtcc attatcatca tggcaggaag 371340
 catgacaaac atggctataa tcaaaaataa cttggggaga aaagggtta tttcatctta 371400
 cactttcagt aaacagtcac tgagggagtc agggcaggaa ctcaagcaag acaggaacct 371460
 ggaggcatga actgaagcag aggccataga gggatgctgt ttactggctt gctgtccata 371520

 gcttgeccat tctgcttctt taaacaacc agaaaaacta gcccaggagt ggcaccatec 371580
 acaatgggct gggccctctc aatcaatca ctaattaaga aaacaccctc acagacttgc 371640
 ctacagccca attatttggg gagaagtttt ctttaattgca gttctctctg ctctggacgg 371700
 caactctage ttctgtcagg ctgacaaaaga aaacaaaaca aacctaccaa tagccataaa 371760
 gagaccacca gcagcaact aaccaggacc gggaggctta gccttgatgg aggaagagca 371820
 tccttggggg tgggatatga aagtgaaaat catcacctag ttctaattgc tctctgagct 371880
 ccatgcttcc acttaagag atgagctctc agcttctctc tctgttgc atgcctccta 371940

 gatgtgatgg acacacatcc ctctggaact glaagcccaa ataaactgtt ttctgtagtt 372000
 gcttttgtca tgatgtttta tcacagtaac agaaaaagca actagtacac ctgcccacat 372060
 acaaagcccg ctctcaaggg ctgcttttta cggaaatctga ggctaacaca ataataataa 372120

caataattcc tgiactggcc tcttctcacc cctgattagg cagtttctcc cactttcttt 372180
cccaactctg acatcctgtg tggcttccag caactaattt atccctgact tcaacctgtt 372240
tttctcattg aagcctacag tactgatgtc ctaaatccct tacaatcctc aggtataaaa 372300
atgccttgat tciatttccc ctgagtccaa atgctcccta atttcagtgg ccataagccc 372360

tggataaggt gagcccagca ctgcatcttt aattaggtac tccccaaatc ccttgtggta 372420
tgtacagttt ggtttagtaa gttatatcaa gggcatttta tgtgaggggg atggagtgtg 372480
aggattatta aaccatggtt tctaataagc ttggatgtc ttgaatgaaa agtgtttttc 372540
aaatatatgg cagtgccttt agtaacagac attgccttag cccacagaat aatttttctt 372600
tgggggaaat gcctcctcta gctaagcctg ggtagactga acatgctgta gcaattccat 372660
acttgacagc ctgggctgct acaatttatc cacccattga ttcagaaaca atcctagata 372720
tttatcaggt gccaggaact ctgctagatc ctatagatta agaaacaccc tctcacctct 372780

gggttgctaa catctgcagg tgggggtgga gtggttctgg gaggaataa acaagtgagc 372840
tgcagataac tggatgaagga ggaggcaaag tgctggggaa gtctggaaga aagcagctca 372900
gatcctggtc gatgtcacaa gttgtcatag gggatgcatt tagatgaagc ttggagggga 372960
gcagaaatth taiggttttt ttgtgctttt ttgagagag agagagaaag aacatgaagt 373020
tgggtgagta gggaggtaaa taaaacaagt ataattttat tagttttatac tctcctagg 373080
ggcagaaatth ggggagggga aagaatatga tcaaaataca ttatcggaa ttcttcagta 373140
aataaaaaca aaacaaatc aaaaggaaaa aaatggatta catttagata aatagcagct 373200

tataaaaactt tatagaggac accacatac ccctaattta atgtgtgtgt gtgtgtgtgt 373260
gtgtgtgtgt gtgtgtgtgt gttgtttgtt tgttttcttg atttattttt taagataggg 373320
tctcacagag ctagccttaa actcaccagg agtgaagggt caccttgaac tctgattct 373380
cttgcctcaa cctcccagct gctgggatta caggcacagc attgtgtttg gettaatccc 373440
accccatccc ccattcttaa cattttacat ttcatggtg catttgtcaa aacaagaat 373500
tcaactttgg ctgagtttat aaagtgcact ctataaccct ttttaatta cctctattht 373560
gatattttgt atgcatgggt gttttgtctg cctgtatgtc tgtgcaccac atatgttct 373620

gggttttccg aatgccagaa gagggcagaa gatcccttgg tgctgcactt gcagaaggtt 373680
gtaagctgcc cgtgggtact gagaattgaa cctggtcttc tggaagagca gccagtgtg 373740
ttaactgagg atttctccat cctctattag ctttttcagt gtcaccagtt tcctagcaa 373800
tgtccctca ctgttcttgg atccagttaa ggcaaccaca cttcattgt tgtggctctt 373860
tagtctctgg tctgtgacaa tttttgtctt agtttatctc catgctgctg actatcttga 373920
gagccagaca tgttgtaaaa tgttctctcc tctagggttg tctgctgttg gagaagagca 373980

ttgcagagga gaactgtcat tcttagacca tgcaggggc cccatagccc acgaacatca 374040

 ctggagatac tgggttgaaa ggtttatgta taaggtgtag ggatacacag ggggcttgg 374100
 ggcagtgaaa agtccagtga acctacaggt ggggtgctgg aaaggagtg gtgacaggaa 374160
 agccatgtgt tggtagtgct tgtatttca taaaagattt tgtgggaatt gtttctttca 374220
 aagcttagca gtacatgta ttatgtatca tattatgggg aatattgtgg tccttgtaa 374280
 aagatgagga aagaggctca aaccgatgaa gggaaggcag aaggtcacac aaatagtgc 374340
 aaagccaggc cttacacaca gccctcctga tctgaccac agtgttcttt gctcattatc 374400
 ctggtcactg caaggggatg atgggacagt gtatatgtca tggccgaaac cttatgctct 374460

 ctcccaacat ttiagctaaa ccgtactcag taaagctggg caaagtgaag ccagttccta 374520
 gtctgaagac atgaaaacct gcgcagggt ggggacattt ccttctttct gtgttgctac 374580
 tcaccacgaa tcttgactt atgtctgaa aggaatatac cactgtgcct ctgagtgtgg 374640
 cactgtttgt cactcccagc agcaagagct cctgggtgat tctaccagca atcaagacag 374700
 atcaacatac tctttggaca gagagctaac tgcacactta gttgaccag atacagattt 374760
 catcaaggac agtttggaaa gagagtgagc agtttctcac tccttcttct ctaacaagct 374820
 atgagatttt accatggcag aaaggaagcc ccaagttggg gaatcataag ttctcatata 374880

 tcaccttctt tggatcttac actcattggc tcatttcaca aacacgtcac agaaacacc 374940
 atgtgttaca taatacaaag gtaaggaaaa atatcagtaa atcattttgt ttctgagaag 375000
 ctccaggta gaaaaccag caagaataa aacaaaatca aacaacaag agcctctgtg 375060
 agctttaagg aaggacgat ggggtgctgga gctgggtgtg tgggacagca aaggcttgg 375120
 gatagccagc acatgtaatg gctagaggag agaggaagag tgtaagctac tgtttcattg 375180
 ctgtgataaa acaccataac caaaaggagc ttatagaagc aagagttaat ttggtttag 375240
 agttccagag agttagagtc catgatgata ggaagacatt ggagcaaact ggatggagga 375300

 gctgagagct cacatcacca tctccaaacc caaagccggg agagcaaacg acgtagagca 375360
 agaccttaaa gctcaaaagt cggtcccag tgacatactt ccctatccag gacacacttc 375420
 ctcaatcttc ccaaacagca ccaccagcag gtgttcaaat gcctaagggt acgggcaagc 375480
 aactttttgg gatgcaacac tgctgggtct tctgaagggg aacactggt gttgctggag 375540
 catggtgagg gtgttgggac agtgagagc agcacaggc aacctaac t gactctagc 375600
 cctgcatctg ggagtggatg gagacttcca aggggaggtc ctccagcctc ctcccttctt 375660
 cactgccatc catcagccag ctagcaattt gatcttctt acttgatctt ggaagtacaa 375720

accctttgta tggttgata gaataatagc atttggcttg agatgggtaa cagactctct 375780
 tgcaagccaa ctttgcatag ctccaggctg agtagaaca tcctactgtc cttaatgtag 375840
 tcttcctgta caacttttat tatcctgtgt cacgtggctt ctctatagtc cccaaagctg 375900
 ctaaagtctt taaaaaggcc aggatttttc cagctctgat ctcatagat gtacaaattc 375960
 caagagcagc ctcccagaaa atagaagggt ttttcaaatt tttttttta taaaacagag 376020
 tggatgtgtg catgaaagat acattgttta ttttcttggc acagacttaa ctctaaaatg 376080
 agattactta attggagcaa acatttcctg acatgctgag aaggagtatt tgaaccaaat 376140

 ctctctctt agattcagtc ttgggtgggt gtgttttagg ctgtttaaac catgcaaatc 376200
 tcaaacgcaa tcctcttac taccgaggca ttcagttggg aaggcagaat gtaactggat 376260
 acaggcggca acagcttgtg atcaattatg ggaaagtcc tggatttgtt gttacagtag 376320
 tagtttattt atttattat ttatgggcac agagcatatt aaatctggaa gcattcagtc 376380
 aaattttta tagcacaggt ctgttcctaa ctttgggtgtg cagagtacca caactcactt 376440
 tcaactgtct tttgagctat ttttttagac ttgggtgcag tattacagta tgcaataata 376500
 tatatattat gcatatgtaa tatgtattct tatgatatat agactaactt taattctgta 376560

 aatattctac aatagaatgt tataataat tatatgcagc tgcatgatct atatgattta 376620
 ctattttata taataatatt tatactagta aaactagtct cagggttca gagatgctca 376680
 gtggtaaga aacttctgt ttcatgcaga ggacctgggt tcagttccaa gccagcttac 376740
 aaccacttgt aactccagtt ccaggggatc aatgccctct atttctctct ctctctctt 376800
 tttttaaga atttattat ttattatgta tacaacattc tgcttccatg tatatctgca 376860
 caccagaaga gggcaccaga tctcataacg gatggttgtg agccaccatg tggttgctgg 376920
 gaggaatga actcaggacc tctggaagag cagccagtgc tcttaacctc tgagccatct 376980

 ctccagccct tctatttgc tttttaagca cctgtatctc catggtgcac attcatacac 377040
 tcctgcacac atacttacac attaaaaaa ccagctctgt ctacttacat atatgtgta 377100
 gtttgaatgt aattggtccc cataatctca tggggagtgg ccctattagg aggtgtggct 377160
 ttgttggagt gggaatggcc ttgttggagg aagtgtgtca ttgtgggggt gggctttgaa 377220
 gtttctgtc tcagttgact tcctgttgc tgcaagatgt aggactctca gctccagcac 377280
 catgtctgcc tgcacactgc catgatgata atggactgaa ccgctgaaac tgtgaaccac 377340
 tctttattaa atgttttct ttataaaagt ttcattggcta tgttctctt ttacagcaat 377400

 agaaaacctt aactaagatg atatatgtgt aaatattttt atatagtaag tatacataca 377460
 tacatacata catacatata taatacatat acacatatcc tagaggtagc tagcctttgt 377520
 tcctgggtgg gacaaggagg tggctacctc atgagaactt atttctaagt ttttcttga 377580

atcaggtaaa gcactatgat aatTTTTacc tccagaatgt gaatgacatg tcaactcaag 377640
 aactgggttt ggatttgggg ctgccctcta cagacctctt gcctctttga gttggctgaa 377700
 atgtaggcat ggagattcag ttttgactag ctgggtaacg gcagcacctt aggatactat 377760
 tacaacatag ggaagggaac ttgggcagag tgcctttggc tacctgggtt gtttacctcc 377820

 aaactgtgtg aagaaaataa attccttagt ttgctaagcc acattatcag acagggttca 377880
 atcagaaagc caaatcatag ggctgggctt atagctcagt tggtagagtg cttttgcctg 377940
 gcacgcacaa ggtccctatt tctgcagcca tatttgctat gaaatgaatt ctttgatcag 378000
 aagcaatgct gtgtagattg gcacagagtg gctatgacat tctctaagcc acacatagtc 378060
 acttagaagc attataagaa ggaagacaag aagggcgagc atccgttcta ataagaacaa 378120
 agtgctgtta cagaaacagc ccaatgtaat caaccagcaa gtagctggct gacctctctg 378180
 ggagctgtgc caatgtagga gctcaaagac tgggcagatt aggcactcag tgggtggtttt 378240

 agctgcatca accctgatga gtggaagtct aagtacagag cccatgcaga atttccatcc 378300
 ttgcctccat ggtcacattg ttcattgagct cactgggtaa cgataaaggt ggatatagaa 378360
 ggagagtggc tgagcaggcc agcctacceca cctgatecac tctcccgtga gcattcacat 378420
 atatccttca tgcccattca gaaatgcata ttcattggacc ttacctata tctcctaatt 378480
 atcagtttcc agtcaacttc ccaggacct gatcactagc caagttacta ctcacagaga 378540
 tggccagcag ctaagatgcc actcatagct tgactctaca aagattatcc ctgtgacat 378600
 tcttcttctt agatgagaca agtgataatg agttgatatc tgacctagga gacacagtca 378660

 tgtctgttcc ccaaatgatt ctactacatt actgggaaac tttgcagctt atctttagtt 378720
 catagacact gatccttgaa tgctatagca tgtatgattc tactccagca gccttctatc 378780
 tggccacaga catttcacca atatttttta gtaagtggat ggatgtggtt cttgaccata 378840
 atactgcaga gactttctga ggacaatcaa atgtaggaaa agtctctaca tetgcccagc 378900
 atctgagatt gcacaacaca taaactga gaatcactct gctgagtatg tgctgaacat 378960
 ctttagaaaa tgtggatatt tgtgtgcttg catatatgca gaagcccagg ggtgtcagca 379020
 gacaagatca gatcccctta aatttgagtt acaggcagtt gtgggctgct atgtgggtgt 379080

 ggggaactga acccaggtcc tctgcaagag cagcaagtgt tcttaactgc taagccatct 379140
 ctccagctct tacagtaact tgtaaaatac taatttggg actacataaa ttttaaagag 379200
 catgacatca atgtgtgac attaagttta tttcttgtct tggttgaaca tatatgtgta 379260
 tccaagcctg gagagttata gctactgcca cagaagtgt cacaatgggc agagaaatgt 379320
 ctgttttatt aataattatg tctctagatt gctgaatcaa tctgttctta agtgctttga 379380
 ggccaaagcc cattccaaca ctggacttgi tttatactct cttcagattt ctttgggtgt 379440

tggcacatga tactaattta taaataatac ccagagaatg aaggagctgt ttatcaagat 379500

 catgtcaaac actagtaact tactgagatg tctcacgttg ctgaccagac agagtggcat 379560
 ctgttttagaa agacctgggc tggggccagg aaagctaagt tcttgcttta getttgcctc 379620
 tccttccta tggacattg ggtaaggcct gcatttttga tggactttga tttctgatc 379680
 tgaggatatt tgggaattga acagcagcca tgggaggccc ttggaccca ggggtgtttt 379740
 atttagaggg cacaatgttc taaacaaaac aaaacaaaac aaaaaacca acagtatttg 379800
 ggggtgtgga tatagttcat tggacagcac ttccttagcc tgcacagagc cctgtgttga 379860
 atgctcagta ccacataaac caagtgtggt tgtgcatgac tgttatttca gtacttggat 379920

 gcagagtcaa gaggatcaga aatttaaagt caccatcagc taaaactcag ttgaagatta 379980
 gcatggctac ctgggacctt gtctcaaatc aaacaaatga acaaacaaa ccaaacaaa 380040
 atactcctat atttcgatgc atttggccac gtgtactttc tgatttgcta gagttttcac 380100
 ttcttctca catctttgga tatttgagtc ctaatctggc cctggagcc acctgacctt 380160
 ataacctctg aatatgacac tcttcagtat tgacattgtc catgttcaag ccagggcagg 380220
 aatgggagge tgccttatga tgctggatac acagtcccag aatggggtct ggaacgcaat 380280
 ggatgcttgt tgaatgaatg aacaaatgga taaatgaata aatgaataaa ggaaaattct 380340

 accaaagcag accttatgga aagggatgtg ggggaccata ttgggagact tctctctaaa 380400
 ctagcaaagt tgittctctt tctgcatttg agattgagta ggaacatctc ttgtcttctc 380460
 caacctctca aggtccctag gggaaatgac atcactgtaa agattccatc ttcagttgaa 380520
 acagctttgt ttaagcacta actgccagga accaaaagga tttcctatgc aaaactgacc 380580
 gccttgtgta gtctcagtc ctgtagacac tgctcagtgt cctcagctga gtttgtgccc 380640
 tgtcttctgg gaaacttaat atcagctact gcaggacaca gctgaggaac tcttgaaaag 380700
 cgtcctttac ggatgttaat ttctttttct ttttgagaat acagaccac agcattgaag 380760

 ctaactccca atacaacttt cttctttctg gaagctgtta aacattaaca ttagattaca 380820
 tacatgtcag cagaatatcc cacacaggcc tctccctcag caccagtga tccccagtg 380880
 catctcctct ggggggcagg ggtaaagaag aattggctca cttttatagc cacgggggga 380940
 ggagtttctg aagttgtacc ttagtccatt agaacagga ctaagccaca tcacactgcc 381000
 tcttgacaaa gtggacaaga ccagctagga ctgagactc gaagagactg attcaatttc 381060
 caaagtaac tagaaattaa tgttgaattc atcaatattt aggctatcac cttagatttt 381120
 tctgactcca tttatttctg gtataaatct tcattttgga ggttaatagt gtaacttgat 381180

gaatthttgtt cgacaaacc aggaagggaa acctacata gagaggctg agccaagttt 381240
 tctccatagc cgtatatacc tatcatctca gcattcagga gatggaggca ggagatcat 381300
 gagtttgagg ctagcctggg ctacccaaag acaccctgtc aatgaagaga gaggagatgg 381360
 agggaggaag gaaggacag aagaaaagga acaatggagg ccatggcctg gaagctgagg 381420
 cctgggtctg aacttcactc ctcttggtag agtgacattt catttacaat gtggacatag 381480
 ggacaagggc tagatctggt ctgtaccctc agaggccaca gtggtactgt ctgagaatgc 381540
 tcagtgggga ctggcatctc tccccagaca tgcagaagag gcccttgttt tcctgggct 381600

 agttctgttt cactggaat atcccagccc aagtttctgc ttttcatttc ccctgtgttt 381660
 gtggacagag aagccagggtg ctttcactct gctgtggctg cccatcaggg tacacagttg 381720
 ggggagcctt ggggaagtaa acaagtgggg gaatctgggc ctgggaggtc gcagttttgc 381780
 ctttacaat taggctgagc tagcacagga ccatgtctgt tctccgtaa gggtagtct 381840
 ggacggaaaa ctgctaaata gccaaagtga gtttatttct gcatcactgg cttgcattac 381900
 gtattgatta tctcatgcc tgattaaaaa taatactgtg aaaattcctt ttaacagaga 381960
 agggggaata gcaagcttct gacttgagac agaagtgaat catgtaaaag gttatcacat 382020

 ggtgacctg aggacagtga aagaagctag ggggctggtt tggaagacca atcctctaac 382080
 attttaaca ggaatagcct gcttcgttac agagttgacg cctgatgaca tcaactccaa 382140
 aatttagtac gtgtacaaac tcacagtttt ctctgggtca gccaccttcg ttatctcaa 382200
 agtgaacaaa ggtcattagg atctaattgt acttgtaagt gcttttgttt ggggtacttt 382260
 ctcatcacc tgaaaagagt tcgagaactg taactttctg ccctgccaat gaattagcct 382320
 cagcttgggg cattctaaga agtttcatga tgagttagga aatcatgacg accacatgtc 382380
 aagctagaac taaaacaaat ggatgtaggt cacgacctgt gatgaggtca ttttttttt 382440

 ttttttttt ttttttttt tttttacat gcatgcctac agcgagggtt gtgtataact 382500
 tatatgaaga caggacactc ctctctacc cttgcctctt ccaccttcac tctctgaaga 382560
 tgaatctacc cagtttttcc aactggttat cttggtattt atgtcctgct atggagggac 382620
 ataatttaga tgtaagagc tctgtcttca gtgtagcagt gtagcgagat gatgcggacc 382680
 tgtaaatagg tgggtcctag tgtgaagtag ttactgaggt cactgctcta ggaaggacta 382740
 gatatagctc tagtagggct taggtaattc atgatagagg gttgtgcaa aagagtgaac 382800
 cagcactgta tcacacceta tcctgccgtg atgccacca ttataagggtg atgcaaacag 382860

 gcaagccct tgcgtagct gtttagactc aaactgtgag ctgtagagat ctcttccca 382920
 cccatcccc ccaactgtg cagcttcaga tatttagtta cagcaatgga aagtgtatta 382980
 atgtagaac atgtttctaa atctcaggct tttactgcta atccttgaat ttatactttt 383040

aaataatc ctc tgatattt caccataaaa ataaagatcc ccttagcact gtcccactca 383100
 cattcccagg attcagcact gccccacct gcaatcctga aacagattac attcagttgt 383160
 atggatgtat atgggccat ttaatgcca tttagaagct attgacaacg gaactgtgtg 383220
 gtctattcag attgatttc ttattttta ttctctctct ctctctgtgt gtgtgtgtct 383280

 ctgtctctgt ctctctctct ctctctctgt gtgtgtgtgt ctctgtctct gtctctctct 383340
 ctctctctct gtgtgtgtgt gtgtgtgtgt gtgtgtgtta ggatacatgt accttgtgag 383400
 tgtgtggagg tcagaggata actctggggf tctcccctcc cacctttaca tgggttccag 383460
 tgatggagct caggtcacca gtctccctgg cctcttttcc catttgaaag tcccacatgg 383520
 ctatctgata tcttgagttc catgccctgg gcatttatta agctgacatg ttccagtaat 383580
 atctttagct cccagggtta agaccagat ttattgttta gatgagtcac ataaaaagct 383640
 cccagagtcc ccttctctgg ccatgggtgtg ctagcacgat cctttatttt aaaggtgttc 383700

 tcttctctta gccctcaggc agggctattc gctcttctt ccttcttcc ttcttctt 383760
 ccttcttct ttcttctt ccttctttt tttctttca gtttttttt tgagacaggg 383820
 tttctctgta ttgctttgga ggctgtctg gaacttgttc agtagaccag getggctttg 383880
 aactcacaga gatccgctg cctctgcctc ctgagtctg ggattaaagg catgcgccac 383940
 cagttccca ctatgtgta tttctaatca gacagattta tattactcag tccattagag 384000
 ctgaagggcc caggattga attgactcct tgggtgtgag agagctttgc tggggaaggg 384060
 ctcaagtctg gacattgga agctccacag atatgtgcc ggggctccat ccagccccac 384120

 actcgggcaa gctgctttca gtgccaacca cattttctgc atgtgtgttt ctatgtaatt 384180
 ttcttcatgt gtgtgtttct atgccattt ctctatgtgt gtgtttctat gccattttct 384240
 gcatgtgtgt gtctataatg cattttctgc atgtgtgttt atatgccatt tttaaagcaat 384300
 actttgcage ttttcttagg agaccacaaa ccagaaatgg aggaaccac acaggccaga 384360
 aaaaaggac actcaggta ctgtttggag aacacgtgga agatgttaga aaccacaaca 384420
 tcccacact gtagcaaac aacatcaact acagatgtgt gtgcactctg gagcccattt 384480
 tagactcaaa tgtatattgc ttctaagaaa caaagccagg ctgtgtttgt teggccctt 384540

 ccagcagatg cctgaccagg cagaggtgt gcctctgtag cgaagagaag acttcatctt 384600
 cgagggttac tgtaactaaa gtcaaggtca tcaatgacct actgttagcg cagttttggc 384660
 ccaggaggtt ctcttgttc attcaaagtg aacagaaagc ccaagcaacc caaaggactt 384720
 aggaaggcaa acagcagctg cccccccc ccatcactca ctcttactg tctgaaagta 384780
 taacctgtag cctctgaatt agttctatga gaaagaaatt ttaattctgt cagttttaac 384840
 tccctcccaa tggatcttc taaaagtga tccaggccc agggaggag ctggagtgtg 384900

gttaggcaac aggaaacttt ccattgacga tccgagtacc ttatcaacag attttatctt 384960

 tgttagcttc ctatataaac cccagccata aacaccataa ccatgagcag tttcactgtt 385020
 cagaatataat gaatgttctc aagattgatg gctatctaca atcttgggtc agatccaagg 385080
 ccataaactc ctgtgtgta tgagaagcag aagtgggcat ggaggccgtg tgtgtgggtg 385140
 ttgtataaca ccttaggaag ccttttagct gggggctttt gtttccattt ttgttttatt 385200
 ctgtgttgat tcccagggtc tttctgctga agacagctat gaagacatgg acatggataa 385260
 tgcttgggtg gagagatgct aatgctctc ctatcttctc cctggagtac ctgaagcac 385320
 tgacagggtc gtgagacaat tagcttctga aatggcacac tcctgttctc gttcagaggg 385380

 cttgagaggc ccatataatc tctttgaaat gcacaaagtg ataataaat caaggigact 385440
 tttgcctgtg aggttaaaga gaagtgtctt cagttacca gtctattagg ttatatactg 385500
 ctctgtaaca gtccaccctc aaactgaact ttagaacaat aaacattcgt tatcacactg 385560
 tttctatggg acaggaattc agaagggatc tagctggctg gttaggcttc aagagctggc 385620
 tcagagtgtg tacttctaag acgactcca tacatgttgt caagagattg cagtttcttg 385680
 gcacatgggg cactttccct gggcttcttc agtatgcatg acacaagac tgacttcttc 385740
 cagagtaagt gagccaaaag aaagcaagta gaagccactg ggtcttttat agcctaaact 385800

 tgggagtac acattgttat ttgcacaata gcctgttatt tatataatc agctatacac 385860
 cacagtggac accataaaaag tggggatacc agagtgacc cctaggagca atgtcaaggg 385920
 ttggctacca caaatctgaa caactactgac aaagaatgaa gtgagctaca agtgggtttg 385980
 aagtacgggt ctaagatcag catgactttg aatgcttga atattgttt atgtgcctc 386040
 agcttaggtt ggtgccatt atctgtcaa ggtcactgga caggctctga gtgtagaatt 386100
 ggcattaaat gtctgtgtt ctggagagag tggtagtat aatactggcc tattccactt 386160
 agttgttcga gctacattt cttgtacatg tgaataata tagttacttc acaggttcc 386220

 tgtaactgca aactaagaaa ccatagatag cacctaagca cccagacact ggtaagtgtt 386280
 ttataaatc tgattgcttt tgccactgat gtcagcttga gagatgaaca cggtagacag 386340
 gctttgaatg ctggctctca tgtaacaaga ccttttagatg ttggccagtt ttagatttga 386400
 ttaatgcaat ggtttgatcc ttagtaagtg cccaggttct tctcatctt cttctctgcc 386460
 attttttga tctcccctc agggctgtaa aatagggtca gcaatcgaag catcagtgtc 386520
 ctcatgtgca tctactacgc caaataaata ccttagtccc gtgtgtgtgt gtgtgtgtgt 386580
 gtgtgtgtgt gtgtgtgtgt gtggggaggt cacgtatact tgtgtgggtg catggacatt 386640

tggaggccag agggcaacct tgggtgtcat tccttttctc atcttcacaa agatttcctc 386700
 tttatttctt gagacattgt ttcttactgg cctcagactc accaacagtt aggctggatg 386760
 gctggccagt gagtcttaaa agagctccct gtctctgcct ccccagtgtc gagattgcct 386820
 ctacccatga cctttttgct tgtgtgctgg ggaccaaact ccttgtactt ttaagggtcc 386880
 ttgtacttca aggcaaacac tttatatact gataatctcc ctagtccca cactgcctcc 386940
 tttaaagtgt aaaagcatct tcctgtattc tagtagatgt tcccatattt gattaatcct 387000
 agccaagttaaatgcctgtt tctaaccxaa tcattggcaa gaaagaagtg gggaatcacc 387060

 agttactgac ttagattaat tgaagctatt ccttatgctt gaagaaaggc atggcttctc 387120
 agaagcatat gtctgtgga gacaggagtt tgtgggtgag tatggtagcc cagcaatata 387180
 ttacagggta tgaggaagat aaaatgttgt gcatgtgaaa aatgtctgta ttctgagtgt 387240
 gtgcttaaag catactttag ctggatatag aattctagac tgaaaagaat ttgaccttaa 387300
 cacttaaaga tactgctcta ttttctttt attcctagtg atatttttga gaagtaatta 387360
 tgattcttaa tttttgatat ggtagaccag atctcttctc gcaagtgttt ttgaagtatg 387420
 attaatttat gaattcctga aatttttgtt gttgtgttgg gtaagcctca ttcttagtgt 387480

 tgggcactta ttgtccatc tagtttaaca ctacatccca gcgagtcttg gggaatttc 387540
 tttaaaaage aaattatttt cttcactttc cttgtagaac tcaattaact gctctatctc 387600
 ttgtatttat tgcaagctt tctttggggg ggggtgcttc cattttttgt tgtttcctca 387660
 aacatttctt caatttcagt tttttttttt ttttaaagat ttattatgca tgcagtattt 387720
 tgctgcatg tatctctgca ggccagaagg gggcacaaga tctcattgta gatggttgtg 387780
 agccagcctg tggttgctgg gaattgaact caggacctct ggaagagcag ttagtgcctc 387840
 taacctctga gacatctcat cagctctcaa ctttagtttt cacactctca ctgaattcat 387900

 gtctagtcca tacttttaat ttctgaattt tttttcttta ttttacaag tttcttttgt 387960
 ggacatcctt cttaatttat gagatgatac cttttctcat tccccaaag attttgcta 388020
 gaaggccatt tctctctgct tcccagatt tttattttc catattgact ttgtctttt 388080
 gttagtgact tttcttaaaa tattttgtga ttcttcgttt tctcgtatcc aagtacatat 388140
 gtacttttac ctgtttgcta cctattagt gtgaacaaaa aggaataacc aaagtctcac 388200
 aatatgatat cataccaga tgaaactcag gcaatcattg ccaatattta ttaagtgtgt 388260
 attctttgtt gaacaccaat aactatggta caagttacaa ctgagaaaac agaggcttac 388320

 agtgttatgt aacctatcca ggaccataga gccagagtga atgtgaatta ttagttacaa 388380
 ggttgcaact cctcttacta ggtgaatgtt gtccctggca gggccttaa tttattcttt 388440
 ctgtatctca ccattctctt ggtcccagca gaaataattt agagataact ttagtgaag 388500

caggaactaa tgacaaagaa agaagtagaa acttntnnnnn nnnnnnnnnn nnnnnnnnnn 388560
 nnnnnnnnnn nnnnnnnnnn nnnnnnnnnn nnnnnnnnnn nnnnnnnnnn nnnnnnnnnn 388620
 nnnnnnnnnn nnnnnnnnnn nnnnnnnnnn nnnnnnnnnn nnnnnnnnnn nnnnnnnnnn 388680
 nnnnnnnnnn nnnnnnnnnn nnnnnnnnnn nnnnnnnnnn nnnnnnnnnn nnnnnnnnnn 388740

 nnnnnnnnnn nnnnnnnnnn nnnnnnnnnn nnnnnnnnnn nnnnnnnnnn nnnnnnnnnn 388800
 nnnnnnnnnn nnnnnnnnnn nnnnnnnnnn nnnnnnnnnn nnnnnnnnnn nnnnnnnnnn 388860
 nnnnnnnnnn nnnnnnnnnn nnnnnnnnnn nnnnnnnnnn nnnnnnnnnn nnnnnnnnnn 388920
 nnnnnnnnnn nnnnnnnnnn nnnnnnnnnn nnnnnnnnnn nnnnnnnnnn nnnnnnnnnn 388980
 nnnnnnnnnn nnnnnnnnnn nnnnnnnnnn nnnnnnnnnn nnnnnnnnnn nnnnnnnnnn 389040
 nnnnnnnnnn nnnnnnnnnn nnnnnnnnnn nnnnnnnnnn nnnnnnnnnn nnnnnnnnnn 389100
 nnnnnnnnnn nnnnnnnnnn nnnnnnnnnn nnnnnntata tatatatata tatatatatt 389160

 tgtgtggagg tgttttgctt gcatgtatat ctgtgcccc a tatgctgcag tacctgtaga 389220
 atccagaaga gggcataaga ttcccctgga attaggagtt acagacagtt gtgagcggcc 389280
 atgtgggtgc tgggaatcag ccatgtgggt gctgtgaatc aaacccgggt cctctggaag 389340
 aacagccagt gctcttagcc actgaacat cctccaacc ccaacattta ctggagtttt 389400
 aaaggggact atgttgattc aagtgaacca tggaatccac aaagataaca ttccctttatc 389460
 tgattttgtg ctgtaagaca ctggcattag ccttgctgac tgtctcttga gagtttcagt 389520
 ttcagctgag gggcagattg cttagcagag gctacatata gtttggatct tctaagtacc 389580

 ctgtgttcca catgttagca gtgtgcttcc cagacattaa tattattggg aaacagtgag 389640
 actttgggga ggtggggtct agtgggagga agttggttat tgggtgcacc tttggagggg 389700
 atcatgggac cagggtctgt tttctttacc tccaactgc catgaggtga gcattttcct 389760
 tccctgtaag gctcccacta tgatgcacct cttgtctata gggcacaagg cagagctcaa 389820
 ataaacttac tatccttttt ttaagttgtt tatcctttgtt acttgatgaa agataattat 389880
 aacatgctaa agtttactca tggagataat cagctcctta aaggtttgcc aacctgaaat 389940
 catagaacaa cttgacctg gaggactcta cgattttaca gggaggtgga ggccccggga 390000

 aggcagacat aggttagttc aggtctgtgca tggaccagtg ggaccagac aagggaact 390060
 gagcagtagg gtggggcccc atgaaagctg atggtggctg tcaactagaag agctggcctc 390120
 cacttttaaa aggtccttga ggcaaggaca caagagtgac acatgaatca gtcaacagtc 390180
 aggtcagttc ctcccagttc ttaaaaattg gaattctcat tggctggcaa agcaacagga 390240
 agaggggggt ttgtttctgt ttacaagaa ctgctctaata ttttccagt ttttcaaag 390300
 aaagtgtttg ctttcaatat atttgaaaat ctggaaggcg tacactataa gtcagtgcatt 390360

gaagcattat caactttaag gttagtcatt gttttcttga acacaattcc cegtgtttaa 390420

 agagcagaaa gaaagcagag tcgttgtcag cactgggaaa gtcagaggta agtaggagcc 390480
 agcaggtccg attttattca aaacacacat caaatcctat tccaacttat ctttgactct 390540
 cagaccttcc cctagatttg agctgtcttc tcgggtatc cttcttctag aggtttgctt 390600
 ctgaaaggag ctaagagacc cctgttctag ttgggcacac agtgatggtc atatcccagg 390660
 ttttctgtag ctagaaaaaa atgtggccct agaaacataa acttaagtcc caacgctggt 390720
 gaccagaag atgtatgtaa aaccacagt ccagacacgc tattaagcat gcctccttgt 390780
 cttgcagga tgttggagtg gagtctgagt tagttaccac aggataaatg ctttctcat 390840

 acaaaacagg ctigcctgat ccaggctggt tcctccgga gacaagaggg tgactggcag 390900
 tggagggtga acccacgaga tctcaactt tcttgggttc ctgggactgg ccagcgggga 390960
 actaaggaca ctagctgctt ccactcgcgt gcacgaccc cgcgagctgt ccccggctca 391020
 tttccactc cgctgcttgg ctggccggac cgtaaaccca acctgacatg gactcattaa 391080
 tttggcagcg actggaaagc tgggcatag cggcacagcc gggaggcctt tgtggaccg 391140
 gggtcaggtc agagggcaac cgaaacaagg ctgagccctg cacgctgctg ctccaggggc 391200
 tggactcccg gcctcctgcc gcattgctcc tgctcgcctt ccggagccag gaaccccgcg 391260

 acccagccgg gtgcttcctc ctcaccagt accggagtct tagccgcatc caggtcgcct 391320
 gctgtcttca agatgcagac tctgggtgac agccaccag ggcggatatg aagatgcgcg 391380
 cttgcagtga cgtggtgatg cgcaggtgca agcctctct cggtgccacc tggagctctg 391440
 gggcagcttc tttggacgcg aagcatctac atttctcgg gtttagtctc ttgcatggtc 391500
 tctcacacat gcctgcgctt aggtagcggg caacaggctg ggggctagag gcctgttctt 391560
 tgttttacia gtggctccag cacagattaa ttttagcaa ttttgaaaa aaacatagcg 391620
 gcctccttct gagcctttag gtgactcttg tgacatttag cagcaaagag aactatttc 391680

 tctgccattc agagctaacc acgtttaatt ggcccagaag tctgttlat tttgggaaac 391740
 tgtttgcgat atcccatctg tttcatctt ggggttcaaa cgagtctgtg tttacccttc 391800
 tgctgggaa attggtttac atgcccagca atttcggtgg acaccgagat attcccttga 391860
 actaatgctg tgggtccgac aggccttgta ccgctaatga cctccatta cgtctgtcag 391920
 gagacattta cacagctcca cggtcagttc cataaaggaa attaagacct taggtttatc 391980
 ataactattt gtaaaccaac tggcttcca cgatggccag aaagctgtag ggccacaagg 392040
 gcaaagtctc cgcggatcag ccatctctaa ctaaggcctt cagccctgct gatgtgcct 392100

ttgtgcccc aaactctccc ccctgattca tgagtgatcc tagagctgtg gcctggctcc 392160
 tcaagtgaca gataaagaaa gattccacgt attgctgacc tgggtatatt caaagactaa 392220
 taattgactg gggcatgggt agttcaggta tggtcctgtg atctctagga ccgcaggaag 392280
 gtcacactc tccaagagg catgactctt gtcctggac tgagggcaca gaaaatggcc 392340
 aggtcaagga tgtgtgagga gccagcatga cggaaatgct gtgaagggtg ctttgtttca 392400
 ggggtggcag acaggtctgg aaagtggctg cacaggagge tccttgacc cctgtgagge 392460
 cctccggttg tgtaatctga gaaattgctc ccaaatcact tcglatgccc tggctgagag 392520

 gtccacaatc aggctctggc aagtgtgcaa atgctcatta tgtgggtgtt acctcatcta 392580
 ccctgcagtg acaagcctgg cttgtggcag gcaggctgca ctcatgctt ggcttgtggc 392640
 aggcagggtt tatcctggca tgagagggca gatgctgaga tggggtggga taaagggtat 392700
 taaccagggg gcccaaggac tgggaataca aaacagtata gaaacgaaga tgttgaagt 392760
 catgcctata gcttggatgc cagatcattg tctctgtag aaatgaacca ctctttctga 392820
 ttacttgatc cccccccc gccccatctt tctcttgagg agaaaaggag tagaacaat 392880
 ccagggtgat taactcagga taaaaagga tcaaggctgc cttgacatc agaggcctgg 392940

 agagggtgaa aaatgtgtgt aaaaatgcct gctctcaggc ctgggtggcct gaggccccac 393000
 tgggaacca ggttaaggtag aaggagagaa gaccacaaag ttgtcatctg gtttccacat 393060
 gcacaccctt gtcccagaat tgtgcacaca taatagtaat actgtaata ctagtttaaa 393120
 attttaata caatgcaaga tccactccag cagacttctc atagcttggg gagaaactgt 393180
 catttgctta gaactctata tctgacaatg aagatgtgtg ttctgcctca taggaactct 393240
 ctctcatttg ttggagaga aaatgatgta aaagacttgg gatatttgtt gcaggaggct 393300
 ggacctccat actattacta taagaacaag tggggcagtt tcaggctgtt cacccaata 393360

 gacacatgaa gaaaggcaca gggctggaag gtggttttca ggccatgcag gagaggaacc 393420
 agaggggagag gtiggaaagc cgtgaggacc cagattaact cttgtttctt tccccacctc 393480
 tgctcctaca gtgggcaatg caaacacct gagctccctg tgcatgtct tgactgttct 393540
 tcgttactg agattggaga gcccatttc tggctattaa cccagctccc actcttctct 393600
 caatacgaca cacacacaca cacacacaca cacacacaca tctcttcttg atttgattat 393660
 tgctgagaga atgcagtgc ctgtaaatgg tcacagtct gtcagtctca aaggtggcaa 393720
 atgcttgatc ttigaatgcc ttttctagt gaaaagttc tagacctga taagcctctc 393780

 agccggccga tgcagaaatc caaatcagac caaatcaaac caaatagaa aaagccgagt 393840
 ttaatgaata caattctctt ggatggcctt ccagcctcc cctagaggag tcaggaaagg 393900
 gagaccagaa aaaccacctg tctgttctct gggggacagt ttaaatacc tgtgggagtg 393960

gccttgagta tcicttgggg agggicatca tttggcaagc tttctgagct gcaaccggtt 394020
 tggagggaga tggaggagg ggcttagatg gaacttccac cataacatcc cagaatctgt 394080
 gggatatatgg atgccagggg ctggggtgaa acttccactt ttacatgcca gactctttgg 394140
 ttcattgtctg gcttcttctt gctgacaagg gaggatgtca gggaaggggg agtcagaagt 394200

cagtgcgac atgctctatg gtatgagtga ccagacctcc atactattac tataagaaca 394260
 agtggggcag tttcaggctg ttcacccaaa tagactcatg aagaaaggca cagggtctga 394320
 aggtggtttt caggccatgc aggagaggaa ccagaggag aggttggaac gccgtgagga 394380
 cccagattaa ctcttgtttt tttcccacc tctgctccta cagtgggcaa tgcaaacac 394440
 ctgagctccc tggcatcgt cttactgtt ctttggttag ctggcatcct gtagacctcg 394500
 gacacctgtt cttgaggag gcagagaagg aaggctgcta ggagaaaaaa tagattgtta 394560
 tcattggccc tatgaatgtg actagccaca ggagggtgat aacagccaga acaaagggaa 394620

tggaaaagca ctttttctt ttttgttgt tctttaagac agattgttgc tatgcagcac 394680
 tgactggtct tgaacttgag gtcttctgga ctcaacctcc tgagcactgg gattatagtg 394740
 tacactacca ggcttctt cagatttctt tttagtgtta ttgcttttaa ttttctcat 394800
 tgcagtgcac ccaacagcta gcctgaagaa gataaagaaa attgtgagat ctttctaggc 394860
 cttttaccag tctgtgccta cgttctctt aagatttgtt tgagatgtgt ctatgaaaga 394920
 gaaatgatag agaaagagag gatggaataa atagatagtc cttggctttt aattttcata 394980
 aatcaaaagg aaatgaaaa taaatcatg gggttgaga gatggctcaa tggtaagag 395040

cacttcttc ctttgcagag gaccaagt ctattgccag cattcatatg gcagctcaca 395100
 ccagtctata acicatttc cagcggatct ggcacttctt ttggcctcct caaacaccag 395160
 gcatactcac agtgcactta catacattca ggcaaaatac caatacatat ataaaataaa 395220
 catgaagaaa gaagaaaatc agagttcata ggttaagtt ttttaattgat taaaataatc 395280
 tattcttaat gtgctgtag gtccagagt ctatcactac tgttgaagg gacagcaaag 395340
 gaggaatfff ccaaatgtt gcagtttccc ccacccaga ggttctctg aaaacacctt 395400
 ccctggggag tgcacttga ctcagcagg agcagagaac ccttaacat tccccttgt 395460

tagtccatga ttcaacaaa ggctgtggca tttttccaca gctgggcaga gcagaaatgg 395520
 actgggcaaa tggctccaag ctaagccctg aattcccga ttgcagattg cgaggccttt 395580
 aatttatacc tctgtgtag tttgtattg acatttatta gccgagagtg tggctgccaa 395640
 caccagttt gagtagattg tggtaaaaac atatttctc tttacacatt ctaaccagt 395700
 gcggaaggac tgtttttatt gaaaccgtat ctcaactcca acctctcat actcacagac 395760
 acacatgtac agagttaaag ttatatttat ggttggtaaa tgttctaatt atgggctgc 395820

gtgtgttcag agaggaaaat taaatcagtg agcatgggag gtcattgccgc ccttccgctc 395880

tagtttgggc tccttatggt tttcagcttt gagaaatcaa tgccgtgaaa tggtaggtga 395940

caagccaage agacatttgt ctccctggtg atttacaatg ttatctgcag attgttgttg 396000

gtttttttt ttccccitga tgaggtgaat ttttgattct ttactgcctg cttcccttaa 396060

cacatcacag agcaatttct aacaagcatc tttcctggat aatgtcccag gccttgcttt 396120

ccatatgagg acacaagaaa tgctgaagta gagatggatg tcattgacac tatgeccaat 396180

gctcagtccc aggctgctgc catgaggatg atgagtagac accagtccctc agagtacctg 396240

cccttctctg agacagaaca gaagtcttga tgcctttac agtgtctcta aagaacaag 396300

tcttaggctt gggttaggtt ggggtgcctc agtcagtaaa gtgtgtgctt tgcaagagca 396360

cagacctaa ttagtccta gaacctatga acaaatgtag tgcaagctca cagtcagcgc 396420

aaggaagaa gagacaggag gatcttgggc tgtttgtcta aattcatgag ttccaggaca 396480

gtaaaggaca ctgtctcaa aaaggtggac agcagccctg aggatgacac atgacgttgt 396540

cctctggcct ttacacacag gtgccagtca tcatgtacat gcacacatat gtataagtgc 396600

attctctcaa gcttgtgac acactggaga aaaaaaagaa tgagtggag ctacaggcga 396660

ttaaagggtc taaaggggtt tgacaaggct gttattgtcc ctgtactgtt agctcaaaga 396720

gattataata ttcaaaaatg ggcacaatct acccaggtct tctctaccac aataaatttg 396780

ctgctacagg cacaatgctt tgtagtgtgg gtttgagttg acagatcact gagggcaagt 396840

tcgtccatac tctccagtta ttcagctcat ttatgaatgc cacacagcct tccatgcaaa 396900

gtgtgtggtg tagacctggc accctccaca gactgatctc tttgctgaca gttaaagta 396960

gaggcatctg tggtagacca atggatgtct tgagttgaat tcagatattg agttgattaa 397020

tattggagtc agcactgcca gcagccagga catgtgagtg ctgatccca ggaagcagtc 397080

ctggtggttg tgacatcagt gaccagtgc ctatctatag ataactaagcg aactgtctat 397140

agatactaaa caggtaccag gactctataa gcttgggtga agtcccagaa gatcctgcag 397200

gatgcaatct tccaacaga aaactggttt gctatttttt catgtttcct aaccaggagg 397260

ctgtttttta aacgtgggaa tttcttaact gagaaatgca acccggaag gaaccaggag 397320

aaaacctctt atacagtgtt aggacctgac taggttataa aaaacataga aaagagtaga 397380

gtgataaate aacatacttc gtaacttctac agtgcctttg atggfccaaa atacaaccag 397440

aattttgtt tctcgcttcc atctcagatc tccatgaaga cagttgatcc cataaaacat 397500

acagtgtgta taccttgaag cctcatgga tataagaagc ccttctctt ctatcttcat 397560

gggctatgat gagatgggta aaagtcacat ggtttagtca agggcagagt ctacagaact 397620
 gaagactcat tgttcatcat ccctgccatc ttttgggcca aatgtttctc aaagtgtggc 397680
 cagcagcacc agcatcatcc aggtttaatt tcagttcaac aatttcccag agatttgtct 397740
 ttaaaaaacta attgtatggt ttgtatttca acaaagtgag gcaaatctct gcttagcaag 397800
 ccctgagcct gtgtggaggg tgggcccgac tctgtgtatt gctgtagctt tgcttatgac 397860
 ctctgtcca aatgtctgtg ctctaaggat gccatgtaca gatacaatac gacagacagg 397920
 taggcagagg agagatgtga gcccaaggac acttcctatg gacagttgac acaccaagag 397980

 cataagtgta catttcttct ttgggggagg ggattctggt tctaagttag gtgtgagtgt 398040
 tcgagagggt ggtaaccttg tcctgtttaa ttacgatgag aaaacaactc agttgcctgc 398100
 agagccaaaa aacaaacctc agaactgctt aattcatccg tcaacaaac tgtattttag 398160
 gaaatgcagg acagagaaaa atgcacaaaa gaaaagattt atttatttgt acaaaagtgg 398220
 aatgacaggc gtttgagcgg atccaatatg aatttaagaa ggaaaaaaaa atgtgattca 398280
 ttgccagcta ttaaatcttg tttatccttt ttaactaac cagaacaca ttttgaaaa 398340
 atccaagtta acagttgaag cattggggagc tgcttcgggc actgcctggg ctccctgcct 398400

 acccaagggg agggcaggag tgacatgagt cagcagattt ccgaactgga aggggtgagcg 398460
 actgtcctga tctggtcacc accaagcctc tgccaggagt ccatcggttt ccatatcatg 398520
 gcagccagaa gaagacagac gtttacactg ctttgaagga cacaatacat ttttctaag 398580
 acacaatcac caagacatgt gtccctccat tgggtccctc cttggatccc tgttgctacc 398640
 tcccaggacg tcatctgatt tgtccagtgc tgtctccaga cagagacata agactgaaat 398700
 tcttcagcac acttgacaag tggctgaaag cttggctgga atcccagttg ttggtggaag 398760
 aaatcccttc catgcatgic tgaggtggcc cttgcatact cccctgccag ggcccaggag 398820

 ggaacagcct tttctagctg cttccatgcc ccatcagcat cctcttgggt taatgtatta 398880
 acgtgtttct gtatagtgcc cttacactga gacagaagga cttagctgta cactcaaaga 398940
 attaagctgt tctaataaac cataaaaggt acacatatca gggggtgagg agagccatgc 399000
 aaaagtaact tttctggagc agaaacctg atctccctct tgtttttcaa gcaagtaatt 399060
 gcagcctgag gaatatctgg ggctactgat ctcatittgt gctgcagatg ggacctctc 399120
 gagtccaaga cctcctcaag aactaccaa gggacaaagc cagagaatc tctgtctcc 399180
 cctcctgtat ggtgatccag gtagaagggt ctagcattta ggcattttgt ctggtctgcc 399240

 tttggagtct gacaagacat gccctcagtt gctgccacta agagcaccac ctgtgcctat 399300
 tcaactgtgt cccittttaa agggccctac ccacctgtcc cccatccct ctctctgtct 399360
 ctctttctc tctcctgctg ctcatgtccc tggagattgg tcccccccc cttttttgt 399420

tttttgagac agagtgtccc tgtggcttta gaggtgtcc tgtaactagc tctttagac 399480
 caggctggtc ttgaactcac agagatccgc ctgctctgc ctgaggagtg ctgggattaa 399540
 aggcatgcat caccactgcc ctgccccctt cctcctttta caattatctt tccctaataa 399600
 aaaagccctc tgcttgaact ctgtcacatg gcatctttct ctctcgagcc acttttatta 399660

 caacagaagg gacaaccatg ttgtgctttg ccaaccttca agcctcaata tacttggtaa 399720
 gcaaaaaatct tacaccagtc tgctcctggt tccccacca acctctgcac tectcattga 399780
 tagttctatc gatactatat ctatgtcttg atgggaagaa ctgggtctta ttcaatatca 399840
 tttcttagca ggatgcctac tgcataaaga aggctcaaa tgtggtaatt aggctgaggc 399900
 ctctgcaaa tagatacaga agcttcggac ctggttacag catgggcat ctgttcagg 399960
 tgcaggtcaa gacatatttc ttcaattgtt tatctcagta tctagtgtt taaagaaat 400020
 gctttaata cactttaact ctagagccaa tatcttaacc acaacagaag aaacattgga 400080

 cttctcatca ggiggacttg aaatctacac tgagagtaag aatccattg agatgtgtc 400140
 acagtgccta tgagataggt actatgggca caaaatgac caagaggga tatagagaaa 400200
 aaacttagaa gaaagtgggt ctatttggcc aggctggcag ttttcagagg gaccagacag 400260
 aaatgcaca ggacaagtgg gatatgccca ctaattaatg ataggtgaac aaaaggcatt 400320
 tcttctcaca acataacact attcagccat aaaacaagta ccctacatga taaaatggaa 400380
 tgaatgaage attacttat attattctat tattaaataa aaccgggag tcagatatca 400440
 gggtaaaaac ctgattgac agagaagcag tagagaagtg gccagtgacc tctctcca 400500

 tccccatcc agcctctccc tactacttcc tgtgtctctc tatatgtatc ctgggtctc 400560
 caaaacctt atggataatt cctgtcaacc aatcactgat tctgcccctt gattcaaagt 400620
 aaagtttatt gtcagtctca gagtgtcagt gagaacaaat atcctacaac atctctctc 400680
 atttgtctaa atgaaaagta acagtttta ctctaactg gtaaaactat atacaataag 400740
 aataattatc aggtattgtc caaataaaaa gggaagggtt taactttaat gaagtaaagt 400800
 tataagaaca attacaaagt aagaattaca ttcacaatat ccagtcatt tgtatttggc 400860
 aaactcagag aaaatataat ctatectatc ttggtgagtc caaagttatg tatctaattc 400920

 actttttaac aaaaattgta ttaccaacct agaaatatct ttttagatct taaaacattt 400980
 tcttagataa acagcttaag cttttatgta tctcagcttc atatacttat catctgtttt 401040
 gtgaatttct tttctgaatt tggtaacaaa gaaaactgta gctataacta tctcatctc 401100
 aaatccatca gagaccaag aaataaacct gagtaataa gaagtcaga acaagcaact 401160
 tccaaaacta tagaaatgac agagacatct ggctacctgg acagttacct ggttctctg 401220
 caatattggg gcatccatct tcagcctaca ggacacagaat atctgacaga cttttctgtg 401280

aagcaggaat ttigaaggac tgtcttacct tgtattgtca aagcttgca gtgaccttct 401340

tttgtgtcct gcttgtccaa ttggacagc attctgtcag tacttgaggc aagggcagtt 401400
tcttgcccaa tggctagact tgccacaatg aaagcaaact ccatatggag gttctttaat 401460
tcccattatc cttttttga aataaactgg tctgccaag agcagatgta tgtcactgcc 401520
atgaaaagcc ttgtattaa aacatcttaa attccatatt ccataggtct ctgaagtgaa 401580
gatcatctat ccacctaaaa tatactcttg acctgaaaa catattgaaa atggccacag 401640
atltgattat tatagatgac tactactaa cctgcatttc ttaattatcc taaatagttt 401700
gtagtaataa ctttcaagaa ctaaaacttt atattgaatt gtttaatgaa ctgcattggt 401760

acaatgcctt aagcaagagt agaaacacat atacagtta acaaatatat cagtatataa 401820
aattccatac caatgtaaaa tatttgagac tagtacttat tcttttttc ttttaataa 401880
tttatttaac tttatgtaca ttgggtgtaa ggtatcagat ccaactggaac tagagttaca 401940
gacagttgtg agctgccatg tgggtgctgg gaattgaacc tgggtcctct ggaagagcag 402000
ccagtgtctt taacctga gccatctctc tagccctact tcttttttt taatctaaaa 402060
gtagattcaa taatctacce tttttatctt atcattecta tactacctt tttcttttea 402120
gaatgaaatt cctgaatcta atctcctttg cttagcttcc tctctgatca tgaccagtaa 402180

caacttgcaa tcaacctccc tacaggatga caagcatcca taacctatg aatgacgcaa 402240
aaccaccac tctacctctt gggaatgtgg gcatcatggt tttaaaatta cttgctgttg 402300
tctggtagta atgacatctt taggagacc tgagaaaact gagataatgt tcaagtcctg 402360
gaagagctaa gtgtatcatt tgggtgccag tttctatgaa atgggggaag ttcaaggctt 402420
atctgaagac ctagctagag tagtctgtga ggttgggcc tctcagttag ctgctttgaa 402480
gttgctctta atgcagattt ttaaggaaac tgcagcaggg ccattctgag aggttggatc 402540
acctgggcta cttgtcttca ttagtgtcta gccctttatt attttttgaa aatatacaaa 402600

catttaaagg tagcatacat atctgcatta acacacgtat gaaatgcgca gtgtacacaa 402660
atcagctaaa gacgattctc tgttctatgt ttgatcaggt aaaagaaatc tgtcaacttt 402720
ataagctgtt ttggactgca taacaaaact gtaacataaa tctccatcca tgtcatatga 402780
aaggatagtg tacaataaga agtcatgaag actctgtagc caacaagatt tatcatgttt 402840
ttcatccagt ctgagagctg tteccatagt agagggatca ggttatatgc cacgtgtttt 402900
gtagtttttc ttgtttctt ctttcatgac tgcaaccaag attttcagga gttctacctc 402960
agtcaaatct gatctttatt cttttgaag gaatccatag tttttgttt cctgtggaag 403020

caaaagcaaa acctctcccc cagtgaaca cttttctga cttccattct aaagttaaga 403080
 cattattaca atatacaggc tggtttaatt tattagtttt tttctataat ccagtgtctc 403140
 tctgaagcat ttgtcctcca ctcatcagca ttttaaagct tcaaagtcaa caaacacca 403200
 tacaagatcc agacactctg tgtatttccc atcctcacat cactattctt tttatattat 403260
 tttactcttt ctttaaagac tttattattt taaaattatt tcggatcatt tcctatgact 403320
 gtctatatec atttactttt ctttcttcag catctaagca cattttaaaa cattctgttc 403380
 ctgtttggag ggttttgttt tgttttgttt tgttttttgg tctggacctg ggtttactaa 403440

 gcacctgcag ttttctctga ccatgtgagc caatccttaa actgctaggc taccactgtc 403500
 tggctccact taacacacag tgctggcagc gggctccacc ccttgggttc aatgaaagcc 403560
 tagcctcatg cctatgggta ctgccatcc agggcctcat ttaccacccc tagctctggg 403620
 aatttctgta gttcatgccg tggcagacag cagatgttcc tgtctagtcc ttcattccag 403680
 tagggcatga ttaagtgct cagctgtata gcagggcctc ttaaggagt catgtctctg 403740
 tacactgcag aagatgaact ttcaaatac tgtgcaagat ttcacttata tgaatttct 403800
 aatgggaaa attcagagaa acagaagtgt gggaagaaat ggcagggact gctgatgaca 403860

 tatcccagca ttgcaggta gtgatggctg actacataaa accacatgtc aagtgttta 403920
 atgccccage cagcggggct gcaatgtggg cccaaacctc aaaggacctg gaataaagg 403980
 acaagagaca caagaaacag acagcaagac aggatttctg atcaagctgc aaaattttat 404040
 ttttctcaga gacctatata gtggttgaag taggaagctt ggcagggcag ggatttctca 404100
 ggtaacccaa gccagaaag tcctgtgtg tgagtcttg aaggcaagca gagagtgcag 404160
 gtgtagataa ggcaggatgc tagcagggc agggtcaggg tcagggaggg agtgttgcta 404220
 agtaacctga ctgtggaacg tttctttctt tactattagc tatttctgta agtccaggtg 404280

 ctatttatca ggaacttggg gaggaagga ttgattggga ctgaaggtag ccattcttec 404340
 aacctaatgg gctattcaa aaaatgcttt ttacaatctt ttacaagagg tcccacaaa 404400
 caatgatctc tctggcact tgaagtggt gtataaaatc aatgtaag aaattaccta 404460
 gaatagtta tctccatcac tgcctaaagt gaaggaaaag tggttctgtg tgattagata 404520
 gaaagagacc tgaaggcagc tcatgggagc aaaggccatc tttcttctt gagccagcta 404580
 ggaacctgt agtcccaaga gctgtcttgg ggatggatgg gctattcttc agccacattt 404640
 cgccacatc tttctcatc tgcattggtt ttcagttctg attagttctc gtggcaccat 404700

 aatgtgaata gatgttagg cttggttgat ctgggcact taactgctct atctccagca 404760
 aagtcacatc tatatggtgt ttttcagaa gccagacatc acaaatgctg gaaagcagca 404820
 ggagtccggc tcaggagact gactgataca caaggcttgg caaatgcca gctctggtga 404880

gcactcatta ctgctgtcaa aagacaaggt cttggggat agagatgaca ctatcacagg 404940
gatcctgagg ctgcattact gctgtcaaaa gacaaggcct tggggatag agatgacact 405000
atcacagga tctgaggat gctgaagggt gttcttccag tctacctgc ccttctca 405060
gcaggtgcca tcacaaacac aacctttatg ccatttgtgt ctttttagag gcaagtgta 405120

aggtcaccca gggccaatc ctcatccaag tggaagccta ggactggct gtgcccactc 405180
atgaagggtc cctctctgc caccttccac acacgatgc cggttctgca ctctgggtgg 405240
atgagaacc ttctcctgc attagtacc aaatccagca tttccatcct cacgtacttg 405300
acctcatttc caataagat aacagaggag tttttcatgt caacaggtga ctgaaagaca 405360
gcatgggggg ctctcatca taccaatcca gggaaggaca gaaactcaca gccaccaggg 405420
aaggcatgct gaaatgtgac aggactaaag tgtgactttc tcaatggggc caatcatcaa 405480
agctaataaa aacagaggct ctgggtttat ttaattttta tcatgaataa cccccagaa 405540

tagtcaaatg gtttgaaac cttcaagtg attcctgcct gaactgat cattgtttag 405600
tcctgaggg tgacacattc ctgatcatta atctagacac atcccagaca accagtagct 405660
tactgagttc tctctcagc agatgtttct ggagtttagaa ataggcttcc ctacttctc 405720
ttggttggtc agtttgggg gcatgaaatg aacaatacac agatattctg gatagaccaa 405780
gtgaaagagt gtttgttggc agccatagtg tgcctcagtt ttgataagga tcttggggga 405840
ccaggcttgg gagaggaaga aataaagacc actatggaga atggaacttg cactgtaaga 405900
tgaggccatg gctggagtaa tctgactaaa gcaaggatag gattcaaagt cttgaggagt 405960

acatctggcg gagacttgtg acaagtcagc tgatgaccac tactgccatg agaaggaaaa 406020
ggatcttctc tcttggcttc tgtgtagaa ggtagatgct attccacaag aggaaaaatg 406080
tccccacct aaagcagtca ggtgccgatg aggaagttag tacagcggta gaaactagcc 406140
atcatttctt atagttgtaa tatagaaaat catcccaaac accaaaactg aataacagct 406200
tctctctgaa tgaggtagt aaagcagtgt tgtatttaca gtcaggtcta aatttgggaa 406260
attcttgcaa aggtggaatc tgggatgag ctaaaggaat atccaacact ggcactagct 406320
aacctgcttg cttggctggg cacatttgac tactttgggg cagataaagt gatctagaac 406380

atggagcagg tatacagcaa atacagatca tatcaaatag tagatttagg caaccctatg 406440
tgatggatgt gtttagtcat ctttttcttt gaaaatatgt aataggtgat tagtagttag 406500
agaaaggat gaaaaggaga ctatcagcat tgagaaatgc tatatgtaat taatgtgcat 406560
ttatagtta tgtatttccc tatgtaggcc gttagcctgt gagagcagcg tagtatgcaa 406620
tgaagagtat acaccatcct tcaggggttg gcagatgagg atccagccat gtgacccttg 406680
gcagagtat gtaggcatg cttttaaatg ggttgtttac tttgctgtga cctctctgac 406740

aattaagttt cattcaggca atgtgttga tgtacagcag ggctgaaaag atccactgtg 406800

atgtatgtgg acccgtttca aagagacaga atctgagaat catccaagac cacaggtttc 406860
acaacaacct attccccact gaacatggtt gagccaatac tgggtagttt ggcaggcagg 406920
aggattgga ggaattcttt aatgtgatgg cagagctcac aagtatcca gcagctttgg 406980
aagactgagt atcgcttttg tgaagacag aggaggagct gtctgcagag gtacactatg 407040
ggaattgga agaactgaag ggtaattgcc aagacagtct gctcatcatt gcctgagggg 407100
gggaccgagt gatgctccat ctctttgga gggccctttc ctcaaaact ggaagatgct 407160
agcatacaag tcccagactg cctccaacag ctgccctttc cctgctagtt ctccagagac 407220

ttgattctca tcttctgctc tgcagagcaa tcccttgagg ctccaggata agggaaacct 407280
glatgtttcc atggtgcttg tcacggttct gtggtttcag taggcacgcc attaggagtc 407340
tgggtgaatg aaccagataa cactctatgt gcctctttgc atgtcatctt agtgatgaag 407400
taatgggcca atattttatt gatgataaag aattatgaat aataatggtt gtgttctttg 407460
gaaagtatct agggaaagat atgtacaaac agattttatt ttttgccata gccatgaaat 407520
aactgctgta ttggtgata aggaatattt ctggaagaat aggtattggt tctctttcta 407580
aagaaagatt tctaaataaa gagcataatg caatgccaaa gattaagaat attgggctgg 407640

aaagatgact cagcagttaa gagaactgga atgctcttcc agaagacctg ggttcaattc 407700
ccagcaccca catggcaact caactgtccc aaactccagt tccaggggat ccaacacctc 407760
tacagacata catgcaggca aaacaccaat gcacataaaa taaaactaaa taatacatt 407820
taaaaaaaga atatgcttgg aaaatctagg agtcagtgag agaaaaaac tatcaacaat 407880
aaaggactca aataaaggct tatgatgctt atgaaatttc acttgcaaaa atttgacttt 407940
aagaaatggt acattgaatt gagtttgacc agccagtgtt tcttttatat tactgagatt 408000
tgccataaag tatccatgca tttataaaga agttttattag ataactctaa atacttaag 408060

tctatgtata tatactgaag tatgtatata tataaatata tataactaaag tctttctctc 408120
tatatctatc tatccatcta tatatatata tatatacata gactttaagt attttattta 408180
ttctatgtat aatacagctt cttttaaaa atggaaaaat gttaaagttg catttcacag 408240
acttagacaa ctttctcatt taactatggg tctctagaca tagcctagaa tgtatTTTT 408300
ttgtaaaaat ccaacattaa aaacagtcac tgcacctgag accattctct gggagattca 408360
caagaaaaca ttttaatttc tgtaacata tgattctttc catgcattca cctcatgatg 408420
taaaaaaaga aaaaaacata gtcacaacag gttctcactg attgggtggg aaaaggagag 408480

caatcaagag tciatgggaa tggccaata agatatagag aaagttggtt ttaggagaga 408540
 acaagaatta ctgttctata ataatatggt aataccatta tactataata cagtcttgta 408600
 atattaaaat tatctaaca aaacccttaa tttttatagt ggtagcctga actatctgtg 408660
 agtggaatgt cciattgect ggagcctgct ttaaaatatt tcagcaagag gaaaagaagt 408720
 gaagcaactt gcacccactc ataattcttt gtttgctgg ctgtttttt tcttttct 408780
 tttttctttt tttgctttgt tttgtcttgt gtttttagac agggctttac tatattgctc 408840
 taactggcct ggaattcact atgtagacta ggatggtctt gaactaactg agatctgcct 408900

 gcctctgcct cctgagtctt gggattagag gtgtgcacca ccacgcctga cctggaatac 408960
 acaaacttta tgagaggctt tgctatacat ggggaacaaa tgaagtctgg aatgaatgtg 409020
 tattgtggac atgagcacca ccatataagc tctaaagtta cacagagaaa cctgtctca 409080
 gaaaacacaa accaacacaa caaacacaa caaacacaa aaaacacaa aaaacacaa 409140
 aaaaaaacct caggtgcctc agactcctgg gaatagcaag gccttgctt gatctgggta 409200
 tggatgttga cagtataac agagagcaac aaccagagct tcctctccc tgatgacagc 409260
 agctgagact gctcccctat agagaccctt gctgagatta gataaccagc ctcttctca 409320

 ttcattctga gttcccaggc tgctgctggt gcacctcat cagagcacac agtcacccta 409380
 catcatcttt tctttctgt ctgttgtttc tacgtccac tcacccagc caggtcagtc 409440
 cctggccttg cagatcatag caactataga ggaaggaaaa ggcaaaagta atgcttggct 409500
 tggcctcgag atgttcttgg tagtccattt gctttttgag acaggagaag ctataggatg 409560
 cttgaggggt gatacatgag cgtgggtgag gcacgcaggg taggcatatc cagcgtgttg 409620
 tccttgagta ggaagaatgg atgagacctt ttgggtgtgc cacatttacc cagagtcaac 409680
 cagagatggc agagaggatg gggaaagggc aggccttctat tggttctagt aagtcacaac 409740

 tgaggtcatg gaccaagggt aaagaataaa gagaaccac tagaggctta agcagagagg 409800
 aaaaggtgag ggagagaggc agagttgcct atagaaatga aacagaattt acagagatta 409860
 tcagagacct acttgaggct gagaccaacc agtaagtga gaagctatgg tggttgtgtt 409920
 catgatacac tgetctcttt ctctcaccac tctcttgggt gcagtgacca tgaccaatta 409980
 actctctatg cctacctgct gtagagaaca cactctgctt gaatatatag agtaactctg 410040
 aggttaggaa gtatttctgc cttcacaag cagcaatcag ccaacagggc tttggttgc 410100
 attaaggact gagtatttat gtttcctga gattcatggg tgaacccta ctgacagata 410160

 gttgcaagc tatgtgatag acaagagaca ctgaggttgg atatagatgg aagatatcag 410220
 tgaatgacag agctgttgca gtgtgggagg aggtgtggaa cacagaagga tgaatttgag 410280
 aacgtgagtt ggagagaatt gaaaatgagg ttagctatta agcattatcc ttggaagagg 410340

ggaaatgaag gaactagaaa cccagagcgt tgcgttatga caggagcaga gtcagggaga 410400
 ttgaacctgg tgggaatctt caaggtctca tctgaggctc ctgggtggtc aggcatccc 410460
 tgatgtttga gaagcaaggt gagagaatgg tttggaaggt agatggagag caaggaggt 410520
 cctgtcccag ttgaggacca cgtgagagga ctgtaaggag acggctcctg cagcttcata 410580

 ttcccatctg agtcagaaag taaagtgcta tacagacaag tgatatagac aagtgggtgga 410640
 gaacattggt ggttttgttg atattgggtg gaatcctaca cagaacatcc aggaaaagtc 410700
 tgggatgcaa acagtggagg gctggtcaca ttggggacat attggattct gtggcgatgc 410760
 agctgaatga gaagggggat ctgggatctt gggcttcttg ttatgattaa aaaaacaaa 410820
 acaacacaac aacaacaaca actaggtagc aaatggggaa gtagataata tcccaggata 410880
 tataaaaatt tcctttctga ttatccattt ctttggcata taaaagaaag ggtttaatta 410940
 tgacattttc acatatgtat gttacagtat attttactta cactaacctc tccttgtctc 411000

 tcctccttct tcccagcagc cccccccc acacacctgg cctcctctgc tcctctgta 411060
 tatataatat gtatatccca ctcttagtct cctgtcacc tttgtgactg tcagggtcct 411120
 tcagtcttct tcctcagga acaaacctctg ttttttgggt gacaagatc ctctcatcta 411180
 ccctatctca tgaaggcagc ttctaattg ctgccattct ttggaaacct catatgaaat 411240
 gtgtccctaa cacatttact ctccccagg actcagctc tgacagtcca tgtctcttt 411300
 tcactcttca ttttctctt gtcagaggta agaacggaga ttaccagtc tgcaaacctt 411360
 tcagattgtc ttatttaact cagttgtgta catttaagct tcgcacttgt cgttatatag 411420

 cgcagtggct catttattg gaagactgaa tgatggttca ttgtctgaca ttccattgtc 411480
 cactcaggtt tgaaggatgat tttggctact tgttctggat gttttgagca gaactgtgat 411540
 tgacataaac aaaagggtt ttgtgagtat ctaagttatg aaggagcaca actgctgatt 411600
 catttggta taaaaaatat attcagaaga aataggcagc ctatctccaa aagtagctgt 411660
 aacattacta acagggatgg tgaggtgact cagtgataa aggtgcctgc tgccaagccc 411720
 gagttcagtc tctgagacc acccagtagg aggagagaac aaattctcac aaactgttct 411780
 ccgatcttca cacatgtaca tgaaccccc cacataccac atacaagcac atgaacacat 411840

 acaagtaata aataactgtc ataaaaggtt ttttaataa aataaaaagc ccaagacatt 411900
 accatgaat gagagtccct gttgtctcat gtccttagcc acaactagtg ttcttctgtg 411960
 tttttattac aactagaaa aaaaaatcag tggcagacat tttgtaatcc tggctccaaa 412020
 tgatacacta agtcctagca agttccctat ttccacgctc tgaaaaacac atttctgtat 412080
 taacataact gcaggagaat ttgagatatt ctgtgggcag agacttgaga aggagacatc 412140
 tttgtagagg acatcctgct ttgaatccaa agaatcagtc atggacattg tccagccaag 412200

gaacacaaac tgtgagtcac cagttgtccc gacccaagct tgcatgtgtt atgggactta 412260

 cttccccaca gagactgggt tctgtactgt tcagaaacct aaacttacat ctccaggata 412320
 ggtatggcag tcttcagaca tccagaaatt gaatttacca tttcccagga accattacca 412380
 ggagcagaac atggtaaac agccgacccc tctcctagtc aatcataaag cccagctttc 412440
 tttcaccttg aatcatctat ttgccactgt gtgggaaggt ggctttgggt ataccaacac 412500
 actgaacagc cccttaggga ttcagtttga ttcattgttg tggcaggggc atgccccata 412560
 taccctttct tgtctcctgg ccctgaggaa atgctctctg tcctcctcac atgcagagga 412620
 ttttaggaag aggggacatt tcaaagtatt gggtttctcg ctggaagtta aaacaagaca 412680

 acacagcagc agggtttict ttgctagctt gactggcccc ttgggtagag agctgcccag 412740
 ccctggcagg ctctgcttcc atccaaacca aactttcccc agtgacctca gggaaagatg 412800
 gtttacatca tgaagagaaa gcccatttat ttatttgcaa taacttcaa ttttatggag 412860
 ccacaagagg atataattta agaaaacatt agcaacaat tccaataacc tccaagttt 412920
 tacagttgc caggtcaaag attcatcaat ggaactattt caacattaag aatgaaaagt 412980
 tacatgagca ttcttttga acggggctgg ggaggtggag gtatttcacg atgtatattt 413040
 ttgttcatga catcctgggg tctaaggaaa agacaactga gtttccagga accattctga 413100

 gcaacatatg acctaagaga agtgggtcct ctaatgctgc ccttggggg cattagcccc 413160
 ataaataatg gaggcagaac atgggctggt ctaaataaac ctcttgagcc ttgctttgaa 413220
 cacagtgttg gagcaaatta cgtggtgttt ttattagggt ttttaagaca aaataaagag 413280
 gttaccagga aaggagtgta gctaagaatg gccccttict gttgaaatat gttggtttta 413340
 aagttccctt tctgttagca gtcactgtt ggtggtatat ttaatctgct aaaacaacca 413400
 atatcatgaa tctttaagaa agtatTTTTG aaccgtgttc aactTTTTTT tctgaattag 413460
 cgattgaatg tagggcctaa catatgctaa gaaagcactc taccactgcg ctataccct 413520

 gtctttgcaa ttttctgtta gaagcatgca ggagccagtg ctggaggaca caagttcctc 413580
 acccaacaga cctcacctt gttcttccag ggagcacagg ttgggaaggg cggatgtgtg 413640
 cttgtgatct ctcaattgtc tcagtcgaga tacttacact aactcttact tacactaaac 413700
 tacttaaaaa ttaggtgtt tatcttcata ctgcacctt ctcagctggc ttcttgaagg 413760
 gtgcaatcaa atctcgtagg tttgtagccc cagaccacc ctggtgctct ttttctggc 413820
 tacatttagg gctatafact cacaggttac tgagttaagc actgtgacag tttctctgga 413880
 atatgcatg aaggcccatg ggtgccttag gagatggtgg gatctgtagg aagtggagcc 413940

tatgggaggt taagtcattc tgggtgtgat tgaagaaagt agcagcaatc tactgtctcc 414000
accactgaac tattgcctct gtccatgtta agcacttttt attatttccg ttacttgaca 414060
atctcatgca tgtacactat attctctaaa tataatagat attatatgtt acacattata 414120
atctgattgc ccctccctt cttgtctcct tttatttacc tcagcaccgc tgatccatag 414180
cagtcctttt cccaggttca tgcttttgtt ttgtgaacca cttaatctaa ccagagccat 414240
ctgcgacacc attggattgg aactatccat tggatgctgg tgtagtcacc agtgaacaca 414300
caactaaagg tcatggttcc ccctctcctt gaatctatca gtagcaaata gtccagcagt 414360

gagtggtagg gtcccctgaa ccctcctct atttatact gactattaat gggcccatta 414420
ttctatcgca tacaccccg cacctgtgag ttgttcaca ttccttgcat cttgcctggg 414480
agatgatact ccacagccct tctccgttct tgctcttaat gtttcttctt ccaccactct 414540
tcctggagac aaggtctcac taaattactc aaatttgctt cttgcctgtt gatctcatgt 414600
agcagggatc acaggtccgt gccaccaggc tggacttctc tctttttggt gtcttagcca 414660
caaggtgagt agttttctca cgtgtaactg ggtgtgctgc ctctcatgg accgcaaagc 414720
gacgatgcca atcaaccatg ggctgaaacc cccaaagctg tgatccaaag taattttctc 414780

tttatgagct gcttagctca gttgtttgtt atggtgaagg aaactgacaa tcccaagcag 414840
tcaggagtga ggaacagtct agaaaagtga tgaggtcatc ttaaacagcc tgagtctgag 414900
gagaggagct ccccctcag aacacagctc aggatctcag cccaagagct aaccaactct 414960
tgaatagcaa gtcacaaaca cttgttctt ggatccacac aaaatcattt acagaggata 415020
gattctcccc ctcctgttt ctcaaatgca gaaatggaga attaaaaagg ctttaagttgc 415080
ttttttcccc aaggtcagag agcagattca gagtgaagct gggcttttga cctacaggtt 415140
tagtttgggt tttgtcactg tgacttctcc ccatacttt ctctaagtca agatattggc 415200

tgtgtgtact taatattttt tctttcacgg taactttatt caaatataat ttatctacca 415260
taaagcccac ctttgaaag acacacctca gtggttttta gtatctcac aaagccaggc 415320
agctgtctc tctgtgtaat tccaaaacca tgcaggaca tcccagagga atcccatgtg 415380
attgtgtttt cccccctccc cctaagagct ctctctttt ggtctctctc tgttcagata 415440
ttttatgtag gtgggatcat acaccctgtg gcctttttgt tggtttattt cacagggcat 415500
gatgtttcct aggttcatct gtgccatgtg tcagagactt tatctgtat agacatatcc 415560
tgttttgttc agecattcac tggctgatgg gtgtgttggt tccattcatt ggctgtcatg 415620

cataatgctg ctataagcat ttcaatacaa gtggttttta ggaaaatgtg tccttaagtc 415680
ccaggcgtag atctaggaat aggaattgta aagttctata gtaattctgt atttaagcat 415740
tttgagagac aaaaaagtg tttccagtgt gacattccta ttttatgttc tctccatcaa 415800

tgcacaagaa ttgcaagttc tctacatctt catcaacatt tattatnttc tattttctgat 415860
 catagctgtc ttaggggcag tgaactgagg tctcactgcg atttcattgg catttccctg 415920
 agggctaaca atttccatat gcttaatgat cactttcaaa tctttataat aaatattttc 415980
 ctattgaggc attaacatgt tttagtcctt tgctcttttt aaaagcttta tttatttcat 416040

 atgtatgggt gtttatcttg catgtatata cgcacatcac atacatgcag tgtcctcaga 416100
 ggccagaaga gaggttcaga tcctttggaa ctggagtaaa aggcaggtgt tagccacctt 416160
 gtgggagcct gggtcctctg gaagagcagc aagtgttctt aaccactgag ccatctctcc 416220
 agcacctgct gtgtccattt ttaatcagat tagtttacct tattgaaacg aattgtctaa 416280
 tatattctct atatgttcta gattcatttc cttagaaaaa aacctccaga tagttcacc 416340
 cattctttgt gttcttcttg tttttctcag tggactttt tgaaatagga acacttagat 416400
 tttgataata ttcaacacat actcaaaaaa tgccttgtgc catttaaagt taagaaatca 416460

 ttacttaatt cactacttaa ttcaagatca taacagtgc tcccattttt taaagcttta 416520
 ttgttttcat tcttattcat aagactattt gaattattha gtatatggaa tgaagcagaa 416580
 atacataaat attcactttt gctgacacac ttgcctgtca ttggaccaa aataacacaa 416640
 tataggttac agacataagc gtaaaatctg agactacata actactgaag aaaaaccaag 416700
 ggagaaaatc ttgttaacat tggctctaac atggatttat gaaaaagaaa cctcaaaaac 416760
 atgaaaaata aaagcaacca aggcaaatgg gattccgtta agttgaaaca tttctatact 416820
 gcagaaaaaa taatcaatgg agaaaacagg caccttcaga atgagagaat atatcagaaa 416880

 ctattacctc ataaaaagtt aacattcaat atacaaggaa ctcaatttaa taacaaaacc 416940
 caattttaa ttaggcaaaa gacctgaaat ggcaattctt aaaaagaga ttaacataac 417000
 taagcattag gaaatgtaa atcaaaacca caaggagatt caatctcaat ccagtcagga 417060
 taacttctat ccagaaaaaa aaaataagac caaaacaaa ccaaaacaac aatgacaaca 417120
 aaaacaaaca acaaaccaa aataaaaaa cccaaccaac caaaaacaaa aacaacaaaa 417180
 aacaacccca aaagataaca agtgccagtg agatacgcag aaaagaaacc tctatgcact 417240
 gttgatggga gcgtaaatta gaacactcat aggaatagga aacagtatgg agtggtgga 417300

 gagatggctc agcagttaag agcactggct gcacttgcag aggacctgag tttggtcac 417360
 agcaccata ctgtgcagct cataactgct ggtaactcca tctccagaga atctgatgtc 417420
 ctcttctggc ctccacaggt acctgaactc atgtgcacaa cacacacaca agacacacac 417480
 acacacacac acacacacac acacacattc agtcagaggt tactatcagg catcttctc 417540
 tatcattctc caattttatt cttttaggca gggctctctca ctgaacctaa gettatcatt 417600
 tcatcgaggc tgattggcta gtgaattcca aggatttctt cctgtctcca cttacctagt 417660

gctgggattc cagatgcacg ctgctgctgc atccagatth ttatgtgagt gctttggaca 417720

caactcaat tcagcaaata tgtaactgac agagccatct cccaactcc ctcttagaa 417780
ctgttctatg taccaaatca ggttgtctat caatataaat atcttttta tttttattc 417840
caatctatgt gcagtttatt tctctttctt gcctaattgc tatggctatt gcctccagta 417900
ctctgttga tagaagcctt agaaatagat atccttgtct ttgtctttat cttaaggag 417960
gcatttattt ttttaagctt ttaaaagaag cttttattta ttttatagta tgtgcattac 418020
aggaaacaaa acacaagaag ccaagaagag tctcccagtc acacacagct cagcttgctg 418080
tgtctgcta gatgctgcaa tgtacataca tttagggat tgagattata cagtatgat 418140

caagctttcc cccacattgt gaatattcac caactaaaa cccaatgct acatgagtat 418200
ttgttaacc aagaatacac ctgccatct caatctgtca gacaagactg taatcctgct 418260
ttccttggca acaaaatctc atagaagaca aaaatggcag caggcttcta gataagaagt 418320
actggcgaag ttacaattag aattctgcat ttggaggcat ttattttgac cattagaggg 418380
catcatgtag atctttgaca gatactttat cccgttgaag gaattctttt ttgttcctaa 418440
ttggccttgc atctttcgc atgaaagagc actgaattht gttacatatt getgcagata 418500
ctgagatgga tigtatgat ttgtctttta ttgtctttta cattacactg atctattctt 418560

tatgttgatg caacctagaa ttagtcttac ttatgttaat agtcctttt tatatgttgc 418620
taaattgagt tcagtgattt tctaaaaata tttttcatc agtatgcaga gagatattag 418680
tctttaattt ttttgtttht taattttgta tcagtatagt actgttctta tgtgagttgg 418740
tgagagttat tgtttctgtht ttatagacga ggctttttaa aataatattc ttatttattc 418800
ttggaaaatt tagtgtgtgt atgtaatgia ttttgatcat acccatctc acttcctcca 418860
ttcagtttct ctgggatcc cacageccat ctcttctcc acttcagcc ctcttatage 418920
atthataaat atcttctttt gtttttagta ataacattta tctagatat gtttacttta 418980

ttattatage tagtctactc atctttgat gatattgca caacatctt cccctcaaac 419040
ttgcttttac tctgtctctt aaagtcta atgctcttct gtcaataata gggagattag 419100
agttagcatc tgggttttgt ctgtttactt gttgtaccaa tctctgtcat ctggttgatg 419160
tttttaaat ttgcttctaa tgtcactgtht gataattggg atatatgctt gtcattagct 419220
agttttagtht tgtgttttcc tattttactc cattatttct caattactgc ctctttttgc 419280
atcaggcaga tattttctat tttattattt tgattccttg gttgtatttt tggcaggtgt 419340
gtgtgtgtgt gtgtgtgtgt gtgtgtgtgt gtgtgtgctt gcctttggat accaaaggtg 419400

caccttgaat gtggttcctc aagagttgcc caccttggct ttgtttgttt gtttgttttt 419460
gagacacatt ctctccctgg gaccaagtc ttgcagatta agctagattg gctggctagt 419520
gagtctcctg tcttatgggt cctgtcttca ccttcccagg gctgggagta caaacacatg 419580
ccaccatgcc cagcttttga catggctgct gctggagata gaacctaggt ccttgtgatt 419640
atgcagcaag cattttacca actgagctat ctcttcaaca ccttaaattg tagctttcaa 419700
ttttgttttt tttttgttt tgtttttttg tttttttttt agtttttccc tgggattaca 419760
aataacacct taatttagaa cagcctgggt tgagataatg ccaacttcat ttcaacaata 419820

tagaatgctt tttctccagt acagatgttt tatccttctc tcttgatcta ctattgtcat 419880
catattgcat ctttatgcat ttttaagccca caaatgattc tatagttgtt gcatttggaa 419940
cttgtctttt aaatcacgta ggagaaaagg ttataaatgg agctattata cactgtcttc 420000
cgcatgtgcc ctgtgtagtt atttttattg gtgggtttta tttctttgta tgatttgagt 420060
tattacctag tgictataat ttcccccaa agggcaagtc tgatagctgt gagttatfff 420120
cactcctgtt gatttaagac gatcttaatt tctctagttt ttcaatgttt ctttcacaga 420180
aatagtatff ttggctgata gtcttttaac acttggagta tatcatccta ctgctgtctg 420240

tcatttatgg tttctgacag gaagccggct gttaggaaat tatccaaga attgacgagg 420300
gaatgaaaaa gttctgcaca gagaaggaaa gaaccagtag agtaaggga ccagctacag 420360
aatggaagaa aaacctttgc cageccacaca tctgataagg gatcagtgcc ttgaatatat 420420
gaagaactaa aaaagttaag cacctctcca caaataattc aaacgataag tgggctagtg 420480
aattgaacgg acaattctca aaagatgaaa tacaaatgaa ccataaatac tgtttaaaag 420540
ttcaacagcc ttagccacta gggaaatgca aaattgtaaa tgtgtttaga tttcatctca 420600
cacaaatgag aagctggaaa gatggcttaa aggttaagag cgttggttgc tcttcctgag 420660

gaccaggta aaatccctag cacctaaatg gcaccaaggc ctgtagtttt gggggaatct 420720
aatgcctctt ctggcttcca caggcaacgc acaaatgtgg gatttaaggg gaagggcct 420780
aaaatgaggg aacagaagag atttagagaa ggcaataagg agaaaaacat aaaatatcac 420840
acattttcct ctcatffact gatttttttt gttatggtaa agcatcaaga acaatatgta 420900
gaacataaag ggtaattta gtttaccatt ccggggggag agtccctaat ggcaggaagg 420960
catgacagca ggtgaccaga acaagaaaga agcttatata taagatfff caactgcaat 421020
caggaagcag aggatgctaa ctggaagagg agcacagcca tggctcccaa agacttacc 421080

ctgtgacatg ctctctcaa caagctgca tctcccacag gttccacaac ctctcaage 421140
agcaccacta actggggacc aagtgttca ctaactgagc ctatggcaga cattgctcat 421200
ttaaactgcc atatatgca agcacaggct taatacata cacagagaga gatggtagaa 421260

aaaactaaag gcagactact tgggggaaga ggaccagcaa gaggaggga aggaaggggc 421320
 ggggtaagg gaggagcaaa tatgagcatg gtacaatgta agctatgaaa gtcaccattt 421380
 tgcattgctaa ctttaattaat caaaatgtca accatgtatt catgaacttc tttcttttgt 421440
 tgttgcaag agictgtgct ttgtgctttg tgctttggca atttgaaaat atcctttcca 421500

 ggggtagaac tctgaattta tctactagg agtttgctga acttattgga tgtgtagttt 421560
 aatgtttcaa tccaagagga agcatttcaa ccatccttgg ttcaattttt ctttctttac 421620
 tctctctct atctctctaa ggatccaact gtgcatgcat gggtttgctt tgtggtagca 421680
 tacagatttc taatgcttgt gtgtttgtat tggctcctgg actgggcagc ctcatattgt 421740
 gaggcttttg gatttctga tcttttctcc tgttacctaa agtctaattg tgggtcctgt 421800
 gacagttaat ttaagtgtc agcttgacca ggttaaggaa ttcctcagct agccgagaaa 421860
 gcattatggt tatgtctgtg aggggaacc tagaaacaac tggaatttga atcagtgagc 421920

 tggataagga gaacctgact ttaccattg tggtagagg cacagcaaag ttagttgagg 421980
 acctgaatag agcaagaaag tgaagaaag gcatgaattt ctatatctgg atgagatcta 422040
 gagatctaga tctgagtagg atggatataca gacagagtcc tagttagcac taattgtcaa 422100
 ctttatacag cctagagtca tttgagaagg aagtcttctg tgaggaattg cctgaatcgg 422160
 attggcctat gggtttgttt gtaggggatt gtcttgattg ttaattgatg caggaggggc 422220
 cagccccagg tggatgttac catcctaagt aggtagaact cactgtatga gaatctagct 422280
 gtcttagtta gaggttctat tctgtgata aaaataccat gacaaaaagc aacttgaga 422340

 gaaaggggtt tatttcattt tacagcttat agtccatcac ctaagagaat cagggcagga 422400
 actcaagaca ggagcctgga gccaggaacc aatgtagagg ccacaaagaa atgttgctca 422460
 ctggcttctt cttctggtt tactcattct tctttcttat agaaccaagg accaccagct 422520
 caagaatgga actgcccaca gtgagctagg cctcccaca tcaaccatac attttctaaa 422580
 aagtgtccca cagggtgtcc ccctggccag cctgatagga gactgttctt acttaggct 422640
 ttttttccc aaatgactct agcttgtgtc aagtcgacat aaaactagcc agagcattga 422700
 ctatgcagga gtcttggtgg gcctatttca agttcttgc ctgaatttcc tcagtgatgg 422760

 actgcaacct gtacaaaag cagaaagaaa ctttttctt tcttaagctg tttatgtca 422820
 tagtatgtt cacaaccact gaaagcctaa atagacagaa taaaagacag acagacagac 422880
 agacagacag acagattgat tgattctggg ctttgagaa cgttgactaa aatagtcct 422940
 cagttatttt tttccaact ttttaattt gaattagaaa caggattgtt ttacatgaca 423000
 atcccagttc ctttctccca tccgtctca cctaccacce cccccccaa atcttatctg 423060
 tcacatatct tttctgctct ccctggatgg tgaggccttc tatagggtgt catcctcagt 423120

tttttttttt atttcaatta ttgttccttt ctgatctcaa gtctctatth ggcactgtgg 423180

 gtactttctg ttttcttatt gatgtcatct atttagtgaa gtgtcattct caaaccttaa 423240
 ttcattagct tttagtgatt aatatttgaa catactatag ctgacaatgt ctccatcatc 423300
 caagtccaac atctgggctt ccttacagaa agttgttact gactgtctca ccacctgtct 423360
 aggccacagt ttccaagttt ctttgtgtgg ctcttaagtt ttcttgcca cgatgaacat 423420
 aaactgttat atcctagaat ctgatccttc cttctcctag tgactatgat getacaaatg 423480
 ccgttgcttc tgttaccctt cttttccctt ccaagatagg gcttctctgt agctttggag 423540
 gctgtcctgg aactcactct gtagaccagg ctggtcttga actcatagag atcctcctgc 423600

 ctctgcctcc caagtgtctg gattaaaggt gtgtgccacc actgcctgga ttttgttagt 423660
 tcttttagtaa ctcttgatt tggataaaat acatattttt tgtcatatgg gactatcгаа 423720
 gtatccactt gtgagcttag aaatttaatg atggcaaaaa gacttcattg gatgggtcaa 423780
 caactaaatt tcccatcttt tctgatggga cccatggcat gttgcagcac gttttttgtg 423840
 tacatgataa ctctacctta gcatctatgt cctgctatcc cagagcctga aggtcaagga 423900
 gaagcaagaa ctcttgctt tcttgtctc tctcctctc tccctggct tgaacaaaac 423960
 tctagatatt tgaaggctc cttagattgca tgtgaccac tagacactct tggcatttct 424020

 gtttttaagt ttgtttggtt tgggtgggaag agacaagctc tcacgtagcc caagctgatg 424080
 ttaaaccact gattatctta tctctacctt ccaagtggct tttaaagatt cttagtaaac 424140
 ctcttagctg agactggaca tgatgccttg ggcatctgtg acattaaata attgtagctg 424200
 agtgttttct gtggctgctt aggggggaga tgtttgcaca cagctctgat ctggaccaa 424260
 taaagacaga tcttggaatg gaactttgca gcaggctgcc aaatcattga gtagtgacac 424320
 tctattgggg atacaatttt taaggagct ccaagcctct ctgctttctt cagtgactgt 424380
 tggatttcta gtttcagttt ccatatttcc tagacttttg acctttccat ggacatgggt 424440

 ggagggagtg gaggttgggtt cagtgaaaac ttgaggctga acctgatctg gactgtccag 424500
 ggttctgagg tcaaatctg atccaagtca aaagacgaag taaataagtt gcacatcctt 424560
 actggcgtgg ctctcttctt aaataacaag gctgtcagta tttcaaaaga aactgtaact 424620
 gacaatgcca agtgctggca aggataggag tgactcaagc tctcatccac tgatggtggg 424680
 aatgcaaaat agcaagccgc tctggaaaac agttcccat tttggataaa gccaaacaca 424740
 cgctttctgt tggataccac agtctcattc tgtgatattt actcgaggga aaagaaagca 424800
 tgtccttgc t aacatctaca tgtgaatgtt tatagctgct ttgtgcatat cacaacacca 424860

agggagaata tgttcttcaa ctggcaaaaa aataaacaata tgaggtacaa gcacacagca 424920
 gaattacatt tggaaaaaaaa aacaaatttc ttatattcca atgacatgga tgaatctcag 424980
 tggtttacc caaaggaaac cagactcaaa caactgaaga tggggtgatt ttatttatag 425040
 catggcttac aaaaggcaga ggtcgtcaga gagcctggag atcagaaaag aaaagaaaag 425100
 gtatgaata ttttgaggtt tgttttgttt tgttttgttt tgttttttga gacagggttt 425160
 ctctgtattg ctttgagggc ttcttggaac tagctcttgt agaccaggct ggtctggaac 425220
 tcacagagat ctgcctgcct ctgcctctgc ctccgccttc caagtgtctgg gactaaaggc 425280

 atgtgccacc actgcccggc tggatgaaa tttttgata gaagggtga ttagcagtt 425340
 gaatgcttg attcaacagg ggtggttcag ggattgtgcc ttttctacat tggaaatag 425400
 tatagatgta caataaaggc caaacttatt atatatgta tacattaatt taaaaagta 425460
 gaaataggaa aagaaagagg caggggagga ggagaggttg actctgtttt attagtctca 425520
 gtaaagaaaa cctattacta ttattattat tattattatt attattatta ttagttaaat 425580
 gtattcaatt atttacctc ctgactgcaa tttccctccc ctcttactc ctatccctga 425640
 ccaagccact tctcctctgt ttctgttcag aaaggggcag gcttctctgt gtgtcaacaa 425700

 atcatggccc atcaagtgtt ggtagaacta agctccttcc cttgaattaa ggttgggcaa 425760
 ggcaaccagc tatgaggaat aggttctctgg aagccagcca aagccttagg gacaggccct 425820
 tcttccatca ctaggagtc cacaagtaga tcaagctatt acacatatgt agagggtcta 425880
 ggttggctcc atgtcagctc cctagctgtt ggtccagagt tggagctcct atgagcctgt 425940
 tagtttttcc tgagggttcc cttgtgatga ccttgaagcc tcttgggtag tacaatccct 426000
 cctccatctc ttcaacagga ttccatgagc tcggccagtg cttggctgtg gatctctgca 426060
 tctgtttcca tcttctctgg atgaagtctc tctgatgaca attgtgaagg ttaccaattg 426120

 attacaagag aagtccagtt caggetacct atccactatt gctgggagtc ttaactgagg 426180
 tcatccttgt agattcgtgg gatttcccct tggaccaggt ttctacctga ccccaaatg 426240
 cctccaaca agatgtctct ttcatgtctt ccctccacc ccctaacce aatcccttat 426300
 gtcccatte ctgctggccc ctgtctatcg aggagatcta tttccccttc ccaggggaat 426360
 ccatgtgtgt ccatcctccc ttgggctctc cttgttacc agcctctctg tctatggatt 426420
 atagcatgat tatcctttat ttacagcta atatctgctt acgagagagt acagaccatg 426480
 tttgtcttcc taggtctgtg ttacctcact caggatgatt ttttttcca tctagtctc 426540

 atccatttgc cttcaaattt cctaagtca ttttttttaa cagctgagta atacgccatt 426600
 gtgtaaatgt accacagttt ctttatccat tctttggttg aggggcatct aggctgttcc 426660
 caggttcttg ctattatgaa taatgccttt tgaacaccga ggtctgggtt gtatcttggg 426720

cagcttcctg caggaagctt cttaggtctg aacttctctc caactaactg aaaatttaga 426780
 taccagata gctcagttga gagggatatt agtgccattc cagtttaac aacagctttg 426840
 tgctggggtc actctctccc aagagcactt tctgaccatt gccaacctct ggggcatgtt 426900
 ggggttccta cagccattgt aagatgcagg taccttgatt ctgagatgat cagatcctag 426960

 ccattgctgg agctacagct gagggtgcta ccagtagctg accactcctt tgcaagctga 427020
 gctttgttta tectatagtt ggagatcatg gtataaagaa aatcaggcac cagcaccata 427080
 ggtggaactt gtaacacata gcttagaaac cattgttctc cgttctgggtg cagagtaaat 427140
 acttgcttgg ttacactttt gaaatctata tgaaaagact atcagctaaa tagaggtgtt 427200
 gcacaaggaa agacgttcag atatcaaaca ttcaagaggg agaaggcctt gtgatgtgag 427260
 tagatcctgc tctgattaca tactgtctac agaggggaagg cttcactggg tgtgggtttg 427320
 gattcacact gctttctact gtgaaggtct ggaaaggtgc tggggccagg gtggctgcca 427380

 tcccagtgga gacacacagt gaccttaact gtcaagcatc ttcggcttgt agtcttgaac 427440
 tttcttctta ggcaggatgt ggcttctca ctccatgcta atggatcaag atgatgcaaa 427500
 gcaatccttg agagaagctg aaggagaggg gaagttgtgg gtacatcctt gagccatcta 427560
 aggctgtttc ctccccctcc tttcttggct tgttctgtta ggaaggaggg cactaaaga 427620
 aggacgtggg atcctctggc tcagagaagc tgcagtttgg acttagcgag cacagtggag 427680
 ttctcaaage tcctctggg tgggtgagac tgcagttctgt agtgagagca tccgaaggag 427740
 gaacagctgc cgggtgttgc aggtgcacac tcggcactgt ggtgggagac tcttagacag 427800

 catgtgtgaa ttggagttta ggactacaca gttgaaacct ccaatgggag attaaagtca 427860
 ctgcttaaag tagatgtttc agggctgtgt agacggctca gctgttatga gcatgiactg 427920
 ttcttcaga gaactcatat ttggttcca gaatccagtc tggaatctca caccactgtt 427980
 aactccagtt caagatgcac ctagtcteca tgagcaettg tacattctct ctctctctct 428040
 ctctctctct ctctctctct ctctctctct ctctctcaca tattctcatg cacacaaaat 428100
 ttaaaattgc taagaaatag atcttctaag atggttgttg cctgccaaca gtggcaatgg 428160
 gatgggggaa agtcagcaat ccagtgtgct gggggtgtgc tctagagtgg agaattttcc 428220

 tcttggattt ggatggagtg aatcagagtg tatcagagtg tttacaaaa cactgtagaa 428280
 tcttcaaaca tcttaataa atgacacaga ctctcatttc tggcagttct cagggtcttt 428340
 ataacttttc ctgttttttt ttttttttt ttttttttt tttgtggctc atcccactca 428400
 accaagtaag ttatattaaa atagaccaac actgaggaac agcaagcagc aagctgagge 428460
 tgctgctaag ggtttagatg ggcatcttgg gctcctagga aacctcttgg ctgtgactec 428520
 aaagctccat gcatctttct gaacttattc tgcaccctc tacagtcttg gtccatgtcc 428580

cagtgtgacc cacttgtccc ctatgtccca tatccagtcc atttatacctg ctgttggatt 428640

 gcagtatagc ctttaggctg gaagggatgt attaacaatg aatctgttgc actttgattc 428700
 cttattgtcc tgtagctatc tcctctgaac tgaagcattc tccttggagg gagaaggagg 428760
 gttcctaaga ctttgggagc taactaaggt tacaaggccc aggaagctca tgaagttac 428820
 aaggtccttt ccaaatgca taaactgtaa gcaatcagtg gagacgcctg tagcttgagc 428880
 agggggctcc acgcatgcag ctctcattgt ttcttgccag tgcagggata ggccctctgg 428940
 tgatgcagct gcctttgagt cagccatgcc ccaggaagta gtcctcgcg catgcttctg 429000
 taagtaaccg ctgtaacctt gcctaactaa ggatttgcgt gcaagccttt ctttggctg 429060

 tccgtggtgc ccigtctggg gtgcgtagat gtgtgttcat atctcctcag gaagaaatag 429120
 agcaaccctt attttaact aataaggggc atgggtgtgt ggagtttat aggtgtgtgt 429180
 gtgtgtgtgt gtgtgtgtgt gtgtgtgtgt gtgcgcgcgt gcgcgcctgg cttatgtgtg 429240
 ggtgctggtc ctctgtttg cacagcaagc cctttactaa ctgagccact ttccagccgt 429300
 gttaatagtt tgtaatgatg aaacactgat aactgacact taactttgct ataggatgaa 429360
 ttacctttcc tagaacttta catattgaag tcctaacccc cacggagtct gtatttggag 429420
 gaaggacat taagaagaaa ttaaggcaa atgaagctga aaagtgcaa tcctcaccta 429480

 atcacattgc cattcacata aaggagaaa cagagaccaa gatatgcaca cagagatggg 429540
 ccaagtgagg tcctagcagc aagctggcca tctgcaagcc aggggaaact gcaggagaag 429600
 ctacatcacc agttccaga ctctagaatg atgagaatga atttctatta gttaaagccat 429660
 cctgcctgtc gcattttgct gtggatttta tagtagtcta ttaactttact gtgaactgaa 429720
 accagttaag tgctttatat ccattatfff aagtaaggtc ttttaagtct tttaaagcaag 429780
 gtcattgat aatccccagc gcatagatag ggaaacacta gtgaataaaa tcagtactga 429840
 gacttgaact ccagtctgct aactgaaaag ctgtgcacat atgttgaaca caaggetacc 429900

 tcaaaagaaa gcatatggtc tagactgctc tcagagatgg gcctgtttgt gttggacttt 429960
 aatgcttgtg tgtgtgtgtg tgtgtgtgtg tgtgagagag agagagagag ggagagagag 430020
 agagagagag agagagagag agaagagagt gtgtgcatgt gtgcggaggc cagaagtcaa 430080
 tggcctatca gcattgtcca tgggaaacc tgactctgac agtgacagag ggctgtcat 430140
 agctccccta aagctaagtc catgtcttaa ttgaaggaat ctgtgactat accatatatg 430200
 gtacaatagt gaacaccacc ttacatggca aaaggcatga tgatttaagg aagaggggct 430260
 tgtcctggtt tatacagggg gaaatctaaa tgctttcaca ggtgccaaaa gaaagagaca 430320

aagattgatg gcacagatgg aggaggagga ggaggaggag gaggaggagg agggggaggg 430380
ggggaacca gagaggggag aaagcaaggt gaagactgaa cacagagaga agcagctaca 430440
agtcatggga ttccaacagc ttgggtttgg acattgggct cctagaccta tgaggaagtc 430500
aattgttgtt gaagctaccg agtttgggtt ggctccttca gagactcaga caggagcctt 430560
agacacctcc gtgactcctc tgaatgagc atgtgaagtt aaggigatgg ctgtagccca 430620
ctggtgacga tgetacacca ccctcacctc cctatgtagt caccaacatg tatgaaagtg 430680
ttgagatggc tggacagatg gctctggctg tggaggacta actgctgggc aagcatgaag 430740

gctggagttt ggatacttgg cagccaccaa aaagtacttt agggcaaagg ggtctataac 430800
tcccaccctt gggggaaggg gaatagagac aggggaatcc ttaatgttca ttggccagac 430860
agtctagcca atccatgagc tctgtgttca gtgggagatc ctgtcttaac aataaggtgc 430920
atgacacctg gtgctgaagg ttttgaagta tgaacatcct cccaaagcaa ctggcaggca 430980
ctacctggag ggtgagttaa ggagccctcc aggtgagtct gttggtacca gccccagtt 431040
ctgtgttcag atctgacagt ttgcatagtc tgtgataccc attgccctc atccccccac 431100
cacaagcctc aaagaaccac gtgaagtttt gagcagtgag aaaactatga atttccagag 431160

tagaaatgga gggctcctgga ggccaccaa gacaggtagg gaacaggaga ggagcacagt 431220
ggtggctgca gtggaggcca gccacctggg aggtctagga gcctcaaaaa cagcacggtg 431280
gaggggcca cgccaggcac ctgtgaaaat agcaaatact tgagccagag aggcaacaca 431340
tcctgcctg ctcccagagg ctccccaccg aggcaaggat caccaggccg gggatgatgtg 431400
tctcccagg tgtctgcgtc ccttgggccc cacaggaatt tgacatgggc aaccacttca 431460
ggctgcagaa aagatactgg agaagggaaa aaggaaagag agggaggagg aggaaggaga 431520
gggaggggag ggagagaagg agagagagag agagagagag agagagagag agagnnnnnn 431580

nnnnnnnnnn nnnnnnnnnn nnnnnnnnnn nnnnnnnnnn nnnnnnnnnn nnnnnnnnnn 431640
nnnnnnnnnn nnnnnnnnnn nnnnnnnnnn nnnnnnnnnn nnnnnnnnnn nnnnnnnnnn 431700
nnnnnnngtg tggaagagag agagagagac agagggagag agagagagag ggggagagag 431760
agatagagag agagagagag agagagagtt ttatggcta agacagcttg ctctgcctc 431820
ctcccctcct gcttgtccag gctgggggac cctgatgagc cagaaagttc tctgggaagc 431880
agggggcttg ggagggggtg ggaggctctc ccccaccaca cagctgacag aacttgaga 431940
actttccttc ccaagcctgt atcctgctgg ttcggggcaa agtgtgcagg tttcccacca 432000

ggatcagtga gaaacggcc tggtttgac tcaaacatgc tgattgttt tctcaacagg 432060
gccccagctc cattcagga gccgggagat gccgcctttt ccagggtgcc tcccctccc 432120
ttccgagaa cacatcacc agtgtctgta aggcttctgc ttctgtttg acatccctta 432180

ttacaaagc aaacagaacg ttccttttaa cacacatcat gctaagtta ttaatgcaga 432240
 aaacaatccc aggaggccga cccgggggcc cegtgaacc tgccagcaca aactcttcaa 432300
 aagctcaggc cggcagatcc tccaggacaa tatttcacac aatggagtaa aaataatatt 432360
 tttctttgga cctttccagc cgcttttggc gcgagcagac agaaattatt ttcttactct 432420

 gctcccagac cagaactcta gatgaagcag cgtttatttg tttaacacaa tgatttcac 432480
 ctaaagtctc cgacagcaaa tagttgggtg ctaataaag ggcccttgaa aggaggctgg 432540
 ggctggggaa atgtggggct gtggctctca ggagccaat gggccagtct gctgagattg 432600
 ggttccccct cagcctgttg gggagccctg tggggaagca tgctactgcc ccttgatca 432660
 caaaccttac actgctggca cttggagacc gcaggagact gagaatttgg tcccaaatgg 432720
 caggccttct ccaagatggg ccctgcaaaa tacagatgga cataaccac aggcagatac 432780
 tcaaccctgt gaggagaaaa gagaactttt gtgttcattt ctgctttccc ctgattaaaa 432840

 atgatgtctt ctgtcaacca aaagtggct gctattctga tgccagctgg gacttctgca 432900
 gccaggcctc ttgattagga gaagagagag ggaacatggc cagcttaggc agaagaatcc 432960
 tccaatcaac agacacttca ctcagccagc taggacaaa gctccctgga cactttcaaa 433020
 gtgcaatcag acgtgtcaac aagaactcca aagggtgtt tgcatctcac tcttttctt 433080
 gggaagaact ggaagggag tgaatgaaa cagagcacac agaagaaaa ccaggaggaa 433140
 gtgaattgta gccaaacttc cagggtccct ggccatcaga gcctagccac cactacacag 433200
 aaaggagggt gggagtatgt ctcaggacac ccagttgtag gagacagggc ctgattggaa 433260

 ccaggcatct gtgtccatgg taggagaaaag aggccagtct tgcctacag ctgaatggca 433320
 agtctcattt tggcaaccag gacttagatg gaacatctcc cctacttcat gactgaatct 433380
 gattcagttc ctggagattt ggtgcctgaa acaacttatt tagatctgag tttgttgcta 433440
 gtctcaacag gggagaagga ctatgttctc acgtatagct acttctaaca ttaaatcaac 433500
 actggtttac tgaaggctgt attgatgaat gtgcacaagt ataacaaga taattactta 433560
 ggccaactca tgataacata cttctgttga ttaattggtc tatcttctct tagtctctta 433620
 gtttctttt ttctctatgc ttttctctt gttattttac aagatgaaaa tatccaaagt 433680

 tgtttatfff tgaagttfff ttgggtcttg agcttcttgc atalcatgct acaaacaca 433740
 gcatttaaat gactgtttga tgctatttca tgetgtagct tatggtgcag ggtattctcc 433800
 agtcccatg ctggttgacg tatacagggt ggtcttgagg actgccagc tgtgtgggaa 433860
 atatgcagaa ggcctagca ttccaaagc aatttaaact tctttccctc agtcttacag 433920
 aggcttcaga ttgcctcaa acccacagct tgacctgccc tcagccccc ttatctttt 433980
 tctactgttt attttctct cttcttccc agacctgaaa taagcagata ttaactctc 434040

agacctgctt ggiatnttac actcccaaag aggtttcaca gaagtgacat tntttgattg 434100

 tcatcaaac cctgcagcct gggcatggag gaatgacctc catttcacaa gcaggaagtg 434160
 tntttgagcc tggcattttg atagtcactg gaggagggac ccaaagaaac tggttcttgt 434220
 ctttggtagt tcttagtcca ggaattcagt agatgatggt tagtcttatt tttggcttat 434280
 atgacttagt tctaccacac gggcaaaaag tggctcaggg aagtaacctt gcacaccctt 434340
 actttctgga ctccatccct tctaccactt ggcatgactg atgaccatta gccacaagta 434400
 ggcccatcct tgggaaggaa gtcaggctag ggagatggtg gggatttcaa acccctggca 434460
 ccctctagca caagcccag tacaagttcc taaccctga atcagcttct aaggggagtg 434520

 agttggtcca tctgttgaac ctttcttaat gttggttaata aaatagatca tttgtcattt 434580
 aatgaacacg tntttgtttg aggacaattt ctgtattctt caagaaggaa aaggaagtac 434640
 cagaaaaact tcccatgggc cactttttat tttggatgct ttgcaaacat tcttctgttt 434700
 aagtcaaat cacaaggctc ttgcatatgc taggaaagca ctccaccaat cagccgcacc 434760
 cctggcctcc tgctctgtta atcacttagg tactaatcag ttctcaacct gtgggtcaaa 434820
 acctcttggg ggccaccaa taacccttc acaggggcca cctaatacaga aaacacagat 434880
 attacatta cagttcataa cagtagcaat attacagtta tgaagtagct acgaaaatat 434940

 tttatggttg gggccaccac aacatgcgga actgtattaa agggttgcaa catcttgaaa 435000
 gttgagaacc actggcttag gatctactta tcacaatgag cctatgaact gtttgcttca 435060
 tcagaggcaa tggtttggat gtcccatttg tagacgagta atggatgctc tgagggatta 435120
 ggcaacctgt actctgtcac atagtatgaa atggaattga aatagaaac cagtctactg 435180
 gctctagcac tgcattttt ccaccactgt acccttggta aactgtatac atcatccagg 435240
 ccatgggaa ctattcagcc tccatgggta tgacagtca gaaacttcaa ttcatagtgc 435300
 actgactage ctcccattca tctttgtctc tttacagttc cttagcactt gccatgaaac 435360

 agcccttgcct ggttcttctt gattgnttg gcttctctg tcttacatca tcaactgcat 435420
 gggactctag agcatgagac tgttaatctc aggtctgtgg gttcaagccc ctgntgggca 435480
 ccaaaatgnt gntggntgnt ttattcttta ctctttgctc tntttgtggg gccccacc 435540
 cagctcccaa gtaaacaca gagtcttatt attacttata aatgccagc cttagcttgg 435600
 ctgnttctt tccagntttt tnttaaaact taaattatcc catctacctt tngtctctgg 435660
 gctnttatct ttctctatnt ctgtatatct tttcatgect tcttattctg tngtctagctg 435720
 tngtctgtg tgactggccc cttntttctt cattcttca tatactntt ctttcttnta 435780

attctctcag cctgccagcc ccacctatcc tttctcctgc ctcaatattg gctattcagc 435840
 tctttattag gccatcaggt gttttaaatg gtcaaagaat caaagcttca cagagttgaa 435900
 caaatgcaat ataaaaaaag gcaacacatc tttgcatcac taaaacaaat gttccacagc 435960
 ataaacaagt gtaacaggcc ttgaaataat attccacaac agggatctga ttcctaaaga 436020
 ggagagtatg ctactttaag gactgctgga ctatctctg cgaaggcaga ctgtgcttgc 436080
 atctcagttc catttctgac tagctattga cctagtactg ctgcctaate actcagaata 436140
 taatctgttc ctgtgtaaac tgggcattca ctcacccagt tattttcaga agaagctaat 436200

 acaaaaaacta aggtcaaatt ttgtcactgt cccttgtgga catgttatgg tccttactag 436260
 agatccagca gcaggagttg acagcttttc aaggagctgc ctcttgaagc cttggaacac 436320
 ccatgatctc acctgatgcc ctgatcctgc aggagctaat tgttagatcc agaaggaaaa 436380
 attctttata gtagaactgc ctgcttagca cacatgtctt tgaattgatt acatagttca 436440
 tcatacagat gcctgtgtag gaatatagac ccttggagct tgtatttcat gtatttccaa 436500
 gatgtacaat gttgtaagat gtttaaaaca gaagtagatg aaatgaaatc agagttgact 436560
 aaactgattt tgctctttct gatagtgagg tcgtgttggg aacacttcta ttgacataag 436620

 aacacattac ttagcaaagg tttagaagca gtctctggga atatccagtt gatgccaaaa 436680
 aaaccacagc agtgctgtgt gagcaagaaa attgatctgt gtcaagaaga gttgcttttg 436740
 gctctggagg atatttgaag tcacttcttc attctccccc tccatcctgt cccaagatac 436800
 acttgttcaa gtatttggtg tgccctggatc tgactaatac cagcaaaata ttttctggac 436860
 tgttctagta tgatttcttt gtcttcatca cctaagtgtg agtcttactg aagcagactt 436920
 tgagcagcct gcctgcttgg agccttcttt cctttcttcc ttccttcttt ccttccccc 436980
 tccatctctt tcttctccc atttttcatt ccttcttccc ccttcttccc ctcaccttcc 437040

 ccttctcttt cttttttatt ttttagatgga tagaggtttt ccaaacagtg gttttatttt 437100
 gaaacttga gaaagtaata ccatcctttc tgaataactt gttttggatc tcaaaatgta 437160
 acctgatgct cctgatcagc attttctctt catggaactc tgcctttatc tcgtagcctc 437220
 ctttaagttac ccagtcagcc tgaatcaaat ctaacatagt tccatggagt ttttattgta 437280
 gttcaccttc gttgacttgc aatgtgcatt cctaacaatg atgtaaatgt aatgatatc 437340
 attggttagg atactgaaca gagtattctg atttaacacc tggcctaaaa taccacactg 437400
 ttttactcag agcaaccagg caacagagtt actttaagac ctcaagttca ttatcatcag 437460

 atcattttaa gctctgtgac aacttttgac accttcata tctatcacag atcaaaagag 437520
 gatcctcaaa cagaacaata acactgagtg aaagttacat aaagtcttcc tctattagaa 437580
 gagtttattt tggccctcca aatatcatct tttatggatt cccatagatc cctgtgtact 437640

agttgttttt ctattactgt gataaagttc atgatcaagg caacgtttaa aagaaagcat 437700
 tttattgggc ttatagtcc agagagtcag tccatgatga cagagtgaag gtgtggtgac 437760
 agcaacatct aggaaggaga gtttacctct cagacagcga gcagtggcag agagaacact 437820
 gggaatgaca caagtctttt gaaacttcaa agcccatccc cagtgcacaca cctcctccaa 437880

 ggctgcacct cctaactctc cccaaacagt tctaccaact ggagaccaag aactcaata 437940
 gctgagctta tagggccatt ctcttcaaa ccaccactca gtgattcttc atagttggag 438000
 tttcaagcct catagtgatt ttcttgggta tgttagttct taaaaattca gaaaaatgg 438060
 ctttcgatgt ttacataaa aatggtcata agtaggctcc agaagatgga gaataaaaag 438120
 actagccagc tcagaatttg agggcttctt ctgtatattg tttgatcaca cacacacaca 438180
 cacacacaca cacacacaca cacacacaca cacaagactt agagttgaaa atgtccataa 438240
 gtgtagttag gaaatgcccc aacaaaagcc tgccttctca agccaccaga ctagtaaagc 438300

 tgtaacttag gaaaacagaa aaataaaca ataaactg ttttcaatca aacacatag 438360
 aagaaatttc agctttattt catcgtggca acaaaggcca aactcccag gcacacagga 438420
 ttctagttaa gcactccagt ccctcatctt aatggagcca gaggagtca aatataaagc 438480
 caggactttg atcccttcta gttataaaca atccctgctc tccacatga tgtcattgag 438540
 gacaatatgg gaaacagga ctccacctc accagcaata gtaagtcacc cttttcttc 438600
 ccaactcagg taicaaggag gctaagttag agtcaggact ttcacaactg cccaatgata 438660
 acaaatctac tccaattaaa tctcagcaac atcccttggg gaccagAAC tcttatatcc 438720

 acccagaaat aatgaggacc accccacttt agatatcagt gttgggcaag tgaggactg 438780
 ggcttctacc tccacctgtt agttacaagc tgaccttgt tgctacaggg cctatgggag 438840
 aaagactctt aactttcaag tcttagcaa aggaaagatg aaaaaaaaaa ggatgaagag 438900
 gagctaagaa ataacagctg aaattttctc aatttttctg gtgaaatgac tgtgatcaac 438960
 acacacacac acacacacaa ttaggaacag gaatacaca taaattgttc ataatcaaac 439020
 ttctgaaaaa ctaaagacaa aagtcttggg agccactaga gtgggtaag acagcttctc 439080
 tttaaagga agaccgaagg ccaggagca gctaatagga tgaggatgaa gtgctcct 439140

 gaagaaggat ctgcctacc agatcttaca tctagagaaa attgacctc tgaaaaatg 439200
 gaaagagaag tataccagc caaaggaaaa tggagagggt ctgtcaccac cagatctgtt 439260
 gtgaaaggat ggctgtcaag aataatctag acaaaaagga agtaaatgaa gggatcttgg 439320
 cataccagga tgggaacaca cactaagc aaacacgttt gtgaacaaga ttcacttcc 439380
 atagtttggg ttttgaatt attcttattt ttattattat caaatgacag tttggaaaat 439440
 taccacattg tctgatatag ttttaagtta tatatagaaa acattggagt catttacgcc 439500

ataaataggg gacataaaag gaggtgaagt gataacagga taccacagcc tgagttattc 439560

ataatagata gaaatttgtc acctcactgc tctggaagct gggaagtaca aatcaaagt 439620
gctggetttt agcaagggcc tccttactgt atcataacaa agcagaaaag ccaaaaatga 439680
gaggaagaga ataagtgatg agattattcc atcacaatc tacttctgtg atagccgat 439740
taactcatac atagggggtt cttaagggtcc cgccccttaa tactgttata atggcaatta 439800
aatcctaaca tgacttttgg agaggaccag cattaaaacc acatcataat gttcctatct 439860
gtcacttga ctaatgaaa gatggagtaa gtagacagaa acctactaca agtcatggg 439920
atcctatcta cagaaccac tgggtgcagtc aactaaagg tataaataa tactatacat 439980

ggctcagatt gaattctaca agaggtttaa gtaacaggaa agacagaaaa gaaaagcaaa 440040
tacaaaacaa agaagaacaa caataaaaag acataagaac caatcgataa aattatatta 440100
attataaatg ctccaattaa actaattaag agagagagag agagagtagc aaaatggaat 440160
taaaactaac ttgacctac tatattctat ctatgagaag ttaactgtag ctacagaggg 440220
gctggggaga taactcagca gattagagca cttgttgctc tcccaaaggc cctgggtcca 440280
attctcagaa ccaacatggt gactcacaac tgtctataag ggagtgggaa gaggctggga 440340
gtcatagagg gaggggaaac tgtaatcagg ttatattgta taagaaaaga agctatttac 440400

aataaaagag gataaattat ctataaatct agtctcaggg gtctgatacc ttttttaggc 440460
ctttaatggc actgcattca taatatgatg cacagacata catgcaagca aaacactcag 440520
acacataaat taaaactaaa ggaaaattaa aataagtaag atatttattt taaaatatga 440580
ttatagggga aatctgaaaa taaagactgc atgagacatt atgcaaacat taaccaaatg 440640
aaaacatgag gatctatgtt aattttaaat aaagcaggct gtagagcaaa gaaaattacc 440700
aaagagggac attgcatagc aataaaagtg tcaattgaag aagaaaaaga acctgaaaaa 440760
tatatgtatc aaccaataga actatagact atatgattca agaacatcta gcctgaaag 440820

gaactgaaaa tctgtactgt agttggaaat atctacagcc ttgtcaactg cttgcaagag 440880
aaaaattaag agtctcatgg acatacaaac cacattaagg gcaggcctca tgcctagcag 440940
tatatggtca acacaaaatg aattcaatgt tattttttga aattttgttt tcttttggtc 441000
tcataatgtg ttgtttgggc atttttacct tactagtctt tgcttctata ttatgattac 441060
aaattttgtg tttttatggt gtgtgtgtgt gtgtgtgtgt gtgtgtgtgt gtgtgtgtgt 441120
gtgtgtgtgt atctcctgtt tttttctttg ttacttttct atttgtttgt tttgttttat 441180
tctggtttgg tggttttttt tttatttggc tgcctctttt cttttcttc tgtttttatt 441240

ttgttttca ttttaagtt ttggagacag ggtttcctct gttgtagcaa ctctagctgt 441300
 cctggaactc actttgtaga ccatactggt cttgaacaca gaaatctgcc gcctctgct 441360
 tcctgagggc tgggattaga agcggggact accattatth tgtgtgcctt ctgtttcct 441420
 aaagagaaaa agaaaggctg ggcatgggtg tgcattgcctt taatcctatc acttaggaga 441480
 aggagacagg tggatttgaa accaacttgg tctacacagt gattcccagg acagccagag 441540
 ctacataata gagagacctt gtttcaaaag tgtgtgtgtg tgtgtgtgtg tgtgtgtgtg 441600
 tgtgtgtgtg tgtgtgtgtt gggggggtgg agttttatga gtcgggaact tgggagaatc 441660

 tgggagaaga tgaggagag aaaacatga tcagaatagt gtatggaaaa aagtacattg 441720
 taaaaatata tatttcacca gaaaaacaaa acaaaacaaa taaaatgcct taggtccctg 441780
 gttgcaatga ttaaatagcc tcagaccttt aagaacaaaa aagactgata gaaggtcagg 441840
 cgttgggtgt gcatgccttt aatcctctga ctcagaaggc agaggcaggt agatctctgc 441900
 gagtttgagg ccagcctggt ctacagagta agctccagga caggctccaa acaatataga 441960
 gaaacctgt ctgaaaaac aaaaacaaca acaaaaaga ctgatagaaa gaacactacc 442020
 catgaaatta gaaagactag ataattatac cactattggc caacaggcta taagggattt 442080

 aagtcattga gattatgat ccaaccacaa tgcagcaaac tggaagtgc tctttgacat 442140
 gctaccccaa ctcaggacc cagtcctctc tgcctctca acacagctct tcagctaacc 442200
 cagactccca cctccccct ccatgtccac agacctccag cgtttgggtt gagttttgca 442260
 gtgttgagaa gctttttatt tgctgtctggg cagcagtggc agtggttttt tttttcagat 442320
 ttattttatt ttttaattg catgtatgca tgtgcatgta tgtgagtgca ggagaggcag 442380
 aagagtacag aactgtcatt gtgggacagc caccctccc gcacaaacag ctctatgcac 442440
 aaagatcatt caaatgaag tagatttttc ttcatatcat gtgcactgtc taggtgctga 442500

 gctctgtgtt gaccattcta agatatgggt taaaatagaa agaaggcctg actcctgtga 442560
 aggaagagct tgattcatgg tttgggaaaa gggaccacac acataaagtg tgaatcgt 442620
 atagggcatt agtatctaag ctacatcatg tgatgggacc tgcaatcagc tgggttggt 442680
 ggagtgagtt ctgcaacccc tctgtttatg cttgactagt ctgtcatgct cagcatggga 442740
 cctcaaagtc tgaaggaaaa acaacgagga ttggaaagga gacagaataa acataatag 442800
 aacttctctg tgatattcag cgtcaagaaa tatcatattc tctttccttg ataaaataa 442860
 cctgggtgtg gtacctctc tctcagtggt cgagagcccc aggatcagat gttggggggg 442920

 ggtctacaac ctccctctgg gaagaacctt tggcctttct gggcaccagg caactgtcca 442980
 catagaggag atgacctccc tagctctctc atatatagc ttggtctcag gagctgtcac 443040
 tgaggagttc agagtccatc gactcattgg aacagtgttt ctggttctac ctcaaggtcc 443100

cttgagtggg tggaccaaaag tgtgtacaga catctgtgtt ttaggaaaca gtgtctccaa 443160
 gtcttgggga tcctcttgc caaccttaag ctcatggcac ccattcttcc cttgttagac 443220
 cctcagccat cttccccagc tcaggtgttc atctttgaaa ccaaaagccc aagaatgagt 443280
 tacctcctgg gaatcctgtg agccaccact acattcagaa acaacaacc tccaagcaaa 443340

 caaacaagg aagcaaggca tatagactag tgtatgccta caatcccagc tcatgggaga 443400
 caagattcag agtcataggt tcaagactgt gtggggacct agtgtctcaa acaaaacaaa 443460
 acaccactcc caccaaaacc aatcaacaaa tagtaacatt cataaaaca gacttttaa 443520
 cctcctctca gcaactggtg gcacacatgg gcaagcacac ccacaccac aactgggta 443580
 atcaaatcaa ggcttttaga aattaaagac ttccccggtt gaaatagaag atctttaact 443640
 aatgtgaaca caggaacagt aatggcatga actgtttcaa cccagaccct ggctcaacca 443700
 ttcattagtc cagcaaatg acttgcttgg tttgttttt tgtttgttt tattttttt 443760

 tcttgtttcc tgggtgtttt tgttttttt gttttgttt gttttgttt ttgtttttt 443820
 ttgtttctg caaattgggg atgaagacca aatcatgggc tattgaatgg ctattgattt 443880
 aaggttggta aagtatgcta actacagaat gctaaggcta atagaacaca cagtacagtt 443940
 ttaacatggg tcatagaca ttctagaagc atcaggggct cactgctctg agctcagcag 444000
 tgtcatctga agcacaggga agatggaggg tgtgctgctg aacttgagca aggcatcca 444060
 taaggaagcc tgtctgtat gggtacatt gtgtcacct ttgacctga gttcactggt 444120
 gaggtcttaa cctccagac ttcacagcag tcctgtagag ggtggtgagt taaaaccagg 444180

 ccgtcatgct ggtcctaact tgatctaac aatgtccttg taagaagata gtaagaccac 444240
 agaggaactc caggggagca tatgcacagg gcatggcgat gccagccacc tgtaagctga 444300
 ggagagagac ctagaacaga tcatgcactc acagctcctg gaagagacta gccttatcgc 444360
 caacaccctt ggctcctaga cttcagaact gtaaagecca cttagcttat taattatgac 444420
 aacctggagc atcatccaga ggtatatact gtcaatgcta cccatccctg acctcaatc 444480
 aggaggagga ttccatgata cgagatgatt cgtagcctgt aaggctaaga tatctttatt 444540
 tagataaaca ccagccaaac acaagccaga gtgtgccagg ggcagcaagg cagggaggcc 444600

 agagagaagg ggttccatg tgccttctg cccttaaaa ccctatcaca tgtcatcctg 444660
 acctcacctt gaccagccc tgacaggeat ggccaggcgc acctgtagcc agctctagca 444720
 ggcgtggctt aactgtctc ctacaattcc ccttttagtc taaaagagga ttaaaactta 444780
 acagtgtaaa gtatcaaaa ttaacaatca taaaggtgaa atacaggaag atacaataat 444840
 atgctatgac acatcctaac tatgtctatt tcagctaac cctaaagtca tetgaaaggt 444900
 ggtatccaag cctgaacgcc tcttccaat cccaacata aacagtagta agttatccct 444960

gactaggctt acactacctt aatagacaat aatggggcaa aggggtgtag catcttccaa 445020

gttacttcct gctgaaatgg gacggtggta gccttgtgga gttctgtggg aagaaaatgt 445080
tagtatagtg aaagtttcta atggattata tccagtecat attagatggg atttgcttga 445140
ttgaagatct aggttgaat cctcaacttg attgaaatca gtacccaaag ctctgtcac 445200
agtgtcagtt gaaatggagt aagtgtatc cagtgcagtc taggaggtat ggcccaattt 445260
ccttccagag cgtccagga ttgctgtcag gcaggctctt attggctgtg tgggactcaa 445320
acataagtgt tagcagagaa atgttttatt gaatatgtgt gcatgctggg aaaggcaacc 445380
atggaaaaat gattatgaga cggtgtactt tcttgaagag tcaagaaaga caaagacagt 445440

ccccaaatc ttctctcatt ctgtattaca tcaattggct tcttgataca atacagaaac 445500
tctaaagttt agtaaaagcc aatccaact ctaaatccag cattgattta ctgaaatagg 445560
gactagaaaa ataaagagaa atagatttaa tgcataatctt actatatggc acattccttt 445620
tgtttgatgg tgatagctac cttctcttct taagcatcta tccatggaac atgtagtgtt 445680
cttagacttc tggagataag ttttctgtg aagatagaag caaaatactt ccctttcctt 445740
tgggaggttt ctattcagtt tactagatgt gcctagtaaa atacctgtca ctgtccttg 445800
tggagaggtt tgccttatgg aactccaatc ttaatcaact ttgatggtat ccaaagtttt 445860

tcttctctg tggaaacaaa tgcaaaactc ctacccaac gtaatacatg tcttggtttc 445920
catacagagg ttagtacatc tttgaagtat actggctgat tcacttcagc agtttttcca 445980
tagtccagtg tctttctgca gctgtttgtc ctttttcatt ggcatthaaga aagtttagtg 446040
tcaataaagc atagcaacc tatgtttggg gggttttgtc ttccagcct gtctatggag 446100
catctcctta agigtctat tagatcttc aaccactgct tgtcctctag gattgtgtgg 446160
tatactggtg acatgcttta tgttataata tttgaaaac cgttccaatt ttgtggagac 446220
aatatttgaa aaactcttct atttttgtgg agacatatgc cagagcattg tcagttttta 446280

tctgtgcaga tatacccaca actgccatca cctctagcag gtgtgtaata acagaatcag 446340
ctttttcagc gttaaagacca gtagccatt ggaaccctga gaatgtgtct attgcatgat 446400
gcacatattt caaatttcca aattctgtaa agtgaaagac atccatctgc cagacctcat 446460
tcctccgaat gcgtttagaa ctgtagcctg ctggcaatag agtttggta taaaaggaac 446520
aagtaggaca gtttttact atctccttgg ctgttgcca agtgatgaag aagtcttta 446580
tttaaacctt tgctatttac atgatgttc ttatgaaatt ctgaggcttc tagcacactt 446640
ccaattaata aatgatcaat ctcatcattg ccttgtgcta gtggcctgg cagacccta 446700

tgggatctga taigtgtaat gtatagagga ttacttctgt ttctgattgt ttctgtaat 446760
 tgtagaaca gtgaagttaa ttctgtatta tcaggaatga attctgcagt ctcaatatgt 446820
 aagatgactc tgcataatgg gaatcagtaa ctatattaag aggttctgta aaaccataa 446880
 gcacctgag aattgcatat aattctgcct tctgtacaga tgtatacga ctttgaacta 446940
 ttttacttac ctacgtgct tcataacat ccttacctga ttgttgga tcagtgtaga 447000
 aggtaagaac tccagaaatg ggagttgtc ttacaatag tggagaatc cagactgtct 447060
 tttttgtgaa ttaattctg tcagttttgt gatagttgtt gctaacttc caaaaagt 447120

 aacaggacag tcccactgtc aacagtaatt aagtttgca caacattaa catactcca 447180
 ttttcaacca tgaatgaca tccccacc cacaacata aacacagagt cacaagttg 447240
 gaaacgttta aaaacatcac aacagcagag ttggagtga aaattcttgg gggttctgtg 447300
 aagggcaaaa atagttacag aaatggaagt caccctcttt ggacatgggc tacatggagg 447360
 tgggctctgt ccatttgcc tgtgctttt aatcagca ctataagcc agtgatgcct 447420
 aaaagtcaac agaatgcttc tgagtgaatc aaattcattt cctagttaa aagcaataa 447480
 gtggggggtt gcaggggagg ggagggagag ggagaagga gaagggatg acatgtgaag 447540

 caagattgtt ctaatttga actaataaaa agaaagcaat atagtgccct aatcaaaata 447600
 gcattagttt gactctgggg agtgacttag tggtaggtaa atgcatagca tgtgctcggg 447660
 taccctgggt tcaatcgtgg agtgtgttaa cacagttgat atccaagag tgacctata 447720
 aacactagat atcttaggtt aggctcaaga aggatttaa ctgtgcaac cctgacactg 447780
 ctccccaaa gcttatttcc gaaccgcctg ggatttgagc aaaggccagt gatatgagag 447840
 tgaagctgc tigtatgga gaaaaaggca tcaatctcca tgcaggactg ggtaagagg 447900
 gtctattaat ctgggaca acttgaattc tgcccctatg tggaaatagg taatttctt 447960

 agcttctctg aacctegatt tegtactgg cacagagtaa gaaggcctgc ctccatgtt 448020
 tttctgaagg gctagggagg aaagcaatga gtgtccaca cagagcagg atgtggggg 448080
 tggaaagtgt agtctatgt ctctaagagc ccctgtgtct ctctgctgc tccagggcag 448140
 ttgtcatcct catcacatgg ctctggagag tgacatttgt agatgaccag ggcagagttc 448200
 atctgtcca aacagaaagc cacagaaaa atcctcacag gcttcagtcc tctctcatag 448260
 gtcagtgtcc aaatgtgggt ccaggaacc agggttccag atcaactgt ggggaccctt 448320
 tgtaaatggt ctctgtctt gccctggtt aaaggacagc cacittacag agtaaaaaag 448380

 aggggtagg ctctgtgact cattctttt gggtgagact ttaacagt gggagacatt 448440
 ccaggttcca gacatattt taggtccttt gtaagcttca atgagtagt tggggacat 448500
 tcaaaaggg cctgctccac atgggatag agatatgtt atggctagct ttttcttggc 448560

gtaagcatag ctigaagagg taccatthgt ttfcagfcaa actgacatca tattccccct 448620
 aagggggcaa gggcagagg gctgcctgg agcaattctc cagcacaact ccagagcaga 448680
 agggccccag ccagctagct ggaaagtctg ggttctagge ccactctgtc actaactgac 448740
 taagtctct cccagatct gtgtatthtc tgtctgtgaa aggggtggga ccaccaaga 448800

 tcattgaatt gctgaccct gggccaaatc caactggtaa tctgtthgt ctgggcca 448860
 caaattatth ttaagagact cgtthgctg cthggaaag ggtgtgtct cthccaccag 448920
 aggctcgaca ccctgggatt gtgtatath agccggatcc tgccttagga atctgtct 448980
 thccctgaaa catctgcagc catctcgta gggcatctta gaggctthca gthccaggct 449040
 ctctggthc thggththc aatggcccc tctaatthc gccgtgcca cthgccaata 449100
 cataccacc thcataaata thgacaatc ccactthtg agthaatth tctthcaga 449160
 aagccaggga aataaaggac ataactcct gagagaaat gaagagaaca acagctataa 449220

 atagcacagt ggcagthga tactcacc cccccacc ccaatctcc thgggttagg 449280
 atggtctgat acctgcctgg tagcctggta gccgggctg aggctaagt acatcagctc 449340
 agattacata cagagthga gactthcac agthcaagca cgcgaagcct gggccacagc 449400
 thctgcagacc agacagthgt thgaccggga aggcathcct acaccacac cthagtgcag 449460
 ccagaaacga caccctacca thgcacactc thccaaaag cactthgtgc ataatagat 449520
 gthccctact cthctgggg ggtctgtgca thgagthctt ccaactthc ataatgthc 449580
 caathcatga accagataaa cagagththaa aagactthca agcaaacact gagcagagcc 449640

 atcctthgact cthccccag thggcccc thctgthgt taaccaaaga gcactthgaca 449700
 gaagacacat atctcgagaa thgaththg thgththth atthththth aaacctcaaa 449760
 cththcagta thgggataat thcggctthc thgagthgac thctthaaag thctagthc 449820
 thgaatgctg thactagthc ththgathca caagctctct thccatctcc agccccaaat 449880
 aaaacatgcc acaccaca cgcctthact thcagagcgtt ccaccctaag cacactthc 449940
 cthactthc cccccagat gthccaatga thgthctth cthactthc gggactctc 450000
 ccactthcatg cctggthcct cthccccaga gaaagthctat gthctctc ccaagaaag 450060

 thctatgthc thgagagaac aagaaccaat thgagagctc agththgtct cacagthca 450120
 gaaaagthth gthcaagac atgaggacca aatgthggt ccccaagthc thgagthagc 450180
 thgagcaggg aagacagthg aggcagagac thgtccatct gthcctggc atccagatcg 450240
 atgctgggaa cacaatgagg thgagathth thaaatgth gthgagthca thctgata 450300
 aaagaagthc thgacacat cthactthgt gactthcaaa aagaaccac thgaaaaaa 450360
 gcaaatthga aactaatg gaagggaaat ggaagaat atgthccta thgthathth 450420

tgctttaaat tttaaaaatt tcattttaaa ttatgtgtat gggtagctgt tatgtccagg 450480

 tatcaagaga ggcagaaga gggtagctgt atgtatctcc tggagctgga gttacagtca 450540
 gctctgagct gtcatgtagg tgctgggaat tgaaccagg tcctctggag gaacagttag 450600
 tgttcttaac tgctaaacca tctctccaac cctagttgcg caaagttgta ctttgcgcaa 450660
 ctagggtta cttccaagc cactgacttt ggggtgagca gaatacctta ttttcgataa 450720
 tgcacacatt ctgaaatcat tcaaggtagc ggaacaagcc tctattactt ggtcagctaa 450780
 cagataagga tigttagtag ctcgattgaa atacatcagc tctctgatac gtgattctac 450840
 agaaagggga ttgttagtt catcagcact gaaagtcaca gtttctgac ttcagattta 450900

 aaggaattct aagtgtgtgt gtgtgtgtgt gtgtgtgtgt gtgtgtgtgt gtgtatcttt 450960
 ttaaaatacc agaagcaact gttagtagct tcagagggca gaggcattgg tagaattatg 451020
 ggcatattgt agcttctaa tgtgggtagc gagaagttaa caaatcctgt gtaggagctg 451080
 ttggtagctt gccttactca ctgagtcacc tctccaggcc cagcagctcc ctaactttta 451140
 taacaaatga cctctctcca ccaatgccag cggtaggggc ttaaaaaaaaa atgctactaa 451200
 acatgttagg aagtggtagc agctacattt agactcaata tttatttctt caataaatat 451260
 tcattgaggg ccacaactgt cttacgggct ttttaagtaa acagaaactg tagacagaag 451320

 tcagagtggg ctttttatag tggcccctca agctgaggag tgcctaaga ggggttggct 451380
 ggtactttaa attcttcate tgggtcgttt ttctctacc tttgtcattt gacaagatgt 451440
 ggtcgtgtga tgttttctg taaattctgc ataactataa aagcatagta agtaacacag 451500
 agaccagcg taaacaaagt tcccagtagc aacctgctg cctcacagac tttctccttt 451560
 tcttttttc attgcagttt taagccattt aaatatttgc tcgtgattta tttttctgta 451620
 agatagagct agggactggt ctatttttca catttcagtg gactctagtt ttaaaaatac 451680
 tctccttgac cttgtggtga aatgtgaatt aagatacttc ctctactgc cctgtgcgaa 451740

 agcgtattc atcagtaggt gttttccagc acatttctta ctctttcaa agtgtaaca 451800
 cagcaagcc ctttataatc aaggagtagc gccatcccag tgtgcacttg gaaattaaca 451860
 acaggcctt cttatttccc ataaacttct ctcttgcgg ctaattctc ccccccccc 451920
 ccaccatac caaacccata actatatcaa accagggtt aatcaaggg aatgagacg 451980
 tgacctatta aaaaggaat gaataatttg agaggggaaa attacatctg tggctggaag 452040
 catggacatc atggcttagc tgtgcaggtt tattctacca ctgtaccag tgacttgctt 452100
 ctgggtgga cctcctccat catcaaaat acctcatgac gtcagcaaaa ttagtcaaat 452160

tgtgtttaga tcccatcaac ttgaatTTTT tttcaagatt ctttccatgg gtccttttta 452220
 aattaatgaa tgtatacata gaagccctct tggaatagtt gtttagatccc ctagaactca 452280
 agctaaacct ggacttaaat gatttTgtta agtgggctca tgggtcaatg tttcattggT 452340
 aaaattatta gcagaattcc ttgtgccttc taagtagcag tgaaatcgac cttgtccctc 452400
 cctgtgagcc ttgcaggatc gacaaagaag gaggtTggga gagccgagac cttatggatg 452460
 cacggtgctg ccaaagtTca agtctaaaag cagcctgcag attggaaagt gtcacatcca 452520
 cacatcatgt taataagTac catcatcata atcaagattt aggtggcttg gctgagcctc 452580

 tTcatgcttg ggtaactatg tttgctaagc ttagaaatag gtctgatagc tattaagctc 452640
 Tgcatccag gcctgagcca atcaaatTta ctctTtaat tTcatgatta Tggagccggg 452700
 TggTggTggT gcatgccttt aatcccagca ctcgggaggc agaggctggT ggatctctgt 452760
 gagTtcgaga ccagcctTga ctacaagagc tagTtcagg acagcctcca aaagccacag 452820
 agaaacctg Tctcgaaaa caaacaaaa caaaaacaaa aaagattcat gattTtgaac 452880
 aactatatgt cagcttctta agaagTtctt aatgctctaa actgcaaaga ataagaacat 452940
 Tcaggaattg aagagTgggt gaggaagtta cagtccattc acagaacaag ggtgctaatg 453000

 Ttcaccagga Tctgtaatag acacttctag Tcagcaatgg aaaataacct caacatgggt 453060
 gaatctcaaa aacagtgctg TtttctTtta agatacaaaa agagaacata gtacatgatt 453120
 TcattTggat gaaattatag agacagcaaa aactactTca taacggaaag agaagctcag 453180
 gagctggaat ggagaacaac cagctTaaag acaccaggaa gtgtTgggt gatagaaagt 453240
 TctagTtgt gattgcaagg gatggcatga ggatgcaaat gTtgagaaa Ttcatcaatt 453300
 Tgcccccaaa TgggtTttat Tttacatatg ctTatatgag TgtagaggTg TggTctTgtt 453360
 ggaggaagtg Tgtaactggg ggtgagctTg aggtTtcaga agTtcaagcc agTtttctgc 453420

 ctgctgatct ggatgtagaa cttcagTtac ctctccagca ccatgtctgc ctggTgctgc 453480
 catgcatcct gccatgataa Tgtactaac ctctaaactg taagccagcc ccagTtaaat 453540
 gTtttctTtt ataggagTtg acatagTcat agTgtctctt cacagcaata aaatcctaac 453600
 taagacgatg agtatagTta aaagaacagc taaaaagtat caataacaag Tgtgtagcct 453660
 TtgagTgcca Tcctggaaga ctggaggaga gagatctgaa agggTgtagc ctggccttcg 453720
 Tcctcttccc agctatacgg gaagatgggc Tgaggaagga aaagaatgtg TttTgtTttc 453780
 TttactTtgt gTccttctca taagcagTat taattTtata ctaagTtgat aaatgataaa 453840

 gTcaaggtcc atgagagaag TcgccctTgc ctagctggg Tgtgctcact cgtatagTat 453900
 aagctTgctt ccatgtgagg TgattTgtta taaacgatg Tcatacagca TgcctTaaac 453960
 agggTgagTc tacaagactc cccagggtcT aggctatggg ctcagaatct gggtTgggta 454020

catttatggg acctcagctt ccctgagcag aaaatagcag ggtttcaaat acttagccat 454080
 gggaatagct gaggacaggt tacaccagct gtggtggttt gaaagaaaat gcccccatg 454140
 gggagtggca ctattagga tgtggtcttg ctggagtagg tgtggtctca ttggaggaag 454200
 tgtcaccaga gaggcgggct ttgaggtctt atatatgctt atgacatgcc cagttagaca 454260

 gaccatttcc tgttgtttat aagatgtagg actctcagct gcttctccag taccatgtct 454320
 gcctgcaaga cacgatgatg caccatgatg atagtggact gaacctctga actataagca 454380
 agccaccaca attaaatatt ttccittata agagtgtctg tggtaaggc atctcttcac 454440
 agtaatagaa accctaacta agacaccaac ctgaataac ttcccagagt gttaaaggca 454500
 gaattagagc cttttggagg ttccaaaga ccgtcgctga tttcagacc ttttctctct 454560
 atagctttta gtattttatt accaaccagt gaacaacaaa acagtctggc ctttctccac 454620
 tgggttaatg ggcaagtctt tcagtcaatt ctttcatttt cttgttact gagatttga 454680

 glaaatcata gacagggctg tctatggtgg ccagacttca tgggactga gacataaaga 454740
 tgaaaagcaa gtagacacct cacacacaaa caactgtcgc ccccccca agtttctgtg 454800
 aaaaccttg gggccagtag gaggaagggt actcagttaa aattgcataa geccaacaga 454860
 aaaactaatt ttcagattag ctggccatgt gttatgcttc tccaatggc cagaagcaag 454920
 tttgaccggg ctgtgtctga caggctggtt tggggaagcc tttgaacacc aatgcttgtg 454980
 atcctgcagg gectgggact aaccgacceca tctgtgtact gtccacttcg gaaagagaaa 455040
 cttccctgat ggcattcgaa agaaaacacc aagtaaatcc caaaaggta actttaacc 455100

 aaagcccaac caagaaagag aatgggagag agactggcag ctgaggccgg gtagaaataa 455160
 aagttccatt gtctgacac ggatggtggc tccccggctg ccagccacac tagcatgctt 455220
 tgccctgtgg tttgtgtggc acacagacac ttttgcctg gagagacat tccagtgtca 455280
 gagtgcagg cggccttcac cccaaactct tcagtcagtg ggggaactca cactagagat 455340
 gggaggtcac agtgtgaaa atcattggac actaatgagc ctggcgctgt atttaccag 455400
 aaataaagga gcgatgttac ctgaaagtgg tgtattcatg gcaagagtca aggaaaggtt 455460
 aggaatcagg gagcaaggaa gaaggggtgt ccaagttcag ctaaagctgg gacatgggac 455520

 ctgcctctat gaatcagccc aggttccaga ttttaatttc cctgtttaca cttgccctg 455580
 ggatcctgga agcaactaag aaatatcccc atagccaagg ccaccaaca gctgactgct 455640
 agtagagtct gcctgaacat ccgtttgctt aatagagagc ctttctagga gcaagaagcc 455700
 ctgaaataaa ggtattatta atttatttat atttatttta ggataaatgg tttaaagagc 455760
 atgtatgaaa ccaaatgcaa agcacctaac ggttgatcca agcattcaat gggattgaag 455820
 ttaggccatc ctgagctacc tcaggagttt taggccagtc tgagacccta tctctcacac 455880

acaaaaatac tcagaccctt aacggggggg ggagaagggc aaagtgtgtt tggggtagg 455940

 gggtcgacag accattgaca gaagagggca gagtggaaag aagctagtgt gaaagtcaag 456000
 atgtcacctg atgacaagga actaaacctc tgaactgtaa gccagcccca attaaatgtt 456060
 ttctttatag gaggttgtct ggtcatggtg tctcttcata gaaatagaaa ccctaactga 456120
 gataattggt ttaacaagt tcaaacagtg catataactg agtgtctagt gtgtgtgtgt 456180
 gtgtgtgtgt gtgtgtgtgt gtgtgtgtgt gcctgctcac acctattcat ggagaagagc 456240
 ttaaaatggc gagaggatac cttgagaaac ttactaatat caatttgcag gtgtttcaga 456300
 ctgagccagt ttttcataaa ctcatgtgaa gaatctggca agacatctgt attgtgaaaa 456360

 ctgataaaga tgactttcga ataactacagt gcaggaatac agccgaggca ggaccatcat 456420
 gggacaagag tgtatgtgta gtcagcaatc actcagaggc atctatatgc tcatatagtc 456480
 atccaaagga gggaaatacca catccatttt tgttttgga actgggggat tcacagttaa 456540
 ctgagaataa gaatttcatt gtagggctgg agagatggct gtgtgatgca gtctcttgca 456600
 gaagacctgg gtttggttcc cggccccact ttgtacaatc acaatgtttg tagctctagt 456660
 tccaatatgt gttggcttcc accagcatct gcacttacat acatgaatac acacacacac 456720
 acacacacac acacacacac acacacacac actccatgca ctacacttgt gcacacacac 456780

 acacacacag agaattaaaa aataaaaact tatttgcatt cattgtttgt tcttccacag 456840
 aagtatcttt gtgtaactctg ttaagagttt gcttactcaa tgaataccta cctccaaaca 456900
 gacaggactt tttttcttaa agataaaaag atattgaata aggacagata gtatacatgt 456960
 agctgcaacc aaataatggg ttcctagaac attagccaaa atgacccttg acctatgac 457020
 tagtccaacc ctctcatttc acagattaga gtctaataa gccatctgag gtcacaaact 457080
 aatcggtacc agaacctggc atccaactcc actgactttt ctctctaaac caccatgcct 457140
 ctgagaatga ggaagcataa ataaagaacc tcagccetta tatatagtct tectaacce 457200

 tcattatgga gggagaagac ctgagctgtt ttaatcacca cctgcagaag tacttggcga 457260
 tccaccgcat tacatatttg gcagggccac gtgaaagacg cttgagggct caggcaagat 457320
 gagaacgtcc atggaatgct ttttatttgt aggttggaac tgaacactct gagctctggc 457380
 cgctggcttt cgagagactt caggcttgcc gctttaatgc ttcagtgagc agcaaattgg 457440
 accacaagag cgtcaatcac gcgatcctgc caagcaacac cctccccgaa gtgtgaagtt 457500
 ctgcttgctc aaaacagctc cattcatagc atgggtgtgg aggaaccctc aatccatggg 457560
 ttctatgtcc cgcaaacatc tgcccctcta tgtgattctt caaagctgag tttctgagtt 457620

gtggccaggt cacaagcaac caatcagatg cagagcaaca ggctgctgct gctgctgctg 457680
ctgtccgagt gggtaggagc agcagtgacc agacagcatt aagacacagc caggaaatta 457740
gtaaggtgca aattgcatag tggtaggctgc agggcaagag gaaaattgca gaccgttgcc 457800
tgaagagaga gagaaatggc tgggtgggtat tttagaatca ggcaacaggg agccactgag 457860
catagttctc attggttaag ggggaaaaat aagtaacagc tcataaaacg gaagtacagt 457920
acgccaacag aaaacttcag tgatcctaga gattcaacgc ctgcatgccc tgtaaccttc 457980
gcctaggtca agacagagag cgccctcttg tgttactcc cagtcacccc acccaggggg 458040

gaagtgccat tctgccttgt gttttcacat aggccaaaat ggcaagccaa gagaagacca 458100
gttagtgaag tccttgatca ccccccccc cccagctcag ctgtggagac agagcctggc 458160
agcctgctaa ccctgcccag caactcctct ggcatgtgtg gctcttgacg ggatcagatt 458220
aggagacccc tggaggacag actaggaggg gacaaccttg agttggccct ggggactcac 458280
atctccttga agagccagct tctcccctgc agagtctgag ggagggtgtg gggctgctca 458340
cagagggctt cttacgtttc ttttctttc ttttctttc ttttctttc ttttctttc 458400
ttctttcttt cttttttttt tttttttttg tgtgtgtttc tgtggtttct tcttttcct 458460

catttcaggc tgctgaatt tgcttagagt ggcaacat catggagaag gtagtatagac 458520
tgttttgctc caggagttc ctgttaggca acaaaactcag gcctgcaagg ctggcagcc 458580
acaatgctga tttttgtggc ctggagtgtt ggctggattt gcttagcttg ccacctggct 458640
gcaggggatg attgaccac gagagtagca agtactgttc cggagaagaa tcaagcatgc 458700
tttaaatagg tttcatattc tggctgtgag ctgggcttg gctttctcc agtgcagtgt 458760
cttgtacct agtgtgtgtg tgtctaagaa ctccattca agttgagcat caaaattaac 458820
ggccatttct cactttggca gatgccaga aactgaatac acggaagatt aacatggccc 458880

ctgtcaagga tgacatgtgg attcgtgagg cagtctgtat tataaaaata aatgaagtg 458940
gcagttagat tccttttgtg tctcctgtga ggtgatgagg ggatgctcat gccctcaagc 459000
aagaacaagc ttccaatgg taactgcac ctgtttttgc tggaaaggagt ttgctttgct 459060
tgctccatt taatattcaa ccctttgcag ttcaacttcc ctgctaacgc aaccagggac 459120
ttcttagata tcaagtccgg tgaggacttt tctttaatgg caatcttagg tcagtcctt 459180
ggtaggagctg gcaactgctg cccgtcatgt tctttttctg ttggccacca gaggatcac 459240
tcttcaagac tttctcttt atctecaggt cctccaattc tgtccctttt gtagtatctc 459300

cttctttcac ttgctatgct ggctttgggc tctcccaggc ttctgtgctt agttcccttc 459360
tgctctccac cctcccatgg gcagtcacca catcaacaca gctccagtct cagatgggtg 459420
cctcaggtaa tggctctcct gtaaatctcc tgctgactac tggcctctgt gtgaccttac 459480

cttcagcadc tgcagccacc actcccaacc cagtagagtc atggtaagtt taaagaaaa 459540
 tcctgagta gctgttacca cctgagctgg tagtgtcadc catgtgtagg ccccaactca 459600
 accaagggtc catctttgga cttttcttca tctttacaat gttttgaaaa tagaaaatgt 459660
 atttcagatt ttcttttctc ctaagccagc aactcacagt agagccctct tgtgctactg 459720

 ggcagcagca gcaaaactgca gttctccatc agtcatgaag tcacaagggg aaaatagttg 459780
 atactctggt ataccacatt gctaagccag gatataatgat aggctaagta tagaaagtgc 459840
 attgttttgc ttacactgtc ccagtgcacg ctgggatatc tggacagcat taagttgagg 459900
 agcaagcata ggtagtctaa tgagtgtca gaaaccagag ccctgaggca taactgacac 459960
 atatgcagac attgaaagga ctttgtctag gaattctcct ccaggacagt aatggccat 460020
 gctggtctc accttccag agctcttagg catatagagt gactctatga cccacaagga 460080
 atggaactgg agaaacggaa aactgaggta atgattatta cctgactcag aacaccagtc 460140

 ctctactccc ttccaaacac agagctgctc tgatcctact tacatcccag agtgagtctg 460200
 gggagttttg aaaggttcac aggtcttcac atatttactg acttcacatt ctatagtaga 460260
 acagcctata ccaaatgagc agaggggttg aagacagtac tagagactct cagagttgta 460320
 gtttctgtc ttgggaaaag ttatggaaag ccagtgaat atcacaatgg cagttgtcac 460380
 gtgtgtccc atctgagacc agactctagc ttctttctgc catggtctaa aatggttgca 460440
 gctatctgtg agcaggaagc agccatacag agcctcctgt ctgactgct ttacaagaaa 460500
 ggagacaggg taagagtgga ctggcaattt cctgactcag cctggtgctc actgcacagc 460560

 tccaatctgc cctcggaggt gatcctgcat gtgtgtaact gggettgact tgtctcatgc 460620
 catctttaca aaccacaagc tctggggact gtctgggta cagggttata tggggaccct 460680
 tctttccaa agaaacaaa gcttccggtt tccccttctc ttcactctgc ctctttctct 460740
 attcaagacc ttgcctacag atggttcttt gtccccaagc tttgatgac tgatgacctc 460800
 ttgctacat accttagggc agtgcttcca acctgtgggg tccaaccctt tgaggaggag 460860
 catatcagct ctctgcatt atcagctatt tacattatga ttcactgtagc aaaactacag 460920
 ttctaagta acaatgaaat gattttatgg ttggggtcac cacaacatga ggaactgtat 460980

 taaagggtca cagcattggg aagattgata accactgctc taggctatct cgggggctaa 461040
 ctgtttggga caacagctga aaaggactca gcataggtga atgctgctct ctggagctag 461100
 actaacctgt gctgtgtctc tgaactaacc ttggaccaga cacagatgct aagtctcaac 461160
 atttttttt aaatctagga gatggtttta tttccagat caggcaggtg agatatttg 461220
 gagaatggag acaattacc taaagagtgg tctcagact tagctgtatg gtgcaattgc 461280
 ttaagagctt aaacccacc cccatgcctt ggctcccgtt ctagaactga ttctattctc 461340

atcaaatttt cagaactcct ccaaatgctt cccacatgca gccaatggg aaaaggtgcc 461400

tgggggtct tagcacggag cagctcaaag aacctggct ctgctagttc gacaaccaca 461460

acaaggctcc ctgcccacca gaacttcaga gctccctaca gggaggactc tggctctctg 461520

ggattcagag gaaggatctt ctgccatcgt cctctttccc agagcttcta ttcccagttt 461580

tcagaaca gtgacctgag aagctaaaga ggaagtgtg gcatctggct gtcacgtgac 461640

agctggcata gctgagcagt aggtcaagc acacggtagc tggccttcgg ggggggggt 461700

ctctttgctt caatgcctgt aaaaaaagg aaggaactgc cattatttct tgcttagata 461760

tgaaggacac agtgctaacc aggactgcct cccctgtctt gctagttacc agctgttggg 461820

aagaaatgga agaaagccag cctgatgcca ttcacagcaa taactgggag cagaggtctc 461880

agactgccac cccccactac acacacacac aactgactg ggtacttcca tcaatcacac 461940

cacctaacca cctattacc tgcaccctgc atctggcagg agggattcct gagcccctga 462000

gcccattcac tttgtaaagg gttgcaccag gatcttacc agacctgaac ttcttgcct 462060

aggggagaat ttagccccag gagaaatagc tcagtgcctg gctggccgac aactccgttg 462120

cctatcctgg ctctcgagag agttacagga actccacgcc agatggttct tggteccagt 462180

aggatgagcc ttgagcctgg ggtgtgactc aggaccagga caagtgggtc actaccagca 462240

gtagattatc ctgctagaa actcactcag ataagcctca gtttcttcca gtttccattt 462300

ctaccaagaa ctcaactctg gatttctatg cactctggcc atttaggact aggtgaccta 462360

ggacagagta aataatctct gagtgtttgg ctgtttgatc tgtaactgt gtcaggctat 462420

tcctacatc ataagtata tgtggaagga agaatgtaa gacactacag tggagagctt 462480

atagtaagca tagcctaagt gtttgatgtt attaatcaag tagatattgc aactgcatca 462540

gctgagtgta ttaggaaga ttcttctgat tagtaagaag agatggatta aataatattt 462600

attacagaca ctattattcc caaagatcct tctccctac tggccactcc tcacttctt 462660

tctcttctt catctcatc tctctctgt tcttcaagcc ttccactct cagcattctc 462720

atccccaca agaactgctt atttctctc cagacttggg ggtggtggtg ggagggaac 462780

agctcgtgac ttagtgccca ctggtaattt cctggggtt ttggaagggt cttagcactg 462840

tcaggctagt acagcacttt tgtttgcaag agggcagtga gaaaattact cttgggctta 462900

gggaagcaaa gaataaacac gttcacagta ggactcttcg gatgttcgta ttttttctt 462960

ggttgtgat ggiccactgc agactgatgt gataccgatg tgccttaata ttaatgggtc 463020

agagctgagt aagcacgggg cccagcaaaa acaaggcaag atgcttattg tcaacttccc 463080

cagctccgaa ttctgcagga aaacatcttc gggactgcac ttgaattaaa acatcccagc 463140
 ttctgagtc attaataattc tgcttaaaca aaaagtcggg agtgcccctc ttgcctgag 463200
 attgggtag taatgcttaa cccttatatg tcgatctcag ccaggctggg cacctgcctt 463260
 ccaaactggc cgcaccaata aatggtcat aaaagtcagc ctttaaaaac tgaggttaga 463320
 ttcggtagt tgcacgtgcc ctctccatcg cgttgctg gcaaagcaca caggtcaaac 463380
 gatttctact gaaaaaggca ctctcagcct ctgtctgtgt cgtttactcc ctctcccac 463440
 ttactgccc aggtgcttcc aagcccttgg cagagtcgaa gtccttgccg gatccagaac 463500

 accgcctccg gatctgaaag ccagtagggc cagcgatctg gctctacata ctttcttagg 463560
 ggctcctaaa aaccgaaggg agggcgcggc taagtttga ccttagggg aaaaaatct 463620
 ggcttttgcc tttgcctcc gtgaaaactc aactggaacc caagagcagc agcaggcagc 463680
 cggagtagcc ccaagagaag agctcagagc caggaagtgt gtgtcaggcg gagagcatgg 463740
 ttgcttgtg agctccaggg cgttcacagt gcgctgggga caccgacag ttgcttctaa 463800
 attcccagg gcaaagcggc acccaggacg ccatttcttt ttgatgcgtt tcctcctgca 463860
 agtgaagggc caacaaagca gtctctata ggcattccag tgcaactgcgg gtgcccctatg 463920

 taaatgcttt tcgtgagcgt taaacaaca cctgctttt gtgtagaaag actagcaagc 463980
 aaacgcggag ccatctttcc ggacctctct ttgattctgt gttggatttg cttagcttta 464040
 ctctgcaaca cgctgcttg tggeccgggc tgaagccccc aggcgcccct ccctccgag 464100
 ctcaagaa agccattgta gggttatca acccctct taagacctcg ggtttcatcc 464160
 tcccccccc accatgttgc gtttgtttc tcaagaccta agcaattttt aatgtactct 464220
 atactcccc ctaaatctc atcgtttatt gtataattat agtttcaaag tgattatgta 464280
 attaaaatca tgttcgttg aaacaggact tcaaaagggc ggcagacccc cactctggca 464340

 ttattttcta gtgatgtaat aatttccctg tgatattta aataaacaca ttagttcaag 464400
 aattctaac atgtctcaa gcatatagta ggcttgattg gcacaggct ggcttgtaaa 464460
 gaaatggtaa aaccatcac tagtttaata tatttctatg ctcccatgca gggtaaatta 464520
 caggataatg gggcgcaggc gatgtaagc tctgtttata taatccattt cttcacacga 464580
 gtcccattg cttcctttt cccttctgctg tgtgtggtgg ttctctgac cctgacctc 464640
 ggccatgtgt tttcactttt tcttctgac tcaattccat gaccagcggg gaataaata 464700
 caaattgaat agtaaccatt cacaggccgc tcttttcaaa ctggtgttaa aacctcttg 464760

 tcttgtctag cggttgatag ataaatgctg tgtgtttctc ctgactttcc cccctgcctt 464820
 tcttcttct tttttttt ccaccctcc ttggccaagg aaaaaataac cctcctcaa 464880
 ttatacgctt taaaaattaa aaccacacc tcctttcaaa ccatctcctg ggcgtcctgc 464940

tcgctcccgg gtcggcccat tggttcggcg gcagcaggat tcaccacgtg gaataaagga 465000
 acgcggcagc tgagcggagt gggggaaggc gaggtgcccc cgtgtgccgt ccttgccatt 465060
 gtcccctcct gaaggttcat ttaaccgaga acctgtactg cctctgatct cctctcagag 465120
 ctcccagaat gggcccggct ggctggggcg gcccccccta ggaattcctg aggccagggg 465180

 gccagggggc cagggggcga gggagggggg ggggataaac cccccctta gccttcgcc 465240
 ctcatccgt gccccctnnn nnnnnnnnnn nnnnnnnnnn nnnnnnnnag aacgagctgt 465300
 ttacagctt acatcccaa agctacagaa cgctccagg tttctgacct gccttccca 465360
 gatccctgtc gcttccacct caagggtgc tgctccgggc ggtcaagcc aaaaccacta 465420
 atagtaactg ggcgctcgt ctgcagccag ccctctctt cccaagagct tccttgagg 465480
 gagggaggtc aaggcnnnn nnnnnnnnnn nnnnnnnnnn nnnnnnnnnn nnnnnnnnnn 465540
 nnnnnnnnnn nnnnnnnnnn nnnnnnnnnn nnnnnnnnnn nnnnnnnnnn nnnnnnnnnn 465600

 nnnnnnnnnn nnnnnnnnnn nnnnnnnnnn nnnnnnnnnn nnnnnnnnnn nnnnnnnnnn 465660
 nnnnnnnnnn nnnnnnnnnn nnnnnnnnnn nnnnnnnnnn ntgagcccgg ctacatgct 465720
 tcacattaaa gttccgtgcc cggtgccttc gtgctttttt tcccttcttc tectcaaaa 465780
 gggttcttat aaacttccct tcgtttatct agcctggttt tcattgctcc agttttgcat 465840
 gggttgactt tgtttagttt attaacccac ggggttactt taactaaaca ttgggctga 465900
 atactttggg attgatttc aacgtttct aacgaaatta cgggggtttt tgaagccga 465960
 cagagaacgc tigttagt ttattagtca attaacaga ctataagtgg gggcgggggt 466020

 gcgttagtt cagttcagat tcgtacceat tcgaccgaag aagtagcca agccttggga 466080
 tagggttcca cccgcgtacg caggccttgt acccagcat ggcctcgggg ttcgccggct 466140
 tcctccgttc gcagactggc tcctgggcgc gccaaagtcc ggcccatgga acctaggcag 466200
 gcgacctagg gcgggacceca gagactagct gggcgacceca gagggtccct cccgacctt 466260
 ccacctctc tcigacagga ggttgtgtt ggtgctagct gtagagggtt tgggtgcttc 466320
 cggtagagag cttgaaagg aaacctggct atggtggaat cttcagaaa gaggtagat 466380
 caatgaataa ctgcctgagg tgagcttgag ggacgacagg ataaccaatt ggccagtca 466440

 tctcccga ggatattcca ccaaaccac tgtatgtttt tccccctaa acctgaagag 466500
 ctgggacatc ccagggttc gacacagtag gaggcatagc ctctgccgc ccacctccag 466560
 cttagcttga gccagaagaa aggaaggtaa cccgatagc ctgagaaca ggaattttct 466620
 ccaccactc ctgccacaca cagactcttg gctttcaagg tttgacctt ggtgccacct 466680
 aaaatgcccg tgaactttat gcactcaga caaaactgag agctgtcggg ggccgtcaaa 466740
 taggaagccc cagaaagtag gctgggggtg ggggggaggg acttcagctt tctggggcaa 466800

cacaaggagc atactgaaca ccaaatagac tggatcagaa aagaaagtcc tcttggcaca 468600
 taataacca aacactaagc atacagaaca aagaaaaaat attaaaagtg gcaagggaaa 468660
 aagactaagt aatataataa ggcagactta ttagaataac acattacttc tcaatggaaa 468720
 ctctaaaagc cagaagggcc tggacagatg actctaagag gccacagatg ccagcccaca 468780
 ttgctatatac cagtaaaaaat tttaaatcac actaggtgga gaaaatatgg ctttctataa 468840
 ttcaattcaa gtcccatact tatgggacac aatataagtg gtattcagag gaaaattctt 468900
 agcactaagt tcctatataa aaatactgga gagatcatgt actagcaact taacagcaca 468960

 cctgaaatct ctagaacaaa aaagaagaaa ttacacccaa aaggagtaca atgcaagaaa 469020
 acttgggact aaaaatcaata aaatagaaac acgaacaaaa acaacacaaa gaatcaatga 469080
 aacagagtgg gttctttgag aaaatcagta agatcgagaa acccttattc aaactcttaa 469140
 gaagacatag agagaatatac caaatagca aaggtagaaa tggaaagtgg gatataacag 469200
 cagacactga gaaaaatcca gagaataata aggacatact ttgaaaacc atactccaca 469260
 aaattggtaa atctaaaaga aatgggtaat tttctcaata catacactt accaaagtta 469320
 aatcaagatc atatacaatt taaatagatg tttaacccct actgaagtag aagcagtaat 469380

 gaaagtctaa caacaacaaa aaacctcagg gccagatgat tttagcagaa ttctaccaga 469440
 ttttcaaaga agagttagta ccaatactcc tcaattatt gcacaaaaca gaaatagaag 469500
 gaatactgcc ctgttcatgt tatgaggeca cagttatcct gatacctaaa tcacataaag 469560
 acccaacaat gagagagaat tacagaccag gttctgttat gaacatagag aaaaaactca 469620
 caataaata tttttgaact gaatccaaga atatctcaa aagattatcc tctatgatca 469680
 agtgagcttc actccagaga tacagggatg gttcaacaca cataaatcaa taaatgcaat 469740
 ccacatata acaaaagtga aagacaaaaa cccatgatt atctcattag atgtagaaaa 469800

 agcctgtggc aaaaatctaac actcttttgt gattcaagtc ctgactggat taagtataca 469860
 aggacacac acaacataag gcagctgca gcaagcccat actcagtatc aaattaaaca 469920
 gagagaaact caaaacagtt ccacaaaaat caggaacaag gcaagattgt ccattctctc 469980
 cacacctatt caatatagta cttgaagata ctggaaggag atcaagggaa tacaatttag 470040
 aaaggaagaa gtcagagtat ctttattagc agatgatata atagtataca taagtacct 470100
 aaaaatccac ttgggaactc ctacagcaga taaacagttt cagcaaagt gctggataca 470160
 aaagcaactc ccagaaatca gtagecctcc tctatacaga tgacaaacca aacagactgc 470220

 aaaagaatc aggaaaacaa catctttcac gataacctct aataataaa aatatcgtgg 470280
 cataactcta accaagtaag tgaaagaatt gtatgataaa aaatttaagg tattgaagag 470340
 agtaattgag gaagatata gaagattgaa agatcttcca tgctcatgga tcggtaggat 470400

taatatagtg aaaatggcca tcctatcaaa agcaatctat agattcagtg cagtcacat 470460
 caaaattcca actcaattt tcacagattt ttgaaagaac aacttttagc tcacaaaaag 470520
 aaacacaaaa aaacagagac accaaacaat ggaatcaaat caaaggccca gactcaagtc 470580
 cacagacaga cciatggaca cctgactttt gacaaaaaaa aaaaaaaaaa aaaaagctaa 470640

 aaatacacac tgaaaaaaga aagcatcttt atcaaactgg atgtctgcag gtagaagaat 470700
 gcaaatagat ccatacttat catcctgcac aaaactcaac tccaacgga tcaaagactt 470760
 ctgcataaaa ccagatacac tgtacctgac agaagagaaa ctgaggaata accatgaatt 470820
 cattggcaca ggaaaagaca ttctgaacag aacaccatta gcacaggcac taagatcaag 470880
 aattaataaa taggacctca tgaaactgag aagatttcta aggcaaagaa cactgtcaac 470940
 aggacaaaat ggctacctat agaatgggaa aagattttca ccaactccac atctgacaga 471000
 gagctaatat ccaaaatata atcaagacac aaagtaacta aatattaaga aaacaaataa 471060

 cctaattata aatagggtac aggtacaatc agagaattct taaaagagga aactcaaatg 471120
 actgagaaac acttaaagaa atgctcaaca ttcttagcca tcaaggaaat gcaaatgagc 471180
 ttcatctta catgtgtcag agtggtctaa ttcaataaaa caagtgcagc ctctgtctgg 471240
 tgagaagata ggacaaaatg aacactcatc ctttctgat gggaatacaa acttgacag 471300
 ccactgagga aataagtgtg gcagttctc aggaagacag gaatcaatct acctcaagat 471360
 ccagctatac catccttggc tatataccca aagggtgctt catcctacca cagagacact 471420
 tgctccgcca tgttcactgc tgctctagtc ataatatcca gaaattagaa acaacctaga 471480

 tgactctcaa cagaagaatg gataaagaaa atgtggaaca tttgtacagt ggagtattac 471540
 tcagccattt aaaacataaa atcatgaaat ccacaggtaa atggatgaaa ctaaaaagac 471600
 aaaatcctcc tgagtgaggt aacctagaca cagaaagaca aatatgatat gtactcattt 471660
 acatgtggat attagctgtt aagtcaatga taaaagttag gtgaagctgc aatcaatgaa 471720
 accacagagg tcaggtacac agcaaggacc aaggggacag atatccctag gaaagggaaa 471780
 tggaaatctt atgcatggct ggtgggcagc gtgtggctgg aatgggaaga tcaagtggca 471840
 aagagaagga ggagggagag tgacaggggg gctgggcgag gaaatcagc gagaggcagc 471900

 taaaattaaa ggccatttga ggcgtaatat gaaatctaa tactgtagaa gtgtgtgtgt 471960
 gtgtgtgtgt gtgtgtgtgt gtgtgtgtgt gtgtgtttta actgaaatca ccaataatg 472020
 gggaagacag tgagtcccaa ctggacatct cttgtcacca aatgaagctt ccaataccag 472080
 ttacatataa ttgagaacct cccaaaaatc taggctgttg ccaagactgt aggttgctct 472140
 ccacaaactg atgacaaagc cccattgatg aagacagcac ctatacattt attgaacagc 472200
 gagaagtga gctgggtgact gcatagagcc ataacacata catgctattg tctttgatat 472260

aggaaggcac tctgcaggct accaaaagag aagtataaac accaagccag ccacaaatcc 472320

 ttgatctac aatggtgtct tgcctgag atatgcta atagtgctga tacaagctt 472380
 gtgggagtaa ccaacaaata tctgttttga ctttaaggccc actccatgag atagaaccca 472440
 tacctgacac tacttgggtg accaagaacc tgagagtaga ttgcctagga acctagggtg 472500
 aaaccaaata ctactgtttt aaaaaaataa aatgaaataa acaccaccac caaaaaaatt 472560
 acagtggcaa tgaatgact cctaattggtg tgctattata ctcataatca gtgcctggtt 472620
 caaccattgt caaagaacct cctcctgcag cagatgggaa caaacagaga gactcacagc 472680
 cagacattat gcagagagtg agagacatcg gaacactcag ccccaaacag gatgattcca 472740

 ttaaattcct accctcctgg ctgagaaac cccaaagaag agtagaaaga aagtaagaac 472800
 cacaggggat ggagaactcc aaggaacaa gactcaataa gtcaaaaga tagagcacat 472860
 accaactcgc agagaccgag gccagaaact ctctctaatt gatagccacc tacaatgaa 472920
 aactgagttt cctccaggag agtctcactg gggaaacaaa ctgctcttaa ggtaggctg 472980
 ctgtccgaag tagatggcca agagaaaaca agctcagtgg catctttgga gttcctgtgc 473040
 tcaatgtcgt gtcagagatt ttctttttt ttaaaaactt aatcatattt tatatttcat 473100
 tttacatcta ttctctctt tttaccctac aagtactttg tgtacacatt atggctccc 473160

 gcttagtggt tttatggatt ctgggaagag aaaggaattt gggatgaata taggcacaag 473220
 agagagacac cagttagaca acgagcaagt tggagataga gaatgggaga gagtataaaa 473280
 accacatagc agaatgttaa ttttaagttt aagaactagt tggaaacaag cctaagctaa 473340
 aggtcaagct ttcataatta atggtlaagtc tctgtgcat tactggggag ctggccatct 473400
 taaaaggctc ccacaaggaa gtctaactat atctgagtgt gcgaatgtgt ggtctctgc 473460
 atctgtatct gtttctgtt cttttcttg ggctctttc cttctgtttg ttttgtctga 473520
 ttccaatgtt gtcccgtgag attgtctcgc aggcaagaac aacacaggac actcggatec 473580

 ttctgcagta aagctttaat gtatcttgag agagagagca taagcttaca aaagcggaga 473640
 ccccagacca agaatcccgt cccctaataa aggctggcaa cgcgccctg agacgtgtca 473700
 cccatgatt ggctgcagct catcgacca tatgaccca cggaagaggc agagatcaag 473760
 gaatggaaag ttaccagcg cctgcccga ttaactttac attcgggtgc tcccgatgc 473820
 aggcgccatc ttgtaatgga gaatgcaggg acggctccct acacaatgtg ctagttttta 473880
 ttttatctta ttatatttg ttttattatt atcccctaga agccttctct tctttgtggc 473940
 aatttattt tgttttatgt gcattggtgt ttgcctgca tgtatgtta tgtgagggtg 474000

tcagttcttg gagttacaga gcagccatgt gagtgttggg aattgaaccc agttcctctt 474060
 gaagaacagc cattgtactt aagcactgag ccatctctcc agcccagcct gtttgitttc 474120
 caacaagaga tagcaaggag gagcatcttt atggtcattt atcccctctc agtttcccat 474180
 taacacagct tcacacatcc agccagtgga cctgaactac tgggtatcgt aagatgccac 474240
 aggagcccag ctactccaaa tattagtgat gctgtgtggc ccattccagg acattttgag 474300
 gtcccagcct cctccctcca gacacatata agtgataagc acttctagag ctagaactgg 474360
 tgtgatggtt tgaatgggaa tggccctcat acacttgtgt ttgaatgctt ggcccaggag 474420

 tggcactggt aggaggtgtg gccttgttga aggaggagtg tcattgtggg ggtgagcttt 474480
 gagctcatat gcicaagcta tgccggtgtg gtacatagtc tcctgctgcc ttcggatcaa 474540
 gatgtagaac tcttagctcc tccaacacca tgtctcctgc gatgatgata atgaactaaa 474600
 tctctgaaac tgtaagccac tccataataa atgttttctt ttataagaat tgctgtggtc 474660
 atggtgtctc ttcacaacta cagaaaccca agctaagaca gctggtctga ctagttttag 474720
 tacttcacia tctgctttc catagagtct acgaagtatg tccaatcca accactgtag 474780
 ggggcagttg caaagtgtg ttcttcattg aaccagtatt aactgccat tgataaaagc 474840

 tgttctctg attacagtga gagaggaaat gggcaaaagc ccgtctctat atgccttgcc 474900
 atcctactcg agggactaca gtagatgttc ttggggctcc acaagtacc aggctcagga 474960
 tggagagacc cttcatctc cagcaactct ggtccctggg taccattgt gtttctggaa 475020
 tatttagctc aatcttgag ttcatcattt cacctccaaa cttggcaaat tttgtgagat 475080
 ttccaagtc cacatgcatt cagatcctct taatgtgaaa tgttcatatg atccagtctg 475140
 gaagtttaat tigtattata aaaggaaatc tgatcagttc tgtggaagag caaaaacaga 475200
 catatgctcc tctctttgct cccacccat gaaaaaaaa aaaaaacca acaacaacia 475260

 acacctgga aagaatctgc agttaaata aaaagcagct ggcaatagc ccatcgtgtg 475320
 tgatgataat tagacaaatg tttccaagg ttgggatgat cttgtgaaga cagcatattg 475380
 ggtggtggg gcttgggaag tgggtagag tgagagcctg cttacagcgg ggttaagtga 475440
 taacacaatg tcatacaatc tctaattttg taccttttgt ttattgtttt tcccattgca 475500
 tcctgggaaa catgtcttca gctaagagag tgaggaaaa ctgaaggctt tgattttcaa 475560
 aaattaaagc catgactagc tttgggttga tcttgagtcc tgagcctgga aagcctcacc 475620
 ctctccatc tccaacctt cctgccccag ggaagagatt aagagtctta agttaatgca 475680

 gigtttctgc catctggggc cctgacttgt ttgacctat cccaattat ttagtctctg 475740
 ggtctggaat agatatacag ctggctcagga cgacatggct gcctctgctt ctgggtggt 475800
 tgtgatcagg agagcaggcc tgggggctca agaagggaaa ggaagccagc accgtcagca 475860

agatgcctct ctttaccact tctgtcctcc tccttagata ttagacattt acacgttagt 475920
 gtgaatatga aggccatgtg ctaaaccacc cagagttgtt tacattttaa gtttaggctt 475980
 tgatttcaga tgaagaatt gtatcctcat tgaagaatt ccgagtatgt gaacatacag 476040
 aagaggctgt tgggtgtaaa aagaattgag ggagagatgc ggaattctct gctaagctat 476100

 ggagaatgct gatctggtat cctaccaccc aatcaatca taggtagcat ggggtgggga 476160
 gactatacag taaaagcaga agaaagaaaa atggtgggga ggttattttt acttaataag 476220
 gggacctacc tgcttttga ttctaaggaa agagactcct aggaaagagc aagtaagaag 476280
 ctgctttag caaggtcaga aggcgtcaga gtgaaaaagc tggggctctg aggtgggaag 476340
 tgcagacacc tggctgcagc agggagacca gcctctgtgt cagattttac cacaggcctg 476400
 tgcctctgt ggatgagaaa gatgccgca gctctgttga gaaccagagc tgggcacact 476460
 cagaagctgg ggtgactggg aatgtattc agtgcacaag tgcacgtgc cctggtgcag 476520

 gctttggggt taattaatac tttgccaggc tggctcctca gtcctcatgc ctctgtcctt 476580
 gagtagctga tatcgtgagc cactgcacct gctaaatgtt attctctttt taaccaaag 476640
 tttttaaata acaaaaacca tttcctaagt gagtaaaagt acaaatgaat acagaaaatt 476700
 atagagatag ttagagaac tcaactcta cccagaggta agcattaca cacttgaag 476760
 aaccttgac ttatgatatt ctccatgcat ggctacctag aactcaccat ttaccgggct 476820
 acagaaatag aaggtactta acatcaatga gcttgcctt cctgatggg gccttcatgc 476880
 ctttccatgc caatgtgcac ctagaatata gatttctgtt tggctctctt gcctgtctcc 476940

 ctgtcttca cttaatcttt ctgtctatct gtctttgtta tttctttgtt ataaaataca 477000
 tagaacagt cacaacat acatgtttta tataatgagt tctcacaagc aatgcaaca 477060
 gccacaacce atcccagc ccacaacatg cccccctca catctgtca ctttgaacc 477120
 ccagccttt ccaagataag cactctctgg actttctata gcctgggatt ggctaggcct 477180
 gagtttgac ttacatcag tgcaaacctg tggtgacac tctttgctc cttctttcac 477240
 ttgtcatcct gcttgtgagc gtcacccatg ttgtgtgtat gtaatgccta tccaccctca 477300
 tggctatatg gtgtcaatt atgtatgaca ggaacttacg gcatattaaa gacatgttac 477360

 attcattat gctgtgaac atttgtggat tttgtggtt ttgtttttgt tttgtttgt 477420
 ttttagagac agggtttctc tgtattgctt tggagcctgt cctggaactc actctgtaga 477480
 ccaggctggc ctgaaacta cagagatctg cctgcctctg cctcccagat gctgggatta 477540
 aaagtgtgcg ccaccaacac ccacctaac atttgtttaa cgatgcaaag atgtgttga 477600
 ttttttagg ttccattgt ttaattctgt gaagctgtgt tactttgctt gcctaaaaca 477660
 cctgattggt ctaataaaca gctgaacagc taatagctag gcaggagagg ggtcggcaga 477720

gttgaagaa taaatagaaa aataagagag gaaggagtga aaaaagaagg agaggaggac 477780

gccaggggcc agccagccag ccatggagta agaaggaaag aaagacaaat agaatagaga 477840

aaggtaaaag cacagaggca aaagatagac agaataatit aagctaagaa aactggcta 477900

gaaacaagcc aagctaaggt caggcattca taagtaagaa taagtctcca tgtatttatt 477960

tatgagcagg gtgatgggtc cccaaggagc aaagaggaaa aaaaaaaaaa aaaccacca 478020

actacaggaa ctgaatttca tctaccccat ctaccactgt tgaccatttg gaaagtttct 478080

agtttgggtc tatcttgaat acagctcctg tggacaatgt tggatgtggt tttgtagtga 478140

atacgatac atattcctgg ggtttataca gaggagtgga gttgctagac cacgggatgt 478200

ttactcactt tcaagggaca ctgtcagatg tcgtatcctt tgtaggggcc acgtggaatt 478260

cttttctatt catgcgccac attcacatat tcctttaacc atattccac agatgggtgt 478320

ttgtggtgat atgttgttta tgataaaaaa ataaagcttg cccggagatc agagtcaaaa 478380

gctaaccaca ctatttagcc atagattcca gcctgtggtg gtacacacct ttaatccag 478440

cactcaggag acagaggcag atggatctct gtgagttcaa ggccaccctg agctacatga 478500

gattgaacct gtcttgaggt cacatgtctt taataccagc actaaggagg tggagacagg 478560

aagagatatg gttgggtaga gagaccagag ggtacaggaa ctcatagcag tctaggcagt 478620

cagtctgagg atttgtagag atagatgcag actaggcact tagtctgagg cagcagttag 478680

tctgaagcag tctgaggagg gagtctagga caggattgac ccttgagtct gaggtagaag 478740

taggagctag tagctagctg ctttgcctct ctggtctttc agcttcccct cttcactcca 478800

atctctgact cgggttttt attattaaga cctattagca ttcattcaac aggtgtttat 478860

ttgctctcct cacttctcc aaaaagagc tgagtcatca ggagactgaa gtctgtgctt 478920

aagtcgtca gggccttccc gaggtactgt aacttgggga atcatcactt gctggatgga 478980

tcactgtgca cacggaggaa aggtcagttt ttgtcatcct cagcacaagc ttttatgaac 479040

aactcgaagt ccaccaacag aatgctcctg tcacctcagt ttcagtcctg tagtgtgtga 479100

agccaggagg acagtctcac ctgctcagct gcaaccttct ctagtgtcca caccaaacca 479160

ggtgaagtaa gcattaagct aaaaggctcc aattactggt gaatataagc aagaaccatc 479220

ctgagtttgg ctttttaaaa atcacatcat gcacttacag ggctcatgaa tccaagtgat 479280

atgaagaatg cgaactgaaa agtctcactg actttgatta gattcatctt tagtcccctg 479340

ggctccaggg ccccgactt ccctggcatt gcattctttg ctattcttta atccaacaat 479400

taaatttaat tccaaaattt ttcttagatt tttttatgt gtgtgtgtgt tttgcctgct 479460

tgtctagttt cagatggtgg tgagctgtca tgtgggtgct ggtaactgaa tctgggtcct 479520
 ccgcaagact aacagtgtct agcttttaac tgctgagcca cctctccagc cccccacatg 479580
 cccttttaat caaaaggagg cacagaacce acgctgctct gtcttctttt gtcttatctc 479640
 ttgaccagg agccctcttc ccatcaggac acagggagca ccgagtgccca tgtggtccca 479700
 ttagtgaggg tctgggctat cccatggcta ttgatcaca tccttgctgt ccttttagtcc 479760
 cactttctgt ttgtttgttt ttcagcccag ttgtactggc agcagcagaa actgccaact 479820
 ttctcaaag gaaggaaaat agataattta gctactttct ctcatthtca tctagaaaaa 479880

 atgcttttgt gggagagtgc ttttcaattc cagctgtcca gtggtcataa aaaggaagtc 479940
 agcaactgtt ttggcttca taagccacac tacagtagtc ttcaaacagc ttgctccctt 480000
 agctggaggc cagaagtctc tactggaggc caaaggtctt tgcatgttgt ttccactgga 480060
 cctctcttag tgtagacaca agcaccaagc tcccaggagt cagtgtggtc agaggctgag 480120
 ggtgtttctt tcctgagag cctatgaggt gtacagctac cccatcacat cctgaggact 480180
 ggataaggag aacacagact ggaagctaaa aataaaaacc agaagacagt agcaggagaa 480240
 ttcatcttca gcactcatga aagattttca aaagtgtga tgttgaaact gggttatgga 480300

 aagatttggc aaaagaaggt tccagaaaga agttagagat tgggtgggtgt cttacagagg 480360
 gtttctgttg cttcaatgaa acaccatgac caaaaagcaa gttggggagg aaagggttta 480420
 ttggcttac acttcagcat tactgaagga cgtcaggaca gtaactcaa caggacagga 480480
 ggcaggagct gatgcagagg ccatggaagg gagttgctta ctggcttgct tccccgatc 480540
 cagcagcca tcttcttata gaaccagga ccagcagccc aggaatggca ccaccaacca 480600
 tgggtctgggt cctccccac tgatctggat ctcacagaaa ggcatttctt caaaggaggc 480660
 tccttctct ctgatgactg tagcttgtgt caagttgaca cacaaaacta gccagtatag 480720

 gtggagttag taitcagga tctgtattgg cctgtccttg gagttcttac aggatacacc 480780
 ctcagctgca gccactaaca gcacctgtgc agattcactg tgttcccttt taaaagagcc 480840
 ctgctacct cccatcttctc tegtctctc tcctctctc tgttagctg ttcctttctt 480900
 tcctctctc tgettctctg tctatctctc tctctctc cccctctctc tgcctctctc 480960
 ttctctctg ctattctgt ccccagagac ctgtctcccc tctccctcc tccattttcc 481020
 cattcacttt cccccataa aaaccttcc acccaagctc gcatgggtgc ttactctctc 481080
 acaccacttt ttaaattaca acaggtggta tgtccccaag ccaactaaag gtgattgaag 481140

 gggctgata tctctggagc agtgatgcat gatagataga tagatagata gatagataga 481200
 tagatagata gatagataga cggacagaaa atagacagac acacacacag agagacacca 481260
 gagagtgtgt gtcttactct gtaccctga ctgaccagga actctcttat gtagactagg 481320

ctagcctcaa acicatatagac acccacctac cgctgcctcc tgagtgttgc atttaaaggc 481380
atgcaccacc aggcctaggt gttcaaaaaa tcttggccag aattcagcac aaattcagta 481440
aagacacagc cattgtgggc ctcactgcag agctcatcac caagaaagta acctggggaa 481500
cacttaggat tcctgagagg cagatgtatg ggagtggaat ctgcagatac agaaaggaag 481560

actgtgctgt gcagccttgc aagctgattc aagcaaaacta ggattccttt caccatattt 481620
tcctctcac acaagcagtc cattatatta actgggcaca aggactgtgt cttctgacta 481680
catttcactc agcaattatt ttattgagca ttgagtcgag ttccatgtaa gcaaacagg 481740
cataagactc agtcatggga aattagcaag ctgtatctgt aaacttacag ttccgtttat 481800
cccttattcc acgtttttaa aatggcactg gcttttggtc agtccctca taacaagatg 481860
aggaagtcc aggaaaccac tttcttacac ctgtattctt ataactgtca aaaagttaa 481920
acaaagcttt tggggaccgc tggcctgaat catctcagtc cttacctgct ctgtgccat 481980

atggctgtga cctttgcttt tctcctctga aaattagata tgacgatccc tcatcaatgt 482040
gctgtgggca caattggtag catatacggg gtgacgagtc tagtatacac aaaggcttaa 482100
tgaatagccc cgctgtgtgc tctgtgggta caataaaaat gtgtcaagtc tggtttctgc 482160
ttcacttggg ttcagtatct actcgggagg ccagagtcaa acgtaagaac taattatgga 482220
gcggggcctg ccagtgtata attaagcggg ctggtgaatt gtagaggct aactataaat 482280
gcaatcggat gtcagcagtg gaaaaggtgg atttgggata gtggaggatt ggacttgtgc 482340
ctggccttgc aggagaagct caaggtgggt taggagggct cttagactaa ggaaaggagt 482400

gaggcagtga gggcctggct tgtctcacgg gtggagtggc ctgaatgaga gagaggaac 482460
caggtcatgg tggagcatgg ggagccagcg ggtacacagc acgataaac ctggttaggc 482520
caatcttggc ccagaaaaga ggagaaggct ctctcattg agcagtagtc tttgctctga 482580
agaaggatgg ctggtgggta ggcaatggct gctcttaatt agggttgata taggagccct 482640
aaagacctta tgttgagagc agtgaactt tcaactagggg atacattacc tagtttacia 482700
aaaacactcg aggcagtttg tctttttcaa gtcaatctaa aggtattcct tgcaagtttc 482760
accatggaag aggggtgtga cagtatttgt gcacatttgg aacaagatgt tccaagacat 482820

ttggcagagg catggagaac atccctactg ctatggtgcc atctttctgg tctctctagg 482880
gtggaaactc tcaggacact gctgcctcac tgcaggacca acctcaggga tgtctggttt 482940
ctgcatccct gctttgtgta ggaagaagtg cccatcacia cggattttaa caacctgtgg 483000
tctagcatgt ccaatacaaa gaagaatcct tttgatccta attaaggcta gggcccaaag 483060
ggttcaaaat ataactatata ttttaggctt tcttcaaagc ctaaaaaagg tgtggcgggg 483120
gccacaaatt aacgattggt tgatcattcc caaggatga tgttatcatc acagctgga 483180

atctgagtg gaaaccgaaa tattcaataa tctaattatg ctatcagtg tgaaaaatca 483240

tgttcctagc ttatagattt aaaaacaaaa gcagacaacc atcagataat ctgcctgcct 483300
ggggctgagg agagattagg caaatcagaa cctctgettc agttatgcat cacacttgg 483360
ggctgcaagc agagcagcca ttggtgagat gacaaaatca atctactcaa gcaacttcta 483420
ttaaataaac ttacatttaa gaatacttta aatttatcc ttgatagttc tatacatgta 483480
acatggtatc ctggtcaaaa ttatectaaa ttctctctct cactcctccc ttctccttg 483540
aacatccaag ttctctctgt ctctgtctct gtctctctct ctctctgtct ctctctattt 483600
ctctctctct gtctctcgtt aaataactca ctggatacaa ttctttcatg ctcatgggtg 483660

tgggaccatc ctccagggga ccccccaat agaacagtga ctccatcttc cccagcagcc 483720
atcaactgcc agtagacct cagctggagc agaaggtctt gagtccttc tcatctgggt 483780
ggagtattga ctggcttgat atttttcagg tcttatgctg acagccgtag ctatgtattc 483840
atgagtgtaa tggctatgcc atgtctggaa gacagcattt cagagtgttc ctctccattc 483900
tcctattctt gctttctgac cccctttca aactgttccc tgaatattg caggggttga 483960
gatgtataa tggtttcatt taggetgcat acaccacat tacttattcg aggcacttca 484020
accatctatg agtttaaact ttgacagctg ctactacac aaagaagggt ctctgatgaa 484080

ggtcgacagt agcgctaate tatgtatata aatataaata tttagaagc agtttgacta 484140
catgtccatt tagcaaaaca agaatactag gttccattct agcatctata accaggcatg 484200
aatccttct tgtggagtgt gcctcaaat catgagaaag cagttggtta cggccttact 484260
gttgttccc tattgctcta ggaggagcac ttgcccgaca ggtcaatttg atagcattca 484320
agttccacca ctatgtaagc cagttgatga cttttcttc ccatcagcct acatggcatc 484380
tctgtgatga tgaagttag tcatcgggaa gaagtttcta ggtcagttct agtttgattt 484440
cttgttctt gaaaccaaac tgctgtgtct tcagcaatag ggtcttacca accagctatg 484500

gtaggcaacc aggagtagtg gccacagttc atgctgtttg gggacctccc gagatttccc 484560
tgatctatat gttttcaca tatagctttt attattttga gatatgctcc ttttttctg 484620
ggttgcttca gggcttttaa caggaagaga tgtagattt tgtcaaaagc cttttcttcg 484680
tcaattgaga tgataatgta atttctgcca ttgaatccat ctatgtcatc taaaacattt 484740
attgattgat gtatattgaa ccatctctga ctctcttgat catggtgaat gatcattttg 484800
atcaagatgt tcttgaatta aatttgaag tattctgttg agaatttttc tatgttcac 484860
aatttaactg gtctgaaatt ctctcttct tctctctgta ctccctctct ccttctctc 484920

ttctctttc cttttctccc tccctctccc ttcttctctt ccttctttta ttttttctc 484980
 cctttctcc tcattttttt tttttttggt cgctgctgtt acacctttac atgtttttgg 485040
 taacagggtta attatgagaa gagtctgatg ggattccttc cttttctatt ctaagggcta 485100
 atttgagaag cattggtagt aattctttga aggtctagta gaagtcacat gtgatgtcac 485160
 ctgggcctgg acttgtttta gttgggagag ttgttattgt ttctcaagac agggcttctc 485220
 tgtgtaactg tggcagtcct ggaactcaact ctgtagacca ggctggcctc aaactcacag 485280
 agatctgcct gcctctgact cccaagagc taggattaaa ggtgtgtgcc accaatgccc 485340

 aattaattgg gagaatttta gttactgttt caatctcaca gcttgttata aaaatgttta 485400
 aattgtcttg ttatttaata tggcacatct agaaattcat ctttttttta gatttttcta 485460
 atttagtgga atatttgttt ttaaggtaag gcctaagat tttctgaatt tcaactagtgt 485520
 ctattgtagt ggttccattt tcatttcgaa tgttagtaat ttggatgtta gctctcttcc 485580
 agttagtttg cctaagggtt tgctgatctt gtgtatcttt ccaaagaacc aactctttgt 485640
 ttcttttatt ctttgtgta gttttgtttg cctgcttact tgcttgtttc cgtttcatta 485700
 atttctgcct tgacctaac ggtttcttcc catttactga cttgaggttt ggcatattct 485760

 tctttttcca aggctctaaa gtatgtcatt aagtatttta ttttcaattt ctctgacttc 485820
 ctaatgttgc cacgggaagc tgtaacttcc ttcttaggac tgtgttttag tggattccat 485880
 aggtttggta tgttgtattt tcatttgact ctataaattt ttaaactttc cttttgattt 485940
 ctttaaggcc ccaattatta ttaatagcg tattgctgtg cctccattac tttgtgatg 486000
 ttctagggtt tctcttgctg ttgttccatt gtgatcaggt agaatgcaag gaattatttc 486060
 tattttccag tgtttgtaa aactttcttt gcgatgtatt ttagagaaag ttctttgagt 486120
 tgttgagaag aatattgttt tggcagtggt tggatgagat gtcctataga tgtttgtaa 486180

 gtacatttaa tctaggatgt catttaattc aggtattttt ctgtttattt atttattttg 486240
 ttgggaagat ctgtcaattg gtgagagttg ggtattgatg tcacctatta ctatagtct 486300
 gggtttcacc tgtgacttca catctcatag tattagtttt ataaagttga ttgttacttt 486360
 ttgagagggt atatgtttag catcataatg tcttcttgac atatctcacc ttctttgact 486420
 tttcccacta tctttggttc gaatctattt tgttggatat tagaacagtg gtgcttttct 486480
 catagattca tttgcttga atatatgttt ctgtccttct tccctaaggt agtgtctttg 486540
 tgtgtgtgtg tgtgtgtgtg tgtgtgtgtg tgtgtgtggg gtgaggtaca tttattggag 486600

 gtaacaaata gacagttctt gatttttgc cagcctacta gtctgtgtcc tttgcttggg 486660
 ggaattaaga ccaactaac ttaacatttg gggttattat ttaaagttat atatttattc 486720
 ctgccatttt gttgcatttg tatttttctt ctttctctct tgcttaagta ttattgtagt 486780

gtgccttatt ctcttatgg cctcatgatg gattcatttt tcctgggagt ctgaaagggt 486840
 cctttaggtg tcttctgtag aaccaactta gtggtcataa attcctcagt ctatttttat 486900
 catgggatgt ttctcgtttt ccttcaatag tgacagatac ttgctagatg gagtagtctg 486960
 gattgicagt tgcctttcat atttttctaa gcctcttgg cttttaaagt ttcagttgag 487020

 aaagctgctg ttgctctggt aggccttccct ttatatatga ctcttgccac attcaacata 487080
 tttcctttgt tctgtatatt tagtgtttta atcataatat gactaaggga gattctcttc 487140
 cagtcttgta tgttctgggt tctaaatc tctctgtgtt ggattggtat ctcttttccc 487200
 aactctgggg aaatttgta tagttctttt aaaatgtctt ttataccttt agaacactat 487260
 tcttctcctt caiccatgcc tacaacttgc agatcatgtc ttttctgaat gaaatatata 487320
 tgttgaatc cccactggta ccttcttatt attttatctt tgtgtctgat tgcctcagtt 487380
 tagccacctt gtctttgaga tcagatattt tatcttctcc ttcattcagt cattctattc 487440

 cacaacactt tttttatcag cttgcaatgt ttatttttat ttccagaatt tcagattttt 487500
 ctccaatatt ttaaatcttt ttaaaattcc ccttttagtat atttcattgt ctccctgttt 487560
 tattcttttg ttttctgtg ttctcaatca ggcgctcacc tcttcattca tctctttgaa 487620
 catgcttaaa tttattcttt tgaattctct gctctgggatt acatctaatt cactcttgct 487680
 agatttcatt actatatgat tagtaatttg agaagaggga tatgttgtgt tttttttttt 487740
 catgtttctt atgttactgt gttgagattt gagcatttgg gatcatttca ttgcttggga 487800
 ttttatcagc tgtattctc cctttgacac atttgtacgc ttaaatgata cttgagtgtg 487860

 gtagaattga agtacataat tcagaaaata gtccccagct ctcaggttgc ctgggtggtc 487920
 cctgtatcat ctcagagtag aatattaacc gtgagaacag ccacagctgc tagatattac 487980
 agctatgcaa atgctactact tgccagttag caaaagtggc cctttgact tcaattgctg 488040
 ttagagttta aacaatcaaa gatagtatgg agtatactgg gattttagtt gtttaagatta 488100
 ggattggaag ggaagtagga tgggtgaaga tagggaaagg attgaattaa atttgaaaa 488160
 aagttaaggt gggtaaagca gtggatctct gtagctccca tgtccttcgt ggttttgaa 488220
 tatgtggaag gggaggctgt aagtccttc ctagtagttc cctggaactc tgcaccgcct 488280

 gcaccctggc atcctctgct tctgcagatc cagtgtttct actgctcttc cctggtggct 488340
 tagttagaga ggaacttgecc ctggcctgag tctccgctcc cctgcttget tccctgcaga 488400
 gatctcccct gcttgatccc ctgcagagat ctcccctgca atcaatcaca agttcattta 488460
 caggccttcc ctcttcgaga ataagtgttt actgtgtgct ctttaatttg ctgtctttta 488520
 aatgtatttt tatccatttg ttattatgtg agtgtgtgct attttctca gggtttcagt 488580
 ggtaaaggct tcaatcctc caatttcccc agaagcctct aaaactatta ttttttaatt 488640

tttaaatttg tgacaaaata catagaaaat cttattatcc aaaccatctt gttactgttt 488700

 tgctggcatg ggggggtac tgctgtgtac atgtggtggt cggacgacaa ctatgaatat 488760
 cattcctaat tgtgtgtgtg catatacaac acatcataac aaggaatcga gtcacgcat 488820
 tctggaggct agagatcctg tcacctgcca tctggaaact ggagggttag ccaaggggcc 488880
 aagtccaaaa gtttaggaag gcctccaaac cagaaggcct gatgtccaag gtttgagaa 488940
 gatggacctc ccagattaag cagagagctc atctgtcctt tctcggtttt tgttttgttc 489000
 aagctaaca cagtgggagt tgccctgcctc actggtgagc actgagtttc attgctccaa 489060
 ttccagtact aatctcttcc agaaacaccc acttgaccaa ccatctaggc atcccacagg 489120

 tggactcaaa attaagiatc ccatatgctt gcataagggt cacccacggt tctgagcatc 489180
 ccatatgctt gtgcatggtg cacacgcagt tctgtacttg cctgtgtgct tatctctgcc 489240
 tctgtagatg gatgttctctg ctgcttgtaa tcttttaagc taacattctg tgttcaaatt 489300
 gaacattaca caglatcatt tcccacaggf gagccagaac tcttcaagag tgtggctgtg 489360
 attctgacaa cctctctcgg ttgtgtgcat agccgatgct tatgggatat tcttcaagtt 489420
 ctactca caccacaacc actctaccaa gtataatcca cctgttccat ggagaagagt 489480
 ctagagaagc aaactggctt gttccagatg ccatggctcat ctgctgtagg ggtctgtgcc 489540

 tacagctcca ttgaccttcc aattgcagtc cttgctcaag atgtatcgtc tgtatgaagt 489600
 ccccgccttc tgagacagat aaatgacact gtgtcacagt gtcctagagt ggggacaggg 489660
 tgggacttga aacaaaactt caaatactcc cttctgtctg gacaaccatt ccctgtccct 489720
 ctcacctgt gtcacacccc acacaccccc acacacctt gaagattctg tgacctctgg 489780
 atgccctggg accaagcctt ccttctgtgt cccacagcaa ccatctctca cacacagact 489840
 tacacatgag gttccttctg tgtcactgag attattcttg agggcattat ttgcttttgt 489900
 ttgacactca cctctgtagc ccageccctc agtggaaata ggctgcttct gaagtttgag 489960

 ctggactcaa atctttcacc taatgcaaca acaggacaag agcttggaaat ctggggcagg 490020
 ggatggggag ggtagggagg gtggcggaat gacttttgct gaaggcttag gaggggatgc 490080
 ctgaggccct ttttagatgc cccatagaga cttgacagac tgcccagcct tgaggcttc 490140
 cccacctctc ccatgaagcc cattccactg atttcatctg ttaatgtgct gtccccacc 490200
 actcttgtgt gtgtgtgtgt gtgtgtgtgt gtgtgtgtgt gtgtgtgtgt gtgtgtatg 490260
 tgcattgtgc tgtgagggtg ttgagggtgag aggagggtgt tgggtacact gctacttcat 490320
 tcttactttt attcccttga gacaggtctt ctattgacc ctggaactag gatggtacca 490380

tcaaacccca gcaaccctcc agtctccact tcccacaaca ctgaggtttc agggagacac 490440
 actttgcctg gctttttaca aggatgccag ggatttgaac acaggtcttc aaacttacag 490500
 agaaagcact cttgccactg aacaatctcc caggcacctt gttctactga cttcttgttt 490560
 tcttcagtcc cactatacat gccttccaca cacttgtctg tggccttgcc ctttctggag 490620
 atgacctta atgcatgtct taatcataac agctagcccc cagacagcac agtctatgtg 490680
 gccaacactt acaaatctgg atgtgcattc agacagtcac ggtgactgca tgggaaggttc 490740
 tgttacgata ttgcctctgc cgcagaaggg atggaggcac actaaggttt agtatactgt 490800

ataaaagtca cagtcaagct gtagggccca gattcacagc cacaaagtct agtttcagaa 490860
 tccatgcctt taaccattac aaggcaaaat tcctcaaggg tcacttttct cagtcactcc 490920
 cacagagtca acccatggaa cccagcaaag gtgtcaagaa tctcagaaat cccttaaagg 490980
 atagcaccta gtctagactt acctggcaat ctcaaatctt cttttggagc cacatggctt 491040
 caaagaccta ctagtcttc ttgtcatctg gatttggctg ctgtggccaa ggctgccttt 491100
 ttgtgcagac cacatcttag aactttcttc attgtttgtc ccttctgac tgctccataa 491160
 caaaggaagc aagcagcaag ctctttcccc acttgtgagc atccttgtga tttcatgcat 491220

gcattcatgt gtccatctct ggagatacgg cagaagctat ggttgcctga gtttgctaa 491280
 ccttaaaacta agcctttcca gggtagctct cagtctagac tgcggatgcc agtagaggag 491340
 caggataaagg ctgagggact tcaattggaa gtcccttgaa gggcagcaca ctgaggactg 491400
 tgctattctt cttaggtagg gtgggggaag gggctatggt cctcacaat caagcaggat 491460
 ttacacacac acacaaaaat ccttctctt tcattcaactg acagttccta ggacagagga 491520
 aacagggagc aagcagaaa gaactggacc ccatgggaca catgaattaa gccttgggta 491580
 gcaggaattt ctgagcatcc ctttccagg gtgcatcaca gaagacctt cctccacagg 491640

tggcctataa gggattgctt tgtattacc aggatgetcc tgttgggggt gccttagctg 491700
 tcatctgcaa gtgggttcta atgttctgtc acgaaggcaa actgaccctc aacagcacgt 491760
 tgaagacaca aatgttctca ctgagctgct ggctgctggg ctactcacc tcatgcccac 491820
 cccccccca ctgaaataga atccagtgat ttaaccaggc tgggaggaaa gccggtgct 491880
 tccagttagt tcctgcatg tgcccctgt tggggccag ctggtgagac accggtgtgg 491940
 gctgaggttt tcatgtggat ttgggaaggt tcccactgat ctgaatgtca tggctgctct 492000
 ggtattttaa gttgaaattc cttgattcgg gtcaactatt ttgtgcagag caaacctgat 492060

gacagtccat ggggaatggc taagaaggaa cactaaagag acatgacaga tcttcaaca 492120
 aagcgaccgg agtttgcta gtggtgtgg tcatctgcag ggtagctta gacactttc 492180
 ttgcttggaa atttcccttt ggaaatccag aacacgctgg atcttcttc aagcctgagg 492240

aataagcaag ggtttatatt gctgaagggtg gatttgattt ggggattttg tcacaaataa 492300
ttcatagcca aatctgggtga tccccctcca ggaaccaagt ctgctgacgc catttgggac 492360
ttaaaccaaa aagcacaatt atcaagtaat gcatctaatt ttcatcctgt gccagttggg 492420
gagctccaga aagaaaaata gagataattc agacgagtga cacttcccaa cttttcaaa 492480

ccaatttcga aggaccagaa ttttttaaac cagcctttct acttgaanaac catacacatt 492540
tgtgttaaaa attccttccc ctcttaaata acctgtgagt ttgtgggggt ttaagcttat 492600
taaccggcac tgttttcttg tattaatcat aggccattaa tttatttcaa tagtcctacc 492660
actgcgcctg tgtttttctt ggctgcagtc cagttcctga atgtactgcc gagcaaggag 492720
caggcagttt atcataacac agagctgaga ttattgttga gaaaagcgca gggggtaggg 492780
ggttggggtc tacaagtga ctgctggcca ggactggaat tcactctggg ctttcttct 492840
ctccagcaat gtcttgctaa ggaggtctcc tgtcatgagg tcattccatt gtgattggct 492900

gagcactaac ccttgcctgg cattagactt agcatttgag gggggttaa gaggagacta 492960
tagctgcat acaaccaatt aaacatgata tcaacctac aactgaagtt aattatgagt 493020
gaggcccaat acaacttct aaaactacc tgaatatata tcagattttt ttgtctattt 493080
actgattgtt ttgatcaaa tggttcttag gtgtgaactc tgtaagtaac actgtggtgg 493140
tgtagccttg ggactttaat atgttgggca taccatgag agacggagaa gcaagcacca 493200
cgaatgagge aaacaggctg ctgtcaggtc atagcataga caaagccaga ggttaaaaac 493260
tcccaatgag tgggtgttga gagacagctc acagagaatg tgttgggagg gtggctgcag 493320

tcctcttcag ctgtccttga acccttttc ttactgatga gttccaacc aggccccag 493380
agctgggtgg gtictgagta tggggttaca gcattaggtg agacattaat cacaaacatg 493440
aatcagcctg ttctgtcctt ctgccaagct gttacctgca tctagagatt gcaggggaat 493500
ttattatgtt acacaggaag agaatccctt ctgtgtggca ggcaggaaga gaaccgatct 493560
taggggctag gtgacctctt tggttccaca aggactgtga ccaccaggaa ggtcttttc 493620
tcaggtagtc caacccccac cccagcctg tgactctctc tggaccttt cactctctct 493680
gggccaatt atgtgtaggt cagaaactgg cttgggctaa ttttctgtt catattggtt 493740

ttctgtcagt ccaggatggt tagcttatac agaaaacaca cttcacatcc aaaccagcag 493800
gtctgggtca ggacctatgg ttcttccaaa tgetcttct tccacagcca tctcgccag 493860
gtggtgttcc ttcagtctaa ccacatgggc tctggacct ccaactaccg cctaattatt 493920
gcagagtaac taccactttt aaatactcac tatggtgtct gtctctactg tttgaggag 493980
cactgttggc ctgttttcat attttgcata cactgtcctt gtgtcttgac actgatggga 494040
ctgcacaacc ttctaaggga aactatggct cagccacacc atcatgaact atttcttcc 494100

ctttagtacc cttagtaaag aagaggcccc aggattctca gagggtaggc agcttcccca 494160

acacctttgt aaatgtaagt gtggatcagg taccacaatc tgtgttctcc ctcctcct 494220

cccttctct gtctgtccct tcctttctcc ctctctct cctgtcctt cttttctec 494280

ttccctttct ttcttttttt tttttactta aaaaatgta ttgcactaaa gttattaca 494340

tgcaactgat tcctcaggaa actttagtgc ctgagacttc ataggtcaat cccaatagt 494400

ctctagaaat tctatttaac tctgcgtttg aatgtcacat ctatgtagca aaggagcct 494460

ggttgttgtt ggtttttgtt ttttgggttt tttccttcta ccttaagaaa gtttcatctg 494520

gaaaacaggc actagagagt gctagaacca acaggttttt gttttgtttt gttttataat 494580

caaaacaaa agcaaggcag gcccatatca ttcattgcaac caaaagtaa cttggacagt 494640

taatctagaa gggagaattt cccacagggg cagaatggtc cagtatccag tgagcaagag 494700

aaagataaaa atacaaaggg aaaggcatca aatgttcaag gagcttttgt ccaactctag 494760

caagcccatc tggacagcaa agggctcagg agacatgtgt gaacagacac ggatgcatgc 494820

ctgtcaacat gtgtgaacag acataatgca tgcctgtttc acttggaggc acatacatca 494880

gggattatgc acataaatac ccctcaaagt caaagtcact tggtagctac aaaggctggg 494940

tgtacattag acaaaagcaa atggaacag aaaaaaaaaa aaacacagat atacacatgc 495000

tcacctgatg ggggacatcc tcaataagat aagtttataa agtatgtaga ttaatgatta 495060

tggttgacac ttaagacaga gatagcagat aagaaatcct agtcattggc cagcagcatt 495120

gtaattaata agagactctg tgtgttattt cgggggcccc catggcgatg gggcttgggc 495180

ggtttggcgg aaagatttat cgttgcactc acctgcaatg tgggtataca agcatgctgt 495240

ccaatgcatg tcagcaggcc accaccctgt cctggatgga gcctatcaac atgattgctc 495300

ctcagacctc tgtttttgct tttagtgtga ttaaaaacat tggcagacaa ggctggccag 495360

gattgttggg atgataggtt tggcatcctc caaagagagg agagcaagtg gtaccaaga 495420

aagcctaagt agggtattta gaagcaggg gtgagctgct agggttgggg atgctaggca 495480

taagcactga tgatgtgatg aacatctgta cctcaaagta cttggggcct caggagtcaa 495540

atccccggc caactccatg cggttggcag tcttggatgc tgtcacctt gcctcaagct 495600

aagcatgctg tctgcagaac accctgtgtt gatggtctgt ggtccatcat ggggaggtct 495660

tgtctggctg tactgtctct cctctggagg ctgaggcagc aggtgtaacta gttcaagtc 495720

tgtctgctac agagtgagtt caaggctgc tttggagggg ggcctatagc ttagtggtag 495780

agtgcttgtc tggtttggg gaggcctag atccaaatac acacacacac acacacacac 495840

acacacacac acacacacac acacagagag agagagagag agagagagag agagagagag 495900
 agaaggagac acacacacac acacacacac acacacacac tcacacacgg taatcatagc 495960
 attcaggatg ctgagggag gagattgtga atgtgaggct acactgggtt acacagtgag 496020
 ttccaggta gcttttagcta ctacaaacca agacatggga gtaagggagg aaggaaagga 496080
 gggaagcaaa caaactaaa aattgaagcc atgctagcct ctttaaaaac cctgtggcag 496140
 ggagtccagg ttaccagagc agagcacatg tcagatgcag gattctagc tatacaatgg 496200
 ctgatgggtg tcatgctacc acacctattt cccagacaaa tgaaaagcac aaaactgcat 496260

 cacatttctt gctatgattc caggaaaga attgatttgg tacctgtccc agtcagggtt 496320
 atatgactgt gatgaaaca catgccaaa agaaacttgg ggaggaaagg ttattcggct 496380
 tcccctccac ataactattc atcaccaaag gaagtcaggg caggaactca cacagggcag 496440
 gatcctggag gaggagctga tgcacaggcc ataccctaca ggtgtgtctg cttatagctg 496500
 ggtcttctgt gggcactttc ccaaatgagg ttctttcctt tcagatgact atagcttgtg 496560
 tcaagatgtg tggatgatga ttagttatga ttattaaag cttgtctgag gattcagaaa 496620
 gcaaagttag tcacaagcca tagaagacag gcacacatct ttaatctcag cagccagaag 496680

 ctaggagggtg gtggatttag gattaagaga tagactggga tcacgtacct ttaatcctag 496740
 ggaggatag aaggcaggag caaggtctcg gtgtcagaca ttcattcccc agccacgttg 496800
 aggatagaa gacattgaag tctgaggatt ctccagcct gctgaggaga ggcagcagtc 496860
 tgaggtttgg tggaccagg atctcaattc agtctgagg agagtgagag acagtgacca 496920
 gctgcttttc ttttctttc ttttcttga agtgtgaacc taaatatcag tctctgggtc 496980
 ttttattttt ttgtacaaca aagatgacat aaaattagcc caacatggaa cttgtgaagg 497040
 atgggttaca aatgctaag aatacttctc ttcaagagac ggacatcatt ttttataaga 497100

 cttaaatctg ttttccaaat cttttccact tatattecaa ggggtccatc tagctctttg 497160
 gacacaacc ctaacctaac aggcctcag taaaggcttg tgatatatag agagcaccta 497220
 tgtgggttgg tggcatgctg agccaacatg tcttagactc atgtttgagg acacacagga 497280
 ggagaataaa aaggcatgct acatacgtag tctctgctgg cagcattatc cactgactct 497340
 cactccaca caaggacag aggcctttct agacaaatgc cgattctctc ccaagggaga 497400
 ggactatcgc tcaggaacta aacagacct caggatggaa aactcttgca gaatgtccac 497460
 caaaggcct gcgaccaga agacacgggtg ctttgttagc cacacaggac ataagccaag 497520

 cagcatgtag cttctcaca tgtaaatgt acagtatgat cgatccagtg agaatgattt 497580
 ccctgtcgga ggagactctg agtgattaaa cacaaaagag aacaatctag tatatccgtt 497640
 cggagaggct gatgatcctg gagagaaagg gagatagatt tgtgaagtag caggaagctg 497700

caatccaaat gcagagcgaa tgagttaatt acacctggag aggtgacctc tcctgtagc 497760
 ccgggctaga gctttgggtg cgaaagtcaa ggagtcagag ctgccacctt catgtctcca 497820
 gttctatgtg cagccaagag ctgtctgcat tacccaagtg ttgtgcagga ttagaggtag 497880
 gcaagggcag ccagcaatgg cgaaacgtca ggtctctgag tggagcaggc tgtgagattt 497940

 ttccacccat tttttctaaa ctttttactt tggagttttt aatctgggaa gcaagagacc 498000
 atcctggggt gacttcttca agtacctgga gaagacaggt atttcagatt ctggggatat 498060
 tggacatgaa ttgttcctag tctatgaacg tgtctataga cataaatggg gtcattccag 498120
 cctagacctg gacatagtc ctggggctta gctggggaaa atgccagtgg agggaggggg 498180
 ctgatgtgta acitgtctat gttctccctt gaatgtcttc ccacagcagc tggaggtctg 498240
 tgccttctct ctacccatag aaaagcagaa cgggtgtccc gtcatttcaa atgaaagtcc 498300
 tttgcttttc tgatgcttca tctatagcct ttcacaccac acctgacata gatcagtcac 498360

 aactgaagc ttgtgaaatg agataggaca agaaagatct gtaaagatgg aaaacaactc 498420
 agaaatgatg aaaattcatg gggacagttt ctactgcctc tctcagcccc tgctgttgaa 498480
 aggacagttt atcatgtgaa tcaatgattt ttttttaaat taagatttag ttttgtttat 498540
 ggggtgtgtg gaatgcttgt gagggtgctc tgggaggcca aaagaggggg ttgtagccct 498600
 cgaagctgaa gttacaggtg gtttcaagct cctgaagta agaaccgttg tcaccaaact 498660
 tatgacactg ctccctttct ccagccctct ttatcagggg ttctaagtcc ttaactatac 498720
 tatccacgag cgttaccatc tcacttacag atcctttttg catctcccct tacacatctg 498780

 ttctctgcct cctcccact tccagtgcta ggatcagaca gcacaccag ccttgtgaac 498840
 tgctgttttc tcttcagaac attccatatt tctgtcgcca gtgtcaatag ataccatctg 498900
 tgtttaaacc tacatgacag taaatgcat gagtagacc aagattacca cccagttggg 498960
 catgggagac tctgggcaga tcttcattta aggggcagaa ggaagaggga tccatgagaa 499020
 actagaaggt ggccagaaag ataagagaaa ggtatgaagc aagaatggca cagagggaaag 499080
 agagagggag aaaaggctgc atcgggaggc agaagtctct ggctcatagg tgggtttcct 499140
 aggtggaatg tgactcagca ggaggggccc acagtgtgct tteccactgt ctctcccac 499200

 taggaaataa agagatttag tcaggtgatg acctttgat tttgaaagag tattagttag 499260
 ggctgcattt ggctacattt gagggaatcc taaacagtaa atcacaacca aaaatatttt 499320
 atttattatt ttigctttca gggctttttg tggcccaagc tagctttgaa cttactatat 499380
 agtgaacacc tgactcttct gcctccatca ccaaaggccc acaccacca gctcagccac 499440
 caagaggate tttttctttt tctttcttcc ttcattcat tctttcttcc tttctttctt 499500
 ttttattttt agttttttgc tcagttgaga agaaatttca aggcaggtaa aggttatgat 499560

aactgggtcaa gggacagagg ggcacaaatc ccattgagtg cttatttacc atgatcagta 499620

agaatgtcct ccttagtttt cattttgttt gagacagggt ctctctatta tacagctttg 499680
gggtgcctag aacttgetat gtagaccacc ctggcctcta actccacagc tatccatcta 499740
cctctgcctt ctgaatactg ggattaaaga catgcaccac tattactggc ctctcaggc 499800
atthaaggta attattcttc ctctaaccat catgccaca ctccaagaaa aagatgggca 499860
aaaggatgaa caaatctcct atattacctg agtctatttg catggaagcc tcaactccaca 499920
aactctaaca tgcatttct cagaactcca tgggttagtt tctccttagg gtagaagagt 499980
ctggaaatgg gcacagatca tttcttctgt caaggaaaat actgggacta gatactagta 500040

agcaacaagc aacatcctcg tataggctga ccatttgaga aaagtttggc ttgaccatta 500100
atagcaggta accttcatag attgatgata tttcctagta aaaaacaaag atattaaagt 500160
aatccatttg atcctaatgc aagtaggaag taaaggataa atcatacca ctctgggccc 500220
agttttcttc acaaagcagg ctagtccag gtattggtgt cagctgacct tctgagtcc 500280
agctctttcc attcccagac agccctctca tgcttttttt ttatattact atgaaattcc 500340
accttgcaaa actagttgga aaaatccaag ctcagcaaat tgccgagaga ctaggccata 500400
tcaggggagc cacttggagc cgggggactc cctgatgaca gacatgcttg aatctgttta 500460

atctccacac ttgcaaagtg ctggcaactt tagctctggg tgacagagag ggaagcccca 500520
tcacaagtac agiatgggtc tccaggctgg ccatggtgca ggaaaaggct actggctagt 500580
tctgagatta aaaaaaaaaa aaaaaaaaaa aaaagaatct gaggtaggga aaggtttccc 500640
tcatcagagg tcatttgggt actgtagttc cattttctcc cagtagcctc tgttcttgac 500700
aggttgactc ccaggctgct gctcttcaaa tagtgcgcta cccagagcag ggcagtatct 500760
ttgagggtga gcctaagctt taattatttt ttttgcttga gacaggatca tatgatgat 500820
cccaggatga cttggaacta ttgagtcccc tgcctcagtt tcgccaggac tgggattata 500880

agtatgtagc acccagtgta gcctgcccc tataaagtca tttacagatg ccccaataga 500940
tggtgtctcc tcagccaca tcttgtctct gcctgttgc cctaccacc aatcccccc 501000
atctccagaa tcatcctttt gtcagctcta cacatgccag aagcgactgc tttctgggaa 501060
caggcccgat gaaagaaaag ttaggcaaag ctgcacaagt gtccaagcc ctggcttcag 501120
aaaggagagt tggttatttc caaggaccag tgatggaac acaccaagat gaggccagct 501180
ggcttccgac tcttcccat tgcccagtac tctctgcca gcaccttcc actgaccatg 501240
ggagatagct ctggggaat tccagtctat aatttgttga agcaggataa acagagtcc 501300

tgctccatgg gattctaaca tgaacaagag gctcttggaa tctccttagg agtcttgata 501360
 tccacgtaag ccataaacat cagaattagg atatgtgtga cgtaacagat tctgaccctc 501420
 aaggccacag gacaggagtg agccatgaca atatactctc gtcttggact ttcacttata 501480
 aagtgacttt gaacagctct gagaagcttc aaagattttg tagagttgcc acaaagattt 501540
 gatgtaaatt tccttgtctt aaaaaaaaaat gcataaggaa gctgggtgtt ggtggctcac 501600
 gcttttaate ccagcactca ggaggcagag gcaggcggat ctctgcgagt ttgaggctag 501660
 cctggctctc agagcgagtg ccaggatagg ctccaaagct acacagagaa accctgtctc 501720

 aaaaaaaca aaaaaaatg caaaaggaaa tcaaatatac catatgccac attttgacca 501780
 ctaaagactg ccggtatgtt cattatcatg ccatgtaaac agggcatgca gacctcataa 501840
 caaaaaggtc tttcagtctg cttaagagaa aagcaccaag attgcaagga aagctatctt 501900
 aacaacaaca aaaaccatc ttaccacatg caactcatta cccaatgag gatttttttt 501960
 ttcttaacat tgcacaacca atgattccag aaatatattg gacacagagg caaatctgac 502020
 tgcccgtatc catctcttca ctttggaaagg ttattaaaaa tgccttagca gagtcatgta 502080
 ttagcctcca tttgaacttc accataactt caaagggtat tgataccaat aaactgctcc 502140

 ttatctaatt gggtttgtgt cctccaaatg tggtttatat tactcagatg tttgaaaggc 502200
 atcagtgcag aagctacaaa ggggcctcag ctgtgattca gcttcctggg tgagcgtga 502260
 atcaccacga caggaattcc cacaggtgca ctgcagggct gcagtgagca caggaggtgt 502320
 gatgcggagg agatggtcaa agttacacac acatctagtg cccagtcagt cagtatccat 502380
 taactggaag agccaagcat taggaggtaa cagatctgtt ctagatttgc aggaaagcca 502440
 gaggcccatg aaagaataag ggcaaagaag ccaccacagc agcagttgat gagtagagca 502500
 ggccagtgt agcaaagtgt tgatgagaaa gtcaggtatt gtgcaagaaa tgaacagatc 502560

 cttagcaaat tgcaagagaa aacctcagc tgataaaact cagcattggg gacctctgag 502620
 taccgcctc aggattcagg caagacctta aacagcatgt gcgcgggctg attaaagga 502680
 tctgagagtg aacgaatcag ctcatactg tattcttctc atgtctcctt attcttcaaa 502740
 tgttctcttt cgtcccacaa ggtttccagc ttatatacce atacagacac aactatcaat 502800
 tctctggcaa tagtaaggat accggacata catttttcag ggccaagaag acaaagaata 502860
 ataaagtggg tacctgttat cttgctaag tcttagaggg ggcatggctg tgaagtacc 502920
 agacatatct gagaacgttc aatagagtaa aaggctacat agtatagaat ccaggacctg 502980

 gcatttccag cctctggacc aagcagtggc tttgttctg ctgatccca gtaagaagaa 503040
 tttcctttcc ctggagcctt ttcaagaata caaggcacc agtatatatt ctatatatea 503100
 agattatacc cagatatatg tgcctagtat attgggaatg tatttatgag acacatacac 503160

atatatacag gctagggaga gaatcaatt agcatattta aaattacagg cagaagtgac 503220
 agatattctg gagtctgtat ttcttgcaaga ctttgcaagg cgagtttctt ctaccagaag 503280
 ttaattctgg tgggttgaca cctagaatat taattgctac ttctggaata agcgataaag 503340
 gatctcagca actcagacct taattcatgc ttcaaacactt gttctgttta ggcccagaga 503400

 cagggcattg gaccctggtg ctagggtgct tgcttaccac aaaaaacat gttctcgggg 503460
 gcacaatcat ttctgtaaca ctgcttgcaag tgaatatacc ttttcagtta catagcatca 503520
 aggtaaaaat aagaactgga aggatcttga tattccctca tccctgcctt gtcactaaca 503580
 gggaggatgc tgattccctg gatggacatg cagggactgt gatgttctcc cttctctgcc 503640
 tatcacacac agcagagaca gagattctca gagaaactgc caaaataggg cactagaacc 503700
 caggtcccag ccatcctgat accacgggat tagcaggag acaaagaaca atcatttaag 503760
 aagatcttaa gtgacactat ctctaccagt gtacaaatgg cactgagtag cactgacata 503820

 aacatctaca ggacacatga tggatctgca gagagggact gcagaaggca gtaagggctc 503880
 tctgtgtctc cgtcatcatc agcactgggg aggtaaagg aagcagagga tgggaatcca 503940
 cagagactgt ggaccagtct ctgtcttggc tcccaaacag agaacaaaat gcagcagaga 504000
 aaggtgagat tgcagcaaga gcaccagaag aatgaaaagg tgtttggatc tggagatcag 504060
 agctgtcaga ctatgactgt ccaacaggta ccttgagggtg ctttctagaa agctttgttg 504120
 tgaggaaggg tacccttgg aggccaagaa caaactcagt cagtactac aaacagagcc 504180
 aggtcacat gcacagtcac atgccagtta ctttttttt tttttgtaa cacggttccc 504240

 gttctgctca ggatgaacc tttctgtgg caaaggtaac aggatttctt cettgtccat 504300
 tactggttta aaagcctgct gcaccgtcac agagcctcct gggtagcatc cgtcctctgt 504360
 tgtgtggct aggaagaat gcccaacaa ctgtttggcg acatgatgag agtaaccctg 504420
 ccatttgaaa atctgctgtt tgaatcctgt actagcecca tgaaaagaga tgggcagatg 504480
 tcctacagcg ctgagtgtgt ggcttcaatt gggaaaatca tgagtcattc ctataaactg 504540
 actaaaacgt tttcttctt tcataattta gccacaagca ttaattaaag catccaagaa 504600
 tatgtatttg gaccataaa atcttcataa tgagccaatg caaaaggaac cactgttgag 504660

 cctttgcagt ttggaaaatg tatttttaag taacgggtct ggagttaaat gtttttctt 504720
 agcaaattha aactccggaa aggaaaacaa aagctcaggt gtgactccaa ctgcttttaa 504780
 gagtttctta aggcaagggt gtttatttcc ctacttacgt gtgagagata gtcctcaacc 504840
 atacaaaata ttacaaaagc ttgttgcaag ttggtgttaa gaagaaaaat gcatcttctc 504900
 acagaaaata gtcattacac atgatagaaa gggagccagt gtggatatgc atatggctga 504960
 tctgctagaa aataaactgg atataggcaa aactgagaaa gccaggatcc tcgaacaagg 505020

atttatgagg aacaactgac cctagataag ttctactttt tcctgagcct tagggtactg 505080

 ctgaaaata ggttgcttat tttttctaata aagtgtgtgt gtgtgtgtgt gtgtgtgtgt 505140
 gtgtgtgtgt gttcatgtgt gggggcacag tcacacttat gctggggcac acatgtggag 505200
 gacaaaggac aacctttggg tgtcagtcct tgagtcatct tgtgtgagcc agagtctctt 505260
 caccgtgtga accaggctgc ccgccctgg agattctggt tatagtaaac ctggctcaaa 505320
 tctgaggat tgaggaaggc atctcagaag aaaactgagt aatctaagac ctgaacgatg 505380
 taaactgtgg acacacagca aagaatcaga gggctcagga aaaacagtgc tttccaagtc 505440
 agggatctgc acacacaaaa tccccagcac actcacatca ggctgcaggg taggaagaaa 505500

 agggaggatt ccctcttaga cgagacagga cagtttccat tctgaaaaat gttgtctgct 505560
 atgtaggtga gatgtcatat cctacaggtg agttgttaca tgggttacag gttggcaggg 505620
 aagcctatgc taaacacaga cacggggcgg ggggtgtttgt gtgtgtgcag gtttgacag 505680
 tgtgtgtgtg tatgtgtgtg tgtatgtgtg tgtgtccaag gacagcagga cccaagaagc 505740
 ctgggaagga agtgtcacia ataggatggg ttatttgatc aaggattttt gaggaagtca 505800
 ggtaaagcaga ggctgcagc ttccttgca ctctccata tctctgggga ttcggggcaa 505860
 aagtggtttc ccagcagggg tcagaagcca gatggaacag gtagaggaag gtaagaaagc 505920

 tgcccacata cacagaaagt agcctttcca gaagactagt cgaggcagag aggcaagact 505980
 gtgtgaaagg tgacttcagg gagaacctct gtggtttgtt tgcttagatg gcaggtgaaa 506040
 ggaggcaata gagagacagg caggaagtgt gagagaaagg aggaaaggaa ctgtaggag 506100
 gtgtgtgatt tgaatagga tggcccccatt agactcttgt gtttgaatgc ttagcccata 506160
 gggagtggca ctattaggtg gtatggtctt gttgaagttag gtgtggactt ctggaggag 506220
 gtgtgccact gtggaggtga gatctaaggt ctcatatgct caagctacac ccaactgtaca 506280
 gggcacagtc tctctgcta cctgccaaac tggatgtaga gctcttact cettctccag 506340

 caccatggct gccatgctg ctgccatgct tccaacatt acaataatgg actaaacctc 506400
 tgaaactgta agccaagccc aattaaatgt ttcttttaca agagtcgcca tggatcatggt 506460
 gtctcttcag agcaatagaa cctccaacta agatgagagg ttaccaagga gacagtgggtg 506520
 agtgggtgcc taaatgcaag ggaaggacca gggccagaa ggaagaaaag tggtagacacg 506580
 gagatgacce ggtagactta gaaagtgtt ccagtgtttt tagggagctg agcatgttcc 506640
 catgggcttc ctccacatgg aggaaggcag agtgcctctc tgaggggaga agagaaatct 506700
 agacaccctg accaaacatt gtttgcctt tccttgact cctcctctc cccacagatc 506760

cctgttccct tcatttcaa gtaataccct tcccaccagc tcccttttct agatgttcaa 506820
catgtctggc ttctatcta gctgaccaga tgtttaatta agaggaagca agcagatgaa 506880
attggttcat gttaaggttg ctctaacca tgcctcacia cccaattgga accatttctg 506940
ttagcaaaagc aacccttaac tccaaaagt tccagactaaa gaacggagtg actacctggg 507000
gggtgggggt ggggcagcac gaaaccagga cagaaatctg gacttcacct ctgagggcac 507060
cttctacca caaatttcca aaaatgacca ctgcagtca caccctcagc tggggcaaac 507120
tgggcctctc ctccagtata gcacctcca ctatgtggaa tccagacagt aggacatgca 507180

gcttgtccac aatacctcac attcagttgg gtttgacctt gtgaatggg gcttcacatg 507240
gtgatggtaa cactaagcag tgggtcgttg ctgcatttcc tcatgggtcac tggaaactatt 507300
gaagcatgca taagctggat aaaacagttc tgtgagctgc atgtcaaag tgtggcactg 507360
tgggcctgct gcaggtcctt gggcccaaga gtgcaactaac acacacaaaa ctccgttcag 507420
tgacctgac ctctatttgc tctgtgggct cagctcagat gtcaaggttg ctgcctttgg 507480
agtcagaaag tcttttaaaa atataatgta cagatcctac cctccccga agaactactg 507540
gctaccgatg gattatggga gatgggcagc cactgtcttc agcactccat taggcaactc 507600

caaaccatg gtiacacaaa taagctgat taaactcagt gggtcacaaa acagaataaa 507660
aagacatact atggaaaagg atctgtatgg aggggtgggg ggaggttgtt gatgggtga 507720
aaggcaaaaga ggagacgatg aagcaagaga aatcagaatg cattaatac aggtatgaca 507780
ttgtcgaaaa ataaatttta aaaattacta tactacaaca acaataata atgttaagaa 507840
tgggttaaga aaaatactgc catttgaaa tacaaaaagg tctcaagaca aaataaaagt 507900
tatctgtaat tctaaattggc tatttcacaa ggatgattac cgggaactat ttagtgcttc 507960
atcttagact ttgttctga cgcctcccc acctacacct acccatctc catccccct 508020

tctaccttt ctcctgtcc ctctctgtc catagcttcc tcattagggg ttgtgtctcc 508080
atccatttac tcacccgcc ccttttact gagctaaatc aggaaatgta aaatctgtaa 508140
cagaagcctt ttattcccc cctccatct ttccttctc ttctgccagt attcctttat 508200
cttggaggtg ttccattttt atacaagttc aattcaaat gtaaaacagt ttatgctttt 508260
cgagtttgat ttctcccta cacttgtaa aacagaccag tcaaagaaaa aaatgccag 508320
attatgatag atccgcctcc aagtgcac caaaggcttcaat tttgagtctt aggataatga 508380
tctgccacca catgtgggtt ataacttgag gtttcataa aaatgcgtct tgatgaacca 508440

actctgccac agtgccaagg agctagcgtg tctctggacg tcccaggcct gcctttcgg 508500
ctgtgtgggtg aggacagctt gctcaggaag gcaacaaca ggaaaaagag attagggata 508560
ggacttcagg tgtggttccg gccccgtgag gtgagatgct ctctgttcta gcagctttag 508620

aaggtagcca ttgggagctg tgggtcttta gaaaataatt atcttattta agcctacact 508680
tgtcagggaa gttgaggtca gccacaaagc catcggaag aaggggctgg ctgccagaga 508740
gaacagtttc tttgcagggg atggggggtg ggggtgtcagt ttgaacaact tggcttttga 508800
atctagtac ctctgagac caggagtctg gaaagattaa acacggagca aactcaggat 508860

gcagttggct cccctctcc cgactcaaaa caaaaacaac aacagaaata ctttaaactt 508920
cccctgcccc ctcaagctgt ctgtcatgct tctgcttga ttattttcat taggggtgtg 508980
ttttctgatg gaaggccagg gccttgtctt tgtgtatttg cagagtgcc tgtctactca 509040
ctggtcttta gaaattacag acaataagag gaattcgggg agctggcagc cccacctcac 509100
agcttttctg cactgaggtt ctgcccacga accagaatgg aatattttta taaggcaata 509160
ttgaaacatt ctaatccaa gaaactaaag gaagcctcca ttaactggat gtaaacaga 509220
gcctgtggtt ggcacggggt cgctgccact tgcattgattc gctggctgcc acgctaacga 509280

gggcctgttc tgggttagg aaaaaggcag cctgtccttc cctgggagtg aacctcaaa 509340
ctgcacgaca cagtggagg ggcaggtgag acttcatact gccctgtcc tttcagagcc 509400
agcctctgg agatccagaa gttctctggga caaacttttt ttaatttaa attagaaaca 509460
atcttatttt acatataat cccagtttcc tctcttccc atcctccat gcaccacact 509520
gacctccatc ccatccccct tctgtctccc agggagagtg aggcctaaga tgggggatca 509580
tcaaagtctg teacatcctt tgggacaagg cctaggtgt gtctagcctg agagagtatc 509640
cctctatggg gaatgggctc ccaaagtcca ttcattgact agggataaat actgatccac 509700

taccagagge cccatagact gcccaggcct cctaaactgac acccaagttc agggagcctg 509760
gttgggtcct atgtctggtt cccagatgtc agtctggagt tcacagctc ccccttgttc 509820
aggtcagctg tttctgtggg tttcccaagc ctggtcttga cccctttgct catcactcct 509880
ccctctctgc aactggattc caggagttag gctcagtggt tagctgtgga tgtctgcttc 509940
tgcttccatc agctactgga tgaaggctct aggatggcat ataaggtagt catcaatctc 510000
attatcagtg aagggcattt aaggtagcct ctccactatt gcttagattc ttagttgggg 510060
tagtcttgt agatctctgg acatttccct agtgccagat ttctctttaa acctataatg 510120

gttcctcta ttaaggtatc tcttttctg ttctctcta ttcttccc tgactcaacc 510180
ttctgtctc ctatgtctc ctctcccctc ctctctccc ctctctatc tectagctcc 510240
ctccccatt ttctgtgct cccaatctac tcaggagatc ttgtccctt cccctctct 510300
gggagaccat gtgtgtctc cttagagtcc tcttgttct ctagcttctc tggcagtgtg 510360
gatttaggag tggtaatcct ttgcccctatg tctaaaatcc atttatgagt gactacatac 510420
aatgtttatc tttttgtgac tggattacgt cattcaggat ggtatcttct agttccatcc 510480

attttctgc agatttcaag atttcattgt ttttttttt ctgctgagta gtactccatt 510540

 gigttaatgt accacatfff ctgtatccat tcttcagtca aggggcatct agattgcctc 510600
 caggttcttg atattacaaa taagactgct atgaacatag tagggacaaa cttcttactg 510660
 tgctcaactc gcaggacata ggagccagga caaaaagaat cagatgtcag ggagacacag 510720
 tgtttggcgt gagctgggga gaactgcaaa gccaatccct acagggcaga gaagaggggc 510780
 agagacatgt ctcccttct gcccctcct cctccttct tcttctctc cctcccttc 510840
 ttctgtctt ctcttctct tccctgtcct ccttccatc ctcttctct cctctgtcc 510900
 cttctttctg tctgtcttc ctccatttcc ctcccttcca gctccctc cctcccttc 510960

 ttctgtctc ctigtctct gtctctccc tctgacctt cctgtctct cctcccttt 511020
 ctgctcaaa ctttcttct ctccacctc ttctcaatt tcccttctc tctctctcc 511080
 tcttctcaa tcttctctt ttctcaacta aaggtagtaa tttgtgtgt ccttcttta 511140
 atcatagggt tggctttata aagacagaga taacttcaaa acaacagttg agatactaac 511200
 attgactgtt gagacagtgc ctgatattc acgtgtgagt tgggcagtgg gaaagatgcc 511260
 aaagtctca ttaccaaaact ctctccccc agaagtgtgg aatgccagca gtgtccagca 511320
 ttgtgagca ggcagggta acactactc ggagatctt tcccttccc cttctctggg 511380

 agaccatgtg tctctctct agagtctcc ttgtttcta gcttctctg cagtgtggat 511440
 tgtaggctgg taatccttg cctatgtct aaaatccatt tatgagtgag tacatacaat 511500
 gtttatctt ttgtgactgg attacgtcat tcaggatgg atcttctagt tccatccatt 511560
 ttctgcaga ttcaagatt tcatgtttt ttttttctg ctgagtagta ctccattgtg 511620
 taaatgtacc acatttctg tatccattct tcagtcaagg ggcatctaga ttgcctccag 511680
 gttctgata ttacaaataa gactgctatg aacatagtag ggacaaactt ctactgtgc 511740
 tcaactcgca ggacatagga gccaggacaa aaagaatcag atgtcaggga gacacagtgt 511800

 ttggcgtgag ctggggagaa ctgcaaagcc aatccctaca gggcagagaa gaggggcaga 511860
 gacatgtctt ccttctgcc ctccgtcct ccttcttcc ttctctcct cctttcttc 511920
 tgttttctc ctcttctc ctgtctccc ttccatctc ctttctccc tctgtcctt 511980
 cttctgtct gtcttctct catttctc cttccagcc tcccctcct cctttcttc 512040
 tgttctctt gcttctgtc tctctctc tgaccttct gctcttccc tcccttctg 512100
 cctcaactt tctctctc caccctatt tcaattctc cttctctct ctctcctct 512160
 tctcaactt ttcttttc tcaactaaag gtagtaatt gtgtctct tctttaaate 512220

atagggtggg ctttataaag acagagataa cttcaaaaca acagttgaga tactaacatt 512280
 gactgttagg acagtgcctg atattcgacg tgtgagttgg gcagtgaggaa agatgccaaa 512340
 gtcttcatta ccaaactctc ctccccaga agtgtggaat gccagcagtg tccagcattg 512400
 ctgagcagag caggttaaca gggacctgct gtggtttccg aaggactcag gggcaatgcc 512460
 catatcacc acagaatgca tgtgttctt cttccaacca ggacacacac tggagaggct 512520
 ggaactgccc caaagtgggc ttacaacttt agggcaacca gccccagtta cggccccaca 512580
 agaatgggaa aatttcttct gaaagctgaa gtaaacaca ttttaaggaat aggtgtcact 512640

 gtggtcattg cagagaacac cgatgtccac cccaggcaag cactgcactc ctgtcccatg 512700
 aagccactct gtaaagtccc agcagagcct tggagggcag caacgtttgg gtttcatttt 512760
 catcttagga gccaacagct gcaacagcta cccaaatgca aacctcacag aatcaggctc 512820
 gaaaactggt aagtgttcgc tctcgggttg gttccaactg tcccttgttg aggaaaagca 512880
 gttacaatg taagttttta aacaattggt actattataa gagggttttt taaaaaatga 512940
 gaacattggt caatgtagtc acattttctt tctaaaata gacaataaa atgattcaca 513000
 gatgttgatt tatgagaaaa atagtaaaga atataaacta aatgtgctt gaagaagggg 513060

 gacagagccc ctattagaa actattctgt agaaagcgc cccactcctg ttctgccag 513120
 gaaaccccaa ggcccagcag gatttgtggc actggactga gagcatgtgt gctggctgta 513180
 cacacatgct gecttactt gtggcacctt gaggaccagg gcacaagcag agatgaagat 513240
 atgagctcta ggcagagcac acactgcaga agtggaccct gctgaagcct acagcttctt 513300
 gaaggacata gctggtctgc atcagaatca catagagctg gtcattgtag tggacacttg 513360
 tcattctagc atttgggagt cttctgaagt tgagaacaga ctgcactatg tattaacc 513420
 tgaggggcta gggagaaaga tgggccgagg taacgagtct ggagggctag ttaagttaaa 513480

 tggtgaccct gccctatgc ttgcagcctc aggtcagtat atctagggtc aagcccagaa 513540
 atgtgcacct ggcacttaca atccaggta cctacaact gcagagctca cacttggctt 513600
 tacataataa cattctcaga gggaaagcat tggcctcatt tttcccactt tcagatcct 513660
 gcctgccatt gacagttgag gtccatttgt ttgttttggt tgtgtgatgt atgtgtgttt 513720
 gcatggtcat gtgtgttag aaggtagcat tggaggccag agatcattgc caaacgtctt 513780
 cctctagtga tctcccat aattttgaa acagtatctc tcagtggact ctattcagct 513840
 agactggctg gccagaaaat cctctgcct ctgagttcct ggtgctaggg ctacaagctc 513900

 atgccaccac accatgttt ttggattttt ggggggggtt tggtaggtac tggggatcaa 513960
 actccggtcc tgatgcttgc gtgttgagca cttatttgc ctagttagca tctccactgg 514020
 ccgctgtcct gtctattaa ggggttttct aatgcccaa ttttgaatc agaaaagaag 514080

taattaaat gactgtgcc acattttgag tgagactgta cagtttcttt ataatgaagc 514140
 atttaatgca catgctacac tcaatccaat gttgctattg atagaagatg tggctctgga 514200
 aatacagcca catctctact atattgtatt actatagtcc catcctacct gtttcaacct 514260
 tagggctctt ccctaagac tgaatctcct ggggcttgaa tttgttttga ccaatgaaat 514320

 gtgagttaga aatggagatg ctccctggaa tgtatcttta aaagctgtgc tttattcttt 514380
 cttctctcca cttctgcca tgactacagc atcccagaca ggaacggttc ctttagtctg 514440
 gacctgagtg ggaagatga gtggggcct ggggagggca cagtggcatc agagcccata 514500
 gcaaccagag gtgagaaata aattttggtt ctccatgat ctataccac agagaggagt 514560
 ggttttagcc acagccaccg actcttacag ctttctcact aatattggca aaatcctctg 514620
 ctgggtgtgg ctgaaggaaa catctctgtc cggttctgtc tggaatttc tactgtcatc 514680
 tgaattccct atgtccaca ccactatgtg aattatagg atggccactt aatattaaat 514740

 catgagtcgt ctgaaaatg ctcacagttg agggttgaaa taccaaatg tcaacagcta 514800
 gatctcacta agttaattct tagccacacg gaacagcaca ctaacttctg agcacttcac 514860
 caccatggct gggtgcagg gccacaactg cacccatgct cctatagcct ctccatttec 514920
 ctgctctaac cacactgtaa tctgtctatg tgccttcatg ggtcagtggg ggcataaaat 514980
 agtgtttatt tgcttctact ttgtggtagc agaataatga caatataaaa atcagttgag 515040
 accatgcttt tggggctcca atacggcttc catgacattt cctgtatcac attatcaagg 515100
 atctctgtgg aaaatgggat tttattgctt aaccatgcca tgtccccac tgtgctcttc 515160

 cagggtcata catcactgtc agaacatgcc cgtgagtcca gatgggtggg agagaagggg 515220
 tttactgct gactagctca ctgtggatcg ccacaggtca cagtgcactc gatttctgtg 515280
 gtgaatgacc cacttttcc ttaatatgac tgggtgttta ccacaccaac gtccaggatt 515340
 ccgagcacca agatgtcgca tgctagagta tgtgtgagca agggatgaaa ttcttccaaa 515400
 gaaaaggctc gtaactcagt tgggaaaaag aatcagtggg ataggccaaa tcacagatgt 515460
 ttccctctac ttccagctgt tattgcttgg tgacgaatgc cccaacctc atgtgatgaa 515520
 ggtttggcct ctagtgagtt gtgttgagag atagtgggac ttttaaaggt gacactagtg 515580

 cgacatgcta ggtcactcag gatgtgcctc cacaccacc acctcctctt gattgttctt 515640
 tggctatgac ctataaggct ttgctctgcc ttgtctgct ttgcctcagg cttaaaggagt 515700
 gaggttgact gaccagggat gagaacccc caaattgaat gcaacaatc ttctctcttc 515760
 ctgagcagac tatcccagat atctgatgga aggctatcat gcttaccaca ttgtctcaat 515820
 gagatgagge tgccatggc tctgaagtcc atattacagg tccagcctca agtctaggag 515880
 gacttgatcc cgcaattctc aattcaaca gttagccaatg ggcactcaga aactcaggt 515940

ggtgcagtgg gtgcttgggt tacatagaga aatggggagc agctgagaag tagaaaatgg 516000

 gaccagagtt atgccctgga aatatgagat caaaatgtca atctatagat cctaccagga 516060
 agagccattg ccacaaagca catagtcca aaggtgacac aaccaaaaaa ggagatgaca 516120
 agtggttttt ttctgcctct gtagttcacc tcctctgggt atgcctcaga ttttcaccag 516180
 ggcatggtaa gactgctgtt atttctctgc attttctttt tcgggccaga tcagtggcta 516240
 atgccattaa cticattca cagaaaacaa aaccagggct ggtataggag gagcaggcag 516300
 caactcctga ggctctttca aagctgatga gtcacatgag cgatcaaatg accagagtgt 516360
 ttctggaatg aattagtagt tgttcacagc attccggaaa gccgtatcat gcaaagccat 516420

 gctgttctgt gactcattcc attccggtct gcttgggaag agaagtgaaa ttagatagtg 516480
 tcttgatcta tcttctatct ctataggaga atgcctgaga ctgcgtaatt tataaagaaa 516540
 atgcgtttgt tttggcttac agttctggaa gactggaaag tctacggtaa ggcagctgta 516600
 tctggcagta agtagatgac aaggaagga gtgaggcaaa gaagataatc caaccaaga 516660
 cctggaggcc agaatgaaca caggctctg aaggggcttc agactgcttc aggtccatgc 516720
 tgtgagtggt aaggaggagg caatgaggcc agtgaagaag gcagtggtga ctcagggaac 516780
 ctggctttag tctgctggta ccgagaatcc ctggttgacc tggtttggat ttaagctgct 516840

 aggggttgag ggggagatga gataataaat gtctttttct tccagttat ttttgaaca 516900
 acatttgtag agcaaacatc cttagaggac agaggtctag tctctggagc aaggggaaag 516960
 gcactatatt tgaactcat ggaaagatat ggactcctta ggcttgggtt tctctgcaga 517020
 ggcagaacac tagtcaatgt gtggcaccta cctgggtcac tccacaatgc ctctgtggga 517080
 cttgggaaac agagagaatg tgaagtttc ctgacttgcc atgctgggag ttagaaagcc 517140
 aggagcttg aatattctgt ccacatcaat gaaactcctg gcattcaact tgttgcttt 517200
 caagtaggta aaacttcttc cctggtgggt cttagatctg tggttctcag atagctattg 517260

 ctgctccaat ggtttggaag ctggtgtaat attcaactg agggggtgaa attacctcat 517320
 tctatctcac atatccaagt gtgtgaaact aagaatagcc tcaaaagatg ccagaaggat 517380
 ttagagaatt gactgagctt gtgctttata agagcctaga aagccaggat tctcagtgca 517440
 tcttaaaca cagatgctaa aggtcaatat atgtatgtag aatattacat gcatgtattt 517500
 gtgctgtat gtatgtataa atgtatgtgt atatattaac aaaccagtgc aatggcttc 517560
 ccagaatgga tgaggacag gactttatcc ttagcattgt tggataaata aataaataaa 517620
 taataaata aataaataac aacccaaacc caacaacatt tggaaagtcc tgaggacttt 517680

ttaaaagtag tcttcaacc aggcttactic aatatatatt taaaaggtgt ttgtagggct 517740
 ggagagaggg ctcagaggtt aagaacactg gctgttcttc tagaggtcct aagttcaatt 517800
 cccagcaacc acatgatggc tcacaacat cagtaatgag atctggtatg ccctcttttg 517860
 gcctgaagaa tacatggaga caaaacaatg tatatataat aaataaatat tttttaaaaa 517920
 aatatttata ttagttattt atattagttt tcaccctg ttgacaattc ccccagagaa 517980
 gcataaaaga aggaatattt tatctcagct catggtttca gaggtttttc aatcagttac 518040
 ttggttccat tgctcctagg cccatgctga ggttcaacat catgacagtg agcactcggt 518100

 taagcagatc cgcttgcttc atgatgggca gggagcagag agaaataaca atggaggtca 518160
 gagccaagac agacccttta aaggcacact gcctgtaatc tactttctcc aacttgcct 518220
 cacttctat aattccaaca cctcccagca ggtgttgctc acagtttgaa ctcatgataa 518280
 ccctttcatt aagtcagagt cctcctggtc tctgaaatga cctcagggac acatccagga 518340
 atgtcttttg ctaatccagg gtctctcacc ttaataaagt cgacaatcaa gatcattaca 518400
 acatctaacc acagcagtag gctaaagaag tcaaaccca catgctcact tcagtagcag 518460
 tataaaaagc acttaacaaa attcaaaaac ccattcaaaa taaaattcc tcaatggagg 518520

 gaaacttctt taaatcatta aagaacattt actggcatca ctgtggttaa aatggaaat 518580
 ctagttaggc agtgggtgtg cacaccttca atcccagcac ttgggaggtg gaggcaggtg 518640
 gatctctgag ttagaggcca gccttatcta cagagcagat tacatactag aagtctggt 518700
 taacaaaata agacaagaaa aataaataga agacatacaa atcagaaaag gataagatgg 518760
 tcattgtaga cagcacgatt atgtgcttag gaaatcctag ggagtcacta aacaatctgc 518820
 aactagtaag ccagcctaag gggctgaaca gctcaaggtc aaaagcctca tttttcatgg 518880
 gtgtgacat gtctgttcca acattgtctc aactggcac tctctcacag ctctttacat 518940

 ggtgatgtca taactcagtt tgtcaateac tccactggtc ttccaggtct ttgagagcag 519000
 gaagaagatg gctcagcctc tctcaattta ggtatttaac aacttctta ccacatacaa 519060
 acttattcac tcaaagtatt cactgagcat gtatacttat gaagtgagtg ggtttctct 519120
 ccccaaaaa accatctagt gagaacctca tgcaccaac tgtttccag ccaaagtct 519180
 tcctgatgaa gacaaggaga aatttattt ctctcttggg tcatttctct ttgaggtat 519240
 gtcactttac ttcagtattt ggaaatgtcc aaaatctgta agcagataat aactgctcat 519300
 ttgtttttat ccagttatct caggagcag ccagaaaacc agcagaagtc agcgctggat 519360

 ctatatgaca aacacaaca aatctcacat gtagattcta acattgcctc agtcctcatg 519420
 ttaacaaaat gattttatac aatctcatgc tgactgtaaa ttaactgctca gettcaact 519480
 agacgaactg ctacatggct tgacaaggaa tgcactgtt gcaaattaca ataatagtg 519540

ccatgtagca acatgggtgg ggcctctcaa agagggccag aaagataatg aaggacacta 519600
 gagaacagga aggaaatgga caatgagaat ggatgtgtaa ggcatatgc aaaagctttg 519660
 ttcactgatt cctttcctac acaggcaaac ctgtctgctg ccctcataga aggctttgtc 519720
 ttggaataag gccatgctac ctgagaagga agaaaatgcc tgttgggaga gcgcctgttc 519780

 ttgtgagatc aaagcacttc ataacagcat catgatttct tctattgatg acttagatcc 519840
 caaatagagt tagggactgg agagatggat ctgtggccaa gagcactgac tgttctccca 519900
 aaggaccag gttcggttcc cagaactcac aagggtcttt acaaccatct gtaactctaa 519960
 ttccaggga gctgatgtcc tcttctggcc tccatgggca tccagcacac acaagcatgc 520020
 tggcaagaca ctatacaca taaaataaaa agaaatcttt ctctaaaagg tagaataatt 520080
 ctgtcttctt tgtgtagtcc tggctgtact ggaactcact atgtagacca ggctggcctc 520140
 aaactcagcg atctttcttt gcctcccaaa agctgggatt aaaggtgtgc accaccacct 520200

 ggctctccct cataacttaa tctcacttta cctggactca tttgttaaaa ctcttttgca 520260
 ataactgact gagcatagaa aaaaattagt gtatcactaa attgttaggt aatTTTTTga 520320
 thtagtagtc tgaaacatgc tactataaga cacgggcata acacagtgcc cagtgtcccc 520380
 tctccccagg gttagctctg tgtgctgagc agcgtgttct caggaagaag taagagggtc 520440
 cagtgttctc cgtagccaca tcagctgacc atcagtgaac taaccaccgt aactggcaga 520500
 ttttaataag aattcagtta cttttgctct atctgcagac agactattta cegttaggcta 520560
 actagaccac ttctaataca ctcggaagac ggaaattaac tttattaaca cttcagaaca 520620

 caaggatggt aaagaaacat gagcattttc ctacataaaa tataaatttc catcttagtc 520680
 catcggcctt gatTTTTTcaa tctgtattag ttcagtatgt aactgcctg ccctgtgctc 520740
 tggagaatgg actgaagttt ttgcttatgg gtttagacca acatttaatt ctatacgttg 520800
 ggcaagattg ggtcaatttt tttaaaaagc atttaatgcc aattaaagag tagatttggg 520860
 ggcgtttctt tggtcagaat gatggagtga gtctaggtcc ttgtgtata ctcatcttc 520920
 actcggcctg tgagctgcac tcggggccaa caagtgatgc ttcacattgc ttattccct 520980
 aagatggaat ccaactgctc agaatgtaa agggacctca catcaagaag ccatgaggtt 521040

 cttcagagcc ccatttaaat tatctgttag cttccattag gaggggtggt caatgggtct 521100
 gcacaacttt gatttattta gagagtgtca tatgtttgag aactgccttg gcaaggaact 521160
 gtgctaaaca tagagataca cactgcatgc ccattgggct cacattaaag ggaaaatcg 521220
 caataggggt ttacctcagt ggggtgagge ttgatacttt ccagatggtt gactccacca 521280
 gtgagctcaa tagaaatata ttcagaaaaa gatgctcaaa tattaataa gcaatgcata 521340
 tacacaacgc catgatctgc tacatttctt tacatctggg ctgggagtgt ctctgtccc 521400

tagctgctga tggggtggtc ttctctgtca gtgggaggcc ccattagatt tcccattagg 521460

aaaattattc tggcagggta tgttctagaa cattgtccat aagtagatgc aggggcttct 521520

cttgggggtg aagaagcaga gaagagaaga aagcagcaaa gaagaaatgt tccttgcgt 521580

gtgggagtga aactgaacat gagagtgggtg attgcttttt gtagctaggg aaaggcccat 521640

aagcacacag ttagaatgcg cgggaagttag atgaagcaag gattctggct ttgccctgaa 521700

atgagccagc cagagcccag agaaccaatg acaggacaga acattatgaa aaggagcaa 521760

gggtcagccc ttigtatagc ctttcttgca tctacatagg aatcccacac ctgtaatcca 521820

agcacttggg agtctgagac atcctgttct gcacagtac atctgtctca aaagtcaaa 521880

cactatcaaa gtccacagtt caggagtctt aggtagtac agaaacctac ccctctgtac 521940

atatgtgat gcacacacac gtgagcacia atgcactcac atggagaaga gtcagtacat 522000

ggcaatctgg aactgatccc ctccccggg aagagctgg gaaggcctca cccaggcccc 522060

caaccccacc ttgtccctag tgccctgagc attccctca gcatttctc agaggctccc 522120

aggctgctca gtcagatctt ggctgcagtt catagaatgc tcaaggcaa agaatactgt 522180

cgtggcattg gggttttgtc acagctctg tcggagctgg tgaggctgtg tcagctctgt 522240

gtgtttacac aatccagtta actcaacc caaagaatat tttccgata aagaatagaa 522300

ctgagggtca gtatattgtg tgaggaagcc agatccagaa agacaaatgt atgtctctc 522360

tcataggtgg aatctagaca acatgtgtgt gttgggggag gggtgcatgt acacatggat 522420

agcaciaaaga ggaagaagaa gggaaggatc aggaggggaa gagagaaagg gagctgacaa 522480

tagtcacagt acatgacaga cttggacaaa aatattcatta ttaagtccta tcaactgaata 522540

ttcataggtt atattcattt aaaaaatgtg ttggtgtaat ggatttaatg aatgattat 522600

gcattgaatt ttttttaaat taagacctac ttgggatttt cttgttttgt tttgctttgt 522660

tttgagacag agtctctctt catagcccta cctggcctgg aactcattat gtagactcaa 522720

gctggccttg aactcacaga gctctgcttg cctctgcctc ccaagatttg gtattaaagg 522780

tgtgtccagc taggacctac tttgaagcct gttctctgta agaacaggga gatgggtcag 522840

tgtcagctct cgggtttagc catttgttgt gttaaccaac gggagtgaat taaaaatggg 522900

tgatgttaag aaaggcaaga agatttttgt tcagaagtgt gccagtgcc aactgtgaa 522960

aaagtgaagc aaacttaaga ctgggccaat ctccaagtc tgtgtgggtg gaaggcaggt 523020

cagacactgt attctctcac acagaagcaa acaagagcaa agatgtcacc aggggagagg 523080

gtacctgga ttttggaga atcccaggaa gtaatcccta aaacaaaaat gatctttgct 523140

ggaattaaga agggggaag ggagacctaa taatatcact gccttattta tgacaaaacg 523200
 aacacctcag ggcttttaat gtgtatcata acttaattca tacaccagaa ttcagatcat 523260
 gaatgactaa caatgttttt gtttgacagt cctgatttaa gtaaaattga cttgtgggta 523320
 agtggatatg atctttttaa aaataacaaa agcaacaaca aagaaccaac agtagttgaa 523380
 acagaaatct ccaggcttaa gccctaagct cctgaagccc catgttcaag tccaagtaga 523440
 tacatgctga tttacatgtt taacaatac cttgggtggtt ttcattggga ttgcaatcc 523500
 cagagggctt tagtgaata cccatgccct cttcagagct tcagtgatca gtggttcagg 523560

 aactgtggac tggagcatag atgtaggtga gatttcagag ctctctcag aaggggaggg 523620
 ggtgggggtt ggggggttgt tcagcagggtt ttgggttta gctcgaactt gagttgtcgc 523680
 atcactagtt acctgtgcaa ctccagacaa tgtaattgat gtctctgaga gtcaagatat 523740
 gatttgcatc ctaggattat tttgaaaatt aacaagctaa ttctgtaagc tacttgccat 523800
 gttacaagca ctcagtgat tttactttca ttattatfff tggatgtgcc cctatgttaa 523860
 taactggaac acaatgaata aagtgcagtt cctgcccag ggtgggacag ggtcccaatg 523920
 tacagagaca gatagacaca gaccatcggg taatccatgg aattcataga gttccatagg 523980

 aatccacaga tgacctgacc ttcagcccat caccattcat tgacaagatg gctcagtctc 524040
 tttgtccaga ggtaacttac tctcaggagg tggataggct cggttataga aattgattcc 524100
 ttgaccagge gggtgggca catcctttaa tcccagcact caggagctag aggcaggcgg 524160
 atctctgtga gttcagagcc agcctggtct acagagtgag ttccaggata gataagactg 524220
 tttcacagag aaatccgttc tataaaacca aaaaagaaaa agaaaaaggg gagagagaga 524280
 gagagagaga gagaggctac tccccactgg ccagttgcct gtctgtgtgg atcatcttgg 524340
 accactctct ggatgaagaa gatggtgggg atgggggatg ctatgaagca ggagagggaa 524400

 gtgaactgag tgatgagaag aaaaggactg taactcctgt gctggccacc tetagggttc 524460
 tccttgaaga gtcttttga tctgagagga ggaagtcaga agagcatgag cataatttaa 524520
 tatcagttct gaacattgtc cagactctaa taaggccaat acaatctcag ttaaaaacag 524580
 taatccaatt ttgctaaagc ataacagcat tctttattat ttggatagtc ccattttaaa 524640
 cttctaatec ttcttttcag tttttttatc ctaaaacaac gtgaaacacc atgaacggct 524700
 gaaatgaaaa tgatgaatca gcacctcatt tgcctttgat aagaagtcta agtgattttc 524760
 aagcttggac ttttaaatg aaatacattg cattattata tgcatttget cagtatccat 524820

 acagagtgtg caatcttaca gaatttctcc aatccctact ggtaattaat aagtctgttg 524880
 ctttaaaaat gcttctgaaa agaatgaagt catgcatcaa attaaatcat aatgacacta 524940
 cagagtaggg atccacaatg ttcctacag tatactcgta ttttgaaaaa gaataagaaa 525000

atgttattaa gagagaaatt tgggttggga ggactggata gtaaagttgc acagcccagt 525060
 ttgcctggcc cagagagaaa cttctggaac ctacagtccc agttcttaca tatgtccatg 525120
 agcatgatcc atgttgaat gttctaaaga ggaatgaca gtatactccc atcactagcc 525180
 aagtgctgca gtcaccattc tgccatcttg aaagggatct gaggagtaac taacattcca 525240

 ggcaaaagga agtaaatgaa atagctggag gtttggctgc ttgctggttt tgctcttga 525300
 taagccactt ggtctctctt cttatttgta aaatggggat ctgtgaagat tagatggact 525360
 gatacatatg agaataccta tattgaggaa gtgctcaata gatgtagct gtcactcaat 525420
 agatgtaac tgtcaataga tggtagctgt cactcagtaa atggtaactg tcactcaata 525480
 gatgtagct atcactcagt agatgatagc tgcactcag ttgatggaaa gagaaggggg 525540
 aatagatcaa tcaaggttcc tgcccagtaa aatccttgg gaatggtctc agttgagttt 525600
 caaggggctg gatgtctatg tcaagccttg aaatcattha gcacctccac tttgcctat 525660

 gagccccctt gaccctattg ccttcttct gcctgcctag ccaatcatct cttagaagtg 525720
 atcctaagcc atacaagtgg tgtgctggga aactagctct cccccaagtc cctggttcat 525780
 aaagtctgtt gectacagtg gtgcaaacc tcccactgtg tggaaattcaa gccacctgat 525840
 tgttttctgt aagtgtgctt gcatcaagt gctttcttcc aagtagtaca gtgtgggaga 525900
 gatgagcaat ttacagcga gaaaagctga ctccctccct caggggtgt tcaagttta 525960
 cctcaatagt catgagtac actggcatct gtagecttca caggctatga tgacaatggc 526020
 aattcgtga tgggatcttc ttccccaaaa catatgttcc tcaagccagc ctgaaaaaaaa 526080

 aaaaaaaaa aaagcaagaa atctccttta agggcttta tataaaacac tgaccaatac 526140
 tcaaaattac gaagattggg gtatggaggg atgactcagt ggttgagtac actggctgct 526200
 ctccagaag accagagttc catttccagt acctacaatg tgactcaca ccatctgtaa 526260
 ctccagttcc agggaatttg acacctctt ctggcctcca caggcaatgc accacacata 526320
 catgcaaaca aaacacccat agacataata aagaccatcc caaacaagta aagtctgaga 526380
 aactgtggca gtctaaagaa aaagaataat tacatacaat gaggttacct ggatgcaatt 526440
 ctggagtaga aaggaacct aagctaaaaa ctaaggggcc aggcagcagt ggagcatgcc 526500

 attaatccta gcacttggag gcagagagag gtggatctct ctgagttcaa gcccagccta 526560
 atctacatag cacataccag aaccatcaga gctacataga gagacctat ctcaaaaca 526620
 aagagcaaca aaagaatcaa ccaataaca ataacaaca actgtgtggg agggagacct 526680
 agcgacagtg ttgggaaga cactgaaaga aaacaatgtt taaaatttat aatgatacac 526740
 tcacatgcaa atatgcatg ctatgatgaa actcattact ttgtatccta atgtaaaggg 526800
 attttttta aagaataatg tatggatc ggtttatcaa atgtaacata taccagtaa 526860

atgtgaaatg ttaacaatgg gaaactgtgg aacacatgga aattgattta ctatcttttc 526920

aatcttttcta tgaatctaaa actatcttaa aataaaaagat tgatgtctaa aaaaaattct 526980

gaatatgtaa cagtggaagt ggacccccctg gggccagtat ggtgggatcc agctccatec 527040

agtactgagc ttatctcaac agaaacttga ggcctctgtg gggaggagca taagatttgc 527100

tcaactgtgc atcctgcggc tggaaagcaac tgaggatgct gatggagtgt ctacactcag 527160

acacgtagaa acagcctcgc tctgcagctt cctagctgtg tggctttgat cgacctcccc 527220

accacgtct tagtttctca gaccataaaa tgggtgtgct aagacatctt catataggtt 527280

tcaggctttg ggagaggtga caccagtgag tctgagtaag cgctatgaac agcactggcc 527340

acacagttct gcttatttct tactagtctt tcctgcctt tacttagctg ctaaggctta 527400

gctgaagtgt tcacccccctc taaagaacct gcattccagct ggtgacagaa cttcagttca 527460

ccttagctcc ccctaaacat gtgttacgt ctggaacct cctctcccc tetaagcagt 527520

gtatagttcc tggctgttct cttctggaca tctttgagcc tgcaatctgc cagctccctt 527580

ttcgtttcct ttgaaagcac cattctgcat gaattggtga gaactgcagc acaaaccac 527640

cactgttgac tcaggaactc aaatatitag acttcgaaag gacgtgcaac tttctctgct 527700

gtttcccttt attagccgtc tcagaagggt gggagataaa taaagaacct cacagaagac 527760

tgggttccca aagcagcagc tgtaggaact gaggcgagcc agaaattcaa tatgtttagg 527820

gtcccttgt gaaaacacaa aaacaaaaat aagaatgcct cccactgctc caacatcgcc 527880

tttctgtgg atgccccca accattctct ttgaaaacaa atgggaaaag ccaactgttg 527940

atgacagtca ctggggcgt aggggatgtc cctggtgtag aggaggcatg cttgttcaca 528000

aaagaggaat tctgccttga ctgacaagcc cctacaaca aaaggcacia atgtgtgtgt 528060

gtgtgtgtgt gtgtgtgtgt gtgtgtgtgt gtacacttac gcgatgccc cacacactaa 528120

tgggtgaact ggaggcagag ctcaacaaaa gtctggattt gattttagg actgtgaatt 528180

gtcttgaatg tttgaggaa agtttaagga tttgggagct atttgagaat tagaagtttt 528240

atttgagggg catttgcgga ttaggagctg gttatttggg aacattaag gaccaacttt 528300

attctcagct gtttctataa aatccctttg ttttgaagtc tgaagttctt tcaaagagaa 528360

gtttgtcct gagatttgag acctgcgatg agtaaacct taaagatgga aaagaaaatg 528420

acaagggag actccgcctc cacctgcacc ctgcttgatg ttctgcteta ccaggcacac 528480

gtgactctcc aatatttcaa gattccacat gccatagggc gattttaagt tgacagactg 528540

atttatagac ctgigattgc taaggagttt gtaaacttta cctgtgtgtg tacttccttt 528600

tcatgggttg cttatgtggt tttcacatgc atattttggt aggttggttt gtttgcctta 528660
 gaaatttaga agtataatat ttttgattga ggacctcatg tatctgaggt tggcttcaga 528720
 ctaccatat agaagaggat gactttgaac ttcttgTTTT ttttaagact acttatcttt 528780
 tatgtatatg catcataaat tcatgaagtg cccaagaagg ccaaaataag gcattggatc 528840
 ccctggaact ggatttataa taagcagttg tgagttgtta tgtgagtact ggaaattgaa 528900
 cccagatctt ctgaaagagc agccagtgct cttaccact gagccatctc tccagcccca 528960
 gtcttaaaact tccaaacttc cttttcccaa ctccagaatg ctagaattat aggcatgtgc 529020

 catcacacgt ggTTTTttg gggtaggcaa acactctatc agccaagatg actgataagt 529080
 ttctaaactt agcattctta gctcttgTTA gactcaatac tataatTTTT gacaatctat 529140
 ggtatgtagt ttgtttacta taattgccaa attgaatcct actgtacgca tacaccagaa 529200
 gctatTTTT cactctgagg gagccctctg tagggTTACA catattaact ctatttctag 529260
 tcaggatcaa gtaagcacc tcgttctgca aatgtatgtc accacacctt ttcatttcca 529320
 ttgtTTTTTT ttcagaact gcagactttt tagtagaatt aaattcattc attctctctg 529380
 tatgattctt tcaattgctt caaagcagat aacatatTTG acttccaagg agctaagtat 529440

 tcattcctgt ttccacattt ttgtttcct tttacctaa ttcTTAACA cttAACACCA 529500
 aaaggagaac agtgggaaca cacatggttt cccctataat ttgtaatcag ttttCAAAG 529560
 ggTTTTgtct gttacaccag tctgtggTTT ttaaccccc ttttaccattc tgaggcatgc 529620
 taagatttat ttgggaatgt tttgttctgt ttaattgata gctgcaacaa gtctttctct 529680
 gtcccacaag ccaggTCCA aataatgatc aggagacttc ttattAATTA tgactgctca 529740
 ttctataacct taggcttgtt cctaaccagc tcttataaac ttaaattaac ccatttagat 529800
 taacttccat tctatcatct tccatcttgt acctctgat tctctctgt gtcccctaga 529860

 gtctcctct cecatagatt cctcctctc ttcttctct cctggaaat cetgtctata 529920
 ccttctgctt agccattggc cattccgttt ttttattaca ccagttacag caacacacct 529980
 tcacacagta tacaatatc ccacagcaca taattatgtg tagtattcct tcaatatttg 530040
 aatcttattt teattatcat tgtttcagca atatatgtcc atagctctc tttttaaatg 530100
 tgatttgagc aggttgtggt ggcgcacatc tttgatcca gcaactcagga agcagaggta 530160
 agcagctcta tgtgagtTat gagtttgagt ccagcctggT ctacatattg agttctagac 530220
 tagccagggc tacatagaag gattctgtct ctaaataaat aatcaacaa ataaaaatta 530280

 tttaaatttc ttaccaattt atgtttttat caattttatt tcaatttcat tggctgggaa 530340
 tgggtggtac atgcctttaa tcccagcacc cgggaggcag aggcaagtgg cagatctctg 530400
 tgagtTccta gaattagttc tagaccagcc aaagctacac aaagaaactg gaaaaaaga 530460

aatttcctag agcatcagaa aaatttgtgt tgtatttcta actagggttg tgctaaaact 530520
atatattaat ctgggataa ttgaaattct gttgacactt cttcaaagta gtctcttggt 530580
tcttttgtct tttcttggtg cataatcacc taccaaaaat gatattttga ctgattatgt 530640
gcaatattta tttatctcat tttattttct tctctttag tatctaaaat gtctcaataa 530700

tctcaacata actgaggcca atgtttaga ttttcaagtt aatgtattga atgcatctac 530760
aaataatfff aggtattagc tcaaggaaat atccttctct tcagttctct ctgtaggttt 530820
ggacttggag atgtgtaag atgatcatag tctctcttag tgacactaat gtacagttgg 530880
gggaggtagg gatgtaactg gtagagttca tgttcaacat gcacaagacc ctggcaccag 530940
tccaagatga aacaaataca cacaccttta tttttctccc ttcattgtatc taagttgtaa 531000
tttcccttat tctatataat gtaattgtct cttataatca acatatagtg ttgacttctg 531060
tctttctacc tgacttgctt tgttttgcct tgtttcaatg ttgaggttgg aacctaaaggc 531120

ttaacacatg ctagacaagc cctttaccac tgcaactgaac cccagctctc cttctccagt 531180
ttttacgttt tctttctcac cttttttatt gaattaaaat ataattacct cattctccac 531240
ccccccagct ccttttcaaa tccatggcct cttattcttt cgttattgtg tgtaactttc 531300
ctgtcatttc tagaagacag tcttgacgca gacttctctg tcttctggct cttacatctt 531360
tctgccccctc cttctaggat gttccctgag acttgggttg tagattttta attggaaaat 531420
tcagtcatte tctgattttt tgactagctg tggctttctg aagtggctctc tatctgctga 531480
aaaaactatt ttgatgagtg gtgagagcta cgtttgccta tgagtatcag gataagtgtt 531540

agggtatagt taggtggaat tatactgggt taggaaaatg gcaactagtcg gttctccacg 531600
gagatctaca tggccttact aacctgaat gataagctag gtttgggta gttggcatga 531660
tttcccttct gttaaatgga ccttaaattc aaagagacag ctgttagtta ccaccaagct 531720
ataagcacta ctatcacagg ttcagggatc ttgccatgca ggttattgtt gtggttcatt 531780
gggtcacaac tggtaggaca atcaaatgca ttctctctt ggcaactttgc atagactttt 531840
ctgctactgt gaaaactatt gctcaggaag gaagcttttt tgggtcagat cccgttggat 531900
tcttgaagat cttgtatctg aagtgcgtgg tctctccacc gatagggact taccttcagt 531960

ttggggagtc cccaaaccaa caactgaga gaagatttct taagcctatt gctgggattt 532020
ttgttagtct attgctcttg agaggagcat tatgttgcca aatagcataa cttcatttaa 532080
actatacaca tatgtatagc tagacactca tgtatgatgt gtaattttag gtaactgtga 532140
aataaatatga tacagttttg tcatttgtat ttatttgtct tgggtgcaga attgtgcttc 532200
atagactatt cgggccagca ctgatacact tggagggaca ttgtcagtgt gaacacttga 532260
ttgtctattg taatgacttg acttattggt gagttggggt aaagcaggtc catggttatt 532320

ggcctcctcc tggaagccag cctgcccaca gagaacatgc tttccaactt agaactcaac 532380

 catacatttt acagggtacc tccatatggg gagcatgtgg taattccgtg ctgtctgtgg 532440
 cagagagcat gggtaatctt aactaagctt cagttttgag aaacccatgg ttgccacaca 532500
 tccaagccac atcctcaaat cctgctttaa ttagctataa aactgttctt tttatttcca 532560
 tctgtctaat ttcttgcct aacaaactca attaatTTTg actttcagt caggggaagg 532620
 gtgtctgtta ggctccttca aacaccagta atgtgacata cactcaaac agacacaaaa 532680
 gccaggaaaa aaatcatggc cggacagtga gatggcttag caggtaaaga tacctgatga 532740
 caaatTtgat ccagagaag gagagaacca acttctaaaa gttacctatt gatttacaca 532800

 cacacacaca cacacacaca cacacacaca cacacacaca cacaatttta aaaatatctg 532860
 ttatgtgtac tctttctgc cagctgcctg ggtcccgccca ccacttcagc ccccaaataa 532920
 cacacagac actatattaa ttataaaget gttggccact gactagagct tcttattggc 532980
 tagctctgtc ttaattacta atctatttct ataaaactaa atattccac atggctttat 533040
 cttaccggag aaaaggtcca ggcctcttac tccattgtgg tctacattgc gtctcctgt 533100
 gcctatactt ccgagaatcc tctctatctc ctgagaccat ctatcttact tccctattgg 533160
 ccaacagtgc tttactcatc aaccaatagg agaacatat ttacagaatg acatctcct 533220

 tcaaaaacct aataaaacct ttaaaaatag atagtgggaa aacaatatc aaagacaatg 533280
 gaaggcaatg gtcatatgac tgtgaacata ctaaaactat tggatgaat agtatttgct 533340
 tgaaatttat ggaacgtgac aaacatctca gtaaaaatgg tgaggaagga ggcagggtgg 533400
 gataatgacc aaccatctta acttaatcag caaggcccag tgaagtgaga atcactgccc 533460
 caaaaatcaa agtagacaat acctgaggag tgacacctga ggtcaatctc tggcctacac 533520
 acacacacac acacacacac acacacacac acacacacac acacaagttt ttgtacaaac 533580
 aagataacag atttaaaacc tttcaaaaat aataaaaaggc agtaattgtt tcaaaaatta 533640

 gtgtgtttca aaatgaagac atctccaggt gcatcatagt gaaagaggat gaccaattct 533700
 taaaagctac caaaaagaaa gatagatgaa ccgggggggaa aaggatgatc atgttagcaa 533760
 acttcttcat ggigcaatag aagctagaag acaatgggac aatatctgta atagattgac 533820
 aaccaacctt aacctcagat aaactattgt gccaaaagcc agcatgaaag aaagacttct 533880
 caatatcatt attacctcaa cactgaatgc cttagtttag aatgacggga ataataatag 533940
 cagaaataca tgaagagat agactgaaat ttctttcaat ctatttaaca gactgaaatt 534000
 tctttcactt taaatagtag gaaagaaata gactgaaagt caccaaagac aaaactagat 534060

tctttgaaaa ggctaataat gggcaaacctt ctttgaacat gactcaaaaa agtagaaaa 534120
agttggagag atggcataga agataaggat gcttgtacag gactggggtt gggttctcag 534180
catccatgtg gtgtctcaca acagcctgtt actccagttc caaaagatct gacattcttt 534240
ctggactcca tgagtactgc atacttgtgg tgcacataga tacaaggaga taaaacactc 534300
agacacataa aataaaaaa ctttataaag acacaagtta tgcaattgca gaaactgaga 534360
ataaaaatgg agtaaacaca aatataaaga aaagattttg aaactgtgca ataattttaa 534420
taagttatgt cactaaatth gaagactaca agatgataat cccaggaaaa atgatatcca 534480

aaacaacagg tgacattaag catccaaata gcttattaaa cattaaagat ttggcctggg 534540
caatagaggc tcatgccttt aatcccagca cctgggaggc agaggcaagt ggctctctgt 534600
gagtgcaagg ccagcctggt ctacagaatg ggtaccaaga cagctaggac tgttacacag 534660
agaaaccctg tcttgaaaa ccaaacaaaa attaaagaag tgaatgttca tctggaagcc 534720
ccaaaaccac tgaagattg gttttctaaa ttctacacaa attgctccaa agacaagagg 534780
gggagtccca agttgtttta tctcttgggt cctgggctct cgctcccatt tcttggatgt 534840
tttagctcct gcctcactat gcttcattcc actattttct cctaaatcct ggtgtgceca 534900

agacattaga cgccttcta atgggagccc ccacaactt ccattttatc cattcattca 534960
ctggacatca cctcttacct tcccctgtct ctctttctag tactctgaat tctgtaagca 535020
ttctgaccta teagaacct catttcattc atcccactac tacattacc atcatgceca 535080
gggctctcct ctgctctcac ttggaattcc tcttgaattc ctcaatatct ctgtcccttt 535140
ccccctaate ataggctcct gaccagacca tgattgcatt taaatccaaa tttccatatt 535200
ttttgagcct gtagaagaaa atcacagagc caggctcacc agctgacttt aagggtcaga 535260
tgctgtaagt tgtctctctg cttattctac tgtgtgctgt ggaatgctga aggttactcc 535320

tccgaactgc atgctgggaa gctcgaacca tccttacttc cctacactct getcagcctc 535380
tgataaccac tgttggactc tggaagatca acatttagct tccatatatg tcaataacaa 535440
tgtgaagtat ttggctgtgc ctgatttatt tctcttgttc aactcacttc tcttaccatt 535500
tccacceaat ttcttttcta gtattaaatt cattttattt acatttttaa ttttactttc 535560
tgtatgtgag agcgtatgca tgcattgga agtcagagga taacttgctg gaggttggtgc 535620
tctccttcca tcatgtaggt tgggggaatt gaaccaggt catcagactt ggcagcaagc 535680
accttcacac ttaagccat ttggcagggc cacttgctaa tctttatgtc aaaattcctt 535740

gaaagaatg tctacactct tcagtgttct gttccactca ttttgctgt gaggaagatc 535800
cccccaacc cctcacttca agttcttca aatggctccc tttcaattga ctgttagctg 535860
gtgtctcagc agtactgaag cataggtggt cactccctgc tctgaacac ccttctttct 535920

tgacttccag gacactagac catcttggig cctgtcecc ttggtggaa catctccttt 535980
 ctgagttctc agagtaccac cagttctctg ctctttatcc ttcctccatt tgtaatcatt 536040
 gtttctgttc tgtcttaggc actcatgact tcacatggct agtaatggat atgcaacaat 536100
 tatcaaattt ccatctccag cccacacctc catctacctt gtgctccaga ctcacggatc 536160

 caactgccta gtaggcactc ctacttgggt agccaacaga gacctccaat ttgacatgtc 536220
 ccaaactgag ctcccagcct tccccacaa attcactct gcatttcccc atcccaatag 536280
 agtagcatca ctctttttct cctatgttcc atatctgtt cattaagaaa ttaaaaaaa 536340
 aaaaacatgg gctggagaga tggctcagag gttaagagca cctactgctc ttccagaggt 536400
 catgagttca attcccagaa accacatggt ggctccaac catctgttat gagatctggt 536460
 gccctcttct gatgtgcaga tataatgga agcagaatgt tgtatacata ataaataat 536520
 aaaaactaaa aaaaatagaa atttaaaaac atggccaaac ccagacctt taccactatt 536580

 tttatttgtt gtgcttttct ctaagtttct gtttatggac tggaccccag caatagcctc 536640
 atgactaatc tcctgtctc ctttctctat ctgcaaatga gatcccttat tactaatatt 536700
 taagtgagaa tacaaaaata tgtatttcat tatgacattt ccatacatat atgceattta 536760
 ctttgccaga gagcctttaa agtgagtcaa ggcatgctag tcctctactc aaacctccat 536820
 aactcacggg atagaaggct cttagcacc cctcttcagc ccccgtaact cactttccca 536880
 ttcaagtcta gtttcaaca tgatctctc ctgttccatc acttcattcc atccacacta 536940
 accaagcagt gcactgggta accagagcca tggctgtttc ctctacttgt gccattactt 537000

 gtgtgggtag ttatccaaag gtcatctaag gctggctttt agtaaactc caattcttta 537060
 tcaccaaacc ctagttttat ttttacctat actatggttt gaacatatat atccccctaa 537120
 ctcatcact gaaatgtagt ccacaaatgt actcacatgg tatttggagg tgaggccttc 537180
 aggaagggcc tctagatgaa gccctcaaat atcattagtg gctttataaa aagaggagga 537240
 gaaactcaca ctagcatgct tgatccatct tgccgagtga ttcttttgcc gtgttacaat 537300
 acagcaggaa gaccttcaca agatgctgag caacaccaag ttccagggcc tcttagcttc 537360
 tagactatga agctaagagt tcactaaact cttagtgtga gtgatctcag gtattataac 537420

 aacacaaaac aggctaagac aattcatatg ccacatattt catccatgga aagtatgcaa 537480
 ttcaacagtt gttagtatat tcactggatt gtgtacccat gaacacaatc aattttagaa 537540
 tattttattg ttictaaaag aaacccttt gtaaacagat actcccgttt ctcttgatt 537600
 cccctctctc cagccctgag caaactgttc agctgttctt gtatttgaca gctccacata 537660
 caggagcaca gccatgtctt tgacacagtg atttcaattc ctttagaaat atccccagaa 537720
 acgggttggg tggatatcat cgtaactgac agatacggag cattttcatg tatgtgttgc 537780

ccaatcgttt gtatatcttt ggaaaattca ggtcatttga ccatctttta gactgtgtta 537840

cttgttttct tgcattgag tactttgcat ttcttgtaca ttttgagtat cattccctta 537900

tctgatgatt tataaatatt tctcatcact tgatggetta ccccttact ggtacagatt 537960

ttctttacta ttcagaagct cttcagtcig atacaactct tgcctgtttt ggcgggccat 538020

tgctgagag atgcaaaatt ttaaacatta ttattttaat agaataaaaa tacaaaaaaa 538080

aaatttctta aagataacac aagtggacag gagacgaagg aagatcagag gcaactggggg 538140

gaggaggagg tacatattac ccagcagtgt aaaaatgtaa aagaaaaagc cgtaactgaa 538200

ttttgcttcc tacagggtct accaaaggtc agcaactcaa agcaaacaaa cctccatcaa 538260

ggaactagtt taiccttctg ggagctgtca ggcaaatgg tgcctgttc aacaccaggt 538320

ttggttataa tttagaccag ctcatggcag gcatgactgg ttagagtccc aagaagaaaa 538380

taaacaggaa ggaatggttg gagcaccaat gtctcaagg cctaagccc tgtaagactc 538440

tagttatgta ggcagtaggt ggtggccagg gccaaagtcct gagggggga actatagagt 538500

cgggaggtea gctctccac aagcccctcc atttccagca ggaagcaca ttccaccact 538560

tggtctctcc caaggagaa caaacagagc aggcacaagg caaaaggctg ggttccagtg 538620

atgagtaatg gagagggtg aaattatgta tcaagatgtc taactacaga aaacatgcag 538680

cacaccctgc taaatgtaca agaggagca tcaagtgaca gagacaatgt tgtcatcagt 538740

cttacaatatt cagcattaaa aacctctat tggggctctg cagttaagag tacttgtctt 538800

ccttgcagag gacaccagg tttgattccc aacatcccac atgggtgctc aaaaccatct 538860

gtaactctaa ttccagggga tccaaagcat tcttctgagc tctgtgtgcc ctggcacaca 538920

catggtgcat actcatacac actgtgtgtg tgttatgcat acacacacat ttaaagtact 538980

tcgttttct caagggtaga ttatttgtct aatctctgta gaacttcttg aggccctgga 539040

ggacgttttt catctcttgt cccaattttg cctctcggaa cactgtatgc aagcccggag 539100

ctgcaaagga caaattgatc ctttgtaaat tacaattgga tggattctc tgaatagact 539160

ttgaccagca cgaatccacc tccacacagt cctccaacce tagccctctg tcatgagctg 539220

acagccgctc ctaaaaagat caggagattc accaggatgt gtgaactcat acagtcaca 539280

gcacatttta accctgcagt tcgctctga ctctctgac ctttggtagg ggttggggga 539340

agaaacctcc ctctcttct cctatcatcc caccctgtca cctccgtttt ctcttaaaca 539400

catgtcggga gagaaacgtt cttcatttga ggcgtgcttt ccttggcctg agcttctctc 539460

tgtgtgggga gacctgaagg gagaggggtt tctcgggcac ctacaaaacc agtctctctg 539520

gggtaacgca cagagagaaa ctcaagtcag agaaggtggt atgcagctct ggtaaggctg 539580
 ggctgtctcac tgtgggcagt cctgaactga tgaagggaaa agagatggag ttggggggag 539640
 ggccgggagga ggaggagggg gcggcccccga gcaattcaat ggcgctttga tttacaact 539700
 ccaagctctt tgaaacatt ttgccaggaa aagcttgcca tcaacacgta taatctctta 539760
 tcagaggccc ctgaaagcca gggcctcggg gtttaattccc ccatcgcaat gaggtttgaat 539820
 cagctctaaa cccgcagtga catgaaagcg cccgggcctc gggccgcaca gaaccactg 539880
 agaaccgccg gccggggagg attacggggc ctgttgacag gcgggctcgc ccgcaggacg 539940

 ggcagctca aaagaaaag aataattagg gataattgct tgtgtccaaa cacaagcatt 540000
 aaggccccct gtccccctt gggactttgt gagccagaat gaaagagaca ccccctgttt 540060
 tgacagctgg accnnnnnnn nnnnnnnnnn nnnnnnnnnn nnnnnnnnnn nnnnnnnnnn 540120
 nnnnnnnnnn nnnnnnnnnn nnnnnnnnnn nnnnnnnnnn nnnnnnnnnn nnnnnnnnnn 540180
 nnnnnnnnnn nnnnnnnnnn nnnnnnnnnn nnnnnnnnnn nnnnnnnnnn nnnnnntac 540240
 cactgcgcga ccaggcccag tgtccggtgc tgcgacctgt ggtggcacag ggactacggg 540300
 actcagaagt ttcccggggc tgcagatcgg gctatgacac tgctcaagtt cacacgcca 540360

 gcagcacgga gtctccacca acaccacac acgggaatat aggatccac ctcgctcggc 540420
 gtggggcggc ctgcgccaca tttggagaca cccaaggcac aggggtggtcc cagccacatc 540480
 tggatgcgtt cttaaagctg aggcccgct aggagcttc tgttcgtgac tcggaagccc 540540
 gagagagcat taacacaaa cagggaaccg agttagcgtt cactcactac gtggggactc 540600
 tccaacacca ccctcagggt gctggggctg ggatcaggct ttcccagag aacactgcac 540660
 agccaaggcc aggggaagcc agcttccggc ttcagaatgt tctagtgcc gaggccaaga 540720
 caggccctga gaggtcctcc aaagaagaca agagtgggga gaaatggggc tggtgccaga 540780

 ggaaggaacc tgaagaaca gtggtgtgcg aagaccacc tgagcacctg gaccaccag 540840
 actgcagcct ggacctaaa aggttcaaga ccggcatagt acacaggcct aaagatctgg 540900
 aacgtggagc ggaccttga gaaagtcaaa atcgggcag tagccaggcg gctcattgct 540960
 aggttcaca gccacgcaa tctaagaaa cgatecaatt ctccttcca aataaccacc 541020
 atagtgaggc tggaggatgc gtggggaagg gcttcgtgga cgcatggcca tgagtgatta 541080
 attaaagaaa aaccacatcc ggaaaaaaa aaattttctg aaaggagctg agtcctagaa 541140
 gggctccggt ccctcggct gcagctgtgg cccagacaga tcagccagct gactcggagc 541200

 ccacccact ccagtctgag gaggggacc gcttggcttt ctggcttcta ataaactcac 541260
 ggtttccgat tttccagta aggtctggga ctgggtggag aggtgactgg ggtgaccct 541320
 gagcctgcca ctggctacct acgaatatca gatccctgct attgcactgg cagtattggg 541380

gggtcagcac aatgtagcca aggtttgact ctgtactgag ctaaggcagc ttgcattccc 541440
 cagatgagac cccatagtca agacaaggat gtgaaatga aaggtttaga cccaggcaaa 541500
 tgcctcttgt cttgcctttt ttcacccctt tagtcccacc cgcgtggttt aagggggaaa 541560
 aaaaaccaag gagggcaaca tagtcaccaa aaatagaaag aaaatcgtat tttctgaata 541620

 tctcttttca ttgttctaata tggcagcatt tattaaaata cttcagcct gttggaatt 541680
 aaaatacagt atgaagtga taattacaga tggagttttt aattttctct ttcttttgc 541740
 ttggtcctac tttttacatg ataggttcc tggtttctta gaataataat tgggaagacc 541800
 cgagagaaga aaaggcctgc ttctaataatg ggaacaatgt agcatgtctg ccacataagg 541860
 ggggggggtg cgcctccttc cagaaagaat acagttcggg aaattatata ttgcttattt 541920
 tcaaagtcag gggccgtttc cttgtagaga aatgggtggc actaactgaa actgcacaca 541980
 gggacacgct tctcgggtta gctcatgttt agagacaatc aatgctctat ttatttgttc 542040

 tgggaggcag gggtagacag aagaatatcc tgatgacagc aaggacctt ctctcttctc 542100
 ctggactcca ctccccacc caacccaccg tgccttaatc aggttccct aaagagaggg 542160
 ctttggtttg gggtttgggt ttgttttgtt tctgagattt aatactacat atatttcac 542220
 acgccacact ggcttcaaca acttttaaaa gccatggaat tgaacattta atttcagagt 542280
 gttggccaac tgttgaanaat gtaaatattca tttcaagagc tttggctaag agatggaatt 542340
 atttattatg acataatggt agtgcctgtg gtgtgtgtgt gagagagaga gagagagaga 542400
 gagagacaga gaaagagagc acattaaaca gcaagaatgc ccatagaatc tataccaat 542460

 cagaattata acattttttg ctgaaactgc tgtgtgggcc agttctcatg agcccaacc 542520
 aaaagggact tggtaaatg atgtaaatg tctgaattca tgcctgcaa aaaaaccag 542580
 cttggtttgc cagggttact ccatagatac acgccagtac actgcaccc aatagacct 542640
 gtaaccaagg cattctgggt aggagtgcac tcccaggat agatcttagg atgtgtcaaa 542700
 ggaggtgggt tcctctaaa tgcaatcatt ccaaaactgc agtcattca aaatttctag 542760
 gattgtaagt gaggaatggc aaagtcaagc atcatgaatt ttgcgatgta ttagcttgg 542820
 gttttaaact gttggtttgt ctctttcctt tggttttgtt ttttaagct ggggtggagg 542880

 tatctcacag gctggcctgg aacttgtgat tcttttgctt ctgcctcca agtgcctgatt 542940
 tcaggactgt gccacctgc cctgctcaga aaaagatata gatttgcctt gcacatagag 543000
 ctaggagagc actaacctgc cccattggca atttggaaac ctgctagtcc tagaaggagt 543060
 agagacctct tagcaactga atcaaaggca ctaggcttaa ttacaactgt ctctgggagc 543120
 taaggaaagg ttctccctt cggaggccnn nnnnnnnnnn nnnnnnnnnn nnnnnnnnnn 543180
 nnnnnnnnnn nnnnnnnnnn nnnnnnnnnn nnnnnnnnnn nnnnnnnnnn nnnnnnnnnn 543240

nnnnnnnnnn nnnnnnnnnn nnnnnatata tctataaatg aaacaaatat ctatgtgat 543300

 agagatagat gcagatgat gtgtgaaata tgfactatag ttttaaattt gcattttaaa 543360
 atgctgcaaa aagttttgtt tttttttttt atcatgactg cacatgccta aactgacat 543420
 gtctggtatc cttaaaatgc taactaaaat gcttcttgct tttcattctt ttaggacctc 543480
 caaggcaaga gcaaacatta ctgcagagtg aagccactct atatgtgtaa agacgacaga 543540
 cataaattac atccacagtg gaatgttga aattcatttc cgcctttgtg gaacctgact 543600
 ttggggcacg ggagtttctt ccttttggag gggcctctag gcagagcctg ggcttggcac 543660
 caaaagcatt gcctggttct gtagaacact aatctggac agatttacac agaacagaag 543720

 cgttcctttc cccttttga ttccagccaa gcagcttggg gactttcctg cgttccagct 543780
 ccttctgagt gttttccag gtttgggct aagcccagga cagagaagac catgttacac 543840
 aacacggtaa tgagatctgt gtcacttctt atttttttaa gctgtgtcct gatttttttg 543900
 gggggggtgg tggcacaggc attgtctctt aaagatgtgg ctgctatgac attgatgaac 543960
 agtgtgtgtc tgtatgataa aataaaaatc ctgaaatagg tttacatgtc gggaagacag 544020
 attgttttct ttgtagtctt ctacttgaat ctgtcttcac atttgtttta cctttttata 544080
 aacaatgttt ttgtaaggac aaaagtcat aaagaaggtt ctgggacat tttccagac 544140

 accatatgaa tgaacaaat gtctcccat ttgacaggcg tgggtctttc tctaacttta 544200
 aataaatgac tactgcttac attggtggga agaccactcg gaaagtggct ctactgtgtt 544260
 ttctcaaat gaaacttgag aactctctaa caggactgct cagatgata gtggcatcta 544320
 aatgttttta tagagagta gccttttctc tgetgggtcc tgggcatgct ggctacacag 544380
 ctagacctcc atagtgatta taatttcaca tcaatacaac tcagaacaca ggctgtgaga 544440
 aaagatacaa gtcaatata cagtccatt ctgtcaaagc gaaggtcatc aatttgaaa 544500
 tcaagtttct tgetgaaacc attcacagt aatgaaataa ctgatggcat ttctccaca 544560

 ttaattttat catgtatttg aagcttgggtg taacctgaca tgtccaata cttctgtagt 544620
 cttctcgaaa gcaatagaaa agcctggaag catggaggga accttgatag caaccttccc 544680
 cacaagccct gcctgtggag aaagagtata gcatacaatg tactcggtta aacaaatatt 544740
 taacttattc ctcatccaag gcaaatcagc ttccagggca acatatgggc tccaattcag 544800
 gggtagagca catggttcaa gtcaggacca ggagtgactg atgtatacag tcatggaaa 544860
 tggctgtgga tggccaggc agatttgggg gtcaaggaga gtggggggac tgaactttgc 544920
 tttactctag tatgcattcc agattagagc tctttgccgt agccccctt actgatctag 544980

aatcagaagg taacatttta gcccaagttc ctttttaaca tagagctgac aaatactatt 545040
gccgggtcta aggtcaaaa cctgactcgc aggacctcac cagaccacaa aggtcacttg 545100
ccaagagtcc acccagtcag gaagatgagt tgaagagggtg aaccaagaaa gaaagtatt 545160
cagtatggct atactggaaa gaaatggggc acatgtgtcc tgaggcctgt cttcgaggag 545220
ctaccaagat ctttggggct atatgaagca aagcacaaaa gctgagagaa taagtaaga 545280
tccatagtea agaggtttg gtcaattgta atatggttgg tcatcagctc aggtctggtt 545340
ctctgggctt cactggtacc aaagaaattg gttcctgtca tagcgggtaa gcctgcaggg 545400

ctcaatcttc ctggaactta agggaatcca tgagggatcc actgaggaa tatgtcagag 545460
gagcaagctt gagcagatca ggacaaggac tggatcctcc atgtgggaac agggccatac 545520
tgaaggcccc cactactctc cgctttctg actttgagct atccatctcc agtactgtgc 545580
ctatgtgtga ccaaacctcc tctgtgtga caggccatgc agatggctta agctcacagt 545640
gcagatttcc ttagggcctg tggcttctcag gtggctgtga gagatcttga gctctgctgt 545700
tctctagtaa ctacttgca cccatggcta ttgatgttg gctggtctag aaattcatct 545760
gtgctatgag tgtaaaatgg aacttgtgtc ctgtttttaa ctgtggaatc ttctcatgta 545820

ttacatagg ctgggtggct tagtcacaaa catttactct cacaaacctg aggttcagaa 545880
gtctaagaat agcatgccag aatacaagga cactattgtc atcttggggg cctgcccact 545940
ctgcctctgt ctaaaattaa ctgectcaa atgactcact cccaaacacc attgtattgg 546000
ggattagagc ttcaacacgt aaactgaaat gggatgaagg aaacaatgac cataacaaaa 546060
actgtatgaa aaattataaa gtatgtcaat ggtgtaataa tttcttgatt attgagttag 546120
gtaaaatatt ttatctaaga ggtctccatt gaatataacc tcttggcatt tgtgccacat 546180
ggaacttctc tcctaaaatt tccttattta ttttcaaat tgcttattat ttattttat 546240

aattttgaga ttgagtctca aactcacat gtagctcagg ctggcttcaa acacatagca 546300
accctctggt ctcagtctat cgagtgtga gccaccacc ctggaccata tagtagttca 546360
gttttagtat agaacaaagc tcatgttata gactgtcgt tccaagctca gatggttaagg 546420
agaccacage tgccatcttg ggtgttattt cttcagctc aacctcattt cttctctatt 546480
tctttttat cttagatccc agtcaactcag gataggatgc catgctgaag gtgccagaca 546540
gagaggacat tgctctggtt tgccacctga acgtttgtgt actggagtct tgagccccag 546600
tgtatcacca caaagtcag gtgtctttaa gagagataat taggtcaagg aggcattgtc 546660

ctcagaaggg actaatgctt gctgtccca ttggtgtgga ctctgtctca agggactaga 546720
ttggttacag aaagggtgac aatgaagtaa acttggctgt cttggttcat cactctctgt 546780
caccctccca actttcctct catttccccg acaatattga gatgcagcca gtagacctt 546840

gtcagatgct aatgccctgt atctgagctt ttacagctgt cacattagaa gacaaaaacc 546900
 ctcttttctt tatatgcat attgtgtctg gtgttttctt gcagcaacac aaaatccact 546960
 aggacaaaaa ggatgagagg ccatgtggaa gacaaaaggag gcacattagt caacagccag 547020
 caacagtggg atgtcatggg agtgagactt cacacaagtg agggaggatt ttgcaaaagg 547080

 actatcctac tctgtcagc actgacaaag gctgtcacta aaccacagct atgactgtag 547140
 actcaggaga acctggagcc aggactattc agctaagcca cttgcatgct getaacccca 547200
 caggcaaaaca atgaaggctt tttgtgttg ttttggggtt ttgtggtttt cttgtttgtt 547260
 ttgttttgtt ttttgtttgt tttttgagat aggatttctc tgagtagctt ttagaccag 547320
 gtggcctca aactcacaga gatctgcctg cctctgcctc ctgagggtg ggactaaagg 547380
 tgtgtccac caccaccag ctaacaatga aggttttata gggaagtttt gaataaatt 547440
 gttatagcaa caaataagga acactatctc taaagttagt tttggatcac tctgagcct 547500

 tttggccaag gtcaagtga gaactgattt tgctgttaa cttgtcattt ttaaaaatgt 547560
 ggctataaga aagttttaat gtccatggct gtcccacagt gtatacctt attgggcagc 547620
 actagtatcc atggttttaga tggtaactaa gtgaccagg cttaatctgg gattataggg 547680
 agctggtctc aattttaca cacaatcaat caaacaataa atcaaatat ttagctaca 547740
 atctaacaat gtatgtaga atgtgtcatt ggtgacaaat tatacagctg tggattgaca 547800
 gtcaagagat accgaatttc ataagtaac cacagttagg aggaaatgt acccagaaag 547860
 atctctttat ctcttttctt ttttctcagt atggaaatgg agtgcaggac cttgcacaag 547920

 ctagacaagt accacacat aaaactaat cttagtccca gatgcccagc gtttctcatc 547980
 cagcattttt tgattgattc agcacttact cactgtcggg gggggggggg ttatgttgtt 548040
 ccttttgaga taaacttcat gttagttagg ccccaacaca aaaatgccc cttacaacaa 548100
 gggataagtg catctgagtg aagagggaac aacctgaaac ccaggaattt tccagcatgc 548160
 ccagaatggg tccccactg tctgtctgcc ccccccca gcactctgtt gagcactggc 548220
 atggctgttc ttcaacaggc tgacgtctca gaactcgaga gagccgtgtt ttcatttagt 548280
 ggcgtatgag ctaccttga agttgggaag aaatgaagga cttcacttcc tatttatttg 548340

 tatttgcaga accacagaga tccaaggtga taattagaaa aatattttag aaaaccatat 548400
 tctattggat tttgttttt ctagtacagt gacaagtctt ggtaagtttt cagtggtgaa 548460
 acagatcaga tctccatcat ttgatgtgag aactgctggc ccaggcctcc tttgctctgg 548520
 ttatttatag attaccatga atagctgtt tcacaaaagc aaactgtc tttcattttt 548580
 tttctgaga ttttaattcaa aagtctctt cttcatatat cttaaatgca ttttagtttg 548640
 acaacataat tgcagatata gccattcct cttcaaagtg gggtgacttc tatggcaaca 548700

tttagtcaag agtagacagt tcaactaaaag gtcacaattg atagttttaa tctttcaaaa 548760

 atggctcttg ataaagctgt agaaagcatt ccagcatgga catgcatgt gattaacact 548820
 ggctaacttt ccctaagtgt tagtacatag aagatgetct gacatttga tcaaaaagct 548880
 aactagctga tccttgatac atatctttaa tcccagctct tataatgctg tggtaggcag 548940
 gtctctgtga gtcttcatct acttagtgaa ttccaggcca gtcagggcta cacagtgaga 549000
 ccctgtctca aaacaacacc agacatctaa tctaaattaa cattatttca gaagctata 549060
 tttattattt tattacatga ttttttgag acagggttgc tgtgtataaa aaccctggct 549120
 gttttggaac ttgctttgtt ccaggctgga ctggaactca cagagatcca cctgcctctg 549180

 cctcccaggt gctgggatca aaggcgtggg ccaccatgtc ggacatattt ctattgtctt 549240
 tagtttcaaa tcctttcaaa ctaatattcc aggtgacatc aagtcctttc tatgactcca 549300
 gagacttggg ttaaaggagg gtgcacgctg atctgtttca agtggacact accaacacac 549360
 attacaatct ggcttccaac ccatacccca ctgatggctc tgatatcttc ctgaagccag 549420
 taacacatgt cacagtgtag aaagtctta ttaaattaa ggtcaaggag tcaaaaagta 549480
 gatcttccca tttttattct cattttaaaa tcaatttcca ttgctttccc attcaatgtt 549540
 aaggaatatt tgcttaaatc ttggggagcc tctcttttcc ctgtagcaca cattagcaaa 549600

 cacaatgtgt atttttcttt taataaaca agctatcagt gatgtctgcc agtgaaattc 549660
 tgctactttc tciggaaaaa aaggatttgc tttataaatg ttaatgcaga ggaacggctc 549720
 tgaaatttca caaaaagcta aacacataaa tagaaacat cattgtttga gtattcattg 549780
 ttttattgca tttctcttat tgcttttccac ctcaatacta cactctctta gtggactttg 549840
 gatttcccat tagacatggc acttagaaaa ccctttggaa ctgaggatgt gaacttatga 549900
 tgggatttta catcttctgc tgctggaatc cattcaatcc aggtctttac tcctcttca 549960
 aacctcttc tgetttccac ctctcttct cattggatgt ccatttagta tetactctac 550020

 catacacact ttaaccttcc ttctcagac atcactgtcc gtagctcttg cttgtaggtg 550080
 accctctaa cttcaggggt ctctaagacc agcagtcact tctggttctct ctacttaag 550140
 ccacaggatt ctgtcctttg caaagatcct gcccttctct cctcagctcc ccaatagctt 550200
 gccattgtg tacagcctca gcaaagaaat gtccatgag caaagagggg aaaagagacc 550260
 tcctagggac ttacatcaga atcaagatct gtaccggga tgctccagac atgccacaca 550320
 atccactaac tccagttata cagatcattt tccaattctc aacctaatc ctgcctcaca 550380
 aaacatgcct tttcaagcaa tcagcacaaa gttattcctgt ggctattatt gtgtggtttt 550440

gagctggtga tgaaggacat aaagtactat cagacaaggc ctcccctggg caatttgctt 550500
 gtagcctctgt gtgggtgcag agccctctct ttgtttgccca ttcagtacaa gactcctgtg 550560
 gatgactgac aagggcagac ttggaacaac attacttcgg gaggataatg accagccatc 550620
 ataaattcct ttcttaaata gtttattgca ggtttagtagac tattgacaat gactttgttt 550680
 tatagcatga aggaagatgt ccttctctgt gtcagtctct aaaacaacat taagagtttt 550740
 tagtaccccc agagaaaaca gcttttcatt aaatgaatca taaatagtgt taaagccata 550800
 gttacatagg ccagggaaga gaagaagagg aaaagaaata gctgtctcgg atgcaaagag 550860

 gtccctctgg tgcctctttc aagtaataa aatagtaagg aagcttcag ggctgtcctt 550920
 ctgtgcctgt ctcccctggg caataaatga aatcggatgt aaaaaactgt gagagacatc 550980
 ataccaccac acagagaaac aaaaaggag atagaaatga ggaagatggg aagctatfff 551040
 gttaatcctt gtgttcggac cctgtcatct cattaccaat tctttttctg tgagagacat 551100
 taatatctcc acaaaaaatc tcatgttata aataatgttt atatattgag ctttaaatag 551160
 gaaacaacag gttgtcgcca tcatcatttg agatccggtg tgactcaact gttactgaaa 551220
 atgcctgcca ggaagtagaa aataattctg tgagtgtttt gtttagaggag acagttcaga 551280

 tgagtgcgca catctttatt ccccccttc ctttaaaaat cttttgtctt tctttggaaa 551340
 aatacattaa gccctaagat atctttttta aggcaagttt tacaagcac acacagagtt 551400
 tgagccacac aagtcatata catatgtgag taatcatatt tttgatatat ctctctgcct 551460
 aatcattaac tttaaatgcc aaataagaat ttgtaatcta ccataaatta tttcacagga 551520
 gtaatttaag agagctgctg accaatgtga aacatgccag tccacaagca attggccgcc 551580
 aaacattgga gggggaaaag gtcccagata aaaattacca taaattacaa tgactgtaag 551640
 tctctaacga tcaagtgggt gtttagagatt attgcattta gaagatagga acaaacctat 551700

 taagcgtcat gacatecatc cagagtccat tttactcatc aggaagctgg atctttcaaa 551760
 atccccttga acatctcac ctctctcac ctacctcac aggatccat ctaaagtgca 551820
 tcatactagt tacagtccat tgaacgtaga aaacagcag gaaatcattt ttgaattatg 551880
 atggactacc caagctctac ttttataatg aaaacttcaa aataaacctt caatttgac 551940
 ttcttgtttt ctcccctcca catataaaaa gcagctgcat gtgagtgaat caggcagaat 552000
 ggttgacaga gtcaaaaacc agaaagggat gcacagcccc ataagcagcg actatgctca 552060
 ggtgggaatt cacaatgggc tgaatttgcct atggttatta ttgtgctcaa agaateccta 552120

 tgaagtgcag gggaaagtat aaatctgttt gagaaaatta attccttttt caaatcttca 552180
 tcttttctct caagatgtgt ctccaagaa agacaattac gtcaagaag gttcgggggc 552240
 ctcatctgc aactgcctt taaacacat tctggaggcc tattaacat catgtaact 552300

gtagacagca atgcttccac caccccagcc cttcacatct gcacaccagc ttcttgggag 552360
 cagaacggag acatgtacat tttagcatat ttcaacaaca gagtcttggg ggctgggagg 552420
 tgtgtacctt tctccatata tggccatcat gaattctacc caagaactca atacagatta 552480
 tttatataat attcccactc ctcaccccca cctccaggct ggcagagggt gaaggaaaca 552540

 ttttgggaaa gtctctacca caactgtctt ccaaaatag gatggtgcta attggttctg 552600
 attttctttt ttaccagcac atggggtatg cagggtatit ttaaaattaa tctttctaaa 552660
 aaatatcaat gtatacaaca agttgaagt atttacacac taaatttatt tatgattgag 552720
 gactctttaa tgaatttact aatttctttg gaaaatccca gtatccactc aaattccagg 552780
 catagaaagg aagccccata gaataaagta gattctggat ggtatitcat aaatgacttg 552840
 gggacaatgc ccaacatgct caaactatgc cttgatgatt aaggagggca aatgtagtca 552900
 ataggtaggg agacagaatg gaaatagatt ccaaaggaaa gataatgttt atatggcaat 552960

 aattatgttt tttcaagag tagaatctgc ataattaaac aagaataagg gaggtcgttt 553020
 tgggtgtagtg gccatttaa gaacatattg caaggacgaa aatgtagtca gaaaagaagc 553080
 tatagtgtgt tataaaat atatggcacag ggaggaaagg gtcattagc ctagatgcca 553140
 cttctgctct attcttagct tctgatctct ccatcagaac tccactccta cctcatagac 553200
 actgtgaaga tagagcaaag aatagtttaa aatggctctg gaaactgtta accaacaatag 553260
 caacacagaa cccagttacc agcacatact tattgttgc tgtttgttg cttgttttt 553320
 gagacagagt ttctcatgta attgcctgg ctgtcctggc actcggctgt agaccaggct 553380

 ggccctgaac tcacagagt cgtgcctctg cttaccgagt gctgggagta gaggeatgca 553440
 ccaacacatt cttaagcatg gtacagagac ctgggtgggag ccctacgttg acagtgcagt 553500
 gaaaatgggt ttgatctgc actgcgggaa cgtagggctc ccaccggggc tctgtactca 553560
 agccctgtct gtctccacag gagcctctgt gtccagaatg gtctcaagac agagtaggtg 553620
 ttgctctatg aatcaacctc tgctgttggt cttccaatat aagatgaaaa caaggctttt 553680
 ctggatacct ccagaatcag aatattcct tggagatcag agaagccgca gatcattggt 553740
 gttgcagggc caaccacct ctaacttggg tcattttctc ctgcaaaaca tactatactt 553800

 cacccattgg tgtgttgta gctctgccc ccaggggagg tgagatgcta aagtgtaat 553860
 aattatctgg agcagaacat ttaacaatct ggatctcagg atggaattta agcctattta 553920
 gatttactgt gaattctttg aggttaatgc aacttctgaa tgtgactagt aatctctaat 553980
 tatttgcgga gatggtagat gtgagaccag attaaatcca cagataatcc ccaaactca 554040
 ttttagccaa cagcgaagct cttttccac caacccaac cccagaagaa tcaactgaaa 554100
 aacggcaagg ttgacttggg gctcagcttt tctttctctg cctaccctct gctagtgcaa 554160

gagccttaca aatgactctc atatctgggt gcatgtgggt acgtggcttt tcctttggcc 555960
acatcagccc tctgggtttc agttgccaaa aactgtgttt actatcctct gtttgtcata 556020
caaggacaaa tccaatgtgt ctgaagaggg ttggcttctt gtctttgctg ccgcctgagg 556080
aataatgctt ggggaacaaa tatcagatgg agaccattc cctgcggcca tccaggtttc 556140
tgctggctca agatcctgag tcaggtaaaa agattggcag tattcaaagc tgtgctaag 556200
aactcaactc tctagaaatc actggttggg tgttgaacaa ggtctgtgtt ttatggaagt 556260
tctctagagg gctttggact atttgttttc aaatctgttt ctcagtttcc agttcctgaa 556320

gaaatcctct tccccagtg agaacagggg aagtcggttt ttgttttgtt ttgttttttg 556380
aggatcttag aacaagagta gttggattta tctgtcactt gccagtcctg agacatctat 556440
tttctatgtg gttggctgaa aacctgagt gagataaggg aagtgaacc cttggacttg 556500
attctggtec cacacttate cctgggtccc agggtcagga tttgcattcc aagtctgttt 556560
gatttgcag gtgaactagt cactgatgct catgtataga tgttttaaa tgccgattct 556620
ggggacatct tgatcctgt gtaaggattg ccgctcgcca gaagtgggtg ctaattgatg 556680
ccaggcagtt ctgcagccaa gacttcaggc tttcgtgtgt tgtgctcttc ctataaaggg 556740

gaaatggtta gccaaaggcct atggtagacc aggaggaact tcatgttacc caaaaagcta 556800
aacaggattg tgattgtcct tggacctgtg aggaaagacg gcacttggat tgattgtccg 556860
ttttgatgcc taacaggaga gtgtttccct ttacacaatg ccaactaaaat tgtcatttcc 556920
cccttcaca cagtgtgttg aggttattag gagcccccta gggaacagcc acttcttgtg 556980
tctgatata tcacatttc atgatttacc tcctagagt cttgagccat aaaagttct 557040
ttggttctcc agctgggect tccaagcaa ggataagcac cccattacc tttccttatt 557100
taaagtttta ctaaacaac aacatccgtg aaaacaaaa gtaaaacaaa caaaaaatta 557160

aaataaaca aagaaagcca tctggtgtgt ttacaaagca tacatttctt actctaaaat 557220
aattaaagcc tgccaaagat tgggctggc ctgcctctgg cttacgtgcc tgctccatgt 557280
cacagctggg aagaagagga ttcaccactg gactctctag tctcattgg ggaggttctt 557340
gctagatag acttcagtt ccggtgtgtc ctcattecac ggctctgag ctacagagag 557400
aaggctttgc catcaggcct tctgggttcc ttctaggtc tcttgggcag tccatgctg 557460
tccccagca gtatccagga aggttcacag cttacctgt tactctgttc tctgcagca 557520
agactaagag tctgggtccc ctctcccag aagcctgccc cctcagtatt taccctccc 557580

ttttcttcc ctctgcct ccaccact gctgagaacc acctgtttg tgttgtgaaa 557640
gcagcccat ctcccctca cagacctccc actgagttcc aattccagt ccaaactcca 557700
catctgagtt ctgactcac tggaaaagta taaaacatc gcagattcgg aactgacttt 557760

catactggag tcttttcttc cagtttgctc ctgtctcaga ggagtagtct cagataagtt 557820
 ctaaactaa ggggtggccc cggactcctc caaatcatg gtcactctctg caggttgcca 557880
 tatggcccat aaacctctc gaatgtccta agtatgattt tacaatcgaa aacctgact 557940
 ttgttggtc aagaactgta taatcacagc ctcaagaaaa caggttcaca ttctcatctg 558000

 cgtgacagga aggaccaaat tccccgactg gcagtttggt actctcctgg tgaagtttat 558060
 ttattgaata ttttcttag cttctacca acatctgtta ctaggcaagt aggagtgagt 558120
 gtcaaagggt gggggaaatt tttttggaa gagtaaagcc ttaagtca ctacagtctc 558180
 agataaagta gacaaaaca tggcctcccc tgaaggcca ctttctaata atggagacgg 558240
 gcgctgttac ctttctggc aaagaaggct tgcagctgtg actatgtcaa gggcttgaa 558300
 atggggacat ttttctgaat gatctgtata gacccatgt aatcacaagg gcctttgtaa 558360
 gtactggagg gaggcaggag agtgacagac agaaagattt gaagatgcca aattgctggc 558420

 ttgatgatg aaggcgagg ctgtggcca agaatgcag gaagcttcta agaagctgga 558480
 aaagtaaaaa agatggattc tccccagag cctccagcag gaacaggcct tgccaacatc 558540
 tcgatttgaa tcacgcgaga cccatttcag actcctgacc tccagcactg tgtgctaata 558600
 aatctgcatt acttaagcc actgaagggt tcgttgctt ccacagtaag atgtcacagt 558660
 gtccgctage ttgtgacac acttgagaaa agtaccttc ttgtttgaa ctgaaggga 558720
 cactgtgata gcattgagaa taaagctgtg cccccatta ttccatcacc ccaagttttg 558780
 ccatttgccg actcataact gacatcatca agaactgttt gaggtaggta ctgtgataaa 558840

 ctttatatgg aggggaaaa tgaggcacac aatgtaacta acgtccctga agctgtgcct 558900
 cagatccaaa cacattctcc tcagcgaatt ccaacattct tctgtgtggt ggaactctac 558960
 cctcctcga gagaacagct caaatacca gcagcatccc cgtacacccc aggaacagtg 559020
 gctcccagtc tgacggcctc ctttcccggg gactcctct tggaggcagc cagcctactg 559080
 ctgcttatag aactgcitta ggctgcagta aggtttctgt tgaaagtcc taggccagtg 559140
 gcacattggg aaattattgg caaattggac ttctgtcac ctaatgcaa ggtctgtgtg 559200
 tcagttgata gttatecttc acttcaaagg ccagggtagg gaaacctcag tttgcctga 559260

 catggcagaa gtccttgtgt ttcttctgg aactgccact tccaaggaa atgaatgcc 559320
 tgattcagtg agtgcagcc ctggccacce attgcaatca ccacaaaagc ttgaggcatc 559380
 agtcagttgc caggttctac cccaaccaat gaagtctggt gtggcctgga catccagacc 559440
 tgttcagtct cccaagagg taggtacct ctgtgggtg aacaaatgca ctgacctagt 559500
 agtcatagaa ttggaaaata gtgctagtcc ccagtgtcc tctgaggaga gtctgtagag 559560
 gtgagctttg gggtttggga gcacaaaaat catgaactgt tttagtggg aacagcaaaa 559620

cacacgtctg tggaggtaa cacttgtggt tgggggaagg taccttgta tcagagtaa 559680

gagctccgtg tgtgtgtg tgtgtgtg tgtgtgtg tgtgtgtg tgtgtgtg 559740
tgtgtgtg tgtatcctg agtatgatg aggctatgcc tgcagtggat atgtgggta 559800
tgtgtgtg tgtgtgtgca tgtgtgtatg agagagagag agagagagag agagagagag 559860
agagagagag agagaacacc tgacaatttt gccagcctac aatctccca ctgcaatggc 559920
ctcaaagtcc ctgtggcctg tgtcacctgg gttgacactg aggcatgctg gggagcagtc 559980
cacagaaagt ttaccctgct gctcactgag ctccggtaga aattgtacat ttattttct 560040
cagtgcagct ataattagct tcctctcttg taagaaatga aaggcagggc gctgctgaca 560100

gctgtgggag ctgccttctt gcccgatga atcgagcctc caccaatgct gttacacctg 560160
tttaacaag gaacagaata ggtatttatt taaagttcaa gagccatgt gagccacggc 560220
ctaaatctag gcttgatgat aattatgaag atacttcac ctttgttcta aaaggttttg 560280
cagcccgtgg cccctcaaag tcttcagagt aggtacctcc cagagcgaga aaaacgtgtg 560340
agcatgactg ttgaagtgga ggtagcagac ctgtgatctc acaaggacac cagaatgatg 560400
acaccaggc cttgctgac gctggaacca tccatgcgga catgtgataa aggtgccaag 560460
aaccagccac ctctcctagc aatagtcttg tacttgaac tgggccaag aatctgcacg 560520

cgtgagtgcc tgcgctcgca cacacacaca cacaacctt ctcttgggct atcaagatgg 560580
ttcagagagt agaggggttt gccgcaaat ctaacacct gagttaatc ccagggacct 560640
acgtgtggga acgagagaac tggctactta acagcaagtt gcttttgat cctcacacac 560700
aggctctagc aacagtgcc caccacccc gccagtaag taaataagtt aaaagaagtc 560760
ccccagaaga gtictaaca tgactccagt ttgatcccc ctgacctagg acctgggcca 560820
ggagtggaag tgtttctgag accagggcag ggacactaaa gcagtaatta gcatttactg 560880
aacatgcaca caagcaagta ccactcatta agccactagg cacaagcaac aattgggctc 560940

tttcttcat tcatctgca tactctgggg gacctcaggg caggagtctt ctgtgtttt 561000
gaggtcatag gctcattga gatgaagaa atctttatta aacctctta cctgaaaatt 561060
gcatgtgaca gaaatttccc acaatttcag agggtttgta gagctcctta agccctctta 561120
atggcttcag atggagaatg tccatcctgg aggacagtcc cttgtggtgt ccatgcacaa 561180
cagcctggat tggagctttt gacacttcc tgatgcaga acacatgaga atgtctgcag 561240
gcacaaaagg gaaagatgag gcaagatagt tggaaagaac tgacagatga ggaagacgat 561300
ataaagtcca agggcattta ttagagatc ttaagaacag gaattggcaa tgtgctcagg 561360

tgccatggac tgtggcccta gtaggagaac tgaactggg gggagccagg ctgtgcctga 561420
 gctcagcaca acagagagga ttatgggtaa ggagctcagc aaacaacctc ttaaagaata 561480
 tggacttctg tggagaagaa gtaaggcata ttcaaagatg agagagagag agagagagag 561540
 agagagagag agagagagag agcgagagag agagagagcg agagagagag agagagagag 561600
 agagacagag agacagagag acagagacag agacagagac agaaagacag acagagacag 561660
 aaagacagac agagacagag acagagacag agtcagagac agtgacagtg acagagacag 561720
 agaaatagaa ggaagaaata tgtgctggtt ggtttttgtc accttgacac aaacctagac 561780

 atatctagga agagagtatc ttaattgaga aagtgggtccc ataggatcag cctgtaggca 561840
 agttttaga gcattttctt gattcatgat tgatgtgaga aggtccagct ctatgtgagt 561900
 agggtcacct ctggctggt ggtcttgggt tctataagaa agtatgaaaa acagctcctg 561960
 cctccagatt cctccctcc ctgtttgagc tctgtctctg acttcctcgg atgatggact 562020
 gtgatggact aaataaaacc tttccttcca aggttgcctt gggacgtgat cttcatcaca 562080
 gcaatagaac cttagtcatg ataaaaggta agggactgag aagatgactc agttgacaaa 562140
 gtgcttctta tacaagacct gagtacttat tgtacaggct tgaagacttt agtttgtctc 562200

 tgggtgacac ataaaagcta ggtgtggcag tgtgggcctg cttaccagc actgaagaca 562260
 ctagagacag tctagtggaa tcaataagct ccaggttcag tgagacccta tctcaaata 562320
 atgtggagaa ctgttggagg aaatatccta ttagactat tgacctacac acacacacac 562380
 acacacacac acacacacac acacacacac acacacacac atagcatact aatttccagt 562440
 tctgacagga cttaaacaag tggcatgtaa cacactgtc cattctcttg ttgcaaatg 562500
 acaccagaag tctaaacttg caactatttg tgaaggtggg atttggggca aacagtctg 562560
 caccctctg tttctttgcc ttatcatata ccaccatac agtggctgta agtctgcaca 562620

 ggaatttgtg ggtctaggtc cctcttaaga gggaccetaa gaattcctcc ctctatcctg 562680
 tagggggagc agctgcagtt ttgaggtctg tctttgagtt cttccagggt ggagggcagg 562740
 gaataaactc tatgctggga gactagccag aaaagaactg tagaggacca gatgcaagta 562800
 ggtgcttgcc aagggcccaag ggacagcaga ccctggtgaa ggtctatcca gacctaggag 562860
 ccagagagag gaggggtgtg caagaccata gctttgttgg agagtggctg agccaatatg 562920
 atatagagg tctcacggca cagaaggcac taggcatggt gaatctgcat agtattgaag 562980
 actaatgcca tgaggcggcc cactgccag ttggcactgc cactctctaa gaggtattgg 563040

 attctgagat gtgtctgctc ctttctatg accaggacct ggactgtga tgtgatgctt 563100
 gggttactga aataggcaag gagtttcagc gactcgagc aagggtcctt gcagatacat 563160
 gaagtgttc agtaatgggt aacatatgaa agtcaactta gaaaaaatg tgaacttga 563220

atggtagatg ttggcagaaa taggagaaaag agctacctag aacggccctg gactttttgg 563280
 gactcacagg aactgccaca ggaaggcagt gatgaggaag tgtggaatca gatgtaaggg 563340
 tctcctaacta gtctgggcca ttagggcatg gtcagaactg tgtatcagca ctgcctggga 563400
 gagaaaaagt gatttcttag acaaagagta gtttccttgt tcagaatgca atttctttgc 563460

 atatcaatga gctgactaaa caaatccaga aattattaca aggtcctaga gcctttttaa 563520
 aacaatggag aacacaccac aaatatgatt tctgttttag atgaagccac acatgacat 563580
 gtttcaagag cagcagcaat gtaagttcac ttagctctgt tccattcaa aatgacactg 563640
 ctgttttcat tcatgaaact ctattccagg atttattct ctgctttaca cgaatgtccc 563700
 ttagtgccca aagggatgag gagtttaaat tatatgcctt tgtattcact ggtgaaaaga 563760
 acccaattcc atcctgtctc ctctaaatta attagaacac agatggtccc ccattctctg 563820
 tccttgtcac ttctgcttgg aatgagaga tgtgcccttt ctggcaccat cctaagtgcc 563880

 atacagtcac gagtcaccta acgacagga tgggatcat tctgagatgt atcattaggt 563940
 gatctcatga ctctgcaaac atcatggggt gcacttataa aacctaggag gcacaggtca 564000
 gtcagagac aagggtcct gatgcaatca agatgtggta atcacagagt gcgtgaagct 564060
 tctgttagga tagcaaggct tactgcttta cagtccactt tttaaaatat aagtaggact 564120
 acagattagc aacttaaggt gtagtgcggt ggctgggtgt ggtggcacac actcctaagc 564180
 ctagaatggt gtgggggtga cagcaaggaa gaatttaagg tcatcctctg ataatggaa 564240
 agttcgaagg gctgcatcaa cctctgtagc aaactatagc agtgtggcca ggaatgggt 564300

 tgatagccca ggaggatctc tgtgagtctg aggccagcct ggtctacaaa acaagttcca 564360
 ggacagccag gactgttaca cagagcaacc ctgtctcaaa aaacaaaaaa gaaaaataac 564420
 tttgaggtaa caatattaaa ctatttagag atgaagaac cgaggcaggt gcataataaa 564480
 gtcattgagt cagtacatga ccgaacaaa ggcagagtcc agagccttca ttttgaccac 564540
 tcttgttttg tcattcatgt aaattggtga aaaaagaaaa ctagactctg ccccatgtc 564600
 cccagatga actaagaatt gacagagcct ttggtattc tcttctgttg aaagcttgc 564660
 tgtaaatgag acaagaggtg ggatctgctg tcaactacat aattgccaca ctaagcattt 564720

 gaaatggtgt ccattgctct gaaaccaaga catgctctca agtccgtggc actcaggggc 564780
 acttaaggac acataggggc acttaggagc attgagctgt gagaaacgca acttcttaga 564840
 actaacacag gtctaaagt caacagattt tctttctggt ttatgggagc ttttgaagaa 564900
 aggtgtacag gtggcaatca catcaaggca caggtaacat ctccactgga tctccatctc 564960
 agaaagaggt caatggtgtt ttaattatct ttcttctga tgtccaactc tgtatccaac 565020
 ataggaatag ttgatcaaca gaggaataga acagccagtc cagaacaagg aagtcaagat 565080

gaagcttcca gaactaaagg taacaagaac ctcttaaagc ccagggtcta ggttgacaag 565140

 agagatttat ttaggttctt tctcttagca agcatgctaa ccaatatctt cagcacctct 565200
 cttttctggg catgacaata ctttctgctt tccagaatcc ttataggcag acacaagcgt 565260
 gtgactggtt atgttcaata aatgttagt agagacgggtg cacattacca atgagccgag 565320
 ggagtgggta cccagctctc ctctcggat gcagctccca tagaggcctc agactgagga 565380
 tgtgggagtc actagatgag tgtgacttga agcactatct gaaggacaga tgcttgagag 565440
 tcacctgaat gtgcaaagga cttcatatga atgaaaaat aagcaaaaca tatgttgtgt 565500
 tgaaacacag agattgaagt ggtagtgggtt gttactgcag caaaagctag accacgctga 565560

 ctaataggca tagctgccta agttttctag gtttcttttg ctaggtcagg taatttacca 565620
 tcccataaaa gtttgtcaat acaggtgact ttttcttct ggagctaaga ggtatgtgga 565680
 tctatgacac catgtagatg tggagtattg ttaaacacag ctattctgct cttcctctgt 565740
 ttccittgta acaaaaaat gcaaaacaag accaccatcc ccagacataa aactccagc 565800
 tcccactacc caggagtcac aatcgttaag atgtcacagt ttggttgctt aagatcacct 565860
 ttgtctgtt ttgtttatc ctctttttcg ttttgtttg agacagtgct ggcaggaact 565920
 cactatgtag acctggtag ccttgaactt gctgttattt ttgcctctc ggtgctgggt 565980

 ttacagcata agccagagcc tccitttttag aaattaaata aaaactgtta tggcttcaat 566040
 tgaagtactc ccatacgtc cccgacctgt cccgtactgt cagtgtctca taagggactg 566100
 ccttgtgctc tggggaatg ggtggggat gtgggcacac ccatcaagtc aagtcctctt 566160
 tatgtctta cctacacaca cacatgtgct aagactcatg tttatcgtg aggaattctt 566220
 ggacttagtt atgttgacg cagtgttaa tgccaaagt tgcctcgggtg ataagtgtgt 566280
 gtgcatatgt ttcagtttt ctctgttttag ccattccat gaatgtgaca catttaccat 566340
 ctctttccct gcagagggtg ccattgcctc cagtctcat ccttgggctc ggtgctatag 566400

 gccacacctt ccagacacct attcaaagag ctgctctagg gagacaaaca ggaacaatag 566460
 aaacggagtt gttggggcat aaggaatgtg aatttttgtt tttccttgat gctatcacat 566520
 gtttctttt tattaaattt ttattttgag ataataatta cattatttct cccttcctt 566580
 tctcctctt aaatcctccc atattcctct gttatacagt tcttgaggag acagattagt 566640
 gtttaccag gaaaactatg ttttaactc atactttgat cccatggcca agttaatgta 566700
 tttcacacat ggaagcttc ccagctgact acacttgtag cggatgattg tgttttacac 566760
 cttaagcat taaggtttg tttttgttt tttcaaaaga catattcatc ataaaacaat 566820

gcccaaagga acaagaact gggaatcact taatccaaac ataaacacct accaaacatt 566880
 cctgatggaa gcagctgtgt gttcgtgttt catatccaga gttgggctat gcctctctcg 566940
 cagcatatgt taggaacatg tgacagttaa ctaagactgt aatagctctg tttgctttgg 567000
 aatggagttt ctcttaggtt cacagctgag gggaaggga taaagaagag gggattaata 567060
 gaaggatgtg ctgtgtgctg gatctgatct gatctttgcc atccaggac acaaggca 567120
 ccatgcttta ccacagaggg ccatggagt ggaactcaag aaagtctctg gttctctac 567180
 atgacttatt tccttccac actgcctgcc ttccactggg atggtatccc tgcctccatc 567240

 ttccatcaaa tccaaagacc ctagaaggtt tgaagatgca ggaggcatgt aaaaccttgg 567300
 tggatccaac agaagcaaga tcttttgagg ttgacatcca ccttccatc tcccatctca 567360
 ggaaacctag cagcagagtc ttcttgaagg ccctgtctgg ggtggggcag ataacagtag 567420
 aaggatgaag atgaaggac atgccttgat ggaaagaagc tgccagatcc tgaggaagg 567480
 ttctgagctc tccacatct gaagagggga tagagagtca ggggacatgg aaagtaaag 567540
 ctgaggtgcc agcattgggt gctaacctg cattccatgt aggaaaagaa cggaaagcct 567600
 gaattcaaga gctaaacttt ctctattgca acaattcct ccctccaca catcagcatc 567660

 aatccctcct gacggtcacg cccagtgac ctaggtcca cactgtaag gttctacaac 567720
 tacgtgggga caagcctct gaatacaaat ctttgaggaa caaacacgt gcaaaccatg 567780
 acagtcacca agccaggac acaaatcacc acataccag caggcttcca ggatggtgag 567840
 gagagagtgc ctaaatgttt tttcaggcta aattgtcttt tatgtgatg agtgtttgc 567900
 ctacatgat gtatgtgtc catctgcatt catagtacc aaggaggtca gaagagggtg 567960
 ttggatctcc tgaattggag ttatagatga ttgtgagatg ccctgtggct gctaggaacc 568020
 aaacctgggt cttttatag aacaagttt ctaaccact gaaccatctc tccagctcca 568080

 ggctgacctt tcaaaactat cttattacat ttactgatt tataatttct tgtacatgtt 568140
 gtggtcacac tcattccatc ctacaataat ttgtttgtt tggttttgt tttttcaag 568200
 acagggttc tctgtgtagc cttggctgtc ctggaactca ttctgtagat caggctggcc 568260
 ttgaactcag ggatcctcaa gtctgggtac tgggattaga ggcatgtgcc aacactgcct 568320
 gcctacaat gatattttt aatatttatt tattgggaga aggtgcaca catgacatag 568380
 cattgagcca tctcaccagc actaggctaa atttattct gtagatataa agcagtttgg 568440
 catttctga acttgattgt gtggttcaga atgtggaact gactacatgg gcagcagacc 568500

 cacatcatca cactcagaag agcctctgga agccaggtgt tgggtgcaca cgcctttaat 568560
 cccagcactc aggaggcaga ggcaggcaga tatcggggag ttcgaggcca gctggtctc 568620
 cagagcgagt gccagatag gctcctaaagc tacacagaga aacctgtct cgaanaacca 568680

aaaaaaaaaa aaaaaaaaaa gagcctctca ctgagctcca ctgaagcact tcattggttc 568740
 tgaacaggca atctgtatct gtacttgtgt ggacgcgcta accaccaagt caacaacatt 568800
 cgtgtgtgtg tgtgtgtgtg tgtgtgtgtg tgtgtgtgtt tggaggggga ggttcgagac 568860
 agggtttctc tgggttttg gaggttgtcc tggaaactagc tctttagac caggctggtc 568920

 tcgaactcac agagatccac ctgctctgca ctctgagtg ctgggattaa aggcattcac 568980
 catcactgcc cagcctgcag cactcttcat aaaccagcct aactaatctt catcagccac 569040
 ctctgggtgt gtgtgtgtg tgtcatctcc aaaggacttc actaaggagg aaaaacacac 569100
 tgtgaatgtg gacagcatca tccaagcca gcatccagga atggacaaaa accagaaagt 569160
 gaactgagtg ccagcatcct tctctgcttc ctgactgcag acaatatgac cagctgcctc 569220
 atacacctgc caccaaacct cccccaccac ggtaggctat gtttttctt tctattttat 569280
 ttgtgtcgcg ggagagcaca agccatggta taggacttga ggtcagagaa caactttag 569340

 gaatcaattt ctcttccac cacgtgggat taaactcagg tccttaggct tggtcgaag 569400
 catcattact agtcagtaaa gatgagccat cctgctgccc ttctactct cttttccaac 569460
 ctaaaccaaa atgaaccctt cacttctaata attgatttgg tcaggtatct tgatatagca 569520
 acaaaaaata tgactgaggc actgttctac ttgcaaaaag cttaccacc cagagaaatg 569580
 atatccatat atatgcatat atcttttcca caaagccaaa tataaacaac atgtgttata 569640
 aaattaagtt tgaagaatgt ggtcatttga atgaaaatg ttccccata ggctcaggtg 569700
 ttgaaacacc tgattcccag ttgtgacatt agttaggaa agtgatagct tttctggcag 569760

 agatatgtca ctgggttagg gctgggagct ttgagagttt atagtctcac cccactttct 569820
 gtttctttc tggcttagt gtttatggtt gagatgtgag ctctcagctt ctgctcctgc 569880
 caccttgctt gcccttgca gctatgctat cccaacaaga tgcattctta tggctcttat 569940
 aaactcaaat aagctccttt tcccataagt cacttttggc catggtgttt tctcacagca 570000
 acatcaagt tccaatacaa agaagtagca tgggtgtgca tagtgagagc agcctaggtg 570060
 gaaacaaggc tgcctctggg gtcccttttc catataacta ggactctaaa gacaccaggg 570120
 aactctgaga agtaaggaag tgttacagca tgcctgacct ccttctagca gtagtctca 570180

 cccaacagga tgggtctggg gtgcttccc aggagagcca gcgcaatac gttctatggt 570240
 ccttcatttg cacgtatctg tagaagtcac cagtcagtct gaagctttg tatatatgtg 570300
 gagctgaatt attccctagt aaaggtccag atgcttgtga tgtctctgca gtttgttccc 570360
 aggtcttat acagatcggg tatacttttt cccacatttc gatgtttgca ctgctgcaact 570420
 acgaggtctc tgaaggtact atgcaggctg agtgcaactg agggttggtt ctgaatgca 570480
 ccaggcatga ggggttatca ggtggaggtg acaccaggaa gcaagaggct ggggcattcc 570540

tcccttctac atcatcacgg ctatgccctc caacactcat tttctccac cacacataac 570600

 tctagtcttc tttctctgta gtgaatatag aggagccacc catcgctcac caaatcacac 570660
 tcaagetgct gtcttgctg tcttattgac agtcagcaac tagaactatt agatgctttc 570720
 ctgtgctttc taatagctct gcagtgagca tcatttcta caacacttcc ttgagagcag 570780
 tggctttcaa ccttctaata gctgtggccc tttaatagag ctctctgtgt tgtggtgacc 570840
 ccgaaccata atattatfff cgttgctact tcacaattgt aattttgcta ctgctatata 570900
 tcataaagta catatctgat atgcaggatt tctgatatgt gaccctgtg aaagggtcat 570960
 ccaaccccaa agggatcatg acccccaggt taagacctac tgctttaaag gataaagaat 571020

 aaaggtgcc cagagactct tcaatgtgaa tgatactctg tgtatgaaag atagctgaca 571080
 ctgagttcag atttctacag tcattaaaga aataatgatc tccatgagat ttcaatagtt 571140
 ccaagcacat atgacaagca tgtgtcctgt agtttgaatg catctccca ctgtttgttg 571200
 gcgagtcaaa tggaaataca gtatagtctg tacctcacag gctttatcta gaagtcaagg 571260
 gtcagaaagc acctgccaca gtgagagctc atcaagtgc aattatcgtt gtgcgctctc 571320
 cgtttctec cctctctc tectgcttt cctctctec cctctccct tetcttcatt 571380
 gttctttct tctctccta cttctctec tctcttctc tccatctccc tgtgatctc 571440

 ttcttctct cctttccctc ctgttcattg ttttcaacca tctattctgc accatggatg 571500
 ttgaggacaa actagcactt ctgagctta ctgatgacct cgttaaaatt cagacactca 571560
 ctcagaagge ctgggtgga ggctgagatt ctaaattccc acaagctctt ggtgatgctt 571620
 gctgcaagcc agtgggacac acttggatg gttgagtacc atggtgactt gatgtccttt 571680
 tcgaatttcc aggaacaaaa caccttgagt atgttcaagc gaagtaactt ttcttctgga 571740
 ctctttgggt agtgtgatgt tgccctgtct ctgaggaac acaatctctt acttcagtgt 571800
 aaggctctct gctgcttctc tgaaatcaag gcatttttca cagcatgggg tetctagctt 571860

 tacagagttt atatttaaca tgtaacatt caagtacagc ctacacaaag ccagacctgg 571920
 gtgttaaatg aggacttcag acaacagaga gcaagactcc agcgtctgta cagaactgag 571980
 gccaaacac cggctttgaa atgttgagga tgaacatatg ctccacatgc cgggcagcat 572040
 tcatatgtct taatgcgacc agtctgtgt cctccatag aaatacacac tcccacagga 572100
 catgggatgt tgtggcgtat cgtcaagtgt tcatagctac aagttttctt cattcccat 572160
 tactggagca acctctagac tgtgatgtgg acccatctgg aacatgcaca cacaggctgc 572220
 tggctgctct gcaccattgt acccattgtt taagcaacat gtttatctca tctggctgca 572280

ttttgggga ttgcagcccc tgctctatta catctgaaga ttattatttg ctatggaaac 572340
 actgatgtca aatggatgtg ggtggggctc aggccatgaa taaacacaaa atagttcatc 572400
 ccacagggtg caagttatta ttgggtctag gaggtgccag ctgtgtgggt caccctcac 572460
 aagctccatg ttttggatgg cacagtctgg aaggcttcag ggtatctcac ttaagagaaa 572520
 atgcatgttt aagaagcagg aacaccttgg gatgagtgtg ttgtccaaa taggacacaa 572580
 tttccctgtg gtaacataga aacagagcag agaggtaact tgaaatgatt ttaggaaaac 572640
 aaaaacttgt gttagcttgc ttttgcataat ataaatgtga ggtatgtgtg catgtgtata 572700

 tgtgtgttca tatgtgtggg gggagtatac atgcaagcac acttgatac ctgtgtgtat 572760
 atgtgtgtag gccacagtt aacctggct gtcttctcc atcattctcc atcttgtga 572820
 aattgaagct tgctgtttta gactactctg gttagccagc ctgctctggg gattcctgtc 572880
 tcacatctca caaggtaaaa ttataggcag gcccctatgc cctctagca tgtagtctca 572940
 gagatatgag tgctagtctt gtcctcacat gtaaacagca aactctacc actgaacat 573000
 atccacacc ctgaccctaa cagtgttca ctactgtgt gtggtgagag aagtgatcaa 573060
 atgttacaat catccttga gttaaatagg gctgaagtca gccatatcta ctatgggaag 573120

 ccaatggagc taggagagtg tgttggaa tattaataaa gatgtattac attctttat 573180
 gctgtgaata tttgtttaat ggtgcaaaga agtgttgcac tcaaatatgc tgcatttgtt 573240
 aaactctgtg aagctgtgtt gctttgcctg tctaaaacac ctgattggcc taataaagag 573300
 ctcaacagcc aatagcaaga caggagaaag gatcgatggg acttccaggt gagagaataa 573360
 atagagaaga gcaagaagag aaggagcaag agaagaagag gagatgagga cgccaggggc 573420
 cagccacca acaacataat cagccacaga gtaaaaagga aagaaaaaga tacagaacag 573480
 agaaaggtaa aagcccagag gcaaatggtg gatgtgctaa ttagttcata aagcctttca 573540

 agttctagga cccgagtttg gtccccagaa cacgggcaaa aatgccacag gttcacactt 573600
 gaggcaatct cagtactcag gaggcagaga caggagctc tttgagactc actggccagc 573660
 tagccagcct acttggtag tctgaaacca gtgagaaacc ctgtctcaag aaataaatat 573720
 gaaatctttg tgaagataag aaaaggaatg ataccaagg ttgcctctg gectctacat 573780
 gtccatgac cacgcacaag tatacatgcc ccaaaacac acacacacac acacacacac 573840
 acacacacac acacacacac acacacacac agtgaagcta agggattggg aggagtttca 573900
 gagtagggaa atttgaaatc atgcaagcct cagaactcaa atcaagtgtg cagtgettaa 573960

 gtctttcage cctggtcaca ggatactgct tgagtcccag cctctaggtt tcattttaat 574020
 ttattttctt tctagaaggc attgttttt cctactatcc tcttgccaac tctttgett 574080
 tccactgccc ctcccccaag tcaggactac acagctgagc agcagaacac atacatcaa 574140

gtccttctga acccgacaat cagctcttct agctgcaggt aggaatactt agggggacct 574200
 taaacattat tgatgttaca aatagtcaaa ttttatggct ctaagctgca ctccggttg 574260
 agaattttaa agctgactag attattctaa cattcagcca cagccgagaa tcatggagtc 574320
 aaacaatgtc atgagtggcc ctacagagggg acatgtgcta cacaactatc catgctgtga 574380

 gtgacacacc cttgagacat gtggcacgtg acccttcatg ctgtctttgc ccaccctct 574440
 ggaccctgca cgatcccaaa taactcaaga gatcacagge taaatgcatg atctggcctc 574500
 gatttcccc cccttgggtt ggagctgggg ttgaagatag tatagatctg aagccccca 574560
 tccttgagg atcctctgct tctgctgcc tctgacaag ggaggggtga gtgagggtt 574620
 gaggttctg aaaactcagg aatcttttca agccccattt tggaggctgc ccagtccag 574680
 tgctctgcc agggtgagca tgttgctttg attgcttggg tgagagcatg atttaagtta 574740
 taggaagaat ctggctcatt tcccctggta cccaggtcat tttccgattg taaatcagcg 574800

 accttagggc tgiattttcc tctcaggcca caaggagct gtgtctttat tttttcctg 574860
 aattcaaatt gaattgtacc aaatacagtc ctaaaggccc cattgaggtc ctagtacctc 574920
 cccaacatgt ctggcttctt gctcttcccc tctgtcacc tteccaaacc aaggagcgcg 574980
 tcccttagat ctcagccctt acaatggtct ttattcggca tgtgttgaca tctcagagc 575040
 ctaccacagg gattcaatgt caatattttt gtaacaactg atggcctca aatggggaga 575100
 tggaagagac caaaatccca caagaattca gcaaaatgag acaaatatgt gacacaaaca 575160
 agtcctcggg tttgtgctaa gtccagagct ggctgtctt acagcttagc tctccgtgac 575220

 tcactgggat tcttaagctg ctgagtgcag ctgtcattcg gaaagtacaa ggtgaacatt 575280
 atccgatgaa gtcttccatc tggcctattt atttatcctt ggcatctcaa aactgctgtt 575340
 tttggttccg cagtagggtt acaagacaaa cattttcttt ttaagttcaa aattctggag 575400
 cagatatttg aatccagact gaagtgaag agacacagag aggagaagaa aagagaatgc 575460
 tatgaacggc agaggttaga agcctactcc atccagttca ctcttcacag cacaatggca 575520
 acaacaaaat acttgtttcc agactccctt gcagcttggg gtggccaatt ttatcagtga 575580
 ggaaggaatg gaagtacaac attctagaaa gaaggaaaga aagaaagaaa gaaagaaaga 575640

 aagaaagaaa gaaagaaaga aagaaagaaa gaaagaaaga aagaaaggga gagaggaag 575700
 gagagggaaa ggaggagag aggaaaaaat tgtttctttt tttttatgt ctatgagtgt 575760
 tttgcctgca tgiaggatg tgcactgtgt gctgcctggg gctcaaggag gcagaagaaa 575820
 gtgctggagc cctgatgttt gtgagccact atgtgggtgc tgggacctga accccagacc 575880
 tatgcaagtg ctcttcacca ctgagctgct tetccagtcc aatcattctt tagtgtcatt 575940
 ggggatcagt tctaggatc cacaccctt tcaaaacca cagatgctca agcctctat 576000

ttaccccagc acagcattta cctgcaactg ctgacagagc cttcatactt taaataacgg 576060

ccatattact tataacgcct aggacatgtc ctctatataa gcagttgttg aatggtttgt 576120

ctagaaaaca gcagcaagac aaaggagaca acccatgttc accagggatg caattacaag 576180

gaatTTTTaa tctgtgattg aagggtctgg aactgagaga cacagaaagc ctatggaact 576240

ttcagaaatg ctttctctaa gaggttgagtt gggcagctga agagatggct cagtggctaa 576300

aagcactggc tgccttcca gaggacctgc gtttaattcc cagcacccat atggcagctc 576360

acaactgtct gcagctccaa gatctgagac cctcacacag atagatatac atacaggcaa 576420

gaaatgaagc aaaacaaaa tgtaagaaca atgcacataa aaagtaaata aaagagttgg 576480

atcagctgtg agggcctcct tttccctcat caattactta aaatggaacc tcggcatcca 576540

tgtcagacca tgaagtcact ttgatgtaac agaaatacag gagccactgg agacaggaga 576600

ggcagccttg tagtgggtta ctctgatttc ctacatatga cagaaagatg aacctatcc 576660

acctaataat atctgagact tttagtcgaa tgacagaatt gaggggctgg tgtgtaattg 576720

tgaaagagag tgcttgctg gcatgcacaa gagcttgagt ttgatccca gactgaaaa 576780

caaaaagcaa acattgaatt ccaataata cattagagta aattttattt tgttaaagtt 576840

atattatctt atatttactt aagactatac acaatacaaa taaaaacaga tgatagatag 576900

atagatagat agatagatag atagatagat agatagatag atgctagaca aattatatac 576960

taaccacaga ctaacaaaac ccacaatatg gggcacaaga aacttccttt agtgtggttg 577020

gtcagggtag cccaagtgc tcccaaaaca atacagctc ttactgtagc tctcattggc 577080

ccctcagagg ttaaagatgg gtccctattg ctgaaaatat ggaatattta ggacacaaga 577140

ctggagctgg atctgacttg aaggcctcct tcatgcagtc tagtttccat ggtgccagtg 577200

cttgctatgt acattgcca cagagggaag caattaatag tcccaccag ctgcgatacc 577260

tatgaaccac aacaatgacc acatggcaag atatctataa aggttctgta agtggctctc 577320

acatgttggg gtatccaaca gctatctgat tggacttaag gcctctcaac aggaggggaa 577380

tcatactgg gactggaaac ttagccacct tccccaggt tcatgagatc acagatctta 577440

gaagagaatc tattgctgcc acttggctag accagcataa ttccttacta cattctaaat 577500

cttacacca cagataggtg tagctactgc caccaccca tcaaaggact tctctttaca 577560

gcaaatggag actatcacag aaaaccacag tftagagatc aacagatagt ggggagccca 577620

gccccaaagg atacgtctac atcacagctc ctgcatctat ggcttaggga acacaaggaa 577680

gaggagacag aaagactgta agaggtaaaa taccaggaag tgggctgtga aacagtgtct 577740

cccagaaacc agaaatggct atataaaca gaccagaatg atggcattat caatggacat 577800
 gccaaacttg aaaggggaag tccttgtggg gtctgcacc tatacaaaga actacaggca 577860
 actaatgact gctgggagaa ggagaattag cctttcccag ggatgaggtt ggttgtccaa 577920
 tagaaatgg tcagccctaa gaccttaaca caaacaaca aacagactc agcagggagt 577980
 ctttgtgtgt gtgtgtgtgt gtgtgtgtgt gtgtgtgtgt gtgtaataa tcaaagaaaa 578040
 agagattatc aacttgatag tggaggtatg tgagaggtta gctagggaaa gtgatataat 578100
 tctatttcaa ttaaaglat gtgtgtactt taaaagtca tctcttaac tatgctaggg 578160

 catttctact catgttgca gctagagtga gcagttttgc ttagaataat gaacttaata 578220
 tttcttgtgc tgctcctgga gagggaggag ggatgaaca aggagccaag atgggtctag 578280
 agaaaccac agaaccagtt gacctgacct agcgagagca cggagaccct agtcataaag 578340
 ctgcgaaac agaattggac cgaaccaggc cctctgaatg tgggtaccag ctaggaggtc 578400
 aagacagtct atgggacctc taacagtgga gccagtcttt aacctggag cacaaatcga 578460
 ctttgggagc ccatttctta tggagggata ctactgcagc ccagatacag caaggaaggc 578520
 ctaggcctcc ccagaatgta tgatggattt taaaggfccc ctgtggaggg cctcactatc 578580

 cctggggagg agltggagga taggttgggg gcgttgggtg ggaacatggg aggggtgggag 578640
 agtgagggaa tgggggaatg gatatgtaa tatgagtgt aattaaaga tttaaattaa 578700
 aaaaaagaaa aaaaatctc ttgtgctcat caaggctaag gtgcttaaag tcaccagtt 578760
 aaaacgtgga agcgtaaaa ttacaattca ccctatgcat ttgcttgaat gttacttaaa 578820
 agcatgagta actatcttta aactcatat agcctttag agttttagtt gttgttgttg 578880
 ttgtttctgg tttttggaga tggggtttct atgtgtagca ttggagcctg tcttggtact 578940
 agctctgtaa atcaggctgg cctcgaactc acagagtctt gcctgcctct gcctggaaag 579000

 tgctgggatt aaagcatgt gccaccacca tctggccgag tttgagtttt taatgagtac 579060
 atatgattat gcttaattct tatgaggctg tgtgtaaag gttagatcca cccaatcca 579120
 tactaaatct gagacatcta gtagacattt gggttttcca acaatctccc ttctagattc 579180
 tgctaggcct ttgtgagca ggttctgga tctctctttt tcttctagct ctccaccatg 579240
 cctgtgctgg ctgggtttta tgttgacttg acctaaagt catctaagaa gagagaactt 579300
 caactgagaa aatgctcca gaacatggtt ctcaaccttt cctaactctg cgaccttta 579360
 acagattcc tcatgttggt gtgactccca accataaac cattttattt ctacttcata 579420

 actgtaattt tgctactgtt atgaatcata atgtaaatat ttgataggca accaccaacg 579480
 gggttaagac ccacaggttg agaactctg ctccagaaga tctgtctgta ggcaaatctg 579540
 taaggtattt tcttaactag tgatcaatag gggaggtccc agcccactgt ggggtggagcc 579600

ttccctgggc tggaggcca gtgttctata agcaatcagg ctgagcaagc cagtaagcag 579660
 cactcctcta tgcctctat atcagctcct atcttcaggt tcctgccctg tttgagtcc 579720
 tgcctgact tccttcaata atggactatg atgcagacgt gtaagccaaa taaactcttt 579780
 cctcccaac ttgcttttgg tcatagtgtc tcatcaaagc aatagtaacc ctaactaaga 579840

 tcctcagtca tcagtaacag ctctgtgtg aatcaaaaga gaagactacc tgagcttcca 579900
 cacagtatct cccttgttta gagaatttgg gttagtgggt ggttccatgg tcaagctga 579960
 ctttctaaga ttacacttc aaagtcagtc agttactgtg ctgataatgg cttgagaggt 580020
 agaagagagc aatcaacaag actatcaatt atctgtggca acccaccagc cctcaggaga 580080
 ggagaccgtc tcigtattt tgggctgagc tcattcatgg agttggagtg atgattggat 580140
 ttacttagga aacttggttt ggaggcattc tggcaactga ccctcagcta agcatgcaca 580200
 caaacctga gatctgtctg cagatcagaa aagtttaagt cgtgcccta cagcaagaag 580260

 ccatctgagt ccctcttccc actgataaca gtgtgctgtt ctattgttgg gcctggacca 580320
 cgctaagccc tagaagagag gtgagtacc cacaatgg tgctgttagg gctcacagct 580380
 cagagcctgg ctaagacagc ctgccagtga cccagactcc ctaagtatc ttcatacagt 580440
 gaaacaaatt tcigaatgcc ttaataatta accattttaa aaagtttatt tatttgtat 580500
 acagcagtct gcctgtatc cagaagaggg cccagatctc attgtagata gttgtgagcc 580560
 atcatgtgat tgctgggaat tgaactcagg acctctggaa gagtagtcag tgctctaac 580620
 ctctgagcca tctctctagc tctataata ttaatcttta atgttcttc aacatgatgt 580680

 taaaaacaat ggttgacatg ggaataaagt ctttagaat gcataagaaa tagctacacc 580740
 gcctatataa ggctaggctc tgggctgga gagatagctc agtggttaag agcacttatt 580800
 gctcttgagc agcaccggg ttcaattccc agcaccaca tgggtgttta caatctcca 580860
 taacttcagt tccaggggat ctgatgcct cttctgacca ctacaggacc aatcacacat 580920
 gtagtcaca tgcatacata caggcaaat actcacgggt ggaagagcag gaggaggaga 580980
 aaggggagaa ggaaggaatc tgtttttaa atagctagat ctttgtgtt tggcctaagc 581040
 atattttcac atttaagga aacagtaca tgggttcta ctgcatgtag cagagaaatg 581100

 aaaggatagt ggcttaagca aaatttactg aataaacaag tttgttttc tttagtgtat 581160
 cagaatccta gagcagacca tcaggcagaa ttaaggatat ggaggtaaag gccttttagt 581220
 ttctttcat cttttgttc ctggacagtc gtcacctcac tacaggtggc ttttgggata 581280
 cctctaactg catgcaagcc tgtgttattc tgtaaaagca aaatttctc agcccttag 581340
 gtagacattc aggtagcctc ttcccctaat ttttcttgc ctctgactag ctagaactaa 581400
 tcacgtggcc atgtgtagct gcaaaggtag ctgggaaatg tagtcttcta actgacaaat 581460

taccatgtgt ttcccgtgat cttttggctct tggaaacatt ttagaccctt aaaaagtatt 581520

gaggaatgcc aagaagtctt atttatggag caatatgtct tattatttac catatcagag 581580

cctaaaaaca aaaatagaaa ataattattt ttcattaatt taaaaataaa aattatgtgg 581640

ttttgtttgt ttiggttttt tcagacaggg tttctctgtg gctttagagg ctgtcctgga 581700

actagctctt gtagaccagg ctggctcga actcacagaa atctgccggc tctgcctcc 581760

caagtgctgg gactaaaggt gtgtgccacc agcttctggc taaaaattat atgttaagta 581820

atgtgttttc caagcaaaa gtcccaaaag catgataagc gaagtttttt gtttttattt 581880

tttacaattt ctttaatgtt gaacttagcg gtgtcagtcc tcttacctct gcttccacct 581940

ttaatctggt atgattttgt ttgggttaa ttatattaat aaactcagac ctctttaga 582000

tgtgtagtca gaaaacagag aagtgatttt ttaagagact tttcagatga tatggatatt 582060

tttcttagac ttgacaccaa aatgtatgtg atagttatcc ggaaaggcca ttgcaatata 582120

gagtctgaag ccatcttctg gaatgtctgc tggcttttac attaaatgc actgaaatgt 582180

ttatacattg aatgggtttc tcccacacat gttattgtac agtgtcatgt catagtcatg 582240

tggactggte tgtttatagg ttaaagtctct tctcccacac atgttattgt ataatgtcat 582300

gtcaaagtta tatggaaagt atctgtactt caagctgtgc agatcttttg aatgtggaca 582360

tatttcattg tatagtattt cttaaaccac attttttaa catcactact ggtcttaaag 582420

gaaaggccta ctttggggat actgtcaagc taatggtgaa cattgcttcc caaagtctt 582480

gttttctgtg gagaggttga gggttatgac tcaacaata ctgtcagta tttcatttga 582540

agtggcagat tcatgttca ccgtgtctcc caaacacatg agcctgagtc actcagagct 582600

gcctactttt atttttgaaa ctagctttta ctacacggcc cagaatggac ttgaaccctt 582660

gatccttgtg cctcttctt ctgagtattg taattacaag catgagctac cacaccccg 582720

tcagtaagtt caaatggttc ttgagagaaa ctgttgggtc agccagccac ccattcacag 582780

acctgctttc ttcagagcga cgtgcaacag atgtgtgttg tatgtgccta ctttctcca 582840

gactactaaa aagacatgtt cccaaggctt ggtgtttaac ctttctgta aggcagtttg 582900

taatgaagct gccatttggc ccctctacac tgagggttga acctaggaca gtcatatgct 582960

ctgcagcgt ctcccgaaca ctgttcttaa acctgtatt atgaacatg ttgccaggc 583020

ggccttgaac tttagcttc tgctcagctt cctgagtaca ggccaggttt agttttcact 583080

glaagtattg ggggaaaata cagctatttt taaattgtaa tttagtcagt tcaattattt 583140

ggtttttgag accaaaataag tttttgtagc ccagtttggc cttaaagtca acagccctcc 583200

tgcctttgcc tcttcagtgc tggcgttaca gatgtgtacc accatgcttg gctaagaact 583260
 actgcttggc aatgtgctgc ttcattactc tcccacgctt actattacaa actaccacaa 583320
 acggggtgac ttaaaacaac agaatTTTTT tctcttgcag tctggaatca agatggtggc 583380
 agggccgcac tccatctggg aattccaggg gacagtctgt tccttgcctc ctggtagctg 583440
 ctggcattcc ttggctggg gccacatctt tccattctct gccagtgtta cgagttggca 583500
 ttttctctga cctgtgaaat ctctctctgt ctctttctg taaggatacc tgtaggtaat 583560
 ggcagtacc acttagatga cccaggataa ataatatctc catcttgagg gccttagacc 583620

 catcatatct gctaaaactg ttttccaaa caagttaaag gtgacatgtt tcaggaacta 583680
 aggtctggg tctgggtcta gcacgaacgg ctgctttgac tggtgccaag ccattggcag 583740
 tctgatccac tggctctggc ttttcaaca tcagtaaact gtccatatga tgtggatgtt 583800
 ttagaatggt attttattg ttttccct gccccatca gtgttgagg tgggagcatc 583860
 ccaggagtc ctagagatct gtgtgtatcc tctgaccaat gcagattaca tgtgaacaga 583920
 gccagttatg tagatagaat tttctgctac agtagccaag gaagggaagc tggctttgt 583980
 gctgctttta ggggacagaa ggtatgaact ctcacaggac acatctctct ccagaggaag 584040

 gcttccctgg ggattctatg cctgagctga gctccacaga accctgatgg ctgtgcacag 584100
 taggtgtgcc tgagctctc agagccctga aggtatgca cagtagggt gcctgagctc 584160
 ctgagagctc tgaagggtat gcacagtagg tgtgcctgag ctccactgag ccctgatgtg 584220
 tgtgagcagt agctgtgctt gagctcagca aagccctgaa ggggtgtgagg taggtaggag 584280
 ggttctccg agaaagaaag agcttctggt gtggacagag agctgacctg gggaccagca 584340
 aagcacacaa gaatgtccca gggcagagct tcaccatact cacagtggtc agcctatttc 584400
 tgtacacccc acccaggctg tccttacag agaagccagg gtcacacaa gcctctgggt 584460

 agtgtcccag ttggttcaaa gagccaggt gctggttagc tcccctctga ccacactgcc 584520
 tctcccaggt gtggagttaa ttaccccagg aactcccagc ctgccaggaa agccagttgc 584580
 ttaggttctt cccattttct cctctctagg tagaagggtg tacctctga ggaccagac 584640
 tgctactggc accccacact tttccaaggt gcaacagcag gtctggattg gaaacgtgca 584700
 tgcacctgct accctgcctg gacatgtcat ctgggaactt cagcaacaaa ggcacatggg 584760
 gattatcaaa tgaatgtctc tccagagaca tggagcctcc aatcaatgtg aaagtgtcgt 584820
 gagcatagtg ggtacagtgt tgcttataca ttgatgtgta tacattacac ttgtgtctgt 584880

 gtcagctttg tttctgcttg gaagactgca acagggtcca cgaaaactat tcattagcag 584940
 aactcaagaa gacagggtca acagcagatg tccacagaga gaaatgcctc catcaggtta 585000
 gcctgtgagc aaatctatgg aagcattttc ttggttaatg attaatatgg aagggccag 585060

ttcactatgg gctgtgtcct ccctgggtgg gtggattccg gttatgtaat aaagaaaact 585120
 agcatccgga gagatggctg cgtgtactgt tctgccagaa gacctgagtt caattccaag 585180
 cacccacatg gaggtttaca accacctata actctagctc tagagggatc tgacacactc 585240
 acattaatth acacacacac acacacacac acacacacac acacacacac ttatacataa 585300

 ttaagaataa tactaaatat aaaataagaa agcaaaactga tcaagccatg agaacaagcc 585360
 agtaagcage attcctccat gtcccttctc ctgtcctgct tgaattcctg cctcgacttc 585420
 cctcagtgat ggacatggaa gcctaataag ccctttctc cccaggttgc ttttggtcac 585480
 gatgtttatc acagcaacag aaacctaaact ggacgagaat gtgtgttaat tcatatgaat 585540
 aactttataa agaggtgcta tatgaatctg atttcttttt tttttttttt tttttttttt 585600
 tttttttttt tttttnnnnn nnnnnnnnnn nnnnnnnnnn nnnnnnnnnn nnnnnnnnnn 585660
 nnnnnnnnnn nnnnnnnnnn nnnnnnnnnn nnnnnnctgc ctctgcctcc caagtgctgg 585720

 gattaaaggc atgcccacc accaccggc tctgaatatg attcttaaaa gtcattagtt 585780
 agtcttccat tttccattcc agaaataacc attaccagtt cttgtgtata gtttgagttt 585840
 tccatgtata aaagtattaa gcatatacaa gaatatttca tacttattca tgtgttcatt 585900
 tattatttat gtattggttt ttttactcac aagggtggat gagagaatgt gcagcccagg 585960
 ctggccacag tctcataatc ctccacctct gcctcttcaa catccaccag agtgtgccac 586020
 tgcaaccage taictctgta cctttgaagc aggggatctc agcatagccc tggctttcct 586080
 ggccatagaac ttgcccctgc ttccttagtg ccggaataac cagcatgcac cactctggg 586140

 tccacattga aaatgttatt cttttgagct aaggctgag agagttagac agggaaaata 586200
 gccctcccct tatagctcac gtatgaacaa gggctggaga gcacattcct gtttgagtct 586260
 atgatttaca ccagtgtagg ttttgaaca cagagcagaa tccttctgaa acccagggaa 586320
 cggatttctt taccattca tctgtctgtt taictttta aaagctcaag acaaacaaaa 586380
 ttccctgtcc gagacctctg tggcttcca aggcgggtga gaacagttc caaggctcg 586440
 tctctgttt ctgatttgc atcaattctt cactgtgac cccatgaage tttatttaca 586500
 gcagctttct gttgatttta tagccaactg ctgactgctt ggggcataaa aacctgatg 586560

 attacaagt aataagtgag gaagaaatcc ataaatcaga ctgtataata agagaacaca 586620
 ggtgaatgag tgtgtacaca cctctgagag taaaattgta tagggcaata ttttaataaa 586680
 gaccaagtga gaggcttcac ctttgatttt gaggaattca aaggagattt tatggtttct 586740
 aggcagagac tgttacagaa aaaaaatgt attgaccagg tcaaagtgt gaagtttgac 586800
 aaggattccc aatgctccca aaacaattct gtgaaagata attctcaaac acccaaaatc 586860
 cctctgtca aactttttc tcttttaggc ctctgtgtgt gtgtgtgtgt gtgtgtgtgt 586920

gtgtgtgtgt gttaggggg ggggtgtctaa taacatgttt aaagtagaga caaaacctac 586980

 aaattccata ggaatcctac agctgggggg ctgctgacaa acagatgtga agtggaaaaa 587040
 ccttaaaaaa catttttgtt tggaaaagtaa agtctgetta ccaactagaaa tgtattgcaa 587100
 actccctgcc acccaagata gagtataaaa catccagagt tttaggcatt taggtattga 587160
 gtaaaataat ctcatTTTTt tgggatcttg atgcaaatca aaaaagtatg agaattagaa 587220
 ataaaagagg ggcaattgcg tactgactag atTTTTgata tggggcaatt atacatTTTT 587280
 acatgtgaag ataggtgtta tagttgttta tgagctttgt ttttttaaag atacacaata 587340
 aaaattgctt ttatggttct ctatgtagcc ctggctcttc tagaattcac tctgtagacc 587400

 aggctgtccc cagaatcaga gaacctgcct gcctctgctt cccaagtact gggattaaag 587460
 gcatgcccc ctgcctagct taataaaatg ttttagatta aataatttgg tcattTTTT 587520
 ttaaatgtgc aggtgacctg gcatagtgtc gttaagtga taatcattga gtttgggtga 587580
 tggctatagc gatttcatag actattatcg tctacttctt atttgttcca agatattaaa 587640
 tcttgtgaaa aacacatagg cccagacatg gtggtgacac ctataatcct ggcactctgg 587700
 aggttagacc agaaggatca tgaaagtga ggtcagcatg tctacgtaat gaaaacctgt 587760
 ctcaaaaaga gaaaaaaaa aaactcagga gaaagaggca ggtggatctt tgagtttgag 587820

 gccagcttgg tcttcagagt gagtcccagg acaggcaggg atgcacagag agacctgcc 587880
 cccctccaca ccccccaaa aaaaaaagaa aaggaaggaa gaaatggagg gaggggaggg 587940
 gagtggaagg gaaaaggaaa gaaaaagag aaaaaaggaa agggaagggg aaggaagggg 588000
 aggggaaggg aggggagggg agggaacaga aaggaaggaa agggaacgga aaggaaggag 588060
 aaagagctca gttgagatag tgcttgcatt caagcaccaa gaactgggtt tgagccttga 588120
 gccccagaat cagttttaaa agaaggctta gctatatagc tgtttaaaat cccagagaca 588180
 gaaagacacc tgggcttcac tggccagcca gcctagecta cgtagttagt tccagccag 588240

 tgagagacc tgcttaaaaa acatggtaga tgtcaactgc tccatagtga tacacacacg 588300
 tgtgcgcaca cacaaggcag agctccagaa gacagacatg aaggtgtatg cctgccgtca 588360
 catctaatac aatgttagt gaaggggtcc atctccaaac aaacagacaa aaccctgcaa 588420
 acagctggca ggctaggta tcttttgcta agttctcata cagtcacctt gcatttgcta 588480
 ctcaacaggg acaaagtatt gactgtgtac aggatcagtg aggccttgt ggatgctgat 588540
 ggtgccgtgg acattaagat agcatgcagg ttgtgtgtga caggtgggga caatgctggg 588600
 atctatacca tatcatacct gatggatact ggaacttctc aattcatggt tcaactgaagg 588660

tttccatggt atggcttcag agaggagcat cggcttagga tacagtcacc cccacagtat 588720
 tgaggaaatc ctactccacc tgtctaacag taacaatgt caaagggagt cccacaagac 588780
 tgaagctgaa aacagacacc caaggtcagt gctccaaaa caagaggctt tgtttttcta 588840
 ctgtatcaag aagaaaagca aggggagaga gagctgaaag ggctgtttgt gtagccaaag 588900
 gccacagggt gaatttgaa agttgctaca tacaggttta gtggagcaa ggggaagtga 588960
 agggagtccc tggggaacct atacctgcag aagtgcagcc ccagtattgg aggagggatc 589020
 tcctgccca ggctcaagag aaaaagggtc ctactggctc tattgaagca tcttgccatg 589080

 ggagtctgg tcttcttct catgagctca tgcctgctgc accaaaggca tcaacagctc 589140
 tcaactttgt caaccagaag acacaactca tctgctccct gattggaac ttctttgttg 589200
 ttctttggtt gtcattgttt cgagactcag cctagcctgg cctaaaattt cctgtgtagc 589260
 tcaagcaagc tttgaacttg gggggtatcct cctgcttcgg cctgccatcc ttatcccaga 589320
 atgctgaagt tacaagagag acccaccatg cccataggag gttcttaagg aacttgtttc 589380
 ctttattcac tagccttttc tccatgcat ctttggggcc ctctgctgga aaagtaggct 589440
 caagtctaa acaattgcag ttcagcgtgt ctactagcac cataataggt cagtgtctaa 589500

 cctcaatggc tctaaaacag cttatacttg ctccataaag cgtagtagtg acctacctt 589560
 atcaaaactg ttctcagtg tgctaccaga atgttctctg tccagacaat gattggcagc 589620
 ctaataaaaa agaatgggt ccagtcceat aacatcaaca gaactgggtc tttcctagga 589680
 ttttggtttt tactttttt tttcaacga agtattctgg gtgtttgtat aactgttatt 589740
 ggtcttttca ttcaaacata aagttaaata tatacatata tactggattt ttggaaacta 589800
 gctgtgttga aactttgagg gaaaaaaact tcaccatggt gagttacat tgcacagaaa 589860
 ttaacagctt tattaaaaat gttgaactta ttttttctt attgtacag cagtaacaca 589920

 cagtattaaa ttgaaaagtc ttatcgggtg gggtttgatt acaacagctc ctaaagtata 589980
 tataatata tatatataaa aaaccacttg tttcctatag tgaagaagac ctttttcagc 590040
 aacatttttg aattttctgt aggtggctctg cccatgacc cactgagge tgagtatagt 590100
 gtgaagagc taataagcct ctgggtcttg gcctaacaga tcacagttct ctcttataaa 590160
 tactcccaca gaatcctgag tttctagctg ctgagtcacc gcgttcccgg gatgcctgtg 590220
 ggagccaaag acttcccagc tggcccctgt gctatcagag ccccaggtg agagctgtcc 590280
 tcaggctggc cctgctgct ctgccacaa cagcagcccc catctcagtt ggctgaccga 590340

 tgctgcacce agcagctggg tcccatggcc cagatcacag ccattacagc tagtatggct 590400
 agcaggctac ccaactgcta gtgcgatcac tgaggtggag ggagaaacgc tgagacctca 590460
 gaagccgac gatcctttca tcgggagcct tgggaagcag cagcagcagc ttctttgttt 590520

ctatgagcga ggacaaattt tgtgtggtgt ttaatgaggg ttccagcгаа gtgctgaggc 590580
 catgtcagac tgcaaatgag ttagtctaат ggagttcacc cccttgctca tgcaaatgac 590640
 cctaатgaaa ctcaatgagc caaacataca acacacacac acacactcat acaccacat 590700
 gctcacacac acagtatac agtcacacac actcatacac tcacacacag acacactcac 590760

acaccacat gctcacatac agtcatacac aactcacac acatgcacac acttgctcac 590820
 acataacaca cacacacaca tactcatact cacacacact catactcaca catagactaa 590880
 cacacatgca cacactcaca cacatgcaca cacacataca ctggcacaca cagagtaaga 590940
 gaggcacatg ttgggaagga gggtttcaat gggacagaga gaaggcgata agaacggtta 591000
 atttttttt aaggttcaaa ttgaagaaat ggaaactcat ctctgatcac caagtatttt 591060
 cacctcaaac aatgaaattg atgatgaaag tacagggtgc aaggctacat gttaaccttc 591120
 tcattattca caccgtactg cctcacatgt caccagactg ttccgactgc attgaaggtc 591180

ccctgaggtg gtggagaatt gggggctggg caaacgattg tgtgtctcac agcaagaaaa 591240
 ttagcgagtt cactccctgt ggacaaaaga ctaaagctcc ctttagggct ggtgtagcag 591300
 gtaagacagc ttctctggcc cacgtgggtg ctcttctgct gcctcccaca cgggtttgca 591360
 ggctcctccc tctgtgtgct gtccttctt ccttttctag taaatatgaa agttcctcta 591420
 agttgtccct acatagtctt cactccctga ccaacaccaa ccagtagctg gectgacct 591480
 gtgaacagca ctccctgggt ttacacaggc tgtggctccg actttacttc tccaggattc 591540
 cccattggaa tctaagaata accaatagat aatagagaaa gtaaccagtg tctatttatt 591600

tccccactag gccagcagca accctgaggg ccgagctgta tctgctcttt tectggtttg 591660
 gtttttcaaa aatattcttct ggctttgggg ccaatgtgcc aacacaaaat agatgtcaac 591720
 aaataagcat ggcttaaaaa aaaccaaatt cccacctta tcttctttt acaacagagt 591780
 tgtgtgtgta tcaggctggc ctcatagtgt gtctggaaca aacaataacc ttgaacttct 591840
 gacctcctg tttccgctg agtgcttggg tcacaggcat ggaccggcat gatcagcata 591900
 ttagcagtg gggatcaagc caggctctg aatgctatgt ttgtagtata tcaactgaac 591960
 tacactctta gtccecaaat tccagttttc tgatcccgac actattgcaa acctcacata 592020

cacctaaac tctgaggac attagtctg aagtagcgtt attggagaca taaatgacat 592080
 ctatgttggc atagggatta caacagtgtt gttgaatgat tgtgtgcct ggagctaaaa 592140
 tccccagagg tccattctt gaaaagctga ctctcccagc aatgccaatg tgactgtctg 592200
 ccttgccaa cccagctctg tgcagattcg ctttctgat attttcttt ccacgtcat 592260
 tatgactcaa atcatgattg gatgagggat agggctgtgt catttgtcag tcagcatgtc 592320
 attaатgatg ctctgtcatg ttctcttctc ccagttttct ccctaaagtc agcggccctt 592380

agctaagaga cccttagcta agaattgggg gatTTTgctg gtcgtgttg tgcctttaat 592440

 ctCGGCacat gtagaggcag aggcaagtgg atctctgtga gattgaggcc agcctgatct 592500
 acacagttac aatagtgagt gtccaggatt tcatgaacat gttggataga gagtcagcat 592560
 gctgagtata aagacttcta gTTTTctatt acttgttatt accaatgtga aaactcacta 592620
 taaaagcttt tatccataat gcataatatg aatcatagta ataagccaag attatTTTtac 592680
 tatcatagaa aaagctagat atTTctgata aaaaataaaa ataacatata tatatatata 592740
 tatatatgta tattaattcc caaaacctta aagacctgct tTTTTgtt tctttcctgg 592800
 gaaaaacacc ttaccatga atggcccttt ctctttgtaa aacctttaga cacctaaagt 592860

 ctgcaccttt gttatggttg ctgatgacac agttgagatt taaaagatg aaggatgatca 592920
 gcttctctgt tctgagat ttagctct tctcacctgt ggagatggc gccttgattc 592980
 acagctgtcc agtgacaggg cagcttgaat ctgtggaacg ttgtgtttga taagccacct 593040
 ggctgagcta gttgaagcca acagatgtag cctgggggtg gggglagggg agtggggacc 593100
 aggaactcac tcacatacat tataccttga attcagcct tgcagaagaa tatagtagca 593160
 gtgggagtca ctgaatttg gtgacagctt atggatttta ttcattatc cactgatctc 593220
 ttccacactg tctcatcagc catccatact attctaacat gaggcattat tttattcac 593280

 tctattcatt tatttgttaa tgggctgtcc cTTTTtatt tcttttacag acttttcgat 593340
 atccaagga aaccaaacag caaccaggtt gtttgggata agtaagtcga ctttgaagg 593400
 tctggcatgg gtgcaggaa atctctatgg ggcctccttt ctcttccctg cttcactgctc 593460
 atcactctga aagctgtcat gactgctgga gttgaaactc ccaagacact aatgccttga 593520
 aatggagacg gggTgggggt ggggaaaaca ggtgaacctt agtagaggga tcttacttgg 593580
 gtttgtttt gttttgttt ttctggcact gagcatgcta catatcttc taagtgatgc 593640
 tgccagctgc agagaatttc ttacctctga gaattcaaac ccgcagcagg gcaatttccc 593700

 cagggcagct taatttaaca gtcttTgtgac atttcacacc ccacccccac ttctttccca 593760
 gcttgaatga catctgtaag attgtctgca ctgctttggc atttaacttt tgaagatcac 593820
 gacacaaatt tcccaagta tcacatcaca atgattcaaa tgtccattct ctagcattac 593880
 aatccctagc gagggagggc atatatctcc tcataggggg gaggagagaa gtgtacacag 593940
 tcctctctt ccactctgat cccttctagc tggteggcat cagagctggg cctgaaacag 594000
 cacaaaacac agttgcactt gcagagatcc attgccgtca ccctgggtgg caggttacac 594060
 tgtttacagt ccctatcacc tgctgtagg tccaaacata gccatagata ctcatgtga 594120

tgctaaatgg gagaggaaca atcccagcac ccagcatacc tgtcatttcc aacagccacg 594180
 aaaggagggt agccctcgtt ctccacaaat gcagcattgt cttgagggta aatggtatag 594240
 tactgagggg gacttgggtc ggcagccact gccccgctag aaggtacaag accgcaaggg 594300
 ttcatcatgg gctgcagata ggcggcgctt atccccagag gctcctgaga agcgtaagga 594360
 ggaggaatgt actgcaccac ggtggccccg tggaaagtga tgggctggtt gatgccggtg 594420
 aaaacgaacg actgtcctcc cgaagtctgg tccgaatcca ggacccttcc ctcactttct 594480
 gtgcacaact ggcaggatag cttttgaac ttgcacacag cgatcaggat gaaggctact 594540

 ccgactgaga ggaggatggg cccgaggagc tgggtccatt caaagtggga gacaccctgg 594600
 tacttgatcc agcccatgac agtgaacgtg atccccacca gtccctagaaa gataccgag 594660
 aaaagcaaag tggccccgc cttgtcgtcg tcggacacct ggatgtcggc ggtactgggt 594720
 gtgtaaggag tgacagagaa cacattaagc gggaagtct ctgagctgct agtgttgtgc 594780
 tccatggctt cccacacaac tatctaact gagaggagac cgagtctgtg ggagcagggga 594840
 gtgcaggttc aggttagtta gagtaggacc tttggttttc cgtggttaac agagtataac 594900
 atgcacaggc tgaactttgt ttagaagaac taaggtccaa gaaatgaggt ctgaagtttt 594960

 gttgcagggt tccagaaaat ggaggtttct gttttatgaa acagtggcca actgtctttc 595020
 tactttacat tcattcatct agacatctac tcattaaata agaataataa taaacacttc 595080
 tcaagccact gttgtgtcag gagatgcttt cctatagtca tggcactgca ctcaagtgtg 595140
 tttctatcct accaaagcca ggtttgtgta aatggcagca ctgctcccaa ggtgaaagga 595200
 gttcttgggt tatctaccac ctgcctgaaa cctaactgaa ctttttgttt tggttttgat 595260
 tcttgatfff tagagatagg gttccagact gtccctggaac tagcactgta gaccaggctg 595320
 gctttgaact cacagagatc tgccctcctc tgccctcga gtccctggcat taaaatagt 595380

 tgtcaccact gcctggggtt tctggctggg tcacctcagc agaaataggg gtccatacat 595440
 agtatttcca gtcttactca tgtaaggaat ctccctaggc attttctaac aggaaaccac 595500
 agctgagtea tttttacaga aaagacagct atttttcaca gttccatggt tctgggacca 595560
 atatcaacat gctggcatct acagacggtc ttctttctgc cacctccacc acctgatgag 595620
 aacactacag tacatgtctc tcttctctc agaaagccac taataccatc agagggcccc 595680
 cccacctgat tatgtcccaa aggttggatc tccaaatacc atcaatacat gaatccaaga 595740
 agtgagtaac gtacaagcct tgggattcca ctcaagccac agctctcagc aaggctctga 595800

 gaacctgctg tatcctggcc tgggttcacg tttctctagc tttctgcggc tggggagaag 595860
 gaagacagca caggagcctt ttctgtgtgc cgcattgctg gcagaggttt tgcattgagca 595920
 tcagatgtgg taagatgtg cctggacacc gacctcaggc cctgtgttct ggtggctgca 595980

cagttccagg tciccaatgt aagacaaaca gctgactttt tgaacctccc ctgttttgca 596040
 actaaccta agctgatgta aagaatcttc aaagacatta tctgtctttt atgactgact 596100
 agagaatttc tatagagacc catggacttc ttctccatt gaacggcaac tctggcttg 596160
 ttcttttttc ctggacagac ttgtccaag cagctcctct caccaatggt taaatattac 596220

 atcaggttcc ttttgcataa gtgagagagc tgcctttttg tccaaggcag ctttcttaaa 596280
 cttcttcaga tgacaacca ctattttctt ttgataggt agagatggag gccagtctgc 596340
 cacatgaggt tagtaaggac tggttttact cccagctgt gtccttagct cttaaacaa 596400
 cacaacaaa acaccaagg gagaagatct tgaagtgcct atgatagta atcttcactc 596460
 tctggtaac cagacttaga gtcacatgg agacacacct ctgggtgtgt ccagaaagat 596520
 ttaaccaagg agagaaaatc caccctgaat gtgggtggca cagtctcaag agcttagtaa 596580
 aaagaaagaa agctggagtg atgtctcagc aattaagggc ctgtgttgct cctgtagagg 596640

 cctgagattt ggttccctgc acccacacgg cgattcaca ccatctgta cttcctttcc 596700
 aggaagtatg ctacctctt ctgtcctccc tagcaccagg caggcatatg gtgcacatac 596760
 atcatgcaag caaacctc gtacacataa aaaaatagtg aatagatct attttgtttt 596820
 attttcttt ttgagacagg gtttctctgt gtagctttgt agaccaggct gcctcgaac 596880
 tcacagagat cccctgcct ctgcctctgc tgggattaaa ggcatgtgta ccaccactgc 596940
 ctgagtagat ctattttttt aaaattgtga atgcttattt tattttattt ttttaagatt 597000
 ttattttatt attatatata caacattgtg ctccatgta tatctgcaca ccagaagagg 597060

 gtaccagatc tcataatgga tagttgtgag ccacatgtg gttgctggga attgaaactca 597120
 ggacctctgg aatagcagcc agtgctctta acctctgggc catctctcca gccctcgatt 597180
 tttttttttt aaaggagaaa gtgaaactgag ctacagtatt catctctctg ctccctgagt 597240
 gtgaacgcaa tgtgactgaa tggctcacag ctctctcacc acacctgtcc ctgccctgat 597300
 gactgtacct tcaaactgta agccacaata aacctttctt ctgtaagtt gctttgtcag 597360
 gtgttttggt agtgcaatgt gaaaaataac taacacagtg cccatgggt ctcatcaaga 597420
 ctcttagaaa actggaacce aggtgaacce caaatgett tcaaagcccc aagacttgtt 597480

 tctacctatc taaatgctc tctttgctaa gagacatgac ctagaacctc ttgtttccct 597540
 gtcaggcata tggaagagca gtatagtggc ctgagaatc ctctgagagc ctccaaacag 597600
 ctaaggttgg gccacctgc tgaaggaggg aatttctttc ctcgagtcca cagacatcga 597660
 cagatgcaac ctctaacac caaccactt ctctctttgg tcaaataatc tctgcttagc 597720
 cagcttaaca tgttttccgg gctcttacgt ctgagctca catagtctct gacactcaga 597780
 aataccagg ctctgaaaac tgtccttcta aagcattgt attgccact tgtctttagt 597840

tataatatac atcacatatt tatggatggt gtgactagtt actcatctca atgctgtgac 597900

caaatccctg gcaaaaataa agcagaaggg ggagggtttt ctttggctca cagtctgagg 597960

atgctgtgac tectcgtctc cagatgaggt ctcatgtctg gacagagcag gaagcagggg 598020

tcaggtcct cagctggagc tccctcactc tcccaaccac acctctttat tcagttcaag 598080

gccccagacc aaagaatggt gtccacattc ctgctcagt taaacttcac tggaaacatg 598140

ctcataaaca ctcccagctt tgacctttgg tgatgtgtca aacatttact ggtaataaat 598200

cattaataac cttattttag aactattctt tggatagat acaattttgc catttactaa 598260

agtaacagca aatttgcagc caaatggagt tcgtctatct acttttatat aaagaattaa 598320

atcttgactg aatatttgat actgcagtat gacataaagt atgttccgtg tttgtctgca 598380

tttgattgac actttgattt aatgagcacc agtgcctgaga acaacgattt tataatcagc 598440

aatgcctcac tcaaatgtgt ggtataaaat gcctgaagtt tgtttaggat gacaaaattt 598500

tttgaattt cttttcta tccaaccaa aactcattga aaaaattttt ttatcaaggt 598560

caagtttgc attctagcac agggcaatct aaagacacac tcagaagtaa gggaaaggaaa 598620

gtatcagacg ttcttatggt ccataaccaa attatgatgt tctacaaca ccagaaaagt 598680

glatgcacag tcaactaag gcagttggtt ccatgtgata gtctagaac caagcctgta 598740

gtgcaaatgt gaccttgga agtgaccaa gcttcagtga agctgagtga tacaaccaac 598800

atgggtgagt gcigtggac acacatcaga tccattttac atttaatttt gaattgctgt 598860

ttagacattg tgcattcaga aacctagcc aagttttcac agaccgtcat gcagtcagct 598920

ggcctcagac ttaagtgtg ctctgaaaaa ctgacgtttc ataaaaagat tgtttgtttg 598980

tttgtttaag ggaatagga gaagtgggia aagtactttc cacacaagtg tgagaacctc 599040

agttcagatc ccaacacca ggtaaacca gccatgatag tgtacttcta taacccagc 599100

gttctacag gaagactgga ggcagagtca ctgggagctc gtaggcccac gtagcctggc 599160

atacaaaga gcaacaaga gaccttgctt caaaaaagc agagggaag gaccaatggt 599220

aaggatgctg tgcgatcact gcacacgtag tagcacacac acgtccacat taacacactc 599280

aaacatgtgt acatacctca taaacatata cacgcacatc tcacctctct ctctcttccc 599340

tcctctttgt ctagtctta attagagctc attggaaggt tctggaaact ggaaattggg 599400

gcctagctga agaagataga tcactggaag caggttctta gtgtgtgaca ttcttgctc 599460

tttccatcac ccgagcttc ttatttagcc aagcagagaa cagctccgat ctgccacca 599520

ctgctaccac catgatgtct tggccaagtg caagagatca agcaaacatg gactgaacce 599580

tctgaaacca gaagccaaaa gcaatctggt ggaccagaag tttctctcca gtattttgat 599640
cataggaaca caaaaatgca aacacaccac taatgctagg atttttatga ttataagcac 599700
actctctcaa gtgattgaca gctttgggtg tcaagtcagt ttctgcttc aatttcctaaa 599760
ctccatttct attctatggg tghtaatatgt cattgggtta catcatccta tagatgtaat 599820
atgtctatag aatatttgag aatattgagt gttaaaactt gaaaatcatt ttctagctaa 599880
atgtgtttca tgagcatcca ctgtaattaa ggagaataat tctactcatg tcatccatac 599940
ctaacctgt gtctggagag atgggtgcttc attacagaga gagiactca tcatgggtat 600000

gcaaaggctg cctatgtctc ctgagttatt agttttctgt ttcatatctg ttgaaagcac 600060
ctacatctga cacattatct ctttcaaat aaacattact gctaattaac tcctcaaat 600120
aggaaaagcc atgcctgtat ggtgctgtgc acctgaagtc cccacacttg ggacgacaga 600180
agaagatagc aagtttgaga ccagactggg ctacatggtg agaccctatt tcgaaagacc 600240
acaggaagca aaaaaagggg gagggggagg cagaagagag gagtggggag gaatgagaga 600300
aaaggagaag agaaaaaata gaacaaaggc aaactttggg gtgctgttct caacaaatac 600360
agtaactact gaagaagtct aagaacccca tcatattaaa aaaaaaatgt ctgcacccat 600420

tattgtctga ccagcatccc ccgtcttcac aggaagcatg tgtggaaact gcaactgaaa 600480
acatgggagt ggtcctcctc tgtctgcagt tgcaatgaca aatgaaaacc agtgaactaa 600540
aaagaaatac ttaaaaggtt gatgaaggcc acttagaaat tagtcctttg gcctggatct 600600
attttacaca aatttaaaa agaaacctgt aaaatggcta cattattgac atctgtgcat 600660
ttctgaaaac attaaaagtt tccatagtcc tttgcaattt ttcaaaaatg actgctaag 600720
cacattaaaa tgcacctctt gagaagctag gcaaggtggc ccgtgtctgc aatctcagca 600780
cctgggagga agaagcagaa gaatcagtag ttcaaagtca tccttggctg cataagaagt 600840

ctgaggccag cctggaactaa caagacctg tctcaaacaa acaaaaatgt gcattttgat 600900
gagaactacc ttttctttt cgtctgccct tgacccaaat ctttcttcag acacatgcag 600960
agaatggagc ctcttcttc ggaagcaact cctggtgggt gttttgttt tgtttgttt 601020
ggggactggg gttgagacag ggtttctctg ttagcactg actgtcctga getctctttg 601080
tagaccaggc tggcctcaaa ttcatagcta tccacctgcc tctgcctcca gactgctgag 601140
attaaaagta tgtgccaca ctgcctgcca gatgatgttt tatctgctgg gctgacctg 601200
atttaccatt agaatggacc tacctcttt tttcacataa atagatcaca ttaactttat 601260

gtttcttcag ctttctttt tcttaattc atccttccca aatcataca atttaactca 601320
gtatcttaat aagaataagt gatgcaatca cagctggaag tttctcagag aagagctaag 601380
aagataacaa caagctactg agaatttagc accttcttt cacagttata aaacctatag 601440

ttgaaatgag aattctggac agttatattat agtgtagtaa tggcatatatt tgggagagag 601500
 ggaaaacaga caccttttag catggttggg agaataataat ggagctgggg atcaaacta 601560
 gggctcttgt gtgctagaca agtgccttga tatagagcat atcccaaacc ctgtcacagg 601620
 gtgggtatct tacaataata taccatcaca caggcaccac caaacagtgg tcattatact 601680

 atggccatca aacagtggca atcacactgt ggccattaca tgggtgtcat caaacagtga 601740
 tcacacgatg gccatcacat agtaactgtc aactccgac tatcaaaagg tggccatcat 601800
 tcagtgttca tcacatagtg gccatcaca tgtagccatt acacagtgac ctcaaatagt 601860
 ggccattgct cagtgttgt cactcagtgg tcatcacata ttgactgtga cacagttagc 601920
 atcattcagt tgttatcaca caactgccat cacacactgt ccactactca gtggccagta 601980
 tatttggct atcacacaat agctatatca cagtgactat catttgggtgc ccaacaacg 602040
 ttgtccatca ggctgtgacc atacacagtg aacatcactc agtgggtcatc acttagaggc 602100

 catcacactg gtcacacac agaagccatc acagagtgac aattacacag tttcatcac 602160
 acaatggtea tctcactgtg accttcacaa gctgtccatc ttaaagtgat gatcaaagag 602220
 tggccactgt gactatcaca gagtcactgt cacatggttg ccatctggta gtttgaatat 602280
 aattggcccc cataatctca tagggaatag cactattagg aggggtgact ctgttggagt 602340
 aggtatggcc ttggaaaag tgtgtcactg tgggggtgga gagactttga tgtctcatgt 602400
 atgtcaate catgcccatt gtctcagttc acttctgtt gcctgtggat caagatgtag 602460
 gacctcagct cttccccag taccatgtct gccttcatgc tgggtgtgat tgccttgatg 602520

 ataatggact aaacctetga actgtaagac accccaatta aatgttttcc tttgtaaag 602580
 ttgccatagc catggtgtct cttcacagca atagaaacct tatcatacaa tgaccatcac 602640
 acagagacca gaaacagtg accatcacat agtggccacc acattgtgta catcatacag 602700
 tggatcatcat gtattgacca ttgaacagtt accattgtaa ccatcaaat gtggccatca 602760
 aactattacc atcatatagt ggccatcaca aagtaaccgt cacacaatgg cctcattcta 602820
 tggtaatcat atggtgacca tcacagagtg gtcattacat ggtggtcata acacagtgga 602880
 tgtcacacag tgaccaccaa acagtggctg ttaccagac attatcacac tgtggcctec 602940

 atatggtggc cgtaacagtc tgaccttcac acagtggcaa tcacacaatt tggagggttt 603000
 ttttttaaac cataatttaa tgtatatata aatataccat gtatgcaaca tgtattcttt 603060
 tttaaatatt attttcatat gtatgggcac tttgattcc tgtatgtctg tgcaccactt 603120
 gcatgcctgg tgcggatccc ctggaactgg agttacagac agttatgacc tggagtttgt 603180
 atgctgggaa tcaagcctgc atcttctggg aaaatgcttt taactgtgag tcatctctec 603240
 agcccttaac aatcattct ttagacagct tcacaggaat atttaccag actagagaac 603300

aaatcactgt agtcagtaag tatagggtgg agagaggaat cctgaaagtc tgatagcttc 603360

 ctgctaaaag actacacttc ccagcttccc ttgtgggcta tggaactcat tcccaccct 603420
 atgagaggcc gctttccatc ttcagtaggc atattgacca tctcacact tggatgacaa 603480
 aagtggcccc tcagtgtgaa taaacactgt caggcctaag gtcagacat gcctctttct 603540
 ctctgccttc tgtctctc caactgcctt ttcataaacc aacatgcagt gccagagact 603600
 gggaacatcc aagtgatctc tttggcagtt gactttatgt ctgcagagtc atcaaatgag 603660
 tctatagagt gatgtcctaa gccctcagat tcttcaggag atgatgtaa tgaagagat 603720
 tctctccaac ctgggctcac ctgtagtgct ttgagaatat aaccaagtgt ccaccagat 603780

 ggagagctcc aaggtcaatt ggtacaccct caccttgaag cctacaaaga atataagggc 603840
 tttgggtggtg aagtaaagtg cctgagttaa aaagatccat cattgttctc caggagctgg 603900
 gcgatgcttg tagatgtttt ccaagaagtt ccaaaagcca gtattgattg aaactcattt 603960
 aattggcttg ctttacaat tatgcctctc aacaaccagt ctatttttac atttaataat 604020
 gttaaaaaac atgctaactg ctgtcagtat gtggcaacct agagatttat ccattgatag 604080
 gaggattaaa gaattggctt tagcctttgt taattcagtc tatgttactt gtatattatt 604140
 ttttttttac agagttgaca taactgggtg cttttgtctt tcatccgttg gctgagtgta 604200

 tagaatgcaa atgttataga gaagtttga aagtttctgt taagagttaa tttttaaaag 604260
 ctttgtaaaa taaatcattt acttttgaca aggtagtcct gtctctggga atatatTTTT 604320
 aaattcgaag ttgaaaagta ttttggggag gggaacagaa cttagaatcc taaggtcctt 604380
 tagaatcaaa ttgtctcttt acatagcctg acaataataa atatatggac tgtaacaatt 604440
 tgccTTTTaa tactctaata atgcttatca ttgggtgact gggtcaatta cagtgataac 604500
 aggataccat atgaggattc ttcaatagaa tatatatat ataacatgtt atataatag 604560
 catatatata tatatatata tcttgtaaga gtatacttat taacattaga ttggcgtaca 604620

 cagtcaaatg ttaattggtc ccacagcagc aatctgtaga tgggagagtc aaagaaactg 604680
 actcagttca ggaagtagga agctcaagag gaccaatgat acaaggctaa aggctgaag 604740
 gtccccagga gaaactctgc tgtaagtcca tggacaacag cagcagaaag tgtaccacc 604800
 tactcaagga tgggaagigg gcgtgtagac acccctttct ttttcttact tgtccatca 604860
 gacgaccagt ctactgggtg gtgccaccta tgtcttccca ctcggttcac taaccatac 604920
 aacaatccac tcgggaaaga ctactgaca gtctccagag aatgctttac ccaccgtaa 604980
 gigtctctca atccagtaaa gttgacagcc caagctagcc attactagga tctgctatta 605040

aaaactaaat cagtctctgtg tgaacatgic tggcagaatc tccaagatg cactgctgcc 605100
 tagaggttgc agaagcaag agaacctact gtgctgtcat ttgcaagggg aaagaggcat 605160
 actggacact gagtgagtgt gtgtataaaa tacggctgat ggctgatggg ataccaact 605220
 gagaaagaga accaggaaga tgttccattt gtacagtgtc ttagagcagg ttgccagct 605280
 ttgccaatcc caggaaaaac atttccattt catttcattg ctgctgact aagccaacce 605340
 tgactgcagg gaatggaagg tgattcttct ttgtaatgag aggaatgtga ccctcacatt 605400
 gcagacagac ctgctgggca ggagattat gtggctgtcc tctttgcaa atacctcca 605460

 ctgaggactt cttattccga cttctgctca catgagaaca cacagagatt cagattggcc 605520
 gtgtctatat ttgtttgcac actggctggt tactaacctc tgtgtcccta agagagacca 605580
 acccactcat caacagaacc acattctgga gttttctgta tctcctgttt gttttcactg 605640
 cttttcagac ttacacatca gacttctctc ttgtaaacca ttcttgcta aaaagtgaaa 605700
 ctctgagatg atggattaat gacataaatg aggaatggca ttaaaataaa aaaagaggat 605760
 tttcaaggct agcagagaca tgtgaaagt tgtgtgtgtg agtgtgtgta ttagtgtgtg 605820
 tgtgtatgtg tgtgagtgtg ttagtgtgtg tgtgcatgag tgtgtatgtg tatgtgagtg 605880

 tgtatgagtg tgcgtgtgtg tgtgtgtgtt tgaatgcttt taaaagagt ttagccagg 605940
 atggtggctc acacctttaa tgctagaact caggatgcag agacagggtg aatccatgg 606000
 atttgaggcc agcctgatcc acacagtggg ttacaggcta gccaaagttc tatcgaggg 606060
 cagcaacaaa agaaaagagt ttagtaatgt gacaaattg agttttgtaa atttagatgc 606120
 tcaggcctg atttgtgatg ttttctcagt gccgtgggcc atattcattc tgttttaact 606180
 accagtgaaa aataccaagc tctctgatag tttttatcta ttgaaaatat tttttcatat 606240
 agtgcattct gttcgcagcc tgccccatc tccttctaga ttcaccccag ttctccatgt 606300

 attcaattcc acaacttctt tttctctcta tttagaaaac aaacaggcca ataaaaaac 606360
 gcaaaccaga ataaaacaaa atagacagag aaaagaaaac agaaaatata aaaaggagaa 606420
 aatataagaa acacattcac acaaatgcac acacatacaa ctcataaaaa cacaaaattg 606480
 aaaaccatac tatacaagca aaagacaagg aaagtaaaaa atgcctgaac aaagaaagca 606540
 agcactatga gacaaaacat ctcaaaaag accattgagt tcctttgtg ttggcatct 606600
 actgctgggc acggagcctg cccttaagtg tggttcacat aacctgag actccattgg 606660
 agataagga tttgtgctc gtgagtgggt gtcaattgga gatcattct ggggtggagt 606720

 agggctcaag tccatgtccc atctcaatgt tggactcca tctggctggg acctgtgcag 606780
 gccctgtgca gctaccatgg tctcagtgg tcatatgcat gtcagtactg ttgctgatgg 606840
 aaggcaccat ttctttgtg tctttcatcc cactggctc tcacaatcct gcatcatctt 606900

ctacatagtt tcctgaggcc taaaaaaaaa ataattttta aatgtcatga gctttgagga 606960
catgaaaaa cagtaatgtc caagattgta aagaaccttt cccaatatt aattgactct 607020
atatgtgact ctgtggcaca ggatgaggag aggagagaca gaggtagaca ctgctctgca 607080
tggtaggacc acatccatgt gtggtaggaa cgaatccatt gccatcatcc ctagaattgg 607140

aaaacaatga agtcaaaagg gtgtagatag cctggctagg gtctcaagta attagcctgt 607200
gggctcagct ttgccctag attgtagagg tatacagagt ctgagttcgg agctaagtta 607260
ccgaggaact agacatgttg atatcccacc caagccagac atcatcacat gcctgatctg 607320
tacatctaga tcagaatcag gcaaatgcca ggaagagggg tgagtggact cagaaaacce 607380
tgcatactca gcictgtgct ttcagggagc caaggatgaa gaccacaaaa gagtctaagc 607440
aaatatgagg caacttgag tactcgcaa catcttcaca aagacttcca acaaagaga 607500
acaaacagta tattaaaaag tgttttggaa cactgcactg gagcatgaac tacctctaag 607560

aggctctaag aagagcctct acctctgtga atgcctagta taacgcattt ggggaggggg 607620
agattgaagg gagtcacagt agcaggaatt atgaagtttt atttatttaa tatgtctaac 607680
tatgttggca aactgttaat attagcctca cggtaaaaag acagggtagt tggctcatag 607740
catacactg tagctatccc agtgttgttg aaaatgaaaa caataacacc gcatttagac 607800
atctctttgt ttcgagaatg gcatgaacca tcaaggttaag gacttctctg tgtgaatcct 607860
acctatttag accttccct gactcagct tccaaggtc ctggcaaggg gtgggcctc 607920
catgttctag gtgattaatc tcaaaagtgg gaagggaagt atttgactta atagcagatg 607980

caggacggtg atctgtttcc ttcacttgtt tttgaactgc tcttccatga agggcatgta 608040
cttgtccaca gggcatctgc ccgtgttcac ttacagtggg ctggtcaggt ggtttccagc 608100
atgttctgac aaactttagt cttttctcct tattgacctt tgagatagct tgagagaact 608160
ggaatatagg tccagccac cctggatagg cacaaggcac aactttgggt cccttccagc 608220
tcccttctgg aagggatggg tatgcagtga gcatcagctt gctttggtcc tcaaggattc 608280
atgttacatg tacagcagtt gtccatggca ggacagctac actgaacgac tcacagctat 608340
agtaagttta gctctcagct cttgagtcag gccagatga attacctgga ggttcagga 608400

agaatatgtc tgagtttctt cagactgttg gcagaattca ttaccaaca gatcttggat 608460
tggggccctt ttaatctag cagcaccag cttttctcat acaacctcc acagctggag 608520
gccagcacac actttcctgc cttcccttc agctttatac tctgtctca ggtcatagaa 608580
agttctctgg tttctatgtg attaaatc actcacacac acacacacac acacacacac 608640
acacacacac acacacactc atgggagtgg gtaaataagg gagtatctta gtgcttctgt 608700
ggtgtttgaa tgaggaaaca tgccacttga gggacaccaa cagtcccctt cccacctga 608760

cctcacagac tggaagacaa tctggccaac aattgccatt aggccccgatg gatccagaac 608820

cctggaggag aggagaaagg ccttctctgag aaggccgctt tctcccaaag ggagctggcc 608880
tcttctccca ggctgggcct gttgtgctga tgtgggaggc aatgctcggg ccaccacagc 608940
tgaactgctg ctgcctgaga tggaatctac tctcctagct gttggcagag acagagggac 609000
tgaggcccac agctgctctc cactcgcagt ctgttcccag gctccacatg gttctgcaac 609060
cctaaatgcc accaagatgc gctcaactaa caaccacaag aactcttggg gcggatgccg 609120
gctggtcttc ttggctgttc tgaggcacat accctggccg ccctggggag cagcaagtcc 609180
ttgcagacat gtgcatgatt tgaggtcagt ctccggctgg atcctaaca gctgccagac 609240

ttttctgtgc ctgatgaaat acgaggaaaa gccaaggaat tcttcttgct tggagaatat 609300
taccagctcc aaggaagcaa agtccccct ggaaagggtg gatlacataa gatggtggat 609360
ctagaagttt tgaaaacctt tcttctccag aggcagatgc ccaaggttgc actcacacgt 609420
gtccttgcaa tctgcaacc aatactctgc tccttgtcat gcctgacata tgaatccaga 609480
ccacagttgg acaactacaa gggcagtgcc ttttgtacc tttgggagtt ccagaaagcc 609540
caatgaaat tagaattgga tcaacaagaa tcccgaatat ccgagaaatc tgcaatacca 609600
aacagtgtc atcaaatatc acagtagaag tcttgaagac tagcagtcag cactgtggag 609660

atgtgtatgt gtgtatgtgt gtgtgagtgt gagtgtgtgt gtgtgtgtgt gtgtgtgtgt 609720
gtgtgtgtgt gtgtgtgtat gtatgtagtt aggaatgagg gagaatgtat caacatgagg 609780
gcaaaagtaa aacataaggt gtgtaaatta aaatgaatac acaaaatagt gtcattgcttt 609840
ataaaactct gtgtgtgtgt gtgtgtgtgt gtgtgtgtgt gtgtgtgtat gagcgcacgt 609900
gcagtataa gacatattgc tgtgattgcc ttttgggaaa aaagcaatct gtgataggag 609960
tagagaagga agggaatcag ggaggaaaag cagaagaggg gaagaagcca atgatgatga 610020
cggacaacca tgcttgaag aatgcaagca tctgtctctc tgttctagga tggaaacaag 610080

aatgaaagc aaggctttgt cctaacttct catccagtgc tccgggtgac tgactaaggt 610140
gtgtgttcag tataggtctg tcttatatc cacaggggtg ctgaggactt gagggttgc 610200
caggattctg gcccgagatg cacatgtgaa gaaatctgaa agcctgcaat cctggctcag 610260
agctacagaa ctggggagtc agctccgggt tcagaaacaa gaggaacaga tggaaactgt 610320
tgggtgaagc cgaagtgcc tgggtgtaaa agaagccagg attgtctgggg agtggctgca 610380
ttggccctgt gaaagcagaa gctgatgtag tcatgggtaa catgccacg cctctgtaaa 610440
taacaggtca cccgtgtctc tgtaataaac ctaattgaa ccattggtta acacacacac 610500

acacacacat acacacacac acacacacat gctgctactt gggaaaagga aggagtcagt 610560
 gggaatggga ggggacaaga cagggtaatg caaatgaata tgattaaaac attatataca 610620
 tgtgtaaagc atcataatga aagacattat tatatataat tagtatgtgc taataatfff 610680
 tttttaaagt ccaagagcag aaactttaac gagaggacac tgatgaccac aggcacatct 610740
 tcgtttgggt acaagcagtg tgcctccatg aafgagcatg aagctgacag gctacgtctc 610800
 tcctgtcttt gttcctgctc tgtggcctct gacctgtggc ctgcatgtca cctctcaaaa 610860
 tgtgtgcacc catagagatg ctgtcattgt ttgttcattc ttttggctga gcagtgtgac 610920

 tatatfffag gaaaactgac ttccagtagc ttcttctfff aaagccacca tggccaatff 610980
 cagatcctca cagacactff ccagatgctc ctgtffgctg ctgccgctgt ctcactctcg 611040
 ttgccaaggg gaggtcacag ctgaaggtgc ttctctccg gaatctagcg aagttctctg 611100
 atgcttctta tffftccaagt taaaagacaa ggaacaaaagt ccagctccct ctgggattff 611160
 aaactggaag aatgaccaaa gaatgacctc agagcatcac tctgtcagtg ttcaatggtc 611220
 atgtgaacca actgacctgt ggcagccatg ctgtgaggaa ggccgtctgt ccctcaggag 611280
 gcacagagag gcacatggct ctggcacacc tggggactac cctgttacac cacagcaaaa 611340

 tggccaactc tactccatct attatgtgtg caaattffca aggtfftgct cttaaaaaca 611400
 gtattgtctt gtgacagctc caaacattgt taacaaaacc attaagtgtc agttatggca 611460
 gccaccaaaa ggacttgcta ctggetcatg actgaagtaa tgatgggccc cttcaacctg 611520
 cagtctgcgc tgactctgga taggaaagat atggtccagg gtacatata taatgttaga 611580
 gcatcctgtc ataacagcta gagcacaacc accatggagt atggtgtgtg tcagctffcc 611640
 atcgctgtga caaaatacat gcgataagca acttaaaatg tgaaagatta tatgcagaga 611700
 taccatggcc agcctagaca cagggtgtt ggggtggaga gctgccttgg tctgcctca 611760

 actagatgat gggacagact tagtagactt cctatgggag gccttacct ctctatggag 611820
 cagataggag gagggggaag tgaagggggg tgggaggaaa ggaggaggagg ggaactggga 611880
 ttggaatgta aaaaataaat taataaaaaa taataatctc attaaactgc tcttcagtga 611940
 ccaagatcac tacaattag gattactatt tacacattac tcctaatata atataataat 612000
 agtgataaaa ataataaat gttaaaaaaa aaagttgaaa gatttagttt gtgtcactgt 612060
 tttggtctgt tttagctcag ggttgcctgc ttgtattgtt tttggtcctg agacaaggca 612120
 gagctfftggt actgaagagc atgtggaact gacctgctca cacaggtagc tgagaaggag 612180

 agaaaaagag aggaaccagg tacciaacaa tcctcccaa gcacgcccc aatggcttct 612240
 ttccactgac cctcaccttg taaagttfcc accaaceccc ccccaccacc accaccgaaa 612300
 agtgacacag gctgatgacc atgccttcaa catacgacct ctggctggca tffaagattg 612360

aagctatagg atgcTTTTaa atctgttga cacggtatct caagcagggc cctcactgag 612420
gccttcacag cccatgtgcc aagaagccat ttaccagaa gcagacttcc tccatctttg 612480
tagccatctc tgccagacac ccaggaggtc agtaaatgtc tgcaaaagaa aatttgTTTT 612540
gcctgctgtg tctgcttctg gaccctccc ctctctctg ctaaaagtga aataatttat 612600

ggatgcctt ttcaacttct ctctgtctg tggccctgac cctctgatca gacctggaca 612660
caatctgagt aggagtgttt gaggaacac atttttattc atgtggcctt tggcaaagca 612720
cctcgaaaat ctagcttgca ttgtctaagc cagtccctgc gccttgcttg tcccatgcct 612780
ttgctgggag actttcaggt tggctggcag aattcaacca aggggagcag agacaaagtt 612840
gaagagggct gaaggggtgg ataactagtt aaccattcac ctccctccca tgaaggagag 612900
aatgagctg ctctctccac caccacctg tgctcagca cctgtgctcc tgattcaata 612960
ccattatcat acttgaaact taataatcat tctataatat tacttgataa ccatgtcata 613020

ttacaacatt cccagatggg actggagaag ggactcagta gttaagacca tgtggtggtt 613080
tgaatgagaa tggttccctt gggctcagat ttttgaatgc ttgttcagaa gtgggtgaa 613140
ctgtttgggg aggattagga ggtgtggcct tgttggagga ggtgtgtcat tggcggtggg 613200
cttgaggttt caaaaactca tgccatttaa agttagagtt tttctctctt tttcccaggc 613260
ctgtggatag aatgtaagct cttagctact actccagcac catgcctgcc tgctgtctg 613320
tctgttgcca tgttctgtc atgatggta tggactcacc ctctggaacc ttgagacca 613380
tatgaaatgc tttattttat aagttttact agtcatggtg tctgctcaca gcaaatgaga 613440

agtaactaag acagagcaca tactgctctt gcagagacct gagtttgatt cccagcacca 613500
atTTtgattc acagctgtct ataacttcag atccaagcca tctctttcct ctgtcctcgg 613560
agggaacagg cattcaaatg caaatactca ctctcagatg catagttaa aaataataaa 613620
atgaatcttt taaaaaaaaa tctaagcaa ccctaaatgg ctctctgtagc tttgtttgta 613680
ccaatcaac atgcagttgg ggaccacaca ttgcattttg ttatTTtccc ttggctctatc 613740
agtttctttt ttaattaagc aaaatcaatg ttcaatgcaa tgaagtaatt ttaaatgtat 613800
ggtttggcaa acttaaaaact tttatcacc ttattacta ccacctccc caaaaatata 613860

ggaaaagtct ttcattttct ttttataacc taccctccc tctctttccc caactcctag 613920
cttgggaaaa ctctgtcttt gccacctta gatagctttg ccagctcaga aactgcatta 613980
gtacaggagt acaagaggag aagaagaaga agaagaagaa gaagaagaag aagaagaaga 614040
agaagaagaa gaagaagaag aagaagaaga agaagaagaa gaagaagaag aagaagaaga 614100
agaggaagaa gaagaggaag aagaagagaa caagaagatg ggaagacgac aatataagaa 614160
cacatccaac aacaggaaaa ccaatgatc accaccagag tctagggact ctacaccagc 614220

aagacatgaa catcccaaca cagaagaagc agatgagagc aaccttaaaa acaacttcat 614280

gcagatgata gagaacctaa gagaggaaat cagaaaatgc tttagaaaaa tggaggaaaa 614340
gacaaaccaa aagatgcaag aaatcaagga aagccaaaaa aagccaagaa aatacaatta 614400
aacagctgaa ggaaacagtt ctggacctga aaaatgaatt agagacaata aagaaaacac 614460
aaactgagga aatactggaa gtggaaaagc tgagtaaaaca atcaggaacc acagatgcaa 614520
gcataacaaa tagaatactc ttctgagatg gaagacagaa tctcagatgc tgaagacaaa 614580
ctagaggaaa taaactcatc aagcaaagaa aatctgaagt ctaacaaatc cataacacaa 614640
aacatccagg aaatatggga caccgtgaaa agaccaaacc taaggataat aattatagaa 614700

gaaggtgaaa aaaaacccaa ctcaaaggig cagaaaacat attcaacaaa atcatagaag 614760
aaaacttccc caacctaaag aaagacatgc caatgaaaat acaagaatcc tacagaacac 614820
caaatagagt gaaccacaaa agaaattccc ctcatcacat aataattaaa acaccaaacg 614880
tacagaataa agaaaaata ttaagggcag caaggaaaaa aggacaagta acatataagt 614940
gcaaacctat cagaattaca ccagacttct ccatggaaac tccgaaagct agaaggacct 615000
ggatagatat tctaccaact ctgagagAAC atggatgcca gccagacta ctataccag 615060
caaagctttc aatcactata aatggagaaa acaagatatt ccacgacaaa accagattta 615120

aacaatatgt aaccactaat ccagccctac agaaagtact ggaaggaaaa ctccagccta 615180
aggaaattaa ctacactcaa tagataatcc cactcaacaa aaacacaaaa taaaaggcag 615240
ggtaaatcca catacaatc cagtaccaac aacaaaccaa aaacaacaa gaataaactc 615300
tccatagaca ttaatttccc tcaatattaa tggctttaa tcgctataa cgacataacc 615360
aaacttatgg gacactttaa aagcagtact aagaggaaag ttcatagtcc taatgttcaa 615420
catgaagaaa ctagagaata gccacaccag agatttgaca tcacagctnn nnnnnnnnnn 615480
nnnnnnnnnn nnnnnnnnnn nnnnnnnnnn nnnnnnnnnn nnnnnnnnnn nnnnnnnnnn 615540

nnnnnnnnnn nnnnnnnnnn nnnnnnnnnn nnnnnnnnnn nnnnnnnnnn nnnnnnnnnn 615600
nnnnnnnnnn nnnnnnnnnn nnnnnnnnnn nnnnnnnnnn nnnnnnnnnn nnnnnnnnnn 615660
nnnnnnnnnn nnnnnnnnnn nnnnnnnnnn nnnnnnnnnn nnnnnnnnnn nnnnnnnnnn 615720
nnnnnnnnnn nnnnnnnnnn nnnnnnnnnn nnnnnnnnnn nnnnnnnnnn nnnnnnnnnn 615780
nnnnnnnnnn nnnnnnnnnn nnnnnnnnnn nnnnnnnnnn nnnnnnnnnn nnnnnnnnnn 615840
nnnnnnnnnn nnnnnnnnnn nnnnnnnnnn nnnnnnnnnn nnnnnnnnnn nnnnnnnnnn 615900
nnnnnnnnnn nnnnnnnnnn nnnnnnnnnn nnnnnnnnnn nnnnnnnnnn nnnnnnnnnn 615960

nnnnnnnnnn nnnnnnnnnn nnnnnnnnnn nnnnnnnnnn nnnnnnnnnn nnnnnnnnnn 616020
 nnnnnnnnnn nnnnnnnnnn nnnnnnnnnn nnnnnnnnnn nnnnnnnnnn nnnnnnnnnn 616080
 nnnnnnnnnn nnnnnnnnnn nnnnnnnnnn nnnnnnnnnn nnnnnnnnnn nnnnnnnnnn 616140
 nnnnnnnnnn nnnnnnnnnn nnnnnnnnnn nnnnnnnnnn nnnnnnnnnn nnnnnnnnnn 616200
 nnnnnnnnnn nnnnnnnnnn nnnnnnnnnn nnnnnnnnnn nnnnnnnnnn nnnnnnnnnn 616260
 nnnnnnnnnn nnnnnnnnnn nnnnnnnnnn nnnnnnnnnn nnnnnnnnnn nnnnnnnnnn 616320
 nnnnnnnnnn nnnnnnnnnn nnnnnnnnnn nnnnnnnnnn nnnnnnnnnn nnnnnnnnnn 616380

 nnnnnnnnnn nnnnnnnnnn nnnnnnnnnn nnnnnnnnnn nnnnnnnnnn nnnnnnnnnn 616440
 nnnnnnnnnn nnnnnnnnnn nnnnnnnnnn nnnnnnnnnn nnnnnnnnnn nnnnnnnnnn 616500
 nnnnnnnnnn nnnnnnnnnn nnnnnnnnnn nnnnnnnnnn nnnnnnnnnn nnnnnnnnnn 616560
 nnnnnnnnnn nnnnnnnnnn nnnnnnnnnn nnnnnnnnnn nnnnnnnnnn nnnnnnnnnn 616620
 nnnnnnnnnn nnnnaaatta aatggagaga aactcgatcc aattcctcta aaatcgggga 616680
 caagacaagg ctgtccactc tctccatacc tcttcaatat tgtccttgaa gtccctagcta 616740
 gagcaataag acaacaaaag gagatgaagg gaatacaaat cagaaaggaa gaagtcaaac 616800

 tctcactatt tgcagacaat atgataatct acattagtga cctgaaaaac tgtaccaggg 616860
 actcctacag ctgataaaca ccttcagcaa agtggcagga cacaagatta actcaaaaaa 616920
 ctccgtagcc ctactataca ccgatgacac attgggtggag aatgaaagca gagaaacatc 616980
 caccgtttac aatgccaca aacaacataa aataccttgg ggtaacacta accaaaaatg 617040
 tgaaagacct gtaccataag aattttgagt atnnnnnnnn nnnnnnnnnn nnnnnnnnnn 617100
 nnnnnnnnnn nnnnnnnnnn nnnnnnnnnn nnnnnnnnnn nnnnnnnnnn nnnnnnnnnn 617160
 nnnnnnnnnn nnnnnnnnng cagcaatttt agattcctct attgagaatt ttttattttg 617220

 ttctgtacce cactttttaa ttggattatt tggatatttg gaaactatct tcttgagttc 617280
 tttgtaaatt ttggagagca ccatcccaga cttcaagctc tattatagag atagtctga 617340
 aaacagtttg gcattagcac aaaaatagac tagtagacta atggaataga attaaaaacc 617400
 ctgatattat cccacacacc tatgaacacc tgatttttga caaacaatcc aaatttatac 617460
 gatggaacaa agagaacatc ttcaacaaat ggtgctggca taactggttg annnnnnnnn 617520
 nnnnnnnnnn nnnnnnnnnn nnnnnnnnnn nnnnnnnnnn nnnnnnnnnn nnnnnnnnnn 617580
 nnnnnnnnnn nnnnnnnnnn nnnnnnnnnn nnnnnnnnnn nnnnnnnnnn nnnnnnnnnn 617640

 nnnnnnnnnn nngcttctcg aacataacac cagtagcaca gacactgaga tcaacaattg 617700
 ataatggga cctcctgaaa ctgagaagat tetataaggc aaaggagata atcagcaaga 617760
 caaaacagca gccacagac tgggaaaaga tattcatcaa tcccacatct gacagagggc 617820

tgatctgcaa aatatagaga gaactcaaga agctagtctc caaaacacca aataatccaa 617880
 ttaaaaagtg gggtagacaa ctaaatagat aattctcaat agaggaatct aaaatggctg 617940
 aaagacacat aagaaagagt tcaacatcct tagccatcag ggaaatgcaa atcaaaacaa 618000
 ctctgagata ccatcttact cctgtcagaa tcgcaaaaat caaaaacacc aatgacagtt 618060

 catgttggag aggatgtgga gaaaggggaa cacttcttca ctgctgggtg gagtgccaac 618120
 ttgtacagcc actttgggaa tcagtatggc aactcctcaa aaaaaaaaaa tgggaatgag 618180
 tctaccacaa gatccagcaa ttccactctt aggcatatac ccaaagaag cacattcata 618240
 caannnnnnn nnnnnnnnnn nnnnnnnttc aacggaagaa tggatagaga aattgtggtg 618300
 catttacaca atggagtact actcagcggg aaaaacaatg gaatcatgaa atttgtagga 618360
 aaatggatgg atctagaaga aaccattctg agcaaggtan nnnnnnnnnn nnnnnnnnnn 618420
 nnnnnnnnnn nnnnnnnnca gatttttagac atagagtaag gattaccagc ctacaatcca 618480

 cactgccaaa gaagctaata aacatggagg accctaagag agacatacat ggtcccatgg 618540
 agaaggggag aagtccaaga tctgctgagc aaattgggag catggggaag aggggggagg 618600
 gagctaggag aatgagaaa ggagtgggaag agggatgcca aggacatgag ggagcagaaa 618660
 ggttgagtca ggggaagaat acannnnnnn nnnnnnnnnn nnnnnnnnnn nnnnnnnnnn 618720
 nnnnnnnnnn nnnnnnnnnn nnnnnnnnnn nnnnnnnnnn nnnnnnnnnn nnnnnnnnnn 618780
 nnnnnnnnnn nnnnnnnnnn nnnnnnnnnn nnnnnnnnnn nnnnnnnnnn nnnnnnnnnn 618840
 nnnnnnnnnn nnnnnnnnnn nnnnnnnnnn nnnnnnnnnn nnnnnnnnnn nnnnnnnnnn 618900

 nnnnnnnnnn nnnnnnnnnn nnnnnnnnnn nnnnnnnnnn nnnnnnnnnn nnnnnnnnnn 618960
 nnnnnnnnnn nnnnnnnnnn nnnnnnnnnn nnnnnnnnnn nnnnnnnnnn nnnnnnnnnn 619020
 nnnnnnnnnn nnnnnnnnnn nnnnnnnnnn nnnnnnnnnn nnnnnnnnnn nnnnnnnnnn 619080
 nnnnnnnnnn nnnnnnnnnn nnnnnnnnnn nnnnnnnnnn nnnnnnnnnn nnnnnnnnnn 619140
 nnnnnnnnnn nnnnnngact ctgatgacac cctatggaag gcctcacat ccagggggag 619200
 cagaaaagat atgtgacaga taagtttta gttggggagg gtgggtaggg gaggacgggt 619260
 gggagaaggg aactgggatt gtcatgtata acaatcctgt ttctaattca aataaaaaaa 619320

 aagttgaaa aaaattgcaa gatttctgaa ttatgtaagt gtatgtttgt taaagagcac 619380
 acacacacac acaagcaaga ggagggcctc tgtgggaaag gggagcagca aaagtgggag 619440
 cagggcagag gtctgaaaga tagaacacga tgtggcacat atctttaatg ccaggatgga 619500
 cagtcagga cgagtgggc tctcggagt caagcaacat cagcctgatg tgtgtaatag 619560
 gctccaactg tgetcaagag atatgtattc atctataaaa atctatgtgt atgtaagagg 619620
 agcggtgaaa cccattactc tacatactaa tttaaaatta acttttaaaa ggagagggct 619680

ggagatatga ctcaacagtt acagcatgia ctgctcttgc agagaacca agtttggttc 619740

 atagcaccca atgtcagggt actcacaact gcctgtaact ccagctcaa gaacataaga 619800
 ggctctgggt ctctatgggc acctgcacc atatgcccgt actcacacac ggagacacag 619860
 acacagacc agacagacag acacacacac acacacacac acacacacac acacacttat 619920
 aaaaataaaa tctttttaa ttgataaaaa gaatatatat gattaacatg ttcattttta 619980
 ctactgaaaa caatattttt atttatttca gtttgcaatc atatgtgcca atagatagat 620040
 aatagatact tgatttatat atatcagctt tatctccttc aggttcactc ttgtgctatt 620100
 tttttttttt gctactgtaa taaaacacat gcattgatac ttcttaaagc aaaagtttac 620160

 ttagctgcaa atcctggagg tgcttcattg gtttctgggt agggctctac tgatatcaca 620220
 tgatgggaac acatgagaga ggtcacatga tgatgaaatt gagctgagaa caccaaacce 620280
 agtctgctct gacagtgacc aatttagttc caaaggetcc tgaactcact ccagcatagt 620340
 tactaatctg ttccaatggt tatagaccaa taacctaatc acctatcatt acccactgct 620400
 attatactga ggaacaagcc tccaacacta gagtcattga gaggcattgt tactttgctt 620460
 ctgtctgtga ccaaatgctt gtcaagaagc aatgtaaggc aggaaggatt tgttgtggct 620520
 cacagtttgc tgggatacac ctcatgaggg aagagaaggg aagggtgtgc tttagggagt 620580

 ggctctgggt tatgatggta agagctgaca gcacagtctg ctacatttt ggagggcca 620640
 cccagaagca gatgggtact tgggtaggag tcagagtcag ggtacagccc tcaaagcctg 620700
 cacttgcact atgtgcagaa tcccacttcc ttaagcaaga ctccactccc cagtttcccc 620760
 cgccaatgct acttagctgg agactaagtg aatagcagga tcaagattta gtaggatttt 620820
 ttttaattt atttattagt tctagttagg gaacaagctt gtttcacatg taagtccctt 620880
 ctccctctcc ctccctcac cccatccctc tccccacc cccacctac tcccctccc 620940
 atccaccac cactcccag gcaggatagg gcctcaacg ggggctctgc aaagtccacc 621000

 aaatcttct gtgctggttc tgggccttc cccatgtgtc caggccaga gtgtaacgt 621060
 tcacgtggga tgggctctca aagtccttc ttgcaccagg gaaaaatgat ttagtaggat 621120
 ttaatagaa ttctgagat tttatagt taaaacctg ctctatggtt ttctaagtgt 621180
 aatattttg ctctttttt actggcctt aagactatta aactgggtgg gtgagagtag 621240
 actttcttc cctgcctga cctggagcag aaacattcag tctttacta aagagtgtga 621300
 tgctaaaggt ttgggaacc catctcttc tctgaactat ttcctgagca gtagtctatc 621360
 agattctcag tctttccag gtgagtcagc cattgttgaa gtgccagac cacattctgt 621420

aaatcactct taaaaaatcc cttttctggt ccttttagagt agtggttctc aaccagtgg 621480
 cccaactcct ttggctcaaa ggctttggag gtctaatac cctttgacag gggtagcatg 621540
 tcggatatct acattactat tcataacagc agcaaaatca cagtatatga gtagcaatga 621600
 aatcatttta tggttggggg tcagcataac actagggact gtattaaagg gcattgggaa 621660
 ggttgagaac cactgccctg gagagcctca ttgcttctgc tctgtcacca cacacctaag 621720
 tcattattgc tcagatacac aaaggctgcc acagacaaca gcaagcttgt gagcggggct 621780
 cttttgatc aaaactttat ttgtatagac aaacaactga cctgccagcc atagctcacc 621840

 agtccttct ctggaacaat acccttgecc atttgttccc tacagattga ctttttcagg 621900
 actccaagct tgggtgcata tttaatcacc ccaattctga attaagctaa ttgtattctt 621960
 aagatgatat gtaatgtgtt tctttatctc tgtgttgaga cattaagcat tttggagcaa 622020
 ggtaggacta ctaaatcttg aaggactgtc actaaagtta atgtgactga gtgttgaacg 622080
 tgaattatct attcagctgt ctatcatcca tttgccaagt gcattgttgc accctctgct 622140
 atgcatgttg gtcaatgatc gaagagacat gtcatatgat ctaacttgcc cttgtagtga 622200
 ggtaagccca ccagagatca ccacctggac attcagctaa aaagaaagac tttattgctc 622260

 accagcaata gtacagggaa cttccccaag tcatgcagac cagagtccta tagacctttg 622320
 tcttghtaatg caaaaccaca gcctggctgt catacctcag ttaccaagaa gcagaactat 622380
 tgaaggcaaa aagcaaggtt agtacattta aggtcttctc ggaactatgg accacgtctt 622440
 tgatgaatta ggtctttgtt ctggttttgg caggatttag ggttttaagg tcagagcagt 622500
 gcctcaacat ggcacagtt gcgctcaggt gtggggcttg ttacatctc agtacactga 622560
 ggcagggatg gtcgggtgtc acaaaatcat ggtgctcatt gtatctagac cactttttag 622620
 ggtacaggtt ttctagctct gtgggctaga aaggacattg taaacaagta tgataaaagt 622680

 cagatcccta gagaggtaga cggcctccg aggccaagct tgggtcagta agccctttgc 622740
 tttcaagaag aaaagcatac tggcttcagg gtctgtggtg acttaaaaat gtgtccttaa 622800
 attccttgtg acatctgctt tctaaaggta aggctaactc ttctgtata tgagctggat 622860
 ttcagctgct tctaatgtct gtagaggaag accagatcat aaaaagcaaa gcagcatccc 622920
 cttttctctc tctaaagcct ccacctctgc aggaaatcag acatcatgtg aagacatccc 622980
 aatgaaggtc tacctggaat ggaatggaga ctctcacca gccagcatca acttgccaac 623040
 tgtgtgagta tcttcaggct gctatgacaa acacagccag actggcggct tttttccagt 623100

 tctgaagtct gagaagagca taattaaggt gctagaaact tcaatatctg gtcagaactt 623160
 ctttctgga ccacagatgg atgactttat gtcttcatat aataggagag gtgaaggagc 623220
 tcccaccctc atgacctgat acctttcaaa ggtgatagtc tgatccatat gtcacacgt 623280

thtagattag agtccaataa gtgaaattat ggaggaatac actgagtcaa agcatcttgg 623340
 aagcaggcct ctggccccac tcacaccttc agacaaccac agtcttggct gacatctctc 623400
 acaccctcat gaactaacta cacagacaag cagcccctga attcctgaaa tgcgagagat 623460
 aacagagcct acctccttaa ggccttcttt ggggagcaat tttactcaa caatagctag 623520

 ataaggggga ctttgcacc tgttggatca catggagagc ttcaccctc catttgtggc 623580
 atctaacttg agacaacaca agcagaagct ctctccctt cctgctgggc acatgtgtct 623640
 ctctgatggc tgctgacctc atagagaaat tcccatgcaa aacttagcac tgaacccta 623700
 aagaacgaca acctgggaca cccacccca gggcgaacta catttggaga tgacgccact 623760
 gcctgtccct cccacagaa gatccttttg agacttctgt ctgaatgtga ggcagctggg 623820
 ctgccacact acttgctaga ggaacagctt tccccatgca gccaacagca catgtggctg 623880
 tgcaagctgc aatctttttt ccattaacac catgttccat tgaaaacgga ggactggcca 623940

 agattccaaa aacactaaag tgggtgattg ttgccaaaat actccaattg attcaatggg 624000
 accttaggg aaaagttaga tattaggacc tcactagcaa aagctagaga aaattttaag 624060
 aaggggagge atcctatatt tcctatggg ttgattttca tttggtttct atataaatta 624120
 gaatataaat atacattaga gtggctttgc ttgcatcggg aaagatttag actctagtct 624180
 tttaaacatt gtactataac ttaataaaca aaagtagact atcaacaagc agttcatagg 624240
 acaacagagt caaacagctt ttaacactga aaaagatgct cagtctcatg gtagttaaag 624300
 aattgtaaat taaaactctc ttgaattctg gcctcttgat ggtaaaattg gcagaaactt 624360

 gaagccatga gaaagctagc atttgtccat gtttctagta aagatacaaa aacggccctc 624420
 atggggctgg agaggcagct cagcagttaa gagcactggc tgctcttcca gaggacctga 624480
 gttcaattcc cagcaccac atgggtactc atgaccatct ataataatgat atgatgcct 624540
 ctcttggcat gcaggtatat gtgcagagca cccatacata aactataaat aaaatttaaa 624600
 aattattttt aaaaaatag gccctcagct tccaagagta ctagatgttc ttgaagagga 624660
 cctgagtttg gttcccagca ccccatggg gctcctaaac tataactcca gttcccaggg 624720
 attcaacacc ctctctgat ctccacaaga accacatac acaaggtcca catacacctt 624780

 caataagtaa atctttttaa acaatgcctg tctcaaggag aagttgagga catctaacag 624840
 aatgatatgt gcattgacc ttttaagataa caacagtgt tctagagatt tacactgaat 624900
 ccacacttc ccaaatgaaa caacatacat gtgaggctgt ttgtgctgac actgtgtgta 624960
 atataaaaga tcagaaacaa cttcaatgca ttagagtatc atggaaaagt catggaatag 625020
 tcacacaatg ggggtgactat actgtcatgc aaaagaaaca ggaatgtatg tggaatgatg 625080
 gctaggagat actgccagat taaaagaaa atttcagagc aatgtttatg tatacatgtg 625140

tgtttccaaa tgaaacacag aaaaaaaaaat ccatgtgaaa gtaataaaat actgatggcc 625200

 tattggaggg cagggtgtggg acagagaagg gaacagccaa agactacatg tcctcctctc 625260
 tgtgtagtat aaaaatgaatc caaaccccaa aattaacctt aaattttaat ataaatagga 625320
 ccaaatgact ctaattgtat gtcatattag taaaatggct ctgcaggtgc ttgtcaccaa 625380
 gtctggccat ctgagtttga tcctcaagac atcatgggga ccatccccag gtccacatgg 625440
 caggaagaga gaagcaatta gagcaagctg tccttgccct ctgtggggca tgatagacac 625500
 agccacacc atccacacac ctccacacag acagaatgtg tgtgtgtgtg tgtgtgtgtg 625560
 tgtgtgtgtg tgtgtgtgtg tgtgtgtgtg ttcaaaggaa acaggatgtt tagacattaa 625620

 aaagcaaaga agaataatg actgaaatgc tttggggtat actactttta ctatatgaat 625680
 gtagtaagat atttgttctt tcctcctctc tctcacacac acacagagtg ctctcctctc 625740
 ctctcctctc cacacacaca cacagagaga gagagggaga gagagagaga gagagagaga 625800
 gagagagaga aacagaggat tcctaattag gaaaagcttc atctccatcc tcttcctcca 625860
 ctttctcct cccagggaac ttgagctggc tgcagcatgc ttgatactcc aggaatgcca 625920
 ggtatgcgag atcaatccca ggagggcttc tgggcaacca tgcattggtc cectcaagtc 625980
 agctcacctc ctctgcccc ccacctccgc agtgtgcttc atgacttcac cctgctcatt 626040

 gctgttgtgt gggaggccca ggatgagggt acagccagca aaaccaacc cagctcatca 626100
 ggaaaactca ctggcctgat tcatcagagt ctgctgggga cagacaggaa gaacctgcc 626160
 tggggccttt ccatgctgtg ttgaacatgg gcagcctcaa gctgttttca cttgacaaac 626220
 atcatgggta ccattgac tagctcttgg tctcctaaga gacacacaag caaagataaa 626280
 atgacacacc ctcttagga gatgagccca ggatttccta cccgggaggc tgaacaagg 626340
 agatagtggg aagcctgcag caacgatagg ggccacctct gacccacag acctcccc 626400
 cacctcaagg tcctcagca ccagctggga aatgtaagca tggactcccc agaagccgga 626460

 gaaggcagct ggaggcagat gtctctgtg tttctctgtg gagtctgtg tccagcattt 626520
 cctaggtgat aaacatggct tgtctagaag tttggattca gtggatggaa ggacttcaca 626580
 tccagcagct gtcttagctg gttcttgcca tccagaaaat tgggggacca ctgtgcagac 626640
 tgctttcggt ttagtaccaa aggtatcttg tctcctgttc tgtcccttcc tgaggtccac 626700
 tcagaagaga caggccctt tggcctgagc ccctgtgcc acacacactc agcaaaaaca 626760
 tggtcacgcc cacaggagga catcaagaga ccaccataac tcttctgtc tcattacca 626820
 ccccacttac ttgctcacc cagaggtgac tctccttctc tgagcacctg cttcccttgg 626880

cttctcccat tcttcttccc tcagttgttg aaatgccaaa gggaattacg agctaaaatt 626940
 tgcagaattg attggctgga atccatttca gcagtcaccag aggaaggcaa tgagctcaca 627000
 agaagctcta cagaggcagc atgggtgtgc ttcccaccat gagtgggtca ttccaccctg 627060
 atttctccaa cctcattgta atttttttgt agtgttttct cccagaacca taagcataga 627120
 ctctgaagta agatctctgt gttagttgtt tcatttttgt aaccggagc aggcttcctt 627180
 aaaaggaaaa gaggtttatt tagctcacag tctggggacc taagcatggt ccaggctcta 627240
 gtgaggcccc tactgatttc attgtgacag attgtctatg ttttctctg tgcactctgtg 627300

 tctggctctt gtccacctc ttagaagcc accaaaattc aatcatgcag ctccaccctg 627360
 atggccttac taaatctagt gccttcctag gcttggcctt cacacatttt gaagttacag 627420
 tatgtcctta cccttataaa atgggtgtgt tactttatth acttatatth ttaattatat 627480
 atgtgcatgt ataatgtaat tatcgccagg gatgcacgtg tactttcatg tatatggatg 627540
 gaagtcagag aacagccctt aggaactggc ttctaaactc taccatgcag attcaggagag 627600
 ctaaattcag gtccctaacct catcggaag ccctttacc cactgaacca tcttgccagc 627660
 cccagttcct acctcccaa gccattaatc catggcttac aggagtaagc tcttggtga 627720

 atttgaaag caaacatag aacctgtat gcttgttcgg ctggatgatc ttggtgtaca 627780
 aatcaagta catgtgaaa agtacacgtc cttctgaca gaatcatcct agctctaaaa 627840
 tgtcccagg atcaccctc tcttcagct ctgtgacctg cagcatgcaa cctctttggg 627900
 actaattgta ctccaagttt gccctctcc tcagccaatg tcttcagct gtggcacc 627960
 cagcattact ggagtacta ccaacacca ggctttacct tcacaacatc acacaatggc 628020
 ctctgagge ctctttgtag gtatccagac cccaccacac atttctggc ttcagttgca 628080
 ctctgaaact atggagcaag tctccctgct cctcagacc tatactttc acacctccag 628140

 agagagctgc acatggacca tgctgctgag tgctgctcca gcttgaatg gaggtctctg 628200
 agtatgcagt ttaccccc ggacagtctt cattccccca gggcagtgca ggagatgaat 628260
 ctctggtgat gagtctagtt tctcagttac agatgaaaaa ctggtttctc agttacagct 628320
 actcctgaaa ggatgctgcc ttgaaacatc cttgtaaata aatccatcat ctttaaatct 628380
 gtctttgctc aggttcttaa gatggaagca caatgaagcc atactcttg ccaaaattcc 628440
 tcaatggccc cttgcttagc tgctgggaga ggcctgttc cctctgaaag gttgacagc 628500
 aggectccag tctgatttc tctcagcacc tttctttcaa gctccacca ggagctggag 628560

 agatggctca gaggtaaaga gcaactggctg ctctccaga ggtcctgagt tcaattcca 628620
 gcacttacat tgtggctcaa gctctacca ggagctggag agatggctca gaggttaaga 628680
 gcaatggctg ctctccaga ggaccaagc tgaattcca gcaacaacat ggtgggtcaa 628740

gcttgtaag ctctgctcca gcacaccaag gctttcctga cactgattat caagtctgc 628800
 tacattccag gcacaaaaca gtttgagagg ccaaagaatc acatgttcag attcctcacc 628860
 tcatacaac ttctgtctta gcttcttttc ctgtgataaa attgtctcat gaaagtaact 628920
 gaagggagaa aggggtgatt tagcttatag ttccactcgc tgcggcagga ggcagcagct 628980

 gctgatcatt tcattccatag ccaggaaaca gatggtgatg tgtgtccatg ttcagctcac 629040
 tctcacctt teattccatt cagagcccag cccaggaacc gatgccatcc atattcccgg 629100
 tgagtgttct tacctagatt gaccaatta agacaatccc tcacagacag gccacaggc 629160
 caagcttate tagacagccc ctcatlaaga gcccttctc aggtgactcc agatcctgcc 629220
 aagttgacaa ttgaaatcat ccatcacat actcaacatc attagtcgtt aggaaaatgc 629280
 aatcaaagc cacaatgaaa tgctactgta tgtcatgtag gaaaagttgt aatttattaa 629340
 agaaaacaag tgttggtgag gatatagaaa agctcaaata cttgctagca gtaacatgaa 629400

 gtggtatttc agtggataaa tggataaaca taccatgga tatccatacc tctgtgtgtg 629460
 tgtgtgtgtg tgtgtgtgtg tgtgtgtgcg cgcgcgcgcg cgcgcgcgcg cgcgcgtgtc 629520
 ccttgtctat aaactaccgg cccggcaagc cctgcaagcc agggagaggt atggaatcca 629580
 taccataaaa aaaggaatga agtagtgata tatgctacaa catggataaa cctcaaata 629640
 tactaaacaa aaacagtga atataggaga ttgtattgta tgaatatcc aaagcagga 629700
 aattcagaat gtctggaagc agcttgggag ttgtgggaag ctgggagtgat ggatgtgatg 629760
 gggaataatg ggaattttgg cttagttagc atgggccttt gttctaagga actggaagga 629820

 agtggtggtt aggaaaatgt agggatgga ctaaatgtta atgagttttc actttaagc 629880
 agttcatttg ggctagagat acagtcattg ctatgactc tgcataacat gcacaaggcc 629940
 caggggtcag tctctgcac cagaaatata tatactcact atatatgtag atatcatttt 630000
 gccacaaaat gatctatfff gtagtgcaaa tattggccca attaaaaag gggggaagga 630060
 gagtagatag ttctgaattg cctgaagccc tgagtaggtt cttggaaggt gtcacctgga 630120
 tccgaacctt acaaaagaaa tcaaaaagga aggacatggc tgctcctagg tatggtggag 630180
 gagaaagttt actgtagaca aaatgcagaa catagtcaaa ggcggagaca tctgggagag 630240

 tccagagtga atatgacct gatccaggcc atgtgaggag tgcagggagg aggatggagg 630300
 agagagccag gaaaataaag gtagacaaa gggcgggcaa ctaaaatggt tgattctgta 630360
 gggaagggca ggccagcctc tggggtgcag agttcagggt agagcagctg tgccagccat 630420
 agcctgtagg gactgagggg tgctgggaga acctggcagc caggccact tttatttgtt 630480
 aaataagcac ctcagtttag tgtttgtecc aggtttgaga accaacatct gtgacattat 630540
 ccaaccagc tctccctcca gccattgcag atctgcagta acatgtgcac atatggccca 630600

cctccgctgg aaggtcatag cctctggcct cattccccca gccattgaag accacaaggg 630660

ttgacaatag atctccataa ccacaggtca gacctacttc tgacccttcc taaccgtttg 630720

cttagcttta caaccacata aaagcaaagc acttgggtcac aaatccaact ttgagccacc 630780

caatagactc tggatgataa atgaaaactc acaactgaag taattctatc tagcagtttc 630840

agcttggcca ttttaagcaa atagccacag aaggaagtaa cgataatcta ccctttgttc 630900

taattttaaa atgtgaataa ttaactttcc aggaggaaga ataacacaga cttttaagag 630960

tggttcaacc taataaatgt ccaattttaa aacagcttag aactgctggc ctaacagcc 631020

accttgattt attacagtgg taattcacat gtgaccagcc agaaccgcag atgaactgcc 631080

ctgcccagca ccgtactct gtggttgggc acttgaatgc tagataaacac tgaggcttgc 631140

agggtctgga gtttatagag aaagacacg cgcgcgcgca cgcacacgtc cacatacaca 631200

caaacacaga gagagagaga gagagagaca gagacagaga cagagagaca gagagaaaga 631260

gagagaaagc aggcattgtg gcttattcct ataatcccag aactctgaag gctgaggcgt 631320

gaggagcgtg agttcgaagc tagcctgggc aacatagcaa aatcctgttt caaaaacaaa 631380

gcagaacaga gtctccaggg aattcacatc ccaatttatt cagaggcttc agactgtcca 631440

tgcgttatga ggctcaaag ctctaaaga agggagagga aatgggaaaa gagcaagagg 631500

gaaagaggag agggatgagg aggaaacatc ataaagaaat ttggacacca atctattcct 631560

tggtttcaga agtgaataac cctggagaca actaaacatt aaccaattct gactggcctc 631620

tggcatctca ggactcfaat aggagcctgg cttaactaa ccagctaaag gcagagtggg 631680

gcaagtggct cagtcaatga ggtgtttgtt ctgaaggcat gaggacctga attcaacacc 631740

aggacctgca gaagctgctg gtggtggcac acttgggaacc ccaggtctga ggaagtgcag 631800

acagacagct cctgaggctt actggccagc cagcctacct acattatgag ttccagacca 631860

atgagagacc ttgtctcga acaacacagg gtacagacag ctctgagga gcaatgtcca 631920

aggttgatct tgggtgggcg tgtgtgtgtg tgtgcacgcg cgcgcgcaca cacacacaca 631980

cacacacac 631989

<210> 38

<211> 23

<212> DNA

<213> Unknown

<220><221> source

<223> /note="Description of Unknown:
 CPEB2A Target Sequence"

<400> 38
 aggggcaaca cagtctgctg cta 23
 <210> 39
 <211> 23
 <212> DNA
 <213> Unknown
 <220><221> source
 <223> /note="Description of Unknown:
 CPEB2B Target Sequence"

<400> 39
 aagctgtatt agctttgctg cta 23
 <210> 40
 <211> 22
 <212> DNA
 <213> Unknown
 <220><221> source
 <223> /note="Description of Unknown:
 SRPR-alpha Target Sequence"

<400> 40
 taatcatggt acaatcactg cc 22
 <210> 41
 <211> 23
 <212> DNA
 <213> Unknown
 <220><221> source
 <223> /note="Description of Unknown:
 CNTFR Target Sequence"

<400> 41
 caccatcaga ttataagctc ctg 23
 <210> 42
 <211> 21
 <212> DNA
 <213> Unknown

<220><221> source
 <223> /note="Description of Unknown:
 EIF3A Target Sequence"
 <400> 42
 cagtctaaat tgaattcttt a 21
 <210> 43
 <211> 20
 <212> DNA
 <213> Artificial Sequence
 <220><221> source
 <223> Synthetic primer
 <400> 43
 tttgggacgt ttctgagtc 20
 <210> 44
 <211> 20
 <212> DNA
 <213> Artificial Sequence
 <220><221> source
 <223> Synthetic primer

 <400> 44
 ctcatccacc acctgttcc 20
 <210> 45
 <211> 20
 <212> DNA
 <213> Artificial Sequence
 <220><221> source
 <223> Synthetic primer
 <400> 45
 gcaagaccgg atgttcaaat 20
 <210> 46
 <211> 20
 <212> DNA
 <213> Artificial Sequence
 <220><221> source

<223> Synthetic primer
 <400> 46
 cctcaaccac gtgaccttt 20
 <210> 47
 <211> 20
 <212> DNA
 <
 213> Artificial Sequence
 <220><221> source
 <223> Synthetic primer
 <400> 47
 ctgcagacaa tgcgagagaa 20
 <210> 48
 <211> 20
 <212> DNA
 <213> Artificial Sequence
 <220><221> source
 <223> Synthetic primer
 <400> 48
 cgacagaaac gggttgagat 20
 <210> 49
 <211> 20
 <212> DNA
 <213> Artificial Sequence
 <220><221> source
 <223> Synthetic primer
 <400> 49
 gaggacatt cgggaccagt 20

 <210> 50
 <211> 20
 <212> DNA
 <213> Artificial Sequence
 <220><221> source
 <223> Synthetic primer

<400> 50
 gtctctgccca ttgaggtggt 20

<210> 51
 <211> 20
 <212> DNA
 <213> Artificial Sequence
 <220><221> source
 <223> Synthetic primer

<400> 51
 gaggacctgt ggcatgtttg 20

<210> 52
 <211> 20
 <212> DNA
 <213> Artificial Sequence
 <220><221> source
 <223> Synthetic primer

<400> 52
 cattttagga cggcgggtag 20

<210> 53
 <211> 20
 <212> DNA
 <213> Artificial Sequence
 <220><221> source
 <223> Synthetic primer

<400> 53
 gaagtcctgt ggtgagctgt 20

<210> 54
 <211> 20
 <212> DNA
 <213> Artificial Sequence
 <220><221> source
 <223> Synthetic primer

<400> 54
 tggccagaaa atccagcagg 20

<210> 55
 <211> 20
 <212> DNA
 <213> Artificial Sequence
 <220><221> source
 <223> Synthetic primer
 <400> 55
 ctggaaggtg ctgaggtacg 20

<210> 56
 <211> 20
 <212> DNA
 <213> Artificial Sequence
 <220><221> source
 <223> Synthetic primer
 <400> 56
 ctcagctcct cggtcacatc 20

<210> 57
 <211> 20
 <212> DNA
 <213> Artificial Sequence
 <220><221> source
 <223> Synthetic primer
 <400> 57
 ctttgtagc tgcttcca 20

<210> 58
 <211> 20
 <212> DNA
 <213> Artificial Sequence
 <220><221> source
 <223> Synthetic primer
 <400> 58
 gtatcctaac gccagaccg 20

<210> 59

<211> 20
 <212> DNA
 <213> Artificial Sequence
 <220><221> source
 <223> Synthetic primer
 <400> 59
 taataaactc cccgggcagc 20
 <210> 60
 <211> 18
 <212> DNA
 <213> Artificial Sequence
 <220><221> source
 <223> Synthetic primer
 <400> 60
 acaacgcgtg gacttctc 18
 <210> 61
 <211> 20
 <212> DNA
 <213> Artificial Sequence
 <220><221> source
 <223> Synthetic primer
 <400> 61
 cactcttccg tggctcggcg 20

 <210> 62
 <211> 19
 <212> DNA
 <213> Artificial Sequence
 <220><221> source
 <223> Synthetic primer
 <400> 62
 gttgtctgac gtcgcacac 19
 <210> 63
 <211> 20
 <212> DNA

<213> Artificial Sequence
 <220><221> source
 <223> Synthetic primer
 <400> 63
 tttccaaggg ttgagtcgca 20
 <210> 64
 <211> 20
 <212> DNA
 <213> Artificial Sequence
 <220><221> source
 <223> Synthetic primer
 <400> 64
 gaatttgcaa gcggggtctt 20

 <210> 65
 <211> 20
 <212> DNA
 <213> Artificial Sequence
 <220><221> source
 <223> Synthetic primer
 <400> 65
 cgacatccgc aaagacctct 20
 <210> 66
 <211> 21
 <212> DNA
 <213> Artificial Sequence
 <220><221> source
 <223> Synthetic primer
 <400> 66
 aggatgctta gctcaccttg a 21
 <210> 67
 <211> 29
 <212> DNA
 <213> Artificial Sequence
 <220><221> source

<223> Synthetic primer
 <400> 67
 ggagttcaaa gccagcttat accaacatg 29

<210> 68
 <211> 27
 <212> DNA
 <213> Artificial Sequence
 <220><221> source
 <223> Synthetic primer
 <400> 68
 gctaaagttg gtatggcagc ctgcacc 27

<210> 69
 <211> 23
 <212> DNA
 <213> Artificial Sequence
 <220><221> source
 <223> Synthetic primer
 <400> 69
 ggatcactct cggcatggac gag 23

<210> 70
 <211> 25
 <212> DNA
 <213> Artificial Sequence
 <220><221> source
 <223> Synthetic primer
 <400> 70
 cctcttcttc agccacagtc acttc 25

<210> 71
 <211> 20
 <212> DNA
 <213> Artificial Sequence
 <220><221> source
 <223> Synthetic primer

<400> 71
gcagcacgaa caagagtcac 20
<210> 72
<211> 20
<212> DNA
<213> Artificial Sequence
<220><221> source
<223> Synthetic primer
<400> 72
gaacctgcgt gcaatccatc 20
<210> 73
<211> 25
<212> DNA
<213> Artificial Sequence
<220><221> source
<223> Synthetic primer
<400> 73
ggacatatct gggatgaagg agctg 25
<210> 74
<211> 30
<212> DNA
<213> Artificial Sequence
<220><221> source
<223> Synthetic primer
<400> 74
cagccgcacg gtaggcttgt actcggatc 30