



(21) (A1) **2,298,553**
(22) 1997/09/23
(43) 1998/04/02
(62) 2,266,454
(22) 1997/09/23

(72) BERTHON-JONES, MICHAEL, AU

(71) RESMED LIMITED, AU

(51) Int.Cl.⁷ A61M 16/00, A61B 5/087

(30) 1996/09/23 (PO 2474) AU

(30) 1997/08/14 (PCT/AU97/00517) AU

(54) **METHODE DE FOURNIR DE L'ASSISTANCE RESPIRATOIRE
CHEZ UN SUJET RESPIRANT SPONTANEMENT**

(54) **METHOD FOR PROVIDING VENTILATORY ASSISTANCE IN A
SPONTANEOUSLY BREATHING SUBJECT**

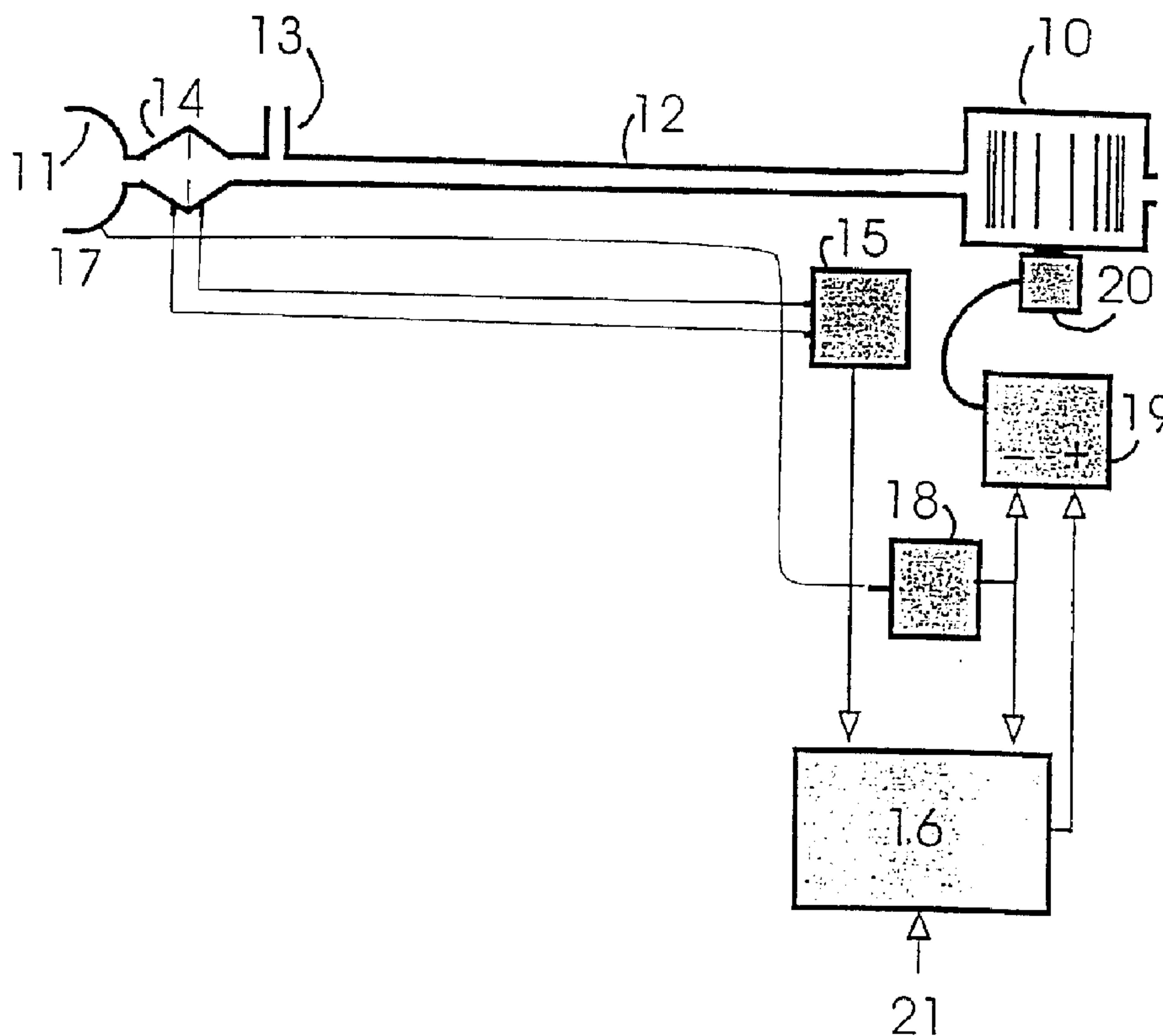

(57) The apparatus provides for the determination of the instantaneous phase in the respiratory cycle, subject's average respiration rate and the provision of ventilatory assistance. A microprocessor receives an airflow signal from a pressure transducer coupled to a port at a mask. The microprocessor controls a servo that in turn controls the fan motor and thus the pressure of air delivered by the blower. The blower is coupled to a subject's mask by a conduit. The invention seeks to address the following goals: while the subject is awake and making substantial efforts the delivered assistance should be closely matched in phase with the subject's efforts; the machine should automatically adjust the degree of assistance to maintain at least a specified minimum ventilation without relying on the integrity of the subject's chemoreflexes; and it should continue to work correctly in the presence of large leaks.

**"METHOD FOR PROVIDING VENTILATORY
ASSISTANCE IN A SPONTANEOUSLY BREATHING SUBJECT"**

Abstract of the Disclosure

5 The apparatus provides for the determination of the
instantaneous phase in the respiratory cycle, subject's average respiration
rate and the provision of ventilatory assistance. A microprocessor receives
an airflow signal from a pressure transducer coupled to a port at a mask.
The microprocessor controls a servo that in turn controls the fan motor and
10 thus the pressure of air delivered by the blower. The blower is coupled to a
subject's mask by a conduit. The invention seeks to address the following
goals: while the subject is awake and making substantial efforts the
delivered assistance should be closely matched in phase with the subject's
efforts; the machine should automatically adjust the degree of assistance to
15 maintain at least a specified minimum ventilation without relying on the
integrity of the subject's chemoreflexes; and it should continue to work
correctly in the presence of large leaks.

"METHOD FOR PROVIDING VENTILATORY ASSISTANCE IN A SPONTANEOUSLY BREATHING SUBJECT"

Field of the Invention

5 The invention relates to a method for the provision of ventilatory assistance matched to a subject's respiratory need. The ventilatory assistance can be for a subject who is spontaneously breathing, or moves between this breathing state. The invention is especially suitable for, but not limited to, spontaneously breathing human subjects requiring
10 longterm ventilatory assistance, particularly during sleep.

 This application is a divisional application of application Serial No. 2,266,454, filed September 23, 1997.

Background of the Invention

 Subjects with severe lung disease, chest wall disease,
15 neuromuscular disease, or diseases of respiratory control may require in-hospital mechanical ventilatory assistance, followed by longterm home mechanical ventilatory assistance, particularly during sleep. The ventilator delivers air or air enriched with oxygen to the subject, via an interface such as a nose mask, at a pressure that is higher during inspiration and lower
20 during expiration.

 In the awake state, and while waiting to go to sleep, the subject's ventilatory pattern is variable in rate and depth. Most known ventilatory devices do not accurately match the amplitude and phase of mask pressure to the subject's spontaneous efforts, leading to discomfort or
25 panic. Larger amounts of asynchrony also reduce the efficiency of the device. During sleep, there are changes in the neural control of breathing as well as the mechanics of the subject's airways, respiratory muscles and chest wall, leading to a need for substantially increased ventilatory support. Therefore, unless the device can automatically adjust the degree of support,
30 the amplitude of delivered pressure will either be inadequate during sleep, or must be excessive in the awake state. This is particularly important in

- 1a -

subjects with abnormalities of respiratory control, for example, central hypoventilation syndromes, such as Obesity Hypoventilation Syndrome, where there is inadequate chemoreceptor drive, or Cheyne Stokes breathing such as in patients with severe cardiac failure or after a stroke, where there
5 is excessive or unstable chemoreceptor drive.

Furthermore, during sleep there are inevitably large leaks between mask and subject, or at the subject's mouth if this is left free. Such leaks worsen the error in matching the phase and magnitude of the machine's effort to the subject's needs, and, in the case of mouth leak,
10 reduce the effectiveness of the ventilatory support.

Ideally a ventilatory assistance device should simultaneously address the following goals:

(i) While the subject is awake and making substantial ventilatory efforts, the delivered assistance should be closely matched in phase with the patient's efforts.

5 (ii) The machine should automatically adjust the degree of assistance to maintain at least a specified minimum ventilation, without relying on the integrity of the subject's chemoreflexes.

(iii) It should continue to work correctly in the presence of large leaks.

10 Most simple home ventilators either deliver a fixed volume, or cycle between two fixed pressures. They do so either at a fixed rate, or are triggered by the patient's spontaneous efforts, or both. All such simple devices fail to meet goal (ii) of adjusting the degree of assistance to maintain at least a given ventilation. They also largely fail to meet goal (i) of closely matching the subjects respiratory phase: timed devices make
15 no attempt to synchronize with the subject's efforts; triggered devices attempt to synchronize the start and end of the breath with the subject's efforts, but make no attempt to tailor the instantaneous pressure during a breath to the subject's efforts. Furthermore, the triggering tends to fail in the presence of leaks, thus failing goal (iii).

20 The broad family of servo-ventilators known for at least 20 years measure ventilation and adjust the degree of assistance to maintain ventilation at or above a specified level, thus meeting goal (ii), but they still fail to meet goal (i) of closely matching the phase of the subject's spontaneous efforts, for the reasons given above. No attempt is made to meet goal (iii).

25 Proportional assistist ventilation (PAV), as taught by Dr Magdy Younes, for example in *Principles and Practice of Mechanical Ventilation*, chapter 15, aims to tailor the pressure vs time profile within a breath to partially or completely unload the subject's resistive and elastic work, while minimizing the airway pressure required to
30 achieve the desired ventilation. During the inspiratory half-cycle, the administered pressure takes the form:

$$P(t) = P_0 + R.f_{RESP}(t) + E.V(t)$$

35 where R is a percentage of the resistance of the airway, $f_{RESP}(t)$ is the instantaneous respiratory airflow at time t, E is a percentage of the elastance of lung and chest wall, and V(t) is the volume inspired since the start of inspiration to the present moment. During the expiratory half-cycle, V(t) is taken as zero, to produce passive expiration.

An advantage of proportional assist ventilation during spontaneous breathing is that the degree of assistance is automatically adjusted to suit the subject's immediate needs and their pattern of breathing, and is therefore comfortable in the spontaneously breathing subject. However, there are at least two important disadvantages. Firstly, $V(t)$ is calculated as the integral of flow with respect to time since the start of inspiration. A disadvantage of calculating $V(t)$ in this way is that, in the presence of leaks, the integral of the flow through the leak will be included in $V(t)$, resulting in an overestimation of $V(t)$, in turn resulting in a runaway increase in the administered pressure. This can be distressing to the subject. Secondly, PAV relies on the subject's chemoreceptor reflexes to monitor the composition of the arterial blood, and thereby set the level of spontaneous effort. The PAV device then amplifies this spontaneous effort. In subjects with abnormal chemoreceptor reflexes, the spontaneous efforts may either cease entirely, or become unrelated to the composition of the arterial blood, and amplification of these efforts will yield inadequate ventilation. In patients with existing Cheyne Stokes breathing during sleep, PAV will by design amplify the subject's waxing and waning breathing efforts, and actually make matters worse by exaggerating the disturbance. Thus PAV substantially meets goal (i) of providing assistance in phase with the subject's spontaneous ventilation, but cannot meet goal (ii) of adjusting the depth of assistance if the subject has inadequate chemoreflexes, and does not satisfactorily meet goal (iii).

Thus there are known devices that meet each of the above goals, but there is no device that meets all the goals simultaneously. Additionally, it is desirable to provide improvements over the prior art directed to any one of the stated goals.

Therefore, the present invention seeks to achieve, at least partially, one or more of the following:

(i) to match the phase and degree of assistance to the subject's spontaneous efforts when ventilation is well above a target ventilation,

(ii) to automatically adjust the degree of assistance to maintain at least a specified minimum average ventilation without relying on the integrity of the subject's chemoreflexes and to damp out instabilities in the spontaneous ventilatory efforts, such as Cheyne Stokes breathing.

(iii) to provide some immunity to the effects of sudden leaks.

Disclosure of the Invention

In what follows, a fuzzy membership function is taken as returning a value between zero and unity, fuzzy intersection $A \text{ AND } B$ is the smaller of A and B , fuzzy union $A \text{ OR } B$ is the larger of A and B , and fuzzy negation $\text{NOT } A$ is $1 - A$.

The invention discloses the determination of the instantaneous phase in the respiratory cycle as a continuous variable.

The invention further discloses a method for calculating the instantaneous phase in the respiratory cycle including at least the steps of determining that if the instantaneous airflow is small and increasing fast, then it is close to start of inspiration, if the instantaneous airflow is large and steady, then it is close to mid-inspiration, if the instantaneous airflow is small and decreasing fast, then it is close to mid-expiration, if the instantaneous airflow is zero and steady, then it is during an end-expiratory pause, and airflow conditions intermediate between the above are associated with correspondingly intermediate phases.

The invention further discloses a method for determining the instantaneous phase in the respiratory cycle as a continuous variable from 0 to 1 revolution, the method comprising the steps of:

selecting at least two identifiable features F_N of a prototype flow-vs-time waveform $f(t)$ similar to an expected respiratory flow-vs-time waveform, and for each said feature:

determining by inspection the phase ϕ_N in the respiratory cycle for said feature, assigning a weight W_N to said phase,

defining a "magnitude" fuzzy set M_N whose membership function is a function of respiratory airflow, and a "rate of change" fuzzy set C_N , whose membership function is a function of the time derivative of respiratory airflow, chosen such that the fuzzy intersection M_N AND C_N will be larger for points on the generalized prototype respiratory waveform whose phase is closer to the said feature F_N than for points closer to all other selected features,

setting the fuzzy inference rule R_N for the selected feature F_N to be: *If flow is M_N and rate of change of flow is C_N then phase = ϕ_N , with weight W_N .*

measuring leak-corrected respiratory airflow,

for each feature F_N calculating fuzzy membership in fuzzy sets M_N and C_N ,

for each feature F_N applying fuzzy inference rule R_N to determine the fuzzy extent $Y_N = M_N$ AND C_N to which the phase is ϕ_N , and

applying a defuzzification procedure using Y_N at phases ϕ_N and weights W_N to determine the instantaneous phase ϕ .

Preferably, the identifiable features include zero crossings, peaks, inflection points or plateaus of the prototype flow-vs-time waveform. Furthermore, said weights can be unity, or chosen to reflect the anticipated reliability of deduction of the particular feature.

5 The invention further discloses a method for calculating instantaneous phase in the respiratory cycle as a continuous variable, as described above, in which the step of calculating respiratory airflow includes a low pass filtering step to reduce non-respiratory noise, in which the time constant of the low pass filter is an increasing function of an
10 estimate of the length of the respiratory cycle.

The invention further discloses a method for measuring the instantaneous phase in the respiratory cycle as a continuous variable as described above, in which the defuzzification step includes a correction for any phase delay introduced in the step of low pass filtering respiratory
15 airflow.

The invention further discloses a method for measuring the average respiratory rate, comprising the steps of:

measuring leak-corrected respiratory airflow,
from the respiratory airflow, calculating the instantaneous
20 phase ϕ in the respiratory cycle as a continuous variable from 0 to 1 revolution, calculating the instantaneous rate of change of phase $d\phi/dt$, and
calculating the average respiratory rate by low pass filtering
said instantaneous rate of change of phase $d\phi/dt$.

Preferably, the instantaneous phase is calculated by the
25 methods described above.

Another aspect of the present invention comprises a method for providing ventilatory assistance in a spontaneously breathing subject, comprising the steps, performed at repeated sampling intervals, of:

calculating the instantaneous phase ϕ in the respiratory cycle
30 as a continuous variable from 0 to 1 revolution,

- 5a -

selecting a desired pressure modulation amplitude A ,
calculating a desired instantaneous delivery pressure as a
function of an end expiratory pressure plus the desired pressure modulation
amplitude A multiplied by the value of a waveform template function $\Pi(\phi)$
5 at the calculated instantaneous phase ϕ , and
delivering pressure to said subject at the calculated desired
instantaneous delivery pressure.

The invention further discloses a method for providing
ventilatory assistance in a spontaneously breathing subject, comprising the
10 steps, performed at repeated sampling intervals, of:

ascribing a desired waveform template function $\Pi(\phi)$, with
domain 0 to 1 revolution and rate 0 to 1,
calculating the instantaneous phase ϕ in the respiratory cycle
as a continuous variable from 0 to 1 revolution,
15 selecting a desired pressure modulation amplitude A ,

calculating a desired instantaneous delivery pressure as an end expiratory pressure plus the desired pressure modulation amplitude A multiplied by the value of the waveform template function $\Pi(\phi)$ at the said calculated phase ϕ , and
setting delivered pressure to subject to the desired delivery pressure.

5

The invention further discloses a method for providing ventilatory assistance in a spontaneously breathing subject as described above, in which the step of selecting a desired pressure modulation amplitude is a fixed amplitude.

10

The invention further discloses a method for providing ventilatory assistance in a spontaneously breathing subject as described above, in which the step of selecting a desired pressure modulation amplitude in which said amplitude is equal to an elastance multiplied by an estimate of the subject's tidal volume.

15

The invention further discloses a method for providing ventilatory assistance in a spontaneously breathing subject as described above, in which the step of selecting a desired pressure modulation amplitude comprises the substeps of:

specifying a typical respiratory rate giving a typical cycle time,

specifying a preset pressure modulation amplitude to apply at said

20

typical respiratory rate,

calculating the observed respiratory rate giving an observed cycle

time, and

calculating the desired amplitude of pressure modulation as said preset

pressure modulation amplitude multiplied by said observed cycle time divided by the

25

said specified cycle time.

The invention further discloses a method for providing ventilatory assistance in a spontaneously breathing subject, including at least the step of determining the extent that the subject is adequately ventilated, to said extent the phase in the respiratory cycle
is determined from the subject's respiratory airflow, but to the extent that the subject's
ventilation is inadequate, the phase in the respiratory cycle is assumed to increase at a
pre-set rate, and setting mask pressure as a function of said phase.

The invention further discloses a method for providing ventilatory assistance in
a spontaneously breathing subject, comprising the steps of: measuring respiratory
airflow, determining the extent to which the instantaneous phase in the respiratory cycle
can be determined from said airflow, to said extent determining said phase from said
airflow but to the extent that the phase in the respiratory cycle cannot be accurately

- 7 -

determined, the phase is assumed to increase at a preset rate, and delivering pressure as a function of said phase.

The invention further discloses a method for calculating the instantaneous inspired volume of a subject, operable substantially without run-away under conditions of suddenly changing leak, the method comprising the steps of:

determining respiratory airflow approximately corrected for leak,

calculating an index **J** varying from 0 to 1 equal to the fuzzy extent to which said corrected respiratory airflow is large positive for longer than expected, or large negative for longer than expected,

identifying the start of inspiration, and

calculating the instantaneous inspired volume as the integral of said corrected respiratory airflow multiplied by the fuzzy negation of said index **J** with respect to time, from start of inspiration.

The invention further discloses a method "A" for providing ventilatory assistance in a spontaneously breathing subject, the method comprising the steps, performed at repeated sampling intervals, of:

determining respiratory airflow approximately corrected for leak,

calculating an index **J** varying from 0 to 1 equal to the fuzzy extent to which said respiratory airflow is large positive for longer than expected, or large negative for longer than expected,

calculating a modified airflow equal to said respiratory airflow multiplied by the fuzzy negation of said index **J**,

identifying the phase in the respiratory cycle,

calculating the instantaneous inspired volume as the integral of said modified airflow with respect to time, with the integral held at zero during the expiratory portion of the respiratory cycle,

calculating a desired instantaneous delivery pressure as a function at least of the said instantaneous inspired volume, and

setting delivered pressure to subject to the desired delivery pressure.

The invention further discloses a method "B" for providing ventilatory assistance in a spontaneously breathing subject, comprising the steps of:

determining respiratory airflow approximately corrected for leak,

calculating an index **J** varying from 0 to 1 equal to the fuzzy extent to which the respiratory airflow is large positive for longer than expected, or large negative for longer than expected,

identifying the phase in the respiratory cycle,

calculating a modified respiratory airflow equal to the respiratory airflow multiplied by the fuzzy negation of said index J ,

calculating the instantaneous inspired volume as the integral of the modified airflow with respect to time, with the integral held at zero during the expiratory portion
5 of the respiratory cycle,

calculating the desired instantaneous delivery pressure as an expiratory pressure plus a resistance multiplied by the instantaneous respiratory airflow plus a nonlinear resistance multiplied by the respiratory airflow multiplied by the absolute value of the respiratory airflow plus an elastance multiplied by the said adjusted
10 instantaneous inspired volume, and

setting delivered pressure to subject to the desired delivery pressure.

The invention yet further discloses a method "C" for providing assisted ventilation to match the subject's need, comprising the steps of:

15 describing a desired waveform template function $\Pi(\phi)$, with domain 0 to 1 revolution and range 0 to 1,

determining respiratory airflow approximately corrected for leak,

calculating an index J varying from 0 to 1 equal to the fuzzy extent to which the respiratory airflow is large positive for longer than expected, or large negative for
20 longer than expected,

calculating J_{PEAK} equal to the recent peak of the index J ,

calculating the instantaneous phase in the respiratory cycle,

calculating a desired amplitude of pressure modulation, chosen to servo-control the degree of ventilation to at least exceed a specified ventilation,

25 calculating a desired delivery pressure as an end expiratory pressure plus the calculated pressure modulation amplitude A multiplied by the value of the waveform template function $\Pi(\phi)$ at the said calculated phase ϕ , and

setting delivered pressure to subject to said desired instantaneous delivered pressure.

30

The invention yet further discloses a method for providing assisted ventilation to match the subject's need, as described above, in which the step of calculating a desired amplitude of pressure modulation, chosen to servo-control the degree of ventilation to at least exceed a specified ventilation, comprises the steps of:

35 calculating a target airflow equal to twice the target ventilation divided by the target respiratory rate,

deriving an error term equal to the absolute value of the instantaneous low pass filtered respiratory airflow minus the target airflow, and

calculating the amplitude of pressure modulation as the integral of the error term multiplied by a gain, with the integral clipped to lie between zero and a maximum.

The invention yet further discloses a method for providing assisted ventilation to match the subject's need, as described above, in which the step of calculating a desired amplitude of pressure modulation, chosen to servo-control the degree of ventilation to at least exceed a specified ventilation, comprises the following steps:

calculating a target airflow equal to twice the target ventilation divided by the target respiratory rate,

10 deriving an error term equal to the absolute value of the instantaneous low pass filtered respiratory airflow minus the target airflow,

calculating an uncorrected amplitude of pressure modulation as the integral of the error term multiplied by a gain, with the integral clipped to lie between zero and a maximum,

15 calculating the recent average of said amplitude as the low pass filtered amplitude, with a time constant of several times the length of a respiratory cycle, and

setting the actual amplitude of pressure modulation to equal the said low pass filtered amplitude multiplied by the recent peak jamming index J_{PEAK} plus the uncorrected amplitude multiplied by the fuzzy negation of J_{PEAK} .

The invention yet further discloses a method for providing assisted ventilation to match the subject's need, and with particular application to subjects with varying respiratory mechanics, insufficient respiratory drive, abnormal chemoreceptor reflexes, hypoventilation syndromes, or Cheyne Stokes breathing, combined with the advantages of proportional assist ventilation adjusted for sudden changes in leak, comprising the steps, performed at repeated sampling intervals, of:

30 calculating the instantaneous mask pressure as described for methods "A" or "B" above,

calculating the instantaneous mask pressure as described for method "C" above,

calculating a weighted average of the above two pressures, and setting the mask pressure to the said weighted average.

35

The invention yet further discloses apparatus to give effect to each one of the methods defined, including one or more transducers to measure flow and/or pressure, processor means to perform calculations and procedures, flow generators for the supply

of breathable gas at a pressure above atmospheric pressure and gas delivery means to deliver the breathable gas to a subject's airways.

The apparatus can include ventilators, ventilatory assist devices, and CPAP devices including constant level, bi-level or auto-setting level devices.

It is to be understood that while the algorithms embodying the invention are explained in terms of fuzzy logic, approximations to these algorithms can be constructed without the use of the fuzzy logic formalism.

Brief Description of the Drawings

A number of embodiments will now be described with reference to the accompanying drawings in which:

Figs. 1a and 1b show apparatus for first and second embodiments of the invention respectively;

Fig. 2 is a pressure waveform function $\Pi(\Phi)$ used in the calculation of the desired instantaneous delivery pressure as a function of the instantaneous phase Φ in the respiratory cycle for a first embodiment of the invention;

Fig. 3 shows fuzzy membership functions for calculating the degree of membership in each of five magnitude fuzzy sets ("large negative", "small negative", "zero", "small positive", and "large positive") from the normalized respiratory airflow according to the first embodiment of the invention; and

Fig. 4 shows fuzzy membership functions for calculating the degree of membership in each of five rate of change fuzzy sets ("rising fast", "rising slowly", "steady", "falling slowly", and "falling fast") from the normalized rate of change of airflow according to the first embodiment of the invention;

Fig. 5 is a pressure waveform function $\Pi(\Phi)$ used in the calculation of the desired instantaneous delivery pressure as a function of the instantaneous phase Φ in the respiratory cycle for a second embodiment of the invention;

Fig. 6 shows calculation of a quantity "lead-in" as a function of time since the most recent mask off-on transition;

Fig. 7 shows a fuzzy membership function for fuzzy set A_I as a function of time since the most recent expiratory-to-inspiratory (negative-to-positive) zero crossing of the respiratory airflow signal, such that the membership function measures the extent to which the respiratory airflow has been positive for longer than expected;

Fig. 8 shows a membership function for fuzzy set B_I as a function of respiratory airflow, such that the membership function measures the extent to which respiratory airflow is large positive;

Fig. 9 shows an electrical analog of the calculation of a recent peak jamming index J_{PEAK} from the instantaneous jamming index J ;

Fig. 10 shows the calculation of the time constant τ used in low pass filtering steps in the calculation of the conductance of a leak, as a function of the recent peak jamming index J_{PEAK} .

Fig. 11 shows a prototypical respiratory flow-time curve, with time on the x-axis, marking nine features;

Fig. 12 shows membership functions for fuzzy sets "large negative", "small negative", "zero", "small positive", and "large positive" as functions of normalized respiratory airflow according to a second embodiment of the invention;

Fig. 13 shows membership functions for fuzzy sets "falling", "steady", and "rising" as functions of normalized rate of change of respiratory airflow df/dt according to a second embodiment of the invention;

Fig. 14 shows the membership function for fuzzy set "hypopnea";

Fig. 15 shows the calculation of the time constant τ for calculation of normalized recent ventilation, as a function of "servo gain" being the gain used for servo-control of minute ventilation to at least exceed a specified target ventilation;

Fig 16 shows the membership function for fuzzy set "hyperpnea" as a function of normalized recent ventilation;

Fig 17 shows the membership function for fuzzy set "big leak" as a function of leak;

Fig. 18 shows the membership functions for fuzzy sets "switch negative" and "switch positive" as a function of normalized respiratory airflow;

Fig. 19 shows the membership functions for fuzzy sets "insp_phase" and "exp_phase" as functions of the instantaneous phase in the respiratory cycle ϕ ;

Fig. 20 shows schematically how function $W(y)$, used in defuzzification, calculates the area (shaded) of an isosceles triangle of unit base and height cut off below height y ;

Figs. 21-26 show actual 60 second flow and pressure tracings from the second embodiment of the invention during operation; the vertical scale for flow (heavy trace) is ± 1 L/sec, inspiration upwards and the vertical scale for the pressure (light trace) is 0-25 cmH₂O; where:

Fig. 21 shows that a short central apnea (b) is permitted when effort ceases at point (c) after a preceding deep breath (a);

Fig. 22 shows that a central apnea is not permitted when effort ceases at arrow (a) without a preceding deep breath;

Fig. 23 is recorded with servo gain set high, and shows that a central apnea is no longer permitted when effort ceases at arrow (a) despite preceding deep breathing;

Fig. 24 shows automatically increasing end-inspiratory pressure as the subject makes voluntarily deeper inspiratory efforts;

Fig. 25 is recorded with a somewhat more square waveform selected, and shows automatically increasing pressure support when the subject voluntarily attempts to resist by stiffening the chest wall at point (a);

Fig. 26 shows that with sudden onset of a sever 1.4 L/sec leak at (a), the flow signal returns to baseline (b) within the span of a single breath, and pressure continues to cycle correctly throughout; and

Fig. 27 shows an actual 60 second tracing showing respiratory airflow (heavy trace, ± 1 L/sec full scale) and instantaneous phase (light trace, 0-1 revolution full scale).

Description of Preferred Embodiments

The two embodiments to be described are ventilators that operate in a manner that seeks to simultaneously achieve the three goals stated above.

First Embodiment

Apparatus to give effect to a first embodiment of the apparatus is shown in Fig. 1a. A blower 10 supplies a breathable gas to mask 11 in communication with the subject's airway via a delivery tube 12 and exhausted via a exhaust diffuser 13. Airflow to the mask 11 is measured using a pneumotachograph 14 and a differential pressure transducer 15. The mask flow signal from the transducer 15 is then sampled by a microprocessor 16. Mask pressure is measured at the port 17 using a pressure transducer 18. The pressure signal from the transducer 18 is then sampled by the microprocessor 16. The microprocessor 16 sends an instantaneous mask pressure request signal to the servo 19, which compares said pressure request signal with actual pressure signal from the transducer 18 to the control fan motor 20. The microprocessor settings can be adjusted via a serial port 21.

It is to be understood that the mask could equally be replaced with a tracheotomy tube, endotracheal tube, nasal pillows, or other means of making a sealed connection between the air delivery means and the subject's airway.

The microprocessor 16 is programmed to perform the following steps, to be considered in conjunction with Tables 1 and 2.

Table 1: Fuzzy Inference Rules for a first embodiment

N	Fuzzy Interference Rule					Fuzzy Phase
1	if size is	Zero	and rate of	Increasing	then phase is	Start Inspiration
2	if size is	Small	and rate of	Increasing	then phase is	Early Inspiration
		Positive	change is	Slowly		
3	if size is	Large	and rate of	Steady	then phase is	Peak Inspiration
		Positive	change is			
4	if size is	Small	and rate of	Decreasing	then phase is	Late Inspiration
		Positive	change is	Slowly		
5	if size is	Zero	and rate of	Decreasing	then phase is	Start Expiration
			change is	Fast		
6	if size is	Small	and rate of	Decreasing	then phase is	Early Expiration
		Negative	change is	Slowly		
7	if size is	Large	and rate of	Steady	then phase is	Peak Expiration
		Negative	change is			
8	if size is	Small	and rate of	Increasing	then phase is	Late Expiration
		Negative	change is	Slowly		
9	if size is	Zero	and rate of	Steady	then phase is	Expiratory Pause
			change is			
10	always				phase is	Unchanged

Table 2. Association of phases with fuzzy rules for a first embodiment.

N	Phase	Φ_N
1	Start Inspiration	0.0
2	Early Inspiration	values intermediate between 0.0 and 0.5
3	Peak Inspiration	
4	Late Inspiration	
5	Start Expiration	
6	Early Expiration	values intermediate between 0.5 and 1.0
7	Peak Expiration	
8	Late Expiration	
9	Expiratory Pause	
10	Unchanged	Φ

5

1. Set desired target values for the duration of inspiration TI_{TGT} , duration of expiration TE_{TGT} , and minute ventilation V_{TGT} . Choose suitable constants P_0 and A_{STD} where P_0 is the desired end expiratory pressure, and A_{STD} is the desired increase in pressure above P_0 at end inspiration for a breath of duration $TT_{TGT} = TI_{TGT} + TE_{TGT}$.

10

- 14 -

2. Choose a suitable pressure waveform function $\Pi(\Phi)$, such as that shown in Fig. 2, such that the desired delivery pressure at phase Φ will be given by:

$$P = P_0 + A \Pi(\Phi)$$

5 where the amplitude A equals the difference between the end inspiratory pressure and end expiratory pressure. However, other waveforms may be suitable for subjects with particular needs.

3. Initialize the phase Φ in the respiratory cycle to zero, and initialize the current estimates of actual inspiratory and expiratory duration TI and TE to TI_{TGT} and TE_{TGT} respectively.

4. Initialize the rate of change of phase during inspiration $\Delta\Phi_I$ between sampling intervals of length T to:

$$15 \quad \Delta\Phi_+ = 0.5 T / TI_{TGT}$$

5. Initialize the rate of change of phase during expiration $\Delta\Phi_E$ to:

$$\Delta\Phi_E = 0.5 T / TE_{TGT}$$

- 20 6. Measure the instantaneous respiratory airflow f_{RESP} .

7. Calculate the average total breath duration $TT = TI + TE$

8. Low pass filter the respiratory airflow with an adjustable time constant τ_f , where τ_f is a fixed small fraction of TT .

9. Calculate the instantaneous ventilation V , as half the absolute value of the respiratory airflow:

$$30 \quad V = 0.5 |f_{RESP}|$$

10. From the target ventilation V_{TGT} and the measured minute ventilation V , derive an error term V_{ERR} , such that large values of V_{ERR} indicate inadequate ventilation:

$$35 \quad V_{ERR} = \int (V_{TGT} - V) dt$$

11. Take V_{BAR} as the result of low pass filtering V with a time constant $\tau_{V_{BAR}}$ which is long compared with TT .

12. Calculate a normalized airflow f_{NORM} , where

$$f_{\text{NORM}} = f_{\text{RESP}}/V_{\text{BAR}}.$$

5

13. From f_{NORM} , calculate the degree of membership in each of the fuzzy sets whose membership functions are shown in Fig. 3.

10

14. Calculate a normalized rate of change $df_{\text{NORM}}/d\Phi$, equal to df_{NORM}/dt divided by the current estimate of the average respiratory cycle time TT .

15. From the normalized rate of change, calculate the degree of membership in each of the fuzzy sets shown in Fig. 4.

15

16. For each row N in Table 1, calculate the degree of membership g_N in the fuzzy set shown in the column labelled **Fuzzy Phase**, by applying the fuzzy inference rules shown.

20

17. Associate with the result of each of the N rules a phase Φ_N as shown in Table 2, noting that Φ_{10} is the current phase Φ .

18. Increase each of the Φ_N excepting Φ_{10} by $0.89 \tau/TT$, to compensate for the previous low pass filtering step.

25

19. Calculate a new instantaneous phase Φ_{INST} as the angle to the center of gravity of N unit masses at polar coordinates of radius g_N and angle Φ_N revolutions.

20. Calculate the *smallest signed difference* $\Delta\Phi_{\text{INST}}$ between the phase estimated in the previous step and the current phase.

30

$$\Delta\Phi_{\text{INST}} = 1 - (\Delta\Phi_{\text{INST}} - \Phi) \quad (\Phi_{\text{INST}} - \Phi > 0.5)$$

$$\Delta\Phi_{\text{INST}} = \Phi_{\text{INST}} - \Phi + 1 \quad (\Phi_{\text{INST}} - \Phi < -0.5)$$

$$\Delta\Phi_{\text{INST}} = \Phi_{\text{INST}} - \Phi \quad (\text{otherwise})$$

21. Derive a revised estimate $\Delta\Phi_{\text{REV}}$ equal to a weighted mean of the value calculated in the previous step and the average value ($\Delta\Phi_I$ or $\Delta\Phi_E$ as appropriate).

35

$$\Delta\Phi = (1-W) \Delta\Phi_I + W\Delta\Phi_{\text{INST}} \quad (0 < \Phi < 0.5)$$

$$\Delta\Phi = (1-W) \Delta\Phi_I + W\Delta\Phi_{\text{INST}} \quad (\text{otherwise})$$

Smaller values of W will cause better tracking of phase if the subject is breathing regularly, and larger values will cause better tracking of phase if the subject is breathing irregularly.

- 5 22. Derive a blending fraction B , such that the blending fraction is unity if the subject's ventilation is well above V_{TGT} , zero if the subject is breathing near or below V_{TGT} , and increasing proportionally from zero to unity as the subject's ventilation increases through an intermediate range.

- 10 23. Calculate $\Delta\Phi_{BLEND}$ influenced chiefly by $\Delta\Phi$ calculated in step 21 from the subject's respiratory activity if the subject's ventilation is well above V_{TGT} ; influenced chiefly by the target respiratory duration if the subject is breathing near or below V_{TGT} ; and proportionally between these two amounts if ventilation is in an intermediate range:

$$15 \quad \Delta\Phi_{BLEND} = B \Delta\Phi + 0.5 (1-B) T / TI_{TGT} \quad (0 < \Phi < 0.5)$$

$$\Delta\Phi_{BLEND} = B \Delta\Phi + 0.5 (1-B) T / TE_{TGT} \quad (\text{otherwise})$$

24. Increment Φ by $\Delta\Phi_{BLEND}$

- 20 25. Update the average rate of change of phase ($\Delta\Phi_I$ or $\Delta\Phi_E$ as appropriate).

$$\Delta\Phi_I = T/\tau_{VBAR} (\Delta\Phi_{BLEND} - \Delta\Phi_I) \quad (0 < \Phi < 0.5)$$

$$\Delta\Phi_E = T/\tau_{VBAR} (\Delta\Phi_{BLEND} - \Delta\Phi_E) \quad (\text{otherwise})$$

26. Recalculate the approximate duration of inspiration TI and expiration TE :

$$25 \quad TI = 0.5 T / \Delta\Phi_I$$

$$TE = 0.5 T / \Delta\Phi_E$$

27. Calculate the desired mask pressure modulation amplitude A_D :

$$30 \quad A_D = A_{STD} / 2 \quad (TT < TT_{STD} / 2)$$

$$A_D = 2 \cdot A_{STD} \quad (TT > 2 \cdot TT_{STD})$$

$$A_D = A_{STD} \cdot TT / TT_{STD} \quad (\text{otherwise})$$

28. From the error term V_{ERR} , calculate an additional mask pressure modulation amplitude A_E :

$$35 \quad A_E = K \cdot V_{ERR} \quad (\text{for } V_{ERR} > 0)$$

$$A_E = 0 \quad (\text{otherwise})$$

where larger values of K will produce a faster but less stable control of the degree of assistance, and smaller values of K will produce slower but more stable control of the degree of assistance.

- 5 29. Set the mask pressure P_{MASK} to:

$$P_{\text{MASK}} = P_0 + (A_D + A_E) \Pi(\Phi)$$

30. Wait for a sampling interval T , short compared with the duration of a respiratory cycle, and then continue at the step of measuring respiratory airflow.

10

Measurement of respiratory airflow

As follows from above, it is necessary to respiratory airflow, which is a standard procedure to one skilled in the art. In the absence of leak, respiratory airflow can be measured directly with a pneumotachograph placed between the mask and the exhaust. In the presence of a possible leak, one method disclosed in European Publication No 0 651 971 incorporated herein by cross-reference is to calculate the mean flow through the leak, and thence calculate the amount of modulation of the pneumotachograph flow signal due to modulation of the flow through the leak induced by changing mask pressure, using the following steps:

- 15
- 20 1. Measure the airflow at the mask f_{MASK} using a pneumotachograph
 2. Measure the pressure at the mask P_{MASK}
 3. Calculate the mean leak as the low pass filtered airflow, with a time constant long compared with a breath.
 4. Calculate the mean mask pressure as the low pass filtered mask pressure, with a
 - 25 time constant long compared with a breath.
 5. Calculate the modulation of the flow through the leak as:

$$\delta(\text{leak}) = 0.5 \text{ times the mean leak times the inducing pressure,}$$

where the inducing pressure is $P_{\text{MASK}} - \text{mean mask pressure}$.

- 30 Thence the instantaneous respiratory airflow can be calculated as:

$$f_{\text{RESP}} = f_{\text{MASK}} - \text{mean leak} - \delta(\text{leak})$$

A convenient extension as further disclosed in EP 0 651 971 (incorporated herein by cross-reference) is to measure airflow f_{TURBINE} and pressure P_{TURBINE} at the outlet of the turbine, and thence calculate P_{MASK} and f_{MASK} by allowing for the pressure drop down the air delivery hose, and the airflow lost via the exhaust:

- 35
1. $\Delta P_{\text{HOSE}} = K_1(F_{\text{TURBINE}}) - K_2(F_{\text{TURBINE}})^2$
 2. $P_{\text{MASK}} = P_{\text{TURBINE}} - \Delta P_{\text{HOSE}}$

$$3. F_{\text{EXHAUST}} = K_3 \sqrt{P_{\text{MASK}}}$$

$$4. F_{\text{MASK}} = F_{\text{TURBINE}} - F_{\text{EXHAUST}}$$

Alternative embodiment

5 The following embodiment is particularly applicable to subjects with varying respiratory mechanics, insufficient respiratory drive, abnormal chemoreceptor reflexes, hypoventilation syndromes, or Cheyne Stokes breathing, or to subjects with abnormalities of the upper or lower airways, lungs, chest wall, or neuromuscular system.

10 Many patients with severe lung disease cannot easily be treated using a smooth physiological pressure waveform, because the peak pressure required is unacceptably high, or unachievable with for example a nose-mask. Such patients may prefer a square pressure waveform, in which pressure rises explosively fast at the moment of commencement of inspiratory effort. This may be particularly important in patients
 15 with high intrinsic PEEP, in which it is not practicable to overcome the intrinsic PEEP by the use of high levels of extrinsic PEEP or CPAP, due to the risk of hyperinflation. In such subjects, any delay in triggering is perceived as very distressing, because of the enormous mis-match between expected and observed support. Smooth waveforms exaggerate the perceived delay, because of the time taken for the administered pressure
 20 to exceed the intrinsic PEEP. This embodiment permits the use of waveforms varying continuously from square (suitable for patients with for example severe lung or chest wall disease or high intrinsic PEEP) to very smooth, suitable for patients with normal lungs and chest wall, but abnormal respiratory control, or neuromuscular abnormalities. This waveform is combined either with or without elements of proportional assist
 25 ventilation (corrected for sudden changes in leak), with servo-control of the minute ventilation to equal or exceed a target ventilation. The latter servo-control has an adjustable gain, so that subjects with for example Cheyne Stokes breathing can be treated using a very high servo gain to over-ride their own waxing and waning patterns; subjects with various central hypoventilation syndromes can be treated with a low servo
 30 gain, so that short central apneas are permitted, for example to cough, clear the throat, talk, or roll over in bed, but only if they follow a previous period of high ventilation; and normal subjects are treated with an intermediate gain.

Restating the above in other words:

- 35 • The integral gain of the servo-control of the degree of assistance is adjustable from very fast (0.3 cmH₂O/L/sec/sec) to very slow. Patients with Cheyne-Stokes breathing have a very high ventilatory control loop gain, but a long control loop delay, leading to hunting. By setting the loop gain even higher, the patient's

controller is stabilized. This prevents the extreme breathlessness that normally occurs during each cycle of Cheyne-Stokes breathing, and this is very reassuring to the patient. It is impossible for them to have a central apnea. Conversely, subjects with obesity-hypoventilation syndrome have low or zero loop gain. They will not
5 feel breathless during a central apnea. However, they have much mucus and need to cough, and are also often very fidgety, needing to roll about in bed. This requires that they have central apneas which the machine does not attempt to treat. By setting the loop gain very low, the patient is permitted to take a couple of deep breaths and then have a moderate-length central apnea while coughing, rolling
10 over, etc, but prolonged sustained apneas or hypopneas are prevented.

- Sudden changes in leakage flow are detected and handled using a fuzzy logic algorithm. The principle of the algorithm is that the leak filter time constant is reduced dynamically to the fuzzy extent that the apparent respiratory airflow is a
15 long way from zero for a long time compared with the patient's expected respiratory cycle length.
- Rather than simply triggering between two states (IPAP, EPAP), the device uses a fuzzy logic algorithm to estimate the position in the respiratory cycle as a
20 continuous variable. The algorithm permits the smooth pressure waveform to adjust its rise time automatically to the patient's instantaneous respiratory pattern.
- The fuzzy phase detection algorithm under normal conditions closely tracks the patient's breathing. To the extent that there is a high or suddenly changing leak, or
25 the patient's ventilation is low, the rate of change of phase (respiratory rate) smoothly reverts to the specified target respiratory rate. Longer or deeper hypopneas are permitted to the extent that ventilation is on average adequate. To the extent that the servo gain is set high to prevent Cheyne Stokes breathing, shorter and shallower pauses are permitted.
- 30 • Airflow filtering uses an adaptive filter, which shortens its time constant if the subject is breathing rapidly, to give very fast response times, and lengthens if the subject is breathing slowly, to help eliminate cardiogenic artifact.
- 35 • The fuzzy changing leak detection algorithm, the fuzzy phase detection algorithm with its differential handling of brief expiratory pauses, and handling of changing leak, together with the smooth waveform severally and cooperatively make the system relatively immune to the effects of sudden leaks.

- By suitably setting various parameters, the system can operate in CPAP, bilevel spontaneous, bilevel timed, proportional assist ventilation, volume cycled ventilation, and volume cycled servo-ventilation, and therefore all these modes are subsets of the present embodiment. However, the present embodiment permits states of operation that can not be achieved by any of the above states, and is therefore distinct from them.

Notes

Note 1: in this second embodiment, the names and symbols used for various quantities may be different to those used in the first embodiment.

Note 2: The term "swing" is used to refer to the difference between desired instantaneous pressure at end inspiration and the desired instantaneous pressure at end expiration.

Note 3: A fuzzy membership function is taken as returning a value between zero for complete nonmembership and unity for complete membership. Fuzzy intersection A AND B is the lesser of A and B, fuzzy union A OR B is the larger of A and B, and fuzzy negation NOT A is $1 - A$.

Note 4: $\text{root}(x)$ is the square root of x , $\text{abs}(x)$ is the absolute value of x , $\text{sign}(x)$ is -1 if x is negative, and $+1$ otherwise. An asterisk () is used to explicitly indicate multiplication where this might not be obvious from context.*

Apparatus

The apparatus for the second embodiment is shown in Fig. 1b. The blower 110 delivers air under pressure to the mask 111 via the air delivery hose 112. Exhaled air is exhausted via the exhaust 113 in the mask 111. The pneumotachograph 114 and a differential pressure transducer 115 measure the airflow in the nose 112. The flow signal is delivered to the microprocessor 116. Pressure at any convenient point 117 along the nose 112 is measured using a pressure transducer 118. The output from the pressure transducer 118 is delivered to the microcontroller 116 and also to a motor servo 119. The microprocessor 116 supplies the motor servo 119 with a pressure request signal, which is then compared with the signal from the pressure transducer 118 to control the blower motor 120. User configurable parameters are loaded into the microprocessor 116 via a communications port 121, and the computed mask pressure and flow can if desired be output via the communications port 121.

Initialization

The following user adjustable parameters are specified and stored:

max permissible pressure	maximum permissible mask pressure
max swing	maximum permissible difference between end inspiratory pressure and end expiratory pressure.
min swing	minimum permissible difference between end inspiratory pressure and end expiratory pressure.
epap	end expiratory pressure
min permissible pressure	minimum permissible mask pressure
target ventilation	minute ventilation is servo-controlled to equal or exceed this quantity
target frequency	Expected respiratory rate. If the patient is achieving no respiratory airflow, the pressure will cycle at this frequency.
target duty cycle	Expected ratio of inspiratory time to cycle time. If the patient is achieving no respiratory airflow, the pressure will follow this duty cycle.
linear resistance andquad resistance	resistive unloading = linear resistance * f + quad_resistance * f ² sign(f), where f is the respiratory airflow. where sign(x) = -1 for x < 0, +1 otherwise
elastance	Unload at least this much elastance
servo gain	gain for servo-control of minute ventilation to at least exceed target ventilation.
waveform time constant	Elastic unloading waveform time constant as a fraction of inspiratory duration. (0.0 = square wave)
hose resistance	ΔP from pressure sensing port to inside mask = hose resistance times the square of the flow in the intervening tubing.
diffuser conductance	Flow through the mask exhaust port = diffuser conductance * root mask pressure

- 5 At initialization, the following are calculated from the above user-specified settings:

The expected duration of a respiratory cycle, of an inspiration, and of an expiration are set respectively to:

$$STD T_{TOT} = 60 / \text{target respiratory rate}$$

$$STD T_I = STD T_{TOT} * \text{target duty cycle}$$

$$STD T_E = STD T_{TOT} - STD T_I$$

- 22 -

The standard rates of change of phase (revolutions per sec) during inspiration and expiration are set respectively to:

$$STD d\phi_I = 0.5 / STD T_I$$

$$STD d\phi_E = 0.5 / STD T_E$$

The instantaneous elastic support at any phase ϕ in the respiratory cycle is given by:

$$PEL(\phi) = swing * \Pi(\phi)$$

where *swing* is the pressure at end inspiration minus the pressure at end expiration,

$$\Pi(\phi) = e^{-2\tau\phi} \quad \text{during inspiration,}$$

$$e^{-4t(\phi-0.5)} \quad \text{during expiration}$$

and τ is the user-selectable waveform time constant.

If $\tau = 0$, then $\Pi(\phi)$ is a square wave. The maximum implemented value for $\tau = 0.3$, producing a waveform approximately as shown in Fig. 5.

The mean value of $\Pi(\phi)$ is calculated as follows:

$$\Pi_{BAR} = 0.5 \int_0^{.05} \Pi(\phi) d\phi$$

Operations Performed every 20 Milliseconds

The following is an overview of routine processing done at 50 Hz:

25

measure flow at flow sensor and pressure at pressure sensing port

calculate mask pressure and flow from sensor pressure and flow

calculate conductance of mask leak

calculate instantaneous airflow through leak

30

calculate respiratory airflow and low pass filtered respiratory airflow

calculate mask on-off status and lead-in

calculate instantaneous and recent peak jamming

calculate time constant for leak conductance calculations

calculate phase in respiratory cycle

35

update mean rates of change of phase for inspiration and expiration, lengths of

inspiratory and expiratory times, and respiratory rate

add hose pressure loss to EPAP pressure

add resistive unloading

- 23 -

calculate instantaneous elastic assistance required to servo-control ventilation
estimate instantaneous elastic recoil pressure using various assumptions
weight and combine estimates
add servo pressure to yield desired sensor pressure
 5 *servo-control motor speed to achieve desired sensor pressure*

The details of each step will now be explained.

Measurement of Flow and Pressure

10

Flow is measured at the outlet of the blower using a pneumotachograph and differential pressure transducer. Pressure is measured at any convenient point between the blower outlet and the mask. A humidifier and/or anti-bacterial filter may be inserted between the pressure sensing port and the blower. Flow and pressure are digitized at 50 Hz
 15 using an A/D converter.

Calculation of mask flow and pressure

The pressure loss from pressure measuring point to mask is calculated from the flow at
 20 the blower and the (quadratic) resistance from measuring point to mask.

$$\text{Hose pressure loss} = \text{sign}(\text{flow}) * \text{hose resistance} * \text{flow}^2$$

where $\text{sign}(x) = -1$ for $x < 0$, $+1$ otherwise. The mask pressure is then calculated by
 25 subtracting the hose pressure loss from the measured sensor pressure:

$$\text{Mask pressure} = \text{sensor pressure} - \text{hose pressure loss}$$

The flow through the mask exhaust diffuser is calculated from the known parabolic
 30 resistance of the diffuser holes, and the square root of the mask pressure:

$$\text{diffuser flow} = \text{exhaust resistance} * \text{sign}(\text{mask pressure}) * \text{root}(\text{abs}(\text{mask pressure}))$$

35 Finally, the mask flow is calculated:

$$\text{mask flow} = \text{sensor flow} - \text{diffuser flow}$$

- 24 -

The foregoing describes calculation of mask pressure and flow in the various treatment modes. In diagnostic mode, the patient is wearing only nasal cannulae, not a mask. The cannula is plugged into the pressure sensing port. The nasal airflow is calculated from the pressure, after a linearization step, and the mask pressure is set to zero by definition.

Conductance of leak

The conductance of the leak is calculated as follows:

10

$$\begin{aligned} \text{root mask pressure} &= \text{sign}(P_{\text{MASK}}) \sqrt{\text{abs}(P_{\text{MASK}})} \\ \text{LP mask airflow} &= \text{low pass filtered mask airflow} \\ \text{LP root mask pressure} &= \text{low pass filtered root mask pressure} \\ \text{conductance of leak} &= \text{LP mask airflow} / \text{LP root mask pressure} \end{aligned}$$

15

The time constant for the two low pass filtering steps is initialized to 10 seconds and adjusted dynamically thereafter (see below).

Instantaneous flow through leak

20

The instantaneous flow through the leak is calculated from the instantaneous mask pressure and the conductance of the leak:

$$\text{instantaneous leak} = \text{conductance of leak} * \text{root mask pressure}$$

25

Respiratory Airflow

The respiratory airflow is the difference between the flow at the mask and the instantaneous leak:

30

$$\text{respiratory airflow} = \text{mask flow} - \text{instantaneous leak}$$

Low pass filtered respiratory airflow

35

Low pass filter the respiratory airflow to remove cardiogenic airflow and other noise. The time constant is dynamically adjusted to be 1/40 of the current estimated length of the respiratory cycle T_{TOT} (initialized to $\text{STD}_T_{\text{TOT}}$ and updated below). This means that at high respiratory rates, there is only a short phase delay introduced by the filter, but at low respiratory rates, there is good rejection of cardiogenic airflow.

Mask on/off status

The mask is assumed to initially be off. An off-on transition is taken as occurring
 5 when the respiratory airflow first goes above 0.2 L/sec, and an on-off transition is
 taken as occurring if the mask pressure is less than 2 cmH₂O for more than 1.5
 seconds.

Lead-in

10

Lead-in is a quantity that runs from zero if the mask is off, or has just been donned, to
 1.0 if the mask has been on for 20 seconds or more, as shown in Figure 6.

Calculation of instantaneous jamming index, J

15

J is the fuzzy extent to which the impedance of the leak has suddenly changed. It is
 calculated as the fuzzy extent to which the absolute magnitude of the respiratory airflow
 is large for longer than expected.

20 The fuzzy extent **A_I** to which the airflow has been positive for longer than expected is
 calculated from the time **t_{ZI}** since the last positive-going zero crossing of the calculated
 respiratory airflow signal, and the expected duration **STD T_I** of a normal inspiration for
 the particular subject, using the fuzzy membership function shown in Figure 7.

25 The fuzzy extent **B_I** to which the airflow is large and positive is calculated from the
 instantaneous respiratory airflow using the fuzzy membership function shown in Figure
 8.

The fuzzy extent **I_I** to which the leak has suddenly increased is calculated by calculating
 30 the fuzzy intersection (lesser) of **A_I** and **B_I**.

Precisely symmetrical calculations are performed for expiration, deriving **I_E** as the
 fuzzy extent to which the leak has suddenly decreased. **A_E** is calculated from **T_{ZE}** and
T_E, **B_E** is calculated from minus **f_{RESP}**, and **I_E** is the fuzzy intersection of **A_E** and **B_E**.
 35 The instantaneous jamming index **J** is calculated as the fuzzy union (larger) of indices
I_I and **I_E**.

Recent peak jamming

If the instantaneous jamming index is larger than the current value of the recent peak jamming index, then the recent peak jamming index is set to equal the instantaneous jamming index. Otherwise, the recent peak jamming index is set to equal the instantaneous jamming index low pass filtered with a time constant of 10 seconds. An electrical analogy of the calculation is shown in Figure 9.

Time constant for leak conductance calculations

10

If the conductance of the leak suddenly changes, then the calculated conductance will initially be incorrect, and will gradually approach the correct value at a rate which will be slow if the time constant of the low pass filters is long, and fast if the time constant is short. Conversely, if the impedance of the leak is steady, the longer the time constant the more accurate the calculation of the instantaneous leak. Therefore, it is desirable to lengthen the time constant to the extent that the leak is steady, reduce the time constant to the extent that the leak has suddenly changed, and to use intermediately longer or shorter time constants if it is intermediately the case that the leak is steady.

20

If there is a large and sudden increase in the conductance of the leak, then the calculated respiratory airflow will be incorrect. In particular, during apparent inspiration, the calculated respiratory airflow will be large positive for a time that is large compared with the expected duration of a normal inspiration. Conversely, if there is a sudden decrease in conductance of the leak, then during apparent expiration the calculated respiratory airflow will be large negative for a time that is large compared with the duration of normal expiration.

25

Therefore, the time constant for the calculation of the conductance of the leak is adjusted depending on J_{PEAK} , which is a measure of the fuzzy extent that the leak has recently suddenly changed, as shown in Figure 10.

30

In operation, to the extent that there has recently been a sudden and large change in the leak, J_{PEAK} will be large, and the time constant for the calculation of the conductance of the leak will be small, allowing rapid convergence on the new value of the leakage conductance. Conversely, if the leak is steady for a long time, J_{PEAK} will be small, and the time constant for calculation of the leakage conductance will be large, enabling accurate calculation of the instantaneous respiratory airflow. In the spectrum of intermediate situations, where the calculated instantaneous respiratory airflow is larger and for longer periods, J_{PEAK} will be progressively larger, and the time constant for

35

- 27 -

the calculation of the leak will progressively reduce. For example, at a moment in time where it is uncertain whether the leak is in fact constant, and the subject has merely commenced a large sigh, or whether in fact there has been a sudden increase in the leak, the index will be of an intermediate value, and the time constant for calculation of the impedance of the leak will also be of an intermediate value. The advantage is that some corrective action will occur very early, but without momentary total loss of knowledge of the impedance of the leak.

Instantaneous phase in respiratory cycle

10

The current phase ϕ runs from 0 for start of inspiration to 0.5 for start of expiration to 1.0 for end expiration = start of next inspiration. Nine separate features (peaks, zero crossings, plateaux, and some intermediate points) are identified on the waveform, as shown in Figure 11.

15

Calculation of normalized respiratory airflow

The filtered respiratory airflow is normalized with respect to the user specified target ventilation as follows:

20

$$\begin{aligned} \text{standard airflow} &= \text{target ventilation} / 7.5 \text{ L/min} \\ f' &= \text{filtered respiratory airflow} / \text{standard airflow} \end{aligned}$$

25

Next, the fuzzy membership in fuzzy sets **large negative**, **small negative**, **zero**, **small positive**, and **large positive**, describing the instantaneous airflow is calculated using the membership functions shown in Figure 12. For example, if the normalized airflow is 0.25, then the airflow is **large negative** to extent 0.0, **small negative** to extent 0.0, **zero** to extent 0.5, **small positive** to extent 0.5, **large positive** to extent 0.00.

30

Calculation of normalized rate of change of airflow

The rate of change of filtered respiratory airflow is calculated and normalized to a target ventilation of 7.5 L/min at 15 breaths/min as follows:

35

$$\begin{aligned} \text{standard } df/dt &= \text{standard airflow} * \text{target frequency} / 15 \\ &\text{calculate } d(\text{filtered airflow})/dt \\ &\text{low pass filter with a time constant of } 8/50 \text{ seconds} \\ &\text{normalize by dividing by standard } df/dt \end{aligned}$$

- 28 -

Now evaluate the membership of normalized df/dt in the fuzzy sets **falling**, **steady**, and **rising**, whose membership functions are shown in Figure 13.

Calculation of ventilation, normalized ventilation, and hypopnea

$$\begin{aligned} 5 \quad \text{ventilation} &= \text{abs}(\text{respiratory airflow}), \\ &\text{low pass filtered with a time constant of } STD \ T_{TOT}. \\ \text{normalized ventilation} &= \text{ventilation} / \text{standard airflow} \end{aligned}$$

Hypopnea is the fuzzy extent to which the normalized ventilation is zero. The membership function for **hypopnea** is shown in Fig. 14.

Calculation of recent ventilation, normalized recent ventilation, and hyperpnea

Recent ventilation is also a low pass filtered $\text{abs}(\text{respiratory airflow})$, but filtered with an adjustable time constant, calculated from **servo gain** (specified by the user) as shown in Figure 15. For example, if the **servo gain** is set to the maximum value of 0.3, the time constant is zero, and **recent ventilation** equals instantaneous $\text{abs}(\text{respiratory airflow})$. Conversely, if **servo gain** is zero, the time constant is twice **STD T_{TOT}**, the expected length of a typical breath.

$$\begin{aligned} 20 \quad \text{Target absolute airflow} &= 2 * \text{target ventilation} \\ \text{normalized recent ventilation} &= \\ &\text{recent ventilation} / \text{target absolute airflow} \end{aligned}$$

Hyperpnea is the fuzzy extent to which the recent ventilation is large. The membership function for **hyperpnea** is shown in Fig. 16.

Big Leak

The fuzzy extent to which there is a **big leak** is calculated from the membership function shown in Figure 17.

Additional fuzzy sets concerned with fuzzy "triggering"

Membership in fuzzy sets **switch negative** and **switch positive** are calculated from the normalized respiratory airflow using the membership functions shown in Figure 18, and membership in fuzzy sets **insp_phase** and **exp_phase** are calculated from the current phase f using the membership functions shown in Fig. 19.

Fuzzy Inference Rules for Phase

Procedure $W(y)$ calculates the area of an isosceles triangle of unit height and unit base, truncated at height y as shown in Figure 20. In the calculations that follow, recall that
 5 fuzzy intersection **a AND b** is the smaller of **a** and **b**, fuzzy union **a OR b** is the larger of **a** and **b**, and fuzzy negation **NOT a** is $1-a$.

The first fuzzy rule indicates that lacking any other information the phase is to increase at a standard rate. This rule is unconditionally true, and has a very heavy weighting,
 10 especially if there is a large leak, or there has recently been a sudden change in the leak, or there is a hypopnea.

$$W_{STANDARD} = 8 + 16 * J_{PEAK} + 16 * hypopnea + 16 * big\ leak$$

15 The next batch of fuzzy rules correspond to the detection of various features of a typical flow-vs-time curve. These rules all have unit weighting, and are conditional upon the fuzzy membership in the indicated sets:

$$W_{EARLY\ INSP} = W(\text{rise and small positive})$$

$$20 \quad W_{PEAK\ INSP} = W(\text{large positive AND steady AND NOT recent peak jamming})$$

$$W_{LATE\ INSP} = W(\text{fall AND small positive})$$

$$W_{EARLY\ EXP} = W(\text{fall AND small negative})$$

$$W_{PEAK\ EXP} = W(\text{large negative AND steady})$$

$$W_{LATE\ EXP} = W(\text{rise AND small negative})$$

25

The next rule indicates that there is a legitimate expiratory pause (as opposed to an apnea) if there has been a recent hyperpnea and the leak has not recently changed:

$$W_{PAUSE} = (\text{hyperpnea AND NOT } J_{PEAK}) * W(\text{steady AND zero})$$

30

Recalling that the time constant for hyperpnea gets shorter as servo gain increases, the permitted length of expiratory pause gets shorter and shorter as the servo gain increases, and becomes zero at maximum servo gain. The rationale for this is that (i)
 35 high servo gain plus long pauses in breathing will result in "hunting" of the servo-controller, and (ii) in general high servo gain is used if the subject's chemoreceptor responses are very brisk, and suppression of long apneas or hypopneas will help prevent the subject's own internal servo-control from hunting, thereby helping prevent Cheyne-Stokes breathing.

Finally, there are two phase-switching rules. During regular quiet breathing at roughly the expected rate, these rules should not strongly activate, but they are there to handle irregular breathing or breathing at unusual rates. They have very heavy weightings.

$$W_{TRIG\ INSP} = 32 W(\text{expiratory phase AND switch positive})$$

$$W_{TRIG\ EXP} = 32 W(\text{inspiratory phase AND switch negative})$$

Defuzzification

For each of the ten fuzzy rules above, we attach phase angles ϕ_N , as shown in Table ZZZ. Note that ϕ_N are in revolutions, not radians. We now place the ten masses $W(N)$ calculated above at the appropriate phase angles ϕ_N around the unit circle, and take the centroid.

Rule	N	ϕ_N
STANDARD	1	current ϕ
TRIG INSP	2	0.00
EARLY INSP	3	0.10
PEAK INSP	4	0.30
LATE INSP	5	0.50
TRIG EXP	6	$0.5 + 0.05 k$
EARLY EXP	7	$0.5 + 0.10 k$
PEAK EXP	8	$0.5 + 0.20 k$
LATE EXP	9	$0.5 + 0.4 k$
EXP PAUSE	10	$0.5 + 0.5 k$

15

where $k = \text{STD } T_I / \text{STD } T_E$.

Note that if the user has entered very short duty cycle, k will be small. For example a normal duty cycle is 40%, giving $k = 40/60 = 0.67$. Thus the expiratory peak will be associated with a phase angle of $0.5 + 0.2 * 0.67 = 0.63$, corresponding 26% of the way into expiratory time, and the expiratory pause would start at $0.5 + 0.5 * 0.67 = 0.83$, corresponding to 67% of the way into expiratory time. Conversely, if the duty cycle is set to 20% in a patient with severe obstructive lung disease, features 6 through 10 will be skewed or compressed into early expiration, generating an appropriately longer expiratory pause.

25

The new estimate of the phase is the centroid, in polar coordinates, of the above ten rules:

- 31 -

$$\text{centroid} = \arctan \left(\frac{\sum W_N \sin \phi_N}{\sum W_N \cos \phi_N} \right)$$

The change in phase $d\phi$ from the current phase ϕ to the centroid is calculated in polar coordinates. Thus if the centroid is 0.01 and the current phase is 0.99, the change in phase is $d\phi = 0.02$. Conversely, if the centroid is 0.99 and the current phase is 0.01, then $d\phi = -0.02$. The new phase is then set to the centroid:

$$\phi = \text{centroid}$$

This concludes the calculation of the instantaneous phase in the respiratory cycle ϕ .

Estimated mean duration of inspiration, expiration, cycle time, and respiratory rate

If the current phase is inspiratory ($\phi < 0.5$) the estimated duration of inspiration T_I is updated:

*LP(d ϕ_I) = low pass filtered $d\phi$ with a time constant of $4*STD T_{TOT}$*

Clip LP(d ϕ_I) to the range $(0.5/STD T_I)/2$ to $4(0.5/STD T_I)$

$T_I = 0.5 / \text{clipped LP}(d\phi_I)$

20

Conversely, if the current phase is expiratory, ($\phi \geq 0.5$) the estimated duration of expiration T_E is updated:

*LP(d ϕ_E) = low pass filtered $d\phi$ with a time constant of $4*STD T_{TOT}$*

Clip LP(d ϕ_E) to the range $(0.5/STD T_E)/2$ to $4(0.5/STD T_E)$

$T_E = 0.5 / \text{clipped LP}(d\phi_E)$

25

The purpose of the clipping is firstly to prevent division by zero, and also so that the calculated T_I and T_E are never more than a factor of 4 shorter or a factor of 2 longer than expected.

30

Finally, the observed mean duration of a breath T_{TOT} and respiratory rate RR are:

$$T_{TOT} = T_I + T_E$$

$$RR = 60/T_{TOT}$$

35

Resistive unloading

- 32 -

The resistive unloading is the pressure drop across the patient's upper and lower airways, calculated from the respiratory airflow and resistance values stored in SRAM

$$f = \text{respiratory airflow truncated to } +/- 2 \text{ L/sec}$$

$$\text{resistive unloading} = \text{airway resistance} * f +$$

$$\text{upper airway resistance} * f^2 * \text{sign}(f)$$

Instantaneous Elastic Assistance

10

The purpose of the instantaneous elastic assistance is to provide a pressure which balances some or all of the elastic deflating pressure supplied by the springiness of the lungs and chest wall (instantaneous elastic pressure), plus an additional component required to servo-control the minute ventilation to at least exceed on average a pre-set target ventilation. In addition, a minimum swing, always present, is added to the total. The user-specified parameter **elastance** is preset to say 50-75% of the known or estimated elastance of the patient's lung and chest wall. The various components are calculated as follows:

20

Instantaneous assistance based on minimum pressure swing set by physician:

$$\text{instantaneous minimum assistance} = \text{minimum swing} * \Pi(\phi)$$

Elastic assistance required to servo-control ventilation to equal or exceed target

25

The quantity *servo swing* is the additional pressure modulation amplitude required to servo-control the minute ventilation to at least equal on average a pre-set target ventilation.

30

Minute ventilation is defined as the total number of litres inspired or expired per minute. However, we can't wait for a whole minute, or even several seconds, to calculate it, because we wish to be able to prevent apneas or hypopneas lasting even a few seconds, and a PI controller based on an average ventilation over a few seconds would be either sluggish or unstable.

35

The quantity actually servo-controlled is half the absolute value of the instantaneous respiratory airflow. A simple clipped integral controller with no damping works very satisfactorily. The controller gain and maximum output ramp up over the first few seconds after putting the mask on.

If we have had a sudden increase in mouth leak, airflow will be nonzero for a long time. A side effect is that the ventilation will be falsely measured as well above target, and the amount of servo assistance will be falsely reduced to zero. To prevent this, to
 5 the extent that the fuzzy recent peak jamming index is large, we hold the degree of servo assistance at its recent average value, prior to the jamming.

The algorithm for calculating servo swing is as follows:

10

error = target ventilation - abs(respiratory airflow) / 2

*servo swing = S error * servo gain * sample interval*

*clip servo swing to range 0 to 20 cmH₂O * lead-in*

set recent servo swing =

15

servo swing low pass filtered with a time constant of 25 sec.

*clip servo swing to be at most J_{PEAK} * recent servo swing*

The instantaneous servo assistance is calculated by multiplying servo swing by the previously calculated pressure waveform template:

20

*instantaneous servo assistance = servo swing * $\Pi(\phi)$*

Estimating instantaneous elastic pressure

The instantaneous pressure required to unload the elastic work of inspiring against the
 25 user-specified elastance is the specified elastance times the instantaneous inspired volume. Unfortunately, calculating instantaneous inspired volume simply by integrating respiratory airflow with respect to time does not work in practice for three reasons: firstly leaks cause explosive run-away of the integration. Secondly, the integrator is reset at the start of each inspiration, and this point is difficult to detect reliably.
 30 Thirdly, and crucially, if the patient is making no efforts, nothing will happen.

Therefore, four separate estimates are made, and a weighted average taken.

*Estimate 1: Exact instantaneous elastic recoil calculated from instantaneous tidal
 35 volume, with a correction for sudden change in leak*

The first estimate is the instantaneous elastic recoil of a specified elastance at the estimated instantaneous inspired volume, calculated by multiplying the specified elastance by the integral of a weighted respiratory airflow with respect to time, reset to

- 34 -

zero if the respiratory phase is expiratory. The respiratory airflow is weighted by the fuzzy negation of the recent peak jamming index J_{PEAK} , to partly ameliorate an explosive run-away of the integral during brief periods of sudden increase in leak, before the leak detector has had time to adapt to the changing leak. In the case where the leak is very steady, J_{PEAK} will be zero, the weighting will be unity, and the inspired volume will be calculated normally and correctly. In the case where the leak increases suddenly, J_{PEAK} will rapidly increase, the weighting will decrease, and although typically the calculated inspired volume will be incorrect, the over-estimation of inspired volume will be ameliorated. Calculations are as follows:

*Instantaneous volume = integral of respiratory airflow * (1- J_{PEAK}) dt*
if phase is expiratory ($0.5 < \phi < 1.0$ revolutions) reset integral to zero
*estimate 1 = instantaneous volume * elastance*

Estimate 2: based on assumption that the tidal volume equals the target tidal volume

The quantity standard swing is the additional pressure modulation amplitude that would unload the specified elastance for a breath of a preset target tidal volume.

target tidal volume = target ventilation / target frequency
*standard swing = elastance * target tidal volume*
*estimate 2 = standard swing * $\Pi(\phi)$*

Estimate 3: based on assumption that the tidal volume equals the target tidal volume divided by the observed mean respiratory rate RR calculated previously.

*Estimate 3 = elastance * target ventilation / RR * $\Pi(\phi)$*

Estimate 4: based on assumption that this breath is much like recent breaths

The instantaneous assistance based on the assumption that the elastic work for this breath is similar to that for recent breaths is calculated as follows:

LP elastic assistance = instantaneous elastic assistance
low pass filtered with a time constant of 2 STD T_{TOT}
*estimate 4 = LP elastic assistance * $\Pi(\phi)$ / P_{BAR}*

The above algorithm works correctly even if $\Pi(\phi)$ is dynamically changed on-the-fly by the user, from square to a smooth or vice versa. For example, if an 8

- 35 -

cmH₂O square wave. ($\Pi_{\text{BAR}}=1$) adequately assists the patient, then a sawtooth wave ($\Pi_{\text{BAR}}=0.5$) will require 16 cmH₂O swing to produce the same average assistance.

Best Estimate of Instantaneous Elastic Recoil Pressure

5

Next, calculate the pressure required to unload a best estimate of the actual elastic recoil pressure based on a weighted average of the above. If $\Pi(\phi)$ is set to the smoothest setting, the estimate is based equally on all the above estimates of instantaneous elastic recoil. If $\Pi(\phi)$ is a square wave, the estimate is based on all the
 10 above estimates except for estimate 1, because a square wave is maximal at $\phi=0$, whereas estimate 1 is zero at $\phi=0$. Intermediate waveforms are handled intermediately. Quantity smoothness runs from zero for a square wave to 1 for a waveform time constant of 0.3 or above.

15

$$\begin{aligned} \text{smoothness} &= \text{waveform time constant} / 0.3 \\ \text{instantaneous recoil} &= (\text{smoothness} * \text{estimate 1} + \\ &\quad \text{estimate 2} + \text{estimate 3} + \text{estimate 4}) / (\text{smoothness} + 3) \end{aligned}$$

20

Now add the estimates based on minimum and servo swing, truncate so as not to exceed a maximum swing set by the user. Reduce (lead in gradually) if the mask has only just been put on.

25

$$\begin{aligned} I = & \quad \text{instantaneous minimum assistance} + \\ & \quad \text{instantaneous servo assistance} + \\ & \quad \text{instantaneous recoil} \end{aligned}$$

*Truncate I to be less than preset maximum permissible swing instantaneous elastic assistance = I * lead-in*

30

This completes the calculation of **instantaneous elastic assistance**.

Desired pressure at sensor

35

$$\begin{aligned} \text{desired sensor pressure} &= \text{epap} + \text{hose pressure loss} + \\ & \quad \text{resistive unloading} + \text{instantaneous elastic assistance} \end{aligned}$$

Servo control of motor speed

- 36 -

In the final step, the measured pressure at the sensor is servo-controlled to equal the desired sensor pressure, using for example a clipped pseudodifferential controller to adjust the motor current. Reference can be made to Fig. 1 in this regard.

5 Device Performance

Figs. 21-27 each show an actual 60 second recording displaying an aspect of the second embodiment. All recordings are from a normal subject trained to perform the required manoeuvres. Calculated respiratory airflow, mask pressure, and respiratory phase are calculated using the algorithms disclosed above, output via a serial port, and plotted digitally.

In Figs. 21-26 respiratory airflow is shown as the darker tracing, the vertical scale for flow being \pm L/sec, inspiration upwards. The vertical scale for the pressure (light trace) is 0.2 cmH₂O.

15

Fig. 21 is recorded with the servo gain set to 0.1 cmH₂O/L/sec/sec, which is suitable for subjects with normal chemoflexes. The subject is breathing well above the minimum ventilation, and a particularly deep breath (sigh) is taken at point (a). As is usual, respiratory effort ceases following the sigh, at point (c). The device correctly permits a short central apnea (b), as indicated by the device remaining at the end expiratory pressure during the period marked (b). Conversely Fig. 22 shows that if there is no preceding deep breath, when efforts cease at (a), the pressure correctly continues to cycle, thus preventing any hypoxia. Fig. 23 is recorded with servo gain set high, as would be appropriate for a subject with abnormally high chemoreflexes such as is typically the case with Cheyne-Stokes breathing. Now when effort ceases at arrow (a), pressure continues to cycle and a central apnea is no longer permitted, despite preceding deep breathing. This is advantageous for preventing the next cycle of Cheyne-Stokes breathing.

20

25

30

The above correct behaviour is also exhibited by a time mode device, but is very different to that of a spontaneous mode bilevel device, or equally of proportional assist ventilation, both of which would fail to cycle after all central apneas, regardless of appropriateness.

35

Fig. 24 shows automatically increasing end-inspiratory pressure as the subject makes voluntarily deeper inspiratory efforts. The desirable behaviour is in common with PAV, but is different to that of a simple bilevel device, which would maintain a constant level of support despite an increased patient requirement, or to a volume cycled device, which would actually decrease support at a time of increasing need.

Fig. 25 is recorded with a somewhat more square waveform selected. This figure shows automatically increasing pressure support when the subject voluntarily attempts to resist by stiffening the chest wall at point (a). This desirable behaviour is common with PAV and volume cycled devices, with the expectation that PAV cannot selectively deliver a squarer waveform. It is distinct from a simple bilevel device which would not augment the level of support with increasing need.

Fig. 26 shows that with sudden onset of a severe 1.4 L/sec leak at (a), the flow signal returns to baseline (b) within the span of a single breath, and pressure continues to cycle correctly throughout. Although timed mode devices can also continue to cycle correctly in the face of sudden changing leak, they are unable to follow the subject's respiratory rate when required (as shown in Fig. 27). Other known bilevel devices and PAV mis-trigger for longer or shorter periods following onset of a sudden severe leak, and PAV can deliver greatly excessive pressures under these conditions.

Fig. 27 shows an actual 60 second tracing showing respiratory airflow (heavy trace ± 1 L/sec full scale) and respiratory phase as a continuous variable (light trace, 0 to 1 revolution), with high respiratory rate in the left half of the trace and low respiratory rate in the right half of the trace. This trace demonstrates that the invention can determine phase as a continuous variable.

Advantageous aspects of embodiments of the invention.

Use of phase as a continuous variable.

In the prior art, phase is taken as a categorical variable, with two values: inspiration and expiration. Errors in the detection of start of inspiration and start of expiration produce categorical errors in delivered pressure. Conversely, here, phase is treated as a continuous variable having values between zero and unity. Thus categorical errors in measurement of phase are avoided.

Adjustable filter frequency and allowance for phase delay

By using a short time constant when the subject is breathing rapidly, and a long time constant when the subject is breathing slowly, the filter introduces a fixed phase delay which is always a small fraction of a respiratory cycle. Thus unnecessary phase delays can be avoided, but cardiogenic artifact can be rejected in subjects who are breathing slowly. Furthermore, because phase is treated as a continuous variable, it is possible to largely compensate for the delay in the low pass filter.

Within-breath pressure regulation as a continuous function of respiratory phase.

With all prior art there is an intrusive discontinuous change in pressure, either at the start of inspiration or at the start of expiration. Here, the pressure change is
5 continuous, and therefore more comfortable.

With proportional assist ventilation, the instantaneous pressure is a function of instantaneous volume into the breath. This means that a sudden large leak can cause explosive pressure run-away. Here, where instantaneous pressure is a function of
10 instantaneous phase rather than tidal volume, this is avoided.

Between-breath pressure-regulation as a function of average inspiratory duration.

Average inspiratory duration is easier to calculate in the presence of leak than
15 is tidal volume. By taking advantage of a correlation between average inspiratory duration and average tidal volume, it is possible to adjust the amplitude of modulation to suit the average tidal volume.

Provision of a pressure component for unloading turbulent upper airway resistance, and avoiding cardiogenic pressure instabilities.

Although Younes describes the use of a component of pressure proportional to the square of respiratory airflow to unload the resistance of external apparatus, the resistance of the external apparatus in embodiments of the present invention is typically
25 negligible. Conversely, embodiments of the present invention describes two uses for such a component proportional to the square of respiratory airflow that were not anticipated by Younes. Firstly, sleeping subjects, and subjects with a blocked nose, have a large resistance proportional to the square of airflow, and a pressure component proportional to the square of airflow can be used to unload the anatomical upper airway
30 resistance. Secondly, small nonrespiratory airflow components due to heartbeat or other artifact, when squared, produces negligible pressure modulation, so that the use of such a component yields relative immunity to such nonrespiratory airflow.

Smooth transition between spontaneous and controlled breathing

35

There is a smooth, seamless gradation from flexibly tracking the subject's respiratory pattern during spontaneous breathing well above the target ventilation, to fully controlling the duration, depth, and phase of breathing if the subject is making no efforts, via a transitional period in which the subject can make progressively smaller

- 39 -

changes to the timing and depth of breathing. A smooth transition avoids categorization errors when ventilation is near but not at the desired threshold. The advantage is that the transition from spontaneous to controlled ventilation occurs unobtrusively to the subject. This can be especially important in a subject attempting to
5 go to sleep. A similar smooth transition can occur in the reverse direction, as a subject awakens and resumes spontaneous respiratory efforts.

- 40 -

The embodiments of the invention in which an exclusive property or privilege is claimed are defined as follows:

1. A method for providing ventilatory assistance in a spontaneously breathing subject, comprising the steps, performed at repeated sampling intervals, of:

calculating the instantaneous phase ϕ in the respiratory cycle as a continuous variable from 0 to 1 revolution,

selecting a desired pressure modulation amplitude A,

calculating a desired instantaneous delivery pressure as a function of an end expiratory pressure plus the desired pressure modulation amplitude A multiplied by the value of a waveform template function $\Pi(\phi)$ at the calculated instantaneous phase ϕ , and

delivering pressure to said subject at the calculated desired instantaneous delivery pressure.

2. A method as in claim 1, wherein the selected desired pressure modulation amplitude A includes a fixed amplitude.

3. A method as in claim 1, wherein the selected desired pressure modulation amplitude A includes a component equal to an elastance multiplied by an estimate of the subject's tidal volume.

4. A method as in claim 1, wherein the selected desired pressure modulation amplitude A includes a component calculated using the sub-steps of:

specifying an expected breath duration,

specifying a preset pressure modulation amplitude to apply for said expected breath duration,

calculating the actual breath duration of said subject, and

calculating the component of said pressure modulation amplitude as a function of at least said specified preset pressure modulation

amplitude multiplied by said calculated actual breath duration divided by the specified expected breath duration.

5. A method as in any one of claims 1 to 4, wherein the phase in the respiratory cycle is calculated using the sub-steps of:

determining the extent to which the subject is adequately ventilated,

to said extent setting the phase in the respiratory cycle in accordance with the subject's respiratory airflow, and

to the converse extent setting the phase in accordance with a preset respiratory rate.

6. A method as in any one of claims 1 to 4, in which the phase in the respiratory cycle is calculated using the sub-steps of:

estimating respiratory airflow,

deriving a measure of mask leak stability,

to the extent that mask leak is stable, calculating the phase in accordance with the estimate of respiratory airflow, and

to the converse extent, calculating the phase in the respiratory cycle in accordance with a preset respiratory rate.

7. A method as in claim 1, wherein the selected desired pressure modulation amplitude includes a component chosen to servo-control the degree of ventilation to at least exceed a specified ventilation.

8. A method as in claim 7, in which said component is calculated using the sub-steps of:

calculating an error term proportional to the absolute value of estimated respiratory airflow minus twice said specified ventilation, and

setting said component proportional to the time integral of said error term.

- 42 -

9. A method as in claim 8, wherein said time integral is clipped to fall between a preset minimum and a preset maximum.

10. A method for providing ventilatory assistance in a spontaneously breathing subject, comprising the steps performed at repeated sampling intervals of:

(a) calculating instantaneous inspired volume by estimating respiratory airflow, calculating an index equal to the fuzzy extent to which any leak is suddenly changing, and calculating instantaneous inspired volume as a function of both the estimated respiratory airflow and said index,

(b) calculating a desired instantaneous delivery pressure as a function of at least said instantaneous inspired volume, and

(c) applying pressure to the subject's airway at the calculated desired instantaneous delivery pressure.

11. A method as in claim 10, in which the calculated desired instantaneous delivery pressure is incremented by an amount proportional to at least one of an estimate of respiratory airflow or the square of an estimate of respiratory airflow.

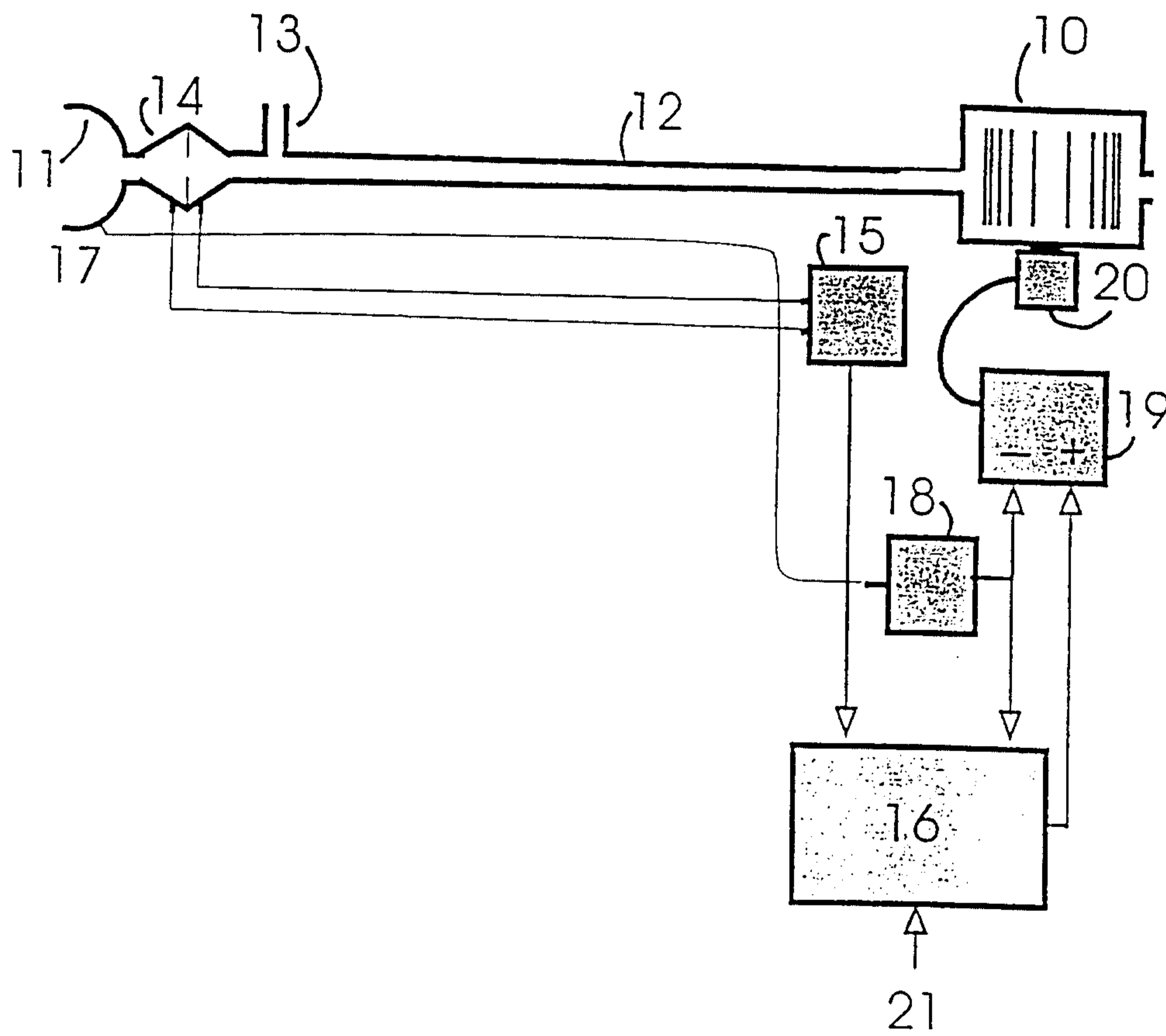

Fig. 1a

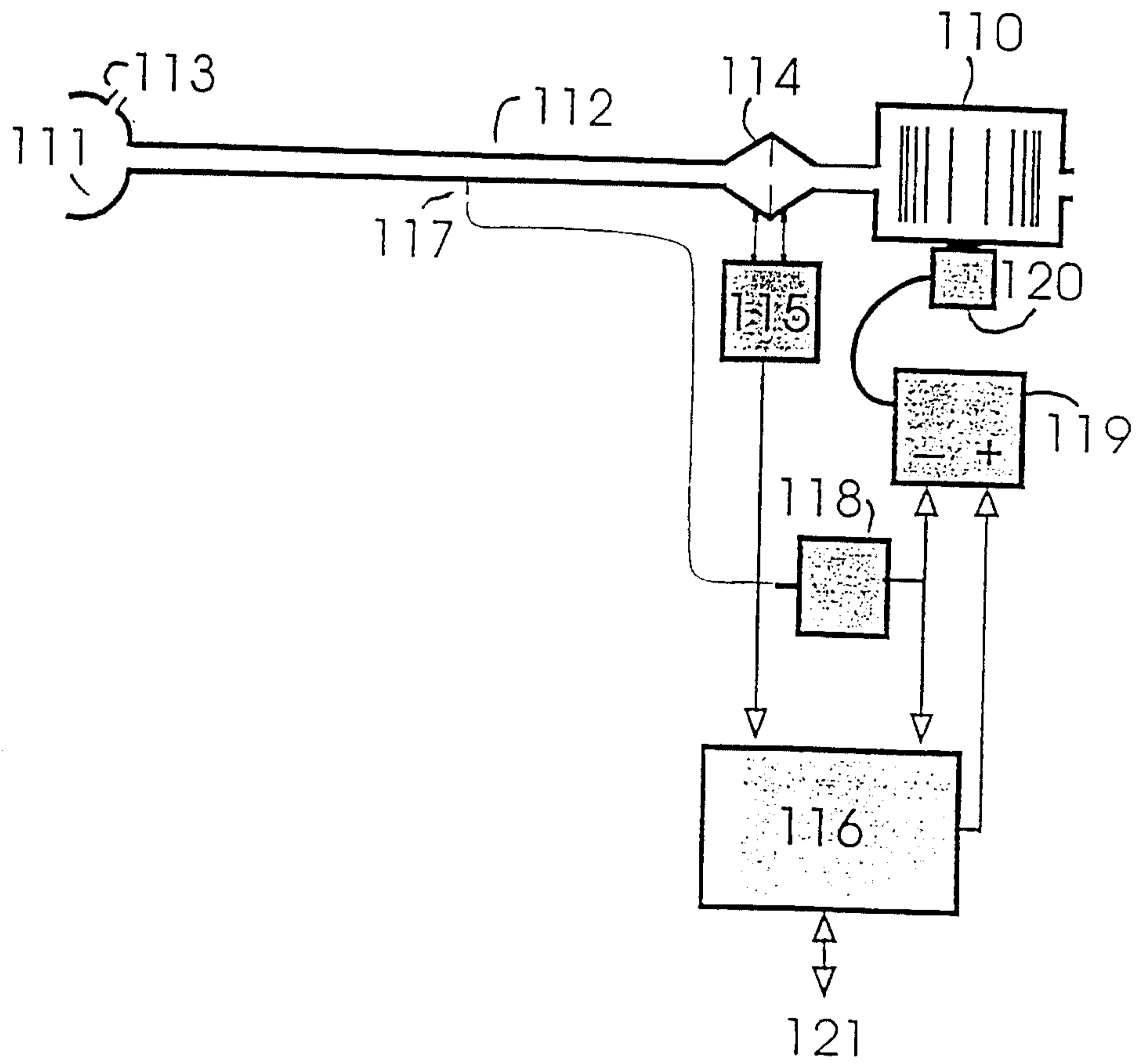

Fig. 1b

3/20

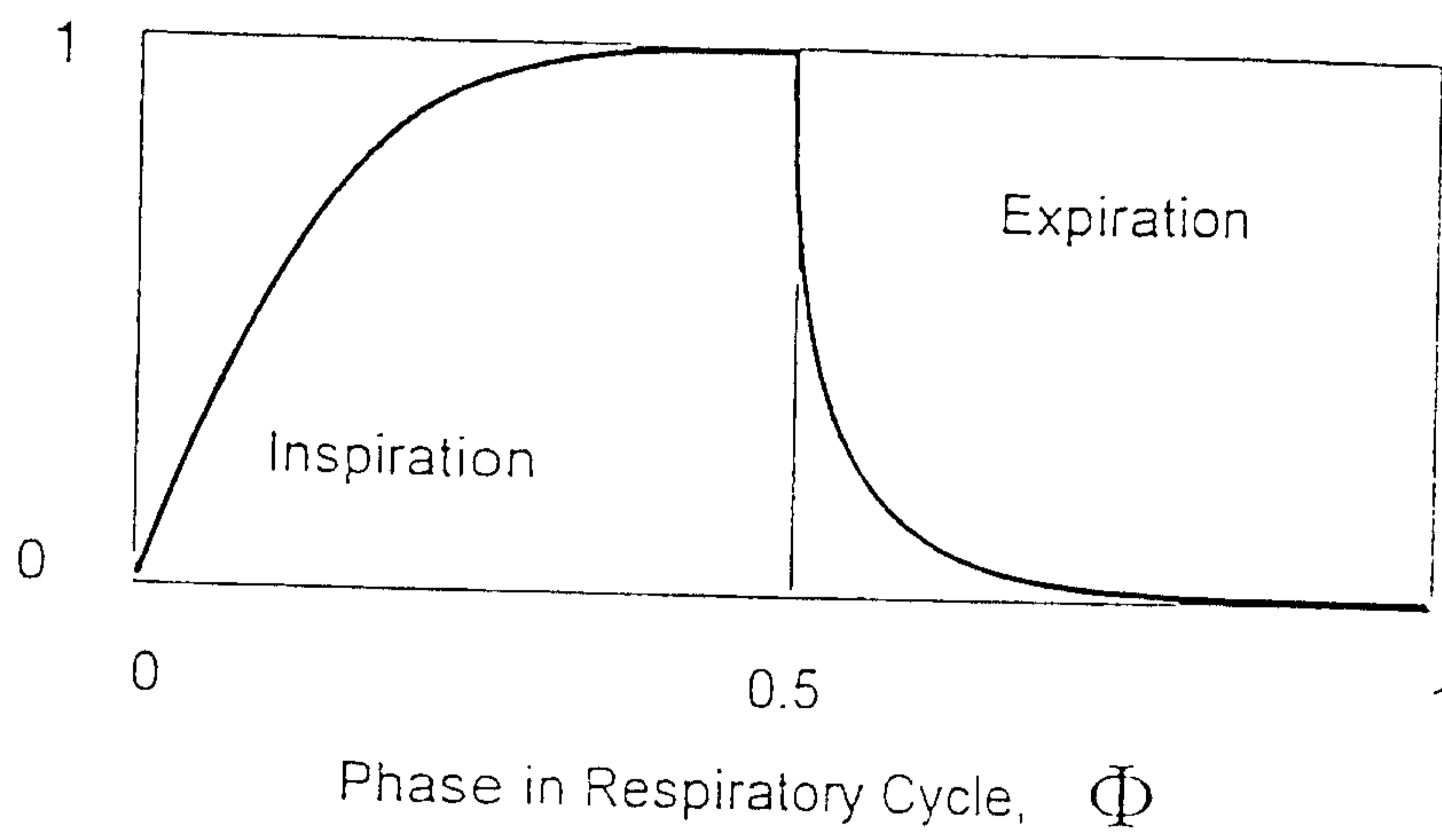

FIG. 2

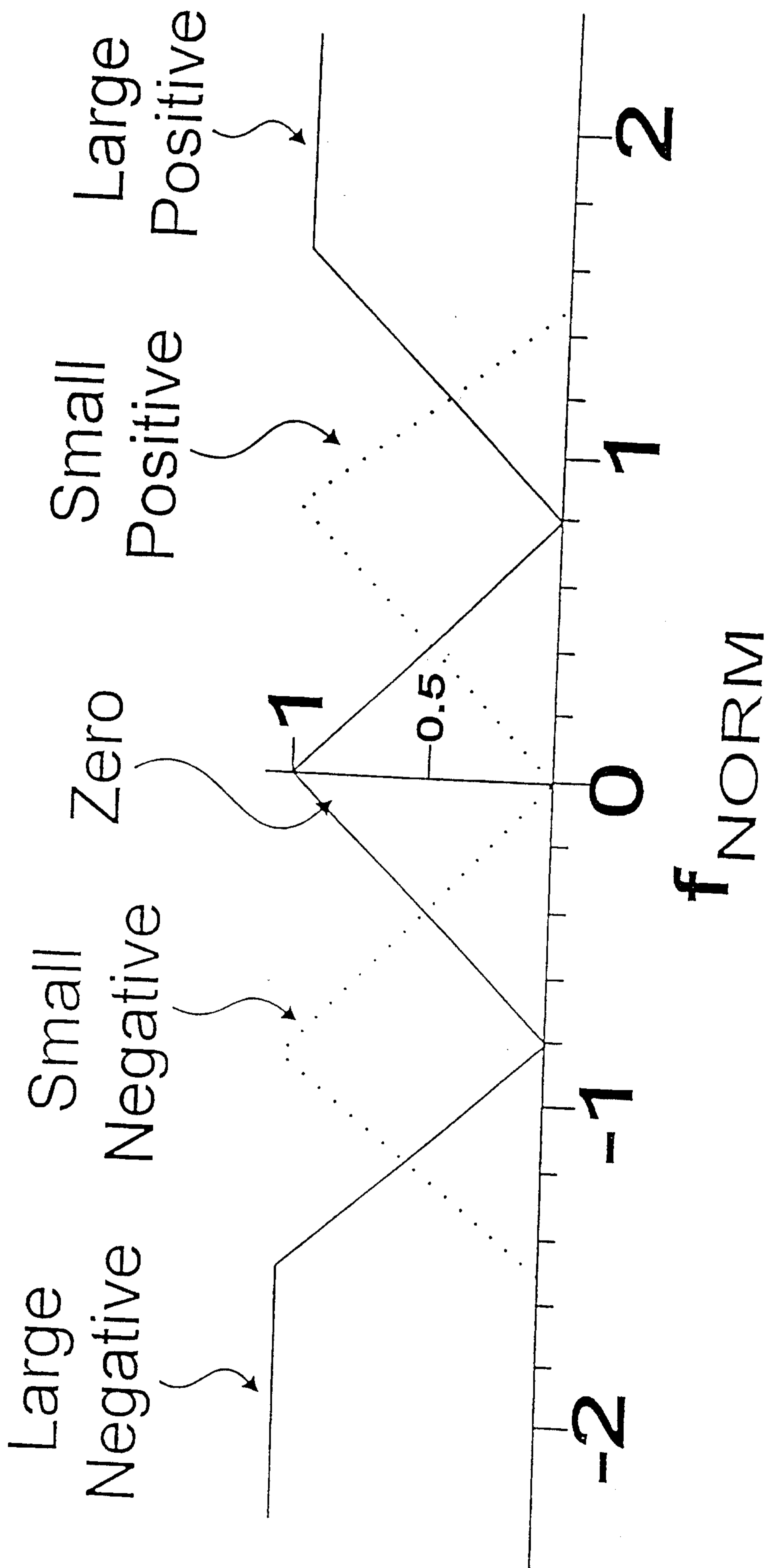
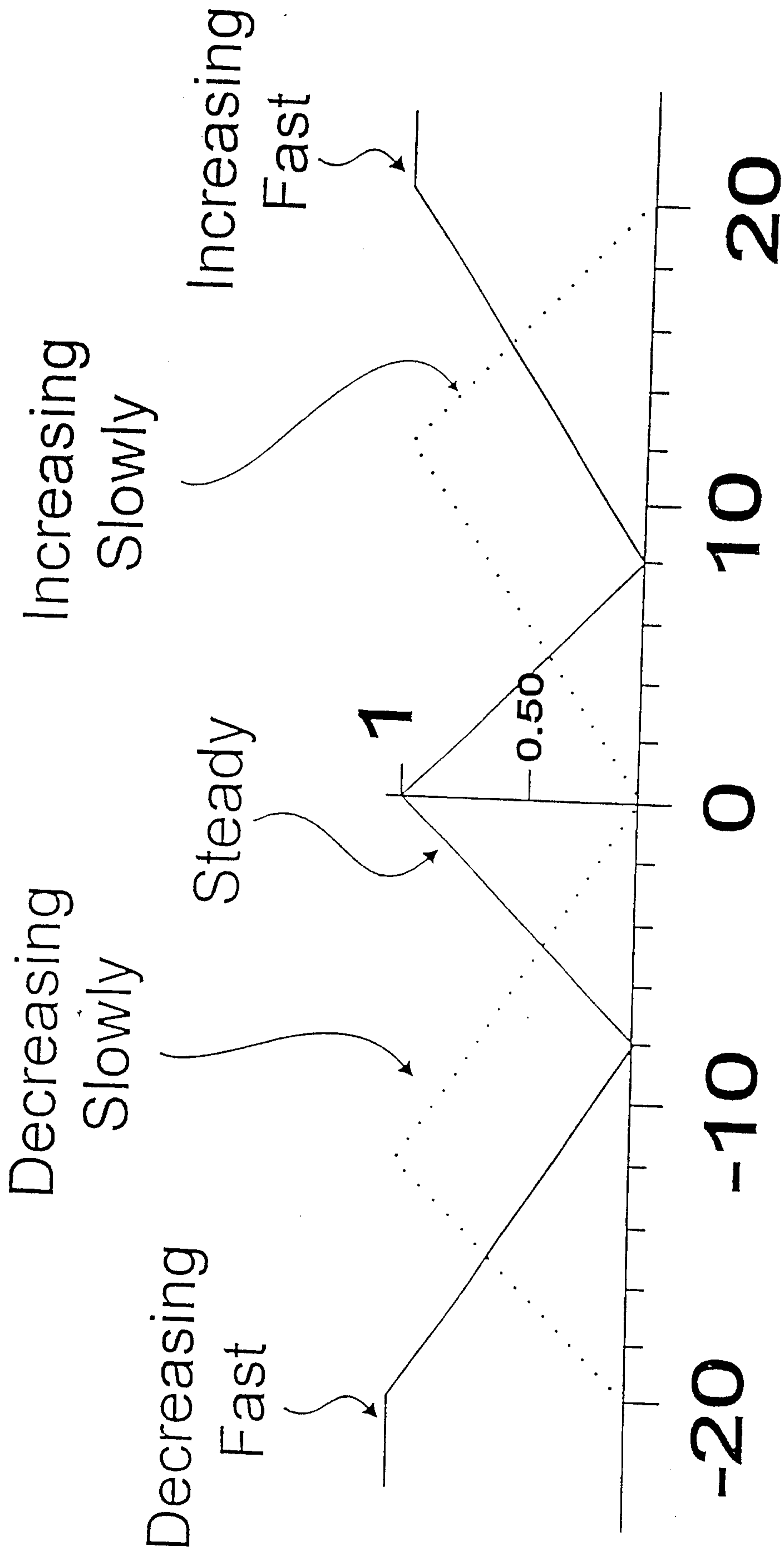

FIG. 3



Normalized Rate of Change of Flow

FIG. 4

6/20

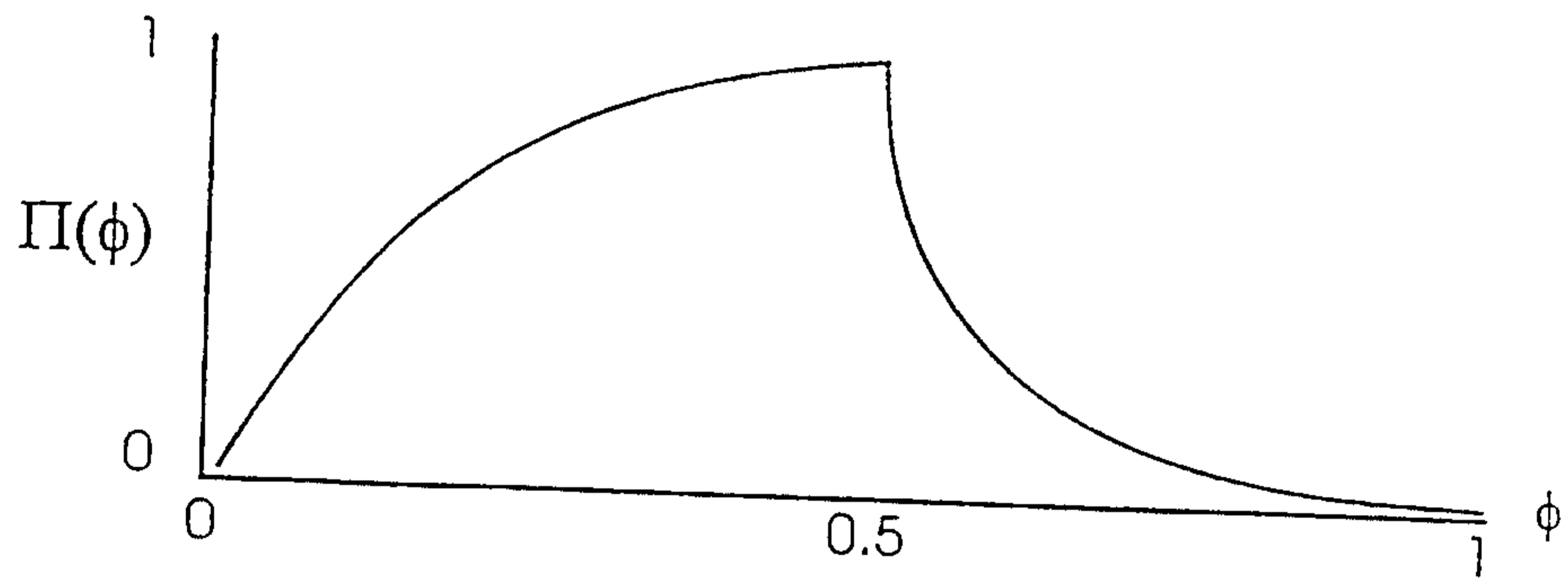

Fig. 5

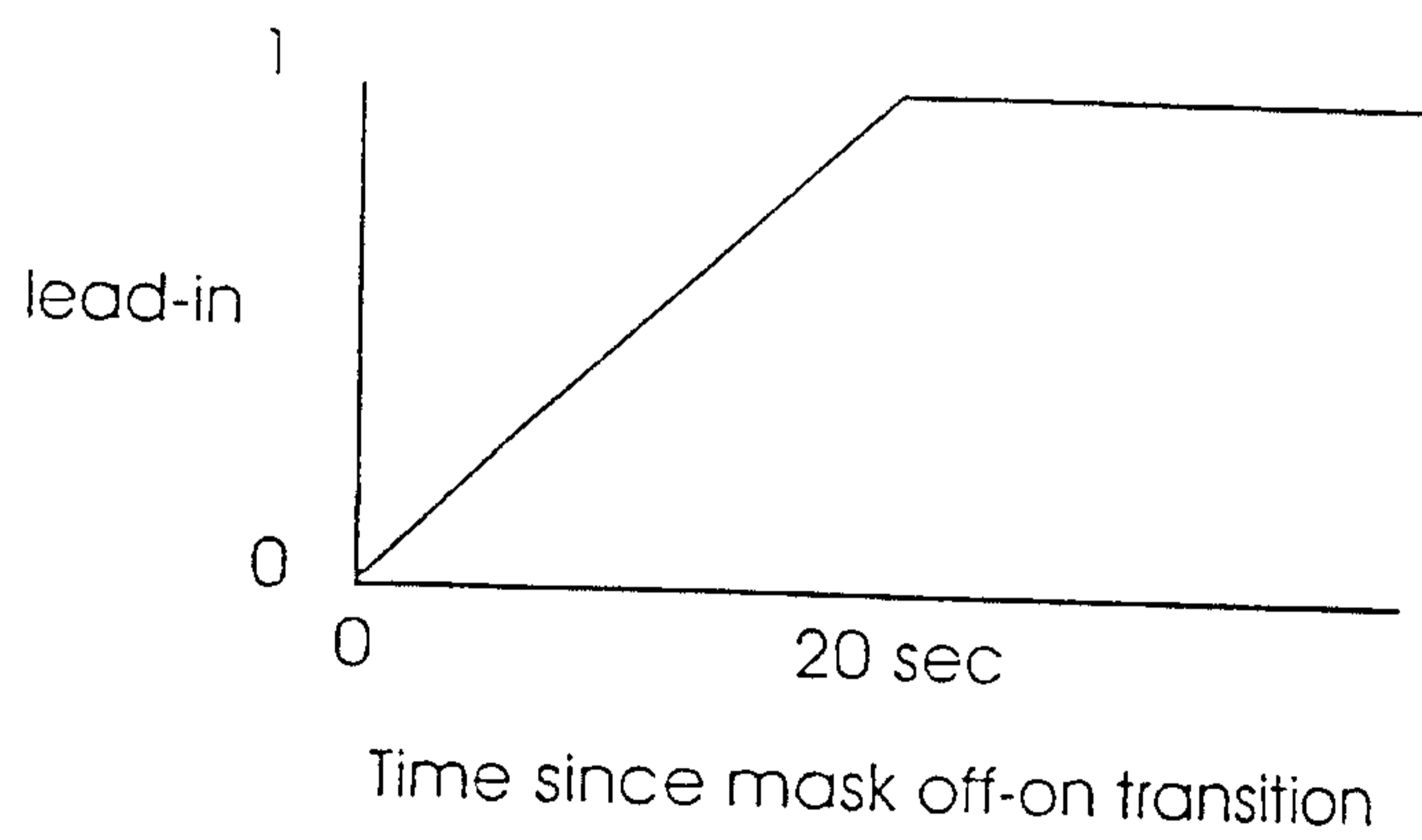

Fig. 6

7/20

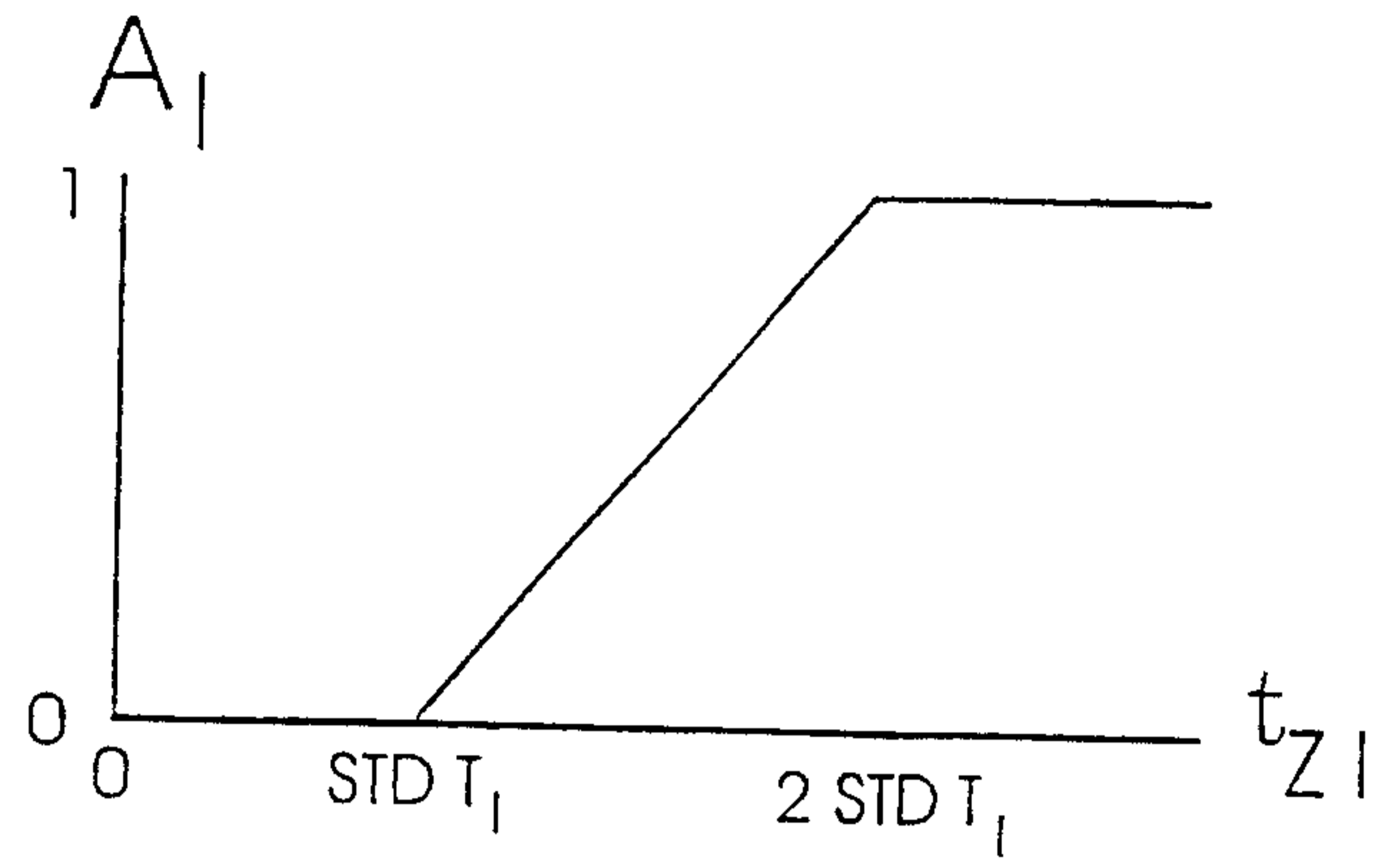

Fig. 7

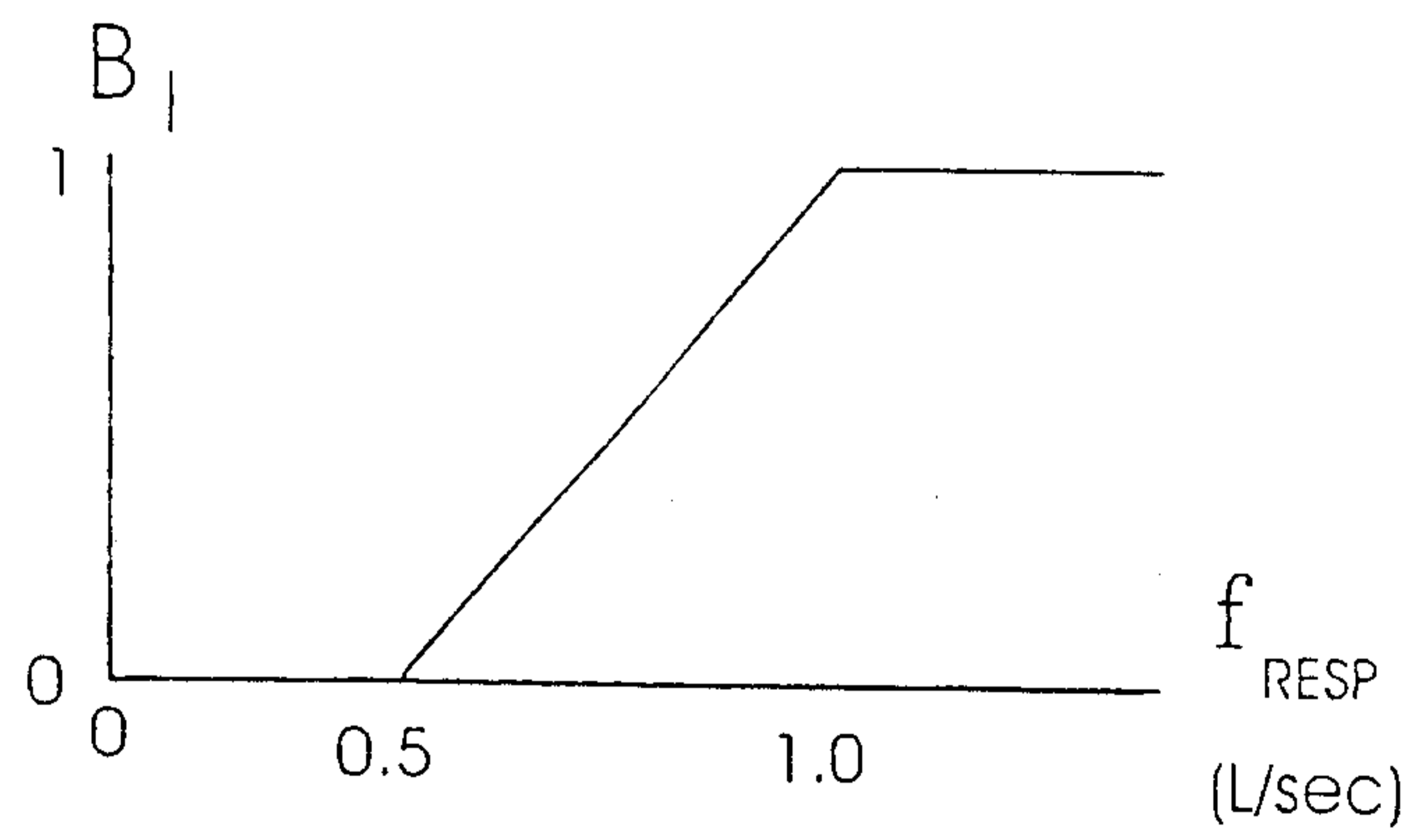

Fig. 8

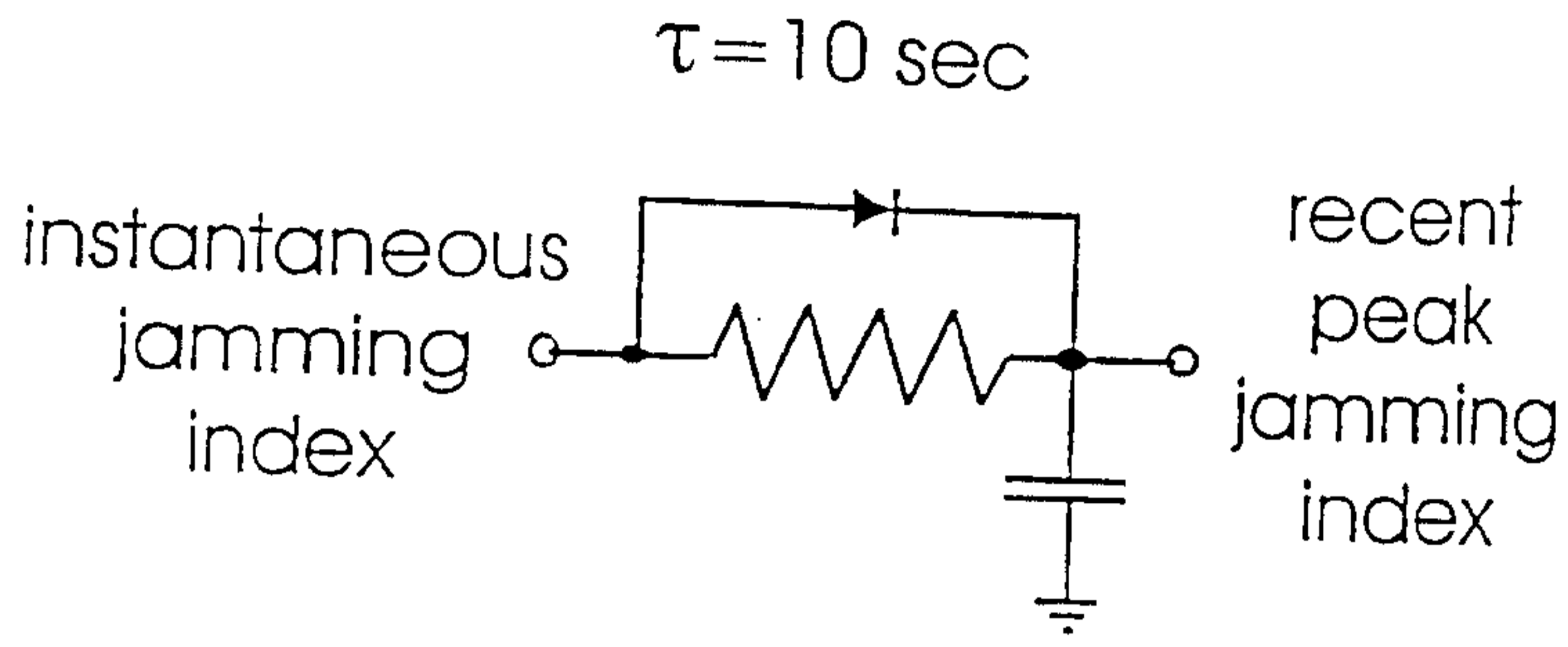

Fig. 9

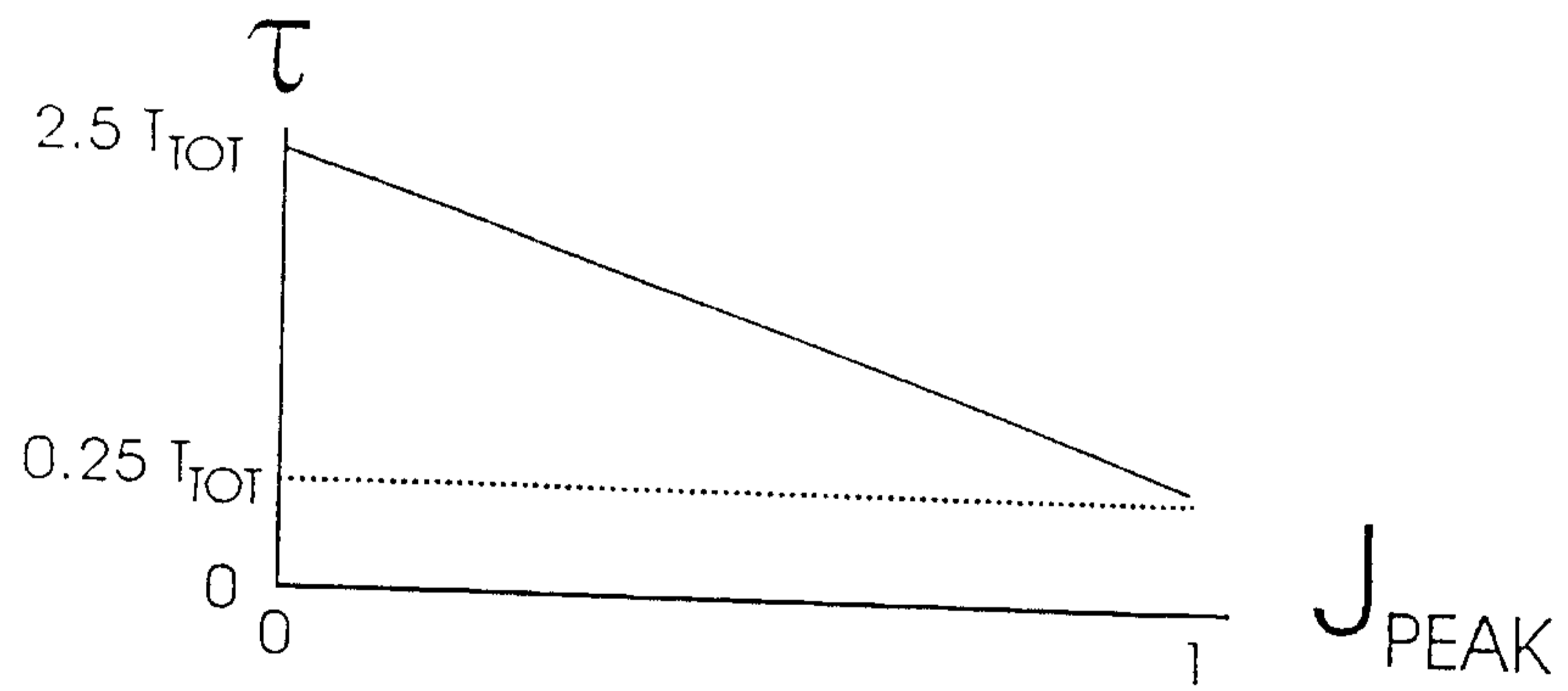

Fig. 10

9/20

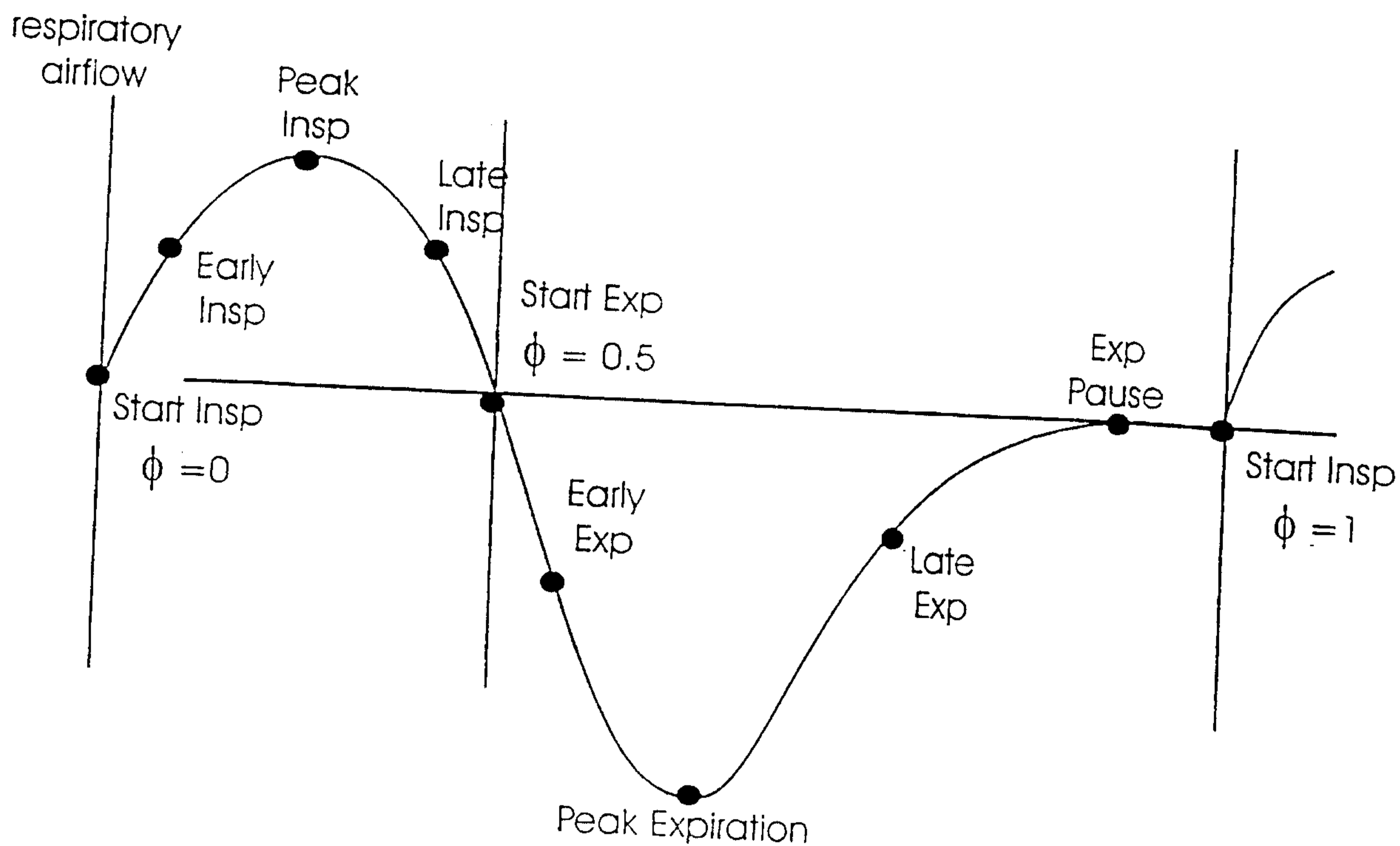

Fig. 11

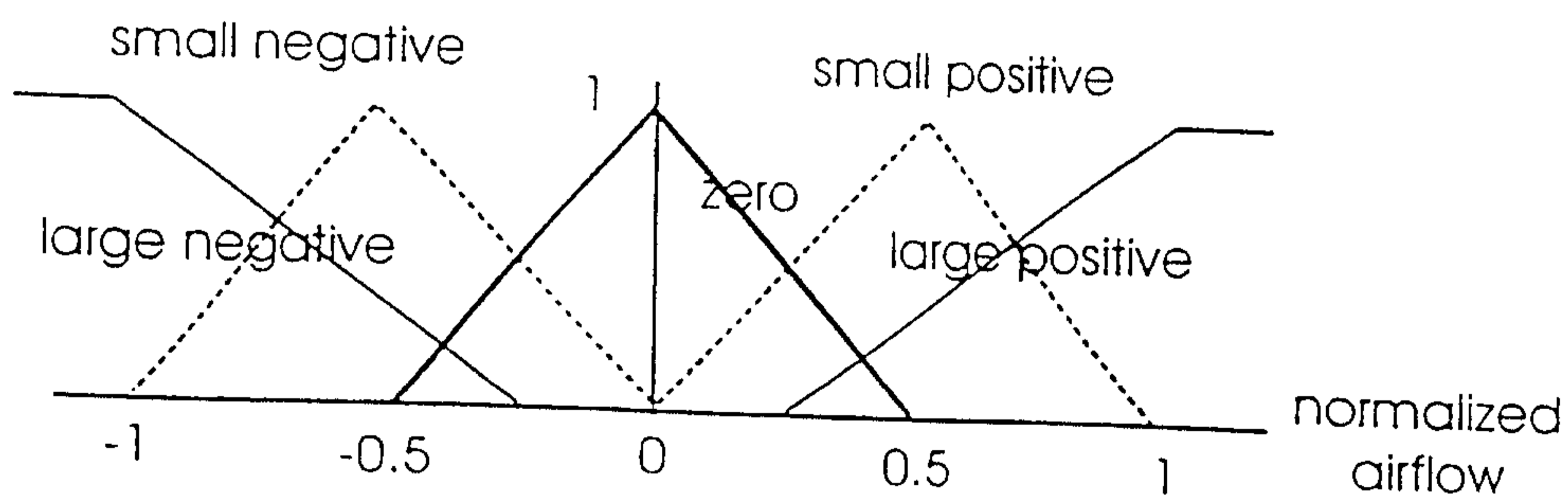

Fig. 12

10/20

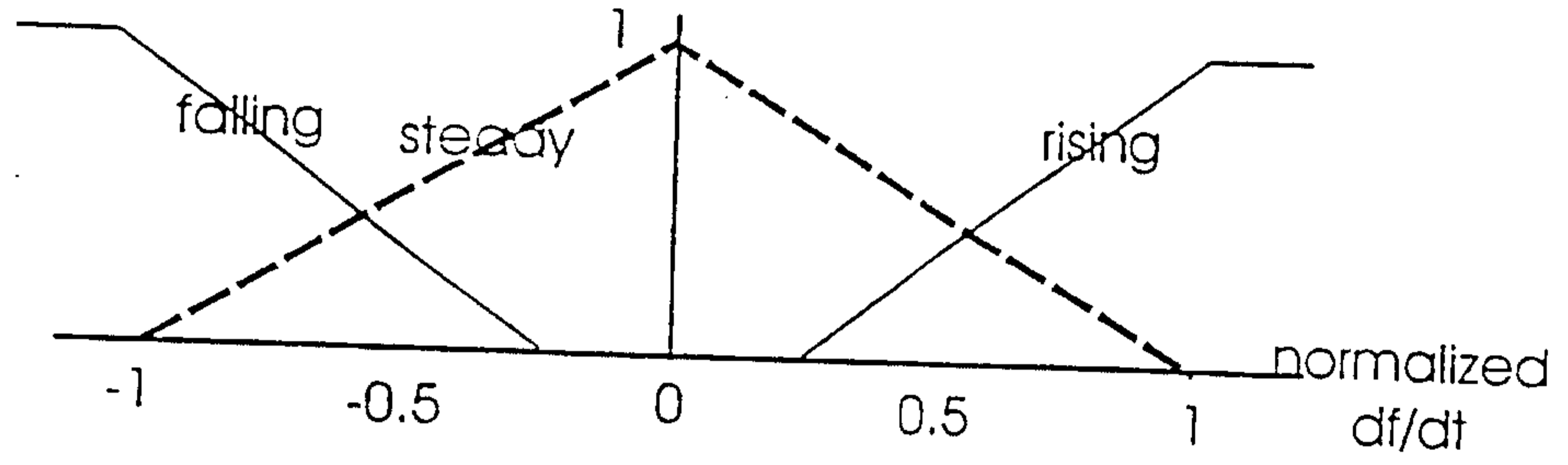

Fig. 13

Hypopnea

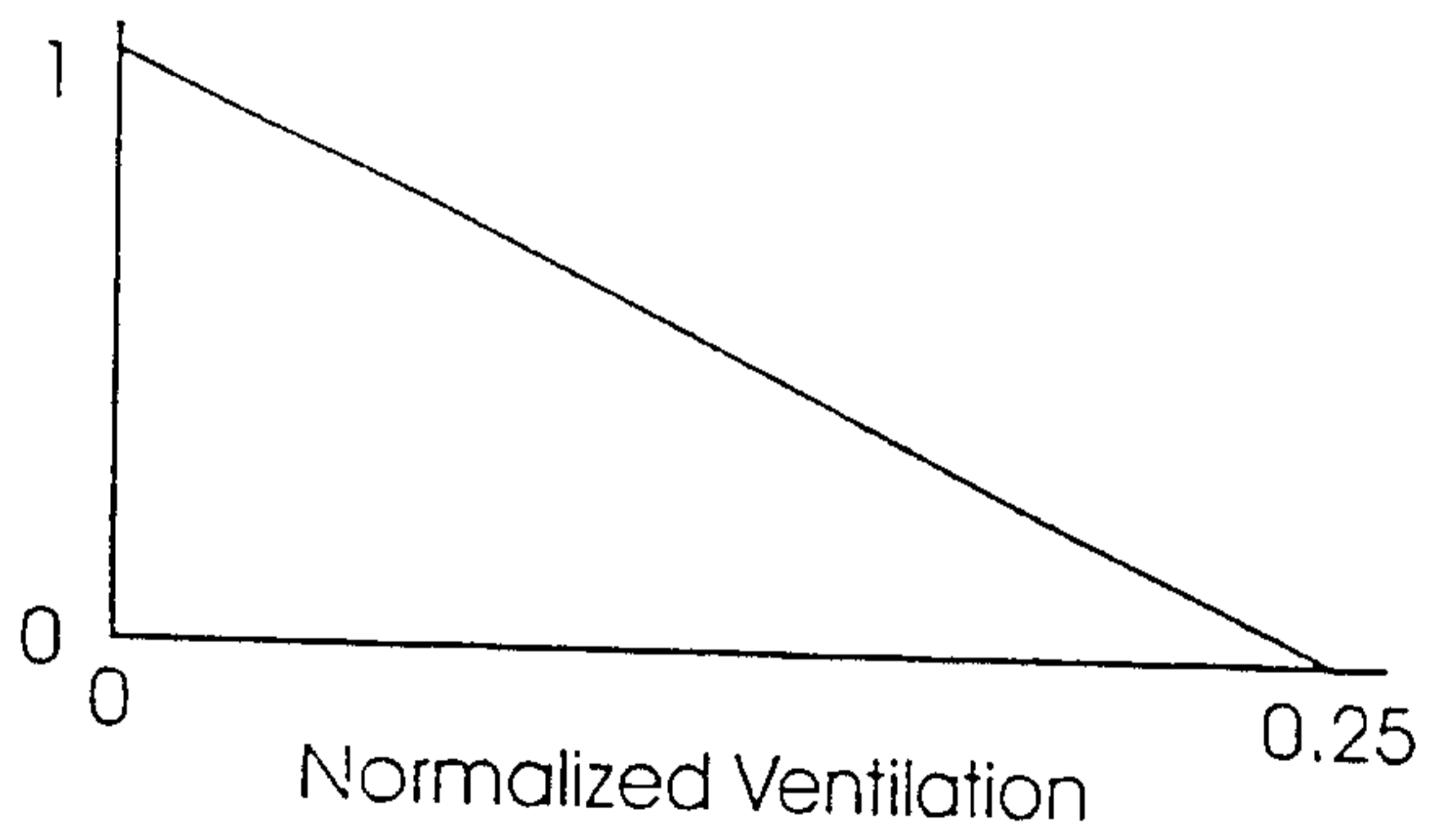

Fig. 14

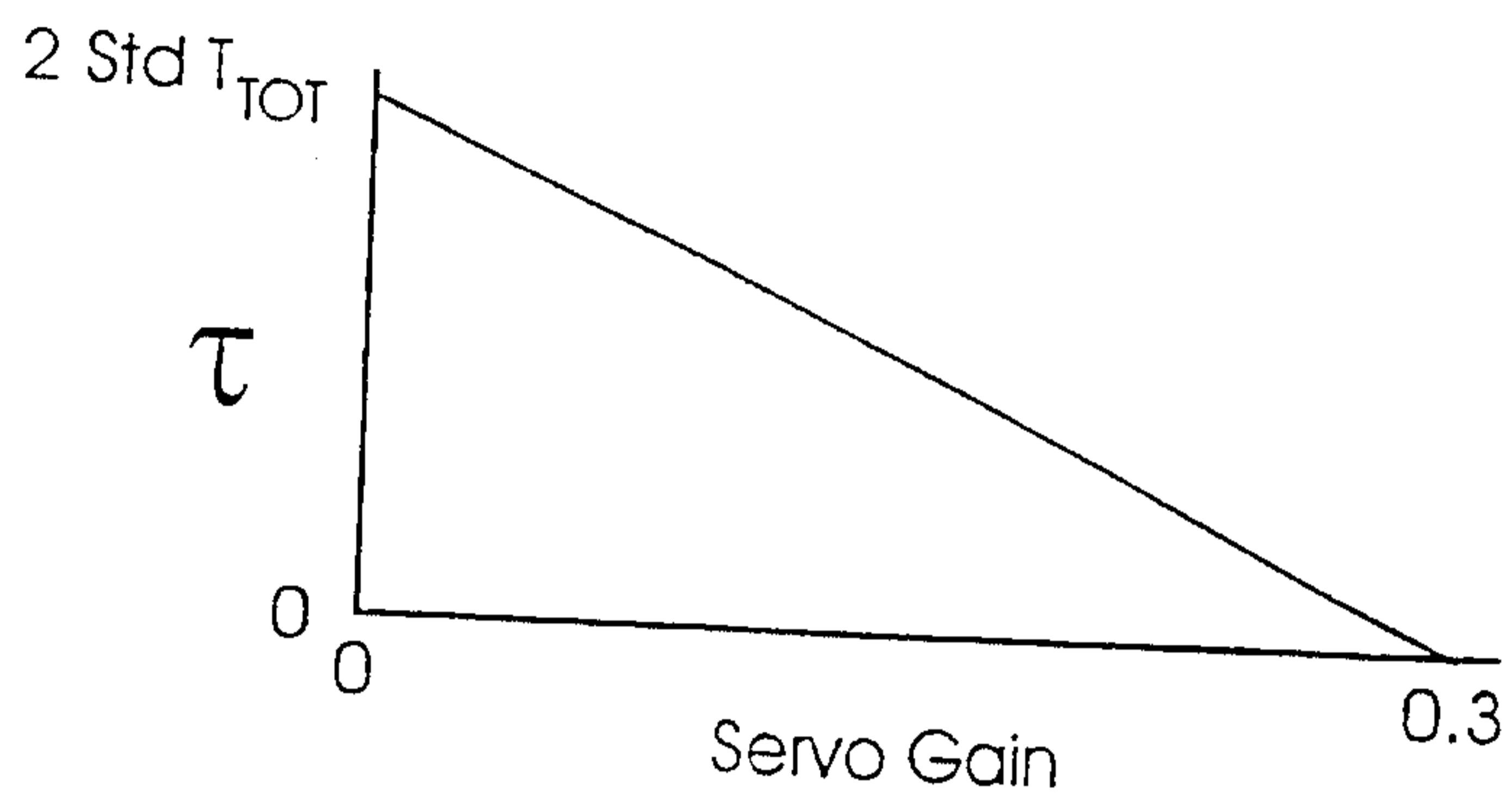

Fig. 15

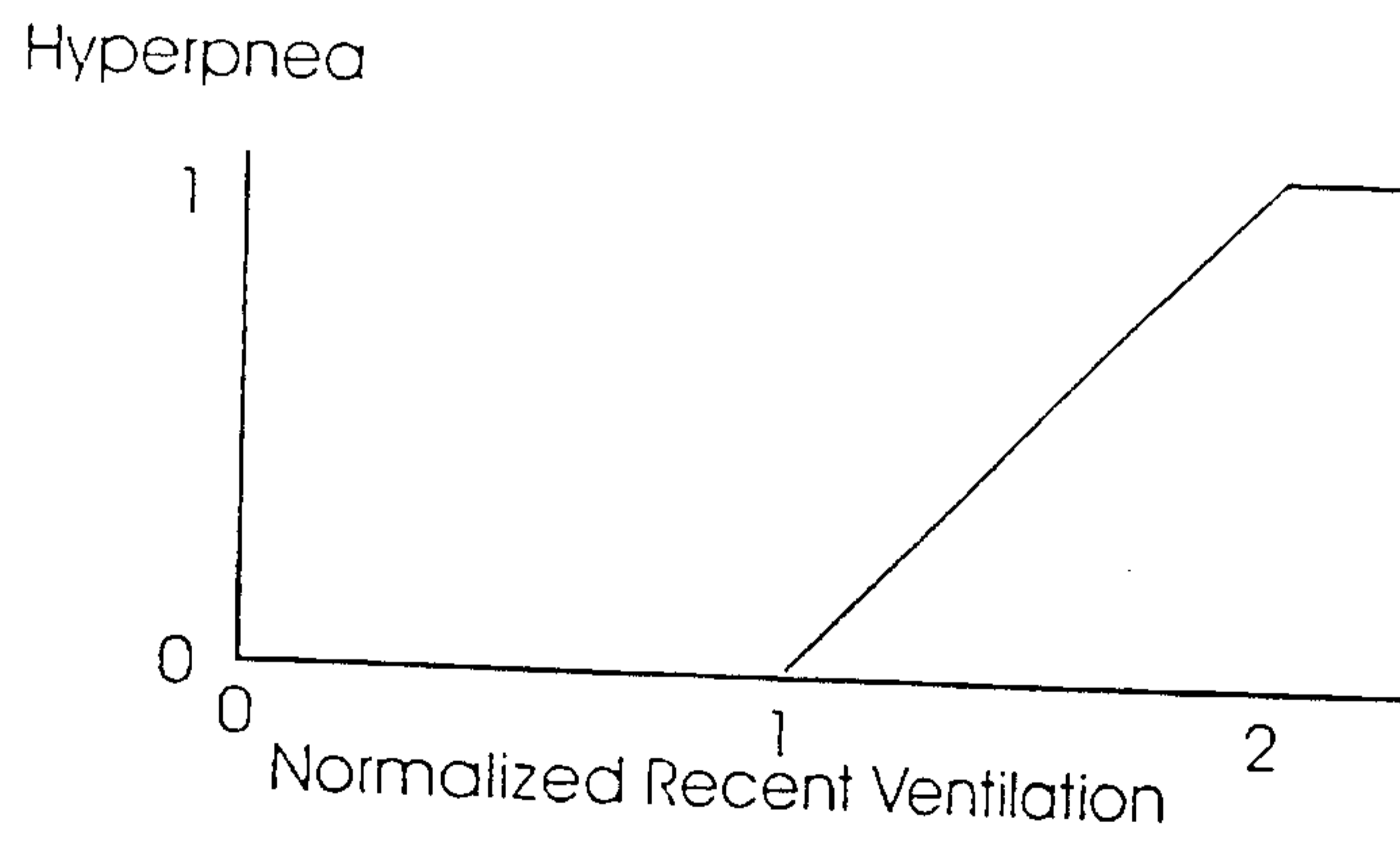

Fig. 16

12/20

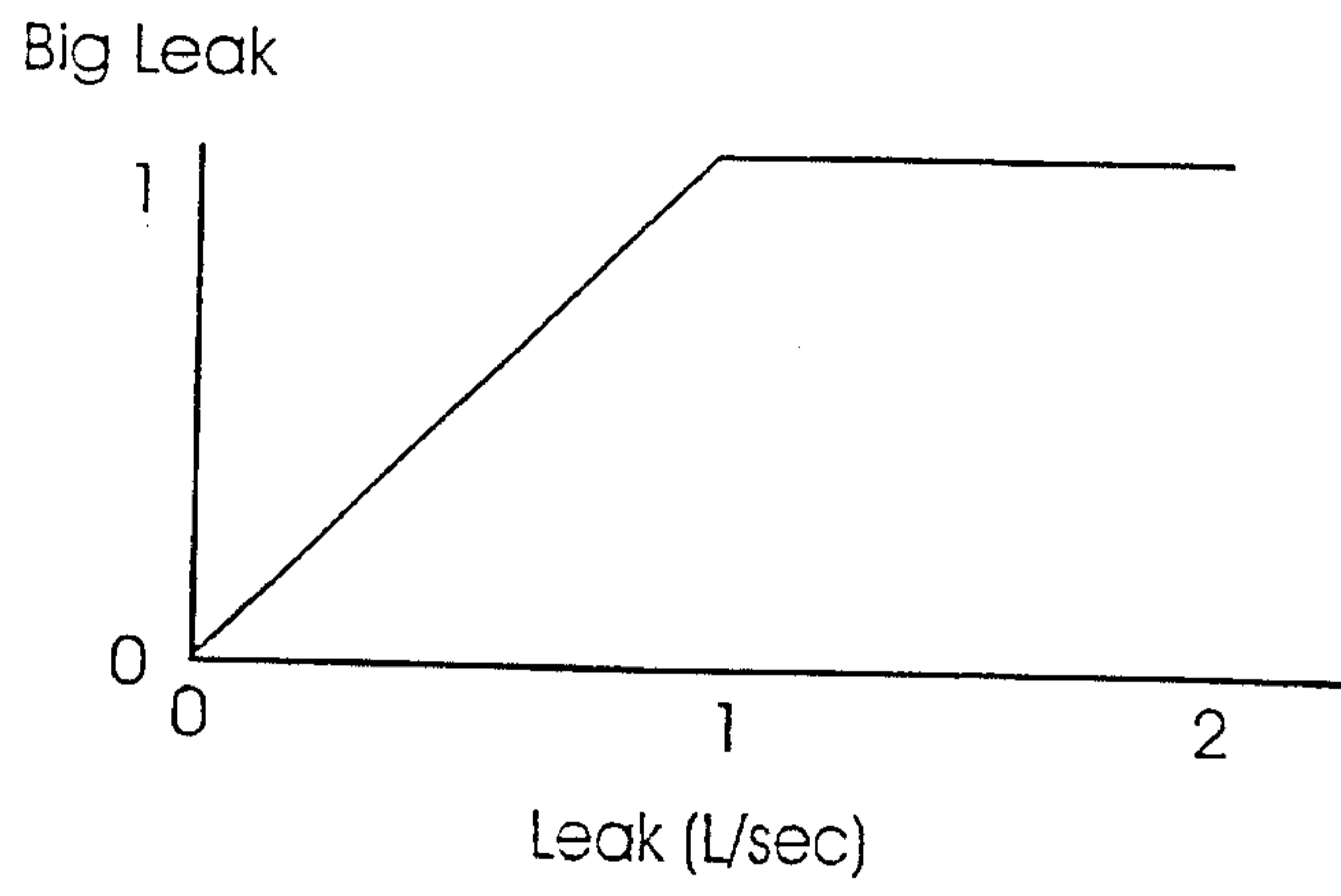

Fig. 17

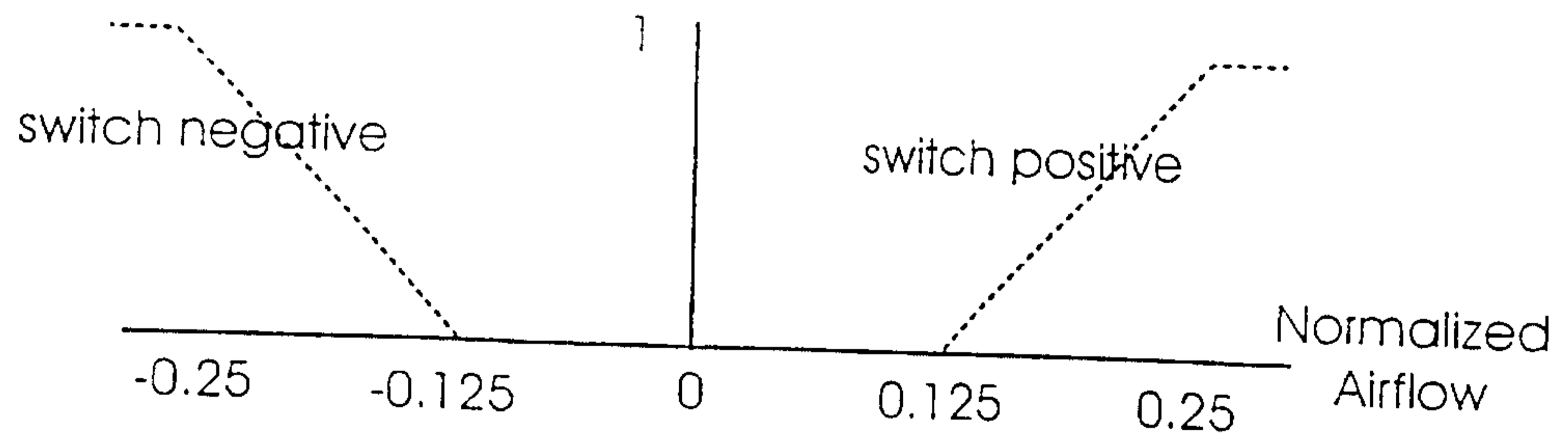

Fig. 18

13/20

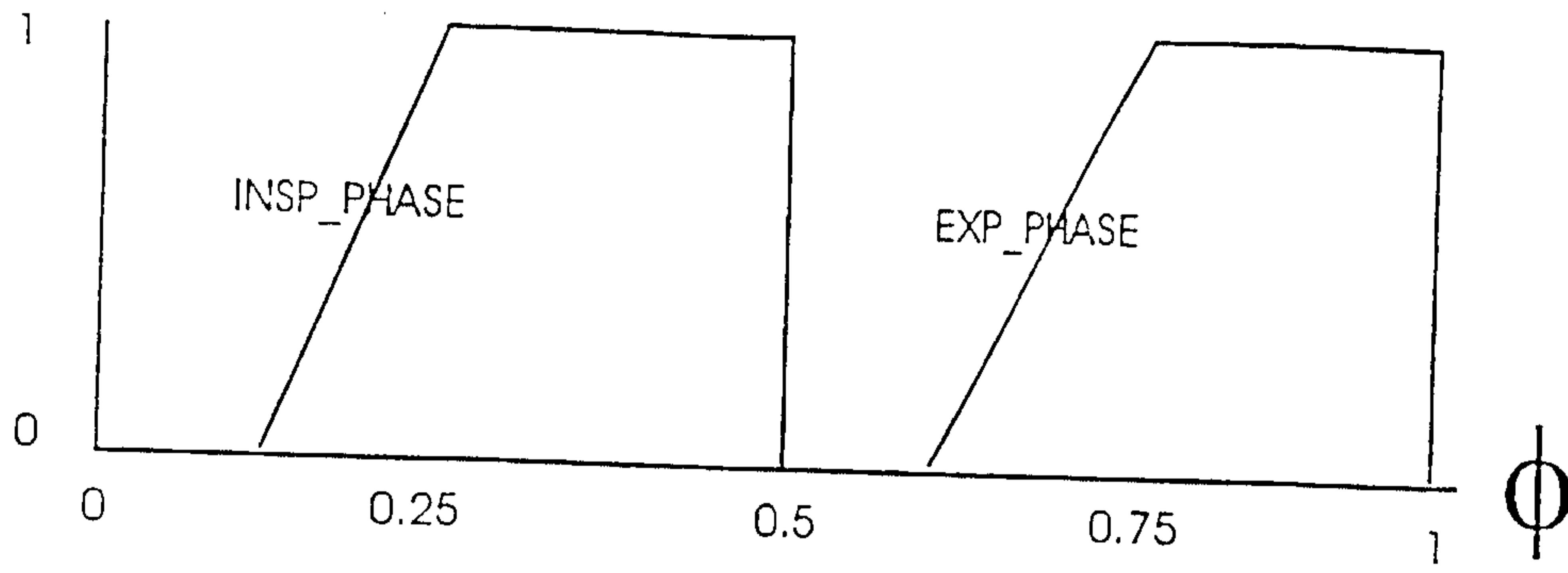

Fig. 19

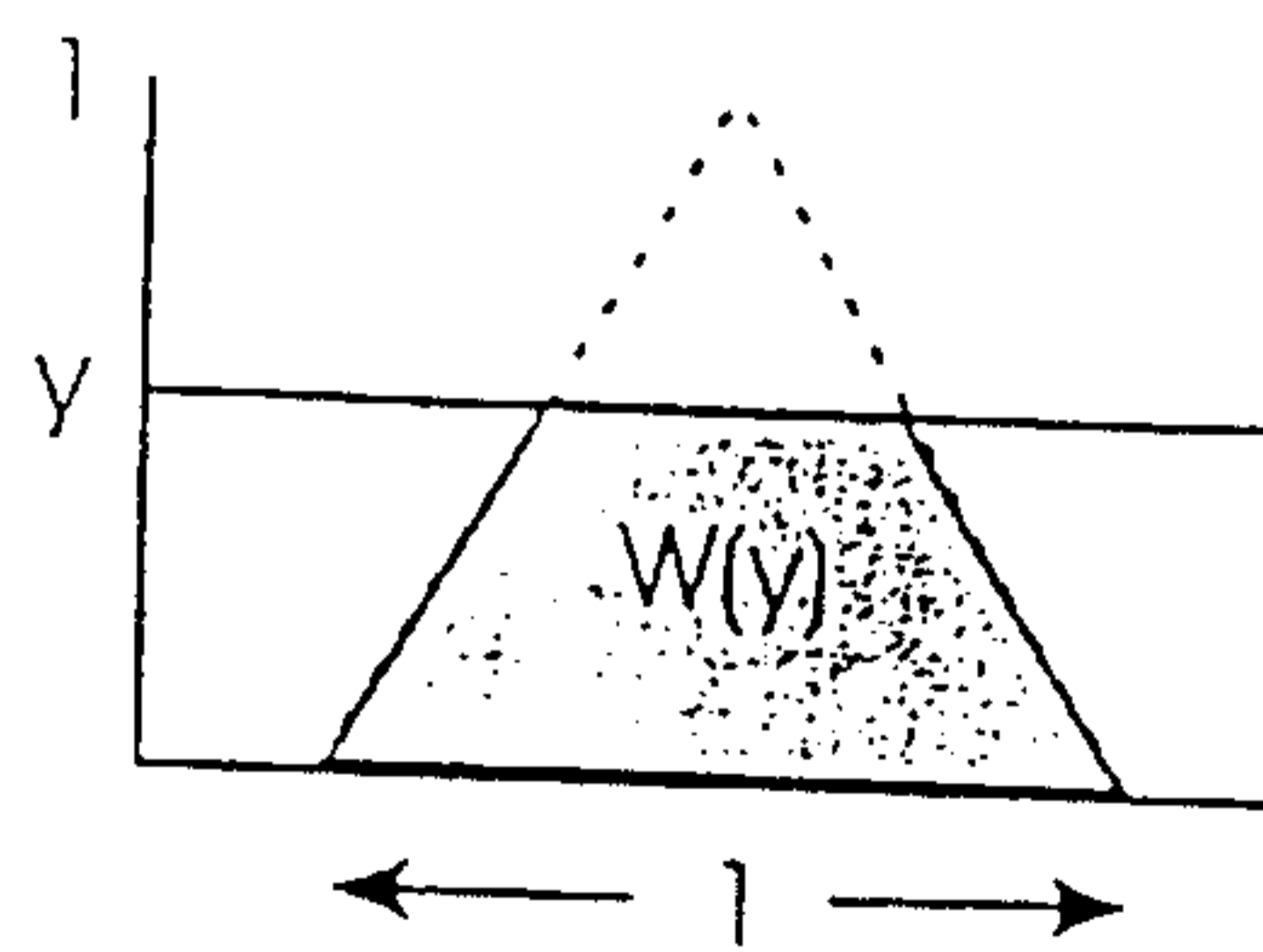

Fig. 20

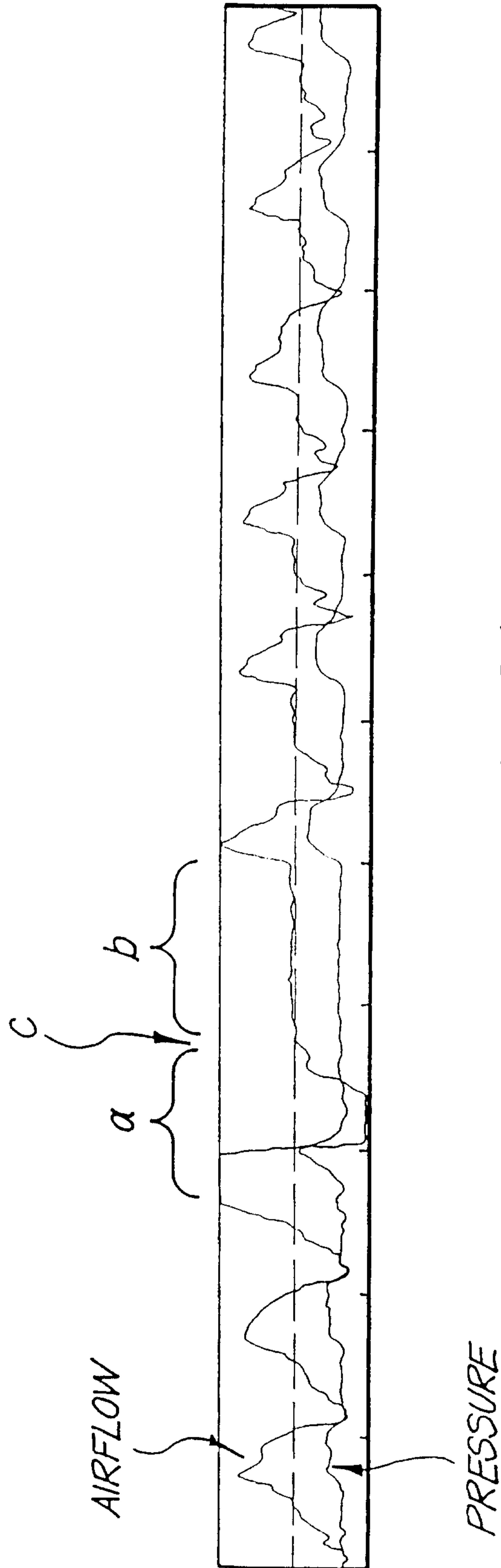

FIG. 21

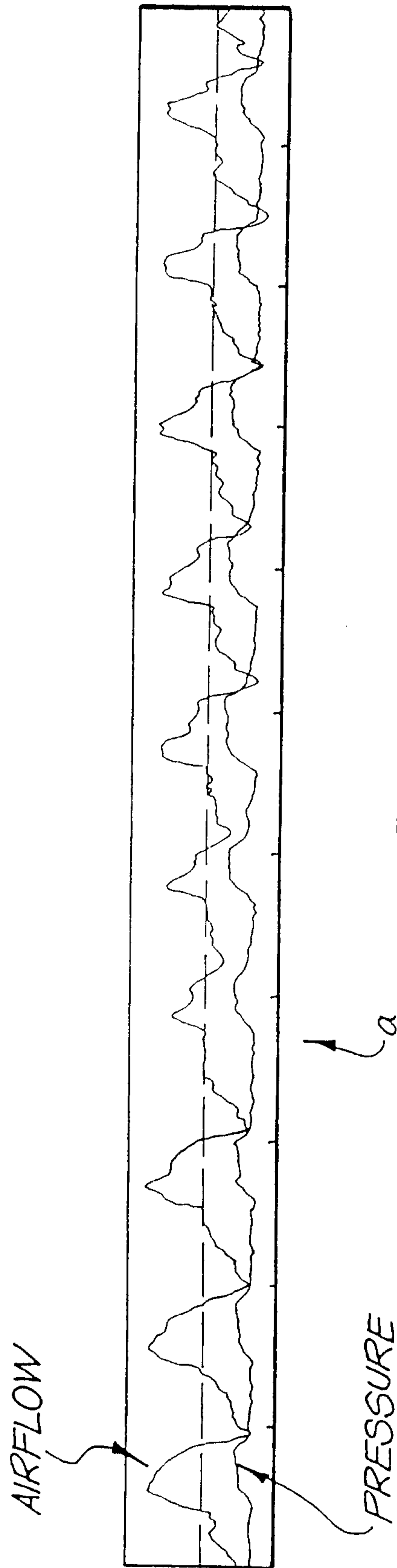

FIG. 22

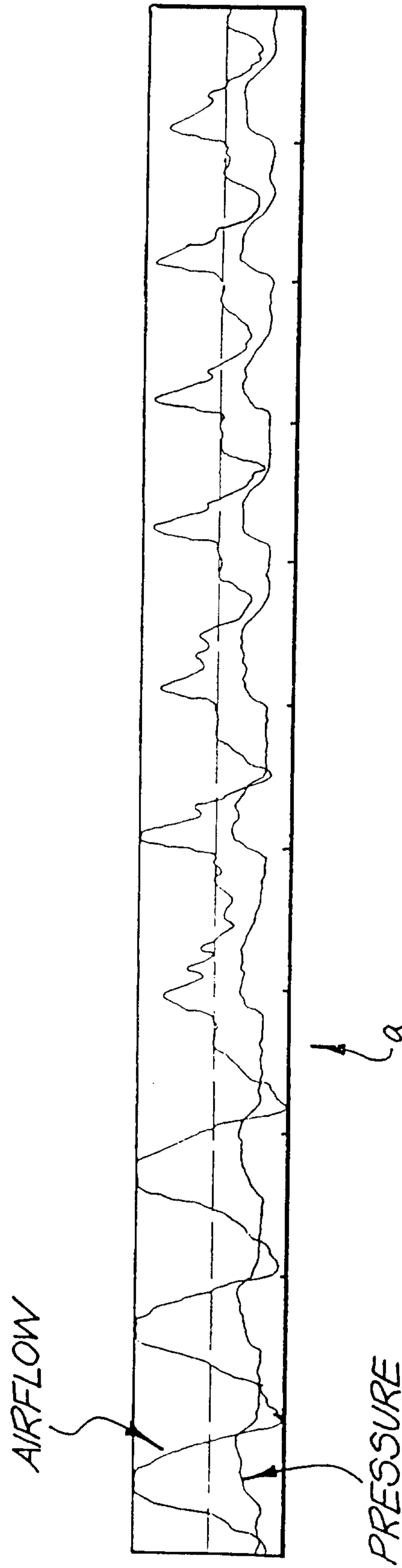

FIG. 23

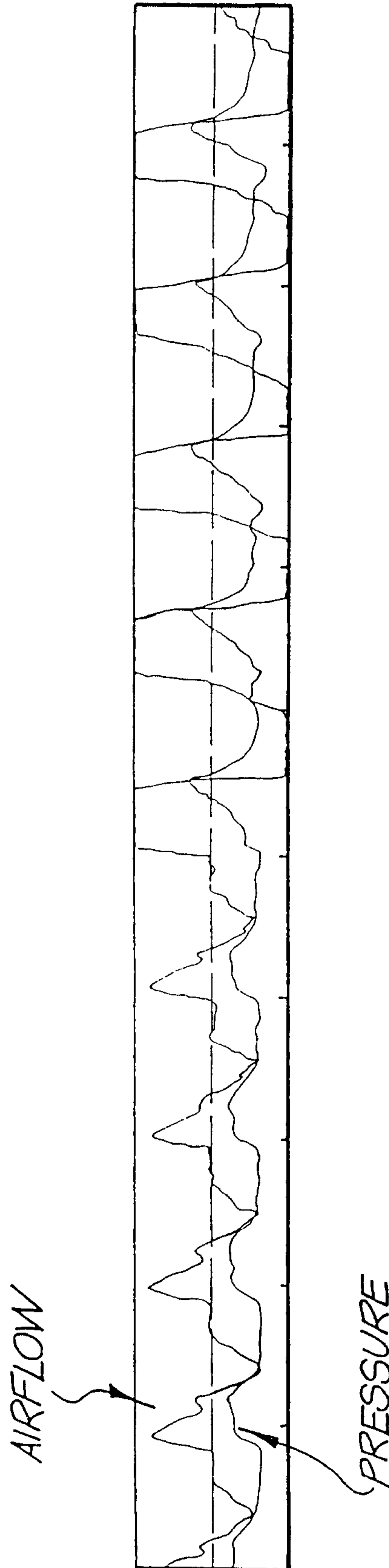

FIG. 24

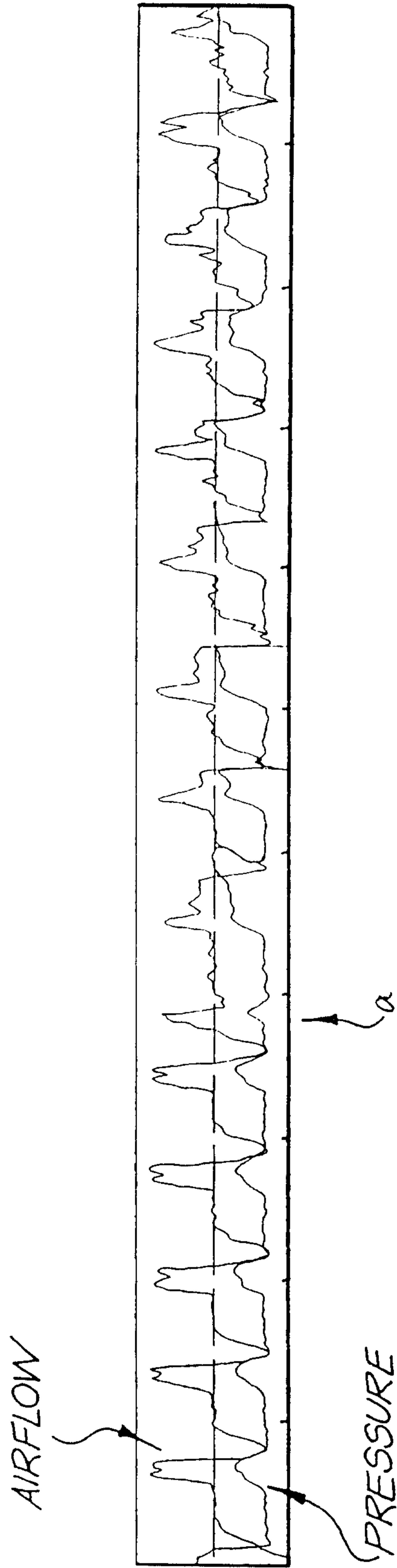

FIG. 25

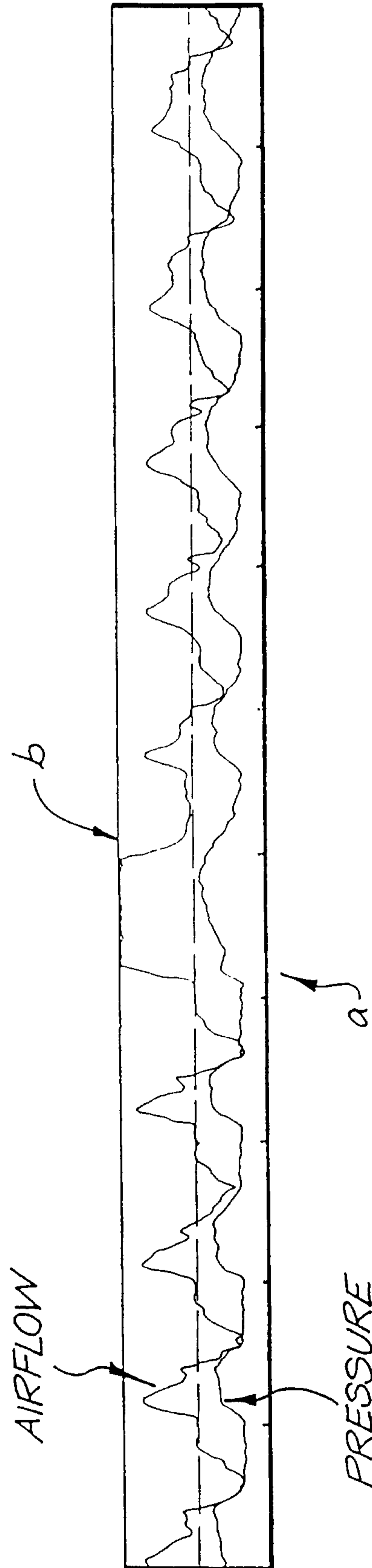

FIG. 26

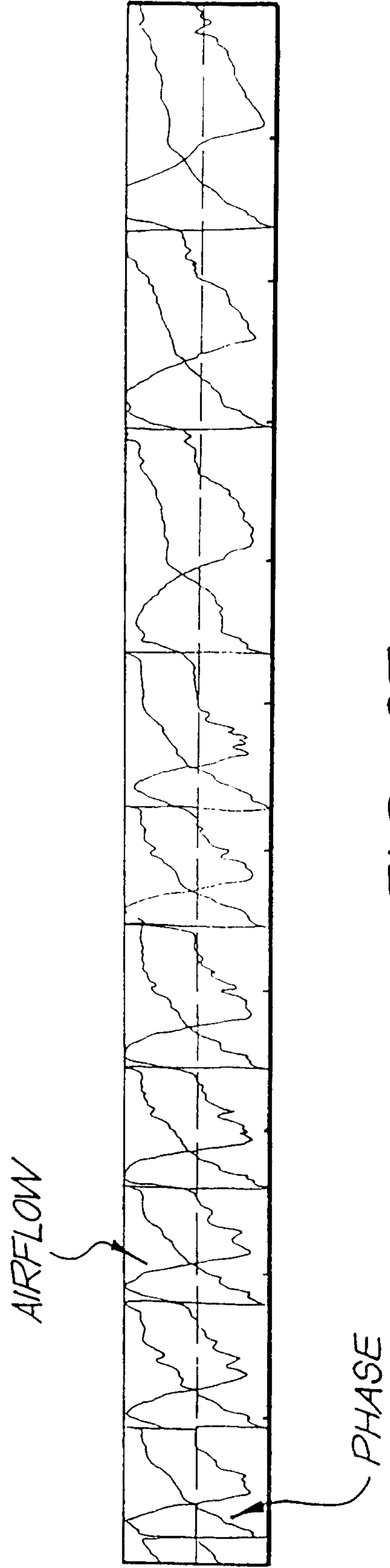

FIG. 27