



US00D660245S

(12) **United States Design Patent**  
**Ngo**

(10) **Patent No.:** **US D660,245 S**

(45) **Date of Patent:** **\*\* May 22, 2012**

(54) **VERTICAL ELECTRICAL CONNECTOR**

FOREIGN PATENT DOCUMENTS

(75) Inventor: **Hung Viet Ngo**, Harrisburg, PA (US)

DE 1 665 181 4/1974

(Continued)

(73) Assignee: **FCI Americas Technology LLC**,  
Carson City, NV (US)

OTHER PUBLICATIONS

(\*\*) Term: **14 Years**

Finan, J.M., "Thermally Conductive Thermoplastics", LNP Engineering Plastics, Inc., *Plastics Engineering* 2000, www.4spe.org, 4 pages.

(21) Appl. No.: **29/403,185**

(Continued)

(22) Filed: **Oct. 3, 2011**

*Primary Examiner* — Daniel Bui

(74) *Attorney, Agent, or Firm* — Woodcock Washburn LLP

**Related U.S. Application Data**

(63) Continuation of application No. 29/389,028, filed on Apr. 6, 2011, now Pat. No. Des. 647,058, which is a continuation of application No. 29/383,232, filed on Jan. 14, 2011, now Pat. No. Des. 640,638, which is a continuation of application No. 29/364,019, filed on Jun. 17, 2010, now Pat. No. Des. 640,637, which is a continuation of application No. 29/345,798, filed on Oct. 22, 2009, now Pat. No. Des. 623,138, which is a continuation of application No. 29/331,013, filed on Jan. 16, 2009, now Pat. No. Des. 608,293.

(57) **CLAIM**

The ornamental design for a vertical electrical connector, as shown and described.

(51) **LOC (9) Cl.** ..... **13-03**

(52) **U.S. Cl.** ..... **D13/147**

(58) **Field of Classification Search** ..... D13/147,  
D13/154, 184, 199; 439/159-160, 260, 325,  
439/329, 395, 492, 495, 607.01, 607.04,  
439/607.05, 607.17, 607.25, 607.34, 607.41,  
439/607.53, 630

**DESCRIPTION**

This application is related by subject matter to U.S. Design patent application Ser. Nos. 29/331,017 filed on Jan. 16, 2009, now U.S. Pat. No. D610,548; 29/330,990 filed on Jan. 16, 2009, now U.S. Pat. No. D606,496; and 29/330,997 filed on Jan. 16, 2009, now U.S. Pat. No. D606,497, and is further related by subject matter to U.S. Design patent applications Ser. No. 29/345,790, filed Oct. 22, 2009, now U.S. Pat. No. D628,536, and U.S. Design patent application No. 29/345,808, filed Oct. 22, 2009, now U.S. Pat. No. D631,442. FIG. 1 is a top, left, rear perspective view of a vertical electrical connector according to my design; FIG. 2 is a top plan view thereof; FIG. 3 is a bottom plan view thereof; FIG. 4 is a rear elevation view thereof; FIG. 5 is a front elevation view thereof; FIG. 6 is a left side elevation view thereof; and, FIG. 7 is a right side elevation view thereof. The broken line portion of the figure drawings is included to show unclaimed subject matter, and forms no part of the claimed design. The dash-dot line represents the boundary of the claimed design.

See application file for complete search history.

(56) **References Cited**

**U.S. PATENT DOCUMENTS**

318,186 A	5/1885	Hertzog
741,052 A	10/1903	Mahon
1,477,527 A	12/1923	Raettig
2,125,816 A	8/1938	Reynolds
2,248,675 A	7/1941	Huppert
2,430,011 A	11/1947	Gillentine
2,759,163 A	8/1956	Ustin et al.

(Continued)

**1 Claim, 4 Drawing Sheets**

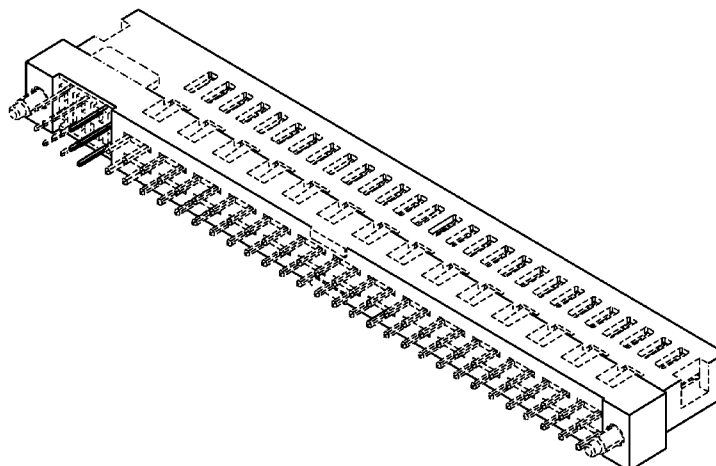

## US D660,245 S

Page 2

U.S. PATENT DOCUMENTS					
2,762,022 A	9/1956	Benander et al.	5,274,918 A	1/1994	Reed
2,762,026 A	9/1956	Knohl	5,276,964 A	1/1994	Anderson, Jr. et al.
2,844,644 A	7/1958	Soule, Jr.	5,277,597 A	1/1994	Masami et al.
3,011,143 A	11/1961	Dean	5,295,843 A	3/1994	Davis et al.
3,178,669 A	4/1965	Roberts	5,302,135 A	4/1994	Lee
3,208,030 A	9/1965	Evans et al.	5,381,314 A	1/1995	Rudy, Jr. et al.
3,286,220 A	11/1966	Marley et al.	5,400,949 A	3/1995	Hirvonen et al.
3,411,127 A	11/1968	Adams	5,427,543 A	6/1995	Dynia
3,420,087 A	1/1969	Hatfield et al.	5,431,578 A	7/1995	Wayne
3,514,740 A	5/1970	Filson	5,457,342 A	10/1995	Herbst, II
3,538,486 A	11/1970	Shlesinger, Jr.	5,475,922 A	12/1995	Tamura et al.
3,634,811 A	1/1972	Teagno et al.	5,490,040 A	2/1996	Gaudenzi et al.
3,669,054 A	6/1972	Desso et al.	5,511,987 A	4/1996	Shinchi
3,692,994 A	9/1972	Hirschman et al.	5,533,915 A	7/1996	Deans
3,748,633 A	7/1973	Lundergan	5,558,542 A	9/1996	O'Sullivan et al.
3,845,451 A	10/1974	Neidecker	5,577,928 A	11/1996	Duclos
3,871,015 A	3/1975	Lin et al.	5,582,519 A	12/1996	Buchter
3,942,856 A	3/1976	Mindheim et al.	5,588,859 A	12/1996	Maurice
3,972,580 A	8/1976	Pemberton et al.	5,590,463 A	1/1997	Feldman et al.
4,070,088 A	1/1978	Vaden	5,609,502 A	3/1997	Thumma
4,076,362 A	2/1978	Ichimura	5,618,187 A	4/1997	Goto
4,136,919 A	1/1979	Howard et al.	5,634,009 A	5/1997	Iddon et al.
4,159,861 A	7/1979	Anhalt	5,637,008 A	6/1997	Kozel
4,217,024 A	8/1980	Aldridge et al.	5,664,973 A	9/1997	Emmert et al.
4,260,212 A	4/1981	Ritchie et al.	5,691,041 A	11/1997	Frankeny et al.
4,288,139 A	9/1981	Cobaugh et al.	5,702,255 A	12/1997	Murphy et al.
4,371,912 A	2/1983	Guzik	5,727,963 A	3/1998	LeMaster
4,383,724 A	5/1983	Verhoeven	5,730,609 A	3/1998	Harwath
4,402,563 A	9/1983	Sinclair	5,741,144 A	4/1998	Elco et al.
4,403,821 A	9/1983	Zimmerman, Jr. et al.	5,741,161 A	4/1998	Cahaly et al.
4,425,015 A	1/1984	Rizzo	5,742,484 A	4/1998	Gillette et al.
4,464,832 A	8/1984	Asick et al.	5,743,009 A	4/1998	Matsui et al.
4,505,529 A	3/1985	Barkus	5,745,349 A	4/1998	Lemke
4,531,793 A	7/1985	Hochgesang	5,746,608 A	5/1998	Taylor
4,533,187 A	8/1985	Kirkman	5,755,595 A	5/1998	Davis et al.
4,536,955 A	8/1985	Gudgeon	5,772,451 A	6/1998	Dozier, II et al.
4,545,610 A	10/1985	Lakritz et al.	5,785,537 A	7/1998	Donahue et al.
4,552,425 A	11/1985	Billman	5,787,971 A	8/1998	Dodson
4,560,222 A	12/1985	Dambach	5,795,191 A	8/1998	Preputnick et al.
4,564,259 A	1/1986	Vandame	5,810,607 A	9/1998	Shih et al.
4,582,386 A	4/1986	Martens	5,817,973 A	10/1998	Elco
4,596,433 A	6/1986	Oesterheld et al.	5,831,314 A	11/1998	Wen
4,685,886 A	8/1987	Denlinger et al.	5,857,857 A	1/1999	Fukuda
4,687,267 A	8/1987	Header et al.	5,874,776 A	2/1999	Kresge et al.
4,717,360 A	1/1988	Czaja	5,876,219 A	3/1999	Taylor et al.
4,734,041 A	3/1988	Bruchmann et al.	5,876,248 A	3/1999	Brunker et al.
4,742,500 A	5/1988	Luce	5,883,782 A	3/1999	Thurston et al.
4,753,609 A	6/1988	Pfeffer et al.	5,888,884 A	3/1999	Wojnarowski
4,767,344 A	8/1988	Noschese	5,908,333 A	6/1999	Perino et al.
4,776,803 A	10/1988	Pretchel et al.	5,919,049 A	7/1999	Petersen et al.
4,815,987 A	3/1989	Kawano et al.	5,919,050 A	7/1999	Kehley et al.
4,820,182 A	4/1989	Harwath et al.	5,930,114 A	7/1999	Kuzmin et al.
4,867,713 A	9/1989	Ozu et al.	5,955,888 A	9/1999	Frederickson et al.
4,878,611 A	11/1989	LoVasco et al.	5,961,355 A	10/1999	Morlion et al.
4,881,905 A	11/1989	Demler, Jr. et al.	5,971,817 A	10/1999	Longueville
4,900,271 A	2/1990	Colleran et al.	5,975,921 A	11/1999	Shuey
4,907,990 A	3/1990	Bertho et al.	5,980,270 A	11/1999	Fjelstad et al.
4,915,641 A	4/1990	Miskin et al.	5,980,321 A	11/1999	Cohen et al.
4,963,102 A	10/1990	Gettig et al.	5,984,726 A	11/1999	Wu
4,973,257 A	11/1990	Lhotak	5,993,259 A	11/1999	Stokoe et al.
4,973,271 A	11/1990	Ishizuka et al.	6,012,948 A	1/2000	Wu
4,975,084 A	12/1990	Fedder et al.	6,036,549 A	3/2000	Wulff
5,016,968 A	5/1991	Hammond et al.	6,050,862 A	4/2000	Ishii
5,024,610 A	6/1991	French et al.	6,059,170 A	5/2000	Jimarez et al.
5,035,639 A	7/1991	Kilpatrick et al.	6,065,951 A	5/2000	Lemke et al.
5,052,953 A	10/1991	Weber	6,068,520 A	5/2000	Winings et al.
5,064,391 A	11/1991	Buchter	6,071,152 A	6/2000	Achammer et al.
5,066,236 A	11/1991	Broeksteeg	6,077,130 A	6/2000	Hughes et al.
5,077,893 A	1/1992	Mosquera et al.	6,089,878 A	7/2000	Meng
5,082,459 A	1/1992	Billman et al.	6,095,827 A	8/2000	Dutkowsky et al.
5,094,634 A	3/1992	Dixon et al.	6,102,754 A	8/2000	Capper et al.
5,104,332 A	4/1992	McCoy	6,123,554 A	9/2000	Ortega et al.
5,147,228 A	9/1992	Miller et al.	6,125,535 A	10/2000	Chiou et al.
5,151,056 A	9/1992	McClune	6,139,336 A	10/2000	Olson
5,174,770 A	12/1992	Sasaki et al.	6,146,157 A	11/2000	Lenoir et al.
5,214,308 A	5/1993	Nishiguchi et al.	6,146,202 A	11/2000	Ramey et al.
5,238,414 A	8/1993	Yaegashi et al.	6,146,203 A	11/2000	Elco et al.
5,254,012 A	10/1993	Wang	6,152,756 A	11/2000	Huang et al.
			6,174,198 B1	1/2001	Wu et al.

# US D660,245 S

6,180,891	B1	1/2001	Murdeshwar	6,740,820	B2	5/2004	Cheng
6,183,287	B1	2/2001	Po	6,743,037	B2	6/2004	Kassa et al.
6,183,301	B1	2/2001	Paagman	6,746,278	B2	6/2004	Nelson et al.
6,190,213	B1	2/2001	Reichart et al.	6,746,281	B1	6/2004	Zhang
6,196,871	B1	3/2001	Szu	6,769,883	B2	8/2004	Brid et al.
6,202,916	B1	3/2001	Updike et al.	6,769,935	B2	8/2004	Stokoe et al.
6,203,328	B1	3/2001	Ortega et al.	6,776,635	B2	8/2004	Blanchfield et al.
6,210,197	B1	4/2001	Yu	6,776,649	B2	8/2004	Pape et al.
6,210,240	B1	4/2001	Comerci et al.	6,780,018	B1	8/2004	Shipe
6,212,755	B1	4/2001	Shimada et al.	6,780,027	B2	8/2004	Allison
6,215,180	B1	4/2001	Chen et al.	6,790,088	B2	9/2004	Ono et al.
6,219,913	B1	4/2001	Uchiyama	6,796,831	B1	9/2004	Yasufuku et al.
6,220,884	B1	4/2001	Lin	D497,598	S	10/2004	Kimura et al.
6,220,895	B1	4/2001	Lin	6,811,440	B1	11/2004	Rothermel et al.
6,220,896	B1	4/2001	Bertoncini et al.	6,814,590	B2	11/2004	Minich et al.
6,234,851	B1	5/2001	Phillips	D499,379	S	12/2004	Zhu et al.
6,238,225	B1	5/2001	Middlehurst et al.	6,829,143	B2	12/2004	Russell et al.
D443,861	S	6/2001	Ko et al.	6,832,933	B2	12/2004	Bu et al.
6,254,435	B1	7/2001	Cheong et al.	6,835,103	B2	12/2004	Middlehurst et al.
6,257,478	B1	7/2001	Straub	6,840,783	B2	1/2005	Wolford et al.
6,259,039	B1	7/2001	Chroneos, Jr. et al.	6,843,687	B2	1/2005	McGowan et al.
6,269,539	B1	8/2001	Takahashi et al.	6,848,886	B2	2/2005	Schmaling et al.
6,272,474	B1	8/2001	Garcia	6,848,950	B2	2/2005	Allison et al.
6,280,216	B1	8/2001	Bernier et al.	6,848,953	B2	2/2005	Schell et al.
6,290,514	B1	9/2001	McHugh et al.	6,863,572	B1	3/2005	Yi et al.
6,293,827	B1	9/2001	Stokoe	6,869,294	B2	3/2005	Clark et al.
6,299,492	B1	10/2001	Pierini et al.	6,884,117	B2	4/2005	Korsunsky et al.
6,309,245	B1	10/2001	Sweeney	6,890,221	B2	5/2005	Wagner
6,319,075	B1	11/2001	Clark et al.	6,905,367	B2	6/2005	Crane, Jr. et al.
6,322,377	B2	11/2001	Middlehurst et al.	6,923,661	B1	8/2005	Bogiel et al.
6,328,602	B1	12/2001	Yamasaki et al.	6,929,504	B2	8/2005	Ling et al.
6,347,952	B1	2/2002	Hasegawa et al.	6,947,012	B2	9/2005	Aisenbrey
6,350,134	B1	2/2002	Fogg et al.	6,975,511	B1	12/2005	Lebo et al.
6,359,783	B1	3/2002	Noble	6,994,569	B2	2/2006	Minich et al.
6,360,940	B1	3/2002	Bolde et al.	7,001,189	B1	2/2006	McGowan et al.
6,362,961	B1	3/2002	Chiou	D517,488	S	3/2006	Riku
6,363,607	B1	4/2002	Chen et al.	7,011,548	B2	3/2006	Bogiel et al.
6,371,773	B1	4/2002	Crofoot et al.	D518,786	S	4/2006	Riku
6,379,188	B1	4/2002	Cohen et al.	7,059,892	B1	6/2006	Trout
6,386,924	B2	5/2002	Long	7,059,919	B2	6/2006	Clark et al.
6,394,818	B1	5/2002	Smalley, Jr.	7,065,871	B2	6/2006	Minich et al.
6,402,566	B1	6/2002	Middlehurst et al.	7,070,464	B2	7/2006	Clark et al.
6,409,534	B1	6/2002	Weisz-Margulescu	7,074,096	B2	7/2006	Copper et al.
6,409,543	B1	6/2002	Astbury, Jr. et al.	7,101,228	B2	9/2006	Hammer et al.
6,428,328	B2	8/2002	Haba et al.	7,104,812	B1	9/2006	Bogiel et al.
6,431,914	B1	8/2002	Billman	7,114,963	B2	10/2006	Shuey et al.
6,435,914	B1	8/2002	Billman	RE39,380	E	11/2006	Davis
6,450,289	B1	9/2002	Field et al.	7,137,848	B1	11/2006	Trout et al.
6,461,202	B2	10/2002	Kline	7,168,963	B2	1/2007	Minich et al.
6,471,523	B1	10/2002	Shuey	D536,668	S	2/2007	Ye et al.
6,471,548	B2	10/2002	Bertoncini et al.	7,182,642	B2	2/2007	Ngo et al.
6,488,549	B1	12/2002	Weller et al.	D540,264	S	4/2007	Zhang
6,489,567	B2	12/2002	Zachrai	7,204,699	B2	4/2007	Stoner et al.
6,506,081	B2	1/2003	Blanchfield et al.	D542,736	S	5/2007	Riku
6,514,103	B2	2/2003	Pape et al.	7,220,141	B2	5/2007	Daily et al.
6,537,111	B2	3/2003	Brammer et al.	D545,275	S	6/2007	Wei et al.
6,544,046	B1	4/2003	Hahn et al.	7,258,562	B2	8/2007	Daily et al.
6,551,112	B1	4/2003	Li et al.	7,273,382	B2	9/2007	Igarashi et al.
6,554,647	B1	4/2003	Cohen et al.	7,303,427	B2	12/2007	Swain
6,572,410	B1	6/2003	Volstorf et al.	7,335,043	B2	2/2008	Ngo et al.
6,575,774	B2	6/2003	Ling et al.	7,347,740	B2	3/2008	Minich
6,592,381	B2	7/2003	Cohen et al.	7,354,282	B2	4/2008	Margulis et al.
6,604,967	B2	8/2003	Middlehurst et al.	7,374,436	B2	5/2008	Schell et al.
6,629,854	B2	10/2003	Murakami	7,402,064	B2	7/2008	Daily et al.
6,645,012	B2	11/2003	Ito et al.	7,488,222	B2	2/2009	Clark et al.
6,648,657	B1	11/2003	Korsunsky et al.	7,520,760	B2	4/2009	Margulis et al.
6,652,294	B1	11/2003	Zhang	7,597,573	B2	10/2009	Defibaugh et al.
6,652,318	B1	11/2003	Winings et al.	D606,496	S	12/2009	Ngo
6,652,322	B2	11/2003	Ito et al.	D606,497	S	12/2009	Ngo
6,663,426	B2	12/2003	Hasircoglu et al.	D608,293	S	1/2010	Ngo
6,665,189	B1	12/2003	Lebo	D610,548	S	2/2010	Ngo
6,669,514	B2	12/2003	Wiebking et al.	D623,138	S	9/2010	Ngo
6,672,884	B1	1/2004	Toh et al.	D628,536	S	12/2010	Ngo
6,672,907	B2	1/2004	Azuma	D631,442	S	1/2011	Ngo
6,692,272	B2	2/2004	Lemke et al.	2001/0003685	A1	6/2001	Aritani
6,702,594	B2	3/2004	Lee et al.	2002/0042225	A1	4/2002	Crane, Jr. et al.
6,705,902	B1	3/2004	Yi et al.	2002/0106930	A1	8/2002	Pape et al.
6,712,621	B2	3/2004	Li et al.	2002/0142676	A1	10/2002	Hosaka et al.
6,716,068	B2	4/2004	Wu	2002/0159235	A1	10/2002	Miller et al.

2002/0168901	A1	11/2002	Choumach	JP	08125379	5/1996
2002/0193019	A1	12/2002	Blanchfield et al.	JP	09 199215	7/1997
2003/0013330	A1	1/2003	Takeuchi	JP	2000-003743	1/2000
2003/0143894	A1	7/2003	Kline et al.	JP	2000-003744	1/2000
2003/0219999	A1	11/2003	Minich et al.	JP	2000-003745	1/2000
2003/0220021	A1	11/2003	Whiteman, Jr. et al.	JP	2000-003746	1/2000
2003/0224628	A1	12/2003	Korsunsky et al.	JP	2003-217785	7/2003
2003/0236035	A1	12/2003	Kuroda et al.	TW	576555	8/1990
2004/0183094	A1	9/2004	Caletka et al.	TW	546872	8/2003
2005/0112952	A1	5/2005	Wang et al.	WO	WO 93/15532	8/1993
2006/0003620	A1	1/2006	Daily et al.	WO	WO 97/43885	11/1997
2006/0128197	A1	6/2006	McGowan et al.	WO	WO 97/44859	11/1997
2006/0228927	A1	10/2006	Daily et al.	WO	WO 98/15989	4/1998
2006/0228948	A1	10/2006	Swain et al.	WO	WO 01/29931 A1	4/2001
2006/0281354	A1	12/2006	Ngo et al.	WO	WO 01/39332 A1	5/2001
2007/0004291	A1	1/2007	Bogiel et al.			
2007/0197063	A1	8/2007	Ngo et al.			
2007/0202748	A1	8/2007	Daily et al.			
2007/0275586	A1	11/2007	Ngo			
2007/0293084	A1	12/2007	Ngo			
2008/0038956	A1	2/2008	Swain			
2008/0207029	A1	8/2008	Defibaugh et al.			
2009/0088028	A1	4/2009	Ngo et al.			
2009/0142953	A1	6/2009	Patel et al.			
2009/0298303	A1	12/2009	Vrenna et al.			
2010/0124848	A1	5/2010	Atkinson et al.			
2010/0184339	A1	7/2010	Ngo et al.			

## FOREIGN PATENT DOCUMENTS

DE	102 26 279	C1	11/2003
EP	0273683	A2	7/1988
EP	0 321 257	B1	4/1993
EP	0 623 248	B1	11/1995
EP	0789422	A2	8/1997
EP	1289070		3/2003
EP	1091449	B1	9/2004
GB	1 162 705		8/1969
JP	06 068943		3/1994
JP	06-236788		8/1994
JP	07-114958		5/1995
JP	07 169523		7/1995

## OTHER PUBLICATIONS

[http://www.molex.com/molex/products/family?channel=products&chanName=family&pageTitle=Introduction&key=extreme\\_poweredge\\_,EXTreme PowerEdge TM: EXTreme PowerEdge TM connectors with signal contacts for combined high-power and signal card edge or busy bar tab applications, printed Feb. 25, 2010, 1 page.](http://www.molex.com/molex/products/family?channel=products&chanName=family&pageTitle=Introduction&key=extreme_poweredge_,EXTreme PowerEdge TM: EXTreme PowerEdge TM connectors with signal contacts for combined high-power and signal card edge or busy bar tab applications, printed Feb. 25, 2010, 1 page.)

Ogando, J., "And now-An Injection-Molded Heat Exchanger", Sure, plastics are thermal insulators, but additive packages allow them to conduct heat instead. Global Design News, Nov. 1, 2000, 4 pages. Product Sketch: PCI Express Card Edge Assembly, Product No. 10018783, Aug. 2, 2008.

Sherman, L.M., "Plastics that Conduct Heat", Plastics Technology Online, Jun. 2001, <http://www.plasticstechnology.com>, 4 pages.

Tyco Electronics Releases new Card Edge Power Connector, Tyco Electronics Corp., Release dated Feb. 16, 2009, Harrisburg Pennsylvania, 4 pages.

Tyco Electronics, "Introduction to High Current Card Edge Connectors", Catalog 1773096, Revised Jul. 2007, 19 pgs.

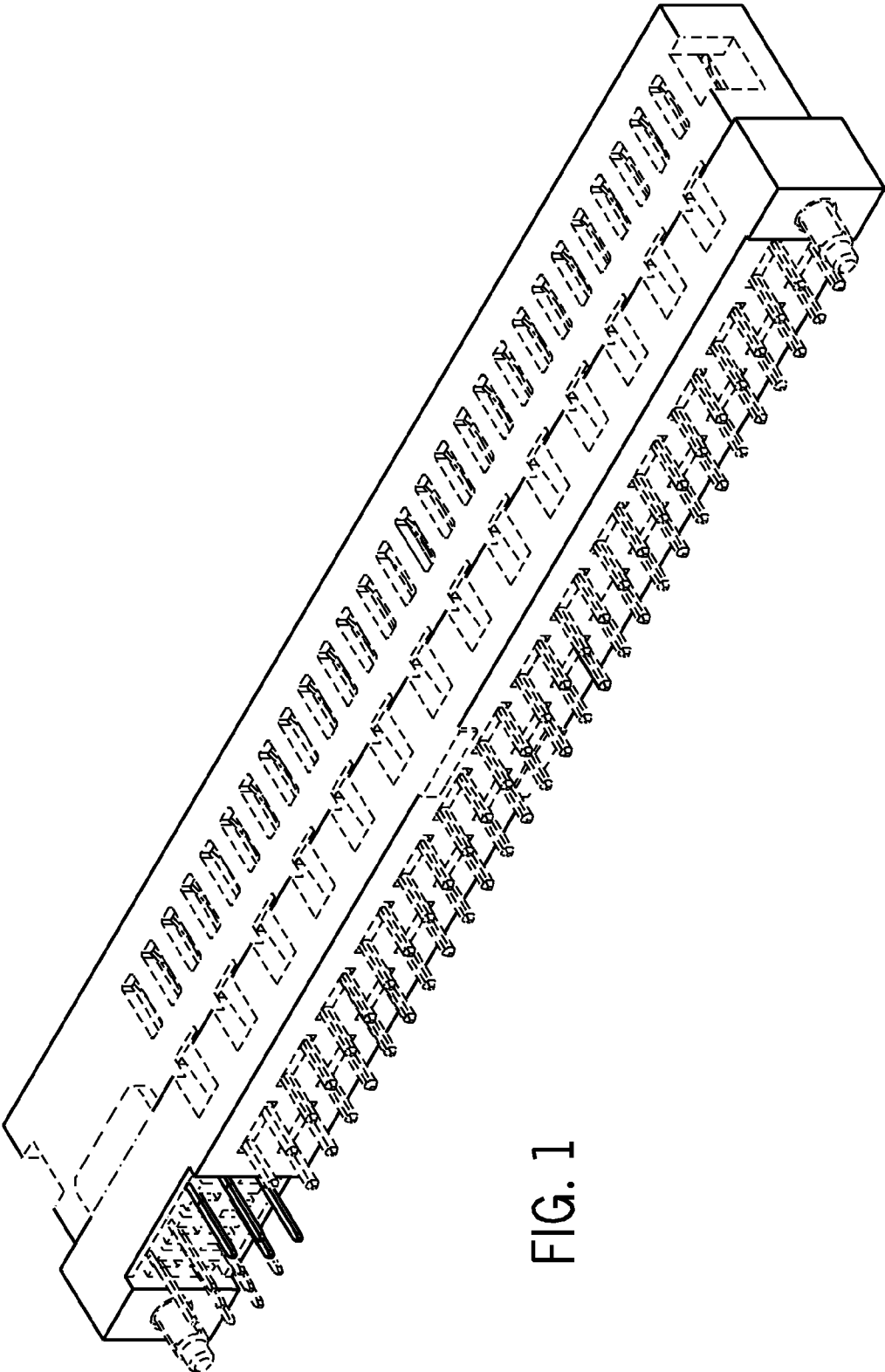

FIG. 1

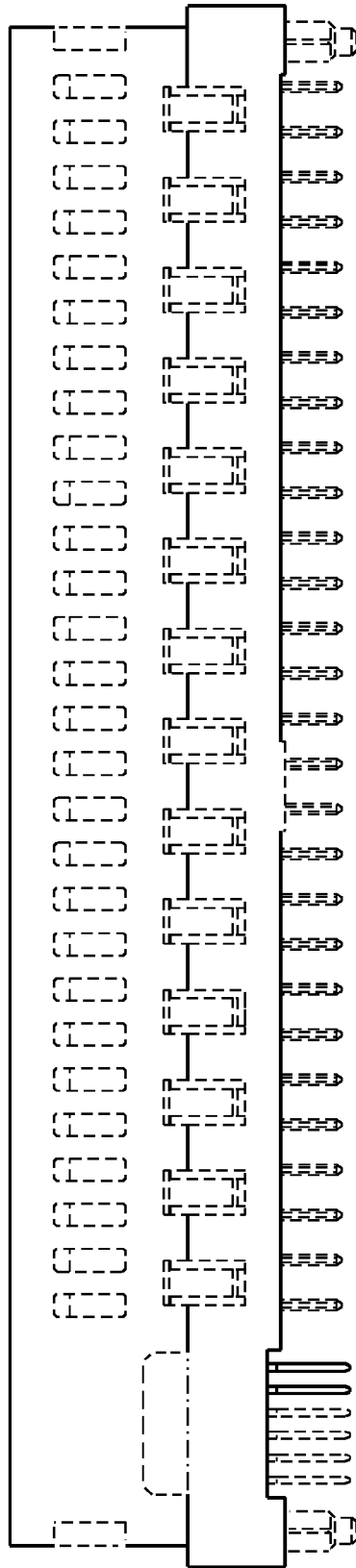

FIG. 2

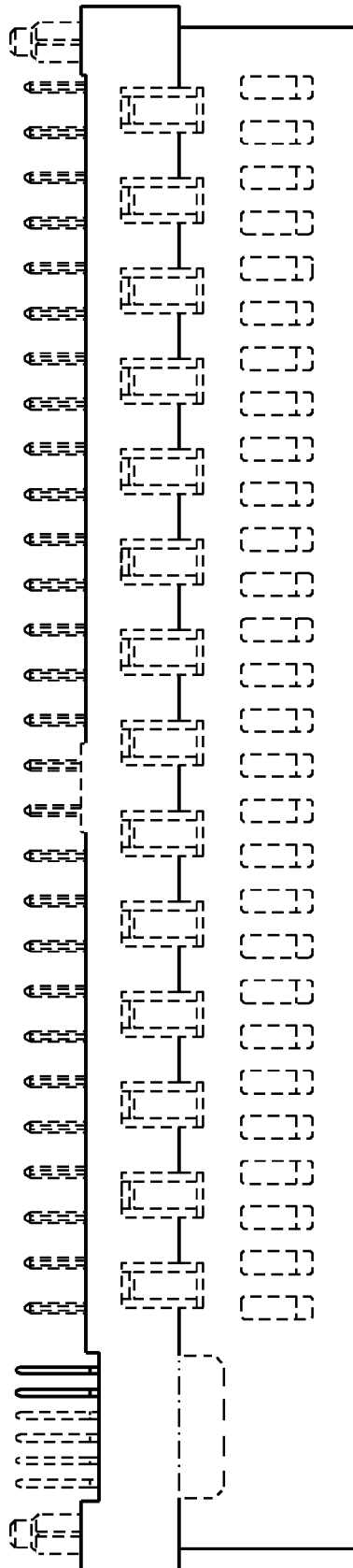

FIG. 3

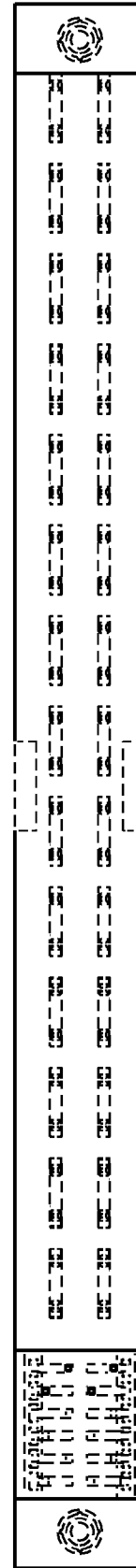

FIG. 4

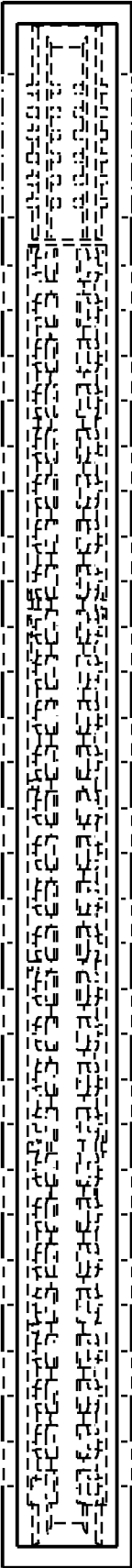

FIG. 5

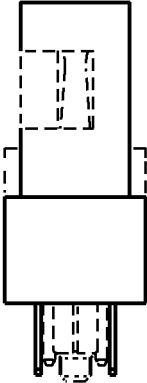

FIG. 6

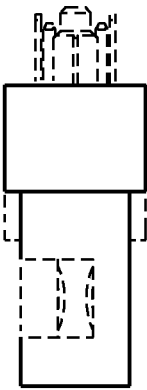

FIG. 7



UNITED STATES PATENT AND TRADEMARK OFFICE  
**CERTIFICATE OF CORRECTION**

PATENT NO. : D660,245 S  
APPLICATION NO. : 29/403185  
DATED : May 22, 2012  
INVENTOR(S) : Hung Viet Ngo

Page 1 of 1

It is certified that error appears in the above-identified patent and that said Letters Patent is hereby corrected as shown below:

At cover page, (57) DESCRIPTION, *before* "U.S. Design Patent Application Serial Nos. 29/331,017" insert --U.S. Provisional Patent Application Serial No. 61/205,276 filed on January 16, 2009, pending, and is further related by subject matter to-- so that the paragraph reads:

--This application is related by subject matter to U.S. Provisional Patent Application Serial No. 61/205,276 filed on January 16, 2009, pending, and is further related by subject matter to U.S. Design Patent Application Serial Nos. 29/331,017 filed on January 16, 2009, now US Patent No. D610,548; 29/330,990 filed on January 16, 2009, now US Patent No. D606,496; and 29/330,997 filed on January 16, 2009, now US Patent No. D606,497, and is further related by subject matter to U.S. Design Patent Applications No. 29/345,790, filed October 22, 2009, now U.S. Patent No. D628,536, and U.S. Design Patent Application No. 29/345,808, filed October 22, 2009, now U.S. Patent No. D631,442.--

Signed and Sealed this  
Twenty-sixth Day of June, 2012

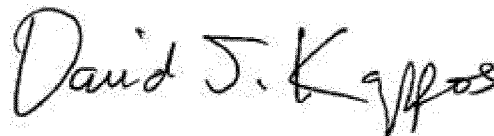

David J. Kappos  
*Director of the United States Patent and Trademark Office*