



US00D735083S

(12) **United States Design Patent**
Kiragu

(10) **Patent No.:** **US D735,083 S**

(45) **Date of Patent:** **** Jul. 28, 2015**

(54) **TRAILER WITH CAR LIFTING ASSEMBLY**

(71) Applicant: **Jacob Kiragu**, Palm Beach, FL (US)

(72) Inventor: **Jacob Kiragu**, Palm Beach, FL (US)

(**) Term: **14 Years**

(21) Appl. No.: **29/470,079**

(22) Filed: **Oct. 17, 2013**

Related U.S. Application Data

(63) Continuation-in-part of application No. 13/664,114, filed on Oct. 30, 2012.

(51) **LOC (10) Cl.** **12-10**

(52) **U.S. Cl.**
USPC **D12/102**

(58) **Field of Classification Search**
USPC D12/100-106, 19, 129, 111-112;
D34/21-26, 12, 16-19; 280/204, 205,
280/63, 475, 482, 647; 296/168, 180,
296/180.2, 61, 10, 100.01-100.08;
D21/425, 435

See application file for complete search history.

(56) **References Cited**

U.S. PATENT DOCUMENTS

3,025,985 A * 3/1962 Crawford 414/537
D648,656 S * 11/2011 Crane D12/101
D661,225 S * 6/2012 Lovett D12/15

D662,856 S * 7/2012 Burchland D12/101
D694,670 S * 12/2013 Oren D12/101
D701,148 S * 3/2014 Brakespeare et al. D12/101
D706,683 S * 6/2014 Cohen D12/101
D710,262 S * 8/2014 Faye D12/101
D720,656 S * 1/2015 Glasener D12/101

* cited by examiner

Primary Examiner — Katrina A Betton

(74) *Attorney, Agent, or Firm* — Melvin K. Silverman

(57) **CLAIM**

The ornamental design for a trailer with car lifting assembly, as shown and described herein.

DESCRIPTION

FIG. 1 is a rear perspective view of my inventive trailer with car lifting assembly.
FIG. 2 is a front elevational view of the trailer of FIG. 1.
FIG. 3 is a rear elevational view of my design.
FIG. 4 is a side view of said trailer with car lifting assembly.
FIG. 5 is a top view of said trailer; and,
FIG. 6 is a bottom view thereof.

1 Claim, 6 Drawing Sheets

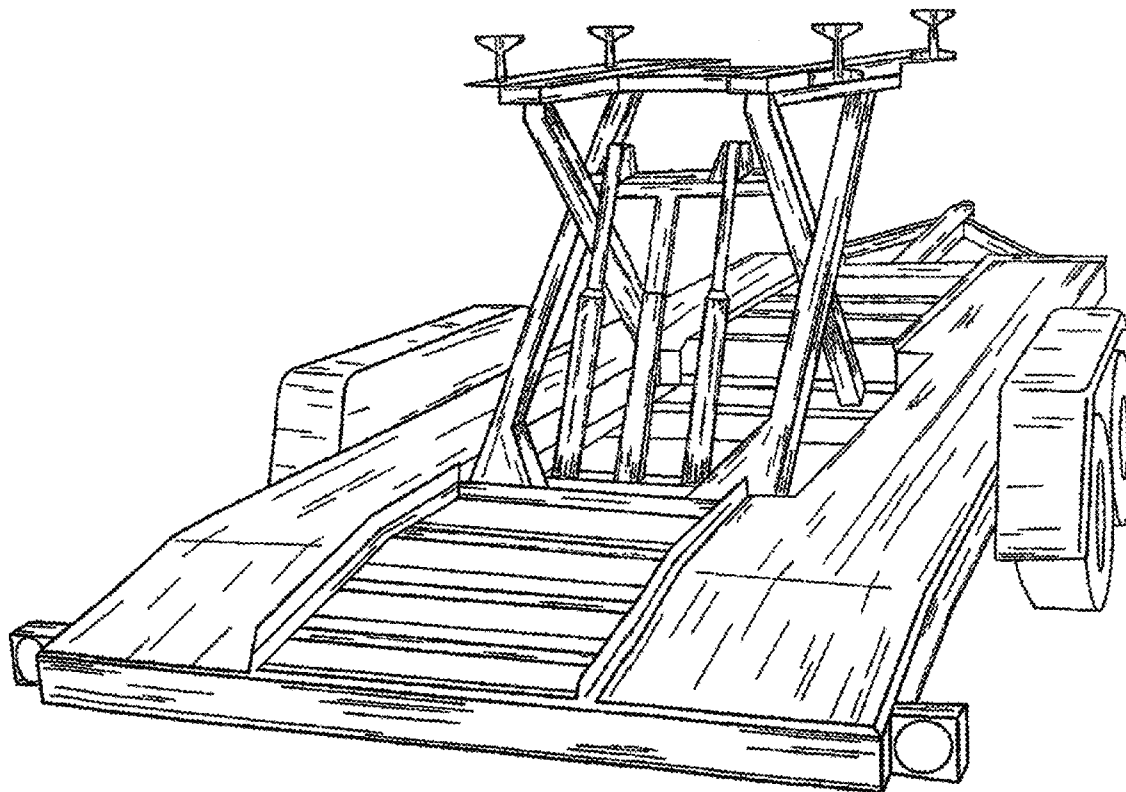

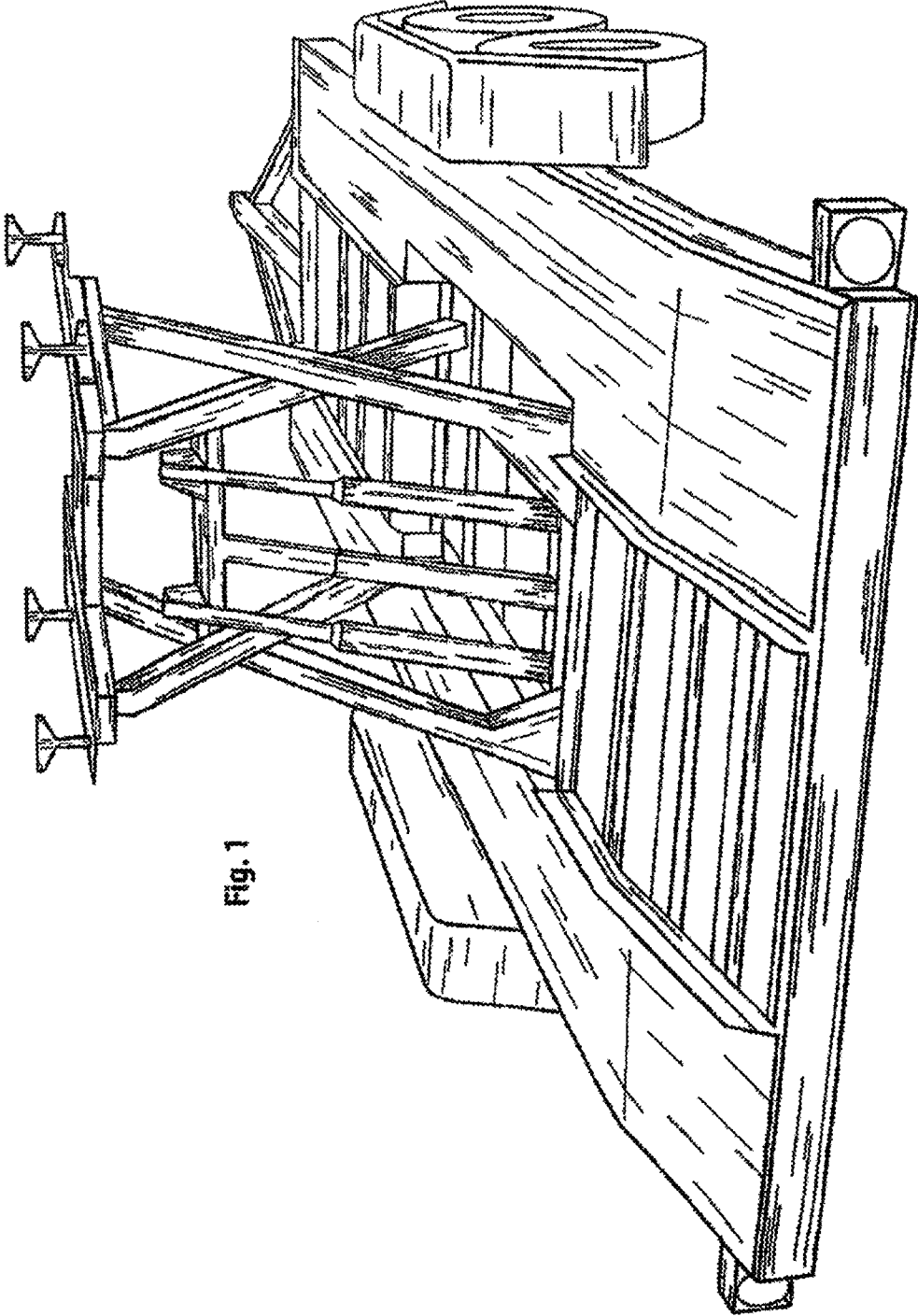

Fig. 1

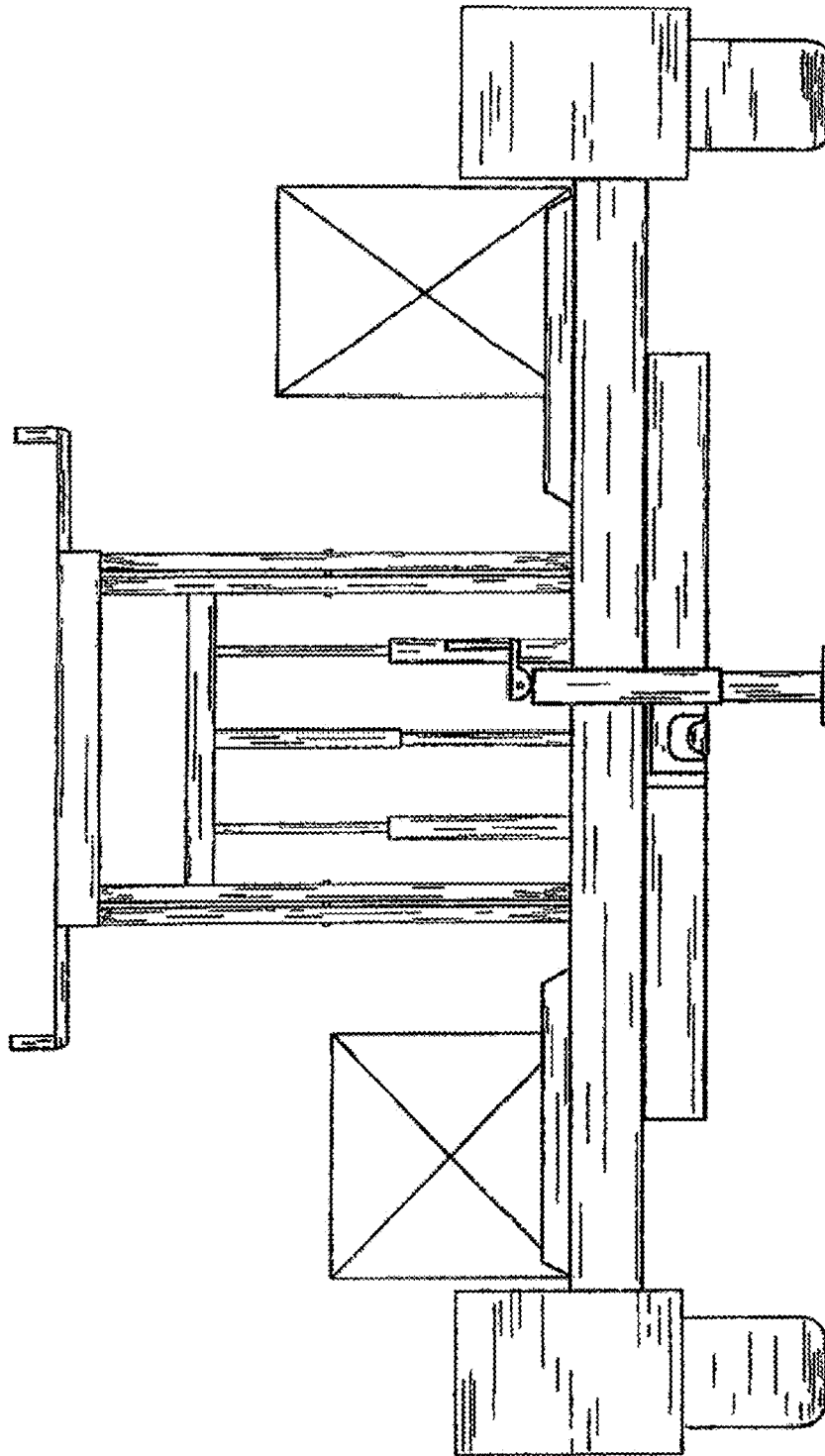

Fig. 2

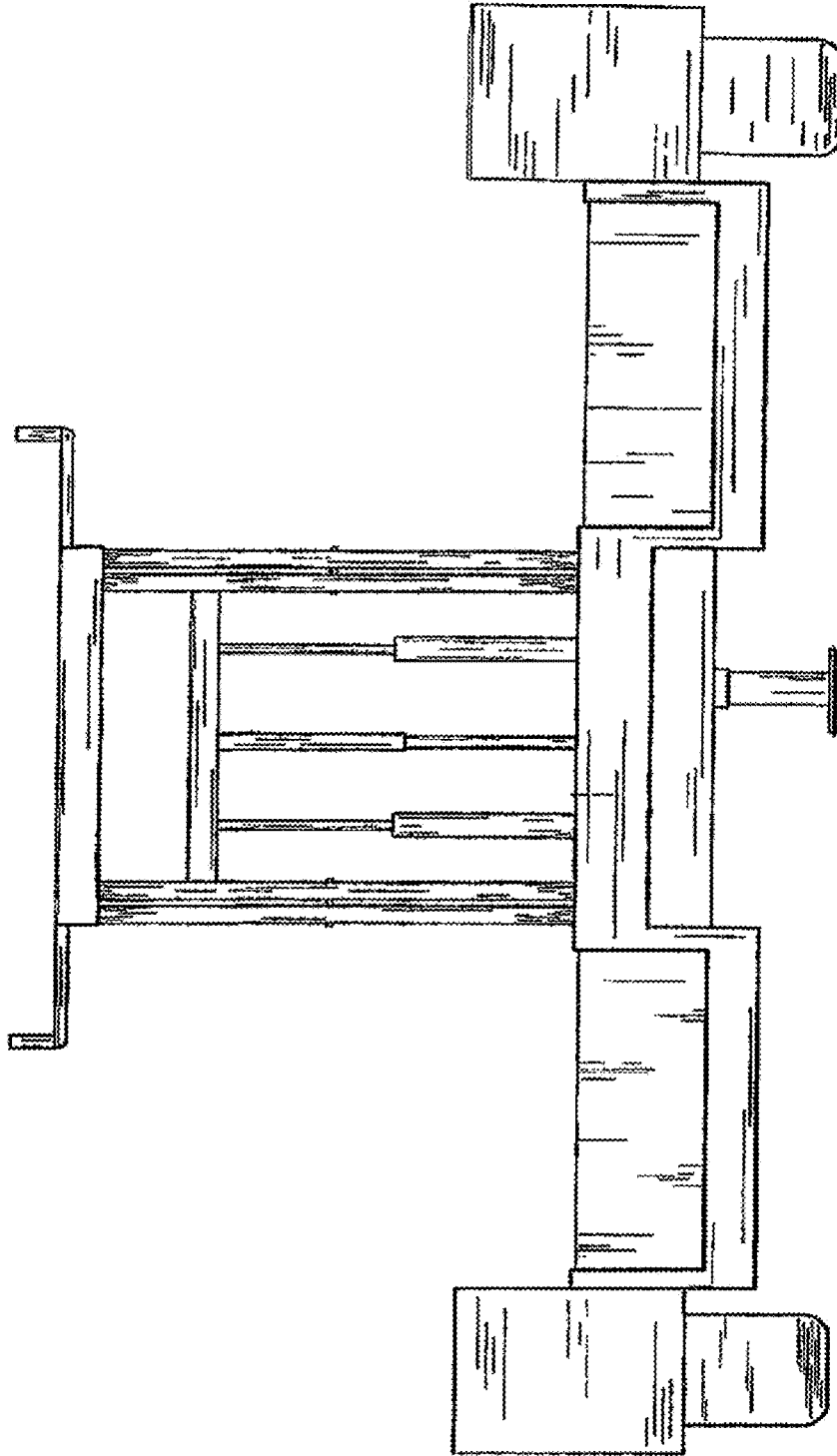

Fig. 3

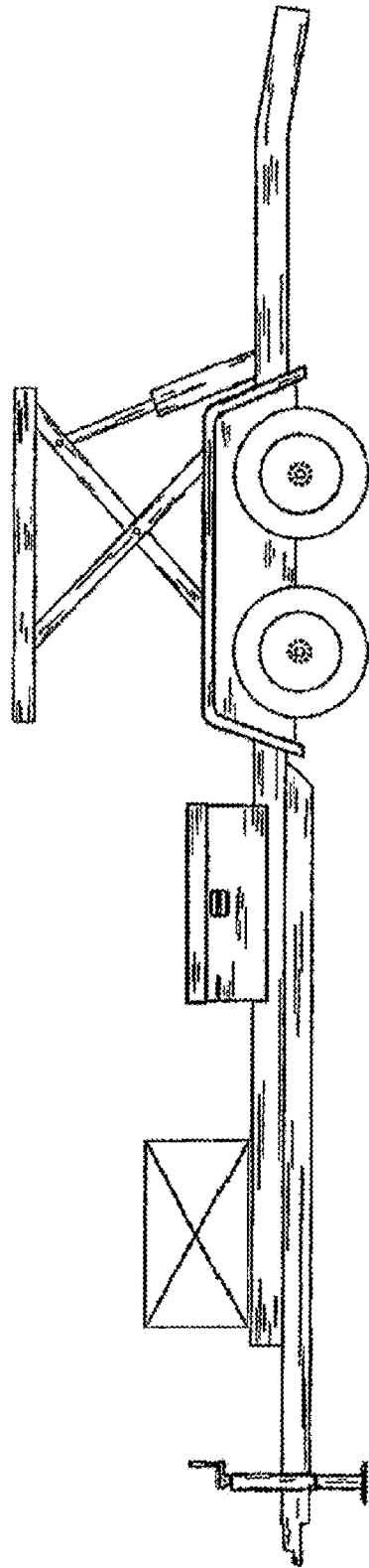

Fig. 4

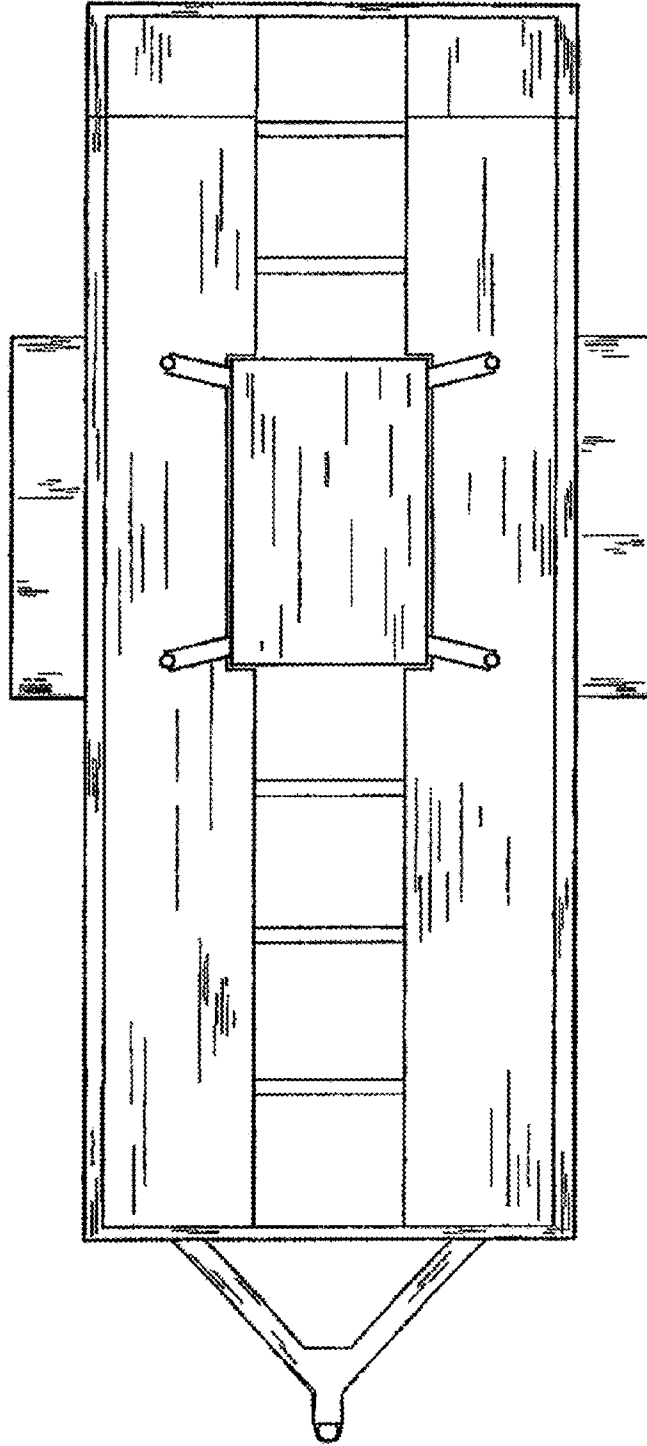

Fig. 5

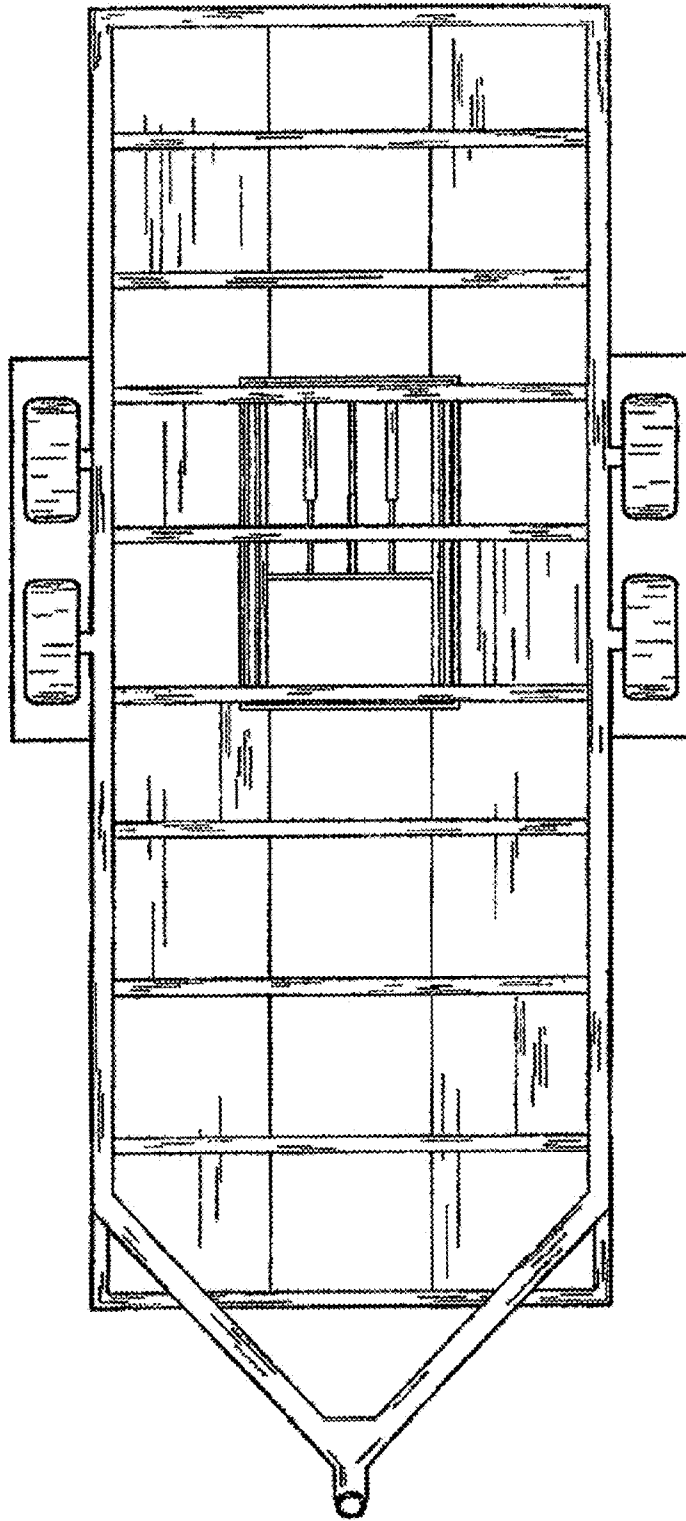

Fig. 6