



US00D855754S

(12) **United States Design Patent**  
**Maibach, Jr.**

(10) **Patent No.:** **US D855,754 S**

(45) **Date of Patent:** **\*\* Aug. 6, 2019**

(54) **SHORT PATH DISTILLATION HEAD**

D634,397 S *	3/2011	Lautzenheiser .....	B01D 1/0094
			D23/207
9,138,657 B1 *	9/2015	Wiederin .....	B01D 3/008
D776,238 S *	1/2017	Kremerman .....	B01D 3/00
			D23/207
D805,600 S *	12/2017	Kremerman .....	B01D 1/0017
			D23/207
D819,779 S *	6/2018	Kremerman .....	B01D 3/00
			D23/207
D828,904 S *	9/2018	Maibach, Jr. ....	B01D 3/008
			D23/207

(71) Applicant: **Lab Society LLC**, Longmont, CO (US)

(72) Inventor: **Michael S. Maibach, Jr.**, Longmont, CO (US)

(73) Assignee: **Michael S. Maibach, Jr.**, Longmont, CO (US)

(\*\*) Term: **15 Years**

\* cited by examiner

(21) Appl. No.: **29/634,400**

*Primary Examiner* — Robin V Webster

(22) Filed: **Jan. 22, 2018**

(74) *Attorney, Agent, or Firm* — Justin McNaughton;  
Greenspoon Marder

(51) **LOC (12) Cl.** ..... **23-01**

(52) **U.S. Cl.**

USPC ..... **D23/207**

(58) **Field of Classification Search**

USPC ..... D23/207, 209; 202/81, 87, 176, 204

CPC ..... C02F 1/04; B01D 5/0051; B01D 3/04;

B01D 3/008; B01D 3/00

See application file for complete search history.

(57) **CLAIM**

The ornamental design for a short path distillation head, as shown and described.

**DESCRIPTION**

FIG. 1 is a right side elevational view of a short path distillation head showing my new design; FIG. 2 is a left side elevational view thereof; FIG. 3 is a front elevational view thereof; FIG. 4 is a rear elevational view thereof; FIG. 5 is top plan view thereof; and, FIG. 6 is a bottom plan view thereof; and, FIG. 7 is a right side cutaway taken long line 7-7 in FIG. 5. The broken lines shown in the figures represent portions of the short path distillation head that form no part of the claimed design.

**1 Claim, 4 Drawing Sheets**

(56) **References Cited**

U.S. PATENT DOCUMENTS

1,418,691 A *	6/1922	Anders .....	B01D 3/00
			422/531
3,020,215 A *	2/1962	Weber .....	B01D 1/0017
			202/197
3,334,025 A *	8/1967	Reid .....	B01D 3/00
			202/161
4,089,749 A *	5/1978	Karamian .....	B01D 3/00
			202/176
4,230,536 A *	10/1980	Sech .....	B01D 1/0094
			122/234
D432,203 S *	10/2000	Edwards .....	D23/207

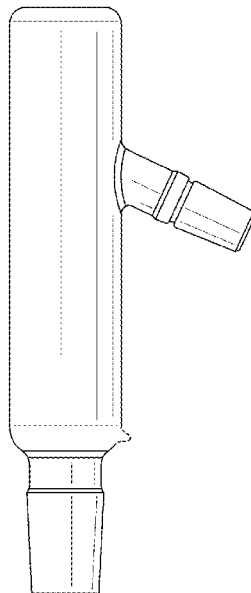

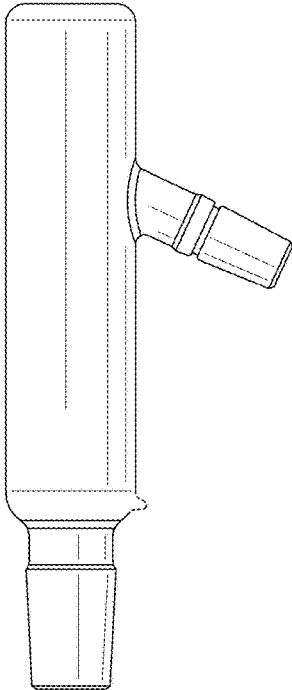

FIG. 1

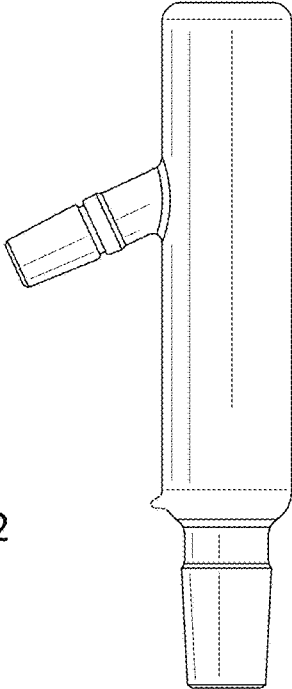

FIG. 2

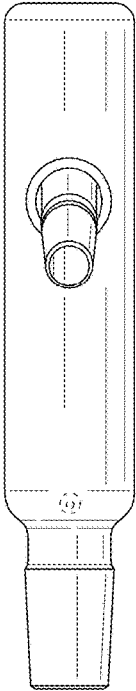

FIG. 3

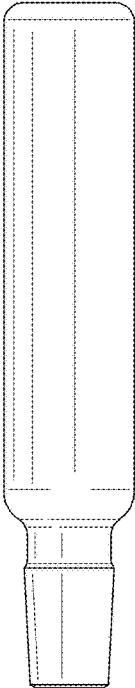

FIG. 4

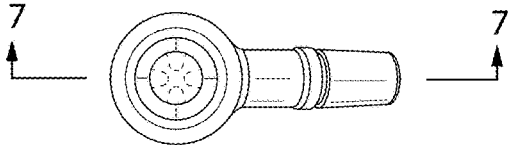

FIG. 5

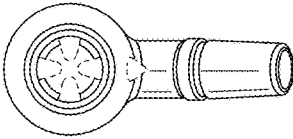

FIG. 6

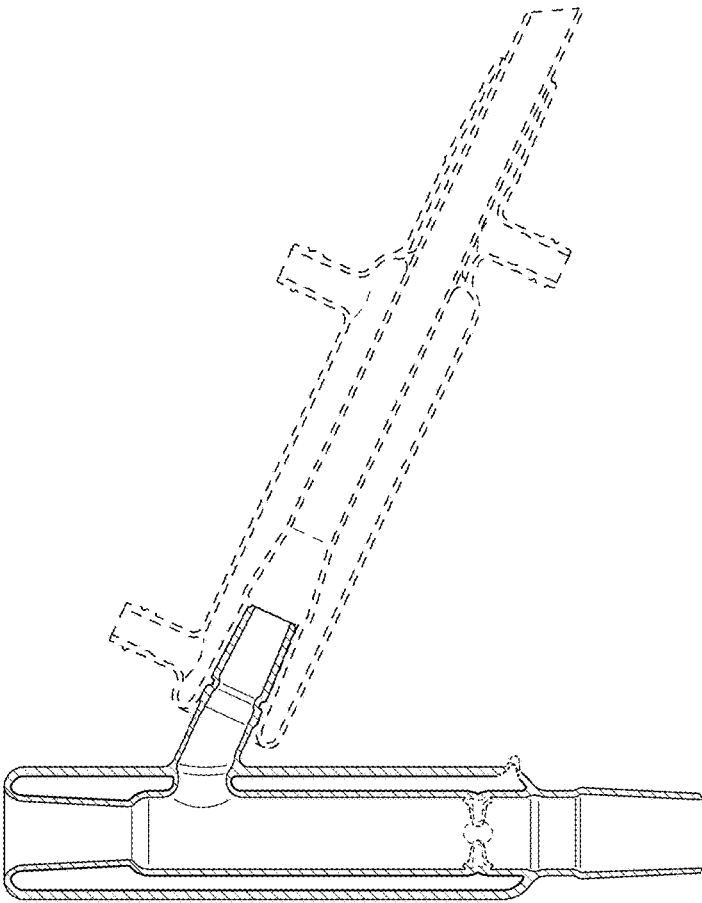

FIG. 7