



US00D993016S

(12) **United States Design Patent**
Holley, Jr.

(10) **Patent No.:** **US D993,016 S**

(45) **Date of Patent:** **** Jul. 25, 2023**

(54) **CARTON**
(71) Applicant: **Graphic Packaging International, LLC**, Atlanta, GA (US)

2,522,950 A 9/1950 Keith
2,558,618 A 6/1951 Lebold
2,563,065 A 8/1951 Price

(Continued)

(72) Inventor: **John Murdick Holley, Jr.**, Lawrenceville, GA (US)

FOREIGN PATENT DOCUMENTS

AR 7877 12/2008
EP 0 024 782 3/1981

(Continued)

(73) Assignee: **Graphic Packaging International, LLC**, Atlanta, GA (US)

OTHER PUBLICATIONS

(**) Term: **15 Years**

How to Make a Beer Caddy on YouTube. Date posted: Dec. 2, 2017. Site visited: Dec. 2, 2022. Available online: https://www.youtube.com/watch?v=PhXF_Nm0pA (Year: 2017).*

(Continued)

(21) Appl. No.: **29/780,009**

(22) Filed: **Apr. 22, 2021**

(51) **LOC (14) Cl.** **09-03**

(52) **U.S. Cl.**
USPC **D9/414**

(58) **Field of Classification Search**
USPC ... D9/414, 415, 416, 419, 420-23, 430-434, D9/456, 457, 711, 713, 721-22, 737, 756, D9/758-60; D3/200, 201, 272-274, 305; D7/601, 602, 397, 396.1, 553.3-554.4, D7/629, 511; D20/5, 37; D6/512
CPC . B65D 5/00; B65D 5/001; B65D 5/02; B65D 5/46192; B65D 5/0209; B65D 5/4295; B65D 5/6697; B65D 1/00; B65D 1/22; B65D 1/0223; B65D 3/06; B65D 3/20; B65D 71/30; B65D 71/36; B65D 71/16
See application file for complete search history.

Primary Examiner — Catherine S Posthauer

Assistant Examiner — Joan E. Diehl

(74) *Attorney, Agent, or Firm* — Womble Bond Dickinson (US) LLP

(57) **CLAIM**

The ornamental design for a carton, as shown and described.

DESCRIPTION

FIG. 1 is a perspective view of a carton showing my new design.

FIG. 2 is a front elevation view of the carton of FIG. 1, the rear elevation view is a mirror image.

FIG. 3 is a left elevation view of the carton of FIG. 1, the right elevation view is a mirror image.

FIG. 4 is a top plan view of the carton of FIG. 1.

FIG. 5 is a bottom plan view of the carton of FIG. 1; and, FIG. 6 is a plan view of the carton of FIG. 1 in an unfolded configuration.

All evenly-spaced broken lines are for the purpose of illustrating parts of the article that form no part of the claim.

(56) **References Cited**

U.S. PATENT DOCUMENTS

1,968,877 A 8/1934 Cubberley
2,289,859 A 7/1942 Arthur
2,345,567 A 4/1944 Arneson
2,384,480 A 9/1945 Lupton
2,417,421 A 3/1947 Koohnis

1 Claim, 6 Drawing Sheets

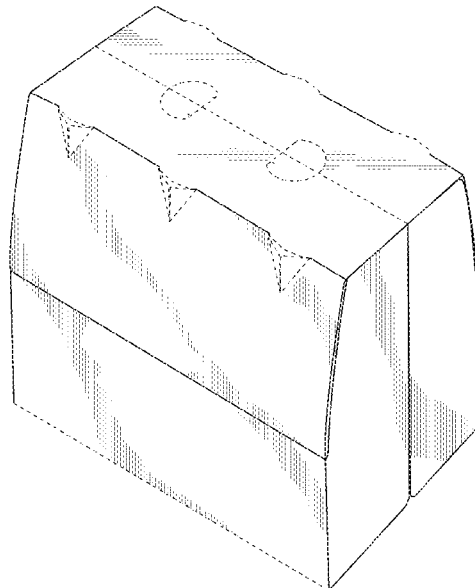

(56)

References Cited

U.S. PATENT DOCUMENTS

6,948,293 B1 9/2005 Eckermann et al.
 6,983,874 B2 1/2006 Bakx
 6,997,372 B2 2/2006 Gasparowicz
 7,028,839 B2 4/2006 Belloli et al.
 7,048,113 B2 5/2006 Gomes
 7,063,208 B2 6/2006 Lebras
 7,070,045 B2 7/2006 Theelen
 7,134,547 B2 11/2006 Auclair
 7,175,020 B2 2/2007 Sutherland et al.
 7,222,777 B2 5/2007 Garnier
 7,234,591 B2 6/2007 LeBras et al.
 7,331,505 B2 2/2008 Holley, Jr.
 7,374,038 B2 5/2008 Smalley
 7,427,010 B2 9/2008 Sutherland
 7,467,729 B2 12/2008 Lown et al.
 D592,501 S * 5/2009 Bone D9/431
 7,552,820 B2 * 6/2009 Kohler B65D 71/36
 206/199
 7,780,067 B2 8/2010 Holley, Jr.
 7,900,815 B2 3/2011 Shmagin
 7,913,844 B2 3/2011 Spivey, Sr.
 8,061,587 B2 11/2011 Blin
 8,070,052 B2 12/2011 Spivey, Sr.
 8,424,677 B2 4/2013 Spivey, Sr. et al.
 8,978,889 B2 3/2015 Fitzwater et al.
 9,636,882 B2 5/2017 Holley, Jr.
 9,708,112 B2 7/2017 Sutherland et al.
 D826,711 S * 8/2018 Boersma B65D 5/0209
 D9/432
 D861,483 S * 10/2019 Smalley D9/754
 D885,887 S * 6/2020 Thompson D9/433
 2004/0000494 A1 1/2004 Sutherland
 2004/0164135 A1 8/2004 Gong et al.
 2006/0186009 A1 * 8/2006 Perkinson B65D 71/36
 206/427
 2007/0056869 A1 3/2007 Tokarski
 2007/0181658 A1 8/2007 Sutherland
 2007/0215682 A1 9/2007 Bates et al.
 2007/0277481 A1 12/2007 LeBras
 2008/0099544 A1 * 5/2008 Skolik B65D 71/36
 206/427
 2008/0203143 A1 8/2008 Holley
 2008/0257942 A1 10/2008 LeBras
 2009/0032425 A1 2/2009 Perkinson
 2009/0065559 A1 3/2009 Parkes
 2009/0101526 A1 4/2009 Sutherland et al.
 2009/0236408 A1 9/2009 Spivey, Sr. et al.
 2010/0140336 A1 6/2010 Ho Fung
 2011/0011924 A1 1/2011 Spivey, Sr. et al.
 2011/0065558 A1 3/2011 Smalley
 2011/0233091 A1 9/2011 Block et al.
 2011/0284622 A1 11/2011 Boukredine
 2011/0290867 A1 12/2011 Schemmel et al.

2012/0080426 A1 * 4/2012 McClure B65D 5/001
 220/6
 2012/0279897 A1 11/2012 Schmal et al.
 2012/0285854 A1 11/2012 Spivey, Sr.

FOREIGN PATENT DOCUMENTS

EP 0 170 490 2/1986
 EP 0 172 932 3/1986
 EP 0 332 153 9/1991
 EP 0 630 825 12/1994
 EP 0 901 969 4/2000
 EP 1 065 151 1/2001
 EP 1 151 935 11/2001
 EP 1 348 638 10/2003
 EP 1 103 481 8/2004
 EP 1 010 637 9/2004
 EP 1 125 858 9/2004
 EP 1 381 545 10/2005
 EP 1 334 043 12/2005
 EP 1698565 A2 * 9/2006 B65D 71/36
 EP 1 513 737 11/2006
 EP 2 055 648 5/2009
 EP 1 749 755 12/2011
 EP 2 673 213 12/2013
 GB 2 279 065 12/1994
 JP 11-124129 5/1999
 JP 3039805 3/2000
 JP 2008 213894 9/2008
 JP 2009-120248 6/2009
 KR 20-2010-0010124 10/2010
 WO 8905268 A1 * 6/1989
 WO 92/09498 6/1992
 WO 93/14991 8/1993
 WO 95/08489 3/1995
 WO 88/02607 4/1998
 WO 02/34639 5/2002
 WO 2005/030604 4/2005
 WO 2005/042370 5/2005
 WO 2007008617 A1 * 1/2007 B65D 5/46192
 WO 2008/036754 3/2008
 WO 2011/022145 2/2011
 WO 2011/049947 4/2011
 WO 2012/109627 8/2012
 WO 2013/109844 7/2013

OTHER PUBLICATIONS

Miller Lite Pilsner Beer, 12 Pack. Date first available: Oct. 15, 2014. Site visited: Oct. 2, 2022. Available online: https://www.amazon.com/Miller-Lite-bottles-4-2-ABV/dp/B0016LT37S/ref=sr_1_15_f3_0o_fs (Year: 2014).
<https://www.amazon.com/Melissa-Doug-Take-Along-Sorting-Flip-Up/dp/B07YR9T251> Wooden Take-Along Sorting Barn Toy. Date first available: Oct. 11, 2019. Site visited: Dec. 2, 2022. Available online: (Year: 2019).*

* cited by examiner

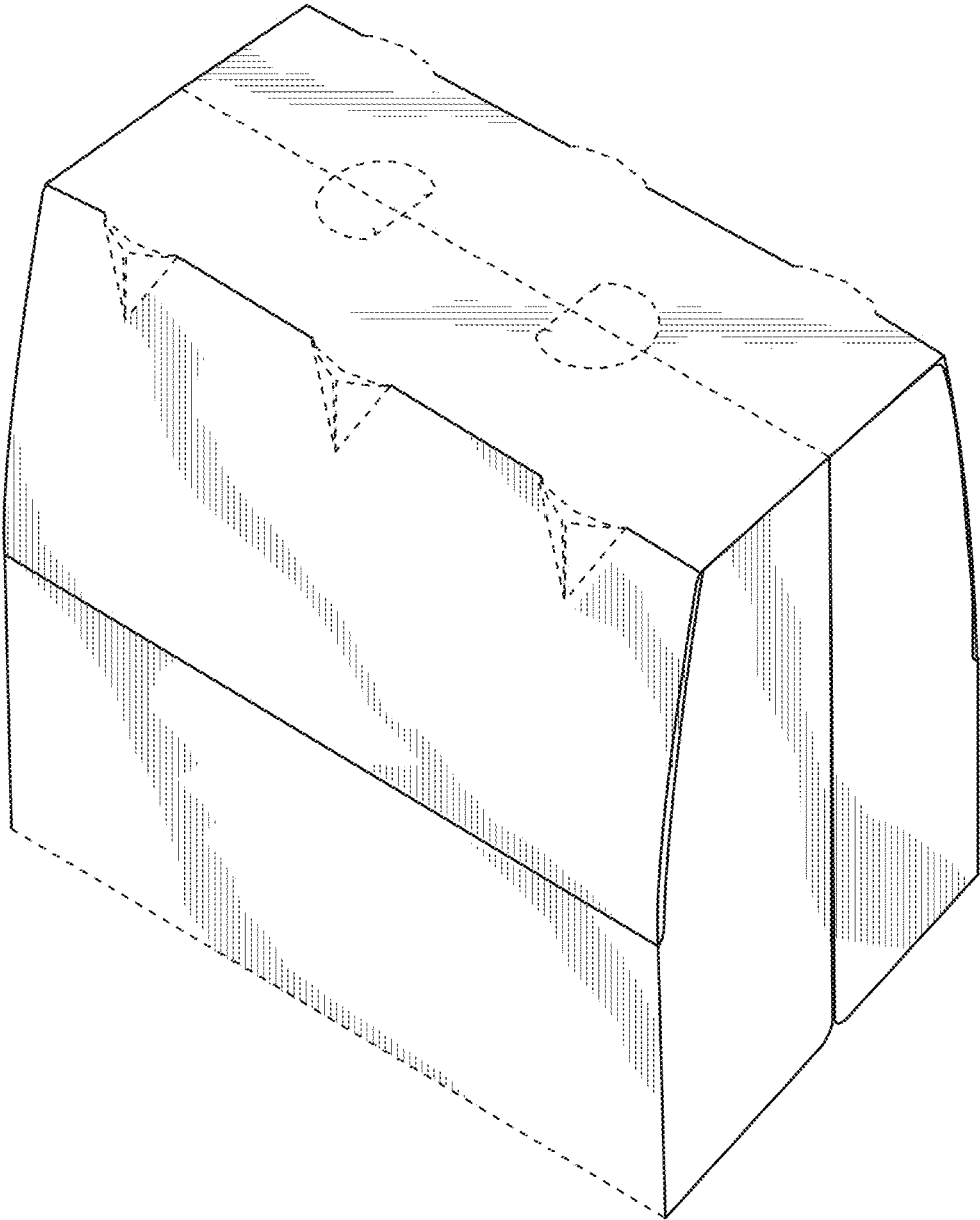

FIG. 1

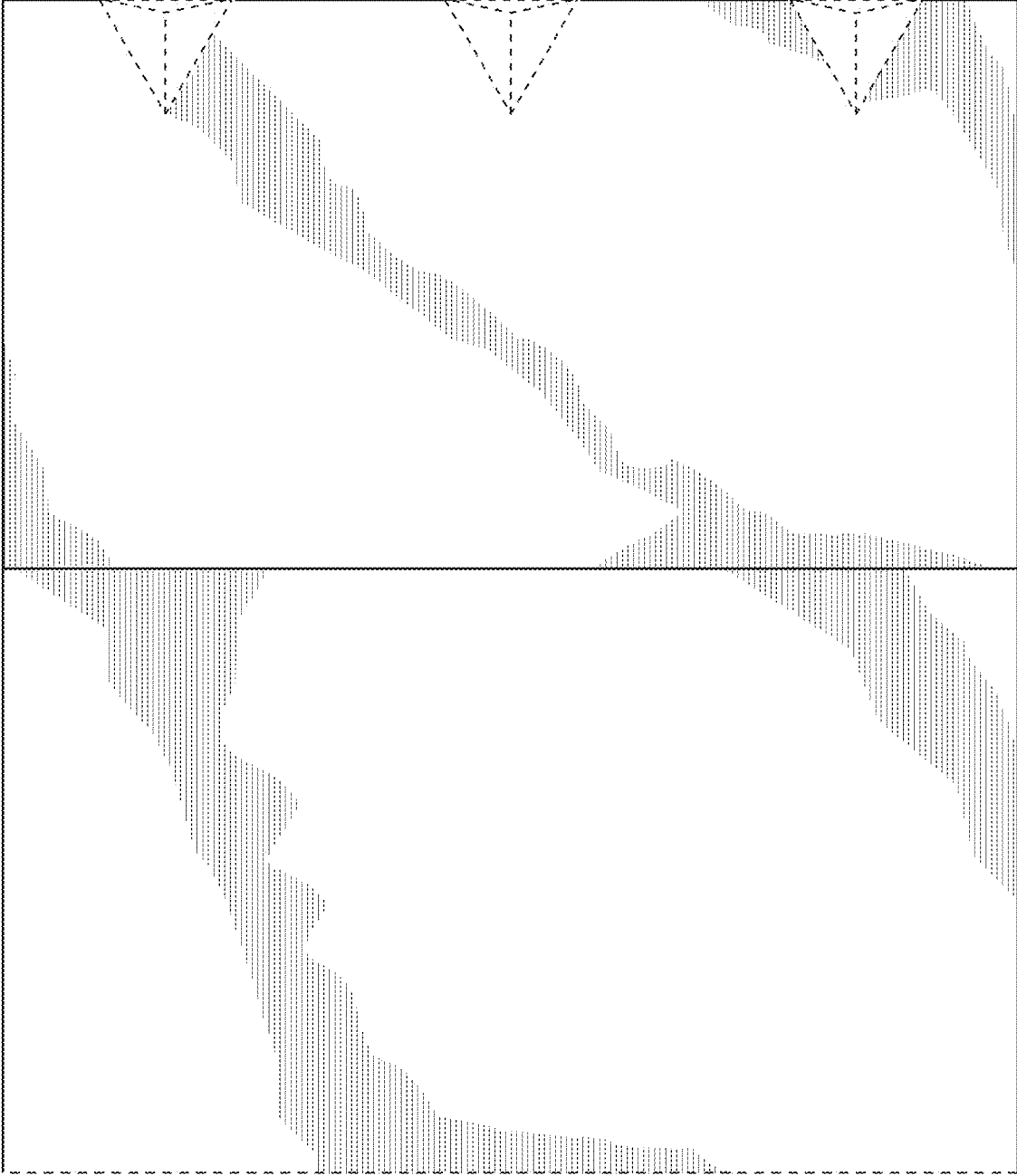

FIG. 2

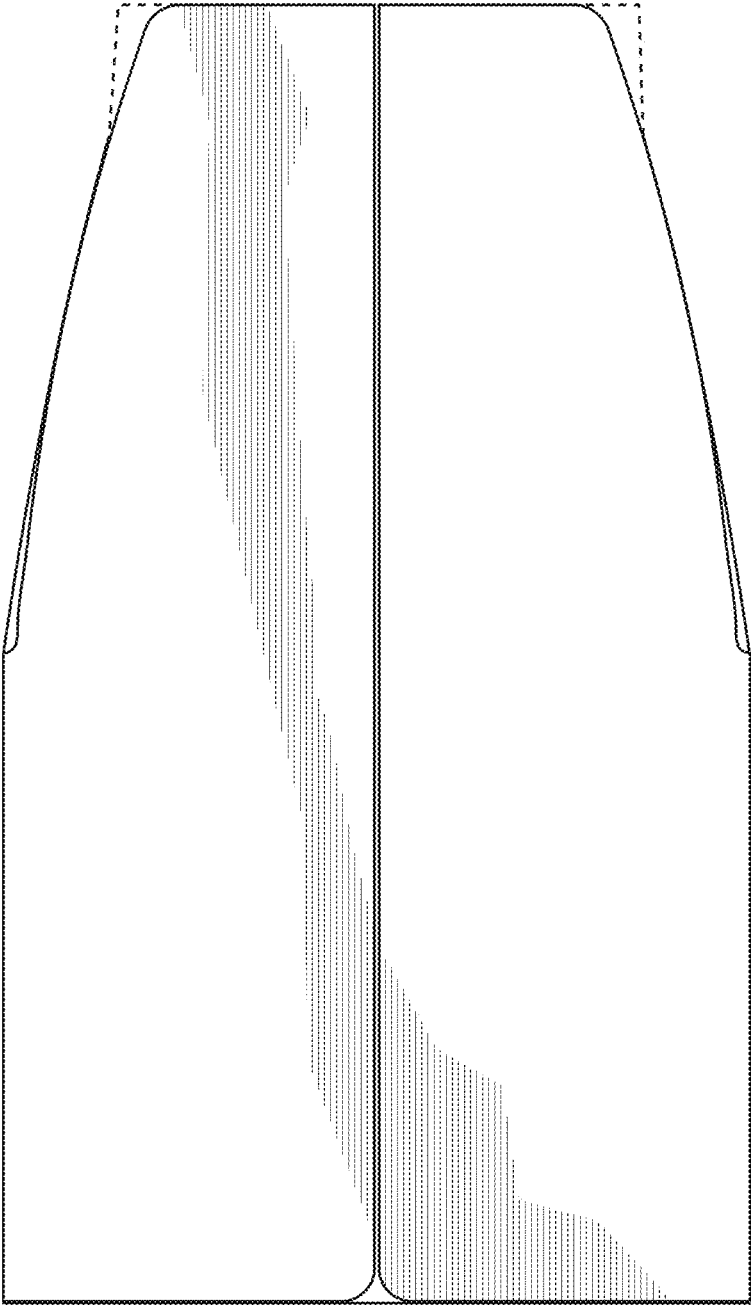

FIG. 3

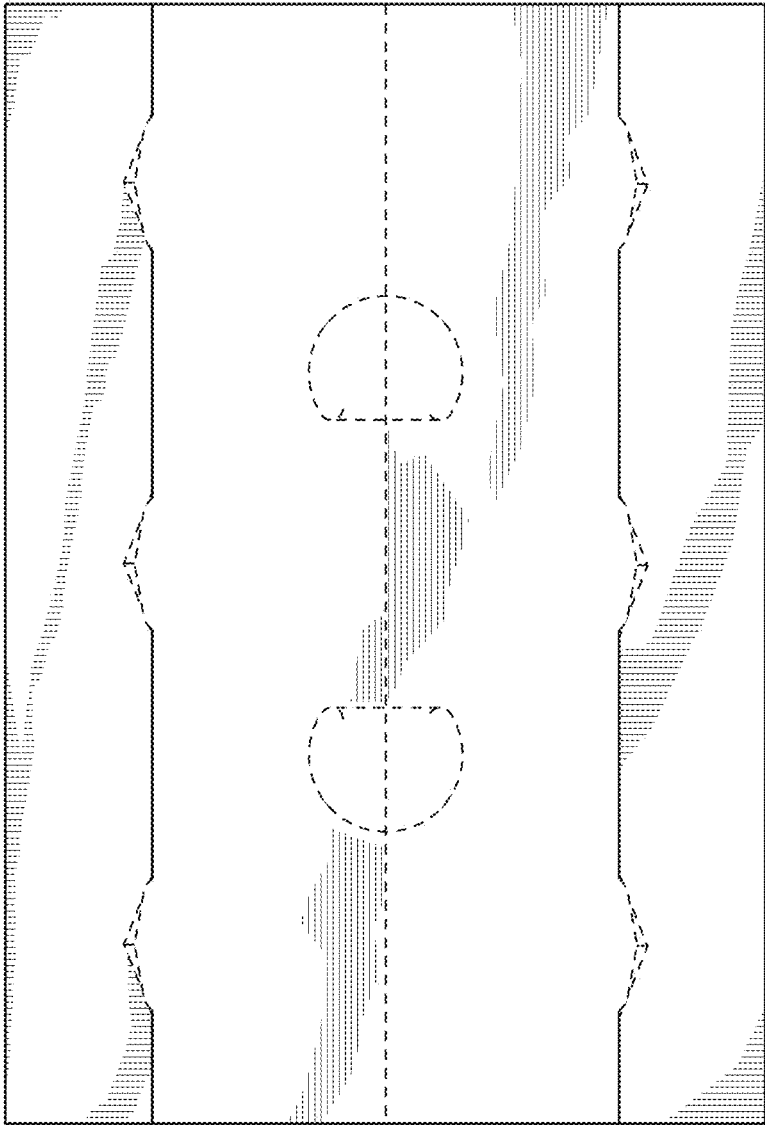

FIG. 4

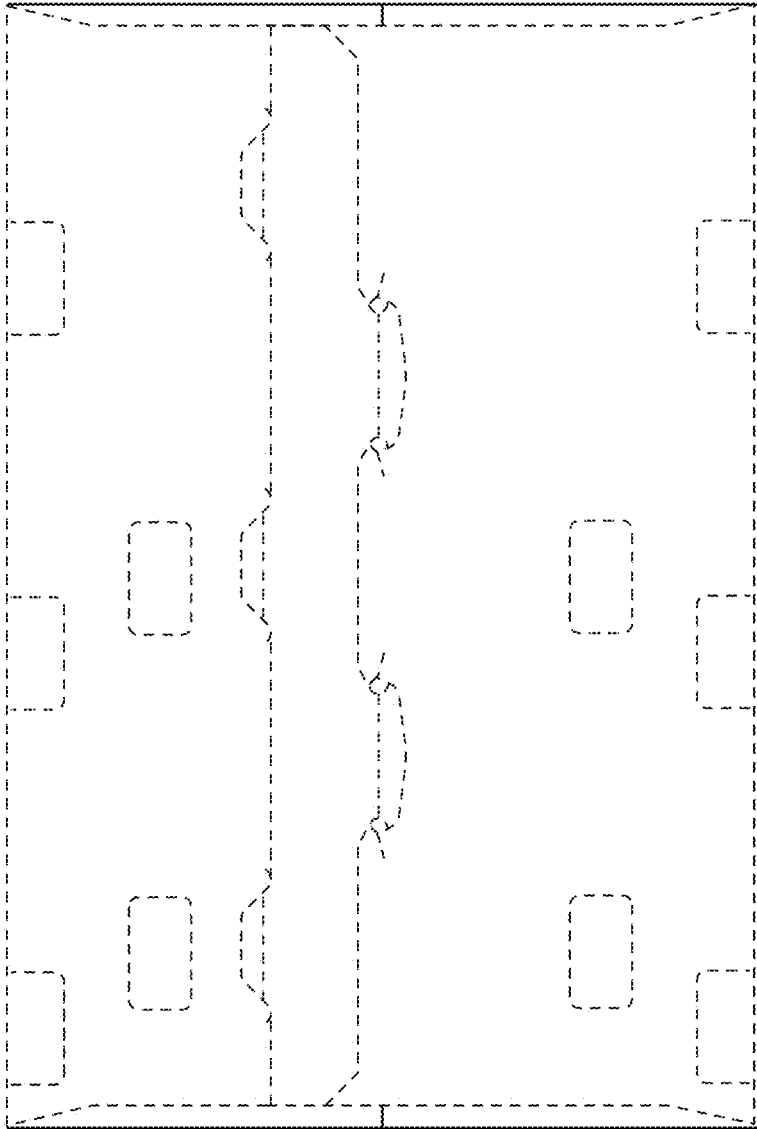

FIG. 5

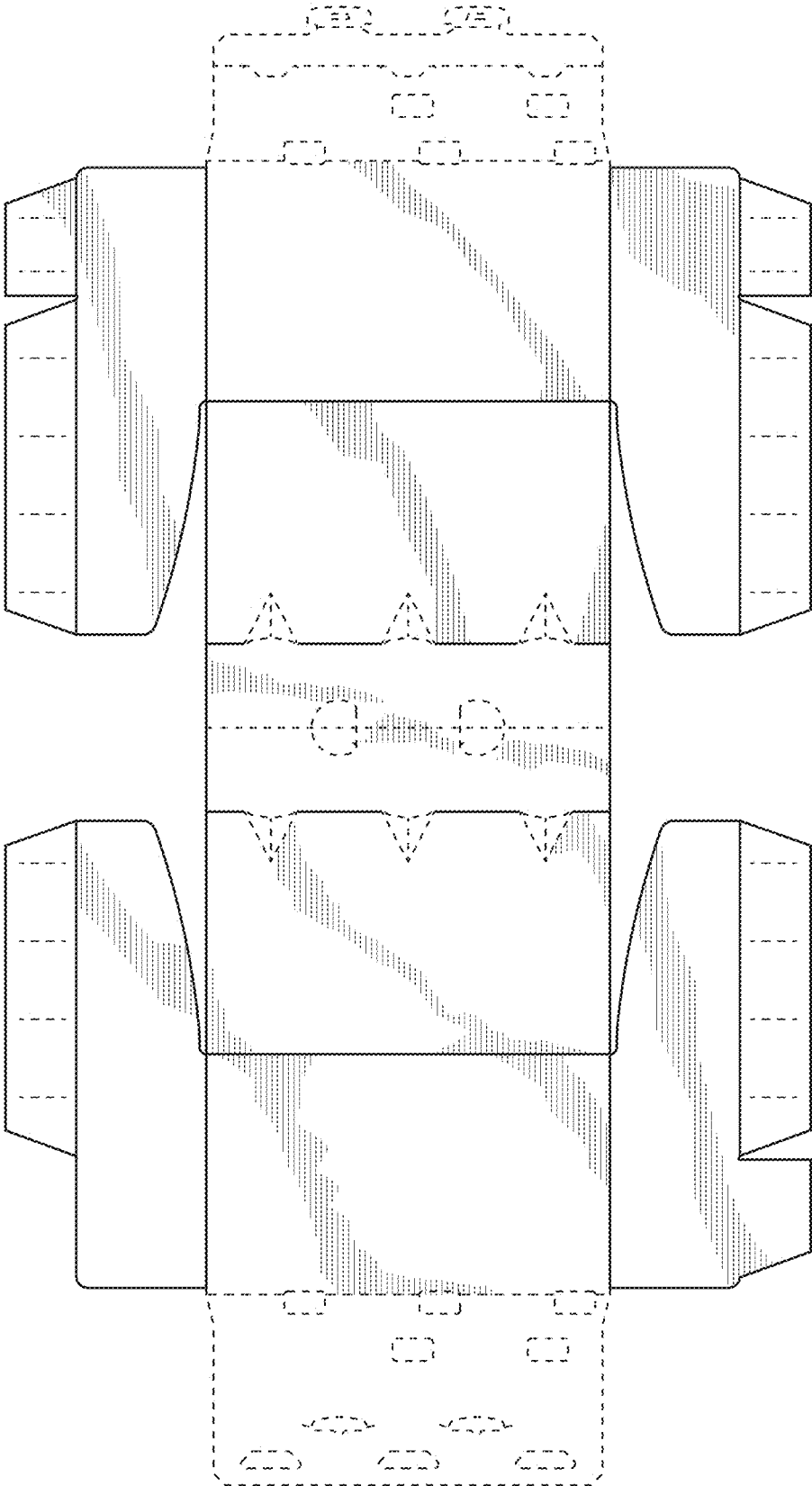

FIG. 6