



US00D354555S

# United States Patent [19]

[11] Patent Number: Des. 354,555

Salach et al.

[45] Date of Patent: \*\* Jan. 17, 1995

[54] **BATHTUB**

[75] Inventors: **Kenneth Salach, Granger, Ind.;**  
**Gregory Salach, Western Springs, Ill.**

[73] Assignee: **G.K.L. Corporation, Romeoville, Ill.**

[\*\*] Term: **14 Years**

[21] Appl. No.: **6,356**

[22] Filed: **Mar. 26, 1993**

[52] U.S. Cl. .... **D23/277**

[58] Field of Search ..... **D23/270, 275, 277-283;**  
**D24/203-205; 4/538, 571.1, 572.1, 578.1, 579,**  
**584, 586, 589, 590, 611**

2,813,276 11/1957 Lanza ..... 4/579

3,359,574 12/1967 Stoneburner .

3,740,908 6/1973 Moore .

4,299,064 10/1981 Daniels .

4,423,528 1/1984 Wiedmeier .

4,578,832 4/1986 Primucci .

4,671,026 6/1987 Wissinger .

4,825,480 5/1989 Moore .

4,897,889 2/1990 Baus .

4,901,380 2/1990 Smith .

4,981,164 1/1991 Reichel .

*Primary Examiner*—James R. Largen  
*Attorney, Agent, or Firm*—Patula & Associates

### [57] CLAIM

The ornamental design for a bathtub, as shown and described.

### [56] References Cited

#### U.S. PATENT DOCUMENTS

D. 93,716 10/1934 Hesler ..... D23/281

D. 241,643 9/1976 Bonsack ..... D23/281

D. 255,262 6/1980 Beddome et al. .... D23/281

D. 266,692 10/1982 Harrison ..... D23/281

D. 275,782 10/1984 Burgess et al. .... D23/282

D. 295,665 5/1988 Salach ..... D23/277

D. 300,556 4/1989 Delepine ..... D23/281

D. 318,323 7/1991 Stairs, Jr. .... D23/277

D. 319,490 8/1991 Stairs, Jr. .... D23/277

1,739,163 12/1929 Mitchell ..... D23/275 X

2,143,034 1/1939 Sakier .

2,236,927 4/1941 Thomas ..... 4/579

2,396,845 3/1946 Gruen .

### DESCRIPTION

FIG. 1 is an exploded perspective view taken from the top and front of a bathtub showing our new design; FIG. 2 is a perspective view taken from the top and front thereof, showing the seat in position; FIG. 3 is a front elevational view thereof; FIG. 4 is a rear elevational view thereof; FIG. 5 is a right side elevational view thereof; FIG. 6 is a left side elevational view thereof; FIG. 7 is a bottom plan view thereof; FIG. 8 is a top plan view of FIG. 2; and, FIG. 9 is another top plan view thereof with the seat removed for convenience of illustration.

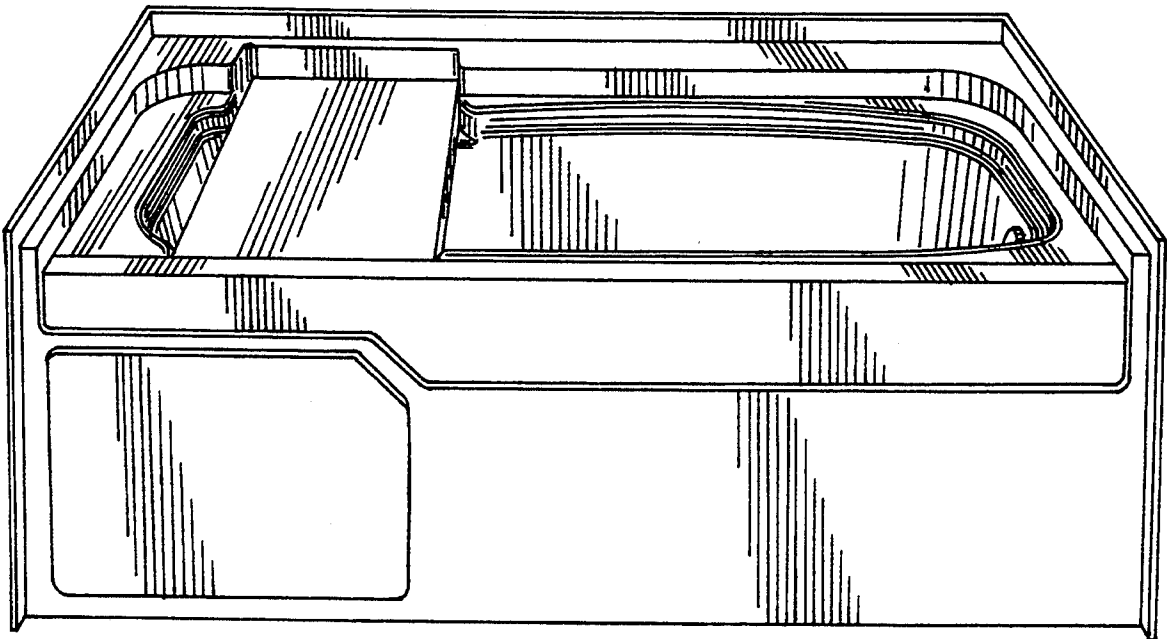

FIG. 1

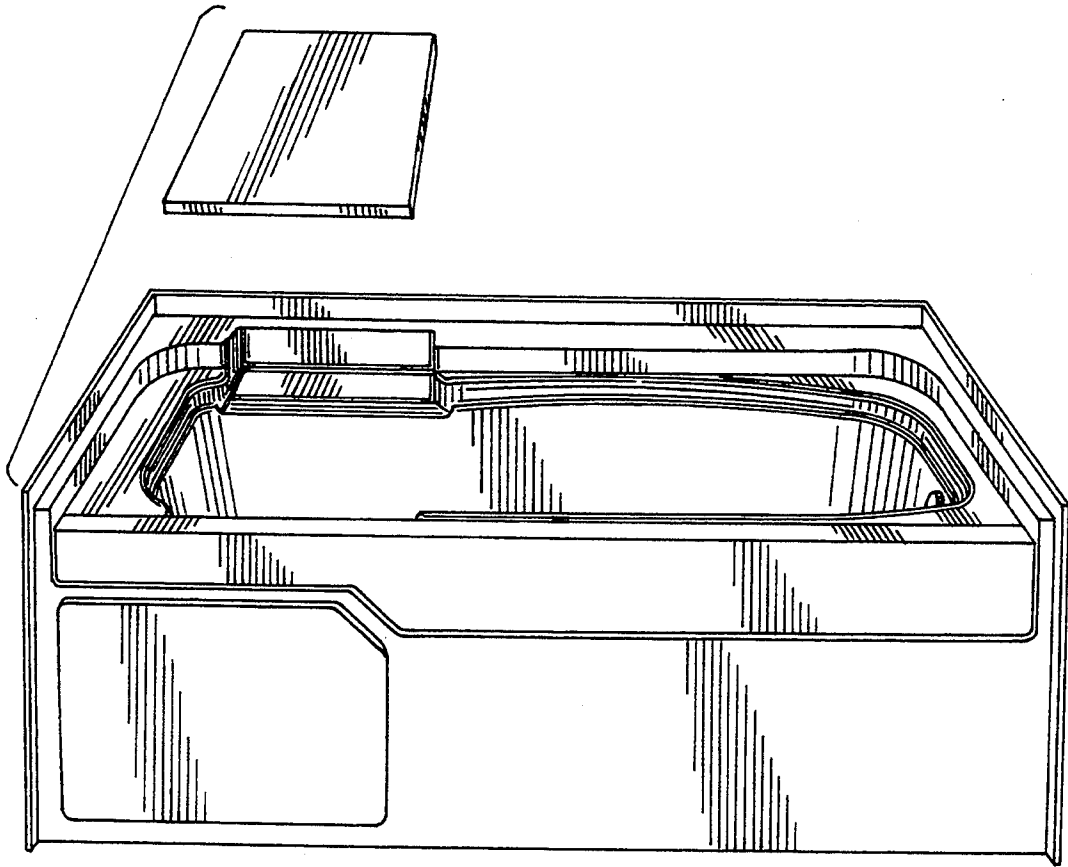

FIG. 2

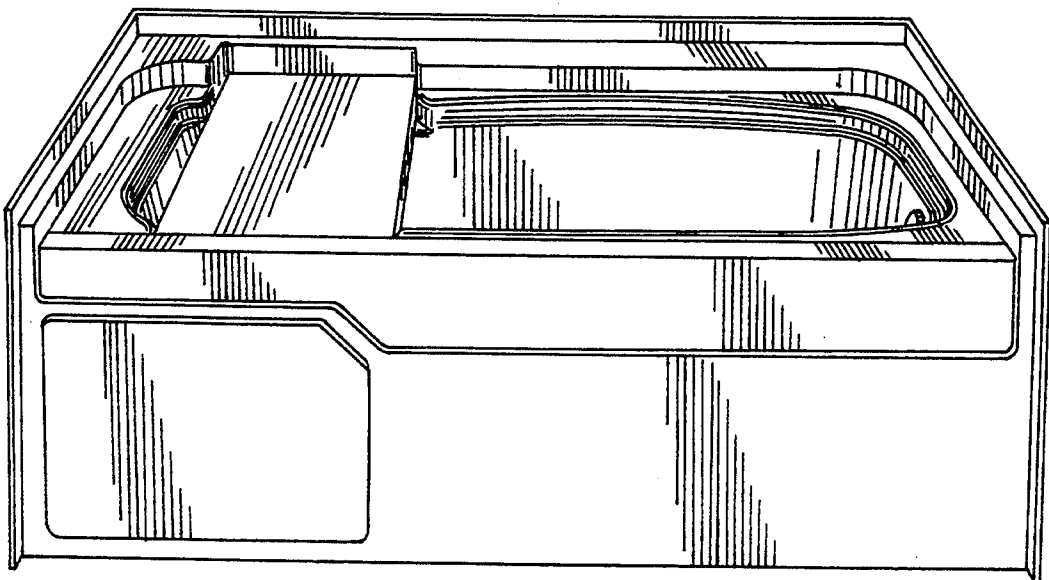

FIG.3

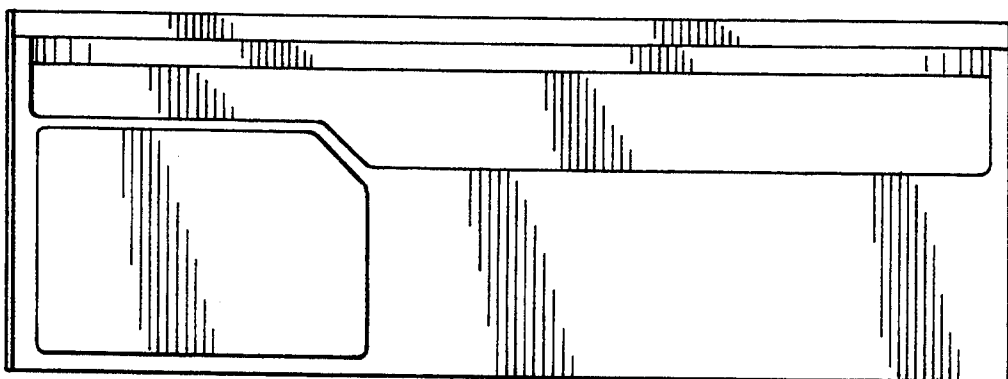

FIG.4

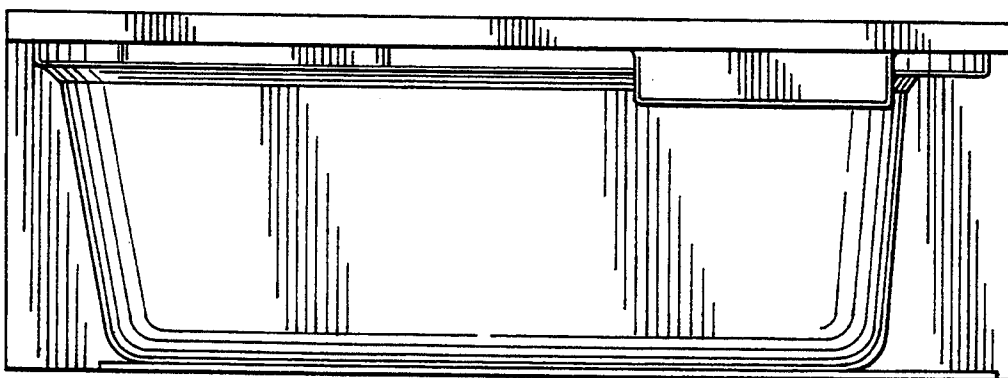

FIG.5

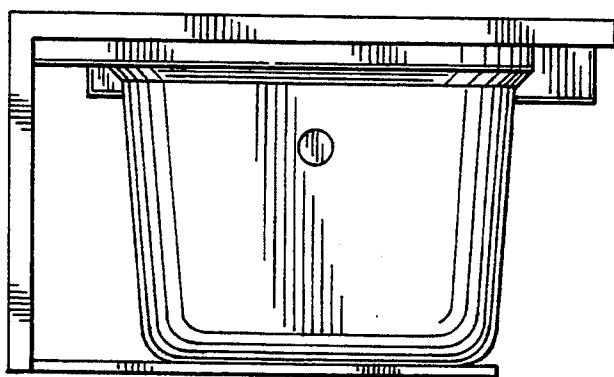

FIG.6

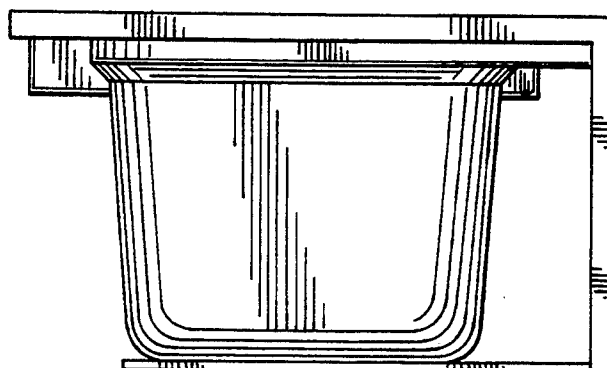

FIG. 7

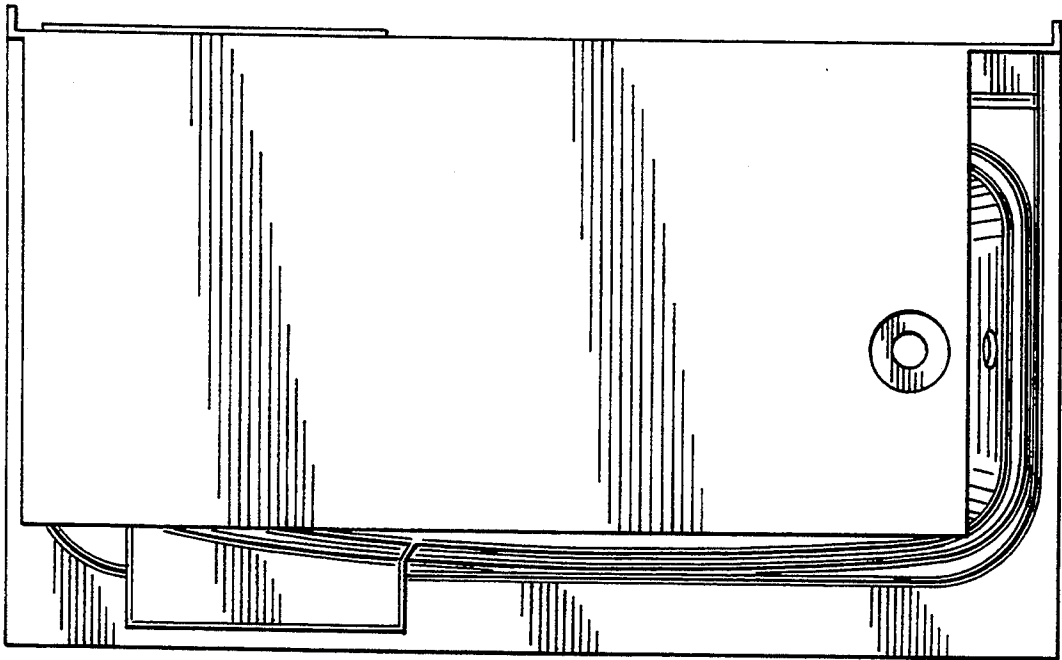

FIG. 8

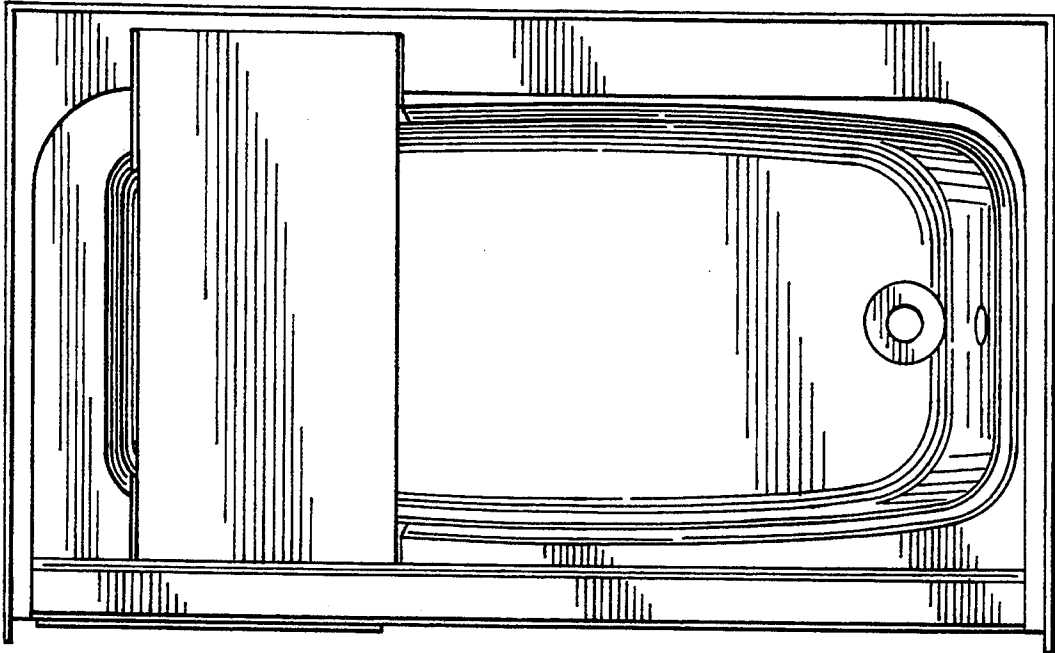

FIG. 9

