



US00D366473S

# United States Patent [19] Behar

[11] Patent Number: **Des. 366,473**

[45] Date of Patent: **\*\*Jan. 23, 1996**

[54] VIDEO DISPLAY TERMINAL

D. 352,940 11/1994 Kazama ..... D14/126

[75] Inventor: **Yves A. Behar**, San Francisco, Calif.

*Primary Examiner*—Freda Nunn

[73] Assignee: **Wyse Technology, Inc.**, San Jose, Calif.

*Attorney, Agent, or Firm*—James E. Eakin; Janet Kaiser Castaneda

[\*\*] Term: **14 Years**

### [57] CLAIM

[21] Appl. No.: **29,809**

The ornamental design for a video display terminal, as shown.

[22] Filed: **Oct. 5, 1994**

[52] U.S. Cl. .... **D14/113; D14/126**

[58] Field of Search ..... D14/100, 101,  
D14/106, 113, 124-129; 345/104, 133,  
156, 168, 87, 173, 901-905; 358/249, 254,  
255; 248/917-924

### DESCRIPTION

FIG. 1 is an elevated, front, right side perspective view of the video display terminal showing our new design;  
FIG. 2 is a front view thereof;  
FIG. 3 is a left side view thereof;  
FIG. 4 is a rear view thereof;  
FIG. 5 is a right side view thereof; and,  
FIG. 6 is a top plan view thereof.

### [56] References Cited

#### U.S. PATENT DOCUMENTS

D. 310,829 9/1990 Suyama et al. .... D14/113  
D. 316,086 4/1991 Gauffin ..... D14/113

**1 Claim, 6 Drawing Sheets**

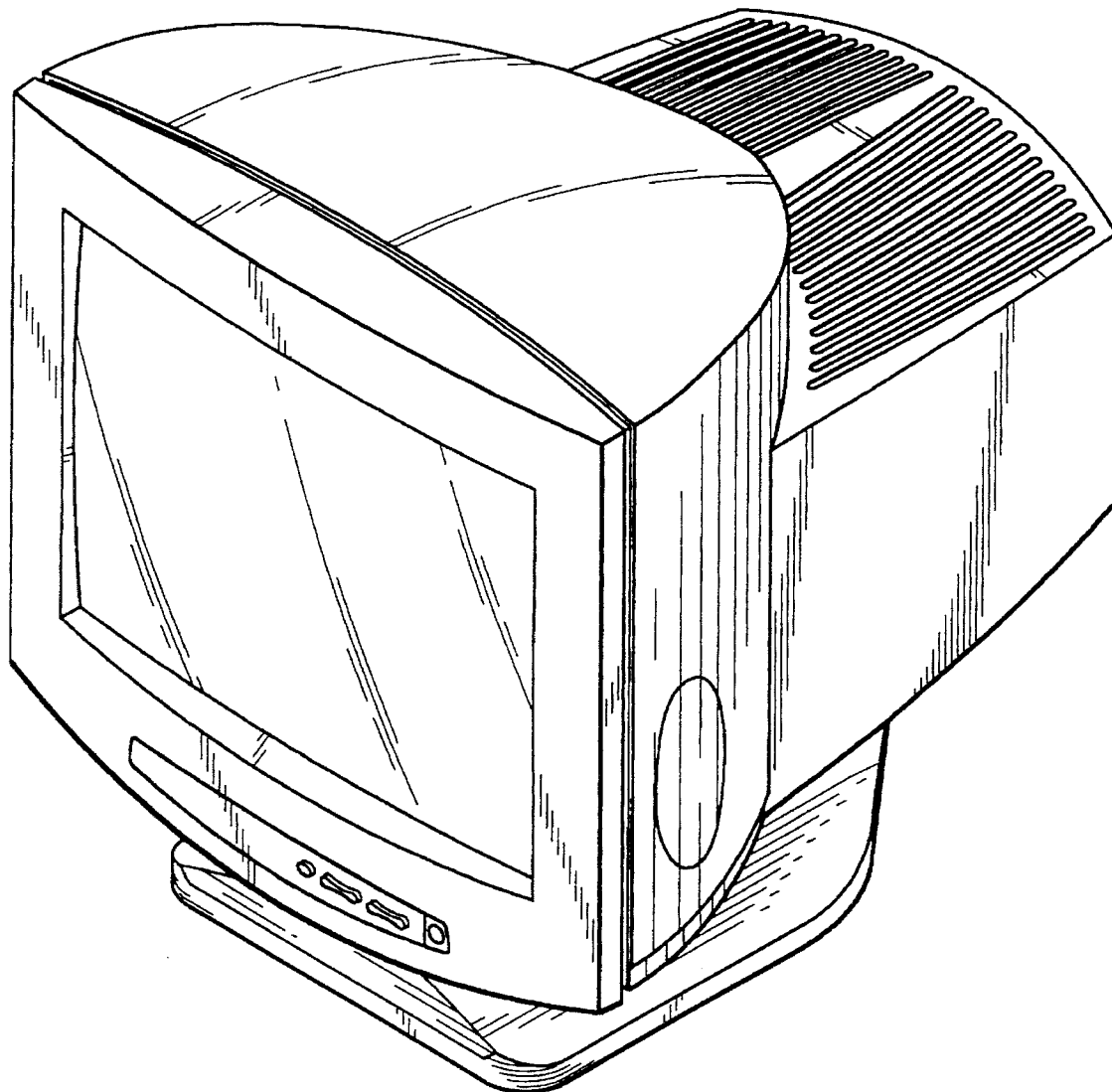

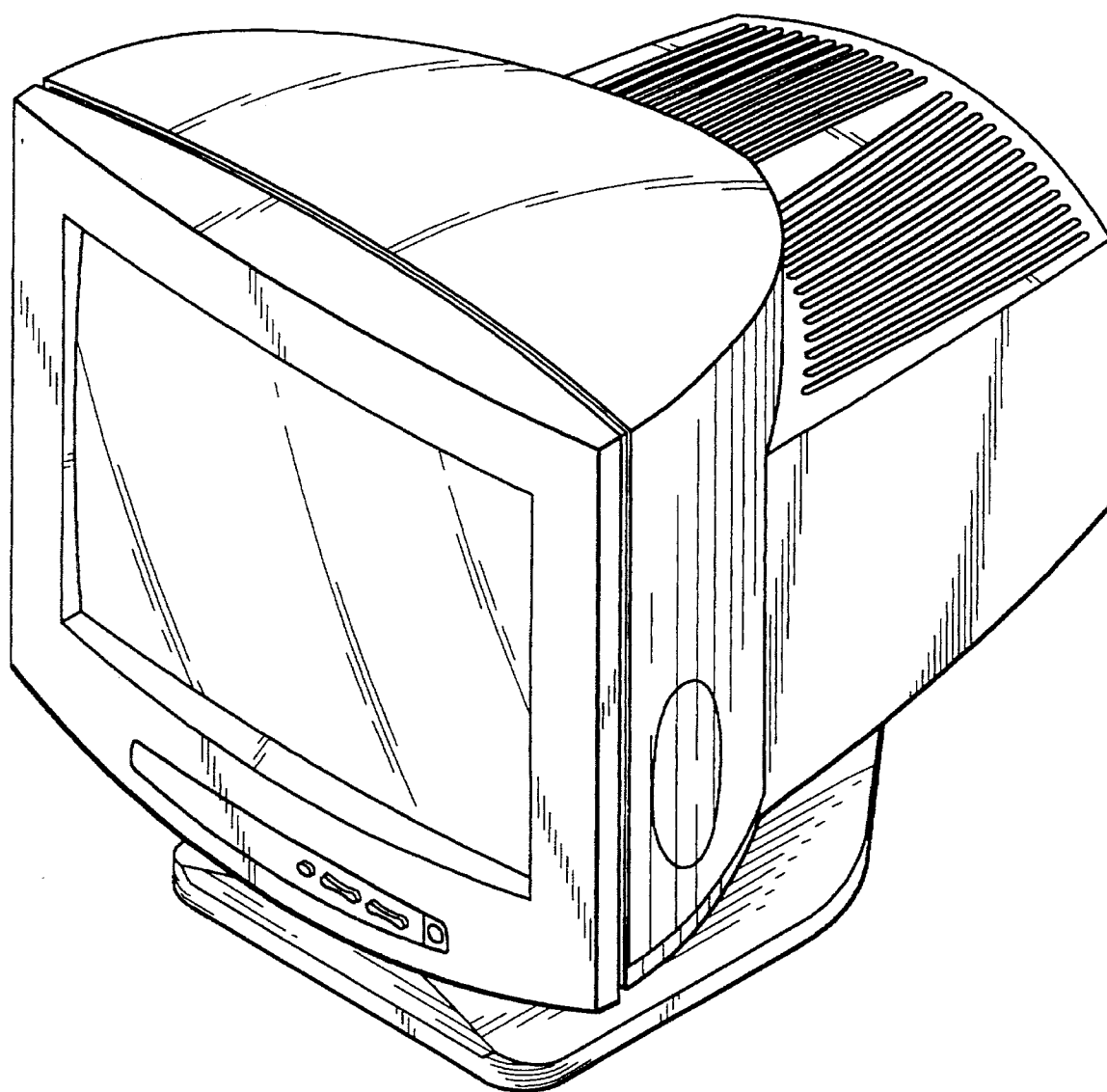
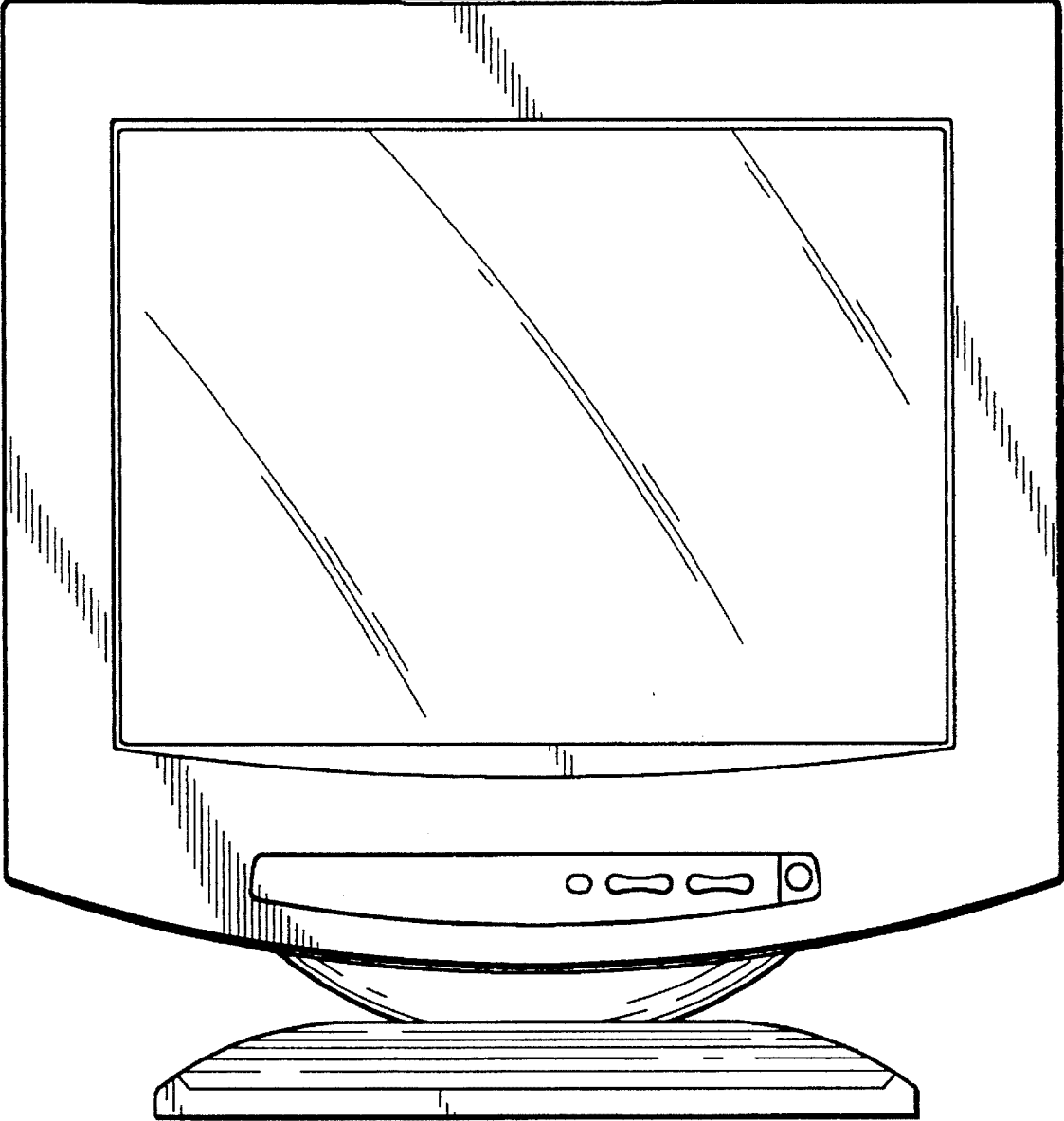
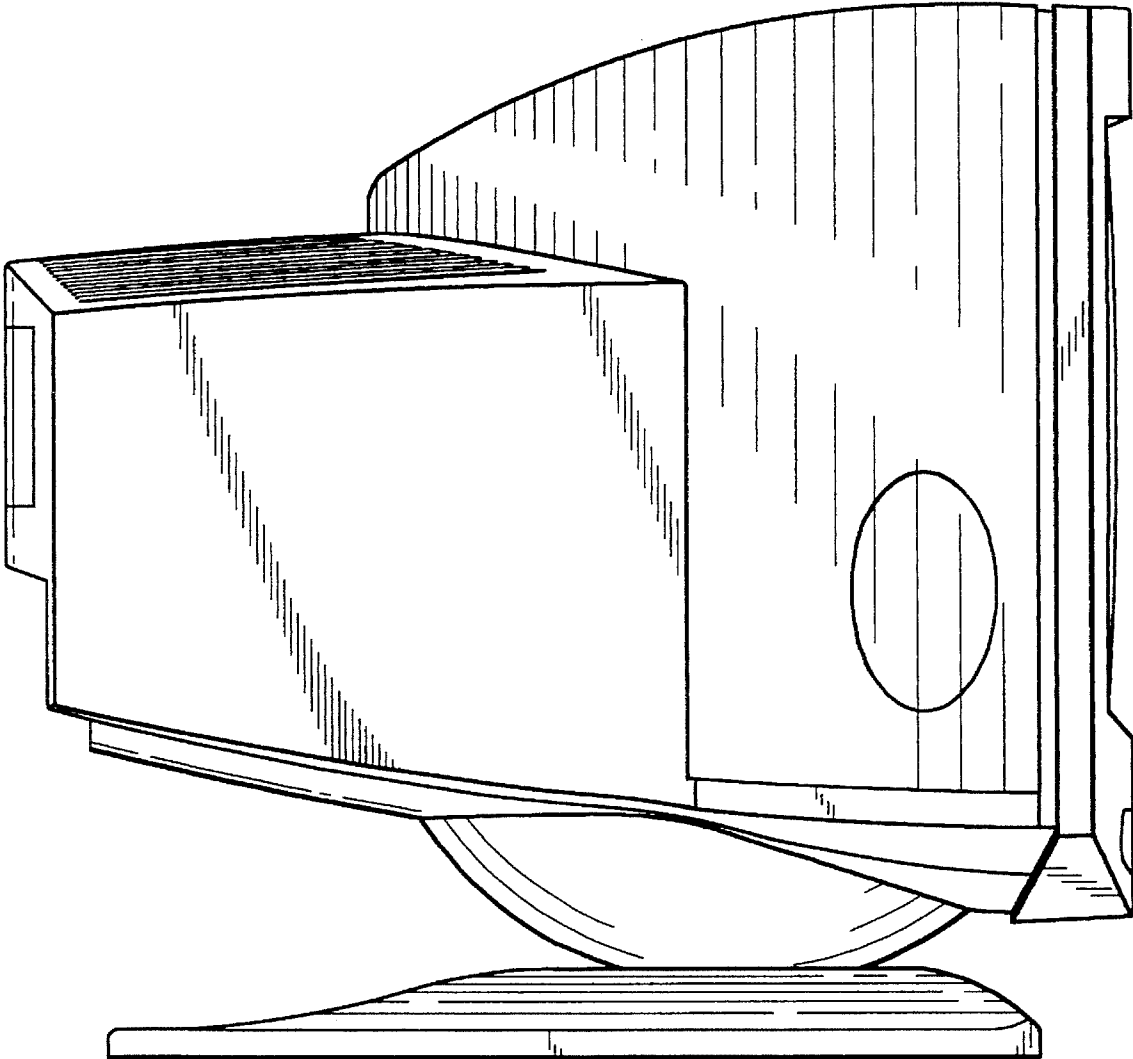

FIG. 1



**FIG. 2**



**FIG. 3**

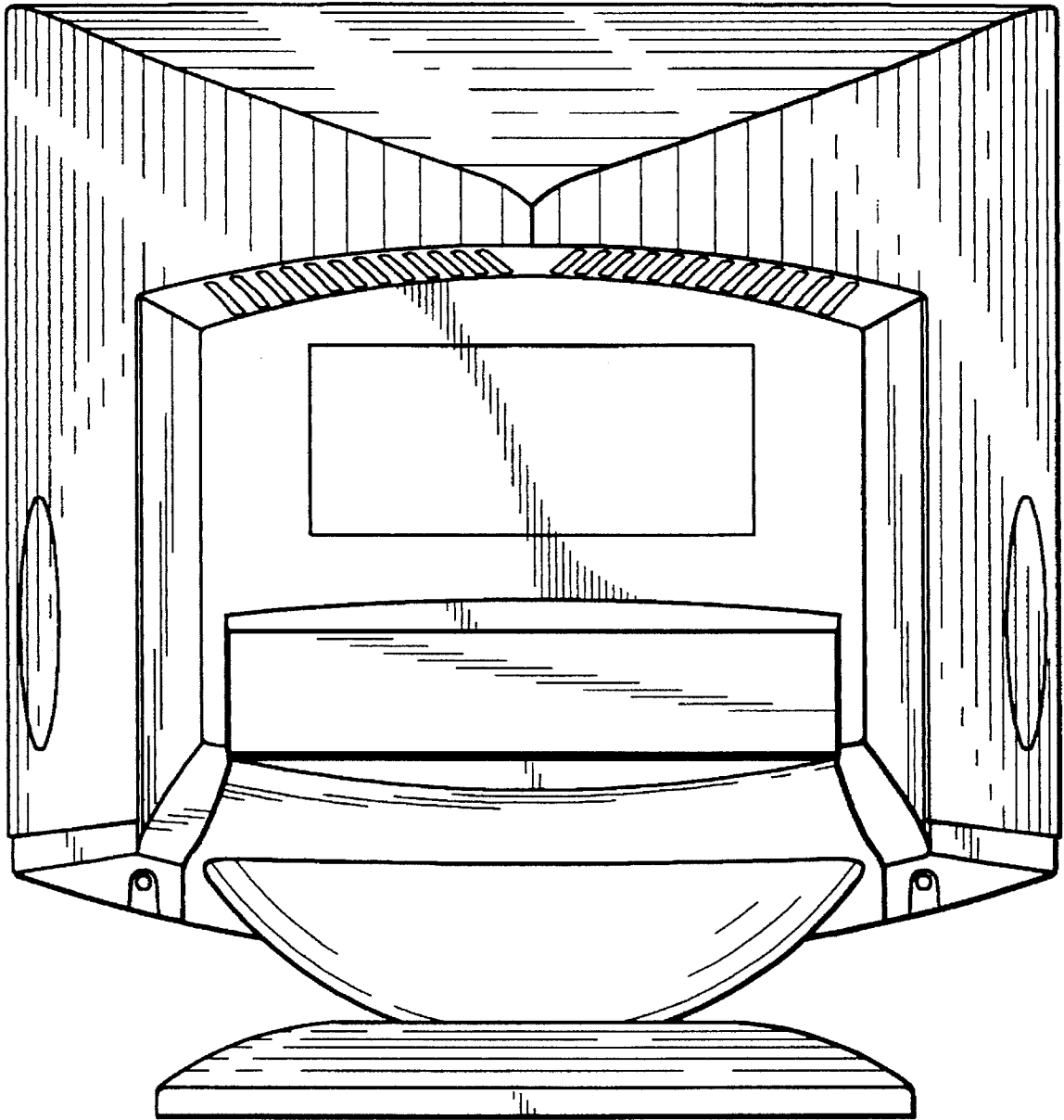

**FIG. 4**

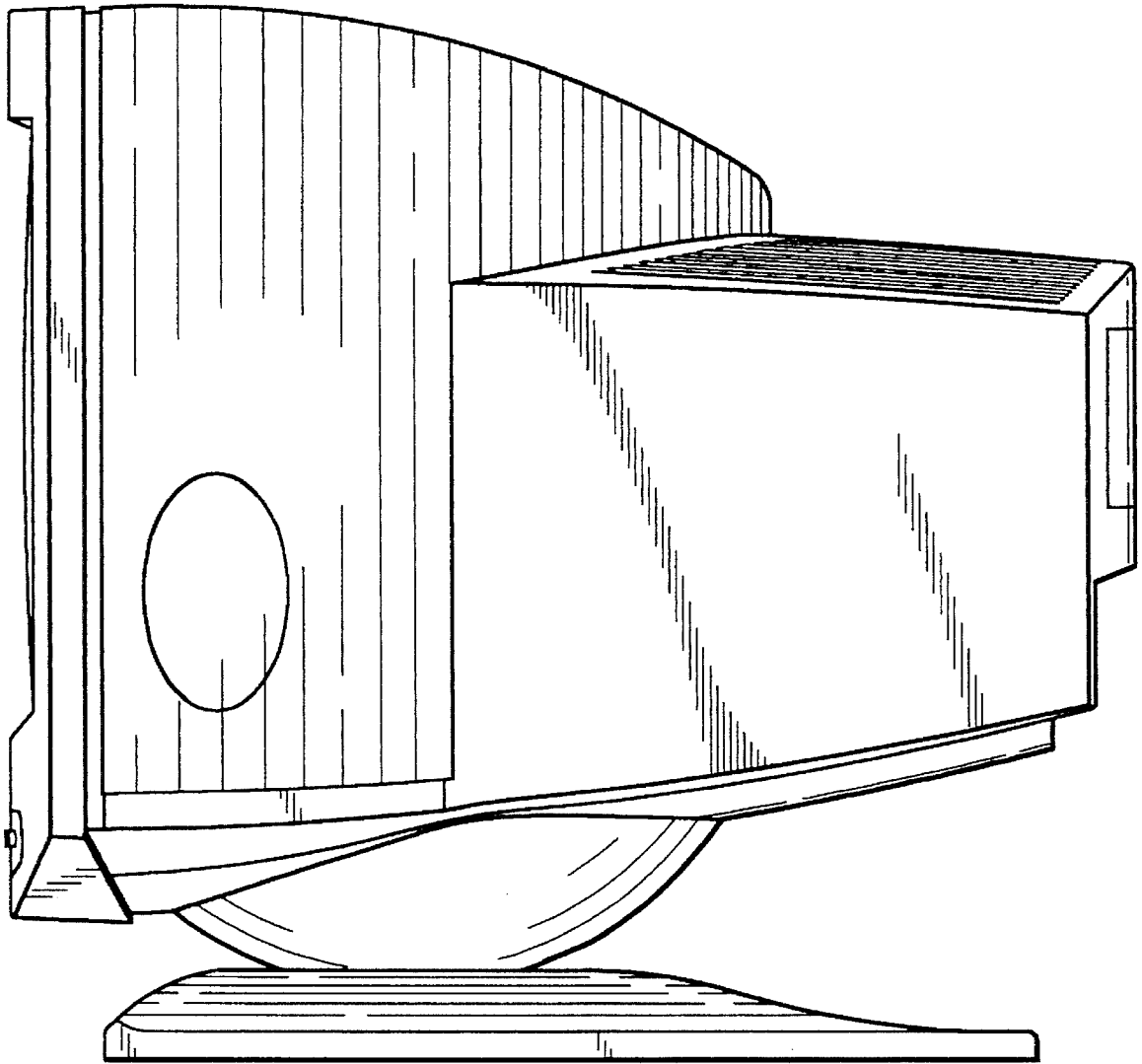

**FIG. 5**

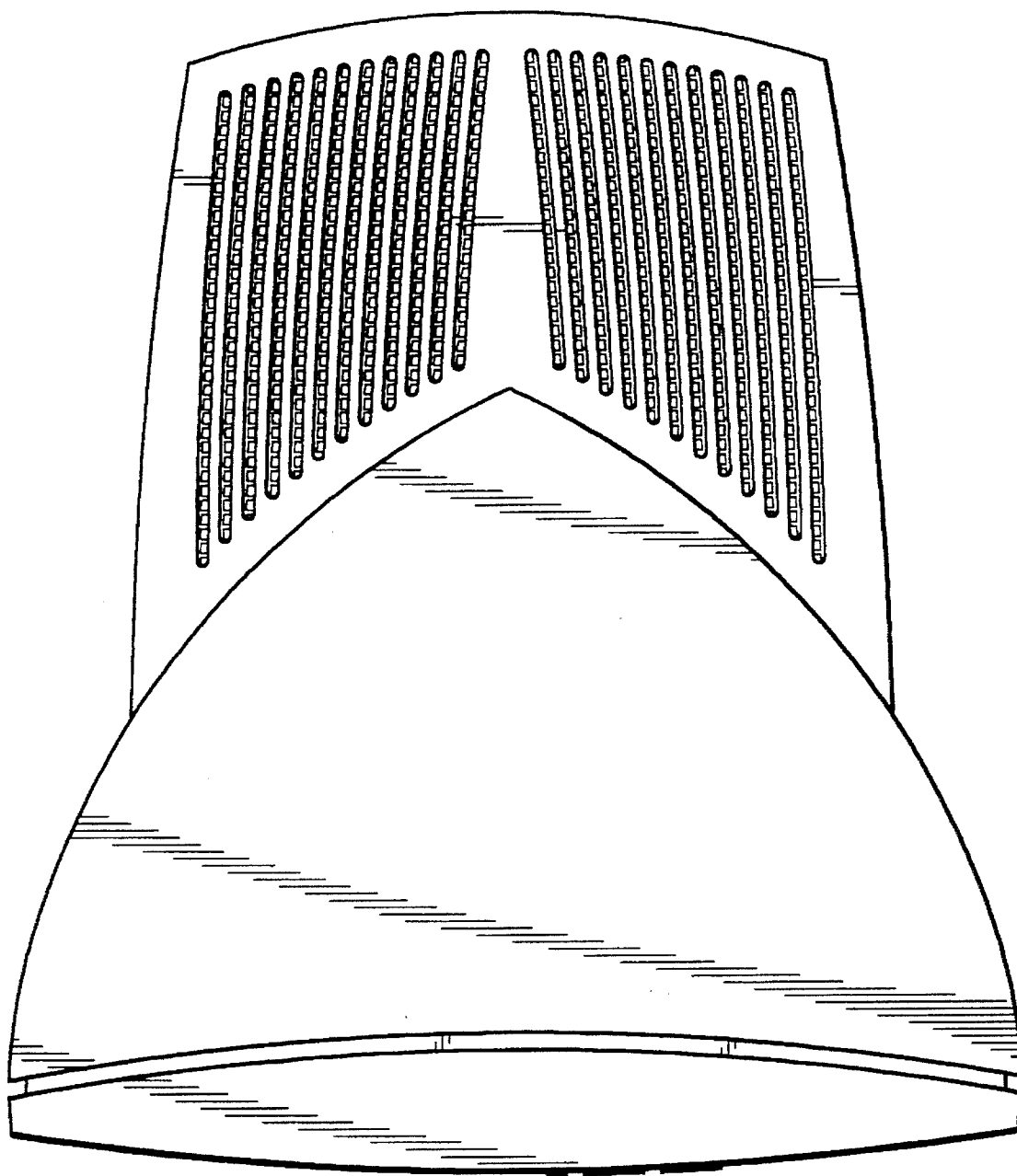

**FIG. 6**