



US00D429950S

United States Patent [19]

[11] Patent Number: Des. 429,950

Yu et al.

[45] Date of Patent: ** Aug. 29, 2000

[54] BODY HANDLE FOR COOKING VESSEL

Primary Examiner—Caron D. Veynar
Attorney, Agent, or Firm—Ladas & Parry

[75] Inventors: Jai Won Yu, Seoul, Rep. of Korea;
Hyun Seok Kim, Mt. Prospect, Ill.

[57] CLAIM

[73] Assignees: Saekwang Aluminum Co., Ltd.,
Ansan, Rep. of Korea; Master
Cookware Corporation, Chicago, Ill.

The ornamental design for body handle for cooking vessel,
as shown and described.

[**] Term: 14 Years

DESCRIPTION

[21] Appl. No.: 29/100,087

FIG. 1 is a front view of the body handle for cooking vessel
showing our new design;

[22] Filed: Feb. 3, 1999

FIG. 2 is a rear view thereof;

[51] LOC (7) Cl. 07-02

FIG. 3 is a right side elevation view thereof, the left side
elevation view is a mirror image thereof;

[52] U.S. Cl. D7/395

[58] Field of Search D7/354-361, 401.2,
D7/393-395; 99/324; 16/110.1, 430, 431;
220/573.1, 752, 753, 769, 912

FIG. 4 is a top view thereof;

FIG. 5 is a bottom view thereof;

[56] References Cited

FIG. 6 is a perspective view thereof; and,

U.S. PATENT DOCUMENTS

FIG. 7 is a cross section view taken along line 7—7 in FIG.
1.

D. 407,600 4/1999 LoGiudice D7/395
4,413,767 11/1983 Hellinger 228/136

Present design is made of steel. Body handle for cooking
vessel is attached to a side of the vessel.

OTHER PUBLICATIONS

The Chef's Catalog; p. 90; Item A—Jacques Pepin signature
8 piece bourgeat copper set; top of page, single handles, Sep.
1996.

1 Claim, 4 Drawing Sheets

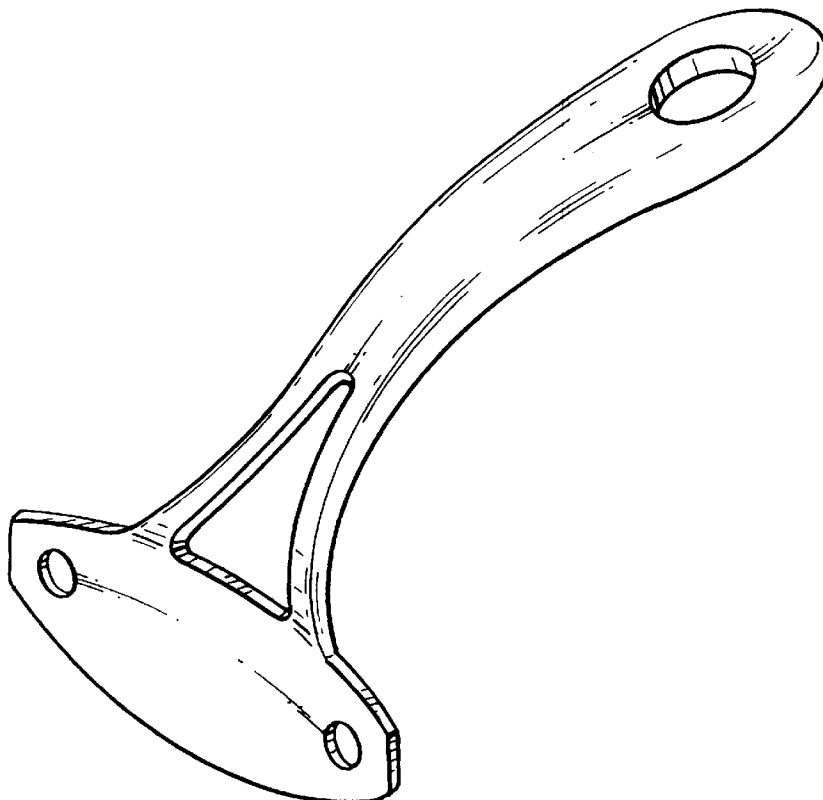

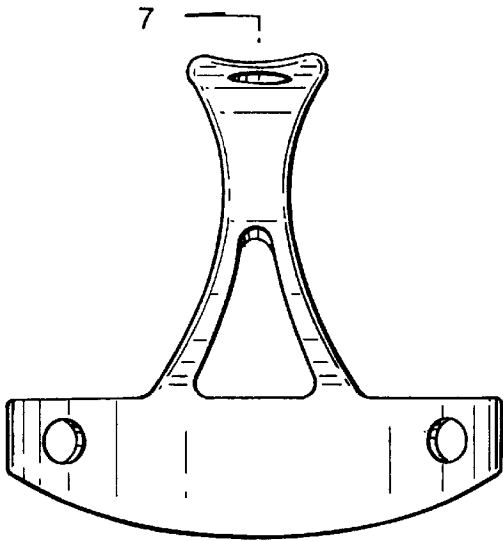

7
FIG. 1

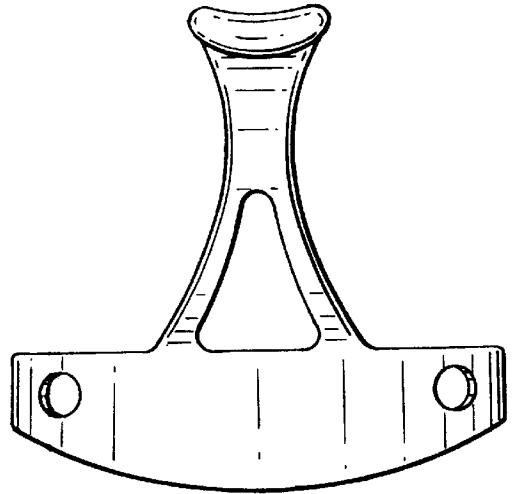

FIG. 2

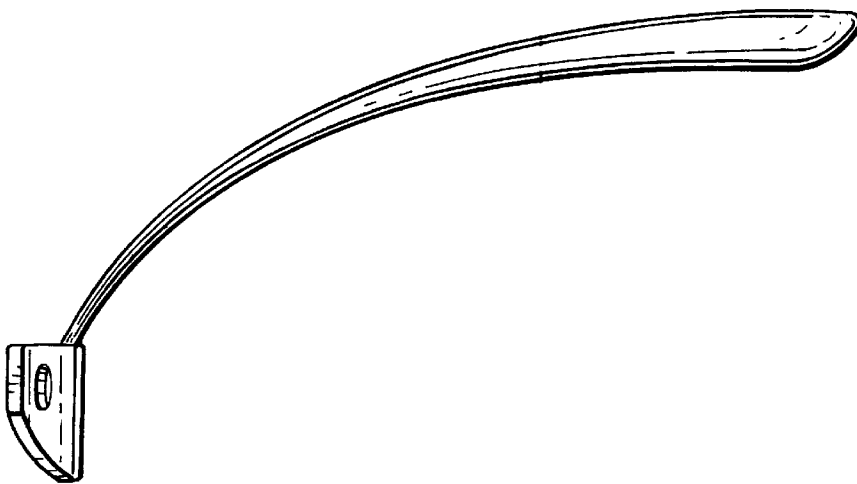

FIG. 3

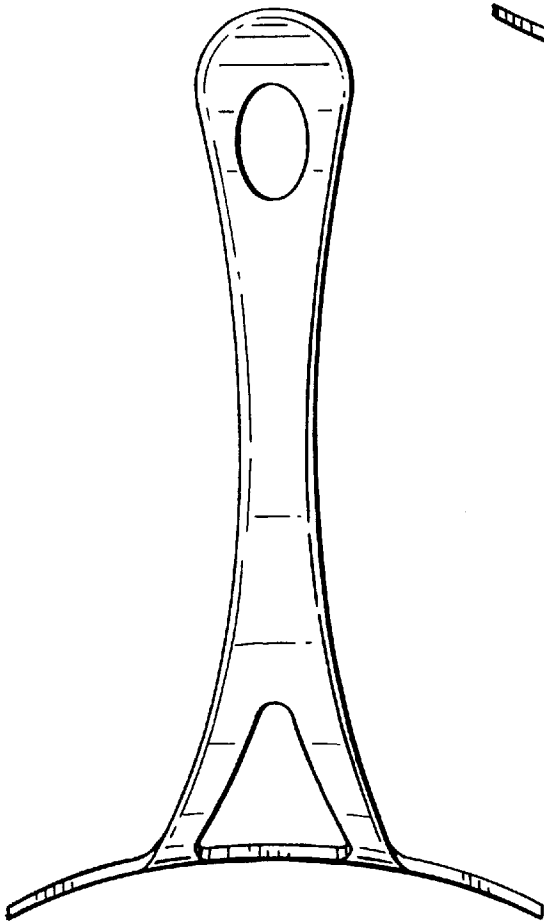

FIG. 4

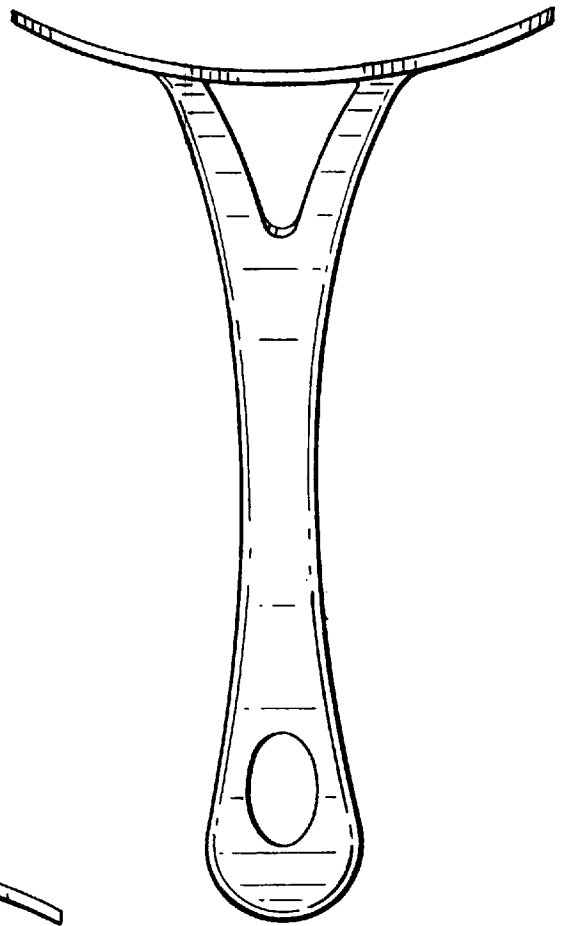

FIG. 5

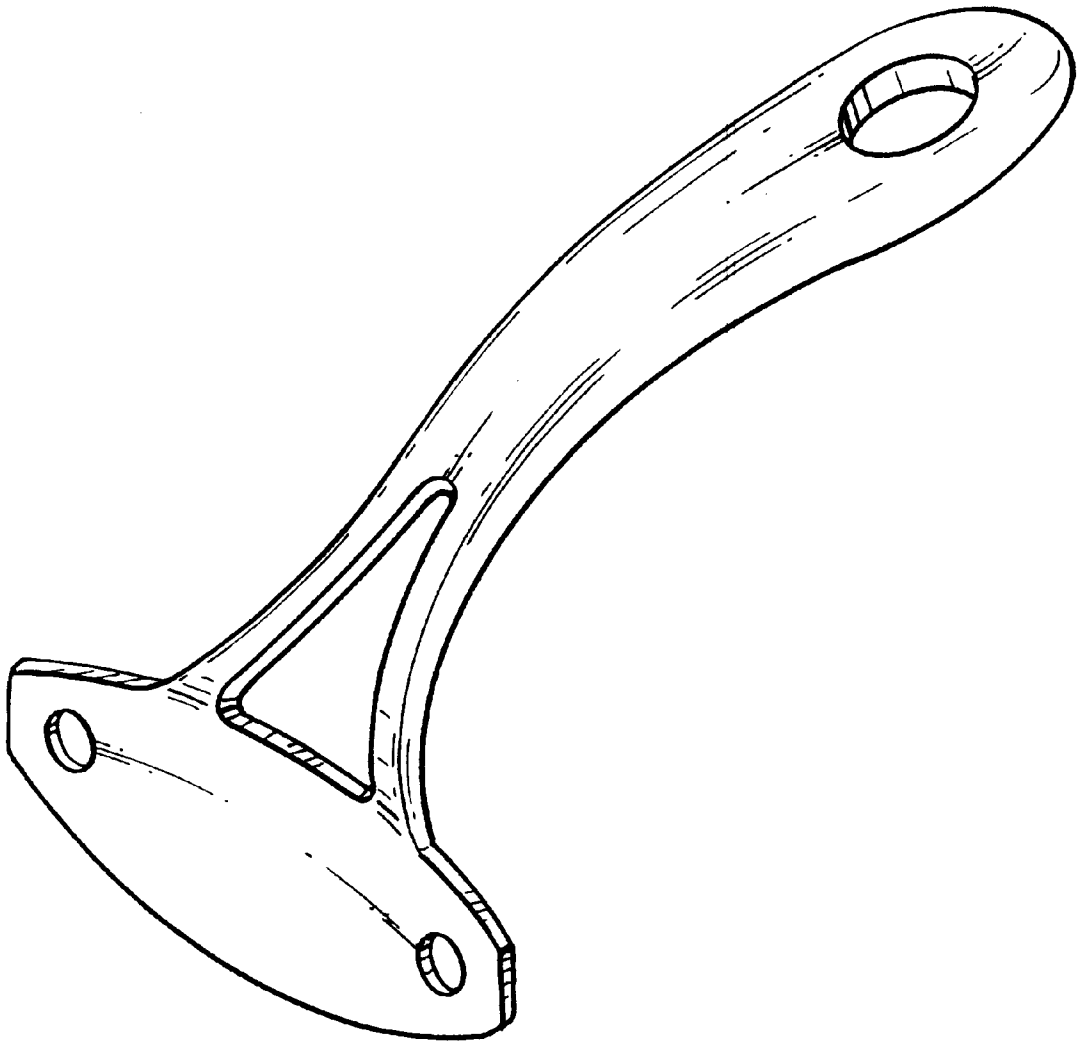

FIG. 6

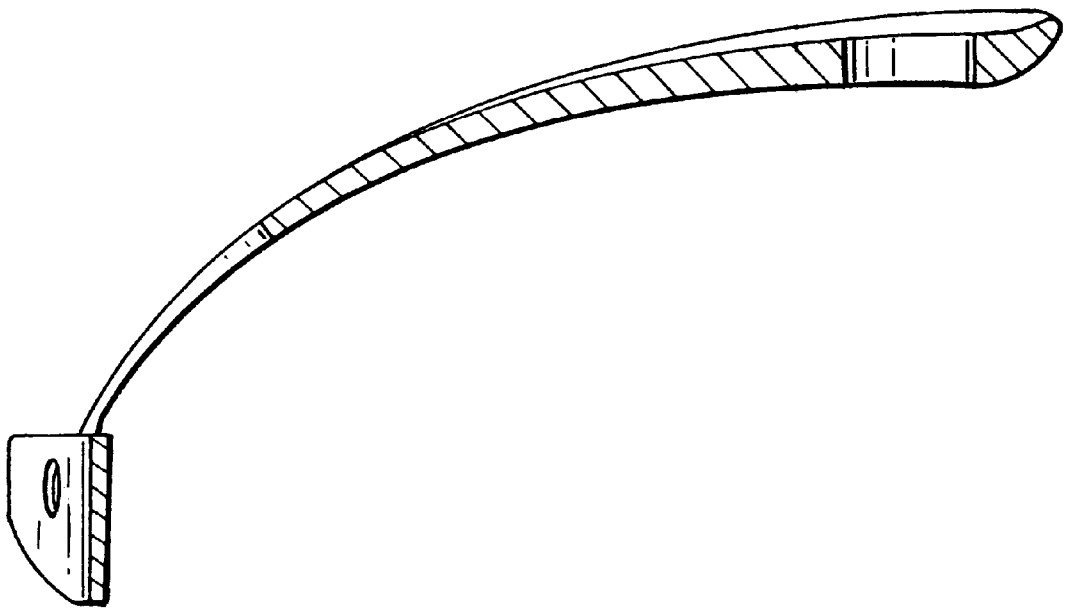

FIG. 7