



INTERNATIONAL APPLICATION PUBLISHED UNDER THE PATENT COOPERATION TREATY (PCT)

<p>(51) International Patent Classification ⁶ : G06F 3/033</p>	<p>A1</p>	<p>(11) International Publication Number: WO 99/28811 (43) International Publication Date: 10 June 1999 (10.06.99)</p>
<p>(21) International Application Number: PCT/IB98/01927 (22) International Filing Date: 3 December 1998 (03.12.98) (30) Priority Data: 08/985,261 4 December 1997 (04.12.97) US (71) Applicant: NORTHERN TELECOM LIMITED [CA/CA]; P.O. Box 6123, Station A, Montreal, Quebec H3C 3J5 (CA). (72) Inventors: BEATON, Brian, Finlay; 6136 SilverBirch Street, Orleans, Ontario K1W 1C4 (CA). SMITH, Colin, Donald; 565 Athlone Avenue, Ottawa, Ontario K1Z 5N1 (CA). BLOUIN, Francois; 29 de la Comète, Hull, Québec J9A 2Y5 (CA). COMEAU, Guillaume; 60 du Meteore, Hull, Quebec J9A 3B5 (CA). CRADDOCK, Arthur, Julian, Patterson; 6486 Waddion Drive, Greely, Ontario K4P 1E7 (CA).</p>	<p>(81) Designated States: BR, CA, CN, IL, JP, KR, MX, VN, European patent (AT, BE, CH, CY, DE, DK, ES, FI, FR, GB, GR, IE, IT, LU, MC, NL, PT, SE). Published <i>With international search report.</i></p>	

(54) Title: CONTEXTUAL GESTURE INTERFACE

(57) Abstract

The system and method consistent with the present invention provides a contextual gesture interface for electronic devices. The contextual gesture interface activates a function corresponding to the characteristics of an object making contact with a display. The system may determine the time period of the contact as well as the size of the contact. The functions may include a wide array of navigation tools or editing tools. The contextual gesture interface of the present invention may be especially useful in portable electronic devices with small displays.

TOUCH POINT DISTRIBUTION

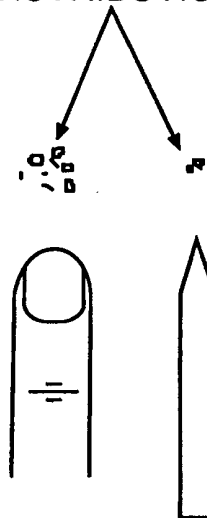

FOR THE PURPOSES OF INFORMATION ONLY

Codes used to identify States party to the PCT on the front pages of pamphlets publishing international applications under the PCT.

AL	Albania	ES	Spain	LS	Lesotho	SI	Slovenia
AM	Armenia	FI	Finland	LT	Lithuania	SK	Slovakia
AT	Austria	FR	France	LU	Luxembourg	SN	Senegal
AU	Australia	GA	Gabon	LV	Latvia	SZ	Swaziland
AZ	Azerbaijan	GB	United Kingdom	MC	Monaco	TD	Chad
BA	Bosnia and Herzegovina	GE	Georgia	MD	Republic of Moldova	TG	Togo
BB	Barbados	GH	Ghana	MG	Madagascar	TJ	Tajikistan
BE	Belgium	GN	Guinea	MK	The former Yugoslav Republic of Macedonia	TM	Turkmenistan
BF	Burkina Faso	GR	Greece	ML	Mali	TR	Turkey
BG	Bulgaria	HU	Hungary	MN	Mongolia	TT	Trinidad and Tobago
BJ	Benin	IE	Ireland	MR	Mauritania	UA	Ukraine
BR	Brazil	IL	Israel	MW	Malawi	UG	Uganda
BY	Belarus	IS	Iceland	MX	Mexico	US	United States of America
CA	Canada	IT	Italy	NE	Niger	UZ	Uzbekistan
CF	Central African Republic	JP	Japan	NL	Netherlands	VN	Viet Nam
CG	Congo	KE	Kenya	NO	Norway	YU	Yugoslavia
CH	Switzerland	KG	Kyrgyzstan	NZ	New Zealand	ZW	Zimbabwe
CI	Côte d'Ivoire	KP	Democratic People's Republic of Korea	PL	Poland		
CM	Cameroon	KR	Republic of Korea	PT	Portugal		
CN	China	KZ	Kazakstan	RO	Romania		
CU	Cuba	LC	Saint Lucia	RU	Russian Federation		
CZ	Czech Republic	LI	Liechtenstein	SD	Sudan		
DE	Germany	LK	Sri Lanka	SE	Sweden		
DK	Denmark	LR	Liberia	SG	Singapore		
EE	Estonia						

- 1 -

CONTEXTUAL GESTURE INTERFACE

RELATED APPLICATIONS

This application is related to U.S. patent application, Serial No. 08/985,265 (Atty. Docket No. 3884.0115-00), entitled NAVIGATION TOOL FOR GRAPHICAL USER INTERFACE; and U.S. patent application, Serial No. 08/985,264 (Atty. Docket No. 3884.0116-00), entitled INTELLIGENT TOUCH DISPLAY, both of which are filed concurrently herewith, and both of which are hereby incorporated by reference.

BACKGROUND OF THE INVENTION

The present invention relates generally to graphical user interfaces (GUI), and more particularly to contextual gesture interface for graphical user interfaces.

Until relatively recently, software-based documents have been primarily viewed and manipulated on desktop or laptop computers with relatively large displays, typically 640 x 480 pixels or larger. These displays are often large enough to display a full page of standard size page or at least a significant portion of the page. Hence, on-screen graphical menus and controls displayed in window of an application did not greatly reduce the display area for the underlying document. Computers also have peripheral devices such as a keyboard or a mouse to control the display of content information. Thus, viewing and navigating around a single-page or multi-page document have not posed much difficulty.

Due to increasing focus on compactness of electronic devices, however, the displays especially in portable electronic devices are becoming smaller and smaller. Popular electronic devices with smaller display area include electronic organizers, PDA's (personal digital assistants), and graphical display-based telephones. Also available today are communicators that facilitate various types of communication such as voice, faxes, SMS (Short Messaging Services) messages, e-mail, and Internet-related applications. These products can likewise only contain a small display area.

To enable users to navigate around a full page of content information, these devices typically provide hard-keys for arrows as shown in Fig. 1. The hard-keys, however, not only increase the size but also add to the cost of the devices. Also, hard-

- 2 -

keys generally provide limited options for direction of movement, *e.g.*, vertical or horizontal. They generally do not provide the freedom to move in any direction.

Some displays of these devices also require a separate stylus having peripheral technology that requires transmission of electromagnetic pulses or light to the display. These devices often require additional controllers such as buttons on the body or the tip of the stylus for activation. Furthermore, these styli require a power source, either through wire or battery, and their compatibility is generally limited to a specific device.

As shown in Fig. 2, other devices substitute hard-keys with graphical on-screen arrows or scroll bars that are typically used in full-size computer displays. The on-screen scroll bars, however, occupy valuable screen real estate and compound the limitations of small displays. Similar to the hard-keys, the on-screen arrows also generally restrict the navigational movement to horizontal or vertical direction.

In other forms of on-screen GUIs, *e.g.*, pop-up menus, also take up valuable screen space, further reducing the available display area for content information. Additionally, on-screen pop-up menus typically provide available functions in multiple layers, thus requiring a user to move deeply into the hierarchy before reaching the desired function. This is time consuming and renders the GUI cumbersome and ineffective.

Therefore, it is desirable to provide navigation tools that allow small-size devices while maximizing the use of available screen real estate.

It is also desirable to provide tools to navigate within a document at any direction at varying speeds.

It is further desirable to provide navigation tools that can be activated without requiring specific electronic devices.

In addition, it is further desirable to provide an improved GUI that simplifies GUI by recognizing various characteristics of the touch input.

SUMMARY OF THE INVENTION

Systems and methods consistent with the present invention provide a contextual user interface for display devices.

- 3 -

Specifically, a method consistent with this invention of providing a contextual user interface comprises several steps. Initially, a system detects an object making contact with a physical viewing area, and determines characteristics of the contact. Thereafter, the system activates a function corresponding to the contact characteristics and current user task.

A system consistent for this invention for providing a contextual user interface comprises detecting means, determining means, and activating means. The detecting means detects an object making contact with a physical viewing area, and determining means determines characteristics of the contact. Finally, activating means activates a function corresponding to the contact characteristics and current user task.

BRIEF DESCRIPTION OF THE DRAWINGS

The accompanying drawings, which are incorporated in and constitute a part of this specification, illustrate the invention and together with the description, serve to explain the principles of the invention.

In the drawings,

Fig. 1 shows conventional hard-key arrows for navigation control;

Fig. 2 shows conventional on-screen graphical navigation tool;

Figs. 3A-3B are diagrams of an exemplary mobile telephone consistent with the principles of the present invention;

Fig. 4 is a block diagram showing the elements of the mobile telephone of Fig. 3A;

Fig. 5 is a block diagram showing the components of the memory of Fig. 4;

Fig. 6 is a block diagram of touch screen functionalities;

Figs. 7A-7B show an exemplary inactive and active graphical navigation tool, respectively;

Fig. 8 is a sample screen showing an active navigation tool;

Figs. 9A-9C show exemplary features of the navigation tool;

Figs. 10A-10C are sample screens showing the navigation tool performing various navigation functions;

Figs. 11A-11B show exemplary features of the navigation tool relating to speed of navigation;

- 4 -

Fig. 12 is a diagram illustrating a touch point distribution; and

Fig. 13 is a flowchart illustrating the process of determining the size of the object making contact with the viewing area.

Figs. 14A and 14B are graphs showing the touch characteristics of a pen and a finger, respectively.

DESCRIPTION OF THE PREFERRED EMBODIMENT

Reference will now be made in detail to the present preferred embodiment of the invention, an example of which is illustrated in the accompanying drawings. Where appropriate, the same reference numerals refer to the same or similar elements. The appended claims define the scope of the invention; the following description does not limit that scope.

The graphical navigation tool of the present invention may be implemented in a wide range of electronic devices mentioned above such as electronic organizers, PDA's, and graphical display-based telephones. Although the need to maximize the use of screen real estate is most critical in portable electronic devices with small displays, the present invention can also be implemented in full-size computers or electronic devices. For purposes of illustration, however, the present invention will be explained in detail in a mobile telephone environment.

Specifically, Fig. 3A shows a mobile telephone 310 and Fig. 3B shows an exemplary wireline telephone preferably having the graphical navigation tool consistent with the present invention. Mobile telephone 310 includes main housing 310, antenna 320, keypad 330, and display 340. Fig. 4 shows the hardware elements in mobile telephone 310 including antenna 410, communications module 420, feature processor 430, memory 440, sliding keypad 450, analog controller 460, display module 470, battery pack 480, and switching power supply 490.

Antenna 410 transmits and receives radio frequency information for mobile telephone 210. Antenna 410 preferably comprises a planar inverted F antenna (PIFA)-type or a short stub (2 to 4 cm) custom helix antenna. Antenna 410 communicates over a GSM (Global System for Mobile Communications) switching fabric using a conventional voice B-channel, data B-channel, or GSM signaling channel connection.

- 5 -

Communications module 420 connects to antenna 410 and provides the GSM radio, baseband, and audio functionality for mobile telephone 310. Communications module 420 includes GSM radio 421, VEGA 423, BOCK 425, and audio transducers 427.

GSM radio 421 converts the radio frequency information to/from the antenna into analog baseband information for presentation to VEGA 423. VEGA 423 is preferably a Texas Instruments VEGA device, containing analog-to-digital (A/D)/digital-to-analog (D/A) conversion units 424. VEGA 423 converts the analog baseband information from GSM radio 421 to digital information for presentation to BOCK 425.

BOCK 425 is preferably a Texas Instruments BOCK device containing a conventional ARM microprocessor and a conventional LEAD DSP device. BOCK 425 performs GSM baseband processing for generating digital audio signals and supporting GSM protocols. BOCK 425 supplies the digital audio signals to VEGA 423 for digital-to-analog conversion. VEGA 423 applies the analog audio signals to audio transducers 427. Audio transducers 427 include speaker 428 and microphone 429 to facilitate audio communication by the user.

Feature processor 430 provides GUI features and a Java Virtual Machine (JVM). Feature processor 430 communicates with BOCK 425 using high level messaging over an asynchronous (UART) data link. Feature processor 430 contains additional system circuitry, such as a liquid crystal display (LCD) controller, timers, UART and bus interfaces, and real time clock and system clock generators (not shown).

Memory 440 stores data and program code used by feature processor 430. Memory 440 includes static RAM 442 and flash ROM 444. Static RAM 442 is a volatile memory that stores data and other information used by feature processor 430. Flash ROM 444, on the other hand, is a non-volatile memory that stores the program code executed by feature processor 430.

Sliding keypad 450 enables the user to dial a telephone number, access remote databases, and manipulate the GUI features. Sliding keypad 450 preferably includes a mylar resistive key matrix that generates analog resistive voltage in response to

- 6 -

actions by the user. Sliding keypad 450 preferably connects to main housing 310 (Fig. 4) of mobile telephone 210 through two mechanical "push pin"-type contacts.

Analog controller 460 is preferably a Phillips UCB1100 device that acts as an interface between feature processor 430 and sliding keypad 450. Analog controller 460 converts the analog resistive voltage from sliding keypad 450 to digital signals for presentation to feature processor 430.

Display module 470 preferably includes a 160 x 320 pixel LCD 472 with an analog touch screen panel 474 and an electroluminescent backlight. LCD 472 operates in conjunction with feature processor 430 to display the GUI features. Analog controller 460 scans touch screen overlay 474 while feature processor 430 refreshes LCD 472.

Battery pack 480 is preferably a single lithium-ion battery with active protection circuitry. Switching power supply 490 ensures highly efficient use of the lithium-ion battery power by converting the voltage of the lithium-ion battery into stable voltages used by the other hardware elements of mobile telephone 210.

Fig. 5 is a block diagram illustrating the components of memory 440. Static RAM 442 stores data and other information used by feature processor 430. Flash ROM 444 contains various programs including a program 510, a touch screen program 520, a navigation program 530, and a drawing program 540. Program 520, preferably written in languages such as Java, C, or C++ for Macintosh, is a main program overseeing the operation of mobile telephone 310.

Touch screen program 520 facilitates processing of touch input on touch screen panel 474 using a typical touch input algorithm. Navigation program 530 handles navigation of the content information display. Drawing program 540 is a graphical drawing package. Programs 520, 530, and 540 may be one of any commercially available packages or a user-defined feature program or macro.

The present invention provides various features through tactile GUI. Initially, LCD 472 displays various GUI features. Referring to Fig. 6, a user touches touch screen panel 474 to provide user input, for example, to navigate around a document or invoke a desired function. Analog controller 460 scans touch screen panel 474 and reads the corresponding analog voltage of touch screen panel 474. Analog controller

- 7 -

460 then converts the analog values into corresponding digital values representing the Cartesian coordinates, which are transmitted to feature processor 430 for processing. The resolution of the touch input depends on the ability of analog controller 460 to discern among multiple levels of analog values, generally defined in bits.

Figs. 7A-7B show an exemplary graphical navigation tool preferably used to navigate around documents that are too large to view within a single screen of a physical display (hereinafter referred as "viewing area"). The navigation tool may be used to view any kind of document including faxes, Web pages, or e-mail. In one embodiment consistent with the present invention, an inactive navigation tool is displayed and accessible to the user at all times (Fig. 7A). The user may activate the navigation tool by touching and holding the center of the navigation tool for a predetermined time period, for example, one to two seconds (Fig. 7B). An activated navigation tool is preferably transparent to avoid hindering the display of content information in the viewing area as shown in Fig. 8. Alternatively, the navigation star may change colors or other features of its appearance to indicate its active status. A solid line image, for example, may be used in greyscale displays that do not support transparency.

The present invention may be designed such that feature processor 430 ignores any touch input on the navigation tool unless the navigation tool has been activated. Instead, the touch input may be interpreted as input to access control buttons in the underlying document, write on the underlying document, or invoke other functions related to the underlying document. This will prevent against unintentional navigation in the viewing window in case the user inadvertently touches touch screen panel 474. In an alternative embodiment, the present invention may accept stylus input to access the underlying document while a finger or non-electromagnetic touch on any part of the navigation tool invokes the navigation function.

Referring to Figs. 9A-9C, once the navigation tool is activated, the user may navigate through the document by selecting the graphical arrows, *e.g.*, up, right, left, and down arrows (Fig. 9A), or graphical page icons, *e.g.*, previous or next page (Fig. 9B). One skilled in the art may vary the type and number of graphical tools

- 8 -

significantly. For example, the navigation tool may provide graphical representations for forward, next document, back, or home functions (Fig. 9C).

Figs. 10A-10C show exemplary screen displays while the user is touching the navigation tool. Upon touching the right arrow of the navigation tool, for example, the right arrow is highlighted and navigation program 530 moves the display to the right (Fig. 10A). Similarly, touching the down arrow moves the display down (Fig. 10B). Although the four arrows are presented to guide the users, navigation program 530 supports navigational movement at any direction. If the user touches an area of the navigation tool equidistant between the up and right arrows, for example, navigation program 530 will move the display towards the upper-right portion of the underlying document at a 45-degree angle. Touching the arrows or any area in between, moves the display in the selected direction until navigation program 530 reaches the edge of the page.

Touching the next page icon moves the viewing window to the next page of the underlying document (Fig. 10C). If a particular document does not have a page corresponding to a previous or next page icon, navigation program 530 will not display the respective previous or next page icons. This would apply to one-page documents, or when the user is at the beginning or end of a multi-page document. In one embodiment consistent with the present invention, a momentary touch of the next page icon causes navigation program 530 to jump to the next page while a continuous touch on the next page icon causes navigation program 530 to continue scrolling through succeeding pages of the underlying document. The previous page icon may embody similar characteristics.

The user may also control the speed of the navigation. As shown in Fig. 11A, the speed of the navigation accelerates as the user touch moves from the center of the circle toward the circumference of the circle, *i.e.*, tip of the arrow. Hence, the viewing window moves slowly when the user touches the blunt end of the arrow located at the center of the circle while the speed accelerates as the user moves the finger towards the tip of the arrow. The speed of navigation, therefore, is determined by the distance of the touch relative to the center of the circle. Likewise, similar principles apply to previous or next page/document icons where a touch closer to the outer edge of the

previous or next page/document icons accelerates navigation through the document as shown in Fig. 11B.

Although the exemplary transparent tool discussed above is for navigation, transparent control tools may be implemented for a variety of functions. A transparent tool may, for example, be used for a Web browser application where the controls may be used for appropriate functions such as moving forwards or backwards through different Web pages or returning to home page. One skilled in the art may easily vary the design or the functionality of the graphical navigation tools described above without departing from the scope of the present invention.

In an exemplary embodiment of a navigation tool described above, a finger touch invokes navigational functions based on the feature selected and the location of the user touch. Alternatively, other objects making contact with touch screen panel 474 may invoke other tools or functions. A pointy stylus touch, for example, may invoke a menu with cardinal points representing multiple line widths, colors, or patterns.

In another embodiment consistent with the present invention, tools or application programs may be stored in flash ROM 444 to provide related interfaces to the user. The use of a finger may, for example, invoke tools or dialogues that are finger-touchable and large whereas the use of a sharp stylus may invoke a modified GUI with smaller touch targets. In a yet another embodiment, in a document viewing application normally navigable by a finger touch, use of a sharp stylus may automatically invoke a document annotation application for marking up the underlying document.

As described above, the touch-responsive GUI of the present invention are facilitated through various components including touch screen panel 474, analog controller 460, and feature processor 430. Specifically, analog controller 460 scans touch screen panel 474 to read the corresponding analog voltage of touch screen panel 474 activated by a user touch. Analog controller 460 then converts the analog values into a digital value representing the Cartesian coordinates, which is transmitted to feature processor 430 for processing according to the functionalities of the present invention.

- 10 -

When a user touches touch screen panel 474, program 510 initiates touch screen program 520 to determine the pointer size of the object making contact with touch screen panel 474 based on a touch point distribution or pointer size of the touch input. As shown in Fig. 12, touch screen program 520 can, for example, determine whether the pointer size of the object is a finger or a sharp object.

Fig. 13 is a flowchart illustrating the process of determining the size of the object making contact with the viewing area. Touch point program 520 first determines the individual points of contact made by the object (step 1310). It computes a centroid, or other average point, of the determined points of contact (step 1320). Touch program 520 then computes a standard deviation of the centroid as well as the variance (step 1330), and determines the pointer size based on the centroid and the standard deviation (step 1340). These computations are preferably performed on a real-time basis to provide immediate system response to the touch input. In order to achieve optimum results and accuracy, analog touch controller 460 preferably generates 150 points per second or more. Touch program 520 may also use the amount of pressure imposed on touch screen panel 474 as a function of time to determine the size of object. As shown in Fig. 14A, for example, if the amount of pressure increases or decreases sharply at a particular instant in time, touch point program 520 may determine that the touch corresponds to a pen. A finger touch, on the other hand, results in a gradual increase and decrease in pressure as illustrated by a smoother curve in Fig. 14B.

Program 510 can also be programmed to correlate certain pointer size to certain objects and invoke corresponding functions or tools. Such GUI provides a richer, yet simplified interaction between the user and mobile telephone 310. If program 510 determines that the pointer size of the object corresponds to the size of a finger, program 510 may initiate a navigation tool. If the pointer size corresponds to the size of several fingers, program 510 may invoke a drag function of the navigation tool. On the other hand, if program 510 determines that the pointer size of the object corresponds to size of a sharp point or pen, program 510 may initiate a drawing tool supported by drawing program 540. Similarly, if program 510 determines that the pointer size of the object corresponds to size of a pencil eraser, program 510 may

- 11 -

initiate an erase function of the drawing tool. One skilled in the art may easily vary the functions or tools initiated by program 510. Additionally, the functions or tools may be commercial software packages, predetermined functions, or user-defined macros.

In addition to using the pointer size to determine the desired GUI, program 510 can also incorporate other characteristics of the user touch, *e.g.*, gestures or movements, to simplify GUI and maximize screen real estate. A gesture recognizing interface extends the ability of the present invention to distinguish between different sized pointers to track gestures and movement of user input based on vector direction and magnitude, all in the context of active user application. This type of contextual gesture interface can infer by context, the implement, and the gesture chosen by the user what functions the user wishes to invoke. Accordingly, all these functions are available without menus or scroll bars and do not require additional screen areas to display the functions.

Program 510 recognizes other characteristics of the touch input including the context of the input, namely the task or sub-task applications running when the GUI is invoked. If a user is in a document navigation application, for example, program 510 interprets a quick drag to the right as a next page function. If the underlying task is an editing application, program 510 may interpret the same gesture as a highlight function and highlight a portion of the document touched by the user. Similarly, in graphics application, a quick drag to the right may invoke a drawing tool to draw from the starting point to the ending point of the touch points. In a document viewing application, the same touch may invoke a navigation tool to move the view of the document in the direction of the finger drag.

All of the above functions and features described above focuses on providing intuitive GUIs and minimize the need for users to memorize complicated, hierarchical menus or procedures. Additionally, the present invention maximize available screen real estate while providing a wide array of GUI and tools.

It will be apparent to those skilled in the art that various modifications and variations can be made in the system of the present invention and in construction of this system without departing from the scope or spirit of the invention. Other

- 12 -

embodiments of the invention will be apparent to those skilled in the art from consideration of the specification and practice of the invention disclosed herein. The specification and examples should be considered as exemplary only, with the true scope and spirit of the invention indicated by the following claims.

WHAT IS CLAIMED IS:

1. A method of providing a contextual user interface comprising the steps of:
detecting an object making contact with a physical viewing area;
determining characteristics of the contact; and
activating a function corresponding to the contact characteristics and current user task.
2. The method of claim 1, wherein the determining step includes the substep of determining the time period of the contact.
3. The method of claim 2, wherein the determining step includes the substep of determining the point size of the contact.
4. The method of claim 3, further including the step of determining the contact characteristics as a prolonged finger-sized object, and wherein the activating step includes the substep of activating a navigation tool.
5. The method of claim 3, further including the step of determining the contact characteristics as a prolonged stylus-sized object, and wherein the activating step includes the substep of activating a drawing tool.
6. The method of claim 1, wherein the determining step includes the substep of determining the direction of movement of the contact.
7. The method of claim 1, wherein the determining step includes the substep of determining the speed of movement of the contact.
8. The method of claim 1, wherein the current user task is a navigation application, and the determining step includes the substep of

- 14 -

determining the contact characteristics as a quick drag, and
wherein the activating step includes the substep of
activating a next page function.

9. The method of claim 1, wherein the current user task is an editing application, and the determining step includes the substep of
determining the contact characteristics as a quick drag, and
wherein the activating step includes the substep of
highlighting a section of a document underlying the user input.
10. The method of claim 1, wherein the current user task is a graphics application, and the determining step includes the substep of
determining the contact characteristics as a quick drag, and
wherein the activating step includes the substep of
drawing a line in a section of a document underlying the user input.
11. The method of claim 1, wherein the current user task is a network browser application and the determining step includes the substep of
determining the contact characteristics as a lingering touch, and
wherein the activating step includes the substeps of
enabling a graphical tool, and
disabling functions of underlying document.
12. The method of claim 1, wherein the detecting step includes the substeps of
measuring an analog voltage signal from the physical viewing area, and
converting the analog voltage signal to a digital value.
13. The method of claim 12, further including the step of
transmitting the digital value to a processor.

- 15 -

14. The method of claim 13, further including the step of analyzing the digital value by the processor.
15. The method of claim 1, wherein the determining step includes the substeps of determining points of contact of the object, computing a centroid of the points of contact, computing a standard deviation of the centroid, and computing the pointer size based on the centroid and the standard deviation.
16. An apparatus for providing a contextual user interface comprising:
 - means for detecting an object making contact with a physical viewing area;
 - means for determining characteristics of the contact; and
 - means for activating a function corresponding to the contact characteristics and current user task.
17. The apparatus of claim 16, wherein the determining means includes means for determining the time period of the contact.
18. The apparatus of claim 17, wherein the determining means includes means for determining the point size of the contact.
19. The apparatus of claim 18, further including
 - means for determining the contact characteristics as a prolonged finger-sized object, and
 - wherein the activating means includes
 - means for activating a navigation tool.

- 16 -

20. The apparatus of claim 18, further including means for determining the contact characteristics as a prolonged stylus-sized object, and wherein the activating means includes means for activating a drawing tool.
21. The apparatus of claim 16, wherein the determining means includes means for determining the direction of movement of the contact.
22. The apparatus of claim 16, wherein the determining means includes means for determining the speed of movement of the contact.
23. The apparatus of claim 16, wherein the current user task is a navigation application, and the determining means includes means for determining the contact characteristics as a quick drag, and wherein the activating means includes means for activating a next page function.
24. The apparatus of claim 16, wherein the current user task is an editing application, and the determining means includes means for determining the contact characteristics as a quick drag, and wherein the activating means includes means for highlighting a section of a document underlying the user input.
25. The apparatus of claim 16, wherein the current user task is a graphics application, and the determining means includes means for determining the contact characteristics as a quick drag, and wherein the activating means includes

- 17 -

means for drawing a line in a section of a document underlying the user input.

26. The apparatus of claim 16, wherein the current user task is a network browser application and the determining means includes

means for determining the contact characteristics as a lingering touch, and wherein the activating means includes

means for enabling a graphical tool, and

means for disabling functions of underlying document.

27. The apparatus of claim 16, wherein the detecting means includes means for measuring an analog voltage signal from the physical viewing area, and

means for converting the analog voltage signal to a digital value.

28. The apparatus of claim 27, further including means for transmitting the digital value to a processor.

29. The apparatus of claim 28, further including means for analyzing the digital value.

30. The apparatus of claim 16, wherein the determining means includes means for determining points of contact of the object, means for computing a centroid of the points of contact, means for computing a standard deviation of the centroid, and means for computing the pointer size based on the centroid and the standard deviation.

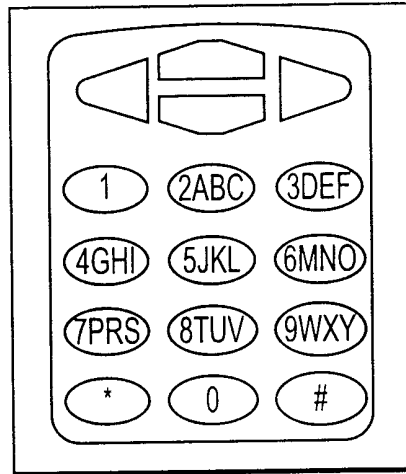

FIG. 1

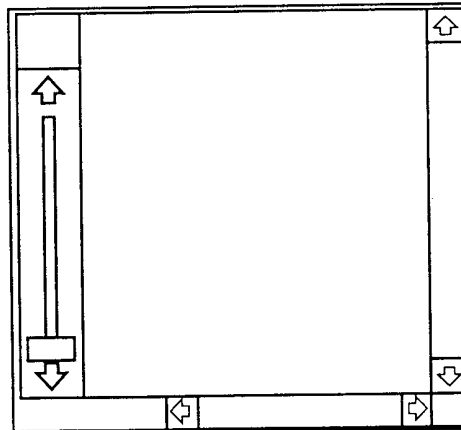

FIG. 2

2/11

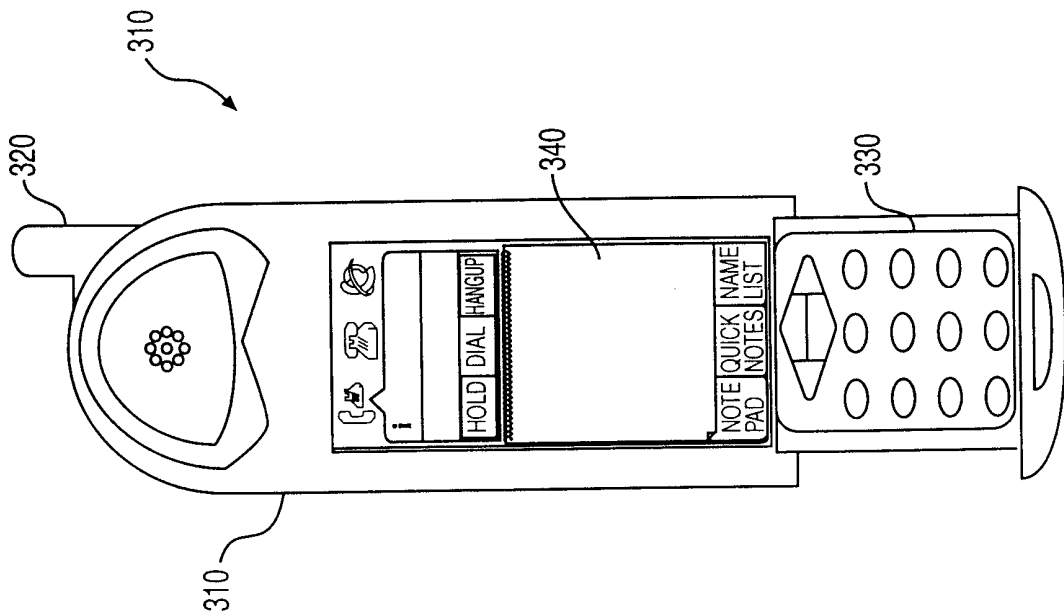

FIG. 3A

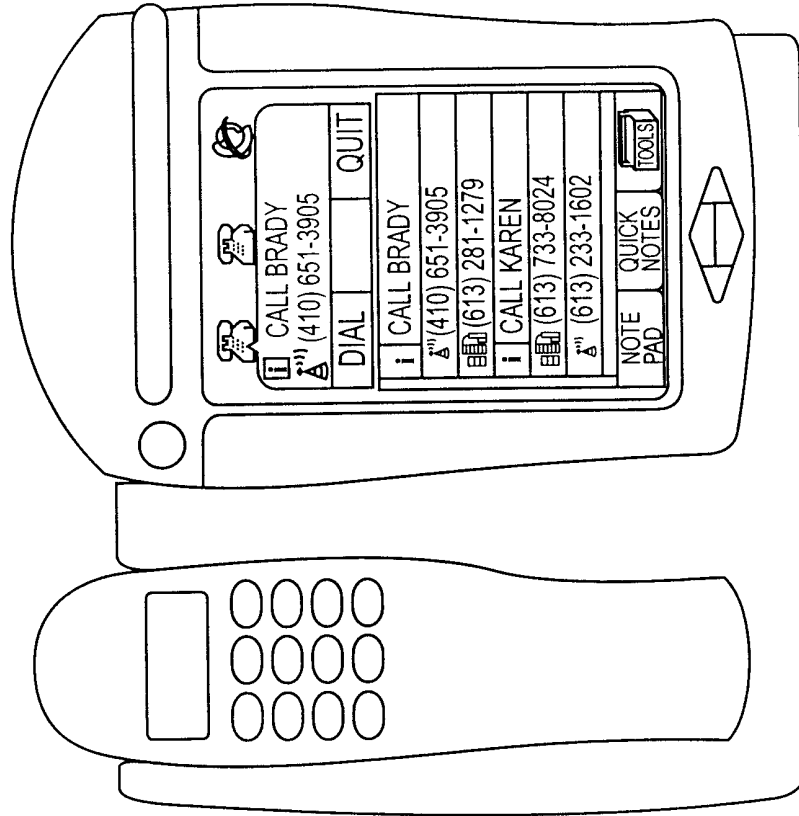

FIG. 3B

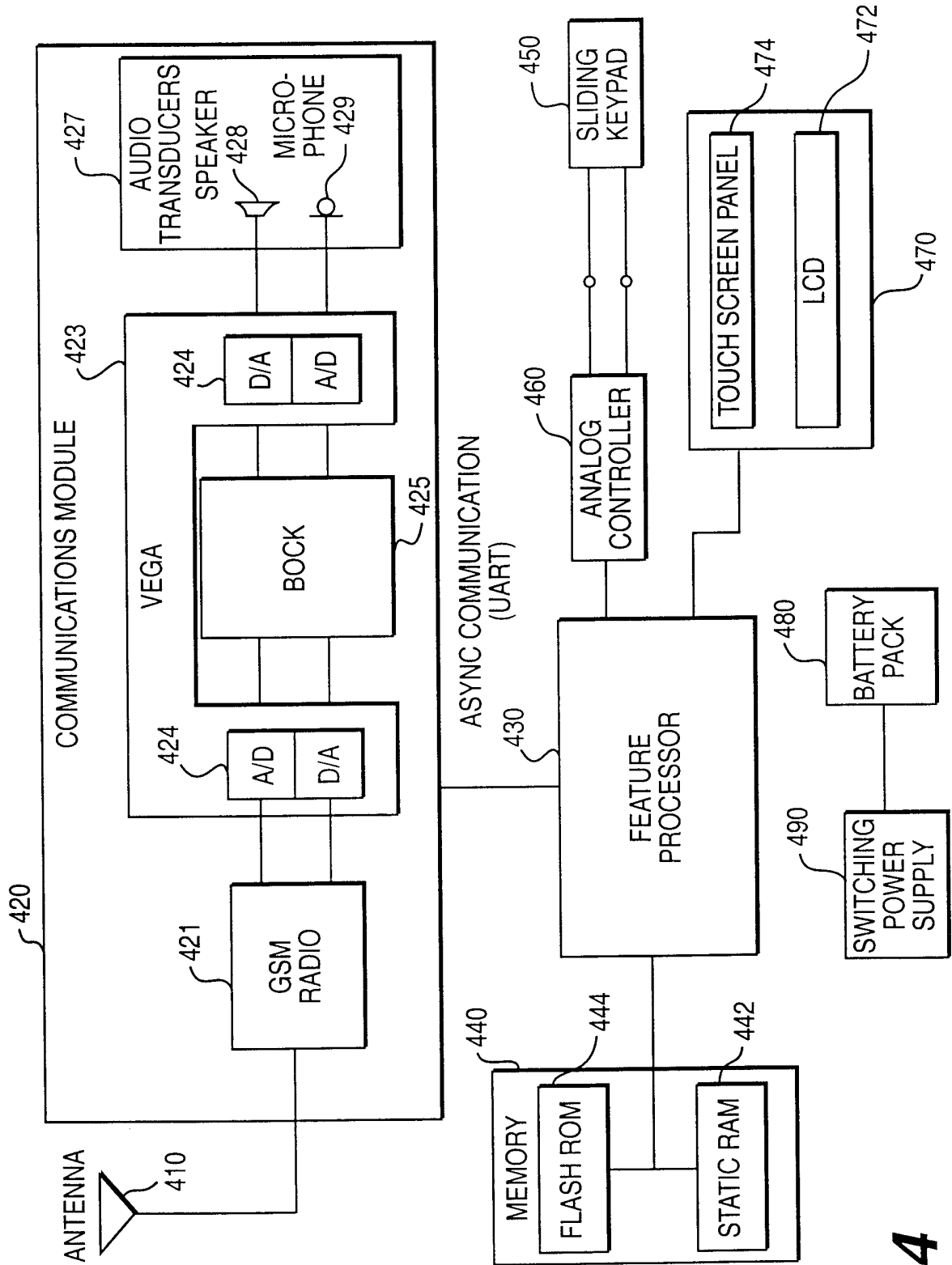

FIG. 4

4/11

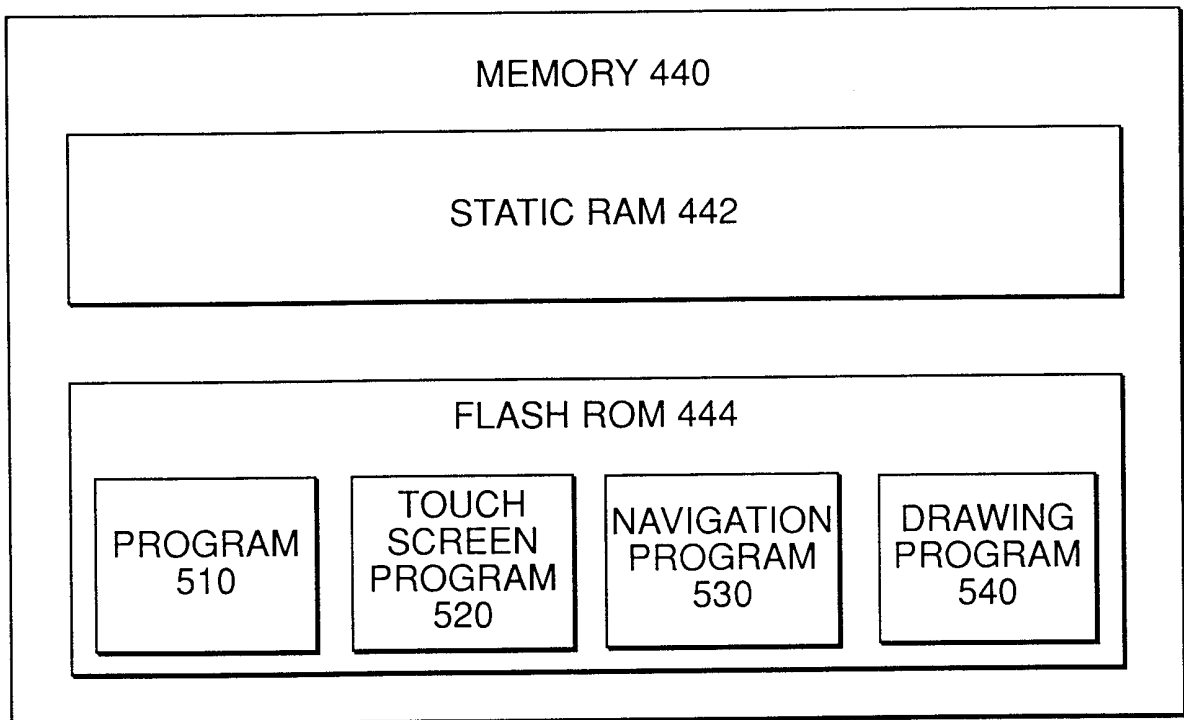

FIG. 5

5/11

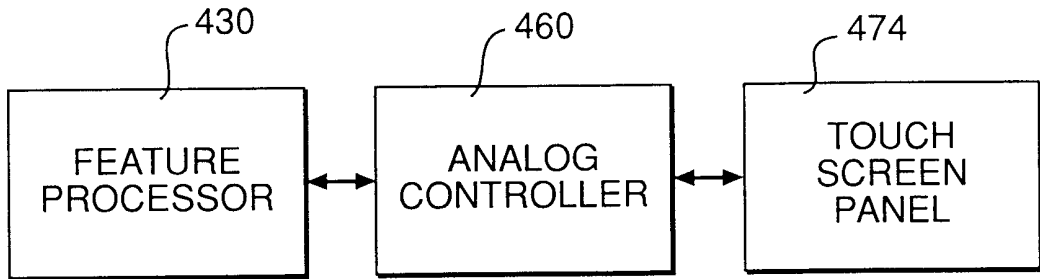

FIG. 6

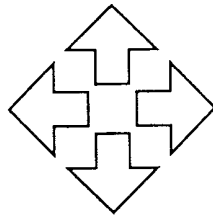

FIG. 7A

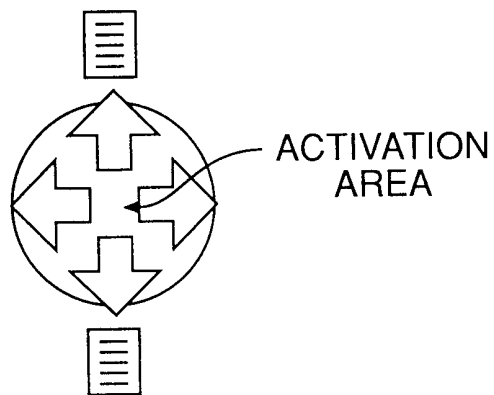

FIG. 7B

6/11

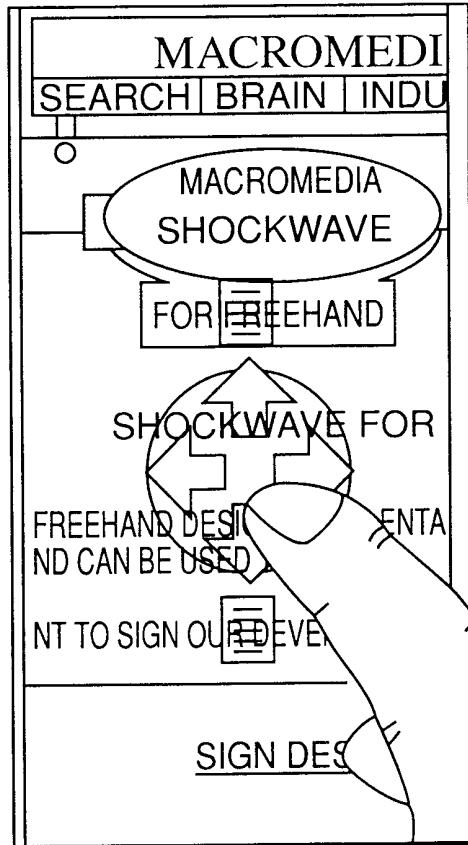

FIG. 8

7/11

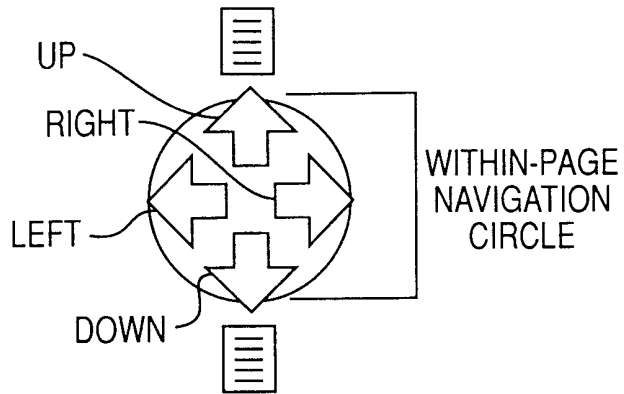

FIG. 9A

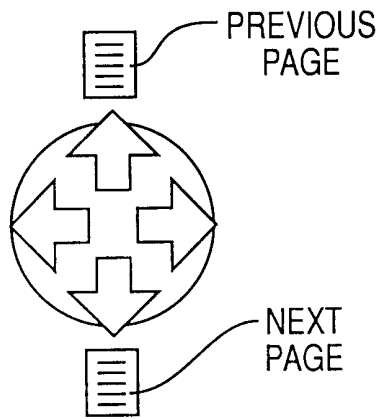

FIG. 9B

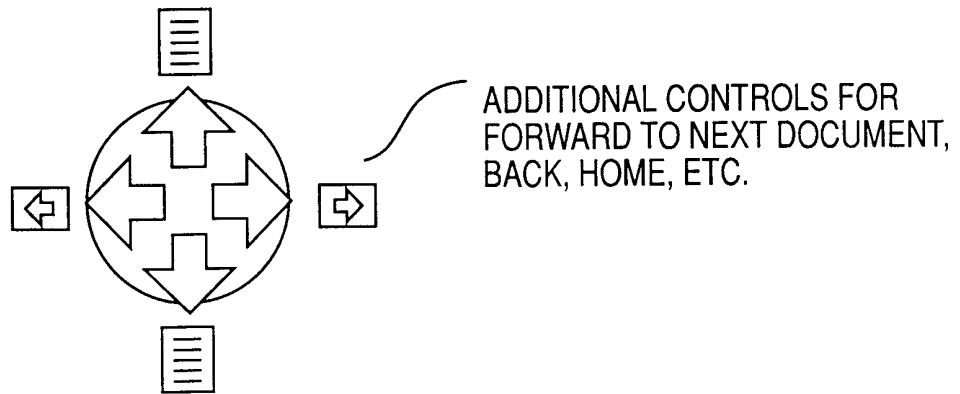

FIG. 9C

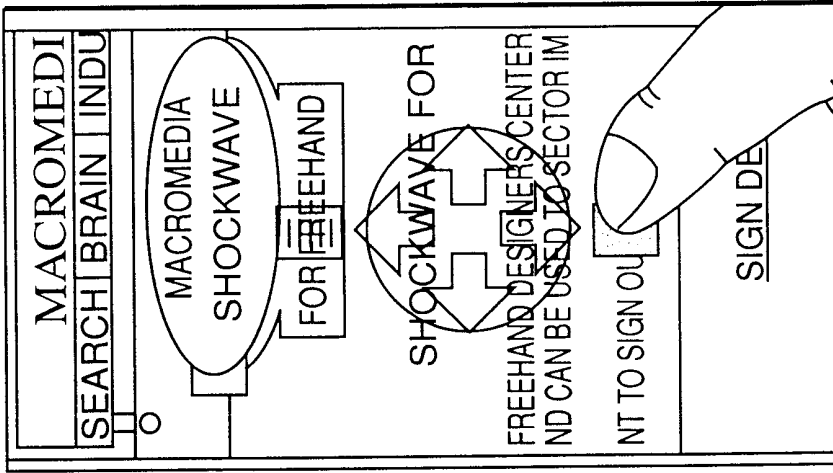

FIG. 10C

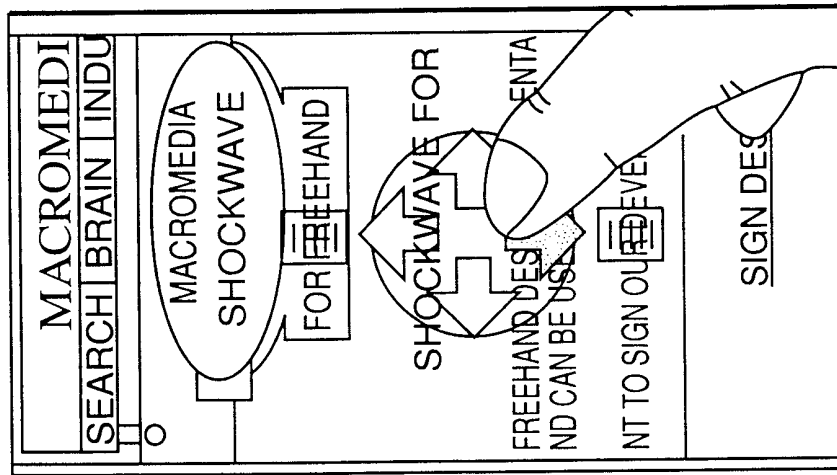

FIG. 10B

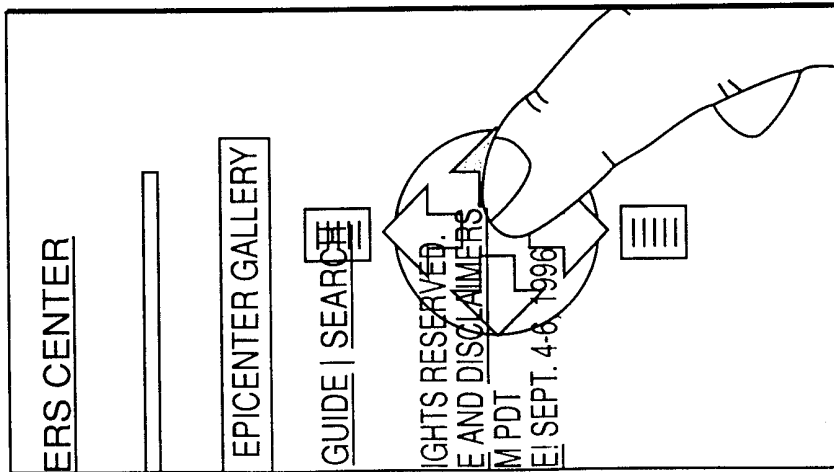

FIG. 10A

9/11

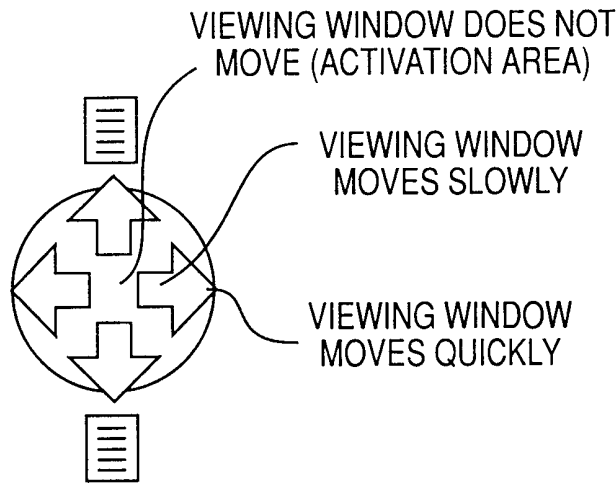

FIG. 11A

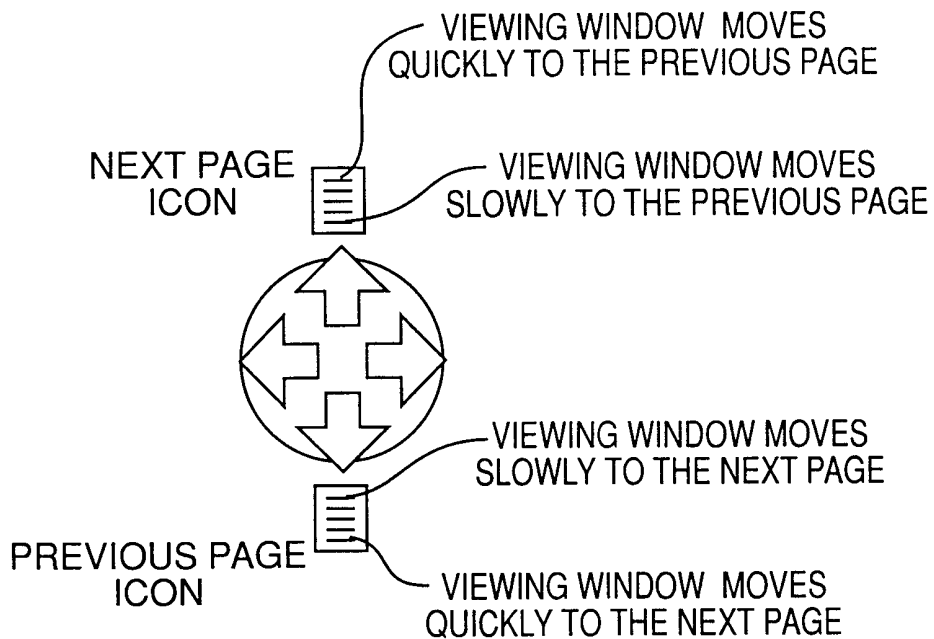

FIG. 11B

10/11

TOUCH POINT
DISTRIBUTION

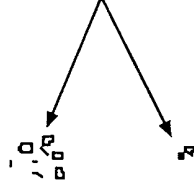

FIG. 12

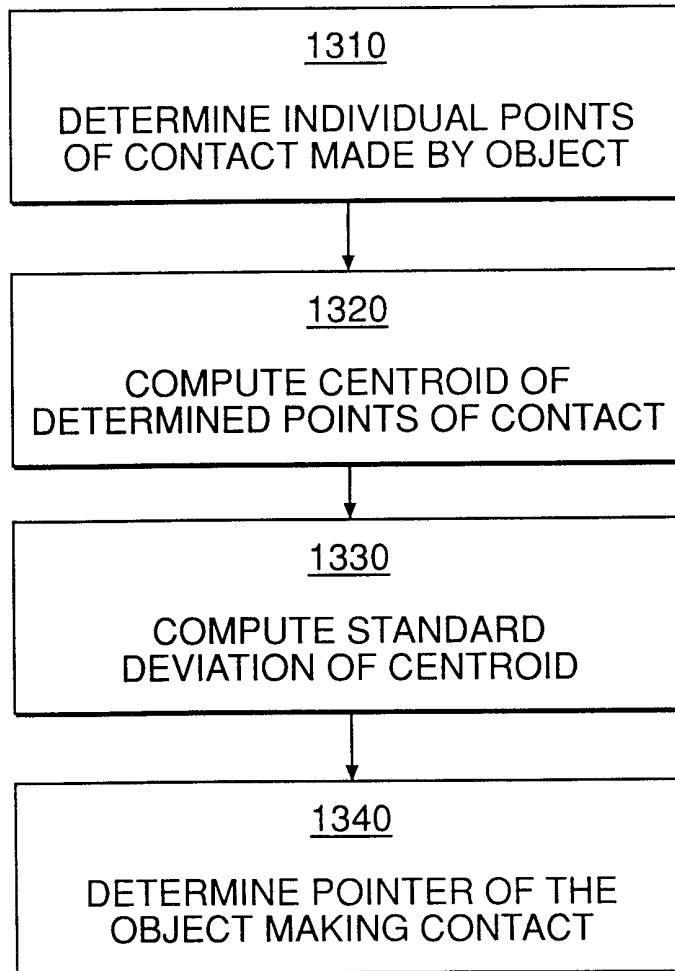
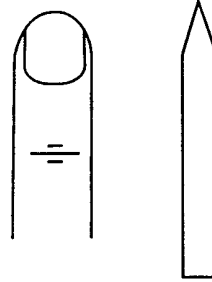

FIG. 13

11/11

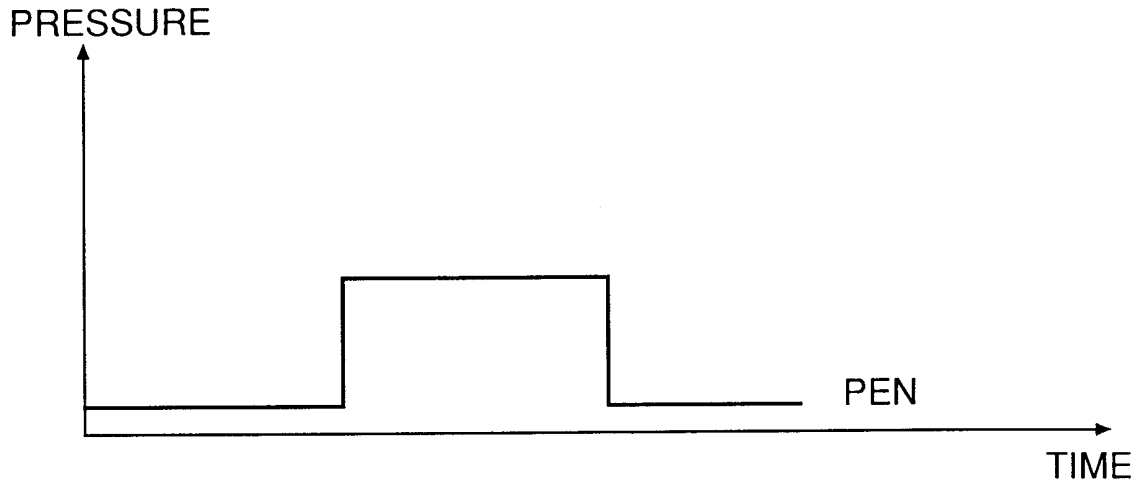

FIG. 14A

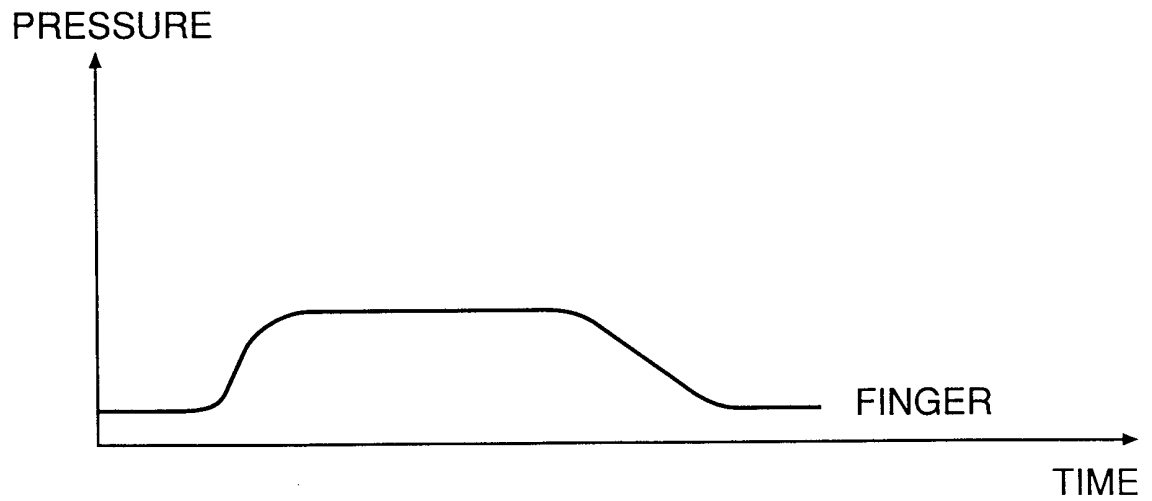

FIG. 14B

INTERNATIONAL SEARCH REPORT

International Application No
PCT/IB 98/01927

A. CLASSIFICATION OF SUBJECT MATTER
IPC 6 G06F3/033

According to International Patent Classification (IPC) or to both national classification and IPC

B. FIELDS SEARCHED
Minimum documentation searched (classification system followed by classification symbols)
IPC 6 G06F

Documentation searched other than minimum documentation to the extent that such documents are included in the fields searched

Electronic data base consulted during the international search (name of data base and, where practical, search terms used)

C. DOCUMENTS CONSIDERED TO BE RELEVANT

Category °	Citation of document, with indication, where appropriate, of the relevant passages	Relevant to claim No.
X	"DATA INTERPRETATION TECHNIQUES FOR A PEN-BASED COMPUTER" IBM TECHNICAL DISCLOSURE BULLETIN, vol. 38, no. 9, 1 September 1995, page 461 XP000540328 see the whole document ---	1, 6, 16, 21
X	WO 92 16900 A (FORCIER MITCHELL D) 1 October 1992 see abstract see page 6, line 28 - page 7, line 29 see page 22, line 27 - page 28, line 9; figures 4-4I see page 50, line 27 - page 51, line 9; figure 7S --- -/--	1, 2, 6, 16, 17, 21

Further documents are listed in the continuation of box C. Patent family members are listed in annex.

° Special categories of cited documents :

<p>"A" document defining the general state of the art which is not considered to be of particular relevance</p> <p>"E" earlier document but published on or after the international filing date</p> <p>"L" document which may throw doubts on priority claim(s) or which is cited to establish the publication date of another citation or other special reason (as specified)</p> <p>"O" document referring to an oral disclosure, use, exhibition or other means</p> <p>"P" document published prior to the international filing date but later than the priority date claimed</p>	<p>"T" later document published after the international filing date or priority date and not in conflict with the application but cited to understand the principle or theory underlying the invention</p> <p>"X" document of particular relevance; the claimed invention cannot be considered novel or cannot be considered to involve an inventive step when the document is taken alone</p> <p>"Y" document of particular relevance; the claimed invention cannot be considered to involve an inventive step when the document is combined with one or more other such documents, such combination being obvious to a person skilled in the art.</p> <p>"&" document member of the same patent family</p>
--	--

Date of the actual completion of the international search 16 March 1999	Date of mailing of the international search report 22/03/1999
---	---

Name and mailing address of the ISA European Patent Office, P.B. 5818 Patentlaan 2 NL - 2280 HV Rijswijk Tel. (+31-70) 340-2040, Tx. 31 651 epo nl, Fax: (+31-70) 340-3016	Authorized officer Bravo, P
--	---

INTERNATIONAL SEARCH REPORT

International Application No

PCT/IB 98/01927

C.(Continuation) DOCUMENTS CONSIDERED TO BE RELEVANT		
Category	Citation of document, with indication, where appropriate, of the relevant passages	Relevant to claim No.
X	WO 94 28505 A (AHA SOFTWARE CORP) 8 December 1994 see abstract see page 5, line 23 - page 8, line 4; figures 2A,2B ---	1,2,6, 16,17,21
X	US 5 512 707 A (OHSHIMA OSAMU) 30 April 1996 see abstract see column 1, line 51 - column 2, line 18 see column 3, line 34 - column 5, line 39; figures 2,3 ---	1,6,7, 16,21,22
A	PATENT ABSTRACTS OF JAPAN vol. 098, no. 001, 30 January 1998 & JP 09 231006 A (NEC HOME ELECTRON LTD), 5 September 1997 see abstract ---	2
A	PATENT ABSTRACTS OF JAPAN vol. 016, no. 256 (P-1368), 10 June 1992 & JP 04 060715 A (SANYO ELECTRIC CO LTD), 26 February 1992 see abstract ---	2
A	PATENT ABSTRACTS OF JAPAN vol. 016, no. 532 (P-1448), 30 October 1992 & JP 04 199416 A (SHARP CORP), 20 July 1992 see abstract ---	2
A	PATENT ABSTRACTS OF JAPAN vol. 016, no. 463 (P-1428), 25 September 1992 & JP 04 165522 A (RICOH CO LTD), 11 June 1992 see abstract ---	2
A	GB 2 301 217 A (NOKIA MOBILE PHONES LTD) 27 November 1996 see abstract -----	8

INTERNATIONAL SEARCH REPORT

Information on patent family members

International Application No PCT/IB 98/01927

Patent document cited in search report	Publication date	Patent family member(s)	Publication date
WO 9216900 A	01-10-1992	US 5231698 A	27-07-1993
		US 5220649 A	15-06-1993
		US 5590257 A	31-12-1993
WO 9428505 A	08-12-1994	US 5517578 A	14-05-1996
		AU 6915694 A	20-12-1994
		CA 2163330 A	08-12-1994
		CN 1127044 A	17-07-1996
		EP 0701720 A	20-03-1996
		JP 8510854 T	12-11-1996
		US 5613019 A	18-03-1997
US 5512707 A	30-04-1996	JP 2682364 B	26-11-1997
		JP 6202656 A	22-07-1994
GB 2301217 A	27-11-1996	CN 1146585 A	02-04-1997