

(19) World Intellectual Property Organization
International Bureau



(43) International Publication Date
1 April 2010 (01.04.2010)

(10) International Publication Number
WO 2010/037047 A1

(51) International Patent Classification:
F41C 27/00 (2006.01)

(21) International Application Number:
PCT/US2009/058642

(22) International Filing Date:
28 September 2009 (28.09.2009)

(25) Filing Language: English

(26) Publication Language: English

(30) Priority Data:
61/194,867 27 September 2008 (27.09.2008) US

(72) Inventor; and

(71) Applicant : SMITH, Shane [US/US]; 2040 S. Beverly
Glen Blvd. #9, Los Angeles, CA 90025 (US).

(74) Agent: CISLO, Daniel, M.; Cislo & Thomas LLP, 1333
2nd Street, Suite No. 500, Santa Monica, CA 90401 (US).

(81) Designated States (unless otherwise indicated, for every
kind of national protection available): AE, AG, AL, AM,
AO, AT, AU, AZ, BA, BB, BG, BH, BR, BW, BY, BZ,
CA, CH, CL, CN, CO, CR, CU, CZ, DE, DK, DM, DO,

DZ, EC, EE, EG, ES, FI, GB, GD, GE, GH, GM, GT,
HN, HR, HU, ID, IL, IN, IS, JP, KE, KG, KM, KN, KP,
KR, KZ, LA, LC, LK, LR, LS, LT, LU, LY, MA, MD,
ME, MG, MK, MN, MW, MX, MY, MZ, NA, NG, NI,
NO, NZ, OM, PE, PG, PH, PL, PT, RO, RS, RU, SC, SD,
SE, SG, SK, SL, SM, ST, SV, SY, TJ, TM, TN, TR, TT,
TZ, UA, UG, US, UZ, VC, VN, ZA, ZM, ZW.

(84) Designated States (unless otherwise indicated, for every
kind of regional protection available): ARIPO (BW, GH,
GM, KE, LS, MW, MZ, NA, SD, SL, SZ, TZ, UG, ZM,
ZW), Eurasian (AM, AZ, BY, KG, KZ, MD, RU, TJ,
TM), European (AT, BE, BG, CH, CY, CZ, DE, DK, EE,
ES, FI, FR, GB, GR, HR, HU, IE, IS, IT, LT, LU, LV,
MC, MK, MT, NL, NO, PL, PT, RO, SE, SI, SK, SM,
TR), OAPI (BF, BJ, CF, CG, CI, CM, GA, GN, GQ, GW,
ML, MR, NE, SN, TD, TG).

Declarations under Rule 4.17:

— of inventorship (Rule 4.17(iv))

Published:

— with international search report (Art. 21(3))



WO 2010/037047 A1

(54) Title: COMBINATION BRUSH AND JAG

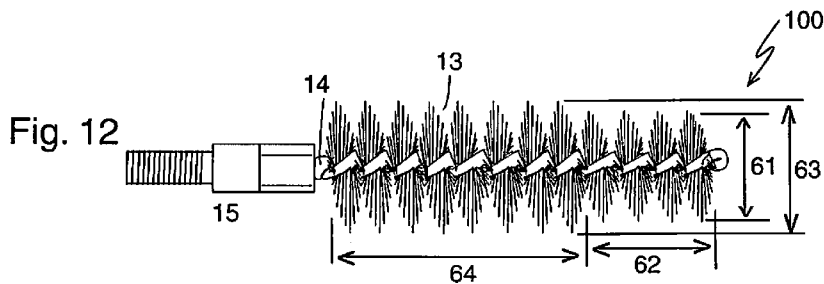

(57) Abstract: A combination brush and jag (100) comprising a stem (14), a set of short bristles (62) having a first transverse diameter (61); a set of long bristles (64) having a second transverse diameter (63); die set of short bristles (62) and long bristles (64) positioned adjacent to each other and secured in between the stem (14); and a patch (71) to cover the set of short bristles (62). The first transverse diameter (61) is smaller titan the second transverse diameter (63). The first transverse diameter (61) is also smaller than the bore diameter 1 or 8 of a bore (73) so as to define a circular gap (3) approximately the size of the thickness of the patch (71).



25189

CUSTOMER NUMBER

UTILITY
PATENT APPLICATION
OF
SHANE SMITH
FOR
UNITED STATES PATENT
ON
COMBINATION BRUSH AND JAG

Sheets of Written Description: THIRTY-THREE (33)

Sheets of Drawings: FIVE (5)

Docket Number: 09-22863

Attorneys
CISLO & THOMAS LLP
1333 Second Street, Suite 500
Santa Monica, California 90401-4110
Tel: (310) 451-0647
Fax: (310) 394-4477
Customer No.: 25,189
www.cislo.com

COMBINATION BRUSH AND JAG

TECHNICAL FIELD

[0001] This invention relates to a combination brush and jag to clean gun barrels and other bores and pipes.

BACKGROUND

[0002] A bore or pipe must be cleaned, polished, lubricated, and preserved in order to allow for the free and ideal flow of projectiles, liquids, gases, or particulate matter that go through it. The process extends the life of a barrel, pipe, or flue, or extends the life of a device connected to it. In the case of firearms, cleaning a bore improves the accuracy of projectiles shot from it. A firearm bore is lubricated and treated in order to preserve the integrity of the metallic inner wall, grooves, and lands. Undesirable wear and tear of the firearm bore include oxidation of the bore's surface, chemical pitting of the bore, and physical scratching of the bore due to projectiles trapping residual particles.

Properly maintaining the bore usually requires the two separate actions of brushing and wiping of the bore. The brushing step is accomplished with a brush having a uniform transverse diameter as shown in Figure 5 while the wiping step is accomplished by inserting a patch into the bore with one of the jags shown in Figures 6-9. A brush with a transverse diameter that is slightly larger than the bore's inner diameter is used to brush the bore and scrape grime loose that has been baked on or chemically bonded to the inner wall or lands. After the brushing procedure is finished, a jag with a patch is used to wipe grime out of the bore.

09-22863
Shane Smith

[0004] Most cleaning devices for the barrels of firearms are single-purpose devices, meaning the cleaning device is used either for scraping residues off the inside of the barrel or for wiping and lubricating the inside of the barrel. To perform both functions, a user would require two separate cleaning devices, a brush to scrape, and a jag to wipe.

[0005] In addition, cleaning devices may be single-action, meaning that the device is sent through the bore in a single direction. In single-action cleaning devices, the device is either pushed or pulled through the barrel. However, due to the design, the device cannot be pushed and pulled repeatedly inside the gun barrel. Thus, cleaning the barrel can be a slow laborious process.

[0006] Single-action cable systems and pulled-only series systems have a long reloading time between strokes, and people in the market report that they use pulled-only systems when they want to clean quickly but not thoroughly. Prior art spiral brushes attached to rods make it easier to clean thoroughly because brushing strokes may occur with no time delay between strokes, and the time saved makes it more likely for a user to run the brush through the bore many times.

[0007] Figure 6 shows prior art jags for firearms that are loops, eye-lets, or slots, through which a patch is drawn halfway. Some jags are twists of wire extending from the jag's front-end through which a patch is drawn and pinched or punctured as shown in Figure 7. The jag is capable of holding the patch to perform successive strokes without having to re-load a patch. The patch, however, is not distributed symmetrically around the jag, and the result is that these jags do not press the patch evenly against the wall of the bore. Some grime can be by-passed or missed on any pass down the bore. Another

09-22863
Shane Smith

disadvantage of these jags is that when using regular non-abrasive fabric, the jag-patch combination wipes but does not brush and is again not dual purpose.

[0008] Thus, there are some cleaning devices that are dual-purpose but not dual-action or dual-action but not dual-purpose. However, these devices only have a single transverse diameter that is either too large to add a patch or too small to apply constant and even pressure against the walls of the barrel.

[0009] For the foregoing reasons there is a need for a combination brush and jag that has the dual-purpose of scraping and wiping and has dual-action of being capable of being pushed and pulled through the bore in repeated strokes while maintaining constant and even pressure on the bore walls so as to make cleaning a gun barrel or other types of bores and pipes more efficient.

SUMMARY

[0010] The present invention is directed to a cleaning device in the form of a combination brush and jag that has the dual-purpose of brushing and wiping a bore and has the dual-action of being capable of being pushed and pulled through the bore in repeated strokes so as to make cleaning a gun barrel or other types of bores and pipes more efficient. The combination brush and jag comprises a stem securing a set of long bristles and a set of short bristles adjacent to the set of long bristles and a patch to wrap around the set of short bristles. The set of short bristles has a transverse diameter that is precisely dimensioned to be slightly smaller than the diameter of the inner wall of a bore, such that a gap is created that is approximately the same thickness as the patch. The set of long bristles are dimensioned to contact the inner wall of the bore when the combination brush

09-22863
Shane Smith

and jag are inserted into the bore. Due to the two different transverse diameters of two different sets of bristles, the precise dimensioning of the transverse diameters, and the application of a patch to the set of short bristles, the brush and jag combination has the dual purpose of serving as a brush and a jag, and has the dual action of being inserted into the bore and pulled out of the bore without losing the patch while the set of short bristles apply even and uniform pressure to the patch against the inner wall of the bore.

BRIEF DESCRIPTION OF DRAWINGS

- [0011] Figure 1 shows a cross-section of a bore;
- [0012] Figure 2 shows a cross-section of another bore;
- [0013] Figure 3 shows a close-up cross-sectional view of an edge of the type of bore shown in Figure 1;
- [0014] Figure 4 shows a close-up cross-section view of an edge of the type of bore shown in Figure 2;
- [0015] Figure 5 shows a prior art brush for brushing a bore;
- [0016] Figure 6 shows a prior art jag;
- [0017] Figure 7 shows another prior art jag;
- [0018] Figure 8 shows another prior art jag;
- [0019] Figure 9 shows another prior art jag;
- [0020] Figure 10 shows a side view of an embodiment of the present invention prior to securing the bristles by twisting the wires;
- [0021] Figure 11 shows rear view of the embodiment shown in Figure 10;
- [0022] Figure 12 shows an embodiment of the present invention;

09-22863
Shane Smith

- [0023] Figure 13 shows another embodiment of the present invention;
- [0024] Figure 14 shows another embodiment of the present invention;
- [0025] Figure 15 shows another embodiment of the present invention;
- [0026] Figure 16 shows another embodiment of the present invention;
- [0027] Figure 17 shows another embodiment of the present invention;
- [0028] Figure 18 shows another embodiment of the present invention;
- [0029] Figure 19 shows a close up view of a bore containing a cross section of a prior art jag with multiple layers of a patch inside the bore;
- [0030] Figure 20 shows a close up view of a cross section of a bore containing an embodiment of the present invention with multiple layers of patch inside a bore;
- [0031] Figure 21 shows a close up view of a cross section of another type of bore containing a prior art jag with multiple layers of a patch inside the bore;
- [0032] Figure 22 shows a close up view of a cross section of another type of bore containing an embodiment of the present invention with multiple layers of patch inside the bore;
- [0033] Figure 23 shows a side view of the bristles and stem before the completion of the assembly;
- [0034] Figure 24 shows a side view of another embodiment of the bristles and stem before the completion of the assembly;
- [0035] Figure 25 shows a side view of another embodiment of the bristles and stem before the completion of the assembly;

09-22863
Shane Smith

[0036] Figure 26 shows a side view of another embodiment of the bristles and stem before the completion of the assembly;

[0037] Figure 27 shows a side view of another embodiment of the bristles and stem before the completion of the assembly;

[0038] Figure 28 shows a side view of another embodiment of the bristles and stem before the completion of the assembly;

[0039] Figure 29 shows an embodiment of the present invention;

[0040] Figure 30 shows a side view of another embodiment of the bristles and stem before the completion of the assembly;

[0041] Figure 31 shows an embodiment of the patch;

[0042] Figure 32 shows another embodiment of the patch;

[0043] Figure 33 shows another embodiment of the patch; and

[0044] Figure 34 shows an embodiment of the combination brush and jag being inserted into a bore.

DETAILED DESCRIPTION OF THE INVENTION

[0045] The detailed description set forth below in connection with the appended drawings is intended as a description of presently-preferred embodiments of the invention and is not intended to represent the only forms in which the present invention may be constructed or utilized. The description sets forth the functions and the sequence of steps for constructing and operating the invention in connection with the illustrated embodiments. It is to be understood, however, that the same or equivalent functions and sequences may

09-22863
Shane Smith

be accomplished by different embodiments that are also intended to be encompassed within the spirit and scope of the invention.

[0046] The combination brush and jag **100** is directed towards a multi-purpose cleaning device for cleaning, wiping, scraping, brushing, polishing, lubricating, and/or protecting bores, chambers, and other holes or cavities of small hand-held firearms, including muzzleloaders, paintball guns, and of larger caliber weapons such as artillery. The combination brush and jag **100** may also be used for cleaning, wiping, scraping, brushing, polishing, lubricating, or protecting exhaust flues, chimney flues, valve bores, boiler pipes, furnace pipes, refrigerator pipes, radiator pipes, air ducts, or any pipes used for transport of fluids composed of liquid, gas, or particulate matter. The combination brush and jag **100** is configured for dual-action of being pushed and pulled through the bores and dual-purpose of brushing and wiping for effective and efficient cleaning.

[0047] An example of a bore **73** may be the barrel of a gun as shown in Figures 1 and 2. The typical gun bore **73** has an inner wall **0** having a diameter **1**. Often times the gun bore **73** may have a rifling created by cutting a twisting groove along the length of the bore **73** to create raised lands **6** circumferentially spaced apart that also twist down the bore **73** to create a helical pattern. The rifling causes the bullets to spiral to improve accuracy and distance of the bullet when shot out of the gun, but causes difficulty in cleaning the bore **73**. Another type of rifling is made by creating a bore **73** having a polygonal cross-section as shown in Figure 2. The distance from one raised land **6** to an opposite raised land is the land-to-land diameter **8**. The bore, therefore, has a bore wall defined by either the inner wall **0** or the lands **6** and the bore diameter **BD** may be either the inner wall diameter **1** or

09-22863
Shane Smith

the land-to-land diameter **8**.

[0048] As shown in Figure 12, the combination brush and jag **100** comprises a stem **14**, a first set of bristles **62** having a first transverse diameter **61**; a second set of bristles **64** having a second transverse diameter **63**, the first set of bristles **62** and second set of bristles **64** positioned adjacent to each other and secured in between the stem **14**; and a patch **71** to cover the first set of bristles **62**. The stem **14** secures the bristles **13** in place, the second set of bristles **64** serves as a brush portion, and the first set of bristles **62** serves as the wiping portion on the jag portion.

[0049] The stem **14** is an elongated wire **55** designed to secure the bristles **13** in place. The stem **14** has a first end **17** and a second end **19** opposite the first end **17**. In some embodiments, the stem **14** is made from a single wire **55**. The wire **55** may be bent upon itself to define a first wire stem **55a**, a second wire stem **55b** parallel to the first wire stem **55a**, a bend **18** at the first end **17** connecting the first and second wire stems **55a**, **55b**, and a longitudinal axis **L** parallel to the first and second wire stems **55a**, **55b**. The first and second set of bristles **62**, **64** are positioned in between the first and second wire stems **55a**, **55b** as shown in Figure 1 and fixed in place by twisting the first and second wire stems **55a**, **55b** about each other along the longitudinal axis **L**, thereby forming a double helix with the bristles **13** projecting away from the stem **14**.

[0050] The number of wires **55** in the twisted-wire stem **14** may vary. The stem **14** may be made using more base wires **55** in order to increase the strength of the stem **14**. For example, if two bent base wires are used, the stem **14** would be made from four wire stems twisted together. In some embodiments, two separate wires, as shown in Figure 23,

09-22863
Shane Smith

may be twisted about each other to form a double helix with the first and second set of bristles **62**, **64** secured in between the two wires. In such an embodiment, the first end **17** of the stem may be capped or finished to provide a smoother surface.

[0051] In some embodiments, the stem **14** may be longer than the standard barrel brush. For example, the stem **14** may be twice as long as the standard brush, with the brush portion **64** and jag portion **62** being of equal lengths. Having a longer stem **14** increases the chances of the stem **14** warping and bending out of shape when it is pushed inside the entrance of the bore **73**. To prevent such bending and warping, the stem **14** may be strengthened during manufacture.

[0052] One way to strengthen the stem **14** would be use of a harder temper metal or composite for base wire **55** by using different metal composition and grade, synthetic composition and grade, composite composition and grade, or varying the density or diameter of the stem. Typical metals used for base wire **55** include carbon steel, such as galvanized steel and stainless steel, aluminum, and brass. However, when a metal is too hard, it is brittle and susceptible to cracking when twisted. To prevent cracking of a hard temper metal a high temper carbon steel may be twisted along with filaments before the wire stem **14** is fully hardened while it is being annealed.

[0053] In another embodiment, after the wire **55** is twisted, a guide **91** may be attached along the length of the twisted-wire stem **14** to strengthen the stem **14** as shown in Figure 13. In some embodiments, the guide **91** may be twisted with the wires.

[0054] The characteristics of the wire **55** can also be altered by coating the wire **55** to increase rigidity, flexibility, or the ability to hold bristles **13** in place.

09-22863
Shane Smith

[0055] In some embodiments, the stem **14** may be hollow and comprise a plurality of pores through which fluids may be distributed to the bristles **13**, via capillary action or a pump.

[0056] The bristles **13** or filaments are designed to perform two separate functions, brushing and wiping. The bristles **13** can vary in density, temper, metal composition and grade, natural fiber composition and grade, synthetic composition and grade, and composite composition and grade. For examples, bristles **13** may be made of any temper or grade of stainless steel, metal, phosphor bronze, brass, copper, animal hair, natural fiber, synthetic, nylon, absorbent, abrasive nylon, micro-tubes, Teflon®, Tynex®, nanotubes, and nanoparticles. In some embodiments, the bristles **13** may be hollow to transmit fluids through the bristles. In some embodiments, the bristles **13** may comprise a pore at the tip to allows the fluid to escape the bristle and coat the outside of the bristle.

[0057] To accomplish the dual function, two separate sets of bristles are secured to the stem. The first set of bristles **62** may comprise short bristles and the second set of bristles **64** may comprise long bristles. The terms long and short describe the length of the bristles relative to each other. The set of short and long bristles **62**, **64**, once secured to the stem **14**, each have a transverse diameter, wherein the transverse diameter **63** of the long bristles **64** is greater than the transverse diameter **61** of the short bristles **62**. The transverse diameter is the average length of all of the bristles **13** in a set of bristles measured from one tip of the bristle **13** to its opposite tip, where each individual bristle **13** in each set is approximately the same length and positioned similarly on the stem **14** as shown in Figure 10.

09-22863
Shane Smith

[0058] In general, the individual bristles **13** are straight filaments. The bristles **13**, however, can be sinusoidal, bent, wavy, or any other shape so long as the proper gap space **3** is created when the brush and jag combination **100** is positioned concentrically to the base **73**.

[0059] In some embodiments, the length of the individual bristles within a set is approximately the same. Therefore, when the bristles **13** are secured to the stem **14**, the bristles **13** form a cylindrical shape with a circular cross section along the stem **14**, wherein the diameter of the circular cross-section defines the transverse diameter **61** or **63**. While the transverse diameters of individual bristles **13** fluctuate, the average of the individual transverse diameters after twisting is the brush's transverse diameter **61** or **63**. Fluctuations may be due to imprecision during manufacturing, and not necessarily due to an end goal or purpose. However, fluctuations in the lengths of individual bristles may be desired in other embodiments. Typical error fluctuations for phosphor bronze brushes differ from an average radius by an amount ranging from 0.0020 inch to 0.0070 inch for all caliber, where the radius is defined by the distance from the tip of a bristle to the stem **14**. In some embodiments, the error fluctuations differ from an average radius by an amount ranging from 0.0020 inch to 0.0040 inch. The error fluctuations of larger caliber, such as 45 and shotgun, may differ from an average radius by an amount as large as 0.0110 inch. It is worth noting that the amounts given are much less than an average patch thickness, which range from 0.0130 to 0.0220 inches. In other words, prior art brushes are not constructed to make room for a patch to fit between its bristle tips and bore wall **0**.

[0060] Thus, the brush and jag combination **100** has at least two sets of bristles **62**, **64**,

09-22863
Shane Smith

wherein the transverse diameter **61** of the first set **62** does not equal the transverse diameter **63** of the second set **64**. More specifically, the set of long filaments **64** are made so that its average transverse diameter **63** is greater than or equal to the bore diameter. This allows the set of long bristles **64** to perform a brushing or abrasive action on the bore.

[0061] The set of short bristles **62** is designed for the wiping function. Unlike prior art jags, the use of bristles **13** allows the brush and jag combination **100** to hold the patch for the dual-action stroke while applying constant and even pressure against the bore wall. The set of short filaments **62** are made so that its transverse diameter **61** is less than the bore's inner wall diameter **1** or land-to-land diameter **8**, thereby defining a cylindrical gap **3** between bristle tips and the bore's inner wall **0** or lands **6** when the brush and jag combination **100** is concentrically aligned with the bore **73**. The size of the gap **3**, or the distance between the bristle tips and the inner wall **0** or lands **6** of the bore **73** when the brush and jag combination **100** is concentrically aligned inside the bore **73**, may be approximately the same size as the thickness of the patch **71**. The patch **71** can then be wrapped around the set of short bristles **62** and still have the brush and jag combination **100** fit inside the bore. Due to the tight fit, the patch **71** then performs a wiping action on the bore **73**.

[0062] The set of short bristles **62** and the set of long bristles **64** may be arranged relative to each other in a variety of ways as shown in Figures 12-15. In some embodiments, there may be one set of long bristles **64** and one set of short bristles **62** adjacent to the set of long bristles **64**. The set of long bristles **64** may be adjacent to the first end **17** nearest the bend **18** with the set of short bristles **62** adjacent to the second end

09-22863
Shane Smith

19. Alternatively, the set of short bristles **62** may be adjacent to the first end **17** with the set of long bristles **64** adjacent to the second end **19**. Having the set of short bristles **62** at the first end **17** may be ideal when pushed and pulled by rods, while having the set of short bristles **62** in the second end **19** may be ideal when pulled by cables.

[0063] In some embodiments, the set of short bristles **62** may be in between two sets of long bristles **64**, with the first set of long filaments adjacent to the first end **17** and a second set of long filaments adjacent to the second end **19** as shown in Figure 13. In some embodiments, a set of long bristles **64** may be in between two sets of short bristles **62** with a first set of short bristles adjacent to the first end **17** and a second set of short bristles adjacent to the second end **19**. In some embodiments, there may be multiple sets of short bristles **62** and long bristles **64** arranged in series in alternating fashion.

[0064] In embodiments having at least two sets of short bristles **62**, two different types of patches may be applied to each set. For example, one set of short filaments **62** may be wrapped with a wiping patch and the second set of short filaments may be wrapped with an abrasive polishing patch **71**.

[0065] In some embodiments, each bristle **13** in a set of bristles may not be uniform in size or may not be uniformly arranged on the stem **14** as shown in Figures 23-30. For example, in one embodiment, the bristles **13** may be uniform in size but positioned offset from each other forming abrupt changes in the distance from the tip of a bristle to the stem from one bristle to the next. In some embodiments, a set of bristles may comprise multiple groups of bristles **13a-13h** of the same length, wherein one group is positioned on the stem offset from an adjacent group as shown in Figure 24. The offset groups within a set may

09-22863
Shane Smith

be aligned in series with the offsetting being reversed from one group to the next, thereby forming a staggered appearance or a jagged shape with teeth that mimic the structure of solid ribbed jags **21**.

[0066] In some embodiments, a set of bristles **13** may be uniform in length but gradually offset more and more in the same direction from one bristle to the next as shown in Figure 25. The direction of the offsetting may be reversed at least once and preferably multiple times so as to form a sinusoidal wave configuration or jagged-shape with rounded teeth.

[0067] In some embodiments, the length of each bristle **13** may change within each set as shown in Figure 26. For example, the bristles may be centered in between the wire stem **55a**, **55b** and the length of the bristles may gradually shorten from one end **19** or **17** of the wires to the other end **17** or **19** giving a tapered appearance as shown in Figures 29 and 30. It is important that each individual transverse diameter in the tapered section is within the range defined by equation 1 below so as to define a proper gap space **3** to receive a patch **71**. In some embodiments, the length of the bristles from one bristle to the next may gradually shorten then elongate and possibly shorten again, repeating this pattern to again form a sinusoidal pattern or jagged shape with pointed teeth as shown in Figure 26.

[0068] Changing the sizes and positions of the bristles, for example, having staggered groups, improves the memory and resilience of the filament matrix that either brushes the bore **73** or holds the patch **71**.

[0069] In some embodiments, nested within a set of bristles **13** may be bristles of

09-22863
Shane Smith

different length **85** intermittently spaced apart as shown in Figure 27. For example, within a first set of bristles **86** may be individual long bristles **85** or groups of long bristles **85** intermittently spaced apart from other long bristles **85** or groups of long bristles **85**. This allows the long bristles **85** to poke patches deep into edges **7** of grooves **4**.

[0070] By varying lengths of bristles **13** in the wiping section **62** of the proposed design, any number of average transverse diameters **61** may be created for any one particular proposed-design brush. Consider the cylindrical space **3** between the land diameter **1** feature of helical rifling and the surfaces of rigid bumps **24** of a solid jag **21** and **27**. As shown in Figure 19, the rigid knurls **24** of prior art jags do not poke into edges **7** at the base of lands **6** of conventional rifling. As shown in Figure 21, the conventional jag also cannot reach into edges **7** of polygonal rifling. The bristles **13** of the brush and jag combination **100**, however, can dig or embed into edges **7** of a bore having either the traditional rifling or the polygonal rifling as shown in Figures 20 and 22. For example, while most bristles **13** in a wiping section **62** would create an average transverse diameter **61** smaller than the bore's land-to-land diameter **8**, some bristles **13** could create an average transverse diameter **61** between the land-to-land diameter **8** and the inner wall diameter **1**, and others could create an average transverse diameter **61** greater than the inner wall diameter **1**.

[0071] As a result, an individual bristle **13** of the proposed design may push a tiny section of single-layered patch fabric **71** into edges **7**, while a rigid knurl cannot. To push patch fabric **71** into the edges **7**, a rigid knurl **24** of solid jags relies on multiple layers **104**, **105**, **106** of patch fabric pushing the outermost layer **104** into edges **7**. Even so, the same

09-22863
Shane Smith

kind of efficacy may never be reached because of the bunching that occurs. When a rigid bump makes multiple layers **104-106** of fabric bulge, the bulge **103** is smooth, rounded, large, and not able to reach into an edge **7**. The proposed design, however is capable of pushing multiple layers **104** into edges **7** as shown in Figures 20 and 22. Furthermore, when a bristle of the proposed design bulges fabric, the bulge **101** may be sharp and small, especially when the bristle pokes one layer. A bristle may poke through inner layers **106** to reach the outer layer **104**. The result is that the proposed design pushes fabric fully into edges **7** of rifling. The flexibility of bristles **13** of the proposed design allow it to form to any rifling shape, conventional type or polygonal type, and to any twist rate.

[0072] In addition, the flexibility of bristles **13** of the proposed design allows for a patch to reshape itself around the lifted ridges of the lands **6**. The inflexibility of solid jags cause the familiar problem of too tight of a fit, causing too much force to be required to make a patch of recommended size to reciprocate inside the bore **73**. The flexibility of the bristles **13** of the proposed design, on the other hand, allows the combination brush and jag **100** to reciprocate greater patch area inside barrels, and the flexibility allows it to variably reduce friction between the patch **71** and bore wall **0** or land **6** when the patch fabric **71** forms multiple layers.

[0073] When too much force is required to stroke the bore **73** with a prior art jag, the jag may punch a large hole through the patch **71**. In that case, the patch **71** remains stationary in the bore **73**, and the jag continues down the bore **73** pushing or pulling nothing. The flexibility of bristles **13** that hold onto the patch **71** makes the proposed design less likely to puncture a patch.

09-22863
Shane Smith

[0074] In some embodiments, the bristles **13** may be altered to increase or decrease the likelihood that the bristle **13** can poke through any particular kind of fabric. For example, concerning multiple layers of fabric **104-106**, bristles **13** may be sharpened so that they poke through multiple inner layers **105, 106** of fabric in order for filament tips to reach the outermost layer **104** or layers.

[0075] In some embodiments, the bristles **13** are positioned on the stem **14** so as to project radially outward, perpendicularly from the stem **14**. In some embodiments, the bristles **91** may be at pitch angles **A** (measured between the bristle and the longitudinal axis) other than ninety degrees to the longitudinal axis **L** of the stem **14**, as shown in Figure 16. For example, the pitch angle **A** may range from approximately 10 degrees to approximately 170 degrees. Preferably, the pitch angle **A** is between 45 degrees and 135 degrees. More preferably, the pitch angle **A** is between 60 degrees and 120 degrees.

[0076] The bristles in a small section or sections may be extended **87** in order to assist the proposed-design brushes in following the rifling, as shown in Figure 15. The locations of multiple extensions **87** may be customized to help the brushes rotate with a particular rifling's twist rate. Some bristles may be absorbent, such as having mop filaments mixed in with abrasive filaments. A mixture of abrasive bristles may be used, such as mixing more abrasive ones with less abrasive ones.

[0077] In some embodiments, the bristles **13** may be coated in order to improve their hold on patches **71**, to affect the coefficient of friction between the bristles and the inner bore wall **0** and lands **6**, or to affect filament memory. The tips of filaments **13**, whether metallic, synthetic, absorbent, or composite, may be enhanced with abrasive or absorbent

09-22863
Shane Smith

materials. For example tip of a filament may have a knob **81** as shown in Figure 20. The knob **81** may be an abrasive or an absorbent. This embodiment may be used with or without a patch **71**.

[0078] In some embodiments, rather than bristles **13**, the brush and jag combination **100** may be made entirely of abrasive ribbons **93**, or it may have ribbons **93** wound or woven in with the filaments **13**, as shown in Figure 17. The ribbons **93** may be gauze or mesh made of metal, natural fiber, synthetic, or a composite.

[0079] The brush and jag combination **100** may be used to work with any kind of patch **71**, swab, or wad material, with any kind of enhanced fabric or absorbent, and any kind of abrasive, and with material made by any technique. A non-exhaustive example of materials include, but are not limited to, any kind of cotton or derivatives thereof, such as flannel or twill or wads of loose fibers, any kind of wool or derivatives thereof, such as felt, or any material derived from polypropylene, from other synthetic resins, or from composites. Patches **71** may be coated or soaked with lubricant, solvent, preservative, or abrasive, whether natural or synthetic.

[0080] The patch **71** may be any shape. In the preferred embodiment, the patch **71** may have a generally rectangular, square, circular, or triangular shape. The patch **71** can be wrapped around a set of short bristles **62** in any fashion. In some embodiments, the center of the patch **71** is placed on the bend **18** at the first end **17** of the stem **14** and the remainder of the patch **71** is placed on the set of short bristles **62**. To that effect, the patch **71** is dimensioned so that the edges of the patch **71** can fully cover a substantial portion of the set of short bristles **62**. Covering a substantial portion of a set of short bristles **62** helps

09-22863
Shane Smith

keep the patch 71 on the bristles 13 during use.

[0081] The patch 71 may come in a variety of thicknesses. However, the dimensions of the brush and jag combination 100 and the dimensions of the patch 71 should correspond so as to substantially cover the set of short bristles 62 and still fit inside the bore 73 so that the set of short bristles 62 evenly distribute the patch 71 against the inner wall 0 or lands 6 of the bore 73. Figure 34 shows the proposed design wrapped by a patch 71 being inserted into a bore 73 of a gun barrel 75.

[0082] The relationship between the bore diameter, the transverse diameter of the set of short bristles 61, and the patch thickness T may be defined by equation 1 as follows:

$$[0083] \quad (BD - TD) = (c * T) * 2,$$

[0084] where BD is the bore diameter (either inner wall diameter 1 or land-to-land diameter 8), TD is the transverse diameter 61 of the set of short bristles 62, T is the thickness of the patch 71, and c is constant less than or equal to 25. The preferred range for constant c is approximately 0.5 to 20. More preferably, the constant is between 0.5 and 5. Most preferably, c is 1.5. The constant determines the amount of friction applied to the bore 73. The gap space 3 is essentially $(BD - TD)/2$.

[0085] The relationship between the dimensions of the set of small bristles 62 and the patch 71 may be defined by equation 2 as follows:

$$[0086] \quad R = (X) + \text{Sqrt}((TD)^2/4 + (B)^2),$$

[0087] where R is the radius 98 of a circular patch or the distance from the center to a corner of a square, rectangular, or triangular patch, X is length of the set of short bristles 62 along the longitudinal axis L, TD is the transverse diameter 61 of the short bristles 62,

09-22863
Shane Smith

and B is the length **68** of the bend **18** along the longitudinal axis **L**. This equation also assumes the center of the patch **71** is placed on the bend **18** and forms generally a conical shape when wrapped around the set of short bristles **62**.

[0088] The brush and jag combination **100** may further comprise a variety of connectors **15**, such as rods, cables, ropes, shafts, and other devices to push and pull the brush and jag combination **100** through the bore. A non-exclusive list of examples includes, but is not limited to, threaded connectors, latch-type connectors, snap-type connectors, slotted connectors, and locking connectors.

[0089] In some embodiments, the brush and jag combination **100** may further comprise a mounting connector **15** attached to both ends of the brush and jag combination **100**, so that the brush and jag combination **100** can be put in series with other brush and jag combinations, prior art jags, prior art brushes, or with other cleaning devices, such as mops.

[0090] In some embodiments, the connector may be rotatably connected to the stem so as to allow the bristles **13** to swivel about the longitudinal axis **L** to allow for rotation with the rifling.

[0091] The brush and jag combination **100** may be printed, stamped, etched, or in way marked with information, such as caliber size. Alternatively the stem, bristles, and/or patch may be color coded to indicate proper caliber size.

[0092] The brush and jag combination **100** may also comprise a cover **95** like sleeves or armor, in order to expose only some of the bristles **13** or some portions of the bristles to increase filament memory and coefficient of friction. The cover **95** may be capable of

09-22863
Shane Smith

holding abrasive material, or it may be abrasive through a roughened surface created by, but not limited to, ribs, nipples, knurls, bumps, or mesh.

[0093] The second end **19** of the brush and jag combination **100** may be adapted to receive other tools, such as power tools that assist in reciprocation, rotation, or vibration.

[0094] In some embodiments, the brush and jag combination **100** may have a tuft **83** of bristles **13** facing outward at the first end **17** of the stem **14** as shown in Figure 15. The tuft **83** makes the jag and brush **100** a multi-purpose cleaning tool. For example, with the tuft **83**, the combination **100** can brush and wipe the bore **73** in the same stroke, or it can brush and wipe other parts of the gun like the chamber. A patch **71** may be placed over the tuft **83** to perform the wiping function.

[0095] The brush and jag combination **100** can be made by placing a plane of straight bristles **51** in between two parallel wire stems **55a**, **55b** as shown in Figures 10 and 11. The plane of filaments **51** may be held together by a thin tape (not shown). The combination is placed into a machine that twists the two wire stems **55a**, **55b** about one another. The machine may twist the wire stems from the first end **17** to the second end **19** or, from the second end **19** to the first end **17** to form the stem **14**. The stem **14** is cut at the second end **19** and may be attached to a connector **15** by crimping, gluing, bending the wire stems, or any other fastening means.

[0096] Another method of manufacturing the brush and jag combination **100** is to put the two wire stems **55a**, **55b** through the eye-let of a connector **15** before the wire stems **55a**, **55b** are twisted from the second end **19** to the first end **17**. After the base wire **55** is twisted, the first end **17** may be cut short. In that case, the wire stems at the first end **17** of

09-22863
Shane Smith

the brush are sharp where they were cut unless made smooth by grinding and brushing wheels.

[0097] The manner that planar packets of bristles **51** or coils of filaments are passed through the base wires **55**, before twisting, may vary. For example, more than one filament may be used, one on each base wire.

[0098] Another kind of spiral bore brush is made, not using a plane of straight filaments, but using a coiled-wire spring **89** as shown in Figure 28. Similar to the construction detailed in the above paragraph, the coiled-wire spring is pushed between two lengths of base wire **55a**, **55b**, and the two lengths are twisted. In other words, the coiled wire **89** may be wound about one of the wire stems **55a** or **55b** and then twisted between both. The final product does not press tips of filament strands **13** against the bore wall, but instead presses the sides of bent coiled filament wire against the bore wall. The proposed design may be made using coiled-wire springs in any manner that results in the product having more than one average transverse diameter. For example, two coils may be used, one resulting in a transverse diameter larger than the bore's inner diameter, and the other resulting in a transverse diameter smaller than the bore's inner diameter.

[0099] The changes in the lengths of the bristles **13** to create the different sets of bristles **62**, **64** can be accomplished in a variety of ways. In some embodiments, a set of long bristles **64** and a set of short bristles **62** may be taped and laid side-by-side in between the stem wires **55a**, **55b**. Alternatively, the set of short and long bristles **62**, **64** may be arranged accordingly before being taped.

[0100] In some embodiments, one set of bristles **51** having a uniform length may be

09-22863
Shane Smith

laid in between the wire stems **55a**, **55b** as shown in Figure 10. A group of bristles **51a** may then be trimmed to the appropriate length to create the set of short bristles **62** as shown in Figure 23. The tips of the filaments may be trimmed after the wire stems **55a**, **55b** are twisted in order to achieve any desired pattern. The creation of smaller radial diameters may be done, using trimming or grinding, after the stem **14** is made.

[0101] In use, a user may simply wrap the patch **71** around the set of short bristles **62** and plunge the brush and jag combination **100** in and out of a bore **73**. In some embodiments, the user may let some of the patch **71** stretch into the set of long bristles **64**. If the user lets too much of the patch **71** wrap around the set of long bristles **64**, then the combination will be too large to fit into the bore **73** or will require too much force to make it stroke the bore **73**. The amount of patch **71** allowed to go into the brushing region **64** of the proposed design depends on a user's preference.

[0102] Prior to use the brush and jag combination **100** may be sprayed, dipped, dunked, or exposed in any way to any kind of gas, liquid, or solid. The patch **71** may be coated or soaked with lubricant, solvent, preservative, or abrasive, whether natural or synthetic.

[0103] Examples

[0104] Examples of brush and jag combinations are given in Figures 23-28 and Table 1. The dimensions in Table 1 are in centimeters and the caliber is in U.S. units.

09-22863
Shane Smith

Filament Material	caliber	63 average	64	61 average	61 max	62	Filament Diameter
Phosphor Bronze	0.22	0.60	3.9	0.43	0.48	2.7	0.010
Nylon	0.22	0.60	3.9	0.43	0.48	2.7	0.026
Phosphor Bronze	0.30	0.81	3.5	0.63	0.67	2.9	0.010
Nylon	0.30	0.81	3.5	0.63	0.67	2.9	0.034
Phosphor Bronze	0.38	0.95	3.5	0.78	0.84	2.9	0.010
Nylon	0.38	0.95	3.5	0.78	0.84	2.9	0.039
Phosphor Bronze	0.45	1.20	3.5	1.04	1.09	2.9	0.015
Nylon	0.45	1.20	3.5	1.04	1.09	2.9	0.046
Phosphor Bronze	12	2.10	4.1	1.74	1.78	3.5	0.015
Nylon	12	2.10	4.1	1.74	1.78	3.5	0.065

Table 1

[0105] The average dimension of a gap 3 created between the inner wall 0 and the set of short bristles 62 differs from a patch's 71 average thickness by a variable amount. If a gap 3 is too large, then the brush and jag combination 100 inside the bore 73 is not tight enough. If a gap 3 is too small, then the brush and jag combination 100 inside the bore 73 is too tight, requiring a stroking force so great that a component may break, damage the bore wall 0 or land 6, or require too much time and energy to complete the strokes.

[0106] Large caliber brush and jag combinations based on the proposed design may have a smaller average gap 3 because the brush and jag combination 100 accommodates multiple layering of a patch 71. The large cylindrical area created by bristle 13 tips of a large caliber brush and jag combination 100 allows a patch 71 to spread over the area

09-22863
Shane Smith

without developing thick multiple layering. The long length of bristles **13** of a large caliber brush and jag combination **100** allows them to bend more readily than shorter bristles when a patch **71** develops thick multiple layering, and in this way the multiple-layered patch **71** does not create too much tension inside the bore **73**.

[0107] Averages for gap **3** dimensions, assuming a patch thickness of 0.0130 to 0.0210 inches, range ideally as follows: for 22 caliber, 0.019 to 0.025 inches; for 30 caliber, 0.023 to 0.028 inches; for 38 caliber, 0.024 to 0.034 inches; for 45 caliber, 0.012 to 0.023 inches; and for 12 gauge, 0.005 to 0.020 inches. The error fluctuation of filament **13** lengths typically ranges between 0.0020 inch to 0.0070 inches.

[0108] The brush and jag combination **100** is more efficient than the separate brushes and jags on the market because the user does not have to switch between alternate uses of the brush and the jag. In addition, both directions of a stroke brush and wipe simultaneously.

[0109] In the locations where the patch is applied, the proposed design has the additional feature of performing abrasion when bristles **13** poke through the patch fabric.

[0110] Due to the precise dimensioning of the transverse diameter **61** of the set of short bristles **62** the brush and jag combination **100** applies absorbent material uniformly or entirely around the circumference of the bore wall **0** and/or land **6**. In addition, the brush and jag combination **100** has the advantage of pressing the patch **71** at many contact points into the edges **7** of the grooves **4** and lands **6**. The number of contact points can be much more than the number of contact points of a solid jag **21** with knurled surface **24** because typical filament diameters, being 0.005 inches, are smaller than typical knurled filament

09-22863
Shane Smith

diameters, being 0.035 inches.

[0111] When undersized brushes wrapped in fabric are used to wipe bores, the transverse diameter of the brushes may be 0.0150 to 0.0800 inches less than the bore's inner diameter. This means the size of the gap **3** between bristle tips and bore wall averages from 0.0075 to 0.0400 inches. For caliber 45 and smaller, the average gap **3** measures 0.0075 to 0.0250 inches. A patch with average thickness 0.0150 inches will not fit into typical gaps **3** of 0.0075 to 0.010 inches because too much force would be required to make the combination stroke the bore. The user plays a game of trial and error to see if a particular make of undersized brush wrapped in fabric fits inside a particular larger caliber bore. Prior art brushes designed for the same caliber may not have the same average transverse diameter, and bores for the same caliber cartridge may not have the same inner bore diameter **1**. Wrapping an undersized brush with a patch is a jerry-rigging since the brush was not designed to wipe bores, but rather it was designed to brush smaller bores. In addition, the maximum lengths of filaments **13** of undersized brushes are not long enough to reach into rifling grooves. When maximum lengths of filaments **13** of a prior art brush are long enough to reach inside rifling grooves, then the brush is not an undersized brush; rather it would be a same-sized or an oversized brush, both of which are too tight inside the bore when wrapped by a patch.

[0112] The proposed designs are inexpensive to make since they use the same technology that current inexpensive twisted-wire stem **14** brushes use. The proposed designs in most cases do not require the construction of molds. The proposed designs work with current gun rods, cables, shafts, and their attachments since the proposed designs can

09-22863
Shane Smith

be made to have the same connectors.

[0113] The foregoing description of the preferred embodiment of the invention has been presented for the purposes of illustration and description. It is not intended to be exhaustive or to limit the invention to the precise form disclosed. Many modifications and variations are possible in light of the above teaching. It is intended that the scope of the invention not be limited by this detailed description, but by the claims and the equivalents to the claims appended hereto.

INDUSTRIAL APPLICABILITY

[0114] This invention may be industrially applied to the development, manufacture, and use of a combination brush and jag for the purpose of simultaneously brushing and wiping a bore. The combination brush and jag comprises a stem securing a set of long bristles and a set of short bristles, wherein the set of short bristles has a transverse diameter that is smaller than a transverse diameter of the set of long bristles. The transverse diameter of the set of short bristles is configured to be smaller than the bore. A patch may be wrap around the set of short bristles, such that the patch can wipe the bore while the set of long bristles simultaneously brush the bore.

09-22863
Shane Smith

CLAIMS

What is claimed is:

1. A combination barrel brush and jag, comprising:
 - a. a set of short bristles having a first transverse diameter;
 - b. a set of long bristles having a second transverse diameter, the set of short bristles being adjacent to the set of long bristles;
 - c. a stem having a first end and a second end, the stem comprising a first wire stem, a second wire stem parallel to the first wire stem, and a longitudinal axis parallel to the first and second wire stem, wherein the first and second set of bristles are positioned in between the first and second wire stem and fixed in place by a twist created by the first and second wire stems about each other along the longitudinal axis, wherein the first transverse diameter does not equal the second transverse diameter, and wherein the first transverse diameter is less than a bore diameter of a bore wall and the second transverse diameter is greater than or equal to the bore diameter; and
 - d. a patch having a thickness configured to wrap around the set of short bristles, wherein the set of short bristles evenly distribute the patch against the bore.
2. The brush and jag combination of claim 1, wherein the set of short bristles is in between two sets of long bristles along the stem.
3. The brush and jag combination of claim 1, comprising multiple sets of short bristles separated by at least one set of long bristles.

09-22863
Shane Smith

4. The brush and jag combination of claim 1, further comprising a tuft of bristles positioned at the second end extending away from the first end.
5. The brush and jag combination of claim 1, wherein the first transverse diameter of the set of short bristles is smaller than the diameter of the bore wall so as to define a circular gap between the bore wall and the set of short bristles when the brush and jag combination is concentrically positioned inside the bore, wherein the distance between the set of short bristles to the bore wall is approximately 0.5 to 25 times the thickness of the patch.
6. The brush and jag combination of claim 1, wherein the set of short bristles and the longitudinal axis define an angle of approximately 10 degrees to approximately 170 degrees.
7. The brush and jag combination of claim 1, further comprising long bristles intermittently spaced apart within the set of short bristles.
8. The brush and jag combination of claim 1, wherein the set of short bristles comprise bristles of varying lengths.
9. The brush and jag combination of claim 1, wherein the set of short bristles comprise groups of bristles offset from an adjacent group of bristles.
10. The brush and jag combination of claim 1, wherein the stem comprises pores to release fluids on to the set of long and short bristles.
11. The brush and jag combination of claim 1, wherein the bristles are coiled springs.
12. The brush and jag combination of claim 1, where in the patch has a shape selected from the group consisting of a rectangle, a triangle, a circle, and a square.

09-22863
Shane Smith

13. The brush and jag combination of claim 12, wherein the patch has a radius defined by equation 2.
14. A method of simultaneously brushing and wiping a bore, comprising:
 - a. providing a cleaning device, comprising:
 - i. a set of short bristles having a first transverse diameter;
 - ii. a set of long bristles having a second transverse diameter, the set of short bristles being adjacent to the set of long bristles; and
 - iii. a wire having a first end and a second end, the wire comprising a first wire stem, a second wire stem parallel to the first wire stem, and a longitudinal axis parallel to the first and second wire stem, wherein the short and long set of bristles are positioned at an angle between approximately 10 degrees to approximately 170 degrees relative to the first and second wire stems and fixed in place by a twist created by the first and second wire stems about each other along the longitudinal axis, wherein the first transverse diameter does not equal the second transverse diameter, and wherein the first transverse diameter is less than a bore diameter and the second transverse diameter is greater than or equal to the bore diameter.
 - b. covering the set of short bristles with a patch; and
 - c. sliding the cleaning device into and out of the bore repeatedly in successive action thereby simultaneously brushing and wiping the bore.

09-22863
Shane Smith

15. The method of claim 14, further comprising exposing the patch to a fluid selected from the group consisting of a lubricant, a solvent, a preservative, and an abrasive.
16. A method of manufacturing a combination brush and jag, comprising:
 - a. providing a wire;
 - b. providing two wire stems parallel to each other, defining a first end and a second end opposite the first end;
 - c. placing a first set of bristles in between the two wire stems;
 - d. placing a second set of bristles in between the two stems;
 - e. twisting the two stems about each other; and
 - f. securing the second end to a connector.
17. The method of claim 16, wherein the first set of bristles is shorter than the second set of bristles.
18. The method of claim 17, wherein a group of bristles within the first set of bristles is offset from an adjacent group of bristles within the first set of bristles.
19. The method of claim 16, further comprising trimming the first set of bristles to be shorter than the second set of bristles.
20. The method of claim 19, wherein the bristles in the first set of bristles is trimmed at different lengths.

Fig. 1

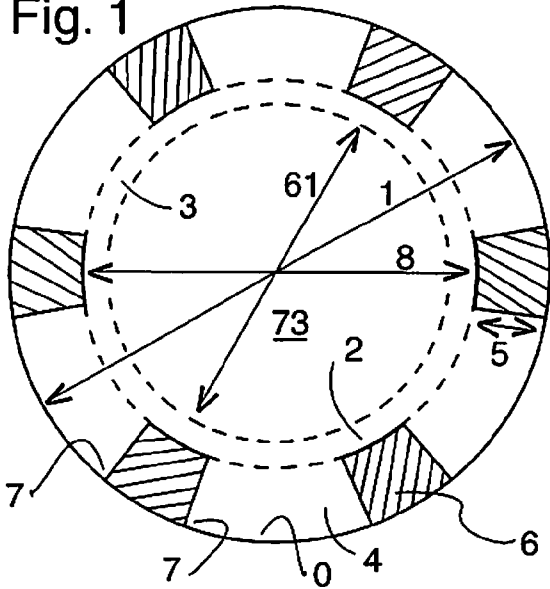

Fig. 2

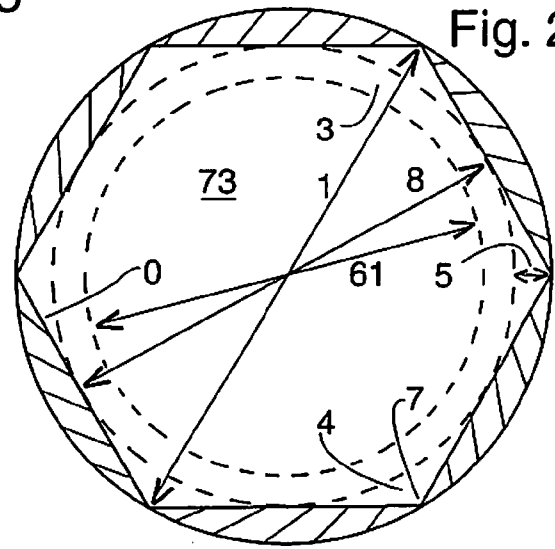

Fig. 3

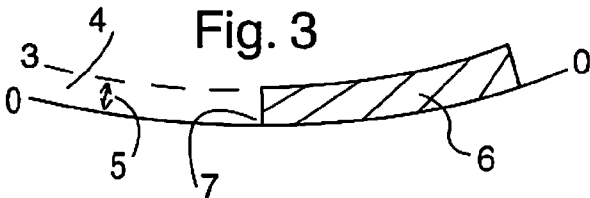

Fig. 4

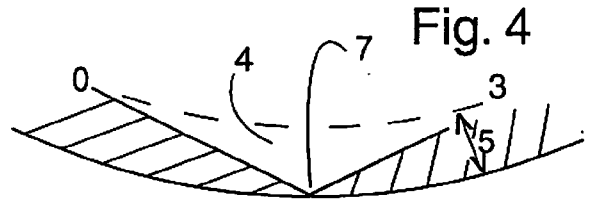

Fig. 5
(Prior Art)

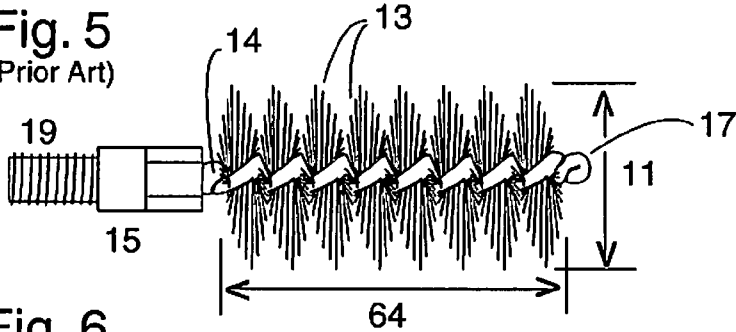

Fig. 6
(Prior Art)

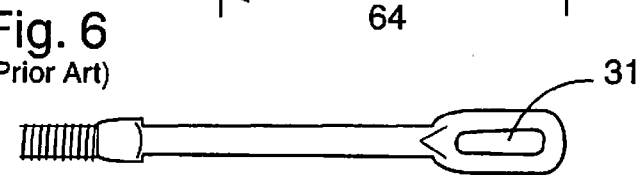

Fig. 7
(Prior Art)

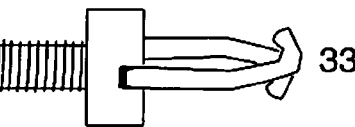

Fig. 8
(Prior Art)

Fig. 8
(Prior Art)

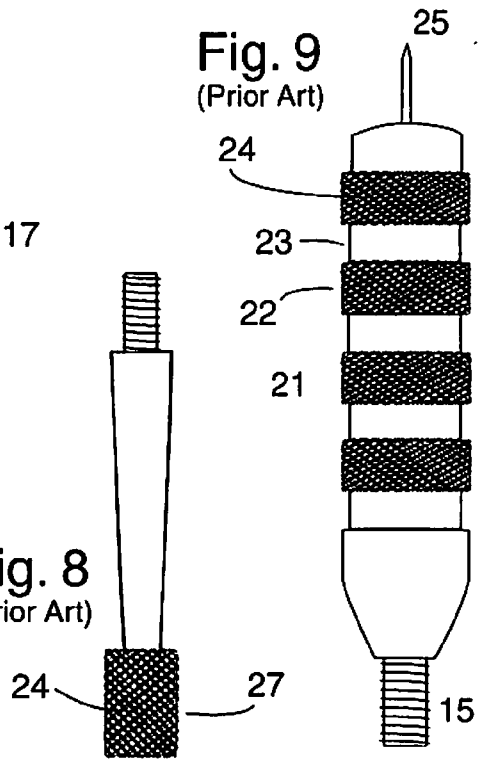
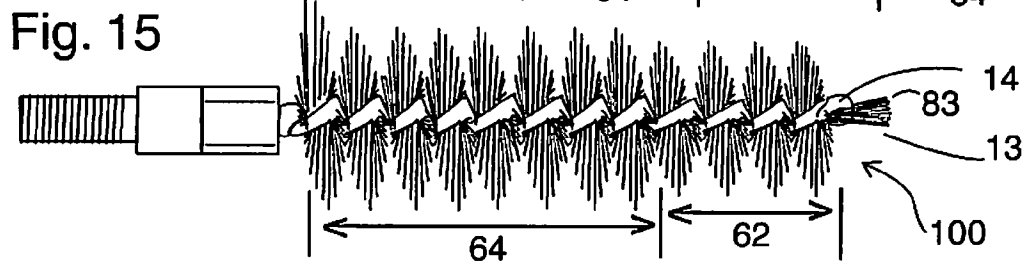
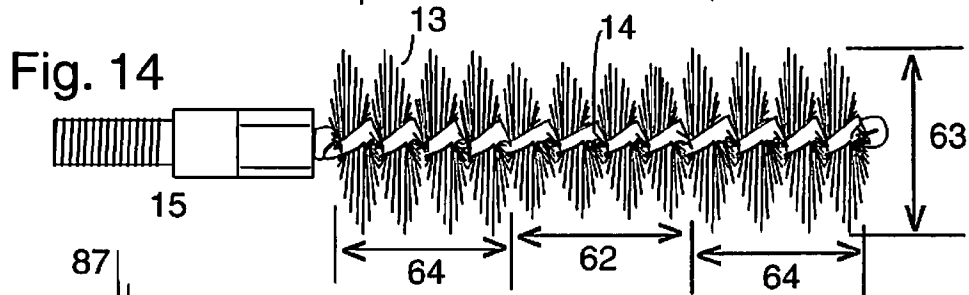
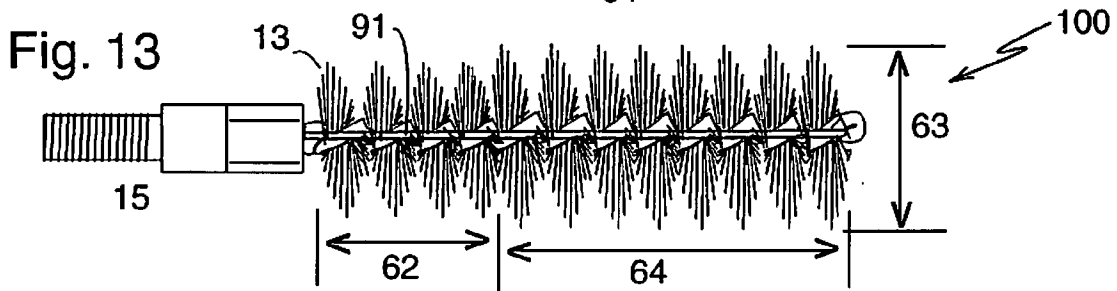
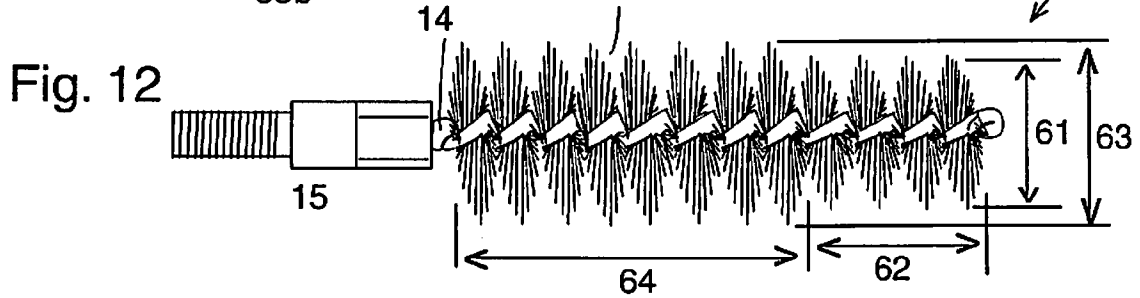
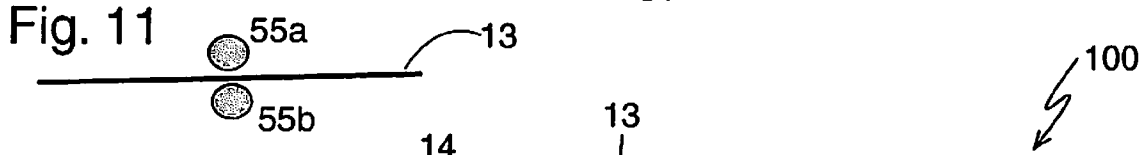
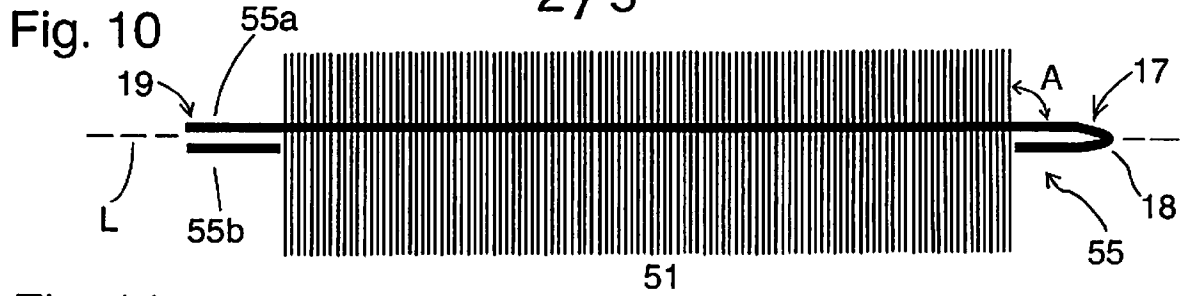
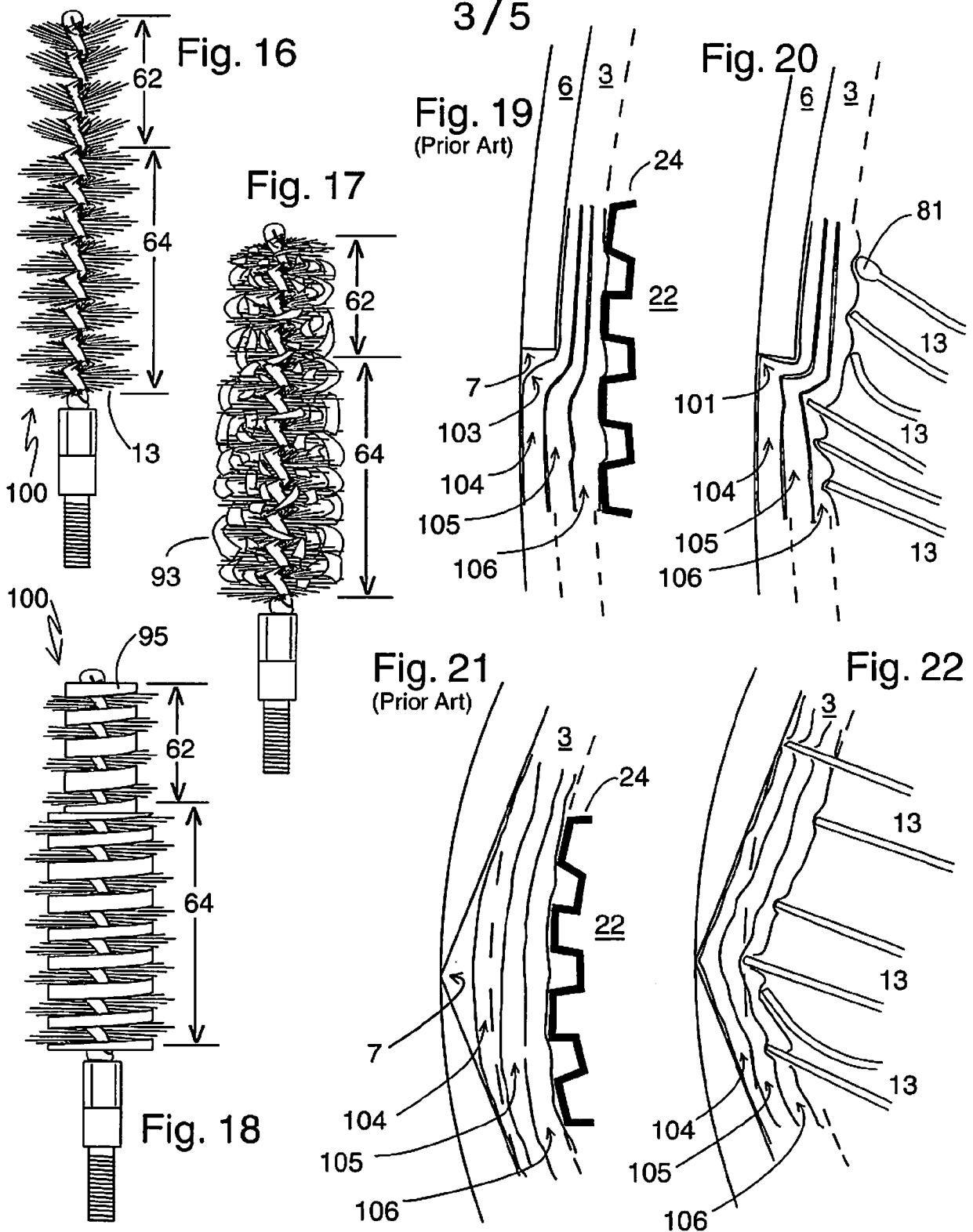
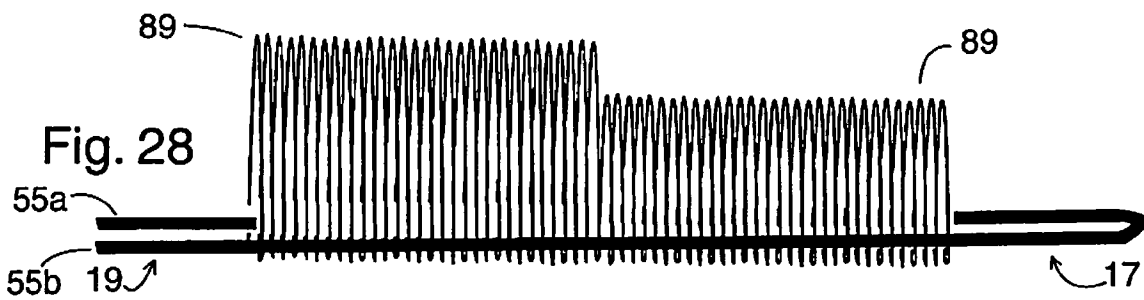
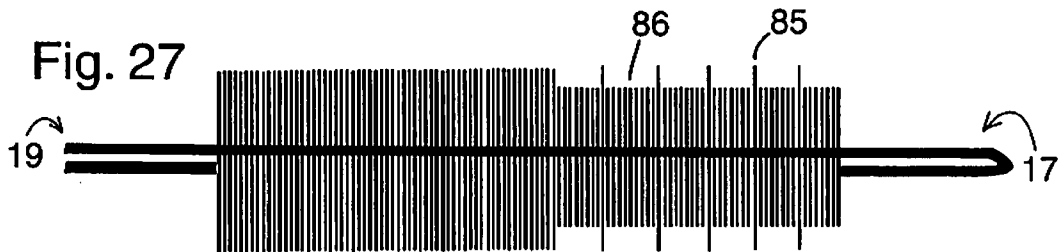
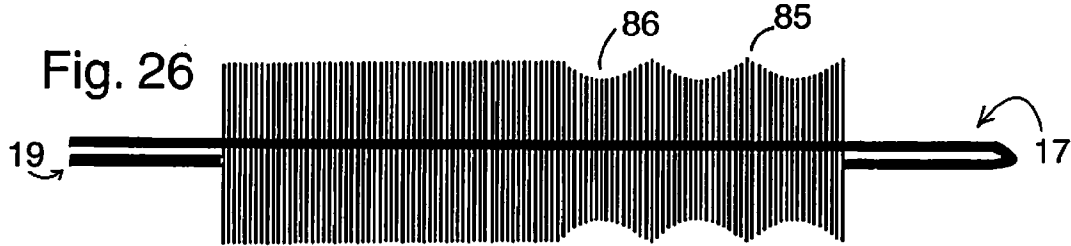
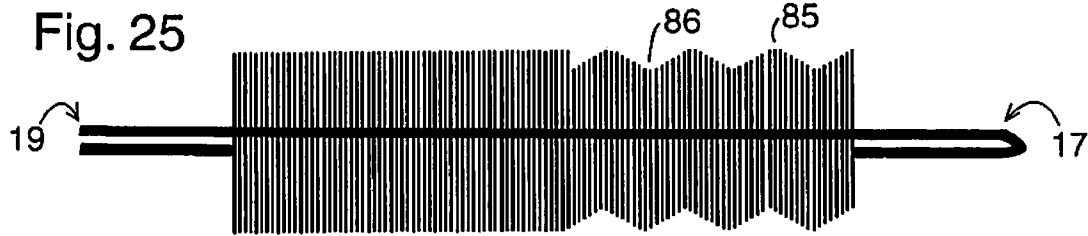
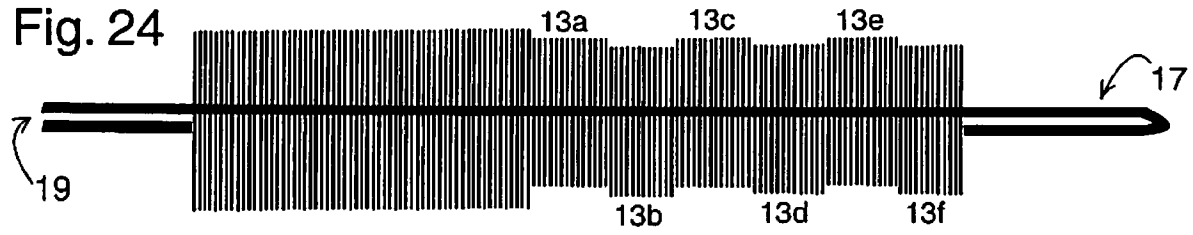
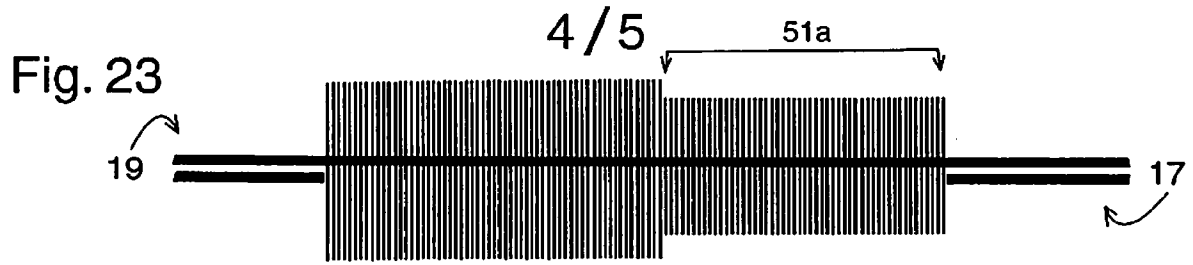

Fig. 9
(Prior Art)







5 / 5

Fig. 29

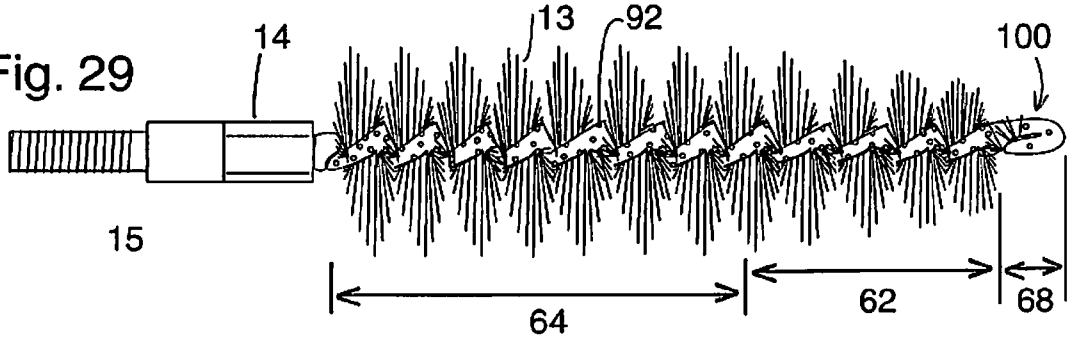

100

Fig. 30

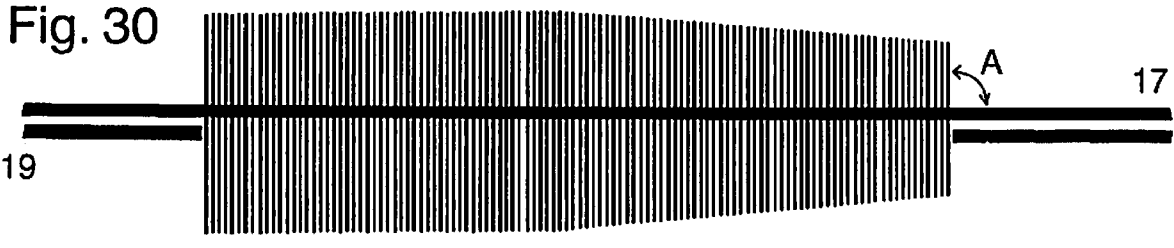

Fig. 32

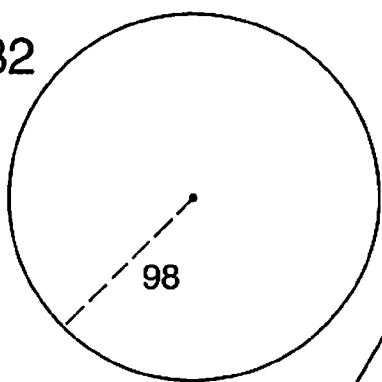

Fig. 31

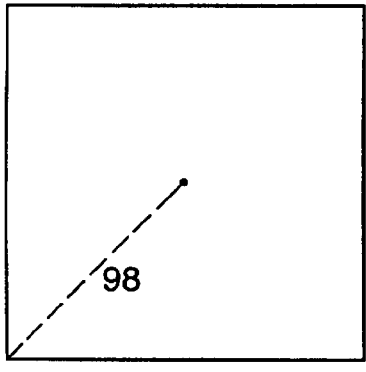

Fig. 33

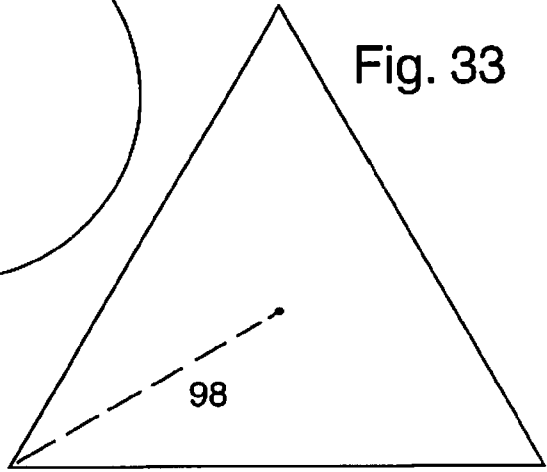
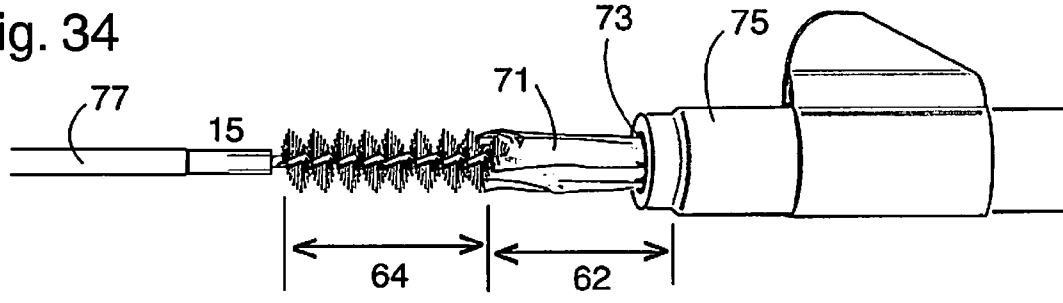

Fig. 34



INTERNATIONAL SEARCH REPORT

International application No.

PCT/US2009/058642

A. CLASSIFICATION OF SUBJECT MATTER

IPC(8) - F41C 27/00 (2009.01)

USPC - 42/95

According to International Patent Classification (IPC) or to both national classification and IPC

B. FIELDS SEARCHED

Minimum documentation searched (classification system followed by classification symbols)

IPC(8) - F41C 27/00 (2009.01)

USPC - 15/207.2; 42/95; 132/320; 300/2

Documentation searched other than minimum documentation to the extent that such documents are included in the fields searched

Electronic data base consulted during the international search (name of data base and, where practicable, search terms used)

PatBase

C. DOCUMENTS CONSIDERED TO BE RELEVANT

Category*	Citation of document, with indication, where appropriate, of the relevant passages	Relevant to claim No.
Y	US 5,588,242 A (HUGHES) 31 December 1996 (31.12.1996) entire document	1-20
Y	US 1,735,277 A (HERTZBERG) 12 November 1929 (12.11.1929) entire document	1-20
Y	US 2,897,525 A (GOODWIN et al) 04 August 1959 (04.08.1959) entire document	1-20
Y	US 7,254,860 B2 (DUMLER et al) 14 August 2007 (14.08.2007) entire document	2, 3, 7, 9, 18-20
Y	US 6,378,236 B1 (SOLBERG et al) 30 April 2002 (30.04.2002) entire document	10
Y	US 3,952,359 A (ROSSEAU) 27 April 1976 (27.04.1976) entire document	11

 Further documents are listed in the continuation of Box C.

* Special categories of cited documents:

"A" document defining the general state of the art which is not considered to be of particular relevance

"E" earlier application or patent but published on or after the international filing date

"L" document which may throw doubts on priority claim(s) or which is cited to establish the publication date of another citation or other special reason (as specified)

"O" document referring to an oral disclosure, use, exhibition or other means

"P" document published prior to the international filing date but later than the priority date claimed

"T" later document published after the international filing date or priority date and not in conflict with the application but cited to understand the principle or theory underlying the invention

"X" document of particular relevance; the claimed invention cannot be considered novel or cannot be considered to involve an inventive step when the document is taken alone

"Y" document of particular relevance; the claimed invention cannot be considered to involve an inventive step when the document is combined with one or more other such documents, such combination being obvious to a person skilled in the art

"&" document member of the same patent family

Date of the actual completion of the international search

11 November 2009

Date of mailing of the international search report

19 NOV 2009

Name and mailing address of the ISA/US

Mail Stop PCT, Attn: ISA/US, Commissioner for Patents
P.O. Box 1450, Alexandria, Virginia 22313-1450

Facsimile No. 571-273-3201

Authorized officer:

Blaine R. Copenheaver

PCT Helpdesk: 571-272-4300

PCT OSP: 571-272-7774