



(19) **United States**

(12) **Patent Application Publication**
Wright et al.

(10) **Pub. No.: US 2011/0027143 A1**

(43) **Pub. Date: Feb. 3, 2011**

(54) **METHOD AND APPARATUS FOR EXTRACTING CARBON DIOXIDE FROM AIR**

(60) Provisional application No. 60/827,849, filed on Oct. 2, 2006, provisional application No. 60/829,376, filed on Oct. 13, 2006.

(76) Inventors: **Allen B. Wright**, Tucson, AZ (US);
Klaus S. Lackner, Tucson, AZ (US);
Ursula Ginster, Tucson, AZ (US)

Publication Classification

(51) **Int. Cl.**
B01J 8/00 (2006.01)
F28D 21/00 (2006.01)
(52) **U.S. Cl.** **422/187; 422/208**

Correspondence Address:
HAYES SOLOWAY P.C.
3450 E. SUNRISE DRIVE, SUITE 140
TUCSON, AZ 85718 (US)

(57) **ABSTRACT**

A method and apparatus for extracting CO₂ from air comprising an anion exchange material formed in a matrix exposed to a flow of the air, and for delivering that extracted CO₂ to controlled environments. The present invention contemplates the extraction of CO₂ from air using conventional extraction methods or by using one of the extraction methods disclosed; e.g., humidity swing or electro dialysis. The present invention also provides delivery of the CO₂ to greenhouses where increased levels of CO₂ will improve conditions for growth. Alternatively, the CO₂ is fed to an algae culture.

(21) Appl. No.: **12/903,970**

(22) Filed: **Oct. 13, 2010**

Related U.S. Application Data

(60) Continuation of application No. 12/638,717, filed on Dec. 15, 2009, Division of application No. 11/866,326, filed on Oct. 2, 2007, now Pat. No. 7,708,806.

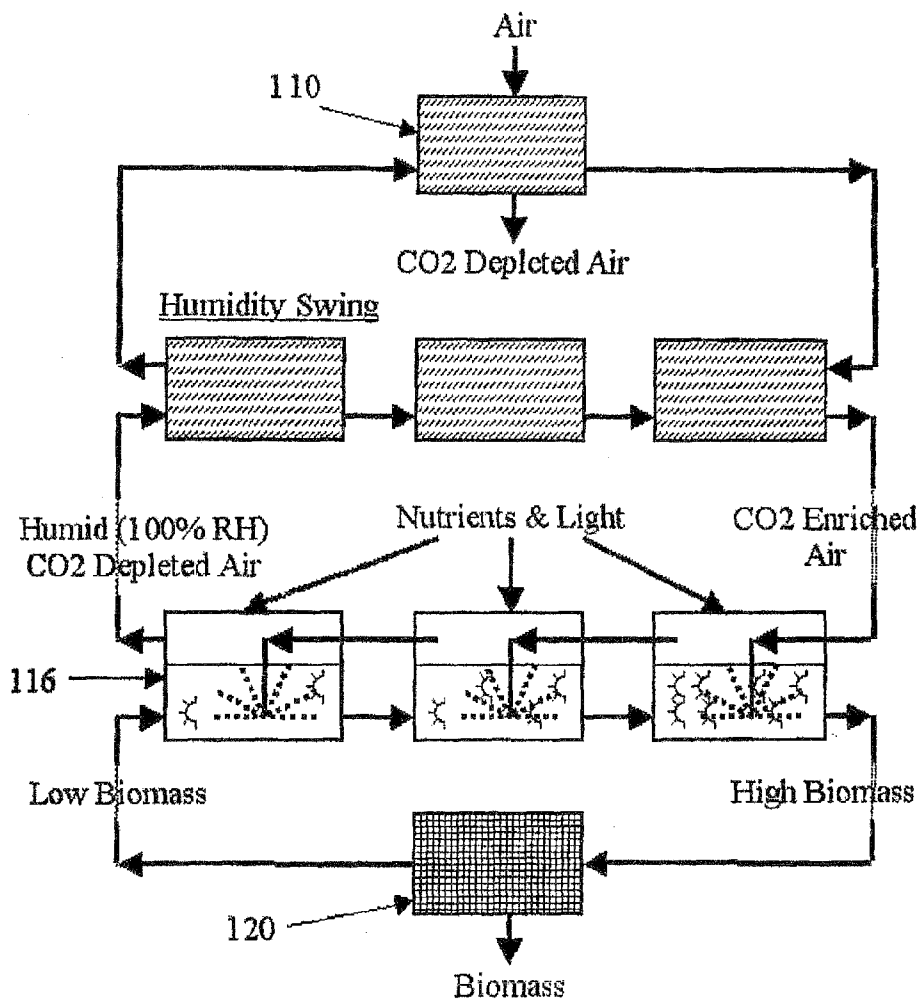

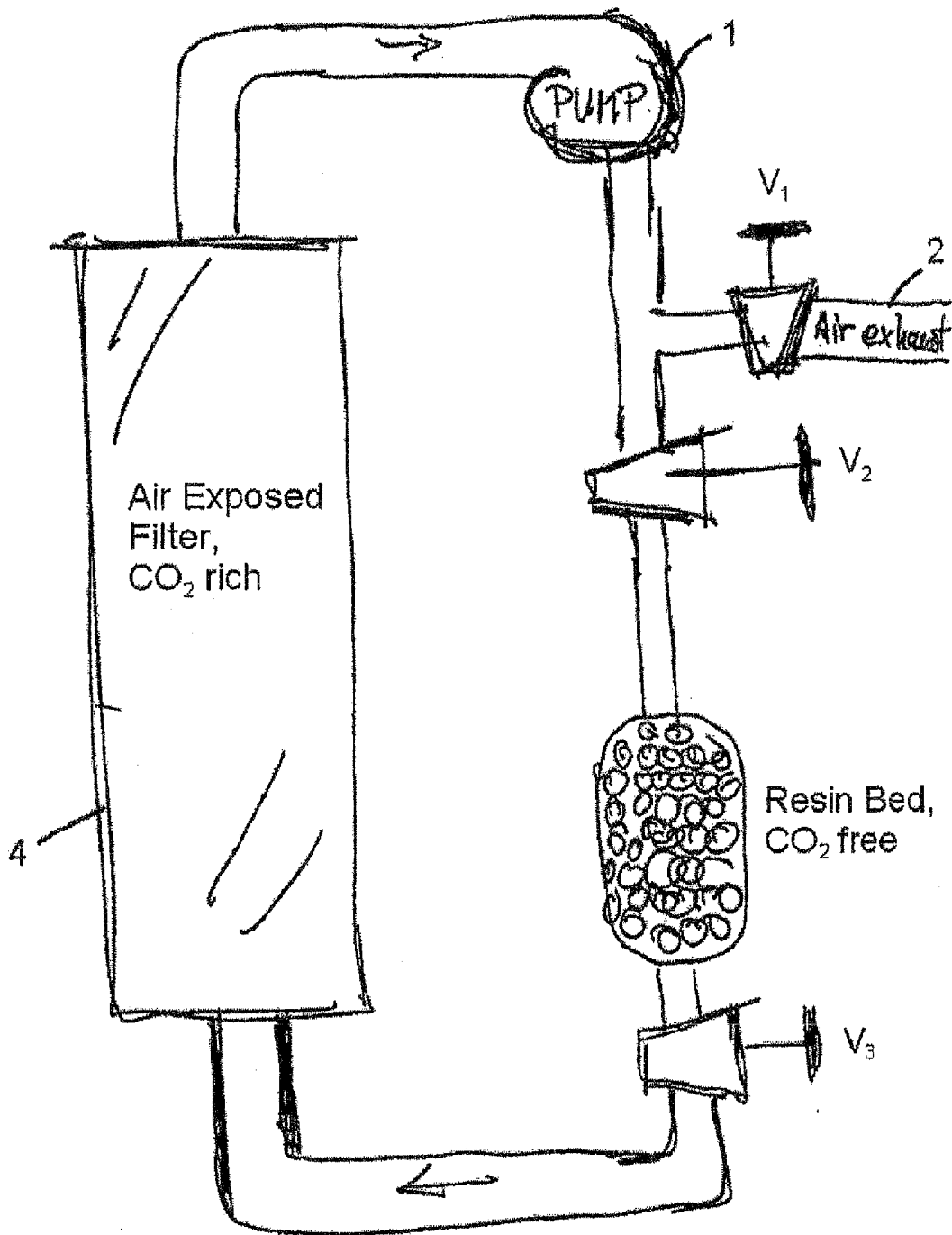

FIG. 1

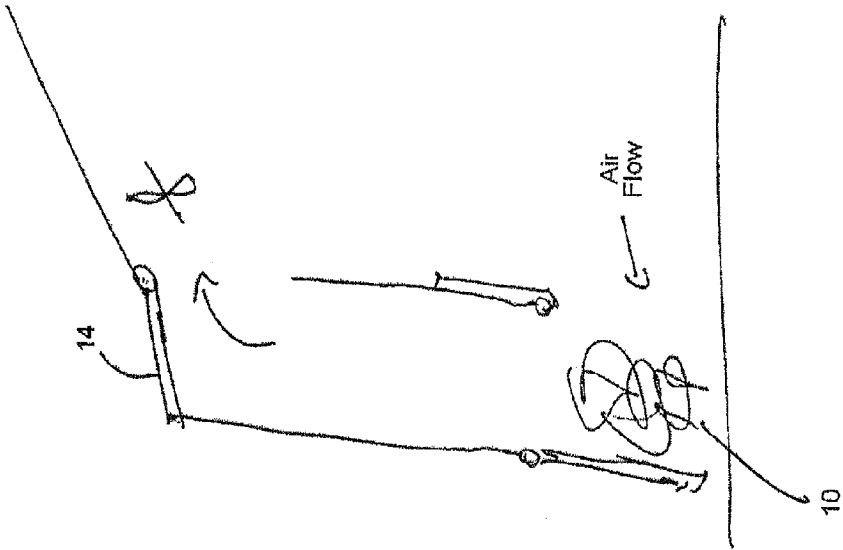

FIG. 2b

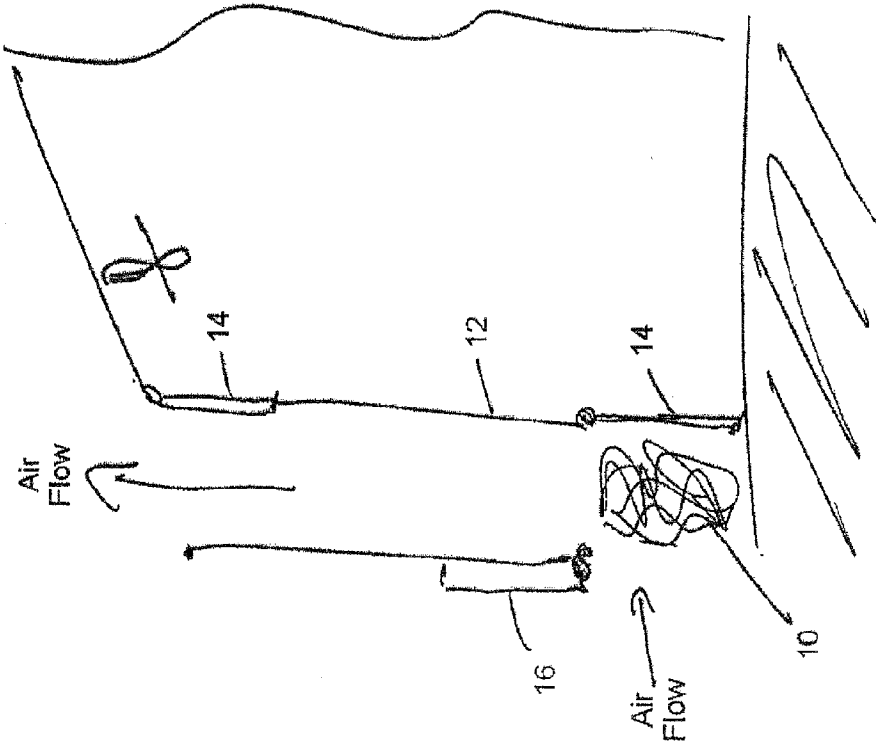

FIG. 2a

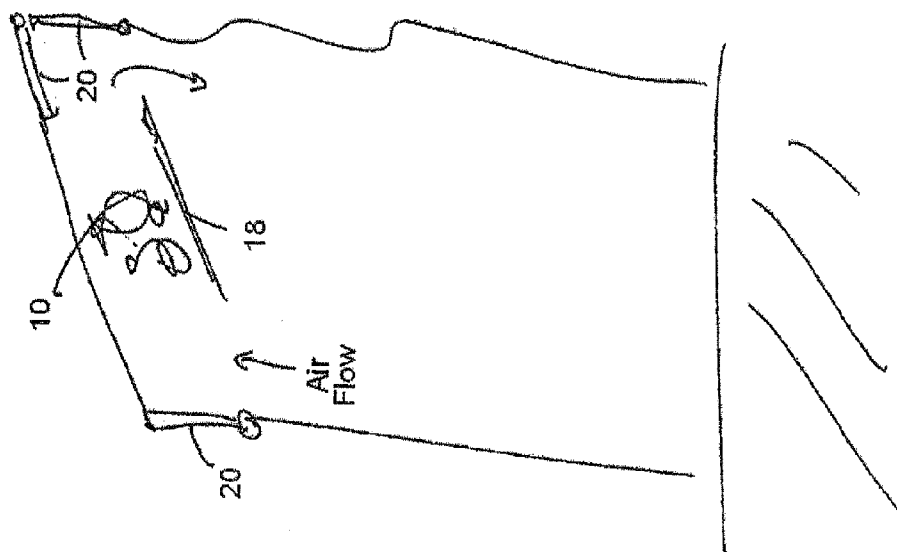

FIG. 3b

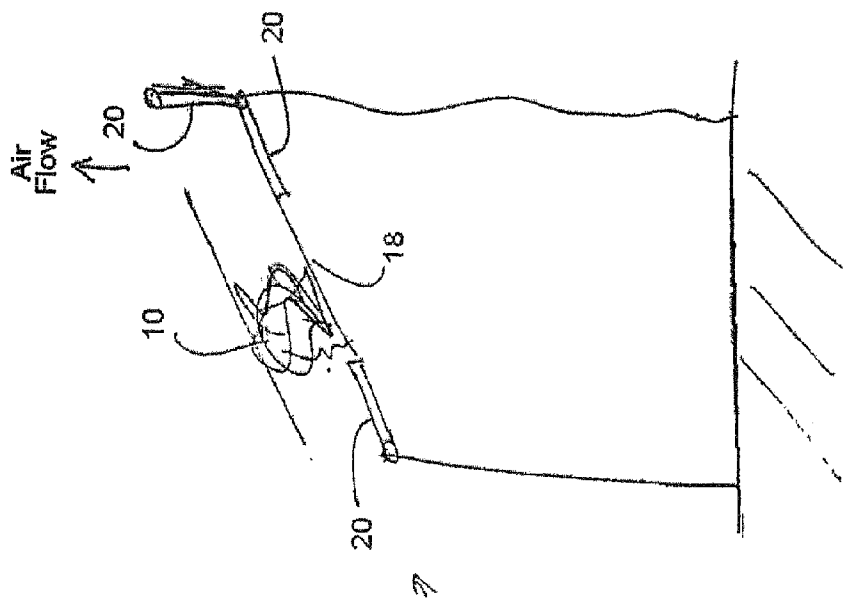

FIG. 3a

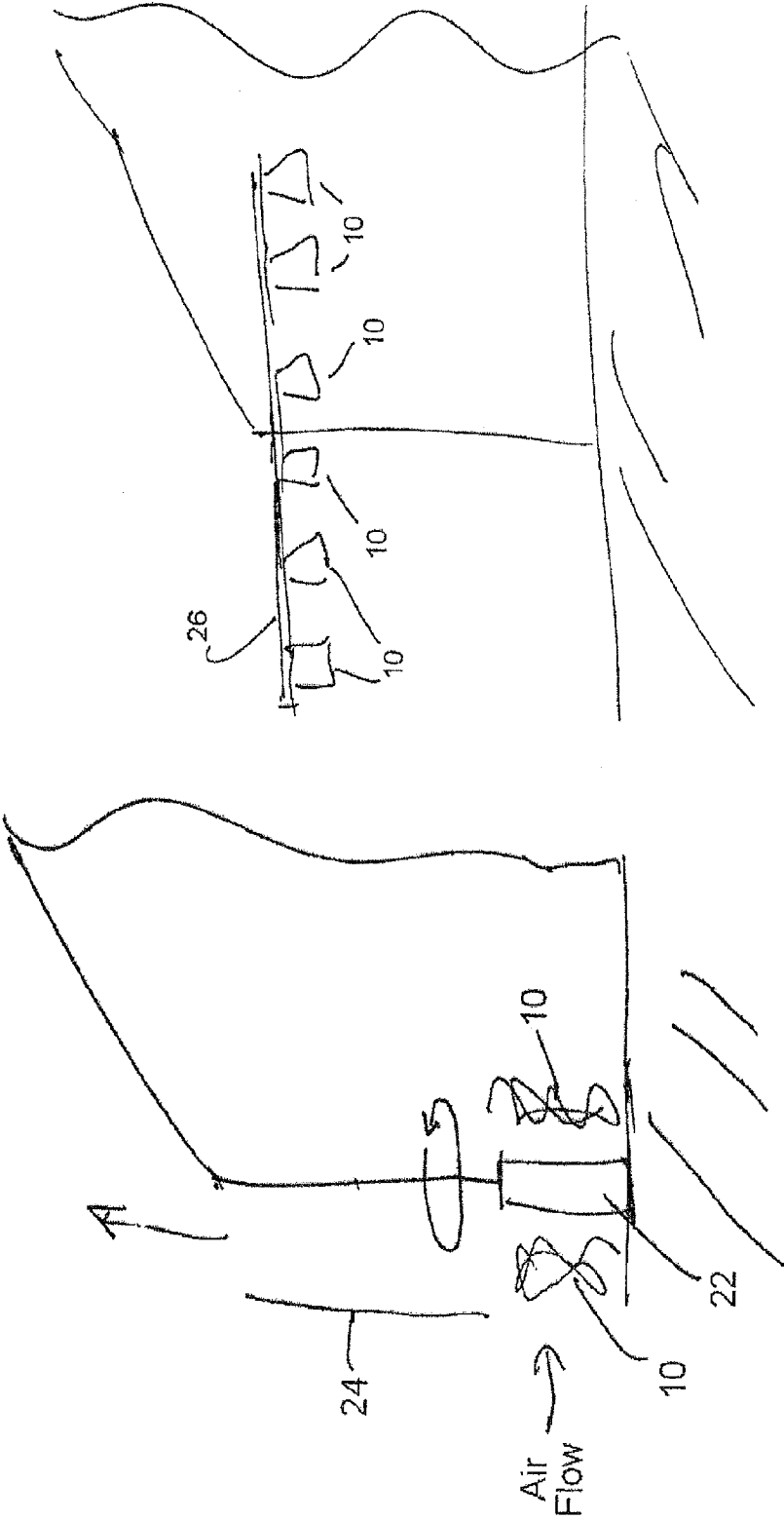

FIG. 5

FIG. 4

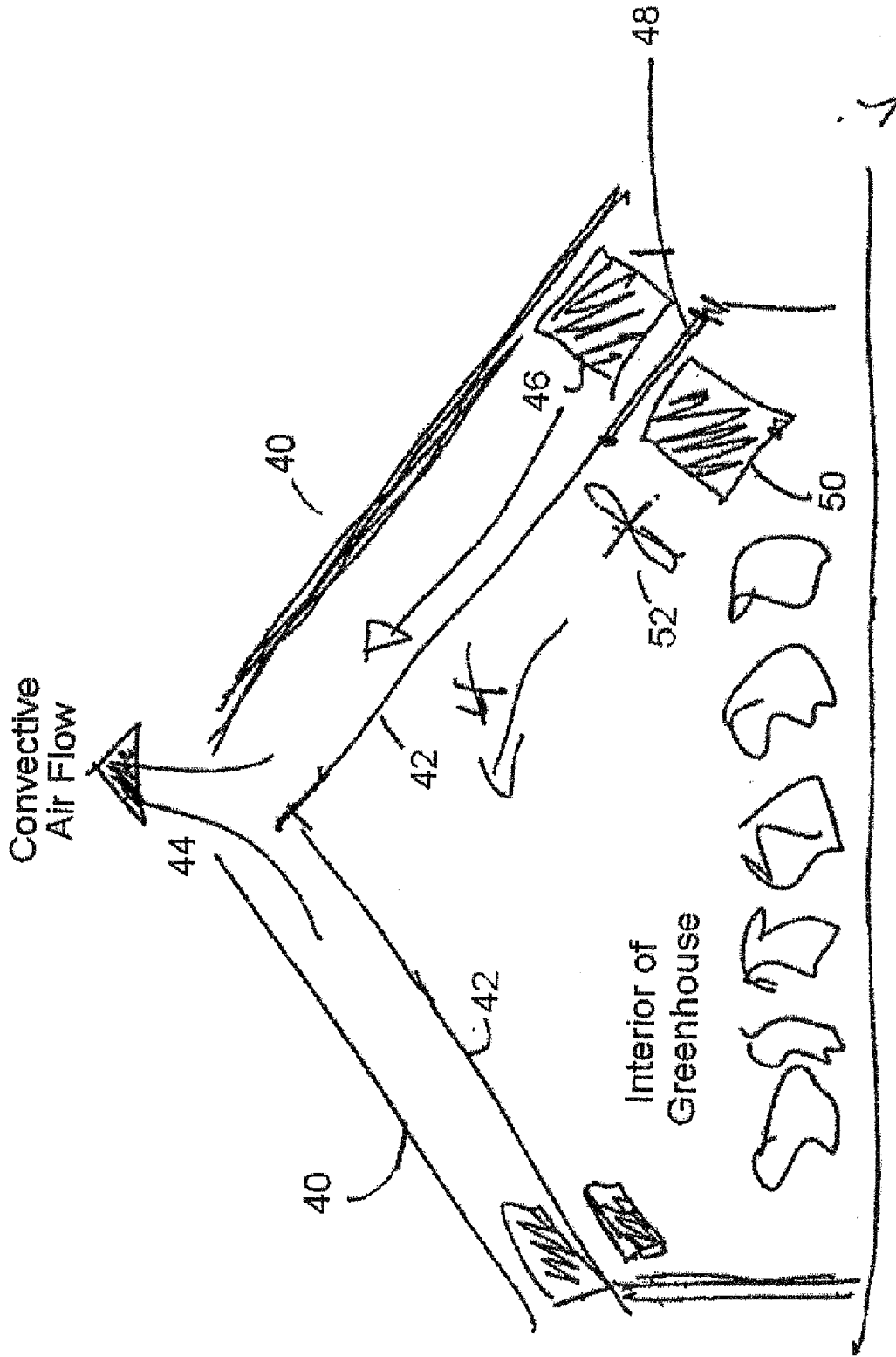

FIG. 6

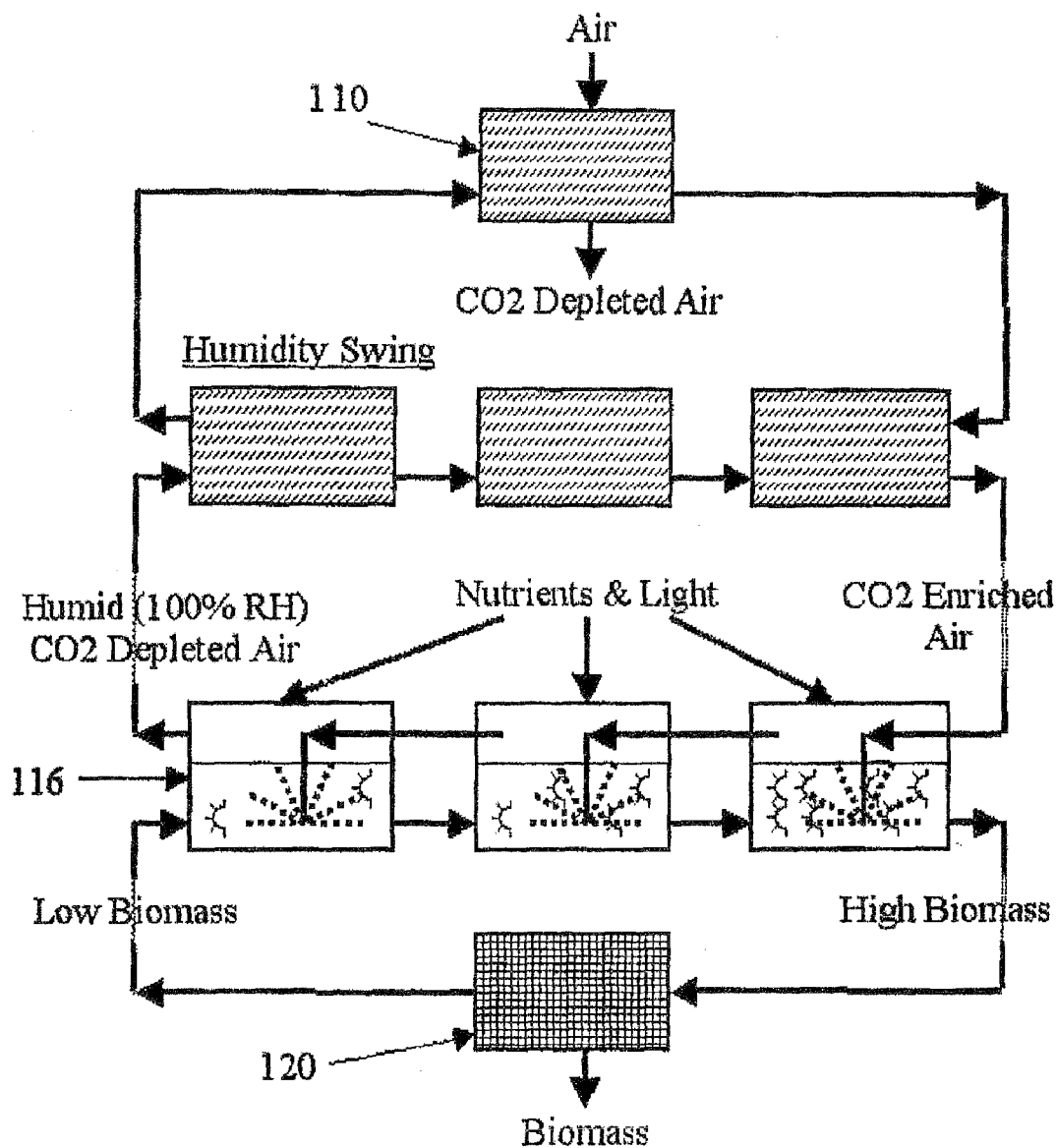

FIG. 7

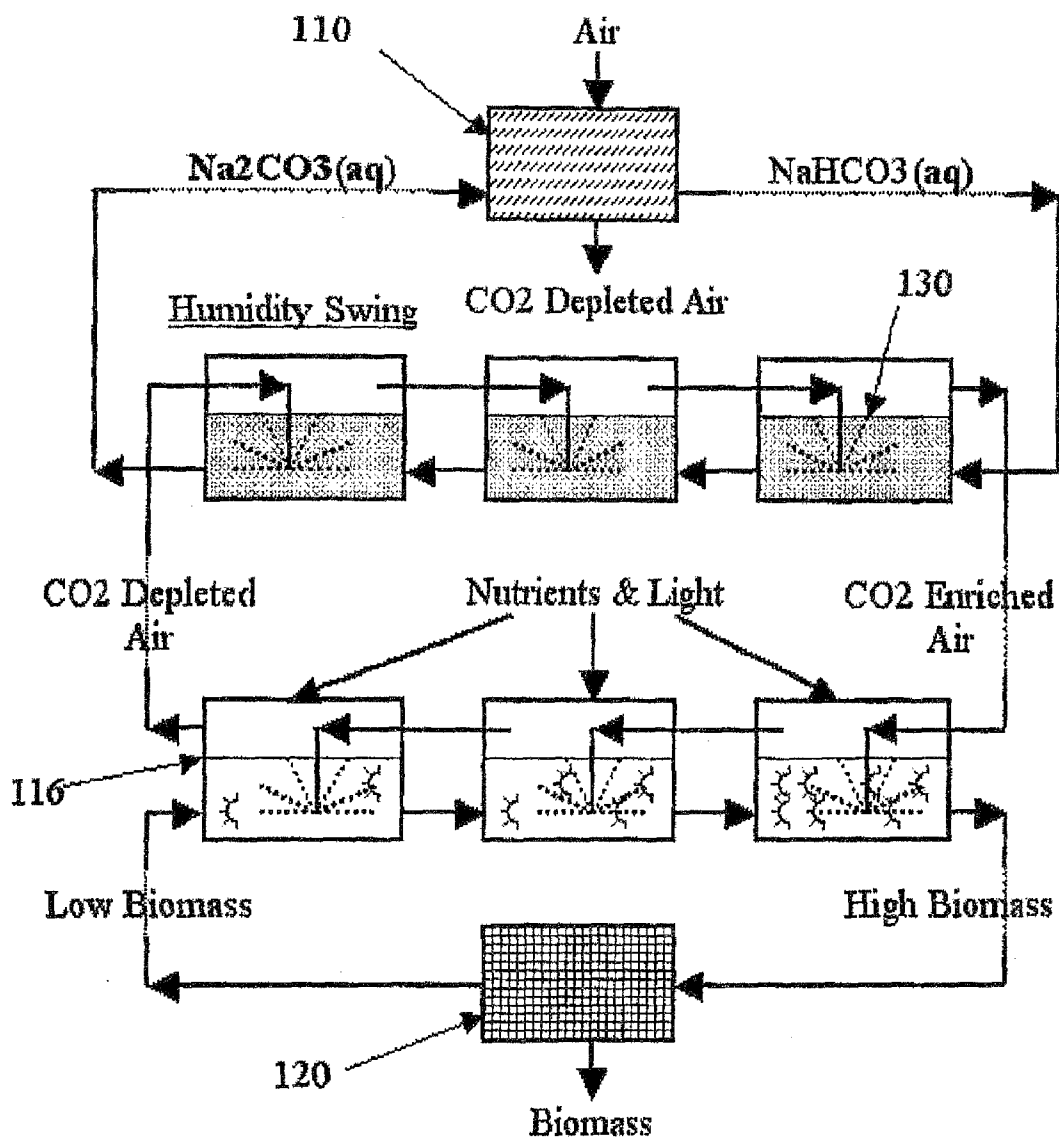

FIG. 8

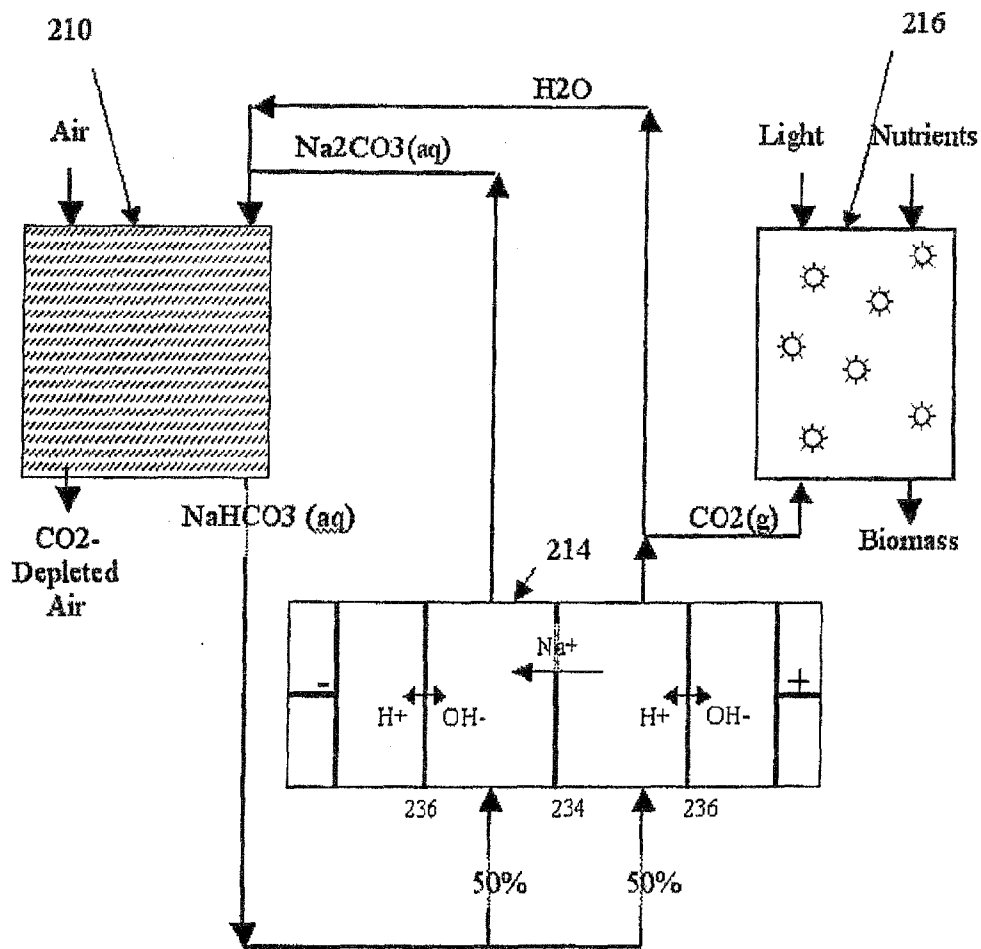

FIG. 9

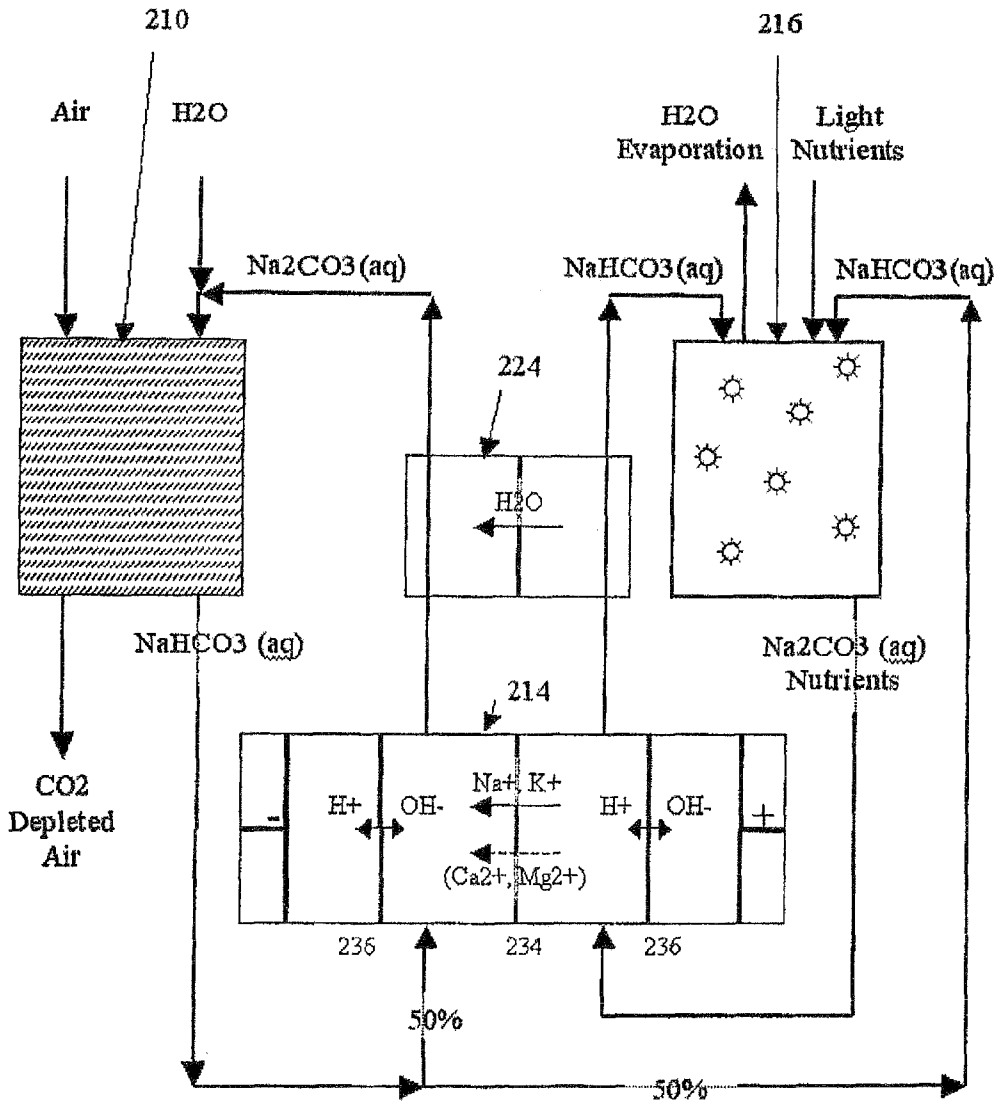

FIG. 10

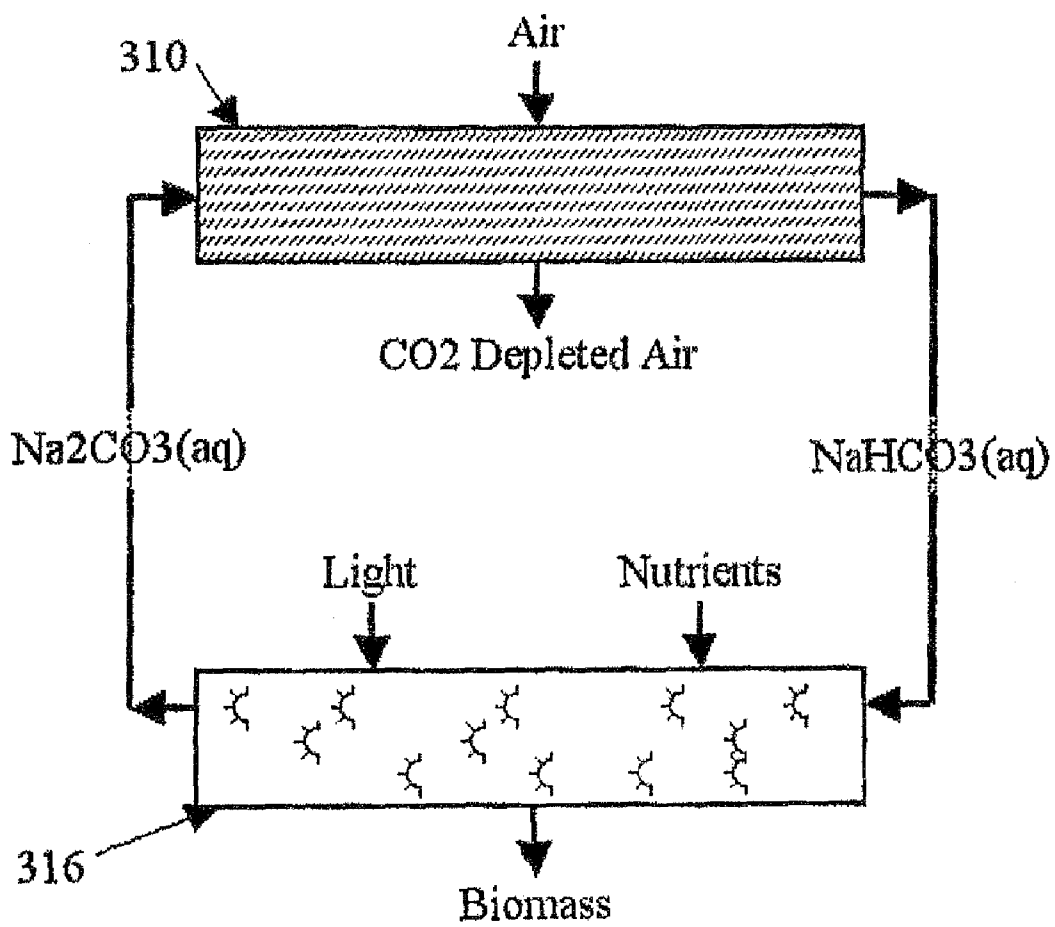

FIG. 11

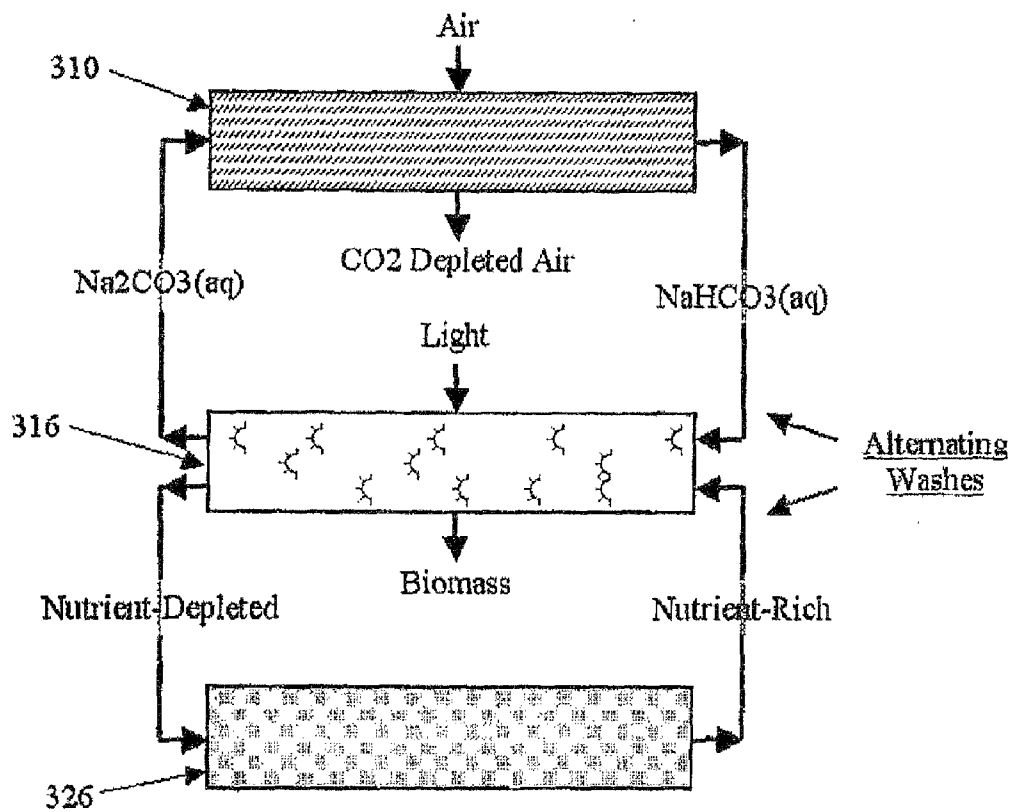

FIG. 12

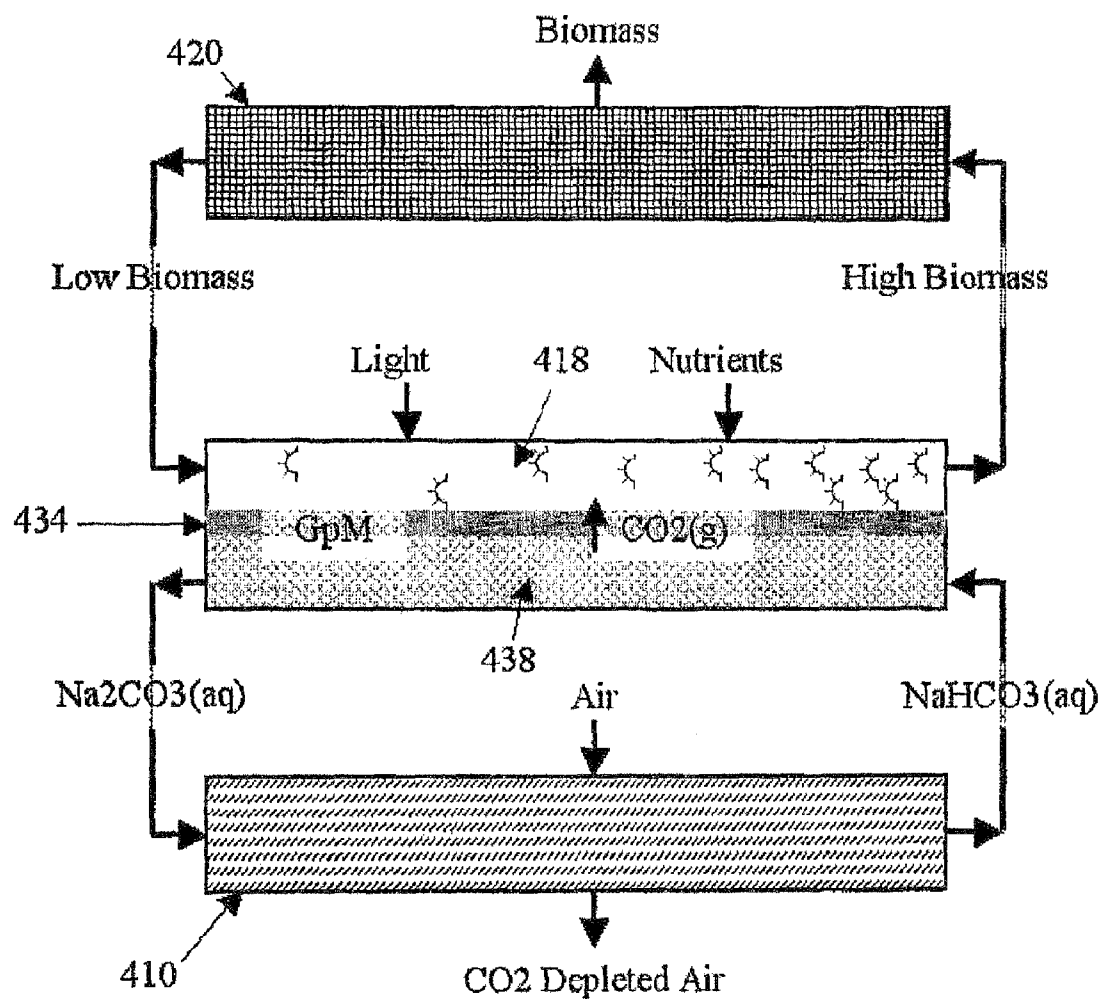

FIG. 13

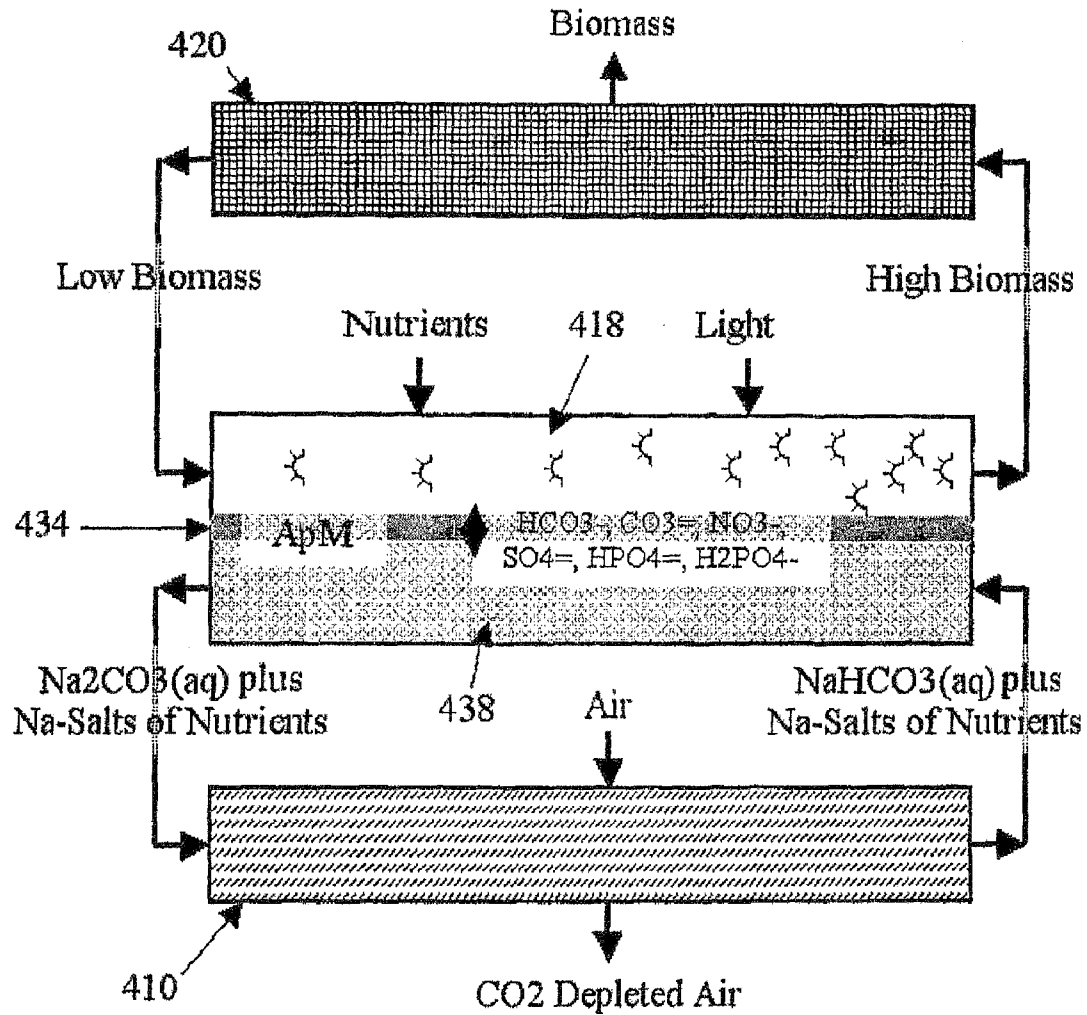

FIG. 14

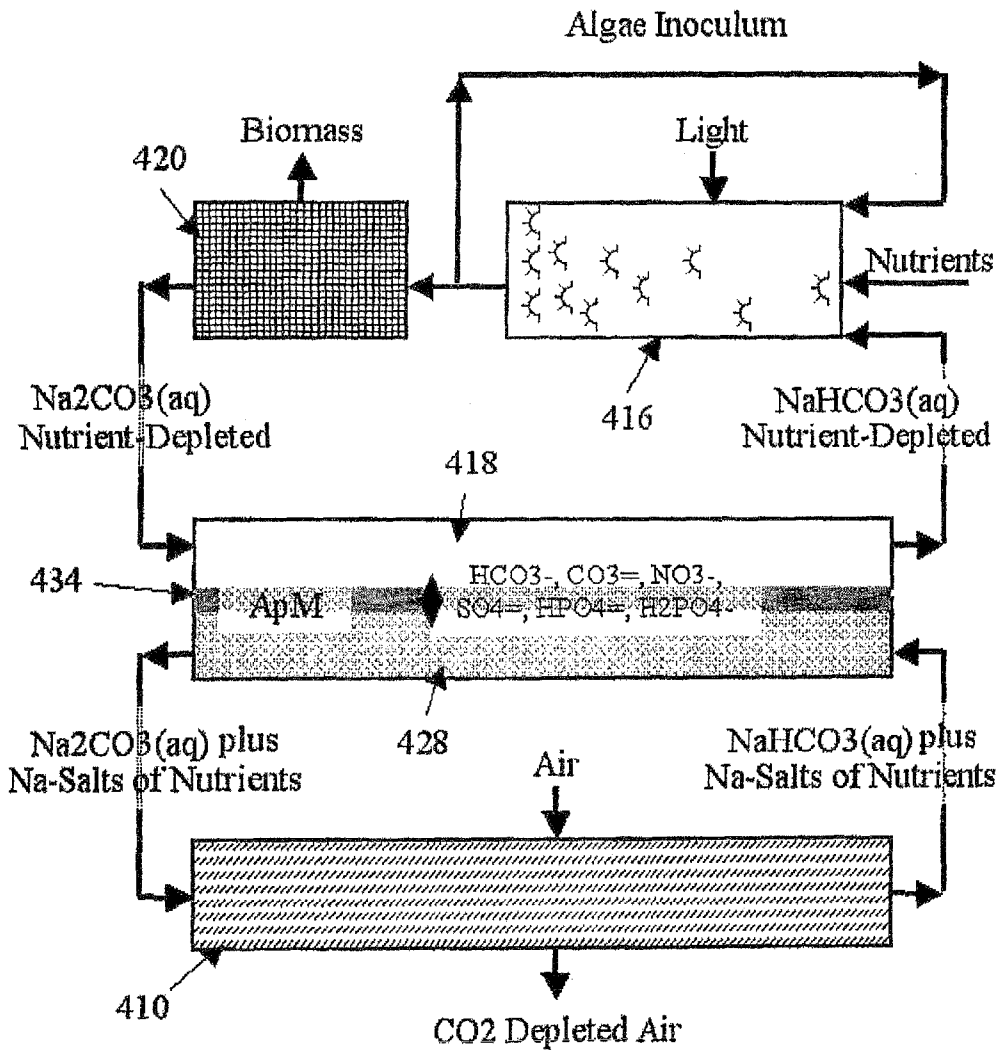

FIG. 15

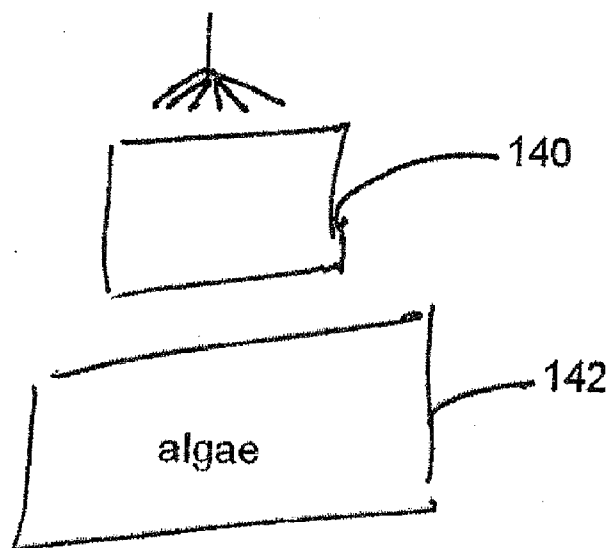

FIG. 16

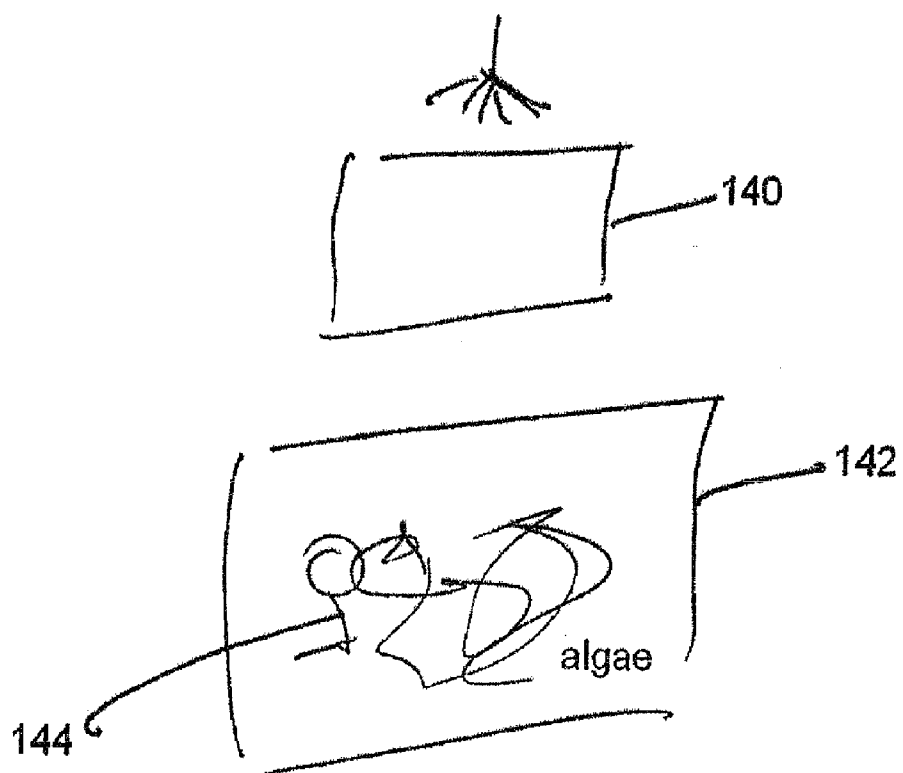

FIG. 17

METHOD AND APPARATUS FOR EXTRACTING CARBON DIOXIDE FROM AIR

CROSS REFERENCE TO RELATED APPLICATIONS

[0001] The present application claims priority from U.S. Provisional Application Ser. No. 60/827,849, filed Oct. 2, 2006, and 60/829,376, filed Oct. 13, 2006, the contents of which are incorporated herein by reference.

FIELD OF THE INVENTION

[0002] The present invention in one aspect relates to removal of selected gases from air. The invention has particular utility for the extraction and sequestration of carbon dioxide (CO₂) from air and will be described in connection with such utilities, although other utilities are contemplated.

BACKGROUND OF THE INVENTION

[0003] There is compelling evidence to suggest that there is a strong correlation between the sharply increasing levels of atmospheric CO₂ with a commensurate increase in global surface temperatures. This effect is commonly known as Global Warming. Of the various sources of the CO₂ emissions, there are a vast number of small, widely distributed emitters that are impractical to mitigate at the source. Additionally, large scale emitters such as hydrocarbon-fueled power plants are not fully protected from exhausting CO₂ into the atmosphere. Combined, these major sources, as well as others, have lead to the creation of a sharply increasing rate of atmospheric CO₂ concentration. Until all emitters are corrected at their source, other technologies are required to capture the increasing, albeit relatively low, background levels of atmospheric CO₂. Efforts are underway to augment existing emissions reducing technologies as well as the development of new and novel techniques for the direct capture of ambient CO₂. These efforts require methodologies to manage the resulting concentrated waste streams of CO₂ in such a manner as to prevent its reintroduction to the atmosphere.

[0004] The production of CO₂ occurs in a variety of industrial applications such as the generation of electricity power plants from coal and in the use of hydrocarbons that are typically the main components of fuels that are combusted in combustion devices, such as engines. Exhaust gas discharged from such combustion devices contains CO₂ gas, which at present is simply released to the atmosphere. However, as greenhouse gas concerns mount, CO₂ emissions from all sources will have to be curtailed. For mobile sources the best option is likely to be the collection of CO₂ directly from the air rather than from the mobile combustion device in a car or an airplane. The advantage of removing CO₂ from air is that it eliminates the need for storing CO₂ on the mobile device.

[0005] Extracting carbon dioxide (CO₂) from ambient air would make it possible to use carbon-based fuels and deal with the associated greenhouse gas emissions after the fact. Since CO₂ is neither poisonous nor harmful in parts per million quantities, but creates environmental problems simply by accumulating in the atmosphere, it is possible to remove CO₂ from air in order to compensate for equally sized emissions elsewhere and at different times.

[0006] Most prior art methods, however, result in the inefficient capture of CO₂ from air because these processes heat or cool the air, or change the pressure of the air by substantial amounts. As a result, the net loss in CO₂ is negligible as the

cleaning process may introduce CO₂ into the atmosphere as a byproduct of the generation of electricity used to power the process.

[0007] Various methods and apparatus have been developed for removing CO₂ from air. For example, we have recently disclosed methods for efficiently extracting carbon dioxide (CO₂) from ambient air using capture solvents that either physically or chemically bind and remove CO₂ from the air. A class of practical CO₂ capture sorbents include strongly alkaline hydroxide solutions such as, for example, sodium or potassium hydroxide, or a carbonate solution such as, for example, sodium or potassium carbonate brine. See for example published PCT Application PCT/US05/29979 and PCT/US06/029238.

[0008] There are also many uses for sequestered CO₂. This includes the use of CO₂ in greenhouses where higher levels of CO₂ contribute to increased plant growth. CO₂ may also be supplied to algae cultures. Researchers have shown that algae can remove up to 90% of gaseous CO₂ from air streams enriched in CO₂ and can also reduce the CO₂ concentration in ambient air.

SUMMARY OF THE INVENTION

[0009] The present invention provides a system, i.e. a method and apparatus for extracting carbon dioxide (CO₂) from ambient air and for delivering that extracted CO₂ to controlled environments.

[0010] In a first exemplary embodiment, the present invention extracts CO₂ from ambient air and delivers the extracted CO₂ to a greenhouse. Preferably, the CO₂ is extracted from ambient air using a strong base ion exchange resin that has a strong humidity function, that is to say, an ion exchange resin having the ability to take up CO₂ as humidity is decreased, and give up CO₂ as humidity is increased. Several aspects of this invention can also be used to transfer CO₂ from the collector medium into the air space of a greenhouse where the CO₂ is again fixed in biomass. In a preferred embodiment of the invention, CO₂ is extracted from ambient air using an extractor located adjacent to a greenhouse, and the extracted CO₂ is delivered directly to the interior of the greenhouse for enriching the greenhouse air with CO₂ in order to promote plant growth.

[0011] In a second exemplary embodiment, this invention allows the transfer of CO₂ from a collector medium into an algae culture, where the CO₂ carbon is fixed in biomass. The algae biomass can then be used for the production of biochemical compounds, fertilizer, soil conditioner, health food, and biofuels to name just a few applications or end-uses.

[0012] This invention also discloses transfer of CO₂ in gaseous phase and as a bicarbonate ion. In one embodiment, a calcareous algae is used which creates calcium carbonate CaCO₃ internally, and precipitates the CaCO₃ out as limestone.

[0013] Accordingly, in broad concept, the present invention extracts CO₂ from ambient air using one of several CO₂ extraction techniques as described, for example, in our aforesaid PCT/US05/29979 and PCT/US06/029238. Where a carbonate/bicarbonate solution is employed as the primary CO₂ sorbent, the CO₂ bearing sorbent may be used directly as a feed to the algae. Where the CO₂ is extracted using an ion exchange resin as taught, for example in our aforesaid PCT/US06/029238 application, the CO₂ is stripped from the resin using a secondary carbonate/bicarbonate wash which then is

employed as a feed to the algae. In a preferred alternative embodiment, the carbonate is fed to the algae in a light enhanced bioreactor.

[0014] Thus, the present invention provides a simple, relative low-cost solution that addresses both CO₂ capture from ambient air and subsequent disposal of the captured CO₂.

BRIEF DESCRIPTION OF THE DRAWINGS

[0015] Further features and advantages of the present invention will be seen from the following detailed description, taken in conjunction with the accompanying drawings, wherein

[0016] FIG. 1 is a block flow diagram illustrating the use of humidity sensitive ion exchange resins in accordance with the present invention;

[0017] FIGS. 2a and 2b are schematic views of a CO₂ extractor/greenhouse feeder in accordance with the present invention, where filter units are located adjacent an exterior wall;

[0018] FIGS. 3a and 3b are schematic views of a CO₂ extractor/greenhouse feeder in accordance with the present invention, where filter units are located adjacent to the roof of the greenhouse;

[0019] FIG. 4 is a schematic view of a CO₂ extractor/greenhouse feeder showing an arrangement of filter units according to the present invention;

[0020] FIG. 5 is a schematic view of a CO₂ extractor/greenhouse feeder showing filter units arranged on a track according to an alternative embodiment of the present invention;

[0021] FIG. 6 is a schematic view of a CO₂ extractor/greenhouse feeder including convection towers according to an alternative embodiment of the present invention;

[0022] FIG. 7 is a schematic view of a CO₂ extractor and algae culture according to the present invention utilizing a humidity swing applied to a collector medium;

[0023] FIG. 8 is a schematic view of a CO₂ extractor and algae culture according to the present invention utilizing a humidity swing applied to a collector solution;

[0024] FIG. 9 is a schematic view of a CO₂ extractor and algae culture according to the present invention transferring gaseous CO₂ by an electro-dialysis process;

[0025] FIG. 10 is a schematic view of a CO₂ extractor and algae culture according to the present invention transferring bicarbonate by an electro-dialysis process;

[0026] FIG. 11 is a schematic view of a CO₂ extractor and algae culture according to the present invention utilizing an algae culture for collector regeneration;

[0027] FIG. 12 is a schematic view of a CO₂ extractor and algae culture similar to FIG. 11 utilizing a nutrient solution;

[0028] FIG. 13 is a schematic view of a CO₂ extractor and algae culture according to the present invention utilizing a gas-permeable membrane;

[0029] FIG. 14 is a schematic view of a CO₂ extractor and algae culture according to the present invention utilizing an anion-permeable membrane;

[0030] FIG. 15 is a schematic view of a CO₂ extractor and algae culture similar to FIG. 14;

[0031] FIG. 16 is a schematic view of a CO₂ extractor and algae culture according to the present invention including a shower; and

[0032] FIG. 17 is a schematic view of a CO₂ extractor and algae culture similar to FIG. 16.

DETAILED DESCRIPTION OF PREFERRED EMBODIMENTS

[0033] In broad concept, the present invention in one aspect extracts carbon dioxide from ambient air using a conventional CO₂ extraction method or one of the improved CO₂ extraction methods disclosed in our aforesaid PCT Applications, or disclosed herein, and releases at least a portion of the extracted CO₂ to a closed environment.

[0034] In a first exemplary embodiment, this closed environment is a greenhouse. Preferably, but not necessarily, the CO₂ extractor is located adjacent to the greenhouse and, in a preferred embodiment the extractor also provides shading for crops grown in greenhouses which are sensitive to strong sunlight, and/or reduces cooling requirements for the greenhouse.

[0035] In one approach to CO₂ capture, the resin medium is regenerated by contact with the warm highly humid air. It has been shown that the humidity stimulates the release of CO₂ stored on the storage medium and that CO₂ concentrations between 3% and 10% can be reached by this method, and in the case of an evacuated/dehydrated system, close to 100% can be reached. In this approach the CO₂ is returned to gaseous phase and no liquid media are brought in contact with the collector material.

[0036] The CO₂ extractor is immediately adjacent to the greenhouse and is moved outside the greenhouse to collect CO₂ and moved into the greenhouse to give off CO₂. In such embodiment, the CO₂ extractor preferably comprises a humidity sensitive ion exchange resin in which the ion exchange resin extracts CO₂ when dry, and gives the CO₂ up when exposed to higher humidity. A humidity swing may be best suited for use in arid climates. In such environment the extractor is exposed to the hot dry air exterior to the greenhouse, wherein CO₂ is extracted from the air. The extractor is then moved into the warm, humid environment of the greenhouse where the ion exchange resin gives up CO₂. The entire process may be accomplished without any direct energy input other than the energy to move the extractor from outside to inside the greenhouse and vice versa.

[0037] Ion exchange resins are commercially available and are used, for example, for water softening and purification. We have found that certain commercially available ion exchange resins which are humidity sensitive ion exchange resins and comprise strong base resins, advantageously may be used to extract CO₂ from the air in accordance with the present invention. With such materials, the lower the humidity, the higher the equilibrium carbon loading on the resin.

[0038] Thus, a resin which at high humidity level appears to be loaded with CO₂ and is in equilibrium with a particular partial pressure of CO₂ will exhale CO₂ if the humidity is increased and absorb additional CO₂ if the humidity is decreased. The effect is large, and can easily change the equilibrium partial pressure by several hundred and even several thousand ppm. The additional take up or loss of carbon on the resin is also substantial if compared to its total uptake capacity.

[0039] There also seems to be an effect on humidity on the transfer coefficient, i.e. the reaction kinetics seem to change with changing humidity. However, the measured flux in and out of the resin seems to depend strongly on the difference between the actual partial pressure and the thermodynamic

equilibrium pressure. As the equilibrium pressure changes with humidity, the size of the flux can be affected without an actual change in the reaction kinetics.

[0040] In addition, it is possible that kinetics is affected by other issues. For example, ion exchange materials which we have found to be particularly useful, are Anion I-200 ion exchange membrane materials available from Snowpure LLC, of San Clemente, Calif. The manufacturer describes Anion I-200 ion exchange membrane material as a strong base, Type 1 functionality ion exchange material. This material, which is believed made according to the U.S. Pat. No. 6,503,957 and is believed to comprise small resin charts encapsulated—or partially encapsulated—in an inactive polymer like polypropylene. We have found that if one first hydrates this material and then dries it, the material becomes porous and readily lets air pass through. The hydration/dehydration preparation is believed to act primarily to swell the polypropylene binder, and has little or no permanent effect on the resin, while the subsequent humidity swings have no observed impact on the polypropylene binder. We have found that these strong base ion exchange resin materials have the ability to extract CO₂ from dry air, and give the CO₂ out when humidity is raised without any other intervention. The ability of these materials to extract CO₂ directly from the air, when dry, and exhale the CO₂ as humidity is raised, has not previously been reported.

[0041] As noted supra, it is necessary to first hydrate this material and then dry it, before using, whereupon the material becomes porous and readily lets air pass through. Before hydration, the membrane material is substantially non-porous, or at least it is unable to permit passage of an appreciable amount of air through the membrane. However, after hydration and drying, the material is believed to undergo irreversible deformation of the polypropylene matrix during the resin swelling under hydration. Once the material has been deformed, the polypropylene matrix maintains its extended shape even after the resin particles shrink when drying. Thus, for substantially non-porous materials such as the Snowpure Ion Exchange material above described, it is necessary to precondition the material by hydrating and then drying the material before use.

[0042] We have observed a large change in the equilibrium partial pressure of CO₂ over the resin with a change in humidity. Humidity either changes the state of the resin, or alternatively the entire system that needs to be considered is the CO₂/H₂O resin system. While not wishing to be bound by theory, it is believed that the free energy of binding CO₂ to the resin is a function of the H₂O partial pressure with which the resin is in equilibrium.

[0043] This makes it possible to have resins absorb or exhale CO₂ with a simple swing in humidity without the need to resort to thermal swing and/or pressure swing, which would add to energy costs which could have an unfavorable effect with regard to the overall carbon dioxide balance of the system.

[0044] The amount of water involved in such a swing appears to be quite small. The possibility of a humidity swing also allows us to recover CO₂ from an air collector with minimal water losses involved.

[0045] Other strong base Type 1 and Type 2 functionality ion exchange materials are available commercially from a variety of vendors including Dow, DuPont and Rohm and Haas, and also advantageously may be employed in the present invention, either as available from the manufacturer,

or formed into heterogeneous ion-exchange membranes following, for example, the teachings of U.S. Pat. No. 6,503,957.

[0046] FIG. 1 illustrates a first embodiment of our invention. A primary ion exchange filter material **4** is provided in a recirculation cycle. A primary pump **1** or a secondary pump (not shown) is used to remove the bulk of the air in the system while valve V₁ is open and push it out through the air exhaust **2**. At this point valve V₁ is closed and a secondary ion exchange capture resin is switched into the system by opening valves V₂ and V₃. The secondary ion exchange resin can be utilized to provide humidity and possibly some heat. Warm steam stimulates the release of CO₂ from the primary ion exchange filter material **4**, which is then captured on the secondary ion exchange resin which is still out of equilibrium with the CO₂ partial pressure. The volume of water in the system remains small as it is recirculated and not taken up by the secondary resin. While CO₂ is unloading from the primary ion exchange resin material **14** and being absorbed by the secondary ion exchange resin, the bulk of the water cycles through the apparatus. The amount of water that can be devolved or absorbed is much smaller than the amount of CO₂ that is transferred. At the end of the cycle the primary ion exchange filter material **14** is refreshed and the secondary ion exchange capture resin is loaded with CO₂.

[0047] This system could be used to transfer CO₂ from the air capture medium, e.g. an ion exchange resin onto a secondary resin without washing or wetting the primary resin. This has two advantages. First, the primary resin is not directly exposed to chemicals such as amines that were used in the past and described in our aforesaid PCT Application PCT/US061/029238. Second, we have seen that wet resins are ineffective in absorbing CO₂ until they have dried out. It is therefore advantageous to avoid the wetting of the material and thus operate in this fashion where the resin is washed with low-pressure steam. Steam pressures could be less than 100 Pa and thus be saturated at temperatures similar to ambient values. However, the CO₂ exchange is obviously accelerated at higher temperatures and higher steam pressures. The disadvantage of raising temperatures would be additional energy consumption.

[0048] The design outlined here is a special example of a broader class of designs where the secondary resin is replaced with any other sorbent material that is capable of absorbing CO₂ without absorbing water. Such sorbents may include liquid amines, ionic liquids, solid CO₂ sorbents such as lithium zirconate, lithium silicate, magnesium hydroxide or calcium hydroxide, or any of a wide class of chemical or physical sorbents capable of absorbing CO₂ from a gas mixture including water vapor and CO₂. The central concept is that of using a humidity swing, rather than a pressure or temperature swing to remove CO₂ from the primary sorbent without bringing it in direct physical contact with a secondary sorbent.

Application in a Greenhouse for Improving Crop Yields

[0049] As noted supra, crop yield in greenhouses can be improved by increasing the carbon dioxide level in the greenhouse air. The present invention provides for the introduction of carbon dioxide into a greenhouse without combusting fuels emitting fossil fuel CO₂ into the air. More particularly, we have found that we can employ humidity sensitive ion exchange resins to capture CO₂ from dry outside air, and then release the CO₂ into the greenhouse by exposing the resins to the warm moist greenhouse air.

[0050] In greenhouses located in warm in desert climates such as found in the Southwest United States, the outside CO₂ loading may be performed at night when outside temperatures are cooler which may enhance CO₂ uptake capacity. In cooler climates where greenhouses rely in part on radiative heating, our system of CO₂ loading avoids the need to let in cold air to replenish the CO₂ and thus reduces the need for heating employing fossil fuel consumption until temperatures drop so low that fuel based heating becomes necessary.

[0051] In one embodiment, we employ several filters made from humidity sensitive ion exchange active material. In one part of the cycle the filters are exposed to outside air that could be driven by natural wind flow, by thermal convection, or fans. It is preferable to avoid fans as they add an unnecessary energy penalty. In a second part of the cycle, moist air from inside the greenhouse preferably is driven through the filter material, e.g. by fans, which then releases CO₂ into the greenhouse atmosphere. Since the climate control of the greenhouse typically will rely on a fan system anyway, there is little or no energy penalty.

[0052] Since plants at night respire, in some greenhouse designs it is possible to strip the CO₂ from the greenhouse air by pulling the greenhouse air through the filters. The filters can then be exposed to higher humidity to facilitate the daytime release of the CO₂ into the greenhouse.

[0053] In one embodiment, as shown in FIGS. 2A and 2B, the filter units 10 are located adjacent an exterior wall 12 of a greenhouse, and outside air or greenhouse air routed selectively therethrough, as the case may be, via pivotally mounted wall panels 14. Alternatively, as shown in FIGS. 3A and 3B, the filter material 10 may be located exterior to and adjacent the roof 18 of the greenhouse, and outside air or greenhouse air routed selectively therethrough, as the case may be, via pivotally mounted roof panels 20.

[0054] In yet another embodiment of the invention, shown in FIG. 4, the filter units 10, can be moved from outside the greenhouse where they extract CO₂ from the air to inside the greenhouse where they release the captured CO₂. One possible option for doing this is to have filter units mounted to pivotally mounted wall or roof panels 22 which can be reversed so that a filter unit on the outside of the greenhouse is exposed to the inside of the greenhouse and vice versa. Filter units that are inside the greenhouse can have air blown through them by a fan system. Filter units on the outside are exposed to ambient air. In a preferred embodiment, shown in FIG. 4, the filter units 10 on the outside are located adjacent the bottom end of a convection tower 24 that is solar driven. Preferably the inlets are installed at the bottom end of the convection towers where cool air enters and flows up the towers through natural convection.

[0055] In yet another embodiment, shown in FIG. 5, the filter units 10 are moved in and out of the greenhouse, e.g. suspended from a track 26.

[0056] Referring to FIG. 6, yet another option for a greenhouse is to locate convection towers as double glass walls on the outside of the greenhouse, and use the convection stream generated to collect CO₂ on the outside. The double walls also serve to reduce the heatload on the interior during the day and thus reduce the need for air exchange which in turn makes it possible to maintain an elevated level of CO₂ in the greenhouse. The double glass walls also reduce heat loss during the night.

[0057] In this example a protective glass surface 40 may be provided to keep some of the heat away from the main roof of

the glass house 42, causing a convective flow 44 of ambient air over the roof surface. The flow of ambient air is passed through a CO₂ absorbing filter medium 46, which can be by some mechanism, such as a rotating roof panel 48, exchange places with a second like filter medium 50, where the air driven by fan 52 on the inside of the greenhouse is passed through the filter medium which gives up the CO₂ captured when the filter medium was exposed to ambient air outside the greenhouse. Because the air inside the greenhouse is moist, the CO₂ readily is released from the filter medium, and adds to the CO₂ available in the greenhouse.

[0058] An advantage of such a unit is that it could operate at elevated levels of CO₂ without combusting fuels. Because CO₂ is delivered to the inside of the greenhouse without blowing air into the greenhouse, this offers a possibility of reducing the exchange of air between the outside and the inside of the greenhouse, thus improving the heat management and moisture management of the greenhouse.

[0059] In a second exemplary embodiment of the invention, the CO₂ is extracted and delivered to an algal or bacterial bioreactor. This may be accomplished using conventional CO₂ extraction methods or by using an improved extraction method as disclosed in our aforesaid PCT applications or disclosed herein; e.g., by a humidity swing. A humidity swing is advantageous for extraction of CO₂ for delivery to algae because the physical separation allows the use of any collector medium without concern about compatibility between the medium and the algae culture solution. Transfer of gaseous CO₂ allows for the selection of any algae species, including macro and microalgae, marine or freshwater algae. Therefore, the selection of algae species to be grown could be solely dependent on environmental factors and water quality at the collector site. For example, the algae species to be used could be selected from algae naturally occurring at the site, which are uniquely adapted to the local atmospheric, environmental and water quality conditions.

[0060] There are two major advantages of transferring captured CO₂ in gaseous form. The first advantage is that the collector medium and/or the collector regeneration solution will not contact the algae culture solution and/or algae. The second is that all species of algae are capable of absorbing gaseous CO₂.

[0061] Depending on the CO₂ tolerance of particular algae cultures, the CO₂-enriched air can be pumped successively through several algae cultures in order of decreasing CO₂ tolerance and increasing CO₂ uptake efficiency. Alternatively the air can be diluted to the optimum CO₂ concentration.

[0062] Referring to FIG. 7, one embodiment of the present invention takes advantage of the fact that gaseous CO₂ can be driven off the collector medium using a humidity swing. The humidity swing will transfer captured CO₂ as gaseous CO₂ from the collector 110 into the algae culture 116. An ion-exchange collector medium loaded with CO₂ will emit gaseous CO₂ when subjected to an increase in humidity or when wetted with water. And the collector medium will absorb more gaseous CO₂ when the humidity of the CO₂-supplying gas stream is decreased and/or the collector medium dries.

[0063] The present invention provides a common headspace above the collector medium and the algae culture. This exposes the algae to gaseous CO₂ while physically separating the collector medium from the algae culture solution. The headspace will be sealed from ambient air. The humidity is then raised in the closed headspace volume. Alternatively, the collector medium may be wetted. The CO₂ emitted from the

collector medium quickly diffuses through the entire headspace and contacts the algae culture solution surface.

[0064] The CO₂ is then transferred into the algae culture either via gas diffusion or by bubbling the headspace gas through the algae culture solution using a recirculating pump. As the algae removes the CO₂ from the headspace, the collector medium continues to offgas until equilibrium is reached. The algae culture solution can be mechanically stirred. All other nutrients and light are provided to the algae as needed. The algae may then be collected in an algae harvester **120**.

[0065] CO₂ concentrations in the headspace above wetted collector medium are up to 20%; or 0.2 atmosphere partial pressure. The concentration can be regulated by the volume to volume ratio of collector medium to headspace. Also the collector medium can release 60% of the captured CO₂ during a humidity swing/wetting.

[0066] Alternatively, it is also possible to pump gas from the collector medium volume through the algae culture in order to transfer the CO₂. If the algae pond is warm and moist the moisture from the algae pond may be sufficient to stimulate the release of CO₂ from the dry resin, again by the humidity swing mechanism.

[0067] Referring to FIG. 8, in another embodiment of the present invention CO₂ concentrations in ambient air can saturate the ion-exchange medium with CO₂ to the level that the CO₂ is bound as bicarbonate anion. This embodiment provides regeneration of the collector medium using an alkaline solution. During the regeneration, the anion composition in the solution is changed to approximately 100% bicarbonate. Aqueous bicarbonate solution is not stable under atmospheric conditions and releases gaseous CO₂. Gaseous CO₂ emission can be enhanced by bubbling the headspace air through the solution using a recirculating pump.

[0068] An alternative embodiment provides a common headspace above the collector regeneration solution and the algae culture solution. This exposes the algae to gaseous CO₂, while separating the regeneration solution from the algae culture solution. In other aspects, this headspace operates similar to the headspace for the collector medium, as discussed above.

[0069] Referring to FIG. 9, another alternative embodiment of the present invention uses an electro dialysis (ED) process to free gaseous CO₂ from the loaded collector solution. The freed CO₂ is then transferred into an algae culture **216**. The transfer of gaseous CO₂ from the collector **210** to the algae culture **216** through an electro dialysis (ED) process has the advantage that the collector solution or sorbent and algae culture solution are physically separated from each other at all stages of the process. This prevents the mixing of the two solutions and also prevents ion exchange between the solutions. The ED process has this in common with the humidity swing process. And as in the humidity process, the physical separation allows the use of any collector medium and any algae without regard to compatibility between the medium and the algae culture solution.

[0070] An alternative embodiment of the invention takes advantage of the fact that gaseous CO₂ can be driven off the collector regeneration solution using an ED process. In the ED process the loaded collector regeneration solution is split into two streams to enter the ED cell **214**. Protons are added to the first stream across a secondary membrane **236** and the inorganic carbon is driven off as gaseous CO₂, while the sodium cations are transferred through a cationic membrane

234 into the second stream. In addition to the sodium ions, hydroxide ions are added to the second stream across another secondary membrane **236** thus neutralizing the bicarbonate in this stream to carbonate.

[0071] The first stream exits the ED cell as water or dilute sodium bicarbonate solution while the second stream exits as a concentrated sodium carbonate solution. The two streams are combined to form fresh collector solution. The gaseous CO₂ that is driven off the first stream is bubbled into the algae culture and is fixated as biomass.

[0072] As inorganic carbon is removed from the brine, the solution turns more alkaline and additional bicarbonate needs to be added to maintain the pH. Filtration allows us to recover some of the fluid and thus return water and sodium from the bioreactor. In one particular implementation the electrochemical cell will run between two separate fluid cycles, one fairly alkaline which runs between the collector and the base side of the electrochemical cell, and the other which runs at near neutral pH between the algae-reactor and the acidic side of the cell. Carbonic acid is transferred from the base side to the acid side of the cell. This step regenerates the wash and reloads the fluid with CO₂.

[0073] By feeding the bicarbonate sorbent to the algae, CO₂ can be removed from the sorbent without first converting the CO₂ back to CO₂ gas. Moreover, by selection of suitable sorbent material for the air capture side, the pH of the washing fluid can be kept relatively low, and if one uses algae that can tolerate a relatively high pH, the pH difference that needs to be made up by electro dialysis becomes relatively small, and in some implementations one can completely eliminate the dialysis cell.

[0074] Referring to FIG. 10, another embodiment of the present invention uses an ED process to decrease the bicarbonate concentration in the collector solution and to increase the bicarbonate concentration in the algae culture solution. The collector solution enters the ED cell **214** in the bicarbonate state, while the algae culture solution enters the ED cell in the carbonate state. When the fluids exit the ED cell, the collector solution is in the carbonate state and the algae culture solution is in the bicarbonate state.

[0075] Since cations are transferred from the algae culture solution to the collector solution, the algae culture solution is diluted to roughly half its normality, while the collector solution roughly doubles its normality. To make up for the sodium imbalance, half of the loaded collector solution (bicarbonate form) is transferred directly from the collector to the algae culture.

[0076] In a process scheme according to the present invention, cations are transferred from the algae solution into the collector solution through a cation exchange membrane **234**. The algae culture solution contains predominantly sodium cations, but also potassium, magnesium and calcium ions as well as traces of other metal cations. The potential transfer of magnesium and calcium is of concern, since both ions form fairly insoluble carbonates and hydroxides. The formation of these salts, also known as scaling, can foul up the membranes in the ED cell and/or the collector medium.

[0077] Calcium and magnesium are added to the algae culture as mineral nutrients, at the start of an algae growing cycle. As the algae biomass increases calcium and magnesium are taken up into the biomass and their concentration in the algae culture solution decreases. Simultaneously, the culture solution pH increases as the bicarbonate solution is changed into a carbonate solution. If magnesium, calcium

and carbonate ions are present above their solubility products, chemical precipitation will further decrease the magnesium and calcium ion concentrations.

[0078] The exhausted culture solution with decreased calcium and magnesium concentrations and a high pH is entered into the ED cell. There the culture solution is changed from a carbonate into a bicarbonate solution and its pH decreases accordingly. As the carbonate ion concentration decreases, the solution can hold more calcium and magnesium. So scaling is unlikely to happen in this part of the ED cell.

[0079] However, at the same time, cations including calcium and magnesium are transferred from the algae culture solution **216** to the collector solution half-cell of the ED. In this half-cell, the bicarbonate solution coming from the collector is changed into a carbonate solution: the carbonate concentration and the pH increase. Further, excess H₂O may be removed from the bicarbonate solution using an osmosis cell **224**.

[0080] The process is designed such that the pH of the exiting collector solution is close to the pH of the incoming algae solution. Therefore, scaling should not occur as long as everything is in balance. However, to keep perfect balance may not always be practical on the macro scale, and it may be impossible on the micro scale within the ED cell. It is possible that micro layers or pockets with increased hydroxide or cation concentrations are formed at the membrane surfaces. Increased concentrations at the surface of the membranes might cause scaling in the collector solution half-cell.

[0081] To minimize scaling, the flux of calcium and magnesium cations has to be minimized. This is a problem well known in the manufacture of salt from seawater, sodium hydroxide manufacture, and in processing of skim milk by electro dialysis (T. Sata, 1972; T. Sata et al., 1979, 2001; 3. Balster, 2006). To minimize flux, the cationic membrane that separates the two half-cells has to be monovalent ion selective. In general, strong acid cation exchange membranes show larger transport numbers for divalent than monovalent ions. It is assumed that this is due to higher electrostatic attraction with the negatively charged fixed ion exchange sites. The prior art has shown that transport numbers for divalent cations decrease with lower charge density on membranes.

[0082] Two commercially available highly monovalent cation selective membranes have been identified as particularly suited for this process. One membrane is manufactured by Asahi Glass and is traded under the name Selemion CSV. The second is manufactured by Tokuyama Soda and is sold under the name Neosepta® CIMS. The transport numbers (t) for Selemion CSV are: t(Na)<0.92 and t(Ca, Mg)<0.04. The transport numbers for Neosepta CIMS are t(Na,K)=0.90 and t(Ca, Mg)=0.10. The transport numbers are defined as the equivalence flux of the cation divided by the total equivalence flux during electro dialysis.

[0083] This aspect of the invention uses a monovalent cation selective membrane to minimize the transfer of multivalent cations from the algae culture solution into the collector regeneration solution. Any scaling built up with time, will be removed using an acid solution.

[0084] Both the algae culture solution as well as the collector solution will be filtered before entering the ED cell to avoid membrane fouling with particles. Organic molecules will be scavenged from the algae culture solution by means of organic scavenging ion exchange resins.

[0085] Referring to FIG. 11, in another embodiment of the present invention the CO₂ captured from air is transferred to

the algae by feeding the loaded collector solution **310** to the algae. The loaded collector solution is enriched in sodium bicarbonate. Nutrients are added to the collector solution and it becomes the feed stock for algae. In this embodiment of the invention the solution feed is not recycled, so that the collector solution becomes a consumable.

[0086] In this process the algae culture solution **316** would increase in salt content as more and more sodium bicarbonate is added. The sodium bicarbonate is changed into carbonate during algae growth. To lower the carbonate concentration and to slow the salting, some of the remaining nutrients can be added as acids instead as sodium salts, which will convert carbonate ions to bicarbonate and minimize the addition of sodium.

[0087] Alternatively, the sodium bicarbonate sorbent is fed directly to an algae-reactor to supply the algae with CO₂, and the algae is removed for further processing, with the sodium carbonate being returned to the air extraction station.

[0088] Many algae can utilize bicarbonate as their carbon source. Also, some algae prefer bicarbonate over CO₂ as their carbon source. These are often algae that are indigenous to alkaline lakes, where inorganic carbon is predominantly present as bicarbonate. These algae can tolerate large swings in pH of 8.5 up to 11. Other algae can utilize HCO₃⁻ as their carbon source, but require pH ranges below pH=9, which would require bubbling CO₂ through the bicarbonate/carbonate solution.

[0089] Algae use the carbon source to produce biomass through photosynthesis. Since photosynthesis requires CO₂ not bicarbonate, the algae catalyze the following reaction:

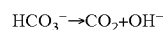

[0090] In the presence of HCO₃⁻, this becomes:

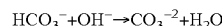

[0091] Algae growth in a bicarbonate solution induces the following changes in the solution: (1) a decrease in HCO₃⁻ concentration; (2) an increase in CO₃²⁻ concentration; and (3) an increase in pH.

[0092] Another embodiment the present invention uses an algae culture solution for collector regeneration. The collector medium in the carbonate form can absorb gaseous CO₂ from ambient air until the anion composition of the medium is nearly 100% bicarbonate. In this state the collector medium is fully loaded and CO₂ absorption comes to a halt. A carbonate solution can be used in regeneration to return the loaded collector medium to a carbonate form through ion exchange. The anion composition of the regeneration solution can be changed from 100% carbonate to nearly 100% bicarbonate through anion exchange with the fully loaded collector medium. In a counter-flow regeneration process the collector medium can be brought into a carbonate form, while the carbonate regeneration solution is changed into a bicarbonate solution. The regeneration solution is fully loaded when it is in the bicarbonate form, since it cannot remove any more bicarbonate from the collector medium.

[0093] The algae are introduced into the process to remove the captured CO₂ from the loaded regeneration solution by bicarbonate dehydration and neutralization (see above). The algae utilize the freed CO₂ for biomass growth. And the regeneration solution is changed from bicarbonate back into a carbonate solution.

[0094] In this process, the carbonate regeneration solution and the collector medium are recycled, while ambient air CO₂ is changed into algal biomass. This is shown in FIG. 11.

[0095] This process provides a cycle in which the ion exchange collector medium absorbs air CO₂. During the absorption the collector medium changes from carbonate to bicarbonate form. Then the regeneration solution pulls the air CO₂ from the loaded collector medium. In this exchange the collector medium is changed back into its carbonate form, while the regeneration solution changes from a carbonate to a bicarbonate solution. Finally, the algae remove the air CO₂ from the loaded regeneration solution by fixating it into biomass. In this step, the algae catalyze the reaction from bicarbonate to CO₂ and carbonate. The CO₂ carbon is bound into the algae biomass. The carbonate is left in solution. The resulting regeneration solution is then in carbonate form.

[0096] In another embodiment of the present invention, the algae culture solution is used as the collector regeneration solution. This means that the collector regeneration solution will in addition to carbonate contain other nutrients as required for the algae. Amongst these nutrients are anions that will compete with the carbonate anion during ion exchange with the collector medium.

[0097] In this process diatoms will not be used, since they require silica, which cannot be efficiently removed from the collector medium with a carbonate wash.

[0098] Other anionic nutrients typically found in algae culture mediums are: nitrate (NO₃⁻), sulfate (SO₄⁻²), and phosphate (PO₄⁻³). Phosphorus may also be present as dibasic (HPO₄⁻) or monobasic phosphate (H₂PO₄⁻) depending on pH.

[0099] Nitrate, sulfate and phosphate concentrations for typical algae culture mediums are:

Nutrient	Bold's Medium Molarity (M)	Zarouk's Medium Molarity (M)
NaHCO ₃		0.2
NaNO ₃	0.00882	0.029
Mg SO ₄ —7H ₂ O	0.0003	0.0008
Fe SO ₄ —7H ₂ O		0.0018
K ₂ SO ₄		0.0058
Total S	Σ = 0.0003	Σ = 0.0084
K ₂ HPO ₄	0.00043	0.0029
KH ₂ PO ₄	0.00129	
Total P	Σ = 0.00172	Σ = 0.0029

[0100] However, the prior art has shown that algae can grow at much lower nutrient concentrations than are contained in typical culture mediums.

[0101] To estimate the effect of the nutrient concentrations on the collector medium a nutrient-containing regeneration solution was mixed as follows: 0.14 M CO₃⁻², 0.04 M NO₃⁻, 0.0017 M SO₄⁻² and 0.0017 M H₂PO₄⁻. These represent the highest concentrations to be found in an algae culture medium and, therefore the worst-case scenario.

[0102] The collector medium was then flushed with this 'worst-case' solution until equilibrium was reached between the solution and the collector medium. At the pH of carbonate solution, phosphorus is present as dibasic phosphate (HPO₄⁻²). Dibasic phosphate is basic enough to absorb CO₂. Therefore, the presence of dibasic phosphate anions on the collector medium will not lower the medium's CO₂ uptake capacity. It was determined that at equilibrium, about 50% of the collector medium's total exchange sites were occupied by carbonate and phosphate ions and 50% by nitrate and sulfate.

Although the other nutrients outnumber carbonate, they do not completely replace it; instead, an anion equilibrium is reached that does not change with application of additional volumes of solution to the collector medium.

[0103] The experiments showed that in a worst-case scenario, the collector medium loses approximately 50% of its CO₂ uptake capacity. However, as determined by the research cited above, the nutrient concentrations in the solution can be depleted significantly during algae growth. For example, nitrate being by far the most abundant nutrient after inorganic carbon, can be reduced to 0.002 M, a mere 5% of the concentration used in the worst-case scenario experiment. And phosphate is reduced to 45% of the worst-case scenario.

[0104] Further, a collector medium washed with a nutrient-depleted solution will lose about 20% of its CO₂-uptake capacity. It is therefore possible to use the collector medium and wash it with a carbonate solution that has been derived from the algae growth medium.

[0105] The algae will secrete or release organic compounds into the solution during metabolism or decay. These organics will be scavenged from the solution, prior to applying the solution to the collector medium. Organics scavenging may be done with an adsorbent-type ion exchange resin or other processes.

[0106] Diatoms will not be used in this process, since they require silica, which cannot be efficiently removed from the collector medium using a carbonate wash.

[0107] A preferred algae for the present embodiment will have the following characteristics: they are adapted to high ionic strength liquids; they can grow in a pH range of 8.5 to roughly 11; they can tolerate a gradual pH change; they can use bicarbonate as their carbon source; they need little silica as a nutrient; they are capable of changing the pH of a solution from 8.5 to 11 or above; they can diminish nutrient concentrations to low levels; they can be used in biochemistry, agriculture, aquaculture, food, biofuels, etc.

[0108] Good candidates are, but are not limited to, algae that live in alkaline waters such as *Spirulina platensis*, *Spirulina fusiformis*, *Spirulina* sp., *Tetraedron minimum* and others.

[0109] There are many alternatives for this embodiment. Loaded collector solution (bicarbonate solution depleted in nutrients) is added to an algae culture together with fresh nutrients; the algal culture utilizes bicarbonate as its inorganic carbon source, by taking up about 50% of the bicarbonate carbon into its biomass and changing the remaining 50% to carbonate anions. Simultaneously, the algae culture depletes the nutrient concentrations in the solution. The culture is filtered, harvesting the algae biomass, while shunting the nutrient depleted solution towards the CO₂ collector. The nutrient depleted solution is cleaned of organics and other materials deleterious to the collector medium. The solution now enriched in carbonate is used to regenerate the collector. In the process each carbonate anion is replaced by two bicarbonate anions, until the collector solution is loaded. The loaded collector solution is added to the algae culture together with fresh nutrients as mentioned above.

[0110] The process can be run as a continuous loop or a batch process, whichever is more practical given location, algae type, etc. The process can employ algae culturing technologies already in use and proven or new technologies. For example, outdoor ponds have proven successful for the cultivation of *Spirulina*, *Chlorella vulgaris*, *Ankistrodesmus braunii* and other species in California, Hawaii, the Philip-

pinus and Mexico among other places. According to the National Renewable Energy Laboratory (NREL), outdoor ponds, e.g. so-called "race ponds", are the most efficient methods for growing a large biomass of algae.

[0111] The cultivation may use solar energy, artificial lighting or both dependent on the algae species and the place of operation. Algae culture solutions may be stirred to return algae to the zone of highest light ingress. Or the light might be brought into the algae cultures through mirrors, fiber optics and other means.

[0112] The algae can be either suspended in solution or immobilized. When suspended, algae follow their own growth patterns: single cells, colonies, clumped and so on. The natural growth pattern may not be the best match for the technology used. For example, small single celled algae may require elaborate harvesting processes.

[0113] Algae may naturally grow immobilized, if they attach themselves to surfaces, e.g., macro algae. Or algae can be immobilized: in beads using k-carrageenan or sodium alginate, in polyurethane foam, on filter material, or as biofilms on column packing, or in other ways.

[0114] In an immobilized state, the algae may still be suspended, for example in bead form, and moving with the solution. Alternatively, the immobilized algae may be stationary in a column or other device, while the solution percolates past.

[0115] In another embodiment of the present invention, the collector medium is immersed into the Algae Culture. This can be done either in a batch process or in a continuous process. In a batch process, a batch of collector medium is alternately immersed in the algae culture and exposed to ambient air. In a continuous process, collector medium is continuously moved along a path on which it is alternately immersed in the algae culture or in exposed to air. The easiest implementation would be a disk of collector medium that rotates continuously around its center. The disk is submerged up to its center point in the algae culture, so that, at any time, one half of the collector medium is submerged in the liquid and the other half is exposed to air.

[0116] In this embodiment of the invention, collector medium could potentially be immersed in the algae culture solution at times of high nutrient content and at times of low nutrient content. The CO₂ capacity of the collector medium will, therefore, range from 50% to 80% of its full capacity. Air exposure times can be adjusted to account for the capacity decrease.

[0117] Referring to FIG. 12, another embodiment of the present invention discloses sodium bicarbonate transferred from the collector solution to the algae by washing the algae in the loaded collector solution. However, nutrients will not be added to the collector solution. Instead, nutrients will be provided to the algae via a second separate wash cycle consisting of nutrient-rich carbon deficient solution.

[0118] In this process the algae will be immersed in nutrient-deficient bicarbonate solution (loaded collector solution) alternating with inorganic carbon-deficient nutrient solution 326. A short rinse cycle will be employed between washes. The rinse will be added to the solution of the preceding wash.

[0119] The cycles of nutrient and bicarbonate washes will be optimized for the algae species used. One or more algae species may be used either mixed or in series to optimize the conversion of the bicarbonate solution (loaded collector solution) to carbonate solution (fresh collector solution). The fresh collector solution may be filtered to remove particles

and cleaned of organic molecules or other deleterious content prior to application on the collector medium.

[0120] The process can be designed to utilize suspended algae or immobilized algae. If the algae are suspended, the process has to be run as a batch process, and the algae have to be filtered from the solution. To ease filtering the algae may be "immobilized" in suspended beads, in order to increase the particle size.

[0121] A process involving immobilized algae can utilize algae that naturally grow immobilized, for example macro-algae that attach themselves to surfaces, or micro-algae that form biofilms etc.

[0122] In addition to others methods disclosed elsewhere in this application, the algae could be immobilized in columns, inclined raceways, ponds or other containers. The containers may be arranged to allow gravitational fluid flow. Immobilization may be on the container walls and floors and/or on structures such as plates, packing etc. installed therein. Light is brought into the containers as needed either by natural lighting, artificial lighting, mirrors, fiber optics, etc.

[0123] Referring to FIG. 13, another embodiment of the present invention transfers gaseous CO₂ from the loaded collector solution 410 to the algae culture solution 416 through a hydrophobic microporous membrane 434. Gaseous CO₂ can be transmitted from a bicarbonate solution through a hydrophobic membrane into a carbonate solution; and that the CO₂ partial pressure differential between the two liquid streams is sufficient to drive the transfer. A transfer of water was noted from the more dilute solution to the more concentrated solution. As the membrane is hydrophobic, the transfer is of gaseous water molecules.

[0124] Simplified, the process can be described as two half-cells separated by a microporous, hydrophobic membrane. The first half cell 438 holds the loaded collector solution (sodium bicarbonate solution); while the second half cell 418 holds the algae culture (sodium carbonate solution including nutrients and algae).

[0125] The collector solution half-cell reaction is defined as follows:

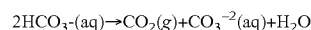

This is followed by CO₂(g) diffusion through membrane into the algae culture half-cell. The reaction in the algae culture half-cell will follow in one of two ways:

[0126] Algae consume CO₂(g)

[0127] or

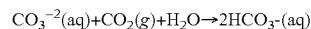

and

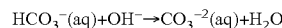

[0128] As can be seen from the half-cell reactions, the pH in the collector solution will continuously increase as bicarbonate is reacted into carbonate through off-gassing of gaseous CO₂. In a balanced system the algae culture solution will not change its pH as the gaseous CO₂ is fixated by algae growth into biomass. The algae culture will preferably be close to a carbonate solution. In that case, it would not contain appreciable amounts of bicarbonate. This condition would maximize the gaseous CO₂ partial pressure differential between the collector solution and the algae culture.

[0129] The physical arrangement of the two half-cells can take many forms including but not limited to the few arrangements described herein. Each arrangement will optimize the

ratio of liquid-membrane contact area to solution volume. In general it is advantageous to run the collector solution through membrane channels submerged in the algae culture, since this will enable light supply to the algae culture. In cases where the algae culture is contained in membrane conduits, light will be supplied inside the conduits.

[0130] The membrane conduits can take many shapes. For example, they can be parallel membrane sheets, causing a sheet flow of solution sandwiched between the membranes. Or they could be tubular with the tube cross-section taking varying forms, for example round, square, rectangular, corrugated, etc. Tubes could form a spiral or other shapes to increase their path length through the solution.

[0131] The process can be run as a batch procedure, a continuous loop process or any combination thereof. Light and nutrients will be supplied as needed.

[0132] In a pure batch process, a batch of loaded collector solution is brought in membrane contact with a batch of algae culture and left to reach equilibrium.

[0133] In a pure continuous loop process both solutions flow in continuous loops. The loaded collector solution would flow along a membrane path, throughout which it transfers its gaseous CO₂ to the algae solution; from there it enters the regeneration system for the collector medium, where it loads up with CO₂ to then reenter the membrane conduit. The algae solution will flow past the membrane path with algae fixating the gaseous CO₂; from there it will enter a harvesting system **420**, where some or all algae are removed from the solution to then reenter the membrane system for renewed CO₂ fixation and algae growth. Continuous flow or loop processes may use concurrent flow or counter-current flow of the two streams.

[0134] The major advantage of transferring the CO₂ through a hydrophobic membrane is that ions cannot cross from the algae culture into the collector solution. The cations contained in the algae solution include earth alkali metals that can cause scaling along the collector solution path as the pH increases. The anions, such as nitrate and sulfate, contained in the algae solution compete with carbonate on the collector medium thus lowering the CO₂ holding capacity of the collector medium. Therefore, it is advantageous to keep the ions from entering the collector solution. Since ions, which constitute the nutrients for the algae, cannot cross into the collector solution, the nutrient content of the algae culture can be permanently kept at the optimum concentration for algae growth.

[0135] In addition, the prior art discloses hydrophobic membranes that are also organophobic and can impede the transfer of organic molecules from the algae solution to the collector solution. Any organics that may be transferred into the collector solution will be removed from the collector solution before it enters the collector medium. For example, this can be done by scavenging the organic compounds onto ion exchange resins.

[0136] The membrane will be selected for its hydrophobicity, CO₂ permeability, organophobicity, and water breakthrough pressure. The preferred algae for this process are those that thrive in carbonate solutions and can both utilize gaseous CO₂ and bicarbonate. However, other algae can also be used to optimize the complete process.

[0137] Referring to FIG. **14**, another embodiment of the present invention transfers bicarbonate from the collector solution **410** into the algae culture solution **418** through an anion permeable membrane. The collector solution is brought into contact with one side of the anion permeable membrane

434, while the algae culture solution is brought into contact with the other side of the membrane.

[0138] The solutions exchange anions along concentration gradients. To optimize this ion exchange, the solutions can be run past the membrane in a counter-current. The solutions can also be run co-current to optimize other parts of the system. Alternatively, the process can be set up as a batch process rather than a continuous flow process.

[0139] The algae culture solution can be entered into the anion exchange process with algae suspended in the solution or without the algae. See FIG. **15**. Dissolved organic compounds can be removed from the algae culture solution prior to entering the membrane chamber.

[0140] Nutrient effects apply as discussed above. If the whole algae culture including algae is entered into the membrane exchanger, the nutrient concentration will be high and the collector solution will gain high nutrient concentrations. This may lead to a reduction in the collector medium's CO₂ uptake capacity of up to 50%. If the culture solution without algae is entered into the membrane exchanger, the process can be set up such that nutrient-depleted solution is entered, in which case the collector capacity might be reduced by up to 20%.

[0141] Cations will not be exchanged between the two solutions, which greatly reduces the potential for scaling.

[0142] Alternatively, one can inject captured CO₂ directly into an algae-bio-reactor synthetic fuel production unit. A particularly simple design is to provide a paddle wheel or disks or the like carrying humidity sensitive ion exchange resins that are exposed primarily above the water surface where CO₂ is extracted from the air, and are slowly rotated to dip a portion under the water surface where the CO₂ is released to provide high air-to-water transfer rates for the CO₂.

[0143] Referring to FIG. **16**, in another embodiment it is possible to shower an ion exchange resin with slightly alkaline wash water at an extraction station **140**, similar to the first exemplary embodiment, to make up evaporative or production losses of water from the bioreactor. As the wash water trickles over the primary resin, it will pick up bound CO₂ and dribble it into the bioreactor system **142**.

[0144] Alternatively, as shown in FIG. **17**, resins **142** may be added to the water at night to retain the CO₂ that may be lost from the algae due to respiration. Thus we can improve the CO₂ uptake efficiency of the algae, by preventing the release of nighttime CO₂ from the bioreactor. In such embodiment, a secondary resin acts as a carbon buffer in the system. At night this buffer stores the CO₂ released by the algae, while during the day it provides CO₂ to the algae, while its CO₂ content may be supplemented by the CO₂ that is collected by the air collector. Once captured, the CO₂ is transferred to the resin from a more concentrated wash used in regenerating the primary resin. Water filtration to keep algae out of the air collector generally is not a problem due to the fact that the air-side primary resin is designed to completely dry out in between cycles.

[0145] This transfer to the secondary resin also could be accomplished without direct contact in a low-pressure closed moist system, such as shown in FIG. **1**, by performing a humidity swing that avoids direct contact with the water. While such a system loses the aforementioned advantage of not bringing CO₂ back to the gas phase, it will have other advantages in buffering the algae pond at a constant pH, without the use of chemicals.

[0146] In a preferred embodiment of the invention, as seen in FIG. 18, in order to reduce water losses, increase yield, and better confine the algae, we employ bioreactors 150 with light concentrators 152. Such systems may be built from glass tubes surrounded by mirrors, or mirror or reflector systems that feed into fiber optic light pipes that distribute the light throughout a large liquid volume. The advantage of the use of a bioreactor with light concentrators is that they greatly reduce the water surface and thus reduce water losses. Thus, the CO₂ can be collected nearby without directly interfering with the algae reactors. Indeed air collectors could take advantage of mirror systems for guiding air flows.

[0147] Algae typically fixate CO₂ during times of light influx, and respire CO₂ during dark cycles. The CO₂ is captured by adding additional collector medium to the system in strategic places. The collector medium can, for example, be immersed in the algae culture. In this case, it will store bicarbonate and release carbonate during respiration as the culture solution pH decreases, and it will release bicarbonate and store carbonate during photosynthesis as the culture solution increases in pH.

[0148] Collector medium can also be placed in the air space in proximity of the algae culture to absorb CO₂ that has been released from the culture solution. This will be especially efficient in closed structures. Collector medium placed in the proximity of the culture solution will be regenerated using one of the processes described above.

[0149] This application is intended to include any combination of the inorganic carbon transfer methods described in this patent using any combination of algae cultures as required to optimize the process. Optimization includes but is not limited to optimization of the carbon transfer efficiency, carbon transfer rate, market value of the biomass (for example oil content, starch content etc.), algae productivity efficiency, and algae growth rate under any climate conditions or climate-controlled conditions.

[0150] While the invention has been described in connection with a preferred embodiment employing a humidity sensitive ion exchange resin material for extracting CO₂ from ambient air and delivering the extracted CO₂ to a greenhouse by humidity swing, advantages with the present invention may be realized by extracting carbon dioxide from ambient air using a sorbent in accordance with the several schemes

described in our aforesaid PCT Application Nos. PCT/US05/29979 and PCT/US06/029238 (Attorney Docket Global 05.02 PCT), and releasing the extracted CO₂ into a greenhouse by suitably manipulating the sorbent.

1-46. (canceled)

47: An apparatus for the capture of CO₂ from air comprising an anion exchange material that captures CO₂ from a flow of air and from which captured CO₂ is releasable by wetting or a swing in humidity; a wetting source; and a pressure source or a heat source that facilitates release of said captured CO₂.

48: The apparatus of claim 47, wherein said anion exchange material is continuously cycled between exposure to air and release of captured CO₂.

49: The apparatus of claim 47, wherein said anion exchange material extracts CO₂ when dry and releases CO₂ when exposed to higher humidity.

50: The apparatus of claim 47, wherein the anion exchange material is a component of a heterogeneous ion exchange material.

51: The apparatus of claim 47, wherein the anion exchange material comprises a strong base resin.

52: The apparatus of claim 51, wherein said resin comprises a Type 1 or Type 2 functionality ion exchange resin.

53: The apparatus of claim 52, wherein said ion exchange resin comprises Anion I-200 ion exchange membrane material.

54: The apparatus of claims 47, further comprising a sorbent to which released CO₂ is transferred.

55: The apparatus of claim 54, wherein said sorbent is selected from the group consisting of: liquid amines, ionic liquids, solid CO₂ sorbents, lithium zirconate, lithium silicate, magnesium hydroxide, and calcium hydroxide.

56: The apparatus of claim 54, wherein said sorbent comprises an ion exchange resin.

57: The apparatus of claim 47, wherein said anion exchange material comprises a material from which 60% of said captured CO₂ is releasable by wetting or swing in humidity.

58: The apparatus of claim 47, wherein said apparatus is located adjacent to a controlled environment into which captured CO₂ is released.

* * * * *