



US00D616009S

(12) **United States Design Patent**  
**Schnell**

(10) **Patent No.:** **US D616,009 S**

(45) **Date of Patent:** **\*\* May 18, 2010**

(54) **MOTION DETECTOR CAMERA**

(74) *Attorney, Agent, or Firm*—Schwegman, Lundberg & Woessner, P.A.

(75) Inventor: **Tim Schnell**, Rancho Santa Fe, CA (US)

(57) **CLAIM**

(73) Assignee: **IP Holdings, Inc.**, Grand Prairie, TX (US)

The ornamental design for a motion detector camera, as shown and described.

(\*\*) Term: **14 Years**

(21) Appl. No.: **29/325,386**

**DESCRIPTION**

(22) Filed: **Sep. 30, 2008**

(51) **LOC (9) Cl.** ..... **16-01**

FIG. 1 is a perspective view of a motion detector camera, incorporating the new design;

(52) **U.S. Cl.** ..... **D16/218**

FIG. 2 is a front view of the motion detector camera of FIG. 1;

(58) **Field of Classification Search** ..... D16/200–204, D16/208, 218; 348/143, 164, 373–376; 396/535–541  
See application file for complete search history.

FIG. 3 is a back view of the motion detector camera of FIG. 1; FIG. 4 is a left side view of the motion detector camera of FIG. 1;

(56) **References Cited**

FIG. 5 is a right side view of the motion detector camera of FIG. 1;

**U.S. PATENT DOCUMENTS**

D472,258 S *	3/2003	Yin et al.	.....	D16/202
D491,592 S *	6/2004	Fang	.....	D16/218
6,768,868 B1 *	7/2004	Schnell	.....	396/427
D527,754 S *	9/2006	Chou	.....	D16/202
7,471,334 B1 *	12/2008	Stenger	.....	348/373

FIG. 6 is a top plan view of the motion detector camera of FIG. 1; and,

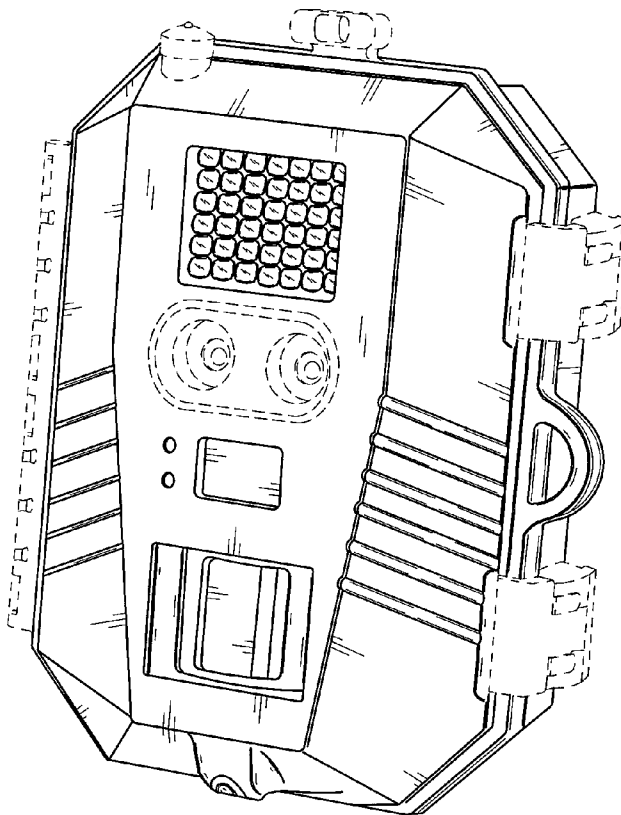
FIG. 7 is a bottom plan view of the motion detector camera of FIG. 1.

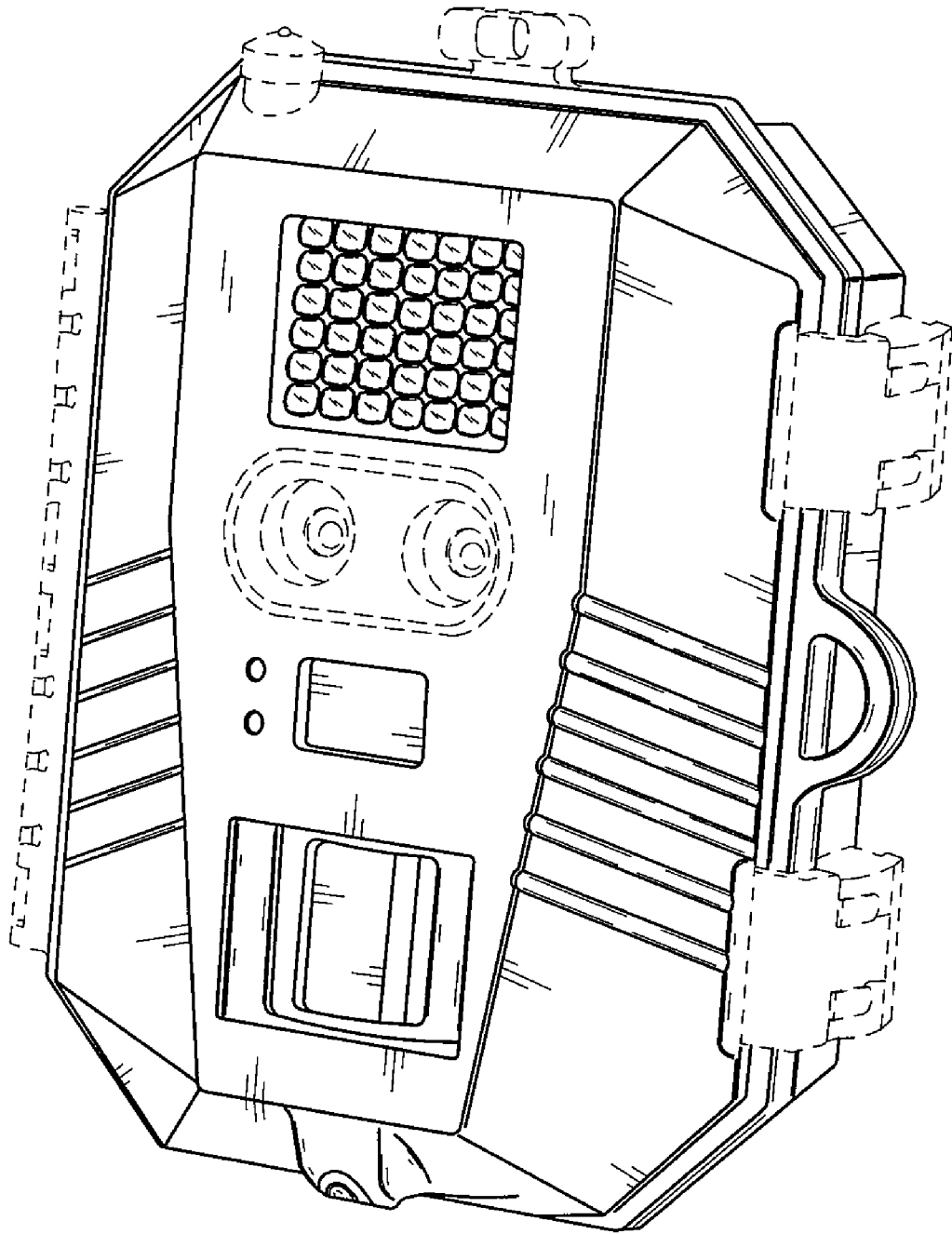
\* cited by examiner

The broken line portions are shown to illustrate environment only and form no part of the claimed design.

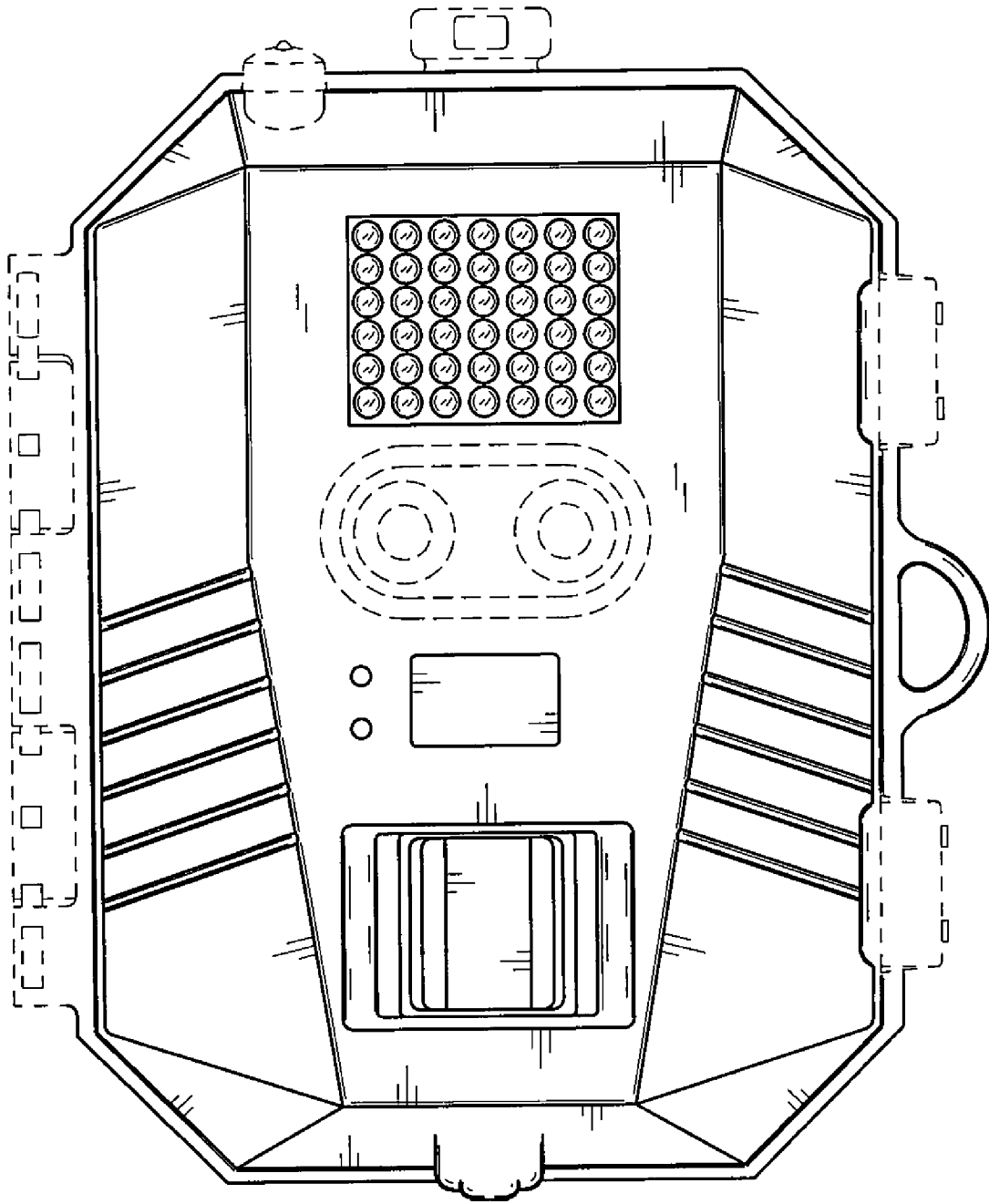
*Primary Examiner*—Adir Aronovich

**1 Claim, 5 Drawing Sheets**

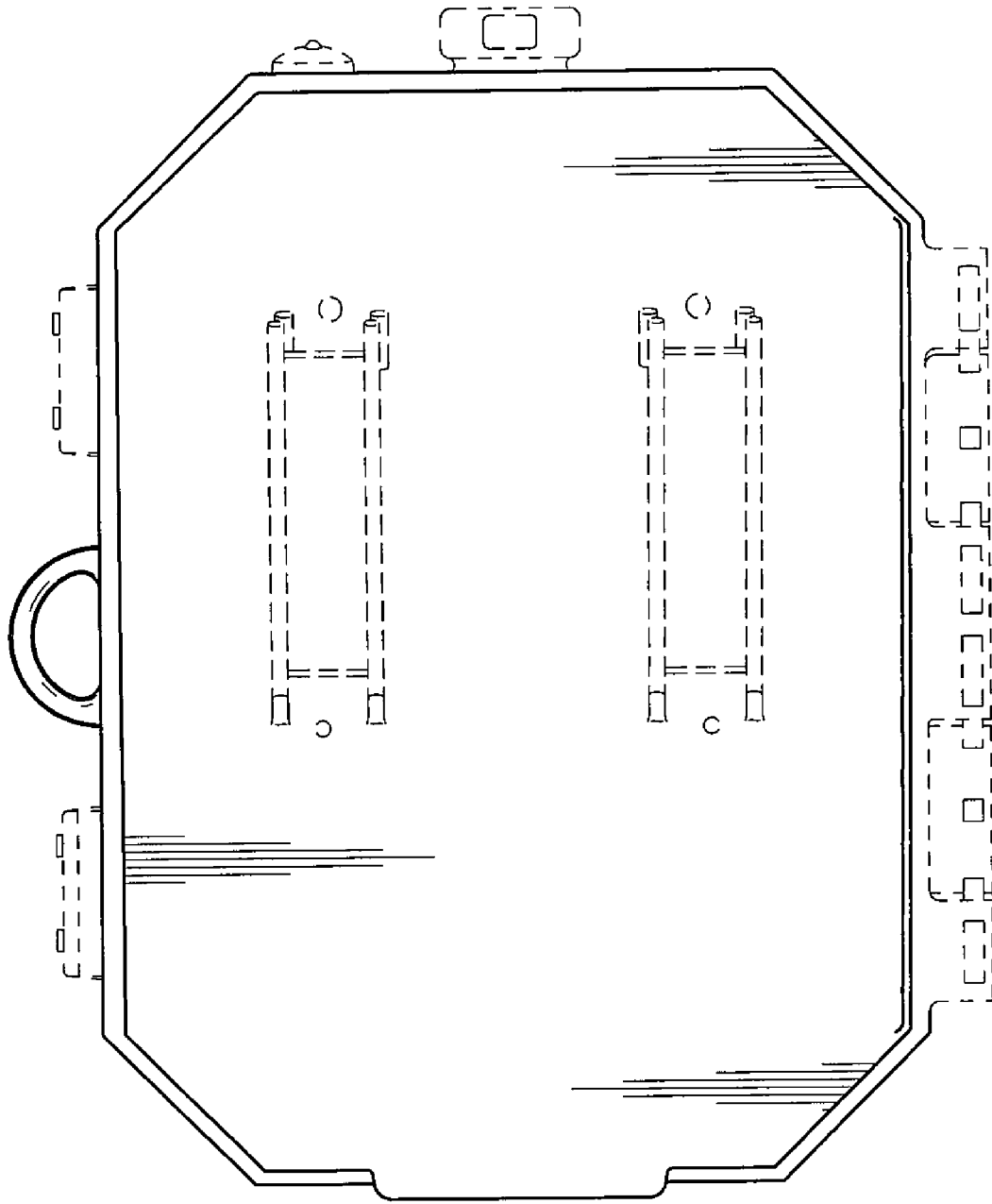




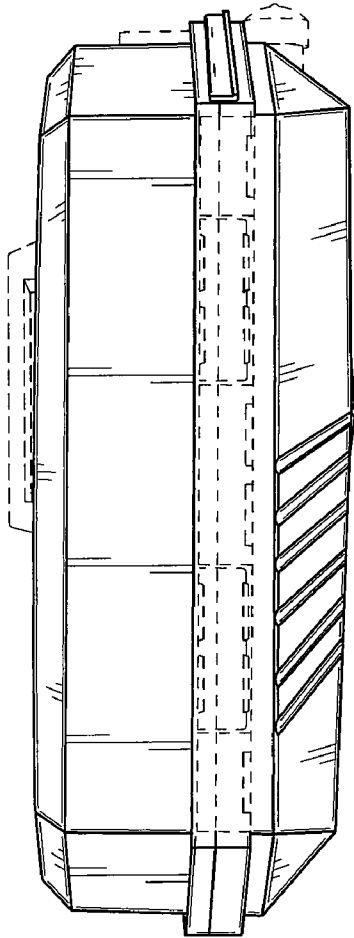
*FIG. 1*



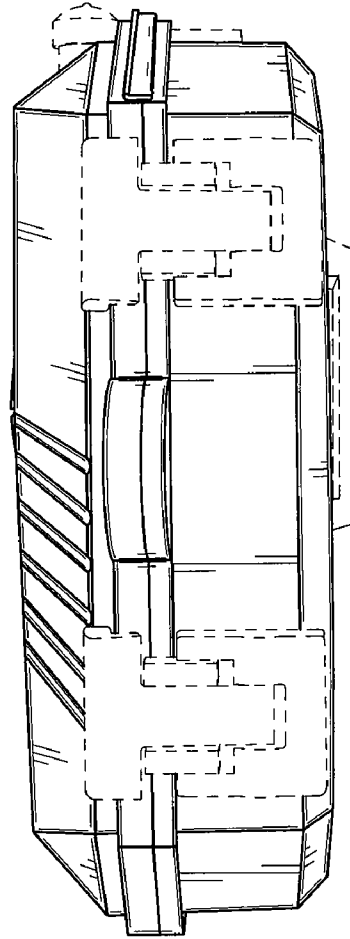
*FIG. 2*



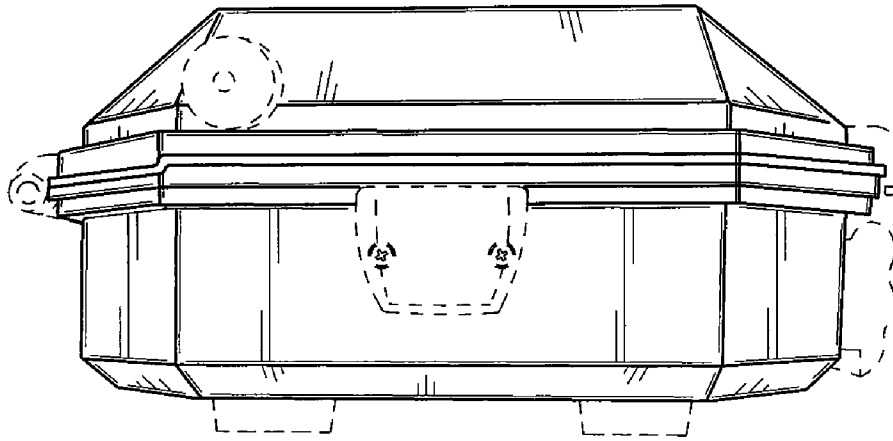
*FIG. 3*



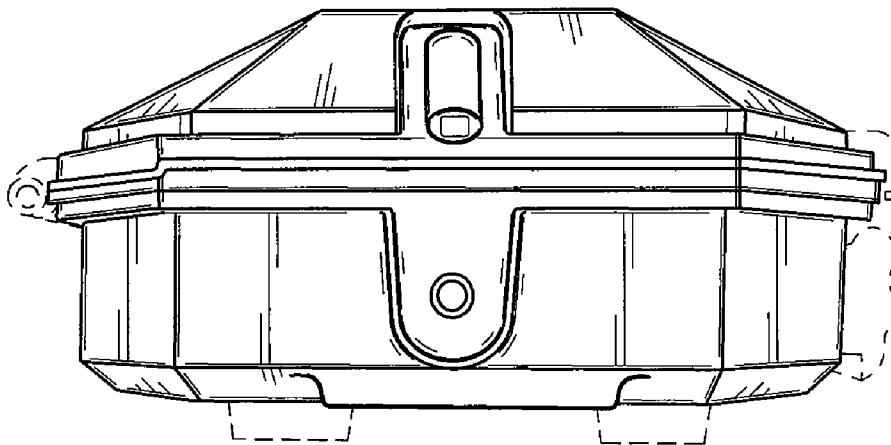
*FIG. 4*



*FIG. 5*



*FIG. 6*



*FIG. 7*