

(12) **United States Design Patent**  
**Sun**

(10) **Patent No.:** **US D967,420 S**  
(45) **Date of Patent:** **\*\* Oct. 18, 2022**

(54) **DIGITAL ENDOSCOPE**  
(71) Applicant: **Yingjie Sun**, Irvine, CA (US)  
(72) Inventor: **Yingjie Sun**, Irvine, CA (US)  
(\*\*) Term: **15 Years**  
(21) Appl. No.: **29/652,326**

D570,890 S \* 6/2008 Yoneya ..... D16/202  
D582,916 S \* 12/2008 Wada ..... D14/371  
D582,917 S \* 12/2008 Wada ..... D14/371  
D583,400 S \* 12/2008 Lee ..... D16/202  
D588,178 S \* 3/2009 Sakai ..... D16/202  
D588,179 S \* 3/2009 Hamamura ..... D16/202  
D589,073 S \* 3/2009 Hibi ..... D16/218  
D602,968 S \* 10/2009 Sato ..... D16/202  
D611,362 S \* 3/2010 Hansen ..... D10/65  
D640,149 S \* 6/2011 Lenz ..... D10/65

(Continued)

(22) Filed: **Jul. 21, 2020**  
(51) **LOC (13) Cl.** ..... **24-02**  
(52) **U.S. Cl.**  
USPC ..... **D24/138; D16/202**  
(58) **Field of Classification Search**  
USPC ..... D24/112-114, 108, 130, 127, 187, 133,  
D24/134, 136, 137, 138, 135, 140, 144,  
D24/145, 146, 147, 158, 189; D13/184;  
D14/125, 357-358, 496, 188, 242, 432,  
D14/341, 344  
CPC ..... H04N 21/00; H04N 21/20; H04N 21/40  
See application file for complete search history.

OTHER PUBLICATIONS

NTS500B Household Inspection Camera, [site visited Mar. 21, 2022], Available from Internet. URL: <https://teslong.com/collections/endoscopes-with-screen/products/nts500b-industrial-endoscope-with-5-inch-hd-ips-screen> (Year: 2022).\*

*Primary Examiner* — T Chase Nelson  
*Assistant Examiner* — Kelly L Gross  
(74) *Attorney, Agent, or Firm* — Dunlap Bennett & Ludwig, PLLC

(56) **References Cited**

U.S. PATENT DOCUMENTS

D371,198 S \* 6/1996 Savage ..... D24/186  
D398,607 S \* 9/1998 Hanafsa ..... D14/191  
D400,880 S \* 11/1998 Hin ..... D14/191  
D401,238 S \* 11/1998 Shiono ..... D14/191  
D402,656 S \* 12/1998 Nishii ..... D14/191  
D499,423 S \* 12/2004 Bahroocha ..... D14/203.7  
D507,003 S \* 7/2005 Pai ..... D14/203.7  
D512,450 S \* 12/2005 Jinde ..... D16/202  
D521,527 S \* 5/2006 Lee ..... D14/203.7  
D523,446 S \* 6/2006 Peng ..... D14/203.7  
D529,045 S \* 9/2006 Shin ..... D14/203.7  
D540,356 S \* 4/2007 Ina ..... D16/202  
D543,528 S \* 5/2007 Kim ..... D14/138 G  
D556,806 S \* 12/2007 Horikiri ..... D16/202  
D557,722 S \* 12/2007 Horiki ..... D16/202  
D560,683 S \* 1/2008 Lee ..... D14/496  
D563,806 S \* 3/2008 Jeon ..... D10/65  
D568,362 S \* 5/2008 Horikiri ..... D16/202

(57) **CLAIM**

The ornamental design for a digital endoscope, as shown and described.

**DESCRIPTION**

FIG. 1 is a top front perspective view of a digital endoscope, showing my new design;  
FIG. 2 is a top rear perspective view thereof;  
FIG. 3 is a front elevation view thereof;  
FIG. 4 is a rear elevation view thereof;  
FIG. 5 is a right elevation view thereof;  
FIG. 6 is a left elevation view thereof;  
FIG. 7 is a top plan view thereof; and,  
FIG. 8 is a bottom plan view thereof.  
The broken lines depict portions of the digital endoscope that form no part of the claimed design.

**1 Claim, 3 Drawing Sheets**

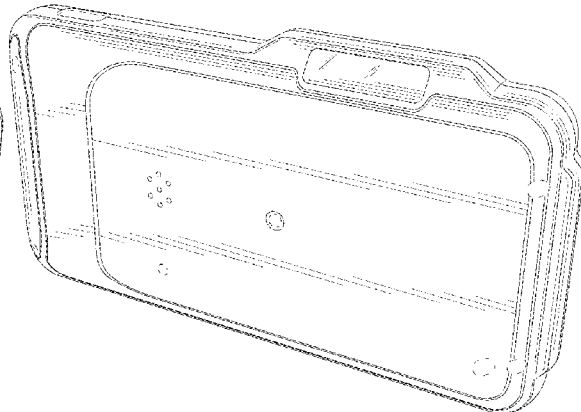
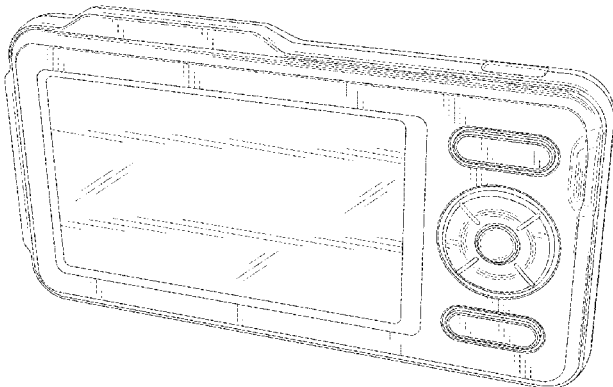

(56)

## References Cited

## U.S. PATENT DOCUMENTS

D641,389	S	*	7/2011	Dastagir	.....	D16/219	
D648,765	S	*	11/2011	Tsukamoto	.....	D16/202	
D652,853	S	*	1/2012	Tsukamoto	.....	D16/202	
D656,935	S	*	4/2012	Jones	.....	D14/341	
D664,177	S	*	7/2012	Oikawa	.....	D16/202	
D672,767	S	*	12/2012	Yoneya	.....	D14/341	
D676,046	S	*	2/2013	Hatori	.....	D14/341	
D676,441	S	*	2/2013	Choi	.....	D14/341	
D677,295	S	*	3/2013	Fujita	.....	D16/202	
D682,334	S	*	5/2013	InShik	.....	D16/202	
D682,335	S	*	5/2013	Kim	.....	D16/202	
D683,780	S	*	6/2013	Sakai	.....	D16/202	
D687,825	S	*	8/2013	Lee	.....	D14/341	
D687,826	S	*	8/2013	Jeon	.....	D14/341	
D687,827	S	*	8/2013	Song	.....	D14/341	
D691,131	S	*	10/2013	Brown	.....	D14/341	
D698,311	S	*	1/2014	Salzman	.....	D13/108	
D700,084	S	*	2/2014	Hsu	.....	D10/70	
D701,551	S	*	3/2014	Inoue	.....	D16/202	
D712,950	S	*	9/2014	Kwon	.....	D16/202	
D719,992	S	*	12/2014	Peng	.....	D16/202	
D722,332	S	*	2/2015	Kobayashi	.....	D16/202	
D723,083	S	*	2/2015	Jang	.....	D16/202	
D723,088	S	*	2/2015	Jang	.....	D16/202	
D724,223	S	*	3/2015	Nishiyama	.....	D24/169	
D727,386	S	*	4/2015	Kobayashi	.....	D16/202	
D732,682	S	*	6/2015	Porat	.....	D24/215	
D734,803	S	*	7/2015	Hallgren	.....	D16/202	
D737,355	S	*	8/2015	Tainaka	.....	D16/202	
D742,310	S	*	11/2015	Yen	.....	D13/108	
D742,858	S	*	11/2015	Morisawa	.....	D14/218	
D756,526	S	*	5/2016	Ho	.....	D24/200	
D757,292	S	*	5/2016	Chen	.....	D24/215	
D758,605	S	*	6/2016	Chen	.....	D24/215	
D758,606	S	*	6/2016	Chen	.....	D24/215	
D758,656	S	*	6/2016	Freshwater	.....	D27/163	
D759,262	S	*	6/2016	Chen	.....	D24/215	
D759,263	S	*	6/2016	Chen	.....	D24/215	
D760,913	S	*	7/2016	Douglas	.....	D24/210	
D762,872	S	*	8/2016	Chen	.....	D24/215	
D763,342	S	*	8/2016	Kim	.....	D16/219	
D773,545	S	*	12/2016	Nikaido	.....	D16/202	
D775,728	S	*	1/2017	Cavada	.....	D24/144	
D779,677	S	*	2/2017	Chen	.....	D24/215	
D785,564	S	*	5/2017	Lee	.....	D13/108	
D794,803	S	*	8/2017	Thom	.....	D24/169	
D801,525	S	*	10/2017	Ohno	.....	D24/138	
D802,132	S	*	11/2017	Ohno	.....	D24/138	
D806,079	S	*	12/2017	Benedetti	.....	D14/440	
D811,459	S	*	2/2018	Fang	.....	D16/130	
D813,376	S	*	3/2018	Peret	.....	D24/111	
D813,407	S	*	3/2018	Chen	.....	D24/215	
D813,408	S	*	3/2018	Chen	.....	D24/215	
D815,730	S	*	4/2018	Collins	.....	D24/111	
D819,811	S	*	6/2018	Ohno	.....	D24/138	
D820,446	S	*	6/2018	Ohno	.....	D24/138	
D820,987	S	*	6/2018	Tam	.....	D24/163	
D822,065	S	*	7/2018	Kang	.....	D14/203.3	
D829,212	S	*	9/2018	Bidwell	.....	D14/426	
D836,074	S	*	12/2018	Sun	.....	D14/125	
D836,788	S	*	12/2018	Peng	.....	D24/200	
D842,488	S	*	3/2019	Gan	.....	D24/215	
D842,736	S	*	3/2019	Laurino	.....	D24/232	
D844,607	S	*	4/2019	Fredette	.....	D18/4.6	
D845,298	S	*	4/2019	Wang	.....	D18/4.6	
D849,076	S	*	5/2019	Bertram	.....	D16/202	
D850,446	S	*	6/2019	Wang	.....	D18/4.6	
D852,771	S	*	7/2019	Hu	.....	D14/155	
D853,583	S	*	7/2019	Pizzochero	.....	D24/138	
D858,464	S	*	9/2019	Li	.....	D13/168	
D861,510	S	*	10/2019	Wang	.....	D16/208	
D885,215	S	*	5/2020	Dewey	.....	D10/78	
D887,555	S	*	6/2020	Uda	.....	D24/170	
D888,247	S	*	6/2020	Takahashi	.....	D24/158	
D897,307	S	*	9/2020	Kawatake	.....	D14/158	
D899,588	S	*	10/2020	Harkin	.....	D24/127	
D907,097	S	*	1/2021	Suurmeijer	.....	D16/206	
D907,232	S	*	1/2021	Reber	.....	D24/216	
D908,157	S	*	1/2021	Sun	.....	D14/138 G	
D909,982	S	*	2/2021	Kawatake	.....	D14/158	
D912,903	S	*	3/2021	Fu	.....	D28/58	
D919,093	S	*	5/2021	Takahashi	.....	D24/158	
D920,518	S	*	5/2021	Takahashi	.....	D24/158	
D927,004	S	*	8/2021	Peng	.....	D24/200	
D930,294	S	*	9/2021	Jia	.....	D10/104.1	
D934,417	S	*	10/2021	Harkin	.....	D24/127	
D935,615	S	*	11/2021	Ben Dor	.....	D24/186	
D936,827	S	*	11/2021	Wang	.....	D24/138	
D940,094	S	*	1/2022	Chen	.....	D14/138 G	

\* cited by examiner

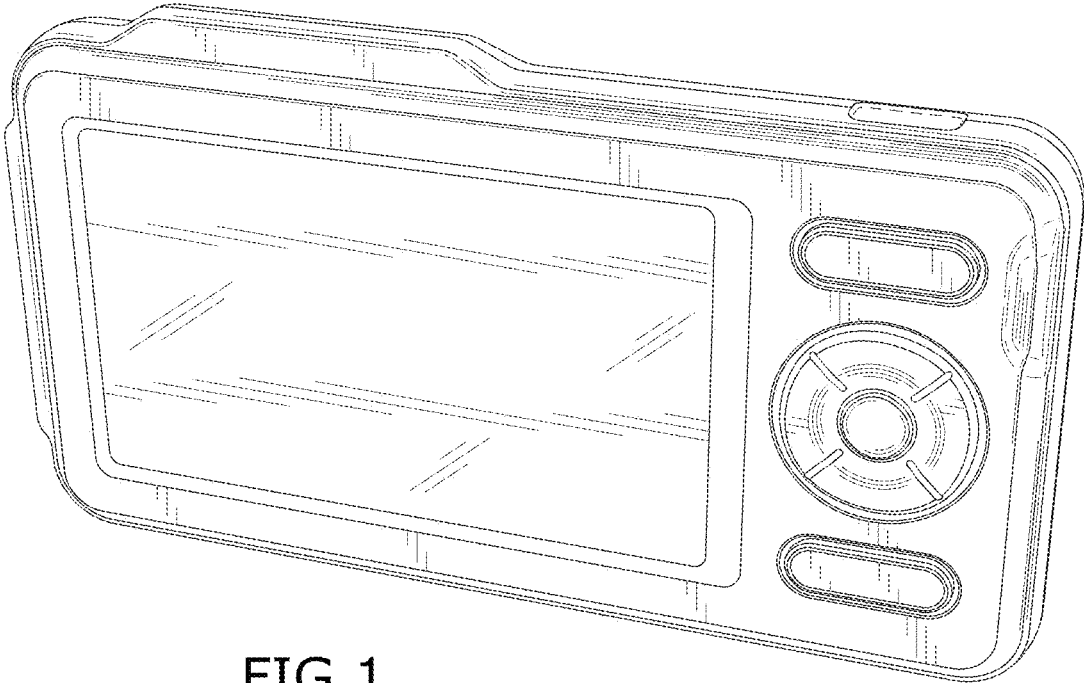

FIG. 1

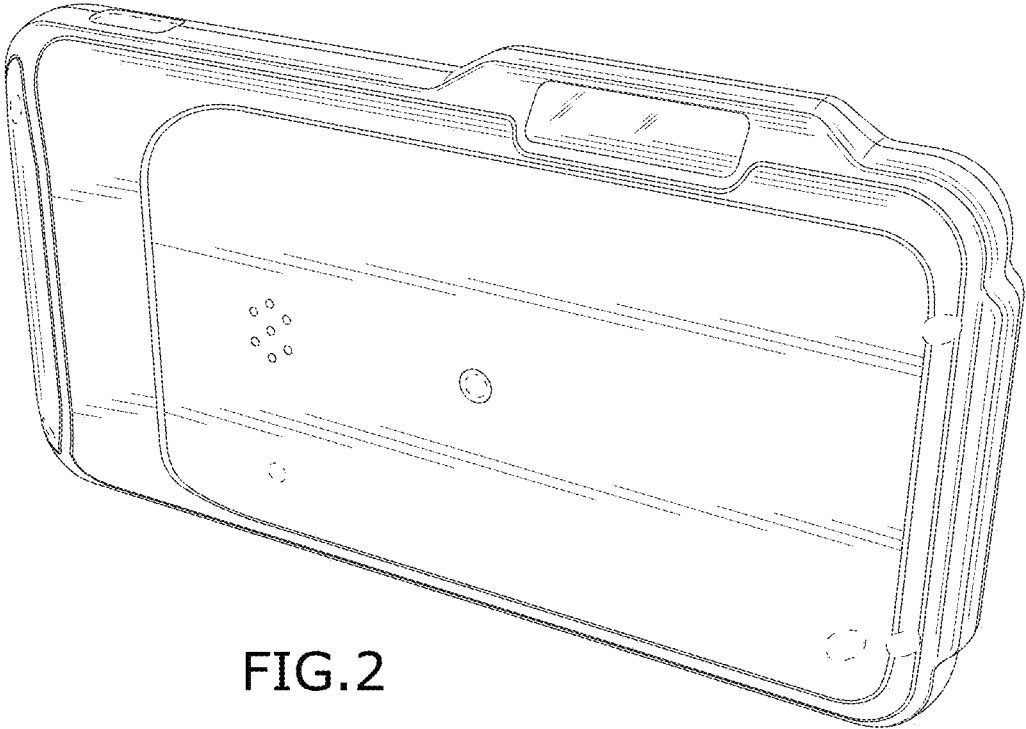

FIG. 2

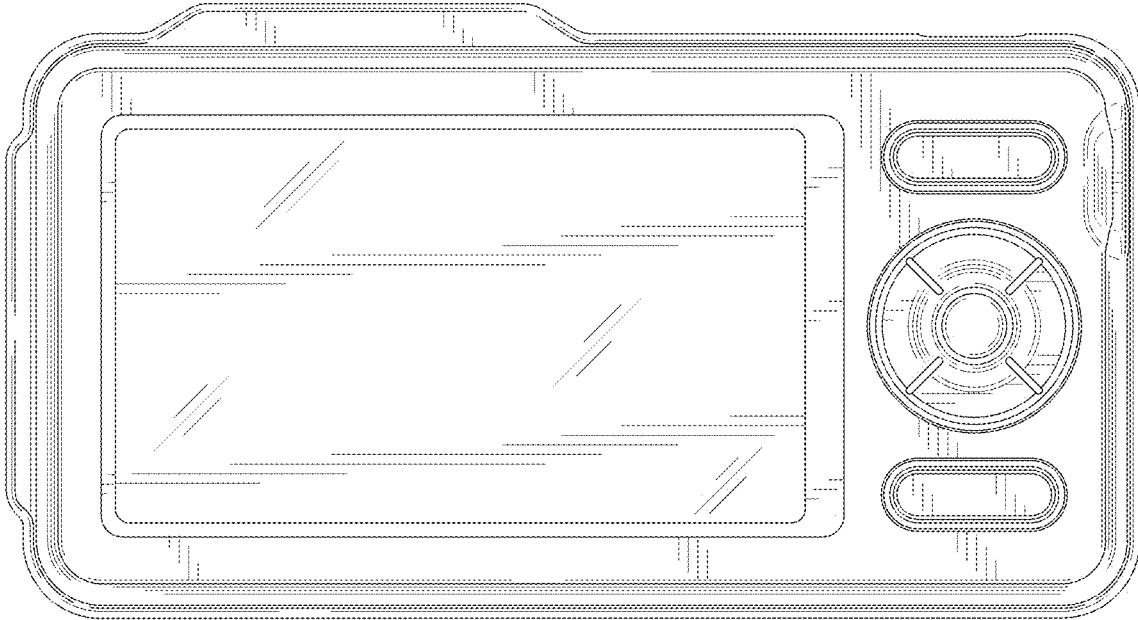

FIG.3

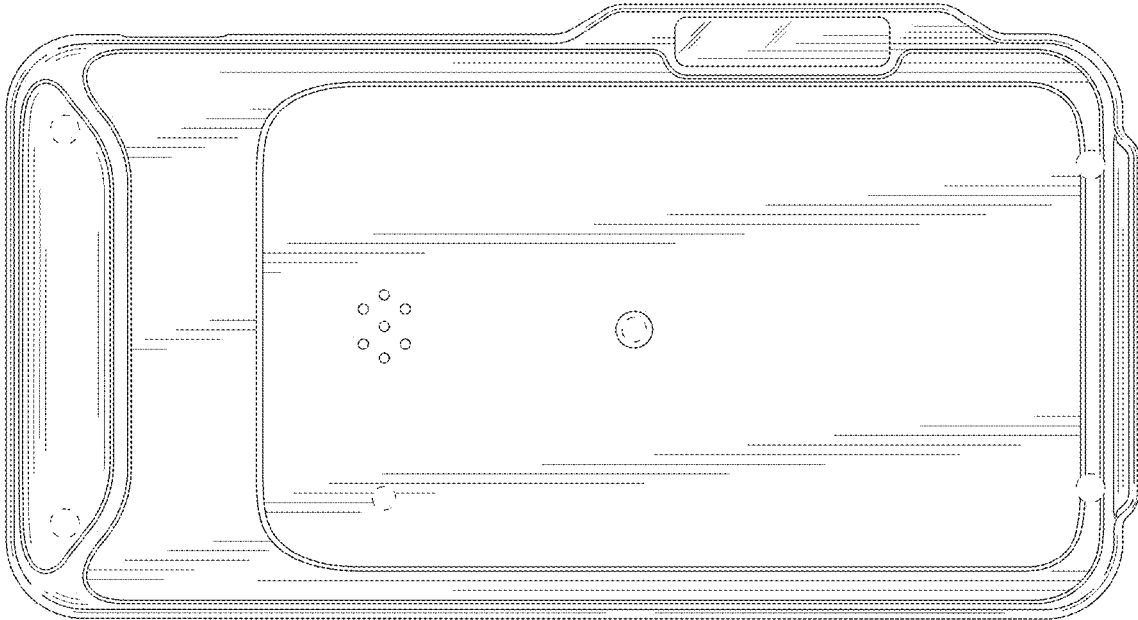

FIG.4

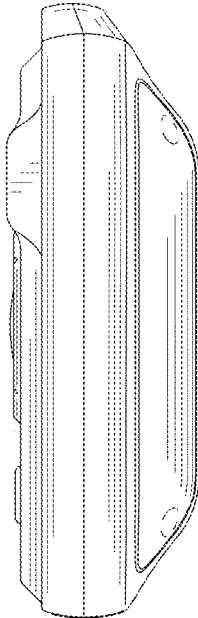

FIG. 5

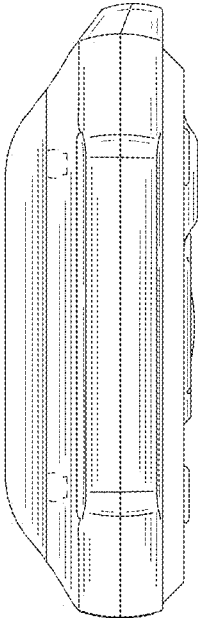

FIG. 6

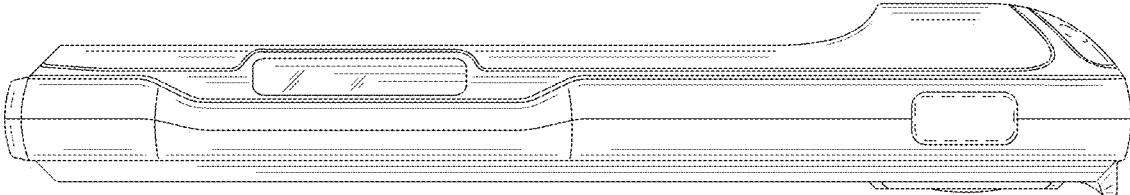

FIG. 7

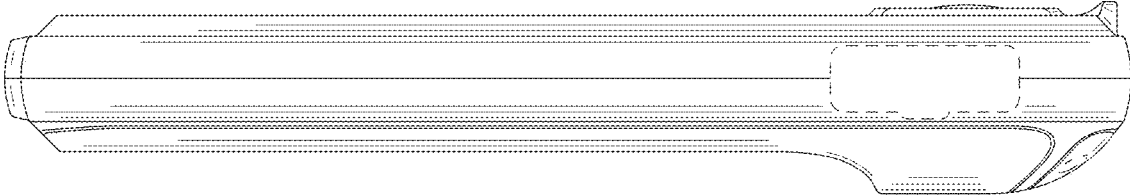

FIG. 8