



US00D463514S

(12) **United States Design Patent**
Chen

(10) **Patent No.:** **US D463,514 S**

(45) **Date of Patent:** **** Sep. 24, 2002**

(54) **FRAME FOR A STATIONARY BIKE**

D407,767 S	*	4/1999	Chang	D21/663
D429,508 S	*	8/2000	Clive	D21/663
D430,240 S	*	8/2000	Chang	D21/663
D431,619 S	*	10/2000	Tsou	D21/670

(76) Inventor: **Tsung-Yu Chen**, No. 23-4, Ting-Liao,
San-Ho Tsun, Shiu-Shang Hsiang,
Chiayi Hsien (TW)

* cited by examiner

(**) Term: **14 Years**

Primary Examiner—Philip S. Hyder

(74) *Attorney, Agent, or Firm*—Rosenberg, Klein & Lee

(21) Appl. No.: **29/141,320**

(57) **CLAIM**

(22) Filed: **May 4, 2001**

The ornamental design for a frame for a stationary bike, as shown and described.

(51) **LOC (7) Cl.** **21-02**

(52) **U.S. Cl.** **D21/697; D21/694**

(58) **Field of Search** D21/662, 663,
D21/664, 665, 666, 667, 694, 697; 482/51,
54, 57, 60

DESCRIPTION

FIG. 1 is a perspective view of a frame for a stationary bike showing my new design;

FIG. 2 is a front elevational view thereof;

FIG. 3 is a rear elevational view thereof;

FIG. 4 is a left side elevational view thereof;

FIG. 5 is a right side elevational view thereof;

FIG. 6 is a top side elevational view thereof;

FIG. 7 is a bottom side elevational view thereof; and,

FIG. 8 is a perspective view thereof, wherein the broken line bike structure is for illustrative purposes only and forms no part of the claimed design.

(56) **References Cited**

U.S. PATENT DOCUMENTS

D251,747 S	*	5/1979	Valentine et al.	D21/697
D280,117 S	*	8/1985	Collins	D12/111
D280,118 S	*	8/1985	Collins	D21/697
D284,596 S	*	7/1986	McNeil	D21/697
D289,782 S	*	5/1987	Szymiski et al.	D21/697
D292,304 S	*	10/1987	Ostrom	D12/111
D372,284 S	*	7/1996	Wang et al.	D21/667
D382,924 S	*	8/1997	Wu	D21/667
D384,711 S	*	10/1997	Wang et al.	D21/697

1 Claim, 7 Drawing Sheets

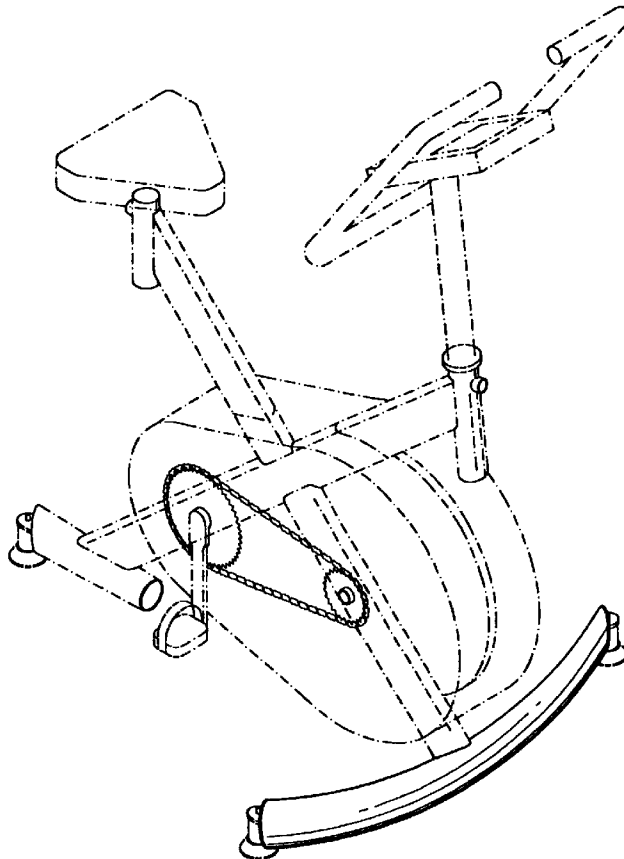

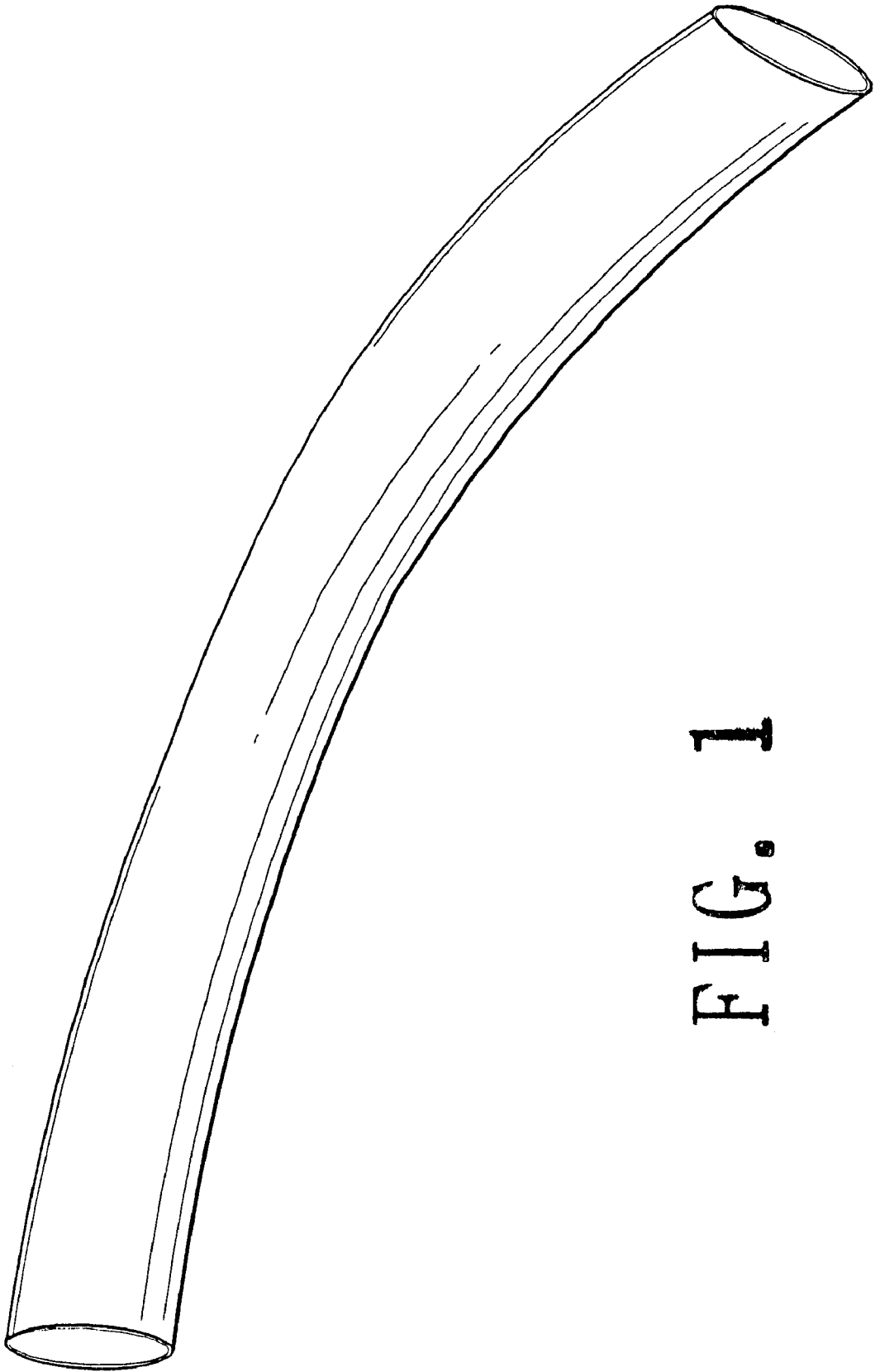

FIG. 1

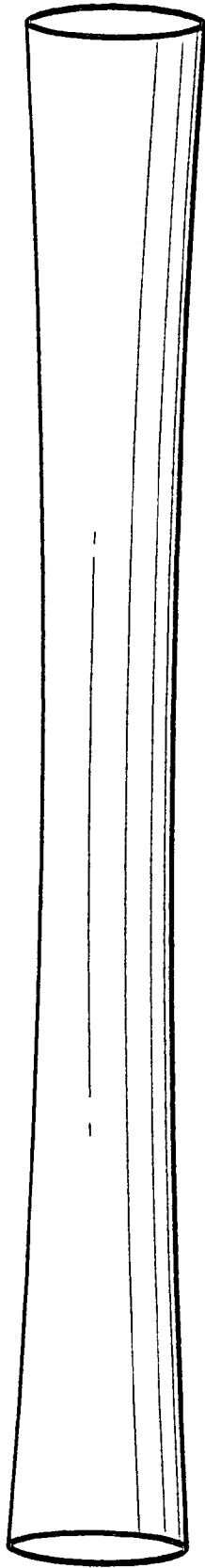

FIG. 2

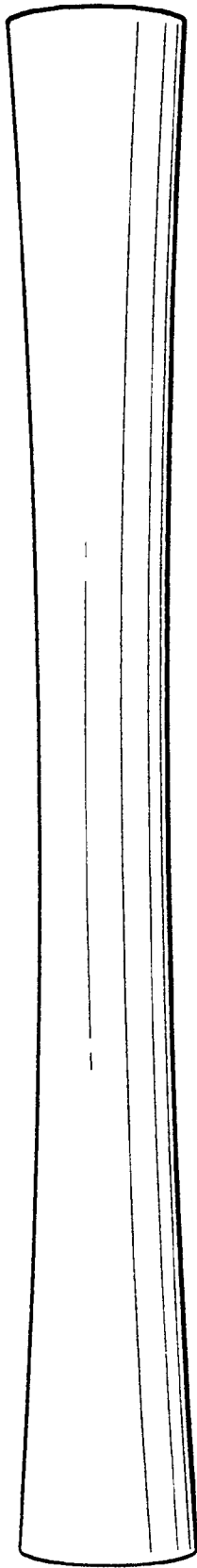

FIG. 3

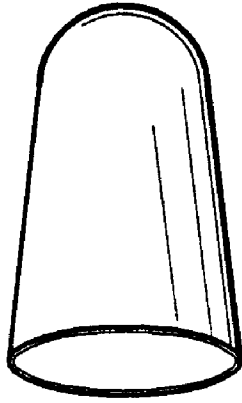

FIG. 5

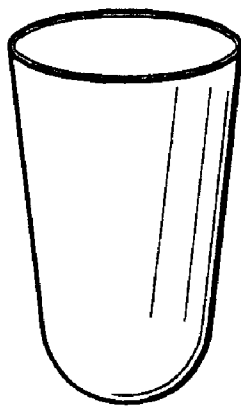

FIG. 4

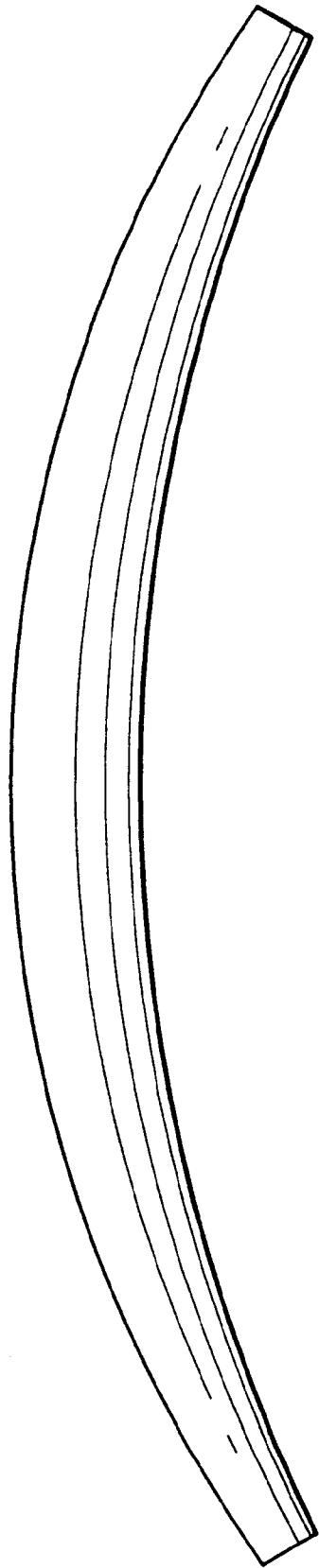

FIG. 6

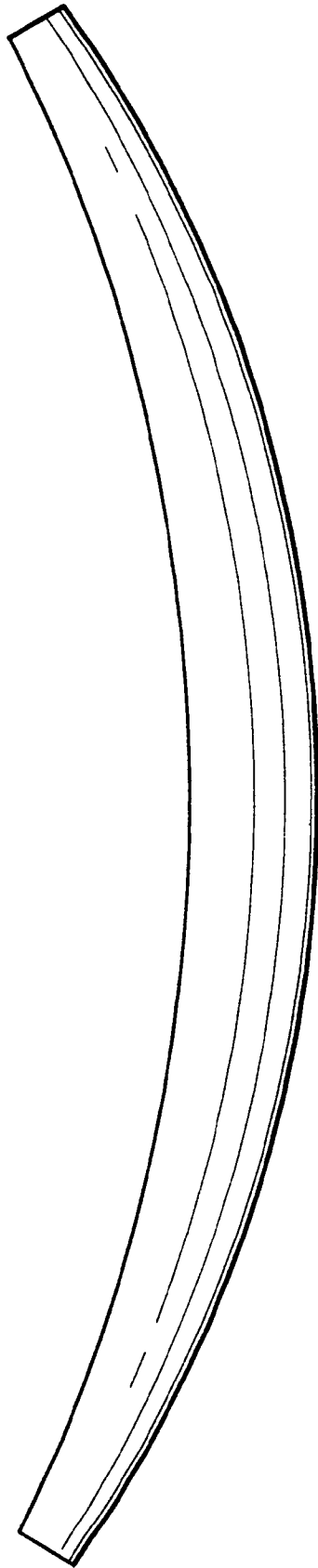

FIG. 7

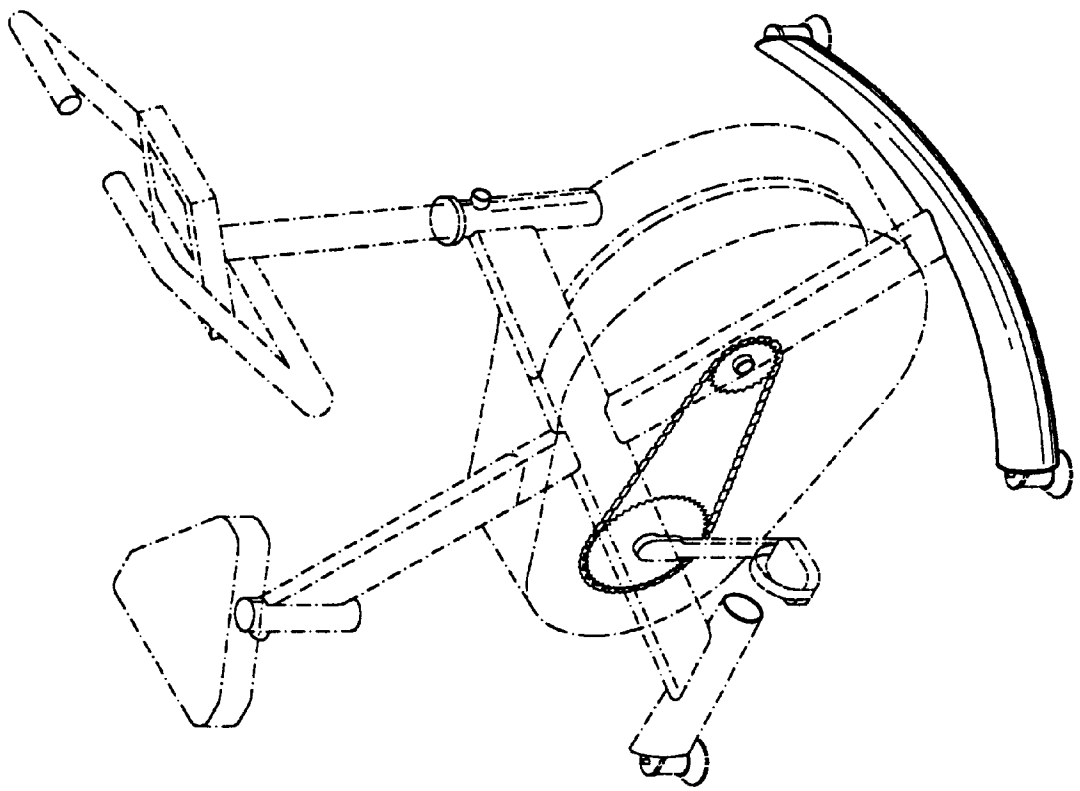

FIG. 8