





EUROPEAN PATENT APPLICATION

 Application number: **86830110.2**

 Int. Cl.⁴: **B 22 D 11/08**

 Date of filing: **06.05.86**

 Priority: **10.05.85 IT 8336785**

 Applicant: **DANIELI & C. OFFICINE MECCANICHE S.p.A.**
Via Nazionale, 19
I-33042 Buttrio (UD)(IT)

 Date of publication of application:
20.11.86 Bulletin 86/47

 Inventor: **Duri, Antonino**
Via Torricelle 20
I-33040 Pradamano (UD)(IT)

 Date of deferred publication of search report: **03.06.87**

 Designated Contracting States:
AT BE CH DE FR GB LI LU NL SE

 Representative: **Petraz, Gilberto Luigi**
G.L.P. S.a.s. di Gilberto Petraz P.le Cavedalis 6/2
I-33100 Udine(IT)

 **54** Protective cover for a starter bar in continuous casting, and starter bar which employs such protective cover in continuous casting.

 **57** Protective cover for a board (10) for a head (12) of a starter bar (11) in continuous casting, which cover is able to protect the inside of the passage for a billet being cooled in an ingot mould (14) during continuous casting and has a jacket-wise shape and encloses the head (12) of the starter bar (11) at least partially, being positioned between such head (12) and the inside of the passage for the billet.

Starter bar (11) for continuous casting, which cooperates with a protective cover (10) that encloses at least a head (12) of a starter bar at least partially at least when such head is inside the passage for a billet being cooled in an ingot mould (14).

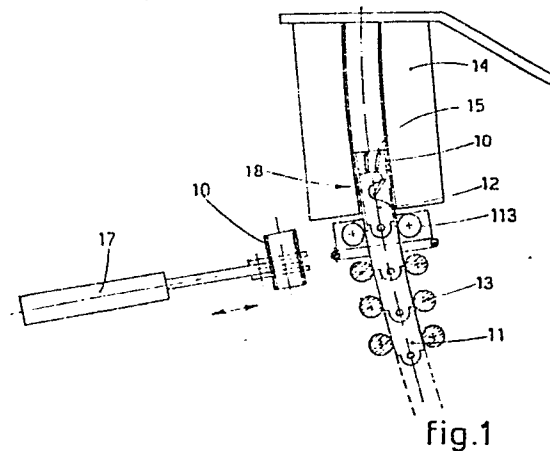



DOCUMENTS CONSIDERED TO BE RELEVANT			
Category	Citation of document with indication, where appropriate, of relevant passages	Relevant to claim	CLASSIFICATION OF THE APPLICATION (Int. Cl. 4)
X	CH-A- 525 049 (CONCAST AG) * Column 2, lines 6-11; column 4, lines 5-15; figures 1-4 *	1-5, 10	B 22 D 11/08
Y		6	
X	--- US-A-3 653 427 (C. EVANS) * Figures 2,6; column 4, line 37 - column 5, line 4 *	1,3	TECHNICAL FIELDS SEARCHED (Int. Cl. 4)
X	--- SU-A- 459 302 (SECONDARY NON-FERROUS) * Figure unique *	1,3,8, 10	
X	--- PATENTS ABSTRACTS OF JAPAN, vol. 7, no. 157 (M-227)[1302], 9th July 1983; & JP-A-58 65 545 (KOBE SEIKOSHO K.K.) 19-04-1983 * Abstract *	1,3-5, 10	B 22 D
A	--- FR-A-2 073 236 (FIVES LILLE CAIL) * Page 3, lines 35-38; figures 1-4 *	1	
Y	--- FR-A-2 381 580 (SCHLOEMANN) * Page 4, lines 9-17; figure unique *	6	

The present search report has been drawn up for all claims			
Place of search THE HAGUE		Date of completion of the search 09-03-1987	Examiner MAILLIARD A.M.
<p>CATEGORY OF CITED DOCUMENTS</p> <p>X : particularly relevant if taken alone Y : particularly relevant if combined with another document of the same category A : technological background O : non-written disclosure P : intermediate document</p> <p>T : theory or principle underlying the invention E : earlier patent document, but published on, or after the filing date D : document cited in the application L : document cited for other reasons & : member of the same patent family, corresponding document</p>			