



(12) **United States Design Patent**
Choi

(10) **Patent No.:** **US D1,069,722 S**
(45) **Date of Patent:** **** Apr. 8, 2025**

(54) **CONNECTOR**

H01R 4/363; H01R 2201/00; H01R 3/08;
G02B 6/38; G02B 6/38875; G02B 6/4284
See application file for complete search history.

(71) Applicant: **LS Mtron Ltd.**, Anyang-si (KR)

(72) Inventor: **Jung Hoon Choi**, Anyang-si (KR)

(56) **References Cited**

(73) Assignee: **LS MTRON LTD.**, Anyang-si (KR)

U.S. PATENT DOCUMENTS

(**) Term: **15 Years**

D767,499 S * 9/2016 Goto D13/147
D923,581 S * 6/2021 Oosaka D13/147
D923,582 S * 6/2021 Oosaka D13/147
D967,033 S * 10/2022 Horino D13/133
D967,034 S * 10/2022 Horino D13/133

(21) Appl. No.: **29/894,374**

(Continued)

(22) Filed: **Jun. 8, 2023**

FOREIGN PATENT DOCUMENTS

(30) **Foreign Application Priority Data**

CN 306308459 * 2/2021
JP D1675220 * 12/2023

Dec. 8, 2022 (KR) 30-2022-0051767

(Continued)

(51) **LOC (15) Cl.** **13-03**

OTHER PUBLICATIONS

(52) **U.S. Cl.**

USPC **D13/147**

2401305G mmWave antenna module connector, posted Jan. 30, 2024 [online], [retrieved Sep. 18, 2024]. Retrieved from internet, <https://www.youtube.com/watch?v=dqrLH52Tf2g> (Year: 2024).*

(Continued)

(58) **Field of Classification Search**

USPC D13/133, 146, 147, 149, 182, 184, 199,
D13/101, 107, 116, 118, 120, 121, 123,
D13/137.1, 137.2, 137.4, 14, 9, 153, 154;
D14/435.1, 433
CPC H01R 24/00; H01R 24/46; H01R 12/00;
H01R 12/70; H01R 12/52; H01R 12/707;
H01R 12/716; H01R 13/40; H01R 13/58;
H01R 13/627; H01R 13/62; H01R 13/66;
H01R 13/6335; H01R 13/6272; H01R
13/6397; H01R 13/639; H01R 13/6275;
H01R 31/06; H01R 43/26; H01R
13/6588; H01R 13/6594; H01R 13/6585;
H01R 13/6471; H01R 13/6597; H01R
13/6582; H01R 13/6598; H01R 13/405;
H01R 13/6587; H01R 24/50; H01R
12/73; H01R 13/00; H01R 13/02; H01R
13/10; H01R 13/2407; H01R 13/2492;

Primary Examiner — George D. Kirschbaum
Assistant Examiner — Denis Houyoux
(74) *Attorney, Agent, or Firm* — K&L Gates LLP

(57) **CLAIM**

The ornamental design for a connector as shown and described herein.

DESCRIPTION

FIG. 1 is a perspective view of a connector showing the new design;
FIG. 2 is a front view thereof;
FIG. 3 is a rear view thereof;
FIG. 4 is a left-side view thereof;
FIG. 5 is a right-side view thereof;
FIG. 6 is a top plan view thereof;

(Continued)

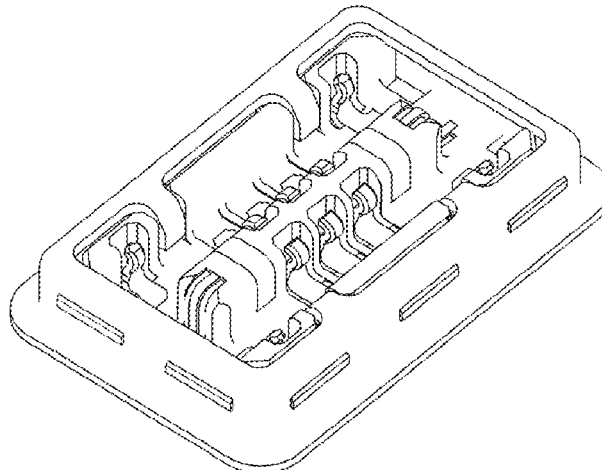

FIG. 7 is a bottom view thereof; and,
FIG. 8 is a bottom perspective view thereof.

1 Claim, 8 Drawing Sheets

(56)

References Cited

U.S. PATENT DOCUMENTS

D972,514 S * 12/2022 Horino D13/133
D985,509 S * 5/2023 Yokoyama D13/147
D1,042,355 S * 9/2024 Ishida D13/147
2021/0359471 A1 * 11/2021 Oosaka H01R 12/73
2022/0052470 A1 * 2/2022 Hosoda H01R 12/7005

FOREIGN PATENT DOCUMENTS

KR 301041468.0000 * 1/2020
KR 301180480.0000 * 9/2022
TW 231182-0001 * 5/2024

OTHER PUBLICATIONS

Molex RF mmWave connectors, posted Sep. 29, 2021 [online],
[retrieved Sep. 18, 2024]. Retrieved from internet, <https://www.connectortips.com/flex-to-board-rf-mmwave-connectors-meet-high-speed-5g-needs/> (Year: 2021).*

LS Mtron GB170 LST03, posted Jan. 21, 2024 [online], [retrieved
Sep. 18, 2024]. Retrieved from internet, <https://www.lsmtron.com/us/en/pr/press/1979> (Year: 2024).*

Jae WP7 series, posted Sep. 18, 2024 [online], [retrieved Sep. 18,
2024]. Retrieved from internet, https://www.jae.com/en/connectors/series/detail/id=64346&type_code=T1020 (Year: 2024).*

* cited by examiner

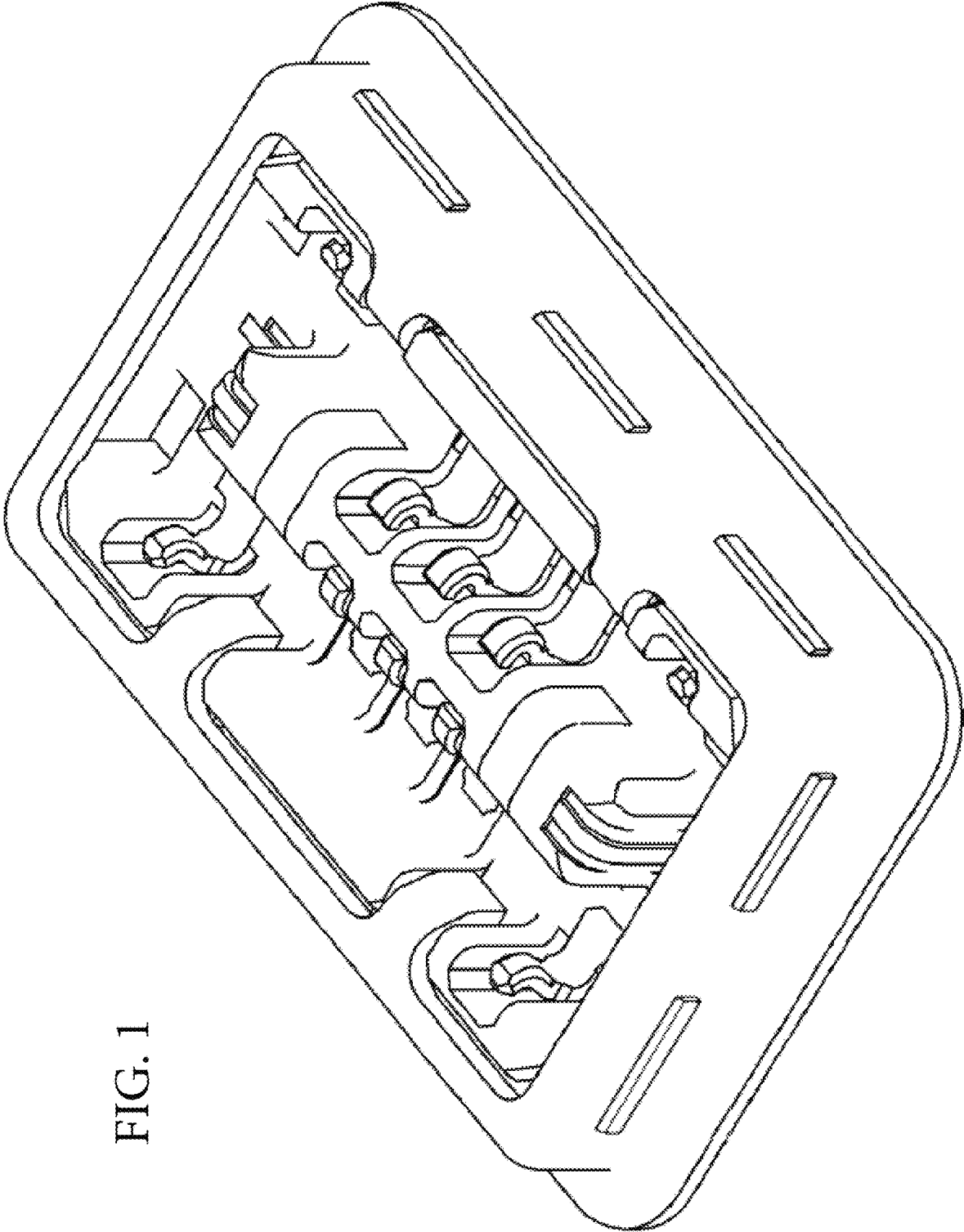

FIG. 1

FIG. 2

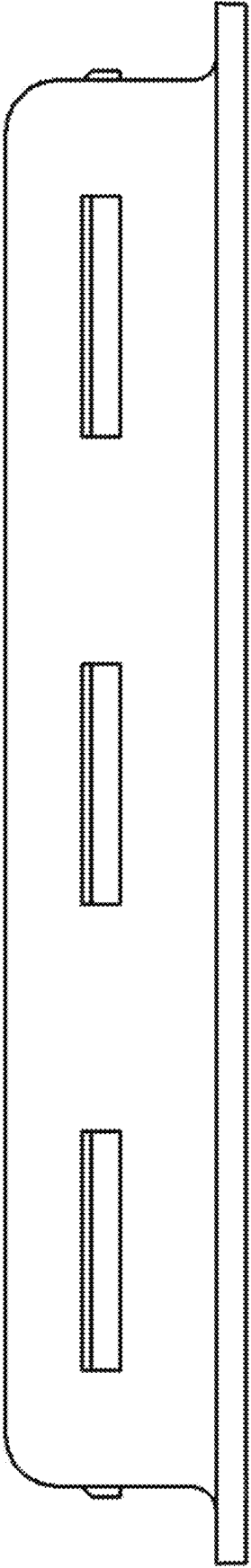

FIG. 3

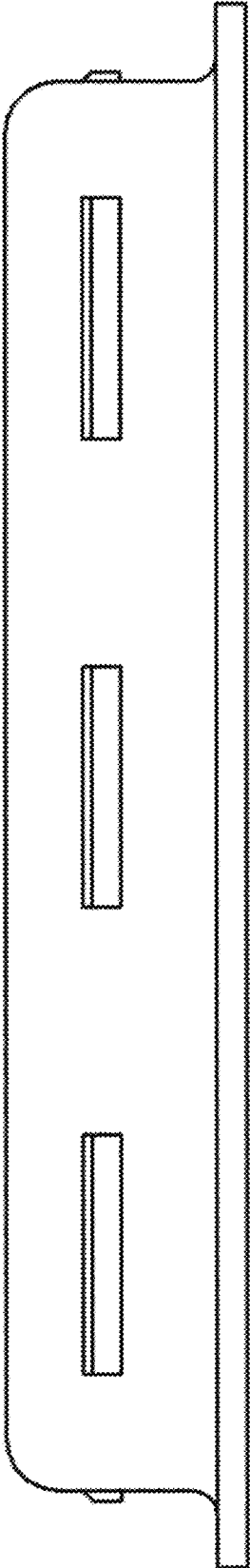

FIG. 4

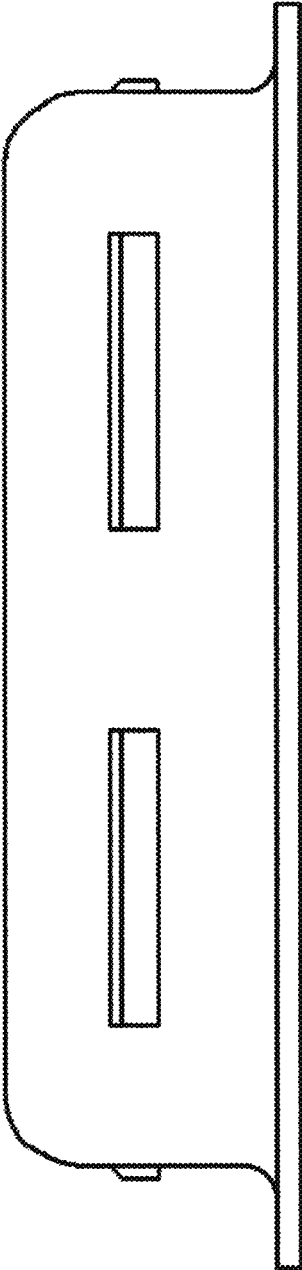

FIG. 5

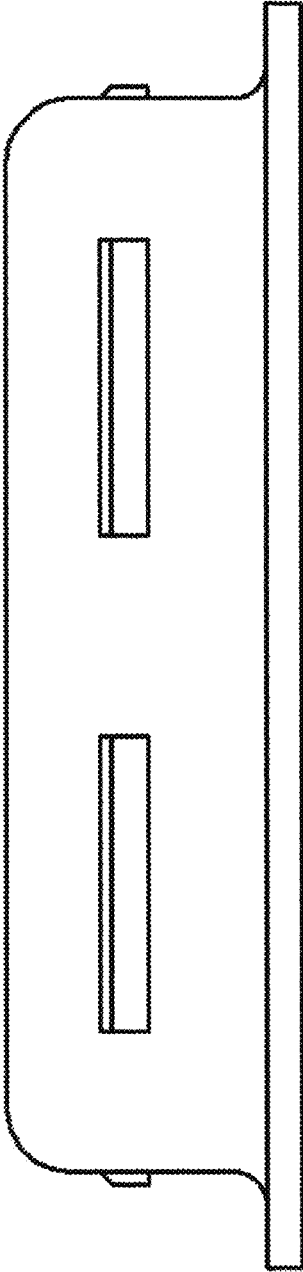

FIG. 6

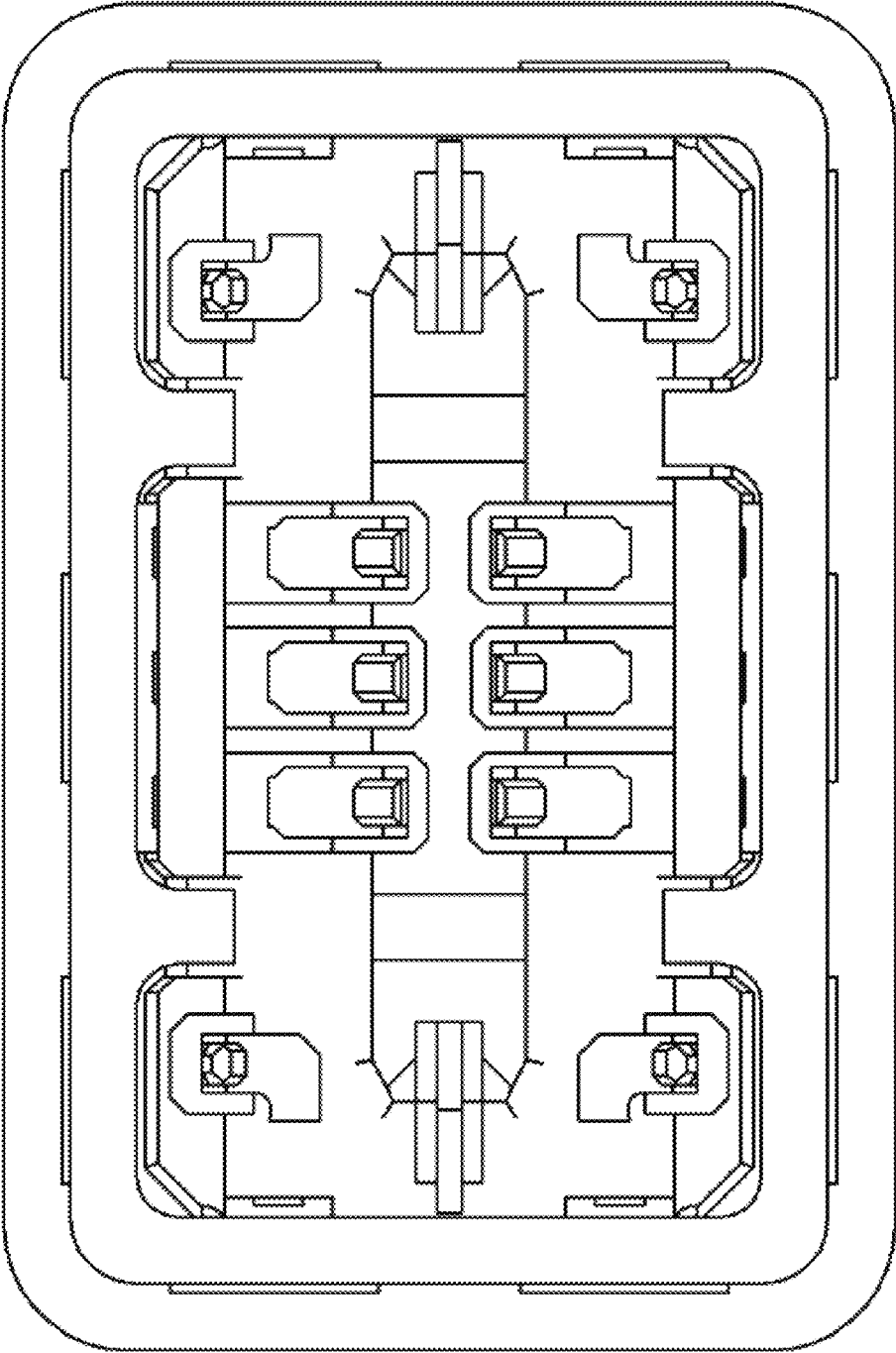

FIG. 7

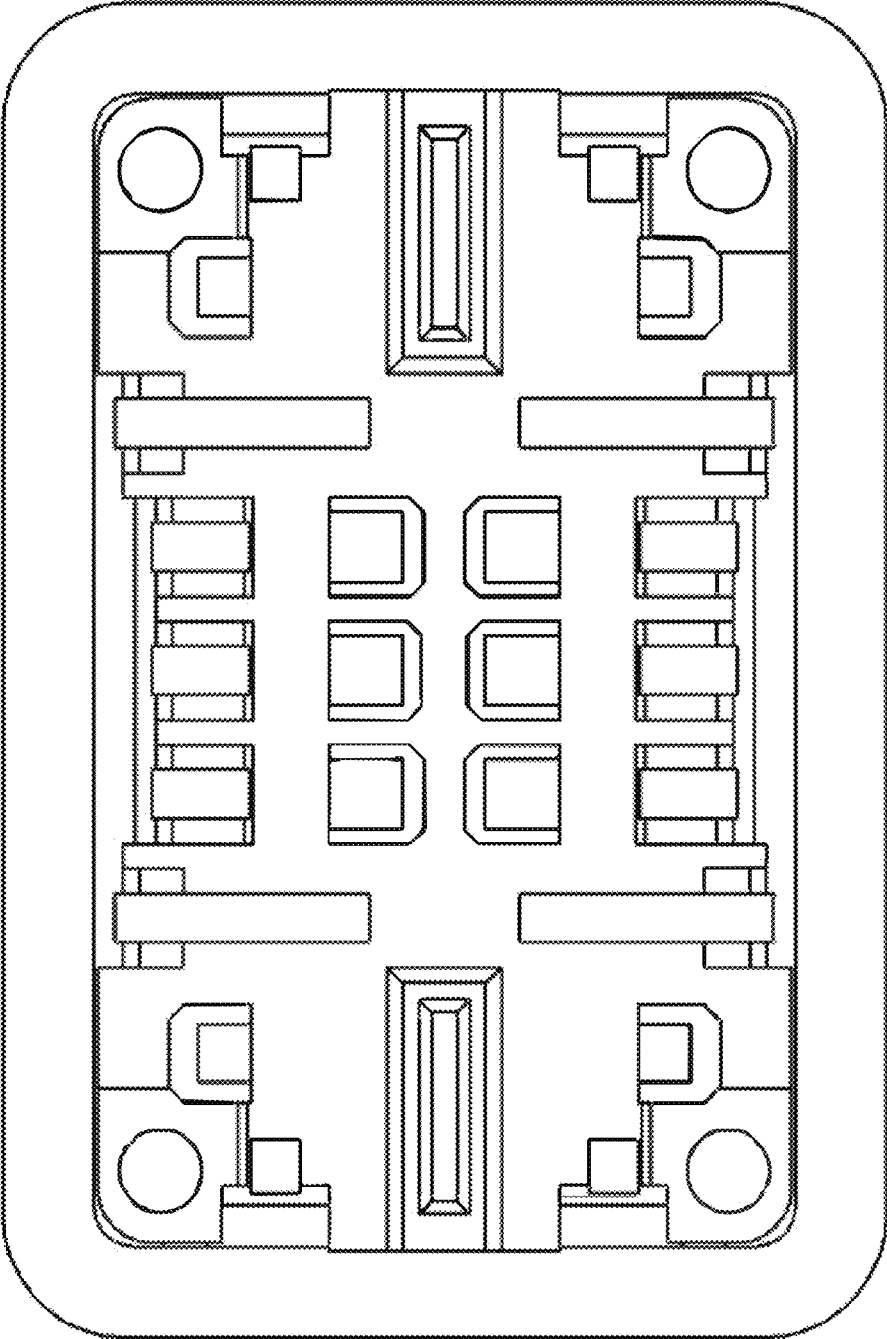

FIG. 8

