



US00D690755S

(12) **United States Design Patent**  
**Nikaido**

(10) **Patent No.:** **US D690,755 S**

(45) **Date of Patent:** **\*\* Oct. 1, 2013**

(54) **DIGITAL CAMERA**

(75) Inventor: **Yutaka Nikaido**, Kamakura (JP)

(73) Assignee: **Nikon Corporation**, Tokyo (JP)

(\*\*) Term: **14 Years**

(21) Appl. No.: **29/426,101**

(22) Filed: **Jun. 29, 2012**

(30) **Foreign Application Priority Data**

Jan. 5, 2012 (JP) ..... 2012-000027

(51) **LOC (9) Cl.** ..... **16-01**

(52) **U.S. Cl.**

USPC ..... **D16/202**; D16/217

(58) **Field of Classification Search**

USPC ..... D16/200, 202, 204, 206, 216–218;  
348/373–376; 358/909.1; 396/176–178,  
396/354–359, 535

See application file for complete search history.

(56) **References Cited**

**U.S. PATENT DOCUMENTS**

D439,922 S *	4/2001	Kumakura	.....	D16/217
D471,222 S *	3/2003	Matsumura	.....	D16/217
D491,593 S *	6/2004	Haga	.....	D16/202
D524,346 S *	7/2006	Haga	.....	D16/202
D557,308 S *	12/2007	Matsuda	.....	D16/217

D559,291 S *	1/2008	Hayashi	.....	D16/202
D560,239 S *	1/2008	Kim et al.	.....	D16/202
D607,481 S *	1/2010	Takahashi	.....	D16/217
7,701,505 B2 *	4/2010	Kikuchi	.....	348/374

\* cited by examiner

*Primary Examiner* — Adir Aronovich

(74) *Attorney, Agent, or Firm* — Wolf, Greenfield & Sacks, P.C.; Randy J. Pritzker

(57) **CLAIM**

The ornamental design for a digital camera, as shown and described.

**DESCRIPTION**

FIG. 1 is front and right side perspective view of a digital camera showing our new design;  
FIG. 2 is rear and left side perspective view of a digital camera showing my new design;  
FIG. 3 is a front elevational view thereof;  
FIG. 4 is a rear elevational view thereof;  
FIG. 5 is a top plan view thereof;  
FIG. 6 is a bottom plan view thereof;  
FIG. 7 is a right side elevational view thereof; and,  
FIG. 8 is a left side elevational view thereof.

The features shown in broken lines in the drawings depict environmental subject matter only and form no part of the claimed design.

**1 Claim, 8 Drawing Sheets**

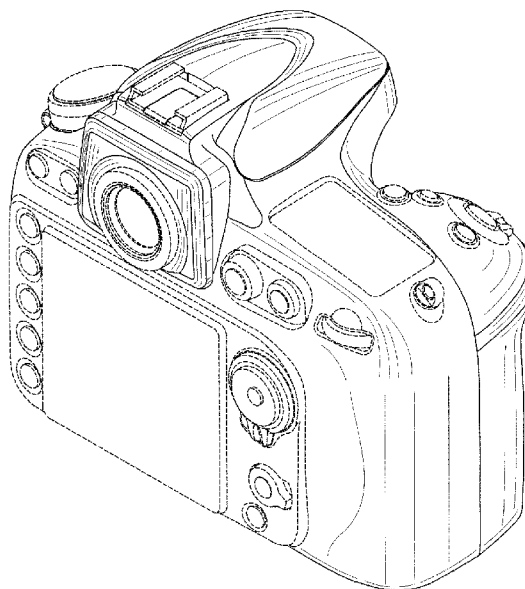
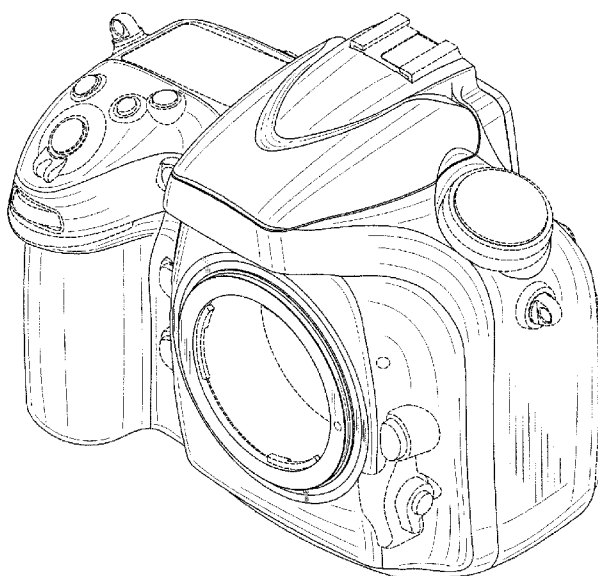

**FIG. 1**

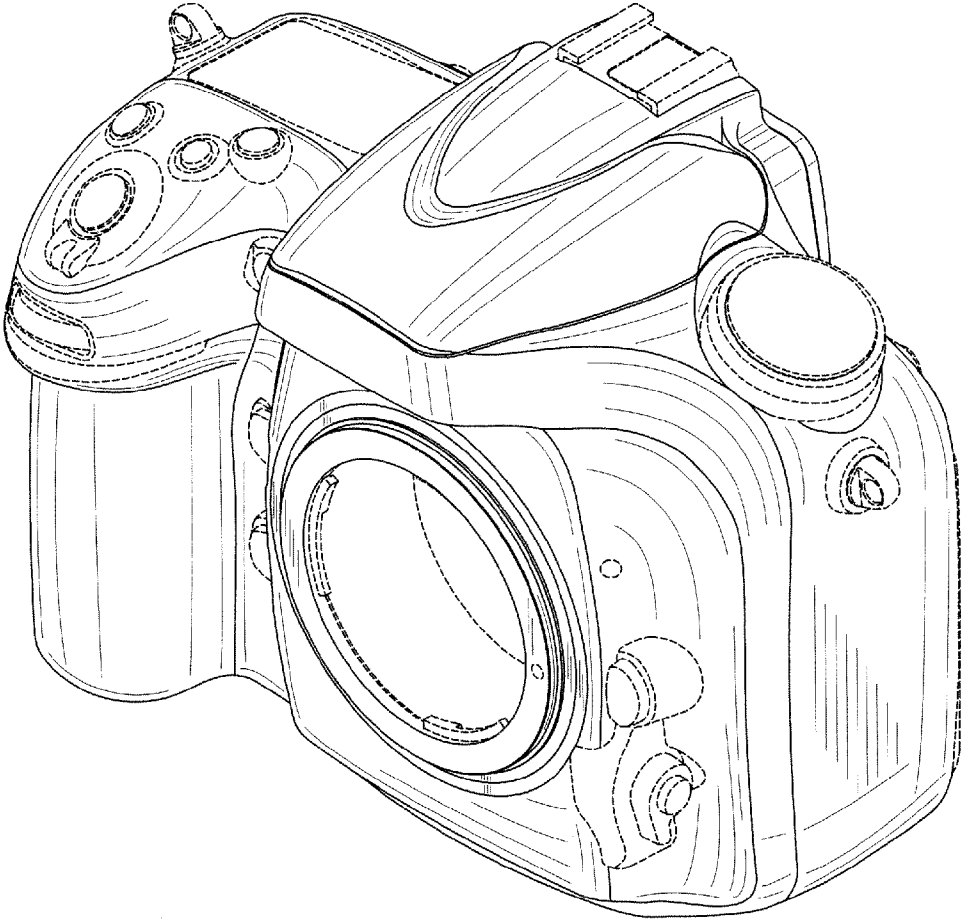

*FIG. 2*

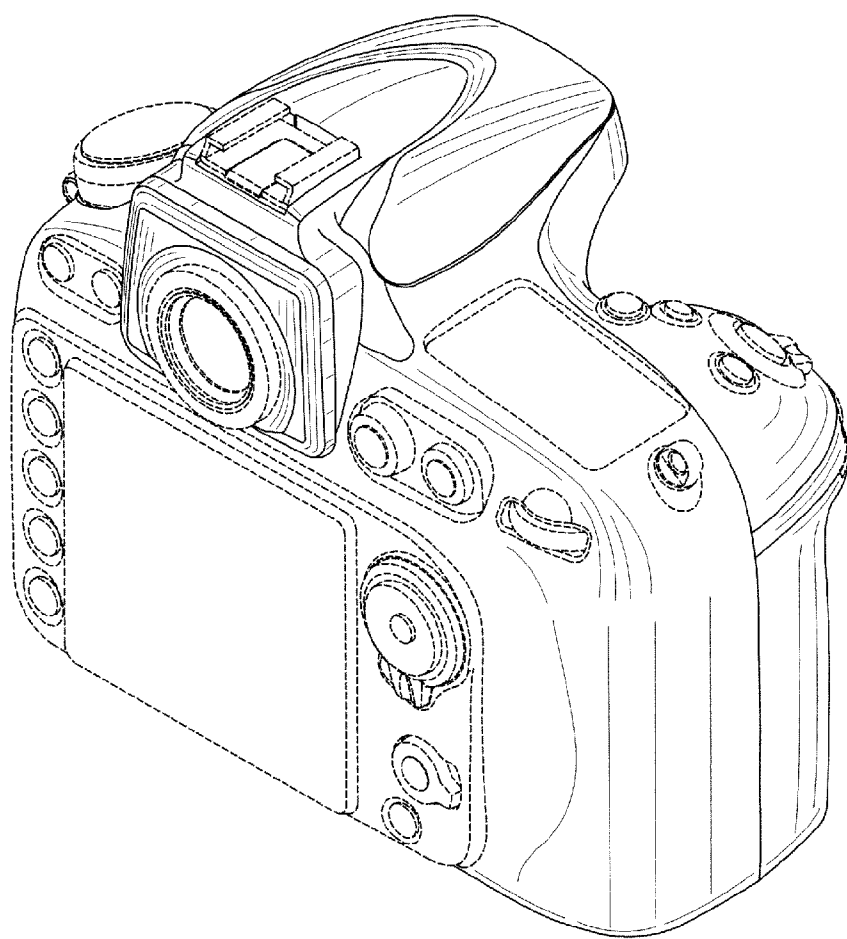

*FIG. 3*

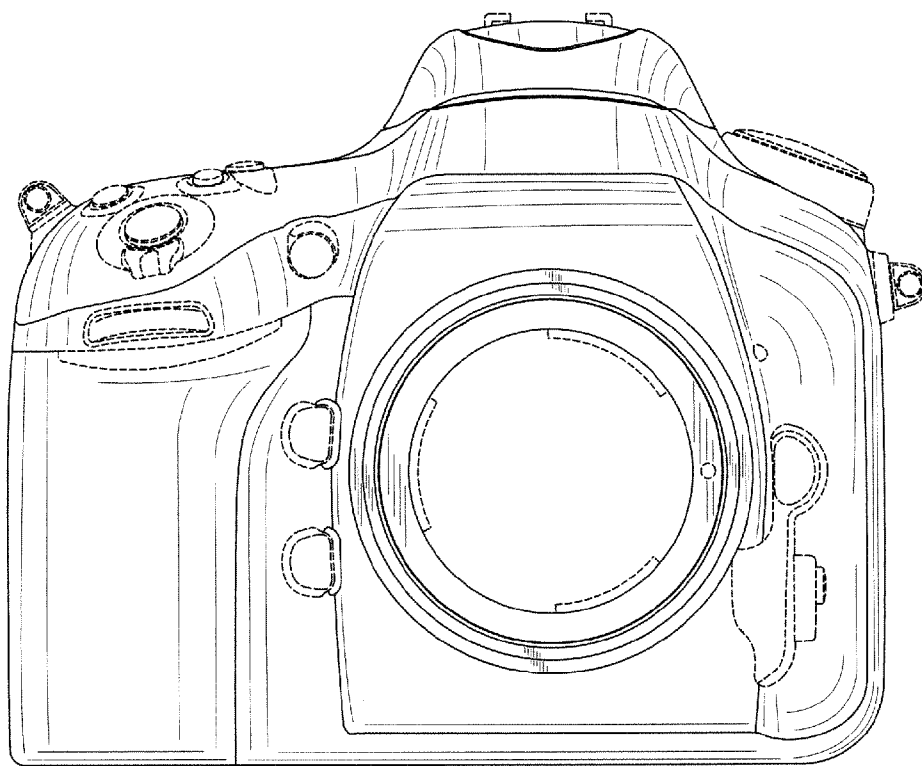

*FIG. 4*

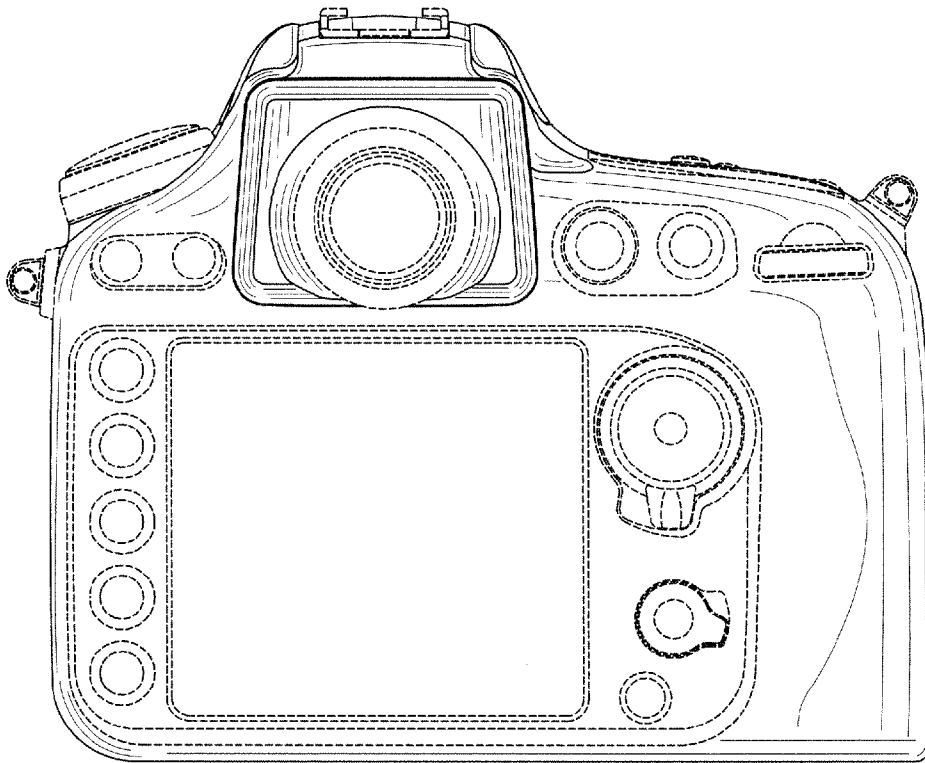

*FIG. 5*

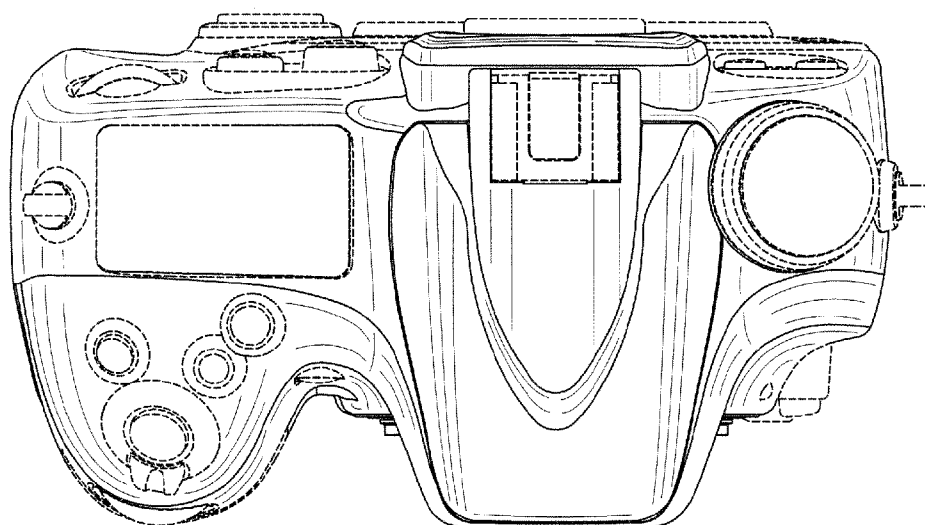

**FIG. 6**

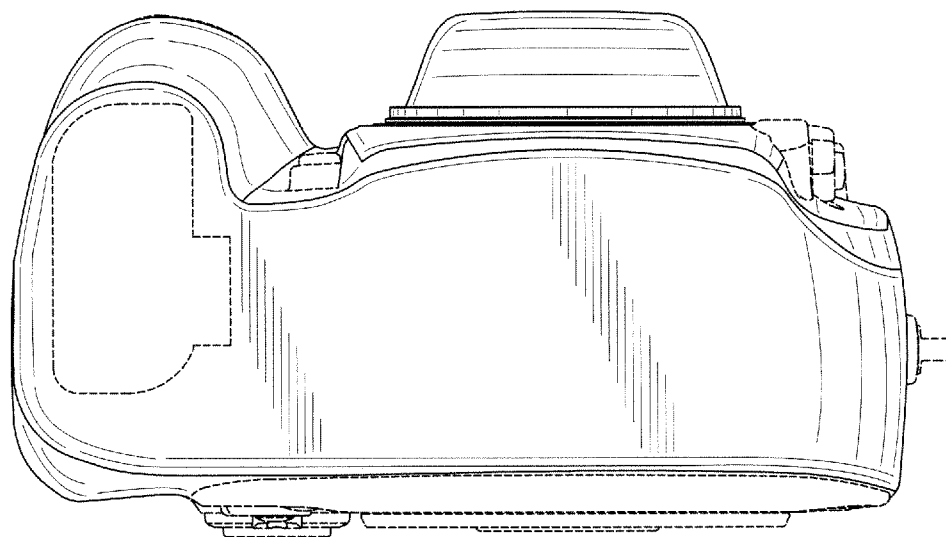

**FIG. 7**

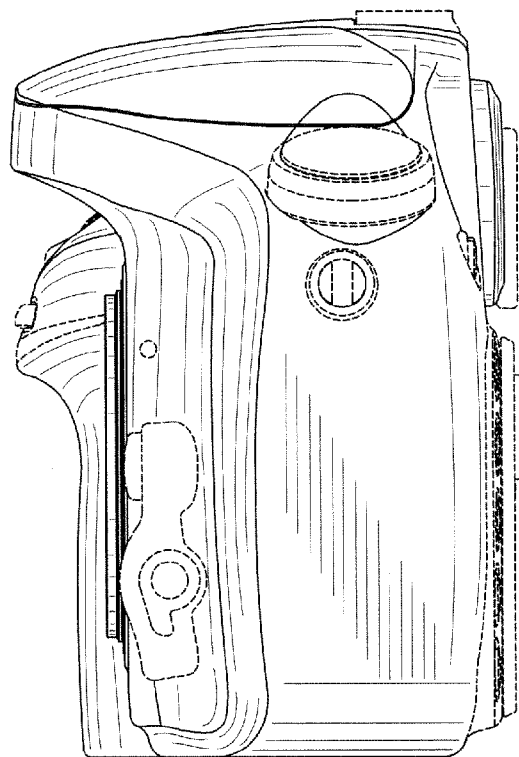



*FIG. 8*

