



US00D999969S

(12) **United States Design Patent**
Ding et al.

(10) **Patent No.:** **US D999,969 S**

(45) **Date of Patent:** **** Sep. 26, 2023**

(54) **LAMP**

OTHER PUBLICATIONS

(71) Applicant: **Shenzhen Intellirocks Tech. Co., Ltd.**,
Shenzhen (CN)

Govee Glide Y Lights, ASIN: B0BC7R9PKV. Date first available at
amazon.com—Nov. 13, 2022. (Year: 2022).*

(Continued)

(72) Inventors: **Dongjun Ding**, Shenzhen (CN);
Wenlong Wu, Shenzhen (CN)

Primary Examiner — Clare E Heflin

(**) Term: **15 Years**

(57) **CLAIM**

(21) Appl. No.: **35/514,696**

The ornamental design for a lamp, as shown and described.

(22) Filed: **Jun. 30, 2022**

(80) **Hague Agreement Data**

DESCRIPTION

Int. Filing Date: **Jun. 30, 2022**

Int. Reg. No.: **DM/222001**

Int. Reg. Date: **Jun. 30, 2022**

Int. Reg. Pub. Date: **Jul. 15, 2022**

- 1. Lamp
- 2. Lamp
- 5. Lamp
- 1.1: Perspective
- 1.2: Perspective
- 1.3: Front
- 1.4: Back
- 1.5: Left
- 1.6: Right
- 1.7: Top
- 1.8: Bottom
- 2.1: Perspective
- 2.2: Perspective
- 2.3: Front
- 2.4: Back
- 2.5: Left
- 2.6: Right
- 2.7: Top
- 2.8: Bottom
- 5.1: Perspective
- 5.2: Perspective
- 5.3: Front
- 5.4: Back
- 5.5: Left
- 5.6: Right
- 5.7: Top
- 5.8: Bottom

(30) **Foreign Application Priority Data**

Apr. 29, 2022 (CN) 202230253527.0

Apr. 29, 2022 (CN) 202230254547.X

(51) **LOC (14) Cl.** **26-03**

(52) **U.S. Cl.**
USPC **D26/89**

(58) **Field of Classification Search**

USPC D26/76, 89, 72, 80, 83, 85

CPC F21S 2/005; F21S 8/03; F21S 8/033; F21S
8/04; F21S 8/046; F21W 2131/1005;
F21W 2131/107

See application file for complete search history.

(56) **References Cited**

U.S. PATENT DOCUMENTS

D97,213 S * 10/1935 Stone D26/83

D130,256 S * 11/1941 Scribner 362/223

D186,129 S * 9/1959 Spaulding D26/76

(Continued)

(Continued)

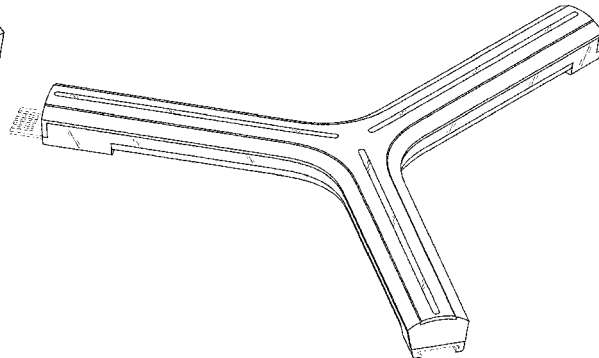
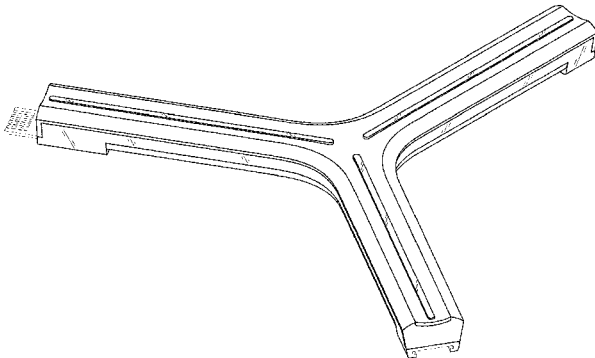

The broken lines shown in the drawings are included for the purpose of illustrating portions of the lamp that form no part of the claimed design.

1 Claim, 24 Drawing Sheets

D930,883	S *	9/2021	Sonneman	D26/89
D975,906	S *	1/2023	Li	D26/76
D977,697	S *	2/2023	Lu	D26/76
2013/0294079	A1 *	11/2013	Tran	F21S 8/043 362/249.15
2019/0211983	A1 *	7/2019	Shine	F21V 15/015
2020/0263859	A1 *	8/2020	Kinsley	F21V 19/0025

(56)

References Cited

U.S. PATENT DOCUMENTS

3,745,327	A *	7/1973	Lowery	F21S 8/033 D26/80
D565,228	S *	3/2008	Lovegrove	D26/2
D655,847	S *	3/2012	Sabernig	D26/86
D664,288	S *	7/2012	De Lucchi	D26/138
D674,528	S *	1/2013	Paz	D26/72
D743,092	S *	11/2015	Paulsen	D26/142
D813,440	S *	3/2018	Xia	D26/80
D849,304	S *	5/2019	Hendifar	D26/86
D853,016	S *	7/2019	Chiesurin	D26/93

OTHER PUBLICATIONS

NanoLeaf Lines review By Jason Cipriani Nov. 10, 2021. <<https://www.cnn.com/cnn-underscored/reviews/nanoleaf-lines>>. (Year: 2021).*

Hoop Pool & Loop LED Lamp, posted by retail design blog on May 4, 2011. <<https://retaildesignblog.net/2011/05/04/hoop-pool-loop-led-lamp/>>. (Year: 2011).*

DXLight Triangle White Light. ASIN: B081T53RBW. Date first available at amazon.com—Nov. 21, 2019. (Year: 2019).*

Modern Indoor LED Y shape suspended architectural lighting. Model No. LL0190S-40W. Available at newshinelighting.com. Site visited Jul. 20, 2023. (Year: 2023).*

* cited by examiner

1.1

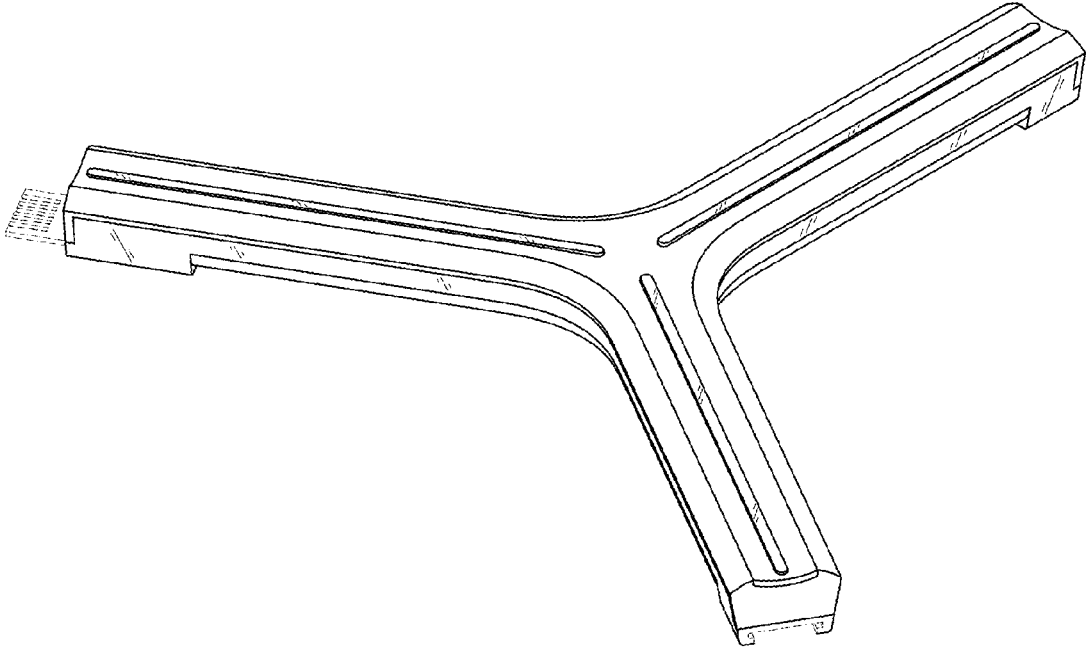

1.2

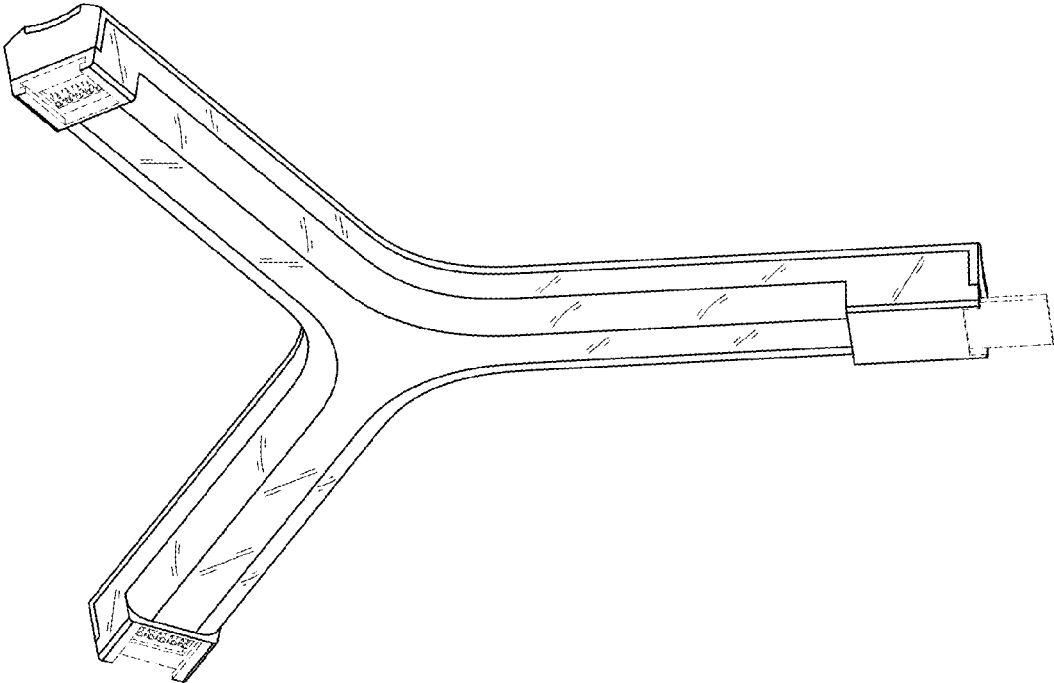

1.3

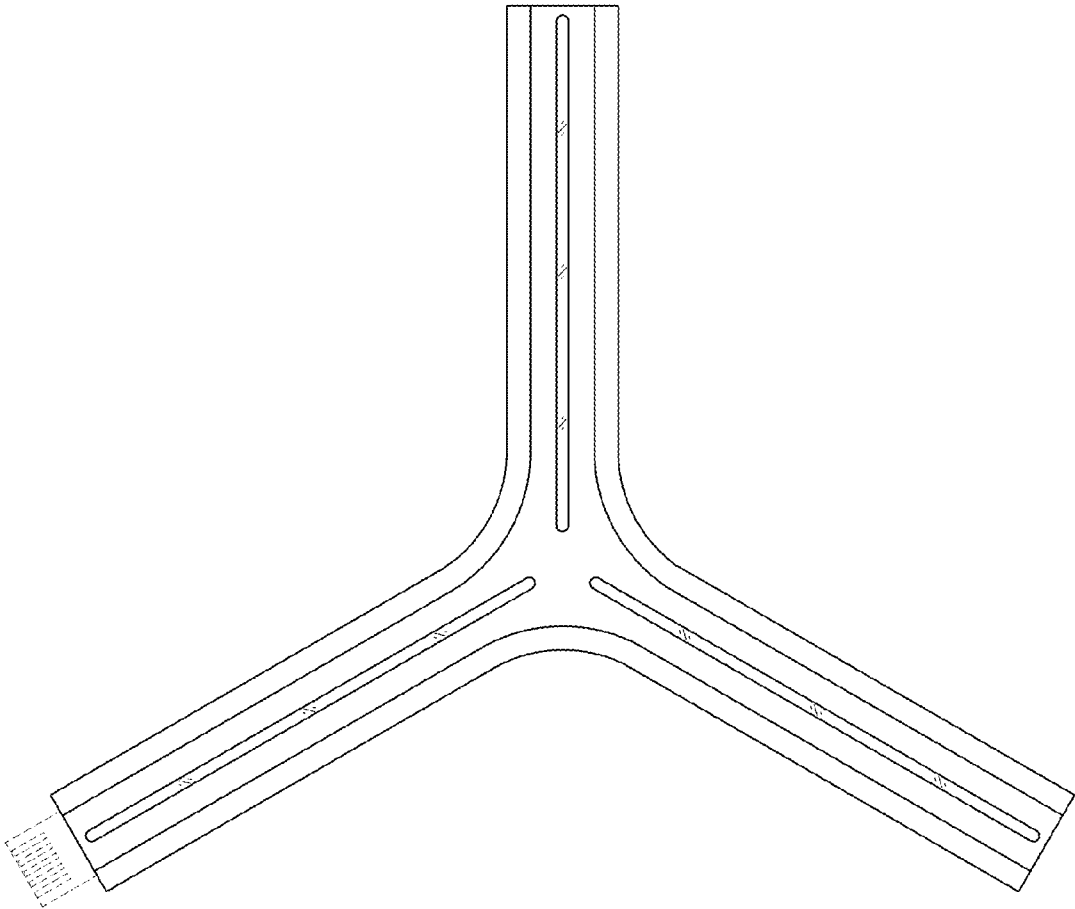

1.4

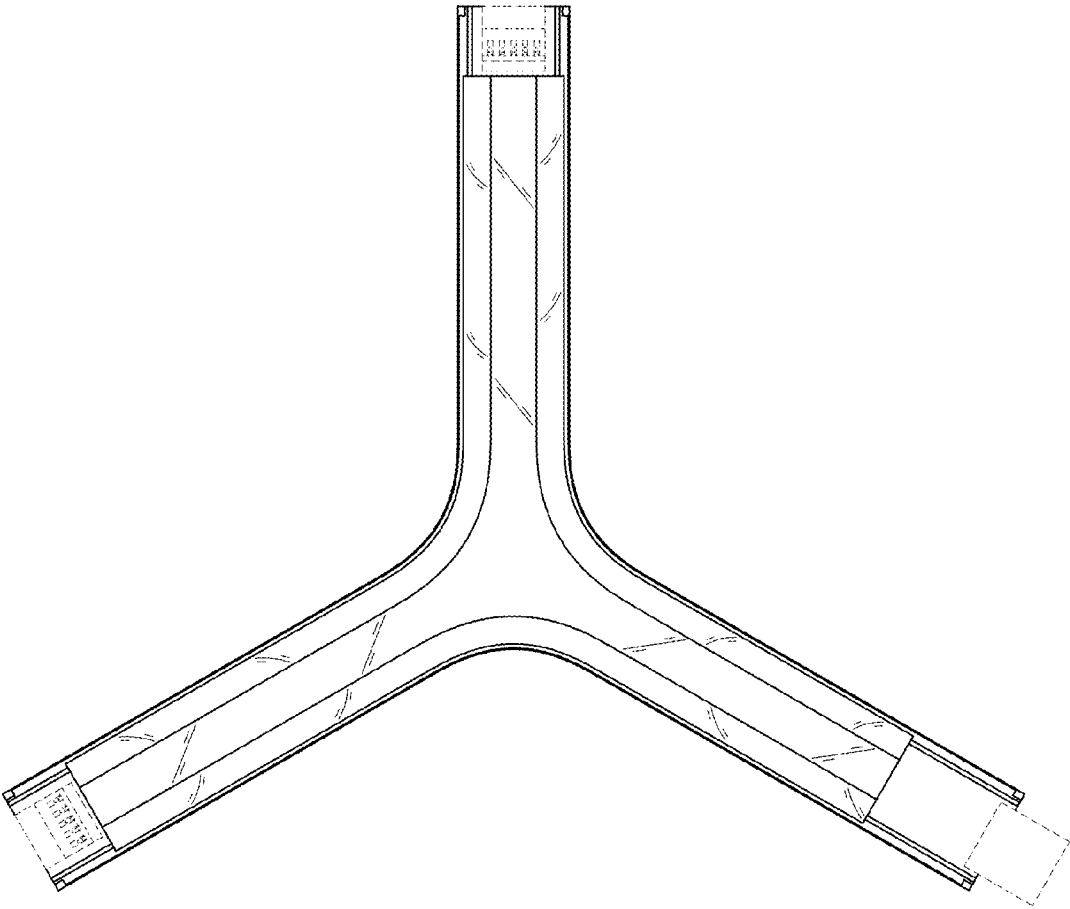

1.5

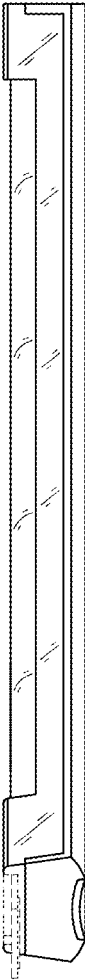

1.6

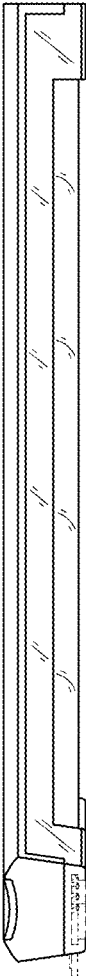

1.7

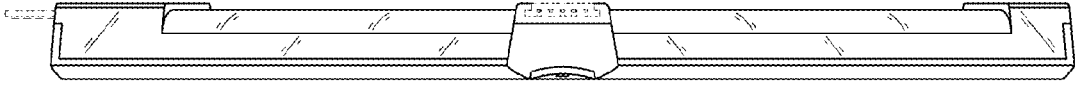

1.8

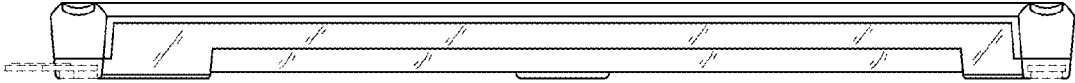

2.1

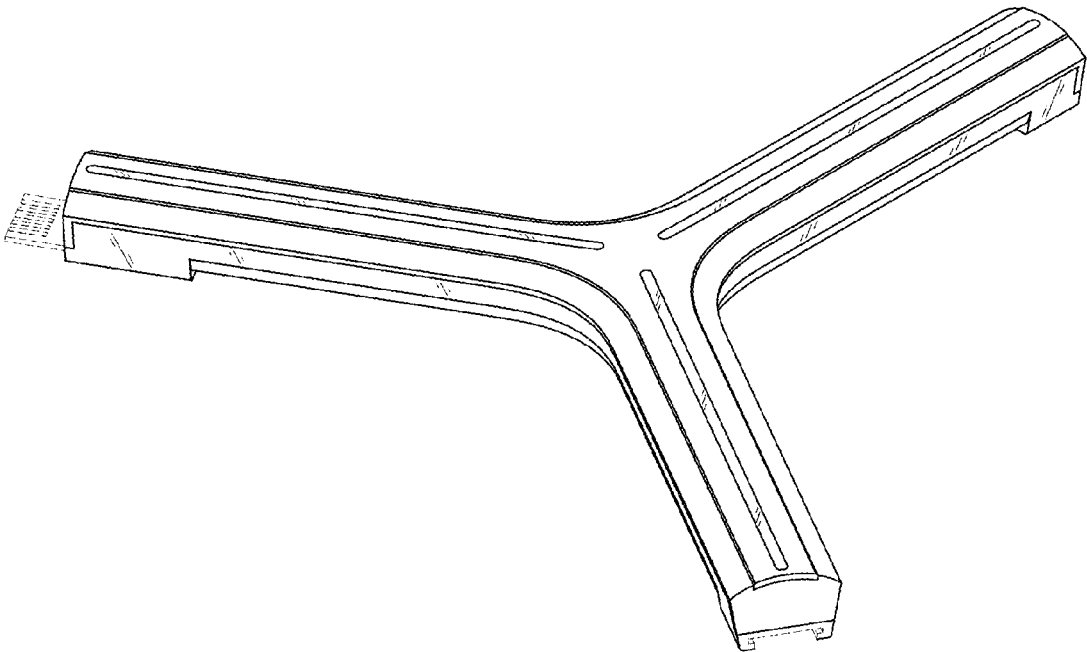

2.2

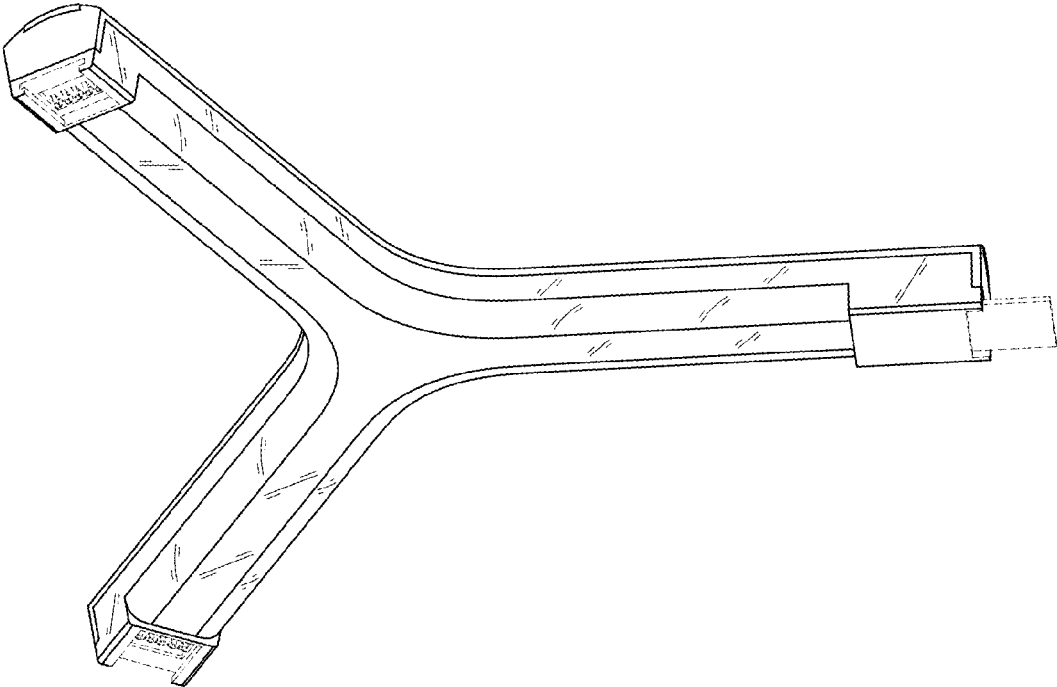

2.3

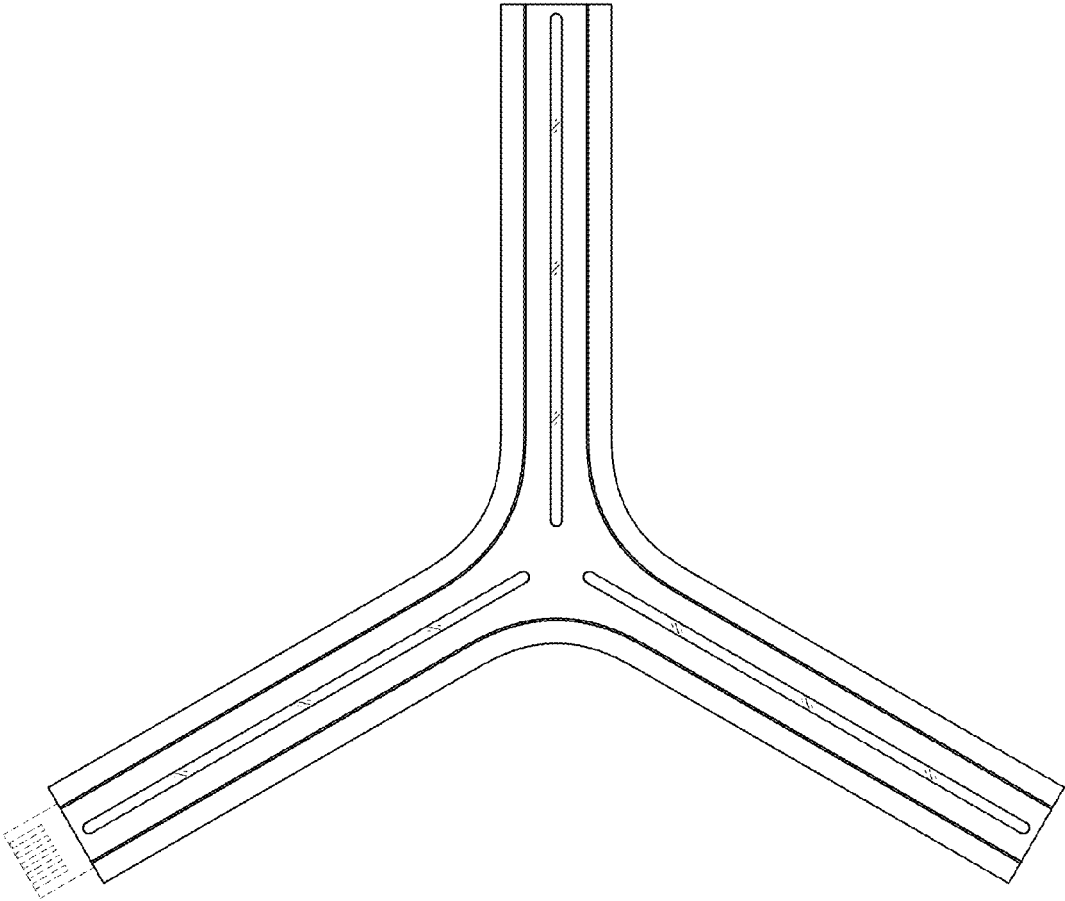

2.4

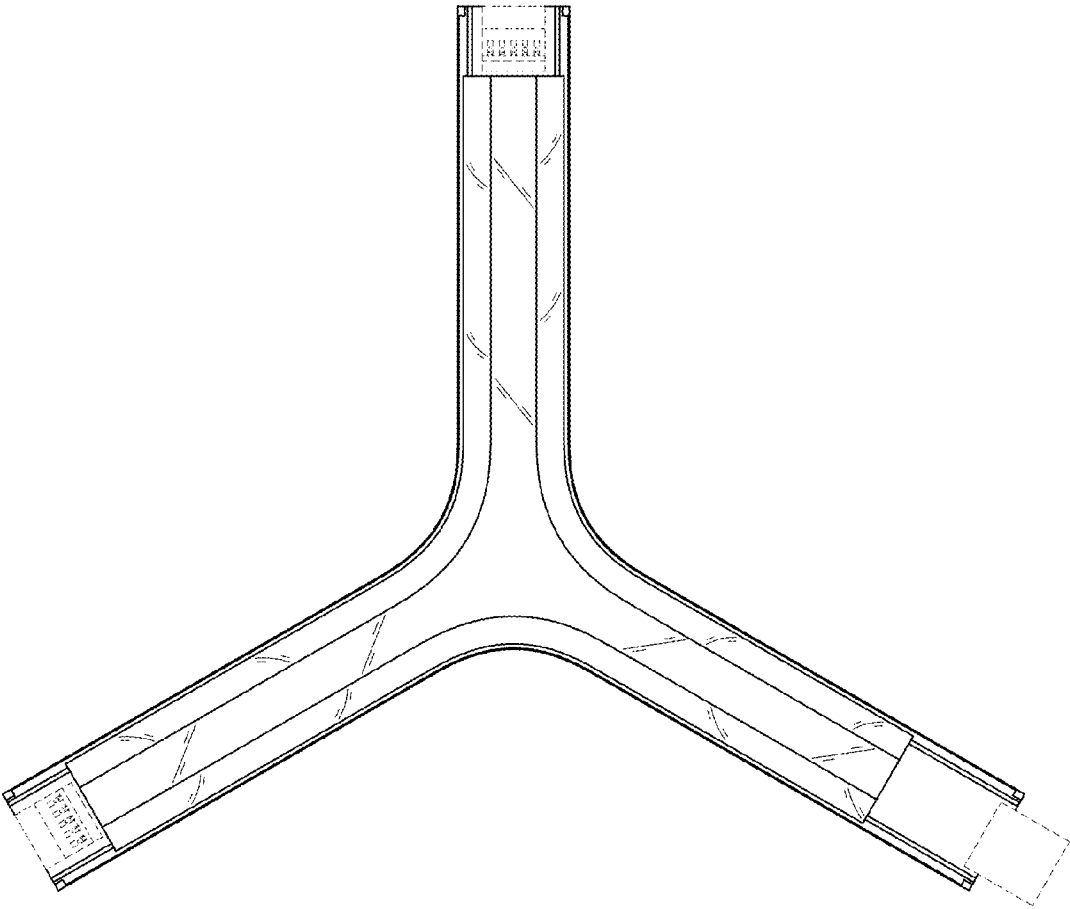

2.5

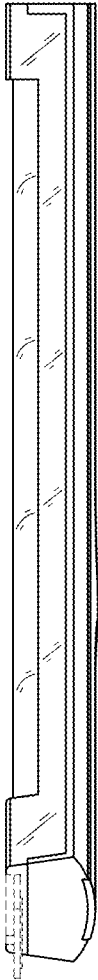

2.6

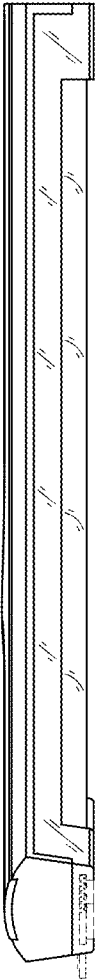

2.7

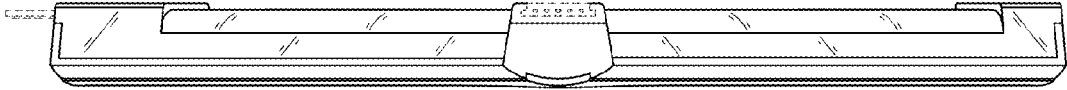

2.8

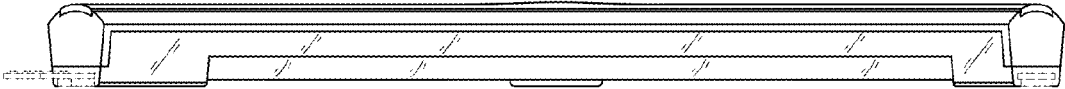

5.1

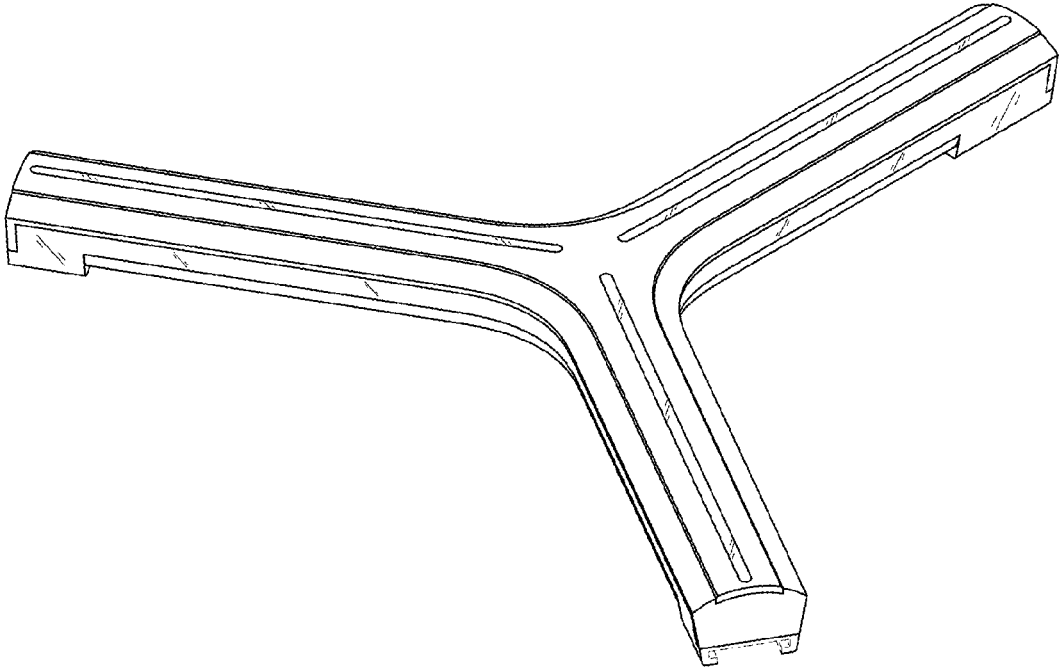

5.2

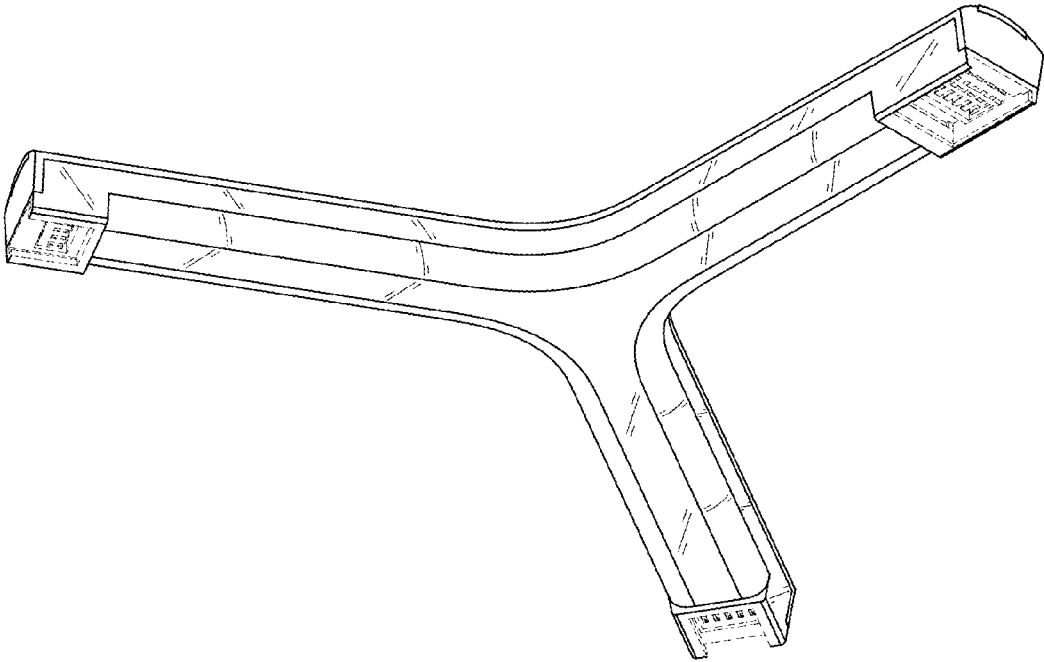

5.3

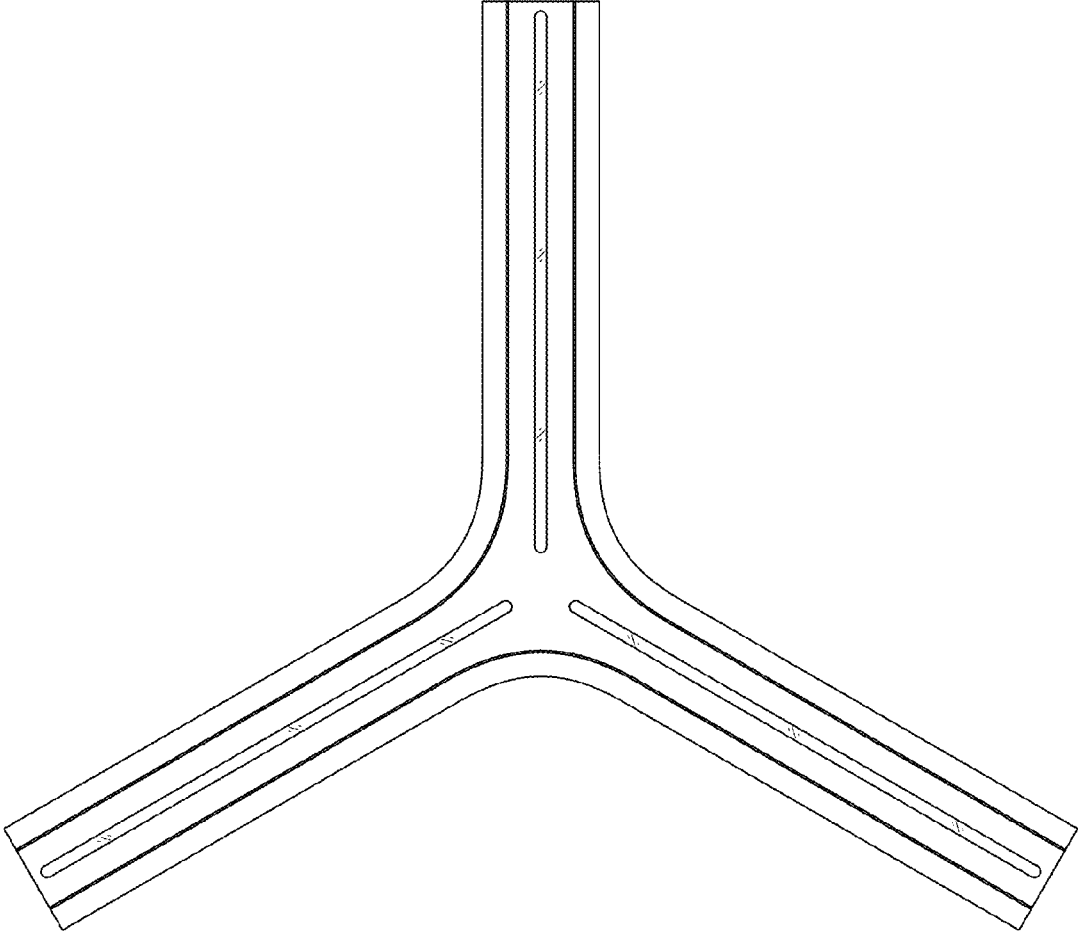

5.4

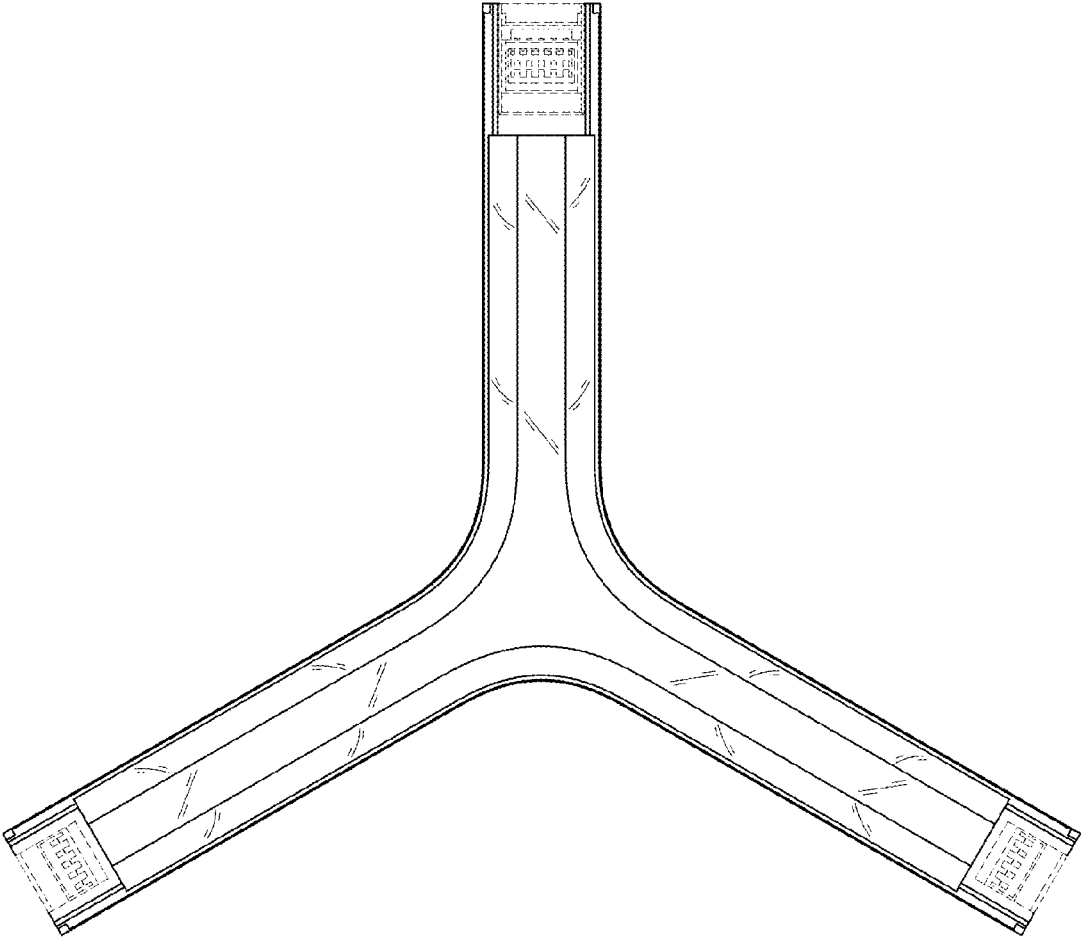

5.5

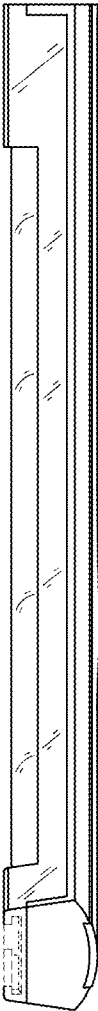

5.6

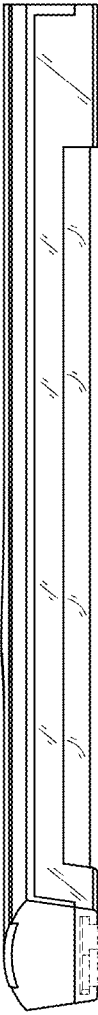

5.7

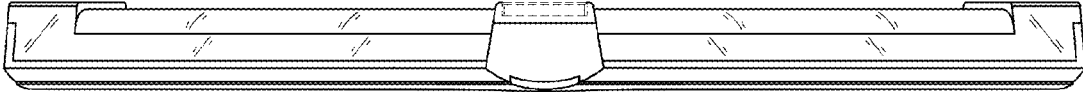

5.8

