

(19) World Intellectual Property Organization
International Bureau



(43) International Publication Date
18 September 2003 (18.09.2003)

PCT

(10) International Publication Number
WO 03/077550 A1

- (51) International Patent Classification⁷: **H04N 7/08**, 7/14, 7/173 (74) Agent: AWAPATENT A/S; Tegholm Allé 13, DK-2450 Kobenhavn SV (DK).
- (21) International Application Number: PCT/IB02/00726 (81) Designated States (national): AE, AG, AL, AM, AT, AU, AZ, BA, BB, BG, BR, BY, BZ, CA, CH, CN, CO, CR, CU, CZ, DE, DK, DM, DZ, EC, EE, ES, FI, GB, GD, GE, GH, GM, HR, HU, ID, IL, IN, IS, JP, KE, KG, KP, KR, KZ, LC, LK, LR, LS, LT, LU, LV, MA, MD, MG, MK, MN, MW, MX, MZ, NO, NZ, OM, PH, PL, PT, RO, RU, SD, SE, SG, SI, SK, SL, TJ, TM, TN, TR, TT, TZ, UA, UG, US, UZ, VN, YU, ZA, ZM, ZW.
- (22) International Filing Date: 12 March 2002 (12.03.2002)
- (25) Filing Language: English
- (26) Publication Language: English
- (71) Applicant (for all designated States except US): **NOKIA CORPORATION** [FI/FI]; P.O. Box 226, FIN-00045 Nokia Group (FI).
- (72) Inventor; and (75) Inventor/Applicant (for US only): **IKONEN, Ari** [FI/FI]; Kaivokuja 12, Fin-21280 Raisio (FI).
- (84) Designated States (regional): ARIPO patent (GH, GM, KE, LS, MW, MZ, SD, SL, SZ, TZ, UG, ZM, ZW), Eurasian patent (AM, AZ, BY, KG, KZ, MD, RU, TJ, TM), European patent (AT, BE, CH, CY, DE, DK, ES, FI, FR, GB, GR, IE, IT, LU, MC, NL, PT, SE, TR), OAPI patent (BF, BJ, CF, CG, CI, CM, GA, GN, GQ, GW, ML, MR, NE, SN, TD, TG).

[Continued on next page]

(54) Title: A SYSTEM AND METHOD FOR TRANSFERRING A MMS BETWEEN MESSAGE COMMUNICATION UNIT AND DIGITAL TV

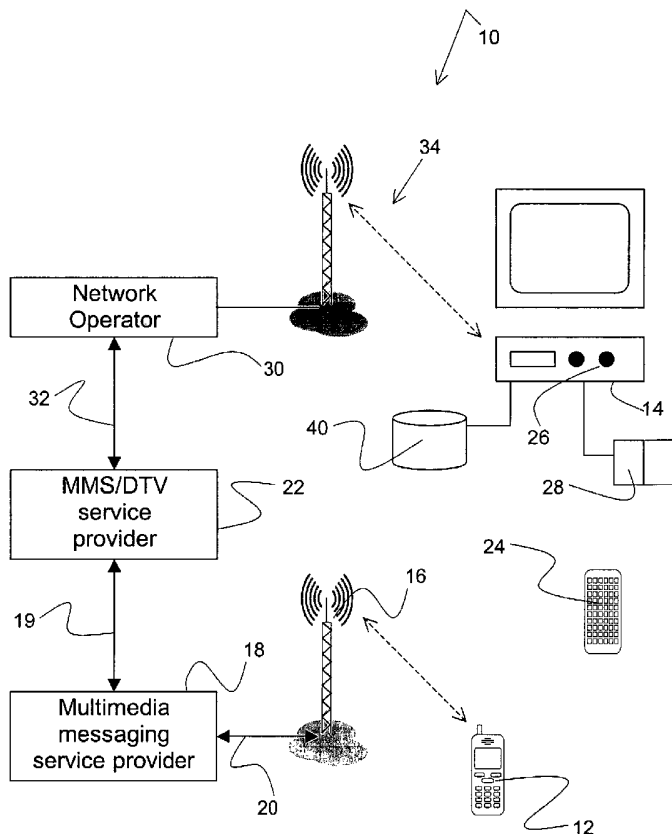

(57) Abstract: This invention relates to a system and method for transferring messages from a message communication unit such as a phone, a cellular or mobile phone, a personal computer, a digital camera, or a digital video camera to other compatible systems such as digital set-top boxes (STB), multimedia terminals, digital TV receivers or digital TVs. The system communicates a message between a message communication unit and a television device, by utilising a base station in a wireless communications network, a communications provider connecting to the base station, a television network operator operating a television distribution network, and a television device.

WO 03/077550 A1

**Declarations under Rule 4.17:**

— as to applicant's entitlement to apply for and be granted a patent (Rule 4.17(ii)) for the following designations AE, AG, AL, AM, AT, AU, AZ, BA, BB, BG, BR, BY, BZ, CA, CH, CN, CO, CR, CU, CZ, DE, DK, DM, DZ, EC, EE, ES, FI, GB, GD, GE, GH, GM, HR, HU, ID, IL, IN, IS, JP, KE, KG, KP, KR, KZ, LC, LK, LR, LS, LT, LU, LV, MA, MD, MG, MK, MN, MW, MX, MZ, NO, NZ, OM, PH, PL, PT, RO, RU, SD, SE, SG, SI, SK, SL, TJ, TM, TN, TR, TT, TZ, UA, UG, UZ, VN, YU, ZA, ZM, ZW, ARIPO patent (GH, GM, KE, LS, MW, MZ, SD, SL, SZ, TZ, UG, ZM, ZW), Eurasian patent (AM, AZ, BY, KG, KZ, MD, RU, TJ, TM), European patent

(AT, BE, CH, CY, DE, DK, ES, FI, FR, GB, GR, IE, IT, LU, MC, NL, PT, SE, TR), OAPI patent (BF, BJ, CF, CG, CI, CM, GA, GN, GQ, GW, ML, MR, NE, SN, TD, TG)

— of inventorship (Rule 4.17(iv)) for US only

Published:

— with international search report

For two-letter codes and other abbreviations, refer to the "Guidance Notes on Codes and Abbreviations" appearing at the beginning of each regular issue of the PCT Gazette.

A SYSTEM AND METHOD FOR TRANSFERRING A MMS BETWEEN MESSAGE COMMUNICATION UNIT AND DIGITAL TV

Field of invention

5 This invention relates to a system and method for transferring messages from a message communication unit such as a phone, a cellular or mobile phone, a personal computer, a digital camera, or a digital video camera to other compatible systems such as digital set top boxes (STB), multimedia terminals,
10 digital TV receivers, or digital TVs.

Background of invention

Transferring of messages between cellular phones or between
15 cellular phones and a computer is generally know as Short Messaging Service (SMS). An SMS consisting of a short text or limited figurative message is transmitted between cellular phones connected to a cellular phone network or between a cellular phone connected to a cellular phone network and a
20 computer connected to a server connected to said cellular phone network. The transmission is generally performed during periods when the normal vocal cellular phone traffic so permits. The problem of the SMS messaging system is that the size of each message is limited, thus preventing an operator to transmit
25 longer text files or detailed picture files.

International patent application WO 01/49032 discloses a system for providing a cable TV subscriber access to a unified messaging system (UMS) and/or a voice mail system (VMS). The

system comprises a TV set having a set-top box connecting to the cable TV network, which set-top box provides a connection between subscribers of the cable TV network and a unified or voice messaging system. The system further comprises an interface for enabling exchange of information between the subscribers and the unified or voice messaging system. The system enables subscribers of a cable TV network to connect to a UMS and VMS, however, the system is limited to the infrastructure of the cable TV.

10

International patent application WO 00/13415 discloses a television message system enabling user of television equipment devices connected to a television distribution facility (i.e. network) to transmit messages regarding television programs or other suitable subjects. The television message system permits users to participate in evaluations, contests, promotions, and surveys related to a television program while watching that television program. The television system further permits the users to compose and send a message directly to a television program entity such as a distributor. In addition, the television message system permits the users to send messages through the television message system to users of computers connected to the television distribution facility through a communications network. As above relating to WO 01/49032 the television message system is limited to the infrastructure of the cable TV.

15

20

25

30

European patent application EP 1 180 903 discloses a system and method for transmitting an image from a first display to a second display. The system comprises a cellular phone, a base station and a TV receiver, where the cellular phone receives a visual message from the base station. An operator of the cellular phone may transfer this visual message to a larger

display, such as a TV display or a computer monitor, by
utilising a bluetooth link. The system enables communication
between a TV and a cellular phone both having bluetooth chips.
However, the system only establishes a communication between a
5 cellular phone and a TV, which is located in the vicinity of
the cellular phone.

The above referenced patent applications do not provide any
disclosure for communicating messages from a cellular phone to
10 any recipient having a television receiver, where the recipient
is not in physical contact with a television receiver nor
within a distance to obtain a direct bluetooth communications
link.

15 The above referenced International patent applications WO
01/49032 and WO 00/13415, and the European patent application
EP 1 180 903 are hereby incorporated in below specification by
reference.

20 **Summary of the invention**

An object of the present invention is to enable an operator of
a cellular phone to transmit messages through a wireless
communications network and/or television distribution network
25 to a set-top box such as a digital television receiver. Thereby
enabling an operator of any particular cellular phone to
transmit messages to any subscriber in a television
distribution network and having a set-top box, which is not
necessarily in the vicinity of the transmitting cellular phone.

30

A further object of the present invention is to enable persons
not having access to message communication units having

multimedia capabilities to receive complex messages utilising a set-top box.

5 An advantage of the present invention is the provision of a system, which enables an operator to display for himself and/or for others particular messages, which might be of interest for a larger group of people.

10 A feature of the present invention is the provision of a message sign on a TV screen connected to a television distribution network through a set-top box. Thus enabling an subscriber instantly to check messages.

15 The above object, advantage and feature together with numerous further objects, advantages and features, which will become evident from below description, is accomplished by a solution in accordance to a first aspect of the present invention by a system for communicating a message between a message communication unit and a television device, said system
20 comprising:

a base station in a wireless communications network adapted to communicate said message between said message communication unit and said base station;

25 a communications provider for connecting to said base station and adapted to communicate said message between said base station and said communications provider; and

a television network operator for operating a television distribution network and adapted to communicate said message between said service provider and said television receiver.

30

The term message communication unit should in this context be construed as a cellular phone, cell phone, a mobile phone, or a wireless phone utilising any transmission method, including,

but not limited to GSM, EDGE, WCDMA, DAB, DVB, or Bluetooth link. The term should further be construed as a common personal computer (PC), digital camera or digital video camera capable of transmitting messages wirelessly themselves or in
5 conjunction with a cellular phone utilising a wireless phone network.

Further, the term "a" or "an" is in this context to be construed as a single, one, or at least one.

10

Additionally, the term television distribution network is to be construed as a cable TV network, a satellite TV network, a radio frequency TV network, and/or any TV network utilising digital transmission techniques.

15

The invention according to the first aspect of the present invention provides the subscriber of a television distribution network with a possibility to display messages transmitted through a wireless communications network by transferring these
20 messages to a television device, and in addition provides operators of further message communication units to transfer messages to the television device.

25

The term television device should in this context be construed as a digital control box for a television distribution network or a digital TV receiver, a set-top box, television receiver, multimedia terminals, digital TV receivers, or digital TVs. The television device may be an integral part of a digital TV or a separate unit working in conjunction with a TV.

30

A further advantage of the system according to the first aspect of the present invention is the provision of a system which

enables users of parallel systems to receive messages from message communication units generating a multimedia message.

The system according to the first aspect of the present invention communicates the message between the message communication unit and the television device by utilising the base station for connecting to the wireless communications network and receiving the message from the message communication unit. Further, the system utilises the communications provider for connecting to the base station, for receiving the message from the base station, for identifying whether a recipient of the message is a subscriber to the television distribution network, and for processing the message into a transmittable format, which is readable by the television device. Furthermore, the system utilises the television network operator for operating the television distribution network, for receiving the processed message and for transmitting the processed message to the television device over the television distribution network.

20

The message according to first aspect of the present invention may comprise a header for identifying a recipient in the television distribution network. The message may further comprise a text, a picture, a series of pictures, a video, a series of videos, an audio recording, a series of audio recordings, or any combination thereof. Any configurations of messages may be implemented in the system according to the first aspect of the present invention. For example, the header may comprise a specific e-mail address to be utilised by the communications provider to identify when a message is to be forwarded on a television distribution network.

30

The term message should in this context be construed as an e-mail encapsulating text and/or files containing a picture, a series of pictures, a video, a series of videos, an audio recording, a series of audio recordings, or any combination thereof, an e-mail encapsulating a multimedia message, which may be handled by a Multimedia Messaging Service (MMS), or a multimedia message per se.

The television device according to the first aspect of the present invention may be a digital television receiver and wherein the television distribution network is a digital television distribution network. Thus enabled utilisation of digital features such as addressing schemes and improved transmission speed and quality. The television distribution network may be a cable TV network, a satellite TV network, a radio frequency TV network, or any combination thereof. Additionally, the television distribution network may be adapted to transmit digitally coded communication such as digital video broadcasting (DVB) and digital audio broadcasting (DAB). The television device should correspondingly be adapted to receive the digitally coded communication.

The communications provider according to a first aspect of the present invention may comprise a multimedia messaging service provider for communicating with the base station, which multimedia messaging service may be adapted to provide messaging services for the message communication unit, and may comprise an interface service provider for communicating with the television network operator, which interface service provider may be adapted to process the message before transmission on the television distribution network. The multimedia messaging service provider performs various tasks for general message communication unit users and identifies

whenever a message is to be forwarded to a television distribution network. The interface service provider processes messages to be transmitted on to the television distribution network.

5

The interface service provider according to the first aspect of the present invention may comprise a formatting unit for performing a first part of the processing of the message by re-formatting the message from message communication unit format to television distribution network format. The interface service provider may further comprise an encryption unit for performing a second part of the processing of the message by encrypting the message before transmission on the television distribution network. The encryption unit may comprise a shared password or a public encryption key for performing the encryption of the message. Any encryption technique may be employed in the system. The encryption ensures that only recipients entitled to a message are allowed to read the message.

20

The term "read" is in this context to be construed as a broad term for accessing content of a message, that is, reading a messages should in this context be construed as hearing, seeing or executing the message.

25

The interface service provider may further comprise a database for storing records of information regarding a subscriber of the television distribution network. Each of the records may comprise address of a subscriber of a specific television distribution network such as an e-mail address, address of the specific television distribution network, a public key of the subscriber and/or a shared password to the subscriber, an indication of a primary message distribution channel on the

30

specific television distribution network, a message priority indication, address of the television device in the specific television distribution network, such as an Internet protocol address, or any combination thereof. By recording this
5 information in the database the communication is greatly improved since the transfer of the message may be initiated immediately, once the subscriber's information is stored in the database.

10 The multimedia messaging service provider according to the first aspect of the present invention may be adapted to identify a recipient for the message by utilising the header of the message. The utilisation of the header may be accomplished by having a part of the header comprising the first characters
15 of the message recipient and thus the present invention may be adapted to identify a recipient from the a part of the header comprising the first characters of the recipient. The header may contain additional packaging information which is not stored in the database, such information as date and time of
20 message generation, file type of message, sender, and so on.

The television device according to the first aspect of the present invention may comprise a storing unit adapted to store the message. The storing unit may be a hard disk, a tape disk,
25 a writable CD-ROM disk, a writable DVD disk, a magneto-optic writable disk or any combination thereof. In addition, the television device may comprise a smart card reader adapted to configure the television device in accordance with instructions on the smart card. The smart card may contain information
30 regarding encryption, primary channel on the television distribution network for transmission of messages and e-mail address of subscriber of the television distribution network. The smart card may in fact contain the same information as

stored in the database. The smart card provides an improved information storage scheme since the smart card is extremely versatile. The smart card may be used at any television device having a smart card reader so that the smart card owner may
5 download messages to any particular television device.

The television network operator according to the first aspect of the present invention may comprise a datacast server adapted to datacast the message to a recipient in the television
10 distribution network. The datacast server may be adapted to broadcast an alert signal prior to datacasting of the message. The alert signal may be broadcasted on at least one channel of the television distribution network. The alert signal may
15 comprise information relating to address of the recipient, date and time of the datacasting of the message. The alert signal is broadcast over the entire television distribution network, so as to enable a user to download a message anywhere in the television distribution network and so as to enable a plurality of recipients of a message to download the message
20 simultaneously. The alert signal may further comprise information relating to a channel in the television distribution network on which the message is to be datacasted.

The television device according to the first aspect of the
25 present invention may be configured to receive and/or transmit the message on a predetermined channel of the television distribution network.

Alternatively, the television device may be configured to
30 determine on the basis of the alert signal a channel in the television distribution network on which the message is to be datacasted. The television device may even be configured to

determine a channel on the basis of the alert signal and/or in accordance with a pre-programmed configuration.

The television device according to the first aspect of the present invention may be adapted to present a screen signal on a TV display when the message has been received by the television device. The recipient is thus notified when a new message is received in the television device. The recipient may now view the message instantly or save the message to the storage unit for later viewing. The recipient may in addition establish folders so as to store specific messages in specific folders.

The above objects, advantages and features together with numerous further objects, advantages and features, which will become evident from below description is accomplished by a solution in accordance to a second aspect of the present invention by a method for communicating a message between a message communication unit and a television device, said method comprising:

generating said message on said message communication unit, said message including a header carrying a recipient address;

transmitting said message from said message communication unit to a base station in a wireless communications network;

forwarding said message from said base station to a messaging service provider communicating with said base station;

forwarding said message from said messaging service provider to an interface service provider communicating with said messaging service provider;

preparing said message for communication on a television distribution network by means of said interface service

provider, and preparing said message so as to provide a processed message;

forwarding said processed message to a television network operator communicating with said interfacing service provider
5 and communicating with said television distribution network;

datacasting said processed message on said television distribution network by means of said television network operator; and

receiving said processed message by means of said
10 television device.

The method according to the second aspect of the present invention may be implemented in the system according to the first aspect of the present invention. Thus the method enables
15 a message communication unit user to transfer a message through a television distribution network to any recipient of any television distribution network.

The preparing of the message for communication on the
20 television distribution network according to the second aspect of the present invention may further comprise:

identifying a recipient in said header by means of said messaging service provider; and when said recipient is a subscriber of a television distribution network then

25 reformatting said message by means of said interface service provider from a message communication unit format to a television distribution network format so as to provide a reformatted message;

encrypting said reformatted message by means of said
30 interfacing service provider so as to provide said processed message; and

forwarding said processed message to a television network operator communicating with said interfacing service provider and communicating with said television distribution network.

5 The encryption of the messages datacasted on the television distribution network ensures that only the rightful recipients have access to the contents of the messages. The encryption may be accomplished in a wide variety of ways as known to the person skilled in the art.

10

The method according to the second aspect of the present invention may further comprise:

15 broadcasting an alert signal on the television distribution network by means of the television network operator prior to communicating the processed message on the television distribution network;

20 identifying the alert signal by means of the television device communicating with the television distribution network, the alert signal comprising information relating to recipient of the message in the television distribution network and relating to date and time for the message to be datacasted on the television distribution network; and

25 configuring the television device in accordance with the information in the alert signal.

30

The term broadcasting should in this context be construed as a transmission to multiple, unspecified recipients. On for example Ethernet, a broadcast packet is a special type of multicast packet, which all nodes on the network are always willing to receive. The term datacast is in this context to be construed as broadcasting of a multimedia message on a television distribution network.

The method according to the second aspect of the present invention may further comprise:

decrypting the processed message by means of the television device so as to re-establish the reformatted
5 message;

providing a message signal on a TV display by means of the television device; and

viewing the re-established reformatted message on the TV display by means of the television device.

10

The method may in addition further comprise:

storing the re-established reformatted message by means of said television device having a local memory; or

storing the processed message by means of the television
15 device having a local memory.

Storing of the message offers great advantages to a recipient since the recipient may assemble series of messages in any particular order, which provides an enhanced overview of the
20 messages.

The method according to the second aspect of the present invention may further incorporate any features of the system according to the first aspect of the present invention.

25

The above objects, advantages and features together with numerous further objects, advantages and features, which will become evident from below description, is accomplished by a solution in accordance to a third aspect of the present
30 invention by a method for communicating a message between a message receiving device and a television device, said method comprising:

generating said message on said television device, said message including a header carrying a recipient address;

transmitting said message from said television device to a television network operator over a television distribution
5 network;

forwarding said message from said television network operator to an interface service provider communicating with said television network operator;

preparing said message for communication on a wireless
10 communications network by means of said interface service provider, and preparing said message so as to provide a processed message;

forwarding said processed message from said interface service provider to a messaging service provider communicating
15 with said interface service provider;

forwarding said processed message from said messaging service provider to a base station communicating with said messaging service provider and communicating with said message receiving device;

20 transmitting said processed message on said wireless communications network by means of said base station; and

receiving said processed message by means of said message receiving device.

25 The method according to third aspect of the present invention may incorporate any features of the system according to the first aspect of the present invention and any features of the method according to second aspect of the present invention.

30 The above objects, advantages and features together with numerous further objects, advantages and features, which will become evident from below description, is accomplished by a solution in accordance to a fourth aspect of the present

invention by a television device for communicating a message, in accordance with the method according to the second and third aspect of the present invention, between a message communication unit and said television device through a television distribution network and comprising:

a communications port communicating with the television distribution network, which communications port is adapted to communicate the message between the television device and the message communication unit through the television distribution network.

The television receiver according to the fourth aspect of the present invention may incorporate any features of the system according to the first aspect of the present invention, any features of the method according to the second aspect of the present invention, and any features of the method according to the third aspect of the present invention.

The above objects, advantages and features together with numerous further objects, advantages and features, which will become evident from below description, is accomplished by a solution in accordance to a fifth aspect of the present invention by a cellular phone for communicating a message to a television device having a specific address in a television distribution network and comprising an interface adapted to enable an operator of said cellular phone to select said television device as recipient of said message by identifying said specific address in said television distribution network.

The specific address according to the fifth aspect of the present invention may comprise an e-mail address and an extension ".tv". That is, the address may be constituted by an ordinary e-mail address and an ".tv" extension added to the

end. Obviously, the extension may be implemented with any combination of characters so as to allow for multiple television distribution networks having a specific extension identifying each television distribution network.

5

The cellular phone according to fifth aspect of the present invention may incorporate any features of the system according to the first aspect of the present invention, any features of the method according to the second aspect of the present invention, any features of the method according to the third aspect of the present invention, and any features of the television device according to the fourth aspect of the present invention.

15 The above objects, advantages and features together with numerous further objects, advantages and features, which will become evident from below description, is accomplished by a solution in accordance to a sixth aspect of the present invention by an interface of a wireless terminal for
20 communicating a message, which interface is adapted to enable selection of a recipient of said message by identifying said specific address in a television distribution network.

The said specific address according to the sixth aspect of the present invention may comprise an e-mail address and an extension ".tv". As described with reference to the fifth aspect of the present invention the extension may take the form of any combination of characters.

30 The interface according to the sixth aspect of the present invention may further be adapted to enable selection of a broadcast transmission of the message.

The interface according to sixth aspect of the present invention may incorporate any features of the system according to the first aspect of the present invention, any features of the method according to the second aspect of the present invention, any features of the method according to the third aspect of the present invention, and any features of the television device according to the fourth aspect of the present invention, and any features of the cellular phone according to fifth aspect of the present invention.

10

Brief description of the drawings

The above, as well as additional features and advantages of the present invention, will be better understood through the following illustrative and non-limiting detailed description of preferred embodiments of the present invention, with reference to the appended drawings, wherein:

Figure 1, shows a schematic view of a system operating in accordance with the present invention and utilising a cellular phone network and a radio frequency television distribution network;

Figure 2, shows a schematic view of a system operating in accordance with the present invention and utilising a cellular phone network and a cable TV distribution network;

Figure 3, shows a schematic view of a system operating in accordance with the present invention and utilising a cellular phone network and a satellite television distribution network; and

Figures 4a to 4c show a flow chart of a method for communicating a message from a cellular phone to a television receiver through a television distribution network.

5 **Detailed description of preferred embodiments**

A system, shown in figure 1 as designated in its entirety by reference numeral 10, enables transferring of multimedia messages from a cellular phone 12 to a set-top box 14 such as a
10 digital television receiver. The transferring is accomplished by the cellular phone 12 communicating a multimedia message to a base station 16 of a wireless communications network, which base station 16 is connected to a multimedia messaging service provider 18 either by a wireless connection or as shown in
15 figure 1 a wire connection 20.

Subsequent to receiving a multimedia message the multimedia messaging service provider 18 determines whether the multimedia message is to be forwarded to a subscriber of a television
20 distribution network and/or to a second cellular phone connected to a wireless communications network. In case the multimedia message has a recipient, which is a subscriber of a television distribution network, the multimedia messaging service provider 18 forwards the multimedia message to a
25 multimedia messaging service to digital TV interface or a MMS/DTV service provider 22.

The transferring cellular phone 12 may utilise various addressing systems to identify a subscriber of a television
30 distribution network. The addressing of the subscriber could be accomplished by an e-mail type address. That is, a specific address extension defining that the multimedia message has to

be distributed over the television distribution network, e.g. john.hopkins@hotmail.com.tv.

When the multimedia messaging service provider 18 receives a
5 multimedia message with an indication of a recipient on a television distribution network, such as identified by a .tv extension on an e-mail address, the multimedia messaging service provider 18 forwards this multimedia message to the MMS/DTV service provider 22.

10

The MMS/DTV service provider 22 comprises a database storing information regarding subscribers of any television distribution network. The information includes name of a television distribution network connecting the subscriber and a
15 primary channel number for datacasting; subscriber addresses, e.g. personal e-mail address having a .tv extension; subscriber's public encryption key or alternatively a shared password, which is required for encrypting a multimedia message before forwarding over the television distribution network;
20 possible definition of subscriber's priority of multimedia messages; IP address or alternative address of set-top box 14 for receiving multimedia messages.

The MMS/DTV service provider 22 performs processing of a
25 multimedia message, which processing includes converting a compressed file formats (J-PEG) used during transmission on the wireless communication network to a file format (MPEG-2 I-frame) used on the television distribution networks. Subsequent to processing the multimedia message the MMS/DTV service
30 provider 22 encrypts the multimedia message in order to secure during data broadcast that only the entitled recipients may read the multimedia message. The encryption is in a first embodiment of the present invention accomplished by a shared

password system and in a second embodiment of the present invention accomplished by a public key system. The encryption per se is based on any standard encryption techniques know to a person skilled in the art. For example the encryption may be
5 accomplished by utilising a data encryption standard (DES) algorithm.

Since the set-top box 14 comprises a hardware decoder for MPEG-2 I-frames the decoding of the multimedia messages are
10 performed much faster by converting the multimedia messages from the JPEG format to the MPEG-2 I-frame format prior to forwarding of the multimedia message from the MMS/DTV service provider 22 to the set-top box 14.

15 If a subscriber of the television distribution network wishes to register to be able to receive multimedia messages through the subscriber's television distribution network, the subscriber contacts directly or through a distributor the MMS/DTV service provider 22. The subscriber communicates a
20 private e-mail address to the MMS/DTV service provider 22 and in return the MMS/DTV service provider 22 communicates a new e-mail address identifying the subscriber on the television distribution network back to the subscriber. For example, as described above, the MMS/DTV service provider 22 adds a further
25 extension to the subscriber's private e-mail address.

In addition, to the MMS/DTV service provider 22 forwarding an e-mail address, the MMS/DTV service provider 22, in accordance with the first embodiment of the present invention, further
30 communicates in return to the reception of the subscriber's private e-mail address a password for decrypting multimedia messages.

22

After the subscriber receives the new e-mail address and password from the MMS/DTV service provider 22 in accordance with the first embodiment of the present invention the subscriber feeds the new e-mail address and password to the set-top box 14. This may be accomplished by means of a remote control unit 24 or by means of keys 26 enabling manual configuration of the set-top box 14.

Alternatively, in addition to the subscriber's private e-mail address the subscriber in accordance with a second embodiment of the present invention transmits a public key to the MMS/DTV service provider 22 in order to enable the MMS/DTV service provider 22 to encrypt incoming multimedia messages for the subscriber.

15

After the subscriber receives the new e-mail address from the MMS/DTV service provider 22 in accordance with the second embodiment of the present invention the subscriber feeds the new e-mail address to the set-top box 14 in addition to a private encryption key for decrypting incoming multimedia messages encrypted with the public encryption key. This may as before be accomplished by means of a remote control unit 24 or by means of keys 26 enabling manual configuration of the set-top box 14.

25

The details communicated by the MMS/DTV service provider 22 may be transferred according to a third embodiment of the present invention from the MMS/DTV service provider 22 to the subscriber through a smart card. The set-top box 14 according to the third embodiment of the present invention comprises a smart card reader 28.

30

The subscriber further in accordance with above referenced embodiments of the present invention defines a designated channel for transmission of multimedia messages and configures the set-top box 14 having the designated channel as primary channel for datacasting. The set-top box 14 will during standby mode automatically shift to the designated channel.

The system 10 enables each subscriber in the television distribution network to install several e-mail addresses in the set-top box 14.

The MMS/DTV service provider 22 forwards the multimedia messages received from the multimedia messaging service provider 18 to a television distribution network operator 30 through a communication line 32 being a regular Internet connection, a designated wire communication link, or a wireless communication link. The network operator 30 provides digital video broadcasting (DVB) signals and/or digital audio broadcasting (DAB) signals to subscribers of a television distribution network.

The network operator 30 comprises a datacast server mechanism enabling delivery of multimedia messages to a subscriber of the television distribution network. The network operator 30 utilises several priority classes and repeating cycles for a multimedia message to be datacasted through the television distribution network.

In order to ensure that a multimedia message has been datacasted successfully to the subscriber by the network operator 30 the system 10 according to above referenced embodiments of the present invention provides an alert signal to be broadcasted through several channels of the television

distribution network. The alert signal comprises subscriber's new e-mail address and date/time of the datacast of a particular multimedia message. When a set-top box 14 recognises the alert signal, it automatically switches to its designated channel on which the multimedia messages are collected from the television distribution network.

In a system 10 according to a fourth embodiment of the present invention the successful datacast of a multimedia message is ensured by the network operator 30 providing an alert signal to be broadcasted through several channels of the television distribution network. This alert signal comprises subscriber's new e-mail address, the channel on which the multimedia message is to be datacasted, and date/time of datacast of a particular multimedia message. When a set-top box 14 recognises the alert signal, it automatically switches to the designated channel on which the multimedia message is datacasted and collects the multimedia message from the television distribution network.

The network operator 30 communicates with each subscriber through either a radio frequency TV network as shown in figure 1 designated in its entirety by reference numeral 34, a cable TV network as shown in figure 2 designated in its entirety by reference numeral 36, a satellite TV network as shown in figure 3 designated in its entirety by reference numeral 38 or in any combination thereof.

According to a fifth embodiment of the present invention the set-top box 14 comprises a native multimedia messaging service application for datacast reception, for displaying multimedia messages on a TV, and for providing a user interface for the subscriber. The application may in alternative embodiments of the present invention be implemented in any application

programming interface such as multimedia home platform (MHP), OpenTV, or MediaHighway. The application may in any of the above referenced embodiments of the present invention be downloaded to the set-top box 14 over the air, over a modem
5 connection, bluetooth connection, or over any data interface known to the person skilled in the art.

When a multimedia message is received the multimedia messaging service application in the set-top box 14 provides a sign
10 (message symbol) on the display of the TV. The sign (message symbol) includes information indicative of the recipient so as to enable a subscriber to instantly identify who the multimedia message is destined for. The provision of information indicative of the recipient becomes particularly useful when
15 there are multiple users of the set-top box 14.

The multimedia message may only be opened on providing a PIN code connected to the specific recipient. Alternatively, the sign comprises a two-level approach, where the first level
20 notifies the users of the set-top box 14 that a multimedia message is received, and where the second level being activated by the users (e.g. by pushing a message key) request the PIN code for opening the multimedia message from that specific recipient. The multimedia message may subsequently be run on
25 the display in accordance with the subscriber's instructions. The subscriber's instructions are communicated to the set-top box 14 by means of the remote control unit 24 or the keys 26.

Activation of the multimedia message may in an alternative
30 embodiment of the present invention be dependent on the subscriber provision of a PIN code. Every e-mail address configured on the set-top box 14 has an associated PIN code so as to allow for several users of a single set-top box 14.

The set-up box 14 in accordance with above referenced
embodiments of the present invention further comprises a
storage device 40 such as an internal or external hard drive,
5 disk drive, tape drive, readable and writable CD drive, DVD
drive, or any other type of storage means known to the person
skilled in the art. Thus the set-top box 14 enables a
subscriber to receive multimedia messages from the television
distribution network and store the received messages on the
10 storage device 40.

Figures 4a through 4c, show a flow chart of a method according
to a sixth embodiment of the present invention, which method is
designated in its entirety by reference numeral 100. The method
15 establishes a transfer of a multimedia message from a cellular
phone to a subscriber of a television distribution network.

The multimedia message is generated in an initial step
designated by reference numeral 102. The user of a cellular
20 phone utilises multimedia functionalities of the cellular phone
for the creation of a multimedia message containing a picture,
a series of pictures, a video sequence, a series of video
sequences, an audio sequence, a text sequence or any
combination thereof. Before transmitting the multimedia message
25 on a wireless communications network the user of the cellular
phone indicates whether the multimedia message is to be
received by a subscriber of a television distribution network.
The indication is provided by utilising an addressing scheme in
which a recipient on a television distribution network is
30 easily recognised.

The user of the cellular phone subsequently during step 104
transmits the multimedia message to a base station, which on

reception forwards the multimedia message during step 106 to a multimedia messaging service provider as described with reference to figures 1 through 3. The multimedia messaging service provider identifies, during step 108, any recipients of the multimedia message, which recipients are subscribers to a television distribution network.

During step 110 it is evaluated whether the multimedia messaging service provider has identified a recipient in a television distribution network. If the multimedia messaging service provider has not identified a recipient in a television distribution network, the multimedia message is forwarded during step 112 to base stations for further transmission to other cellular phones and/or forwarded to access nodes of an Internet connection. If on the other hand the multimedia messaging service provider has identified a recipient in a television distribution network, the multimedia message is forwarded during step 114 to a MMS/DTV service provider, as described with reference to figures 1 through 3.

The MMS/DTV service provider performs an interfacing during step 116 of the multimedia message to conform to a digital television distribution network thus establishing a processed multimedia message. Subsequently the MMS/DTV service provider encrypts during step 118 the processed multimedia message in order to ensure that only the rightful recipients of the processed multimedia message are able to read the message. It should be noted the flow chart is continued from figure 4a to figure 4b between step 116 and step 118, which is illustrated by "A".

The encrypted and processed multimedia message is forwarded during step 120 to a network operator as described with

reference to the figures 1 through 3. The network operator broadcasts, during step 122, an alert signal to the subscribers of the television distribution network.

5 The alert signal is identified, during step 124, by recipient set-top boxes, as described with reference to the figures 1 through 3, which set-top boxes represent recipient subscribers on the television distribution network.

10 Subsequently, the set-top box, during step 126, configures itself for receiving the processed and encrypted multimedia message. In this context configuring is to be construed as reading information of the alert signal, which information is used for locating on which channel and at what time the
15 processed and encrypted multimedia message is datacasted on the television distribution network.

During step 127, the processed and encrypted multimedia message is datacasted on the television distribution network by the
20 television distribution network operator.

During step 128, the processed and encrypted multimedia message is received at the recipient set-top box of the television distribution network. After reception, the set-top box decrypt,
25 during step 130, the processed and encrypted multimedia message.

When the set-top box has finalised the decryption process the set-top box signals, during step 132, to a subscriber watching
30 the TV display. The signal is a new message signal ready to be viewed. The subscriber watching the TV display may now select, during step 134, to view the decrypted multimedia message during step 136, or to skip the viewing. It should be noted the

flow chart is continued from figure 4b to figure 4c between step 132 and step 134, which is illustrated by "B".

During step 138 the subscriber watching the TV display may
5 select to store the decrypted multimedia message, during step 140, for later or additional viewing.

Finally, the set-top box returns to resting state during step 142.

Claims

1. A system for communicating a message between a message communication unit and a television device, said system
5 comprising:
 a base station in a wireless communications network adapted to communicate said message between said message communication unit and said base station;
 a communications provider for connecting to said base
10 station and adapted to communicate said message between said base station and said communications provider; and
 a television network operator for operating a television distribution network and adapted to communicate said message between said communications provider and said television
15 device.
2. A system according to claim 1, wherein said message comprises a header for identifying a recipient in said television distribution network.
20
3. A system according to claims 1 or 2, wherein said message comprises a text, a picture, a series of pictures, a video, a series of videos, an audio recording, a series of audio recordings, or any combination thereof.
25
4. A system according to any of claims 1 to 3, wherein said television device is a digital television receiver and wherein said television distribution network is a digital television distribution network.
30
5. A system according to any of claims 1 to 4, wherein said communications provider comprises a multimedia messaging service provider for communicating with said base station and

adapted to provide messaging services for said message communication unit, and an interface service provider for communicating with said television network operator and adapted to process said message before transmission on said television
5 distribution network.

6. A system according to claim 5, wherein said interface service provider comprises a formatting unit for performing a first part of said processing of said message by re-formatting
10 said message from message communication unit format to television distribution network format.

7. A system according to claims 5 or 6, wherein said interface service provider further comprises an encryption unit for
15 performing a second part of said processing of said message by encrypting said message before transmission on said television distribution network.

8. A system according to claim 7, wherein said encryption unit
20 comprises a shared password or a public encryption key for performing said encryption of said message.

9. A system according to any of claims 5 to 8, wherein said interface service provider further comprises a database for
25 storing records of information regarding a subscriber of said television distribution network.

10. A system according to any of claims 5 to 9, wherein said multimedia messaging service provider is adapted to identify a
30 recipient for said message by utilising said header of said message.

11. A system according to claims 9 or 10, wherein each of said records comprises address of a subscriber of a specific television distribution network such as an e-mail address, address of said specific television distribution network, a public key of said subscriber and/or a shared password to said subscriber, an indication of a primary message distribution channel on said specific television distribution network, a message priority indication, address of said television device in said specific television distribution network, such as an Internet protocol address, or any combination thereof.

12. A system according to any of claims 1 to 11, wherein said television distribution network is a cable TV network, a satellite TV network, a radio frequency TV network, or any combination thereof.

13. A system according to any of claims 1 to 12, wherein said television device comprises a storing unit adapted to store said message.

14. A system according to any of claims 1 to 13, wherein said television device comprises a smart card reader adapted to configure said television device in accordance with instructions on said smart card.

15. A system according to any of claims 1 to 14, wherein said television network operator comprises a datacast server adapted to datacast said message to a recipient in said television distribution network.

16. A system according to claim 15, where said datacast server is adapted to broadcast an alert signal prior to datacasting of said message, said alert signal being broadcasted on at least

one channel of said television distribution network, said alert signal comprising information relating to address of said recipient, date and time of said datacasting of said message.

5 17. A system according to any of claims 1 to 14, wherein said television device is configured to communicate said message on a predetermined channel of said television distribution network.

10 18. A system according to claim 16, wherein said alert signal further comprises information relating to a channel in said television distribution network on which said message is to be datacasted.

15 19. A system according to claim 18, wherein said television device is configured to determine on the basis of said alert signal a channel in said television distribution network on which said message is to be datacasted.

20 20. A system according to any of claims 1 to 19, wherein said television device is adapted to present a screen signal on a TV display when said message has been received by said television device.

25 21. A method for communicating a message between a message communication unit and a television device, said method comprising:

generating said message on said message communication unit, said message including a header carrying a recipient
30 address;

transmitting said message from said message communication unit to a base station in a wireless communications network;

forwarding said message from said base station to a messaging service provider communicating with said base station;

5 forwarding said message from said messaging service provider to an interface service provider communicating with said messaging service provider;

10 preparing said message for communication on a television distribution network by means of said interface service provider, and preparing said message so as to provide a processed message;

forwarding said processed message to a television network operator communicating with said interfacing service provider and communicating with said television distribution network;

15 datacasting said processed message on said television distribution network by means of said television network operator; and

receiving said processed message by means of said television device.

20 22. A method according to claim 21, wherein said preparing of said message for communication on said television distribution network further comprises:

25 identifying a recipient in said header by means of said messaging service provider; and when said recipient is a subscriber of a television distribution network then

reformatting said message by means of said interface service provider from a message communication unit format to a television distribution network format so as to provide a reformatted message;

30 encrypting said reformatted message by means of said interfacing service provider so as to provide said processed message; and

forwarding said processed message to a television network operator communicating with said interfacing service provider and communicating with said television distribution network.

5 23. A method according to claims 21 or 22, wherein said method further comprises:

broadcasting an alert signal on said television distribution network by means of said television network operator prior to communicating said processed message on said television distribution network;

10 identifying said alert signal by means of said television device communicating with said television distribution network, said alert signal comprising information relating to recipient of said message in said television distribution network and relating to date and time for said message to be datacasted on said television distribution network; and

configuring said television device in accordance with said information in said alert signal.

20 24. A method according to claims 22 or 23, wherein said method further comprises:

decrypting said processed message by means of said television device so as to re-establish said reformatted message;

25 providing a message signal on a TV display by means of said television device; and

viewing said re-established reformatted message on said TV display by means of said television device.

30 25. A method according to any of claims 22 to 24, wherein said method further comprises:

storing said re-established reformatted message by means of said television device having a local memory.

26. A method according to any of claims 21 to 24, wherein said method further comprises:

5 storing said processed message by means of said television device having a local memory.

27. A method according to any of claims 21 to 26, wherein said method incorporates any features of the system according to any of claims 1 to 20.

10

28. A method for communicating a message between a message receiving device and a television device, said method comprising:

15 generating said message on said television device, said message including a header carrying a recipient address;

transmitting said message from said television device to a television network operator over a television distribution network;

20 forwarding said message from said television network operator to an interface service provider communicating with said television network operator;

25 preparing said message for communication on a wireless communications network by means of said interface service provider, and preparing said message so as to provide a processed message;

forwarding said processed message from said interface service provider to a messaging service provider communicating with said interface service provider;

30 forwarding said processed message from said messaging service provider to a base station communicating with said messaging service provider and communicating with said message receiving device;

transmitting said processed message on said wireless communications network by means of said base station; and

receiving said processed message by means of said message receiving device.

5

29. A method according to claim 28, wherein said method incorporates features of the system according to any of claims 1 to 20 and features of the method according to any of claims 21 to 27.

10

30. A television device for communicating a message, in accordance with the method according to any of claims 21 to 27 and in accordance with the method according to any of claims 28 or 29, between a message communication unit and said television device through a television distribution network and comprising:

15

a communications port communicating with said television distribution network, which communications port is adapted to communicate said message between said message communication unit and said television device through said television distribution network.

20

31. A television device according to claim 28, wherein said television device incorporates features of the system according to any of claims 1 to 20, features of the method according to any of claims 21 to 27, and features of the method according to any of claims 28 and/or 29.

25

32. A cellular phone for communicating a message to a television device having a specific address in a television distribution network and comprising an interface adapted to enable an operator of said cellular phone to select said

30

television device as recipient of said message by identifying said specific address in said television distribution network.

33. A cellular phone according to claim 32, wherein said
5 specific address comprises an e-mail address and an extension ".tv".

34. A cellular phone according to claims 32 or 33, wherein said
cellular phone incorporates any features of the system
10 according to any of claims 1 to 20, features of the method
according to any of claims 21 to 27, features of the method
according to any of claims 28 or 29, and features of television
device according to any of claims 30 and 31.

15 35. An interface of a wireless terminal for communicating a
message, which interface is adapted to enable selection of a
recipient of said message by identifying said specific address
in a television distribution network.

20 36. An interface according to claim 35, wherein said specific
address comprises an e-mail address and an extension ".tv".

37. An interface according to claims 35 or 36, wherein said
interface is further adapted to enable selection of a broadcast
25 transmission of said message.

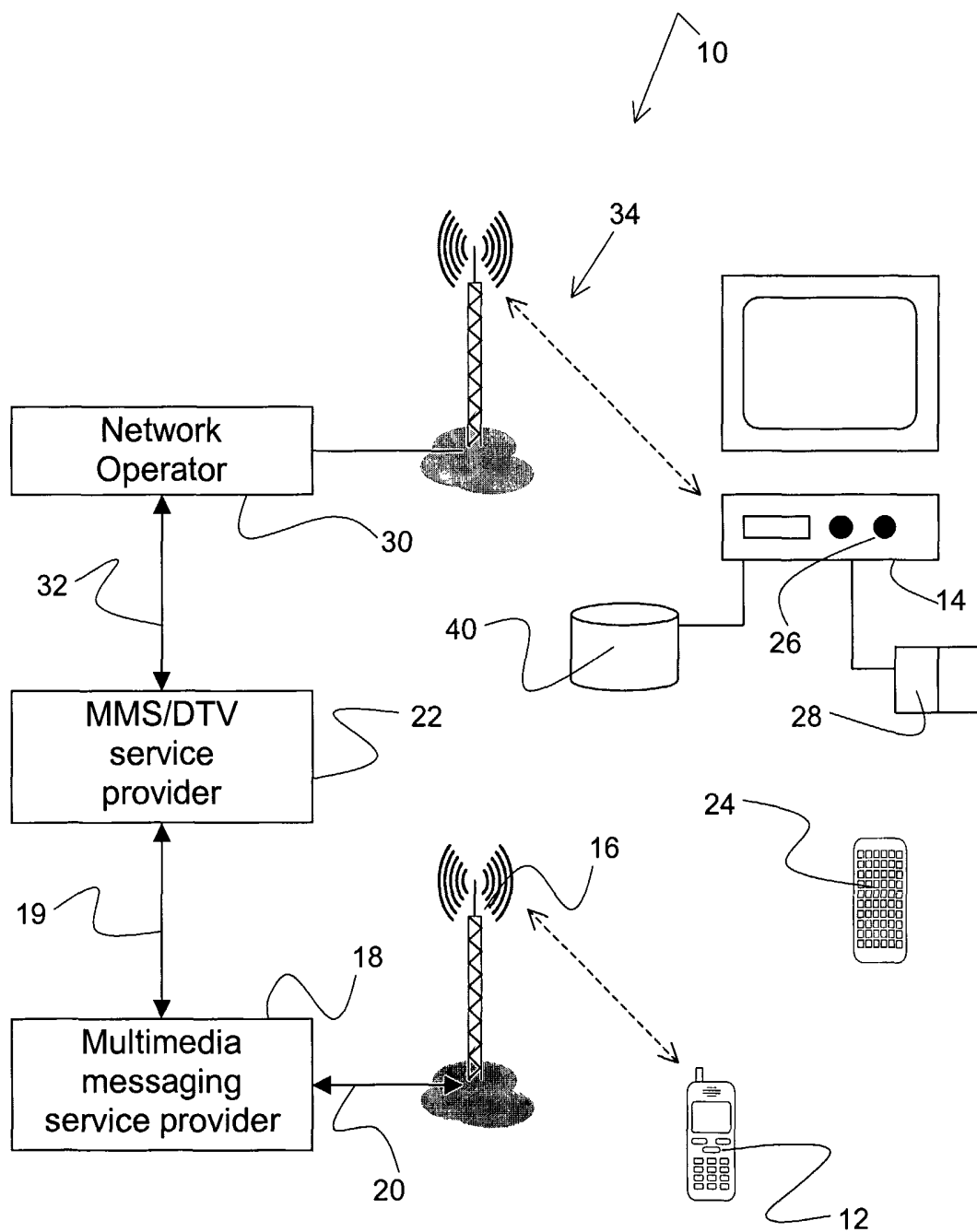

Fig. 1

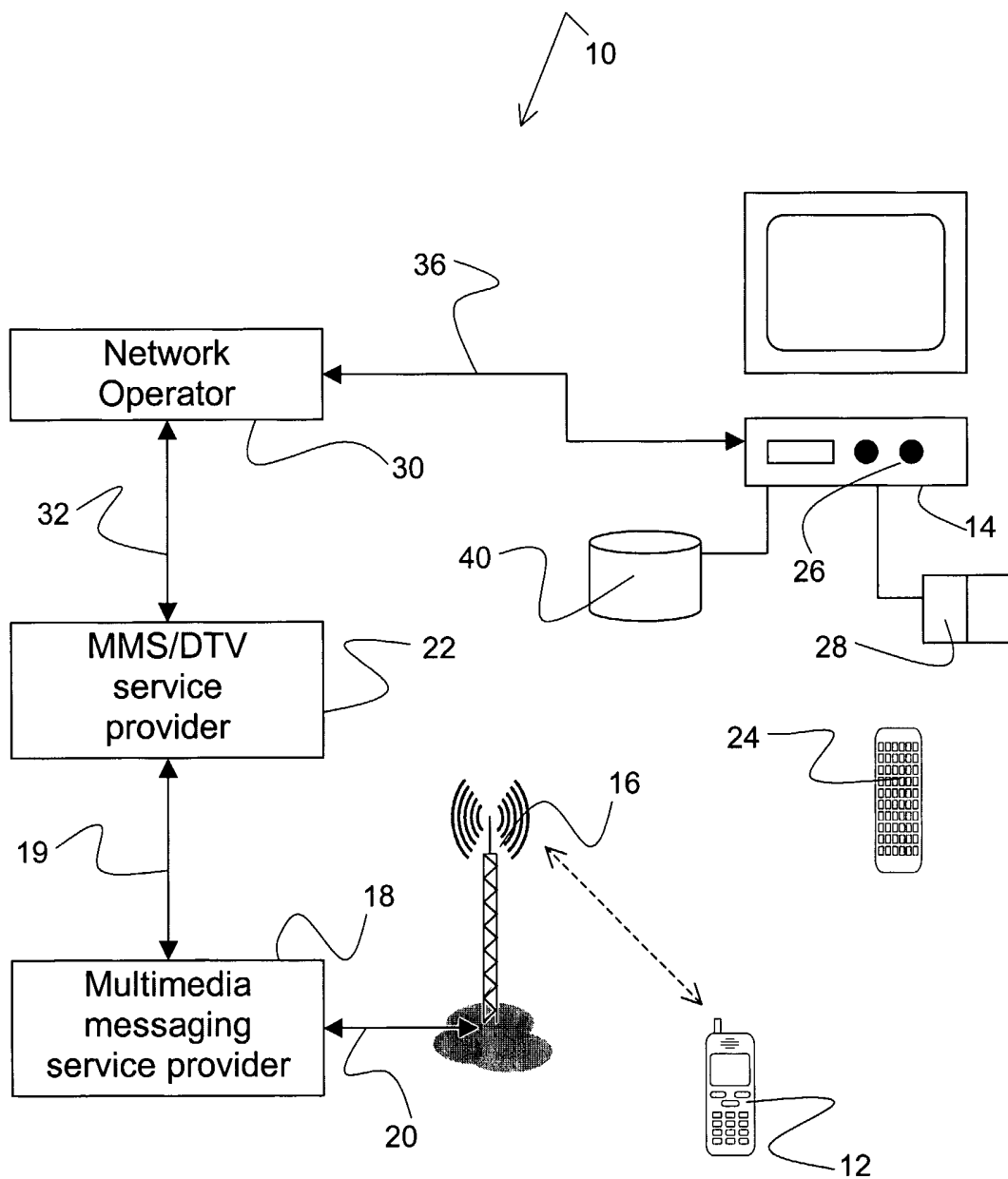

Fig. 2

3/6

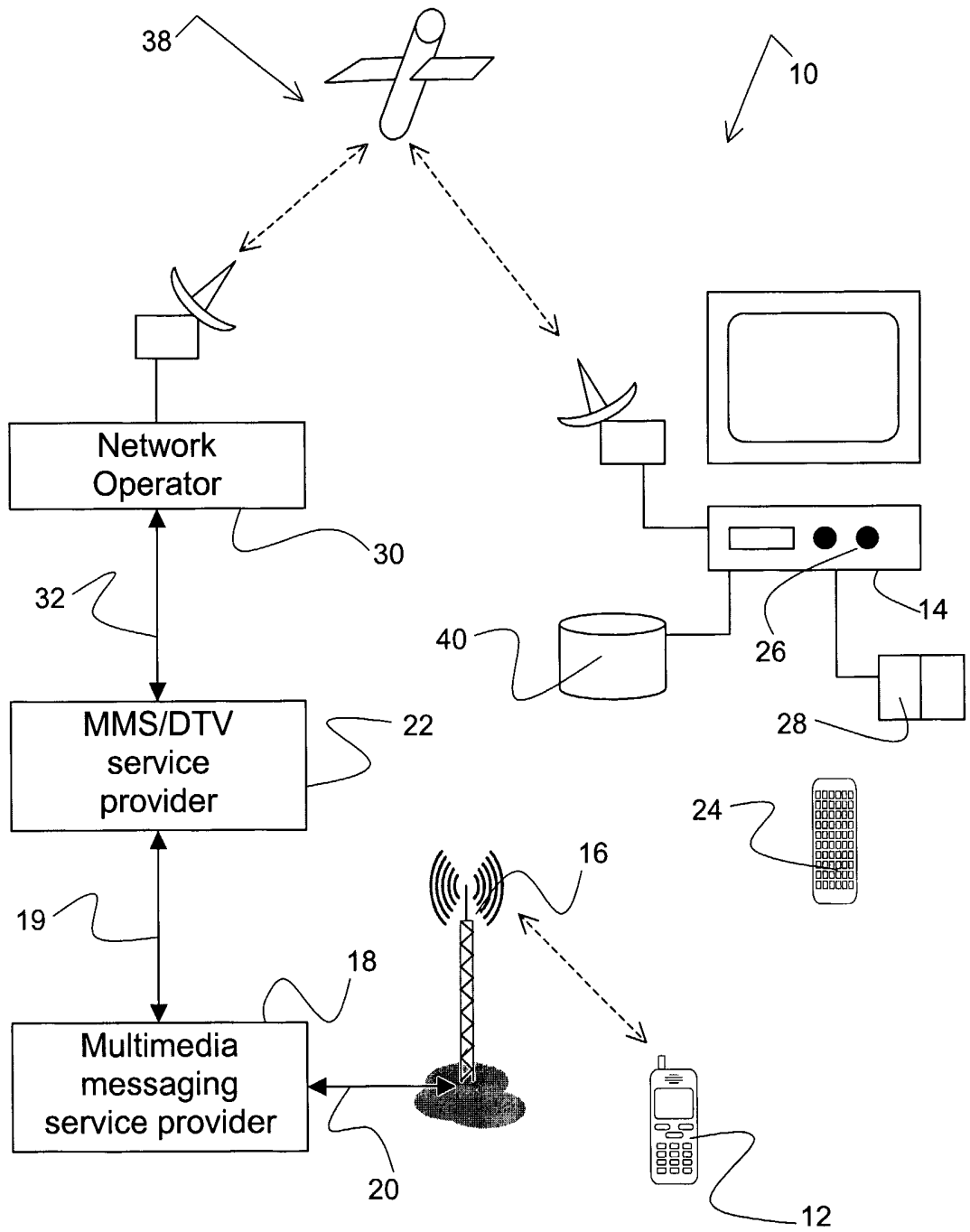

Fig. 3

4/6

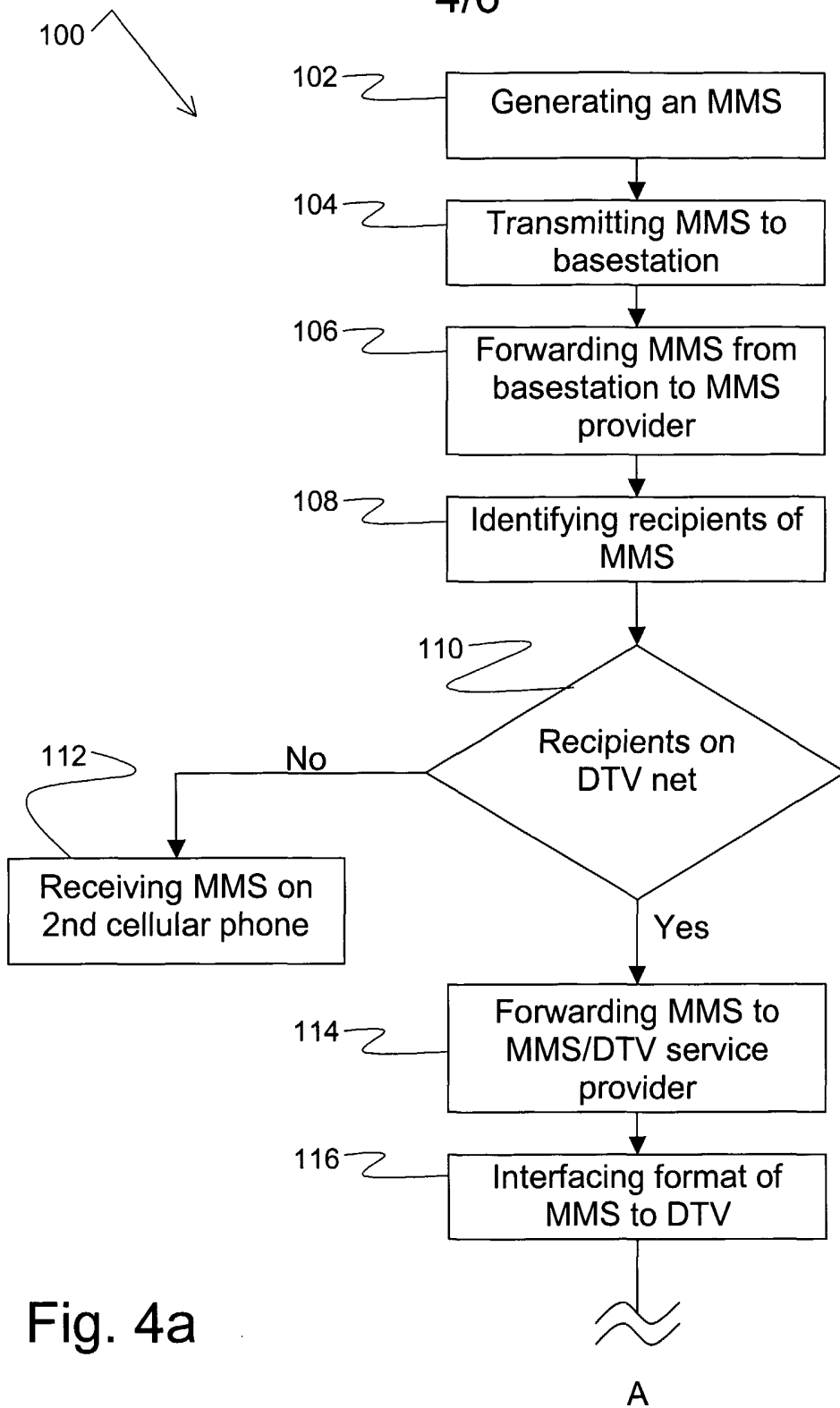

Fig. 4a

5/6

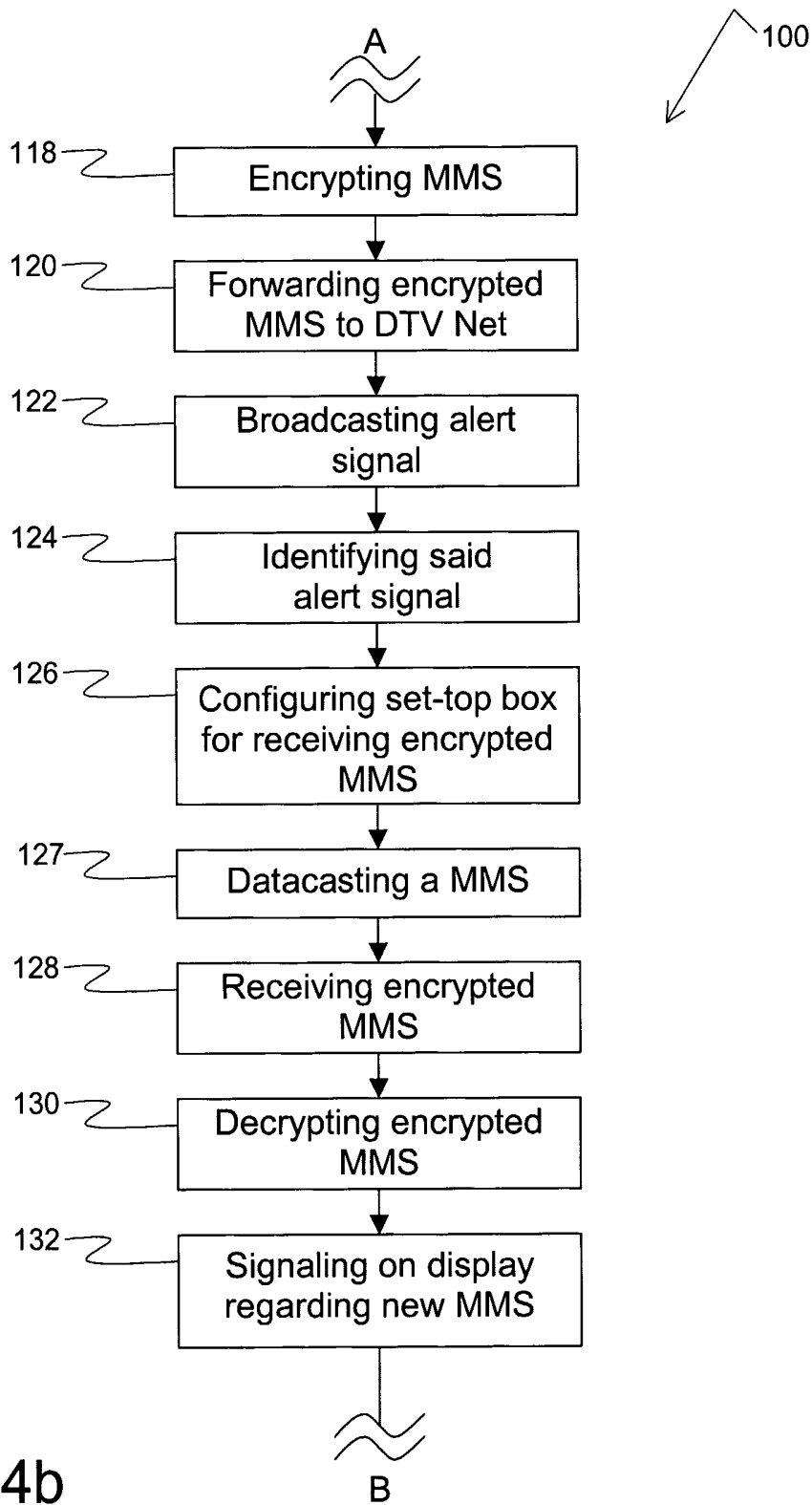

Fig. 4b

6/6

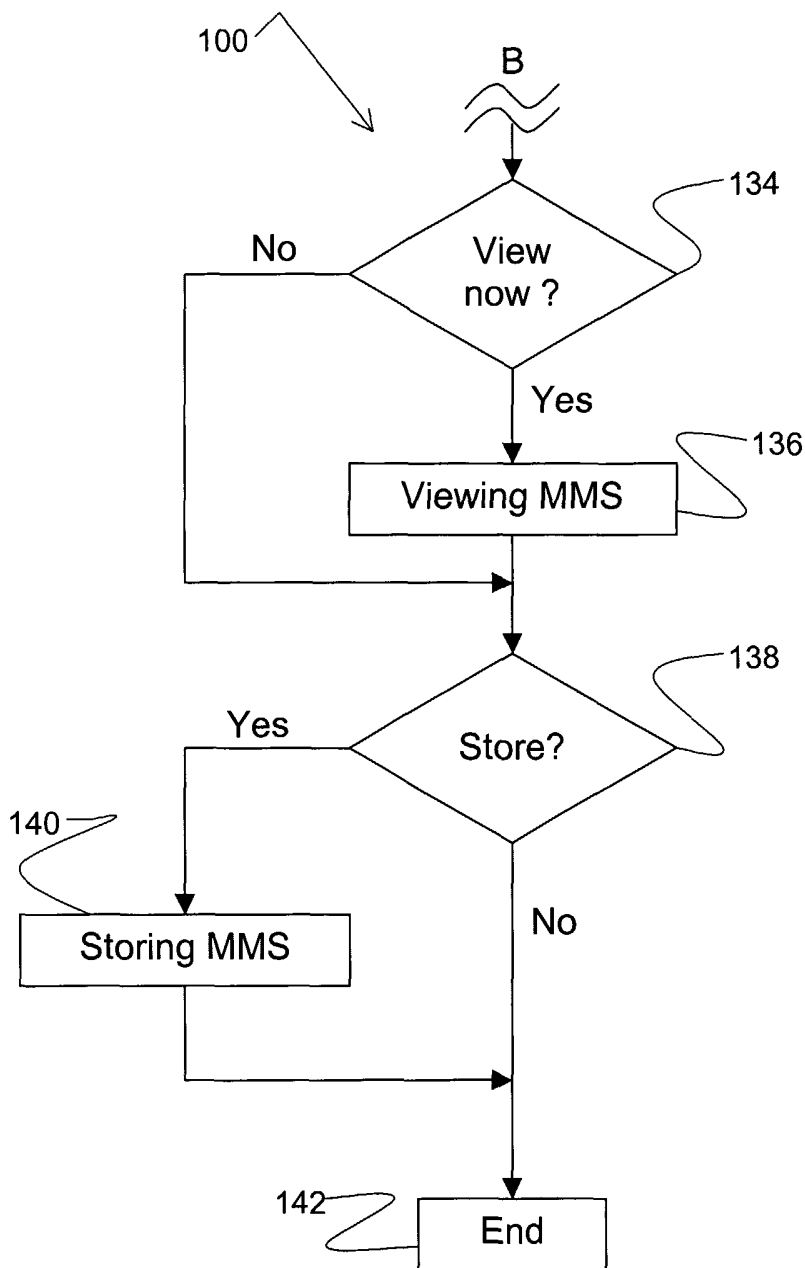

Fig. 4c

INTERNATIONAL SEARCH REPORT

PCT/IB 02/00726

A. CLASSIFICATION OF SUBJECT MATTER
 IPC 7 H04N7/08 H04N7/14 H04N7/173

According to International Patent Classification (IPC) or to both national classification and IPC

B. FIELDS SEARCHED

Minimum documentation searched (classification system followed by classification symbols)
 IPC 7 H04N

Documentation searched other than minimum documentation to the extent that such documents are included in the fields searched

Electronic data base consulted during the international search (name of data base and, where practical, search terms used)

EPO-Internal, INSPEC, IBM-TDB, WPI Data, COMPENDEX

C. DOCUMENTS CONSIDERED TO BE RELEVANT

Category °	Citation of document, with indication, where appropriate, of the relevant passages	Relevant to claim No.
X	WO 98 17064 A (WESTBERG THOMAS E ;KWOH DANIEL S (US); LEUNG ELSIE Y (US); MANKOVI) 23 April 1998 (1998-04-23) page 13, line 35-37 page 14, line 14-17; claim 1; figure 9 abstract ---	1,2,21, 28,32,35
X	EP 1 180 903 A (NOKIA CORP) 20 February 2002 (2002-02-20) paragraphs 2-13 ---	1,2,21, 28
A	WO 01 60070 A (DELAMONT DEAN) 16 August 2001 (2001-08-16) the whole document ---	1-37
A	WO 00 13415 A (UNITED VIDEO PROPERTIES INC) 9 March 2000 (2000-03-09) the whole document ---	1-37
	-/--	

Further documents are listed in the continuation of box C.

Patent family members are listed in annex.

° Special categories of cited documents :

"A" document defining the general state of the art which is not considered to be of particular relevance
 "E" earlier document but published on or after the international filing date
 "L" document which may throw doubts on priority claim(s) or which is cited to establish the publication date of another citation or other special reason (as specified)
 "O" document referring to an oral disclosure, use, exhibition or other means
 "P" document published prior to the international filing date but later than the priority date claimed

"T" later document published after the international filing date or priority date and not in conflict with the application but cited to understand the principle or theory underlying the invention
 "X" document of particular relevance; the claimed invention cannot be considered novel or cannot be considered to involve an inventive step when the document is taken alone
 "Y" document of particular relevance; the claimed invention cannot be considered to involve an inventive step when the document is combined with one or more other such documents, such combination being obvious to a person skilled in the art.
 "&" document member of the same patent family

Date of the actual completion of the international search

4 November 2002

Date of mailing of the international search report

20. 11. 2002

Name and mailing address of the ISA

European Patent Office, P.B. 5818 Patentlaan 2
 NL - 2280 HV Rijswijk
 Tel. (+31-70) 340-2040, Tx. 31 651 epo nl,
 Fax: (+31-70) 340-3016

Authorized officer

JESPER BERGSTRAND/ ELY

INTERNATIONAL SEARCH REPORT

PCT/IB 02/00726

C.(Continuation) DOCUMENTS CONSIDERED TO BE RELEVANT

Category °	Citation of document, with indication, where appropriate, of the relevant passages	Relevant to claim No.
A	WO 01 49032 A (COMVERSE NETWORK SYSTEMS LTD) 5 July 2001 (2001-07-05) the whole document -----	1-37

INTERNATIONAL SEARCH REPORT

PCT/IB 02/00726

Patent document cited in search report		Publication date	Patent family member(s)	Publication date
WO 9817064	A	23-04-1998	AU 726960 B2	30-11-2000
			AU 4823197 A	11-05-1998
			BR 9712352 A	31-08-1999
			CN 1251723 A	26-04-2000
			EP 0932979 A1	04-08-1999
			JP 2002515207 T	21-05-2002
			WO 9817064 A1	23-04-1998

EP 1180903	A	20-02-2002	EP 1180903 A1	20-02-2002

WO 0160070	A	16-08-2001	AU 3208701 A	20-08-2001
			WO 0160070 A1	16-08-2001

WO 0013415	A	09-03-2000	AU 5694399 A	21-03-2000
			AU 5787299 A	21-03-2000
			BR 9913230 A	17-07-2001
			BR 9913659 A	05-06-2001
			CA 2338488 A1	09-03-2000
			CA 2341451 A1	09-03-2000
			CN 1315113 T	26-09-2001
			CN 1320336 T	31-10-2001
			EP 1241890 A2	18-09-2002
			EP 1110396 A2	27-06-2001
			EP 1099345 A1	16-05-2001
			JP 2002524934 T	06-08-2002
			JP 2002524935 T	06-08-2002
			TW 463503 B	11-11-2001
			TW 447221 B	21-07-2001
			WO 0013415 A2	09-03-2000
			WO 0013416 A1	09-03-2000

WO 0149032	A	05-07-2001	AU 2212201 A	09-07-2001
			EP 1243137 A1	25-09-2002
			WO 0149032 A1	05-07-2001
