



HU000027966T2

(19) **HU**(11) Lajstromszám: **E 027 966**(13) **T2****MAGYARORSZÁG**  
Szellemi Tulajdon Nemzeti Hivatala**EURÓPAI SZABADALOM**  
**SZÖVEGÉNEK FORDÍTÁSA**(21) Magyar ügyszám: **E 09 837427**(51) Int. Cl.: **A61F 2/16** (2006.01)(22) A bejelentés napja: **2009. 04. 08.**

(86) A nemzetközi (PCT) bejelentési szám:

(96) Az európai bejelentés bejelentési száma:  
**EP 20090837427****PCT/JP 09/001631**(97) Az európai bejelentés közzétételi adatai:  
**EP 2377493 A1** **2011. 10. 19.**

(87) A nemzetközi közzétételi szám:

**WO 10079537**(97) Az európai szabadalom megadásának meghirdetési adatai:  
**EP 2377493 B1** **2015. 08. 05.**

(30) Elsőbbségi adatok: <b>2009001169</b> <b>2009. 01. 06.</b> <b>JP</b>	(73) Jogosult(ak): <b>Carl Zeiss Meditec AG, 07745 Jena (DE)</b>
(72) Feltaláló(k): <b>KOBAYASHI, Atsushi, Kasugai-shiAichi 487-0032 (JP)</b> <b>SUZUKI, Hiroaki, Kasugai-shiAichi 487-0032 (JP)</b> <b>ANDO, Ichiro, Kasugai-shiAichi 487-0032 (JP)</b>	(74) Képviselő: <b>Szabó Zsolt, DANUBIA Szabadalmi és Jogi Iroda Kft., Budapest</b>

(54) **Eljárás aphakiás intraokuláris lencse előállítására**

Az európai szabadalom ellen, megadásának az Európai Szabadalmi Közlönyben való meghirdetésétől számított kilenc hónapon belül, felszólalást lehet benyújtani az Európai Szabadalmi Hivatalnál. (Európai Szabadalmi Egyezmény 99. cikk(1))

A fordítást a szabadalmas az 1995. évi XXXIII. törvény 84/H. §-a szerint nyújtotta be. A fordítás tartalmi helyességét a Szellemi Tulajdon Nemzeti Hivatala nem vizsgálta.



(11) **EP 2 377 493 B1**

(12) **EUROPEAN PATENT SPECIFICATION**

(45) Date of publication and mention  
of the grant of the patent:  
**05.08.2015 Bulletin 2015/32**

(21) Application number: **09837427.5**

(22) Date of filing: **08.04.2009**

(51) Int Cl.:  
**A61F 2/16 (2006.01)**

(86) International application number:  
**PCT/JP2009/001631**

(87) International publication number:  
**WO 2010/079537 (15.07.2010 Gazette 2010/28)**

(54) **METHOD FOR MANUFACTURING APHAKIC INTRAOCULAR LENS**

VERFAHREN ZUR HERSTELLUNG EINER APHAKEN INTRAOKULARLINSE

PROCÉDÉ DE FABRICATION DE LENTILLE INTRAOCULAIRE APHAQUE

(84) Designated Contracting States:  
**AT BE BG CH CY CZ DE DK EE ES FI FR GB GR  
HR HU IE IS IT LI LT LU LV MC MK MT NL NO PL  
PT RO SE SI SK TR**

(30) Priority: **06.01.2009 JP 2009001169**

(43) Date of publication of application:  
**19.10.2011 Bulletin 2011/42**

(73) Proprietor: **Carl Zeiss Meditec AG  
07745 Jena (DE)**

(72) Inventors:  
• **KOBAYASHI, Atsushi  
Kasugai-shi  
Aichi 487-0032 (JP)**

• **SUZUKI, Hiroaki  
Kasugai-shi  
Aichi 487-0032 (JP)**  
• **ANDO, Ichiro  
Kasugai-shi  
Aichi 487-0032 (JP)**

(74) Representative: **Samson & Partner Patentanwälte  
mbB  
Widenmayerstraße 6  
80538 München (DE)**

(56) References cited:  
**EP-A2- 0 393 639 WO-A1-2006/047698  
JP-A- 2008 043 752 JP-T- 2008 517 731  
JP-U- 3 035 502 US-A- 5 122 903  
US-A1- 2007 182 924**

**EP 2 377 493 B1**

Note: Within nine months of the publication of the mention of the grant of the European patent in the European Patent Bulletin, any person may give notice to the European Patent Office of opposition to that patent, in accordance with the Implementing Regulations. Notice of opposition shall not be deemed to have been filed until the opposition fee has been paid. (Art. 99(1) European Patent Convention).

**Description**

TECHNICAL FIELD

5 **[0001]** The present invention relates to a method of manufacturing an aphakic intraocular lens having a diffraction grating, and also an aphakic intraocular lens with a structure that can be favorably manufactured thereby.

BACKGROUND ART

10 **[0002]** As is well known, the crystalline lens that controls the vision sometimes lessens its adjustment function or has its characteristics such as transparency of the lens itself deteriorated due to genetic or aging factors. This consequently causes problems such as refractive disorders including myopia, hyperopia and presbyopia, or even cataract and the like, which makes it hard to obtain effective vision. To deal with such situations, an aphakic intraocular lens (hereinafter called "intraocular lens" as appropriate) has been conventionally used that is set in place in the capsule to replace the  
15 crystalline lens after enucleation and removal thereof.

**[0003]** However, since the intraocular lenses that have been conventionally used are monofocal ones, the problem is that the eye function ends up with no focal adjustment, although the vision is restored after the eye surgery.

**[0004]** To cope with such a problem, an intraocular lens capable of generating multiple foci by adopting a diffraction lens described, for example, in Patent Document 1 and the like and making use of diffraction of light is proposed. The  
20 diffraction lens described in Patent Document 1 is provided with a diffraction grating with reliefs on the lens surface and made capable of forming two foci generated by the 0th order light and first order diffracted light. Therefore, a bifocal intraocular lens is available by assigning the foci by the 0th order light and first order diffracted light for far vision and near vision respectively.

**[0005]** However, it is increasingly recognized in recent years that a bifocal intraocular lens that adopts a conventional diffractive lens structure is not sufficient enough to improve vision. That is, in case of an intraocular lens that adopts the diffractive lens structure described in the above Patent Document 1, for example, the 0th order light and first order diffracted light are assigned for far vision and near vision respectively, which revealed a problem that allocating energy to the mid-section between the 0th order light and first order diffracted light becomes more difficult and the contrast in the intermediate vision range gets too low. **[0006]** Under these circumstances, an intraocular lens that generates multiple  
30 foci by forming multiple areas with different reliefs on the lens in its radial direction is proposed in Patent Document 2, for example, in order to make it possible to generate more number of foci. However, the intraocular lens described in Patent Document 2 had a risk of failing to achieve the desired focal effect when the diameter of incident light beam varies in cases such as pupil shrinkage. In addition, even if the design of the lens is based on a consideration of physiological pupil diameter, it is not necessarily possible to insert an intraocular lens in the desired position relative to  
35 the pupil and keep it stable therein, which poses a risk of failing to achieve the desired focal effect due to the eccentricity of the lens.

**[0006]**

Patent Document 1: U.S. Patent No. 5121980

40 Patent Document 2: U.S. Patent No. 7188949

**[0007]** EP 0 393 639 A2 describes a multifocal optical device directing light to a first order focal point and a 0th order focal point.

**[0008]** WO 2006/047698 A1 describes an ophthalmic lens with a first optical region formed multifocal phase plate diffracting light in the first and second diffraction orders, and a spatially separated second optical region.

**[0009]** US 5 122 903 describes an optical device with a Fresnel-lens pattern and a superimposed pattern with equally separated linear ridges together forming an astigmatic optical element.

SUMMARY OF THE INVENTION PROBLEM THE INVENTION ATTEMPTS TO SOLVE

50 **[0010]** With the foregoing in view, it is accordingly an object of the present invention, to provide a method of manufacturing an aphakic intraocular lens that is capable of ensuring every multi-focusing effect more securely, while reducing the impact of pupil shrinkage and lens eccentricity.

**[0011]** Furthermore, this invention aims at providing an aphakic intraocular lens with a structure which can be favorably  
55 manufactured by the manufacturing method.

## MEANS FOR SOLVING THE PROBLEM

**[0012]** Modes of this invention contrived to solve the above problems are described in the following paragraphs. Also, the components adopted in each modes described below are adoptable in any other possible combination.

5 **[0013]** A first mode of this invention relating to a method of manufacturing an aphakic intraocular lens as disclosed in claim 1 provides a manufacturing method of an aphakic intraocular lens to be set in place in a lens capsule provided with a diffraction grating having reliefs extending concentrically on a lens surface, comprising the steps of: adopting various types of reliefs whose first order diffracted lights give respective focal distances different from one another for the relief pattern; setting up a synchronous structure where at least two reliefs are set to overlap with each other in at least a part of an area in a radial direction of the lens, and with respect to every grating pitches of one relief having a maximum grating pitch among the reliefs set up in overlap, grating pitches of another relief are overlapped periodically, in order to obtain the relief pattern; and forming the resulting relief pattern on the lens surface.

10 **[0014]** According to the manufacturing method of this invention, at least two foci can be generated by each first order diffracted light of at least two reliefs. With this arrangement, the 0th order light by the refractive surface of the intraocular lens, for example, is set to focus for far vision, while the first order light by one of the two reliefs is set to focus for near vision, in addition to having the other first order light set to focus for intermediate vision. This makes it possible to obtain good diffraction intensity in the intermediate vision range in addition to the far and near vision ranges, thus providing an intraocular lens capable of delivering good vision in the intermediate range. The word "relief" in this invention refers to a jagged form.

15 **[0015]** According to the intraocular lens manufactured by the present manufacturing method, various types of reliefs are set to overlap with each other. This allows the first order diffracted light to be generated by each relief in the entire area where various types of reliefs are overlapped. Therefore, unlike a diffraction lens on which different reliefs are set up in each area, as described in the above Patent Document 2 for example, it is now possible to obtain an intraocular lens more securely with an unprecedented new optical properties, whereby the desired optical properties are obtained by restricting relative variations of the diffraction intensity in a particular area caused by changes in diameter of incident light following changes in aperture and the eccentricity of the lens and the like.

20 **[0016]** Besides, especially by the present manufacturing method, a synchronous structure is set up where grating pitches of other reliefs are overlapped periodically with each grating pitch of the relief having the maximum grating pitch among the reliefs set up in overlap. That is, the synchronous structure is set up where zone radii of other reliefs are overlapped periodically with each zone radius of the relief having the maximum grating pitch. Here, the word "grating pitch" means a width of each relief between the ridge and valley lines in the radial direction. The "zone radius" refers to a radius of a ridge or valley line located on the outer side of the concentric center measured from the concentric center in the zone between the ridge and valley lines of each relief extending concentrically. Also, "concentrically" means a state of multiple streaks in forms of circles or something similar such as ovals extending in an annular pattern centered on an optical axis or an eccentric axis. Also, the "radial direction of the lens" mentioned in the claims of this invention means a radial direction centered on the optical axis, and in case the optical axis is off the geometric center of the lens, it is not necessarily identical to the radial direction of the lens relative to its outer peripheral configuration. This makes it possible to distinctly generate a peak of diffraction intensity of the first order diffracted light of each relief and to obtain a multitude of foci more certainly. In other words simply overlapping various types of reliefs cannot clearly obtain a peak of diffraction intensity of any relief and results in generating peaks of unintended order of light beams, while increasing the quantity of glare caused by stray light beams. On the contrary, according to the present manufacturing method, diffraction intensity can be allocated effectively to the first order diffracted light of other reliefs by synchronizing grating pitches of different relief patterns, thus reducing the intensity of unnecessary nth order diffracted light beams including second order diffracted light. As a result, the quantity of stray light and so forth can be lowered and the glare and the like can be reduced.

25 **[0017]** Meanwhile, the first order diffracted light in this invention is first order interference light accompanying diffraction and also is diffracted light that generates a phase difference of one wavelength. In other words, since the speed of light is slower in a medium with higher refractive index than that of air, it is the positive first order diffracted light that is the first order interference light obtained by making use of this phenomenon, and by overlapping, in delayed phases by one wavelength, the light beams that pass through reliefs adjacent to each other from the concentric center toward the periphery on a diffraction grating with reliefs having a ridge line on the center side of the concentric circle, and on the contrary, in case of using a diffraction grating with reliefs with their positive and negative reversed having a ridge line on the outer side of the concentric circle, it is the negative first order diffracted light that is the first order interference light generated on the opposite side of the reliefs obtained by overlapping, in advanced phases by one wavelength, the light beams that pass through reliefs adjacent to each other from the center toward the periphery. The "first order light" described in the claims of this invention is to be interpreted as first order light with an absolute value of both the positive first order diffracted light and negative first order diffracted light.

30 **[0018]** Also in this invention, it will suffice for various types of reliefs to be set overlapped in at least a part of the area

in the radial direction of the lens, and not necessarily to be set overlapped all across the lens surface. Therefore, for example, various types of reliefs may be set overlapped only at the center of the lens or at the intermediate area in the radial direction of the lens, while only one relief may be set in other areas.

**[0019]** Moreover, as various types of reliefs in this invention, at least two types are good enough, and as a matter of course, three or more relief patterns can be set overlapped.

**[0020]** Also, the "aphakic intraocular lens" in this invention refers to an intraocular lens set in place in the lens capsule to replace the crystalline lens after the removal thereof. The shapes and materials and so forth of the reference plane where the synchronous structure of the reliefs is formed are not particularly limited. For example, such a reference plane can be an aspheric, cylindrical or toric plane as well as a spherical plane including a convex or concave surface, or even a flat plane. Especially, in case the reference plane is other than a flat plane, optical refractive properties, in addition to the diffraction of this invention, are to be demonstrated.

**[0021]** A second mode of this invention related to the method of manufacturing an aphakic intraocular lens, according to the first mode, further comprising the step of setting a focal distance for a 0th order light by a refractive surface of the lens a focal distance being different from that of any of first order diffracted lights generated by the various types of reliefs.

**[0022]** According to the present mode, it is possible to obtain an intraocular lens with three or more foci including the focus generated by each first order diffracted light of at least two reliefs as well as the focus of the 0th order light by the refractive surface. The various types of reliefs can be formed on a refractive surface or a plane other than the refractive surface. Therefore, this mode includes an arrangement wherein a relief is formed on the non-refractive side of a lens, one side of which is a curved plane as a concave or convex refractive surface and the other is a plane as a non-refractive surface, and further includes, as a third mode of this invention related to the method of manufacturing an aphakic intraocular lens according to the second mode, an arrangement wherein the above lens surface formed with the relief pattern is the refractive surface.

**[0023]** A fourth mode of this invention related to the method of manufacturing an aphakic intraocular lens according to one of the first through third modes, further comprising the step of setting each relief depth of the relief having the maximum grating pitch, which is obtained by overlapping the various types of reliefs, is made constant in a zone direction.

**[0024]** Here, the word "relief depth" means a height of a relief in the optical axis direction at each zone radius position. According to the present mode, it is rendered unnecessary to set the depth of the relief with the maximum grating pitch for each zone, thus making it easier to set the relief pattern.

**[0025]** A fifth mode of this invention related to the method of manufacturing an aphakic intraocular lens according to the fourth mode, further comprises the steps of forming in each zone in the relief having the maximum grating pitch another type of relief with at least two relief depths in the area in the radial direction of the lens where the various types of reliefs set up in overlap, and setting dimensions of the at least two relief depths relative to a virtual base curve surface so as to gradually vary in the zone direction.

**[0026]** According to the present mode, the depth of the relief of another type can be set with more accuracy, and the peak of diffraction intensity by the relief of another type can be generated more distinctly. In this mode, the phrase "relief depths relative to the virtual base curve surface are set to gradually vary in the zone direction" includes modes where the depth gradually increases and decreases.

**[0027]** A sixth mode of this invention related to the method of manufacturing an aphakic intraocular lens according to the fourth mode, further comprising the steps of forming in each zone in the relief having the maximum grating pitch another type of relief with at least two relief depths in the area in the radial direction of the lens where the various types of reliefs set up in overlap, and setting dimensions of the at least two relief depths relative to the virtual base curve surface so as to be constant in the zone direction. According to the present mode, it is rendered unnecessary to set the form of another type of relief per each zone radius, thus making it easier to set the form of another type of relief.

**[0028]** A seventh mode of this invention related to the method of manufacturing an aphakic intraocular lens according to one of the first through sixth modes, wherein each of the various types of reliefs has a ridge line extending circumferentially with a cross-section formed with an acute vertex angle and a valley line extending circumferentially with a cross-section formed with an acute included angle.

**[0029]** According to the present mode, it is now possible to effectively generate diffraction effects in each of multiple reliefs and effectively generate a peak for the first order diffracted light of each type of relief.

**[0030]** An eighth mode of this invention related to the method of manufacturing an aphakic intraocular lens according to one of the first through seventh modes, further comprising the steps of: setting to the 0th order light by the refractive surface of the lens set a focus for far vision; setting to the first order diffracted light by one type of the relief a focus for near vision; and setting to the first order diffracted light by another type of the relief a focus for intermediate vision.

**[0031]** According to the present mode, it is now possible to obtain an intraocular lens having a focus for intermediate vision in addition to far vision and near vision. Therefore, the conventional problem with diffraction type lenses of lowered contrast for intermediate vision can be improved, thus making it possible to provide better intermediate vision.

**[0032]** A ninth mode of this invention related to the method of manufacturing an aphakic intraocular lens according to one of the first through seventh modes, further comprising the steps of: setting to the 0th order light by the refractive

surface of the lens a focus for near vision; setting to the first order diffracted light by one type of the relief a focus for far vision; and setting to the first order diffracted light by another type of the relief a focus for intermediate vision.

**[0033]** Also in the present mode, it is now possible to obtain an intraocular lens having a focus for better intermediate vision. Here, in this mode, both near vision focus and far vision focus turn out to be the ones of the negative first order light by the corresponding relief, but as described above, the first order light in this invention is to be interpreted as first order light with an absolute value including the negative first order light.

**[0034]** A tenth mode of this invention related to the method of manufacturing an aphakic intraocular lens according to one of the first through ninth modes, wherein the various types of reliefs are arranged to satisfy a following equation:

$$A = (2(m - NM) + a) / N$$

where A is a zone constant of the one relief, 'a' is a zone constant of the other relief, M is a zone number of the one relief, m is a zone number of the other relief, and N is a ratio of a focal distance of the one relief relative to that of the other relief, which is expressed as:

$$\text{(focal distance of the one relief) / (focal distance of the other relief).}$$

**[0035]** Here, the "zone constant" means a constant for setting a zone radius of a given zone number at a certain value, and the zone radius is given by the following equation using the zone constant 'a':

$$\text{Zone radius} = \sqrt{(2m + a) \lambda f}$$

where  $\lambda$  is the design wavelength, and f is a focal distance. Also, the "zone number" refers to a number allocated for each zone in the order of 1, 2, 3, ... from the center at 0 outward in the zone direction.

**[0036]** According to the present mode, it is easy to set up a synchronous structure where a grating pitch of the other relief is overlapped periodically with that of the one relief.

**[0037]** An eleventh mode of this invention related to the method of manufacturing an aphakic intraocular lens according to one of the first through tenth modes, wherein the various types of reliefs are arranged to satisfy a following equation:

$$D \leq \lambda / (N_{\text{lens}} - N_{\text{med}})$$

where D is a dimension of the relief depth,  $\lambda$  is a design wavelength,  $N_{\text{lens}}$  is a refractive index of an optical material, and  $N_{\text{med}}$  is a refractive index of a surrounding medium.

**[0038]** According to the present mode, the maximum relief depth is equal to one wavelength, which makes it possible to more securely facilitate the allocation of the 0th order light and first order light. Therefore, the present mode is preferably used in combination with other modes such as the above third mode, wherein the relief pattern is formed on the refractive surface. With this arrangement, intensity of unnecessary nth order light such as the second order light can be reduced, and the focal effects of the 0th order light and first order light can be effectively produced.

**[0039]** Another aspect of the present invention relates to an aphakic intraocular lens. A first mode of the invention related to the aphakic intraocular lens as disclosed in claim 5 provides an aphakic intraocular lens adapted to be set in place in a lens capsule, and provided with a diffraction grating having a relief pattern extending concentrically on the lens surface, comprising: a synchronous structure where various types of reliefs including at least two reliefs whose first order diffracted lights give respective focal distances different from one another are set to overlap with each other in at least a part of an area in a radial direction of the lens, and with respect to every grating pitches of one relief having a maximum grating pitch among the reliefs set up in overlap, grating pitches of another relief being overlapped periodically.

**[0040]** According to the intraocular lens of the present mode, at least two foci can be generated by each first order diffracted light of at least two reliefs. This makes it possible to obtain a focus for far vision of the 0th order light by the refractive surface of the intraocular lens, for example, while obtaining a focus for near vision of the first order light by one of the two reliefs, in addition to obtaining a focus for intermediate vision by the other first order light. This makes it possible to obtain good diffraction intensity in the intermediate vision range in addition to the far and near vision ranges, thus providing an intraocular lens capable of delivering good vision in the intermediate range. The word "relief" in this invention refers to a jagged form.

**[0041]** Especially according to the intraocular lens of the present mode, the various types of reliefs are set overlapped.

This allows the first order diffracted light to be generated by each relief in the entire area where various types of reliefs are overlapped, and therefore, unlike a diffraction lens on which different reliefs are set up in each area, as described in the above Patent Document 2 for example, it is now possible to restrict relative variations of the diffraction intensity in a specific area caused by changes in diameter of incident light following aperture changes and eccentricity of the lens and the like, thus enabling to obtain an intraocular lens with an unprecedented new optical properties whereby the desired optical properties are more securely obtained.

**[0042]** And especially in the present mode, a synchronous structure where grating pitches of other reliefs are overlapped periodically with each grating pitch of the relief having the maximum grating pitch among the reliefs set up in overlap, that is, zone radii of other reliefs are overlapped periodically with each zone radius of the relief having the maximum grating pitch. The word "concentrically" means a state of multiple streaks in forms of circles or something similar such as ovals extending in an annular pattern centered on an optical axis or an eccentric axis. Also, the "radial direction of the lens" mentioned in the claims of this invention means a radial direction centered on the optical axis, and in case the optical axis is off the geometric center of the lens, it is not necessarily identical to the radial direction of the lens relative to its outer peripheral configuration. This makes it possible to distinctly generate a peak of diffraction intensity of the first order diffracted light of each relief and to obtain a multitude of foci more certainly. In other words simply overlapping various types of reliefs cannot clearly obtain a peak of diffraction intensity of any relief and results in generating peaks of unintended order of light beams while increasing the quantity of glare caused by stray light beams. On the contrary, according to the intraocular lens in the present mode, diffraction intensity can be allocated effectively to the first order diffracted light of other reliefs by synchronizing grating pitches of different types of relief, thus reducing the intensity of unnecessary nth order diffracted light including second order diffracted light. As a result, light intensity of stray light beams and so forth can be lowered and the glare and the like can be reduced.

**[0043]** Also in the present mode, it will suffice for various types of reliefs to be set overlapped in at least a part of the area in the radial direction of the lens, and not necessarily to be set overlapped all across the lens surface. Therefore, for example, various types of reliefs can be set overlapped only at the center of the lens or at the intermediate area in the radial direction of the lens, while only one relief can be set in other areas.

**[0044]** Furthermore, as various types of reliefs in the present mode, at least two types are good enough, and as a matter of course, three or more types of reliefs can be set overlapped.

**[0045]** Meanwhile, the aphakic intraocular lens in the present mode means an intraocular lens set in place in the lens capsule to replace the crystalline lens after removal thereof. And the shapes and materials and so forth of the reference plane where the synchronous structure of the reliefs is formed are not particularly limited. For example, such a reference plane can be an aspheric, cylindrical or toric plane as well as a spherical plane including a convex or concave surface, or even a flat plane. Especially, in case the reference plane is other than a flat plane, the optical refractive property, in addition to the diffraction of this invention, is to be exerted.

**[0046]** The second mode of this invention related to the aphakic intraocular lens according to the first mode, wherein a focal distance different from that of any first order diffracted light generated by the various types of reliefs is set for a 0th order light by the refractive surface of the lens.

**[0047]** According to the present mode, it is possible to obtain an intraocular lens with three or more foci including the foci generated by each first order diffracted light of at least two reliefs as well as the focus of the 0th order light by the refractive surface. In this situation, the various types of reliefs can be formed on a refractive surface or a plane other than the refractive surface. Therefore, this mode includes a mode wherein one side is a curved plane as a concave or convex refractive surface and the other a plane as a non-refractive surface where a relief is formed on the non-refractive side, and further includes, as a third mode of this invention related to an aphakic intraocular lens, a mode wherein the lens surface formed with the relief pattern is the refractive surface.

**[0048]** A fourth mode of this invention related to an aphakic intraocular lens according to one of the first through third modes, wherein each relief depth of the relief having the maximum grating pitch, which is obtained by overlapping the various types of reliefs, is made constant in a zone direction.

**[0049]** Here, the word "relief depth" means a height of a relief at each zone radius position in the optical axis direction. According to the present mode, it is rendered unnecessary to set the depth of the relief with the maximum grating pitch for each zone, thus making it easier to set the relief pattern and to manufacture the products.

**[0050]** A fifth mode of this invention related to an aphakic intraocular lens according to the fourth mode, wherein in each zone in the relief having the maximum grating pitch, another type of relief with at least two relief depths is formed in the area in the radial direction of the lens where the various types of reliefs set up in overlap, and dimensions of the at least two relief depths relative to a virtual base curve surface vary gradually in the zone direction.

**[0051]** According to the present mode, the depth of the relief of another type can be set with more accuracy, and the peak of diffraction intensity by the relief of another type can be generated more distinctly. Here, in this mode, the phrase "relief depths relative to the virtual base curve surface are set to gradually vary in the zone direction" includes modes where the depth gradually increases and decreases.

**[0052]** A sixth mode of this invention related to an aphakic intraocular lens according to the fourth mode, wherein in

each zone in the relief having the maximum grating pitch, another type of relief with at least two relief depths is formed in the area in the radial direction of the lens where the various types of reliefs set up in overlap, and dimensions of the at least two relief depths relative to the virtual base curve surface are set constant in the zone direction. According to the present mode, it is rendered unnecessary to set the form of another type of relief per each zone radius, thus making it easier to set the form of another type of relief.

**[0053]** A seventh mode of this invention related to an aphakic intraocular lens according to one of the first through sixth modes, wherein each of the various types of reliefs has a ridge line extending circumferentially with a cross-section formed with an acute vertex angle and a valley line extending circumferentially with a cross-section formed with an acute included angle.

**[0054]** According to the present mode, it is now possible to effectively generate diffraction effects in each of various types of reliefs and effectively generate a peak for the first order diffracted light of each type of relief.

**[0055]** An eighth mode of this invention related to an aphakic intraocular lens according to one of the first through seventh modes, wherein the 0th order light by the refractive surface of the lens is set to a focus for far vision, the first order diffracted light by one type of the relief is set to a focus for near vision, and the first order diffracted light by another type of the relief is set to a focus for intermediate vision.

**[0056]** According to the present mode, it is now possible to obtain an intraocular lens having a focus for intermediate vision in addition to far vision and near vision. Therefore, the conventional problem with diffraction type lenses of lowered contrast for intermediate vision can be improved, thus making it possible to provide better intermediate vision.

**[0057]** A ninth mode of this invention related to an aphakic intraocular lens according to one of the first through seventh modes, wherein the 0th order light by the refractive surface of the lens is set to a focus for near vision, the first order diffracted light by one type of the relief is set to a focus for far vision, and the first order diffracted light by another type of the relief is set to a focus for intermediate vision.

**[0058]** Also in the present mode, it is now possible to obtain an intraocular lens having a focus for better intermediate vision. Here, in this mode, both near vision focus and far vision focus turn out to be the ones of the negative first order light by the corresponding relief, but as described above, the first order light in this invention is to be interpreted as first order light with an absolute value including the negative first order light.

**[0059]** A tenth mode of this invention related to an aphakic intraocular lens according to one of the first through ninth modes, wherein the various types of reliefs are arranged to satisfy a following equation:

$$A = (2(m - NM) + a) / N$$

where A is a zone constant of the one relief, 'a' is a zone constant of the other relief, M is a zone number of the one relief, m is a zone number of the other relief, and N is a ratio of a focal distance of the one relief relative to that of the other relief, which is expressed as:

$$(\text{focal distance of the one relief}) / (\text{focal distance of the other relief}).$$

**[0060]** Here, the "zone constant" means a constant for setting a zone radius of a given zone number at a certain value, and the zone radius is given by the following equation using the zone constant 'a':

$$\text{Zone radius} = \sqrt{(2m + a) \lambda f}$$

where  $\lambda$  is the design wavelength, and f is a focal distance. Also, the "zone number" refers to a number allocated for each zone in the order of 1, 2, 3, ... from the center at 0 outward in the zone direction.

**[0061]** According to the present mode, it is easy to set up a synchronous structure where a grating pitch of the other relief is overlapped periodically with that of the one relief.

**[0062]** An eleventh mode of this invention related to an aphakic intraocular lens according to one of the first through tenth modes, wherein the various types of reliefs are arranged to satisfy a following equation:

$$D \leq \lambda / (N_{\text{lens}} - N_{\text{med}})$$

where D is a dimension of the relief depth,  $\lambda$  is a design wavelength,  $N_{\text{lens}}$  is a refractive index of an optical material, and  $N_{\text{med}}$  is a refractive index of a surrounding medium.

**[0063]** According to the present mode, the maximum relief depth is equal to one wavelength, which makes it possible to more securely facilitate the allocation of the 0th order light and first order light. Therefore, the present mode is preferably used in combination with other modes such as the above third mode, wherein relief patterns are formed on the refractive surface. This way, intensity of unnecessary nth order light such as the second order light can be reduced, and the focal effects of the 0th order light and first order light can be effectively produced.

BRIEF DESCRIPTION OF THE DRAWINGS

**[0064]**

FIG. 1 is a front view diagram showing an intraocular lens as a first embodiment of the present invention.  
 FIG. 2 is a cross-section diagram of the intraocular lens taken along line 2-2 of FIG. 1.  
 FIG. 3 is a cross-section diagram for explaining a form of a relief pattern provided on the intraocular lens shown in FIG. 1.  
 FIG. 4 is a cross-section diagram for explaining a form of a relief for near vision, which composing the relief pattern.  
 FIG. 5 is a cross-section diagram for explaining a form of a relief for intermediate vision, which composing the relief pattern.  
 FIG. 6 is a graph showing a simulation result of diffraction intensity in the relief pattern.  
 FIG. 7 is a diagram for explaining a design method of the relief pattern.  
 FIG. 8 is a relief profile of the relief for near vision, which composing the relief pattern.  
 FIG. 9 is a relief profile of the relief for intermediate vision, which composing the relief pattern.  
 FIG. 10 is a relief profile of the relief pattern.  
 FIG. 11 is a relief profile of a relief pattern as a second embodiment of this invention.  
 FIG. 12 is a graph showing a simulation result of diffraction intensity in the relief pattern.  
 FIG. 13 is a relief profile of a relief pattern as a third embodiment of this invention.  
 FIG. 14 is a graph showing a simulation result of diffraction intensity in the relief pattern.  
 FIG. 15 is a relief profile of a relief pattern as a fourth embodiment of this invention.  
 FIG. 16 is a graph showing a simulation result of diffraction intensity in the relief pattern.  
 FIG. 17 is a relief profile of a relief pattern as a fifth embodiment of this invention.  
 FIG. 18 is a graph showing a simulation result of diffraction intensity in the relief pattern.  
 FIG. 19 is a cross-section diagram showing an optical part of an intraocular lens as a different aspect of this invention.  
 FIG. 20 is a cross-section diagram showing an optical part of an intraocular lens as a further different aspect of this invention.  
 FIG. 21 is a graph showing a simulation result of diffraction intensity of a relief pattern according to a conventional structure.  
 FIGS. 22A and 22B show simulation results of diffraction intensity of relief patterns with a structure according to this invention and a structure according to the prior art.  
 FIG. 23 is a relief profile of a relief for near vision, which composing a relief pattern as a comparative example 2.  
 FIG. 24 is a relief profile of a relief for intermediate vision, which composing the relief pattern as the comparative example 2.  
 FIG. 25 is a relief profile showing the relief pattern as the comparative example 2.  
 FIG. 26 is a graph showing a simulation result of diffraction intensity of the relief pattern.

EMBODIMENTS FOR CARRYING OUT THE INVENTION

**[0065]** To further illustrate this invention more specifically, its embodiments will be described in detail below referring to each figure.

**[0066]** First of all, FIG.1 shows a front view diagram of an intraocular lens 10 as a first embodiment related to the aphakic intraocular lens in this invention, and FIG.2 shows a cross-section diagram of an optical part 12 of said intraocular lens 10 described later. Here in FIGS.1 and 2, a relief pattern 24 described later is shown with its size exaggerated for better understanding.

**[0067]** The intraocular lens 10 comprises the optical part 12 that is part of the lens main body and gives optical properties of the intraocular lens 10 and a pair of haptics 14 that extend out from the optical part 12. The optical part 12 comprises an optical front surface 16 in an approximate convex shape of a sphere as a whole, and an optical rear surface 18 in also an approximate convex shape of a sphere as a whole. And, the optical part 12 is, in its entirety, in an approximate shape of a disc with the thicker center, and is formed as a solid of revolution formed around a geometric lens center axis 20 as a rotation axis. Meanwhile, the pair of haptics 14 are formed extending from two positions opposed in the radial direction along the periphery of the optical part 12, and each tip of the pair of haptics 14 constitutes a free end

formed to curve in a direction of the lens's circumference. Such intraocular lens 10 is inserted into the lens capsule after removal of the crystalline lens and set in place to replace it by having the haptics 14 support the optical part 12 at a given position within the capsule.

**[0068]** The optical part 12 is provided with, as lens surfaces, the optical front surface 16 and optical rear surface 18, both made to be refractive surfaces. Also, a given focal distance is set for the 0th order light by these optical front surface 16 and optical rear surface 18.

**[0069]** Meanwhile, as forming materials of the optical part 12, publicly known resin materials and the like composed of various types of polymerized monomers having optical properties such as optical transparency and so forth are preferably adopted, which are exemplified more specifically by polymethylmethacrylate (PMMA) and silicone rubbers.

**[0070]** Also, especially on the optical front surface 16 of the present embodiment, a diffraction grating 22 is formed almost all over it. The diffraction grating 22 comprises a relief pattern 24, which has a jagged form extending continuously in the circumferential direction of the lens in a concentric way around the lens center axis 20.

**[0071]** FIG.3 shows a cross-section diagram of the relief pattern 24 in the radial direction. Especially, the relief pattern 24 in the present embodiment is formed with an overlap of a relief 26 for near vision shown diagrammatically in FIG.4 in cross-section in the radial direction and a relief 28 for intermediate vision shown diagrammatically in FIG.5 in cross-section in the radial direction. These FIGS. 3 through 5 are relief profiles showing changes in height of each of the relief pattern 24 and the reliefs 26, 28, in the lens radial direction, from the base curve surface assuming that the base curve surface of the optical front surface 16 is the line BC.

**[0072]** These relief 26 for near vision and relief 28 for intermediate vision are each extending concentrically around the lens center axis 20, and is made in a jagged form having a ridge line 30 protruding outward (upward in FIGS.3 through 5) from the optical part 12 and a valley line 32 protruding inward (downward in FIGS.3 through 5) of the optical part 12.

**[0073]** In the following descriptions, "grating pitch" means a width between the ridge line 30 and valley line 32 in the radial direction. "Zone" means an area between the ridge line 30 and valley line 32, and a zone number is allocated for each zone in the order of 1, 2, 3... from the center at 0 outward in the zone direction. Also, "zone radius" means an outer peripheral radius in each zone, that is, a radius of the ridge line 30 or valley line 32 in each zone located on the outer side of the concentric circle measured from the center of the concentric circle (lens center axis 20 in the present embodiment). Therefore, "grating pitch" is a width of each zone in the radial direction, and grating pitch of a given zone is a difference between the zone radius of said zone and the zone radius of the zone numbered one less. Also, "relief depth" is a separation distance between the ridge line 30 and valley line 32 in the optical axis direction at the zone radius position.

**[0074]** Especially in the present embodiment, the ridge line 30 extends circumferentially with a cross-section formed with an acute vertex angle, while the valley line 32 is formed to extend circumferentially of the optical part 12 with a cross-section with an acute included angle. These relief 26 for near vision and relief 28 for intermediate vision are each in a jagged form, wherein the ridge line 30 and valley line 32 are formed right next to each other in the lens radial direction with the valley line 32 positioned farther from the lens center axis 20, whereas the nearer side to the lens center axis 20, as opposed to the farther side, is made protruded from the optical front surface 16 in each zone.

**[0075]** These relief 26 for near vision and relief 28 for intermediate vision are set in such a way that each of their first order diffracted light gives a different focal distance from each other, and in the present embodiment, a refractivity of +4.00D is given to the relief 26 for near vision so as to set the first order diffracted light by the relief 26 for near vision to focus for near vision, while a refractivity of +2.00D is given to the relief 28 for intermediate vision so as to set the first order diffracted light by the relief 28 for intermediate vision to focus for intermediate vision. In addition, focal distances of the 0th order light by the optical front surface 16 and optical rear surface 18 are made different from those of the first order diffracted light of any of these relief 26 for near vision and relief 28 for intermediate vision, and the 0th order light by the optical front surface 16 and optical rear surface 18 is set to focus for far vision.

**[0076]** Then, the relief pattern 24 is formed by having these relief 26 for near vision and relief 28 for intermediate vision set to overlap with each other. In this situation, the grating pitch of the relief 28 for intermediate vision is made larger than that of the relief 26 for near vision, and a synchronous structure is set up where the grating pitch in each zone of the relief 26 for near vision is overlapped periodically with that in each zone of the relief 28 for intermediate vision. This allows the zone radius in each zone of the relief 26 for near vision to be overlapped periodically with that in each zone of the relief 28 for intermediate vision. Especially in the present embodiment, one of the relief depths of the relief 26 for near vision is formed in one of the zones of the relief 28 for intermediate vision, and two zones of the relief 26 for near vision are formed in one of the zones of the relief 28 for intermediate vision. In other words, each one zone of the relief 28 for intermediate vision is overlapped with two zones of the relief 26 for near vision.

**[0077]** In addition, these relief 26 for near vision and relief 28 for intermediate vision are set to satisfy the following equation:

$$A = (2 (m - NM) + a) / N$$

where A is a zone constant of the relief 28 for intermediate vision, 'a' is a zone constant of the relief 26 for near vision, M is a zone number of the relief 28 for intermediate vision, m is a zone number of the relief 26 for near vision, and N is a ratio of the focal distance of the relief 28 for intermediate vision relative to that of the relief 26 for near vision, which is expressed as:

$$\frac{\text{(Focal distance of the relief 28 for intermediate vision)}}{\text{(Focal distance of the relief 26 for near vision)}}$$

**[0078]** This allows a synchronous structure to be set where the relief 26 for near vision and relief 28 for intermediate vision are periodically overlapped. Here, the zone constants A and 'a' are those for setting a zone radius of a certain zone number at a given value, and the zone radius is determined by the following equation using the zone constant 'a':

$$\text{Zone radius} = \sqrt{(2m + a) \lambda f}$$

where  $\lambda$  is the design wavelength, and f is a focal distance.

**[0079]** Furthermore, these relief 26 for near vision and relief 28 for intermediate vision are each set to satisfy the following equation:

$$D \leq \lambda / (N_{\text{lens}} - N_{\text{med}})$$

where D is a dimension of the relief depth,  $\lambda$  is the design wavelength,  $N_{\text{lens}}$  is a refractive index of the lens material, and  $N_{\text{med}}$  is a refractive index of the surrounding medium. This makes it possible to more securely facilitate the allocation of the 0th order light and first order light in each of the relief 26 for near vision and relief 28 for intermediate vision. Then, the relief depth of the relief pattern 24 at the position where the relief 26 for near vision and relief 28 for intermediate vision overlap with each other turns out to be a composition of the relief depths of these reliefs 26 and 28. Moreover, especially in the present embodiment, each relief depth of the relief 28 for intermediate vision overlapped with the relief 26 for near vision is made constant in the zone direction (right-left direction in FIG.3).

**[0080]** In addition, the diffraction grating 22 is formed by having the relief pattern 24 made by overlapping these relief 26 for near vision and relief 28 for intermediate vision formed on the base curve surface of the optical front surface 16.

**[0081]** According to the intraocular lens 10 with such a structure, the 0th order light of the optical front surface 16 and optical rear surface 18 gives a focus for far vision, while the first order diffracted light of the relief 26 for near vision gives a focus for near vision, and further, the first order diffracted light of the relief 28 for intermediate vision gives a focus for intermediate vision. This makes it possible to obtain a focus for intermediate vision in addition to far vision and near vision, thus enabling to obtain sufficient quantity of light and clearer contrast for intermediate vision.

**[0082]** Also, FIG.6 shows a result of computer simulation of diffraction intensity along the optical axis obtained by a relief pattern according to the present embodiment. As evident from FIG.6, according to this working example, it can be seen that a peak of diffraction intensity appears at the focus for intermediate vision of the first order diffracted light by the relief 28 for intermediate vision between the focus for far vision of the 0th order light by the optical front surface 16 and optical rear surface 18 as refractive surfaces and the focus for near vision of the first diffracted light by the relief 26 for near vision. It can also be seen that a peak is clearly generated in each of far, near and intermediate vision ranges.

**[0083]** Then, especially in the present embodiment, since the relief pattern 24 is formed by an overlap of the relief 26 for near vision and relief 28 for intermediate vision, each first order diffracted light is formed in the entire range of the relief pattern 24. This makes it possible to restrict relative variations of the diffraction intensity in a particular area caused by changes in diameter of incident light following pupil shrinkage and eccentricity of the optical part 12 and the like, thus enabling to obtain the desired optical properties more securely.

**[0084]** Additionally, especially in the relief pattern 24 of the present embodiment, the relief 26 for near vision and relief 28 for intermediate vision are formed in a synchronous structure where their grating pitches overlap periodically with each other. This makes it possible to clearly obtain a peak of each first order diffracted light of the relief 26 for near vision and relief 28 of intermediate vision, thus decreasing the quantity of light such as stray light and reducing the glare and the like.

**[0085]** Next, a method of manufacturing an aphakic intraocular lens that can be favorably used in manufacturing the

intraocular lens 10 such as the one mentioned above will be described below in reference to FIG.7.

[0086] First of all, forms of the optical front surface 16 and optical rear surface 18 where the 0th order light generates a focus for far vision are designed as refractive surfaces. In this situation, the focal distance of the 0th order light by the optical front surface 16 and optical rear surface 18 is set at a distance different from the focal distance of the first order light of either the relief 26 for near vision or relief 28 for intermediate vision. A conventionally known method can be adopted, as appropriate, in the design of such optical front surface 16 and optical rear surface 18.

[0087] Next, the form of the relief 26 for near vision with the dioptric power at +4.00D is designed. The relief depth is generally determined by the following equation:

$$\text{Relief depth} = p / (n_{\text{lens}} - n_{\text{med}}) \dots (1)$$

where p is a phase difference,  $n_{\text{lens}}$  is a refractive index of the lens material, and  $n_{\text{med}}$  is a refractive index of the surrounding medium.

[0088] Here, the relief depth is desirably a phase difference of no more than one wavelength considering the allocation to the 0th order light that generates far vision, and more preferably, is equal to or smaller than a phase difference of half the wavelength. Then, assuming that  $\lambda$  is the design wavelength and, for example,  $p = \lambda/3$ ,  $n_{\text{lens}} = 1.500$ ,  $n_{\text{med}} = 1.336$ ,  $\lambda = 500\text{nm}$ , the following value is obtained:

$$\begin{aligned} \text{Relief depth} &= (0.0005/3) / (1.500 - 1.336) \\ &= 0.001016260163\dots \end{aligned}$$

[0089] Next, the zone radius of the central zone (zone number =0) is determined upon consideration of the pupil diameter and zone pitch. For example, the central zone is set small enough at 0.2mm compared to the pupil diameter. A diffraction formula with the central zone diameter set at any value is given by modifying the following equation;

$$\text{Zone radius} = \sqrt{2m\lambda f} \dots (2)$$

into the following equation;

$$\text{Zone radius} = \sqrt{(2m + a) \lambda f} \dots (3)$$

where m is a zone number,  $\lambda$  is the design wavelength, f is a focal distance ( $f = 1,000/\text{power}$ ), and 'a' is a zone constant.

[0090] Therefore, assuming that the central zone radius is 0.2mm, the zone constant 'a' can be determined by the following equation;

$$0.2 = \sqrt{(2 \times 0 + a) 0.0005 \times 250}$$

and therefore  $a = 0.32$ ,

and consequently, the equation to calculate the zone radius with the central zone radius set at 0.2mm is given as follows:

$$\text{Zone radius} = \sqrt{(2m + 0.32) \lambda f} \dots (4)$$

[0091] As evident from the equation (3), an increment of the zone constant 'a' by 2 corresponds to an increment of the zone number by one. Therefore, the height of the central relief is determined as follows:

$$\begin{aligned} \text{Height of central relief} &= \text{relief depth} \times (a / 2) \\ &= 0.0001626016261\dots \end{aligned}$$

[0092] Besides, since the midpoint of the relief depth is where it intersects with the virtual base curve, the Y-axis value of the central apex is determined as follows on a coordinate system with its origin at the base curve apex:

$$\begin{aligned}
 \text{Y-axis value of central apex} &= \text{height of central relief} - (\text{relief depth} / 2) \\
 &= 0.0001626016261 - (0.001016260163 / 2) \\
 &= -0.0003455284554 \dots
 \end{aligned}$$

[Table 1]

Relief for near vision					
Zone No.	Curvature radius of virtual base curve	Zone origin (X-axis)	Zone terminal (X-axis)	Curvature center of Zone (Y-axis)	Zone curvature radius
0	14.384	0.0000000	0.2000000	-12.8785710	12.8782254
1	14.384	0.2000000	0.5385165	-12.8791445	12.8798150
2	14.384	0.5385165	0.7348469	-12.8808691	12.8825535
3	14.384	0.7348469	0.8888194	-12.8825939	12.8852901
4	14.384	0.8888194	1.0198039	-12.8843189	12.8880248
5	14.384	1.0198039	1.1357817	-12.8860440	12.8907576
6	14.384	1.1357817	1.2409674	-12.8877693	12.8934885
7	14.384	1.2409674	1.3379088	-12.8894947	12.8962175
8	14.384	1.3379088	1.4282857	-12.8912204	12.8989446
9	14.384	1.4282857	1.5132746	-12.8929461	12.9016697
10	14.384	1.5132746	1.5937377	-12.8946721	12.9043930
11	14.384	1.5937377	1.6703293	-12.8963982	12.9071144
12	14.384	1.6703293	1.7435596	-12.8981244	12.9098338
13	14.384	1.7435596	1.8138357	-12.8998508	12.9125514

**[0093]** As described above, curvature of the diffractive surface, geometric parameters such as the center position, and the relief profile of the relief 26 for near vision can be derived from the geometric relation. Table 1 shows geometric parameters of the relief 26 for near vision, and FIG.8 shows the relief profile thereof.

**[0094]** Next, the relief pattern with the dioptric power at +2.00D is designed as the relief 28 for intermediate vision. The relief 28 for intermediate vision needs to be designed by designing the first order light with a different focal distance from that of the relief 26 for near vision while synchronizing it with the relief 26 for near vision determined by the above process.

**[0095]** First, a formula for calculating a zone radius of the relief 28 for intermediate vision is defined as follows:

$$\text{Zone radius} = \sqrt{\{ (2M + A) \lambda (Nf) \}} \dots (5)$$

where M is a zone number, A is a zone constant, and N is a ratio of the focal distance of the relief for intermediate vision relative to that of the relief for near vision, which is expressed as:

$$\begin{aligned}
 & \text{(Focal distance of the relief for intermediate vision)} \\
 & / \text{(Focal distance of the relief for near vision)}.
 \end{aligned}$$

**[0096]** Then, in order to synchronize the relief 26 for near vision and relief 28 for intermediate vision, assuming that a given zone of the relief 26 for near vision coincides with a given zone of the relief 28 for intermediate vision, the following equation is derived from the above equations (3) and (5):

$$\sqrt{(2m + a) \lambda f} = \sqrt{(2M + A) \lambda (Nf)}$$

which is modified to obtain the following equation:

$$A = \{ 2 (m - MN) + a \} / N \dots (6)$$

although  $A > 0$ .

**[0097]** From the equation (6), the zone constant A is determined by the following equation, assuming that, for example, the zone No.1 of the relief 26 for near vision coincides with the zone No.0 of the relief 28 for intermediate vision:

$$A = \{ 2 (1 - 0 \times 2) + 0.32 \} / 2 = 1.16$$

**[0098]** The zone radius of the relief 28 for intermediate vision synchronized with the zone radius of the relief 26 for near vision is determined by the following equation:

$$\text{Zone radius} = \sqrt{\{ (2M + 1.16) \lambda (Nf) \}} \dots (7)$$

[Table 2]

Relief for intermediate vision					
Zone No.	Curvature radius of virtual base curve	Zone origin (X-axis)	Zone terminal (X-axis)	Curvature center of Zone (Y-axis)	Zone curvature radius
0	14.384	0.0000000	0.5385165	-13.5901614	13.5902427
1	14.384	0.5385165	0.8888194	-13.5914234	13.5925192
2	14.384	0.8888194	1.1357817	-13.5932909	13.5953967
3	14.384	1.1357817	1.3379088	-13.5951586	13.5982706
4	14.384	1.3379088	1.5132746	-13.5970264	13.6011407
5	14.384	1.5132746	1.6703293	-13.5988945	13.6040072
6	14.384	1.6703293	1.8138357	-13.6007627	13.6068698
7	14.384	1.8138357	1.9467922	-13.6026312	13.6097288
8	14.384	1.9467922	2.0712315	-13.6044998	13.6125840
9	14.384	2.0712315	2.1886069	-13.6063686	13.6154355
10	14.384	2.1886069	2.3000000	-13.6082376	13.6182832
11	14.384	2.3000000	2.4062419	-13.6101067	13.6211272
12	14.384	2.4062419	2.5079872	-13.6119761	13.6239675
13	14.384	2.5079872	2.6057628	-13.6138457	13.6268040

**[0099]** Besides, the height of the central relief and Y-axis value of the central apex can be determined in the same way as in the above relief 26 of near vision, and curvature of the diffractive surface, geometric parameters such as the center position, and the relief profile of the relief 28 for intermediate vision, which synchronizes with the relief 26 for near vision, is derived from the geometric relation. Table 2 shows geometric parameters of the relief 28 for intermediate vision, and FIG.9 shows the relief profile thereof.

[Table 3]

Synchronized relief					
Zone No.	Curvature radius of virtual base curve	Zone origin (X-axis)	Zone terminal (X-axis)	Curvature center of Zone (Y-axis)	Zone curvature radius
0	14.384	0.0000000	0.2000000	-12.2385466	12.2382824
1	14.384	0.2000000	0.5385165	-12.2391288	12.2398806
2	14.384	0.5385165	0.7348469	-12.2416996	12.2444795
3	14.384	0.7348469	0.8888194	-12.2434392	12.2472303
4	14.384	0.8888194	1.0198039	-12.2465019	12.2523122
5	14.384	1.0198039	1.1357817	-12.2482418	12.2550588
6	14.384	1.1357817	1.2409674	-12.2513056	12.2601331
7	14.384	1.2409674	1.3379088	-12.2530457	12.2628754
8	14.384	1.3379088	1.4282857	-12.2561104	12.2679422
9	14.384	1.4282857	1.5132746	-12.2578509	12.2706802
10	14.384	1.5132746	1.5937377	-12.2609166	12.2757395
11	14.384	1.5937377	1.6703293	-12.2626573	12.2784732
12	14.384	1.6703293	1.7435596	-12.2657240	12.2835250
13	14.384	1.7435596	1.8138357	-12.2674651	12.2862544

**[0100]** Subsequently, a relief profile of the relief pattern 24 having a synchronous structure where the relief 26 for near vision and relief 28 for intermediate vision are periodically overlapped by combining the relief profiles of the relief 26 for near vision and the relief 28 for intermediate vision is completed. Table 3 shows geometric parameters of the relief pattern 24 and FIG.10 shows the relief profile thereof.

**[0101]** Then, according to the relief profile obtained, the relief pattern 24 is formed on the optical front surface 16. Formation of the relief pattern 24 on the optical front surface 16 is made not only by molding but also by machining and the like including laser processing, etching and cutting as appropriate. In this way, the intraocular lens 10 as the above embodiment is obtained.

**[0102]** An embodiment and a manufacturing method of this invention have been described thus far, but these are just examples, and this invention is not to be interpreted in a limited sense by any specific description of such embodiments. Several other aspects that can be preferably adopted in this invention will be shown below, but it should be understood that this invention is not limited to those aspects. In the descriptions below, details are omitted by applying the same reference numerals as those of the above embodiment to the same materials and parts as those thereof.

**[0103]** First, FIG. 11 shows a relief profile of a relief pattern 50 as a second embodiment of this invention. In the present embodiment, a synchronous structure where two reliefs with the dioptric power at +3.0D for near vision and the other at +1.0D for intermediate vision are periodically overlapped. By the way, the relief profile of the present embodiment is the one obtained under the following settings:

Radius of the base curve of the optical front surface 16 = 8.000mm

Dioptric power of the optical part 12 = +25.0D

Refractive index of the lens material = 1.500

Refractive index of the surrounding medium = 1.336

Designed wavelength = 500nm

Zone constant of the relief for near vision 'a' = 1

**[0104]** Meanwhile, the grating pitch is larger in the relief for intermediate vision than in the relief for near vision.

**[0105]** Especially in the present embodiment, two relief depths of the relief for near vision are provided per each zone of the relief for intermediate zone, and these three zones in total are formed, that is, in one out of three zone radii of the relief for near vision, the zone radius of the relief for intermediate vision is made equal to that of the relief for near vision. In each zone of the relief for intermediate vision composed of an overlap of reliefs for near vision, the height of the relief depth of the relief for near vision located between the relief depths of the relief for intermediate vision relative to the

virtual base curve surface is made to vary gradually in the zone direction (left-right direction in FIG. 11), and in the present embodiment, the height is made to gradually decrease moving away from the center in the zone direction. Such relief pattern 50 can also be formed according to the same manufacturing method as the above first embodiment.

5 **[0106]** Also, FIG. 12 shows a result of computer simulation of diffraction intensity along the optical axis obtained by the relief pattern 50 according to the present embodiment, just like the above first embodiment. As evident from FIG. 12, also in the present embodiment, it was confirmed that a peak of diffraction intensity is generated at the focus for intermediate vision of the first order diffracted light by the relief for intermediate vision between the focus for far vision of the 0th order light by the refractive surface and the focus for near vision of the first order diffracted light by the relief for near vision, and a peak is clearly generated in each of far, near and intermediate vision ranges.

10 **[0107]** In addition, especially in the present embodiment, the second order diffracted light of the relief for intermediate vision is generated. Thus, by changing the design parameters of the relief pattern 50, it is possible to generate multiple light beams for intermediate vision. Also, peak intensity and focal position of the diffracted light can be set in various aspects by means of, for example, further adding a relief that periodically overlaps with the relief pattern 50 having a synchronous structure.

15 **[0108]** Next, FIG. 13 shows a relief profile of a relief pattern 60 as a third embodiment of this invention. In the present embodiment, a synchronous structure where two reliefs with the dioptric power at +3.0D for near vision and at +1.0D for intermediate vision are periodically overlapped. Meanwhile, the grating pitch is larger in the relief for intermediate vision than in the relief for near vision.

20 **[0109]** In the present embodiment, two relief depths of the relief for near vision are provided per each zone of the relief for intermediate zone, and these three zones in total are formed, that is, in one out of three zone radii of the relief for near vision, the zone radius of the relief for intermediate vision is made equal to that of the relief for near vision. In each zone of the relief for intermediate vision composed of an overlap of reliefs for near vision, the height of the relief depth of the relief for near vision located between the relief depths of the relief for intermediate vision relative to the virtual base curve surface is kept approximately constant in the zone direction (left-right direction in FIG. 13).

25 **[0110]** Such relief pattern 60 can be manufactured by an easier method than the above first and second embodiments. In other words, a relief with a synchronous structure can be easily obtained by means of increasing the relief depth where the relief with a smaller grating pitch is overlapped with the one with a larger grating pitch based on the overlapping cycle of multiple reliefs on top of each other. For example, the dioptric power of the reliefs for near vision and intermediate vision in the present embodiment are the same as those of the above second embodiment, but as evident from the  
30 second embodiment (see FIG. 11), the relief for intermediate vision is synchronized with the relief for near vision once in every three times. Therefore, after designing the relief form for near vision according to the above manufacturing method, a relief pattern similar to that of the second embodiment can be obtained easily by means of increasing the relief depth of the obtained relief form for near vision once in every three times without exactly designing the relief form for intermediate vision like the above manufacturing method.

35 **[0111]** Also, FIG. 14 shows a result of computer simulation of diffraction intensity along the optical axis obtained by the relief pattern 60 according to the present embodiment, as was done in the above first embodiment. As evident from  
40 **[0112]** FIG. 14, despite that diffraction intensity for intermediate vision drops slightly as opposed to the above second embodiment (see FIG. 12), it was confirmed that an effect similar to that of the above second embodiment can be achieved by generating a peak of diffraction intensity at the focus for intermediate vision by an easy manufacturing method according to the present embodiment.

**[0113]** Next, FIG. 15 shows a relief pattern 70 in profile as a fourth embodiment of this invention. In the present embodiment, a synchronous structure where two reliefs with the dioptric power at +4.0D for far vision and at +2.0D for intermediate vision are periodically overlapped. Meanwhile, the grating pitch is larger in the relief for intermediate vision than in the relief for far vision.

45 **[0114]** As evident from FIG. 15, the relief pattern 70 of the present embodiment has its depth with the positive and negative reversed from that of relief pattern 24 (see FIG. 10) in the above first embodiment, and the ridge line 30 is positioned closer to the center than the valley line 32 in each zone. According to the present embodiment, the 0th order light of the refractive surface is set to focus for near vision and the negative first order light of the relief for far vision is set to focus for far vision, while the negative first order light of the relief for intermediate vision is set to focus for intermediate  
50 vision. And as described above, the first order diffracted light of this invention is to be interpreted as first order light with an absolute value including the negative first order light.

**[0115]** Also, FIG. 16 shows a computer simulation result of diffraction intensity along the optical axis obtained by the relief pattern 60 according to the present embodiment, as was done in the above first embodiment. As evident from  
55 FIG. 16, a peak of diffraction intensity at the focus for far vision by the negative first order light of the relief for far vision is generated in addition to that at the focus for near vision by the 0th order light of the refractive surface, according to the present embodiment, while a peak of diffraction intensity at the focus for intermediate vision by the negative first order light of the relief for intermediate vision is generated between these foci for near vision and far vision. Also, it was confirmed that a peak can be clearly generated in each of far, near and intermediate vision ranges in the present

embodiment, too.

**[0116]** Next, FIG.17 shows a relief pattern 80 in profile as a fifth embodiment of this invention. In the present embodiment, a synchronous structure where two reliefs with the dioptric power at +3.0D for near vision and at +1.0D for intermediate vision are periodically overlapped. Meanwhile, the grating pitch is larger in the relief for intermediate vision than in the relief for near vision.

**[0117]** The relief pattern 80 of the present embodiment is in a similar form to that of the relief pattern 50 (see FIG.11) as the above second embodiment, and especially in the present embodiment, only the relief component for near vision is made to increase outward from the center at zero as compared to the relief pattern 50 as the above second embodiment. This makes it possible to reduce diffractive intensity for near vision.

**[0118]** Also, FIG.18 shows a computer simulation result of diffractive intensity along the optical axis obtained by the relief pattern 80 according to the present invention, as was done in the above first embodiment. As evident from FIG.18, it is confirmed that a peak of diffraction intensity at the focus for near vision can be reduced, according to the present embodiment, as compared to the above second embodiment (see FIG.12).

**[0119]** Also, in each of the above embodiments, a diffraction grating with a synchronous structure where multiple reliefs are periodically overlapped was formed almost all over the optical front surface 16 of the optical part 12, but it will suffice for such a diffraction grating to be formed in at least a part of the area in the radial direction of the lens, for example, only in the middle of the optical front surface 16 in the radial direction. Consequently, only a single relief can be formed or the like in the other part of the area. For example, in case of the relief pattern 24 formed on the intraocular lens 10 as the above first embodiment, it is of course possible to form the diffraction grating with a synchronous structure on the optical rear surface 18.

**[0120]** Additionally, the lens surface where the diffraction grating with a synchronous structure is formed is not limited to refractive surfaces. For example, as shown diagrammatically in FIG.19, the diffraction grating 22 can be formed on a plane 102, one of the two planes 102 and 104 of an optical part 100 of an intraocular lens as a different aspect of this invention, or as shown diagrammatically in FIG.20, the diffraction grating 22 can even be formed on a plane 112 of an optical part 110 of an intraocular lens as a further different aspect of this invention where one surface is the flat plane 112 and the other is a curved plane 114 as refractive surface.

**[0121]** Furthermore, for the purpose of reducing aberration, it is possible to form a diffraction grating according to this invention, for example, on a surface of a laminate of two materials with different dispersion, as described in JP-A-2001-42112.

**[0122]** Also, as the comparative example 1 as compared to the working example according to the above first embodiment (see FIG.6), a computer simulation has been performed of diffraction intensity obtained by a relief pattern of a bifocal lens according to the conventional structure. The relief pattern of the comparative example 1 was set at a dioptric power of +4.00D for near vision. A result of such simulation is shown in FIG.21. As is publicly known, in the comparative example 1 according to the conventional structure, it is confirmed that only two peaks can be generated, one by the 0th order light of the refractive surface and the other by the first order diffracted light of the relief for near vision, unlike the working example.

**[0123]** In addition, in order to enhance the reliability of the simulation result, generation of peaks of diffraction intensity was verified for the relief pattern according to the working example and the relief pattern according to the comparative example 1 using an wave-optical design and analysis software (VirtualLab, a brand name of LightTrans). Such verifications are shown in FIG.22A for the working example and in FIG.22B for the comparative example 1. As evident from FIGS.22A and 22B, it was also confirmed in this simulation, according to the working example with a structure following this invention, that an intensive peak of diffraction intensity at the focus for intermediate vision is generated between the foci for far vision and near vision, unlike in the conventional structure.

**[0124]** Also, as the comparative example 2, an intraocular lens having a relief pattern with an asynchronous structure where the reliefs for near vision and intermediate vision are simply overlapped with no synchronization prepared. In this comparative example 2, an intraocular lens in a biconvex form was set to have its dioptric power at +20.0D, refractive index of the lens material at 1.500, refractive index of the surrounding medium at 1.336, and design wavelength at 500nm, while the relief for near vision with the dioptric power at +4.00D and the relief for intermediate vision with the dioptric power at +2.00D, with each zone constant set at 1, were overlapped in an asynchronous form to set a relief pattern, which was formed on the optical front surface. FIGS.23 and 24 show the relief profiles of the relief for near vision and intermediate vision, respectively. FIG.25 shows, as the comparative example 2, a relief profile which is an overlap of these reliefs for near vision and intermediate vision with no synchronization, while FIG.26 shows a simulation result of diffraction intensity obtained by the relief pattern of said comparative example 2. As evident from FIG.26, in the comparative example 2 which is a simple overlap of multiple relief patterns, it was confirmed that no obvious generation of peaks was detected in any of the 0th order light by the refractive surface, the first order diffractive light by the relief for near vision, or the first order diffractive light by the relief for intermediate vision, causing to generate peaks of unintended order of light. This revealed the usefulness of this invention wherein a synchronous structure is set where multiple reliefs are periodically overlapped.

KEYS TO SYMBOLS

[0125] 10: Intraocular lens, 12: Optical part, 16: Optical front surface, 20: Lens center axis, 22: Diffraction grating, 24: Relief pattern, 26: Relief for near vision, 28: Relief for intermediate vision.

5

Claims

- 10 1. A manufacturing method of an aphakic intraocular lens (10) to be set in place in a lens capsule provided with a diffraction grating (22) having a relief pattern (24, 50, 60, 70, 80) extending concentrically on a lens surface (16, 102, 112), **characterised in that** it comprises the steps of:

15 adopting various types of reliefs (26, 28) whose first order diffracted lights give respective focal distances different from one another for the relief pattern (24, 50, 60, 70, 80);  
 15 setting up a synchronous structure where at least two reliefs (26, 28) are set to overlap with each other in at least a part of an area in a radial direction of the lens (10), and with respect to every grating pitches of one relief (28) having a maximum grating pitch among the reliefs (26, 28) set up in overlap, grating pitches of another relief (26) are overlapped periodically, in order to obtain the relief pattern (24, 50, 60, 70, 80); and  
 20 forming the resulting relief pattern (24, 50, 60, 70, 80) on the lens surface (16, 102, 112).

2. The manufacturing method of an aphakic intraocular lens (10) according to claim 1, further comprising the step of setting a focal distance for a 0th order light by a refractive surface (16, 114) of the lens (10) a focal distance being different from that of any of first order diffracted lights generated by the various types of reliefs (26, 28).

- 25 3. The manufacturing method of an aphakic intraocular lens (10) according to any one of claim 1 or 2, wherein the various types of reliefs (26, 28) are arranged to satisfy a following equation:

30 
$$A = (2(m - NM) + a) / N$$

where A is a zone constant of the one relief (28), 'a' is a zone constant of the other relief (26), M is a zone number of the one relief (28), m is a zone number of the other relief (26), and N is a ratio of a focal distance of the one relief (28) relative to that of the other relief (26), which is expressed as:

35 
$$(\text{focal distance of the one relief (28)}) / (\text{focal distance of the other relief (26)}).$$

- 40 4. The manufacturing method of an aphakic intraocular lens (10) according to any one of claims 1-3, wherein the various types of reliefs (26, 28) are arranged to satisfy a following equation:

45 
$$D \leq \lambda / (N_{\text{lens}} - N_{\text{med}})$$

where D is a dimension of the relief depth,  $\lambda$  is a design wavelength,  $N_{\text{lens}}$  is a refractive index of an optical material, and  $N_{\text{med}}$  is a refractive index of a surrounding medium.

- 50 5. An aphakic intraocular lens (10) adapted to be set in place in a lens capsule, and provided with a diffraction grating (22) having a relief pattern (24, 50, 60, 70, 80) extending concentrically on a lens surface (16, 102, 112), **characterised in that** it comprises:

55 a synchronous structure where various types of reliefs (26, 28) including at least two reliefs (26, 28) whose first order diffracted lights give respective focal distances different from one another are set to overlap with each other in at least a part of an area in a radial direction of the lens (10), and with respect to every grating pitches of one relief (28) having a maximum grating pitch among the reliefs (26, 28) set up in overlap, grating pitches of another relief (26) being overlapped periodically.

6. The aphakic intraocular lens (10) according to claim 5, wherein a focal distance different from that of any first order diffracted light generated by the various types of reliefs (26, 28) is set for a 0th order light by a refractive surface (16) of the lens (10)
- 5 7. The aphakic intraocular lens (10) according to claim 6, wherein the lens surface (16) formed with the relief pattern (24, 50, 60, 70, 80) is the refractive surface (16).
- 10 8. The aphakic intraocular lens (10) according to any one of claims 5-7, wherein each relief depth of the relief (28) having the maximum grating pitch, which is obtained by overlapping the various types of reliefs (26, 28), is made constant in a zone direction.
- 15 9. The aphakic intraocular lens (10) according to claim 8, wherein in each zone in the relief (28) having the maximum grating pitch, another type of relief (26) with at least two relief depths is formed in the area in the radial direction of the lens (10) where the various types of reliefs (26, 28) set up in overlap, and dimensions of the at least two relief depths relative to a virtual base curve surface vary gradually in the zone direction.
- 20 10. The aphakic intraocular lens (10) according to claim 8, wherein in each zone in the relief (28) having the maximum grating pitch, another type of relief (26) with at least two relief depths is formed in the area in the radial direction of the lens (10) where the various types of reliefs (26, 28) set up in overlap, and dimensions of the at least two relief depths relative to the virtual base curve surface are set constant in the zone direction.
- 25 11. The aphakic intraocular lens (10) according to any one of claims 5-10, wherein each of the various types of reliefs (26, 28) has a ridge line (30) extending circumferentially with a cross-section formed with an acute vertex angle and a valley line (32) extending circumferentially with a cross-section formed with an acute included angle.
- 30 12. The aphakic intraocular lens (10) according to any one of claims 5-11, wherein the 0th order light by the refractive surface (16) of the lens (10) is set to a focus for far vision, the first order diffracted light by one type of the relief (26) is set to a focus for near vision, and the first order diffracted light by another type of the relief (28) is set to a focus for intermediate vision.
- 35 13. The aphakic intraocular lens (10) according to any one of claims 5-11, wherein the 0th order light by the refractive surface (16) of the lens (10) is set to a focus for near vision, the first order diffracted light by one type of the relief (26) is set to a focus for far vision, and the first order diffracted light by another type of the relief (28) is set to a focus for intermediate vision.
- 40 14. The aphakic intraocular lens (10) according to any one of claims 5-13, wherein the various types of reliefs (26, 28) are arranged to satisfy a following equation:

$$A = (2(m - NM) + a) / N$$

45 where A is a zone constant of the one relief (28), 'a' is a zone constant of the other relief (26), M is a zone number of the one relief (28), m is a zone number of the other relief (26), and N is a ratio of a focal distance of the one relief (28) relative to that of the other relief (26), which is expressed as:

$$(focal\ distance\ of\ the\ one\ relief\ (28)) / (focal\ distance\ of\ the\ other\ relief\ (26)).$$

- 50 15. The aphakic intraocular lens (10) according to any one of claims 5-14, wherein the various types of reliefs (26, 28) are arranged to satisfy a following equation:
- 55

$$D \leq \lambda / (N_{lens} - N_{med})$$

where D is a dimension of the relief depth,  $\lambda$  is a design wavelength,  $N_{\text{lens}}$  is a refractive index of an optical material, and  $N_{\text{med}}$  is a refractive index of a surrounding medium.

5 **Patentansprüche**

1. Herstellungsverfahren für eine aphakische Intraokularlinse (10), die in eine Linsenkapsel eingesetzt wird und die mit einem Beugungsgitter (22) ausgestattet ist, das ein Reliefmuster (24, 50, 60, 70, 80) hat, das sich konzentrisch auf einer Linsenoberfläche (16, 102, 112) erstreckt,

10 **dadurch gekennzeichnet, dass** es die folgenden Schritte umfasst:

Verwenden unterschiedlicher Typen von Reliefs (26, 28), deren gebeugte Lichtanteile erster Ordnung für das Reliefmuster (24, 50, 60, 70, 80) voneinander verschiedene Brennpunkt-Abstände liefern;

15 Einrichten einer synchronen Struktur, bei der wenigstens zwei Reliefs (26, 28) so eingerichtet sind, dass sie einander in wenigstens einem Teil eines Bereichs in einer radialen Richtung der Linse (10) überlagert sind, wobei bezüglich jedes Gitterabstandes eines einen Reliefs (28), das unter den überlagerten Reliefs (26, 28) einen maximalen Gitterabstand hat, Gitterabstände eines anderen Reliefs (26) periodisch überlagert werden, um das Reliefmuster (24, 50, 60, 70, 80) zu erhalten; und

20 Ausbilden des resultierenden Reliefmusters (24, 50, 60, 70, 80) auf der Linsenoberfläche (16, 102, 112).

2. Herstellungsverfahren für eine aphakische Intraokularlinse (10) gemäß Anspruch 1, das außerdem einen Schritt zum Einrichten eines Brennpunkt-Abstands für einen Lichtteil Oter Ordnung durch eine brechende Oberfläche (16, 114) der Linse (10) umfasst, wobei der Brennpunkt-Abstand verschieden ist von dem eines jeden gebeugten Lichtanteils erster Ordnung, der von den unterschiedlichen Relieftypen (26, 28) erzeugt wird.

25

3. Herstellungsverfahren für eine aphakische Intraokularlinse (10) gemäß einem der Ansprüche 1 oder 2, bei dem die unterschiedlichen Relieftypen (26, 28) dafür eingerichtet sind, der folgenden Gleichung zu genügen:

30

$$A = (2(m-NM) + a) / N$$

wobei A eine Zonenkonstante des einen Reliefs (28) ist, 'a' eine Zonenkonstante des anderen Reliefs (26) ist, M eine Zonennummer des einen Reliefs (28) ist, m eine Zonennummer des anderen Reliefs (26) ist, und N ein Verhältnis eines Brennpunkt-Abstands des einen Reliefs (28) relativ zu demjenigen des anderen Reliefs (26) ist, das wie folgt ausgedrückt wird:

35

(Brennpunkt-Abstand des einen Reliefs (28)) / (Brennpunkt-Abstand des  
40 anderen Reliefs (26)).

4. Herstellungsverfahren für eine aphakische Intraokularlinse (10) gemäß einem der Ansprüche 1 - 3, wobei die unterschiedlichen Relieftypen (26, 28) eingerichtet sind, die folgende Gleichung zu erfüllen:

45

$$D \leq \lambda / (N_{\text{Linse}} - N_{\text{Umg}})$$

wobei D eine Abmessung der Relieftiefe ist,  $\lambda$  eine Design-Wellenlänge ist,  $N_{\text{Linse}}$  ein Brechungsindex eines optischen Werkstoffes ist, und  $N_{\text{Umg}}$  ein Brechungsindex eines umgebenden Mediums ist.

50

5. Aphakische Intraokularlinse (10), die dafür ausgebildet ist, in eine Linsenkapsel eingesetzt zu werden, und die mit einem Beugungsgitter (22) ausgestattet ist, das ein Reliefmuster (24, 50, 60, 70, 80) hat, das sich konzentrisch auf einer Linsenoberfläche (16, 102, 112) erstreckt,

55

**dadurch gekennzeichnet, dass** sie folgendes umfasst:

eine synchrone Struktur, bei der unterschiedliche Relieftypen (26, 28), die wenigstens zwei Reliefs (26, 28) umfassen, deren gebeugte Lichtanteile erster Ordnung voneinander verschiedene Brennpunkt-Abstände erge-

ben, dafür ausgebildet sind, in wenigstens einem Teil eines Bereichs in radialer Richtung der Linse (10) einander zu überlagern, wobei bezüglich jedes Gitterabstandes eines einen Reliefs (28), das unter den überlagernd eingerichteten Reliefs (26, 28) einen maximalen Gitterabstand hat, Gitterabstände eines anderen Reliefs (26) periodisch überlagert sind.

- 5
6. Aphakische Intraokularlinse (10) nach Anspruch 5, wobei ein Brennpunkt-Abstand, der verschieden ist von demjenigen eines beliebigen gebeugten Lichtanteils erster Ordnung, der von den unterschiedlichen Relieftypen (26, 28) erzeugt wird, für einen Lichtanteil Oter Ordnung durch eine brechende Oberfläche (16) der Linse (10) bereitgestellt ist.
- 10
7. Aphakische Intraokularlinse (10) nach Anspruch 6, wobei die Linsenoberfläche (16), die mit dem Reliefmuster (24, 50, 60, 70, 80) ausgebildet ist, die brechende Oberfläche (16) ist.
8. Aphakische Intraokularlinse (10) nach einem der Ansprüche 5 - 7, wobei jede Relieftiefe des Reliefs (28) mit dem maximalen Gitterabstand, die durch das Überlagern der unterschiedlichen Relieftypen (26, 28) erhalten wird, in einer Zonenrichtung konstant ist.
- 15
9. Aphakische Intraokularlinse (10) nach Anspruch 8, wobei in jeder Zone in dem Relief (28) mit dem maximalen Gitterabstand ein weiterer Relieftyp (26) mit wenigstens zwei Relieftiefen in dem Bereich in der radialen Richtung der Linse (10), wo die unterschiedlichen Relieftypen (26, 28) überlagert sind, ausgebildet ist, und wobei Abmessungen der wenigstens zwei Relieftiefen relativ zu einer virtuellen Basiskurvenoberfläche in der Zonenrichtung fortschreitend variieren.
- 20
10. Aphakische Intraokularlinse (10) nach Anspruch 8, wobei in jeder Zone in dem Relief (28) mit dem maximalen Gitterabstand ein anderer Relieftyp (26) mit wenigstens zwei Relieftiefen in dem Bereich in der radialen Richtung der Linse (10), wo die unterschiedlichen Relieftypen (26, 28) überlagert sind, ausgebildet ist, und wobei Abmessungen der wenigstens zwei Relieftiefen relativ zu der virtuellen Basiskurvenoberfläche in der Zonenrichtung konstant sind.
- 25
11. Aphakische Intraokularlinse (10) nach einem der Ansprüche 5 - 10, wobei jede der unterschiedlichen Relieftypen (26, 28) eine Kammlinie (30) hat, die sich in Umfangsrichtung erstreckt, mit einem Querschnitt, der mit einem spitzen Scheitelwinkel ausgebildet ist, sowie eine Tallinie (32) hat, die sich in Umfangsrichtung erstreckt, mit einem Querschnitt, der mit einem spitzen eingeschlossenen Winkel ausgebildet ist.
- 30
12. Aphakische Intraokularlinse (10) nach einem der Ansprüche 5 - 11, wobei für den Lichtanteil Oter Ordnung durch die brechende Oberfläche (16) der Linse (10) ein Brennpunkt für Fernsicht bereitgestellt ist, für den gebeugten Lichtanteil erster Ordnung durch einen Relieftyp (26) ein Brennpunkt für Nahsicht bereitgestellt ist, und für den gebeugten Lichtanteil erster Ordnung durch einen anderen Relieftyp (28) ein Brennpunkt für mittlere Sicht bereitgestellt ist.
- 35
13. Aphakische Intraokularlinse (10) nach einem der Ansprüche 5 - 11, wobei für den Lichtanteil Oter Ordnung durch die brechende Oberfläche (16) der Linse (10) ein Brennpunkt für Nahsicht bereitgestellt ist, für den gebeugten Lichtanteil erster Ordnung durch einen Relieftyp (26) ein Brennpunkt für Fernsicht bereitgestellt ist, und für den gebeugten Lichtanteil erster Ordnung durch den anderen Relieftyp (28) ein Brennpunkt für mittlere Sicht bereitgestellt ist.
- 40
14. Aphakische Intraokularlinse (10) nach einem der Ansprüche 5 - 13, wobei die unterschiedlichen Relieftypen (26, 28) eingerichtet sind, der folgenden Gleichung zu genügen:
- 45

$$A = (2(m-NM) + a) / N$$

wobei A eine Zonenkonstante des einen Reliefs (28) ist, 'a' eine Zonenkonstante des anderen Reliefs (26) ist, M eine Zonennummer des einen Reliefs (28) ist, m eine Zonennummer des anderen Reliefs (26) ist, und N ein Verhältnis eines Brennpunkt-Abstandes des einen Reliefs (28) zu demjenigen des anderen Reliefs (26) ist, das wie folgt ausgedrückt wird:

50

55

(Brennpunkt-Abstand des einen Reliefs (28)) / (Brennpunkt-Abstand des  
 5  
 10  
 15  
 20  
 25  
 30  
 35  
 40  
 45  
 50  
 55  
 55  
 60  
 65  
 70  
 75  
 80  
 85  
 90  
 95  
 100  
 105  
 110  
 115  
 120  
 125  
 130  
 135  
 140  
 145  
 150  
 155  
 160  
 165  
 170  
 175  
 180  
 185  
 190  
 195  
 200  
 205  
 210  
 215  
 220  
 225  
 230  
 235  
 240  
 245  
 250  
 255  
 260  
 265  
 270  
 275  
 280  
 285  
 290  
 295  
 300  
 305  
 310  
 315  
 320  
 325  
 330  
 335  
 340  
 345  
 350  
 355  
 360  
 365  
 370  
 375  
 380  
 385  
 390  
 395  
 400  
 405  
 410  
 415  
 420  
 425  
 430  
 435  
 440  
 445  
 450  
 455  
 460  
 465  
 470  
 475  
 480  
 485  
 490  
 495  
 500  
 505  
 510  
 515  
 520  
 525  
 530  
 535  
 540  
 545  
 550  
 555  
 560  
 565  
 570  
 575  
 580  
 585  
 590  
 595  
 600  
 605  
 610  
 615  
 620  
 625  
 630  
 635  
 640  
 645  
 650  
 655  
 660  
 665  
 670  
 675  
 680  
 685  
 690  
 695  
 700  
 705  
 710  
 715  
 720  
 725  
 730  
 735  
 740  
 745  
 750  
 755  
 760  
 765  
 770  
 775  
 780  
 785  
 790  
 795  
 800  
 805  
 810  
 815  
 820  
 825  
 830  
 835  
 840  
 845  
 850  
 855  
 860  
 865  
 870  
 875  
 880  
 885  
 890  
 895  
 900  
 905  
 910  
 915  
 920  
 925  
 930  
 935  
 940  
 945  
 950  
 955  
 960  
 965  
 970  
 975  
 980  
 985  
 990  
 995  
 1000  
 1005  
 1010  
 1015  
 1020  
 1025  
 1030  
 1035  
 1040  
 1045  
 1050  
 1055  
 1060  
 1065  
 1070  
 1075  
 1080  
 1085  
 1090  
 1095  
 1100  
 1105  
 1110  
 1115  
 1120  
 1125  
 1130  
 1135  
 1140  
 1145  
 1150  
 1155  
 1160  
 1165  
 1170  
 1175  
 1180  
 1185  
 1190  
 1195  
 1200  
 1205  
 1210  
 1215  
 1220  
 1225  
 1230  
 1235  
 1240  
 1245  
 1250  
 1255  
 1260  
 1265  
 1270  
 1275  
 1280  
 1285  
 1290  
 1295  
 1300  
 1305  
 1310  
 1315  
 1320  
 1325  
 1330  
 1335  
 1340  
 1345  
 1350  
 1355  
 1360  
 1365  
 1370  
 1375  
 1380  
 1385  
 1390  
 1395  
 1400  
 1405  
 1410  
 1415  
 1420  
 1425  
 1430  
 1435  
 1440  
 1445  
 1450  
 1455  
 1460  
 1465  
 1470  
 1475  
 1480  
 1485  
 1490  
 1495  
 1500  
 1505  
 1510  
 1515  
 1520  
 1525  
 1530  
 1535  
 1540  
 1545  
 1550  
 1555  
 1560  
 1565  
 1570  
 1575  
 1580  
 1585  
 1590  
 1595  
 1600  
 1605  
 1610  
 1615  
 1620  
 1625  
 1630  
 1635  
 1640  
 1645  
 1650  
 1655  
 1660  
 1665  
 1670  
 1675  
 1680  
 1685  
 1690  
 1695  
 1700  
 1705  
 1710  
 1715  
 1720  
 1725  
 1730  
 1735  
 1740  
 1745  
 1750  
 1755  
 1760  
 1765  
 1770  
 1775  
 1780  
 1785  
 1790  
 1795  
 1800  
 1805  
 1810  
 1815  
 1820  
 1825  
 1830  
 1835  
 1840  
 1845  
 1850  
 1855  
 1860  
 1865  
 1870  
 1875  
 1880  
 1885  
 1890  
 1895  
 1900  
 1905  
 1910  
 1915  
 1920  
 1925  
 1930  
 1935  
 1940  
 1945  
 1950  
 1955  
 1960  
 1965  
 1970  
 1975  
 1980  
 1985  
 1990  
 1995  
 2000  
 2005  
 2010  
 2015  
 2020  
 2025  
 2030  
 2035  
 2040  
 2045  
 2050  
 2055  
 2060  
 2065  
 2070  
 2075  
 2080  
 2085  
 2090  
 2095  
 2100  
 2105  
 2110  
 2115  
 2120  
 2125  
 2130  
 2135  
 2140  
 2145  
 2150  
 2155  
 2160  
 2165  
 2170  
 2175  
 2180  
 2185  
 2190  
 2195  
 2200  
 2205  
 2210  
 2215  
 2220  
 2225  
 2230  
 2235  
 2240  
 2245  
 2250  
 2255  
 2260  
 2265  
 2270  
 2275  
 2280  
 2285  
 2290  
 2295  
 2300  
 2305  
 2310  
 2315  
 2320  
 2325  
 2330  
 2335  
 2340  
 2345  
 2350  
 2355  
 2360  
 2365  
 2370  
 2375  
 2380  
 2385  
 2390  
 2395  
 2400  
 2405  
 2410  
 2415  
 2420  
 2425  
 2430  
 2435  
 2440  
 2445  
 2450  
 2455  
 2460  
 2465  
 2470  
 2475  
 2480  
 2485  
 2490  
 2495  
 2500  
 2505  
 2510  
 2515  
 2520  
 2525  
 2530  
 2535  
 2540  
 2545  
 2550  
 2555  
 2560  
 2565  
 2570  
 2575  
 2580  
 2585  
 2590  
 2595  
 2600  
 2605  
 2610  
 2615  
 2620  
 2625  
 2630  
 2635  
 2640  
 2645  
 2650  
 2655  
 2660  
 2665  
 2670  
 2675  
 2680  
 2685  
 2690  
 2695  
 2700  
 2705  
 2710  
 2715  
 2720  
 2725  
 2730  
 2735  
 2740  
 2745  
 2750  
 2755  
 2760  
 2765  
 2770  
 2775  
 2780  
 2785  
 2790  
 2795  
 2800  
 2805  
 2810  
 2815  
 2820  
 2825  
 2830  
 2835  
 2840  
 2845  
 2850  
 2855  
 2860  
 2865  
 2870  
 2875  
 2880  
 2885  
 2890  
 2895  
 2900  
 2905  
 2910  
 2915  
 2920  
 2925  
 2930  
 2935  
 2940  
 2945  
 2950  
 2955  
 2960  
 2965  
 2970  
 2975  
 2980  
 2985  
 2990  
 2995  
 3000  
 3005  
 3010  
 3015  
 3020  
 3025  
 3030  
 3035  
 3040  
 3045  
 3050  
 3055  
 3060  
 3065  
 3070  
 3075  
 3080  
 3085  
 3090  
 3095  
 3100  
 3105  
 3110  
 3115  
 3120  
 3125  
 3130  
 3135  
 3140  
 3145  
 3150  
 3155  
 3160  
 3165  
 3170  
 3175  
 3180  
 3185  
 3190  
 3195  
 3200  
 3205  
 3210  
 3215  
 3220  
 3225  
 3230  
 3235  
 3240  
 3245  
 3250  
 3255  
 3260  
 3265  
 3270  
 3275  
 3280  
 3285  
 3290  
 3295  
 3300  
 3305  
 3310  
 3315  
 3320  
 3325  
 3330  
 3335  
 3340  
 3345  
 3350  
 3355  
 3360  
 3365  
 3370  
 3375  
 3380  
 3385  
 3390  
 3395  
 3400  
 3405  
 3410  
 3415  
 3420  
 3425  
 3430  
 3435  
 3440  
 3445  
 3450  
 3455  
 3460  
 3465  
 3470  
 3475  
 3480  
 3485  
 3490  
 3495  
 3500  
 3505  
 3510  
 3515  
 3520  
 3525  
 3530  
 3535  
 3540  
 3545  
 3550  
 3555  
 3560  
 3565  
 3570  
 3575  
 3580  
 3585  
 3590  
 3595  
 3600  
 3605  
 3610  
 3615  
 3620  
 3625  
 3630  
 3635  
 3640  
 3645  
 3650  
 3655  
 3660  
 3665  
 3670  
 3675  
 3680  
 3685  
 3690  
 3695  
 3700  
 3705  
 3710  
 3715  
 3720  
 3725  
 3730  
 3735  
 3740  
 3745  
 3750  
 3755  
 3760  
 3765  
 3770  
 3775  
 3780  
 3785  
 3790  
 3795  
 3800  
 3805  
 3810  
 3815  
 3820  
 3825  
 3830  
 3835  
 3840  
 3845  
 3850  
 3855  
 3860  
 3865  
 3870  
 3875  
 3880  
 3885  
 3890  
 3895  
 3900  
 3905  
 3910  
 3915  
 3920  
 3925  
 3930  
 3935  
 3940  
 3945  
 3950  
 3955  
 3960  
 3965  
 3970  
 3975  
 3980  
 3985  
 3990  
 3995  
 4000  
 4005  
 4010  
 4015  
 4020  
 4025  
 4030  
 4035  
 4040  
 4045  
 4050  
 4055  
 4060  
 4065  
 4070  
 4075  
 4080  
 4085  
 4090  
 4095  
 4100  
 4105  
 4110  
 4115  
 4120  
 4125  
 4130  
 4135  
 4140  
 4145  
 4150  
 4155  
 4160  
 4165  
 4170  
 4175  
 4180  
 4185  
 4190  
 4195  
 4200  
 4205  
 4210  
 4215  
 4220  
 4225  
 4230  
 4235  
 4240  
 4245  
 4250  
 4255  
 4260  
 4265  
 4270  
 4275  
 4280  
 4285  
 4290  
 4295  
 4300  
 4305  
 4310  
 4315  
 4320  
 4325  
 4330  
 4335  
 4340  
 4345  
 4350  
 4355  
 4360  
 4365  
 4370  
 4375  
 4380  
 4385  
 4390  
 4395  
 4400  
 4405  
 4410  
 4415  
 4420  
 4425  
 4430  
 4435  
 4440  
 4445  
 4450  
 4455  
 4460  
 4465  
 4470  
 4475  
 4480  
 4485  
 4490  
 4495  
 4500  
 4505  
 4510  
 4515  
 4520  
 4525  
 4530  
 4535  
 4540  
 4545  
 4550  
 4555  
 4560  
 4565  
 4570  
 4575  
 4580  
 4585  
 4590  
 4595  
 4600  
 4605  
 4610  
 4615  
 4620  
 4625  
 4630  
 4635  
 4640  
 4645  
 4650  
 4655  
 4660  
 4665  
 4670  
 4675  
 4680  
 4685  
 4690  
 4695  
 4700  
 4705  
 4710  
 4715  
 4720  
 4725  
 4730  
 4735  
 4740  
 4745  
 4750  
 4755  
 4760  
 4765  
 4770  
 4775  
 4780  
 4785  
 4790  
 4795  
 4800  
 4805  
 4810  
 4815  
 4820  
 4825  
 4830  
 4835  
 4840  
 4845  
 4850  
 4855  
 4860  
 4865  
 4870  
 4875  
 4880  
 4885  
 4890  
 4895  
 4900  
 4905  
 4910  
 4915  
 4920  
 4925  
 4930  
 4935  
 4940  
 4945  
 4950  
 4955  
 4960  
 4965  
 4970  
 4975  
 4980  
 4985  
 4990  
 4995  
 5000  
 5005  
 5010  
 5015  
 5020  
 5025  
 5030  
 5035  
 5040  
 5045  
 5050  
 5055  
 5060  
 5065  
 5070  
 5075  
 5080  
 5085  
 5090  
 5095  
 5100  
 5105  
 5110  
 5115  
 5120  
 5125  
 5130  
 5135  
 5140  
 5145  
 5150  
 5155  
 5160  
 5165  
 5170  
 5175  
 5180  
 5185  
 5190  
 5195  
 5200  
 5205  
 5210  
 5215  
 5220  
 5225  
 5230  
 5235  
 5240  
 5245  
 5250  
 5255  
 5260  
 5265  
 5270  
 5275  
 5280  
 5285  
 5290  
 5295  
 5300  
 5305  
 5310  
 5315  
 5320  
 5325  
 5330  
 5335  
 5340  
 5345  
 5350  
 5355  
 5360  
 5365  
 5370  
 5375  
 5380  
 5385  
 5390  
 5395  
 5400  
 5405  
 5410  
 5415  
 5420  
 5425  
 5430  
 5435  
 5440  
 5445  
 5450  
 5455  
 5460  
 5465  
 5470  
 5475  
 5480  
 5485  
 5490  
 5495  
 5500  
 5505  
 5510  
 5515  
 5520  
 5525  
 5530  
 5535  
 5540  
 5545  
 5550  
 5555  
 5560  
 5565  
 5570  
 5575  
 5580  
 5585  
 5590  
 5595  
 5600  
 5605  
 5610  
 5615  
 5620  
 5625  
 5630  
 5635  
 5640  
 5645  
 5650  
 5655  
 5660  
 5665  
 5670  
 5675  
 5680  
 5685  
 5690  
 5695  
 5700  
 5705  
 5710  
 5715  
 5720  
 5725  
 5730  
 5735  
 5740  
 5745  
 5750  
 5755  
 5760  
 5765  
 5770  
 5775  
 5780  
 5785  
 5790  
 5795  
 5800  
 5805  
 5810  
 5815  
 5820  
 5825  
 5830  
 5835  
 5840  
 5845  
 5850  
 5855  
 5860  
 5865  
 5870  
 5875  
 5880  
 5885  
 5890  
 5895  
 5900  
 5905  
 5910  
 5915  
 5920  
 5925  
 5930  
 5935  
 5940  
 5945  
 5950  
 5955  
 5960  
 5965  
 5970  
 5975  
 5980  
 5985  
 5990  
 5995  
 6000  
 6005  
 6010  
 6015  
 6020  
 6025  
 6030  
 6035  
 6040  
 6045  
 6050  
 6055  
 6060  
 6065  
 6070  
 6075  
 6080  
 6085  
 6090  
 6095  
 6100  
 6105  
 6110  
 6115  
 6120  
 6125  
 6130  
 6135  
 6140  
 6145  
 6150  
 6155  
 6160  
 6165  
 6170  
 6175  
 6180  
 6185  
 6190  
 6195  
 6200  
 6205  
 6210  
 6215  
 6220  
 6225  
 6230  
 6235  
 6240  
 6245  
 6250  
 6255  
 6260  
 6265  
 6270  
 6275  
 6280  
 6285  
 6290  
 6295  
 6300  
 6305  
 6310  
 6315  
 6320  
 6325  
 6330  
 6335  
 6340  
 6345  
 6350  
 6355  
 6360  
 6365  
 6370  
 6375  
 6380  
 6385  
 6390  
 6395  
 6400  
 6405  
 6410  
 6415  
 6420  
 6425  
 6430  
 6435  
 6440  
 6445  
 6450  
 6455  
 6460  
 6465  
 6470  
 6475  
 6480  
 6485  
 6490  
 6495  
 6500  
 6505  
 6510  
 6515  
 6520  
 6525  
 6530  
 6535  
 6540  
 6545  
 6550  
 6555  
 6560  
 6565  
 6570  
 6575  
 6580  
 6585  
 6590  
 6595  
 6600  
 6605  
 6610  
 6615  
 6620  
 6625  
 6630  
 6635  
 6640  
 6645  
 6650  
 6655  
 6660  
 6665  
 6670  
 6675  
 6680  
 6685  
 6690  
 6695  
 6700  
 6705  
 6710  
 6715  
 6720  
 6725  
 6730  
 6735  
 6740  
 6745  
 6750  
 6755  
 6760  
 6765  
 6770  
 6775  
 6780  
 6785  
 6790  
 6795  
 6800  
 6805  
 6810  
 6815  
 6820  
 6825  
 6830  
 6835  
 6840  
 6845  
 6850  
 6855  
 6860  
 6865  
 6870  
 6875  
 6880  
 6885  
 6890  
 6895  
 6900  
 6905  
 6910  
 6915  
 6920  
 6925  
 6930  
 6935  
 6940

$$D \leq \lambda / (N_{\text{lens}} - N_{\text{med}})$$

où D est une dimension de la profondeur de relief,  $\lambda$  est une longueur d'onde de conception,  $N_{\text{lens}}$  est un indice de réfraction d'un matériau optique, et  $N_{\text{med}}$  est un indice de réfraction d'un milieu environnant.

- 5  
10
5. Lentille intraoculaire aphakique (10) conçue pour être placée dans une capsule de cristallin, et pourvue d'un réseau de diffraction (22) comportant un motif à reliefs (24, 50, 60, 70, 80) s'étendant de manière concentrique sur une surface de lentille (16, 102, 112), **caractérisée en ce qu'elle comprend :**

15

une structure synchrone dans laquelle divers types de reliefs (26, 28) comprenant au moins deux reliefs (26, 28) dont les lumières diffractées du premier ordre donnent des distances focales respectives différentes les unes des autres sont placés de manière à se superposer les uns aux autres dans au moins une partie d'une zone dans une direction radiale de la lentille (10), et en relation avec chaque pas de réseau d'un relief (28) ayant un pas de réseau maximum parmi les reliefs (26, 28) placés en superposition, les pas de réseau d'un autre relief (26) se superposant périodiquement.

- 20
6. Lentille intraoculaire aphakique (10) selon la revendication 5, dans laquelle une distance focale différente de celle de n'importe quelle lumière diffractée du premier ordre générée par les divers types de reliefs (26, 28) est établie pour une lumière d'ordre 0 par une surface de réfraction (16) de la lentille (10).

7. Lentille intraoculaire aphakique (10) selon la revendication 6, dans laquelle la surface de lentille (16) formée par le motif à reliefs (24, 50, 60, 70, 80) est la surface de réfraction (16).

- 25
8. Lentille intraoculaire aphakique (10) selon l'une quelconque des revendications 5 à 7, dans laquelle chaque profondeur de relief du relief (28) ayant le pas de réseau maximum, qui est obtenue en superposant les divers types de reliefs (26, 28), est rendue constante dans une direction de zone.

- 30
9. Lentille intraoculaire aphakique (10) selon la revendication 8, dans laquelle, dans chaque zone dans le relief (28) ayant le pas de réseau maximum, un autre type de relief (26) avec au moins deux profondeurs de relief est formé dans la zone dans la direction radiale de la lentille (10) où les divers types de reliefs (26, 28) sont placés en superposition, et les dimensions desdites au moins deux profondeurs de relief par rapport à une surface de courbe de base virtuelle varient graduellement dans la direction de zone.

- 35
10. Lentille intraoculaire aphakique (10) selon la revendication 8, dans laquelle, dans chaque zone dans le relief (28) ayant le pas de réseau maximum, un autre type de relief (26) avec au moins deux profondeurs de relief est formé dans la zone dans la direction radiale de la lentille (10) où les divers types de reliefs (26, 28) sont placés en superposition, et les dimensions desdites au moins deux profondeurs de relief par rapport à la surface de courbe de base virtuelle sont déterminées de manière à être constantes dans la direction de zone.

- 40
11. Lentille intraoculaire aphakique (10) selon l'une quelconque des revendications 5 à 10, dans laquelle chacun des divers types de reliefs (26, 28) a une ligne de crête (30) s'étendant circonférentiellement avec une section formée par un angle de sommet aigu et une ligne de creux (32) s'étendant circonférentiellement avec une section formée par un angle inclus aigu.

- 45
12. Lentille intraoculaire aphakique (10) selon l'une quelconque des revendications 5 à 11, dans laquelle la lumière d'ordre 0 par la surface de réfraction (16) de la lentille (10) est établie pour une mise au point pour une vision de loin, la lumière diffractée du premier ordre par un type du relief (26) est établie pour une mise au point pour une vision de près, et la lumière diffractée du premier ordre par un autre type du relief (28) est établie pour une mise au point pour une vision intermédiaire.

- 50
13. Lentille intraoculaire aphakique (10) selon l'une quelconque des revendications 5 à 11, dans laquelle la lumière d'ordre 0 par la surface de réfraction (16) de la lentille (10) est établie pour une mise au point pour une vision de près, la lumière diffractée du premier ordre par un type du relief (26) est établie pour une mise au point pour une vision de loin, et la lumière diffractée du premier ordre par un autre type du relief (28) est établie pour une mise au point pour une vision intermédiaire.

## EP 2 377 493 B1

14. Lentille intraoculaire aphakique (10) selon l'une quelconque des revendications 5 à 13, dans laquelle les divers types de reliefs (26, 28) sont agencés pour satisfaire à une équation suivante :

5 
$$A = (2(m - NM) + a) / N$$

où A est une constante de zone dudit relief (28), 'a' est une constante de zone de l'autre relief (26), M est un nombre de zones dudit relief (28), m est un nombre de zones de l'autre relief (26), et N est un rapport entre une distance focale dudit relief (28) et celle de l'autre relief (26), qui est exprimé par :

10

$$\frac{\text{(distance focale dudit relief (28))}}{\text{(distance focale de l'autre relief (26))}}.$$

15

15. Lentille intraoculaire aphakique (10) selon l'une quelconque des revendications 5 à 14, dans laquelle les divers types de reliefs (26, 28) sont agencés pour satisfaire à une équation suivante :

20

$$D \leq \lambda / (N_{\text{lens}} - N_{\text{med}})$$

25

où D est une dimension de la profondeur de relief,  $\lambda$  est une longueur d'onde de conception,  $N_{\text{lens}}$  est un indice de réfraction d'un matériau optique, et  $N_{\text{med}}$  est un indice de réfraction d'un milieu environnant.

30

35

40

45

50

55

FIG.1

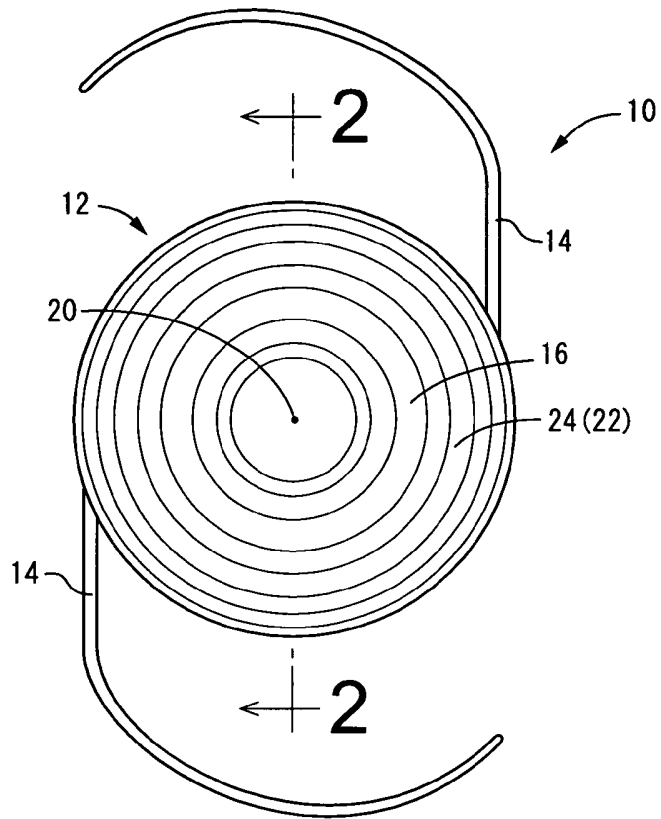
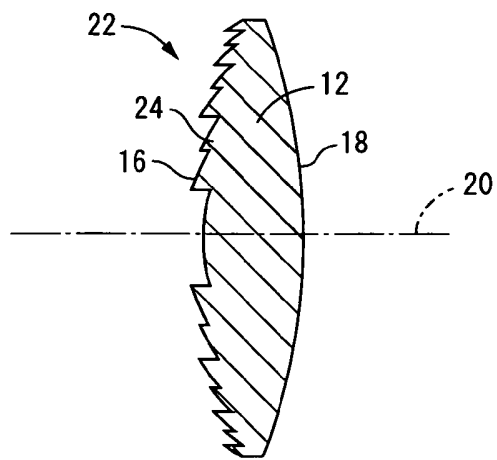
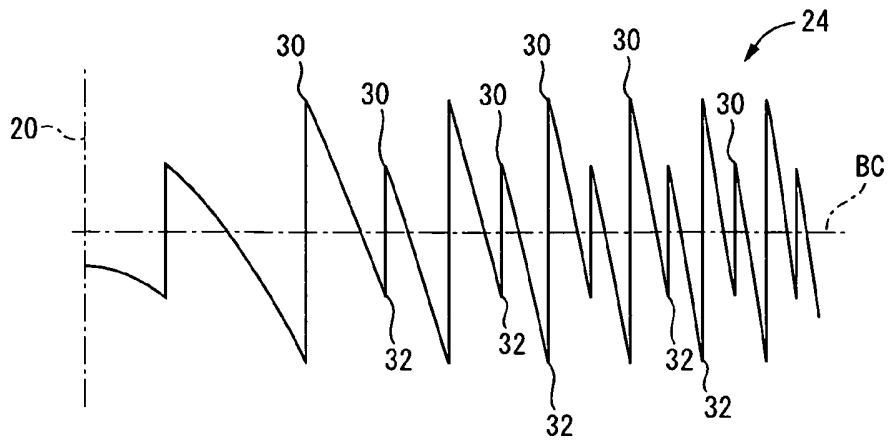

FIG.2



# FIG.3



# FIG.4

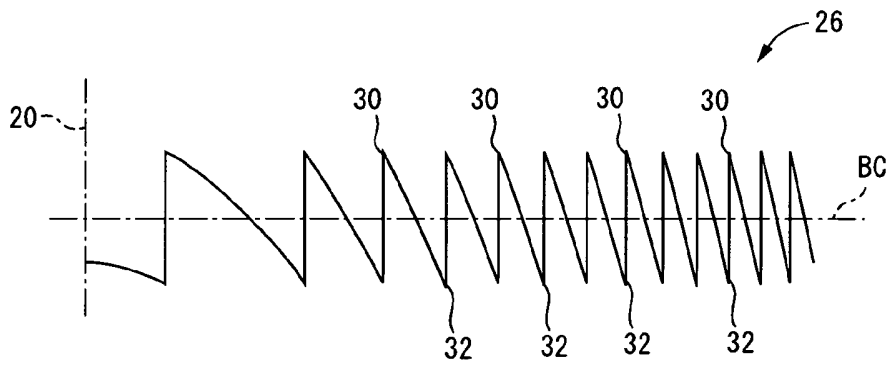

# FIG.5

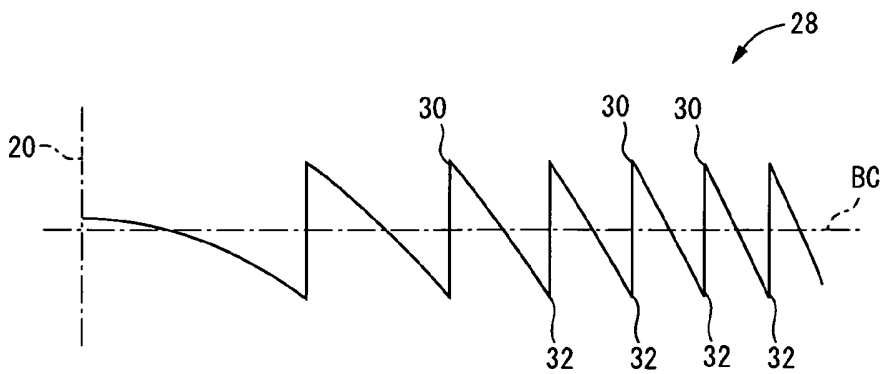

# FIG.6

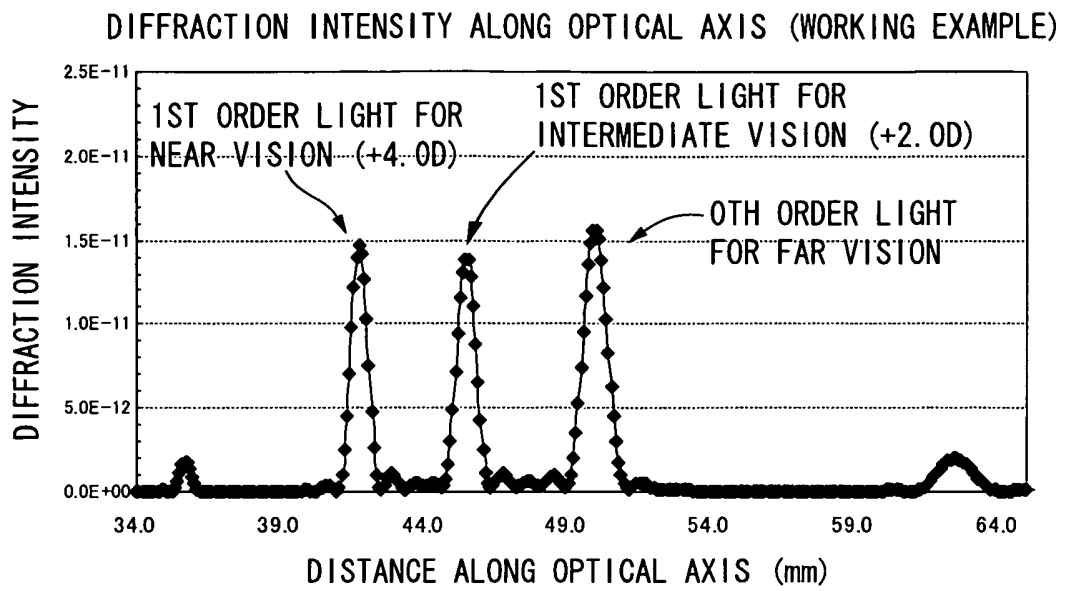

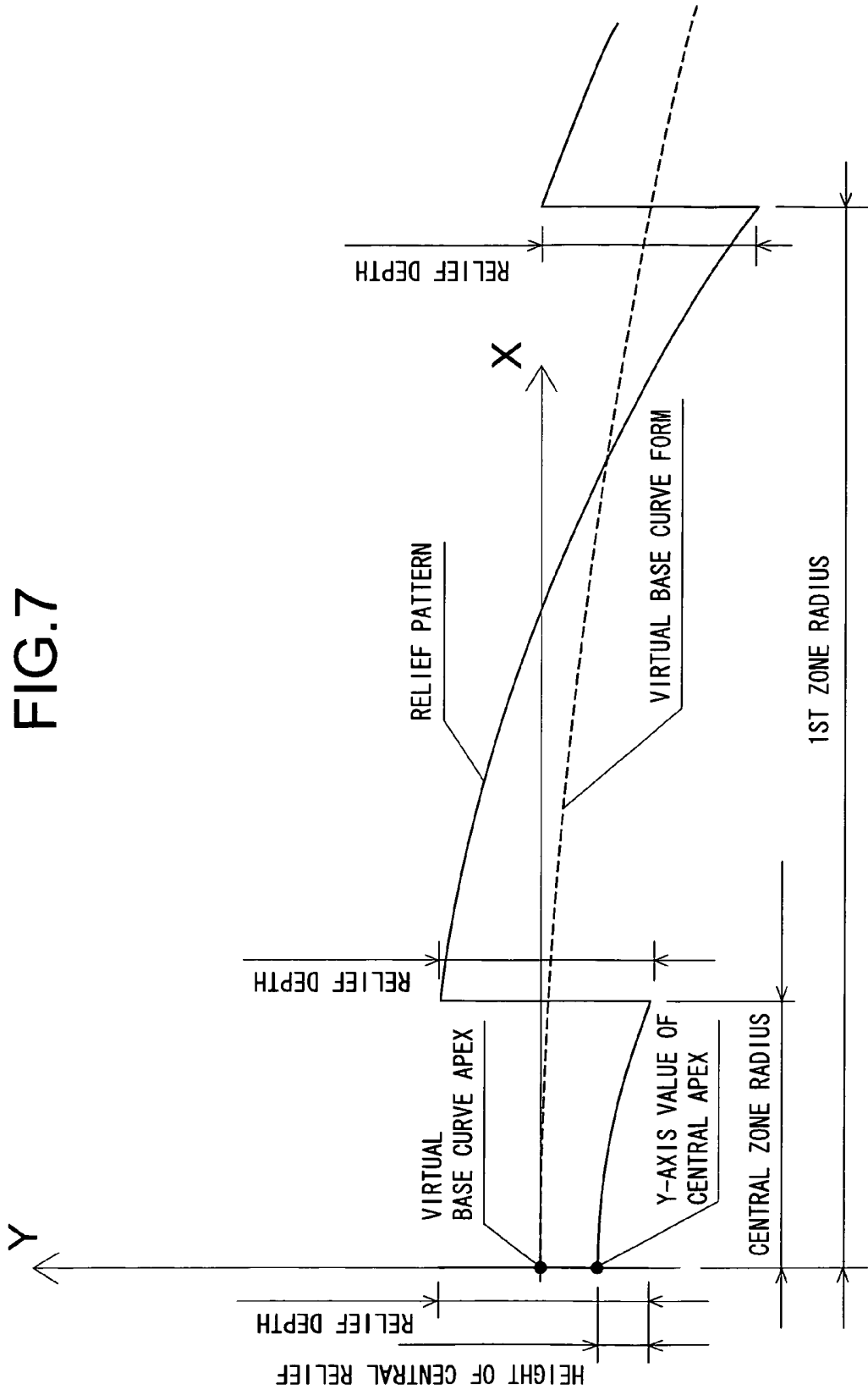
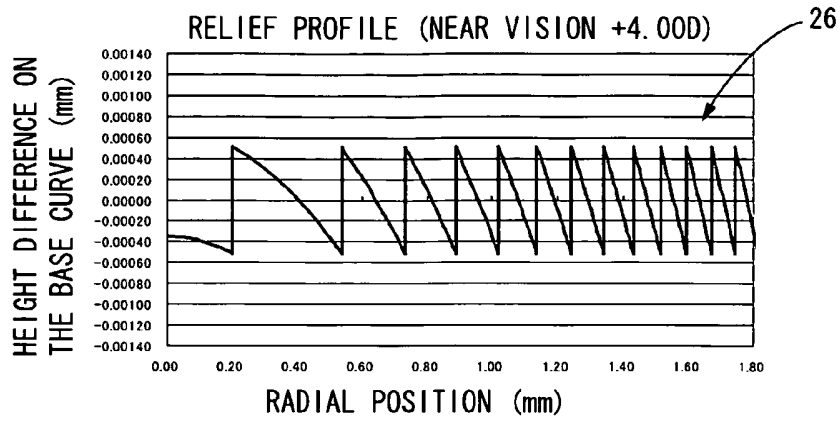
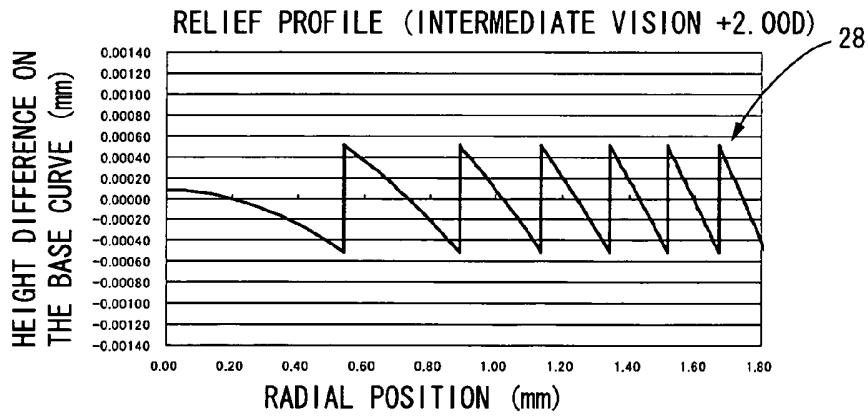

FIG.7

# FIG.8



# FIG.9



# FIG.10

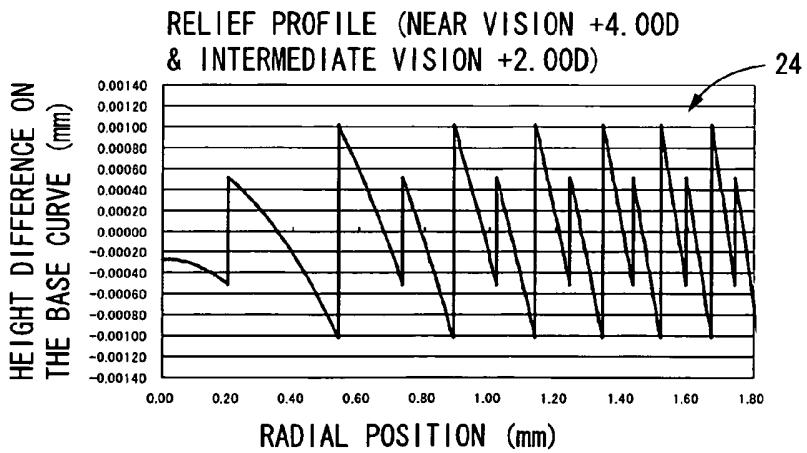

FIG.11

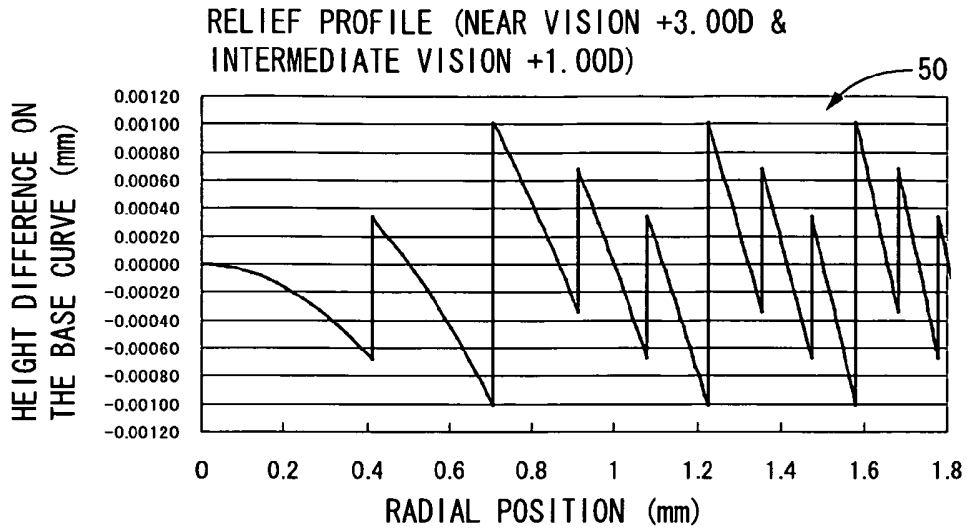
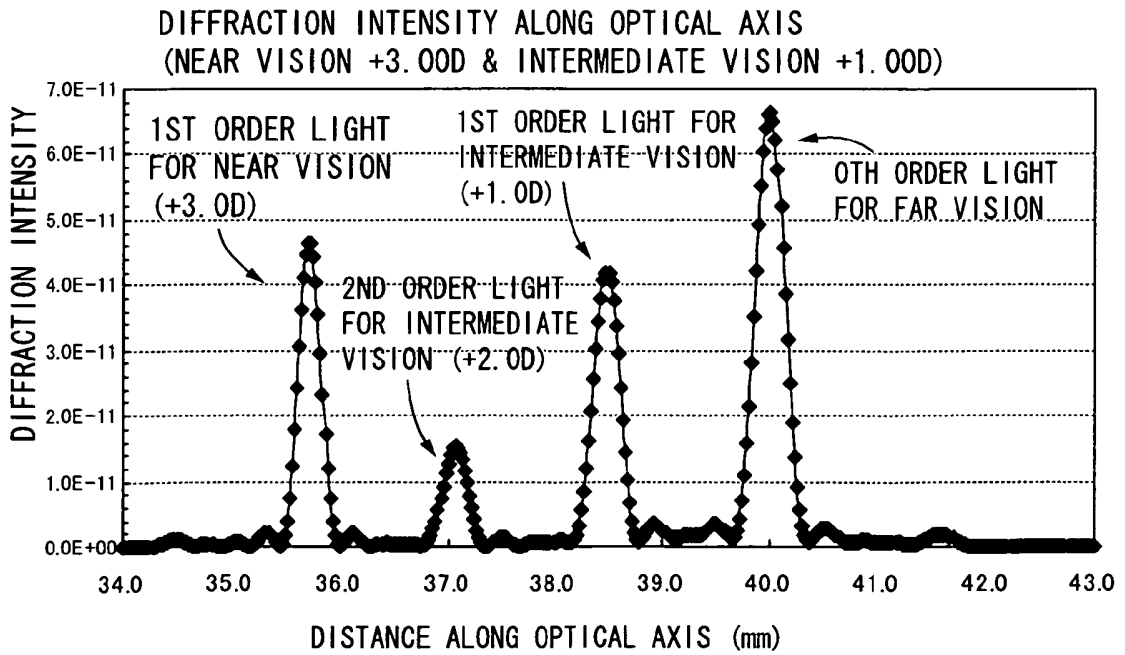
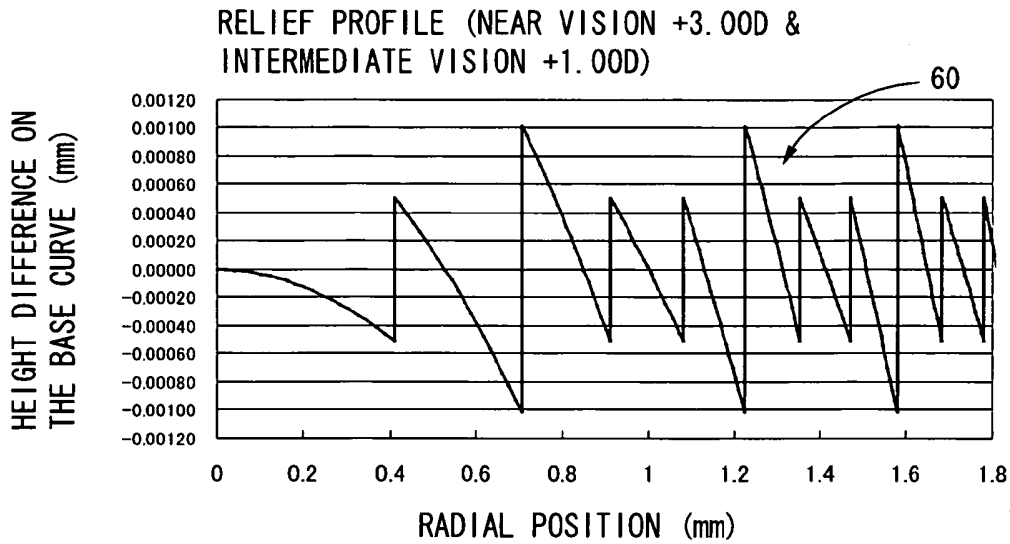

FIG.12



# FIG.13



# FIG.14

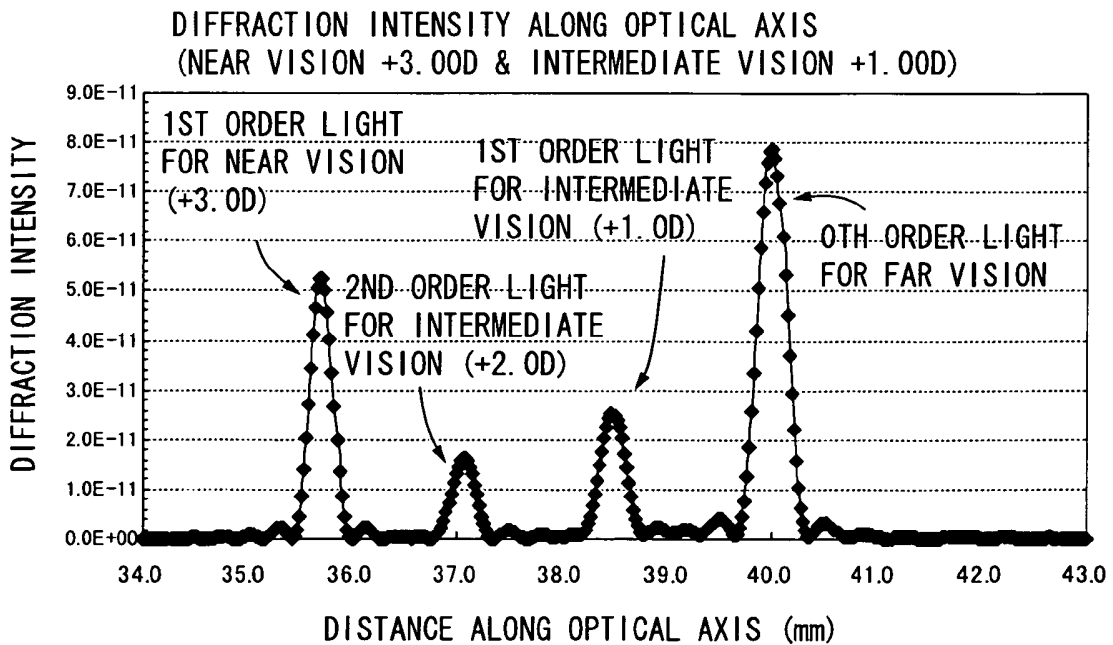

# FIG.15

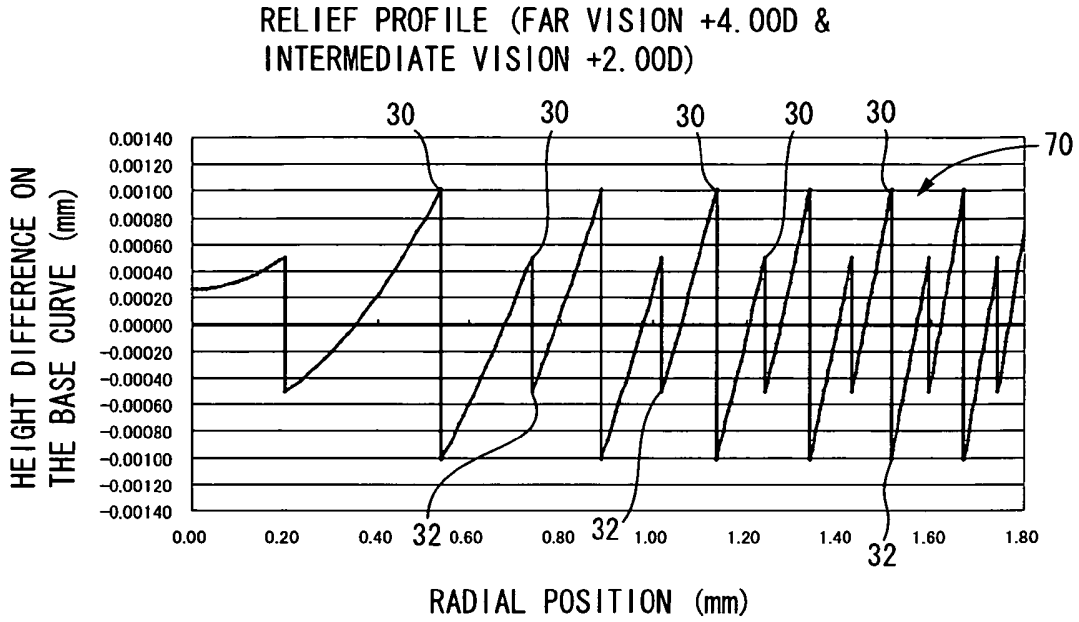

# FIG.16

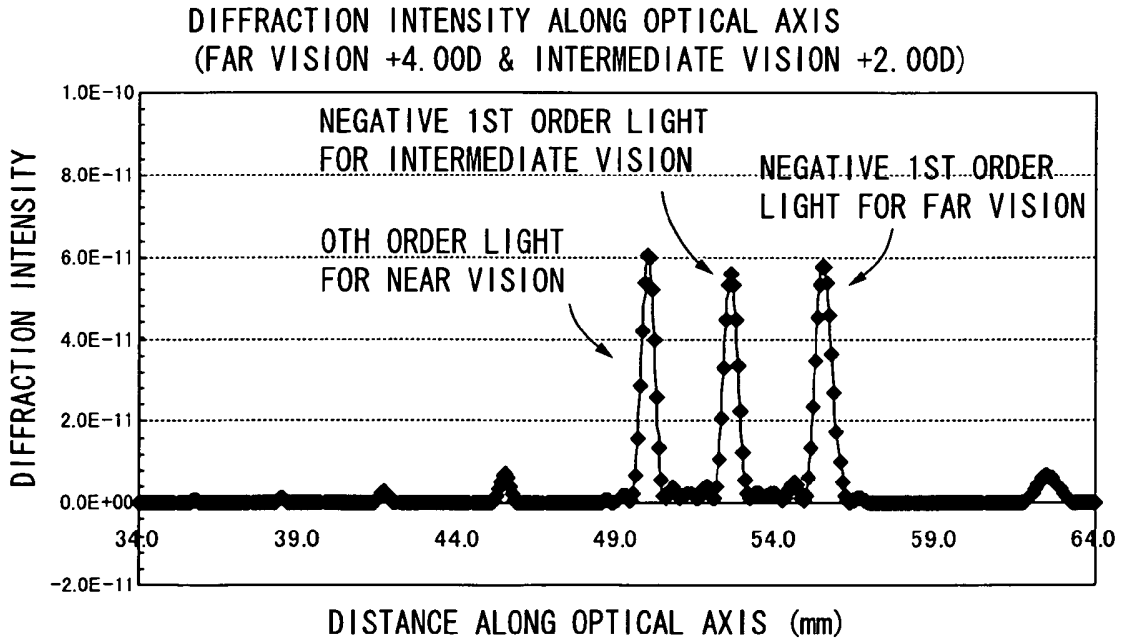

FIG.17

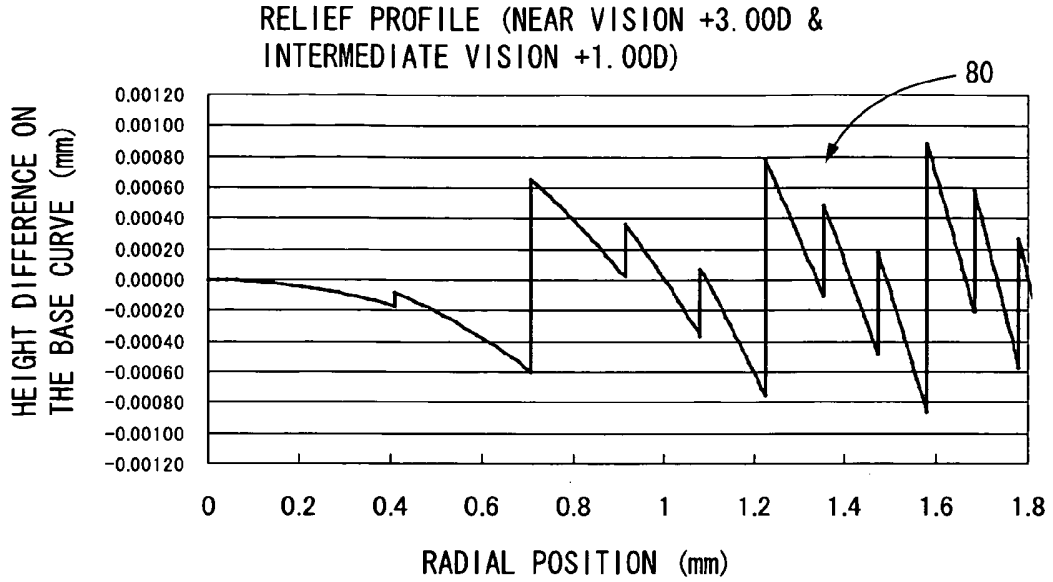

FIG.18

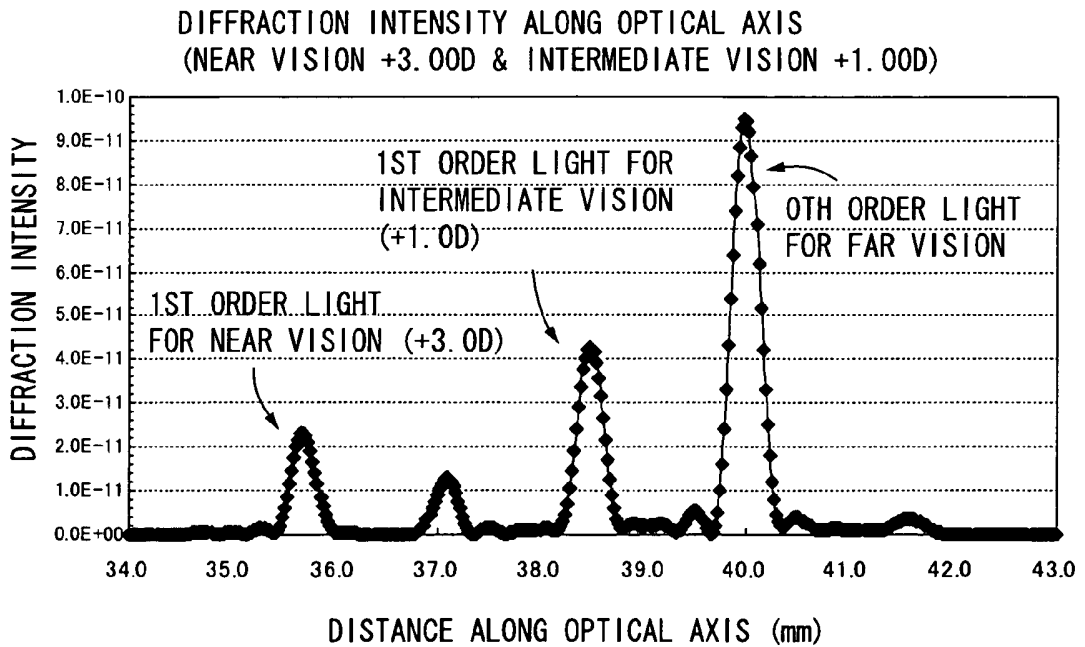

FIG.19

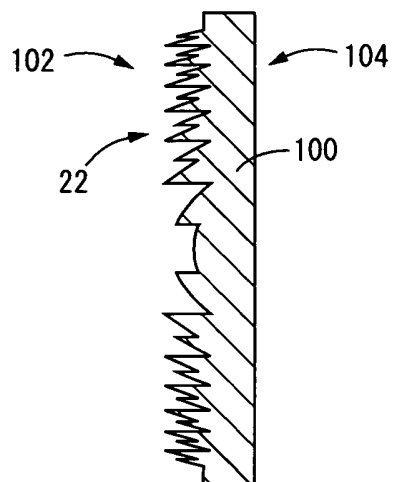
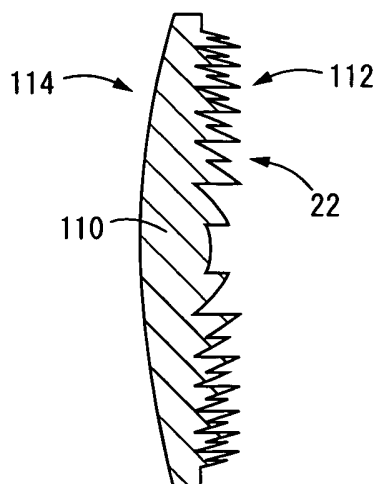
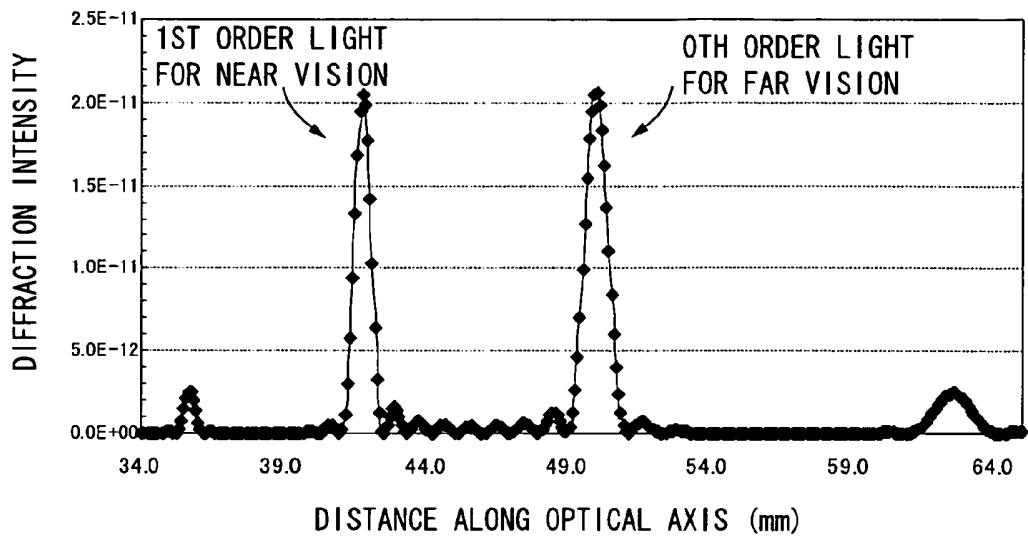

FIG.20



# FIG.21

DIFFRACTION INTENSITY ALONG OPTICAL AXIS  
(COMPARATIVE EXAMPLE 1)



# FIG.22A

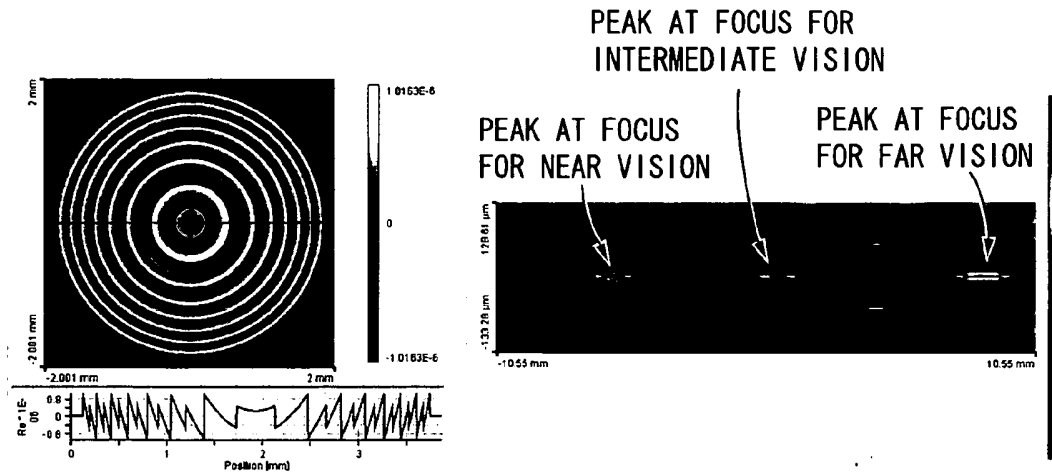

# FIG.22B

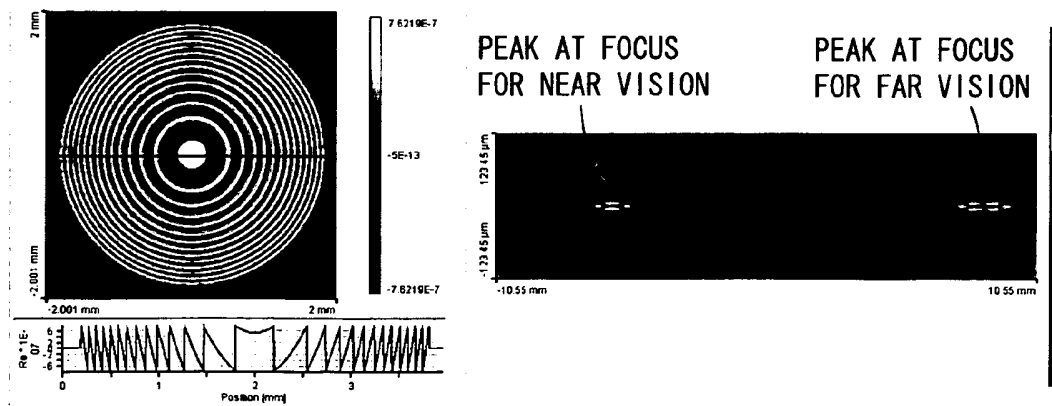

# FIG.23

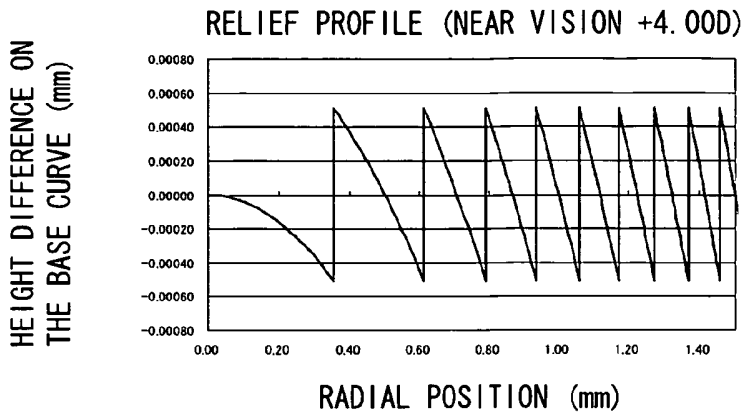

# FIG.24

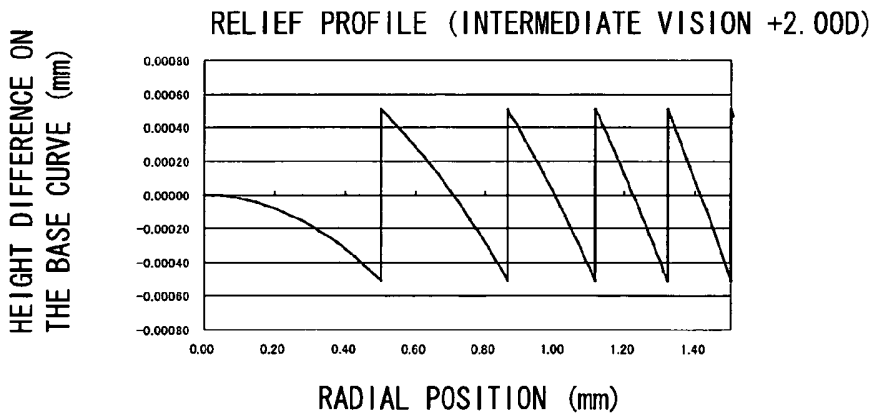

# FIG.25

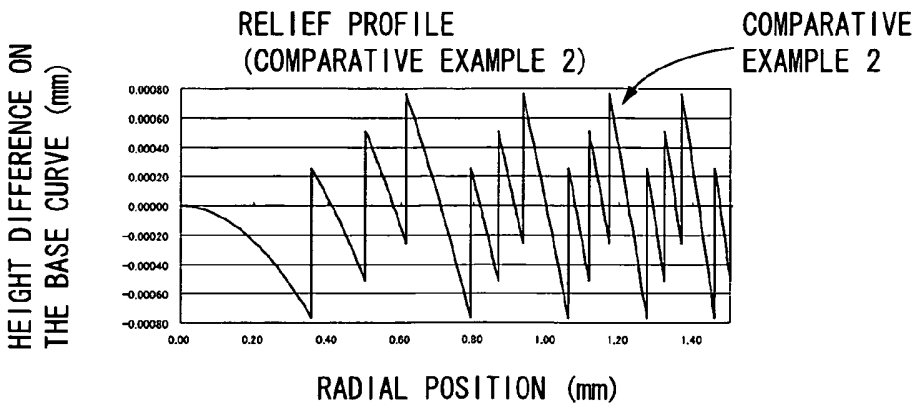

# FIG.26

DIFFRACTION INTENSITY ALONG OPTICAL AXIS  
(COMPARATIVE EXAMPLE 2)

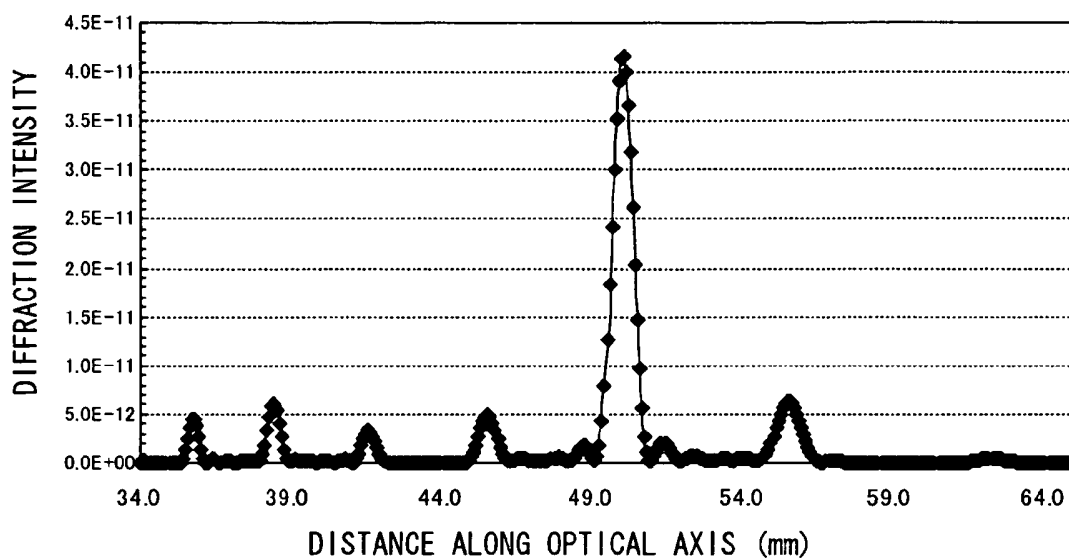

**REFERENCES CITED IN THE DESCRIPTION**

*This list of references cited by the applicant is for the reader's convenience only. It does not form part of the European patent document. Even though great care has been taken in compiling the references, errors or omissions cannot be excluded and the EPO disclaims all liability in this regard.*

**Patent documents cited in the description**

- US 5121980 A [0006]
- US 7188949 B [0006]
- EP 0393639 A2 [0007]
- WO 2006047698 A1 [0008]
- US 5122903 A [0009]
- JP 2001042112 A [0121]

## ELJÁRÁS APHAKIÁS INTRAOKULÁRIS LENCSE ELŐÁLLÍTÁSÁRA

*Szabadalmi igénypontok*

- 5 1. Eljárás lencsetokba behelyezhető aphakiás intraokuláris lencse (10) előállítására, amely lencsefelületen (16, 102, 112) koncentrikusan terjedő reliefmintázattal (24, 50, 60, 70, 80) rendelkező diffrakciós ráccsal (22) van ellátva, **azzal jellemezve**, hogy az eljárás során

a reliefmintázathoz (24, 50, 60, 70, 80) különböző típusú reliefeket (26, 28) alkalmazunk, amelyeknek az első rendben elhajló fényhez tartozó fókusztávolságai egymástól rendre eltérőek;

- 10 szinkronstruktúrát állítunk össze, amelyben legalább két reliefet (26, 28) a lencse (10) sugárirányában egy tartomány legalább egy részén egymással átfedően rögzítünk, és a reliefmintázat (24, 50, 60, 70, 80) létrehozásához az átfedően rögzíteti reliefek (26, 28) közül a legnagyobb rácsosztású egyik relief (28) valamennyi rácsosztásával egy másik relief (26) rácsosztását periodikus átfedésbe hozzuk; és az így nyert reliefmintázatot (24, 50, 60, 70, 80) a lencsefelületen (16, 102, 112) kialakítjuk.

- 15 2. Az 1. igénypont szerinti eljárás aphakiás intraokuláris lencse (10) előállítására, amelynél a lencse (10) törőfelületével (16, 114) a nulladrendű fényhez egy a különböző típusú reliefeken (26, 28) első rendben elhajló fényhez tartozó valamennyi fókusztávolságtól eltérő fókusztávolságot is beállítunk.

3. Az 1. vagy a 2. igénypont szerinti eljárás aphakiás intraokuláris lencse (10) előállítására, ahol a különböző típusú reliefeket (26, 28) az

$$20 \quad A = (2(m - Nm) + a) / N$$

összefüggést kielégítőn rendezzük el, ahol  $A$  az egyik relief (28) zónaállandója, „ $a$ ” a másik relief (26) zónaállandója,  $M$  az egyik relief (28) zónaszáma,  $m$  a másik relief (26) zónaszáma, továbbá  $N$  az egyik relief (28) és a másik relief (26) fókusztávolságának a hányadosa, amit az

$$(az\ egyik\ relief\ (28)\ fókusztávolsága) / (a\ másik\ relief\ (26)\ fókusztávolsága)$$

- 25 összefüggéssel határozzuk meg.

4. Az 1-3. igénypontok bármelyike szerinti eljárás aphakiás intraokuláris lencse (10) előállítására, ahol a különböző típusú reliefeket (26, 28) a

$$D \leq \lambda / (N_{inc} - N_{med})$$

- 30 összefüggést kielégítőn rendezzük el, ahol  $D$  a reliefmélység nagysága,  $\lambda$  egy tervezési hullámhossz,  $N_{inc}$  az optikai anyag törésmutatója és  $N_{med}$  a környező közeg törésmutatója.

5. Aphakiás intraokuláris lencse (10) lencsetokba történő behelyezésre, amely lencsefelületen (16, 102, 112) koncentrikusan terjedő reliefmintázattal (24, 50, 60, 70, 80) rendelkező diffrakciós ráccsal (22) van ellátva, **azzal jellemezve**, hogy tartalmaz

- 35 szinkronstruktúrát, melyben az első rendben elhajló fényhez tartozó fókusztávolságot tekintve egymástól eltérő legalább két reliefet (26, 28) tartalmazó különböző típusú reliefek (26, 28) a lencse (10) sugárirányában egy tartomány legalább egy részén egymással átfedően vannak rögzítve, továbbá az átfedően rögzí-

tett reliefek (26, 28) közül a legnagyobb rácsosztású egyik relief (28) valamennyi rácsosztása egy másik relief (26) rácsosztásával periodikus átfedésben van.

6. Az 5. igénypont szerinti aphakiás intraokuláris lencse (10), ahol a lencse (10) törőfelületével (16, 114) a nulladrendű fényhez egy a különböző típusú reliefeken (26, 28) első rendben elhajló fényhez tartozó valamennyi  
5 fókusz távolságtól eltérő fókusz távolság van beállítva.

7. A 6. igénypont szerinti aphakiás intraokuláris lencse (10), ahol a reliefmintázattal (24, 50, 60, 70, 80) ellátott lencsefelület (16) a törőfelület (16).

8. Az 5-7. igénypontok bármelyike szerinti aphakiás intraokuláris lencse (10), ahol a legnagyobb rácsosztású relief (28) különböző típusú reliefek (26, 28) átfedésével nyert valamennyi reliefmélysége egy zóna irányban  
10 állandó.

9. A 8. igénypont szerinti aphakiás intraokuláris lencse (10), ahol a legnagyobb rácsosztású relief (28) mindegyik zónájában egy legalább két reliefmélységgel rendelkező másik relief (26) van a lencse (10) radiális irányában azon tartományban kiképezve, ahol a különböző típusú reliefek (26, 28) átfedőn vannak rögzítve, továbbá a legalább két reliefmélység nagysága egy virtuális alapgörbe-felülethez képest a zóna irányban fokozatosan változik.  
15

10. A 8. igénypont szerinti aphakiás intraokuláris lencse (10), ahol a legnagyobb rácsosztású relief (28) mindegyik zónájában egy legalább két reliefmélységgel rendelkező másik relief (26) van a lencse (10) radiális irányában azon tartományban kiképezve, ahol a különböző típusú reliefek (26, 28) átfedőn vannak rögzítve, továbbá a legalább két reliefmélység nagysága a virtuális alapgörbe-felülethez képest a zóna irányban állandó.

20 11. Az 5-10. igénypontok bármelyike szerinti aphakiás intraokuláris lencse (10), ahol valamennyi különböző típusú reliefnek (26, 28) kör mentén terjedő, hegyesszögű csücsszög meghatározta keresztmetszettel rendelkező gerincvonala (30), valamint kör mentén terjedő, hegyesszögű bezárt szög meghatározta keresztmetszettel rendelkező völgyvonala (32) van.

25 12. Az 5-11. igénypontok bármelyike szerinti aphakiás intraokuláris lencse (10), ahol a nulladrendű fény a lencse (10) törőfelületével (16) távolra látáshoz fókuszáltan van beállítva, az első rendben elhajlított fény az egyik típusú relief (26) közelre látáshoz fókuszáltan van beállítva, továbbá az első rendben elhajlított fény a másik típusú relief (28) köztes látáshoz fókuszáltan van beállítva.

30 13. Az 5-11. igénypontok bármelyike szerinti aphakiás intraokuláris lencse (10), ahol a nulladrendű fény a lencse (10) törőfelületével (16) közelre látáshoz fókuszáltan van beállítva, az első rendben elhajlított fény az egyik típusú relief (26) távolra látáshoz fókuszáltan van beállítva, továbbá az első rendben elhajlított fény a másik típusú relief (28) köztes látáshoz fókuszáltan van beállítva.

14. Az 5-13. igénypontok bármelyike szerinti aphakiás intraokuláris lencse (10), ahol a különböző típusú reliefek (26, 28) az

$$A = (2(m-NM) + a) / N$$

összefüggést kielégítőn vannak elrendezve, ahol  $A$  az egyik relief (28) zónaállandója, „ $a$ ” a másik relief (26) zónaállandója,  $M$  az egyik relief (28) zónaszáma,  $m$  a másik relief (26) zónaszáma, továbbá  $N$  az egyik relief (28) és a másik relief (26) fókusz távolságának a hányadosa, amit az

$$(az\ egyik\ relief\ (28)\ fókusz\ távolsága) / (a\ másik\ relief\ (26)\ fókusz\ távolsága)$$

5 összefüggés határoz meg.

15. Az 5-14. igénypontok bármelyike szerinti aphakiás intraokuláris lencse (10), ahol a különböző típusú reliefek (26, 28) a

$$D \leq \lambda / (N_{lens} - N_{med})$$

összefüggést kielégítőn vannak elrendezve, ahol  $D$  a reliefmélység nagysága,  $\lambda$  egy tervezési hullámhossz,  $N_{lens}$

10 az optikai anyag törésmutatója és  $N_{med}$  a környező közeg törésmutatója.