



US00D643303S

(12) **United States Design Patent**  
**Bicknell et al.**

(10) **Patent No.:** **US D643,303 S**

(45) **Date of Patent:** **\*\* Aug. 16, 2011**

(54) **CONTAINER**

(75) Inventors: **David Huw Bicknell**, London (GB);  
**James Edward Roe**, Glossop (GB)

(73) Assignee: **Conopco Inc.**, Englewood Cliffs, NJ  
(US)

(\*\*) Term: **14 Years**

(21) Appl. No.: **29/378,179**

(22) Filed: **Nov. 1, 2010**

(30) **Foreign Application Priority Data**

May 5, 2010 (EM) ..... 001704628-0001

(51) **LOC (9) Cl.** ..... **09-01**

(52) **U.S. Cl.** ..... **D9/689**

(58) **Field of Classification Search** ..... D9/682-694,  
D9/500-505, 516-575, 434-454; 222/129,  
222/135, 153.01, 153.03, 153.04, 153.09,  
222/153.11-153.14, 182, 631, 635, 209,  
222/211-213, 215, 321.7-321.9, 372, 373,  
222/378, 379, 383.1, 384-386, 398, 400.7,  
222/400.8, 401, 402.1-402.25

See application file for complete search history.

(56) **References Cited**

**U.S. PATENT DOCUMENTS**

D236,084	S	*	7/1975	Petterson	.....	D9/688
6,000,633	A	*	12/1999	Lund et al.	.....	239/211
D462,896	S	*	9/2002	Crawford et al.	.....	D9/693
D482,972	S	*	12/2003	Young et al.	.....	D9/523
D490,699	S	*	6/2004	Nelson et al.	.....	D9/689
D491,064	S		6/2004	Miller et al.	.....	D9/448
D492,193	S		6/2004	Miller et al.	.....	D9/300
D507,487	S	*	7/2005	Marroncles	.....	D9/448
D508,209	S	*	8/2005	Lamb et al.	.....	D9/689
D511,302	S	*	11/2005	Lamb et al.	.....	D9/689
D512,313	S	*	12/2005	Liu	.....	D9/502
D557,145	S	*	12/2007	Miller et al.	.....	D9/689

D602,363	S	*	10/2009	Chaffier	.....	D9/521
D604,641	S	*	11/2009	Renz et al.	.....	D9/776
2003/0129142	A1	*	7/2003	Schroeder et al.	.....	424/47

**FOREIGN PATENT DOCUMENTS**

EM	000512207-0002	*	6/2006
EM	000749148-0007	*	7/2007
GB	DES. 3020280	*	3/2005
WO	D072539-003	*	4/2010
WO	2010/052168		5/2010

**OTHER PUBLICATIONS**

Dove Original Antiperspirant; front and back photos (Aug. 2008).  
Imperial Leather Foamburst Foaming Shower Gel; front and back  
photos (Aug. 2008).

MUM Active Clear Antiperspirant; front and back photos (May  
2008).

Co-pending Application: Applicant: Bicknell et al., U.S. Appl. No.  
29/378,177, filed Nov. 1, 2010.

Co-pending Application: Applicant: Bicknell et al., U.S. Appl. No.  
29/378,180, filed Nov. 1, 2010.

\* cited by examiner

*Primary Examiner* — Catherine Tuttle

(74) *Attorney, Agent, or Firm* — Karen E. Klumas

(57) **CLAIM**

The ornamental design for a container, as shown and  
described.

**DESCRIPTION**

FIG. 1 is a top, front and side perspective view of our con-  
tainer;

FIG. 2 is a front elevational view thereof;

FIG. 3 is a rear elevational view thereof;

FIG. 4 is a side elevational view thereof;

FIG. 5 is an elevational view of the other side thereof;

FIG. 6 is a top plan view thereof; and,

FIG. 7 is a bottom plan view thereof.

The broken lines are included for the purpose of illustrating a  
portion of the container that forms no part of the claimed  
design.

**1 Claim, 2 Drawing Sheets**

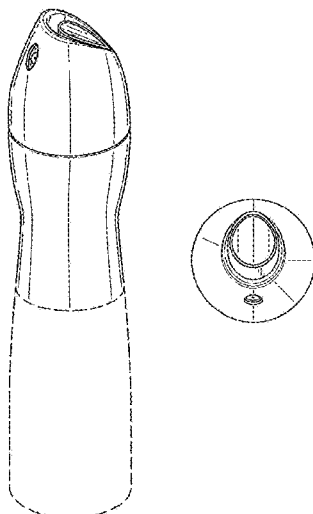

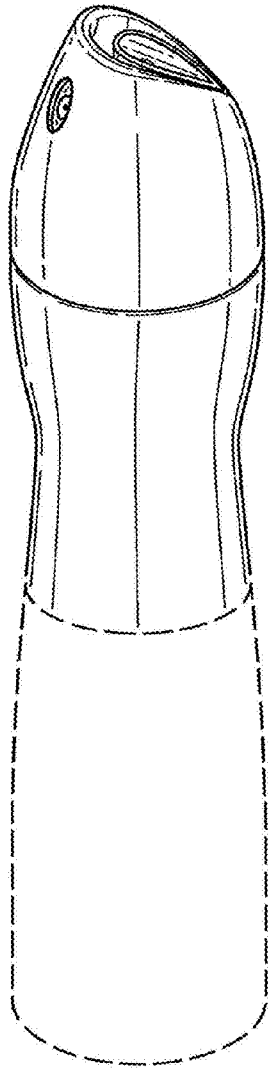

Fig. 1.

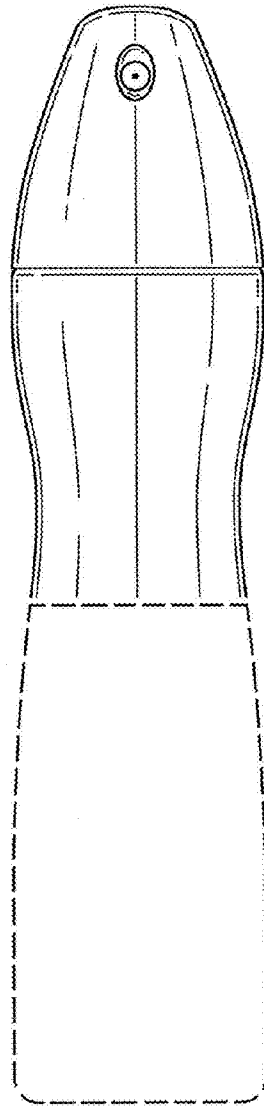

Fig. 2.

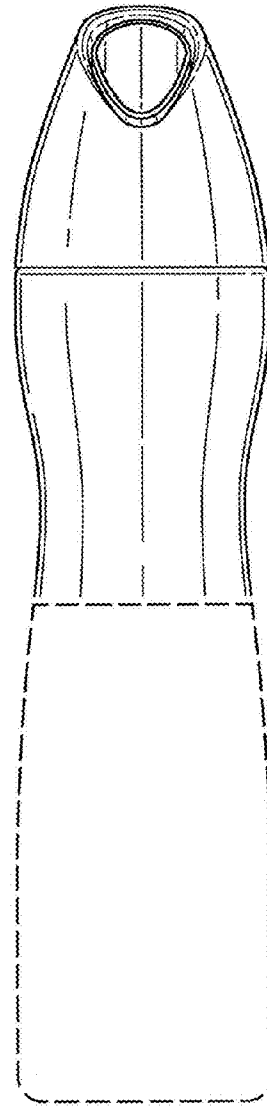

Fig. 3.

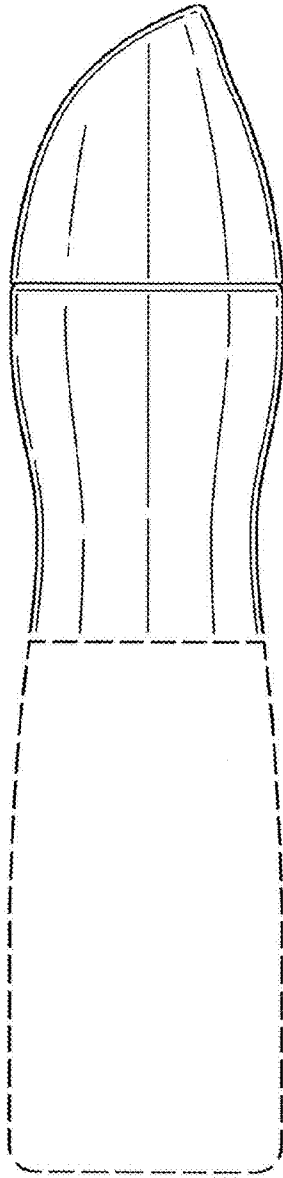

Fig. 4.

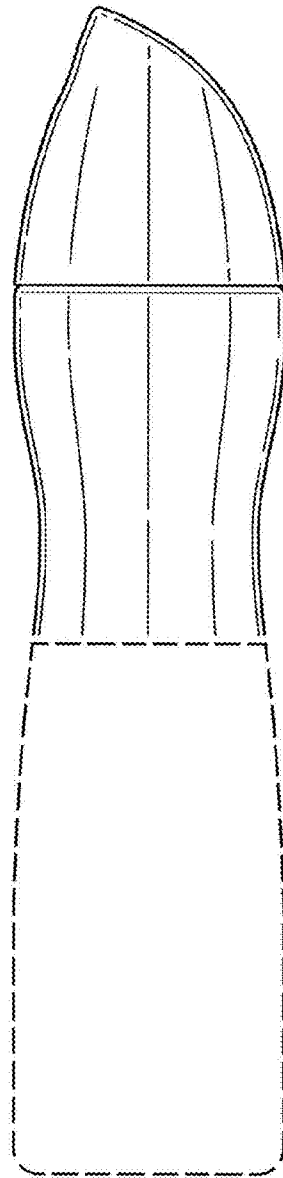

Fig. 5.

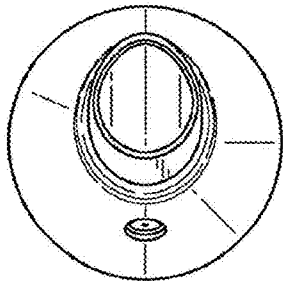

Fig. 6.

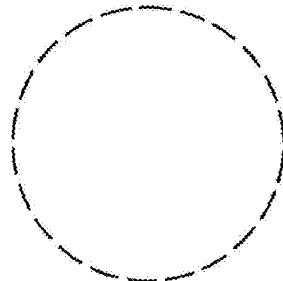

Fig. 7.