



(12) **United States Design Patent**
Levy

(10) **Patent No.:** **US D796,257 S**
(45) **Date of Patent:** **** Sep. 5, 2017**

(54) **CARAFE**
(71) Applicant: **SOCIETE JAS HENNESSY & CO.,**
Cognac (FR)
(72) Inventor: **Arik Levy,** Paris (FR)
(73) Assignee: **SOCIETE JAS HENNESSY & CO.,**
Cognac (FR)
(**) Term: **15 Years**
(21) Appl. No.: **29/539,976**

3,690,610 A * 9/1972 Peirce A21B 3/00
108/101
4,311,237 A * 1/1982 Hayes A47G 23/08
206/203
D291,583 S * 8/1987 Bateman D21/471
D312,965 S * 12/1990 Mansau D26/103
D313,351 S * 1/1991 Mansau D26/103
D321,626 S * 11/1991 Kouts D7/510
(Continued)

Primary Examiner — Marianne Pandozzi
Assistant Examiner — Jae Liang
(74) *Attorney, Agent, or Firm* — Baker & McKenzie LLP

(22) Filed: **Sep. 18, 2015**
(30) **Foreign Application Priority Data**

Jun. 24, 2015 (EP) 02725507
(51) **LOC (10) Cl.** **07-01**
(52) **U.S. Cl.**
USPC **D7/397; D7/300; D7/532; D7/505;**
D9/434

(57) **CLAIM**
The ornamental design for a carafe, as shown and described.

(58) **Field of Classification Search**
USPC D7/507, 509, 510, 511, 512, 513, 523,
D7/529, 530, 531, 532, 608, 300, 300.1,
D7/591, 598, 312, 392.1, 396.2, 398, 505,
D7/610, 624.1, 317, 318, 305, 213, 397,
D7/396.1; D9/501, 502, 500, 503, 505,
D9/516, 523, 530, 537, 546, 550, 552,
D9/563, 565, 569, 571, 434, 447, 440;
D3/202; 220/592.16, 592.17, 200, 703;
D21/390, 389, 392, 393, 426, 403, 404,
D21/471, 455, 459, 463, 680, 681
CPC A45F 3/16; B65D 47/066; A47G 19/2272;
A47G 19/2266; A47J 43/27
See application file for complete search history.

DESCRIPTION

FIG. 1 is a perspective view of a carafe in its first position in use showing my new design;
FIG. 2 is a front view of a carafe shown in FIG. 1;
FIG. 3 is a rear view of a carafe shown in FIG. 1;
FIG. 4 is a first side view of a carafe shown in FIG. 1;
FIG. 5 is a second side view of a carafe shown in FIG. 1;
FIG. 6 is a top view of a carafe shown in FIG. 1;
FIG. 7 is a bottom view of a carafe shown in FIG. 1;
FIG. 8 is a perspective view of a carafe in its second position in use;
FIG. 9 is a front view of a carafe shown in FIG. 8;
FIG. 10 is a rear view of a carafe shown in FIG. 8;
FIG. 11 is a first side view of a carafe shown in FIG. 8;
FIG. 12 is a second side view of a carafe shown in FIG. 8;
FIG. 13 is a top view of a carafe shown in FIG. 8; and,
FIG. 14 is a bottom view of a carafe shown in FIG. 8.
The broken lines in the drawing depict portions of the carafe that form no part of the claimed design.

(56) **References Cited**
U.S. PATENT DOCUMENTS
535,535 A * 3/1895 Gardner A63F 9/20
273/294
2,623,633 A * 12/1952 Bladow A45F 3/46
108/91

1 Claim, 14 Drawing Sheets

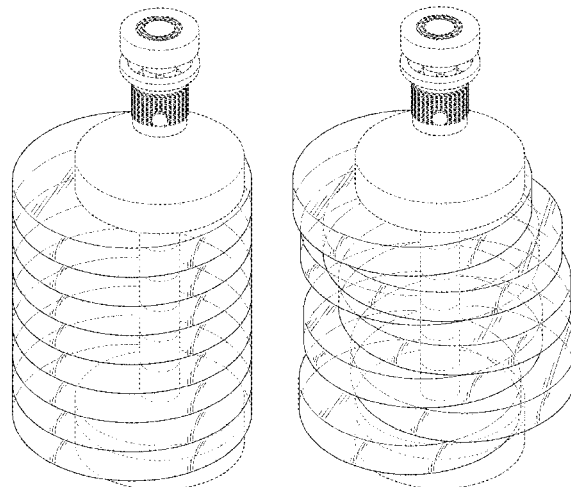

(56)

References Cited

U.S. PATENT DOCUMENTS

D329,169 S * 9/1992 Robbins, III D7/300
D329,548 S * 9/1992 Wells D6/407
5,300,001 A * 4/1994 Sealy A63B 21/0602
128/DIG. 15
5,400,907 A * 3/1995 Chen A47G 19/2227
206/459.1
5,407,413 A * 4/1995 Kupferman A63B 21/0728
482/106
D359,196 S * 6/1995 Nichols D7/511
D397,932 S * 9/1998 Mazda D9/683
D413,046 S * 8/1999 Fritze D7/505
D499,023 S * 11/2004 Amos D10/101
D499,968 S * 12/2004 Lam D10/15
D574,188 S * 8/2008 Beny D7/500
D609,526 S * 2/2010 Tuttle D21/681
D676,277 S * 2/2013 Riedel D7/396.1
8,556,099 B2 * 10/2013 Perlman A45F 3/20
206/217
D695,128 S * 12/2013 Ozsinmaz D21/681
D696,953 S * 1/2014 Kanda D9/516
D706,134 S * 6/2014 Sory D9/435
D746,168 S * 12/2015 Vaughan D11/81
2008/0185781 A1 * 8/2008 Mascolo A63F 9/0073
273/153 P

* cited by examiner

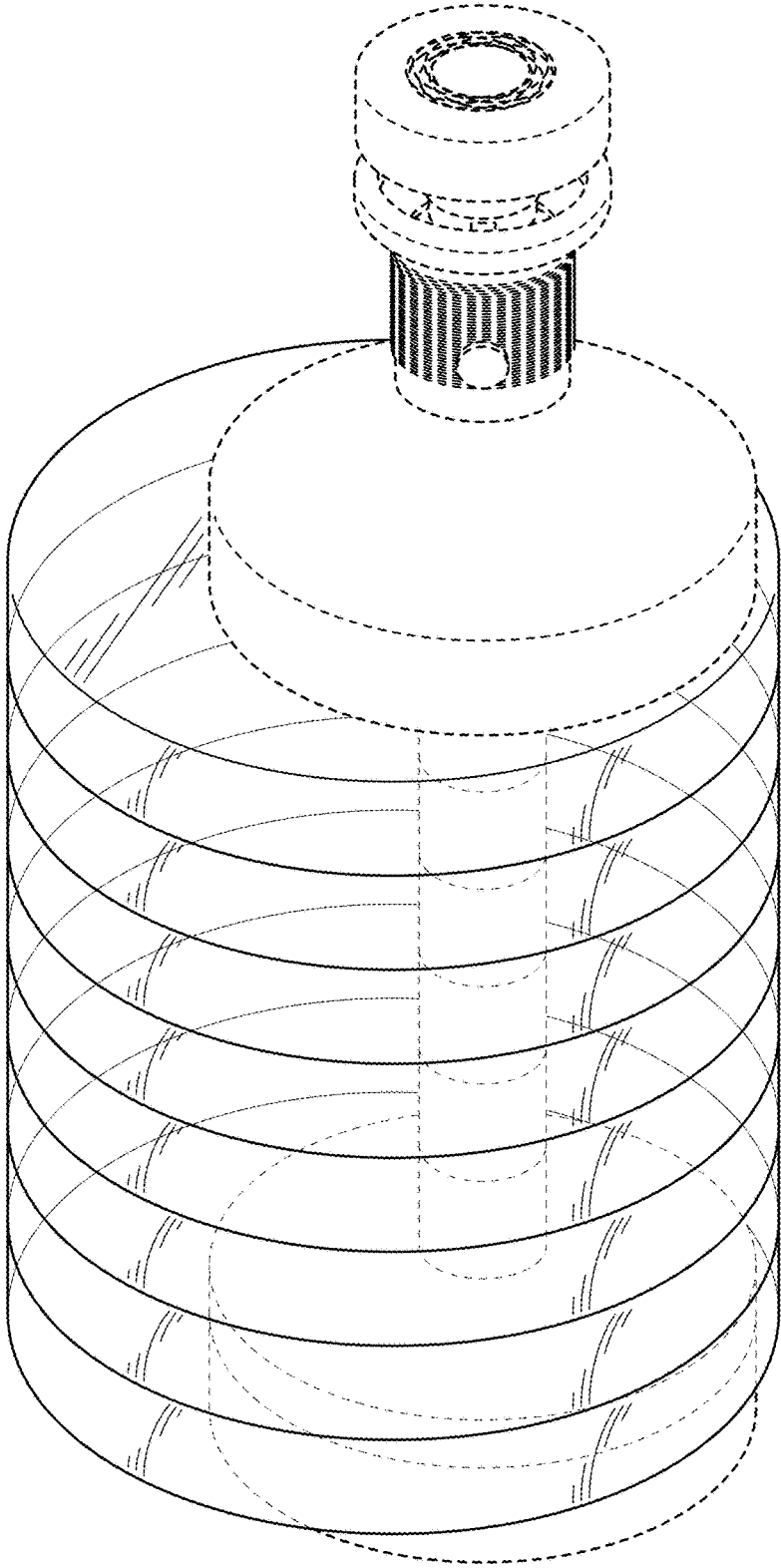

FIG. 1

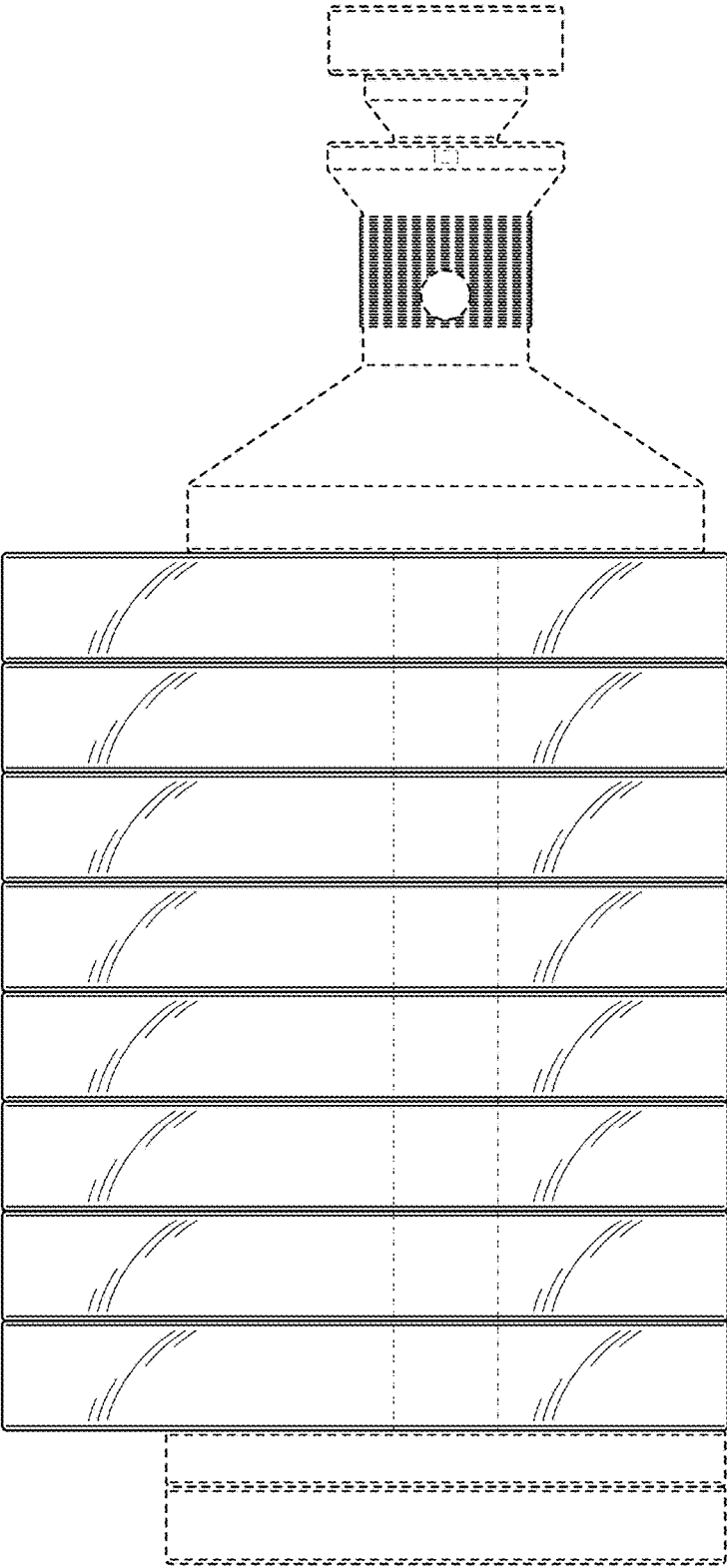

FIG. 2

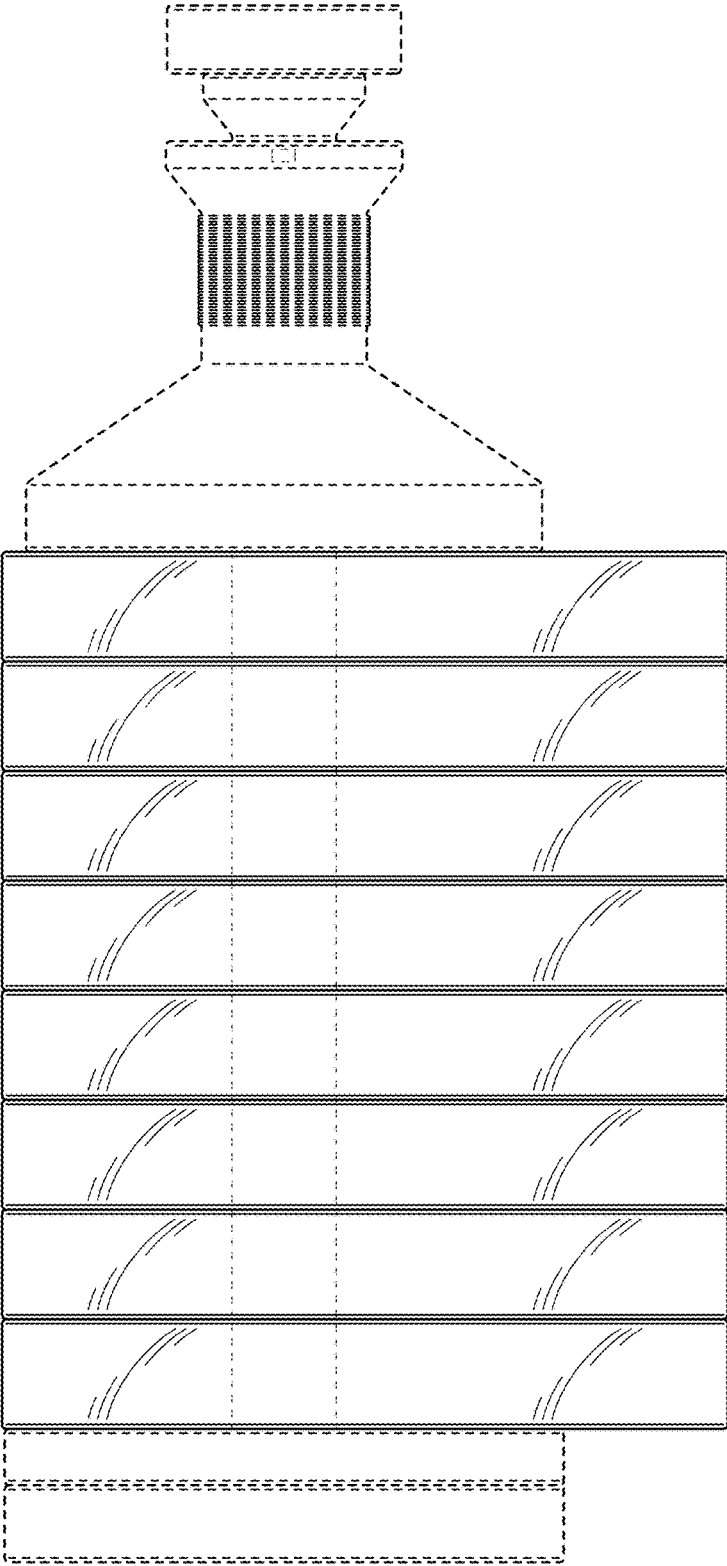

FIG. 3

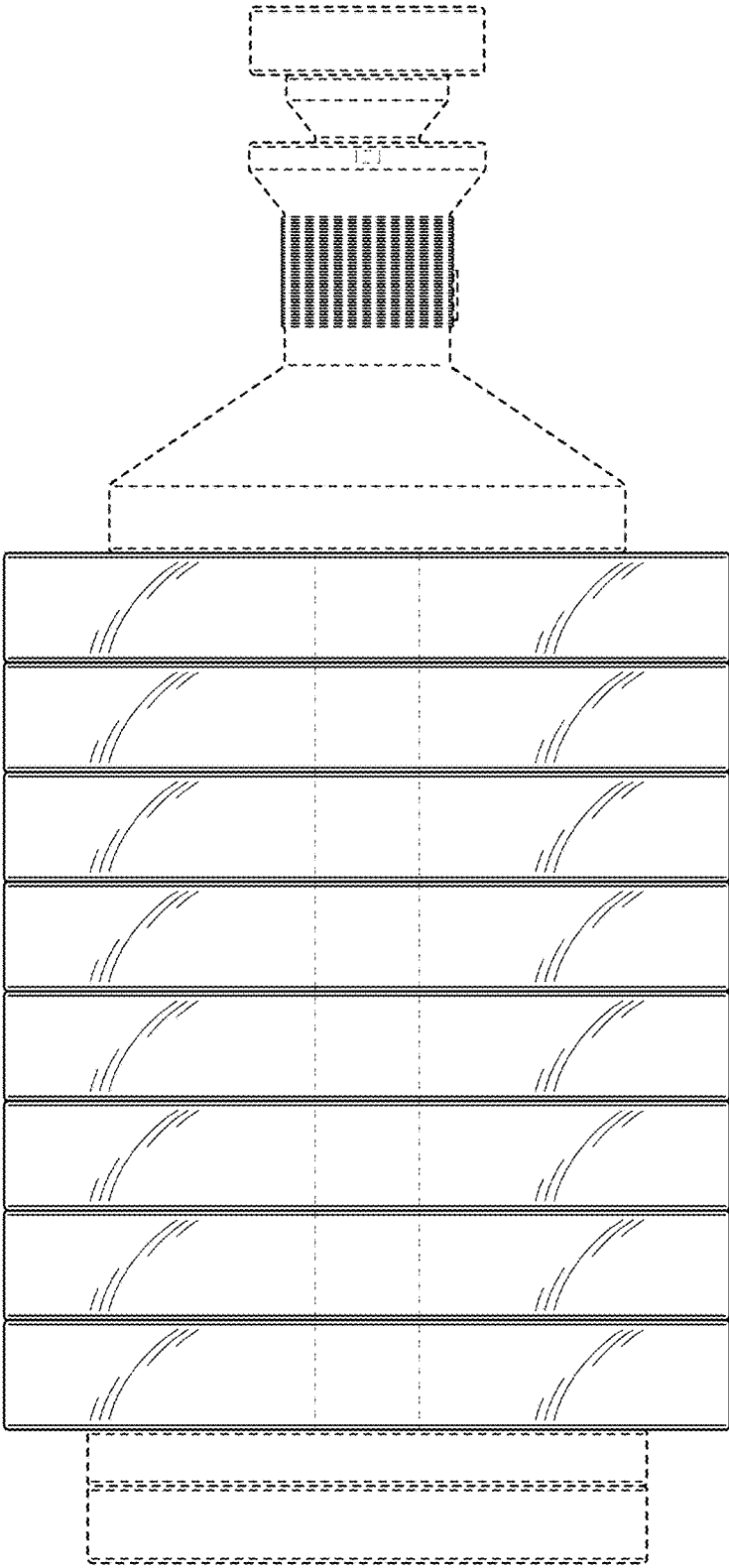

FIG. 4

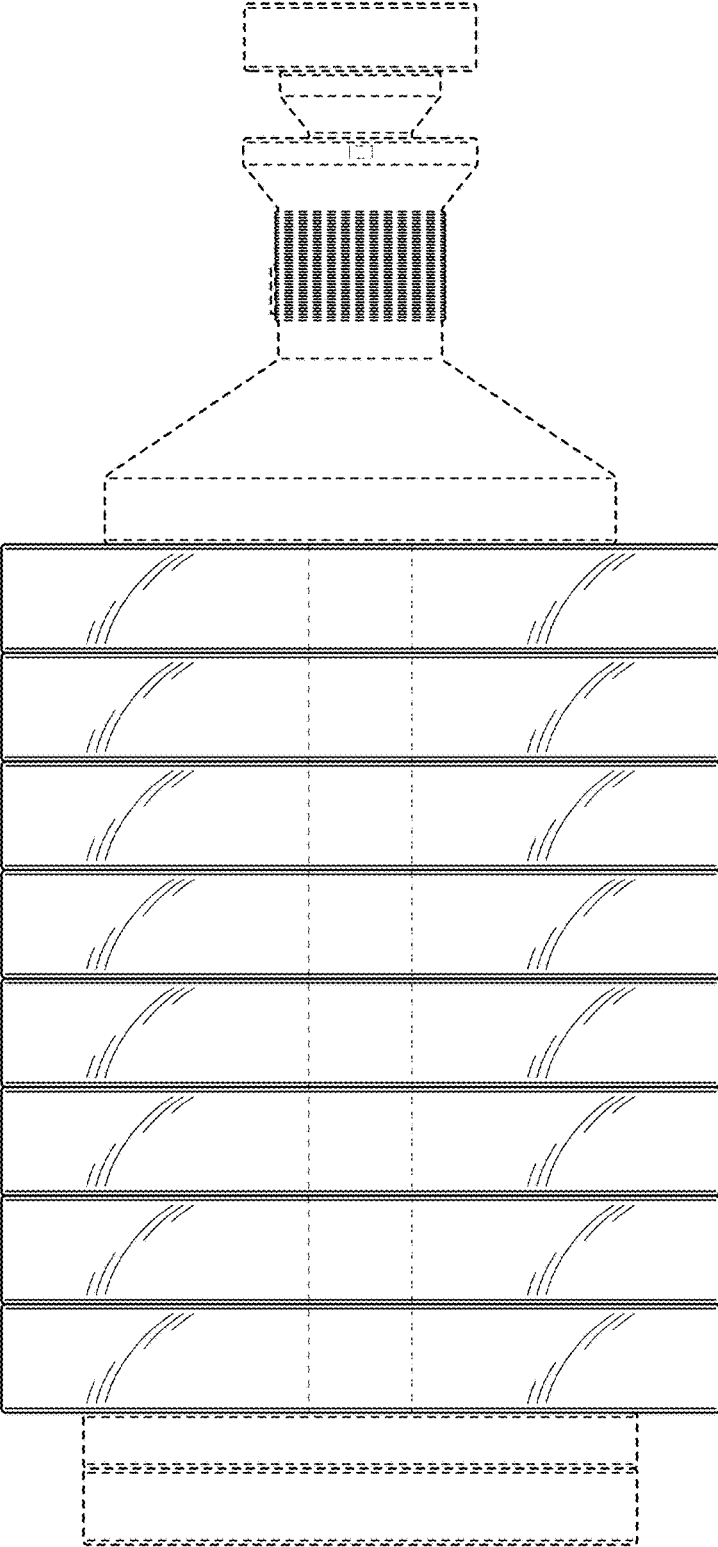

FIG. 5

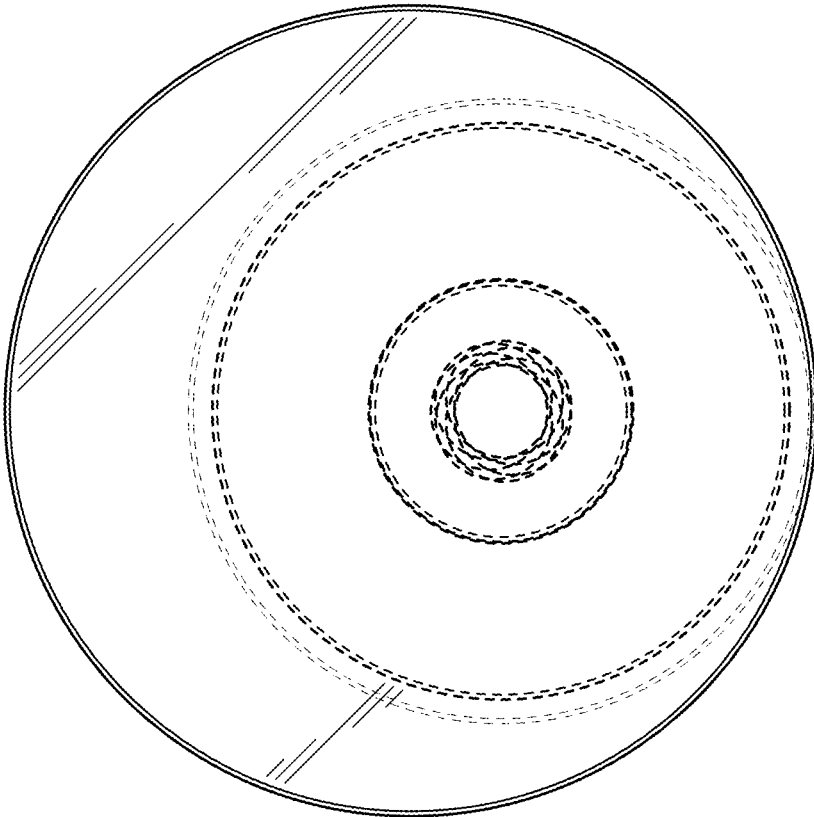

FIG. 6

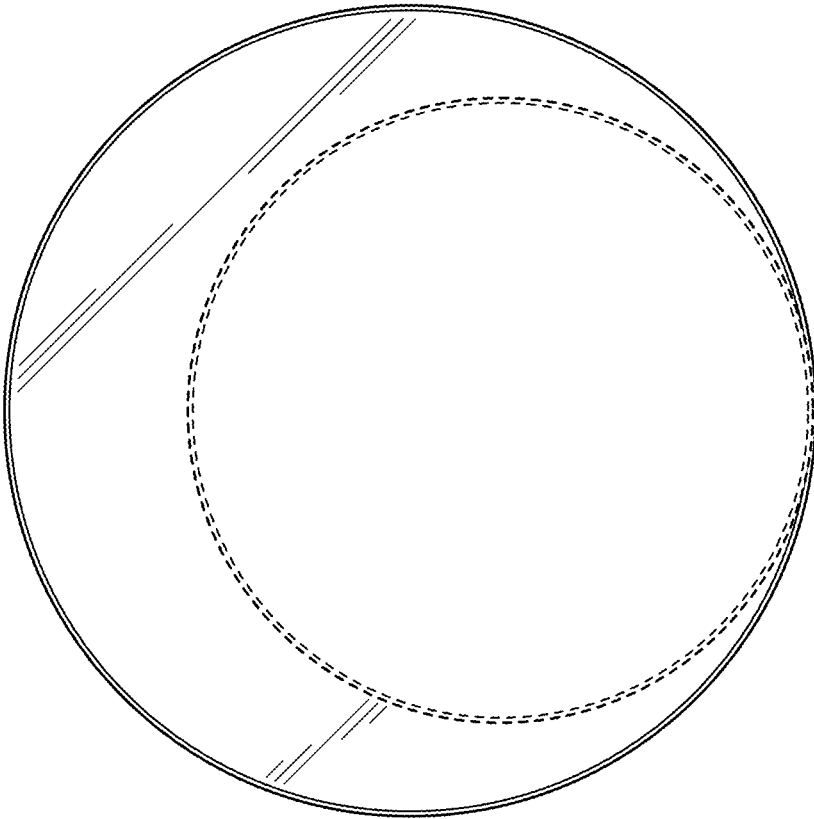

FIG. 7

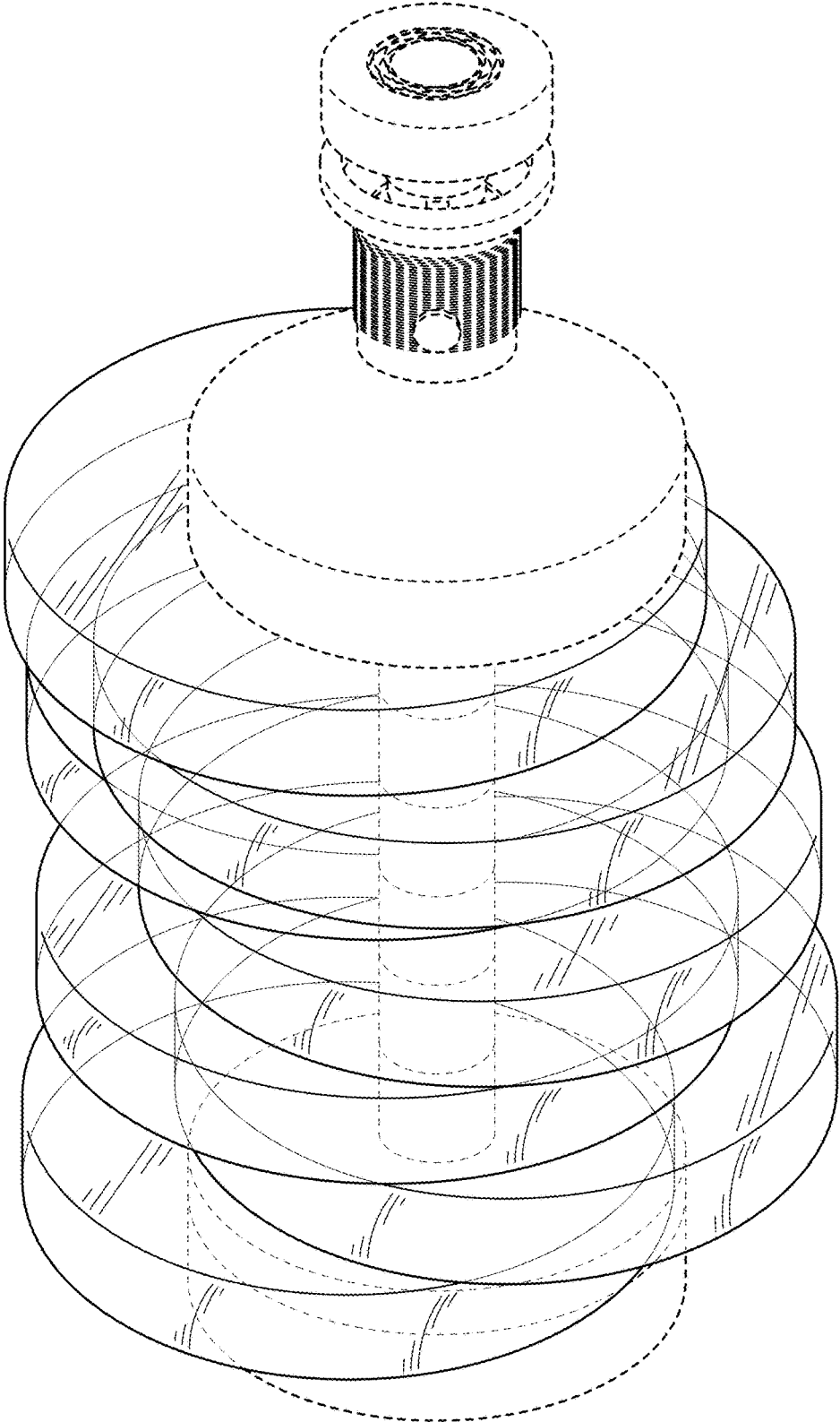

FIG. 8

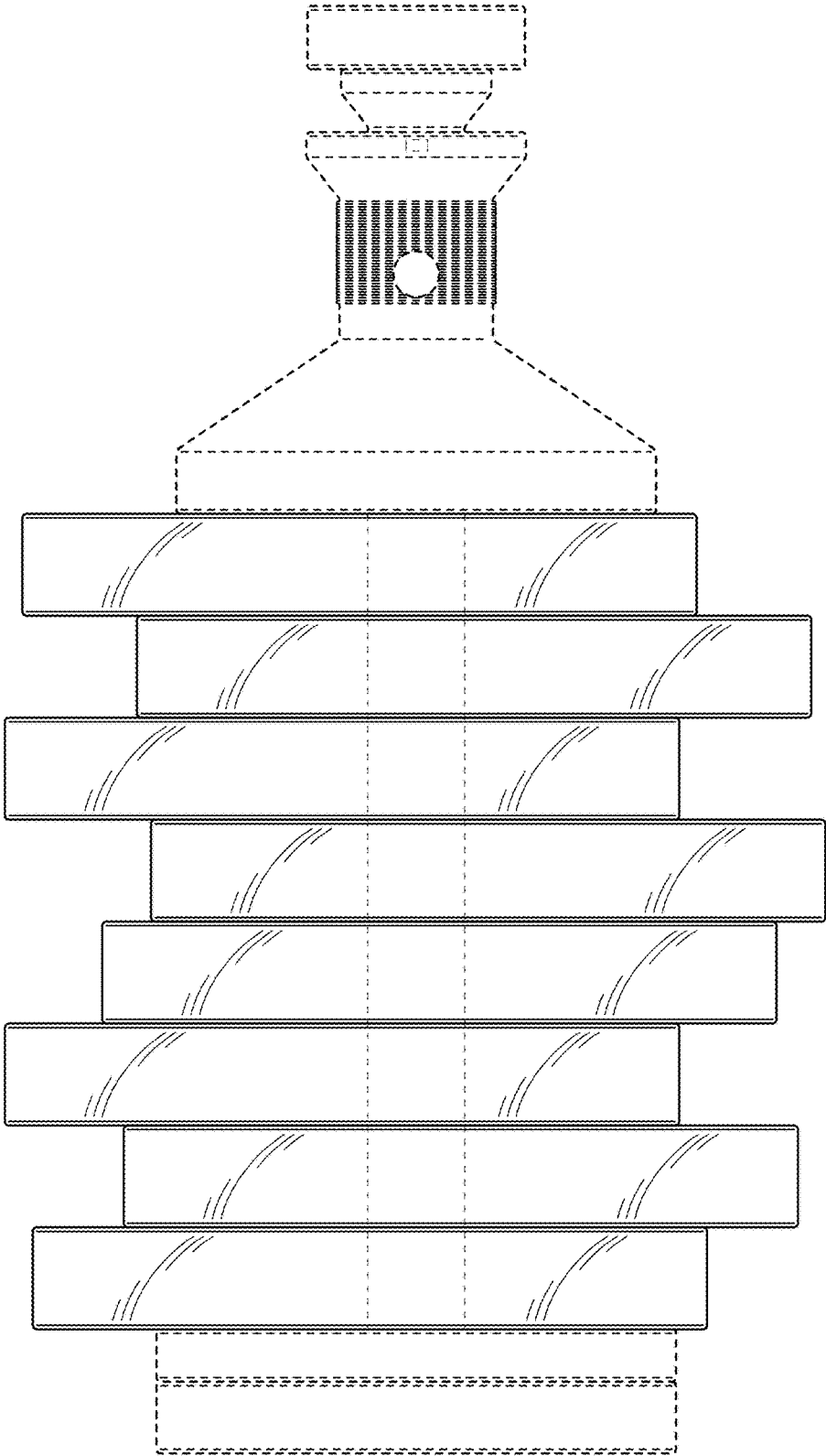

FIG. 9

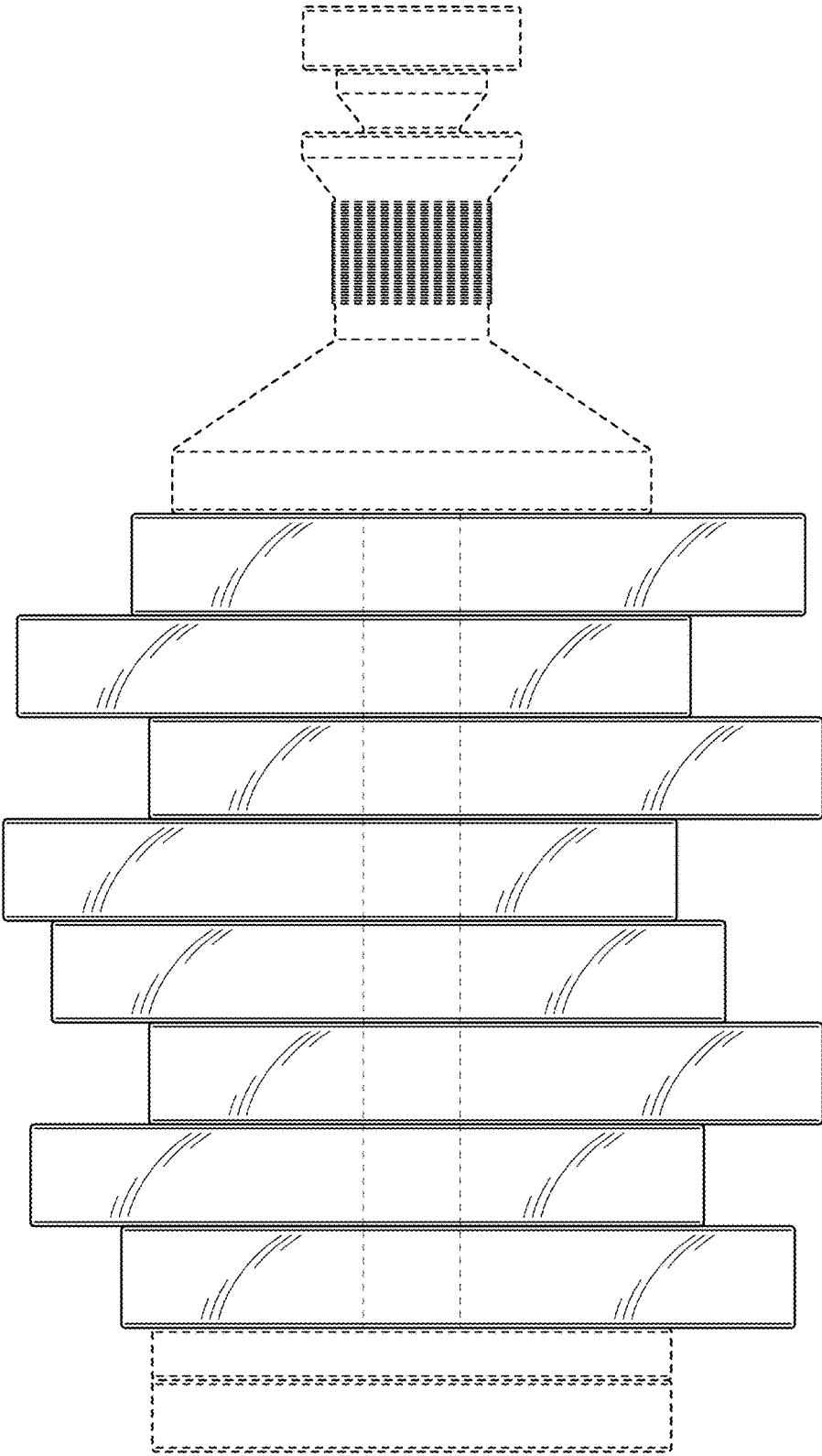

FIG. 10

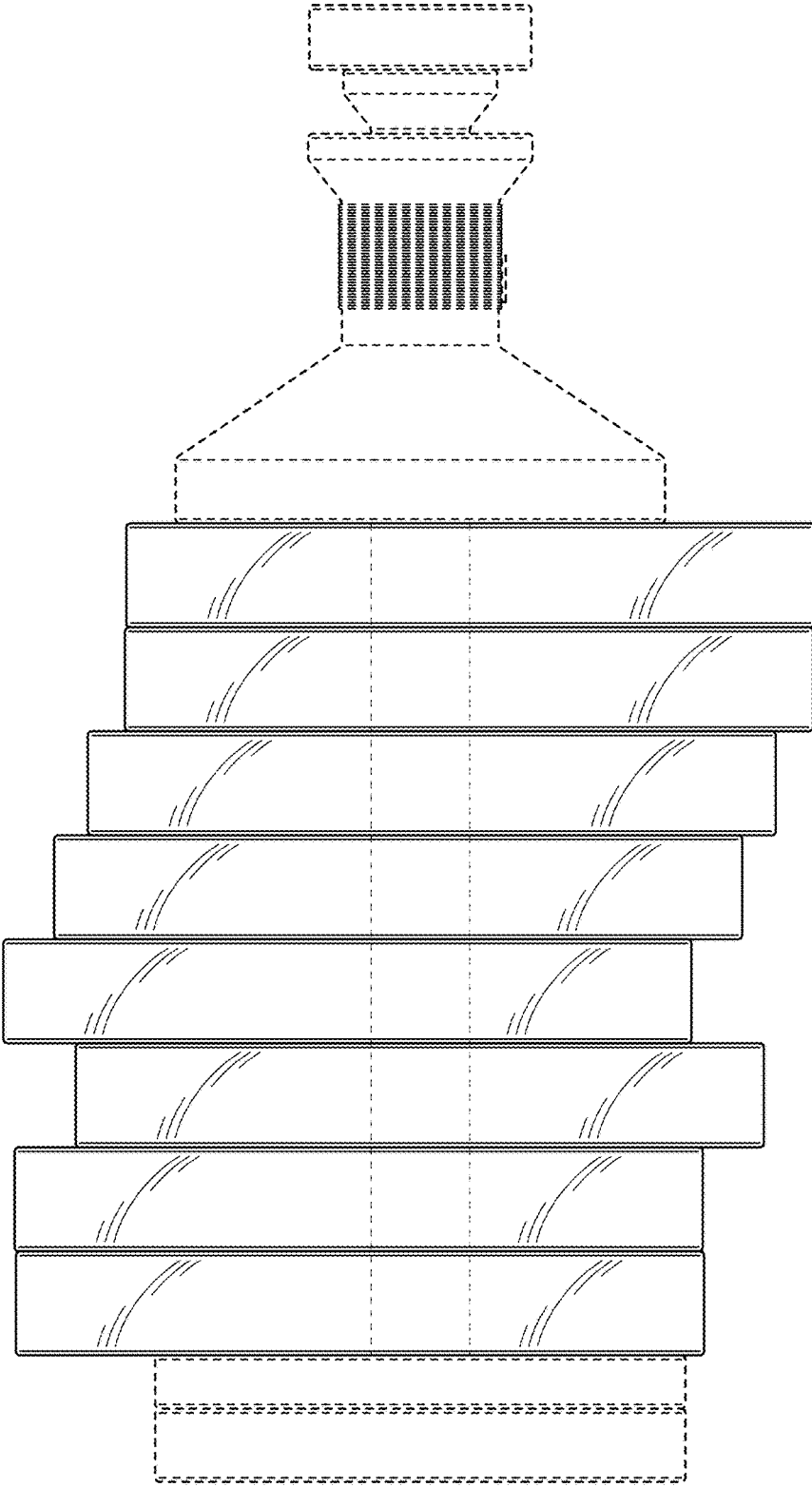

FIG. 11

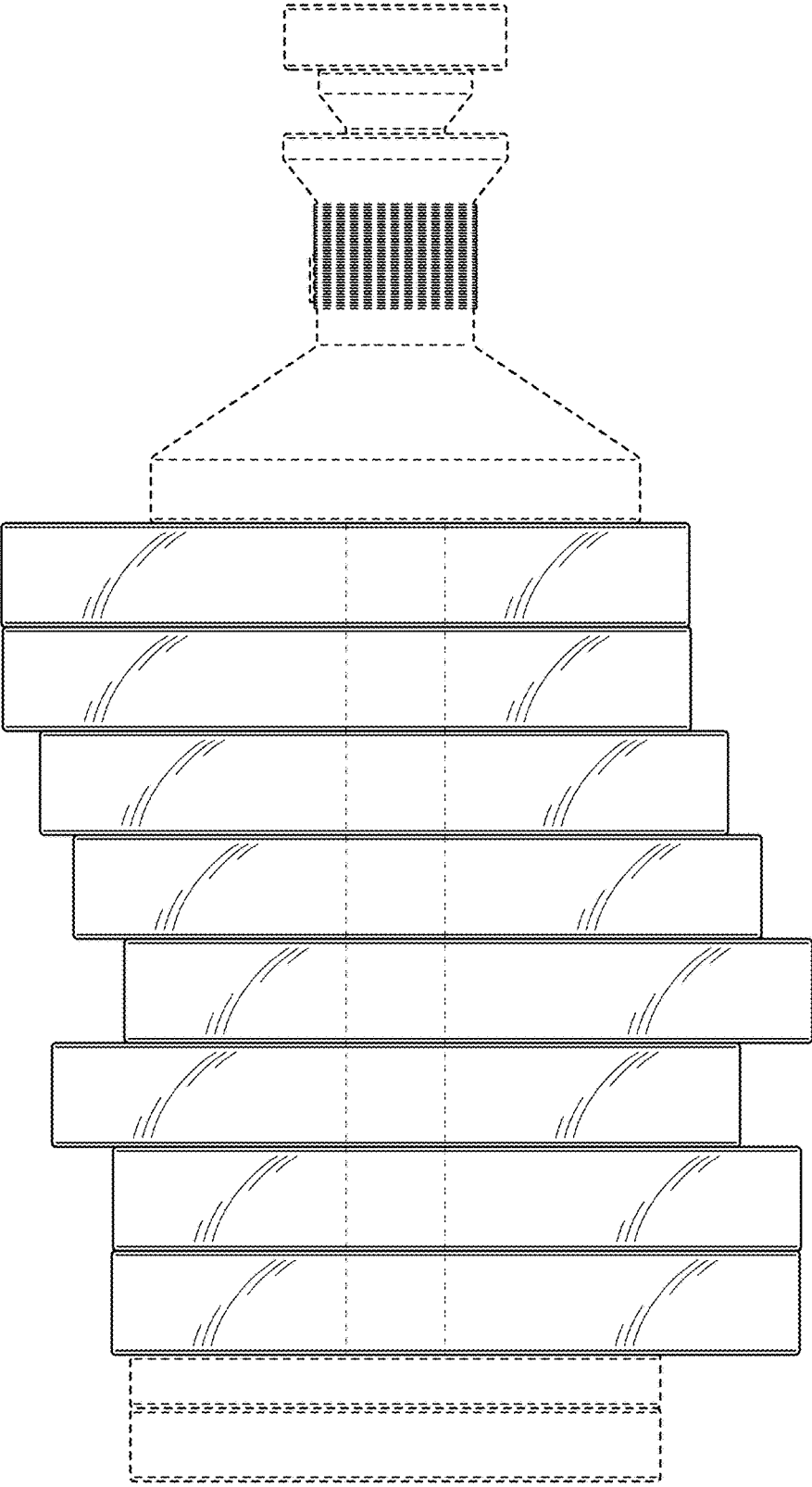

FIG. 12

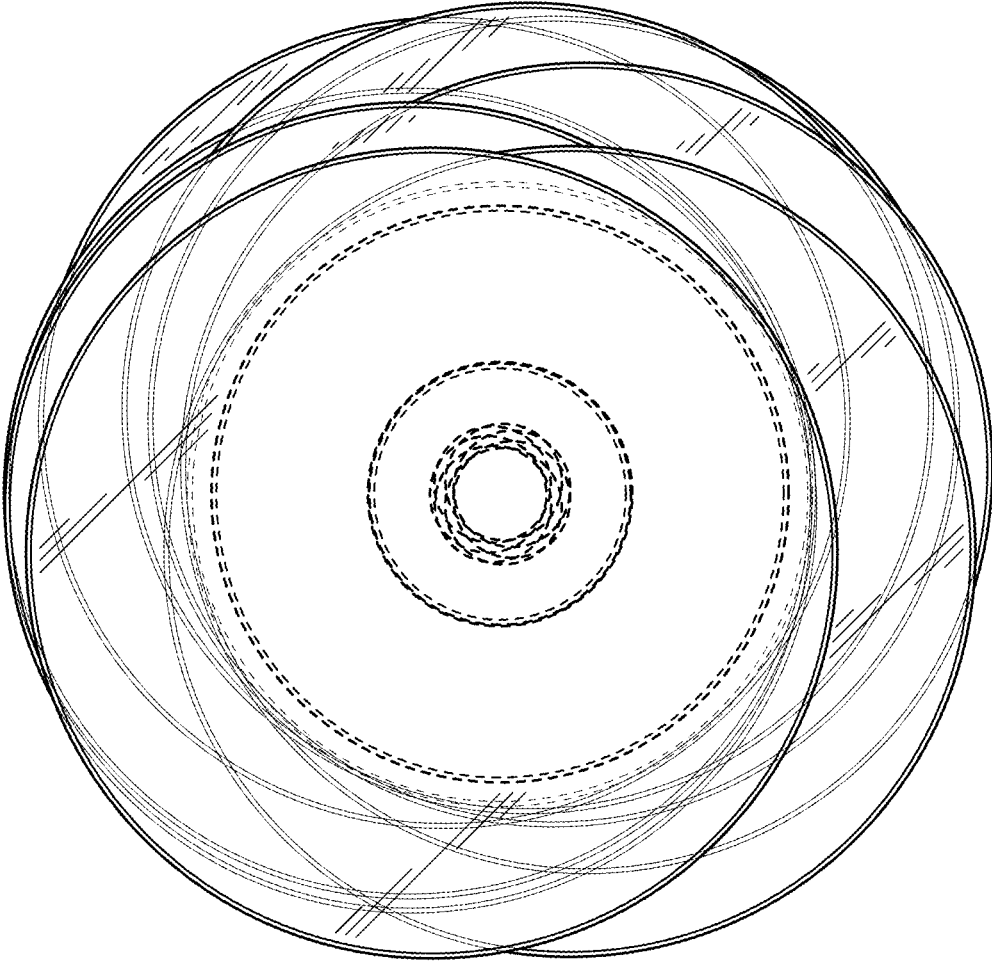

FIG. 13

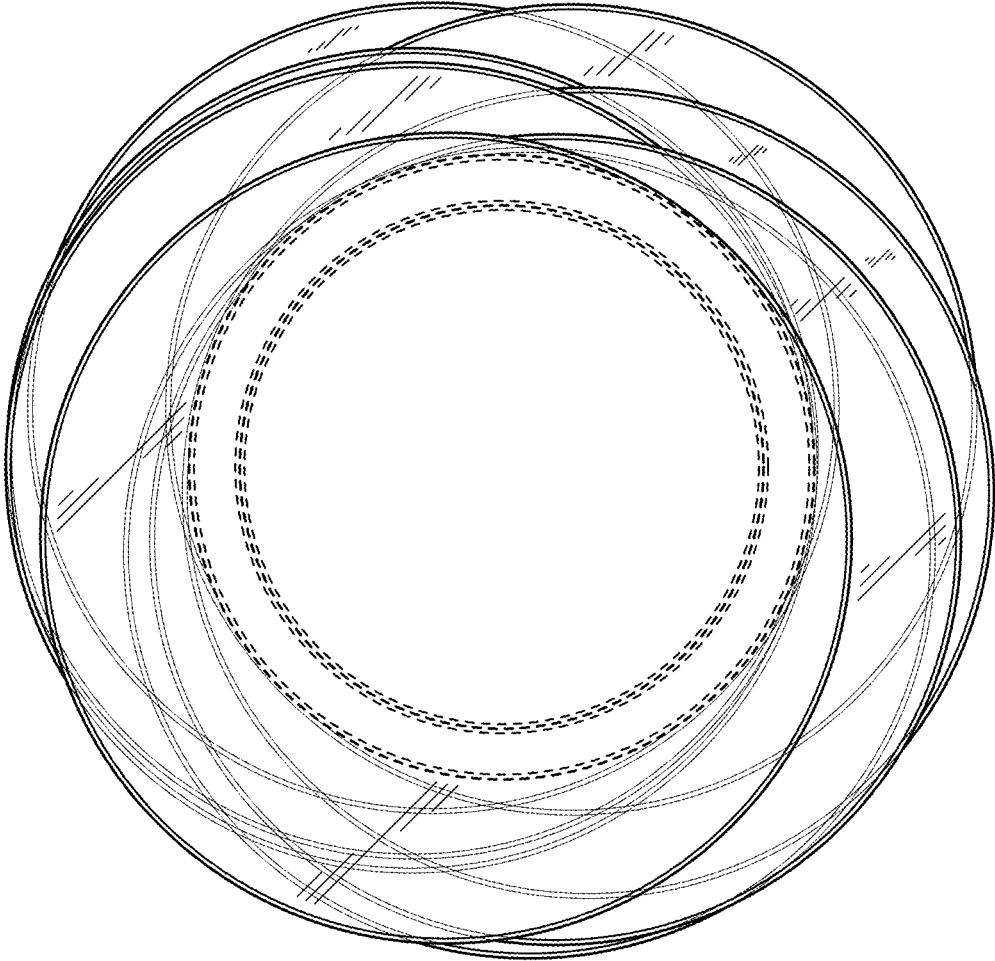

FIG. 14