



US00D697126S

(12) **United States Design Patent**
Kim et al.

(10) **Patent No.:** **US D697,126 S**

(45) **Date of Patent:** **** Jan. 7, 2014**

(54) **FLASH FOR DIGITAL CAMERA**

OTHER PUBLICATIONS

(75) Inventors: **Joo-Hyung Kim**, Seoul (KR); **InShik Kim**, Seoul (KR)

Samsung SEF15A Flashlight. [online] Retrieved Aug. 20, 2013 from URL: <<http://www.rakuten.com/prod/samsung-sef15a-flashlight-atl/218170287.html?listingId=119558178>>.*

(73) Assignee: **Samsung Electronics Co., Ltd.**, Gyeonggi-do (KR)

Olympus FL-LM2 Flash for E-M5 Digital Camera. [online] Retrieved Aug. 20, 2013 from URL: <http://www.bhphotovideo.com/c/product/853231-REG/Olympus_V3261400W000_FL_LM2_Flash_for_E_M5.html>.*

(**) Term: **14 Years**

* cited by examiner

(21) Appl. No.: **29/410,297**

Primary Examiner — Susan Bennett Hattan

(22) Filed: **Jan. 6, 2012**

Assistant Examiner — Vy Koenig

(51) **LOC (10) Cl.** **16-05**

(74) *Attorney, Agent, or Firm* — Harness, Dickey & Pierce

(52) **U.S. Cl.**

USPC **D16/239**

(58) **Field of Classification Search**

USPC D16/202, 237, 239, 240; D26/24, D26/37–38, 63, 110, 113, 129; 362/3, 362/16–18, 182, 552, 612; D13/180, 182; 313/313–316; 348/370; 396/200

See application file for complete search history.

(57) **CLAIM**

We claim the ornamental design for a flash for digital camera, as shown.

DESCRIPTION

FIG. 1 is a front/right-side/top perspective view of a flash for digital camera showing our new design; FIG. 2 is a front-side elevational view thereof; FIG. 3 is a rear-side elevational view thereof; FIG. 4 is a left-side elevational view thereof; FIG. 5 is a right-side elevational view thereof; FIG. 6 is a top plan view thereof; FIG. 7 is a bottom plan view thereof; and, FIG. 8 is a front/right-side/top perspective view thereof in association with a digital camera shown in broken lines for environmental reference.

The broken lines shown in the drawings depict environmental subject matter and form no part of the claimed design.

(56) **References Cited**

U.S. PATENT DOCUMENTS

D245,613 S *	8/1977	Woodring et al.	D16/239
D260,399 S *	8/1981	Quinn	D16/240
D260,997 S *	9/1981	Asaki et al.	D16/209
D318,679 S *	7/1991	Tanaka et al.	D16/239
D577,052 S *	9/2008	Orion et al.	D16/239
D628,221 S *	11/2010	Chen et al.	D16/202
D632,718 S *	2/2011	Tzeng	D16/202
D634,039 S *	3/2011	Lee	D26/24
D662,636 S *	6/2012	Katsaros	D26/60
D664,579 S *	7/2012	Tzeng	D16/202
D674,427 S *	1/2013	Khamsepoor et al.	D16/202

1 Claim, 6 Drawing Sheets

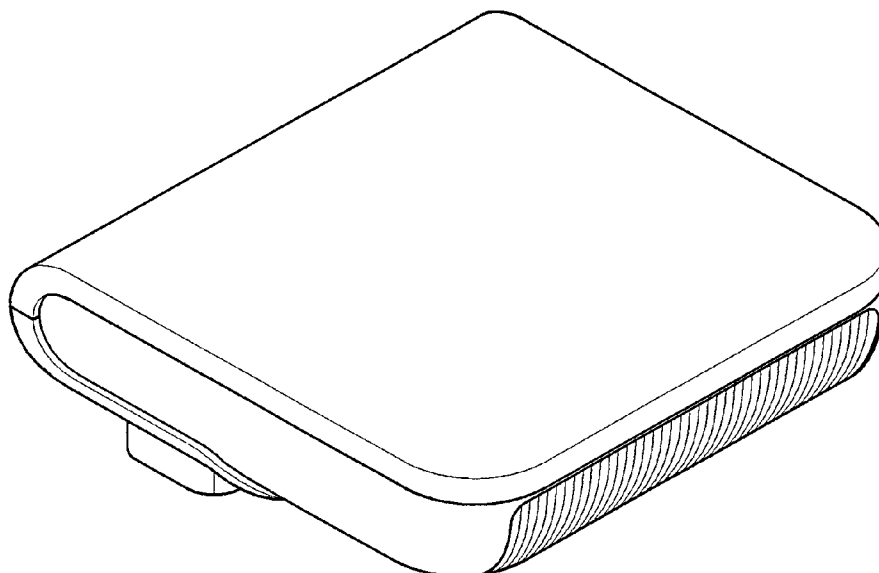

FIG. 1

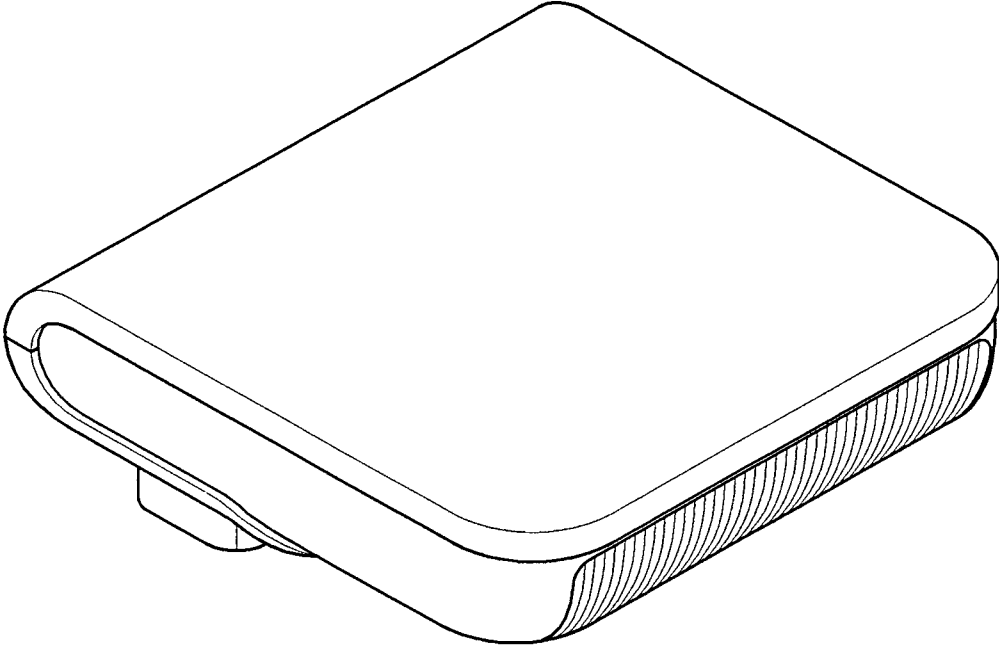

FIG. 2

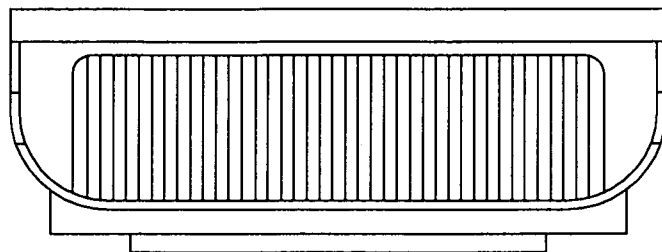

FIG. 3

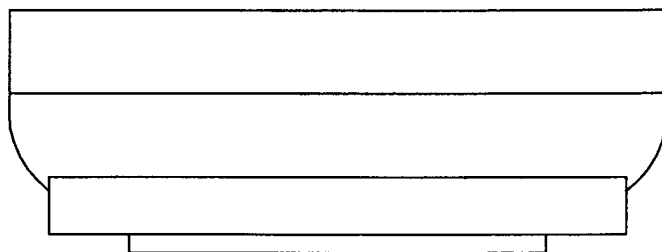

FIG.4

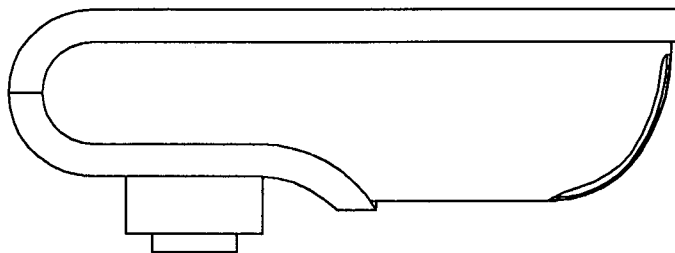

FIG.5

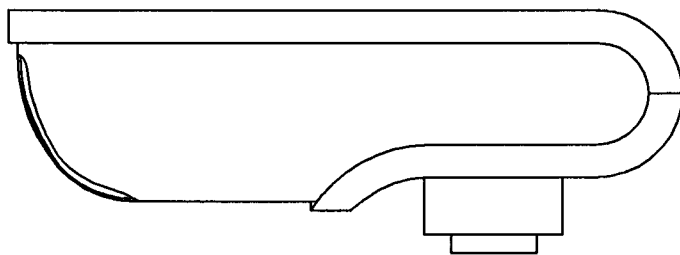

FIG.6

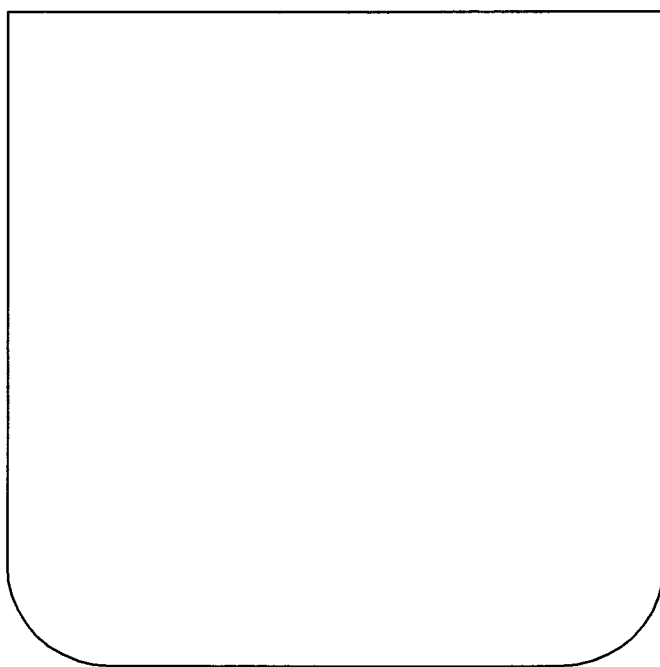

FIG. 7

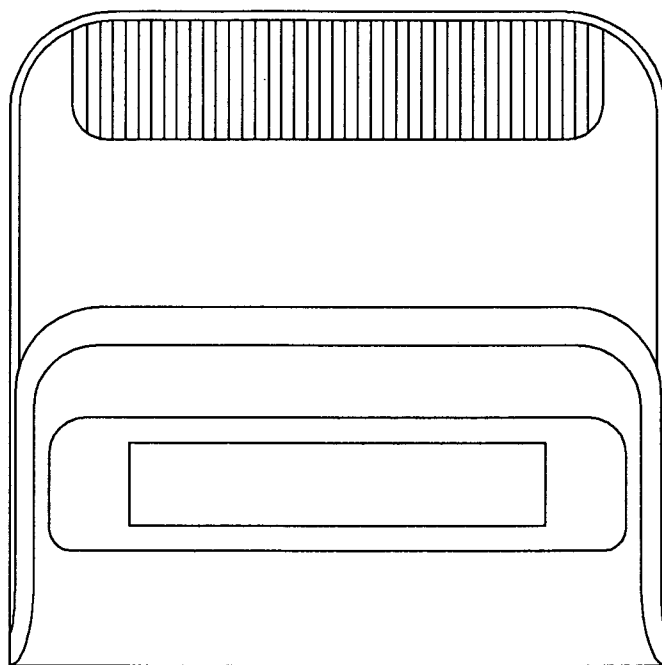

FIG. 8

