



US00D992504S

(12) **United States Design Patent**
Bochud

(10) **Patent No.:** **US D992,504 S**

(45) **Date of Patent:** **** Jul. 18, 2023**

(54) **INVERTER CHARGER**
(71) Applicant: **Studer Innotec SA**, Sion (CH)
(72) Inventor: **Jean-Daniel Bochud**, Ollon (CH)
(**) Term: **15 Years**
(21) Appl. No.: **35/512,891**
(22) Filed: **May 12, 2021**
(80) **Hague Agreement Data**
Int. Filing Date: **May 12, 2021**
Int. Reg. No.: **DM/214258**
Int. Reg. Date: **May 12, 2021**
Int. Reg. Pub. Date: **Nov. 12, 2021**

7,304,852 B2 * 12/2007 Hernandez H05K 7/20409
361/625
D620,885 S * 8/2010 Donth D13/110
7,817,406 B2 * 10/2010 Bremicker H05K 7/1432
361/679.01
D627,719 S * 11/2010 DuMelle D13/110
D677,222 S * 3/2013 Haapaniemi D13/110
D682,779 S * 5/2013 Magnusson D13/107
D706,214 S * 6/2014 Benn D13/110
D724,535 S * 3/2015 Wang D13/110
D728,474 S * 5/2015 Orlando D13/110
D775,076 S * 12/2016 Tsai D13/137.1
D789,887 S * 6/2017 Zeng D13/110
D831,569 S * 10/2018 Simoni D13/110
D853,962 S * 7/2019 Kanarellis D13/110

* cited by examiner

Primary Examiner — Derrick E Holland

(30) **Foreign Application Priority Data**
Nov. 17, 2020 (WO) WIPO99553
(51) **LOC (14) Cl.** **13-02**
(52) **U.S. Cl.**
USPC **D13/110**
(58) **Field of Classification Search**
USPC D13/110, 107, 108, 118, 123, 162, 164,
D13/168, 169, 174, 177, 184, 199;
D14/257, 432, 438
CPC H05K 5/00; H05K 5/02; H05K 5/0247;
H05K 7/00; H05K 7/20; H05K 7/20136;
H05K 7/20154; H05K 7/209; H05K
7/1417; H05K 7/1427; H05K 7/20918;
H02M 7/00; H02M 7/003; H02J 7/0042
See application file for complete search history.

(57) **CLAIM**

The ornamental design for an inverter charger, as shown and described.

DESCRIPTION

- 2. Inverter charger
- 2.1 : Front
- 2.2 : Back
- 2.3 : Top
- 2.4 : Bottom
- 2.5 : Left
- 2.6 : Right
- 2.7 : Perspective

The portions of the inverter charger shown in broken lines form no part of the claimed design.

(56) **References Cited**
U.S. PATENT DOCUMENTS
5,091,823 A * 2/1992 Kanbara H05K 7/20927
361/736

1 Claim, 7 Drawing Sheets

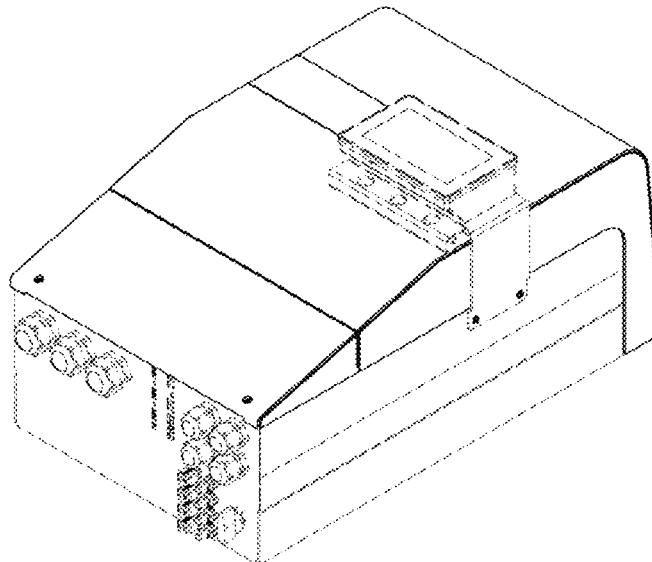

2.1

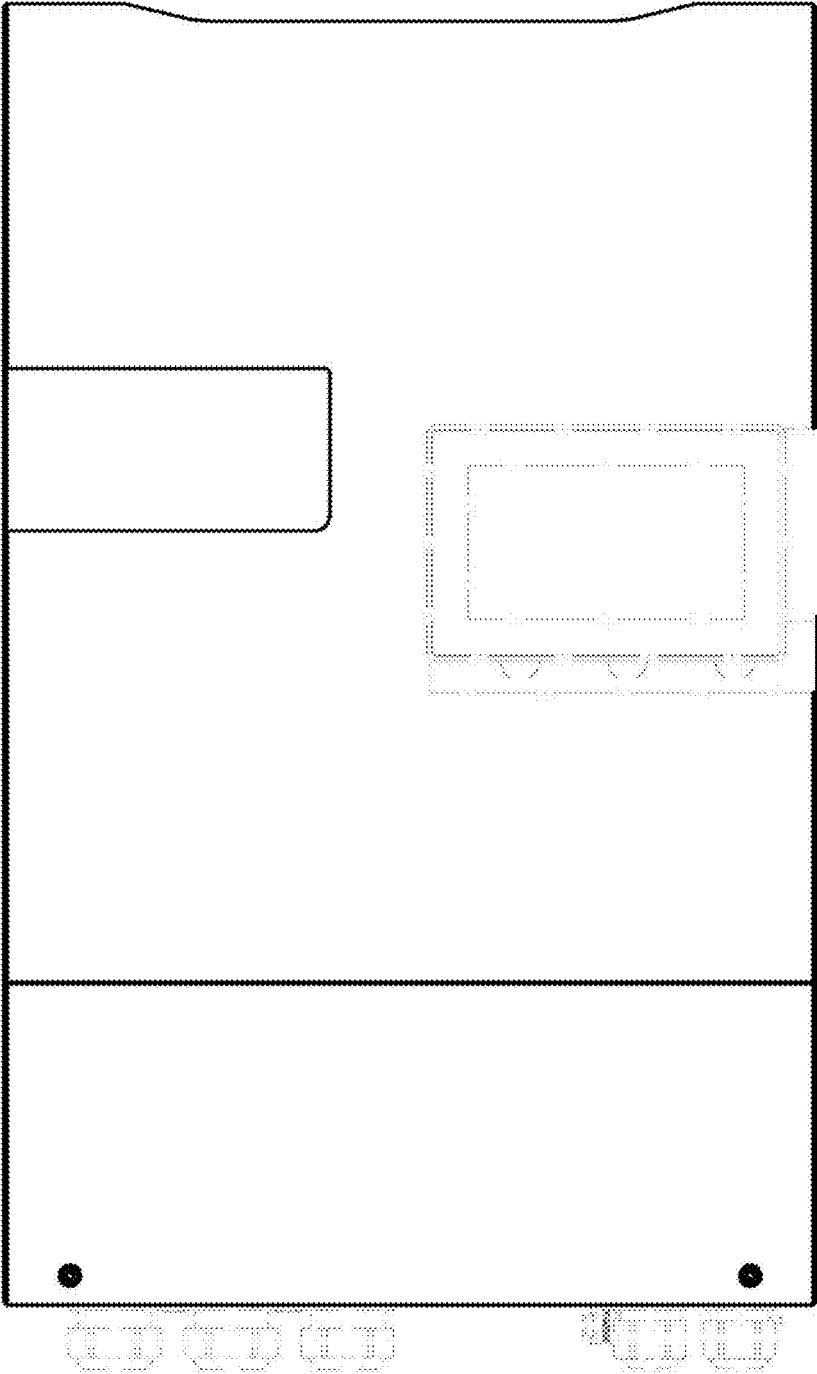

2.2

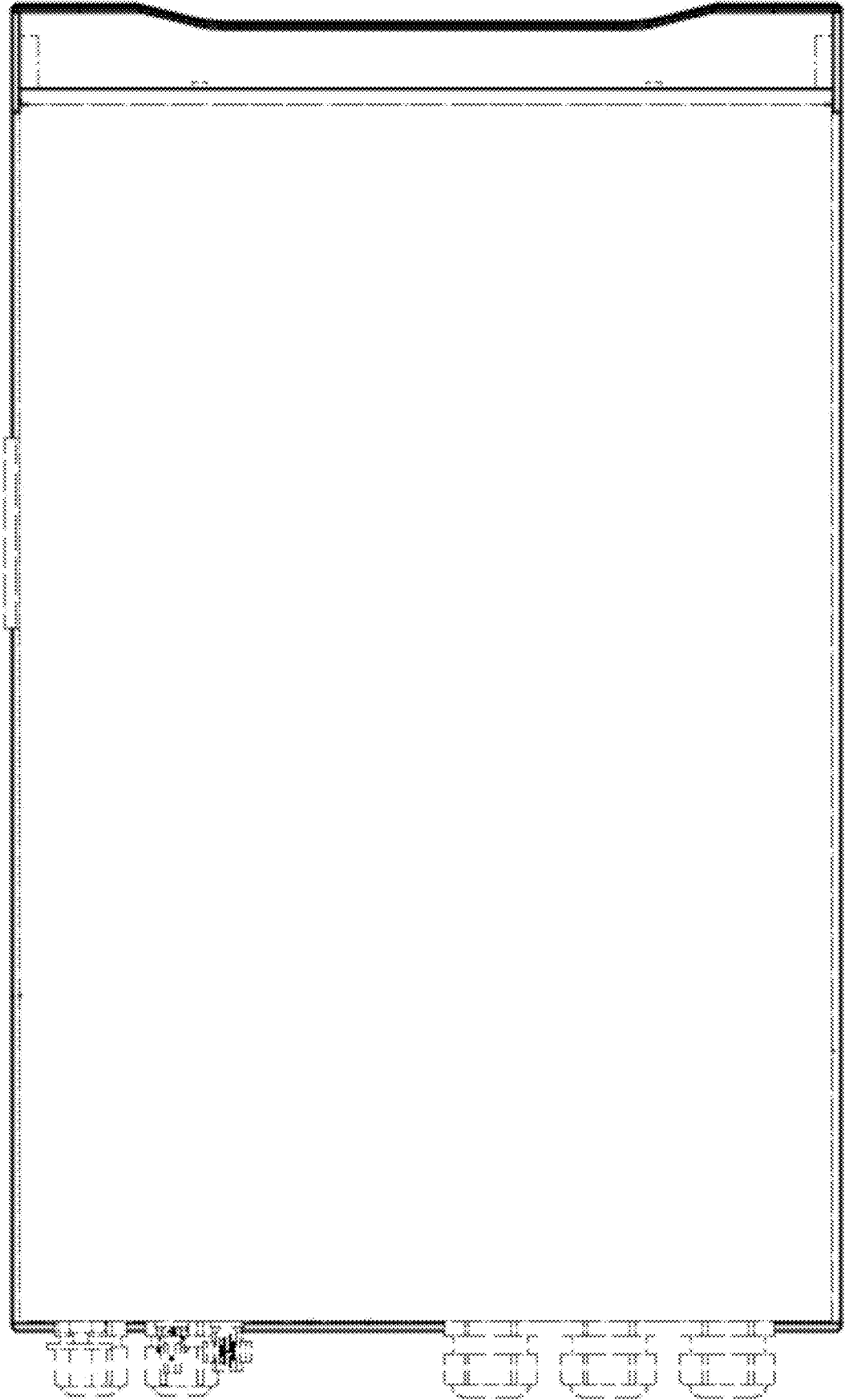

2.3

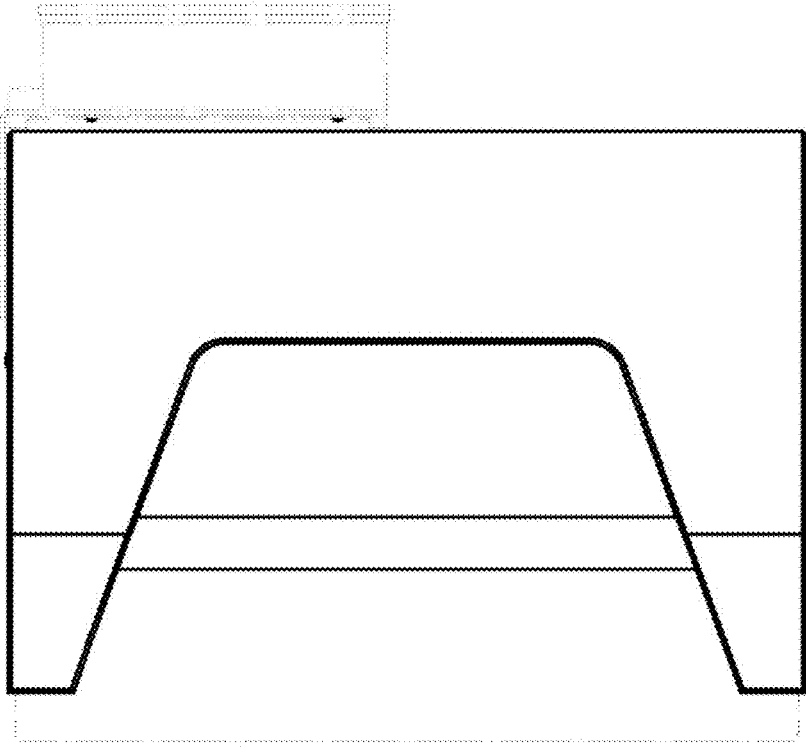

2.4

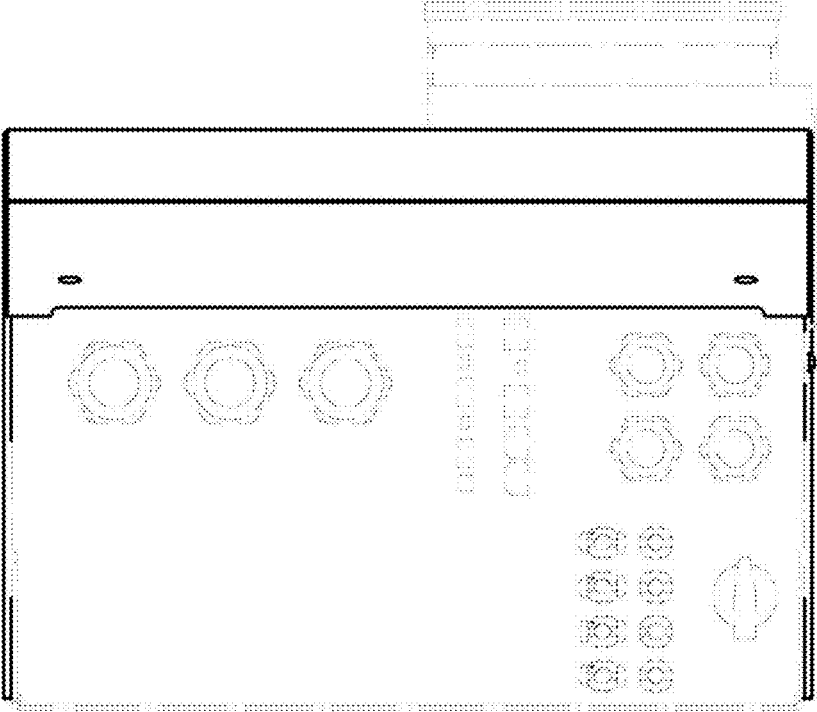

2.5

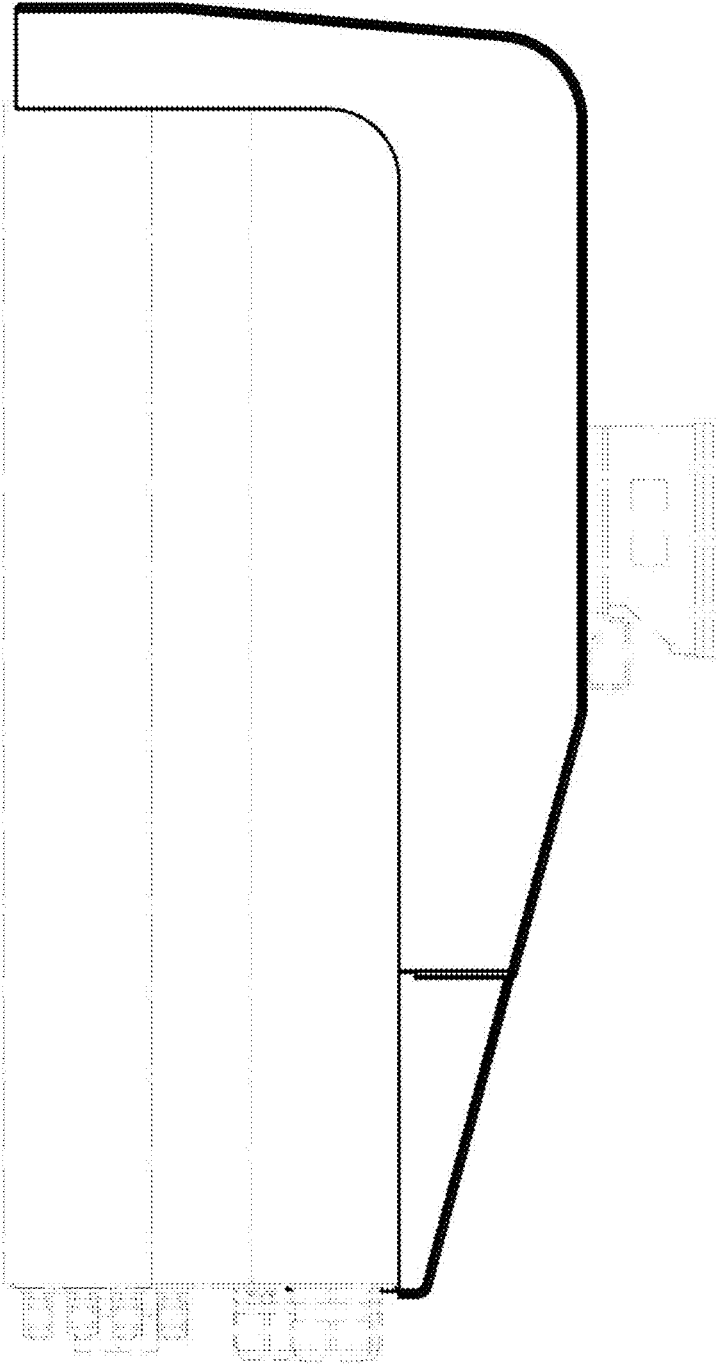

2.6

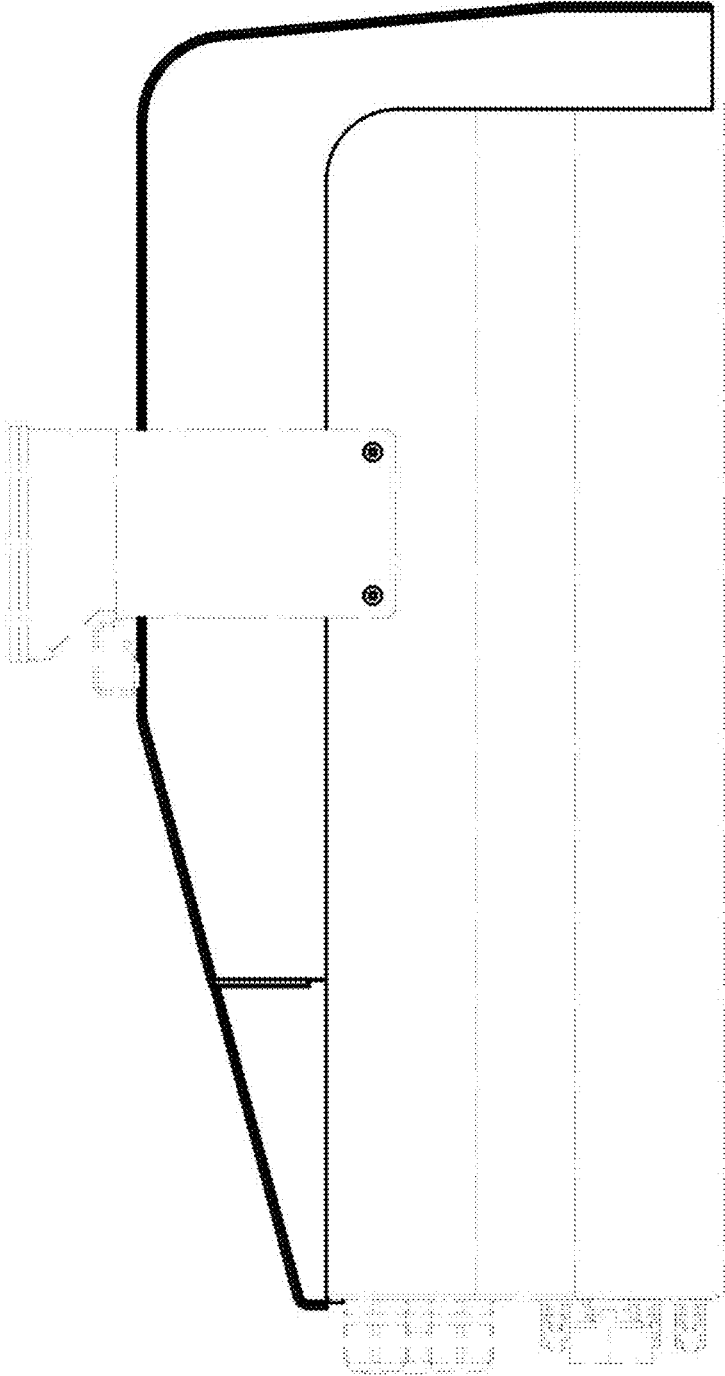

2.7

