



US00D757479S

(12) **United States Design Patent**
Steiner

(10) **Patent No.:** **US D757,479 S**

(45) **Date of Patent:** **** May 31, 2016**

(54) **COFFEEMAKER**

(71) Applicant: **Hamilton Beach Brands, Inc.**, Glen Allen, VA (US)

(72) Inventor: **Mark C Steiner**, Midlothian, VA (US)

(73) Assignee: **Hamilton Beach Brands, Inc.**, Glen Allen, VA (US)

(**) Term: **14 Years**

(21) Appl. No.: **29/519,341**

(22) Filed: **Mar. 4, 2015**

(51) **LOC (10) Cl.** **07-01**

(52) **U.S. Cl.**
USPC **D7/309; D7/311**

(58) **Field of Classification Search**
USPC D7/300, 309-311, 306-308, 305;
222/146.6, 185.1; 99/295, 273, 304
CPC A47J 31/46; A47J 31/407; A47J 31/50;
A47J 31/18
See application file for complete search history.

(56) **References Cited**

U.S. PATENT DOCUMENTS

D181,720	S	*	12/1957	Fitzgerald	D7/301
4,323,171	A	*	4/1982	Whorton, III	B67D 1/0079 222/180
D345,484	S	*	3/1994	Mason	D7/309
D354,193	S	*	1/1995	Storsberg	D7/309
D395,975	S	*	7/1998	Munoz	D7/308

D408,206	S	*	4/1999	Stafford	D7/306
D430,448	S	*	9/2000	De' Longhi	D7/309
6,722,265	B2	*	4/2004	Priley	A23F 3/18 99/299
D666,864	S	*	9/2012	Dahlstrom	D7/309
D678,718	S	*	3/2013	Grassia	D7/309
D686,033	S	*	7/2013	Burton	D7/306
D689,726	S	*	9/2013	Romandy	D7/309
D702,237	S	*	4/2014	Oberpriller	D14/420
D707,485	S	*	6/2014	Thul	D7/300
D733,481	S	*	7/2015	Rousselin	D7/306
D738,151	S	*	9/2015	Weseman	D7/306
D740,600	S	*	10/2015	Damon	D7/307

* cited by examiner

Primary Examiner — Marianne Pandozzi

(74) *Attorney, Agent, or Firm* — Alexander D. Raring

(57) **CLAIM**

The ornamental design for a coffeemaker, as shown and described.

DESCRIPTION

FIG. 1 is a perspective view as seen from the top, front and right side of a coffeemaker showing the new design; FIG. 2 is a front view thereof; FIG. 3 is a rear view thereof; FIG. 4 is a left side view thereof; FIG. 5 is a right side view thereof; FIG. 6 is a top view thereof; and, FIG. 7 is a bottom view thereof. The broken lines in the drawings depict portions of the coffeemaker that form no part of the claimed design.

1 Claim, 7 Drawing Sheets

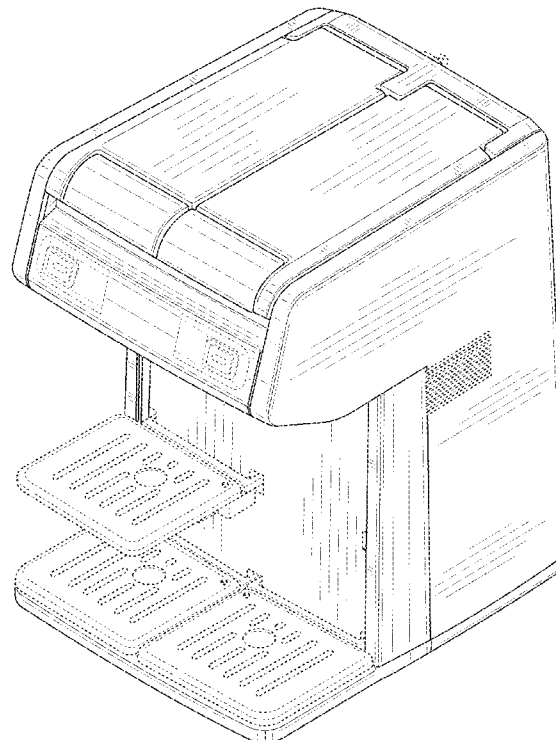

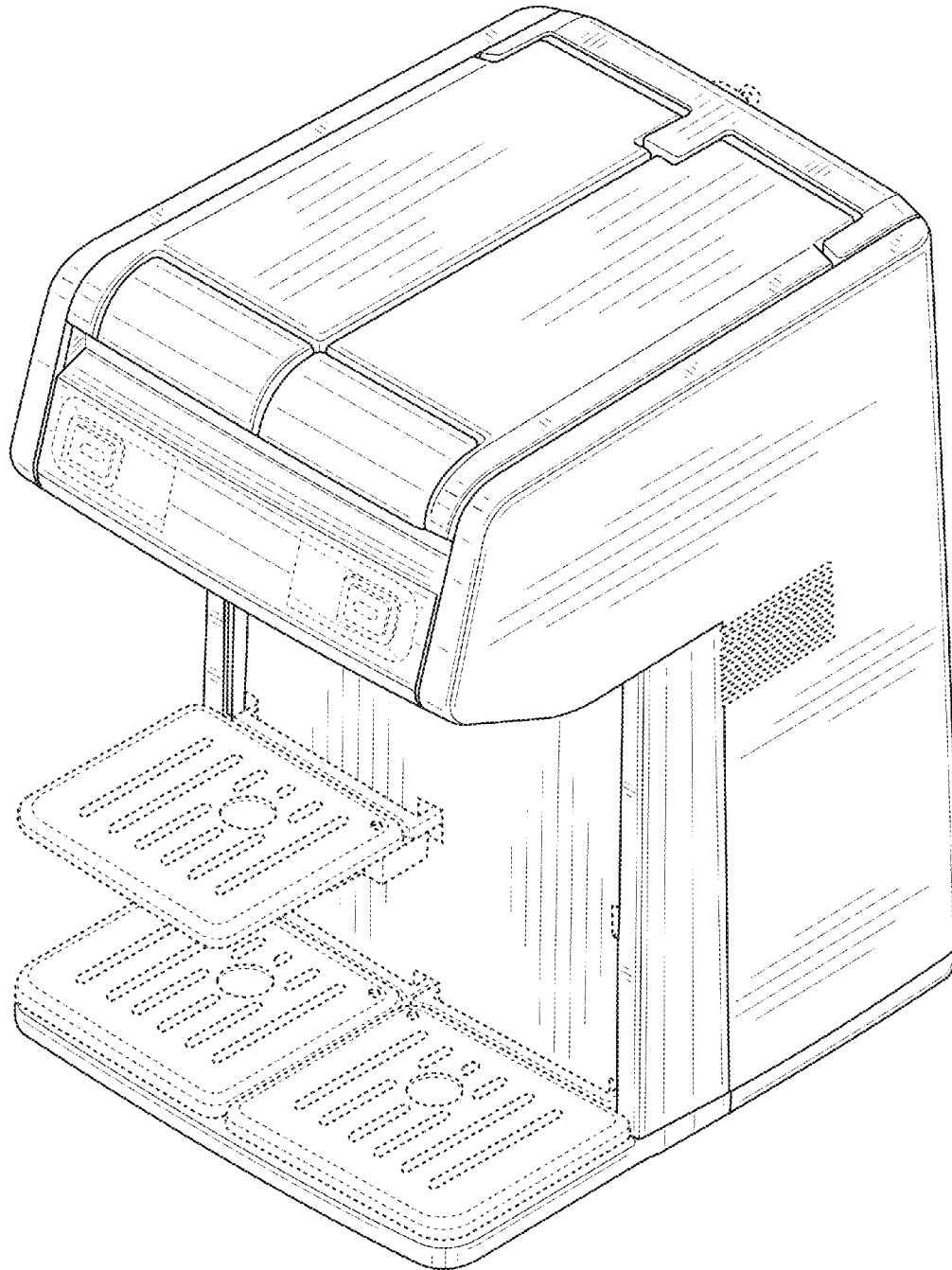

FIG. 1

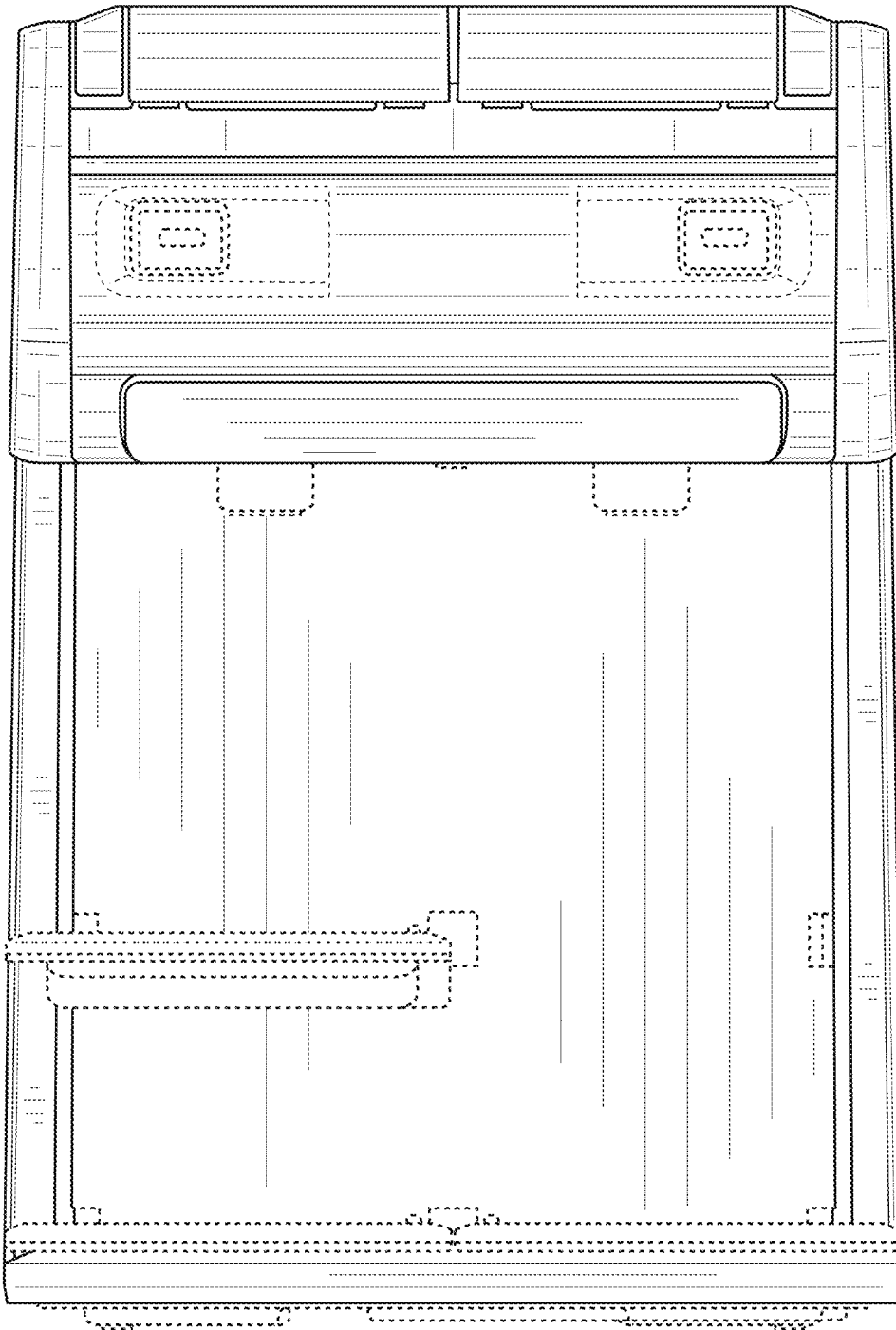

FIG. 2

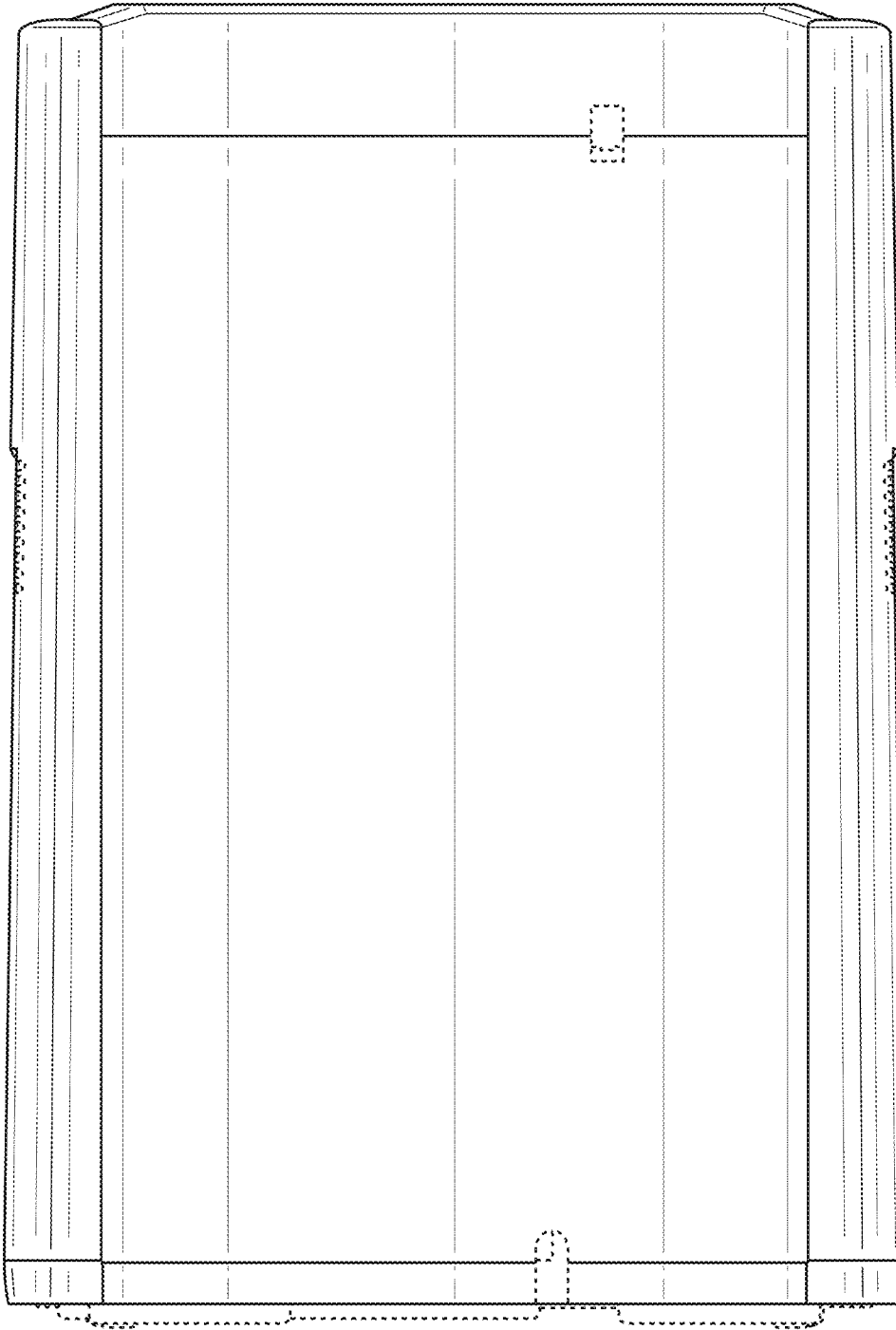

FIG. 3

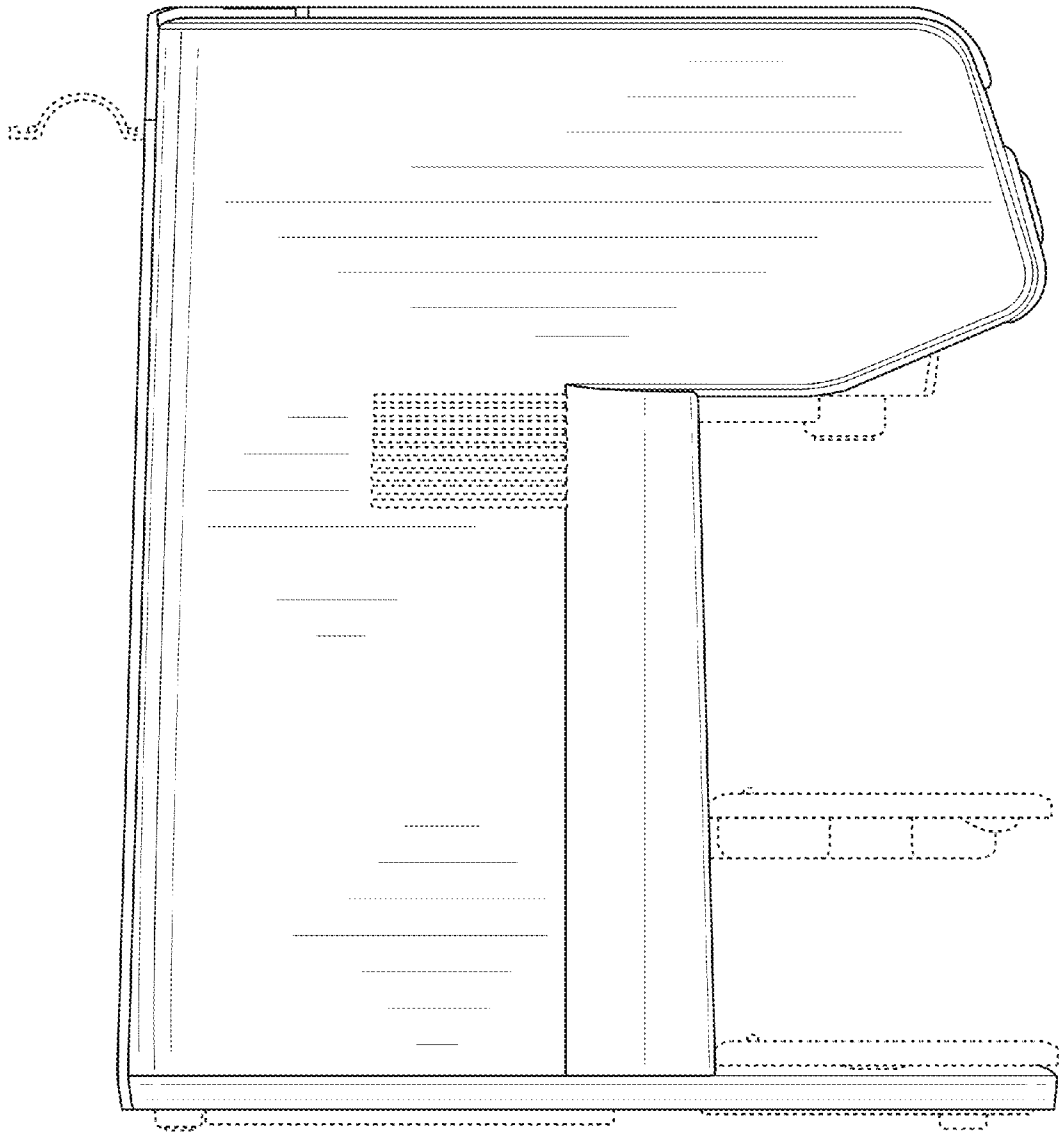

FIG. 4

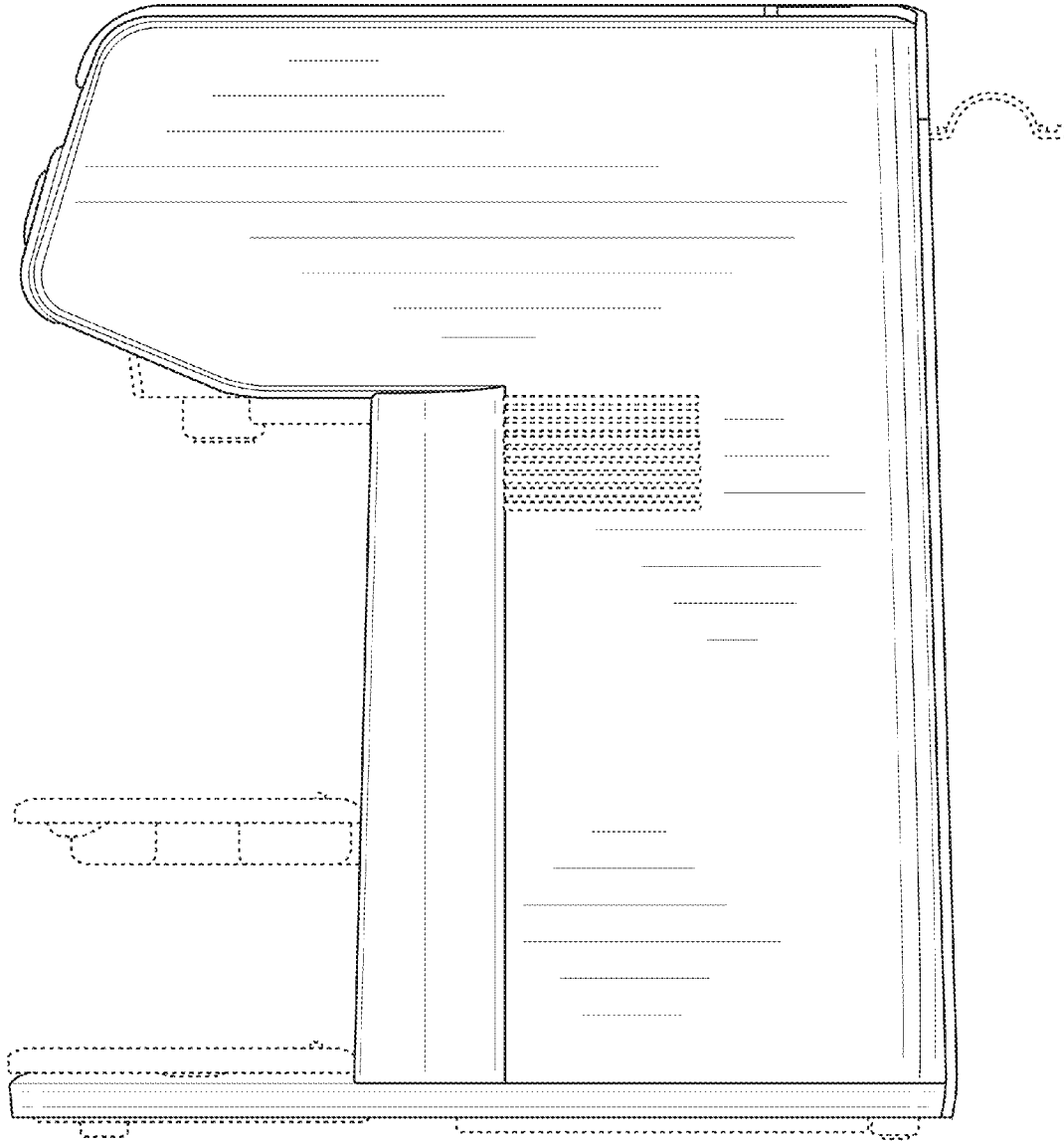

FIG. 5

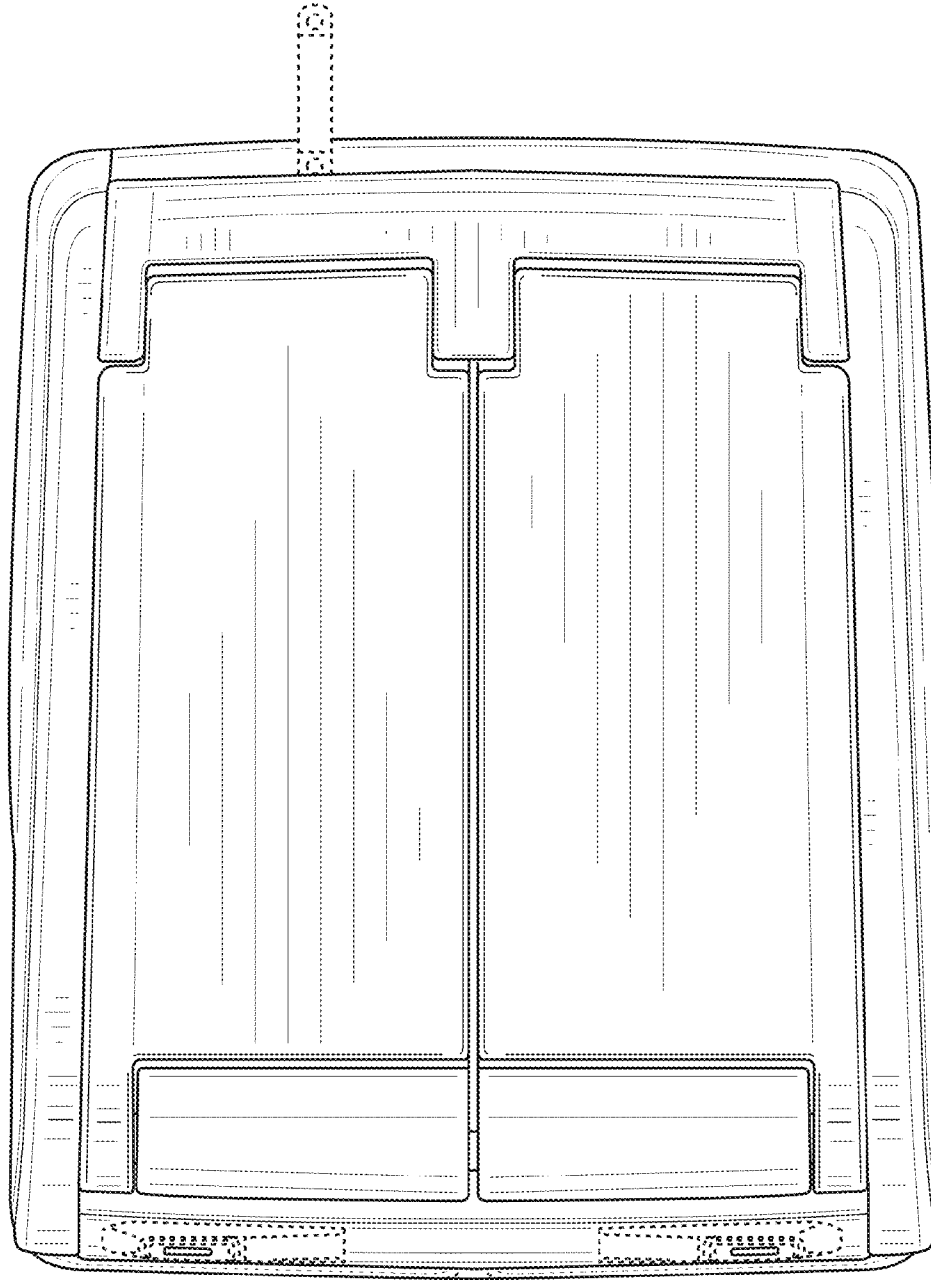

FIG. 6

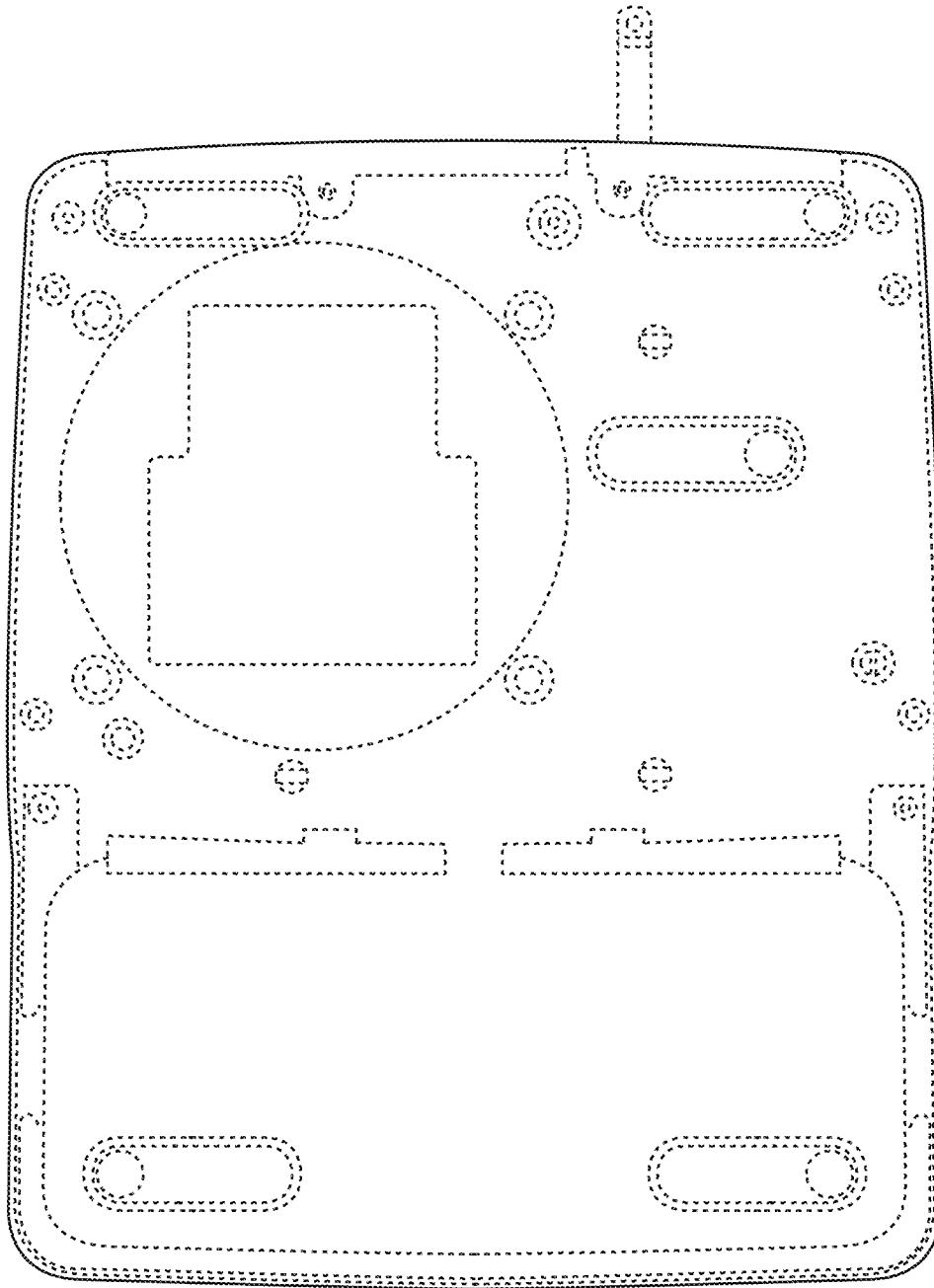

FIG. 7