



US00D780180S

(12) **United States Design Patent**  
**Ironmonger et al.**

(10) **Patent No.:** **US D780,180 S**  
(45) **Date of Patent:** **\*\* Feb. 28, 2017**

(54) **GAMES CONTROLLER**  
(71) Applicant: **Ironburg Inventions Ltd.**, Wincanton,  
Somerset (GB)  
(72) Inventors: **Duncan Ironmonger**, Brookhaven, GA  
(US); **Carl S. Jeffrey**, Cheltenham  
(GB)  
(73) Assignee: **Ironburg Inventions Ltd.**, Wincanton  
(GB)  
(\*\*) Term: **15 Years**

7,314,413 B2 \* 1/2008 Ogata ..... A63F 13/06  
273/148 B  
7,510,477 B2 3/2009 Argentar  
7,854,655 B2 \* 12/2010 Mao ..... G06F 3/017  
273/148 B  
7,859,514 B1 12/2010 Park  
D638,017 S \* 5/2011 Ortiz ..... D14/401  
D667,892 S \* 9/2012 Burgess ..... D21/333  
(Continued)

**FOREIGN PATENT DOCUMENTS**

EP 2 479 636 7/2012  
EP 2 698 185 2/2015  
(Continued)

(21) Appl. No.: **29/556,666**  
(22) Filed: **Mar. 2, 2016**  
(51) **LOC (10) Cl.** ..... **14-03**  
(52) **U.S. Cl.**  
USPC ..... **D14/401; D21/333**  
(58) **Field of Classification Search**  
USPC ..... D14/496, 401, 435, 474, 483, 217, 137,  
D14/138, 160, 168, 356, 203.1–203.8,  
D14/507; 345/156, 169, 173–179, 905;  
715/727–729, 864, 700, 706, 719; 710/1,  
710/5, 8; 713/1, 600; 455/1.1, 1.7, 73,  
455/344–347, 93, 95, 3.01–3.06, 550.1,  
455/573.1; 370/342–344; 369/1, 2, 6–12;  
463/40–47, 51–57, 1, 29–35; D21/324,  
D21/328, 333; 273/148 B  
CPC ..... A63F 13/00; A63F 13/02; A63F 9/00;  
G06F 17/00; G06F 19/00  
See application file for complete search history.

**OTHER PUBLICATIONS**

Burns, "Review: Scut Xbox 360 Controller," Xboxer360.com  
(2010).  
(Continued)

*Primary Examiner* — Prabhakar Deshmukh  
(74) *Attorney, Agent, or Firm* — Walters & Wasylyna  
LLC

(57) **CLAIM**

The ornamental design for a games controller, as shown and  
described.

**DESCRIPTION**

FIG. 1 is a perspective view of a games controller in  
accordance with the present design;  
FIG. 2 is a front view of the games controller of FIG. 1;  
FIG. 3 is a rear view of the games controller of FIG. 1;  
FIG. 4 is a bottom view of the games controller of FIG. 1;  
FIG. 5 is a top view of the games controller of FIG. 1;  
FIG. 6 is a left side view of the games controller of FIG. 1;  
and,  
FIG. 7 is a right side view of the games controller of FIG. 1.

(Continued)

(56) **References Cited**  
**U.S. PATENT DOCUMENTS**

6,171,191 B1 \* 1/2001 Ogata ..... A63F 13/06  
273/148 B  
6,231,444 B1 \* 5/2001 Goto ..... G05G 9/047  
273/148 B  
6,251,015 B1 6/2001 Caprai  
6,572,108 B1 \* 6/2003 Bristow ..... A63F 13/06  
273/148 B

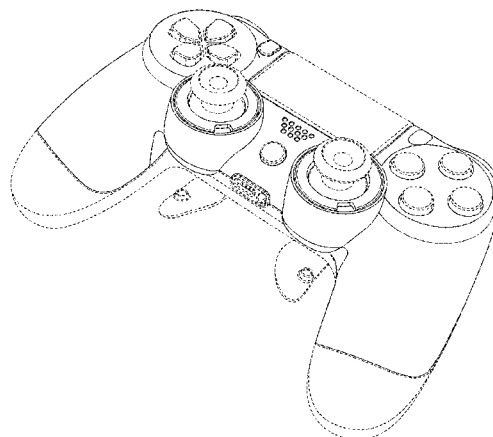

The broken lines in the drawings show environment that forms no part of the claimed design.

**1 Claim, 7 Drawing Sheets**

2009/0258705	A1	10/2009	Guinchard
2010/0304865	A1	12/2010	Picunko
2011/0256930	A1	10/2011	Jaouen
2011/0281649	A1	11/2011	Jaouen
2012/0322553	A1	12/2012	Burgess et al.
2014/0274397	A1	9/2014	Sebastian
2015/0238855	A1	8/2015	Uy et al.

(56)

**References Cited**

U.S. PATENT DOCUMENTS

8,641,525	B2 *	2/2014	Burgess	.....	A63F 13/24
					200/329
D715,296	S *	10/2014	Huang	.....	D14/401
D733,802	S *	7/2015	Burgess	.....	D14/401
D748,734	S *	2/2016	Burgess	.....	D21/333
D766,375	S *	9/2016	Kujawski	.....	D14/401
2001/0003713	A1	6/2001	Willner et al.		
2002/0052237	A1	5/2002	Magill		
2002/0128064	A1	9/2002	Sobota		
2003/0067111	A1	4/2003	Swan		
2004/0259059	A1	12/2004	Aoki		
2005/0083297	A1	4/2005	Duncan		
2005/0255918	A1	11/2005	Riggs et al.		
2009/0088250	A1	4/2009	Carlson		

FOREIGN PATENT DOCUMENTS

GB	2 244 546	12/1991
GB	2 481 633	1/2012
WO	WO 2008/131249	10/2008

OTHER PUBLICATIONS

“Rapid Fire Mod for Wireless Xbox 360 Controller,” forum on xbox-scene.com, (2008).  
 “Thrustmaster USB game controller roundup,” dansdata.com/tmsticks.htm (2002).  
 Coles, Olin, “Thrustmaster Run-N-Drive PC/PS3 Wireless Gamepad” BenchmarkReviews.com (2009).

\* cited by examiner

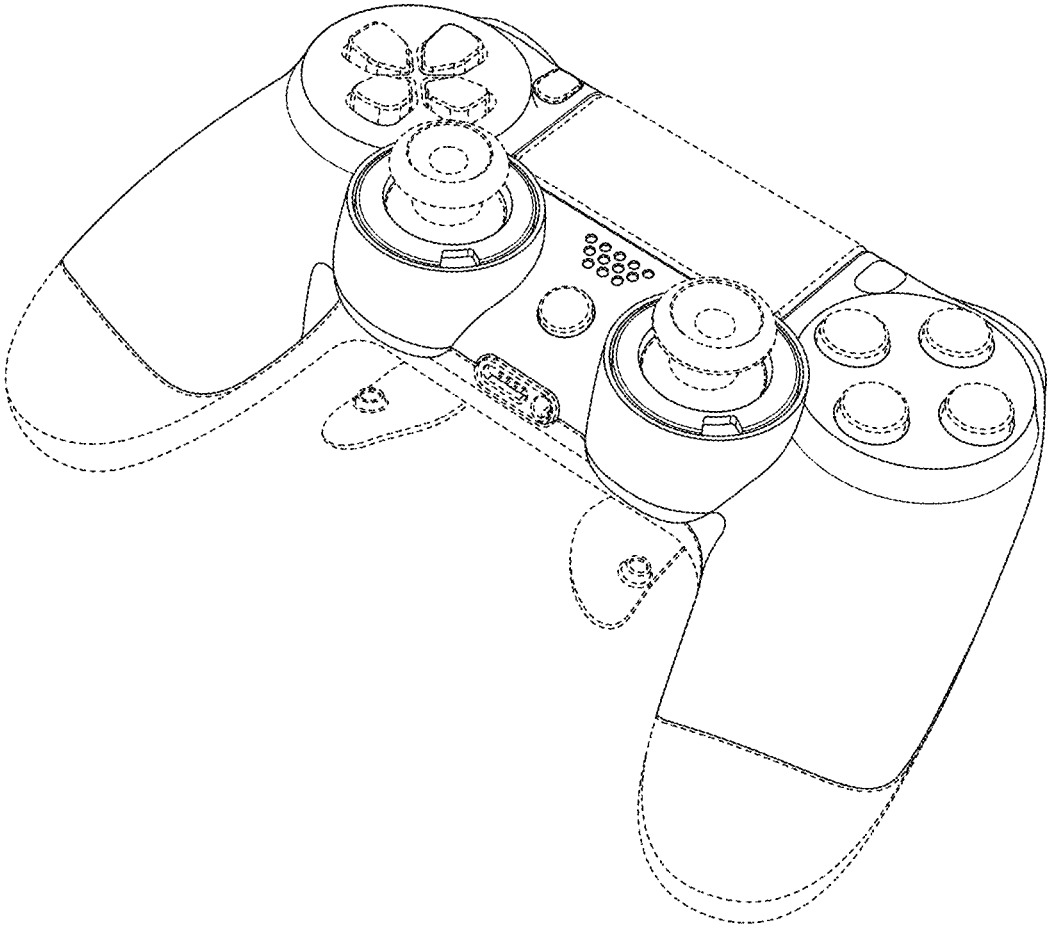

FIG. 1

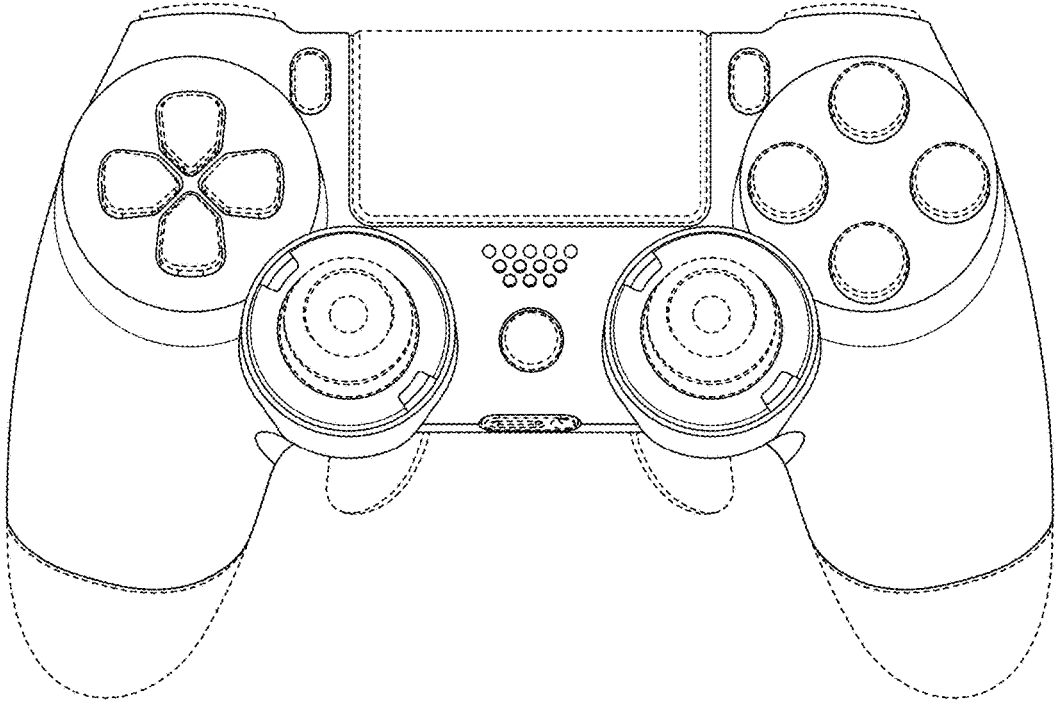

FIG. 2

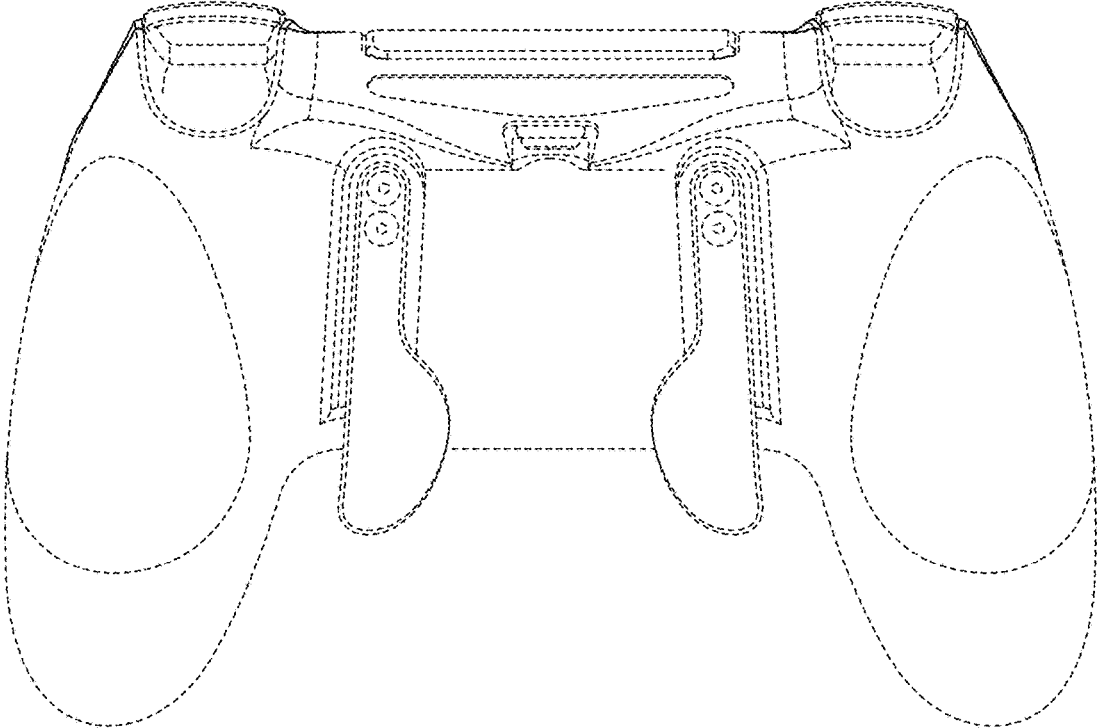

FIG. 3

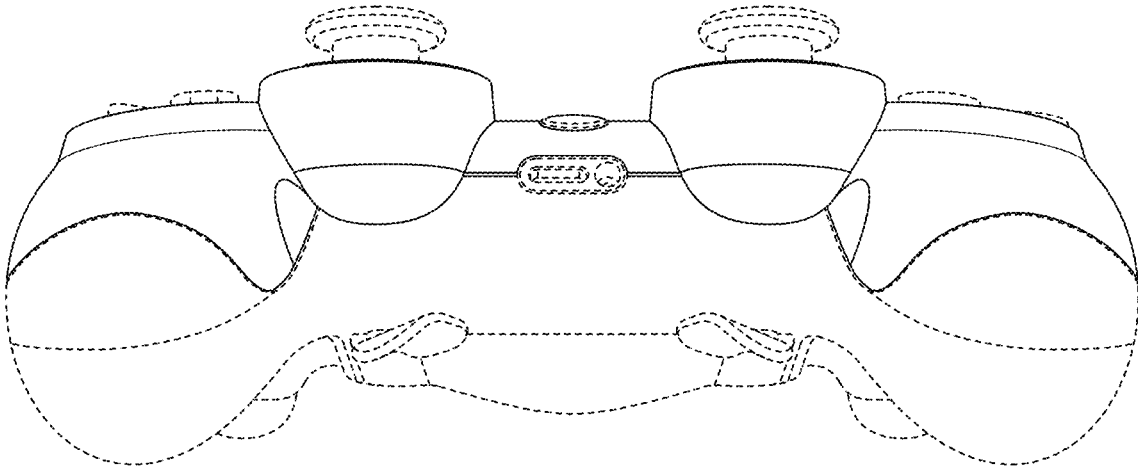

FIG. 4

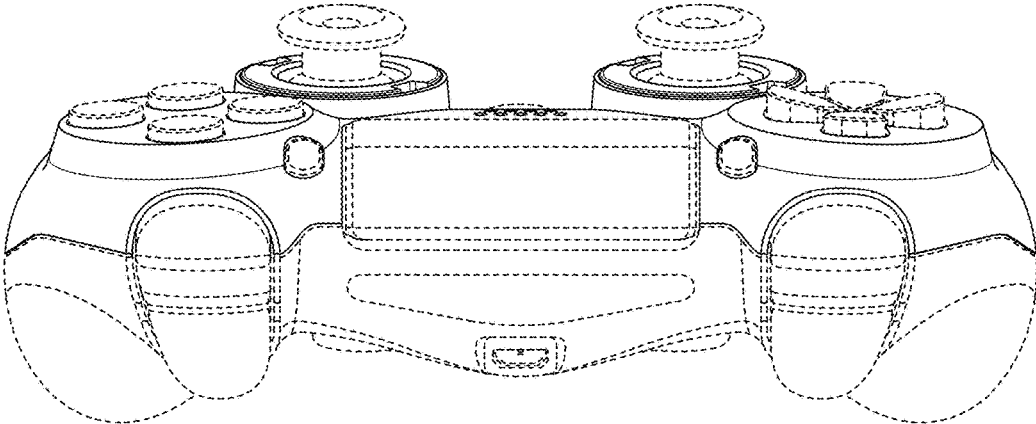

FIG. 5

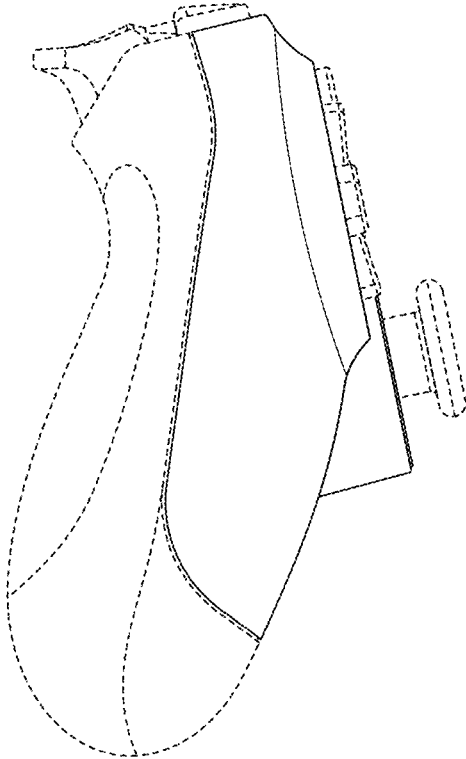

FIG. 6



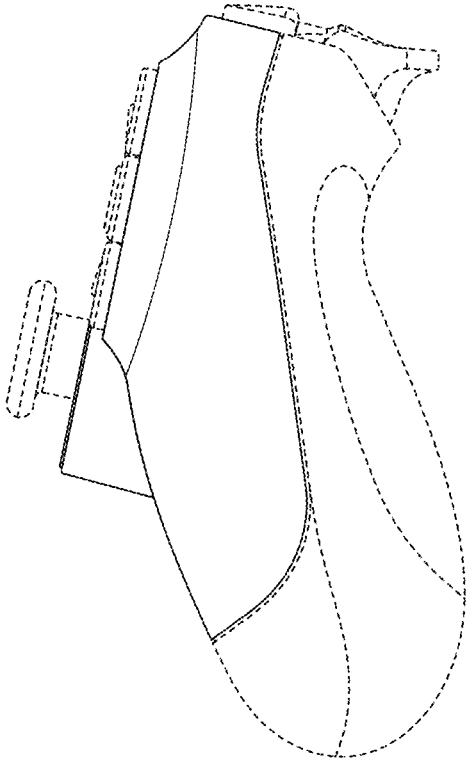

FIG. 7