



US00D729657S

(12) **United States Design Patent**
Behar

(10) **Patent No.:** **US D729,657 S**

(45) **Date of Patent:** **** May 19, 2015**

- (54) **ACTIVITY TRACKING BAND**
- (71) Applicant: **AliphCom**, San Francisco, CA (US)
- (72) Inventor: **Yves Albert Behar**, San Francisco, CA (US)
- (73) Assignee: **AliphCom**, San Francisco, CA (US)
- (**) Term: **14 Years**
- (21) Appl. No.: **29/508,180**
- (22) Filed: **Nov. 4, 2014**
- (51) **LOC (10) Cl.** **10-04**
- (52) **U.S. Cl.**
USPC **D10/70; D10/78**
- (58) **Field of Classification Search**
CPC G08G 1/096883; G08G 1/096872;
G08G 1/096775; G01C 21/16; G01C 21/3688;
G01C 21/30; G01V 8/20; G01J 5/02; G01J
5/023; G01J 5/24; G01J 5/10; G01J 5/20;
G01J 5/0235; G01J 5/08; G01J 5/0853;
G01J 5/33; G01J 5/34
USPC D10/70, 78, 103
See application file for complete search history.

D549,602 S *	8/2007	Oberrieder et al.	D10/65
D550,105 S *	9/2007	Oberrieder et al.	D10/65
D560,520 S *	1/2008	Oberrieder et al.	D10/65
D569,282 S *	5/2008	Daniel	D10/65
D573,905 S *	7/2008	Poirier	D10/65
D610,476 S *	2/2010	Daniel	D10/65
D645,360 S *	9/2011	Kiser et al.	D10/32
D670,583 S *	11/2012	Shaanan	D10/70
D672,667 S *	12/2012	Mix	D10/65
D718,647 S *	12/2014	Roush et al.	D10/98

* cited by examiner

Primary Examiner — Antoine D Davis
(74) *Attorney, Agent, or Firm* — Kilpatrick Townsend & Stockton LLP

(57) **CLAIM**
The ornamental design for a activity tracking band, as shown and described.

DESCRIPTION

FIG. 1 is a perspective view of an activity tracking band showing my new design;
FIG. 2 is an alternative perspective view of the activity tracking band;
FIG. 3 is a front elevational view thereof;
FIG. 4 is a back elevational view thereof;
FIG. 5 is a left side elevational view thereof;
FIG. 6 is a right side elevational view thereof;
FIG. 7 is a close up section view of the portion of FIG. 6 shown;
FIG. 8 is a top view of the activity tracking band; and,
FIG. 9 is a bottom view thereof.
The broken line showing of the human hand and arm is included for the purpose of illustrating non-claimed subject matter and forms no part of the claimed design.

1 Claim, 8 Drawing Sheets

- (56) **References Cited**
U.S. PATENT DOCUMENTS
D299,718 S * 2/1989 Steer et al. D14/247
D305,422 S * 1/1990 Steer et al. D14/247
D331,020 S * 11/1992 Ishii et al. D10/31
D455,093 S * 4/2002 Fitzgerald

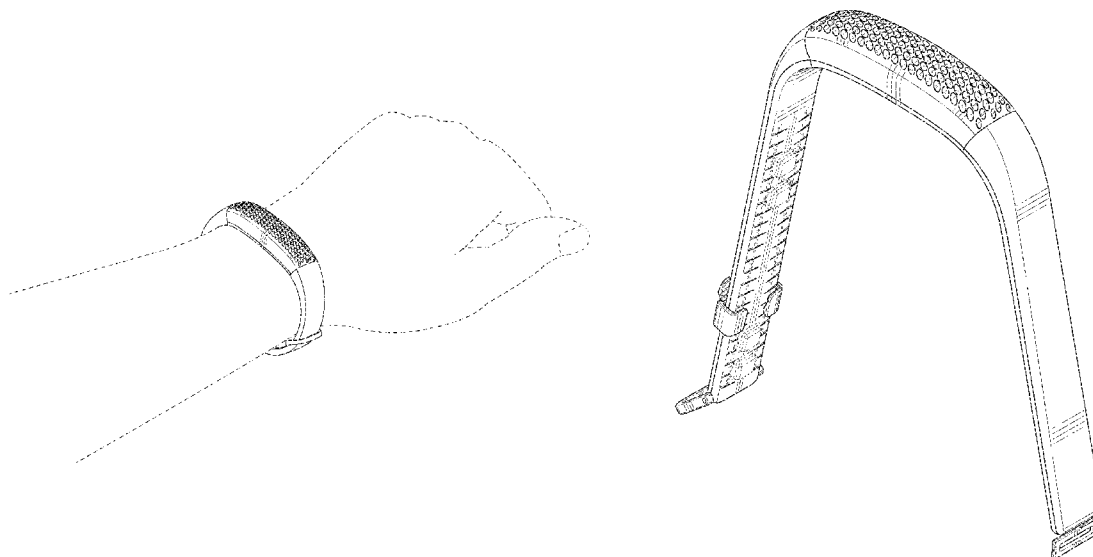

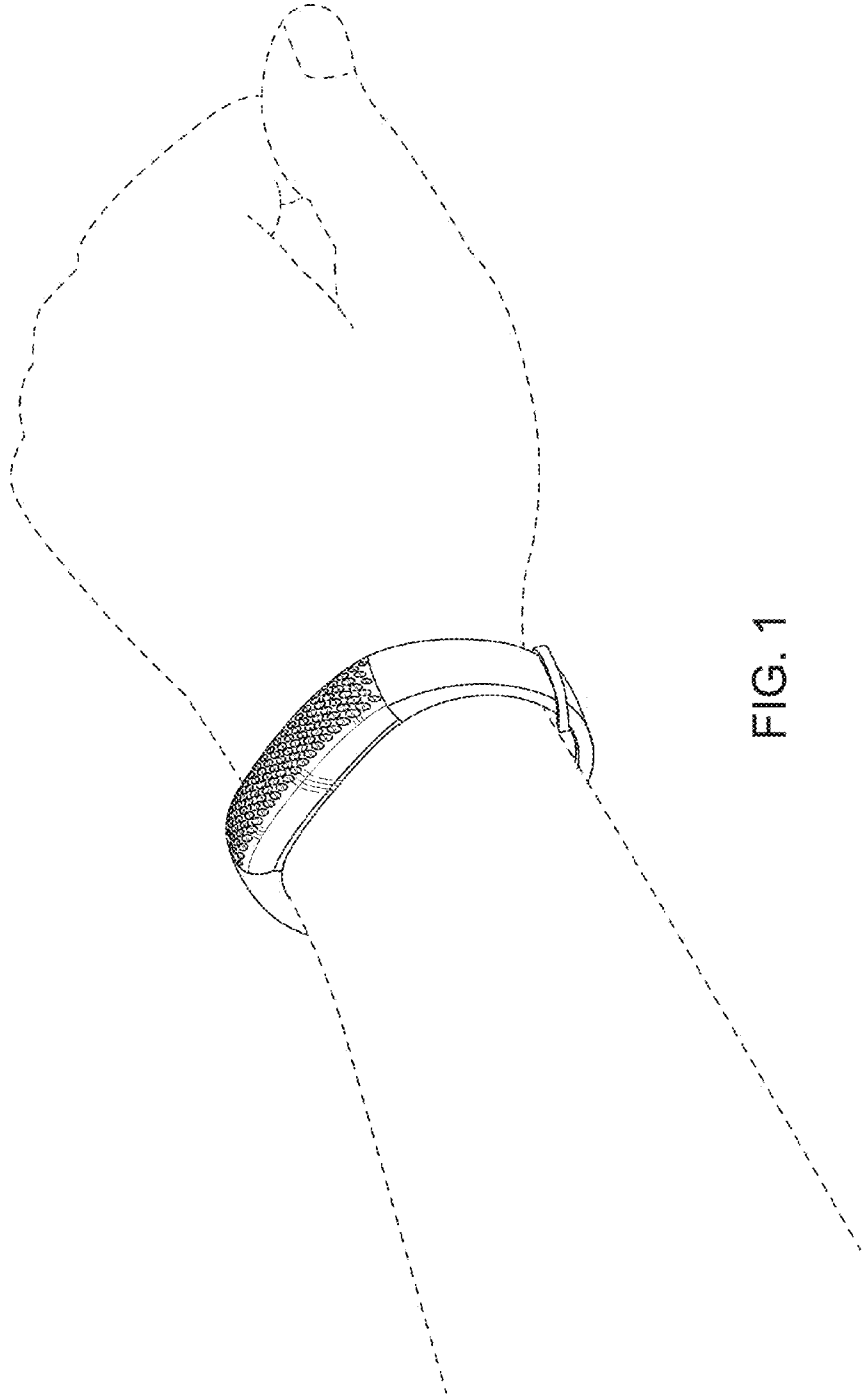

FIG. 1

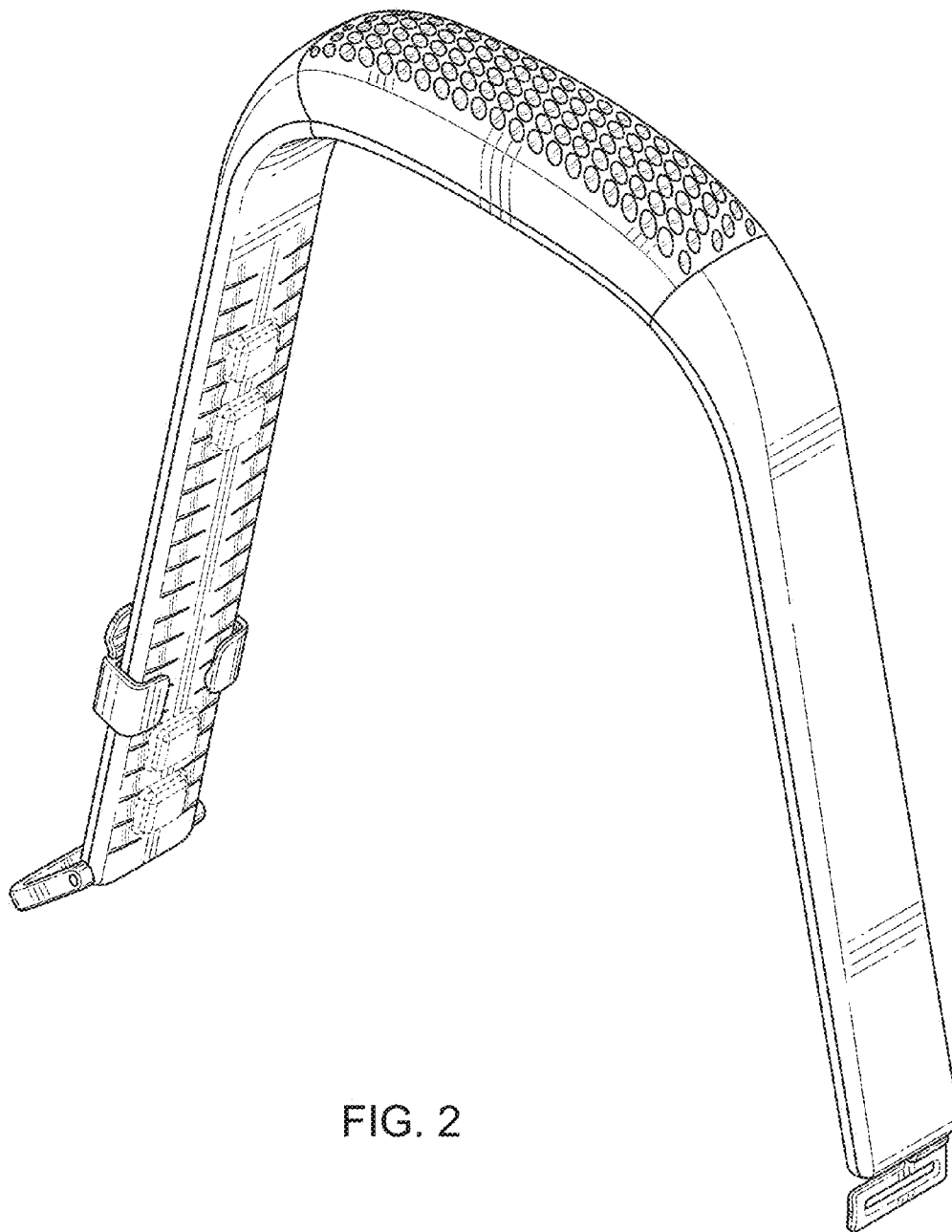

FIG. 2

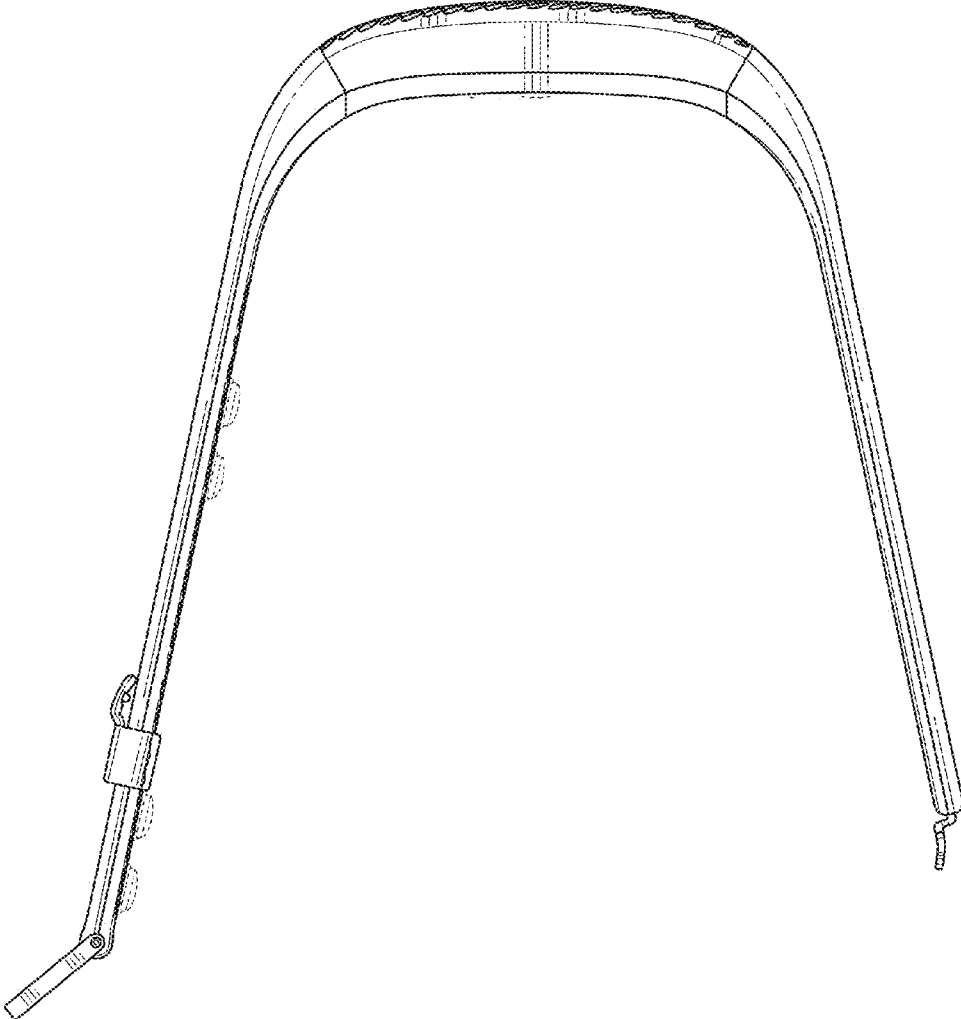

FIG. 3

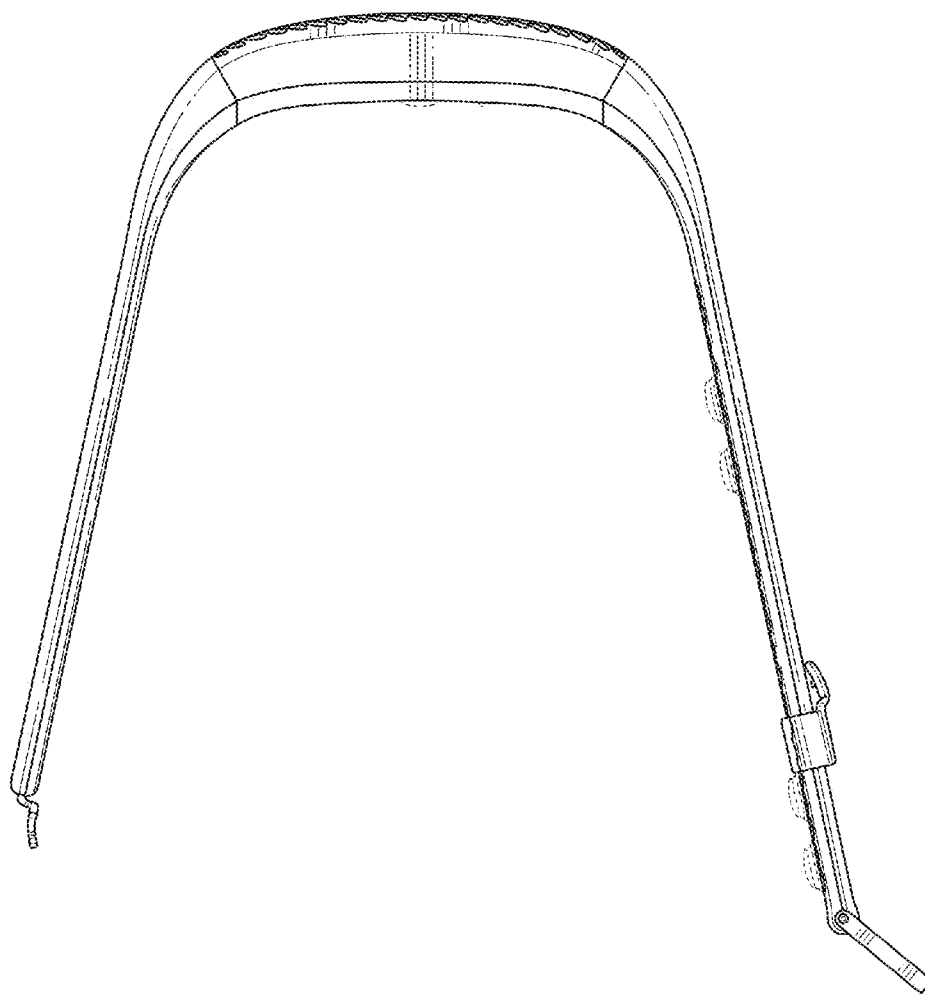

FIG. 4

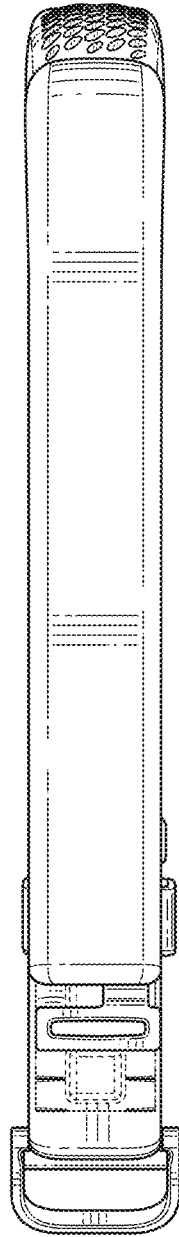
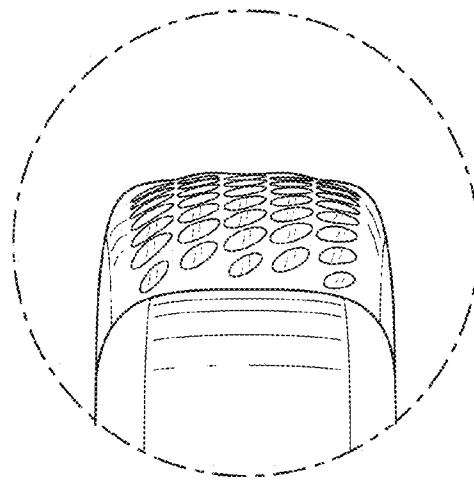
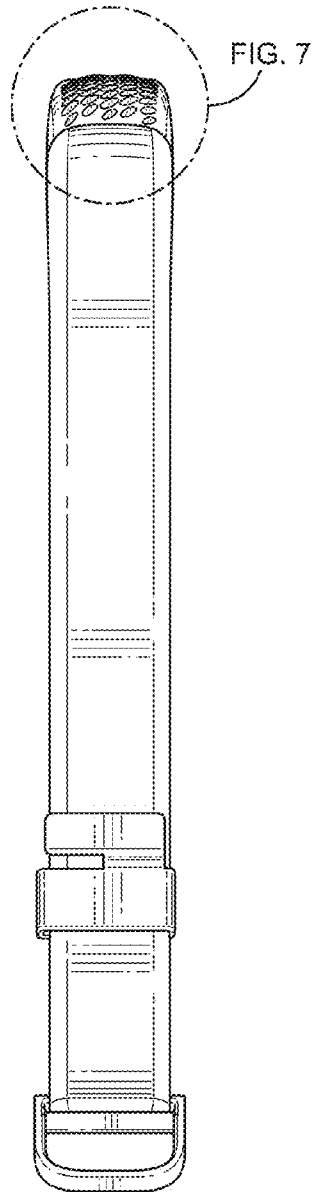

FIG. 5



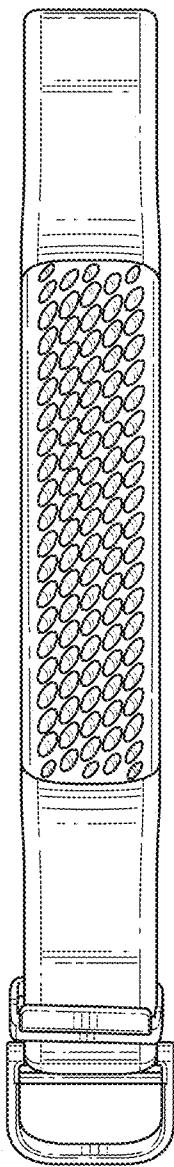

FIG. 8

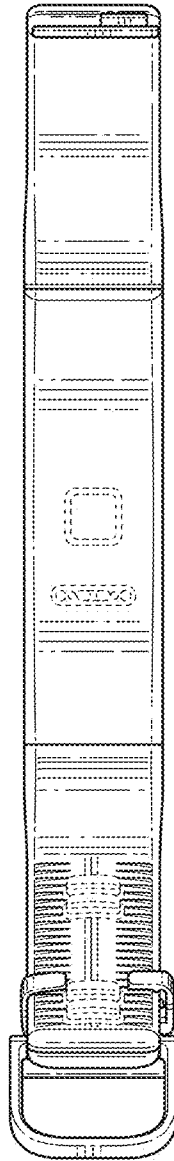

FIG. 9