



US00D365427S

United States Patent [19]
Brightbill et al.

[11] **Patent Number: Des. 365,427**
[45] **Date of Patent: **Dec. 19, 1995**

[54] **WASTEBASKET**

[75] Inventors: **Keith E. Brightbill**, Wooster; **Stephen P. Casteel**, Wadsworth, both of Ohio; **Henry Y. Chin**, Portland, Oreg.; **Charles W. Craft**, Apple Creek, Ohio; **Robert O. Dillon**, Venice, Calif.

[73] Assignee: **Rubbermaid Incorporated**, Wooster, Ohio

[**] Term: **14 Years**

[21] Appl. No.: **32,369**

[22] Filed: **Dec. 16, 1994**

[52] U.S. Cl. **D34/1**

[58] Field of Search D34/1, 5, 7-11;
220/908-911, 675, 404; D32/36, 37, 53

[56] **References Cited**

U.S. PATENT DOCUMENTS

D. 198,950	8/1964	Hollis	D34/8
D. 200,882	4/1965	Benjamin	D58/17
D. 201,055	5/1965	Ebert	D34/1
D. 280,459	9/1985	McClelland	D34/8
D. 281,111	10/1985	McClelland	D34/8
D. 311,982	11/1990	Ladney	D34/7
D. 318,354	7/1991	Delmerico	D34/7
D. 321,576	11/1991	Hradisky	D34/8
D. 324,122	2/1992	Brussing	D34/10
D. 324,594	3/1992	Tocci et al.	D34/1
D. 326,343	5/1992	Hradisky	D34/7
D. 326,345	5/1992	Mandell et al.	D32/37
D. 326,754	6/1992	Hradisky	D34/7
D. 327,756	7/1992	Klein et al.	D34/1
D. 342,817	12/1992	Lippisch et al.	D34/7
D. 355,739	2/1995	Bird et al.	D34/1
4,765,579	8/1988	Robbins et al.	248/101
5,092,480	3/1992	Waterston	200/23.4
5,129,535	7/1992	Hradisky	220/23.4

OTHER PUBLICATIONS

Sell sheet, Wastebasket; Sterilite Corporation, P.O. Box 524, Main Street, Townsend, Mass. Published at least as early as Jan. 17, 1990.

Sell sheet, Wastebaskets; Tucker Housewares, 25 Tucker

Drive, Leominster, Mass. 01453. Published at least as early as Sep., 1994.

Sell sheet, Wastebaskets; Tucker Housewares, 25 Tucker Drive, Leominster, Mass. 01453. Published at least as early as Sep., 1994.

Pp. 2, 3, 4, 5, 6 and 7, Wastebaskets; Tucker Housewares, 25 Tucker Drive, Leominster, Mass. 01453. Published at least as early as Sep., 1994.

Sell sheet, Wastebaskets; Tucker Housewares, 25 Tucker Drive, Leominster, Mass. 01453. Publication date Jan., 1983.

P. 67, Wastebasket; Iwasaki Industry Inc., No. 26 Showa Kogyo Danchi 1216-5, Nukatabe Kita-machi, Yamato-Koriyama, Nara, 639-11 Japan. Publication date 1990.

P. 5, Wastebaskets, Curver, Takkebijsters 75, Postbus 6810, 4801 HV Breda, The Netherlands. Publication date 1991.

P. 6, Wastebasket; Dupol-Rubbermaid GmbH, An der Trift 63, D-6072 Dreieich, Germany. Publication date 1989.

P. 6, Wastebaskets; Rubbermaid Commercial Products Inc., 3124 Valley Avenue, Wooster, Ohio 44691. Publication date 1992.

Sell sheet, Wastebaskets; Rubbermaid Incorporated, 1147 Akron Road, Wooster, Ohio 44691. Publication date 1993.

Primary Examiner—A. Hugo Word

Assistant Examiner—Robin V. Taylor

Attorney, Agent, or Firm—Richard B. O'Planick; Lisa B. Riedesel

[57] **CLAIM**

The ornamental design for a wastebasket, as shown and described.

DESCRIPTION

FIG. 1 is a top right front perspective view of a wastebasket showing our new design;

FIG. 2 is a top plan view thereof;

FIG. 3 is a front elevational view thereof;

FIG. 4 is a right side elevational view thereof; the left side elevational view being a mirror image;

FIG. 5 is a rear elevational view thereof; and,

FIG. 6 is a bottom plan view thereof.

1 Claim, 3 Drawing Sheets

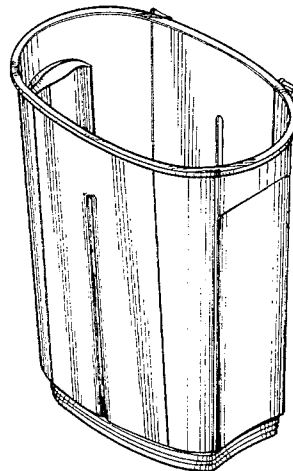

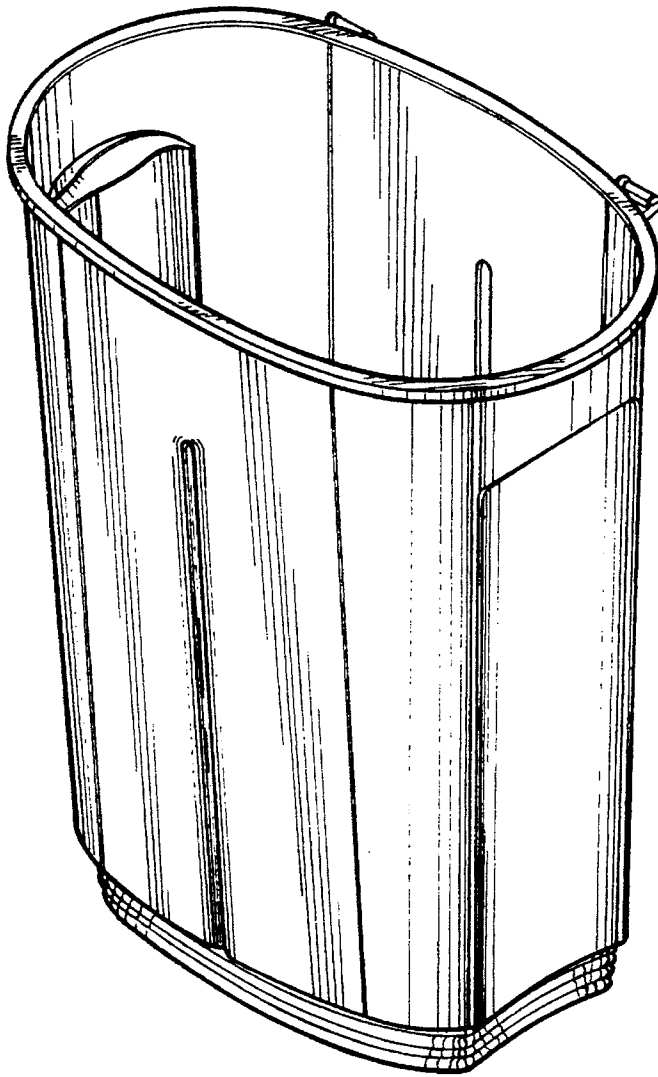

Fig-1

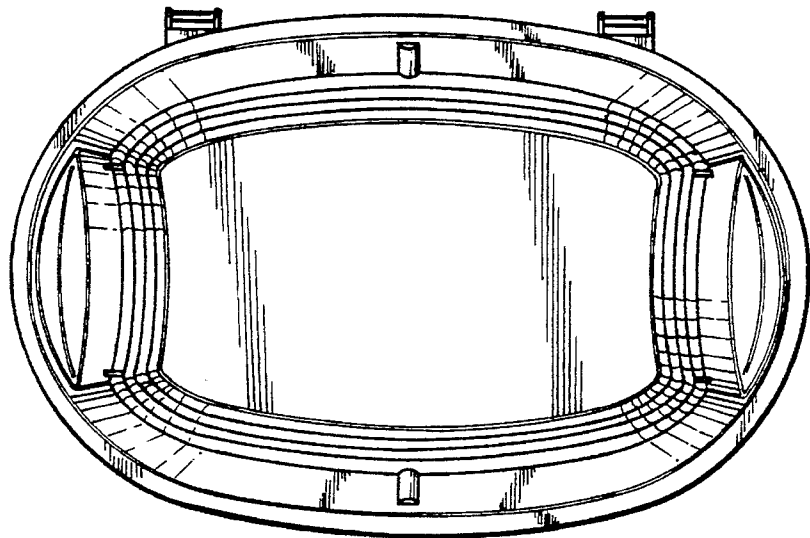

Fig-2

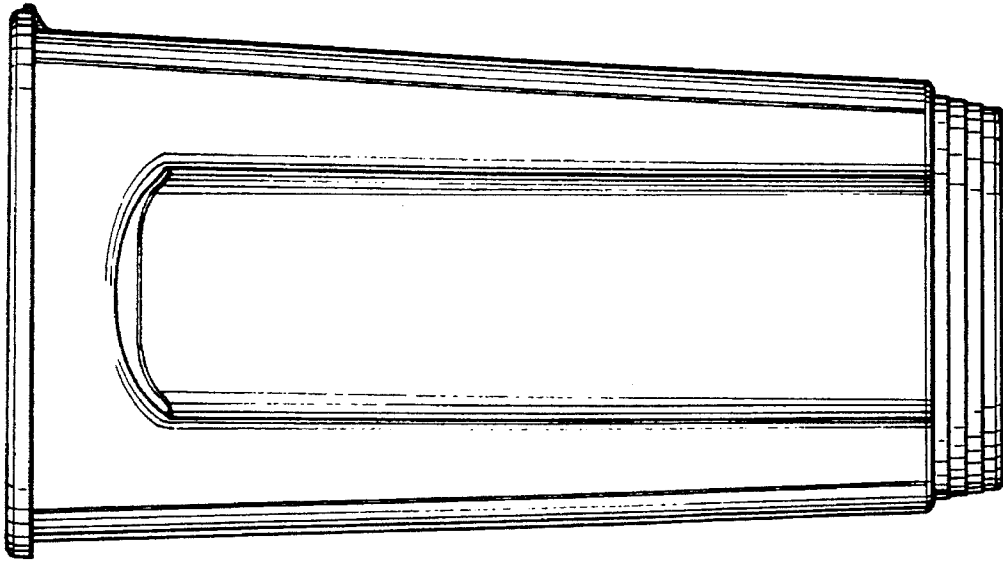

Fig - 4

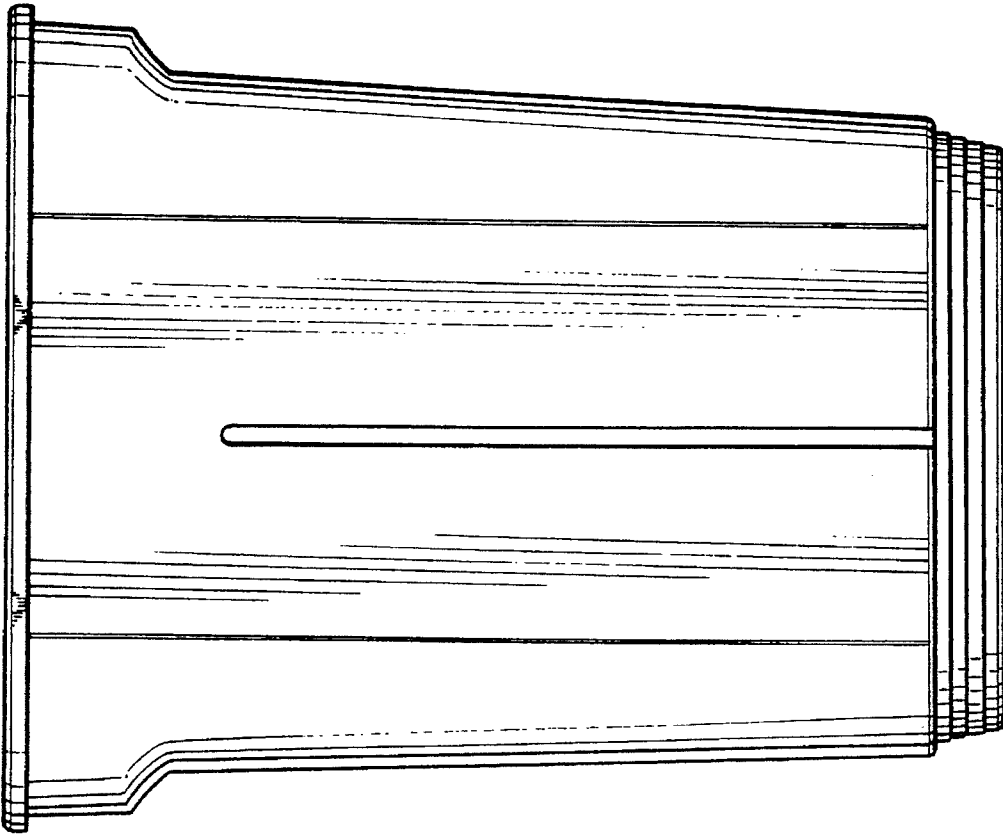

Fig - 3

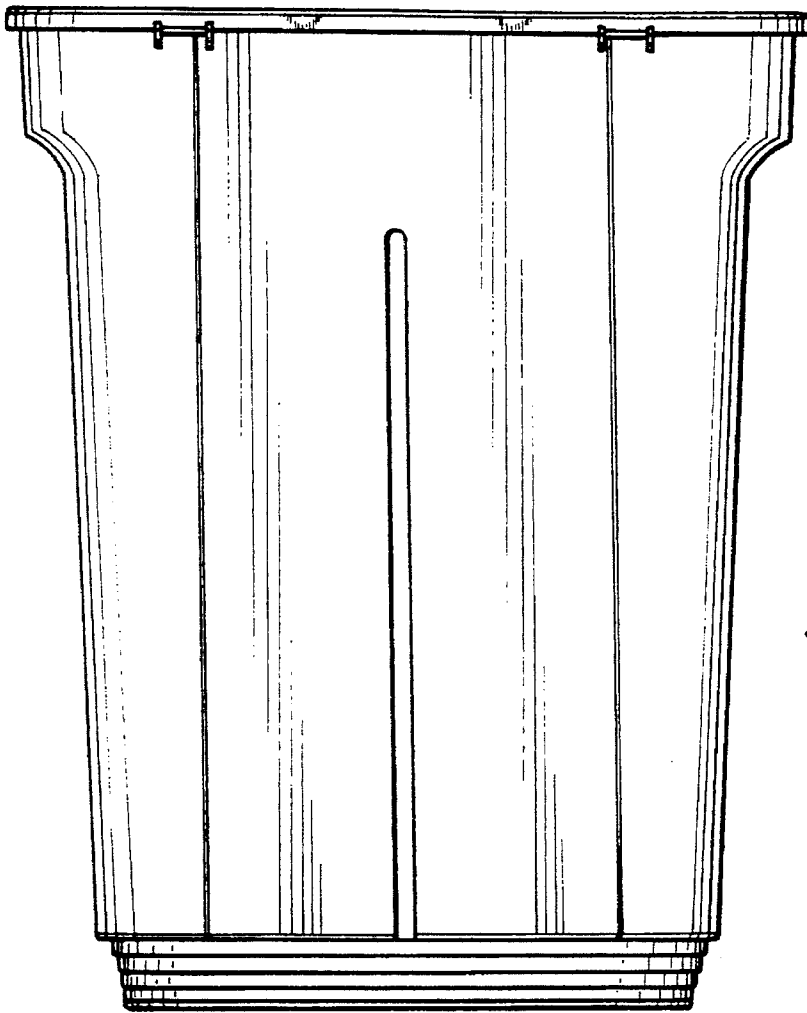

Fig-5

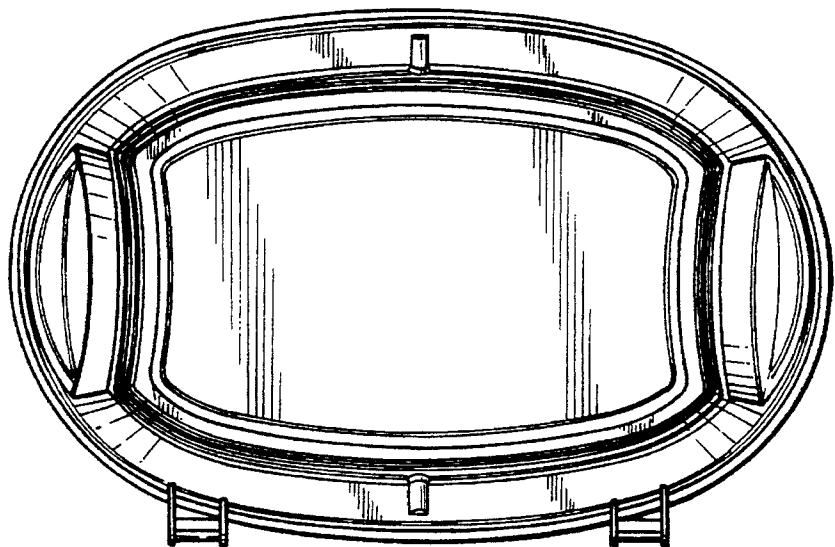

Fig-6