



HU000035783T2

(19) **HU**(11) Lajstromszám: **E 035 783**(13) **T2****MAGYARORSZÁG**
Szellemi Tulajdon Nemzeti Hivatala**EURÓPAI SZABADALOM**
SZÖVEGÉNEK FORDÍTÁSA(21) Magyar ügyszám: **E 11 154868**(51) Int. Cl.: **H04W 4/06** (2006.01)(22) A bejelentés napja: **2005. 02. 11.**

(96) Az európai bejelentés bejelentési száma:

EP 20050154868

(97) Az európai bejelentés közzétételi adatai:

EP 2326111 A2 2011. 05. 25.

(97) Az európai szabadalom megadásának meghirdetési adatai:

EP 2326111 B1 2017. 06. 14.

(30) Elsőbbségi adatok:

544283 P 2004. 02. 11. **US**
55921 2005. 02. 10. **US**

(73) Jogosult(ak):

QUALCOMM Incorporated, San Diego, CA
92121-1714 (US)

(72) Feltalálók(k):

Vayanos, Alkinoos Hector, San Diego, CA, 92121-1714
(US)
Gaal, Peter, San Diego, CA, 92121-1714 (US)

(74) Képviselő:

Danubia Szabadalmi és Jogi Iroda Kft.,
Budapest

(54)

Értesítések átvitele broadcast és multicast szolgáltatásokhoz

Az európai szabadalom ellen, megadásának az Európai Szabadalmi Közlönyben való meghirdetésétől számított kilenc hónapon belül, felszólalást lehet benyújtani az Európai Szabadalmi Hivatalnál. (Európai Szabadalmi Egyezmény 99. cikk(1))

A fordítást a szabadalmas az 1995. évi XXXIII. törvény 84/H. §-a szerint nyújtotta be. A fordítás tartalmi helyességét a Szellemi Tulajdon Nemzeti Hivatala nem vizsgálta.

(19)



(11)

EP 2 326 111 B1

(12)

EUROPEAN PATENT SPECIFICATION

(45) Date of publication and mention of the grant of the patent:
14.06.2017 Bulletin 2017/24

(51) Int Cl.:
H04W 4/06^(2009.01)

(21) Application number: **11154868.1**

(22) Date of filing: **11.02.2005**

(54) Transmission of notifications for broadcast and multicast services

Übertragung von Benachrichtigungen für Broadcast- und Multicast-Dienste

Transmission de notifications pour des services de diffusion et de multidiffusion

(84) Designated Contracting States:
AT BE BG CH CY CZ DE DK EE ES FI FR GB GR HU IE IS IT LI LT LU MC NL PL PT RO SE SI SK TR

(74) Representative: **Wegner, Hans**
Bardehle Pagenberg Partnerschaft mbB
Patentanwälte, Rechtsanwälte
Prinzregentenplatz 7
81675 München (DE)

(30) Priority: **11.02.2004 US 544283 P**
10.02.2005 US 55921

(56) References cited:
EP-A- 0 940 935 EP-A- 1 283 648
EP-A- 1 377 099 WO-A-2004/017581

(43) Date of publication of application:
25.05.2011 Bulletin 2011/21

(62) Document number(s) of the earlier application(s) in accordance with Art. 76 EPC:
10161776.9 / 2 207 370
05713534.5 / 1 721 485

- "Physical layer issues for MBMS notification", 3GPP DRAFT; R1-040018 MBMS NOTIFICATION PHY ISSUES, 3RD GENERATION PARTNERSHIP PROJECT (3GPP), MOBILE COMPETENCE CENTRE ; 650, ROUTE DES LUCIOLES ; F-06921 SOPHIA-ANTIPOLIS CEDEX ; FRANCE, vol. RAN WG1, no. Espoo, Finland; 20040120, 20 January 2004 (2004-01-20), XP050111947,
- 3GPP TSG RAN 1, MEETING 39: "25.211 Change Request 193: INTRODUCTION OF MICH", 25.221 CR 193, 15 November 2004 (2004-11-15), - 19 November 2004 (2004-11-19), pages 1-10, XP002329099, SHIN-YOKOHAMA, JAPAN

(73) Proprietor: **QUALCOMM Incorporated**
San Diego, CA 92121-1714 (US)

- (72) Inventors:
- **Vyanos, Alkinoos Hector**
San Diego, CA, 92121-1714 (US)
 - **Gaal, Peter**
San Diego, CA, 92121-1714 (US)

EP 2 326 111 B1

Note: Within nine months of the publication of the mention of the grant of the European patent in the European Patent Bulletin, any person may give notice to the European Patent Office of opposition to that patent, in accordance with the Implementing Regulations. Notice of opposition shall not be deemed to have been filed until the opposition fee has been paid. (Art. 99(1) European Patent Convention).

Description

BACKGROUND

5 **II. Field**

[0001] The present invention relates generally to communication, and more specifically to techniques for transmitting and receiving notifications for broadcast and multicast services in a communication system.

10 **III. Background**

[0002] A communication system may provide unicast, multicast, and/or broadcast services. A unicast service provides point-to-point communication between at least one base station and a specific wireless device. A multicast service provides point-to-multipoint communication between at least one base station and a group of wireless devices. A broadcast service provides point-to-multipoint communication between at least one base station and all wireless devices within a designated broadcast area. Some examples of multicast and broadcast services include news and data services, subscription-based services, push-to-talk, and so on. Multicast and broadcast services may send data to wireless devices sporadically, periodically, or continuously.

[0003] The communication system may need to send signaling (e.g., control information, configuration information, and so on) for the broadcast and multicast services supported by the system. This signaling may be sent on a control channel. A wireless device receiving one or more services would then monitor the control channel for signaling sent for the service(s) being received. The wireless device may operate in an idle state whenever it is not actively exchanging data with one or more base stations in the system. In the idle state, the wireless device wakes up periodically to receive page messages and overhead messages from the system and powers down as much circuitry as possible in the remaining time in order to conserve battery power. It is highly desirable for the wireless device, while it is awake, to somehow be informed of any signaling being sent on the control channel for the service(s) being received. The wireless device would then be able to receive both pertinent messages for itself and signaling for the service(s) being received without expending too much battery power.

[0004] There is therefore a need in the art for techniques to send notifications for signaling sent for broadcast and multicast services.

[0005] Technical document R1-040018 entitled "Physical layer issues for MBMS notification" submitted by Samsung for discussion and decision at the 3GPP TSG-RAN1 Adhoc meeting held in Espoo, Finland from January 27 - 30, 2004, discusses specific aspects of MBMS (Multimedia Broadcast/Multicast System) notification relating to the physical layer. The User Equipment (UE) wakes up according to its DRX cycle, checks the value of its paging indicator on the PICH and further checks the value of the concerned MBMS notification indicator. The MBMS notification indicator is not specific to UE but to the MBMS service. Notification is used to inform UE of the forthcoming MBMS session, session stop, or change of configuration. Within a single DRX cycle, UE monitors both the paging indicator and the MBMS notification indicator. In order to guarantee that all UEs will detect the MBMS notification indicator at least once within a single DRX cycle, the MBMS notification indicator should be repeated at least during the longest DRX cycle.

BRIEF DESCRIPTION OF THE DRAWINGS

[0006]

- 45 FIG. 1 shows a wireless communication system.
- FIG. 2A shows the format of the PICH in Universal Mobile Telecommunication System (UMTS).
- FIG. 2B shows the format of one frame of the PICH.
- FIG. 3 shows exemplary transmissions on the PICH, MICH, MCCH and MTCH in UMTS.
- FIG. 4 shows two random sequences with random locations for notification indicators.
- 50 FIG. 5 shows a process performed by a base station to transmit notification indicators for broadcast and multicast services supported by the base station.
- FIG. 6 shows a process performed by a wireless device to receive notification indicators for at least one service.
- FIG. 7 shows a block diagram of the base station and the wireless device.

55 **DETAILED DESCRIPTION**

[0007] The word "exemplary" is used herein to mean "serving as an example, instance, or illustration." Any embodiment described herein as "exemplary" is not necessarily to be construed as preferred or advantageous over other embodi-

ments. The invention is defined in the independent claims.

[0008] Techniques for transmitting and receiving notification indicators for broadcast and multicast services in a communication system are described herein. A base station maps the services to random sequences, one random sequence for each service, based on identifiers for the services. The base station generates the random sequence for each service based on a hash function or a pseudo-random number (PN) generator and the service identifier. Regardless of how the random sequences are generated, each random sequence is associated with a specific location for sending a notification indicator in each frame. The locations for the notification indicators for each random sequence are randomized with respect to the locations for the notification indicators for each remaining random sequence. This randomness characteristic reduces the likelihood of false alarm, as described below. For each service, the base station sets the notification indicators to the same notification value in each modification period, which may be any duration of time. The base station transmits the notification indicators for each service on an MBMS Indicator Channel (MICH) at the random locations determined by the random sequence for that service. The base station also transmits paging indicators for each idle wireless device on a Page Indicator Channel (PICH) in frames assigned to the wireless device and at locations determined by a PICH sequence for the wireless device.

[0009] To receive the notification indicators for at least one desired service, a wireless device determines the random sequence for each desired service. The wireless device also determines the frames in which to receive its paging indicators. For each of these "awake" frames, the wireless device receives (1) the notification indicator for each service at the location on the MICH determined by the random sequence for the service and (2) the paging indicator for the wireless device at the location on the PICH determined by the PICH sequence. The wireless device determines the notification value for each service in each modification period based on all of the notification indicators received for that service in that modification period.

[0010] FIG. 1 shows a wireless communication system 100 capable of supporting multimedia broadcast and multicast services. System 100 includes base stations 110 that communicate with wireless devices 120. For simplicity, only two base stations 110 and six wireless devices 120 are shown in FIG. 1. A base station is a fixed station and may also be called a Node B, a base transceiver subsystem (BTS), an access point, or some other terminology. A wireless device may be fixed or mobile and may also be called a user equipment (UE), a mobile station, a terminal, or some other terminology.

[0011] A radio network controller (RNC) 130 couples to base stations 110 and provides coordination and control for these base stations. RNC 130 may also be called a base station controller (BSC) or some other terminology. A core network (CN) 132 couples to RNC 130 and other systems and networks, such as a public switched telephone network (PSTN), a packet switched data network, and so on. Core network 132 interconnects system 100 with these other systems and networks.

[0012] System 100 may be a Code Division Multiple Access (CDMA) system, a Time Division Multiple Access (TDMA) system, a Frequency Division Multiple Access (FDMA) system, an Orthogonal Frequency Division Multiple Access (OFDMA) system, or some other multiple access system. A CDMA system may implement one or more CDMA radio access technologies (RATs) such as Wideband-CDMA (W-CDMA) and cdma2000. cdma2000 covers IS-2000, IS-856, and IS-95 standards. A TDMA system may implement one or more TDMA RATs such as Global System for Mobile Communications (GSM). These various RATs and standards are well known in the art. UMTS is a system that uses W-CDMA and GSM as RATs and is described in documents from a consortium named "3rd Generation Partnership Project" (3GPP). cdma2000 is described in documents from a consortium named "3rd Generation Partnership Project 2" (3GPP2). 3GPP and 3GPP2 documents are publicly available. For clarity, the notification transmission and reception techniques are specifically described below for UMTS. These techniques may be used for multimedia broadcast multicast service (MBMS) in UMTS.

[0013] In UMTS, a Page Indicator Channel (PICH) is used to send paging indicators to idle wireless devices. An idle wireless device is a wireless device that has registered with the system and is operating in an idle mode or a PCH mode. The paging indicators for each idle wireless device indicate whether messages are being sent on a Paging Channel (PCH) for the wireless device. The PCH is a transport channel that is carried in a Secondary Common Control Physical Channel (S-CCPCH). Each idle wireless device monitors the PICH for its paging indicators. If these paging indicators are set to '1', then the wireless device processes the S-CCPCH to look for any messages sent for the wireless device. A key characteristic of indicator channels such as the PICH and MICH is that the information carried on these channels is short and un-coded and can thus be received and interpreted very quickly.

[0014] FIG. 2A shows the format of the PICH in UMTS. The PICH is partitioned into frames, with each frame having a duration of 10 millisecond (ms). Each frame is identified by a 12-bit system frame number (SFN) that is simultaneously transmitted on a Primary CCPCH (P-CCPCH). The SFN is reset to 0 at a specific time, incremented by one for each frame thereafter, and wraps around to zero after reaching the maximum value of 4095.

[0015] Each idle wireless device is assigned paging occasions, which are specific frames in which the wireless device can receive its paging indicators. The paging occasions for each wireless device are separated by a time interval called a DRX (discontinuous receiving mode) cycle. The DRX cycle is configurable for each wireless device and is typically

1.28 seconds. In general, the DRX cycle can range from 80 milliseconds (ms) to 5.12 seconds, or from 8 frames to 512 frames. The paging occasions for each wireless device are determined based on several parameters including an International Mobile Subscriber Identifier (IMSI), which is an identifier that is unique for each wireless device. Different wireless devices with different IMSIs may be assigned different paging occasions even if they have the same DRX cycle. The DRX cycles and the frames for UMTS correspond to slot cycles and slots, respectively, in some other systems that support slotted mode paging.

[0016] FIG. 2B shows the format of one frame for the PICH. Each PICH frame includes 300 bits, which are labeled as bits b_0 through b_{299} . The first 288 bits are used for N_p paging indicators, and the last 12 bits are reserved for other uses. The number of paging indicators (N_p) in each PICH frame is configurable by the system and can take on a value of 18, 36, 72 or 144. Each paging indicator is sent in $288/N_p$ consecutive bits in the PICH frame, where $288/N_p$ can take on a value of 16, 8, 4 or 2. The $288/N_p$ bits are all set to '1' if the paging indicator is equal to '1' and are set to '0' if the paging indicator is equal to '0'. The N_p paging indicators are sent in N_p paging indicator locations that are numbered from 0 through N_p-1 (not shown in FIG. 2B).

[0017] Each idle wireless device is associated with a paging indicator in each paging occasion. The paging indicator for each wireless device is sent at a location that is determined as follows:

$$q_p = \left(\text{PI} + \left[\left(18 \times \left(\text{SFN} + \left\lfloor \frac{\text{SFN}}{8} \right\rfloor + \left\lfloor \frac{\text{SFN}}{64} \right\rfloor + \left\lfloor \frac{\text{SFN}}{512} \right\rfloor \right) \right) \bmod 144 \right] \times \frac{N_p}{144} \right) \bmod N_p, \text{ Eq (1)}$$

where SFN is the system frame number for the paging occasion;

PI = (IMSI div 8192) mod N_p ;

$\lfloor x \rfloor$ is a floor operator that provides the next lower integer value for x ;

mod denotes a modulo operation; and

q_p is the location of the paging indicator within the paging occasion.

[0018] As shown in equation (1), the location of the paging indicator for a given wireless device changes among the N_p possible locations based on the SFN of the paging occasion. Thus, depending on the SFN of the paging occasion, the wireless device would need to process a different location to obtain its paging indicator.

[0019] Equation (1) also indicates that up to N_p non-overlapping sequences of paging indicators (or PICH sequences) may be formed. Each PICH sequence is associated with a different value of PI, which can range from 0 through N_p-1 because of the modulo- N_p operation to compute PI. Each PICH sequence is associated with a specific location for sending the paging indicator in each frame (or each SFN). The N_p PICH sequences are non-overlapping in that no two PICH sequences use the same paging indicator location in any frame. In fact, the (N_p-1) PICH sequences for PI=1 through N_p-1 are merely different shifted versions (by modulo N_p) of the PICH sequence for PI = 0.

[0020] Two wireless devices may map to the same PI value based on their IMSIs. These two wireless devices would then have the same PICH sequence, and their paging indicator locations would overlap in every frame. If these two wireless devices also have the same paging occasions, then their paging indicators would be sent in the same frames and at the same location in each frame. If multiple paging indicators are mapped to the same location, then a value of '1' is sent in the location if any one of these paging indicators is equal to '1', and a value of '0' is sent in the location if all of the paging indicators are equal to '0'. For two wireless devices with the same PICH sequence and paging occasions, whenever a paging indicator is set for one wireless device, the other wireless device would also (possibly erroneously) detect this paging indicator and would process the PCH to look for page messages.

[0021] In UMTS, an MBMS Indicator Channel (MICH) is used to send MBMS notification indicators (or simply, notification indicators) that indicate whether messages are being sent on an MBMS point-to-multipoint Control Channel (MCCH). The MCCH is a transport channel that is also carried in the S-CCPCH. The messages sent on the MCCH contain information that allows the wireless devices to receive an MBMS point-to-multipoint Traffic Channel (MTCH). Such information may indicate, for example, which services are active, how to decode the MTCH, whether soft combining is possible, and so on. The MTCH is a transport channel that carries traffic data or content for the services.

[0022] The MICH has a format that is similar to the PICH format shown in FIG. 2B. Each MICH frame includes 300 bits, which are labeled as bits b_0 through b_{299} . The first 288 bits are used for N_n notification indicators, and the last 12 bits are reserved. The number of notification indicators (N_n) in each MICH frame is configurable by the system and can take on a value of 18, 36, 72 or 144. Each notification indicator is sent in $288/N_n$ consecutive bits in the MICH frame, where $288/N_n$ can take on a value of 16, 8, 4 or 2. The N_n notification indicators are sent in N_n indicator locations that are numbered from 0 through $N_n - 1$. Notification indicators may also be sent using the last 12 bits in each PICH frame.

[0023] Each multicast/broadcast service is assigned specific notification indicators, which are set to '1' whenever messages are being sent on the MCCH for the service. Each wireless device monitors the notification indicators for all

of the services desired by the wireless device (or "desired services"). Whenever the notification indicator for any desired service is set, the wireless device further processes the S-CCPCH to look for messages sent for that service.

[0024] The notification indicators for all of the services supported by the system (or "supported services") may be sent on the MICH in a manner to achieve the following goals:

- Minimize the awake time, and hence power consumption, for each idle wireless device to receive its paging indicator and the notification indicators for all desired services during each awake period;
- Minimize false alarm caused by the overlapping of the notification indicators for different services; and
- Minimize transmit power used for the notification indicators for all supported services.

[0025] For the PICH, a false alarm occurs whenever a wireless device erroneously detects a paging indicator that is set for another wireless device as being set for itself. For the MICH, a false alarm occurs whenever a wireless device erroneously detects a notification indicator that is set for a non-desired service as being set for a desired service. In any case, a false alarm causes the wireless device to process the PCH or MCCH for messages that are not applicable for the wireless device, which consumes battery power and shortens standby time.

[0026] False alarms are inevitable for the PICH if there are more idle wireless devices than the number of available paging indicator locations, and the paging indicators for multiple wireless devices map to and overlap at the same location. However, false alarms for the PICH do not adversely impact performance for several reasons. First, each wireless device typically receives only a small number of pages, so the paging indicators for each wireless device are infrequently set and the number of false alarms is small. Second, not all wireless devices that map to the same PICH sequence have overlapping paging indicators since their paging occasions, which constitute an additional dimension by which to distinguish among the wireless devices, may be different. Third, the wireless devices typically need to detect their paging indicators as quickly as possible and often use an aggressive detection algorithm that can falsely declare a paging indicator as being set when such is not the case. Fourth, because the PICH is only monitored by idle wireless devices, a false alarm for the PICH merely impacts battery life but does not adversely impact service reception.

[0027] False alarms are also inevitable for the MICH if the number of supported services exceeds the number of available notification indicator locations. However, false alarms for the MICH may be more detrimental than false alarms for the PICH. For a wireless device that is not yet receiving a service, the impact of false alarms for the MICH may be some additional battery power consumption. For a wireless device that is already receiving a service and is not capable of concurrently receiving the MCCH and MTCH, a false alarm causes the wireless device to process the MCCH instead of the MTCH and results in data loss for the MTCH.

[0028] To achieve the first goal noted above for the notification indicators, each service may be assigned a notification indicator in each frame. If a message is to be sent on the MCCH for the service, then the notification indicators for the service are set to '1' for a period long enough so that even a wireless device with the longest possible DRX cycle is able to receive the notification indicator with good probability of detection.

[0029] FIG. 3 shows exemplary transmissions on the PICH, MICH, MCCH and MTCH. Paging indicators for each idle wireless device are sent on the PICH in paging occasions for the wireless device, as shown at the top of FIG. 3. The notification indicators for each service are sent in each frame on the MICH and are set to the same notification value (either '1' or '0') for the entire modification period. The modification period may represent a time interval in which "critical" signaling information, which is information that is needed in order to receive MBMS content, may be changed. In general, signaling information may be service independent information and/or service specific information.

[0030] The modification period is selected to be sufficiently long so that all wireless devices can reliably detect at least one notification indicator sent on the MICH during the modification period. A wireless device with a DRX cycle that is shorter than the modification period can read the MICH during its paging occasion in each DRX cycle. A wireless device with a DRX cycle that is longer than the modification period can wake up between paging occasions to read the MICH. The modification period may be selected to be equal to or greater than a predetermined minimum duration (e.g. 2 seconds) so that wireless devices with long DRX cycles do not need to wake up too frequently. Depending on how the DRX cycle and the modification period are configured, a wireless device may be able to read one or multiple notification indicators for each desired service in each modification period.

[0031] If the notification indicators for all supported services are sent in each MICH frame, then the only level of dimensionality is the number of indicator locations (Nn) within one MICH frame. If equation (1) is used to determine the location of the notification indicator for each service in each frame, then the notification indicators for any two services having the same PI value would overlap in each frame. False alarms for the MICH would then be dominated by the overlapping of the notification indicators for different services. If a notification is sent for a service, then all wireless devices interested in any one of the other services mapped to the same PICH sequence defined by equation (1) would erroneously detect this notification and would also process the MCCH. This would result in a high false alarm probability for the MICH, which is undesirable.

[0032] To reduce the likelihood of false alarm for the MICH, a large number of sequences of notification indicators (or

random sequences) may be formed by randomizing the locations of the notification indicators for these random sequences. This randomization may be achieved in various manners, for example, by using a hash function, a PN generator, and so on. For clarity, several schemes for generating the random sequences are described below.

[0033] In a first randomization scheme, the random sequences are formed based on a hash function that maps each random sequence to a random location in each frame based on an identifier for the random sequence. Each random sequence is associated with a different NI value that can range from 0 through G-1, where G is a parameter that determines the number of possible random sequences.

[0034] For each random sequence, the location of the notification indicator in each frame may be determined as follows:

$$q_{n1} = \left\lfloor \left\{ [C \times (NI \oplus ((C \times SFN) \bmod G))] \bmod G \right\} \times \frac{Nn}{G} \right\rfloor, \quad \text{Eq (2)}$$

where C is a constant that is described below;

\oplus denotes a bit-wise exclusive OR (XOR) operation; and

q_{n1} is the location of the notification indicator within the frame.

The parameter G may be selected as a relatively large power of two and further based on a tradeoff between computational complexity and the probability of default collisions between the notification indicators for different services. Default collisions mean that the random sequences always share the same locations for their notification indicators. In an embodiment, G is selected as $G = 2^{16}$, NI is a 16-bit value, and there are 2^{16} possible random sequences.

[0035] The constant C may be defined, for example, as follows:

$$C = \left\lfloor G - \frac{(\sqrt{5} - 1)}{2} \times G \right\rfloor = 25,033. \quad \text{Eq (3)}$$

In general, the constant C may be defined such that C and G are relative primes.

[0036] Each service is identified by a service identifier, which may be a Temporary Mobile Group Identity (TMGI). The services may thus be uniquely identified by their TMGIs in the same way that the wireless devices may be uniquely identified by their IMSIs. Each service may be mapped to a specific NI value based on its TMGI, for example, as follows:

$$NI = \left(\text{TMGI} + \left\lfloor \frac{\text{TMGI}}{G} \right\rfloor \right) \bmod G. \quad \text{Eq (4)}$$

In general, each service may be mapped to a specific NI value based on any function of the service identifier. For example, the mapping may be based on a function $f(x) = (x + \lfloor x/G \rfloor + \lfloor x/G^2 \rfloor + \lfloor x/G^3 \rfloor \dots) \bmod G$, where x is the service identifier and $f(x)$ is the NI value. Other functions may also be used to map service identifiers to NI values.

[0037] The hash function shown in equation (2) scrambles a function of SFN with a function of the service identifier (or NI) to ensure that different services are associated with different random locations for their notification indicators in different frames. The use of C and G in the hash function ensures that all indicator locations within each frame are equally likely to be allocated for each service.

[0038] From a complexity point of view, the hash function in equation (2) has an advantage in that it can be computed directly based on the SFN and NI values and does not require clocking a PN generator for each frame in which the wireless device was idle. Each value of q_{n1} can be computed with three multiplications, an XOR operation, and a few truncations for the modulo operations.

[0039] In a second randomization scheme, the random sequences are formed based on a hash function that resembles the hash function for the PICH. Each random sequence is associated with a different NI value that can range from 0 through G - 1. For each random sequence, the location of the notification indicator in each frame may be determined as follows:

$$q_{n2} = \left\lfloor \left[(C \times (NI \oplus \left(\text{SFN} + \left\lfloor \frac{\text{SFN}}{8} \right\rfloor + \left\lfloor \frac{\text{SFN}}{64} \right\rfloor + \left\lfloor \frac{\text{SFN}}{512} \right\rfloor \right))) \bmod G \right] \times \frac{Np}{G} \right\rfloor, \quad \text{Eq (5)}$$

where q_{n2} is the location of the notification indicator within the frame.

[0040] The hash function shown in equation (5) also scrambles a function of SFN with a function of the service identifier to ensure that different services are mapped to different locations for their notification indicators in different frames. The hash function shown in equation (5) uses a different function of SFN than the hash function shown in equation (2). Each value of q_{n2} can be computed with four additions, two multiplications, and few truncations.

[0041] In a third randomization scheme, the random sequences are formed based on a PN generator that selects different random indicator locations in different frames for each random sequence. The selection of the random indicator locations may be achieved in various manners. For clarity, a specific embodiment is described below. For this embodiment, the PN generator is implemented with a 16-bit linear feedback shift register (LFSR) that implements a selected generator polynomial. This generator polynomial may be, for example, $x^{16}+x^{12}+x^3+x+1$. The implementation of the linear feedback shift register is known in the art and not described herein. The shift register is reset to a predetermined non-zero value whenever the SFN wraps around (or rolls over) to zero. The content of the shift register at any time instant is not specific to any wireless device or any service. Each base station may thus maintain one PN generator for all supported services.

[0042] Each random sequence (and thus each service) is associated with a different NI value that can range from 0 through $G - 1$. For each random sequence, the location of the notification indicator in each frame may be determined as follows:

$$q_{n3} = \left\lfloor r \times \frac{Np}{G} \right\rfloor, \quad \text{Eq (6)}$$

where r is an intermediate 16-bit binary number generated with the PN generator; and q_{n3} is the location of the notification indicator within the frame.

Equation (6) indicates that the constant C , which is used for the hash functions in equations (2) and (5), is not needed for the third randomization scheme.

[0043] Each bit of the 16-bit binary number r may be determined based on the state of the shift register and the NI value for the random sequence. Each bit i of the number r may be determined, for example, by performing the following operations:

1. Clock the PN generator once to update the content of the shift register.
2. Perform a bit-wise AND operation between the updated content of the shift register and the NI value to generate a 16-bit number s .
3. Perform a modulo-2 summation over all 16 bits of the number s to obtain a binary value for bit i of the number r .

[0044] The set of operations described above is performed 16 times, once for each of the 16 bits of the number r . The shift register is thus clocked 16 times for each frame. The PN generator is also clocked for each frame in which the wireless device is asleep so that the PN generator is at the proper state. A single PN generator may be used to generate all G random sequences.

[0045] For the embodiment described above, the random sequences have a length of 4096 frames due to the use of a 16-bit linear feedback shift register for the PN generator and the clocking of the PN generator 16 times for each frame. Random sequences of longer or shorter lengths may be obtained by using PN generators with more or fewer bits. The length of the random sequences should be at least as long as the longest possible modification period.

[0046] In another embodiment of the third randomization scheme, different random sequences are associated with different seed values for the linear feedback shift register. These random sequences are thus mapped to different positions on a PN sequence generated by the PN generator. Each random sequence may be generated by, for example, initializing the PN generator with the associated seed value (e.g., whenever the SFN wraps around to zero), clocking the PN generator once for each frame, and performing a modulo- Nn operation on the content of the shift register to obtain the indicator location for the frame. For this embodiment, a PN generator is maintained for each random sequence to be generated. In yet another embodiment, each random sequence may be generated by resetting the PN generator (e.g., to a predetermined value whenever the SFN wraps around to zero), clocking the PN generator once for each frame, performing an exclusive-OR of the content of the shift register with a mask value for the random sequence, and performing a modulo- Nn operation on the result of the exclusive-OR operation to obtain the indicator location for the frame. For this embodiment, different random sequences are associated with different mask values, and a single PN generator may be used to generate all random sequences. The random sequences may also be generated in other manners using the PN generator.

[0047] FIG. 4 shows two random sequences X and Y with random locations for the notification indicators. These two

random sequences may be generated using a hash function or a PN generator. Random sequence X is generated with an NI value of X, and random sequence Y is generated with an NI value of Y, where X and Y may each be any value within the range of 0 through G-1.

[0048] For simplicity, FIG. 4 shows a case where $N_n = 8$ and there are 8 indicator locations in each frame. For each random sequence, the notification indicator is sent in a random location in each frame. For the example shown in FIG. 4, random sequences X and Y collide and their notification indicators overlap in only frame n and no other frames shown in FIG. 4. If the notification indicators for only one random sequence are set to '1', then a wireless device may encounter a false alarm if it reads only the notification indicator sent in frame n . The wireless device would not encounter a false alarm if it reads the notification indicator sent in any other frame or if it reads multiple notification indicators. The wireless device may perform an AND of all of the notification indicators detected for each desired service and may process the MCCH only if all of the detected notification indicators are set. However, to avoid missing signaling information due to detection errors, the wireless device may process the MCCH if any one of the detected notification indicators is set or if some number or percentage of notification indicators is set.

[0049] FIG. 5 shows a process 500 performed by a base station to transmit notification indicators for broadcast and multicast services supported by the base station. The base station maps the services to random sequences, one random sequence for each service (block 512). This may be achieved by mapping the identifier (e.g., the TMGI) for each service to an NI value, e.g., as shown in equation (4). The base station then generates the random sequence for each service based on a hash function (e.g., as shown in equation (2) or (5)) or a PN generator (e.g., as shown in equation (6)) and the identifier or NI value for the service (block 514). Regardless of how the random sequences are generated, each random sequence is associated with a specific location for sending a notification indicator in each frame. The locations for the notification indicators in different frames for each random sequence are randomized with respect to the locations for the notification indicators for each remaining random sequence.

[0050] The base station determines the notification value (either '0' or '1') for each service in each modification period (block 516). For each service, the base station sets the notification indicators for all frames in the modification period to the notification value for the service for that modification period. The base station also determines the indicator value to send for each location in which multiple notification indicators for multiple services map to the same location. In any case, the base station transmits the notification indicators for each service at the random locations determined by the random sequence for that service (block 518). The base station also transmits paging indicators for each idle wireless device on the PICH in the frames assigned to the wireless device and at locations determined by the PICH sequence for the wireless device.

[0051] FIG. 6 shows a process 600 performed by a wireless device to receive notification indicators for at least one service desired by the wireless device. The wireless device determines the random sequence for each service in similar manner as the base station (block 612). The wireless device also determines the frames or paging occasions in which to receive paging indicators (block 614). For each of these awake frames, the wireless device receives the notification indicator for each service on the MICH at the location determined by the random sequence for the service (block 616). The wireless device also receives the paging indicator for itself on the PICH at the location determined by the PICH sequence for the wireless device (block 618).

[0052] The wireless device may elect to read any number of notification indicators for each service based on, for example, the desired probability of false alarm. The wireless device may wake up more often than its DRX cycle to receive more notification indicators and thus lower the probability of false alarm. In any case, the wireless device determines a notification value for each service in each modification period based on all of the notification indicators received for that service in that modification period (block 620).

[0053] The randomization of the indicator locations for the random sequences introduces additional dimensionality in time. This randomization further ensures that the collisions among the notification indicators for different services are spread uniformly across all services and are not correlated among any of these services. The likelihood of the notification indicators for two different services overlapping over an entire modification period is minimized. A wireless device is able to reduce the probability of false alarm for a given desired service by reading the MICH multiple times during the modification period to detect multiple notification indicators for the service. The wireless device may then process the MCCH if all of the detected notification indicators are set. The detected notification indicators are less likely to overlap the notification indicators for any one of the other services supported by the system. The probability of false alarm, which is the likelihood of all of the detected notification indicators being set to '1' by some other services, is relatively low and is dependent on the loading on the MICH. The probability of false alarm can be reduced by reading more notification indicators for the desired service. The wireless device can achieve a very low probability of false alarm by reading all notification indicators for the desired service, e.g., if the wireless device is actively receiving the service.

[0054] The false alarm performance for the three randomization schemes described above was analyzed. The analysis assumes that each notification indicator can be detected without error by the physical layer and any error is due to overlap between notification indicators for different services. For simplicity, the analysis also assumes that the indicator locations used for each service are perfectly random and the probability of an overlap between two notification indicators

in different frames is perfectly independent.

[0055] The notification load of the system is denoted as P_{load} and represents the probability of a given notification indicator being set to '1' on the MICH. The number of notification indicators that is detected for each desired service in each modification period is denoted as N_{ni} . For each service, the notification indicators are set to the same notification value for the entire modification period. All of the N_{ni} detected notification indicators for a given desired service would be equal to '1' if a notification value of '1' is sent to indicate a notification for the desired service. If any one of the N_{ni} detected notification indicators is equal to '0', then a notification value of '0' may be presumed to have been sent for the desired service, and any detected notification indicators that are equal to '1' are presumed to have been set by collision with the notification indicators for other services. To account for possible detection errors by the physical layer, a detection algorithm may declare a notification value of '0' if at least two detected notification indicators are equal to '0' and may declare a notification value of '1' otherwise. For this detection algorithm, a false alarm would occur if at least $N_{ni} - 1$ detected notification indicators falsely indicate the presence of a notification.

[0056] For the detection algorithm described above, the probability of false alarm for a given service, $P_{FA}^{service}$, may be expressed as:

$$P_{FA}^{service} = \sum_{k=N_{ni}-1}^{N_{ni}} \binom{N_{ni}}{k} \times (P_{load})^k \times (1 - P_{load})^{N_{ni}-k}, \quad \text{Eq (7)}$$

where $\binom{N_{ni}}{k}$ denotes the number of different combinations of k notification indicators among N_{ni} notification indicators.

If a wireless device is interested in multiple (N_{ser}) services, then the probability of false alarm for the wireless device,

P_{FA}^{device} , may be expressed as:

$$P_{FA}^{device} = 1 - (1 - P_{FA}^{service})^{N_{ser}}. \quad \text{Eq (8)}$$

[0057] A computer simulation was performed to determine the probability of false alarm for a given wireless device with the three randomization schemes described above. The following parameter values were used for the simulation: $N_n = 144$, $G=2^{16}$, $N_{ni} = 5$, and $N_{ser} = 10$. Table 1 shows the probability of false alarm for the wireless device for each randomization scheme and for different notification loads for the system. The simulation results indicate that all three randomization schemes provide lower probability of false alarm than without randomization, e.g., using equation (1). The simulation results also indicate that the probability of false alarm is lower with the hash function shown in equation (2) and the PN generator shown in equation (6).

Table 1 - Probability of False Alarm

	$P_{load} \approx 5\%$	$P_{load} \approx 10\%$	$P_{load} \approx 20\%$	$P_{load} \approx 30\%$
Without Randomization	38.4%	62.2%	86.6%	94.4%
Randomization with equation (2)	0.14%	0.84%	6.39%	19.6%
Randomization with equation (5)	7.7%	16.5%	38.1%	57.8%
Randomization with equation (6)	0.02%	0.36%	4.68%	16.1%

[0058] The PICH uses quadrature phase shift keying (QPSK) for the paging indicators. Each paging indicator is represented by a set of modulation symbols. With QPSK, each modulation symbol is transmitted at a predetermined power level. The same amount of transmit power is used for each modulation symbol regardless of whether a value of '0' or '1' is sent for the paging indicator.

[0059] The MICH may be designed to use On/Off keying (OOK) for the notification indicators, which may reduce the amount of transmit power for the MICH. With OOK, a notification indicator value of '1' is transmitted at a predetermined power level, and a notification indicator value of '0' is transmitted with zero power (i.e., not transmitted). The transmit power for a notification indicator sent with OOK should be twice the transmit power for a notification indicator sent with QPSK in order to achieve the same detection performance for both OOK and QPSK. The total transmit power for the

MICH is determined by the MICH loading, which is the average fraction of the notification indicators that are set to '1' in a given frame. A reduction in the total transmit power for the MICH is achieved if the MICH loading is less than 50%. The MICH loading is likely to be less than 50% in order to avoid high false alarm rates for the wireless devices. Thus, the use of OOK is likely to reduce the total transmit power for the MICH for the same detection performance as QPSK.

5 [0060] FIG. 7 shows a block diagram of an embodiment of a base station 110x and a wireless device 120x. At base station 110x, an encoder 710 receives traffic data for page and other messages, processes (e.g., encodes, interleaves, and symbol maps) the traffic data, and generates modulation symbols. A modulator 712 performs channelization, spectral spreading, scrambling, and so on, on the modulation symbols for various physical channels (e.g., the PICH, MICH, and S-CCPCH) and provides a stream of data chips. A transmitter unit (TMTR) 714 conditions (e.g., converts to analog, amplifies, filters, and frequency upconverts) the data chips and generates a downlink signal, which is transmitted via an antenna 716.

10 [0061] At wireless device 120x, an antenna 752 receives the downlink signal from base station 110x and provides a received signal to a receiver unit (RCVR) 754. Receiver unit 754 conditions (e.g., filters, amplifies, and frequency down-converts) the received signal, digitizes the conditioned signal, and provides data samples. A demodulator (Demod) 756 processes the data samples and provides symbol estimates. Demodulator 756 further performs detection for notification indicators and paging indicators as directed by a controller 760. A decoder 758 processes (e.g., demaps, deinterleaves, and decodes) the symbol estimates and provides decoded data for messages sent by base station 110x.

15 [0062] Controllers 720 and 760 direct the operation at base station 110x and wireless device 120x, respectively. Controller 720 and 760 may also perform various functions for transmission and reception, respectively, of notification indicators and paging indicators. For example, controller 720 may perform process 500 in FIG. 5 for transmission of notification indicators, and controller 760 may perform process 600 in FIG. 6 for reception of notification indicators. Memory units 722 and 762 store data and program codes for controllers 720 and 760, respectively. A timer 764 provides time information, which is used by controller 760 to determine when to wake up to process the PICH and MICH.

20 [0063] The notification transmission and reception techniques described herein may be implemented by various means. For example, these techniques may be implemented in hardware, software, or a combination thereof. For a hardware implementation, the processing units used to transmit notification indicators may be implemented within one or more application specific integrated circuits (ASICs), digital signal processors (DSPs), digital signal processing devices (DSPDs), programmable logic devices (PLDs), field programmable gate arrays (FPGAs), processors, controllers, microcontrollers, microprocessors, other electronic units designed to perform the functions described herein, or a combination thereof. The processing units used to receive notification indicators may also be implemented within one or more

25 [0064] For a software implementation, the notification transmission and reception techniques may be implemented with modules (e.g., procedures, functions, and so on) that perform the functions described herein. The software codes may be stored in a memory unit (e.g., memory unit 722 or 762 in FIG. 7) and executed by a processor (e.g., controller 720 or 760). The memory unit may be implemented within the processor or external to the processor, in which case it can be communicatively coupled to the processor via various means as is known in the art.

30 **Claims**

40 1. A method of transmitting notifications from a base station in a communication system, comprising:

- determining a plurality of notification indicators for a plurality of Multimedia Broadcast and Multicast services, MBMS;
- 45 mapping the plurality of notification indicators to a plurality of locations in a frame; and
- transmitting the plurality of notification indicators using On/Off keying; **characterized in that** the location within a frame for a notification indicator is based on the following equation:

$$50 \quad q = \left\lfloor r \times \frac{Nn}{G} \right\rfloor$$

- wherein G is a constant;
- Nn is the number of available locations in the frame;
- 55 r is an intermediate K-bit binary number generated with a PN generator;
- $\lfloor x \rfloor$ is a floor operator that provides the next lower integer value for x; and
- q is the location for the notification indicator within the frame;

wherein each bit i of the number r is determined by the following steps:

clock the PN generator once to update the content of a linear feedback shift register, LSFR;
 perform a bitwise AND operation between the updated content of the LSFR and a value NI determined by
 the identifier for the service to generate a K -bit number s ;
 perform a modulo-2 summation over all K bits of the number s to obtain a binary value for bit i of the number r .

2. An apparatus operable in a communication system, comprising:

means for determining a plurality of notification indicators for a plurality of Multimedia Broadcast and Multicast services, MBMS;
 means for mapping the plurality of notification indicators to a plurality of locations in a frame; and
 means for transmitting the plurality of notification indicators using On/Off keying; **characterized in that** the location within a frame for a notification indicator is based on the following equation:

$$q = \left\lfloor r \times \frac{N_n}{G} \right\rfloor$$

wherein G is a constant;
 N_n is the number of available locations in the frame;
 r is an intermediate K -bit binary number generated with a PN generator;
 $\lfloor x \rfloor$ is a floor operator that provides the next lower integer value for x ; and
 q is the location for the notification indicator within the frame;

wherein each bit i of the number r is determined by the following steps:

clock the PN generator once to update the content of a linear feedback shift register, LSFR;
 perform a bitwise AND operation between the updated content of the LSFR and a value NI determined by
 the identifier for the service to generate a K -bit number s ;
 perform a modulo-2 summation over all K bits of the number s to obtain a binary value for bit i of the number r .

3. A computer program comprising instructions which, when executed by a processor, cause said processor to perform all the steps of a method according to claim 1.

Patentansprüche

1. Ein Verfahren zum Senden von Benachrichtigungen von einer Basisstation in einem Kommunikationssystem, aufweisend:

Ermitteln einer Vielzahl von Benachrichtigungsindikatoren von einer Vielzahl von Multimedia-Rundfunk/Mehrfachfunk-Diensten, MBMS;
 Abbilden der Vielzahl der Benachrichtigungsindikatoren auf eine Vielzahl von Positionen innerhalb eines Rahmens; und
 Senden der Vielzahl der Benachrichtigungsindikatoren mittels Ein-Aus-Eintasten;
dadurch gekennzeichnet, dass die Position innerhalb eines Rahmens für einen Benachrichtigungsindikator auf der folgenden Gleichung basiert:

$$q = \left\lfloor r \times \frac{N_n}{G} \right\rfloor$$

wobei G eine Konstante ist;
 N_n die Anzahl der verfügbaren Positionen innerhalb des Rahmens ist;
 r eine vermittelnde K -Bit binäre Zahl ist, die mit einem PN-Generator erzeugt ist;
 $\lfloor x \rfloor$ ein Floor-Operator ist, welcher den nächstkleineren Wert für x liefert; und
 q ist die Position für den Benachrichtigungsindikator innerhalb des Rahmens;

EP 2 326 111 B1

wobei jedes Bit i der Zahl r durch folgende Schritte bestimmt wird:

einmaliges Takten des PN-Generators zum Aktualisieren des Inhaltes eines linearen rückgekoppelten Schieberegister, LSFR;

Durchführen einer bitweisen UND-Operation zwischen dem aktualisierten Inhalt des LSFR und einem Wert N_i , der von der Kennung für den Dienst bestimmt wird, zum Erzeugen einer K -bit Zahl s ;

Durchführen einer Modulo-2-Addition über alle K -Bits der Zahl s zum Erlangen eines binären Wertes für Bit i der Zahl r .

2. Eine Vorrichtung zum Senden von Benachrichtigungen von einer Basisstation in einem Kommunikationssystem, aufweisend:

Mittel zum Ermitteln einer Vielzahl von Benachrichtigungsindikatoren von einer Vielzahl von Multimedia-Rundfunk/Mehrfachfunk-Diensten, MBMS;

Mittel zum Abbilden der Vielzahl der Benachrichtigungsindikatoren auf eine Vielzahl von Positionen innerhalb eines Rahmens; und

Mittel zum Senden der Vielzahl der Benachrichtigungsindikatoren mittels Ein-Aus-Eintasten;

dadurch gekennzeichnet, dass die Position innerhalb eines Rahmens für einen Benachrichtigungsindikator auf der folgenden Gleichung basiert:

$$q = \left\lfloor r \times \frac{N_n}{G} \right\rfloor$$

wobei G eine Konstante ist;

N_n die Anzahl der verfügbaren Positionen innerhalb des Rahmens ist;

r eine vermittelnde K -Bit binäre Zahl ist, die mit einem PN-Generator erzeugt ist;

$\lfloor x \rfloor$ ein Floor-Operator ist, welcher den nächstkleineren Wert für x liefert; und

q ist die Position für den Benachrichtigungsindikator innerhalb des Rahmens;

wobei jedes Bit i der Zahl r durch folgende Schritte bestimmt wird:

einmaliges Takten des PN-Generators zum Aktualisieren des Inhaltes eines linearen rückgekoppelten Schieberegister, LSFR;

Durchführen einer bitweisen UND-Operation zwischen dem aktualisierten Inhalt des LSFR und einem Wert N_i , der von der Kennung für den Dienst bestimmt wird, zum Erzeugen einer K -bit Zahl s ;

Durchführen einer Modulo-2-Addition über alle K -Bits der Zahl s zum Erlangen eines binären Wertes für Bit i der Zahl r .

3. Ein Computerprogramm, welches Anweisungen umfasst, die einen Prozessor veranlassen alle Schritte eines Verfahrens gemäß Anspruch 1 durchzuführen, wenn sie vom Prozessor ausgeführt werden.

Revendications

1. Un procédé d'émission de notification à partir d'une station de base dans un système de communication, comprenant :

la détermination d'une pluralité d'indicateurs de notification pour une pluralité de services multimedia broadcast et multicast, MBMS ;

le mappage de la pluralité d'indicateurs de notification vers une pluralité d'emplacements dans une trame ; et l'émission de la pluralité d'indicateurs de notification en utilisant une modulation en tout ou rien ;

caractérisé en ce que l'emplacement au sein d'une trame d'un indicateur de notification est basé sur l'équation suivante :

$$q = \left\lfloor r \times \frac{N_n}{G} \right\rfloor$$

5

G étant une constante ;
 N_n étant le nombre d'emplacements disponibles dans la trame ;
 r étant un nombre binaire intermédiaire sur K bits généré avec un générateur PN ;
 ⌊x⌋ étant un opérateur plancher qui donne pour x la valeur entière inférieure suivante ; et
 q étant l'emplacement de l'indicateur de notification au sein de la trame ;

10

dans lequel chaque bit i du nombre r est déterminé par les étapes suivantes :

15

avance d'une impulsion d'horloge du générateur PN pour mettre à jour le contenu d'un registre à décalage à rétroaction linéaire, LSFR ;
 exécution d'une opération ET bit à bit entre le contenu mis à jour du LSFR et une valeur NI déterminée par l'identifiant pour le service afin de générer un nombre s sur K bits ;
 exécution d'une sommation modulo 2 sur la totalité des K bits du nombre s pour obtenir une valeur binaire pour le bit i du nombre r.

20

2. Un appareillage pouvant être mis en oeuvre dans un système de communication, comprenant :

25

des moyens de détermination d'une pluralité d'indicateurs de notification pour une pluralité de services multi-media broadcast et multicast, MBMS ;
 des moyens de mappage de la pluralité d'indicateurs de notification vers une pluralité d'emplacements dans une trame ; et
 des moyens d'émission de la pluralité d'indicateurs de notification en utilisant une modulation en tout ou rien ;
caractérisé en ce que l'emplacement au sein d'une trame d'un indicateur de notification est basé sur l'équation suivante :

30

$$q = \left\lfloor r \times \frac{N_n}{G} \right\rfloor$$

35

G étant une constante ;
 N_n étant le nombre d'emplacements disponibles dans la trame ;
 r étant un nombre binaire intermédiaire sur K bits généré avec un générateur PN ;
 ⌊x⌋ étant un opérateur plancher qui donne pour x la valeur entière inférieure suivante ; et
 q étant l'emplacement de l'indicateur de notification au sein de la trame ;

40

dans lequel chaque bit i du nombre r est déterminé par les étapes suivantes :

45

avance d'une impulsion d'horloge du générateur PN pour mettre à jour le contenu d'un registre à décalage à rétroaction linéaire, LSFR ;
 exécution d'une opération ET bit à bit entre le contenu mis à jour du LSFR et une valeur NI déterminée par l'identifiant pour le service afin de générer un nombre s sur K bits ;
 exécution d'une sommation modulo 2 sur la totalité des K bits du nombre s pour obtenir une valeur binaire pour le bit i du nombre r.

50

3. Un programme informatique comprenant des instructions qui, lorsqu'elles sont exécutées par un processeur, font en sorte que ledit processeur met en oeuvre toutes les étapes d'un procédé selon la revendication 1.

55

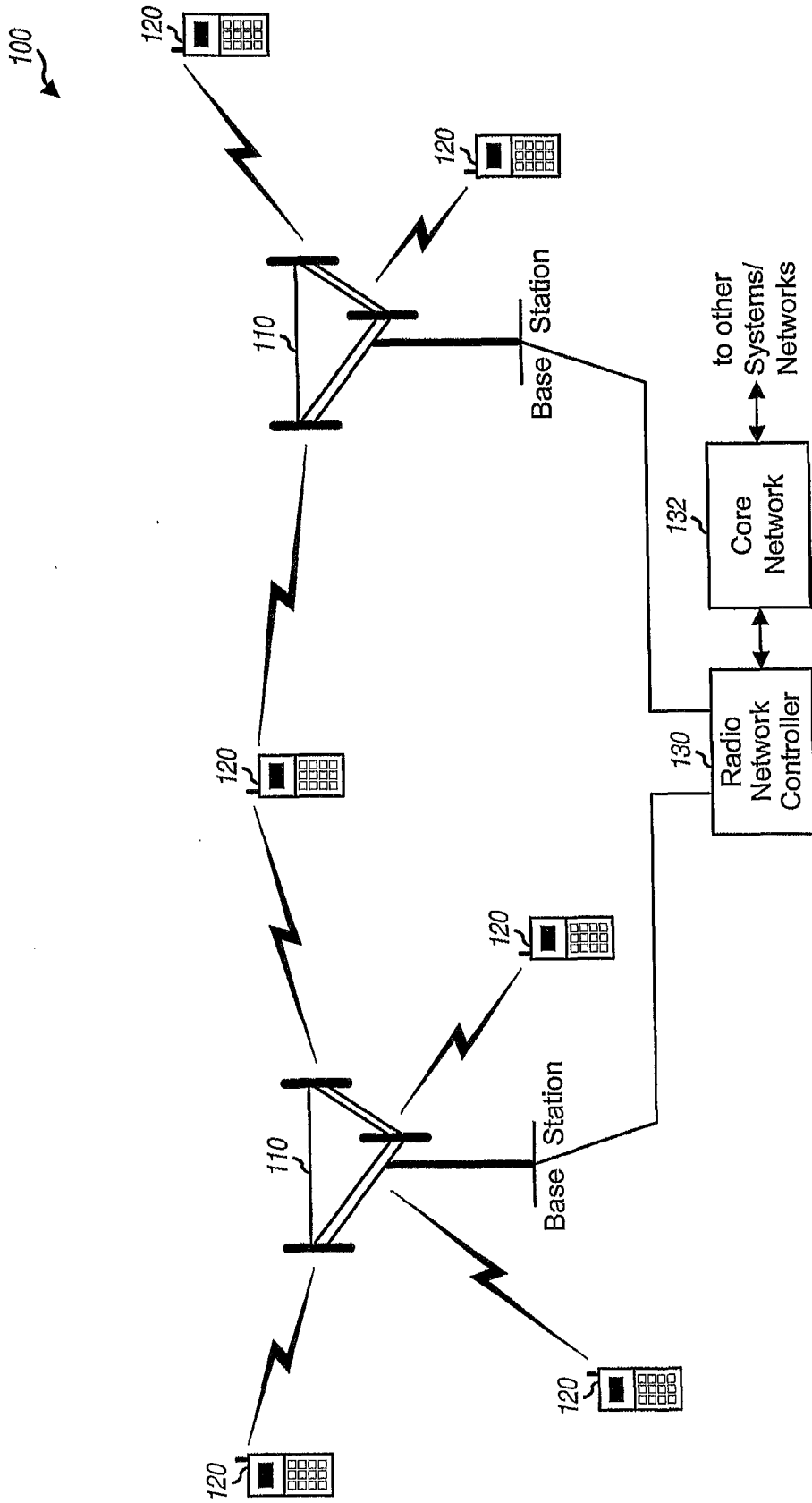

FIG. 1

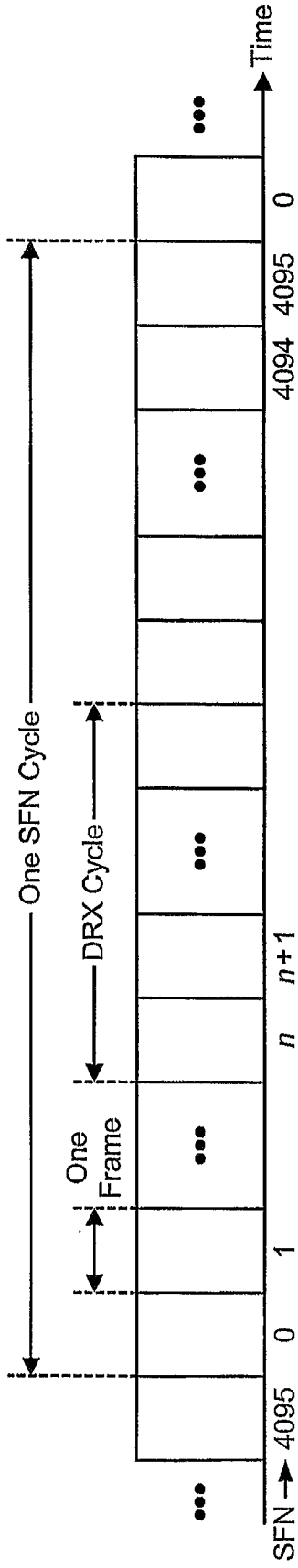

FIG. 2A

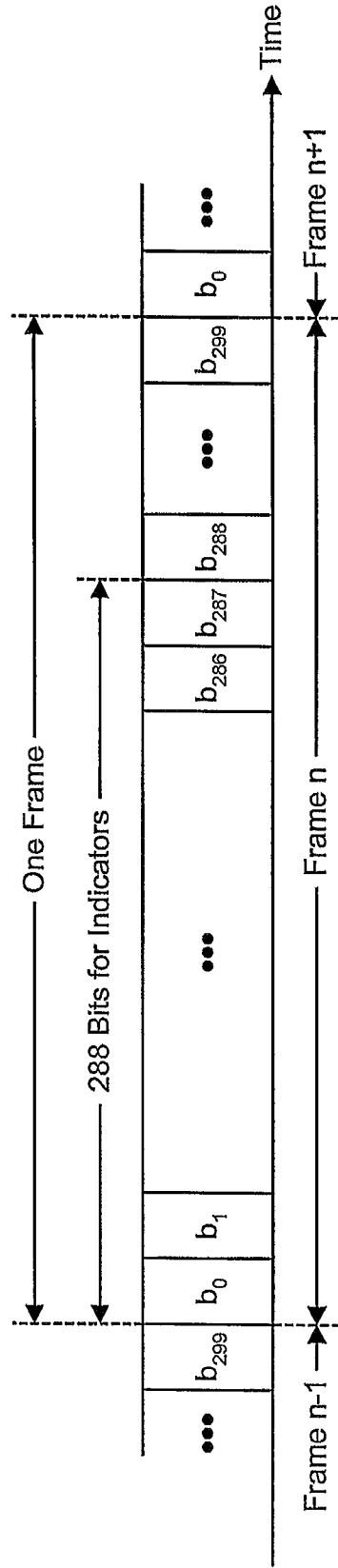

FIG. 2B

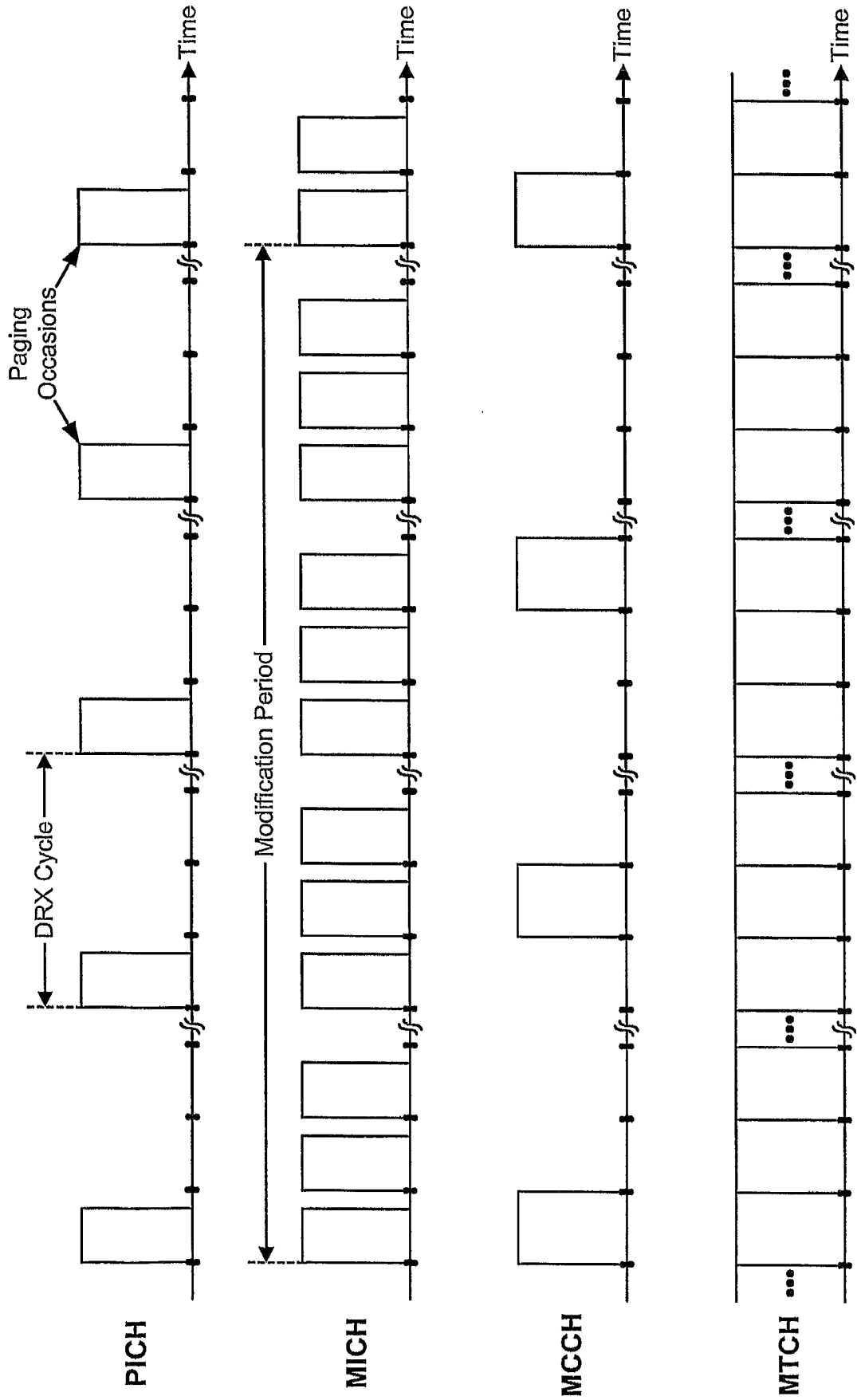

FIG. 3

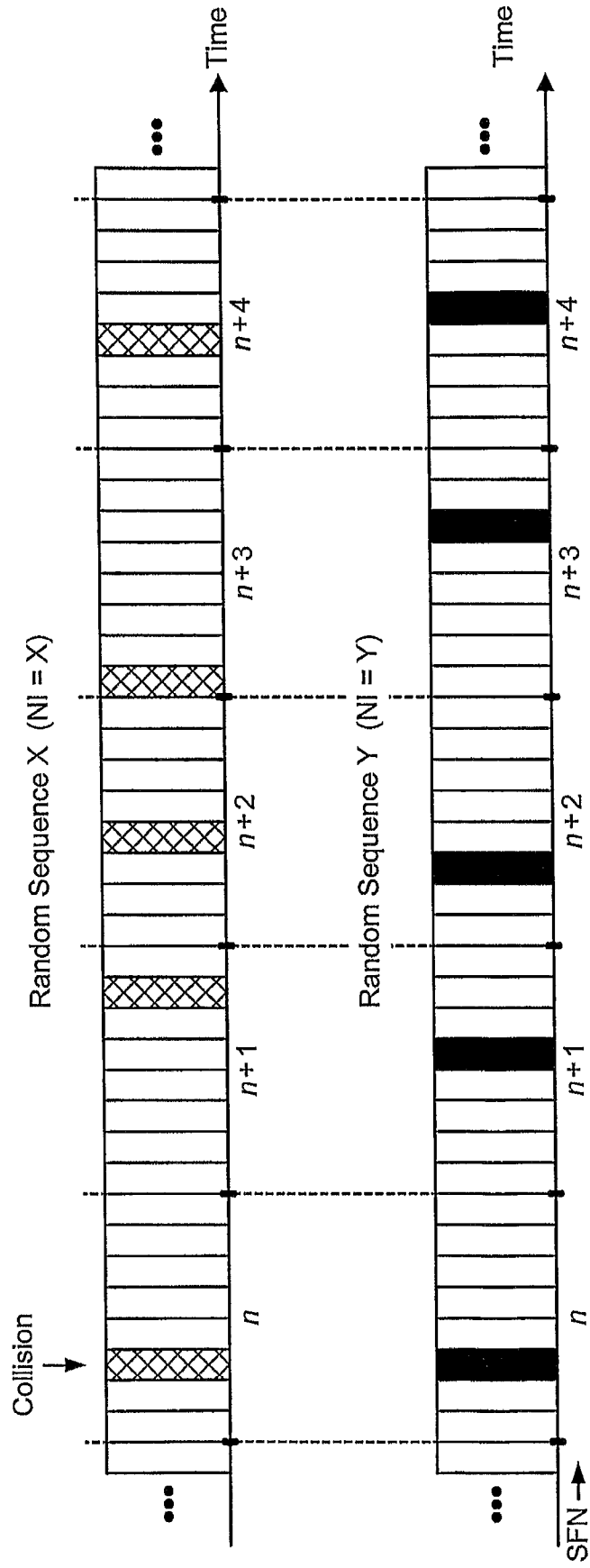

FIG. 4

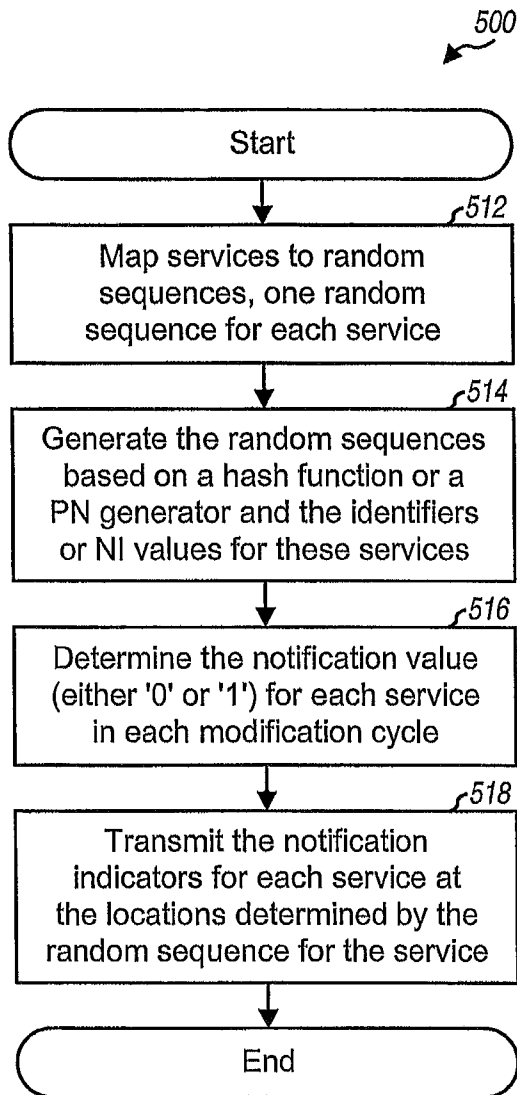

FIG. 5

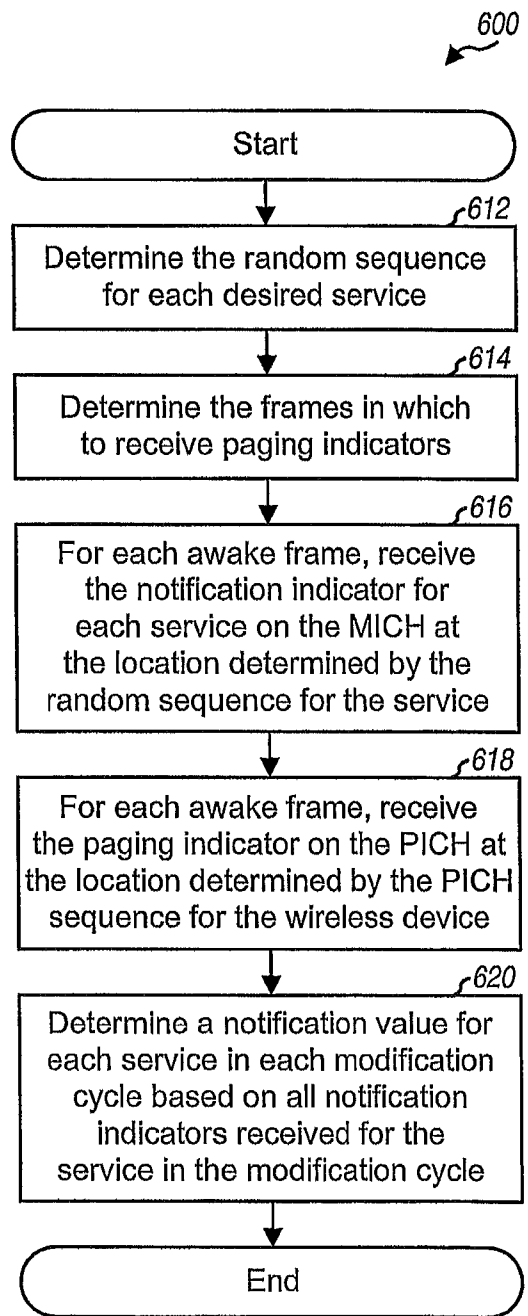

FIG. 6

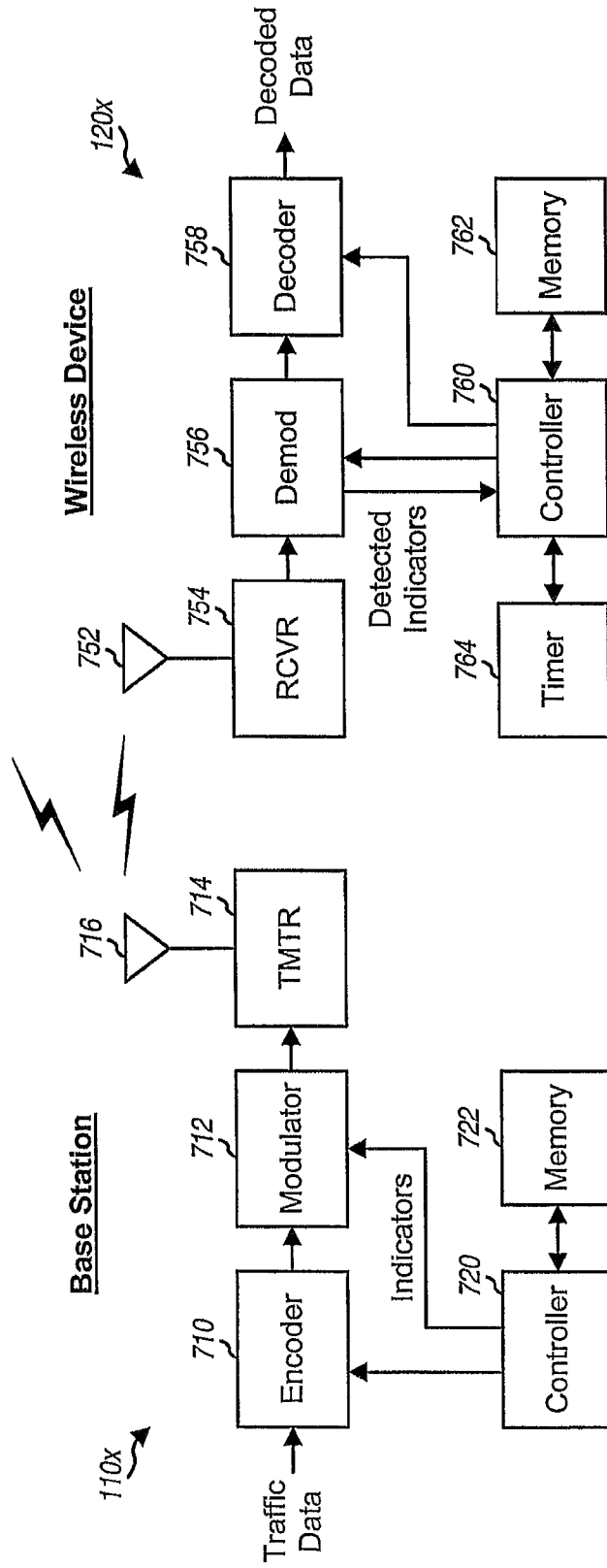

FIG. 7

REFERENCES CITED IN THE DESCRIPTION

This list of references cited by the applicant is for the reader's convenience only. It does not form part of the European patent document. Even though great care has been taken in compiling the references, errors or omissions cannot be excluded and the EPO disclaims all liability in this regard.

Non-patent literature cited in the description

- Physical layer issues for MBMS notification. 3GPP
TSG-RAN1, 27 January 2004 [0005]

Értesítések átvitele broadcast és multicast szolgáltatásokhoz

Szabadalmi igénypontok

1. Eljárás értesítések átvételére egy bázisállomástól egy kommunikációs rendszerben, az eljárás tartalmazza:
több értesítés indikátor meghatározását több multimédia broadcast és multicast szolgáltatáshoz, MPMS;
a több értesítés indikátor leképezését egy keretben több helyhez; és
a több értesítés indikátor átvitelét be-ki billentyűzés használatával,
azzal jellemezve, hogy a hely egy keretben belül egy értesítés indikátor számára a következő képleten alapul:

$$q = \left\lfloor r \times \frac{N_n}{G} \right\rfloor$$

ahol G egy állandó;

N_n az elérhető lokációk száma a keretben;

r egy közbenső K bites bináris szám, amelyet egy PN generátorral állítottunk elő;

$\lfloor x \rfloor$ egy alsó egész rész operátor, amely a következő alacsonyabb integer értéket adja x számára; és

q az értesítés indikátor lokációja a keretben belül;

ahol az r szám minden egyes l bitjét a következő lépésekkel határozzuk meg:

a PN generátor egyszeri órajellel ellátása egy lineáris visszacsatolási léptetőregiszter, LSFR, tartalmának frissítésére;

egy bitenkénti ÉS művelet végrehajtása az LSFR frissített tartalmával és a szolgáltatáshoz tartozó azonosító által meghatározott N_l értékkel egy K -bites s szám előállítására,

modulo-2 összegzés végrehajtása az s szám összes K bitjén, az r szám l bitjére vonatkozó bináris érték megszerzéséhez.

2. Berendezés, amely egy kommunikációs rendszerben működtethető, és tartalmaz:

eszközt több értesítés indikátor meghatározására több multimédia broadcast és multicast szolgáltatáshoz, MPMS;

eszközt a több értesítés indikátor leképezésére egy keretben több helyhez; és

eszközt a több értesítés indikátor átvételére be-ki billentyűzés használatával,

azzal jellemezve, hogy a hely egy keretben belül egy értesítés indikátor számára a következő képleten alapul:

$$q = \left\lfloor r \times \frac{N_n}{G} \right\rfloor$$

ahol G egy állandó;



N az elérhető lokációk száma a keretben;

r egy közbenső K bites bináris szám, amelyet egy PN generátorral állítottunk elő;

$\lfloor x \rfloor$ egy alsó egész rész operátor, amely a következő alacsonyabb integer értéket adja x számára; és

q az értesítés indikátor lokációja a kereten belül;

ahol az r szám minden egyes i bitjét a következő lépésekkel határozzuk meg:

a PN generátor egyszeri órajellel ellátása egy lineáris visszacsatolási léptetőregiszter, LSFR, tartalmának frissítésére;

egy bitenkénti ES művelet végrehajtása az LSFR frissített tartalmával és a szolgáltatáshoz tartozó azonosító által meghatározott N_i értékkel egy K -bites s szám előállítására,

modulo-2 összegzés végrehajtása az s szám összes K bitjén, az r szám i bitjére vonatkozó bináris érték megszerzéséhez.

3. Számítógépi program, amely utasításokat tartalmaz, amelyek egy processzorral történő végrehajtásuk esetén az említett processzort az 1. igénypont szerinti eljárás összes lépésének végrehajtására készítetik.