



US00D844514S

(12) **United States Design Patent**
Wagner et al.

(10) **Patent No.:** **US D844,514 S**

(45) **Date of Patent:** **** Apr. 2, 2019**

- (54) **MULTI-FUNCTIONAL JOYSTICK FOR AN AGRICULTURAL VEHICLE**
- (71) Applicant: **Deere & Company**, Moline, IL (US)
- (72) Inventors: **Christoph Wagner**, Reilingen (DE);
Sebastian Himpel, Mannheim (DE);
Thorsten Hagner, Ilvesheim (DE);
Nicolas Staack, Heddesheim (DE);
Jonathan E. Drum, Raleigh, NC (US)

D536,153 S * 1/2007 Niebuhr D14/415
 D571,268 S * 6/2008 Hoffman D12/179
 7,497,298 B2 * 3/2009 Shearer E02F 3/7663
 180/333
 D595,744 S * 7/2009 Umeda D15/28
 D606,100 S * 12/2009 Kobayashi D15/28
 D606,567 S * 12/2009 Kobayashi D15/28
 7,641,019 B2 * 1/2010 Pline B60K 26/02
 180/315
 D640,258 S * 6/2011 Hobenshield D14/412
 D656,073 S * 3/2012 Foerster D12/179
 (Continued)

(73) Assignee: **DEERE & COMPANY**, Moline, IL (US)

(**) Term: **15 Years**

(21) Appl. No.: **29/634,510**

(22) Filed: **Jan. 23, 2018**

(30) **Foreign Application Priority Data**

Jul. 26, 2017 (EM) 004121028

(51) **LOC (11) Cl.** **12-16**

(52) **U.S. Cl.**
USPC **D12/179**

(58) **Field of Classification Search**

USPC D12/7, 114, 126, 159, 174, 177, 179,
 D12/180, 192, 195, 215, 223, 345, 400,
 D12/415, 421, 568

CPC A61M 21/00; B60L 15/20; B60R 11/0264;
 B64C 13/04; B64C 13/503; B64C 27/56;
 B64D 11/0689; B66C 13/56; G05G 1/06;
 G05G 1/105; G06F 3/0362; G06F 3/0482;
 G06F 3/04847; G09F 13/04; G09F 13/08;
 H03J 5/0272; H04B 1/405; H05K 11/02

See application file for complete search history.

(56) **References Cited**

U.S. PATENT DOCUMENTS

4,702,520 A * 10/1987 Whisler B60N 2/767
 297/411.36
 D463,459 S * 9/2002 Tamaru D15/28

OTHER PUBLICATIONS

Gear selector in the 2015 Jeep Grand Cherokee, image post date Jun. 22, 2016, site visited Aug. 1, 2018, (online), <<https://money.cnn.com/2016/06/22/autos/jeep-chrysler-shifter-recall-fix/index.html>>.*

(Continued)

Primary Examiner — Kevin K Rudzinski

(57) **CLAIM**

The ornamental design for a multi-functional joystick for an agricultural vehicle, as shown and described.

DESCRIPTION

FIG. 1 is a perspective view of a multi-functional joystick for an agricultural vehicle embodying our new design; FIG. 2 is a left side view thereof; FIG. 3 is a right side view thereof; FIG. 4 is a front view thereof; FIG. 5 is a rear view thereof; FIG. 6 is a top view thereof; and, FIG. 7 is a bottom view thereof.

The broken line representations in the figures show unclaimed environment or boundaries, and thus form no part of the claimed design.

1 Claim, 7 Drawing Sheets

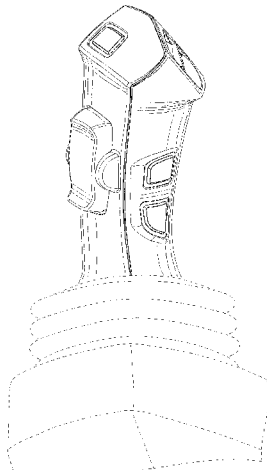

(56)

References Cited

U.S. PATENT DOCUMENTS

D686,622	S *	7/2013	Rey	D14/412	D800,183	S *	10/2017	Wuisan	D15/28
D687,075	S *	7/2013	Richard	D15/28	D800,784	S *	10/2017	Collins	D15/5
D698,358	S *	1/2014	Beams	D14/412	D801,974	S *	11/2017	Stadlbauer	D14/415
8,714,049	B2 *	5/2014	Ast	G05G 1/04 296/1.09	9,963,084	B2 *	5/2018	Jacobsthal	A01D 41/12
D709,102	S *	7/2014	Tokuda	D15/28	2010/0123345	A1 *	5/2010	Steege	B60N 2/797 297/411.2
8,807,635	B2 *	8/2014	Taylor	B60N 3/06 296/190.08	2011/0072934	A1 *	3/2011	Ulbrich	G05G 1/06 74/558.5
D722,415	S *	2/2015	Castagnola	D34/31	2015/0101440	A1 *	4/2015	Bonneau	G05G 1/01 74/484 R
D723,033	S *	2/2015	Hoock	D14/412	2015/0128741	A1 *	5/2015	Farkas	F16H 59/0278 74/473.3
D723,559	S *	3/2015	Hein	D14/413	2015/0253801	A1 *	9/2015	Wuisan	G05G 1/06 74/479.01
D725,681	S *	3/2015	Bonneau	D15/28	2016/0229523	A1 *	8/2016	Scacchi	B64C 13/04
D727,904	S *	4/2015	Jensen	D14/415	2018/0004310	A1 *	1/2018	Drum	G06F 3/0338
D731,487	S *	6/2015	Matloff	D14/412	OTHER PUBLICATIONS					
9,058,051	B2 *	6/2015	Miura	G05G 1/06	Gear shifters from the New York Auto Show, image post date Apr. 20, 2017, site visited Jul. 30, 2018, (online), < https://www.theverge.com/2017/4/20/15346160/gear-shifters-bmw-volvo-honda-ford-lexus-cadillac-new-york-international-auto-show >.*					
D741,863	S *	10/2015	Hoock	D14/413	Controllers of New holland t4.65 powerstar, image post date 2012, site visited Aug. 1, 2018, (online), < http://www.affaretrattore.it/annunci/new-holland-t4-65-powerstar-364557.html >.*					
D745,008	S *	12/2015	Jensen	D14/415	Hand Controller of CX8.90 conventional combine harvester, image post date Nov. 10, 2015, site visited Aug. 1, 2018, (online), < https://www.terre-net.fr/materiel-agricole/recolte-fenaison/article/avec-490-ch-la-cx8-90-devient-la-conventionnelle-la-plus-puissante-au-monde-208-114397.html >.*					
D745,009	S *	12/2015	Jensen	D14/415	* cited by examiner					
D747,721	S *	1/2016	Gentle	D12/179						
D751,027	S *	3/2016	Kasparian	D12/345						
D753,118	S *	4/2016	French	D12/179						
D758,949	S *	6/2016	Tran	D12/345						
D759,731	S *	6/2016	Roemer	D15/28						
D765,079	S *	8/2016	Hoock	D14/412						
D768,210	S *	10/2016	Jacobsthal	D15/31						
D768,728	S *	10/2016	Okuyama	D15/28						
D777,803	S *	1/2017	Wuisan	D15/28						
D778,219	S *	2/2017	Choi	D12/174						
D784,785	S *	4/2017	Sasaki	D12/179						
D784,872	S *	4/2017	Kanatani	D12/177						
D786,944	S *	5/2017	Okuyama	D15/28						
D797,743	S *	9/2017	Awad	D14/412						

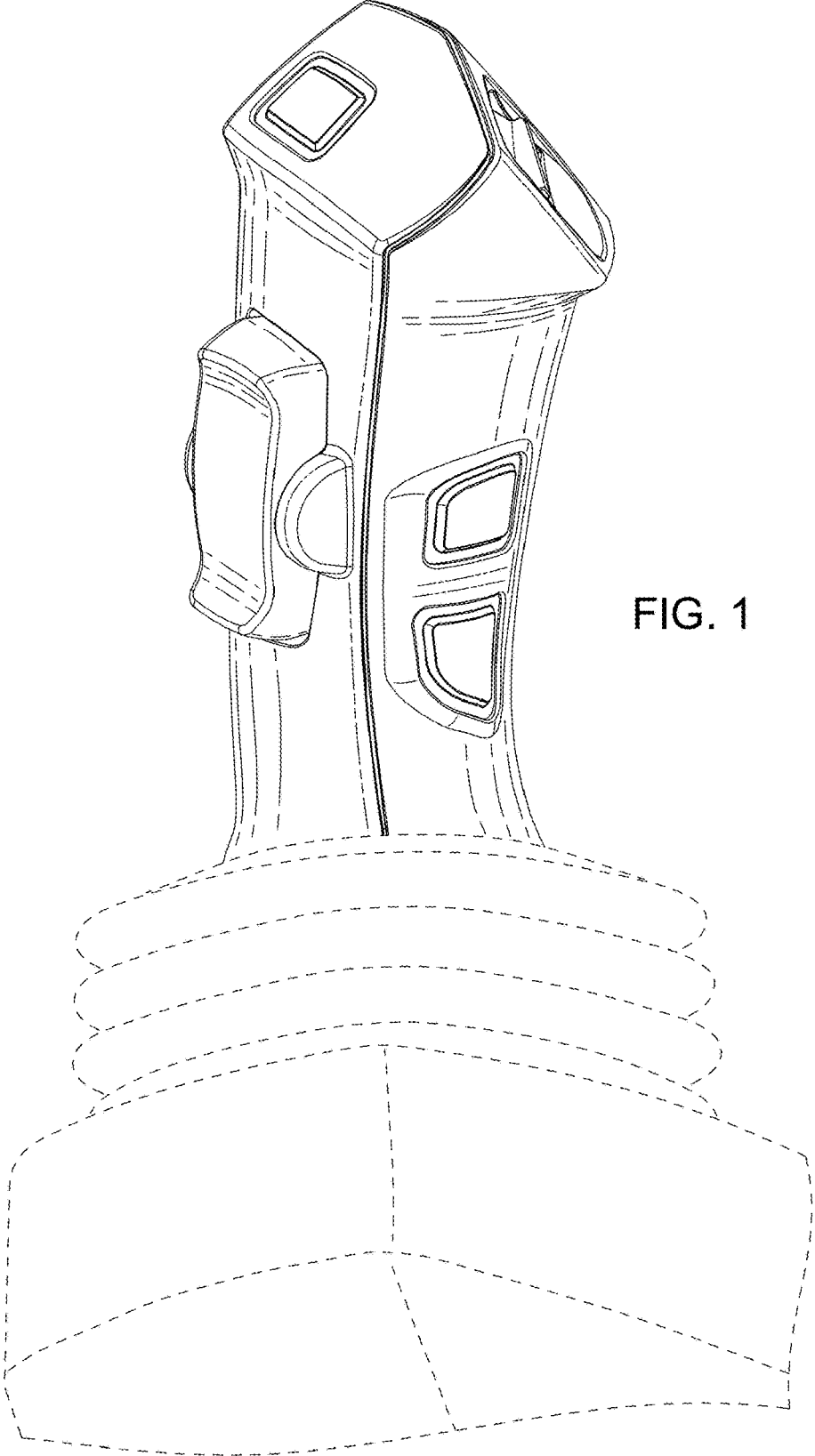

FIG. 1

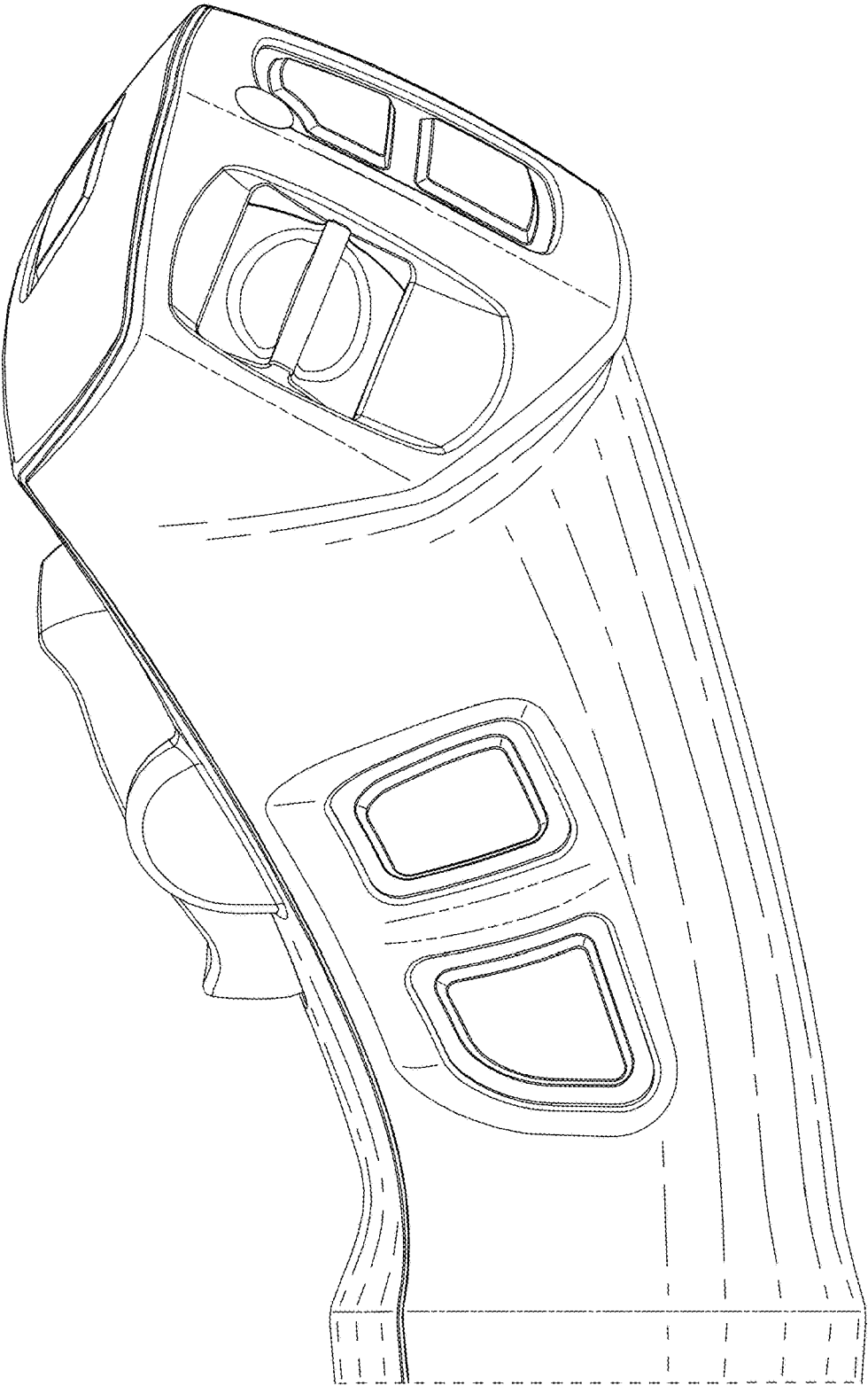

FIG. 2

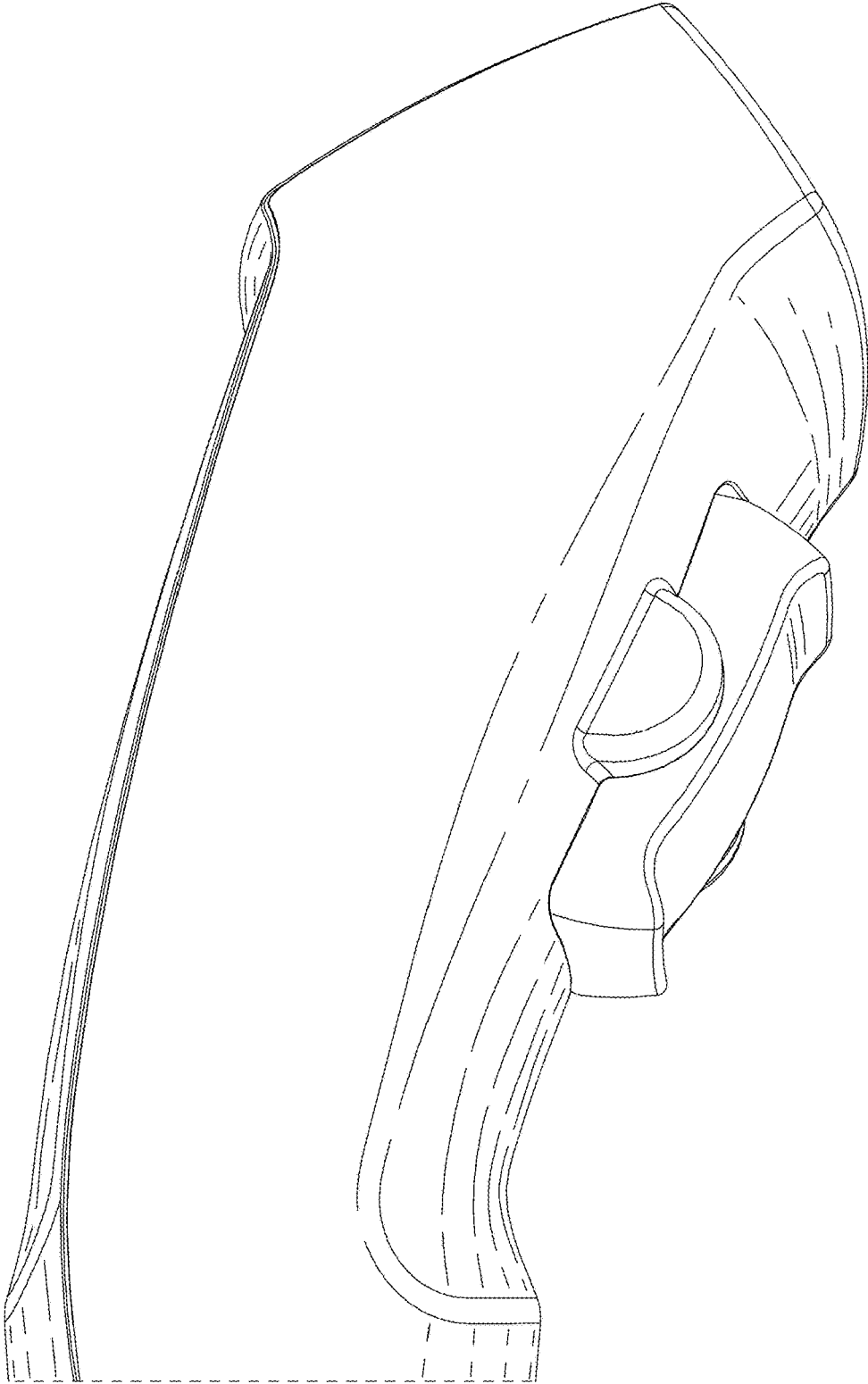

FIG. 3

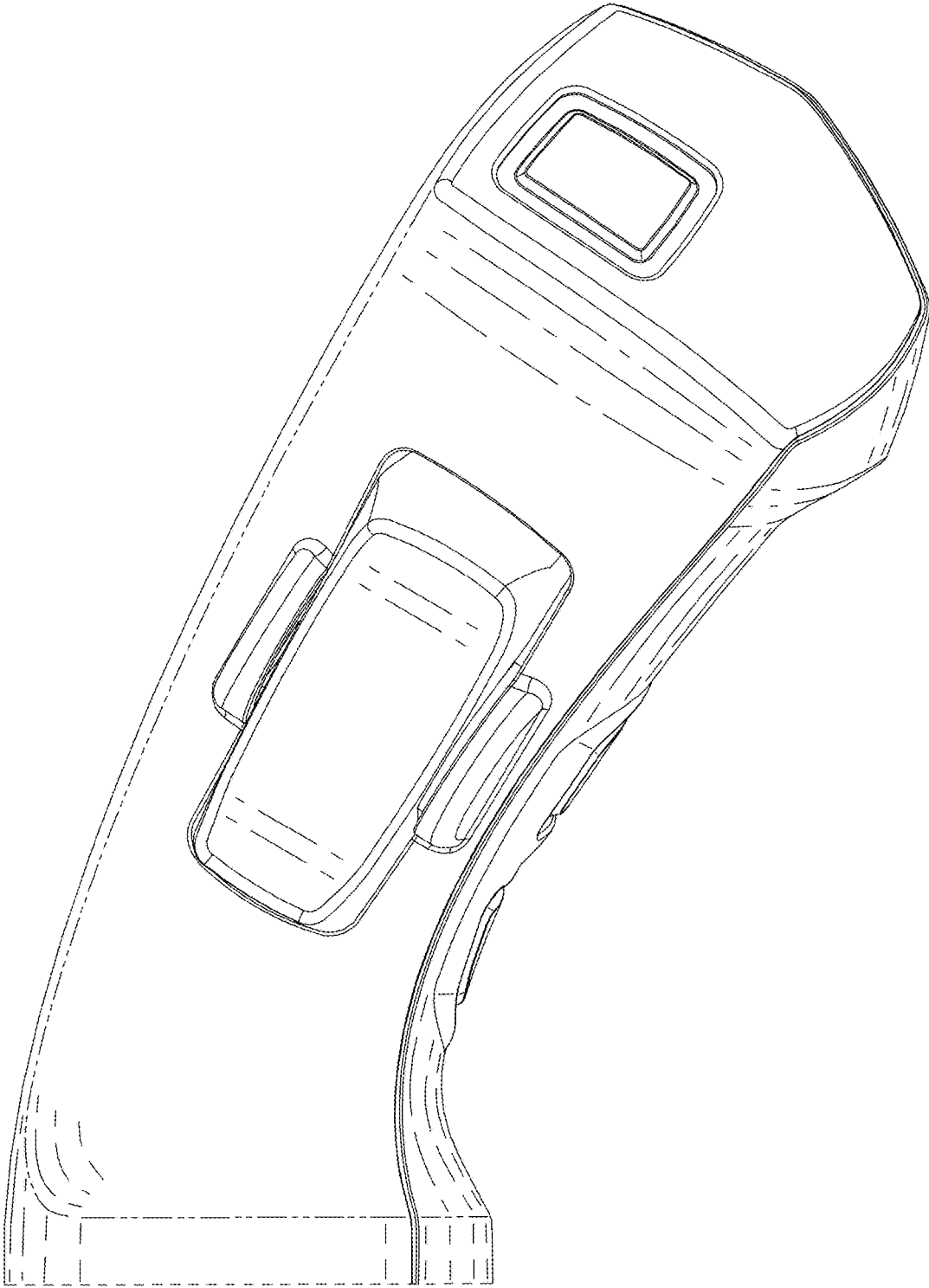

FIG. 4

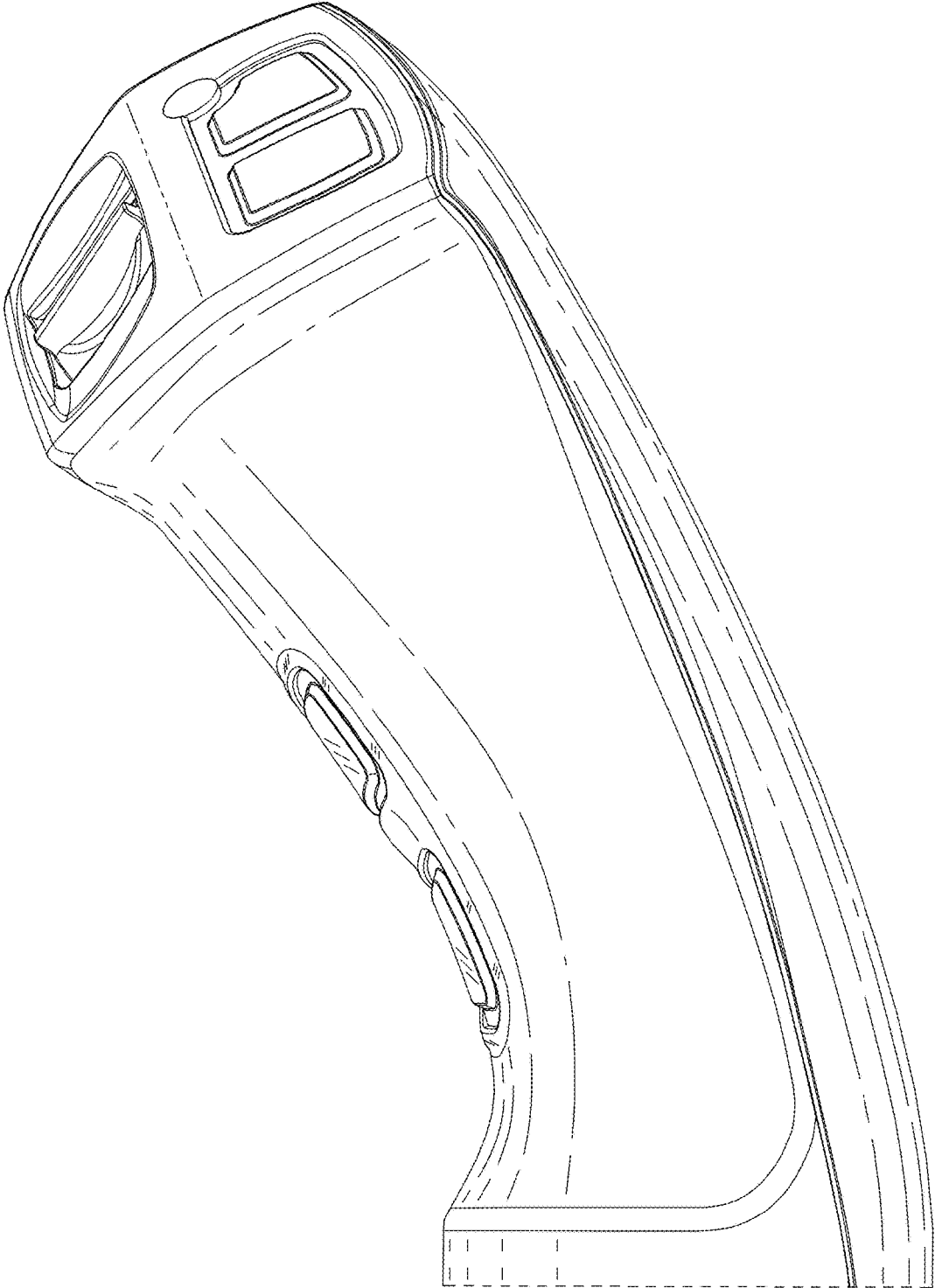

FIG. 5

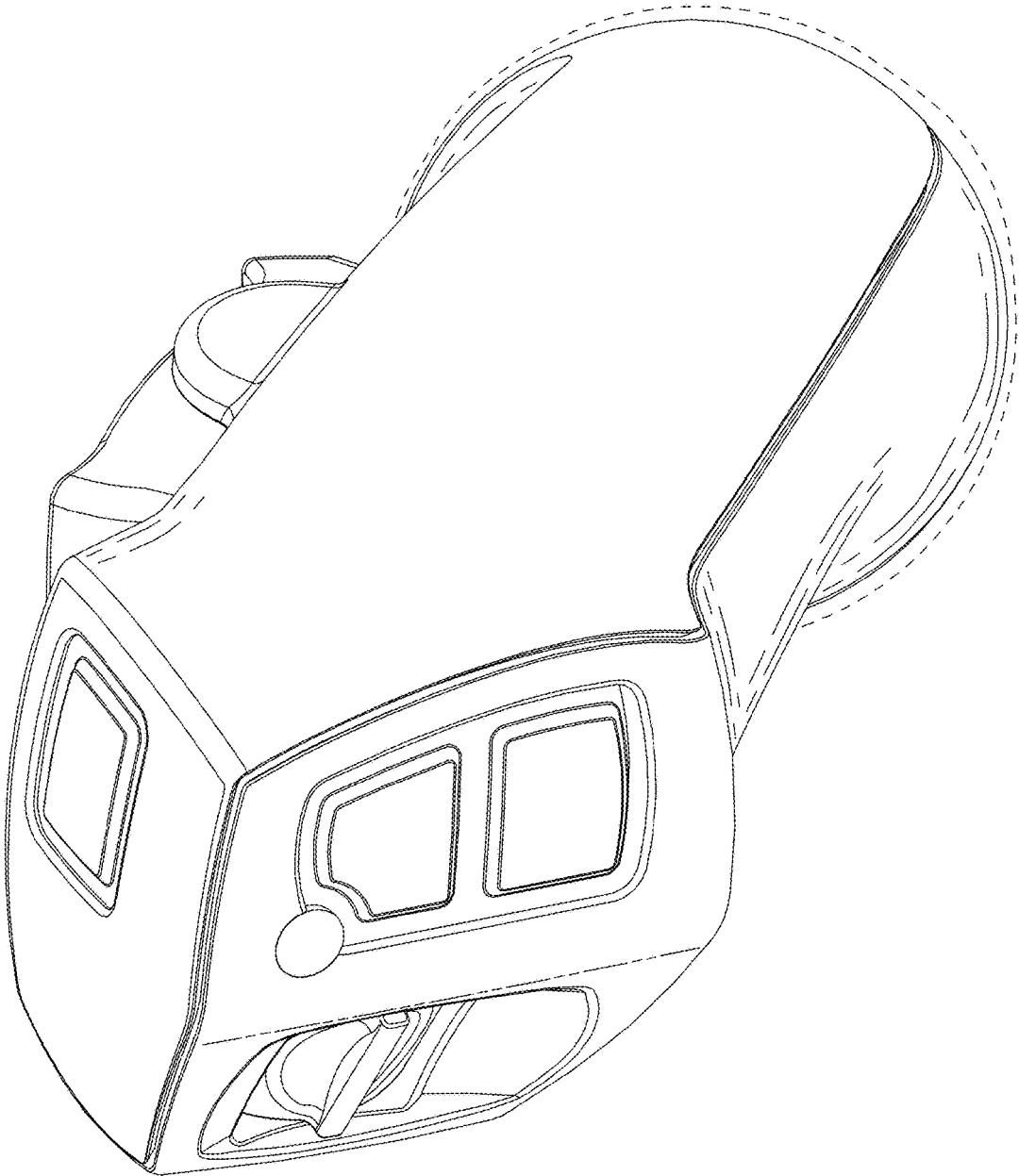

FIG. 6

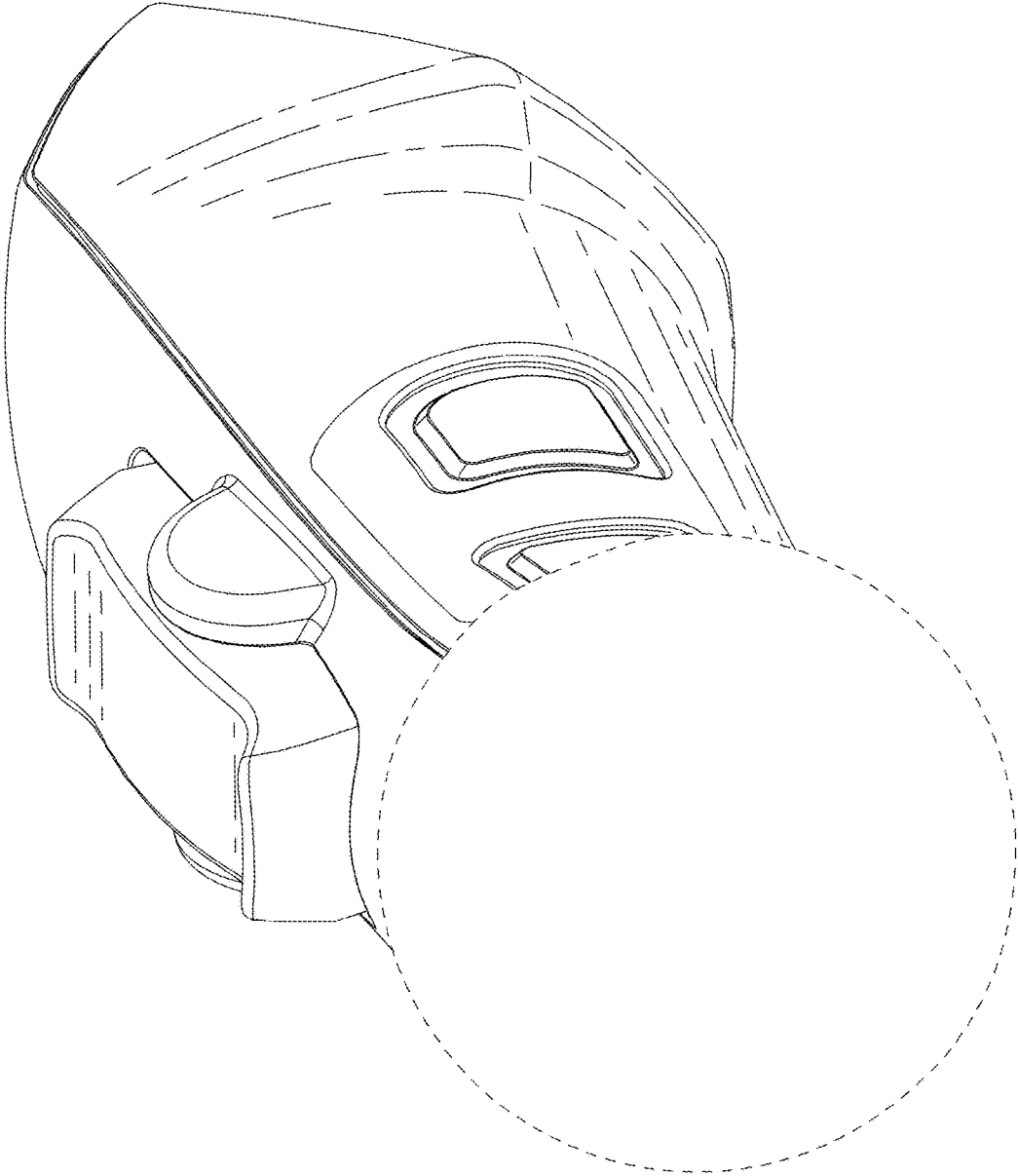

FIG. 7