



(86) Date de dépôt PCT/PCT Filing Date: 1995/08/31
 (87) Date publication PCT/PCT Publication Date: 1996/03/07
 (45) Date de délivrance/Issue Date: 2005/11/01
 (85) Entrée phase nationale/National Entry: 1997/02/27
 (86) N° demande PCT/PCT Application No.: US 1995/011173
 (87) N° publication PCT/PCT Publication No.: 1996/007270
 (30) Priorités/Priorities: 1994/08/31 (08/298,997) US;
 1994/09/27 (08/312,863) US; 1995/01/05 (08/369,522) US;
 1995/04/17 (08/424,863) US; 1995/06/07 (08/475,395) US

(51) Cl.Int.⁶/Int.Cl.⁶ H04N 7/08, H04N 5/445
 (72) Inventeurs/Inventors:
 YUEN, HENRY C., US;
 KWONG, DANIEL S., US;
 MANKOVITZ, ROY J., US;
 LEUNG, ELSIE Y., US
 (73) Propriétaire/Owner:
 E GUIDE, INC., US
 (74) Agent: FETHERSTONHAUGH & CO.

(54) Titre : PROCÉDE ET DISPOSITIF D'AFFICHAGE DE PROGRAMMES DE TELEVISION ET DE LEUR TEXTE D'ACCOMPAGNEMENT

(54) Title: METHOD AND APPARATUS FOR DISPLAYING TELEVISION PROGRAMS AND RELATED TEXT

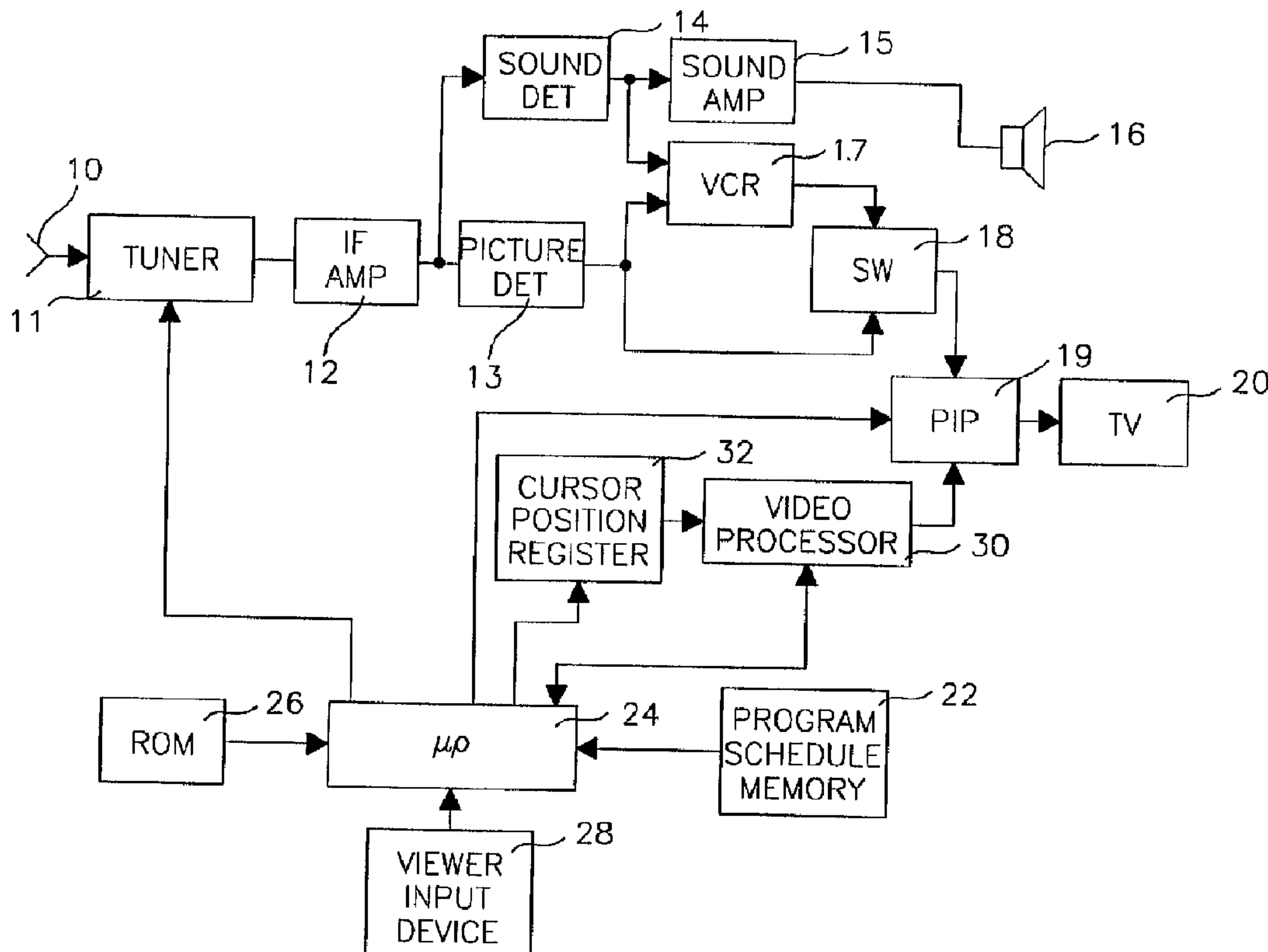

(57) Abrégé/Abstract:

A television viewer uses a PIP format for display of program related information (46) such as television program listings from a program schedule data base (22) in the background and moving, real time or stored video clip images of a program selected from the displayed listings in the PIP window (42). All the text of the background information lies outside the PIP window. In one embodiment, as the viewer selects a particular program from the display of current television program listings by means of a cursor (48) or a code number, the corresponding program automatically appears in the PIP window.



INTERNATIONAL APPLICATION PUBLISHED UNDER THE PATENT COOPERATION TREATY (PCT)

<p>(51) International Patent Classification ⁶ : H04N 5/445, 7/087</p>	<p>A1</p>	<p>(11) International Publication Number: WO 96/07270 (43) International Publication Date: 7 March 1996 (07.03.96)</p>
<p>(21) International Application Number: PCT/US95/11173 (22) International Filing Date: 31 August 1995 (31.08.95)</p> <p>(30) Priority Data: 08/298,997 31 August 1994 (31.08.94) US 08/312,863 27 September 1994 (27.09.94) US 08/369,522 5 January 1995 (05.01.95) US 08/424,863 17 April 1995 (17.04.95) US 08/475,395 7 June 1995 (07.06.95) US</p> <p>(60) Parent Application or Grant (63) Related by Continuation US 08/475,395 (CIP) Filed on 7 June 1995 (07.06.95)</p> <p>(71)(72) Applicants and Inventors: <u>YUEN, Henry, C.</u> [US/US]; P.O. Box 1159, Redondo Beach, CA 90278 (US). <u>KWOH, Daniel, S.</u> [US/US]; 3975 Hampstead Road, La Canada/Flintridge, CA 91011 (US). <u>MANKOVITZ, Roy, J.</u> [US/US]; 18057 Medley Drive, Encino, CA 91316 (US). <u>LEUNG, Elsie, Y.</u> [US/US]; 1302 Via Del Rey, South Pasadena, CA 91030 (US).</p>	<p>(74) Agent: RAHN, Leroy, T.; Christie, Parker & Hale, Suite 500, 350 West Colorado Boulevard, P.O. Box 7068, Pasadena, CA 91109-7068 (US).</p> <p>(81) Designated States: AM, AT, AU, BB, BG, BR, BY, CA, CH, CN, CZ, DE, DK, EE, ES, FI, GB, GE, HU, IS, JP, KE, KG, KP, KR, KZ, LK, LR, LT, LU, LV, MD, MG, MN, MW, MX, NO, NZ, PL, PT, RO, RU, SD, SE, SG, SI, SK, TJ, TM, TT, UA, UG, US, UZ, VN, European patent (AT, BE, CH, DE, DK, ES, FR, GB, GR, IE, IT, LU, MC, NL, PT, SE), OAPI patent (BF, BJ, CF, CG, CI, CM, GA, GN, ML, MR, NE, SN, TD, TG), ARIPO patent (KE, MW, SD, SZ, UG).</p> <p>Published <i>With international search report.</i></p> <p style="text-align: right; font-size: 2em;">2198740</p>	

(54) Title: METHOD AND APPARATUS FOR DISPLAYING TELEVISION PROGRAMS AND RELATED TEXT

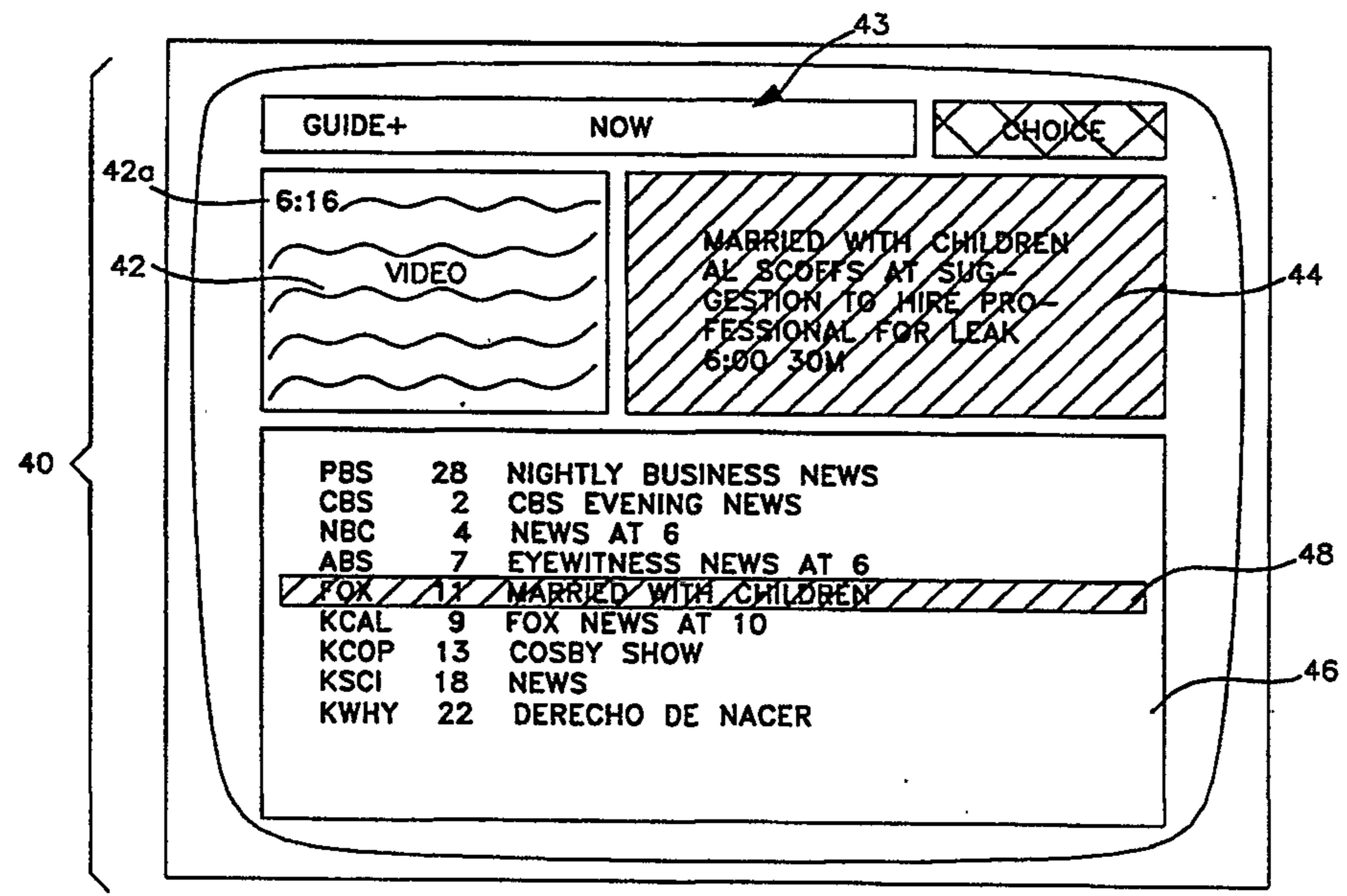

(57) Abstract

A television viewer uses a PIP format for display of program related information (46) such as television program listings from a program schedule data base (22) in the background and moving, real time or stored video clip images of a program selected from the displayed listings in the PIP window (42). All the text of the background information lies outside the PIP window. In one embodiment, as the viewer selects a particular program from the display of current television program listings by means of a cursor (48) or a code number, the corresponding program automatically appears in the PIP window.

1

METHOD AND APPARATUS FOR DISPLAYING TELEVISION PROGRAMS AND RELATED TEXT

5 Background of the Invention

This invention relates to the field of television and, more particularly, to a method and apparatus for simultaneously displaying video programs and related text on a television screen.

10 For a number of years television receivers have been equipped with picture-in-picture (PIP) capability. In PIP format, the moving, real time images of one television channel are displayed on the background of the screen and the moving, real time images of another television channel are displayed in a PIP window overlaid on a small area of the background. Because two channels are simultaneously displayed by the television receiver, two tuners are required. The viewer enters the PIP mode by pressing a PIP key of his or her controller.
15 Then, the viewer can change either the channel of the background or the channel of the PIP by resetting the appropriate tuner. To reverse the background and PIP images, the viewer simply presses a SWAP key. To collapse the PIP window, the viewer again presses the PIP key.

20 Television program guides help television viewers select programs to watch. Such television program guides list the available television programs by day of the week, time of day, channel, and program title. For many years television program guides have been published in hard copy form. More recently as illustrated by Levine Patent 4,908,713, television program guides have begun to take an electronic form. In other words, the schedule of program listings is stored in an electronic memory connected to the television
25 receiver. The program listings are recalled from memory by the viewer on command for display on the television screen.

Despite the prevalence of television program guides, many viewers still make their program selections by switching the television tuner from channel to channel and observing on the screen what program is being received on the respective channels. This process is
30 sometimes called "grazing."

Emanuel Patent 5,161,019 discloses an automated form of channel grazing. A preselected group of channels are sequentially scanned by switching the tuner of the television receiver from channel to channel. A still image of the program received on each channel is stored in a memory. After all the channels have been scanned, the still images
35 from all the channels are simultaneously displayed on the television screen. This process gives the viewer more information about the program choices in addition to that obtainable from a television program guide, namely, the displayed still images of the actual programs.

Summary of the Invention

Accordingly, the present invention provides an entertainment system comprising:

a display having a screen;

a television tuner for recovering currently telecast video programs;

5 a source of a schedule of program listings including listings for currently telecast video programs;

means for displaying some of the program listings for currently telecast video programs from the source in a first area of the screen;

10 an input device for selectively marking one of the displayed program listings for a currently telecast video program; and

means responsive to the input device for controlling the tuner to display in a second smaller and nonoverlapping area of the screen simultaneously with the program listings the currently telecast video program corresponding to the marked program listing, such that the entire image of the video program is visible in real time, and to play the audio corresponding
15 to the displayed video program.

The present invention also provides a system comprising:

a video display;

a video signal tuner;

a memory that stores program listings for a plurality of television programs;

20 means for displaying a plurality of program identifiers, each related to one of the program listings, in a schedule area of the video display; means for displaying a cursor highlighting a first program identifier in the schedule area;

means for displaying substantially all of an image output by the video signal tuner in a window area of the video display; and

25 means for displaying in a description area of the video display, additional information from the program listing related to the first program identifier highlighted by the cursor in the schedule area, wherein the additional information comprises information not in the first program identifier, and wherein the plurality of program identifiers, the image output by the video signal tuner and the additional information are simultaneously displayed.

30 The present invention also provides a system comprising:

a video display;

a video signal tuner;

a memory that stores program listings for a plurality of television programs; means for displaying a plurality of program identifiers, each related to one of the program listings, in a schedule area of the video display;

5 means for displaying a cursor highlighting a first program identifier in the schedule area;

means for displaying an image output by the video signal tuner in a video area of the video display; and

10 means for displaying in a description area of the video display, additional information from the program listing related to the first program identifier highlighted by the cursor in the schedule area, wherein the additional information comprises information not in the first program identifier, wherein the description area is arranged so that the description area does not significantly overlap the schedule area, and wherein the plurality of program identifiers, the image output by the video signal tuner and the additional information are simultaneously displayed.

15 According to the invention, the moving images of a television program are displayed in a PIP widow on the screen of a television monitor and textual information related to the television program is displayed in the background on the screen. Preferably, the audio portion of the television program displayed in the PIP window is also reproduced by the sound system of the television monitor. The textual information is arranged on the screen so
20 none of it is covered by the moving images.

In one embodiment, the textual program related information (PRI) is a television program schedule. One of the program listings of the schedule identifies by title and time and/or channel the television program in the PIP window, which comprises moving images.

25 To facilitate channel grazing, a television viewer can use a PIP format for display of current television program listings from a program schedule data base in the background and moving, real time images of a program selected from the displayed listings in the PIP window. Specifically, as the viewer selects a particular program from the displayed current television program listings by means of a cursor or a code number, the corresponding program automatically appears in the PIP window. In this way, the viewer can channel graze
30 by sequentially selecting the individual program listings in the background. When the viewer finds a program that the viewer wishes to watch, the viewer leaves the PIP format and returns to full screen television viewing, the tuner already being set to the desired program. To do this the viewer can reverse the background and PIP window and then collapse the

window, leaving the desired program on the full screen or apparatus can be configured to return to full screen viewing in a single step.

To permit the viewing of programs scheduled for future broadcast without losing sight of the current program being watched, a television viewer can use a PIP format for display of television program listings for a specific channel from a program schedule data base in the background and moving, real time images of the current program on that channel in the PIP window. Specifically, as the viewer changes channels, the current program on that channel automatically appears in the PIP window. The viewer can control the background to display program listings for a period of days, e.g. a week, in the future. In this way, the viewer can continue to watch a television program while ascertaining the future programs on the channel to which the television tuner is set. When the viewer finds a program that the viewer wishes to watch, the background disappears, leaving the program on the channel to which the tuner is set on the full screen.

In another embodiment, a television viewer can use a PIP format for display of future television program listings from a program schedule data base in the background and moving images of a video clip of one of the program listings in the background display selected for example by a cursor.

In yet another embodiment, the textual program related information (PRI) is a message that is broadcast in the vertical blanking interval of the television signal contemporaneously with the television program displayed in the PIP window.

In a further aspect, the present invention provides a method of channel surfing with a television apparatus receiver having a tuner and a screen, the method comprising the steps of:

storing in a memory a plurality of current television program listings, each program listing including a channel identification;

setting the tuner to receive a particular channel;

displaying in a first area of the screen in real time the entire image of the program telecast on the particular channel and playing the audio corresponding to the displayed program;

simultaneously displaying in a second area of the screen at least some of the current program listings stored in the memory, such that the program listings in the second area of the screen block from view none of the image of the telecast program in the first area;

marking on the screen one of the displayed current program listings;
 retrieving from the memory the channel identification of the marked program listing;
 and

5 using the retrieved channel identification to set the tuner to receive and substitute on
 the screen for the program telecast on the particular channel the program telecast on the
 identified channel, and to play the audio corresponding to the displayed program on the
 identified channel.

The present invention also provides a method using a video display, a video signal
 tuner and a memory, comprising:

10 storing program listings for a plurality of television programs in the memory;
 displaying a plurality of program identifiers, each related to one of the program
 listings, in a schedule area of the video display;
 displaying a cursor highlighting a first program identifier in the schedule area;
 displaying substantially all of an image output by the video signal tuner in a window
 15 area of the video display, the window area being arranged so that the schedule area does not
 significantly overlap the window area; and

displaying in a description area of the video display, additional information from the
 program listing related to the first program identifier highlighted by the cursor in the
 schedule area, wherein the additional information comprises information not in the first
 20 program identifier, and wherein the plurality of program identifiers, the image output by the
 video signal tuner and the additional information are simultaneously displayed.

The present invention also provides a method using a video display, a video signal
 tuner and a memory, comprising:

25 storing program listings for a plurality of television programs in the memory;
 displaying a plurality of program identifiers, each related to one of the program
 listings, in a schedule area of the video display;
 displaying a cursor highlighting a first program identifier in the schedule area;
 displaying an image output by the video signal tuner in a video area of the video
 display; and

30 displaying in a description area of the video display, additional information from the
 program listing related to the first program identifier highlighted by the cursor in the
 schedule area, wherein the additional information comprises information not in the first
 program identifier, the description area being arranged so that the description area does not

significantly overlap the schedule area, and wherein the plurality of program identifiers, the image output by the video signal tuner and the additional information are simultaneously displayed.

The present invention also provides a method for displaying television program
5 information comprising the steps of:

storing in electronic memory electronic program guide information including for each television program, title, start time, and regional channel name;

storing in electronic memory a channel map that links channel names with local
channel numbers;

10 selecting a particular on-screen guide for display;

retrieving from electronic memory electronic program guide (EPG) information required to display the selected on-screen guide, including title, start time, and regional channel name;

retrieving from electronic memory the local channel number linked to each regional
15 channel name retrieved from electronic memory;

displaying the retrieved titles, start times, regional channel names, and the local channel numbers as the selected on-screen guide.

The present invention also provides a method of storing show data items in a memory for display on a television screen, the method comprising the steps of:

20 transmitting to the memory show data items each representing a time period, a channel, and a title of a program to be telecast during the time period on the channel;

storing the title of each show data item at a specific address in a first area of the memory; and

storing the specific address at a location in a second area of the memory assigned to
25 the telecast time and channel represented by the show data item.

The present invention also provides a method of displaying internal television channel numbers in an electronic program guide (EPG) comprising the steps of:

storing in memory an EPG identifying television programs by title, provider channel designation, and time of telecast;

30 storing in memory a table that links internal channel numbers and provider channel designations;

selecting from the EPG television programs meeting one or more criteria;
 recovering from memory the title, provider channel designation, and time of telecast
 of programs meeting the one or more criteria;

recovering from memory the internal channel number of each provider channel
 5 designation recovered from memory; and

displaying the title, internal channel number, and time of telecast of each of the
 selected programs.

Brief Description of the Drawings

The features of specific embodiments of the best mode contemplated of carrying out
 10 the invention are illustrated in the drawings, in which:

FIG. 1 is a schematic block diagram of a television receiver that has an electronic
 television program guide incorporating the principles of one embodiment of the invention;

FIGS. 2 to 5 are television screens formatted in accordance with the embodiment of
 FIG. 1;

15 FIG. 6 is a top plan view of a remote controller for operating the electronic program
 guide of FIG. 1;

FIGS. 7 to 14 are flow diagrams showing how a viewer navigates through the
 electronic program guide of FIG. 1 and the screen formats encountered by the viewer during
 such navigation;

20 FIG. 15 is a schematic diagram depicting the hierarchy of prompts and guides shown
 in FIGS. 7 to 14;

FIGS. 16 and 17 are screens formatted to designate by color coding the title of the
 program in the PIP window and the title of the program in the program description area;

25 FIG. 18 is a screen formatted to display a real time television program with an
 electronic program guide, and thereby simulate the screen format of FIG. 2, 3, 4, or 5, with a
 television receiver that does not have a PIP chip;

FIG. 19 is a graph illustrating an alternative way for the viewer to navigate through
 the television program guide;

30 FIG. 20 is a schematic block diagram of a television receiver that has an electronic
 television program guide that displays PRI in accordance with the principles of another
 embodiment of the invention; and

FIG. 21 is a screen formatted to display the PRI recovered by the receiver of FIG. 20;

FIG. 22 is a diagram of the RAM memory data base that illustrates the static and dynamic areas of the invention; and

FIG. 23 is a diagram of the download packet received by the system.

FIG. 24 is a representation of the memory bit map contained in the RAM memory.

5 FIG. 25 is a representation of the pre-established time list data structure contained in the static area of the RAM memory.

FIG. 26 is an illustration of a show information package data structure.

FIG. 27 is an illustration of a section of a show information package data structure.

FIG. 28 is an illustration of an extended theme show list.

10

1 FIG. 29 is a representation of the channel map data structure contained in the static area of the RAM memory.

FIG. 30 is a representation of the control array data structure contained in the static area of the memory.

5 FIG. 31 is a representation of the call letter map data structure located in the static area of the RAM memory.

FIG. 32 is a representation of the record queue data structure located in the static area of the RAM memory.

10 FIGS. 33 to 35 are television screens formatted in accordance with another embodiment of the invention;

FIGS. 36 to 38 are flow diagrams showing how a viewer navigates through the electronic program guide of FIG. 1 that includes the screen formats of FIGS. 33 to 35; and

FIG. 39 is a schematic diagram depicting the hierarchy of prompts and guides shown in FIGS. 36 to 38.

15 Detailed Description of a Specific Embodiment

In the following description of the embodiments of the invention, common reference numerals are used to represent the same components. If the features of all the embodiments are incorporated into a single system, these components can be shared and perform all the functions of the described embodiments.

20 In a preferred embodiment, the invention displays information about television program schedules and content in a tripartite electronic television program guide. One screen format is a time specific program guide (TISPG); another screen format is a channel specific program guide (CSPG); and the third screen format is a theme specific program guide (THSPG). In each case, the moving images of a currently broadcast television program are displayed in real time in a PIP window.

25 With reference to FIG. 1, a source of television signals 10 such as a terrestrial antenna, or a cable is connected to a television tuner 11. The output of tuner 11 is a modulated intermediate frequency signal containing video and audio television information. Tuner 11 is connected by an intermediate frequency amplifier (IF AMP) 12 to a picture detector (PICTURE DET) 13 and a sound detector (SOUND DET) 14, which produce base band video and audio signals, respectively. The audio signal is coupled by a sound amplifier (SOUND AMP) 15 to a loudspeaker 16. The video signal is coupled by a video amplifier not shown to one input of a switch 18. Sound detector 14 and picture detector 13 are connected to the audio and video inputs, respectively, of a video cassette recorder (VCR) 17. 30 (Alternatively, television signal source 10 could be directly connected to the RF input of VCR 17, if its internal tuner and demodulating circuitry is to be utilized.) The output of VCR 17 is connected to the other input of switch 18. The output of switch 18 is connected to one input of a conventional picture-in-picture (PIP) integrated circuit chip 19. The output of PIP 35

1 chip 19 is connected to the video input of a television receiver or monitor (TV) 20 having
a screen (not shown).

5 An updatable data base of the schedule of program listings of all the available channels
for a prescribed period of time, e.g. a day or a week, is electronically stored in a program
schedule memory 22. These program listings typically include for each program the title,
a program description, the day of the week, the start time of the day, the program length,
and the channel on which the program is transmitted and thus available for reception at
10 source 10. In a preferred embodiment of the invention, the period of time for which the
program listings are stored is different for the guides, depending upon viewer priorities and
preferences. For example, the information needed to display the TISPG and CSPG may be
stored for one or two days and the information needed to display the TSPG may be stored
for a week or more. The data base can be updated by a continuous data link in the vertical
15 blanking interval (VBI) of one television channel broadcast to the television receiver in well
known fashion. Alternatively, the data base can be updated by unplugging memory 22 and
replacing it with a memory having the updated data base. Memory 22 is connected to a
microprocessor 24 that is programmed to control the operation of the described equipment.
An operating program for microprocessor 24 is stored in a read only memory (ROM) 26.
A viewer input device 28, preferably in the form of a remote IR controller, is coupled to
20 microprocessor 24 to provide commands from the viewer. A video processor 30 is coupled
to microprocessor 24. When the viewer wishes to see television program listings,
microprocessor 24 recalls a portion of the program schedule data base from memory 22 and
couples it to video processor 30, where the program listings are formatted for display.
Preferably, the information stored in video processor 30 is a bit map of what is displayed on
the screen of television receiver 20. Video processor 30 is connected to the other input of
25 PIP chip 19. Preferably, viewer input device 28 controls microprocessor 24 by cursor
movement on the screen of television receiver 20. To this end, microprocessor 24 and video
processor 30 are coupled to a cursor position register 32. (Alternatively, the viewer can
select items of information displayed on the screen by keying into viewer input device 28
code numbers assigned to these items.) Microprocessor 24 is also coupled to tuner 11 for
30 channel change, to VCR 17 for play/record selection and start/stop, to switch 18 for selection
of one of its inputs, and to PIP chip 19 for selection of the mode of PIP operation.

35 The formats of the electronic program guide are shown in FIGS. 2 to 5. Each format
has a background area 40 and an overlaid PIP window 42 in the upper left-hand corner of
the screen. The real time, i.e., 6:15 p.m., is displayed in a sub-area 42a PIP window 42.
Background area 40 includes a banner and message prompting area 43 at the top of the
screen, a program description area 44 in the upper right-hand corner of the screen adjacent
to PIP window 42, and a program schedule area 46 below areas 42 and 44. Program
description area 44 includes the start time and length (duration) of the program being

1 described. The viewer can move a cursor 48 vertically to highlight one of the program
listings displayed in area 46. The highlighted background of cursor 48 and the background
of program description area 44 are the same color or shade. In each format, the complete,
5 moving images of a currently broadcast television program in real time and the current time
are displayed in PIP window 42 and the audio portion of the television program displayed
in PIP window 42 is reproduced by the sound system of monitor 20. The information
displayed in areas 43, 44, and 46 varies depending upon the format.

One version of the TISPG screen format is shown in FIG. 2, namely a version that
displays program listings of television programs being broadcast at the current time. In the
10 following description, this format is sometimes called the "NOW" guide or the "ALL
CHANNEL" guide. Program schedule area 46 has a column for channel name or call
letters, a column for channel number, and a column for program title; each line of area 46
represents a separate program listing. The moving, real time images of the current television
program highlighted by cursor 48 are displayed in PIP window 42 and a brief program
15 description of the highlighted program is displayed in area 44.

In FIG. 3 another version of the TISPG screen format displays in area 46 program
listings being broadcast at a future time, i.e., 8:00 p.m. In the following description, this
format is sometimes called the "NEXT" guide. The viewer can select the future time of the
program listings to be displayed at intervals such as one-half hour. The selected future time,
20 i.e., 8:00 p.m., for the program listings displayed in area 46 is shown in a sub-area 43a of
area 43. A brief program description of the program listing highlighted in area 46 by cursor
48 is displayed in area 44. The current program being broadcast remains displayed in PIP
window 42, and a banner 49 which identifies the current program by channel name, channel
number, and program title is displayed between PIP window 42 and area 46 on a background
25 having a different color or shade than cursor 48.

In FIG. 4, the CSPG screen format is shown. In the following description, this format
is sometimes called the "THIS CHANNEL" guide. All the program listings for a selected
channel, i.e., FOX Channel 7, are displayed in area 46, from the currently broadcast
program into the future for a specified time period, e.g., 24 hours or until the end of the next
30 day. Area 46 has a column for time and a column for program title; each line of area 46
represents a separate program listing. The moving, real time images of the current television
program are displayed in PIP window 42. If the cursor also highlights the current program,
a brief program description of the current program is displayed in area 44. If the cursor
highlights another program listing, as shown in FIG. 4, a brief program description of the
35 highlighted program is displayed in area 44 and the current program is identified in banner
49 by time and title.

In FIG. 5, the THSPG screen format is shown. In the following description, this
format is sometimes called the "SORT" guide. The program listings for a selected theme

1 or subtheme, i.e., ALL MOVIES, are displayed in area 46, from the next broadcast program
into the future for a specified time period, e.g., one week. Area 46 has a heading 46a that
identifies the theme or subtheme, date, and day, i.e., ALL MOVIES DEC 12 MON, a
5 column for title, a column for start time, and a column for channel name or number; each
line of area 46 represents a separate program listing. The moving, real time images of the
current television program are displayed in PIP window 42 and the current program is
identified in banner 49 by channel name or number and title. A brief program description
of the program highlighted by cursor 48 is displayed in area 44.

10 All four areas of background 40 are formatted in video processor 30. The memory
space of video processor 30 corresponding to the area in which PIP window 42 appears on
the screen is left blank; i.e., although overlaid on background area 40, PIP window 42 does
not cover up any of the information of background area 40. By means of a pair of up/down
arrows on viewer input device 28, the viewer can move a cursor 48 vertically to highlight
the listing of one of the currently playing television programs displayed in area 46.
15 Preferably, to reduce delays in displaying the program schedules, all the program listings for
the particular screen format are stored in video processor 30, even though only a fraction of
them are displayed at the same time. When the cursor reaches the top or bottom listing in
area 46, microprocessor 24 recalls further program listings from video processor 30 for
display on the screen of television receiver 20.

20 In all the formats, the moving, real time images of the current television program
highlighted by cursor 48 are displayed in PIP window 42, the program description of the
highlighted program is displayed in area 44, program listings of one type or another are
displayed in area 46, and one or more prompts are displayed in banner area 43 as described
in more detail below. The audio portion of the television program displayed in PIP window
25 42 is reproduced by the sound system of monitor 20. The PIP display, the sound
reproduction, and the program description in area 44 enable the viewer to assess better
whether or not to watch the highlighted program. As the viewer moves cursor 48 vertically
from program listing to program listing, the current television program displayed in window
42 and the program description displayed in area 44 automatically change accordingly to
30 match the highlighted program in area 46. As the cursor moves from one program listing
to another, tuner 11 is set to the channel for the highlighted program listing so the program
can be displayed in PIP window 42, microprocessor 24 recalls the program description for
the highlighted listing from program schedule memory 22, and video processor 30 formats
this program description so it can be displayed in area 44.

35 Preferably, two levels of detail are available for the program description. Normally,
the first level detail of the program description is displayed in area 44 as described above.
When more detail is desired, the viewer operates input device 28 to display a second level
detail of the program description. There are two options for the display of the second level

1 detail. As one option, the second level detail can replace the first level detail in area 44.
This has the advantage that the program listings can continue to be seen by the viewer while
more detail about the program description is displayed. As the other option, the second level
detail can replace the program listings in area 46. This has the advantage that more space
5 is available to display the second level of detail than the first level.

Reference is made to FIGS. 6 to 14 for a description of the steps taken by a viewer
to navigate about the preferred embodiment of the television program guide. Viewer input
device 28 preferably takes the form of a hand-held remote infrared (IR) transmitter which
communicates with an infrared receiver connected to microprocessor 24. As shown in FIG.
10 6, the IR transmitter has a housing 50 on which a number of control buttons are mounted.
A GUIDE/TV button 52, an INFO button 54, and a VCR PLUS+ button 56 are located
above up and down arrow buttons 58 and 60. A row of buttons 62, 64, 66 and 68 which
marked with the colors red (R), green (G), yellow (Y), and blue (B), respectively, underlie
down arrow button 60. Red, green, yellow, and blue prompts are displayed in area 43 of
15 the electronic guides. To select a prompt on the screen, the button of the IR transmitter
having the corresponding color is pressed, i.e., to select the blue prompt on the screen, blue
button 68 is pressed.

The screen formats and the links between the individual guides are designed with two
objectives in mind--first, always to display the program the viewer was watching before
20 entering the electronic guide and second, never to leave the electronic guide while navigating
through it, until the viewer returns to the TV mode. As described below, the guides are
linked to each other in a one way hierarchy that is accessed by on screen prompts color
coded to the buttons on the remote control transmitter. At each level of the hierarchy, the
viewer has the choice of returning to a backbone guide, or moving down to a guide at a
25 lower level in the hierarchy. At the lowest level, the only choice is to return to the backbone
guide. At each level, the viewer's choices are displayed on the screen by the prompts, so
the need to use the buttons on viewer input device 28 to navigate through the guide is
minimized.

As represented in FIG. 7 by a box 70, the viewer enters the electronic guide by
30 pressing GUIDE/TV button 52 on the remote transmitter. As represented by a box 72, the
so-called "NOW" guide is then displayed on the screen. This is the "backbone" of the
electronic guide in that it is the starting point for entry into each other guide.

As represented by a box 74 in each of FIGS. 8 to 14, the viewer may cursor up and
down the program listings in area 46 to select a particular program. As represented by a box
35 76 in each of FIGS. 8 to 14, the viewer presses GUIDE/TV button 52 to return to the full
screen TV mode and presses INFO button 54 to display the second level detail of the
program information in area 44 or area 46.

1 In FIG. 7 a box 80 depicts the layout of the NOW guide, which is a version of the
TISPG screen format. Area 43 has a blue "CHOICE" prompt and a banner that identifies
the format as the "NOW" format and displays the date, day, and time. When the viewer
presses blue button 68 on the remote transmitter (FIG. 6), as represented by a block 82, four
5 prompting choices are presented to the viewer. As represented by a block 84 in FIG. 8,
these prompting choices are displayed in an "ALL CHANNEL" guide.

Block 86 represents the "ALL CHANNEL" guide, which is identical to the "NOW"
guide except for area 43. This is a transition guide in that it permits the viewer to enter
other guides at a lower level of the hierarchy by following the displayed prompts. In the
10 "ALL CHANNEL" guide, a red NOW prompt, a green CSPG prompt, a yellow NEXT
prompt, and a blue SORT prompt are displayed. As represented by a box 88, in each of the
guides of FIGS. 8 to 14, a return to the NOW guide of FIG. 7 occurs when the viewer
presses red button 62 on the remote control transmitter.

As represented by a box 90 in FIG. 8 and a box 92 in FIG. 9, when green button 64
15 is pressed from the ALL CHANNEL guide, a "THIS CHANNEL" guide in the CSPG format
described above is displayed. A box 94 depicts the THIS CHANNEL guide, which is at the
bottom of the hierarchy. So, only one prompt is displayed in area 43, namely the red NOW
prompt, which permits the viewer to return to the NOW guide. Area 43 also displays the
name and channel number of the specific channel, e.g. ABC, Channel 7.

As represented by a box 96 in FIG. 8 and a box 98 in FIG. 10, to display the
20 "NEXT" guide, the viewer presses yellow button 66 on the remote control transmitter. The
NEXT guide, which has the TISPG format, is depicted by a box 100. Initially, current
programs are displayed in area 46, as in the NOW guide (FIG. 2). Area 43 in the NEXT
guide has in addition to the red NOW prompt, a green up arrow prompt, a blue down arrow
25 prompt, and the time of the programs displayed in guide between the up and down arrows.
Area 43 also displays the time at which the listed programs are broadcast, i.e., initially the
current time. Each time the viewer presses blue button 68, the guide advances one half hour
so the programs broadcast at a one-half hour later time are displayed, as represented by a
box 104, and the time displayed in area 43 changes accordingly. Each time the viewer
30 presses green button 64, the guide retreats one half hour so the programs broadcast at a one-
half hour earlier time are displayed, as represented by a box 102 and the time displayed in
area 43 changes accordingly. When buttons 64 and 66 are pressed to display future
programs in area 46, banner 49 (FIG. 3) appears to identify the current real time television
program being displayed in PIP window 42. The NEXT guide is at the bottom of the
35 hierarchy so the only route of exit from this guide is the RED prompt to return to the NOW
guide.

As represented by a box 105 in FIG. 8 and a box 106 in FIG. 11, a first level of
"SORT" prompts is displayed when the viewer presses blue button 68 while in the ALL

1 CHANNEL guide. As depicted by a box 108 (FIG. 11), in addition to the red NOW
prompt, there are a first level of SORT buttons that comprise a green MOVIES prompt, a
yellow SPORTS prompt, and a blue OTHERS prompt in area 43. The ALL CHANNEL
guide for the current time, i.e., NOW guide remains displayed in area 46. When the viewer
5 presses green button 64, an "ALL MOVIES" guide is displayed in area 46, as represented
by a box 109 in FIG. 11 and a box 112 in FIG. 12, and screen-1 of a second level, i.e.,
subtheme, of movie SORT buttons is displayed in area 43, as represented graphically in a
box 114 in FIG. 12. When the viewer presses blue button 68, the NOW guide is displayed
in area 46, as represented by a box 130 in FIG. 14 and screen-2 of the first level, i.e., the
10 SORT buttons, is displayed in area 43, as represented graphically in a box 111 in FIG. 11
and a box 132 in FIG. 14.

In addition to the red NOW prompt, the screen-1, second level movie SORT buttons
(FIG. 12) comprise a green ACTION prompt, a yellow COMEDY prompt and a blue
OTHER prompt for calling up a screen-2 series of SORT buttons to permit selection of other
15 subcategories of movies. In the ALL MOVIES guide, the sum of all the movies in all the
subcategories are displayed. When the viewer presses green button 64, an ACTION
MOVIES guide (not shown) is displayed in area 46. When the viewer presses yellow button
66, a COMEDY MOVIES guide (not shown) is displayed in area 46. In each of these cases,
only a RED prompt is displayed in area 43 because the electronic guide is at the bottom of
20 the hierarchy and the only route the viewer can take is to return to the NOW guide (FIG. 7).
When the viewer presses green button 64, an ACTION MOVIES guide (not shown) is
displayed in area 46. When the viewer presses yellow button 66, a COMEDY MOVIES
guide (not shown) is displayed in area 46. In each of these cases, only a RED prompt is
displayed in area 43 because the electronic guide is at the bottom of the hierarchy and the
25 only route the viewer can take is to return to the NOW guide (FIG. 7). When the viewer
presses blue button 68, as represented by a box 120 in FIG. 12 and a box 122 in FIG. 13,
the ALL MOVIES guide remains displayed in area 46 and the screen-2 series of second level
movie SORT buttons is displayed in area 43. As represented graphically by a box 124, the
screen-2 series of SORT buttons for the second movie level comprise, in addition to the red
30 NOW prompt, a green DRAMA prompt, a yellow HORROR prompt, and a blue ALL
OTHER prompt. When the viewer presses green button 64, a DRAMA MOVIES guide (not
shown) is displayed in area 46. When the viewer presses yellow button 66, a HORROR
MOVIES guide (not shown) is displayed in area 46. When the viewer presses blue button 68,
a ALL OTHER MOVIES guide (not shown) is displayed in area 46. In each of these cases,
35 only a RED prompt is displayed in area 43 because the electronic guide is at the bottom of
the hierarchy and the only route the viewer can take is to return to the NOW guide (FIG. 7).

The reason for multiple screens of prompts in the movie theme guide is to provide the
number of prompts in area 43 to display all the subcategories of movies. Instead of an ALL

1 OTHER movie prompt, a screen-3 series of second level movie SORT buttons could be
displayed if more movie subcategories are desired. This pattern of screen could be extended
as far as necessary to satisfy the need for subcategories.

5 As represented in FIGS. 11 and 14, when the viewer presses blue prompt button 68
in the first level of SORT buttons, a screen-2 of first level SORT buttons is displayed in area
43 and the NOW guide remains displayed in area 46. As depicted graphically by box 132,
in addition to the red NOW prompt, the screen-2 SORT buttons comprise a green CHILD
prompt, a yellow SPECIAL prompt, and a blue SERIES prompt. When the viewer presses
10 green button 64, an ALL CHILDREN's guide (not shown) is displayed in area 46 as
represented by a box 134. When the viewer presses yellow button 66, an ALL SPECIAL
guide (not shown) is displayed in area 46 as represented by a box 136. When the viewer
presses blue button 68, an ALL SERIES guide (not shown) is displayed in area 46 as
represented by a box 138. In each of these cases, only a RED prompt is displayed in area
15 43 because the electronic guide is at the bottom of the hierarchy and the only route the
viewer can take is to return to the NOW guide (FIG. 7).

As represented by block 110 in FIG. 11, when the viewer presses yellow prompt
button 66, an ALL SPORTS guide is displayed in area 46. Alternatively, there could be
multiple levels and screens of sports SORT buttons in analogous fashion to the hierarchy of
the movie prompts and guides. (Such a hierarchy could also be provided for any of the other
20 categories of the SORT guide.)

FIG. 15 shows the hierarchy of prompts and guides described in connection with
FIGS. 7 to 14, beginning with the entry into the electronic guide by pressing button 52 on
the IR transmitter. The particular guide displayed on the screen in area 46 when a prompt
is selected is designated in parentheses, e.g. the NOW guide is displayed when the CHOICE
25 prompt is selected. In each case the guide remains unchanged from the preceding guide in
the hierarchy. If no guide is designated in parentheses, the guide displayed when a prompt
is selected is the same as the prompt, e.g., the THIS CHANNEL guide is displayed when
the CSPG prompt is selected and the ALL MOVIES guide is displayed when the ALL
MOVIES prompt is selected. Note that a broken line 150 depicts the levels of the SORT
30 hierarchy--the first level lies above line 150 and the second level lies below line 150. At any
level of the hierarchy, the viewer has two choices for navigating through the guide--select
the RED prompt to return to the NOW guide or select one of the GREEN, YELLOW, or
BLUE prompts to move to the following level. As stated above, the hierarchy of guides and
prompts can be expanded to provide more themes by changing the ALL SERIES prompt to
35 a OTHERS SCREEN-3 prompt and to provide more subthemes of movies by changing the
ALL OTHER MOVIES prompt to a ALL MOVIES SCREEN-3 prompt, etc. Similarly, the
hierarchy of guides and prompts can be expanded to provide subthemes for other themes,
e.g., SPORTS, in the same manner as illustrated for MOVIES.

1 A feature of the invention that facilitates viewer orientation in the electronic guide is
to color code PIP window 42 and program description area 44 consistently with the titles of
the programs to which the information in these areas relate. Specifically, as illustrated in
FIG. 16, in the NOW guide (FIG. 2) PIP window 42 has a border 152 that is the same color,
5 e.g., dark blue, as the background of area 44 and cursor 48, which forms a color bar.
Further, as illustrated in FIG. 17, in the NEXT guide (FIG. 3), as well as the THIS
CHANNEL guide (FIG. 4) and the SORT guide (FIG. 5), where the description in area 44
relates to a different program than that displayed in PIP window 42, the background of area
44 is a different color or shade than border 152. The latter guides all have a cursor (color
10 bar) 48 that identifies the title of the program described in area 44. For example, the
background of area 44 and cursor 48 are light blue to signal to the viewer that the title
highlighted by cursor 48 identifies the program described in area 44, while border 152 and
banner 49 remain dark blue to signal that the title in banner 49 identifies the program in PIP
window 42.

15 If the television receiver does not have a PIP chip, the described screen formats can
be simulated by rearranging the prompts and the guide and program description information
and overlaying such information over the real time moving images of the current television
program. In contrast to the PIP format, this results in loss of part of the picture of the
television program. But, the remainder of the picture, which is the center part of the image,
20 together with the sound portion thereof generally conveys most of the essential information
of the television program. In FIG. 18, such a simulation has a truncated real time picture
area 160, instead of PIP window 42, a message prompting area 162, instead of area 43, a
program description area 164, instead of area 44, and an electronic program guide area 166,
instead of area 46. Area 164 is located across the full width at the top of the screen area and
preferably does not include the program title. Prompt area is at the bottom of the screen area
25 and is otherwise like the PIP screen format described above. Guide area 166 is between
areas 160 and 162 and preferably has several fewer lines of program listings than the PIP
screen format. The size of the picture in area 160 is the same as the picture when the
electronic guide is not operating, but the top and bottom parts of the picture are cut off by
30 areas 162, 164, and 166. To implement this embodiment of the invention, the following
changes in the television receiver of FIG. 1 are made:

- Microprocessor 24 is configured to format the screen as shown in FIG. 18, leaving
blank area 160.
- PIP chip 19 is replaced by a video mixer.

35 FIG. 19 illustrates another way to navigate through the electronic guides described
above. The abscissa represents time and the ordinate represents channel. As represented by
a line 170, starting in the NOW guide, the viewer moves the cursor from channel to channel
and current programs are displayed in the PIP window. As represented by a line 172, the
viewer selects the THIS CHANNEL guide and moves the cursor from time slot to time slot.

1 The program on the channel to which the tuner was last set in the NOW guide remains
displayed in PIP window 42 and the description of the program on said channel at the time
slot highlighted by the cursor is displayed in area 44. As represented by a 174, the viewer
selects the NEXT guide and moves the cursor from channel to channel. The program on the
5 channel to which the tuner was last set in the NOW guide remains displayed in PIP window
42 and the description of the program on the channel highlighted by the cursor at the time
slot last highlighted in the NEXT guide is displayed in area 44. As represented by a line
176, the viewer again selects the THIS CHANNEL guide and moves the cursor from time
slot to time slot. The program on the channel to which the tuner was last set in the NOW
10 guide remains displayed in PIP window 42 and the description of the program on the channel
last highlighted in the NEXT guide at the time slot currently highlighted by the cursor is
displayed in area 44. As represented by a line 178, the viewer selects the NEXT guide and
moves the cursor from channel to channel. The program on the channel to which the tuner
was last set in the NOW guide remains displayed in PIP window 42 and the description of
15 the program on the channel highlighted by the cursor at the time slot last highlighted in the
NEXT guide is displayed in area 44. As represented by a line 180, the viewer again selects
the THIS CHANNEL guide and moves the cursor from time slot to time slot. The program
on the channel to which the tuner was last set in the NOW guide remains displayed in PIP
window 42 and the description of the program on the channel last highlighted in the NEXT
20 guide at the time slot currently highlighted by the cursor is displayed in area 44. In this
manner the viewer can navigate either into the future or toward the current time and across
channels to determine the television program schedule.

In summary, rather than navigating through a two dimensional (time/channel) grid
guide, the technique described in connection with FIG. 19 isolates the two dimensions, i.e.,
25 time and channel, and displays all the channels at any time selected by the viewer or all the
times on any channel selected by the viewer.

Another feature that is particularly useful in the NOW guide calls for the temporary
selective elimination of program listings by viewer command. Thus, in the NOW guide
when the viewer is not interested in a displayed program, the viewer can move the cursor
30 to the unwanted program and press a dedicated DELETE button (not shown) on the IR
transmitter or an existing function button such as ENTER. The microprocessor is configured
to delete the listing for the program from the NOW guide and to block the tuner from being
set to the channel that carries the unwanted program. As a result, the viewer can graze
through the programs of interest much more quickly. When the unwanted program is
35 finished, the microprocessor unblocks the tuner from being set to the channel and displays
the next program on the channel in the NOW guide. If desired, the microprocessor can be
configured to keep the tuner blockage in effect in the THIS CHANNEL guide and the normal
television mode.

1 A variation of the above feature is to configure the microprocessor to display the
unwanted programs marked with the cursor in a manner that distinguishes from the wanted
programs, e.g., in a half gray scale. When the viewer moves the cursor to the unwanted
program and presses the DELETE button, the microprocessor is configured to display the
5 unwanted program in the half gray scale, to prevent the cursor from highlighting the
unwanted program, and to block the tuner from being set to the channel that carries the
unwanted program. Since the unwanted program is still visible, the viewer can change his
or her mind before the end of the unwanted program. Thus, the microprocessor is configured
to return the program display to normal, to permit the cursor to highlight the program, and
10 to unblock the tuner, when a special cursor control sequence is executed. For example, the
sequence could be to move the cursor to the program listing immediately above the unwanted
program or series of programs, press the right arrow button to permit movement of the
cursor to the unwanted program or programs, highlight with the cursor the unwanted
program that it is desired to restore, and then press the DELETE button.

15 As described in more detail below, in program schedule memory 22, the program
listings are coded by day of the week, time of day, and channel so that they can be accessed
by microprocessor 24 when necessary to supply program schedule information to video
processor 30 to compose the program listings and the program descriptions. Microprocessor
24 has a real time clock (not shown), the time of which is compared with the time of day and
20 day of the week codes to select the program listings for the TISPG mode. The functional
storage areas of cursor position register 32 are mapped to the storage areas of video
processor 30 where the program schedule is formatted for display on background area 40 so
cursor position register 32 points to the area of the screen, and thus the particular program,
that is highlighted by cursor 48. By comparing the cursor position in register 32 with the
25 channel corresponding to the highlighted area of video processor 30, the channel of the
highlighted program is derived and coupled to microprocessor 24. Microprocessor 24 then
sets tuner 11 to this channel.

In TISPG operation, microprocessor 24 recalls the appropriate program listings from
memory 22 and transmits them to video processor 30 where the program listings of area 46
30 and the program description of the highlighted program in area 44 are composed. At the
same time, microprocessor 24 operates switch 18 so the output of tuner 11 is directly
connected to the one input of PIP chip 19 and switches PIP chip 19 into a PIP mode, such
that the input from tuner 11 is displayed in the PIP window and the program schedule from
video processor 30 is displayed in the background. Microprocessor 24 senses the channel
35 to which the tuner is set when the TISPG mode is entered, and initially positions cursor 48
at the program listing broadcast on this channel. As the viewer moves the up/down arrows
of the cursor control key set, tuner 11 is reset accordingly and new program schedule
information is fed through microprocessor 24 to video processor 30 to recompose the

1 program listings so cursor 48 remains visible and the program description remains current.
The described TISPG mode facilitates channel grazing by the viewer. When the viewer finds
the video program he or she wishes to watch, the viewer leaves the TISPG mode. As a
result, microprocessor 24 switches PIP chip 19 out of the PIP mode, such that the video
5 program inputted from tuner 11 is displayed full screen.

If the viewer wishes to record the program highlighted in the TISPG mode, the viewer
commands microprocessor 24 to turn on VCR 17 for recording.

If the viewer wishes to play a video tape cassette on VCR 17, the viewer commands
microprocessor 24 to turn on VCR for playback and to operate switch 18 for connection of
10 the output of VCR 17 through PIP chip 19 to television receiver 20.

The television receiver of FIG. 1 can also be used with the format of FIGS. 3, 4, or
5 in an extension of the CSPG mode to display previews of future programming as video
clips. The video clips are stored on a video tape cassette that is loaded into VCR 17. The
addresses of the video clips on the tape of the video cassette are stored in program schedule
15 memory 22 as part of the data base. These addresses are linked to the respective future
program listings in the data base so that a video clip can be accessed on the tape when a
program listing is designated in the database. When the viewer presses the CSPG mode key,
in addition to the operation as described in connection with FIG. 4, microprocessor 24 places
the current program title in banner 49, as illustrated in FIG. 4. So long as cursor 48
20 highlights the title of the current program, the CSPG mode operates as described above.
When the viewer moves cursor 48 vertically by operating the cursor control key set on
viewer input device 28 to highlight the title of a future program displayed in area 46, the
address of the video clip of the highlighted program listing is retrieved by microprocessor
24 from program schedule memory 22 and transmitted to VCR 17. The video clip is
25 retrieved from the tape in VCR 17 and coupled through switch 18 and PIP chip 19 to
television receiver 20 for display in PIP window 42. The video clips on the tape of the
videocassette are indexed and accessed in the manner described in U.S. Patent No.
6,091,884.

30

An extension of the TISPG mode illustrated in FIG. 2 also permits display of video
clips of future programming. Specifically, in the time-channel grid format microprocessor
24 also controls cursor 48 responsive to the cursor key set of viewer input device 28, which
in this embodiment includes a horizontal cursor control, such as a pair of right/left arrows.
35 As described above, the address for the highlighted future program listing is retrieved by
microprocessor 24 from program schedule memory 22 and transmitted to VCR 17 to access
the corresponding video clip, which is displayed in PIP window 42.

1 Another embodiment in which video clips can be displayed in PIP window 42 is
illustrated in FIG. 5. In addition to banner area 43 and program description area 44,
background area 40 has program schedule area 46, in which program listings are displayed
by theme such as movies, sports, current events, etc. Area 46 contains a column for
5 program start time, a column for program channel, and a column for program title. To
implement this embodiment, the program listings of the data base stored in program schedule
memory 22 are also coded by theme so that they can be accessed by microprocessor 24 in
response to the viewer selection of themes from an on-screen menu in well known fashion.
As described in connection with the extended TISPG and CSPG modes described above,
10 when the title of a future program listing is highlighted by cursor 48, the corresponding
moving image video clip is displayed in PIP window 42. If desired, a video disc player
could be substituted for VCR 17 to provide the video clips to switch 18 in order to speed up
the access time to the moving images displayed in PIP window 42.

In another embodiment, program related information (PRI) is displayed in background
15 area 40 while the real time television program to which the PRI relates is displayed in PIP
window 42. The PRI is transmitted in the vertical blanking interval (VBI) of the television
signal of the channel carrying the television program to which the PRI relates,
contemporaneously with this television program. As illustrated in FIG. 19, to implement this
embodiment a VBI decoder 53 is connected between the output of tuner 11 and
20 microprocessor 24 and a PRI memory 57 is connected to microprocessor 24 as shown in
FIG. 20. The PRI is stripped from the VBI of the television signal by decoder 53 and stored
in memory 57 by microprocessor 24.

In operation, when the viewer presses a PRI key on viewer input device 28 the real
time television program of the channel to which tuner 11 is set is displayed in PIP window
25 42. In addition to banner area 43 and program description area 44, background area 40 has
a PRI area 59 in which different types of PRI are displayed. In FIG. 21 the real time
television program is a cooking demonstration by Julia Child and the PRI displayed in area
59 is a recipe made in the course of the demonstration. Other information about the program
is displayed in area 44. Another example for the real time television program could be a
30 commercial for Lexus automobiles and the PRI displayed in area 59 could be a test drive
offer for Lexus. The name and address of the local Lexus dealer in the geographic area of
the viewer might be displayed in area 44.

Another version of the NOW guide is shown in FIG. 33. This version is the same as
the guide of FIG. 2 except for the prompts in area 43, which are SORT NOW, SERVICE,
35 CABLE, and LATER. The SORT NOW prompt permits the viewer to sort by theme, and
thus reduce the number of displayed programs, by "filtering out" all the programs that do
not meet a selected theme. The SERVICE prompt permits the viewer to enter a mode in
which a number of various items of information such as news, weather, sports scores, or

1 financial data can be selected for display. The CABLE prompt permits the viewer to obtain
information unique to the particular cable system such as pay per view offerings or special
promotions on premium channel packages. The LATER prompt permits the viewer to
advance to the screen shown in FIG. 8 and continue to navigate as described in connection
5 with FIGS. 8 to 15.

In FIG. 34, the prompts in area 43 are NOW and SELECT. The real time images of
the last program highlighted by cursor 48 in area 46 of the NOW guide are displayed in PIP
window 42, the program description of this program is displayed in area 44, and the title and
channel of the program are displayed in banner 49. A list of program themes is displayed
10 in area 46, instead of program listings. Any of the themes can be highlighted by cursor 48.

In FIG. 35, the NOW prompt and a selected theme are displayed in area 43. A list
of the current programs meeting the selected theme identified in area 43 is displayed in area
46. As in the NOW guide of FIG. 2, when the viewer moves cursor 48 from program to
program in area 46, the real time images of the highlighted program are displayed in PIP
15 window 42 and the program description is displayed in area 44. By thus filtering out the
programs meeting the other, nonselected themes, the list of displayed current programs can
be sharply reduced. This facilitates channel grazing the programs of interest to the viewer
in PIP window 42 because the viewer has fewer programs to highlight with cursor 48.

Reference is made to FIGS. 36 to 39 for a description of the steps taken by the viewer
20 to navigate about the television program guide of the preferred embodiment described in
connection with FIGS. 6 to 14 modified to incorporate the screens of FIGS. 32 to 34.
Microprocessor 24 is programmed to carry out the described operations.

FIG. 36 is the same as FIG. 7 except that the flow is to FIG. 37, instead of FIG. 8.
Thus, when the viewer enters the electronic guide by pressing GUIDE/TV button 52 on the
25 remote transmitter, the NOW guide is displayed on the screen. When the viewer presses red
button 68 on the remote transmitter, four prompting choices are presented to the viewer. As
represented by a block 400 in FIG. 37, these prompting choices are displayed in an "ALL
CHANNEL" guide.

Block 401 represents an "ALL CHANNEL" guide, which is identical to the "NOW"
30 guide except for area 43. This is a transition guide in that it permits the viewer to enter the
other modes described above in connection with FIG. 33. In this "ALL CHANNEL" guide,
a blue SORT NOW prompt, a green SERVICE prompt, a yellow CABLE prompt, and a red
LATER prompt are displayed. In this guide, the viewer cannot return directly to the NOW
guide. To return to the NOW guide, the viewer must first return to the TV mode by
35 pressing button 52.

As represented by a box 402 in FIG. 37 and a box 404 in FIG. 38, when blue button
62 is pressed from this ALL CHANNEL guide, the list of themes is displayed. In FIG 38,
as represented by a block 405 a blue NOW prompt and a red SELECT prompt are displayed.

1 When the viewer presses blue button 62, the NOW guide is displayed in area 46, as
represented graphically by a box 406. To select a theme, the viewer, operates arrow buttons
58 and 60 to highlight the selected theme and then presses red button 68, as represented by
box 68, to select the theme as represented by a box 408. Thereupon, the NOW guide
5 filtered by theme is displayed in area 46, as represented by a box 410. Instead of a single
theme, microprocessor 24 could be programmed to select two or more themes, in which case
the current programs meeting all the selected themes would be displayed.

FIG. 39 shows the hierarchy of prompts and guides described in connection with
FIGS. 35 to 37. The hierarch shown in FIG. 15 is incorporated into the hierarchy of FIG.
10 39 as illustrated.

Data Base Operations

In the preferred embodiment, the system contains a data base used to store all the
information needed to create the program guides and to carry out requests, such as
requests to record specific future programs. The data base is stored in program schedule
15 memory 22 and is directly accessible by the system microprocessor 24. The data base is
divided into a static area 300 and a dynamic area 301. The static area contains several
pre-allocated tables used to store, locate and search data for the creation of program
guides. The pre-allocated tables are placed at fixed, unchanging addresses in the static
area to facilitate rapid searching by the microprocessor. The dynamic area is used to
20 store actual television program schedule data. Since the system always contains data for
the current day(today) and the following day(tomorrow), the dynamic area is updated as
new data is received.

FIG. 22 depicts the program schedule memory data base. Static area 300 contains
the call letter map, the pre-established time list, the channel map, the control array, the
25 memory map, the source map, the record queue, and pointers to the extended theme show
lists. These structures will be described in greater detail below. Dynamic area 301 is
used to store television program schedule data. This data takes the form of show
information packages (SIPs) and extended theme show list entries. These structures are
also described more fully below.

30 Data Transmission

Television program data is received in download packets. The download packets
are sent over the VBI and received by microprocessor 24 in the manner described in FIG.
20. A download packet contains television program schedule information along with
routing data that enables the system to determine how to store the information in memory.

35 FIG. 23 illustrates a download packet. The packet begins with a packet header
containing packet ID number 302 used to distinguish this packet from other packets. The
packet header also contains number of bytes 303 and number of blocks 304. These
values are used to determine the size of the packet.

1 The packet header is followed by the show information package (SIP) header.
There is a show information package header for each show information package in the
packet. The SIP header contains: guide number 305 which is the internal channel number
of the data in the show information package; source ID 306 used to determine the source
5 of the data in the show information package; and time slot 307 used to designate the time
and day of the data in the show information package. A show information package 308
follows the SIP header.

 Upon receipt, the system microprocessor extracts a show information package from
the download packet and temporarily stores it in program schedule memory. The show
10 information package contains a date field that is used to determine if the data is for the
current day(today) or the next day(tomorrow).

 If the package falls within this two day window the system determines if the data is
duplicative of existing data. The show information package contains a version number
used to determine if the data is new or if it already exists in memory. If the data is new
15 then it is stored and the address of the show information package is placed in the
appropriate pointer in the pre-established time list. The pre-established time list will be
explained more fully below.

 If the show information package is outside of the current two-day window (today
and tomorrow)and the show information package contains programs that have theme
20 information, those programs with theme information are pulled out of the show
information package and placed in the appropriate extended theme show list. The
extended theme show list is described more fully below. If the show information package
is outside of the current two-day window and does not contain theme information, or if
the show information package is duplicative of one that is already stored the entire show
25 information package is discarded.

 The system uses a memory bit map in order to keep track of which parts of the
program schedule memory are currently holding program data and which parts of the
program schedule memory are free to store new program data. The memory bit map
divides the memory into 32 byte blocks. Each block is represented by a bit in the
30 memory bit map.

 The memory bit map is depicted in FIG. 24. Each bit in the map 310 represents a
32 byte block of memory. A "1" in the bit position 311 indicates that program data is
stored in that block. A "0" in the position 312 indicates that the block is free. When
new data arrives in the system, microprocessor 24 searches through the memory bit map
35 to locate a sufficient number of adjacent free positions in which to store data. When the
positions are located, microprocessor 24 stores the data and then changes those numbers
in the memory bit map from "0" to "1" to indicate that those memory locations are
occupied.

1 For example, referencing FIG. 24, if data is received that requires ten blocks of storage the system will scan the memory map and store the data in the space represented by bits 0-7 in row 3 and bits 0-1 in row 4. These bits will then be set to "1" in the memory bit map.

5 The system will also periodically re-order the memory so that free space is grouped contiguously. For example, referencing FIG. 24, the data starting in the block represented by bit 2 in row 0 and ending in the block represented by bit 1 in row 1 would be slid over to the block represented by bit 3 in row 0. This will remove the "0" gap in row zero. This process is repeated throughout the memory map so that all free space is
10 grouped together at the end of memory.

The system also contains procedures for reducing the amount of new data that is stored if there is only limited memory space available. By scanning the memory map the system can determine if the memory is becoming full. When this happens the system may discard some new data such as program descriptions in order to maximize the
15 number of individual shows that can be stored in the available memory.

Data Structures

Data in the program schedule memory is stored in data structures that enable the system to interpret the data. Several of the data structures are of fixed length and reside in the static area 300. These data structures reside at fixed addresses and therefore can
20 be accessed by the microprocessor without further memory calculations. Other data structures are of variable length and reside in the dynamic area 301. The fixed data structures include: the pre-established time list, the channel map, the control array, the call letter map, the memory map, the source map and the record queue. The variable data structures include: show information packages and extended theme show lists.

25 The pre-established time list is used to locate television program information for each channel in the system. The pre-established time list only references program information that will be broadcast on the current day (today) or on the next day (tomorrow). The pre-established time list references data through the use of pointers which are pieces of data that contain addresses of desired data items in dynamic area 301.

30 FIG. 25 illustrates the pre-established time list. The pre-established time list contains a set of twelve pointers 313 for each channel in the system. Each pointer corresponds to a show information package that contains data for a four hour block of television programming. For example, in FIG. 25, the pointer E1 corresponds to program data on channel 1 from four p.m. to eight p.m. Twelve pointers represent the
35 sum of 24 hours of programming information for the current day and 24 hours of program information for the next day.

Pointers A2 through L2 are used to represent the program data associated with channel 2 in the system. Each pointer contains an address of a show information package

1 of variable length containing actual television program data. When specific data is
needed, the system first looks in the pre-established time list to secure the pointer, then
uses the address found in that location to determine where the data is actually stored. For
example if data for the channel 2 in the system is needed for a television program
5 between eight p.m. and twelve midnight the system will use the address in pointer F2 to
determine the location of the show information package containing the data.

Show information packages are variable length data structures that contain actual
television program schedule data. Each show information package contains data for a
four hour block of television programming for a specific channel. The show information
10 package length is variable because the number of shows in each four hour block will
depend on the duration of the individual shows.

FIG. 26 depicts a show information package. A show information package
contains the following: amount of memory - used to determine how much space was used
to store the show information package and therefore, how much space is freed up after
15 the show information package is no longer needed; control date - used to determine
whether the data in a specific show information package is for the current day, the next
day, or outside of the current two-day window; and version number used to specify the
specific version of the program data.

Following these three fields is specific data for each show that fits within the four-
20 hour time block. For a given show, represented by block 314, the following fields are
present in the show information package: multiple show flag field - used to determine if
this show is the last show within the package, or if there are other shows following to be
processed; start time field - an offset from the start time of the four-hour block, this
offset is added to the time of the four-hour block to determine the start time of the show;
25 duration field - specifies the air time for the particular show, this field is used if the
show is selected for recording to determine the length of the recording; theme field -
contains information on the type of show; for example, the show may be a sporting event,
a news program, or a movie; CC field - determines whether or not the show is closed
captioned; stereo field - determines whether or not the show is broadcast in stereo; add-
30 ons field - is a field left for expansion, this field will contain more information about the
show as that information becomes standard in the art.

Following these fields are fields representing program title, primary description - a
short description of the program, secondary description - a longer description of the
program and VCR+ PLUSCODE. Each of these items are represented by two fields,
35 one containing the length of a specific item, such as title length, and one containing the
item itself, such as title.

Following this information is an end-of-show field. The end-of-show field is used
to indicate that the information for that particular show is finished. A show information

1 package may contain information for one or more shows depending on how many shows
are broadcast within the four hour block. The presence of multiple shows is represented
by 315 and 316.

5 A show information package is structured so as to provide several unique features
for storing data. The title length, primary description length, secondary description
length and VCR+ PLUSCODE length fields can be expanded for values that are beyond
the maximum value that can be stored within one byte. For example, referring to FIG.
27, if the secondary description length equals a number greater than the maximum
number that can be stored within one byte, the length byte is set to this maximum value.
10 The system then assumes that the following byte also represents length and adds the two
values to determine the total length of the secondary description. In this way, a show
information package can dynamically allocate space to accommodate longer descriptions
or longer titles.

15 The end-of-show field allows for the inclusion of data in the show information
package that is not read by the current version of the system. As shown again in FIG.
27, following the VCR+ PLUSCODE field, there are two fields of unspecified data.
This is data which may be read by future versions of the system but is currently not
processed. When processing show information package data the system expect an end-of-
show field following the VCR+ PLUSCODE field. If an end-of show field is not found
20 the system will discard the data and look at the next byte. The system will not begin
processing data for a new show until an end-of-show field is found. This feature allows
the system to access the same data as a potential future version which may process data
beyond title, description and VCR+ PLUSCODE. For example a future version might
also include a list of the actors in a particular show. This information would be added to
25 the download data after the VCR+ PLUSCODE. Older versions which did not include
the feature of displaying the new data would discard it without causing an error in the
download process.

30 Television programming information for shows that contain a theme (movie,
sporting event, etc.) but have a start time beyond the current two day window (i.e. shows
that will air after tomorrow) are stored in an extended theme show list. An extended
theme show list is a linked list of television shows. Each show in the list contains data
for a single program. The system contains an extended theme show list for each of the
different theme categories (sports, movies, children's programming, specials, info).

35 An extended theme show list is depicted in FIG. 28. The address 317 of the first
show in the list 318 is stored in static area 300. Show 318 is stored in dynamic area 301
and contains a pointer 319 to the next show that will play. This scheme is repeated for
all shows in the list. The pointer field in the last show contains the value "NULL" to
indicate that there are no other shows in the list. Because each show in the list is linked

1 to the next show, an entire list can be traversed by ascertaining the address of the first show in the list.

Each show contains the same field format as show information package 314 with the exception that the channel ID is stored for each show. The conventions applying to show information package 314 that allow for extending the length fields and for additional data before the end-of-show flag also apply in the extended theme show list.

The program schedule memory also contains a channel map located in static memory 300. The channel map links the channel number of television program information with the internal guide channel. For example, in FIG. 29, channel 7 is assigned to internal channel 1 and channel 11 is assigned to internal channel 3. The channel map is referenced in order to identify a channel number when creating a program guide display. The source channel number is also used to tune to a specific channel upon operator selection.

The program schedule memory also contains a preallocated control array located in static memory 300. The control array is used by the system to track channels which have been inhibited for display by the operator. The control array is depicted in FIG. 30. For each channel, there is a display field 320 which is set to the "1" if the channel is to be displayed and set to the "0" if the channel is to be inhibited. Referring to FIG. 30, channels 0, 1, 3, and 4 will be displayed in a program guide while channel 2 will be inhibited. There is also a field for each channel for additional "add-on" information. This field allows for the addition of other operator controlled functions in future versions of the system such as a parental lock-out facility.

The program schedule memory also contains a call letter map located in static memory 300. The call letter map links the call letters corresponding to the source channel with the internal guide channel. For example, in FIG. 31, the call letters KABC are linked to internal channel 0 and WWOR is linked to internal channel 1. The call letter map is referenced in order to identify source channel call letters when creating a program guide display.

The program schedule memory also contains a source map located in static memory 300. The source map links the particular source of a television station with the internal guide number. Several stations may have the same source. For example the source "Home Box Office" may be associated with HBO, HBO2, HBO3, etc.. In an alternative embodiment the system could be configured to reorder program guide channels based on the source information. For example, the system could be directed to place all channels coming from the source "Home Box Office" at the beginning of a program guide.

1 Operator requests for recording future programs are stored in the record queue.
The record queue is a fixed length table (20 entries) located in static area 300. The record
queue is depicted in FIG. 32.

5 Each show in the queue contains a value representing the channel that the show
will air on and a value representing the start time of the show. The record queue is
structured so that programs are in time sequence order. That is, the first item in the list
will be broadcast earlier than any of the other items, and so on. This allows the system
to easily find the next program to be recorded.

Data Base Processing

10 Interaction between the data structures and the system is illustrated through the
following examples of system operation.

A. The operator, using viewer input device 28 requests a time specific program
guide (TISPG), the current time is 7 p.m.

15 When the user requests a TISPG for information pertaining to television shows
that are currently being broadcast, the system first reads the current time (7 p.m.) from
the microprocessor clock. The system then determines the pointers that correspond to
current time in the pre-established time list, FIG. 25. Since the current time is 7 p.m.
the system will look to the fifth pointer (this pointer corresponds to the data from 4 p.m.
to 8 p.m.) for each channel: Channel 1 - E1, Channel 2 - E2, Channel 3 - E3, . . . ,
20 Channel n - En.

For each pointer the system accesses the associated show information package,
FIG. 26. The system adds the start time of the four hour block (4 p.m.) to the time
offset in each show in the show information package to determine the show that is
currently airing on that channel. Information for the show is then extracted from the
25 show information package. The extracted information includes title, primary description,
secondary description and VCR+ PLUSCODE.

Each internal channel number is also used to index into the channel map, FIG. 29.
Specifically, the channel number is used to pull out the specific source channel number
for display in the guide: Channel 1 - 7, Channel 2 - 6, Channel 3 - 11, . . . , Channel n -
30 172. The channel number is also used to index into the call letter map, FIG. 31.
Specifically, the channel number is used to pull out the station identification call letters
for display in the guide: Channel 1 - KABC, Channel 2 - WWOR, . . . , Channel n -
KTVR. All of the information from the show information package, the channel map and
the call letter map is used to create formatted text lines for display in the guide.

35 B. The operator, using viewer input device 28 requests a channel specific program
guide (CSPG), the current channel being viewed is channel 6, the current time is 3 p.m.

When the user requests a CSPG for information pertaining to television shows that
are airing or will be broadcast on a specific channel (channel 6) at a specific time (3 p.m.)

1 the system determines the internal channel corresponding to the displayed channel by reading
a system variable. For this example the internal channel is channel 2. The system then
reads the current time (3 p.m.) from the microprocessor clock. The system determines the
pointer that corresponds to current time for the selected internal channel in the pre-
5 established time list, FIG. 25. Since the current time is 3 p.m. and the selected internal
channel is channel 2 the system will look to the fourth pointer (this pointer corresponds to the
data from 12 noon to 4 p.m.) in the second set of pointers. This pointer is D2, FIG. 25.

The system then accesses the associated show information package, FIG. 26, for
pointer D2. The system adds the start time of the four hour block (12 noon) to the time
10 offset in each show in the show information package to determine the show that is currently
airing. Information for the show is then extracted from the show information package. The
extracted information includes title, primary description, secondary description and VCR+
PLUSCODE. The system extracts data for all shows in the show information package pointed
to by D2 that occur after the selected show. Information is then extracted for all shows in
15 show information packages pointed to by pointers E2 - L2.

The internal channel number is also used to index into the channel map, FIG. 29.
Specifically, the channel number is used to pull out the specific channel ID, channel 6, for
display in the guide. The channel number is also used to index into the call letter map, FIG.
31. Specifically, the channel number is used to pull out the station identification call letters,
20 WWOR, for display in the guide. All of the information from the show information
package, the channel map and the call letter map is used to create formatted text lines for
display in the guide.

C. The operator, using viewer input device 28 requests a theme specific program
guide (THSPG), the selected theme is "MOVIE", the current time is 10:30 a.m.

25 When the user requests a THSPG for information pertaining to television shows
having a specific theme (MOVIE) that are airing or will be broadcast, the system first reads
the current time (10:30 a.m.) from the microprocessor clock. The system then determines
the pointers that correspond to current time in the pre-established time list, FIG. 25. Since
the current time is 10:30 a.m. the system will look to the third pointer (this pointer
30 corresponds to the data from 8 a.m. to 12 noon) for each channel: Channel 1 - C1, Channel
2 - C2, Channel 3 - C3, . . ., Channel n - Cn.

For each pointer the system accesses the associated show information package, FIG.
26. The system adds the start time of the four hour block (8 a.m.) to the time offset in each
show in the show information package to determine the show that is currently airing on that
35 channel. Once the show is determined the system compares theme information for that show
with the selected theme, "MOVIE". If the show is a movie, information for the show is
extracted from the show information package. The extracted information includes title,
primary description, secondary description and VCR+ PLUSCODE.

1 The system then increments the current time by five minutes (10:35) and repeats the
above process. The clock is incremented again by five minutes and the process is repeated
until the clock time is at the end of the four hour block, i.e. 12 noon. The system then
access all remaining pointers, D1 - Dn, E1 - En, . . . , L1 - Ln, and extracts information for
5 all shows that contain the theme "MOVIE".

 Once data has been extracted for all shows occurring within the two day window
(today and tomorrow) that contain the theme "MOVIE" the system begins extracting data
from the "MOVIE" extended theme show list, FIG. 28. The system has the address of the
first entry in the "MOVIE" extended theme show list since it is stored in static area 300.
10 Data for all shows in the "MOVIE" extended theme show list is extracted.

 In an alternate embodiment of the system, the system user would have the capability
to block certain channels. Blocking a channel would inhibit the channel from being displayed
on the system, therefore the channel would not be part of the TISPG, CSPG, or THSPG.
This feature is implemented through the use of the control array, FIG. 30.

15 When the user selects a channel for non-display, the display flag in the control array
is set to "0". Whenever the system user requests a program guide display, the system first
checks the control array before proceeding with processing on the pre-established time list.
If the control array for a specific channel is set to "0", no other processing is performed for
that channel and the system goes on with the next channel. If the user were to re-select that
20 channel for display in subsequent processing, the system would enact the change the next
time a program guide was created.

 The control array may also be used to inhibit the storing of data for selected channels.
For example, in an alternative embodiment of the system, the system would first check the
control array before storing data for a specific channel. If the control array for a specific
25 channel contained a "0" no data corresponding to that channel would be stored. Note that
a channel may be inhibited for display as described above without necessarily inhibiting the
storage of data.

 In another alternative embodiment the user would have the option of toggling between
the TISPG and the CSPG as in FIG. 19. Toggling between these displays would allow the
30 user to create a guide of all program information for a future, user selected, time. The
database processing associated with this option is similar to that used for the TISPG and
CSPG with the exception that the time used to locate each program is the user specified time
in the CSPG in lieu of the current time and the channel would be that specified in the TISPG.
Recording

35 When the user selects a program for recording the system stores the internal channel
number of the selected program and the program start time in the record queue, FIG. 32.
The program start time is computed by adding the offset contained in the show information
package to the start time of the associated four hour block of data.

1 The record queue is put in time order whenever a new entry is added. This ordering
facilitates periodic polling of the start time in the first show of the queue to determine the
next recording command to be executed. The address of the queue is known to the system
as it is in static area 300. When a show is recorded the next show in the queue is moved to
5 the beginning of the queue.

 When the operator requests a display of the record queue the system reads the internal
channel number and start time for the first entry in the record queue. This data is used to
locate the pointer to the corresponding SIP package in the pre-established time list (FIG. 25).
The pointer is used to extract the title of the show. The internal channel number is also used
10 to extract the source channel number and call letters corresponding to the show. The system
then uses this information to create a line of text representative of the show to be recorded.
This process is repeated for each show in the record queue.

 The described embodiments of the invention are only considered to be preferred and
illustrative of the inventive concept; the scope of the invention is not to be restricted to such
15 embodiment. Various and numerous other arrangements may be devised by one skilled in
the art without departing from the spirit and scope of this invention. For example, the
disclosed electronic guide features, including the techniques for navigating through the guide,
can be used without displaying a real time image of a current television program.

20

25

30

35

The embodiments of the invention in which an exclusive property or privilege is claimed are defined as follows:

1. An entertainment system comprising:
 - 5 a display having a screen;
 - a television tuner for recovering currently telecast video programs;
 - a source of a schedule of program listings including listings for currently telecast video programs;
 - means for displaying some of the program listings for currently telecast video programs from the source in a first area of the screen;
 - 10 an input device for selectively marking one of the displayed program listings for a currently telecast video program; and
 - means responsive to the input device for controlling the tuner to display in a second smaller and non-overlapping area of the screen simultaneously with the program listings the currently telecast video program corresponding to the marked program listing, such that the entire image of the video program is visible in real-time, and to play the audio corresponding to the displayed video program.
 - 15
2. The system of claim 1, in which the schedule source also includes a program description at a first level of detail for each program listing and the system additionally comprises means for displaying in a third area of the screen the program description at the first level of detail corresponding to the marked program listing.
- 20
3. The system of claim 2, in which, the program displayed in the second area and the program description displayed in the third area change as the marked program listing changes responsive to the input device without further actuation of the input device.
- 25
4. The system of claim 2, in which the input device has up/down keys the operation of which changes the marked program listing displayed in the first area of the screen, the tuner control means changes the video program displayed in the second area of the screen responsive to said operation of the up/down keys to correspond to the changed marked program listing, and the means for displaying the program description changes the
- 30

program description displayed in the third area of the screen responsive to said operation of the up/down keys to correspond to the changed marked program listing so that the displays in the first, second, and third areas all change responsive to the same operation of the up/down keys.

5

5. The system of claim 4, in which the first, second, and third areas substantially fill the screen, the second and third areas lie side by side at the top of the screen, and the first area lies at the bottom of the screen and extends across the entire screen.

10

6. The system of claim 1, in which the source also includes a program description at a second level of detail for each program listing and the system additionally comprises means for displaying in the first area of the screen as a substitute for the program listings the program description at the second level of detail for the marked program listing.

15

7. The system of claim 1, in which the input device marks one the program listings with an on screen cursor.

8. The system of claim 1, in which the input device marks one of the program listings with an on screen cursor that highlights the marked program listing.

20

9. A method of channel surfing with a television apparatus receiver having a tuner and a screen, the method comprising the steps of:

storing in a memory a plurality of current television program listings, each program listing including a channel identification;

25

setting the tuner to receive a particular channel;

displaying in a first area of the screen in real time the entire image of the program telecast on the particular channel and playing the audio corresponding to the displayed program;

30

simultaneously displaying in a second area of the screen at least some of the current program listings stored in the memory, such that the program listings in the second area of the screen block from view none of the image of the telecast program in the first area;

marking on the screen one of the displayed current program listings;
retrieving from the memory the channel identification of the marked program listing; and

5 using the retrieved channel identification to set the tuner to receive and substitute on the screen for the program telecast on the particular channel the program telecast on the identified channel, and to play the audio corresponding to the displayed program on the identified channel.

10 10. The method of claim 9, in which the storing step stores a title for each program listing and the second recited displaying step displays the titles of the current program listings.

15 11. The method of claim 10, in which the storing step also stores listings of future programs.

12. The method of claim 11, additionally comprising the step of alternatively displaying on the screen at least some of the future program listings instead of the first recited displaying step.

20 13. The method of claim 12, additionally comprising the step of marking one of the displayed future program listings without changing the program displayed in the first area.

25 14. The method of claim 13, additionally comprising the step of displaying in a third area of the screen a program description for the marked program listing.

15. The method of claim 9, additionally comprising the step of displaying in a third area of the screen a description of the program displayed in the first area.

30 16. The method of claim 9, in which the marking step marks one of the displayed program listings with a cursor.

17. The method of claim 9, in which the cursor highlights the marked program listing.
18. The method of claim 13, additionally comprising the step of recording the program identified by the marked future program listing.
- 5
19. The method of claim 18, in which the recording step comprises setting the tuner to the channel identified by the marked future program listing at the time identified by the marked future program listing.
- 10 20. A system comprising:
a video display;
a video signal tuner;
a memory that stores program listings for a plurality of television programs;
means for displaying a plurality of program identifiers, each related to one of the
15 program listings, in a schedule area of the video display;
means for displaying a cursor highlighting a first program identifier in the schedule area;
means for displaying substantially all of an image output by the video signal tuner in a window area of the video display; and
20 means for displaying in a description area of the video display, additional information from the program listing related to the first program identifier highlighted by the cursor in the schedule area, wherein the additional information comprises information not in the first program identifier, and wherein the plurality of program identifiers, the image output by the video signal tuner and the additional information are simultaneously
25 displayed.
21. The system of claim 20 wherein the program identifiers include at least a program title.
- 30 22. The system of claim 20 or 21 further comprising
a user input,

means for moving the cursor in the schedule area, based on input received from the user input, to highlight a second program identifier and automatically change the additional information in the description area to additional information from the program listing identified by the second program identifier.

5

23. The system of claim 20 or 22 further comprising:

a user input,

means for controlling the video signal tuner to automatically tune to the channel of the program corresponding to the program identifier highlighted in the schedule area by the cursor in response to movements of the cursor in the schedule area, based on input received from the user input.

10

24. The system of claim 20 or 22 further comprising:

means for controlling the video signal tuner not to change tuning when the cursor

15

in the schedule area is moved from highlighting a first program identifier to highlighting a second program identifier.

25. The system of any one of claims 20 to 24 in which the means for displaying additional information displays the description area such that the description area does not significantly overlap the window area.

20

26. The system of any one of claims 20 to 25 in which the means for displaying additional information displays the description area such that the description area does not significantly overlap the schedule area.

25

27. The system of any one of claims 20 to 26 wherein all of the image output by the video signal tuner is displayed in the window area of the video display.

28. The system of any one of claims 20 to 27 wherein the additional information is at a first level of detail, and wherein the system further comprises means for substituting additional information at a second level of detail corresponding to the marked program listing for the program listings displayed in the first area.

30

29. The system of any one of claims 20 to 28 wherein the image output by the video signal tuner is video for a currently telecast program.
- 5 30. The system of claim 20 wherein the image output by the video signal tuner is a video clip.
31. A system comprising:
a video display;
10 a video signal tuner;
a memory that stores program listings for a plurality of television programs;
means for displaying a plurality of program identifiers, each related to one of the program listings, in a schedule area of the video display;
means for displaying a cursor highlighting a first program identifier in the
15 schedule area;
means for displaying an image output by the video signal tuner in a video area of the video display; and
means for displaying in a description area of the video display, additional information from the program listing related to the first program identifier highlighted by
20 the cursor in the schedule area, wherein the additional information comprises information not in the first program identifier, wherein the description area is arranged so that the description area does not significantly overlap the schedule area, and wherein the plurality of program identifiers, the image output by the video signal tuner and the additional information are simultaneously displayed.
- 25 32. The system of claim 31 wherein the program identifiers include at least a program title.
33. The system of claim 31 or 32 further comprising
30 a user input,
means for moving the cursor in the schedule area, based on input received from the user input, to highlight a second program identifier and automatically change the

additional information in the description area to additional information from to the program listing identified by the second program identifier.

34. The system of claim 31 or 33 further comprising:
5 a user input,
means for controlling the video signal tuner to automatically tune the video signal tuner to the channel of the program corresponding to the program identifier highlighted in the schedule area by the cursor in response to movements of the cursor in the schedule area upon input received from the user input.
- 10
35. The system of claim 31 or 33 further comprising:
means for controlling the video signal tuner not to change tuning when the cursor in the schedule area is moved from highlighting a first program identifier to highlighting a second program identifier.
- 15
36. The system of any one of claims 31 to 35 in which the means for displaying additional information displays the description area such that the description area does not significantly overlap the video area.
- 20
37. The system of any one of claims 31 to 36 in which the means for displaying a plurality of program identifiers displays the schedule area such that the schedule area does not significantly overlap the video area.
- 25
38. The system of any one of claims 31 to 37 wherein the description area is arranged so that the description area does not overlap the schedule area at all.
39. The system of any one of claims 31 to 38 wherein substantially all of the image output by the video signal tuner is displayed in the window area of the video display.
- 30
40. The system of any one of claims 31 to 39 wherein the additional information is at a first level of detail, and wherein the system further comprises means for substituting

additional information at a second level of detail corresponding to the marked program listing for the program listings displayed in the first area.

41. The system of any one of claims 31 to 40 wherein the image output by the video
5 signal tuner is video for a currently telecast program.

42. The system of claim 31 wherein the image output by the video signal tuner is a video clip.

10 43. A method using a video display, a video signal tuner and a memory, comprising:
storing program listings for a plurality of television programs in the memory;
displaying a plurality of program identifiers, each related to one of the program
listings, in a schedule area of the video display;
displaying a cursor highlighting a first program identifier in the schedule area;
15 displaying substantially all of an image output by the video signal tuner in a
window area of the video display, the window area being arranged so that the schedule
area does not significantly overlap the window area; and
displaying in a description area of the video display, additional information from
the program listing related to the first program identifier highlighted by the cursor in the
20 schedule area, wherein the additional information comprises information not in the first
program identifier, and wherein the plurality of program identifiers, the image output by
the video signal tuner and the additional information are simultaneously displayed.

44. The method of claim 43 wherein the program identifiers include at least a
25 program title.

45. The method of claim 43 or 44 further comprising:
moving the cursor in the schedule area, based on input received from a user input,
to highlight a second program identifier and automatically change the additional
30 information in the description area to additional information from to the program listing
identified by the second program identifier.

46. The method of claim 43 or 45 further comprising:
controlling the video signal tuner to automatically tune to the channel of the program corresponding to the program identifier highlighted in the schedule area by the cursor in response to movements of the cursor in the schedule area, based on input
5 received from a user input.

47. The method of claim 43 or 45 further comprising:
controlling the video signal tuner not to change tuning when the cursor in the schedule area is moved from highlighting a first program identifier to highlighting a
10 second program identifier.

48. The method of any one of claims 43 to 45 in which displaying additional information displays the description area such that the description area does not significantly overlap the window area.
15

49. The method of any one of claims 43 to 48 in which displaying additional information displays the description area such that the description area does not significantly overlap the schedule area.

20 50. The method of any one of claims 43 to 49 wherein displaying substantially all of the image output by the video signal tuner comprises displaying all of the image output by the video signal tuner.

25 51. The method of any one of claims 43 to 50 wherein displaying additional information comprises displaying additional information at a first level of detail, and wherein the method further comprises substituting additional information at a second level of detail corresponding to the marked program listing for the program listings displayed in the first area.

30 52. The method of any one of claims 43 to 51 wherein displaying substantially all of an image output by the video signal tuner comprises displaying substantially all of a video for a currently telecast program.

53. The method of claim 43 wherein displaying substantially all of an image output by the video signal tuner comprises displaying substantially all of a video clip.
- 5 54. A method using a video display, a video signal tuner and a memory, comprising:
storing program listings for a plurality of television programs in the memory;
displaying a plurality of program identifiers, each related to one of the program
listings, in a schedule area of the video display;
displaying a cursor highlighting a first program identifier in the schedule area;
10 displaying an image output by the video signal tuner in a video area of the video
display; and
displaying in a description area of the video display, additional information from
the program listing related to the first program identifier highlighted by the cursor in the
schedule area, wherein the additional information comprises information not in the first
15 program identifier, the description area being arranged so that the description area does
not significantly overlap the schedule area, and wherein the plurality of program
identifiers, the image output by the video signal tuner and the additional information are
simultaneously displayed.
- 20 55. The method of claim 54 wherein the program identifiers include at least a
program title.
56. The method of claim 54 or 55 further comprising
moving the cursor in the schedule area, based on input received from a user input,
25 to highlight a second program identifier and automatically change the additional
information in the description area to additional information from to the program listing
identified by the second program identifier.
57. The method of claim 54 or 56 further comprising:
30 controlling the video signal tuner to automatically tune to the channel of the
program corresponding to the program identifier highlighted in the schedule area by the

cursor in response to movements of the cursor in the schedule area, based on input received from a user input.

58. The method of claim 54 or 56 further comprising:

5 controlling the video signal tuner not to change tuning when the cursor in the schedule area is moved from highlighting the first program identifier to highlighting the second program identifier.

59. The method of any one of claims 54 to 58 in which displaying additional
10 information displays the description area such that the description area does not significantly overlap the video area.

60. The method of any one of claims 54 to 59 in which displaying a plurality of
15 program identifiers displays the schedule area such that the schedule area does not significantly overlap the video area.

61. The method of any one of claims 54 to 60 wherein displaying the image output by
the video signal tuner comprises displaying substantially all of the image output by the
20 video signal tuner.

62. The method of any one of claims 54 to 61 wherein displaying the description area
such that the description area does not significantly overlap the schedule area comprises
displaying the description area such that the description area does not overlap the
25 schedule area at all.

63. The method of any one of claims 54 to 62 wherein displaying additional
information comprises displaying the additional information at a first level of detail, and
wherein the method further comprises substituting additional information at a second
level of detail corresponding to the marked program listing for the program listings
30 displayed in the first area.

64. The method of any one of claims 54 to 63 wherein displaying substantially all of an image output by the video signal tuner comprises displaying substantially all of a video for a currently telecast program.

5 65. The method of claim 54 wherein displaying substantially all of an image output by the video signal tuner comprises displaying substantially all of a video clip.

66. A method for displaying television program information comprising the steps of:
 storing in electronic memory electronic program guide information including for
 10 each television program, title, start time, and regional channel name;
 storing in electronic memory a channel map that links channel names with local
 channel numbers;
 selecting a particular on-screen guide for display;
 retrieving from electronic memory electronic program guide (EPG) information
 15 required to display the selected on-screen guide, including title, start time, and regional
 channel name;
 retrieving from electronic memory the local channel number linked to each
 regional channel name retrieved from electronic memory;
 displaying the retrieved titles, start times, regional channel names, and the local
 20 channel numbers as the selected on-screen guide.

67. A method of storing show data items in a memory for display on a television
 screen, the method comprising the steps of:
 transmitting to the memory show data items each representing a time period, a
 25 channel, and a title of a program to be telecast during the time period on the channel;
 storing the title of each show data item at a specific address in a first area of the
 memory; and
 storing the specific address at a location in a second area of the memory assigned
 to the telecast time and channel represented by the show data item.

30

68. A method of displaying internal television channel numbers in an electronic
 program guide (EPG) comprising the steps of:

storing in memory an EPG identifying television programs by title, provider channel designation, and time of telecast;

storing in memory a table that links internal channel numbers and provider channel designations;

5 selecting from the EPG television programs meeting one or more criteria;
 recovering from memory the title, provider channel designation, and time of telecast of programs meeting the one or more criteria;

 recovering from memory the internal channel number of each provider channel designation recovered from memory; and

10 displaying the title, internal channel number, and time of telecast of each of the selected programs.

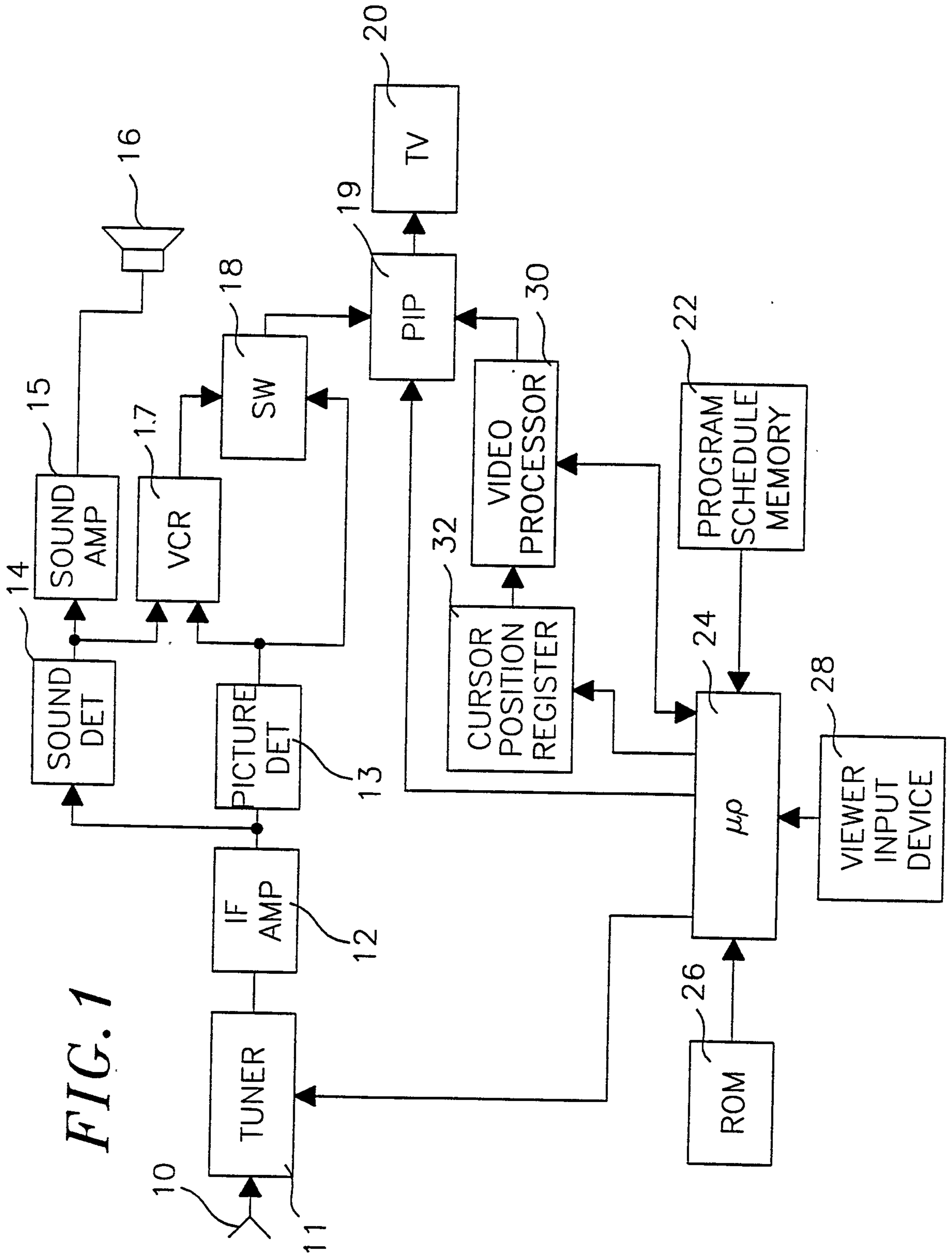

FIG. 1



FIG. 2

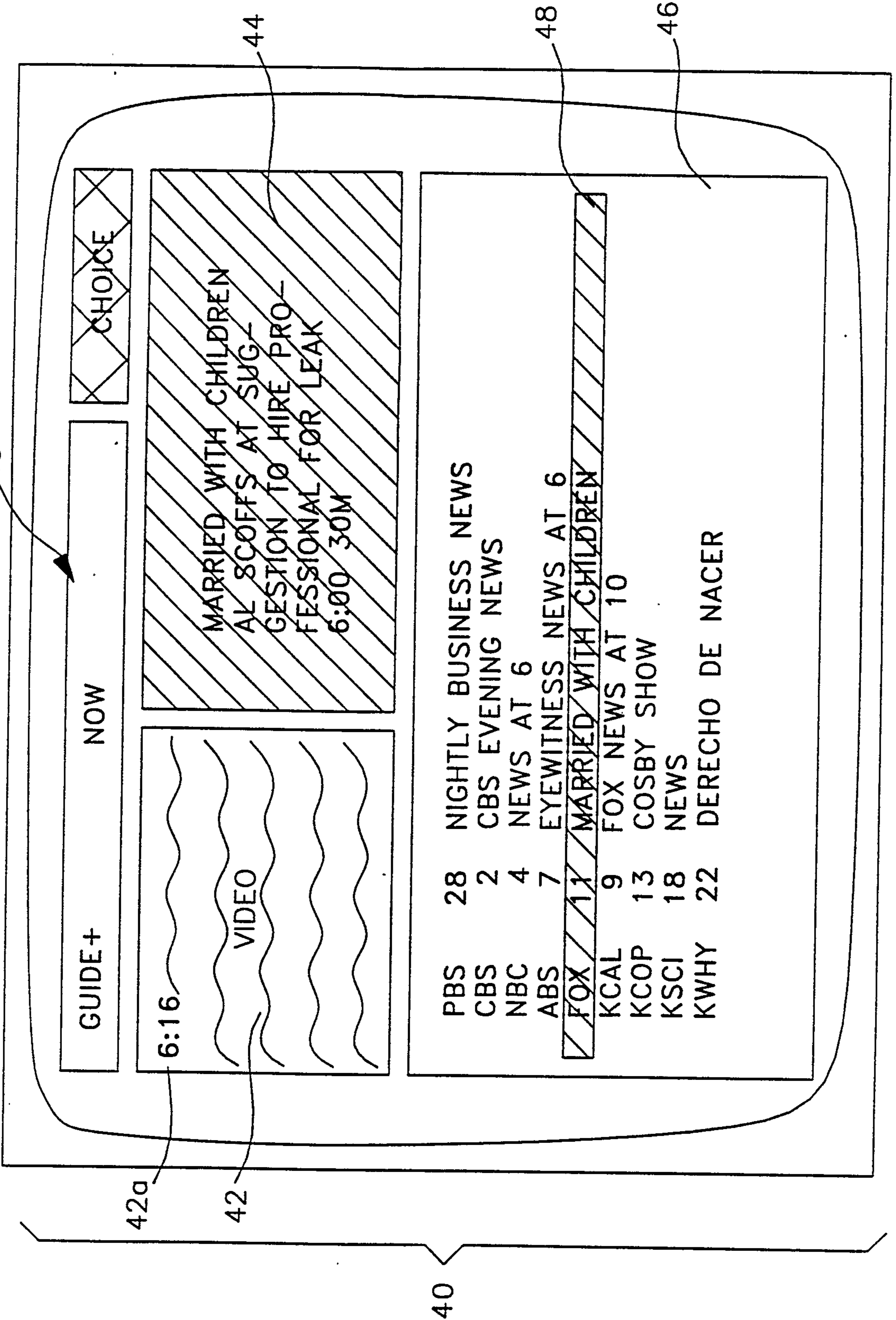
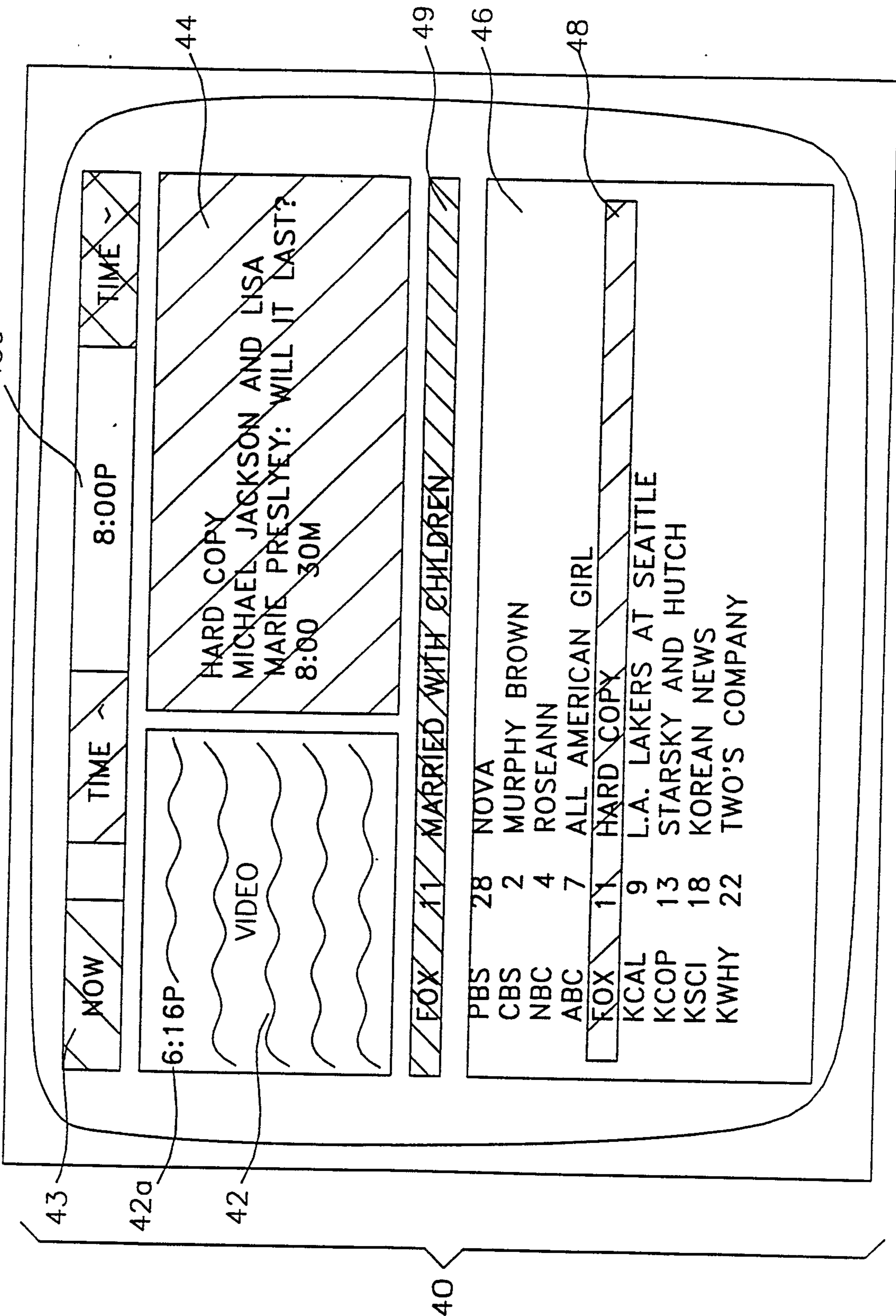

FIG. 3



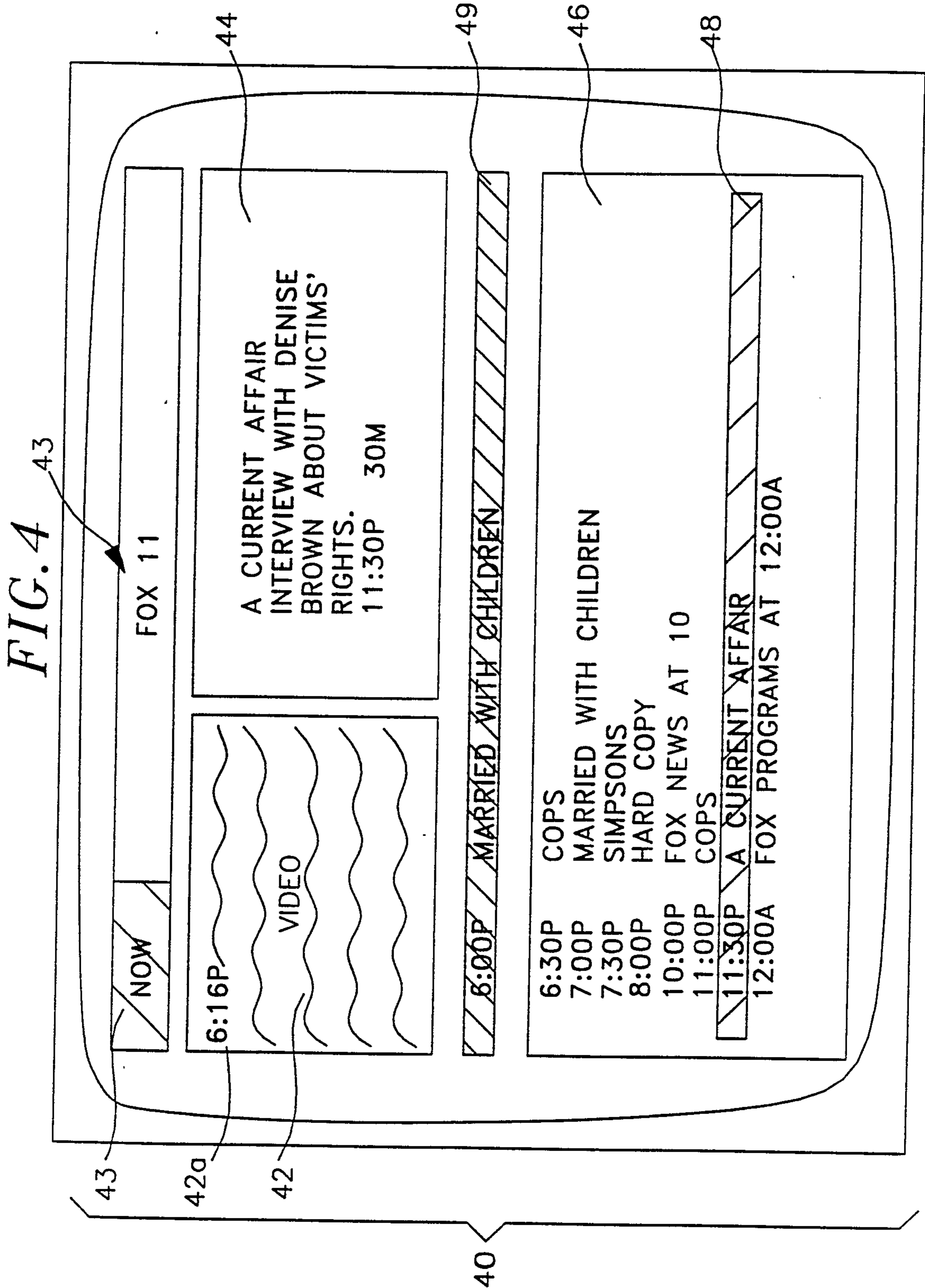

FIG. 5

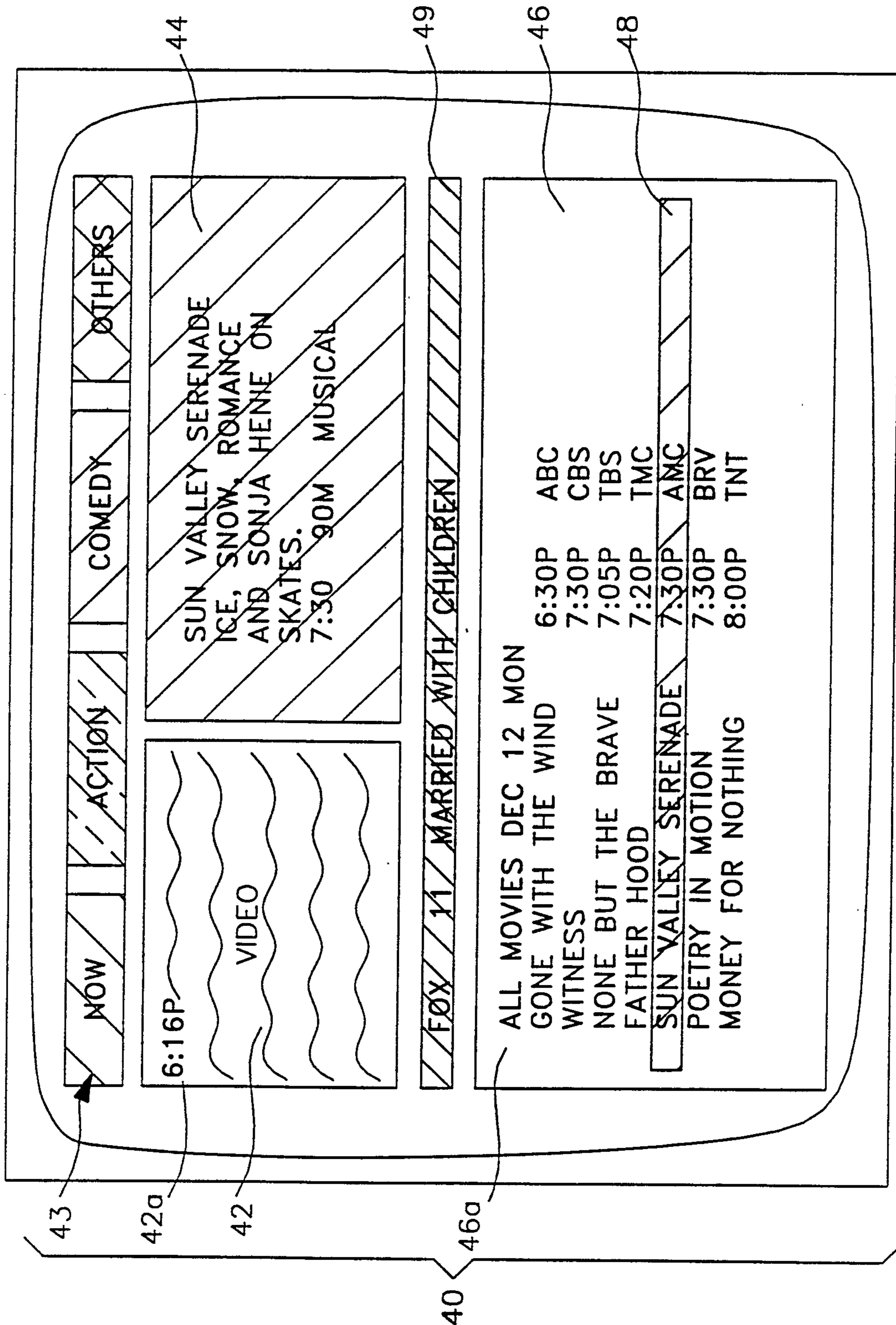
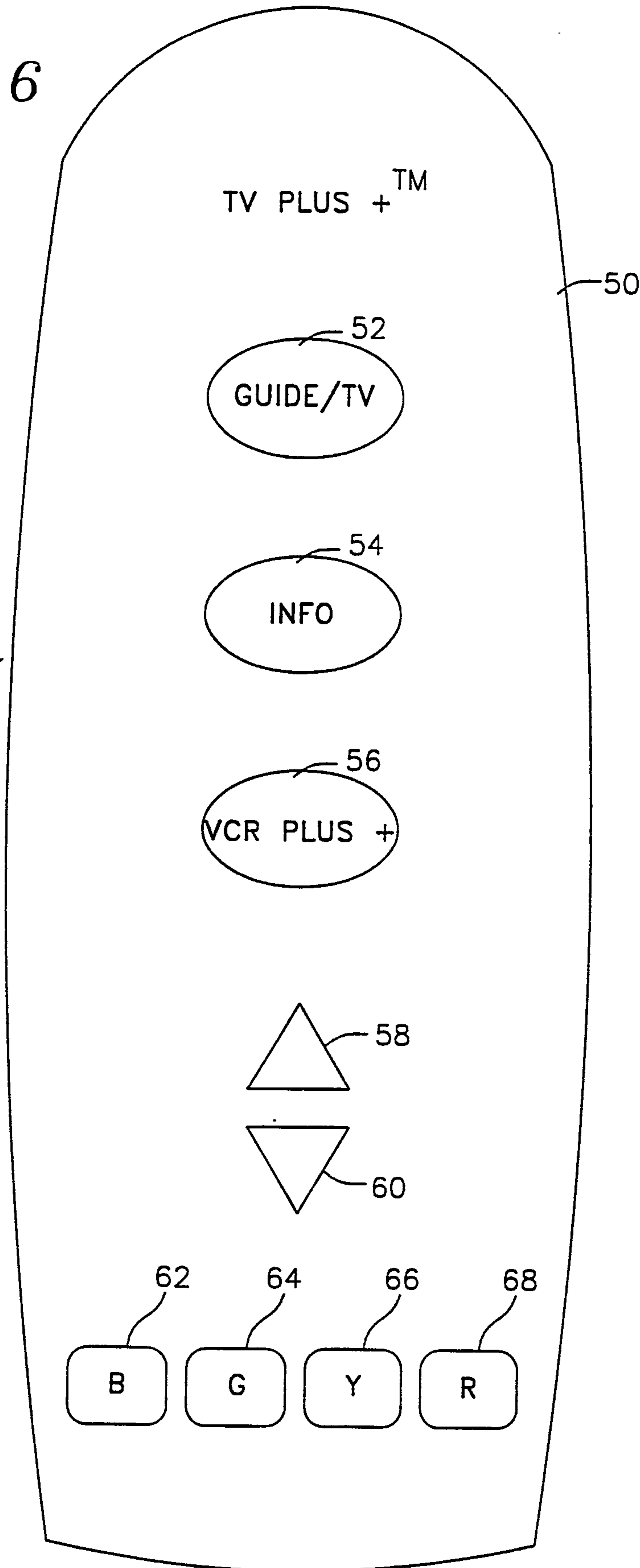
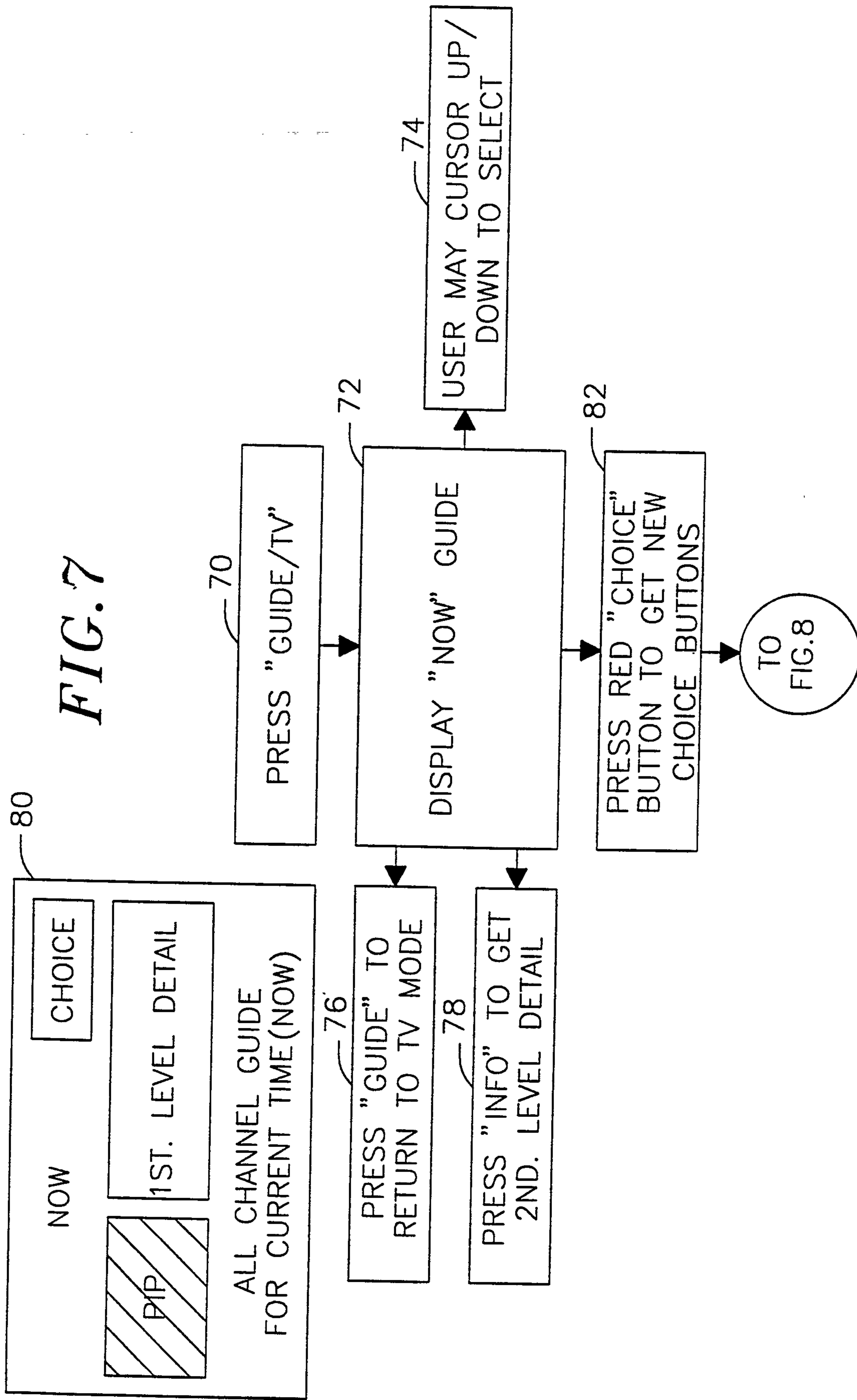

FIG. 6





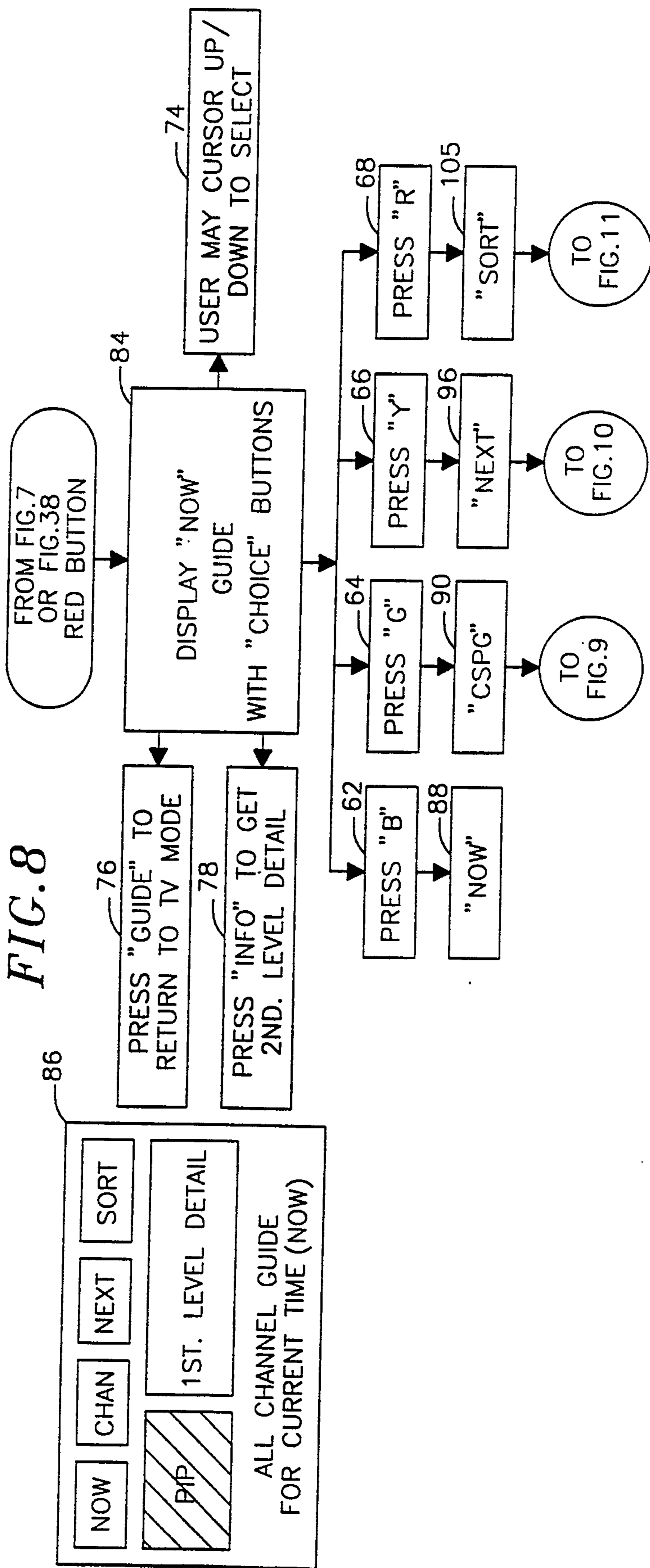

FIG. 8

FIG. 9

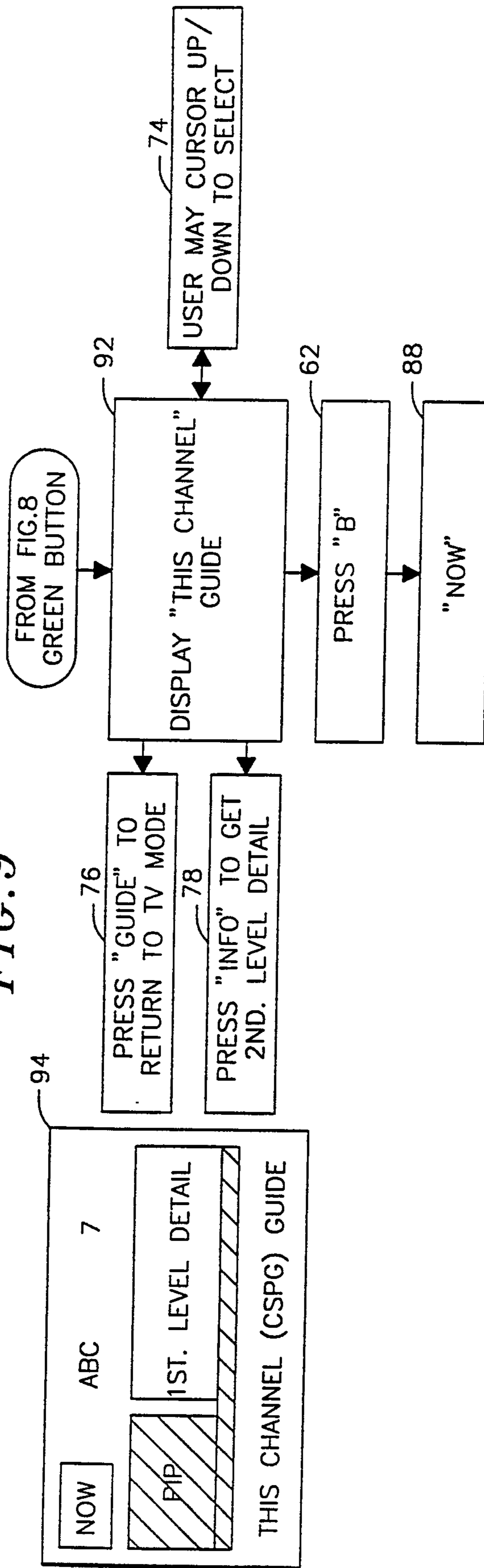
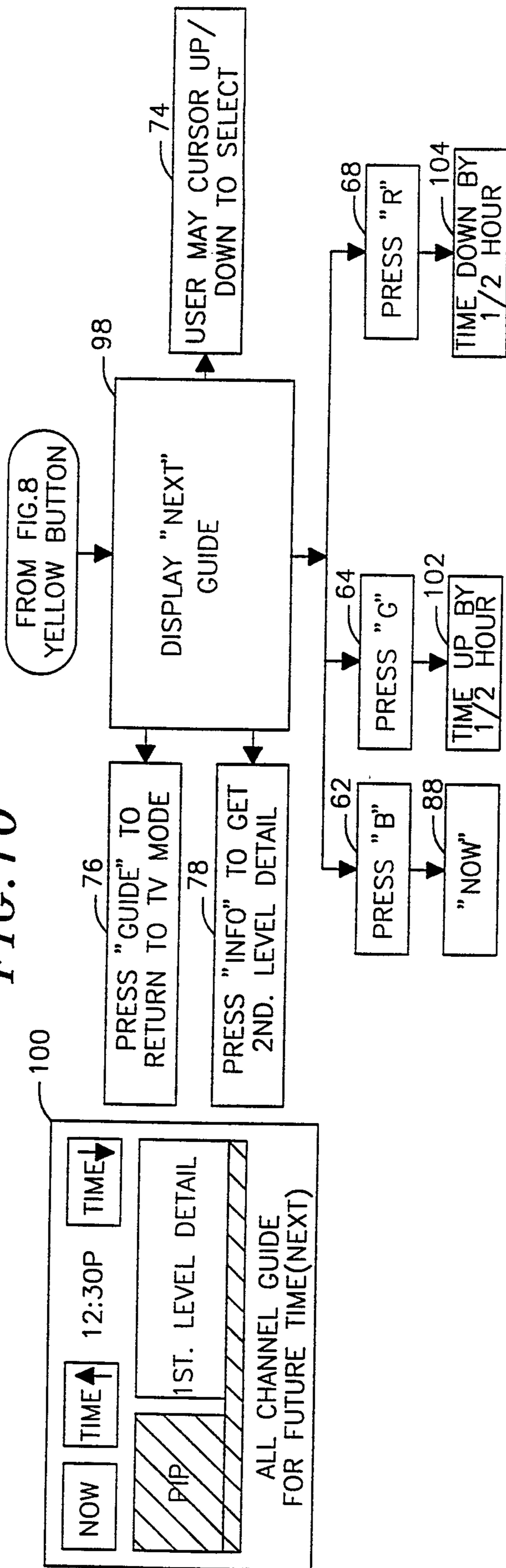

FIG. 10



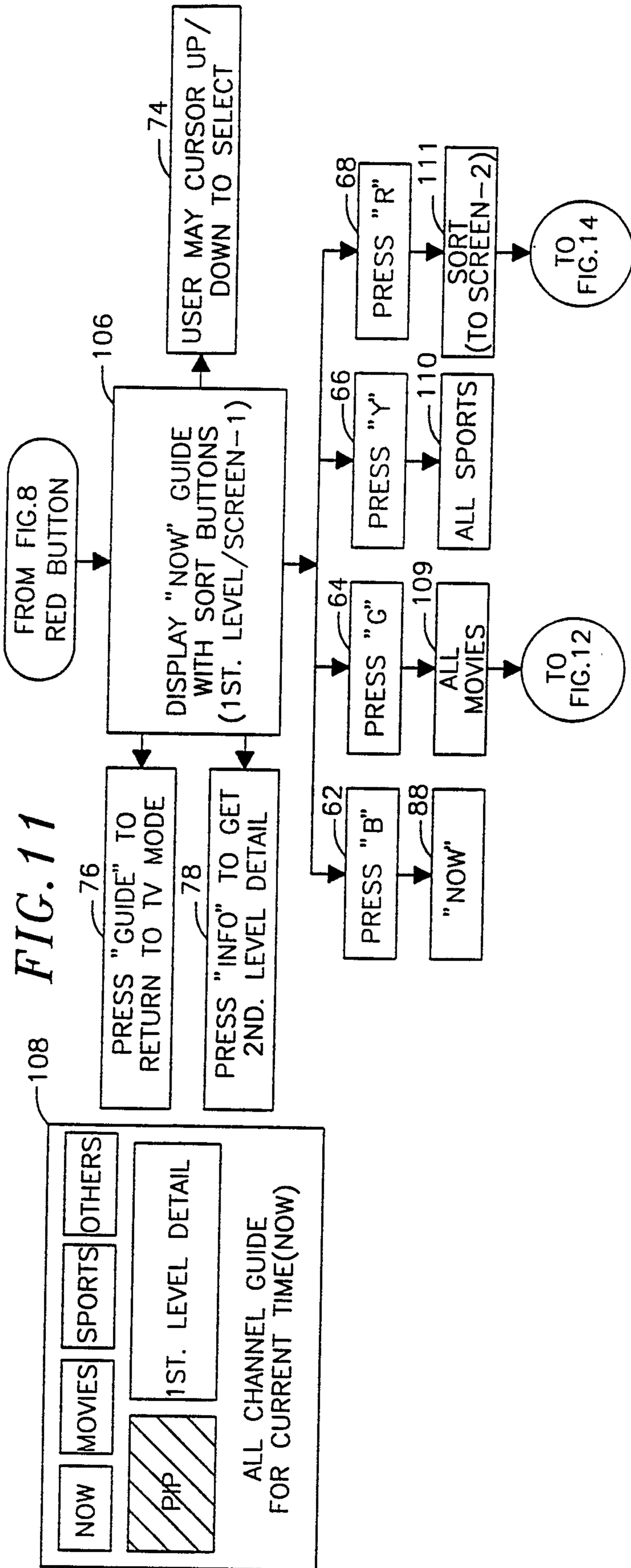

FIG. 12

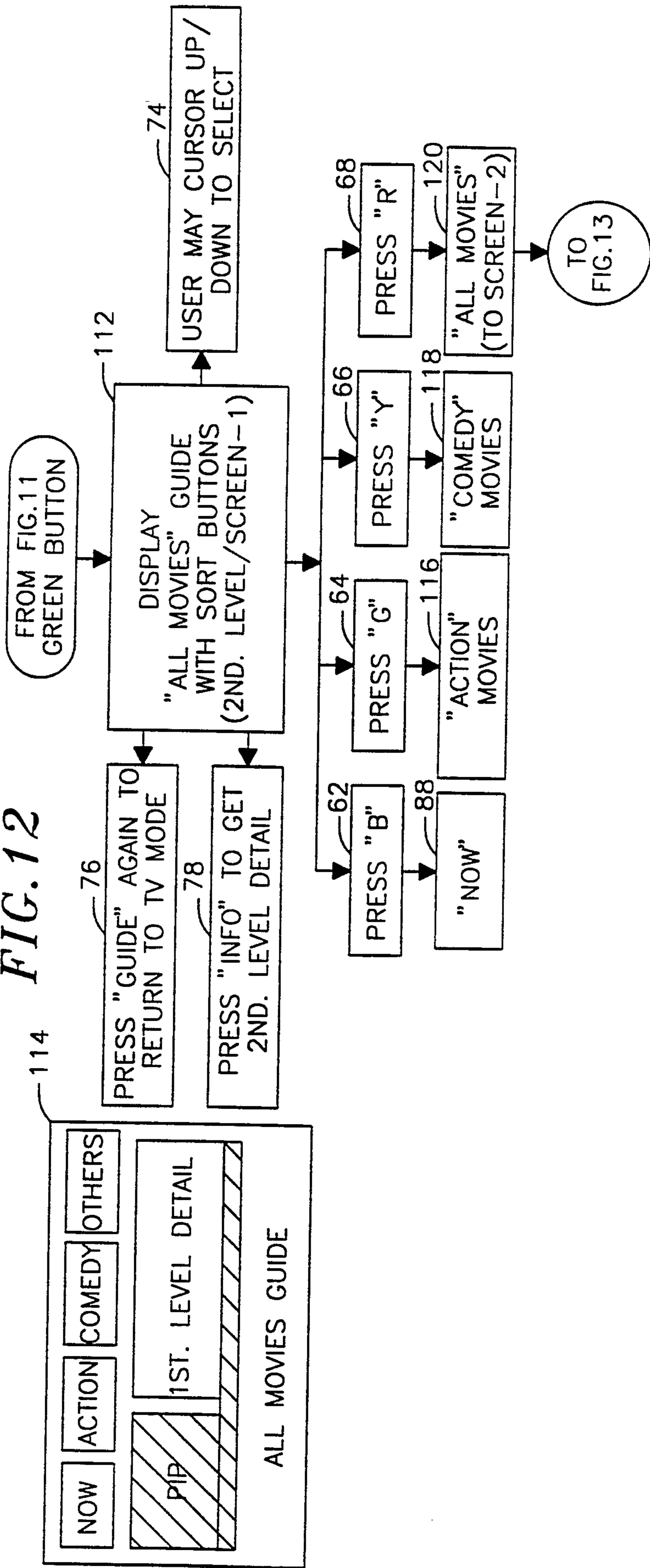

FIG. 13

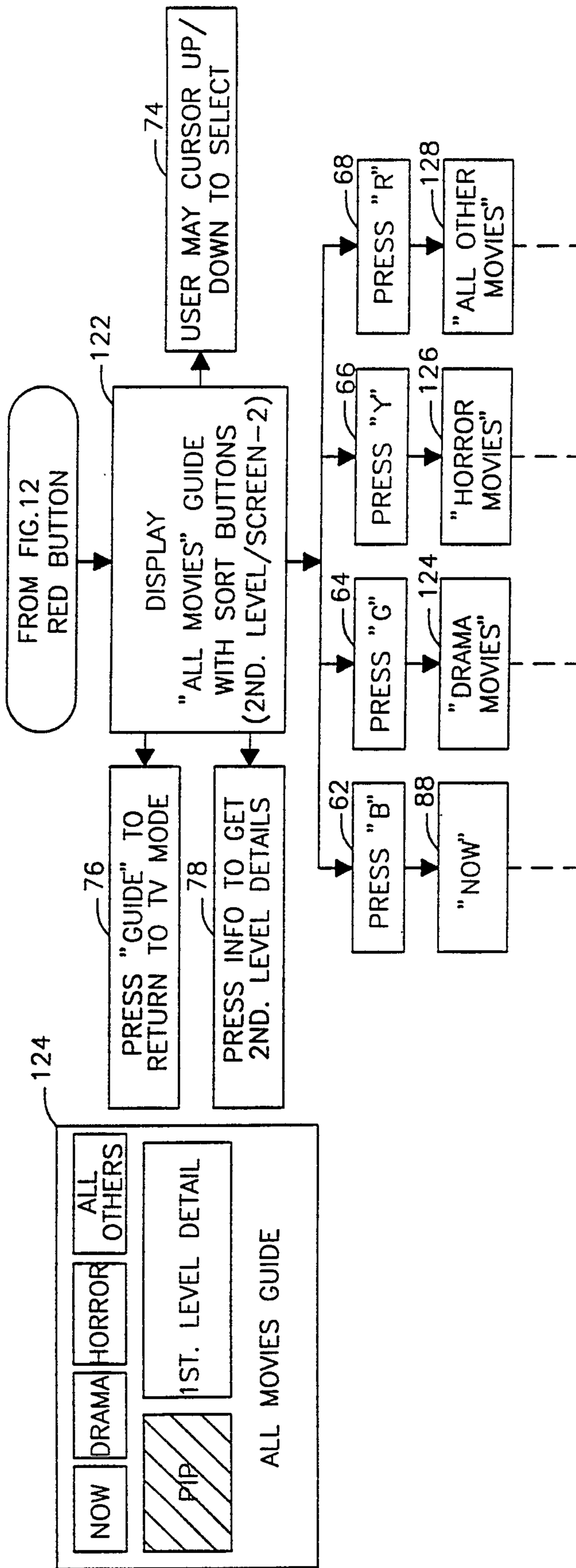

FIG. 14

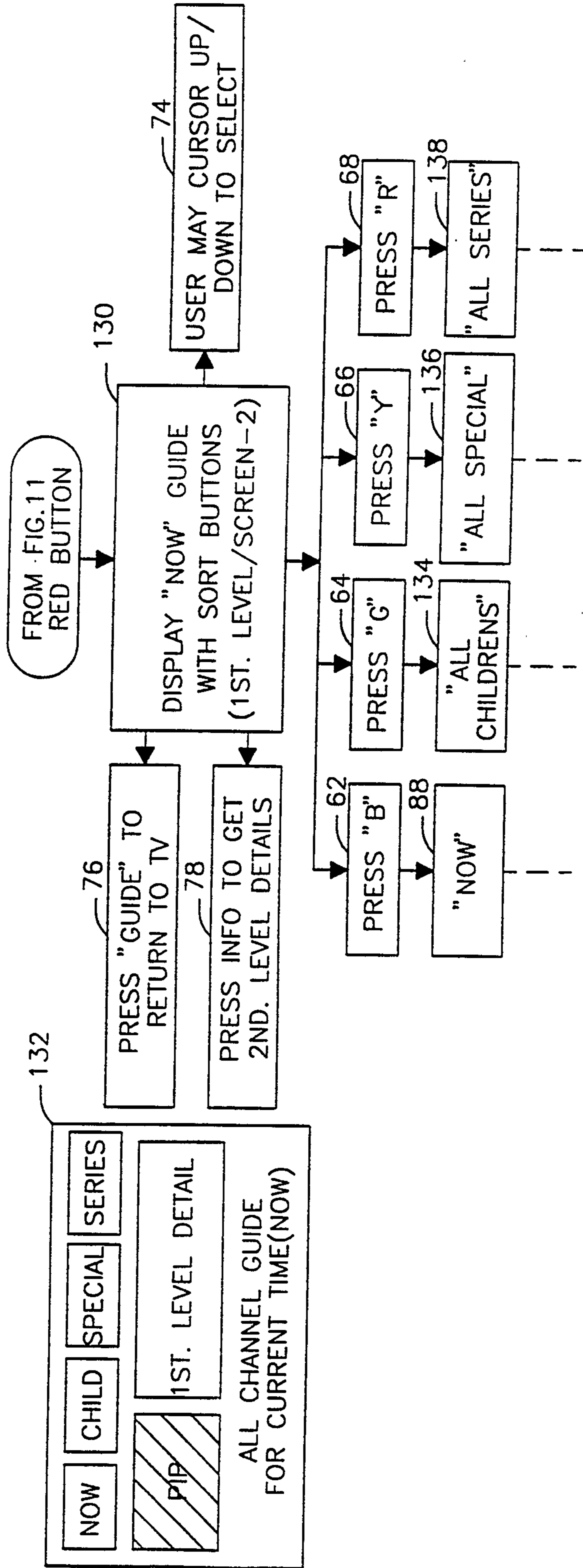

FIG. 15

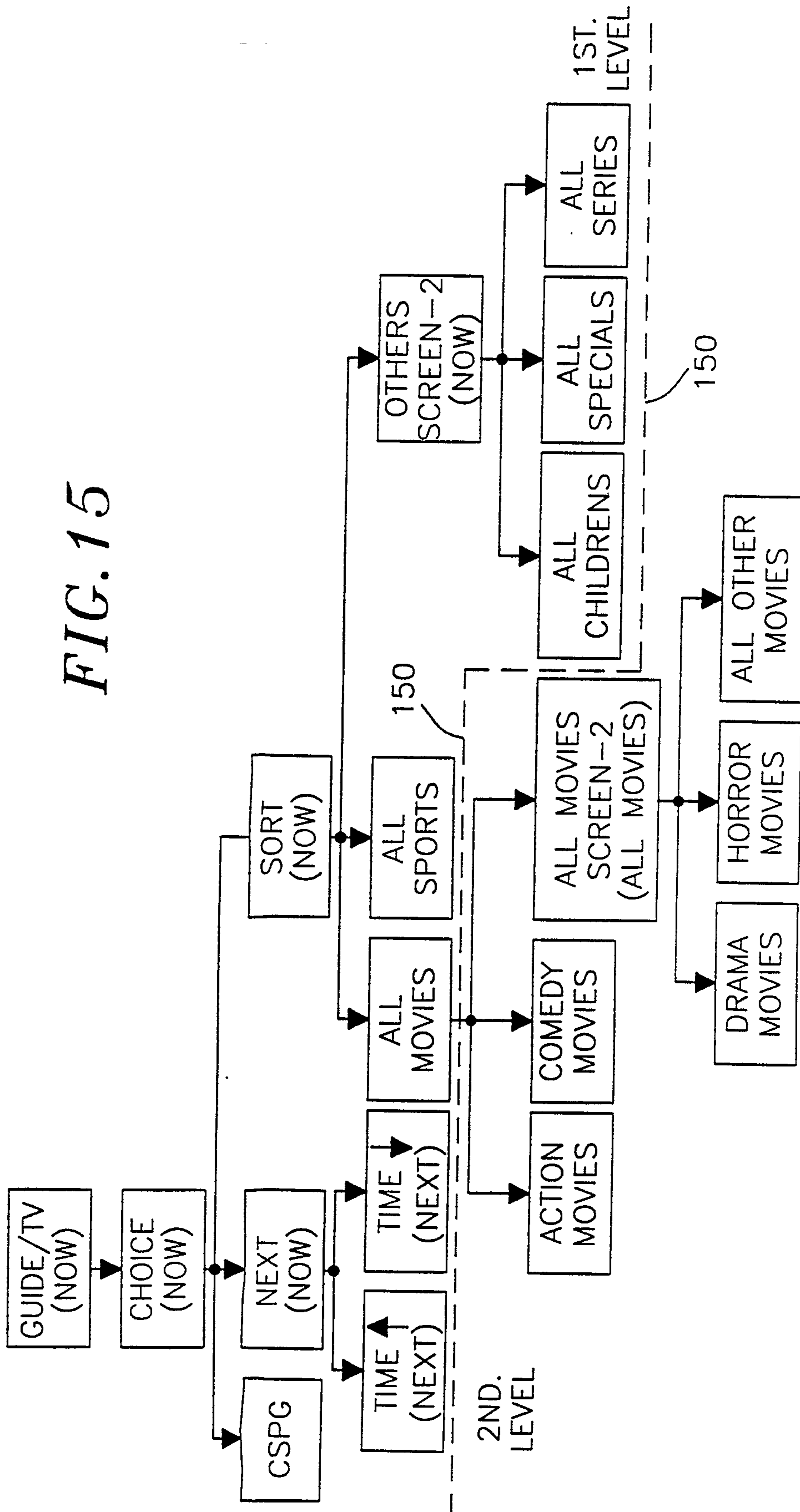

FIG. 16

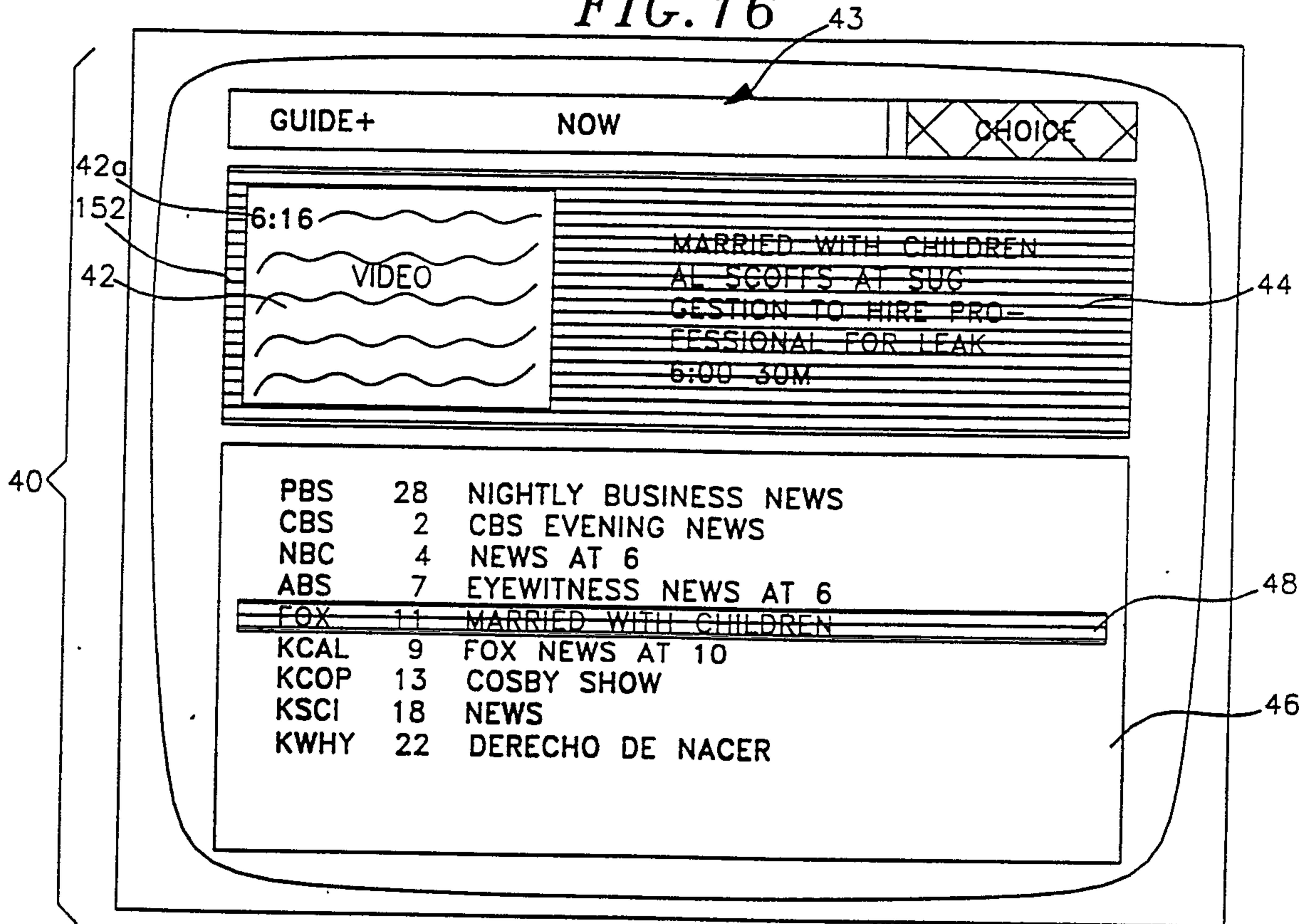

FIG. 17

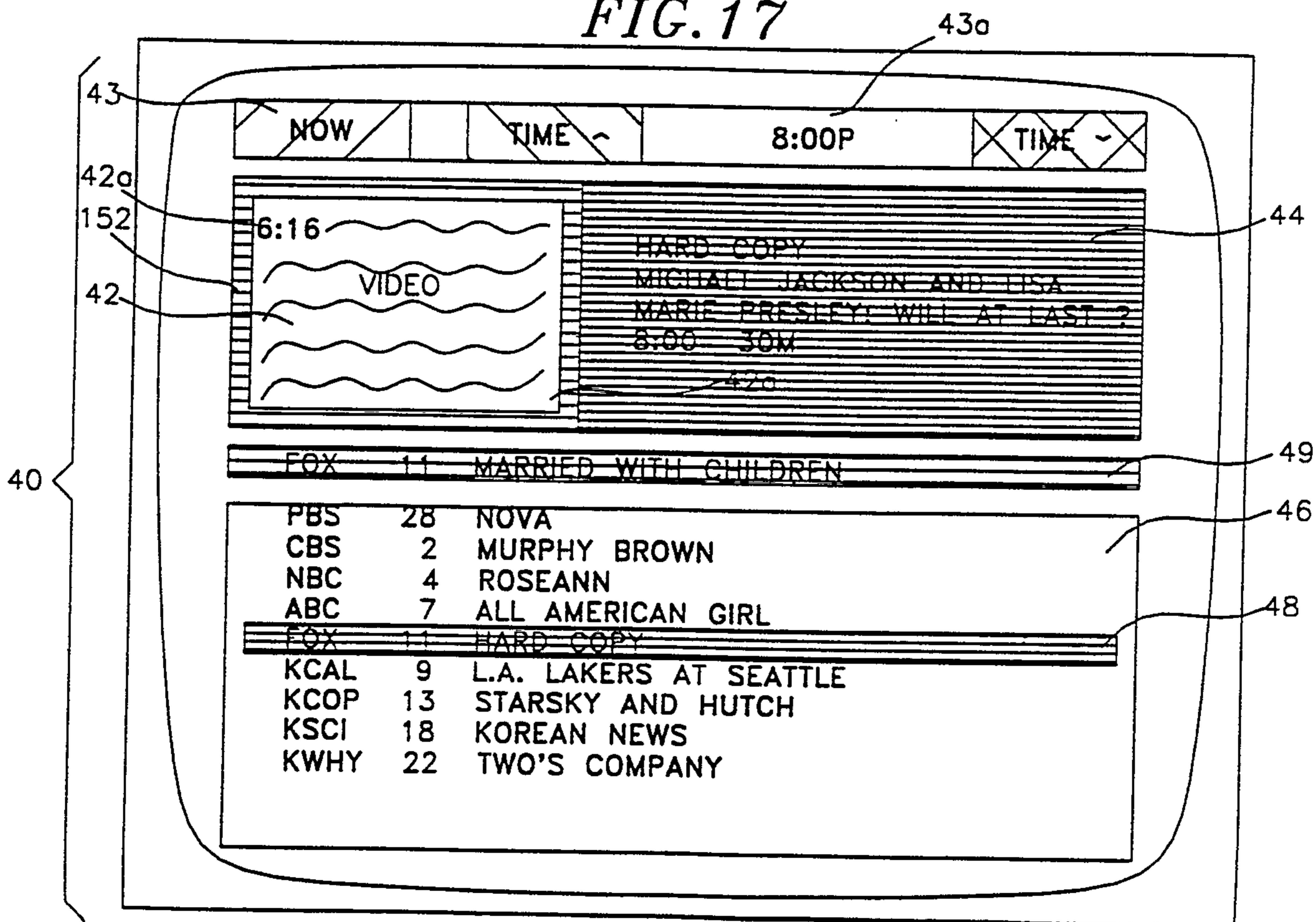

FIG. 18

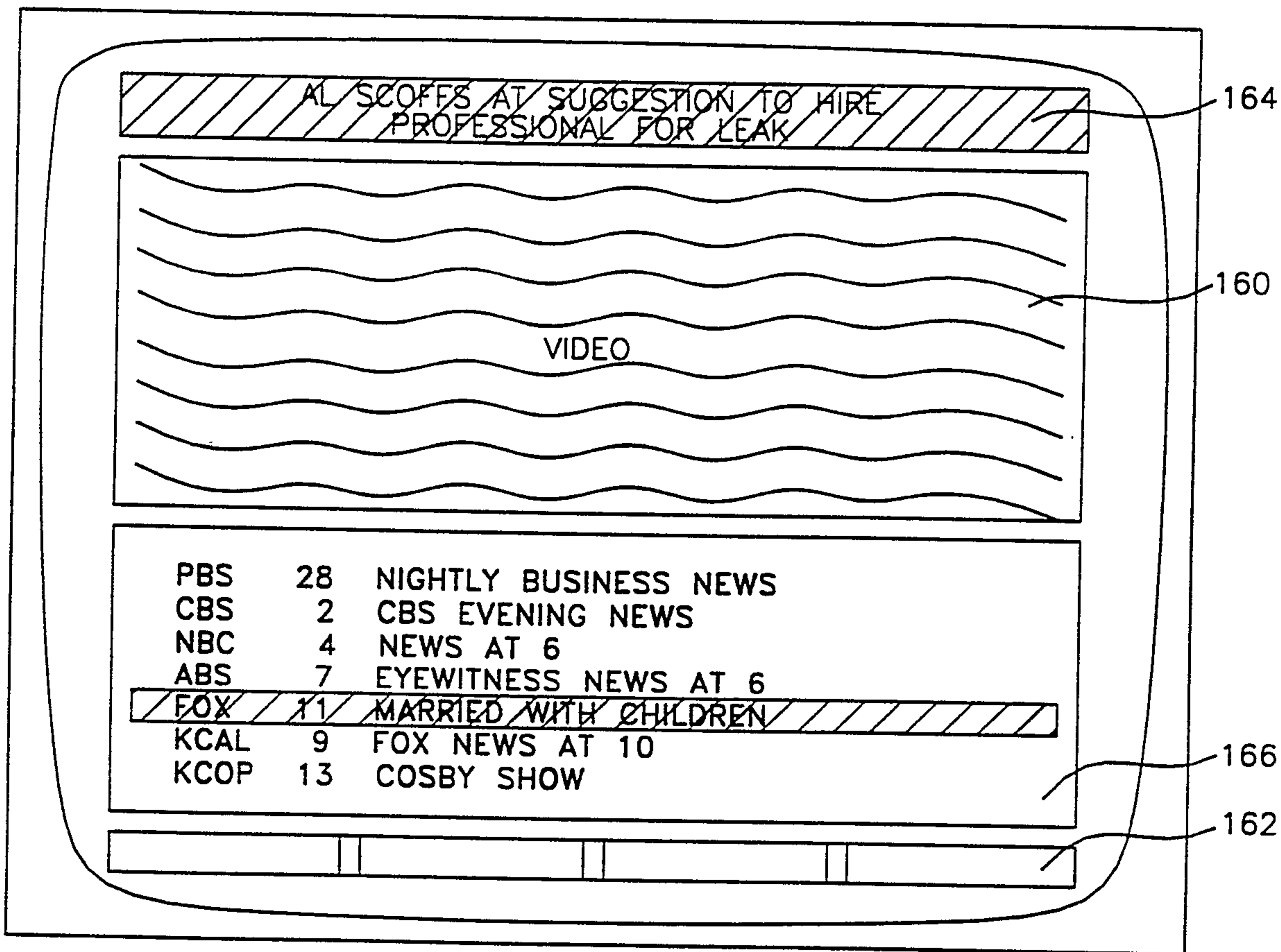
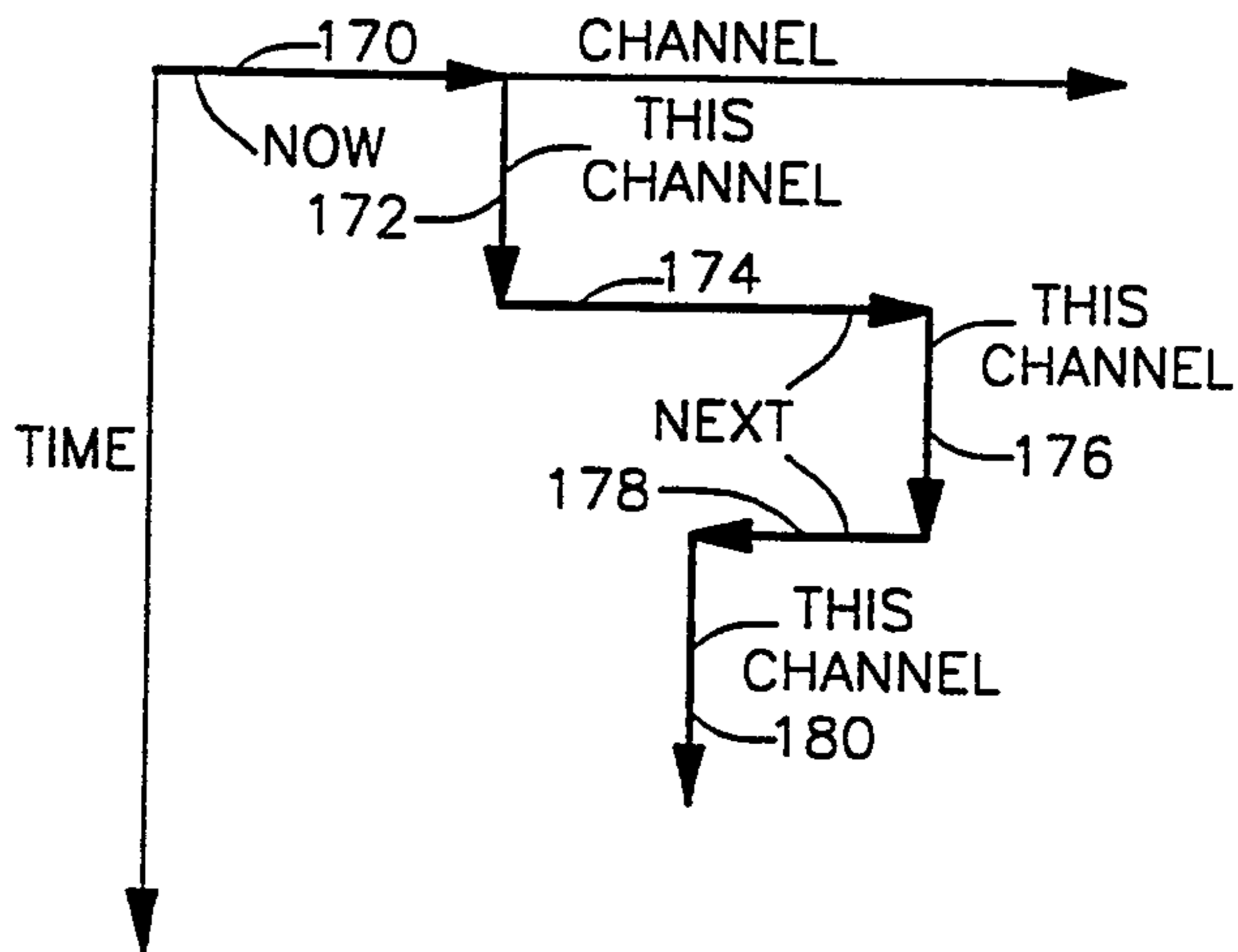

FIG. 19



2198740

18/33

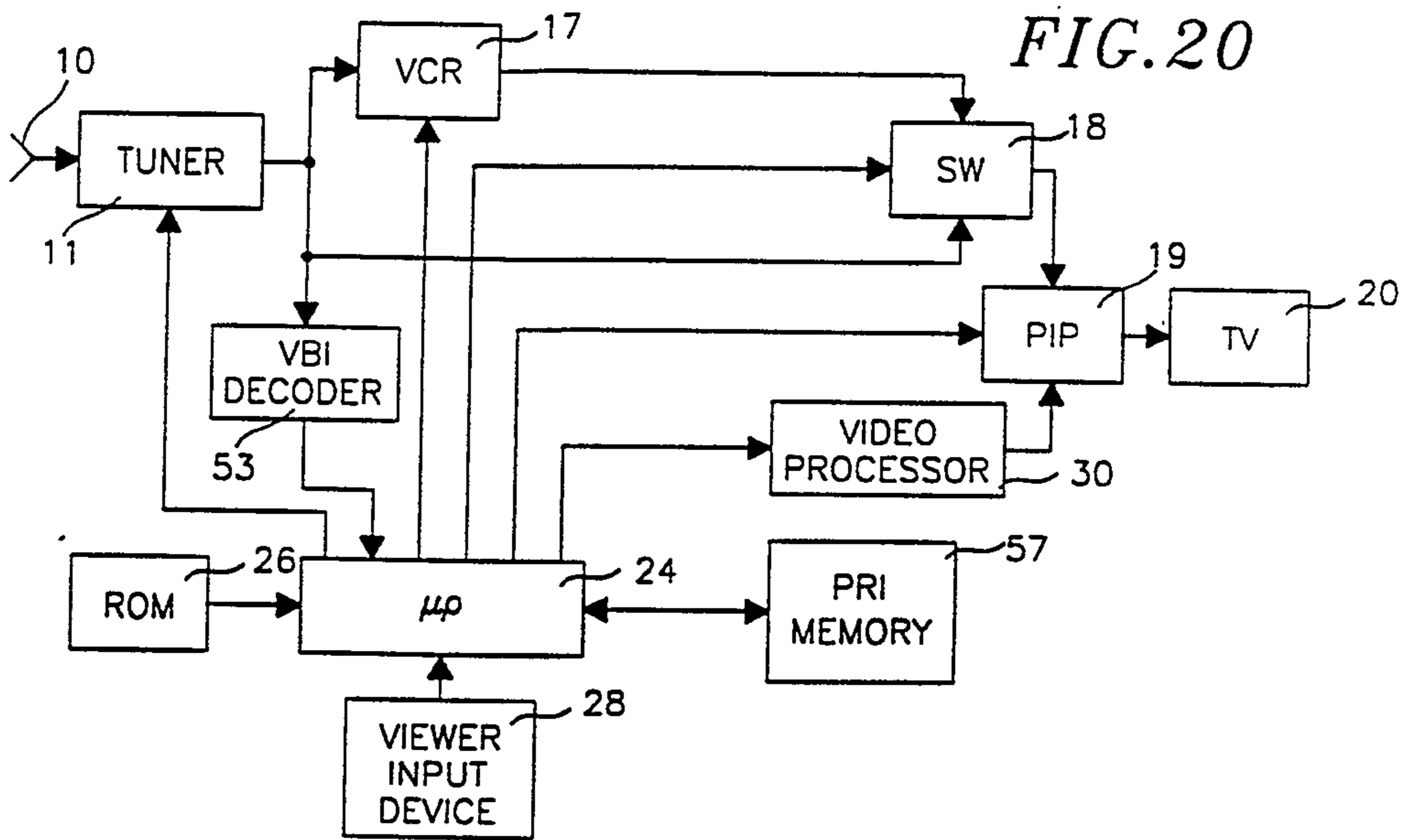

FIG. 21

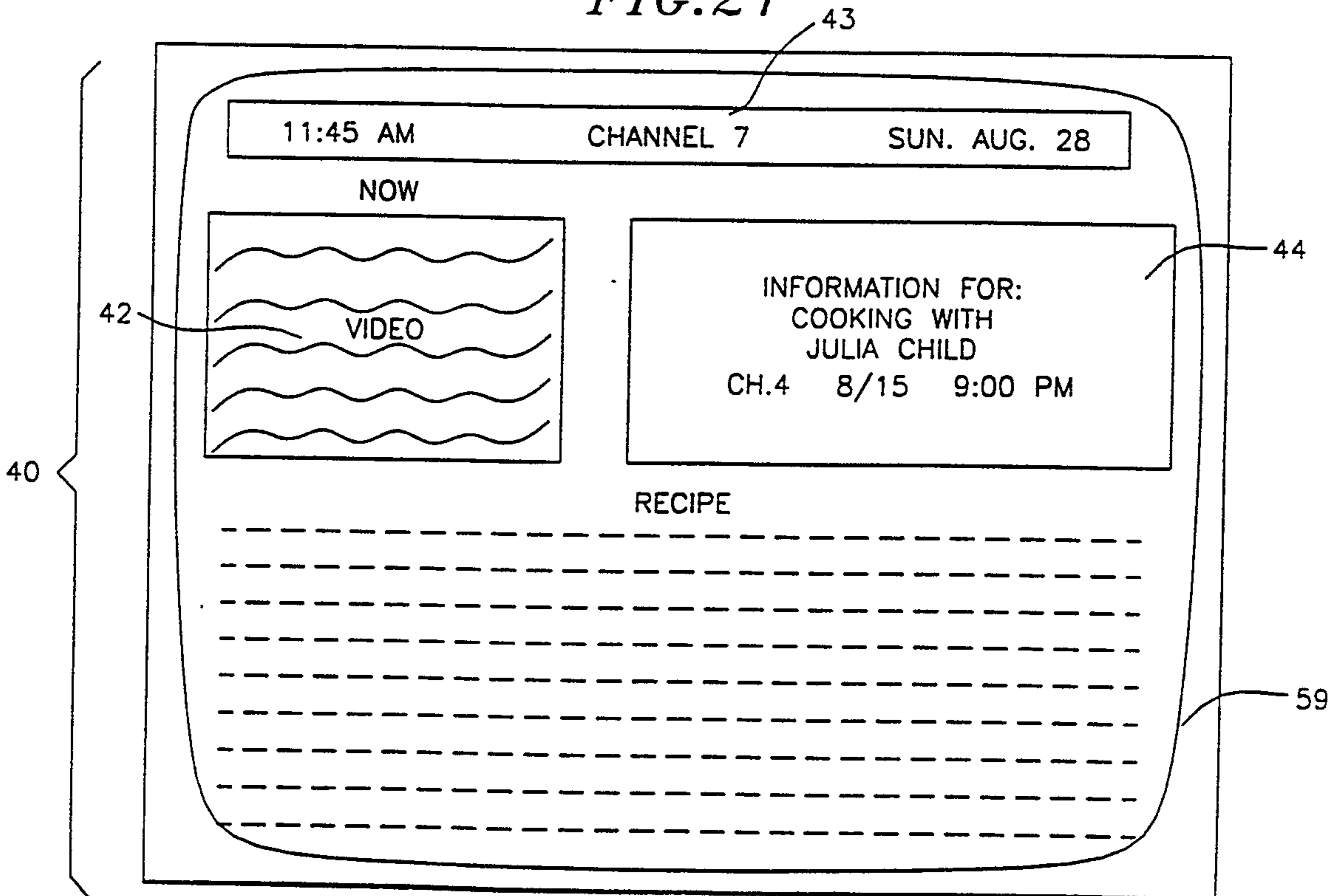

FIG. 22

RAM MEMORY DATA BASE

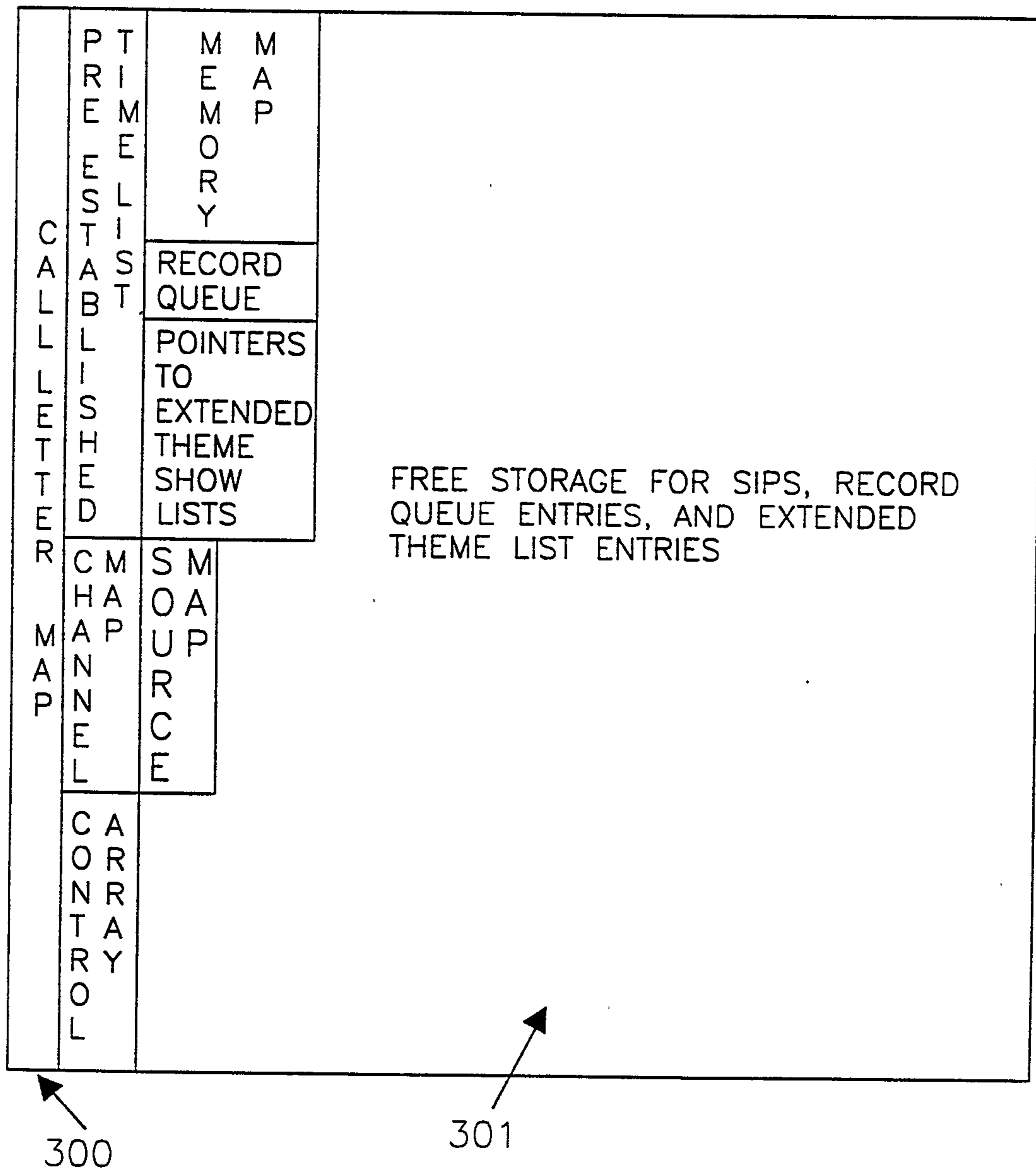

FIG. 23

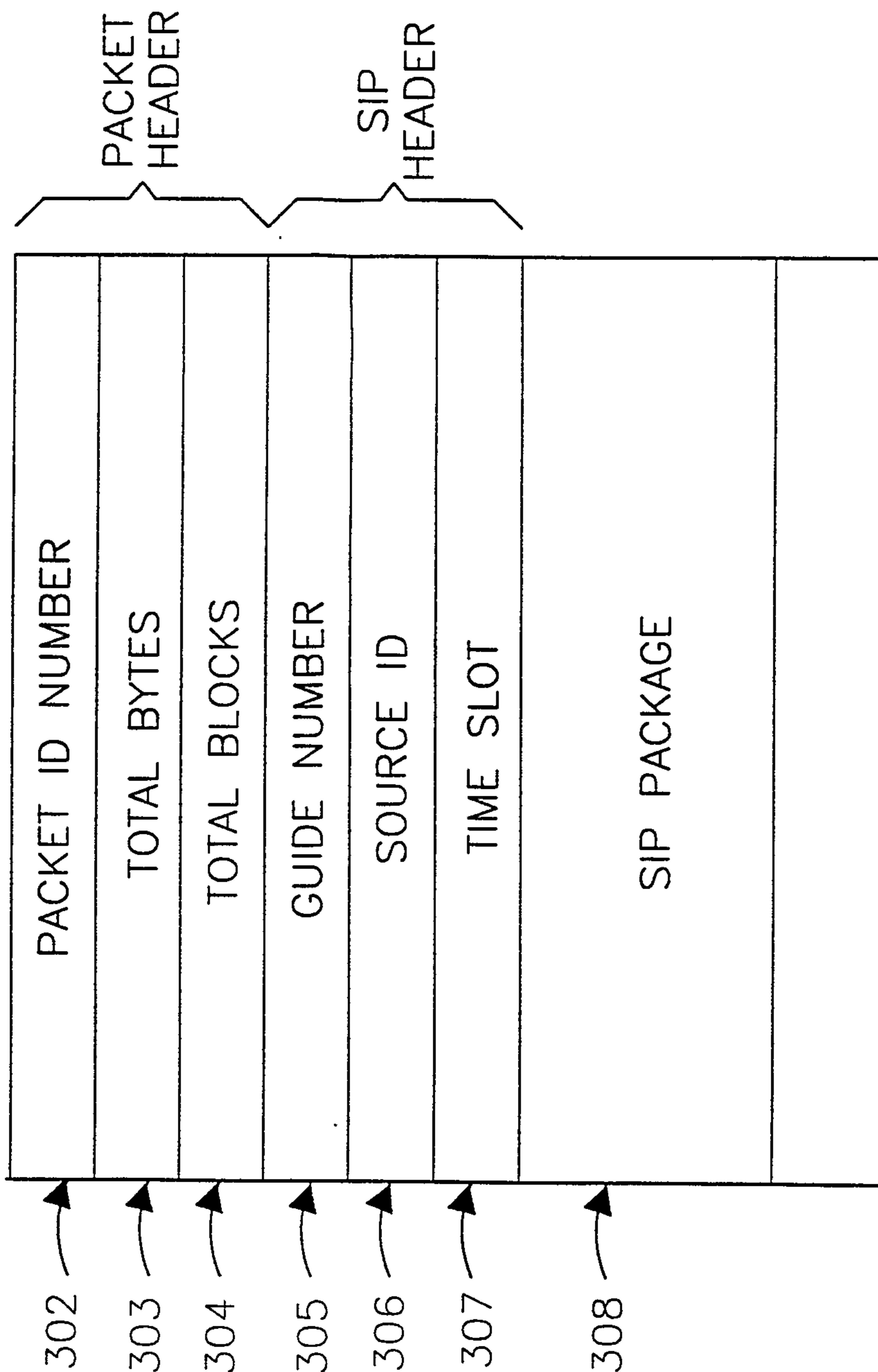

FIG. 24

MEMORY BIT MAP

	7	6	5	4	3	2	1	0
0	1	1	1	1	0	1	1	1
1	1	0	0	1	1	1	0	1
2	1	1	1	1	1	1	1	1
3	0	0	0	0	0	0	0	0
4	1	1	1	1	1	1	0	0
5	1	1	1	1	0	0	1	1
6	1	0	1	1	1	1	1	1
7	1	1	0	0	0	0	0	1
8	1	0	0	1	1	1	1	0
9	0	1	1	1	1	1	0	0
10	0	0	0	0	0	0	0	0
11	0	0	0	0	0	0	0	0
12	0	0	0	0	0	0	0	0
13	1	1	1	1	1	1	0	1
14	1	1	1	1	1	1	1	1
15	1	1	1	0	1	0	0	0
16	0	0	0	0	0	0	0	0
17	0	0	0	0	1	1	0	1

310

311

312

FIG.25

PRE-ESTABLISHED TIME LIST

	00-04	04-08	08-12	12-16	16-20	20-24
1	A ₁	B ₁	C ₁	D ₁	E ₁	F ₁
2	G ₁	H ₁	I ₁	J ₁	K ₁	L ₁
3	A ₂	B ₂	C ₂	D ₂	E ₂	F ₂
4	G ₂	H ₂	I ₂	J ₂	K ₂	L ₂
5	A ₃	B ₃	C ₃	D ₃	E ₃	F ₃
6	G ₃	H ₃	I ₃	J ₃	K ₃	L ₃
			⋮			
Z _{N-1}	A _N	B _N	C _N	D _N	E _N	F _N
Z _N	G _N	H _N	I _N	J _N	K _N	L _N

N=THE MAXIMUM NUMBER OF CHANNELS

FIG.26

SHOW INFORMATION PACKAGE

AMOUNT OF MEMORY USED	
CONTROL DATE	
VERSION NUMBER	
MULTIPLE SHOW FLAG	START TIME
DURATION	
THEME	
CC	STEREO
ADD ONS	
TITLE LENGTH	
TITLE	
PRIMARY DESCRIPTION LENGTH	
PRIMARY DESCRIPTION	
SECONDARY DESCRIPTION LENGTH	
SECONDARY DESCRIPTION	
VCR PLUSCODE LENGTH	
VCR PLUSCODE	
END OF SHOW=NULL	
MULTIPLE SHOW FLAG	START TIME
DURATION	
THEME	
CC	STEREO
ADD ONS	
TITLE LENGTH	
TITLE	
PRIMARY DESCRIPTION LENGTH	
PRIMARY DESCRIPTION	
SECONDARY DESCRIPTION LENGTH	
SECONDARY DESCRIPTION	
VCR PLUSCODE LENGTH	
VCR PLUSCODE	
END OF SHOW=NULL	
⋮	
⋮	
⋮	
MULTIPLE SHOW FLAG	START TIME
DURATION	
THEME	
CC	STEREO
ADD ONS	
TITLE LENGTH	
TITLE	
PRIMARY DESCRIPTION LENGTH	
PRIMARY DESCRIPTION	
SECONDARY DESCRIPTION LENGTH	
SECONDARY DESCRIPTION	
VCR PLUSCODE LENGTH	
VCR PLUSCODE	
END OF SHOW=NULL	

23/33

FIG. 27

SHOW INFORMATION PACKAGE FEATURES

SECONDARY DESCRIPTION LENGTH=MAX
SECONDARY DESCRIPTION LENGTH
SECONDARY DESCRIPTION
VCR PLUSCODE LENGTH
VCR PLUSCODE
EXTRA DATA LENGTH
EXTRA DATA
END OF SHOW=NULL

FIG. 28

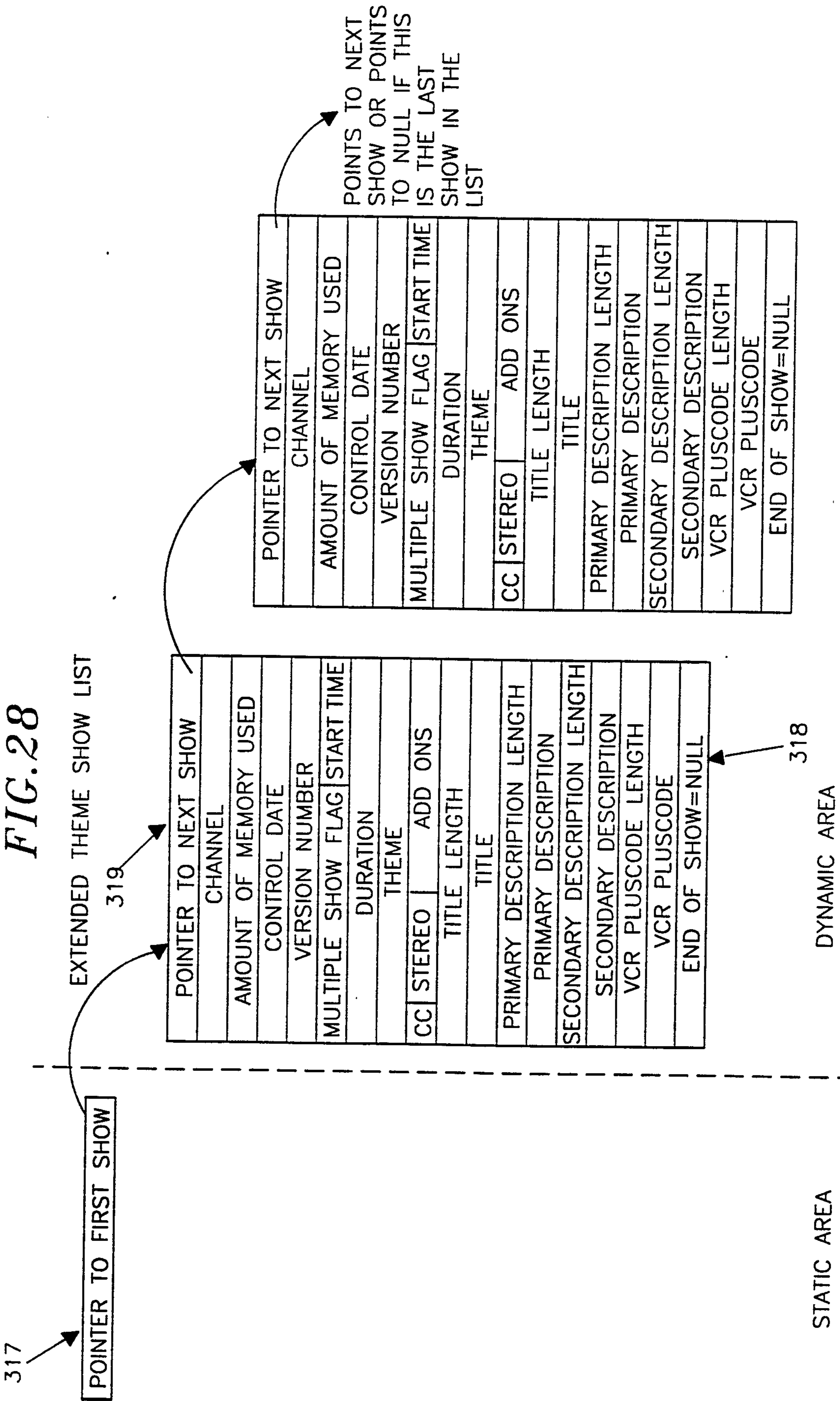

FIG. 29

CHANNEL MAP

1	7
2	6
3	11
4	2
5	4
	•
	•
	•
N	172

N=MAX NUMBER OF CHANNELS

FIG. 30

CONTROL ARRAY

320



1	DISPLAY	ADD ONS
2	DISPLAY	ADD ONS
3	DO NOT DISPLAY	ADD ONS
4	DISPLAY	ADD ONS
5	DISPLAY	ADD ONS
		•
		•
		•
N	DISPLAY	ADD ONS

N=MAX NUMBER OF CHANNELS

FIG. 31

CALL LETTER MAP

1	K
2	A
3	B
4	C
5	W
6	W
7	O
	R
	•
	•
	•
(N×4)-3	K
(N×4)-2	T
(N×4)-1	V
N×4	R

FIG. 32

RECORD QUEUE

1	CHANNEL	START TIME
2	CHANNEL	START TIME
3	CHANNEL	START TIME
		•
		•
		•
20	CHANNEL	START TIME

FIG. 33

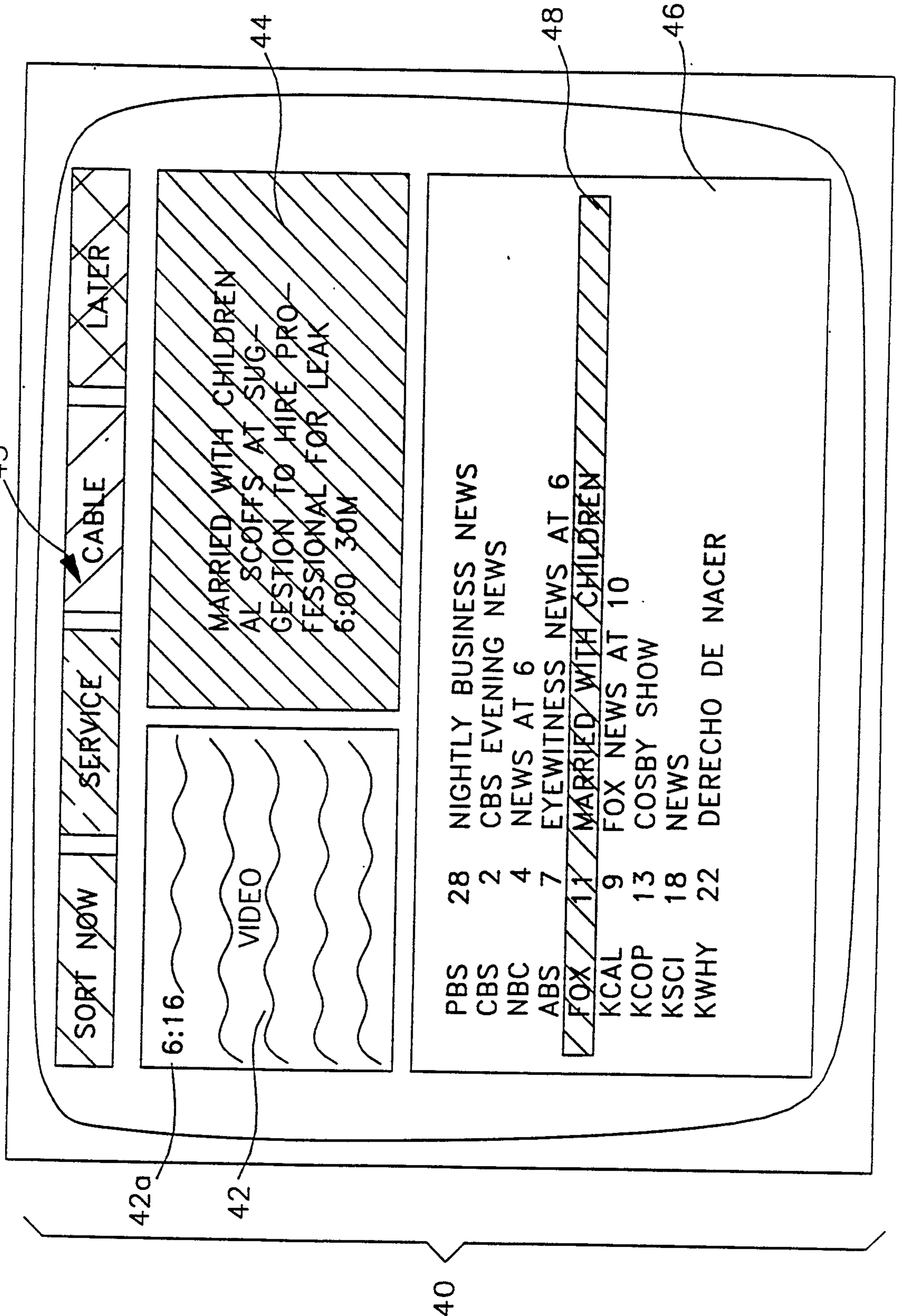

FIG. 34

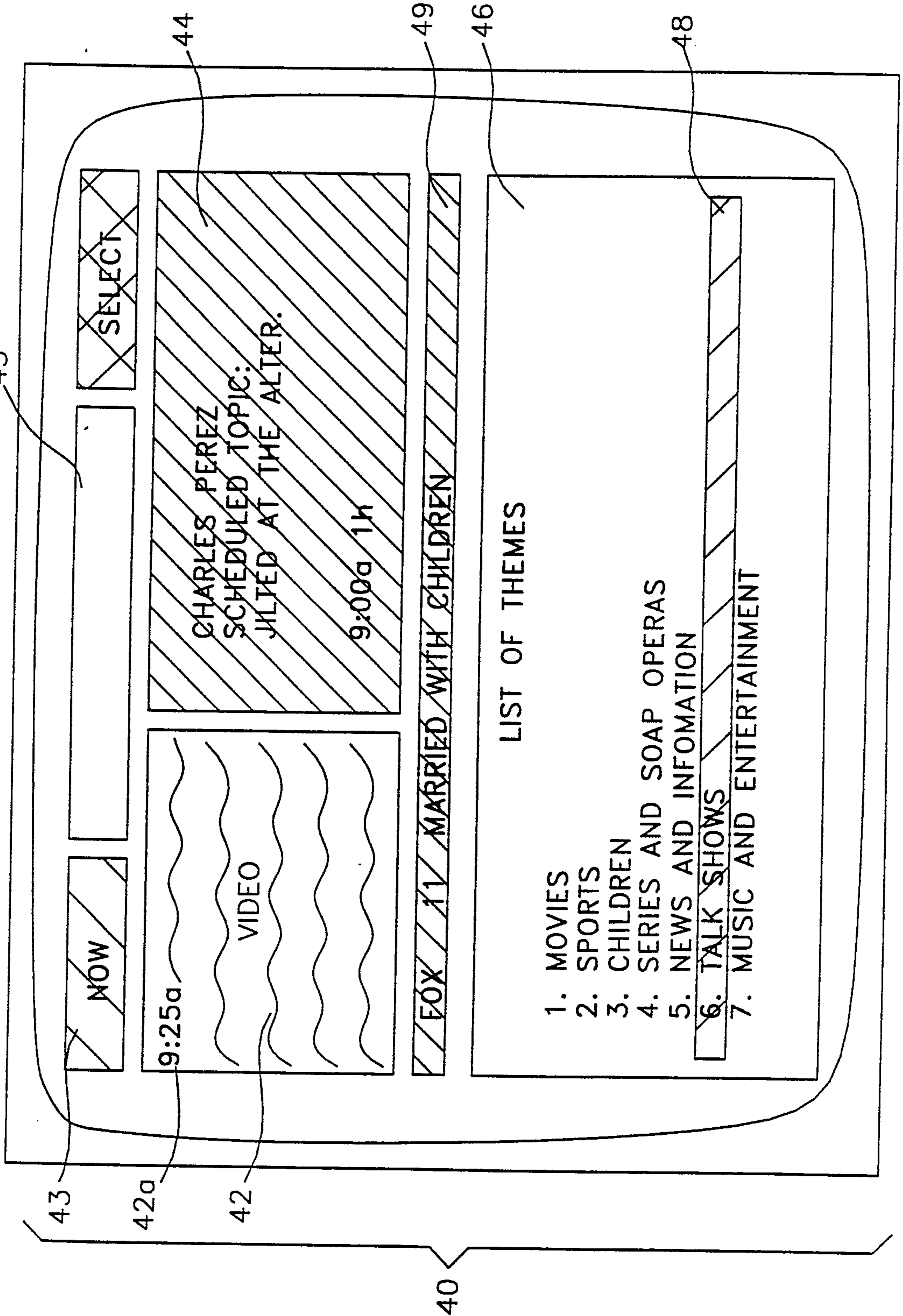

FIG. 35

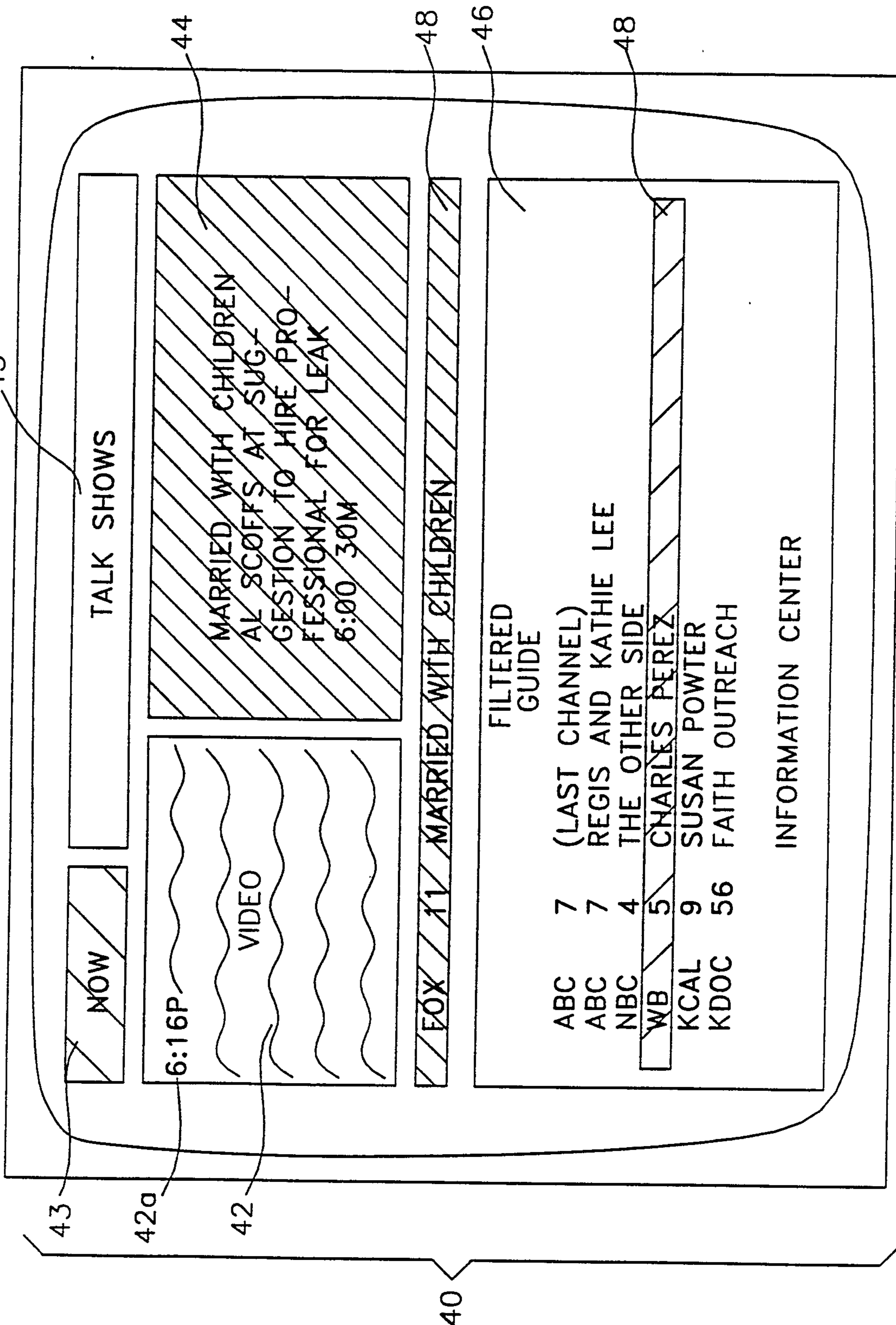
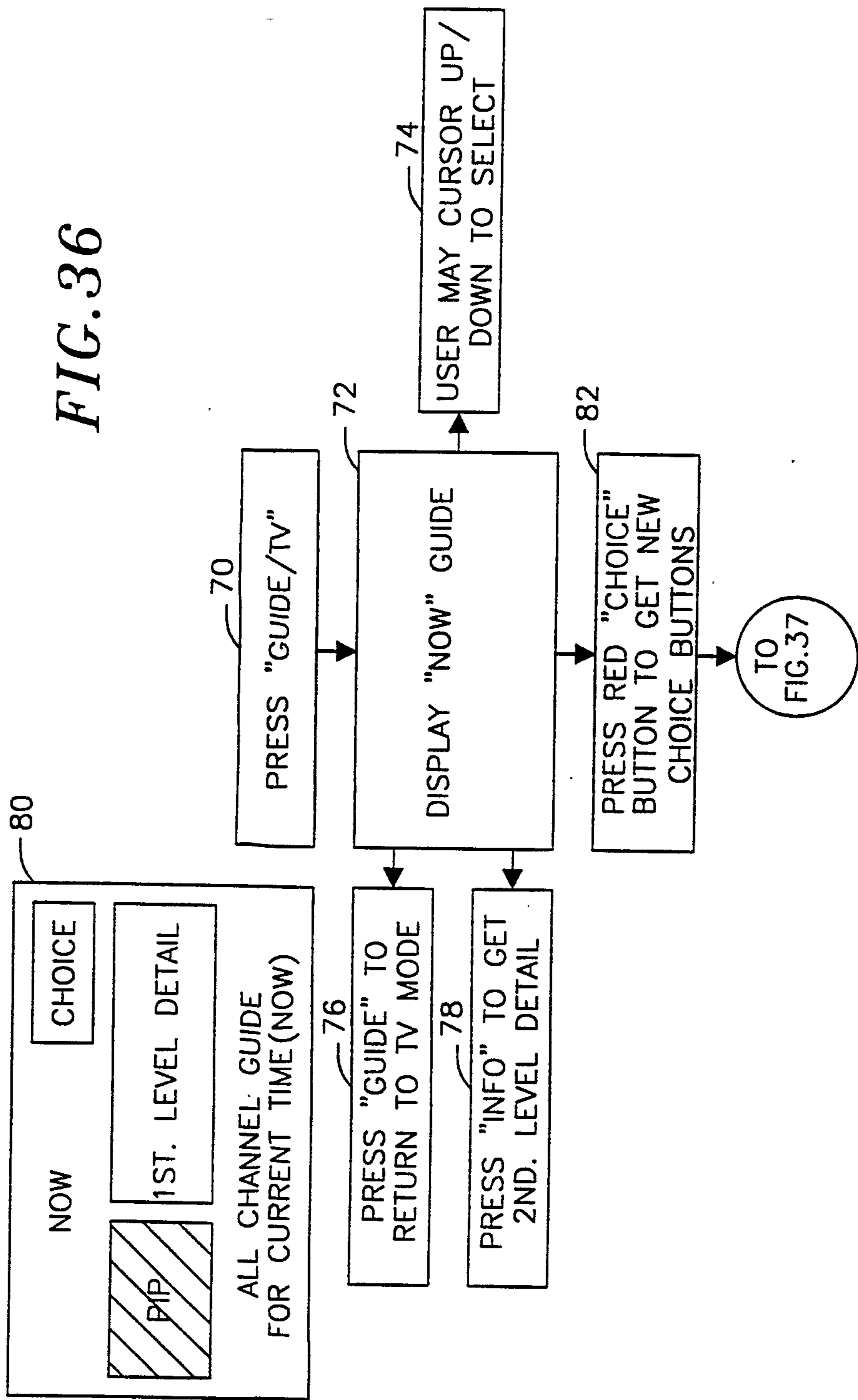
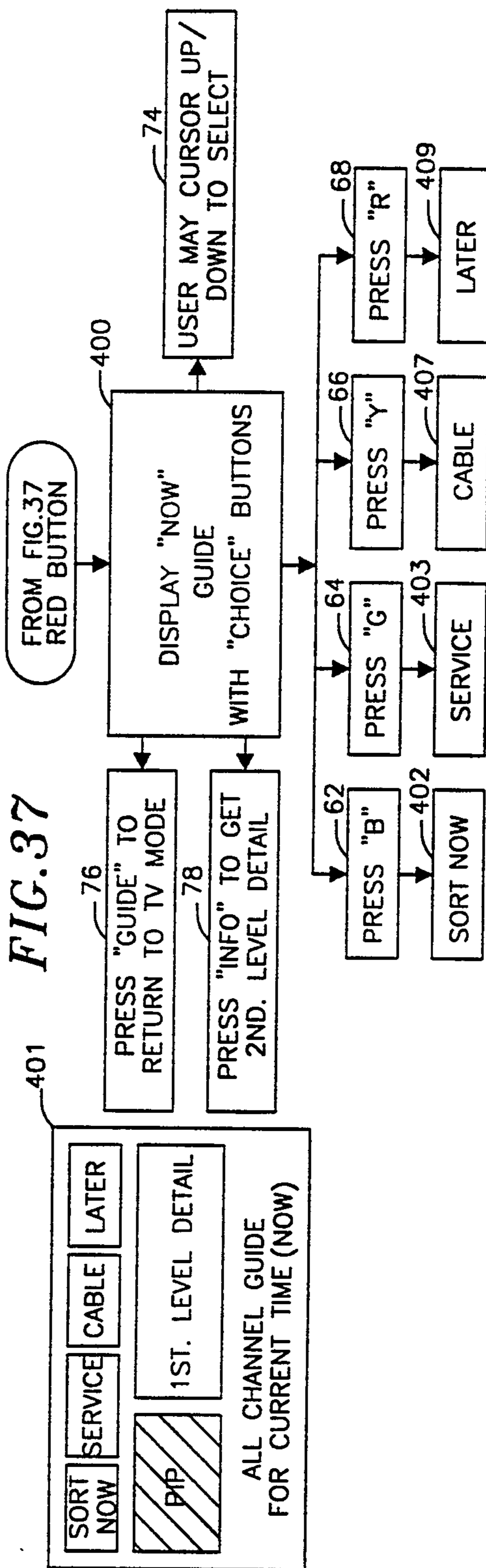
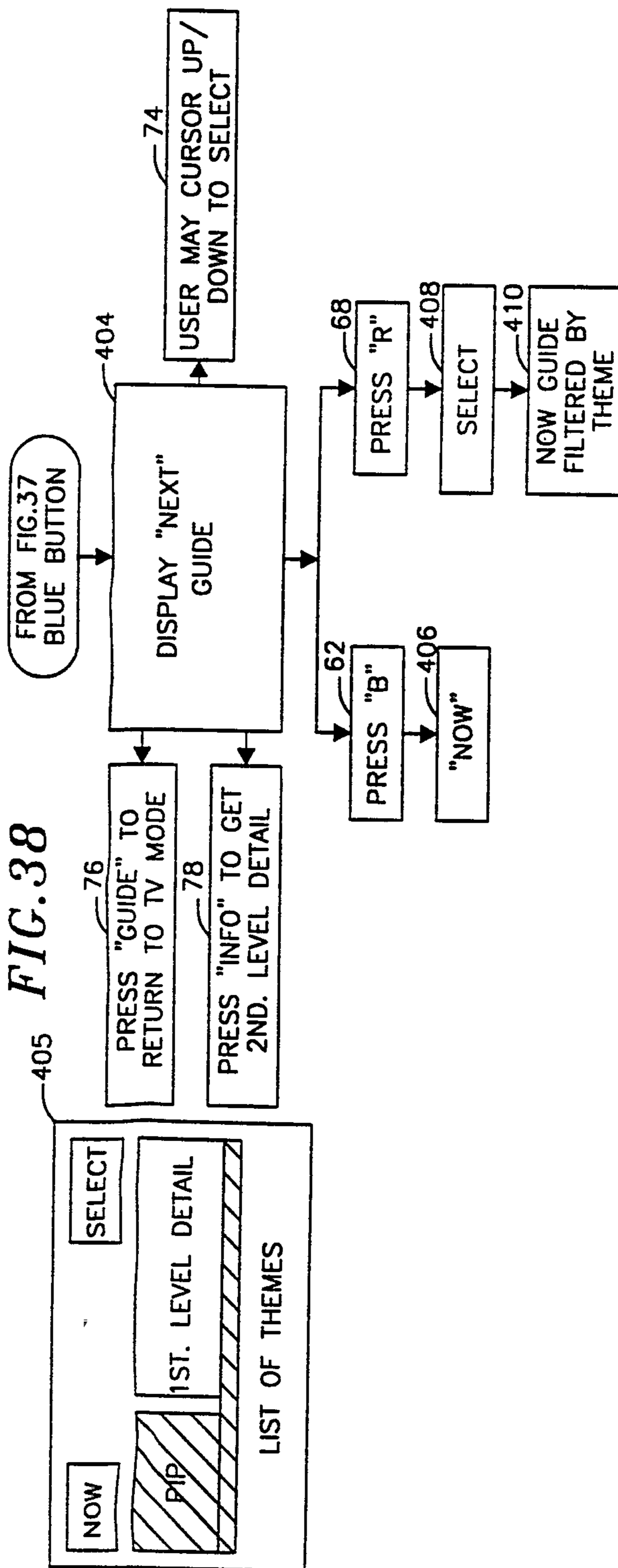

FIG. 36







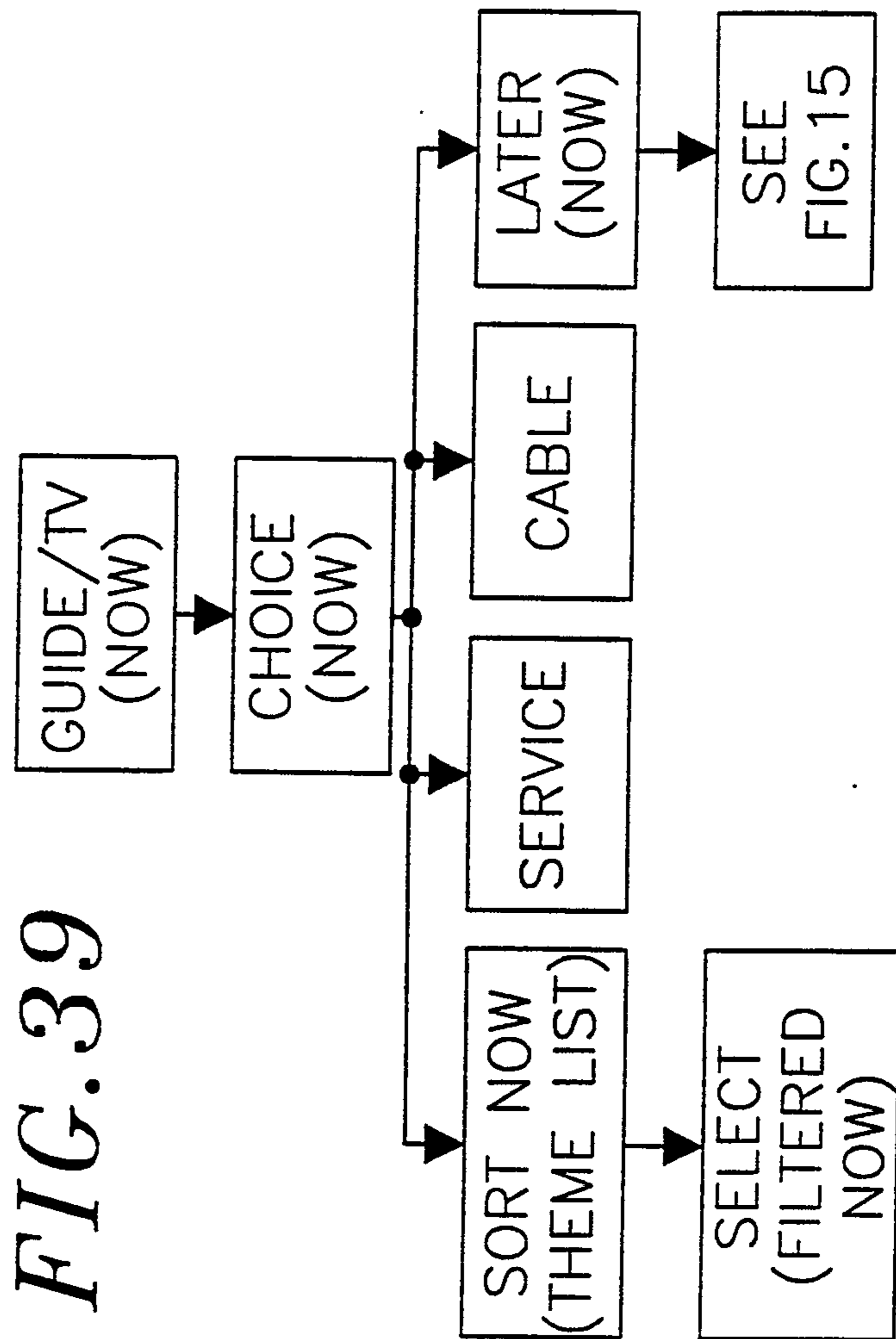

FIG. 39

