



US00D744825S

(12) **United States Design Patent**
Johansen

(10) **Patent No.:** **US D744,825 S**

(45) **Date of Patent:** **** Dec. 8, 2015**

(54) **LUNCH BOX**

(71) Applicant: **Tablebox A/S, København (DK)**

(72) Inventor: **Lasse Johansen, København (DK)**

(73) Assignee: **Tablebox A/S, København K (DK)**

(**) Term: **14 Years**

(21) Appl. No.: **29/507,582**

(22) Filed: **Oct. 29, 2014**

(30) **Foreign Application Priority Data**

May 7, 2014 (EM) 002459529-0003

(51) **LOC (10) Cl.** **09-03**

(52) **U.S. Cl.**
USPC **D9/418**

(58) **Field of Classification Search**
USPC D9/414-418, 704, 711, 430-43, 636,
D9/640; 206/0.815, 777; 229/117.14,
229/117.06, 117.08; D11/143
CPC A45C 1/12; B65D 5/4204; B65D 5/3685;
B65D 5/3642; B65D 5/16096
See application file for complete search history.

(56) **References Cited**

U.S. PATENT DOCUMENTS

720,864	A	*	2/1903	Walter	206/0.815
1,527,399	A	*	2/1925	Davidson	229/117.14
1,532,316	A	*	4/1925	Kaufman	229/117.06
2,638,210	A	*	5/1953	Sparks	206/777
D261,861	S	*	11/1981	Carter	D9/704
D267,475	S	*	1/1983	Maroszek et al.	D9/418
D271,944	S	*	12/1983	Wood	D9/416
D346,738	S	*	5/1994	Kinigakis	D9/711
D350,692	S	*	9/1994	Seki	D9/636
D382,510	S	*	8/1997	Dallimore	D11/143
D396,805	S	*	8/1998	Broyles	D9/432
D401,147	S	*	11/1998	Miller	D9/431
D418,751	S	*	1/2000	Wolf	D9/432

D420,582	S	*	2/2000	Zellner et al.	D9/418
D424,433	S	*	5/2000	Perkins et al.	D9/431
D424,931	S	*	5/2000	Teasdale et al.	D9/418
D425,413	S	*	5/2000	Heeley et al.	D9/415
D425,788	S	*	5/2000	Teasdale et al.	D9/418
D438,464	S	*	3/2001	Newhouse et al.	D9/417
D442,859	S	*	5/2001	Hirschey	D9/418
D527,998	S	*	9/2006	Nixon	D9/431
D548,071	S	*	8/2007	Chen	D9/432
7,255,261	B2	*	8/2007	Mesly	229/117.08
D567,079	S	*	4/2008	Fant	D9/753
D578,876	S	*	10/2008	Ambelang et al.	D9/418
D610,904	S	*	3/2010	Russell et al.	D9/432
D622,139	S	*	8/2010	Marcott et al.	D9/418
D674,690	S	*	1/2013	Sill	D9/431
D680,425	S	*	4/2013	Boswell	D9/431
D684,464	S	*	6/2013	Swart et al.	D9/430
D685,633	S	*	7/2013	Thomas	D9/431
D688,939	S	*	9/2013	Pearson et al.	D9/431

(Continued)

Primary Examiner — Holly Baynham

Assistant Examiner — Rhea Shields

(74) *Attorney, Agent, or Firm* — Abelman, Frayne & Schwab

(57) **CLAIM**

The ornamental design for a lunch box, as shown and described.

DESCRIPTION

FIG. 1 is a top, front, and right side perspective view of a lunch box showing the new design;
FIG. 2 is a top plan thereof;
FIG. 3 is a front elevation view thereof;
FIG. 4 is a right side elevation view thereof;
FIG. 5 is a left side elevation view thereof;
FIG. 6 is a rear elevation view thereof; and,
FIG. 7 is a bottom plan.
In the drawings, the broken lines are for the purpose of illustrating environment only and form no part of the claimed design.

1 Claim, 7 Drawing Sheets

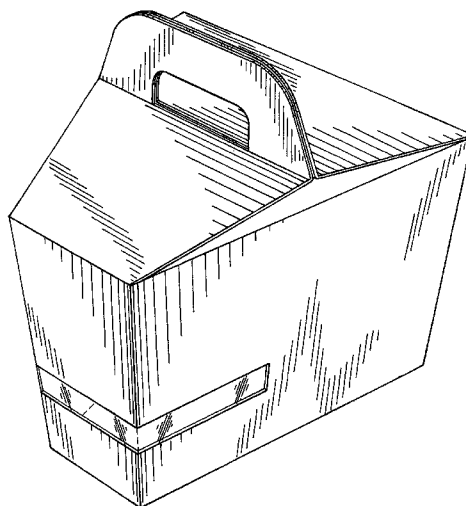

US D744,825 S

Page 2

(56)

References Cited

U.S. PATENT DOCUMENTS

D693,677 S * 11/2013 Pearson et al. D9/431
D701,455 S * 3/2014 Shepherd et al. D9/418
D702,546 S * 4/2014 McAdam D9/418

D690,590 S * 10/2013 Fux D9/431 * cited by examiner

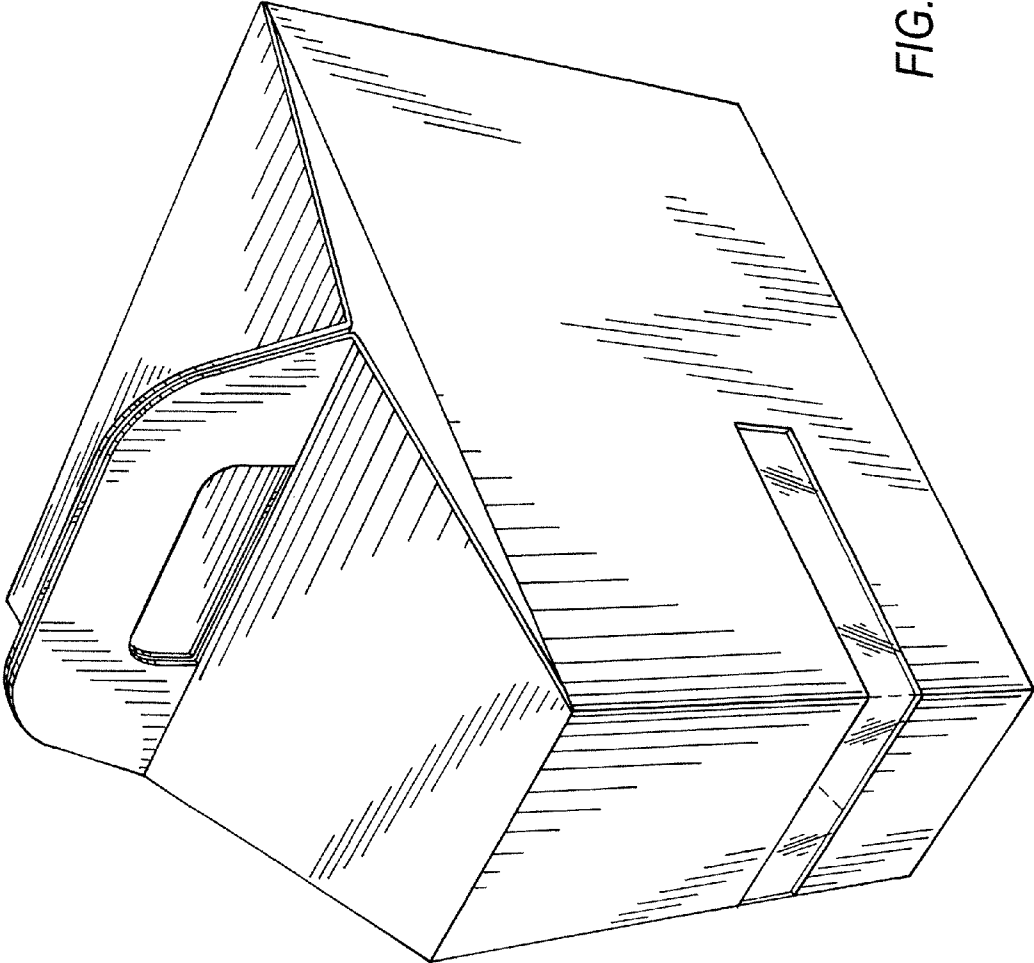

FIG. 1

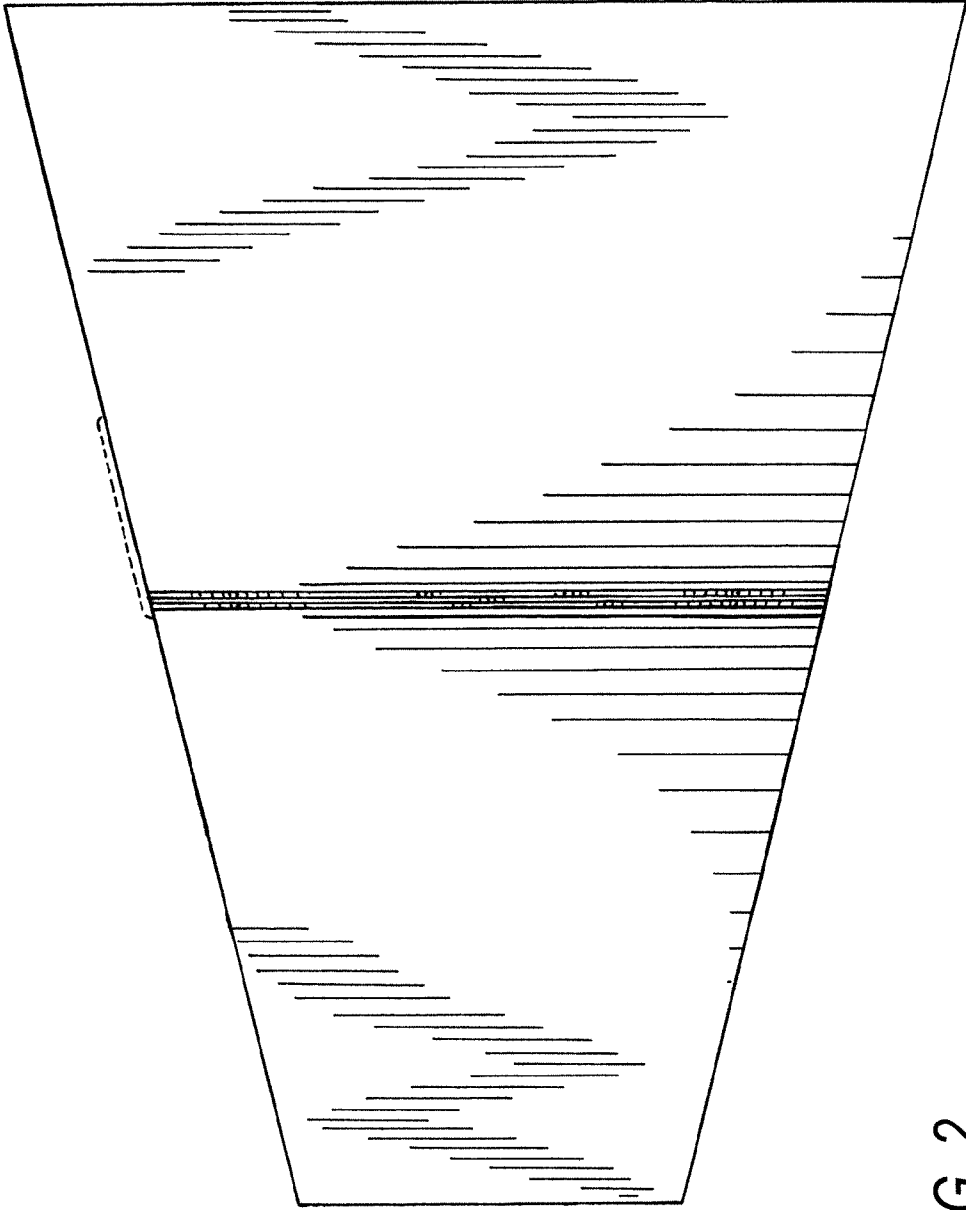

FIG. 2

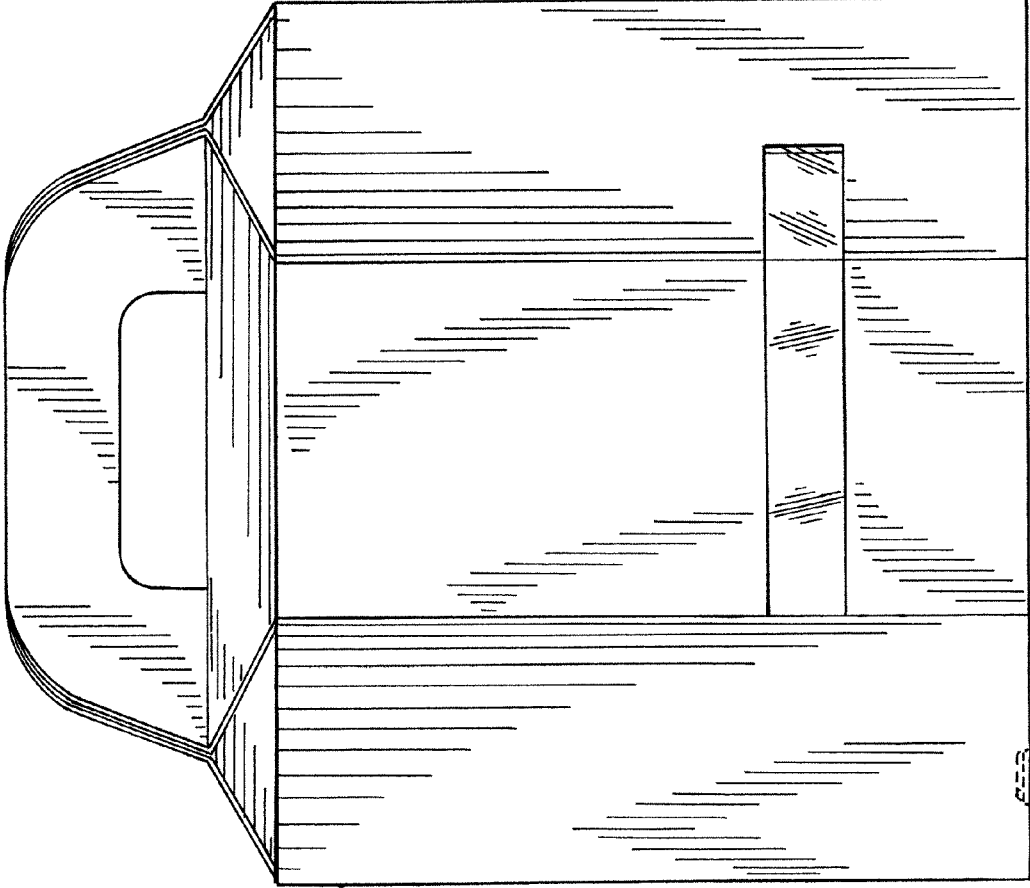

FIG. 3

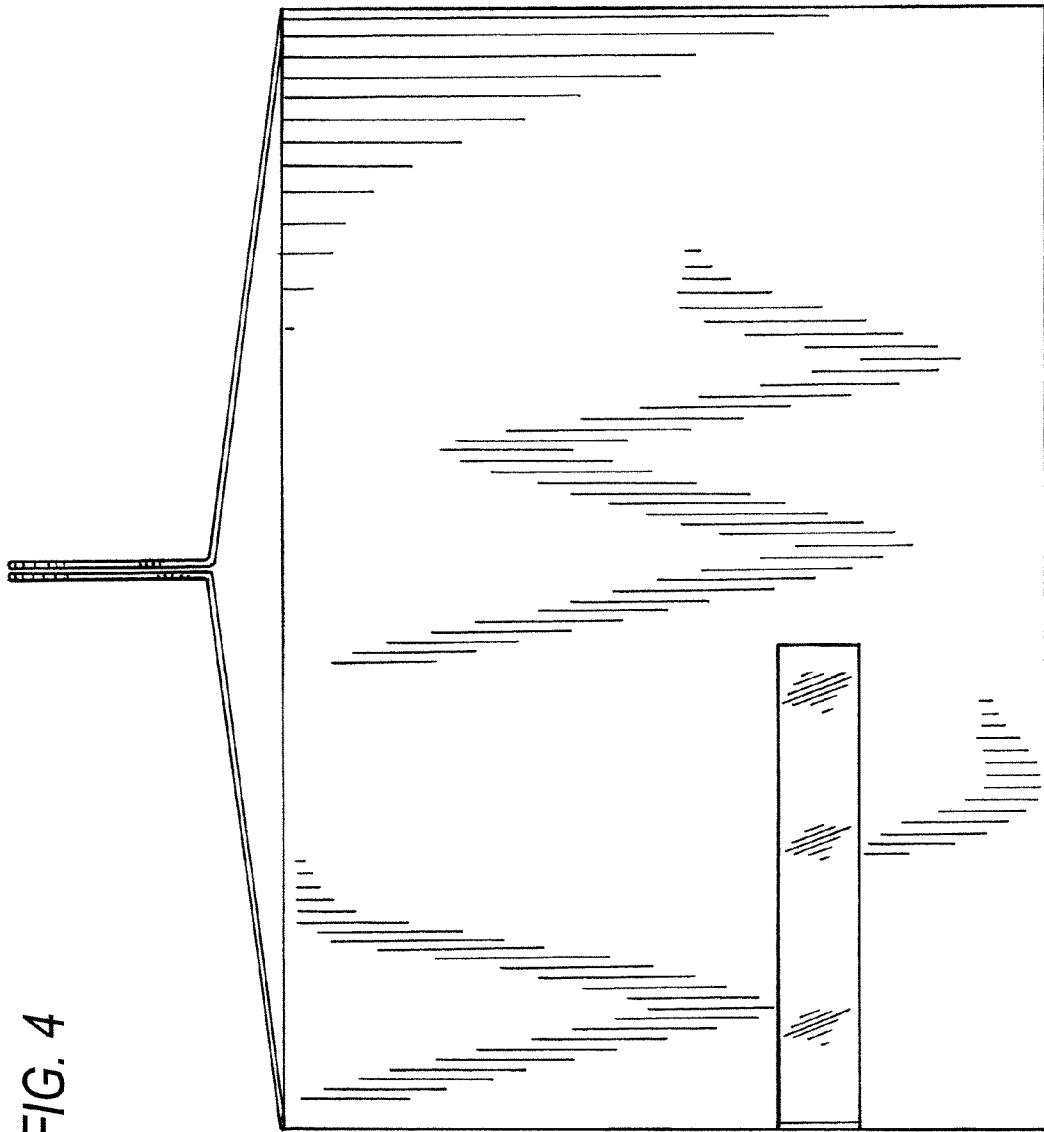

FIG. 4

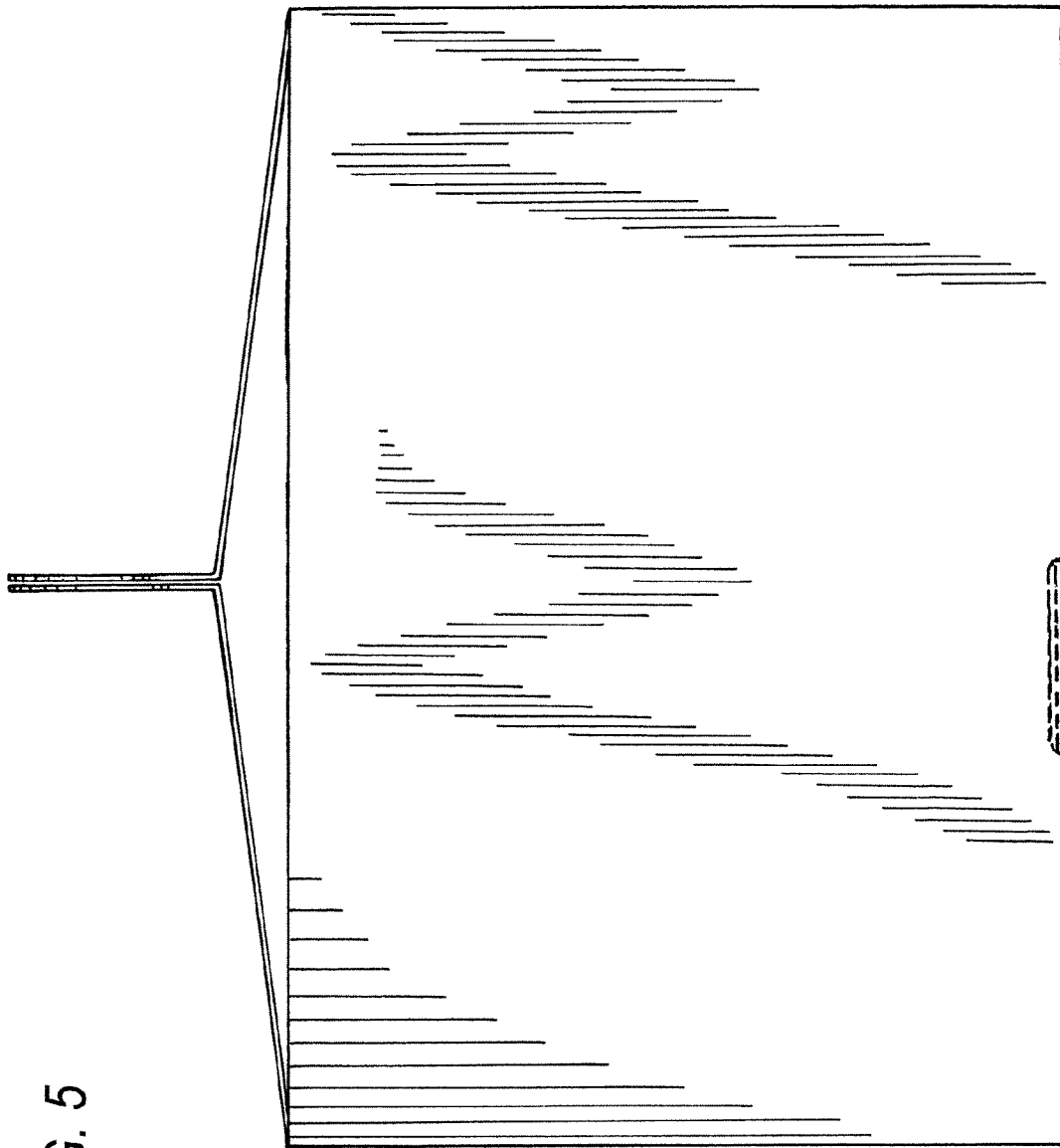

FIG. 5

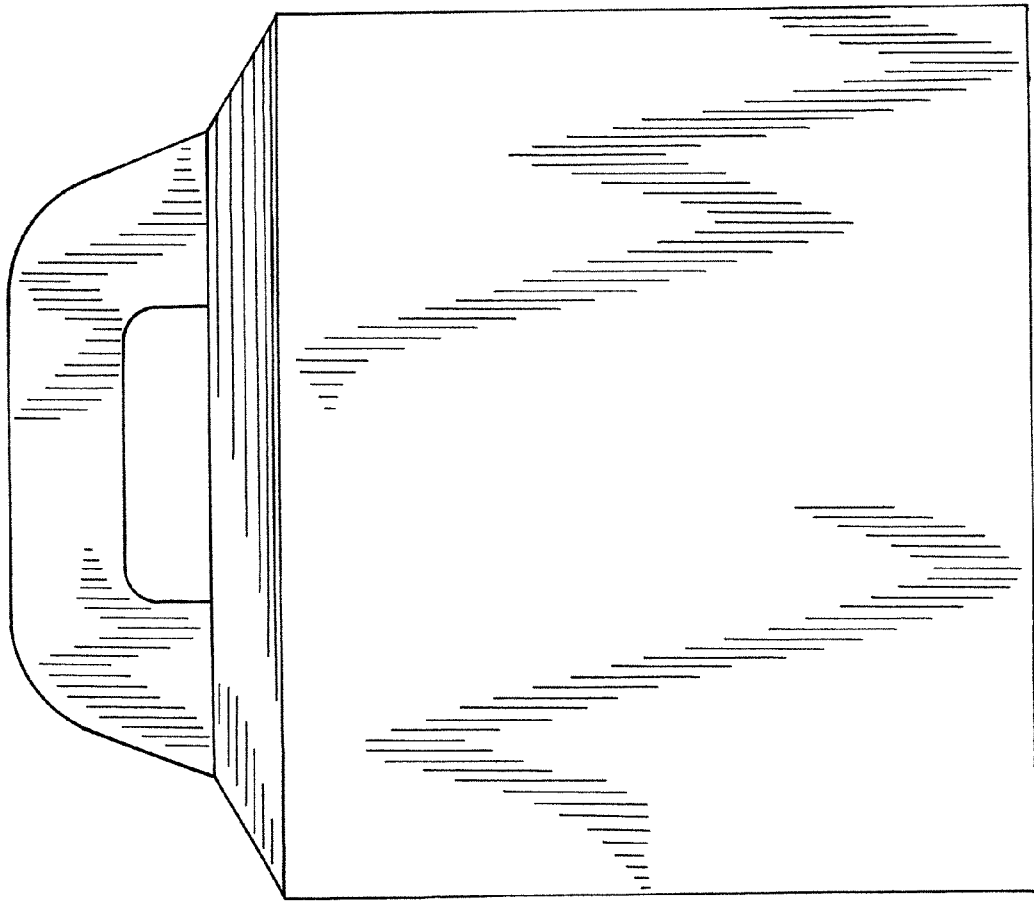

FIG. 6

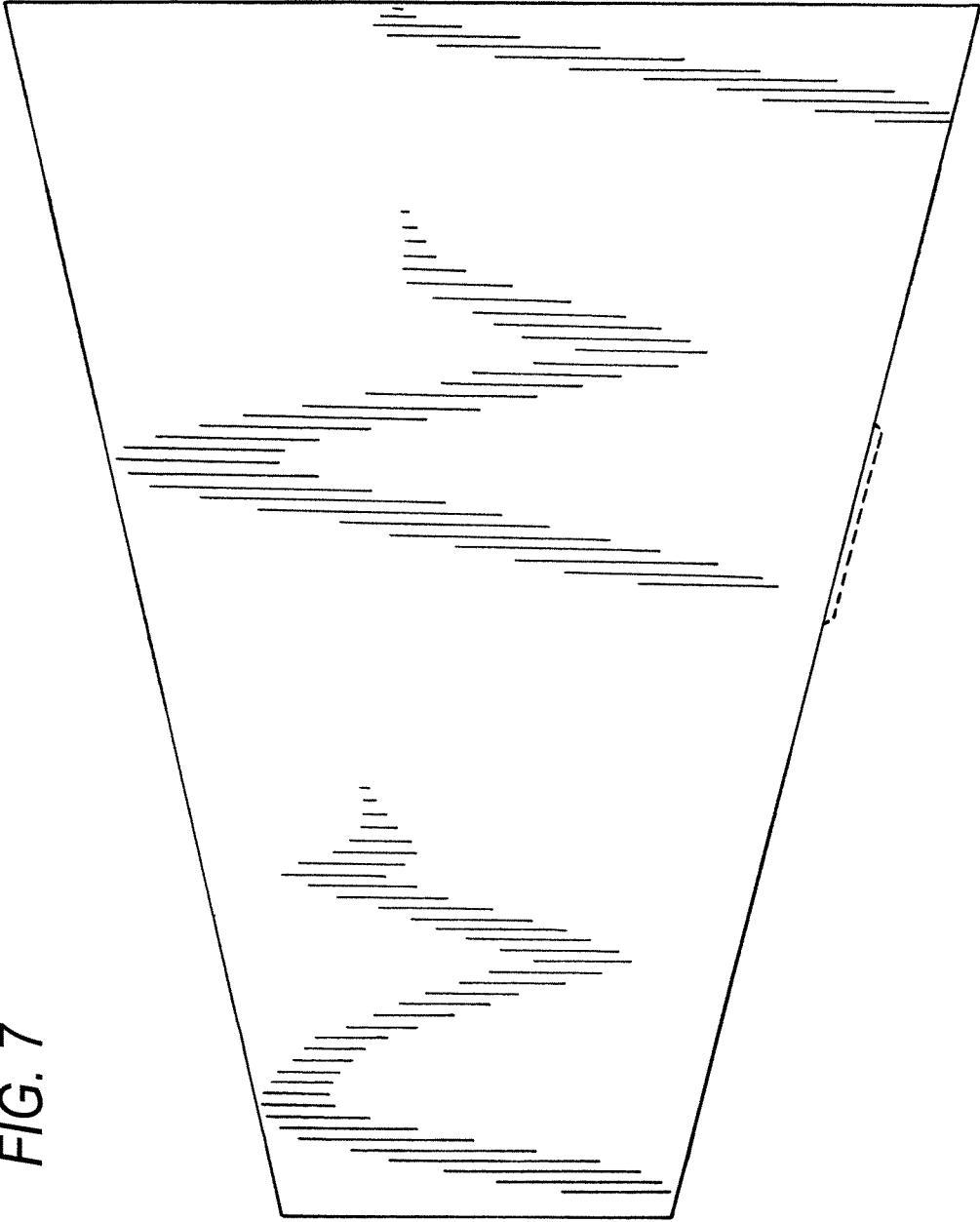

FIG. 7