



(12) **EUROPEAN PATENT APPLICATION**

(43) Date of publication: **05.03.2008 Bulletin 2008/10** (51) Int Cl.: **G09G 3/32^(2006.01)**

(21) Application number: **07252875.5**

(22) Date of filing: **19.07.2007**

(84) Designated Contracting States:
AT BE BG CH CY CZ DE DK EE ES FI FR GB GR HU IE IS IT LI LT LU LV MC MT NL PL PT RO SE SI SK TR
 Designated Extension States:
AL BA HR MK YU

(71) Applicant: **Samsung SDI Co., Ltd.**
Suwon-si, Gyeonggi-do (KR)
 (72) Inventor: **Kim, Yang-Wan**
Suwon-si, Gyeonggi-do (KR)
 (74) Representative: **Mouteney, Simon James**
Marks & Clerk
90 Long Acre
London WC2E 9RA (GB)

(30) Priority: **24.08.2006 KR 20060080302**

(54) **Pixel and electroluminescent displays using the same**

(57) **BACKGROUND OF THE INVENTION**

A pixel includes a first transistor including a gate electrode coupled to a scan line and a first electrode coupled to a data line, a second transistor including a gate electrode coupled to a second electrode of the first transistor, and a first electrode coupled to a first power supply, a third transistor including a first electrode coupled to a

second electrode of the second transistor, and a gate electrode coupled to an emission control line, an organic light emitting diode coupled between a second electrode of the third transistor and a second power supply, and a storage capacitor coupled between the gate electrode of the second transistor and the second electrode of the third transistor.

FIG. 2

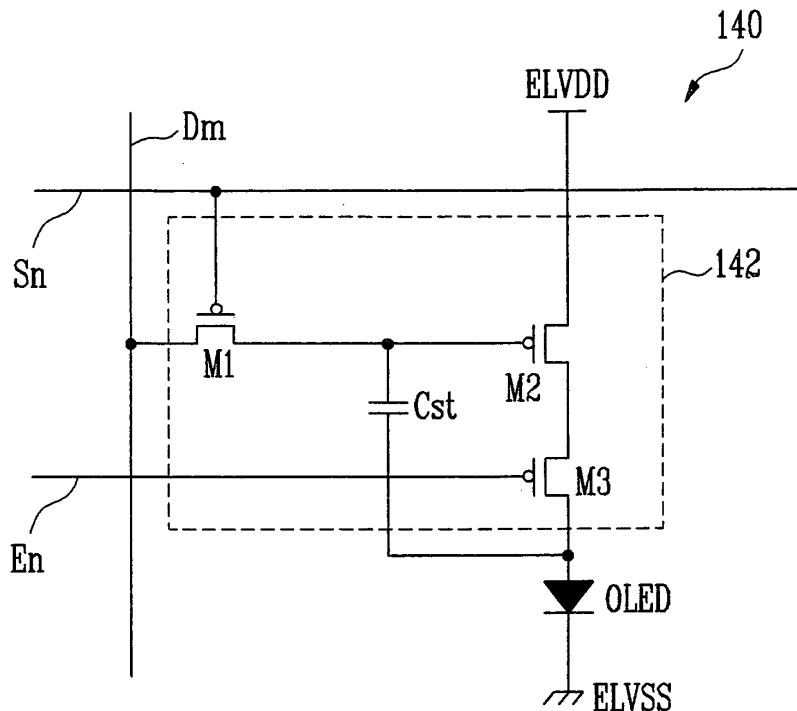

Description**BACKGROUND OF THE INVENTION**5 **1. Field of the Invention**

[0001] The present invention relates to pixels, electroluminescent (EL) displays using such pixels, and methods for driving such EL displays. More particularly, the invention relates to pixels, EL displays, e.g., organic light emitting diode (OLED) displays, and methods for driving EL displays using such pixels, which may reduce and/or minimize a number of transistors included in a pixel while also enabling image(s) of uniform or substantially luminance to be displayed.

10 **2. Description of the Related Art**

[0002] Various types of flat panel displays are being researched and developed. For any given screen size, flat panel displays generally have a lower weight and a lower volume than a CRT of the same screen size. Flat panel displays include, e.g., liquid crystal displays (LCDs), field emission displays (FEDs), plasma display panels (PDPs), and EL displays, e.g., OLED displays.

[0003] OLED displays make use of organic light emitting diodes that emit light by re-combination of electrons and holes. In general, OLED displays have advantages such as high response speed(s) and low power consumption.

20 [0004] For EL displays, e.g., OLEDs, to display images having a uniform and/or substantially uniform luminance on a display, pixels of a display should have uniform and/or substantially uniform luminance characteristics. Characteristics, e.g., a threshold voltage of a transistor of each pixel that controls an amount of electric current flowing to an OLED, may prevent the pixels of the display from having uniform and/or substantially uniform luminance characteristics. In general, threshold voltages of transistors may be different as a result of processing variations. Thus, when the threshold voltages of the transistors controlling the flow of electric current to the respective OLED are different, although a data signal corresponding to a same gradation may be supplied to each of the pixels, the respective OLEDs may emit light of different luminance.

25 [0005] Pixels having additional transistors, i.e., pixels having a total of six or more transistors, for compensating for threshold voltage differences in the transistor(s) that controls a current flow to the OLED have been proposed. However, when six or more transistors are included in a pixel circuit, a structure of a pixel circuit becomes complex, and additional wirings for controlling the transistors included in the pixel circuit may be required. Further, although the six or more transistor pixel including the additional transistors may be able to compensate for threshold voltage differences, the additional transistors may not compensate for other characteristics such as, e.g., mobility of the transistor controlling current flow to the respective OLED.

35 **SUMMARY OF THE INVENTION**

[0006] The present invention is therefore directed to pixels, and EL displays, e.g., OLED displays using such a pixel, which substantially overcome one or more of the problems due to the limitations and disadvantages of the related art.

40 [0007] It is therefore a feature of an embodiment of the present invention to provide pixels and EL displays, e.g., OLED displays using such a pixel, and a method for driving an EL display including such a pixel having a reduced and/or minimized number of transistors therein while being capable of displaying image(s) of uniform and/or substantially uniform luminance.

[0008] According to a first aspect of the invention there is provided a pixel as set out in Claim 1. Preferred features of this aspect are set out in Claims 2 to 7.

45 [0009] According to a second aspect of the invention there is provided an electroluminescent display as set out in Claim 9. Preferred features of this aspect are set out in Claims 10 to 17.

[0010] According to another aspect of the invention, there is provided a pixel including a first transistor including a gate electrode coupled to a scan line and a first electrode coupled to a data line, a second transistor including a gate electrode coupled to a second electrode of the first transistor, and a first electrode coupled to a first power supply, a third transistor including a first electrode coupled to a second electrode of the second transistor, and a gate electrode coupled to an emission control line, an organic light emitting diode coupled between a second electrode of the third transistor and a second power supply, and a storage capacitor coupled between the gate electrode of the second transistor and the second electrode of the third transistor.

55 **BRIEF DESCRIPTION OF THE DRAWINGS**

[0011] The above and other features and advantages of the present invention will become more apparent to those of

ordinary skill in the art by describing in detail exemplary embodiments thereof with reference to the attached drawings, in which:

[0012] FIG. 1 illustrates a block diagram of an OLED display according to an embodiment of the present invention;

[0013] FIG. 2 illustrates a circuit diagram of a pixel employable by the OLED display shown in FIG. 1;

[0014] FIG. 3 illustrates a waveform diagram of exemplary driving signals employable for driving the exemplary pixel shown in FIG. 2;

[0015] FIGS. 4 and 5 illustrate circuit diagrams including operation states of transistors of the exemplary pixel circuit shown in FIG. 2 resulting from the exemplary driving signals shown in FIG. 3; and

[0016] FIG. 6 illustrates a graph of threshold voltages and mobility compensation abilities of a pixel employing one or more aspects of the invention and a conventional pixel.

DETAILED DESCRIPTION OF THE INVENTION

[0017] The present invention will now be described more fully hereinafter with reference to the accompanying drawings, in which exemplary embodiments of the invention are illustrated. The invention may, however, be embodied in different forms and should not be construed as limited to the embodiments set forth herein. Rather, these embodiments are provided so that this disclosure will be thorough and complete, and will fully convey the scope of the invention to those skilled in the art.

[0018] In the following description, it will also be understood that when an element is described as being connected to another element, the element may be directly connected to the other element, or the element may be connected to the other element via one or more intervening elements. Further, elements and/or features that are obvious to and/or commonly known by those of ordinary skill in the art are omitted for clarity. Like reference numerals refer to like elements throughout the specification.

[0019] FIG. 1 illustrates a block diagram of an OLED display according to an embodiment of the present invention.

[0020] Referring to FIG. 1, the OLED display includes a pixel portion 130, a scan driver 110, a data driver 120, and a timing controller 150. The pixel portion 130 includes a plurality of pixels 140. The pixels 140 is coupled with scan lines S1 to Sn, emission control lines E1 to En, and data lines D1 to Dm. The scan driver 110 drives the scan lines S 1 to Sn and the emission control lines E 1 to En. The data driver 120 drives the data lines D1 to Dm. The timing controller 150 controls the scan driver 110 and the data driver 120.

[0021] The scan driver 110 receives the scan driving control signal SCS from the timing controller 150, and sequentially provides a respective scan signal to the scan lines S 1 through Sn. Further, the scan driver 110 generates emission control signal(s), and sequentially provides the respective emission control signal to the emission control lines E1 through En. In some embodiments of the invention, the emission control signal(s) may be set to have a greater width, e.g., greater "on" pulse width, than that of the scan signal(s). In some embodiments of the invention, a width of an emission control signal supplied to an i-th emission control line may be set so that it does not overlap with a scan signal supplied to an i-th scan line, i.e., the emission control signal is at an "off" level when the scan signal is at an "on" level.

[0022] The data driver 120 receives a data driving signal DCS from the timing controller 150. The data driver 120 uses the received data driving signal DCS to generate and provide data signal(s) to the data lines D1 through Dm in synchronization with the data signal.

[0023] The timing controller 150 generates the data driving signal(s) DCS and the scan driving signal(s) SCS corresponding to externally supplied synchronizing signals. The data driving signal(s) DCS generated from the timing controller 150 are provided to the data driver 120, and the scan driving signal(s) SCS are provided to the scan driver 110. Further, the timing controller 150 provides externally supplied data DATA to the data driver 120.

[0024] The pixel portion 130 receives power of the first external power supply ELVDD and power of the second external power supply ELVSS, and may supply the received power to the pixels 140. When the pixels 140 receive power from the first power supply ELVDD and the second power supply ELVSS, they generate light corresponding to the respective data signal. Emission times of the pixels 140 may be controlled by an emission control signal. A voltage of the first power supply ELVDD may be set to be greater than a voltage of the second power supply ELVSS.

[0025] FIG. 2 illustrates a circuit diagram of a pixel employable by the exemplary OLED display shown in FIG. 1. More particularly, FIG. 2 illustrates a nm-th pixel connected to a n-th scan line Sn and a m-th data line Dm. However, the exemplary pixel illustrated in FIG. 2 may be employed for one, some or all the pixels 140 of the pixel portion 130.

[0026] Referring to FIG. 2, the pixel 140 includes an organic light emitting diode OLED and a pixel circuit 142. In the exemplary case of an nm-th pixel 140, the pixel circuit 142 of the nm-th pixel 140 may be connected to the m-th data line Dm, the n-th scan line Sn, and the n-th emission control line En, and may control the respective organic light emitting diode OLED.

[0027] An anode electrode of the organic light emitting diode OLED is connected to the pixel circuit 142, and a cathode electrode thereof is connected to the second power supply ELVSS. The organic light emitting diode OLED generates light having a predetermined luminance corresponding to an electric current supplied thereto from the pixel circuit 142.

[0028] When the respective scan signal is supplied to the scan line S_n , the pixel circuit 142 controls an amount of an electric current supplied to the organic light emitting diode OLED based on the respective data signal, which may be supplied to the data line D_m . More particularly, in some embodiments of the invention, a predetermined electric current from a drive transistor included in the pixel circuit 142 is supplied to the organic light emitting diode OLED and a predetermined voltage is applied to the respective organic light emitting diode OLED. In such cases, the pixel circuit 142 controls an amount of electric current flowing to the organic light emitting diode OLED based on the predetermined voltage applied to the organic light emitting diode OLED, which may also compensate for some or all of any difference in threshold voltage and/or mobility of the drive transistor of the pixel relative to drive transistors of other pixels, and/or a predetermined threshold voltage and/or mobility.

[0029] Referring to FIG. 2, the pixel circuit 142 includes first, second and third transistors M1 to M3, and a storage capacitor C_{st} .

[0030] A gate electrode of the first transistor M1 is coupled to the n -th scan line S_n , and a first electrode of the first transistor M1 is coupled with the data line D_m . A second electrode of the first transistor M1 is coupled to a gate electrode of the second transistor M2, i.e., drive transistor. When the respective scan signal is supplied to the scan line S_n , the first transistor M1 transfers the respective data signal supplied to the data line D_m to the gate electrode of the second transistor M2.

[0031] A first electrode of the second transistor M2 is coupled with the first power supply ELVDD. A second electrode of the second transistor M2 is coupled with a first electrode of the third transistor M3. The second transistor M2 controls an amount of an electric current flowing from the first power supply EVDD to the second power supply EVSS through the organic light emitting diode OLED, which may correspond to a voltage applied to the gate electrode of the second transistor M2.

[0032] The first electrode of the third transistor M3 is coupled to the second electrode of the second transistor M2, and a second electrode of the third transistor M3 is coupled with the organic light emitting diode OLED. A gate electrode of the third transistor M3 is coupled to the emission control line E_n . When the emission control signal is provided to the emission control line E_n , e.g., when the emission control line is in an "on" state, the third transistor M3 is turned-off, whereas in remaining cases, e.g., when the emission control line is in an "off" state, the third transistor M3 may be turned-on.

[0033] One terminal of the storage capacitor C_{st} is coupled to a gate electrode of the second transistor M2, and another terminal thereof may be coupled to the second electrode of the third transistor M3, i.e., the anode electrode of the organic light emitting diode OLED. When the first transistor M1 is turned-on, the storage capacitor C_{st} is charged with a voltage corresponding to a data signal. Further, the storage capacitor C_{st} transfers a voltage variation amount corresponding to a voltage difference at the anode electrode of the organic light emitting diode OLED to the gate electrode of the second transistor M2. The storage capacitor is an example of a passive component acting as a voltage compensation means for at least partially compensating for the threshold variation of the second transistor based on the voltage at the anode terminal of the light emitting diode resulting from current supplied thereto via the second transistor. It will be appreciated that other voltage compensation means, including other passive means, could also be used.

[0034] In the exemplary embodiment illustrated in FIG. 2, each of the transistors M1, M2, M3 are P-type transistors. However, embodiments of the invention are not limited to such transistors.

[0035] FIG. 3 illustrates a waveform diagram of exemplary driving signals employable for driving the exemplary pixel shown in FIG. 2. FIGS. 4 and 5 illustrate circuit diagrams including operation states of transistors of the exemplary pixel circuit shown in FIG. 2 resulting from the exemplary driving signals shown in FIG. 3.

[0036] Referring to FIG. 3, before a scan signal, e.g., a low level signal portion, is supplied to a scan line S_n , an emission control signal, e.g., a high level signal portion, is supplied to an emission control line E_n , so that the third transistor M3 is turned-off. Next, the scan signal, e.g., the low level signal portion, is supplied to the scan line S_n , so that the first transistor M1 is turned-on.

[0037] When the first transistor M1 is turned-on, as shown in FIG. 4, a data voltage V_{data} corresponding to a data signal may be applied to a first node N1. Referring to FIG. 4, when the first transistor M1 is turned-on, the third transistor M3 may be turned off, and a threshold voltage V_{OLED} (V_{TH}) of the organic light emitting diode OLED is applied to the second node N2. Accordingly, the storage capacitor C_{st} is charged with a voltage corresponding to a difference between a data voltage V_{data} and the threshold voltage V_{OLED} (V_{TH}) of the organic light emitting diode OLED.

[0038] Thereafter, a supply of the scan signal to the scan line S_n and a supply of the emission control signal to the emission control line E_n stops, e.g., at that stage, the scan signal has a high level and the emission control signal has a low level. Accordingly, as shown in FIG. 5, the first transistor M1 is turned-off and the third transistor M3 is turned-on.

[0039] At this stage, the second transistor M2 transfers an electric current corresponding to the voltage applied to the first node N1 to the organic light emitting diode OLED. In such cases, a voltage of the second node N2 may change according to following Equation 1:

$$\Delta N2 = V_{\text{OLED}} - V_{\text{OLED}} (V_{\text{th}}), \quad (\text{Equation 1})$$

5

where, V_{OLED} represents a voltage applied to the organic light emitting diode OLED corresponding to an electric current flowing through the organic light emitting diode OLED.

[0040] Accordingly, a voltage V_{OLED} is increased in proportion to an amount of an electric current flowing through the organic light emitting diode OLED.

10 **[0041]** With reference to the Equation 1, a voltage of the second node N2 varies by a voltage applied to the organic light emitting diode OLED when an electric current flows from the threshold voltage $V_{\text{OLED}} (V_{\text{th}})$ of the organic light emitting diode OLED. Accordingly, a voltage of the first node N1, which is in a floating state, varies corresponding to a voltage variation amount of the second node N2 by the storage capacitor Cst.

15 **[0042]** In some embodiments of the invention, because the voltage variation amount of the second node N2 changes based on a threshold voltage of the second transistor M2, i.e., based on an amount of an electric current flowing to the organic light emitting diode OLED, the threshold voltage of the second transistor M2 may be compensated for corresponding to the voltage variation at the second node N2.

[0043] Thus, in some embodiments of the invention, the second transistor M2 then transfers an electric current corresponding to a voltage applied to the first node N1 to the organic light emitting diode OLED, so that the organic light emitting diode OLED generates light of a predetermined luminance corresponding to an electric current supplied thereto.

20 **[0044]** As described earlier, embodiments of the present invention feed back a voltage applied to the organic light emitting diode OLED to the gate electrode of the second transistor M2 corresponding to an amount of an electric current supplied to the organic light emitting diode OLED from the second transistor M2 using a storage capacitor Cst. Here, because the electric current supplied to the organic light emitting diode OLED from the second transistor M2 is affected by the threshold voltage of the second transistor M2, non-uniformity(ies) in the threshold voltage of the second transistor M2 may be substantially and/or completely compensated for.

25 **[0045]** In other words, an amount of an electric current flowing into an organic light emitting diode OLED may change corresponding to a threshold voltage of the second transistor M2, thereby changing an electric current flowing to the organic light emitting diode OLED. In this case, a difference of the voltage variation amount at the second node N2 is supplied to the gate electrode of the second transistor M2 to substantially and/or completely compensate for the threshold voltage of the second transistor M2.

30 **[0046]** In some embodiments of the invention, each of the pixels 140 are divided into a red pixel R, a green pixel G, and a blue pixel B. In such a case, the red pixel R may include a red organic light emitting diode OLED(R), the green pixel G may include a green organic light emitting diode OLED(G), and the blue pixel B may include a blue organic light emitting diode OLED(B). Different degradation degrees in the red organic light emitting diode OLED(R), the green organic light emitting diode OLED(G) and/or the blue organic light emitting diode OLED(B) may be set according to a respective length of time. The threshold voltage $V_{\text{OLED}} (V_{\text{TH}})$ of the respective organic light emitting diode OLED may vary according to the degradation degrees.

35 **[0047]** On the other hand, in some embodiments of the present invention, because the second node N2 may vary from the threshold voltage $V_{\text{OLED}} (V_{\text{TH}})$ of the organic light emitting diode OLED to a voltage V_{OLED} applied to the organic light emitting diode OLED, the degradation of the organic light emitting diode OLED may be substantially and/or completely compensated for. More particularly, e.g., because a gate electrode of the second transistor M2 may change corresponding to a variation amount of the threshold voltage $V_{\text{OLED}} (V_{\text{TH}})$ of the organic light emitting diode OLED, which may be varied according to the degradation of the organic light emitting diode OLED, degradation characteristics of the organic light emitting diode OLED may be substantially and/or completely compensated for.

40 **[0048]** FIG. 6 illustrates a graph of a threshold voltages and mobility compensation abilities of a pixel employing one or more aspects of the invention and a conventional pixel. A Y axis of FIG. 6 corresponds to an amount of influence of a deviation of a threshold voltage V_{th} and mobility on a scale of 0 to 10. The relationships illustrated in FIG. 6 corresponds to about a 40 mV deviation in the threshold voltage V_{TH} of a drive transistor and about a 10 m^2/Vs deviation in the mobility of the drive transistor.

45 **[0049]** As illustrated in FIG. 6, for conventional pixels, a threshold voltage V_{th} of the drive transistor significantly influences an amount of electric current flowing through the pixel. In other words, a significant difference in an electric current amount flowing through each pixel significant occurs as a result of a deviation in the threshold voltage of the drive transistor. Relative to conventional pixels, a pixel(s) employing one or more aspects of the present invention may be less influenced by a deviation in threshold voltage of the drive transistor. Accordingly, relative to conventional pixels, embodiments of the invention enable smaller differences in amounts of electric current flowing through each pixel as a result of a deviation in the threshold voltage of the drive transistor. Thus, embodiments of the invention, enable an image (s) of uniform luminance to be displayed by reducing and/or eliminating an influence of deviation(s) in threshold voltage

55

and/or mobility of drive transistors of pixels of a display. Further, embodiments of the invention, enable an amount of variation of an electric current resulting from a deviation in mobility to be reduced relative to conventional pixels and/or eliminated.

[0050] As discussed above, in a pixel and an OLED display using such a pixel according to one or more aspects of the present invention, a voltage at a gate electrode of a drive transistor corresponds to an electric current amount flowing to the organic light emitting diode, and thus, embodiments of the invention may substantially and/or completely compensate for non-uniformity(ies) in the threshold voltage of the drive transistor. Because the voltage feedback to the gate electrode of the drive transistor may be determined according to an electric current amount supplied from the drive transistor, the mobility of the drive transistor may be substantially and/or completely compensated for. In some embodiments of the invention, a threshold voltage of the drive transistor may be substantially and/or completely compensated using only three transistors and one capacitor. Embodiments of the invention may substantially and/or completely compensate for degradation of an organic light emitting diode.

[0051] Embodiments of the present invention have been disclosed herein, and although specific terms are employed, they are used and are to be interpreted in a generic and descriptive sense only and not for purpose of limitation. Accordingly, it will be understood by those of ordinary skill in the art that various changes in form and details may be made without departing from the scope of the present invention as set forth in the following claims.

Claims

1. A pixel, comprising:

a first transistor including a gate electrode coupled to a scan line and a first electrode coupled to a data line;
 a second transistor including a gate electrode coupled to a second electrode of the first transistor, and a first electrode coupled to a first power supply;
 a third transistor including a first electrode coupled to a second electrode of the second transistor, and a gate electrode coupled to an emission control line;
 a light emitting diode coupled between a second electrode of the third transistor and a second power supply; and
 voltage compensation means for at least partially compensating for a threshold voltage variation of the second transistor based on a voltage at an anode terminal of the light emitting diode resulting from a current supplied thereto via the second transistor.

2. A pixel according to claim 1, wherein the voltage compensation means is coupled between the gate electrode of the second transistor and the second electrode of the third transistor.

3. A pixel according to claim 1 or 2, wherein the voltage compensation means is a passive component.

4. A pixel according to any one of claims 1 to 3, wherein the voltage compensation means is a storage capacitor.

5. A pixel according to any one of claims 1 to 4, wherein the first power supply has a voltage higher than that of the second power supply.

6. A pixel according to any one of claims 1 to 5, wherein the first, second and third transistors are P-type transistors.

7. A pixel according to any one of claims 1 to 6, wherein the pixel only includes the storage capacitor, the first, second and third transistors, and interconnection lines.

8. A pixel according to any one of claims 1 to 7, wherein the light emitting diode is an organic light emitting diode.

9. An electroluminescent display, comprising:

a scan driver for sequentially providing a scan signal to scan lines, and for sequentially providing an emission control signal to emission control lines;
 a data driver for providing a data signal to data lines; and
 a plurality of pixels coupled to the scan line and a data line,

wherein each of the pixels is according to any one of claims 1 to 8.

10. A display according to claim 9, wherein the first transistor is arranged to be turned-on when the scan signal is supplied to the scan line.

5 11. A display according to claim 9 or 10 when dependent on claim 4, wherein the storage capacitor is arranged to be charged with a voltage corresponding to the data signal when the first transistor is turned-on.

10 12. A display according to any one of claims 9 to 11 when dependent on claim 4, wherein the second transistor is arranged to supply an electric current corresponding to the voltage stored in the storage capacitor from the first power supply to the second power supply through the organic light emitting diode.

13. A display according to any one of claims 9 to 12, wherein the third transistor is arranged to be turned-on or turned-off according to the emission control signal.

15 14. A display according to any one of claims 9 to 13 when dependent on claim 4, wherein the storage capacitor is arranged to transfer a voltage variation amount of the light emitting diode to the gate electrode of the second transistor when an electric current is supplied to the light emitting diode.

20 15. A display according to any one of claims 9 to 14, wherein the voltage variation amount of the organic light emitting diode corresponds to a voltage applied to the light emitting diode when an electric current corresponding to a threshold voltage of the second transistor is supplied to the light emitting diode.

16. A display according to any one of claims 9 to 15, wherein the third transistor is turned-off when the emission control signal is supplied, and turned-on in other cases.

25 17. A display according to any one of claims 9 to 10, wherein the emission control signal is supplied to an i-th emission control line when the scan signal is supplied to an i-th scan line, where i is a natural number.

30

35

40

45

50

55

FIG. 1

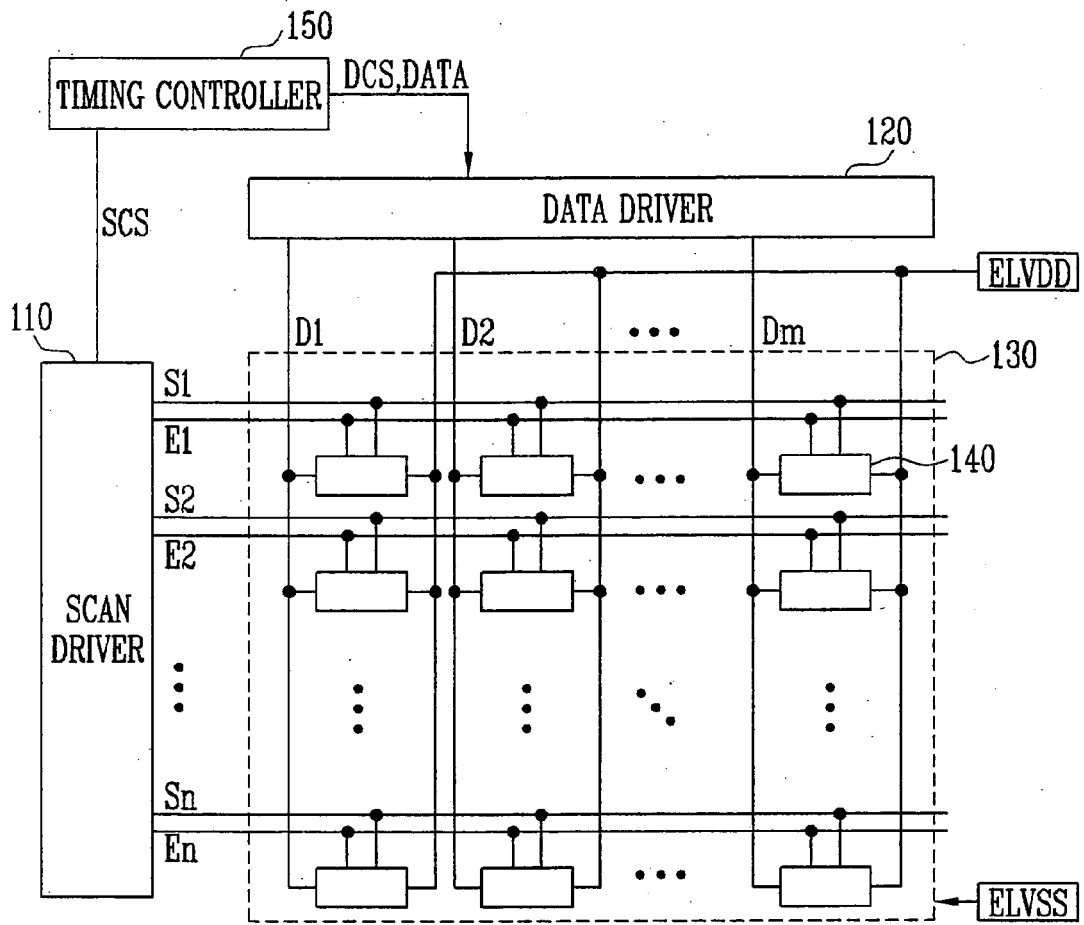

FIG. 2

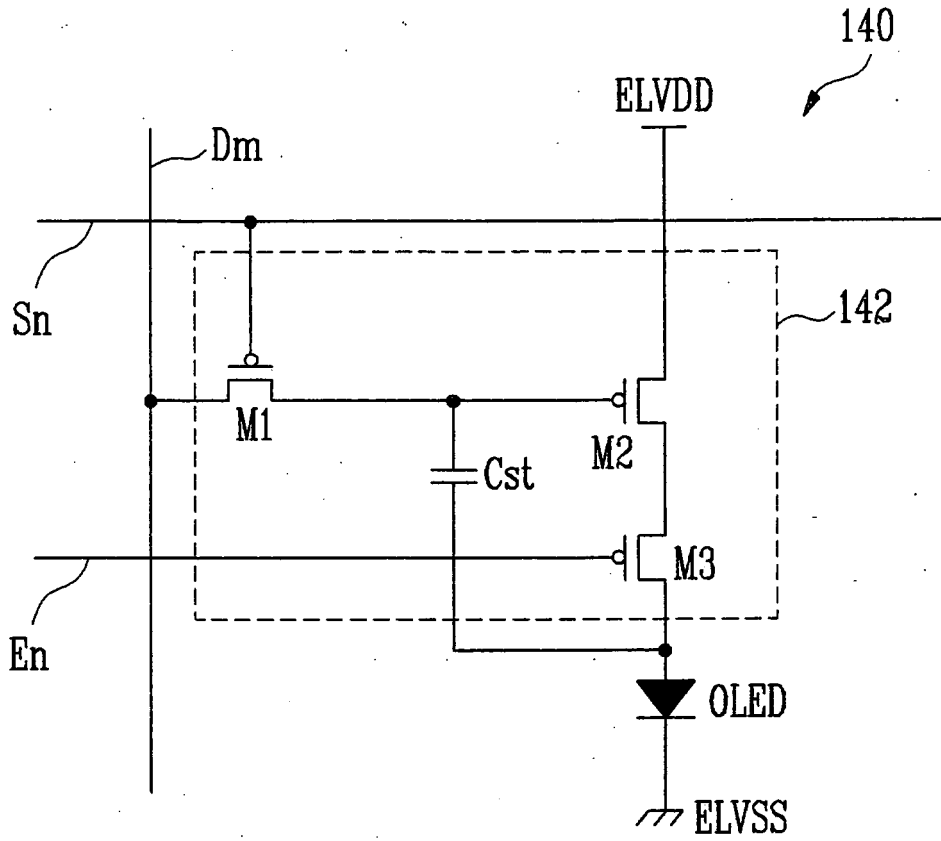

FIG. 3

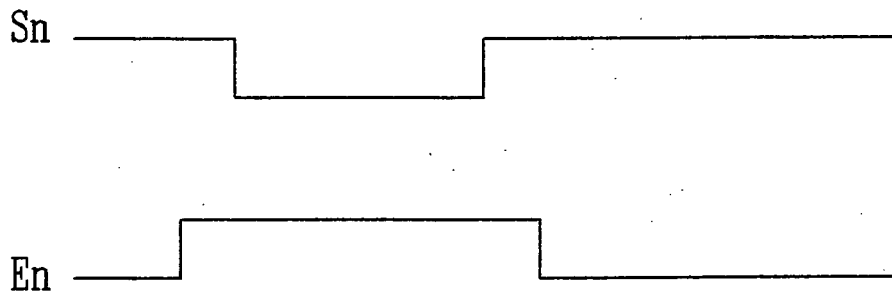

FIG. 4

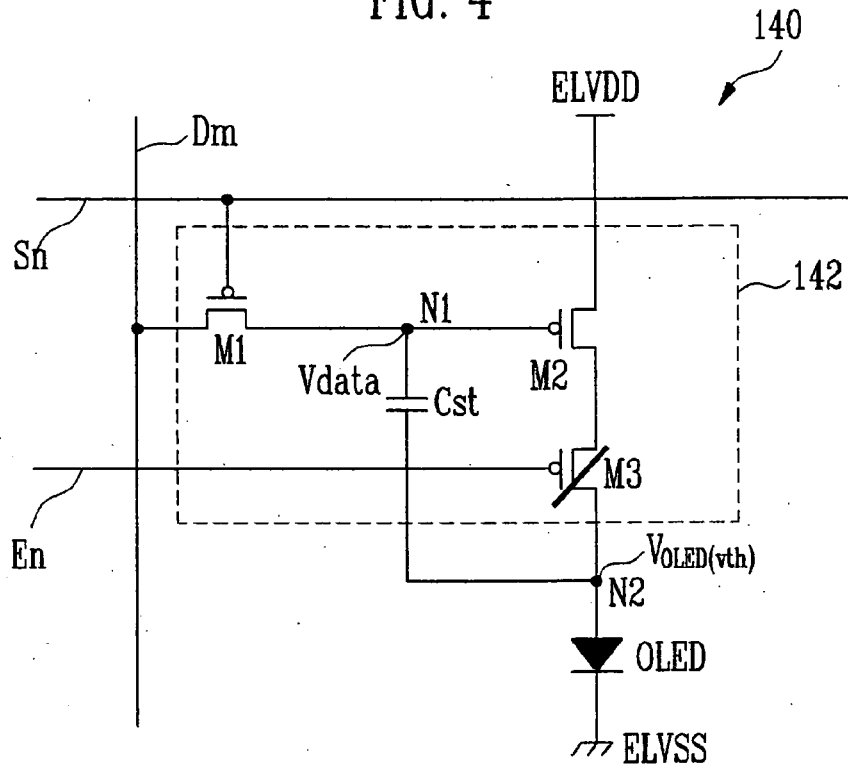

FIG. 5

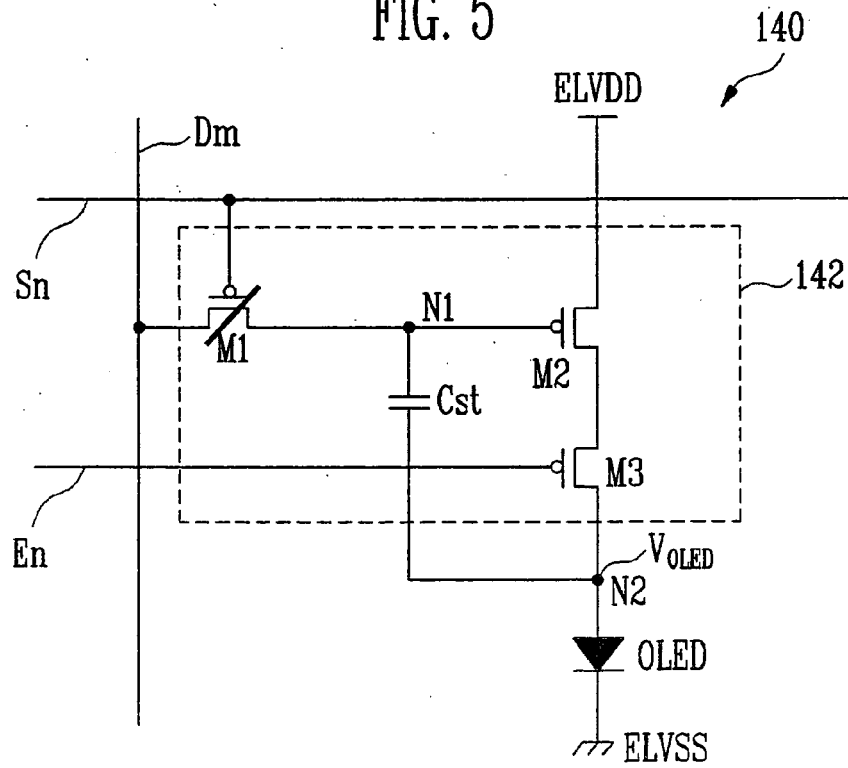
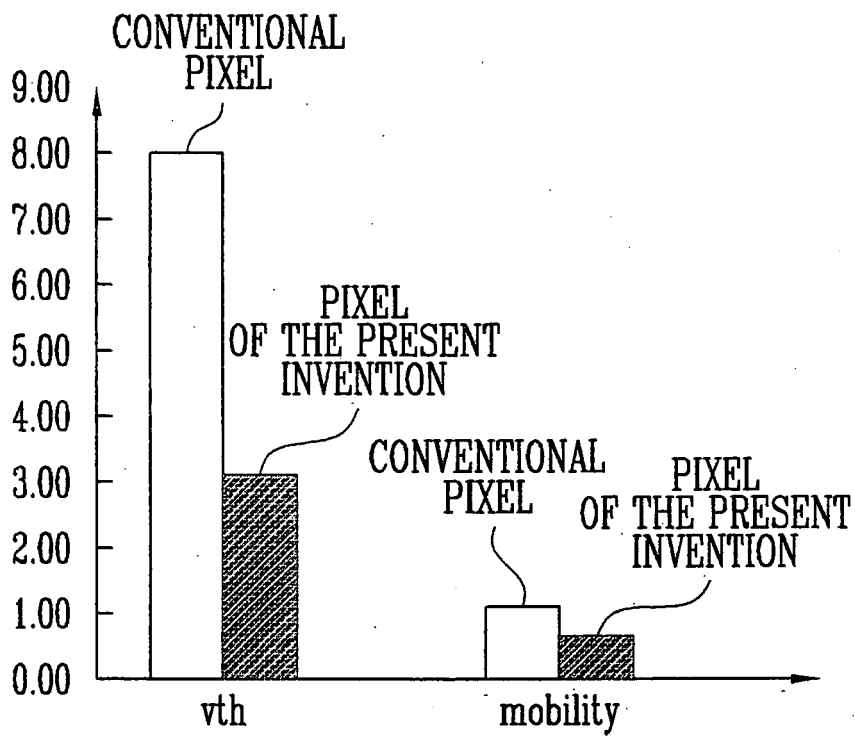

FIG. 6





DOCUMENTS CONSIDERED TO BE RELEVANT			
Category	Citation of document with indication, where appropriate, of relevant passages	Relevant to claim	CLASSIFICATION OF THE APPLICATION (IPC)
X	US 2004/174349 A1 (LIBSCH FRANK ROBERT [US] ET AL) 9 September 2004 (2004-09-09) * figure 3 *	1-17	INV. G09G3/32
X	WO 2006/060902 A (IGNIS INNOVATION INC [CA]; NATHAN AROKIA [CA]; CHAJ REZA G [CA]; SERVA) 15 June 2006 (2006-06-15) * figure 2a *	1-17	
			TECHNICAL FIELDS SEARCHED (IPC)
			G09G
The present search report has been drawn up for all claims			
Place of search The Hague		Date of completion of the search 22 January 2008	Examiner Stoffers, Christian
CATEGORY OF CITED DOCUMENTS X : particularly relevant if taken alone Y : particularly relevant if combined with another document of the same category A : technological background O : non-written disclosure P : intermediate document		T : theory or principle underlying the invention E : earlier patent document, but published on, or after the filing date D : document cited in the application L : document cited for other reasons & : member of the same patent family, corresponding document	

2
EPO FORM 1503 03.82 (F04C01)

**ANNEX TO THE EUROPEAN SEARCH REPORT
ON EUROPEAN PATENT APPLICATION NO.**

EP 07 25 2875

This annex lists the patent family members relating to the patent documents cited in the above-mentioned European search report. The members are as contained in the European Patent Office EDP file on The European Patent Office is in no way liable for these particulars which are merely given for the purpose of information.

22-01-2008

Patent document cited in search report	Publication date	Patent family member(s)	Publication date
US 2004174349 A1	09-09-2004	JP 2004295131 A TW 269258 B	21-10-2004 21-12-2006

WO 2006060902 A	15-06-2006	CA 2490858 A1 EP 1859431 A1 US 2006176250 A1	07-06-2006 28-11-2007 10-08-2006

EPO FORM P0459

For more details about this annex : see Official Journal of the European Patent Office, No. 12/82