

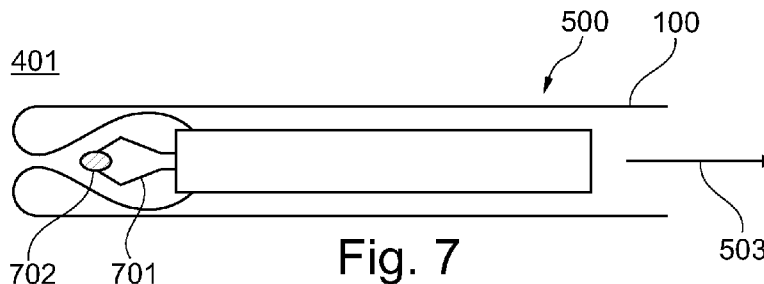

- (51) **International Patent Classification:**  
*A61B 10/02* (2006.01)
  - (21) **International Application Number:**  
PCT/IB2012/051142
  - (22) **International Filing Date:**  
12 March 2012 (12.03.2012)
  - (25) **Filing Language:** English
  - (26) **Publication Language:** English
  - (30) **Priority Data:**  
11158596.4 17 March 2011 (17.03.2011) EP
  - (71) **Applicant (for all designated States except DE, US):**  
**KONINKLIJKE PHILIPS ELECTRONICS N.V.** [NL/NL]; Groenewoudseweg 1, NL-5621 BA Eindhoven (NL).
  - (71) **Applicant (for DE only):** **PHILIPS INTELLECTUAL PROPERTY & STANDARDS GMBH** [DE/DE]; Lübeckertordamm 5, 20099 Hamburg (DE).
  - (72) **Inventors; and**
  - (75) **Inventors/Applicants (for US only):** **MAZURKEWITZ, Peter** [DE/DE]; c/o High Tech Campus Building 44, NL-5656 AE Eindhoven (NL). **LEUSSLER, Christoph** [DE/DE]; c/o High Tech Campus Building 44, NL-5656 AE Eindhoven (NL). **VERNICKEL, Peter** [DE/DE]; c/o High Tech Campus Building 44, NL-5656 AE Eindhoven (NL). **LIPS, Oliver** [DE/DE]; c/o High Tech Campus Building 44, NL-5656 AE Eindhoven (NL). **KRUEGER, Sascha** [DE/DE]; c/o High Tech Campus Building 44, NL-5656 AE Eindhoven (NL).
  - (74) **Agents:** **VAN VELZEN, Maaike** et al.; High Tech Campus 44, NL-5600 AE Eindhoven (NL).
  - (81) **Designated States (unless otherwise indicated, for every kind of national protection available):** AE, AG, AL, AM, AO, AT, AU, AZ, BA, BB, BG, BH, BR, BW, BY, BZ, CA, CH, CL, CN, CO, CR, CU, CZ, DE, DK, DM, DO, DZ, EC, EE, EG, ES, FI, GB, GD, GE, GH, GM, GT, HN, HR, HU, ID, IL, IN, IS, JP, KE, KG, KM, KN, KP, KR, KZ, LA, LC, LK, LR, LS, LT, LU, LY, MA, MD, ME, MG, MK, MN, MW, MX, MY, MZ, NA, NG, NI, NO, NZ, OM, PE, PG, PH, PL, PT, QA, RO, RS, RU, RW, SC, SD, SE, SG, SK, SL, SM, ST, SV, SY, TH, TJ, TM, TN, TR, TT, TZ, UA, UG, US, UZ, VC, VN, ZA, ZM, ZW.
  - (84) **Designated States (unless otherwise indicated, for every kind of regional protection available):** ARIPO (BW, GH, GM, KE, LR, LS, MW, MZ, NA, RW, SD, SL, SZ, TZ, UG, ZM, ZW), Eurasian (AM, AZ, BY, KG, KZ, MD, RU, TJ, TM), European (AL, AT, BE, BG, CH, CY, CZ, DE, DK, EE, ES, FI, FR, GB, GR, HR, HU, IE, IS, IT, LT, LU, LV, MC, MK, MT, NL, NO, PL, PT, RO, RS, SE, SI, SK, SM, TR), OAPI (BF, BJ, CF, CG, CI, CM, GA, GN, GQ, GW, ML, MR, NE, SN, TD, TG).
- Published:**  
— with international search report (Art. 21(3))

(54) **Title:** CATHETER BIOPSY DEVICE WITH REDUCED CONTAMINATION RISK



**Fig. 7**

(57) **Abstract:** An envelope for covering a device is provided. The envelope has a longitudinal shape and comprises an inner surface, an outer surface, a first end and a second end. The first end and the second end are arranged opposite to each other in a longitudinal direction of the envelope, wherein the first end is attachable to a device and wherein the second end is open. The envelope is arranged to upend inwards while pulling the first end towards the second end, such that at least a part of the outer surface is facing inwards.



## CATHETER BIOPSY DEVICE WITH REDUCED CONTAMINATION RISK

## FIELD OF THE INVENTION

The present invention relates to an envelope for covering a medical examination device, a medical examination apparatus, a system with a medical examination apparatus, a use of an envelope, and a method for retracting a device with an envelope out of a surrounding region. However, it is to be appreciated that the exemplary embodiments can also find application in conjunction with other medical devices and the like.

## BACKGROUND OF THE INVENTION

An example for a medical examination where a device is inserted and then retracted out of a surrounding region is the field of biopsy. Catheter biopsy is minimally invasive and is typically a very safe procedure. For example, WO 2009/153723 A1 describes a method and system for performing biopsies with a deployable biopsy needle for performing a biopsy procedure. Biopsy can include a medical test involving the removal of cells or tissues from a living subject for examination, for example the tissue sample is analyzed microscopically by a pathologist and/or also chemically to determine the presence or extent of a disease. Biopsies may be taken percutaneously (via a needle through the skin), transvenously (through the blood vessels), or directly during abdominal surgery. Irrespective of the modality, an interventional device, for example a needle, is used, which has to be firstly inserted into tissue and then usually removed via the same channel. However, healthy tissue can be contaminated by the suspicious sample of tissue while removing the device, for example.

## SUMMARY OF THE INVENTION

It can be seen as an object of the present invention to minimize the risk of contamination of healthy tissue by an extracted device, for example a catheter or a needle.

The object of the present invention is solved by the subject-matter of the independent claims, wherein further embodiments are incorporated in the dependent claims.

It should be noted that the following described aspects of the invention apply also for the envelope, the medical examination apparatus, the system with a medical

examination apparatus, and the method for retracting a device with an envelope out of a surrounding region.

According to an aspect of the invention, an envelope for covering a medical examination device is provided. The envelope has a longitudinal shape and comprises an inner surface, an outer surface, a first end, and a second end. The first end and the second end are arranged opposite to each other in a longitudinal direction of the envelope, wherein the first end is attachable to a device and wherein the second end is open. Furthermore, the envelope is arranged to upend inwards while pulling the first end towards the second end, such that at least a part of the outer surface is facing inwards. The envelope is adapted to assume a first state and a second state, wherein in the first state, the outer surface is facing outwards and wherein in the second state at least a part of the outer surface is facing inwards.

A device provided with an envelope according to an aspect of the invention allows retracting of the device from a surrounding region in a way without moving the envelope at a contact surface of the envelope and the surrounding region along the retracting direction of the device.

Hence, a potentially contaminated part of the envelope is upended inwards and a contact of the potentially contaminated part of the envelope with the surrounding region around the retracting direction of the device with the envelope is avoided.

According to another aspect of the invention, a medical examination apparatus comprises a device and an envelope according to the above mentioned aspect of the invention, wherein the device is adapted to be insertable at least partly into an object and wherein the first end of the envelope is attached to the device. Thereby, the device is pullable in a first direction from the first end of the envelope to the second end of the envelope, such that at least a part of the outer surface of the envelope is facing inwards, thereby forming a receiving volume separated from the surrounding region.

The above and hereinafter described envelope can be a thin membrane. In particular, the envelope can be made from very thin material, for example much smaller than 1 mm, thus the overall diameter of the device essentially does not increase when covered with the envelope.

The membrane may be at least partially permeable for a fluid or a gas. The membrane may be permeable only in a bended region, for example in a curved part of the membrane while upending the membrane.

While the device is being retracted from a surrounding region, the envelope upends inwards and may also cover a tissue sample taken. As the outside of the envelope

may also be contaminated, the risk of contaminating the surrounding region along the retracting channel is further reduced by upending inwards the envelope.

The device can be any medical interventional device which has to be inserted and then retracted from a surrounding region.

The above and hereinafter described envelope may comprise a flexible and strong material, for example latex. The envelope may comprise another material, as long as this material is flexible and strong. The material of the envelope should at least be that flexible that it allows the envelope upending inwards. The material of the envelope may be as strong as to avoid tearing of the envelope while introducing the device with an envelope into an object, for example the body of a patient.

According to another aspect of the invention, a system comprises a medical examination apparatus according to the above mentioned aspect of the invention, a locating unit, a feedback unit, and a pullback unit. The locating unit is adapted to determine a position of the device, the feedback unit is adapted to display a position of the device, and the pullback unit is adapted to pull the device in a direction from the first end of the envelope to the second end of the envelope, such that at least a part of the outer surface of the envelope is facing inwards.

The locating unit may be an X-ray detector, an ultrasound scanner or a magnetic resonance scanner, adapted to determine the position of the device of the medical examination apparatus in an object, for example the body of a patient.

The feedback unit may be a monitor. The feedback unit may be connected to a computer. The feedback unit may be adapted to display the position of the device of the medical examination apparatus in the object the device has been inserted to.

The pullback unit may be coupled to the device, such that the pullback unit may pull the device out of an object. The pullback unit may be coupled to the device by a cord, by a cable or by other kinds of attachment. A shaft may also be used for coupling the pullback unit to the device, for example.

According to another aspect of the invention, an envelope according to the above mentioned example is used in order to avoid contamination along a moving path in an object while pulling out the device from the object.

According to another aspect of the invention, a method for retracting a device with an envelope out of a surrounding region is provided. In a first step, an envelope with a longitudinal shape, a first end and a second end is provided, wherein the first end is attached to a device. In a second step, the device is being pulled out of the surrounding region. In a

third step, the envelope is being gradually upended by pulling the first end towards the second end while retracting the device out of the surrounding region, such that a lengthwise movement between a contact region of the envelope and the surrounding region is avoided.

It should be noted that the present invention is not limited to medical devices. The invention may be used in any fields where a contamination of a surrounding region along a retracting path of, for example for taking a sample, is to be avoided.

It can be seen as the gist of the invention to provide an envelope for a device, wherein a first end of the envelope is attached to a device and upends inwards while the device is being pulled from the first end towards a second end of the envelope, such that the upending envelope is forming a receiving volume to separate a sample from a surrounding region and an outer surface of the envelope, which may be contaminated, is being upended inwards and a lengthwise movement between a contact region of the envelope and a surrounding region is avoided.

These and other aspects of the present invention will become apparent from and elucidated with reference to the embodiments described hereinafter.

## BRIEF DESCRIPTION OF THE DRAWINGS

Exemplary embodiments of the invention will be described in the following with reference to the following drawings.

Fig 1 illustrates a perspective view of an envelope according to an exemplary embodiment of the invention.

Fig. 2 illustrates a side view of an envelope according to another exemplary embodiment of the invention.

Fig. 3 illustrates a side view of an envelope according to another exemplary embodiment of the invention.

Fig. 4 illustrates an envelope according to another exemplary embodiment of the invention in a partly upended state.

Fig. 5 illustrates a medical examination apparatus according to an exemplary embodiment of the invention.

Fig. 6 illustrates a medical examination apparatus according to another exemplary embodiment of the invention.

Fig. 7 illustrates a medical examination apparatus according to another exemplary embodiment of the invention.

Fig. 8 illustrates a medical examination apparatus according to another exemplary embodiment of the invention.

Fig. 9 illustrates a medical examination apparatus according to another exemplary embodiment of the invention.

Fig. 10 illustrates a medical examination apparatus according to another exemplary embodiment of the invention.

Fig. 11 illustrates a medical examination apparatus according to another exemplary embodiment of the invention.

Fig. 12A illustrates a medical examination apparatus according to another exemplary embodiment of the invention.

Fig. 12B illustrates a medical examination apparatus according to another exemplary embodiment of the invention.

Fig. 13 illustrates a system according to an exemplary embodiment of the invention.

Fig. 14 illustrates a flowchart of a method according to an exemplary embodiment of the invention.

## DETAILED DESCRIPTION OF EMBODIMENTS

Fig. 1 illustrates an envelope 100 with an inner surface 101, an outer surface 102, a first end 103, and a second end 104. The envelope has a longitudinal shape in the direction from the first end 103 to the second end 104.

Even though the envelope 100 is provided with a circular cross-section, the envelope 100 may be provided with the cross-section of another geometric form, for example rectangular or elliptical. An envelope with a rectangular cross-section may be provided with rounded edges.

Fig. 2 illustrates another view of an exemplary embodiment of an envelope 100. The envelope 100 has an inner surface 101, and outer surface 102, a first end 103, and second end 104. The envelope 100 is depicted with a first end 103 and a second end 104 open.

Fig. 3 illustrates an envelope according to another exemplary embodiment of the invention. The envelope 100 has an inner surface 101, an outer surface 102, a first end 103, and a second end 104. The envelope 100 may be provided with a rounded section 105 at the first end 103. The envelope 100 may also be provided with a rounded section 105 at the second end 104.

The first end 103 may be closed, which is illustrated with a dotted line.

The rounded section 105 implicates that the diameter at the first end 103 of the envelope is smaller than the diameter of the envelope in a middle section 106.

Fig. 1, Fig. 2, and Fig. 3 show the envelope in a first state, wherein the outer surface is facing outwards.

Fig. 4 illustrates the envelope according to an exemplary embodiment of the invention, wherein the envelope has assumed a second state, wherein in the second state at least a part of the outer surface 102 is facing inwards.

In the second state shown in Fig. 4 a part of the outer surface 102 is facing outwards.

By pulling the first end 103 of the envelope 100 in a direction from the first end 103 towards the second end 104, a receiving volume 402 is formed such that the receiving volume 402 is separated from the surrounding region 401 by being enclosed by the envelope 100.

The first end 103 may be closed or open and may be provided with rounded edges 105.

As the envelope 100 is gradually upended inwards by pulling the first end 103 towards the second end 104, a lengthwise movement between a contact region of the envelope 100 and a surrounding region 401 is avoided.

To ensure an upending of the envelope 100 by pulling the first end 103 towards the second end 104, a first friction characteristic of the outer surface 102 may be arranged to be higher than a second friction characteristic of the inner surface 101. Hence, a body or a device (not shown) may be pulled in a direction from the first end 103 towards the second end 104 and an upending may be ensured as the friction characteristic of the outer surface 102 is larger than the friction characteristic of the inner surface 101. While pulling the device or body, the layer friction between the envelope and the surrounding results in that the device can be pulled out without the envelope sticking to the device, but rather sticking to the surrounding. Thus, the device can so to speak slide along or in relation to the inner side of the envelope.

Fig. 5 illustrates a medical examination apparatus 500 according to an exemplary embodiment of the invention. The apparatus 500 comprises a device 501 and an envelope, for example the envelope 100 as described above and hereinafter, wherein the first end 103 of the envelope 100 is attached to the device 501.

The apparatus 500 may be inserted or injected in a surrounding region 401 of an object 510, such that the apparatus 500 is introduced at least partly into the object 510, wherein the outer surface 102 of the envelope 100 is touching the surrounding region 401.

The device 501 may be pulled in a direction 503 from the first end 103 of the envelope towards the second end 104 of the envelope. By pulling the device 501 in the direction 503, the medical examination apparatus 500 is being extracted from the body 510.

The device 501 as described above and hereinafter may be a medical device.

The object 510 may be a body region of a patient, for example a cancer tissue area.

Fig. 6 illustrates a further example of the medical examination apparatus 500. The apparatus 500 comprises a device 501 and an envelope 100. The envelope 100 is shown in a second state, wherein at least a part of the outer surface 102 is upended inwards and encloses at least a part 601 of the device 501.

The first end 103 of the envelope 100 may be attached to the device 501 in a front region 602, a middle region 603, or a rear region 604 of the device 501 (the latter two examples not further shown). The closer the envelope 100 is attached to the front region 602 of the device 501, the smaller is the part of the device 501 sticking out from the first end 103 of the envelope 100 in a first state of the envelope 100.

The device 501 as described above and hereinafter may be a biopsy needle. The first end 103 of the envelope 100 may be attached in front portion of the biopsy needle.

Fig. 7 illustrates another exemplary embodiment of the invention. The medical examination apparatus 500 as described above and hereinafter may comprise a catcher 701. The catcher 701 may adapted to grasp a sample 702. The envelope 100 is adapted to enclose the catcher 701 and the sample 702 while pulling the device in the direction 503.

The catcher 701 may be a medical forceps.

The envelope 100 encloses the catcher 701 and the sample 702, such that the sample 702 is separated by the upended envelope 100 from the surrounding region 401. Hence, the risk of contamination of the surrounding region 401 by the sample 702 may be minimized.

Fig. 8 illustrates an example of the medical examination apparatus 500 according to another exemplary embodiment of the invention. A first substance 801 may be provided between the inner surface 101 of the envelope 100 and the device 501, adapted such that friction between the inner surface 101 of the envelope 100 and the device 501 is reduced.

The first substance 801 may be a fluid, a gas, or a powder. The first substance 801 may be a lubricant.

The first substance may be provided to ensure that a second friction characteristic of the inner surface 101 and the device 501 is lower than a first friction characteristic of the outer surface 102 and a contacting surface of the surrounding region 401. The first substance 801 may be provided to ensure the upending of the envelope 100 while retracting the device 501 from the surrounding region 401.

Fig. 9 illustrates a medical examination apparatus 500 according to another exemplary embodiment of the invention. The outer surface 102 of the device 501 may comprise a layer 902, wherein the layer 902 is adapted to reduce friction between the outer surface of the device and the inner surface of the envelope.

The layer 902 may be used as an alternative to the first substance 801. The layer 902 may also be used in conjunction, i.e. in addition with a substance such as the first substance 801. The layer 902 may comprise Teflon.

Fig. 10 illustrates a medical examination apparatus 500 according to another exemplary embodiment of the invention. The apparatus 500 may be adapted to deliver a second substance 1001 to the inner surface 101 of the envelope 100, such that the outer surface 102 of the envelope 100 may be pressed in a direction along the arrows 1002 against an abutting surface 1003 of a surrounding region 401, such that a friction between the outer surface 102 of the envelope 100 and the abutting surface 1003 is increased.

The first substance may also be used for this purpose, as the second substance may be used to reduce the friction between the inner surface 101 of the envelope 100 and the device 501.

The second end 104 of the envelope 100 as described above and hereinafter may be closable such that a pressure may be applied between the inner surface 101 and the device 501.

Fig. 11 illustrates a medical examination apparatus 500 according to another exemplary embodiment of the invention. The apparatus 500 may comprise a drug unit 1101 to deliver drugs 1102 to at least a part of the surrounding region 401 of the first end 103 of the envelope 100. The drug unit 1101 may be arranged centrally or off-center in a front portion of the device 501, wherein the front portion of the device 501 is close to the first end 103 of the envelope 100.

The drug unit 1101 may also be arranged along the edge of the device 501, and it may be arranged in between these two areas.

Fig. 12A illustrates a medical examination apparatus 500 according to an exemplary embodiment of the invention, wherein the envelope 100 is shown in a first state. The envelope 100 may be an adaptive emitting envelope, wherein the envelope is adapted to release drugs 1102 in a bent region 1201 of the envelope 100, such that the drugs 1102 are delivered to the surrounding region 401 along the arrows 1202.

The drugs may be enclosed in ventricles under the outer surface of the envelope. The ventricles and the envelope may be adapted to be opened in a bent region of the envelope while upending the envelope, such that the enclosed drugs are released in the bent region 1201 of the envelope 100.

Fig. 12B illustrates an exemplary embodiment of the medical examination apparatus 500 according to the invention, wherein the envelope 100 is shown in a second state. Fig. 12B depicts that by upending the envelope 100, another region of the envelope 100 is being bent, such that other pores of the porous layer of the envelope 100 are being opened and thereby releasing drugs 1102 in the gradually moving bent region 1201 and delivering drugs along the arrows 1202 to the surrounding region 401.

Fig. 12B shows that by delivering drugs in a bent region of the envelope, it is possible to ensure that the opening of the surrounding region of the envelope is being delivered with drugs, such that a contamination risk is further reduced.

Fig. 13 illustrates a system 1300 according to an exemplary embodiment of the invention. The system 1300 comprises a medical examination apparatus 500 as described above and hereinafter, a locating unit 1301, a feedback unit 1302, and a pullback unit 1303.

The locating unit may be adapted to determine a position of the device 501 of the medical examination apparatus 500. The locating unit may be an X-ray, an ultrasonic device or a magnetic resonance scanner or another device adapted to determine a position of a device injected into an object.

The feedback unit may be adapted to display the position of the device. The feedback unit may be a monitor or a display. The feedback unit may be connected to a computer. The feedback unit may be connected to the locating unit and adapted to receive information regarding to the position of the device.

The pullback unit may be adapted to pull the device in a direction from the first end of the envelope to the second end of the envelope, such that at least a part of the outer surface of the envelope is facing inwards. The pullback unit may comprise an actuator, wherein the actuator is adapted to apply a force to the device, such that the device is retracted of a body.

The feedback unit may be connected to the pullback unit, such that the feedback unit controls the actuator of the pullback unit. The feedback unit may be adapted to control the motion of the device by the pullback unit. The pullback unit may be adapted to be controlled manually.

Fig. 14 depicts a flowchart of a method 1400 according to an exemplary embodiment of the invention. The flowchart depicts a method for retracting a device with an envelope out of a surrounding region.

In a first step 1401, an envelope is provided with a longitudinal shape, the first end and a second end, wherein the first end is attached to a device.

In a second step 1402, the device is being pulled out of the surrounding region.

In a third step 1403, the envelope is being gradually upended during the pulling out in the second step, e.g. of the first end towards the second end while retracting the device out of the surrounding region, such that a lengthwise movement at a contact region of the envelope and a surrounding region is avoided.

In a further exemplary embodiment (not shown), a volume is gradually enclosed by the upended envelope.

In a further exemplary embodiment (not shown), a tissue sample is enclosed in the volume formed by the upended envelope.

It has to be noted that embodiments of the invention are described with reference to different subject-matters. In particular, some embodiments are described with reference to method type claims, whereas other embodiments are described with reference to the device type claims. However, a person skilled in the art will gather from the above and the following description that, unless otherwise notified, in addition to any combination of features belonging to one type of subject-matter, also any combination between features relating to different subject-matters is considered to be disclosed with this application. However, all features can be combined providing synergetic effects that are more than the simply summation of the features.

In the claims, the word “comprising” does not exclude other elements or steps, and the indefinite article “a” or “an” does not exclude a plurality. The mere fact that certain measures are recited in mutually different dependent claims does not indicate that a combination of these measured cannot be used to advantage.

## CLAIMS:

1. Envelope (100) for covering a medical examination device, wherein the envelope is provided with a longitudinal shape; wherein the envelope comprises:
  - an inner surface (101);
  - an outer surface (102);
  - a first end (103); and
  - a second end (104);wherein the first end and the second end are arranged opposite to each other in a longitudinal direction of the envelope;  
wherein the first end is attachable to a device;  
wherein the second end is open;  
wherein the envelope is arranged to upend inwards while pulling the first end towards the second end, such that at least a part of the outer surface is facing inwards;  
wherein the envelope is adapted to assume a first state and a second state; and  
wherein in the first state the outer surface is facing outwards and wherein in the second state at least a part of the outer surface is facing inwards.
2. Envelope according to claim 1,  
wherein the outer surface (102) is forming a receiving volume (402), such that the receiving volume is separated from the surrounding (401) by being enclosed by the envelope.
3. Envelope according to claim 1,  
wherein a first friction characteristic of the outer surface is larger than a second friction characteristic of the inner surface.
4. Medical examination apparatus (500), comprising:
  - a device (501); and
  - an envelope (100) according to one of claims 1 to 3;

wherein the device is adapted to be insertable at least partly into an object (510);

wherein the first end of the envelope is attached to the device; and

wherein the device is pullable in a first direction (503) from the first end of the envelope to the second end of the envelope, such that at least a part of the outer surface is facing inwards and thereby forming a receiving volume (402) separated from the surrounding region.

5. Medical examination apparatus according to claim 4,  
wherein the outer surface of the envelope facing inwards encloses at least a part of the device.

6. Medical examination apparatus according to claim 4,  
wherein the device is a biopsy needle; and  
wherein the first end of the envelope is attached in a front portion of the biopsy needle.

7. Medical examination apparatus according to claim 4,  
further comprising a catcher (701);  
wherein the catcher is adapted to grasp a sample (702); and  
wherein the envelope is adapted to enclose the catcher and the sample while pulling the device in the first direction.

8. Medical examination apparatus according to claim 4,  
wherein a first substance (801) is provided between the inner surface of the envelope and the device, adapted such that friction between the inner surface of the envelope and the device is reduced.

9. Medical examination apparatus according to claim 4,  
wherein an outer surface (901) of the device comprises a layer (902) adapted to reduce friction between the outer surface of the device and the inner surface of the envelope.

10. Medical examination apparatus according to claim 4, wherein the apparatus is adapted to deliver a second substance (1001) to the inner surface of the envelope, such that the outer surface of the envelope can be pressed (1002) against an abutting surface (1003) of a surrounding region (401) to increase friction between the outer surface of the envelope and the abutting surface.
11. Medical examination apparatus according to claim 4, comprising means (1101) to deliver drugs (1102) to at least a part of a surrounding region of the first end of the envelope.
12. A system (1300), comprising:
- a medical examination apparatus according to claim 4;
  - a locating unit (1301);
  - a feedback unit (1302); and
  - a pullback unit (1303);
- wherein the locating unit is adapted to determine a position of the device; wherein the feedback unit is adapted to display a position of the device; and wherein the pullback unit is adapted to pull the device in a direction from the first end of the envelope to the second end of the envelope, such that at least a part of the outer surface is facing inwards.
13. Use of an envelope according to claim 1, in order to avoid contamination along a moving path in an object while pulling out a device from the object.
14. Method (1400) for retracting a device with an envelope out of a surrounding region, comprising the following steps:
- providing an envelope (1401) with a longitudinal shape, a first end and a second end, wherein the first end is attached to a device;
  - pulling out the device (1402) of the surrounding region;
  - gradually upending the envelope (1403) by pulling the first end towards the second end while retracting the device out of the surrounding region, such that a lengthwise movement between a contact region of the envelope and a surrounding region is avoided.

1/4

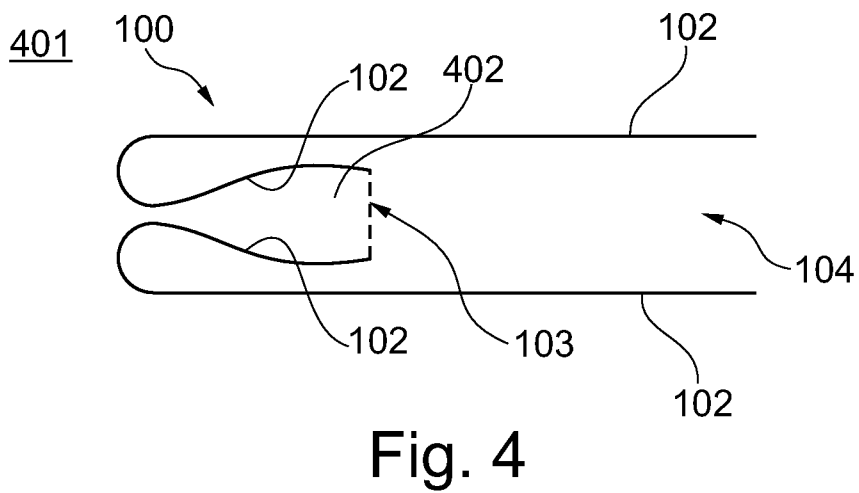
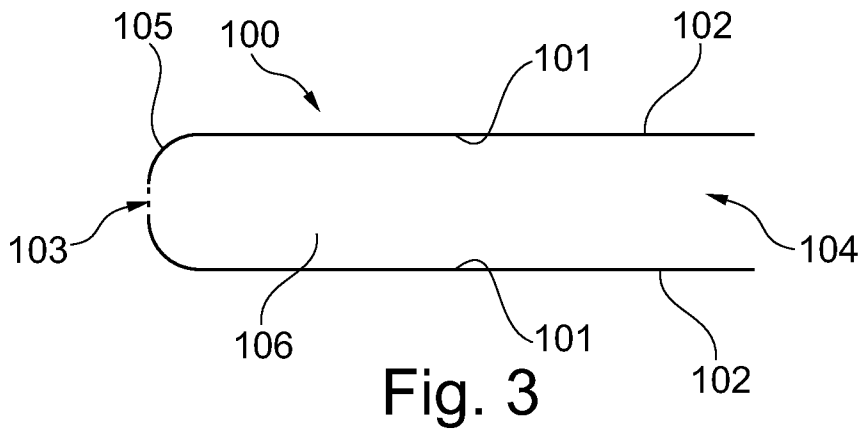
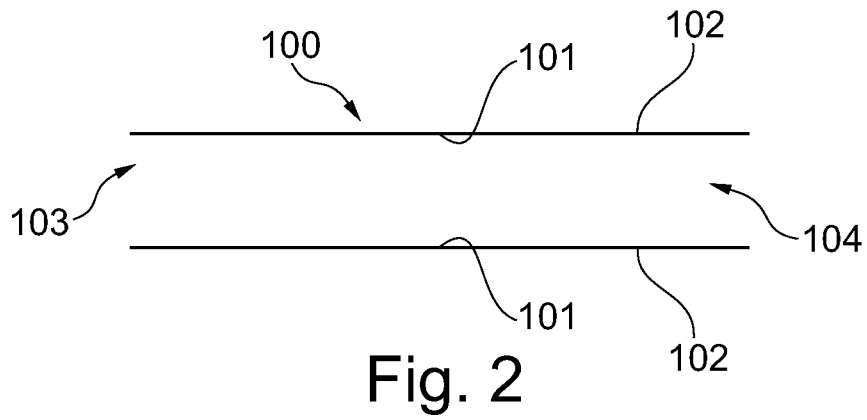
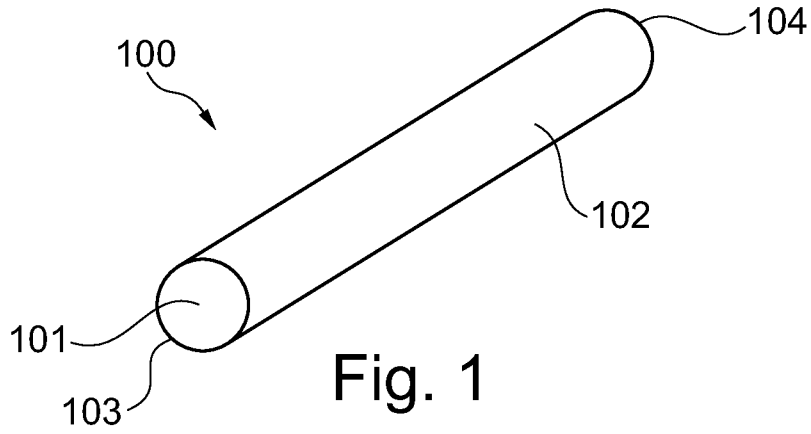

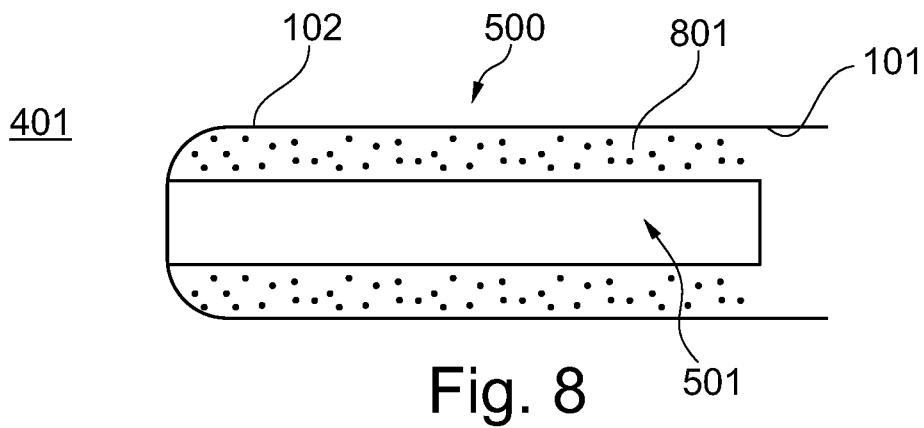
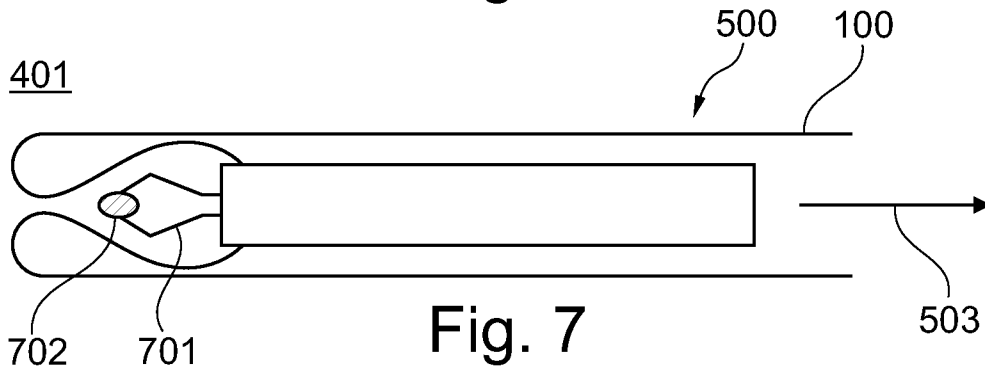
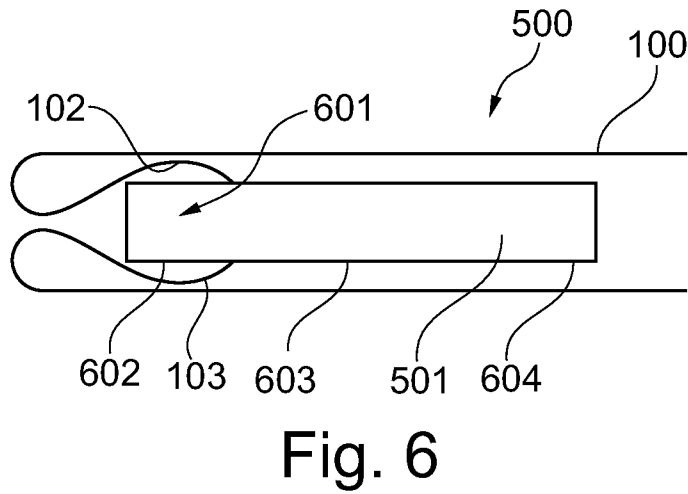
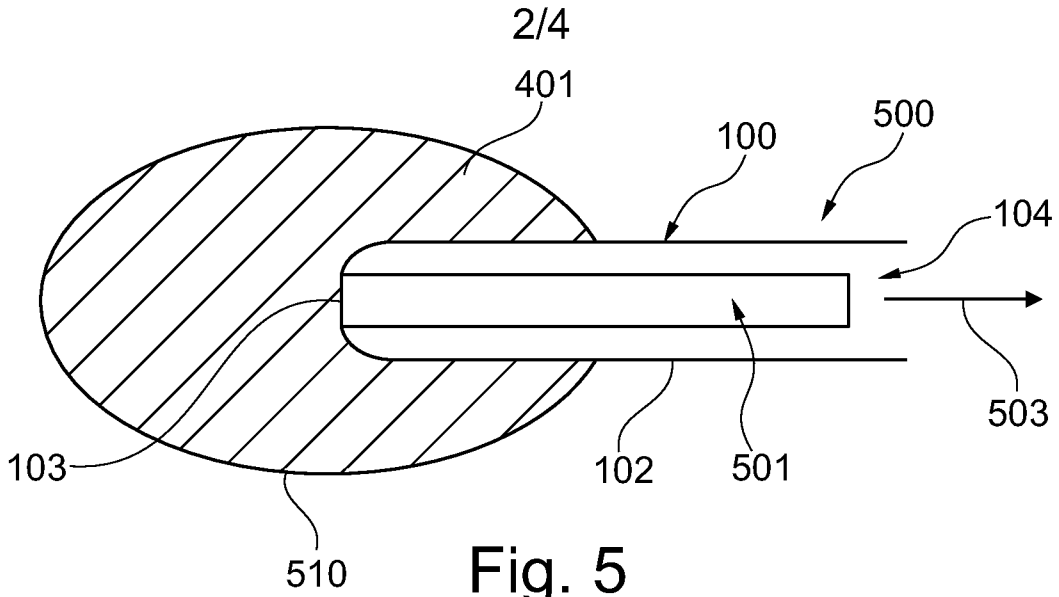

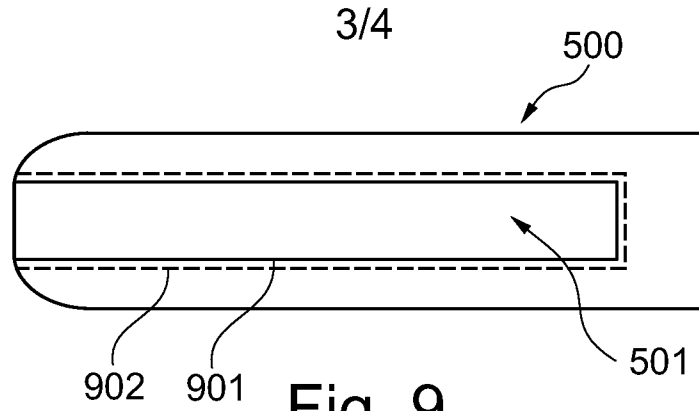

Fig. 9

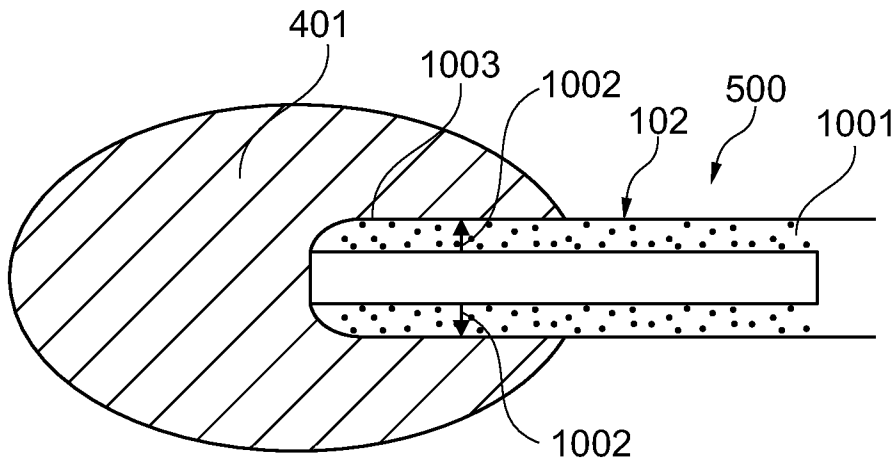

Fig. 10



Fig. 11

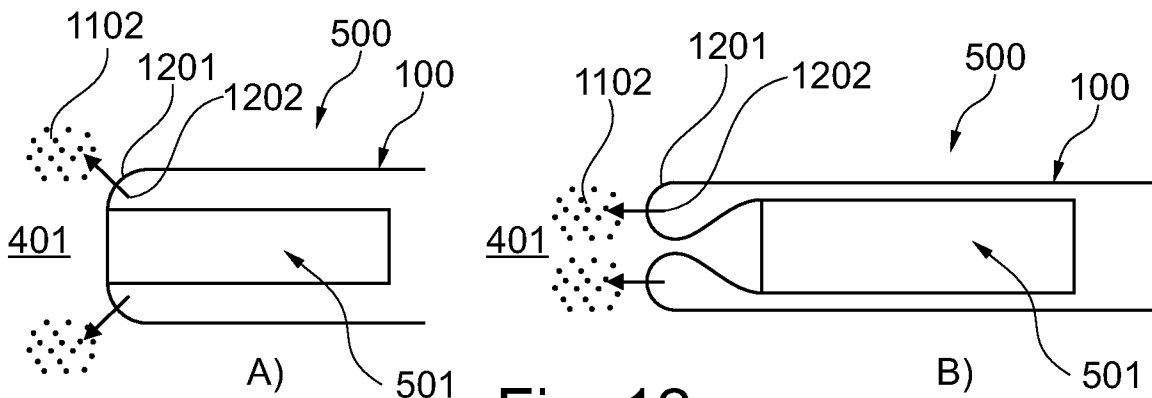
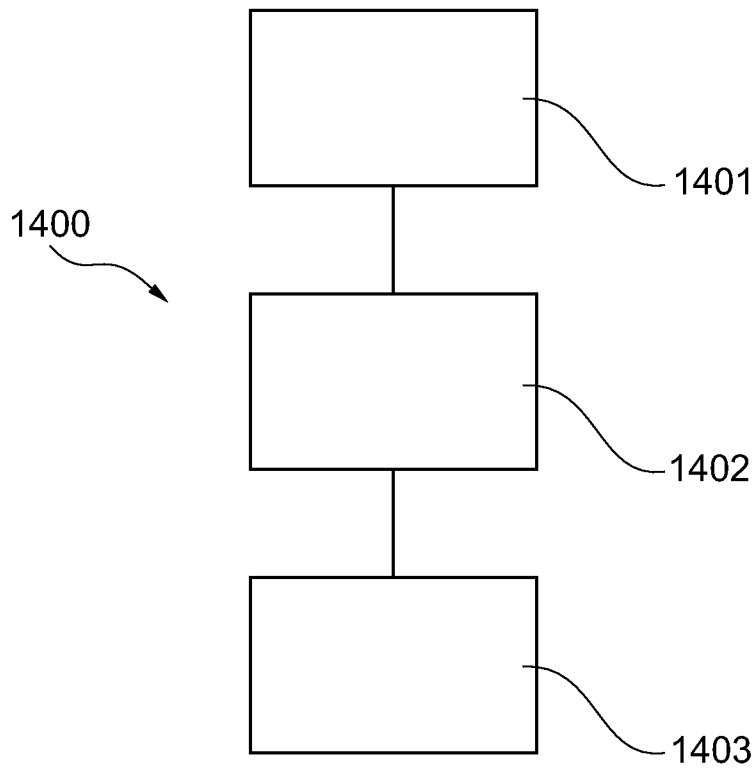
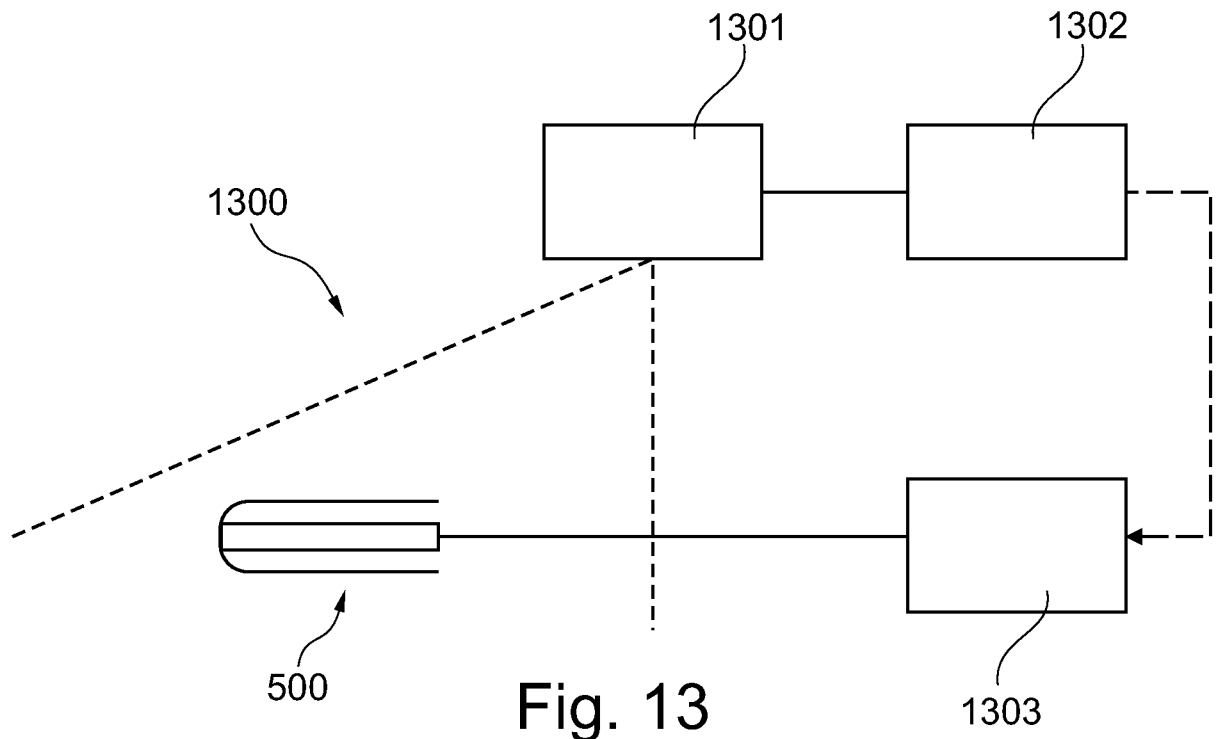

Fig. 12



## INTERNATIONAL SEARCH REPORT

International application No  
PCT/IB2012/051142

## A. CLASSIFICATION OF SUBJECT MATTER

INV. A61B10/02  
ADD.

According to International Patent Classification (IPC) or to both national classification and IPC

## B. FIELDS SEARCHED

Minimum documentation searched (classification system followed by classification symbols)  
A61B A61M

Documentation searched other than minimum documentation to the extent that such documents are included in the fields searched

Electronic data base consulted during the international search (name of data base and, where practicable, search terms used)

EPO-Internal, WPI Data

## C. DOCUMENTS CONSIDERED TO BE RELEVANT

Category*	Citation of document, with indication, where appropriate, of the relevant passages	Relevant to claim No.
X	WO 2008/044044 A2 (IMP INNOVATIONS LTD [GB]; LAMPERTH MICHAEL ULRICH [GB]; YOUNG IAN ROBE) 17 April 2008 (2008-04-17)	1-6
Y	page 6, line 4 - page 7, line 6; figures 1-4	11,12
Y	----- US 2008/306404 A1 (RONALD TIMOTHY R [US]) 11 December 2008 (2008-12-11) paragraph [0020]; figure 1	11
Y	----- US 2009/112119 A1 (KIM STANLEY I [US]) 30 April 2009 (2009-04-30) figure 59	12
X	----- US 2005/197595 A1 (HUANG ALEXANDER [US] ET AL) 8 September 2005 (2005-09-08) paragraphs [0014] - [0016]; figures 1,3a,3b	1-6,8,9
	----- -/--	

 Further documents are listed in the continuation of Box C. See patent family annex.

\* Special categories of cited documents :

"A" document defining the general state of the art which is not considered to be of particular relevance

"E" earlier application or patent but published on or after the international filing date

"L" document which may throw doubts on priority claim(s) or which is cited to establish the publication date of another citation or other special reason (as specified)

"O" document referring to an oral disclosure, use, exhibition or other means

"P" document published prior to the international filing date but later than the priority date claimed

"T" later document published after the international filing date or priority date and not in conflict with the application but cited to understand the principle or theory underlying the invention

"X" document of particular relevance; the claimed invention cannot be considered novel or cannot be considered to involve an inventive step when the document is taken alone

"Y" document of particular relevance; the claimed invention cannot be considered to involve an inventive step when the document is combined with one or more other such documents, such combination being obvious to a person skilled in the art

"&amp;" document member of the same patent family

Date of the actual completion of the international search

27 April 2012

Date of mailing of the international search report

09/05/2012

Name and mailing address of the ISA/

European Patent Office, P.B. 5818 Patentlaan 2  
NL - 2280 HV Rijswijk  
Tel. (+31-70) 340-2040,  
Fax: (+31-70) 340-3016

Authorized officer

Grieb, Christian

## INTERNATIONAL SEARCH REPORT

International application No  
PCT/IB2012/051142

C(Continuation). DOCUMENTS CONSIDERED TO BE RELEVANT

Category*	Citation of document, with indication, where appropriate, of the relevant passages	Relevant to claim No.
X	WO 01/00080 A2 (JONES JEFFREY S [US]) 4 January 2001 (2001-01-04) figures 1,5,8 -----	1-7
X	EP 1 772 104 A2 (TSION ISRAEL MEDICAL SYSTEMS L [IL]) 11 April 2007 (2007-04-11) figures 3a-3c -----	1-6

# INTERNATIONAL SEARCH REPORT

International application No.  
PCT/IB2012/051142

## Box No. II Observations where certain claims were found unsearchable (Continuation of item 2 of first sheet)

This international search report has not been established in respect of certain claims under Article 17(2)(a) for the following reasons:

1.  Claims Nos.: 13, 14  
because they relate to subject matter not required to be searched by this Authority, namely:  
Rule 39.1(iv) PCT - Method for treatment of the human or animal body by surgery
2.  Claims Nos.:  
because they relate to parts of the international application that do not comply with the prescribed requirements to such an extent that no meaningful international search can be carried out, specifically:
3.  Claims Nos.:  
because they are dependent claims and are not drafted in accordance with the second and third sentences of Rule 6.4(a).

## Box No. III Observations where unity of invention is lacking (Continuation of item 3 of first sheet)

This International Searching Authority found multiple inventions in this international application, as follows:

1.  As all required additional search fees were timely paid by the applicant, this international search report covers all searchable claims.
2.  As all searchable claims could be searched without effort justifying an additional fees, this Authority did not invite payment of additional fees.
3.  As only some of the required additional search fees were timely paid by the applicant, this international search report covers only those claims for which fees were paid, specifically claims Nos.:
4.  No required additional search fees were timely paid by the applicant. Consequently, this international search report is restricted to the invention first mentioned in the claims; it is covered by claims Nos.:

### Remark on Protest

- The additional search fees were accompanied by the applicant's protest and, where applicable, the payment of a protest fee.
- The additional search fees were accompanied by the applicant's protest but the applicable protest fee was not paid within the time limit specified in the invitation.
- No protest accompanied the payment of additional search fees.

# INTERNATIONAL SEARCH REPORT

Information on patent family members

International application No

PCT/IB2012/051142

Patent document cited in search report	Publication date	Patent family member(s)	Publication date
WO 2008044044	A2	17-04-2008	NONE
-----			
US 2008306404	A1	11-12-2008	US 2008306404 A1 11-12-2008
			US 2009182260 A1 16-07-2009
-----			
US 2009112119	A1	30-04-2009	EP 2205170 A2 14-07-2010
			US 2009112119 A1 30-04-2009
			WO 2009059236 A2 07-05-2009
-----			
US 2005197595	A1	08-09-2005	CA 2558699 A1 22-09-2005
			EP 1729648 A2 13-12-2006
			JP 2007527298 A 27-09-2007
			KR 20060135867 A 29-12-2006
			US 2005197595 A1 08-09-2005
			WO 2005086711 A2 22-09-2005
-----			
WO 0100080	A2	04-01-2001	AU 5778500 A 31-01-2001
			CA 2375953 A1 04-01-2001
			WO 0100080 A2 04-01-2001
-----			
EP 1772104	A2	11-04-2007	EP 1772104 A2 11-04-2007
			US 2007123798 A1 31-05-2007
-----			