



(86) Date de dépôt PCT/PCT Filing Date: 2011/09/21
 (87) Date publication PCT/PCT Publication Date: 2012/03/29
 (85) Entrée phase nationale/National Entry: 2013/03/21
 (86) N° demande PCT/PCT Application No.: US 2011/052633
 (87) N° publication PCT/PCT Publication No.: 2012/040379
 (30) Priorité/Priority: 2010/09/21 (US61/385,029)

(51) Cl.Int./Int.Cl. *B32B 33/00* (2006.01),
A47B 95/04 (2006.01)
 (71) Demandeur/Applicant:
HARRIS RESEARCH, INC., US
 (72) Inventeurs/Inventors:
DAVIS, BENJAMIN N., US;
MURPHY, DAVID H., US;
MIYASAKI, BRYAN R., US;
SPINNING, VINCENT R., US
 (74) Agent: SMART & BIGGAR

(54) Titre : APPAREIL DE CORRESPONDANCE DE COULEURS TRANSLUCIDE ET SOUPLE
 (54) Title: FLEXIBLE TRANSLUCENT COLOR MATCHING APPARATUS

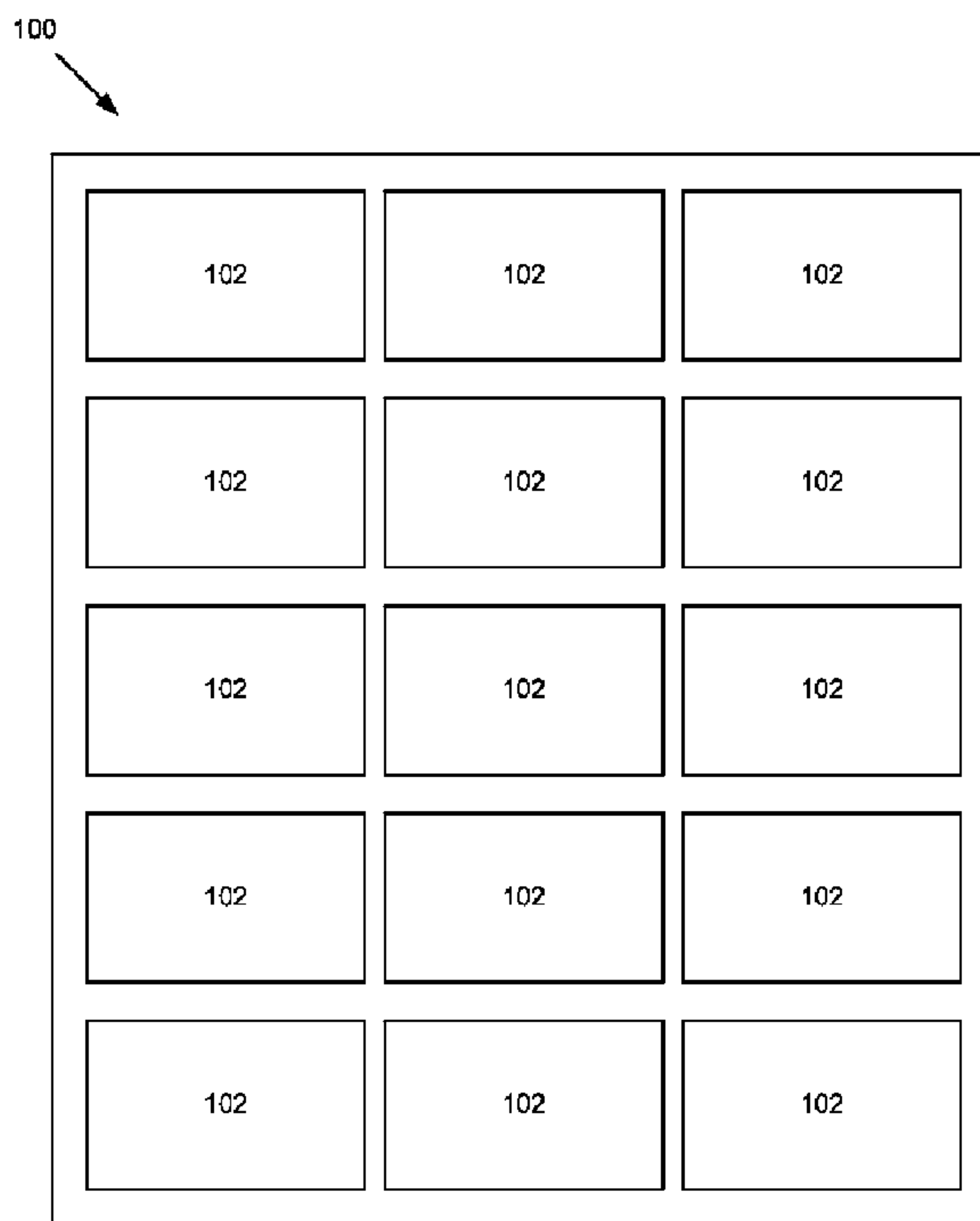

Figure 1

(57) Abrégé/Abstract:

An apparatus, system, and method are disclosed for selecting a finish for applying to an item. The apparatus includes a flexible translucent sheet 100, and at least one semi-translucent color 102 applied to the translucent sheet 100 such that a surface to



(57) **Abrégé(suite)/Abstract(continued):**

which the translucent sheet 100 is attached is visible through the translucent sheet 100 and the semi-translucent color 102. The system includes the apparatus and a protective laminate surface covering the at least one semi-translucent color 102. The method includes providing a plurality of translucent sheets 100 each having at least one semi-translucent color 102, examining an item 502 to determine the type of finish of the item 502, selecting a flexible translucent sheet 100 according to the finish of the item 502, conforming and affixing the selected translucent sheet 100 to the surface of the item 502, and viewing the surface of the item 502 through the selected translucent sheet 100.

(12) INTERNATIONAL APPLICATION PUBLISHED UNDER THE PATENT COOPERATION TREATY (PCT)

(19) World Intellectual Property
Organization
International Bureau(43) International Publication Date
29 March 2012 (29.03.2012)(10) International Publication Number
WO 2012/040379 A3

- (51) International Patent Classification:
B32B 33/00 (2006.01) *A47B 95/04* (2006.01)
- (21) International Application Number:
PCT/US2011/052633
- (22) International Filing Date:
21 September 2011 (21.09.2011)
- (25) Filing Language: English
- (26) Publication Language: English
- (30) Priority Data:
61/385,029 21 September 2010 (21.09.2010) US
- (71) Applicant (for all designated States except US): **HARRIS RESEARCH, INC.** [US/US]; 1530 N. 1000 W., Logan, Utah 84321 (US).
- (72) Inventors; and
(75) Inventors/Applicants (for US only): **DAVIS, Benjamin N.** [US/US]; 1530 N. 1000 W., Logan, Utah 84321 (US). **MURPHY, David H.** [US/US]; 1530 N. 1000 W., Logan, Utah 84321 (US). **MIYASAKI, Bryan R.** [US/US]; 1530 N. 1000 W., Logan, Utah 84321 (US). **SPINNING, Vincent R.** [US/US]; 1530 N. 1000 W., Logan, Utah 84321 (US).
- (74) Agents: **KUNZLER, Brian, C.** et al.; 8 East Broadway, Suite 600, Salt Lake City, Utah 84111 (US).
- (81) Designated States (unless otherwise indicated, for every kind of national protection available): AE, AG, AL, AM, AO, AT, AU, AZ, BA, BB, BG, BH, BR, BW, BY, BZ, CA, CH, CL, CN, CO, CR, CU, CZ, DE, DK, DM, DO, DZ, EC, EE, EG, ES, FI, GB, GD, GE, GH, GM, GT, HN, HR, HU, ID, IL, IN, IS, JP, KE, KG, KM, KN, KP, KR, KZ, LA, LC, LK, LR, LS, LT, LU, LY, MA, MD, ME, MG, MK, MN, MW, MX, MY, MZ, NA, NG, NI, NO, NZ, OM, PE, PG, PH, PL, PT, QA, RO, RS, RU, RW, SC, SD, SE, SG, SK, SL, SM, ST, SV, SY, TH, TJ, TM, TN, TR, TT, TZ, UA, UG, US, UZ, VC, VN, ZA, ZM, ZW.

[Continued on next page]

(54) Title: FLEXIBLE TRANSLUCENT COLOR MATCHING APPARATUS

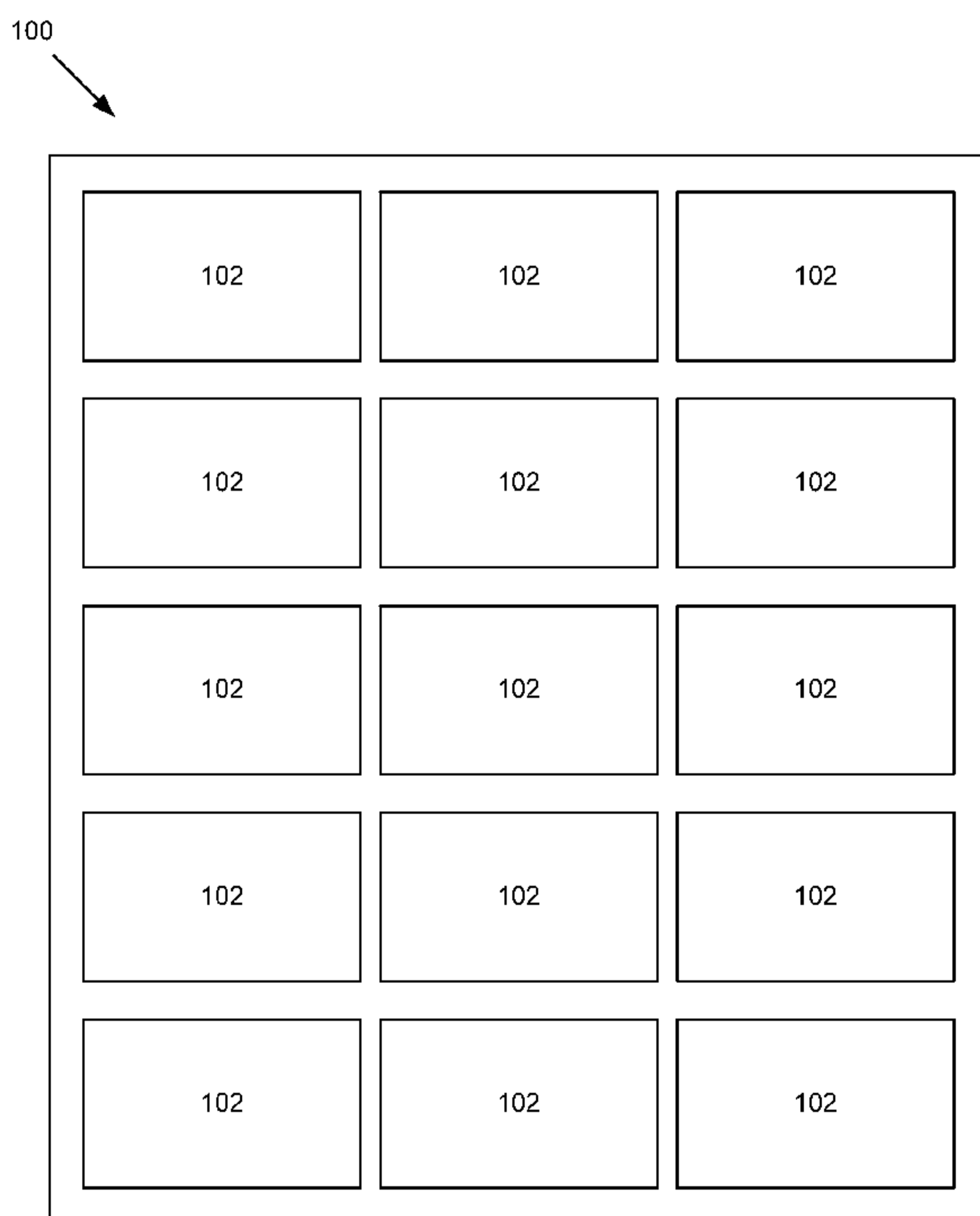

Figure 1

(57) Abstract: An apparatus, system, and method are disclosed for selecting a finish for applying to an item. The apparatus includes a flexible translucent sheet 100, and at least one semi-translucent color 102 applied to the translucent sheet 100 such that a surface to which the translucent sheet 100 is attached is visible through the translucent sheet 100 and the semi-translucent color 102. The system includes the apparatus and a protective laminate surface covering the at least one semi-translucent color 102. The method includes providing a plurality of translucent sheets 100 each having at least one semi-translucent color 102, examining an item 502 to determine the type of finish of the item 502, selecting a flexible translucent sheet 100 according to the finish of the item 502, conforming and affixing the selected translucent sheet 100 to the surface of the item 502, and viewing the surface of the item 502 through the selected translucent sheet 100.

 WO 2012/040379 A3

WO 2012/040379 A3

- (84) Designated States** (*unless otherwise indicated, for every kind of regional protection available*): ARIPO (BW, GH, GM, KE, LR, LS, MW, MZ, NA, SD, SL, SZ, TZ, UG, ZM, ZW), Eurasian (AM, AZ, BY, KG, KZ, MD, RU, TJ, TM), European (AL, AT, BE, BG, CH, CY, CZ, DE, DK, EE, ES, FI, FR, GB, GR, HR, HU, IE, IS, IT, LT, LU, LV, MC, MK, MT, NL, NO, PL, PT, RO, RS, SE, SI, SK, SM, TR), OAPI (BF, BJ, CF, CG, CI, CM, GA, GN, GQ, GW, ML, MR, NE, SN, TD, TG).
- Published:**
- *with international search report (Art. 21(3))*
 - *before the expiration of the time limit for amending the claims and to be republished in the event of receipt of amendments (Rule 48.2(h))*
- (88) Date of publication of the international search report:**
21 June 2012

FLEXIBLE TRANSLUCENT COLOR MATCHING APPARATUS

CROSS-REFERENCES TO RELATED APPLICATIONS

This application claims the benefit of, United States Provisional Patent Application Number 61/385,029 entitled “FLEXIBLE TRANSLUCENT COLOR MATCHING APPARATUS” and filed on September 21, 2010 for Benjamin N. Davis et al., which is incorporated herein by reference.

TECHNICAL FIELD

This disclosure relates to color matching devices and more particularly relates to translucent flexible sheets having color samples.

BACKGROUND

Wood products are used extensively in both commercial and residential buildings. Wood products are used to make furniture, decorations, and floor coverings. Wood can be finished using wood stains and varnishes or paints. Generally, wood finishing protects and embellishes the surface of the wood product, and is achieved by filling imperfections, sanding, and painting and/or staining. Due to the nature of wood, often times it is necessary to refinish the wood product by reapplying stain.

Unlike paint, getting a good stain match while refinishing, or selecting the right color of stain in the first place, is problematic with stains. Stain is transparent, for the most part, and therefore any variation in the wood can cause variation in the finish. The process, generally, includes selecting a base stain and then adding stain colorants to match the wood product by staining a test wood product, tweaking the color combination, and staining the test wood product again until a match is achieved.

Unfortunately, this process commonly takes place away from the location of the wood product, for example, at the paint store, or in a woodshop. Therefore, other considerations, like lighting, that factor into the stain matching process, may result in an undesirable stain match.

SUMMARY

From the foregoing discussion, it should be apparent that a need exists for an apparatus, system, and method for a flexible and translucent color matching apparatus. The present disclosure has been developed in response to the present state of the art, and in particular, in response to the problems and needs in the art that have not yet been fully solved by currently available color matching apparatuses. Accordingly, the present disclosure has been developed to provide an apparatus, system, and method that overcome many or all of the above-discussed shortcomings in the art.

An apparatus is provided that includes a flexible translucent sheet, and at least one semi-

translucent color pattern applied to the translucent sheet such that a surface to which the translucent sheet is attached is visible through the translucent sheet and the semi-translucent color pattern. The flexible translucent sheet may be formed of a static cling vinyl film having a thickness in the range of between about .04 and .12 mm. The color pattern further, in one
5 embodiment, is a pattern representative of wood grain and a color representative of wood.

The apparatus may also include a protective laminate surface covering the color pattern. The protective laminate surface may be formed of a coating of static cling vinyl film. The apparatus may also include multiple color patterns, where each of the color patterns represents a unique color/grain/finish combination. The color patterns may be arranged in a grid pattern on
10 the flexible translucent sheet, with boundaries separating adjacent color patterns. Alternatively, the color patterns may be arranged on the flexible translucent sheet so that the color patterns gradually blend from one color pattern to an adjacent color pattern without a distinctive boundary between adjacent color patterns. Furthermore, each color pattern may represent one of a gloss, semi-gloss, satin, or matte finish.

15 A system of the present disclosure is also presented and includes a flexible translucent sheet, at least one semi-translucent color pattern applied to the translucent sheet such that a surface to which the translucent sheet is attached is visible through the translucent sheet and the semi-translucent color, and a protective laminate surface covering the at least one semi-translucent color pattern.

20 A method of the present disclosure is also presented. The method in the disclosed embodiments substantially includes the steps necessary to carry out the functions presented above with respect to the operation of the described apparatus and system. In one embodiment, the method includes providing a plurality of translucent sheets each having at least one semi-translucent color pattern, examining an item to determine the type of finish of the item, selecting
25 a flexible translucent sheet according to the finish of the item, conforming and affixing the selected translucent sheet to the surface of the item, and viewing the surface of the item through the selected translucent sheet.

Reference throughout this specification to features, advantages, or similar language does not imply that all of the features and advantages that may be realized with the present disclosure
30 should be or are in any single embodiment of the disclosure. Rather, language referring to the features and advantages is understood to mean that a specific feature, advantage, or characteristic described in connection with an embodiment is included in at least one embodiment of the present disclosure. Thus, discussion of the features and advantages, and similar language, throughout this specification may, but do not necessarily, refer to the same embodiment.

Furthermore, the described features, advantages, and characteristics of the disclosure may be combined in any suitable manner in one or more embodiments. One skilled in the relevant art will recognize that the disclosure may be practiced without one or more of the specific features or advantages of a particular embodiment. In other instances, additional features and advantages
5 may be recognized in certain embodiments that may not be present in all embodiments of the disclosure.

These features and advantages of the present disclosure will become more fully apparent from the following description and appended claims, or may be learned by the practice of the disclosure as set forth hereinafter.

BRIEF DESCRIPTION OF THE DRAWINGS

In order that the advantages of the disclosure will be readily understood, a more particular description of the disclosure briefly described above will be rendered by reference to specific embodiments that are illustrated in the appended drawings. Understanding that these drawings depict only typical embodiments of the disclosure and are not therefore to be
15 considered to be limiting of its scope, the disclosure will be described and explained with additional specificity and detail through the use of the accompanying drawings, in which:

Figure 1 is a schematic block diagram illustrating one embodiment of a flexible translucent color matching apparatus;

Figure 2 is an illustration of color patterns having different translucent finishes;

20 Figure 3 is a block diagram illustrating another embodiment of a sheet;

Figure 4 is a perspective view diagram illustrating one embodiment of a sheet attached to an item;

Figure 5 is a perspective view diagram of a sheet conforming to a profile of an item; and

25 Figure 6 is a schematic flow chart diagram illustrating one embodiment of a method for presenting color patterns to customers.

Figure 7 is a schematic block diagram illustrating another embodiment of a sheet; and

Figure 8 is a schematic block diagram that illustrates a method of selecting a color, color intensity, sheen, and application style.

DETAILED DESCRIPTION

30 Reference throughout this specification to “one embodiment,” “an embodiment,” or similar language means that a particular feature, structure, or characteristic described in connection with the embodiment is included in at least one embodiment of the present disclosure. Thus, appearances of the phrases “in one embodiment,” “in an embodiment,” and similar language throughout this specification may, but do not necessarily, all refer to the same

embodiment.

Furthermore, the described features, structures, or characteristics of the disclosure may be combined in any suitable manner in one or more embodiments. In the following description, numerous specific details are provided to give a thorough understanding of embodiments of the disclosure. One skilled in the relevant art will recognize, however, that the disclosure may be practiced without one or more of the specific details, or with other methods, components, materials, and so forth. In other instances, well-known structures, materials, or operations are not shown or described in detail to avoid obscuring aspects of the disclosure.

Figure 1 is a schematic block diagram illustrating one embodiment of a flexible translucent color matching apparatus 100 (hereinafter “sheet”). The sheet 100 is formed of a translucent, or see-through, flexible and supple material. As used herein, the term “translucent” means substantially optically transparent. Furthermore, as used herein, the term “semi-translucent” means having an opacity between translucent and opaque.

One example of a flexible and supple material suitable for use in the present disclosure is a clear static cling vinyl film. Static cling vinyl is a special formulation of polyvinyl chloride (PVC) to which a large amount of plasticizer has been added. The large amount of plasticizer results in a pliable or supple vinyl film that adheres to smooth surfaces without the need for an adhesive. The static cling vinyl film is used because the static cling vinyl film is capable of temporarily affixing to smooth surfaces without the need for an adhesive, and the pliable and supple nature of the vinyl allows the sheet 100 to conform to the profile of the item to be color matched. Alternatively, a flexible and supple film having a positional or reusable adhesive may be used instead of a static cling vinyl film.

In one embodiment, the vinyl film has a thickness in the range of between about .04 and .12 mm. In a further embodiment, the vinyl film has a thickness of about .08 mm. The height and width of the sheet 100 is determined according to the item that will be color matched and the desired number of color patterns included on the sheet 100. For example, the sheet 100 may have the dimensions of common letter paper. Alternatively, the sheet 100 may be scaled up or down depending on the item.

The sheet 100 includes a plurality of color patterns 102. As used herein, the term “color pattern” refers to a representative portion or sample that is indicative of how a stain or paint would appear on an item such as a cabinet. The color pattern may depict a color and a wood grain, thereby illustrating a wood stained finish, or alternatively, the color pattern may depict a solid color.

In the depicted embodiment, the sheet 100 has 15 color patterns 102; alternatively, the

sheet 100 may include any number of color patterns 102. The color patterns 102, in one example, are printed on the sheet 100 using an inkjet printer. The color patterns 102 are semi-translucent so that a person may view the surface that is under the color pattern 102. Alternatively, other methods of applying the color patterns 102 to the sheet 100 include, but are not limited to, lithographic printing, screen printing, flexographic printing, and thermal transfer. In other words, any manner of color application that results in at least a semi-transparent color pattern is suitable for use with the present disclosure.

In a further embodiment, the sheet 100 may include a thin protective laminate film or layer to protect the color patterns 102. The thin protective laminate film or layer helps prevent damage to the color patterns from contact with items that might rub or scratch off the color 102. Additionally, the thin protective laminate film or layer functions to prevent fading of the color patterns 102, for example, fading caused by exposure to UV rays.

Figure 2 is an illustration of color patterns 102a, 102b, 102c having different translucent finishes. The color patterns 102a, 102b, 102c of Figure 2 are similar to the color patterns 102 described above with reference to Figure 1. In other words, although the sheet 100 is not depicted here in Figure 2, the color patterns 102a, 102b, 102c function in a similar manner as described above in that the semi-translucent quality of the color patterns 102a, 102b, 102c allows a user to visualize what an item might look like with a particular finish.

The color patterns 102a, 102b, 102c, in one embodiment, have different colors and wood grain patterns that are representative of different stains, paints, of finishes that a person might select. This allows a person to visualize what an item, such as a piece of furniture, would look like with a selected finish. Although the depicted embodiment illustrates semi-translucent finishes having a wood grain, the color patterns 102a, 102b, 102c might alternatively be provided without a wood grain. As such, a person is able to visualize what an item such as a wall, floor, or piece of furniture might look like without a wood grain finish.

Figure 3 is a block diagram illustrating another embodiment of a sheet 300. The sheet 300, similar to the sheet 100 of Figure 1, includes a set of color patterns 302a, 302b, 302c, 302d, 302e, 302f (referred to collectively as "color patterns 302"). The color patterns 302, in one example, are printed as rectangular-shaped color patterns and arranged in a grid pattern as illustrated. The grid pattern may be adjusted with differing numbers of rows and columns accordingly. Alternatively, the color patterns 302 may be printed as hexagon-shaped color patterns and arranged in a honey-comb configuration, for example. Any number of color patterns 302 may be organized on the sheet 100. In a further embodiment, the color patterns 302 are not distinct color patterns 302 as illustrated, rather the color patterns 302 gradually blend

from one sample to another. In this further embodiment, a person is able to select a combination of the gradually blended color patterns 302.

Figure 4 is a perspective view diagram illustrating one embodiment of a sheet 400 attached to an item 402. As described above, the sheet 400, similar to the sheet 100 of Figure 1, attaches to smooth surfaces such as the surface of the item 402. In the depicted embodiment, the item 402 is a piece of furniture, however the sheet 400 is also capable of attaching to other items besides furniture including, but not limited to, floors, walls, countertops, etc.

The sheet 400 clings to the surface of the item 402 and allows a person to visualize what the item would look like with a particular finish applied. The different finishes available are represented by the color patterns 404. The depicted embodiment illustrates four different color patterns, however, any number of color patterns 404 may be included on the sheet 400. In another embodiment, multiple sheets 400, each having a set of unique color patterns 404 may be attached to the item 402 to give a wide range of visualizations to the person.

Figure 5 is a perspective view diagram of a sheet 500 conforming to a profile of an item. In one embodiment, the sheet 500 is formed of a supple and pliable vinyl material as described above with reference to Figure 1. As such, the sheet 500 is capable of conforming to the profile of an object 502. In this embodiment, the object 502 is a piece of furniture similar to that of Figure 4. In other words, the pliable and supple features of the sheet 500 allow a person to “bend” the color pattern around an edge of the object 502, thereby giving the person a better idea or visualization of what the object will look like with a particular finish applied. This visualization is possible because of the translucent sheet 500 and semi-translucent color patterns 504. Stated differently, a person is able to visualize what the object 502 will look like because the person can see the surface of the object 502 through the sheet 500 and the color pattern 504.

The schematic flow chart diagrams included herein are generally set forth as logical flow chart diagrams. As such, the depicted order and labeled steps are indicative of one embodiment of the presented method. Other steps and methods may be conceived that are equivalent in function, logic, or effect to one or more steps, or portions thereof, of the illustrated method. Additionally, the format and symbols employed are provided to explain the logical steps of the method and are understood not to limit the scope of the method. Although various arrow types and line types may be employed in the flow chart diagrams, they are understood not to limit the scope of the corresponding method. Indeed, some arrows or other connectors may be used to indicate only the logical flow of the method. For instance, an arrow may indicate a waiting or monitoring period of unspecified duration between enumerated steps of the depicted method. Additionally, the order in which a particular method occurs may or may not strictly adhere to the

order of the corresponding steps shown.

Figure 6 is a schematic flow chart diagram illustrating one embodiment of a method 600 for presenting color patterns to customers. The method starts 602 and a color professional consults 604 with the customer or owner of the item. The item, as described above, may be a piece of furniture, floor, wall, countertop, etc. The color professional selects 606 at least one sheet to present to the customer according to the present state of finish of the item. For example, the item may be unfinished, or alternatively, the item may be an antique with a faded finish. The sheets can be provided with color patterns according to the item to which the finish will be applied. In other words, in one embodiment a sheet has color patterns for unfinished furniture and another sheet has color patterns for furniture having a cherry finish, or a maple finish, etc.

The color professional applies 608 or attaches the sheet to the item, conforming the sheet to the surface of the item as described above with reference to Figure 5. The color professional and or the customer then views 610 the item through the sheet and the color pattern 610. The customer or the color professional may then decide 612 if another layer of color pattern from another sheet is desirable.

One benefit of the present disclosure is the capability of simulating multiple coats of finish. If a customer desires a darker oak finish, for example, another sheet having oak finish color patterns can be applied over the top of the first sheet. Returning to the method 600, if the customer wants to apply another layer, the customer and or the color professional selects 614 another sheet, applies 616 the new sheet over the original or first sheet, and views 618 the item through the sheet and color pattern. Once the customer is satisfied and has selected a finish, or a combination of finishes represented by the color patterns, the method 600 ends 620.

Figure 7 is a schematic block diagram illustrating another embodiment of a sheet 700. In the depicted embodiment, the sheet 700 includes rows 702a, 702b, 702c, 702d, 702e (referred to collectively as rows 702) and columns 704a, 704b, 704c (referred to collectively as columns 704) of color patterns. The color patterns may be arranged so that each row contains a single color, and variations of that color. The variations include, but are not limited to, increasing color intensity, different sheen finishes, and different application techniques.

For example, the sheet 700 might include a row 702a depicting a stain finish called burnt sienna. The first column 704a of row 702a, in one embodiment, would comprise a color pattern depicting the application of one coat of burnt sienna wood stain. Column 704b, therefore, would be a variation of that color, and for example, might depict the application of four coats of burnt sienna wood stain. Likewise, column 704c might depict 8 applications of the wood stain. The numbers of coats given above are for example only, as other variations may be implemented.

In another embodiment, the variation shown on the sheet comprises color patterns that depict the color with a high-gloss, semi-gloss, satin, or matte finish. Alternatively, the sheet might depict different application techniques such as spraying on the finish, or hand pulling the finish. Furthermore, multiple sheets each showing the above described variations may be provided so that a person is able to visualize the many different options. This will be described below in greater detail with reference to Figure 8.

Figure 8 is a schematic block diagram that illustrates a method of selecting a color, color intensity, sheen, and application style. The method 800 starts 802 and a color sheet having various different colors is attached to an item so a person may select 804 a color. The color sheet may be the sheet 100 of Figure 1, sheet 700 of Figure 7, or alternatively, a sheet having a single color pattern. For example, the color sheet may only comprise a single enlarged color pattern that fills the entire sheet. In a further embodiment, the sheet may be formed of a colored plastic. In other words, instead of a translucent color sheet having color patterns printed on, the color sheet may be formed of a plastic material formulated to produce the desired color and opacity of the color patterns described above.

Upon selecting a color, a new sheet is provided that depicts the selected color with varying color intensities. A person is able to select 806 a color intensity by comparing the color intensities on the color intensity sheet. As described above, the color intensity, in one embodiment, is the number of coats of finish that can be applied to an item. For example, one, four, or eight coats of finish.

The person then selects 808 the sheen of the finish. A new sheen sheet is provided with the selected color and color intensity. In one example, the sheen sheet comprises four columns of color patterns. The first column depicts the selected color and color intensity having a matte finish, the second column shows a satin finish, the third column shows a semi-gloss finish, and the fourth column shows a high-gloss finish, for example. Alternatively, individual sheets with the different sheens are provided.

The person then selects 810 the application method. An application method sheet is provided with different application techniques illustrated to give the person an idea of what the selected color, color intensity, and sheen will look like when applied by hand or by sprayer, for example. Similarly, the application method sheet may include different samples depicting the available options, or individual sheets may be provided. The method 800 then ends 812.

The present disclosure may be embodied in other specific forms without departing from its spirit or essential characteristics. The described embodiments are to be considered in all respects only as illustrative and not restrictive. The scope of the disclosure is, therefore,

indicated by the appended claims rather than by the foregoing description. All changes which come within the meaning and range of equivalency of the claims are to be embraced within their scope.

CLAIMS

1. An apparatus to select a finish, the apparatus comprising:
a flexible translucent sheet; and
at least one semi-translucent color pattern applied to the translucent sheet such that a
5 surface to which the translucent sheet is attached is visible through the translucent
sheet and the semi-translucent color pattern.
2. The apparatus of claim 1, wherein the flexible translucent sheet is formed of a static cling
vinyl film.
3. The apparatus of claim 1, wherein the flexible translucent sheet has a thickness in the
10 range of between about .04 and .12 mm.
4. The apparatus of claim 1, wherein the color pattern further comprises a pattern
representative of wood grain and a color representative of wood.
5. The apparatus of claim 1, further comprising a protective laminate surface covering the at
least one color pattern.
- 15 6. The apparatus of claim 5, wherein the protective laminate surface comprises a coating of
static cling vinyl film.
7. The apparatus of claim 1, further comprising a plurality of color patterns, each of the
plurality of color patterns representative of a unique color/grain/finish combination.
8. The apparatus of claim 7, wherein the plurality of color patterns are arranged in a grid
20 pattern on the flexible translucent sheet, with boundaries separating adjacent color patterns.
9. The apparatus of claim 7, wherein the plurality of color patterns are arranged on the
flexible translucent sheet, and individual color patterns of the plurality of color patterns gradually
blend from one color pattern to an adjacent color pattern without a distinctive boundary between
adjacent color patterns.
- 25 10. The apparatus of claim 1, wherein the color pattern comprise a finish representative of
one of a gloss, semi-gloss, satin, or matte finish.
11. A system to select a finish, the apparatus comprising:
a flexible translucent sheet;
at least one semi-translucent color pattern applied to the translucent sheet such that a
30 surface to which the translucent sheet is attached is visible through the translucent

sheet and the semi-translucent color; and
a protective laminate surface covering the at least one semi-translucent color pattern.

12. The system of claim 11, wherein the flexible translucent sheet is formed of a static cling vinyl film.

5 13. The system of claim 11, wherein the flexible translucent sheet has a thickness in the range of between about .04 and .12 mm.

14. The system of claim 11, wherein the color pattern further comprises a pattern representative of wood grain and a color representative of wood.

10 15. The system of claim 11, further comprising a plurality of color patterns, each of the plurality of color patterns representative of a unique color/grain/finish combination.

16. The system of claim 15, wherein the plurality of color patterns are arranged in a grid pattern on the flexible translucent sheet, with visual boundaries separating adjacent color patterns.

15 17. The system of claim 15, wherein the plurality of color patterns are arranged on the flexible translucent sheet, and individual color patterns of the plurality of color patterns gradually blend from one color pattern to an adjacent color pattern without a distinctive boundary between adjacent color patterns.

18. The system of claim 11, wherein the color pattern comprise a finish representative of one of a gloss, semi-gloss, satin, or matte finish.

20 19. A method to select a finish, the method comprising:
providing a plurality of translucent sheets each having at least one semi-translucent color pattern;
examining an item to determine the type of finish of the item;
selecting a flexible translucent sheet according to the finish of the item;
25 conforming and affixing the selected translucent sheet to the surface of the item; and
viewing the surface of the item through the selected translucent sheet.

20. The method of claim 19, further comprising providing a plurality of color patterns, each of the plurality of color patterns representative of a unique color/grain/finish combination

100
↙

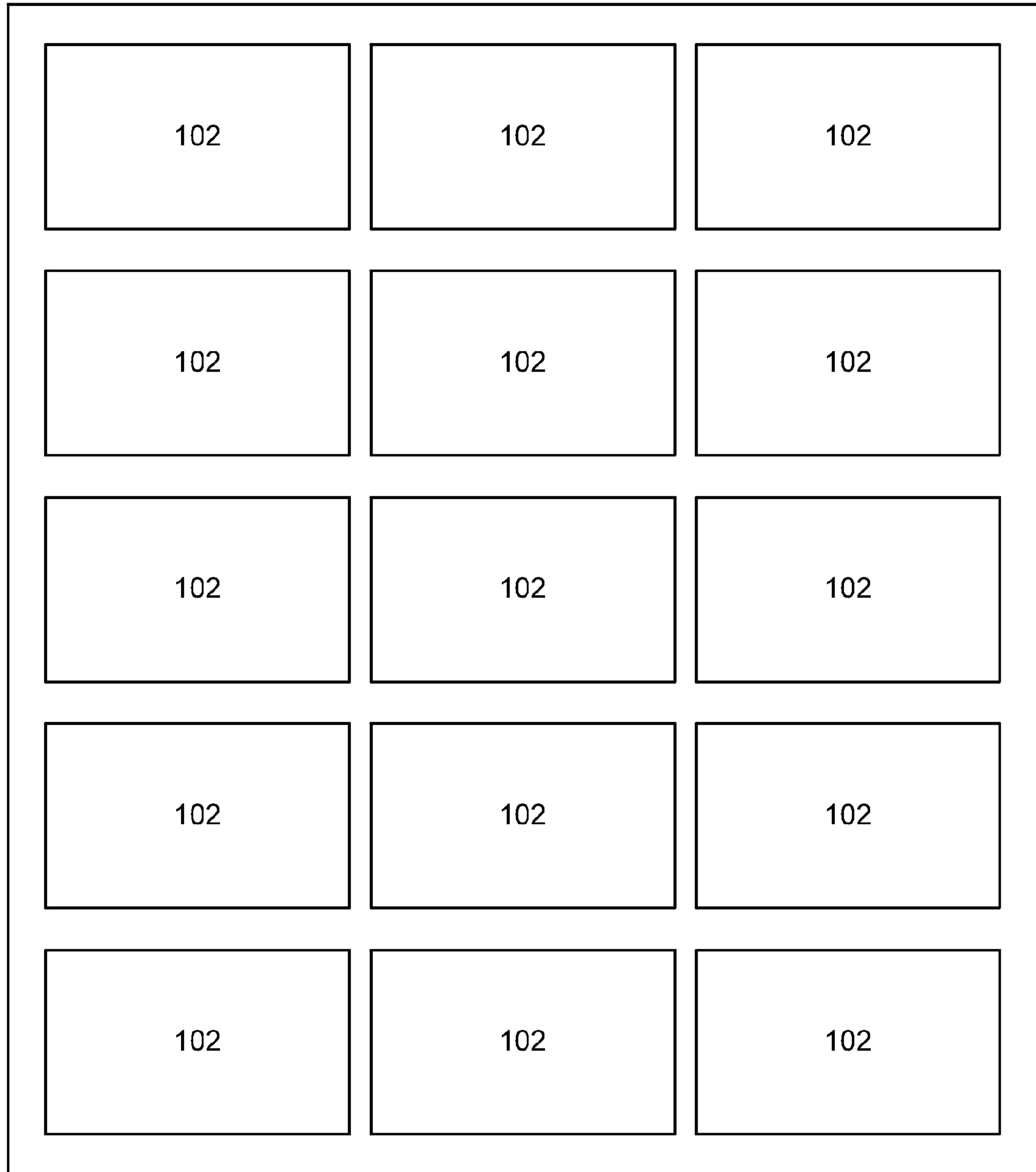

Figure 1

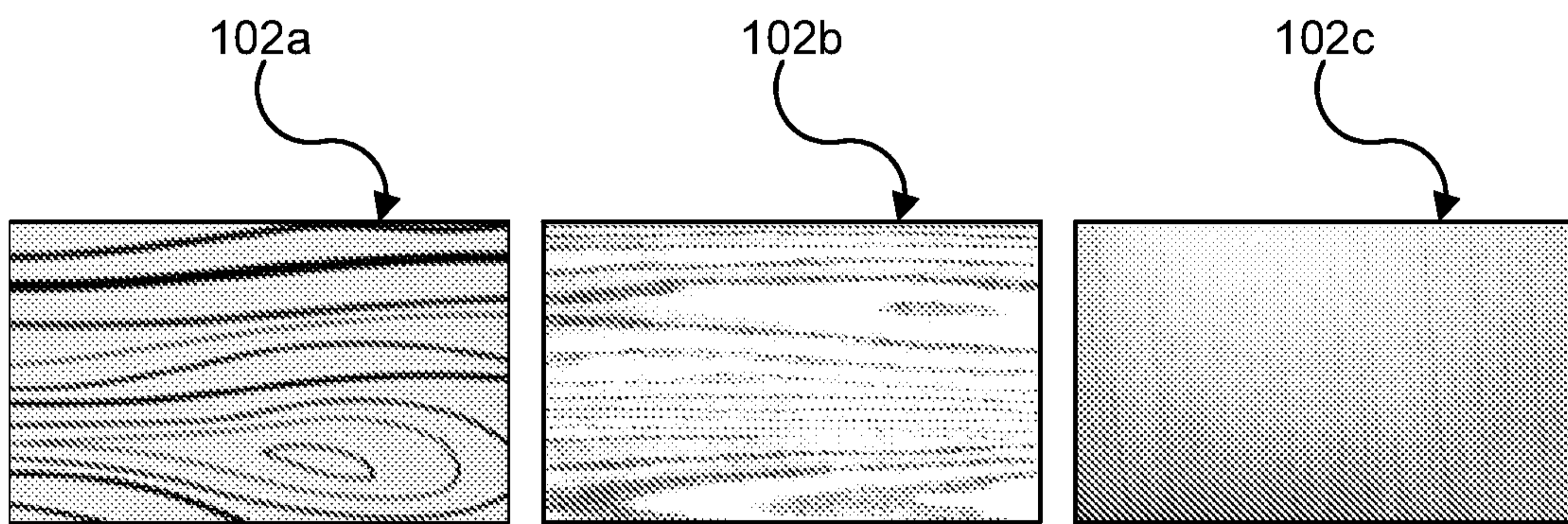

Figure 2

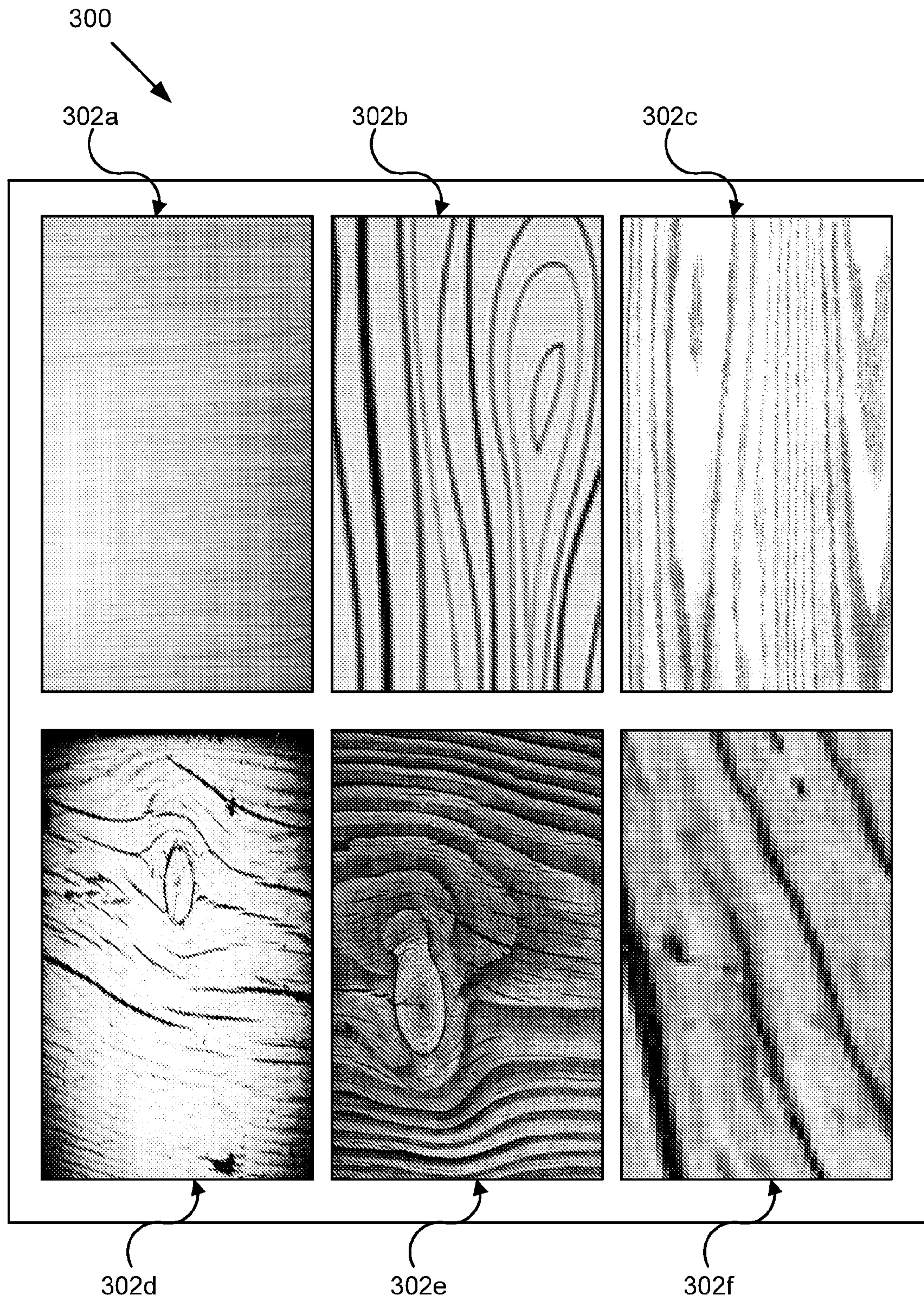

Figure 3

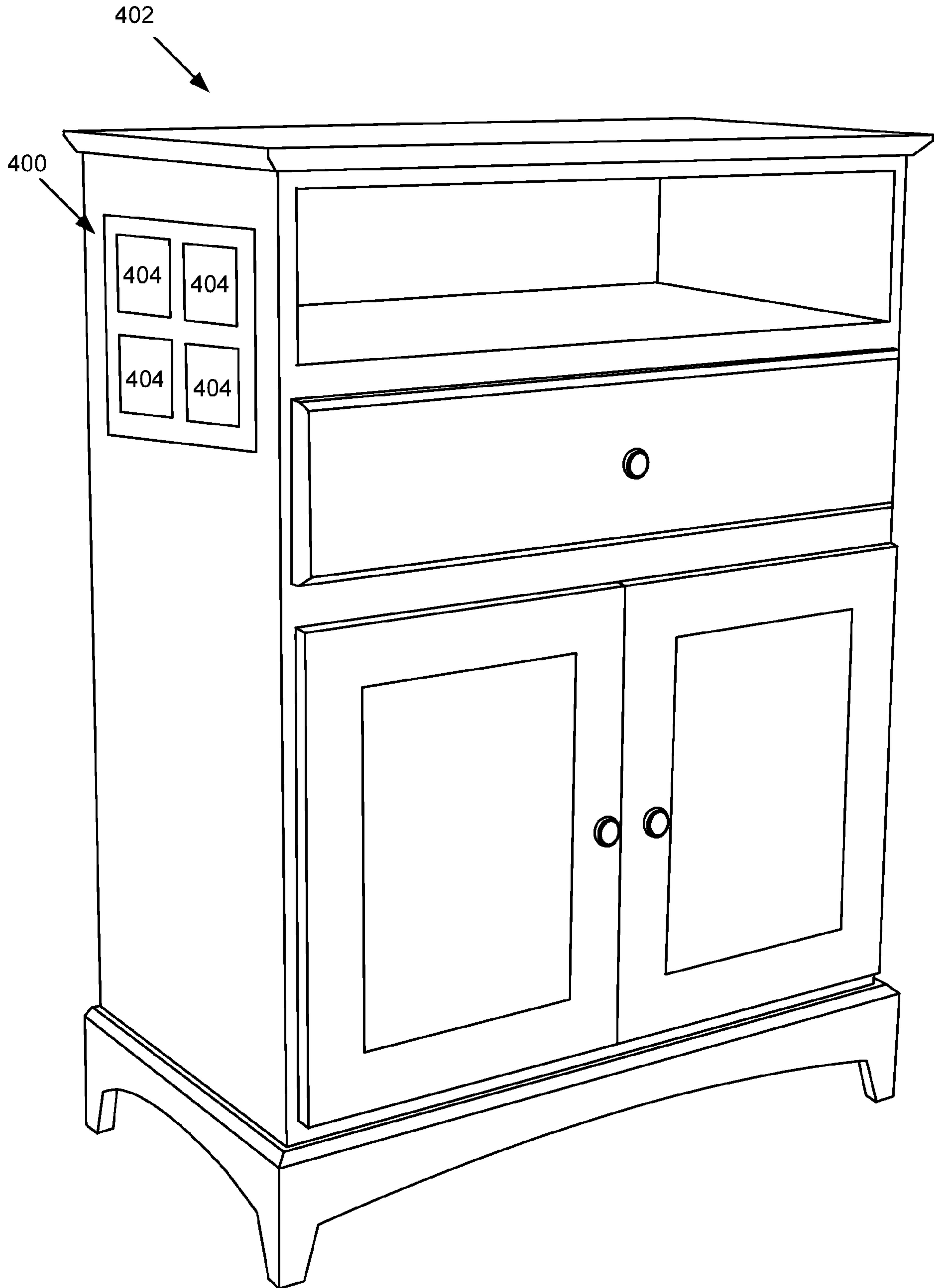

Figure 4

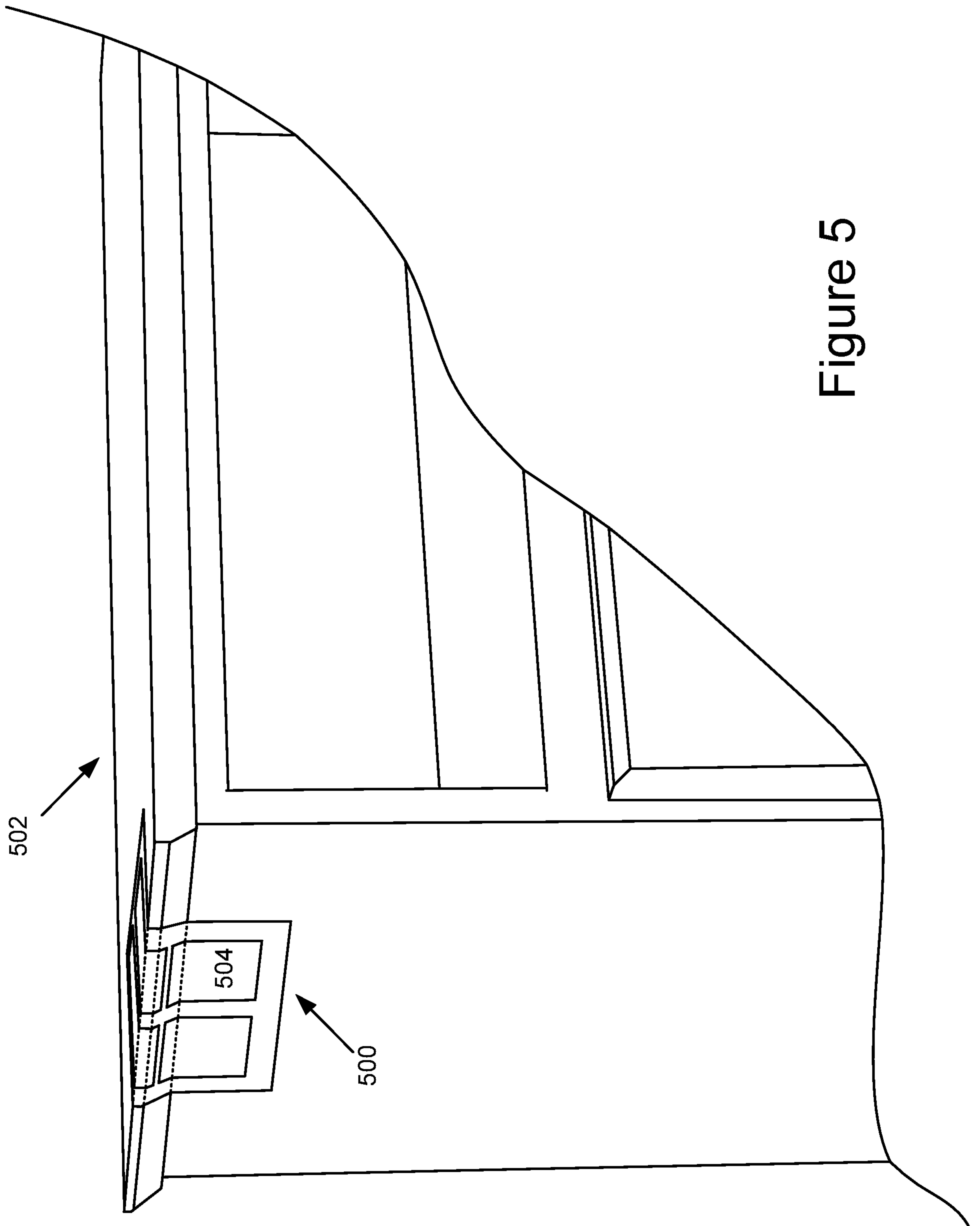

Figure 5

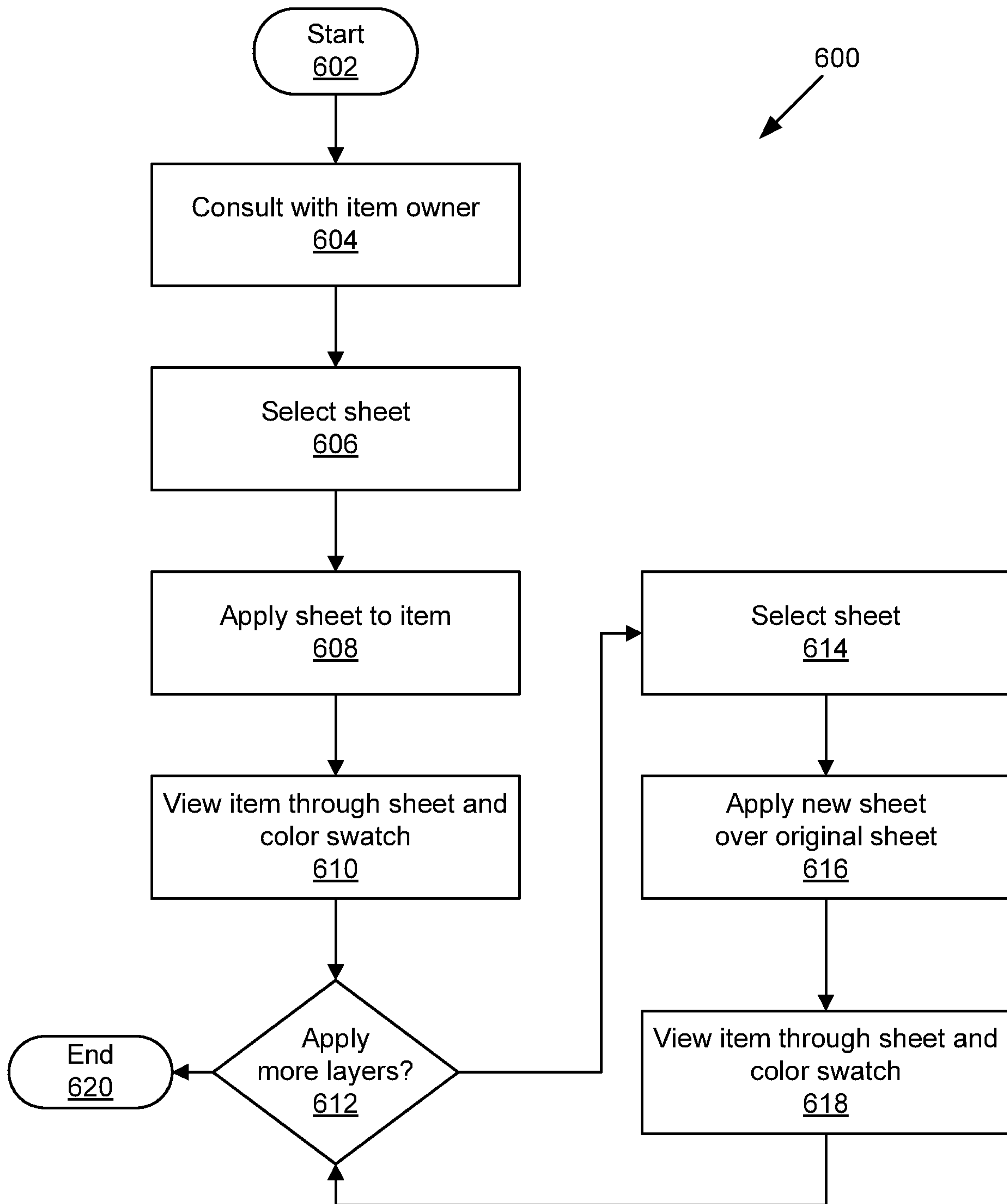

Figure 6

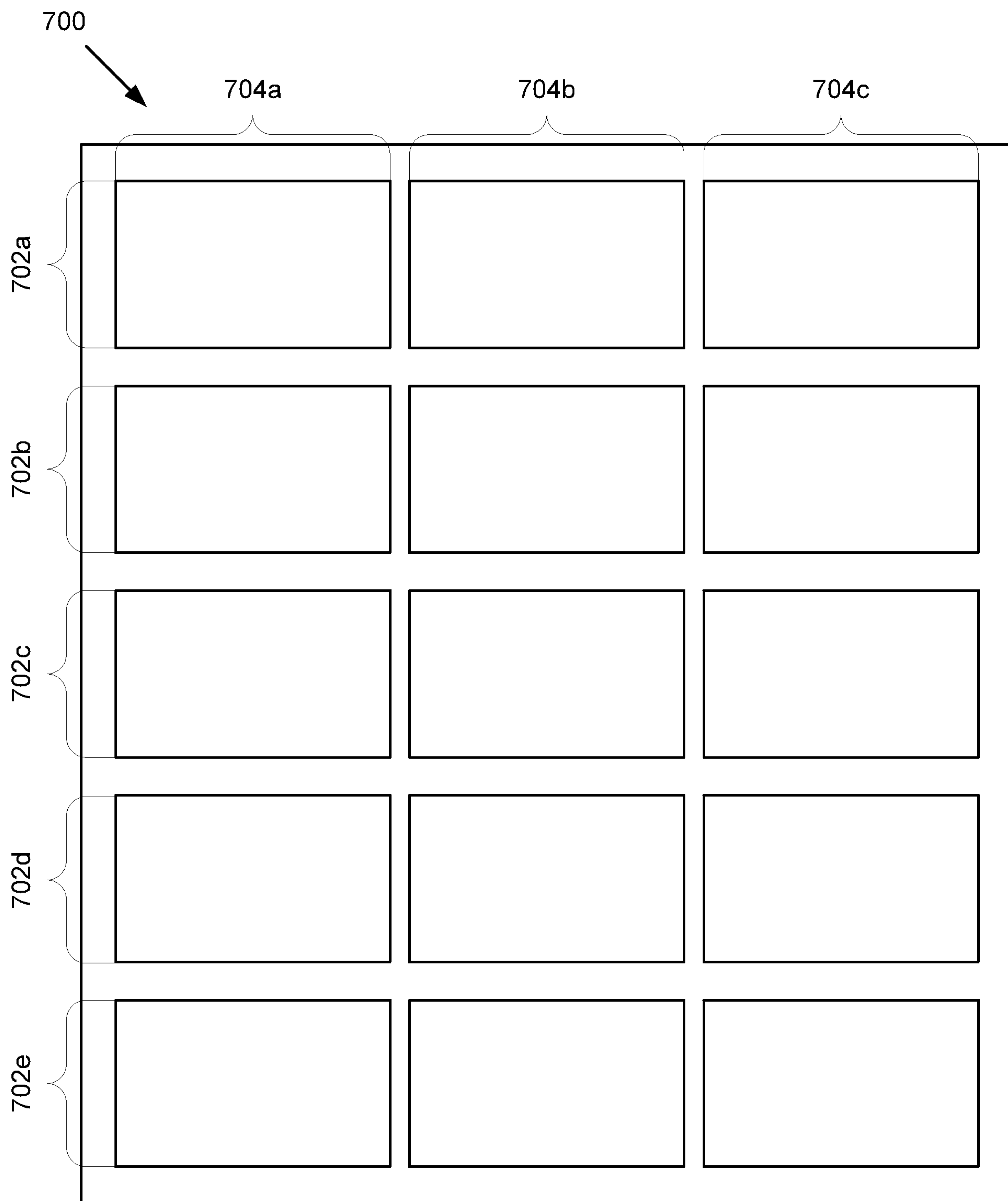

Figure 7

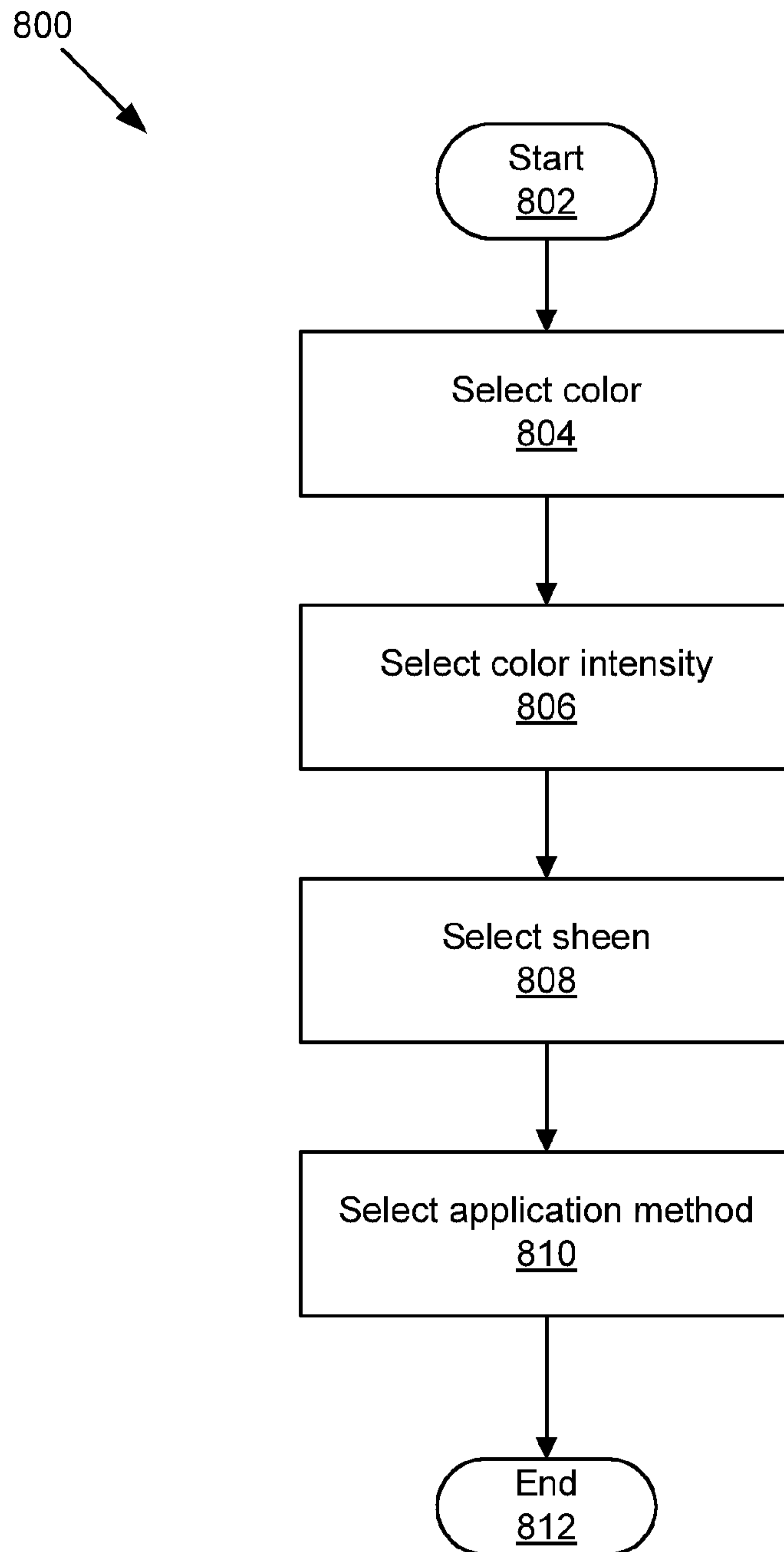

Figure 8

100

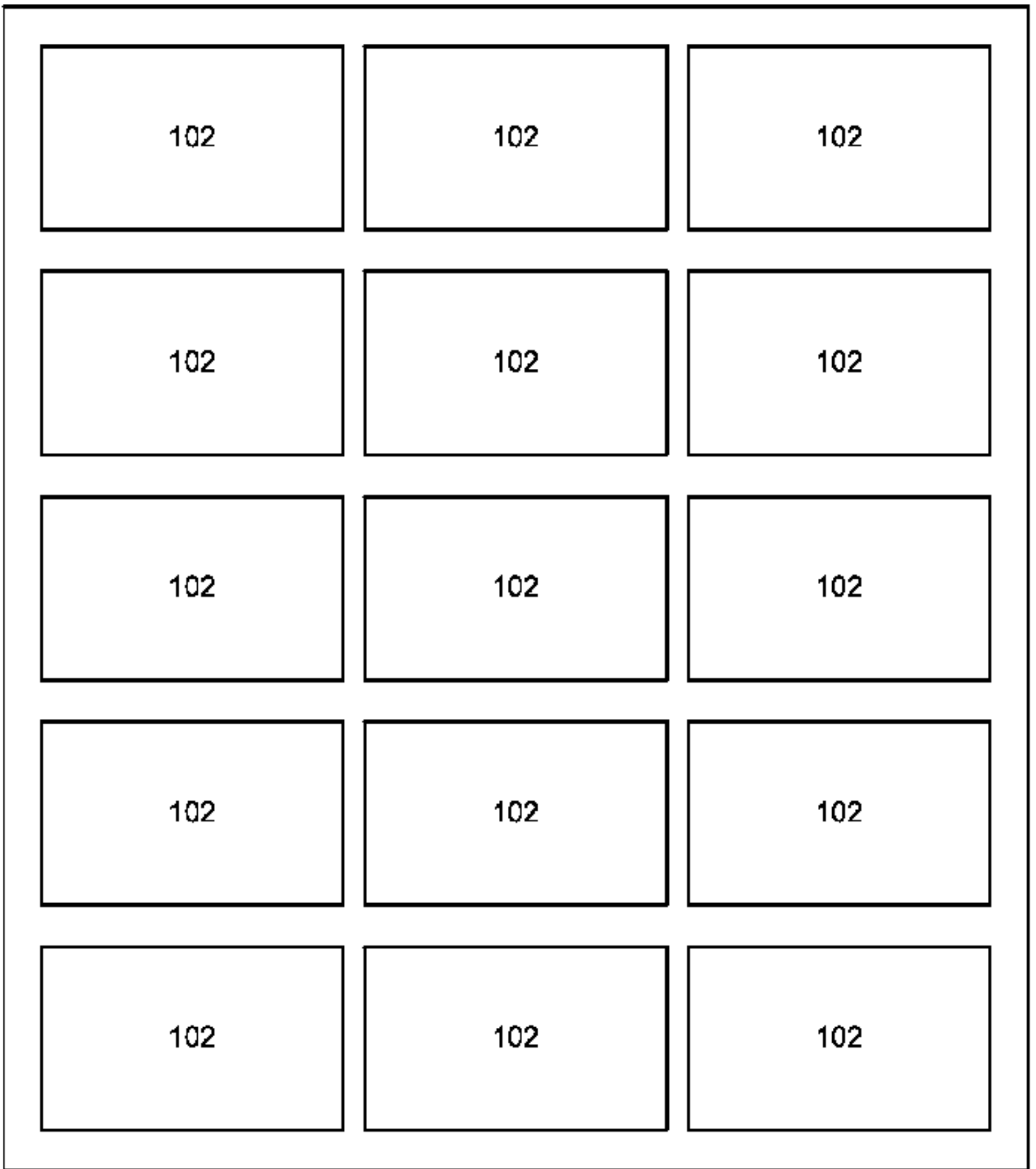

Figure 1