



US00D677743S

(12) **United States Design Patent**  
**Koshiishi**

(10) **Patent No.:** **US D677,743 S**

(45) **Date of Patent:** **\*\* Mar. 12, 2013**

(54) **ROBOT**

(75) Inventor: **Takeshi Koshiishi**, Saitama (JP)

(73) Assignee: **Honda Motor Co., Ltd**, Tokyo (JP)

(\*\*) Term: **14 Years**

(21) Appl. No.: **29/416,676**

(22) Filed: **Mar. 26, 2012**

(30) **Foreign Application Priority Data**

Sep. 28, 2011 (JP) ..... 2011-022187

(51) **LOC (9) Cl.** ..... **21-01**

(52) **U.S. Cl.** ..... **D21/578; D15/199**

(58) **Field of Classification Search** ..... D21/578-583,  
D21/621, 622; 446/268-274, 279, 280, 285,  
446/289-292, 294, 297-303, 353-355, 376-384;  
D15/199; 318/568.11, 568.12, 568.2

See application file for complete search history.

(56) **References Cited**

**U.S. PATENT DOCUMENTS**

D410,476 S \* 6/1999 Gomi et al. .... D15/199  
D453,199 S \* 1/2002 Sawai et al. .... D21/578  
D458,319 S \* 6/2002 Koshiishi et al. .... D21/578  
D460,131 S \* 7/2002 Koshiishi ..... D21/578  
D460,503 S \* 7/2002 Koshiishi et al. .... D21/578

D541,353 S \* 4/2007 Takahashi ..... D21/578  
D628,609 S \* 12/2010 Linn et al. .... D15/199  
D658,501 S \* 5/2012 Modaberi ..... D9/620

**OTHER PUBLICATIONS**

Notification of Refusal Reasons dated Mar. 23, 2012, issued in corresponding Japanese Patent Application No. 2011-022187.

\* cited by examiner

*Primary Examiner* — Zenia Bennett  
*(74) Attorney, Agent, or Firm* — Westerman, Hattori, Daniels & Adrian, LLP

(57) **CLAIM**

The ornamental design for, a robot, as shown and described.

**DESCRIPTION**

FIG. 1 is a first perspective view of a robot showing new design;

FIG. 2 is a second perspective view thereof;

FIG. 3 is a front elevational view thereof;

FIG. 4 is rear elevational view thereof;

FIG. 5 is a right side elevational view thereof;

FIG. 6 is a left side elevational view thereof;

FIG. 7 is a top plan view thereof; and,

FIG. 8 is a bottom plan view thereof.

The broken lines are for environmental purposes only and form no part of the claimed design.

**1 Claim, 7 Drawing Sheets**

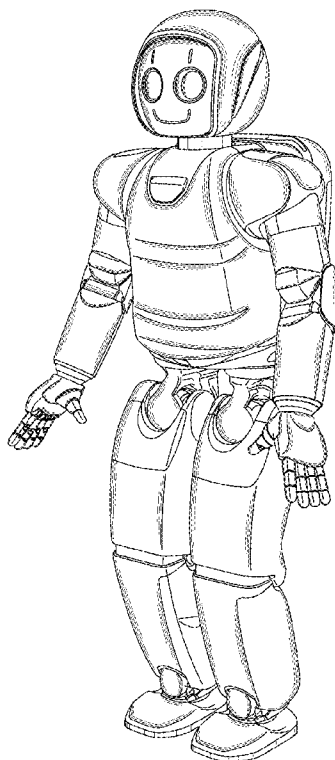

Fig. 1

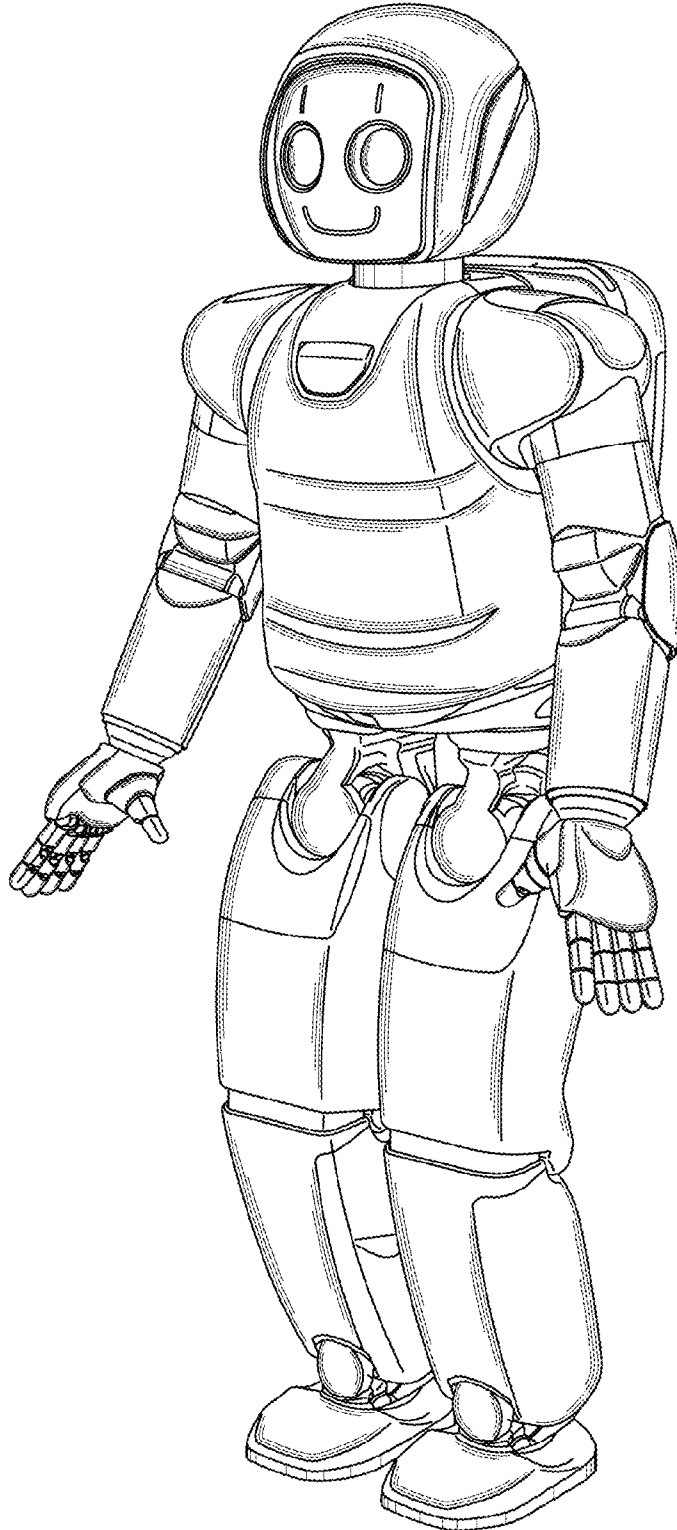

Fig. 2

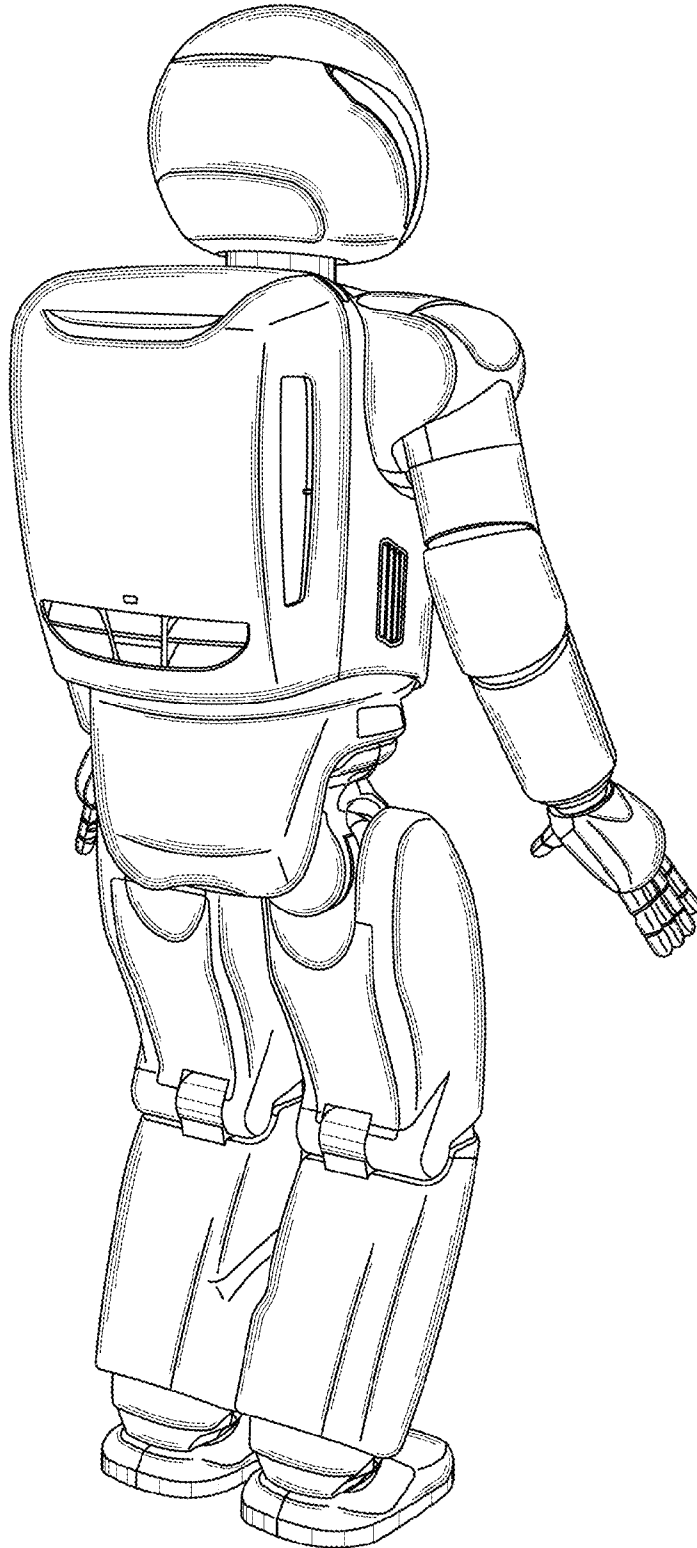
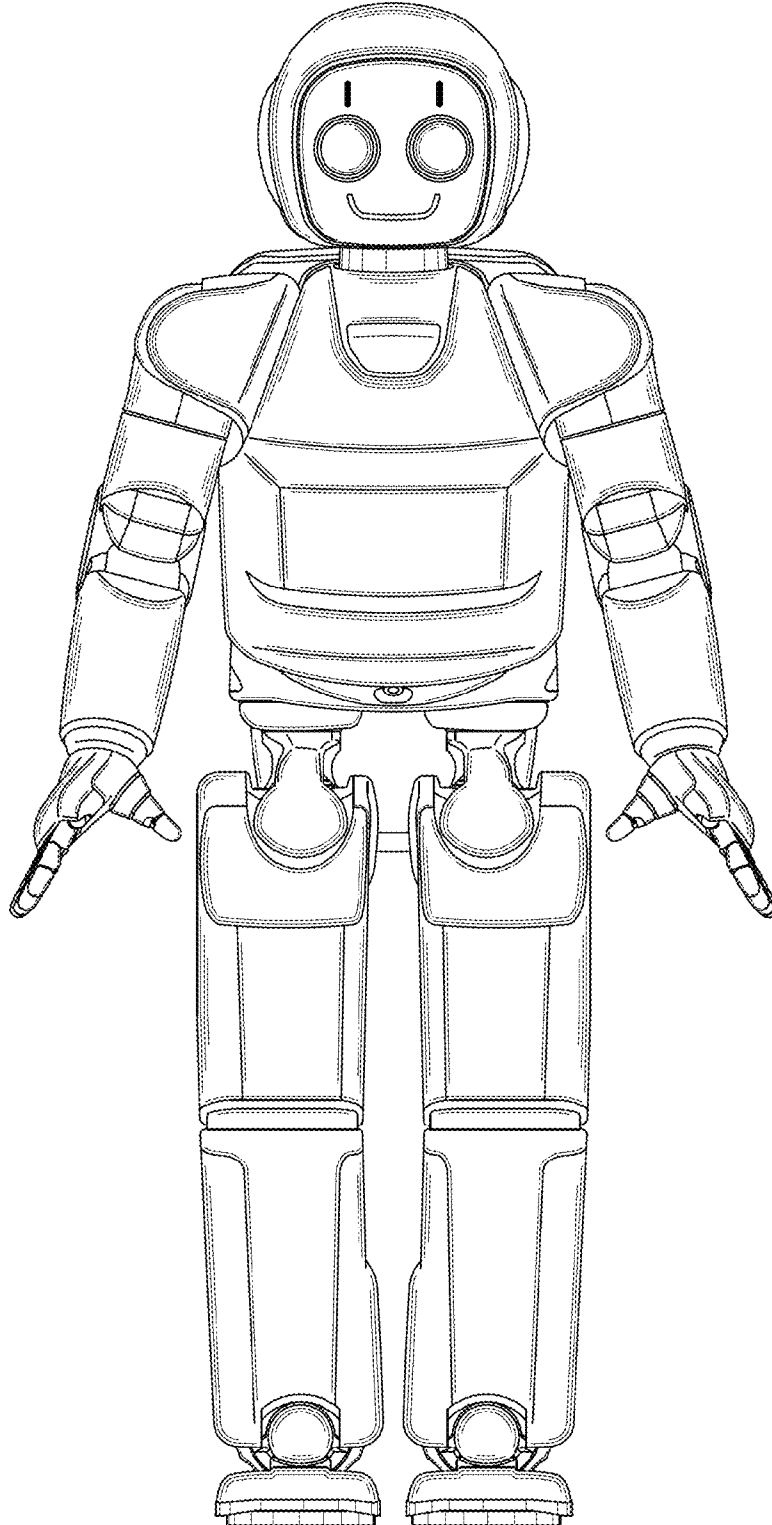

Fig. 3



*Fig. 4*

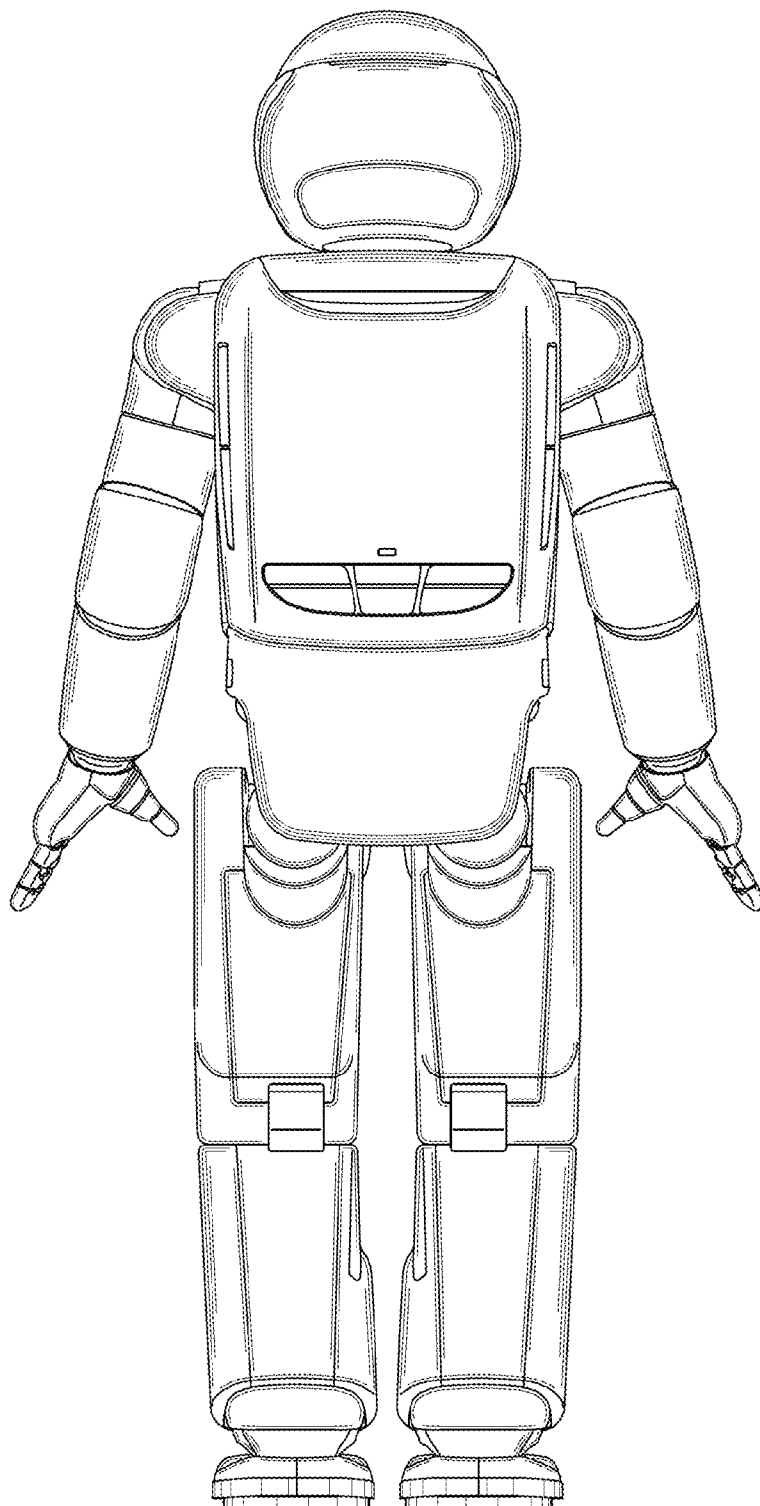
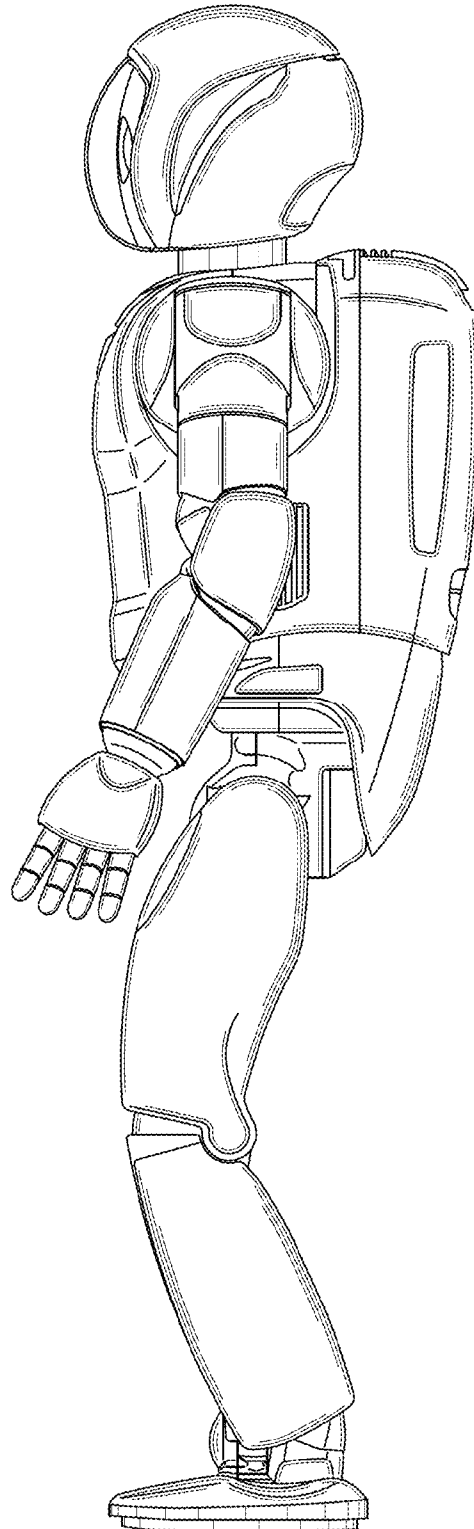

Fig.5



*Fig. 6*

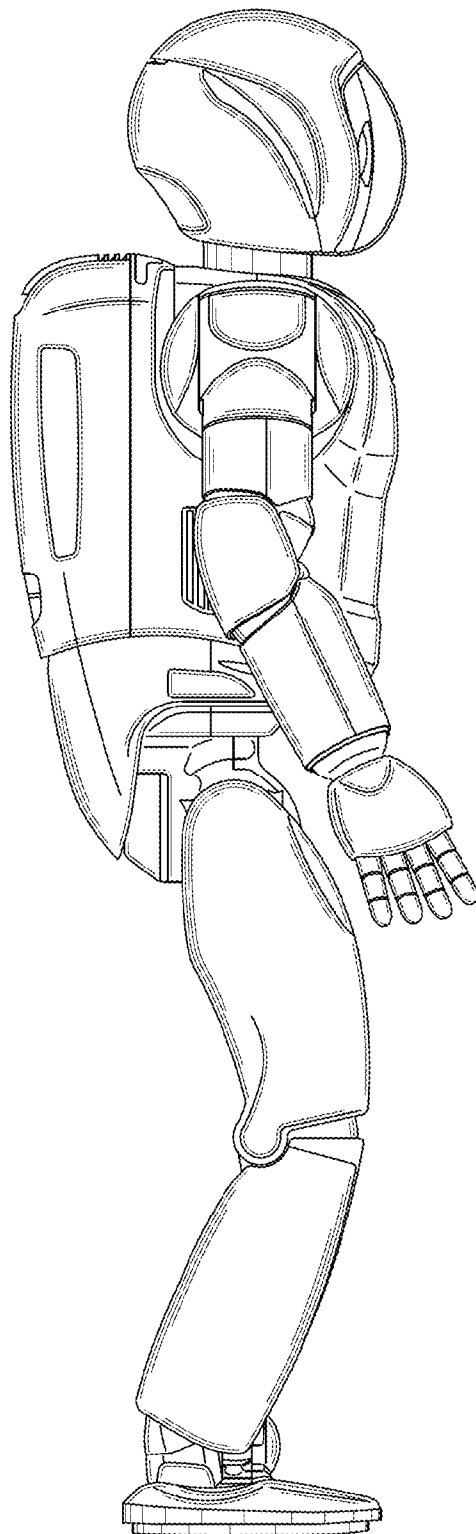

Fig.7

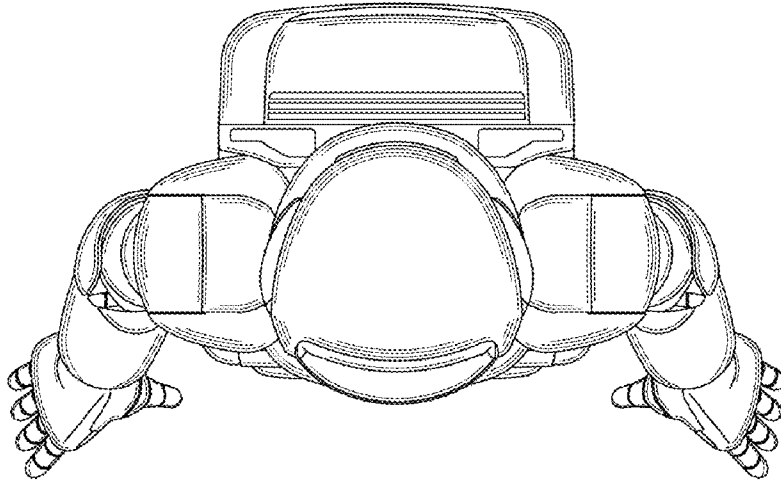

Fig.8

