

1

1 I M T - 2000 S A W ,
 2 1 I M T - 2000 S A W 4 -
 ,
 3 1 I M T - 2000 S A W 1, 2, 3, 4
 ,
 4 1 I M T - 2000 S A W 1, 2, 3, 4
 ,
 5 1 I M T - 2000 S A W 4 -
 .

<

100 : 4 - 201 : 1
 202 : 2 203 : 3
 204 : 4 301 : 1 S A W
 302 : 2 S A W 303 : 3 S A W
 304 : 4 S A W 401 : 1
 402 : 2 403 : 3
 404 : 4 500 : 4 -

I M T (International Mobile Telecommunication; 'IMT' .) - 2000 (System) S A
 W(Surface Acoustic Wave; 'SAW' .) (Filter) , , IMT - 2000
 I M T - 2000 (Broad Band) I M T - 2000
 S A W .

, IMT - 2000

(Internet Service)

(File)

, IMT - 2000

가 5MHz

IMT - 2000 /
IMT - 2000

SAW 가
IMT - 200

0

1.25MHz

SAW

IMT - 2000
I M T - 2000

SAW
S A W

IMT - 2000 /
CDMA

2000

I M T - 2000

S A W

, F₀

IMT -

4 -

4 -

4 -

IMT - 2000

2, 3, 4

1, 2, 3, 4 ;

IMT - 2000

1, 2, 3, 4

1,

IMT - 2000

IMT - 2000

1, 2, 3, 4

SAW

;

1, 2, 3,

4

SAW

1, 2, 3, 4

SAW

1, 2, 3, 4 ;

1, 2, 3, 4

F_C

IMT -

2000

4 -

I M T - 2000

S A W

1

I M T - 2000

S A W

I M T - 2000

S A W

4 - (Way)

(100),

1 (Mixer)

(201),

2 (2

02),

3 (203),

4 (204),

1 SAW

(301),

2 SAW

(302),

3 S

AW

(303),

4 SAW

(304),

(404)

4 -

(500)

1

(401),

2

(402),

3

(403),

4

.

4 -

(100) F₀

'5MHz' IMT - 2000

1, 2, 3, 4

(201, 202, 203, 204)

1 (201)

4 -

(100)

4 -

(100)

F₀

5MHz IMT - 2000

5MHz IMT - 2000

(Local Frequency)(F_C - (F₀ - 1.875MHz))

5MHz IMT - 2000

F_C - (F₀ - 1.875MHz)

1

SAW (

301)

(F_C - (F₀ - 1.875MHz)) F_C

1

SAW (3

01)

, 2 (202) 4 - (100) (100) 5MHz IMT - 2000
 , 4 - (100) F_O (5MHz IMT - 2000)
 5MHz IMT - 2000 $(F_C - (F_O - 0.625\text{MHz}))$, 5MHz IMT - 2000
 $F_C - (F_O - 0.625\text{MHz})$ 2 SAW (302)
 , $(F_C - (F_O - 0.625\text{MHz}))$ F_C 2 SAW (302)

, 3 (203) 4 - (100) (100) 5MHz IMT - 2000
 , 4 - (100) F_O (5MHz IMT - 2000)
 5MHz IMT - 2000 $(F_C - (F_O + 0.625\text{MHz}))$, 5MHz IMT - 2000
 $F_C - (F_O + 0.625\text{MHz})$ 3 SAW (303)
 , $(F_C - (F_O + 0.625\text{MHz}))$ F_C 3 SAW (303)

0 , 4 (204) 4 - (100) (100) 5MHz IMT - 2000
 , 4 - (100) F_O (5MHz IMT - 2000)
 5MHz IMT - 2000 $(F_C - (F_O + 1.875\text{MHz}))$, 5MHz IMT - 2000
 $F_C - (F_O + 1.875\text{MHz})$ 4 SAW (304)
 , $(F_C - (F_O + 1.875\text{MHz}))$ F_C 4 SAW (304)

, 1 SAW (301) 1 (201) F_C
 , 1 (201) ' $F_C - (F_O - 1.875\text{MHz})$ ' '5MHz' IMT - 2000
 , ' $F_C - (F_O - 1.875\text{MHz})$ ' '1.25MHz'
 1 (401)

, 2 SAW (302) 2 (202) F_C
 , 2 (202) ' $F_C - (F_O - 0.625\text{MHz})$ ' '5MHz' IMT - 2000
 , ' $F_C - (F_O - 0.625\text{MHz})$ ' '1.25MHz'
 2 (402)

, 3 SAW (303) 3 (203) F_C
 , 3 (203) ' $F_C - (F_O + 0.625\text{MHz})$ ' '5MHz' IMT - 2000
 , ' $F_C - (F_O + 0.625\text{MHz})$ ' '1.25MHz'
 3 (403)

, 4 SAW (304) 4 (204) F_C
 , 4 (204) ' $F_C - (F_O + 1.875\text{MHz})$ ' '5MHz' IMT - 2000
 , ' $F_C - (F_O + 1.875\text{MHz})$ ' '1.25MHz'
 4 (404)

W (301) 1 (401) 1 SAW (301) , 1 SA
 ' $F_C - (F_O - 1.875\text{MHz})$ ' '1.25MHz',
 4 - (500)

W (302) 2 (402) 2 SAW (302) , 2 SA
 ' $F_C - (F_O - 0.625\text{MHz})$ ' '1.25MHz',
 4 - (500)

W	3	(403)	3	SAW	(303)		3	SA
	(303)					' $F_C - (F_O + 0.625\text{MHz})$ '		
	4 -					(500)		
							'1.25MHz'	
W	4	(404)	4	SAW	(304)		4	SA
	(304)					' $F_C - (F_O + 1.875\text{MHz})$ '		
	4 -					(500)		
							'1.25MHz'	
	4 -					(500)		
	1, 2, 3, 4	(401, 402, 403, 404)		1, 2, 3, 4	(401, 402, 403, 404)			
						F_C		
							'5MHz' IMT - 2000	
		가	IMT - 2000	SAW			2, 3, 4, 5	
	4 -		(100)	2		F_O		'5MHz' IMT - 2000
							1, 2, 3, 4	(201, 202, 203, 204)
000	1	(201)	4 -	(100)	F_O			'5MHz' IMT - 2
								($F_C - (F_O - 1.875\text{MHz})$)
SAW	(301)			1	(201)	' $F_C - (F_O - 1.875\text{MHz})$ '		1
							3 (a)	'5MHz'
	1	SAW	(301)	1	(201)	' $F_C - (F_O - 1.875\text{MHz})$ '		
	'5MHz' IMT - 2000							' $F_C - (F_O - 1.875\text{MHz})$ '
	'1.25MHz'							
							1	(401)
	1	(401)	1	SAW	(301)	' $F_C - (F_O - 1.875\text{MHz})$ '		
	'1.25MHz'						4 -	(500)
	1	(401)	4	(a)				'1.25MHz'
00	2	(202)	4 -	(100)	F_O			'5MHz' IMT - 20
								($F_C - (F_O - 0.625\text{MHz})$)
AW	(302)			2	(202)	' $F_C - (F_O - 0.625\text{MHz})$ '		2 S
							3 (b)	'5MHz'
	2	SAW	(302)	2	(202)	' $F_C - (F_O - 0.625\text{MHz})$ '		
	'5MHz' IMT - 2000							' $F_C - (F_O - 0.625\text{MHz})$ '
	'1.25MHz'							
							2	(402)
	2	(402)	2	SAW	(302)	' $F_C - (F_O - 0.625\text{MHz})$ '		
	'1.25MHz'						4 -	(500)
	2	(402)	4	(b)				'1.25MHz'

00 , 3 (203) 4 - (100) F_0 '5MHz' IMT - 20
 '5MHz' IMT - 2000 ($F_C - (F_0 + 0.625\text{MHz})$)
 AW (303) , 3 (203) ' $F_C - (F_0 + 0.625\text{MHz})$ ' 3 S
 '5MHz'

, 3 SAW (303) 3 (203) ' $F_C - (F_0 + 0.625\text{MHz})$ '
 '5MHz' IMT - 2000 , ' $F_C - (F_0 + 0.625\text{MHz})$ '
 '1.25MHz' 3 (403)

, 3 (403) 3 SAW (303) ' $F_C - (F_0 + 0.625\text{MHz})$ '
 '1.25MHz' , 4 - (500)
 3 (403) 4 (c) '1.25MHz'

00 , 4 (204) 4 - (100) F_0 '5MHz' IMT - 20
 '5MHz' IMT - 2000 ($F_C - (F_0 + 1.875\text{MHz})$)
 AW (304) , 4 (204) ' $F_C - (F_0 + 1.875\text{MHz})$ ' 4 S
 '5MHz'

, 4 SAW (304) 4 (204) ' $F_C - (F_0 + 1.875\text{MHz})$ '
 '5MHz' IMT - 2000 , ' $F_C - (F_0 + 1.875\text{MHz})$ '
 '1.25MHz' 4 (404)

, 4 (404) 4 SAW (304) ' $F_C - (F_0 + 1.875\text{MHz})$ '
 '1.25MHz' , 4 - (500)
 4 (404) 4 (d) '1.25MHz'

, 4 - (500) 1, 2, 3, 4 (401, 402, 403, 404)
 '5MHz' IMT - 2000 , 5 F_C

, IMT - 2000 IMT - 2000 SAW , F_0 '5MHz' IMT - 2000 '5
 F_C

CDMA 1.25MHz IMT - 2000 SAW , SAW ,
 IMT - 2000 IMT - 2000 / 가 SAW

(57)

1.

F_0 ; 4 - IMT - 2000 , 4 - F_0
 ; 4 - IMT - 2000 , IMT - 2000
 , 1, 2, 3, 4 ; 1, 2, 3, 4
 , 1, 2, 3, 4 IMT - 2000 IMT
 - 2000 , 1, 2, 3, 4
 SAW ; 1, 2, 3, 4 SAW , 1, 2, 3, 4
 SAW , 1, 2, 3, 4 ;
 1, 2, 3, 4
 F_C IMT - 2000 4 -
 I M T - 2000 S A W .
 2.
 1 ,
 1 ' $F_C - (F_0 - 1.875\text{MHz})$ ' , F_C 1
 SAW I M T - 2000 S A W .
 3.
 1 ,
 2 ' $F_C - (F_0 - 0.625\text{MHz})$ ' , F_C 2
 SAW I M T - 2000 S A W .
 4.
 1 ,
 3 $F_C - (F_0 + 0.625\text{MHz})$, F_C 3 S
 AW I M T - 2000 S A W .
 5.
 1 ,
 4 $F_C - (F_0 + 1.875\text{MHz})$, F_C 4 S
 AW I M T - 2000 S A W .

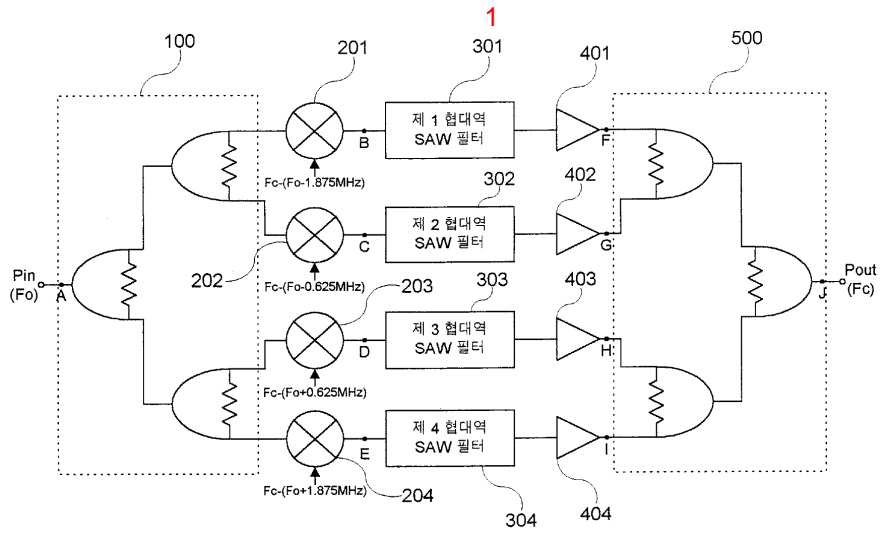

2

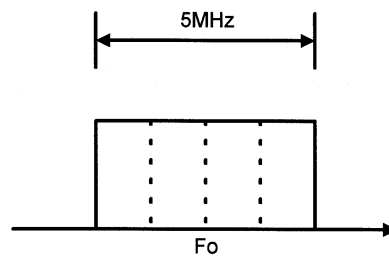

< point A >

3

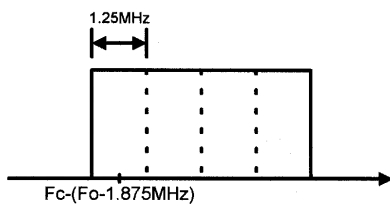

(a) point B

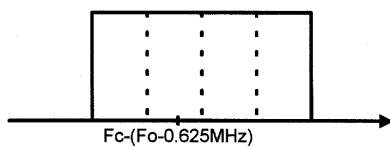

(b) point C

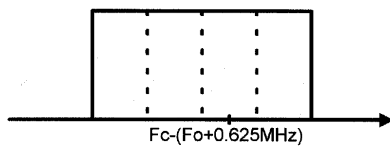

(c) point D

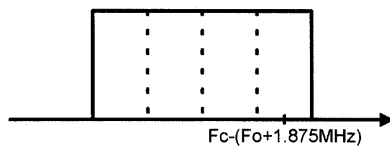

(d) point E

4

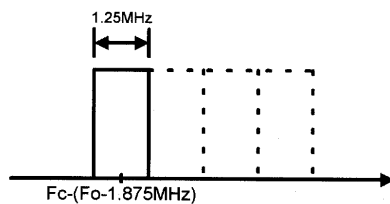

(a) point F

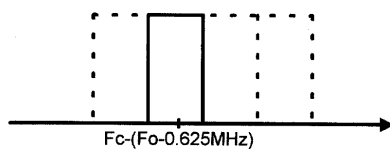

(b) point G

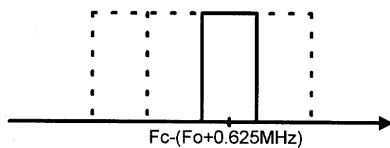

(c) point H

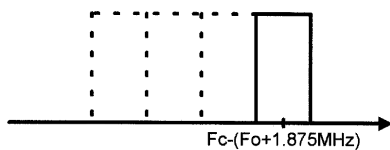

(d) point I

5

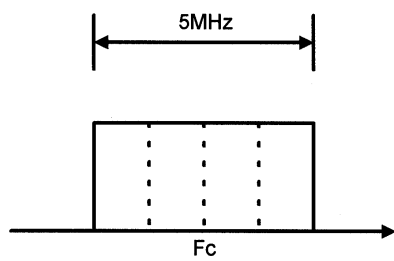

< point J >