

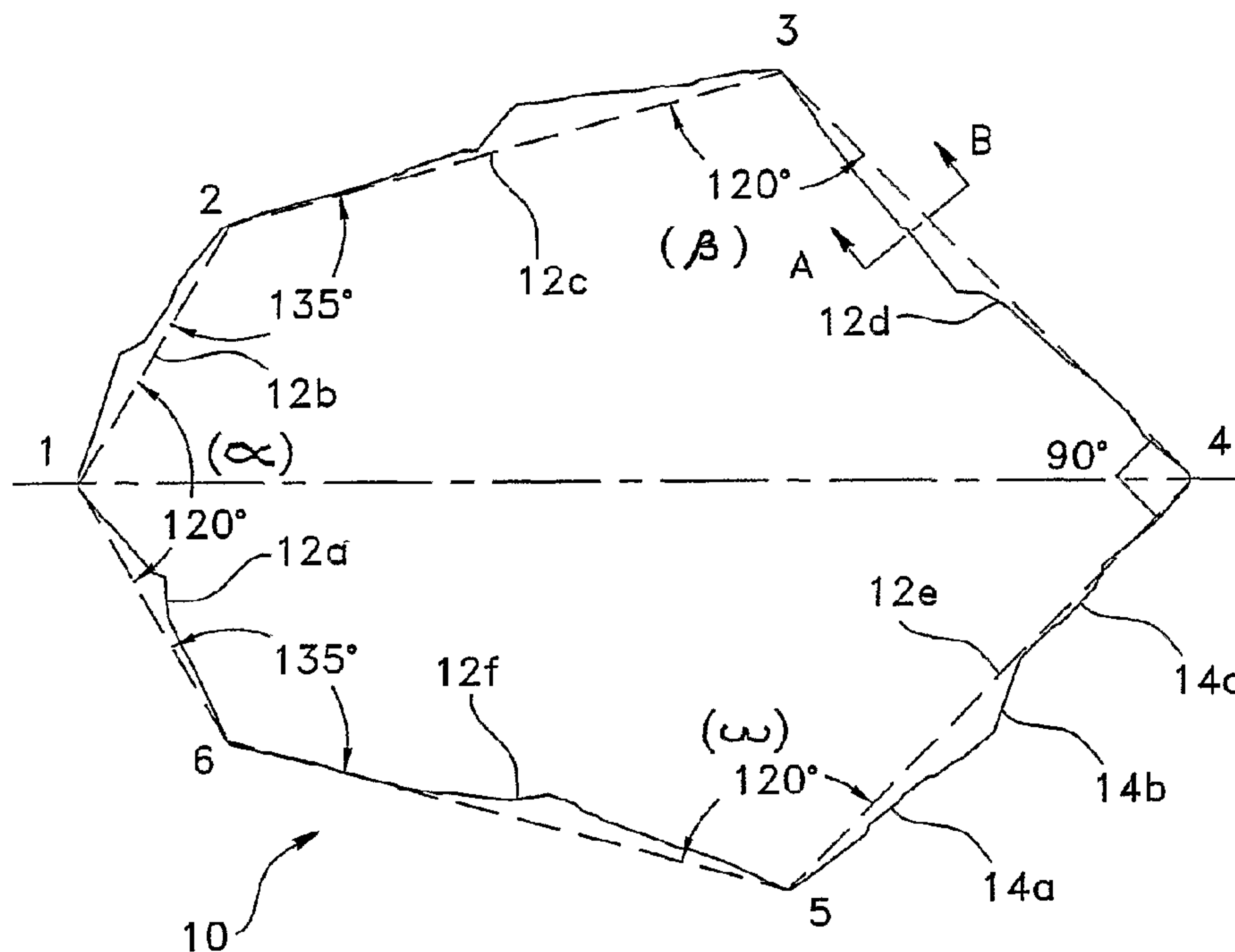

(86) Date de dépôt PCT/PCT Filing Date: 2005/10/25
 (87) Date publication PCT/PCT Publication Date: 2006/05/04
 (45) Date de délivrance/Issue Date: 2007/05/15
 (85) Entrée phase nationale/National Entry: 2006/12/22
 (86) N° demande PCT/PCT Application No.: CA 2005/001644
 (87) N° publication PCT/PCT Publication No.: 2006/045192
 (30) Priorité/Priority: 2004/10/25 (US60/621,054)

(51) Cl.Int./Int.Cl. *E01C 5/00* (2006.01),
E01C 15/00 (2006.01), *E01C 5/02* (2006.01),
E01C 5/06 (2006.01), *E04F 13/00* (2006.01)
 (72) Inventeurs/Inventors:
 CASTONGUAY, BERTIN, CA;
 THOMASSEN, MARCEL, CA
 (73) Propriétaire/Owner:
 OLDCASTLE BUILDING PRODUCTS CANADA, INC.,
 CA
 (74) Agent: ROBIC

(54) Titre : DALLE ARTIFICIELLE FOURNISSANT UNE SURFACE A L'APPARENCE ALEATOIRE NATURELLE
 (54) Title: AN ARTIFICIAL FLAGSTONE FOR PROVIDING A SURFACE WITH A NATURAL RANDOM LOOK



(57) **Abrégé/Abstract:**

An artificial flagstone for use in combination with other similar flagstones for covering a surface with a natural random look, the flagstone having a generally hexagonal body comprising a first, second, third, fourth, fifth and sixth consecutive vertices; a first pair of generally congruent irregularly-shaped first and second sides extending radially from the first vertex and being rotationally spaced from each other by an angle α of approximately 120°; a second pair of generally congruent irregularly shaped third and fourth sides extending radially from the third vertex and being rotationally spaced from each other by an angle β of approximately 120°; a third pair of generally congruent irregularly shaped fifth and sixth sides extending radially from the fifth vertex and being rotationally spaced from each other by an angle ω of approximately 120°; wherein the sides of each of the first, second and third pair of sides have at least one split deviation along their length and are respectively rotational images of each other, whereby in use in combination with other flagstones, each one of the sides is matingly engageable with the sides of an equivalent pair of sides of a neighbouring flagstone.

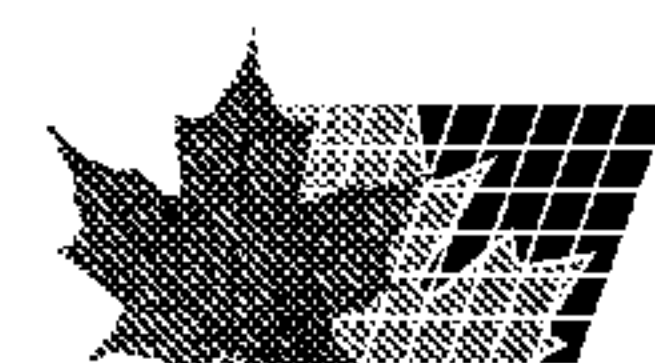

ABSTRACT

An artificial flagstone for use in combination with other similar flagstones for covering a surface with a natural random look, the flagstone having a generally hexagonal body comprising a first, second, third, fourth, fifth and sixth consecutive vertices; a first pair of generally congruent irregularly-shaped first and second sides extending radially from the first vertex and being rotationally spaced from each other by an angle α of approximately 120° ; a second pair of generally congruent irregularly shaped third and fourth sides extending radially from the third vertex and being rotationally spaced from each other by an angle β of approximately 120° ; a third pair of generally congruent irregularly shaped fifth and sixth sides extending radially from the fifth vertex and being rotationally spaced from each other by an angle ω of approximately 120° ; wherein the sides of each of the first, second and third pair of sides have at least one split deviation along their length and are respectively rotational images of each other, whereby in use in combination with other flagstones, each one of the sides is matingly engageable with the sides of an equivalent pair of sides of a neighbouring flagstone.

AN ARTIFICIAL FLAGSTONE FOR PROVIDING A SURFACE WITH A NATURAL RANDOM LOOK

FIELD OF THE INVENTION

The present invention relates generally to the field of artificial stones or flagstones
5 for laying out pavements or for covering a wall surface, and is more particularly
directed to such stones giving the resulting pavement or wall surface a natural-
looking appearance.

BACKGROUND OF THE INVENTION

It is worth mentioning that the expressions "stone" and "flagstone" are used
10 throughout the present description without distinction to define a flat slab of stone
used as a paving or building material. Artificial stones often made of concrete are
well-known to lay out pavements or covering wall surfaces on residential or
commercial properties, for example defining the surface of walkways or patios.
Such stones are advantageously relatively inexpensive to make, as opposed to
15 natural carved flagstones, but the resulting pattern is often repetitive or has what is
called in this field an unnatural "linear line effect". Great efforts are therefore being
made to design artificial stones which provide a more natural look, creating the
effect of old world craftsmanship, while still retaining the ease of their manufacture.

One example of a prior art artificial flagstone is the flagstone marketed under the
20 trademark Kusel-Form. One drawback however with that prior art flagstone, which
is provided with regular segments, is that it still does not provide a satisfactory old
natural look. It still looks artificial.

Other attempts have been made in the past to develop sets of artificial stones
comprising stones of different shapes used in combination with each other for
25 paving a surface. The natural random look in those cases is obtained by
combining artificial stones of different shapes. A major drawback however with

those sets is that it often becomes a real puzzle for a user to install and combine those stones in a proper way.

Thus, there is still presently a need for an artificial flagstone that provides the real natural random look, long sought after, while at the same time being easy to manufacture at a reasonable cost and easy to install for any unskilled person.

SUMMARY OF THE INVENTION

An object of the present invention is to provide an artificial flagstone that satisfies the above-mentioned need.

In accordance with the present invention, that object is achieved with an artificial flagstone for use in combination with other ones of said artificial flagstones for covering a surface with a natural random look. The flagstone has a generally hexagonal body comprising:

- a first, second, third, fourth, fifth and sixth consecutive vertices;
- a first pair of generally congruent first and second sides extending radially from the first vertex and being rotationally spaced from each other by an angle α of approximately 120° ;
- a second pair of generally congruent third and fourth sides extending radially from the third vertex and being rotationally spaced from each other by an angle β of approximately 120° ;
- a third pair of generally congruent fifth and sixth sides extending radially from the fifth vertex and being rotationally spaced from each other by an angle ω of approximately 120° ;

wherein the sides of at least one of the first, second and third pair of sides have at least one split deviation along their length and are respectively rotational images of each other, whereby in use in combination with the other flagstones, each one of

the sides is matingly engageable with the sides of an equivalent pair of sides of a neighbouring flagstone.

Advantageously, the present invention makes it possible to obtain a pavement with a real natural random look with no "linear line effect" by simply using a plurality of artificial flagstones having all the same shape. In other words, a single module is sufficient to create a multitude of different designs. There is no need to use different shapes of flagstone to obtain the sought after natural look. Also, the split deviation provided on the side provides an irregular profile that gives the flagstone a more natural look.

The flagstone according to the invention can advantageously be used for creating patio, pathways, sidewalks or stepping stones. Its asymmetrical shape makes the flagstone the ideal material for creating a great variety of designs. With its six irregular sides, the flagstone fits perfectly together, since the flagstone is provided with matingly engageable stone, the end result is extremely stable. Also, for a different look, you can leave wider joints between them and fill the voids with grass.

The present invention is also very advantageous for a manufacturer, since the production of the flagstones requires only a single shape for the mould used for moulding the flagstones.

In accordance with another aspect of the invention, the above-mentioned object is also achieved with an artificial flagstone for use in combination with other ones of said artificial flagstones for covering a surface with a natural random look. The flagstone has a generally hexagonal body comprising:

- a first, second, third, fourth, fifth and sixth consecutive vertices;

- a first pair of generally congruent first and second sides extending radially from the first vertex and being rotationally spaced from each other by an angle α of approximately 120° ;

- a second pair of generally congruent third and fourth sides extending radially from the third vertex and being rotationally spaced from each other by an angle β of approximately 120° ;

5 - a third pair of generally congruent fifth and sixth sides extending radially from the fifth vertex and being rotationally spaced from each other by an angle ω of approximately 120° ; and

-a top face comprising deep joints dividing the top face into smaller top sections.

10 In accordance with a further aspect of the invention, the above-mentioned object is also achieved with An artificial flagstone for use in combination with other ones of said artificial flagstones for covering a surface with a natural random look, the flagstone having a generally hexagonal body comprising:

- a first, second, third, fourth, fifth and sixth consecutive vertices;

15 - a first pair of generally congruent first and second sides extending radially from the first vertex and being rotationally spaced from each other by an angle α of approximately 120° ;

- a second pair of generally congruent third and fourth sides extending radially from the third vertex and being rotationally spaced from each other by an angle β of approximately 120° ;

20 - a third pair of generally congruent fifth and sixth sides extending radially from the fifth vertex and being rotationally spaced from each other by an angle ω of approximately 120° ;

25 wherein the body of the flagstone is divided into a bottom part devised to contact the surface to cover and an upper part topping the bottom part, the upper part having a contour line generally similar to the bottom part and a surface area

smaller than the surface area of the bottom part whereby spaces are created between the upper part of adjacent flagstones covering a surface.

In accordance with a preferred embodiment, the sides of the second pair of sides are generally congruent to the sides of the third pair of sides.

5 Also preferably, the fourth and fifth sides, which extend radially from the fourth vertex, are rotationally spaced from each other by an angle θ of approximately 90° .

Still preferably, the sides of the first pair are approximately half the length of the sides of the second and third pair of sides.

10 Also preferably, each of the sides has a chiselled upper edge to imitate a Paleolithic stone, and the top face of the stone has a texture that imitates a natural flagstone.

The present invention also concerns a paving covering a surface, the paving comprising a plurality of randomly laid identical flagstones, each of the flagstones being as described hereinabove.

15 Advantageously, the flagstones of the present invention can easily be laid out to form a pavement or a wall surface where no straight lines and hardly any repetition can be seen, giving as a result, the look of old world craftsmanship.

20 Further aspects and advantages of the present invention will be better understood upon reading of preferred embodiments thereof with respect to the appended drawings.

BRIEF DESCRIPTION OF THE DRAWINGS

FIGs. 1A and 1B are respectively schematic top and partial side views of an artificial flagstone according to a first preferred embodiment of the invention.

25 FIGs. 2A and 2B schematically illustrates two possible arrangements showing the three possible relative orientations of the flagstone of FIG. 1A when laid out to

form a pavement or for covering a wall surface, FIG. 2C is an enlargement of zone 2C of FIG. 2A.

FIG. 3 schematically shows a section of a pavement made of artificial flagstones as shown in FIG. 1A; FIG. 3A is an enlargement of zone 3A of FIG. 3.

5 FIG. 4 shows a plurality of laid out flagstones as shown in FIGs. 1A and 1B, identified according to their relative orientation.

FIG. 5 is

10 a schematic side view of piled up flagstones of different textures according to another aspect of the invention.

FIG. 6 is a perspective view of a flagstone having a top surface provided with deep joints according to another preferred embodiment of the invention.

15 FIG. 7A is a schematic top view of an artificial stone according to a second preferred embodiment of the invention and FIG. 7B schematically shows a section of a pavement made of artificial flagstone as shown in FIG. 7A.

FIG. 8A is a schematic top view of an artificial stone according to a third preferred embodiment of the invention; FIG. 8B schematically shows a section of a pavement made of artificial flagstone as shown in FIG. 8A.

20 FIG. 9A is a schematic top view of an artificial stone according to a fourth preferred embodiment of the invention; FIG. 9B schematically shows a section of a pavement made of artificial flagstone as shown in FIG. 9A.

DESCRIPTION OF PREFERRED EMBODIMENTS OF THE INVENTION

25 In the following description, similar features in the drawings have been given similar reference numerals and in order to lighten the figures, some elements are not referred to in some figures if they were already identified in a preceding figure.

Referring to either one of FIGs. 1A, 7A, 8A and 9A, the outline of an artificial flagstone 10 according to the invention is illustrated. The illustrated flagstone 10 has a generally hexagonal body with six (6) consecutive vertices 1 to 6 and six (6) sides 12a to 12f, defining three pairs 12a-12b, 12c-12d and 12e-12f of mutually engageable surfaces. The first and second sides (12a-12b) extend radially from the first vertex 1 and are rotationally spaced from each other by an angle α of approximately 120° . The third and fourth sides (12c-12d) extend radially from the third vertex 3 and are rotationally spaced from each other by an angle β of approximately 120° . Finally, the fifth and sixth sides (12e-12f) extend from the fifth vertex 5 and are rotationally spaced from each other by an angle ω of approximately 120° . It can also be appreciated that the sides of at least one, preferably each, of the first, second and third pair of sides have at least one split deviation 14b along their length, and are respectively rotationally images of each other, whereby in use in combination with identical flagstones, each one of the sides is matingly engageable with the sides of an equivalent pair of sides of a neighbouring flagstone, as shown for example in FIGs. 4, 7B, 8B and 9B. In each of the preferred embodiments illustrated, each side comprises a split deviation which divides the sides in three segments, 14a, 14b and 14c projecting outwardly and inwardly with respect to the body of the flagstone.

More particularly, each side has a specific shape along its length which is formed of three end-to-end segments: a first generally straight segment 14a, followed by the split deviation 14b and a second generally straight segment 14c.. While conserving this general profile, the sides 12a to 12f are however slightly irregular, to give the flagstone a more natural looking aspect.

The sides of a given pair have mating profiles, that is the profile of side 12b rotated by 120° mates (in other words conforms or fits) with the profile of side 12a, and similarly for sides 12c-12d, and 12e-12f. In the case of the embodiment shown in FIG. 1A, it will be observed that the sides of each pair respectively project inwardly and outwardly with respect to the body of the flagstone.

As can be appreciated, in the first, third and fourth preferred embodiments (FIGs 1, 8A and 9A, the sides of the second pair of sides (12c-12d) are generally congruent (same length) to the sides of the third pair of sides (12e-12f).

5 It is worth mentioning that the angle between the sides forming the second, fourth and sixth vertices can take numerous values as long as their sum equals 360° . As for example, in the preferred embodiment shown in FIG. 1A, the sides forming the second and sixth vertices, that is to say, sides 12b and 12c and sides 12a and 12f, form an angle equal to 135° , whereas the angle separating the sides (12d, 12e) forming the fourth vertex is equal to 90° .

10 In the preferred embodiment shown in FIG. 7A, the angle between the sides 12b-12c forming the second apex 2 is equal to 93.58° , the sides 12d-12e forming the fourth apex 4 form an angle of 80.88° and the angle between the sides 12f-12g forming the sixth apex 6 is 185.54° . As can be appreciated, the same angles in the preferred embodiments shown in FIGs. 8A and 9A take other values.

15 Referring to FIG. 1B, a section of the flagstone of FIG. 1A is shown, where it can be seen that the side walls and top surface thereof are also irregular.

The characteristics of a pavement made of flagstones as described above will now be described with reference to FIGs. 2 to 5, and 7B, 8B, 9B. It will be appreciated that all of the flagstones of a pavement are the same, but still create a visually
20 "random" effect in which no straight lines can be seen. As illustrated more particularly in FIGs. 2A, 2B and 4, each flagstone is laid out relative to the others in one of three orientations A, B, and C. In every case, side 12a of one flagstone is adjacent to side 12b of another, and the same is true for sides 12c-12d and 12e-12f. Spaces of about 2 to 7 mm in width can be seen between adjacent flagstones
25 due to the irregularity of the side edges (see more particularly FIG. 3A).

Referring to FIG. 5, there are shown possible patterns for the top surface of the artificial stones of the invention. The top surface is preferably given a texture which imitates real flagstones or the like, and the side edges have chiselled upper edges

to imitate a Paleolithic stone. Preferably, the top surface of the stones has several regions of the same height, facilitating stacking of the stones.

Referring to FIG. 6, there is shown an artificial flagstone in accordance with yet another preferred embodiment of the invention. In this embodiment, a flagstone of the profile described above has a top surface 16 provided with deep joints 18
5 therein. The deep joints 18 preferably extend through a portion of the height of the flagstone, so that when the stone is laid out, it gives the visual impression of an arrangement of smaller stones, while still retaining the advantages of handling only a larger block. In the illustrated embodiment, the deep joints separate the stone
10 into five sections 20A-20E of various shapes and sizes, and are arranged so that they intersect the sides 12a-12f of the stone either at the joints of two sides or at the sloped segment of a given side. It will be observed from FIG. 6 that with this embodiment, the resulting pavement will seem even more random to the eye. The deep joints 18 may in addition be filled with sand or another filling material, giving
15 an even more natural look to the pavement. The body of the flagstone shown in Fig. 6 is preferably divided into a bottom part 32 devised to contact the surface to cover and an upper part 34 topping the bottom part 32. The upper part 34 has a contour line generally similar to the bottom part 32 and a surface area smaller than the surface area of the bottom part 32 whereby spaces are created between the
20 upper part of adjacent flagstones covering a surface.

In another aspect of this embodiment, the stone may preferably be breakable along the deep joints 18. This allows breaking off one or more of the stone sections 20. Advantageously, as the broken off stone section will still have at least one side following one of the profiles 12a-12f of the general stone, it will still be
25 possible to matingly engage it with the side of another stone having the matching profile. For example, section 20A having a side 12e, it could be laid about the side 12f of a similar stone in the same mating engagement described above. This particular embodiment is particularly advantageous to provide a more regular profile at the edge of a pavement, particularly for narrow patterns such as
30 walkways. A side section 20 outwardly projecting at an edge of the walkway may

be broken off and used to fill a hole at another portion of the edge or at any appropriate location.

Now referring to FIGs. 2A and 2B, there is shown an artificial flagstone in accordance with a still further preferred embodiment of the invention. In this
5 embodiment, the perimeter of the flagstone is identical to any one of the above-described flagstones. It is however preferably provided with distinctive markers (22a to 22f) used for guiding the laying out of a plurality of flagstones on a surface. More preferably, these distinctive markers (22a to 22f) are located at the vertices of the flagstone and consist of thin generally plate members protruding from the
10 vertices.

As can be appreciated, the distinctive markers 22b, 22d, 22f located at the second, fourth and sixth vertices 2, 4, 6 are substantially identical to each other, whereas the distinctive markers 22a, 22c, 22e located at the first, third and fifth
15 vertices 1, 3, 5 are different from each other and different from the markers of the second, fourth and sixth vertices.

Even more preferably, the plate-shaped member 22a of the first vertex 1 comprises four grooves 24. Two of these grooves are located on the first side 12a and the other two grooves 24 are located on the second side 12b, whereas the
20 plate-shaped member 22e of the fifth vertex 5 comprises two grooves, one on each of the fifth and sixth sides 12e-12f, respectively.

Therefore, for combining, as for example, a side 12a with a side 12b of a neighbour flagstone, the user just simply has to guide himself by associating the side with identical markers with each other, as shown in FIG. 2C.

The stone according to the present invention has several advantages over prior art
25 products. Its installation is easy, and does not generally require professional skills. The resulting pavement has no "linear effect", that is, a person walking thereon would not see any straight line in front of him or her. It has a random look, achieved with a single stone design.

The present invention is also advantageous over the prior art since it provides a one piece engageable unit that can cover a surface by simply rotating the one piece unit of 120° , as shown for example in FIGs. 2A and 2B.

Of course, numerous modifications could be made to the embodiments above
5 without departing from the scope of the invention.

CLAIMS

1. An artificial flagstone for use in combination with other ones of said artificial flagstones for covering a surface with a natural random look, the flagstone having a generally hexagonal body comprising:

- 5 - a first, second, third, fourth, fifth and sixth consecutive vertices;
- a first pair of generally congruent first and second sides extending radially from the first vertex and being rotationally spaced from each other by an angle α of approximately 120° ;
- 10 - a second pair of generally congruent third and fourth sides extending radially from the third vertex and being rotationally spaced from each other by an angle β of approximately 120° ;
- a third pair of generally congruent fifth and sixth sides extending radially from the fifth vertex and being rotationally spaced from each other by an angle ω of approximately 120° ;

15 wherein the sides of at least one of said first, second and third pair of sides have at least one split deviation along their length and are respectively rotational images of each other, whereby in use in combination with said other flagstones, each one of said sides is matingly engageable with the sides of an equivalent pair of sides of a neighbouring flagstone.

20 2. The flagstone as claimed in claim 1, wherein the sides of the second pair of sides are generally congruent to the sides of the third pair of sides.

3. The flagstone as claimed in claim 2, wherein the fourth and fifth sides extend radially from the fourth vertex and are rotationally spaced from each other by an angle θ of approximately 90° .

25 4. The flagstone as claimed in claim 3, wherein the sides of the first pair are approximately half the length of the sides of the second and third pair of sides.

5. The flagstone as claimed in claim 1, wherein each of said sides has a chiselled upper edge.

6. The flagstone as claimed in claim 1, having a top face with a texture that imitates a natural flagstone.

5 7. The flagstone as claimed in claim 6, wherein the top face comprises deep joints dividing the top face into smaller top sections.

8. The flagstone as claimed in claim 1, wherein the sides of said first, second and third pair of sides having said at least one split deviation define along their length a first generally straight segment, followed by said split deviation and a second
10 generally straight segment.

9. The flagstone as claimed in 1, wherein the sides of each of the first, second and third pair of sides have said at least one split deviation

10. The flagstone as claimed in claim 1, wherein the second side and third side are rotationally spaced from each other by an angle of approximately 135°; and the
15 sixth side and first side are rotationally spaced from each other by an angle of approximately 135°.

11. The flagstone as claimed in claim 1, wherein all of said pairs of sides have distinctive markers guiding a lay out of a plurality of said flagstone on a surface.

12. The flagstone as claimed in claim 11, wherein said distinctive markers are
20 located at said vertices.

13. The flagstone as claimed in claimed 12, wherein said distinctive markers consist of thin plate-shaped members protruding from said vertices.

14. The flagstone as claimed in claim 13, wherein the distinctive markers located at the second, fourth and sixth vertices are substantially identical to each other,
25 whereas the distinctive markers located at the first, third and fifth vertices are

different from each other and different from the markers of the second, fourth and sixth vertices.

15. The flagstone as claimed in claim 14, wherein the plate-shaped member of said second, fourth and sixth vertices is uniform, the plate-shaped member of the first vertex comprising four grooves, two on each of the first and second sides respectively, the plate-shaped member of the third vertex being uniform and the plate-shaped member of the fifth vertex comprising two grooves, one on each of said fifth and sixth sides respectively.

16. The flagstone as claimed in claim 7, wherein the body of the flagstone is divided into a bottom part devised to contact the surface to cover and an upper part topping the bottom part, the upper part having a contour line generally similar to the bottom part and a surface area smaller than the surface area of the bottom part whereby spaces are created between the upper part of adjacent flagstones covering a surface.

17 (new). An artificial flagstone for use in combination with other ones of said artificial flagstones for covering a surface with a natural random look, the flagstone having a generally hexagonal body comprising:

- a first, second, third, fourth, fifth and sixth consecutive vertices;

- a first pair of generally congruent first and second sides extending radially from the first vertex and being rotationally spaced from each other by an angle α of approximately 120° ;

- a second pair of generally congruent third and fourth sides extending radially from the third vertex and being rotationally spaced from each other by an angle β of approximately 120° ;

- a third pair of generally congruent fifth and sixth sides extending radially from the fifth vertex and being rotationally spaced from each other by an angle ω of approximately 120° ; and

- a top face comprising deep joints dividing the top face into smaller top sections.

18 (new). The flagstone as claimed in claim 17, wherein the sides of at least one of said first, second and third pair of sides have at least one split deviation along their length and are respectively rotational images of each other, whereby in use in combination with said other flagstones, each one of said sides is matingly engageable with the sides of an equivalent pair of sides of a neighbouring flagstone.

19. (new) The flagstone as claimed in claim 17, wherein the sides of the second pair of sides are generally congruent to the sides of the third pair of sides.

20 (new). The flagstone as claimed in claim 19, wherein the fourth and fifth sides extend radially from the fourth vertex and are rotationally spaced from each other by an angle θ of approximately 90° .

21 (new). The flagstone as claimed in claim 20, wherein the sides of the first pair are approximately half the length of the sides of the second and third pair of sides.

22 (new). The flagstone as claimed in claim 17, wherein each of said sides has a chiselled upper edge.

23 (new). The flagstone as claimed in claim 17, having the top face has a texture that imitates a natural flagstone.

24 (new). The flagstone as claimed in claim 18, wherein the sides of said first, second and third pair of sides having said at least one split deviation define along their length a first generally straight segment, followed by said split deviation and a second generally straight segment.

25. (new) The flagstone as claimed in 18, wherein the sides of each of the first, second and third pair of sides have said at least one split deviation

26 (new). The flagstone as claimed in claim 17, wherein the second side and third side are rotationally spaced from each other by an angle of approximately 135°; and the sixth side and first side are rotationally spaced from each other by an angle of approximately 135°.

5 27 (new). The flagstone as claimed in claim 17, wherein all of said pairs of sides have distinctive markers guiding a lay out of a plurality of said flagstone on a surface.

28 (new). The flagstone as claimed in claim 27, wherein said distinctive markers are located at said vertices.

10 29 (new). The flagstone as claimed in claimed 28, wherein said distinctive markers consist of thin plate-shaped members protruding from said vertices.

30 (new). The flagstone as claimed in claim 29, wherein the distinctive markers located at the second, fourth and sixth vertices are substantially identical to each other, whereas the distinctive markers located at the first, third and fifth vertices
15 are different from each other and different from the markers of the second, fourth and sixth vertices.

31 (new). The flagstone as claimed in claim 30, wherein the plate-shaped member of said second, fourth and sixth vertices is uniform, the plate-shaped member of the first vertex comprising four grooves, two on each of the first and second sides
20 respectively, the plate-shaped member of the third vertex being uniform and the plate-shaped member of the fifth vertex comprising two grooves, one on each of said fifth and sixth sides respectively.

32. The flagstone as claimed in claim 17, wherein the body of the flagstone is divided into a bottom part devised to contact the surface to cover and an upper part topping the bottom part, the upper part having a contour line generally similar
25 to the bottom part and a surface area smaller than the surface area of the bottom

part whereby spaces are created between the upper part of adjacent flagstones covering a surface.

33. (new) An artificial flagstone for use in combination with other ones of said artificial flagstones for covering a surface with a natural random look, the flagstone
5 having a generally hexagonal body comprising:

- a first, second, third, fourth, fifth and sixth consecutive vertices;

- a first pair of generally congruent first and second sides extending radially from the first vertex and being rotationally spaced from each other by an angle α of approximately 120° ;

10 - a second pair of generally congruent third and fourth sides extending radially from the third vertex and being rotationally spaced from each other by an angle β of approximately 120° ;

15 - a third pair of generally congruent fifth and sixth sides extending radially from the fifth vertex and being rotationally spaced from each other by an angle ω of approximately 120° ;

20 wherein the body of the flagstone is divided into a bottom part devised to contact the surface to cover and an upper part topping the bottom part, the upper part having a contour line generally similar to the bottom part and a surface area smaller than the surface area of the bottom part whereby spaces are created between the upper part of adjacent flagstones covering a surface.

34 (new). The flagstone as claimed in claim 33, wherein the sides of at least one of said first, second and third pair of sides have at least one split deviation along their length and are respectively rotational images of each other, whereby in use in combination with said other flagstones, each one of said sides is matingly
25 engageable with the sides of an equivalent pair of sides of a neighbouring flagstone.

35. (new) The flagstone as claimed in claim 33, wherein the sides of the second pair of sides are generally congruent to the sides of the third pair of sides.

36 (new). The flagstone as claimed in claim 35, wherein the fourth and fifth sides extend radially from the fourth vertex and are rotationally spaced from each other
5 by an angle θ of approximately 90° .

37 (new). The flagstone as claimed in claim 36, wherein the sides of the first pair are approximately half the length of the sides of the second and third pair of sides.

38 (new). The flagstone as claimed in claim 33, wherein each of said sides has a chiselled upper edge.

10 39 (new). The flagstone as claimed in claim 33, having the top face has a texture that imitates a natural flagstone.

40 (new). The flagstone as claimed in claim 34, wherein the sides of said first, second and third pair of sides having said at least one split deviation define along their length a first generally straight segment, followed by said split deviation and a
15 second generally straight segment.

41. (new) The flagstone as claimed in 34, wherein the sides of each of the first, second and third pair of sides have said at least one split deviation

42 (new). The flagstone as claimed in claim 33, wherein the second side and third side are rotationally spaced from each other by an angle of approximately 135° ;
20 and the sixth side and first side are rotationally spaced from each other by an angle of approximately 135° .

43 (new). The flagstone as claimed in claim 33, wherein all of said pairs of sides have distinctive markers guiding a lay out of a plurality of said flagstone on a surface.

25 44 (new). The flagstone as claimed in claim 43, wherein said distinctive markers are located at said vertices.

45 (new). The flagstone as claimed in claimed 44, wherein said distinctive markers consist of thin plate-shaped members protruding from said vertices.

46 (new). The flagstone as claimed in claim 45, wherein the distinctive markers located at the second, fourth and sixth vertices are substantially identical to each other, whereas the distinctive markers located at the first, third and fifth vertices are different from each other and different from the markers of the second, fourth and sixth vertices.

47 (new). The flagstone as claimed in claim 46, wherein the plate-shaped member of said second, fourth and sixth vertices is uniform, the plate-shaped member of the first vertex comprising four grooves, two on each of the first and second sides respectively, the plate-shaped member of the third vertex being uniform and the plate-shaped member of the fifth vertex comprising two grooves, one on each of said fifth and sixth sides respectively.

48. The flagstone as claimed in claim 39, wherein the top face comprises deep joints dividing the top face into smaller top sections

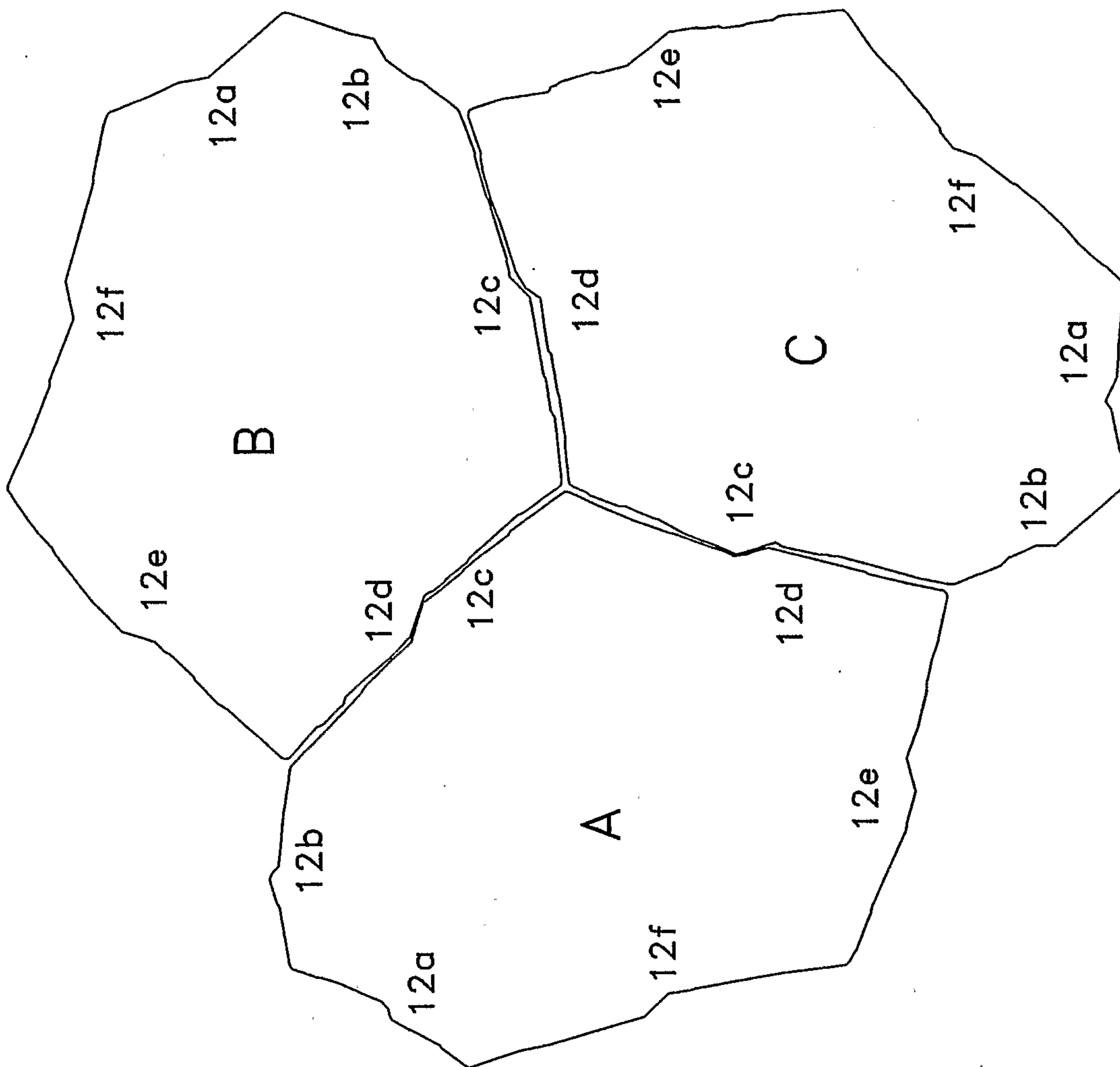

FIG. 2A

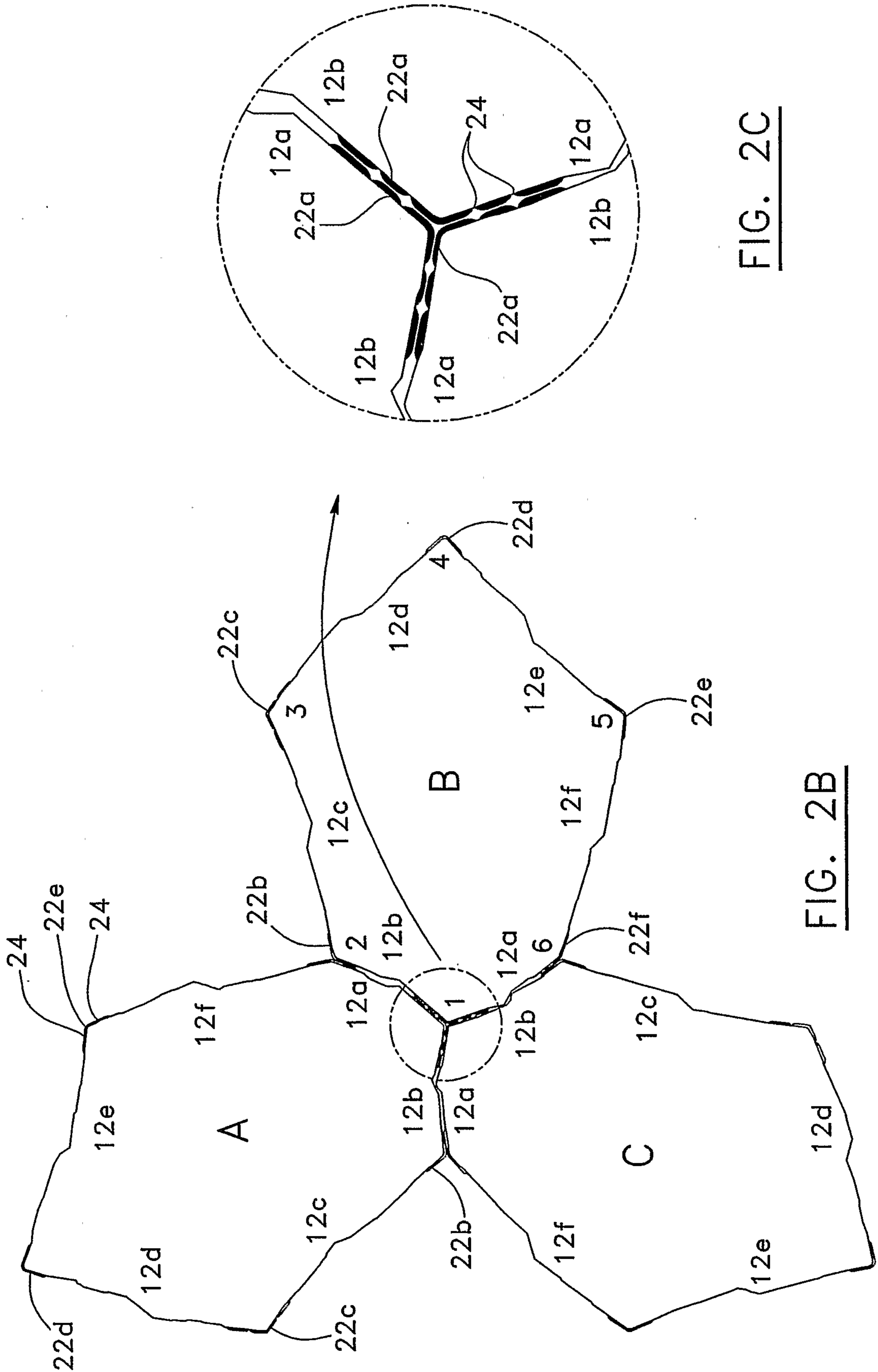

FIG. 2C

FIG. 2B

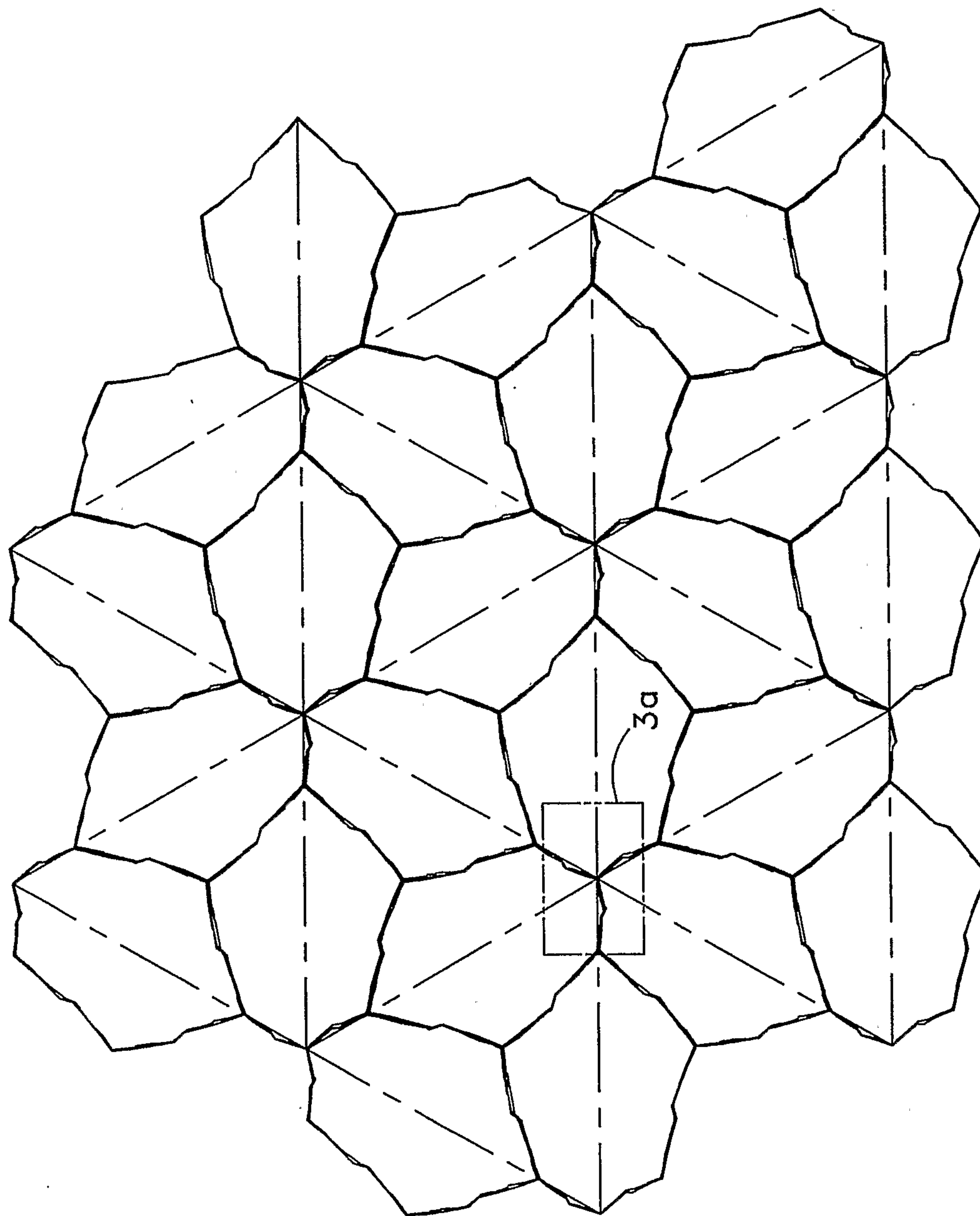

FIG. 3

5/11

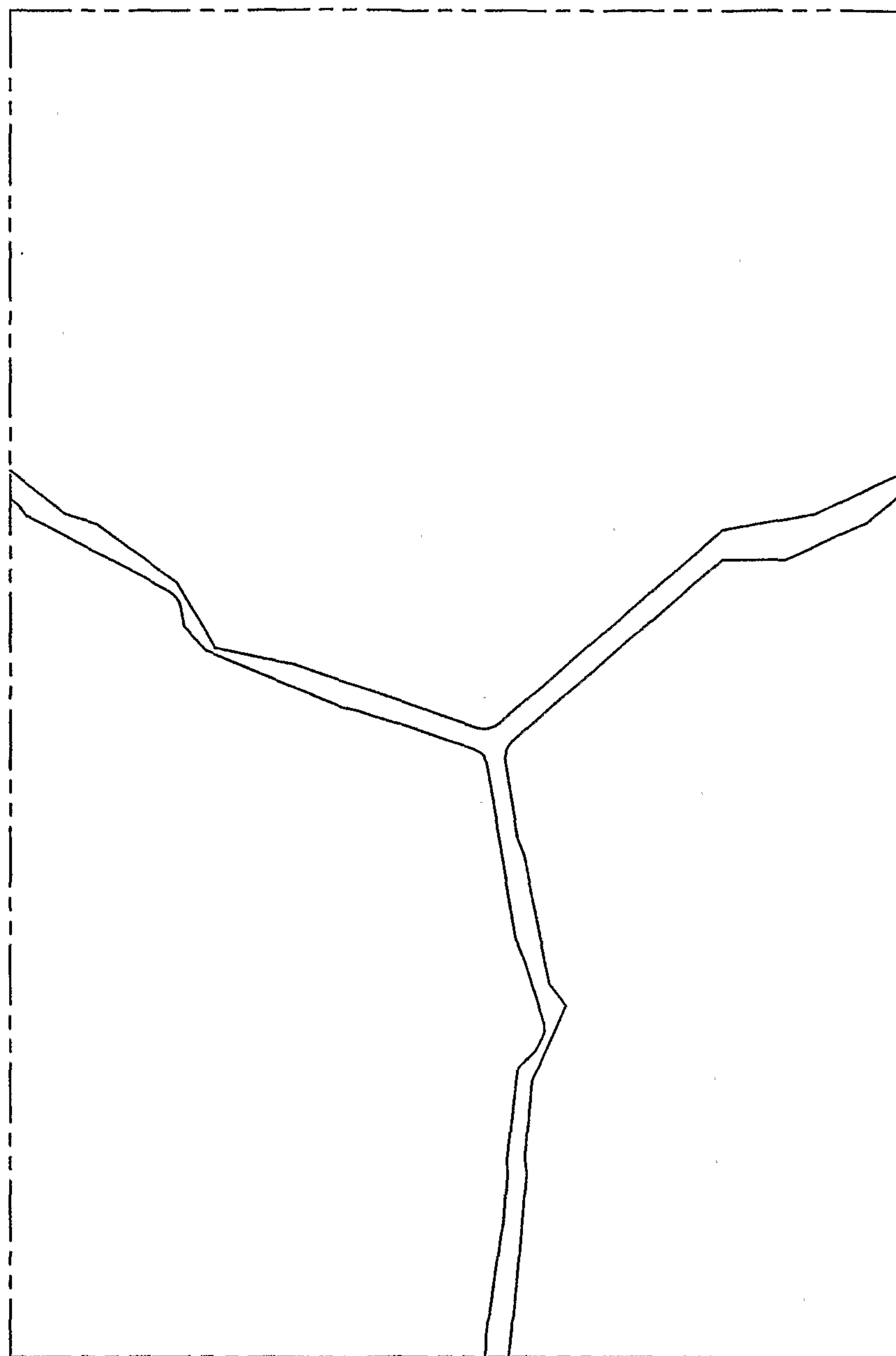

FIG. 3A

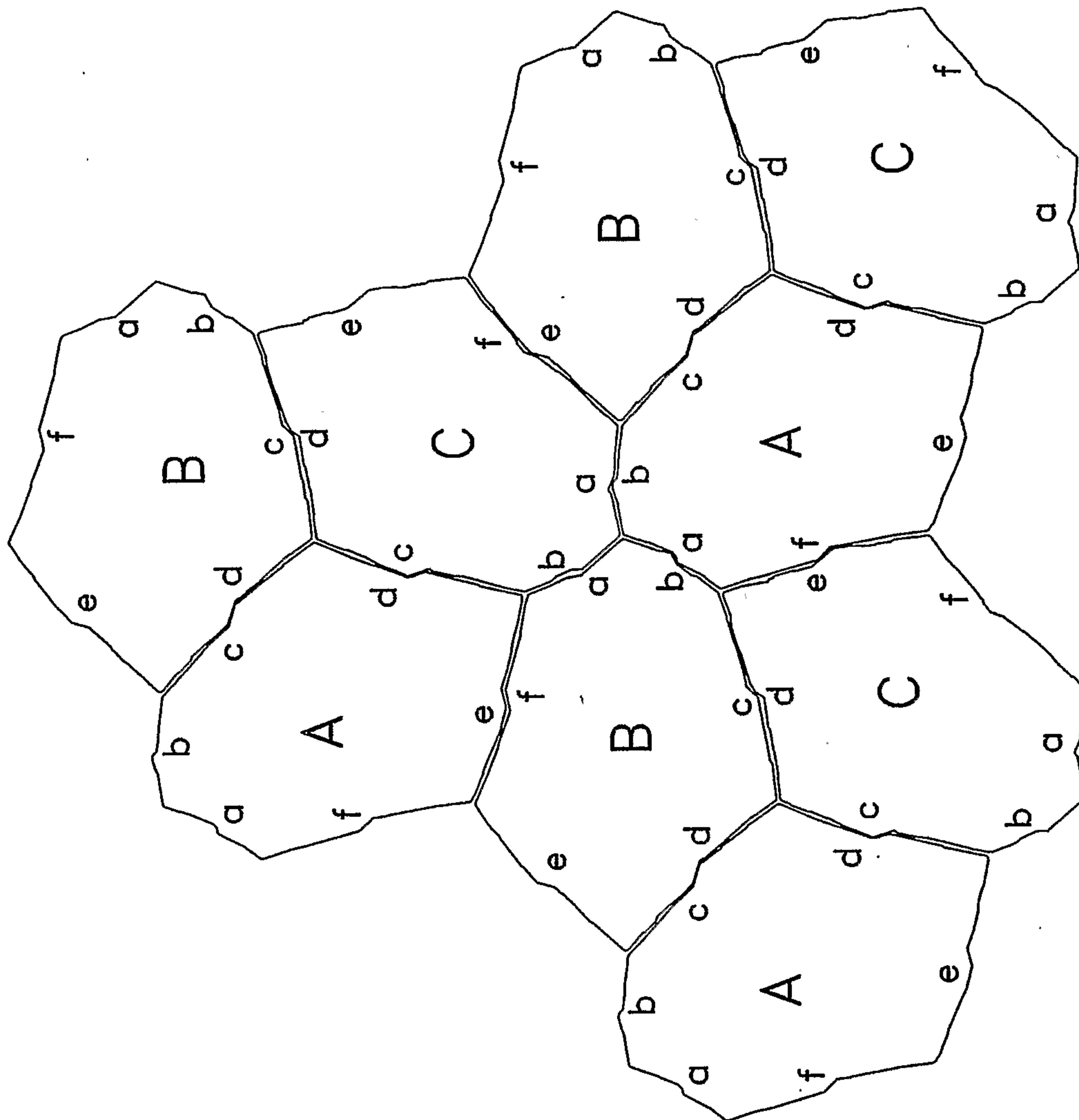

FIG. 4

7/11

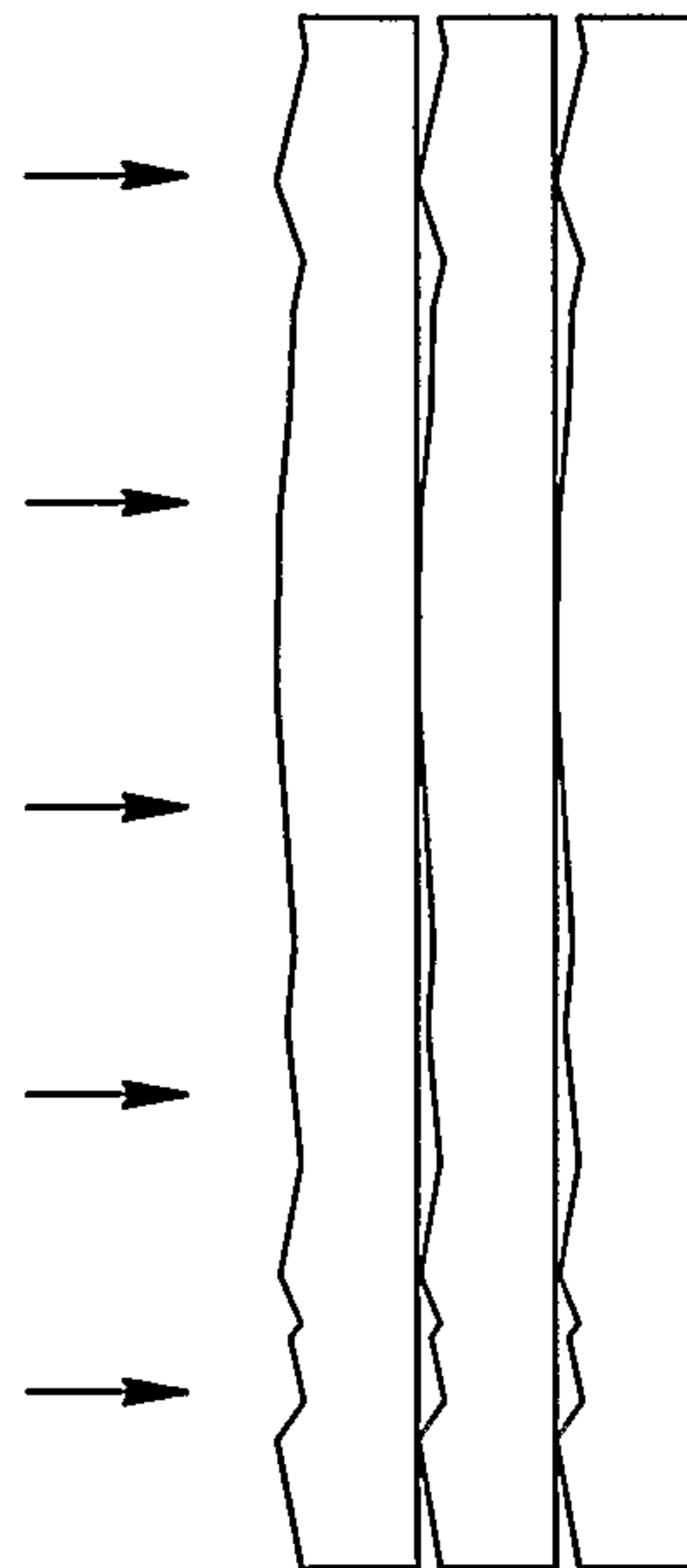

FIG. 5

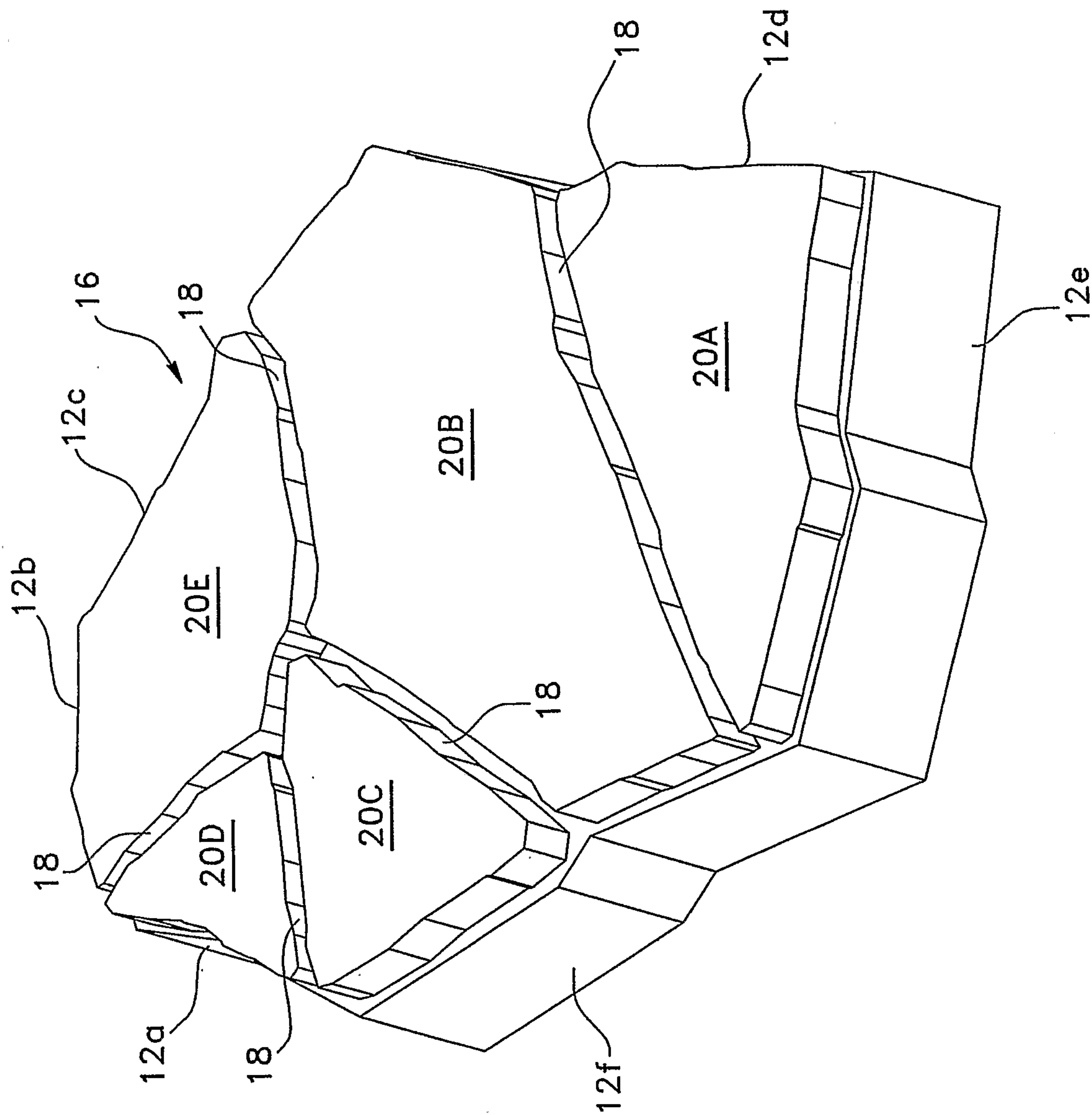

FIG. 6

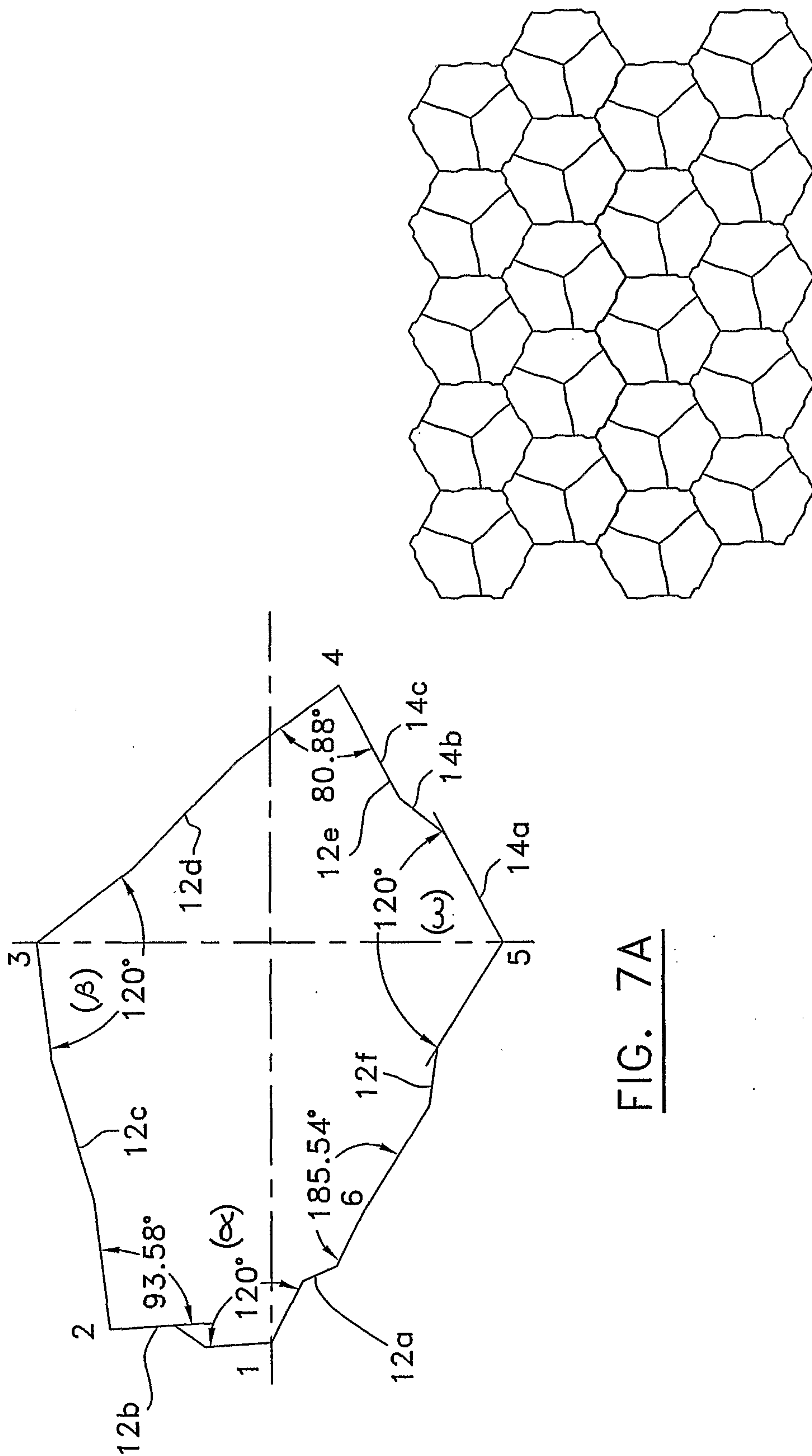

FIG. 7A

FIG. 7B

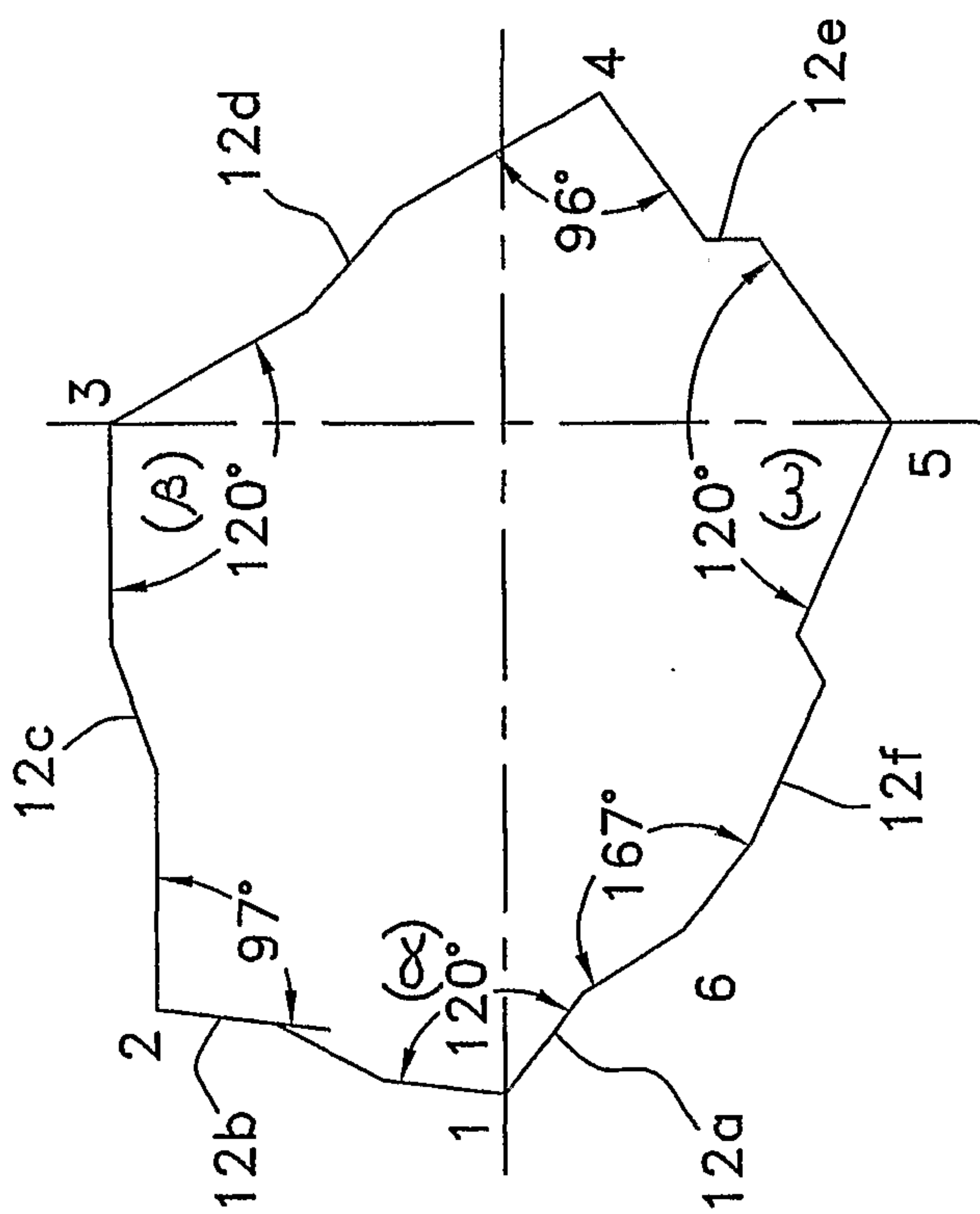

FIG. 8A

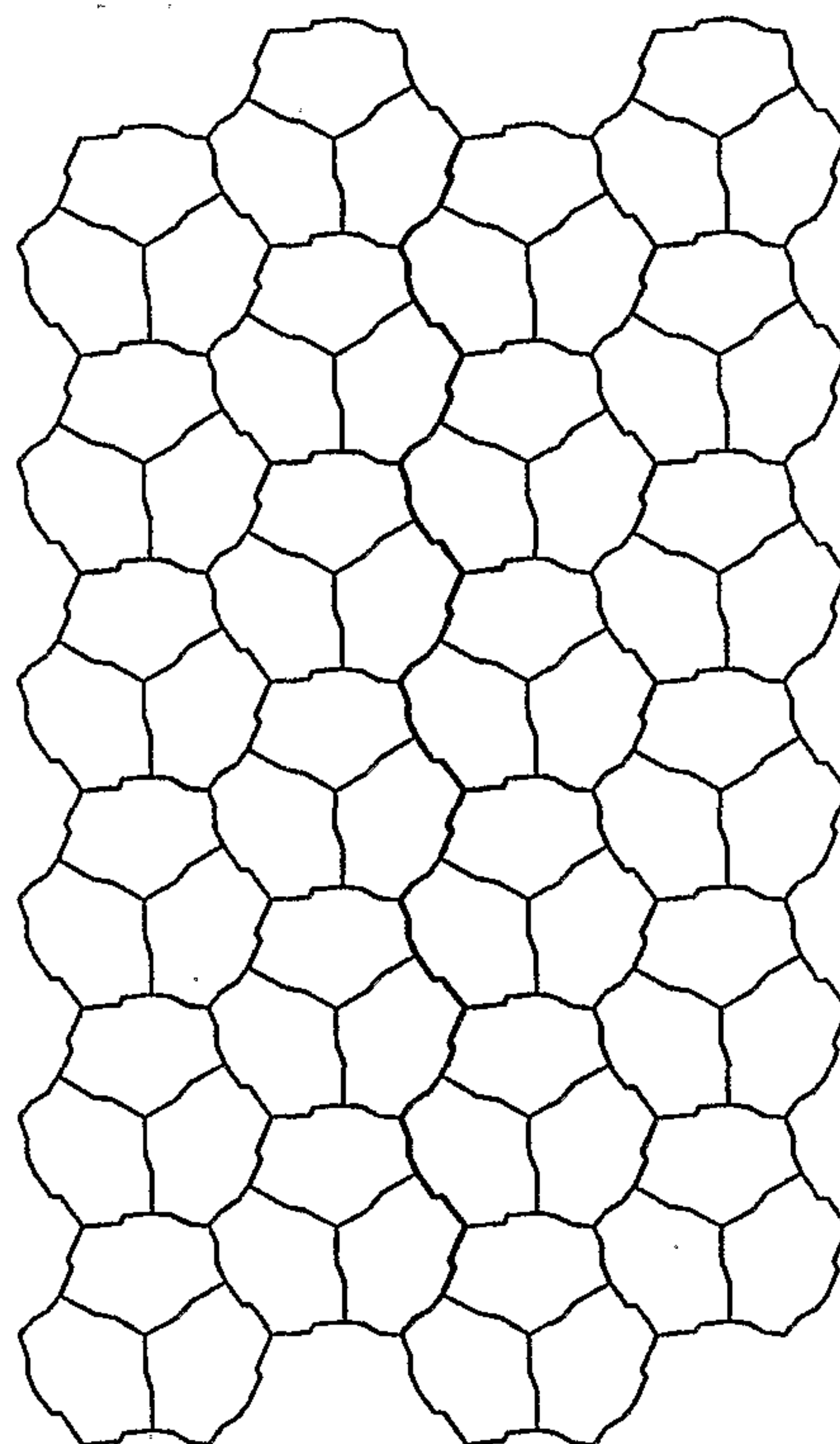

FIG. 8B

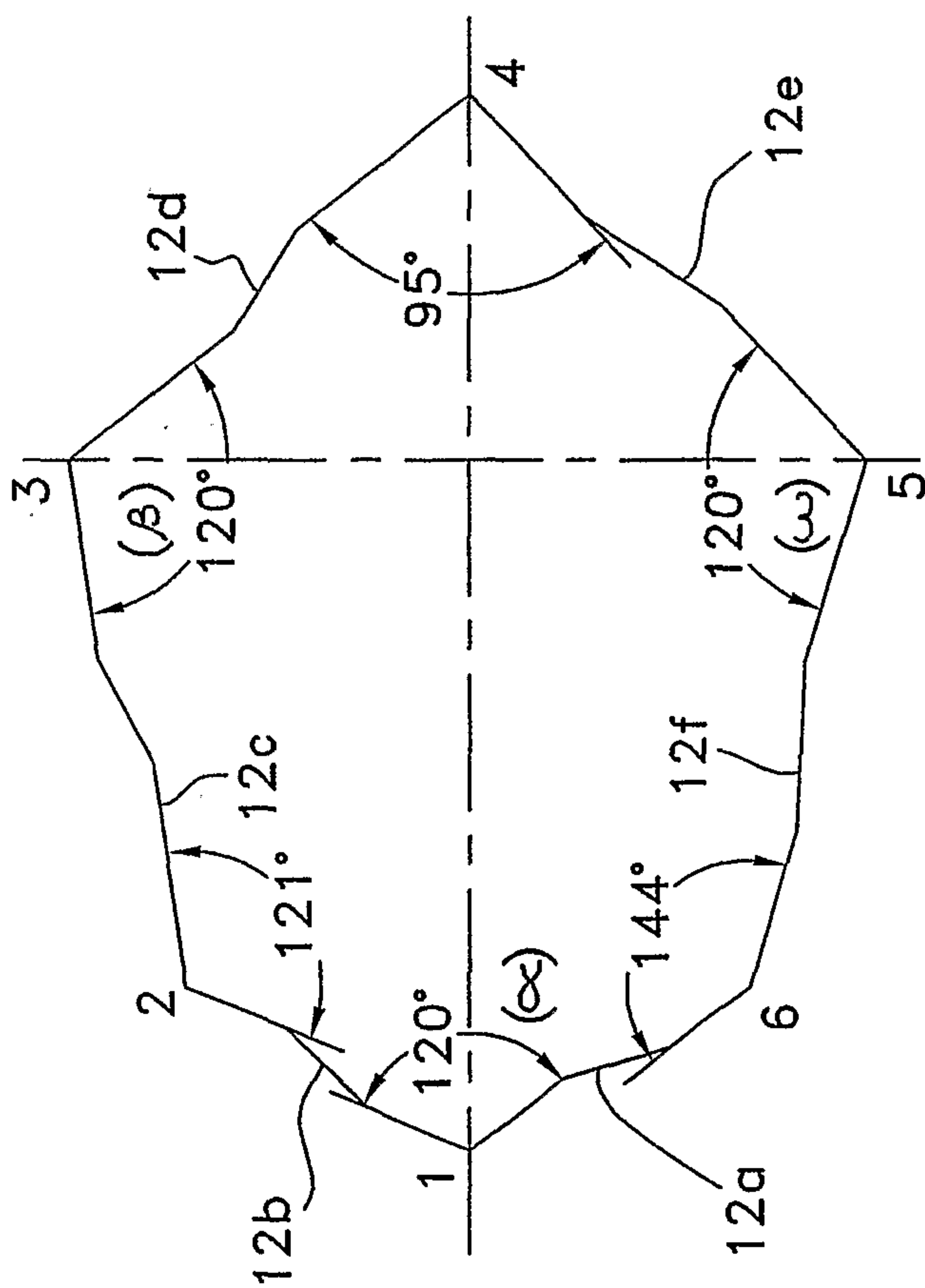

FIG. 9A

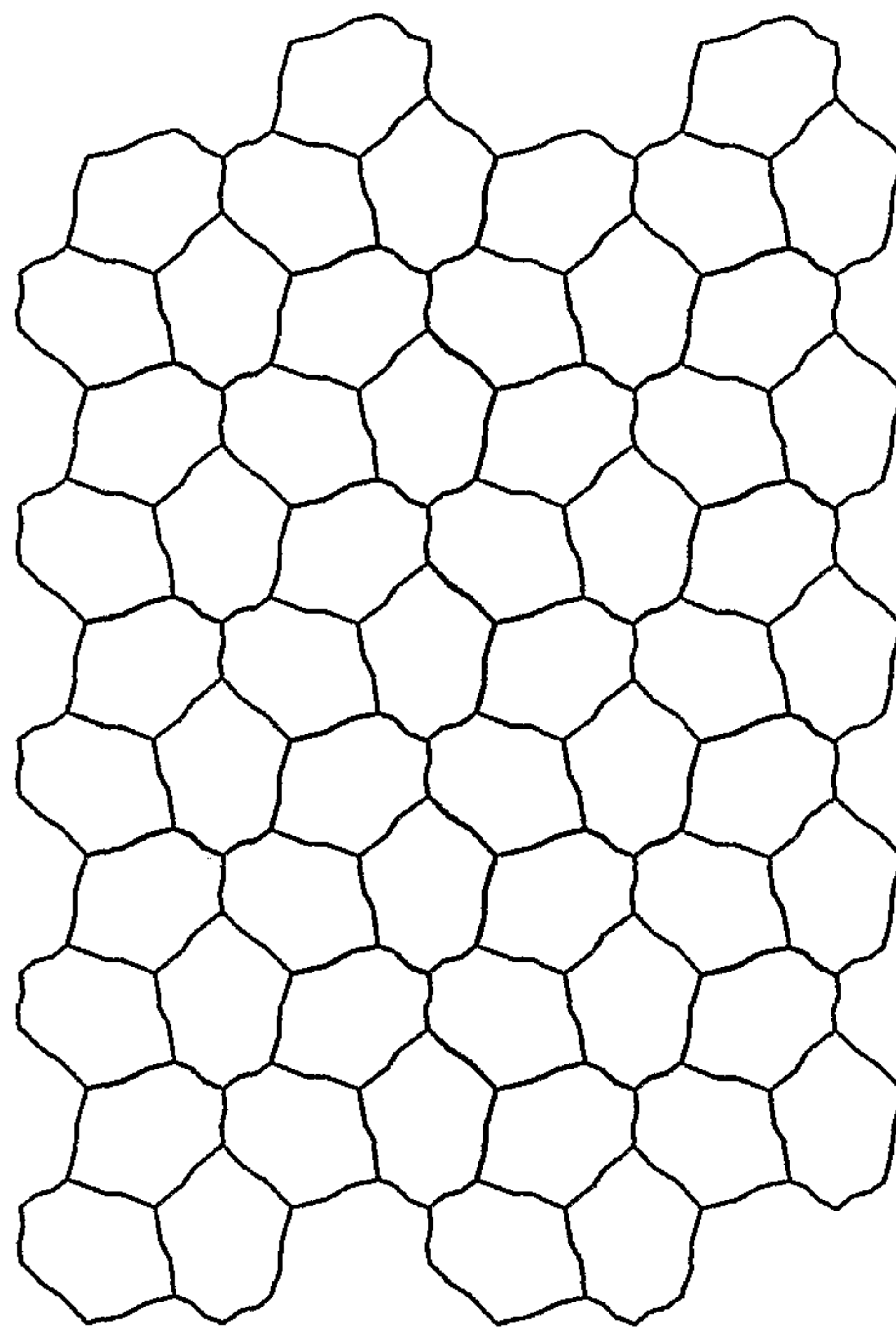

FIG. 9B

