



US0D1040586S

(12) **United States Design Patent**
Gomez Abuin

(10) **Patent No.:** **US D1,040,586 S**

(45) **Date of Patent:** **** Sep. 3, 2024**

(54) **SHELVING UNIT AND COMPONENTS**

(71) Applicant: **Gonzalo Gomez Abuin**, Ciudad Autonoma de Buenos Aires (AR)

(72) Inventor: **Gonzalo Gomez Abuin**, Ciudad Autonoma de Buenos Aires (AR)

(**) Term: **15 Years**

(21) Appl. No.: **29/750,032**

(22) Filed: **Sep. 10, 2020**

(30) **Foreign Application Priority Data**

Mar. 11, 2020 (AR) 96910
Mar. 11, 2020 (AR) 96911
Mar. 11, 2020 (AR) 96912
Mar. 11, 2020 (AR) 96913
May 18, 2020 (AR) 97197
May 18, 2020 (AR) 97198
May 18, 2020 (AR) 97199
May 18, 2020 (AR) 97200

(51) **LOC (14) Cl.** **06-06**

(52) **U.S. Cl.**
USPC **D6/705.7**

(58) **Field of Classification Search**
USPC D6/641-642, 653, 653.1, 655, 698, 705, D6/705.2, 706, 705.4, 705.7
CPC A47B 43/00; A47B 46/00; A47B 47/0025; A47B 47/0075; A47B 47/0091; A47B 57/00; A47B 57/34; A47B 63/00; A47B 87/002

See application file for complete search history.

(56) **References Cited**

U.S. PATENT DOCUMENTS

213,848 A * 4/1879 Stevens B65D 85/327
217/32
3,600,792 A * 8/1971 Valluy F16L 3/22
165/172
4,153,311 A * 5/1979 Takahashi A47B 47/042
312/265.5

D259,317 S 5/1981 Gilmore
4,562,776 A * 1/1986 Miranda A47B 47/042
108/190
4,582,002 A * 4/1986 Wright A47B 47/042
211/187
D284,245 S 6/1986 Santner
5,012,937 A * 5/1991 Owens A47B 5/04
40/124
6,595,378 B2 * 7/2003 Wang A47B 47/0075
211/186
6,615,999 B1 * 9/2003 Culp A47B 47/042
211/186
6,845,871 B1 * 1/2005 Culp A47B 47/042
211/186
D522,779 S * 6/2006 Ng D6/705
D522,848 S * 6/2006 Nawrocki D8/381
7,114,300 B1 * 10/2006 Culp A47B 47/042
211/186

D665,198 S 8/2012 Levy et al.
8,266,849 B2 * 9/2012 Bravo E04F 15/105
52/177
8,662,326 B2 * 3/2014 Brick A47B 47/042
211/186

D798,087 S 9/2017 Donnelly
D842,629 S 3/2019 Grupenhof
D850,820 S 6/2019 Chapman et al.
D857,434 S 8/2019 Liu
D867,039 S 11/2019 Ying
D869,882 S 12/2019 Dunigan
10,555,605 B1 * 2/2020 Berger A47B 47/047
D985,987 S * 5/2023 Vitalini D6/705
2001/0037987 A1 * 11/2001 Culp A47B 47/042
211/186

2003/0066814 A1 * 4/2003 Wang A47B 47/0075
211/188
2008/0308508 A1 * 12/2008 Fischer A47B 73/00
211/2
2009/0309464 A1 * 12/2009 Schwartz A47B 47/042
312/107

* cited by examiner

Primary Examiner — Kelley A Donnelly

(74) *Attorney, Agent, or Firm* — The Morales Law Firm; Joseph L. Morales, Esq.

(57) **CLAIM**

I claim the ornamental design for a shelving unit and components, as shown and described.



DESCRIPTION

FIG. 1A is a perspective view of a first component of the shelving unit.

FIG. 1B is a right view of the first component of the shelving unit.

FIG. 1C is a left view of the first component of the shelving unit.

FIG. 1D is a front view of the first component of the shelving unit.

FIG. 1E is a rear view of the first component of the shelving unit.

FIG. 1F is a top view of the first component of the shelving unit.

FIG. 1G is a bottom view of the first component of the shelving unit.

FIG. 2A is a perspective view of a second component of the shelving unit.

FIG. 2B is a right view of the second component of the shelving unit.

FIG. 2C is a left view of the second component of the shelving unit.

FIG. 2D is a front view of the second component of the shelving unit.

FIG. 2E is a rear view of the second component of the shelving unit.

FIG. 2F is a top view of the second component of the shelving unit.

FIG. 2G is a bottom view of the second component of the shelving unit.

FIG. 3A is a perspective view of a third component of the shelving unit.

FIG. 3B is a right view of the third component of the shelving unit.

FIG. 3C is a left view of the third component of the shelving unit.

FIG. 3D is a front view of the third component of the shelving unit.

FIG. 3E is a rear view of the third component of the shelving unit.

FIG. 3F is a top view of the third component of the shelving unit.

FIG. 3G is a bottom view of the third component of the shelving unit.

FIG. 4A is a perspective view of a fourth component of the shelving unit.

FIG. 4B is a right view of the fourth component of the shelving unit.

FIG. 4C is a left view of the fourth component of the shelving unit.

FIG. 4D is a front view of the fourth component of the shelving unit.

FIG. 4E is a rear view of the fourth component of the shelving unit.

FIG. 4F is a top view of the fourth component of the shelving unit.

FIG. 4G is a bottom view of the fourth component of the shelving unit.

FIG. 5A is a perspective view of a fifth component of the shelving unit.

FIG. 5B is a right view of the fifth component of the shelving unit.

FIG. 5C is a left view of the fifth component of the shelving unit.

FIG. 5D is a front view of the fifth component of the shelving unit.

FIG. 5E is a rear view of the fifth component of the shelving unit of the shelving unit.

FIG. 5F is a top view of the fifth component of the shelving unit.

FIG. 5G is a bottom view of the fifth component of the shelving unit.

FIG. 6A is a perspective view of a sixth component of the shelving unit.

FIG. 6B is a right view of the sixth component of the shelving unit.

FIG. 6C is a left view of the sixth component of the shelving unit.

FIG. 6D is a front view of the sixth component of the shelving unit.

FIG. 6E is a rear view of the sixth component of the shelving unit.

FIG. 6F is a top view of the sixth component of the shelving unit.

FIG. 6G is a bottom view of the sixth component of the shelving unit.

FIG. 7A is a perspective view of a seventh component of the shelving unit.

FIG. 7B is a right view of the seventh component of the shelving unit.

FIG. 7C is a left view of the seventh component of the shelving unit.

FIG. 7D is a front view of the seventh component of the shelving unit.

FIG. 7E is a rear view of the seventh component of the shelving unit.

FIG. 7F is a top view of the seventh component of the shelving unit.

FIG. 7G is a bottom view of the seventh component of the shelving unit.

FIG. 8A is a perspective view of an eighth component of the shelving unit.

FIG. 8B is a right view of the eighth component of the shelving unit.

FIG. 8C is a left view of the eighth component of the shelving unit.

FIG. 8D is a front view of the eighth component of the shelving unit.

FIG. 8E is a rear view of the eighth component of the shelving unit.

FIG. 8F is a top view of the eighth component of the shelving unit.

FIG. 8G is a bottom view of the eighth component of the shelving unit.

FIG. 9A is a perspective view of a first alternate configuration of shelving unit.

FIG. 9B is a front view thereof.

FIG. 9C is a left view thereof.

FIG. 9D is a right view thereof.

FIG. 9E is a top view thereof.

FIG. 9F is a bottom view thereof.

FIG. 9G is a rear view thereof.

FIG. 10A is a perspective view of a second alternate configuration of shelving unit.

FIG. 10B is a front view thereof.

FIG. 10C is a left view thereof.

FIG. 10D is a right view thereof.

FIG. 10E is a top view thereof.

FIG. 10F is a bottom view thereof.

FIG. 10G is a rear view thereof.

FIG. 11A is a perspective view of a third alternate configuration of shelving unit.

FIG. 11B is a front view thereof.

FIG. 11C is a left view thereof.

FIG. 11D is a right view thereof.

FIG. 11E is a top view thereof.

FIG. 11F is a bottom view thereof.

FIG. 11G is a rear view thereof.

FIG. 12A is a perspective view of a fourth alternate configuration of shelving unit.

FIG. 12B is a front view thereof.

FIG. 12C is a left view thereof.

FIG. 12D is a right view thereof.

FIG. 12E is a top view thereof.

FIG. 12F is a bottom view thereof; and,

FIG. 12G is a rear view thereof.

The figures show various views of each component of the shelving unit. The broken lines in the various views depict the boundaries of the claim and form no part of the claim.

1 Claim, 34 Drawing Sheets



Fig.1A



Fig.1B



Fig.1C



Fig. 1D



Fig. 1E



Fig. 1F



Fig. 1G

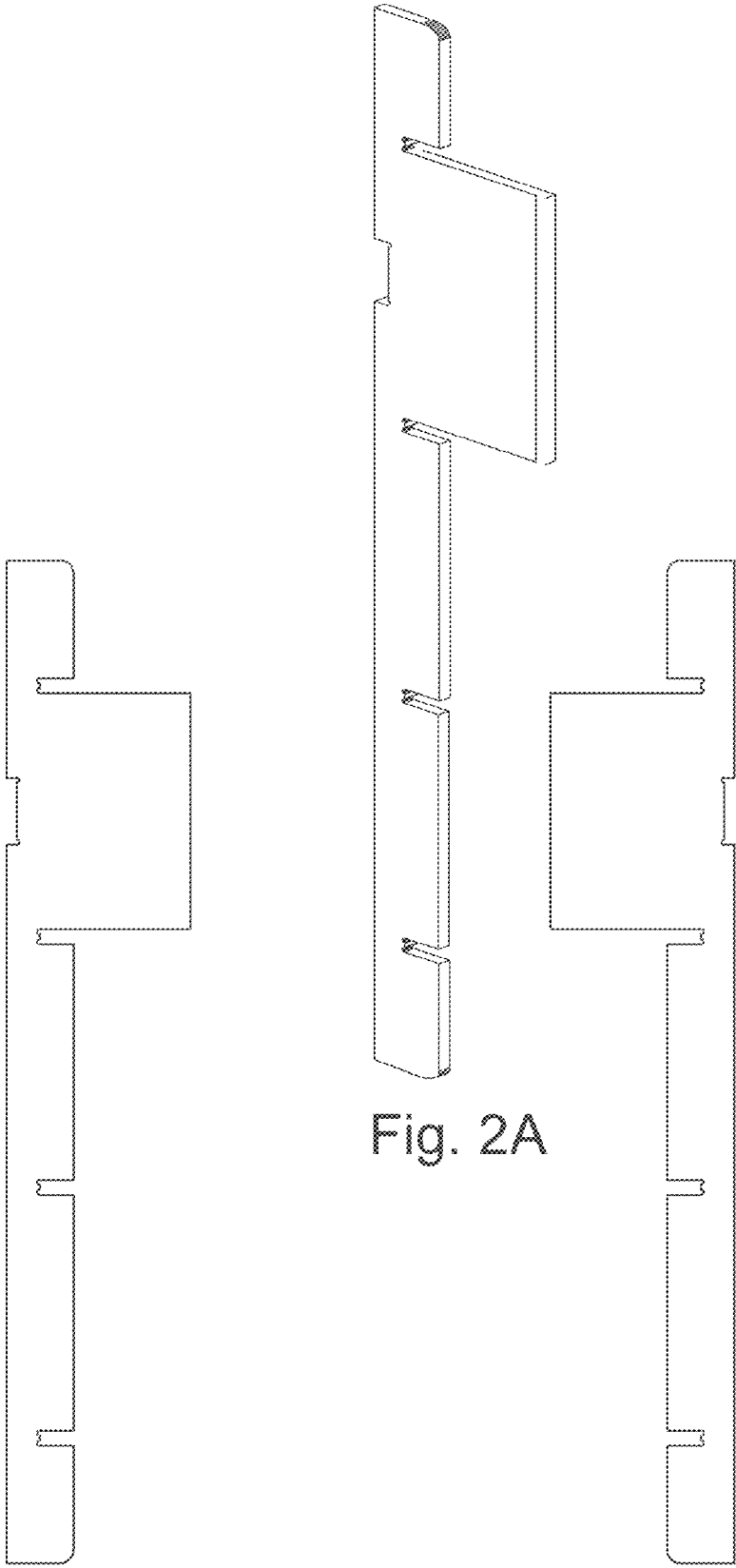

Fig. 2A

Fig. 2B

Fig. 2C



Fig. 2D



Fig. 2E

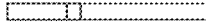

Fig. 2F

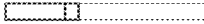

Fig. 2G

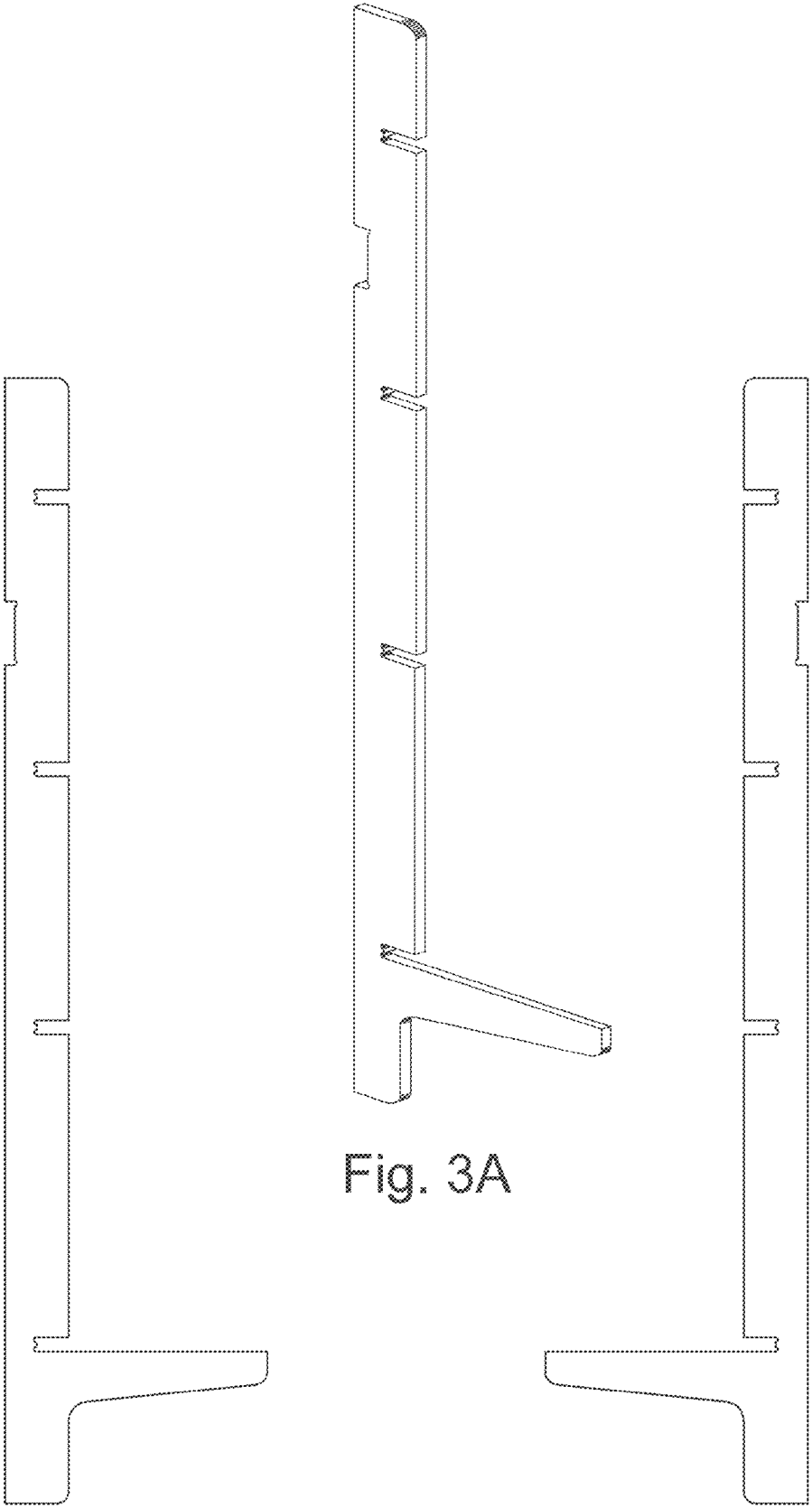

Fig. 3A

Fig. 3B

Fig. 3C



Fig. 3D

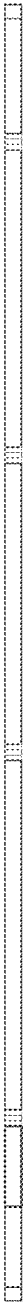

Fig. 3E



Fig. 3F



Fig. 3G

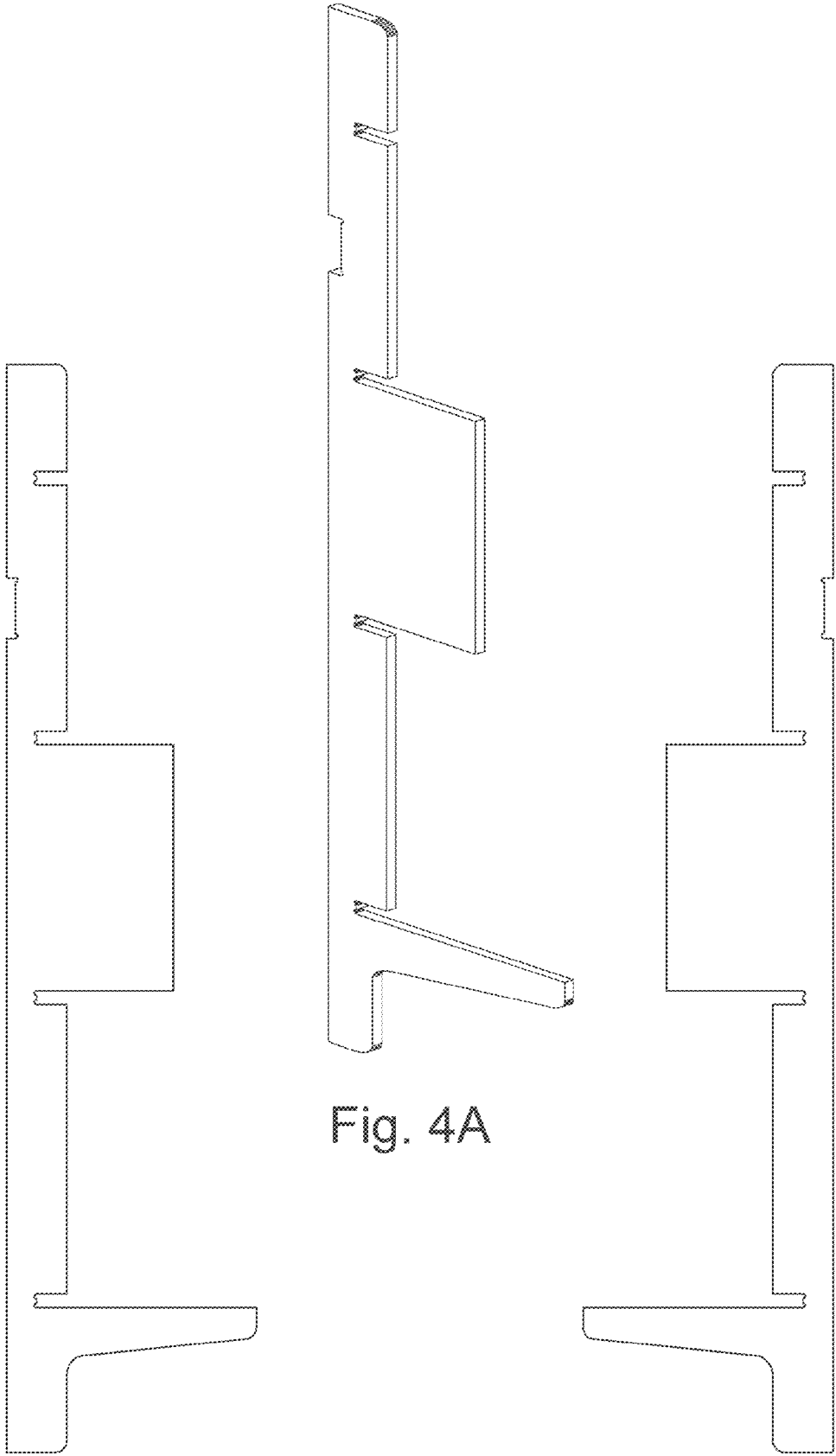

Fig. 4A

Fig. 4B

Fig. 4C



Fig. 4D

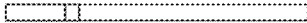

Fig. 4F



Fig. 4E



Fig. 4G

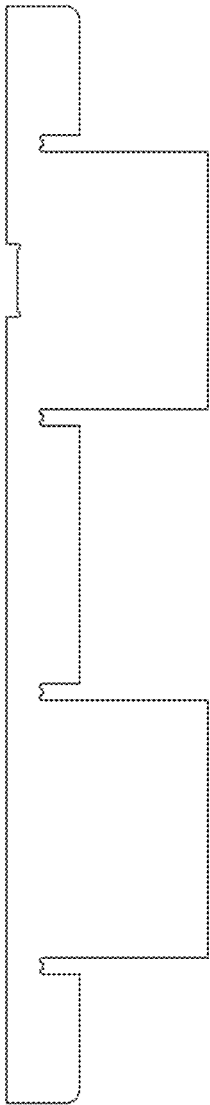

Fig. 5B

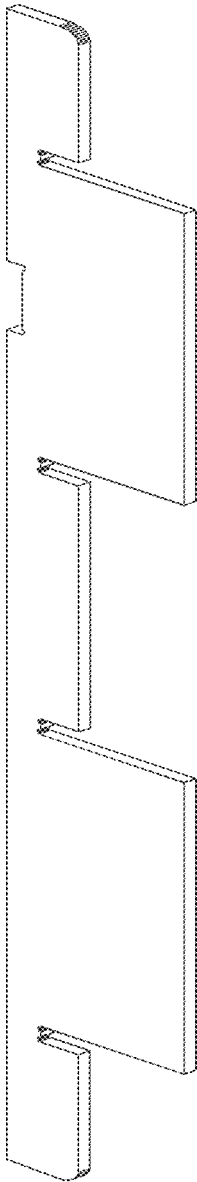

Fig. 5A

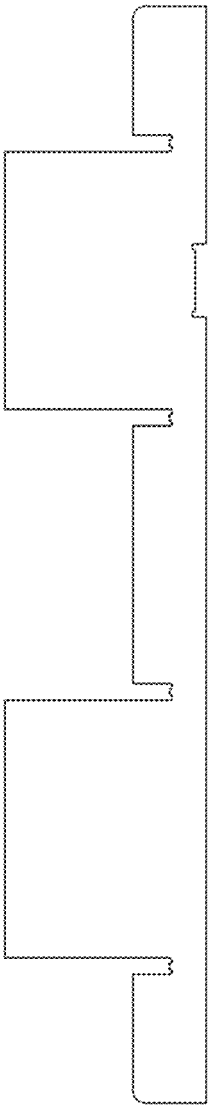

Fig. 5C



Fig. 5D



Fig. 5E



Fig. 5F

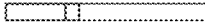

Fig. 5G

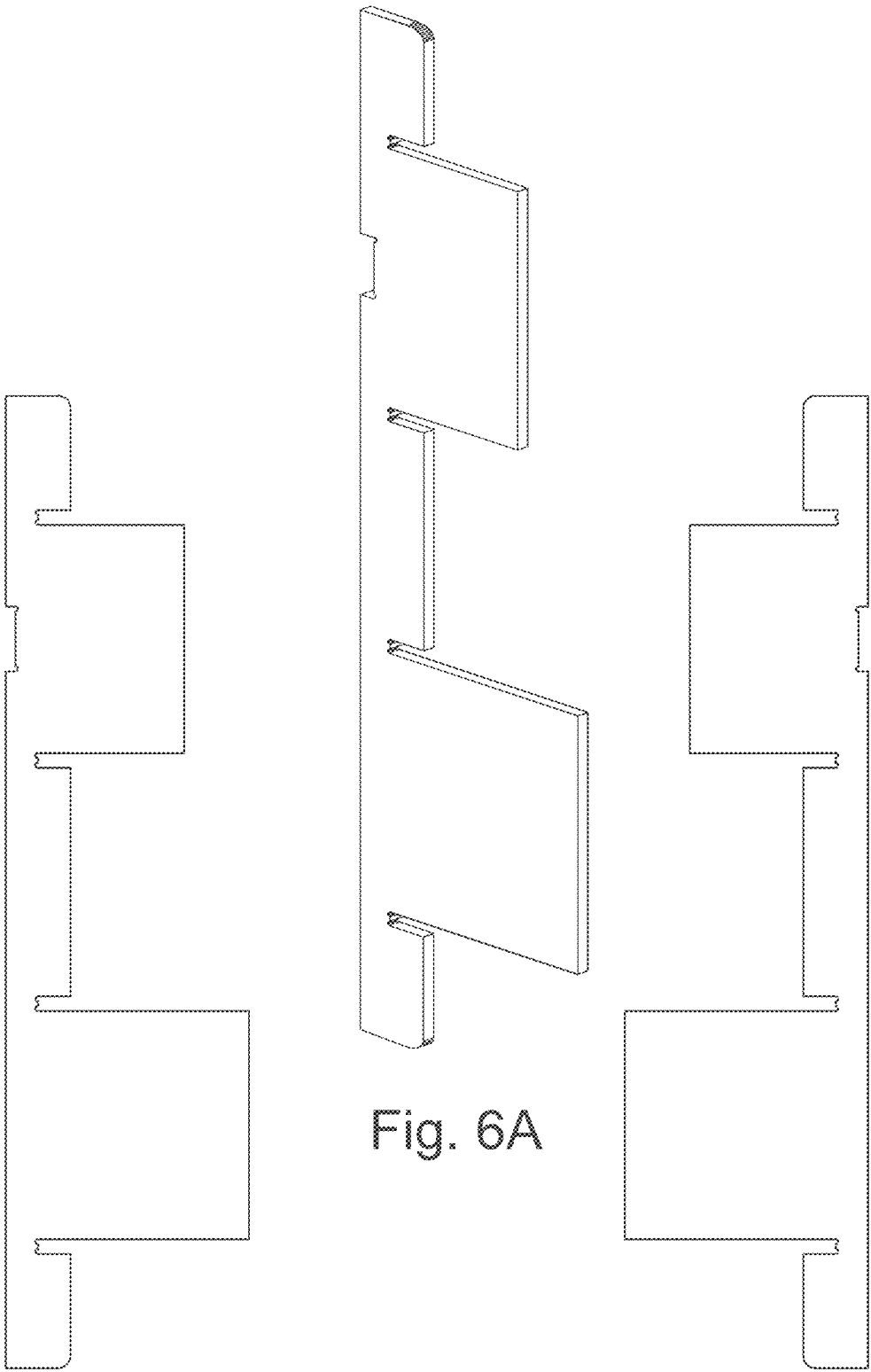

Fig. 6A

Fig. 6B

Fig. 6C



Fig. 6D



Fig. 6E

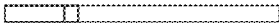

Fig. 6F

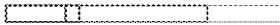

Fig. 6G

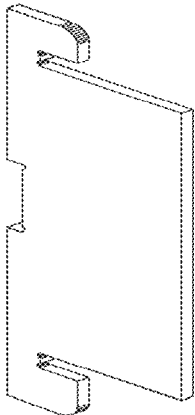

Fig. 7A

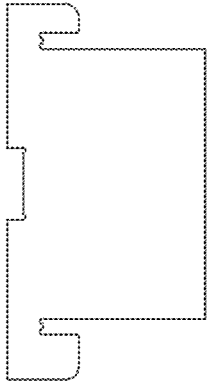

Fig. 7B

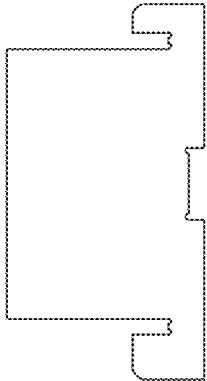

Fig. 7C



Fig. 7D



Fig. 7E

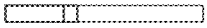

Fig. 7F

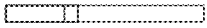

Fig. 7G

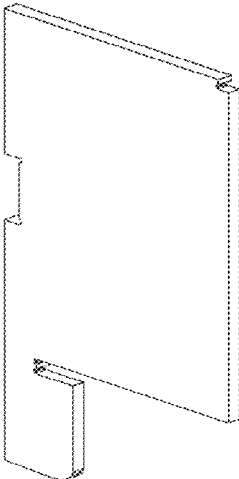

Fig. 8A

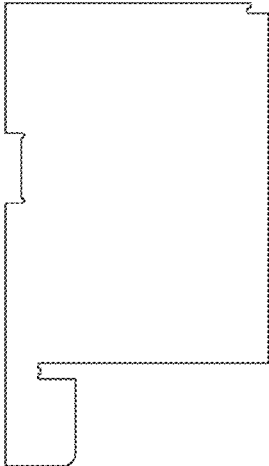

Fig. 8B

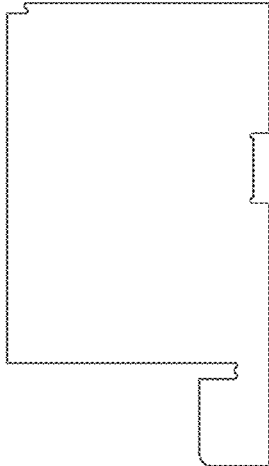

Fig. 8C



Fig. 8D



Fig. 8E

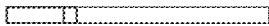

Fig. 8F

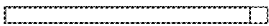

Fig. 8G

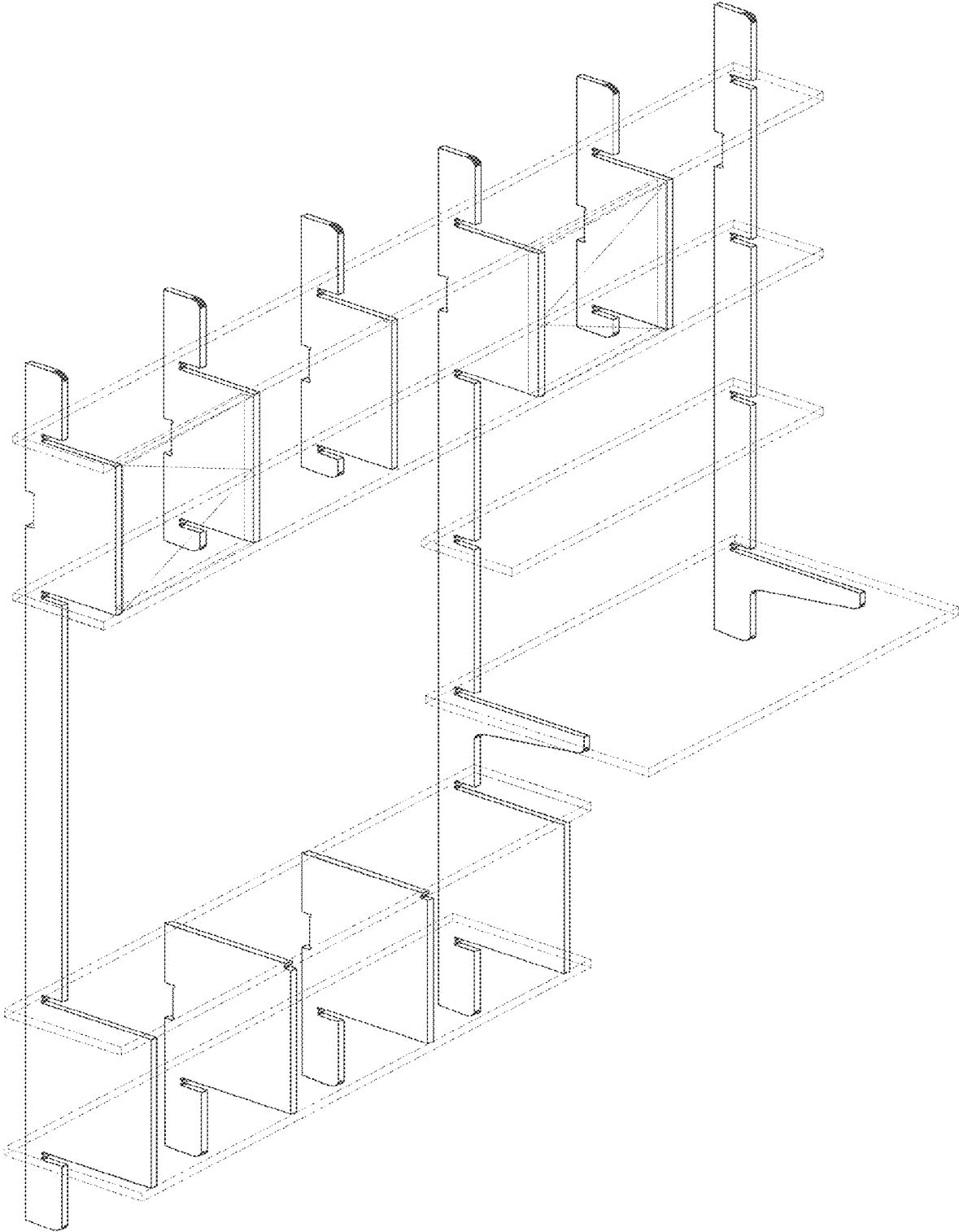

FIG. 9A

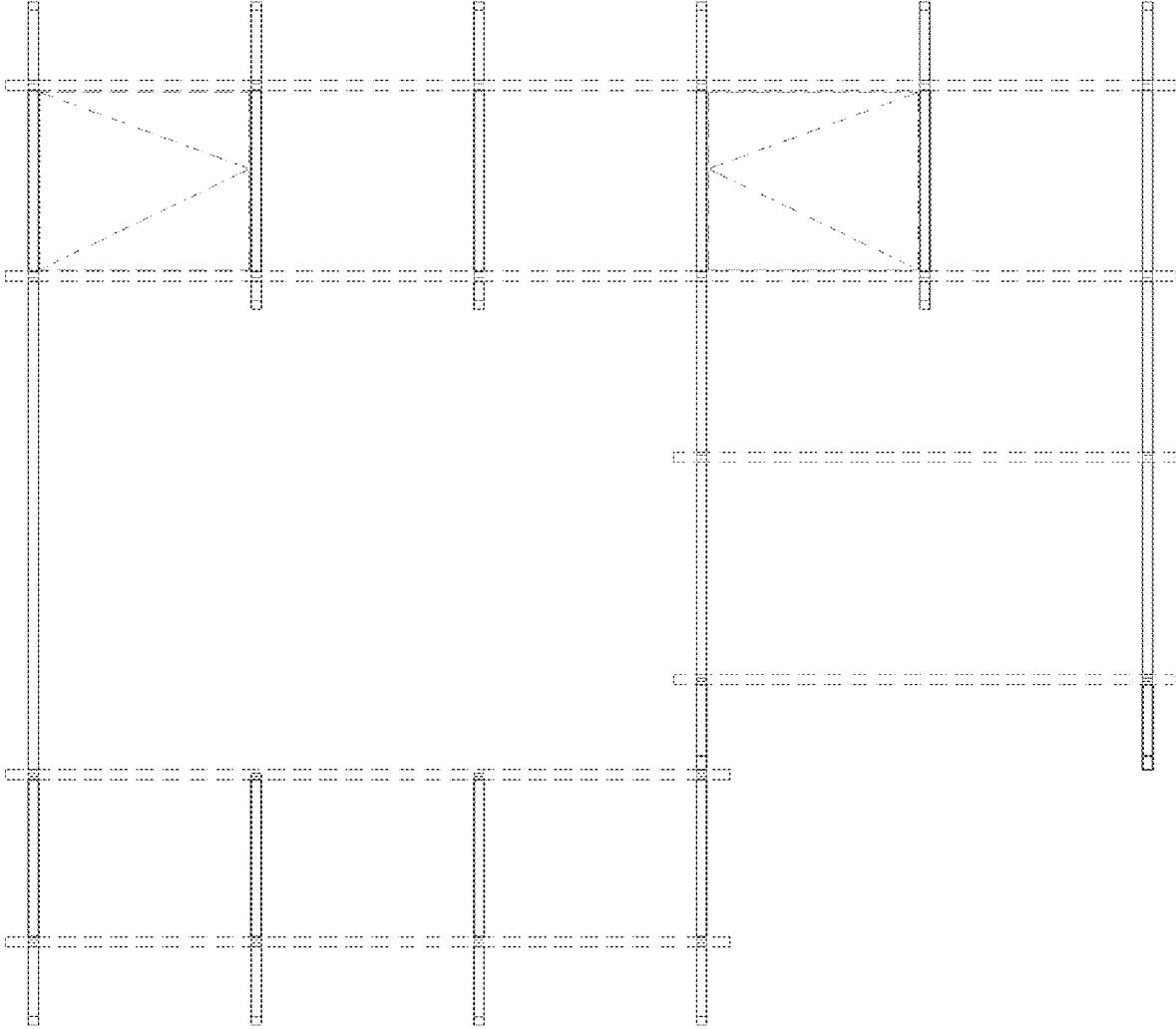

FIG. 9B

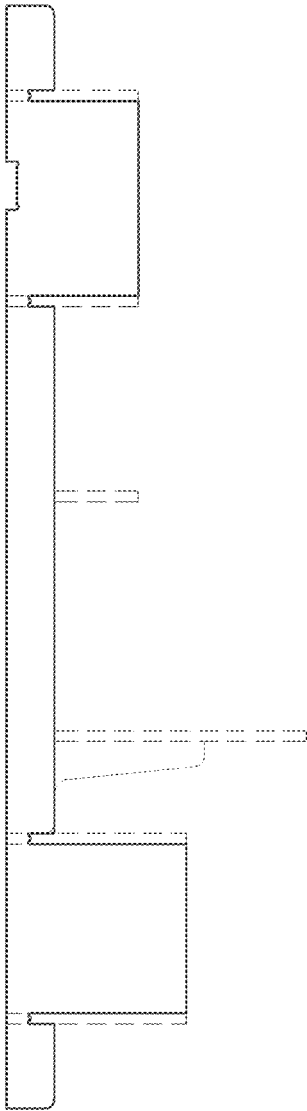

FIG. 9C

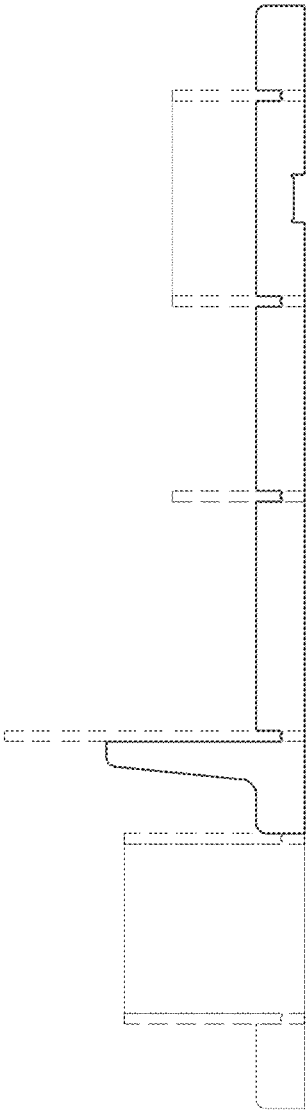

FIG. 9D

FIG. 9E

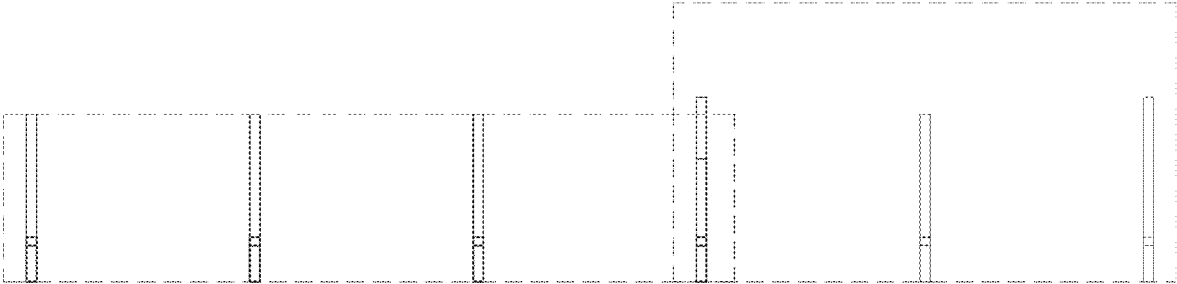
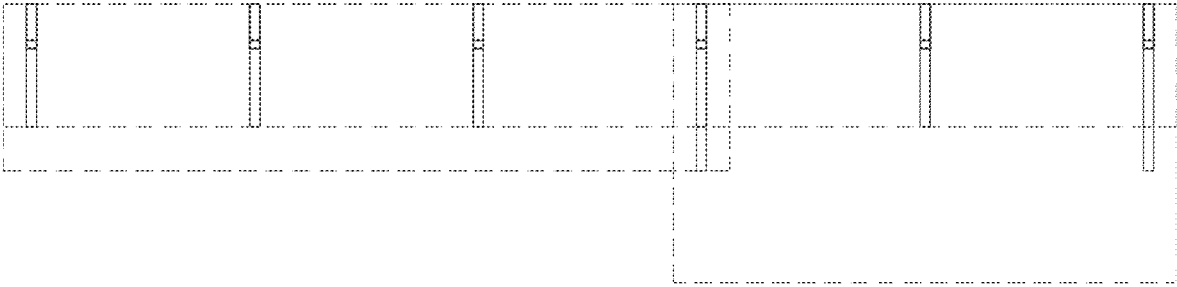

FIG. 9F

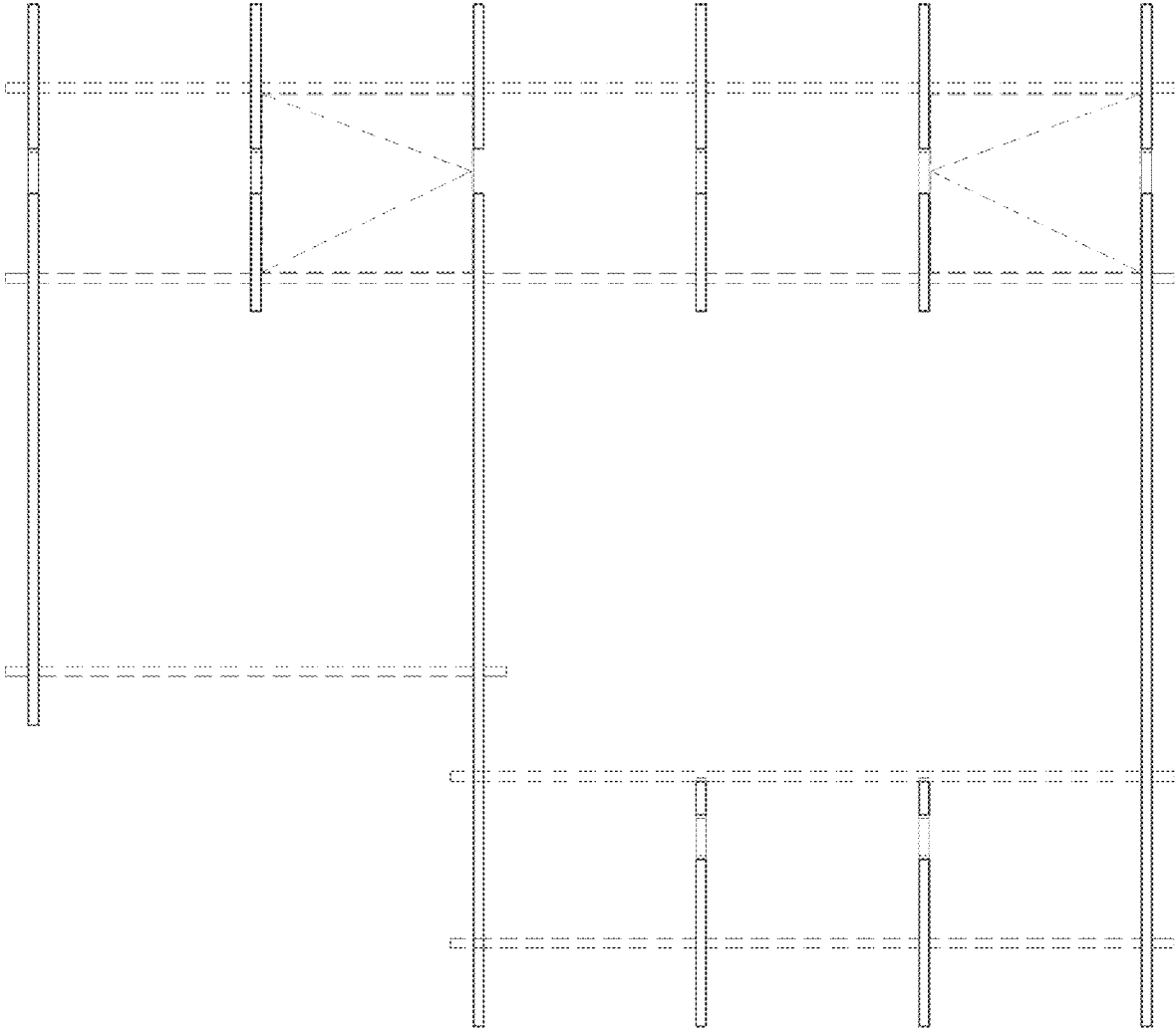

FIG. 9G

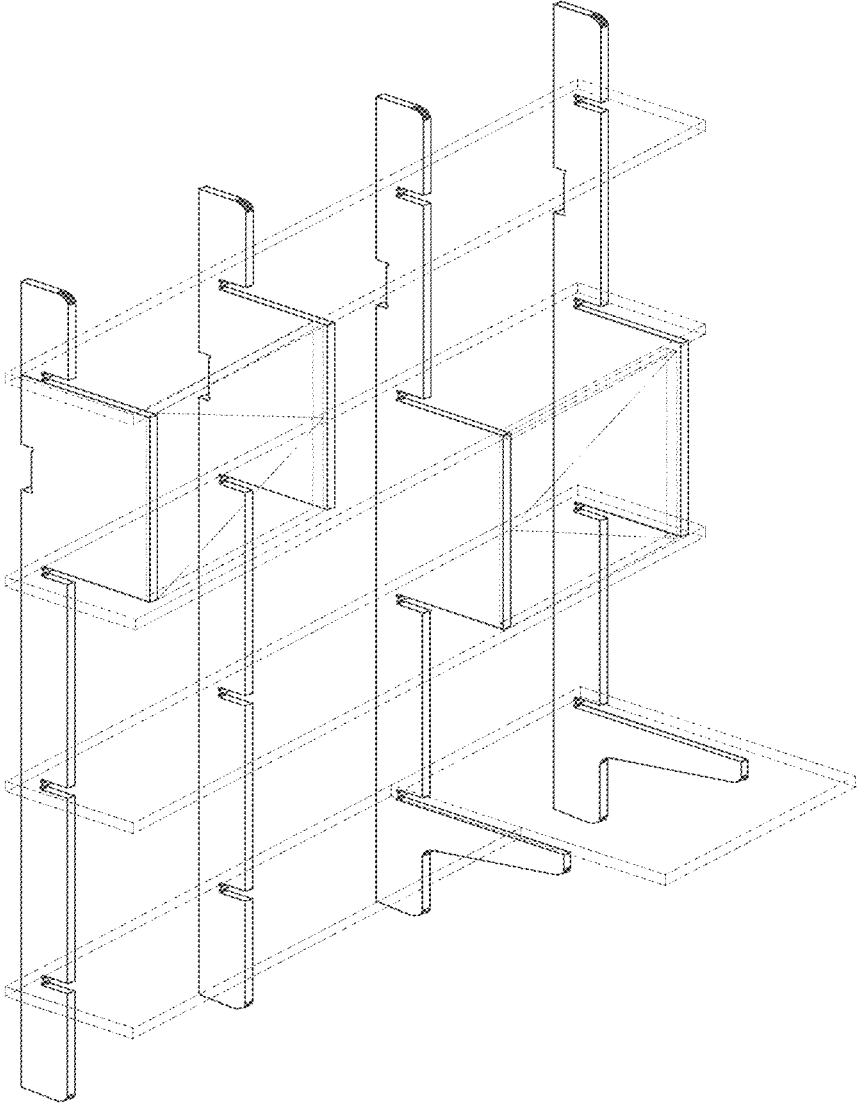

FIG. 10A

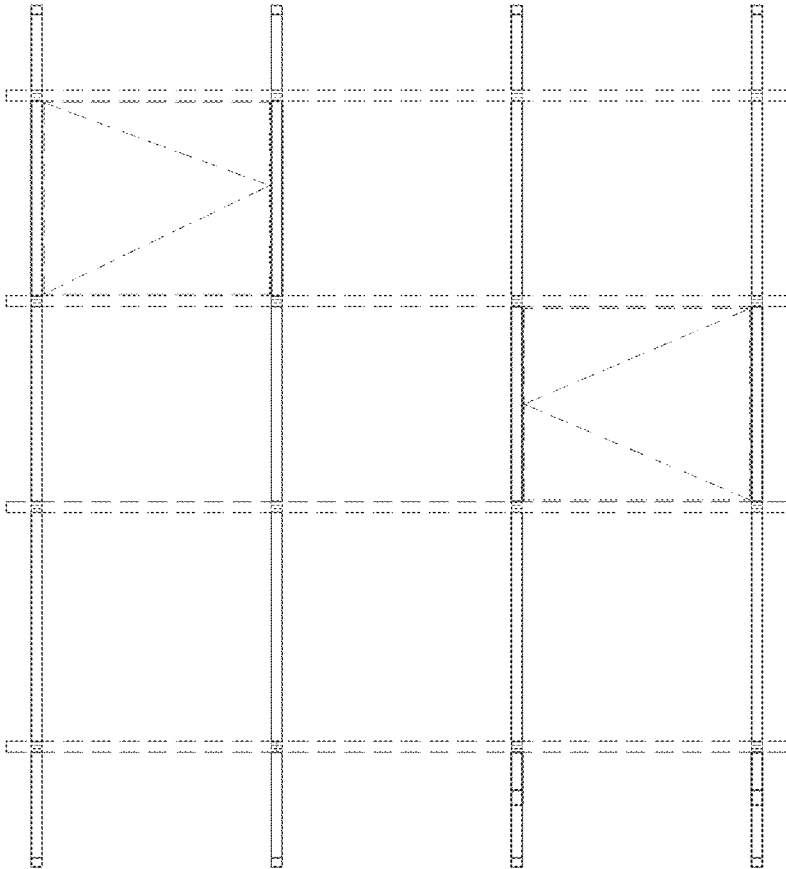

FIG. 10B

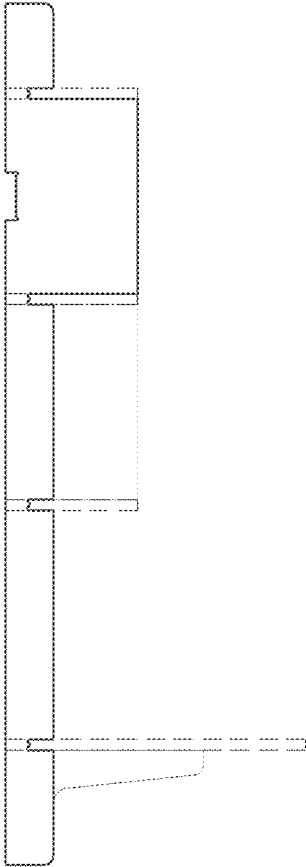

FIG. 10C

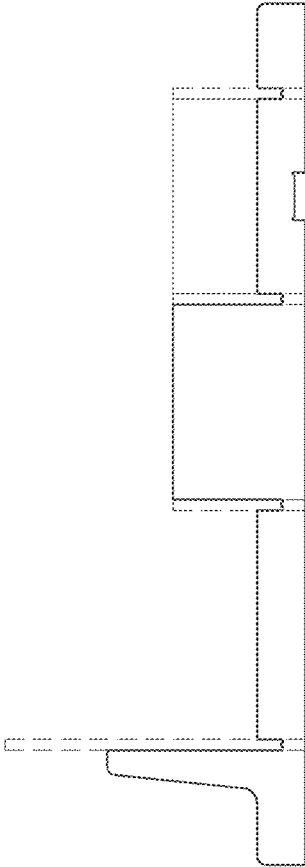

FIG. 10D

FIG. 10E

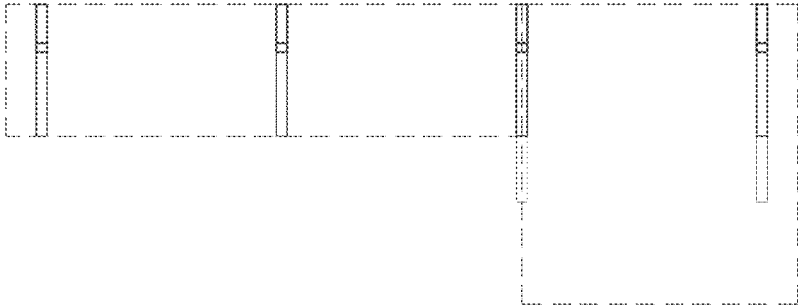
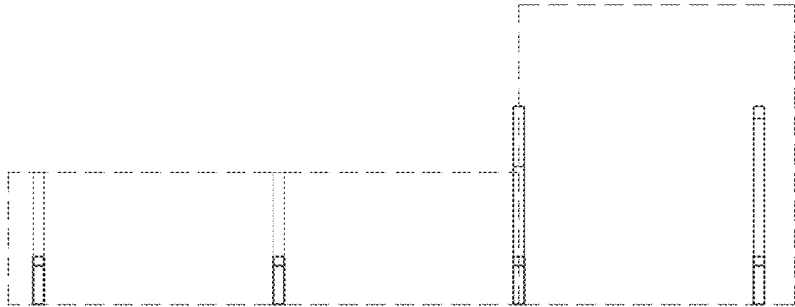

FIG. 10F



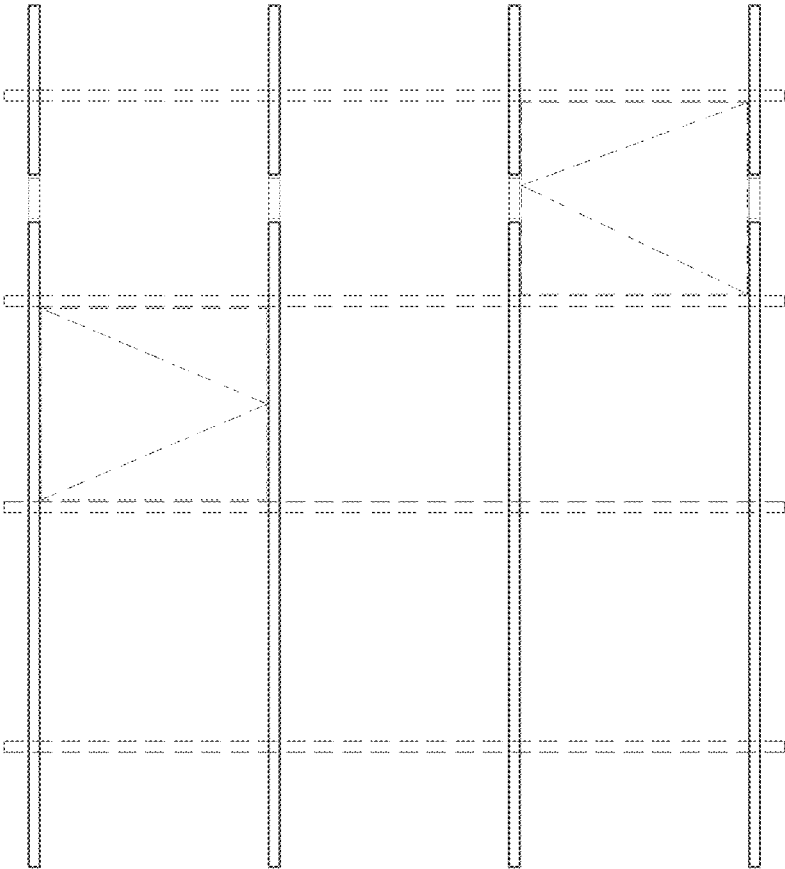

FIG. 10G

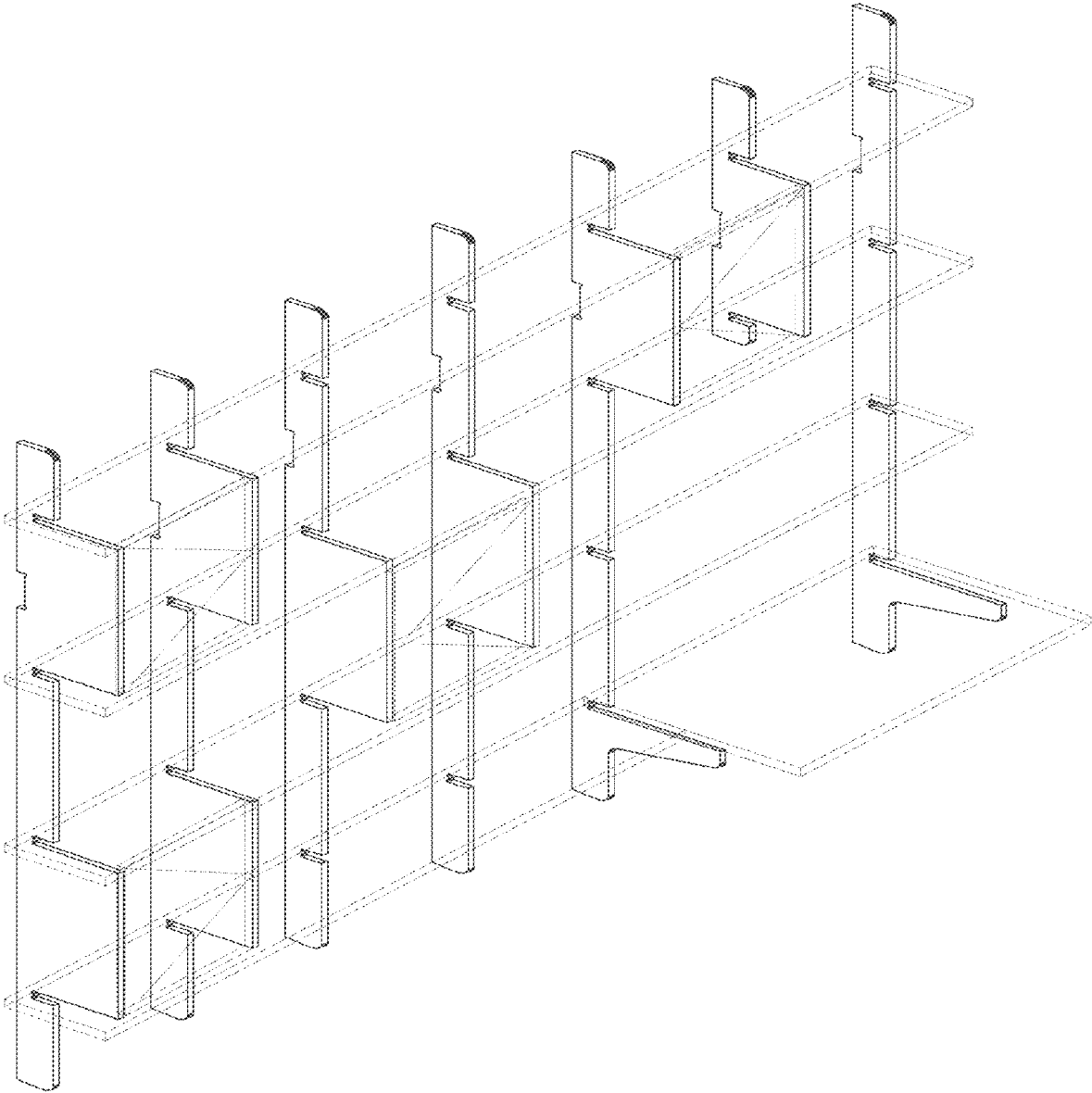

FIG. 11A

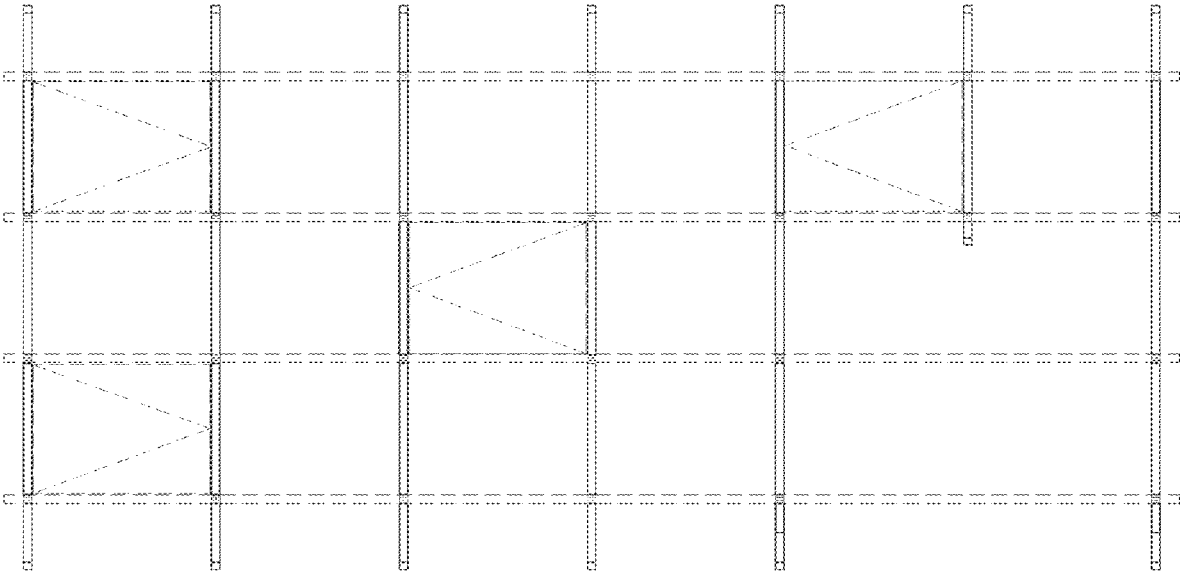

FIG. 11B

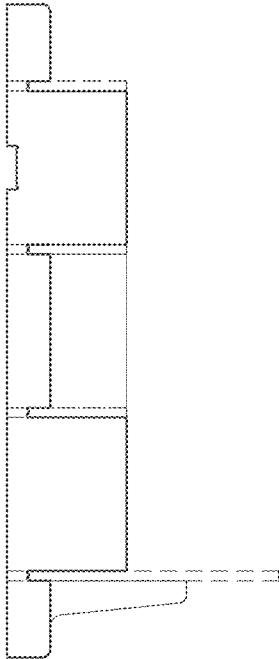

FIG. 11C

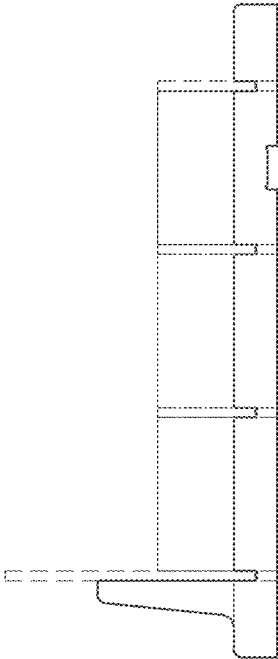

FIG. 11D

FIG. 11E

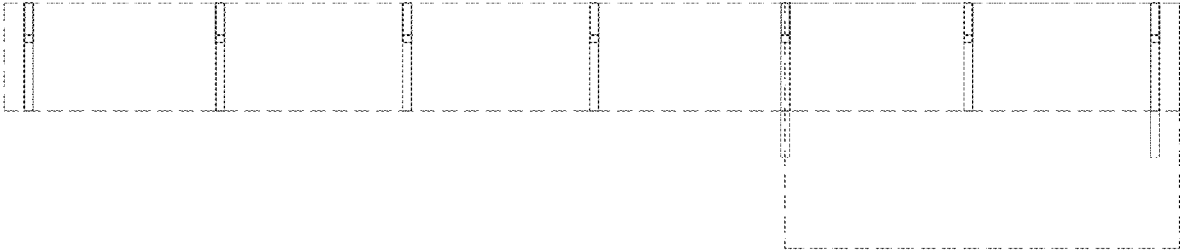
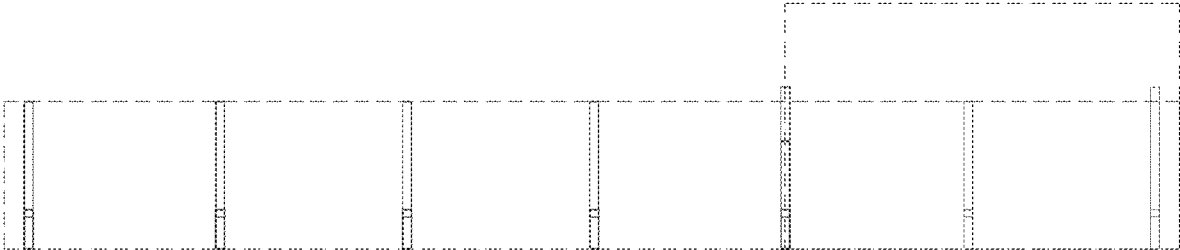

FIG. 11F



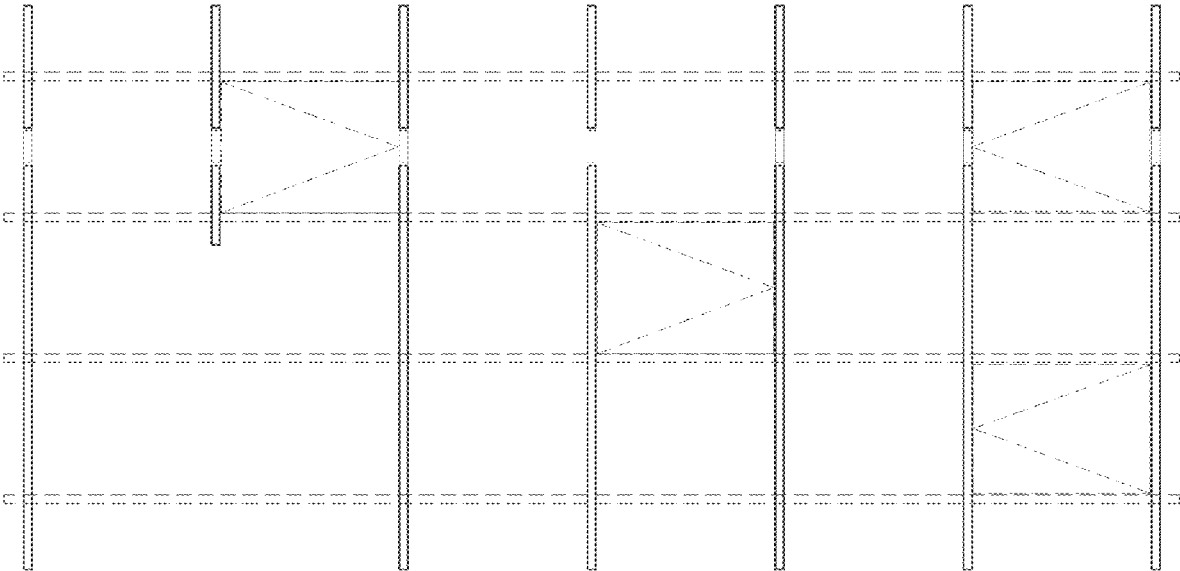

FIG. 11G

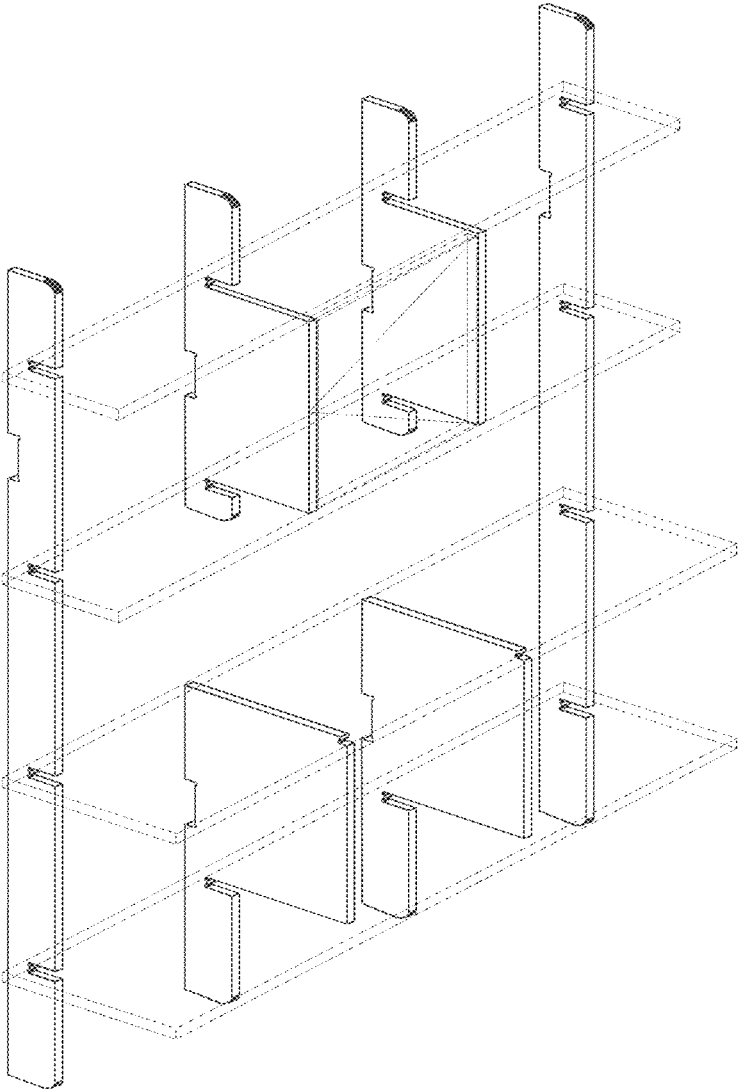

FIG.12A

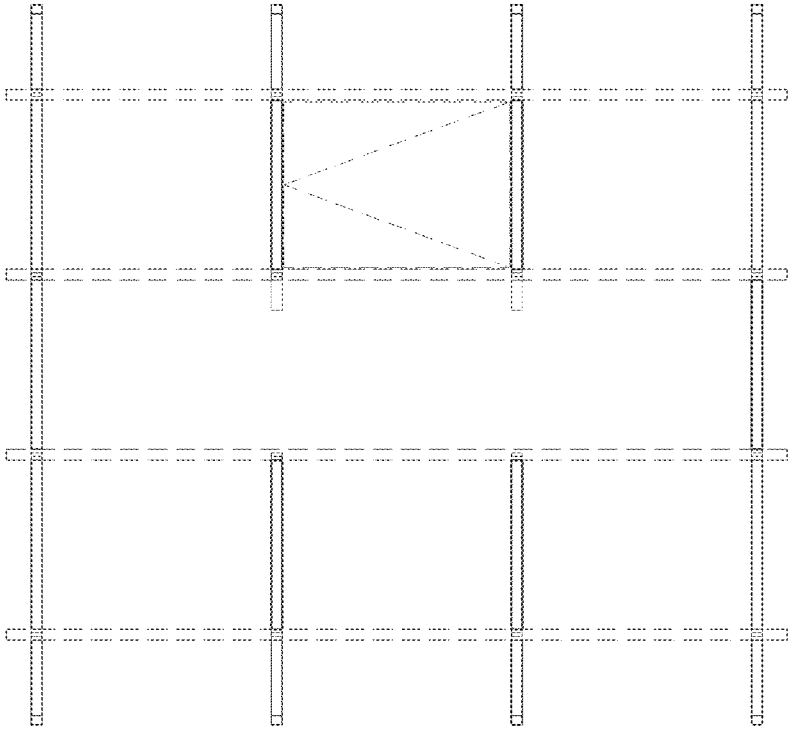

FIG. 12B

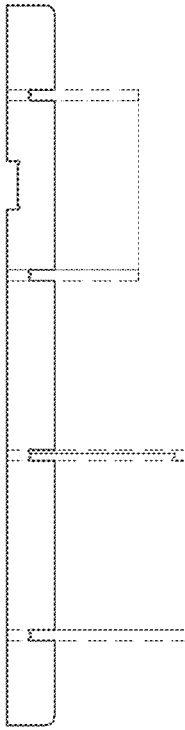

FIG. 12C

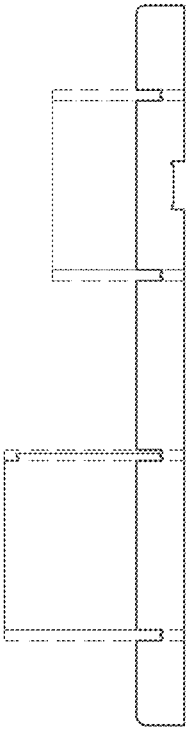

FIG. 12D

FIG. 12E

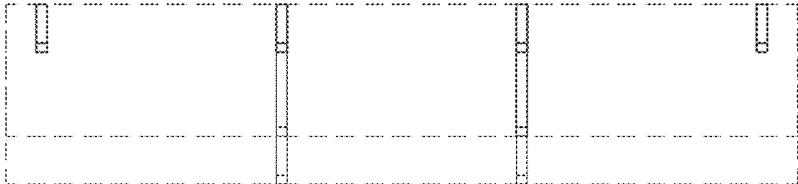
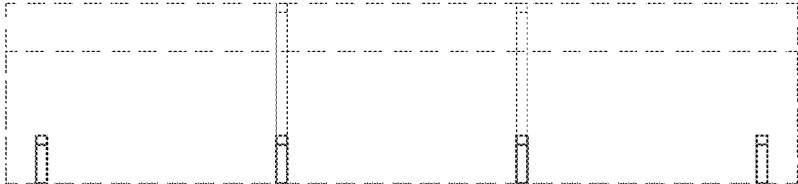

FIG. 12F



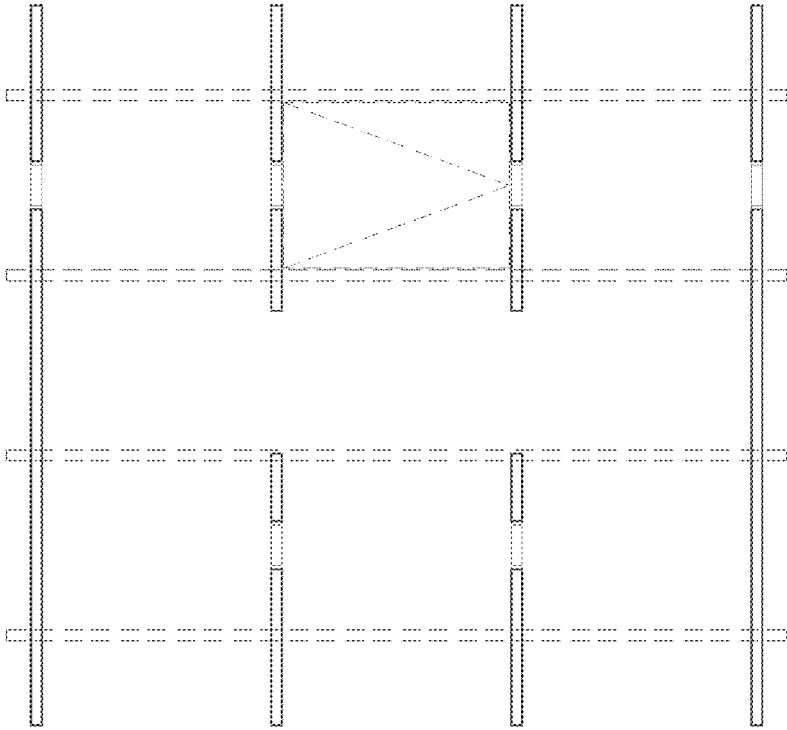

FIG.12G