

[54] BOWL

[75] Inventors: Robert H. C. M. Daenen, Hekelgem; Victor J. J. Cautereels, Zandhoven, both of Belgium

[73] Assignee: Dart Industries Inc., Northbrook, Ill.

[\*\*] Term: 14 Years

[21] Appl. No.: 594,597

[22] Filed: Mar. 29, 1984

[52] U.S. Cl. .... D7/23; D9/418

[58] Field of Search ..... D7/23, 1, 17, 16, 3, D7/79, 77, 81; D9/418, 428

[56] References Cited

U.S. PATENT DOCUMENTS

D. 30,087	1/1899	Kremer	.....	D7/23 X
D. 161,605	1/1951	Wright	.....	D7/17
D. 175,753	11/1954	Barnhart	.....	D7/17
D. 243,912	4/1977	Daenen	.....	D7/23
D. 259,625	6/1981	Hamilton et al.	.....	D9/428
D. 276,401	11/1984	Daenen et al.	.....	D7/79
D. 276,402	11/1984	Daenen et al.	.....	D7/79
D. 280,281	8/1985	Conti et al.	.....	D7/79

OTHER PUBLICATIONS

*Better Homes & Gardens*, Sep. 1972, p. 124, Rubbermaid Food Keepers, Uncovered Bowl at top.

Primary Examiner—Winifred E. Herrmann  
Attorney, Agent, or Firm—A. Lewis Worthem, Jr.; John A. Doninger

[57] CLAIM

The ornamental design for a bowl, as shown and described.

DESCRIPTION

FIG. 1 is a top perspective view of a bowl showing our new design;  
FIG. 2 is a top plan view thereof;  
FIG. 3 is a front or rear elevational view thereof;  
FIG. 4 is a left or right side elevational view thereof;  
FIG. 5 is a bottom plan view thereof;  
FIG. 6 is a top perspective view of a second embodiment of our new design for a bowl;  
FIG. 7 is a front or rear elevational view of the bowl of FIG. 6;  
FIG. 8 is a bottom plan view of the bowl of FIG. 6;  
FIG. 9 is a top perspective view of a third embodiment of our new design for a bowl;  
FIG. 10 is a front or rear elevational view of the bowl of FIG. 9; and  
FIG. 11 is a bottom plan view of the bowl of FIG. 9; and  
FIG. 12 is a sectional view taken on line 12—12 of FIG. 2.  
A top plan view of the bowl of FIG. 6 and FIG. 9 is substantially similar to the top plan view of FIG. 2.

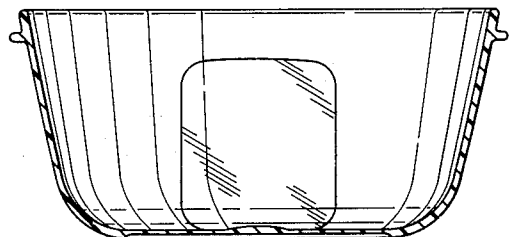
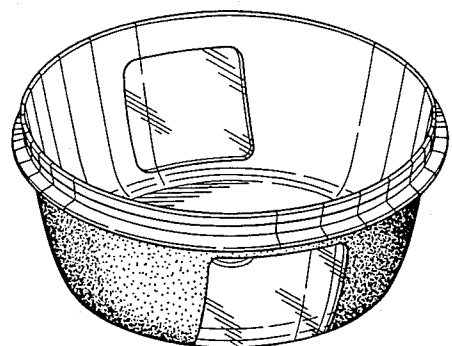
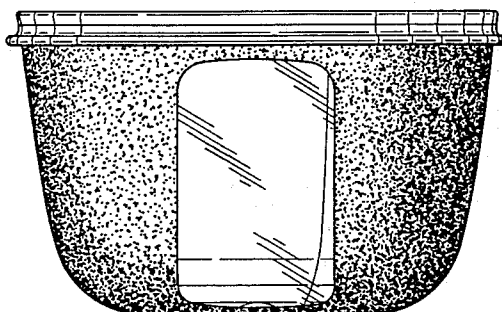
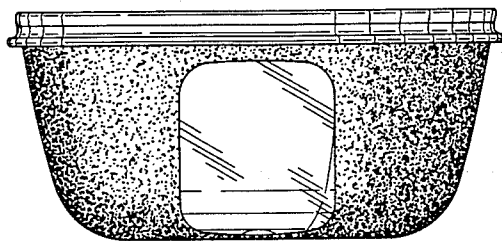
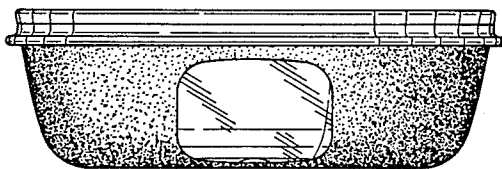

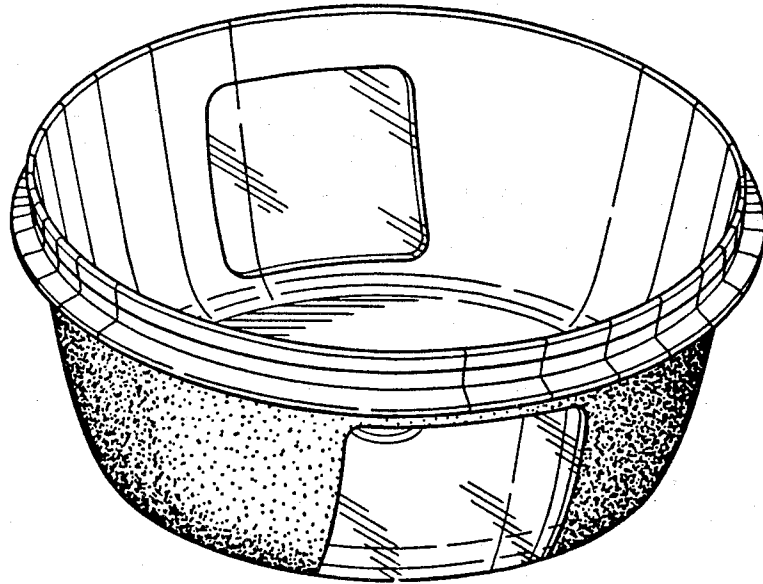

FIG. 1

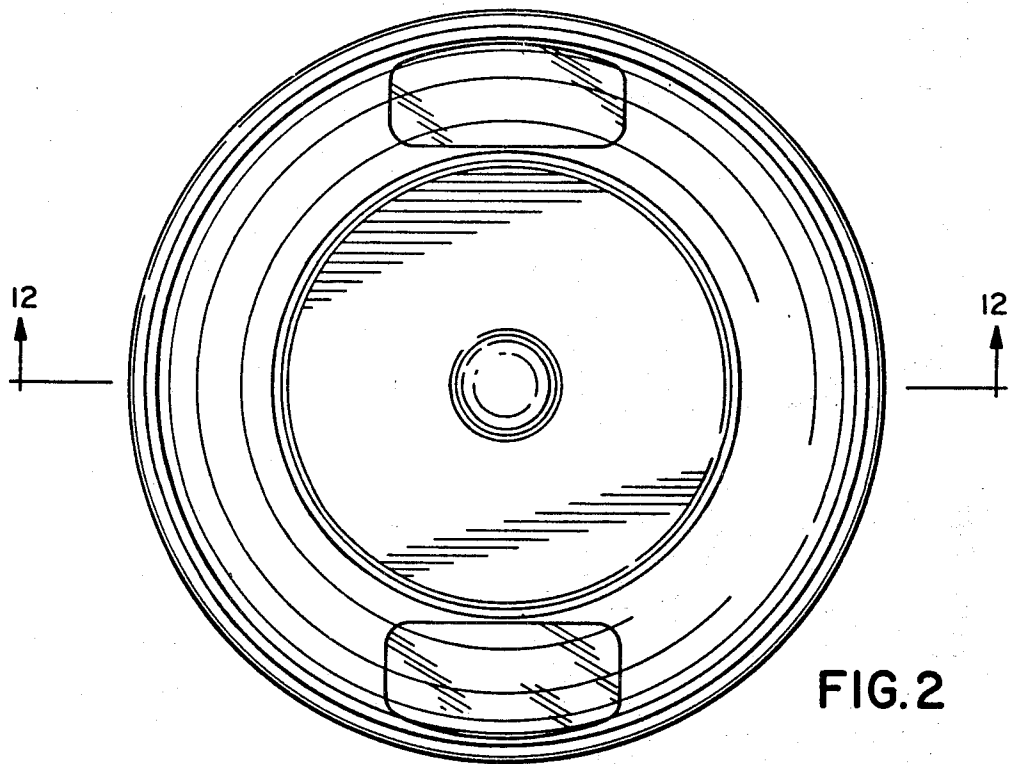

FIG. 2

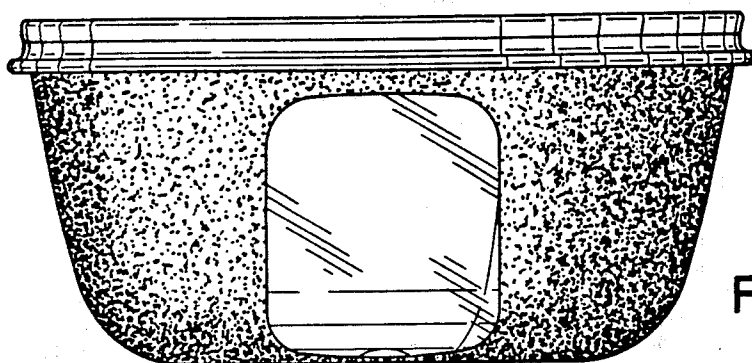

FIG. 3

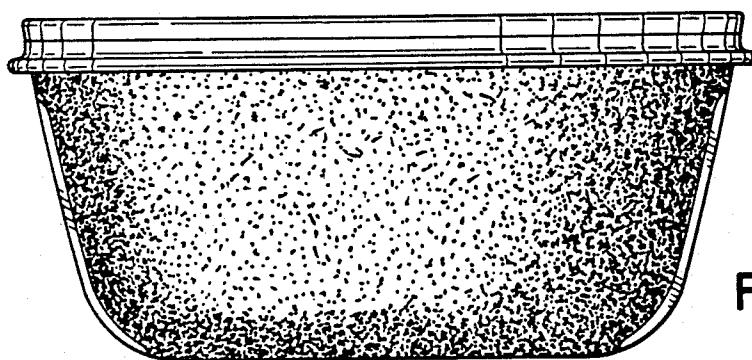

FIG. 4

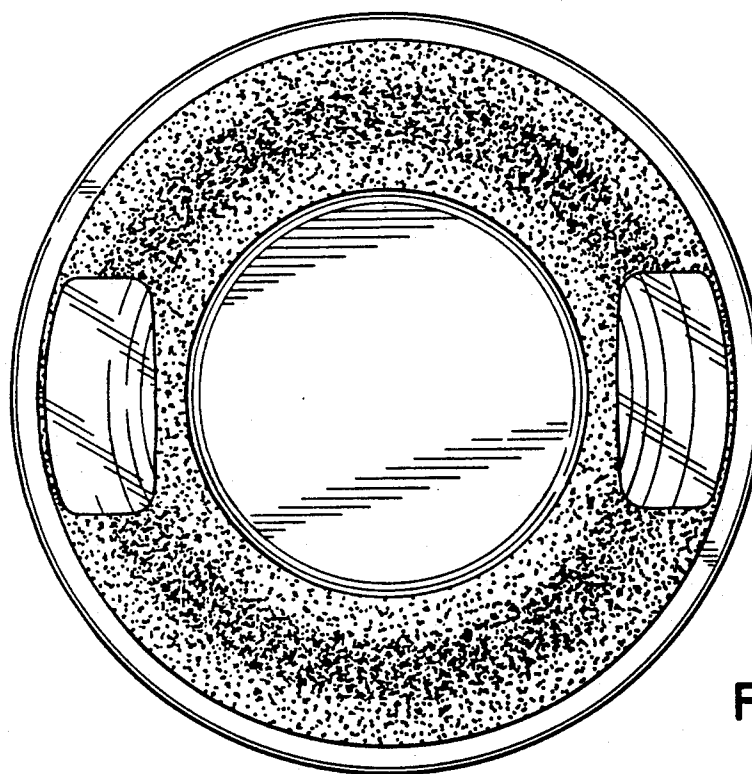

FIG. 5

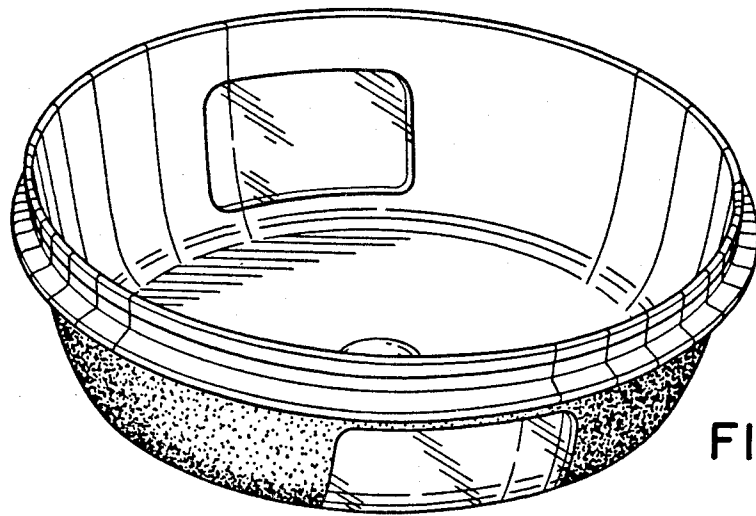

FIG. 6

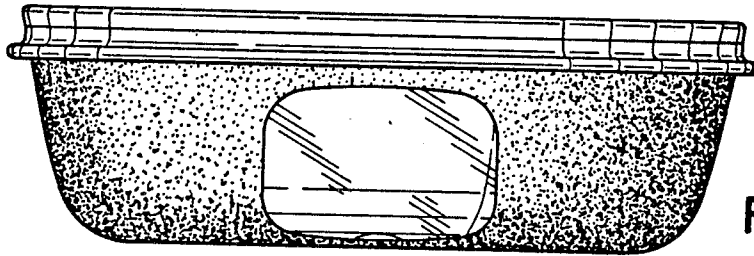

FIG. 7

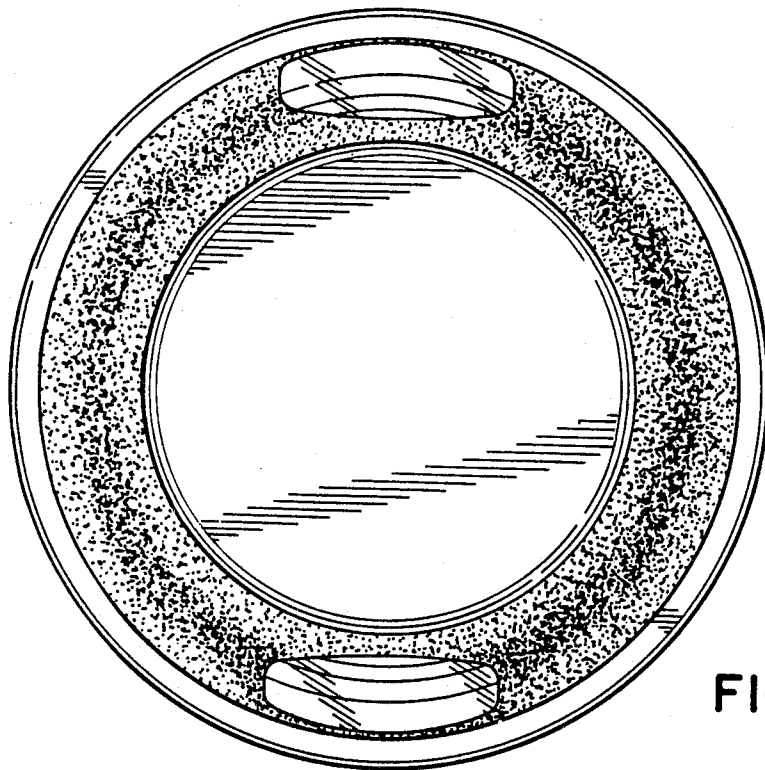

FIG. 8

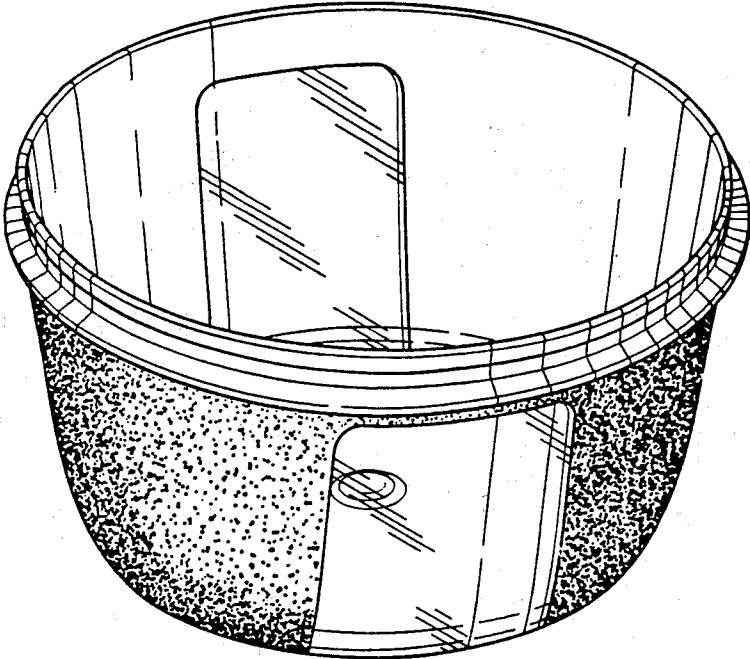

FIG. 9

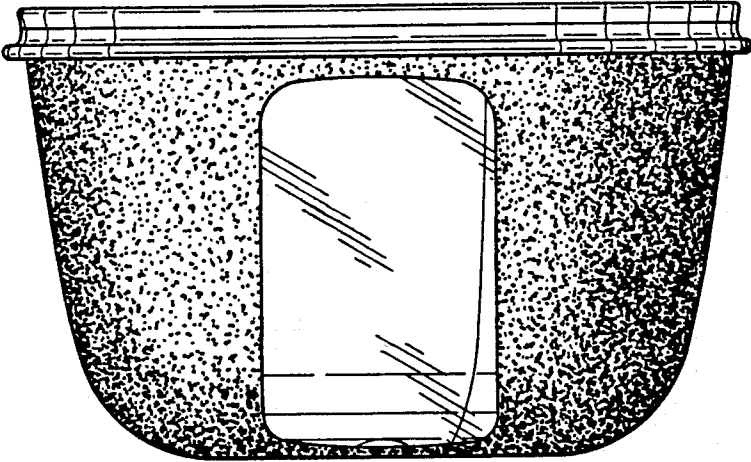

FIG. 10

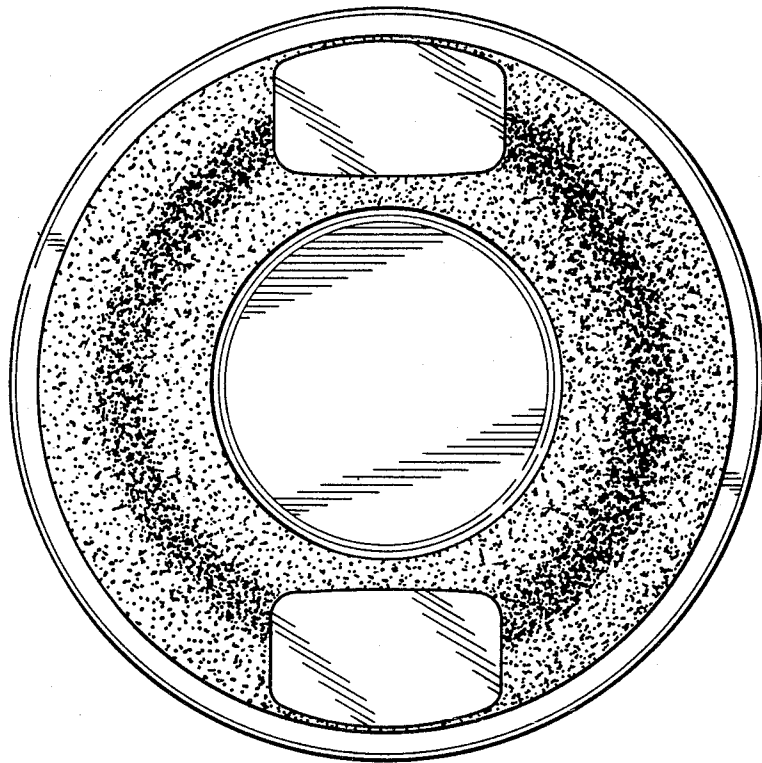

FIG. 11

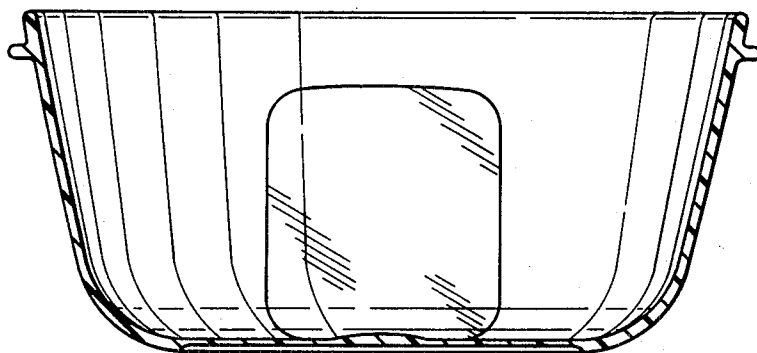

FIG. 12