



US0D1040976S

(12) **United States Design Patent**
Zhang

(10) **Patent No.:** **US D1,040,976 S**

(45) **Date of Patent:** **** Sep. 3, 2024**

(54) **SINK**

(71) Applicant: **Shenzhen Tetai Technology Co., Ltd.**,
Shenzhen (CN)

(72) Inventor: **Cheng Zhang**, Shenzhen (CN)

(73) Assignee: **SHENZHEN TETAI TECHNOLOGY**
CO., LTD., Shenzhen (CN)

(**) Term: **15 Years**

(21) Appl. No.: **29/926,591**

(22) Filed: **Jan. 31, 2024**

(51) **LOC (14) Cl.** **23-01**

(52) **U.S. Cl.**
USPC **D23/284**

(58) **Field of Classification Search**
USPC D21/473, 374, 524; D23/284, 285, 286,
D23/287, 290, 291, 292, 293.1
CPC E03C 1/18; E03C 1/33; E03C 1/04; E03C
1/14; E03C 1/29; E03C 1/326; E03C
1/01; E03C 1/186
See application file for complete search history.

(56) **References Cited**

U.S. PATENT DOCUMENTS

| | | | | |
|--------------|---------|----------------|-------|---------|
| D602,136 S * | 10/2009 | Lee | | D23/292 |
| D914,167 S * | 3/2021 | Parisio | | D23/286 |
| D948,004 S * | 4/2022 | Zhang | | D23/286 |
| D948,005 S * | 4/2022 | Zhang | | D23/286 |
| D961,741 S | 8/2022 | Kuch et al. | | |
| D967,360 S | 10/2022 | Grybush et al. | | |
| D970,704 S * | 11/2022 | Zhang | | D23/286 |
| D978,298 S * | 2/2023 | Zhang | | D23/286 |
| D984,600 S * | 4/2023 | Zhang | | D23/286 |
| D984,601 S * | 4/2023 | Zhang | | D23/286 |
| D987,785 S | 5/2023 | Starck | | |
| D990,639 S * | 6/2023 | Reinhart | | D23/290 |

OTHER PUBLICATIONS

[GGW 3], available in amazon.com, announced 2023 [online], [site visited Mar. 14, 2024], Internet URL: <https://www.amazon.com/dp/B0CPXNZW1N/> (Year: 2023).*

[GGW 4], available in amazon.com, announced 2023 [online], [site visited Mar. 14, 2024], Internet URL: <https://www.amazon.com/Stainless-Steel-Sink-Commercial-Restaurant/dp/B0CCNS8DYY/> (Year: 2023).*

[Kingbo], available in amazon.com, announced 2024 [online], [site visited Mar. 14, 2024], Internet URL: <https://www.amazon.com/dp/B0CTFNR37P/> (Year: 2024).*

[Vevor], available in wayfair.com, announced 2023 [online], [site visited Mar. 14, 2024], Internet URL: <https://www.wayfair.com/home-improvement/pdp/vevor-217-1-x-197-w-silver-free-standing-laundry-sink-with-faucet-fxnu2303.html> (Year: 2023).*

* cited by examiner

Primary Examiner — George J Ulsh

Assistant Examiner — Jihyung Yoon

(74) *Attorney, Agent, or Firm* — Shen Huang

(57) **CLAIM**

The ornamental design for a sink, as shown and described.

DESCRIPTION

FIG. 1 is a first perspective view of a sink showing my new design;

FIG. 2 is a second perspective view thereof;

FIG. 3 is a front view thereof;

FIG. 4 is a back view thereof;

FIG. 5 is a left side view thereof;

FIG. 6 is a right side view thereof;

FIG. 7 is a top view thereof; and,

FIG. 8 is a bottom view thereof.

The broken lines shown in the drawings depict portions of the sink that form no part of the claimed design.

1 Claim, 8 Drawing Sheets

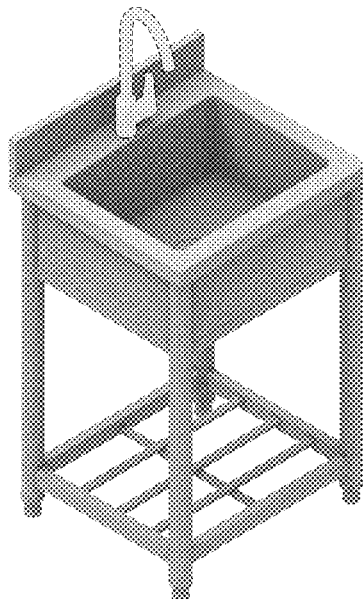

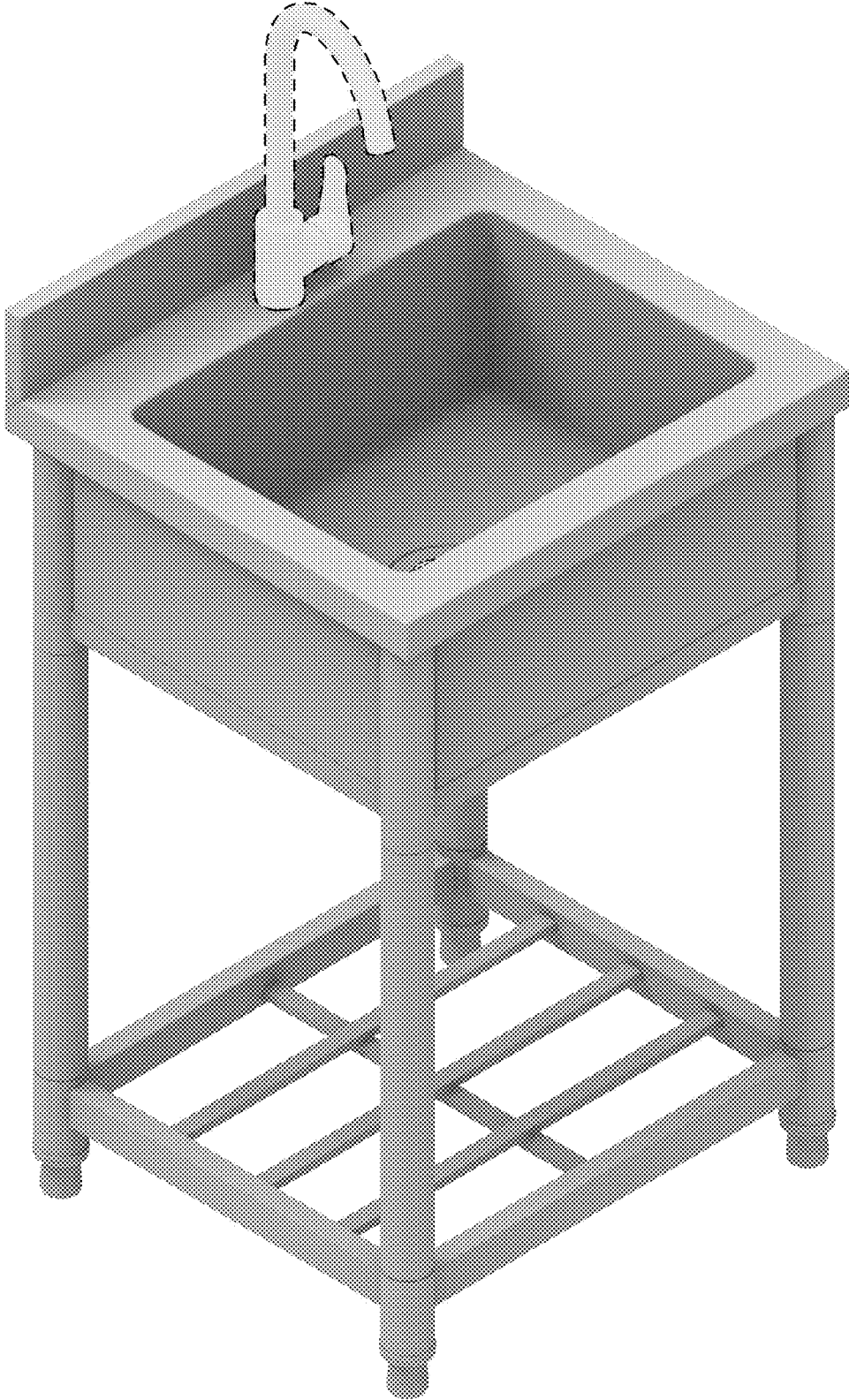

FIG.1



FIG.2

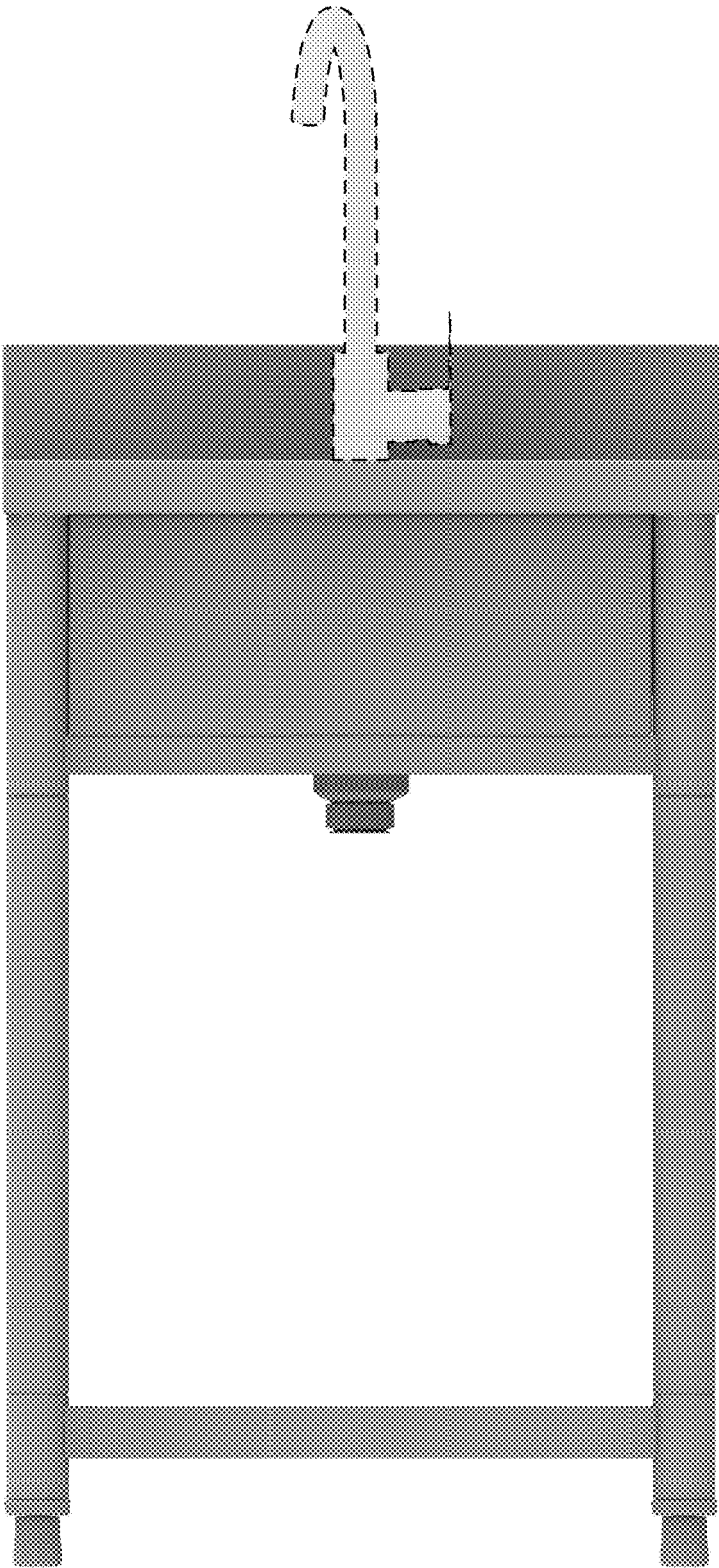

FIG.3

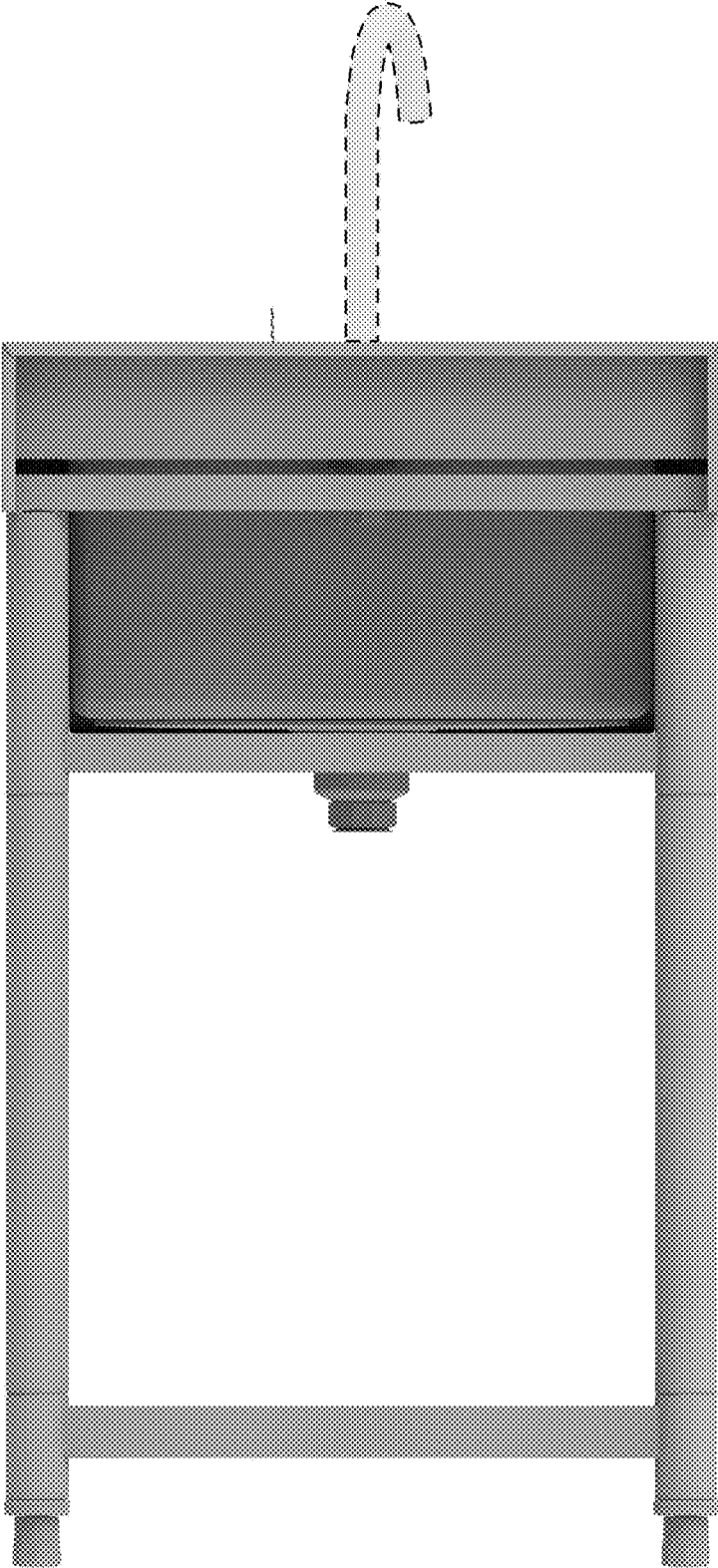

FIG. 4

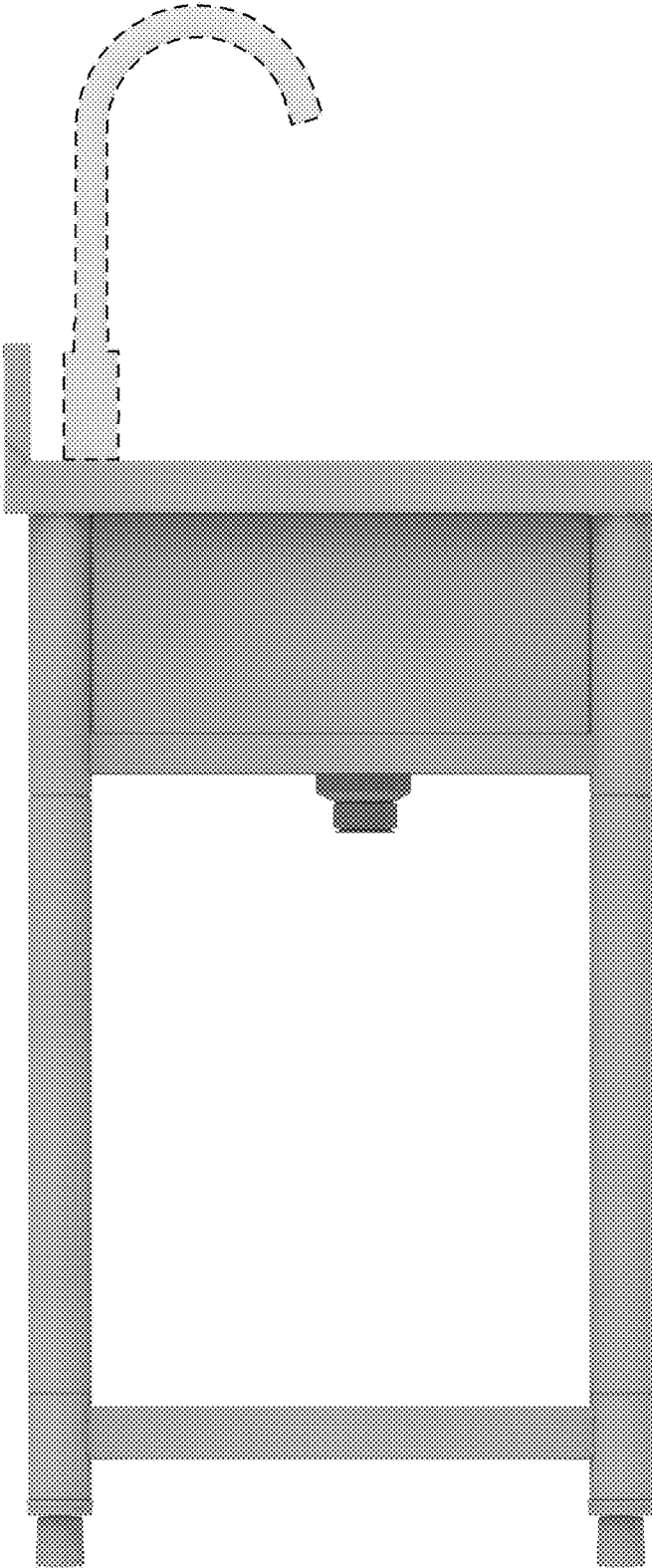

FIG.5

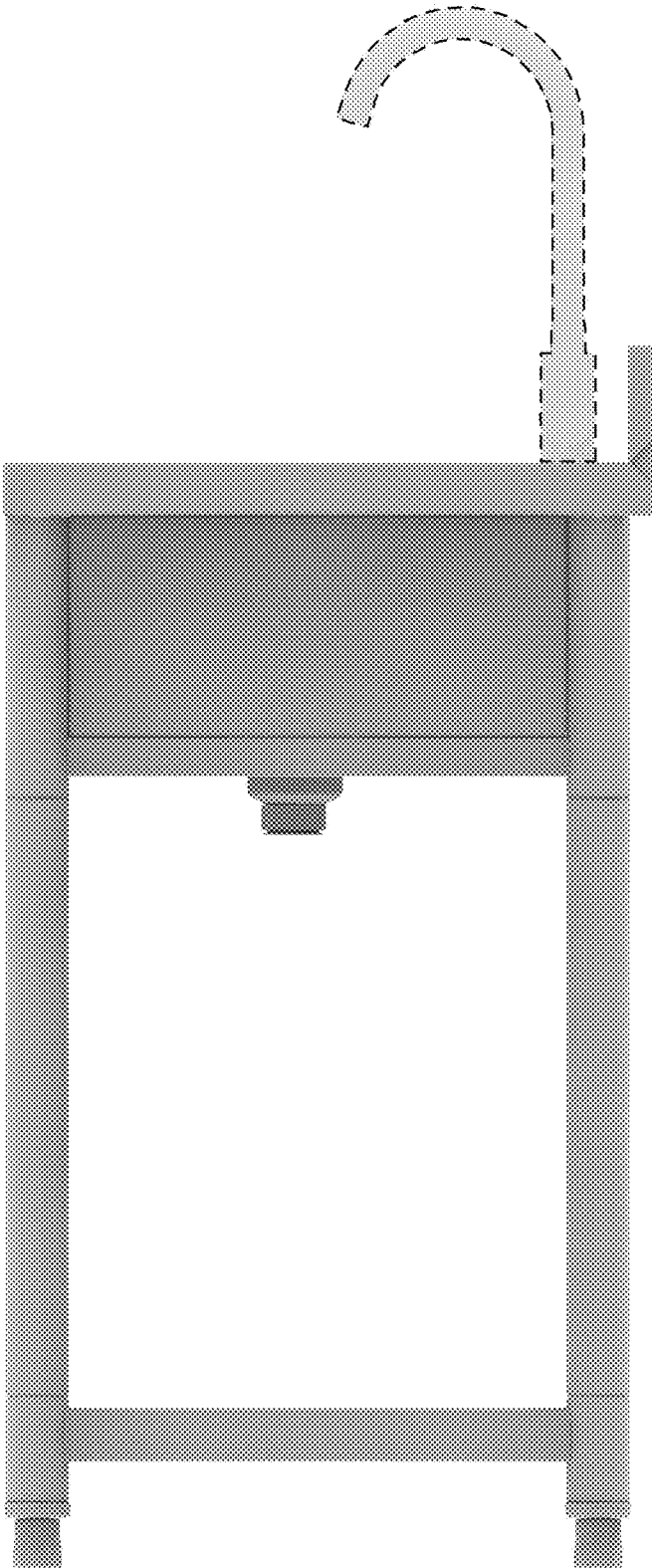

FIG.6

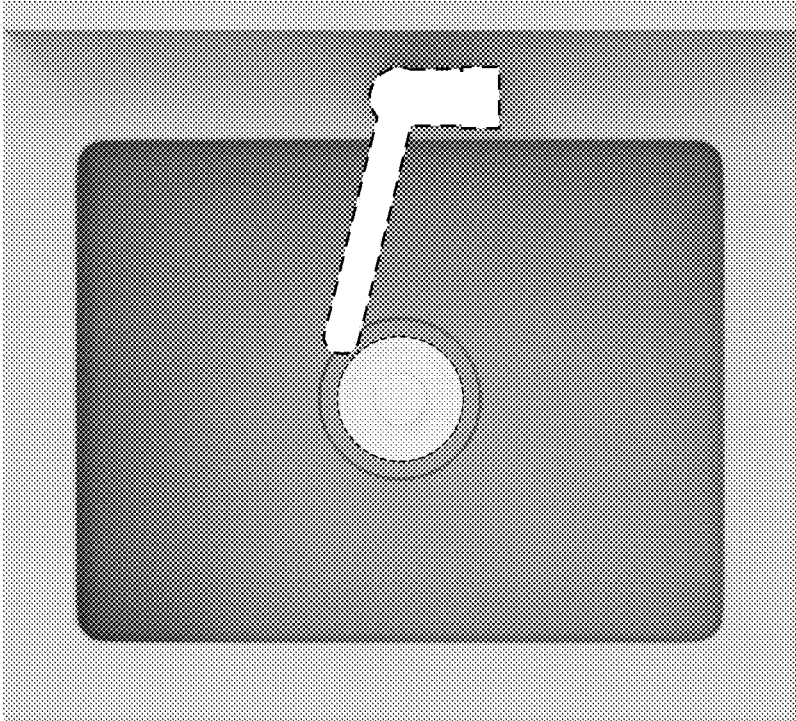

FIG.7

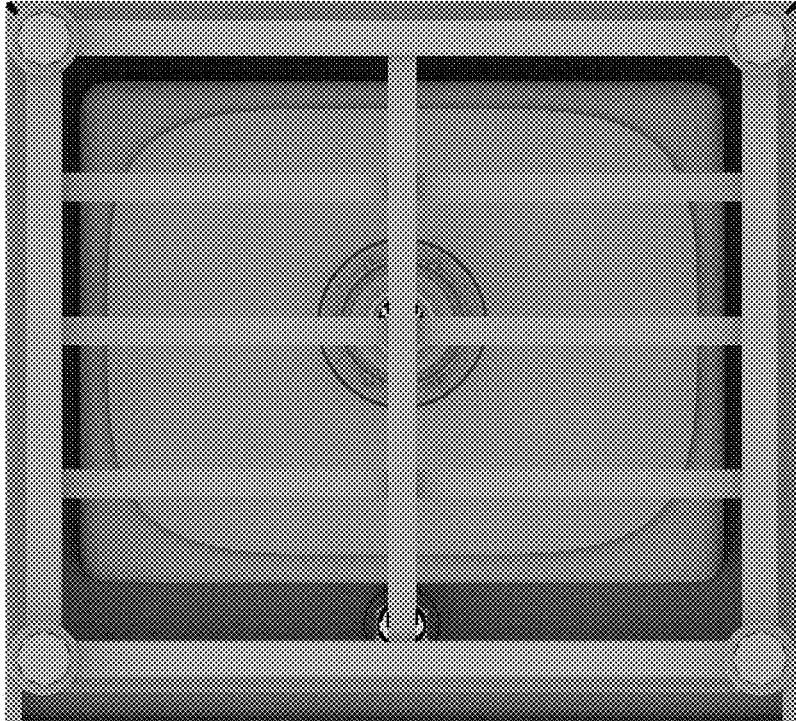

FIG.8