



US00D656372S

(12) **United States Design Patent**
Noyes

(10) **Patent No.:** **US D656,372 S**

(45) **Date of Patent:** **** Mar. 27, 2012**

(54) **HUB TOOL**

(75) Inventor: **Rusty J. Noyes**, Bellgrade, MT (US)

(73) Assignee: **Tatarka Tools & Design, LLC**,
Bozeman, MT (US)

(**) Term: **14 Years**

(21) Appl. No.: **29/365,045**

(22) Filed: **Jul. 1, 2010**

(51) **LOC (9) Cl.** **08-05**

(52) **U.S. Cl.** **D8/14; D12/180**

(58) **Field of Classification Search** D8/14,
D8/44, 51, 70, 349, 354; D10/103; D11/47;
D21/680-682; 29/259, 261, 263, 265-267,
29/426.5, 598, 764; 157/21; D12/180
See application file for complete search history.

(56) **References Cited**

U.S. PATENT DOCUMENTS

1,016,253	A *	2/1912	Denegar	144/218
1,725,114	A *	8/1929	Van Gelderen	30/90.1
D85,697	S *	12/1931	Holzworth	D11/147
2,755,601	A *	7/1956	Lux	451/178
3,875,644	A	4/1975	Simpson		
D255,768	S *	7/1980	Immel et al.	D8/51
4,283,827	A	8/1981	Abel		
4,642,866	A *	2/1987	Murtaugh	29/259
4,675,968	A *	6/1987	Bartlett	29/254
4,700,434	A *	10/1987	Fambrough	242/388.2
D292,963	S *	12/1987	Murtaugh	D8/51
4,893,395	A *	1/1990	Crowder	29/259
5,211,211	A *	5/1993	Rubino et al.	29/259
5,322,415	A	6/1994	White et al.		
5,349,736	A *	9/1994	Rubino et al.	29/426.5
D355,823	S *	2/1995	Dumas et al.	D8/51
D358,119	S *	5/1995	Winter	D12/160
D359,670	S *	6/1995	Cutter	D8/51
D361,926	S *	9/1995	Strickland	D8/14
5,606,788	A *	3/1997	Rubino et al.	29/259
5,613,288	A	3/1997	Lundsten		

5,853,033	A *	12/1998	Kavanagh	140/123
6,012,211	A *	1/2000	Ochoa et al.	29/426.5
D422,427	S *	4/2000	Packer	D6/403
6,382,276	B1 *	5/2002	Daniels et al.	144/135.2
D462,256	S *	9/2002	Jaynes	D8/382

(Continued)

FOREIGN PATENT DOCUMENTS

JP	2001-277148	A	10/2001
KR	20-0116834	Y1	6/1998
KR	20-0125671	Y1	2/1999
KR	10-2002-0080711	A	10/2002

OTHER PUBLICATIONS

International Searching Authority—PCT—Notification of Transmittal of the International Search Report and the Written Opinion of the International Searching Authority, or the Declaration. (PCT/US2010/032432).

Primary Examiner — Philip S Hyder

Assistant Examiner — Roselynn Cody

(74) *Attorney, Agent, or Firm* — Hamilton IP Law, PC; Jay R. Hamilton; Charles A. Damaschen

(57) **CLAIM**

The ornamental design for a hub tool, as shown and described.

DESCRIPTION

US non-provisional utility patent application filed Apr. 26, 2010 and assigned Ser. No. 12/767,054.

FIG. 1 is a front perspective view showing my new design;

FIG. 2 is a front side view thereof;

FIG. 3 is a top side view thereof;

FIG. 4 is a bottom side view thereof;

FIG. 5 is a right side view thereof; and,

FIG. 6 is a left side view thereof.

The broken lines in the Figures are for illustrative purposes only and form no part of the claimed design.

1 Claim, 5 Drawing Sheets

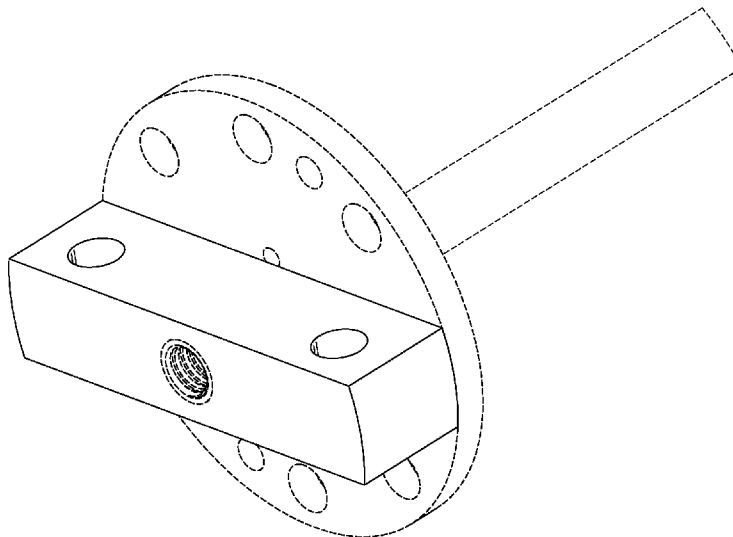

US D656,372 S

Page 2

U.S. PATENT DOCUMENTS

D467,485	S *	12/2002	Daniels et al.	D8/70	D610,577	S *	2/2010	Jenkins	D14/238
6,502,293	B1 *	1/2003	Khurana	29/426.5	D625,650	S *	10/2010	Simpson et al.	D11/147
D483,237	S *	12/2003	Matney	D8/14	2005/0079056	A1	4/2005	Welsh	
D510,388	S *	10/2005	Siegel	D19/77	2009/0300896	A1 *	12/2009	Ozzimo	29/267
D519,584	S *	4/2006	Brice et al.	D21/681	2010/0101736	A1 *	4/2010	Warkotsch	157/21

* cited by examiner

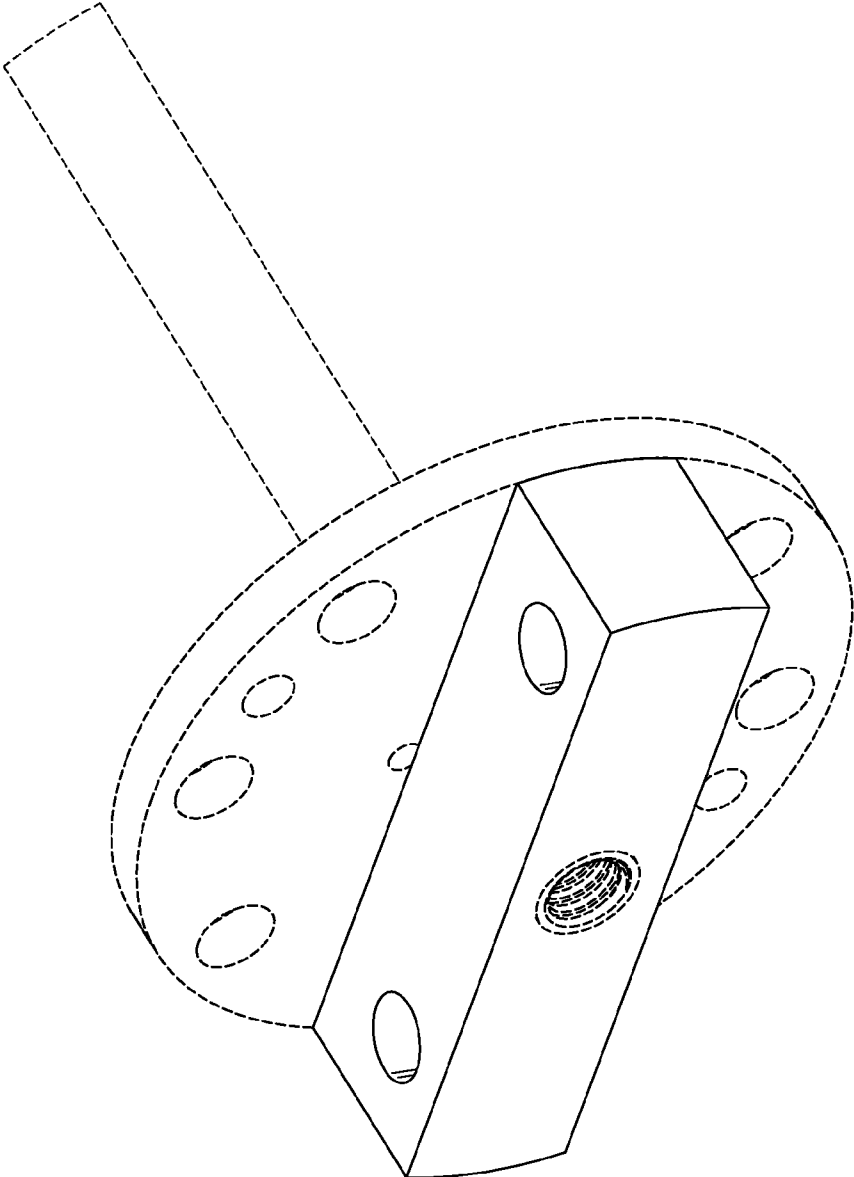

FIG. 1

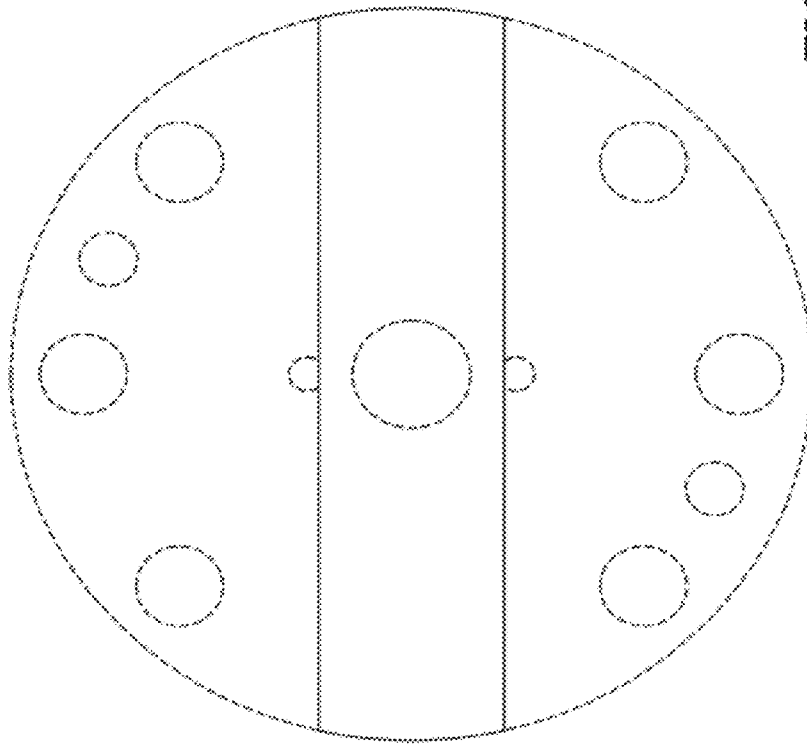

FIG. 2

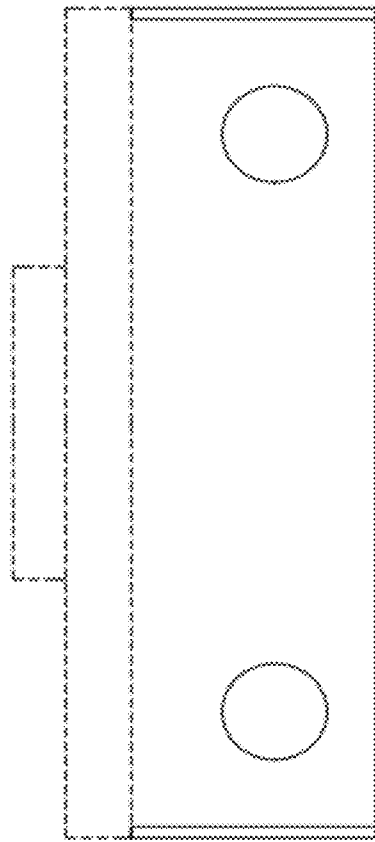

FIG. 3

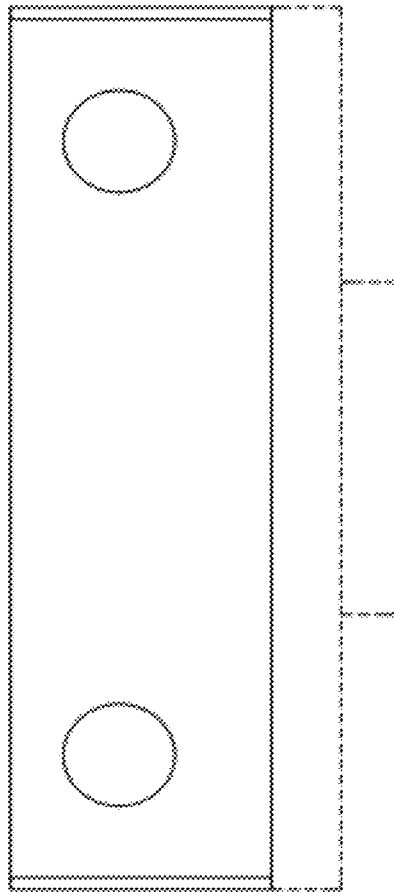

FIG. 4

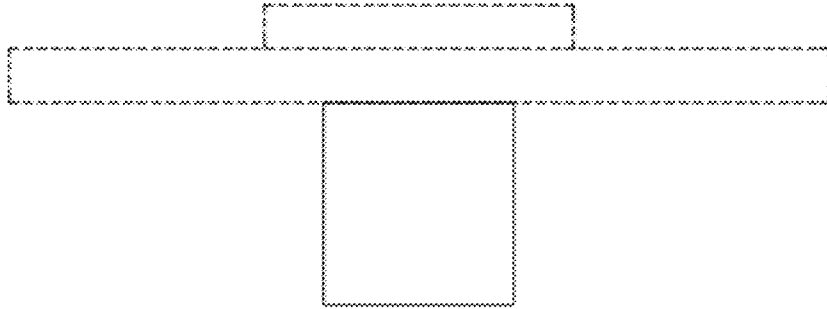

FIG. 6

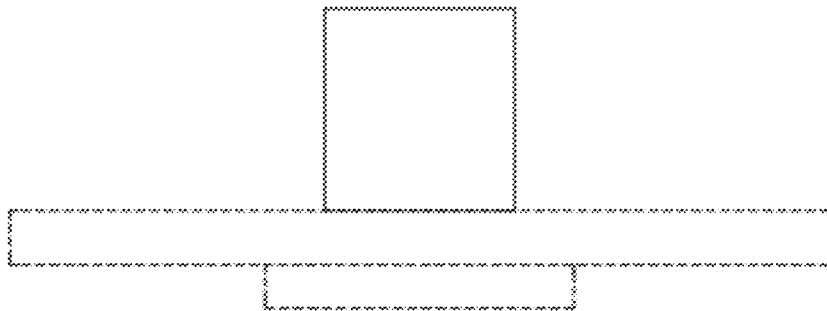

FIG. 5