

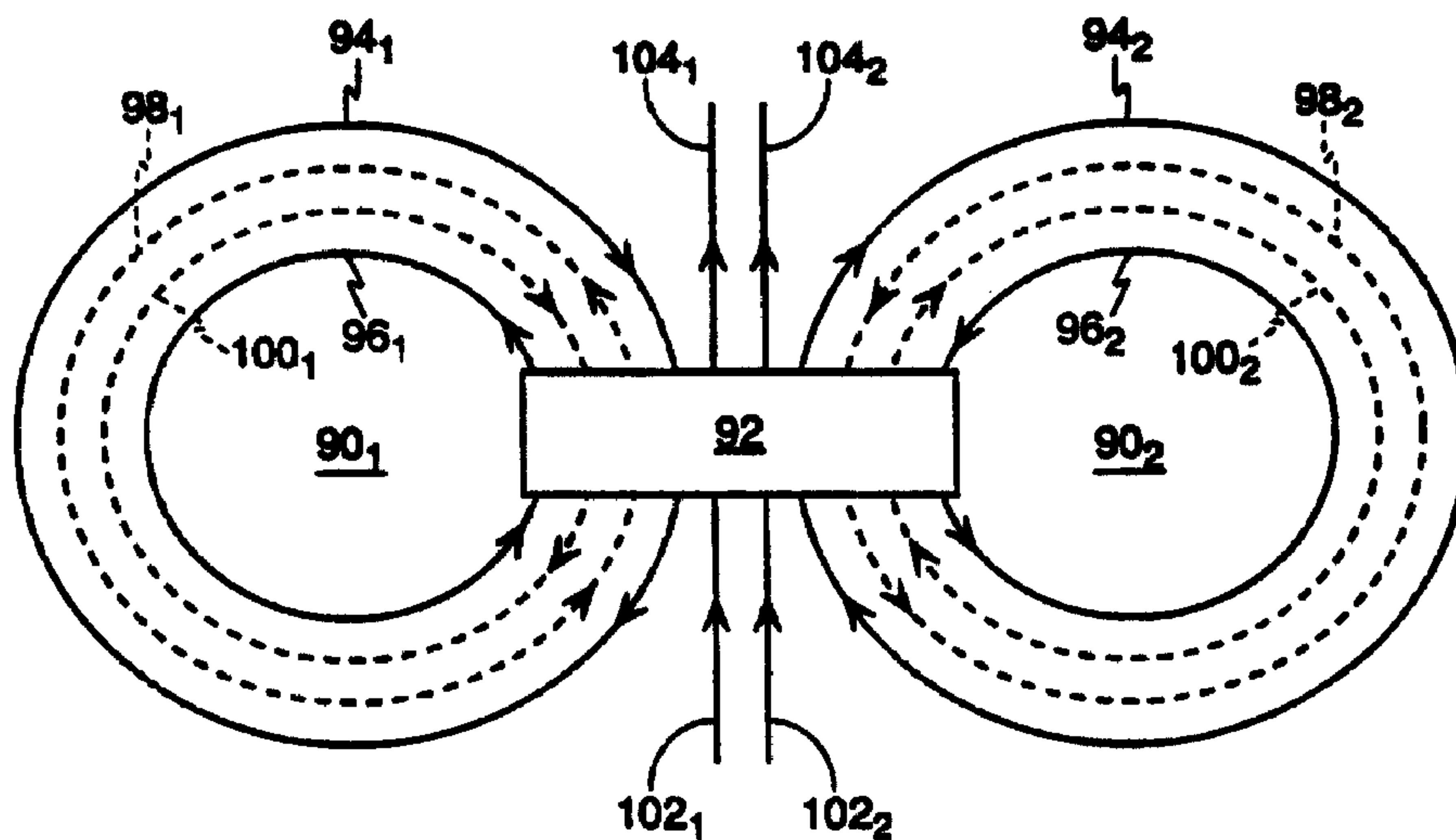

- (72) CHANG, Gee-Kung, US
(72) ELLINAS, Georgios N., US
(72) GAMELIN, John K., US
(72) IQBAL, Muhammed Z., US
(72) KHANDKER, Mamun R., US
(71) BELL COMMUNICATIONS RESEARCH, INC., US
(51) Int.Cl.⁶ H04J 3/14, H04L 12/46, G02B 6/36, H04J 3/02, G02B 6/293,
H04L 1/22
(30) 1996/12/06 (60/032,120) US
(54) **INTERCONNEXION INTERANNULAIRE POUR RESEAUX
DURCIS DE COMMUNICATION OPTIQUE A MULTIPLES
LONGUEURS D'ONDES**
(54) **INTER-RING CROSS-CONNECT FOR SURVIVABLE MULTI-
WAVELENGTH OPTICAL COMMUNICATION NETWORKS**



(57) Il s'agit d'une interconnexion pour un réseau de télécommunications multi-anneaux et multichaînes, notamment pour un réseau optique de multiplexage par répartition de longueur d'onde (MRL). Chaque anneau interconnecté est autorégénéré par un anneau redondant contrarotatif ou par une capacité excessive sur des paires d'anneaux contrarotatifs. Parce qu'il n'est pas nécessaire qu'une interconnexion entre les anneaux s'autorégénérant connecte les fibres actives avec celles de protection, ou aussi fibres redondantes, la complexité de l'interconnexion peut être substantiellement réduite. Dans le cadre de plusieurs architectures importantes,

(57) A cross-connect (92) for a multi-ring, multi-channel telecommunications network, especially for a wavelength-division multiplexed (WDM) optical network. Each of the interconnected rings (94 and (100) is self-healing by provision of a redundant counter-rotating ring (96 and 98)) or excess capacity on pairs of counter-rotating rings. Because an interconnect between self-healing rings (90) does not need to connect working to protection fibers, or similarly redundant fibers, the complexity of the interconnect can be substantially reduced. For several important architectures, the interconnect can be decomposed into one or two 3x3



(21) (A1) **2,273,053**
(86) 1997/12/04
(87) 1998/06/11

l'interconnexion peut être décomposée en une ou deux interconnexions 3x3. En outre, une interconnexion 3x3 non bloquante au sens large peut être favorablement mise en oeuvre sous forme de quatre commutateurs 2x2, qui peut être une composante de base de commutateurs optiques. Un nouvel algorithme permet d'ajouter de nouveaux chemins parcourant une telle interconnexion 3x3. Lors de l'ajout/suppression de lignes, l'interconnexion est susceptible d'être décomposée en une ou deux interconnexions 4x4. Une telle architecture fournit une connectivité complète entre les noeuds utilisateur connectés aux lignes ajoutées/supprimées et ceux associés aux anneaux.

interconnects. Further, a wide-sense non-blocking 3x3 interconnect can be advantageously implemented as four 2x2 switches, which may be a basic building block of optical switches. A novel algorithm is available to add new paths through such a 3x3 interconnect. The interconnect can be decomposed into one or two 4x4 interconnects when another pair of add (102)/drop (104) lines are added. Such an architecture provides full connectivity between user nodes connected to the add (102)/drop (104) lines and user nodes attached to the rings.

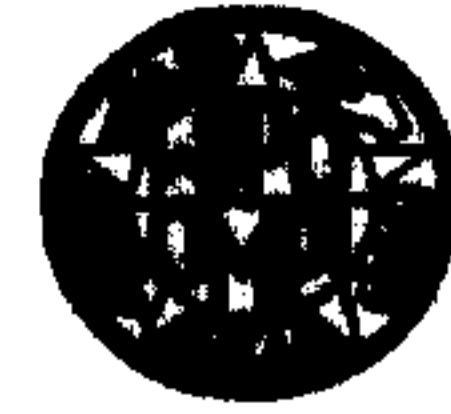
PCTWORLD INTELLECTUAL PROPERTY ORGANIZATION
International Bureau

INTERNATIONAL APPLICATION PUBLISHED UNDER THE PATENT COOPERATION TREATY (PCT)

<p>(51) International Patent Classification ⁶ : H04J 3/14, 3/02, 4/02, G02B 6/293, 6/36, H04L 12/46, 1/22</p>	A3	<p>(11) International Publication Number: WO 98/25365</p> <p>(43) International Publication Date: 11 June 1998 (11.06.98)</p>
<p>(21) International Application Number: PCT/US97/23155</p> <p>(22) International Filing Date: 4 December 1997 (04.12.97)</p> <p>(30) Priority Data: 60/032,120 6 December 1996 (06.12.96) US</p> <p>(71) Applicant: BELL COMMUNICATIONS RESEARCH, INC. [US/US]; 445 South Street, Morristown, NJ 07960-6438 (US).</p> <p>(72) Inventors: CHANG, Gee-Kung; 7 East Lawn Drive, Holmdel, NJ 07733 (US). -ELLINAS, Georgios, N.; Apartment 42, 420 W. 119th Street, New York, NY 10027 (US). -GAMELIN, John, K.; 98 Habor Green Circle, Red Bank, NJ 07701 (US). -IQBAL, Muhammed, Z.; Shahjalal University of Science and Technology, Teachers Quarter, 1E, Sylhet (BD). -KHANDKER, Manum, R.; Seroil Colony (Near LSD Godown), Rajshahi 6100 (BD).</p> <p>(74) Agents: GIORDANO, Joseph et al.; International Coordi- nator, Rm. 1G112R, 445 South Street, Morristown, NJ 07960-6438 (US).</p>	<p>(81) Designated States: AU, CA, CN, ID, JP, KR, MX, NO, PL, RU, SG, European patent (AT, BE, CH, DE, DK, ES, FI, FR, GB, GR, IE, IT, LU, MC, NL, PT, SE).</p> <p>Published <i>With international search report.</i></p> <p>(88) Date of publication of the international search report: 20 August 1998 (20.08.98)</p>	

(54) Title: INTER-RING CROSS-CONNECT FOR SURVIVABLE MULTI-WAVELENGTH OPTICAL COMMUNICATION NETWORKS

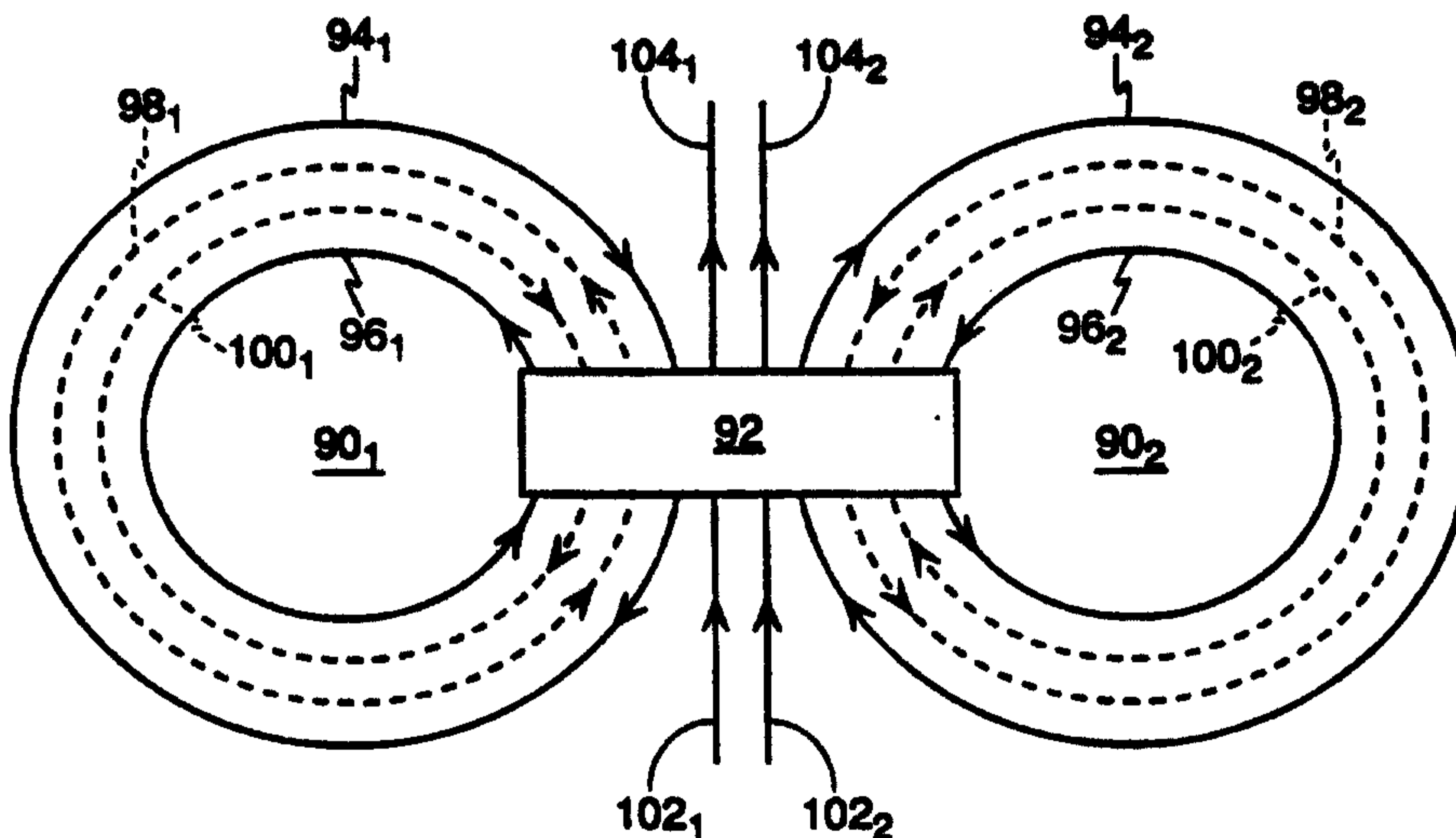

(57) Abstract

A cross-connect (92) for a multi-ring, multi-channel telecommunications network, especially for a wavelength-division multiplexed (WDM) optical network. Each of the interconnected rings (94 and (100) is self-healing by provision of a redundant counter-rotating ring (96 and 98)) or excess capacity on pairs of counter-rotating rings. Because an interconnect between self-healing rings (90) does not need to connect working to protection fibers, or similarly redundant fibers, the complexity of the interconnect can be substantially reduced. For several important architectures, the interconnect can be decomposed into one or two 3x3 interconnects. Further, a wide-sense non-blocking 3x3 interconnect can be advantageously implemented as four 2x2 switches, which may be a basic building block of optical switches. A novel algorithm is available to add new paths through such a 3x3 interconnect. The interconnect can be decomposed into one or two 4x4 interconnects when another pair of add (102)/drop (104) lines are added. Such an architecture provides full connectivity between user nodes connected to the add (102)/drop (104) lines and user nodes attached to the rings.

WO 98/25365

PCT/US97/23155

INTER-RING CROSS-CONNECT FOR SURVIVABLE
MULTI-WAVELENGTH OPTICAL COMMUNICATION NETWORKS

5

BACKGROUND OF THE INVENTION

The invention generally relates to multi-wavelength
10 optical communication networks, especially multi-wavelength
optical networks. In particular, the invention relates to
cross-connects between multiple rings for which the rings are
designed to be self-healing to faults.

15 The introduction of optical fibers as the transmission
medium for communication networks has slowly been altering the
fundamental architecture of the networks. Originally, optical
fibers simply represented a replacement for the electronic
links usually carried on copper cable. The electrical signals,
20 which otherwise would have been transmitted on copper links,
were used to modulate lasers on the transmission end, and
optical detectors, on the receiver end, were used to reconvert
the signal to its original electrical form. That is, the use of
optical fibers did not affect the fundamental architecture of
25 the network. Also, the original application of optical fibers
was to the long-distance transmissions, but its utility is
becoming more obvious to the more local networks.

The existing network architecture upon which the fiber
30 link has been imposed may be characterized as a multi-level
mesh. At the level of a Local Access and Transport Area (LATA),

WO 98/25365

each central office is typically connected to several neighboring offices with electrical links having capacity appropriate for that link. This architecture was implemented in hardware designed in the early 1980's and was driven by a
5 paucity of bandwidth and the relatively slow electronics then available.

The voice traffic dominant at the time of the design of the present network is digitized into DS0 channels, each of
10 64 kb/s (kilobits per second). Twenty-four DS0 channels are multiplexed into a DS1 channel at 1.544 Mb/s, and, if required, 28 DS1 channels are multiplexed in a separate step into a DS3 channel at 44.736 Mb/s. These rates are not exact multiples, and bits are stuffed into the transmission stream as are necessary.
15 Further, each link has its own clock. The result is an asynchronous network in which a high-level multiplexed signal needs to be completely demultiplexed in order to extract any signal or to substitute another low-level signal.

20 Optical fiber changed the equation because its intrinsic bandwidth is nearly unlimited. In a fiber network, the terminal equipment for the most part determines the bandwidth, and the cost of the link becomes relatively small compared to that of the terminal equipment. As a result, a new standard was proposed
25 and largely accepted in the U.S.A. This standard is referred to as the Synchronous Optical Network (SONET). A closely related architecture, Synchronous Digital Hierarchy (SDH), is followed in Europe. The basic building block is called the Synchronous Transport Signal-Level 1 (STS-1) which has a bit rate of
30 51.84Mb/s. The transmission is divided into frames transmitting at a frame rate of 125 μ s. The frames are further divided into

WO 98/25365

PCT/US97/23155

810 eight-bit bytes, many of which are overhead. The STS-1 frames are carried on an OC-1 optical channel operating at the same bit rate. Higher rates are available which are multiples of those above. These are STS-N signals, which are formed by simply interleaving N STS-1 signals. Currently, OC-48 fiber links operating at 2488.32Mb/s represent the most advanced system that is commonly deployed. For the most part, the maximum signal rate is determined by the electronic and opto-electronic equipment attached to the fiber ends and not by the fiber itself. SONET is a synchronous signal, and extracting individual bytes or lower-level channels is much easier than with an asynchronous signal.

The increased capacity of optical fiber has raised concerns about the reliability and survivability of optical networks since a single cable or equipment malfunction can impact a large amount of traffic. Cable cuts are frequent and almost impossible to avoid, whether from human or weather causes, and equipment failures resulting from central-office fires or other disasters cannot be totally eliminated. Accordingly, more survivable network architectures are sought. One architecture that offers high survivability is a self-healing ring. Several versions of this architecture are described by Wu in *Fiber Network Service Survivability*, (Artech House, 1992), pp. 123-207. The self-healing function mitigates against network disasters, but its implementation must be simple, high-speed, and highly reliable. The self-healing should be totally automatic and provide 100% restoration capability for a single fiber-cable cut or equipment failure through its ring topology and simple but fast protection switching scheme. Many self-healing ring architectures have the

WO 98/25365

PCT/US97/23155

advantage of being able to recover from the failure of a single node, such as a hub, along with the ability to recover from a cable cut.

5 An exemplary unidirectional self-healing fiber ring 10 is illustrated in FIG. 1. This is one type of self-healing ring network and is presented here to support the introductory discussion. A more complete description of the different architectures of self-healing rings will be presented later.

10

In FIG. 1, a number of nodes 12, here illustrated as four nodes A, B, C, D, are interconnected in a ring configuration by two counter-rotating optical fibers 14, 16. That is, one fiber 14 forms a ring around which signals propagate in the counter-
15 clockwise direction while the other fiber 16 forms another ring around which signals propagate in the clockwise direction. Each node 12 can be a central office, a remote distribution point within the local network, or other high-traffic node. Importantly, each node 12 is connected to each of the fibers 14,
20 16 at two points, one for reception, one for transmission. The first fiber 14 is a working fiber and, in this particular architecture, carries all the traffic. The second ring fiber 16, indicated by the dashed line, is a protection fiber. In normal operation, it is dark for Automatic Protection Switching
25 (APS), but for Path Protection (PP) it carries some or all of the traffic nominally assigned to the working fiber 14. The protection fiber 16 propagates whatever signals it carries around the ring 10 in a direction opposite to that of the working fiber 14, and the choice of which fiber 14, 16
30 propagates in the clockwise direction is, of course, immaterial.

WO 98/25365

The number M of nodes 12 within the ring can vary but is generally in the range of 4 to 10. A smaller number of nodes can be accommodated within a mesh architecture without the need for protection fibers or for multi-hop transmission. This
 5 difference arises because a ring network of M nodes requires W wavelengths for full mesh connectivity within the ring, where for odd values of M

$$W = \frac{M^2 - 1}{8}$$

10

and for even values of M

$$W = \frac{(M+1)^2 - 1}{8}$$

15

A larger number of nodes introduces a high excess level of traffic through each node that is not needed by that node.

It is assumed that the working and protection fibers 14,
 20 16 are co-located along virtually the same geographic paths so that a cable break arising from a construction accident, a weather disaster, or the like is likely to affect both of them. However, it is also assumed that the fibers 14, 16 are routed such that the different inter-nodal portions extend for the
 25 most part along different paths so that cable breaks usually affect only one inter-nodal portion of the dual ring. Although the figures show a neat circular ring, it is to be appreciated that rings can be set up within the existing mesh network, even using existing point-to-point fibers, resulting in a more
 30 ragged shape. It is also to be appreciated that these rings can be enlarged or shrunk to a different set of nodes within the ring without necessarily laying new fiber between the nodes.

WO 98/25365

The most common fiber failure is a cable break 20, illustrated in FIG. 2 as occurring between nodes C and D and assumedly cutting both a portion 14' of the working fiber 14 and the corresponding portion 16' of the protection fiber 16. In the case of Automatic Protection Switching (APS), the APS equipment associated with each node 12 can sense such a fault and activate protection switches 22, 24 associated with the bracketing C and D nodes 12 to transfer signals between the working and protection fibers 14, 16. Similar protection switches are disposed on the other sides of the C and D nodes 12 as well as on both sides of the remaining nodes 12 of whatever type. The counter-rotating protection fiber 16 functionally substitutes for the broken portion 14' of the working fiber 14 and restores the network continuity between all nodes 12.

15

Self-healing networks also guard against failure of any one node 12, for example, a fire or loss of power in a central office or switching center. Although traffic destined to or originating from that node is typically lost, the traffic between the operational nodes is saved. For APS self-healing networks, the APS equipment in the two nodes bracketing the failed node redirect the traffic from the working fiber to the counter-rotating protection fiber, thus avoiding the failed node.

25

Thus, the self-healing protects fully against cable breaks and protects against nodal failures except for the loss of traffic originating from and terminating to the failed node.

30

The self-healing architecture of FIGS. 1 and 2, as well as for other related self-healing rings, introduces bandwidth

WO 98/25365

penalties into both the fibers 14, 16 as well as the nodes 12. However, optical fiber has come to incur a relatively low cost for overall system design, especially when parallel fibers are considered. Also, the SONET architecture has allowed the
5 production of lower cost equipment, particularly of add/drop multiplexers (ADMs), which can be used in the nodes 12 to extract or insert separate lower-level channels from a SONET signal on the ring. As a result, the excess capacity and
10 redundant processing of signals for a self-healing ring are no longer prohibitively expensive.

Some of the more important architectures for self-healing rings will now be described in general terms. Several
15 embodiments of the invention specifically described below will incorporate these different architectures.

Unidirectional rings use two fibers, one working fiber and one protection fiber. They are called unidirectional because all working traffic goes around the dual ring in one
20 direction. There are two principal types of unidirectional rings, Automatic Protection Switching (APS) and Path Protection (PP).

A loop back APS ring has been described with reference to
25 FIGS. 1 and 2 and that architecture is referred to as a folded U-SHR architecture or (U-SHR/APS). Note that APS corresponds to "line switching", that is, a physical rerouting over different lines.

30 Self-healing can also be achieved in a unidirectional ring by low-speed Path Protection in an architecture called

WO 98/25365

path protected SHR (U-SHR/PP) or dedicated protection rings. This form of path protection is based usually on the concept of a dual feed of signal (1+1) in which two transmitters at each node transmit identical signals on the two fibers propagating in opposed directions. The counter-propagating signals provide network survivability when a link is cut. In normal operation, one receiver at each node selects the signal from the working fiber, but when the working fiber has been cut for that transmission the receiver can select the protection fiber. In practice, the receiver selects the stronger of the two incoming signals.

Bidirectional rings may use two or four fibers. They are called bidirectional because the working traffic can go around the ring in either direction. The transmitting node makes an informed choice as to which direction it should transmit a signal to the receiving node. Even though usually the minimum distance is preferred, sometimes a longer path is chosen, for instance, when it is desired to evenly distribute the load.

A four-fiber bidirectional ring referred to as B-SHR/4 or a shared protection ring includes two working fibers and two protection fibers. Each working fiber is intended to carry half the total traffic. To recover from link failure, B-SHR/4 uses line protection switching, for example APS, to perform a loop-back function to avoid cable cuts or node failures. This architecture requires a 1:1 nonrevertive lower-speed electronic protection switch at each office. With the nonrevertive protection switch, the signals need not be switched back when the failed line is repaired.

WO 98/25365

A two-fiber bidirectional ring, referred to as B-SHR/2, uses two fibers, both designated as working fibers. The traffic is divided generally equally between the two counter-propagating fibers, and each fiber is operated at only half its total capacity. The other half of the capacity of each fiber is reserved to protect the counter-propagating fiber. In the case of a link failure whether due to fiber break or equipment failure at a node, the transmitter switches from one line to the other in conjunction with time-slot interchange to automatically redirect traffic to fill vacant time slots propagating in the opposite direction so as to avoid the failure. Such redirection resembles automatic protection switching even though APS is usually associated with line protection switching, which this described procedure does not perform. For wavelength-division multiplexing, to be discussed later with respect to the invention, the two sets of signals are wavelength multiplexed rather than time multiplexed. The bandwidth of all working paths should occupy less than 50% of the entire ring bandwidth to allow recovery of all working paths against single transmission line failure. Although such reduced bandwidth may seem wasteful, the cost of increasing the system capacity should be compared with the cost of more complex control and administration.

Another recent development in high-speed communication networks involves wavelength-division multiplexing (WDM). As noted before, optical fiber has an extremely wide bandwidth, significantly larger than the available electronic frequencies available to impress optical data signals on the fiber. Accordingly, it was early recognized that multiple electrical data signals can modulate different laser transmitters having W

WO 98/25365

separated emission wavelengths $\lambda_1, \lambda_2, \dots, \lambda_w$, and the outputs of the different lasers are impressed upon a single optical fiber. At the receiving end, the different optical signals can be optically separated and then electrically detected. The modulation and detection rates for a separate channel occur at the electrical data rate of that channel rather than the overall optical data rate. The number W of WDM channels is limited in common, large sized networks to about 8 to 32.

10 Although WDM was initially thought of only as a capacity multiplier, more sophisticated WDM architectures have been suggested, e.g., by Brackett et al. in "A Scalable Multiwavelength Multihop Optical Network: A Proposal for Research on All-Optical Networks", *Journal of Lightwave*
15 *Technology*, vol. 11, 1993, no. 5/6, pp. 736-753. These advanced architectures become particularly advantageous if the wavelength-differentiated optical signals can be routed through a node or other switching point according to their respective optical wavelengths (or frequencies) without the need to
20 convert the signals to electronic form. That is, two optical signals coming into the switching point on a single fiber can be switched into different outgoing directions according to their optical wavelengths, all the while the signals remain in the optical domain. Such optical switching has the further
25 advantage that the switching is independent of the signal format of the different WDM channels. For example, one or more optical wavelengths could be dedicated to an analog cable television signal while other optical wavelengths are dedicated to digital SONET signals. Of course, the formatting of the
30 television channels is completely different from that of the SONET channels. Nonetheless, a WDM switch operating according

WO 98/25365

to the optical carrier wavelength equally well switches the television and SONET signals without regard to their format. Even within the confines of a SONET network, a WDM switch switches SONET channels without regard to their bit rates, that is, without regards to the OC level. That is, multiple OC levels can be accommodated within a single network. Further, the OC level is not critical for optical switching. The terminal nodes common to channels of different rates need to operate at the highest optical channel rate. However, the nodes receiving or transmitting only a lower-rate signal need to operate only at the lower rates. Thereby, lower-cost, low-capacity terminals can be attached to a network including higher-capacity terminals.

Wavelength-division multiplexing offers many advantages, not the least of which is the multiplication of network capacity without needing to lay additional fiber. However, its integration with SONET and survivable rings remains to be shown. Elrefraie et al. have suggested one self-healing ring in "Self-healing WDM ring networks with all-optical protection path", *Optical Fiber Conference '92*, paper ThL3, pp. 255, 256 and in "Multiwavelength Survivable Ring Network Architectures", *Proceedings of the International Communication Conference*, Geneva, Paper 48, 7 pp. Wu has suggested a WDM self-healing loop, *ibid.*, pp. 189-195, but the architecture is narrow, overly general, and does not take advantage of the available WDM switching components.

We observe that WDM technology is well suited for ring architectures. A fundamental structure of a 2x2 multi-wavelength switch 26 is illustrated in FIG. 3. It is connected

WO 98/25365

PCT/US97/23155

through two ports to the receiving and transmitting ends of an optical fiber 27, which is assumed to be connected through other similar switches 26 in a loop configuration. The multi-wavelength switch 26 has the capability of selecting one or more optical wavelength channels for adding and dropping. That is, the switch 26 can select one (or possibly more) of the W WDM channels in the loop fiber 27 to remove the signal carried by that channel from the fiber 27 and substitute another signal at the same optical wavelength into the loop fiber 27. Such a switch is called a wavelength-selective add/drop switch. The added and dropped signals are transferred via drop and add fibers 28, 29 to and from a nodal network 30, which may be a multiplexer/demultiplexer for an electrical network or may be another network element.

For Automatic Protection Switching (APS) self-healing rings, the loop fiber 27 is the working fiber. APS line switching equipment located on both sides of the switch 26 selectively connects the working fiber to the protection fiber, which does not go through an equivalent switch to the nodal network 30. For Path Protected (PP) self-healing rings, both the working and protection fibers have their own switches 26, and additional circuitry within the nodal network 30 determines which fiber is being used for a particular signal.

The illustrated multi-wavelength switch 26 is a 2×2 cross-connect switch that can assume two states for each of the W optical wavelengths. In the bar state, the signals of that wavelength carried on the ring fiber 27 remain on the ring fiber 27. However, in the cross state, optical signals received from the ring fiber 27 at one or more optical wavelengths are

WO 98/25365

PCT/US97/23155

switched to the drop fiber 28 while other data signals of a same optical wavelengths are received from the add fiber 29 and transmitted onto the ring fiber 27.

5 There are at least three technologies for implementing the multi-wavelength switch 26.

 A first technology involves a hybrid mechanically actuated optical WDM switch, such as described by Iqbal et al. in "High Performance Optical Switches For Multiwavelength Rearrangeable Optical Networks", *Government Microelectronic Circuits Application Conference (COMAC) '94*, San Diego, CA, November 1994, 3 pp. This 4-wavelength 2x2 switch includes cascaded multilayer thin-film interference filters and discrete 2x2 cross-bar, relay-actuated optical switches connected to the outside with optical multiplexers and demultiplexers. The hybrid, fiber-based, WDM switch demultiplexes the input wavelengths to different 2x2 optical switches, and the signals that are optically switched by mechanical actuation are recombined at the output. The relay-actuated optical switches are mechanical switches in which fibers connected to the two inputs are mechanically moved into alignment with different output fibers. Although this technology is conceptually relatively unsophisticated, its sub-second switching speed is satisfactory for many envisioned architectures, it offers the assurance and reliability of a mechanical part, and is currently commercially available from JDS Fiber.

 The second technology involves acousto-optical tunable filters (AOTFs), usually formed in a LiNbO₃ substrate, in which the selected optical frequencies are related to RF frequencies

WO 98/25365

PCT/US97/23155

impressed on an interdigitated electrode formed over an optical waveguide in the piezo-electric LiNbO_3 substrate, causing the selected signal to change its polarization state and thus to be switched by a polarization coupler. Such AOTFs are described by
5 Cheung et al. in U.S. Patent 5,002,349.

A third technology involves liquid-crystal switches, as described by Patel et al. in U.S. Patents 5,414,540 and 5,414,541 and in "Liquid Crystal and Grating-Based Multiple-
10 Wavelength Cross-Connect Switch", *IEEE Photonics Technology Letters*, vol. 7, 1995, pp. 514-516. By means of wavelength-dispersive layers and segmented liquid-crystal polarization-rotation layers, the different WDM channels can be switched in different directions.

15

Although it is possible to extend the optical signals further into the nodal network 30, at the present time it is assumed that the nodal network 30 is formed around an electronic switch 31, illustrated in FIG. 4. An optical demultiplexer 32
20 receives the W WDM signals on the drop fiber 28 and splits them into separate optical paths according to their wavelengths $\lambda_1, \lambda_2, \dots, \lambda_W$. An optical detector array 33 converts the optical signals to electrical signals for input to the switch 31. Similarly on the output side, a laser array 34 is controlled by
25 electrical outputs of the switch 31 to emit modulated optical signals of wavelengths $\lambda_1, \lambda_2, \dots, \lambda_W$. An optical multiplexer 35 combines the W WDM signals onto the add fiber 29. The switch 31 has additional electrical input and output lines 36, 37, for example, to the local loop network. These additional input and
30 output lines 36, 37 may be characterized as drop/add lines.

WO 98/25365

PCT/US97/23155

The add/drop ports on the switch 31 are useful for a number of reasons. In one type of use, they may provide links to external users, whether single users or used attached to local-area networks (LANs) connected to the switch 31. The add/drop ports may provide a gateway for interconnections of different LANs which are designed for lower-density traffic than that of the traffic being switched between the fibers 28, 29. The add/drop ports may also provide a link to other networks at a single wavelength in the case where low-bandwidth connection is all that is required. In a second type of use, the add/drop ports may provide a monitoring point for inter-ring traffic so that the local controller can check the traffic before passing it between rings. In a third type of use, the add/drop ports provide a point for wavelength interchange between the rings. That is, if an optical data signal on a first ring is desired to be transferred to a second ring, but at a different optical wavelength, it can be dropped at the switch, converted to a different wavelength by all-optical or opto-electronic means, and reinserted into the network by being added at the same switch. In the case of the electronic switch 31 shown in FIG. 4, the wavelength conversion is performed by assigning the same data signal to different wavelengths in the optical detector array 33 and the laser array 34. Finally, the add/drop ports provides a port for the local switch controller to receive or inject signaling information.

A controller 38 controls the switching states of the switch 31, and may receive network control information over one of the WDM channels. For a SONET network, the SONET framing and other functions can be incorporated into the switch 31 and controller 38. The ADM switch system shown in FIG. 4 is

WO 98/25365

PCT/US97/23155

connected to only one fiber of a self-healing ring. For an APS ring, only one connection to the working fiber is required since the APS equipment provides access to the protection fiber, but for a path protected ring both fibers need to be accessed.

5

ADMs of the type mentioned above may be satisfactory for the simple nodes distributed around a ring, but are insufficient for completely implementing a large, complex network. As mentioned above, rings are limited to a fairly small number of nodes. It is greatly desired to increase the number of accessible nodes by interconnecting multiple rings through use of at least one inter-ring node. Also, as mentioned before, rings are often formed from already existing inter-office trunks that overall resemble a mesh. Thus, ring interconnections are usually established at larger central offices having trunk lines to at least four other offices. As a result, the inter-ring node must be connected to two separate rings as well as perform the add/drop functions expected at a central office.

20

As shown in the network diagram of FIG. 5, two self-healing rings $10_1, 10_2$ are interconnected by an inter-ring node 40. Each ring $10_1, 10_2$ includes a respective working fiber $14_1, 14_2$ and a respective protection fiber $16_1, 16_2$. More specifically, the inter-ring node 40 is connected to input fibers $14_{1-IN}, 14_{2-IN}, 16_{1-IN}, 16_{2-IN}$ and to output fibers $14_{1-OUT}, 14_{2-OUT}, 16_{1-OUT}, 16_{2-OUT}$. The inter-ring node 40 is also connected to two pairs $42_1, 42_2$ of add/drop fibers comprising respectively add fibers $42_{1-IN}, 42_{2-IN}$ and drop fibers $42_{1-OUT}, 42_{2-OUT}$. It is assumed that the add/drop fibers ultimately connect to different types of transmission lines, e.g., through

30

WO 98/25365

PCT/US97/23155

a switch to the local loop network. The two pairs 42_1 , 42_2 of add/drop fibers allow the inter-ring node 40 to independently add/drop signals on the two rings 10_1 , 10_2 without concern of wavelength contention as long as the same wavelength is not
5 dropped twice to the same ring. Since the add/drop fibers 42_1 , 42_2 are typically routed within conventional switching offices or hubs that do not utilize wavelength-division multiplexing, the add/drop fibers 42_1 , 42_2 are typically bundles of W such fibers, where W is the number of WDM wavelengths and
10 unillustrated multiplexers and demultiplexers may be required depending on the type of optical switching element. The following description and illustrations will only occasionally address this distinction between ring fibers and add/drop fibers.

15

The inter-ring node 40 can thus be characterized as a 6×6 switch, as shown in the schematic of FIG. 6. Furthermore, in a WDM network, the W wavelengths must be separately switched so that the 6×6 switch is in some sense replicated W times. In most
20 current demonstration projects, W is no more than 8. In WDM networks, it is not atypical at the present time because of preexisting nodal architectures that the fibers 14_1 , 14_2 , 16_1 , 16_2 in the two rings 10_1 , 10_2 are each carrying W WDM signals while the add/drop fibers 42_{1-IN} , 42_{2-IN} , 42_{1-OUT} , 42_{2-OUT} are each
25 carrying only one optical signal so they each need to be arranged in bundles of W add/drop fibers if full add/drop capability is to be achieved.

If the switching is performed with the previously
30 described mechanically actuated optical switches, each W -fold WDM signal must be demultiplexed into W optical signals which

WO 98/25365

PCT/US97/23155

are led on separate fibers to different wavelength planes of the 6x6 switch and the outputs of the planes are multiplexed into an optical WDM output signal. If the switching is done electronically, as is conventional now, optical sources and detectors are additionally required, but the same size 6x6 electronic switch is required.

Such a switch has the disadvantage of being complex. The most straightforward implementation requires for each wavelength plane six 1x6 switches on the input side interconnected to six 6x1 switches on the output side. This structure can be implemented with multiplexers, demultiplexers, and mechanically actuated optical switches, but it requires many components, e.g., 96 1x6 or 6x1 switches for 8 optical wavelengths. Further, it is preferred to eliminate the multiplexers and demultiplexers and the parallel replication. Simultaneous multi-wavelength switching reduces the count of switching elements and eliminates the need for wavelength multiplexers and demultiplexers.

20

Optical (photonic) switches are known that can selectively switch signals of different wavelength onto different output ports. However, these are generally based on 1x2 or 2x2 switching units, such as illustrated in FIG. 3, and larger switches are built up from the smaller switching units. Hence, a relatively large number of these switching units are required for a 6x6 photonic switch desired for interconnecting two SONET rings. Such optical switching units present challenges in fabrication, and integration of a large number of switching units on a single substrate has not been commercially achieved.

30

WO 98/25365

PCT/US97/23155

Therefore, it is greatly desired to reduce the complexity of a photonic switch usable between two self-healing rings.

5

SUMMARY OF THE INVENTION

In one aspect, the invention can be summarized as the interconnection between two or more self-healing optical network rings in which the interconnection can be simplified because of the self-healing architecture of the connected rings. In particular, because several of the multiple inputs to the interconnect are intended to be redundant or otherwise not intended to be selectively interconnected, the complexity of the interconnect can be reduced by eliminating those inputs and outputs not needing to be interconnected even in case of a failure in either of the connected networks. The forms of the inter-connect are presented for 2-fiber and 4-fiber, uni-directional and bi-directional self-healing rings.

20

In another aspect of the invention, the interconnection between multiple self-healing rings is shown to be independent of the self-healing functions of the multiple rings. Therefore, the interconnection state of a cross-connect can remain constant while separate apparatus is healing a fault in one or the other of the rings.

25

Many important interconnects, both between two self-healing rings and for other applications, can be accomplished with at least one 3x3 interconnect. Such a 3x3 interconnect is advantageously implemented with four 2x2 interconnects so as to

30

WO 98/25365

PCT/US97/23155

be wide-sense non-blocking. Possible wavelength contention at the add/drop lines of the interconnect can be removed by enlarging it into a 4x4 interconnect.

5 An algorithm is presented for assigning switching states for new paths through the four 2x2 switches composing the wide-sense non-blocking 3x3 interconnect. The algorithm recognizes that two combinations of states of the four 2x2 switches can be associated with each state of the 3x3 interconnect as viewed
10 from the interconnect ports. It also recognizes that only three reconfigurations of a fully connected interconnect state are possible, and one of the two possible switch state combinations provides an allowable transition.

15

BRIEF DESCRIPTION OF THE DRAWING

20 The present invention will be described with reference to the accompanying drawing of which:

 FIG. 1 is a network diagram of a self-healing communication ring of the prior art;

25 FIG. 2 is a network diagram showing how the ring of FIG. 1 can be reconfigured to survive a cable cut;

 FIG. 3 is a network diagram of an add/drop multiplexer of the prior art attached to a communication ring;

30

 FIG. 4 is a diagram of an electronic switching system combined with an optical add/drop multiplexer;

WO 98/25365

PCT/US97/23155

FIG. 5 is a network diagram of a node connecting two self-healing multi-wavelength rings, in particular rings using path protection;

5 FIG. 6 is a schematic diagram of the switch required at the initial level of consideration for the interconnect node of FIGS. 5 and 21;

10 FIG. 7 is a network diagram of a simplified inter-ring cross-connect for the network of FIG. 5 using 3x3 switches;

FIG. 8 is a network diagram of a inter-ring cross-connect similar to that of FIG. 7 but using 4x4 switches;

15 FIG. 9 is a network diagram of a two unidirectional self-healing rings with Automatic Protection Switching (APS) that are interconnected;

20 FIG. 10 is a network diagram of a simplified cross-connect for the network of FIG. 9 using a 3x3 switch, which is wide-sense non-blocking when implemented using 2x2 switches;

25 FIG. 11 is a network diagram of a simplified cross-connect similar to that of FIG. 10 but using 4x4 switches;

FIG. 12 is a network diagram of two interconnected bidirectional self-healing rings using four fibers apiece (B-SHR/4);

30 FIG. 13 is a network diagram of a simplified cross-connect for the network of FIG. 12 using 3x3 switches;

WO 98/25365

PCT/US97/23155

FIG. 14 is a network diagram of a simplified cross-connect similar to that of FIG. 13 but using 4x4 switches;

FIG. 15 is a network diagram of two interconnected
5 bidirectional self-healing rings using two fibers apiece
(B-SHR/2);

FIG. 16 is a simplified network diagram illustrating
SONET time-slot interchanging for the B-SHR/2 network of
10 FIG. 16;

FIG. 17 is a timing diagram of SONET frames used in the
network of FIG. 19;

FIG. 18 is a simplified network diagram illustrating WDM
15 wavelength interchanging for the B-SHR/2 network of FIG. 15;

FIG. 19 is a network diagram of a simplified cross-
connect for the network of FIG. 15 using 3x3 switches;
20

FIG. 20 is a network diagram of a simplified cross-
connect similar to that of FIG. 19 but using 4x4 switches;

FIG. 21 is a network diagram of three interconnected
25 unidirectional self-healing rings with path protection;

FIG. 22 is a network diagram of a simplified cross-
connect for the network of FIG. 18;

FIG. 23 is a network diagram of a simplified cross-
30 connect for the generalized case of K interconnected
unidirectional self-healing rings with path protection;

WO 98/25365

PCT/US97/23155

FIG. 24 is a schematic of a 2x2 switch;

FIG. 25 is a schematic of a 4x4 switch that is wide-sense non-blocking;

5

FIG. 26 is a schematic of a 3x3 wide-sense non-blocking switch using 2x2 switches, particularly applicable to a multi-wavelength switch; and

10

FIG. 27 is graphical illustration of an algorithm for unique transitions of the 3x3 switch of FIG. 26.

DESCRIPTION OF THE INVENTION

15

The invention recognizes that the cross-connect between self-healing rings requires fewer cross-connecting points than are apparent from a first inspection of the number of ports to the cross-connects. Other inventive features follow from this new architecture.

20

We observe that the full functionality of the 6x6 switch of FIG. 6 is not required to connect the self-healing rings 10_1 , 10_2 of FIG. 5 because of the constraints imposed on the connections between the working and protection fibers. Although the description until now about FIGS. 5 and 6 has for the most part been quite general, the interconnected network of FIG. 5 will be assumed to be based on two unidirectional path-protected self-healing rings 10_1 , 10_2 (U-SHR/2-PP).

30

WO 98/25365

PCT/US97/23155

In FIG. 7 is shown a two-ring U-SHR/2-PP network, that is, a unidirectional, two-fiber, path-protected self-healing network. An inter-ring node 50 connects two communication rings 52₁, 52₂. Each communication ring 52₁, 52₂ includes a respective working fiber 54₁, 54₂ and a respective protection fiber 56₁, 56₂. In this architecture, within each ring, the working or protection fibers 54₁, 56₁, or 54₂, 56₂ are normally carrying duplicate signals in counter-rotating directions. Note that the figure for convenience has interchanged the inner and outer positions of the working and protection fibers between the two rings. Other access nodes 12 are connected along the respective rings 52₁, 52₂. The 6x6 switching function of the node 50 can be performed by two 3x3 switches 60, 62. The first 3x3 switch 60 has two of its inputs and two of its outputs connected to the working fibers 54₁, 54₂ of both rings 52₁, 52₂ while the second 3x3 switch 62 is similarly connected to the protection fibers 56₁, 56₂ of both rings 52₁, 52₂. Each 3x3 switch 60, 62 also has an input receiving a respective add fiber 64, 66 and an output transmitting onto a respective drop fiber 68, 70.

20

For self-healing networks using Path Protection (PP), there is no need to interconnect working and protection fibers since they are already carrying equivalent information. Specifically, each data transmitter impresses the same signals on both the associated working and protection fibers in a (1+1) protection scheme.

25

One 3x3 switch 60 of the PP network of FIG. 7 can be viewed as the working cross-connect while the other 3x3 switch 62 is the protection cross-connect. For survivability, a cross-connect controller 72 needs to simultaneously set both 3x3

30

WO 98/25365

PCT/US97/23155

switches 60, 62 to a common switching state so that signals follow equivalent paths in both the working fibers 54₁, 54₂ and the protection fibers 56₁, 56₂. As a result, if a failure occurs in either of the working fibers 54₁, 54₂, the protection fibers 56₁, 56₂ are already properly interconnected and carrying the desired signals for the receivers at the various intra/inter-ring nodes to pick up so that the cross-connect controller 72 does not need to reconfigure the 3x3 switches 60, 62 in response to a ring failure. The cross-connect controller 72 reconfigures the 3x3 switches 60, 62 only in response to long-term changes in the traffic pattern, on periods of the order of hours. Of course, once a ring failure has been detected, the traffic can be rearranged, but the rearrangement occurs after the failure has been successfully circumvented. The cross-connect controller 72 receives reconfiguration commands from an unillustrated network controller, and the commands can be received over the add/drop lines 42₁, 42₂ according to a control protocol that is beyond the scope of this invention. The common state configuration of the two 3x3 switches 60, 62 will likely involve the common cross-connect controller 72, a source of single-point failure in an otherwise redundant design. However, the replication of the two switches 60, 62 eliminates the single-point failure mode inherent in the unitary 6x6 cross-connect of FIG. 6.

25

For the simplified PP cross-connect 50 of FIG. 7, an inoperable working or protection fiber in one network does not supply data to the corresponding fiber on the other network. As a result, this PP design can tolerate anywhere from one fault per ring to one fault for the entire network depending on where the fault or faults occur. In contrast, as will be discussed

30

WO 98/25365

PCT/US97/23155

later, APS networks can tolerate one fault per ring regardless of the location of the faults.

The simplification allowed by implementing the 6x6 cross-
5 connect 40 of FIG. 6 with the two 3x3 switches 60, 62 of FIG. 7
is purchased at a cost of losing some functionality. Although
there are two pairs of add/drop lines 64, 66, 68, 70, there is
only one pair 64, 68 for the working fibers 54_1 , 54_2 . As a
result, at any time only a single signal of a given wavelength
10 can be dropped from and a single signal at that wavelength added
to the combination of the two rings 52_1 , 52_2 . There is no
limitation on the traffic interconnecting the rings (inter-ring
traffic). The limitation applies only to the traffic to and from
the user at the inter-ring access node 50 accessing the network
15 through the add/drop lines 64, 66, 68, 70. No two ring users 12
attached on different rings 52_1 , 52_2 can drop the same
wavelength to the inter-ring access node 50, and the user at the
inter-ring access node 50 cannot set up a connection with two
ring users 12 in different rings 52_1 , 52_2 using the same
20 wavelength. This limitation may result in some additional
blocking for the traffic to and from the inter-ring access node
50.

If interference is to be avoided between two signals of
25 the same wavelength being added or dropped at the inter-ring
access node 50, a dual-ring control algorithm under the control
of a multi-ring network controller needs to be implemented which
resolves such wavelength contentions between the two rings 52_1 ,
 52_2 . The master control algorithm could attempt to reallocate
30 wavelength assignments on one or the other of the rings 52_1 , 52_2
to avoid such add/drop contentions.

WO 98/25365

PCT/US97/23155

The problem of wavelength blocking for add/drop signals at the inter-ring node 84 can be avoided, as illustrated in the network diagram of FIG. 8, with a less simplified PP cross-connect 74 including two 4x4 switches 76, 78, each having a pair of respective add lines 64₁, 64₂ or 66₁, 66₂ and a pair of
5 of respective drop lines 68₁, 68₂ or 70₁, 70₂. As will be explained later in more detail, the hardware requirements of 4x4 switches are much greater than for 3x3 switches, but the hardware complexity purchases a significant simplification in the
10 network control algorithms since the two rings 52₁, 52₂ do not need to coordinate between them which is dropping or adding a signal at a particular wavelength at the inter-ring node 74. Two add lines 64₁, 66₁ and two drop lines 68₁, 70₁ may be dedicated to the first ring 52₁ while the other two add lines 64₂, 66₂ and
15 other two drop lines 68₂, 70₂ may be dedicated to the other ring 52₂. The increased hardware complexity does not reduce the inter-ring blocking problem and its associated control problem of assigning wavelengths to reach across multiple rings, but it does resolve the intra-ring blocking problem of reaching the
20 inter-ring node 74 from a node 12 located in the same ring. If a path exists between the inter-ring node 74 and another node 12 within one of the rings 52₁, 52₂, the management algorithm does not need to consider what is the wavelength assignments that already exist in the other of the rings 52₁, 52₂.

25

Another self-healing ring network, illustrated in FIG. 9, is the two-fiber unidirectional self-healing ring with automatic protection switching (U-SHR/2-APS). A cross-connect 84 connects two rings 52₁, 52₂ comprising respective working
30 fibers 54₁, 54₂ and protection fibers 56₁, 56₂. In normal operation, only the working fibers 54₁, 54₂ in the two rings 52₁, 52₂ carry data so that the data is being carried

WO 98/25365

PCT/US97/23155

unidirectionally, clockwise as illustrated. For self-healing networks using Automatic Protection Switching (APS), APS equipment is associated with each node 12 of the rings 52_1 , 52_2 , including the inter-ring node 50 to interconnect within the
5 respective rings 52_1 , 52_2 the working fiber 54_1 , 54_2 to the associated protection fiber 56_1 , 56_2 when a failure occurs. Conventional APS equipment detects a cable break or nodal failure from the SONET overhead and thereafter enables the links 22, 24 shown in FIG. 2, between the working and protection
10 fibers. This linking is done for all wavelengths so that a wavelength-selective APS switch is not required. For multi-wavelength rings, alternative forms of APS can be utilized, for example, detecting the optical power on the working fiber. If one ring 52_1 develops a break 20, the APS equipment quickly
15 enables links 22, 24 to reroute the data onto the protection fiber 56_1 so as to avoid the break 20. Only a single add line 80 and a single drop line 82 connected to the respective add/drop ports are associated with the cross-connect 84 between the two APS rings 52_1 , 52_2 , so that the simplification again incurs the
20 constraint of limiting simultaneous adding or dropping of the same wavelength on both rings.

Viewed most generally, the cross-connect for this two-fiber APS network should be a 6x6 switch, and eight 6x6 switches
25 are required for an 8-wavelength WDM system. However, we observe that the protection fiber 56_1 , 56_2 does not need to be switched at any ring access node 12 or at the cross-connect 84 since it is acting simply to bridge the missing portion of the working fiber and the automatic protection system 22, 24 does
30 the only required protection switching. That is, the cross-connect 84 never switches to or from a protection fiber 56_1 ,

WO 98/25365

PCT/US97/23155

56₂. This constraint is allowed even for a line failure in the path from a node 12 to the cross-connect 84 because of the activatable APS links adjacent to the cross-connect 84. Hence, as illustrated in the network diagram of FIG. 10, the cross-connect 84 can be implemented as one 3x3 switch 86 having inputs from the two working fibers 54₁, 54₂ and from the add line 80 and having outputs to the two working fibers 54₁, 54₂ and to the drop line 82. The two protection fibers 56₁, 56₂ are permanently connected around the 3x3 switch 86. The controller for the 3x3 cross-connect 86 is not illustrated.

The wavelength contention problems with the add/drop lines at the inter-ring cross-connect using 3x3 switches can be eliminated, as illustrated in the network diagram of FIG. 11, with a somewhat simplified cross-connect 87 including a 4x4 switch 88 connected to two add lines 80₁, 80₂ and two drop lines 82₁, 82₂, which are connected to respective add and drop ports.

The preceding embodiments of interconnected self-healing rings illustrated in FIGS. 5 and 9 are both unidirectional in the sense that data normally propagates in a given direction around the ring (although in the 1+1 architecture equivalent data is transmitted in both directions). The reverse-rotating ring is used only for protection. Unidirectional rings enjoy architectural simplicity but do not fully utilize the bandwidth of the network, which is usually determined by the bandwidth of the electronics at the nodes. If two adjacent nodes 12 in a unidirectional ring are interchanging large amounts of data, in one direction the data needs to travel only a small portion of ring while in the second direction the data needs to traverse all the other nodes in the ring before reaching the desired

WO 98/25365

PCT/US97/23155

node. As a result, frequency reuse in the case of unidirectional WDM rings provides only marginal increase in total capacity. On the other hand, in bidirectional rings, two working fibers circle the ring and provide two counter-propagating paths linking any pair of nodes. The selection of which working fiber is chosen for a particular channel may depend on many factors, but, under one rule, the working fiber with the shortest path would be selected. This control protocol would halve the maximum transmission distance and would allow effective frequency reuse especially if neighboring nodes tend to exchange larger amounts of traffic than separated nodes.

In FIG. 12 is illustrated an interconnected WDM network of two four-fiber bidirectional APS self-healing rings 90_1 , 90_2 (B-SHR/4-APS) interconnected by a cross-connect 92. Each ring 90_1 , 90_2 includes a respective clockwise propagating working fiber 94_1 , 94_2 and a respective counter-clockwise propagating working fiber 96_1 , 96_2 . Associated with each working fiber 94_1 , 94_2 , 96_1 , 96_2 is a parallel but counter-propagating protection fiber 98_1 , 98_2 , 100_1 , 100_2 . Unillustrated automatic protection switches associated with the nodes 12 of the two rings 90_1 , 90_2 selectively loop signals from one of the working fibers 94_1 , 96_2 , 96_1 , 96_2 to its associated protection fiber 98_1 , 98_2 , 100_1 , 100_2 when a fiber break or nodal failure is detected. That is, line switching is used to heal a break or nodal failure. The cross-connect 92 includes two add fibers 102_1 , 102_2 and two drop fibers 104_1 , 104_2 connected to respective add/drop ports so as to enable the cross-connect 92 to independently add and drop from the two rings 90_1 , 90_2 .

As illustrated, the B-SHR/4 cross-connect 92 for WDM

WO 98/25365

PCT/US97/23155

needs a wavelength-selective 10x10 switch. However, almost complete functionality can be maintained if the cross-connect 92, as illustrated in FIG. 13, is implemented with two 3x3 switches 106, 108, each switching one working fiber 94₁, 94₂, 96₁, 96₂ in each of the two rings 90₁, 90₂ as well as one pair of add/drop fibers 102₁, 102₂ 104₁, 104₂. Just as for the APS embodiment of FIG. 9, the protection fibers 98₁, 98₂, 100₁, 100₂ are not directly switched through the cross-connect 92 and therefore bypass the 3x3 switches 106, 108. Although as illustrated the first 3x3 switch 106 inter-switches the counter-clockwise propagating fibers 96₁, 96₂ and the second 3x3 switch 106 inter-switches the clockwise propagating fibers 98₁, 98₂, clockwise and counter-clockwise signals in the two rings can just as easily be inter-switched. An unillustrated controller separately controls the switching states of the two 3x3 switches 106, 108.

The simplified inter-ring cross-connect of FIG. 13 suffers two constraints over the general 10x10 switch of FIG. 12. Signals traveling on one working fiber in the first ring cannot be selectively switched to one or the other of the working fibers of the other ring. The permanent fiber connections determine which two fibers can be inter-switched. This constraint does not limit the functionality of the cross-connect but implies that the second node cannot always use the shortest path to the desired destination node. This may be a minor concern for a small number of interconnected rings, and a large number of rings interconnected in a chain does not favor the 4-fiber architecture that provides a shortest path. Similarly, each 3x3 switch 106, 108 can drop (or add) only one signal at a given wavelength. Hence, the channel assignment

WO 98/25365

PCT/US97/23155

protocol must assure that two channels of the same wavelength to be dropped at the cross-connect are directed to different 3x3 switches 106, 108.

5 The corresponding non-conflicting architecture is shown in the network diagram illustrated in FIG. 14. A somewhat simplified cross-connect 92' includes two 4x4 switches 106', 108' having the previously described connections to the rings 90₁, 90₂. The number of add/drop lines is doubled so that at
10 its add/drop ports the 4x4 switch 106' receives two add lines 102₁₋₁, 102₁₋₂ and transmits to two drop lines 104₁₋₁, 104₁₋₂, and the other 4x4 switch 108' receives two add lines 102₂₋₁, 102₂₋₂ and transmits to two drop lines 104₂₋₁, 104₂₋₂. Thereby, either ring 90₁, 90₂ can add or drop signals at the inter-ring node 92'
15 without concern for the other ring.

As illustrated in FIG. 15, a bidirectional path-protected self-healing ring can alternatively be implemented with only two fibers (B-SHR/2-PP). Each ring 110₁, 110₂ includes
20 respectively fibers 112_{1A}, 112_{2A} propagating in the clockwise direction and parallel fibers 112_{1B}, 112_{2B} propagating in the counter-clockwise direction. The two rings 110₁, 110₂ are interconnected by a cross-connect 114, which also connects to two add fibers 102₁, 102₂ and two drop fibers 104₁, 104₂. Note
25 that the networks of FIGS. 9 and 15, although topologically similar, provide different functionality. The former is unidirectional; the latter, bidirectional. In the bidirectional embodiment of FIG. 15, all the ring fibers 112_{1A}, 112_{1B}, 112_{2A}, 112_{2B} are considered as working fibers since they carry data
30 under normal conditions, and the data is not normally replicated on the counter-propagating fiber. However, each

WO 98/25365

PCT/US97/23155

fiber is normally operated at only half of its capacity or less so that half of its capacity is held in reserve.

Conventionally, the path protection afforded by this
5 architecture has been accomplished by reducing capacity in
SONET rings by normally using only half of the SONET time slots.
As illustrated in the network diagram of FIG. 16, a transmitter
12_T transmits SONET signals to a receiver 12_R over a SONET ring
110 including counter-propagating fibers 112_A and 112_B. It is
10 understood that the transmitter 12_T and receiver 12_R are part of
nodes 12 which are also capable of receiving and transmitting in
the reverse direction. In normal operation, the transmitter 12_T
transmits a first SONET frame DATA1, shown in FIG. 17 onto the
clockwise fiber 112_A and a second SONET frame DATA2 onto the
15 counter-clockwise fiber 112_B. However, as illustrated in the
framing structures of FIG. 17, in normal operation, the
transmitter 12_T uses only half of the SONET data time slots 113,
leaving alternating time slots E empty. SONET overhead slots
are not illustrated in FIG. 17. In the event of a fiber break
20 20₁ or 20₂ or of intervening node failure, the receiver 12_R
detects which fiber 112_A, 112_B is inactive as far as its
reception is concerned and notifies the transmitter 12_T on which
fiber 112_A, 112_B transmitting from the transmitter 12_T to the
receiver 12_R the failure occurred, that is, whether it is
25 failure 20₁ or 20₂. Of course, a double failure 20₁ and 20₂ would
isolate the transmitter 12_T from the receiver 12_R. The
transmitter 12_T, in response to determining which fiber has
failed, combines the data from the two SONET frames into a
single frame DATA1+DATA2 by using the empty slots E and
30 transmits the combined frame DATA1+DATA2 onto the surviving
fiber.

WO 98/25365

PCT/US97/23155

However, in WDM networks the reduction in capacity can be more directly accomplished in the wavelength domain. For example, as illustrated in the network diagram of FIG. 18 for an 8-wavelength WDM network, the transmitter 12_T normally transmits only half the WDM wavelengths, for example, $\lambda_1 \dots \lambda_4$ onto the first fiber 112_A while it transmits the other four wavelengths $\lambda_5 \dots \lambda_8$ onto the other fiber 112_B. However, in the case of a failure 20₁ the receiver 12_R detects the failure in transmission at a given wavelength and notifies the transmitter 12_T of the failure's location, which is identified with the wavelength. In response, the transmitter 12_T begins transmitting all 8 WDM wavelengths $\lambda_1 \dots \lambda_8$ onto the surviving fiber 112_A that can be used for the link. This transfer can be accomplished in the optical domain without the necessity of demultiplexing to the electrical domain, as would be required to exchange time slots within the SONET frame.

The constraint is imposed that wavelengths passing from the failed ring to another ring may be placed on a fiber to which they are not normally assigned, and the receivers in the second ring must be notified of this reconfiguration. With this constraint, there is never a reason to switch a signal from a clockwise propagating fiber on one ring to a counter-clockwise propagating fiber on another ring since they are carrying signals of different wavelengths. Of course, the distinction does not involve the direction of rotation but involves the set of wavelengths being carried.

As a result of the limitation of interchange, the cross-connect 114 can be reduced from a 6x6 switch 114 most broadly apparent from FIG. 15 to a pair of 3x3 switches 116, 118

WO 98/25365

PCT/US97/23155

illustrated in FIG. 19. One 3x3 switch 116 is connected to the two clockwise propagating fibers 112_{1A}, 112_{2A} carrying the four wavelengths $\lambda_1 \dots \lambda_4$ as well as to a pair of add/drop fibers 102₁, 104₁ while the other 3x3 switch 118 is connected to the
5 two counter-clockwise propagating fibers 112_{1B}, 112_{2B} carrying the other four wavelengths $\lambda_5 \dots \lambda_8$. This simplification has the advantage that the 3x3 switches 116, 118 in normal operation need switch only four wavelengths instead of eight although in case of failure each 3x3 switch 116, 118 needs to be able to
10 switch all eight wavelengths if the inter-ring node (cross-connect) 114 is to dependably access all eight wavelengths. The simplification produces the usual restraint that two signals of the same wavelength cannot be added or dropped at the cross-connect 114.

15

An unillustrated controller, similar to the controller 72 of FIG. 7, controls the switching states of the two 3x3 switches 116, 118. In a WDM network, the two 3x3 switches 116, 118 are controlled to the same switching state insofar as a signal at a
20 given WDM wavelength within a given ring 110₁, 110₂ is switched similarly by either switch 116, 118 regardless of which switch it transits. In normal operation, in each B-SHR/2 ring 110₁, 110₂ one fiber 112_{1A}, 112_{1B} routes half the WDM signals to one 3x3 switch 116, and the other fiber 112_{1B}, 112_{2B} routes the
25 other half of the WDM signals to the other 3x3 switch 118. As a result, only half of the matching controller signals are significant at each 3x3 switch 116, 118. However, in case of a failure, all WDM wavelength signals are carried on one fiber and enter one of the 3x3 switches 116, 118, and all the required
30 switch state control signals are already available at that 3x3 switch 116, 118.

WO 98/25365

PCT/US97/23155

As for the other embodiments, contention at the inter-ring node 114 can be removed, as illustrated in the network diagram of FIG. 20, by a cross-connect 114' including two 4x4 switches 116', 118' having the previously described connections to the two rings 110₁, 110₂ but also having additional add/drop lines. Specifically, the first 4x4 switch 116' receives a pair of add lines 102₁₋₁, 102₁₋₂ and transmits on a pair of drop lines 104₁₋₁, 104₁₋₂. Similarly, the second 4x4 switch 118' receives a pair of add lines 102₂₋₁, 102₂₋₂ and transmits on a pair of drop lines 104₂₋₁, 104₂₋₂. If the ports connected to all eight add/drop lines can accommodate all the WDM wavelengths, wavelength contention at the inter-ring node 114' is removed, and the self-healing algorithm is simplified.

The component count for cross-connects XC and switches Sw is given in TABLE 1 for the different self-healing rings. This table is based on a single pair of add/drop lines in the cross-connects resulting in the use of 3x3 switches.

Ring \ Switch	U SHR/2 APS	U SHR/2 PP	B SHR/2 PP	B SHR/4 APS
6x6 XC	1	1	1	-
10x10 XC	-	-	-	1
1x6 Sw	12W	12W	12W	-
1x10 Sw	-	-	-	20W
3x3 XC	1	2	2	2
1x3 Sw	6W	12W	12W	12W
2x2 Sw	4W	8W	8W	8W
Mux/Demux	2	4	4	4
2x2 mλSw	4	8	8	8

TABLE 1

WO 98/25365

PCT/US97/23155

In this table, a cross-connect, XC, is assumed to be able to independently switch all W WDM wavelengths, while a simple switch, Sw, is assumed to not be able to differentiate the different wavelengths. For such simple switches additional
 5 multiplexers and demultiplexers are required. However, a multi-wavelength switch $m\lambda Sw$ is assumed to be able to independently switch the different WDM wavelengths. In the case in which the multi-wavelength switch is of the mechanically actuated type using different physical wavelength levels, multiplexers and
 10 demultiplexers are required.

If 4x4 switches are instead used to prevent the wavelength contention at the inter-ring node, the part count increases significantly, as is shown in following TABLE 2.

15

20

25

30

Ring Switch	U SHR/2 APS	U SHR/2 PP	B SHR/2 PP	B SHR/4 APS
6x6 XC	1	1	1	-
10x10 XC	-	-	-	1
1x6 Sw	12W	12W	12W	-
1x10 Sw	-	-	-	20W
4x4 XC	1	2	2	2
1x4 Sw	8W	16W	16W	16W
2x2 Sw	8W	16W	16W	16W
Mux/Demux	4	8	8	8
2x2 $m\lambda Sw$	8	16	16	16

TABLE 2

WO 98/25365

PCT/US97/23155

For example, rather than four 2x2 switches required to implement a 3x3 wide-sense non-blocking switch, eight 2x2 switches are required to implement a 4x4 wide-sense non-blocking switch. These numbers are multiplied by the number W of WDM wavelengths if the switches are not multi-wavelength. Of course, the additional add/drop lines require their own transmitters and receivers.

The architecture of interconnected survivable rings is often imposed upon an existing mesh network having a few large hubs at existing major central offices having fiber trunk lines extending in a number of directions. As a result, more than two rings may pass through the hub, and it may be advantageous to use a single cross-connect to switch between the three or more rings. The case of three path-protected, unidirectional self-healing rings (U-SHR/PP) will be developed, and this case will be generalized to K such rings.

The U-SHR/PP architecture impresses all signals upon both a working fiber and a protection fiber. The concepts applied to U-SHR/PP ring interconnects are easily extended to other types of rings.

As shown in FIG. 21, a single cross-connect 120 interconnects three rings 122₁, 122₂, 122₃, each including a respective working fiber 124₁, 124₂, 124₃ and a respective protection fiber 126₁, 126₂, 126₃. Also, the selective connections extend to two drop/add clusters, each including a respective drop fiber 128₁, 128₂ and a respective add fiber 130₁, 130₂, which together provide an access node at the cross-connect 120. Two pairs of drop/adds are required since, in path-

WO 98/25365

PCT/US97/23155

protected architectures, both the working and protection fiber need drop/adds. As illustrated, the cross-connect 120 requires an 8x8 wavelength-selective switch. For unidirectional path-protected rings, the cross-connect 120 can be simplified, as
5 illustrated in FIG. 22, to two 4x4 switches 132, 134. The first 4x4 switch 132 is connected to both ends of all three working fibers 124₁, 124₂, 124₃ as well as to a first pair of add/drop fibers 128₁, 130₁ while the second 4x4 switch 134 is connected to both ends of all three protection fibers 126₁, 126₂, 126₃ as
10 well as to a second pair of add/drop fibers 128₂, 130₂. Although for convenience the second ring 122₂ is illustrated as being substantially included inside the third ring 122₃, the rings are usually expected to extend over different geographical areas. In any case, the topology of the rings is not directly relevant
15 to the invention, and they may exhibit nearly arbitrary topology.

It is seen that the self-healing interconnected ring network of FIG. 22 differs from that of FIG. 7 in that the 4x4
20 switches 132, 134 for interconnecting three rings replace the 3x3 switches 60, 62 for interconnecting two rings.

For interconnecting four U-SHR/PP rings, a 10x10 cross-connect is required. This can however be simplified to two 5x5
25 switches. In general, for interconnecting K WDM U-SHR/PP rings, a $(2K+2) \times (2K+2)$ cross-connect is required. However, as illustrated in FIG. 23, this can be simplified to two $(K+1) \times (K+1)$ switches 140, 142 interconnecting K rings, the rings comprising respective pairs 144₁, 144₂, ... 144 _{K} of working
30 and protection fibers. The first switch 140 is connected to the K working fibers and to the first pair of add/drop fibers 128₁,

WO 98/25365

PCT/US97/23155

130₁, and the second switch 142 is connected to the K protection fibers and to the second pair of add/drop fibers 128₂, 130₂.

The same generalized procedure can be applied to a cross-
 5 connect between more than two rings having configurations other than U-SHR/PP. In TABLE 3 are shown the type and number of cross-connects needed for the four network embodiments discussed above in detail.

Ring Type	U SHR/2 APS	U SHR/2 PP	B SHR/2 PP	B SHR/4 APS
Dual-Ring	one 3x3	two 3x3	two 3x3	two 3x3
Triple-Ring	one 4x4	two 4x4	two 4x4	two 4x4
K-Ring	one (K+1)x(K+1)	two (K+1)x(K+1)	two (K+1)x(K+1)	two (K+1)x(K+1)

TABLE 3

The higher-order cross-connects shown in FIGS. 21-24 and the parts count given in TABLE 3 are exposed to wavelength blocking for signals originating or terminating at the inter-ring node due to a paucity of add/drop lines. This contention can be removed by increasing the size of the switches 132, 134,
 25 140, 142 to provide one add line and one drop line for each of the interconnected rings. For interconnecting three rings, one or two 6x6 switches are required to remove the blocking. Similarly, for interconnecting K rings one or two $2K \times 2K$ switches are required. Whether one or two switches are required
 30 depends upon the type of self-healing architecture, as summarized in TABLE 3.

WO 98/25365

PCT/US97/23155

The cross-connects between two self-healing WDM rings, as presented above, can be simplified to 3x3 multi-wavelength optical switches if some wavelength blocking at the inter-ring node is tolerated. One 3x3 optical switch can be implemented
5 with three 1x3 switches and three 3x1 switches, for a total of six switches; but, this number is considered excessive, especially for a cost-sensitive design.

A more fundamental structure is a 1x2 optical switch
10 which can switch an input to one of two output dependent upon typically a non-linear interaction. This structure can sometimes be inverted to form a 2x1 switch, and four of these switches can then be combined into a 2x2 switch. Other technologies, such as acousto-optical tunable filters and
15 liquid crystal switches readily form a 2x2 switch, such as switch 150 illustrated in FIG. 24, as a fundamental block, as has been explained with reference to FIG. 3. Such a 2x2 switch can be made at low cost, is easily implemented, and is more readily available.

20

The 2x2 switch 150, as shown in FIG. 24, has two optical inputs 152, 154 and two optical outputs 156, 158. The switch has two states. In the bar state, the upper optical input 152 is connected to the upper optical output 156, and the lower optical
25 input 154 is connected to the lower optical output 158. In the cross state, the connections are reversed so that the upper optical input 152 is connected to the lower optical output 158 and the lower optical input 154 is connected to the upper optical output 156. In a well designed switch, the cross talk
30 between selected channels is very small. The advantage of a multi-wavelength switch is that the switching is done in the

WO 98/25365

PCT/US97/23155

optical domain, and the switch can independently and simultaneously switch the optical channels of different wavelength.

5 Higher-order optical switches are often implemented as multiple stages of 2x2 switches. For example, a 4x4 optical switch is illustrated in FIG. 25 includes eight 2x2 switches 150 arranged in four stages and connecting four optical inputs 160 to four optical outputs 162 via the illustrated internal
10 connections. Hinton in *An Introduction to Photonic Switching Fabrics*, (Plenum, 1993), pp. 90, 91 discloses that this network is a wide-sense non-blocking network, and he provides guidance for the routing algorithm through such a network. Particularly, the middle four 2x2 switches 150 should never be in the same
15 state. See also, Bene' et al., "Wide-sense non-blocking networks, and some packing algorithms", *Electronics Letters*, vol. 17, 1981, p. 697. The so called Bene' network has one less stage of 2x2 switches but provides only a rearrangeably non-blocking switch, that is, one which allows any combination of
20 any input being singly connected to any output, but a new path through the switch may require the existing paths to be rearranged.

The 4x4 wide-sense non-blocking network of FIG. 25 can be
25 used for the 4x4 switches described for the non-contending cross-connects. It could also be used for implementing a 3x3 switch, but it would require eight 2x2 switches. It is preferred that a switching network be found for a 3x3 switch that requires fewer components.

30

There are six states in a 3x3 switch, as shown in TABLE 4. For a WDM optical switch, there are six such states for each wavelength.

STATE	INPUT		
	1	2	3
	OUTPUT		
a	1	2	3
b	1	3	1
c	3	2	1
d	2	1	3
e	2	3	1
f	3	1	2

TABLE 4

15 A wide-sense non-blocking architecture for a 3x3 switch
 is shown in FIG. 26. A wide-sense non-blocking switch is a
 switch that can in all cases achieve an allowed transition from
 any one state to any other state without interrupting the
 traffic through the preexisting connections that themselves do
 not require changing. A clever algorithm may be required to
 20 accomplish wide-sense non-blocking. Such a wide-sense non-
 blocking 3x3 switch includes four 2x2 switches 164₁, 164₂, 164₃,
 164₄ arranged in a staggered configuration to connect three
 inputs 166₁, 166₂, 166₃ to three outputs 168₁, 168₂, 168₃ with
 25 the illustrated internal connections. In a WDM network, the 2x2
 switches 164₁, 164₂, 164₃, 164₄ are preferably all-optical
 switches, most preferably multi-wavelength switches. The
 subscripts on the inputs 166 and the outputs 168 in FIG. 26 can
 be used to numerically identify the input or output in TABLE 4.
 30 Similarly, the subscripts on the switches 164 can be used to
 provide the ordering of the switches in TABLE 5, to be

WO 98/25365

PCT/US97/23155

introduced below. For example, the "A" state in TABLE 5 is listed as (0101). The first "zero" means that the first switch 164₁ is in the BAR state. A "one" in the same position would mean it is in the CROSS state. In the context of the 3x3 switches 116, 118 of FIG. 19, the inputs 166₁, 166₂ and the outputs 168₂, 168₃ are connected to ring fibers 112_{1A}, 112_{1B} or 112_{2A}, 112_{2B} while the input 166₃ is connected to an add wavelength multiplexer 170 and the output 168₁ is connected to a drop wavelength demultiplexer 172. The add lines 102₁, 102₂ are then bundles of *W* fibers input to the multiplexer 170, and the drop lines 104₁, 104₂ are bundles of *W* fibers output from the demultiplexer 172.

One of the 2x2 switches 164 could be eliminated, but the 3x3 switch would then not be wide-sense non-blocking but only rearrangeably non-blocking in the sense that prior connections may need to be interrupted to be rearranged for a new permitted connection.

An algorithm will now be developed that shows how to select the four 2x2 switch states for the switching system of FIG 26 to achieve a wide-sense non-blocking 3x3 switch state. Wide-sense non-blocking for a 3x3 switch requires that one input-to-output connection be maintained while the other two connections are changed or at least set up. The algorithm is executed by a controller 170 having control lines connected to the four 2x2 switches 164₁, 164₂, 164₃, 164₄

From combinatorial mathematics or simply by inspecting TABLE 4, it is seen that each of the states a, b, ... f can experience only three possible transitions to other states in which one connection is preserved. Each of the four switches 164

WO 98/25365

PCT/US97/23155

can assume one of two states. The bar state will be denoted by 0 while the cross state will be denoted by 1. The four 2x2 switches 164 as a whole can have sixteen state combinations. Twelve of these are selected, two for each of the six 3x3 switch states of TABLE 4, and these are labeled A, A', B, B', ... F' and presented in TABLE 5.

A	(0101)	A'	(1010)
B	(1011)	B'	(0100)
C	(1110)	C'	(0111)
D	(1101)	D'	(0010)
E	(1111)	E'	(0110)
F	(1100)	F'	(0011)

TABLE 5

In this table, the rows represent the 3x3 switch states with the two allowed 2x2 switch combinations being listed in the second and fourth columns. The pairs of 3x3 switch states on each row represent different combinations of 2x2 switch states but produce equivalent outputs for given inputs of the 3x3 switch.

The required algorithm can be represented by the geometric structure of FIG. 27, which may be characterized as a two-level hexagon or hexagonal column. The switch state combinations A, A', B, B', ... F' are identified with the vertices (corners) of the hexagonal column with the complementary combinations, e.g., A, A', being on opposed vertices on different planes (hexagonal faces). Permitted transitions are identified with single edges of the hexagonal column. For example, state combination A can transition to any

WO 98/25365

PCT/US97/23155

of state combinations B', C', D, but to no other state combination. Any other transition would interrupt not only the connections being set up but also the connection that should be preserved.

5

Thus, to make a transition between any two of the 3x3 states of TABLE 4, the preexisting state combination of TABLE 5 must be known. For example, if the transition is between the states a, b of TABLE 4, it must be known whether the initial state combination of TABLE 5 is A or A' so that present configuration of all four 2x2 switches is identified. Assuming that the initial switch combination is A, then the permitted transition is to B', which requires the fourth 2x2 switch 164₄ to toggle from the cross to the bar state while the first three switches 164₁, 164₂, 164₃ remain respectively in the bar, cross, and bar states. Thereby, the connection between the first input 166₁ and the first output 168₁ is preserved without interruption. Although a transition from the state combination A to B would have produced the desired final connections between the inputs 166 and outputs 168, it would have momentarily interrupted the preserved connection as its path was reconfigured. If, on the other hand, the initial switch combination had been A', then the algorithm would have indicated a transition to the switch combination B. We believe that the states presented in TABLE 5 and the transition arrangement of FIG. 21 are unique for producing a wide-sense non-blocking transition although it is possible that equivalent combinations are available.

30

Although the above invention has been described in the context of optical network, many of its features can be applied to electrical networks.

WO 98/25365

PCT/US97/23155

The invention thus provides several important advantages in a communication network of interconnected self-healing rings, particularly optical fiber rings carrying WDM traffic. The complexity of the network can be substantially reduced by recognizing that many of the data paths through the interconnect do not need to be interconnected. As a result, the size of the interconnect can be made small enough as to be achievable with simple components. In particular, for two interconnected rings, one or two 3x3 switches may suffice. The invention further provides a wide-sense non-blocking 3x3 switch constructed from four 2x2 switches. Such simple switches are available as wavelength-selective optical cross-connects that can switch selected optical wavelengths in different directions. Thereby, the invention provides a simple switch that is usable with a WDM communication network in which conversion to the electrical domain is not required at the connection between two self-healing rings.

20

25

30

WO 98/25365

PCT/US97/23155

What is claimed is:

5 1. A cross-connect between at least two self-healing communication rings, each ring comprising at least a first data ring channel propagating in a respective first direction and a second data ring channel substantially parallel to said first data ring channel and propagating in a respective second direction opposite said respective first direction, said cross-connect comprising a switching element interconnecting said first data ring channel of said first communication ring to said first data ring channel of said second communication ring but not to
10 either of said second data ring channels of said first and second communication rings.

15 2. The cross-connect of Claim 1, wherein all said data ring channels comprise optical fibers and said switching element is an optical switching element.

20 3. The cross-connect of Claim 2, wherein all said data ring channels carry wavelength-division multiplexed optical signals and said optical switching element is wavelength selective between said wavelength-division multiplexed optical signals.

4. The cross-connect of Claim 3, wherein said optical switching element is a 3x3 switching element.

25 5. The cross-connect of Claim 4, wherein said optical switching element is a 4x4 switching element.

30 6. The cross-connect of Claim 1, further comprising a second switching element interconnecting said second data ring channel of said first communication ring to said second data ring channel of said second communication ring but not to either of said first data ring channels of said first and second communication rings.

WO 98/25365

PCT/US97/23155

7. The cross-connect of Claim 1, wherein said cross-connect does not itself interconnect said second data channels of said first and second communication rings.

5

8. A cross-connect between two communication rings, each ring comprising at least a first data path and a second data path propagating in opposed directions around said each ring, said cross-connect comprising:

10

a first switch receiving inputs from and providing outputs to said first data paths in said two communication rings and additionally receiving an input from a third data path and providing an output to a fourth data path outside of said two communications rings.

15

9. The cross-connect of Claim 8, further comprising:

a second switch receiving inputs from and providing outputs to said second data paths in said two communication rings and additionally receiving an input from a fifth data path and providing an output to a sixth data path outside of said two communications rings.

20

10. The cross-connect of Claim 8, wherein said switch is a 3x3 switch.

25

11. The cross-connect of Claim 9, wherein said switches are 3x3 switches.

12. The cross-connect of Claim 8, wherein said switch is a 4x4 switch.

30

13. The cross-connect of Claim 9, wherein said switches are 4x4 switches.

WO 98/25365

PCT/US97/23155

14. The cross-connect of Claim 9, wherein said first and second paths carry equivalent data, thereby forming a path-protected ring.

5 15. The cross-connect of Claim 14, wherein said first and second paths comprise first and second optical fibers and said switches are optical switches, and wherein said first and second optical fibers normally carry optical signals of respectively a first set and a second set of differing wavelength carriers, and further comprising means within each transmitting
10 node for detecting a failure with one of said first and second optical fibers and as a result transmitting both said first and second set of carriers onto the other of said first and second optical fibers.

15 16. The cross-connect of Claim 8, wherein said each ring further comprises a fifth data path and a sixth data path propagating in opposed directions around said each ring and acting respectively as protection data paths for said first and second data paths, said fifth and sixth data paths not being interconnected between two of said rings.

20 17. The cross-connect of Claim 8, wherein said first data paths are working data paths and said second data paths are protection data paths and wherein said second data paths are not directly interconnected.

25 18. The cross-connect of Claim 8, wherein each of said communication rings carries a plurality W of wavelength-division multiplexed optical signals and wherein said first and second switches comprise optical switches selectively switching any of said multiplexed optical signals.

30 19. The cross-connect of Claim 8, wherein each of said data paths comprises an optical fiber and said switch is an optical switch.

WO 98/25365

PCT/US97/23155

20. A cross-connect between K communication rings, K being greater than 2, each ring comprising at least a first data path and a second data path propagating in opposed directions around said each ring, said cross-connect comprising:

5 a first $L \times L$ switch receiving inputs from and providing outputs to said first data paths in said K communication rings and additionally receiving an input from a third data path and providing an output to a fourth data path, wherein L is equal to at least $K+1$.

10 21. The cross-connect of Claim 20, further comprising:
a second $L \times L$ switch receiving inputs from and providing outputs to said second data paths in said K communication rings and additionally receiving an input from a fifth data path and providing an output to a sixth data path.

15 22. A communication network, comprising;
a first and a second self-healing unidirectional ring, each unidirectional ring comprising
a working fiber,
20 a protection fiber, and
a plurality of nodes distributed around said unidirectional ring including a switch connected to said working fiber for adding or dropping signals from said working fiber and line switching equipments for Automatic Protection Switching disposed on either sides of said switch for selectively linking
25 said working and protection fibers; and

30 a first switch connected between said working fibers of said first and second self-healing ring and to an add line and to a drop line, said protection fibers of said first and second self-healing rings not being otherwise connected together by a another switch.

WO 98/25365

PCT/US97/23155

23. The communication network of Claim 22, wherein said first switch is a 3x3 switch.

24. The communication network of Claim 22, wherein said first switch is a 4x4 switch.

25. The network of Claim 22, wherein said self-healing rings carry wavelength-division multiplexed signals and said switch is a multi-wavelength optical switch.

26. A communication network, comprising:
a first and a second self-healing bidirectional ring, each unidirectional ring comprising
a first fiber,
a second fiber, and
a plurality of nodes distributed around said bidirectional ring including two switches connected respectively to said first and second fibers for adding or dropping signals from said first and second fibers and transmitting and receiving equipment connected through said switches to both said first and second fibers; and
a first switch connected to both said first fibers of said first and second self-healing rings, to a first add line, and to a first drop line; and
a second switch connected to both said second fibers of said first and second self-healing rings, to a second add line, and to a second drop line.

27. The communication network of Claim 26, wherein said switches are 3x3 switches.

28. The communication network of Claim 27, wherein said switches are 4x4 switches.

WO 98/25365

PCT/US97/23155

29. The network of Claim 26, wherein said self-healing rings carry wavelength-division multiplexed signals and said two switches are multi-wavelength optical switches.

5 30. A self-healing ring network, comprising:
first and second rings, each said ring comprising
at least one pair of counter-rotating communication paths and
means for healing a failure at a point in each said
ring; and
10 a cross-connect between said first and second rings connected to at least one of each of said at least one pair of counter-rotating communication paths for conveying signals between said rings, said cross-connect remaining in a same state during an operation of said healing means while said failure is being detected and healed.
15

31. The ring network of Claim 30, further comprising a controller for said cross-connect operating independently of said healing means.

20 32. The ring network of Claim 30, wherein said communication paths comprise optical fibers and said cross-connect is an optical cross-connect.

25 33. The ring network of Claim 32, wherein said optical cross-connect comprises 3x3 optical switches.

34. The ring network of Claim 32, wherein said optical cross-connect comprises 4x4 optical switches.

30 35. The ring network of Claim 32, further comprising at least one pair of add/drop optical fibers connected to said optical cross-connect.

WO 98/25365

PCT/US97/23155

36. A method of controlling interconnected self-healing communication rings, each of said rings comprising at least one pair of counter-propagating communication paths, said rings being interconnected by a cross-connect connected to at least one communication path of each of said rings, said method comprising:

healing at least one fault in at least one of said communication rings, whereby said fault does not stop an operation of said at least one communication ring; and

selectively connecting said communication paths between said communication rings through said cross-connect, said selective connecting and said healing being performed independently.

37. The method of Claim 36, wherein said healing step does not affect a state of said cross-connect imposed by said selectively connecting step.

38. The method of Claim 36, wherein said communication paths comprises optical fibers.

40. A 3x3 switch, comprising:

a first 2x2 switch receiving first and second input lines of said 3x3 switch;

a second 2x2 switch receiving a third input line of said 3x3 switch and a first output of said first 2x2 switch;

a third 2x2 switch receiving a second output of said first 2x2 switch and a first output of said second 2x2 switch; and

a fourth 2x2 switch receiving a first output of said third 2x2 switch and a second output of said second 2x2 switch;

wherein a first output line of said 3x3 switch is connected to a second output of said third 2x2 switch and second and third output lines of said 3x3 switch are connected to outputs of said fourth 2x2 switch.

WO 98/25365

PCT/US97/23155

41. The 3x3 switch of Claim 40, wherein all of said 2x2 switches are optical switches.

5 42. The 3x3 switch of Claim 41, wherein said optical switches are wavelength-selective switches.

10 43. The 3x3 switch of Claim 40, further comprising control means controlling each of said 2x2 switches to one of two 2x2 switching states, combinations of said 2x2 switching states for said four 2x2 switches constituting 3x3 switching states, said control means including an algorithm in which 12 of said 3x3 switching states are arranged on vertices of a hexagonal column and said control means selects only transitions corresponding to edges of said hexagonal column.

15 44. The 3x3 switch of Claim 43, wherein said hexagonal column includes two hexagonal faces extending in lateral directions and arranged along an axial direction;

wherein said 12 3x3 switching states includes pairs that produce equivalent connections through said 3x3 switch; and

20 wherein each of said pairs are arranged at two vertices of said hexagonal column that are on different hexagonal faces and are opposed in said lateral directions.

25 45. The 3x3 switch of Claim 44, wherein said 12 3x3 states are those of TABLE 5 and are arranged in the hexagonal column of FIG. 27.

46. A method of controlling four 2x2 switches interconnected to form a wide-sense non-blocking 3x3 switch, comprising the steps of:

30 selecting 12 combinations of states of said four 2x2 switches, pairs of said 12 combinations representing equivalent 3x3 switching states;

WO 98/25365

PCT/US97/23155

assigning said 12 combinations to vertices of an hexagonal column; and

selecting transitions for said four 2x2 switches corresponding to edges of said hexagonal column.

5

47. The method of Claim 46, wherein said 12 combinations are selected according to TABLE 5 and are arranged on the hexagonal column of FIG. 27.

10

15

20

25

30

1/13

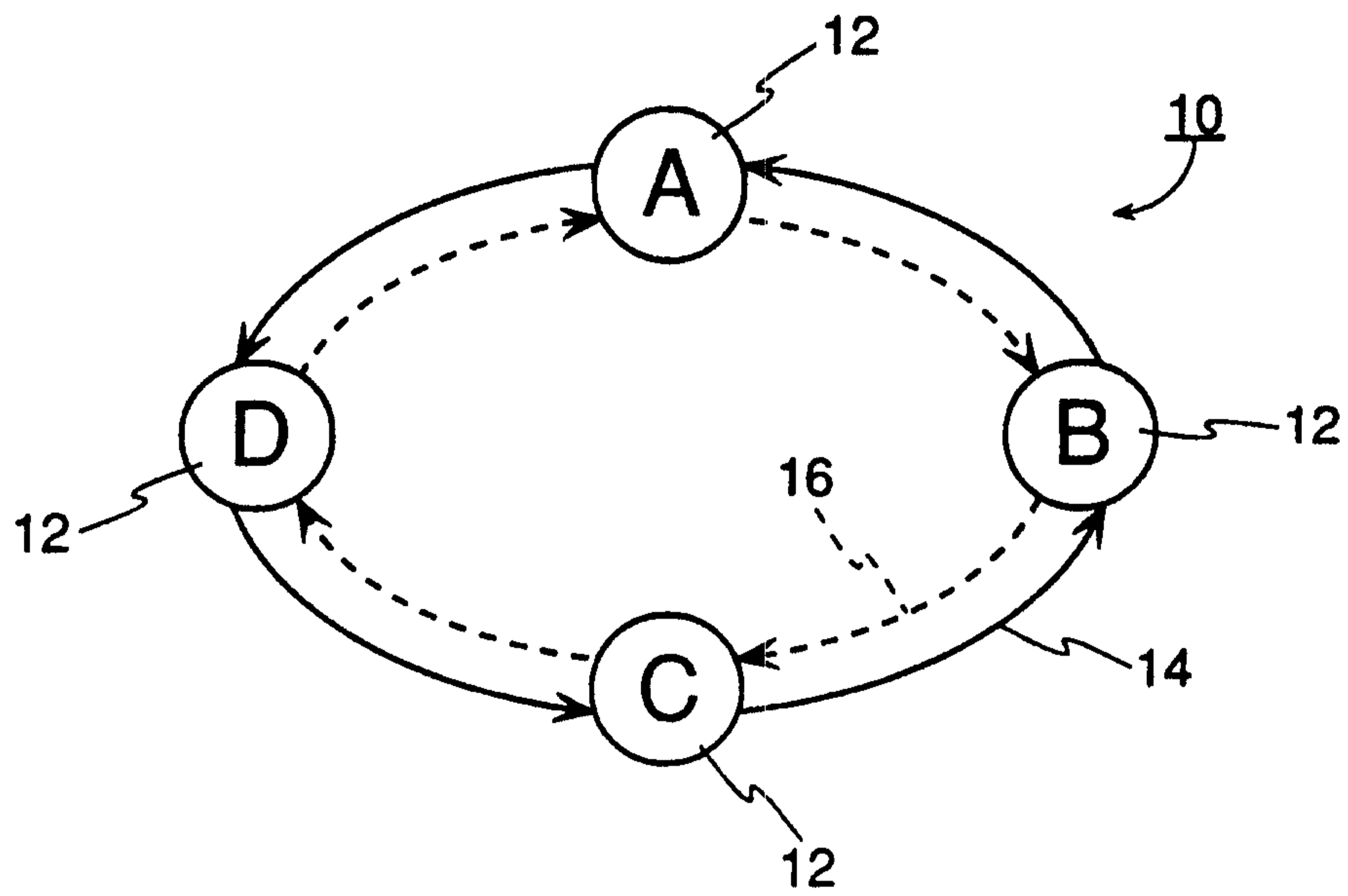

FIG. 1
(PRIOR ART)

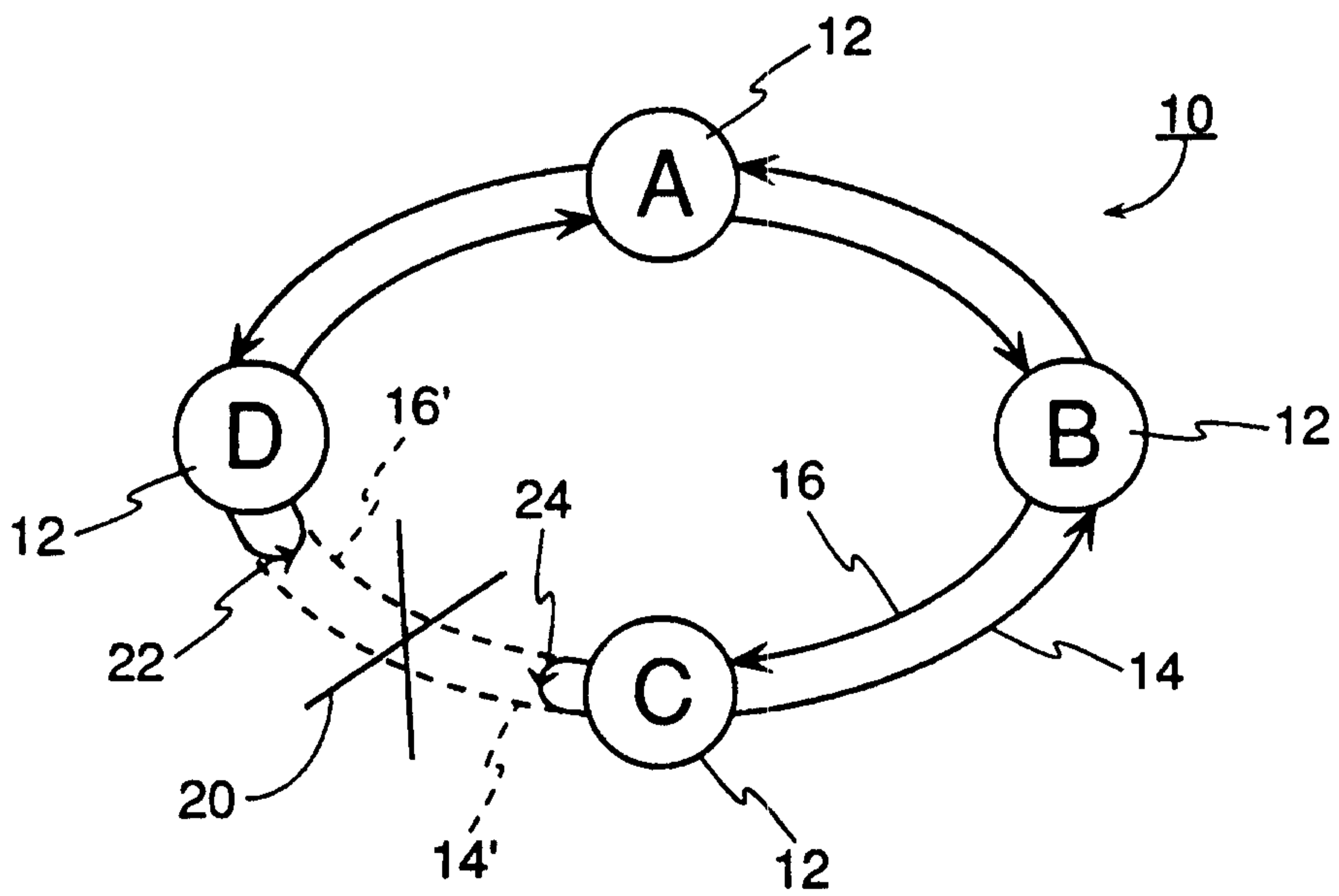

FIG. 2
(PRIOR ART)

2/13

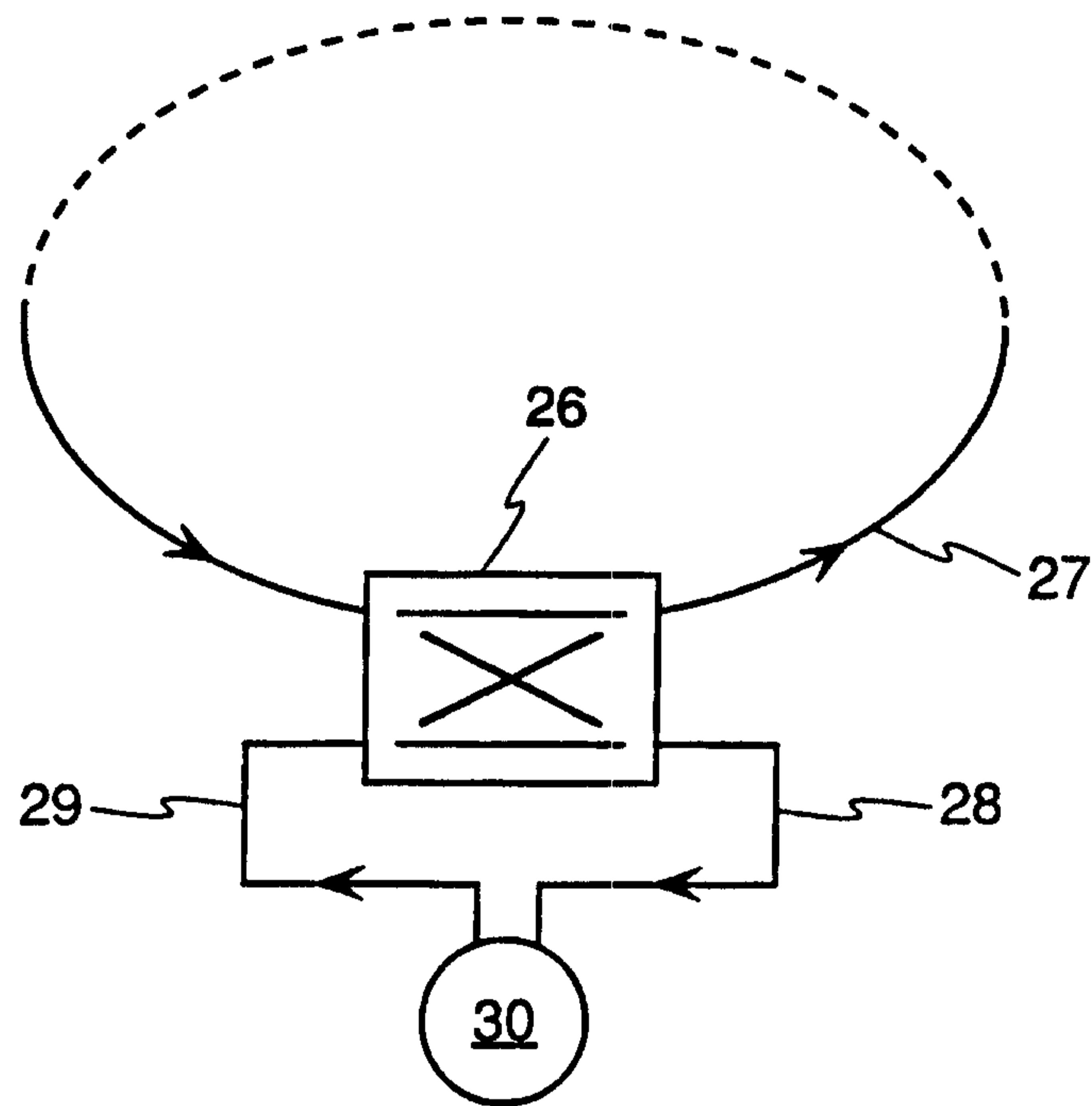

FIG. 3
(PRIOR ART)

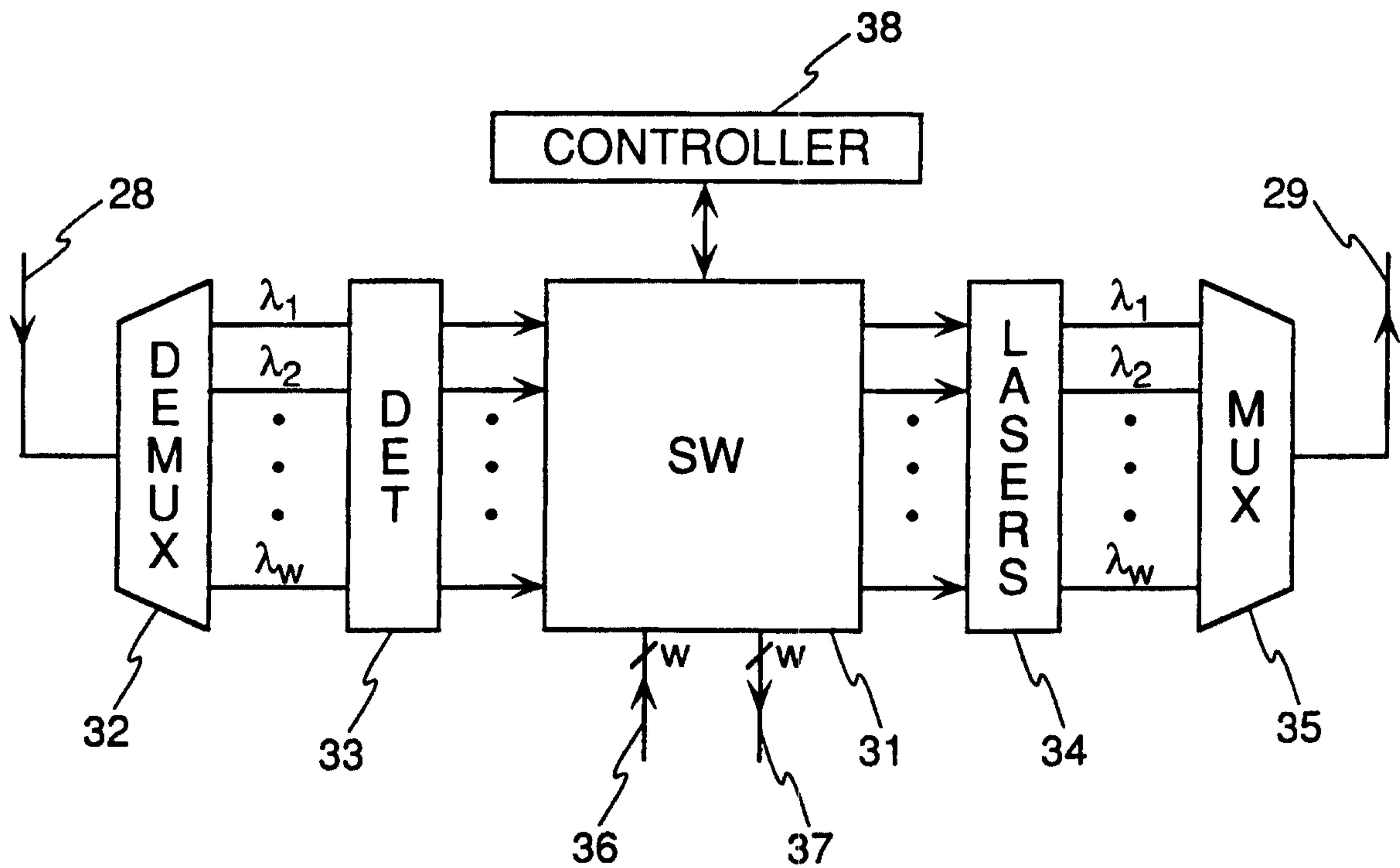

FIG. 4

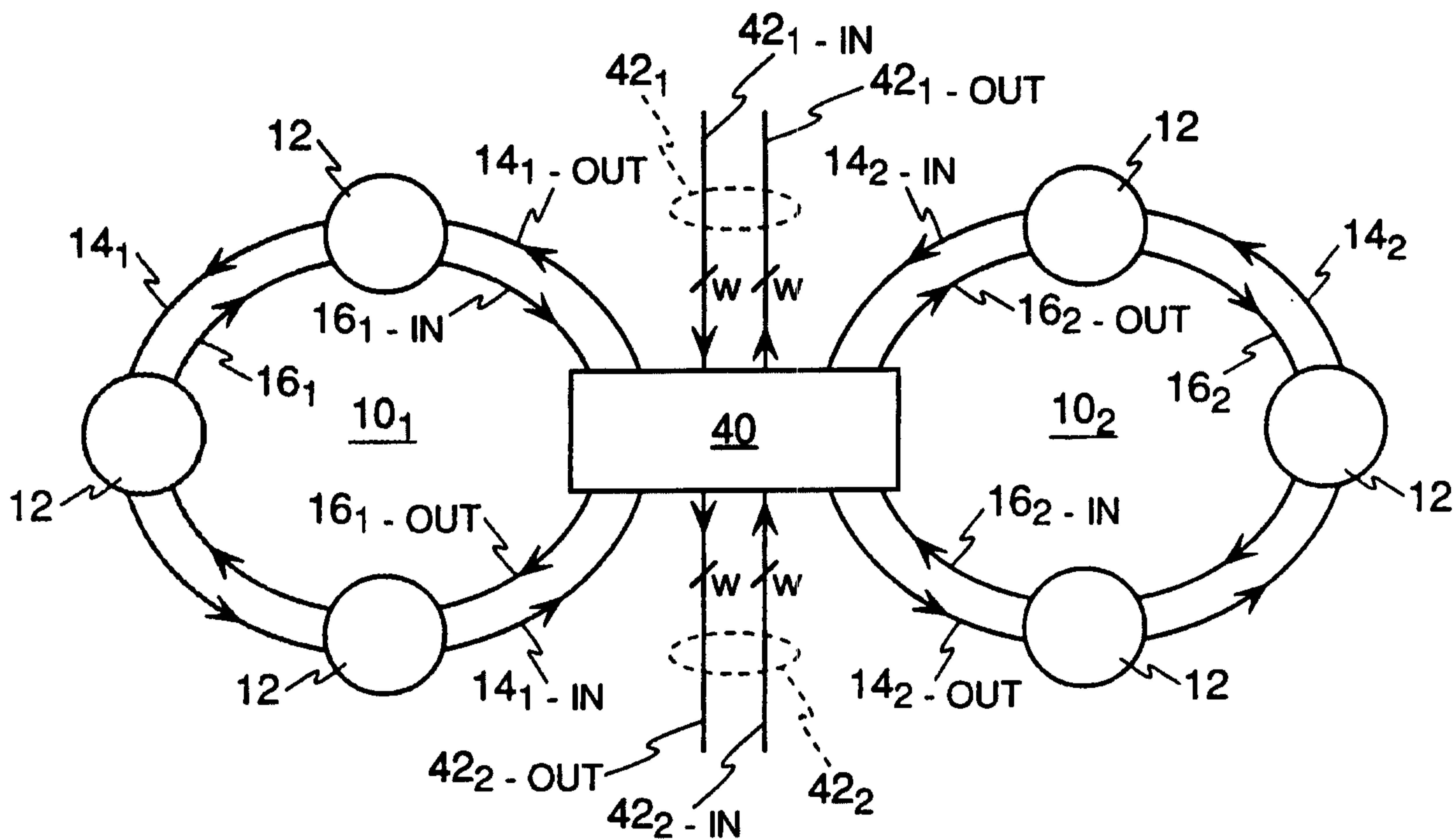

FIG. 5

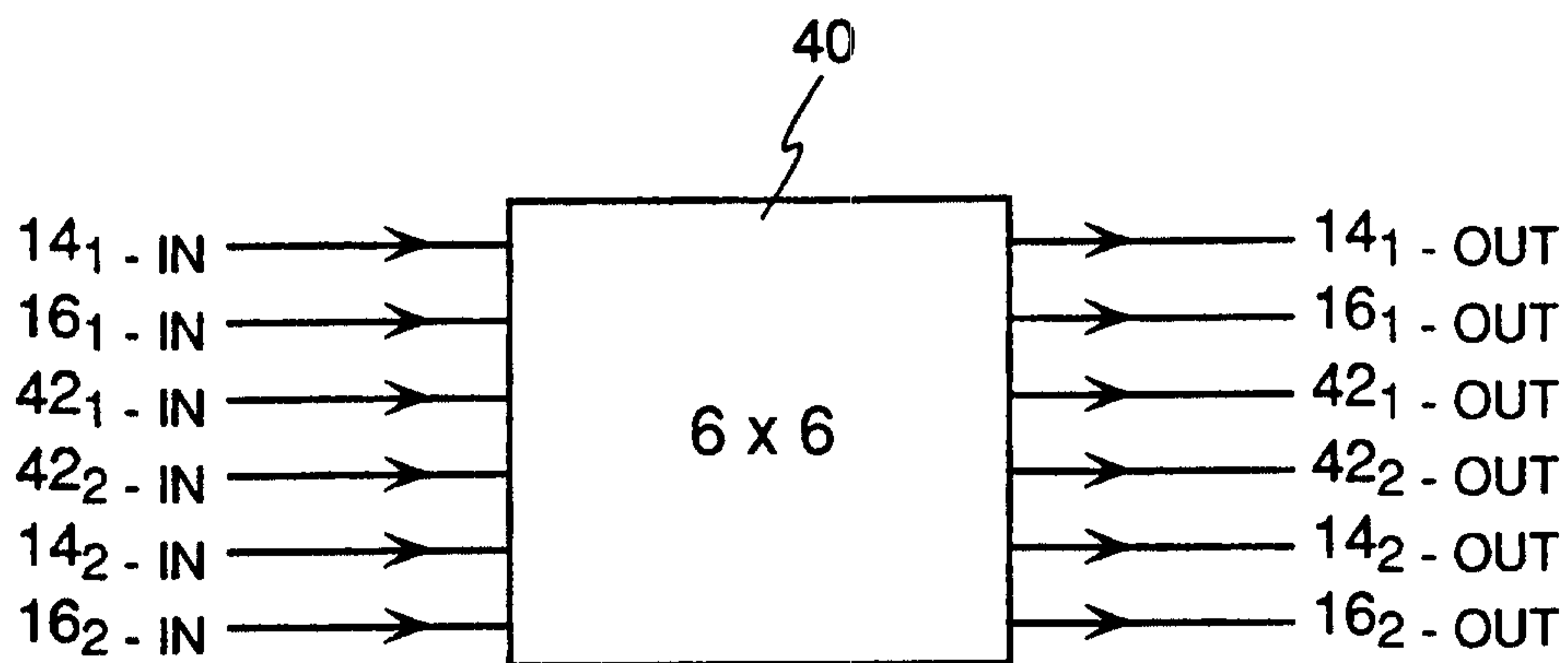

FIG. 6

4/13

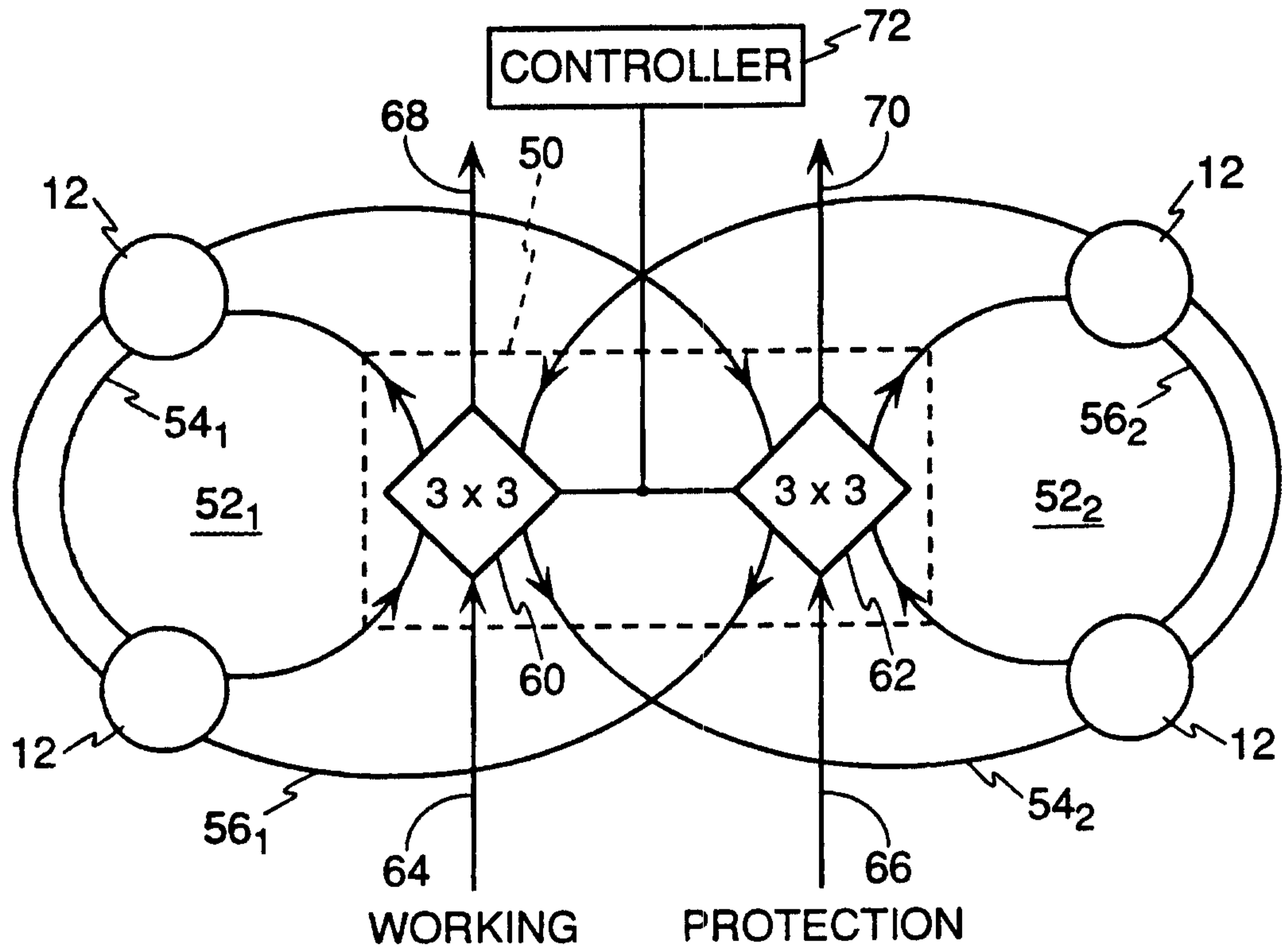

FIG. 7

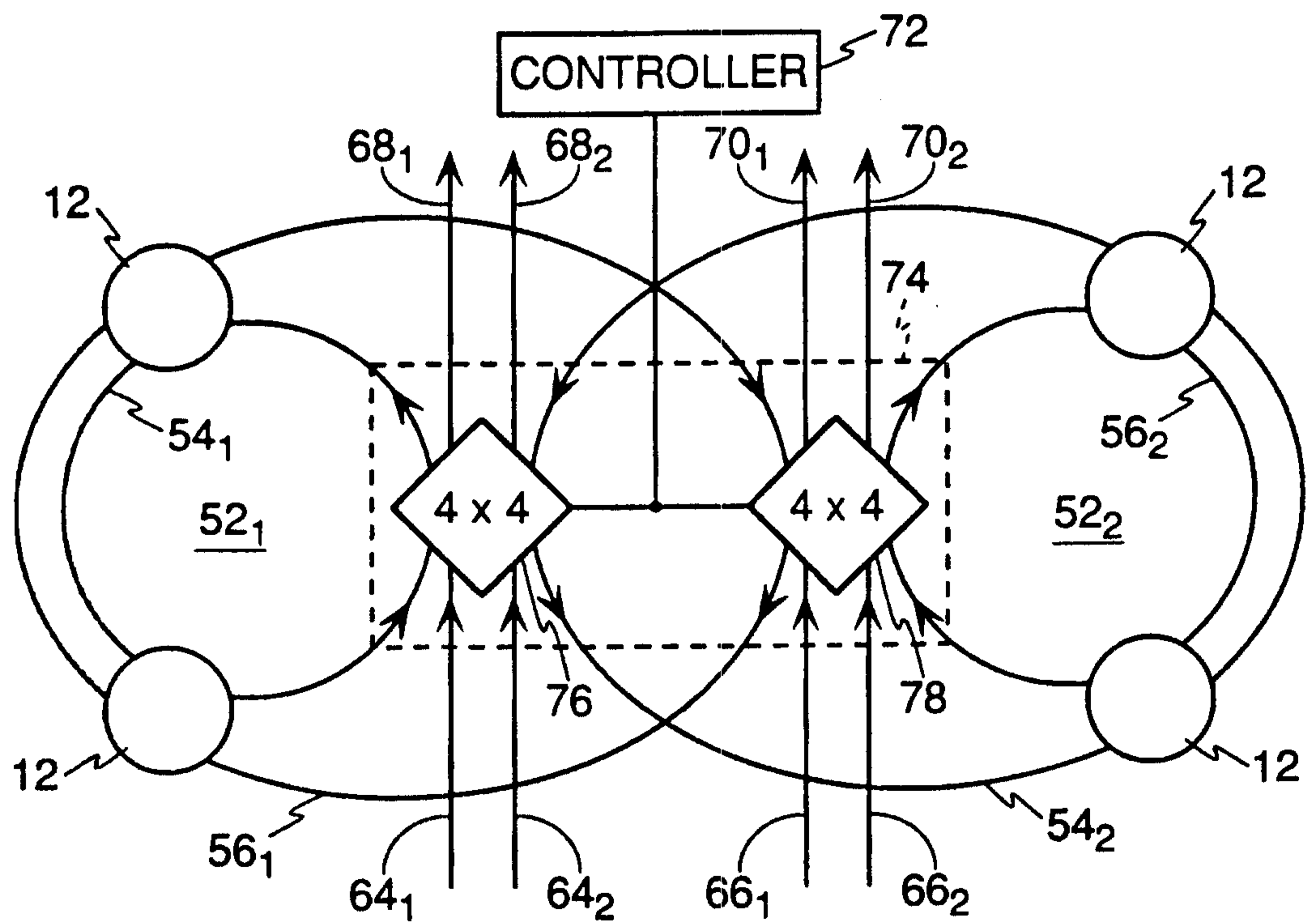

FIG. 8

5/13

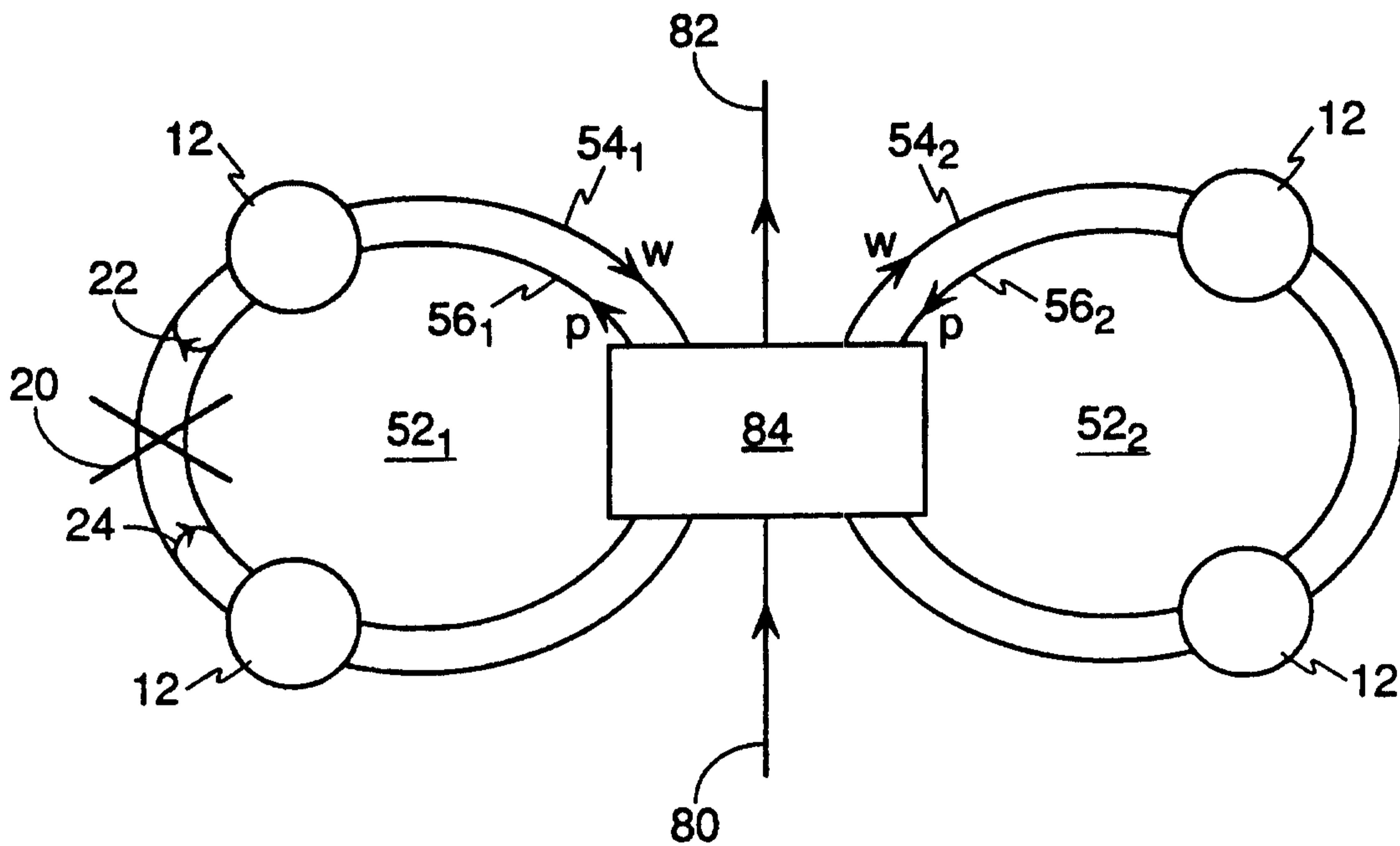

FIG. 9

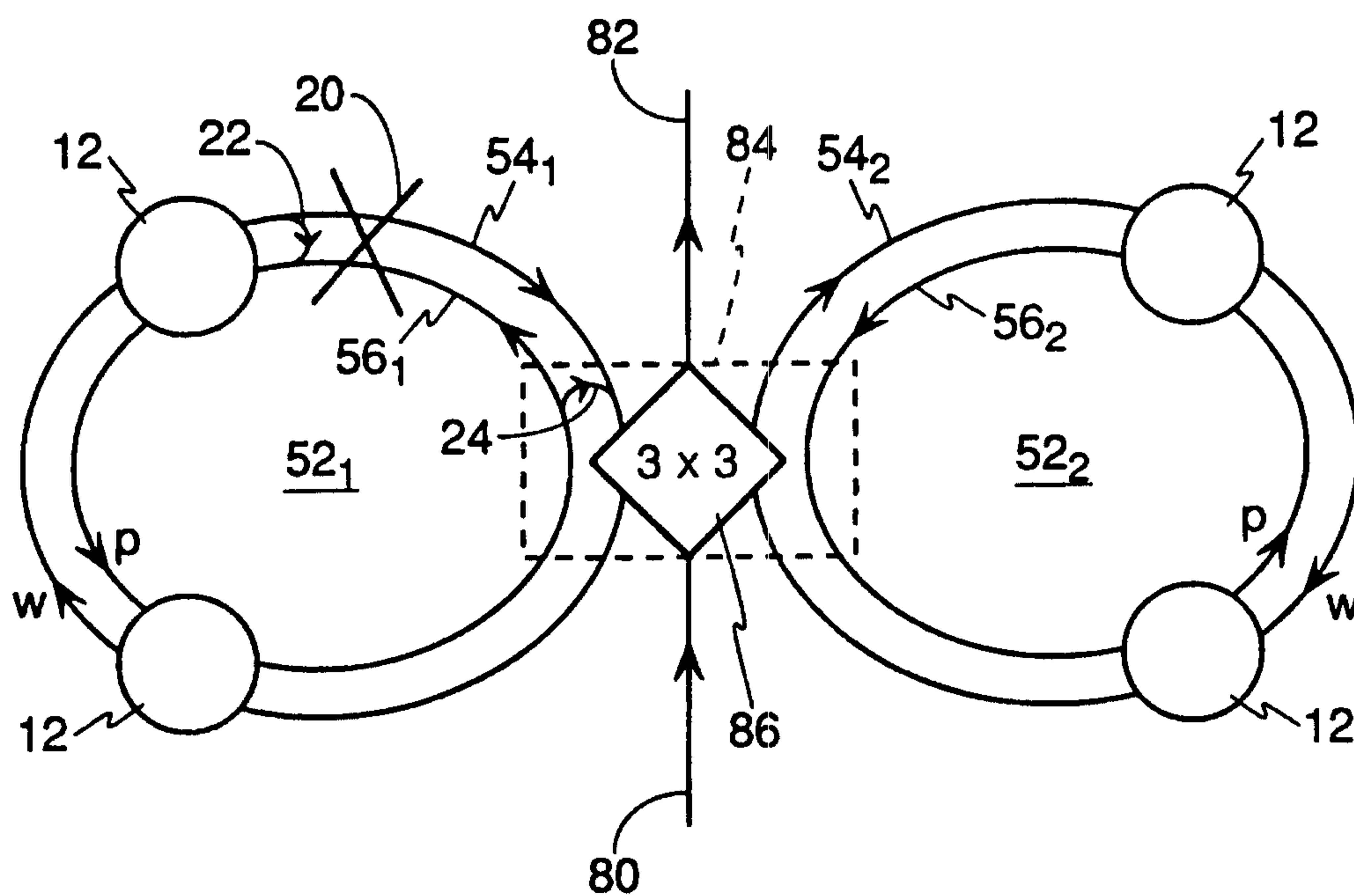

FIG. 10

6/13

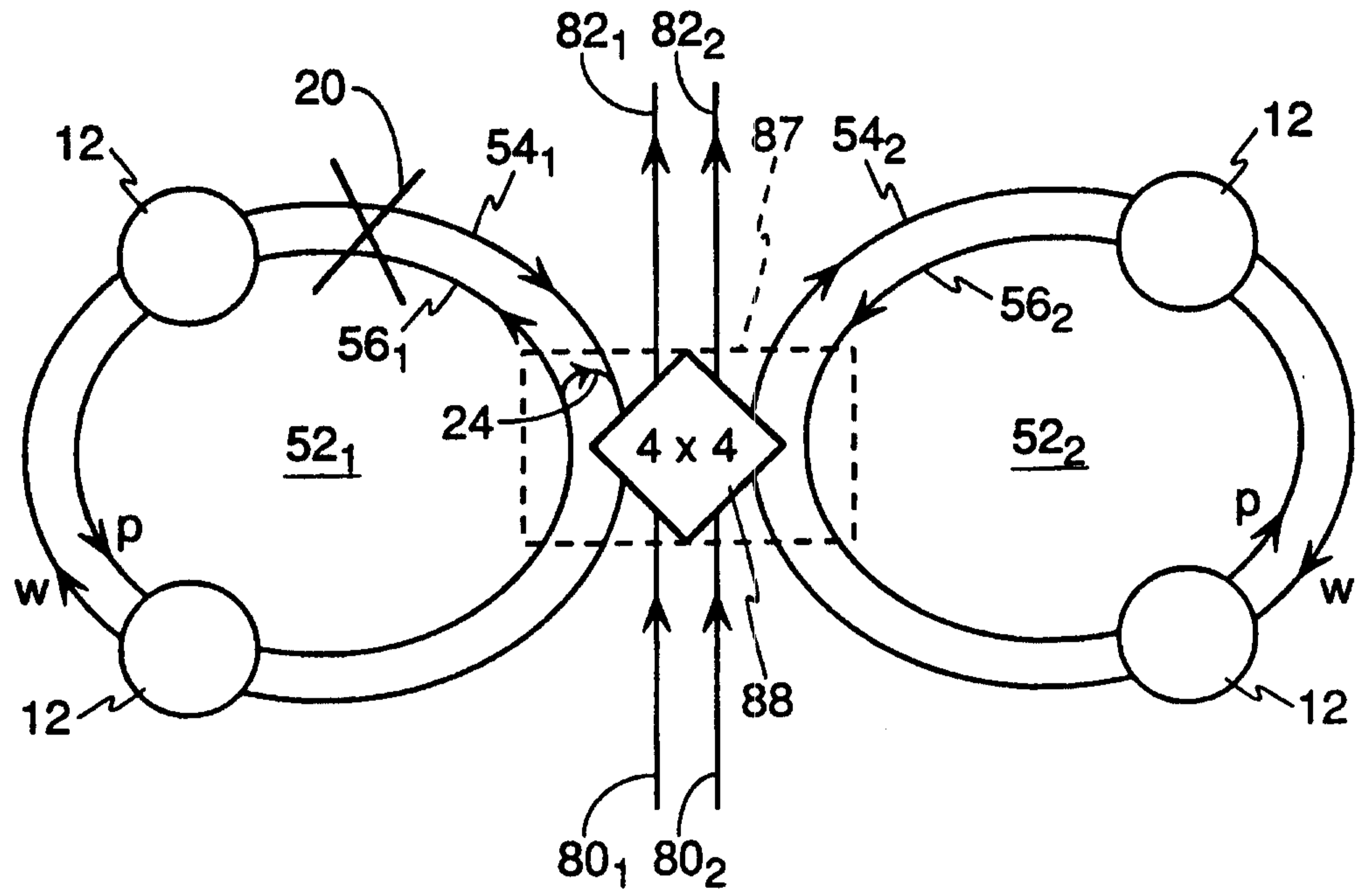

FIG. 11

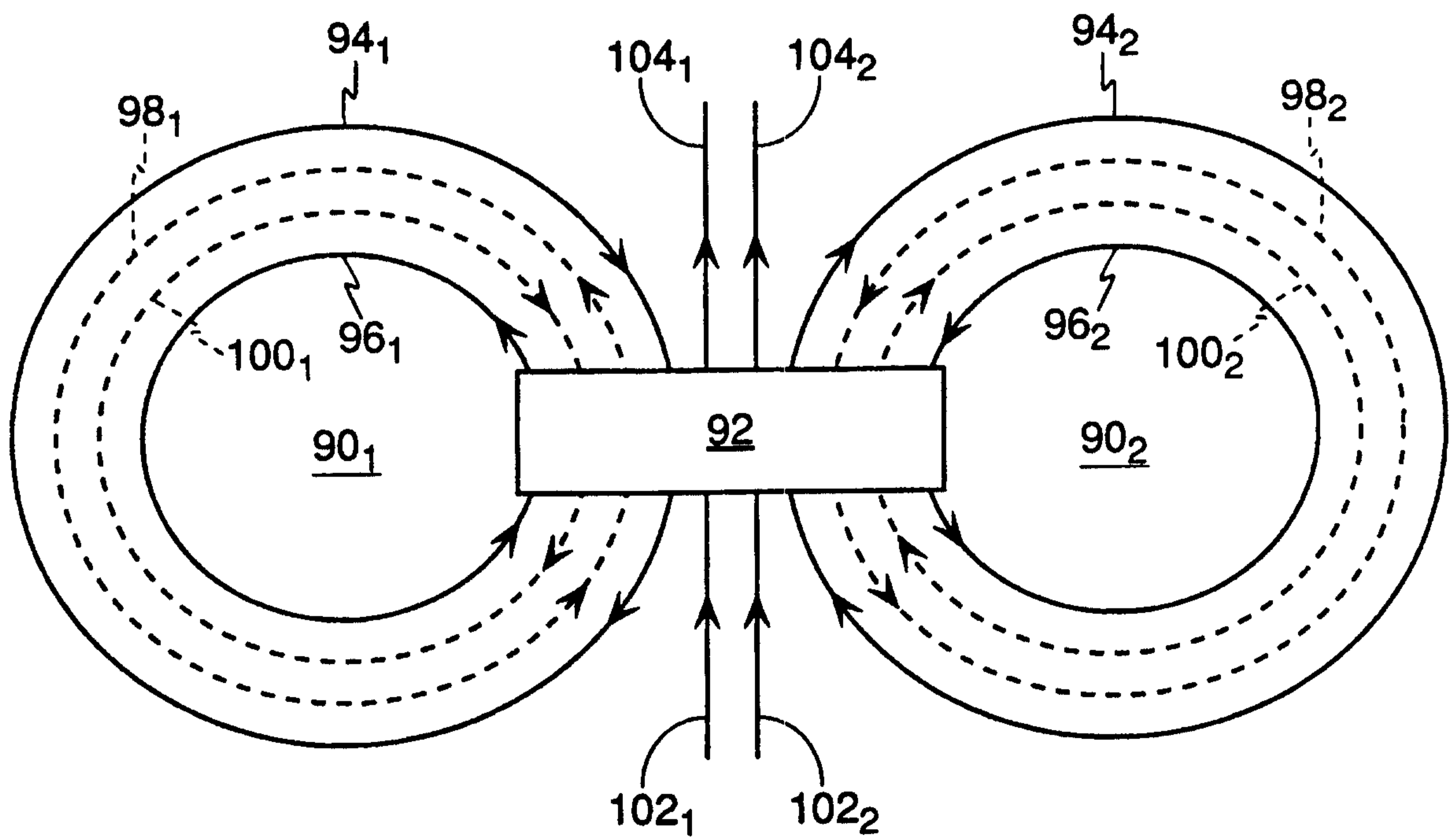

FIG. 12

7/13

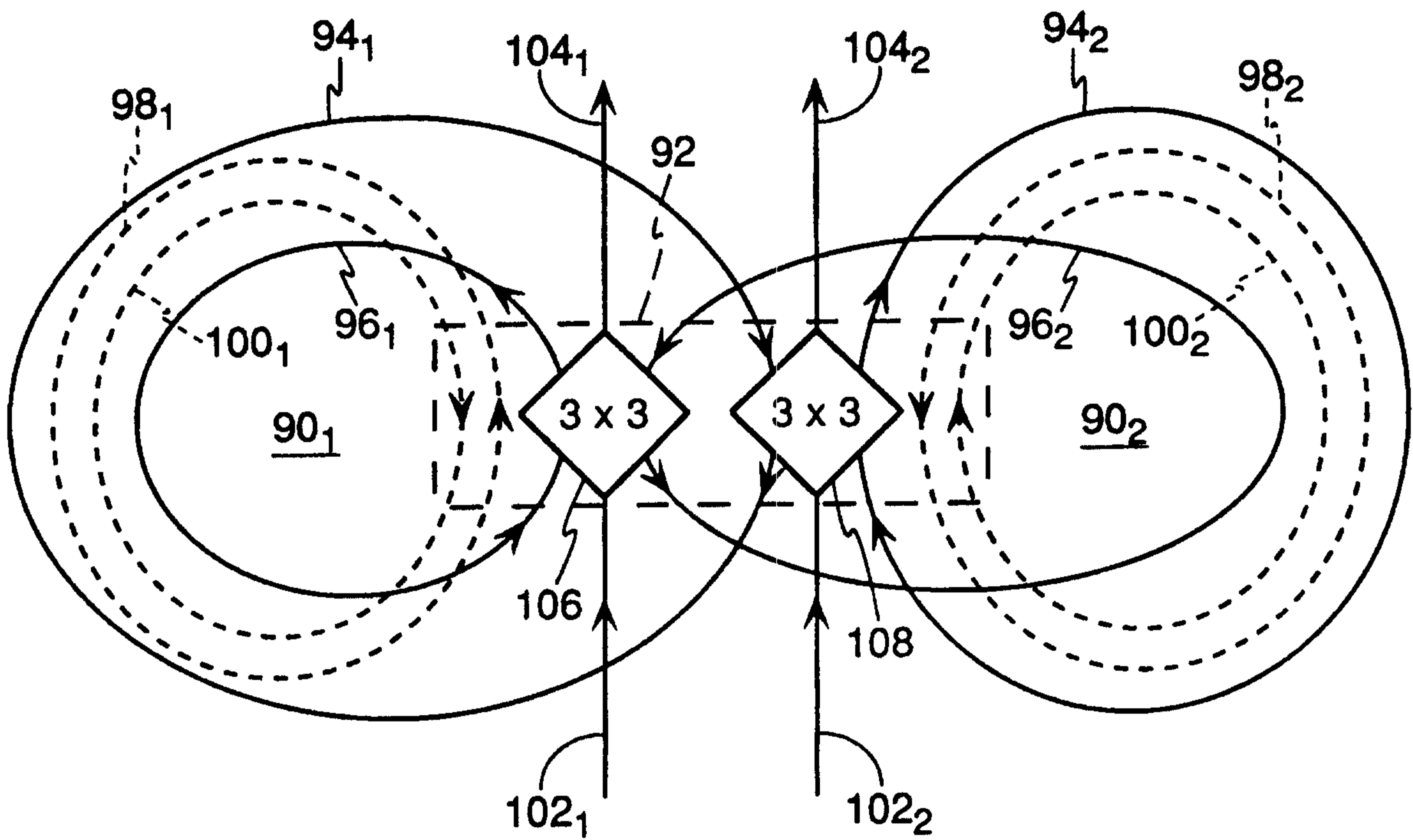

FIG. 13

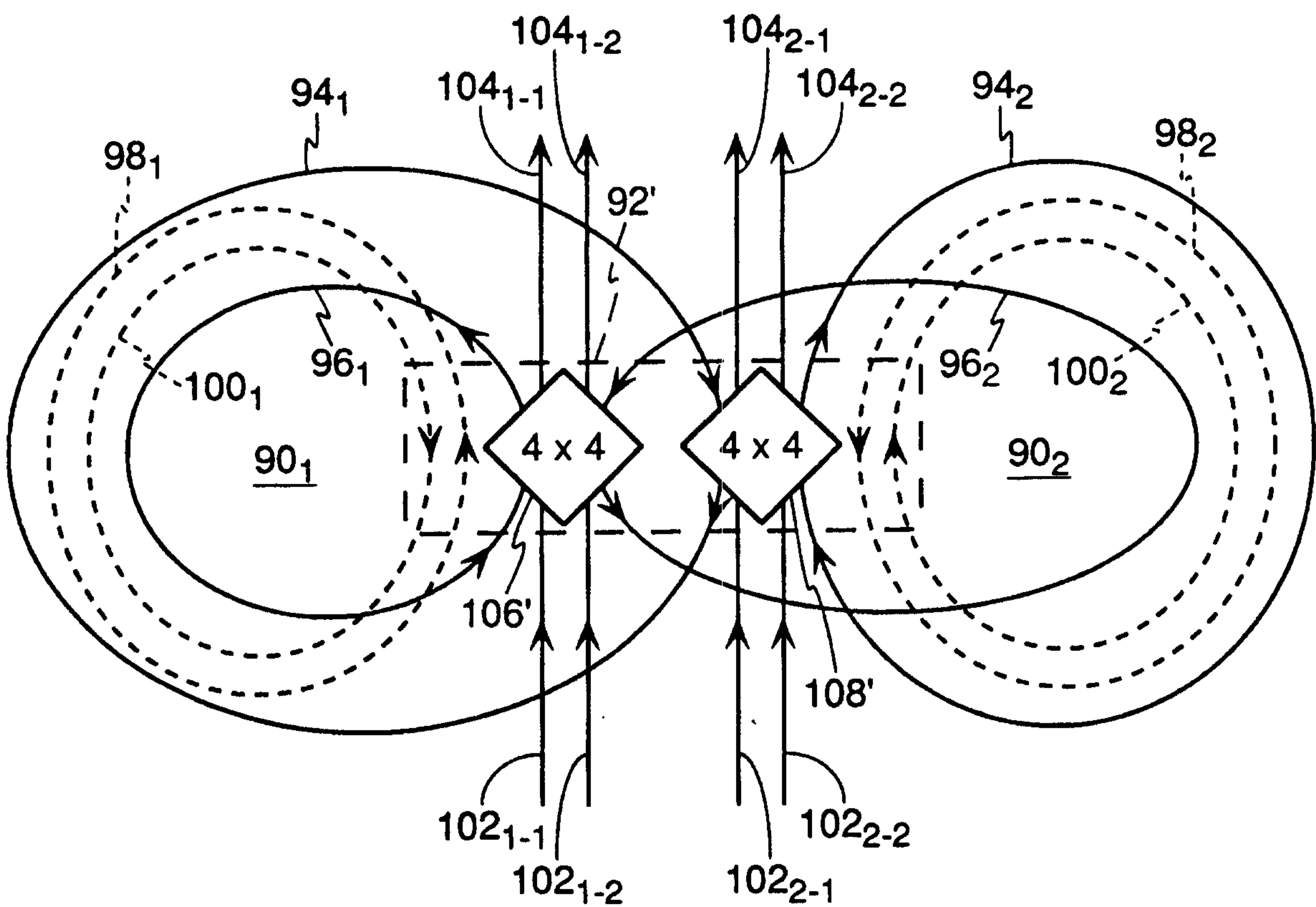

FIG. 14

8/13

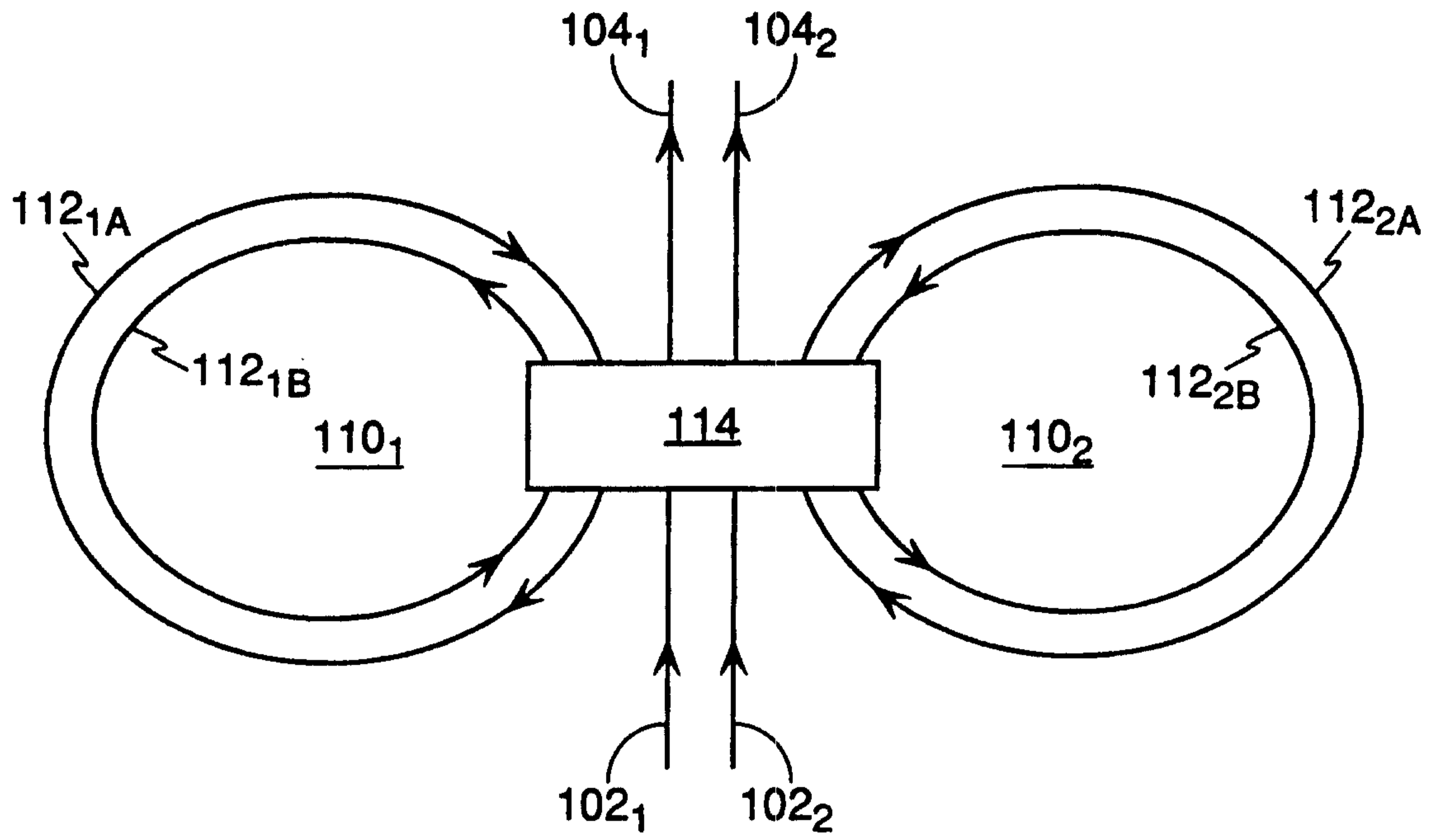

FIG. 15

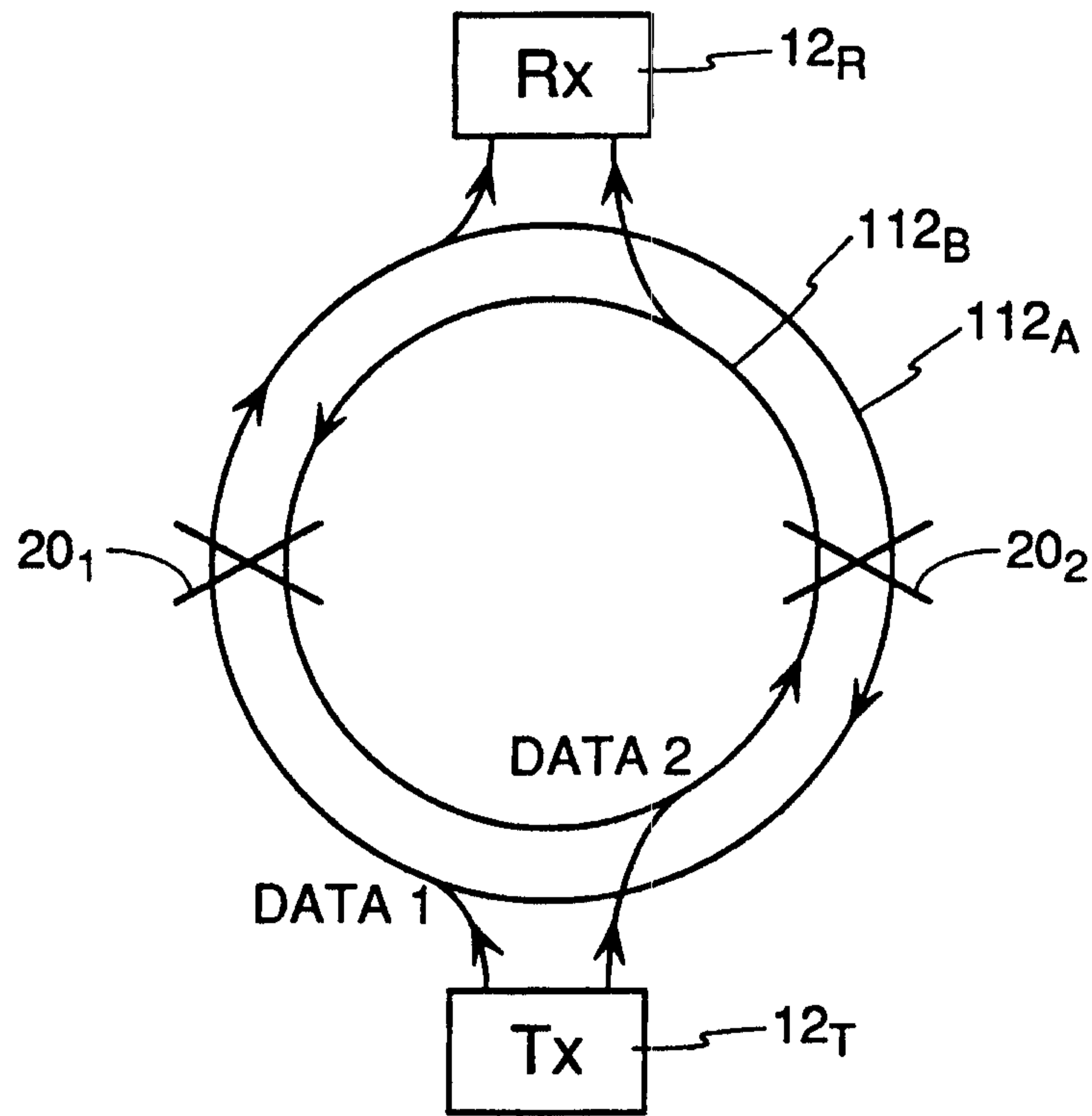

FIG. 16

9/13

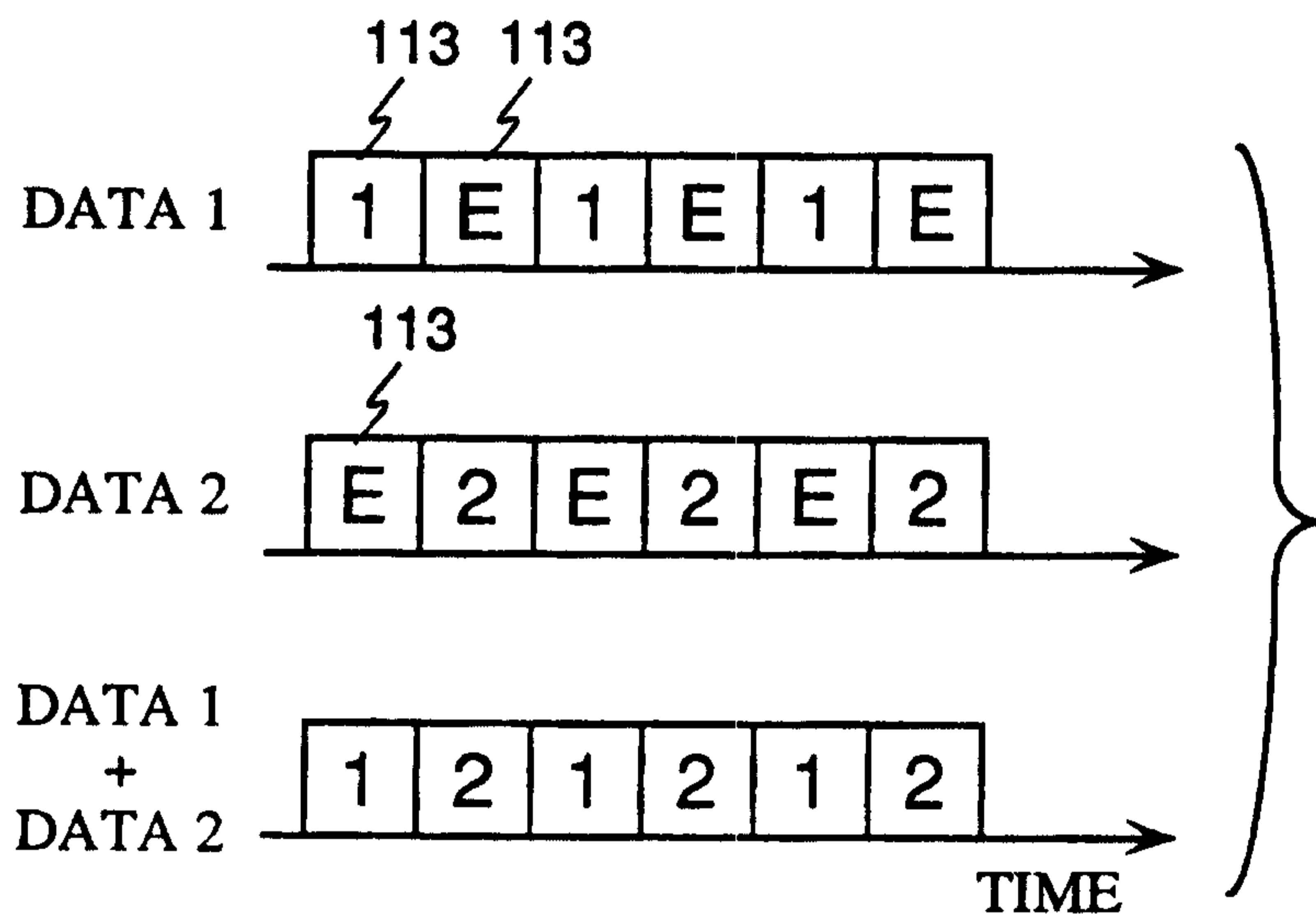

FIG. 17

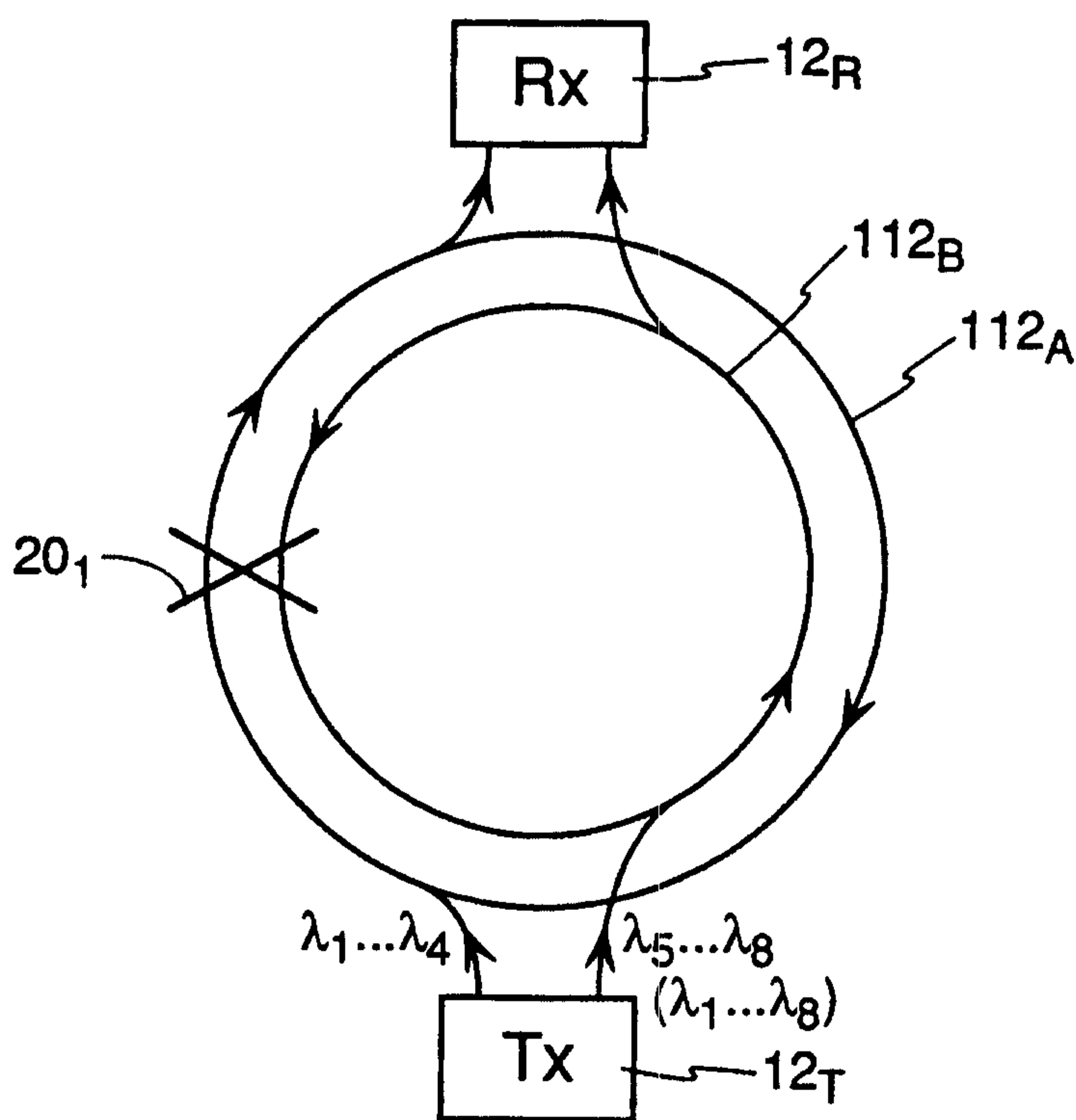

FIG. 18

10/13

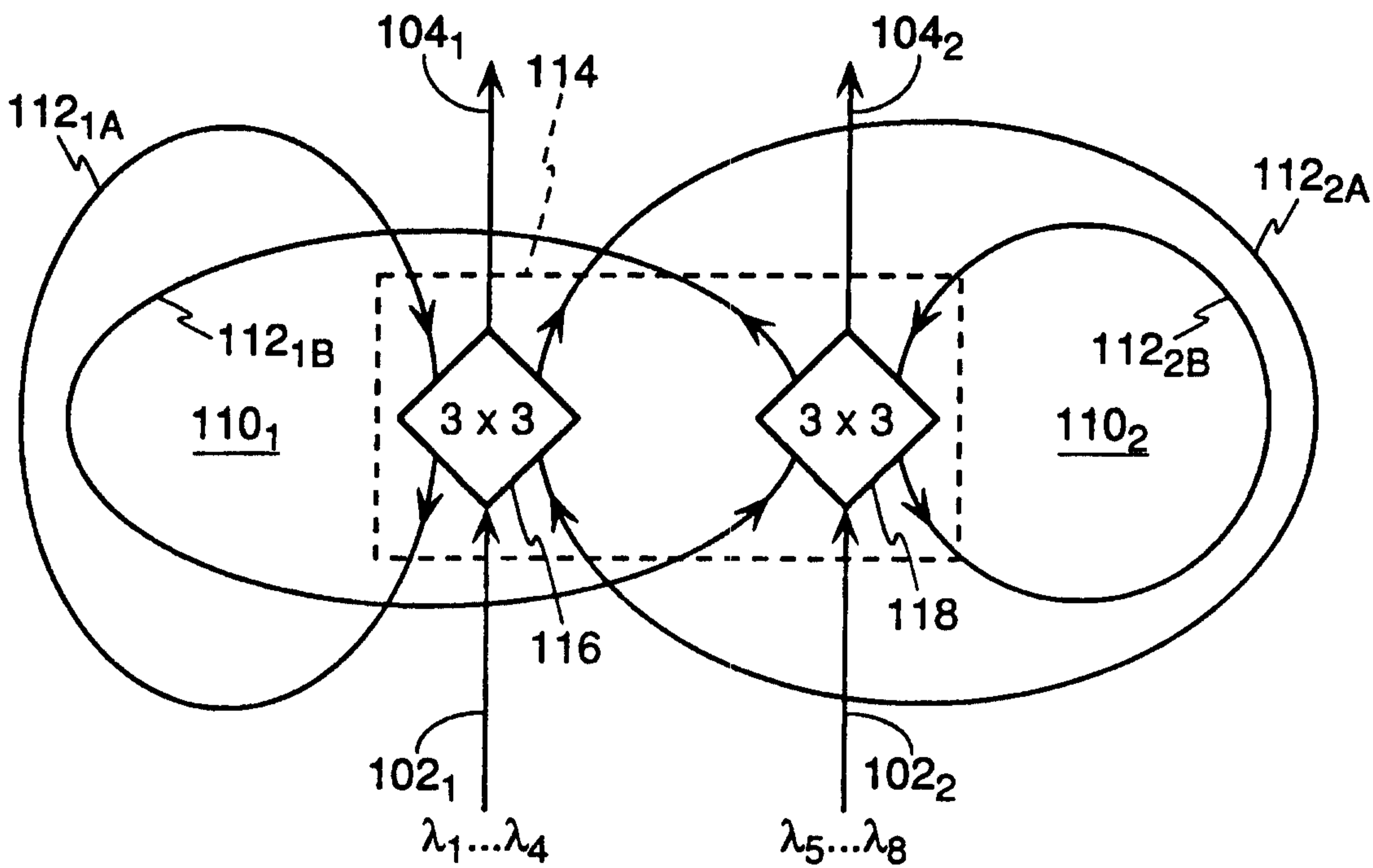

FIG. 19

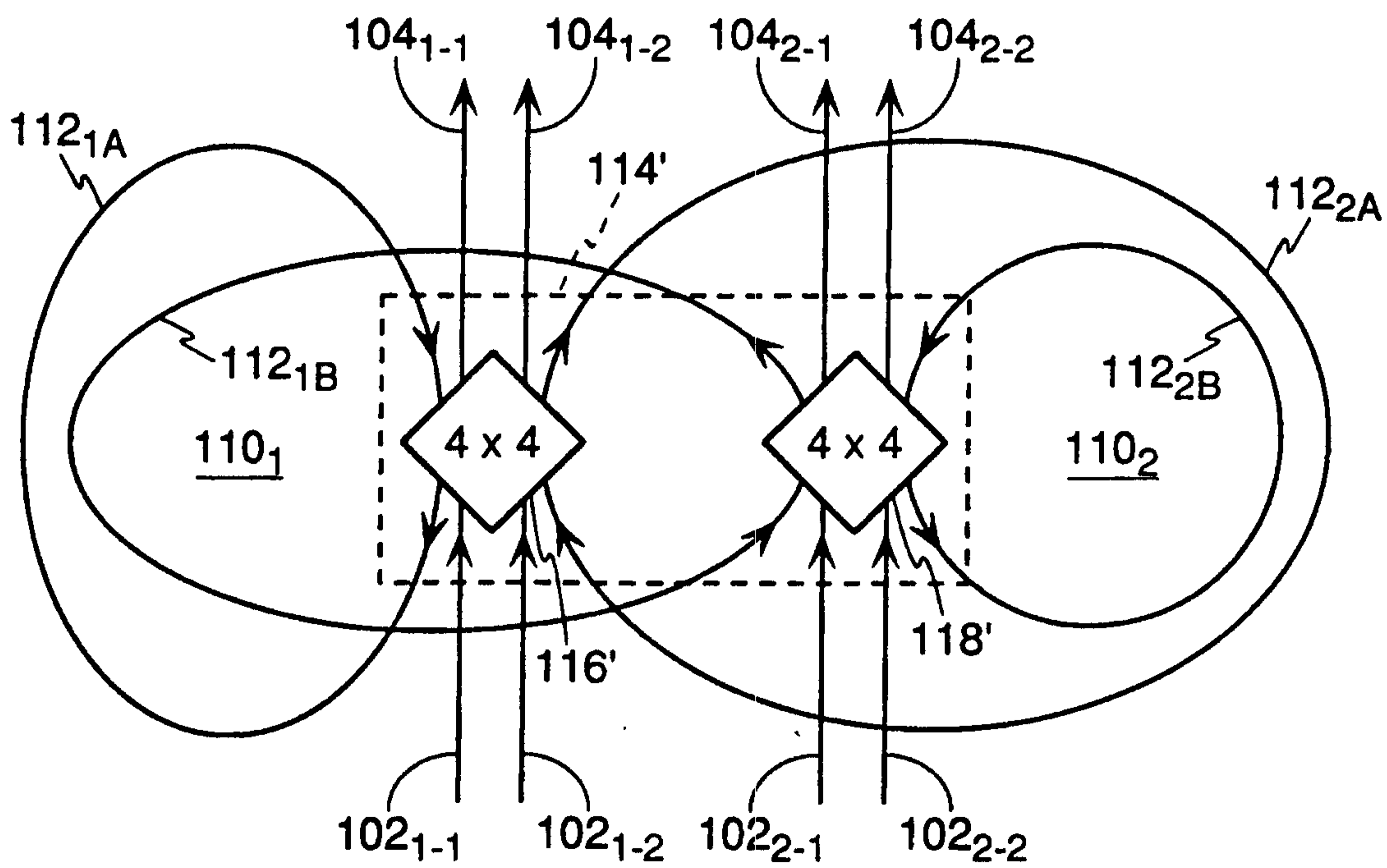

FIG. 20

11/13

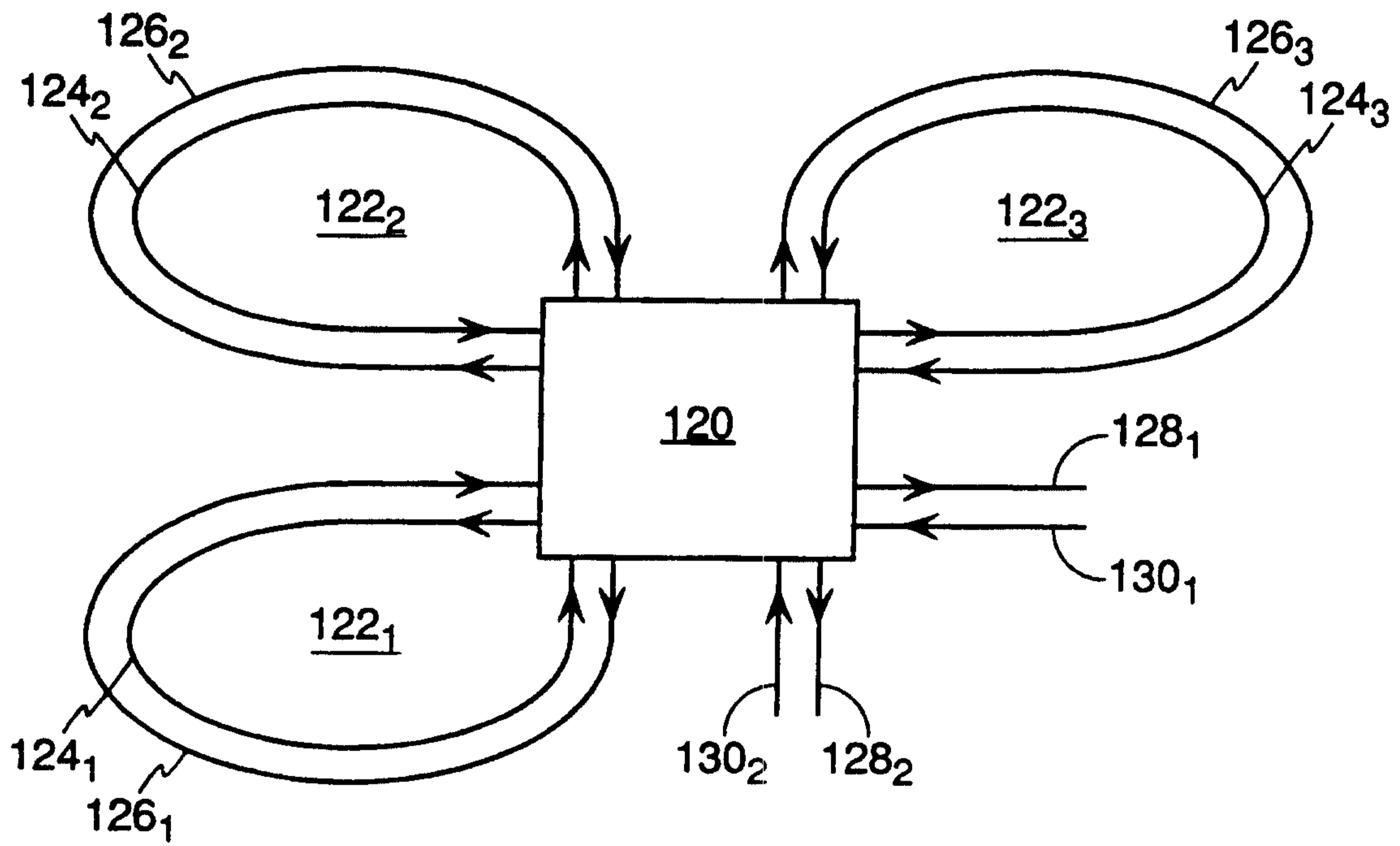

FIG. 21

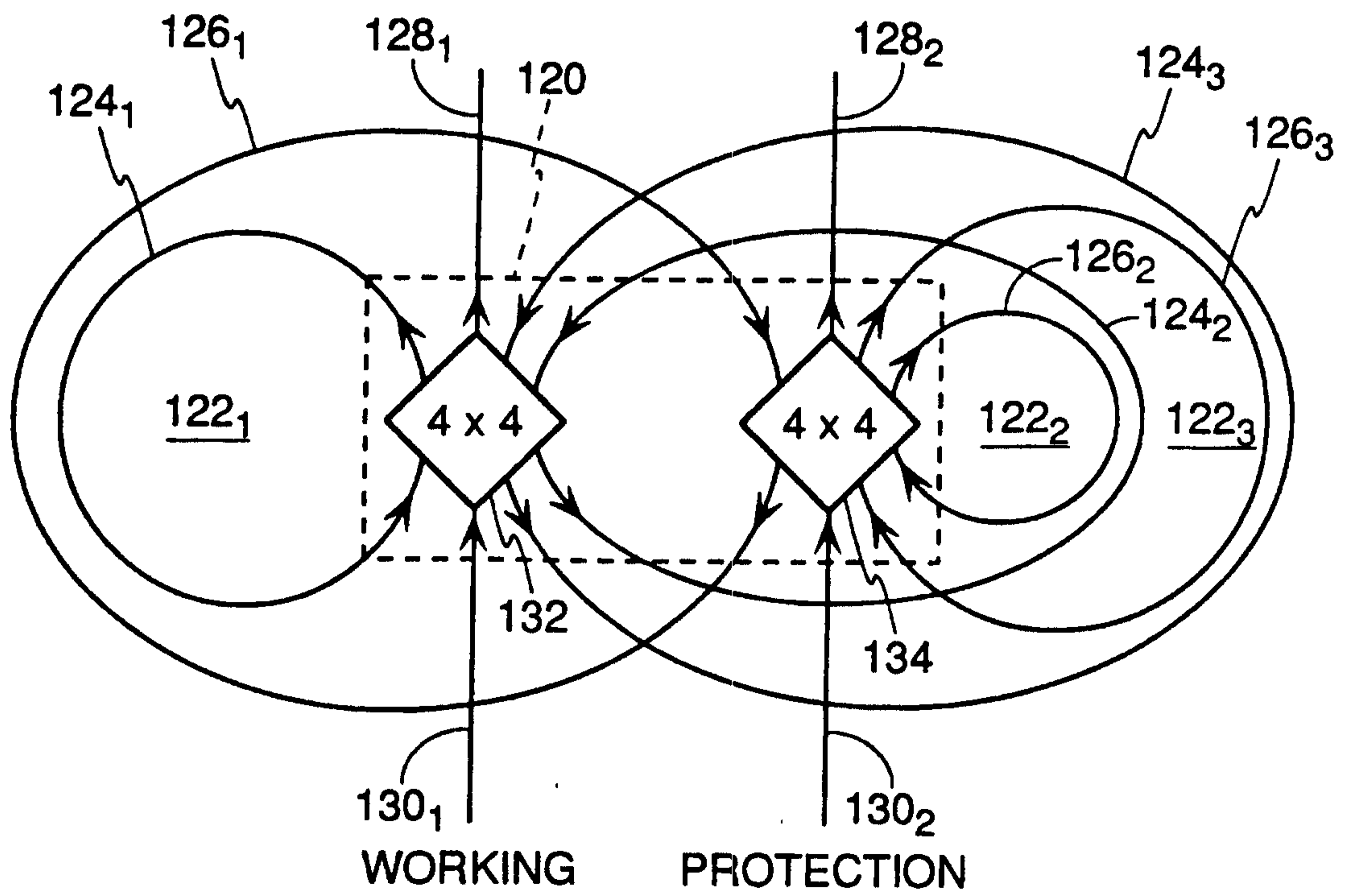

FIG. 22

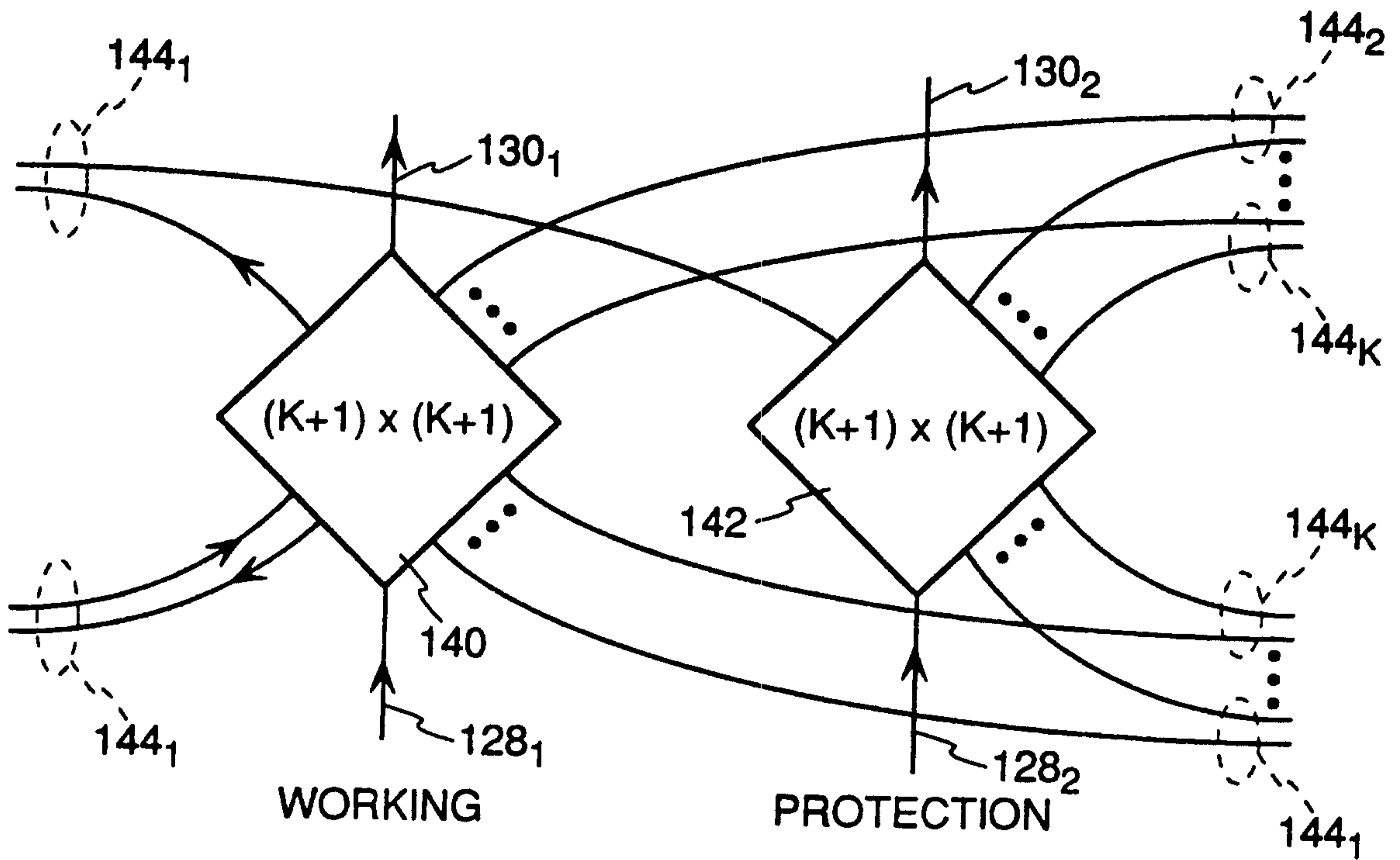

FIG. 23

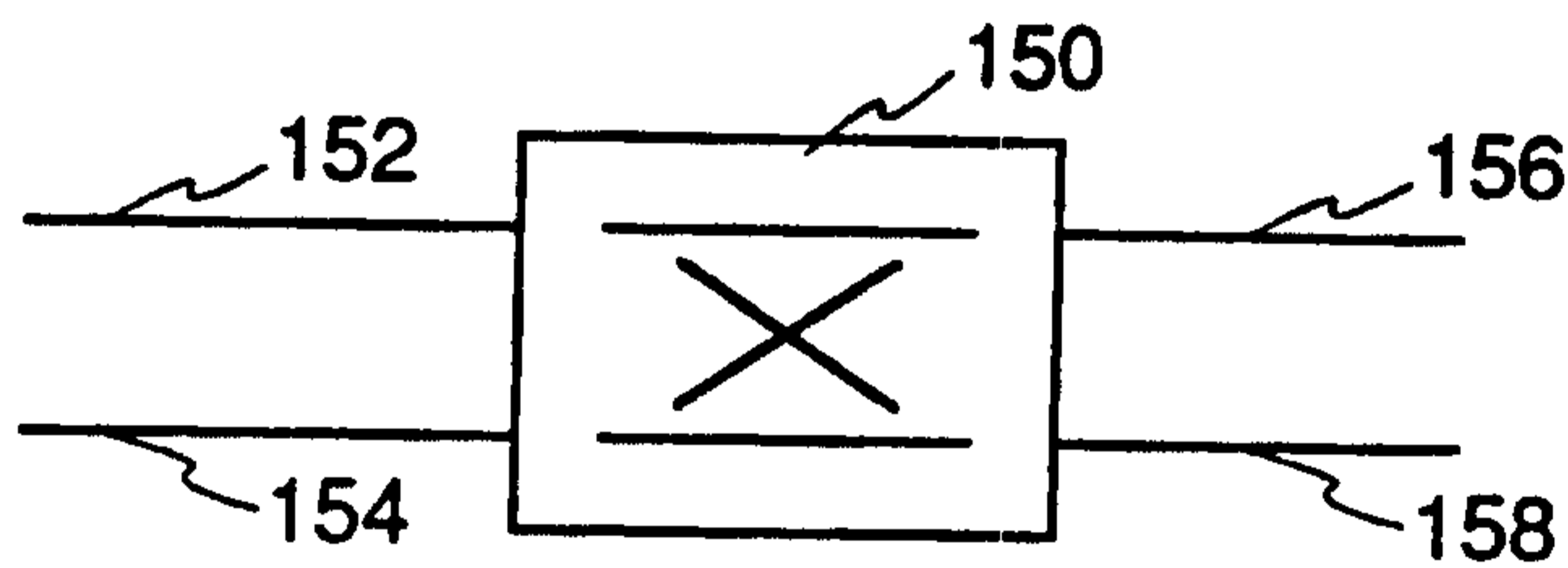

FIG. 24 (PRIOR ART)

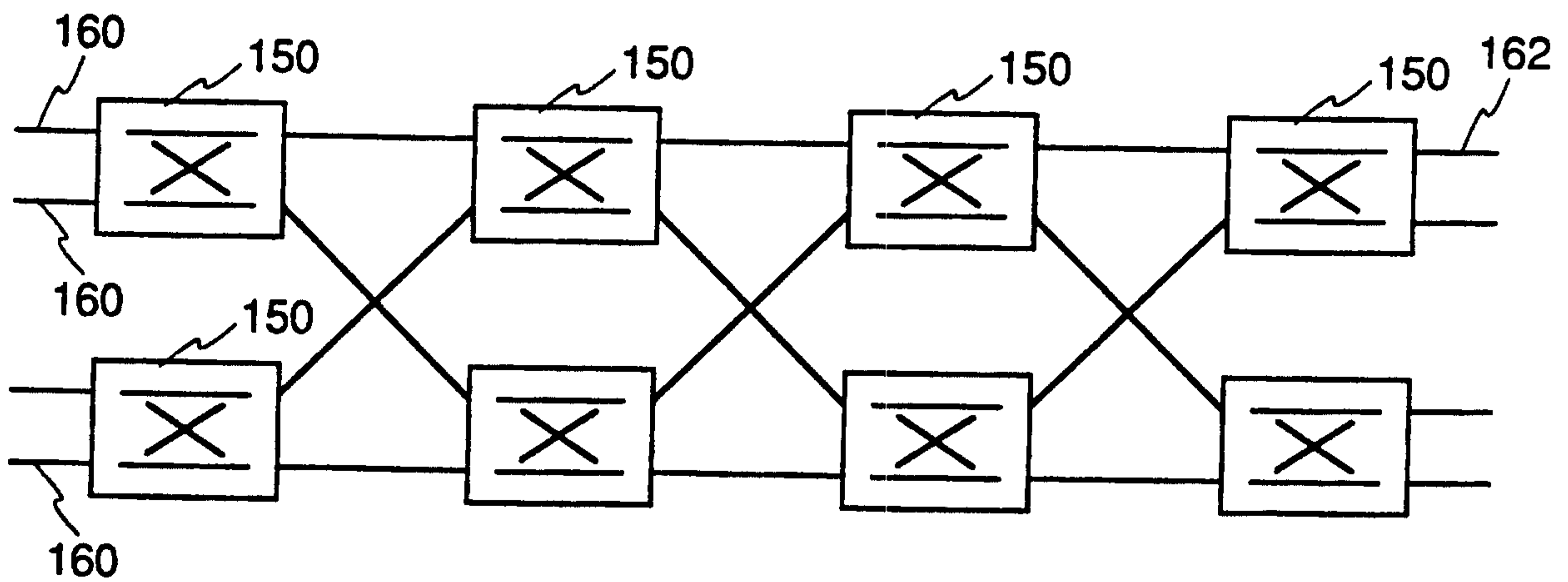

FIG. 25 (PRIOR ART)

