



INTERNATIONAL APPLICATION PUBLISHED UNDER THE PATENT COOPERATION TREATY (PCT)

<p>(51) International Patent Classification ⁶ : G07F 7/08</p>	<p>A1</p>	<p>(11) International Publication Number: WO 98/13793 (43) International Publication Date: 2 April 1998 (02.04.98)</p>
---	------------------	---

<p>(21) International Application Number: PCT/EP97/04880 (22) International Filing Date: 4 September 1997 (04.09.97) (30) Priority Data: 96202661.3 24 September 1996 (24.09.96) EP (34) Countries for which the regional or international application was filed: NL et al. (71) Applicant: KONINKLIJKE PTT NEDERLAND N.V. [NL/NL]; 7 Stationsplein, NL-9726 AE Groningen (NL). (72) Inventor: FEIKEN, Albertus; Praam 135, NL-1186 TD Amstelveen (NL). (74) Agent: BEITSMA, Gerhard, Romano; Koninklijke PTT Nederland N.V., P.O. Box 95321, NL-2509 CH The Hague (NL).</p>	<p>(81) Designated States: AU, BG, BR, CA, CN, CZ, EE, HU, IL, IS, JP, KR, LT, LV, MX, NO, NZ, PL, RO, SG, SI, SK, TR, Eurasian patent (AM, AZ, BY, KG, KZ, MD, RU, TJ, TM), European patent (AT, BE, CH, DE, DK, ES, FI, FR, GB, GR, IE, IT, LU, MC, NL, PT, SE). Published <i>With international search report. Before the expiration of the time limit for amending the claims and to be republished in the event of the receipt of amendments.</i></p>
--	---

(54) Title: METHOD OF MAKING RECOVERABLE SMART CARD TRANSACTIONS

(57) Abstract

The invention provides a method of recovering and thus possibly completing interrupted smart card transactions. To this end, a smart card (1) according to the invention stores a first (CRP) and a second pointer (NRP), the second pointer (NRP) being used to indicate an update of the first pointer (CRP). In the case of an interruption of a smart card transaction, these pointers may be used to indicate whether a change of a card balance has taken place.

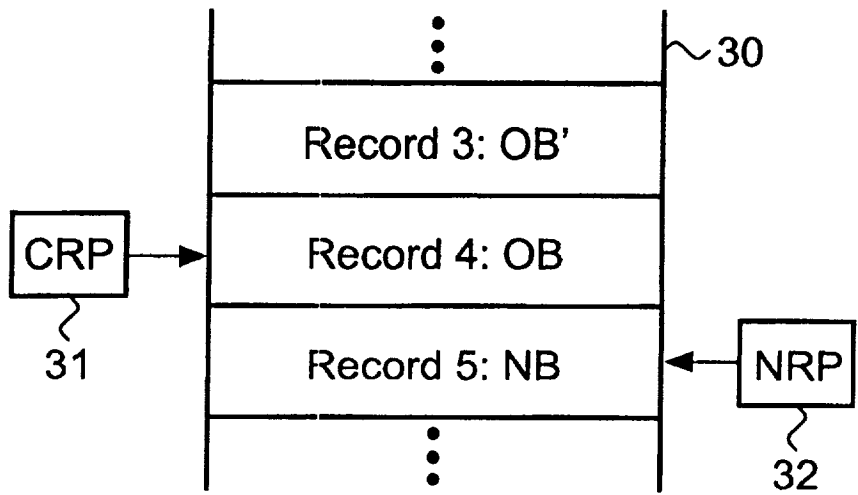

FOR THE PURPOSES OF INFORMATION ONLY

Codes used to identify States party to the PCT on the front pages of pamphlets publishing international applications under the PCT.

AL	Albania	ES	Spain	LS	Lesotho	SI	Slovenia
AM	Armenia	FI	Finland	LT	Lithuania	SK	Slovakia
AT	Austria	FR	France	LU	Luxembourg	SN	Senegal
AU	Australia	GA	Gabon	LV	Latvia	SZ	Swaziland
AZ	Azerbaijan	GB	United Kingdom	MC	Monaco	TD	Chad
BA	Bosnia and Herzegovina	GE	Georgia	MD	Republic of Moldova	TG	Togo
BB	Barbados	GH	Ghana	MG	Madagascar	TJ	Tajikistan
BE	Belgium	GN	Guinea	MK	The former Yugoslav Republic of Macedonia	TM	Turkmenistan
BF	Burkina Faso	GR	Greece	ML	Mali	TR	Turkey
BG	Bulgaria	HU	Hungary	MN	Mongolia	TT	Trinidad and Tobago
BJ	Benin	IE	Ireland	MR	Mauritania	UA	Ukraine
BR	Brazil	IL	Israel	MW	Malawi	UG	Uganda
BY	Belarus	IS	Iceland	MX	Mexico	US	United States of America
CA	Canada	IT	Italy	NE	Niger	UZ	Uzbekistan
CF	Central African Republic	JP	Japan	NL	Netherlands	VN	Viet Nam
CG	Congo	KE	Kenya	NO	Norway	YU	Yugoslavia
CH	Switzerland	KG	Kyrgyzstan	NZ	New Zealand	ZW	Zimbabwe
CI	Côte d'Ivoire	KP	Democratic People's Republic of Korea	PL	Poland		
CM	Cameroon	KR	Republic of Korea	PT	Portugal		
CN	China	KZ	Kazakstan	RO	Romania		
CU	Cuba	LC	Saint Lucia	RU	Russian Federation		
CZ	Czech Republic	LI	Liechtenstein	SD	Sudan		
DE	Germany	LK	Sri Lanka	SE	Sweden		
DK	Denmark	LR	Liberia	SG	Singapore		
EE	Estonia						

Method of making recoverable smart card transactions.

BACKGROUND OF THE INVENTION

The present invention relates to a method of recovering transactions made with smart cards. More in particular, the present invention relates to a method of completing interrupted smart card payments and revaluations. The present invention further relates to a smart card allowing interrupted transactions to be completed.

In existing smart card transactions, such as payments, an exchange of data takes place between a terminal (such as an electronic cash register equipped with a smart card reader) and a smart card (also called IC card). It can happen that an interruption of the payment takes place before this exchange of data is completed. Such an interruption may e.g. be caused by a power failure, or by a premature withdrawal of the card from the card reader. The result of such an interruption may cause a loss of data, which in turn may cause a loss of money.

European Patent Application EP 0 637 004, which is herewith incorporated by reference in this text, discloses a method of exchanging data between a smart card and a terminal. In this Prior Art method, it is ensured that the (security module of the) terminal is not credited before the smart card is debited. However, if the communication between the card and the terminal is interrupted after the card is debited but before the terminal is credited, it remains uncertain whether the debiting of the card has actually taken place.

The Prior Art does therefore not provide a method of making payments in which interrupted payments can be continued.

SUMMARY OF THE INVENTION

It is an object of the invention to overcome the above-mentioned and other disadvantages of the prior art and to provide a method which allows the recovery and completion of interrupted payments. It is another object of the present invention to provide a method which allows to determine whether a change of a card balance has taken place. It is a further object of the present invention to provide a smart card allowing the recovery of interrupted payments.

Accordingly, the present invention provides a method of changing a balance in a memory of a smart card in response to a command from a terminal, the method comprising the steps of:

- retrieving an old balance from a memory location indicated by

- the value of a first pointer,
- adding an offset to the value of a second pointer, said value initially being equal to the value of the first pointer,
 - storing a new balance in the memory location indicated by the
 - 5 sum of the value of the first pointer and the offset, and
 - adding the offset to the value of the first pointer.

Using this method, the equality of the first and second pointer permits to conclude that the new balance has been stored in the memory. In the case of an interrupted transaction, a proper

10 continuation of the procedure can thus be effected.

It will be understood that the initial equality of the first and second pointers is chosen for convenience only and that any (second) offset between the pointers may in practice exist.

By using a second pointer, it can thus effectively be checked

15 whether the first pointer has been updated.

Advantageously, the method of the invention further comprises the step of storing in the smart card a random number received from the terminal. This allows to determine with virtual certainty that the interrupted transaction, rather than another transaction, is being

20 completed.

Preferably, the method of the invention further comprises the step of invalidating the random number stored in the smart card if the card receives a new random number not equal to the stored random number. A new random number indicates either a new transaction or

25 replay (by an unauthorized party) of the interrupted transaction. The invalidation of the stored random number is thus appropriate.

By storing a random number identifying the transaction, it is thus possible to complete that transaction at a later stage.

The present invention further provides a method of completing

30 the changing of a balance in a memory of a smart card, the changing being effected by a method of any of the preceding claims, the completing comprising the steps of:

- sending a restore command from the terminal to the card,
- comparing, in the card, the values of the first pointer and the
- 35 second pointer,
- sending, in the case of equality of the values, an acknowledgement from the card to the terminal.

In this way the two pointers can advantageously be used to determine

whether the balance change had actually taken place before the interruption occurred. As a result, a change of a balance kept in the security module of the terminal may be made. Preferably, in case the terminal stores a random number previously sent to the card to
5 identify the transaction, the above method further comprises the step of:

- retrieving, upon receipt of the restore command, the random number stored in the card,
- generating, in the card, a message authentication code using the
10 retrieved random number, and adding said code to the acknowledgement,
- checking, in the terminal, the authentication code, and
- discarding the acknowledgement if the authentication code is not correct.

15 It is possible to include in the restore command a random number identifying the interrupted transaction, and to compare, in the card, the retrieved and received random numbers so as to verify the identity of the transaction. However, the re-transmission of the random number may be omitted if the message authentication code is checked in the
20 terminal, e.g. by re-generating the code using the stored random number.

The message authentication code, based on the random number identifying the transaction, is thus effectively used to determine whether an actual completion of the interrupted transaction is
25 attempted or a new transaction is started. In the latter case, the pointers may be influenced by the new transaction, invalidating the result of a completion and thus necessitating the invalidation of the identifying random numbers and/or pointers.

30 BRIEF DESCRIPTION OF THE DRAWINGS

The invention will further be explained with reference to the accompanying drawings, in which:

Fig. 1 schematically shows a smart card as well as a terminal equipped for smart card transactions,

35 Fig. 2 schematically shows the exchange of data between a smart card and a terminal during a payment transaction,

Fig. 3 schematically shows in greater detail part of the process shown in Fig. 2,

Fig. 4 schematically shows a memory section comprising records indicated by pointers,

Fig. 5 schematically shows an alternative embodiment of a memory section comprising records indicated by pointers, and

5 Fig. 6 schematically shows a data format of data allowing the completion of an interrupted transaction.

EXEMPLARY EMBODIMENTS

The payment system shown schematically and by way of example in
10 Fig. 1 comprises a smart card 1 and a terminal 2. The smart card 1 comprises an integrated circuit 3 embedded in a substrate. The integrated circuit 3 may e.g. comprise a processor, one or more memory circuits (e.g. RAM and/or EEPROM) and an I/O (input/output) circuit linked by a data bus. The terminal 2, which may be a suitable cash
15 register, comprises e.g. a card reader/writer (denoted as "Reader") 5, processing means 6 (denoted as "Processor" and comprising e.g. a microprocessor and a memory) and at least one security module (denoted as "SM") 7. The card 1 may exchange data with the terminal 2 when inserted in the reader 5. In the case of contactless cards, the reader
20 5 may be equipped with suitable electromagnetic or infrared means for contactless data exchange. The security module 7 is a unit in which certain transaction data are securely stored. Preferably, a security module is a removable, fraud-proof unit. However, the term security module as used in this text may also refer to a memory location or
25 register for the storage of transaction data.

In Fig. 2, an exchange of data between (the integrated circuit of) a smart card ("Card") and the security module ("SM") of a terminal is shown. In the example of Fig. 2, a decrease transaction (decrease of the balance of the card by way of payment) is shown. It will be
30 understood that the invention is equally well applicable to increase transactions, also called revalue transactions, in which the card balance is increased.

The process shown by way of example in Fig. 2 begins with the card generating a random number R1 in step 10. It will be understood
35 that other steps, which (like steps 10-12) are not essential to the present invention, may precede step 10. The random number R1, which serves to authenticate the security module and to prevent replay of the transaction, is sent to the security module (SM) of the terminal.

In response, the security module generates in step 11 a first message authentication code MAC1 on the basis of a decrease command DC and the random number R1. This code may be generated using a suitable cryptographic function, such as a so-called hash function. The decrease command DC comprises the amount A the card balance is to be decreased with. The command DC and the appended code MAC1 are sent to the card.

As stated before, instead of a decrease command, another command can be sent to the card. Such a change balance command may be an increase balance command, or a set balance command in which a new balance is written independent of the existing one. It will be understood that a particular smart card may store more than one balance, e.g. different balances for several different currencies and/or for units corresponding with different institutions (banks, airlines, etc.).

In step 12, the card checks the received message authentication code MAC1, e.g. by regenerating the code on the basis of the received decrease command DC and the random number R1 temporarily stored in the card. If the message authentication code is found to be correct, the card may optionally issue an Authentication Valid Message (not shown in Fig. 2) and the procedure continues with step 13. If the code is found to be incorrect, the procedure may be terminated or a request for repeated transmission of the decrease command may be issued.

In the mean time, the security module generates a second random number R2 in step 13 and sends this random number R2 to the card. The card stores the second random number R2 in step 14.

In step 15, the card balance is decreased (in general: changed) by storing the new balance, i.e. the old balance minus the amount A, in a suitable memory location: $NB \leftarrow (OB - A)$. This will further be explained below with reference to Figs. 3, 4 and 5.

In step 16, the card generates a second message authentication code MAC2 on the basis of a response message RM and the stored second random number R2. The response message RM constitutes an acknowledgement of the successful execution of the decrease command DC and comprises e.g. the new balance and/or the amount A. The message RM and the appended code MAC2 are sent to the security module.

It should be noted that the message authentication code MAC2 could be stored for recovery purposes, rather than the random number

R2. Storing the number R2, as done in step 14, has the advantage of being earlier in time, i.e. before the actual change of the balance in step 15.

The security module checks the received code MAC2 in step 17, using the second random number R2 stored in the security module. In step 18, the data contained in the response message RM may be checked. In step 19, the amount A may be added to a terminal balance.

In Fig. 3 step 15 of Fig. 2 is schematically shown in more detail. Step 15 consists of a number of substeps, of which the substeps 151-153 are shown. In accordance with the present invention, two pointers will be used to indicate memory locations (in general: records) where balances are stored. It will be assumed that the old and the new balance will be stored in different memory locations. A first pointer, the Current Record Pointer CRP, points at the record (memory location or set of memory locations) where the last balance (i.e. the "old" balance) was stored. A second pointer, the Next Record Pointer NRP, points at the memory location where the new balance is to be stored.

It will be understood that the pointers NRP and CRP are stored in suitable memory means, such as counters 31 and 32 shown in Fig. 4. Advantageously, EEPROM type memory means are used to store these pointers to prevent the loss of these pointers in the case of a power loss.

Substep 151 involves, in accordance with the present invention, the increment of a Next Record Pointer NRP, rendered as $NRP \leftarrow NRP + OS$, the sign " \leftarrow " meaning "taking on the value of". This pointer, the use of which will further be explained with reference to Fig. 4, points after the execution of step 151 at the memory location where the new balance, i.e. the old balance minus the decrease amount A, will be stored. In step 152, the actual decrease of the card balance takes place by reading the old balance OB from the memory location indicated by the Current Record Pointer CRP, subtracting (in the case of a decrease of the card balance) the amount A from the old balance OB and storing the new balance NB in the memory location indicated by the sum of the Current Record Pointer CRP and an offset OS, the offset OS preferably being equal to one. That is, the memory location in which the new balance is stored depends on the Current Record Pointer CRP and is preferably the "next" memory location, i.e. the memory location

having an address $CRP+1$. Alternatively, another offset OS could be used, such as 2, 4 or -1. It will be understood that the result of the adding operation $CRP+OS$ will yield a result modulo N, N being the number of records available.

5 After storing the new balance, the Current Record Pointer CRP is incremented by the offset OS (i.e. preferably +1) in step 153, after which the Current Record Pointer points at the new balance NB.

 The use of the Next Record Pointer NRP of the present invention will now be explained with reference to Fig. 4. As stated before, the
10 Next Record Pointer NRP points at the location where the new balance is to be stored, i.e. at a location having the address $CRP+OS$. After the successful completion of a decrease action, the Next Record
 Pointer NRP and the Current Record Pointer CRP should point to the same memory location and thus have identical values. However, after an
15 unsuccessful action, the pointers will not have identical values. Assume, referring to Fig. 4, that record 4 of a cyclical memory 30 contains the current or last stored balance, i.e. the "old" balance OB (the preceding record 3 may store a previous balance OB'). Both CRP and NRP have the value four. In step 151 (as shown in Fig. 3) the Next
20 Record Pointer NRP is incremented. If the offset OS equals one, the new value of NRP is five and NRP points at record 5. In step 152 of Fig. 3, the old balance OB is read from record 4 and the new balance NB is stored in record 5, as a new balance is stored in record
 ($CRP+1$). At that stage of the procedure, the situation as depicted in
25 Fig. 4 results. If the action is successful, the Current Record Pointer CRP is incremented in step 153, resulting in the equality of the Current Record Pointer CRP and the Next Record Pointer NRP. However, if the procedure was broken off in step 152, Current Record
 Pointer CRP will not have been incremented and there will be no
30 equality of CRP and NRP. This result can advantageously be used to detect whether the storing of a new balance has been completed.

 That is, if the procedure is interrupted, e.g. because the card was prematurely removed from the reader, it is possible to detect whether the change of the card balance has taken place by comparing
35 the values of NRP and CRP. Referring again to Fig. 2, if the procedure is interrupted, e.g. by a power failure in the terminal before the security module has completed the procedure or by a premature removal of the card before step 16 has been completed, it is now possible to

repeat part of the procedure, e.g. by sending a restore command (RC) to the card. When the card receives a restore command, it checks whether the pointers NRP and CRP are equal. If NRP equals CRP, a decrease of the card balance has taken place and the response message RM may be sent again by way of acknowledgement. If NRP does not equal CRP, the decrease has not taken place and the entire payment (decrease) transaction may be either repeated or cancelled.

It should be noted that in principle step 151 of Fig. 3 could be carried out after step 153. However, by keeping the number of (sub)steps after the updating of the balance to a minimum, the chance of the transaction being interrupted is diminished.

It should further be noted that if a new balance influencing command (such as a decrease or increase command) is received, the random number R2 is preferably invalidated in order to prevent replay. Alternatively or additionally, the Next Record Pointer NRP is invalidated. It should be noted that a restore command is not normally considered to constitute a balance influencing command.

Fig. 5 shows an embodiment of memory means in which the old and new balance are alternately written in a first register 30a and a second register 30b. That is, if the old balance OB is stored in the first register 30a then the new balance NB will be stored in the second register 30b and vice versa. It will be understood that this embodiment is equivalent to the embodiment of Fig. 4.

Fig. 6 shows an example of the format of a data field stored in the card which enables the completion of an interrupted transaction. The data field 40 comprises sub-fields 41-44 containing a File Identifier FI, the above-mentioned second random number R2, the Next Record Pointer NRP and a Validity Bit VB respectively. The Validity Bit VB indicates whether the random number R2 may be used to complete a transaction, i.e. to execute step 16 of Fig. 2 again.

It will be understood by those skilled in the art that the embodiments described above are given by way of example only and that many modifications and additions are possible without departing from the scope of the present invention.

CLAIMS

1. Method of changing a balance in a memory of a smart card (1) in response to a command from a terminal (2), the method comprising the steps of:
 - 5 - retrieving an old balance from a memory location (e.g. Record 4) indicated by the value of a first pointer (CRP),
 - adding an offset to the value of a second pointer (NRP), said value initially being equal to the value of the first pointer (CRP),
 - 10 - storing a new balance in the memory location (e.g. Record 5) indicated by the sum of the value of the first pointer (CRP) and the offset, and
 - adding the offset to the value of the first pointer (CRP).
2. Method according to claim 1, wherein the changing involves a
15 decrease of the balance.
3. Method according to claim 1 or 2, wherein the offset equals one.
4. Method according to any of the preceding claims, further comprising the step of storing in the smart card (1) a random number (R2) received from the terminal (2).
- 20 5. Method according to claim 4, further comprising the step of invalidating the random number (R2) stored in the smart card (1) if the card receives a new balance influencing command.
6. Method according to any of the preceding claims, further comprising the step of producing in the card (1) a response message
25 (RM) after the step of adding the offset to the value of the first pointer (CRP), a message authentication code (MAC2) being added to the response message (RM).
7. Method of completing the changing of a balance in a memory of a smart card (1), the changing being effected by a method of any of the
30 preceding claims, the completing comprising the steps of:
 - sending a restore command from the terminal (2) to the card (1),
 - comparing, in the card (1), the values of the first pointer (CRP) and the second pointer (NRP),
 - sending, in the case of equality of the values, an
35 acknowledgement (RM) from the card (1) to the terminal (2).
8. Method according to claims 4 and 6, further comprising the step of:
 - retrieving, upon receipt of the restore command, the random

- number (R2) stored in the card (1),
- generating, in the card (1), a message authentication code (MAC2) using the retrieved random number (R2), and adding said code (MAC2) to the acknowledgement (RM),
 - 5 - checking, in the terminal (2), the authentication code (MAC2), and
 - discarding the acknowledgement (RM) if the authentication code (MAC2) is not correct.
9. Smart card (1), comprising an integrated circuit (3) comprising
- 10 a memory (30) and a first register (31) for storing a first pointer (CRP) and a second register (32) for storing a second pointer (NRP), the first register (31) being arranged for being incremented immediately after the storing of a new balance in the memory (30) and the second register (32) being arranged for being incremented before
- 15 the storing of the new balance.
10. Smart card (1) according to claim 9, the integrated circuit comprising means for generating message authentication codes (e.g. MAC2).

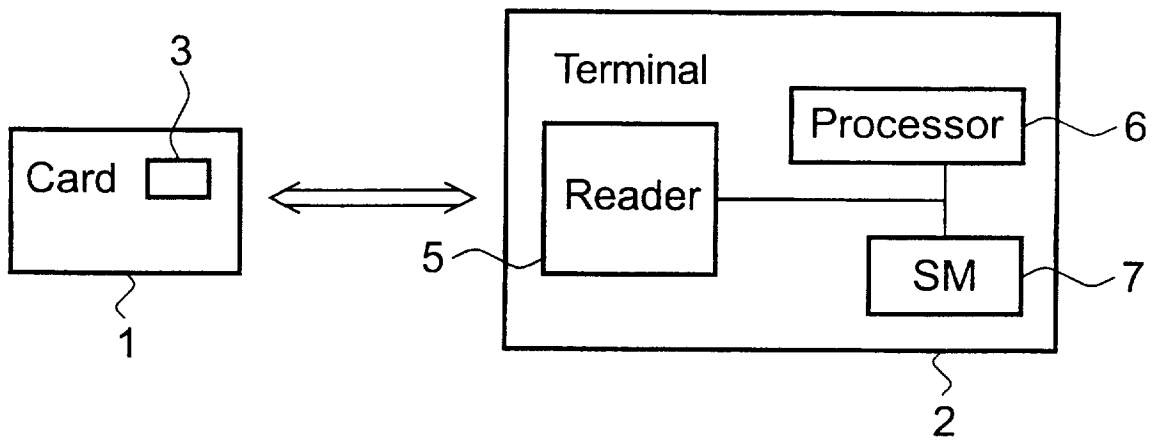

Fig. 1

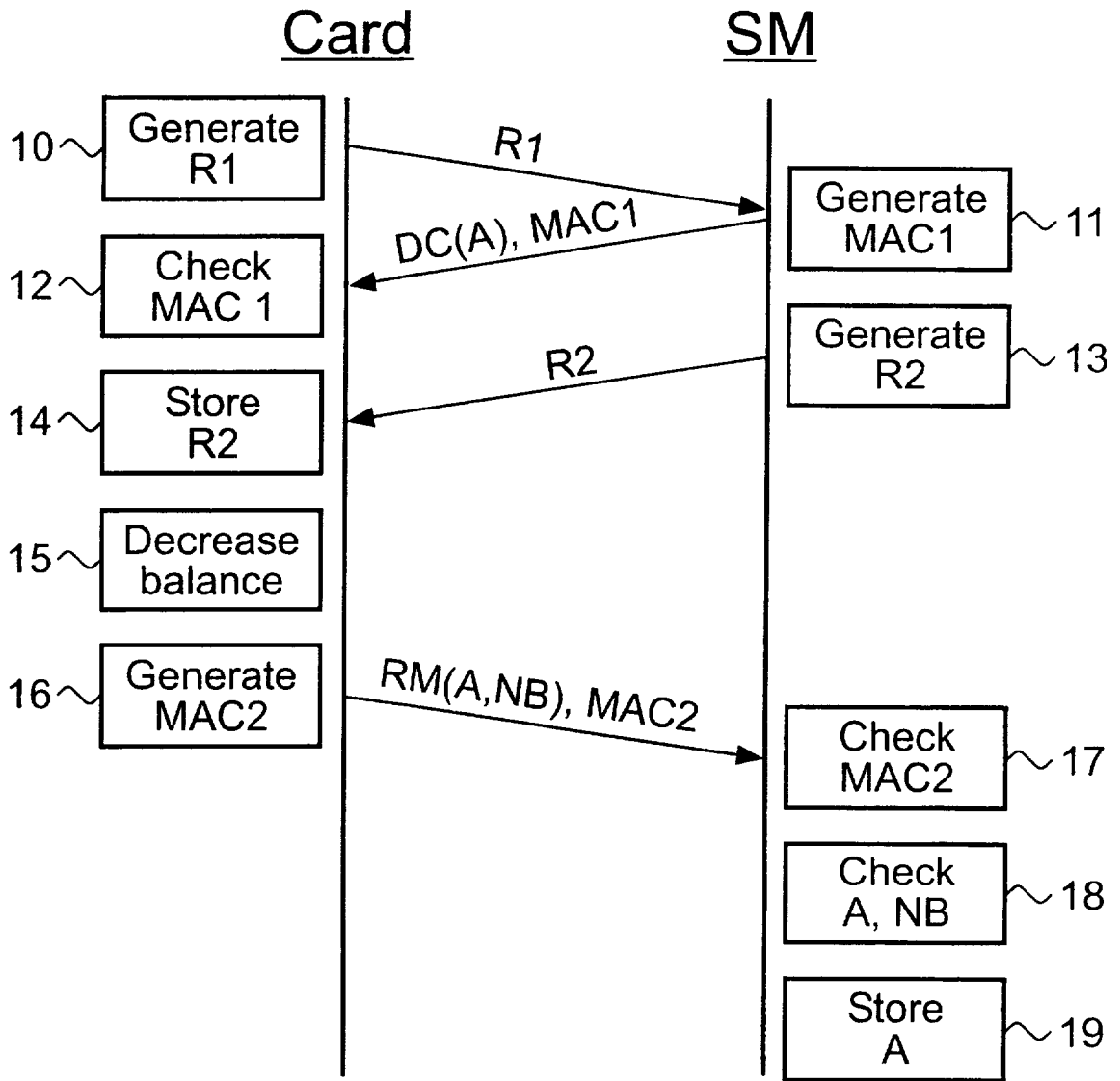

Fig. 2

3/4

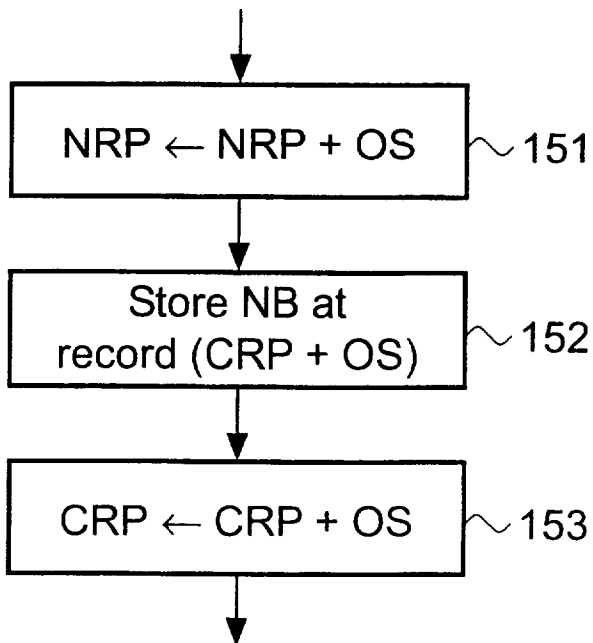

Fig. 3

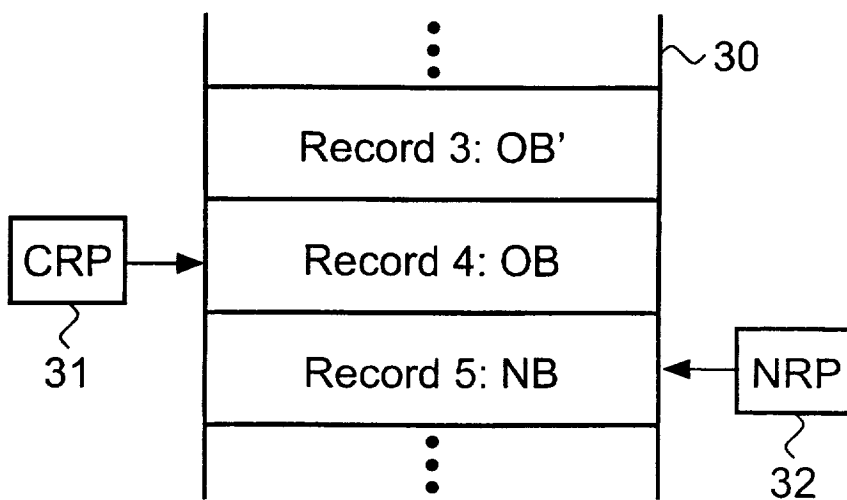

Fig. 4

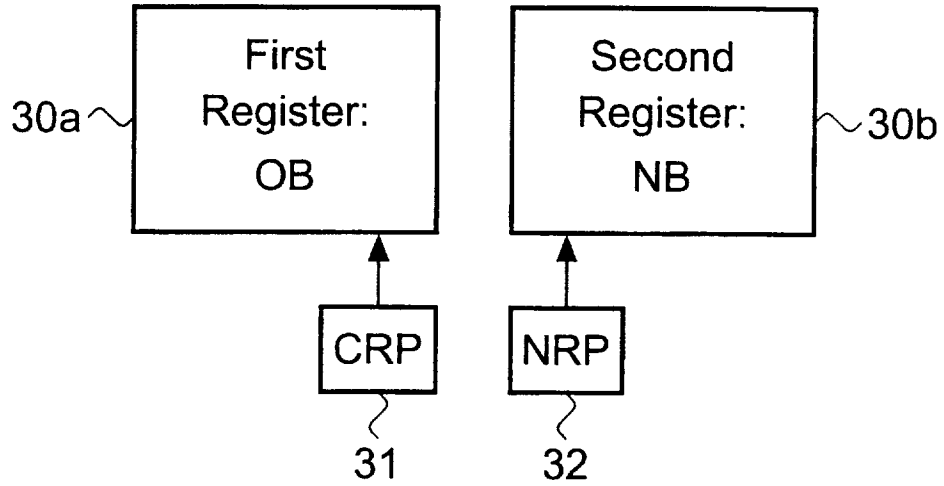

Fig. 5

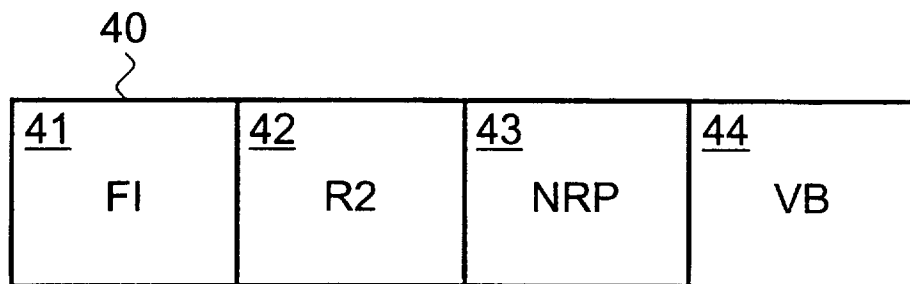

Fig. 6

INTERNATIONAL SEARCH REPORT

International Application No
PCT/EP 97/04880

A. CLASSIFICATION OF SUBJECT MATTER
IPC 6 G07F7/08

According to International Patent Classification (IPC) or to both national classification and IPC

B. FIELDS SEARCHED

Minimum documentation searched (classification system followed by classification symbols)
IPC 6 G07F G06K G11C

Documentation searched other than minimum documentation to the extent that such documents are included in the fields searched

Electronic data base consulted during the international search (name of data base and, where practical, search terms used)

C. DOCUMENTS CONSIDERED TO BE RELEVANT

Category	Citation of document, with indication, where appropriate, of the relevant passages	Relevant to claim No
A	EP 0 686 947 A (GEMPLUS) 13 December 1995 see abstract; claims; figures ---	1,2,7-10
A	WO 94 24673 A (JONHIG) 27 October 1994 see abstract; claims; figures see page 5, line 33 - page 6, line 32 ---	1,7,9
A	DE 44 39 266 A (SIEMENS) 11 April 1996 see abstract; claims; figure ---	1,2,4,8, 10
A	EP 0 570 924 A (SIEMENS) 24 November 1993 see abstract; claims; figure ---	1,2,4,6, 8-10
A	DE 35 16 358 A (ROBERT BOSCH) 13 November 1986 ---	
	-/--	

Further documents are listed in the continuation of box C

Patent family members are listed in annex.

Special categories of cited documents

- "A" document defining the general state of the art which is not considered to be of particular relevance
- "E" earlier document but published on or after the international filing date
- "L" document which may throw doubts on priority claim(s) or which is cited to establish the publication date of another citation or other special reason (as specified)
- "O" document referring to an oral disclosure, use, exhibition or other means
- "P" document published prior to the international filing date but later than the priority date claimed

- "T" later document published after the international filing date or priority date and not in conflict with the application but cited to understand the principle or theory underlying the invention
- "X" document of particular relevance; the claimed invention cannot be considered novel or cannot be considered to involve an inventive step when the document is taken alone
- "Y" document of particular relevance; the claimed invention cannot be considered to involve an inventive step when the document is combined with one or more other such documents, such combination being obvious to a person skilled in the art.
- "&" document member of the same patent family

Date of the actual completion of the international search

6 February 1998

Date of mailing of the international search report

13/02/1998

Name and mailing address of the ISA
European Patent Office, P. B. 5818 Patentlaan 2
NL - 2280 HV Rijswijk
Tel. (+31-70) 340-2040, Tx. 31 651 epo nl.
Fax: (+31-70) 340-3016

Authorized officer

David, J

INTERNATIONAL SEARCH REPORT

In tional Application No

PCT/EP 97/04880

C.(Continuation) DOCUMENTS CONSIDERED TO BE RELEVANT

Category	Citation of document, with indication where appropriate, of the relevant passages	Relevant to claim No
A	FR 2 689 662 A (GEMPLUS CARD INTERNATIONAL) 8 October 1993 ---	
A	FR 2 667 192 A (GEMPLUS CARD INTERNATIONAL) 27 March 1992 -----	

INTERNATIONAL SEARCH REPORT

Information on patent family members

International Application No

PCT/EP 97/04880

Patent document cited in search report	Publication date	Patent family member(s)	Publication date
EP 0686947 A	13-12-95	FR 2720848 A DE 69500751 D DE 69500751 T JP 8063531 A	08-12-95 30-10-97 15-01-98 08-03-96
WO 9424673 A	27-10-94	AU 676731 B AU 6507794 A CA 2137683 A CN 1110488 A EP 0645046 A JP 7508120 T MD 960344 A NO 944720 A PL 306763 A ZA 9402553 A	20-03-97 08-11-94 27-10-94 18-10-95 29-03-95 07-09-95 30-06-97 09-02-95 18-04-95 05-06-95
DE 4439266 A	11-04-96	WO 9610810 A EP 0783741 A JP 9512368 T	11-04-96 16-07-97 09-12-97
EP 0570924 A	24-11-93	EP 0570828 A	24-11-93
DE 3516358 A	13-11-86	NONE	
FR 2689662 A	08-10-93	NONE	
FR 2667192 A	27-03-92	NONE	