

FIG.1

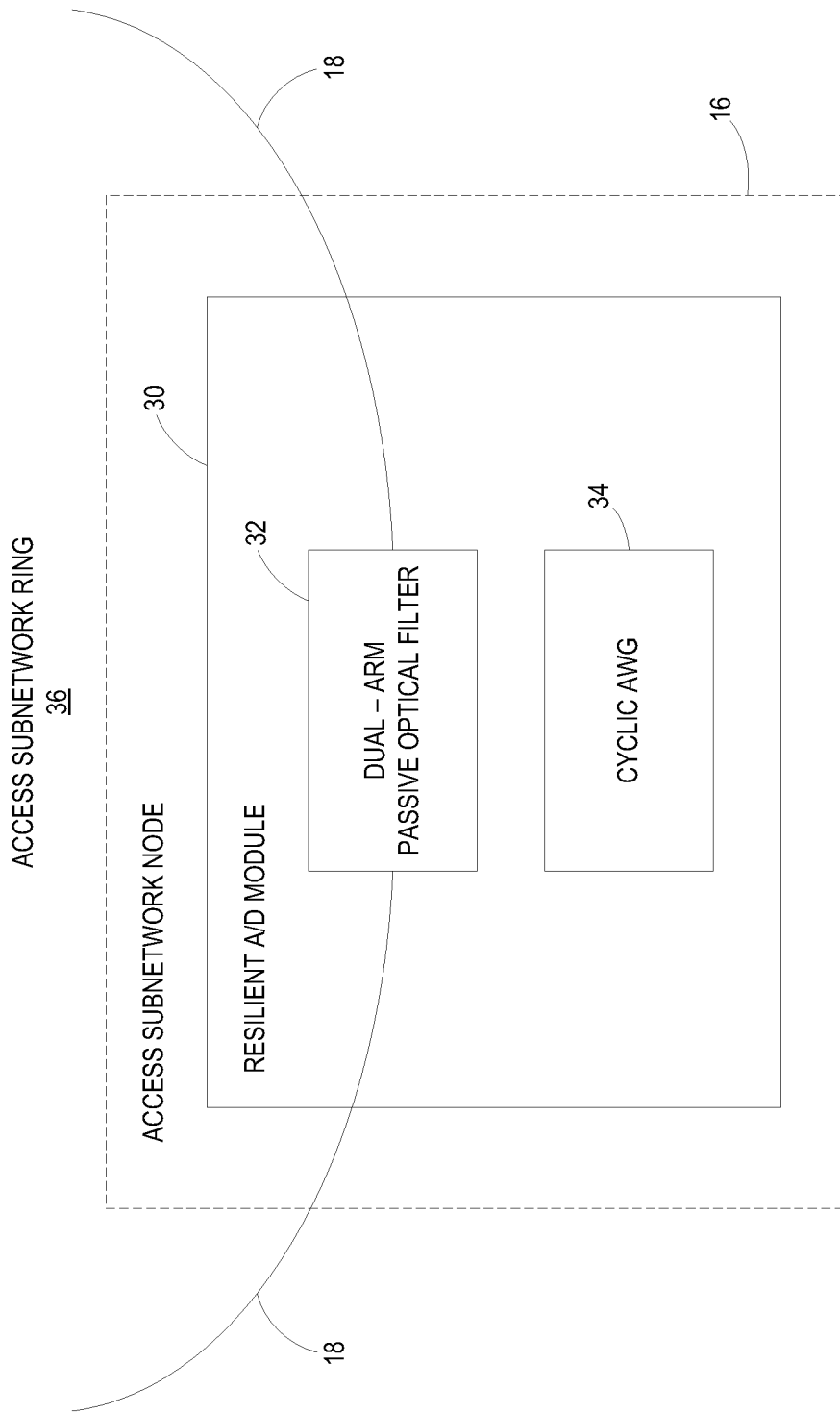

FIG. 2

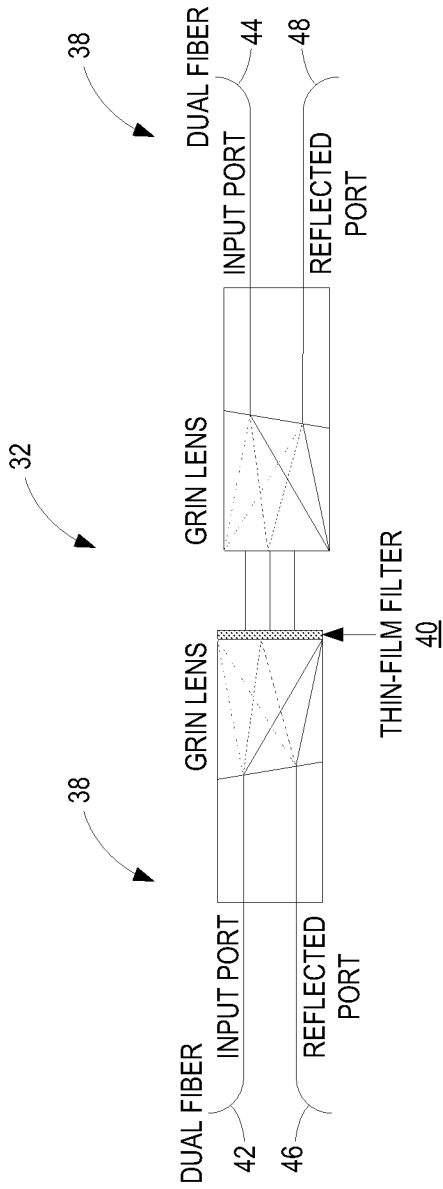

FIG. 3

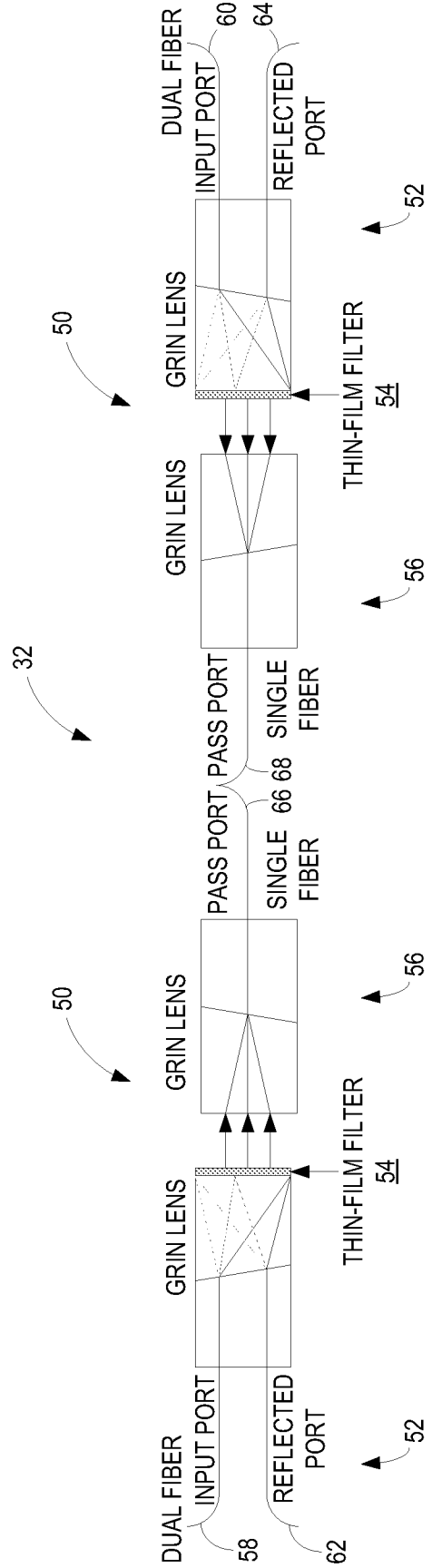

FIG. 4

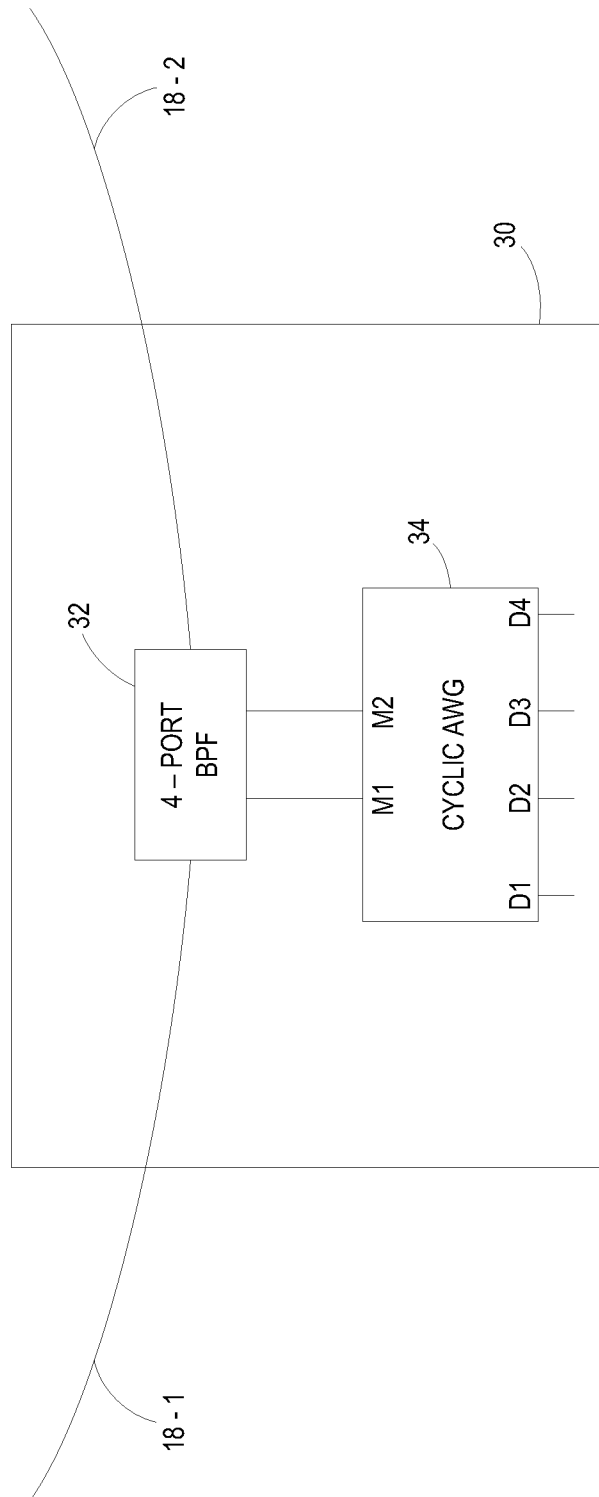
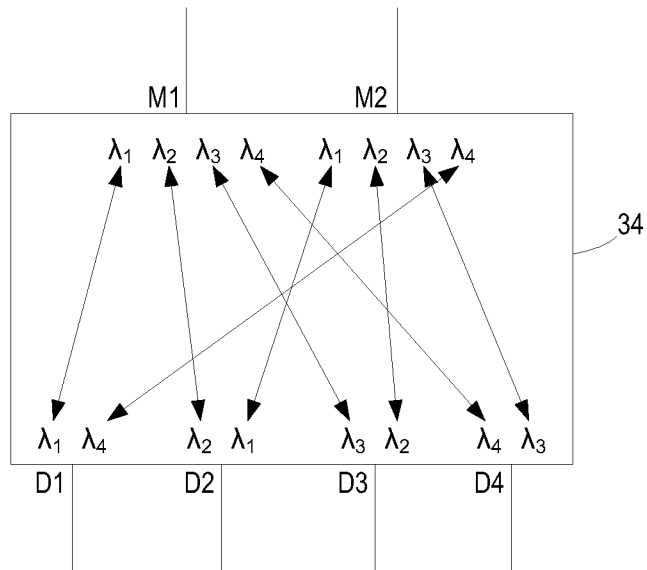

FIG. 5



M1: $\{\lambda_1, \lambda_2, \lambda_3, \lambda_4\} \longleftrightarrow \{D1, D2, D3, D4\}$

M2: $\{\lambda_1, \lambda_2, \lambda_3, \lambda_4\} \longleftrightarrow \{D2, D3, D4, D1\}$

$P_{\lambda_1} = \{D1, D2\}$

$P_{\lambda_2} = \{D2, D3\}$

$P_{\lambda_3} = \{D3, D4\}$

$P_{\lambda_4} = \{D1, D4\}$

FIG. 6

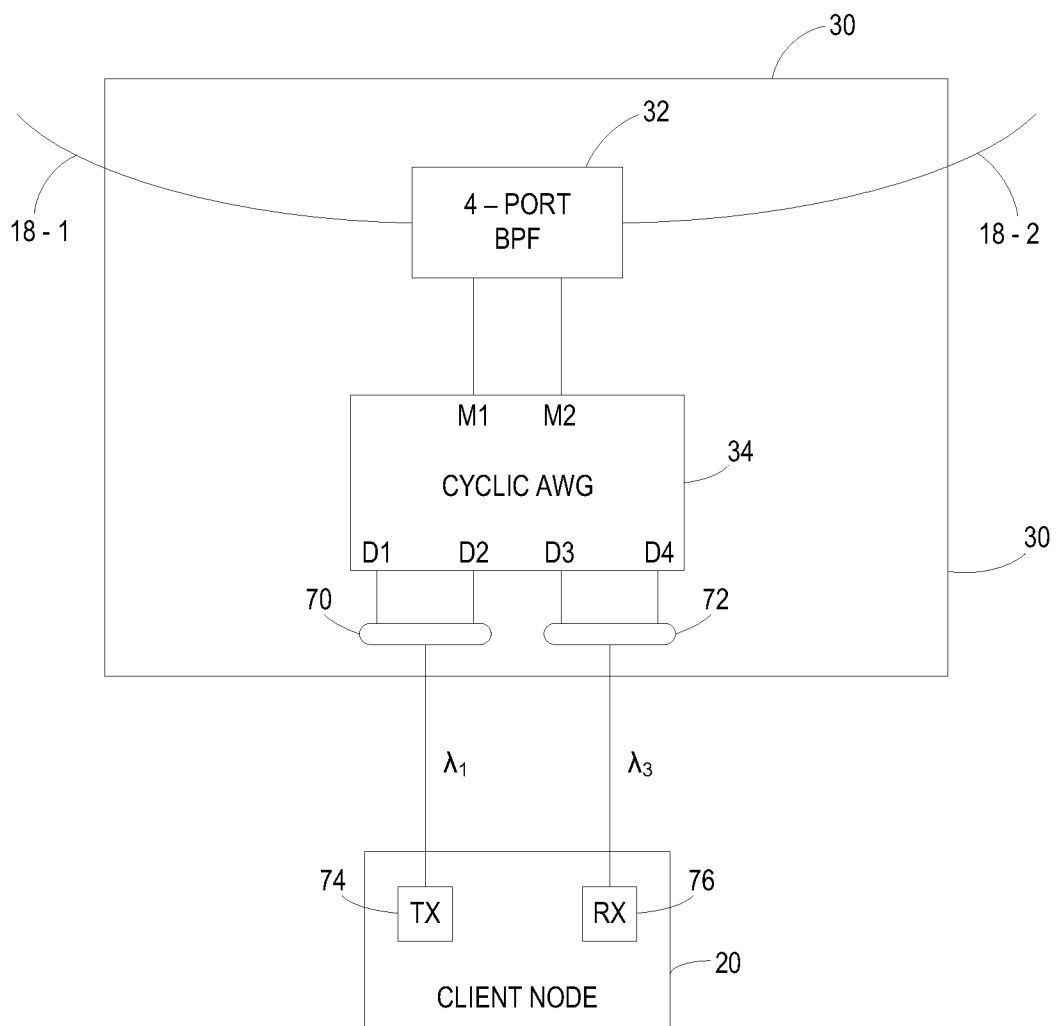

FIG. 7

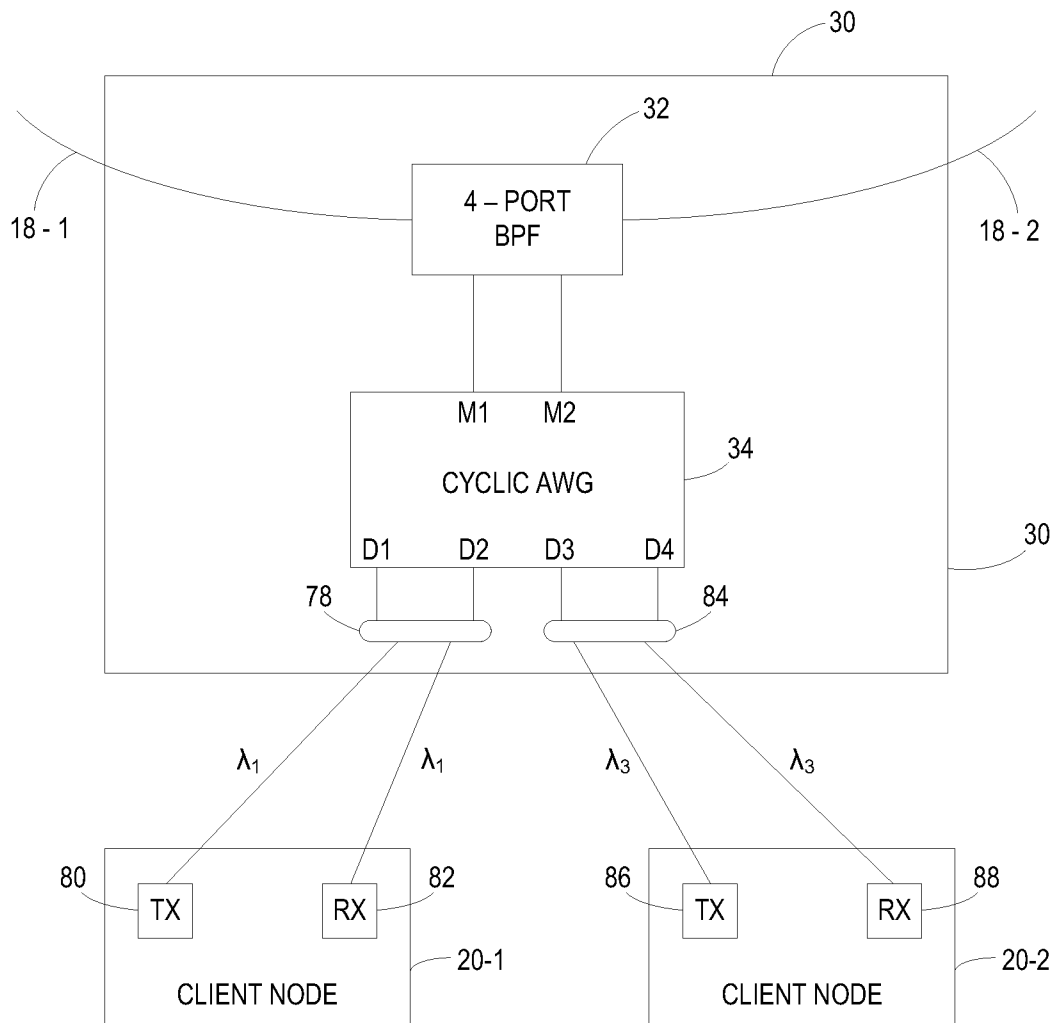

FIG. 8

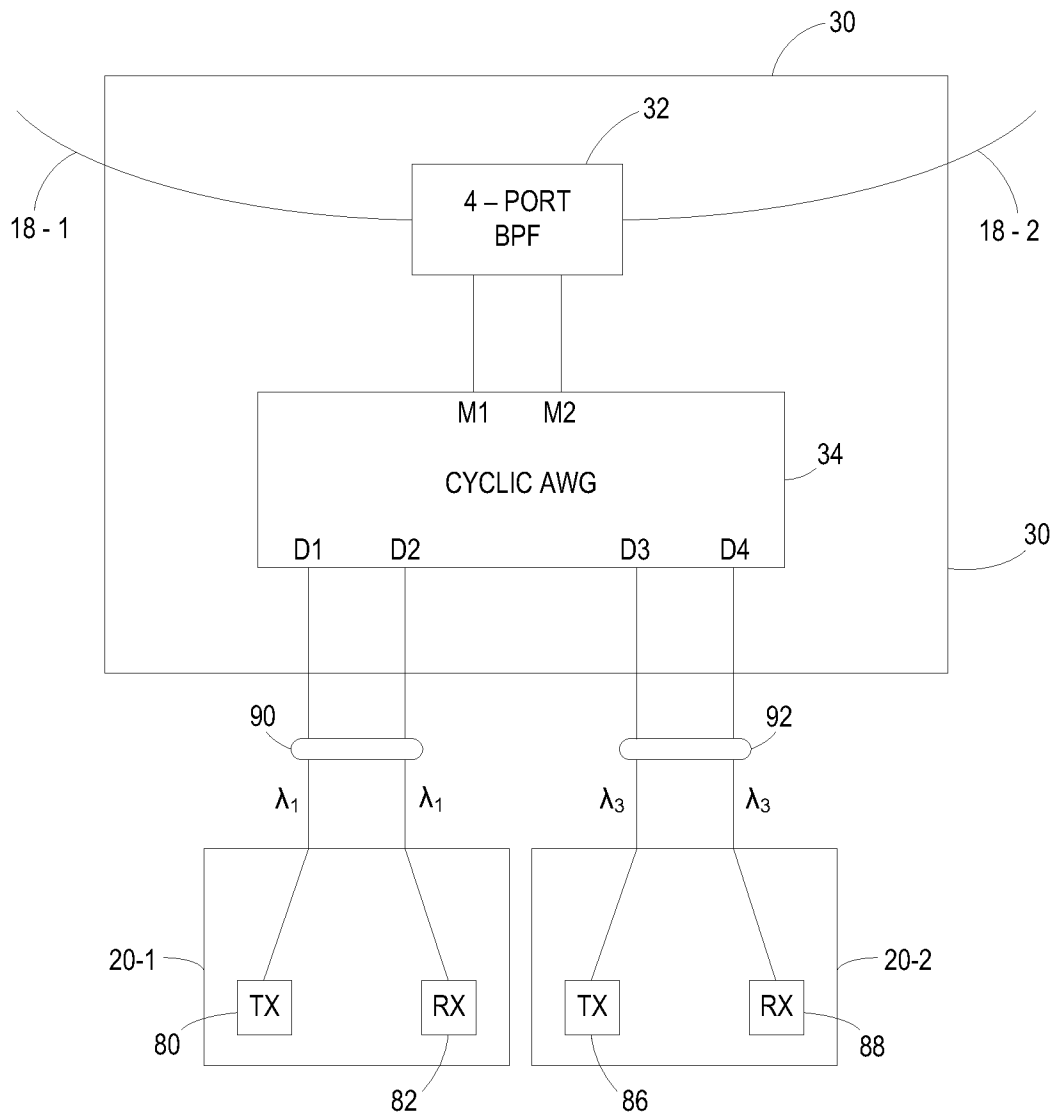

FIG. 9

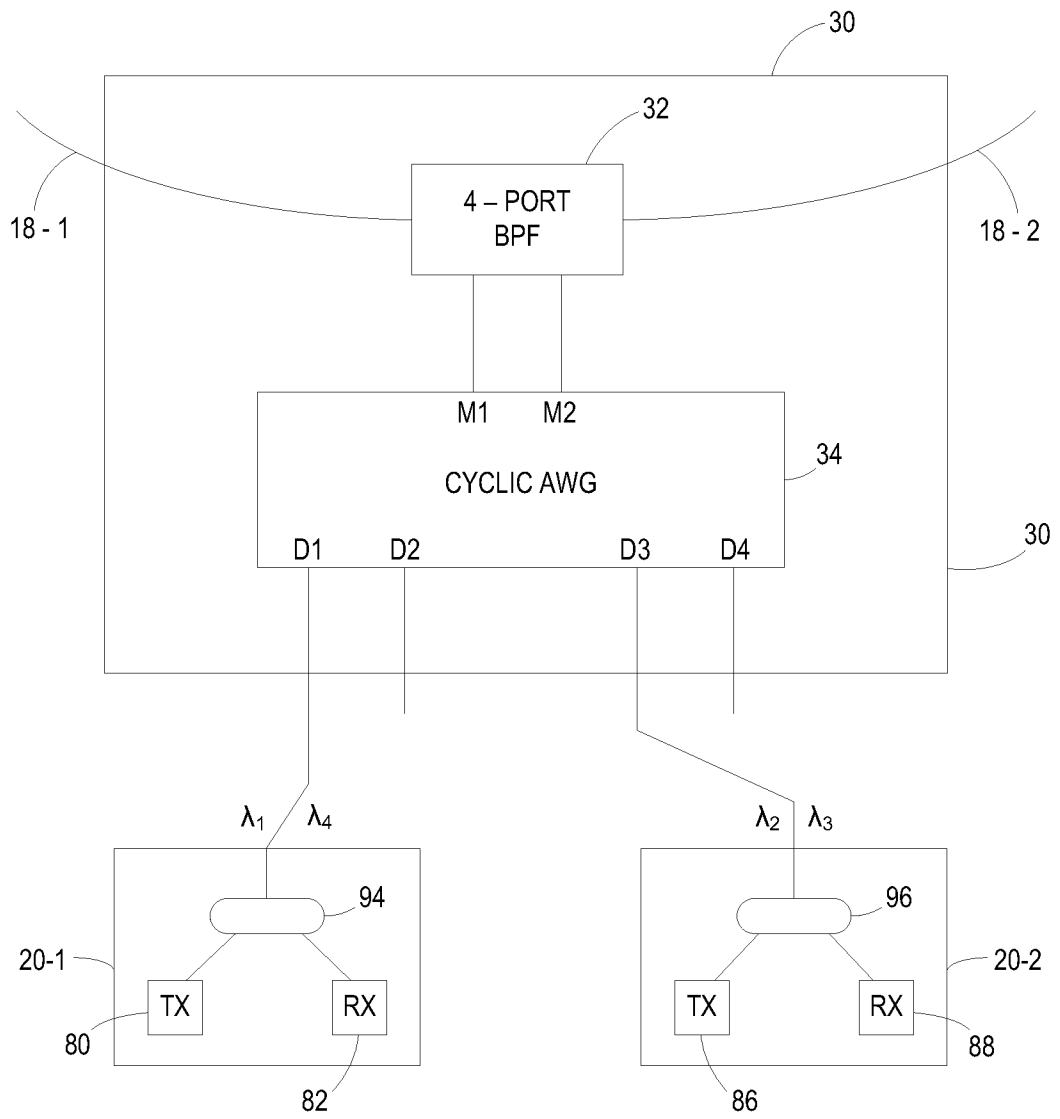

FIG. 10

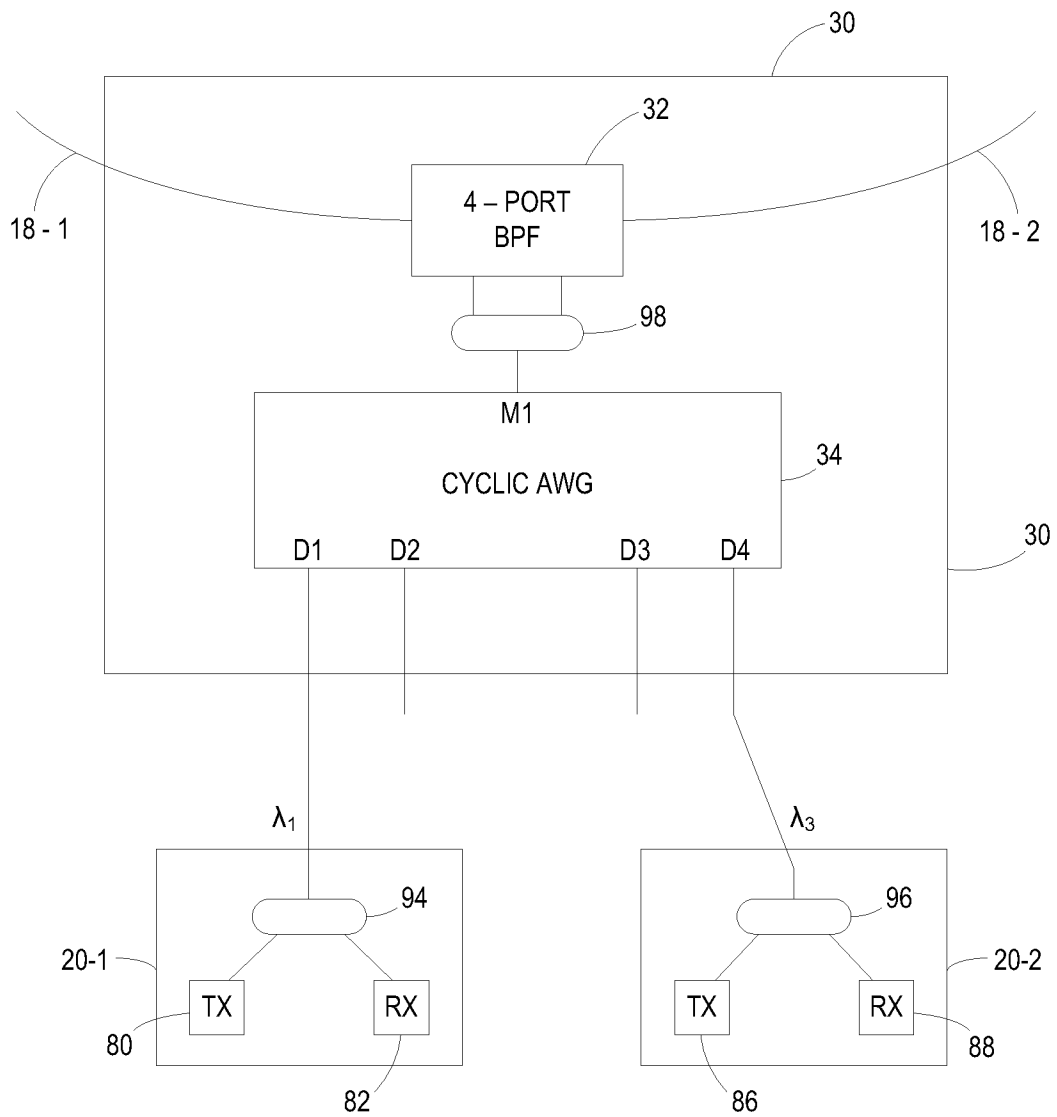

FIG. 11

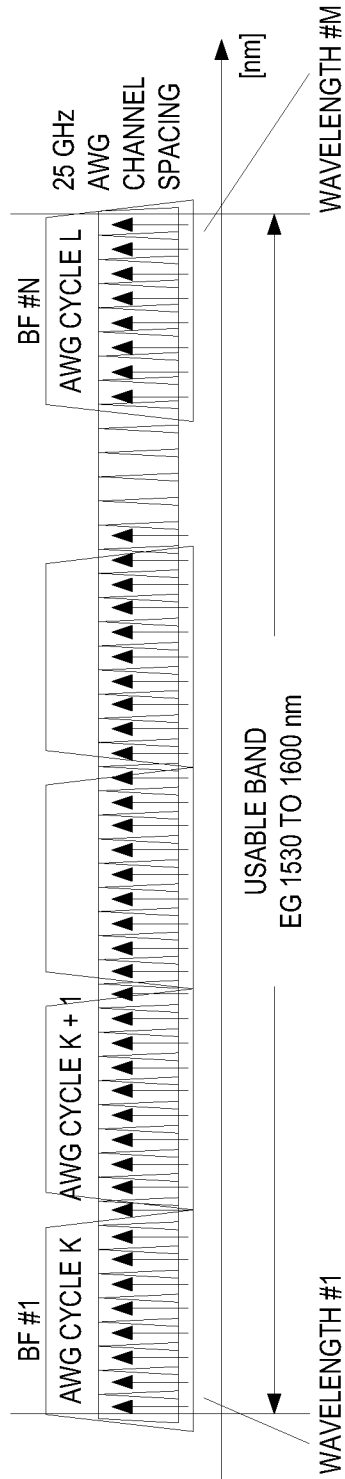

FIG. 12

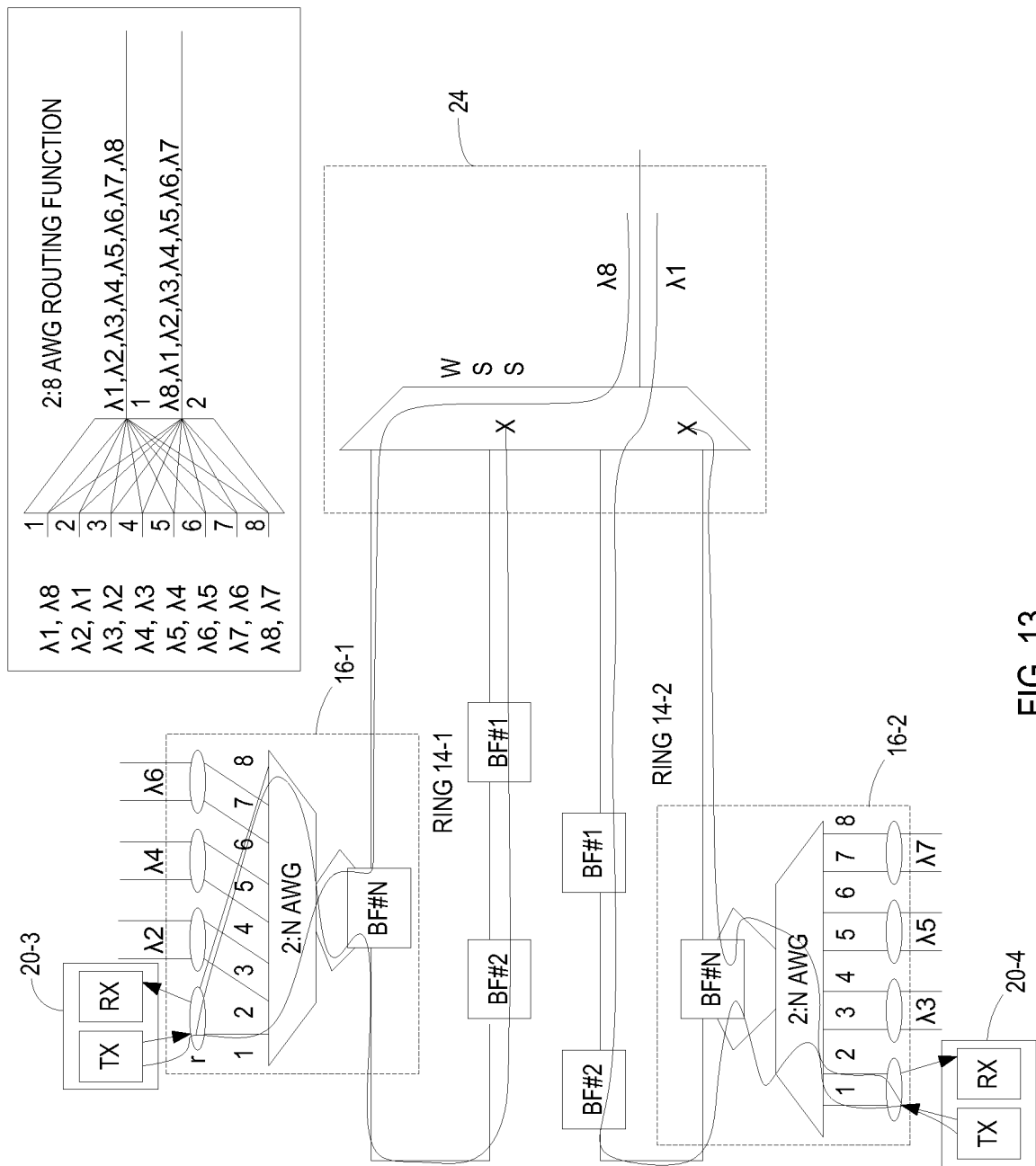

FIG. 13

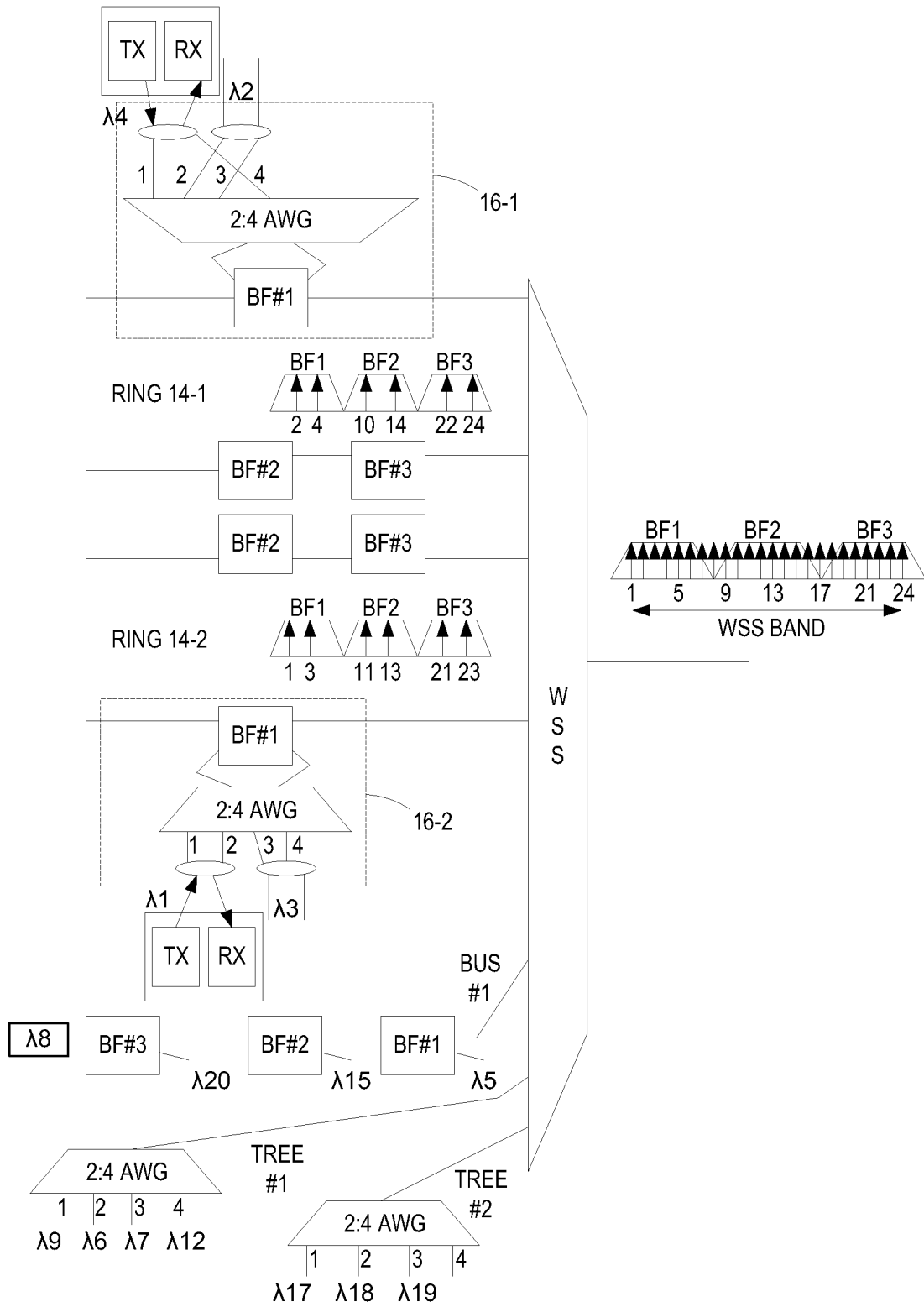

FIG. 14

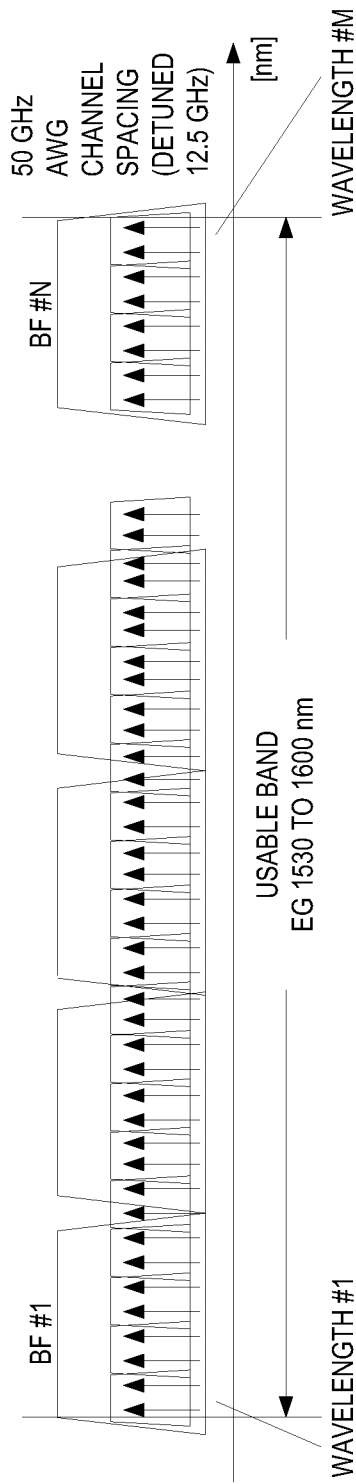

FIG. 15

15/15

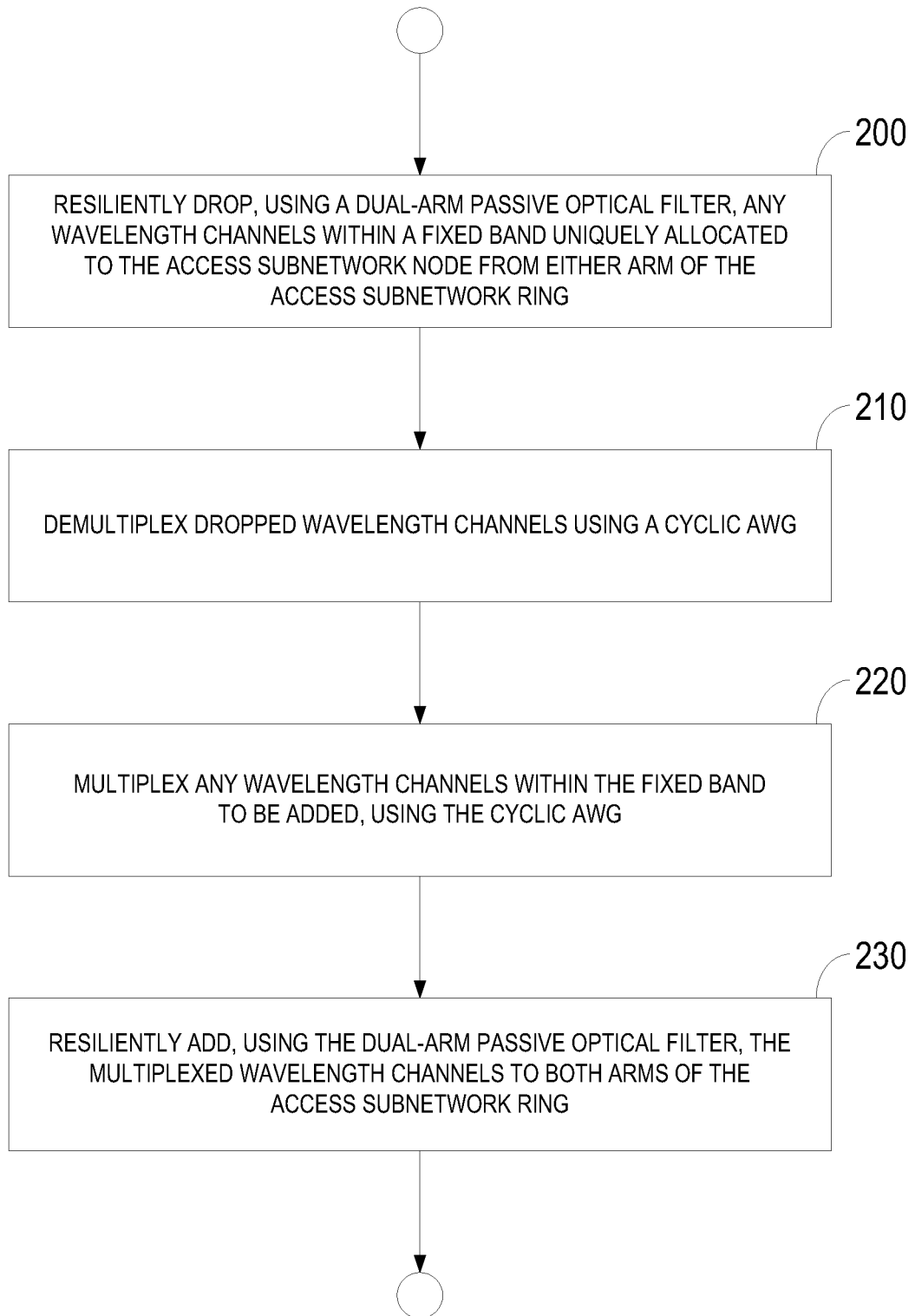

FIG. 16