



US00D724975S

(12) **United States Design Patent**  
**Emge et al.**

(10) **Patent No.:** **US D724,975 S**

(45) **Date of Patent:** **\*\* Mar. 24, 2015**

(54) **ELECTRONIC DEVICE**

(71) Applicant: **Garmin Switzerland GmbH**,  
Schaffhausen (CH)  
  
(72) Inventors: **Mark B. Emge**, Olathe, KS (US);  
**Shawn R. Harvill**, Kansas City, KS  
(US)  
  
(73) Assignee: **Garmin Switzerland GmbH** (CH)  
  
(\*\*) Term: **14 Years**

(21) Appl. No.: **29/472,086**

(22) Filed: **Nov. 8, 2013**

(51) **LOC (10) CI.** ..... **10-04**

(52) **U.S. CI.**  
USPC ..... **D10/74**

(58) **Field of Classification Search**  
CPC .... B60R 11/00; B60R 11/02; B60R 11/0211;  
B60R 11/0229; B60R 11/0235; B60R  
11/0252; B60R 11/0258; B60R  
2011/0001–2011/0098; F16B 2/00–2/06;  
F16M 11/00–11/425  
USPC ..... D10/74  
See application file for complete search history.

(56) **References Cited**

**U.S. PATENT DOCUMENTS**

D626,439	S	*	11/2010	Lee et al.	.....	D10/74
D629,315	S	*	12/2010	McAlpine et al.	.....	D10/74
D658,523	S	*	5/2012	Lan	.....	D10/74
D659,571	S	*	5/2012	Hoggarth et al.	.....	D10/74
D659,573	S	*	5/2012	Riddiford et al.	.....	D10/74
D705,680	S	*	5/2014	Wiercinski et al.	.....	D10/74
2010/0123059	A1	*	5/2010	Saez	.....	248/201

**OTHER PUBLICATIONS**

Printout from [http://store.humminbird.com/products/314022/XTM\\_9\\_20\\_T](http://store.humminbird.com/products/314022/XTM_9_20_T) published prior to Nov. 8, 2013.  
Printout from <http://www.marinonics.com.au/navico-sstdfsblk-skimmer-mount-transducer-p-67.html> published prior to Nov. 8, 2013.  
Printout from <http://www.basspro.com/Lowrance-LSS2-StructureScan-HD-Sonar-Imaging-Skimmer-Mount-Transducer/product/261905581/> published prior to Nov. 8, 2013.  
Printout from <http://www.thegpsstore.com/Raymarine-Dragonfly-CPT-60-Transom-Mount-Transducer--P3699.aspx> published prior to Nov. 8, 2013.

\* cited by examiner

*Primary Examiner* — Antoine D Davis

(74) *Attorney, Agent, or Firm* — Samuel M. Korte;  
Mohammad M. Ali

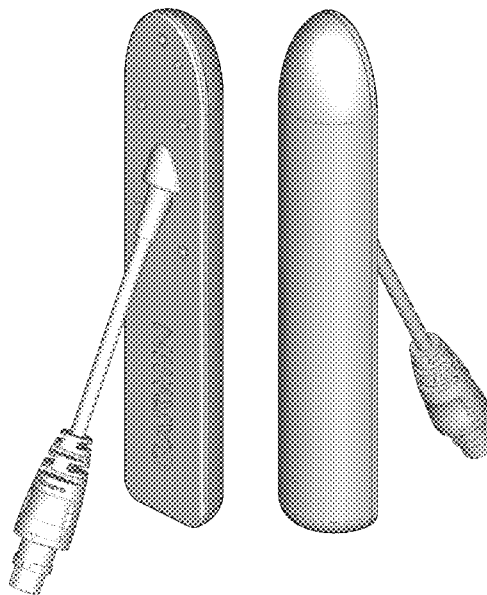
(57) **CLAIM**

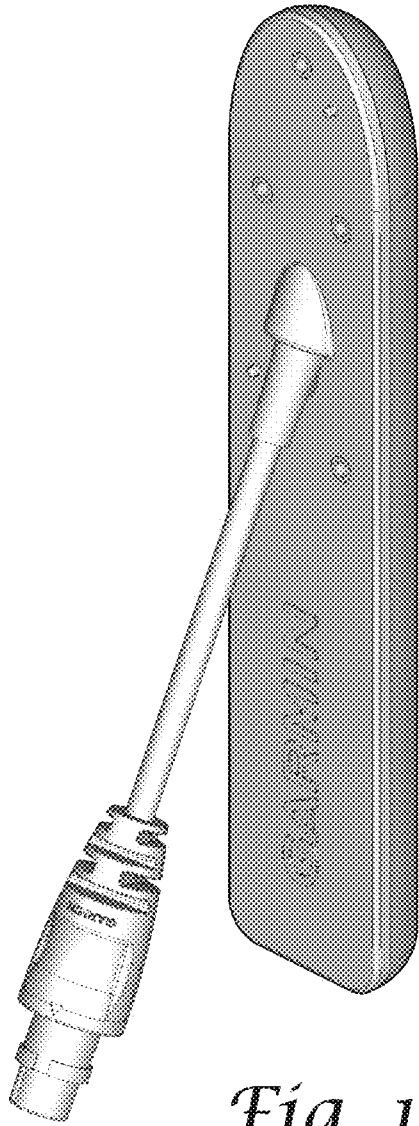
The ornamental design for an electronic device, as shown and described.

**DESCRIPTION**

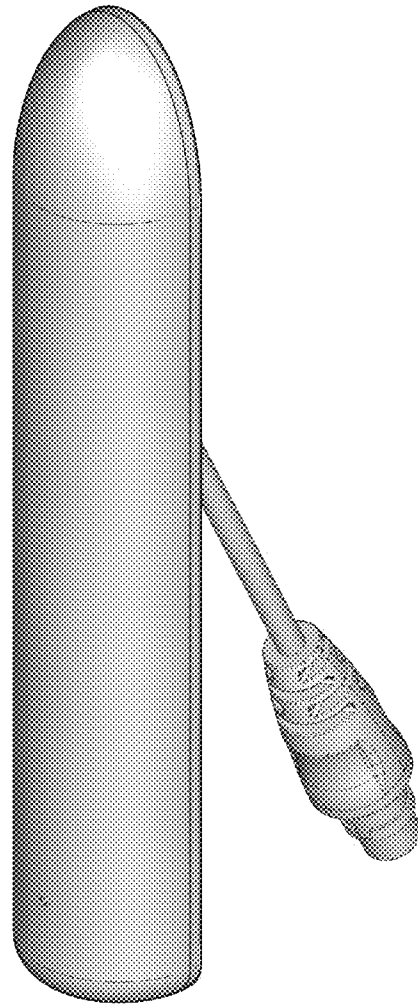
FIG. 1 is a front perspective view of an electronic device according to embodiments of the present invention; FIG. 2 is a rear perspective view of the electronic device; FIG. 3 is a top view of the electronic device; FIG. 4 is a front view of the electronic device; FIG. 5 is a bottom view of the electronic device; FIG. 6 is a rear view of the electronic device; FIG. 7 is a left side view of the electronic device; and, FIG. 8 is a right side view of the electronic device. Portions of FIGS. 1 through 8 are shown in dashed lines for illustrative purposes only and form no part of the claimed design.

**1 Claim, 3 Drawing Sheets**

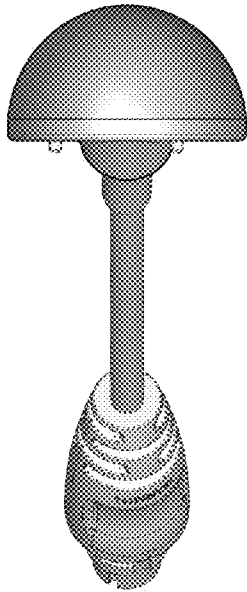




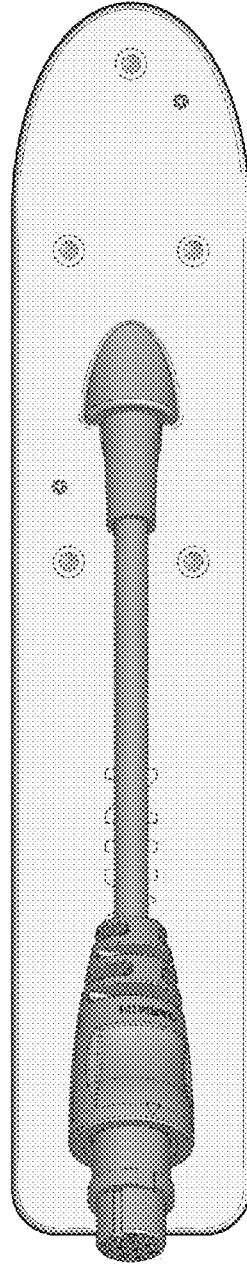
*Fig. 1*



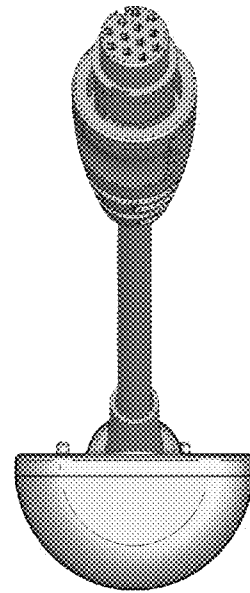
*Fig. 2*



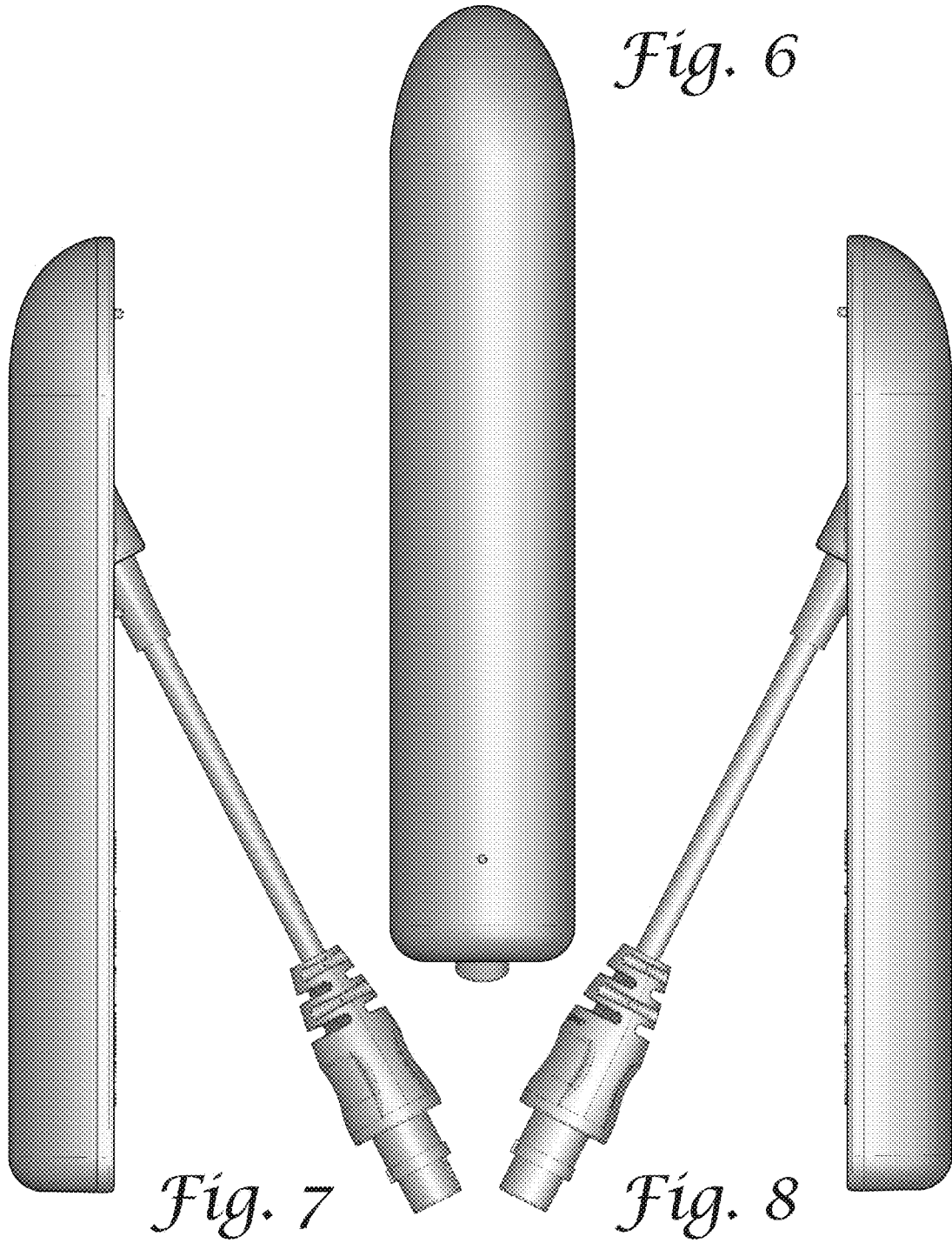
*Fig. 3*



*Fig. 4*



*Fig. 5*



*Fig. 6*

*Fig. 7*

*Fig. 8*