



US00D898164S

(12) **United States Design Patent**  
**Ruan**

(10) **Patent No.:** **US D898,164 S**

(45) **Date of Patent:** **\*\* Oct. 6, 2020**

(54) **LED SOFT-WATER AROMA FILTER**

(71) Applicant: **Hangzhou Enjoywater Technology Co., Ltd., Zhejiang (CN)**

(72) Inventor: **Chenhai Ruan, Zhejiang (CN)**

(\*\*) Term: **15 Years**

(21) Appl. No.: **29/695,117**

(22) Filed: **Jun. 17, 2019**

D733,258 S *	6/2015	Sandee	.....	D23/223
D737,931 S *	9/2015	Schoenherr	.....	D23/223
D737,932 S *	9/2015	Nikles	.....	D23/223
D743,507 S *	11/2015	Georgeson	.....	D23/252
D746,955 S *	1/2016	Corder	.....	D23/261
D752,711 S *	3/2016	Georgeson	.....	D23/213
9,387,495 B2 *	7/2016	Schumacher	.....	B05B 1/30
D778,404 S *	2/2017	Schoenherr	.....	D23/223
D779,038 S *	2/2017	Hanna	.....	D23/223
D779,039 S *	2/2017	Hanna	.....	D23/223
D801,475 S *	10/2017	Naslund	.....	D23/213
D803,350 S *	11/2017	Tian	.....	D23/213
D808,499 S *	1/2018	Naslund	.....	D23/213

(Continued)

(30) **Foreign Application Priority Data**

Mar. 13, 2019 (CN) ..... 2019 3 0102237

(51) **LOC (12) CL.** ..... **23-01**

(52) **U.S. CL.**  
USPC ..... **D23/213**

(58) **Field of Classification Search**  
USPC ..... D23/213, 214, 215, 223, 224, 226, 229,  
D23/230  
CPC ..... A61H 9/0021; A61H 33/00; B05B 1/00;  
B05B 1/14; B05B 1/185; B05B 1/08;  
B05B 1/02; B05B 1/26; B05B 12/002;  
B05B 1/18; B05B 9/01  
See application file for complete search history.

(56) **References Cited**

**U.S. PATENT DOCUMENTS**

D487,498 S *	3/2004	Blomstrom	.....	D23/213
D508,730 S *	8/2005	Blomstrom	.....	D23/229
D524,412 S *	7/2006	Blomstrom	.....	D23/229
D680,619 S *	4/2013	Zhadanov	.....	D23/223
D681,776 S *	5/2013	Cutler	.....	D23/223
D694,357 S *	11/2013	Brodey	.....	D23/213
D694,359 S *	11/2013	Schoenherr	.....	D23/213
D707,330 S *	6/2014	Schoenherr	.....	D23/223
D713,004 S *	9/2014	Schoenherr	.....	D23/223
D713,496 S *	9/2014	Schoenherr	.....	D23/213
D718,418 S *	11/2014	Georgeson	.....	D23/213
D730,493 S *	5/2015	Sehl	.....	D23/261

**OTHER PUBLICATIONS**

<https://www.amazon.com/Luxsego-Showerhead-Stainless-Adjustable-Experience/> (Year: 2019).\*

*Primary Examiner* — Manpreet S Matharu

*Assistant Examiner* — Keith J Wilson

(74) *Attorney, Agent, or Firm* — Prakash Nama; Global IP Services, PLLC

(57) **CLAIM**

The ornamental design for a LED soft-water aroma filter, as shown and described.

**DESCRIPTION**

FIG. 1 is a front elevational view of a LED soft-water aroma filter showing my new design;  
FIG. 2 is a rear elevational view thereof;  
FIG. 3 is a left side view thereof;  
FIG. 4 is a right side view thereof;  
FIG. 5 is a top plan view thereof;  
FIG. 6 is a bottom plan view thereof; and,  
FIG. 7 is a perspective view thereof.

The broken lines shown represents portions of a LED soft-water aroma filter and forms no part of the claimed design.

**1 Claim, 7 Drawing Sheets**

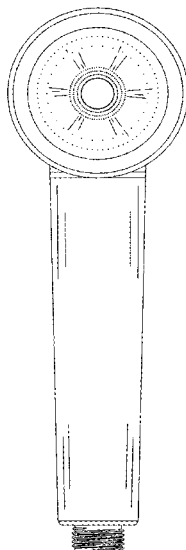

(56)

**References Cited**

U.S. PATENT DOCUMENTS

D809,094	S	*	1/2018	Naslund .....	D23/213
D810,233	S	*	2/2018	Winter .....	D23/213
D810,861	S	*	2/2018	Weaver .....	D23/213
D811,524	S	*	2/2018	Bossini .....	D23/223
D820,388	S	*	6/2018	Seum .....	D23/213
D820,949	S	*	6/2018	Reinecker .....	D23/213
D821,542	S	*	6/2018	Reinecker .....	D23/213
D824,485	S	*	7/2018	Montoya .....	D23/213
D833,575	S	*	11/2018	Soulier .....	D23/223
D839,384	S	*	1/2019	Svendsen .....	D23/213
D840,503	S	*	2/2019	Stein .....	D23/213
D841,121	S	*	2/2019	Kiefer .....	D23/213
D841,125	S	*	2/2019	Lai .....	D23/223
D842,429	S	*	3/2019	Huang .....	D23/213
D842,430	S	*	3/2019	Huang .....	D23/213
D842,431	S	*	3/2019	Cacka .....	D23/213
D842,967	S	*	3/2019	Farley .....	D23/213

\* cited by examiner

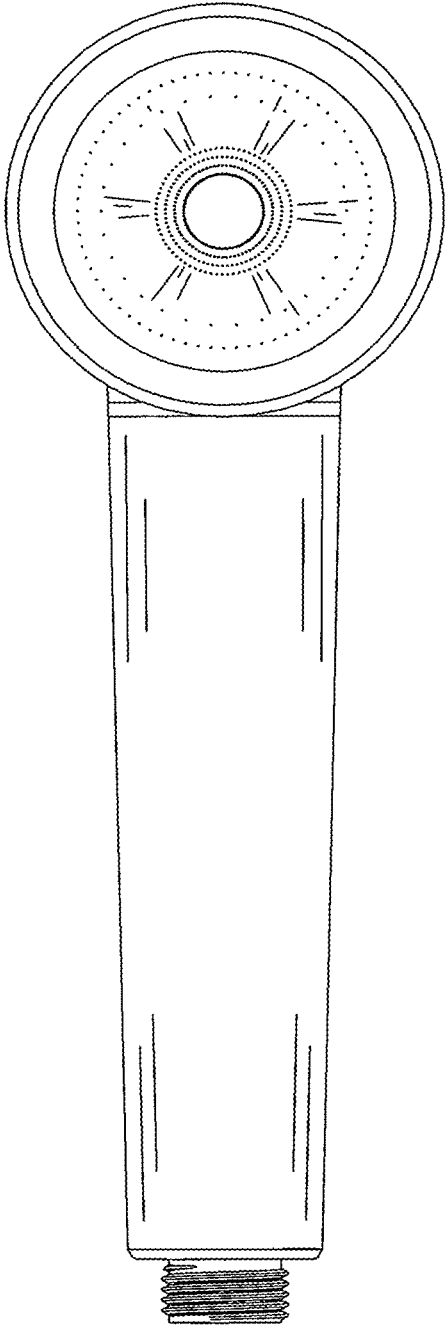

Fig. 1

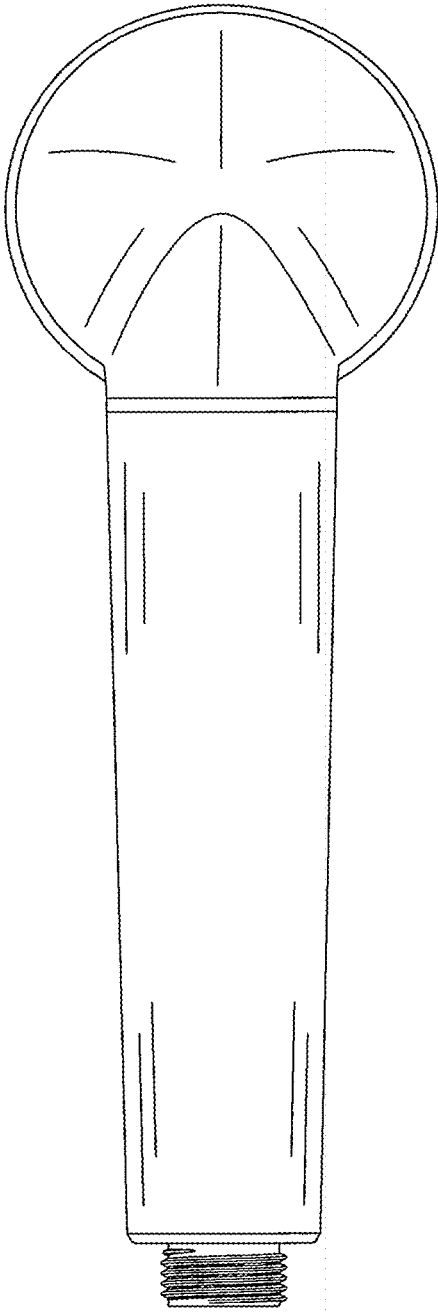

Fig. 2

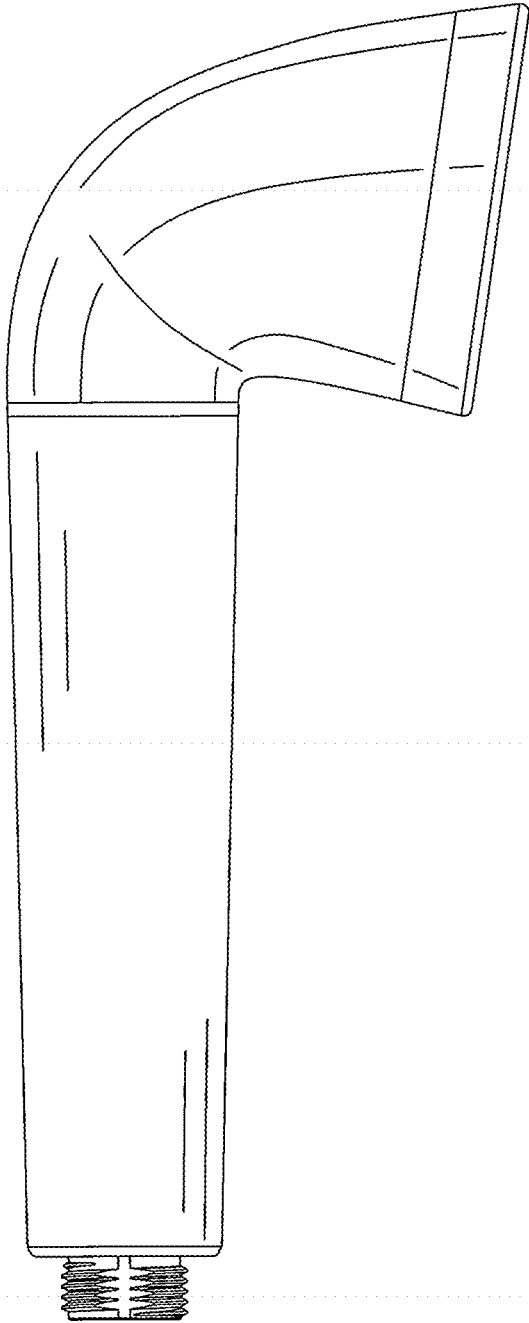

Fig. 3

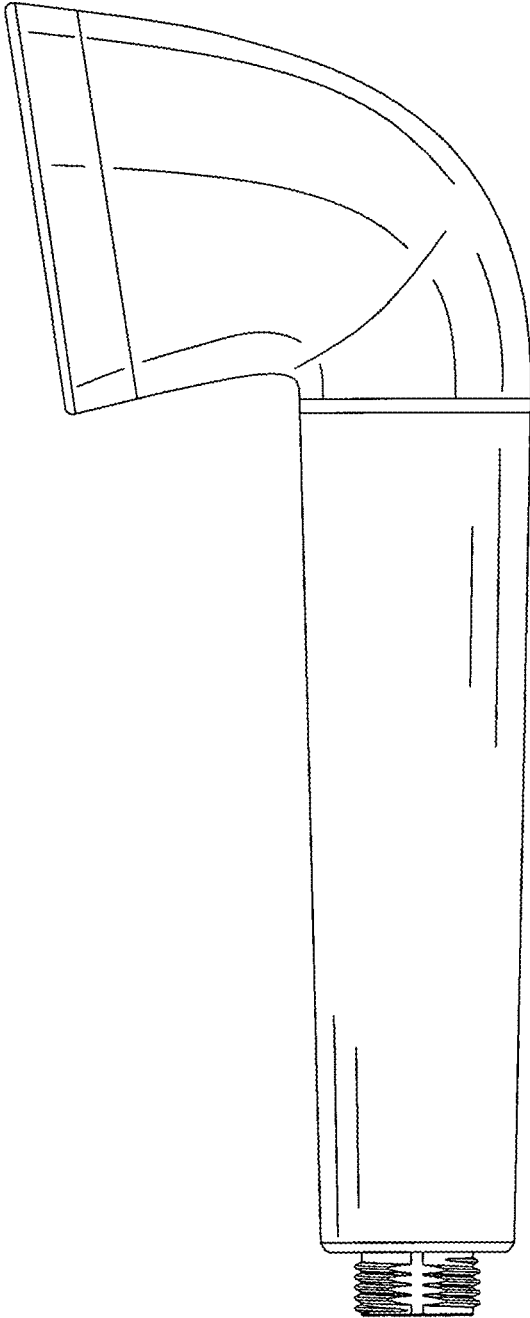

Fig. 4

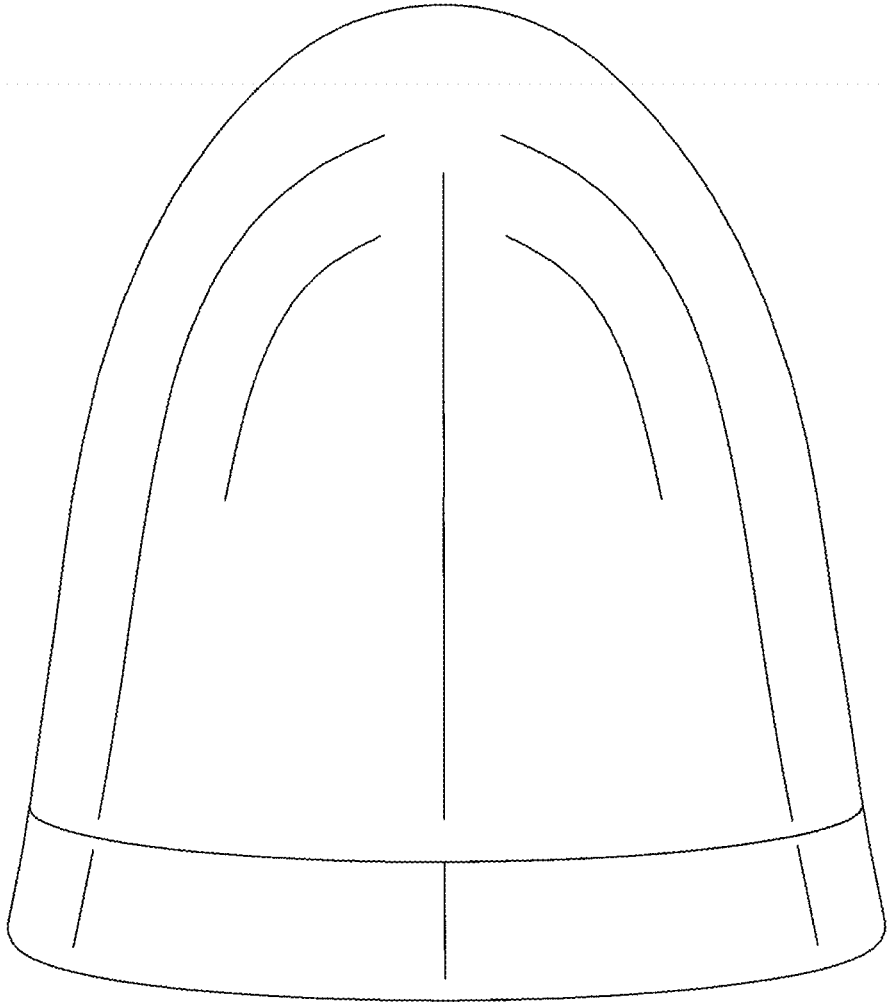

Fig. 5

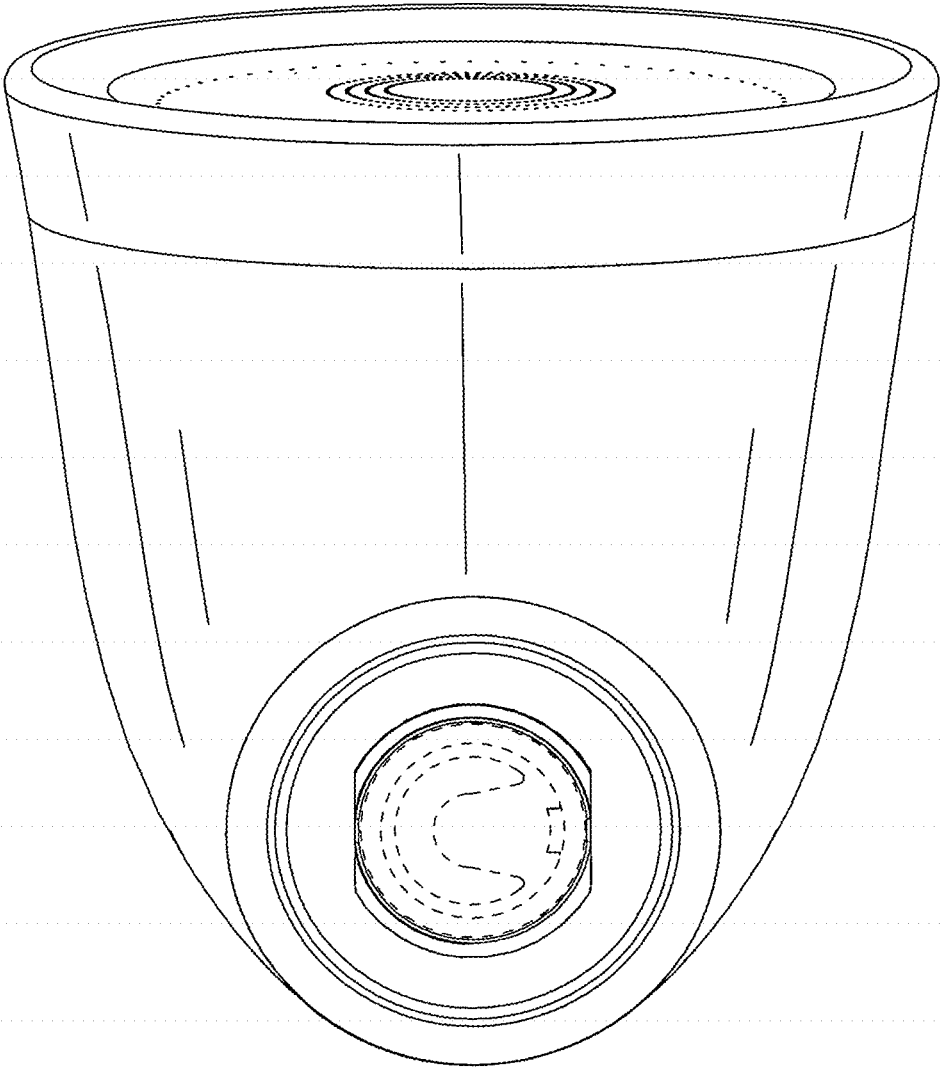

Fig. 6



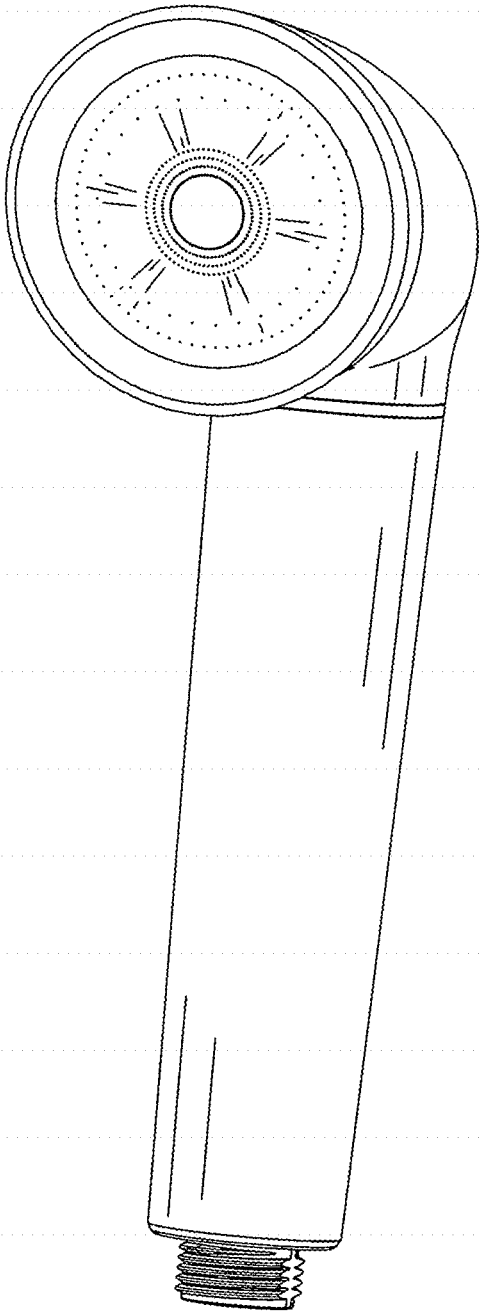

Fig. 7