

(19) World Intellectual Property
Organization
International Bureau



(43) International Publication Date
1 July 2004 (01.07.2004)

PCT

(10) International Publication Number
WO 2004/055198 A2

- (51) International Patent Classification⁷: **C12Q**
- (21) International Application Number: PCT/US2003/039505
- (22) International Filing Date: 12 December 2003 (12.12.2003)
- (25) Filing Language: English
- (26) Publication Language: English
- (30) Priority Data:
60/432,665 12 December 2002 (12.12.2002) US
60/435,287 23 December 2002 (23.12.2002) US
- (71) Applicant (*for all designated States except US*): **CHIRON CORPORATION** [US/US]; 4560 Horton Street, Emeryville, CA 94608-2916 (US).
- (72) Inventors; and
- (75) Inventors/Applicants (*for US only*): **CHIEN, David** [US/US]; Chiron Corporation, 4560 Horton Street, Emeryville, CA 94608-2916 (US). **PHELPS, Bruce** [US/US]; Chiron Corporation, 4560 Horton Street, Emeryville, CA 94608-2917 (US).
- (74) Agent: **PEET, Richard, C.**; Foley & Lardner, Suite 500, 3000 K Street, N.W., Washington, D.C. 20007-5143 (US).
- (81) Designated States (*national*): AE, AG, AL, AM, AT, AU, AZ, BA, BB, BG, BR, BW, BY, BZ, CA, CH, CN, CO, CR, CU, CZ, DE, DK, DM, DZ, EC, EE, EG, ES, FI, GB, GD, GE, GH, GM, HR, HU, ID, IL, IN, IS, JP, KE, KG, KP, KR, KZ, LC, LK, LR, LS, LT, LU, LV, MA, MD, MG, MK, MN, MW, MX, MZ, NI, NO, NZ, OM, PG, PH, PL, PT, RO, RU, SC, SD, SE, SG, SK, SL, TJ, TM, TN, TR, TT, TZ, UA, UG, US, UZ, VC, VN, YU, ZA, ZM, ZW.
- (84) Designated States (*regional*): ARIPO patent (BW, GH, GM, KE, LS, MW, MZ, SD, SL, SZ, TZ, UG, ZM, ZW), Eurasian patent (AM, AZ, BY, KG, KZ, MD, RU, TJ, TM), European patent (AT, BE, BG, CH, CY, CZ, DE, DK, EE, ES, FI, FR, GB, GR, HU, IE, IT, LU, MC, NL, PT, RO, SE, SI, SK, TR), OAPI patent (BF, BJ, CF, CG, CI, CM, GA, GN, GQ, GW, ML, MR, NE, SN, TD, TG).
- Published:**
— *without international search report and to be republished upon receipt of that report*
- For two-letter codes and other abbreviations, refer to the "Guidance Notes on Codes and Abbreviations" appearing at the beginning of each regular issue of the PCT Gazette.*



WO 2004/055198 A2

(54) Title: DEVICE AND METHOD FOR IN-LINE BLOOD TESTING USING BIOCHIPS

(57) Abstract: A device for in-line blood screening and testing using biochips is disclosed. The screening methods include nucleic acid amplification techniques and antibody/antigen assays to detect target molecules and agents indicative of infectious diseases or metabolic diseases.

DEVICE AND METHOD FOR IN-LINE BLOOD TESTING USING BIOCHIPS

Background Of The Invention

This invention relates to the field of blood screening and provides improvements that
5 enable more comprehensive, accurate and convenient screening to be performed, for
detecting the presence of targeted molecules that indicate the presence of a pathogen,
infectious agent or metabolic disease. More specifically, the invention provides a
method and system for in-line blood screening, wherein an in-line removable
screening capture device with biochips is provided between a blood collection needle
10 and a blood collection bag, such that collected blood flows through the screening
capture device and contacts the biochips before being collected in the blood collection
bag. Alternatively, the biochips are provided in an inlet of the blood collection bag,
inside the blood collection bag or inside a separate diversion blood collection bag.

Currently, blood banks use several individual assays to test for the presence of
15 multiple agents or molecules associated with or indicative of a disease or condition.
Exemplary agents or molecules include anti-HIV I/II antibodies, anti-HCV antibodies,
HBV surface antigen, anti-HBC antibodies, liver enzyme (ALT), syphilis and HIV
P24 antigen. Additionally, infectious agents such as pathogenic bacteria and fungi,
prions and protozoa, including the causative agents of small pox, malaria, West Nile
20 disease, Chagas disease, and variant Creutzfeldt Jacob disease (CJD) may be detected.
Also, non-infectious agents such as molecules that indicate metabolic disorders,
including the molecules measured in various metabolite panels, may be detected,
including a lipid panel (cholesterol, triglycerides, LDLs and HDLs), thyroid hormone
panel (T3, T4, TBP and TSH) and liver enzyme panel (ALT (alanine
25 aminotransferase), ALP (alkaline phosphatase), AST (aspartate aminotransferase),
GGT (gamma-glutamyl transferase), LDH (lactic acid dehydrogenase), bilirubin, and
albumin).

The current methods involve collecting blood directly into a blood collection bag via
a collection needle and collecting duct, with a very minute fraction of the collected
30 blood being segregated into another compartment for testing/screening purposes.

Current methods of blood screening, therefore, involve testing a very small portion, or sample, of the collected blood and may not effectively detect analytes that are sparsely dispersed in the blood. Some potential problems of testing small samples include (1) non-homogeneous distribution of the testing agent (or analyte), (2) micro-
5 aggregation of the analytes and/or binding of the analytes to serum proteins, and (3) cross-contamination between samples taken for the various tests that may be conducted, such as in the nucleic acid technology assays (NAT).

Furthermore, performing multiple individual assays requires duplicative time and effort because the sample must be prepared and labeled for each individual assay.
10 Additionally, the performance of multiple individual assays compounds the problem of appropriately labeling and tracking blood samples so that they can be correlated to the correct patient or donor. Errors and inaccuracies therefore can result from clerical errors in labeling, correlating and storing information generated from the multiple individual assays. Another problem is that too much blood may be used for testing
15 because a separate sample is required for each of the various tests to be conducted.

Additionally, separating a collected blood sample into portions for multiple individual assays increases the potential for contamination, due to the additional handling required. Of course, the conduct of multiple individual assays also increases the risk that at least one assay will be corrupted by contamination.

20 **Brief Summary of the Invention**

The present invention provides a new platform technology for screening blood. The technology ensures that a much larger fraction of blood collected, even every drop, is tested. Under previous screening methods, only very small fractions of roughly 450 ml of collected blood was used for screening. For example, 0.5 ml was used for NAT
25 testing, 20 µl each for anti-HIV I/II, anti-HCV, anti-HBC, ALT, and syphilis testing, and 100 µl each for HbsAg and HIV p24 testing. Using such small fractions creates a sampling risk, because the fractions may not be representative of the entire volume of collected blood. That is, disease agents that are relatively scarcely scattered in the collected blood may not be contained within a small fraction or volume. The present

invention addresses this problem by ensuring a more thorough and more comprehensive screening of collected blood. The present invention also enables testing for hundreds of agents or molecules to be performed at once, rather than testing for a small number of agents or molecules in separate assays.

5 Accordingly, in one aspect, the invention provides for the use of an in-line screening capture device that includes one or more biochips. Advantageously, low density biochips can be used. The capture device is removable and can be arranged or located between a collection needle and collection bag, such that all collected blood flows through the screening capture device and thereby contacts the biochips. Alternatively,
10 the screening capture device may be positioned at an inlet of a blood collection bag or even inside of a blood collection bag. The biochips bind target agents or molecules in the blood being tested and can then be used to detect the bound target agents and molecules. Preferably, the detection of target agents or molecules is facilitated by a separate multiplex assay system, or biochip processor, designed to execute target
15 and/or signal amplification and antibody/antigen binding reactions. As an example, microfluidic technologies and chemiluminescent detection systems can be employed for detecting targeted agents or molecules on the biochips.

The invention also contemplates an in-line rapid assay system that enables blood testing to be completed simultaneously with or soon after the completion of blood
20 collection.

The invention further includes a screening capture device for in-line screening of blood collected using a collection needle connected by a collection duct to a collection bag, comprising an inlet for blood collected from the collection needle; a biochip unit that captures target agents or molecules from the blood; and an outlet that
25 drains the blood from the screening capture device to the collection duct. A method for using the screening capture device also is included. In alternative embodiments of the invention, the screening capture device and/or biochip are positioned at an inlet of a blood collection bag or inside of a blood collection bag.

The present invention provides at least the following advantages over currently known procedures for screening blood:

- 5 (1) The screening process uses an in-line capture technique; therefore, almost no collected blood is lost because practically every drop that goes to the collection bag flows through, or alternatively a large sample of the blood contacts, the screening capture device and/or biochips provided by the invention.
- (2) The invention enables use of a multiplex assay system; all assays can be run on one or more of the biochips that contact the blood.
- 10 (3) The invention can employ low-density biochips, so adding additional targets, such as components of new emerging diseases, is easier and more efficient.
- (4) The assays of the invention are rapid, due to minimized reaction times resulting from the use of micro-volumes of sample in a biochip processor.
- 15 (5) The “laboratory on a chip” screening system of the invention provides a confined environment for running the multiple assays. The screening capture unit and biochip processing unit are both self-sealed, consume little space and diminish the opportunity for human error and/or contamination that may be caused by exposing the sample to the surrounding environment or by extra handling of the sample required to conduct multiple individual assays.
- 20 (6) The detection systems employ technology that not only can detect the presence of a sequence indicative of a disease, but can also detect different genotypes of each agent as well as point mutations of the captured targets.
- 25 (7) The invention can employ assays that provide a quantitative readout, such as by controlling PCR cycle number. For instance, Taqman PCR technology works on such a principle. By using a standard, or calibrator, (*i.e.*, with a known copy number) and comparing the cycle numbers of a test sample with the standard, it is possible to obtain a quantitative result.

Brief Description of the Drawings

The accompanying drawings, which are incorporated in and constitute a part of the specification, illustrate presently preferred embodiments of the invention. Together with the general description given above and the detailed description given below, the drawings serve to explain principles of the invention.

Fig. 1A shows one embodiment of the invention as a self-contained screening capture device (10) as part of the blood collection system from the patient to the blood collection bag.

Fig. 1B illustrates an alternate embodiment, in which the screening capture device containing one or more biochips is located within the neck of a diversion blood collection bag.

Fig. 2 illustrates a more detailed view of the screening capture device (10) in relation to the blood inlet 30 and the funnel (35) and filter (40) as the blood drains from the filter into the collecting duct.

Fig. 3 illustrates one example of the various dimensions of the components of the screening capture device (10).

Fig. 4A illustrates an arrangement of different analytes on a three dimensional matrix in a latitudinal (in the direction of blood flow 20a) linear fashion.

Fig. 4B shows a three-dimensional matrix using Hypogel technology that enhances the space for conjugation/capture and sensitivity.

Fig. 4C shows a three-dimensional matrix as a glass biochip with wells containing villi-like protrusions.

Fig. 4D shows another embodiment of a glass biochip in which the entire surface of the biochip is rough with villi-like protrusions.

Fig. 5 shows one example of a biochip (20) produced by Rockefeller University's Gene Array Resource Center that is designed for performing a NAT system assay.

Fig. 6 illustrates removal of a screening capture device (10) from a blood collection apparatus.

5 Fig. 7A illustrates a sealed bioprocessor that contains two separate sections sealed from one another - one for processing a NAT biochip and one for processing an immunoassay biochip.

Fig. 7B illustrates an alternate embodiment of the bioprocessor in which there is only one biochip with two separate sections sealed from one another - one for processing
10 the NAT biochip and one for processing the immunoassay biochip.

Fig. 8 illustrates the relationship of reagent containers to the bioprocessors.

Fig. 9 illustrates a close-up view of PCR and RT-PCR reaction chambers and the relationship to the reaction channels, which contain devices to prevent backflow of reagents. Additionally, shown are the relationships of the reaction chambers to the
15 amplification chambers to the microfluidity chamber.

Fig. 10 illustrates a cross section of a microfluidic channel containing poly dT extenders with a detectable signal.

Fig. 11A illustrates a general overview of the immunoassay portion of the biochip processor as shown in Figs. 7A and 7B for capturing and detecting antibody in the
20 blood.

Fig. 11B illustrates an embodiment of an antibody detection method utilizing specially coated microfluidity channels containing anti-human IgG that are modified from the microfluidity channels of Fig. 11A.

Fig. 11C illustrates an embodiment of an antibody detection method utilizing
25 specially coated microfluidity channels containing antigen specific for an antibody

directed against a disease to be detected that are modified from the microfluidity channels of Fig. 11A.

Fig. 12 illustrates a general overview of the immunoassay portion of the biochip processor as shown in Figs. 7A and 7B for capturing and detecting antigen in the
5 blood.

Fig. 13 illustrates an apparatus for simulating blood-drawing conditions, in which blood is pumped across a biochip.

Fig. 14 shows that a biochip coated with monoclonal antibody against HIV P-24 antigen captured the antigen.

10 Fig. 15 shows that a biochip coated with HIV P-24 core protein captured anti-P-24 monoclonal antibodies.

Detailed Description of the Invention

The present invention relates to a system for screening blood and to several components of a blood screening system, including screening capture devices, capture
15 systems, amplification systems and detection systems for target agents or components of interest. The system is designed to detect target agents and molecules associated with or indicative of a disease, a condition or contamination in blood. Target agents and molecules may be associated with pathogens, including viruses, bacteria, fungi and prions. Such target agents and molecules include HIV (human immunodeficiency
20 virus) and associated proteins, such as GP120, P24 core, P55 core and P31, and fragments thereof; HBV (hepatitis B virus) and associated proteins, such as core, HbeAg, HbsAg, S1 and S2 and fragments thereof; and HCV (hepatitis C virus) and associated proteins, such as core (C22), envelope (E1E2), and NS3, NS4 and NS5, and fragments thereof; nucleic acid molecules, such as HCV (such as in the NTR
25 region), HIV (such as LTR region or pol gene region), and HBV (such as preS1/2 and S region). Additionally, the target agents further include parvovirus B19, HGV (GBV-C), TTV, SEN-V, HHV-8, nvCJD, vCJD (prion), Plasmodium species, the causative agent of malaria, Flavivirus species, the causative agents of West Nile virus,

St. Louis encephalitis, Japanese encephalitis, yellow fever virus, Dengue virus.
Further, target agents and molecules include blood components or factors, such as
ABO, RhD factor, and irregular red cell antibodies. The system employs recombinant
proteins for antibody detection, monoclonal and polyclonal antibodies for antigen
5 detection, and nucleic acids for nucleic acid detection.

Screening Capture Device Design

As noted, the invention provides a screening capture device for in-line screening of
blood that is collected using a collection needle connected by a collection duct to a
collection bag. "In-line" screening refers to the ability to screen blood as it is
10 collected from a donor, and is possible by the use of a flow-through screening capture
device. Accordingly, the inventive screening capture device comprises a case having
an inlet for blood collected from the collection needle and an outlet that drains the
blood from the screening capture device to the collection duct; the case houses a
biochip unit that captures target agents or molecules from the blood. In one
15 embodiment the inlet of the screening capture device is directly connected to the rear
end of the collection needle, meaning that the screening capture device is connected
distal to the end of the collection needle that is inserted into the donor. Alternatively,
the inlet of the screening capture device is connected, via a collection duct, proximate
to the collection needle, so the temperature of blood in the screening capture device is
20 approximately 37 °C. In still other embodiments, the screening capture device is
located at an inlet of the blood collection bag or even inside of the bag.

In one embodiment, the biochip unit of the screening capture device contains a first
biochip and a second biochip that are sequentially arranged between the inlet and the
outlet, such that blood first flows across the first biochip, then flows across the second
25 biochip. In such an arrangement, the biochips may be arranged end-to-end, side-to-
side, or in a parallel stacked fashion. Alternatively, the biochips may be arranged
non-sequentially. Preferably, the dimensions of the screening capture device are
designed such that a flow rate of blood flowing through the screening capture device
is roughly equal to the flow rate of collected blood in the absence of the screening
30 capture device. In one embodiment, the dimensions of the screening capture device

are designed such that the flow rate of the blood flowing through the screening capture device is roughly 450 ml per 10 minutes. The screening capture device also is preferably designed such that the dimensions of the inlet, the outlet, the surface area of biochips in the biochip unit, and the screening capture device case allows the collected blood to maintain a constant flow rate through the screening capture device. The outlet optionally includes a funnel and a filter. In one embodiment, the screening capture device further comprises an anti-backflow device that prevents the blood from flowing back towards the inlet. In a further embodiment, the inlet and outlet are designed to be sealed when the screening capture device is removed from the collection needle and the collection duct. Various means for sealing the inlet and outlet can be employed, including plugs, caps, heat seals, clamps, welds and so forth.

As used in the description of this invention, "biochip" refers to a device comprising a substrate that incorporates one or more analytes, or biological recognition components. For example, biochips include measurement devices that incorporate an analyte into or with devices that are prepared using microlithography or microarraying technologies. Analytes include DNA, RNA and proteins (including enzymes, antibodies, receptors and their functional fragments and biomimetic equivalents), subcellular organelles, cells and tissues. The "biochip" can take any form that provides a substrate for incorporating analytes. Thus, biochips may be in the form of a chip, a bead, a gel, a microparticle, a membrane, a slide, a plate, a pellet, a disk, a capillary, a hollow fiber, a needle, a solid fiber or another form capable of providing a substrate for capturing target agents or molecules.

Biochips may comprise a wide variety of compositions, including glass, plastic, silicon, alkanethiolate-derivatized gold, cellulose, low crosslinked and high crosslinked polystyrene, silica gel, polyamide, and the like.

Biochips preferably are capable of supporting a microarray. The term "microarray" refers to the panel of analytes, or biological recognition components, used for testing, and to the panel's ordered two-dimensional presentation on a biochip. "Low density biochips" contain microarrays of less than 100 analytes. "Medium density biochips"

contain microarrays of 100 to 1000 analytes. "High density biochips" contain microarrays of more than 1000 analytes.

The inventive screening capture device is used to capture, on a biochip, one or more target agents or molecules comprising at least one protein or nucleic acid molecule, or
5 a fragment thereof, indicative of or specific for a disease or an infectious agent. The target agents or molecules may be antigens, including viral proteins, bacterial proteins, prion proteins, antibodies, and antigen-antibody complexes; whole bacterial cells; whole fungal cells; whole viruses; or nucleic acids, particularly DNA. For capturing targets, the biochip contains analytes, or biological recognition components,
10 that bind to the target agents or molecules. These analytes may be proteins, including antigens and antibodies, small peptides, oligonucleotides, lectins, small organic molecules, inorganic metallo-complexes, ions, modified peptides or peptidomimetics. The selection of particular analytes for binding particular target agents or molecules is well within the skill or ordinary artisans in this field.

15 The first biochip of the screening capture device is a nucleic acid amplification technique (NAT) biochip, on which multiple assays may be run. The first biochip captures at least one infectious organism or cell containing a targeted nucleic acid molecule. The infectious organism may be a virus, bacteria, fungi, protozoan, mycoplasma or prion. The cell is a cell from the donor of the blood sample. The first
20 biochip will contain one or more analytes for capturing target agents or molecules. These analytes may be proteins, including antigens and antibodies, small peptides, oligonucleotides, lectins, small organic molecules, inorganic metallo-complexes, ions, modified peptides or peptidomimetics. The analytes should possess high binding affinity for target agents or molecules, and should not leach out to blood. Multiple
25 analytes with different chemical natures may be employed on the same biochip to achieve simultaneous capturing and screening for multiple targets.

The second biochip of the screening capture device is an immunoassay chip, on which multiple assays may be run. The second biochip captures targeted antigens and/or antibodies. The second biochip also will contain one or more analytes for capturing
30 target agents or molecules. These analytes also may be proteins, including antigens

and antibodies, small peptides, oligonucleotides, lectins, small organic molecules, inorganic metallo-complexes, ions, modified peptides or peptidomimetics. The analytes should possess high binding affinity for target agents or molecules, and should not leach out to blood. Again, multiple analytes with different chemical
5 natures may be employed on the same biochip to achieve simultaneous capturing and screening for multiple targets.

In one embodiment, the first and second biochips are low density biochips. In a further embodiment, the first and second biochips are microarrays having the analytes that bind to target agents or molecules arranged along the length of the biochip in the
10 direction of blood flow over the first and second biochips, respectively. Analytes preferably are covalently bound to the biochips.

Rather than containing two biochips, the screening capture device alternatively may contain a single first biochip that is a NAT biochip or is an immunoassay chip or constitutes both an NAT biochip and an immunoassay chip. For example, a biochip
15 that captures whole pathogens can be used to detect both antigen targets, by immunoassay detection techniques, and nucleic acid targets, by NAT detection techniques.

The surface of biochips used in the invention may be composed of any material that that allows covalent attachment of nucleic acids and/or proteins, preferably at a high
20 density. Exemplary materials are glass, quartz, plastics, biopolymers and semiconductor nanocrystals, such as Quantum dots or Quantum Beads. Any of these materials may have surface modifications to enhance their performance.

In some embodiments, the screening capture device comprises one or more semi-permeable membranes that insulate cellular components of the blood from the
25 biochip, where binding events between biological recognition components and target agents or molecules occurs. Such membranes are permeable to target agents and molecules, but not to blood cells. To protect the integrity of cellular components in blood, the membranes may be positioned upstream of a biochip or may entirely envelop a biochip. The membranes may operate based on size exclusion or other

functional principles. Selection of a particular membrane is dictated by purpose. For example, membranes comprising a pore size of between 500 angstroms and 5 microns, preferably about 1 micron, will allow viral particles and target molecules to pass, but not blood cells.

- 5 One or more semi-permeable membranes also may be employed to prevent materials from leaching out from the screening capture device into the collected blood. Used in this context, the semi-permeable membranes permit cells to pass, but not proteins or small molecules. To protect collected blood from materials leaching out of the screening capture device, the membranes may be positioned downstream of a biochip
10 or may entirely envelop a biochip.

The screening capture device additionally may comprise a lid that can be robotically removed to facilitate sequential robotic removal of the first biochip and the second biochip.

- In one embodiment, the screening capture device of the invention accommodates
15 biosensors capable of supporting a “self-performing” screening assay. For example, engineered B-cells with surface antibodies specific for target agents or molecules may be attached to the biochip. The engineered B-cells express cytosolic aequorin, a calcium-sensitive bioluminescent protein from *Aequoria victoria* jellyfish. Once a target binds to the B-cell, it will trigger an elevated intracellular calcium
20 concentration, which will illuminate aequorin. See, *e.g.*, Rider *et al.*, *Science*, 301: 213-215 (2003). A “self-performing” screening assay is particularly advantageous when the screening capture device is located inside of a blood bag, because the assay results can be determined without opening the bag and thereby potentially
25 contaminating its contents. It also allows for continuous monitoring of a blood sample, such that pathogens growing over time can be detected.

In another aspect, the invention provides a screening system for in-line screening of blood collected using a collection needle connected by a collection duct to a collection bag. The screening system comprises a screening capture device as described herein and at least one biochip processor for amplifying and/or detecting at

least one captured target agent or molecule. The screening system may contain multiple biochip processors.

In one embodiment, the biochip processor of the screening system comprises a sealed disposable unit having a nucleic acid amplification technique (NAT) portion for
5 processing a biochip and/or an immunoassay portion for processing a biochip.

For detecting nucleic acid target molecules, the NAT portion of the biochip processor may comprise a biochip holder, one or more reservoirs for holding an eluted or lysed target agent or molecule, *i.e.* - a sample, one or more amplification reaction chambers connected to the reservoir, and one or more detection components connected to the
10 amplification reaction chamber. The NAT portion may further comprise one or more reagent containers connected to the reservoir and one or more reagent containers connected to the reaction chamber. The NAT portion may further comprise a biochip held in the biochip holder. In one embodiment, the biochip is held such that the analytes are in contact with at least one elution and lysing buffer. The detection
15 component of NAT portion of the biochip processor may comprise one or more microfluidity chambers.

For detecting antibody and/or antigen target molecules, the immunoassay portion of the biochip processor may comprise a biochip holder, one or more reservoirs for holding an eluted or lysed target agent or molecule, *i.e.* - a sample, one or more
20 reaction chambers connected to the reservoir, and one or more detection components connected to the reaction chamber. The immunoassay portion may further comprise one or more reagent containers connected to the reservoir and one or more reagent containers connected to the reaction chamber. The immunoassay portion may further comprise a biochip held in the biochip holder. In one embodiment, the biochip is held
25 such that the attached analytes are in contact with at least one buffer. The detection component of the immunoassay portion of the biochip processor may comprise one or more microfluidity chambers. The biochip processor generally comprises at least two reaction chambers, one for the detection of a target antibody and one for the detection of a target antigen. The biochip processor is designed so that each reaction chamber

is connected to at least one detection component comprising one or more microfluidity chambers.

In a related aspect, the invention provides methods of screening blood collected from a donor by using a collection needle connected by a collection duct to a collection
5 bag. The methods employ the screening capture devices and screening systems described herein. One method comprises the following steps: (a) providing a screening capture device comprising: an inlet for blood collected from a collection
needle, a biochip unit that captures a target agent or molecule from collected blood, and an outlet that drains the blood from the screening capture device to a collection
10 duct; (b) inserting the screening capture device between the collection needle and the collection duct proximate to the collection needle so that blood flowing through the screening capture device is approximately at a human body temperature, and (c)
allowing blood to flow through the screening capture device. The method may further comprise (d) removing the sealed screening capture device for further processing of
15 the biochip unit.

In some embodiments, the method further comprises (a) opening the screening capture device to remove the biochip unit, and (b) inserting the biochip unit into a biochip processor for processing. These steps may be performed robotically.

When a target molecule is a nucleic acid, the biochip processor comprises a nucleic
20 acid amplification technique (NAT) portion for processing the biochip. This NAT portion may comprise a biochip holder for holding the biochip, one or more reservoirs for holding a sample eluted from the biochip, one or more amplification reaction chambers connected to the reservoir, and one or more detection components connected to the amplification reaction chamber. The NAT portion may further
25 comprise one or more reagent containers connected to the reservoir.

In such cases, the method further comprises contacting the biochip with at least one buffer from the reagent container that elutes and lyses the captured target agents and molecules from the biochip to form a solution that collects in the reservoir. The method further comprises moving a solution in the reservoir to the amplification

reaction chamber, providing one or more reagent containers that contain nucleic acid amplification reagents and allowing the amplification reagents to flow into the amplification reaction chamber containing the solution, providing sufficient conditions to amplify at least one nucleic acid molecule in the solution, and detecting
5 the presence of the amplified nucleic acid molecule in the detection component. In one embodiment, the detection component comprises one or more microfluidity chambers for detecting the presence of an amplified nucleic acid molecule by a nucleic acid hybridization and signal detection. More than one biochip processor may be utilized in parallel.

10 When the target molecule is an antibody or antigen, the biochip processor comprises an immunoassay portion for processing the biochip. This immunoassay portion may comprise a biochip holder, one or more reservoirs for holding a sample eluted from the biochip, one or more reaction chambers connected to the reservoir, and one or more detection components connected to the reaction chamber. The immunoassay
15 portion further comprises one or more reagent containers connected to the reservoir.

In such cases, the method further comprises contacting the biochip with at least one buffer from the reagent container that elutes the captured target molecules from the biochip to form a solution that collects in the reservoir. The method further comprises moving the solution in the reservoir into the one or more reaction chambers, providing
20 one or more additional reagent containers that contains a reagent comprising an antigen linked to a signal amplification system or an antibody linked to a signal amplification system and allowing the reagent to flow into the reaction chamber containing the solution, providing sufficient conditions to allow binding of the reagent to a target antibody or antigen in the solution, and detecting the presence of the target
25 antibody or antigen in the detection component. In one embodiment, the method utilizes a detection component that comprises one or more microfluidity chambers for detecting the presence of the signal by binding to an antibody immobilized on the wall of the chamber. In one embodiment, the method employs least two reactions chambers, one for the detection of a target antibody and one for the detection of a
30 target antigen. Each reaction chamber is connected to at least one detection

component comprising one or more microfluidity chambers. Also, more than one biochip processor may be utilized in parallel.

Reference to the figures will provide a more complete understanding of the screening capture devices and screening systems. As shown in Fig. 1A, the invention provides a self-contained screening capture device (10) that is removable and preferably secured
5 between a collection needle (100) and a collecting duct (150) that transfers collected blood to a collection receptacle or container, for example, a blood bag (200). Fig. 1A is exemplary only, and one skilled in the art would recognize various alternatives and improvements, which the invention also embraces. The screening capture device (10)
10 is preferably located close to the donor of the blood, preferably connected directly to the collection needle (100) (for example, near or at the back end of the needle) to ensure that the temperature of the blood is still close to 37 °C or an appropriate temperature for effective capture of target agents or components of interest (for example, antigens/antibodies and nucleic acid complexes).

15 In an alternative arrangement, as shown in Fig. 1B, the screening capture device may also be located within the blood bag (200). This arrangement is particularly advantageous in a system in which the blood from a donor is collected in multiple blood bags. In such a system, the screening capture device can be arranged inline with a first bag or diversion bag that collects the initial blood collected from a subject.
20 For example, 10-40 ml may be collected in the first bag. The first bag may then be removed or bypassed so that the remainder of the collected blood is stored in one or more additional blood bags.

This multiple bag configuration, with the biochip contained in the first bag that collects blood, provides several advantages. First, potential bacterial contamination
25 from the skin of the blood donor may be collected in the first bag so that the second and subsequent bags are free from or have reduced bacterial contamination. Second, the biochip(s) contained in-line with the first bag, by being located in the top of or inside of the first bag, may be kept in contact with the blood for a longer duration of time at any desired temperature before elution and testing.

One of skill in the art would recognize that the principles of arranging the biochip(s) in the first bag can also be extended to placing biochips in the first few bags that collect blood if different processing or analysis is desired for the biochip(s) in the separate bags. For example, biochips may be placed in the first two or more bags, with additional blood being collected in one or more additional bags after the first two or more bags have been sequentially disconnected or bypassed.

As shown in Fig. 2, in one embodiment, the screening capture device (10) is designed as a small box that contains an inlet (30), a biochip unit (15) (shown having two biochips (20) and (25)), and a funnel (35) with a filter (40) at the bottom. Fig. 2 is exemplary only and one skilled in the art would recognize various alternatives and improvements, which the present invention also encompasses. Blood will flow from the collection needle (100) through the collecting tube (150) and then through the chambers of the screening capture device (10), and out of the bottom of the screening capture device (10) (via the funnel (35)), into the blood bag (200). As an alternative, the screening capture device (10) may be directly connected to the collection needle (100) (for example, at a rear end thereof) so that the collected blood flows directly from the collection needle (100) to the screening capture device (10) before entering the collection duct, or tube, (150) for transmission to the blood bag (200).

Preferably, the screening capture device (10) is removably attached to the collection needle (100) or the collection duct (150) so that the screening capture device (10) can be removed for further processing after blood is collected. Furthermore, the screening capture device (10) is attached to the collection needle (100) or the collection duct (150) as close as possible to the blood donor so that blood flowing through the screening capture device (10) is as close as possible to a human body temperature (roughly 37 °C or 98.6 °F).

As shown in Fig. 2, preferably a first biochip (20) lays securely suspended in a plane parallel to and above a second biochip (25). Below the second biochip (25), is arranged a funnel (35) and a filter (40), preferably with pores around 100 to 200 microns, that allow blood to flow out of the screening capture device (10) into a collection duct (150) that is connected to the blood bag (200). As blood enters the

removable screening capture device (10), which is completely sealed prior to removal, it is forced to flow across the entire surface of first biochip (20). As the blood reaches the end of first biochip (20), it cascades down to the second biochip (25) and flows along the surface of the second biochip (25). After flowing along the surface of the second biochip (25), the blood then cascades down to the funnel (35) and filter (40), and then onto the collection duct (150) and the blood bag (200). One skilled in the art would recognize that the collection duct (150) is only provided so that the blood bag (200) may be located at a suitable position. Alternatively, the screening capture device (10) may be directly connected to the blood bag (200). The funnel (35) and the filter (40) are preferably encased in the lower portion of the screening capture device (10), which preferably is shaped as a box-shaped device. Anti-coagulants and other additives are provided in the blood bag (200), as is known to those skilled in the art. Additionally, conventional or known anti-backflow devices may be installed at several locations in the blood flow path that includes the collection needle (100), the screening capture device (10), the collection duct (150), and the blood bag (200).

The screening capture device (10) may be removed from the collection needle (100) or the collection duct (150) after blood collection from a donor has been completed. This can be accomplished, for example, by thermally sealing the inlet and the outlet of the screening capture device (10). The screening capture device (10) can then be removed for further processing and analysis of the biochips.

In addition to the "tandem" arrangement of the two biochips, the present invention also contemplates that more than two biochips may be arranged in tandem. Furthermore, in an alternate embodiment, the present invention contemplates that a single biochip, for example, a single "cylindrical" biochip may be used instead. In this cylindrical biochip embodiment, for example, one half of cylindrical biochip could be used for the NAT assay while the other half of the cylindrical biochip could be used for the immunoassay. The size and dimensions of the biochips should be designed to maximize contact between the blood sample and the surface of the biochip. When using a single biochip, a different (more harsh) elution is used for the nucleic acids tested while a less harsh elution is used for the antigens and antibodies

tested. One of the skill in the art would also recognize that while the embodiment discussed herein discloses the NAT assay biochip as the first biochip and the immunoassay biochip as the second biochip, the relative arrangement of the biochips are interchangeable.

5 The current apparatus used to collect blood typically yields a collection rate of about 450 ml, or one pint, per 10 minutes. To maintain this flow rate or a similar desired flow rate, the dimensions of the screening capture device (10) are designed so that it does not slow down the flow of blood. Thus, the screening capture device's (10) chambers through which the blood flows are designed to have a cross-sectional area
10 that is no smaller than that of the commonly used collection tube. In addition to this requirement, the height of the chambers should be minimized, and the surface area dimension corresponding to biochip surface area that contacts the blood should be maximized, to enhance the fraction of blood that contacts the biochips in the screening capture device (10). As one example, given an estimated radius of 2 mm
15 for the commonly used collection tube and a desired chamber height of 1 mm, calculations yield a proposed width of 2 cm and length of 2 cm for the biochips. Fig. 3 illustrates one example of the various dimensions of the components of the screening capture device (10) in order that the blood flow through the screening capture device (10) is no slower than the flow through the collection tubes (150) in
20 the absence of the screening capture device (10). One skilled in the art would recognize that various dimensions of the screening capture device (10) and its components can be determined based on the design principles disclosed herein and all such dimensions are considered to be a part of the present invention.

Capture Design

25 The purpose of the biochips (20), (25), in the screening capture device (10) is to capture target disease agents or components or metabolic molecules from the blood. For example, these target agents or components include viruses, cells, proteins, such as antibodies, antigens or other proteins that are indicative or specific for a disease agent, and other molecules that are indicative or specific for a disease agent or disease
30 condition, contained in the blood. Preferably, the biochips (20), (25) provide both a

qualitative and quantitative readout of the identity and level of target agents or components in the blood. In one embodiment, the first biochip is a NAT (nucleic acid amplification technique) system, while the second biochip (25) is an immunoassay chip. Therefore, the first biochip (20) will capture viruses or cells that contain at least one nucleic acid molecule or nucleic acid complex, associated with disease agents, *e.g.*, viral or bacterial nucleic acid molecules. The captured cells may possess a viral epitope on the cell surface or these cells may be of a type that are targeted by viruses and can be identified by a specific cell surface marker. The second biochip (25) will capture viruses, cells, proteins and/or viral/protein complexes and detect proteins, such as antibodies to specific target disease agents or components or specific target disease antigens that are recognized and bind to a corresponding antibody. Preferably, both the first and second biochips are medium- or low-density chips, each with space for the immobilization of several hundred analytes that function as potential binding moieties to the target agents and molecules. These analytes may be spotted onto the respective biochips by a robotic spotting device.

The first and second biochips described above may be combined into a single biochip capable of supporting an NAT and an immunoassay detection system.

In one embodiment, as shown in Fig. 4A, different analytes are spotted on microarray slides in a latitudinal linear fashion, in the direction of blood flow 20a, so that every analyte covers the entire length of the biochip (20), to maximize biochemical interaction or binding between the target agent or component of interest in the blood and the latitudinally arranged analyte microarray. Thus, one of the features of the present invention is that multiple spots are provided for detecting particular analytes so that even non-homogeneously distributed analytes may be detected. As shown in Fig. 4A, therefore, the respective probe elements of the analytes of interest are latitudinally, or linearly arranged on the biochip in the direction of blood flow 20a across the biochip (20). Preferably, the binding surface will be three-dimensional to increase binding capacity. For example, currently available three-dimensional biochips in gel format may be used, provided that the leaching is minimized. Therefore, the surface selected preferably is a three-dimensional solid surface that

provides more surface area and more binding capacity, with minimized leaching from the surface. Examples of such surfaces are plastic, silicon, rubber and resins. Commercially available Hypogel (Sigma-Aldrich Corp., St. Louis, MO) is one example of a three-dimensional binding surface, such as shown in Fig. 4B, and provides a three-dimensional matrix that enhances the space for conjugation/capture as well as increases the sensitivity. A glass chip with similar capabilities to the Hypogel may be designed to maximize the capture of disease agents, as shown in Figs. 4C and 4D. Fig. 4C shows a glass biochip with wells. The surface in the wells are rough with small protrusions to maximize surface area and binding capacity. Fig. 4D shows another embodiment of a glass biochip in which the entire surface of the biochip is rough with villi-like protrusions. The villi-like protrusions enhance the surface area for binding and form a mesh-like surface with sub-micron size spaces in-between. The material of the biochip should be selected to maximize the binding surface to increase binding capacity, without resulting in leaching of the bound target molecules to the surrounding bio-fluidic environment.

Fig. 5 discloses one example of a biochip (20) produced by Rockefeller University's Gene Array Resource Center that is designed for performing a NAT system assay that spots the analytes listed in box 22 in Fig. 5. The specific analytes disclosed in Fig. 5 include antibodies for capturing the antigen and nucleic acid complexes, while the only nucleic primers disclosed for NAT capture are from the NTR region for HCV and the LTR region for HIV.

To protect collected blood from contamination by analytes immobilized on the biochips (20), (25), the antigens coated on the second biochip (25) are preferably attached covalently. Also, with respect to the biochip material used as well as the material used for the remaining components of the screening capture device (10), surface considerations with respect to flow and contamination are considered to maximize the blood flow across the various surfaces of the screening capture device (10) while minimizing or preventing contamination of the blood flowing therethrough. Factors such as analyte array element density and purity, substrate attachment and biological activity of the material should be considered to conform to

the needs of a particular blood collection project and to ensure protection of the blood from alterations or adulteration. For example, Versalinx chemistry may be used to conjugate the proteins and the nucleic acids on the biochips, to minimize leaching of the analytes into the blood stream and into blood collected in the blood bag.

5 Versalinx is a chemical affinity tool made by Prolinx Company, Bothwell, WA. The Versalinx protein microarray technology is based on interaction of synthetic molecules that allow the formation of a stable complex to immobilize proteins, peptides and nucleic acids onto solid surfaces. Another solution to this problem, as discussed earlier, involves using a first bag or a diversion bag with the biochip(s) to
10 collect the initial flow of blood from a donor before the first bag is disconnected or bypassed, so that the blood can flow directly into a second or additional blood bags without flowing over the biochip.

As shown in Fig. 6, once blood collection is complete, the screening capture device (10) is removed from the blood collection apparatus, with its contents remaining
15 sealed from the environment. For example, the inlet of the screening capture device (10) is unscrewed (or otherwise detached) from the collection needle or duct through which the blood of the donor is received. Likewise, the outlet of the screening capture device (10) is then unscrewed or unattached from the collection duct (150) through which the blood flow to the blood bag (200). The inlet and outlet of the
20 screening capture device (10) may then be sealed so that it may be removed for further processing of the biochip. Sealing may be accomplished with a cap, plug, heat seal, weld or any other appropriate means. Of course, as discussed earlier, the invention also contemplates that a rapid assay mechanism may be provided in the screening capture device (10) itself so that the assay can be performed substantially
25 simultaneously or soon after the blood collection is performed.

Preferably, the screening capture device (10) itself is then disassembled carefully by robotics in a controlled environment, with a lid (11) of the screening capture device (10) being removed first. Preferably, an O-ring is released when the right pressure is applied to a bracket/clip that keeps the lid shut, and the lid is preferably slid off
30 horizontally. The biochips (20), (25) are then removed, preferably vertically, from

their support brackets, which hold them in position in the screening capture device (10). The removed biochips (20), (25) are then inserted into a biochip processing system that supports the next stages of the screening process, such as amplification of captured or bound nucleic acid molecules, antigen/antibody reactions of captured
5 binding partners, and detection of the target agents or molecules.

The machine that the biochips are transferred to, the biochip processor, preferably is a self-sealed disposable unit. As shown in Fig. 7A, this sealed "laboratory on a chip" platform diminishes the chance for human error and prevents contamination of surrounding environments, as well as infection of lab workers. The biochip processor
10 itself preferably contains two separate sections sealed from one another - one for processing a NAT biochip (I) and one for processing an immunoassay biochip (II), for running the NAT and immunoassays in parallel.

Figure 7B provides an alternate embodiment of the biochip processor in which biochips I and II from Figure 7A are combined into one biochip. In this embodiment
15 the biochip is processed so as to release target molecules for the immunoassay under gentle elution conditions, followed by the harsher elution conditions to release nucleic acid target molecules from the virions and/or cells for the NAT assay.

In each of Figures 7A and 7B, the NAT portion of the biochip processor unit supports nucleic acid amplification reactions and a microfluidic detection system, and can be
20 further adapted to other configurations to utilize other detection systems. The immunoassay portion of the unit supports antigen/antibody reactions with subsequent detection of target antigens or antibodies. The reagent(s) for each respective reaction are pumped into the two portions of the unit via connecting tubes as shown in Figure 8. These tubes are disconnected from the unit once the assays are performed, and the
25 unit is discarded. The reagents are stored in separate external bottles and can be kept through many uses. Biochip processors can be used as single testing units or can be run in parallel, allowing for many blood samples to be tested at once.

Amplification of nucleic acid sequences from Biochip I is a primary function of the NAT portion of the biochip processor unit. The self-contained machine in which the

biochips are placed also contains an immunoassay portion for processing Biochip II, through interaction or binding of antibody and antigen. The biochips are locked, for example, into a position with a narrow space underneath the binding surface of about 0.25 mm, through which the elution and lysing buffers remain in contact with the
5 biochip for a period of time and then pass through to a reservoir.

In the NAT system shown in Figs. 7A and 7B, the immobilized target agents, molecules, cells or other components of interest are eluted from the biochip and, if necessary, lysed in appropriate elution and lysing buffers, resulting in target nucleic acid(s) in solution which collects in reservoir B prior to flowing to the PCR and/or
10 RT-PCR chambers where amplification reactions occur. In one embodiment, PCR and RT-PCR are multiplexed, meaning that multiple primers and amplifiers are used to detect all eluted target nucleic acids or analytes. For example, from reservoir B, 50 μ l is pumped into the PCR reaction chamber and another 50 μ l is pumped into the RT-PCR reaction chamber. Standard PCR and RT-PCR reagents are present in the
15 miniature wells located above the reaction chambers, allowing the force of gravity to pull reagents into the reaction chamber through reaction channels. Procedures utilized in the NAT portion of the biochip processor are based on standard PCR assays that are normally performed in a test tube. Standard PCR and RT-PCR protocols and reagents are known to persons skilled in the art, such as those disclosed in Molecular
20 Cloning, A Laboratory Manual, 2nd Ed., Sambrook *et al.*, Chapter 14, Cold Spring Harbor Laboratory Press (1989), and in other scientific publications and manuals. The standard methods are easily adaptable for use in the NAT portion of the biochip processor. Particularly, the selection and amounts of the reagents and the assay conditions may be adapted from known PCR and RT-PCR methods.

25 In an alternate design, as shown in Fig. 7B, the biochips I and II are combined in one biochip processor. Instead of running the reagents for each biochip in parallel, they are run in sequence. Microprocessor controlled electronic valves may be used to control the flow of reagents and other solutions into the biochip processor so that the NAT assay and the immunoassay may be run sequentially.

As shown in Fig. 9, the reaction channels may have devices to prevent backflow of reagents. The limiting factor in this technology is enzyme reaction rate, and estimated amplification time is about 10 to 15 minutes. All reservoirs in the NAT system preferably are of the same volume, for example, about 200 μ l, to avoid overflow.

5 After reagents have mixed in the reservoirs, the mixture flows to separate amplification chambers surrounded by heating blocks for thermal cycling where for PCR and RT-PCR amplification occurs.

In certain embodiments shown in Figs. 9 and 10, once the amplification process is complete in the NAT portion of the system, a small volume of sample, approximately
10 5 μ l, enters a microfluidic device containing one or more microfluidic channels. The purpose of this microfluidic device is to detect whether a specific target nucleic acid is present in the blood utilizing the NAT screening system. The microfluidic channels contain capture molecules that are bound covalently to the interior walls of these channels. The channels can be made of any material that will allow covalent binding,
15 such as plastic, rubber or other suitable materials. Such microfluidic channels are available from Caliper Technologies Corp., Mountain View, CA or from Fluidigm Corporation, South San Francisco, CA. A sample flows through the chamber, whose walls contain poly dT extenders containing a detectable signal. The detection process involves hybridization of a target amplified nucleic acid sequence to matching
20 sequences fixed within the microfluidity chamber and detection of this hybridization by chemiluminescence/fluorescent signaling.

Attached to the extenders are fluorescently marked sequences with quenched signaling. As the sample flows through the chamber, the amplified sequences hybridize with these fixed sequences, releasing the suppressed signal. The signal
25 probes, each having a specific sequence designed to detect specific mutations, genotype and SNIPs, may be arrayed. Using such methods, the presence of a disease sequence can be detected, as well as point mutations based on the generation of signals. For an example of a nucleic acid sequence based amplification assay that utilizes quenched signaling, see Lanciotti and Kerst, J. Clinical Microbiology, pages
30 4506-13, (December 2001).

Also, by fixing variable chains in the chamber, different genotypes of each agent also are detectable. The principle behind heating the microfluidity chamber to an un-annealing temperature is to release the quenched fluorescent signal while allowing the NAT amplified sequences to complete hybridization to the sequences on the channel.

5 If the sample sequences are complementary to the sequences on the channel, then that prevents the original sequences from annealing back and generating the quenched signal again. Detection may be visualized by digital CCD imaging of the signals given off within the chambers. Such cameras are available from Hamamatsu or other suppliers of detecting equipment. The signals can also be quantitatively measured by

10 comparison with a standard or calibration signal.

The immunoassay portion of the biochip processing unit is employed to process Biochip #2, and uses an elution and neutralizing buffer solution to wash off the antibodies and antigens from Biochip #2. The antibody- or antigen-containing solution generated by elution is directed into two main reaction chambers - one for

15 antibody detection (see Figures 11A, 11B and 11 C) and one for antigen detection (see Figure 12). The reaction chambers, which are about 200 μ l in volume, are connected to reagent reservoirs positioned, for example, slightly above them via reaction ducts. The reagent for the antibody detection system contains antigens labeled with a signal amplification system, and the reagent for antigen detection

20 contains monoclonal antibodies also labeled with a signal amplification system. The sample is exposed, in the reaction chamber, to about 2-5 μ l of the reagents.

Immunocomplexes of Ag-Ab-Samp (Ag=antigen, Ab=antibody (including polyclonal and/or monoclonal antibodies), Samp=signal amplification) form in the chambers if target Ag and Ab are present in the sample. After completion of the interaction and

25 binding, the sample flows to separate microfluidic channels for detection.

The detection system used for antibody detection employs a capillary-like microfluidic channel heavily coated inside with monoclonal antibodies (mAbs), such as anti-human IgG mAb. These monoclonal antibodies recognize the Fc portion of the antibodies attached to the Ab-Ag-Samp. As for antigen detection, the microfluidic

30 channels are heavily coated with monoclonal antibodies, such as goat anti-mouse IgG

antibodies, that detect the antibody in the Ag-mAb-Samp immunocomplexes. For antigen detection, the signal amplification labeled monoclonal antibody is preferably from the rabbit species, such as that produced by Epitomics Corporation, South San Francisco, CA. The complexes, along with other random non-target antibodies
5 present in the sample, bind to the walls of the microfluidic channels. The channels are heavily coated, or coated in excess, with the desired monoclonal antibodies to avoid competition between non-target antibodies and target antibody complexes. Signal is only generated where immunocomplexes with target antibodies are bound. The entire channel can be viewed as a column with three major sections, as shown,
10 for example, in Figures 11A and 12. The distribution of signals along the top, middle, and bottom sections of the channel provide an estimate of the concentration of target antibodies in the sample, which can be viewed by a CCD snapshot (digital camera). Such cameras are available from Hamamatsu or other suppliers of detecting equipment. As described above, the signal can be quantitatively measured by
15 comparison to a standard or calibration signal.

With reference to Fig. 11A, as a first example of an antibody assay, the microfluidity channels are coated with recombinant antigen A. The reaction chamber has recombinant antigen B with signal amplification molecules attached to form an immunocomplex with antibodies of the analyte. When the signal amplification
20 molecules flow through the channel, the immunocomplex with specific signal amplification molecules attached will bind to the recombinant B antigen in the channel to generate a signal. This conjugated antigen-antibody from sample antigen in a solid phase sandwich assay configuration has proved to work for anti-HIV I/II assays.

25 As a second example of an antibody assay, as shown in Fig. 11B, the microfluidity channels may be coated with an anti-human IgG Fc antibody. The reaction chamber with labeled recombinant antigen to specific antibody to a signal amplification system will form immunocomplexes if the specific antibodies are present. When the immunocomplex with signal amplification molecules binds to the anti-human IgG Fc,

it generates a signal. This assay works well when the anti-human IgG Fc on the channel exists in sufficient quantity.

Figure 11C depicts yet another example of an antibody assay that may be used with the present invention. Instead of exposing the eluted target (disease) antibodies to a labeled antigen reagent, they are exposed to an anti-human IgG Fc antibody labeled with a signal amplification system. The formed antibody-antibody immunocomplexes are then passed through a microfluidic channel coated with an antigen specific to the target antibody. In the presence of the target antibody, a complex illustrated in Fig. 11C (Ag>captured Ab>anti-human IgG Fc with signal amplification) will form and the detection will be completed with signal amplification.

As one example for the antigen assay, shown in Fig. 12, the microfluidity channels are coated with a specific antibody to react to epitope "a" of analyte "A". In the meantime, within the reaction chamber has formed an immunocomplex of analyte A binding to another specific antibody that reacts to the epitope "b" on analyte A. The anti-epitope b antibody is conjugated to a signal amplification system. When the immunocomplex with the signal amplification molecules flows through the channel, the antibody that reacts to epitope "b" in the channel will bind with the epitope "a" on the immunocomplex to form a traditional sandwich immunoassay. The signal amplification system can be, for example, dextran sulfate or PEG molecules conjugated to nanocrystal molecules such as that provided by the Quantum Dot system.

Signal Amplification and Detection

As noted above, signal amplification may be necessary to detect target agents or molecules that are present at small quantities in blood. The inventive screening system, particularly the biochip processor, and screening methods are readily adaptable to such amplification.

In the case of nucleic acid targets, signal amplification can be accomplished by amplifying the target itself, using standard techniques, such as PCR. This is described above.

Alternatively, a signal itself may be amplified, which is particularly useful for detecting non-nucleic acid targets. For example, tyramide signal amplification (TSA) systems can enhance detection limits up to 100-fold with no loss in resolution, enabling users to see signals unobtainable by other methods. TSA, sometimes called
5 CARD, for Catalyzed Reporter Deposition — is an enzyme-mediated detection method that utilizes the catalytic activity of horseradish peroxidase (HRP) to generate high-density labeling of a target protein or nucleic acid. TSA kits are commercially available.

Another example of a signal amplification system useful for detecting non-nucleic
10 acid targets is described in Nam et al., Science, 301(5641): 1885-1886 (2003). This system employs a second antibody that recognizes a different epitope of targets than the capture antibody. The second antibody is conjugated to nanoparticles tagged with “bar code” DNA. The bar code DNA comprises numerous, perhaps thousands, of single-stranded DNA molecules having a known sequence. The bar code DNA can be
15 amplified using standard PCR techniques and detected as any other nucleic acid target.

Reference to the following non-limiting examples will provide a fuller understanding of the claimed invention.

Example 1

20 This example demonstrates the use of a biochip coated with antibody to capture corresponding antigen in blood and detection of the target antigen by mass spectroscopy.

A biochip (CIPHERGEN PS20 Protein chip) was covalently bound to a mouse monoclonal antibody against HIV P-24 core protein. The biochip then was placed in
25 a tube where 12 ml of human blood was circulated a flow rate of about 30 ml/min at 37 °C, to mimic the flow rate and temperature of a normal blood drawing. See Figure 13. HIV P-24 antigen was spiked in the blood at a concentration of 0-200 ng/ml. After 10 min of circulation, the chip was removed and the bound antigen was detected by mass spectroscopy (CIPHERGEN Protein Chip Reader).

The results showed that antigen can be detected at a concentration of about 8 ng/ml in a 12 ml blood sample. Figure 14 depicts a typical result.

Example 2

This example demonstrates the use of a biochip coated with antigen to capture
5 corresponding antibody in blood and detection of the target antibody by mass spectroscopy.

A biochip (CIPHERGEN PS20 Protein chip) was covalently bound to HIV P-24 core
protein. The biochip then was placed in a tube where 12 ml of human blood was
circulated at a flow rate of about 30 ml/min at 37 °C, to mimic the flow rate and
10 temperature of a normal blood drawing. Mouse monoclonal antibody against HIV P-24 was spiked in blood at a concentration of 0-20 ug/ml. After 10 min. of circulation, the chip was removed and the bound antibody was detected by mass spectroscopy (SELDI-MS from CIPHERGEN).

The results showed that antibody can be detected at a concentration of about 1 ug/ml
15 in a 12 ml blood sample. Figure 15 depicts a typical result.

Example 3

This example demonstrates the use of an antibody against viral surface protein to capture a virus in blood, followed by detection of viral nucleotides using a nucleic acid technology assay.

20 West Nile virus was captured by an Elisa assay. An Elisa plate was coated with West Nile Virus Monoclonal Antibody 3A3 (from BioReliance, Rockville, MD) as a capture antibody. Purified West Nile virus samples then were added. After incubation, a polyclonal antibody (rabbit anti mouse West Nile virus, from BioReliance, Rockville, MD) was added and incubated. The detection antibody was
25 goat anti rabbit antibody conjugated with HRP. Other anti-West Nile virus antibodies, such as mouse monoclonal antibody 3.91D, also have been shown to capture West Nile virus. See, e.g., Hunt et al., 2002.

Table 1 (below) summarizes results of the virus-capture procedure.

Table 1: Capture virus using monoclonal antibody.

1 Virus	2 Viral Antigen PreM-3	3 Vero Cell Supernatant	4 Sample diluent
1.100		0.295	0.208
0.554	0.118		0.054

- 5 The absorbance (O.D.) was much higher in the samples containing virus or viral envelop antigen, columns 1 and 2, respectively. The negative control, vero cell supernatant, column 3, gave an O.D. reading very similar to the assay buffer background, column 4.

The experiment was repeated using human serum containing different concentrations of the virus culture. West Nile virus culture in 1:50 or 1:100 dilution was spiked to normal human serum and incubated at 37C for 10, 30 and 60 min. Table 2 summarizes results using human serum.

Table 2: Capture virus in serum using monoclonal antibody.

	Sample Incubation Time		
	1Hr	30 min	10 min
	Signal	Signal	Signal
Normal human serum alone	0.599	0.601	1.000
1:50d	1.608	1.361	1.119
1:100d	1.017	0.766	1.168

15

The signals were higher in the presence of the virus than its absence, and displayed a time-dependent manner. Similar results were obtained when the virus was spiked in whole blood (data not shown).

Following capture of the West Nile virus with antibody, the virus was lysed and viral RNA detected and quantitated by Taqman PCR. See, *e.g.*, Shymala 2002, 2003(a) and 2003(b). Briefly, the captured viruses were suspended in 100 ul Taqman reagents

20

and transferred to Taqman microtiter plate for detection by Taqman PCR. The Taqman reaction mix in a final volume of 100 ul contained, 50 ul One-Step RT PCR mix (Applied Biosystems, Inc., Foster City, CA), 1 pmol each of the amplification primers, and 0.4 pmol of the probe. The reaction conditions included 30 min at 48 °C for the RT reaction, 10 min at 95 °C to activate the Taq enzyme followed by 50 cycles of 30 secs at 95 °C, alternating with 1 min at 60 °C in ABI 7900 Sequence Detector. Alternatively, the beads can be suspended in 100 ul of reaction mix containing 2 ul of Superscript III RT/Platinum Taq mix (Invitrogen Corporation, Carlsbad, CA), 50 ul of 2X Reaction mix, 4 mM MgSO₄, 2 ul of Rox, 1 pmol each of the amplification primers, 0.4 pmol of the probe. The reaction conditions include 15 min at 50 °C for the RT reaction, 2 min at 95 °C to activate the enzyme followed by 50 cycles of 30 sec at 95 °C, alternating with 1 min at 60 °C in ABI 7900 Sequence Detector. PCR amplification primers corresponding to conserved regions within capsid (VWNV1-VWNV3) were chosen for robust amplification and detection. They were:

15 VWNVA1-CCGGGCTGTCAATATGCTAAA (Sense Primer-nt129-149)
 VWNVA2-AGCCCTCTTCAGTCCAATCAAG (Anti-sense Primer-nt174-195)
 VWNVA3-xCGGAATGCCCCGCGTGTTGz (Probe-nt153-171).

20 Where X= 6-FMA, and Z = linker plus Tamra.
 (All numberings are as in GenBank deposit-AF196835)

An Internal control transcript of 750 nt, which is amplifiable by VWNAV1 and 2, but with an altered probe binding sequence and coupled to a different fluorophore, was used to detect PCR false negatives.

25 The publications and patent documents cited herein are incorporated in their entirety by reference, including the following:

Fortina, P. *et al.*, *European J. Human Genetics* 8:884-894 (2000).

Fortina, P. *et al.*, *Methods in Molecular Biology* 163:211-219 (2001).

Hunt, R. *et al.*, *J. Clin. Microbiology* 40(6): 2023-2030 (2002).

Yuen, P-K. *et al.*, *Genome Research* 11:405-412 (2001).

Petrick, J. *Vox Sanguinis* 80:1-11 (2001).

Gilles, P.N. *et al.*, *Nature Biotechnology* 17:365-370 (1999).

Davies, H. *et al.*, *Biotechnology* 27:1258-1261 (1999).

5 Carson, R.T. *et al.*, *J. Immunol. Methods* 227:41-52 (1999).

Okamoto, T. *et al.*, *Nature Biotechnology* 18:436-443 (2000).

Shyamala, V. *et al.*, *Transfusion*. 43, p.128 (2003). Detection and
Quantitation of West Nile Virus RNA by the Alternative NAT WNV Assay.
56th Annual AABB meeting, 56th Annual AABB meeting, 1st-4th November,
10 San Diego, CA.& XII APISBT 15th-18th November, New Delhi, India.
("Shyamala 2003(a)").

Shyamala, V. *et al.* (2003) Use of quantitative NAT assay to correlate West
Nile Virus titration bioassay (pfu/ml) with genomic copy numbers (geq/mL).
10th EPFA/NIBSC workshop & SoGAT meeting, 3rd -4th July, Langen,
15 Germany. ("Shyamala 2003(b)").

U.S. Prov. App. No. 60/480,431, filed June 20, 2003: V. Shyamala,
Identification of oligonucleotides for the capture, detection and quantitation of
West Nile Virus.

Other embodiments of the invention will be apparent to those skilled in the art from a
20 consideration of the specification and from the practice of the invention as disclosed
herein; the invention embraces such other embodiments. Thus, this specification is
exemplary only.

What is claimed is:

1. A screening capture device for in-line screening of blood collected from a donor using a collection needle connected by a collection duct to a collection bag, comprising:
an inlet for blood collected from the collection needle;
a biochip unit that captures target agents or molecules from the blood; and
an outlet that drains the blood from the screening capture device to the collection duct.
2. The screening capture device according to claim 1, wherein the inlet of the screening capture device is directly connected to a rear end of the collection needle.
3. The screening capture device according to claim 1, wherein the inlet of the screening capture device is connected, via a collection duct, proximate to the collection needle.
4. The screening capture device according to claim 3, wherein the inlet of the screening capture device is connected, via a collection duct, proximate to the collection needle so that the temperature of the blood in the screening capture device is approximately 37 °C.
5. The screening capture device according to claim 1, wherein the biochip unit comprises a first biochip and a second biochip that are sequentially arranged between the inlet and the outlet.
6. The screening capture device according to claim 1, wherein the first biochip and second biochip are arranged in a parallel stacked fashion.
7. The screening capture device according to claim 1, wherein the dimensions of the screening capture device are such that a flow rate of blood flowing through the screening capture device is equal to the flow rate of the collected blood in the absence of the screening capture device.

8. The screening capture device according to claim 1, wherein the dimensions of the screening capture device are such that the flow rate of blood flowing through the screening capture device is about 450 ml per 10 minutes.
9. The screening capture device according to claim 7, wherein the dimensions of the inlet, the outlet, a surface area of biochips in the biochip unit, and the screening capture device case are such that the collected blood maintains a constant flow rate through the screening capture device.
10. The screening capture device according to claim 1, wherein the target agent or molecule comprises at least one protein, nucleic acid molecule or molecule or fragment thereof indicative of or specific for a disease in a subject or an infectious agent.
11. The screening capture device according to claim 10, wherein the protein is an antibody or an antigen.
12. The screening capture device according to claim 5, wherein the first biochip is a nucleic acid amplification technique (NAT) biochip designed to run multiple tests on the first chip.
13. The screening capture device according to claim 12, wherein the first biochip captures at least one infectious organism or cell containing a targeted nucleic acid molecule.
14. The screening capture device according to claim 13, wherein the infectious organism is a virus, bacteria, fungi, protozoan, mycoplasma or prion and said cell is a cell from the donor of the blood sample.
15. The screening capture device according to claim 5, wherein the second biochip is an immunoassay chip designed to run multiple assays on the second biochip.
16. The screening capture device according to claim 15, wherein the second biochip captures targeted antigens and antibodies.

17. The screening capture device according to claim 5, wherein the first and second biochip are low density biochips.
18. The screening capture device according to claim 5, wherein the first and second biochips comprise microarrays in which the analytes that bind to the target agent or molecule, if present in the blood, are arranged along the length of the biochip in the direction of blood flow over the first and second biochips, respectively.
19. The screening capture device according to claim 16, wherein the first and second biochips comprise covalently attached analytes.
20. The screening capture device according to claim 1, wherein the outlet includes a funnel and a filter.
21. The screening capture device according to claim 1, further comprising an anti-backflow device that prevents the blood from flowing back towards the inlet.
22. The screening capture device according to claim 1, wherein the inlet and outlet are capable of being sealed when the screening capture device is removed from the collection needle and the collection duct.
23. The screening capture device according to claim 5, wherein the screening capture device comprises a lid that can be robotically removed to facilitate robotic removal of the first biochip and the second biochip.
24. A screening system for in-line screening of blood collected from a donor using a collection needle connected by a collection duct to a collection bag, comprising:
 - a screening capture device for in-line attachment between the collection needle and the collection duct, the screening capture device comprising:
 - an inlet for blood collected from the collection needle;
 - a biochip unit that captures target agents or molecules from the blood; and

- an outlet that drains the blood from the screening capture device to the collection duct; and
at least one biochip processor for detecting at least one captured target agent or molecule.
25. The screening system of claim 24, wherein said biochip process is capable of amplifying said target agent or molecule.
26. The screening system according to claim 24, wherein the biochip processor is a sealed disposable unit having a nucleic acid amplification technique (NAT) portion for processing a first biochip and an immunoassay portion for processing a second biochip.
27. The screening system according to claim 26, wherein said target molecule is a nucleic acid molecule and the NAT portion comprises:
a biochip holder;
at least one reservoir for holding a sample;
at least one amplification reaction chamber connected to the reservoir; and
at least one detection component connected to the amplification reaction chamber.
28. The screening system according to claim 27, wherein the NAT portion further comprises:
at least one reagent container connected to the reservoir; and
at least one reagent container connected to the reaction chamber.
29. The screening system according to claim 28, wherein the NAT portion further comprises:
the first biochip held in the biochip holder.
30. The screening system according to claim 29, wherein the first biochip is held such that a surface containing analytes is in contact with at least one elution and lysing buffer.

31. The screening system according to claim 28, wherein the detection component is at least one microfluidity chamber.
32. The screening system according to claim 24, comprising more than one biochip processors.
33. The screening system according to claim 26, wherein the target molecule is a target antibody or a target antigen and the immunoassay portion comprises:
 - a biochip holder;
 - at least one reservoir for holding a sample;
 - at least one reaction chamber connected to the reservoir; and
 - at least one detection component connected to the reaction chamber.
34. The screening system according to claim 33, wherein the immunoassay portion further comprises:
 - at least one reagent container connected to the reservoir; and
 - at least one reagent container connected to the reaction chamber.
35. The screening system according to claim 34, wherein the immunoassay portion further comprises:
 - the second biochip held in the biochip holder.
36. The screening system according to claim 35, wherein the second biochip is held such that the attached analytes are in contact with at least one buffer.
37. The screening system according to claim 33, wherein the detection component is at least one microfluidity chamber.
38. The screening system according to claim 33, comprising at least two reaction chambers, one for the detection of a target antibody and one for the detection of a target antigen.
39. The screening system according to claim 38, wherein each reaction chamber is connected to at least one detection component comprising is at least one microfluidity chamber.

40. A method of in-line screening of blood collected from a donor using a collection needle connected by a collection duct to a collection bag, comprising:
providing a screening capture device comprising: an inlet for blood collected from the collection needle, a biochip unit that captures a target agent or molecule from the blood, and an outlet that drains the blood from the screening capture device to the collection duct;
inserting the screening capture device between the collection needle and the collection duct proximate to the collection needle so that blood flowing through the screening capture device is approximately at a human body temperature; and
allowing blood to flow through said screening capture device.
41. The method of claim 40, further comprising the step of removing the screening capture device for further processing of the biochip unit.
42. The method according to claim 40, further comprising:
robotically opening the screening capture device to remove the biochip unit;
and
inserting the biochip unit into a biochip processor for processing of biochips in the biochip unit.
43. The method according to claim 42, wherein the biochip processor comprises a nucleic acid amplification technique (NAT) portion for processing a first biochip and an immunoassay portion for processing a second biochip.
44. The method according to claim 43, wherein said target molecule is a nucleic acid molecule and the NAT portion comprises:
a biochip holder comprising a first biochip;
at least one reservoir for holding a sample eluted from the first biochip;
at least one amplification reaction chamber connected to the reservoir; and
at least one detection component connected to the amplification reaction chamber.

45. The method according to claim 44, wherein the NAT portion further comprises:
at least one reagent container connected to the reservoir, wherein said method further comprises contacting the first biochip with at least one buffer from the reagent container that elutes and lyses the captured target agents and molecules from the first biochip to form a solution that collects in the reservoir.
46. The method according to claim 45, further comprising:
pumping the solution in the reservoir to the at least one amplification reaction chamber;
providing at least one additional reagent container that contains nucleic acid amplification reagents and allowing the reagents to flow into the amplification reaction chamber containing the solution;
providing sufficient conditions to amplify at least one nucleic acid molecule in the solution; and
detecting the presence of the amplified nucleic acid molecule in the detection component.
47. The method according to claim 46, wherein the detection component is at least one microfluidity chamber and detecting the presence of the amplified nucleic acid molecule by a nucleic acid hybridization method and the detection of a signal.
48. The method according to claim 42, further comprising utilizing more than one biochip processors in parallel.
49. The method according to claim 43, wherein said target molecule is an antibody or an antigen and the immunoassay portion comprises:
a biochip holder comprising a second biochip;
at least one reservoir for holding a sample eluted from the first biochip;
at least one reaction chamber connected to the reservoir; and
at least one detection component connected to the reaction chamber.

50. The method according to claim 49, wherein the immunoassay portion further comprises:
at least one reagent container connected to the reservoir, wherein said method further comprises contacting the second biochip with at least one buffer from the reagent container that elutes the captured target molecules from the second biochip to form a solution that collects in the reservoir.
51. The method according to claim 50, further comprising:
pumping the solution in the reservoir into the at least one reaction chamber;
providing at least one additional reagent container that contains a reagent comprising an antigen linked to a signal amplification system or an antibody linked to a signal amplification system and allowing the reagent to flow into the reaction chamber containing the solution;
providing sufficient conditions to allow binding of the reagent to a target antibody or antigen in the solution; and
detecting the presence of the target antibody or antigen in the detection component.
52. The method according to claim 51, wherein the detection component is at least one microfluidity chamber and detecting the presence of the signal by binding to an antibody immobilized on the wall of the chamber.
53. The method according to claim 49, further comprising utilizing more than one biochip processors in parallel.
54. The method according to claim 49, comprising at least two reactions chambers, one for the detection of a target antibody and one for the detection of a target antigen.
55. The method according to claim 54, wherein each reaction chamber is connected to at least one detection component comprising is at least one microfluidity chamber.

Diagram 1

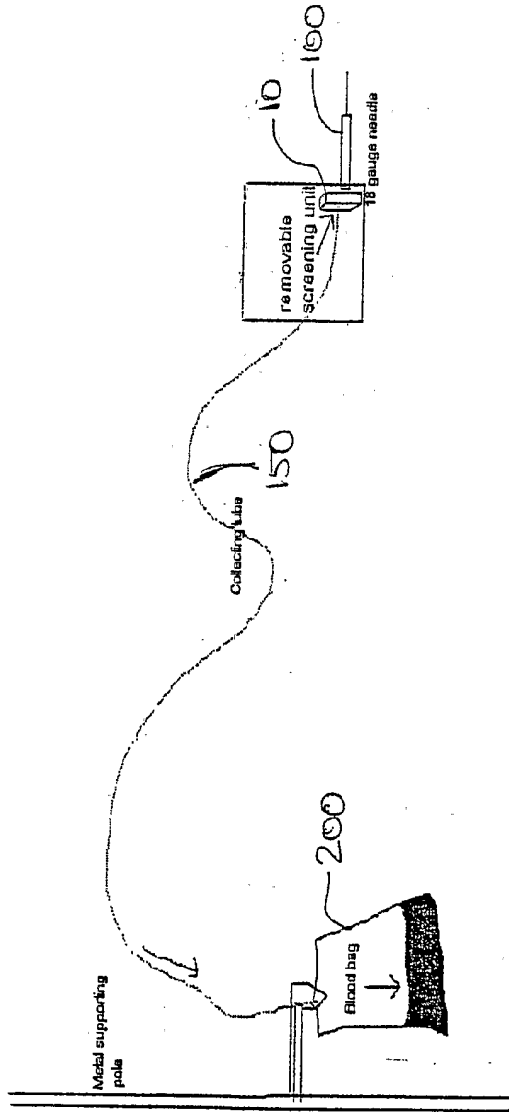
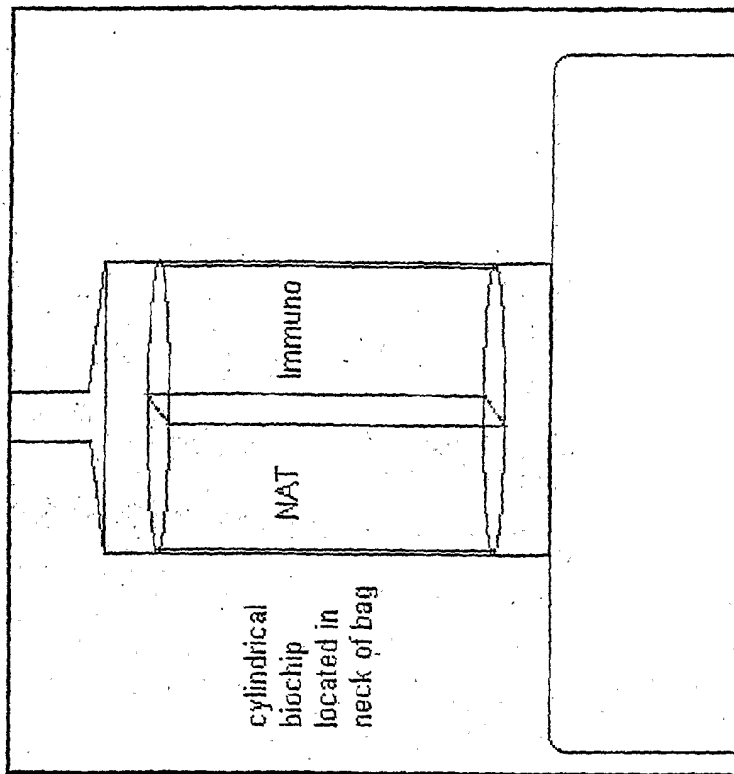
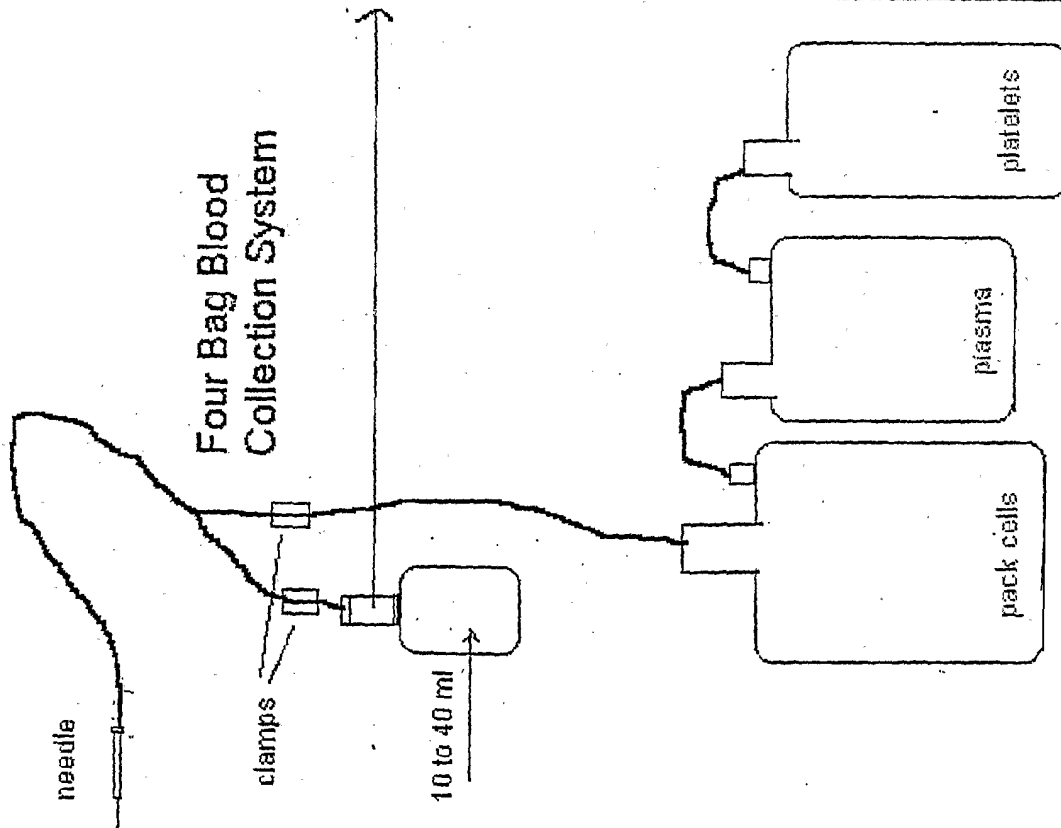

FIGURE 1A



Once collection of initial 10 to 40 ml is complete, the tube leading to that bag will be clamped and sealed off using a thermo sealer, while the clamp leading to the second bag will open. The bag with the biochip will then be put on a slow shaker to maximize contact of biochip with blood.

Diagram 2

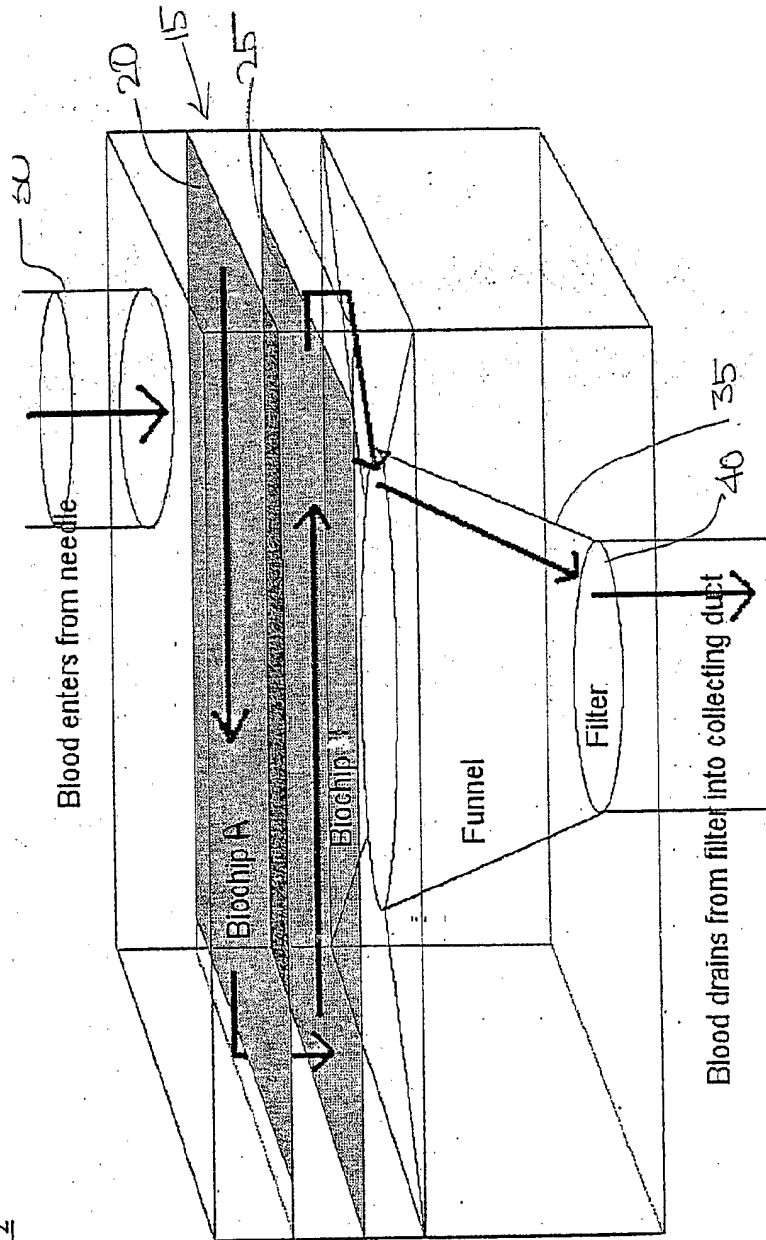

FIGURE 2

Diagram 3

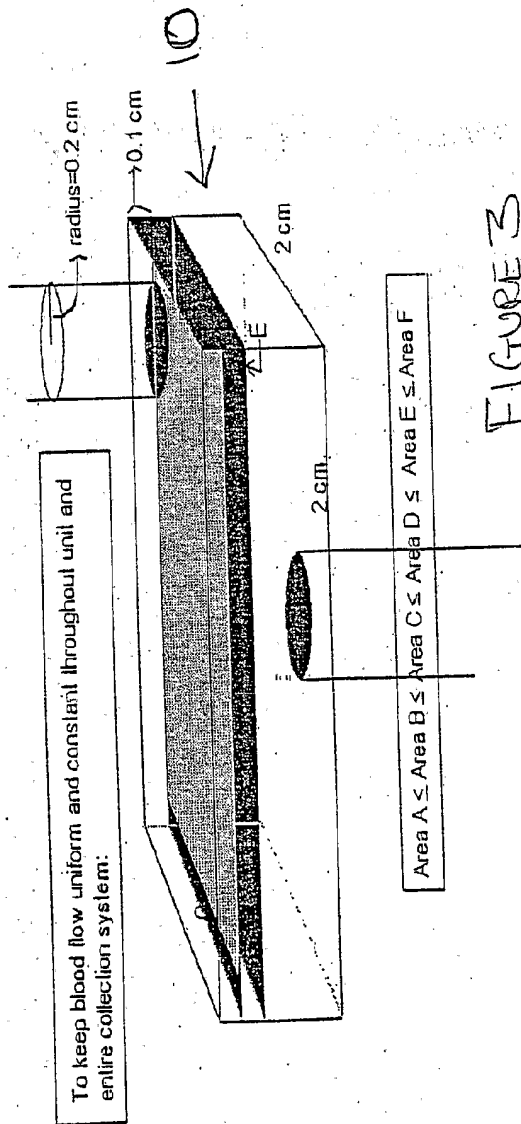
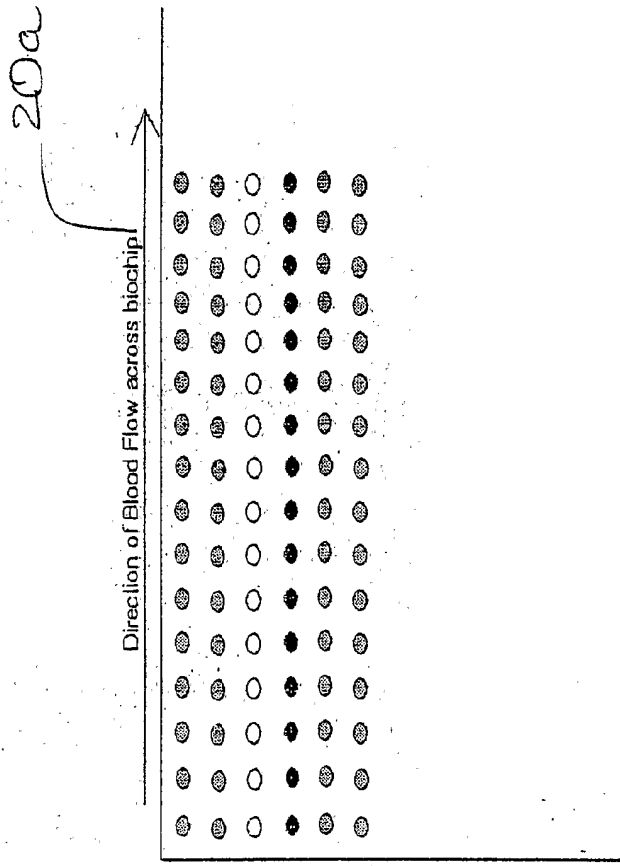

Diagram 4



- Analyte 1
 - Analyte 2
 - Analyte 3
 - Analyte 4
 - Etc.
 - Etc.
- 

FIGURE 4A

Hypogel technology - 3D matrix to enhance space for conjugation/capture, as well as sensitivity.....

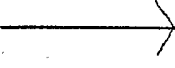
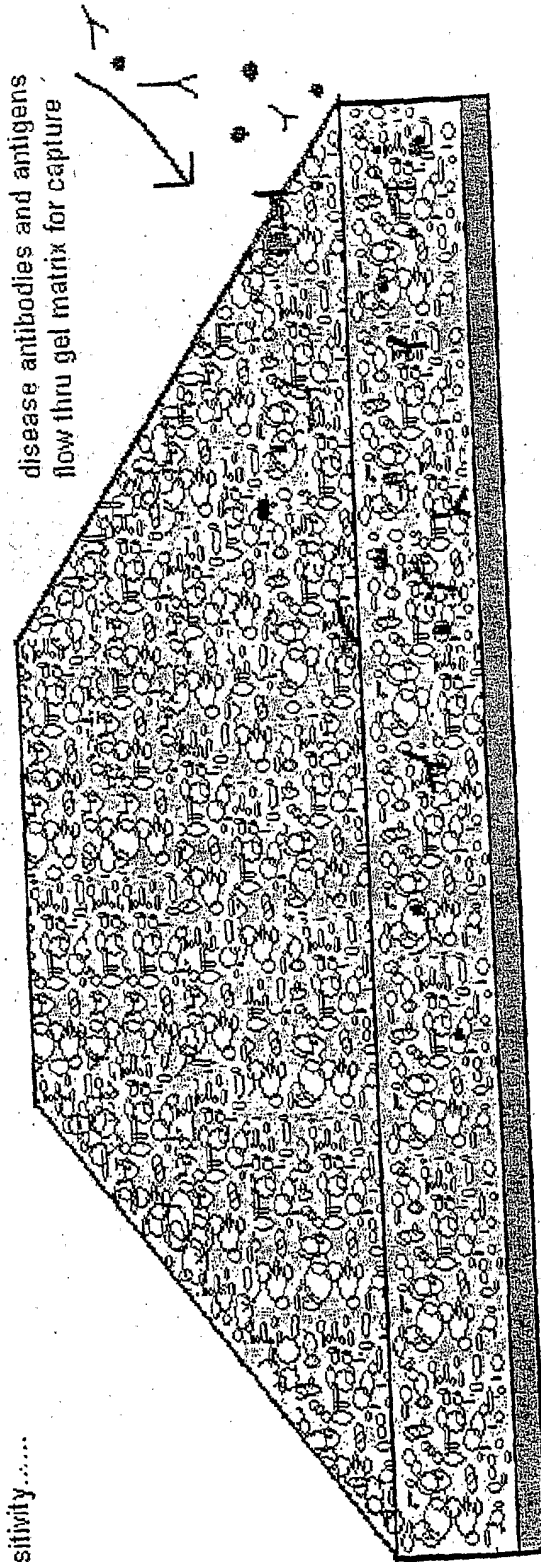

HypoGel® is a hydrophilic polystyrene gel-type resin. Based on a low crosslinked (1% DVB) polystyrene matrix, oligo ethylene glycols are grafted to form a high loaded hydrophilic resin. The reactive centers are located at the terminus of the glycol spacers. NMR measurements indicate high flexibility.

FIGURE 4B

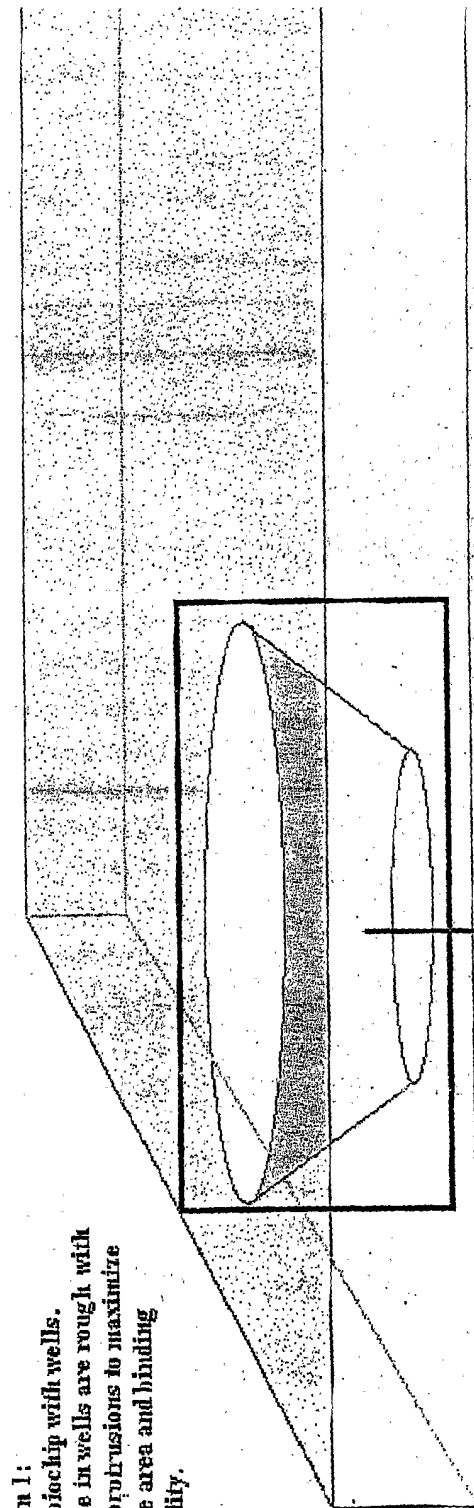

Version 1:
Glass biochip with wells.
Surface in wells are rough with
small protrusions to maximize
surface area and binding
capability.

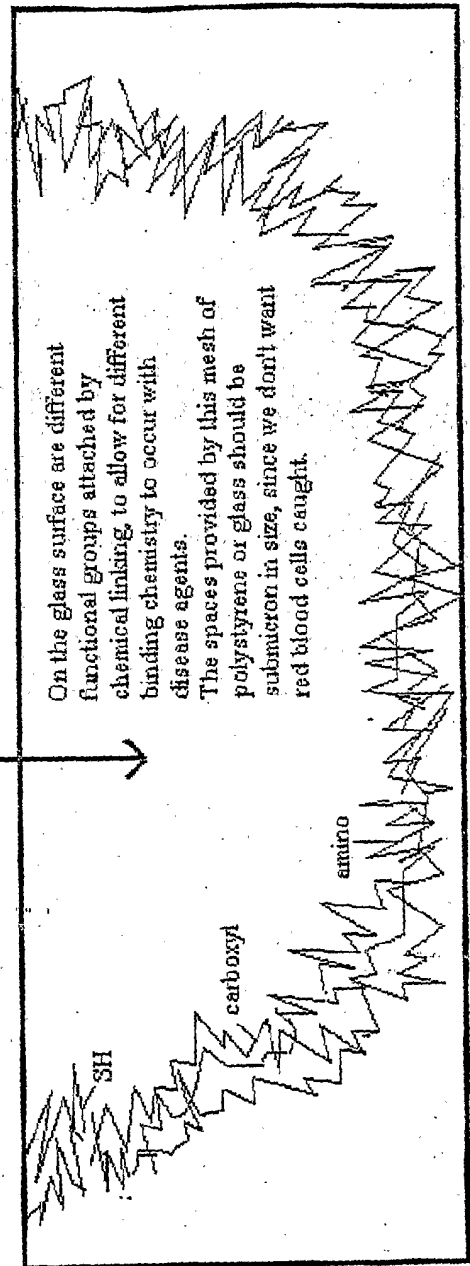

On the glass surface are different functional groups attached by chemical linking, to allow for different binding chemistry to occur with disease agents.
The spaces provided by this mesh of polystyrene or glass should be submicron in size, since we don't want red blood cells caught.

FIG. 4C

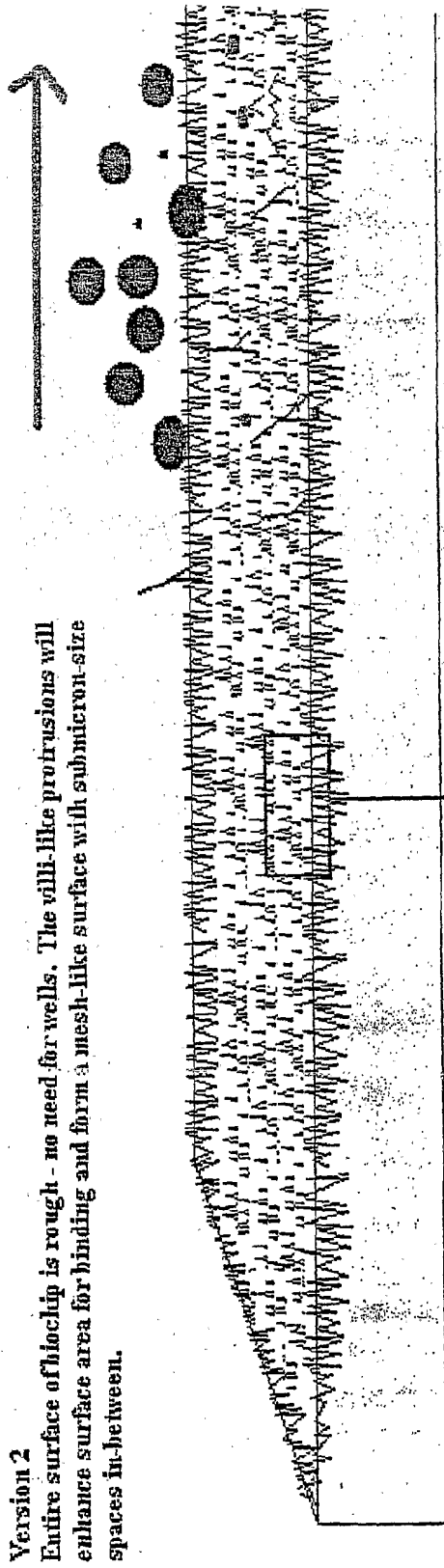

Version 2
 Entire surface of biochip is rough - no need for wells. The villi-like protrusions will enhance surface area for binding and form a mesh-like surface with submicron-size spaces in-between.

Red blood cells will flow pass these inlets, as they are of submicron size. Also, the varying functional groups will allow for different binding chemistry on the biochip.

Different functional groups will be bound by chemical linking to the glass or polystyrene surface.

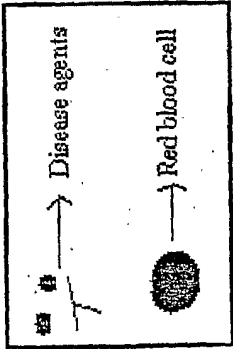
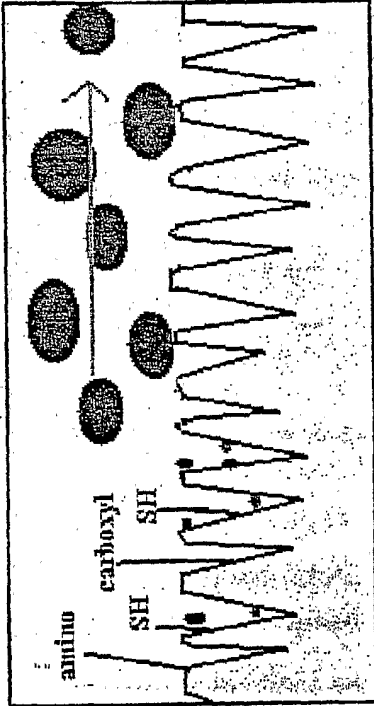
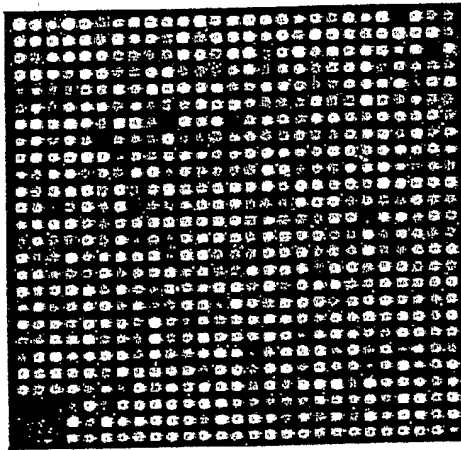

FIG. 4D.

Example of a biochip by Rockefeller University's Gene Array Resource Center (www.rockefeller.edu)



← 20

Analytes to be spotted on Biochip #1 (NAT)	
HCV:	mAb against core (C22) mAb against env E1E2 mAb against NS3, NS4, NS5
HIV:	mAb against GP120 mAb against P24 core mAb against P55 core mAb against P31
HBV:	mAb against core mAb against HBeAg mAb against HBsAg mAb against S1 and S2
Also, nucleic acids themselves will be spotted for hybridization: HCV: 5' and NTR; HIV: LTR region, pol gene region; HBV: preS1/2 and S region	

← 22

FIGURE 5

Diagram 5

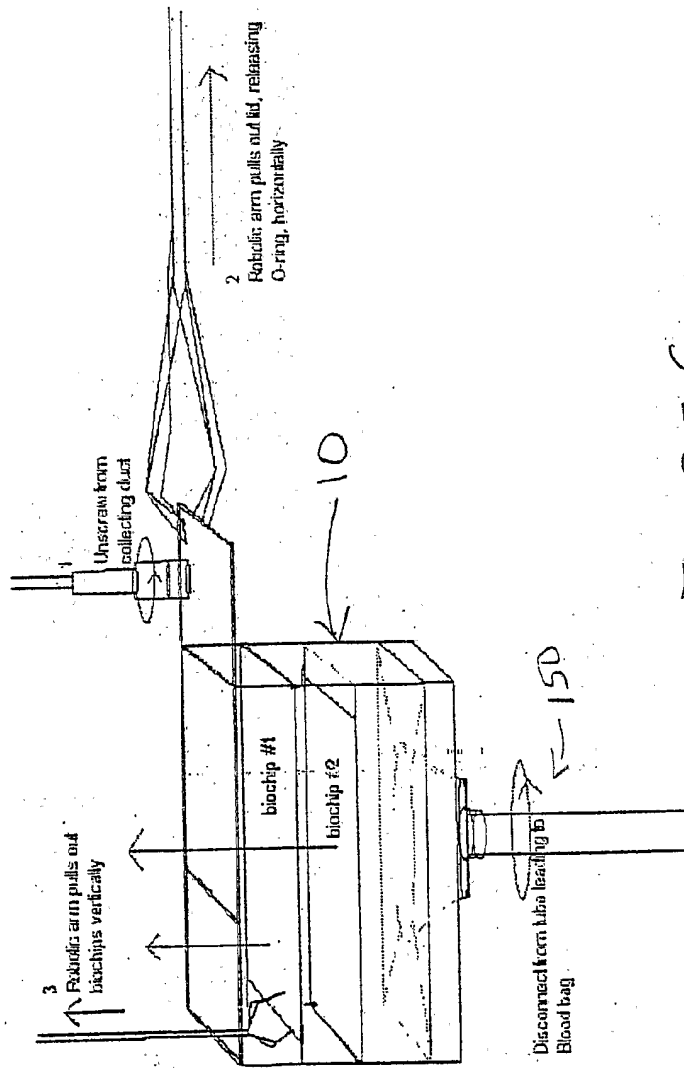

FIGURE 6

Diagram 6

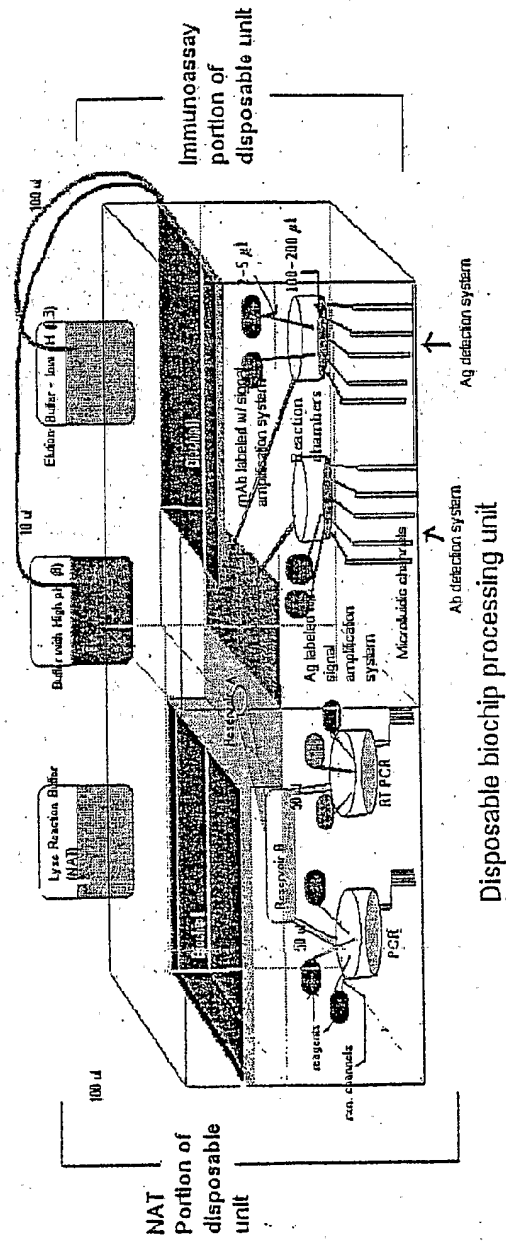

FIGURE 7A

Alternate design for disposable bioclip processor:

Chip I and Chip II are combined in one. Instead of running reagents for each in parallel, they will run in series, leading ultimately to two separate portions: NAT and Immunoassay.

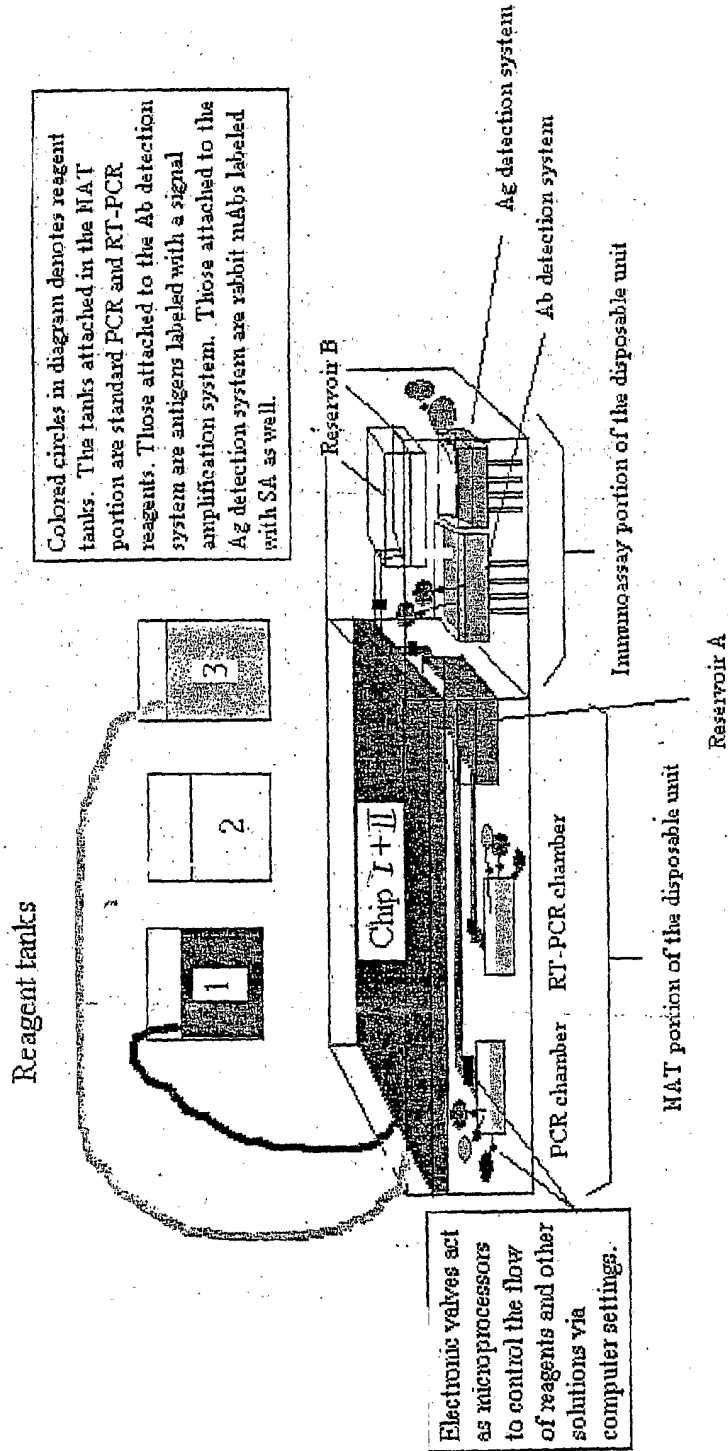
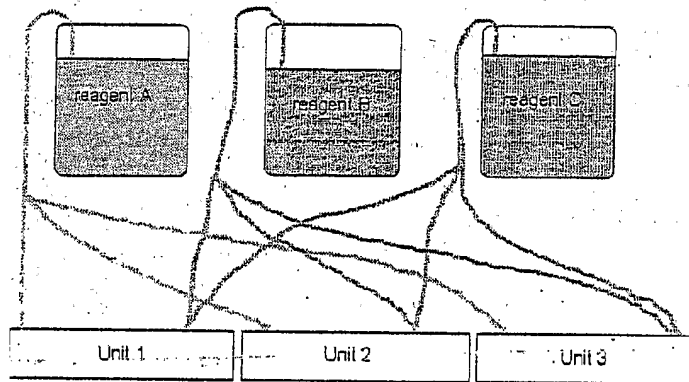

FIGURE 7B

Diagram 7



In theory, hundreds of these disposable units could be hooked up to the reagent dispensers and run in parallel.....

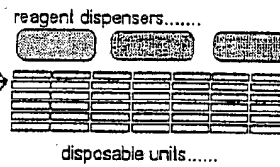

FIGURE 8

Diagram 8

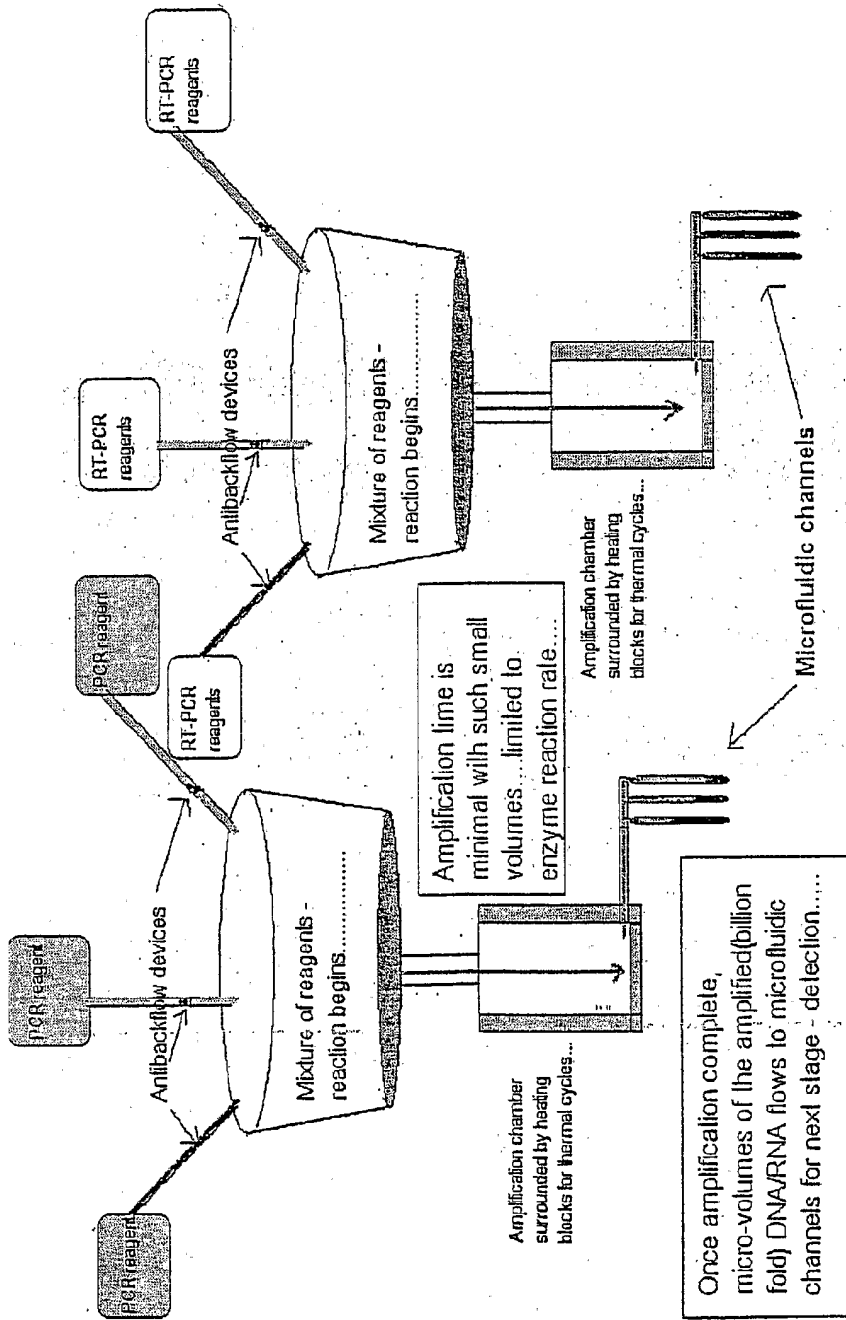

FIGURE 9

Diagram 9

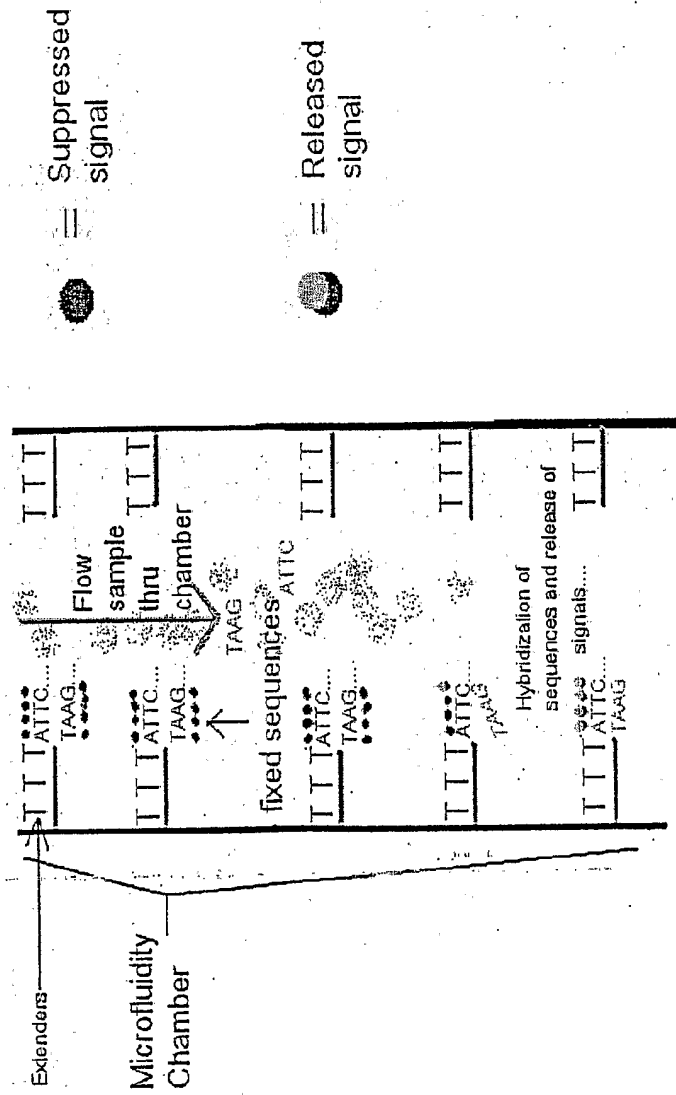

FIGURE 10

Antibody capture and detection.

Version 1

Concept:

Signal amplification system attached

Reagent reservoirs with recombinant Ag with signal amplification

Ag-Samp

Ag-Samp

Ag-Samp

Pump in 2-5 μ l of reagents

Expose the eluted sample to reagents

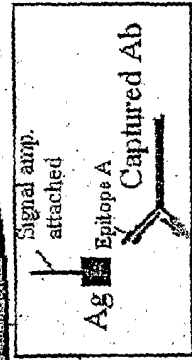

This immunocomplex forms in the reaction chamber if the target antibody is present in the sample.

Ag(2)

Captured Ab

Ag(1)

Biotin

5 μ l

Section 1

Section 2

Section 3

Microfluidicity channels

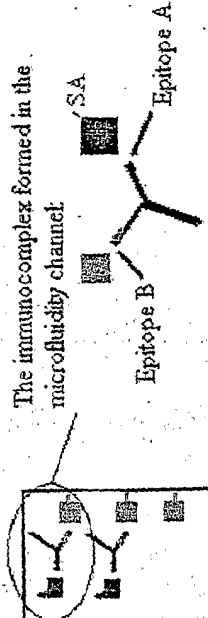

The inside of the microfluidicity channel is coated with recombinant antigen specific for epitope B of the captured antibody. Once the binding is complete, the signal amplification is turned on.

FIG. 11A

Antibody detection
Version 2

The eluted antibodies from the biochip will still be exposed to antigen reagents labeled with signal amplification systems to create an immunocomplex similar to that in Version 1. However.....

Instead of coating the microfluidity channels with recombinant antigen, we would coat them with an excess of anti-human IgG Fc specific for the captured antibody....the human IgG will recognize and bind to the Fc region of the captured antibody.

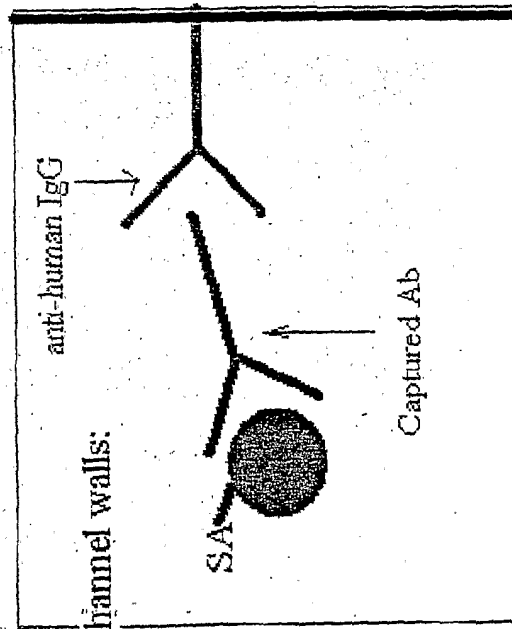

Immunocomplex formed on channel walls:

FIG. 11B

Antibody detection Version 3

Instead of exposing the eluted disease antibodies to a labeled antigen reagent, we will expose them to an anti-human IgG Fc antibody labeled with a signal amplification system. The formed antibody:antibody immunocomplex will then be passed through a microfluidic channel coated with antigen specific to the disease antibodies. In the presence of disease antibodies, the below complex will form and detection is completed via signal amplification.

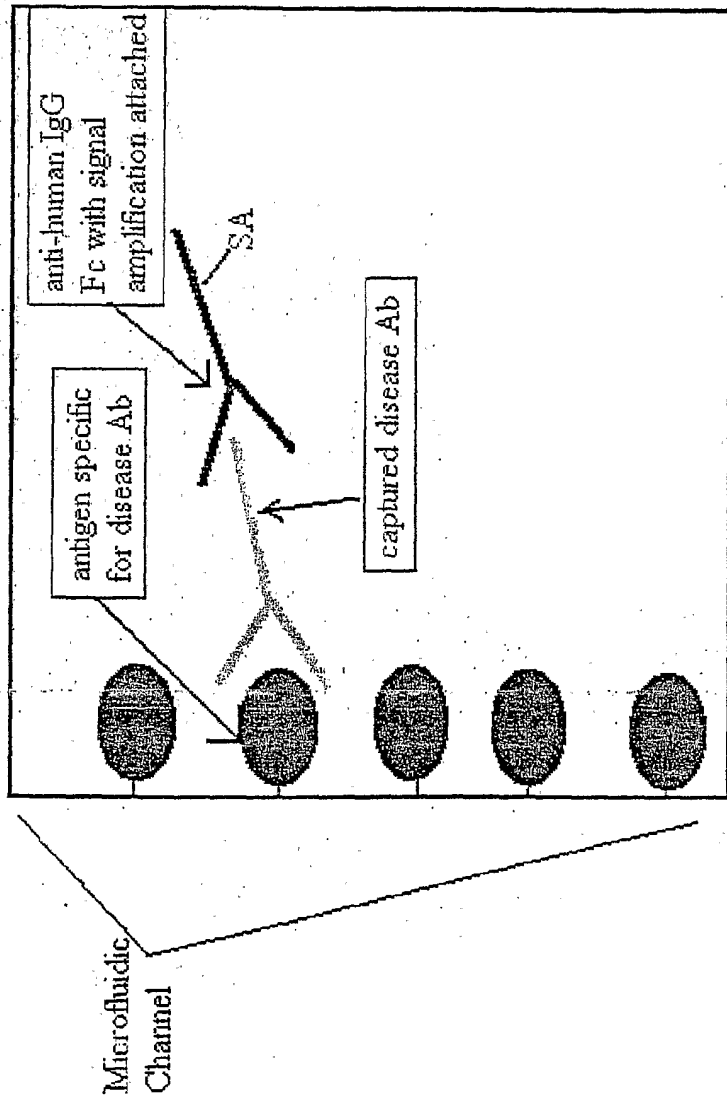
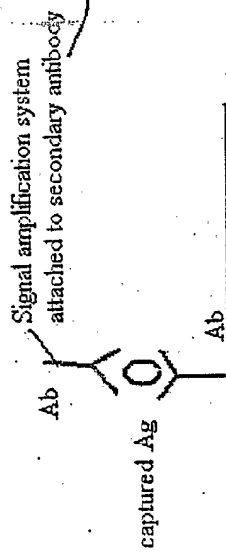

FIG. 11C

Antigen Capture and Detection:

Concept:



Reagent reservoirs with rabbit mAb with signal amplification

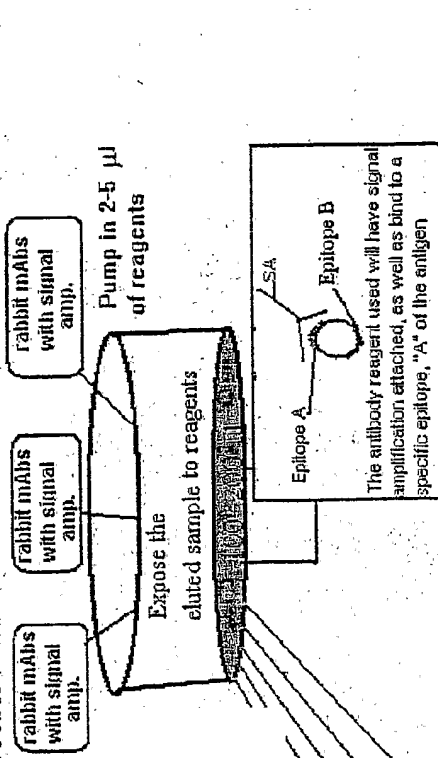

This immunocomplex forms in the reaction chamber if the target antibody is present in the sample.

Mouse mAbs specific to epitope B of the captured antigen are coated on the walls of the microfluidity channels. No false positives

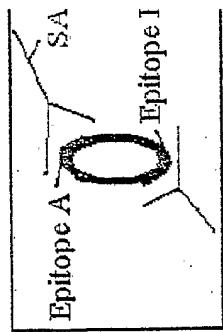

Immunocomplex formed in channel

5 μ l

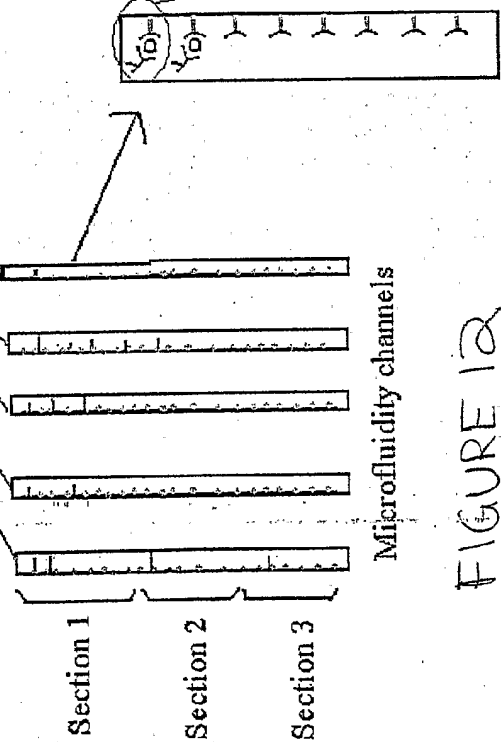

FIGURE 12

Figure 13: Apparatus for capturing blood pathogen when the blood is flown through:

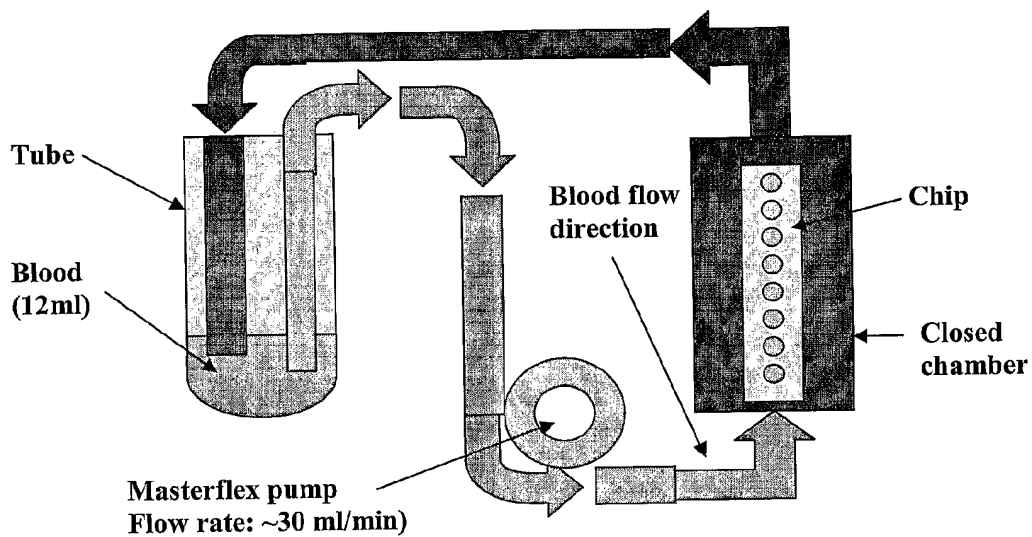

Figure 14: Capture antigen in blood.

In this example, the chip was coated by bovine IgG (A) or monoclonal antibody against HIV P-24 antigen (B). P-24 antigen was added to blood, and was captured by the chip that was coated by monoclonal antibody (B) as shown in the graph, but not by bovine IgG (A).

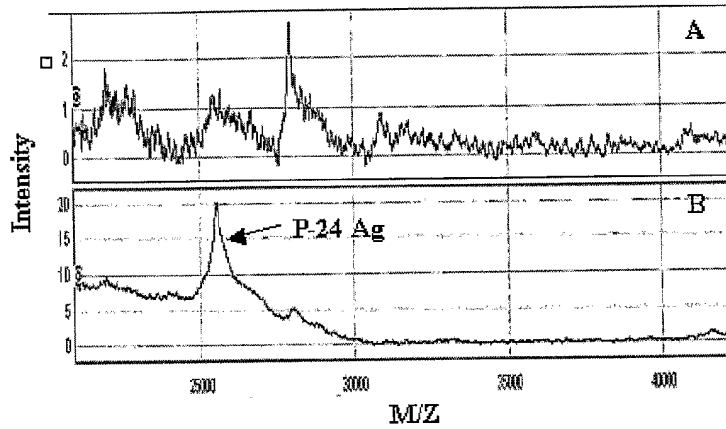

Figure 15: Capture antibody in blood.

In this example, the chip was coated by HIV gp120 envelop protein (A) or HIV P-24 core protein (B). Monoclonal antibody (MonoAb) against P-24 was added to blood, and was captured by the chip that was coated by P-24 antigen (B) as shown in the graph, but not by gp120 antigen (A).

