

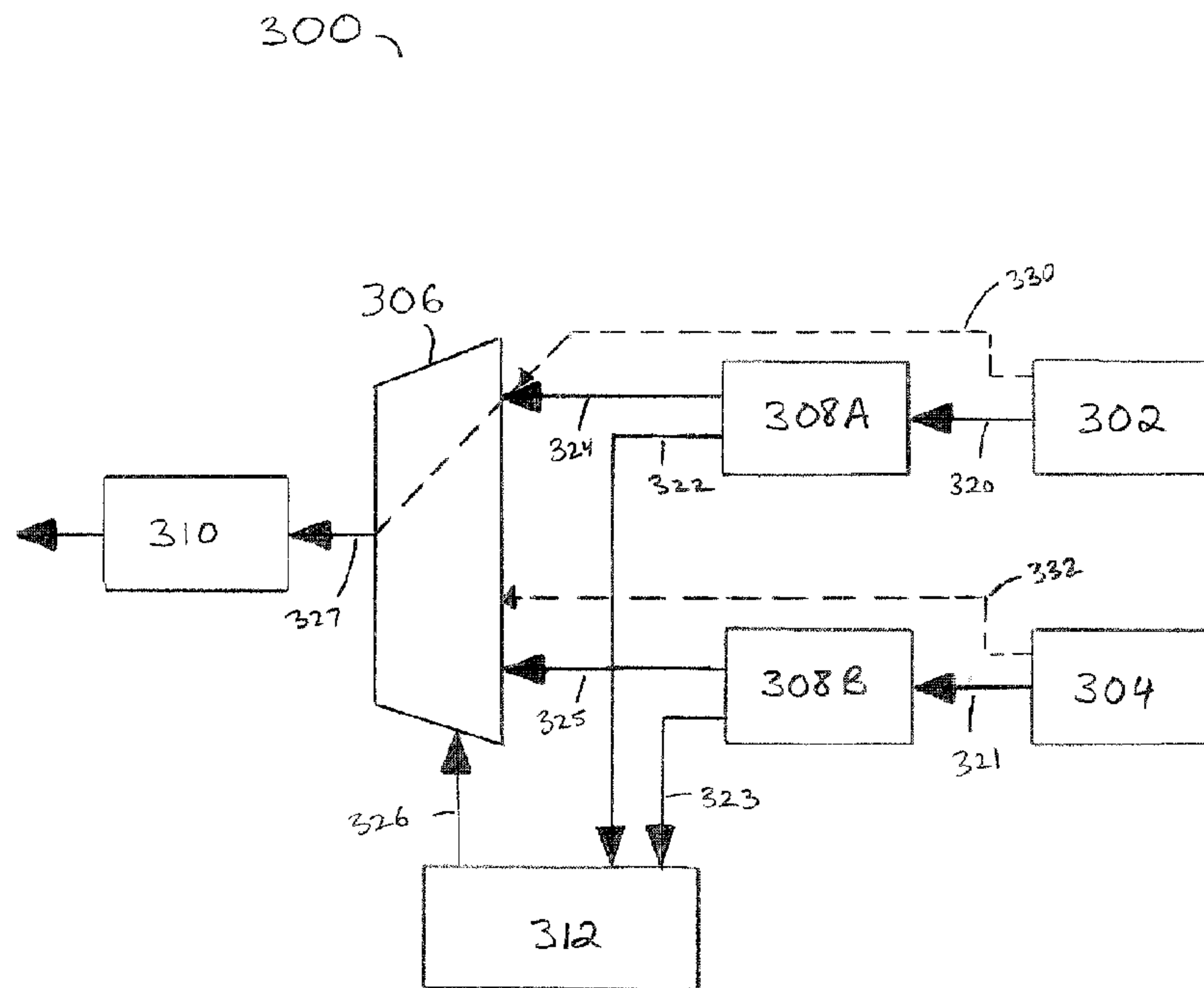

(22) Date de dépôt/Filing Date: 2001/09/27
(41) Mise à la disp. pub./Open to Public Insp.: 2003/03/27

(51) Cl.Int.⁷/Int.Cl.⁷ H04L 1/20, H04L 12/24, H04L 29/02
(71) Demandeur/Applicant:
ALCATEL CANADA INC., CA
(72) Inventeurs/Inventors:
CHOW, JOEY, CA;
COTE, JOE, CA
(74) Agent: BLAKE, CASSELS & GRAYDON LLP

(54) Titre : SYSTEME ET METHODE DE SELECTION DE SOURCES POUR ELEMENT DE RESEAU A SOURCES REDONDANTES
(54) Title: SYSTEM AND METHOD OF SELECTING SOURCES FOR A NETWORK ELEMENT HAVING REDUNDANT SOURCES



(57) Abrégé/Abstract:

A source selection system for a communication switch for selecting a primary datasource from a plurality of datasources is provided. The system includes a validation module associated with the plurality of datasources adapted to monitor each datasource of the plurality of datasources for transmission errors in output originating from each datasource and adapted to provide information relating to the transmission errors. The system also includes a source selector associated with the validation module and the plurality of datasources, the source selector adapted to select an output datasource from the plurality of datasources. The system further includes an assessment module associated with the validation module adapted to identify the primary datasource from the plurality of datasources utilizing the information provided by the validation module and adapted to cause the source selector to select the output datasource associated with the primary datasource.

ABSTRACT

A source selection system for a communication switch for selecting a primary datasource from a plurality of datasources is provided. The system includes a validation module associated with the plurality of datasources adapted to monitor each datasource of the plurality of
5 datasources for transmission errors in output originating from each datasource and adapted to provide information relating to the transmission errors. The system also includes a source selector associated with the validation module and the plurality of datasources, the source selector adapted to select an output datasource from the plurality of datasources. The system further includes an assessment module associated with the validation module adapted to identify
10 the primary datasource from the plurality of datasources utilizing the information provided by the validation module and adapted to cause the source selector to select the output datasource associated with the primary datasource.

15

**TITLE: SYSTEM AND METHOD OF SELECTING SOURCES FOR A NETWORK
ELEMENT HAVING REDUNDANT SOURCES**

FIELD OF THE INVENTION

The invention relates to a system and method of selecting a source in a communication device having redundant sources.

BACKGROUND OF INVENTION

Communications switch and router systems need to provide a low failure rate for
5 communication routing and transmission. Many systems use an architecture which provides
redundant communication capabilities to switch away from failures when they occur. A
common reliability measure is whether or not the system provides six 9's reliability, i.e. is
available 99.9999% of a given time period. This requires rapid fault detection and correction.

Prior art systems provide redundancy for a primary source element in a communication
10 switch. A validation module assesses the health of the primary source. When the validation
module determines that the health of the primary source has deteriorated below a defined
threshold, a switch is made to make the redundant source the primary source.

However prior art systems do not consider a scenario where the redundant source has a
relative health worse than the primary source. In that scenario, if a switch is made, the new
15 primary source provides worse service than the original primary source. Switching to a
redundant source in this case may result in unavailability of the communications device,
adversely affecting its reliability percentage.

There is a need for a system and method providing switching redundancy that improves upon the prior art systems.

SUMMARY OF INVENTION

In a first aspect, a source selection system for a communication switch for selecting a
5 primary datasource from a plurality of datasources is provided. The system includes a validation
module associated with the plurality of datasources adapted to monitor each datasource of the
plurality of datasources for transmission errors in output originating from each datasource and
adapted to provide information relating to the transmission errors. The system also includes a
source selector associated with the validation module and the plurality of datasources, the source
10 selector adapted to select an output datasource from the plurality of datasources. The system
further includes an assessment module associated with the validation module adapted to identify
the primary datasource from the plurality of datasources utilizing the information provided by
the validation module and adapted to cause the source selector to select the output datasource
associated with the primary datasource.

15 The validation module may include a plurality of validation sub-modules, each one of the
plurality of validation sub-modules associated with one of the plurality of datasources.

The validation module may perform an integrity check on data transmitted by each
datasource to provide information relating to transmission errors for each datasource.

The assessment module may evaluate severity of the transmission errors provided in the
20 information and cause the source selector to select the output datasource associated with the

primary datasource based on the severity of the transmission errors for each of the plurality of datasources.

The integrity check on the data may include a parity check and a cyclic redundancy check. The integrity check may be performed on a payload portion of the data. The integrity
5 check may be performed on a header portion of the data.

The communication switch may include a plurality of output cards and an input card, each one of the plurality of datasources originating from one of the plurality of output cards and the source selector operating at input to the input card. At least one of the output cards may include a component and the integrity check is performed upon the data being received by the
10 component in the at least one of the output cards of the communication switch. The source selector may be a multiplexer.

In a second aspect, a method of selecting a primary datasource from a plurality of datasources in a communication switch is provided. The method includes the step of receiving data from each datasource of the plurality of datasources. The method also includes the step of
15 monitoring each datasource for transmission errors originating in output from each datasource. The method further includes the step of identifying the primary datasource from the plurality of datasources utilizing information relating the transmission errors for each datasource.

In other aspects, the invention provides various combinations and subsets of the aspects described above.

BRIEF DESCRIPTION OF THE DRAWINGS

The foregoing and other aspects of the invention will become more apparent from the following description of specific embodiments thereof and the accompanying drawings which illustrate, by way of example only, the principles of the invention. In the drawings, where like
5 elements feature like reference numerals (and wherein individual elements bear unique alphabetical suffixes):

- Fig. 1A is a block diagram of components and connections of the routing switch of the embodiment of the invention;
- Fig. 1B is a block diagram of the redundant system of the I/O shelf of Figure 1A;
- 10 Fig. 2 is a block diagram of aspects of a routing switch embodying prior art;
- Fig. 3 is a block diagram of the aspects of the routing switch of an embodiment of the invention;
- Fig. 4 is a block diagram of the flow of cells between elements of an I/O shelf of the routing switch of Fig. 1A;
- 15 Fig. 5A is a table depicting the contents of a cell transmitted in the ingress direction between a framer and an Automatic Protection Source (APS) block in an I/O card in the I/O shelf of Fig. 4;
- Fig. 5B is a table depicting the contents of a cell transmitted in the ingress direction between an APS block in an I/O card and a Field Programmable
20 Gate Array (FPGA) in a line card in the I/O shelf of Fig. 4;

- Fig. 5C is a table depicting the contents of a cell transmitted in the ingress direction between a FPGA and an Application Specific Integrated Circuit (ASIC) in a line card in the I/O shelf of Fig. 4;
- 5 Fig. 5D is a table depicting the contents of a cell transmitted in the ingress direction between an ASIC and a FPGA in a line card in the I/O shelf of Fig. 4;
- Fig. 5E is a table depicting the contents of a cell transmitted in the ingress direction between a FPGA and an ASIC in a fabric interface card in the I/O shelf of Fig. 4;
- 10 Fig. 5F is a table depicting the contents of a cell transmitted in the ingress direction between a FPGA and an ASIC in a fabric interface card in the I/O shelf of Fig. 4;
- Fig. 5G is a table depicting the contents of a cell transmitted in the ingress direction between an ASIC in a fabric interface card in the I/O shelf and
15 the switching core of Fig. 4;
- Fig. 5H is a table depicting the contents of a cell transmitted in the egress direction between the switching core and an ASIC in a fabric interface card in the I/O shelf of Fig. 4;
- Fig. 5I is a table depicting the contents of a cell transmitted in the egress direction
20 between an ASIC in a fabric interface card and a FPGA in a line card in the I/O shelf of Fig. 4;

- Fig. 5J is a table depicting the contents of a cell transmitted in the egress direction between a FPGA and an ASIC in a line card and in the I/O shelf of Fig. 4;
- Fig. 5K is a table depicting the contents of a cell transmitted in the egress direction between an ASIC and a FPGA in a line card in the I/O shelf of Fig. 4;
- 5 Fig. 5L is a table depicting the contents of a cell transmitted in the egress direction between a FPGA in a line card and an APS block in an I/O card in the I/O shelf of Fig. 4; and
- Fig. 5M is a table depicting the contents of a cell transmitted in the egress direction between an APS block and a framer in an I/O card in the I/O shelf of Fig.
- 10 4.

DETAILED DESCRIPTION OF THE EMBODIMENTS

The description which follows, and the embodiments described therein, are provided by way of illustration of an example, or examples, of particular embodiments of the principles of the present invention. These examples are provided for the purposes of explanation, and not

15 limitation, of those principles and of the invention. In the description which follows, like parts are marked throughout the specification and the drawings with the same respective reference numerals.

1.0 Basic Features of System

Briefly, the system of the embodiment provides a means for assessing and selecting a

20 source between a primary source and a redundant source for a routing switch in a communication

network. The system evaluates the health of the primary source and the redundant source of the routing switch. From the evaluation, the system determines whether and when to switch the source between the primary source and the redundant source.

2.0 Prior Art

5 Referring to Fig. 2, system 200 is a prior art system which selects between a primary source 202 and a redundant source 204. System 200 comprises multiplexer 206, validation module 208 and processing block 210.

In normal operation, primary source 202 has been selected by a validation module 208 to provide its functionality to circuit 200. Accordingly, validation module 208 provides a control
10 signal to multiplexer 206 to ensure that the output of primary source 202 is provided to processing block 210, through validation block 208. As the output of primary source 202 is processed by validation block 208, the health of the data provided by primary source 202 is evaluated. If validation module 208 determines that the health of the data provided by primary source 202 has deteriorated below a predetermined threshold, then primary source 202 is no
15 longer viable as a source. Accordingly, validation module 208 switches the data source to redundant source 204. This is accomplished by providing an appropriate control signal to multiplexer 206 to cause the source of the data to be switched from primary source 202 to redundant source 204. Thereafter, data flows from redundant source 204 through multiplexer 206 through validation module 208 to processing block 210.

20 It will be appreciated that the prior art circuit 200 does not monitor the health of the redundant source.

3.0 System Architecture

The following is a description of part of a network associated with the routing switch associated with the embodiment.

Referring to Fig. 1, routing switch 100 is a multi-protocol backbone system, which can process both ATM cells and IP traffic through its same switching fabric. In the present embodiment, routing switch 100 allows scaling of the switching fabric capacity by the insertion of additional shelves and cards into the multishelf switch system.

Routing switch 100 is a multi-shelf switching system enabling a high degree of re-use of single shelf technologies. Routing switch 100 comprises a switching core 101 and I/O shelves 104A, 104B, 104C, ... 104O, (providing a total of 15 I/O shelves) and the various shelves and components in switch 100 communicate with each other through data links. Switching core 101 provides cell switching capacity for routing switch 100. I/O shelves 104 provide I/O for routing switch 100, allowing connection of devices, like customer premise equipment (CPEs) 102A, 102B, and 102C to routing switch 100.

Communication links enable switching core 101 and I/O shelf 104 to communicate data and status information with each other. High Speed Inter Shelf Links (HISL) 106 link switching core 101 with I/O shelves 104. Switching core 101 communicates with the rest of the fabric through High Speed Fabric Interface Cards (HFICs) 118 and Peripheral Fabric Interface Cards (PFICs) 132 and 134 on the I/O shelves 104.

A terminal (not shown) is connected to routing switch 100 and runs controlling software, which allows an operator to modify and control the operation of routing switch 100.

There are two types of I/O shelves 104. The first type is a High Speed Peripheral Shelf (HSPS), represented as I/O shelf 104A. I/O shelf 104A contains High Speed Line Processing Cards (HLPC) 120, I/O cards 122, HFICs 118 and two redundant High Speed Shelf Controller (HSC) cards 124. In the embodiment, I/O cards 122 are connected to HLPCs 120 and HLPCs 120 are connected to HFICs 118 using a midplane connection 136. In the embodiment, signals transmitted through midplane connections 136 use Low Voltage Differential Signalling (LVD signalling) which indicate binary signals by positive and negative voltage values about 0 volts.

The second type of I/O shelf contains I/O cards 128, Line Processing Cards (LPC) 130 and PFICs 132 or 134. The PFICs are either configured as Dual Fabric Interface Cards (DFIC), as shown in PFICs 132 of I/O shelf 104C, or Quad Fabric Interface Cards (QFIC), as shown in PFICs 134 of I/O shelf 104B. I/O shelves 104B and 104C also have two shelf controllers 126 each. In the embodiment, I/O cards 128 are connected to LPCs 130 and LPCs 130 are connected to PFICs 132 or 134 using a midplane connection 136.

Routing switch 100 incorporates the redundancy scheme of the embodiment. As can be seen from Figure 1A, I/O shelves 104B and 104C provide for 1+1 redundancy for I/O cards 128, LPCs 130, PFICs 132 and PFICs 134. Referring to Figure 1B, the redundancy scheme of I/O shelf 104A is illustrated in greater detail. In the embodiment, redundancy is provided between pairs of adjacent slots 140 in I/O shelf 104A. As mentioned previously, I/O cards 122A and 122B are connected to both HLPCs 120A and 120B using midplane connections 136. HLPCs 120A and 120B are also connected to both HFICs 118A and 118B using midplane connections 136. I/O shelf 104A provides 1+1 redundancy for I/O cards 122, HLPCs 120 and HFICs 118 by this cross-connection of cards.

In the ingress direction (shown by arrow 190), I/O card 122A provides data to HLPC 120A, shown by arrow 160, and to HLPC 120B, shown by arrow 162. Similarly, I/O card 122B provides data to HLPC 120A, shown by arrow 164, and to HLPC 120B, shown by arrow 166. Data arrives from I/O cards 122A and 122B at circuit 150A in HLPC 120A. Similarly, data arrives from I/O cards 122A and 122B at circuit 150B in HLPC 120B. Circuit 150 in the active HLPC 120 chooses which of I/O cards 122A and 122B is the primary source and provides its functionality to active HLPC 120. The non-selected I/O card 122 is the redundant source. Active HLPC 120 processes data from the chosen active I/O card 122. Circuit 150 in the inactive HLPC 120, as the redundant HLPC 120, also chooses active I/O card 122 and processes data from that card.

After processing, HLPC 120A provides data to HFIC 118A, shown by arrow 170, and to HFIC 120B, shown by arrow 172. Similarly, HLPC 120B provides data to HFIC 118A, shown by arrow 174, and to HFIC 120B, shown by arrow 176. Data arrives from HLPCs 120A and 120B at circuit 148A in HFIC 118A. Similarly, data arrives from HLPCs 120A and 120B at circuit 148B in HFIC 118A. Circuit 148 in the active HFIC 120 chooses which of HLPCs 120A and 120B is the primary source and provides its functionality to active HFIC 118. The non-selected HLPC 120 is the redundant source. Active HFIC 118 processes data from the chosen active HLPC 120. Circuit 148 in the inactive HFIC 118, as the redundant HFIC 118, also chooses active HLPC 120 and processes data from that card.

In a similar manner, in the egress direction (shown by arrow 192), circuits 152 in I/O cards 122 choose the primary source from HLPCs 120A and 120B and circuits 154 in HLPCs 120 choose the primary source from HFICs 118A and 118B.

Although illustrated in relation to a high speed peripheral shelf, I/O shelf 104A, it will be appreciated that I/O shelves 104B and 104C operate with a similar redundancy scheme.

It will be appreciated that terms such as “routing switch”, “communication switch”, “communication device”, “switch”, “network element” and other terms known in the art may be used to describe routing switch 100. Further, while the embodiment is described for routing switch 100, it will be appreciated that the system and method described herein may be adapted to any switching system.

Referring to Figure 3, an embodiment in circuit 300 addresses deficiencies in the prior art. Circuit 300 comprises primary source 302, redundant source 304, multiplexer 306, validation module 308A, validation module 308B, processing block 310, assessment module 312 and links 320-327.

Herein, circuit 300 has a dedicated validation module 308A for primary source 302 and a dedicated validation module 308B for redundant source 304. Link 320 connects primary source 302 with validation module 308A and link 321 connects redundant source 304 with validation module 308B. Accordingly, data provided by primary source 302 is continually evaluated by validation module 308A. Similarly, data provided by redundant source 304 is continually evaluated by validation module 308B. It will be appreciated that a single validation module may monitor both primary source 302 and redundant source 304. In such a situation, validation modules 308A and 308B are validation sub-modules of the single validation module.

In this embodiment, validation modules 308A and 308B have continuous and up-to-date status on the respective health of primary source 302 and redundant source 304.

In order to assess the results of each validation module 308A and 308B, reports regarding the output from validation modules 308A and 308B are sent to assessment module 312 through links 322 and 323 respectively. Accordingly, the reports are processed by assessment module 312 to select the source having the better health. It will be appreciated that the switching may be done as soon as it is determined that the health of the redundant source is better than the primary source. Other switching triggers may also be used in other embodiments. In the embodiment, validation modules 308A and 308B provide data from primary source 302 and redundant source 304 to multiplexer 306 through links 324 and 325 respectively. Once assessment module 312 selects the source with the better health, it provides an appropriate control signal through link 326 to multiplexer 306 to select the better source. Accordingly, data from the better source is allowed to flow through multiplexer 306 and is provided to processing module 310 by link 327. In the illustrated example, the validation reports from validation module 308A and 308B have been assessed by assessment module 312 and assessment module 312 has determined that primary source 302 is the better source. Accordingly, assessment module 312 provides control signals to multiplexer 306 to allow the data from primary source 302 to flow through multiplexer 306.

An alternative embodiment is illustrated in Figure 3 using links 330 and 332. In the alternative embodiment, data from primary source 302 and redundant source 304 flows directly to multiplexer 306. Data does not flow from primary source 302 and redundant source 304 through validation modules 308A and 308B and links 324 and 325 to arrive at multiplexer 306. Other aspects of circuit 300 are as described above.

Routing switch 100 encompasses the source selection scheme of circuit 300 of Figure 3 at several points as data, in the ingress direction, is transmitted from CPEs 102 to I/O cards 122, to HLPCs 120 and to HFICs 118. A similar set of tests are performed in the egress direction.

First, referring to Figure 4, a layout of elements of I/O shelf 104A of routing switch 100 is provided. I/O shelf 104A has I/O cards 122A and 122B, HLPCs 120A and 120B and HFICs 118A and 118B connected to provide 1+1 redundancy as is shown in Figure 1B. Active I/O card 122A, HLPC 120A and HFIC 118A, are shown connected in the foreground with their respective sub-elements. Inactive I/O card 122B, HLPC 120B and HFIC 118B are shown in the background. Data flow to active I/O card 122A, HLPC 120A and HFIC 118A is indicated by solid-head arrows while data flow to inactive I/O card 122B, HLPC 120B and HFIC 118B is indicated by hollow-head arrows. I/O cards 122A and 122B comprise framer 402, Automatic Protection Source (APS) blocks 404 and 426, serializer 450 and deserializer 457. HLPCs 120A and 120B comprise Field Programmable Gate Arrays (FPGAs) 406, 410, 420 and 424, ASICs 408 and 422, serializers 452 and 456 and deserializers 451 and 455. HFICs 118A and 118B comprise FPGA 412, ASIC 414, serializer 454 and deserializer 453.

In the ingress direction, as indicated by arrow 442, data from CPEs 102 is transmitted to both active and inactive I/O cards 122A and 122B over optical connections. It is known that optical connections and interfaces where electrical signals are converted to optical signals are points at which errors may be introduced into the datastream. Accordingly, these errors need to be identified and processed. Framer 402 on active I/O card 122A receives and extracts the cells from the datastream. The data then flows from framer 402 to APS block 404.

APS block 404 then sends the data to serializer 450 which converts the data into electronic signals for LVD signalling. The converted data is sent to both active and inactive HLPCs 120A and 120B through midplane connections 136. Similarly, APS block 404 on inactive I/O card 122B also sends the data to a serializer 450. The datastream leaves I/O cards 5 122A and 122B over signals carried through midplane connection 136 and is transmitted to both active and inactive HLPCs 120A and 120B. The data arrives at deserializer 451 in both active and inactive HLPCs 120A and 120B. Deserializer 451 converts the data back into its original parallel format and sends it to FPGA 406. In the embodiment, FPGA 406 comprises four separate cards to enhance capacity of FPGA resources. Four connections are used between other 10 components in Figure 4 to enhance capacity of the connections between components. It will be appreciated that the conversion and transmission of LVD signalling by serializer 450 and deserializer 451 is another point where errors can be introduced into the datastream. FPGAs 406 are programmed to encompass the functionality of multiplexer 306 and validation modules 308A and 308B of Figure 3. FPGAs 406 in HLPC 120A and 120B communicate with assessment 15 module 312 to select I/O card 122A or 122B as the primary source based on the detection of errors in the data which are reported to validation modules 308A and 308B.

Next, data from the selected primary source, I/O card 122A, is transmitted from FPGA 406 to ASIC 408 and then to FPGA 410. FPGA 410 on active HLPC 120A sends the data to serializer 452 which converts the data for LVD signalling. The converted datastream is 20 transmitted from serializer 452 over midplane connection 136 to active and inactive HFICs 118A and 118B. Similarly, FPGA 410 on inactive HLPC 120B sends the data to a serializer 452 and the serialized data is sent to active and inactive HFICs 118A and 118B.

At HFICs 118A and 118B, the serialized data is received by a deserializer 453 which converts the data back to its original parallel format for use by HFICs 118A and 118B. As with the interface between I/O cards 122A and 122B and HLPCs 120A and 120B, it will be appreciated that this is another point where errors can be introduced into the datastream. The data is then sent to FPGAs 412 in HFICs 118A and 118B. FPGAs 412 are also programmed to encompass the functionality of multiplexer 306 and validation modules 308A and 308B of Figure 3. FPGAs 412 in HFICs 118A and 118B communicate with assessment module 312 which selects HLPC 120A or 120B as the primary source based on the detection of errors in the data which are reported to validation modules 308A and 308B. Finally, data from the selected primary source, HLPC 120A, is provided to ASIC 414. ASIC 414 converts the data into an optical signal format suitable for engaging the optical transmission devices (not shown) to send the data over an optical connection to switching core 101.

Similarly, in the egress direction as indicated by arrow 444, validation is performed at several stages in the data path. Switching core 101 sends data over an optical connection to active HFIC 118A and inactive HFIC 118B. As with the optical connections from CPEs 102, the conversion of the datastream from electrical values to optical signals and transmission of the optical signals over fibre may introduce errors into the datastream. The data from switching core 101 arrives at ASIC 414 in HFICs 118A and 118B. The data is then sent to serializer 454 which converts the electrical signals to LVD signalling. The converted data is sent to a deserializer 455 in both active HLPC 120A and inactive HLPC 120B over midplane connections 136.

Deserializer 455 converts the data back to its original parallel format at appropriate electrical values for HLPCs 120A and 120B and sends it to FPGA 420. As before, this is another point where errors can be introduced into the datastream. FPGAs 420, in communication with

assessment module 312, choose HFIC 118A or 118B to be the primary source based on the detection of errors in the data which are reported to validation modules 308A and 308B. The data is transmitted from the selected primary source, HFIC 118A, to ASIC 422 and then to FPGA 424.

5 FPGA 424 on both active HLPC 120A and inactive HLPC 120B transmit the data to a serializer 456 to convert the data into LVD signalling. The converted data is transmitted from serializer 456 over midplane connections 136 to deserializer 457 in both active and inactive I/O cards 122A and 122B. At I/O cards 122A and 122B, deserializer 457 converts the data back to its original parallel format and sends it to APS block 426. The conversion point again provides
10 another point where errors can be introduced into the datastream. APS blocks 426 on I/O cards 122A and 122B, in communication with assessment module 312, choose HLPC 120A or 120B as the primary source based on the detection of errors in the data which are reported to validation modules 308A and 308B. APS block 426 then transmits data from the selected primary source, HLPC 120A, to framer 402. Framer 402 then encapsulates the cells into a SONET datastream
15 for transmission onto the optical medium.

Although the embodiment is illustrated in relation to a high speed peripheral shelf, I/O shelf 104A, it will be appreciated that I/O shelves 104B and 104C choose between active and inactive I/O cards 128, LPCs 130 and PFICs 132 and 134 in a manner employing a similar source selection scheme shown in circuit 300 of Figure 3.

20 In the embodiment, as both the primary and redundant data sources are providing their respective validated datastreams to the selection module, when the selection module performs a switch from one datasource to another, the datastream from the new source is almost instantly

available, subject to processing delays for effecting the switchover. Accordingly, when a redundant datasource provides its datastream to the selection module, until that datastream is required, the selection module simply discards or overwrites its buffers and registers receiving the redundant datastream.

5 In addition to the places mentioned above in Figure 4 where errors may be introduced, errors may occur inside of and between elements of I/O cards 122, HLPCs 120 and HFICs 118. Errors may be introduced because of shorts and opens on printed circuit board tracks, cold solder joints, damaged devices and EMC interference. In transmission of data between and within I/O cards 122A and 122B, HLPCs 120A and 120B and HFICs 118A and 118B, a number of checks
10 are performed by the modules on the contents of the cells of the data. These checks are used to evaluate the validity of the data received by each respective element. The embodiment utilizes cyclic redundancy checks (CRCs) and modified CRCs. As data is transmitted from one location to another, a CRC can be used to detect errors that have been introduced into a block of data. In the embodiment, at a data check point, a module sending the data calculates the CRC number for
15 a block of data and inserts the value into the header corresponding to the cell associated with the data. The module which receives the cell then checks the CRC value against the data received.

 In a CRC calculation, the bits of a binary block of data represent coefficients of a binary polynomial. The sender multiplies the binary polynomial representing the block of data by x^k , k the degree of the generator polynomial, and divides the result by the generator polynomial. The
20 remainder polynomial of this division has a degree smaller than the generator polynomial (degree of remainder polynomial $< k$). The number of bits required to represent the remainder polynomial is equal to the degree of the generator polynomial since one bit is required for each

coefficient from degree $k - 1$ to degree zero (0) in the remainder polynomial. The sender appends a binary number representing coefficients of the remainder polynomial to the block of data transmitted to be checked by the receiver. The receiver receives the binary block of data with the appended binary number and divides its representative binary polynomial by the generator polynomial. A non-zero result indicates at least one error in the block of data introduced between the sender and the receiver.

A CRC calculation is used in the embodiment for the data and header portions of cells in the datastream. They include Data Check (DCHK) and Header Error Check (HEC). Each is described in turn followed by a description of their application in the embodiment. It will be appreciated that other methods of checking the integrity of the header information and payload information of a cell may be used other than the DCHK and HEC CRCs described below.

DCHK is a CRC performed over the payload portion of the cell to detect corruption of the payload in the cell. Errors in data in a cell, indicated by DCHK errors, do not necessarily warrant the cell to be discarded as higher layer protocols may be able to identify and correct the errors. DCHK is generated and checked at a number of points in I/O cards 122A and 122B, HLPCs 120A and 120B and HFICs 118A and 118B, described later. The embodiment uses the generator polynomial x^4+x+1 , representing prime number 19 (2^4+2^1+1), for DCHK requiring four (4) bits to store the binary number representing the DCHK remainder polynomial.

DCHK-8 is a more complex form of CRC which uses an 8th degree generator polynomial and can detect errors introduced by 8B/10B encoding. Accordingly, 8B/10B transmission protocols, e.g. Ethernet, used in the switch may be monitored by the embodiment. The embodiment uses the polynomial x^8+x^2+x+1 , representing prime number 263 ($2^8+2^2+2^1+1$), for

DCHK-8 testing requiring eight (8) bits to store the binary number representing the DCHK-8 remainder polynomial.

HEC is a CRC performed over the cell header. HEC is generated and checked at a number of points in I/O cards 122A and 122B, HLPCs 120A and 120B and HFICs 118A and 5 118B, described later. The number of bytes that HEC covers changes as the headers change and must be recalculated each time any field in the header or the size of the header changes. HEC errors indicate potential errors in routing information within the header and, as a result, these cells are discarded. The embodiment uses the polynomial x^8+x^2+x+1 for HEC testing requiring eight (8) bits to store the binary number representing the HEC remainder polynomial.

10 In the ingress direction, indicated by arrow 442, framer 402 outputs cell 500 at position 430 in Figure 4 with a format as shown in Figure 5A. APS block 404 receives cell 500 and generates a DCHK at point 460 of Figure 4. The DCHK is calculated over payload portion 550A of cell 500 of Figure 5A. DCHK is written to cell 500. Figure 5B shows the format of cell 500 output from APS block 404 at position 432 of Figure 4 with the binary number representing the 15 DCHK remainder polynomial in location 502. DCHK requires four (4) bits of cell 500 to store its remainder polynomial given that its generator polynomial has degree four (4). FPGA 406 checks DCHK of location 502 at point 462 of Figure 4. FPGA 406 checks the DCHK by dividing the representative polynomial of DCHK in location 502 appended onto payload portion 550B by the generator polynomial of the DCHK. A non-zero remainder indicates that at least 20 one error has been introduced into payload portion 550B of cell 500 in Figure 5B.

FPGA 406 generates a DCHK and a HEC at point 464 of Figure 4. HEC is calculated over header portion 552B of cell 500 of Figure 5B while DCHK is calculated over payload

portion 550B of Figure 5B. DCHK and HEC are written to cell 500. Figure 5C shows the format of cell 500 exiting FPGA 406 at position 434 of Figure 4 with DCHK in location 504 and HEC in location 506. HEC requires eight (8) bits of cell 500 to store its remainder polynomial given that its generator polynomial has degree eight (8). ASIC 408 checks the DCHK at point 466 of Figure 4 in a similar manner as described earlier. ASIC 408 checks the HEC by dividing the representative polynomial of HEC in location 504 appended onto header portion 552C by the generator polynomial of the HEC. A non-zero remainder indicates that at least one error has been introduced into header portion 552C of cell 500 in Figure 5C.

ASIC 408 generates a DCHK over payload portion 550C and a HEC over header portion 552C of Figure 5C at point 468 of Figure 4. DCHK and HEC are written to cell 500. Figure 5D shows the format of cell 500 exiting ASIC 408 at position 436 of Figure 4 with DCHK in location 508 and HEC in location 510. FPGA 410 checks the DCHK and HEC at point 470 of Figure 4 in a similar manner as described earlier.

FPGA 410 generates a HEC over header portion 552D of Figure 5D at point 472 of Figure 4. HEC is written to cell 500. The previously generated DCHK remains in cell 500. FPGA 412 checks the DCHK and HEC at point 474 of Figure 4 in a similar manner as described earlier.

FPGA 412 generates a DCHK over the payload portion and a HEC over the header portion of the cell it received from serializer 453 at point 476 of Figure 4. DCHK and HEC are written to cell 500. Figure 5E shows the format of cell 500 for ATM Unicast exiting FPGA 412 at position 438 of Figure 4 with DCHK in location 512 and HEC in location 514. Figure 5F shows the format of cell 500 for ATM Multicast exiting FPGA 412 at position 438 of Figure 4

with DCHK in location 516 and HEC in location 518. ASIC 414 checks the DCHK and HEC at point 478 of Figure 4 in a similar manner as described earlier.

For ATM Unicast, ASIC 414 generates a DCHK-8 over payload portion 550E and a HEC over header portion 552E of cell 500 of Figure 5E at point 480 of Figure 4. For ATM Multicast, ASIC 414 generates a DCHK-8 over payload portion 550F and a HEC over header portion 552F of cell 500 of Figure 5F at point 480 of Figure 4. DCHK and a HEC are written to cell 500. Figure 5G shows the format of cell 500 exiting ASIC 414 at position 440 of Figure 4. Switching core 101 checks the DCHK-8 and HEC generated by ASIC 414 of Figure 4 in a similar manner as described earlier.

10 In the egress direction, indicated by arrow 444, Figure 5H shows the format of cell 530 exiting switching core 101 at position 440 of Figure 4. ASIC 414 checks the DCHK-8 and HEC generated by switching core 101 at point 482 of Figure 4 in a similar manner as described earlier.

ASIC 414 generates a DCHK and a HEC at point 484 of Figure 4. HEC is calculated over header portion 556H of cell 530 while DCHK is calculated over payload portion 554H of cell 530 of Figure 5H. HEC and DCHK are written to cell 530. Figure 5I shows the format of cell 530 exiting ASIC 414 at position 438 of Figure 4 with DCHK in location 532 and HEC in location 534. FPGA 420 checks the DCHK and HEC at point 486 of Figure 4 in a similar manner as described earlier.

FPGA 420 generates a HEC over header portion 556I of Figure 5I at point 488 of Figure 4. HEC is written to cell 530. The previously generated DCHK remains in cell 530. Figure 5J shows the format of cell 530 exiting FPGA 420 at position 436 of Figure 4 with DCHK in

location 536 and HEC in location 538. ASIC 422 checks the DCHK and HEC at point 490 of Figure 4 in a similar manner as described earlier.

ASIC 422 generates a DCHK over payload portion 554J and a HEC over header portion 556J of Figure 5J at point 492 of Figure 4. HEC and DCHK are written to cell 530. Figure 5K shows the format of cell 530 exiting ASIC 422 at position 434 of Figure 4 with DCHK in location 540 and HEC in location 542. FPGA 424 checks the DCHK and HEC at point 494 of Figure 4 in a similar manner as described earlier.

FPGA 424 generates a DCHK over payload portion 554K of Figure 5K at point 496 of Figure 4. DCHK is written to cell 530. Figure 5L shows the format of cell 530 exiting FPGA 424 at position 432 of Figure 4 with DCHK in location 544. APS block 426 checks the DCHK at point 498 of Figure 4 in a similar manner as described earlier. APS block 426 outputs cell 530 at position 430 of Figure 4 with a format as shown in Figure 5M.

In addition to DCHK and HEC testing, routing switch 100 also performs parity checks on all datastreams and on all devices that access external memories. While parity checking is mostly redundant considering the DCHK and HEC checking performed, a parity check is valid when there is no data flow and therefore no DCHK or HEC test. Parity errors are reported to software via interrupts and status bits. In general, data with parity errors are not discarded. These checks are also used at each validation module 308A and 308B in a similar manner as described earlier.

The embodiment has validation modules 308A and 308B checking for runt cells from the primary and the redundant sources. Runt cells are caused when a spike appears in the clock

signal used to time the sending of cells between elements in I/O shelf 104A. As the main clock signal is used by the system to indicate the beginning of a cell, the spike falsely indicates that a cell has been generated when the cell has not in fact been completed. This results in two runt cells, the first containing the data gathered before the spike occurred and the second containing the remaining data from the cell. Runt cells are detected by counting the bytes of the cells and by looking at control signals. Runt cells are discarded.

Errors detected through the tests performed on the cells, including DCHK, DCHK-8, HEC, parity and runt cell tests, are reported to assessment module 312. Assessment module 312, combined with validation modules 308A and 308B, monitor errors on both active and inactive I/O cards 122, HLPCs 120 and HFICs 118 and only switch the primary and the redundant source if the relative health of the redundant source is superior to the primary source.

Assessment module 312 uses a scoring system to track the relative health of active and inactive I/O cards 122A and 122B, HLPCs 120A and 120B and HFICs 118A and 118B. The scoring system ranks errors in the header information detected by a HEC test as more serious than DCHK or parity test errors since these errors result in the cell being discarded. Monitoring the health of both the primary and redundant sources results in avoidance of faults caused by a switchover to an inferior redundant source in routing switch 100. Additionally, assessment module 312 can identify when an inactive card is not operational and can direct an operator to replace the inactive card.

In the embodiment, assessment module is a CPU programmed to implement the demerit system and to direct multiplexer 306 to use the chosen source as primary source 302.

It is noted that those skilled in the art will appreciate that various modifications of detail may be made to the present embodiment, all of which would come within the scope of the invention.

WE CLAIM

1. A source selection system for a communication switch for selecting a primary datasource from a plurality of datasources, said system comprising:
 - a validation module associated with said plurality of datasources adapted to monitor each
5 datasource of said plurality of datasources for transmission errors in output
 originating from said each datasource and adapted to provide information relating
 to said transmission errors;
 - a source selector associated with said validation module and said plurality of datasources,
 said source selector adapted to select an output datasource from said plurality of
10 datasources; and
 - an assessment module associated with said validation module adapted to identify said
 primary datasource from said plurality of datasources utilizing said information
 provided by said validation module and adapted to cause said source selector to
 select said output datasource associated with said primary datasource.
- 15 2. A source selection system as claimed in claim 1, wherein said validation module
comprises a plurality of validation sub-modules, each one of said plurality of validation sub-
modules associated with one of said plurality of datasources.
3. A source selection system as claimed in claim 2, wherein said validation module
20 performs an integrity check on data transmitted by said each datasource to provide information
relating to transmission errors for said each datasource.
4. A source selection system as claimed in claim 3, wherein said assessment module
evaluates severity of said transmission errors provided in said information and causes said source
selector to select said output datasource associated with said primary datasource based on said
severity of said transmission errors for said each of said plurality of datasources.
- 25 5. A source selection system as claimed in claim 4, wherein said integrity check on said data
comprises a parity check and a cyclic redundancy check.

6. A source selection system as claimed in claim 5, wherein said integrity check is performed on a payload portion of said data.
7. A source selection system as claimed in claim 6, wherein said integrity check is performed on a header portion of said data.
- 5 8. A source selection system as claimed in claim 7, wherein said communication switch comprises a plurality of output cards and an input card, said each one of said plurality of datasources originating from one of said plurality of output cards and said source selector operating at input to said input card.
9. A source selection system as claimed in claim 8, wherein at least one of said output cards
10 comprises a component and said integrity check is performed upon said data being received by said component in said at least one of said output cards of said communication switch.
10. A source selection system as claimed in claim 9, wherein said source selector is a multiplexer.
11. A method of selecting a primary datasource from a plurality of datasources in a
15 communication switch comprising the steps of:
receiving data from each datasource of said plurality of datasources;
monitoring said each datasource for transmission errors originating in output from said
each datasource; and
identifying said primary datasource from said plurality of datasources utilizing
20 information relating said transmission errors for said each datasource.
12. A method of selecting a primary datasource as claimed in claim 11, further comprising the step of outputting data from said primary datasource identified.
13. A method of selecting a primary datasource as claimed in claim 12, further comprising the step of gathering information relating to health of said each datasource.

14. A method of selecting a primary datasource as claimed in claim 13, wherein said monitoring said each datasource for transmission errors is executed by performing an integrity check on data originating from said each datasource.

5 15. A method of selecting a primary datasource as claimed in claim 14, wherein said gathering information relating to said health of said each datasource records severity of said transmission errors monitored and said primary datasource is identified based on said severity of said errors for said each datasource.

16. A method of selecting a primary datasource as claimed in claim 15, wherein said integrity check on said data comprise parity checks and cyclic redundancy checks.

10 17. A method of selecting a primary datasource as claimed in claim 16, wherein said integrity check is performed on a payload portion of said data.

18. A method of selecting a primary datasource as claimed in claim 17, wherein said integrity check is performed on a header portion of said data.

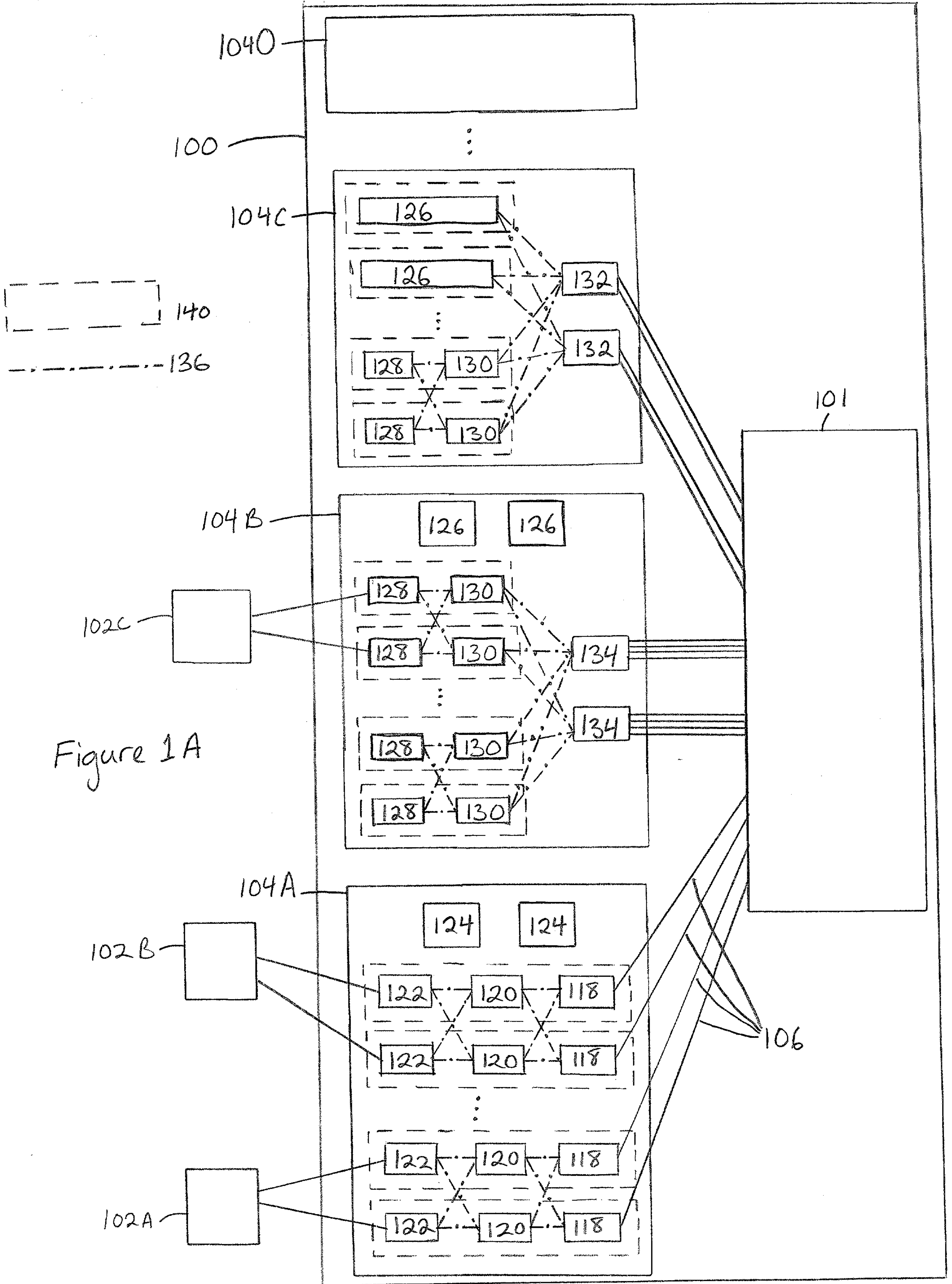

Figure 1A

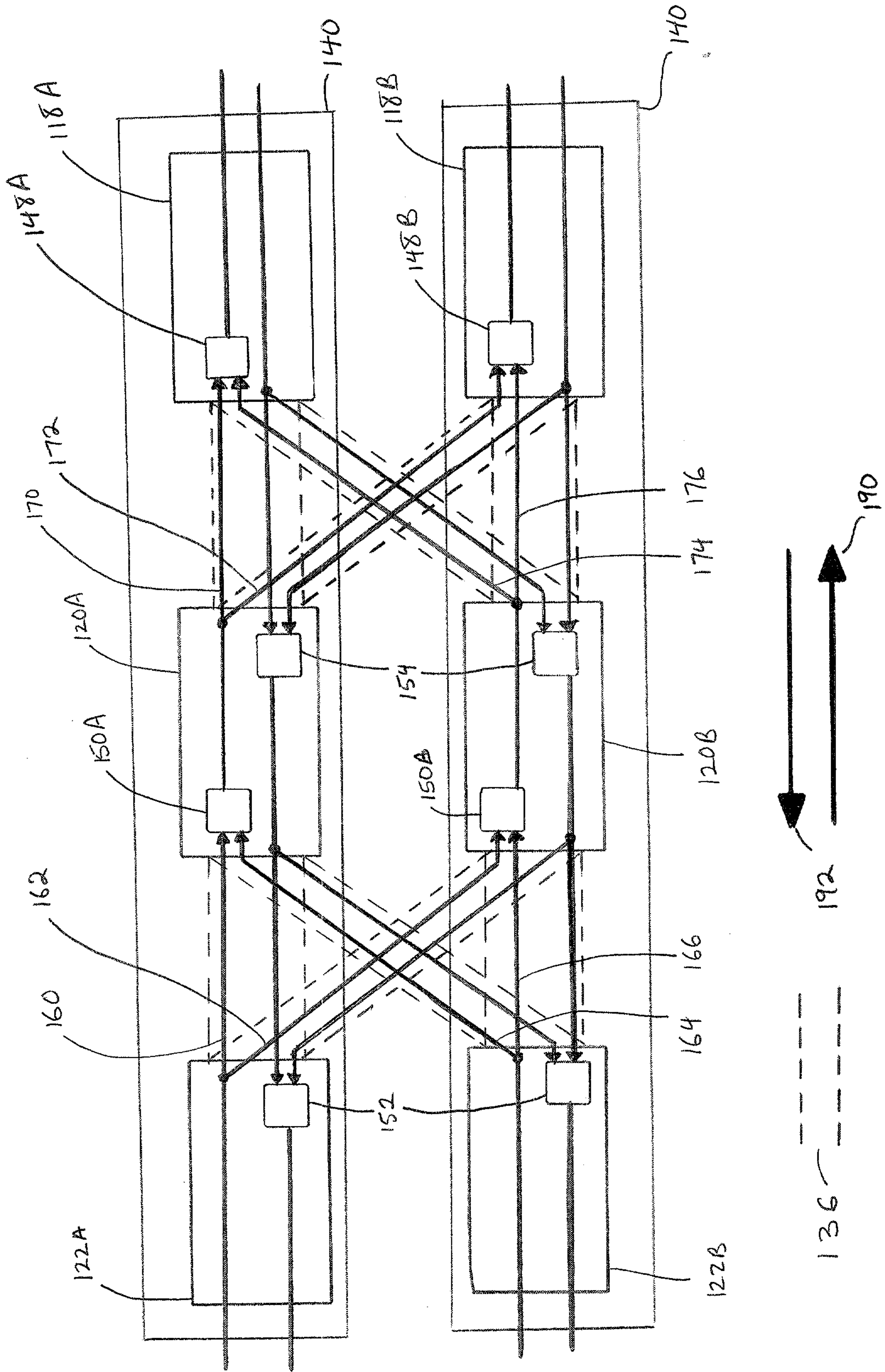

Figure 1B

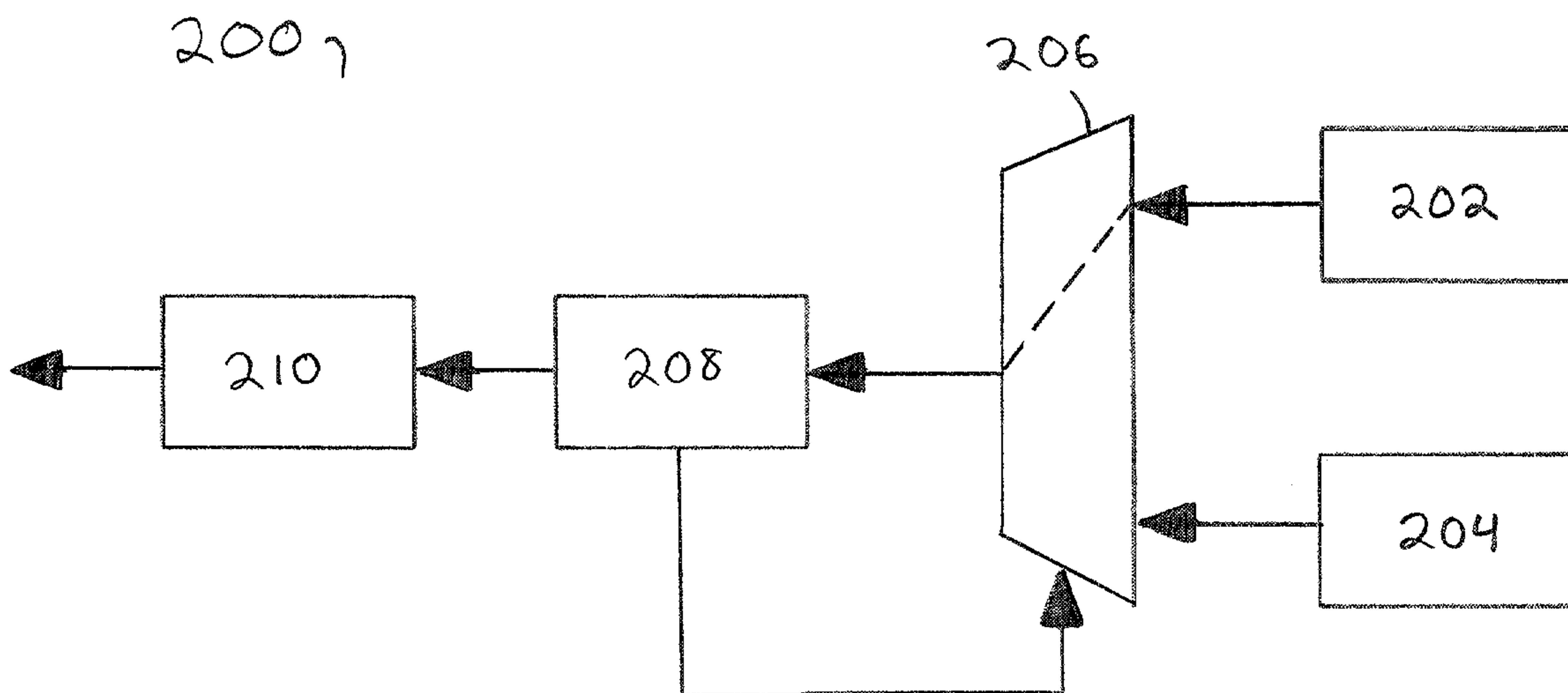

Figure 2

300,

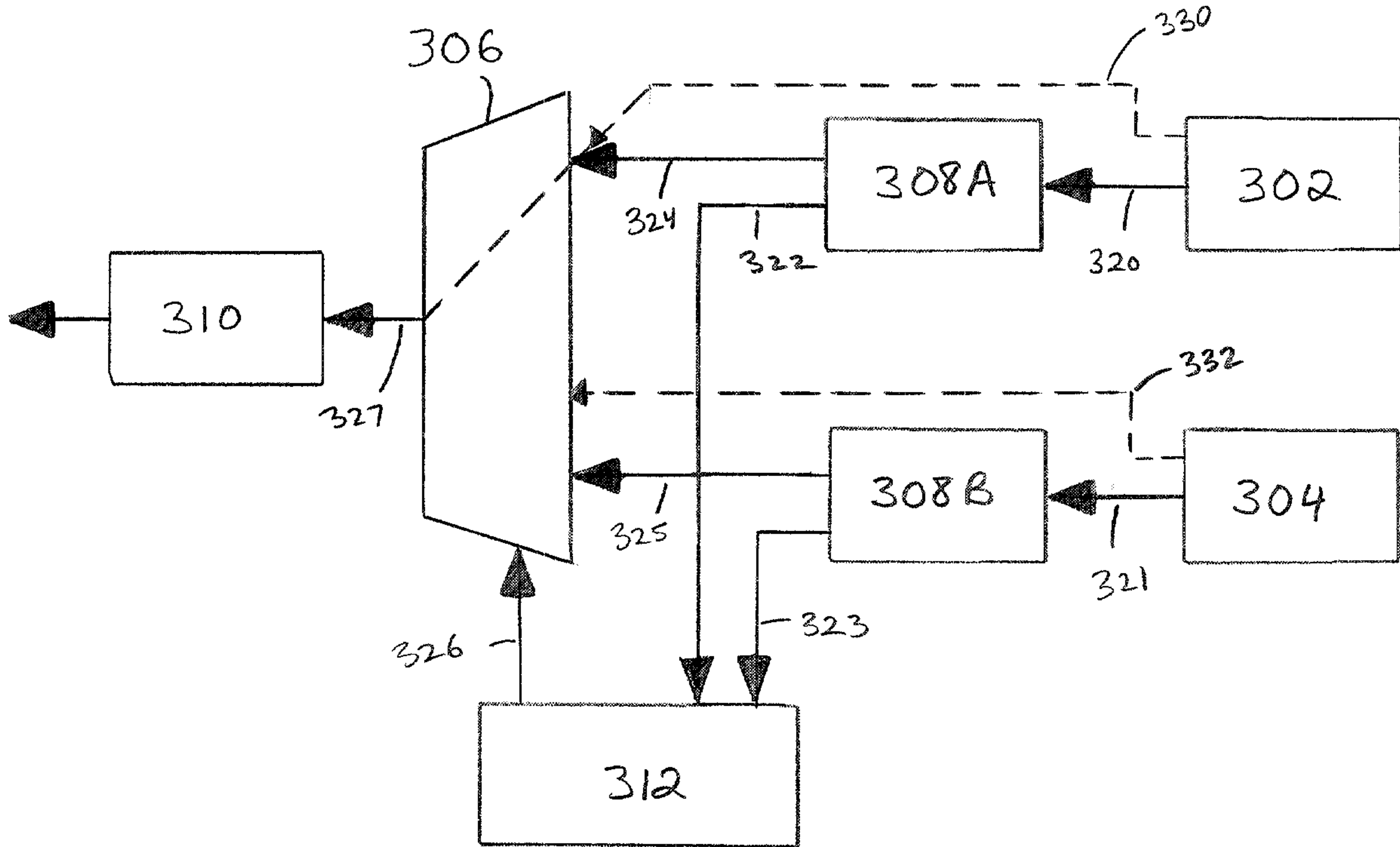

Figure 3

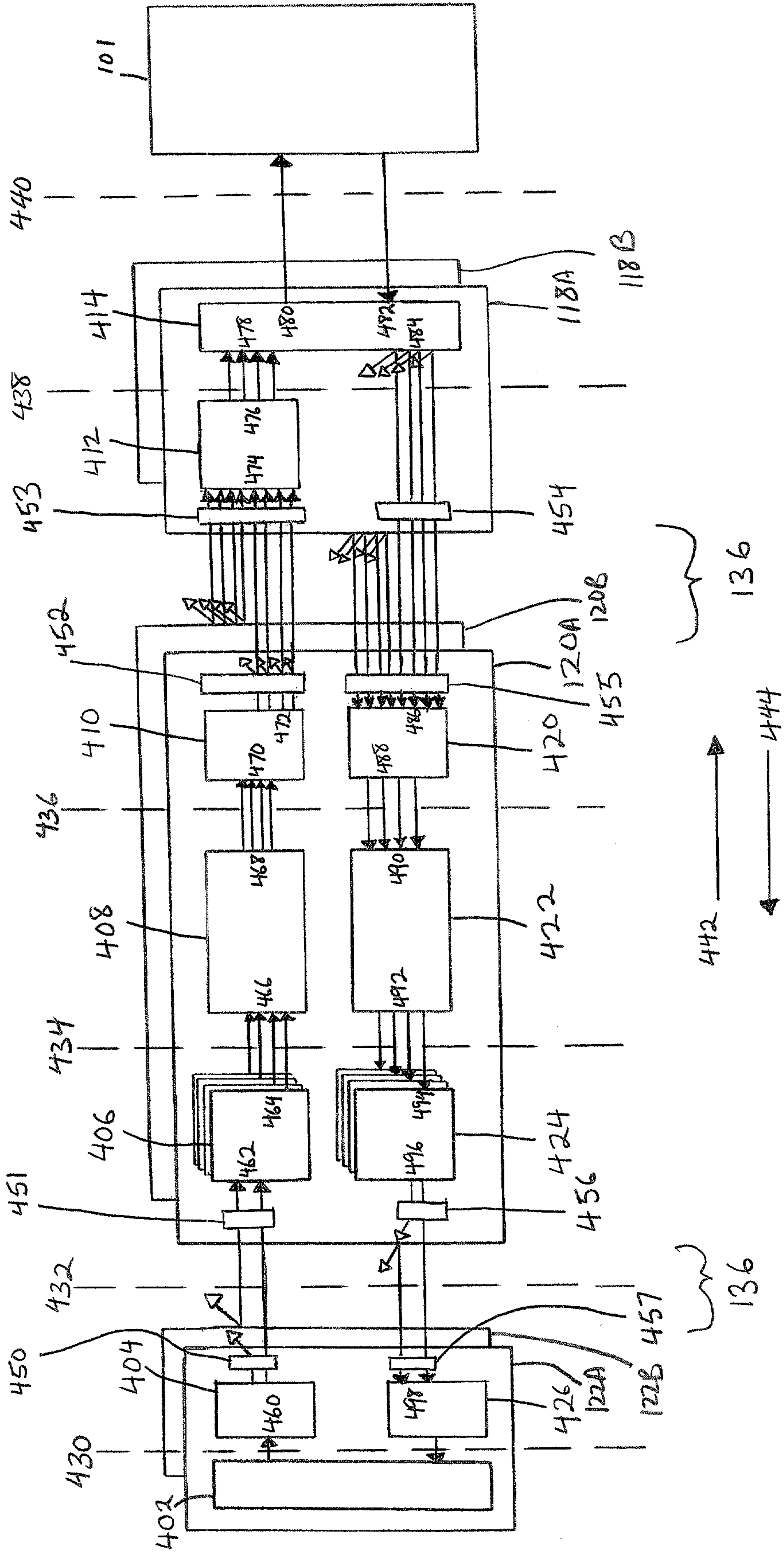

Figure 4

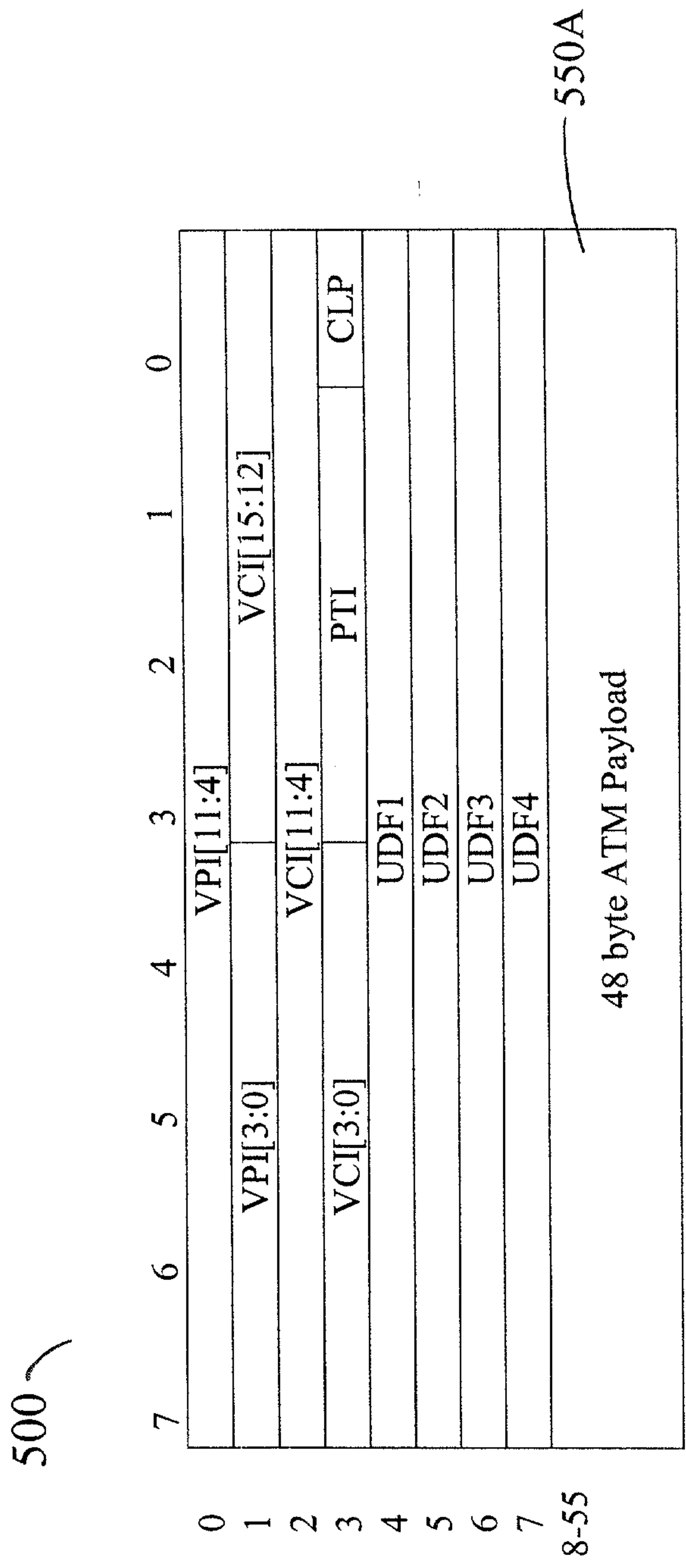

FIGURE 5 A

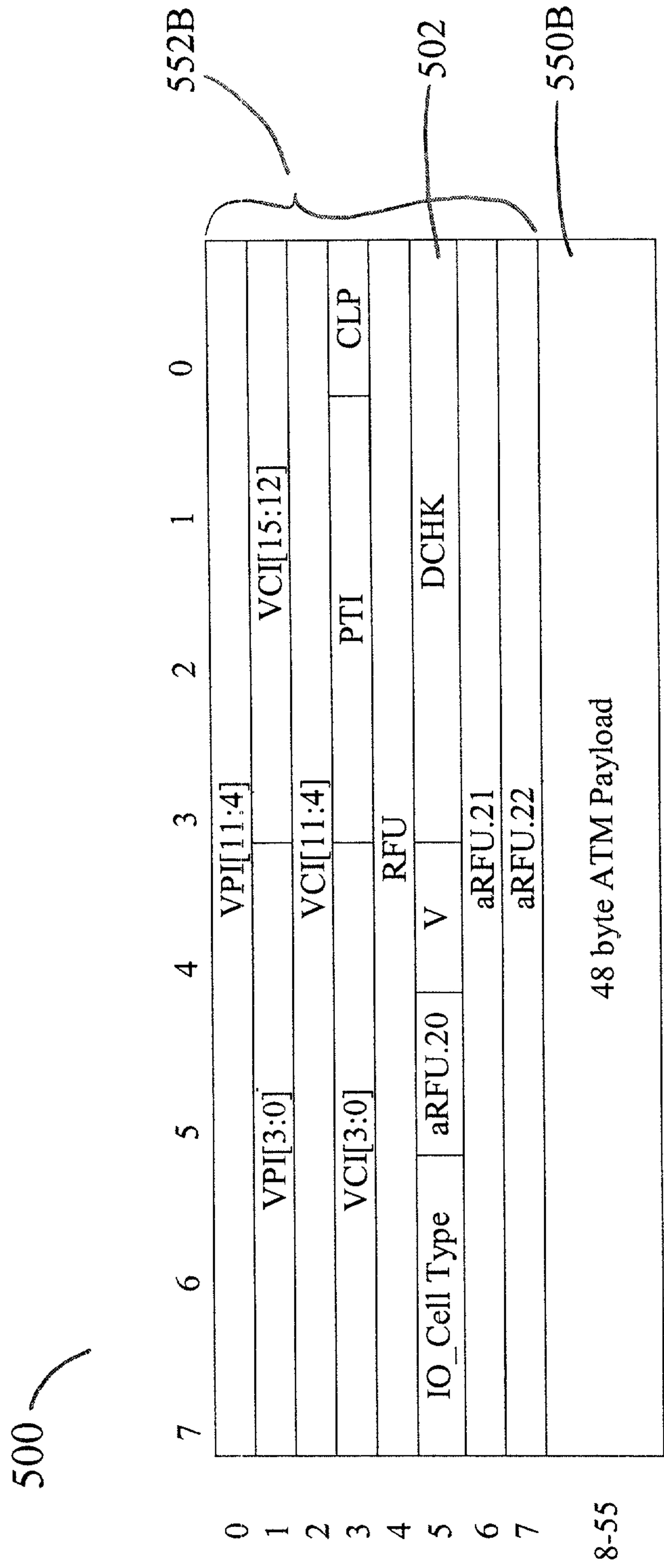

FIGURE 5 B

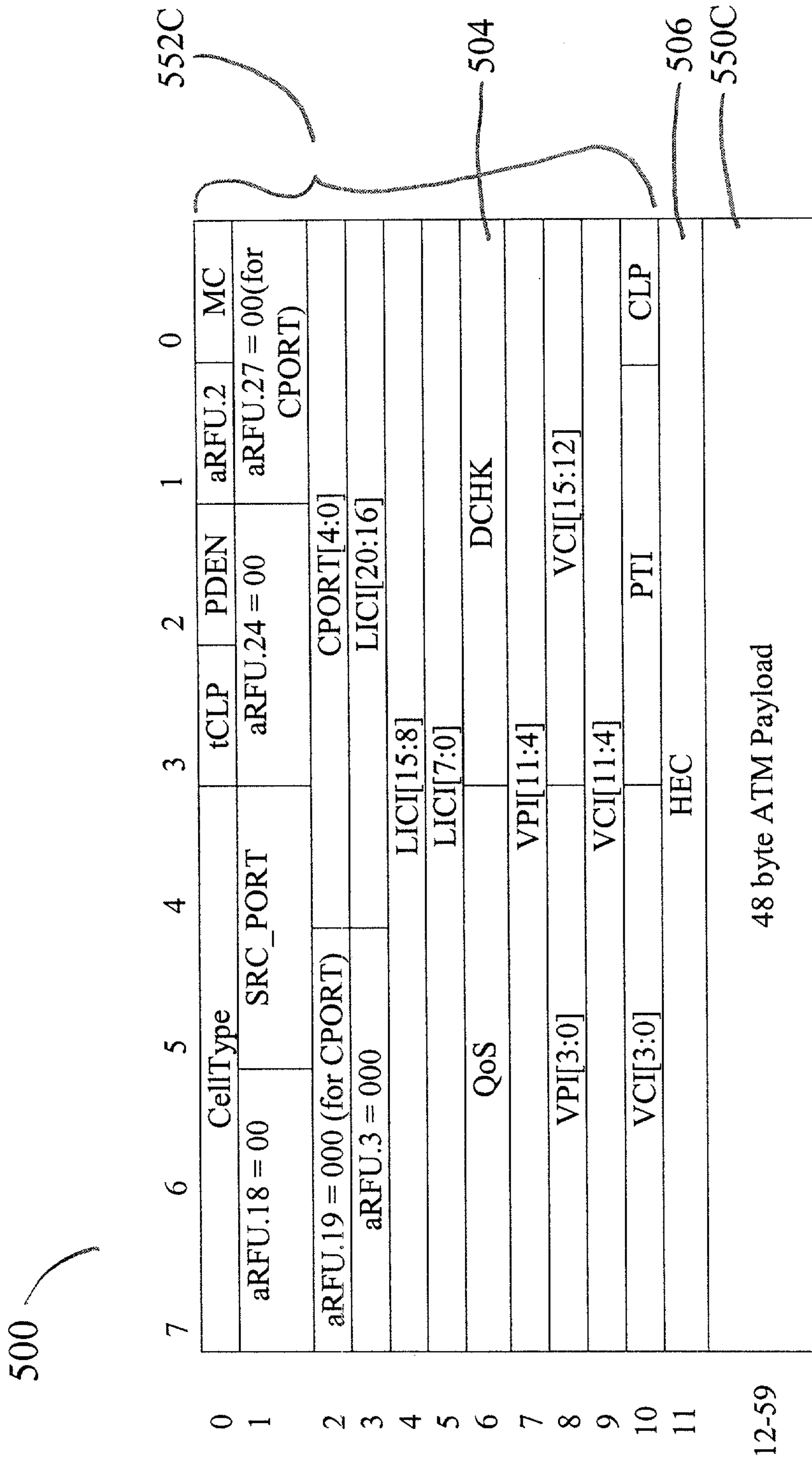

FIGURE 5 C

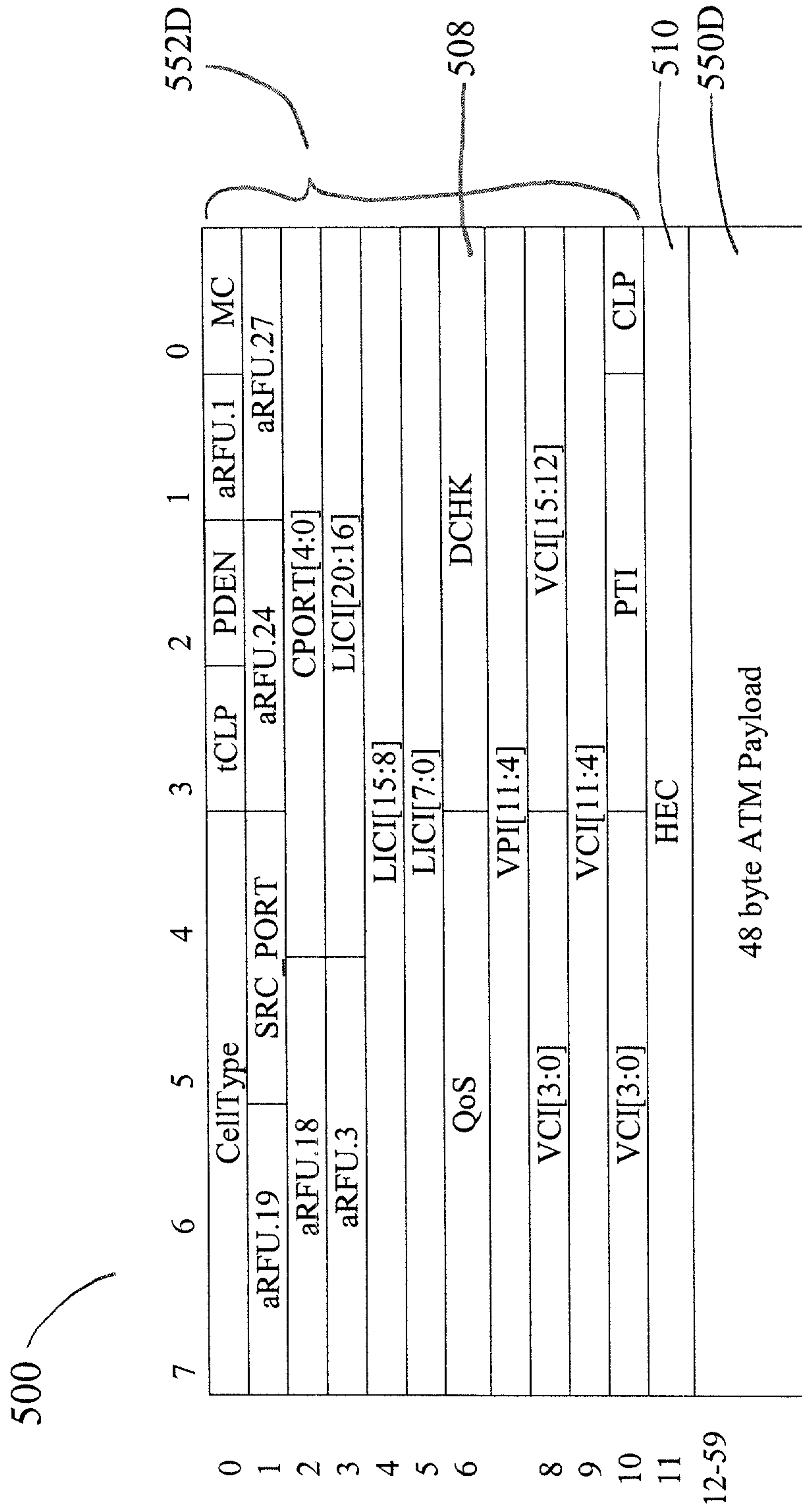

FIGURE 5 D

500

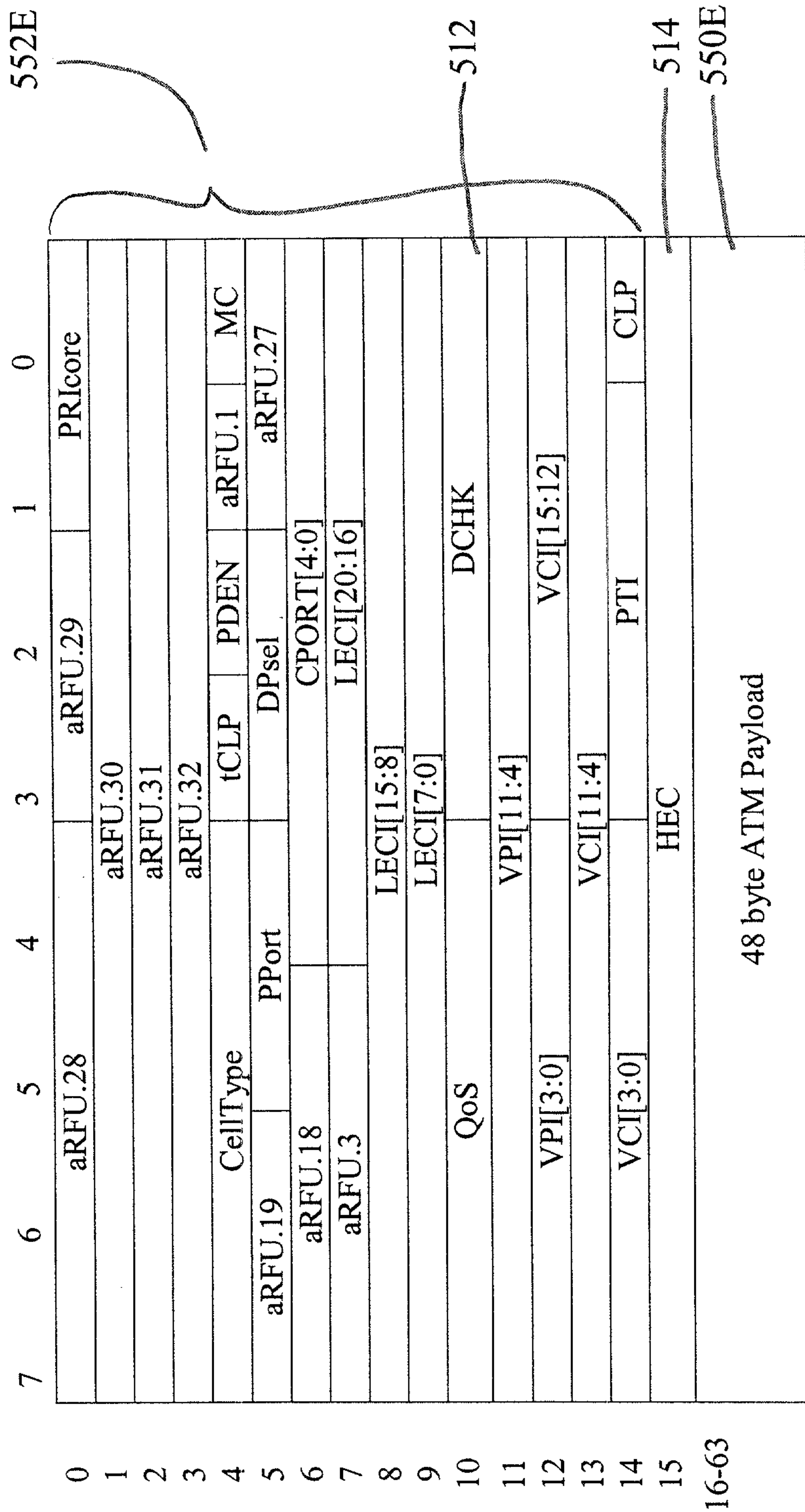

FIGURE 5 E

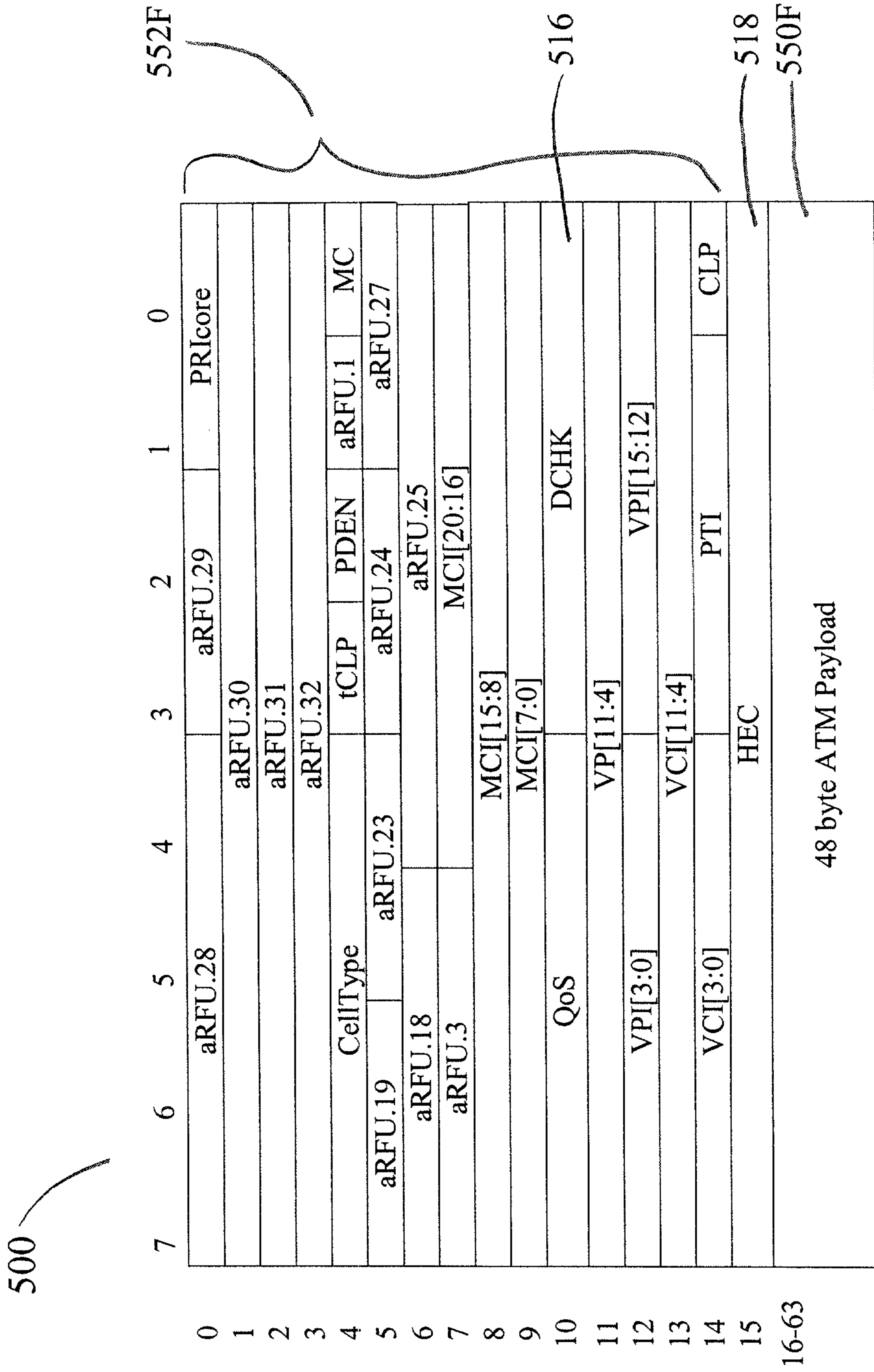

FIGURE 5 F

500

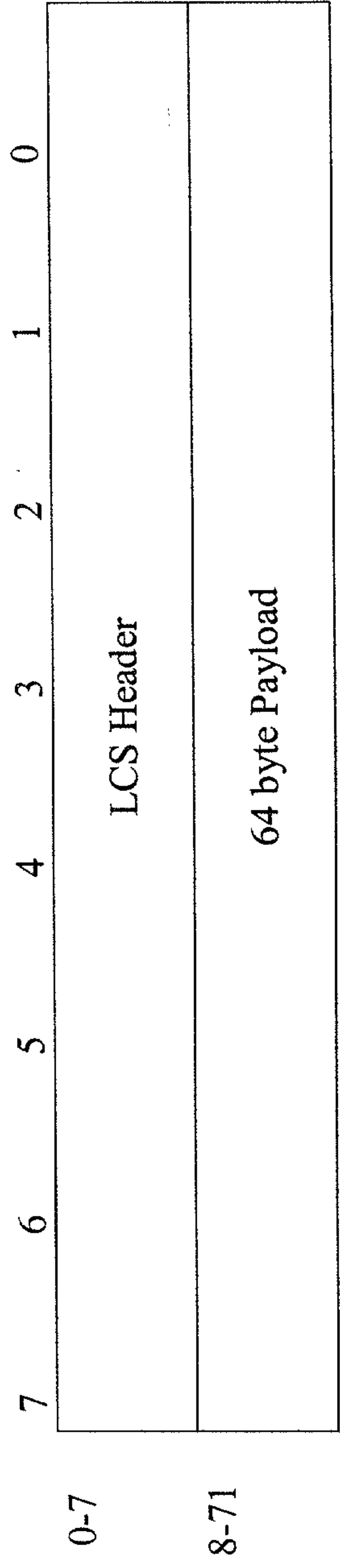

FIGURE 5 G

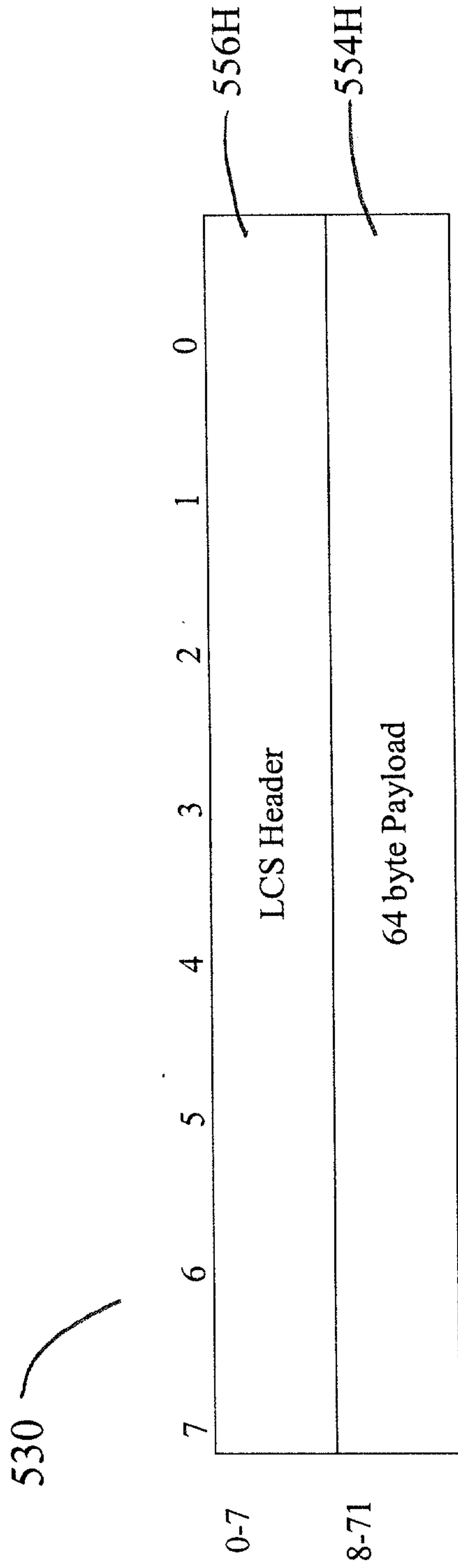

FIGURE 5 H

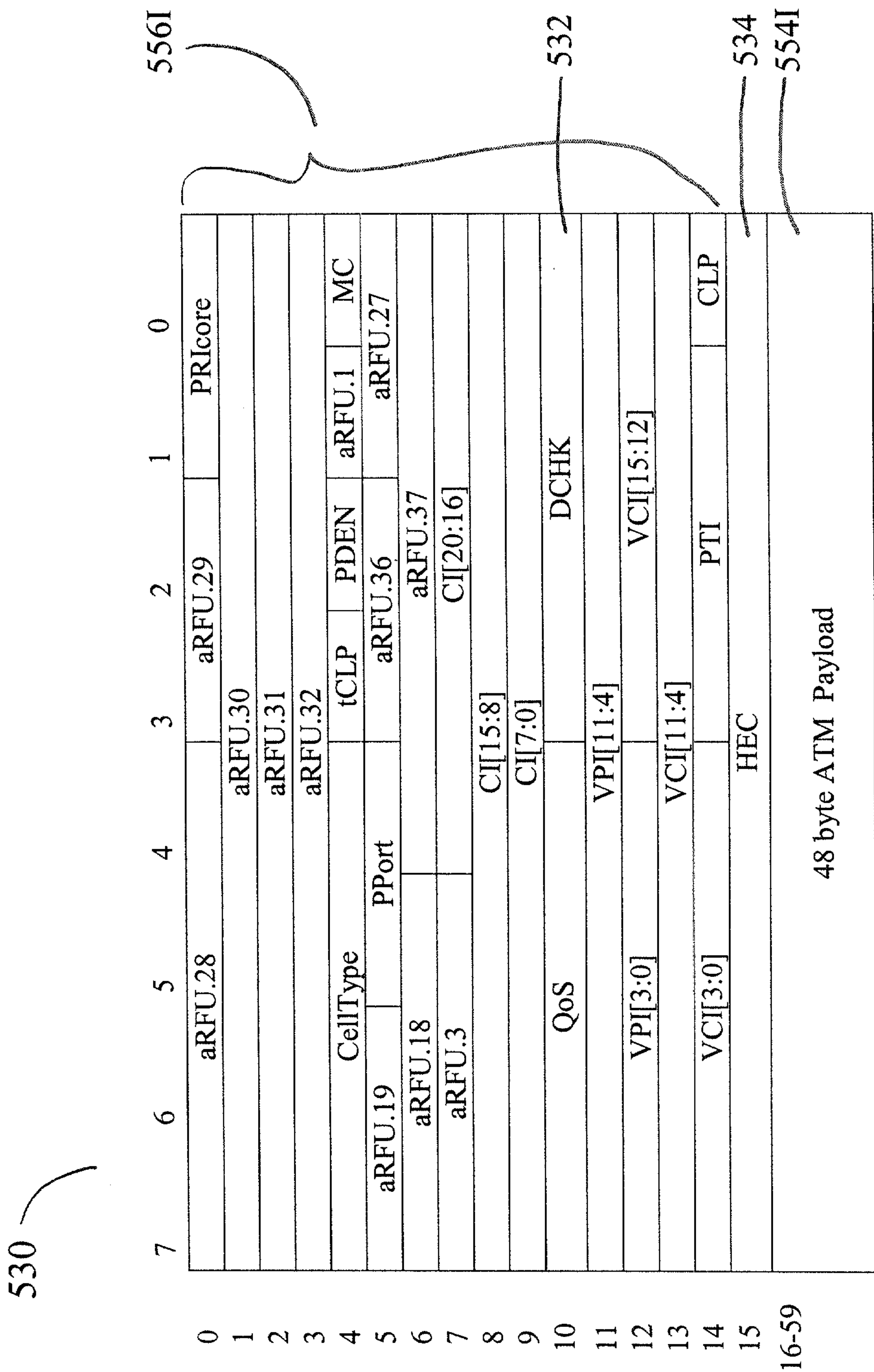

FIGURE 5 I

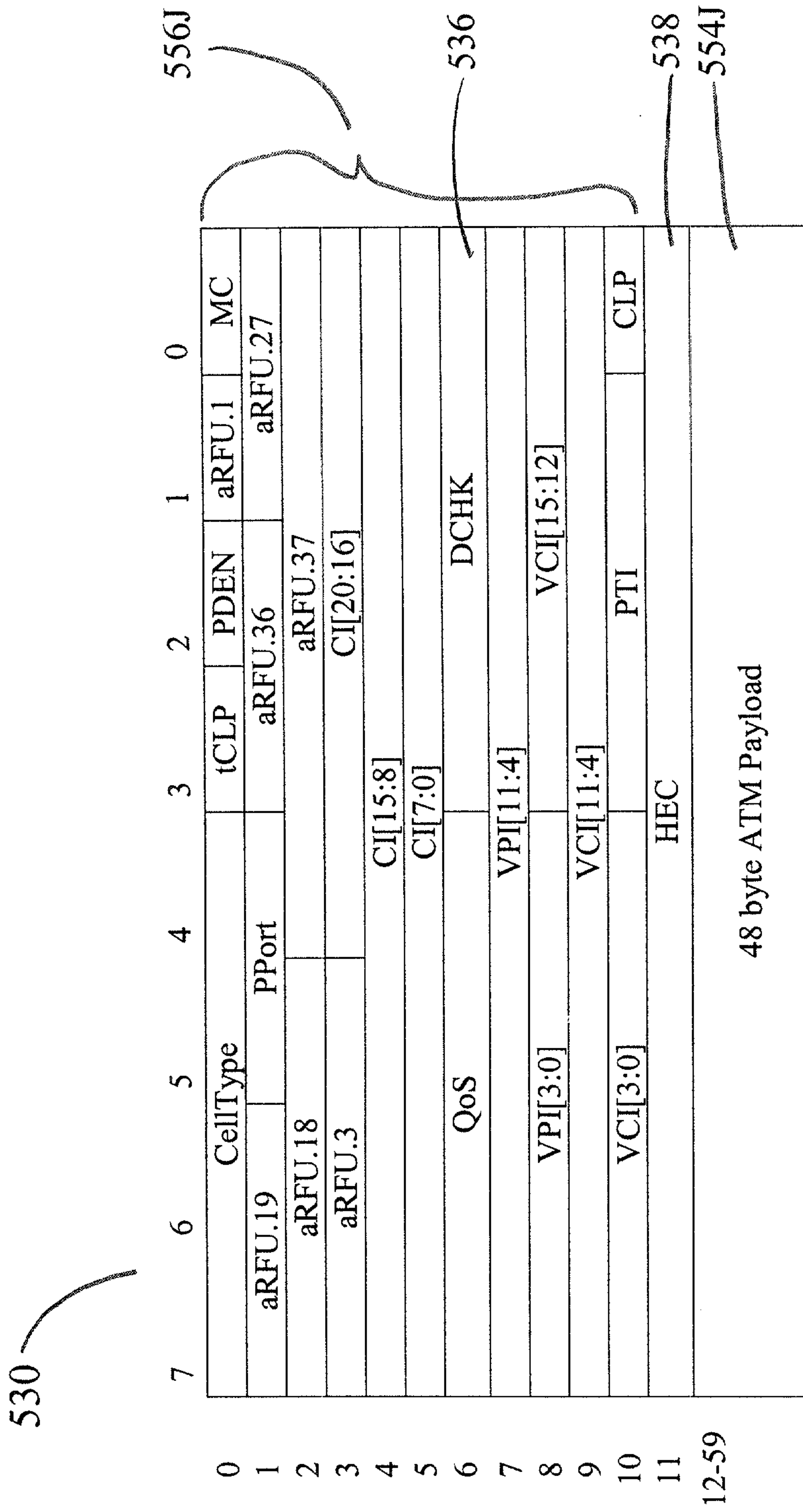

FIGURE 5 J

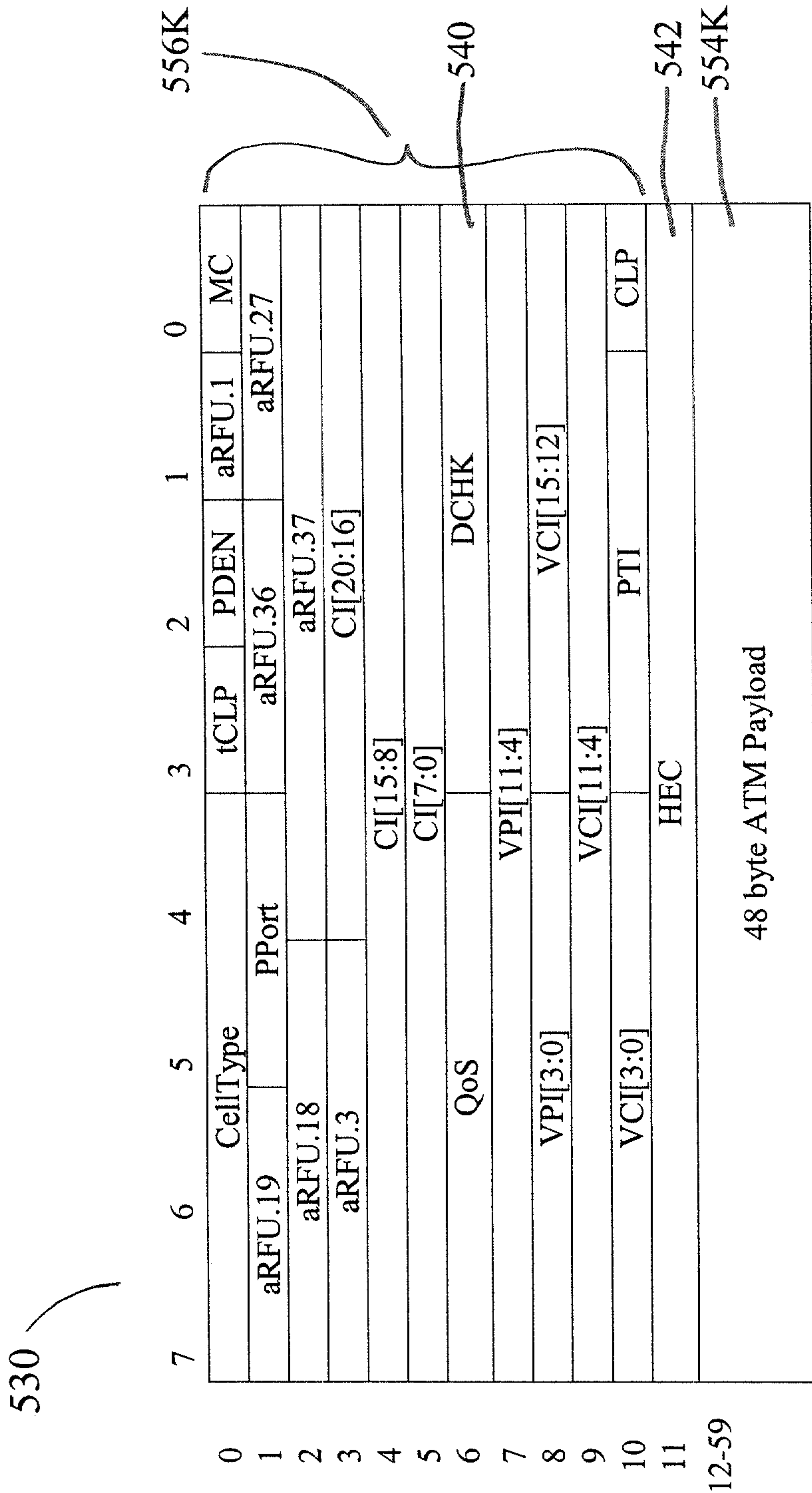

FIGURE 5 K

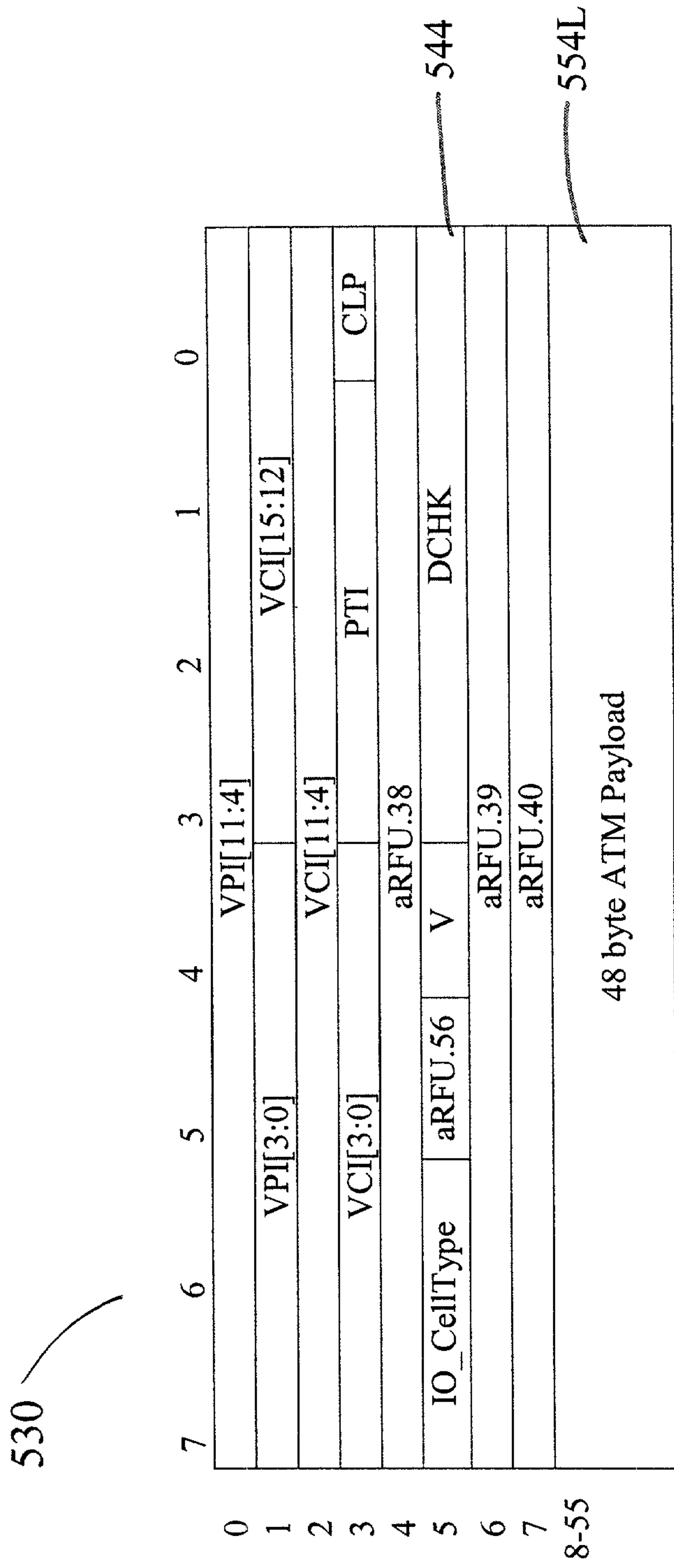

FIGURE 5 L

530

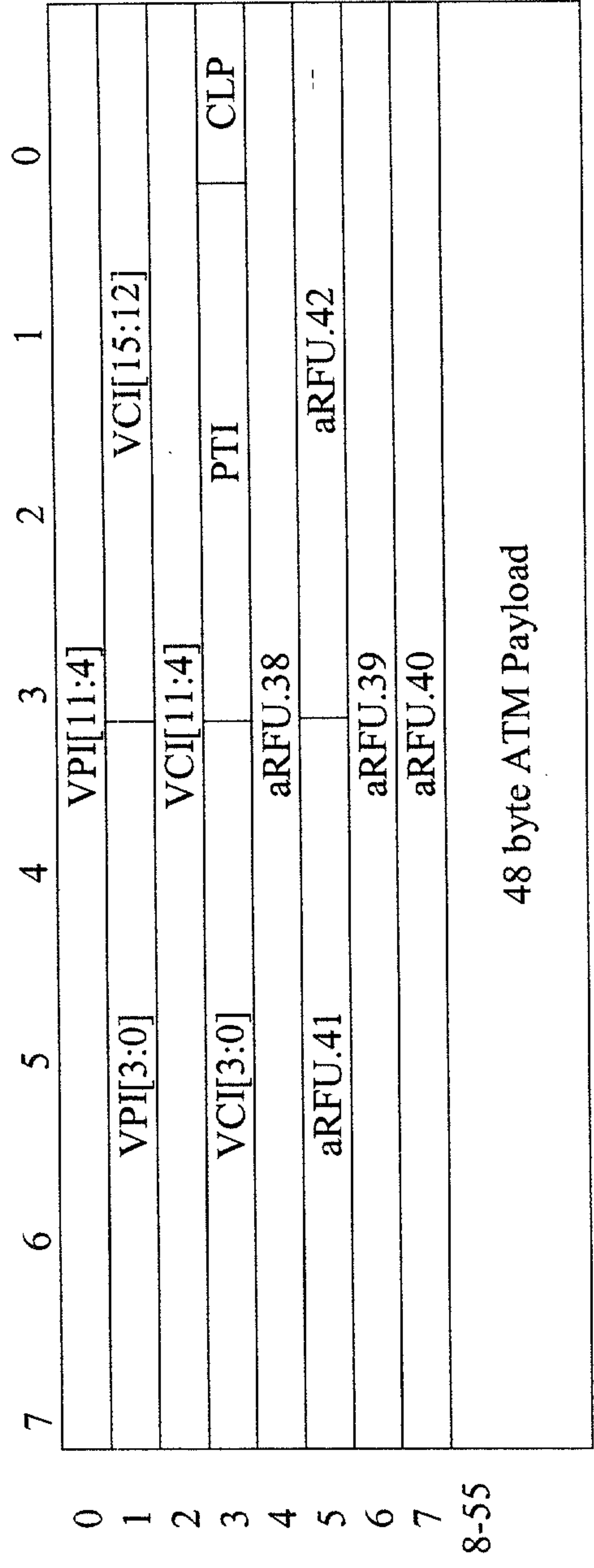

FIGURE 5 M

300,

